



73 Magazine

for Radio Amateurs

- 28 One Step at a Time: Designing Your Own Ham Gear**
—part I..... W4RNL
- 36 Down with Interpolation**
—a digital display for the Triton and others
..... W4FQ
- 42 Hooray! An AFSK Auto IDer!**
—a clean and legal ending for RTTY transmissions..... K3IJ
- 44 Let's QSY to .52**
—ah, technology..... WB2RVA
- 46 Five Test Equipment Bargains from Heath**
—the 5280 series features plenty of measuring power per dollar..... W2QFC
- 48 The Phoenix Fix**
—an alarming analog-to-digital conversion for out-of-time clock-radios..... WA3AJR
- 50 QRQ, QRS—By the Numbers!**
—a digital CMOS code-speed indicator
..... W7BBX
- 54 Adding a Scanner to Your 2m Rig**
—here's a method that works with many scanner/transceiver combos..... WA8HEB
- 56 Digital Transistor Checker**
—a "hands-on" project..... W4QBU/PY2ZBG
- 58 CB to 10**
—part XXV: using those surplus 40-channel boards..... AF8B
- 60 The Stolen Rig Retriever**
—built-in gadget automatically sends your call with every transmission..... WB6KBM
- 64 Constructing QRP Dummy Loads**
—useful and inexpensive..... W1OLP
- 68 The IC-211 Cookbook**
—mods and tweaks to improve performance
..... K3VGX
- 74 Take a Hike**
—backpacking with an HW-8..... K4FD
- 78 Tuning Antenna-Mounted Preamps**
—do it without additional wiring..... Staff
- 80 PC Artwork Made Easy**
—lift layouts from the page with transparent contact paper..... W3HIK
- 82 Electronic Dice—a Family Pleaser**
—Las Vegas, look out!..... W7BBX
- 84 Fun with Fozle**
..... W7BBX
- 88 The Demise of Component Stores**
—parts places are past their prime..... VE3FLE
- 90 Priority Frequency Power-Up for the FT-227R**
—the right place every time..... WA1AUM
- 94  Computerize Your Contest Paperwork**
—two BASIC programs do it all... WA8WIA
- 98  Emulate an Elephant**
—but let your micro bear the burden
..... VE6BB
- 104  Prefix Challenge**
—try this while you're waiting for the band to open up..... AG6P
- 111 Check Chirp with a Choke**
—get 599 every time with this quick fix
..... WA2MEL/6
- 112 Reawaken that Sleeping Rx**
—first steps in receiver alignment..... Sara
- 114 Rubber Thumbs and Pilot Lamps**
—if you're all thumbs, enlighten yourself!
..... K3MPJ
- 118 Tempo S1 2-Meter Portable**
—800 channels, to go!..... WB9HRV
- 120 A Proper Pedestal for PCBs**
—handy holder eases circuit board construction and repair..... Staff
- 122 Surplus Treasures**
—assemble a quality ham station for less than \$200..... K1VIC/2
- 124 Listen in Secrecy with a Giant Inductive Loop**
—monitor your rig from anywhere in the house—without wires..... ZL2AMJ
- 130 Those Hamtronics Kits... How Can You Use Them?**
—an in-depth look at some electronic bargains
..... WA4PYQ
- 134 10 Meters for the SB-221**
—add the "missing" band..... WA2KSM
- 136 Another Place, Another Time**
—working the paranormal band..... Anon.
- 144 Who Needs a \$40 Soldering Iron?**
—here's why you may want to invest in one
..... Staff
- 146 Outboard Power for the 820**
—it's easy to connect a second set of ears to the Kenwood transceiver..... KL7GRF/6
- 148 CB to 6**
—convert a 49-MHz HT into something... W9CGI
- 152 Digital Boat Anchor**
—using pencil, paper, and a frequency counter for receiver readout..... WB1ASL



tempo...

the first in synthesized portables gives you the broadest choice at the lowest price

...the new S-5

- * The only synthesized hand-held offering 5 watts output. (Switchable for 1 or 5 watt operation)
- * The same dependability as the time proven S-1. Circuitry that has been proven in more than a million hours of operation.
- * Heavy duty battery pack.
- * External microphone capability.
- * The S-5's exciting low price...only \$299.00
- * With touch tone pad \$339.00

SPECIFICATIONS

Frequency Coverage: 144 to 148 MHz
 Channel Spacing: Receive every 5 kHz, transmit Simplex or ± 600 kHz
 Power Requirements: 9.6 VDC
 Current Drain: 17 ma-standby, 900 ma-transmit
 Antenna Impedance: 50 ohms
 Dimensions: 40 mm x 62 mm x 170 mm (1.6" x 2.5" x 6.7")
 Weight: 17 oz.
 Sensitivity: Better than 5 microvolts nominal for 20 db

SUPPLIED ACCESSORIES

Telescoping whip antenna, ni-cad battery pack, charger.

OPTIONAL ACCESSORIES

12 Button touch tone pad (not installed): \$39 • 16 Button touch tone pad (not installed): \$48 • Tone burst generator: \$29.95 • CTCSS sub-audible tone control: \$29.95 • Rubber flex antenna: \$8 • Leather holster: \$16 • Cigarette lighter plug mobile charging unit: \$6 • Matching 30 watt output 13.8 VDC power amplifier (S30): \$89 • Matching 80 watt output power amplifier (S80): \$149

The Tempo S-2

Tempo is first again. This time with a superior quality synthesized 220 MHz hand held transceiver. With an S-2 in your car or pocket you can use 220 MHz repeaters throughout the U.S. It offers all the advanced engineering, premium quality components and exciting features of the S-1. The S-2 offers 1000 channels in an extremely lightweight but rugged case.

If you're not on 220 this is the perfect way to get started. With the addition of the S-25 (25W output) or S-75 (75W output) Tempo solid state amplifier it becomes a powerful mobile or base station. If you have a 220 MHz rig, the S-2 will add tremendous versatility. Its low price includes an external microphone capability, heavy duty ni-cad battery pack, charger, and telescoping whip antenna. Price...\$349.00 With touch tone pad...\$399.00

TEMPO VHF & UHF SOLID STATE POWER AMPLIFIERS

Boost your signal... give it the range and clarity of a high powered base station. VHF (135 to 175 MHz)

Drive Power	Output	Model No.	Price
2W	130W	130A02	\$209
10W	130W	130A10	\$189
30W	130W	130A30	\$199
2W	80W	80A02	\$169
10W	80W	80A10	\$149
30W	80W	80A30	\$159
2W	50W	50A02	\$129
2W	30W	30A02	\$ 89

UHF (400 to 512 MHz) models, lower power and FCC type accepted models also available.

The new improved Tempo S-1

- The first and most thoroughly field tested hand-held synthesized radio available. 800 channels in the palm of your hand.
- Simple to operate. (You don't need a degree in computer programming)
- Heavy duty battery pack allows more operating time between charges.
- External microphone capability
- The lowest price ever...\$259.00
- The S-1T (With touch tone pad installed)...\$289.00

The Tempo line also features a fine line of extremely compact UHF and VHF pocket receivers. They're low priced, dependable, and available with CTCSS and 2-tone decoders. The Tempo FMT-2 & FMT-42 (UHF) provides excellent mobile communications and features a remote control head for hide-away mounting.

The Tempo FMH-42 (UHF) and the NEW FMH-12 and FMH-15 (VHF) micro hand held transceivers provide 6 channel capability, dependability plus many worthwhile features at a low price. FCC type accepted models also available. Please call or write for complete information. Also available from Tempo dealers throughout the U.S. and abroad.



TOLL FREE ORDER NUMBER: (800) 421-6631
 For all states except California.
 Calif. residents please call collect on our regular numbers.

11240 W. Olympic Blvd., Los Angeles, Calif. 90064 213/477-6701
 931 N. Euclid, Anaheim, Calif. 92801 714/772-9200
 Butler, Missouri 64730 816/679-3127

Henry Radio

Prices subject to change without notice.

Move over imports, here's the new TEN-TEC

DELTA

the notable change in hf transceivers



All new, all **nine** hf bands and only \$849!

DELTA — the symbol of change—the name of a great new TEN-TEC transceiver. A transceiver for changing times, with new features, performance, styling, size and value.

TOTAL SOLID-STATE. By the world's most experienced manufacturer of hf solid-state amateur radio equipment.

ALL 9 HF BANDS. First new transceiver since WARC. 160-10 Meters including the three new hf bands (10, 18 & 24.5 MHz). Ready to go except for plug-in crystals for 18 and 24.5 MHz segments (available when bands open for use).

SUPER RECEIVER. New, low noise double-conversion design, with 0.3 μ V sensitivity for 10 dB S+N/N.

HIGH DYNAMIC RANGE. 85 dB minimum to reduce overload possibility. Built-in, switchable, 20 dB attenuator for extreme situations.

SUPER SELECTIVITY. 8-pole monolithic SSB filter with 2.4 kHz bandwidth, 2.5 shape factor at 6/60 dB points. And optional 200 Hz and 500 Hz 6-pole crystal ladder filters. Eight pole and 6-pole filters cascade for 14 poles of near ultimate skirt selectivity. Plus 4 stages of active audio filtering. To sharpen that i-f response curve to just 150 Hz bandwidth. 4-position selectivity switch.

BUILT-IN NOTCH FILTER. Standard equipment. Variable, 200 Hz to 3.5 kHz, with notch depth down to -50 dB. Wipes out interfering carriers or CW.

OFFSET TUNING. Moves receiver frequency up to ± 1 kHz to tune receiver separately from transmitter.

"HANG" AGC. For smoother, clearer, receiver operation.

OPTIONAL NOISE BLANKER. For that noisy location, mobile or fixed.

WWV RECEPTION. Ready at 10 MHz.

"S"/SWR METER. To read received signal

strength and transmitted standing wave ratio. Electronically switched.

SEPARATE RECEIVER ANTENNA JACK. For use with separate receiving antenna, linear amplifier with full break-in (QSK) or transverters.

FRONT PANEL HEADPHONE AND MICROPHONE JACKS. Convenient.

DIGITAL READOUT. Six 0.3" red LEDs.

BROADBAND DESIGN. For easy operation. Instant band change—no tuneup of receiver or final amplifier. From the pioneer, TEN-TEC.

SUPER TRANSMITTER. Solid-state all the way. Stable, reliable, easy to use.

200 WATTS INPUT. On all bands including 10 meters (with 50 ohm load). High SWR does not automatically limit you to a few watts output. Proven, conservatively rated final amplifier with solid-state devices warranted fully for the first year, and pro-rata for five more years.

100% DUTY CYCLE. All modes, with confidence. 20 minutes max. key-down time. Brought to you by the leader in solid-state finals, TEN-TEC.

QSK — INSTANT BREAK-IN. Full and fast, to make CW a real conversation.

BUILT-IN VOX AND PTT. Smooth, set-and-forget VOX action plus PTT control. VOX is separate from keying circuits.

ADJUSTABLE THRESHOLD ALC & DRIVE. From low level to full output with ALC control. Maximum power without distortion. LED indicator.

ADJUSTABLE SIDETONE. Both volume and pitch, for pleasant monitoring of CW.

SUPER STABILITY. Permeability tuned VFO with less than 15 Hz change per F° change over 40° range after 30 min. warmup—and

less than 10 Hz change for 20 Volt AC line change with TEN-TEC power supply.

VERNIER TUNING. 18 kHz per revolution, typical.

SUPER AUDIO. A TEN-TEC trademark. Low IM and HD distortion (less than 2%). Built-in speaker.

SUPER STYLING. The '80s look with neat, functional layout. "Panelized" grouping of controls nicely human engineered for logical use. New, smaller size that goes anywhere, fixed or mobile (4 $\frac{3}{4}$ "h x 11 $\frac{3}{8}$ "w x 15"d). Warm, dark front panel. Easy-to-read contrasting nomenclature. Black "clam-shell" aluminum case. Tilt bail.

MODULAR/MASS-TERMINATION CONSTRUCTION. Individual circuit boards with plug-in harnesses for easy removal if necessary. Boards are mailable.

FULL ACCESSORY LINE. All the options: Model 282 200 Hz CW filter \$50; Model 285 500 Hz CW Filter \$45; Model 280 Power Supply \$139; Model 645 Dual Paddle Keyer \$85; Model 670 Single Paddle Keyer \$34.50; Model 247 Antenna Tuner \$69; Model 234/214 Speech Processor & Condenser Microphone \$163; Model 215 PC Ceramic Microphone \$34.50. Model 283 Remote VFO, Model 287 Mobile Mount, and Model 289 Noise Blanker available soon.

Experience The Notable Change In HF Transceivers, Experience DELTA. See your TEN-TEC dealer or write for full details.

TEN-TEC, INC.
SEVIERVILLE, TENNESSEE 37862
EXPORT: 5715 LINCOLN AVE., CHICAGO, ILL. 60646

Info

Manuscripts

Contributions in the form of manuscripts with drawings and/or photographs are welcome and will be considered for possible publication. We can assume no responsibility for loss or damage to any material. Please enclose a stamped, self-addressed envelope with each submission. Payment for the use of any unsolicited material will be made upon acceptance. All contributions should be directed to the 73 editorial offices. "How to Write for 73" guidelines are available upon request.

Editorial Offices:

Pine Street
Peterborough NH 03458
Phone: 603-924-3873

Advertising Offices:

Elm Street
Peterborough NH 03458
Phone: 603-924-7138

Circulation Offices:

Elm Street
Peterborough NH 03458
Phone: 603-924-7296

Subscription Rates

In the United States and Possessions:
One Year (12 issues) \$18.00
Two Years (24 issues) \$30.00
Three Years (36 issues) \$45.00
Lifetime subscription \$240.00

Elsewhere:

Canada—add \$2.00 per year unless paid with U.S. currency.

All other foreign—one year only—\$26.00 payable in U.S. currency through a U.S. bank (surface mail).

**To subscribe,
renew or change
an address:**

Write to 73 Magazine, Subscription Department, PO Box 931, Farmingdale NY 11737. For renewals and changes of address, include the address label from your most recent issue of 73. For gift subscriptions, include your name and address as well as those of gift recipients. Postmaster: Send form #3579 to 73 Magazine, Subscription Services, P.O. Box 931, Farmingdale, NY 11737.

**Subscription
problem or
question:**

Write to 73 Magazine, Subscription Department, PO Box 931, Farmingdale NY 11737. Please include an address label.

73 Magazine (ISSN 0098-9010) is published monthly by 73, Inc., 80 Pine Street, Peterborough NH 03458. Second class postage paid at Peterborough NH 03458 and at additional mailing offices. Copyright (c) 1980 by 73, Inc. All rights reserved. No part of this publication may be reprinted or otherwise reproduced without written permission from the publisher. Microfilm Edition—University Microfilm, Ann Arbor MI 48106.

W2NSD/1 NEVER SAY DIE

editorial by Wayne Green



W1HR

Jim Fisk, editor of *Ham Radio*, passed away on April 18th. His name will continue to remain synonymous with ham radio, in the generic as well as the journalistic sense. His tireless efforts to propagate amateur radio will be missed. Anyone who knows anything about hams will say, quite simply, "Thank you, Jim. Your key will never be silent."

TRAVELS WITH WAYNE

With ten meters opening up to Japan, I'm hearing from more and more of the charming people Sherry and I had dinner with in Tokyo... members of the Tokyo International Amateur Radio Association.

As a remembrance of the dinner, those present signed a card. If we can get a group together for the electronics show tour this coming October, we'll have a chance again to see the top-notch hams in Tokyo. We might also get a chance to

see Yaesu or Kenwood.

Just to give you an idea... here's a picture I took of part of the Yaesu new product development labs. I suspect that there are more development engineers and technicians in this one lab than all of the American ham manufacturers have combined.

THE ASIAN CONNECTION

There are several good reasons why you should make the big step and break loose this

fall to join Sherry and me on a trip to Asia. The trip, which costs only about \$2,000, will include attending consumer electronics shows in four countries—Japan, Taiwan, Korea, and Hong Kong.

If you've ever wanted to get into business for yourself, you may want to look over the electronics shows carefully. You'll find a lot of smaller businesses with products which could be imported and sold in the US. There are a lot of firms smaller than Sony and Panasonic, you know, and many of these don't have the connections to sell over here... yet. Owners of ham stores in particular will want to look for interesting ham gear and consumer electronic gadgets which can be imported to give you an edge.

After the first two weeks of the tour, sponsored by the IEEE,



Hand-shack.

**Synthesized,
big LCD,
10 memories,
scanning, DTMF**
Touch-Tone®

TR-2400

Put a ham shack in your hand. The TR-2400 is the ideal hand-held for 2 meters FM. It features a large LCD readout that can be read in direct sunlight or in the dark, 5-kHz-step PLL synthesized operation, 10-channel memory, scanning, and 16-button autopatch DTMF encoder.

TR-2400 FEATURES:

- **Large LCD digital readout**
Readable in direct sunlight (better than LEDs). Readable in the dark (with lamp switch). Virtually no current drain (much less than LEDs) and display stays on. Rugged and dependable in hot or cold temperature ranges. Shows receive and transmit frequencies and memory channel.
- **5-kHz-step frequency selection**
PLL synthesized keyboard channel selection system. No "5 up" switch needed. Selects from 144.000 to 147.995 MHz.
- **UP/DOWN manual scan**
Single or fast continuous 5-kHz steps from 143.900 to 148.495 MHz for Amateur and MARS or CAP simplex or repeater operation.
- **10 memories**
Retained with battery backup (only 0.8 mA). "MO" memory may be used to shift the transmit frequency any desired amount to operate on repeaters with nonstandard split frequencies.
- **Built-in autopatch DTMF (Touch-Tone®) encoder**
Uses all 16 buttons of keyboard while transmitting.



- **Automatic memory scan**
Checks all 10 memory channels. Programmable to lock automatically on either BUSY (signal present) or OPEN (no signal) channels.
- **Subtone switch**
Activates subaudible tone encoder (not Kenwood-supplied).



- **Repeater or simplex operation**
Convenient mode switch shifts transmit frequency +600 kHz or -600 kHz or to the frequency stored in "MO" memory.
- **Reverse operation**
Nonlocking switch shifts receiver to transmit frequency and transmitter to receive frequency.
- **Extended operating time**
With LCD and overall low-current circuit design. Only draws about 28 mA squelched receive and 500 mA transmit (at 1.5 W RF output), for longer operating time between charges.
- **Two lock switches**
Prevent accidental frequency change and accidental transmission.
- **BNC antenna connector**
Easy to connect external antenna.
- **LCD "arrow" indicators**
Show "ON AIR," "MR" (memory recall), "BATT" (battery status), and "LAMP" switch on.
- **High-impact case and zinc die-cast frame**
Extremely rugged with antenna counterpoise.
- **External PTT microphone and earphone connectors**
Easily accessible on right side of transceiver.
- **Compact and lightweight**
Only 2-13/16 inches wide, 7-9/16 inches high, and 1-7/8 inches deep. Weighs only 1.62 pounds (including antenna, battery, and hand strap).

- **Microphone PTT and audio terminals**
- **Charger terminal**
- **Earphone Jack**

STANDARD ACCESSORIES INCLUDED:

- Flexible rubberized antenna with BNC connector
- Heavy-duty (450-mAh) NiCd battery pack
- External-standby (PTT) plug
- AC charger
- External-microphone plug
- Hand strap
- Earphone

NOTE: Price, specifications subject to change without notice and obligation.

OPTIONAL ACCESSORIES:

- ST-1 base stand (shown) which provides 1.5-hour quick charge and automatic switch to trickle charge, floating charge (operate while charging), 4-pin connector for dynamic microphone, and SO-239 antenna connector
- BC-5 DC quick charger (1.5 to 2.0 hours)
- LH-1 deluxe leather case (top-grain cowhide)
- PB-24 extra battery pack with charger adapter
- BH-1 belt hook



Staff

EDITOR/PUBLISHER
Wayne Green W2NSD/1

ASSISTANT PUBLISHER
Jeffrey DeTray WB8BTH

MANAGING EDITOR
John Burnett

ASSISTANT MANAGING EDITOR
Susan Philbrick

NEWS EDITOR
Gene Smarte WB6TOV/1

EDITORIAL ASSISTANTS
Nancy Noyd
Richard Phenix

PRODUCTION MANAGER
Noel Self WB1ARP

ASSISTANT PRODUCTION MANAGER
Robin Sloan

ART DEPARTMENT

Steve Baldwin
James Butler
Robert Drew
Bruce Hedin
Kenneth Jackson
Clare McCarthy
Michael Murphy
Dion Owens
Patrice Scribner
Susan Symonds
John White

BOOK PUBLICATIONS
Jim Perry

BOOK PRODUCTION
Emily Gibbs
Chris Brown N1AU1

PHOTOGRAPHY
Bill Heydolph
Tedd Cluff
Terrie Anderson

TYPESETTING
Barbara Latti
Sara Bedell
Sandie Gunseth
Karen Podzycki

EXECUTIVE VICE PRESIDENT
Sherry Smythe

CORPORATE CONTROLLER
Alan Thulander

EXECUTIVE ASSISTANT
Leatrice O'Neil

ACCOUNTING MANAGER
Knud Keller KV4GG/1

DATA ENTRY
Cathy DeSilva

CIRCULATION MANAGER
Debra Boudrieau

ASSISTANT CIRCULATION MANAGER
Barbara Block

CIRCULATION
Pauline Johnstone

BULK SALES MANAGER
Ginnie Boudrieau

SHIPPING
Mark Dendy
Bill Barry
Bryan Hastings KA1HY

RECEPTIONIST
Helen Grammer

ASSOCIATES
Robert Baker WB2GFE
Sanger Green
Dave Ingram K4TWJ
Larry Kahaner WB2NEL
Joe Kasser G3ZCZ
Bill Pasternak WA6ITF
John Schultz W4FA
Peter Stark K2OAW

ADVERTISING
(603) 924-7138

Aline Coutu, Mgr.
Kevin Rushalko
Nancy Ciampa
Marcia Stone
Louise Holdsworth
Jerry Merrifield
Rita Rivard
Hal Stephens
Phoebe Taylor
Shirley Lary
Linda Cate

you can add another country or two to your itinerary. I'm planning on getting up to Macao (CR9) and Canton, China (BY), if it is at all possible this time. And you can bet that I'll be getting on the air from Korea (HL9) and Hong Kong (VS6), at the least.

If you'd like to join me on this trip, drop me a line and I'll send you further information. I figure that one or two tables (about 12 to a table in China) of hams will be a lot more fun for a trip like this than traveling with the average businessman. This is an opportunity which comes along rarely, so make your plans now and come on along. It runs from October 2nd to 22nd and you didn't have anything important then anyway.

LINEAR SUIT LOST

While the FCC ban on the manufacture and sale of linear amplifiers capable of being used on the amateur ten-meter band was an excellent example of legislative overkill, that doesn't excuse the blundering amateur representative reaction to the situation. For those of you who are a bit hazy on just who did what to whom, I'll give you a fast reprise.

The FCC, after being plagued by a rising number of TVI and other interference complaints, enacted a law making the manufacture or sale of an 11-meter amplifier illegal. This put all of the "legitimate" makers of these amplifiers out of business and left the field wide open for the fly-by-night operators. Oddly enough, these birds didn't care how clean or dirty the signals from their amplifiers were... since they sold mostly by virtue of their price and the buyers were completely unsophisticated.

The result was an ever increasing amount of interference as more and more of the dirty amplifiers were sold. The FCC, lacking money to do much more than grind its teeth over the situation, fumed.

Some of the amplifiers were being peddled as "amateur" equipment, even though the parameters were totally CB-oriented and the products not even advertised or known to the hams. So the FCC decided that it was time to outlaw any amplifier which would be usable on the 11-meter band... and that obviously would have to include all designed to work on 10

meters. Such a proposal was made and the public asked to comment on it at an open hearing.

A number of representatives from the Amateur Radio Manufacturer's Association (ARMA) went to Washington to participate. They got together the night before the hearing and developed their approach to the situation. The ARRL counsel, though he refused to cooperate with ARMA, did sit in on the strategy discussions... something ARMA was to seriously rue the following day. Due to the heavy support of ARMA by some of the importers of ham equipment, the major US manufacturers also refused to work with ARMA. The result was an uncoordinated mess when the time came for testimony.

One of the first on the line when the FCC commissioners opened the hearing was the ARRL counsel. He talked at incredible length, putting the commissioners down as knowing little about what they were doing (they were new commissioners, for the most part). He went on to randomly cover virtually every point that the ARMA group had outlined for comments, shooting down the industry group presentation completely. The commissioners took turns leaving the room during the filibuster.

The key to getting cooperation from the FCC is, as with any other sales problem, looking at the situation from their viewpoint. The FCC was getting heat from Congress over TVI from CB radios with amplifiers. Their engineers had proposed making amplifiers illegal, including ham 10m amplifiers. They were not interested in hearing that this would not work. All they wanted to do is what any other bureaucrat wants to do: give the impression of *doing* something.

My proposed approach to the situation was to agree with the FCC that something should be done and then come up with some suggestions on other approaches to the solution of their problem. Since amplifiers and the use of them were already illegal, it was more a matter of running down the users and getting them off the air than trying, at this late date, to stop the supply... something which I thought was not practical anyway. I tried to get ARMA to support a position of getting the

FCC to work with ham clubs to hunt down errant CBers and do the legwork for them. This would do more to solve the problem than any laws. I just couldn't get ARMA to go for the positive approach... they insisted on going for the negative... telling the FCC that a new law wouldn't work and that banning ham amplifiers was a rotten way to go.

So, after hours and hours of being told that the ban wouldn't work, up popped the Washington lobbyist for the Electronic Industries Association (EIA)... a chap who knows how to get the FCC to do what he wants... and he told 'em the ban would work wonders. He told them this within five minutes and sat down. And he won the day.

By this time, the commissioners were about ready to vote for anything to shut up the hams. I remember one commissioner getting really fed up with the League counsel. A simple question had been asked and the answer went on for ever. Finally the commissioner broke in and said, "We asked what time it was, not how to make a watch." And that's the way it was.

Still not having learned anything from all of this, the League proceeded to go to court to try to force the FCC to back down on the linear ban. The courts are very reluctant to go against a government agency... knowing that it is the government which pays them and holds their promotions in their hands. Further, the general rule in the past on court cases against the FCC has been for the judges to dismiss the case on the basis that the FCC has the technical expertise to deal with technical matters... and that these are far beyond the possibility for the judge to understand.

There was also some legal hassle over the failure of the League to raise a "lack of notice" argument in their Partial Petition for Reconsideration and Rehearing before the Commission. This turned out to be a serious oversight and considerably contributed to the loss of the case.

If I wasn't such a known fan of the League, I could be very critical of them in this ten-meter linear ban situation.

Continued on page 182

The Question we seem to get most often from our customers:

"WHEN IS ICOM COMING OUT WITH A HAND-HELD?"

ICOM IC-2A SYNTHESIZED 2 METER HAND-HELD

FEATURES YOU'VE WANTED

- 800 T/R Channels. Synthesized.
- 1.5 Watt Output High/Low Power Battery Saving Switch to .15 Watt.
- Separate built in Speaker & Mic. Excellent audio quality.
- Compact. About the size of a dollar bill.
- Variable size NiCd Power Pack, 3 sizes available to suit your needs. (250 MA standard). Makes the IC-2A the most compact synthesized HT on the market.
- ICOM level Receiver Performance-ICOM Quality Receiver in a compact package (.2uv/20db typical)
- Optional Tone Pad, Desk Charger, Speaker/Mic available.
- With slip on/slip off Bottom NiCd Pack, you can vary the size of the HT from about 116 mm high to 175 mm high. Easy to carry extra Snap-on packs with you for extended trips.

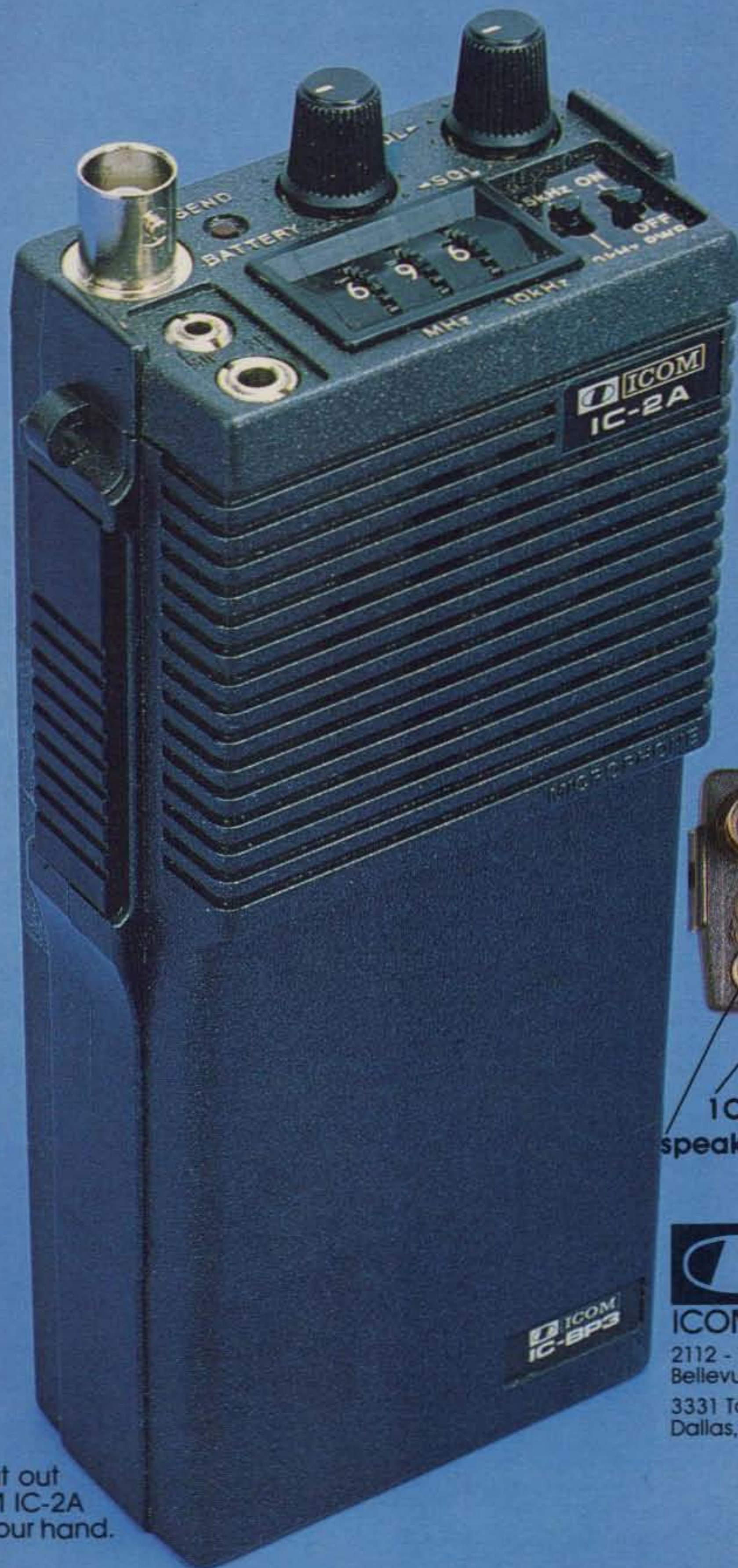

Actual size: Cut out and put the ICOM IC-2A in the palm of your hand.

BACK VIEW
±600 kHz offset
simplex/duplex
Hi/lo power



TOP VIEW

BNC antenna connector
"Rubber Duckie"
standard



 **ICOM**

ICOM AMERICA, INC.

2112 - 116th Avenue NE
Bellevue, WA 98004

3331 Towerwood Dr., Suite 307
Dallas, TX 75234

THE ANSWER IS: NOW!

All 800 channels of it!

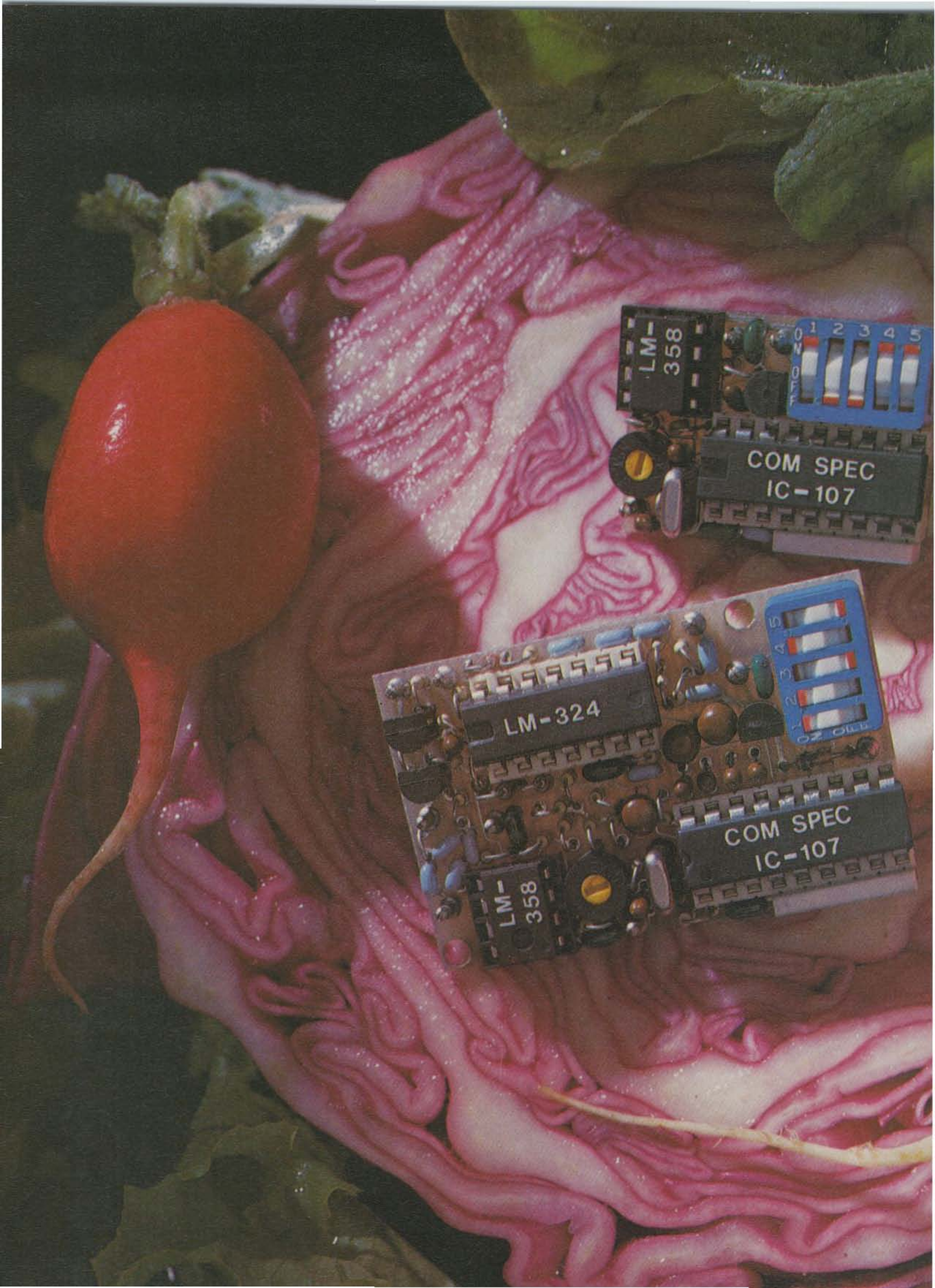



A fresh idea!

Our new crop of tone equipment is the freshest thing growing in the encoder/decoder field today. All tones are instantly programmable by setting a dip switch; no counter is required. Frequency accuracy is an astonishing $\pm .1$ Hz over all temperature extremes. Multiple tone frequency operation is a snap since the dip switch may be removed. Our SS-32 encode only model is programmed for all 32 CTCSS tones or all test tones, touch-tones and burst-tones.

And, of course, there's no need to mention our 1 day delivery and 1 year warranty.

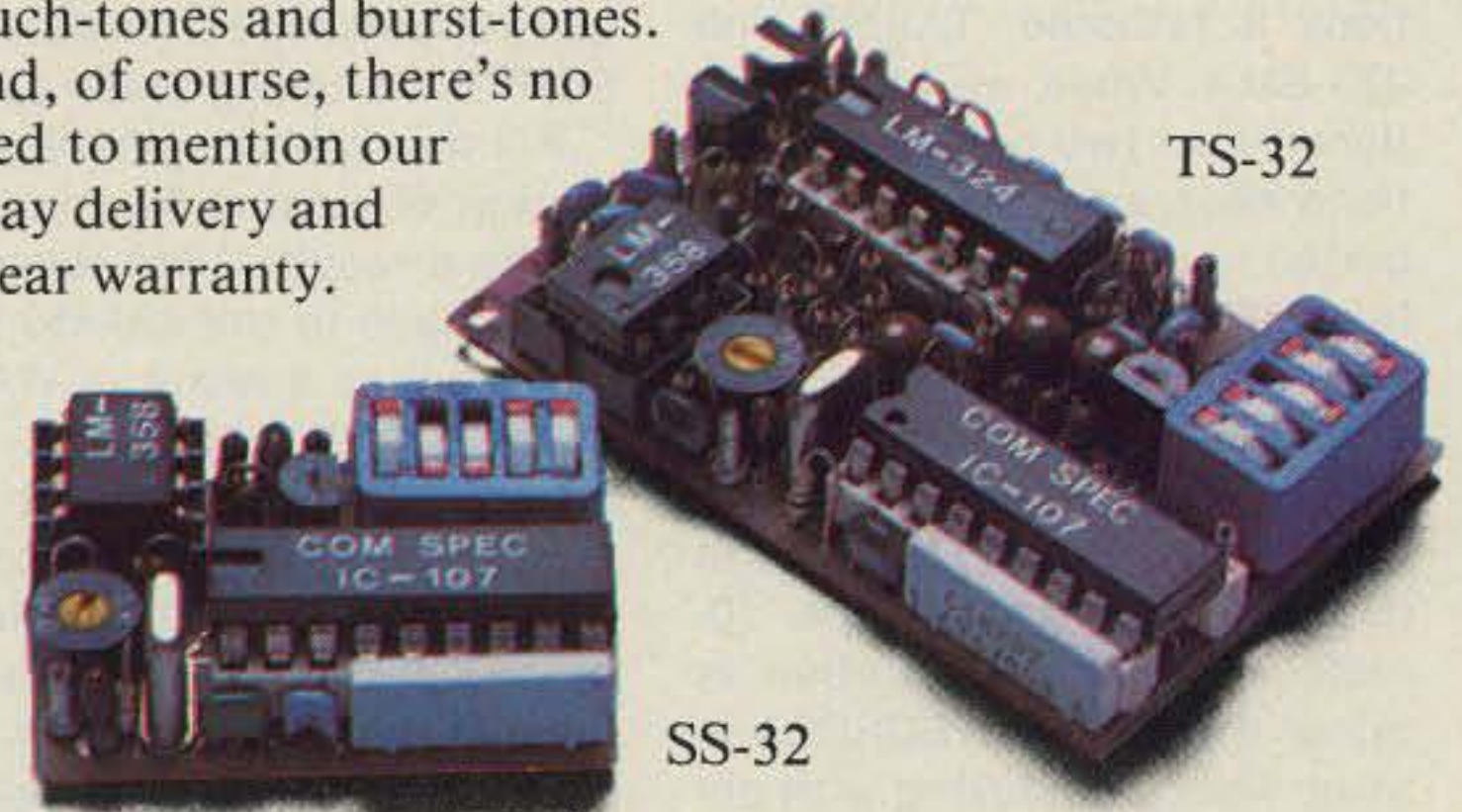

TS-32 Encoder-Decoder

- Size: 1.25" x 2.0" x .40"
- High-pass tone filter included that may be muted
- Meets all new RS-220-A specifications
- Available in all 32 EIA standard CTCSS tones

SS-32 Encoder

- Size: .9" x 1.3" x .40"
- Available with either Group A or Group B tones

Frequencies Available:

Group A			
67.0 XZ	91.5 ZZ	118.8 2B	156.7 5A
71.9 XA	94.8 ZA	123.0 3Z	162.2 5B
74.4 WA	97.4 ZB	127.3 3A	167.9 6Z
77.0 XB	100.0 1Z	131.8 3B	173.8 6A
79.7 SP	103.5 1A	136.5 4Z	179.9 6B
82.5 YZ	107.2 1B	141.3 4A	186.2 7Z
85.4 YA	110.9 2Z	146.2 4B	192.8 7A
88.5 YB	114.8 2A	151.4 5Z	203.5 M1

- Frequency accuracy, $\pm .1$ Hz maximum - 40°C to + 85°C
- Frequencies to 250 Hz available on special order
- Continuous tone

Group B			
TEST-TONES:	TOUCH-TONES:	BURST-TONES:	
600	697 1209	1600	1850 2150 2400
1000	770 1336	1650	1900 2200 2450
1500	852 1477	1700	1950 2250 2500
2175	941 1633	1750	2000 2300 2550
2805		1800	2100 2350

- Frequency accuracy, ± 1 Hz maximum - 40°C to + 85°C
- Tone length approximately 300 ms. May be lengthened, shortened or eliminated by changing value of resistor

Wired and tested: TS-32 \$59.95, SS-32 \$29.95



COMMUNICATIONS SPECIALISTS

426 West Taft Avenue, Orange, California 92667
(800) 854-0547 / California: (714) 998-3021

Looking West

Bill Pasternak WA6ITF
24854-C Newhall Ave.
Newhall CA 91321

Over the past nine years, we have written quite a bit about the original Southern California Repeater Association, as well as the two offshoot organizations it fathered: Tasma and 220 SMA. While we have mentioned that two other organizations exist, we have never really gotten involved very much with them. The other two to which I refer are the 10 meter AM/SSB QRP Band Planning Council and the Southern California Repeater Remote Base Association (SCRRBA). Currently, the 10-meter non-FM organization is rather dormant, but SCRRBA is alive, well, and looking with anticipation toward the future.

SCRRBA differs markedly from most other area coordination bodies. First, they hold but one meeting annually, and may-

be that accounts for the fact that the get-together is always packed solid with attendees. Second, the political power of SCRRBA is vested in the organization's elected officials. Having recently attended the 1980 annual meeting held in Burbank, California, I can say that I am quite impressed by the direction SCRRBA is taking these days.

For example, they have no intention of waiting for the ax to fall as a result of the reassignment made to the 420-450 MHz spectrum as a result of WARC. SCRRBA officials realize that changes are inevitable, and that the best defense in spectrum preservation is a strong offense based upon careful preparation. Because of this, SCRRBA officials will begin now to develop a dialogue with the ARRL, VRAC, and other concerned organizations with regard to protecting the viability of the current UHF spectrum. Should some other

service prepare overtures toward taking spectrum based on WARC decisions, SCRRBA wants to be ready to ward off such attacks.

SCRRBA is also looking for input on the utilization of the proposed 900-MHz band. It is believed that the FCC may be hard put to assign 902 through 928 MHz to any other service in light of Canada's implementation of amateur operation in that spectrum already. If you have any ideas on this topic, you might send them to SCRRBA at PO Box 5967, Pasadena CA 91109.

Unlike most other organizations of their ilk, SCRRBA does not seek widespread recognition for their work. They believe strongly in the concept of regional band planning for spectrum that is not usually utilized by transient operators, and are totally dedicated to advancement of the technical state of the art. They are an interesting organization to watch, and over the years have quietly contributed much to the science of amateur relay technology.

SCRRBA oversees voluntary coordination for FM operations on 10 meters, 6 meters, 420 through 450 MHz, and all spectrum above. They also publish a listing of what they term "Public Repeaters and Simplex Channels" for southern California. The latest list was recently made available to us and is reprinted here for those of you who might wander out to this region carrying equipment for the bands listed.

There are two things to remember in relation to this list. First, it is probably the most accurate listing of its type. Also, do not be deceived by the small number of UHF listings. Again, the ones listed are the "open" systems—available for use by any amateur. It is no secret that between 300 to 400 other systems are operational in the UHF spectrum in this area, but all others are categorized as "private." Happy QSOing.

PLUGGING VIDEOTAPE DEPARTMENT

How would you like to have your very own copy of the new Dave Bell film, "The World of Amateur Radio"? The film is available for direct sale in four formats, at a price which is close to "cost plus shipping." The idea is to get as many prints into circulation as quickly as

possible, and to do this it was felt that videotape might be the best way to go. The price schedule is: 1/2" VHS (SP speed only) — \$30; 1/2" Beta (Beta I or II only) — \$30; and 3/4" U-Matic — \$55.

Videotapes are available from me directly on a prepaid basis only. Checks or money orders should be made out to William M. Pasternak, and all videotape orders sent to me in care of Westlink, 7046 Hollywood Boulevard, Suite 718, Hollywood CA 90028.

In addition, 16mm sound film prints are available directly from Dave Bell for \$95 each. Film orders should be made payable to Dave Bell Associates, and sent to 3211 Cahuenga Blvd. West, Hollywood CA 90068. Mark film orders for the attention of Theresa Modnick, and allow 4 to 6 weeks delivery on all orders (film or tape). Then, once you have enjoyed it yourself, take it out and show it to civic groups, church groups, CB clubs or whatever. The purpose of the film is to introduce amateur radio to the rest of the world, and a film or tape is of little value sitting on your library shelf. Each of you has the ability to become a spokesperson for amateur radio. The tools are available and the audiences await you. The best public relations corps we in amateur radio have is ourselves.

GOING TO THE AIRPORT CAN BE HAZARDOUS TO YOUR HEALTH DEPARTMENT

Rob Diefenbach WD4NEK had a rather unpleasant experience not long ago. He had taken his wife to Atlanta's Hartsfield Airport, and like most devoted amateurs, he was carrying an HT with him. That's when the problem began, and at this point we will let Rob tell the story:

"Despite what overzealous rent-a-cops at America's second busiest airport may try to tell you, there is no prohibition against carrying or using amateur transceivers in the gate areas there.

"When I was told recently that I must remove the batteries from my 2-meter handie-talkie before passing a security checkpoint at Atlanta's Hartsfield International Airport, I complied without argument. 'If you don't, you'll be in a lot of trouble,' a smartly-uni-

Continued on page 169

SOUTHERN CALIFORNIA PUBLIC REPEATERS AND SIMPLEX CHANNELS

Location	Call	Input	Output	Access
Sierra Madre	WR6BDG	29.52	29.62	107.2 Hz
Mt. Wilson	WR6AAK	29.54	29.64	107.2 Hz
Palos Verdes	WR6AQS	29.58	29.68	107.2 Hz
6 Meters				
Mt. Wilson	WR6AAK	52.76	52.525	carrier
Johnstone Peak	WR6AAJ	52.76	52.525	carrier
San Miguel	N6AEG/R	52.76	52.54	carrier
Baldwin Hills	WR6AQR	52.90	52.68	carrier
Santiago Peak	WR6ADP	53.38	53.72	carrier
34 Meters				
Palos Verdes	WR6AKU	440.500	445.500	131.8 Hz
Catalina Is.	WR6AAA	442.000	447.000	carrier
San Diego	WR6AFE	442.025	447.025	carrier
Sulphur Mt.	WR6AOX	442.325	447.325	carrier
Table Mt.	WR6AZN	442.325	447.325	carrier
Monrovia	WC6AAD	442.575	447.575	carrier
Crestline	WR6ANP	443.350	448.350	carrier
Palomar Mt.	WR6AII	444.425	449.425	carrier
Santa Monica	WA6RJG	444.425	449.425	carrier
Mt. Otay	WR6ACF	444.500	449.500	107.2 Hz
ATV				
Johnstone Peak	W6ORG	434.000	1265.00	15,750 Hz
Simplex				
29.50				
29.60				
52.525				
446.000				
446.500				
439.500 (ATV audio channel, ± 5 kHz deviation)				

Notes

1. SCRRBA believes the above data to be correct, but is not responsible for its ultimate accuracy.
2. No impression is intended or implied that the amateur frequency bands which SCRRBA coordinates are devoid of activity except for that listed above. These listings represent in actuality only a very tiny percentage of the total southern California activity. Repeaters and remote base stations not listed above are coordinated as private (i.e., closed) systems; such systems generally do not welcome visitors.
3. Errors in the above listing should be reported to the SCRRBA Technical Committee.

enter the new world of TEN-TEC

OMNI-Series C



new features, new performance + all 9 hf bands

NEW — ALL 9 HF BANDS. Full coverage from 160 through 10 Meters. Ready to go, with crystals supplied for seven bands (crystals for 18 and 24.5 MHz bands available when bands are ready for use).

ALL SOLID-STATE. From the pioneer.

BROADBAND. From the pioneer.

NEW 3-MODE, 2-RANGE OFFSET TUNING. Another TEN-TEC first... (1) Offset Receiver Tuning, (2) Offset Transmitter Tuning and (3) Offset Transceiver Tuning. None other has it. For complete flexibility, to meet all needs, fine tuning or DX. 2-ranges: ± 500 Hz or ± 4 kHz.

OPTIMIZED RECEIVER SENSITIVITY. For an ideal balance between dynamic range and sensitivity... from $2 \mu\text{V}$ on 160 to $0.3 \mu\text{V}$ on 10 Meters.

NEW OPTIMIZED BANDWIDTH. Seven response curves—four for SSB, three for CW. Standard i-f filter is an 8-pole 2.4 kHz crystal ladder type. Options include a 1.8 kHz 8-pole crystal ladder type, a 500 Hz 8-pole CW filter and a 200 Hz 8-pole CW filter. Switch an optional filter from the front panel to put it in series for up to 16 poles of filtering. And the standard CW active audio filter has 450 and 150 Hz bandwidths for added attenuation. New toggle switches select i-f and audio filtering. Selectivity for any situation.

BUILT-IN NOTCH FILTER. Variable null eliminates unwanted signals and carriers in a pass band from 200 Hz to 3.5 kHz with a notch depth of more than 50 dB.

NEW BUILT-IN NOISE BLANKER. Standard equipment. New 2-pole monolithic crystal filter handles big signals easily, makes impossible locations usable.

GREATER DYNAMIC RANGE. Better than 90 dB, typically. Reduces front-end overload and distortion. Plus a PIN diode switchable 18 dB attenuator on the RF gain control.

NEW "HANG" AGC. Smoother operation.

2-SPEED BREAK-IN. "Fast" or "Slow" speeds. "Fast" for instant, full break-in. "Slow" has a longer mute time before receiver is actuated for working crowded bands with heavy QRM and for mobile.

WWV RECEPTION. On the 10 MHz band.

DIGITAL READOUT. 6 shielded 0.43" LEDs with 5 in red, the 6th (100 Hz) in green.

SEPARATE RECEIVING ANTENNA CAPABILITY. Use with separate components, instant break-in linears, or transverters.

"S"/SWR METER. Easy-to-read. Electronically switched.

200 WATTS INPUT. On all bands, when used with 50 ohm load. Proven, conservatively rated design. Fully warranted for first year, pro-rata warranty for five extra years!

100% DUTY CYCLE. Full power hour after hour without fail. Ideal for RTTY, SSTV or any hard usage.

BUILT-IN VOX AND PTT. Smooth VOX with 3 front panel controls. And PTT control at both front and rear panel jacks.

BUILT-IN PHONE PATCH JACKS. Easy interface to speaker and microphone signals.

BUILT-IN CW ZERO-BEAT SWITCH. Puts you on exact frequency of a station being worked without being on the air.

BUILT-IN ADJUSTABLE SIDETONE. Vary pitch and volume for easy listening.

ADJUSTABLE THRESHOLD AUTOMATIC LEVEL CONTROL. From low power to full output with full ALC control.

FRONT PANEL CONTROL OF LINEAR OR ANTENNA. Auxiliary bandswitch terminals on rear panel permit simultaneous control of external relays or circuits. Disregard to interface with new TEN-TEC solid-state/CW Linear.

AUTOMATIC SIDEBAND SELECTION. And you can reverse it with the mode switch.

SUPER AUDIO. A TEN-TEC trademark. Proper shaping plus low distortion.

IMPECCABLE SIGNAL. Clean. Easily exceeding FCC requirements, thanks to meticulous design, fine components, and conservative ratings.

HIGH STABILITY. Deviation is no more than 15 cycles per degree temperature change after warm-up.

HIGH ARTICULATION KEYING. 2½ msec rise and decay time for sharp, clean keying.

BUILT-IN SPEAKER. Built into the bottom of the cabinet shell. Compression-loaded for better quality and higher efficiency. External speaker connections on rear panel.

PLUG-IN CIRCUIT BOARDS. For easy removal if needed.

FUNCTIONAL STYLING. Dark front panel, convenient control groupings, "clamshell" cabinet, full shielding, and easier-to-use size: 5¾" h x 14¼" w x 14" d.

POWER. Operates on 12-14 VDC for mobile or storage battery use. For 117 VAC use, an external supply is required.

FULL ACCESSORY LINE. Model 217 500 Hz CW filter \$55, Model 219 200 Hz CW filter \$60, Model 218 1.8 kHz SSB filter \$55, Model 243 Remote VFO \$139, Model 255 Power Supply/Speaker \$169, Model 280 Power Supply \$139, Model 645 Dual Paddle Keyer \$85, Model 670 Single Paddle Keyer \$34.50, Model 234/214 Speech Processor & Condenser Microphone \$163, Model 247 Antenna Tuner \$69. All in matching color.

Model 546 OMNI-Series C \$1189

See your TEN-TEC dealer, or write for full details.

TEN-TEC, INC.
SEVIERVILLE, TENNESSEE 37862
EXPORT-5735 LINCOLN AVE., CHICAGO, ILL. 60646

RTTY Loop

Marc I. Leavey, M.D. WA3AJR
4006 Winlee Road
Randallstown MD 21133

This month marks the beginning of the fourth year of RTTY Loop. Several of you have asked

how this whole thing got started, and it occurred to me that I never really told that story, so here goes. As they say (whoever "they" are), there's a lesson in here for you!

Several years back, our local

ham club, the Baltimore Amateur Radio Club, was in the process of expanding and improving its journal, *The Modulator*. Knowing that I was a RTTY buff and that I had written many articles for 73 (thus presuming literacy, I suppose), I was asked to write a column for the "new" *Modulator*. After some mulling over (must have taken all of thirty or forty microseconds), I

agreed and a column was born. Titled "Tele-Tips," the articles were about half the length of a typical RTTY Loop and dealt with radioteletype basics.

After writing the first few columns, it became evident that the material being presented had a far wider appeal than the club newsletter afforded, and

Continued on page 176

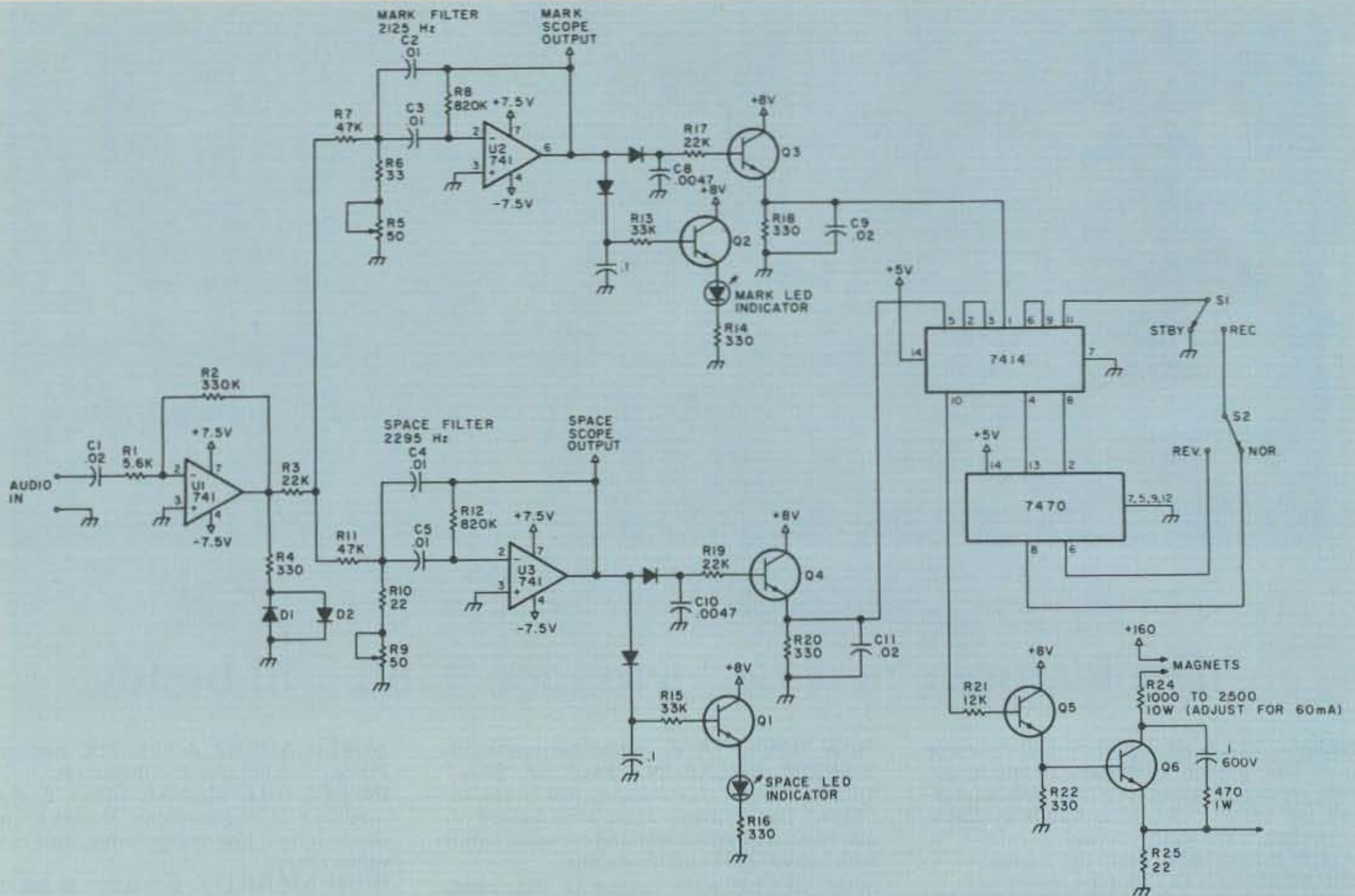

RTTY Demodulator Parts List

C1, C7, C9, C14	.001 disc ceramic
C2	.005 disc ceramic
C3, C4	500 pF 5% polycarbonate or mylar*
C5	.01 disc ceramic
C6, C16	2 uF 25 V dc electrolytic
C8	.01 uF 5% polycarbonate or mylar*
C10	.47 uF mylar
C11, C15	.1 uF disc ceramic
C12	6.8 uF 25 V dc electrolytic
C13	680 pF disc ceramic
C17	500 uF 25 V dc electrolytic
C18, C19	100 uF 25 V dc electrolytic
*to limit the amount of drift due to heat.	
All resistors 1/4 Watt 10% except as noted.	
R1, R5, R17, R20	4.7 megohm
R2, R18, R21	2.2 megohm
R3	1.0 megohm 1/4 Watt 5%
R4	2.2 megohm 1/4 Watt 5%
R6	7.5k Ohm 1/4 Watt 5%
R7, R13, R22, R23	10k Ohm potentiometer, printed circuit type
R8, R9, R15, R30	
R31	10k Ohm
R10, R11	4.7k Ohm
R12	12k Ohm 1/4 Watt 5%
R14, R37, R38	1k Ohm
R16	3.3k Ohm
R19	150k Ohm

R24, R25, R26, R27	
R32, R33	1 megohm
R28	100k Ohm potentiometer, printed circuit type
R29	15k Ohm
R34, R35	3.9k Ohm
R36	10k Ohm 1/2 Watt 10%
CR1, CR2, CR3, CR4	1N34A germanium diode
CR5, CR6	1N914 silicon diode
CR7, CR8, CR9, CR10	
CR11	1N4007 rectifier
CR12	12 volt 1 Watt zener diode
LED	light emitting diode
IC1, IC3	LM3900 CN (National)
IC2	LM565 CN (National)
Q1	MPF 102 or equivalent N-channel FET
Q2	High voltage silicon NPN transistor (Sylvania ECG 228 or equivalent)
T1	1.2k Ohm center-tapped to 8 Ohm transistor type output transformer used backwards.
T2	115 V ac to 12.6 V ac 1/2 Amp filament transformer
F1	1/2 Amp fast blow fuse and holder
S1	SPST on-off switch
S2	SPDT sense switch
Miscellaneous	
5 x 7 chassis, terminal strip, #6-32 nuts and bolts, insulated spacers for #6-32 to mount boards on chassis, holder for LED	

Fig. 1.

SOMETIMES THE BEST COSTS A LITTLE MORE...

**BUT you get a LOT more
for your money.
For instance:**

- Full length 72 character line and 24 line screen
- True "ASR" operation—type into 50 line on-screen buffer *while* receiving
- 150 line receive buffer and power off EAROM storage
- Ten HERE IS messages plus CW ID, WRU, and SEL-CAL
- Original split-screen plus bright/dim display of RX/TX text
- Control Functions *clearly marked* on the keytops
- On screen status indicators and time
- P31 eye-ease green screen phosphor (white also available)
- All three modes—CW, Baudot RTTY, and ASCII Computer code
- Upper/lower case ASCII with all control characters; 110-9600 baud
- ST6000 multiple active filters and detectors for super reception
- Crystal controlled TX tones matched to RX filters for true transceive
- Interface LOOP, RS232, MIL188 and CMOS with no extra options to buy
- Full RS232 Modem connector and full or half-duplex for computer use
- HAL one year warranty and ten years' experience with RTTY



DS3100 & ST6000 ... \$2550*

...AND THEN SOMETIMES IT DOESN'T!

**COMPARE with other similarly
priced systems — note these
extra features and better
performance for fewer dollars:**

- Full length 72 character lines and 24 line screen
- "Semi-ASR" operation by typing into 255 character buffer *while* receiving
- Pretype the entire 1728 character screen
- Two programmable HERE IS messages plus CW ID
- Keyboard Operated Switch (KOS) for automatic TX/RX control
- Bright/dim display of RX/TX text
- Labeled controlled keys plus on-screen status line for easy operation
- All three modes—CW, Baudot RTTY, and ASCII Computer code
- 1-175 wpm CW; 60, 66, 75, 100, 133 wpm Baudot; 110, 300 baud ASCII
- Word wrap-around, Unshift On Space, Synchronous Idle
- Edit as you type with Word Mode
- High performance external demodulator rather than built-in compromise
- Internal Loop Supply and Motor control for full TTY machine compatibility
- Solid state RTTY Loop interface; both cathode and grid-block CW outputs
- HAL one year warranty and ten years' experience in RTTY



DS2000, MR2000
ESM914, ST5000 ... \$1029*

LOOK FOR THE BEST or THE MOST ECONOMICAL ... WE HAVE BOTH!

* Prices for U.S. customers purchasing complete systems as specified in our catalog. Write for our complete catalog for detailed specifications and other system combinations. Prices and specifications subject to change without notice.



HAL COMMUNICATIONS CORP.
Box 365
Urbana, Illinois 61801
217-367-7373

For our European customers, contact: Richter & Co. D3000
Hannover 1 • Transradio SA, 6816 Bissone/Lugano • Radio
Shack Ltd., London NW6 3AY • Erik Torpdahl Telecom, DK 3660
Stenlose Denmark

James D. Cain K1TN
306 Vernon Avenue
Vernon CT 06066

73 Magazine is unique in many respects, not the least of which is that we can publish color photos in columns such as this; witness the DXers pictured herein. This should be encouragement enough for you to send in your favorite snapshot for these pages. Please do so. US and Canadian hams, when you work a DX station, ask him to send a photo to the above address or direct to you for forwarding to this column. Thanks!

While this is a DX column, not a contesting column, it seems prudent to discuss the ARRL DX Contest briefly. The League has given until June 15 for interested parties to express their opinions regarding new rules which went into effect this year. A little background is in order. The ARRL International DX Competition began in the 1930s as a marathon affair. It was always a "world works the US and Canada" activity. Through 1978, the Competition was two weekends for CW and two weekends for phone; in 1979, the format remained unchanged but the schedule was cut to one weekend per mode. Then, late in 1979, despite reservations of the League's Contest Advisory Committee, the format of the Competition (and its name) was changed. The 1980 ARRL DX Contest was run by a set of rules closely paralleling those of the CQ Worldwide DX Contest.

Everyone was allowed to work everyone (except within one's own country) with a point structure just slightly favoring the rest of the world working W/VE stations. Still with me?

Well, it has really hit the fan. It seems that those responsible for the changes *thought* that the rest of the world's amateurs, contesters in particular, didn't like spending an entire weekend working just the US and Canada. Something of the "Ugly American" mentality was at work here, only it was the American sponsors of the operating activity who were in that mode. They don't seem to have reminded us anywhere that the ARRL DX Competition has grown in number of entries steadily through the years. They were concerned that the CQ Worldwide DX Contest touts having more entries, which is true. But the real truth is that the CQ Contest, due to its format, results in hundreds of entries reflecting Europeans working each other on 80 and 40 meters (same continent, two points each), with nary a "DX" contact in the log. That is perfectly reasonable within the rules of the CQ Contest, but it is no reason to make the ARRL Competition into a poor carbon copy.

We have letters from European amateurs who have gone so far as to boycott the 1980 ARRL DX Contest because of the new rules. Unbelievable as it may seem to the Newington promulgators of the new rules, many of the contesters around

the world absolutely love the two weekends of the year working W/VE. There are parallels to that format: The All Asia Contest is the world working Asia, and then there's the Worked All Europe every summer and the Bermuda Contest in March.

So what's the connection to pure DXing, which is what this column is about? Presently, the United States is undergoing one of its recurring periods of patriotic fervor. Nothing wrong with that, and the concept can extend to amateur radio. After all, we have more amateurs on the HF bands than the rest of the world and we are omnipresent. That is exactly why the old ARRL International DX Competition "world-works-the-US/Canada" format was so popular. Just as many of us enjoy working scads of Japanese stations once a year in the All Asia Contest, much of the world participated in the ARRL Competition for the pleasure of logging 100-contact hours. That's what DX contesting is for. That's why European DXers put up special low-band fixed antenna arrays toward North America — to work us during the International DX Competition.

If you agree with this point of view, send a letter to the Chairman of the ARRL's Volunteer Contest Advisory Committee: Jim Stahl K8MR, 3592 Atherstone Road, Cleveland Heights OH 44121. Of course, if you like the *new* rules, they would like to hear from you, too.

Summertime propagation conditions are in full swing now, and if you are not familiar with the consequences, maybe a few words are in order. The low bands (160, 80, and 40 meters)

propagate just as well now as they did in the winter. The problem is, of course, static masking the weaker signals. On quiet summer nights, the signals will come through just fine, so don't give up on these bands. 20 meters will be open round-the-clock, with openings to Asia from North America lasting later into the evening than they do in winter. Long-path openings will occur earlier in the morning than during the winter.

15 meters can be fascinating during the summer. Look for weird openings to unexpected spots. Last July, during the IARU Radiosport Championship, 15 meters opened from the US to Japan at 1300 UTC and stayed open until after 1800 UTC! Both days of the contest, no less. On the other hand, at the same time that 15 was open to Japan, 10 meters was dead as the proverbial doornail. 15 is not normally good on the North Pole path in summer, and 10 meters can die for days at a time. 10 will, during these sunspot-rich times, occasionally stay open from North America as late as 0000 UTC into western Europe.

The various magazines are full of articles on the malicious interference problem these days. While it is easy to take the attitude that the good old days were better (in many ways they were!), there are pros and cons to DXing and HF operating in the 1980s. On the positive side, more rare stations are using better equipment and beam antennas, and the AM carriers are gone from the bands. Yet, as Larry Brockman N6AR stated in a recent article in *CQ Magazine*, ten years ago there was definitely less of the ugly nonsense con-



Father Edmund HV2VO (on right) and Tony Privitera, 101J (photo courtesy K3ZJ).



Nao Akiyama JH1VRQ, Overseas Liaison Officer of the Japan DX Radio Club and active DXer.

ected with HF operating, especially DXing. If some nerd breaks up your rag chew, you can just change frequencies or bands, but if deliberate interference voids your QSO with a new country of expedition, there may not be a second chance. Brockman asserts that some of us have lost our manners; maybe some of us just never had any in the first place. Peer pressure seems the only answer, although most of us are hesitant to apply it. But good operators are still in the vast majority.

And now for a wrap-up of February and March DX happenings . . .

TZ4AQS finished his operating from Mali, topped by a two-week stint of heavy guest operating by his QSL manager, ON6BC.

Fred Laun HS1ABD leaves Thailand this August. His 80-meter aspirations were thwarted by terrible power-line noise, although he managed to work W8AH, N4AR, and K4DY on 3.5. He was very active on 40 meters, reporting that the "gray-line" path on that band paid off. It didn't work on 80. HS1WR will try to take up the slack which will come with Fred's departure.

Toshio Yai EP2TY continues active from Iran, despite internal problems there. QSL him direct only, not to any Japanese manager. He is on 15 and 20 SSB regularly and on 10 meters occasionally.

At press time, Peter S2BTF was back home in Germany and it is not known if he returned to Bangladesh. He had been active on the controlled operation by W7RQ and W7PHO every evening at 0045 UTC on 21340.

March saw FR7AI operating /T from Tromelin Island for about two weeks. The proposed Indian Ocean Union operation of N2KK, N5AU, and K5CO was scuttled and thereby went the hopes of those needing Glorioso and Europa, among others.

TN8AJ, in the Congo Republic, was workable on 15 meters via a weekend list operation at 21210 or so on CW. His manager is WB9TTM.

As for China, ZL1ADI had some plans in the works, but they fell through. In March, at least one American amateur was in Peking, and he was listening, but without hopes for a license to transmit. There is talk out of Yugoslavia of a license

for China operation sometime this year.

Jim Smith P29JS got around; he operated VK9NS from Christmas Island in February. Karl Geng DL2AA/W1 operated as VK8GK/Lord Howe, also in February.

28750 became a favorite spot for DXers this past winter; a group run by DK2OC attracted considerable quantities of rare stations, many of them being Europeans operating from African countries. The group met at 1200.

Mike Smedal, formerly EP2LI, continued active from Qatar (A7XD) and was found regularly on the Afrikaner Net (1800, 21355), as well as on 20 and 10 meters. A7XE was workable from lists on 15 meters.

YI1BGD continued to be difficult to work for those who can't get to their radios Monday-Friday. The Kansas City DX Club donated 500 QSL cards to the Iraqis to send to the lucky ones who have worked the club station.

By the time you read this, the country of Burma will either be off most DXers' need lists or it won't. How's that for hedging? George Collins VE3FXT/HS4AMI purportedly has permission to operate as XZ0ONU 15 April to 15 June, in conjunction with UNICEF (United Nations Children's Emergency Fund). We'll see.

If you're trying for a TZ QSL card from a VE3HRS/TZ contact in September or October of 1979, forget it. You worked a bootlegger. Same for 5X1AA and any BYs.

I8KDB reported in late March that they were 3,000 QSLs through the 5,000 requests resulting from the TL0BQ operation last December.

PP0MAG came on from Trinidad Island in February and March, working CW only with plenty of 40/80-meter activity. He was there a full two months, awaiting the next boat out.

Sri Lanka became easier and easier to work as John Ackley KP2A spent several weeks operating as 4S7DX. He then spent two weeks on the Maldives as 8Q7AR, followed by stops at East Malaysia, Thailand, Nepal, and Macao.

Eric Sjolund SM0AGD began an African safari in Guinea Bissau, operating as J5AG. He was scheduled to be in 9Q5, ZS, A22, and others, with operating



Chet Lambert KX6PP, Marshall Islands.

permission for most pending. All QSLs for his activity go to SM3CXS.

March's big event was the operation from Heard Island by VK0RM. Here it is, as published immediately afterward in *The DX Bulletin*.

HEARD ISLAND VK0RM, MARCH, 1980

A scientific expedition to Heard Island left Australia about 1 March 1980, intending to operate on the amateur bands with a Kenwood TS-120 when time permitted. En route, expedition leader Con Veenstra and radio operator Bob McManama operated VK0RM/MM to familiarize themselves with the radio. During the boat trip, the receiver in the TS-120 failed (switching diodes), but McManama repaired it. On Wednesday, 12 March, seven members of the crew were helicoptered to McDonald Island, west of Heard, for a two-day stay; Veenstra and McManama stayed aboard ship. The crew was reunited on 14 March and arrived in the cove at Heard Island on Saturday, 15 March. A handful of amateur-band contacts were made from the ship.

Ashore on Heard at daybreak on Sunday, 16 March, the group was maintaining twice-daily schedules with OZ8AE/MM, and at 0900 UTC on the 16th, P29JS

began taking a list of stations to be worked by VK0RM. Listed were two from each South American country, three from each JA and W/K call area, two from each major European country, three from each VE call area, and 108 VK/ZL stations. At 1200, VK0RM came on the frequency of P29JS and announced that the TS-120 receiver had failed, but that they would attempt operations the next day.

Some stations were worked on Monday, 17 March; VK0RM showed at 1200, extremely weak, with transmitter problems. Many VK and ZL stations on the original list were worked along with a couple of JAs. The operation was moved above 14200 in an attempt to work North Americans, but without success. Jammers aggravated the situation.

Further attempts were made on Tuesday, 18 March; OZ8AE/MM reported that the TS-120 had been taken back to the ship, were the final amplifier transistors were found to be destroyed, probably due to power-supply problems (overvoltage or spikes). While some spare radio parts were kept on the ship, the Kenwood could not be repaired. A few stations were worked on Tuesday, but all of these had

Continued on page 180

Leaky Lines

Dave Mann K2AGZ
3 Daniel Lane
Kinnelon NJ 07405

Question: What, precisely, is an S-meter, anyway?

Answer: Nothing more than an extremely erratic, undependable instrument frequently used when giving signal reports.

I attempted to deal with this before, but to little avail. The erroneous practice persists, and it would take an earthquake, a tidal wave, a volcanic eruption, and a Kansas cyclone to bring home, finally, to the adamant ones who insist upon continuing with this meaningless exercise in futility that an S-meter report has about as much validity as a message from a Ouija board. Maybe even less!

The problem arose years ago when someone mistakenly concluded, because there are nine "S" units on the meter and nine gradations on the signal strength chart, that Eureka!, this must mean that there is some correlation between the two. Balderdash! There is none!

Properly calibrated, an S-meter is supposed to read S-9 for an incoming signal of 50 microvolts. That some contemporary manufacturers have seen fit to adjust their meters to 100 microvolts has no more significance than the fact that some car manufacturers install speedometers that go up to 140 mph in cars that can't exceed 90 or 100 mph. The important thing to know about S-meters is that apparently no two of them give the same reading on a given signal. Even the meters on two identical rigs made by the same manufacturer will vary.

Granted that the signal report represents a piece of useful, valuable information to the transmitting operator, how can he make use of the data if it is rendered inconclusive by broad variations in accuracy? The answer, of course, is that he cannot make use of it.

Signal reports should not be based on the S-meter reading for the simple reason that they happen to be the least standardized item in your ham shack and can't be depended upon for accurate measurements.

If you bought a frequency counter or a signal generator

that operated with as much inaccuracy as your S-meter does, you would take it around to the guy who sold it to you and bust him over the head with it!

Just to refresh the memory of anyone who doesn't happen to have an ARRL logbook around (the R-S-T System of Signal Reports is reproduced therein), here is the table which represents the accepted standard:

1. Faint signals—barely perceptible
2. Very weak signals
3. Weak signals
4. Fair signals
5. Fairly good signals
6. Good signals
7. Moderately good signals
8. Strong signals
9. Extremely strong signals

As you can see, there is nothing here to indicate any meter readings. The report is based upon a judgment call... a conclusion.

But it has now gotten so out of hand that if the incoming signal makes the meter needle deflect to only S-5 or 6, the guy is embarrassed and tells the transmitting station, "You're only showing a 6, but my meter is 'Scotch.' You sound like an S-9." Well, for Pete's sake, if he sounds like a nine, that's what you're supposed to give him. Never mind what the blasted S-meter says!

Only a couple of days ago, I heard a fellow give a report of 2 and 1. He didn't miss a single word of the other guy's transmission, yet he gave a report that indicated that the other station was practically unreadable. It was obvious that he was using his S-meter. How can you give an S-1 report when you copy solid, without losing a single syllable?

I wish I had a buck in my pocket for every time I've copied solid signals from someone whose S-meter reading was zero... the meter didn't even deflect. And I needn't remind anyone that there are times when 9-plus signals are creamed by atmospheric, QRM, impulse noise, and the like. Even worse, you may hook up with one of those people who never learned how properly to modulate a mike and his audio is so damned confidential

that you can't understand a blasted thing he says. The needle of your S-meter may be deflecting pretty vigorously, but his audio sounds like loose cowflop... no definition, no diction, no highs... nothing but a super-saturated glob of soft glop that sounds as though he's got his head down in the toilet bowl! Readability, zilch! Strength? Stength of what? If there's little or no intelligibility, how in the hell can you assign him a reading of any kind? Yet your stupid S-meter is showing a good reading.

The only time I've found a fairly useful application for the S-meter would be when two stations, operating at roughly the same power from the same general location, were to run a test to see who had the relative advantage. This might reflect many things—antenna performance, transfer of power, audio frequency response with higher audio peaks, and so forth. The meter would show the difference.

The most reliable way to give a signal report is by using the ears that the good Lord gave you. Use the R-S-T system (or the old and very reliable QSA system) and forget about the S-meter.

Now, about the phenomenon sometimes called "one-way skip," another pet bete noire of mine. Is it possible for two stations to copy each other at varying levels? Well, maybe... and then again, maybe not. Suppose that one of them doesn't know how to use his receiver prop-

erly... doesn't take advantage of his notch filter, his noise blanker, etc. Suppose one is using a beam and the other a simple wire.

Here's an example. Some of us decided to go down to 40 meters to see if there were any Pacific stations lurking out there in the middle of the night. Since I happened to own a beam for that band, we decided that I would call CQ DX Pacific. Quite a few Oceania stations responded. All the other guys were on dipoles and inverted V antennas. The DX stations were giving these jokers 5/7, 5/8, and 5/9 reports, but they couldn't even hear them! I copied every word due to the beam, of course, but although they were evidently putting good signals out into the Pacific, they couldn't hear their own reports. Said one of them, "Sorry, old man, but would you mind repeating my report? We have one-way skip."

One-way skip, hell! He simply had a lousy receiving antenna, that's all. It operated fine on transmit, but on receive, it was the pits!

So there you have it. My recommendation for this month is that you replace the S-meter on your front panel with a clock or a photo of the presidential candidate of your choice... and please, the next time you work a guy with fairly good signals, give him the 5/7 he's entitled to instead of a crummy 5/2 that you'd report if you were relying on your stupid meter! And string up a good aerial instead of complaining about one-way skip.

Ham Help

I need a service manual or a schematic for a Harrison Laboratories model 855B power supply (0-18 V, 0-1.5 A).

H. Wade Krizan W5GHQ
4801 Goldfield, Space 46
San Antonio TX 78218

I am in need of any info at all on what appears to be a digital-data cassette recorder. It is identified as a CompuCORD 1210, a product of CompuCORD, Inc., of Waltham MA. Unfortunately, as far as I can find out, this company no longer exists, at least not under that name and/or not in Waltham. Any info on this device or the whereabouts of the

manufacturer would be greatly appreciated. Of course, I will copy and return any material or pay, for copying and postage. Thank you.

Fred Goldberg WA2BJZ
29 Clearview Road
E. Brunswick NJ 08816

I would like to start a singles net: divorced, widowed, never married—any age. Let's get together and share our common situation. Women are encouraged to participate. An SASE would be appreciated.

Tim Skoning N9ASI
800 Water Street
Dundee IL 60118

Buy Direct from the Tri-Ex[®] Factory

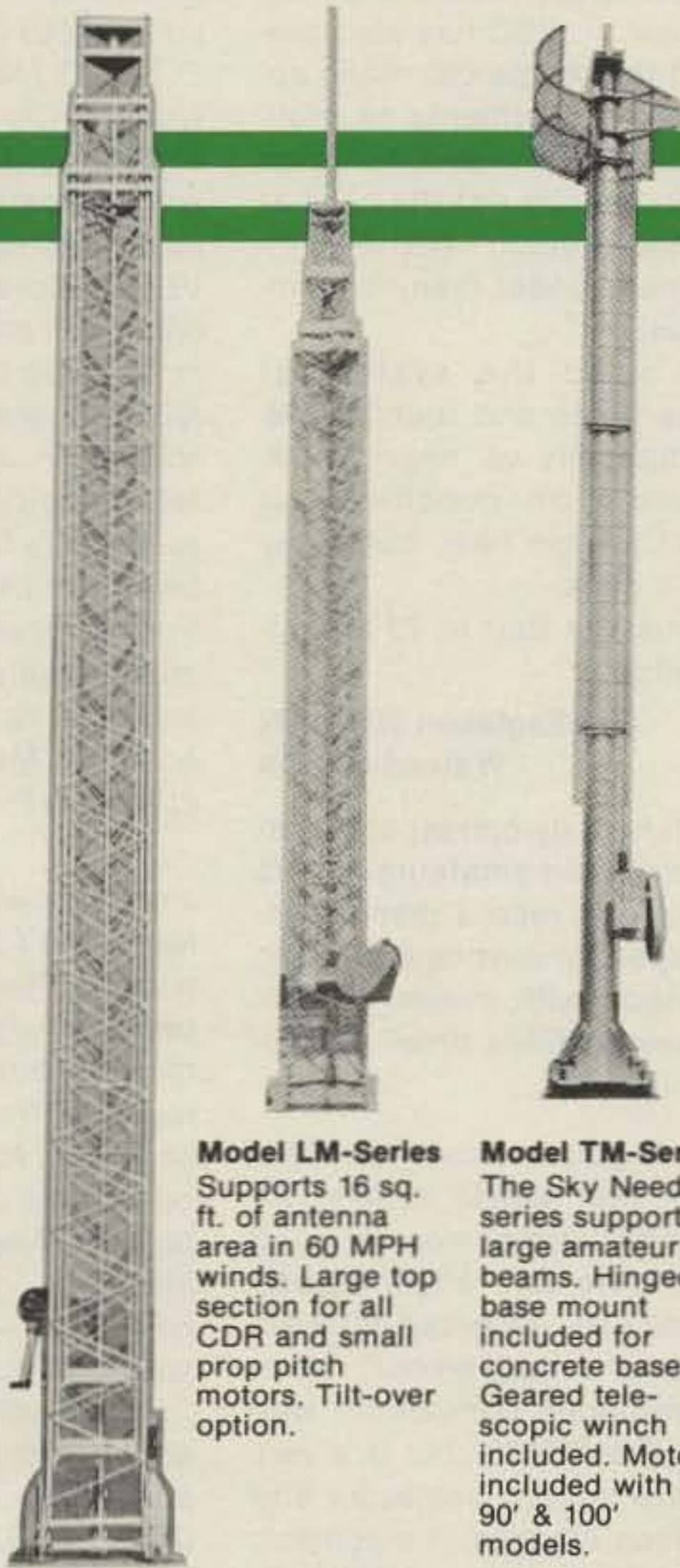

Model W-Series
Supports 9 sq. ft. of antenna area in 50 MPH winds. CDR rotator mounting plate in top section. Rigid base mount included.

Model LM-Series
Supports 16 sq. ft. of antenna area in 60 MPH winds. Large top section for all CDR and small prop pitch motors. Tilt-over option.

Model TM-Series
The Sky Needle series supports large amateur beams. Hinged base mount included for concrete base. Geared telescopic winch included. Motor included with 70', 90' & 100' models.

Come to Tri-Ex for innovative tower design and engineering! Our towers are famous all over the world for their strength, stress and wind resistance. Now you can buy a superior Tri-Ex tower at **FACTORY SAVINGS!**

Choose your metal. Towers can be fabricated in steel to ASTM Specifications with hot-dipped galvanized finish (done after construction so that inside surfaces are zinc-coated, too). Or in Triexium[™], our lightweight, corrosion resisting, high-strength light alloy.

Tri-Ex HAM towers are available self-supporting or guyed; take your choice. The W series of crank-up towers, the LM series of crank-up/tilt-over towers and the TM sky needles are self-supporting.

Use your charge power to buy your tower. Tri-Ex honors Visa and Master Charge credit cards. **If you have questions about tower accessories or which size tower is right for your antenna, call Bill Salerno, his technical sales know-how is ready to serve you.**

Save 25% on the best towers made!

*Call me!
73 Bill Salerno*



W2ONV

**TOLL FREE
800-526-5277
in New Jersey
201-279-7528
CALL NOW**

or



USE THIS HANDY ORDER FORM

Mail to Tri-Ex Tower Corp.
7182 Rasmussen Avenue, Visalia, CA 93277

Name

Street

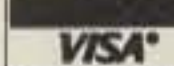
City..... State..... Zip.....

Check Enclosed Visa  M/C 

Card #..... Expires.....

Bank #..... Signature.....

Model Number	Nested Height	Extended Height	Wind Load or 50 MPH Antenna Load	Factory Direct Price
ED 40*	13' 0"	40'	6.0 Sq. Ft.†	\$ 346.00
MW 35**	20' 5"	35'	9.5 Sq. Ft.‡	435.00
MW 50**	20' 10"	50'	8.6 Sq. Ft.‡	668.00
MW 65**	21' 3"	65'	5.0 Sq. Ft.‡	913.00
W 36**	20' 6"	36'	9.0 Sq. Ft.	546.00
W 51**	21' 0"	51'	9.0 Sq. Ft.	844.00
WT 51*	21' 0"	51'	9.0 Sq. Ft.	923.00
W 67**	22' 0"	67'	9.0 Sq. Ft.	1,816.00
LM 237**	20' 6"	37'	16.0 Sq. Ft.	1,064.00
LM 354**	21' 0"	54'	16.0 Sq. Ft.	1,537.00
LM 470**	23' 6"	70'	16.0 Sq. Ft.	2,826.00
LM 470D** Motorized	23' 6"	70'	16.0 Sq. Ft.	3,221.00
TM 490** Sky Needle	28' 0"	90'	37.8 Sq. Ft.	10,560.00

*Triexium[™]

**Also available in Triexium. Please consult factory for prices.

†When properly guyed 2 positions.

‡Roof bracket or guyed at 1st level.

NOTE: All products FOB Visalia, CA. Prices and specifications subject to change without notice. Ninety day limited warranty. California residents add sales tax.



Tri-Ex[®]
TOWER CORPORATION

✓ 335

7182 Rasmussen Ave., Visalia, CA 93277

LETTERS

NBVM PRO

I got a real kick out of the staff article about NBVM (73, January, p. 30). It reminded me much of the articles and comments in the '50s about SSB vs. AM.

You old-timers will remember: "SSB sounds bad," "SSB is too expensive," "SSB is incompatible with AM — you need special equipment to receive it," "SSB is hard to tune and drifts too much," and "SSB requires constant readjustment of rf and af gain controls." Well, we all now know that this was like arguing "apples and oranges."

True, on the equipment of the '50s, SSB was pretty strange sounding, required some calisthenics with the gain controls, was hard to tune, and, while it didn't drift (usually), many of the receivers we used back then did!

If your current "Super Dumaflit" transceiver isn't far more stable, with far better agc action and better sideband detection capability than the one you used in the '50s, you're probably still using the one you used in the '50s!

Just one example: N8RK talks about problems of fooling with gain controls using the amplitude expander.

I've used the same expander circuit as contained in the VBC 3000 (using my own NE570 purchased from Jameco) and once I got the hang of where to set the basic level controls, I find I only have to use the receiver af gain control on my Argonaut, KLM Force Five, Echo II, Echo 70, or my SBE Sidebander III converted CB set. On the lower HF frequencies, some improvement can be gotten by reducing the rf gain control when talking to strong stations, but that is normally the case with or without the expander.

As expanding the signal causes a change of 2 dB for each change of 1 dB of incoming audio, agc overshoot and agc level changes, etc., will be

expanded by the same amount. Obviously, a properly designed, tight agc with fast attack (5 ms), delayed decay (hang time), and a one-half to one second decay time is more compatible with amplitude expansion than the usual simpler agc circuits found in many ham rigs. (The audio-derived agc chip sold by Plessey as the SL620 should work well.)

Rather than go into a long technical treatise into the many presumptions and misunderstandings concerning NBVM that make N8RK's review marginal, at best (I've given Wayne Green much of the data and technical papers concerning the FCC tests, plus offers of tapes of my own data and experience — no response — "too busy," he says), let me throw out a few questions, instead:

1) How many years and how much flak came about before SSB got the bugs worked out? 2) How good did early units sound compared with the better AM rigs of the day? 3) How long did it take for operators to learn proper use of the mode? 4) How much modification of agc techniques and audio shaping was required to bring SSB up to current levels of performance?

Along the political lines:

1) Do you agree with N8RK's evaluation that the 2100 Hz position (1800 Hz bandwidth) is only a 33% savings? Seems to me that 33% out of 100 possible stations on a given band would allow 33 additional stations!

2) Has the editorial policy of 73 Magazine ever left you with the feeling that if the ARRL came out for something (especially strongly for something) that 73 would take a negative viewpoint concerning it? Admitting that QST's editorial was overzealous (a common failing in that magazine... all magazines?), is that sufficient cause for 73 to "drive a stake into the heart" of a small American company? I think Wayne ought to reread his own "the Japanese are ahead of us, U.S. business is falling behind" editorial in the same issue as N8RK's attack on

VBC and see if there isn't a bit of inconsistency there!

I'd be the first to admit that NBVM is not yet perfect. It is, after all, the first product of a small company which is involved in larger, more complicated research. VBC has also presumed that hams can make appropriate adjustments to properly interface with unit with their rigs (apparently not the case at 73, if they couldn't find any improvement under many circumstances).

I've used the system at various times and found QRM-free capability vs. heavy QRM, depending on conditions. It doesn't always help, but many times it does.

Slams like that in 73 are unwarranted.

**Jim Eagleson WB6JNN
Watsonville CA**

P.S. I'll happily correspond with any interested amateurs on this subject and record demonstration tapes for anyone supplying a cassette with mailer, assuming Wayne "finds time" to publish this letter.

If Mr. Eagleson would carefully reread the NBVM article, he will find that a number of good things were said about NBVM. In particular, we noted "at least 12 dB of improvement" when the amplitude compandor was used. The NE570 chip is a very effective speech processor and had been covered in electronic publications before NBVM arrived on the scene. If the VBC unit is marketed as being compatible with current ham rigs, then it should be mentioned that agc problems exist. Of course, the user can modify his radio to have a "properly designed agc," a topic that is not mentioned in the VBC owner's manual or QST articles.

Mr. Eagleson claims that the 73 report contained presumptions and misunderstandings about NBVM. However, the theoretical portions of the article were based on information provided by VBC and what is in the ARRL Radio Amateur's Handbook. Is that information "marginal," too? The 73 viewpoint is not a solitary one. The July, 1978, issue of Spectrum, a publication of the Institute of Electrical and Electronic Engineers, included an article about SSB NBVM and its possibilities as a replacement for the land-mobile FM service. Because of wide-

spread disagreement over NBVM, a dissenting view was published alongside the favorable article. The disagreement over NBVM is also found in the December, 1978, Spectrum, where several letters raise questions about NBVM.

The 73 Magazine review was written after a thorough on-the-air testing and correspondence with communications specialists. Electrical engineers, the VBC Corporation, an ARRL technical staff member, and perhaps most importantly, a number of NBVM users were consulted. If NBVM or any other possible technological advance is going to reach its full potential, it must be able to withstand and benefit from an open and, if necessary, critical evaluation of its merits and downfalls. Would the readers of 73 Magazine want it any other way? — Tim Daniel N8RK.

Jim, there was no one more anxious than I to have NBVM be a winner. There may have been people more disappointed by it than me, but my disappointment resulted from giving it a real solid try. Harking back to the early days of SSB is an unfair parallel. And trying to discredit me as a reactionary fighting new ideas and techniques must strain all but Bill Orr's credulity.

I can answer your questions about SSB for you. I was there and I was one of the pioneer users of SSB.

1. How long before the bugs were worked out of SSB? There were no serious bugs. The early ham SSB equipment worked just fine. Old-timers with investments in AM equipment felt threatened by it and fought back emotionally over it. The use of AM receivers for tuning in SSB was not the best, but it worked well enough after about two minutes instruction on turning down the rf gain control. I visited many DX ham shacks and showed them how to tune it in... only to hear the chaps appear on SSB a few months later.

2. The early SSB rigs sounded fine... little different from those we hear today. AM rigs sounded okay if you had a clear channel... but with the bandwidth and QRM, we did not often have clear channels and the resulting sound was deafening as the carriers created a sea of heterodynes up and down the

Continued on page 177

A SWAN FOR EVERY NEED

Talk State of the art, Versatility, or Economy — SWAN'S famous "world's best" Engineering team has designed a complete line of Transceivers to suit your need.

Take a look at the three hottest new SSB Transceivers this year. They're all made in America and they're all from Swan. Whatever your dreams—from a compact fully synthesized mobile to a full-blown base station with dual PTO's—one of these will bring them to reality today. They're all solid state, all 235 Watts PEP and CW on all frequencies, and most of all they're affordable.

Most Advanced HF Transceiver in the World—ASTRO 150

HF SSB Transceiver featuring "VRS" a knob with a new twist, and over 100,000 fully microprocessor-controlled frequencies on present or envisioned "ham" bands.

High Power — Full 235 Watts PEP & CW, all bands Truly Synthesized in accurate 100Hz steps Full CW Break-In with narrow XTAL Filter Standby Memory — ALL BANDS True PEP

output meter Model 150 — 80 thru 10 meters Model 151 — 160 thru 15 Meters

ASTRO 102 BX



100 MX



Most Versatile HF 160M-10M Transceiver in the World—ASTRO 102 BX

Dual PTO's, 235 Watts PEP & CW on all frequencies, IF Passband tuning, with LED position indicators and full break-in.

All solid state Modern design and styling Tunable notch filter 4 Function Meter Speech Processor VOX Adjustable AGC Decay 2 Position CW Wave Shaping 16 Pole IF Filter Crystal CW Filter PLL Synthesized Band Selection

Economy with top SWAN quality and mobility—100MX

235 Watts PEP & CW on all frequencies. The field-proven Rig the whole world's talking about.

All solid-state Modern design and styling VOX Noise Blanker Semi-CW Break-in RIT ± 1.5 KHz 25 KHz Calibrator, built-in CW side tone with adjustable pitch and level Internal speaker Jack for external counter



ASTRO 150



A division of Cubic Communications, Inc.

305 Airport Rd. • Oceanside, Ca. 92054
(714) 757-7525

Look to Swan for Quality Accessories . . . and Service

70



Contests

Robert Baker WB2GFE
15 Windsor Dr.
Atco NJ 08004

MYSTERY HILL DXPEDITION

Starts: 1800 GMT June 7
Ends: 1800 GMT June 8

The Mount Moriah Repeater Society will hold a DXpedition at Mystery Hill, North Salem NH, on the dates/times shown above. Mystery Hill is a 4000-year-old astronomical observatory and prehistoric temple presumed built by Celtic and Iberian cultures. It is the "stonehenge of America" and has been defined as potentially the most important archaeological find in the Western Hemisphere. It is most likely the oldest man-made structure in the United States. An attractive certificate will be awarded for all contacts with K1MDX, the DXpedition station. Send a legal size SASE to: K1RCT, PO Box 123, North Salem NH 03073.

FREQUENCIES:

Phone — 3980, 7280, 14280, 21380, 28580, 146.52.
CW — 3550, 3710, 7050, 7110, 14050, 21050, 21110, 28150.

ARP CONTEST

Starts: 0000 GMT June 7
Ends: 2400 GMT June 8

Sponsored by the Associacao de Radioamadores Portugueses. Only CT1 and CT4 stations will count for this contest. Please note CT2 and CT3 stations are excluded. Fixed stations can be worked once per band, independent of mode. Mobile stations can be worked once per band and per county. Use all bands 80 through 10 meters on SSB, CW, or AM.

EXCHANGE:

RS(T) and serial number starting with 001. CT1/CT4 stations will indicate their county by a 3-letter abbreviation.

SCORING:

QSOs with stations located in

the county of Porto count 2 points, while QSOs with stations in other counties count 1 point each. The multiplier is the number of Portuguese continental counties worked, 275 maximum per band. Multiply the QSO points on each band by the number of counties worked on that band and add the band totals to compute the final score.

LOGS & ENTRIES:

The following information must be stated in the logs: call, name and address of applicant, call of station contacted, QSO number, abbreviation of county and report, points per QSO. New multipliers must be underlined. Use a separate sheet for final score calculations. Log sheets and county lists may be obtained from ARP or from WB9RCY. Send \$1.00 US for postage and printing. Log sheets must be mailed not later than July 30th to: ARP Contest Committee, PO Box 1245, 4021 — Porto — Codex, Portugal.

Certificates will be awarded for highest general classification, highest score from each DXCC country, and highest YL score from each DXCC country.

Radio Teleprinter Society, PO Box 860, Crows Nest, N.S.W., Australia. Entry classes include: single-operator, multi-operator, and SWL. Each station may be worked only once per band, but may be worked on another band for further multipliers.

EXCHANGE:

Serial number consisting of RST, zone number, and time in GMT.

SCORING:

As per CARTG Zone Chart, multiplied by the number of countries worked, multiplied by the number of continents worked (6 max.). After the above calculations, world stations add 100 points for each VK/ZL station worked on 20 meters, 200 points for each on 15 meters, and 300 points for each on 10 meters. Countries count as per the ARRL list of countries, except that each VK, ZL, JA, VO, and W/K district count as separate countries. Contacts with one's own country count as zero points for multipliers.

AWARDS:

Awards will be issued for 1st, 2nd, and 3rd on a world basis and also on a country basis.

ENTRIES:

Logs must show in this order: date and time (GMT), callsign of station worked, serial number sent and received, points claimed. Logs of multi-operator stations must be signed by all operators, together with a list of their callsigns. Logs of SWL listeners must contain both numbers sent and received by the station logged. Incomplete loggings are not eligible for scor-

Calendar

Jun 7-8	Mystery Hill DXpedition
Jun 7-8	ARP Contest
Jun 14-15	ARRL VHF Contest
Jun 14-15	VK/ZL/Oceania RTTY DX Contest
Jun 21-22	All Asian Contest — Phone
Jun 22	Worked All Britain Contest — LF Phone
Jun 28-29	ARRL Field Day
Jun 28-29	QRP ARC International QRP Field Day Contest
Jul 1	Canada Day Contest
Jul 12-13	IARU Radiosport Championship
Jul 19-20	Maine QSO Party
Jul 20	Worked All Britain Contest — LF CW
Aug 2-3	ARRL UHF Contest
Aug 9-10	European DX Contest — CW
Aug 23-24	All Asian DX Contest — CW
Aug 31	Worked All Britain Contest — VHF
Sep 13-14	European DX Contest — Phone
Sep 13-14	ARRL VHF Contest
Sep 13-15	Washington State QSO Party
Sep 14	North American Sprint
Sep 27	DARC Corona 10-Meter RTTY Contest
Oct 4-5	California QSO Party
Oct 4-5	ARRL Simulated Emergency Test
Oct 11-12	ARRL CD Party
Nov 1-2	ARRL Sweepstakes — CW
Nov 8-9	European DX Contest — RTTY
Nov 8-9	IPA Contest
Nov 9	International OK DX Contest
Nov 15	DARC Corona 10-Meter RTTY Contest
Nov 15-16	ARRL Sweepstakes — Phone
Dec 6-7	ARRL 160-Meter Contest
Dec 13-14	ARRL 10-Meter Contest

VK/ZL/OCEANIA RTTY DX CONTEST

Contest periods:
0000 to 0800 GMT
Saturday, June 14
1600 to 2400 GMT
Saturday, June 14
0800 to 1600 GMT
Sunday, June 15

This contest is now being organized and conducted by the Australian National Amateur

Results

RESULTS OF THE 1979 VK/ZL/OCEANIA RTTY DX CONTEST (Number of QSOs in parentheses)

1. G3HJC	319,700	(100)	15. ZL2BR	115,668	(41)
2. HB9AVK	317,804	(84)	16. W4YZ	114,460	(36)
3. JA8ADQ	295,580	(62)	17. VE2QO	107,725	(44)
4. SM6ASD	284,996	(104)	18. VK2ATQ	93,345	(31)
5. F6ECI	280,742	(91)	19. VK2AJT	78,320	(29)
6. VK2CBW	273,420	(60)	20. OZ2X	75,400	(49)
7. EA4XW	252,375	(103)			
8. W7DPW	223,750	(64)			
9. DJ6JC	216,635	(78)			
10. VK3KF	194,724	(49)			
11. F8XT	146,920	(71)			
12. WD8IUP	144,400	(44)			
13. JE2JWK	120,375	(41)			
14. VK4AHD	119,424	(48)			

MULTI-OPERATOR STATIONS

1. I5MYL	1,156,744	(184)
2. VK2TTY	381,780	(62)
3. DK9MM	269,525	(79)
4. VK2WG/P	184,788	(47)
5. VK2BY1	138,360	(38)

SWL STATIONS

1. Horst Ballenberger	DL SWL	333,764	(91)
2. Hans Norbert Sokol	DL SWL	115,155	(84)
3. Kurt Wustner	DL SWL	95,450	(77)

New Products

REVIEW OF THE MORSEMATIC™

I never thought I'd be excited over an electronic keyer again. Like many other hams, I built a WB4VVF Accu-Keyer several years ago and was perfectly satisfied with it—until a few months ago. The happy relationship with my old keyer was upset by the arrival of the MorseMatic, a remarkable little black box produced by Advanced Electronic Applications, Inc., of Lynnwood WA.

The MorseMatic has so many features that it's hard to know where to start. There are four basic modes of operation: Keyer, Memory Keyer, Beacon, and Morse Trainer. These four modes are selected via the rotary switch on the right side of the unit's sloping control panel. Once a particular mode is selected, control is transferred to the keypad. By entering two-, three-, and four-key sequences, the many options of the MorseMatic can be programmed to do your bidding. Now, don't be concerned that you'll need a degree in computer science to operate the MorseMatic. To the contrary, AEA has taken pains to provide a good, clear instruction manual, with examples. In addition, a chart containing a summary of the various commands is permanently affixed to the control panel of the keyer.

Let's take a closer look at each of the four modes of operation.

Keyer

On power-up, the MorseMatic is ready to go as a 20 wpm automatic keyer, with dot and dash memories and a 500-Hz sidetone. From that point onward, you are in control. Is 20 wpm a bit too fast for you? If you tap out "*615" on the keypad, the keyer will be set to 15 wpm. "*635" sets it to 35 wpm. Speeds from 2 to 99 wpm can be selected.

If you type an asterisk and hold down the "1" key, the pitch of the sidetone will begin to rise. When it gets to a pitch you like, releasing the "1" will keep it there. Two asterisks and the "1" key will lower the tone.

For those who like to customize their CW, both the dot-space and dash-space ratios can be changed from their customary 1 and 3 to other values. Other simple commands allow the dot and dash memories to be disabled and enabled at will.

Perhaps the ultimate in keyer customization occurs when you type "*5" on the keypad. Believe it or not, this converts the MorseMatic into a semi-automatic keyer, or "bug." Look out Vibroplex!

Memory Keyer

The memory feature of the MorseMatic is, quite simply, outstanding. It's easy to use, extremely flexible, and makes CW operation, be it contesting or rag chewing, much, much easier.

There are 10 memories available, up to a maximum of 500 characters. Thus you can store one message of 500 characters, 10 messages of 50 characters each, seven 50-character messages and one of 150 characters, etc. The optional memory expansion boosts total capacity to 2,000 characters.

Loading a memory keyer is sometimes a trying experience, but AEA seems to have perfected it. Once you've placed the rotary switch in the "memory load" position, it's a matter of selecting a memory (pressing one of the number keys) and sending with your paddle the message you wish to store. The normal "automatic" loading mode even allows you to take long pauses while loading a message without having the pause show up when that message is played back. This works out great for those of us who can't always remember what we wanted to say. A "real-time" mode is available for those who are a bit more sure of themselves. Messages are conveniently erased and edited.

When you've loaded your messages, the main switch is turned back to the "keyer" position and you can send from memory or from the paddle, at your option. To send from one of the memories, you just tap the appropriate number key. The message will be sent immediately, at whatever speed you have set on the keyer. Herein lies a nice feature of the MorseMatic: You can record messages at one speed and play them back at another. This is a real convenience. For example, when I begin a session of CW work with the MorseMatic, I usually set up the first four memories as follows. Message 1 is a CQ; message 2 is my answer to someone else's CQ; message 3 contains information on my location, name, and weather; message 4 tells about my rig, my job, my age, and any other "standard" information I wish to pass along. Once these four memories have been set up, about 75% of my sending has been eliminated for the remainder of the operating session. I can talk to Novices or Extras and merely change the keyer speed to match the skills of the other fellow. It quickly becomes natural to intersperse material sent from the paddle with messages from the keyer memory.

An added plus is that a memory message can be interrupted at any time, either by hitting the "#" key or by tapping the paddle.

The MorseMatic has come in handy when operating CW on the OSCAR satellites. With two antenna rotators to operate, along with transmitter and receiver tuning, it's great to have the keyer do most of the sending.

CW contesters were among the first to use the MorseMatic. One of the reasons they were so eager to get their hands on it is the provision for automatic generation of contact serial numbers. With this feature, a contester can load his exchange into a memory, programming the MorseMatic to insert the serial number in the proper place. Thereafter, each time the exchange is sent, the keyer will automatically increment the serial number. It's a simple matter to repeat the serial number or the whole exchange if the other station misses it the first time around. Without a MorseMatic or similar keyer, it will be difficult to remain competitive in CW contesting.

Beacon

I'm told that the fellows who are experimenting with some of the more unusual types of propagation really appreciate this feature of the MorseMatic. In this mode, the keyer sends a message for a given length of time, then remains silent for another period of time before sending the message again. The guys who operate moonbounce and meteor scatter, for instance, often find it necessary to alternate sending and receiving in this way in order to establish contact.

With the proliferation of propagation beacons on 10, 6, and 2 meters, I suspect someone will put a MorseMatic to work at this job. Now *that* would be a classy beacon.

Morse Trainer

A great number of optional functions are available in this mode, making the MorseMatic an outstanding gadget for teaching and learning Morse code. Two features of the Trainer mode deserve special mention.

First of all, the Trainer can be programmed to gradually increase the code speed during a given practice session. It works

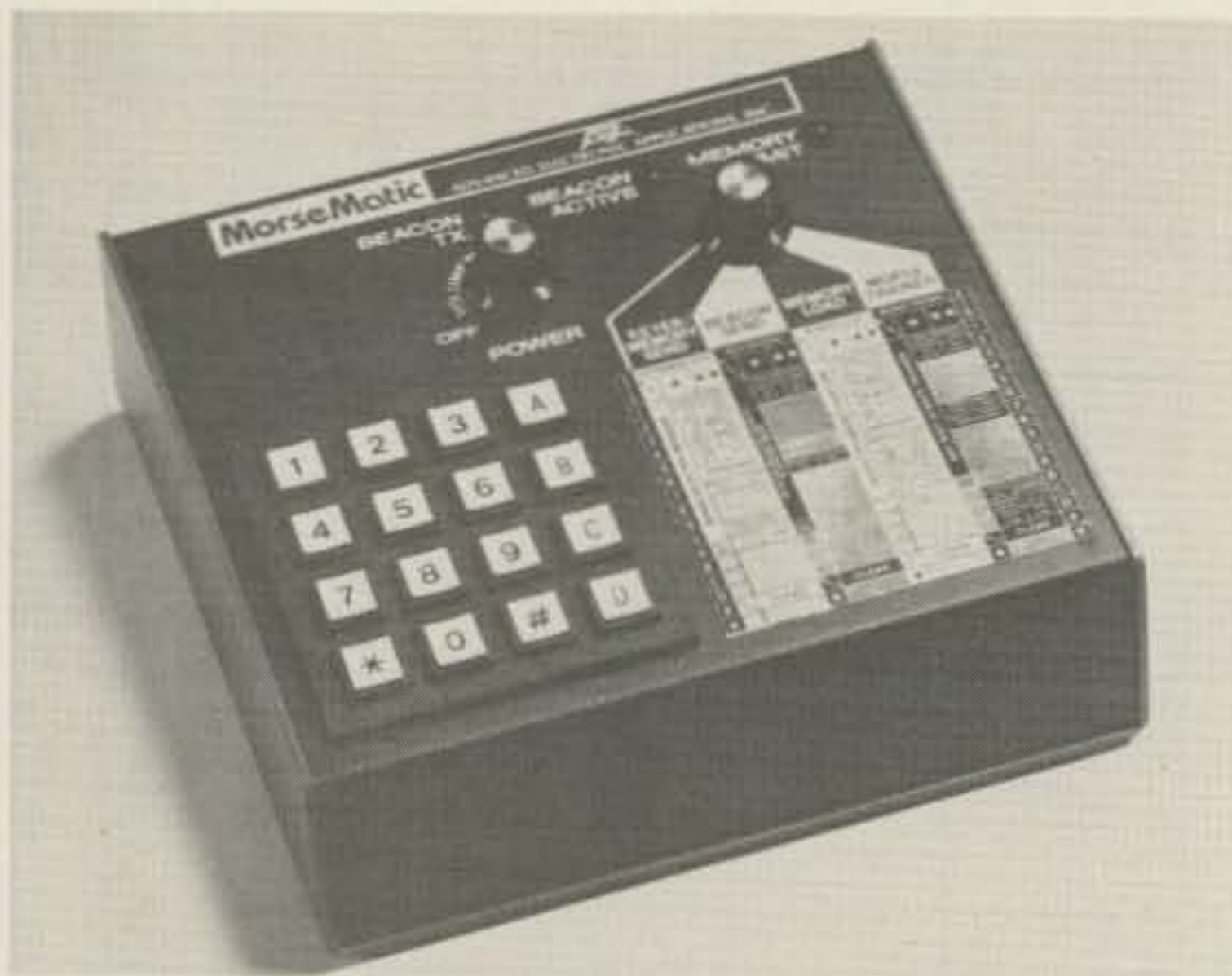

The MorseMatic™ keyer from AEA.

this way: You begin by entering the starting speed, let's say 7 wpm. Then you enter the finishing speed, say 13 wpm, followed by the duration of the practice session, perhaps 15 minutes. When the keyer is activated, it then begins a 15-minute practice session of random five-letter code groups, starting at 7 wpm and gradually increasing the speed to 13 wpm by the end of the 15-minute session. The practice sessions can be as long as 59.9 minutes, with code speeds from 2 to 99 wpm, same as the regular keyer.

The second feature of note in the Trainer mode is its use of the Farnsworth method of instruction. In the practice session described above, for example, the actual characters would be sent at 13 wpm throughout the entire 15-minute practice session. However, the inter-character space would be adjusted to make the starting speed equal to 7 wpm. As the session progressed, the inter-character space would be gradually shortened, so that by the end of the 15 minutes, both the characters *and* the spacing would be at the 13-wpm rate. The *73 Magazine* code tapes have used a similar method for years. It works so well because the brain gets used to the sound of the letters sent at the higher speed.

Getting on the Air

Some of the newer solid-state rigs are a bit particular about the method used to key them. The Icom 701, for instance, has problems with some electronic keyers. By the same token, an older transmitter, with fairly high voltage at the keying jack, can zap the keying transistor of some units. The MorseMatic, though, seems to be immune to these problems. I've used it to key all types of rigs without a hint of trouble. The rear panel has two keying outputs, one for grid block (rated up to -300 V and 30.0 mA) and a second for cathode or transistor keying (+300 V, 300 mA). That should handle whatever you have lying around the shack.

Aside from a lead to your keying jack, the MorseMatic requires only a source of 12-V dc power and a paddle. The sidetone volume is adjustable from a front-panel control that also serves as an on-off switch. By the way, any messages you've stored in memory will remain in-

tact as long as the 12-V supply to the keyer is not interrupted . . . even when the front-panel control is turned off.

AEA has taken all the best features from the many previous electronic keyers on the market and combined them into one easy-to-use unit. In five months of use, it's been 100% reliable, something one can't say about some memory keyers. If you operate CW, this may be the ultimate accessory. Besides, Father's Day is coming up; do you really need another tie?

AEA, Inc., PO Box 2160, Lynnwood WA 98036. Reader Service number 483.

Jeff DeTray WB8BTH
Assistant Publisher

GLOBAL SPECIALTIES CORPORATION INTRODUCES WIRE KIT FOR BREADBOARDS

Global Specialties Corporation, world leader in solderless breadboards, has added to the extraordinary utility of these products with the introduction of Model WK-1 Wire Jumper Kit, a fully prepared assortment of insulated solid hookup wire in fourteen discrete, color-coded lengths.

While ordinary hookup wire can be and usually is used for terminal-to-terminal connections in preparing a circuit on a solderless breadboard, it is nevertheless necessary to cut, strip, and bend the leads. This task is accomplished for the breadboard user with the WK-1.

AWG #22 solid hookup wire is pre-cut, pre-stripped, and the ends bent 90 degrees. Lengths are coordinated with insulation color to provide standard color-code jumper length identification. The fourteen lengths and their codes are as follows:

0.1-inch (no insulation), 0.2-inch (red), 0.3-inch (orange), 0.4-inch (yellow), 0.5-inch (green), 0.6-inch (blue), 0.7-inch (violet), 0.8-inch (grey), 0.9-inch (white), 1.0-inch (brown), 2.0-inch (red), 3.0-inch (orange), 4.0-inch (yellow), 0.5-inch (green). The above lengths are exclusive of the 1/4-inch stripped ends.

Twenty-five pieces of each of these fourteen lengths are sorted into compartments in a hinged-lid plastic case. For more information, contact *Global Specialties Corporation, 70 Fulton Terrace, New Haven CT 06509; (203)-624-3103*. Reader Service number 477.

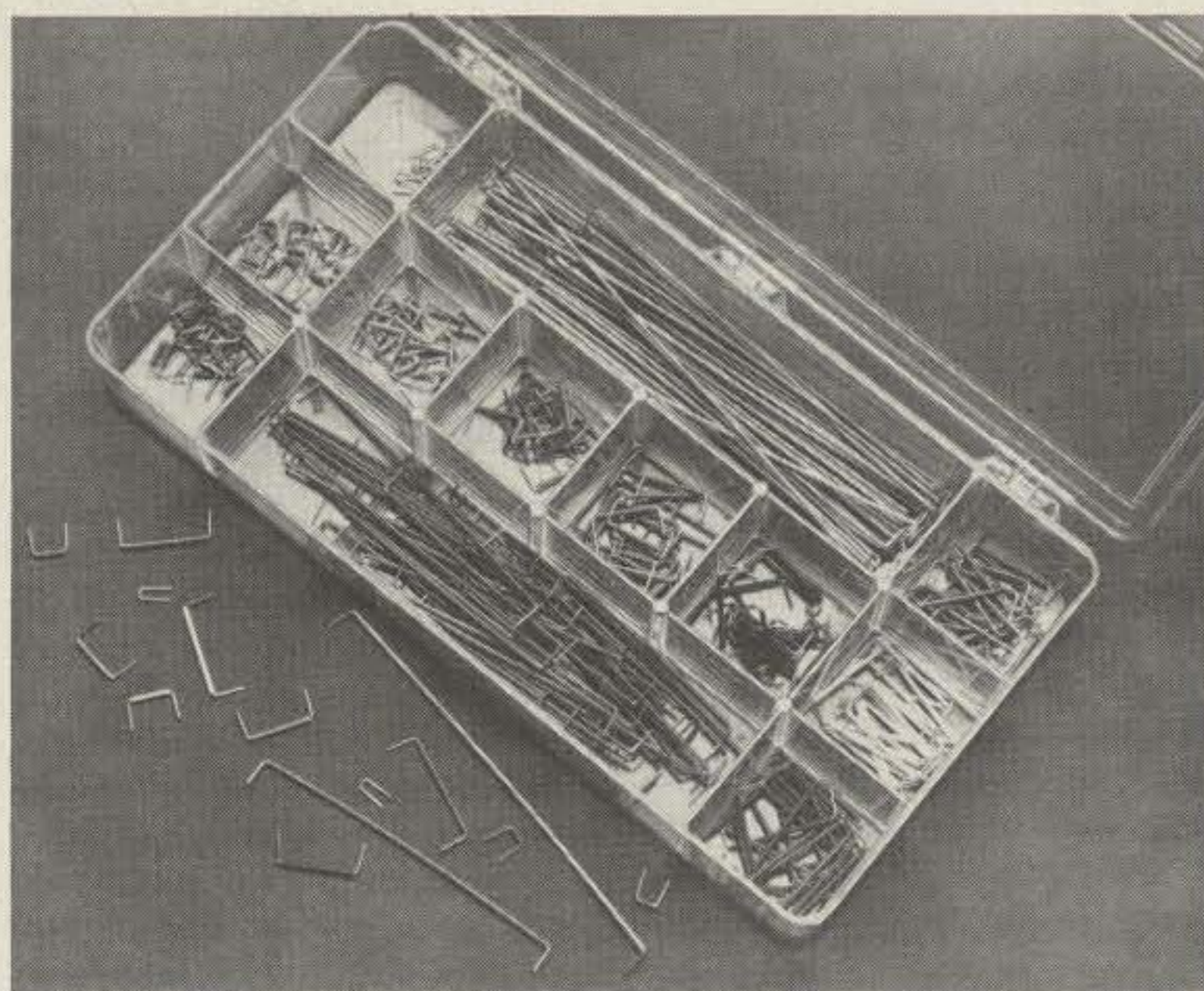

Wire Jumper Kit from Global.

UNIBOX ELECTRONIC PACKAGING COMPONENTS

Unibox is a versatile line of packaging components designed for industrial, OEM and experimenter use. Composed of a series of attractive enclosures and a wide selection of accessories, the components may be custom assembled to meet the user's specific requirements.

Enclosures are available in six sizes and five color combinations. Manufactured from a tough engineering-grade thermoplastic, the enclosures may be readily customized with hand tools. Enclosure sizes range from 1 1/4" x 2" x 2 3/4" to 2" x 4" x 5 1/4".

For circuitry construction, custom epoxy-glass gridboards are available for horizontal and vertical mounting in the enclosures. The gridboard hole pattern accepts IC sockets and other standard lead configuration components.

Two sizes of transparent red and smoke-grey windows are

available for use with LED or incandescent readouts, indicators, etc.

Also available are two sizes of opaque grey panels for mounting switches, potentiometers, connectors, etc.

Resilient, non-marring feet, which fit all enclosures, may be utilized for bench or desk-top applications.

For more information, contact *Amerex, PO Box 2815, Riverside CA 92516; (714)-686-1414*. Reader Service number 479.

NEW FREQUENCY DIRECTORY FROM GROVE ENTERPRISES

The first comprehensive print-out of official government radio communications frequency listings has just been released by Grove Enterprises.

The *Federal Frequency Directory* features more than 100,000 discrete listings of frequencies, agencies, and locations of US

Continued on page 166

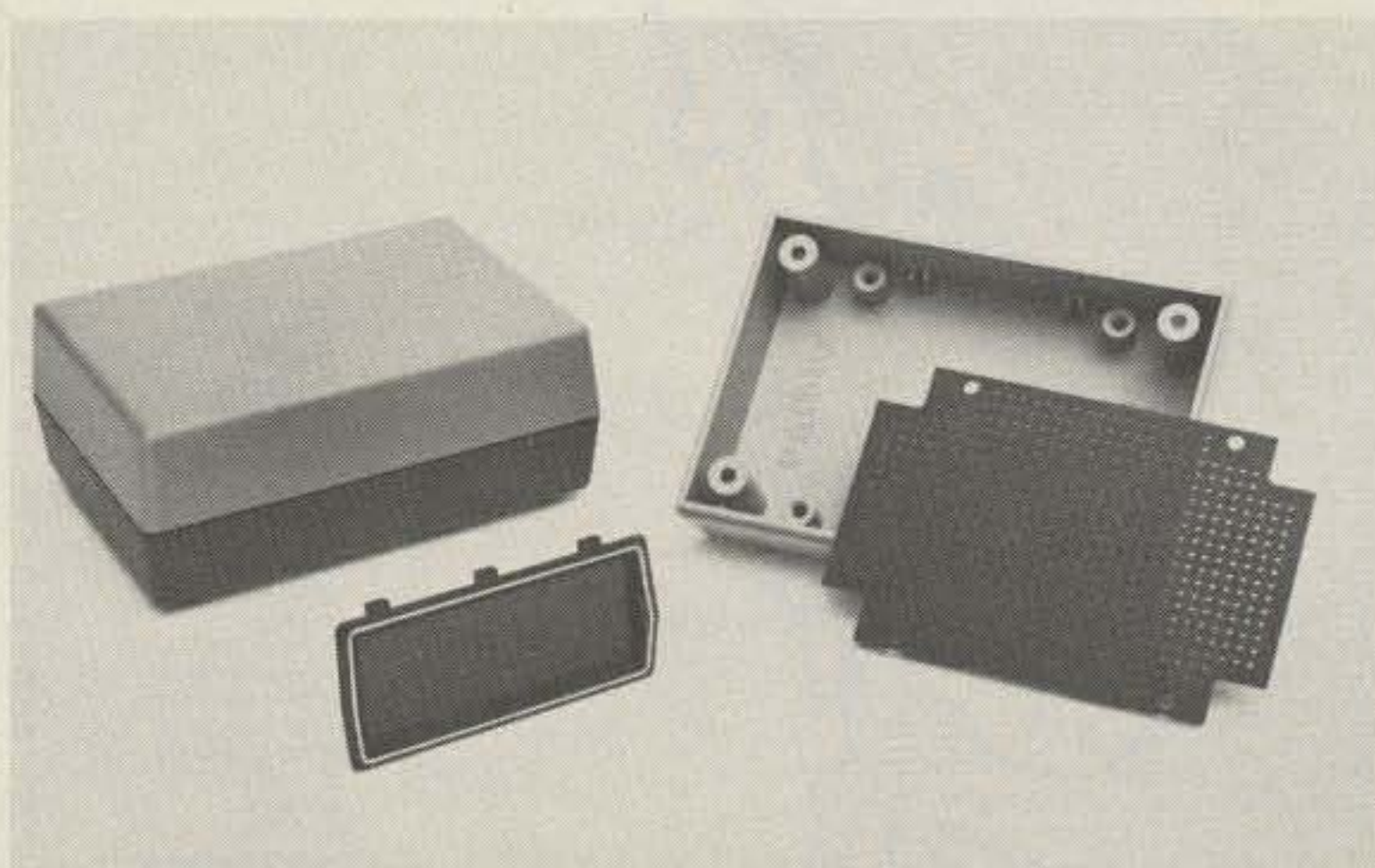

Unibox electronic packaging components from Amerex.

Awards

Bill Gosney WB7BFK
2665 North 1250 East
Whidbey Island
Oak Harbor WA 98277

Traveling to Scandinavia, we find our friends in Norway offering amateurs worldwide a special achievement award for having made contact with amateurs in their country. Here are two awards that are sponsored by the Norwegian Radio Relay League and the Larvik Society of NRRL, respectively.

WORKED ALL LA AWARD

The WALA Award is available to any amateur who can provide evidence of having filled the following requirements of the award:

Applicants in Denmark, Finland, Sweden, and Norway must have two contacts on separate bands with a total of 20 counties of Norway.

Applicants outside Scandinavia must work 20 different LA/LB stations on any amateur band. At least 6 of these stations must be located north of the Arctic Circle. Contacts with stations from JW (Svalbard), JW (Bear

Island), and JX (Jan Mayen) count for this award.

All contacts must be made after January 1, 1950. Usual logbook information is required for claiming your contacts, along with the exact QTH of the station worked. Award fee is Nkr. 10, or 10 IRCs mailed to: NRRL Award Manager, Alf Almedal LA5QK, N-4052 Roeyneberg, Norway.

WORKED NORWEGIAN CITIES AWARD

This award requires applicants to work a minimum of Norwegian cities with no limit to date, band, or mode. It should be noted this award will not recognize contacts with LJ, LF, or LH stations. The three award classes are: Class 3—DX stations work 5 cities, Europeans must work 10 cities; Class 2—DX stations work 10 cities, Europeans must work 20 cities; Class 1—DX stations work 15 cities, Europeans work 30 cities.

GCR apply. Send your completed list of contacts and application along with the award fee of \$1.00 and 2 IRCs or a total of 10 IRCs to: Larvik Society of

NRRL, PO Box 59, N-3251 Larvik, Norway.

Valid Norwegian cities are:

Arendal, Bergen, Bodo, Drammen, Egersund, Fredrikstad, Gjovik, Hammerfest, Halden, Hamar, Harstad, Haugesund, Horten, Kongsberg, Kristiansand S., Kristiansund N., Kragero, Larvik, Lillehammer, Mandal, Molde, Mosjoen, Moss, Mo i Rana, Namsos, Narvik, Notodden, Oslo, Porsgrunn, Sarpsborg, Sandnes, Sandefjord, Stavanger, Skien, Steinkjer, Trondheim, Tonsberg, Tromso, Vardo, Aalesund.

From the Vadso Society of the Norwegian Radio Relay League comes details about the worked all "communes" award for this Scandinavian country.

WORKED ALL NORWEGIAN COMMUNES AWARD

Licensed amateurs and SWLers worldwide are encouraged to pursue the requirements of this very challenging awards program. This award is issued for contact with 25 different Norwegian communes and endorsement stickers recognize additional communes in increments of 25 each. At present there are over 454 communes and 5 Norwegian arctic/antarctic areas which qualify for contacts. A special award will be issued to those who can work all communes and all arctic/antarctic areas. Only contacts on or after January 1, 1975, will count for WANCA.

All bands or modes may be used; no crossmode contacts or contacts via repeater will be allowed for credit. QSOs via OSCAR satellites do count. Minimum reports in all cases must be RST 338 or RS 33. Mobile or portable contacts count, but QTH must be stated on the QSL card.

QSL cards are not required. GCR apply. Award fees: Nkr. 30 for the basic award (10 IRCs) and Nkr. 10 (3 IRCs) for endorsement stickers. No fee for handicapped amateurs/SWL stations.

A record book listing all Norwegian communes and areas for 15 Nkr. (3 IRCs) is available from the Award Manager.

Certificates are issued for mixed mode, CW only, SSB only, all RTTY, all SSTV, Novice, Mobility (only contacts with mobile or portables), and All WANCA.

All fees are contributed to the LA5LG Fund for Norwegian

Blind-Handicapped Amateurs. All inquiries should be accompanied with at least 2 IRCs for an expected reply.

All applications should be forwarded with the appropriate fee to: WANCA Award Manager, Sverre J. Schmidt LA1QK, PO Box 3, N-9801 Vadso, Norway.

DX AWARDS FROM NEW ZEALAND

I just received a very informative packet of information from Jock White ZL2GX representing NZART, the national amateur society in New Zealand. Jock, as Awards Manager, indicates all NZART awards are available for a very nominal fee and QSL cards are not required where verified lists can be provided as an alternative. To qualify, all contacts claimed for NZART awards must be made on or after November 1, 1945. Special endorsements are given for single band or mode accomplishments. Send all applications to ZL2GX, 152 Lytton Rd., Gisborne, New Zealand.

WORKED ALL PACIFIC AWARD

To qualify for the WAP Award, an applicant must confirm two-way contact with 30 different Oceanic countries from the WAP list below. The cost of this award is 2 IRCs or US \$.60.

Eligible Oceanic contacts: Port Timor, Philippines, Adelle Land, New Caledonia, French Oceania, Wallis Island, New Hebrides, Baker/Howland/American Phoenix Islands, East Carolines, West Carolines, Mariana Islands, Marcus Island (Minami Torishima), Guam, Hawaiian Islands, Johnston Island, Midway Island, Palmyra Island, American Samoa, Wake Island, Marshall Island, Java, Sumatra, Borneo, Celebes, West Irian, Australia, Lord Howe Island, Willis Island, Macquarie Island, New Guinea, Norfolk Island, Papua, Nauru, Christmas, Cocos, Gilbert, Ellice, British Phoenix Islands, Fiji, Fanning and Washington Islands, Solomon Island, Tonga, Pitcairn, Sarawak, Brunei, North Borneo, North Cook Islands, South Cook Islands, Samoa, Tokelau Islands, Kermadec Islands, Niue Island, New Zealand, Chatham Island, Auckland and Campbell Island, Antarctica (ZL5 only).

WORKED ALL LA AWARD

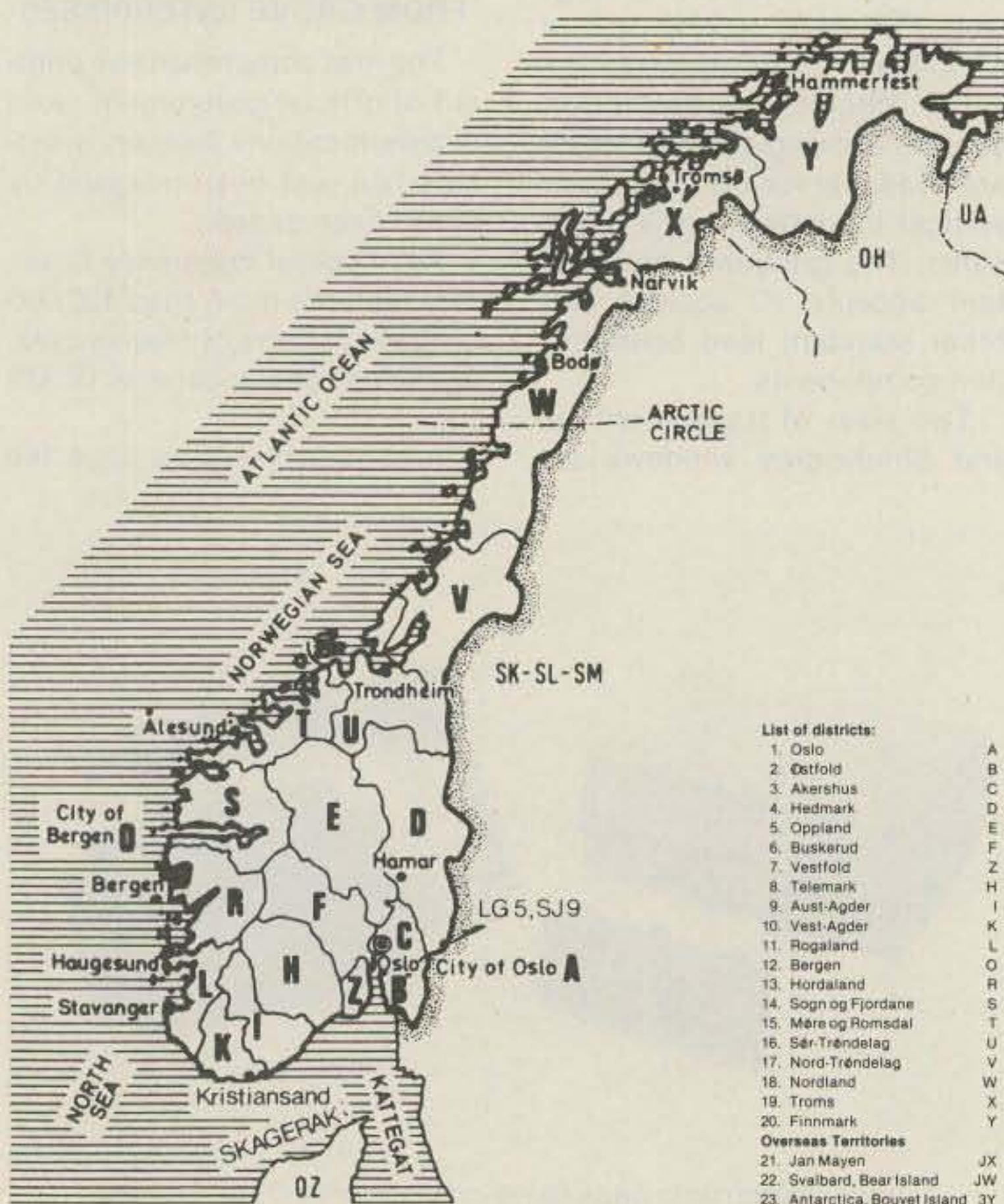



143.800 — 148.200 MHz Mobile Transceiver

Power to the mobile operators! This one is brand new, and it carries a powerhouse punch wherever you're going. ICOM unveils a full 25 watts of mobile power with the introduction of the new **IC-255A**. When you want increased mobile QSO range, ICOM delivers; and **nobody does it better.**

The microprocessor controlled **IC-255A** is a deceptively compact unit which packs more big, multifeature flexibility than any other ICOM mobile to date. This one offers a 5 channel memory, complete with memory scan, adjustable scanning speed, and auto-stop. The 5 channels can easily be written from any inband frequencies; and the scan function can be programmed to scan all 5 or only 2, stopping on any signal.

Like the other new ICOM transceivers, the IC-255A comes with 2 VFO's built-in at no extra cost. The radio is programmed to come up to power operating at 600Khz splits,

but it can be reprogrammed to any split of your choice. The dual VFO's and single tuning knob provide you with smooth, easy tuning in 15Khz or 5Khz steps.

The use of new low-noise, dynamic range junction FET's (for the RF amplifier and the first mixer) and helical cavity filters (for the antenna and RF circuits) provides excellent sensitivity and intermodulation distortion characteristics. A pair of high quality monolithic crystal filters and ceramic filters facilitates interference free reception reliability.

The new **IC-255A's** power is selectable 25W high or 1W low, yet it draws only 5.5 amps when transmitting in the high power mode. A directly amplified VCO output, without the use of multipliers or mixers, and a power module in the PA unit produce a very clean transmitted signal, with low spurious radiation. When you're in an RF trap, the **IC-255A** can get out the signal. To give your mobile FM operations big features with a power punch, give yourself the **IC-255A.**

HF/VHF/UHF AMATEUR AND MARINE COMMUNICATION EQUIPMENT



ICOM

ICOM AMERICA, INCORPORATED

Sales Service Centers located at:

2112 116th Avenue NE
Bellevue, WA 98004
Phone (206) 454-8155

3331 Towerwood Dr., Suite 307
Dallas, TX 75234
Phone (214) 620-2780

ICOM INFORMATION SERVICE

3331 Towerwood Dr., Suite 304 H
Dallas, Texas 75234

Please send me: IC-255A specifications sheet; full color ICOM Product Line Catalog; List of Authorized ICOM Dealers.

NAME _____ CALL _____

ADDRESS _____

CITY _____ STATE _____ ZIP _____

You may send a machine copy of this form

Loop Antenna

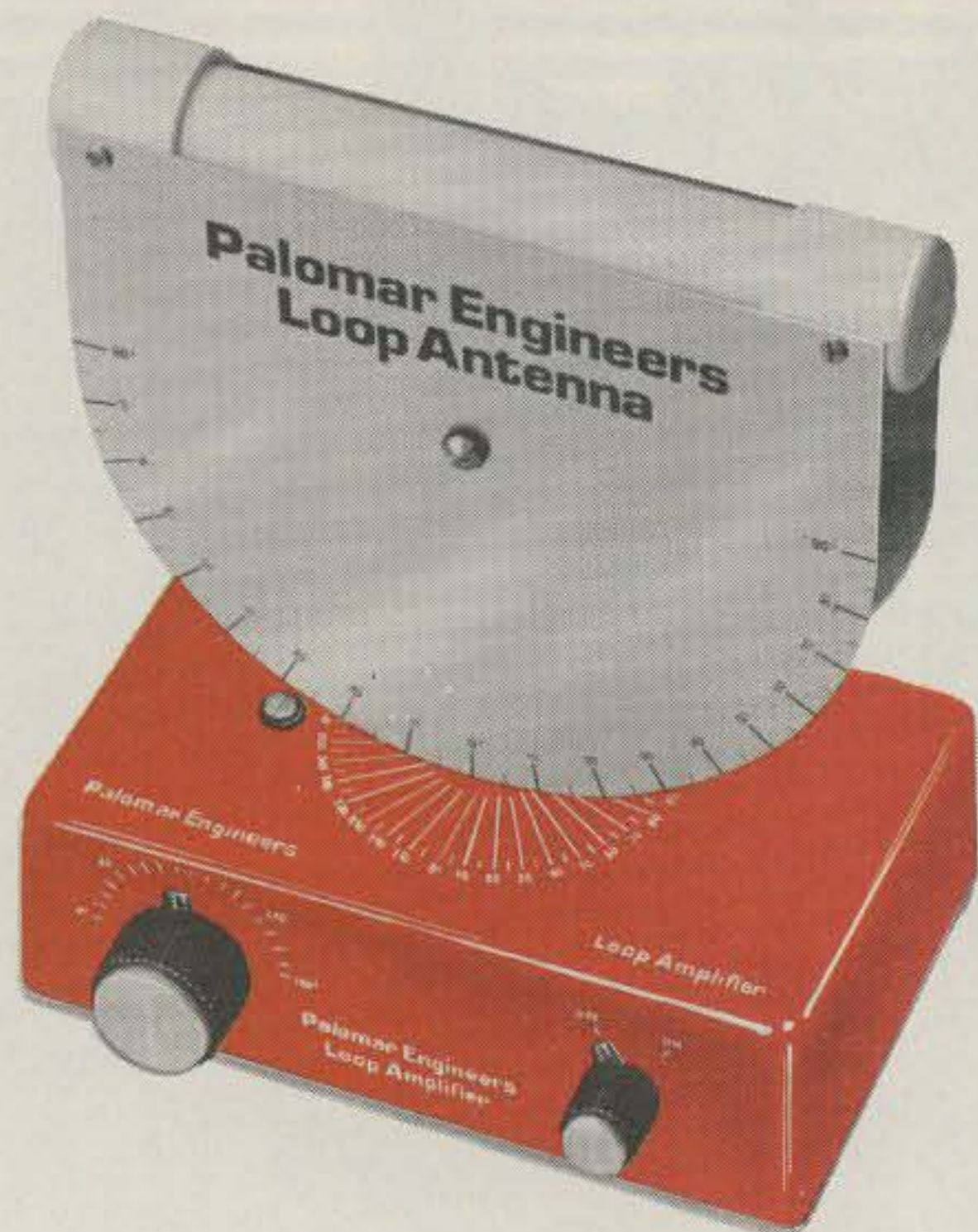

Here is an exciting new device to improve your reception on 160, 80, the broadcast band, and on VLF.

It is well known that loops pick up far less noise than most other antennas. And they can null out interference. Now Palomar Engineers brings you these features and more in a compact, carefully engineered, attractive desktop package.

Unlike ordinary direction-finder loops, it tilts to match the incoming wave front. The result: Deep nulls up to 70 db. You have to listen to believe it!

Does the Loran on 160 give you a headache? The loop practically eliminates it. Broadcast station 2nd harmonic ruining your DX? Turn and tilt the loop and it's gone. Does your friend in the next block with his kilowatt block those weak ones? Use the loop and hear him fade out.

Loop nulls are very sharp on local and ground wave signals but usually are broad or nonexistent on distant skywave signals. This allows local interference to be eliminated while DX stations can still be heard from all directions.

The loops are Litz-wire wound on RF ferrite rods. They plug into the Loop Amplifier which boosts the loop signal 20 db and isolates and preserves the high Q of the loop. The tuning control peaks the loop and gives extra preselection to your receiver.

Plug-in loops are available for these bands:

- 150-550 KHz (VLF)
- 540-1600 KHz (Broadcast)
- 1600-5000 KHz (160 & 80 meters)
- 10-40 KHz (Omega)
- 40-150 KHz (WWVB, Loran)
- 5-15 MHz (HF-1)



Send for free descriptive brochure.

Loop Amplifier \$67.50; Plug-in Loop Antennas \$47.50 each [specify frequency band]. To order add \$3 packing/shipping. Calif. residents add sales tax.

Palomar Engineers

Box 455, Escondido, CA. 92025 • Phone: [714] 747-3343

✓ 76

TRAC

DELUXE MESSAGE MEMORY KEYS



Features: Model TE-284

- State-of-the-Art CMOS Circuitry
- Three choices of Message Storage
 - A. Two (50 character each) message storage
 - B. Four (25 character each) message storage
 - C. One (50 character and two 25 character message storage)
- Records at any speed—plays at any speed
- Memory operating LED
- Use for daily QSO or contests

PLUS:

- Self-completing dots and dashes
- Both dot and dash memory
- Iambic Keying with any squeeze paddle
- 5-50 w.p.m.
- Speed, volume, tone, tune and weight controls
- Sidetone and speaker
- Low current drain CMOS battery operation—portable
- Deluxe quarter-inch jacks for keying and output
- Keys grid block and solid state rigs
- WIRED AND TESTED FULLY GUARANTEED—LESS BATTERY

"BRAND NEW"

\$89.95

MESSAGE MEMORY KEYS



Model # TE201

\$69.95

Features:

- Advanced CMOS message memory
- Two (50 char. each) message storage
- Repeat function
- Records at any speed—plays back at any speed
- Longer message capacity
- Example: send CQ CQ CQ DX de WB2YJM WB2YJM K—then play second message on contact—de WB2YJM QSL NY NY 579 579 Paul Paul K
- Use for daily QSOs or contests

PLUS:

- State-of-the-art CMOS keyer
- Self-completing dots and dashes
- Both dot and dash memory
- Iambic keying with any squeeze paddle
- 5-50 wpm
- Speed, volume, tone, tune and weight controls
- Sidetone and speaker
- Low current drain CMOS battery operation—portable
- Deluxe quarter-inch jacks for keying and output
- Keys grid block and solid state rigs
- WIRED AND TESTED FULLY GUARANTEED—LESS BATTERY

"BRAND NEW"

Model # TE144

59.95



Features: Deluxe CMOS Electronic Keyer

- State-of-the-art CMOS circuitry
- Self-completing dots and dashes
- Both dot and dash memory
- IAMBIC keying with any squeeze paddle 5-50 wpm
- Speed, weight, tone, volume tune controls & sidetone and speaker
- Semi-automatic "bug" operation & straight keying—rear panel switch
- Low current drain CMOS battery operation—portable
- Deluxe quarter inch jacks for keying and output
- Keys grid block and solid state rigs
- Wired and tested—fully guaranteed—less battery

MODEL TE133—same as TE144 with wgt and tone control internal, less semi-auto keying. \$49.95

MODEL TE122—same as TE133 less wgt, tune, solid state keying \$36.50

AT YOUR DEALER OR SEND CHECK OR MONEY ORDER. (plus \$2.00 s/h. NY res. add tax.)

TRAC ELECTRONICS, INC
1106 RAND BLDG.
BUFFALO NY 14203

ATR-6800

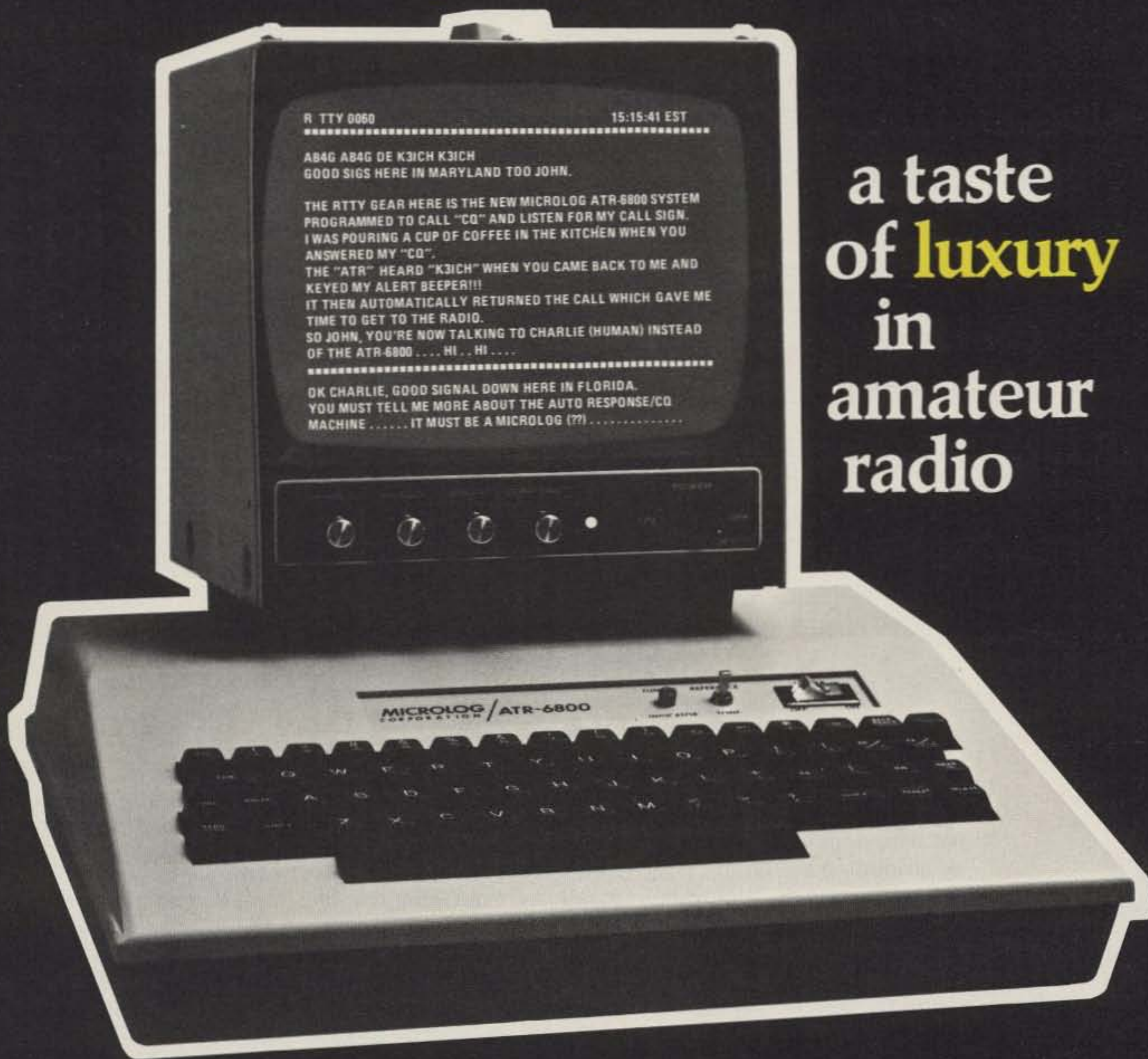

a taste
of **luxury**
in
amateur
radio

The best of both worlds . . . a simple, easy to use video system for CW/RTTY/SSTV and an automatic computer station control.

Learn a few keyboard commands; plug in your transceiver and you're on the air with performance that leaves the others "in the noise." With the program permanently stored in ROM, there's no need to fumble with loading. To get it going, you just turn it on!

The complexity of its operation is up to you; the capability is there when you need it. Use the computer mode to add a new dimension to your station's operation. It virtually obsolete-proofs the system for future developments by allowing direct control or modification

of all operating parameters in all modes. With battery backup memory it will remember your ID, stored messages and special programs.

SLOW SCAN TV? Sure, why didn't you say so? It's easy with the ATR-6800, our SSTV program outputs standard tones for sending characters and computer graphics. Compose a full screen and transmit it, just like you would on RTTY!

ATR-6800 with 9" monitor \$1995.00

Ask your dealer or drop by. MICROLOG CORPORATION, 4 Professional Drive, Suite 119, Gaithersburg, MD 20760, Telephone (301) 948-5307.

MICROLOG ✓ 51

INNOVATORS IN DIGITAL COMMUNICATIONS

One Step at a Time: Designing Your Own Ham Gear

— part I

L.B. Cebik W4RNL
5105 Holston Hills Road
Knoxville TN 37914

One of the most difficult steps to take in our growth as radio amateurs is the one that carries us from building to designing. The engineer has learned, through his intensive college training, complex mathematical ways to design circuits and equipment. The experienced technician seems intuitively to know what to look for and what to do. What they do seems a mystery, but they do it well and their equipment works.

But what about the ham who has just received his General class license? He has built a kit or two, and therefore is familiar with components, soldering, and adjustment of equipment.

He has even built a device or two, perhaps a keyer, by reproducing the circuit and layout he saw in 73. Now he has been looking at some of the home-brew designs and wishes he could tackle something that complex. He does not exactly like what he has seen, however. Some of it is too complex for his needs; some is too simple. He has some parts on hand which none of the designs uses. But all he knows about ham radio is what he has learned from his fellow hams, his club's radio classes, and the books published especially for hams. As a salesman, school teacher, carpenter, or whatever the profession, he feels unprepared to tackle the big task of designing his own gear.

If this description fits you, even if only loosely, this article is written for you. There is a way to go

about designing, even though you are treading on new ground, which will maximize your chances of successfully building a piece of equipment that suits your specific needs—and which works.

Designing, for the beginning designer, requires a step-by-step process to rely upon for the journey from thinking to operating. Fortunately, the process is not long or involved in its main steps. In fact, there are only seven major steps, along with a couple of smaller ones. Here are the steps which you should use as a checklist for any building projects, the first three of which will be covered in Part One of this two-part article:

- 1) Setting down design objectives.
- 2) Blocking out circuitry by stages.
- 3) Circuit research and se-

lection; circuit interaction: drive, matching, and switching.

- 4) *Parts* acquisition.
- 5) *Layout* planning; circuit interaction: shielding and isolation.

- 6) *Building*, one stage at a time.

- 7) *Testing* of each stage as completed, and circuit interaction: spurious oscillations and emissions.

That is the entire list. The key words are italicized. Let's take a closer look at each of the items on the list and see how it fits into place as we design a piece of equipment. I hope that by the time we have finished at least one doubtful builder will have been encouraged to step into the workshop as a novice designer.

Setting Down Design Objectives

For any human endeavor,

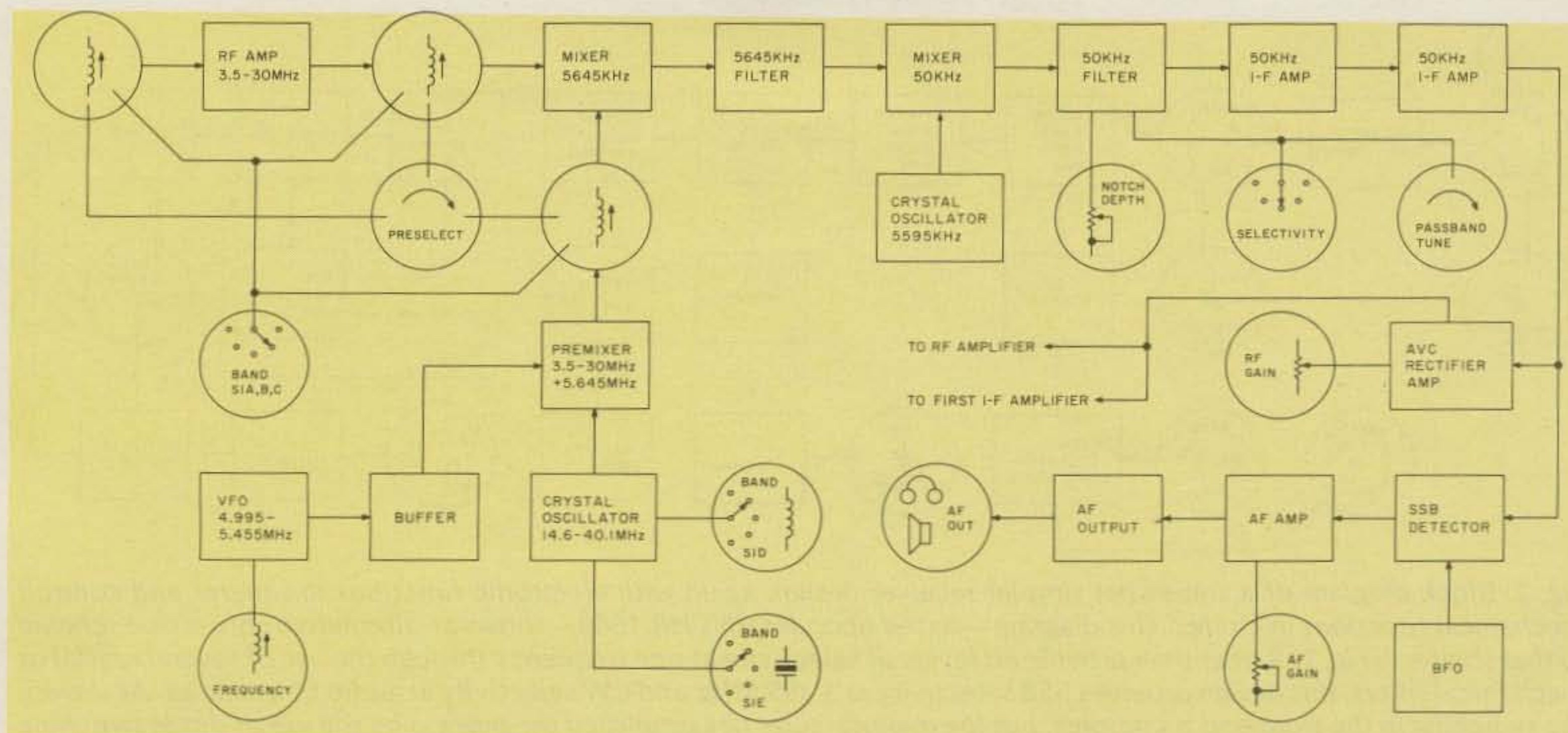

Fig. 1. A block diagram of a 3.5-30-MHz SSB receiver showing electronic stages in squares and control/mechanical elements in circles. This diagram—simplified from the Drake R-4B—is presented to show the techniques of embodying design objectives in a function diagram. It provides the designer with a general view of the stages through which the signal is processed and the switching and other control mechanisms, either necessary or available. Note, for example, that a five-section bandswitch is needed. Controls such as the notch depth and passband tuner are available, but the designer may later choose to include or delete them from the final design. The diagram also provides the elements of the conversion scheme—one of several possible schemes as shown in Figs. 2 and 3. Diagramming commercial and home-built equipment as presented in amateur journals can assist you in deciding the functional details of the unit you want to build, as well as helping you to understand the equipment you have diagrammed.

success demands that we set forth our objectives. Only when we are clear on what we are aiming for do we have any good chance of achieving it. Designing a piece of ham equipment is no exception.

The task of getting our objectives down on paper is not too difficult if we ask ourselves the right questions. Here are some good starters: 1) What can this equipment do (and what can it *not* do)? 2) Why do I want to have it? 3) What features or characteristics do I want it to have?

The first question—what can the equipment do and what can it not do?—provides a very important review of the basic purposes of electronic gear. It is not enough to think that a receiver just receives rf energy and converts it to audio (or some other form of) energy. We must think in more precise terms. A high-frequency receiver for SSB and CW is a more exact de-

scription. This sets limits to what we can put into it and what we cannot get out of it. It tells us that we are limited to the ham bands between 3.5 and 30 MHz, and that we should not expect good AM reception from the unit. Every piece of equipment we can think of will have some limits, and it is important to be aware of them.

Knowing why you want to build the piece of equipment is equally important, since it allows you to note all the functions you want it to fulfill. If you want to build an OSCAR receiver, then perhaps coverage of all of the ham bands is not necessary. Converters placed ahead of a receiver for 28 MHz might fulfill your needs. Now ask what the receiver has to do to the OSCAR signals. Besides converting them to audio, it has to provide selectivity. And because OSCAR signals near the horizon are likely to be weak, the

receiver must be sensitive. Now the list of objectives is beginning to move away from the abstract and into the realm of the concrete. The next step is to refine further these objectives. How selective? 2 kHz for SSB and .5 kHz for CW. How sensitive? Less than a microvolt.

The third question—concerning the main features and characteristics desired—includes many different kinds of concerns. First, it can refer to operating ease or complexity—lots of adjustments or few. Second, it can refer to building ease, e.g., use of circuit boards or perfboards, metal work and cabinetry, tricky circuits or reliable ones. Third, it can refer to the nature of the item. Is it to be an experimental unit under constant revision, or a reliable piece of operating gear? Is it for your own use or for use by others? Is it to be a finished unit or a breadboard item?

Even if you see an item in a handbook or article that seems to have just the features you think you want, it will pay to make a list of its advantages and disadvantages in light of just why you want to build it.

In order to keep track of your answers, you should make a list, and as you proceed with the design process, add to the list. In your reading, you will find new possible uses for a piece of equipment. For example, you may discover that a frequency counter might be used as a station read-out for both transmit and receive. If you decide you want the device to fulfill that function, be sure to put it on your list, since that decision will make a difference in the specific design of the gear. As your list grows, you also will find yourself becoming more precise in knowing what you want. The design objectives will eventually form a list of specifications for the

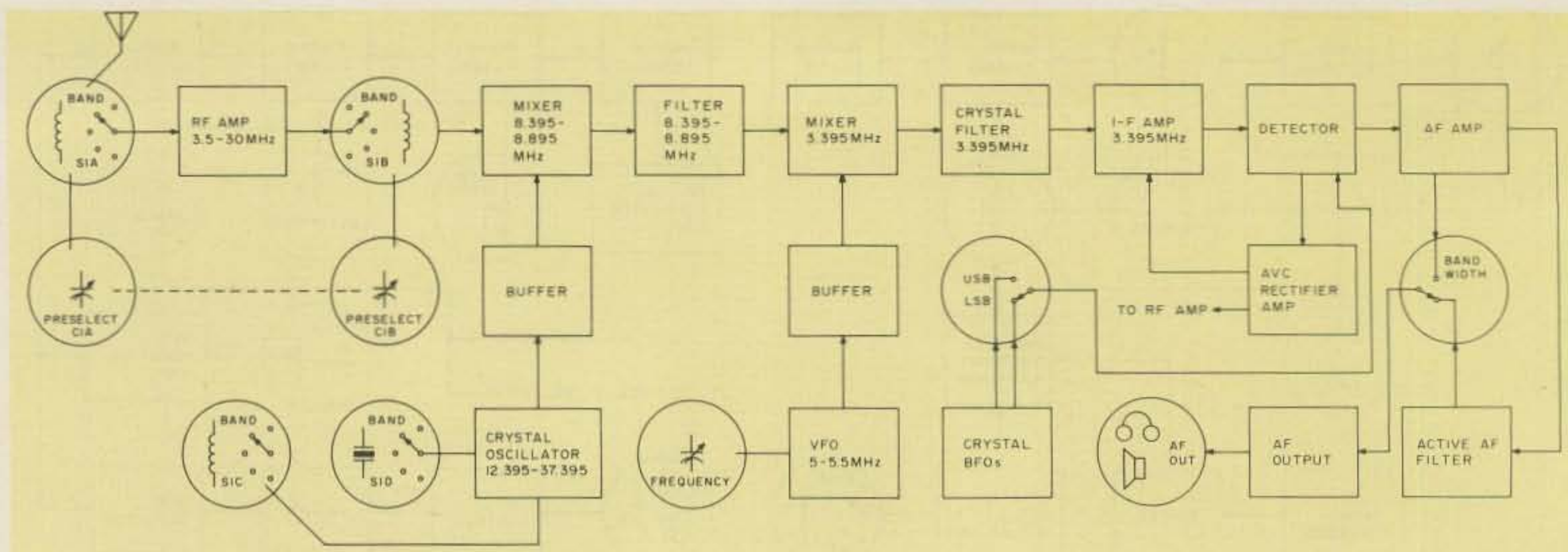

Fig. 2. Block diagram of a somewhat simpler receiver design, again with electronic functions in squares and control/mechanical functions in circles. This diagram—based upon Heath's HR-1680—shows an alternative conversion scheme to that shown in Fig. 1. Rather than provide all levels of selectivity at one frequency through the use of several crystal or mechanical filters, this design provides SSB selectivity at 3.395 MHz and CW selectivity at audio frequencies. As shown, the switching in the front end is complex, but the manufacturer has simplified the process by the use of diode switching techniques. Rf and af gain controls have been omitted, since they occur in the same points of the circuit as in Fig. 1. Notice that this circuit uses fixed adjustments in its filter circuits, thus providing less flexibility than the receiver of Fig. 1 (a much higher-priced receiver). For the home designer, there is often a trade-off until considerable experience is obtained. Simplicity of design with less flexibility is often the price of successful design and construction. With care, however, one can design a simpler unit both electronically and mechanically so that circuit refinements and additional features can be added later. If you have this in mind, special planning will be needed in the circuit selection and layout (both mechanical and circuit) phases of your design work.

equipment you want to build. Clear thinking here will save many a headache later on.

Blocking Out Circuitry By Stages

Because many equipment articles begin with a schematic diagram of the unit, we can easily be tempted to make a mistake at this point. It seems natural to leap from our objectives into trying to find circuits which will achieve them. We quickly get lost in the maze of bypass capacitors, coil winding instructions, and coupling methods; our objectives soon take a backseat to the intricacies of components. As a result, when we do get the equipment working (if we get it working), it does not do what we hoped it would.

To avoid this problem, we need to put a step between our objectives list and our individual circuits. We need to *block out* the circuitry which will achieve these objectives.

But first, let's make an-

other set of lists. There will be two, one for the electronic functions and the other for the mechanical functions. As you will readily see, these two lists will overlap in a number of places, and that is important, too.

On the electronics list, you should enter all of the functions you can think of that go into the unit you wish to build. Some of them will be taken from your objectives list and others will come from your knowledge of what goes into a unit like the one you have in mind. Here, handbooks and articles can help. For example, suppose you want to build an HF receiver. Most such receivers will have the following stages: an rf amplifier, a mixer and heterodyne oscillator, another mixer and vfo, SSB and CW filters, i-f amplifiers, a detector, audio amplifiers, agc, and methods of tuning, adjusting gain, switching bands, and metering signal strength. This is your starting list.

On the mechanical list,

you should enter all of the mechanical functions that are part of a piece of equipment. This includes variable controls, switches, and tuning devices, as well as plugs, jacks, cables, and other appendages. For the HF receiver referred to above, we will need a tuning mechanism and dial, rf and af gain controls, an on-off switch, a fuse, a line cord, an antenna jack, a speaker jack, a phone jack, an agc on-off switch, and a band switch. Like the first list, this is only a starter.

The next step is to make a diagram of what is on your lists. The block diagram of these lists will differ somewhat from those block diagrams that appear in equipment articles; they are designed to show only the functions which the author thinks are important. The one made from your lists is for design, so it must include both electronic and mechanical blocks. The easiest way to accomplish this is to choose different shaped blocks for electronic stages and mechan-

ical stages—say a square for one and a circle for the other. (It does not matter whether professional diagrams use this method. As long as a diagram makes something clear to you, it is a good one.) Notice Fig. 1. It sums up the entries on our list so far.

Ah, but notice Fig. 2! It also sums up the entries. The point is that there are always going to be alternative ways to accomplish your objectives. Just as your reading and your conversations with other hams gave you alternatives for your objectives, so, too, your reading will show you different ways to accomplish your selected objectives, and so will manufacturers. Drake uses the pre-mixing system in Fig. 1; Heath uses the system of Fig. 2. Which, if either, will you use? Notice the complex switching system common to both; that is hard to build and may lead to alignment difficulties. Fig. 3 shows still another alternative: separate converters for each band. Although

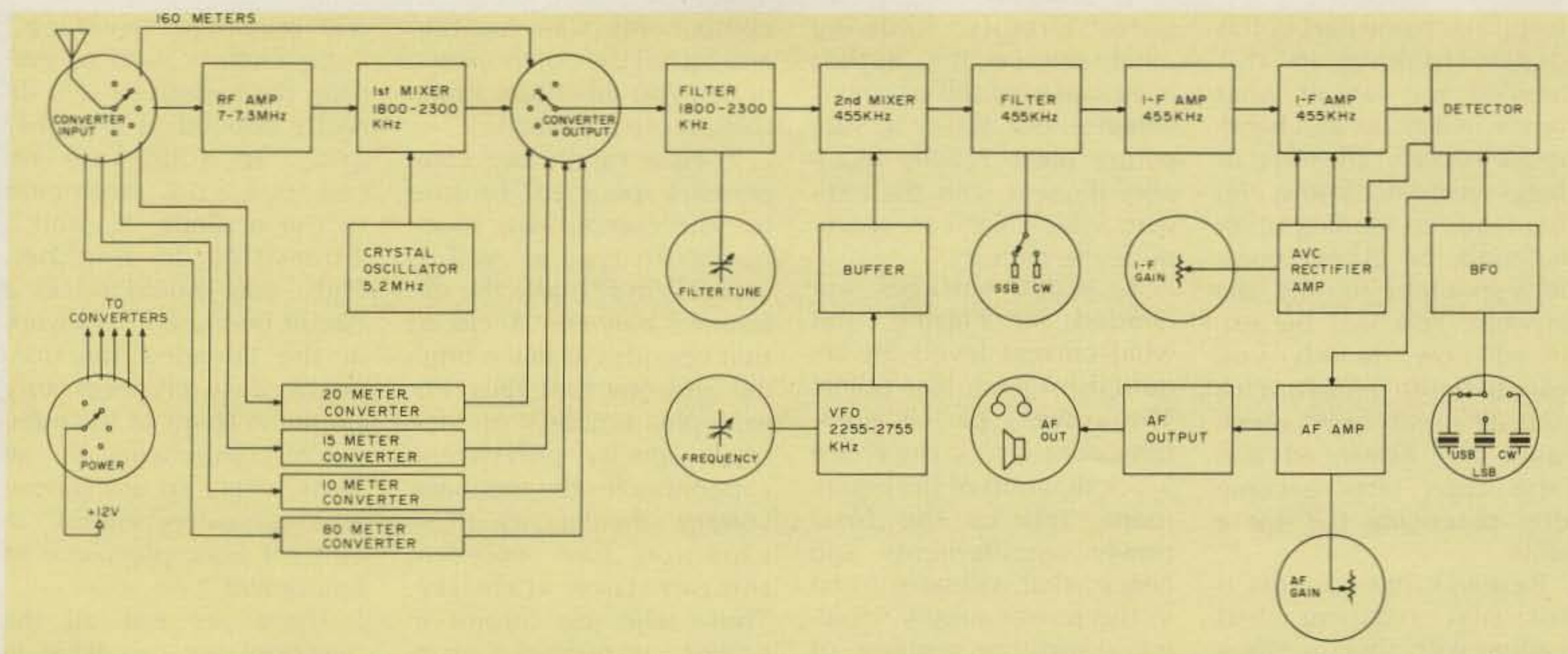

Fig. 3. This shows a third block diagram of a receiver design, this one based on a receiver in the 1978 ARRL Handbook. The design uses a common conversion scheme, although in the past, many receivers omitted 160 meters and designed the basic receiver around 80 meters. Some of the design strategies are aimed at the home builder. Notice the use of separate converters for each band, which simplifies switching and permits optimizing performance for each band. The use of a 455-kHz i-f allows the use of easily obtainable components, such as the filters. With proper selection of circuits, one might add other operating aids, such as an ultra-sharp audio frequency CW filter. Combining ideas from all three design philosophies, as well as others, can produce as simple or complex a receiver as one wants or needs; the point is to design to your objectives and within your construction skills.

this may mean a few more parts and active devices, the switching is so much easier that the increase in size may be worth it. And it does make home construction easier, especially for the beginning designer.

The block diagram, therefore, is a good decision-making aid. By exploring the alternatives in block form, we can make basic decisions about what means we will use to accomplish our objectives. At the same time, we also can think through a number of important questions, such as what circuitry schemes will be the easiest to produce with the methods I have of building and with the test equipment I have or will have?

It is not necessary to make final decisions at this point. Having two or three alternative block diagrams will not hurt as you move to the next stage, as long as you remember the overall objectives and as long as you keep in mind that you are moving toward decisions which will result in spending money. On the

other hand, every decision you can make at this level will be one more out of the way at the next level. That is why making lists and notes next to your diagrams is so important; they help you keep your place.

The process, as described generally and with examples, sounds a good deal more complex than it is in reality. We do part of this work in our heads whenever we read through an article that attracts us. All these procedures call for is to write on paper some of what we do in our heads. Paper-and-pencil is cheaper than burned-up or unused components. The Wright brothers are reputed to have said that they spent time with design drawing because what would work on paper would work when built. The same thought applies here. And even if we never went a stage further, think of the advantages. First, we would have spent no money, and second, we would have learned a great deal about the workings of equipment like the item we wanted to build.

Circuit Research and Selection

Now is the time for more reading and writing, for now the time has come to fill in the blocks of stage 2 with actual circuitry. Sometimes we will see an article which shows circuits that are perfect for several of the blocks in our diagram. But let's not count on it. Even if it does happen, it pays to look at several alternative articles. Comparison of circuits for each stage and function can teach us a great deal about what is going on in each circuit and about what we should expect in the way of performance and difficulties.

By now it should be clear that you are developing a fairly extensive file or notebook in the process of designing the piece of equipment you have in mind. Loose-leaf binders, spiral notebooks, or just a file folder all work well to keep your notes and plans together. And the notebook will grow as you get to the layout-planning stage and

to the test stage. Keep it. Besides being a virtual textbook on the type of equipment you are designing, it also will be useful after the equipment is built. More about that later on, but for now, here's just one hint based on personal experience.

Although Xerox®-type reproductions are speedy for filling up the notebook, they are not the best planning device. Instead, draw out the circuit you are evaluating. In the process, you can think through the function of every component and the original author's rationale for choosing particular values. Understanding a piece of equipment means, ideally, understanding its overall function, understanding the function of every electronic and mechanical circuit block, and, finally, understanding the function of every component. Rarely does anyone ever reach this ideal, even for relatively simple pieces of equipment, but in our research and selection of circuits we have a perfect opportunity

to approach one part of this ideal. Thinking in this detailed way about what we see in articles and handbooks reveals all sorts of things we do not know, and that leads to reading other materials or asking questions in order to find the answers. You will be surprised how quickly you learn to figure things out for yourself and how much easier the Advanced and Extra class tests become after practicing this for a while.

Research into circuits is not just reading, but reading with specific questions in mind. Here are some useful starters.

1. What drive level is required for this circuit? Does it require driving voltage only, or driving power? The answer to this question often will determine what the circuit for the preceding stage must be like. Of course, most low-level tube and FET circuits require only driving voltage, whereas power stages and most transistor circuits require that both voltage and current be supplied to the signal input of the stage. Except for rf power amplifiers, however, articles and their associated schematic diagrams rarely give anything more than the signal voltages at certain points in the circuit (if they give anything at all). So you may have to do some additional reading in order to make good educated guesses.

2. What device is used in the circuit? The type of device—e.g., MOSFET, JFET, transistor, tube, etc.—tells us much about other circuit requirements such as drive, output, power-supply voltages, possible operational and adjustment difficulties, and cost. For example, we quickly learn to think in terms of 12 volts and careful handling while soldering for MOSFETs, ± 15 volts for op amps, and possible spurious oscillations and extra bypassing for power tran-

sistor circuits. Knowing what device the author used can also tell us about expense, our ability to substitute more readily available devices, and the ease with which we can reproduce the circuit.

3. What voltages are needed for biasing, and what current levels are required for each bias point? The answers to this question, considering the entire block diagram of the equipment, tell us the total power requirements and hence what will have to be in the power supply. Holding down the number of different voltages needed by the entire unit simplifies power supply design and, in turn, helps us make decisions as to what circuits we ought to use. Here we have to compromise between the best circuits for the job and the complexity of power needs. Biasing requirements also tell us much about what we may need in the way of filtering and regulation.

4. What output level will the circuit provide? Again, the level may be specified in terms of either voltage or power, and we may have to reinterpret what is given, depending upon what the next stage requires.

5. What are the input and output impedances? For many circuits, just the notation "high" or "low" may suffice; for others, careful matching is a must. Reading the text accompanying the schematic can often provide much of this information.

6. Are there any specialized components in the circuit? *Specialized* components may be a relative term. Toroid inductors are special for some builders, natural for others. Crystal or mechanical filters may be thought of as specialized in the sense that they will be a major expense. Evaluate the circuit in terms of the accessibility or affordability of specialized

components: Can you find and afford the components, or can you substitute something more accessible?

7. How rigidly are components specified? Be sure to note components specified as to type as well as value; it may make the difference between a circuit that operates as in the original and one that fails. For example, builders of vfos often specify polystyrene capacitors for the feedback voltage divider, as these capacitors have excellent temperature stability. Those who use toroids in power amplifiers, especially in solid-state designs, may be depending on the "self-shielding" property of the toroid in order to build the unit compactly; another builder may only have used them because they were on hand, without really needing them. In short, evaluate the types as well as the values of components given.

8. Are buffer or isolation stages associated with a given circuit? If they are, do not omit them without first examining their function and necessity. Transistors and resistors are generally cheap, and an additional buffer stage can prevent problems of stability, especially with oscillators. Or, the buffer may provide impedance transformation. In general, design thinking has changed with the transition from tubes to transistors. Given the heat, size, and power requirements, the minimum number of tubes used to be better for the home builder. Transistors are cheap, small, low on power drain, and cool devices; thus, we have begun to think more in terms of circuit performance. Rather than operate them at maximum gain, we use combinations of transistors to ensure that a circuit operates over the needed range (of frequencies, avc voltages, or whatever) and is reliably reproducible

with minimum "twiddling." Tube circuits used to employ diode-derived avc directly applied to amplifier grids. In solid-state receivers, it is not uncommon to use a diode, IC, and a 2-transistor dc amplifier. Thus, you should select a circuit because it will work in the intended function, not because it is necessarily simple in terms of the number of components. By the same token, do not choose an excessively-complex circuit for a simple piece of equipment.

These are not all the questions we can have in mind as we research circuits, but they will help us formulate others specific to the stage we are working on at the moment. It may be helpful to copy each circuit candidate in the center of a single sheet of paper in your notebook. Then you can use the surrounding space for notes taken either from the source of the schematic or from your thinking on how this circuit will interact with others. Fig. 4 shows a sample page from one of my notebooks. I like to ask my questions in the margins and then write down answers as I find them, even if I find the answer after I have tried to build the circuit. Although I rejected this circuit, it proved helpful in designing the amplifier I did build. On pages of schematics which entered into the final design, I also list (in circles) test values of voltages, rf and dc, as well as current drawn.

The process of research is also the process of selection. Circuits that are too uncertain in repeatability or for which components are too expensive or hard to get find their way naturally into the reject pile. You may get specific ideas, e.g., on biasing or bypassing, from one of the rejects, but the page ends up in the back of the notebook. That's right, in the back of

the notebook, not in the wastebasket. You never know when a new project will make a reject into just the right circuit.

With this reduced number of circuits—no more than two or three for each stage, and often only one—the final selection takes place. But not quite yet.

Circuit Interaction: Drive, Matching, and Switching

Before we can make a final selection of circuits to go into our equipment, we must evaluate their interaction in at least three main areas: drive levels, impedance matching, and switching. Other interactions will emerge later in the design process, but, for now, these will give you some idea of the process of translating your detailed thinking on individual circuits back into thinking about the organized functioning of the entire piece of equipment.

The reason drive levels were recorded for individual circuits is that each stage must supply signals to some other stage. The exception, of course, is the oscillator. Every other stage will be a mixer, amplifier, or other type of signal processor (e.g., IC divider or latch). In general, we want the drive levels neither too low nor too high. If the drive level is too low, we may need to go to higher gain devices or circuits (especially with tubes) or add another stage (especially with solid state). Drive levels that are too high can be equally troublesome and may even take out the base of a transistor or the gate of an FET. Matching levels for the two inputs to a mixer is also important; sometimes, depending upon circuit arrangement, having the same level at both inputs may be exactly wrong. Thus, the designer must think about getting the right levels. Using transformers,

Questions:

1. Would a JFET or MOSFET be stabler and easier to use?
(probably easier to use with changes in circuit values)
2. How can switching of tuned circuits be avoided?
(use mixer with xtal oscillator and 5-MHz vfo—see next two pages)
3. Will surplus—e.g., 2N2222 or 2N4124—work as well as the HEPs?
(probably)
4. Note problem of keying with a CW transmitter.
(need a keying transistor a la ZOI or use a keyed mixer with 5-MHz vfo)

Notes:

1. Circuit is high-C Colpitts.
2. Switching occurs outside of tuned circuits to minimize mechanical instabilities.
3. Feedback taken from emitter of HEP55 by tapping above emitter resistor.
4. Ferrite beads and 100-Ohm resistor in HEP55 leads suppress harmonics.
5. 1k resistor in base lead of HEP758 provides loose coupling.
6. Tuned circuit with step-down winding follows .001 uF to amplifier input.,
7. No dc or rf voltages are given.

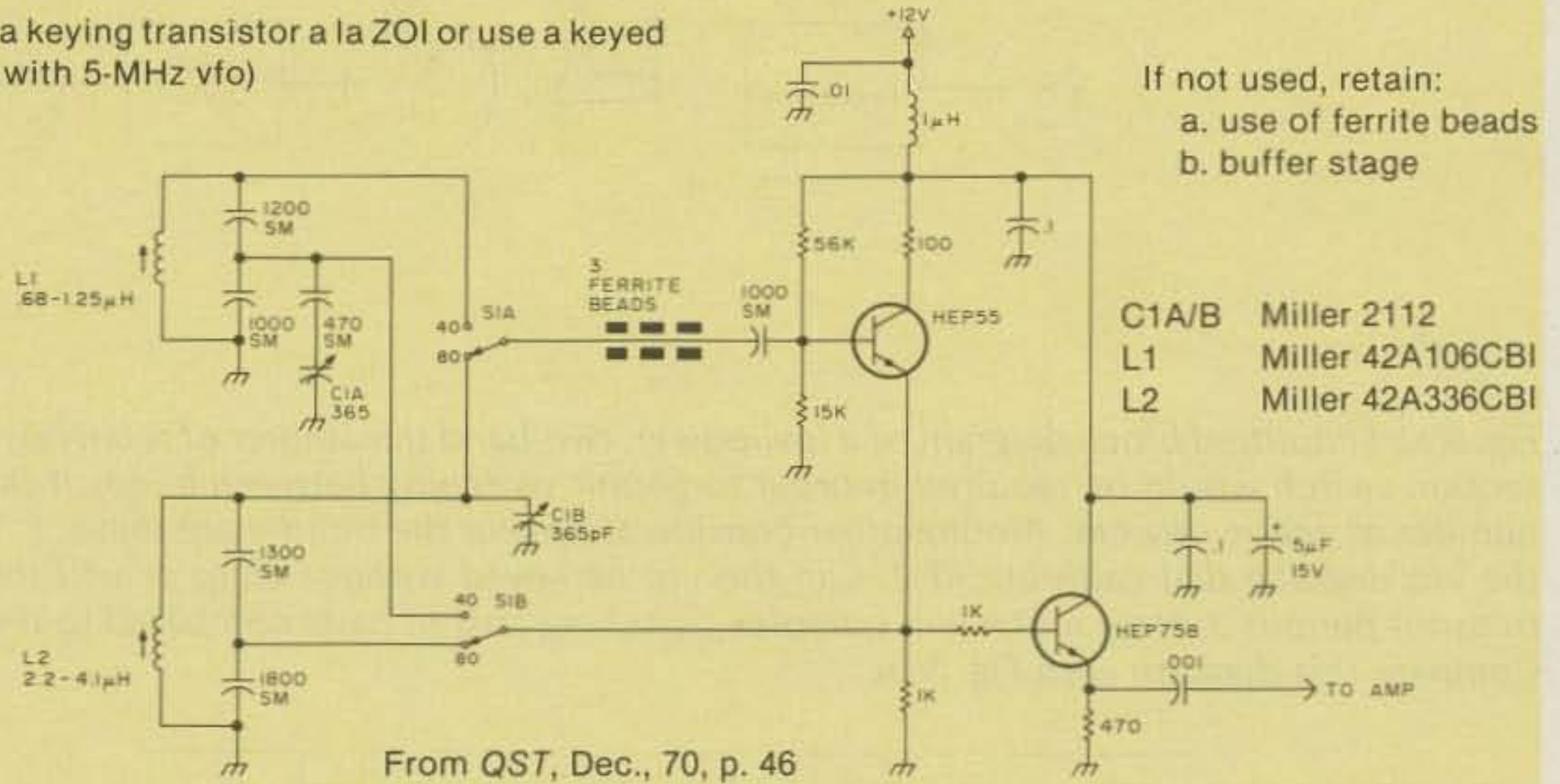

Fig. 4. Sample page from one of the author's notebooks illustrating the method of copying circuits for possible use. The vfo circuit with its buffer stage was not finally used, but much was learned from working with the circuit and the article from which it came. Notice the questions and notes which surround the schematic. Only a few have been included from the original in order to preserve clarity. Answers inserted later have been put in parentheses. This was one of eight pages devoted to vfos alone before selection of the final circuit was made.

capacitive dividers, or lower stage gain are three handy ways to reduce drive levels.

The digital equivalent to drive is called fanout. For most digital devices, fanout, or the number of stage devices driven by an output, is not a great problem. That does not mean that ICs present no problems, just different ones. If our unit combines different types of ICs—e.g., TTL, CMOS, etc.—we must be sure that the output(s) of one IC is(are) compatible with the inputs of others. Data sheets are often helpful here. Since TTLs are still the main type available for ham use, data sheets for other types specify whether or not they are TTL-compatible. Two other digital interaction questions are these: Is the

speed of the devices sufficient for this application? (There are high-speed as well as low-current alternatives to most "regular" TTL ICs.) Will the timing sequence of events create false or irregular operation of any later stage? In short, digital circuitry has analogies with the interaction questions we pose to rf circuitry.

Impedance matching is especially significant with transistors, but does not disappear as a consideration with high-impedance devices. Even tubes and FETs require step-up transformers for linking devices to low-impedance antenna lines. Crystal and mechanical filters usually are critical in matching, whether to tubes or transistors. Transistors have moderate im-

pedances in low-power circuits: Their input and output impedances are high compared with the usual 50-Ohm antenna line, but low compared with corresponding tube or FET values. Thus, when combining circuits from earlier research, one cannot assume that a given rf transformer or coil with link coupling will work with a subsequent circuit when fed a different source. Handbooks can help you estimate values by referring you to tube/transistor charts or to coil-winding formulas. The problem becomes more critical with higher-power transistor stages, since impedances may be exceedingly low. Modern design leans toward the use of baluns, but even the ratio of these must be chosen with care.

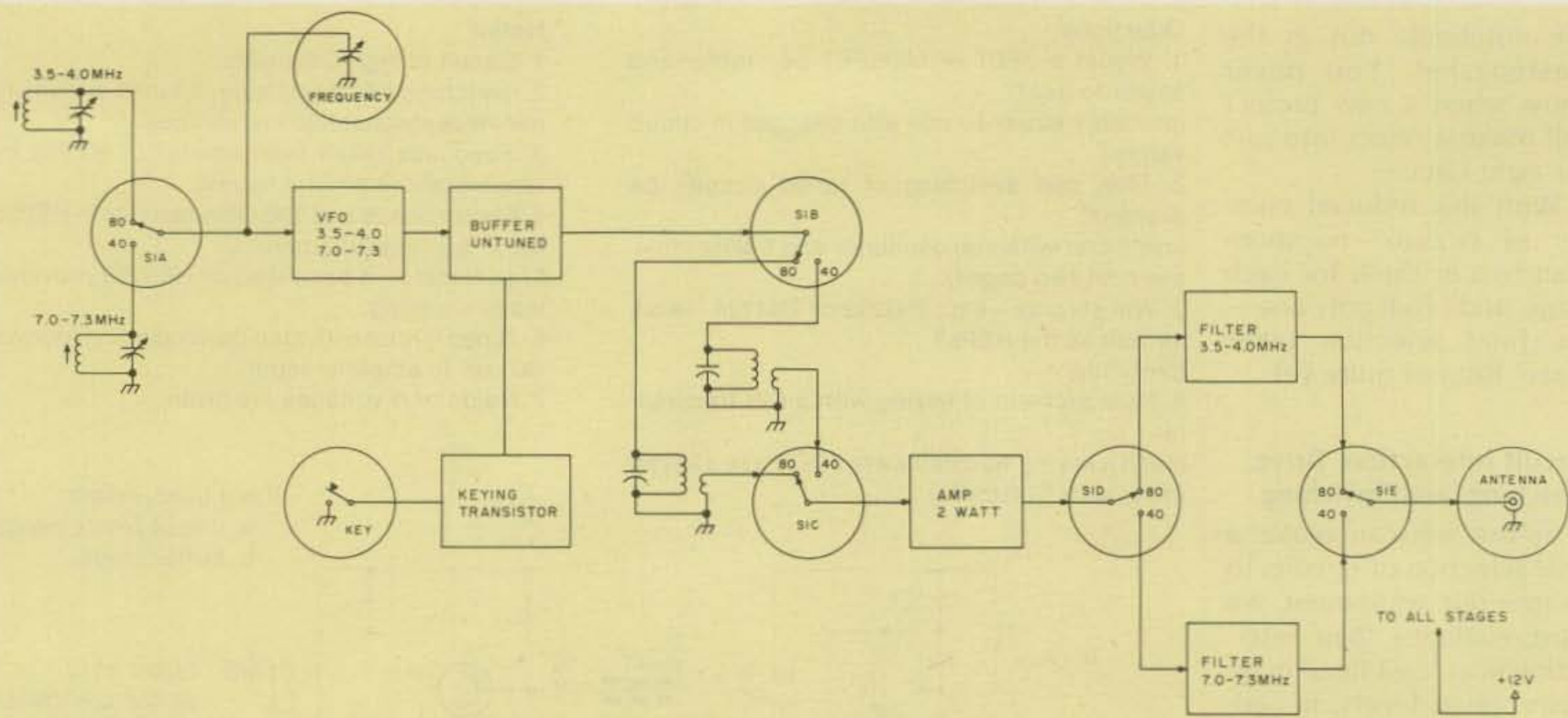

Fig. 5(a). Simplified block diagram of a low-power, two-band transmitter of relatively standard design. Notice that a five-section switch would be required in order to permit switching between bands if the designer's aim is to minimize the number of active devices. Among other considerations for the builder are these: 1. Will switching the tuned circuits in the vfo degrade dial calibration? 2. Can the vfo be keyed without chirp or will the vfo have to run during the entire transmit period? 3. How much will complex switching cost in parts compared to the cost of additional active devices? Compare this diagram with Fig. 5(b).

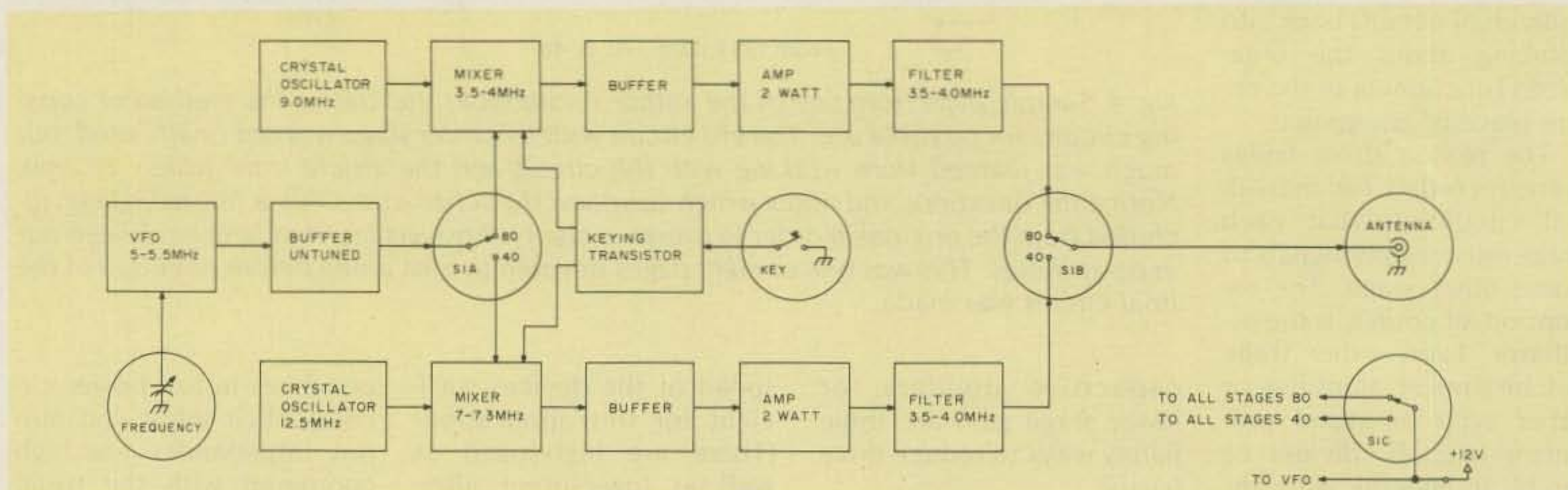

Fig. 5(b). Simplified block diagram of a low-power transmitter performing similarly to the one shown in Fig. 5(a). Separate crystal oscillator-mixer-amplifier chains are run for each band, permitting each circuit to be optimized and simplifying switching. No additional tuned circuits are required over 5(a), only active devices. The cost of the devices is more than offset by the savings on switching. Switching is done at low impedance. Since the vfo operates on a frequency outside the ham bands, break-in keying is possible. Building each band assembly on a separate board provides easier construction with fewer possible problems. The only additional design complexity lies in the need for a mixer for each band. Note that the three major questions raised in Fig. 5(a) are answered by this design.

Switching is not just a mechanical means for changing components in a circuit. Care must be given to what sort of energy is in the switching circuit and how it will interact with other energies in the same or nearby circuits. In general, it is best to switch only dc. If rf must be switched, low-impedance lines should be used to and from the switch. Wherever possible, avoid switching high-im-

pedance rf, especially in oscillators. Not only will the switch introduce mechanical instabilities, but the length of the lines introduces unwanted capacitances. These lines supplement capacitances ordinarily used in fixed components and can produce undesirable coupling to other circuits; an oscillating amplifier is often the result. Where such switching must take place—in a high-

power tube amplifier for the HF region, for example—shielding is the main answer, as well as careful routing of rf leads. With transistors at low power, it is often easier and cheaper to build separate circuits for each band. This permits low-impedance switching at only the input and output circuits, along with power. Figs. 5(a) and 5(b) make the difference clear in the simplified drawing of a

transmitter design for QRP.

The interaction considerations given here should be enough to let you make the final selection of circuits. If two circuits seem of equal value to you, a simple coin flip will settle the matter of where to start. Remember, you can always change your mind again later in the process. The building part of the process has not yet begun. ■

Tomorrow's Technology—Here Today!

THE YAESU FT-207R

The "horse-and-buggy" days of crystal-controlled radios are gone! Yaesu's engineers have harnessed the power of the microprocessor, bringing you 800 channels, digital display, memory, and scanning from a hand-held package. Only with Yaesu can you get these big performance features in such a compact package.

- 4 bit CPU chip for frequency control.
- Keyboard entry of all frequencies
- Digital frequency display.
- 800 channels across 144-148 MHz.
- Up/Down manual scan, or auto scan for busy/clear channels. 10 kHz scanning steps.
- Five channels of memory
- Priority channel with search-back feature.
- Keyboard lock to prevent accidental frequency change.
- Memory backup
- ± 600 kHz or odd repeater splits.
- Display ON/OFF switch for battery conservation.
- Equipped with rubber flex antenna, wallmount battery charger, earphone, shoulder strap, and belt clip.
- Switchable RF output 2.5 watts (minimum) or 200 mW
- Earphone for private listening
- 2 Tone (Touchtone®) Input from Keyboard
- Highly reliable LED frequency display (works in cold temperatures and does not fade with age)

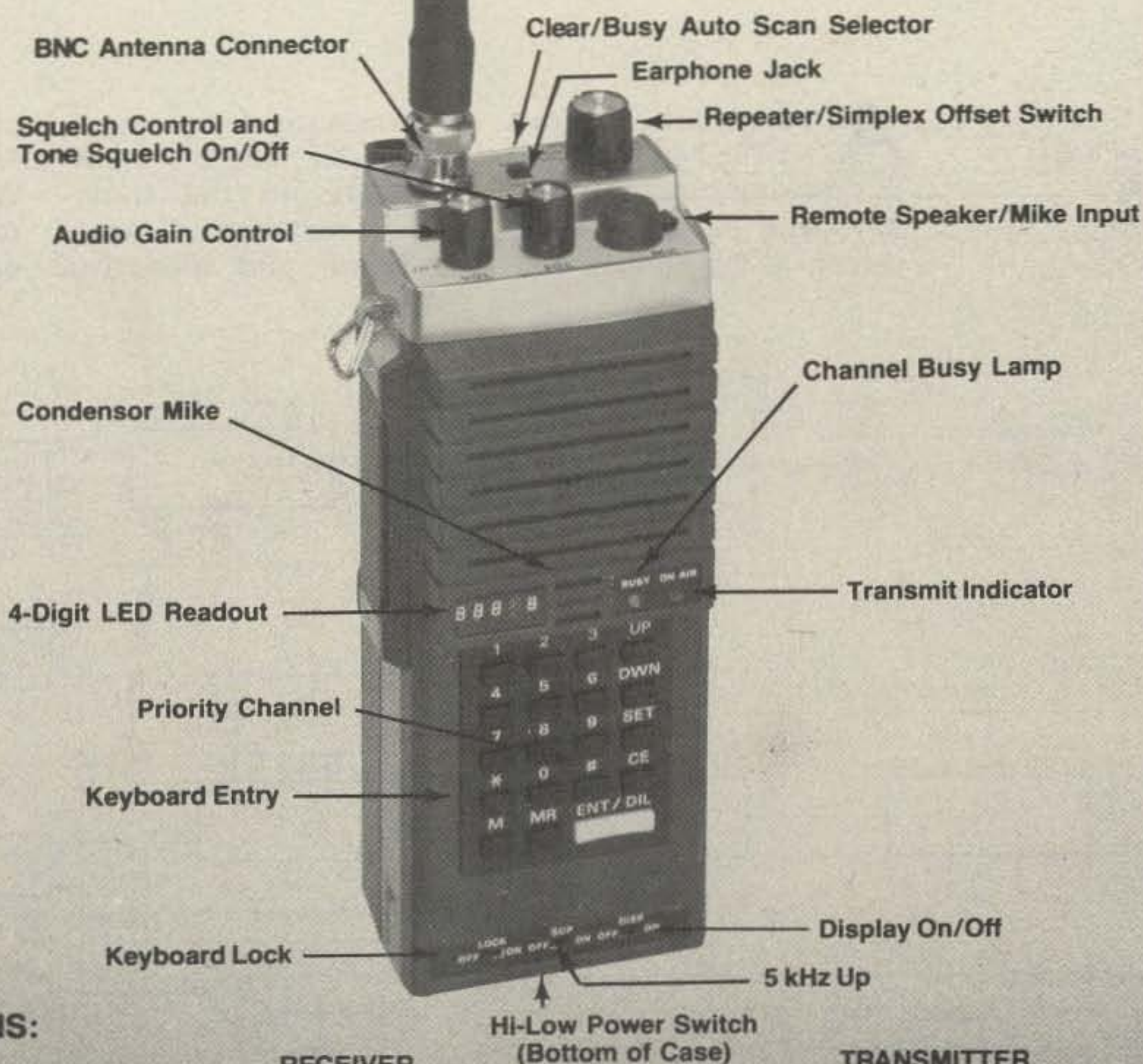

SPECIFICATIONS:

GENERAL

Frequency coverage: 144-148 MHz
 Number of channels: 800
 Emission type: F3
 Batteries: NiCd battery pack
 Voltage requirement: 10.8 VDC
 $\pm 10\%$, maximum
 Current consumption:
 Receive: 35 mA squelched (150 mA unsquelched with maximum audio)
 Transmit: 800 mA (full power)
 Case dimensions: 68x181x54 mm (HWD)
 Weight (with batteries): 680 grams

RECEIVER

Circuit type: Double conversion superheterodyne intermediate frequencies.
 1st IF = 10.7 MHz
 2nd IF = 455 kHz
 Sensitivity: 0.32 μ V for 20 dB quieting
 Selectivity: ± 7.5 kHz at 60 dB down
 Audio Output: 200 mW at 10% THD

Price And Specifications Subject To Change Without Notice Or Obligation

TRANSMITTER

Power Output: 2.5 watts minimum /200mW
 Deviation: ± 5 kHz
 Spurious radiation: -60 dB or better
 Microphone: Condenser type (2000 ohms)

OPTIONS

LC-C7 Leather Carrying Case
 YM-24 Remote Speaker/Microphone
 Tone Squelch Unit
 NB-P9 Battery Pack
 NC-2 Quick Charger

YAESU
The radio.



180

83

Down with Interpolation

— a digital display for the Triton and others

Brooks Carter W4FQ
Rt. 2, Box 407
Irmo SC 29063

Although designed for a Ten-Tec 540 or Triton, this readout should be easy to adapt to other transceivers using similar conversion systems. It is a very small unit that sits unobtrusively on the transceiver, costs little, is easy to build, and measures only 5 1/4" × 3 1/8" × 1 1/8" (13.3 × 7.9 × 2.9 cm). With seven ICs, six transistors, four display LEDs, and one voltage regulator, the

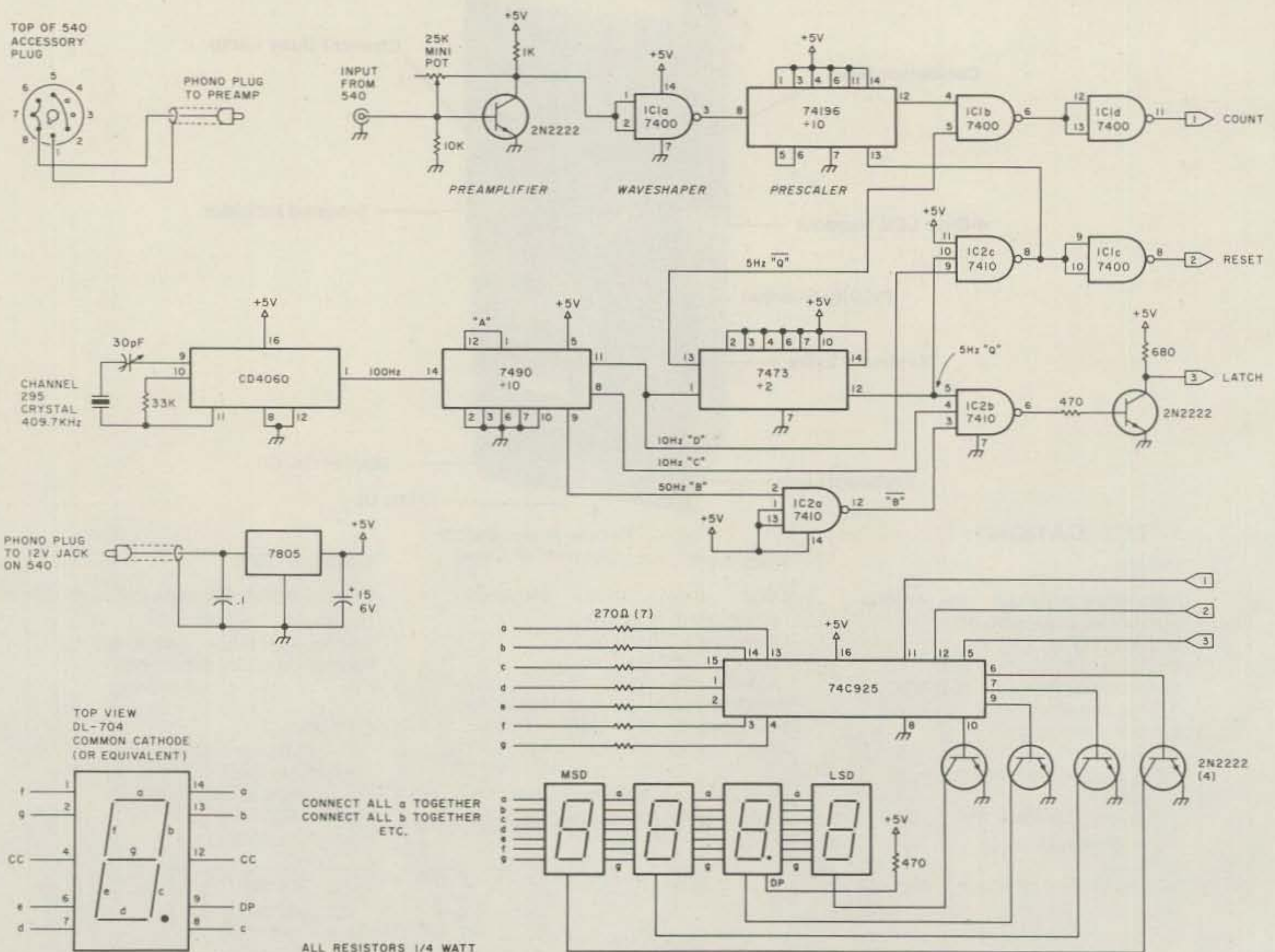

Fig. 1. Readout schematic.

parts cost is less than \$20.

The 540 is single conversion, and its vfo operates from 5 to 5.5 MHz on all bands. Vfo output is mixed with signals from a crystal oscillator, with crystals for each band, to produce mixer injection frequencies between 5 and 21 MHz for conversion of incoming signals to 9 MHz. The display reads the mixer injection frequency down to hundreds of Hertz.

Megahertz are not displayed; this would necessitate a complicated switching and diode presetting arrangement and is neither worth it nor needed. As it is, no switching at all is required. Incidentally, the Ten-Tec 544 digital dial also reads the mixer injection frequency, and additional wafers are incorporated in the bandswitch to provide a megahertz display.

Integrated Circuits

Two of the seven ICs serve to eliminate an additional fifteen or more, if conventional TTL circuits were to be used. The CMOS CD4060, plus a 7490, a 7473, and a few gates provide the time base and logic circuits. The 4060 oscillates well with FT-241 surplus crystals, available from Jan Crystals.

Crystal frequency is 409.6 kHz, but a channel 295 at 409.7 kHz will do nicely; the frequency is easily pulled to 409.6 kHz with the 30-pF series trimmer in the crystal circuit. The 4060 can divide by 2^4 through 2^{14} (except 2^{11}). In this oscillator, the crystal frequency is divided by 2^{12} , or 4096, to provide an output of 100 Hz at pin 1. How much simpler this is than a long string of divide-by-ten TTLs!

The 100 Hz is fed to a 7490 to be further divided for outputs of 50 and 10 Hz. The 7473 divides the 10



Photo A.

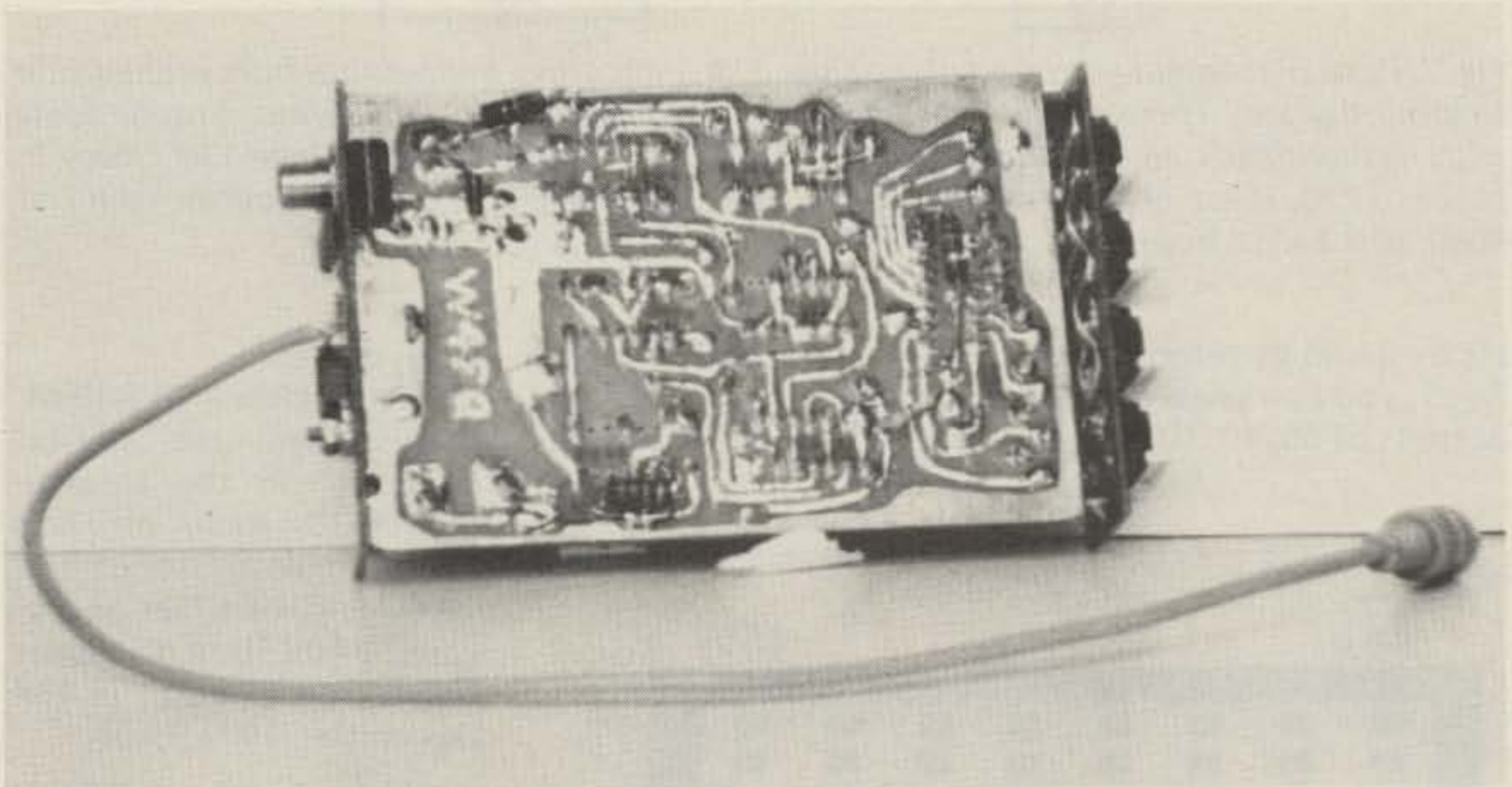

Photo B.

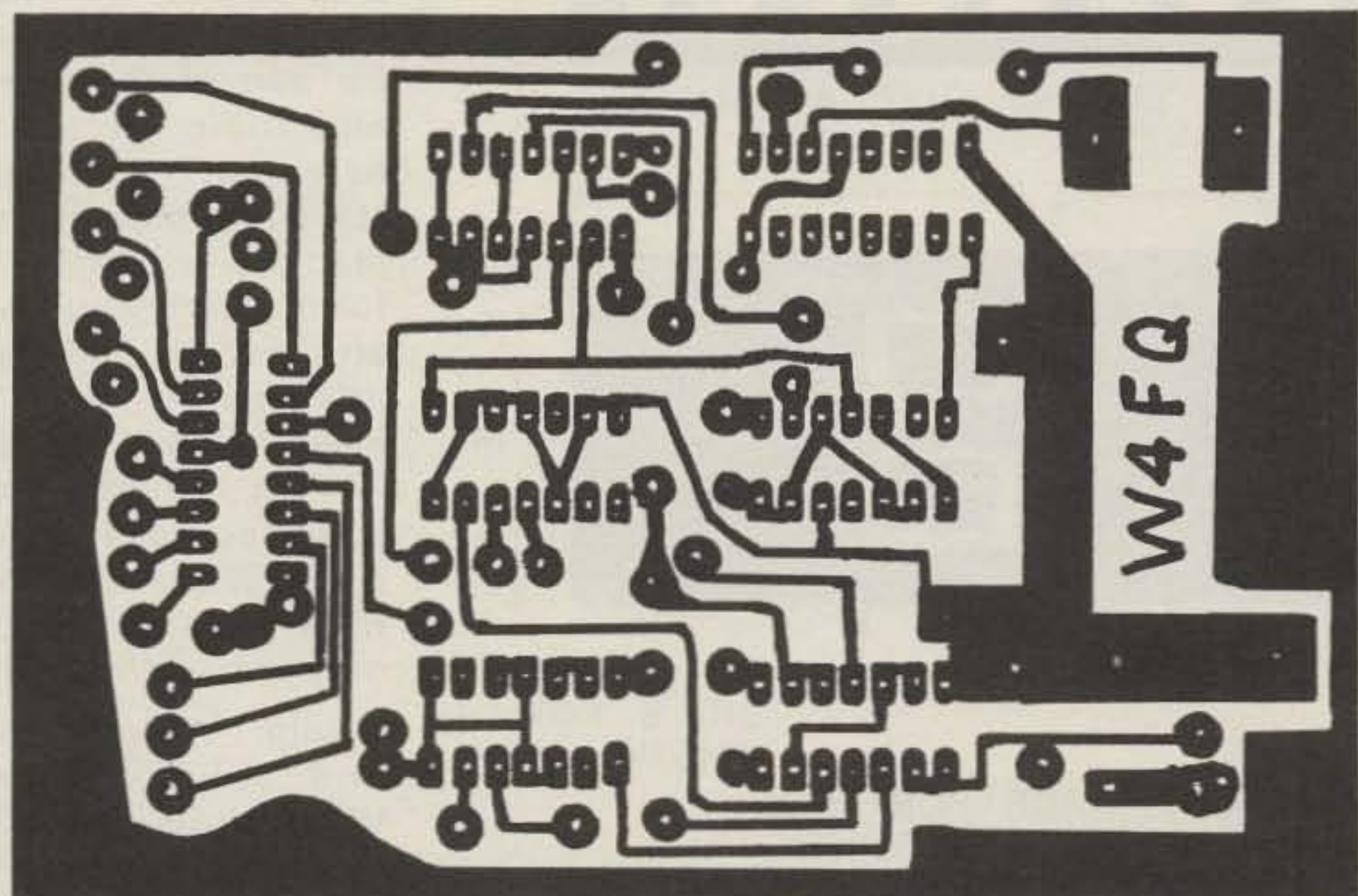

Fig. 2. Circuit board.

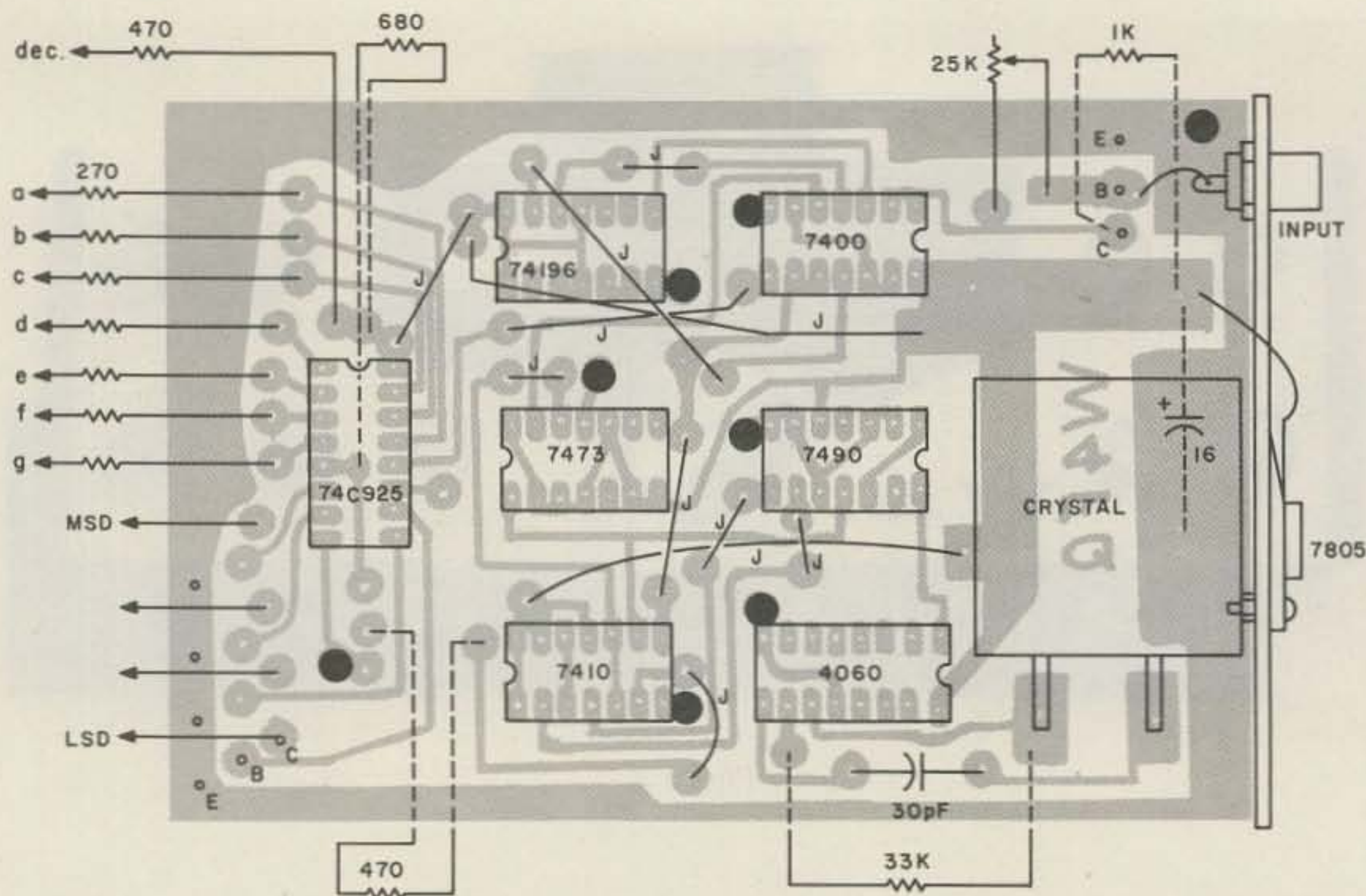

Fig. 3. Parts placement—ground plane side. A ● indicates a connection from etched side to ground plane. There are eight ground connections and 12 jumper wires. Components with dashed leads are mounted on etched side. For brighter display, use 150 Ohms in place of 270. These crystal frequencies may be used: 409.6 kHz with output from pin 1 of 4060, 819.2 kHz from pin 2, and 1638.4 kHz from pin 3.

Hz by 2 and by referring to Fig. 1, you can see we have outputs of 50, 10, 10, 5 and

5 Hz (some inverted) now available for the logic gates for count, reset, and

latch pulses.

Gerd Schrick WB8IFM, in his "Universal Digital Readout" in the December, 1978, issue of *Ham Radio*, makes use of the 4060, as does Klaas Spaargaren PA0KSB in his "Drift Correction Circuit" in the December, 1977, issue.

Philip Rand W1DBM's fine article entitled "A Versatile Digital Frequency Display" in *QST* for November, 1977, is the source for part of the time base and logic circuits used here. For easy-to-understand information on logic, read this article. His waveform chart applies here also, except that the negative-going reset pulse must be inverted, as the 74C925 requires positive-going reset and latch. I use a 2N2222 as an inverter rather than another IC with only one section utilized.

John Wolcott W4CCX and Johnny Chestnut WA4PIN use the 74C925 in their "Lunch Counter," described in *73 Magazine* for December, 1978, and that is

where I became acquainted with this labor- and parts-saving chip. It contains the equivalent of counters, latches, and decoders for four displays, also internal multiplexing with a free-running oscillator, and four outputs for common-cathode display LEDs.

A 74196 prescaler lowers the 5-to-21 MHz input frequencies from the 540 for the readout to 500 to 2100 kHz for input to the 74C925. The 2N2222 pre-amplifier has a 25k-Ohm minipot for adjusting bias and the operating point of the 7400 waveshaper. This adjustment is somewhat critical at 21 MHz. If desired, the pot can be replaced by a fixed resistor once the correct value has been determined. Be sure the pot is connected as shown, and not directly to plus 5 volts. A 2N3904 can be used here and throughout as a substitute for the 2N2222s.

Construction Notes

I used double-sided PC board, with the holes for the IC sockets and jumpers reamed slightly on the ground plane side to remove copper which could short pins to ground. Grounds on the etched side were wired through to the gp side. Laundry marking pens make good resist lines for the etched circuit; if you use these, buy two (at 60¢ from K-Mart). If the point dries, it probably will be tomorrow before the ink flows freely again, so keep it capped every second that it is not in use.

A damp rag and kitchen cleanser (Ajax, Comet, etc.) will clean the copper PC board before etching, and will remove the resist after. Ferric chloride is an easy-to-use etchant and takes about 30 minutes. The 1" x 3" board for the display is spaced about 1/4" from the circuit board to allow room for wiring, and is fixed in place by soldering

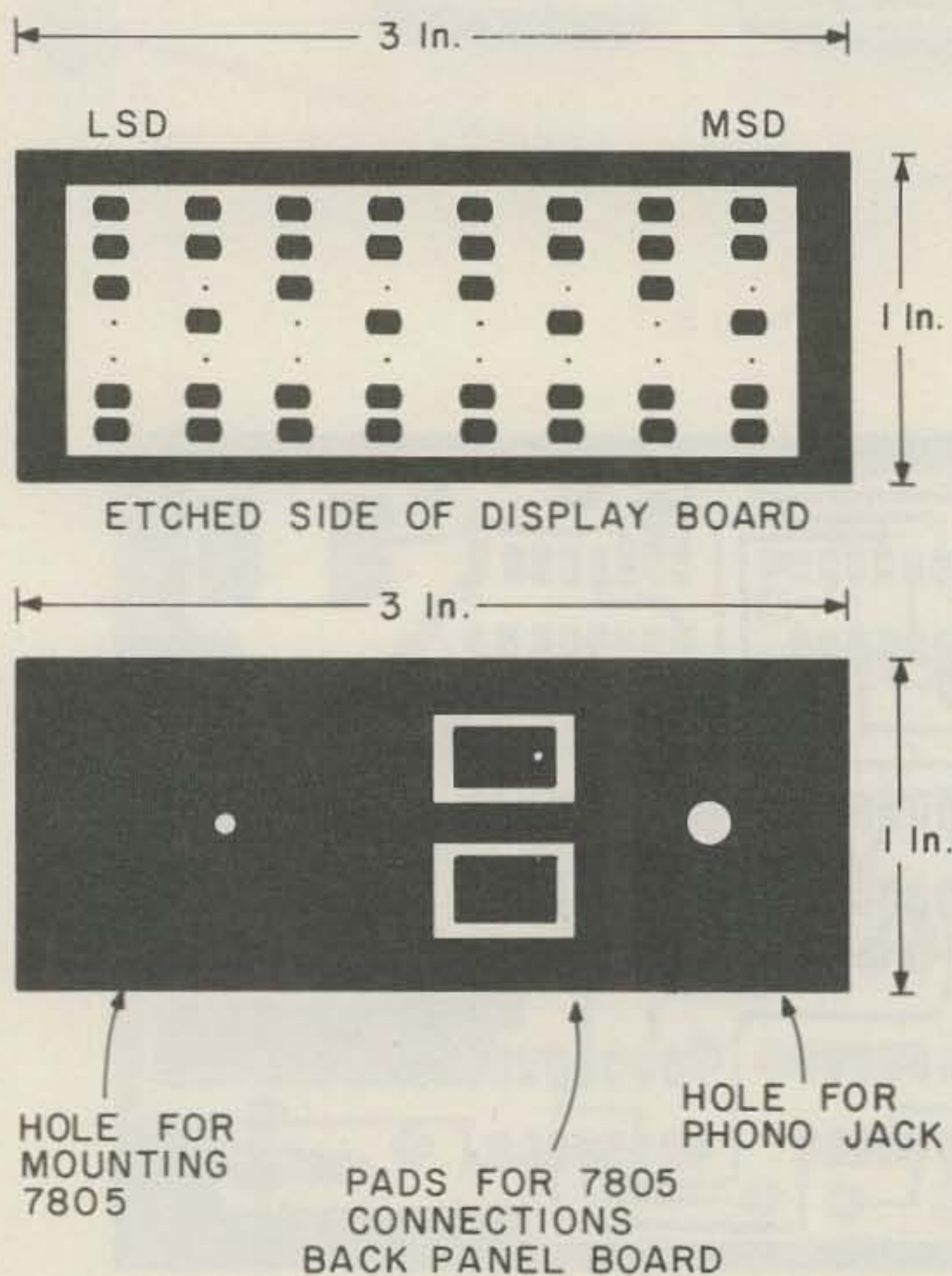

Fig. 4. Display and back panel boards.

scraps of PC board at each end. A press-fitted enclosure made from PC board and covered with black contact paper is used here to give the unit a finished appearance. A red transparent window is cemented in place, through which the display is viewed. Shielding does not seem to be necessary, so the enclosure can be made of just about anything.

Checkout

When the readout has been assembled, and without ICs in their sockets, check for solder bridges between pins. Almost certainly there will be some; use an ohmmeter—don't depend on your eyes. With the ICs in their sockets and power applied but with no input to the preamplifier, the display should read 000.0 or 000.1. If not, check these pins for fast needle fluctuations on a volt-

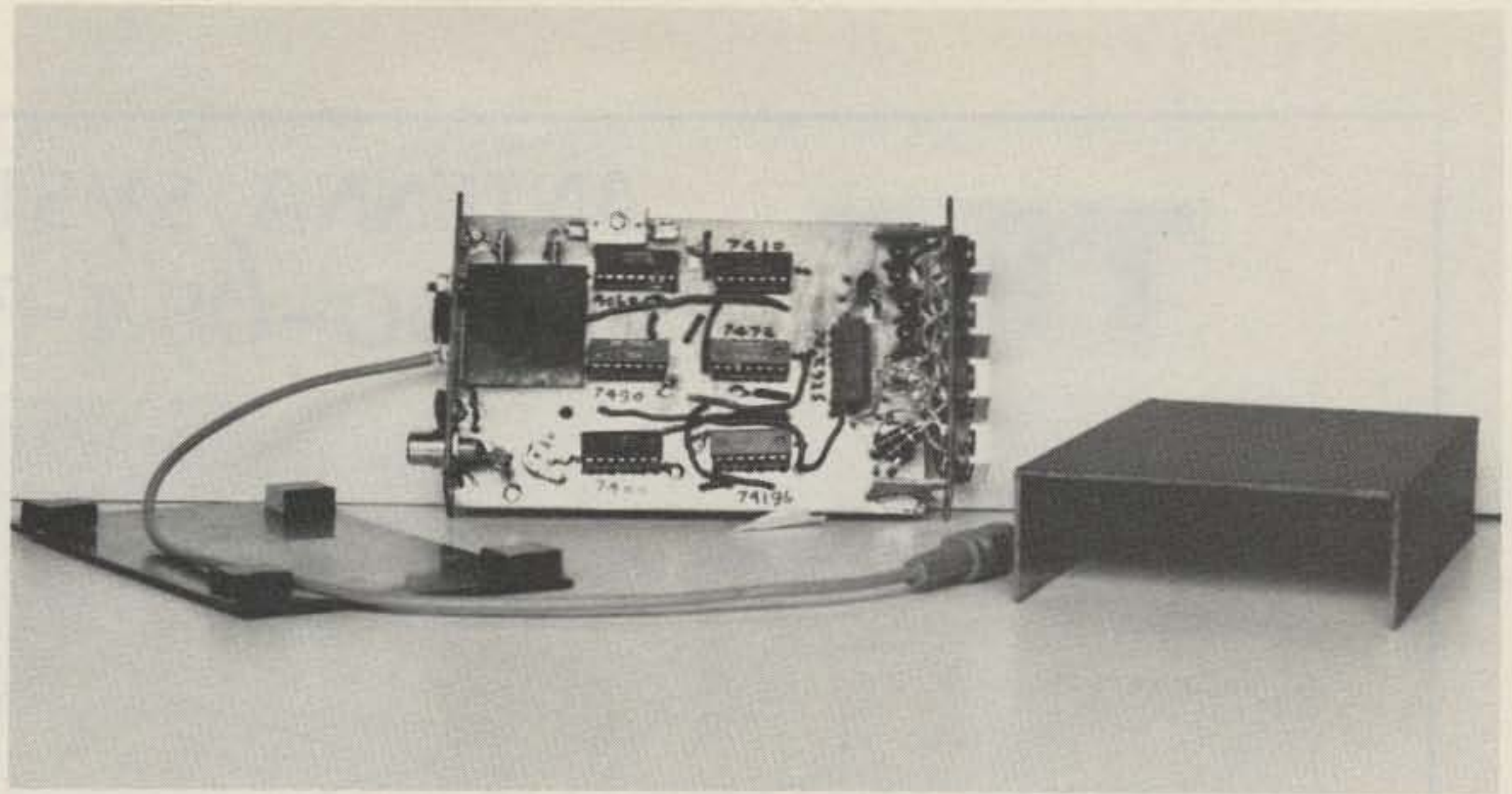

Photo C.

meter set for 5 volts or more: 7490, pins 5 and 12; 7473, pins 12 and 13; 7410, pins 6, 8 and 12; 74C925, pins 5 and 12 (with input to the preamplifier from the 540, there should also be fluctuations on pin 11). If any of these pins reads a steady voltage, the thing

will not work and some checking is in order.

Hash from the readout is completely suppressed by the .1-uF and 15-uF capacitors at the input and output of the 7805 voltage regulator. No other bypassing is necessary. The unit draws 150 mA.

Calibration

Calibration is a snap. Zero beat the 540 with WWV on 15 MHz (band-switch on 21, dial at 0, resonate between 3.5 and 7) and adjust the crystal trimmer until the display shows 000.0. That's all there is to it. ■

SCANNERS:

**NOW INTRODUCING A SCANNER FOR THE TEMPO S-1
COMTRONIX FM 80 & FM 200
KDK 2015R, KDK 2016A
MIDLAND 13-510, 13-513, CLEGG FM-28
YAESU FT227R, ICOM IC22S,
KENWOOD TR7400A, TR7600, & TR7625**

- AED continues to expand its line of quality scanners. All of the above scanners are custom designed for their respective rigs.
- All scanners install completely inside the rig. No obtrusive external connections.
- All are easy to assemble and come complete with a detailed instruction manual.
- Scanned frequency displayed on digital readout (except IC22S and TEMPO S-1).
- In the scanner OFF mode the rig operates normally. In the scanner ON mode the scanner locks an occupied frequency, pauses for a preset time (about 5 secs.) and then resumes scanning (except IC22S).
- This gives you the ability to eavesdrop all over the band without lifting a finger. When you hear something interesting, you flip the switch to the LOCK mode and the rig is ready to transmit.

AED SCANNER SPECIFICATIONS

	TEMPO S-1	COMTRONIX FM 80/200	KDK 2015R	KDK 2016A	KENWOOD TR7400 TR7600 TR7625	KENWOOD TR7400A	YAESU FT227R	MIDLAND 13-510 13-513 FM-28	ICOM IC22S
SCAN RATE	Adjustable in assembly normally 15 sec./MHz	10 frequencies (automatic)	Adjustable by pot on scanner board 100 kHz/sec. 1 MHz/sec.		10 kHz/sec. Can be set to changing meter on board	200 kHz/sec.	100 kHz/sec.	100 kHz/sec.	
SWEEP WIDTH	Scans the MHz range selected by the MHz switch	See note on when it is necessary to change or when it is not	100 kHz	142 kHz (95%)	Complete band or MHz segment you want	adjustable e.g. 140 kHz 144 kHz 146 kHz	Scans the MHz range selected by the MHz switch	145 kHz 147 kHz	
SCAN CONTROLS	1 three position micro-switch toggle switch (off scan lock)	2 mini toggle switches mounted on rig	2 mini toggle switches mounted on rig (LOCK switch may be mounted on mic)		2 mini toggle switches on rig	1 mini toggle switch mounted on mic or rig	2 mini toggle switches on rig	1 mini toggle switch on mic or rig	
LOCATION OF SCANNER IN RIG	On transmitter board	On top of receiver circuitry	Behind frequency selector board	Mounts on top of PLL frequency divider section	Under PLL compartment just behind frequency selector board	Mounts along bottom left-hand frame	Mounts just in front of PA compartment	Mounts on frame vertically next to PLL board	
KIT PRICE	No kit	\$49.95	\$39.95		\$39.95				
PREASSEMBLED PRICE	\$49.95	\$39.95	\$49.95						

10 METER FM

-THE NEW FRONTIER

The AED FM ADAPTER is now available

- The AED FM adapter converts existing HF transceivers to work on 10 meter FM.
- This AED kit consists of 2 P.C. boards designed to fit entirely inside your rig (each board measures 1" x 2").
- One board serves as the modulator which FM's your existing HF transceiver.
- The second board is a receiver-adaptor which converts your HF transceiver's I.F. to a 2M frequency.
- This will allow you to receive noise-free 10M. FM on your 2M transceiver.
- The kit comes complete with all parts and a detailed instruction manual (crystal not included).

KIT PRICE \$39.95
PREASSEMBLED \$49.95

Special \$10.00 off
All Preassembled items.



AED ELECTRONICS

750 LUCERNE RD., SUITE 120 DEPT. A
MONTREAL, QUEBEC, CANADA H3R 2H6
TEL. 514-737-7293

INCLUDE \$1.50 FOR POSTAGE AND HANDLING PER ITEM

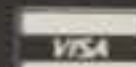

TET[®]

ANTENNA SYSTEMS 1-800-654-3231

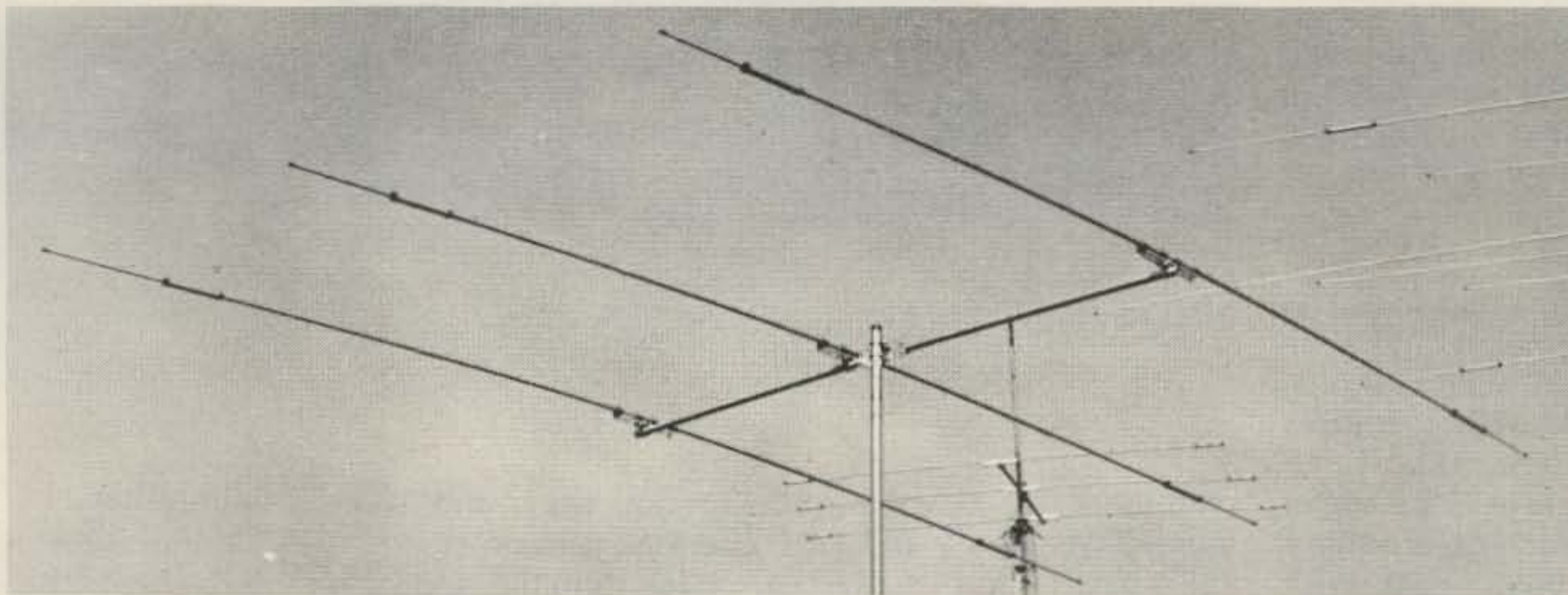

TE33SP COMPACT SIZE MULTIPLE DRIVEN ELEMENTS

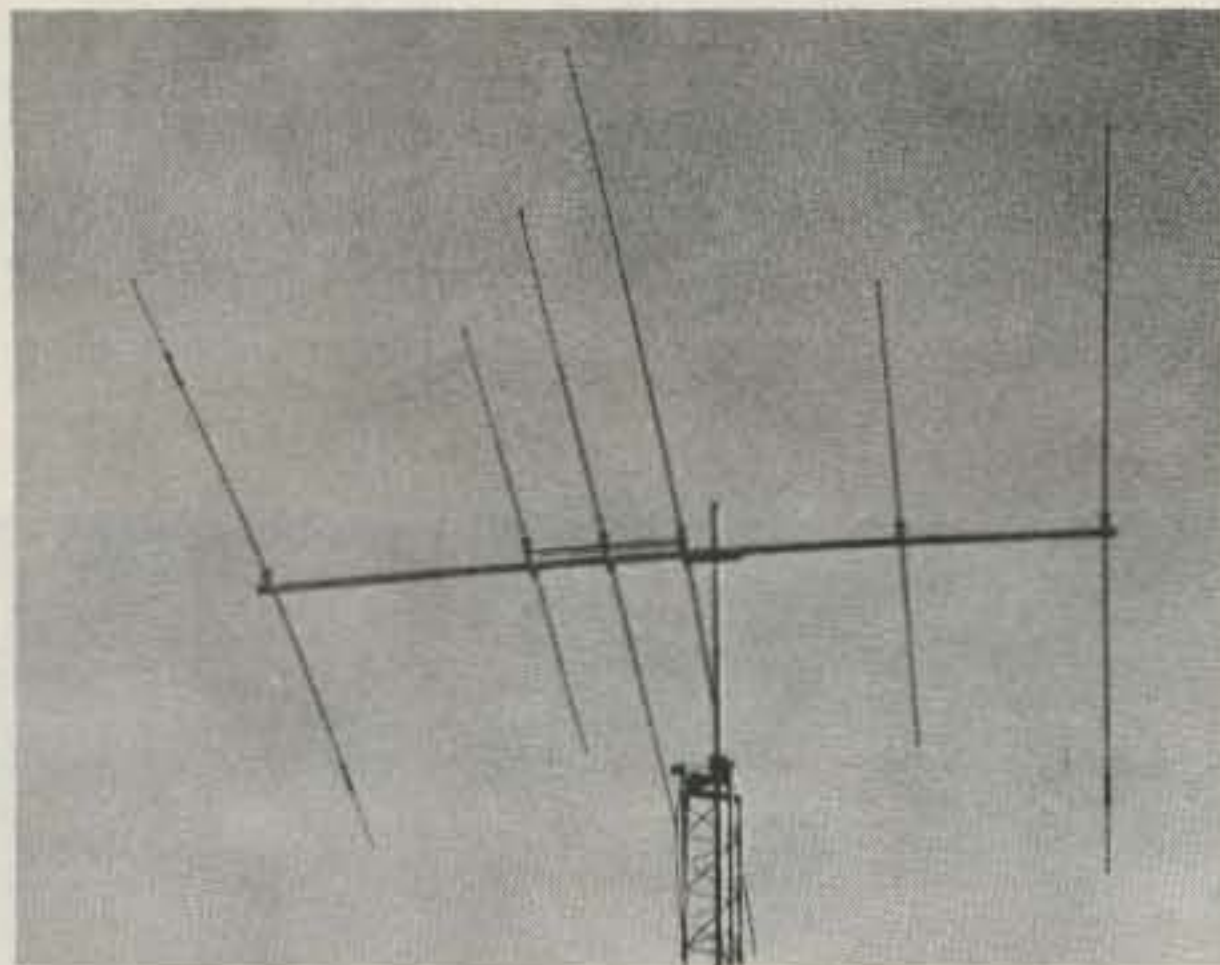

3F36DX FULL SIZE DRIVEN ELEMENTS



TET, the leader in wideband antenna design, is proud to announce a totally new concept in antenna design with the all new TE33SP. The TE33SP employs two driven elements to achieve previously unattainable performance from a triband yagi. Power is applied to the radiator and coupled through a rigid phasing line operates in conjunction with a specially engineered printed circuit board to provide the required phase shift for full sized performance on each band. This multi element drive network, combined with Hi Q traps provides greatly improved performance and true wide band operation. 1.5:1 VSWR bandwidth is at least 1 MHz on ten meters. Fifteen and twenty meters can be expected to produce VSWR of less than 1.5:1 from edge to edge.



The TET 3F36DX and 3F37DX triband beams provide excellent performance across the complete spectrum of the 10, 15 and 20 meter amateur bands. High performance is accomplished through the use of a full sized driven element for each band combined with efficient Hi Q traps for the parasitic elements. No Phone and CW settings with the 3F36DX and 3F37DX. Full band coverage is possible even with the new all solid state transceivers. You can expect VSWR below 1.5:1. The 3F36DX and 3F37DX are fed directly with a single 50 ohm coaxial line. No baluns or difficult to adjust matching networks are used.

TET invites you to compare our performance data against that of other antenna manufacturers. TET, the leader in wideband antenna design, offers superior performance at an affordable price. Join the crowd and switch to TET.

	BAND	ELE- MENTS	ELE- MENTS PER BAND	MAX PWR	VSWR	IMPEDANCE	MAX ELEMENT LGTH	BOOM LGTH	TURN- ING RADIUS	WIND SURFACE AREA	WIND LOAD @ 80 mph	MAST SIZE	WT
TE33SP	14/21/28	3	3	2KW	BELOW 1.5	50ohm	27'	13'2"	15'	5.1 sq. ft.	102 lb.	2"	29.5 lb.
3F36DX	14/21/28	6	3/4/4	2KW	BELOW 1.5	50 Ohm	34'5"	16'5"	17'3"	9.58 sq. ft.	191 lb.	2"	46.3 lb.
3F37DX	14/21/28	7	3/5/5	2KW	BELOW 1.5	50 Ohm	34'11"	24'8"	17'5"	11.3 sq. ft.	226 lb.	2"	55 lb.

Call Factory for ANTENNA GAIN dBd and FRONT TO BACK RATIO.

TET FACTORY DIRECT PRICE

3F36DX	\$ 199.95
3F37DX	\$ 249.95
TE33SP	\$ 154.95

LIMITED TIME ONLY

CALL TOLL FREE 1-800-654-3231



✓73

TET U.S.A., INC.



425 HIGHLAND PARKWAY, NORMAN, OKLAHOMA 73069 TEL: 405-360-6410

SWISS QUAD Series • PORTABLE TOWER

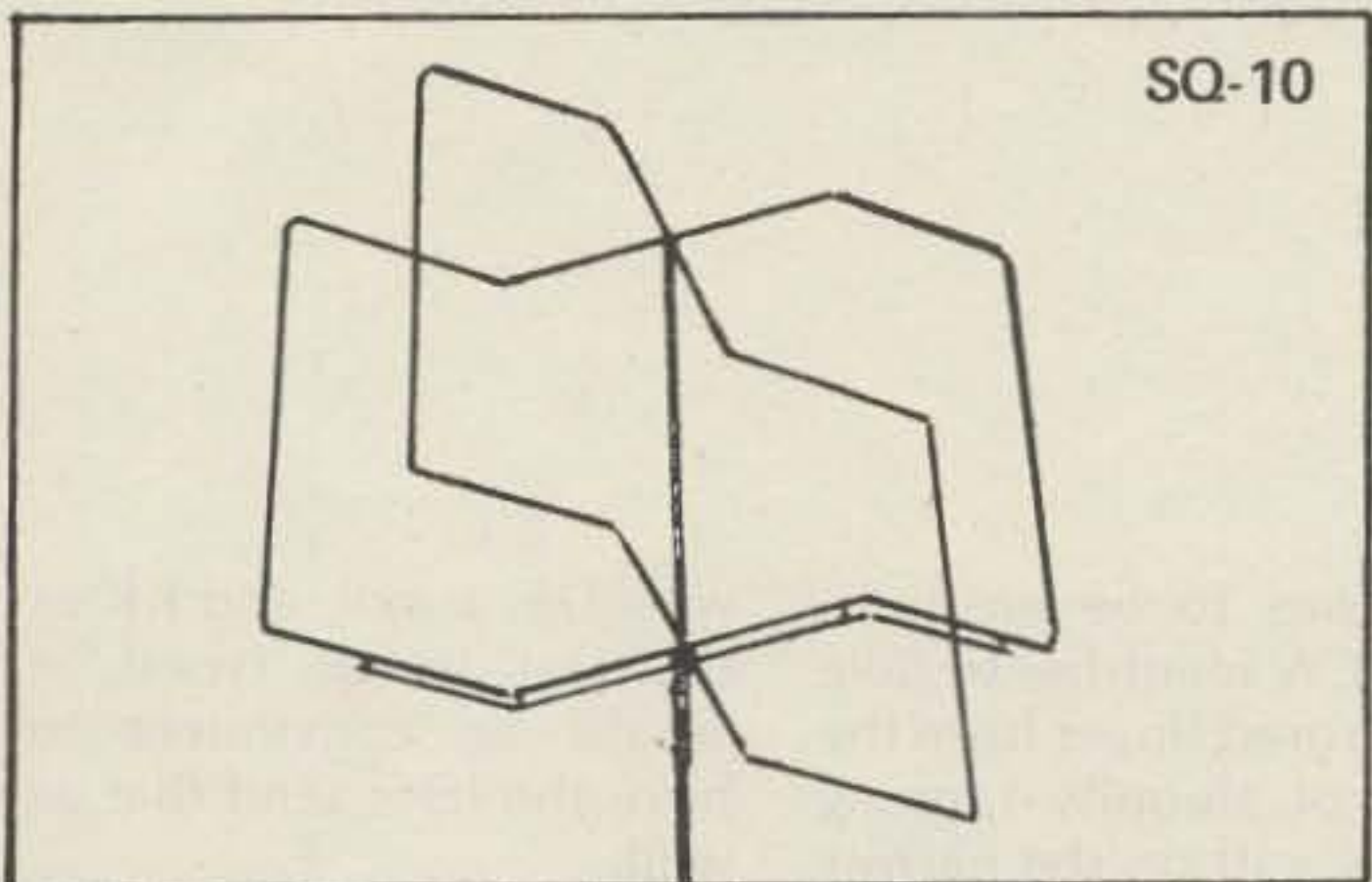
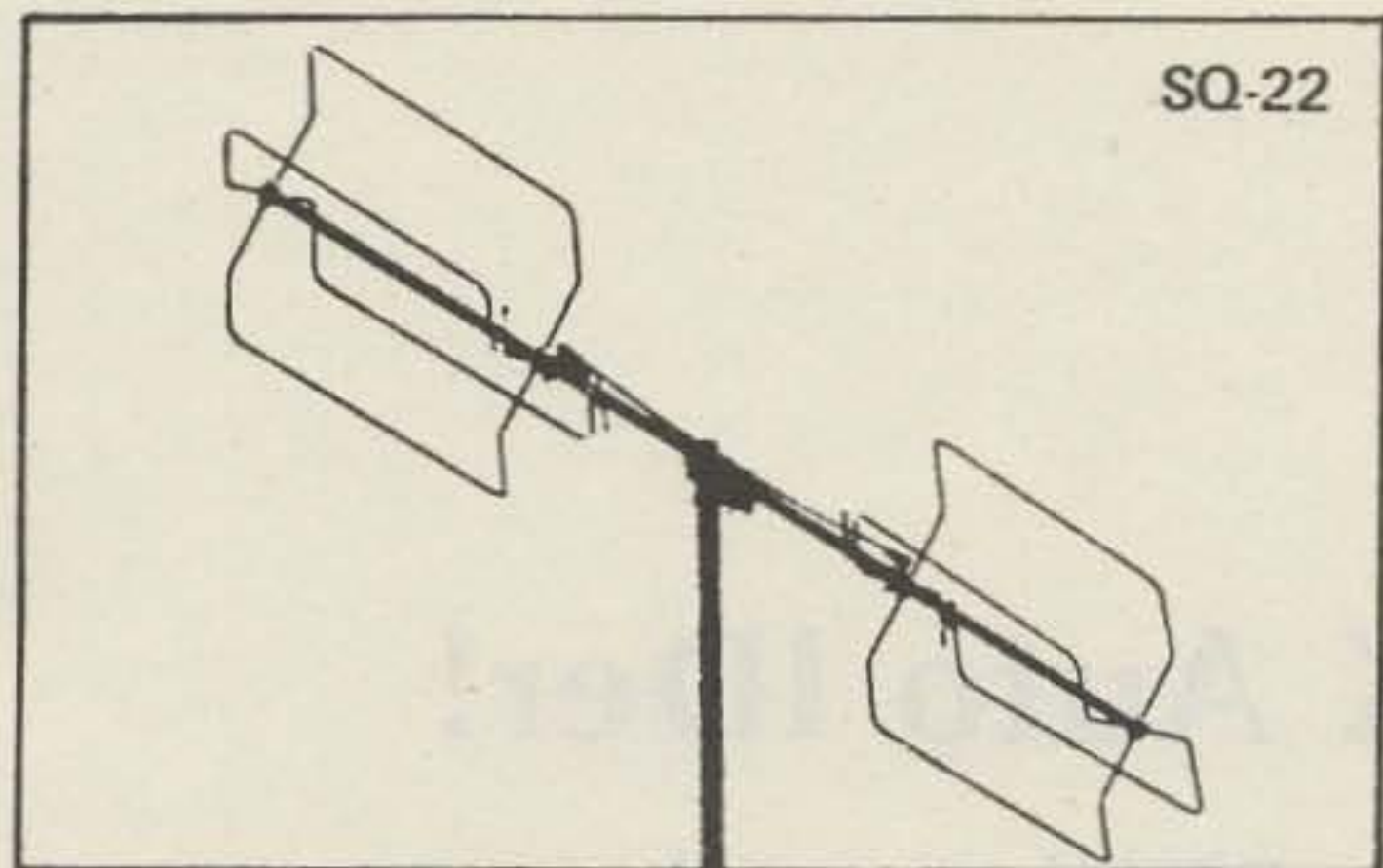

PORTABLE TOWER—
EASY TO ERECT ANYWHERE!!

GOOD DX HUNTING

- Light Weight
- High Stability
- High Quality

Aluminum Alloy

- 3 Sizes Available

- Inc 2½" thrust

Bearing

- SQ22 \$45.95
- SQ10 \$59.95
- TE35A 11.6' tower \$149.95
- TE55B 18' tower \$214.95
- TE75C 25' tower \$279.95

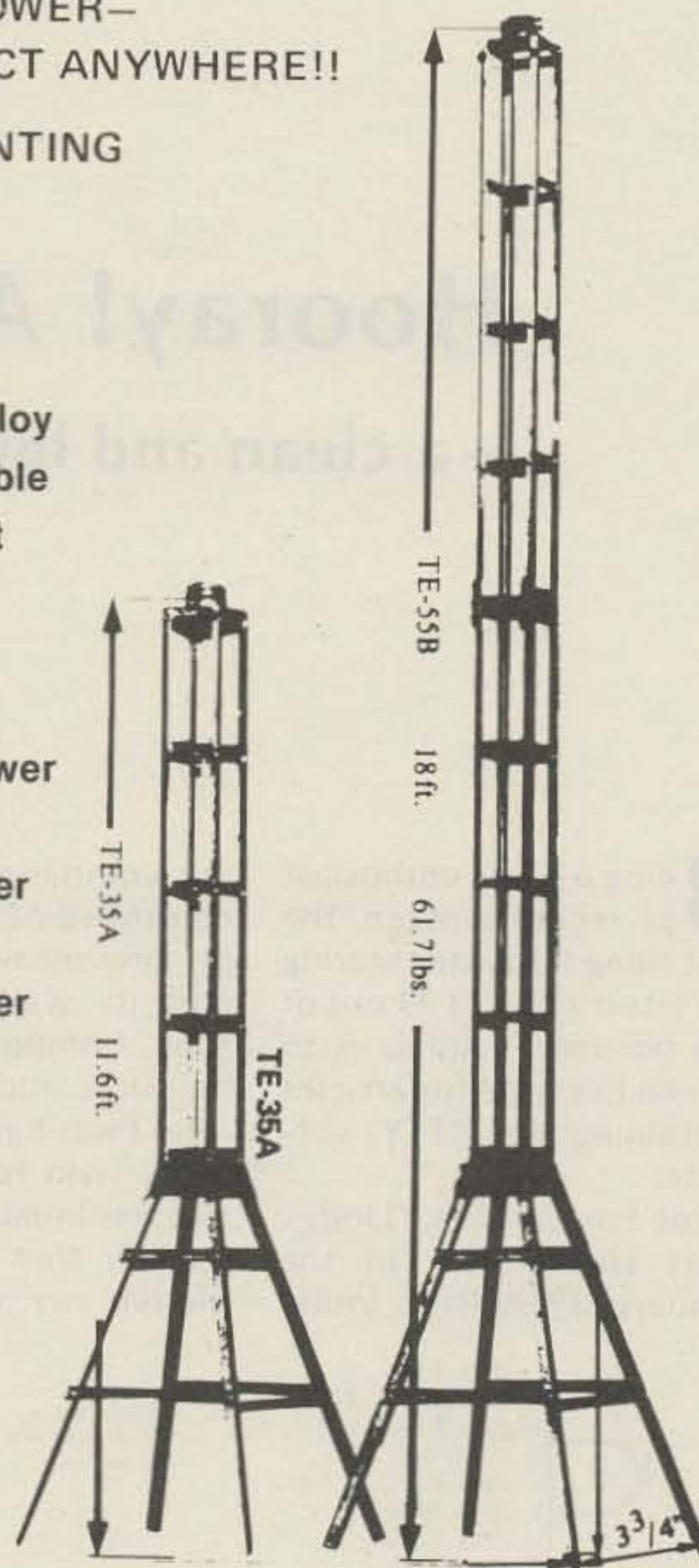

ANTENNA GAIN AND FRONT-TO-BACK RATIO ARE WELL IMPROVED WHEN TWO ELEMENTS ARE DRIVEN AT ONE TIME WITH PHASED DIFFERENCE COMPARED TO A SINGLE DRIVEN ELEMENT SUCH AS A CONVENTIONAL QUAD OR YAGI. THE SQ-22 AND SQ-10 PROVIDE THE OWNER WITH SUCH FEATURES AS SIMPLE ASSEMBLY AND LIGHT WEIGHT.



\$249.95



\$139.95



\$84.95



\$169.95



\$29.95

TOLL FREE # 1-800-654-3231



✓ 73

TET U.S.A., INC.



425 HIGHLAND PARKWAY, NORMAN, OKLAHOMA 73069 TEL: 405-360-6410

data output from pin 5, U5, to the opposite input. This routes data contained in the last 16 words of the PROM to the output pin of gate U6B. See Fig. 1.

This same line is inverted in U6C and applied to an input of U6A, whose opposite input receives data from the selector IC. This enables data in the first half of the PROM to be available at the output of U6A. These output lines are inverted data, just right to sink the inputs to the AFSK.

Our dual output problem being solved, attention is paid now to turning the circuit on and off. Neither Joe's use of a timer to periodically start the cycle nor his inhibit circuitry to delay the ID until the completion of incoming traffic was needed, so ICs U1 and U6 on his design were replaced by two NAND gates, U1A and U1B. These are wired in an RS latch configuration, the output connected to the reset input on counters U2 and U4.

With the latch reset, the output is high and holds the counters at zero. By grounding pin 2 of U1B, the latch is set and the output goes low, allowing the clock to step the counters, addressing the PROM and data selector IC.

The 8-input NAND gate, U8, whose inputs monitor all the address lines, senses when the counters are full. When all address lines are high, the output of U8 goes low and resets the latch, completing the cycle.

Checkout of the unit at this point provided perfect RTTY ID, but the CW came forth at blazing speed. A way to reduce the CW speed was deemed necessary. Back to the drawing board.

The only way to slow down the CW speed is to decrease the clock speed. Looking again at pin 9 of U5, this level, high during

the last half of the cycle, is used to turn on Q1. This simply switches in additional capacitance across the clock timing circuit just for the duration of the CW ID. Eureka! Slow CW! The value of this capacitance can be selected to produce the speed desired.

Construction

Considering the blood, sweat, and tears that went into the production of the printed circuit board for the AFSK, I conceded that I was not yet ready for the second round, so the ID board was wire-wrapped on a piece of perfboard with an edge connector attached. This system proved convenient in troubleshooting a few gremlins that showed up in the form of a bad counter IC and a mislabeled IC pin on the original schematic.

Parts placement is not critical, but be sure to scatter a few .1-uF disc capacitors around to soak up the spikes. My layout is shown in Fig. 2.

The PROM

The 8223 or 82S23 is a 256-bit programmable read-only memory. The PROM outputs 32 words of 8 bits each.

In laying out the program for your PROM, a truth table (Fig. 3) should be prepared. This type of device is the fusible-link

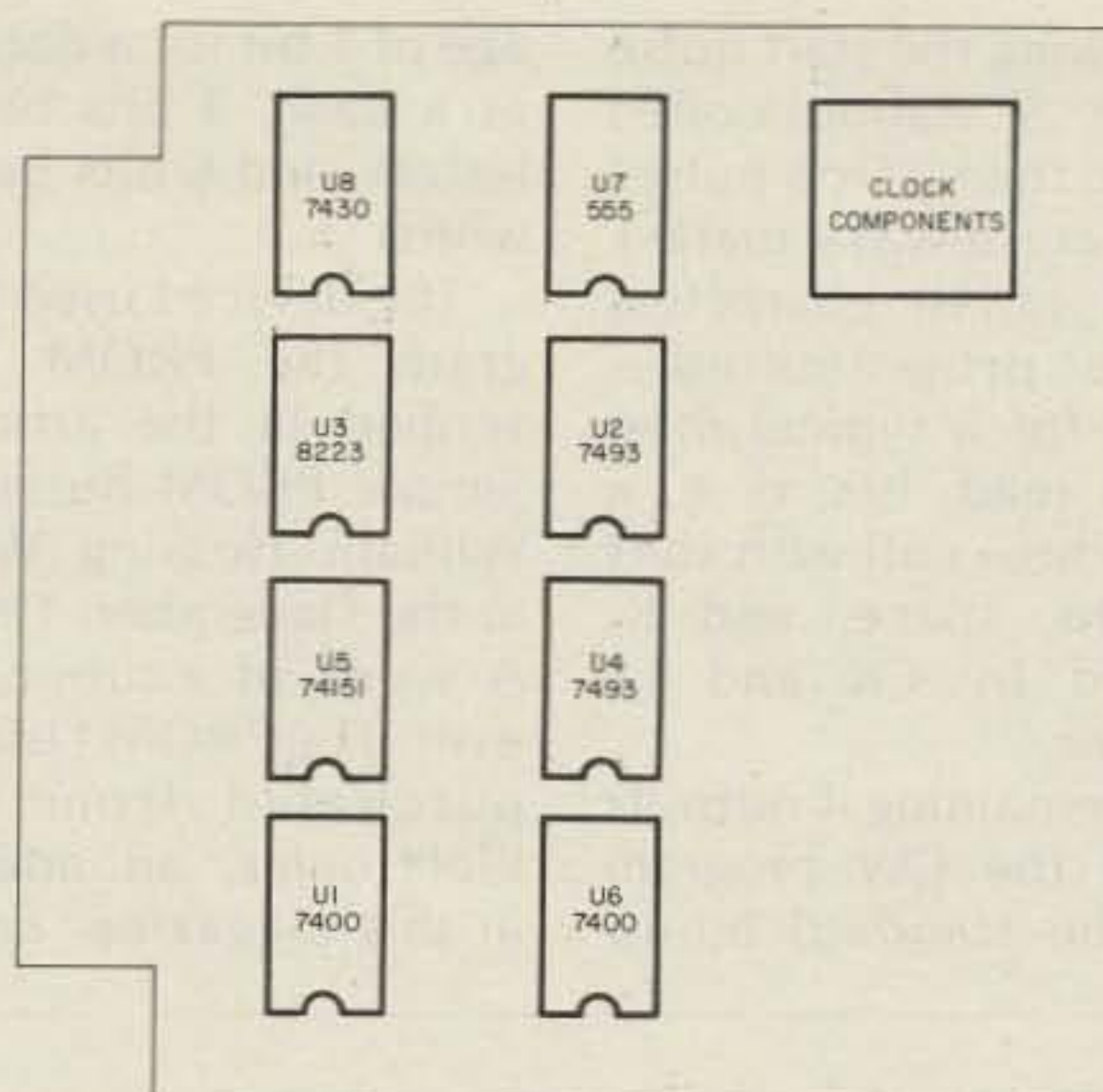

Fig. 2. Suggested component layout.

type where once a bit is programmed, it is irreversible. The truth table will reduce the chance of a misplaced bit. The device is delivered with all memory locations low, and when a bit is "burned" into it, that bit will appear as a logic high output. In our IDer, the low is used as a mark with the high levels indicating a space and CW output.

The IDer described here scans the entire contents of the PROM one bit at a time, starting with output 0. For the first 31 clock cycles, the 74151 data selector selects the PROM output at output 0 and transfers this data inverted to output pin 5. At the 32nd count, the data selector is instructed to select data from the output 1 output. For the following 31

cycles, all output 1 data is transferred to the output, then on to output 2. This sequence continues until all bits of each address are scanned. When the counters are full, the count is reset by gate U8, and its output pulse resets latch U1, which completes the ID cycle.

Programming the PROM

The first 4 outputs contain the Baudot information, with each character and function occupying 8 bits of data. The first bit, the start pulse, is always a space. Note that PROM address 0 contains all mark levels with the start pulses beginning at address 1; this is necessary to ensure no output from the IDer while being held at zero by the latch.

OUTPUTS	PROM Address																																	
	0	1	2	3	4	5	6	7	8	9	0	1	2	3	4	5	6	7	8	9	0	1	2	3	4	5	6	7	8	9	0	1		
											1	1	1	1	1	1	1	1	1	1	2	2	2	2	2	2	2	2	2	2	3	3		
0	M	S	-	-	-	-	-	M	M	S	-	-	-	-	M	M	S	-	-	-	-	M	M	S	-	-	-	M	M	S	-	-	-	M
1	M	S	-	-	-	-	-	M	M	S	-	-	-	-	M	M	S	-	-	-	-	M	M	S	-	-	-	M	M	S	-	-	-	M
2	M	S	-	-	-	-	-	M	M	S	-	-	-	-	M	M	S	-	-	-	-	M	M	S	-	-	-	M	M	S	-	-	-	M
3	M	S	-	-	-	-	-	M	M	S	-	-	-	-	M	M	S	-	-	-	-	M	M	S	-	-	-	M	M	S	-	-	-	M
4					S	S	S	S	S	S					S							S	S	S	S	S	S							
5			S	S	S	S	S	S	S	S	S	S	S	S						S	S					S	S	S	S	S	S			
6	S	S	S	S																														
7																																		

Fig. 3. PROM Truth Table. M = logic 0, S = logic 1. Unmarked positions in CW portion of program remain marks. Fill in dashed data from RTTY character table.

Following the start pulse are the 5 Baudot-coded bits, and then 2 stop pulses (which are always marks). A total of 16 characters can be programmed—enough for a typical message to read, ltrs, d, e, a two-by-three call with shift functions, space, and K, followed by CR and LF functions.

The remaining 4 outputs contain the CW program using the standard bit-us-

age of 1 bit for a dot, 3 bits as a dash, 3 bits between letters, and 6 bits between words.

The device I used to program the PROM is described in the article "A Simple PROM Burner," by William Hosking W7JSW, in the December, 1977, 73. A word of caution, however. The PROM I used was purchased from Quest Electronics, an advertiser in this magazine, and was

marked as an 8223. I was unable to get it to accept a program—a problem described in Mr. Hosking's article. Using his advice, the programmer was changed to 82S23 type. The device then accepted the program easily, regardless of its marking.

Operation

For operation, the board needs to be supplied only +5 V, ground, the outputs

connected to the AFSK generator, and a push-button switch to momentarily ground pin 2 of U1. The IDer will do the rest.

The clock oscillator must be set to the Baudot frequency used, 22 ms for 60 wpm, 18 ms for 75 wpm, or 11 ms for 100 wpm.

My thanks to Joseph Fox WB4IXK for his excellent article—which inspired me to write this piece for 73. ■

Edward D. Hesse WB2RVA
2134 Decker Avenue
North Merrick NY 11566

Let's QSY to .52

— ah, technology

"So you've got that new two-meter rig you wanted, huh, Joe?"

"That's right, Ernie. A fantastic rig. Fully synthesized, too. Lets you go anywhere you want on the band."

"Fine business, Joe. Hey, let's not tie up the repeater with this QSO. Since you're synthesized, let's go to a simplex channel. What do you say?"

"Right, Ernie. Okay, let's try 146.52. How about that?"

"Well, Joe, they like to keep .52 clear for calling. They get kinda annoyed if you rag chew on .52."

"Yeah, that's right. Okay, how about 146.55?"

"Not a bad idea, Joe, but lately they've been using .55 for RTTY. We could talk on .58, I guess."

"Uh-uh, Ernie. I was just

on it a moment ago and there's a bunny hunt about to start on it."

"Yeah, yeah. Say, you can go off on a 5-kHz offset, can't you?"

"Sure can, Ernie. Want to try, say, .535?"

"Naw. Just checked it a few minutes ago. Two guys are chewing the rag down there. How about .565?"

"Just checked it while you were transmitting. Someone's calling CQ DX on it. Must be a band opening tonight."

"Can you go up to 147?"

"Sure can, Ernie, this Hara-kiri-400 goes anywhere. How about 147.51?"

"Sorry, Joe, that's a problem, too. .51 is our club's simplex channel. They like to keep it clear for club business—stuff like that."

"Okay, I can understand that. Let's try .54. What

say?"

"Well, they've been using that for highway traffic for the east-west roads. Sort of reserved for mobiles, you know?"

"Yeah, I can see that. Well, how about .57?"

"Well, that's for north-south road traffic. How about 147.525? That should be clear, right?"

"Sorry, Ernie. The Bugville net is passing traffic on it right about now."

"Boy, things are getting tight, Joe. I'd suggest .555 but I'm afraid someone will let me know 'the frequency's in use, old man.' Say, how about going somewhere between 146.40 and 146.60. That's simplex, isn't it?"

"Hold it, Ernie. There are some repeaters in that area, operating on one meg splits. We don't want to go

simplex on an input frequency. How about going below 146? That's all simplex, isn't it?"

"No, sir. They've got repeaters there, but I don't know what frequencies are involved. Also, sidebanders, CWers, and AMers are roaming around down there. Say, Joe, just got a real inspiration. Should have thought of it before."

"Well, come on. Where do we go?"

"Joe, 15 meters is dead this time of night. Let's QSY to 21.365 and we'll chew the rag down there."

"Fine business, Ernie, see you on 15. I want to tell you all about this 2-meter rig, especially the synthesizing. Just a super rig. You can go anywhere you want on that band. I'll tell you all about it—we're QSYing." ■

HAM RADIO CENTER HAS BRANCH STORES ALL OVER THE COUNTRY

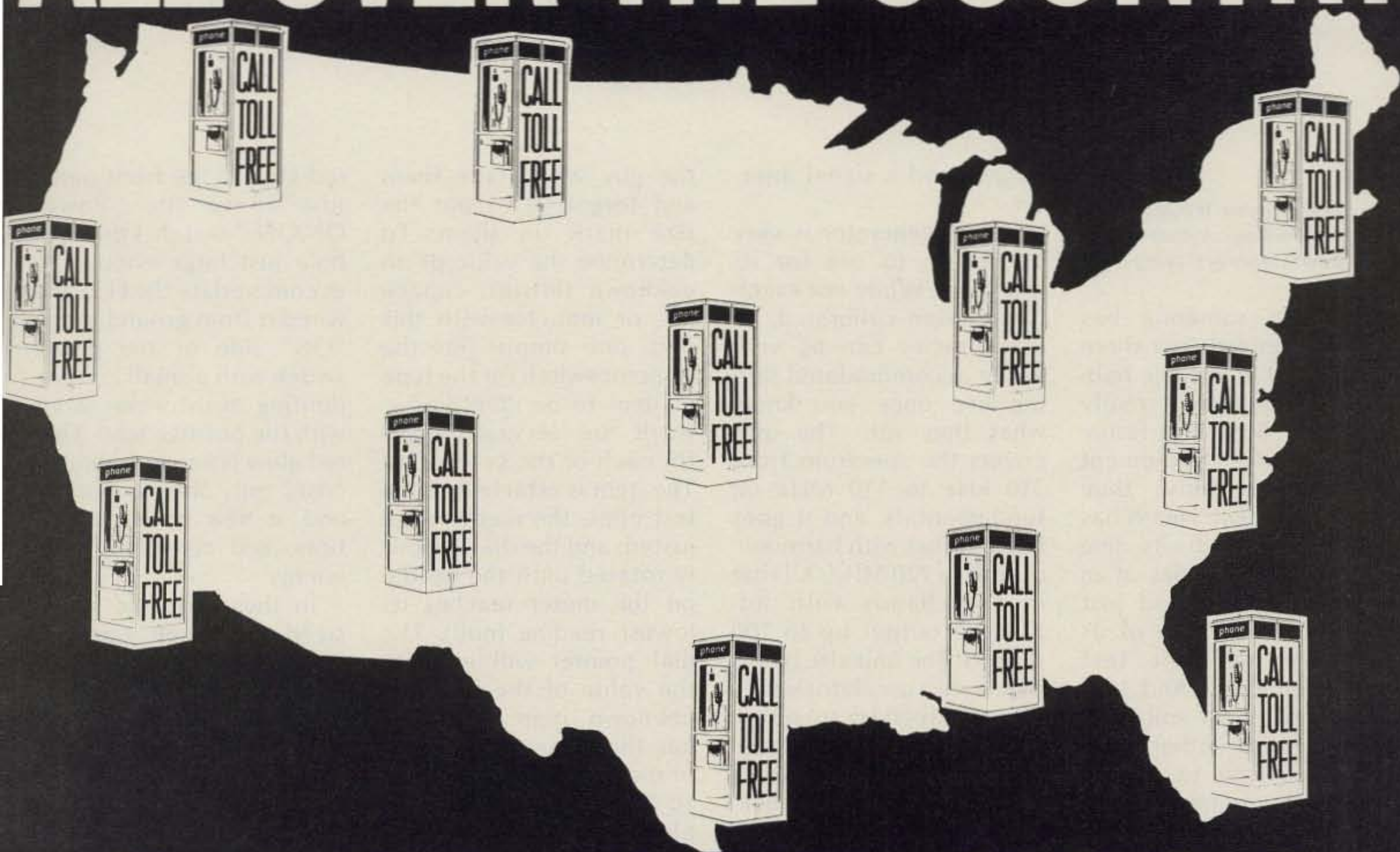

1-800-325-3636

FOR

BEST PRICE — FAST DELIVERY

HAM RADIO CENTER

8340-42 Olive Blvd • P O Box 28271 • St Louis, MO 63132



Five Test Equipment Bargains from Heath

— the 5280 series features plenty of measuring power per dollar

*D.E. Wagner W2QFC
308 Parkdale Avenue
East Aurora NY 14052*

At last someone has recognized that there are a lot of electronic hobbyists who do not really want to buy big fancy pieces of test equipment for the few times they might use them. Heath has the answer with its line called the 5280 series, at an affordable price and just the ticket for those of us who are part-time test equipment users. And, best of all, no longer will it be necessary to either hunt down a friend to borrow from or visit or pay through the nose a high hourly rate for a professional to do the job for you. Each piece is just \$37.95, and there are five of them in the series plus a power supply for those who prefer not to use battery power. So far, I've built the signal generator (Heath calls it an rf oscillator) model IG-5280 and the RCL bridge model IB-5281. They work just great and are extremely easy to build and to use. They also have available an audio frequency generator, a great-looking volt/ohm/mil multimeter and excellent

ranges, and a signal injector.

The rf generator is very impressive to use for its low price. While not exactly precision calibrated, its inaccuracies can be very easily accommodated during use once you know what they are. The unit covers the spectrum from 310 kHz to 110 MHz on fundamentals, and it goes beyond that with harmonic output to 220 MHz. All that in five bands with adjustable output up to 100 mVrms. The unit also has its own audio oscillator with a pleasant 1000-Hz tone that can be switched to modulate the rf oscillator (a great help for identification in a band full of signals) or can be used as an audio signal generator. It, too, has a variable output of up to 2 volts rms.

The RCL bridge is something I should have had many years ago as I recall the many resistors, capacitors, and inductors that were discarded because they were unmarked. In these days of low-priced kits of assorted parts, many of them unmarked, comes a reasonably priced kit from Heath making it possible for you to know as much about the parts as

the guy who made them and forgot (?) to put the size mark on them. To determine the value of an unknown resistor, capacitor, or inductor with this unit, one simply sets the selector switch for the type of item to be identified—there are several ranges for each of the categories. The item is attached to the test clips, the meter is adjusted, and the dial is slowly rotated until the needle on the meter reaches its lowest reading (null). The dial pointer will indicate the value of the formerly unknown item. The unit has three ranges for each of the three categories, i.e., 10 Ohms to 10M Ohms, 10 pF to 10 uF, and 10 uH to 10 Henries. It may also be used for exact matching of any two or more items.

Power for these kits is provided by a power supply (\$24.95) or each of the units may be powered by two nine-volt "transistor-radio-type" batteries. I chose the latter and regretted it the second time I wanted to use the RCL bridge. The batteries were dead; I had neglected to turn the thing off! This prompted me to devise a very simple "power on" indicator by adding a small

red LED to the front panel just above the "Power ON/OFF" switch. I drilled a hole just large enough to accommodate the LED and wired it from ground to the "ON" side of the power switch with a small current-limiting resistor in series with the positive lead. That red glow is a sure reminder, costs only a few pennies and a few moments of time, and consumes little energy.

In these days of small-sized equipment, I am not impressed with the large cabinet for these kits. They all use the same type case, but it does have a lot of convenient storage space. Don't overlook the great advantage of portability of these units when battery powered. Field days, emergencies, vacations, or work time on the mobile rig finds these units perfect, rugged, and portable. The kits build easily; the instructions are about the most extensive I have seen from Heath, or anyone else for that matter. They include many illustrations, circuit drawings (some greatly enlarged), and a very explicit discussion of exactly how the circuit works and what it does when testing parts. ■

COMPACT RTN

TU-170

\$159.95 buys a terminal unit kit with capabilities beyond your expectations for the price. And

the Flesher Corp TU-170 won't devour your precious space. Wired units are available at \$234.95. Call or write today for our free 1980 catalog of affordable kits, wired units and accessories.



FLESHER CORP ✓23

P.O. Box 976 • Topeka, Kansas 66601 • 913 • 234 • 0198

TWO REALLY GREAT ANTENNAS

THE JOYSTICK VFA (Variable Freq. Antenna) claims unbeaten scoring over commercial and/or conventional antennae.

• Simple, rapid erection • Not only 6-band but CONTINUOUS 0.5 - 30Mhz., incl. BC & MARS • Omni-directional • Substantially Harmonic FREE • 1,000,000 miles per watt, world record! • Poor QTH's enhanced! CLIFF DWELLERS DREAM ANTENNA! • QUOTE from RADIO ZS (South Africa): "A remarkable antenna with great possibilities. Its physical size makes confined space operation a practical proposition."

SYSTEM 'A' \$110.00
150 W.P.E.P. &/or Receiving only

SYSTEM 'J' \$130.00
500 W.P.E.P. &/or Improved Q Factor Receive

UP-DATE FOR THE EIGHTIES
NEW JOYMASTER

You get all the JOYSTICK VFA top-notch capability plus the JOYMASTER BONUS of EARTH INDEPENDENCE. This new system gives you TUNED ARTIFICIAL EARTH radials on ham bands 80 thru 10. Now snap your fingers at 99% of QTH problems!

SYSTEM 'JM1' \$147.00
150 W.P.E.P. &/or Receiving only

SYSTEM 'JM2' \$162.00
500 W.P.E.P. &/or improved Q Factor Receive

JOYSTICK VFA OWNERS, update your system to JM1/JM2 for \$86.00 and \$101.00, respectively. Rush Master-charge/Visa no. or check or request FREE literature. All goods assemble easily from the pack — then you have your REALLY COMPACT ANTENNA SYSTEM. Matching ATU's. Air mail cost incl.

PARTRIDGE ELECTRONICS LTD
8, Partridge House,
G3CED Broadstairs, Kent, England. **G3VFA**
Tel: 011 44 0843 62535

Please send all reader enquiries directly

DUPLXERS



US PATENT
4080601

✓79

OUR NEW BANDPASS-REJECT DUPLEXERS WITH OUR EXCLUSIVE

BpBr CIRCUIT*

... provides superior performance, especially at close frequency spacing.

Models available for all Ham bands. Special price for Amateur Repeater Clubs

CALL OR WRITE FOR DETAILS:

WACOM PRODUCTS, INC.



P. O. Box 7127
Waco, Texas 76710
817/848-4435 ✓79

Signalcrafters Presents The Most Advanced Automatic Computing Power Meters In Amateur Radio!



MODELS 31 and 32*

Our portable Models 31 and 32 feature the same state-of-the-art technology that is incorporated in their Big Brother, the Model 30. Never again will you have to bother with SWR "calibrate" controls and switches! Signalcrafters' custom integrated circuit makes power and SWR measurement a "handoff" operation by automatically computing SWR. The result is unparalleled accuracy and ease of operation.

FEATURES:

- **CUSTOM IC**—Computes SWR from the level sensed on the transmission line independent of the power level. This analog computer operates over a range of only one watt to the full scale of the meter with unequalled accuracy.
- **RUGGED TAUT-BAND METERS**—Provide accuracy and readability that must be seen to be appreciated.
- **HEAVY DUTY CABINETS**—Handsome heavy duty metal cabinets complement virtually every transceiver on the market today.
- **TWO MODES—PEAK OR AVERAGE**—The amateur may choose between either peak or average power readings.
- **POWER REQUIREMENTS**—Due to the advanced low current design, battery life is truly outstanding, making this meter a natural for portable or field day operation. Uses standard 9 volt battery or 120V AC with optional AC adaptor.
- **ATTRACTIVE AFFORDABLE PRICING**
*Model 31A (0 to 200w)
31B (0 to 20w)
..... only \$149.00
Model 32A (0 to 200w, 0 to 2000w)
32B (0 to 20w,
0 to 200w)
✓66 only \$169.00

SIGNALCRAFTERS, INC.
5460 BUENA VISTA DRIVE
SHAWNEE MISSION, KANSAS 66205
913/262-6565; TELEX 42-4171

All Signalcrafters products are designed, engineered, and produced in the U.S.A. Prices include shipping to all U.S.A. VISA and Master Charge accepted. Kansas Residents please add 3% percent.

The Phoenix Fix

— an alarming analog-to-digital conversion
for out-of-time clock-radios

In mythology, the Phoenix was a great bird from which, upon its death, was born a new Phoenix. How many times have you wished you could do that with electronic equipment? This article describes just such a transformation.

There can be little doubt that one of the most

widely-owned pieces of consumer electronics is the clock-radio. Almost everybody has one, and many have several. Certainly one of the most common types of clock movements is the "flipping card" display, as in the pictured Sony Digimatic. In this clock, a cylinder turns and sequen-

tially exposes cards with the digits printed on them to display the time. After a while, however, the movement becomes erratic as the motor seizes, and it eventually stops. Suggestions for re-starting a stuck clock abound, from spraying the gears with silicone to popping it in the oven. This article describes a better way.

The MA1001-A digital clock module has become available lately from several suppliers and is regularly featured in their advertisements. For around \$10, this module has all the features one could want in a clock-radio (time, sleep-radio, snooze-alarm, etc.) in a tiny package. With just a little work, this module, transformer and all, will fit easily into the space vacat-

ed by the old flipping card display.

Fig. 1 diagrams the connections to the module. Note the rather unusual voltage requirements, rather neatly supplied by the special transformer available from the dealers. Note also that the alarm output is not a tone, but a positive voltage intended to activate an external signaling device or tone generator. The LED display at 1.22 cm (0.5 inch) is quite readable, and no RFI is generated since direct drive rather than multiplex circuitry is employed. This eases the marriage with a radio.

The actual conversion is relatively straightforward. After removing the radio from its case, identify the microswitch connected to



The front of the clock-radio before modification.

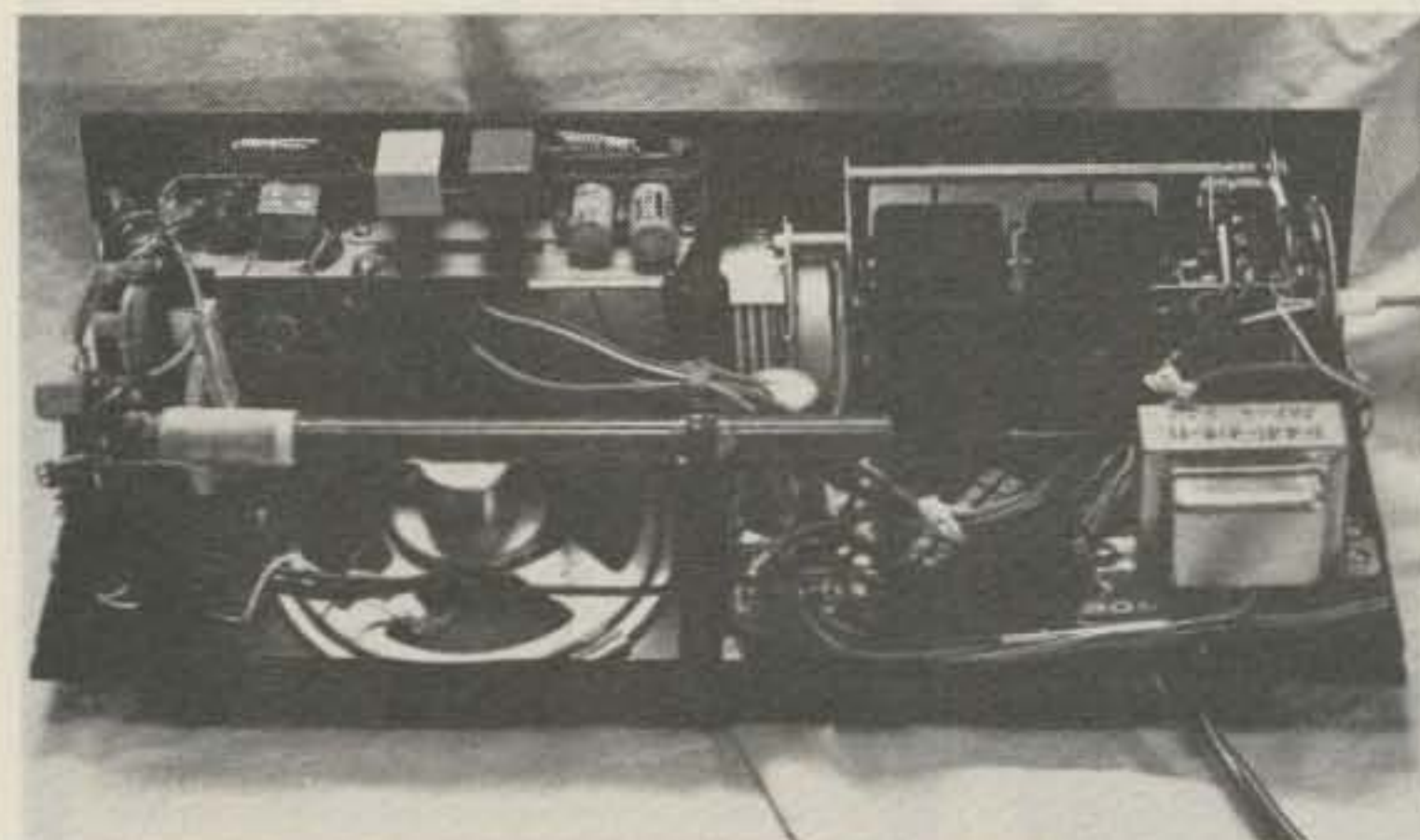

An open view of the clock-radio before modification.

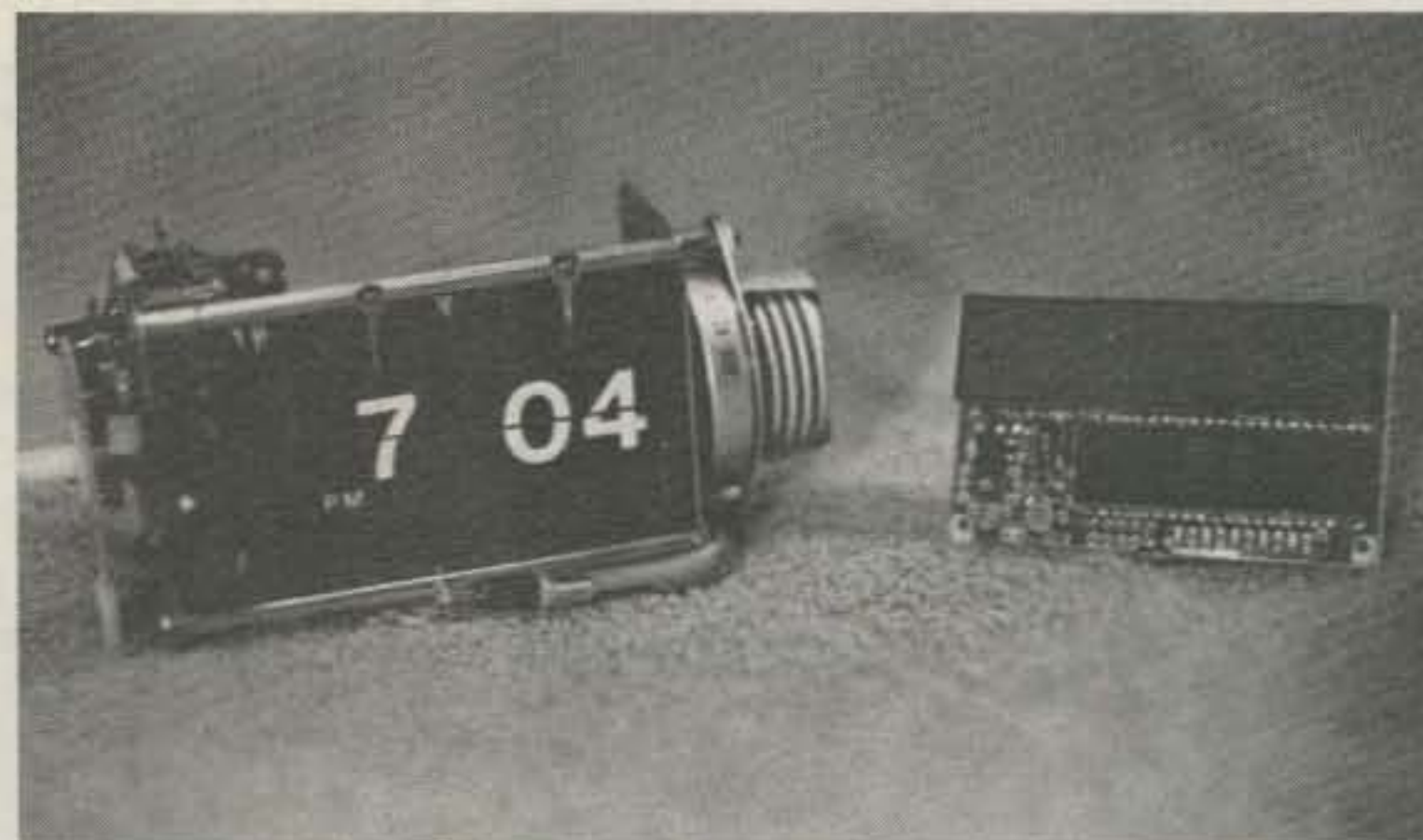

The old and the new side-by-side.

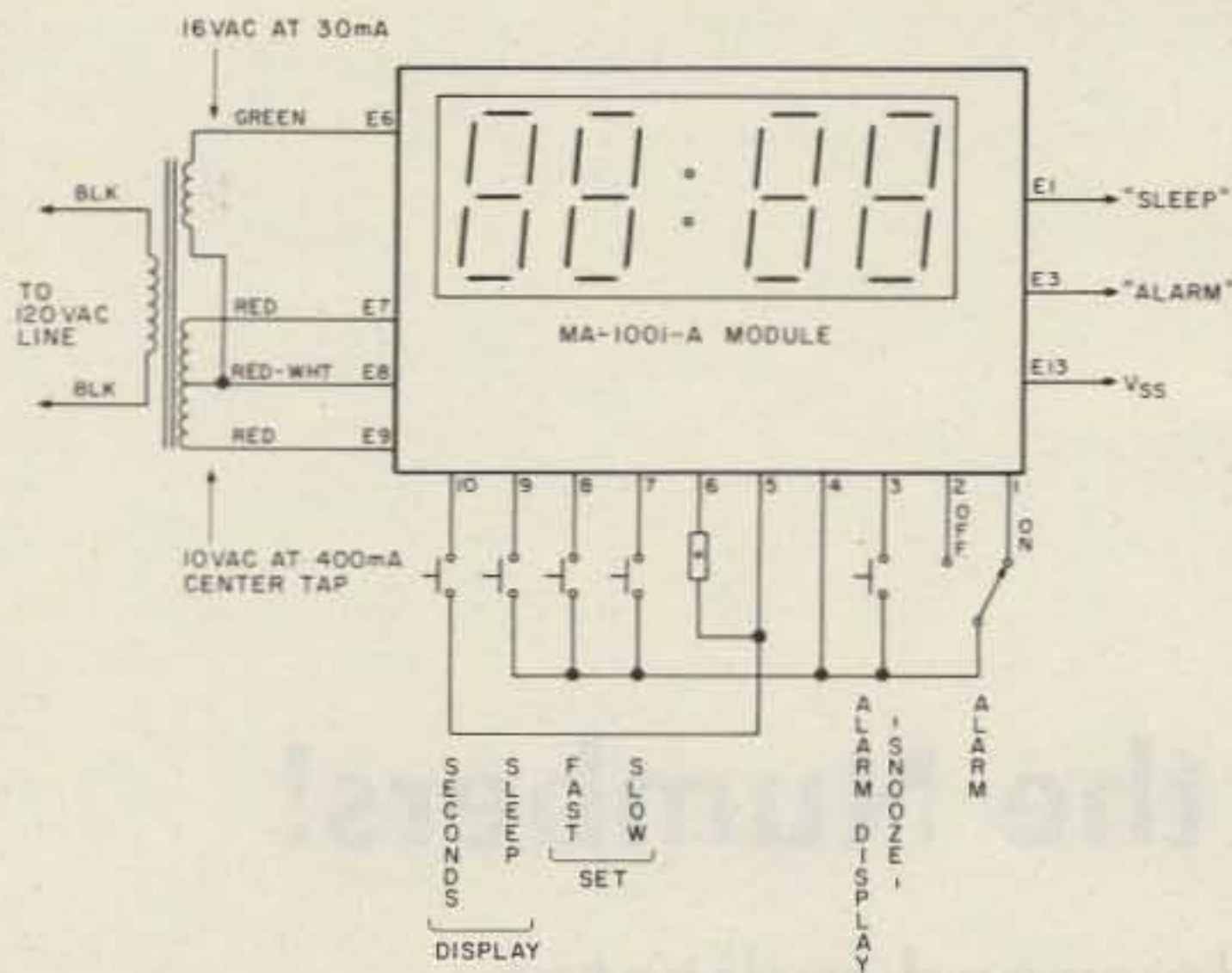

Fig. 1. MA1001-A connections. Use wire jumper at pin 6 location (*) for full brightness of LEDs, or a resistor and switch for variable brightness.

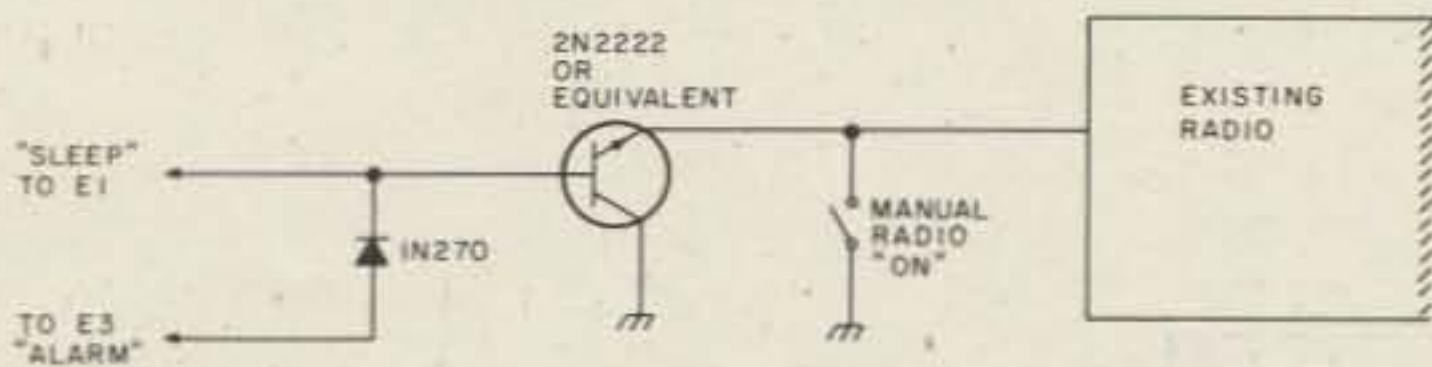

Fig. 2. Connecting MA1001-A to existing radio.

the Sleep lever. The contacts of this switch, when closed, enable the radio. If there is a separate manual radio switch, leave it alone! It will still work when the conversion is completed.

Put a tag on the enable line, remove the entire clock movement from the case, and discard it. Position the MA1001-A behind the panel opening. It was necessary to enlarge the opening in the prototype by removing a partition between the old display opening and the

alarm set-wheel. Decide on a location for the six required switches and transformer. In the prototype, the two control switches (Fast and Slow) were mounted underneath to prevent accidental use, and the Sleep, Snooze, and Seconds push-buttons were mounted on the top. The old Alarm/Radio switch existing on the chassis was used to enable the alarm mode.

Interfacing between the clock module and the radio is diagrammed in Fig. 2. With this arrangement,

either activation of the Sleep mode or Alarm output will enable the radio. If untimed radio activation is desired, the original manual switch retains control.

A great deal of information is available from the four-digit display. Two LED "dots" note pm (vs. am) and arming of the alarm.

Some may find this display too bright for bedside use at night. A poten-

tiometer, resistor-and-switch, or photocell arrangement can be inserted at the indicated point to effect brightness control of the display, if desired.

By means of this conversion, a useful piece of equipment can be returned to active duty. Besides being gratifying in its own right, this is one project that even the XYL will appreciate. Who could ask for anything more? ■

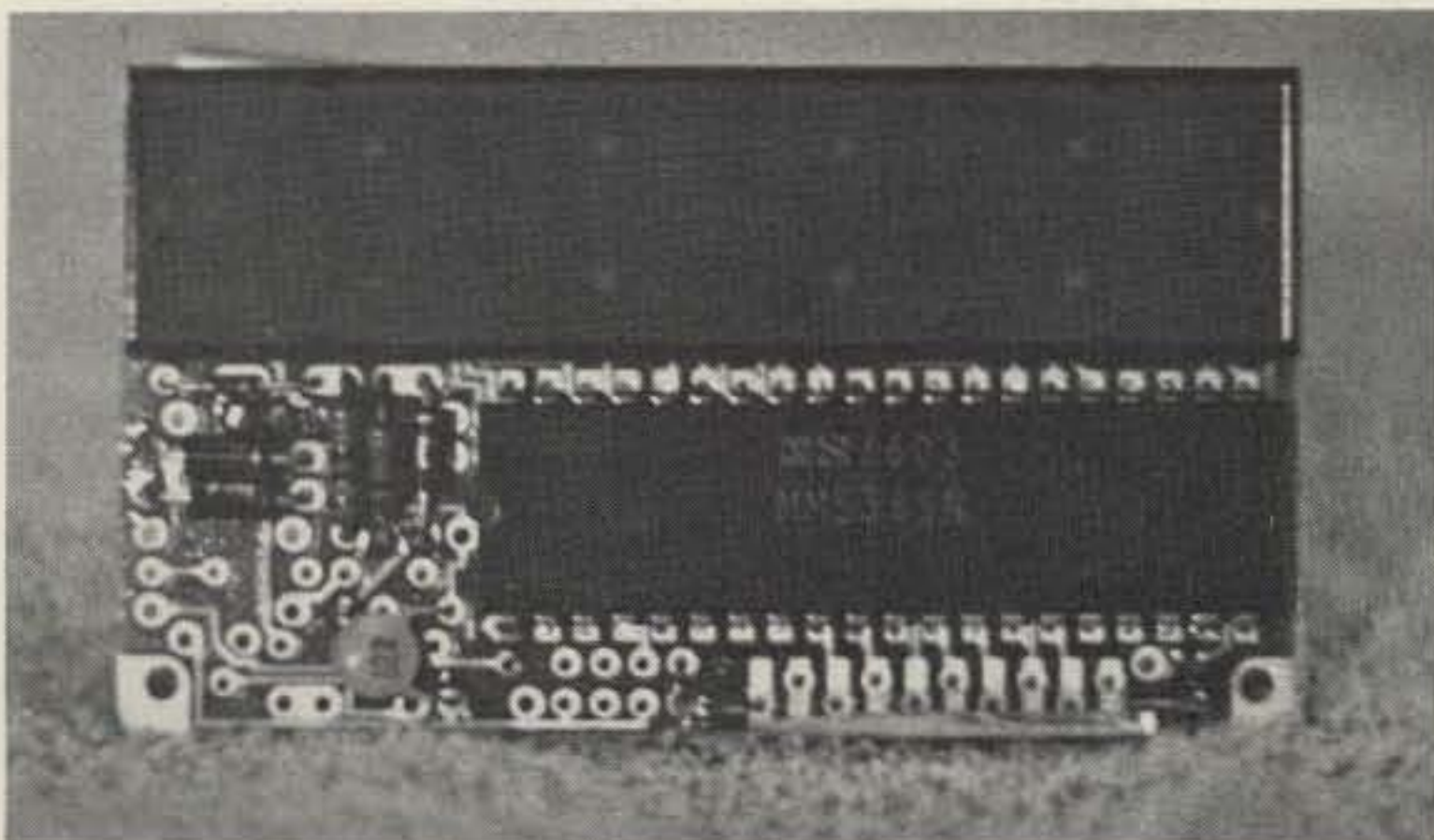

A front view of the MA1001-A module.

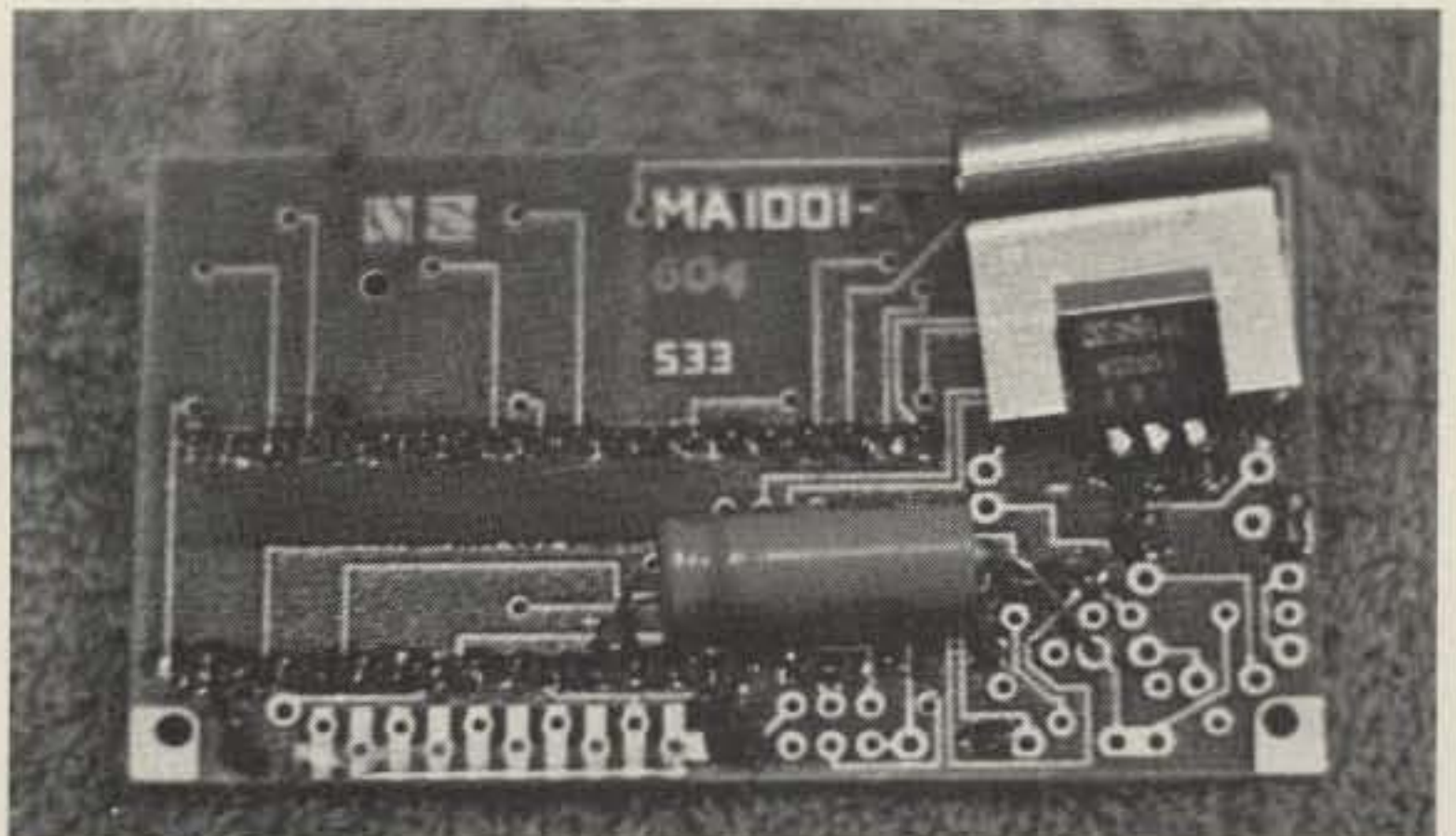

A rear view of the MA1001-A module.



GREGORY ELECTRONICS
The FM Used
Equipment People.

MOTOROLA USED NI-CADS

BENCH
TESTED



MX-300 Rapid 1 Hour Charge

NLN8834B (60-5201E01) **\$15⁰⁰**
Medium Capacity...

NLN8835B (60-5201E02) **\$20⁰⁰**
High Capacity...

HT-220 Omni-Housing Rapid Charge **\$15⁰⁰**
NLN6900ASP01 (60-5742E01)..

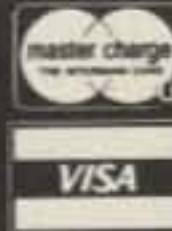

GREGORY ELECTRONICS CORP.

251 Rt. 46, Saddle Brook, N.J. 07662
Phone: (201) 489-9000

QRQ, QRS — By the Numbers!

— a digital CMOS code-speed indicator

Howard F. Batie W7BBX
12002 Cheviot Drive
Herndon VA 22070

With many electronic keyers and a wide variety of do-it-yourself circuits now available,^{1,2,3} this direct-reading code-speed indicator calibrated in words per minute should find its way into a good many shacks. Whether used for code practice or on-the-air operation, now you can tell your sending speed easily at a glance. In addition, this versatile unit can be used as an accurate event counter for a range of about 5-99 counts per second.

Since the unit also has an input waveform conditioner, it has a high degree of noise immunity; the input keyer clock waveform which is counted may be sinusoidal, square, triangular, positive or negative-going pulses, or complex combinations of these, with

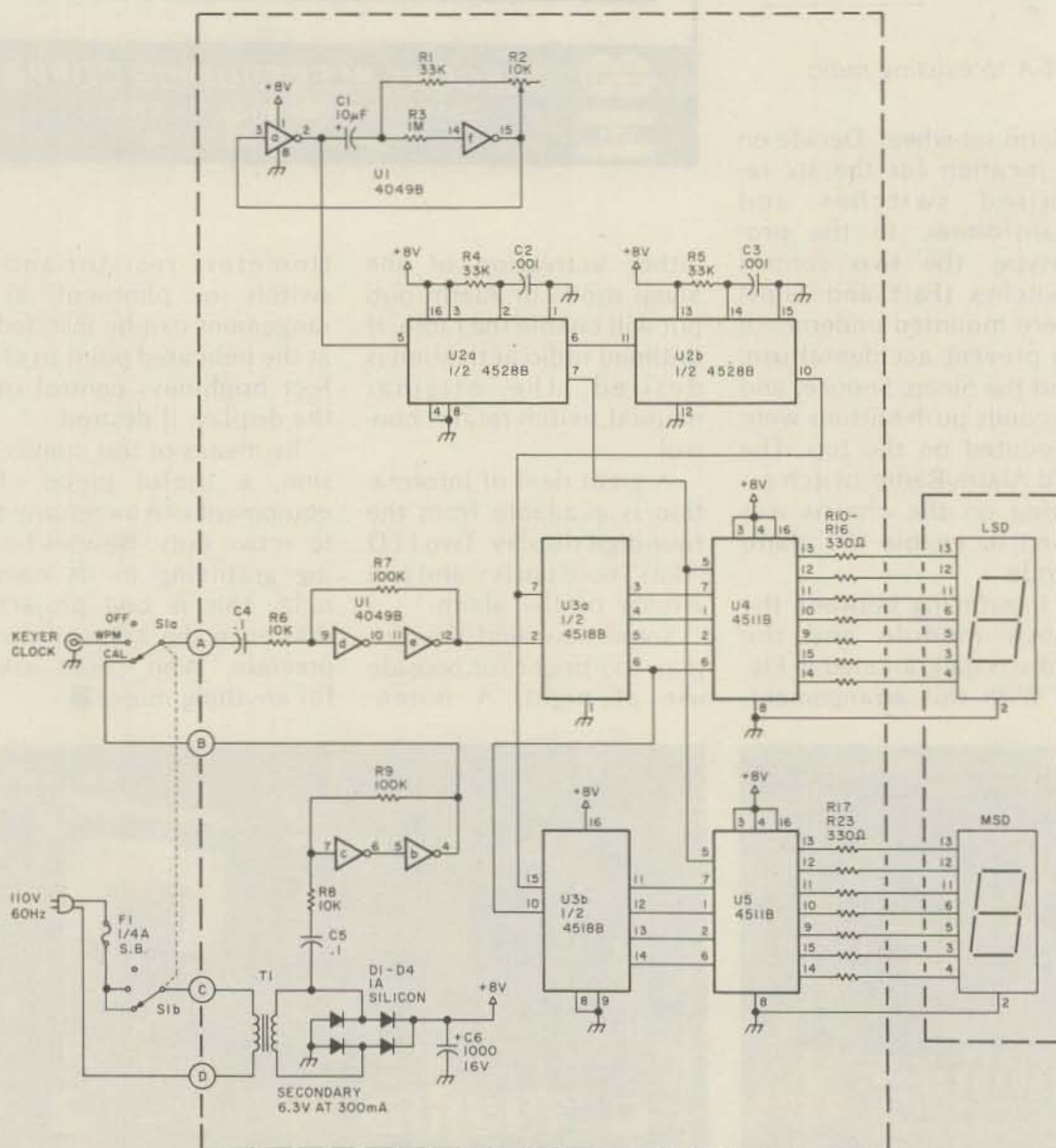

Fig. 1. Schematic diagram.

a peak-to-peak amplitude of from about 3½ to 20 volts. Being fully CMOS, the two 7-segment readouts are the only real contributors to current drain. But the best part is that the entire unit uses a minimum number of readily available parts, and it can easily be constructed for about \$25 if all parts are purchased new.

Fig. 1 shows the complete schematic for the code-speed readout. The circuit is basically a CMOS adaptation of an earlier TTL version described by Jones,⁴ but with many fewer components and a significantly smaller current requirement. For most electronic keyers which use a flip-flop dot generator,⁵ the code speed in words per minute is equal to the number of keyer clock pulses which occur in 1.2 seconds. With S1 in the WPM position, the keyer clock pulses are led from your electronic keyer to J1, conditioned by U1d and U1e, and fed to U3, a dual BCD counter. Each half of U3 drives a combination latch-decoder-driver for each digit. By this process, the number of clock pulses occurring in the 1.2-second interval ($f = 0.833$ Hz) generated by U1a and U1f are counted and displayed. Additionally, the readout display will be updated automatically every 1.2 seconds.

U1a and U1f are configured as an astable multivibrator with a period of from 0.8 to 1.05 seconds, the period being adjustable by R2. This multivibrator has a 50% duty cycle, and its frequency is very stable with large power supply fluctuations. The multivibrator output is taken from U1a pin 2 and fed to a dual monostable multivibrator (one-shot). With each falling transition of the U2a pin 5 input, a positive-going pulse of about 20 microsec-

onds is generated at U2a pin 6, and its complement at pin 7. When pin 7 of U2a goes low, the BCD count from both halves of U3 is latched into U4 and U5 where it is decoded into 7-segment format and displayed.

When pin 7 of U2a returns to a logic 1, pin 6 of U2a returns to a logic 0; this transition triggers U2b, and a 20-microsecond positive-going pulse resets both U3 counters to zero. As long as you continue sending, a synchronous keyer clock will continue to generate pulses and the count-latch-reset sequence of U3, U4, and U5 will update the display; when you stop sending, the keyer clock input also stops and 00 will be displayed on the readout. If your keyer has an asynchronous clock, it will continue to generate clock pulses whether you are sending or not; in this case, the speed at which the keyer is set will be continuously displayed.

C4 provides ac coupling from the keyer clock to the input conditioner R6-R7-U1d-U1e. This configuration of inverters is actually a high input impedance Schmitt trigger. The amount of hysteresis of the Schmitt trigger is determined by the ratio of R6 to R7, in this case, 10% of Vcc or about 0.8 volts.⁶ See Fig. 2.

Power is furnished to the entire circuit by a conventional full-wave rectifier bridge (D1-D4) and filter capacitor C6. One side of the transformer secondary is ac coupled to a second Schmitt trigger by C5. This Schmitt trigger, R8-R9-U1b-U1c, samples the T1 secondary voltage and produces a 60-Hz square-wave output at pin 4 of U1b. With S1a in the CAL position, the 60-Hz square wave is again conditioned by U1d-U1e and then counted and displayed by U3, U4, and U5.

This provides a means of calibrating the U1a-U1f oscillator to 0.833 Hz, or a period of 1.2 seconds; simply adjust R2 for a reading of 72 on the display (60 if your ac-line frequency is 50 Hz) and return S1 to the WPM position for direct calibrated readout of the keyer speed in words per minute.

The values of C1, R1, and R2 have been chosen to allow a U1a-U1f oscillation of 1.0 Hz, as well. With R2 set to display 60 on the readouts in the CAL position (50 if your ac-line frequency is 50 Hz), U3 is now being reset each second; therefore, when S1 is returned to the WPM position the readouts will display the number of input pulses per second (up to 99, directly).

The frequency-determining components R1, R2, and C1 can be adjusted as necessary to cover the range of 0.95-1.25 seconds, or other suitable intervals as desired. If your display will not read up to 72 when calibrating, increase either R1 or C1; if your display will not go down to 60, try de-

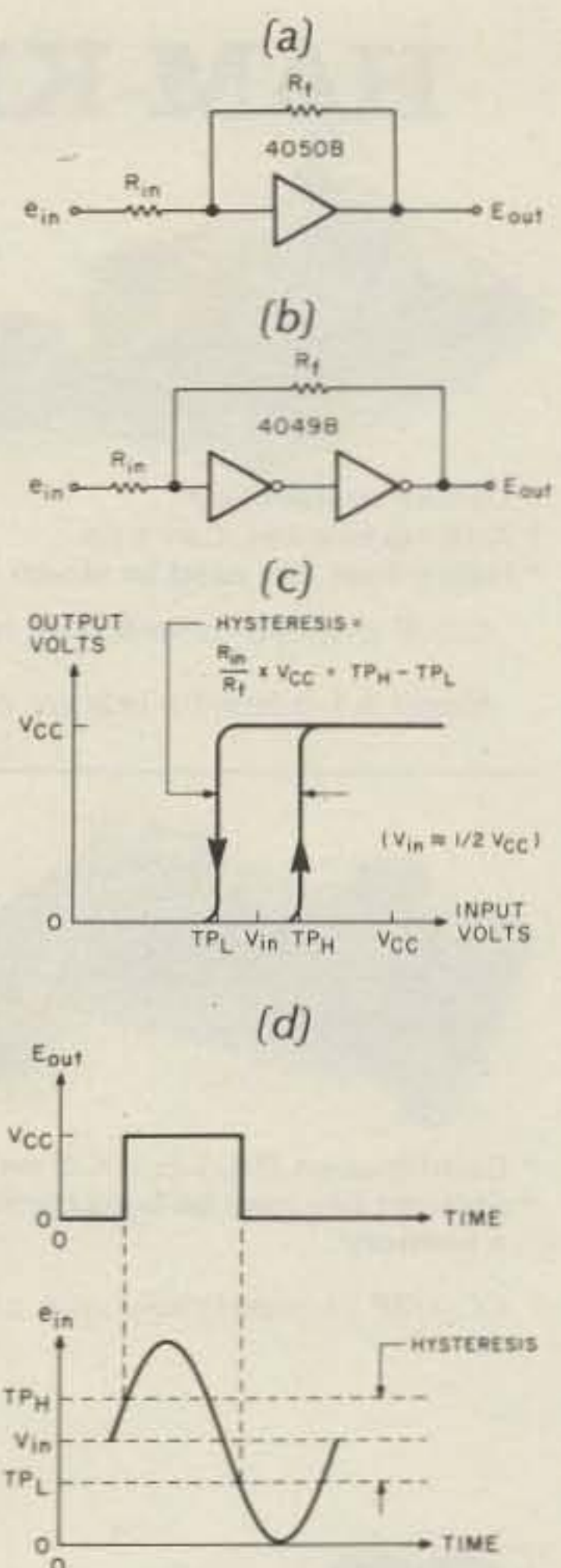

Fig. 2. CMOS Schmitt trigger characteristics. (a) Basic CMOS Schmitt trigger. (b) CMOS Schmitt trigger using inverters. (c) Schmitt trigger transfer characteristics. (d) Sinewave response.

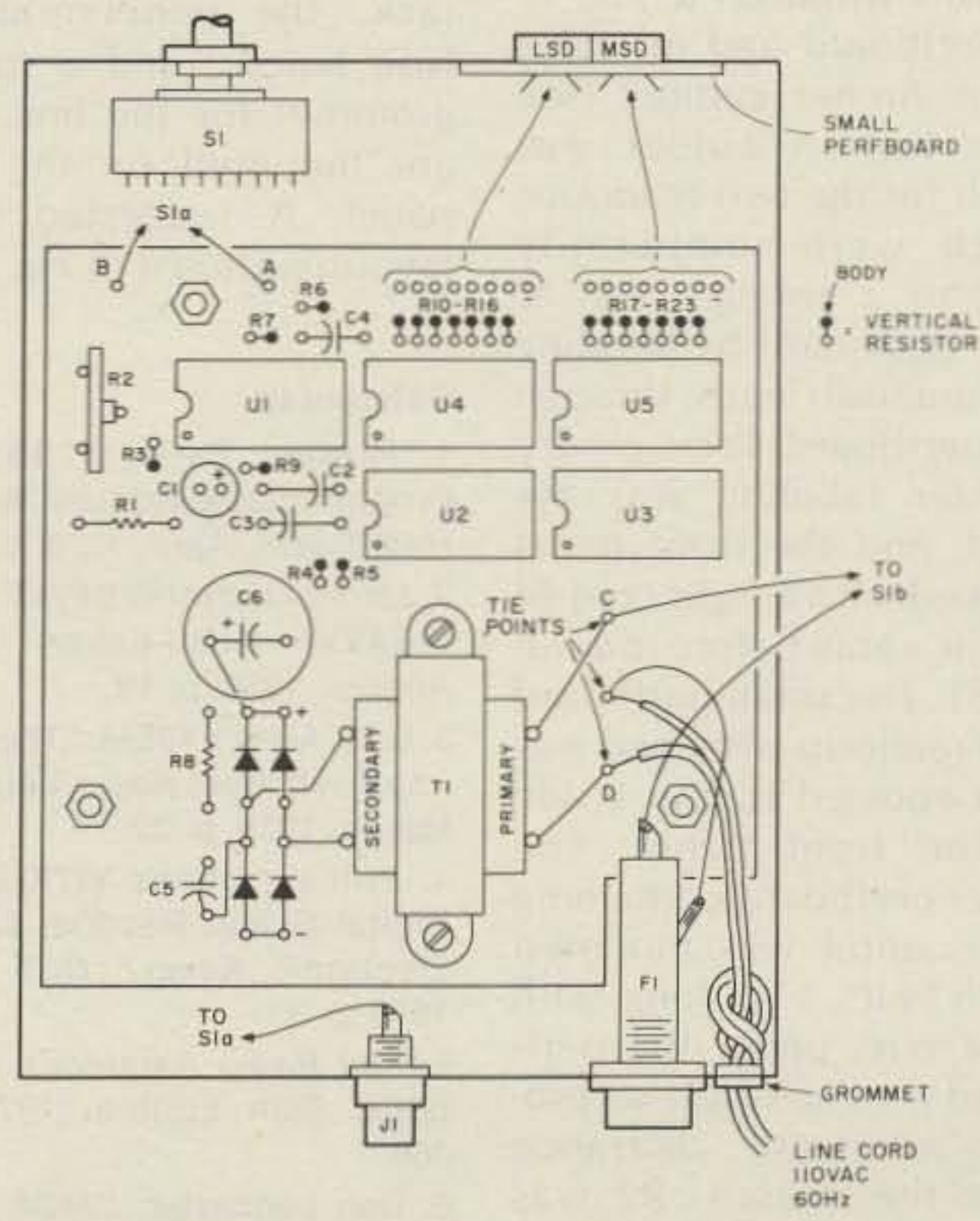

Fig. 3. Perfboard parts layout.

HAM-KEY™ RADIO TELEGRAPH SENDING DEVICES



Model **HK-3M**

\$19⁹⁵

Add \$2.00 Shipping & Handling.

- * Deluxe straight key
- * Anti-tip bracket. Can't tip
- * Heavy base. No need to attach to desk

- * Navy type knob
- * Smooth action

CC-3P shielded cable & plug for HK-3M \$2.49.

Add \$.50 Shipping & Handling.

Model AT-B anti-tip bracket only, to convert any HK-3 to HK-3M. \$2.99 Postpaid



Model **HK-1** \$29⁹⁵

Add \$2.00 Shipping & Handling.

- * Dual lever squeeze paddle
- * For use with all electronic keyers
- * Heavy base with non-slip rubber feet
- * Paddles reversible for wide or close finger spacing

CC-1P shielded cable & plug for HK-1 \$3.75

Add \$.75 Shipping & Handling.

Model HK-2, same as HK-1 but less base for incorporation in your own keyer. \$19.95

Add \$1.00 Shipping & Handling.

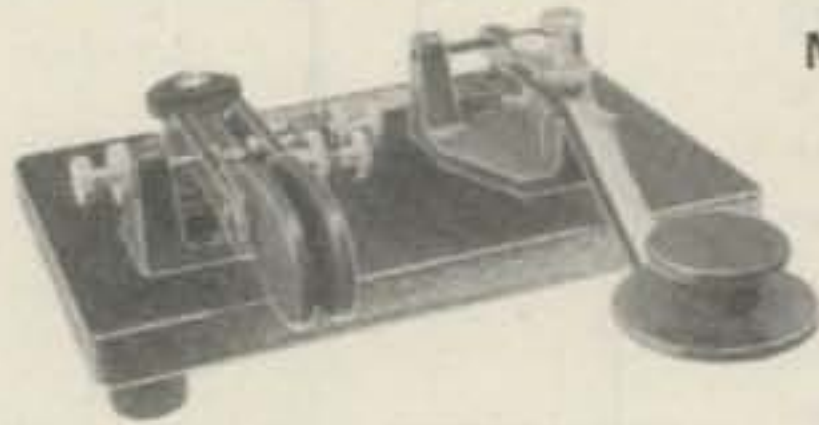

Model **HK-4**

\$44⁹⁵

Add \$2.00 Shipping & Handling.

- * Combination HK-1 & HK-3 on same base
- * Straight key may be used conventionally or as a switch to trigger a memory.

CC-1/3P Shielded cable with plugs for HK-4 \$5.99.

Add \$1.00 Shipping & Handling



Model **HK-5A** Electronic Keyer

\$69⁹⁵

Add \$2.00 Shipping & Handling.

- * Iambic circuit for squeeze keying
- * Self completing dots & dashes
- * Dot & dash memory
- * Built-in sidetone
- * Battery operated with provisions for external power

- * Uses Curtis 8044 keyer chip
- * Grid block or direct keying
- * Speed, volume, tone & weight controls on front panel
- * Use with HK-1 or HK-4

Order direct or from your favorite dealer. ✓ 30

The HAM-KEY Co.

P.O. Box 28271

St. Louis, MO 63132

Phone TOLL-FREE 1-800-325-3651



creasing R1 or C1 until both 60 and 72 can be displayed within the range of R2.

The entire unit, including T1, was wired on a 3 3/4" x 4" perfboard and installed in an Archer cabinet (see parts list). A cutout was made for the two readouts, which were temporarily held to a smaller 1 1/4" x 1 1/4" perfboard by bending the readout leads through the perfboard. Press-on dry transfer labeling was applied, and the front panel sprayed with a light coat of acrylic spray before mounting S1. The small perfboard with readouts attached was then epoxied to the inside of the front panel. The larger perfboard containing the counter was mounted on #6 bolts, 1 1/4" long, with three nuts under the perfboard on each bolt to provide adequate clearance from the chassis. R2 was mounted near the edge of the perfboard and a hole

was drilled in the side of the cabinet to permit calibration with a small screwdriver without removing the cover. J1, an RCA phono jack, the panel-mounted fuse holder, and a rubber grommet for the line cord are mounted on the rear panel. A suggested parts layout is shown in Fig. 3. ■

References

1. Howard Batie W7BBX, "A Programmable Contest Keyer," *Ham Radio*, April, 1976, p. 10.
2. James Garrett WB4VVF, "The WB4VVF Accu-Keyer," *QST*, August, 1973, p. 19.
3. S.M. Allen K4JEM, "The New, Improved 'Best Keyer Yet,'" *73*, March, 1978, p. 22.
4. William Jones W7KGZ, "A Digital Speed Readout for the Electronic Keyer," *QST*, July, 1978, p. 11.
5. *The Radio Amateur's Handbook*, 55th Edition (1978), p. 356.
6. Don Lancaster, *CMOS Cookbook*, Howard Sams & Co., Inc., 1977, p. 222.

Parts List

Component	Description	Archer Part No.	Qty.
C1	10-uF electrolytic	272-1025	1
C2, C3	.001-uF disc	272-126	1
C4, C5	0.1-uF disc	272-135	1
C6	1000-uF electrolytic	272-958	1
D1-D4	Si 1A diode	276-1101	2
F1	1/4-A Slo-Blo fuse	270-1288	1
J1	RCA phono jack	274-346	1
R1, R4, R5	33k, 1/4-Watt resistor	271-1341	1
R2	10k PC-mount trimmer	271-218	1
R3	1M, 1/4-Watt resistor	271-1356	1
R6, R8	10k, 1/4-Watt resistor	271-1335	1
R7, R9	100k, 1/4-Watt resistor	271-1347	1
R10-R23	330-Ohm, 1/4-Watt resistor	271-1315	3
S1	2P3T rotary switch	275-1386	1
T1	6.3-V ac/300-mA transformer	273-1384	1
U1	4049B CMOS IC	276-2449	1
U2	4528A or 4528B CMOS IC		1
U3	4518A or 4518B CMOS IC	276-2490	1
U4, U5	4511B CMOS IC	276-2447	2
	common-cathode 7-segment readout	276-062	2
Miscellaneous			
Cabinet		270-252	1
Line cord		278-1255	1
Panel-mount fuse holder		270-364	1
Perfboard		276-1394	1
#6-32 1 1/4" bolts			3
#6-32 1/4" bolts			2
#6 lockwashers			12
#6-32 nuts			14
Rubber grommet			1

When it comes to
**AMATEUR
RADIO QSL's...**



it's the
ONLY BOOK!
US or DX Listings

1980
callbooks
NOW READY!

Here they are! The latest editions. World-famous Radio Amateur Callbooks, the most respected and complete listing of radio amateurs. Lists calls, license classes, address information. Loaded with special features such as call changes, prefixes of the world, standard time charts, world-wide QSL bureaus and more. The new 1980 Radio Amateur Callbooks are available now. The U.S. Edition features over 400,000 listings, over 120,000 changes from last year. The Foreign Edition, over 315,000 listings, over 90,000 call changes. Place your order now.

	Each	Shipping	Total
<input type="checkbox"/> US Callbook	\$16.95	\$1.75	\$18.70
<input type="checkbox"/> Foreign Callbook	\$15.95	\$1.75	\$17.70

Order both books at the same time for \$34.65, includes shipping.

Order from your favorite electronics dealer or direct from the publisher. All direct orders add \$1.75 for shipping. Illinois residents add 5% Sales Tax.



SPECIAL LIMITED OFFER!
**Amateur Radio
Emblem Patch
only \$2.50 postpaid**

Pegasus on blue field, red lettering. 3" wide x 3" high. Great on jackets and caps. Sorry, no call letters.

ORDER TODAY!

✓61

RADIO AMATEUR
callbook INC.



925 Sherwood Drive
Lake Bluff, IL 60044



Radio equipment
not included

Also Available . . .
Floor Space: 51" Wide by 30" Deep
\$192.50

... at last ...
your shack organized!

A beautiful piece of furniture — your XYL will love it!

\$16450 S-F RADIO DESK
Deluxe - Ready to Assemble

Designed with angled rear shelf for your viewing comfort and ease of operation.

FINISHES: Walnut or Teak Stain.

Floor Space: 39" Wide by 30" Deep

Additional Information on Request.

Checks, Money Orders, BankAmericard
and Master Charge Accepted.

F.O.B. Culver City. (In Calif. Add 6% Sales Tax.)

DEALER INQUIRIES INVITED

S-f Amateur Radio Services

4384 KEYSTONE AVENUE • CULVER CITY, CALIF. 90230 — PHONE (213) 837-4870

SF

✓65

The BEST in Code Converters **THE INFO-TECH M200-F TRI-MODE CONVERTER**

Converts Morse
& RTTY
(Baudot & ASCII)
to video, and serial

Baudot or ASCII for hard copy

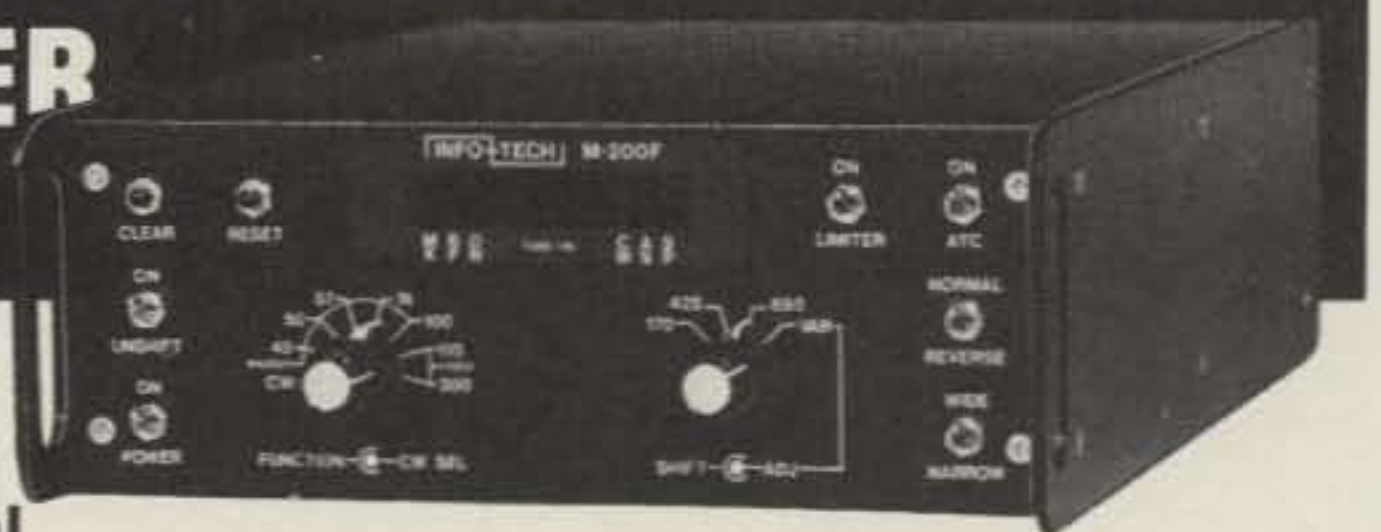

Morse Reception: 6-55 wpm standard (simple user adjustment for higher speeds). Automatic speed tracking & word space adjustment.

RTTY/ASCII Operation: Decodes RTTY (45, 50, 57, 74, 100 Baud) and ASCII (110 & 300 Baud), Auto CR/LF, automatic threshold control, selectable unshift on space, limiter is switch selectable, solid state tuning "meter". Demodulator has 3 fixed shifts and 1 tunable shift, user selectable printer outputs in ASCII or Baudot for all modes with crystal controlled baud rate generator. RS232, TTL & isolated loop outputs. User adjustable autostart.

Video Display Formats

(User Selectable)

16 lines x 32 characters, 16 lines x 72 characters,
25 lines x 32 characters, 25 lines x 72 characters
50 or 60 Hz operation. Cursor, on or off

Built-in 115/230v power supply

Price **\$575.00**

FOB factory

We accept
Mastercharge, Visa

or See These Dealers

A-1 Technik
Blomberg 3
D-5882 Meinerzhagen 2
West Germany

Cohon Amateur Supply
307 McLean Avenue
Hopkinsville, Kentucky 42240
(502) 886-4534

Dialta Amateur Radio Supply
212 48th Street
Rapid City, South Dakota 57701
(605) 343-6127

Emona Electronics
Room 208/661 George Street
Sydney NSW 2000
Australia

Germantown Amateur Supply
3202 Summer Avenue
Memphis, Tennessee 38112
1-800-238-6168

Gilfer Associates, Inc.
52 Park Avenue
Park Ridge, New Jersey 07656
(201) 391-7887

Global Communications
606 Cocoa Isles Blvd.
Cocoa Beach, Florida 32931
(305) 783-3624

Ham Radio Center
8342 Olive Blvd.
St. Louis, Missouri 63132
1-800-325-3636

Marcucci SPA
Via F LLI Bronzetti
37 20129
Milan, Italy

N & G Distributing
7285 N.W. 12th Street
Miami, Florida 33126
(305) 592-9685, 763-8170

Panacom
P.O. Box 76093
Caracas 107
Venezuela

Radio World
Terminal Bldg.
Oneida County Airport
Oriskany, New York 13424
(315) 337-2622

Universal Amateur Radio
1280 Aida Drive
Reynoldsburg, Ohio 43068
(614) 866-4267

INFO-TECH ELECTRONIC
EQUIPMENT ✓35

Manufactured by:

DIGITAL ELECTRONIC SYSTEMS, INC.

1633 Wisteria Court • Englewood, Florida 33533 • 813-474-9518

Adding a Scanner to Your 2m Rig

— here's a method that works with many scanner/transceiver combos

Using a scanning monitor receiver along with a two-meter transceiver will add a new dimension to your mobile or base installation. It lets you keep track of which frequencies are in use, increases the chance of getting the traffic report that

you need, better your chance of receiving a page while listening on another frequency, and permits you to eavesdrop on out-of-band transmissions such as NOAA weather broadcasts, police and fire dispatchers, etc., just to name a few.

Adding a scanner can be

as simple as installing another antenna and turning it on. This has several disadvantages which become apparent very quickly—such as: having to shut off the scanner before transmitting in order to eliminate feedback, possible destruction of the scanner rf input transistor, and the additional cost of another antenna.

In this modern, push-button age, there must be a better way to accomplish our goal, and there is. By taking a systems approach to the problem, the second antenna was eliminated and the scanner is muted automatically whenever the PTT switch is activated. When the PTT switch is released, the scanner resumes normal operation.

Although this article is written with specific references to the Realistic PRO-40 scanner and Kenwood TR-7500 transceiver, the principles are described so that other combinations of equipment may be used. In fact, another system was built for a base station us-

ing a Realistic PRO-7B and Standard SRC-826MA, with excellent results.

Scanner Modifications

If you use the scanner on the frequencies for which it was designed, alignment of the front end is not required. For reception of two-meter signals, however, some alignment of the tuned circuits will usually be required. This is easy if the circuit shown in Fig. 1 is used.

With no signal applied to the scanner and the squelch open, adjust the volume control so that the VOM indicates about 80 percent of full scale. The exact voltage is not important and will fluctuate with random noise. Most scanners have a front end similar to the illustration in Fig. 2. Apply a weak signal on the frequency of interest. Notice that the VOM reading will be less than before. This is caused by the limiting action of the receiver. Carefully adjust the tuned circuits in the order shown in Fig. 2 until the lowest VOM

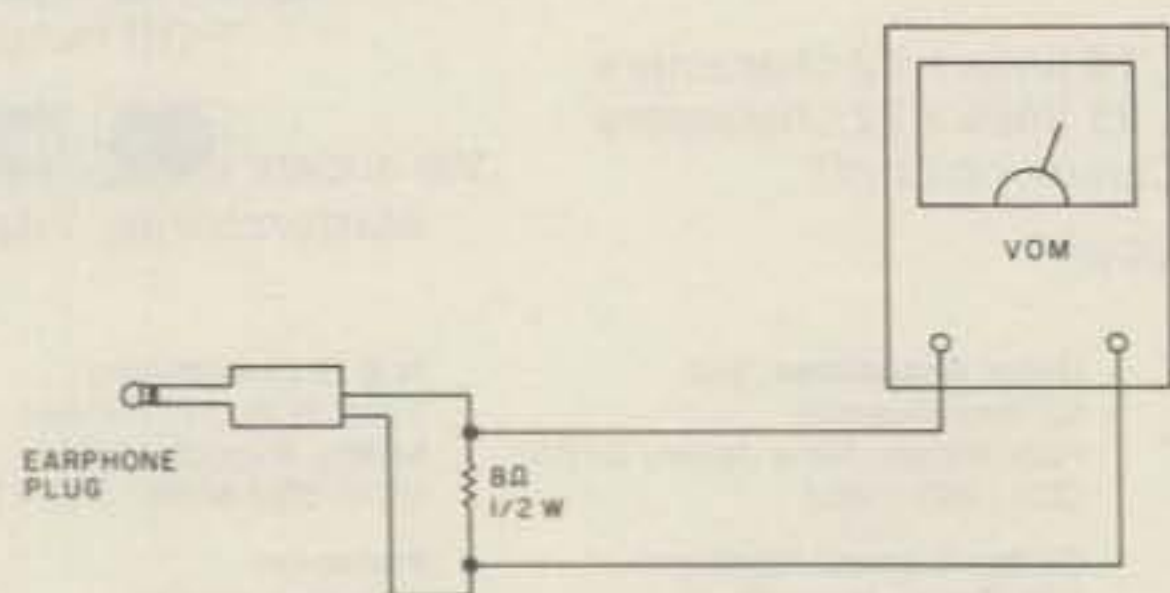

Fig. 1. Test circuit for scanner front-end alignment. Set VOM on decibel or low ac voltage range.

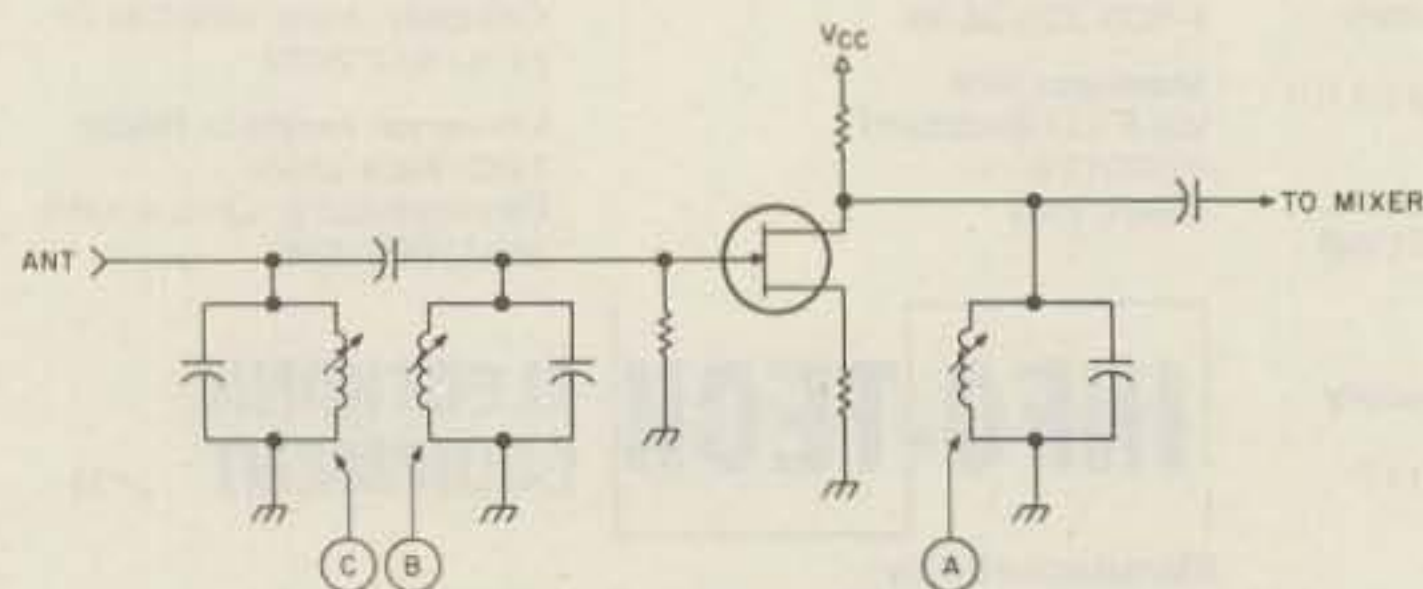

Fig. 2. Typical scanner front-end circuit. Alignment sequence is A, B, then C.

reading is obtained, i.e., maximum quieting is achieved. In most of the scanners, the dips are quite sharp and usually within ± 2 turns of the factory settings.

This completes the alignment phase. Disconnect the test circuit. With an antenna connected, the scanner should now receive signals on two meters.

The final scanner modification consists of adding an electronic switch to mute the scanner while transmitting. It consists of adding a resistor and transistor and changing a second resistor. Before going ahead blindly, refer to Fig. 3 to see how the muting is accomplished.

The partial schematic shows a typical, series-type voltage regulator. The zener diode establishes a constant base voltage for the pass transistor. The pass transistor has unity voltage gain but provides current gain. As a result, whatever voltage applied at the base of the transistor appears at the output of the regulator but at a higher current-sourcing capability.

In the case of the PRO-40, +13.6 volts from the automobile battery drives the regulator. The zener diode holds the base of the pass transistor at +9.1 volts, and the output of the regulator is about +9.8 volts. In case you are wondering where the additional 0.7 volts came from, it is the diode drop between the emitter-base junction in the pass transistor.

It is obvious then, that if the base voltage of the pass transistor could be reduced to zero during periods of transmitting, the output of the regulator would be zero for all practical purposes and the scanner would be muted. The electronic switch will do just that.

By adding a garden-variety NPN transistor such as a 2N3904, as shown in Fig. 4, the pass transistor base

voltage will be at ground potential whenever a mute signal is present. The mute signal turns on the switching transistor which effectively shorts out the zener diode. When this occurs, the input voltage is shunted to ground through the current limiting resistor, R1. Since this resistor was not rated for the extra current, it must be replaced with a larger wattage resistor having the same resistance as the former resistor. The power dissipated in the resistor can be calculated from $P = E^2/R$, where E is 13.6 volts and R is the resistance in Ohms.

The exact value of resistor R2 is dependent upon the mute voltage. It should be selected so that the Q2 base voltage is between +0.7 and +1.0 volts when Q2 is turned on. In the example, a value of 12k provides satisfactory performance with a mute control voltage of +9 volts.

The mute control voltage originates at the transceiver and must be applied to the scanner over a wire. A convenient way to do this is to rewire the earphone jack to accept the mute signal. This negates the use of this jack for its original purpose, but since the internal speaker is used exclusively anyway, the jack would serve no useful purpose in our system. Use of the jack also avoids the need for another hole in the scanner.

Note that if the mute plug is removed, the scanner will operate normally. The scanner thus may be used apart from the transceiver.

Transceiver Modifications

The transceiver requires two modifications: An antenna lead must be brought out to drive the scanner antenna jack, and the mute control voltage must be generated.

The TR-7500 has an accessory jack on the rear panel which may be used

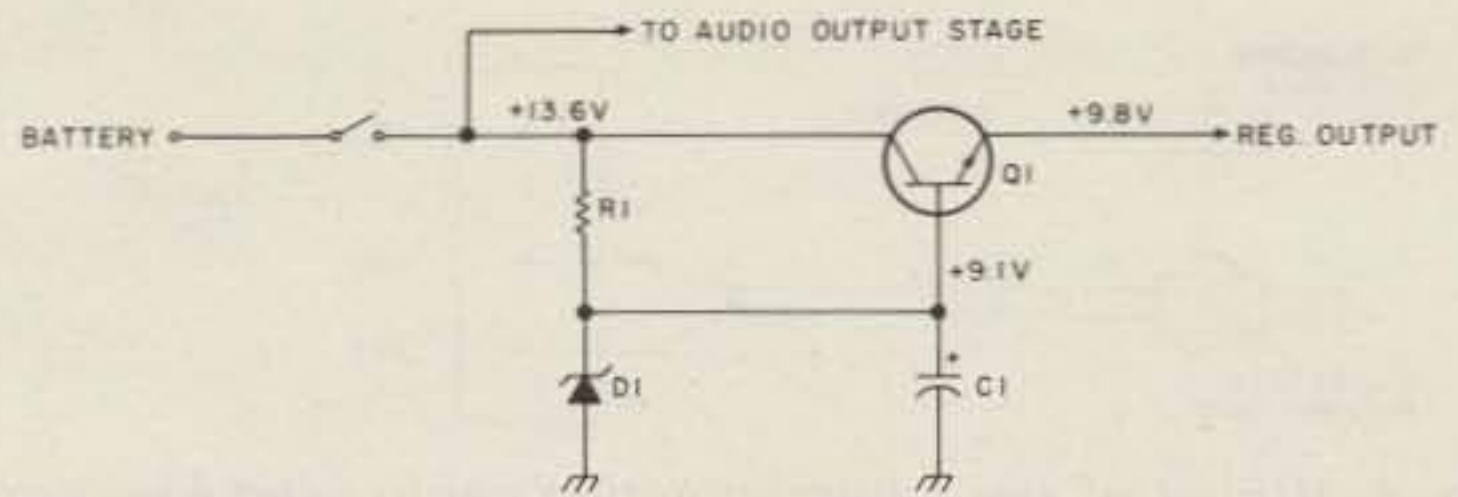

Fig. 3. Original voltage-regulator schematic.

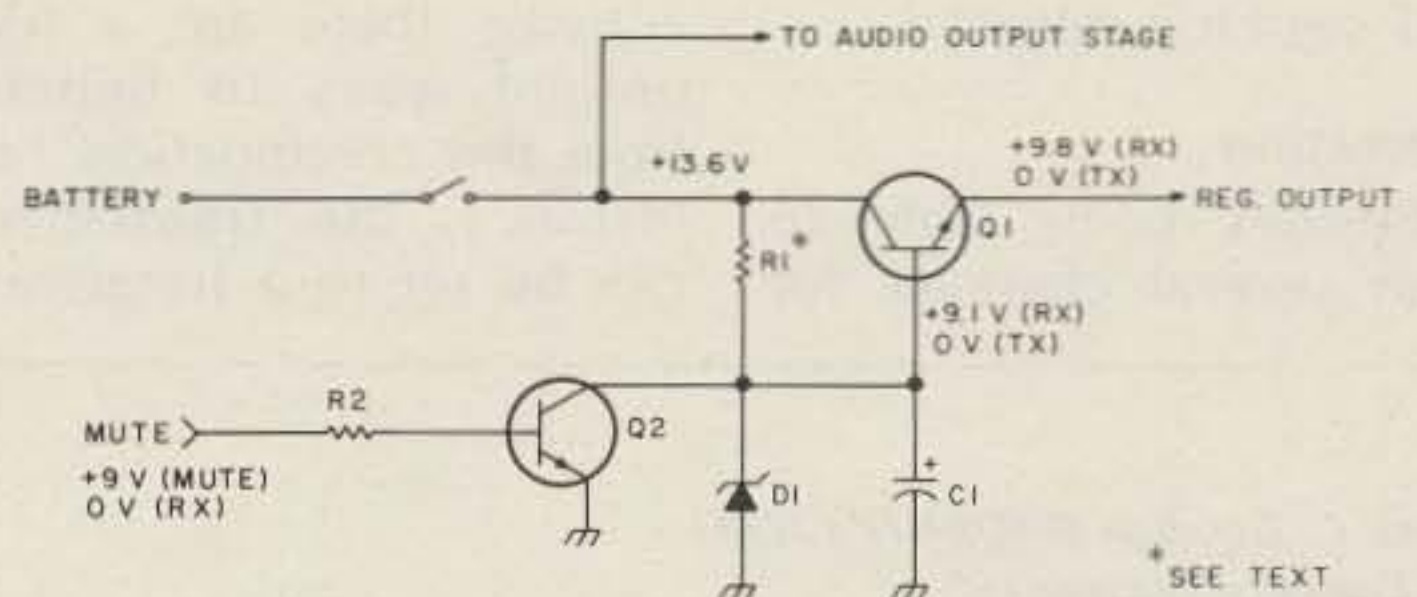

Fig. 4. Modified voltage regulator showing the electronic switch. R1 must be replaced with another resistor having the same resistance but a higher power rating.

for all connections if you can compromise one of the functions provided for at this point. Fig. 5 shows the functions available at this jack. The T9 output provides +9 volts during transmit only. Since this is just what is needed for the mute control signal, it can be used directly. The center-meter (CM) output would not normally be used, so it can be unsoldered and taped. This pin may then be used for the scanner antenna lead.

The antenna lead for the scanner must come off the receiver side of the antenna relay. In the TR-7500, antenna switching is done electronically, so the antenna lead was picked off the receiver printed circuit board and brought to the accessory jack with RG-174/U miniature coaxial cable. The receiver board can be removed quite easily by removing a few machine screws and unplugging the interconnecting harnesses. It is much easier to solder the coax to the board when it can be supported in a vise or on a table.

After all connections have been made, reassemble the transceiver and construct an interconnect

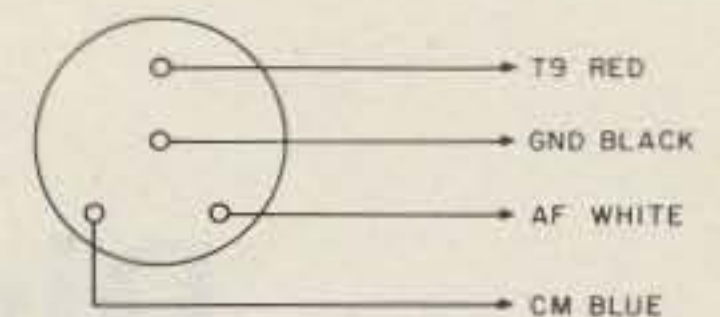

Fig. 5. Wiring of the TR-7500 accessory jack on the rear panel. The CM wire is removed and taped. The scanner antenna lead is then connected to this pin.

cable to run from the transceiver to the scanner (See Fig. 6).

Testing

Connect the scanner and transceiver power leads to the power supply and the interconnect cable between the units. Connect the antenna to the transceiver.

Turn on the scanner and the transceiver. Each should operate normally, as before the modifications, with the sole exception being a slight loss in sensitivity on the part of the transceiver. This is not significant, since it is less than a 0.1-microvolt degradation.

Depress the PTT switch. The scanner should be disabled, as evidenced by the LED indicators being off. Normal scanner operation should resume when the

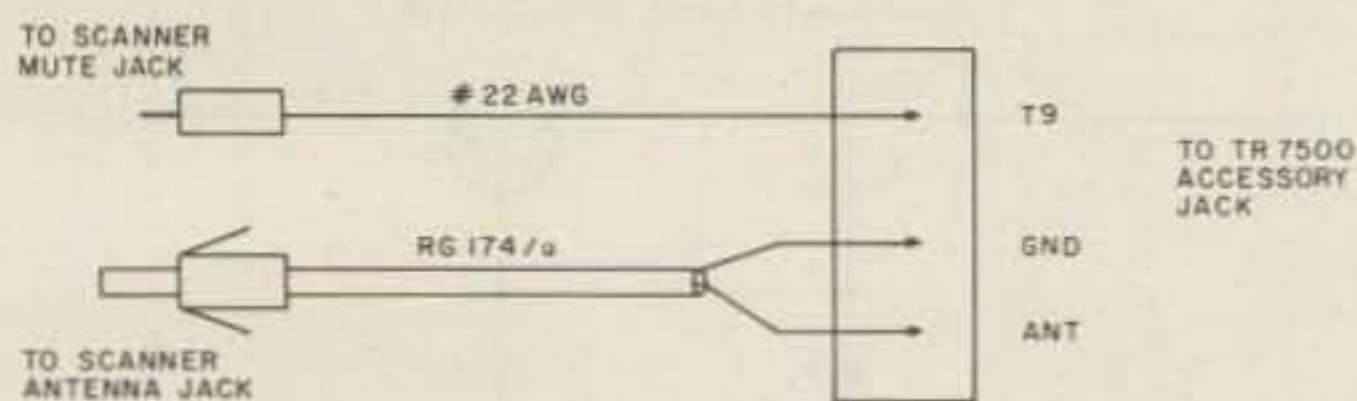

Fig. 6. Wiring of the interconnecting cable used between the scanner and the transceiver.

PTT switch is released.

Operation

Besides being able to scan several channels for

activity, there are a few unique ways to benefit from this combination. For instance, the transceiver can be set to a frequency

you wish to monitor full-time, and the scanner will allow you to monitor the others. Or, you can "lock-out" all channels but one and listen fulltime on two frequencies simultaneously. This comes in handy particularly for monitoring a repeater and a simplex frequency during emergencies.

If you have a TR-7500, and duplicate this system,

you might want to program the six available channel-selector switch positions to correspond to the first six scanner frequencies. This is really handy in mobile operation.

Whatever your desire is, I am sure that once you've teamed a scanner and a transceiver with the automatic switching described, you will wonder how you ever got along without it. ■

Curtis C. Goodson W4QBU/PY2ZBG
 Av Francisco Glicerio 467
 Apartment 502
 13100 Campinas Sp. Brasil

Digital Transistor Checker

— a "hands-on" project

Most of us are familiar with the method of checking transistors for shorts and opens using the x100 ohmmeter scale. Now

you can check for amplifying action as well, using just your ohmmeter and your digits (fingers).

In the case of an un-

known transistor, first determine which is the base lead by checking for diode action: Put one probe on any transistor lead and check for continuity to each of the other two leads. It usually will be between 200 and 2000 Ohms. Reverse the meter leads and check again. It should read an open circuit. The base lead is the one which reads like a diode to both other leads (see Fig. 1).

Next, connect the ohmmeter prods to the collector and emitter leads. We don't know which is which, but it doesn't matter yet. Now moisten your index digit and touch it to both the base lead and either of the other leads. If you've hit it right, the meter will show a lower resistance. If nothing happens, touch your still wet finger to the base and

the other transistor lead. If your luck is as poor as mine, and still nothing happens, don't give up. Now reverse the ohmmeter prods on the collector and emitter and repeat the wet-digit test. One of the four tests will show a lower resistance between the collector and emitter if the transistor is amplifying. In effect, the wet finger serves as a high resistance from collector to base, biasing the transistor partially on (see Fig. 2).

You now know the collector lead. It is the one that gives the lowered resistance when "digitally" connected to the base. If you know the polarity of your ohmmeter prods, you also can determine if it is an NPN or PNP transistor: If the positive prod is on the collector, it's an NPN. ■

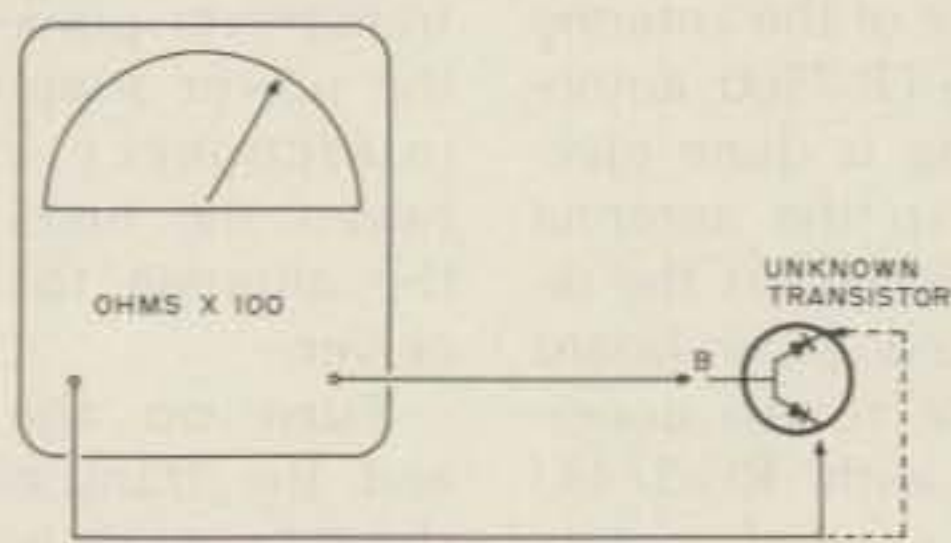

Fig. 1.

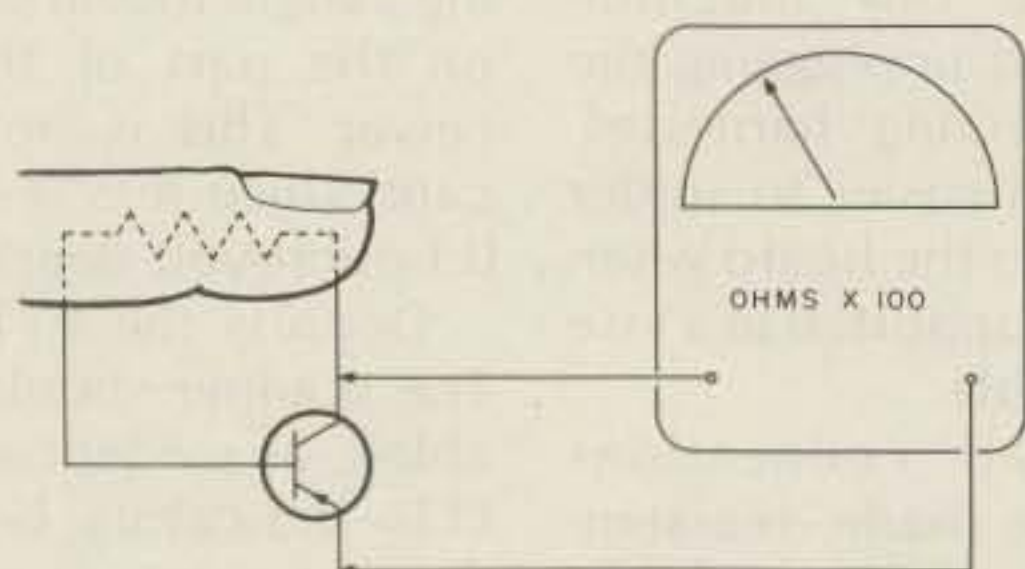

Fig. 2.

SOMETHING DIFFERENT

The FT-107 Series with "DMS"*

"It's A Cut Above The Rest"

* **OPTIONAL DIGITAL MEMORY SHIFT ("DMS")**
12 discrete memories. Stores individual frequencies or use as 12 full coverage VFOs (500 kHz each)

- Solid State
- 240 watts DC SSB/CW
- 160-10 meters, WWV
(2 auxiliary band positions are available for future expansion)
- RF Speech Processor
- SSB, CW, AM, FSK
- Built-in SWR Meter
- Excellent Dynamic Range
- Audio Peak/Notch Filter
- Variable Bandwidth
- Full Line of Accessories



The FT-107 has been created as a result of a blending of technologies — computer, solid state and RF design. By careful utilization of these disciplines and the experience gained from our FT-301 series, YAESU has achieved an HF transceiver which offers unique features (e. g. "Digital Memory Shift"), efficient operation and a level of performance that has been previously unattainable.

(Receiver Section) FT-107 TRANSCEIVER SPECIFICATIONS (Transmitter Section)

Sensitivity: 0.25 μ V for 10dB S/N, CW/SSB, FSK
1.0 μ V for 10dB S/N, AM

Image Rejection: 60dB except 10 meters (50dB)

IF Rejection: 70dB

Selectivity: SSB 2.4 kHz at -6dB, 4.0 kHz at -60dB.
CW 0.6 kHz at -6dB, 1.2 kHz at -60dB.
AM 6 kHz at -6dB, 12 kHz at -60dB
Variable IF Bandwidth

20dB RF Attenuator

Peak/Notch Audio Filter

Audio Output: 3 watts (4-16 ohms)

Accessories: FV-107 VFO (standard not synthesized)
FTV-107 VHF (UHF Transverter)
FC-107 Antenna Tuner
SP-107 Matching Speaker
FP-107 AC Power Supply

Power Input: 240 watts DC SSB/CW
80 watts DC AM/FSK

Opposite Sideband Suppression: Better than 50dB

Spurious Radiation: -50dB.

Transmitter Bandwidth 350-2700 hz (-6dB)

Transmitter: 3rd IMD -31dB neg feedback 6dB

Transmitter Stability: 30 hz after 10 min. warmup
less than 100 hz after 30 min.

Antenna Input Impedance: 50 ohms

Microphone Impedance: 500 ohms

Power Required: 13.5V DC at 20 amps
100/110/117/200/220/234V AC at 650 VA

Price And Specifications Subject To
Change Without Notice Or Obligation

1179R

YAESU ELECTRONICS CORP., 6851 Walthall Way, Paramount, CA 90723 • (213) 633-4007
YAESU ELECTRONICS Eastern Service Ctr., 9812 Princeton-Glendale Rd., Cincinnati, OH 45246

YAESU ⁸³ 
The radio.

CB to 10

— part XXV: using those surplus 40-channel boards

The Poly Paks flyer aroused my curiosity with the ad for "A 40-channel CB board complete with channel selector for only \$14.88," and in a reasonable time UPS delivered what proved to be a rather sophisticated 40-channel PLL CB set minus the case, speaker, microphone, and volume and squelch controls.

A little examination and research revealed that this is a very versatile printed board, used in several Hy-Gain units and several Kraco models. What appear to be missing parts are deliberate omissions. These parts are ones that function in some other unit than that for which this board was intended.

With a little work and ingenuity, this board can be turned into a fully-functioning and illegal CB transceiver, and, with a little more work, it can become a neat 10-meter rig. All part numbers are silk-screened on the board, and all wiring is attached to numbered wire-wrap posts or to numbered holes in the board. My wiring instructions will denote wire-wrap posts with a "P" and a number and board holes with an "H" and a number.

Only the board mount-

ing screws, the heat sinks, the antenna connector shield, and the two disc capacitors on the bottom of the board go to chassis ground. All other grounding points are attached to one of the board grounds, G1, G2, G3, or G4. Board grounds will be "BG" and chassis grounds "CG." Got it? Heat up the iron and go!

Wiring

Solder a red lead for +12 V to H1. Solder a black lead for -12 V to H2. Wire the center pin of an antenna connector to P58 and the shield to CG. Attach the leads of the two disc caps on the bottom of the board to CG. Install a jumper from P9 to P20. Wire a power on-off switch between P20 and P25. Wire an outer lug of a 15k squelch pot to P7 and the other two lugs to BG. Wire an outer lug of a 50k volume control to P19. Wire the center lug to P21 and the remaining lug to BG.

Wire the + terminal of a 0-1-mA S/rf meter to H34 and the - terminal to BG. Wire one speaker lead to P23 and attach the other speaker lead to BG temporarily. In actual operation, the speaker lead is routed to BG through the PTT switch on the microphone. A 500-Ohm dynamic mike

is used. This mike has a DPDT PTT switch that opens the speaker lead as it grounds the PTT line. This is necessary since the modulation transformer is also used as the audio output transformer, and an unearthly howl results if the speaker is not disabled. This mike audio line goes to P22, the PTT line to P13, and the neutral to BG.

Tune-Up

Tuning up the receive requires a signal generator, a VTVM, and a little patience. The first step is to set the voltage on the PLL. Check your wiring a last time, apply power, and check for smoke. If everything is OK, turning the volume and squelch controls should produce noise in the speaker. Squelch range can be set with the on-board pot, RV101. Attach a VTVM probe to the end of R113 nearest T101 and the ground to BG.

What we're looking for here is 1.5 V on channel 1. Since the switch is not marked, we have no idea where channel 1 is, so tune T101 for 1.5 V on the VTVM and then rotate the channel selector clockwise. The voltage should rise and abruptly drop. The voltage drop indicates that you have just gone from

channel 40 to channel 1. Reset T101 for 1.5 V and remove the VTVM.

Feed a 455-kHz signal through a .01 capacitor to the emitter of Q116, and tune T109, T108, and T107 for highest reading on the S/rf meter. The S-meter range may be adjusted with the on-board pot, TV103. Feed a 10.7-MHz signal through a .01 cap to the base of Q115 and tune T106 and L112 for the highest S-meter reading. Set the channel selector to channel 13 and feed a 27.115-MHz signal into the antenna connector. Tune T105 and T104 for highest S-meter reading. You now can attach an antenna and check for "Big 10-4s" and other esoterica amongst the local Good Buddies.

Set the channel selector to channel 13, attach a 10-Watt dummy load, key the mike or ground the PTT line, and adjust L103, L104, T102, T103, L106, L109, and L110 for the highest S/rf meter reading. Rf-meter range may be adjusted with the on-board pot, RV104.

10-Meter Conversion

Getting the rig on 10 involves replacing crystal X101 and retuning the PLL, the transmitter, and the

receiver front end. The crystal formula for the new X101 is: $N/3 + 11.806$ MHz, when N equals the new channel 1 frequency minus 26.965 MHz.

For example: If we wished the new channel 1 to be 28.965 MHz, then: $N = 28.965 - 26.965 = 2.000$; $2.000/3 = .667$; $.667 + 11.806 = 12.473$ MHz for the new X101. The crystal may be ordered from any of several suppliers. Specify a parallel resonant mode, with a 30-pF load capacitance, an HC-18 holder, and .005% or better tolerance.

When the new X101 is installed, return to the section on tune-up and reset T101 for 1.5 V on channel 1. Retune the transmitter. It may be necessary to use the S-meter on a 10-meter receiver during initial transmitter tune-up until enough signal is obtained to register on the S/rf

meter. Using a signal generator or on-the-air signal, retune T105 and T104 for the highest S-meter readings. The center frequency may be adjusted by tuning CT101. The automatic modulation-limiting level is set with the on-board pot, RV102.

Additional information on rigs using this board and their conversion to 10 may be found in previous issues of 73^{2,3} and in *Sams Photofact*® CB-116.⁴ ■

References

1. Part #92CU5554. Poly Paks, PO Box 942-A3, South Lynnfield MA 01940.
2. Cliff Wiginton, Sr. WB5BSG, "CB to 10—Hy-Gain's PLL Rigs," 73, September, 1978, p. 172.
3. Clay Webb W1PI, "CB to 10—Convert a Kraco PLL Rig," 73, October, 1978, p. 254.
4. "Kraco Model KCB-2330B," *Sams Photofact CB Radio Series (CB-116)*, Howard W. Sams and Co. Indianapolis IN, 1977, p. 5.

FAST SCAN ATV

WHY GET ON FAST SCAN ATV?

- You can send broadcast quality video of home movies, video tapes, computer games, etc, at a cost that is less than sloscan.
- Really improves public service communications for parades, RACES, CAP searches, weather watch, etc.
- DX is about the same as 2 meter simplex — 15 to 100 miles.

ALL IN ONE BOX



TC-1 Transmitter/Converter
Plug in camera, ant., mic, and TV and you are on the air. Contains AC supply, T/R sw, 4 Modules below \$ 399 ppd

PUT YOUR OWN SYSTEM TOGETHER



TXA5 ATV Exciter contains video modulator and xtal on 434 or 439.25 mHz. All modules wired and tested \$ 84 ppd

PA5 10 Watt Linear matches exciter for good color and sound. This and all modules run on 13.8 vdc. \$ 79 ppd

TVC-1B Downconverter tunes 420 to 450 mHz. Outputs TV ch 2 or 3. Contains low noise MRF901 preamp. . . \$ 49.50 ppd

PACKAGE SPECIAL all four modules \$ 225 ppd

FMA5 Audio Subcarrier adds standard TV sound to the picture \$ 25 ppd

SEND FOR OUR CATALOG, WE HAVE IT ALL

Modules for the builder, complete units for the operator, antennas, color cameras, repeaters, preamps, linears, video ider and clock, video monitors, computer interface, and more. 19 years in ATV.

Credit card orders call (213) 447-4565. Check, Money Order or Credit Card by mail.



P.C. ELECTRONICS ✓ 57

Maryann
WB6YSS

2522 PAXSON
ARCADIA, CA 91006

Tom
W6ORG



NEW!

HAL

PS-1.0 GHZ

- 1.00 GHZ pre-scaler ÷ by 1000
- Broadband operation 10HZ to 1.25 GHZ
- High sensitivity
- Standard T2L or ECL power supply
- Dual mode operation—VHF/UHF
- Independent VHF and UHF inputs
- Divide by 1000 so it can be used with any counter having seven digits or more.
- Circuit uses only four chips.
- Fully assembled and tested.

\$79.95



HAL-TRONIX ✓ 31

P.O. Box 1101
Southgate, MI 48195
(313) 285-1782

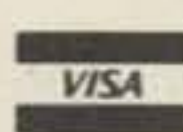

PA-19

WIDEBAND PREAMPLIFIER

- 2 to 200 MHz band width (— 3db points)
- 19 db gain
- 50 ohms input & output impedance
- Tiny PC Board size (7/8" × 1-5/8")
- Absolutely no tuning required
- Extremely stable
- Draws only 20MA at 12 v dc
- Great way to increase sensitivity of receivers, counter, etc.
- Fully assembled and tested
- Instructions provided, full warranty.

\$8.95

SHIPPING INFORMATION ORDERS OVER \$15.00 WILL BE SHIPPED POSTPAID EXCEPT ON ITEMS WHERE ADDITIONAL CHARGES ARE REQUESTED. ON ORDERS LESS THAN \$15.00 PLEASE INCLUDE ADDITIONAL \$1.00 FOR HANDLING AND MAILING CHARGES. SEND SASE FOR FREE FLYER.

The Stolen Rig Retriever

— built-in gadget automatically sends your call with every transmission

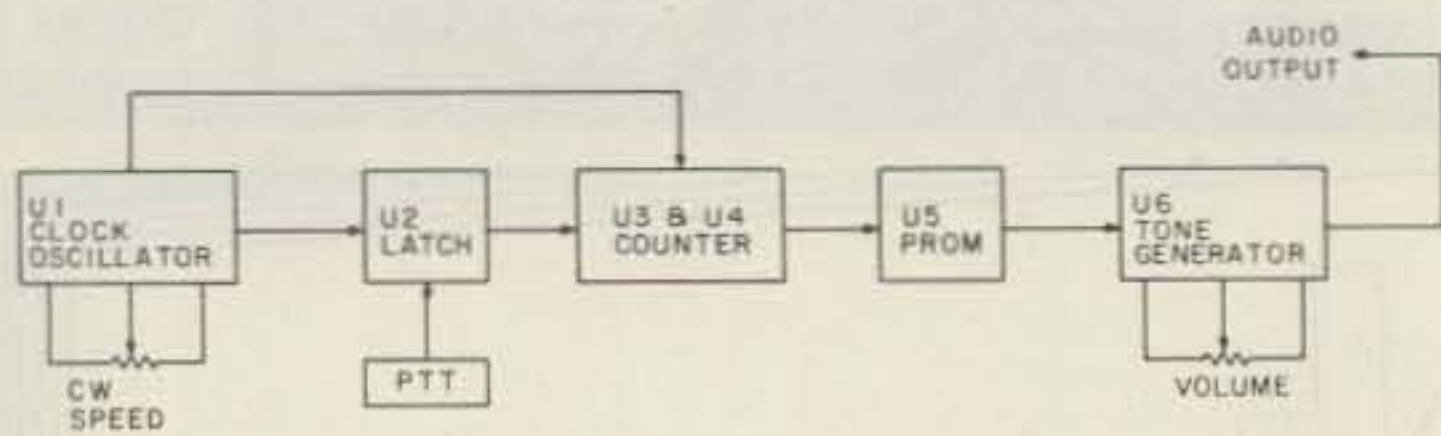

Fig. 1. Block diagram.

When VHF-FM activity got into full swing, equipment manufacturers started producing the "do-everything" transceiver. For the average amateur, these radios are expensive, and rather than purchase single-

mode or limited-coverage crystal-controlled units, a single transceiver ends up as his only purchase.

These expensive rigs, when mounted in cars, have become tempting targets for the burglar. To counter the threat of rip-off, the amateur's resourcefulness is being severely challenged. He has responded with a number of strategies to outwit thieves and protect his equipment.

The best strategy, of course, is to remove the rig when the vehicle is unattended. Next best is to hide it by stowing it under a seat or, better yet, by mounting it in the trunk or glove box. Locking mounts and alarm systems are also recommended. Antennas may be disguised to resemble standard broadcast antennas, which helps to reduce vulnerability. However, all of these steps may fail to prevent the loss of an expensive investment.

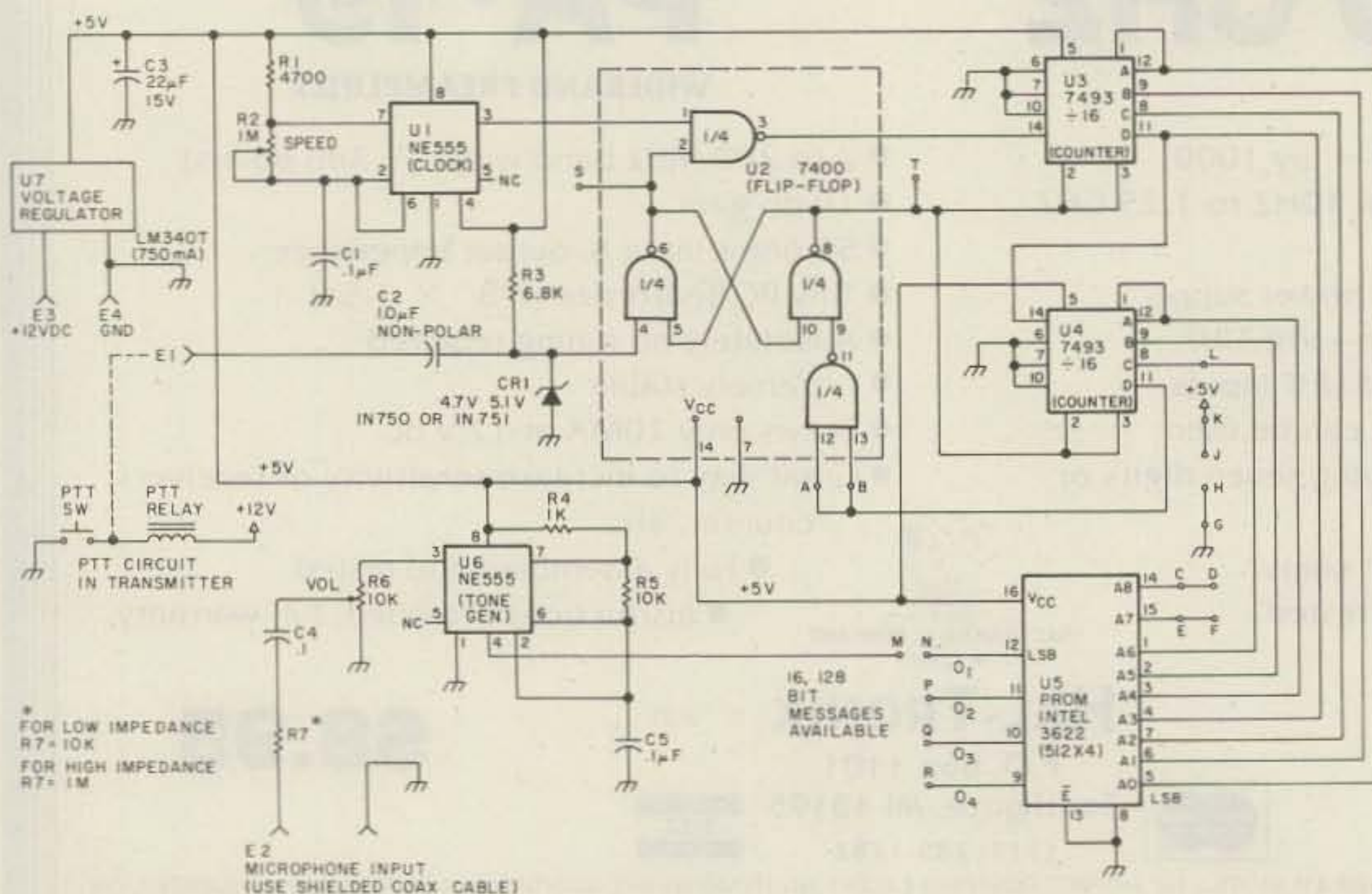

Fig. 2. Schematic diagram. Note: If the IDer is desired to be used as a CW beacon (continuous identification), connect pin 4 of U2 to ground.

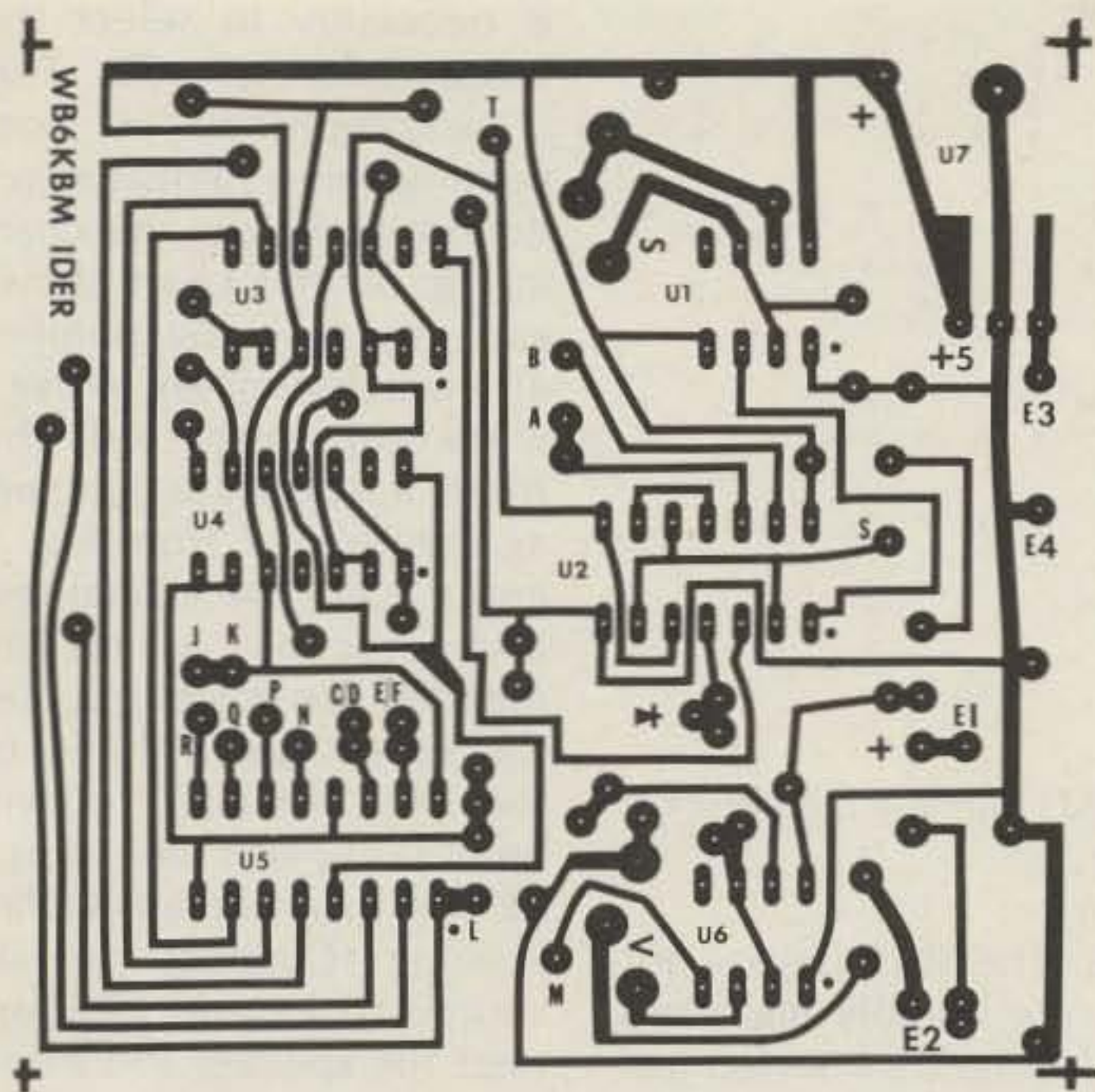

Fig. 3. Printed circuit board (foil side).

For that reason, it makes sense to have some means of recovering your rig if it is stolen. The automatic CW identifier described here does just that. It identifies your call letters every time you "squeeze the pickle." Because the IDer is hidden inside the transmitter and is silent to its operator, a thief may be unaware that the IDer is proclaiming your ownership after you have lost possession!

Several of these devices are now available commercially. But if you want to save money and like to build or tinker with small projects, then this article is written especially for you. Because of the large capacity of the PROM used in the identifier, it turns out to be an excellent club project, the beauty being that the PROM can be programmed to contain sixteen different calls of 128 bits each. Therefore, once the PROM has been preprogrammed and the three unique address jumpers have been properly connected, the circuit will automatically transmit your selected call or any other short CW message.

A block diagram, Fig. 1, is provided as an aid in understanding the functions of

the circuit, while Fig. 2 is a complete schematic diagram showing the pin numbers discussed.

How It Works

The clock oscillator determines the speed at which counters U3 and U4 will scan the PROM, U5. The output of U1 pin 3 goes low (ground) and arms the latch, U2. Pin 3 of latch U2 now goes high, which turns on counters U3 and U4. The clock oscillator puts out pulses which are divided by the counters. The counters scan the PROM, U5, column by column, until the last bit has been reached. The last bit in our case is number 128. Having counted 128 bits, pin 11 of counter U4 goes low, which causes pin 5 of U2 to go high and then the IDer is shut off (latched). When pin 4 is reset, the IDer will recycle itself, causing the message to be sent again.

Although a perfboard can be used, when you get the members of your club interested in a project like this, fabrication of printed circuit boards, programming of the PROM, and assembly of the IDer become simple problems to solve. Fig. 3 is a foil side printed circuit positive, and

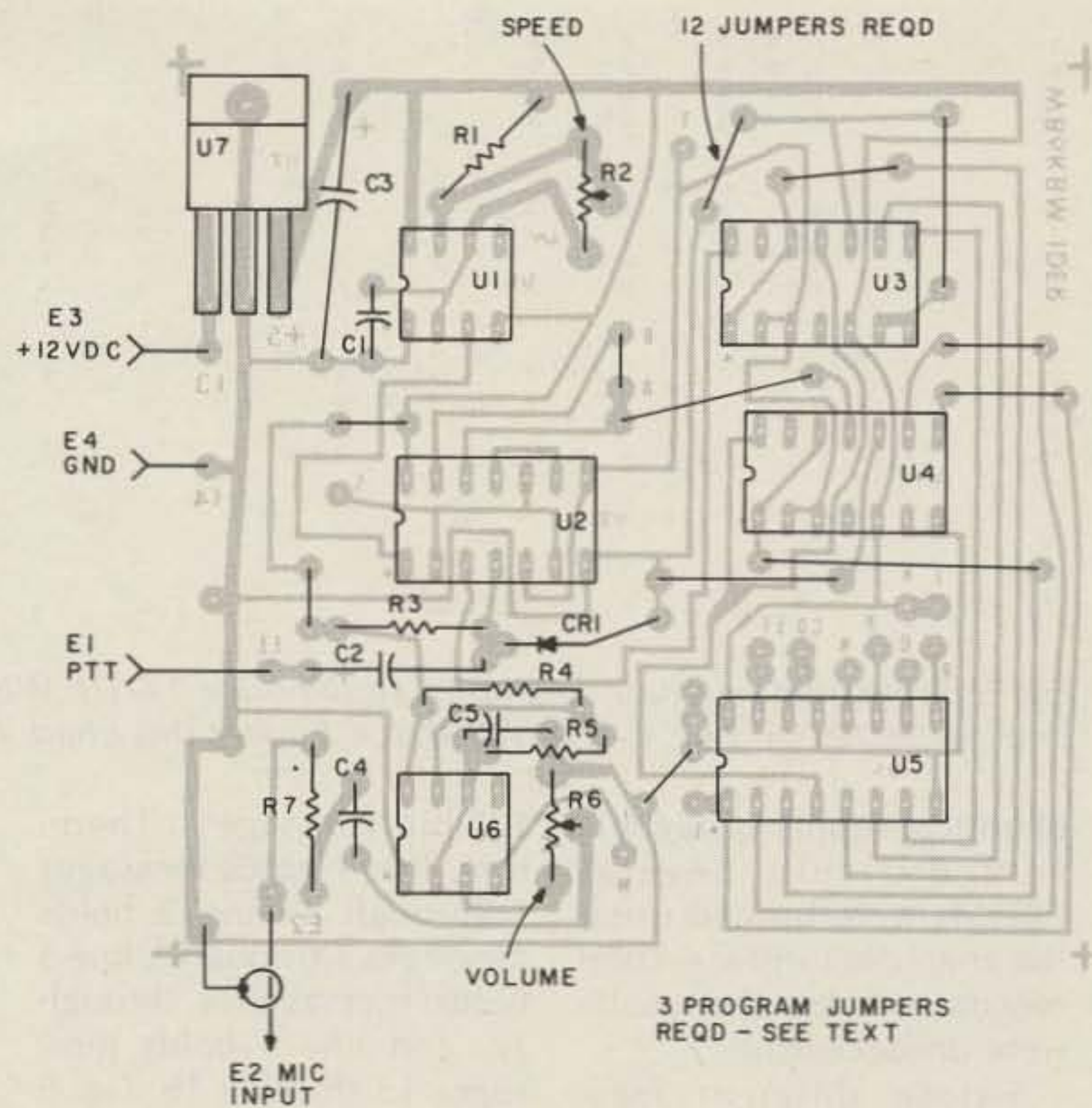

Fig. 4. Component layout.

Message Number	Address Jumper		
1	M T O N	D T O H	F T O G
2	P	H	G
3	Q	H	G
4	R	H	G
5	N	H	J
6	P	H	J
7	Q	H	J
8	R	H	J
9	N	K	G
10	P	K	G
11	Q	K	G
12	R	K	G
13	N	K	J
14	P	K	J
15	Q	K	J
16	M T O R	D T O K	F T O J

Fig. 5.

Fig. 4 shows the component layout.

Once you have the PC board in hand, careful examination of the component layout is a must. You should have a colored pencil to mark the symbols and jumpers as they are installed. All of the components are mounted on the clear (non-foil) side of the PC board. It is recommended that the resistors be installed first, as their cut-off leads are used for the twelve jumpers that are required. Sockets for the ICs are not necessary, but they

simplify troubleshooting and component replacement.

Programming the PROM

The PROM selected for the IDer is the Intel 3622. Its selection was determined by availability, large capacity, and price. Most electronic suppliers have this PROM in stock, and for about \$8.50 and a coding sheet, they will program the PROM for you.

PROM burning circuit requirements are given in the Intel data sheet, but construction and maintaining

1		4		8		12		16		20		24		28		32	
5		X	X	X		X		X		X		X	X	X		X	
9		X	X	X		X		X		X		X	X	X		X	
13		X	X	X		X		X		X		X	X	X		X	
1			36		40		44		48		52		56		60		64
5		X	X	X		X		X		X		X	X	X		X	
9	X	X	X	X		X		X		X		X	X	X		X	
13	X	X	X	X		X		X		X		X	X	X		X	
1			68		72		76		80		84		88		92		96
5	X	X	X	X		X		X		X		X	X	X		X	
9	X	X	X	X		X		X		X		X	X	X		X	
13	X	X	X	X		X		X		X		X	X	X		X	
1			100		104		108		112		116		120		124		128
5			X		X		X		X		X		X		X		X
9			X		X		X		X		X		X		X		X
13			X		X		X		X		X		X		X		X

Fig. 6. Programming chart. Examples shown: line 1—DE WB6KBM; line 2—DE W6JAZ; line 3—DE N6XA; line 4—DE WB6KYO. Repeat this chart 4 times.

of critical supply voltages is very difficult. Several PROMs were burned using the manufacturer's recommendations, but the results were unsuccessful.

Sixteen different messages should be determined prior to programming the PROM in order to utilize its full capacity. Each line on the coding sheet is 512 bits long, so each line holds four

128-bit messages. Therefore, line 1 holds messages 1 through 4, line 2 holds messages 5 through 8, line 3 holds messages 9 through 12, and line 4 holds messages 13 through 16. Fig. 6 shows a portion of a coding sheet with the coding for 4 sample messages.

Before you start to fill in the coding sheet, you must know the following param-

eters. The 3622 device outputs are initially high, and, if it is directly inserted into the IDer without first being programmed, a continuous tone would be produced. It is necessary to burn out the selected bits for the desired message. Before you determine the selected message, you must keep in mind the 128-bit limit of each message. A single bit is a unit of time from which the Morse code is comprised. That is, a dot is one bit in length while a dash is three bits in length. Space between dots and dashes of a letter is one bit, between letters it is 3, and between words it is 7. The first 4 bits of each message are left blank, thereby ensuring proper key-down of the transmitter and no loss of the message.

Upon completion of the coding sheet, have a friend double-check your work. Errors must be corrected, as the PROM cannot be reprogrammed.

When ordering your PROMs, you must state, "positive logic, high output, ones indicate high and blanks indicate zero." This information will tell the company which programs your PROM which way to throw the logic switch.

Testing and Connections to Transceiver

Prior to installation of the programmed PROM, it

is necessary to select the proper address codes. This is accomplished by connecting three jumper wires determined from the chart in Fig. 5. This chart shows each message by number and which jumpers to use.

Having installed the three appropriate jumpers as determined from Fig. 5 and the PROM, a final test and checkout is recommended, as it lets you set the speed and volume of the IDer off the air. You will need a 12-volt dc source of 300 mA and an 8-Ohm speaker. Connect the dc source to E3 and E4. Connect the speaker to E2 and ground. Ground the PTT circuit, E1, and adjust the CW speed control, R2, and the volume control, R6, to the desired settings.

Connection to the transceiver is quite simple. First find a suitable location. If none exists, then remove the speaker and install the IDer in its place. Most transceivers have an auxiliary speaker jack, so just add an external speaker and away you go. Refer to the schematic diagram, Fig. 2, for wiring connections. RG-122/U coaxial cable should be used for audio input to the mic if the distance is more than 6 inches.

Since the CW speed has already been set, an on-the-air test of the volume should be made. The CW audio should be just below the level of your voice to provide for proper audibility of your voice and the Morse code identification.

That's all there is to it! No more concern if you forget to identify yourself every time you go on the air, and you also can be proud of a job well done. This should get your club active again in the homebrew department.

I wish to give credit and many thanks to W6JAZ and N6XA for their testing, programming, and technical support on this project. ■

FOX-TANGO CORP.
Box 15944S, West Palm Beach, FL 33406
Visa/MC welcomed. Money back if not satisfied.

8-POLE FILTER BANDWIDTHS IN STOCK

CRYSTAL FILTER	CW (Hz)						SSB-AM (kHz)				
	125	250	400	500	600	800	1.8	2.1	2.4	6.0	8.0
YAESU	\$55 EACH										
*FT-101/F/FR-101		✓		✓	✓		✓		✓	✓	
*FT-301/FT-7B/620		✓		✓			✓		✓	✓	
*FT-901/101ZD/107		✓		✓			✓				✓
FT-401/560/570		✓		✓			✓	✓			
FT-200/TEMPO 1							✓	✓			
KENWOOD	\$55 EACH										
*TS-520/R-599		✓	✓				✓				● 2nd IF \$125 for R-820 only
*TS-820/R-820		✓	✓				✓	●			
HEATH	\$55 EACH										
ALL HF		✓	✓				✓	✓			
DRAKE	FOR PRICES SEE NOTES										
R-4C											
	GUF-1 Broad 1st IF Superior Shape Factor/Ult Rej \$65										
	GUF-2 Narrow 1st IF	✓	✓								+ pcb w sw relays \$90
	56H125	✓									Very sharp 2nd IF - Plug in type - \$90
	GUD Product Detector - w pcb w relay double balanced type \$30										
COLLINS	SPECIAL \$125 EACH										
75S-3B/C		✓									EQUALS OR EXCELS \$400 COLLINS UNIT

*DIODE SWITCHING BOARDS available to permit 1, 2 or more filters than those for which manufacturer provides room. SPECIFY make and model.
Single-filter type: \$12 Airmail postpaid
Dual-filter type: \$21 Airmail postpaid
Florida residents add 4% (sales tax) (FOREIGN ADD \$3 per filter)

BROCHURE ON REQUEST
Dealer Inquiries Welcomed

323

CALL TOLL FREE
1-800-228-4097

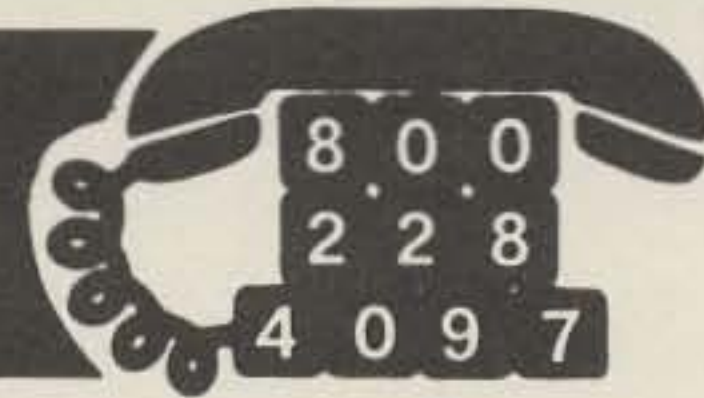

RCA SPECIAL BUY
Black-and-White Video Camera
Model BW007

Features

- 1 4.1 zoom lens with special macro focus for close-ups to within 4 inches
- 2 Deluxe boom microphone telescopes out to 7 1/2 inches
- 3 Deluxe through-the-lens viewfinder lets you see exactly what you're recording
- 4 Built-in indicator light signals operator that VCR is recording
- 5 Hand-molded pistol grip for convenient handling
- 6 Press trigger in to record; press again to stop recording. Trigger automatically locks in for continuous recording
- 7 Special light compensating circuits automatically adjust for different light conditions
- 8 Flexible 9' 10" cable included (Additional cable is available as an optional extra)
- 9 Compact power supply features a convenient built-in 500-watt AC outlet for VCR hook-up

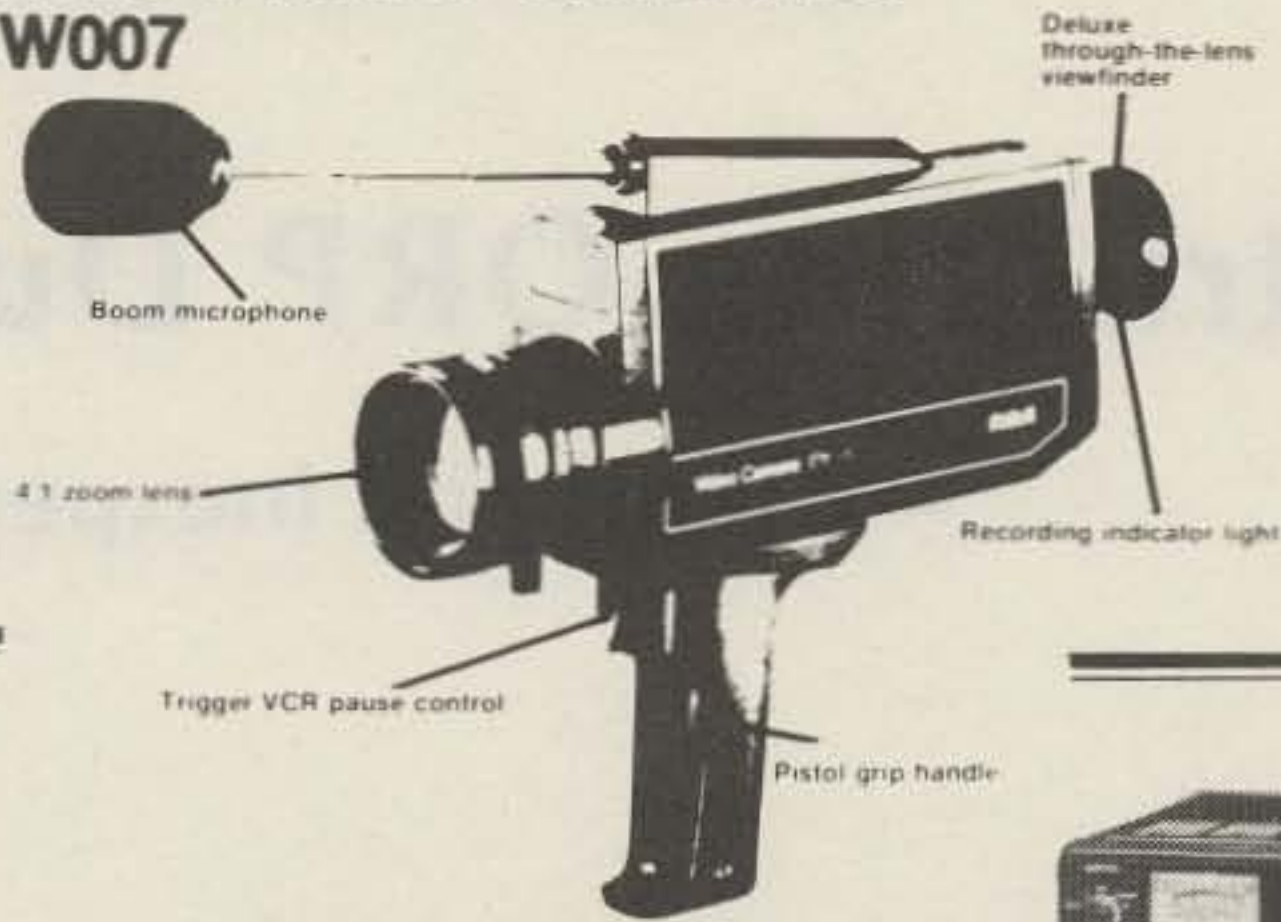

ONLY \$179.95
GREAT FOR SSTV

KENWOOD TR-7800
2 Mtr. Transceiver
CALL for Discount Price



KENWOOD TS-180S
CALL for Spring Special Prices

HY-GAIN 3806 ACCESSORIES

1104	T.T. Pad	44.95
1106	Wall Charger	9.95
3807	Nicad Battery Pack	31.95
269	Rubber Duck	5.95

HY-GAIN PRICES!

HY-GAIN		Regular	Special
TH6DX	Super Thunderbird	\$329.95	\$249.95
TH3MK3	3 el. 10-15-20M beam	222.95	169.95
TH3JR	3 el. 10-15-20M beam	169.95	129.95
Hy-Quad	2 el. 10-15-20M Quad	274.95	209.95
205BA	5 el. "Long John" 20M beam	329.95	249.95
155BA	5 el. "Long John" 15M beam	199.95	149.95
105BA	5 el. "Long John" 10M beam	129.95	99.95
204BA	4 el. 20M beam	249.95	189.95
204MK5	5 el. conversion kit	99.95	79.95
153BA	3 el. 15M beam	89.95	79.95
103BA	3 el. 10M beam	74.95	59.95
402BA	2 el. 40M beam	239.95	189.95
BN-86	Balun for beam antennas	15.95	15.95
TH2MK3	2 el. 10-15-20M beam	149.95	119.95
18HT	Hy-Tower 80-10M vertical	\$359.95	\$289.95
18AVT/WB	80-10M Trap vertical	105.95	84.95
14AVQ/WB	40-10M Trap vertical	69.95	57.00
12AVQ	20-10M Trap Vertical	42.95	34.95
14RMQ	Roof Mounting kit (verticals)	33.95	29.95
58DQ	80-10M Trap doublet	109.95	89.95
28DQ	80-40M Trap doublet	59.95	49.95
66B	6 el. 6M beam	119.95	99.95
203	3 el. 2M beam	15.95	
205	5 el. 2M beam	21.95	
208	8 el. 2M beam	29.95	
214	14 el. 2M beam	34.95	
LA-1	Deluxe lightning arrestor	59.95	49.95
TH5DX	5 el. 10-15-20 M. Beam	269.95	199.95

Call for discounts on Cushcraft, Mosley, Hustler

SUPER SAVERS

	REGULAR	CLEAN OUT
Yaesu FT-107	H.F. Transceiver 1045.00	899.00
Yaesu FT-901DM	H.F. Transceiver 1535.00	CALL
Yaesu FRG-7000	General Coverage Receiver 655.00	519.95
Swan MKII	2KW Linear Amp. 995.00	799.00
Avanti AH151.3	Thru the Glass Antenna 34.95	29.95
Tempo S-1	Synthesized hand held 299.95	269.95
Bencher BY-1	Paddle 39.95	36.95
CDE Ham 4	Rotor 199.95	149.95
CDE Tailtwister	Rotor 299.95	199.95
Alliance HD-73	Rotor 154.95	109.95
Kenwood TS-520SE	H.F. Transceiver 629.95	CALL
Kenwood TS-120S	H.F. Transceiver 699.95	CALL
Dentron GLA-1000B	H.F. Amp. 399.95	349.95
Mirage B-108	2 M. Amp. 179.95	149.95
Atari 800	Computer 999.00	CALL
Panasonic RF-4900	Gen. Coverage Rcvr. 549.95	399.95

We Export

ALL PRICES SUBJECT TO CHANGE

Communications Center

443 N. 48th, Lincoln, Nebraska 68504

In Nebraska Call (402)466-8402



Constructing QRP Dummy Loads

— useful and inexpensive

Small rf dummy loads are one of the more useful things to have around your workbench. A high-power rf load for off-the-air transmitter tune-up and high-power testing is almost a necessity, but that is not the present subject.

Commercially-available loads tend to be precision

devices that are relatively expensive. The ordinary workbench needs loads that are close to the standard impedances and that have very little capacitive or inductive reactance. This is another way of saying that they should have essentially one-to-one vswr (voltage standing wave ratio) at their operating fre-

quency. Loads of this type that will handle ten Watts for short periods and five Watts for two or three minutes can be constructed easily and inexpensively as explained in this article.

Construction

The loads are built using several two-Watt carbon resistors clustered around

a coax connector or the end of a coax cable. Five two-Watt resistors will allow ten Watts dissipation until they heat to a couple hundred degrees. If they are arranged with an eighth of an inch of clearance between them to allow cooling air to flow between them, they will handle their full ten-Watt rating long enough to adjust a two-meter FM transmitter rated at 10 to 20 Watts for maximum output. Additional dissipation can, of course, be achieved by blowing cool air over the resistors.

The photograph shows two forms of the load. One is connected directly to a UHF connector and the other is at the end of a short length of coax cable terminated at the opposite end with a BNC connector.

The resistors may be chosen from Table 1 or, if you have a special load value requirement, the parallel resistor formula— $R = 1 / (1/R_1 + 1/R_2 + 1/R_3 + 1/R_4 + 1/R_5)$ —may be used to arrive at suitable values for your special case.

The first version of the load is constructed by

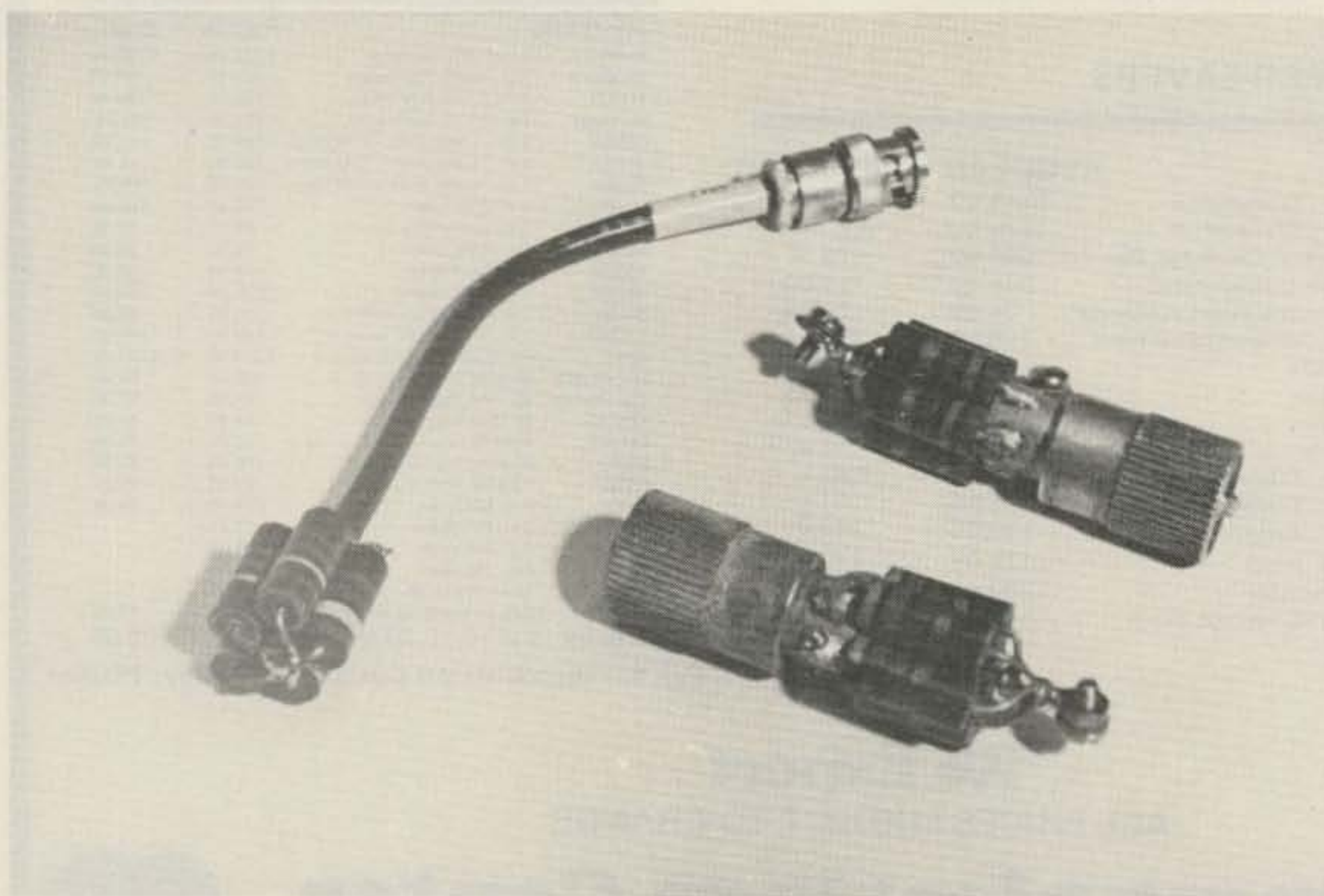

Photo A. Typical dummy loads as described in the text. Note the screw terminals shown on the UHF connector loads. These are for the connection of power-measuring circuitry.

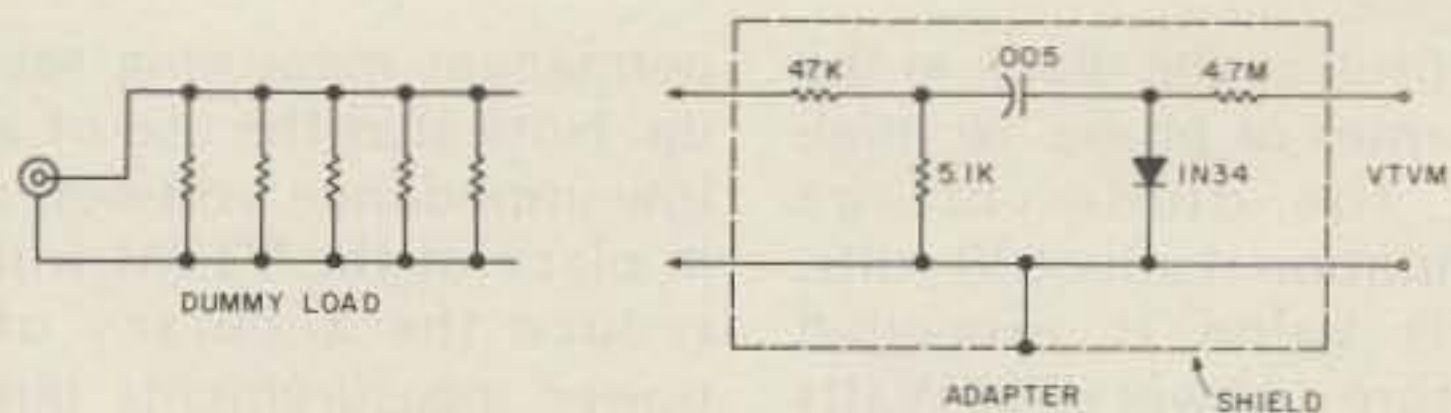

Fig. 1. Adapter circuit for VTVM with 11 megohms input resistance. Use carbon resistors only. The capacitor is in μF and should be a ceramic type rated at 100 V or more. Resistors may be $\frac{1}{2}$ Watt for power levels less than 100 Watts.

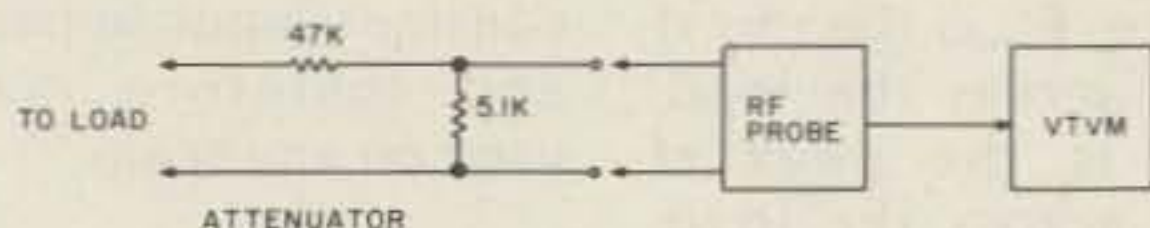

Fig. 2. A 10:1 attenuator for use with an rf probe and VTVM. The 47k resistor should be 2 Watts for 1000 Watts and the measurements limited to short periods.

soldering a piece of #12 or #14 solid copper wire into the center pin of a UHF connector. Allow this wire to protrude about $1\frac{1}{2}$ " from the end that would normally accept the coax cable. Solder the resistors around the center conductor just installed. One end of each resistor goes to the center conductor and the other end goes to the edge of the connector where the outer diameter of the coax cable would normally enter the connector. Space the resistors $\frac{1}{8}$ inch apart (more rather than less) to allow for air circulation. Trim the center conductor, leaving about $\frac{1}{4}$ inch extending beyond the solder joint. The extension can be used to connect a measuring circuit if you so desire.

The second load is constructed at the end of a coax cable using a similar technique to that just described. The outer insulation and braid are stripped back about $1\frac{1}{2}$ inches. Divide the braid into five approximately equal groups of strands and twist each group together. Trim their length to about $\frac{1}{4}$ inch and tin each group with solder. Minimize the heat applied to these points while tinning and, later, while soldering, to avoid melting the coaxial insulating material and

causing a short circuit. The resistors are now soldered from the center conductor to the five tinned points. The arrangement of resistors should be as previously described for the load mounted directly on the coax connector.

Results

The original loads were constructed using 5% resistors and their resistance values were as calculated using a calibrated Simpson 260 multimeter. The vswr was essentially one to one as indicated on a Heathkit® swr meter at 147 MHz. Chances of an equally good match at lower frequencies is excellent. These loads are probably useful at 220 MHz, but they were not tested at this frequency.

Power Measurements

Most amateur bench measurements do not have to be super-accurate. The most frequent need is to maximize or minimize the power being measured and to be assured that the power being measured is roughly what it should be. Remember that doubling or halving the transmitter's output will affect the signal received at another station by one-half an S-unit. Fighting for an additional five Watts out of a

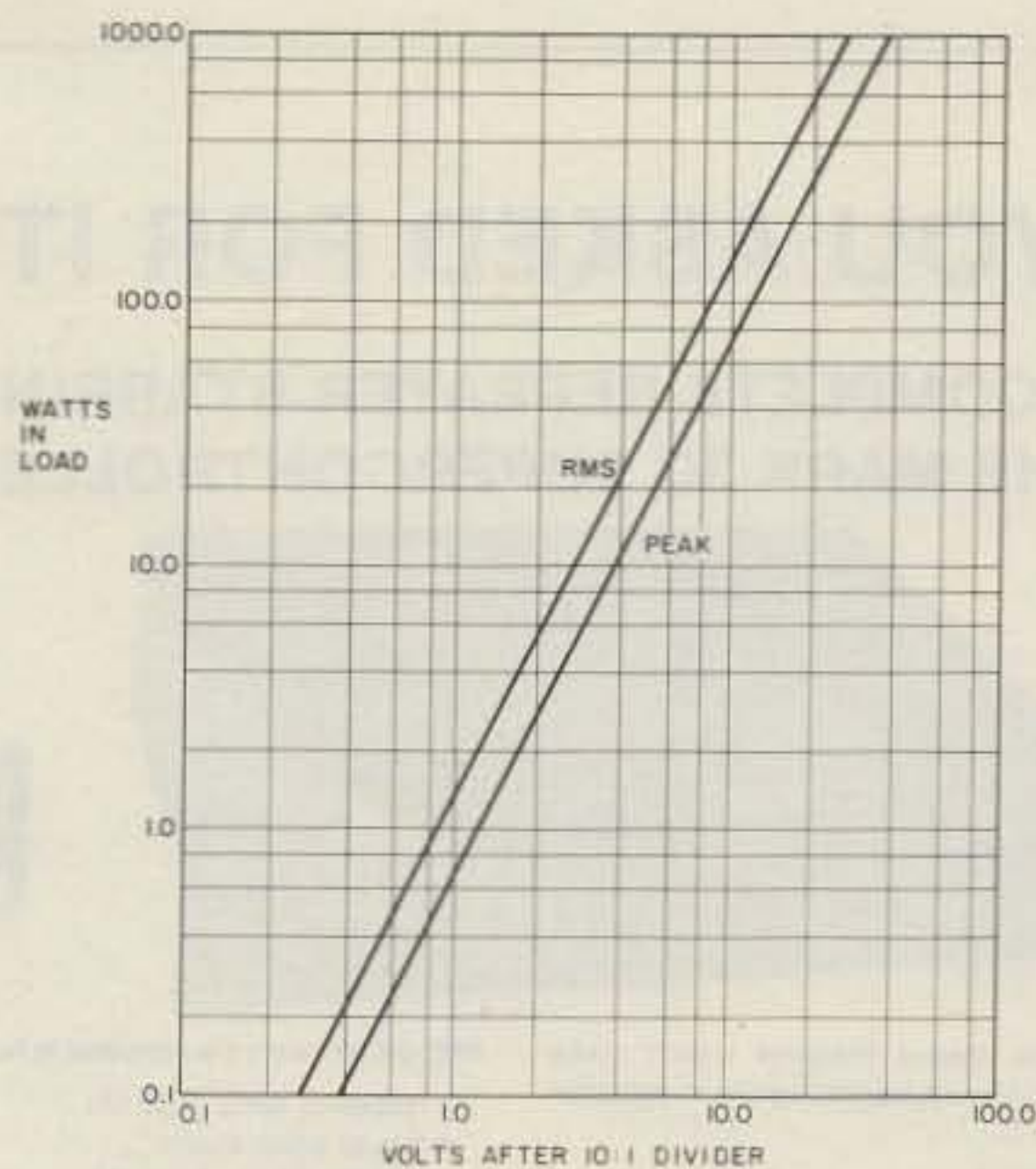

Fig. 3. Power calibration for a 75-Ohm load.

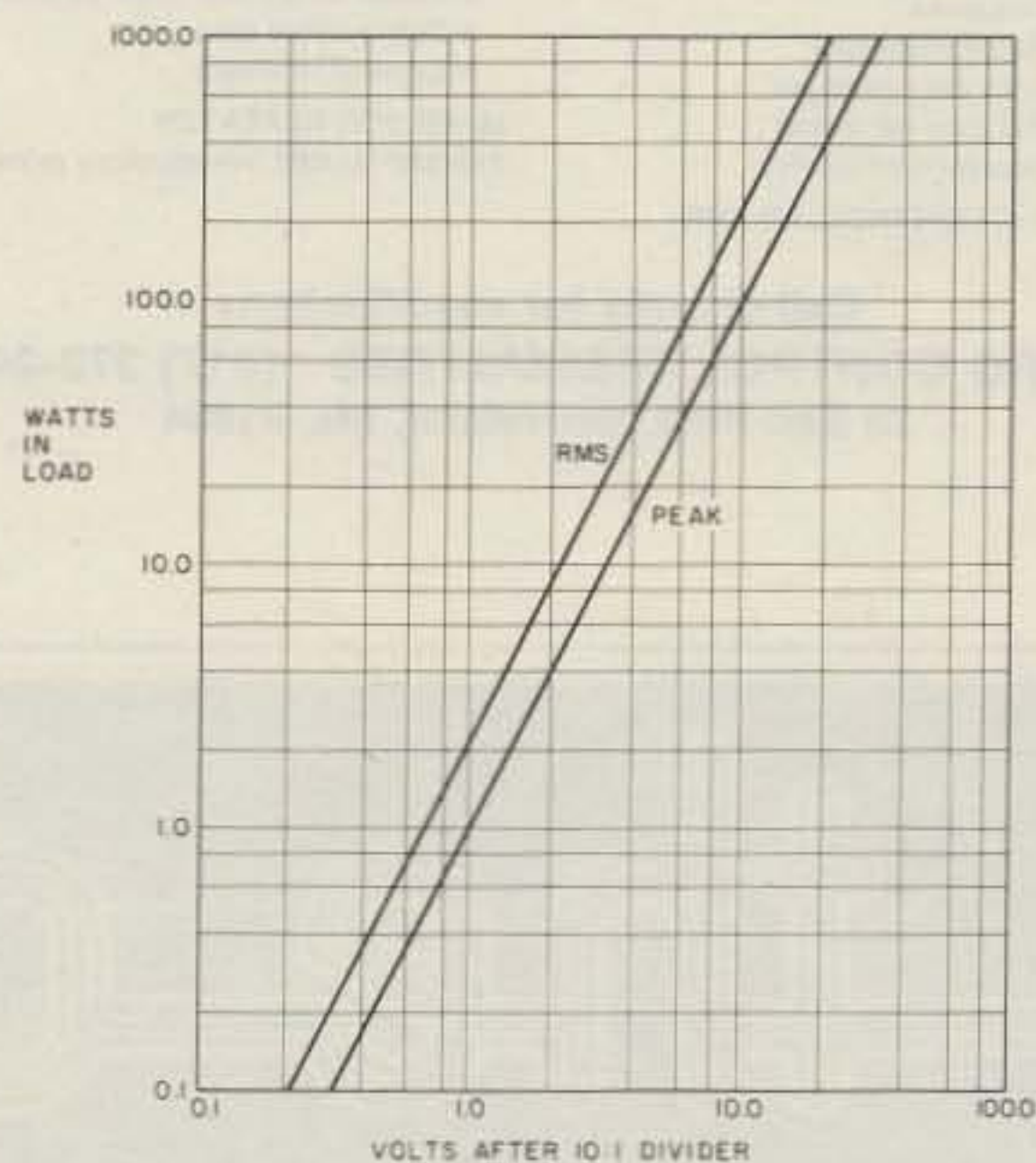

Fig. 4. Power calibration for a 50-Ohm load.

Qty.	Resistance	Qty.	Resistance	Combined Resistance
5	240	—	—	48
5	270	—	—	54
3	240	2	300	52.2
5	360	—	—	72
3	330	2	470	74.9

Table 1. Resistor choices for common load resistances (Ohms).

100-Watt transmitter is just not worth it! And, similarly, knowing what your output power is (as long as it is within the law), to better the 20% is an unnecessary labor.

Using the circuits and graphs shown in the figures, good approximations of the rf power delivered to a dum-

my load can be made. Problems such as capacitive coupling to the measuring circuit and poor rf waveform can be ignored if the rf being measured is relatively free of harmonics and the adapter circuit or probe is shielded.

The attenuator resistors (47k and 5.1k) are included

★ YOU ASKED FOR IT ★

A COMPLETE REPEATER STARRING THE MARK 3C SUPERCONTROLLER



ALL the unique features which make Mark 3C the acclaimed leader in repeater control —

- Autopatch
- Reverse patch
- Autodial
- 40 Functions
- 13 Morse messages
- Custom tail messages
- Digital tone decoding
- Microprocessor control

MARK 3-C CONTROLLER \$995.

AND NOW, even the repeater is built in —

- Receiver sens. 0.25 UV
- Super crisp audio
- Transmitter output 2W

PLUS options —

- Power amplifiers (pick your level)
- Sub-audible tone
- Control receivers

MARK 3CR REPEATER
144-220 \$1495. Introductory price.

Call or write for specifications

MICRO CONTROL SPECIALTIES (617) 372-3442
23 Elm Park, Groveland, Ma. 01834

✓ 49

to protect the diode in the adapter or probe. Normally, the diode-voltage limitation is about 30 volts. This value is exceeded before a power of 10 Watts is reached with 50- or 70-Ohm loads.

The formula for calculating the power in a load is $W = (E_{rms})^2 / R = (E_p \times .707)^2 / R$, where W is the power in the load, R is the load resistance, E_{rms} is the rms rf voltage across the load, and E_p is the peak rf voltage across the load. The graphs plot the value of rms voltage (as read on the VTVM's dc scale when using an rf probe or the adapter shown in the figure) versus power in the load. Peak voltage is also plotted in case the voltage is measured with a VTVM directly across the diode. The formula or graph can be used to change the scale on a meter if you are ambitious enough to build a

permanent measuring set-up. Note that the use of a low-impedance voltmeter in place of the VTVM will reduce the accuracy of power measurements but can be used to maximize the power in the load. Use the highest voltmeter scale possible to minimize the error in power measurement. A VTVM, on the other hand, normally has constant input impedance and, therefore, may be used on any scale.

Conclusion

Loads such as those described here will increase the potential of your workbench, making it possible to perform some of the measurements normally performed by the well-instrumented service shop.

The assistance of L.G.S. Wood W1WK in preparing the article is gratefully acknowledged. ■

the direct connection

AVANTI • ASTRON • ALLIANCE • ATLAS • ALPHA • BIRD • CUSHCRAFT • COLLINS • CDE • DRAKE • DEN-TRON • HY-GAIN • HUSTLER • ICOM • KLM • KENWOOD • MOSLEY • MICRO-LOG • MOR-GAIN • MIRAGE • MFJ • PALOMAR ENG. • SWAN • TEN-TEC • TAYLOR • TRI-EX • TELE-TOW'R • UNIVERSAL • UNARCO-ROHN ... ALL THESE AND MORE

MIDCOM ELECTRONICS, INC.

2506 S. BRENTWOOD BOULEVARD
ST. LOUIS, MISSOURI 63144



1-800-325-3609

MO. RESIDENTS CALL COLLECT 314-961-9990



THE NEW AEA MORSEMATIC! 37 FANTASTIC FEATURES!

The amazing AEA MorseMatic. Whether you are a contester, serious VHF DXer, learning code for the first time, studying for a marine radio operator's ticket, or simply a CW enthusiast, you can now own the finest electronic Morse keyer ever built and program it to your specific needs. Count these features!

1. Two custom designed microcomputer chips. 2. Two wpm to 99 wpm in one wpm increments. 3. Selectable dot and/or dash memory.

4. MorseMatic is a memory keyer. 5. 500 Morse character memory (optional to 2,000 characters) 6. Unique "Soft-Partitioning"™ to eliminate wasted memory space. 7. Use entire memory for one message or divide memory in up to ten messages. 8. Message loading begins with first character sent. 9. Easy to load memory. Choice of automatic mode for perfect format or real-time mode for individualizing messages. 10. Special editing mode for memory load correction. 11. Load memory in automatic keyer mode or semi-automatic "bug" mode (garbage in/perfection out). 12. Low power memory hold. 13. Memory limit indicator lights when 20 characters are left in memory. Monitor tone changes when memory overflows.

14. MorseMatic is a Morse trainer. 15. Computer generated Morse trainer. Incorporates ten repeatable (answers available) and one random starting position. 16. Programmable speed-up of code rate from beginning to end of practice session. 17. Select "slow code" or "fast (Farnsworth) code" method. 18. Select five character code groups or random group lengths. 19. Selectable, unselectable, uncommon characters for advanced radio operator training. 20. Use trainer mode to key transmitter for on-air practice.

21. MorseMatic is a beacon. 22. Unique beacon mode for beacons; moon-bounce, scatter or tropospheric DX scheduling. 23. Computers set message code speed to fit programmed transmitting window.

24. MorseMatic has serial number. 25. Automatic serial number sequencing for sweepstakes and other contests. 01 - 9999 (even beacon mode). 26. Serial number placement at any point within message. 27. Serial number repetition within same message. 28. Easy serial number repeat in next message.

29. Operates with all popular paddles. 30. Easy to learn and use keypad control for all features. 31. Plug in IC's. 32. Independently selectable dot and/or dash weighting. 33. Can be used to key transmitter for tuning. 34. Transmitter keying output for grid block, cathode or transistor circuits. 35. Operates off 8 to 16 volts DC. 36. Fully tested and 96 hour burn-in. 37. Introductory price only \$199.95.

The MorseMatic is also available strictly as a non-memory keyer for only \$79.95 (introductory price). For your free MorseMatic booklet explaining these and more features, or for information about ordering a MorseMatic, write or call Advanced Electronic Applications, Inc., P.O. Box 2160, Lynnwood, WA 98036. Phone 206/775-7373. (Dealer inquiries invited.)



AEA

Brings you the breakthroughs!

S9
S-F Amateur Radio Services
(213) 837-4870
4384 KEYSTONE AVE.,
CULVER CITY, CA. 90230

the W6TOG
RECEIVER MODIFICATION KITS
INCREASE SELECTIVITY
IMPROVE SENSITIVITY
LOWER INTERNAL NOISE
COMBAT BLOCKING
FROM LOCAL SIGNALS

TS-520 KIT	\$27.50
TS-520S KIT	32.50
TS-820 & 820S KIT	34.50
TS-820 MIXER KIT	27.50
TS-120S KIT	32.50
R-820 KIT	34.50
FRG-7000 KIT	32.50
FT-101 SERIES KIT	32.50
FT-101ZD KIT	34.50
FR-101 SERIES KIT	34.50
FT-301 SERIES KIT	34.50
FT-901 SERIES KIT	34.50
ATLAS-210 OR 215X KIT	34.50
ALDA-103 OR 105 KIT	32.50

MAGICOM
PROCESSOR
MODIFICATION KIT

INCREASES AUDIO PUNCH
IMPROVES
PROCESSED SPEECH QUALITY

TS-520/S	42.50
TS-820/S	27.50

NEW

TS-120/S	42.50
DRAKE T4XC	52.50
DRAKE TR7	42.50

The "MAGICOM" provides up to 6dB increase in output with smooth, clean, non-distorted audio and more penetration for those pile-ups. Easy installation. (No front panel alteration)

HI POWER
KITS

INCREASE OUTPUT POWER BY 30%

Set of (2) 6146-W final tubes
Plate rating 40W per tube

GET MORE DRIVE FOR
THOSE HI POWER AMPLIFIERS!!!
TS-520 / 520S QRO KIT \$39.50
TS-820 / 820S QRO KIT 39.50

10% OFF ON KIT ORDERS
TOTALING \$75.00 OR MORE

SEND FOR PRICING
AND INFORMATION ✓65

ALL PRICES POSTPAID
IN CALIF. ADD 6% SALES TAX
MASTERCHARGE & VISA ACCEPTED
SATISFACTION GUARANTEED
OR MONEY REFUNDED

The IC-211 Cookbook

— mods and tweaks to improve performance

Brian M. Manns K3V GX
Box 2124, R.D. 2
Seven Valleys PA 17360

Tired of listening to white noise during SSB monitoring? Try this squelch modification.

The above title was chosen for my original draft of an article which never made it into print. I had lent the article to a friend for review to detect any errors in spelling or punctuation and by the time I received the article back, I had investigated a number of different areas and compiled a lot of new information. This article includes all of the new information, plus the original SSB squelch modi-

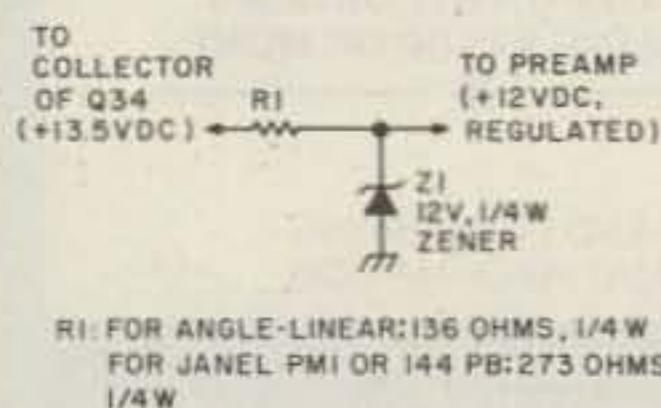

Fig. 1. +12-V dc power supply.

fications.

Since I don't have any convenient way of submitting nice pictures without many more weeks and/or months of delay, I'm afraid everyone will have to use the pictures in the Icom manual and my sketches. I would also like to say that some of the information to be presented was obtained directly from Icom East and Icom West and is so noted in the article. The following areas will be covered:

- Service manual
- Preamp installation and adjustments
- SSB squelch modification
- CW mode frequency offset problems and corrections
- Frequency adjustments
- Miscellaneous internal adjustments

SERVICE MANUAL

While talking with the sales people at Icom East, I was told that a service manual "is being developed" and will be available, although no projected availability date was given. Great! Unfortunately, this meant that all of my other questions had to be answered

from a 13" x 20" schematic loaded with lines and parts, and by hunting around on the circuit boards.

PREAMP INSTALLATION AND ADJUSTMENTS

The stated Icom specifications of 0.6 μ V or better for 20 dB of quieting on FM and 0.5 μ V or better for 10 dB (S+N)/N for SSB looked good, but not great. Since I've had "Proglines" down to about 0.2 μ V on FM, a preamp looked like a good bet if I could improve the noise figure and sensitivity on the solid-state front end of the 211.

Mounting and In-Circuit Placement

The preamp can be mounted on the power supply supporting bar since there is free space available. This will also place the preamp close to the area where the input and output leads are to be connected. To place the preamp into the circuit, it initially looked like the foil on the circuit board would have to be cut. However (courtesy Icom East), removing C202, which is located near the rf amplifier, Q47, and replacing it with

the preamp solved the problem. Be sure that the input/output sides of the preamp match the input/output sides of C202. The input side of C202 is on the antenna jack-L38 side, while the output side is toward L52.

Power

The preamp that I used (Angle-Linear) has a +12-V dc requirement to maintain the noise figure. Also, I only wanted power applied to the preamp during the receive mode. These requirements were met by running the power lead from the preamp to the collector of Q34, which supplies +13.5 V dc, and by using a zener diode and limiting resistor to obtain the +12 V dc at the preamp. (See Fig. 1.)

Adjustment

Once the preamp is installed and operational, R106 (which is the agc control) should be turned fully counterclockwise to stop the agc voltage from being applied on low-level signals. Without this adjustment, the preamp would add nothing!

For those interested in recalibrating their S-meters, the following information

(courtesy Icom West) may be beneficial: In the FM mode, 10 μ V produces S9; adjusted by R167. In the USB/CW mode, 32 μ V produces S9; adjusted by R132. Then, 320 μ V should produce a +20 dB indication; adjusted by R26. A 0.32 μ V signal should just move the needle.

Results

Without the preamp, the IC-211 sensitivity measured 0.5 to .6 μ V in the SSB mode. With the preamp installed and the agc adjusted, I had 0.1- μ V sensitivity in the SSB mode. The tests were conducted using a Singer FM10.

SSB SQUELCH MODIFICATION

Most of my 2-meter work is done on SSB and many hours are spent monitoring. The ability to have squelch operation during these times (instead of listening to noise) seemed imperative.

Normal Operation

The circuit in question is comprised of Q11, Q49, Q50, Q51, Q53, and Q54. Their functions are as follows:

Q11—SSB audio preamp
Q49—FM audio preamp
Q50—audio low-pass filter
Q51—receive LED switch
Q53, Q54—noise amplifiers

During normal operation in the FM mode, audio from the discriminator is supplied to two points: the base of Q49 (FM audio) and the input of noise amplifiers Q53 and Q54 via the squelch control. Basically, noise present at Q53 and Q54 keeps Q52 (squelch switch) turned on. Q52, when turned on, keeps Q49 and Q51 off; thus, there is no audio output or receive signal LED lamp lighted. With a signal present, the noise at Q53 and Q54 is reduced, allowing Q52 to turn off. With Q52 off, Q49 and Q51 turn on, allowing audio to pass and lighting the re-

ceive lamp.

Modifications

In the SSB mode, two things prevent the squelch from operating: +9 V dc is removed by the mode switch from Q53 and Q54, which keeps Q52 off; the SSB audio from Q11 is placed on the collector side of Q49, thus bypassing Q52's switch action upon Q49. To complete these modifications, proceed as follows:

1. Remove the top and bottom covers from the set, power supply module, and PLL box. (Note: Both units are connectorized for easy removal.)
2. Unsolder the top side of R214. This side normally faces toward L53.
3. Solder a wire to the free end of R214, route it underneath the circuit board, and attach it to the emitter of the Q34 and D28 anode junction pad. This point supplies +9 V dc during receive.
4. Unsolder the top side of C210 (+ side).
5. Solder a wire to the C210 lead (+ side), route it underneath the circuit board, and attach it to the junction pad of the squelch cable (center conductor) and C164.

That's it—just two wiring changes! This modification seems to work quite well and even SSB signals that just move the S-meter will open the squelch if it is set loose. I have not noticed any degradation in either FM or SSB audio or any "different" operation of the squelch on FM. (Note: The agc circuit is operational when in the SSB mode and the agc fast/slow switch will control the length of the "squelch tail.")

CW MODE FREQUENCY OFFSET PROBLEMS AND CORRECTIONS

When you operate, let's say, on 145.100.0 on FM and then switch to the CW

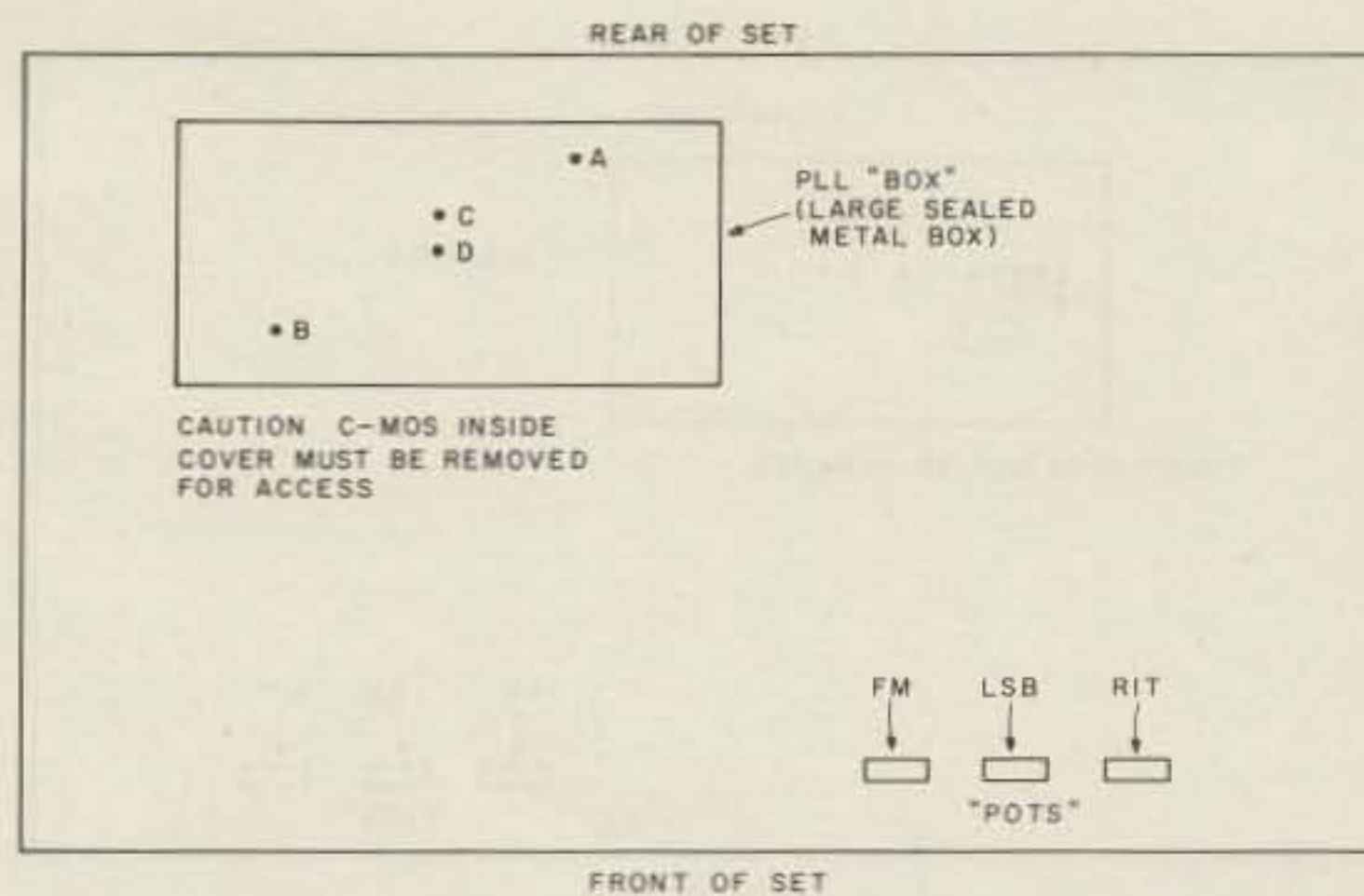

Fig. 2.

mode, your CW carrier should be on 145.100.0 and your receiver on 145.100.0. This is not the case with the IC-211. There is a +300-to-400-Hz receive shift and about a +800-to-1-kHz transmit shift. The transmit offset was manufactured into the IC-211 but, evidently, the receive change was not intended. These frequency shifts pose quite a problem when trying to work EME or aurora and, during general contacts, may cause leapfrogging around the band.

Receive Shift

I eliminated the receive shift by shorting out R17 (68 Ohms), which is located on the small circuit board near the mode switch (bottom side of rig).

Transmit Shift

On CW transmit, +9 V dc or less is put to D50 (anode), which cuts off D51. This removes C316 and C251 from the oscillator circuit and raises the transmit frequency about 800 to 1000 Hz. A cure appeared to be easy: Lift the anode of D50 from the circuit board. This did correct the frequency shift, but the power output went to zero! The FL1 filter will not pass the corrected frequency.

Since the transmit offset cannot be corrected easily, a change in operating procedures will have to suffice. Once you determine the

amount of frequency shift, you can compensate by using split-frequency operation. For example, using a +800-Hz shift with a desired operating frequency of 144.100.0:

1. Use vfo A as transmit: Set dial to 144.099.2; your carrier will be on 144.100.0.
2. Use vfo B as receive: Set dial to 144.100.0.

The receiver and transmitter will then track correctly, the receive readout would be correct, and you can ignore the transmit readout. Any minor adjustments to the receive frequency could be done with the RIT control.

FREQUENCY ADJUSTMENTS

Since the IC-211 has a nice 7-digit readout, I would like to feel sure that it is correct. The IC-211 does not "compute" the operating frequency like the Kenwood TS-820. However, neither does the TS-700SP, which only reads the vfo injection. (And, I might add, the vfos are generally not linear over the entire 4-MHz band!) The IC-211 breaks down the LO injection voltage into 100 discrete dc voltage steps and uses phase comparison of the vco and the LO, which is referenced to a very stable crystal standard. This makes for an extremely accurate readout once the rig is aligned properly.

Now, on with ad-

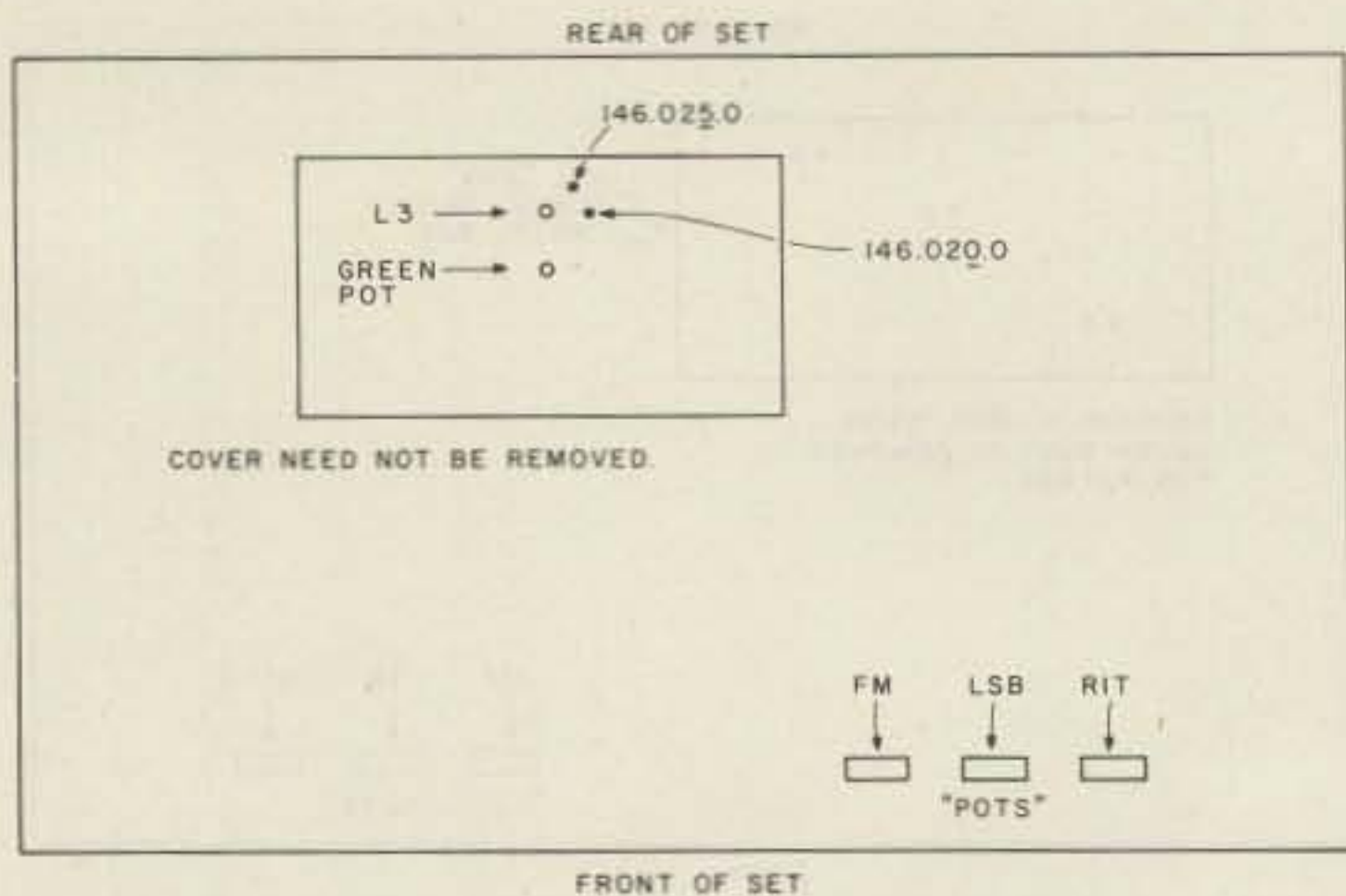

Fig. 3.

adjustments. There are two versions of the IC-211 out and the type which you have is easily determined by looking at the large sealed box underneath the rig. The older units, like the picture in the Icom manual, do not have openings in the case to get to all the adjustments; the newer units do.

Note: The rig should be turned on for about 30 minutes to an hour before starting; *all steps must be done in the order indicated*, and, for the older units, the cover must be removed from the PLL box. (Caution—CMOS inside!) The older unit is aligned as follows (see Fig. 2):

144-146 MHz

- Using either a signal generator or second 2-meter rig, set the signal source to 145,100,000 Hz as verified by a frequency counter.
- Set the IC-211 to 145.100.0, USB, receive, and adjust the coil at "A" for zero beat.
- Set signal source to 145,099,900 Hz.
- Set IC-211 to 145.099.9, USB, receive, and adjust pot at "B" for zero beat.
- Set IC-211 to 145.100.0, FM, transmit, and adjust R18 for exact frequency on the frequency counter. (Note: R16 and R18 are reversed in the Icom manual picture.)
- Set signal source to

145,100,000 Hz.

- Set IC-211 to 145.100.0, LSB, receive, and adjust R16 for zero beat. (Note: R16 and R18 are reversed in the Icom manual picture.)

146-148 MHz

- Set IC-211 to 146.025.0, FM, transmit, and adjust capacitor at point "C" for exact frequency on the frequency counter.
- Set IC-211 to 146.020.0, FM, transmit, and adjust capacitor at point "D" for exact frequency on the frequency counter.
- Repeat steps 1 and 2 as necessary to obtain correct readings, since these steps interact. The newer unit is aligned as follows (see Fig. 3): The rig should be turned on for about 30 minutes to an hour before starting; *all steps must be done in the order indicated*.

144-146 MHz

- Using either a signal generator or second 2-meter rig, set the signal to 145,100,000 Hz as verified by a frequency counter.
- Set the IC-211 to 145.100.0, USB, receive, and adjust L3 for zero beat.
- Set signal source to 145,099,900 Hz.
- Set IC-211 to 145.099.9, USB, receive, and adjust the green pot/trimmer for zero beat.
- Set IC-211 to 145.100.0, FM, transmit, and adjust R18 for exact frequency on the frequency counter.

(Note: R16 and R18 are reversed in the Icom manual picture.)

- Set signal source to 145,100,000 Hz.

- Set IC-211 to 145.100.0, LSB, receive, and adjust R16 for zero beat. (Note: R16 and R18 are reversed in the Icom manual picture.)

146-148 MHz

- Set IC-211 to 146.025.0, FM, transmit, and adjust rear trimmer for exact frequency on the frequency counter.
- Set IC-211 to 146.020.0, FM, transmit, and adjust front trimmer for exact frequency on the frequency counter.
- Repeat steps 1 and 2 as necessary to obtain correct readings, since these steps interact.

MISCELLANEOUS INTERNAL ADJUSTMENTS

RF Power Output

The transmit stages and adjustments are as follows: Q28—2 mW (alc-controlled stage)
Q30—100 mW; adjust C119, C123
Q31—1.6 W; adjust C132, C134
Q32—10 W; adjust C142, C144

FM

On the front panel, you have the rf power adjust which only functions in the FM mode. In addition to this control, there are two pots inside the top cover directly behind the front-panel power control. The pot on the left sets the lower power limit (typically 0.5 W) and is adjusted with the front-panel rf control set fully *counterclockwise*. The pot on the right sets the upper power level (typically 10 W) and is adjusted with the front-panel control set fully *clockwise*.

SSB/CW

Power output can be set for SSB/CW operation by adjusting R129, the alc con-

trol pot. R129 is adjusted for maximum power output, then backed off until the power just begins to decrease.

If your IC-211 has much more than 10 Watts of output, you should check the idling current on the driver and final (Q31 and Q32) to make sure they are set correctly. The proper current for Q31 should be 30 mA and is obtained by adjusting R127. The current for Q32 should be between 60 and 70 mA and is adjusted by pot R130. The adjustment procedure is as follows:

- Remove the top cover.
- Locate the plastic 4-pin plug near the back, left-hand side of the set.
- Remove the male plug.
- Insert an ammeter in series with pins 2 and 3.
- Clip-lead pin 1 to pin 4.
- Turn rig on and place in USB mode, microphone gain off.
- Key microphone and adjust R127 for 30 mA.
- Turn rig off.
- Insert an ammeter in series with pins 1 and 4.
- Clip-lead pin 2 to pin 3.
- Turn rig on and place in USB mode, microphone gain off.
- Key microphone and adjust R130 for between 60 and 70 mA.
- Turn rig off, remove meter and clip leads, and replace jumper plug.

SSB Audio Gain

In the SSB mode, using either an audio tone or voice input (a long "five"), adjust R273 for maximum power output on a wattmeter.

Carrier Balance Adjust

Using a second receiver tuned to the operating frequency of the IC-211, put the IC-211 in the USB mode, microphone gain off, and key the transmitter. Adjust R270 for the *least* amount of signal/carrier received by the second monitor. (Note: A police/fire scanner that

covers the 2-meter band works nicely as the second set.)

Swr Control Set

1. Connect rig to a non-reactive 50-Ohm dummy load.
2. With the transmitter keyed, put the slide switch (located beneath the top access panel) to the Set position (right). Using the Swr Set pot, adjust for full-scale reading on the meter.
3. With the transmitter still keyed, put the slide switch to the Swr position (left) and adjust R135 for a null on the meter. R135 is located near the antenna jack on the top side of the set.
4. Remove the dummy load (set will not be connected to any antenna), put the slide switch back to the Swr Set position (right), key the transmitter, and adjust R136 to read +20 dB on the meter. R136 is located next to R135.

5. Reconnect the dummy load and key the transmitter. The meter should still read full scale.

Bfo Adjustments

1. For USB/CW operation, the 10.6985-MHz crystal is adjusted by C255. Measure with a frequency counter connected to CP9 (free end of R218, 470 Ohms).
2. For LSB operation, the 10.7015-MHz crystal is adjusted by C259. Measure with a frequency counter at CP9.

FM Transmit Modulator

The 10.7-MHz crystal is adjusted by L12 and measured with a frequency counter connected to CP2 (free end of R317, 470 Ohms).

In conclusion, I hope that the information and various modifications provided here may be of interest and help to all IC-211 owners in enjoying this truly unique set. ■

State of the art TECHNICAL EXCELLENCE in RTTY



The FSK-1000 Demodulator

If you demand the finest, no compromise technology, you need the FSK-1000 demodulator. Can't be outcopied because its design, computer grade parts, and modern technology offer landline copy over radio circuits.

Stops QRM with selectable 55 or 100 Hz. filters and two tone limiterless operation

Video operation available. Interfaces microcomputers. We can install your Xitex SCT-100 board inside, too

Decision level correction improves selective fading

Continuously adjustable shift from 100 to 1000 Hz.

Uses either 170 volt, 60 Ma. or RS-232 loops

Write for details. Visa and Master Charge accepted.

\$449.00

FOB Columbus, Ohio

Dealer Inquiries Welcome

IRL ✓37

700 Taylor Road
Columbus, Ohio 43230
(614) 864-2464

New 2 Meter Avanti Mobile Antenna

Mounts on glass — no holes!

- Receives and transmits through glass.
- Superior performance equivalent to 5/8 wave.
- Superior radiation full Omni-Directional.

It's easy to install — No holes to drill, no magnet to scratch the paint, no clamps. Uses an especially developed epoxy adhesive that secures antenna to window like a 1/4" bolt. The capacity coupling box is simply attached with a special adhesive tape to inside of window. Worried about crimping or corroding coaxial cables? It's all inside and out of sight.

Models also available for 220 MHz and 450 MHz.

AH 151.3G SPECIFICATIONS

Gain	Equivalent to 5/8 wave
2 meter V.S.W.R. Band Width	Better than 1.5:1
Maximum power	150 watts
Nominal Impedance	50 Ohms
Chrome plated casting. Stainless Steel hardware. Swivel whip holder	
Height	33"
Performance and Mechanical Patents Pending	

Buy one from your nearest AVANTI dealer. If your dealer does not have one in stock, have him call the following toll free number and we will ship him one within 24 hours:

(800) 323-9429

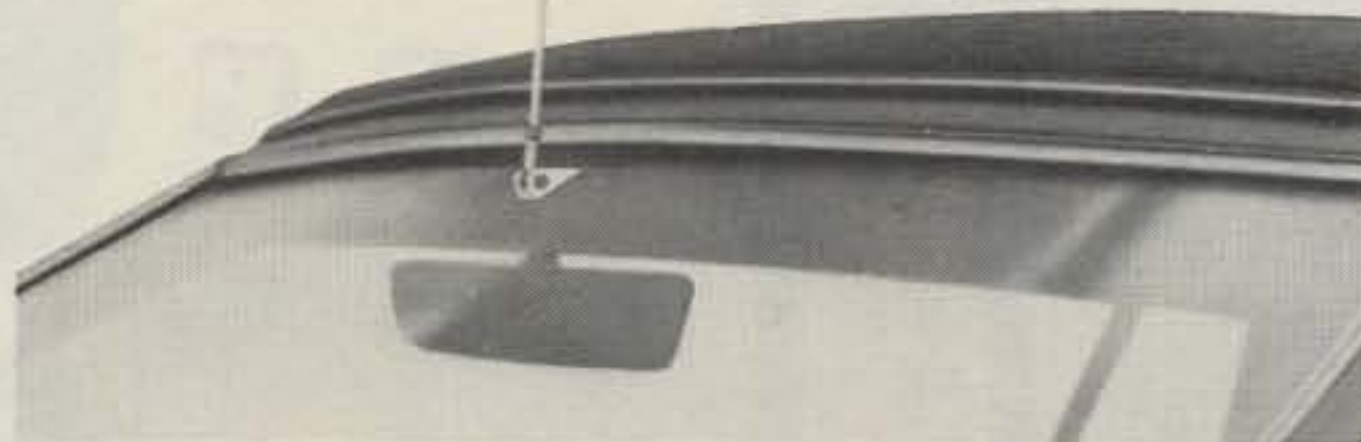
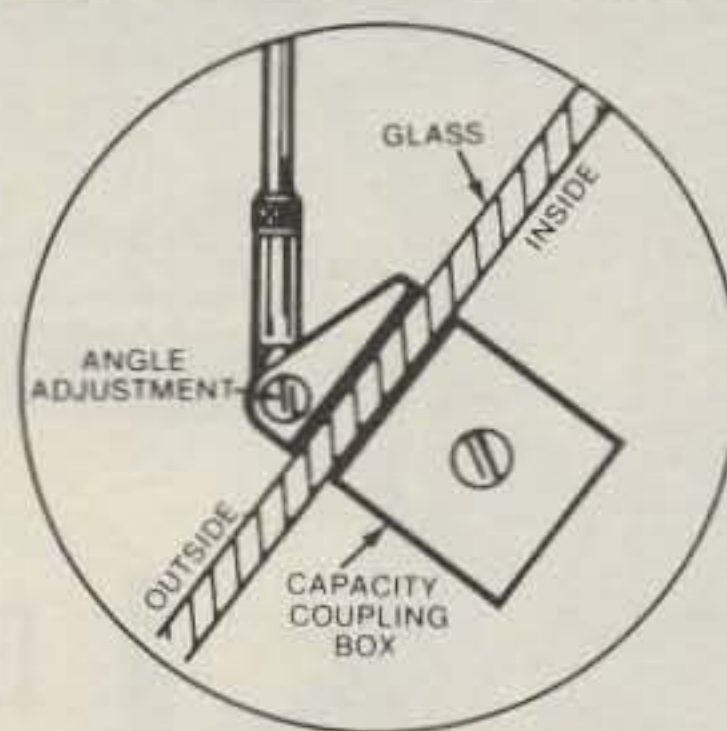

See Avanti's other new amateur mobile and base antennas. Write for new catalog today.

Send 50¢ for handling and postage.

avanti antennas

Avanti Research and Development, Inc.,
340 Stewart Ave., Addison, IL 60101
1979 In Canada: Lenbrook Ind., Scarborough, Ontario M1H 1H5

SCR1000VHF—SCR4000UHF

For Your New Repeater System, Or, to Replace Your Old "Klunker"

*Go First
Class!*

**2 Mtr.
220 MHz
450 MHz**

- 30W Output.
- Low Noise/Wide Dynamic Range Front End for Excellent Sensitivity & IM Rejection.
- Sensitivity: 0.35uV Typ.
- 8 Pole IF Crystal Filter.
- Full Metering, Lighted Status Indicators/Control Push-buttons, Btry. Power Input, AC Pwr. Supply, CW I.D., etc., etc.!

Made in USA

Go With Spec Comm!

Whether you want to install a new repeater system or upgrade your old one, don't you want the *finest* repeater available... at a reasonable price? And don't you want to buy it from a reputable firm with years of experience in Repeater Systems? Check around—check features, performance, availability of a full line of accessories and options... check prices, and *check quality of construction!*

If you do, you'll find that there isn't a repeater on the market that really compares to the SCR1000 or 4000! There are cheaply made low-power "barebones" units, and there are super-expensive repeaters (which don't even offer many of our features)! All things considered, we feel that the SCR1000 & 4000 are simply the *finest repeaters available*—produced by a very reliable company which specializes specifically in this field. So, make your next repeater a Spec Comm. Years from now, you'll still be glad you did!

Shown in Optional Cabinet



SCR1000 IS FCC
TYPE ACCEPTED
for Commercial
Services

**30 or 70 WATTS
on 2 Mtrs.!**

Available just the way you want it—with Full Autopatch/Reverse Patch/Land-Line Control; Touch Tone Control of various repeater functions; "PI"; "Emergency Pwr. I.D."; various Tone & Timer Units, etc. PLUS—the finest Duplexers, Cabinets, Antennas, Cables, etc. Our Repeaters are sold factory direct only, or through Foreign Sales Reps. Get your order in A.S.A.P.!

180 Day Warranty

Call or write today and get the details!



SPECTRUM

Export Orders — Contact our International Dept.

1055 W. Germantown Pk., Dept. S6

new

COMMERCIAL MOBILE & BASE TRANSCEIVERS

Spec Comm "Professional Communications Line"

136-174 MHz

Features

- 6 channels.
- 0.35 uV Rcvr.
- 6 or 8 Pole Crystal Filtr.
- Beautiful Audio—RX & TX.
- Very Reasonable Price!

PCL250 25 Wt. Mobile Unit

- "Super Rugged" Housing
- Solid 1/8" Thk. Aircraft Aluminum!



220-240 MHz (Commercial Export and Amateur)

- Very attractive woodgrain housing.

PCL300 25 Wt. Base Station

- Built-in AC Power Supply.
- Front Panel Status Indicator Lights.
- Optional Rcvr. Scanning Function Available.



SPEC COMM REPEATER BOARD & SUB-ASSEMBLIES

These are Professional "Commercial Grade" Units—Designed for Extreme Environments (-30 to +60° C). All equipment assembled & tested. For 2M, 220 MHz & New 450 MHz!

SCR450 BOARD



SCR100 VHF Receiver Board

- Wide dynamic range! Reduces overload, 'de-sense', and IM.
- Sens. 0.3 uV/20 dB Qt. typ.
- Sel. -6dB @ ± 6.5 KHz, -110dB @ ± 30KHz. (8 Pole Crystal Filtr.)
- 'S Meter' Output.
- Exc. audio quality! Fast squelch! w/xtal.

SCR100 Receiver Assembly

- SCR100 mounted in shielded housing
- Same as used on SCR1000
- Completely asmbld. w/F.T. caps, SO239 conn., AF GAIN POT, etc.

SCR450 UHF Receiver Bd. or Assy.

- Similar to SCR100, except with 12 Pole IF Filtr. & 8 Resonator Front End Filtr.!
- Discriminator & Deviation Mtr. Outputs
- **Totally New Advanced Design!**



SCAP Autopatch Board

- Provides all basic autopatch functions
- 3 Digit Access; 1 Aux. On/Off function; Audio AGC; Built-in Timers; etc.
- 0/1 Inhibit bd. also available.
- Write/call for details and a data sheet.

RPCM Board

- Used w/SCAP board to provide "Reverse Patch and Land-Line Control of Repeater.
- Includes land line "answering" circuitry

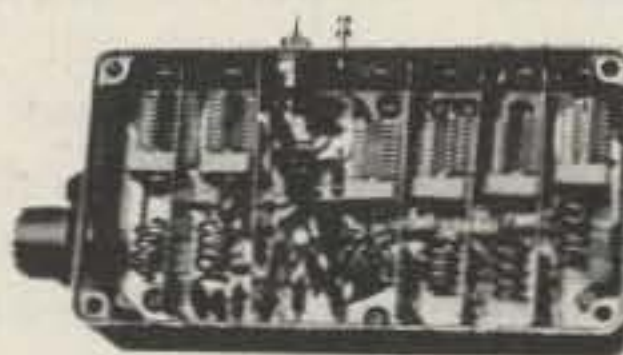

FL-6

FL-6 Rcvr. Front-End Preselector

- 6 Hi Q Resonators with FET amp (2M or 220 MHz).
- Provides tremendous rejection of "out-of-band" signals w/out the usual loss! Can often be used instead of large, expensive cavity filters.
- Extremely helpful at sites with many nearby VHF transmitters.
- Voltage Gain: apx. 10 dB.
- Selectivity: -20 dB @ ± 2.0 MHz; -60 dB @ ± 6 MHz (typ.)

ID1000 Automatic Base Station CW Identifier

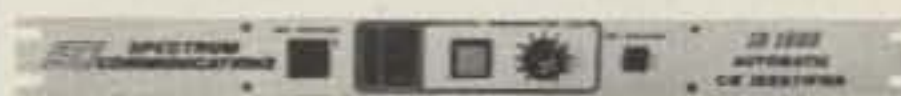

- For Repeaters, Base Xmtrs., etc.
- Fully Automatic ID timing & xmtr. keying.
- Convenient Front Panel Controls. Many Deluxe Features!
- AC or DC powered
- Easy to install! 19" Rack Mount
- Reasonable Price! Ask for Data Sheet

CTC100 COR/Timer/Control Board

- Complete COR circuitry.
- Carrier 'Hang' & T.O. Timers.
- Remote xmtr. Inhibit/Reset control.
- Provision for panel control switches & lamps.
- 100% Solid State CMOS logic.
- Many other features

ID250 CW ID & Audio Mixer Board

- Adjustable ID tone, speed, level, timing cycle.
- 4 Input AF Mixer & Local Mic amp.
- COR input & xmtr. hold circuits.
- CMOS logic; PROM memory—250 bits/channel.
- Up to 4 different ID channels!
- Many other features Factory Programmed



SCT410 XMTR. ASSY.

SCT110 VHF Xmtr/Exciter Board

- 7 or 10 Wts. Output. 100% Duty Cycle!
- Infinite VSWR proof
- True FM for exc. audio quality
- New Design—specifically for continuous rpt. service
- Very low in "white noise"
- Spurious -70 dB. Harmonics -60 dB.
- With .0005% xtal.
- BA-10 30 Wt. Amp board & Heat Sink, 3 sec. L.P. Filter & rel. pwr. sensor.

SCT110 Transmitter Assembly

- SCT110 mounted in shielded housing
- Same as used on SCR1000
- Completely asmbld. w/F.T. caps, SO239 conn.
- 7, 10 or 30 Wt. unit.

SCT410 UHF Transmitter Bd. or Assy.

- Similar to SCT110. 8-10 Wts.
- Avail. w/ or w/o OS-18 Super High Stability Crystal Osc./Oven.
- BA-40 30W. min. UHF Amp. Bd. & Heat Sink.

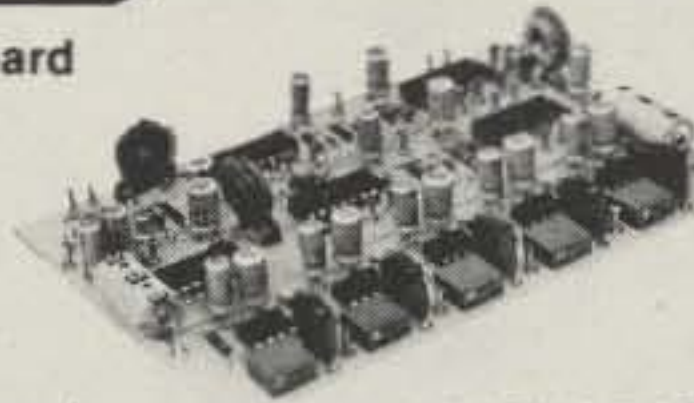

TTC100 Touchtone Control Board

- 3 digit ON, 3 digit OFF control of a single repeater function. Or, (optional) 2 functions (2 digits ON/OFF each).
- Can be used to pull in a relay, trigger logic, etc.
- Typically used for Rptr. ON/OFF, HI/LO Pwr., P.L. ON/OFF, Patch Inhibit/Reset, etc.
- Stable, anti-falsing design. 5s Limit on access.
- For Add'l Function(s)—Add a "Partial TTC" Board.

COMMUNICATIONS CORP.

Send for Data Sheets!

Norristown, PA 19401 • (215) 631-1710

Take a Hike

— backpacking with an HW-8

It isn't often that you can enjoy three hobbies at the same time, but the junior op, Scott WD4LYN, and I did just that for a couple of days two summers ago. Scott assembled an HW-8 QRP rig a few months before he received his Novice ticket and I quickly saw the possibilities of using it on camping trips. We

each took along a camera, completing the hobby picture.

This summer, rather than just piling all (XYL, campstove, cots, pots, pans, cats, and rig) into the car and heading for "civilized camping" complete with showers, we decided to trek, or backpack as it's sometimes called, into a

wilderness area nearby. We collected all the special gear needed: mountain tent, packs and frames, hiking boots, portable stove and cookgear, sleeping bags, light and heavyweight socks, and the not-to-be-forgotten first aid kit with "moleskin" for those inevitable blisters. On-the-air testing of the QRP station,

using all accessories and the antenna we'd be taking, was the next step in getting ready.

The HW-8 had been on the air from the home QTH a few times and was used another time on an automobile camping trip, so we knew it would work well the way it was—no mods required yet. The greatest concern was the antenna. We wanted something both light and practical. I wanted the simplest type so that we could work several bands without too much fuss. The solution was an endfed 65-foot wire with a counterpoise about the same length to substitute for a ground. To facilitate loading, I built a compact wire tuner and chose a lightweight plastic-cased Radio Shack CB swr bridge to see what was happening.

The portable power source was almost a greater challenge until I recalled that the junk box contained two 6-volt motorcycle wet cells that I had on hand for a doorbell and burglar alarm project. They were spillproof and rated at 3 Ah. Taped together and wrapped in plastic to contain any accidental leakage, they made a neat 5-pound package. Other



Photo A. The QRP station assembled and ready for packing. Note the antenna and counterpoise (plastic-covered hookup wire) wound on empty vitamin bottles, just behind the key and antenna tuner.

types of rechargeable cells could have been used (nicads and gel-cells), but the added cost and weight to achieve the same capacity were not considered worthwhile. Our HW-8 drew less than 500 milliamperes key down, so there would be plenty of juice for all the operating we'd get in on a 3-day trek.

A final weighing-in of the gear rang up another 5 pounds for the transceiver, plus 2 pounds for the tuner, swr bridge, straight key, featherweight earphones, cables, and the antenna and counterpoise wire, for a total of 12 pounds. To save weight, I mounted RCA-type phono jacks on the swr bridge and tuner and used phono plugs on RG-174/U miniature coax for rf interconnections.

Our first trek was planned for mid-July, but Murphy's law governed and Scott ended up with a broken wrist from a skateboard fall, which meant a full-length cast on the right arm—and a postponement. After 3 weeks the cast was shortened, and with his fall school-opening only a week away, Scott announced that he was ready to go. We made a quick trip to the local outdoor outfitters for freeze-dried food and maps, jammed everything into our packs, and informed the XYL that we were off. We weighed our packs before loading up the car and found we'd each be carrying 10 to 12 pounds more than recommended by the guide books: Scott would be carrying 32 pounds, and I'd have 47 to tote. We couldn't throw out any of the food, and the QRP station required everything we had assembled. We finally decided we could sacrifice a couple of changes of underwear, but this drastic action resulted in a decrease in the weight of our packs of only a few ounces.

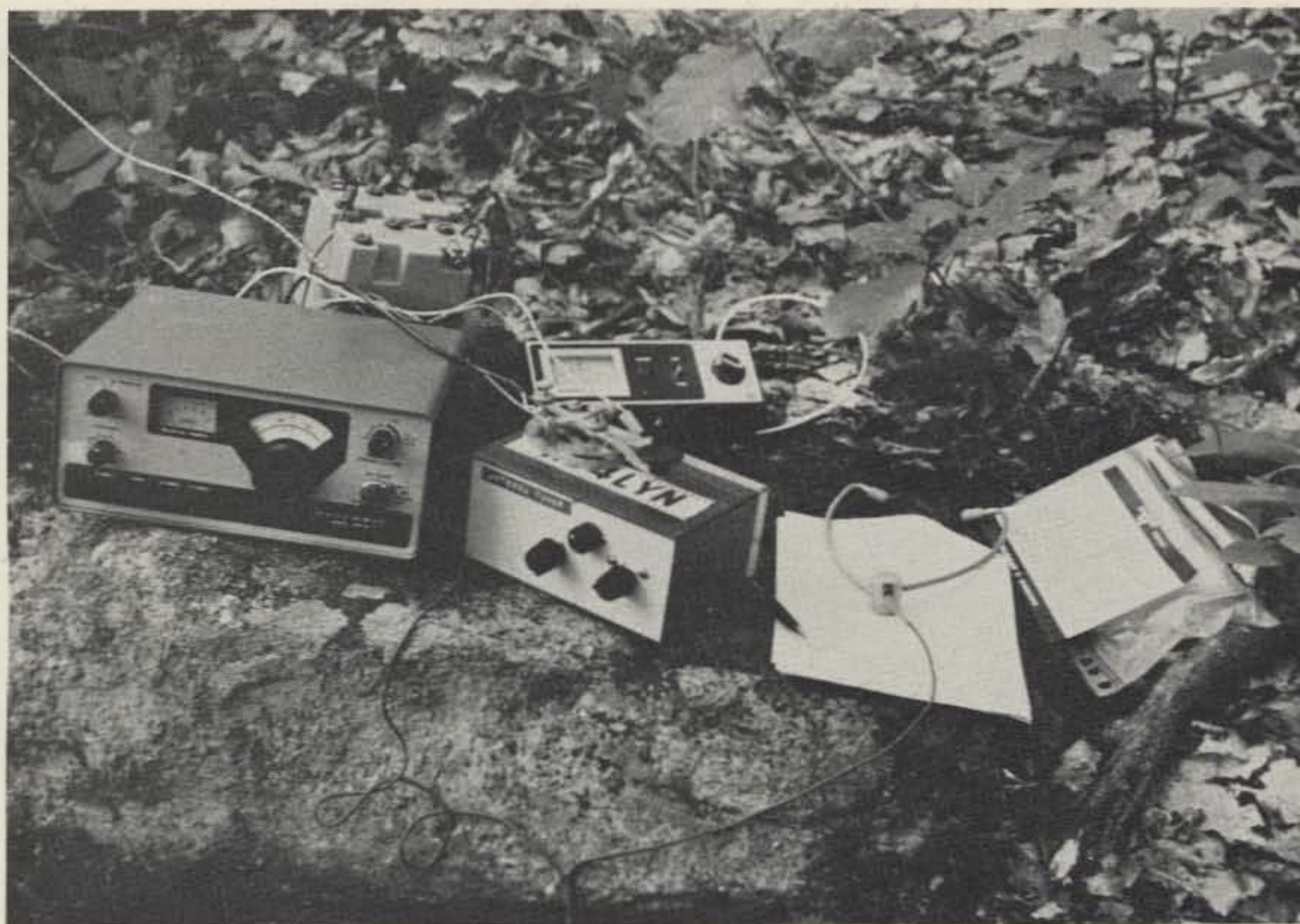

Photo B. A close-up of the QRP station as set up the first morning.

The area where we planned to backpack was in the upper part of the George Washington National Forest near Front Royal, Virginia, only 70 miles from home. We arrived at a US Forest Service recreation area early in the afternoon of August 28th, parked our car in the day picnic area, pulled on socks and boots, adjusted our packs, and were on our way by 3 o'clock. Our plan was to hike about six miles that afternoon, to reach by nightfall the Little Crease trail shelter, built and maintained by the Forest Service. The rugged terrain, uphill much of the way, plus 80 degree weather with high humidity, delayed us considerably so that stumbling along with flashlights at 9:00 pm, canteens dry, we finally decided to put up our tent by the side of the trail, close to a stream. Exhausted, we both decided to forego a hot meal and any attempt at operation that night. So it was water from the stream, trail snacks for the meal, and to bed—to listen to creeping and chirping things play

leapfrog on the tent the rest of the night!

I managed to get up early the next morning, assemble the stove, and fix a passable meal of freeze-dried scrambled egg with imitation ham, powdered-juice drinks, and hot chocolate. Next the rig came out of the plastic wrappings, and I strung out the antenna. It loaded up easily and I was ready for a 9:00 am sked with Jim WD4LWE on 40 meters. I listened for him and called a few times with no response, so in 10 minutes we decided to try a few CQs. The signals were pouring in on 80, 40, and 20 and there was absolutely no QRN, but no one came back. A bit disappointed, we packed up and headed for the destination of the previous day, the trail shelter. It turned out that the shelter was only another 45 minutes down the trail we'd been on the night before!

The shelter was in great shape, had four plywood bunks, and offered good protection from the elements. It featured a clean

stream nearby and a nice campfire area. This looked like just the place to spend the rest of the day and night and try some more hamming. We had reached the shelter at lunchtime, but were still somewhat tired from our previous day's trek and decided to make use of those bunks for awhile.

Late afternoon, I fixed a dinner of freeze-dried stew; after cleanup, it was time to pull the rig out again and warm up the fist. The antenna was supported at the far end by a sapling only 10 feet above the ground and the counterpoise was placed on the ground directly beneath it. The map showed that we were in a depression between two ridges which were 2,200 feet high. Our altitude was 1,600 feet above sea level. Everything was "go" and the bands sounded just as noise-free and hot as they had that morning.

This time, instead of wasting time calling CQ, I decided to try something different: answer only the strongest CQs. The strong-

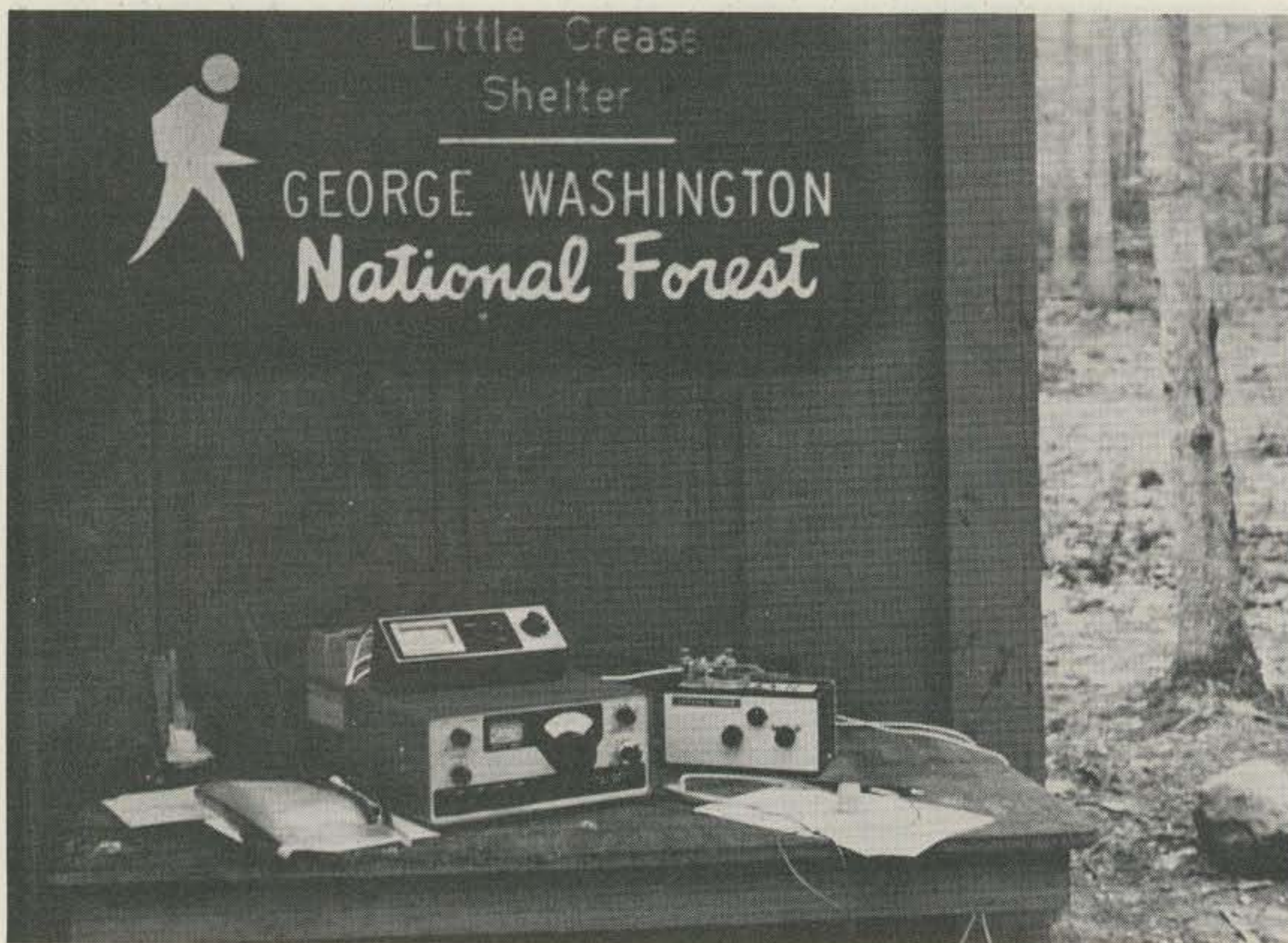

Photo C. The setup at Little Crease Shelter, George Washington National Forest, Virginia.

est on 40 at that time, 1930 Clarence VE3EZL on hours Eastern Daylight, was Georges Bay, Ontario. Clar-

ence came right back and gave us a 559. When I told him about our operation, he expressed surprise in being able to copy our flea-power at that distance. After I signed with him, Scott decided to try out the rig in the Novice bands for awhile, but soon found that operating a straight key with the wrong wrist didn't work well at all. Operation was now by flashlight and a candle "lantern" left by a previous hiker. Scott got no replies, so we decided it was time to QRT.

The next morning, the 30th, it was scrambled, freeze-dried omelets, hot and cold drinks, and time to turn on the rig once more. Forty meters was again lively, and at 7:00 am the strongest CQ heard was Jack W8JZH in Toledo. A quick call, and Jack responded with 559, solid copy. There was no QRM, so I was able to get across details of the rig, where we were, and that we were planning to pack up the rig shortly after our QSO and retrace our steps to the car. We had a 20-minute QSO—

a record for my QRP work on 40!

It took us only about half the time to walk out as it took us to walk in, even with generous rest stops for picture-taking and eating wild blueberries which the bear and deer had overlooked. Our packs were only slightly lighter since one can only eat so much food (we still had enough for two more days) and there is little one leaves in the wilderness unless it can be turned into ashes in a campfire.

A few days after returning home, I dropped W8JZH a note to describe the QRP operation in greater detail. Jack very kindly replied and emphasized what is perhaps the real key to working QRP, an effective antenna. The antenna we used was a compromise, of course, but it was tunable to several bands easily and worked as well as expected. Perhaps we could have gotten out better if the antenna had been higher, but that would have meant carrying more equipment—at least a slingshot and a ball of string.

One lesson learned was that calling CQ with low power produces little in the way of QSOs. Always pick the strongest CQs to answer, but answer only if it appears the frequency is reasonably clear of QRM. If you get a response and it remains clear, you've got a good chance of completing the QSO for your QRP logbook.

Next time out we plan to take less in the way of clothes and food. Plans are underway already for these modifications to the rig: more audio to drive a built-in speaker, an internal swr bridge, and a 25-kHz crystal calibrator. Now, does anyone have any ideas for an inexpensive, lightweight, biodegradable battery that can be activated by dipping it in a cool mountain stream? ■

RAPID MOBILE CHARGER



Charge your handheld radio off 12 volt source in 4-6 hours. Will not overcharge your batteries due to automatic shut-off circuitry.

Equipped with a cigarette lighter plug on the input side and the appropriate charging plug on the output side.

CORD LENGTHS ALLOW FOR CONVENIENT USE WHILE CHARGING!

Models available now for the Kenwood TR2400, the Yaesu 207R Tempo S1, Wilson Mark II and the Wilson Mark IV.

Other models available also please call or write for more info. \$29.95

Order by mail or phone. All orders add 5% shipping, C.O.D. add additional \$1.15 Bac/Visa/MC. Ohio Res. add 4 1/2% Tax

Phone (513) 731-7220

✓ 330



DEBCO ELECTRONICS
P.O. BOX 9169
CINCINNATI, OHIO 45209

Call 1-203-667-0811

ORDER YOURS TODAY!

USED EQUIPMENT		NEW EQUIPMENT SPECIALS	
ATLAS 210X Limited Edition w/NB, DMK	\$ 429	REGENCY HR-6 6 Meter Xcvr.	169
ALLIED A-2517 Xcvr w/PS/Spkr	399	SWAN 350A Xcvr. 600R Rcvr. 250 6 Meter Xcvr. w/117XC, P.S. Spkr. 500CX Xcvr. w/117XC P.S., Spkr. VX-2 Vox Unit 117C AC Supply 14C DC Models	349 350 289 479 39 59 39
COLLINS R390A .5-32 MHz Rcvr. 75S-3B Rcvr. 75S-3 Rcvr. 75S-3 Rcvr. (modified) KWM-2 (round) w/516F-2 Power Supply KWM-2 (round) 516E-1 D.C. Supply	549 649 449 349 1099 949 69	TEN-TEC Triton II Xcvr. w/CW Filter Triton IV Xcvr. w/CW Filter Omni D (B Series) w/NB, 217, 218 Filters Omni D Xcvr. 252 Power Supply 252MO Power Supply	399 499 899 799 69 99
DRAKE R-4B Rcvr. T-4X Xmtr. w/AC-4 T-4XB Xmtr. w/AC-4 TR-4 Xcvr. w/AC-4 R-4A Rcvr. FF-1 Fixed Freq. Adapt. TR-22 2 Meter Port.	349 418 458 478 279 39 119	YAESU FT-901DE "Demo" w/FM Option installed—full warranty FTdx-560 Xcvr. FV-400S Remote VFO FT-720B 6 Meter Xcvr. FTV-650B 6 Meter Xvtr.	999 449 69 309 179
DENTRON HF-200A Xcvr. w/HF-ACS P.S./Spkr, Mike Clipperton L Amp.	499 450	HYGAIN TH3 Jr. TH3 Mk 3 TH5 DX TH6DXX 12AVQ 14AVQ/WB 18AVT/WB	139 189 219 269 35 58 87
ELECTRONIC RESEARCH CORP. SL-55 Audio Filter	49	ICOM IC2A List: \$229.50 IC2AT List: \$249.50 255A List: \$389.00 260A List: \$489.00 551 List: \$449.00 551D w/PS20 List: \$849.00 251A List: \$699.00	Call for Quote Call for Quote Call for Quote Call for Quote Call for Quote Call for Quote
HALLICRAFTERS SX-111 Rcvr. FPM-300 Xcvr.	129 349	KENWOOD I20S, 180S, 520SE, TR7625, TR2400	Call for Quote
HEATHKIT HW-104 Xcvr. w/PS, Spkr., CW Filter, NB, mike SB-614 Scope SB-110 6 Meter Xcvr. w/HP23B	549 159 329	ROHN 25G Towers & Accessories 20% to 25% Off	
ICOM IC22S 2 Meter Xcvr. w/TTP IC-245 2 Meter Xcvr. IC-3PA D.C. Supply/Spkr. IC-215 2 Meter Port. w/BC-20	219 249 49 179		
JOHNSON Viking Valiant II Xmtr.	149		
KENWOOD TS-600 6 Meter Xcvr. TR-7625 2 Meter Xcvr.	499 299		
NATIONAL NCX-5 Xcvr. w/P.S. Spkr. NC-200 Xcvr. w/P.S. Spkr.	359 249		

ROBOT Model 400	649
SWAN TB-3HA Tribander 10-40V Vertical	159 89
YAESU FT-7B Xcvr. CPU-2500R/K FT-207R List: \$399.00 FT101ZD List: \$895.00 FT-901DM List: \$1459.00 FT-107 List: \$1045.00 FT-707 "In Stock"	569 399 Call for Quote Call for Quote Call for Quote Call for Quote

ANTENNA PACKAGES	
Cushcraft ATB-34 Tribander w/ Alliance HD73 Rotor	339
Cushcraft A-3 Tribander w/HD- 73 Rotor (Alliance)	259
Hygain TH3 Jr. Tribander w/ Alliance HD-73 Rotor	229
Hygain TH3MK3 Tribander w/ Alliance HD-73 Rotor	279
Hygain TH5DX Tribander w/ Alliance HD-73 Rotor	309



WE TAKE PHONE ORDERS OR SHIP C.O.D.

**Call
or Write
for your
super quote
today!**



**WE EXPORT
(Sub-Dealers
wanted in
foreign countries)**

**We Sell and Service the Following
New and Used Equipment:**

Alda	DSI	Mirage
Alliance	ETO Alpha	Mosley
Ameco	Ham Key	Murch
ARRL	Hustler	PIPO
Atlas	Hy-Gain	Robot
Bencher	ICOM	Rohn
Bird	JW Miller	Saxton Wire
B & W	KDK	Shure
Callbook	KLM	SST Electronics
CDE	Larsen	Swan
CES	MFJ	Telex
Covercraft	Microlog	Ten Tec
Cushcraft		TET Antennas
Dentron		Trac
Drake		Unadilla
		VHF Engineering
		Vibroplex
		Wilson
		Wilson Commercial
		Yaesu



95 Kitts Lane, Newington, Conn. 06111
"Near ARRL Headquarters"

Call: 203-667-0811
OPEN MON.-FRI. 10:30-Sat. 10-4
EASY DIRECTIONS: Rt. 15 South 2 blocks past McDonald's (Berlin Turnpike)

SUB-DEALER INQUIRIES INVITED! (Send letterhead for complete package)

Tuning Antenna-Mounted Preamps

— do it without additional wiring

73 Magazine Staff

It is often desirable to place a receiving preamplifier as close as possible

to an antenna. This is particularly true on VHF/UHF frequencies, since placing the preamplifier at the receiver does not improve the overall receiving system sensitivity as much as having the preamplifier at the antenna. The reason for this is that the attenuation of the transmission line used adds directly to the overall noise figure of the receiving system, and, at VHF/UHF, most commonly-used coaxial transmission lines do have significant attenuation.

to keep the installation as simple as possible by running the dc voltage for the preamplifier over the transmission line using rf chokes and dc blocking capacitors.

Quite by accident, a way was found to have the best of both worlds. That is, one can still run the dc voltage needed for a preamplifier over the transmission line, and, at the same time and over the same transmission line, have a means to remotely tune the preamplifier. An application for this idea for a particular 2-meter preamplifier is described in this article, but it can be modified to be usable with almost any remotely-located preamplifier.

The accidental discovery of how to remotely tune the preamplifier came about when a 2-meter preamplifier was installed at the antenna with the dc power supplied over the transmission line. A vari-

The disadvantage of having the preamplifier at the antenna is that it has to be of the broadband type. One cannot have the advantage of being able to have the "front-end" selectivity possible with a tunable preamplifier. Of course, there are ways around this, but most amateurs do not want to run extra control lines up to a preamplifier. Usually, in fact, it is desired

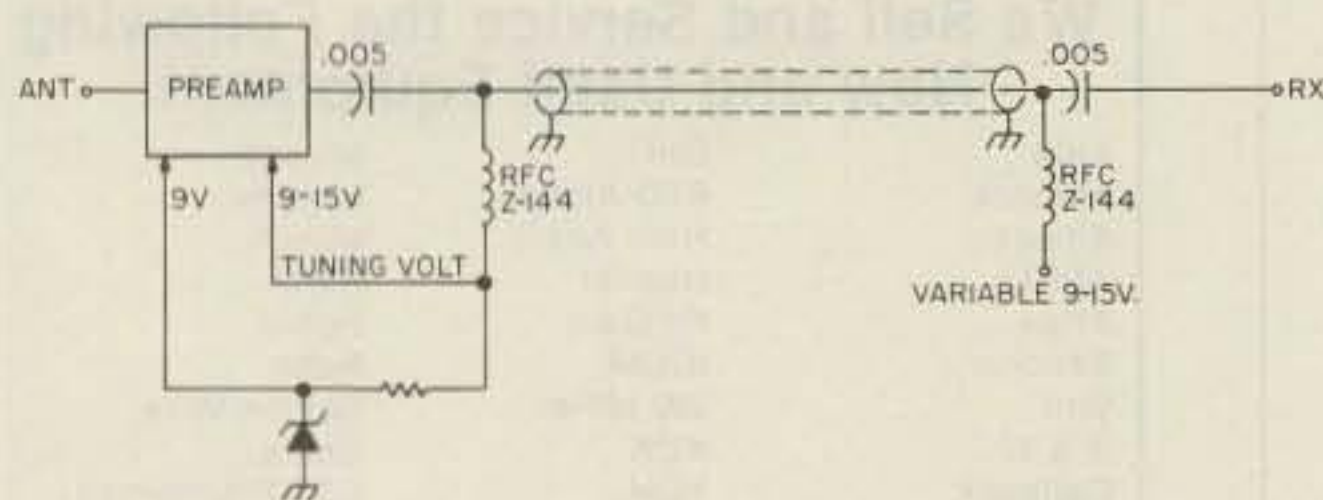

Fig. 1. The basic idea of how to both power and tune a preamplifier over the same coaxial line that carries the rf signal.

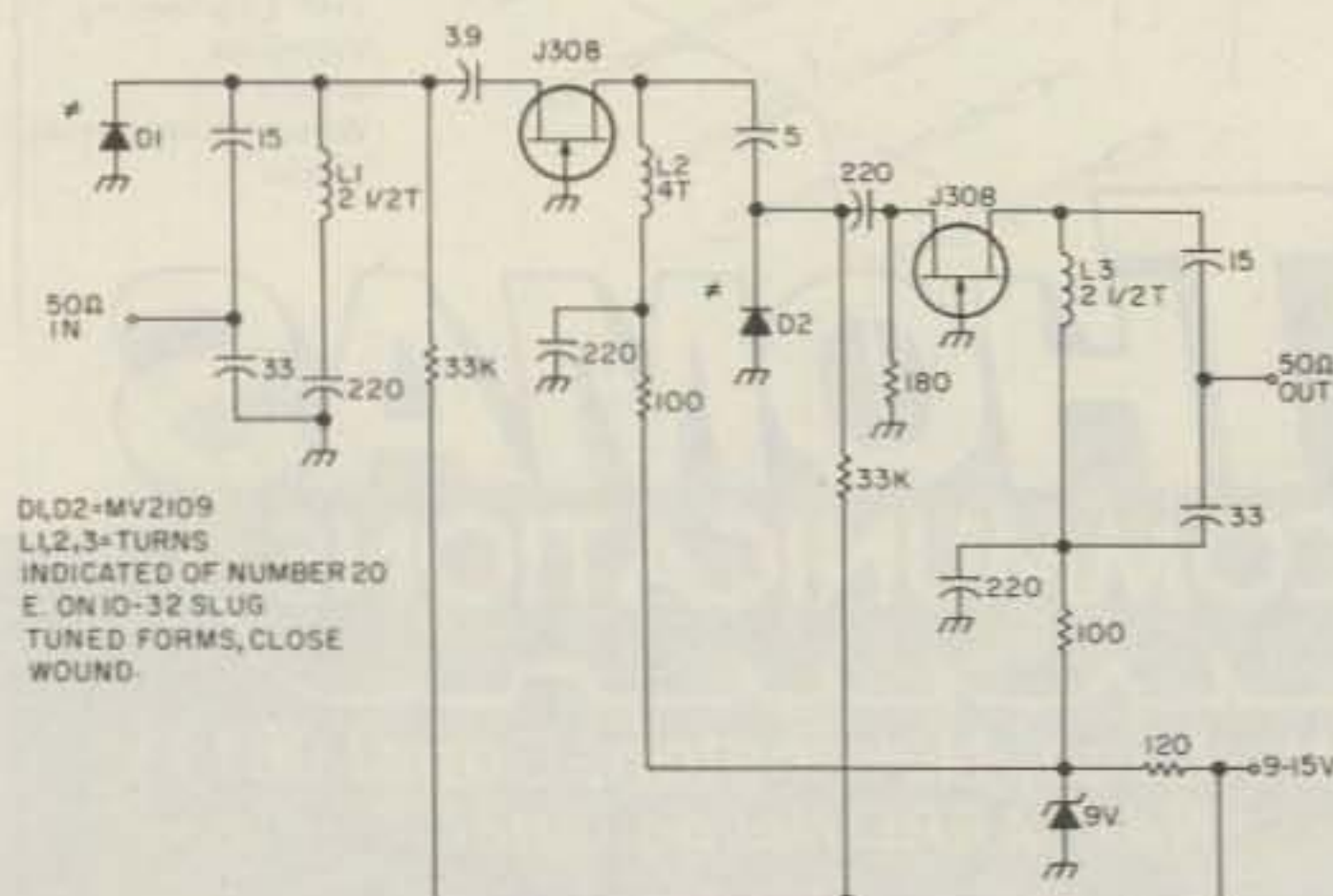

Fig. 2. An example of a 2-meter preamplifier to which remote tuning was applied.

able-voltage bench-type power supply was being used inside to temporarily test the preamplifier. It was noticed that when the power supply voltage was varied, the preamplifier could actually be tuned or peaked as indicated by the S-meter on the receiver. There were some protective diodes in the preamplifier and, as it turned out, these diodes were acting as varactor diodes when the dc supply voltage was varied and were actually tuning the circuits they were placed across.

A simple extension of what was observed led to the idea illustrated in Fig. 1. In this case, the dc supply voltage is fed over the transmission line in the usual fashion, using rf chokes and dc blocking capacitors. The operating voltage for the preamplifier stages is zener-regulated so that the stages have a constant operating point. However, by using a variable supply voltage, and having the variable voltage control varactor diodes, one can remotely tune the preamplifier while remotely powering it at the same time.

A specific application for the idea is shown in Fig. 2. This is a dual-FET amplifier designed for the 2 meter band using two of the newer Siliconix "super" FETs. The preamplifier will provide a gain of about 20 dB and 1.5- to 2.0-dB noise figure. The FETs are available directly from Circuit Specialists, P.O. Box 3047, Scottsdale AZ 85257, at only 75 cents each plus 40 cents for shipping.

Although the purpose of this article was not to describe a preamplifier as such, those who do duplicate the preamplifier will find that it performs extremely well. As in any such VHF preamplifier, lead lengths must be kept

short. There are so few components involved in the preamplifier that using the "isolated pad" type of construction on a single-sided PC board is probably easier for the individual builder than trying to etch a PC board. The circuit is inherently stable, and one has only to sufficiently isolate the various coils. This can be done by individual can-type shields, or by simple barriers of PC board between the coils with the copper side of the barriers grounded to the main board containing the circuit.

The coils are first peaked in the middle of the desired operating range with a supply voltage of about 12 volts. Then as one changes frequency and varies the supply voltage, it should be readily noted how the preamplifier can be peaked using the variable supply voltage. One will probably have to do a bit of adjustment of the slugs in L1 and L2 to get reasonable tracking between the two tuned circuits over the band. It should be possible, however, to have the preamplifier tune over the entire band.

All of this work can be done on the bench before the preamplifier is remotely installed. Assuming that bench adjustment is done using the same enclosure, connectors, etc., as will be used in the final installation, the preamplifier should work without difficulty when remotely installed.

The remote tuning idea described can be applied to a host of preamplifiers.

Tuning Diode Type	Capacitance (pF at 9 V)	Capacitance (pF at 20 V)
MV 2101	5	3.9
MV 2105	10	6
MV 2109	25	15
MV 2112	40	25
MV 2115	70	50

Fig. 3. The inexpensive Motorola MV series of tuning diodes will satisfy most needs for remotely tuning a VHF or even an HF preamplifier.

INTERNATIONAL ELECTRONICS TOURS

THREE ELECTRONICS TOURS ABROAD

Electronics Representative Association, Northern California Chapter, and Commerce Tours International will co-sponsor three electronics tours in 1980 as follows:

COMPUTER TOUR:

Will visit Tokyo Information Processing Exhibition and 8th World Computer Congress in Tokyo from October 4th to October 10th, 1980.

FAR EAST ELECTRONICS TOUR:

Will visit four foreign electronics shows in Japan, Korea, Taiwan, and Hong Kong from October 8th to October 22nd, 1980.

EUROPE ELECTRONICS TOUR:

Will visit London, Paris, and Munich Electronica '80 from October 29th to November 9th, 1980.

As described by Wayne Green in January, Feb. 1980 73 Magazine

Business appointments will be arranged in advance and at the shows. For further information, please contact:

Janet Smith
Commerce Tours International, Inc. 332
870 Market Street, Suite 744
San Francisco, CA 94102
Tel: (415) 433-3072, (415) 433-3408

The only thing required is to modify the tuned circuit(s) with suitable varactor tuning diodes. Table 1 gives some of the capacitance variations possible between 9 and 20 volts for the readily-available and inexpensive Motorola MV series of voltage-variable capacitance diodes. Usually, by some form of parallel or series combination of the varactor diode with a fixed value capacitor, any tuned circuit can be modified for remote tuning.

The basic scheme worked so well in the case of the preamplifier application that the idea came up to

have the remote tuning of the preamplifier coupled to the main tuning on a receiver. That undoubtedly can be done using sufficient circuit sophistication, but one should be aware of the fact that the varactor diode capacitance value is temperature-dependent. The variation is not significant enough to be noticed during the course of a whole afternoon of operating, but it will be significant enough after periods of extreme temperature change to persuade one to leave the remote tuning control for the preamplifier as a separate one. ■

PC Artwork Made Easy

— lift layouts from the page with
transparent contact paper

A commercial product was introduced recently to lift PC artwork from magazine articles. The material was quite expensive for my 14-year old son,

Chris, a prolific builder, who hit upon an inexpensive alternative.

Essentially all you need is some clear contact-type paper from your local K-Mart store (Kwik Kover), or any pressure-sensitive

transparent plastic. Currently, we pay about \$.59 for a square yard.

Make a Xerox® copy of the magazine pattern you wish to produce. The reason for this will be clear as you read on. Now carefully peel off the contact paper backing and apply the plastic to your Xerox copy of the artwork, forcing out all the air bubbles with a blunt instrument. The next step is to soak it in a dish of warm soapy water for about twenty minutes. After soaking, rub the Xerox paper with your finger until it is completely dissolved. At this point you will have the plastic with an image lifted off the artwork.

Now prepare your circuit board by washing it with scouring powder to remove contaminants, and allow to dry overnight. The board, as prepared now, is ready for sensitizing in a safelight area. We use a yellow bug light in a dark room for this operation. Since most magazine articles show positive artwork, we use a positive photoresist and carefully spray it on the copper side. This is then allowed to air-dry overnight in a dark room.

Now place your contact

paper mask over the copper side of the board and use your exposure frame (we use two pieces of plate glass held together with clothespins). This should be done under safelight conditions only.

Exposure can be done with sunlight, photoflood lamp, or even a fluorescent lamp. About four minutes in sunlight works for us; you may have to experiment at this point.

After exposure, remove the mask and place the circuit board in a developer solution per the instructions on the solution bottle and slowly agitate. When all of the resist is gone, wash the board in fresh water to stop the resist action. Now clean the board with an SOS pad and soapy water.

Use the previously-made mask as a drill guide when drilling out your board.

As you can see, this is a very inexpensive way to reproduce professional circuit boards. The contact paper also can be used to make decals for panels or meter scales, even in color. Naturally, the edges should be sealed with a little clear urethane to keep them from lifting. ■

Command Your Frequency

WITH A DATONG MODEL ASP



\$ 259.⁹⁵

Including Pre-Paid
Shipping &
Full Insurance
Dealer Inquiries Invited

AUTOMATIC RF SPEECH PROCESSOR

Made in England • 90 Day Warranty • Visa-Mastercharge Accepted

- Gives increased "punch" or "talk power" comparable to a times-ten increase in peak sideband power (SSB or AM) or peak deviation (FM).
- Instant push-button selection of 0, 6, 12, 18, 24 or 30dB of true r. f. Clipping for optimum talk-power enhancement under all conditions.
- No manual input level setting is required; it sets itself, automatically.
- Connects between microphone and transmitter - no internal connections required.
- Unique "TONE" button simplifies transmitter adjustment.
- LO/HI microphone impedance matching.
- Internal or external supply only 15mA at 6 and 16V.
- Eight ICs, eleven transistors, three LEDs.
- Elegantly styled to match any equipment.

Dedicated to Excellence (Exclusive Importers of DATONG FL-1's)

AR Technical Products Corp.  Box 62
Birmingham, Michigan 48012
Telephone 313/644-5698

NEW! MFJ INTRODUCES THE GRANDMASTER MEMORY KEYERS

At \$139.95 this MFJ-484 GRANDMASTER memory keyer gives you more features per dollar than any other memory keyer available — and Here's Why . . .

WEIGHT CONTROL TO PENETRATE QRM. PULL TO COMBINE MEMORIES A AND B FOR 1, 2, OR 3 FIFTY CHARACTER MESSAGES.

MESSAGE BUTTONS SELECT DESIRED 25 CHARACTER MESSAGES.

RESETS MEMORY IN USE TO BEGINNING.

SPEED CONTROL, 8 TO 50 WPM. PULL TO RECORD.

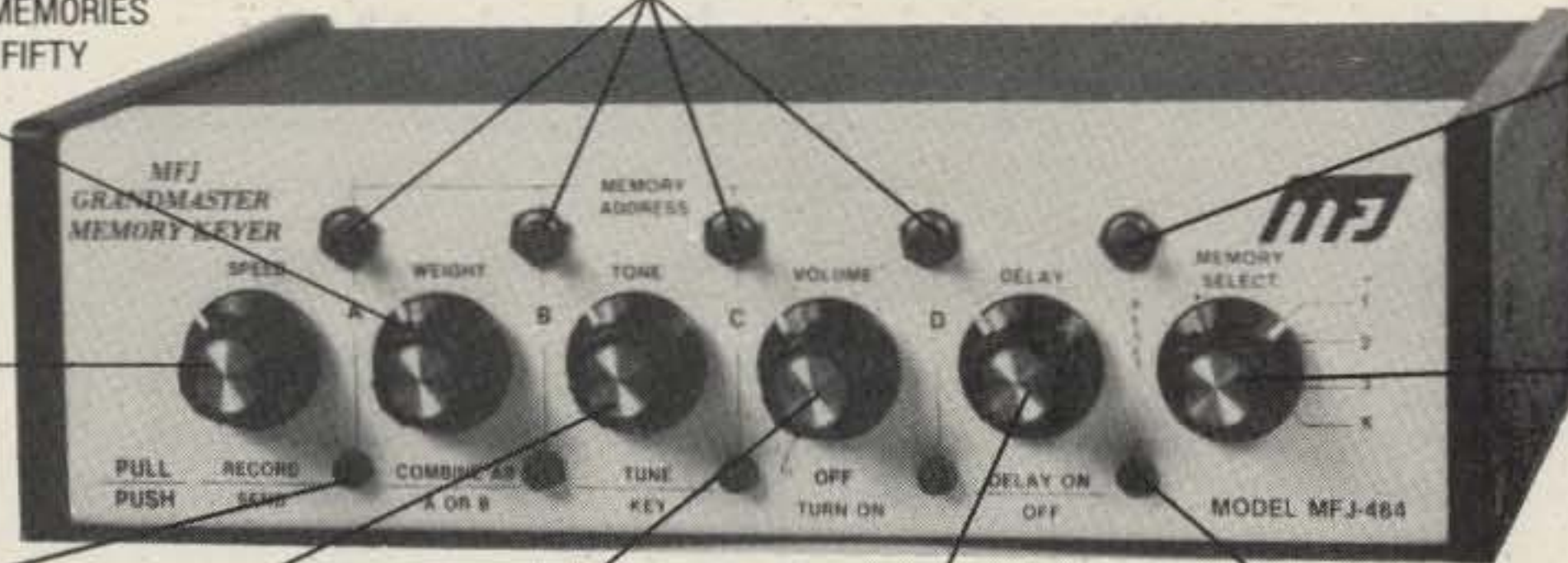

MEMORY SELECT: POSITIONS 1, 2, 3 ARE EACH SPLIT INTO MEMORY SECTIONS A, B, C, D (UP TO TWELVE 25 CHARACTER MESSAGES). SWITCH COMBINES A AND B. POSITION K GIVES YOU 100, 75, 50, OR 25 CHARACTERS BY PRESSING BUTTONS A, B, C, OR D.

LEDs (4) SHOW WHICH MEMORY IS IN USE AND WHEN IT ENDS.

LEDs (4) SHOW WHICH MEMORY IS IN USE AND WHEN IT ENDS.

TONE CONTROL. PULL TO TUNE.

VOLUME CONTROL. POWER ON-OFF.

DELAY REPEAT CONTROL (0 TO 2 MINUTES). PULL FOR AUTO REPEAT.

LED INDICATES DELAY REPEAT MODE.

NOW YOU CAN CALL CQ, SEND YOUR QTH, NAME, ETC., ALL AUTOMATICALLY.

And only MFJ offers you the MFJ-484 Grandmaster memory keyer with this much flexibility at this price.

Up to twelve 25 character messages plus a 100, 75, 50, or 25 character message (4096 bits total).

A switch combines 25 character messages for up to three 50 character messages.

To record, pull out the speed control, touch a message button and send. To playback, push in the speed control, select your message and touch the button. That's all there is to it!

You can repeat any message continuously and even leave a pause between repeats (up to 2 minutes). Example: Call CQ. Pause. Listen. If no answer, it repeats CQ again. To answer simply start sending. LED indicates Delay Repeat Mode.

Instantly insert or make changes in any playing message by simply sending. Continue by touching another button.

Memory resets to beginning with button, or by tapping paddle when playing. Touching message button restarts message.

LEDs show which 25 character memory is in use and when it ends.

Built-in memory saver. Uses 9 volt battery, no drain when power is on. Saves messages in memory when power loss occurs or when transporting keyer. Ultra compact, 8x2x6 inches. All IC's in sockets.

PLUS A MFJ DELUXE FULL FEATURE KEYER. Iambic operation with squeeze key. Dot-dash insertion.

Dot-dash memories, self-completing dots and dashes, jamproof spacing, instant start (except when recording).

All controls are on front panel: speed, weight, tone, volume. Smooth linear speed

control. 8 to 50 WPM.

Weight control lets you adjust dot-dash-space ratio; makes your signal distinctive to penetrate QRM.

Tone control. Room filling volume. Speaker.

Tune function keys transmitter for tuning.

Ultra reliable solid state keying: grid block, cathode, solid state transmitters (-300 V, 10 ma. max., +300 V, 100 ma. max.). CMOS ICs, MOS memories. Use 12 to 15 VDC or 110 VAC with optional AC adapter, \$7.95.

Automatically switches to external batteries when AC power is lost.

OPTIONAL BENCHER IAMBIC PADDLE for all memory keyers. Dot and dash paddles have fully adjustable tension and spacing for the exact "feel" you like. Heavy base with non-slip rubber feet eliminates "walking". \$39.95 plus \$3.00 for shipping and handling.



THIS MFJ-482 FEATURES FOUR 25 OR A 50 AND TWO 25 CHARACTER MESSAGES.

- Speed, volume, weight, tone controls
- Combine memory switch
- Repeat, tune functions
- Built-in memory saver

\$99⁹⁵



Similar to MFJ-484 but with 1024 bits of memory, less delay repeat, single memory operating LED. Weight and tone controls adjustable from rear panel. 6x2x6 inches. 110 VAC or 12 to 15 VDC.

THIS MFJ-481 GIVES YOU TWO 50 CHARACTER MESSAGES.

- Speed, volume, tone controls
- Repeat function
- Tune function
- Built-in memory saver

\$79⁹⁵



Similar to MFJ-482 but with two 50 character messages, less weight controls. Internal tone control. Volume control is adjustable from rear panel. 5x2x6 inches. 110 VAC or 12 to 15 VDC.

For Orders Call toll-free 800-647-1800

Order any product from MFJ and try it. If not delighted, return within 30 days for a prompt refund (less shipping).

Order today. Money back if not delighted. One year unconditional guarantee. Add \$3.00 shipping/handling. For technical information, order/repair status, in Mississippi, outside continental USA, call 601-323-5869.

Order By Mail or Call TOLL FREE 800-647-1800 and Charge It on

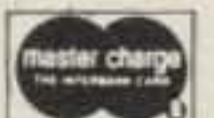

MFJ ENTERPRISES, INC.

P. O. BOX 494 ✓47

MISSISSIPPI STATE, MISSISSIPPI 39762

Electronic Dice — a Family Pleaser

— Las Vegas, look out!

Howard F. Batie W7BBX
12002 Cheviot Drive
Herndon VA 22070

Looking for an inexpensive, easy construction project which can be used by the whole family? Try "electronic dice" for a fun project with no hassle, no hard-to-get parts, and quick assembly in an evening or two. With its small size and complete portability, this

goof-proof project was an instant hit and has been in nearly continuous use since it was eagerly snatched off the bench by my avid 14-year-old "war-gamer."

The schematic diagram, Fig. 1, shows the simplicity of the completed project. U1b is configured as a simple gated oscillator, its frequency being determined by R4 and C1. The output of the oscillator is fed directly to a programmable counter, U2, whose BCD

output goes to U3, a single-chip latch, decoder, and 7-segment LED driver for a common-cathode display. U2 and U3 are repeated at U4 and U5 for the second digit. Additional digits can be added as indicated, with each digit representing one die.

Operation is very simple: U1b oscillates at a very high frequency (about 50 kHz) for as long as the dice are being "rolled" by depressing S1. U2 is programmed

by DP1-DP4 (pins 2, 5, 11, and 14) to count downward from 6 to 1 with each input clock-pulse. When U2 reaches digit 1, the next clock pulse resets the counter to 6 instead of continuing to 0, and the count continues to recirculate downward through only the digits 6 to 1. At some random time when you release S1, the clock stops and the count is displayed. Randomness is ensured by keeping the clock frequency very high in comparison with the number of times per second you could manually depress and release S1.

After S1 is released, the display will stay lighted for about four seconds and then go out to conserve battery power. This time delay is generated by the time the charge on C2 takes to decay through R3 to the lower trip voltage of Schmitt trigger U1c. Depressing S2 recalls the last digit rolled by restoring the charge on C2, and the display will remain lighted for another four seconds after S2 is released.

When adding more display digits to the two shown in Fig. 1, any of the four BCD output lines of the pro-

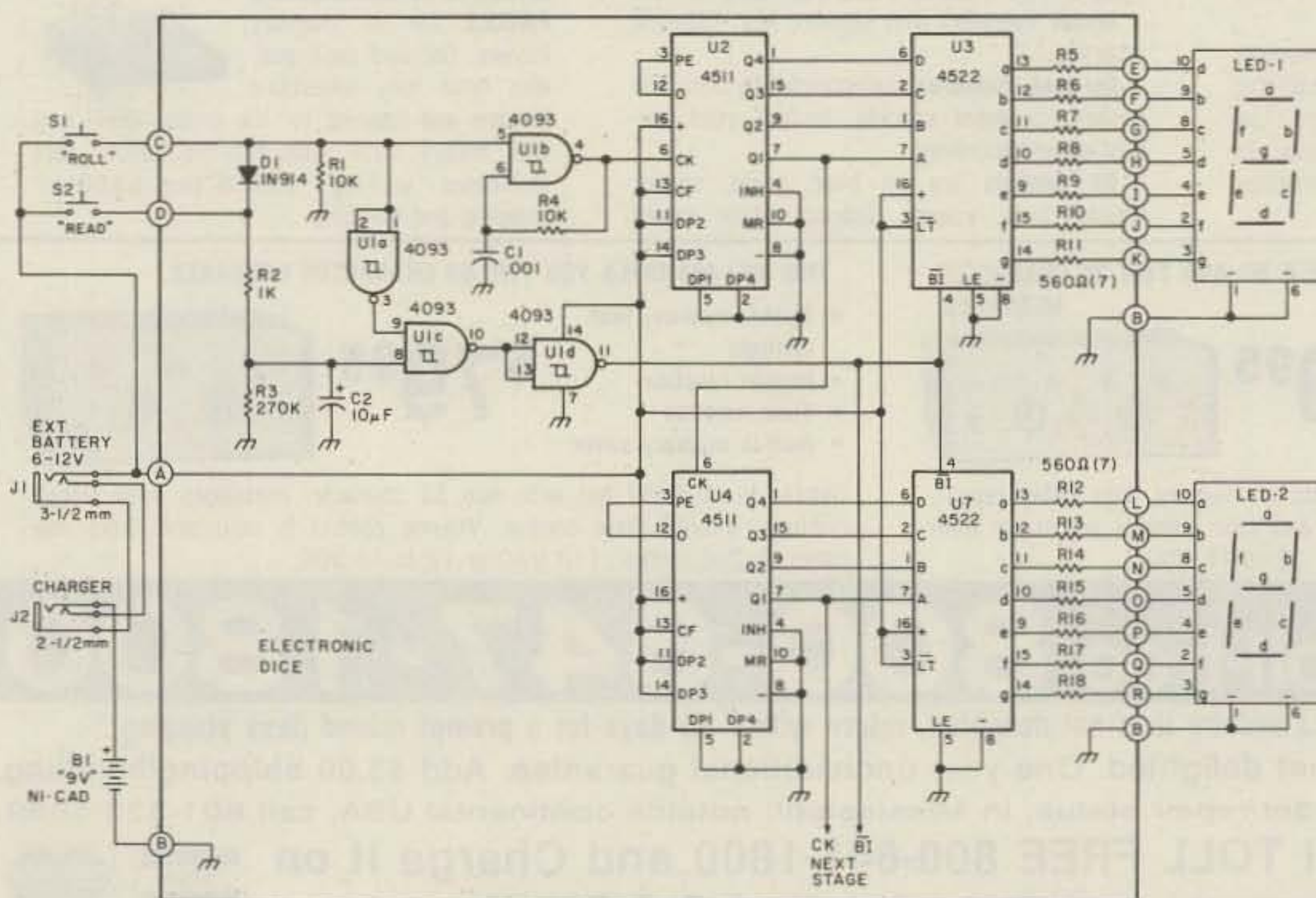

Fig. 1. Schematic diagram.

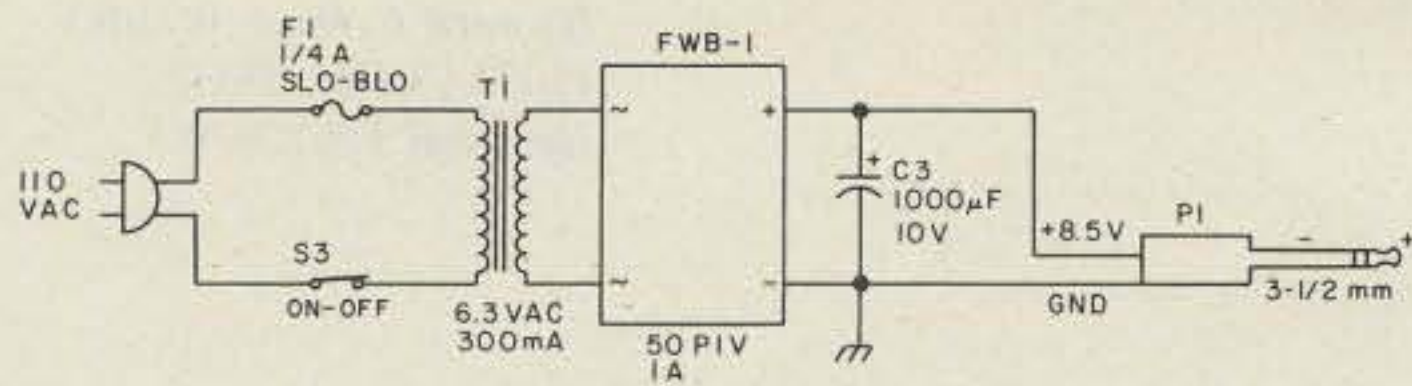

Fig. 2. Nine-volt battery eliminator (0-100 mA).

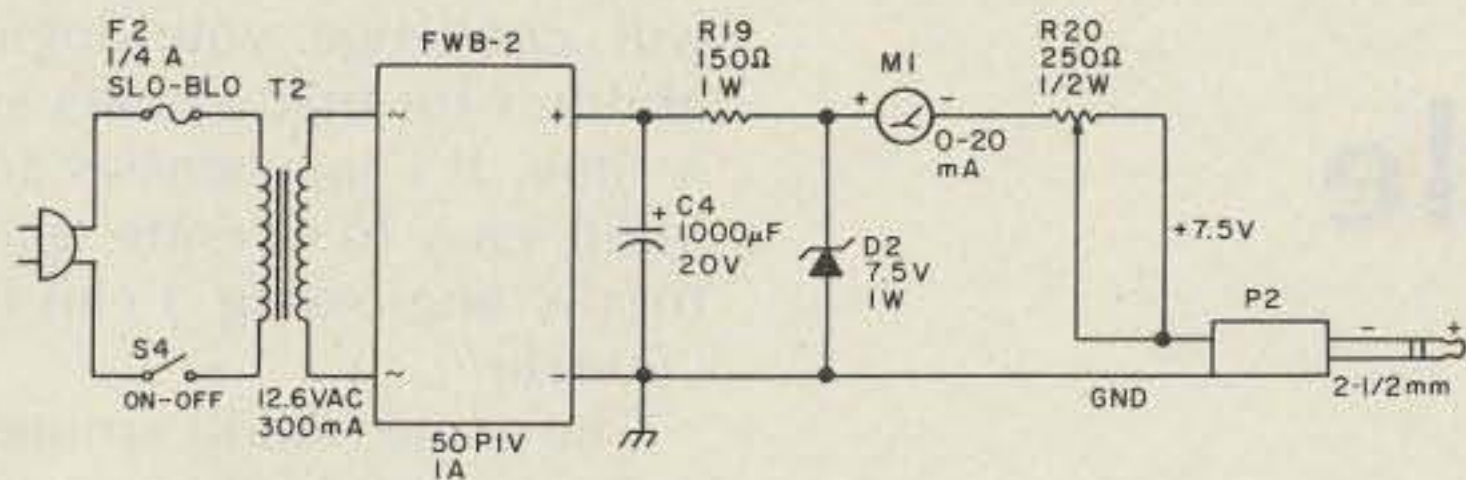

Fig. 3. "Nine-volt" nicad charger.

grammable counter can be used for the clock input of the next digit's counter. Although this divides the input clock frequency, the basic oscillator, U1b, is operating at a frequency high enough to ensure randomness in many succeeding counter stages. However, it is important that a counter-input clock signal be derived from one of the outputs of the preceding counter stage (pins 1, 7, 9, or 15), not its input (pin 6), since otherwise the counters would be clocking at the same frequency and there would be no randomness whatsoever in the displayed digits.

Note the absence of an on-off switch. Since all ICs are CMOS, idle current drain is negligible (about 0.005 microamps!) unless the displays are lighted. The drain is then just under 100 mA, maximum, which obviously is the reason why the four-second display feature was incorporated. Although a 9-V nicad (actually 7.2 V) transistor radio battery was used to permit recharging after a particularly furious day of wargaming, a standard inexpensive 9-V battery could be used equally as well and could be connected directly to point A (if no external power source is desired) or to the center pin of J1 (if an external power source is desired).

J1 is a 3½-mm jack to allow the electronic dice to be powered from an external battery or power supply. The simple power supply shown in Fig. 2 was constructed in a minibox 1½" high by 2" wide and 4" deep. It powers not only the electronic dice, but also a few thousand other gadgets around the house which use 9-V transistor batteries, such as the Little Professor Mathbox™, Mattell's electronic football game, calculators, radios, etc. It's really a battery-saver (money-saver)!

J2 is a 2½-mm earphone jack to allow charging the nicad inside the electronic dice cabinet. The 9-V nicad used is actually rated at 7.2-7.8 volts and requires 7-10 mA charging current for 16 hours. An inexpensive nicad charger could have been built, as shown schematically in Fig. 3, but the simplest, easiest, and cheapest way to recharge the nicad is to connect it to a current-regulated power supply as shown in Fig. 4 and adjust the current and voltage controls for the minimum required to supply 10 mA to the nicad. The earphone jack for the charger (J2) was purposely made smaller than the external Vcc jack, J1, on all our "toys" to make external hookups as "kid-proof" as possible.

The entire circuit shown

in Fig. 1 was constructed on a scrap of perfboard about 1½" × 2" using IC sockets and point-to-point wiring. The perfboard is mounted on two ¾" #2 bolts, with three nuts under the perfboard to provide some spacing between it and the chassis. Component leads themselves can provide good attachment points for the ribbon cable to the displays and for the wires to the jacks on the rear panel, S1 and S2 (see Fig. 5). An inexpensive clip-holder for the battery is bolted to the chassis bottom with #2 hardware. The cabinet used gives a nice finished appearance, as do the use of a panel-mounted display assembly and bezel, although these certainly are not necessary.

After being in near-constant use for the last few months on both the external power supply and the internal nicad, I'm glad I in-

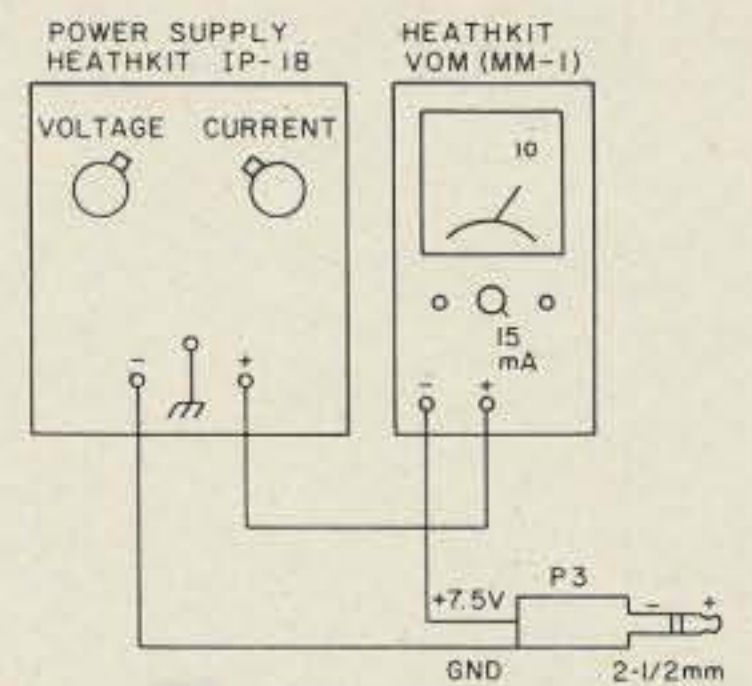

Fig. 4. Alternative 9-V nicad charger.

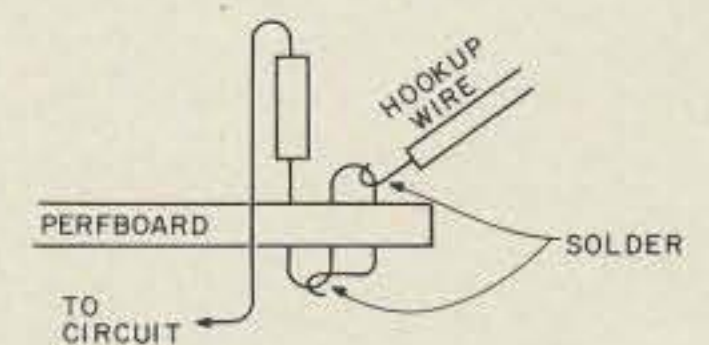

Fig. 5.

cluded the option. The electronic dice themselves have instant kid appeal, and the nicad permits complete portability. The only gripe I've had with this project is that initially I made up only one unit! Try it; you'll like it, too! ■

NEW!! **ATTENTION MOBILE HAMS**
15 METER MOBILE TRANSCEIVER
CW & USB
NCG 15SB

THE QRP RIG WITH THE **BIG RIG SOUND** ACTIVE NOISE BLANKER—RF GAIN—CW SWITCH—SQUELCH—MIC GAIN—DIGITAL FREQUENCY DISPLAY—HI/LO POWER SWITCH—13.8 VDC 5A POSITIVE OR NEGATIVE GROUND.

DEALER INQUIRY INVITED.

NCG Co. 318
 1275 N. GROVE ST.
 ANAHEIM, CALIF. 92806 (714) 630-4541

Fun with Fozzle

Here's a fun little construction project that will challenge your logic abilities for many hours at a time. It's inexpensive to build, easy to operate, and totally engrossing. I call it "Fozzle."

The game is built around a 7-segment LED readout and seven push-buttons. The object of the game is to start with all segments off, and then, by pressing one push-button at a time, to turn all the segments on, find a different sequence which will turn all segments off, and then find a third sequence which will turn them all on again. There are two catches, however. The first is that each push-button controls more than one segment at a time; whether the segments turn on or off depends on whether they were on or off before the button was pushed. The second catch is that the first and third sequences which turn on all the segments cannot be the same (the logic won't permit it)!

Your assignment, should you choose to accept it, is first to figure out the logic of which segments are controlled by each push-button and then to figure out the minimum number of push-button depressions in each of the three sequences which will take you from all segments off to all on, back to all off, and finally back to all segments on. The START push-button initializes the display by turning all segments off and resetting all the logic gates.

Although the logic principles of Fozzle can be figured out easily from Fig. 1 (if you want to cheat before the unit is built), the

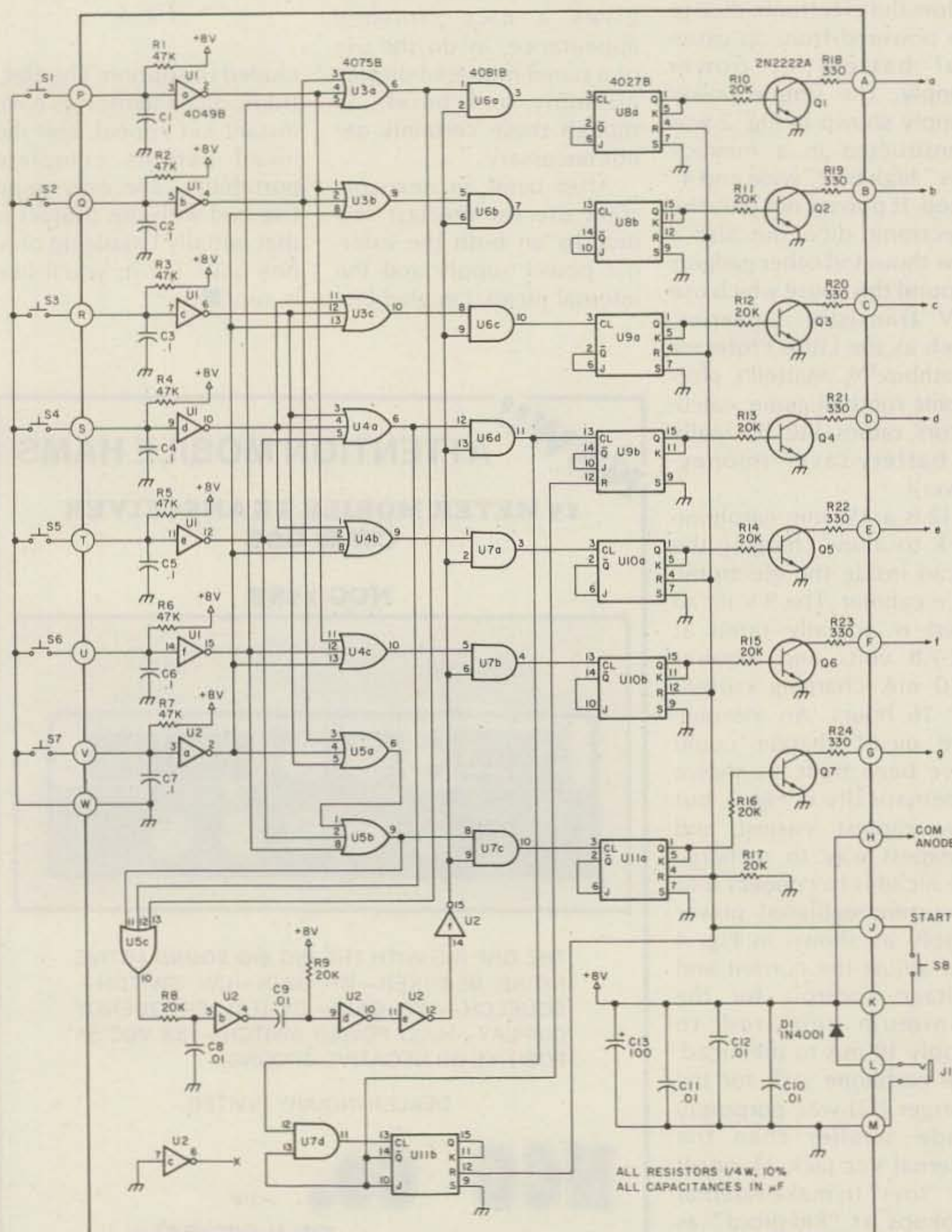

Fig. 1. Schematic diagram.

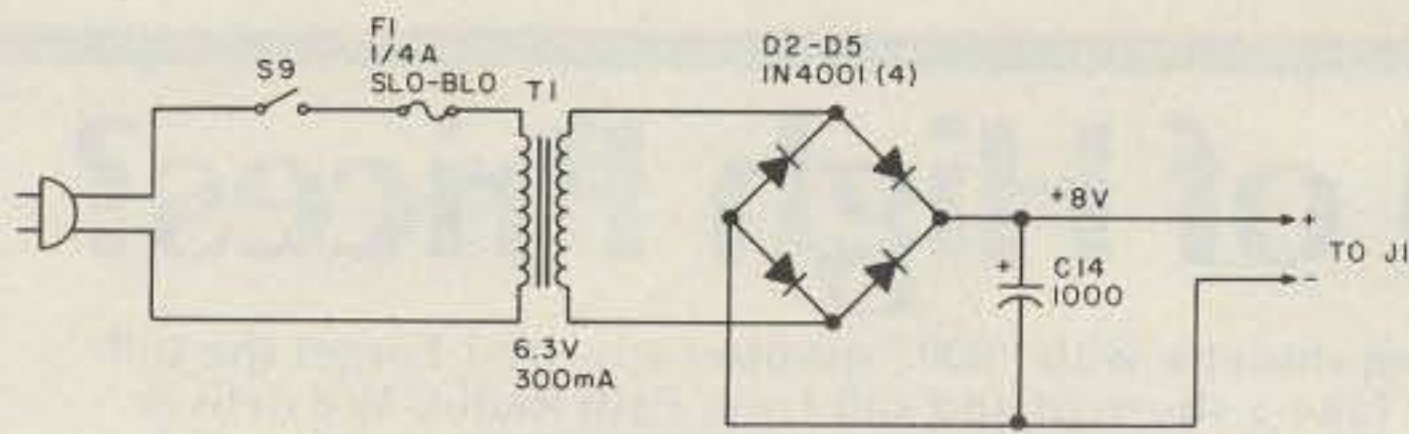

Fig. 2. Power supply.

minimum number of steps in each sequence is not so obvious, and I'm not going to give you any help there. What good is a game if there is no challenge to it?

The logic is, of course, hard-wired and does not have any variation from game to game unless you want to interchange two or more push-button leads or 7-segment display leads later on. However, should you happen to stumble across a sequence of steps which does "win," the chances are that you won't remember them all, since there are an infinite number of sequences. The chances are even greater that the sequence you stumbled across was not the one having the minimum number of steps!

What the circuit does is change the logic state of selected segments when certain push-buttons are pressed. The seven input inverters serve to debounce the push-buttons; the U3, U4, U5a, and U5b gates serve as logic encoders that determine which segments are controlled by which push-buttons. With each push-button depression, a single positive-going pulse is generated by U2b and U2d. This pulse is fed to all AND gates, U6, U7a, U7b, and U7c; however, only those AND gates selected by the encoding logic of U3, U4, U5a, and U5b are enabled to allow the pulse to go to flip-flops U8, U9, U10, and U11a. These are J-K flip-flops configured for alternate action: Each pulse on the clock input causes that flip-flop to change state. When the Q output of each

flip-flop goes to logic 1, its corresponding driver transistor is saturated, allowing current to flow through that segment of the read-out display. Depressing S8 resets all flip-flops so that all Q outputs are logic zero; this cuts off all transistors and turns all the display segments off.

The unit shown was mounted in a standard LMB enclosure about 2" x 3 1/2" x 6". The common-anode 7-segment readout was cemented onto a small piece of perfboard, which then was cemented to the cabinet. The eight push-buttons then were installed and hookup wires connected to them and to the display leads (see Fig. 3). All the basic logic circuitry of Fozzie was built up on a separate perfboard about 2 1/2" x 5 1/2" and mounted on four #4 bolts 1 1/2" long. The wires from the push-buttons and display were then connected to the logic board. Finally, a 3 1/2-mm earphone jack was added for supply of power to the entire unit.

Since the game is completely CMOS, current drain with all segments off is on the order of microamps. Any power source from 6-12 volts capable of delivering up to about 80 mA (at 6 volts) to 130 mA (at 12 volts) will be adequate. The standard Radio Shack battery eliminators work very well for this game. D1 was added just to make sure that no damage is done if the supply polarity gets reversed unintentionally.

One final circuit note: If you wish, the 7 driver transistors can be eliminated

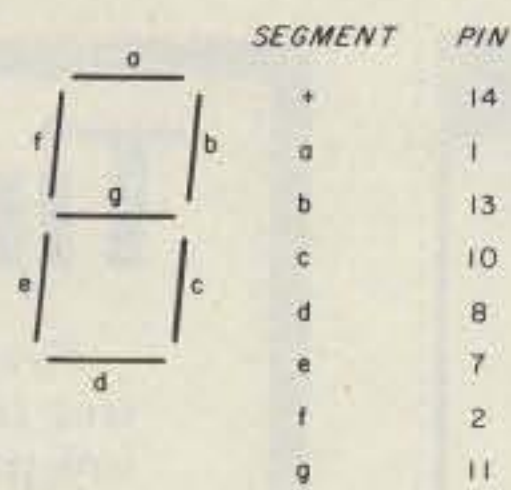

Fig. 3. 7-segment display (common-anode).

and replaced with the circuit shown in Fig. 4. This saves seven transistors and seven resistors; however, a common-cathode display must then be used. I built the circuit up as shown in Fig. 1 since I had the required parts on hand.

Well, if you've read this far, the chances are that you've accepted the challenge and are willing to spend an evening or two building it up. One word of caution, though: It probably will take much longer than that to get the minimum number of steps in each sequence down

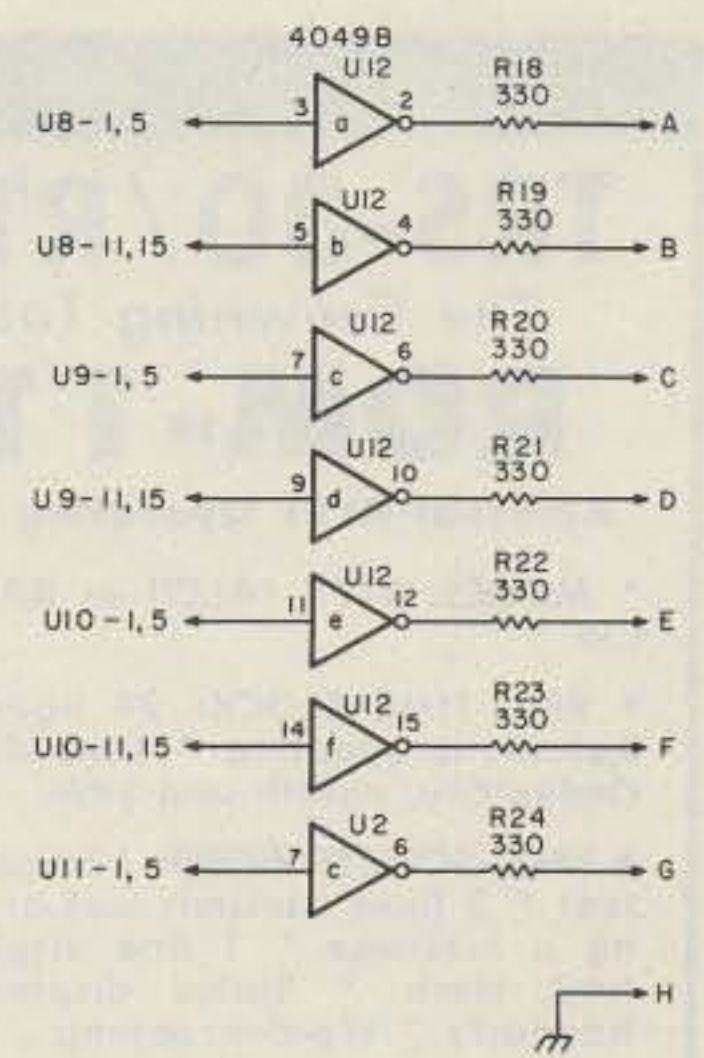

Fig. 4. Alternate common-cathode display drivers.

pat! (Hint: The minimum number of push-button depressions for each of the three sequences is less than 12. Would you believe less than 10? Than 8?) Don't get too frustrated; if you feel you're about ready to self-destruct, take another hard look at the schematic and think about it for a minute! ■

A BETTER BALUN

from Barker & Williamson, Inc.

BROAD BAND BALUNS

- Power Rating 2.5 KW-5 KW PEP
- Frequency Range 3.5-30 MHz
- SO 239 CONNECTOR

Types Available

Model BC-1

50 ohms unbalanced to 50 ohms balanced

Model BC-2

50 ohms unbalanced to 200 ohms balanced

Model BC-3

50 ohms unbalanced to 300 ohms balanced

Model BC-4

50 ohms unbalanced to 600 ohms balanced

See your dealer or write:

Barker & Williamson, Inc.
10 Canal Street
Bristol, Pa. 19007



TRS-80/RTTY The Crowning Touch ROM-116

Amateur RTTY Operating System

* MODES: RTTY (ASCII or BAUDOT) * CW *

• REAL-TIME CLOCK: 24 hour clock * Automatic updating * Time display includes day, month and year.

• SPLIT-SCREEN VIDEO: 12 lines receive text * 3 lines transmit text or pre-typing a message * 1 line display, real-time clock * Status displayed continuously * Word-wrapping.

• TWO SERIAL PORTS PROVIDED: Port "A" -Interfaced to internal or external terminal unit * RS-232, TTL and 60 ma. * ASCII/BAUDOT * Baud rates of 60, 66, 75, 100 wpm, or 110, 300, 600, 1200, 2400, 4800 and 9600 baud * Mode/baud rate keyboard selectable any time * BAUDOT/ASCII feature wide range of speeds compatible now and in the future. Port "B" RS-232/20ma * Baud rates of 110, 300, 600, 1200, 2400, 4800 and 9600 * Supports any 8-level serial printer or modem * Baud rate keyboard selectable * Expansion interface not required for operation of serial printer or modem.

• BUFFERS: 7.5K Main text buffer * Pre-typed messages up to 7.5K possible. * 2.5K general purpose buffer * Program with CQ, TEST, CALL SIGNS, CONTEST MESSAGES, BRAG TAPES, ETC. * Loadable from cassette * Contents may be saved to cassette * 1/4K Call sign buffer * Program with any message (call signs, etc.).

• AUTOMATIC CW/ID: At the start/end of each transmission * Every 10 minutes * Provision for quick break (no ID).

• TRANSMITTER CONTROL: Transmitter turns on/off automatically via software control * Provisions made for quick break.

• OTHER FEATURES: WRU * RY/FOX tests * Repeat last transmission. * SELCAL: Selcal saves all or selected transmissions to cassette tape, serial printer or both.

• SOFTWARE PROVIDED: 2 RTTY Programs (Cassette/Disk version) * ASCII/BAUDOT Driver routines (permits use of "LLIST" and "LPRINT" commands from basic) * CW send/receive program.

• HARDWARE REQUIREMENTS: TRS-80 with 16K RAM * External terminal unit recommended (Fletcher TU-170, ST-6 etc) * AFSK/FSK unit.

• Board size 6x8, cabinet size 7x10x3.

INTRODUCTORY PRICE **\$240**

less cabinet

 **CROWN** ¹⁶
MicroProducts

P. O. Box 892

Marysville, Washington 98270
206-659-4279 / 206-659-9512

*A Trademark of The Tandy Corp.

VISA



Tired of High Prices?

Tired of playing roulette with "800" number specials? Forget the toll-free frustration. Take a shortcut and call Long Path Radio. We deliver low prices from the ground up — on towers, rotators, antennas, and accessories. Our goal is to have what you want in stock.

Take a look at the complete line:

HyGain Antennas	HDBX48 self	16 element-
TH6DXX \$219.00	supp. tower ... \$316.99	2 meter \$ 55.00
TH5DX \$179.00	HBX56 self	CDE Rotators
TH3MK3 \$153.00	supp. tower ... \$333.99	Call or write for your low
TH2MK3 \$ 99.00	3/16 EHS guy wire,	price.
TH3JR \$113.00	500 ft. \$ 63.00	Cushcraft Antennas
105BA \$ 86.00	3/16 CCM cable	ATB34 Tribander . \$199.00
155BA \$133.00	clamp \$.44	20-3CD \$133.00
205BA \$219.00	1/4 turnbuckle,	20-4CD \$222.00
204BA \$166.00	eye & eye \$ 6.60	15-3CD \$ 76.00
402B \$159.00	M200H 10 ft.	15-4CD \$ 87.00
DB1015A \$103.00	H.D. galvanized	10-3CD \$ 54.00
18AVT \$ 70.00	mast \$ 36.99	10-4CD \$ 66.00
14AVQ \$ 46.00	Tonna F9FT	ATV-4 \$ 74.00
BN86 \$ 12.00	4 element-	ATV-5 \$ 82.00
Rohn Towers	2 meter \$ 21.95	ARX-2 \$ 30.00
and Accessories	9 element-	ARX-450 \$ 30.00
25G section \$ 37.99	2 meter \$ 29.95	A-147-11 \$ 30.00
45G section \$ 76.00		32-19 Boomer ... \$ 65.00

Except for Rohn towers, all items shown are complete stock. Sorry, no other products available.

We're here to serve you from 8:30 to 5:00, Monday through Friday, at 1-214-369-3401. Ask for Long Path Radio.

LONG PATH RADIO, INC. ✓84

P.O. Box 29682/Dallas, Texas 75229/1-214-369-3401

TERMS:

All prices F.O.B. Dallas. C.O.D. requires 25% deposit. Money order, cashier's check, O.K. No personal checks. We ship freight collect. If you desire prepaid freight, a small Per Item charge will be made for shipping and handling.

All Solid-State! BASE STATION amplifiers

160 THRU 2 METERS
80 WATTS-600 WATTS



RF POWER LABS, INC.

21820 87th S.E., Maltby Industrial Village,
Woodinville, WA 98072, (206) 481-8833

Telex No. 32-1042

This MFJ RF Noise Bridge . . .

lets you adjust your antenna quickly for maximum performance. Measure resonant frequency, radiation resistance and reactance. Exclusive range extender and expanded capacitance range gives you much extended measuring range.



- Exclusive range extender
- Expanded capacitance range
- Series Bridge

\$54⁹⁵

This new MFJ-202 RF Noise Bridge lets you quickly adjust your single or multiband dipole, inverted Vee, beam, vertical, mobile whip or random system for maximum performance.

Tells resonant frequency and whether to shorten or lengthen your antenna for minimum SWR over any portion of a band.

MFJ's exclusive range extender, expanded capacitance range (± 150 pf) gives unparalleled impedance measurements, 1 to 100 MHz. Simple to use. Comprehensive computer proven manual.

Works with any receiver or transceiver. SO-239 connectors. 2 x 3 x 4 inches. 9 volt battery.

Other uses: tune transmatch; adjust tuned circuits; measure inductance, RF impedance of amplifiers, baluns, transformers; electrical length, velocity factor, impedance of coax; synthesize RF impedances with transmatch and dummy load.

Order from MFJ and try it — no obligation. If not delighted, return it within 30 days for a refund (less shipping). This bridge is unconditionally guaranteed for one year.

To order, simply call us toll free 800-647-1800 and charge it on your VISA or MasterCard or mail us a check or money order for \$54.95 plus \$3.00 for shipping and handling.

Don't wait any longer to enjoy maximum antenna performance. Order today.

CALL TOLL FREE . . . 800-647-1800

Call 601-323-5869 for technical information, order/repair status. Also call 601-323-5869 outside continental USA and in Mississippi.

MFJ ENTERPRISES, INC.

BOX 494, MISSISSIPPI STATE, MS 39762

The UDT 170

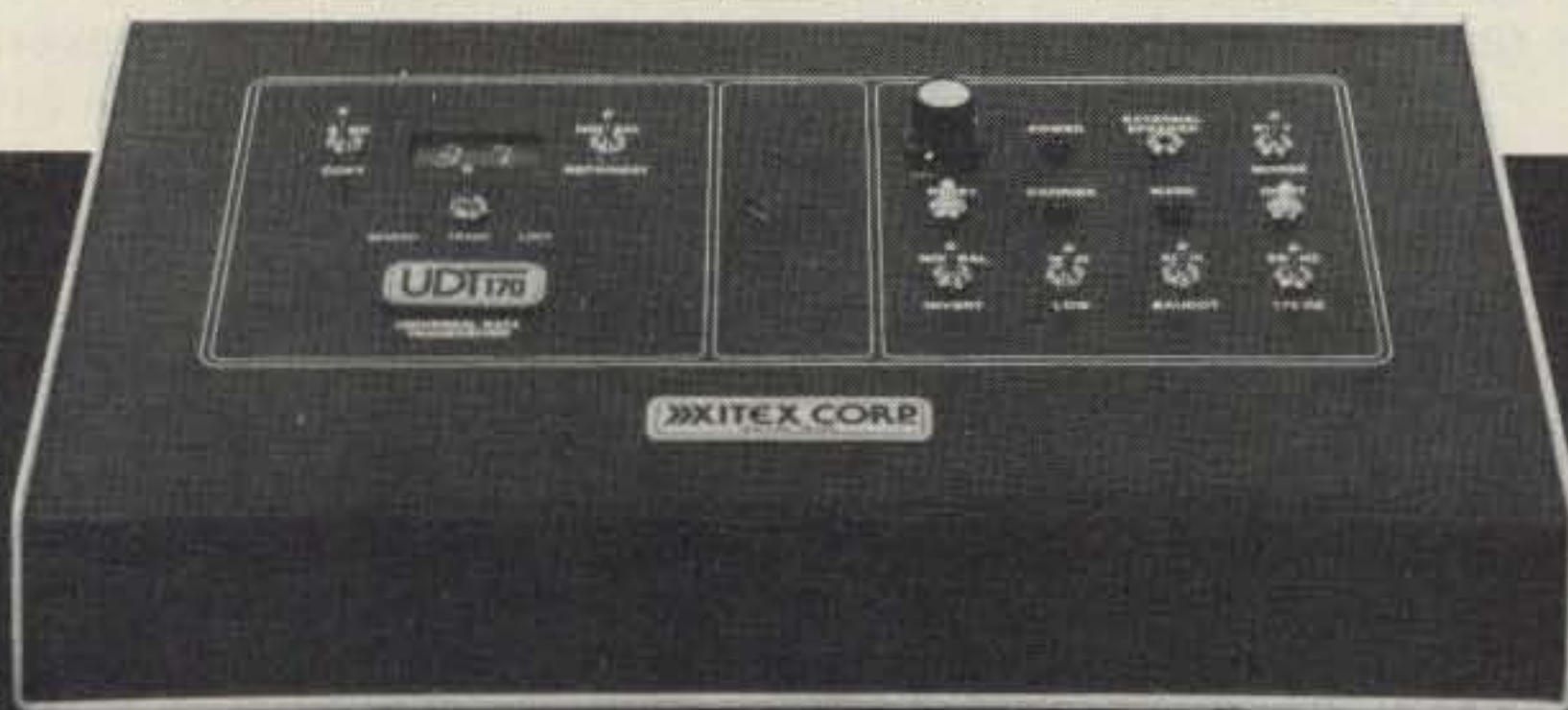

The SMART TU for RTTY & MORSE

The UDT 170 Universal Data Transceiver will instantly convert any ASCII or Baudot teletype or video terminal into a multiple baud rate data transceiver for ASCII, Baudot or Morse operation. It features . . .

- 170/850 HZ Shift
- Dual 6 pole active filters for weak signal operation
- ASCII/Baudot Regeneration with multiple baud rates
- CW Auto Ident (optional)
- 1-150 WPM Morse with Auto-track
- Computes & Displays WPM copy rate & Buffer Status
- Selectable line length from 40 to 80 characters
- Metal Enclosure 12"x7 1/4"x3 1/2"

For more information write or phone

Special Introductory Price, Assembled **\$479**

Reg. \$549

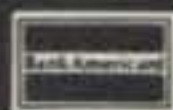

Price subject to change without notice

XITEX CORP.

9861 Chartwell Drive
Dallas, Texas 75243
(214) 349-2490



FM-88S with SCANNER (optional)

CLEGG FM-88 & 88S

25 watts/143.0-149.0 MHz

In the tradition of the famous FM-DX and the FM-28, Clegg proudly presents the 2 Meter FM Transceiver of the next decade.

We've retained all the features and performance of the popular FM-28. And we've added CAP and MARS frequency coverage (an optional offset crystal may be required). And we've added an optional SCANNER. You'll have continuous control of output power from 1-25 watts right from the panel.

Our confidence in the FM-88 & 88S is great enough that we provide a full 1 year warranty. (Do the other 2 Meter rigs you've considered offer such a warranty?)

Because the FM-88 is available ONLY DIRECTLY from CLEGG and there is no "MIDDLEMAN" involved, we are able to deliver to you much more RADIO for your hard earned dollar. You are virtually buying WHOLESALÉ!

Whether you elect the FM-88S at \$429.95 or the FM-88 (without SCANNER) at only \$329.95, we are certain you'll be delighted with your selection.

Each unit is supplied complete with mobile mounting bracket, base station bale, microphone, two DC power cables and many, many hours of Operating Enjoyment. (The optional PS-12A power supply adds full base station performance).

A detailed SPECIFICATION sheet describing the new transceivers and Clegg's coordinated accessories and antennas is yours for the asking. Phone 1 (800) 233-0250 today for your copy or to order either one of these super TRANSCEVERS!

Clegg Communications Corp.

1911 Old Homestead Lane
Greenfield Industrial Park East
Lancaster, PA 17601
(717) 299-7221

FM-88 & FM-88S — 1 YEAR WARRANTY . . . FM-88 & FM-88S — 1 YEAR WARRANTY . . . FM-88 & FM-88S — 1 YEAR WARRANTY . . .

The Demise of Component Stores

—parts places are past their prime

L. Foord VE3FLE
763 Gladstone Drive
Woodstock, Ontario
Canada N4S 5T1

Each time I drive past Peter's Wholesale Electronics, I slow down, almost reverently, and permit myself aged but fond memories.

Those were the days—decades ago, it seems—when we would rummage through the barrels of tubes and transformers and capacitors, searching for the bargains, and then laboriously spend hours transforming them into some useful contribution to amateur radio. In those days, Peter himself would wait on us, offering advice on parts substitutions, searching for some requested, exotic item, and answering our questions about the new gear on the shelves. We would elbow up to the counter amidst the TV re-

pairmen, and Peter would patiently wait as we spent our pittance, never once complaining about how our two-dollar orders might be interfering with his regular trade.

Times have changed of course. Peter graduated himself to an office upstairs, hired a flock of yearlings to tend the store, had a tendency to ignore his ham radio customers, and devoted his attention to the industrial trade. Can't really blame him, though—a guy's got to make a living—but it surely would be nice if it were easier to obtain parts nowadays.

And I've changed. I'm an appliance operator now, and I know it. I have lists of cliché-type arguments justifying my demise: lack of time, the difficulty in trying to keep up with technology, family responsibilities, career pressures... Still, I have those memories to recall: the late hours spent hunched over the work-

bench, the ecstatic joy of discovery when a project actually worked.

My amateur radio interest has been waning and my involvement has become stifled and stereotyped: regular rag chewing on 75, occasional DX-chasing on 20, semiconscious activity on 2-meter FM.

Why not, I asked myself, get back to building? Why not, I said, face the obstacles, overcome them, and return to the joy of home-brewing?

It didn't take long for a project to come to mind. I needed a keyer, and just a short time ago 73 ran an excellent construction article on one, complete with dot memory, automatic spacing...

A few days later, I presented myself at the store armed with a list of the parts my junk box lacked, bursting with novice-like enthusiasm.

As I approached the counter the clerk took a

look at me and said, "Be with you in a minute," and sidestepped me in favor of a TV repairman. Be humble, I told myself.

That clerk never did return; finally, one of his colleagues approached me with raised and questioning eyebrows.

"Peter around?" I asked, knowing what the answer would be, yet hoping that the fact that I knew the boss might influence the service and pricing I would get.

"Nah," was the reply. "He's playing golf."

I should have known. Ever since Peter got rich, that's all he does—play golf. (Except in the winter; then he takes extended vacations.)

"Need some parts," I said, extracting the list from my pocket. The clerk's eyebrows shot up in despair. Quickly I added, "Just a few."

I gave him the size for a small cabinet to house my

keyer. He shook his head. "We don't stock cabinets anymore," he said. "Too many sizes. We just order them on request. Takes about six weeks to get 'em."

I shrugged. "How about a miniature 1000-Ohm pot?" I requested.

He glanced on a shelf behind him. "Sorry," he said, "We're out. They're back-ordered."

"Really?"

"Yup. Happens all the time."

"I need a couple of 1/2-Watt, 22-Ohm resistors," I said.

He nodded and disappeared, returning with a bin and a confused look. "These things are all mixed up," he groaned. "Let's see," he mused, "if I can figure this out without looking at the chart. Would it be red, red... black or brown?" "Brown," I said frowning, and then I realized my mistake. But it was too late; he already had

plucked my choice from the bin and I couldn't admit my error. Perhaps I might be able to find them in the junk box after all.

"A 6.3-volt transformer, about 200 mA," was my next request.

He returned with what would appear as a monster in a keyer circuit. "It's the closest I have," he offered. "One Amp."

"Well, maybe I can get the power from the exciter," I said.

"I don't think we stock them," he said.

"What?"

"Exciters," he replied, solemnly.

I wanted to cry. "Never mind," I replied. "I'll skip the transformer. How about a half-dozen zero-one bypasses, low voltage?"

He returned the transformer to stock, lifted a blister-pack from a shelf, and tossed it to me.

"I don't need all those," I pleaded.

"There's only twenty-five," he said.

"But I need only six."

"Well, the package will cost you two bucks. If I break it, I have to charge you twenty cents each, so that's a buck-twenty."

I sighed and nodded my agreement, then gave him my list of semis. He disappeared behind a wall, reappearing with a package of universal replacements.

"Don't you have the originals, the jedec numbers?" I asked.

He frowned at me. "Do you know how many transistors there are? The numbers you want are back-ordered. But these will work OK." Then he added, "Of course you know we don't guarantee transistors?"

I cringed. "Could I order the original numbers?"

It was his turn to cringe. "I guess..." he replied, not very convincingly. "But we have a twenty-five dollar minimum invoice charge."

"Twenty-five dollars!" He smiled, and grudgingly I agreed. "Order them."

He reached under the counter, but his hand came up empty. Again he disappeared, this time returning with a sheepish grin. "You won't believe this, but we're out of order forms. They're back-ordered. Let me get a pad of blank paper and I'll take your order."

As I waited, my eyes wandered about the store, comparing its image with the vision of yesteryear. In the corner, with the few remaining pieces of ham gear Peter stocked, I spotted an old Hallicrafters TO keyer. I could remember reading the ads for them years ago and wishing I had one.

"How much?" I asked the clerk when he returned, pointing to the keyer.

He thought for a moment, then shrugged. "Fifteen bucks?"

Without hesitation I replied, "Sold!" ■

INSTRUMENTS YOU CAN COUNT ON...

- 4½ DIGIT MULTIMETER/THERMOMETER
- FREQUENCY COUNTERS TO 1.3 GHz
- PRECISION DIGITAL THERMOMETER
- CAPACITANCE METER

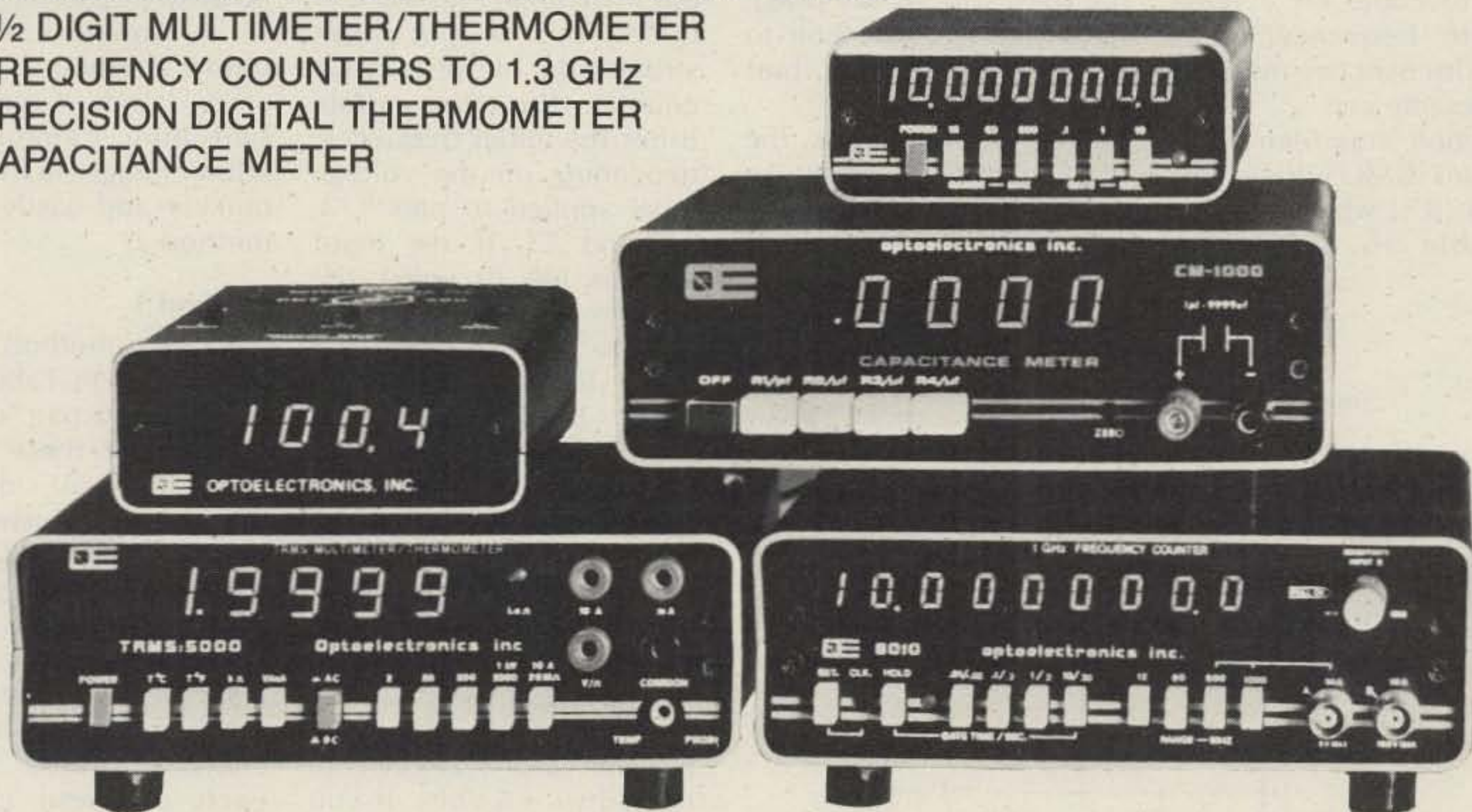

FOR ORDERS, INFORMATION OR A CATALOG WRITE OR PHONE

800-327-5912

FROM FLORIDA PHONE (305) 771-2050/771-2051

Optoelectronics inc

5821 N.E. 14 AVE. FT. LAUDERDALE, FL. 33334



Priority Frequency Power-Up for the FT-227R

— the right place, first time, every time

Tired of finding your FT-227R on 147.000 MHz each time you bump the cigarette lighter plug? Would you like the Memorizer to come on at your favorite frequency? Read on to discover two methods to the same end.

Caution: Your Memorizer contains CMOS logic elements (ICs) which are susceptible to permanent

damage due to static discharge. Check your pencil soldering iron with an ohmmeter to ensure that the tip is grounded (connected to the third wire of the plug). If not, this is the time to update this very important tool.

With both methods, the PLL counter is preset to your favorite frequency each time the Memorizer is

turned on. (Consult Fig. 8 on page 19 of your manual.) As +5 volts rises from 0 to +5, C702 (with R702) produces a positive pulse to pin 1 of Q707, Q708, and Q709. This is the preset strobe input of the up/down counter. Presetting establishes the initial frequency, depending on the voltage level applied to pins 3, 4, 12, and 13. If the input level is low (0 volts), the counter stage will be set to a "zero." Conversely, if the input level is high (+5 volts), the counter stage will be set to a "one." Note that these inputs on Q707 and Q708 are connected to ground so that both the 100-kHz digit and 10-kHz digit are reset, i.e., set to zero. By inspection, you will note that pins 3, 4, and 12 of Q709 are also ground, but pin 13 of Q709 is connected to +5 volts. If you check the Q308 Code Chart on page 36, you will find that this corresponds to bit P11 and results in 7 MHz. To alter this start-up frequency, it is simply a case of removing the appropri-

ate grounded inputs and connecting them through a "pull-up" resistor to +5 V.

Should you be fortunate enough to have only one favorite frequency, or want to minimize your cost, follow method 1. On the other hand, if you want switching capability to allow changes in frequency quickly and easily, follow method 2.

Method 1

In this method, locate the "ones" in Table 1. Using a sharp pair of small cutters, cut these pins on the component side of the PLL board between the chip and the board. Cut the pins as close to the board as possible. Then carefully bend each of these pins up from the board so that they are pointing up from the chips. Carefully connect each of these cut pins together with jumper wire, and then connect a resistor (2k or higher) from the jumper wire to +5 volts. If you have selected any MHz value other than 7 (144, 145 or 146 MHz), it

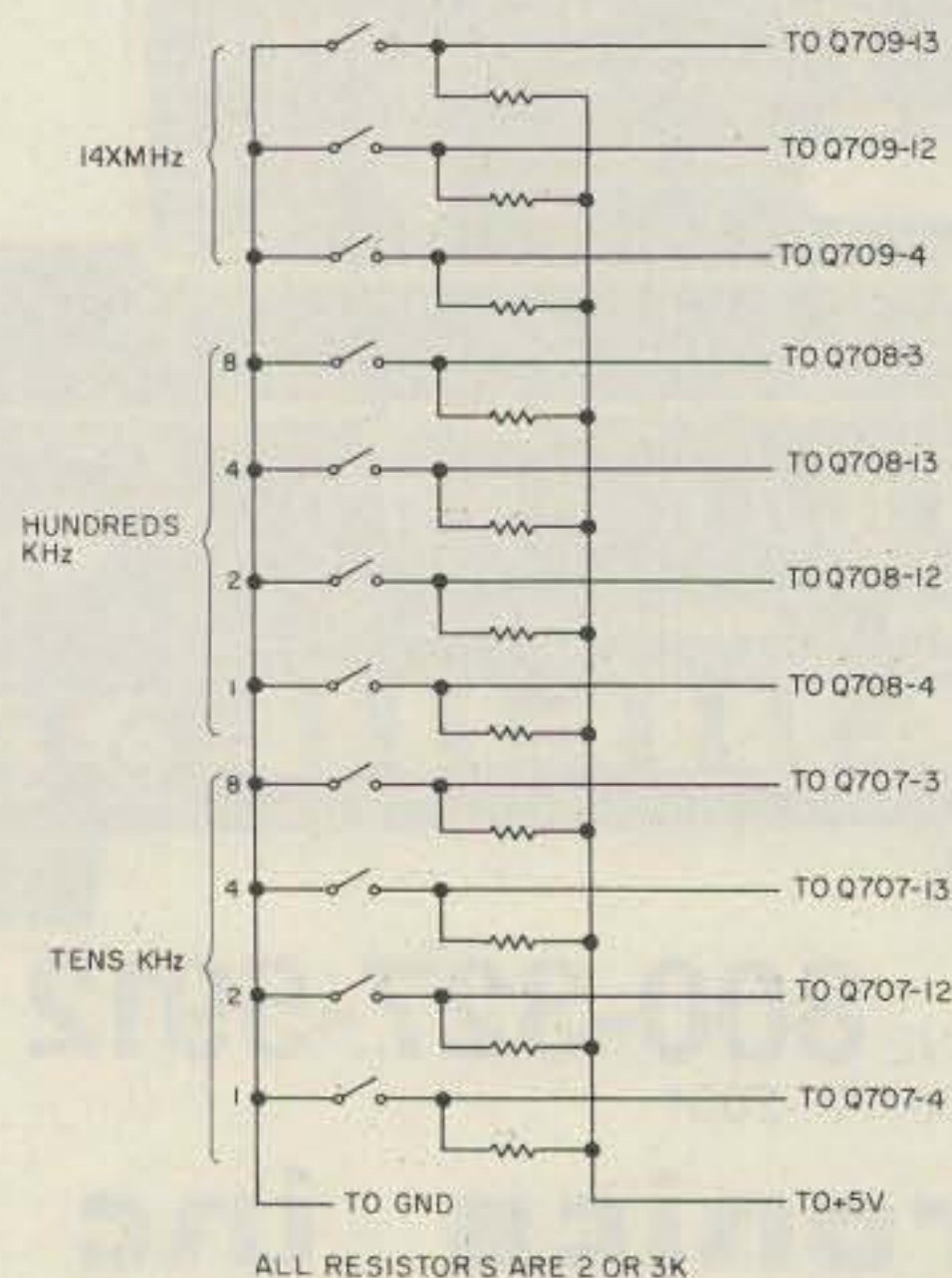

Fig. 1.

will be necessary to remove the +5 volts which Yaesu connected to Q709 pin 13. Clip this pin in the same manner, and connect a jumper wire from it to ground.

Method 2

Cut and bend up Q707 and Q708 pins 3, 4, 12, 13, and Q709 pins 4, 12, and 13.

Cement 11 SPST switches (mini dip-switches) to a piece of Vectorboard® cut to fit in the tone squelch area. Note that the pins presently located in this area will line up with holes in the vectorboard. Solder a wire to one side of each of these switches. The other end of this wire will be attached to ground. Connect one end of a "pull-up" resistor (2k or higher) to the opposite end of each switch. Bus the opposite end of each of these resistors together and connect to +5 volts. Connect a wire

from the junction of the resistor and each switch to the pin indicated in Fig. 1.

Slip the vectorboard assembly over the pins in the tone squelch area. It can be secured easily by twisting one turn of wire on two of these pins above the vectorboard and soldering the wires to the pins.

Consult Table 1 for switch settings. A logic 1 is an open switch.

Observation of the frequency versus bit-pattern of the 100-kHz and 10-kHz switch banks will reveal that the coding is binary-coded decimal (BCD). Obviously, the same pattern exists in part for the MHz bank. If you attempt to set the MHz bank to an invalid frequency such as 143 or 149 MHz, the PLL will not lock up and the display will indicate one of two images. If the attempted frequency is lower than 144 MHz, the MHz digit will be blank. If

Digit	Q709-Pin 13	Q709-Pin 12	Q709-Pin 4	Q708-Pin 3	Q708-Pin 13	Q708-Pin 12	Q708-Pin 4	Q707-Pin 3	Q707-Pin 13	Q707-Pin 12	Q707-Pin 4
0	Not Used			0 0 0 0				0 0 0 0			
1	Not Used			0 0 0 1				0 0 0 1			
2	Not Used			0 0 1 0				0 0 1 0			
3	Not Used			0 0 1 1				0 0 1 1			
4	0 0 1			0 1 0 0				0 1 0 0			
5	0 1 0			0 1 0 1				0 1 0 1			
6	0 1 1			0 1 1 0				0 1 1 0			
7	1 0 0			0 1 1 1				0 1 1 1			
8	Not Used			1 0 0 0				1 0 0 0			
9	Not Used			1 0 0 1				1 0 0 1			
				MHz				100 kHz			10 kHz

Table 1. 1 = +5 volts; 0 = 0 volts.

the attempted frequency is higher than 145 MHz, the display will read 9.XXX, where X is a valid digit. However, the entire display will blink.

A convenient method for simulating power-on cycles consists of momentarily shorting out capacitor C702. By setting each switch on, one by one, starting with the right-hand switch in each decade

(bank), followed by shorting out C702 while power is applied, you will rapidly check your success. With all switches closed, the display will show .000. Opening the right hand switch of each decade will change that decade display to 1. The next switches have the value of 4 and 8 respectively.

Follow the chart to your favorite frequency. ■

FAST SCAN AMATEUR TELEVISION PRODUCTS FOR THE 420-450 MHz BAND

*ATV REPEATER

Model 1570B - a complete system with filters ready to connect to antennas

*ATV REPEATER ANTENNA - a dual antenna system, omnidirectional, vertical polarization

*ATV TRANSCEIVERS

Model TXR 15A - 15 watt peak output, audio subcarrier, 2 frequency crystal controlled receiving converter
Model TXR 15T - 15 watt peak output, audio subcarrier, tuneable receiving converter

*ATV TRANSMITTER

Model TX 15A - 15 watt peak output, audio subcarrier

*IN-LINE DETECTOR

Model XD 25C - monitor your actual transmitted picture

*ATV RECEIVING CONVERTERS

Model TR 70A - tuneable 420-450 MHz
Model XR 70A - crystal controlled, single frequency
Model XR 70B - crystal controlled, dual frequency

*AUDIO-VIDEO DEMODULATOR

Model TD 100A - connect a converter, speaker, and video monitor and you have a commercial quality receiving system

TELEVISION HANDBOOK FOR THE AMATEUR

*ANTENNAS - 48 and 88 element models

*COMBLINE and INTERDIGITAL FILTERS - for repeater and base station use

EVERY APTRON ATV PRODUCT IS.....

COMPLETE, FACTORY ASSEMBLED AND TESTED...

PROVIDES COMMERCIAL QUALITY COLOR PERFORMANCE...

SOLD WITH A 30 DAY SATISFACTION OR MONEY BACK GUARANTEE—

AND A ONE YEAR WARRANTY

FOR INFORMATION CALL 812-336-4775, OR WRITE TO—

APTRON LABS ✓8

PO BOX 323
BLOOMINGTON
INDIANA, 47402

Instant Software™ New Releases

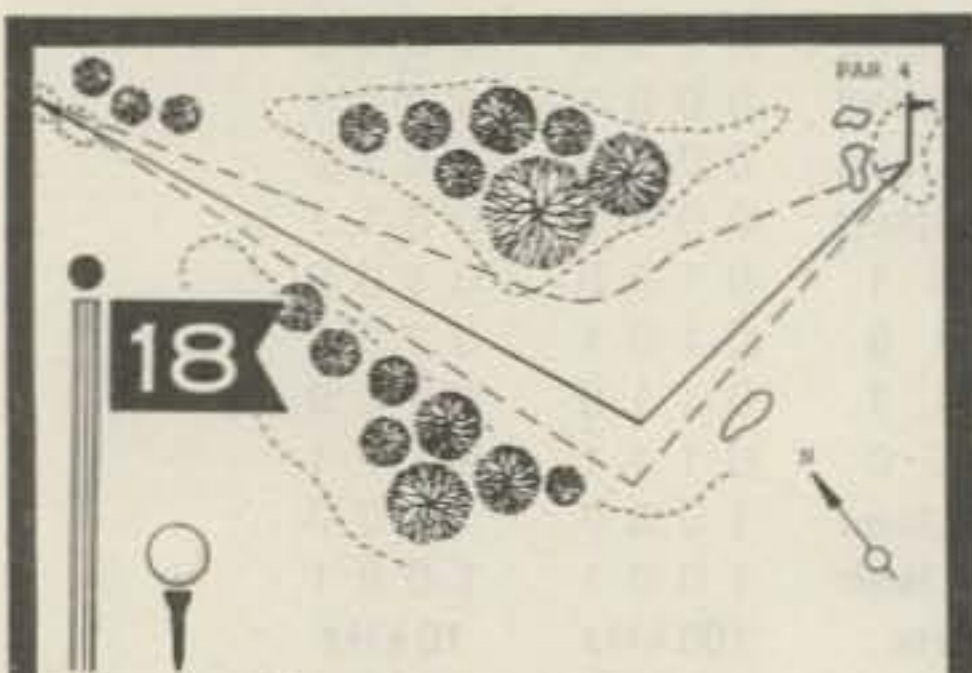

GOLF/ CROSS- OUT

Why wait for good weather? With the *Golf/Cross-Out* package you have 11 clubs and a putter with which to play the finest (electronic) golf course in the country. The Golf program is almost the real thing. It includes sand traps, water hazards, roughs and putting greens. It even includes variable wind factors which must be taken into consideration if you want to score in the low 70's.

You can play the standard 18 holes in the program, or design your own championship course. Simple instructions are included that let you design fairways, relocate greens and place water hazards where you want them.

The Crossout program is the old favorite peg puzzle game in a new computerized form. You play the game by jumping a peg over another into an empty square. The object is to leave one peg on the board in the center square. It sounds easy, but it's not.

Order No. 0009R \$7.95.

Featuring
SOUND EFFECTS

BALL TURRET GUNNER

For years the Petro Resource Conglomerate has attacked our photon collection stations and strangled our deep-space trade routes. The PRC's Exxonators Class light fighters (code name: Gnat) have been their main weapon. Now you can strike back, by joining the Ball Turret Gunner Service.

Imagine yourself at the control console of the LW-1417 Stratoblazer (Type B Strategic Laser Weapon). Your Hindsight Director informs you that a Gnat fighter is coming in for an attack. You position your gigawatt laser turret until you can see the target on your monitor. The Range Indicator shows he's coming in fast. You center your target sights on his location. The Targeting Computer

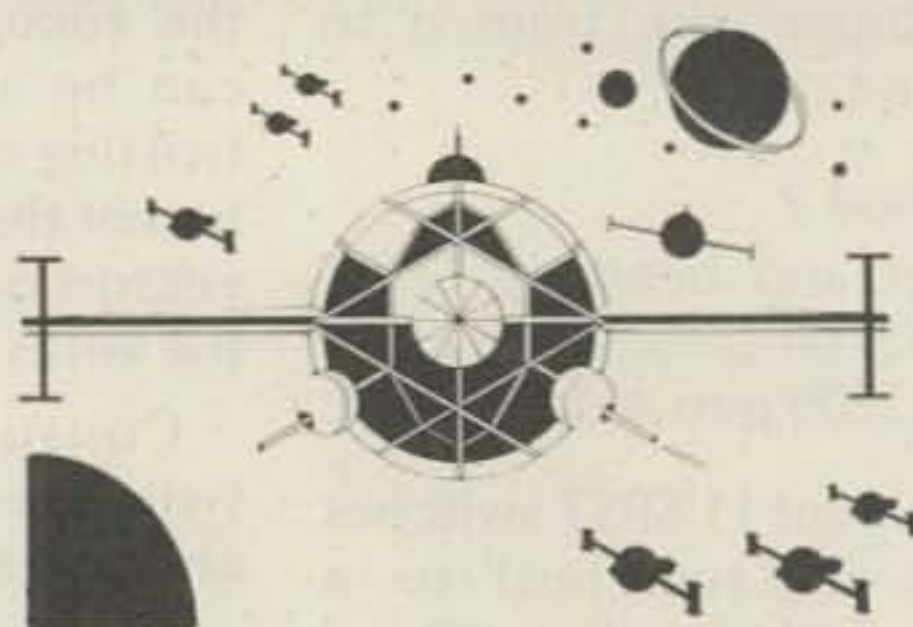

studies his course and speed as your finger tenses over the firing key. You know you'll have only a fraction of a second in which to react. The Gnat fighter's evasive maneuvers cause him to dance in your sights. Suddenly you see the fire command, and you instinctively react. Your Stratoblazer's laser beam lashes out and reduces the Gnat fighter to an expanding ball of ionized gas. Mission accomplished.

Ball Turret Gunner, with your choice of multiple levels of difficulty, optional sound effects programming, and superb graphics, is more than just a game. It's an adventure. Experience it!

Order No. 0051R \$9.95

TO ORDER:

Look for these programs at the dealer nearest you (See the list on the next page). If your store does not stock Instant Software send your order with payment to:

Instant Software Inc.
Order Dept.
Peterborough, N.H. 03458
(Add \$1.00 for handling)

or call toll-free 1-800-258-5473 (VISA, Master Charge and American Express accepted).

For a free catalog listing over 200 programs write: Instant Software Catalog Dept., Peterborough, N.H. 03458.

Prices subject to change without notice.



PET UTILITY I

You're working under a serious handicap if you can't write programs in machine language. The PET Utility I package gives you the tools you need:

•**Monitr**—The Monitr program lets you write, edit, save, and verify any machine language and/or BASIC program. Just load and run the Monitr program and then load the program you want to edit.

•**Programmer's Calculator**—This program will convert numbers into the binary, octal, decimal, and hexadecimal systems and function as a floating point calculator. It will also display all four numbering systems simultaneously and allow you to handle large numbers limited only by the size of your screen. For the 8K PET. Order No. 0105P. \$9.95.

Now available for TRS-80, PET and Apple.

MIMIC

A fast-action memory game.

In Mimic, players are shown a sequence of graphic characters that appear in random locations within a 3x3 grid. You'll have to remember the order and location in which the characters were shown, and "mimic" that sequence on your keyboard.

With several levels of skill, it's not hard to see why people of all ages enjoy this exercise of concentration and dexterity.

TRS-80 Level II 16K, Order No. 0066R \$7.95
PET 8K, Order No. 0039P \$7.95
Apple 24K (Integer), Order No. 0025A \$7.95

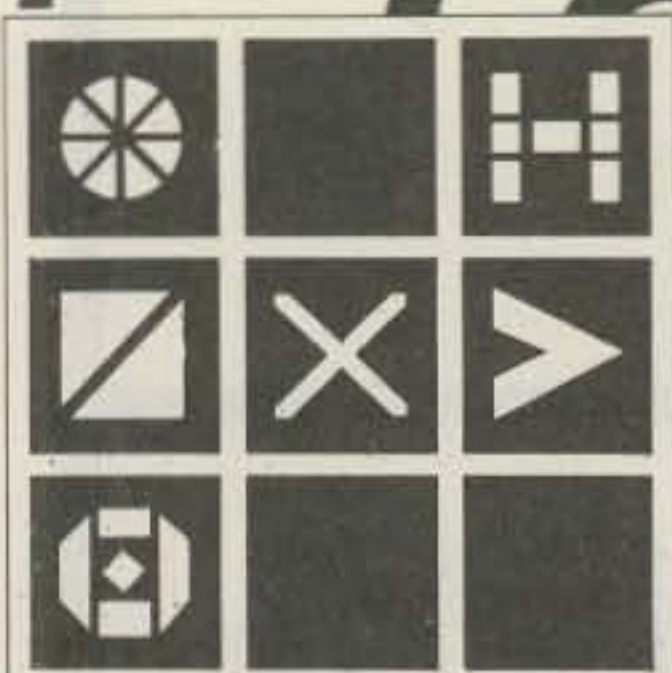

ACCOUNTING ASSISTANT

This package will help any businessman solve many of those day-to-day financial problems. Included are:

•**Loan Amortization Schedule**—This program will give you a complete breakdown of any loan or investment.

•**Depreciation Schedule**—You can get a depreciation schedule using any one of the following methods: straight line, sum of years-digits, declining balance, units of production, or machine hours.

This package requires the Apple 16K and Applesoft II BASIC. Order No. 0088A \$7.95.

Instant Software Inc.

Peterborough, New Hampshire 03458 603-924-7296

Ask for Instant Software at a computer store near you.

- Alabama**
Anderson Computers
3156 University Dr., Huntsville
Computerland of Huntsville
3020 University Dr., Huntsville
Olensky Bros.
3763 Airport Blvd., Mobile
- Arizona**
Ham Shack
450 6-A N. 16th St., Phoenix
Millets TV & Radio
621 East Broadway, Mesa
- California**
Byte Shop
8038 Clairmont Mesa Blvd., San Diego
Byte Shop
123 E. Yorba Linda, Placentia
Byte Shop of Mt. View
1415 West El Camino Real, Mt. View
Byte Shop of Sacramento
6041 Greenback Ln., Citrus Heights
Capital Computer Systems
3396 El Camino Ave., Sacramento
Computers Made Easy
819 East Ave. Q-9, Palmdale
Computer Store of San Leandro
701 MacArthur Blvd., San Leandro
Computer World
6791 Westminster Ave., Westminster
Computerland
16720 S. Hawthorne, Lawndale
Computerland of W. LA
6840 La Cienega Blvd., Inglewood
Coast Electronics
3118 No. Main St., Morro Bay
Computerland
24001 via Fabricante No 904, Mission Viejo
Hobbytronics
1378 So. Bascom Ave., San Jose
Hobby World
19511 Business Ctr. Dr., Unit 6, Borthridge
I.C.E. House Inc.
398 North E. St., San Bernardino
Jade Computer Products
4901 W. Rosécrans, Hawthorne
Marlam Co.
6351 Almaden Rd., San Jose
Opamp/Technical Books
1033 N. Sycamore Ave., Los Angeles
Q.I. Computers, Inc.
15818 Hawthorne Blvd., Lawndale
Radio Shack Dealer
8250 Mira Mesa Blvd., San Diego
Radio Shack Dealer
50 N. Cabrillo Hwy., Half Moon Bay
Santa Rosa Computer Center
604 7th St., Santa Rosa
Silver Spur Elect. Comm.
13552 Central Ave., Chino
The Computer Store
820 Broadway, Santa Monica
- Colorado**
Byte Shop
3464 S. Acoma St., Englewood
Colorado Computer Systems
311 W. 74th Ave., Westminster
Computerland of North Denver
8749 Wadsworth Blvd., Arvada
Computer Shack
1635 South Prairie, Pueblo
The Computer Store
2300 Welton St., Denver
- Connecticut**
American Business Computers
454 Thames St., Groton
Computerlab
130 Jefferson, New London
Computerland
1700 Post Rd., Fairfield
Computerland
60 Skiff St., Hamden
Computer Works
1439 Post Rd. E., Liberty Plaza, Westport
- D.C.**
The Program Store
4200 Wisconsin Ave., N.W., Washington, D.C.
- Florida**
Adventure International
200 Bald Cypress Ct., Longwood
AMF Electronics
11146 N. 30th St., Tampa
Boyd-Ebert Corporation
1328 West 15th St., Panama City
Computer Center
6578 Central Ave., St. Petersburg
Computerland of Ft. Lauderdale
3963 N. Federal Hwy., Ft. Lauderdale
- Computerland of Jacksonville
2777-6 University Blvd. W. Jacksonville
Computerland of Tampa
1520 E. Fowler Ave., Tampa
Computer Shack
3336 Beach Blvd., Jacksonville
Curtis Waters Enterprises
236 Talbot Ave., Melbourne
Heath Kit Electronic
4705 W. 16th Ave. Center, Hialeah
HIS Computeration
1295 Cypress Ave., Melbourne
Sound Ideas
2201-C N.W. 13th, Gainesville
Ukatan Computer Store
Airport Rd., Destin
Williams Radio & TV Inc.
2062 Liberty St., Jacksonville
- Georgia**
Atlanta Computer Mart
Atlanta
Computerland of Atlanta
2423 Cobb Parkway, Smyrna
- Hawaii**
Computerland of Hawaii
567 N. Federal Hwy., Honolulu
Radio Shack Assoc. Store
1712 S. King St., Honolulu
- Idaho**
Electronic Specialists
8411 Fairview Ave., Boise
- Illinois**
Computerland
4507 North Sterling, Peoria
Computerland
9511 N. Milwaukee Ave., Niles
Computer Station
3659 Nameoki Rd., Granite City
Midwest Micro Computers, Inc.
708 S. Main St., Lombard
- Kansas**
Central Kansas Computers
6 S. Broadway, Herington
- Maine**
Main Computronics
Intown Plaza, Bangor
Radio Shack
315 Main Mall Rd., So. Portland
- Maryland**
Jack Fives Electronics
4608 Debilen Circle, Pikesville
The Comm Center
9624 Ft. Meade Rd., Laurel
- Massachusetts**
ComputerCity
175 Main St., Charlestown
ComputerCity
50 Worcester Rd., Framingham
Computerland of Boston
214 Worcester Rd., Wellesley
Computer Packages Unlimited
244 W. Boylston St., West Boylston
Lighthouse Computer Software
14 Fall River Ave., Rehoboth
New England Electronics Co.
679 Highland Ave., Needham
The Computer Store
120 Cambridge St., Burlington
Tufts Radio & Electronics
206 Mystic Ave., Medford
- Michigan**
Computer Center
28251 Ford Rd., Garden City
Computer Connections
38437 Grand River, Farmington Hills
Computerland of Grand Rapids
2927 28th St. S.E., Kentwood
Computerland of Rochester
301 S. Livernois, Rochester
Computerland of Southfield
29673 Northwestern Hwy., Southfield
Computer Mart
560 W. 14 Mile Rd., Clawson
Hobby House
1035 W. Territorial Rd., Battle Creek
The Alternate Source
1806 Ada, Lansing
Ye Olde Teacher Shoppe
1823 Witmyre St., Ypsilanti
- Minnesota**
Computerland of Hopkins
11319 Hwy F., Hopkins
Digital Den
Burnsville Center
Minnesota Software Inc.
5422 Fisher St., White Bear Lake
Zim Computers
5717 Xerxes Ave., N. Brooklyn Center
- Mississippi**
Dyer's, Inc.
200 E. Main St., West Point
- Softwarehouse
816 Foley St., Jackson
W. Vernon Foster Inc.
816 Foley St., Jackson
- Missouri**
Computervan, Inc.
51 Florissant Oaks Shopping Center
Florissant
Consolidated Software
16501 Greenwald Court, Belton
- Montana**
Intermountain Computer
529 So. 9th St., Livingston
Personal Computer
121 Red Oak Dr., Carl Junction
The Computer Store
1216 16th St. W. #35, Billings
- Nebraska**
Computerland of Omaha
11031 Elm St., Omaha
Midwest Computer Co. Inc.
8625 I St., Omaha
Midwest Computer Co. Inc.
4442 S. 84th St., Omaha
Midwest Computer Co. Inc.
4403 S. 87th St., Omaha
Scottsbluff Typewriters Inc.
1824 Broadway, Scottsbluff
- Nevada**
Century 23
4566 Spring Mountain Rd., Las Vegas
- New Hampshire**
Bitsnbytes Computer Center
568 Pleasant St., Concord
ComputerCity
1525 S. Willow, Manchester
Paul's TV
Main St., Fremont
Portsmouth Computer Center
31 Raynes Ave., Portsmouth
Radio Shack Assoc. Store
Fairbanks Plaza, Keene
- New Jersey**
Computer Encounter
2 Nassau St., Princeton
Computerland
35 Plaza Rte. #4, W. Paramus
Computer Mart of NJ
501 Rte. 27, Iselin
Dave's Electronics
Pennsville Shopping Ctr., Pennsville
GHB Enterprises Inc.
Rte. 38, Rudderow Ave., Mapleshade
Personal Computing Inc.
51 Central Sq., Linwood
Radio Shack/J&J Electronic
Mansfield Shopping Ctr.
Rt. 57 Allen Rd., Hackettstown
The Bargain Brothers
Glen Roc Shopping Center
216 Scotch Road, Trenton
The Computer Emporium
Bldg. 103, Avenues of Commerce
2428 Rte. 38, Cherry Hill
- New Mexico**
Autel Electronics Co.
232 Wisconsin N.E., Albuquerque
Legay and Associates
2908 Tahiti Ct. N.E., Albuquerque
Mitchell's Music (Radio Shack)
407 W. Church, Carlsbad
South West Computer Center
121 Wyatt Drive, Suite 7, Las Cruces
- New York**
Aristo Craft
314 Fifth Ave., NYC
Bits & Bytes
2800 Straight Rd., Fredonia
Computer Corner
200 Hamilton Ave., White Plains
Computer Era Corp.
1570 3rd Ave., New York
Computer Factory
485 Lexington Ave., NYC
Computer House, Inc.
721 Atlantic Ave., Rochester
Computerland of Nassau
79 Westbury Ave., Carle Place
Computer World
519 Boston Post Rd., Port Chester
Comtek Electronics, Inc.
2666 Coney Island Ave., Brooklyn
Comtek Electronics, Inc.
Staten Island Mall
Store 220A, Staten Island
Digibyte Systems Corp.
31E. 31st St., New York
Home Computer Center
671 Monroe Ave., Rochester
Key Electronics
Schenectady
Lashen Electronics Inc.
21 Broadway, Denville
- Mr. Computer
Imp. Plaza, Rte. 9, Wappingers Falls
Softtron Systems
308 Columbia Turnpike, Rensselaer
The Computer Tree Inc.
409 Hooper Rd., Endwell
Upstate Computer Shop
629 French Rd., Campus Plaza
New Hartford
- North Carolina**
Byte Shop of Raleigh
1213 Hillsborough St., Raleigh
- Ohio**
Altair Business Systems, Inc.
5252 North Dixie Dr., Dayton
Astro Video Electronics
504 E. Main St., Lancaster
Cincinnati Computer Store
4816 Interstate Dr., Cincinnati
Computerland
4579 Great Northern Blvd., N. Olmstead
Computerland
6429 Busch Blvd., Columbus
Computerland
1288 Som Rd., Mayfield Heights
Computer Store of Toledo
18 Hillwyck Dr., Toledo
Forbes Microsystems Inc.
35 N. Broad, Fairborn
Microcomputer Center
7900 Paragon Rd., Dayton
Micro-Mini Computer World
74 Robinwood, Columbus
Universal Amateur Radio, Inc.
1280 Aida Dr., Columbus
- Oklahoma**
Sounds, Etc.
Hwy. 33, Watonga
Vern Street Products
Radio Shack Dealer
114 W. Taft St., Sapulpa
- Oregon**
Computerland of Portland
12020 S.W. Main St., Tigard
Computer Pathways Unlimited, Inc.
2151 Davcor St. S.E., Salem
TRS-80 Products Ltd.
3520 S.E. Vineyard Rd., Portland
- Pennsylvania**
Artco Elect.
302 Wyoming Ave., Kingston
Artco Elect.
Back Mountain Shop. Ctr.
Shavertown
Audio Mart
518 Fifth Ave., New Brighton
Computer Workshope
3848 William Penn Hwy, Monroeville
Computerland of Harrisburg
4644 Carlisle Pike, Mechanicsburg
Erie Computer Co.
2127 West 8th St., Erie
Mighty Byte Computer Center
537 Easton Rd., Horsham
Personal Computer Corp.
24-26 West Lancaster Ave., Paoli
Personal Computer Corp.
Frazer Mall, Lancaster Ave., Frazer
- Rhode Island**
Computer City
165 Angell St., Providence
- South Dakota**
CB Radio Shack
21st and Broadway, Yankton
- Tennessee**
Computerlab
671 S. Menden Hall Rd., Memphis
H & H Electronics Inc.
509 N. Jackson St., Tullahoma
- Texas**
Computer Port
926 N. Collins, Arlington
Houston Computer Tech
5313 Bissonet, Bellarie
Interactive Computer
7620 Dashwood, Houston
K.A. Elect.
9090 Stemmons Frwy., Dallas
Pan American Elect. Inc.
1117 Conway, Mission
Radio Shack Dealer
21969 Katy Freeway, Katy
Ram Micro Systems
6353 Camp Bowie Blvd., Ft. Worth
Waghalter Books Inc.
3 Greenway Plaza E., Houston
- Utah**
DC Computer Co.
1911 West 70 South, Provo
Quality Technology
470 E. 2nd So., Salt Lake City
- Virginia**
Computer Works
Rte. 6, Box 65A, Harrisonburg
- Home Computer Center
2927 Virginia Beach Blvd.
Virginia Beach
Southside Radio Comm.
135 Pickwick Ave., Colonial Heights
- Washington**
American Mercantile Co. Inc.
2418 1st Ave. S., Seattle
Byte Shop of Bellevue
14701 N.E. 20th St., Bellevue
Computerland of South King Co.
1500 S. 336 St., Suite 12
Federal Way
Magnolia Micro Systems
2812 Thorndyke Ave., Seattle
Personal Computers
S 104 Freva, Spokane
Ye Old Computer Shop
1301 G. Washington, Richland
- West Virginia**
The Computer Corner Inc.
22 Beechurst Ave., Morgantown
The Computer Store
Municipal Parking Bldg., Charleston
- Wisconsin**
Byte Shop Of Milwaukee
6019 West Layton Ave., Greenfield
Computerland
690 S. Whitney Way, Madison
Petted Microsystems
4265 W. Loomis Rd., Milwaukee
- Wyoming**
Computer Concepts
1104 Logan Ave., Cheyenne
- Puerto Rico**
The Microcomputer Store
1568 Ave. Jesus T. Pinero
Caparra Terrace
- Canada**
- CANADIAN DISTRIBUTORS:
Micron Distributing
409 Queen St., W. Toronto, Ont.
M5V 2A5
- Computerland of Winnipeg
715 Portage Ave., Winnipeg, Man.
Compumart
411 Roosevelt Ave., Ottawa, Ontario
Micromatic Systems Inc.
101 8136 Park Rd., Richmond, B.C.
Micro Shack of W. Canada
333 Park Street, Regina, Sask.
Orthon Holdings Ltd.
12411 Stony Plain Road
Edmonton, Alberta
Total Computer Systems
Ajax, Ontario
- Austria**
Byte Shop Microelectronic
Favoritenstr. 20, Wien
- England**
Mighty Micro
33 Cardiff Rd., Watford Herts
- France**
Sivea s.a.
20, Rue de Leningrad, Paris
- Italy**
HOMIC s.r.l.
Piazza De Angeli 1, Milano
- Switzerland**
Tandy Corp.
Baslerstr. 145, Zuerich
- West Germany**
- EUROPEAN DISTRIBUTOR:
Microshop Bodensee
Markstr. 3, 7778 Markdorf
- AAA-Electronic
Habsburgerstr. 134, Freiburg
Basic Software und Schulung
Constantinstr. 88, Koeln 21
Electronic Hobby Shop
Maximilianstr. 22, Bonn
Henniger Computers
Landwehrstr. 39, Muenchen 2
Microcomputer Center
Aisfelderstr. 7, Darmstadt
Muenzenlohr
Toelzerstr. 5, Holzkirchen
R + R Electronic
Adlerstr. 55, Heidelberg
- Australia**
Computer Country Pty Ltd.
5 Tonkin Ave., Balwyn VIC
Deforest Software
36 Glen Tower Drive
Glen Waverly, VIC.
Sure-Load Software
P.O. Box 26, Weston, A.C.T.
- South Africa**
- SOUTH AFRICAN DISTRIBUTOR:
Eddie Talberg
P.O. Box 745, Johannesburg

Instant Software Inc.

Peterborough, N.H.
03458 ✓ 337

Computerize Your Contest Paperwork

— two BASIC programs do it all

Bernard Hohman WA8WIA
95 Prospect Street
Tiffin OH 44883

Are you a contest operator? Have you been assigned as a Field Day Chairman? If the answer to either question is yes, this

article is for you! The two BASIC programs presented here will check for duplicate contacts, alphabetize, and print results in a form

acceptable to most contest managers. You don't own a microcomputer? I don't either. I bet you can find someone who does.

```
0005 REM AMATEUR CALL DUP CHECK AND SAVE PROGRAM
0006 REM WRITTEN BY BERNARD HOHMAN WA8WIA
0007 REM REVISED JULY 20, 1978
0008 REM SWTP BK BASIC VER. 2.0
0010 POKE( 62, 6)
0015 LINE= 100
0020 DIM D$(60), E$(60), F$(130), G$(120), H$(30)
0025 DIM I$(10), J$(20), K$(130), L$(120), M$(75)
0028 D$(1)="0":E$(1)="0":F$(1)="0":G$(1)="0":H$(1)="0"
0029 I$(1)="0":J$(1)="0":K$(1)="0":L$(1)="0":M$(1)="0"
0060 PRINT "ENTER DATA":CHR$(17):
0065 INPUT B$
0066 PRINT CHR$(19)
0080 IF B$="RECORD" THEN GOTO 2100
0090 W$=MID$(B$,2,1)
0100 IF W$="9" THEN 155
0112 LET R=VAL(W$)
0113 IF R=0 THEN R=10
0120 ON R GOTO 200,300,400,500,600,700,800,900,1000,1100
0155 W$=MID$(B$,3,1):IF W$<="9" THEN 100
0160 PRINT B$;" IS AN INVALID CALL":GOTO 60
0200 FOR D1=1 TO 500
0210 IF D$(D1)="0" THEN 240
0220 IF D$(D1)=B$ THEN PRINT "DUP":GOTO 60
0230 NEXT D1
0240 D$(D1)=B$:D$(D1+1)="0":PRINT D$(D1),D1:GOTO 60
0300 FOR E1=1 TO 500
0310 IF E$(E1)="0" THEN 340
0320 IF E$(E1)=B$ THEN PRINT "DUP":GOTO 60
0330 NEXT E1
0340 E$(E1)=B$:E$(E1+1)="0":PRINT E$(E1),E1:GOTO 60
0400 FOR F1=1 TO 500
0410 IF F$(F1)="0" THEN 440
0420 IF F$(F1)=B$ THEN PRINT "DUP":GOTO 60
0430 NEXT F1
0440 F$(F1)=B$:F$(F1+1)="0":PRINT F$(F1),F1:GOTO 60
0500 FOR G1=1 TO 500
0510 IF G$(G1)="0" THEN 540
0520 IF G$(G1)=B$ THEN PRINT "DUP":GOTO 60
0530 NEXT G1
0540 G$(G1)=B$:G$(G1+1)="0":PRINT G$(G1),G1:GOTO 60
0600 FOR H1=1 TO 500
0610 IF H$(H1)="0" THEN 640
0620 IF H$(H1)=B$ THEN PRINT "DUP":GOTO 60
0630 NEXT H1
0640 H$(H1)=B$:H$(H1+1)="0":PRINT H$(H1),H1:GOTO 60
0700 FOR I1=1 TO 500
0710 IF I$(I1)="0" THEN 740
0720 IF I$(I1)=B$ THEN PRINT "DUP":GOTO 60
0730 NEXT I1
0740 I$(I1)=B$:I$(I1+1)="0":PRINT I$(I1),I1:GOTO 60
0800 FOR J1=1 TO 500
0810 IF J$(J1)="0" THEN 840
0820 IF J$(J1)=B$ THEN PRINT "DUP":GOTO 60
0830 NEXT J1
0840 J$(J1)=B$:J$(J1+1)="0":PRINT J$(J1),J1:GOTO 60
0900 FOR K1=1 TO 500
0910 IF K$(K1)="0" THEN 940
0920 IF K$(K1)=B$ THEN PRINT "DUP":GOTO 60
0930 NEXT K1
0940 K$(K1)=B$:K$(K1+1)="0":PRINT K$(K1),K1:GOTO 60
1000 FOR L1=1 TO 500
1010 IF L$(L1)="0" THEN 1040
1020 IF L$(L1)=B$ THEN PRINT "DUP":GOTO 60
1030 NEXT L1
1040 L$(L1)=B$:L$(L1+1)="0":PRINT L$(L1),L1:GOTO 60
1100 FOR M1=1 TO 500
1110 IF M$(M1)="0" THEN 1140
1120 IF M$(M1)=B$ THEN PRINT "DUP":GOTO 60
1130 NEXT M1
1140 M$(M1)=B$:M$(M1+1)="0":PRINT M$(M1),M1:GOTO 60
2100 PRINT CHR$(18):C=10
2110 FOR V1=1 TO 50:NEXT V1
2120 Q=0-1
2125 IF Q=0 THEN Q=10
2130 FOR V2=1 TO 100
2140 FOR W2=1 TO 50:NEXT W2
2150 ON Q GOTO 2200,2300,2400,2500,2600,2700,2800,2900,3000,3100
2160 NEXT W
2200 IF D$(W)="0" THEN 2120
2210 PRINT D$(W):GOTO 2160
2300 IF E$(W)="0" THEN 2120
2310 PRINT E$(W):GOTO 2160
2400 IF F$(W)="0" THEN 2120
2410 PRINT F$(W):GOTO 2160
2500 IF G$(W)="0" THEN 2120
2510 PRINT G$(W):GOTO 2160
2600 IF H$(W)="0" THEN 2120
2610 PRINT H$(W):GOTO 2160
2700 IF I$(W)="0" THEN 2120
2710 PRINT I$(W):GOTO 2160
2800 IF J$(W)="0" THEN 2120
2810 PRINT J$(W):GOTO 2160
2900 IF K$(W)="0" THEN 2120
2910 PRINT K$(W):GOTO 2160
3000 IF L$(W)="0" THEN 2120
3010 PRINT L$(W):GOTO 2160
3100 IF M$(W)="0" THEN 3200
3110 PRINT M$(W):GOTO 2160
3200 PRINT CHR$(20):GOTO 60
3300 END
```

Fig. 1. Program 1 listing.

For a number of years I have had the job of preparing Field Day forms (dupe check sheets) for submission. Even before the June, 1978, event, I started thinking that there ought to be a better way to process the logs. Why not a microcomputer? I was aware that Dick Wright owned an SWTP system, so I called him and introduced myself.

Dick did not have much experience in handling strings (alphanumeric characters), and I had never written a computer program in my life. I explained that I was willing to learn the language, so he lent me his BASIC manual and I began one of the more challenging and satisfying experiences in my life (I am now a confirmed computer freak). Dick and I spent at least ten long July nights developing the programs to do the manipulations I wanted, and these two BASIC programs are the result.

Dick's system included: SWTPC 6800, AC-30, CT-1024, KSR 33, 16K RAM, and 8K BASIC Version 2.0. We had only 8K of available memory, so neither program is documented with instructions or REM statements. We found 500 string variables (calls) impossible to process in 8K of RAM without two programs and the POKE(62,6) trick published in *Kilobaud* (#19, July, 1978, "Little Bits"). Thanks, Dale, you saved our lives!

Although the data was already on log sheets, the first program was written so that it could be used during a contest. It checks for duplicate contacts, places calls in ten different lists, and then records the valid data on cassette for processing by Program 2 later. Program 2 takes the data from cassette, alphabetizes the calls, and prints

the lists for submission.

Program 1

Subscript string processing is rather slow when checking a single list of 500 plus contacts for duplicates, so I assigned a different subscript string for each of the ten call areas: D\$(D1) for the 1s, E\$(E1) for the 2s, and so on. By using this routine, only the calls in the area of interest will be searched for duplicates. You will have to redimension the arrays in lines 20 and 25 according to an estimate of the contacts you will be making with each of the call areas from your location. As listed, lines 20 and 25 allow sufficient memory for contacts on 40 meters from northwest Ohio.

Since the number in a call always appears in position two or three of the call, the MID\$ function was put to good use. Lines 60 through 160 decide which list to search for duplicates, and then the computer jumps to that routine. If a duplicate is found, DUP is printed, and the computer again prompts with INPUT DATA? It's easy to make a mistake at 3 am. If that happens, use CTRL C to get out of the program. In the direct mode (no line numbers), make the subscript string variable in error equal to "@".

For example, an error in call area three, position 22, can be corrected by entering LET F\$(22)="@"; GOTO 60; and then you are ready to enter the next call. In order to know which string to change, I suggest you write D\$=1, E\$=2, F\$=3...M\$=0 on a piece of paper for reference. Lines 200 through 1150 are the dupe find routines.

When all the calls have been entered, it's time to record the calls on cassette for processing by the sec-

```

ENTER DATA? K3DEU
K3DEU          100
ENTER DATA? K3YBW

DUP
ENTER DATA? K9AOM

DUP
ENTER DATA? W8MVE

W8MVE          62
ENTER DATA? K8DFX

K8DFX          63
ENTER DATA? K4WJJ

K4WJJ          78
ENTER DATA?
READY
#LETGS(78)="@"

READY
#GOTO60
ENTER DATA? K4WJ

K4WJ           78
ENTER DATA? K4KA

K4KA           79
ENTER DATA? W84NTA

W84NTA         80
ENTER DATA? RECORD

K9URN
N9IF
VA9AEK
W9LRG
WB9TXO
K9EYA
W9CEQ
W9GL
W9DQA
N9RD
W9IC

ENTER DATA? W80Y

W80Y IS AN INVALID CALL
ENTER DATA?

ENTER DATA? K3DEA
K3DEA          101
ENTER DATA? W8MVB

W8MVB          64
ENTER DATA? K3YBW

DUP
ENTER DATA? K9AOM

DUP
ENTER DATA? K80Y

K80Y IS AN INVALID CALL
ENTER DATA? K80Y

K80Y           65
ENTER DATA? W8MVB

DUP
ENTER DATA? K4WJJ

K4WJJ          81
ENTER DATA?
READY
#LETGS(81)="@"

READY
#GOTO60
ENTER DATA? K4WJG

K4WJG          81
ENTER DATA? REVORD

REVORD IS AN INVALID CALL
ENTER DATA? RECORD

K9URN
N9IF
VA9AEK
W9LRG
WB9TXO
K9EYA
W9CEQ
W9GL

```

Fig. 2. Program 1 sample run.

PHOTO ETCH™

PRINTED CIRCUIT KIT

Makes circuits **THREE WAYS**

1 FULL SCALE ARTWORK MASTER →

2 MAGAZINE ART ILLUSTRATION → **FILM POSITIVE** → **NEGATIVE** → **DEVELOPED PHOTO RESIST IMAGE ON COPPER CLAD CIRCUIT BOARD** → **ETCHED CIRCUIT BOARD**

3 DIRECT ETCH DRY TRANSFERS APPLIED TO COPPER CLAD BOARD →

Copy circuits right from a magazine using special photo film. No camera or darkroom used. Page is not destroyed in process. Do your own master art, make negatives, sensitize boards and etch one or a hundred circuits; all identical, all perfect. For one-of-a-kind PC's, use special dry transfer patterns as a direct etch resist right on the blank copper board. Do it all with the ER-4. In stock at parts distributors or order direct. Add 7% shipping. Minimum factory order: \$30.00.

ER-4 Complete Photo Etch Set	\$29.95
ER-2 Assorted Etch Resist Patterns & Tapes	4.25
ER-3 1/4 lb. Dry Ferric Chloride (makes one pint)	1.95
ER-5 Six sheets Pos-Neg Copy Film, 5"x6"	5.15
ER-6 Film Process Chemicals	2.50
ER-71 Photo Resist Liquid (negative) does 1700 in ²	6.50
ER-8 Photo Resist Developer, 16 oz.	3.30
ER-12 Power Etch bubble pump unit*	7.25

*not included in ER-4 set

the **DATAK** corp. ✓331
 65 71st St. • Guttenberg, N. J. 07093

```

0005 REM AMATEUR CALL SORT AND PRINT PROGRAM
0006 REM WRITTEN BY BERNARD MOHMAN WABWIA
0007 REM REVISED JULY 24, 1978
0008 REM SWTP 8K BASIC VER. 2.0
0010 POKE( 62, 6)
0015 LINE= 100
0020 DIM D$(60), E$(80), F$(130), G$(120), H$(30)
0025 DIM I$(10), J$(20), K$(130), L$(120), M$(75)
0030 PRINT "ENTER DATA": CHR$(17):
0035 INPUT B$
0040 PRINT CHR$(19)
0045 IF B$="PRINT" THEN 1220
0050 IF B$="SORT" THEN 250
0055 V$=MID$(B$, 2, 1)
0060 IF V$="9" THEN 155
0065 LET R=VAL(V$)
0070 IF R=0 THEN R=10
0075 IF R=1 THEN D1=D1+1: D$(D1)=B$
0080 IF R=2 THEN E1=E1+1: E$(E1)=B$
0085 IF R=3 THEN F1=F1+1: F$(F1)=B$
0090 IF R=4 THEN G1=G1+1: G$(G1)=B$
0095 IF R=5 THEN H1=H1+1: H$(H1)=B$
0100 IF R=6 THEN I1=I1+1: I$(I1)=B$
0105 IF R=7 THEN J1=J1+1: J$(J1)=B$
0110 IF R=8 THEN K1=K1+1: K$(K1)=B$
0115 IF R=9 THEN L1=L1+1: L$(L1)=B$
0120 IF R=10 THEN M1=M1+1: M$(M1)=B$
0125 GOTO 60
0130 V$=MID$(B$, 3, 1): IF V$<="9" THEN 180
0135 PRINT B$: " IS AN INVALID CALL": GOTO 60
0140 IF D1<2 THEN 295
0145 FOR N=1 TO D1-1
0150 FOR K=N+1 TO D1
0155 IF D$(N)<D$(K) THEN 285
0160 X$=D$(N)
0165 D$(N)=D$(K)
0170 D$(K)=X$
0175 NEXT K
0180 NEXT N
0185 PRINT "1'S SORTED"
0190 IF E1<2 THEN 395
0195 FOR N=1 TO E1-1
0200 FOR K=N+1 TO E1
0205 IF E$(N)<E$(K) THEN 385
0210 X$=E$(N)
0215 E$(N)=E$(K)
0220 E$(K)=X$
0225 NEXT K
0230 NEXT N
0235 PRINT "2'S SORTED"
0240 IF F1<2 THEN 495
0245 FOR N=1 TO F1-1
0250 FOR K=N+1 TO F1
0255 IF F$(N)<F$(K) THEN 485
0260 X$=F$(N)
0265 F$(N)=F$(K)
0270 F$(K)=X$
0275 NEXT K
0280 NEXT N
0285 PRINT "3'S SORTED"
0290 IF G1<2 THEN 595
0295 FOR N=1 TO G1-1
0300 FOR K=N+1 TO G1
0305 IF G$(N)<G$(K) THEN 585
0310 X$=G$(N)
0315 G$(N)=G$(K)
0320 G$(K)=X$
0325 NEXT K
0330 NEXT N
0335 PRINT "4'S SORTED"
0340 IF H1<2 THEN 695
0345 FOR N=1 TO H1-1
0350 FOR K=N+1 TO H1
0355 IF H$(N)<H$(K) THEN 685
0360 X$=H$(N)
0365 H$(N)=H$(K)
0370 H$(K)=X$
0375 NEXT K
0380 NEXT N
0385 PRINT "5'S SORTED"
0390 IF I1<2 THEN 795
0395 FOR N=1 TO I1-1
0400 FOR K=N+1 TO I1
0405 IF I$(N)<I$(K) THEN 785
0410 X$=I$(N)
0415 I$(N)=I$(K)
0420 I$(K)=X$
0425 NEXT K
0430 NEXT N
0435 PRINT "6'S SORTED"
0440 IF J1<2 THEN 895
0445 FOR N=1 TO J1-1
0450 FOR K=N+1 TO J1
0455 IF J$(N)<J$(K) THEN 885
0460 X$=J$(N)
0465 J$(N)=J$(K)
0470 J$(K)=X$
0475 NEXT K
0480 NEXT N
0485 PRINT "7'S SORTED"
0490 IF K1<2 THEN 995
0495 FOR N=1 TO K1-1
0500 FOR K=N+1 TO K1
0505 IF K$(N)<K$(K) THEN 985
0510 X$=K$(N)
0515 K$(N)=K$(K)
0520 K$(K)=X$
0525 NEXT K
0530 NEXT N
0535 PRINT "8'S SORTED"
0540 IF L1<2 THEN 1095
0545 FOR N=1 TO L1-1
0550 FOR K=N+1 TO L1
0555 IF L$(N)<L$(K) THEN 1085
0560 X$=L$(N)
0565 L$(N)=L$(K)
0570 L$(K)=X$
0575 NEXT K
0580 NEXT N
0585 PRINT "9'S SORTED"
0590 IF M1<2 THEN 1195
0595 FOR N=1 TO M1-1
0600 FOR K=N+1 TO M1
0605 IF M$(N)<M$(K) THEN 1185
0610 X$=M$(N)
0615 M$(N)=M$(K)
0620 M$(K)=X$
0625 NEXT K
0630 NEXT N
0635 PRINT "0'S SORTED"
0640 GOTO 60
0645 INPUT "ENTER DATE OF FIELD DAY IE: 6,23,78", Z5, Z6, Z7
0650 INPUT "ENTER FIELD DAY CALL USED", A$(2)
0655 INPUT "ENTER BAND WORKED FOR THIS REPORT", A$(3)
0660 INPUT "ENTER MODE OF OPERATION", A$(4)
0665 FOR X=1 TO 10: PRINT: NEXT X
0670 PRINT "PAGE #1": PRINT: PRINT: PRINT
0675 GOSUB 1700
0680 S=H1
0685 IF D1>S THEN S=D1
0690 IF E1>S THEN S=E1
0695 IF F1>S THEN S=F1
0700 IF G1>S THEN S=G1
0705 FOR T=1 TO 5
0710 IF T<=D1 THEN PRINT D$(T):
0715 PRINT TAB(16);
0720 IF T<=E1 THEN PRINT E$(T):
0725 PRINT TAB(32);
0730 IF T<=F1 THEN PRINT F$(T):
0735 PRINT TAB(48);
0740 IF T<=G1 THEN PRINT G$(T):
0745 PRINT TAB(64);
0750 IF T<=H1 THEN PRINT H$(T):
0755 PRINT
0760 NEXT T
0765 FOR X=1 TO 10: PRINT: NEXT X
0770 PRINT "PAGE #2": PRINT: PRINT: PRINT
0775 GOSUB 1700
0780 S=I1
0785 IF J1>S THEN S=J1
0790 IF K1>S THEN S=K1
0795 IF L1>S THEN S=L1
0800 IF M1>S THEN S=M1
0805 FOR T=1 TO 5
0810 IF T<=I1 THEN PRINT I$(T):
0815 PRINT TAB(16);
0820 IF T<=J1 THEN PRINT J$(T):
0825 PRINT TAB(32);
0830 IF T<=K1 THEN PRINT K$(T):
0835 PRINT TAB(48);
0840 IF T<=L1 THEN PRINT L$(T):
0845 PRINT TAB(64);
0850 IF T<=M1 THEN PRINT M$(T):
0855 PRINT
0860 NEXT T
0865 PRINT : PRINT: PRINT
0870 A=D1+E1+F1+G1+H1+I1+J1+K1+L1+M1
0875 PRINT "TOTAL NUMBER OF CONTACTS = "; A
0880 FOR X=1 TO 10: PRINT: NEXT X
0885 GOTO 60
0890 PRINT TAB(17);
0895 PRINT "AMATEUR RADIO FIELD DAY CONTACT REPORT"
0900 PRINT : PRINT: PRINT
0905 PRINT "DATE "; Z5; "/" ; Z6; "/" ; Z7; TAB(20);
0910 PRINT "CALL "; A$(2); TAB(40);
0915 PRINT "BAND "; A$(3); TAB(60);
0920 PRINT "MODE "; A$(4)
0925 FOR X=1 TO 7: PRINT "-"; : NEXT X
0930 PRINT
0935 RETURN

```

Fig. 3. Program 2 listing.

ond program. Set up the cassette interface and the cassette machine for record and enter RECORD. The computer will jump to line 2100 and the valid calls will be saved on tape.

Program 2

The contacts saved on tape by Program 1 are now ready to be used by lines 60

to 160 of Program 2. As in Program 1, the calls are put into ten separate arrays. After all data is loaded, type SORT and the ordering begins. SWTP BASIC is rather slow. To avoid the feeling that something is surely wrong, I had the computer print "1's SORTED", "2's SORTED", etc., after each array has

been alphabetized.

After all sorting is completed, type PRINT. The program then jumps to line 1300 and asks for the date, call used, band, and mode. It then prints the calls on two pages with five call areas per page. At the end of page two, the total number of contacts is printed. In Dick's system,

his CT-1024, TVT, and KSR 33 are all interfaced with port 1. If you have a different arrangement, you must change the print routine accordingly.

Conclusion

With some changes, the two programs were tried on a TRS-80 Level II 16K and an OSI 1P 8K. If you send

ENTER DATA? WBRFZ
 ENTER DATA? SORT
 1'S SORTED
 2'S SORTED
 3'S SORTED
 4'S SORTED
 5'S SORTED
 6'S SORTED
 7'S SORTED
 8'S SORTED
 9'S SORTED
 0'S SORTED
 ENTER DATA? PRINT
 ENTER DATE OF FIELD DAY 1E: 6, 23, 78? 7, 2, 79
 ENTER FIELD DAY CALL USED? W8XXX
 ENTER BAND WORKED FOR THIS REPORT? 40M
 ENTER MODE OF OPERATION? A3

me an SASE, I would be glad to forward the pertinent information to adapt both programs for use with either of the above-named microcomputers.

Don't forget that there are a lot of computer owners out there who are

eager to show off their systems and do something worthwhile at the same time. Thanks, Dick, for the use of your system, for the help in programming, and for helping with the development of this article. ■

AMATEUR RADIO FIELD DAY CONTACT REPORT

AMATEUR RADIO FIELD DAY CONTACT REPORT

DATE 7 / 2 / 79	CALL W8XXX	BAND 40M	MODE A3
K1AM	K2AA	K3BQZ	AA4AA
K1AR	K2AZ	K3CSG	AA4AQ
K1CE	K2DR	K3CZ	AA4HF
K1VEW	K2GE	K3EF	AA4RX
K1XR	K2HVR	K31VQ	K4BFG
N1OM	K2IH	K3LF	K4BFT
W1BW	K21JL	K3NJK	K4DQ
W1ECV	K2IZ	K3PI	K4FOY
W1HEB	K2KO	K3SSC	K4HEX
W1JP	K2PLF	K3SZG	K4HYB
W1MV	K2RQA	K3TJM	K41QT
W1QQN	K2WI	K3YBW	K4JK
W1RK	K2YNT	N3AY	K4JUO
W1RT	K2ZV	N3EA	K4NC
W1SW	N2HR	N3EI	K4NE
W1SY	N2MD	N3FM	K4PJ
W1TH	N2NV	N3IC	K4QMH
W1TR	N200	N3KK	K4SE
W1VW	VE2CR0	N3SB	K4STR
W1VE0	VE2CW1	VE3AAC	K4UAS
W1YR	VE2DUB	VE3AC	K4UWH
VA1KUL	VE2WX	VE3AEA	K4UV
VA1UBC	VE2XL	VE3AEO	K4VHF
VA1YGA	W2AA	VE3AWJ	K4VLY
VA1ZMM	W2AE	VE3BA	K4VX
WB1ABY	W2CVI	VE3BGA	N4A1
WB1DXE	W2CXV	VE3BPC	N4DJ
	W2EEL	VE3CRC	N4EN
	W2FSL	VE3DEC	N4GA
	W2GLQ	VE3DIF	N4HR
	W2GOQ	VE3DNG	N4KG
	W2GSN	VE3DRT	N4RA
	W21JO	VE3EA	N4TH
	W2KLV	VE3EC	N4UR
	W2KPV	VE3ECP	VE4BB
	W2OT	VE3EWN	W4AM
	W2PGS	VE3FIU	W4BEJ
	W2PHF	VE3GCB	W4BFB
	W2RCX	VE3HIR	W4BKM
	W2RR	VE3IBH	W4BTI
	W2SB	VE31EM	W4CQ
	W2SV	VE31HZ	W4DV
	W2VA	VE3HRC	W4FEG
	W2YNT	VE3NAR	W4FM
	W2YV	VE3NSR	W4IKR
	W2ZJ	VE3ORC	W4KOW
	W2ZQ	VE3OV	W4LEN
	W2ZV	VE3PRC	W4NYK
	WA2DEB	VE3RAL	W4POX
	WA2IUC	VE3RAM	W4POP
	WA2JAS	VE3RC	W4TP
	WA2NSM	VE3RPT	W4TRC
	WA2QME	VE3S00	W4UR
	WA2TGV	VE3TG	W4XD
	WA2ZYX	VE3UE	W4XQ
	WB2BHX	VE3UOT	W4YJ
	WB2EOK	VE3VFK	W4YKH
	WB2GPN	VE3VN	W4ZCV
	WB2RLO	VE3YNA	WA4AAC
	WB2TLK	VE3ZM	WA4GNU
	WB2VUK	W3ACH	WA4BTG

DATE 7 / 2 / 79	CALL W8XXX	BAND 40M	MODE A3
VE7N0H	K8AA	AA9A	AA0N
	K8ALB	K9AOM	K8AV
	K8CC	K9CDB	K8CWW
	K8CM	K9LDM	K8ER
	K8LAC	K9LXD	K8GFV
	K8DDV	K9EC	K8KT
	K8DXF	K9EYA	K8LIE
	K8EA	K9FC	K8NB
	K8EMY	K9IJ	K8SG
	K8FA	K9IU	K8SVV
	K8KRG	K9IV	K8VM
	K8PJ	K9LCR	K8WKS
	K8QDP	K9QAT	K8YH
	K8SF	K9SA	N8AN
	K8TK	K9UQN	N8II
	K8TV	K9VQC	N8NT
	K8ZPL	N9AX	W8AJA
	K8ZUU	N9DF	W8BA
	N8CG	N9EV	W8BMJ
	N8ED	N9GT	W8CS
	N8JV	N9IF	W8DCW
	N8KK	N9JR	W8EEE
	N8LT	N9RD	W8GN
	N8RR	N9RF	W8HJA
	N8VT	W9AIU	W8HWJ
	W8AEO	W9A0	W8JV
	W8AL	W9CAF	W8NE
	W8AVE	W9CEQ	W8PU
	W8BEP	W9CUS	W8SJ
	W8CC	W9DF	W8SN
	W8CDZ	W9DK	W8TQA
	W8DF	W9DQA	W8WRD
	W8EBG	W9DUA	W8CGV
	W8FH	W9DUP	W8QIT
	W8FY	W9DY	W8MVE
	W8GI	W9EOC	W8SSV
	W8KEA	W9EPU	W8WEB
	W8KGG	W9GFD	
	W8KVV	W9GL	
	W8LC	W9HD	
	W8MRM	W9HE	
	W8MVE	W9HQH	
	W8OGV	W9IC	
	W8RFZ	W9IKN	
	W8RSN	W9JB	
	W8UM	W9JUQ	
	W8VA	W9JZE	
	W8VVL	W9KQ	
	W8WE	W9LMN	
	W8WHT	W9LM	
	W8WUE	W9LO	
	W8YJE	W9LRG	
	W8ZID	W9LTU	
	W8FAA	W9MEP	
	W8IEN	W9MM	
	W8PPG	W9NEN	
	W8UCV	W9NQ	
	W8VCU	W9OBF	
	W8VUY	W9PC	
	W8EGW	W9PCS	
	W8GOM	W9PJT	

Fig. 4. Program 2 sample run.



**10% DISCOUNT
Off List**

64K 1 Drive \$3499.00

AUTHORIZED
Radio Shack DEALER A301
 COMPUTER SPECIALISTS

- Popular 16K Level II System..... \$ 722.00
- 26-1145 RS-232 Board..... 84.00
- 26-1140 "O" K Interface..... 254.00
- 26-1160 Mini Disk..... 424.00
- 26-1171 Telephone Modem..... 169.00
- Fast 100 CPS Centronics 730 Printer..... 675.00
- Highly Reliable Lobo 5 1/4" Drives..... 375.00
- Versatile Lobo Interface, 8" Drives and IMI Hard Drives..... Call For Prices

MICRO MANAGEMENT SYSTEMS, INC. 313

DOWNTOWN PLAZA SHOPPING CENTER
 115 C SECOND AVE. S.W.
 CAIRO, GEORGIA 31728 • 912-377-7120

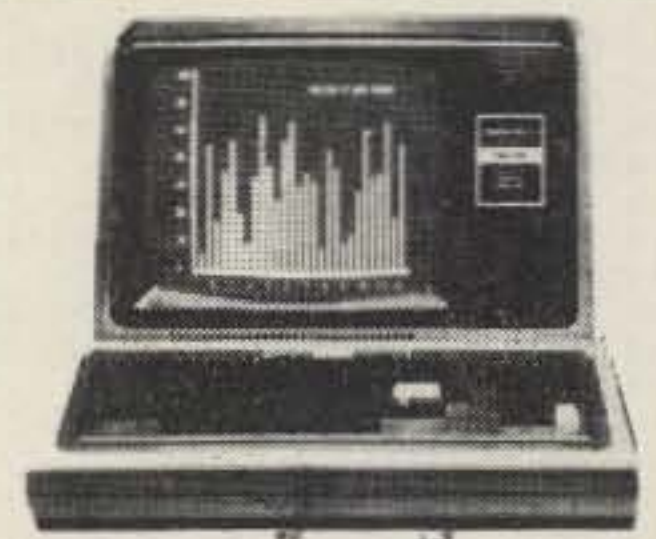

**15% DISCOUNT
Off List**

4K Level II \$527.00

Full Factory Warranty on All Items Sold.
 VISA, Master Charge and COD's, Add 3%

Emulate an Elephant

— but let your micro bear the burden

Has the following ever happened to you? You're tuning around 80 meters one night, call a CQ, and listen to the reply and a familiar voice:

"VE6BB, this is VE6XYZ. Hi, Basil, old buddy. How

are the wife and kids? Did you ever get that 101 of yours fixed? Say, are you going to the picnic again this year? ... " etc.

Now, you know the guy. You've met him lots of times. The only thing is that

you can't for the life of you remember his name right now, and he's waiting. Is it Joe? Bill? Arthur? (You haven't actually worked him for over a year now—that's 1500 contacts ago.) Finally, you try "Jim" and the cool reply from the other end tells you two things: First, his name is Ken (oh, of course, now I remember!). And second, you just lost another friend (relations are never the same again).

Does that sound familiar? I'm sure that it's happened to many others besides myself, and after the first time or two, it virtually forces one to implement some form of card index system.

Well, if you have a microcomputer and a North Star floppy disk system, then the following program can prove very useful. It

stores, for instant recall, the callsigns, names, and QTHs of all hams that you work, with some additional side benefits that I'll explain later. If you have a floppy disk system that is not North Star, then you will have to modify both the data-accessing procedures and the North Star BASIC instruction set.

The program is written in Release 4.0 of North Star BASIC. Once the program is typed up, then merely order NSAVE AMATEUR and the interpreter will create the file (type 2) and save the program for you.

Disk Creation

Type in Program 1, check it thoroughly, and save it (NSAVE AMATEUR). Now create some data files using radio prefixes for the file name, as in Fig. 1, for example. With the example

```

20 ICHR$(12):!"      HAM DIRECTORY":!:"
30 INPUT"WHICH PREFIX ARE YOU INTERESTED INT ",P$
40 !:"YOU MAY ADD (A),DELETE (D),LIST (L), OR SEARCH (S) FOR HAMS"
50 !"WHICH DO YOU WANT? ",:A$=INCHAR$(0):!A$
60 IF A$(1,1)="A" THEN 110
70 IF A$(1,1)="L" THEN 410
80 IF A$(1,1)="D" THEN 220
90 IF A$(1,1)="S" THEN 280
100!"BAD INPUT ... REMEMBER":GOTO40
110 OPEN#0,P$:!"TYPE 'DONE' FOR THE CALL WHEN YOU COMPLETE."
120 GOSUB 540
130 READ#0%43*Z,A$,B$,C$:IFA$(1,3)="END"THEN150
140 Z=Z+1:GOTO130
150 Z=Z-1
160 GOSUB540:Z=Z+1
170 INPUT"CALL? ",A$(1,7):IFA$(1,4)="DONE"THEN200
180 INPUT"NAME? ",B$(1,10):INPUT"QTH? ",C$(1,10)
190 WRITE#0%43*Z,A$,B$,C$:GOTO160
200 A$(1,3)="END":B$(1,2)="OF":C$(1,4)="FILE"
210 WRITE#0%43*Z,A$,B$,C$:GOTOS20
220 INPUT"WHICH CALL DO YOU WISH TO DELETE? ",Z8$:Z8$=Z8$+" "
230 OPEN#0,P$:Z=0
240 READ#0%43*Z,A$,B$,C$:IFZ8$=A$1,LEN(Z8$))THEN260
250 IFA$(1,3)="END"THEN510:Z=Z+1:GOTO240
260 Z=Z+1:READ#0%43*Z,A$,B$,C$:Z=Z-1:WRITE#0%43*Z,A$,B$,C$
270 IFA$(1,3)="END"THEN500ELSEZ=Z+1:GOTO260
280 !"BY CALL, NAME, OR QTH? ",:Z9$=INCHAR$(0):!Z9$
290 INPUT"WHAT ARE YOU LOOKING FOR? ",Z8$:!
300 OPEN#0,P$:Z=0
310 GOSUB540
320 READ#0%43*Z,A$,B$,C$:IFA$(1,3)="END"THEN500
330 IF Z9$(1,1)<>"C"THEN 360
340 IFZ8$=A$(1,LEN(Z8$))THEN!A$,TAB(15),B$,TAB(25),C$
350 Z=Z+1:GOTO310
360 IFZ9$(1,1)<>"N" THEN 390
370 IFZ8$=B$(1,LEN(Z8$))THEN!A$,TAB(15),B$,TAB(25),C$
380 Z=Z+1:GOTO310
390 IFZ8$=C$(1,LEN(Z8$))THEN!A$,TAB(15),B$,TAB(25),C$
400 Z=Z+1:GOTO320
410 !:OPEN#0,P$:Z=0
420 Y=0
430 READ#0%43*Z,A$,B$,C$
440 IFA$(1,3)="END"THEN500
450 !A$,TAB(15),B$,TAB(25),C$:Y=Y+1
460 IF Y>13 THEN 470 ELSE Z=Z+1:GOTO 430
470 !"PRESS RETURN TO CONTINUE ":Z9$=INCHAR$(0)
480 IF ASC(Z9$)<>13 THEN 500
490 Z=Z+1:GOTO 420
500 !:!TAB(12),"FINISHED":GOTO520
510 !:"NOT FOUND"
520 CLOSE#0:!"AGAIN? ",:E$=INCHAR$(0):!E$
530 IF E$(1,1)="Y" THEN 40 ELSE 550
540 A$="          ":B$=A$:C$=A$:RETURN
550 END
  
```

Program listing.

```

CREATE "VE",30
CREATE "DX",30
CREATE "W6",30
  
```

An example of using the "CREATE" command to create data files (type 3) on North Star disc.

Fig. 1.

```
115 Z=-1:GOTO 160
```

Enter this line into the program when accessing a data file for the first time only. Make one entry (at least) into the file and then delete this line. Use line 115 for each new prefix data file.

Fig. 2.



CM-600 Circuit Mount

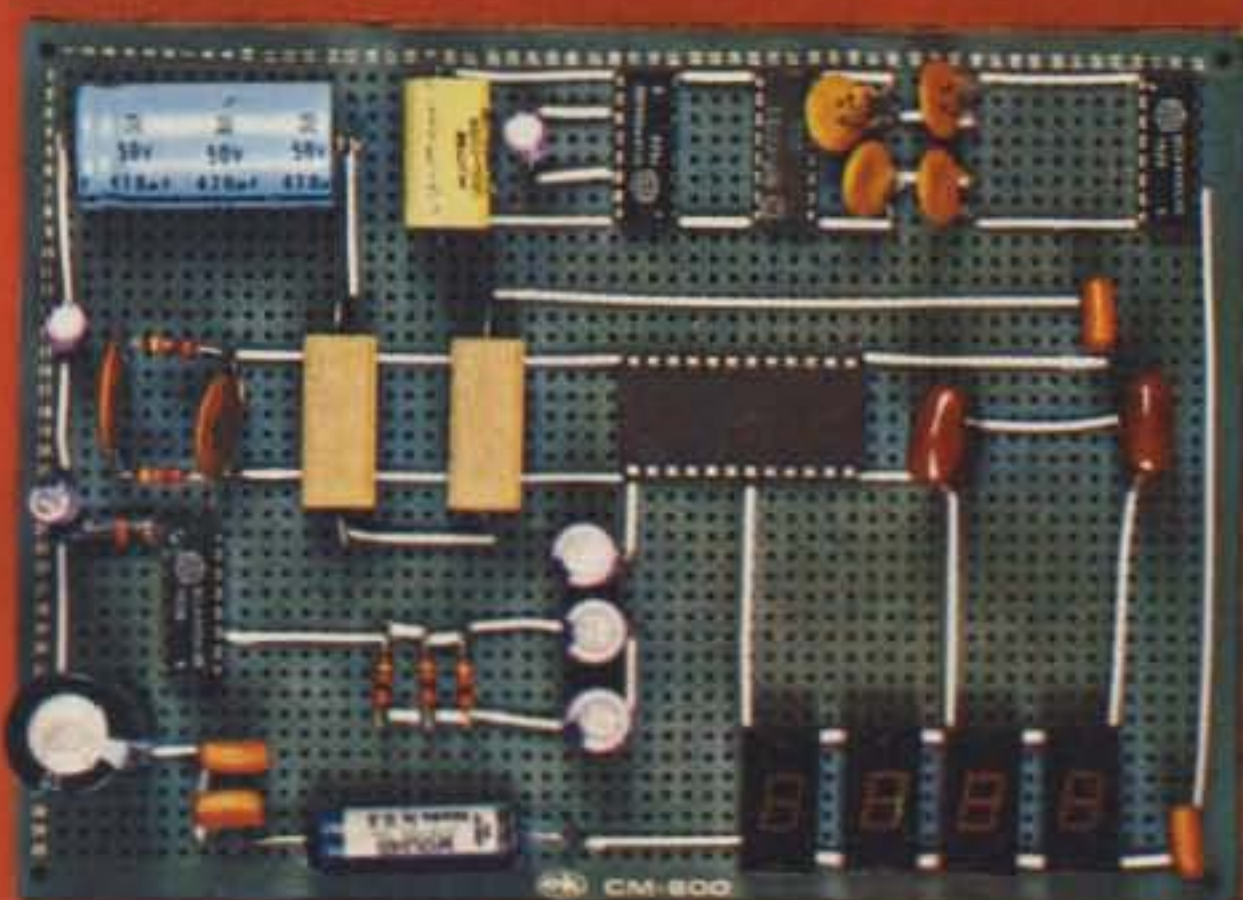

CM-600 \$6.95*
RW-50 \$2.98*

NEW CM-600 SOLDERLESS PROTOTYPE BOARD

CM-600 is a unique system for solderless construction of circuit prototypes, useful to both engineers and hobbyists. The CM-600 is a neoprene board 4½" (114mm) x 6" (152mm) with 2280 holes on .100" (2.54mm) centers. Standard components including DIP's are mounted by simply inserting leads into the holes in the long life neoprene material. Interconnections are easily made using 20 or 22 AWG (0,8 or 0,65mm) wire jumpers. Positive contact is assured by the elasticity of the hole, which compresses the leads together. To remove components or leads, simply pull out. This facilitates easy circuit changes making it ideal for breadboarding experimental circuits. CM-600 also features numbered rows and columns for easy reference.

Accessory Kit RW-50 contains 50 pcs of AWG 20(0,8mm) insulated jumper wires of assorted lengths from ½" (13mm) to 4" (100mm). Both ends are stripped and bent 90° for easy insertion. In stock directly from

OK Machine & Tool Corporation ✓54
3455 Conner St., Bronx, N.Y. 10475 U.S.A.
Tel. (212) 994-6600 Telex 125091

*Minimum billings \$25.00, add shipping charge \$2.00
New York State residents add applicable tax

shown, you will have three files, for VE, DX, and W6 contacts. You can open files for any prefix you wish. You are limited only by the size of your disk storage, so I would suggest that you keep at least one disk just for your card index (byte index?) files. In opening a new file that has just been created, however, you must make a slight modification to the program—but only the first time. This is because our random access data file is set up as follows:

```
[CALL, NAME, QTH]
[CALL, NAME, QTH] [ ... ]
["END", "OF", "FILE"]
```

The program expects "END OF FILE" to be in the data storage as the last entry and looks for this to finish whatever it's doing. Consequently, when you have a brand new data file, you don't have an "END OF FILE" written in for the program to find, and it will return a TYPE ERROR. This is how we get around it:

(a) Enter the line from Fig. 2 in your program.

(b) Now RUN the program and enter your new data file name as the prefix when requested by the program. Enter one call/name/QTH at least, and then type "DONE" for the call when it is requested. An example of this is shown in Fig. 3.

(c) Finally, delete line 115 and your data file is ready.

Remember, you have to do this only once for every new data file you create. Once it is done and you have entered the calls, names, and QTHs of hams you've worked, then you can recall any detail instantly.

The side benefits of this program include the fact that you also can search for all the hams you have worked who live in a particular location. Thus, you can display all hams who live in Hobart, for example,

or those whose names begin with B, or BOR, or JI, or even all VK7s. The program searches for whatever you have asked for, and examples of this are given in Fig. 4.

The Program Itself

The program is written in North Star BASIC, Release 4.0, using a DOS personalized for VDM and 3 P+S I/O. North Star BASIC permits multiple statements per line, separated by a colon (:) or backslash (\). "PRINT" may be abbreviated by "!",. Any portion of a string may be accessed by string delimiters. For example, if A\$ = "DEVONPORT", then A\$(1,1) = "D", A\$(1,3) = "DEV", and A\$(6,9) = "PORT".

In line 20, the CHR\$(12) is a clear screen command. You may have to change that to suit your own system.

The "INCHAR\$" command in lines 50, 280, 470, and 520 waits for a single character to be input and operates on that character immediately without waiting for a carriage return. To modify these lines for Release 3 of North Star BASIC, refer to Fig. 5.

No dimensioning of character strings is necessary with North Star BASIC, but other forms of BASIC may require this during modifications.

Random Access Files

All files are accessed randomly, and for this to work satisfactorily, all blocks of data should be the same length. Therefore, line 540 sets A\$, B\$, and C\$ to a certain length with a number of blanks, and entries made by you take up the first portion of that length. Should you enter any name or QTH longer than is allowed, the excess is truncated.

Data [CALL, NAME, QTH] are read (and written) in blocks of 43 bytes, so

```
(Operator entries are underlined)
H A M   D I R E C T O R Y
WHICH PREFIX ARE YOU INTERESTED IN? VE
YOU MAY ADD (A), DELETE (D), LIST (L) OR SEARCH (S) FOR HAMS
WHICH DO YOU WANT? A
TYPE 'DONE' FOR THE CALL WHEN YOU COMPLETE.
CALL? VE6RB
NAME? BASIL
QTH? BONNYVILLE
CALL? DONE
An example of a typical ADD entry into the data file. Following
this entry delete line 115 (if entered) from the program, and the
prefix file 'VE' is ready for further entries.
```

Fig. 3.

```
YOU MAY ADD (A), DELETE (D), LIST (L) OR SEARCH (S) FOR HAMS
WHICH DO YOU WANT? S
BY CALL, NAME OR QTH? C
WHAT ARE YOU LOOKING FOR? VK7
VK7DK   DEN      PERTH
VK7TR   RAY      HOBART
VK7MG   MAURICE  SWANSEA
FINISHED
AGAIN? Y
YOU MAY ADD (A), DELETE (D), LIST (L) OR SEARCH (S) FOR HAMS
WHICH DO YOU WANT? S
BY CALL, NAME OR QTH? N
WHAT ARE YOU LOOKING FOR? JO
VK6AM   JOHN     PERTH
VK7JV   JOHN     LAUNCESTON
FINISHED
AGAIN? N
Some examples of using the search routine in the program to
isolate particular calls or names, or parts of calls or names.
```

Fig. 4.

```
50 INPUT "WHICH DO YOU WANT? ",A$
280 INPUT "BY CALL, NAME, OR QTH? ",Z$
470 INPUT "PRESS RETURN TO CONTINUE ",Z$
520 CLOSE#0::INPUT"AGAIN? ",E$
```

If using Release 3 North Star Basic, then changes will have to be made to the above lines as shown. (Release 3 does not incorporate the "INCHAR\$" command).

Fig. 5.

that to successively read (and write) the blocks of data requires multiplying 43 by 1, then by 2, then by 3, and so on. This is handled by incrementing a counter, "Z". Thus, you can access any block merely by setting Z to the correct value (the number of the block minus one), multiplying it by 43, and reading (or writing) from that point in the file. For example, the statement in line 130—

```
130 READ#0%43*Z,A$,B$,C$ . . .
```

—means that from file No. 0 (previously opened in line 110), move the file pointer to the (43 x Z) position and read A\$, B\$, and C\$.

The counter, "Z", which appears in lines 420-460 of Program 1 is designed to

allow the VDM driver to display 14 lines and then wait for a carriage return to be input before displaying another 14 lines, ad infinitum. Otherwise, the whole file can zip right past your eyes in a flash in a "LIST" command. In effect, this is a form of in-program paging. When the program pauses at that point, if it receives any character other than a CR, it stops at that point.

Conclusion

Don't let the small size of this program put you off. It's powerful enough to get the job done, and you'll appreciate having your index at your fingertips. The program can stand further optimizing, but I'll leave that to you. ■



DECIDE NOW . . . BECAUSE THE PRICES ARE GOING UP.

If you haven't made up your mind whether to subscribe to 80 Microcomputing . . . NOW IS THE TIME. July 1, 1980 the cover price is increasing to \$2.50 and along with it the subscription prices are going up. BUT, 80 Microcomputing is giving you from now until July 18, 1980 to SUBSCRIBE OR RENEW AT THE OLD RATES.

SUBSCRIBE TODAY to the industry's only complete journal for the users of the TRS-80* at the old rates of \$15.00/1 year; \$24.00/2 years and \$36.00/3 years. Don't wait and have inflation hit again and pay the new rates of \$18.00/\$30.00/\$45.00.

OF COURSE, I'LL BEAT INFLATION . . .

- New Subscriber Renewal (please affix an address label from your most recent magazine)
- 1 year/\$15.00 2 years/\$24.00 3 years/\$36.00
- Payment enclosed Bill: Me Master Charge
- Visa Amerex

Card # _____
 Signature _____
 Expire Date _____
 Interbank # _____
 Name/Label _____
 Address _____
 City _____ State _____ Zip _____

Canadian: \$15.00, 1 year only, US funds.
 Foreign: \$20.00, 1 year only, US funds.
 Please allow 6-8 weeks for processing.
 "THIS CARD EXPIRES JULY 18, 1980"

ALL previous subscription offers to 80 Microcomputing are void July 18, 1980.

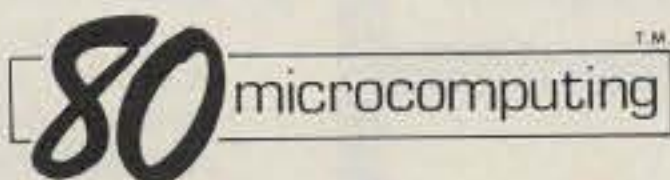

PO BOX 981
 FARMINGDALE NY 11737

*a trademark of Tandy Corporation 306B7

NEW

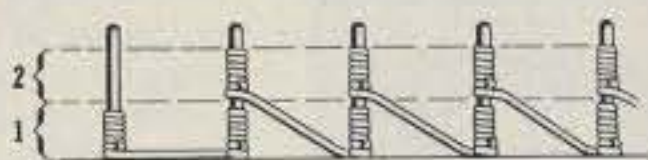
Traditional

 Wire-Wrapping

JUST WRAP

 Wire-Wrapping

**WHY CUT?
 WHY STRIP?
 WHY NOT . . .**

JUST WRAP™ WIRE WRAPPING TOOL

- AWG 30 Wire
- .025" Square Posts
- Daisy Chain or Point To Point
- No Stripping or Slitting Required
- JUST WRAP™
- Built In Cut Off
- Easy Loading of Wire
- Available Wire Colors:
- Blue, White, Red & Yellow

PATENTED U.S.A.
FOREIGN PATENTS PENDING

JUST WRAP TOOL WITH ONE 50 FT. ROLL OF WIRE

COLOR	PART NO.	U.S. LIST PRICE
BLUE	JW 1 B	\$ 14.95
WHITE	JW 1 W	14.95
YELLOW	JW 1 Y	14.95
RED	JW 1 R	14.95

REPLACEMENT ROLL OF WIRE 50 FT.

BLUE	R JW B	\$ 2.98
WHITE	R JW W	2.98
YELLOW	R JW Y	2.98
RED	R JW R	2.98

JUST WRAP-UNWRAPPING TOOL

JW 1	\$ 3.49
------	---------

* Minimum billings \$25.00, add shipping charge \$2.00/New York State residents add applicable tax



OK Machine & Tool Corporation ✓ 54
 3455 Conner St., Bronx, N.Y. 10475 U.S.A.
 Tel. (212) 994-6600 Telex 125091



If you enjoy driving, you're going to get a **COMPUCRUISE**. Once you see what it can do, you just won't be able to live without it.



This gadget fits into most dashboards... no strain even in a tiny sports car like the Mazda RX-7... and once you have it, every trip is like flying a 747. The darned thing tells you the time, how fast you're going, how far you've been on this trip or since the last regassing, how many miles per gallon you're getting, either at the instant or the average on the trip... or gallons per hour at the moment or for the trip... temperature outside... inside (or coolant temperature, if you prefer)... oh, it has an elapsed time for the trip, a stop watch, lap time, an alarm... how much further for your trip, how many gallons more the trip will take, how much longer for the trip at your present average speed... yes, it gives you your average speed for the trip. You prefer it in metric, no strain... liters remaining, etc. Did we mention that it also has cruise control either at a speed set on the control board or at whatever speed you are traveling? The Compucruise will keep you busy and entertained during any trip... telling you more than you will ever want to know.

The Compucruise is not difficult to install... though it does connect to everything except the cigarette lighter. Until you've tried computerized travel, you haven't found out how much fun driving can be. It will work on any car not having fuel injection... and there is a front-wheel drive accessory gadget available for only \$4.40-#P001 (regularly \$5.50).

The price for the Compucruise is regularly \$199.95... and a bargain at that price. We'll sell you one of these fantastic gadgets for \$159.95 with cruise control (Model 44-#P002), and \$127.95 without (Model 41-#P003). Send money... and start having fun!

MOM'S

MAIL ORDER MICROS

Dept. 673 • PO Box 427 • Marlboro NH 03455
Phone: (603) 924-3041



Steel Stopper

Ever had your car stolen?
The first reaction is one of disbelief...
... you know it was right there!

What you want is a modern combination lock on your ignition... The Steel Stopper. It's easy to install and almost impossible to defeat. You can by-pass it, if you want, for parking attendants or a car wash. Other than that, you get a secret four digit code and only will then be able to start the car... even if you have the keys in the ignition.

This protection retails for \$50... but we have a special for you at \$39.95. Don't procrastinate. Order #P004.

Note: This product works best on Detroit cars. Mazda RX7 owners must order additional module, #P008, which costs \$8. The Steel Stopper can be modified for Mercedes, Porsche, Ferrari, or other high performance European cars by returning unit to manufacturer with \$3. They promise quick modification and return.

MAGIC LIGHT BULB SAVER

If you've got a light bulb you need our MAGIC L.B.S. which increases the life expectancy of a new bulb 93 times!... and saves you 44% on energy costs. Regularly \$2.50... MOM's price is \$1.99 each. #LS001.

POLY-88 ACCESSORIES

- 1 Software on 5 1/4"—This is system software that requires a PolyMorphic Disk Controller in a System 88 Cabinet. #D002S-\$100.
- 1 Electric Pencil-#D003-\$80

MOM'S SOFTWARE SPEED READING COURSE

A tachistoscope simulation which enables the user to increase reading and comprehension speeds. A must for any TRS-80 16K Level II owner. Only \$5 per cassette. Order #R2001.

HEAD ALIGNMENT KIT

Best cassette recorder tape head alignment kit available. Solves loading problems. #K001-only \$9.95.

HONEYWELL

- 15 Honeywell ASR-33 Communications Consoles with TTY, paper tape reader and punch. Used, working when removed from service. Shipped freight collect or you pick up. Weight 300 lbs. \$375. Order #P006S.

ABACUS

- 112 Abacus Paperweight—Hefty, brass, excellent condition. #S024-\$3 SPECIAL PRICE.

PANASONIC TAPE DECKS

Panasonic RS261 US Stereo Cassette Decks—with auto-stop, record level adjust, VU meters, used condition; all have had heads replaced and aligned. #T001-\$50.

Panasonic RS260 US Stereo Cassette Decks—same as above, but also has bias switch for chrome tapes. #T002-\$50.

COMPUCOLOR HARDWARE

- 2 Compucolor Computer 8001 (use as computer or 75 MHZ Color Monitor)—8K RAM, BASIC and DOS in ROM, good condition. #S025S-\$1400 each. SPECIAL PRICE.
- 2 Compucolor MiniFloppy—5 1/4 inch, good condition. #S026S-\$500 each. SPECIAL PRICE.
- 4 Compucolor 8K RAM card—Static RAM, good condition. #S027S-\$190 each. SPECIAL PRICE.
- 3 Compucolor Floppy Tape Drive—Uses eight-track cartridges, good condition. #S028S-\$60 each. SPECIAL PRICE.

ALS-80

- 13 ALS-80 Operating system—This system requires 12K RAM from D000 to FFFF; as well as either the SOLOS or CUTTER monitor; it includes an Assembler/Editor. #D018-\$11.60 each.

POLYMORPHIC HARDWARE

- 6 PolyMorphic Video Terminal Interface—Memory mapped video for S-100 bus, good to excellent condition. #S044-\$150 each.
- 1 SPECIAL PRICE PolyMorphic S-100 Cabinets—Nice 5 slot S-100 mainframe, good to excellent condition. #D049—\$248 each.

PROCESSOR TECH SOFTWARE

- 2 Processor Tech Extended Disk BASIC—This is full disk BASIC on 8" disk for HELIOS II disk controllers with PTDOS and greater than 16K. #D015S-\$70 each.
- 1 Extended Disk BASIC on cassette—This is the same as previously mentioned for the Disk BASIC from Processor Tech. Needs more than 16K. #D017S-\$62.
- 4 Extended Cassette BASIC—This includes all file operations, advanced functions for doing more than playing games; for SOLOS, CUTTER, and CONSOL Monitors. #D016-\$22 each.
- 16 BASIC 5 from Processor Tech—This is a simple BASIC for a SOLOS, CUTTER, or CONSOL Monitor and 8K of RAM. #D013-\$11.60 each.
- 4 Processor Tech GAMEPAC for above BASIC—Various simple games. #D014-\$10.00 each

TDL ZAPPLE

- 3 TDL ZAP 1K Monitor—Simple monitor. #D0073S-\$10.

LIMITED SUPPLY 73 MAG. AUG. '79

Contains controversial article "You Can Watch Those Secret TV Channels." Order #M001-\$5 each. (Plus shipping and handling.)

IMSAI PARALLEL I/O CARDS

- 1 IMSAI Parallel I/O card 4-4—Four parallel ports, S-100, excellent condition. #D0093S-\$176.

IMSAI SERIAL I/O CARDS

- 2 IMSAI Serial I/O card 2-1 (kit)—One serial port, full control RS-232 control, S-100, new. #D0092S-\$90.

ICOM DISK DRIVE ACCESSORIES

- 1 ICOM PROM and 8" Disk for SOL FDOS—This disk requires an ICOM S-100 Disk Controller installed in an S-100. #D031S-\$150.
- 1 ICOM CP/M on 8" Disk for S-100—Requires an ICOM S-100 controller in an S-100 cabinet. #D032S-\$90.
- 2 ICOM FDOS-II on 8" Disk for S-100—Requires an ICOM S-100 cabinet, no documentation. #D033S-\$170 each.
- 1 ICOM FDOS-II on 5 1/4" Disk for S-100—Requires an ICOM S-100 Mini-Floppy Controller in an S-100 cabinet. #D034S—\$155.

IMSAI SOFTWARE

- 2 IMSAI IMDOS V2.02 on 8" Disk for S-100—No documentation, but this is apparently IMSAI's version of CP/M for S-100 systems with an IMSAI Disk Controller. #D0056S-\$75 each.

PROCESSOR TECH SOL

- 4 SOL Computers—8K RAM Monitor, S-100, excellent condition. #D004S-\$950 each.
- 17 TREK-80 on cassette for SOL—This is one of the best real time space games available today; needs 8K. #D005-\$11 each.

NORTH STAR HARDWARE

- 1 North Star Floating Point BASIC card—With special BASIC, new. #D0059S-\$270.
- 5 North Star Floppy Disk Controller card—Single density, S-100, new. #D0061-\$248.
- 56 S-100 Edge Connector—Gold Contacts, new. #D050-\$2 each.
- 6 Extender Card for S-100 (kit)—New. #D051S-\$20 each.

SPECIAL 10% DISCOUNT
FROM LIST PRICES
SCOTT ADAMS ADVENTURES
FOR TRS-80 • SORCERER • APPLE

#1 ADVENTURELAND

YOU'LL WANDER THROUGH AN ENCHANTED LAND ENCOUNTERING WILD ANIMALS AND MAGICAL BEINGS WHILE YOU TRY TO RECOVER LOST TREASURES. Order #SA001T for TRS Level II 16K, #SA001S for Sorcerer 16K, #SA001A for Apple 24K—\$13.45 each, on cassette.

#2 PIRATE ADVENTURE

SAIL TO TREASURE ISLAND AND TRY TO RECOVER LONG JOHN SILVER'S LOST TREASURES. Order #SA002T for TRS Level II 16K, #SA002S for Sorcerer 16K, #SA002A for Apple 24K—\$13.45 each, on cassette.

#3 MISSION IMPOSSIBLE ADVENTURE

SAVE THE WORLD'S FIRST AUTOMATED NUCLEAR REACTOR WHEN YOU COMPLETE YOUR MISSION. Order #SA003T for TRS Level II 16K, #SA003S for Sorcerer 16K, #SA003A for Apple 24K—\$13.45 each, on cassette.

#4 VOODOO CASTLE

SAVE COUNT CRISTO FROM THE FIENDISH CURSE OR FOREVER BE DOOMED—BEWARE THE VOODOO MAN. Order #SA004T for TRS Level II 16K, #SA004S for Sorcerer 16K, #SA004A for Apple 24K—\$13.45 each, on cassette.

#5 THE COUNT

LOVE AT FIRST BYTE FROM YOUR BIG BRASS BED IN PENNSYLVANIA. Order #SA005T for TRS Level II 16K, #SA005S for Sorcerer 16K, #SA005A for Apple 24K—\$13.45 each, on cassette.

#6 STRANGE ODYSSEY

YOU'RE MAROONED AT THE GALAXY'S EDGE AND DISCOVER RUINS OF AN ANCIENT ALIEN CIVILIZATION AND TRY TO COPE WITH UNEARTHLY TECHNOLOGIES WHILE YOU AMASS FABULOUS TREASURES. Order #SA006T for TRS Level II 16K, #SA006S for Sorcerer 16K, #SA006A for Apple 24K—\$13.45 each, on cassette.

#7 MYSTERY FUN HOUSE

FIND YOUR WAY THROUGH THE STRANGEST FUN HOUSE BEFORE THE WEIRD PARK CLOSES. Order #SA007T for TRS Level II 16K, #SA007S for Sorcerer 16K, #SA007A for Apple 24K—\$13.45 each, on cassette.

#8 PYRAMID OF DOOM

AN EGYPTIAN TREASURE HUNT THROUGH A NEWLY UNCOVERED PYRAMID, COMPLETE WITH AN ANCIENT CURSE. Order #SA008T for TRS Level II 16K, #SA008S for Sorcerer 16K, #SA008A for Apple 24K—\$13.45 each, on cassette.

MOM'S



SALE

MAIL ORDER MICROS ✓ 53

Dept. 673 • PO Box 427 • Marlboro NH 03455
Phone: (603) 924-3041

TDL SOFTWARE-DISK

- 1 TDL FDOS & SuperBASIC on 8" Disk—This requires an ICOM Disk Controller and at least 20K of memory, plus a ZAPPLE Monitor in an S-100 Cabinet (Altair, IMSAI, etc.). #D0065S-\$125.
- 1 TDL System Software on 5 1/4" disk—This set of system software requires a North Star Disk Controller, and a TDL Systems Monitor Board I, and consists of 12K BASIC, Relocator/Linking Loader, Z-80 Editor, and Text Processor. #D0066S-\$170.
- 1 TDL System Software on 5 1/4" disk—This is the same as above, but does not require the Systems Monitor Board I. #D0067S-\$190.
- 1 TDL System Software on 5 1/4" disk—Again, as above, but requires a HELIOS Disk Controller and the TDL Systems Monitor Board II (not I). #D0068S-\$170.

CALLBOOKS
10% OFF

JS-#CX01—was \$16.95, now \$15.25
DX-#CX02—was \$15.95, now \$14.35

BOOK CLEARANCE
UP TO 50% OFF

- Chemistry with a Computer (Educamp-publisher) #BK1010—was \$9.95, now \$5.00.
- Computer Dictionary (Camelot-publisher) #BK1018—was \$5.95, now \$3.00.
- FORTAN Programming (Camelot-publisher) #BK1019—was \$7.95, now \$4.00.
- FORTAN Workbook (Camelot-publisher) #BK1020—was \$4.95, now \$2.50.
- A Quick Look at BASIC (Camelot-publisher) #BK1043—was \$4.95, now \$2.50.
- How to Buy and Use Minis and Micros (Sams-publisher) #BK1025—was \$9.95, now \$5.00.
- Home Computers Questions and Answers, Hardware. (Dilithium Publishers) was \$7.95 now \$4.00 #BK1023.

VECTOR GRAPHIC
S-100

- 3 Vector Graphic ROM/RAM card—12K empty ROM sockets, 1K RAM, excellent condition. #D0078S-\$100.
- 4 Vector Graphic Analog Interface—Allows hobbyist to interface analog experiments, S-100, new. #D0079-\$79.20.

ASK MOM

For details of October 1980 Asian and European Electronics Tours. See January Wayne Green editorials in Feb. 1980 73 Magazine. Info #002. No charge.

VERBATIM MINI DISKS

For TRS-80, Pet, Apple (Please specify which)
10 PACK—ONLY \$26.00
#P007 MOM's offers the Best for Less... Again!

IMSAI SOFTWARE

- 2 IMSAI IMDOS V2.02 on 8" Disk for S-100—No documentation, but this is apparently IMSAI's version of CP/M for S-100 systems with an IMSAI Disk Controller. #D0056SS-\$75 each.

PHONE INTERFACE

- 5 Novation Modem #3102A—Connects to any phone, originate only, good condition. #S021-\$165 each. **SPECIAL PRICE.**
- 1 Novation Modem #43—Connects to any phone, originate only, good condition. #S023S-\$155. **SPECIAL PRICE.**

MOUNTAIN HARDWARE

- 7 Mountain Hardware AC Controller—Remote AC outlet control, S-100, new. #D040S-\$90 each.

HEURISTICS
SPEECH LAB

- 1 Heuristics Speech Lab—S-100, used, fair condition. #S042S-\$90 as is. **SPECIAL PRICE.**

WAMECO S-100 Bare Computer Boards

	Retail	MOM'S Price	
10 ea CPU-1 8080 CPU Board	26.95	22.95	#LP001
10 ea MEM-1A 8K Memory Board (2102)	25.95	21.95	#LP002
10 ea Mem-2 16K Memory Board (2114)	26.95	22.95	#LP003
10 ea EPM-2 2708/2716 EPROM Board	25.95	21.95	#LP004
10 ea EPM-1 1702 EPROM Board	25.95	21.95	#LP005
10 ea RTC-1 Real Time Clock	23.95	20.50	#LP006
10 ea QM-9 The Little Mother (9 slot)	30.95	26.50	#LP007
10 ea QM-12 The Quite Mother (12 slot)	34.95	29.95	#LP008
5 ea FDC-1 Floppy Disk Board	42.95	36.95	#LP009
7 ea FPB-1 Front Panel IMSAI size)	44.50	37.95	#LP010
1 ea EPM-1 1702 EPROM Board (asmbld) without EPROMS	49.95	42.50	#LP011

BRAND NEW* TRS-80's
and accessories at FANTASTIC SAVINGS

LEVEL II 16K COMPLETE.....	\$720 #TRS-001S	FRICION MODEL PRINTER.....	\$870 #TRS-005S
16K EXPANSION UNIT.....	\$400 #TRS-002S	TRACTOR FED MODEL PRINTER.....	\$1350 #TRS-006
32K EXPANSION UNIT.....	\$525 #TRS-003	LINE PRINTER III (AND CABLE).....	\$1550 #TRS-007
DISK DRIVES\$425 each (Specify which drive you want) #TRS-004		MOD II 64K.....	\$3400 #TRS-008

TERMS: Shipment normally within one week of receipt of your order (with cashier's check, money order, or credit card) for micro-computer and three weeks for accessories (checks take two weeks extra to clear bank). ADD \$2.50 PER ITEM for HANDLING. Everything will be sent to you with UPS freight charges COLLECT.

*NOT UPGRADED USED OR RECONDITIONED LEVEL I's WITH OLD KEYBOARDS BUT BRAND SPANKING NEW TRS-80's IN FACTORY CARTONS WITH FULL FACTORY WARRANTY! COMPARE PRICES AND QUALITY AND ORDER FROM MOM'S.

SIMULATED SURVEILLANCE VIDEO SYSTEMS

Since the video camera systems are totally psychological, that is, the visibility and suggestion of video cameras is what deters the thief's desire to steal, all that is really needed is a device that appears to be a functioning video camera. The SSV System provides the businessman with the same deterrent to crime as real systems at a fraction of the cost, because the cameras and alarm boxes are empty of electronics, but would-be crooks don't know this, and SSV Systems are extremely realistic in detail. Some scan back and forth and all have red neon lights. They feature easy installation, mount on any wall, have metal construction throughout, with wrinkle finish paint, all aluminum lens barrel with f-stops, footage markings, and convex optics, simulated coaxial cable and wall plate, manufacturer's unconditional guarantee, plus warning stickers included with all orders.

SVS 900 Scanning camera features 155 degree scanning action, long-life quiet, 1 rpm motor, only \$100 (regularly \$119.95) catalog #P0010. SVS-880 stationary camera is adjustable to any angle for fixed view coverage with mounting brackets and hardware, only \$50 (regularly \$58.95) catalog #P0011; or go first class with the SVS-2000, which has a soft blue finish with satin mylar trim only \$105 (regularly \$124.95) catalog #P0012, the stationary version is only \$55 (regularly \$62.95) catalog #P0013. Alarm boxes are only \$20 (regularly \$24.95) catalog #P0014 and complete your look of having real surveillance equipment installed at your business, home or office.

SPECIAL PRICE includes more than 20% discount. * indicates extra price reduction since last ad. Quantities are limited, immediate refund if ordered item is no longer available.

TERMS: FOB Marlboro, NH USA. Limited stock; everything guaranteed as described; you pay postage on returns. PRINT orders clearly. Minimum order \$10 plus \$2.50 shipping and handling charge in USA only. DOUBLE THAT ELSEWHERE. Orders over \$50 add 5% for shipping in Continental USA; 10% elsewhere. (We will refund excess.) Orders shipped UPS or insured mail only. No COD's please. Send US funds by check or money order. For credit card purchases, add 4%, list AE, MC or VISA, number, and expiration date. Mail to MOM's, Department 673, PO Box 427, Marlboro NH 03455.

Condition of Inventory:
New = original container
Excellent = new, but not in original container
Good = tested or used in store

* Phone answered by machine. Orders taken with credit cards. Questions answered by mail. Please leave your name and address.

Prefix Challenge

— try this while you're waiting for the band to open up

When fellow hams visit your computer, do you spend time *telling* them what it will do? Well, here's a way to *show* them what it will do, be they new Novices or seasoned DX Honor Roll veterans.

Lay "Ham Prefix" on them and let them select their own level of difficulty. This 7K BASIC program will give prefixes/countries like W, F, Canada, Mexico, and

VK to the Novice and rate him at Extra, Advanced, General, or Novice (under 30% yields "TRY AGAIN").

The veteran, on the other hand, gets none of these goodies, but, instead, gets to cope with ST, Turkey, Uruguay, VP1, Clipperton, and the like.

All will receive one of 12 full-screen awards at the end, along with final score

and appropriate comments. Many may want a second chance, and every game is different!

Most people even remotely associated with ham radio will earn the SHORT-NOVICE level award, while not every DXCC holder will achieve the top CHALLENGE-EXTRA endorsement on their certificate.

This program runs on the 8K Commodore PET™ as is, but will also adapt to any 8K RAM/BASIC operating system in a TRS-80, Apple II, Heath, etc., with a few simple mods that I will explain in detail at the end of this article.

If you've read this far, you'll appreciate a description of the program's features. The 3 levels of difficulty revolve around 15, 35, or 60 country/ham prefix identifications. Each series draws randomly from a pool of country/prefix pairs which are twice the size of the game, except that the CHALLENGE

(60) series omits the easiest 26 from its pool of 120.

In any game, 90% yields an Extra rating, while Advanced, General, and Novice follow at 70%, 50%, and 30% respectively. Under 30% brings up "SRI OM, TRY AGAIN."

Since the computer can only spell perfectly and since this is not a spelling test, there is an arbitration feature that allows you to call up a PROTEST to allow someone else to judge if you're close enough. Who wants to let someone else beat him out just because it's hard to spell Rumania or Lithuania correctly?

My compliments to Gary Toncre WA4FYZ and Chris Wiener N2CR on the basic idea which appeared in the May, '79, 73 Magazine. It has kept me busy for days. Further evolution could take place, for instance, by adding some competitive scoring features (before taking it to the local DX club meeting, of course!).

Most of the required



ITEM NO.
WK-7

CMOS SAFE

IC INSERTION/EXTRACTION KIT

✓54

- KIT INCLUDES**
- MOS-1416 14-16 CMOS SAFE INSERTER
 - MOS-2428 24-28 CMOS SAFE INSERTER
 - MOS-40 36-40 CMOS SAFE INSERTER
 - EX-1 14-16 EXTRACTOR
 - EX-2 24-40 CMOS SAFE EXTRACTOR



OK MACHINE & TOOL CORPORATION
3455 CONNER ST., BRONX, N.Y. 10475 U.S.A.
PHONE (212) 994-6600 TELEX NO. 125091



PRINTED IN U.S.A.

PATENT PENDING

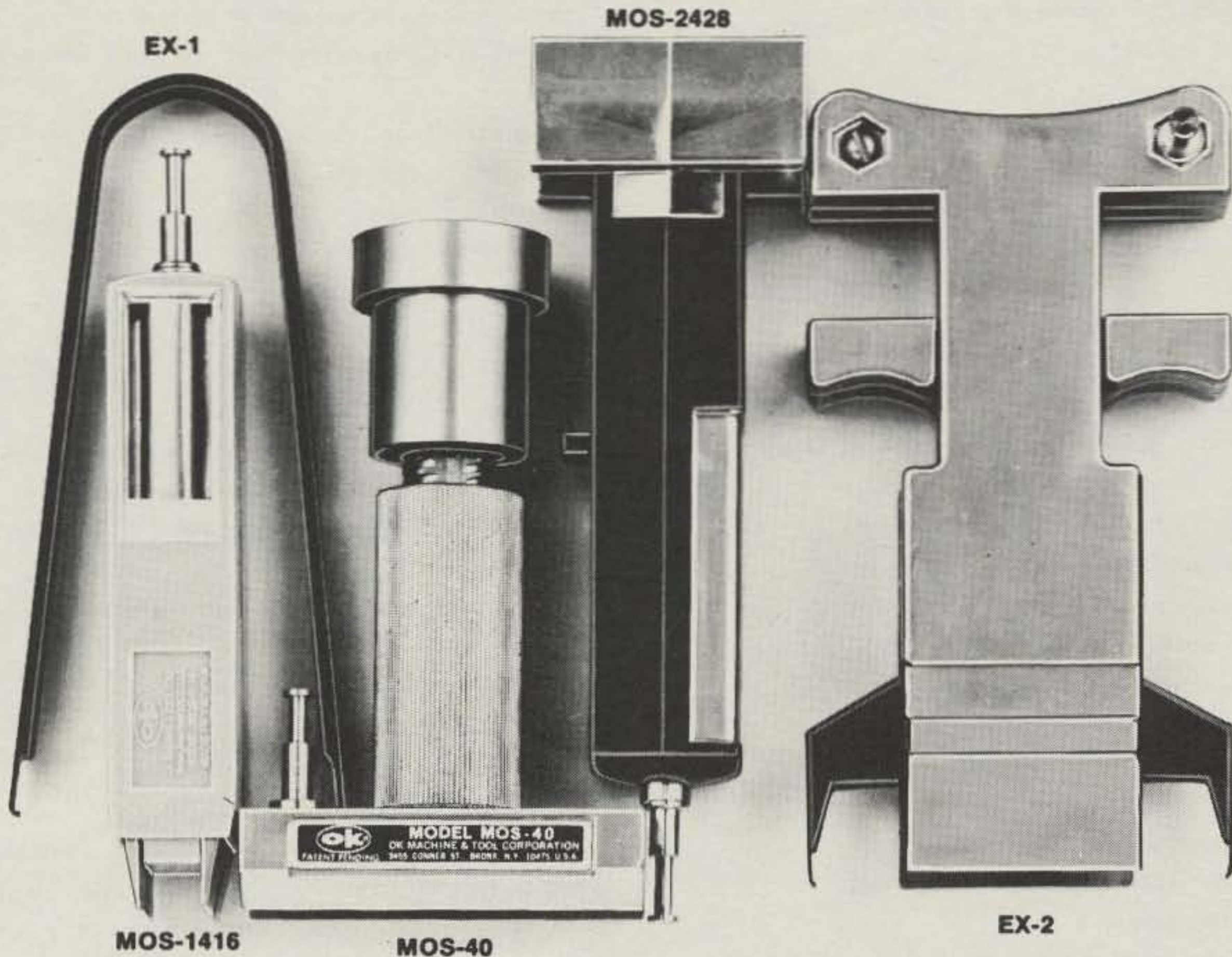

WK-7	COMPLETE IC INSERTER/EXTRACTOR KIT	\$29.95
------	------------------------------------	---------

INDIVIDUAL COMPONENTS

MOS-1416	14-16 PIN MOS CMOS SAFE INSERTER	\$ 7.95
MOS-2428	24-28 PIN MOS CMOS SAFE INSERTER	\$ 7.95
MOS-40	36-40 PIN MOS CMOS SAFE INSERTER	\$ 7.95
EX-1	14-16 PIN EXTRACTOR TOOL	\$ 1.49
EX-2	24-40 PIN CMOS SAFE EXTRACTOR TOOL	\$ 7.95

MINIMUM BILLING \$25.00. ADD SHIPPING CHARGE \$2.00. NEW YORK RESIDENTS ADD APPLICABLE TAX.

OK MACHINE & TOOL CORPORATION 3455 CONNER ST., BRONX, N.Y. 10475 (212) 994-6600/TELEX 125091

Program listing.

```

5 REM HAM PREFIX COPYRIGHT 1979 BY RON GUNN
20 FORU=0TO29:PRINT:NEXT
30 PRINT"WELCOME TO HAM PREFIX2 AND QRZ?"
40 FORM=0TO10:PRINT:NEXT
50 PRINT"11111":
55 INPUT"NAME OR CALL ":H#
60 FORB=1TO30:PRINT:NEXT
80 PRINT"OK, ";H#,"YOU WILL BE ASKED TO
90 PRINT"IDENTIFY RANDOM HAM PREFIXES AND THE"
100 PRINT"COUNTRIES THEY BELONG TO.":PRINT
102 PRINT"YOU WILL BE CREDITED WITH ONE QSO2 FOR"
104 PRINT"EACH QUESTION, AND ONE QSL2 FOR EACH"
106 PRINT"CORRECT ANSWER."
109 PRINT:POKE59468,14
110 PRINT"You will be rated by your percent"
120 PRINT"correct, given TWO tries on each."
125 PRINT
130 PRINT"IF YOU HAVE NO IDEA, ENTER '7'
135 PRINT"-THINK ";
140 PRINT"YOU'RE RIGHT? ENTER 'P' FOR "
145 PRINT"PROTEST2 ";
150 PRINT"INSTEAD OF SECOND GUESS"
152 PRINT:PRINT"GO SLOW - RETURN WITHOUT DATA IS FATAL2":PRINT
162 PRINT"YOU MAY CHOOSE A SHORT2, COMMON PREFIX, "
164 PRINT"GAME OF 15 COUNTRIES, AN EXPERT2 LEVEL"
166 PRINT"GAME OF 35, OR A CHALLENGE2 SERIES OF"
168 PRINT"60, INCLUDING THE MORE ARCANE. ":PRINT
170 PRINT"SELECT S(SHORT), E(EXPERT), OR "
175 INPUT"(C)CHALLENGE SERIES NOW":E#
180 POKE59468,12
190 IFE#="S"THEN260
192 IFE#="E"THEN270
194 IFE#="C"THEN280
200 PRINT"S=SHORT,E=EXPERT,C=CHALLENGE":GOTO162
260 N=15:B#="SHORT":GOTO445
270 N=35:B#="EXPERT":GOTO445
280 N=60:B#="CHALLENGE":GOTO445
445 PRINT:PRINT
450 PRINT"OMIT 'ISLAND' IN ANY NAME"
460 PRINT"'#' MEANS PREFIX INCLUDES THE NUMBER"
475 PRINT
490 L#(1)="GOT YOU ON THAT ONE, ANSWER IS
500 LETW=0:REM HEART OF PCM
510 LETX=0
515 C=2*N:REM NR OF COUNTRIES
520 DIMQ#(C),A#(C)
525 FORI=1TOC
530 READQ#(I),A#(I):REM SET UP ARRAY
535 PRINTA#(I):" ":NEXTI:PRINT:PRINT
540 FORI=1TON
545 S=(C*RND(1))+1:REM RANDOM SELECTION 550
548 LETT=0:PRINT
552 S=INT(S)
554 IFQ#(S)="NO"THEN545
555 IFN()60THEN558
556 IFB(26)THEN545
558 PRINTQ#(S):PRINTTAB(25)S
560 INPUTC#
562 IFQ#="?"THEN545
570 IFA#(S)=C#THEN650:REM A WINNER!
575 IFQ#="P"THEN1800
580 IFT=0THENPRINT"SRI OM, TRY AGAIN."
585 IFT=0THENG1#="G#
590 IFT=1THENPRINTL#(1)
600 T=T+1
610 IFT=1THEN558
620 PRINTTAB(15)A#(S)
632 IFX()8THEN635
633 IFW=8THENPRINT"VG! KEEP IT UP O M"
635 IF(W-X)=13THEN PRINT:PRINT"HOW ABOUT TRYING FOR W A S?"PRINT
637 W=W+1
640 PRINT:GOTO680
650 PRINT"CORRECT, WELL DONE"
660 LETX=X+1,W=W+1
680 PRINT"YOU NOW HAVE ";W;" / ";X;" QSO/QSL"
685 Q#(S)="NO"
700 NEXTI
710 IFX)=.3#NTHEN744
720 PRINT
725 PRINT"YOU ENDED UP WITH ";X/N;" PERCENT ":PRINT
727 PRINT"WE HAVE NO AWARDS TO COVER THAT"
730 PRINT"SRI, TRY AGN OM? EACH GAME IS DIFFERENT"
735 PRINT" DR..."
740 PRINT"YOU CUD TRY UR HAND AT COMPUTER PROGRAMS"
742 GOTO850
744 IFX)0.9#NTHENC#="EXTRA":GOTO754
746 IFX)0.7#NTHENC#="ADVANCED":GOTO756
748 IFX)0.5#NTHENC#="GENERAL":GOTO758
750 C#="NOVICE"
752 D#="A START,":E#=" WITH SOME EFFORT,":GOTO760
754 D#="SIMPLY OUTSTANDING!":E#="WITH EASE,":GOTO760
756 D#="QUITE GOOD,":E#="RAPIDLY,":GOTO760
758 D#="OK,":E#="BY WORKING ON IT,":GOTO760
760 PRINT"YOUR KNOWLEDGE OF THIS SUBJECT"
770 PRINT"COMPELS US TO AWARD YOU ";C#" DXCC,":PRINT
790 LETY=X/W*100,Y=INT(Y)
800 PRINT"YOU HAVE ACHIEVED A ";Y;"% QSO/QSL "
810 PRINT"RECORD, THAT IS ";D#":PRINT
820 PRINT"YOU ARE GOOD ENOUGH TO GET THAT OTHER2"
825 PRINT"DXCC AWARD ";E#":
830 PRINT"WE ARE GENERATING YOUR AWARD - QRX 1"
831 FORB=1TO10000:NEXTB
840 GOSUB1020
850 PRINT"73 ";H#
860 PRINT"THIS IS YOUR PET SAYING ... PRINT 'RUN'"
865 GOTO3999
880 DATA DENMARK,OZ,CANADA,VE
885 DATA TI,COSTA RICA,FRANCE,F
890 DATA KP4,PUERTO RICO,W,USA,G,ENGLAND
895 DATA BELGIUM,ON,4X4,ISRAEL
900 DATA XE,MEXICO,DK,GERMANY,YV,VENEZUELA
905 DATA ITALY,I

```



```

910 DATA KZ5,CANAL ZONE,COLUMBIA,HK,PY,BRAZIL
915 DATA SPAIN,EA
920 DATA DE,AUSTRIA,AUSTRALIA,VK,HB,SWITZERLAND
925 DATA JA,JAPAN
930 DATA CE,CHILE,FINLAND,OH,KL7,ALASKA
935 DATA RUSSIA,UA,CO,CUBA,NEW ZEALAND,ZL
940 DATA HC,ECUADOR,BULGARIA,LZ,ZB,SOUTH AFRICA
945 DATA URUGUAY,CX
950 DATA FC,CORSICA,WAKE*,KW6,REM 30
952 DATA POLAND,SP,GUANTANAMO BAY*,KG4
955 DATA LIBERIA,EL,GW,WALES
957 DATA KG6,GUAM,PITCAIRN*,VR6,JAMAICA,6Y
960 DATA YD,RUMANIA,LIECHTENSTEIN*,HBO
962 DATA UR2,ESTONIA,CHRISTMAS IS.*,VK9,TF,ICELAND
965 DATA ZDB,ASCENSION,FORMOSA,BV
967 DATA GUATEMALA,TG,OH,FINLAND,LU,ARGENTINA
970 DATA JT,MONGOLIA
972 DATA NORWAY,LA,LUXEMBOURG,LX,SK,SWEDEN
975 DATA JY,JORDAN,NAVASSA*,KC4,MIDWAY*,KM6
977 DATA GM,SCOTLAND,HUNGARY,HA
980 DATA ST,SUDAN,GREECE,SV,VP1,BELIZE,REM 60
989 DATA ANDORRA*,C31
990 DATA VU,INDIA,IVORY COAST,TU
995 DATA KP6,PALMYRA,TURKEY,TA
1000 DATA AP,PAKISTAN,CLIPPERTON*,FDB
1020 PRINT"YOUR CERTIFICATE OF ACHIEVEMENT"
1030 FORB=1TO25:PRINT:NEXT
1033 PRINT
1040 FORI=0TO38
1050 PRINTTAB(I)"(")
1060 NEXTI
1070 PRINT
1080 PRINTTAB(3);"GARY,WA4FYZ,CHRIS,N2CR,AND RON,AG6P"
1090 PRINTTAB(5);"HEREBY CONFER THE AWARD OF"
1095 PRINTTAB(8);C#;" DXCC TO ";H#
1500 FORI=0TO38
1510 PRINTTAB(I)"&"
1520 NEXTI
1521 PRINT" ";
1525 PRINT"&                                &"
1530 PRINT"&  DDDD X      X  CCCC      CCCC  &"
1540 PRINT"&  D  D X  X  C  C  C  C  &"
1550 PRINT"&  D  D X X  C      C      &"
1560 PRINT"&  D  D  X  C      C      &"
1570 PRINT"&  D  D X X  C      C      &"
1580 PRINT"&  D  D X  X  C  C  C  C  &"
1590 PRINT"&  DDDD X      X  CCCC      CCCC  &"
1600 PRINT"&                                &"
1610 PRINT"&                                &"
1630 FORI=0TO38
1640 PRINTTAB(I)"&"
1650 NEXTI
1660 PRINT:PRINT
1670 PRINTTAB(8)B#;PRINTTAB(18)C#
1680 FORI=0TO38
1690 PRINTTAB(I)"(")
1700 NEXTI

```

```

1705 PRINT
1707 RETURN
1710 GOTO3999
1800 PRINT
1810 PRINT"THIS IS NOT A SPELLING TEST. HAVE AN "
1815 PRINT"IMPARTIAL OBSERVER PRESS ANY KEY AND "
1820 INPUT"COMPARE ANSWERS,";M#
1822 IFM#=""THEN1822
1823 PRINT:PRINTTAB(5)G1#;TAB(20)A#(8)
1824 PRINT:PRINT"ENTER 'A' IF PROTEST ALLOWED."
1826 INPUT"ANY OTHER LETTER TO CONTINUE";F#
1830 IFF#="A"THEN650
1840 FORY=0TO25:PRINT:NEXT:PRINT
1850 T=0:GOTO580
2000 DATA IS,SARDINIA,KURE IS.*,KH6,MIDWAY*,KM6
2010 DATA OA,PERU,SURINAM,PZ,SV,CRETE
2020 DATA VP9,BERMUDA,VS6,HONG KONG,HL,KOREA
2030 DATA PANAMA,HP,VATICAN,HV,HZ,SAUDI ARABIA
2040 DATA SVALBARD,JW,YUGOSLAVIA,YU,ZA,ALBANIA
2041 REM 82
2050 DATA GUADELOUPE,FG,NEW CALEDONIA,FK
2060 DATA FM,MARTINIQUE,ST.PIERRE,FP,YEMEN,4W
2070 DATA 487,SRI LANKA,5A,LIBYA,NIGERIA,5N
2080 DATA SIERRA LEONE,9L,9V,SINGAPORE,TRINIDAD,9Y
2090 DATA MELLISH REEF*,VK9,LATVIA*,UQ2,UP2,LITHUANIA
2100 DATA UG6,ARMENIA,MALI REP.,TZ,UB,UKRAINE
2110 DATA THAILAND,HS,HR,HONDURAS,HAITI,HH
2120 DATA REUNION,FR,FB8X,KERGUELEN,IRAN,EP
2130 DATA COOK IS.*,ZK1,ZE,RHODESIA,GIBRALTAR,ZB
2140 DATA ZA,ALBANIA,YN,NICARAGUA,IRAQ,YI
2141 REM110
2150 DATA OX,GREENLAND,DENMARK,OZ,NETHERLANDS,PA
2160 DATA SU,EGYPT,XV,VIETNAM,LAOS,XW
2170 DATA AFGHANISTAN,YA,CAYMAN IS.,ZF
2180 DATA CEOA,EASTER,MOROCCO,CN,CT2,AZORES
3000 PRINT"OK (DIAGNOSTIC)"
3999 END
READY.

```

play instructions come up at the start of the program. Your teaching responsibility will be limited essentially to showing each member how to type in and (return) (enter) (line-feed) the responses.

You will have to put in the goodies that you have worked, and a little time spent on the CHALLENGE series will make you a tiger in the DX bands yourself.

Now let's look at the listing for function: The program starts with a request for your name or callsign, gives instructions, then asks for your choice

of series, be it SHORT, EXPERT, or CHALLENGE.

Lines 110 and 120 list strangely because of PET's lower-case organization. Make them read "You will be rated by your percent" "correct, given TWO tries on each."

At line 500, the program begins by taking the series selected and loading up the appropriate data matrix from the data statements containing the prefix/country pairs. W and X are part of the scoring. T keeps track of how many guesses you've had, while I (line 540) watches the

Weird Symbol	You Type In
11111 (line 50)	"CRSR CRSR CRSR CRSR CRSR"
2 (after word)	RVS before word, SHIFT and RVS after word
"(" or "&"	SHIFT and a bar graphic (remember the quotes)

Fig. 1.

number of pairs you've been given, as determined by N.

545 randomly selects the next Q\$-A\$ pair to be presented.

554 rejects previously used pairs.

575 brings up the PROTEST subroutine.

685 sets the Q\$ just used to "no," so line 554 will recognize that it has been used already.

700 directs the program execution back to line 540, until there have been N questions.

710 starts the scoring, which goes on for a bit. Ap-

propriate comments are picked by the percent correct to be used in the closing remarks.

This section contains the author's message: Nowhere is anyone, in any way, repeatedly put down. I feel that a put-down is funny, once. Then it gets old. I am human, however. I could not resist putting in the comment, at 13 misses, "How about trying for WAS?"

The program avoids "screen clear" and certain cursor-positioning commands that are not general BASIC functions except as noted below. If you have a screen clear, you can use it on lines 20, 60, and 1030.

Some of the award graphics starting on line 1050 should be made up using whatever you have on your machine. Experiment with this. It's fun and you can get many nice effects. How would the let-

ters DX look as a border? Try it by making line 1040 read: For I=0 TO 19 STEP 2. Then put "DX" in line 1050.

If you need a non-PET program, mark the listing as follows:

Omit lines 50, 109, and 180.

Delete strange characters showing in lines 30, 102, 104, 145, 152, 162, 164, 166, and 820.

Look at the discussion of the listing for the text of lines 110 and 120.

860: Put in your machine's name (Emily???)

Option: The A\$(answers) appear on the screen while the matrix is loading at the start. Go to line 535 and remove all up through the first colon(:) and it will not print. Keep it in until you have it running OK, as it is a great way to see if the matrix is loading properly. It can then be removed if you don't like it.

For those of you who are typing this program into your PET, you must interpret the listing as shown in Fig. 1.

This program was a pleasure to work on and is a challenge to run. It loads in a couple of minutes from a cassette and is guaranteed to be a pleasurable adjunct to your computer system.

I'll try to help you with your Ham Prefix bugs. Please describe them as completely as possible and enclose an SASE. In the meantime, type carefully (especially those fly speck (.), (.), (:), and (:)) characters. They bear an importance that is all out of proportion to their size.

My compliments to Wayne, who in less than two decades has led me to SSB, FM, and now computers! Oh God, what next? ■

HF/SSB 5 BAND TRANSCEIVER

THE SS-105

- Wt: 3 kg (6.6 lbs)
- Dim: 17.8W x 12.4H x 27.2cm W (7 x 4.9 x 10.7 inches)
- Incl. sep. xcvr. input and output connex.
- Pwr. output: Model SS-105S 10 watts
Model SS-105D 100 watts
- Covers the 80M, 40M, 20M, 15M and 10M bands
- Acc. avail. incl. Noise Blanker, 500Hz CW filter, FM, RX and TX modules. Clip-on rechargeable battery pack.

Model SS-105S
\$499⁹⁵

Model SS-105D
\$599⁹⁵



EXCLUSIVE FROM M&M!

NMT-11 144 & 220 YAGIS

- Handles legal power
- Lightweight at 4 kg
- 31 degree bandwidth
- High efficiency performance
- Easily arrayed for increased gain
- Low VSWR, under 1.21:1 at resonance
- Parasitic elements, 144/120: 1/4" al rod
- DE, 144/220: 1/4" brass .020 wall, 7/32" insert

NMT-11/144 or 146 \$59.95
NMT-11/220 or 223 \$54.95

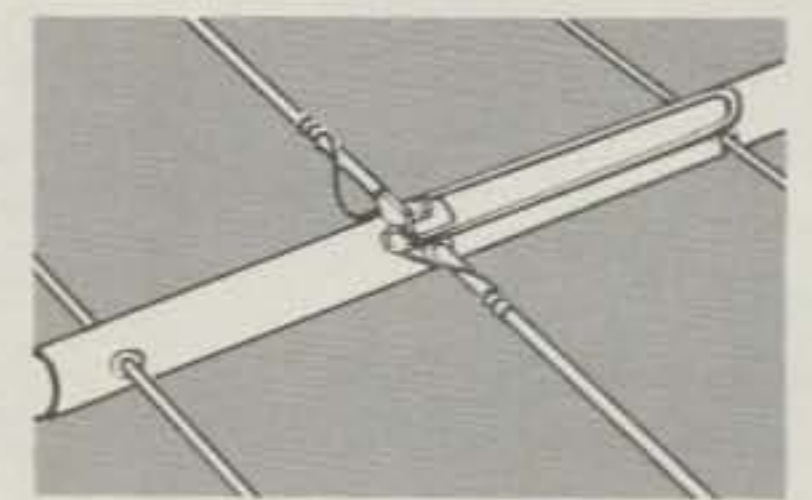

Prices FOB San Diego.

M&M RF DISTRIBUTORS
P.O. Box 82183, San Diego, CA 92138

CALL
(714) 299-9741

The 1980 Atlanta HamFestival and Georgia State ARRL Convention June 21-22, 1980

Downtown Atlanta Marriott Hotel

- GIANT covered Fleamarket/Swapshop!
- More than 25 Forums/Meetings!
- FCC Exams!
- Parking for thousands of cars!
- 140 Major Exhibits!
- Special MICROPROCESSOR Section!
- Programs for Ladies & Children!
- Activities Galore!

Registration: \$3 per person IN ADVANCE, \$4 at the door
Children FREE!

If you do not receive a Preregistration Packet by May 15th, write:

Atlanta Hamfestival 1980

P.O. Box 45183
Atlanta, GA 30320

Hotel Rates: \$36 per day single OR double!

Write for Hotel Reservations to:

Marriott Hotel • Courtland at International Blvd. • Atlanta, GA 30303
or phone: Area 404/659-6500 and hurry, hurry, hurry!

THE BEST HAMFEST IN THE WORLD!

AN INVITATION

July 1, 1980, the cover price of *KILOBAUD MICROCOMPUTING* is going up to \$2.95. Inflation has finally hit. BUT, we would like to extend you an *INVITATION TO BEAT INFLATION . . . SUBSCRIBE OR RENEW* your present subscription from now until July 18, 1980, *AT THE OLD RATES.*

Don't miss an issue of the industry's most complete and informative journal by letting this *SAVINGS* pass by . . . fill out the coupon below today. This price increase makes all other Kilobaud Microcomputing subscription offers void on July 18th . . . so hurry and *BEAT THE 18% INFLATION.*

TO BEAT

INFLATION

OF COURSE, I'LL BEAT INFLATION . . .

- New Subscriber Renewal (please affix an address label from your most recent magazine)

1 year/\$18.00 2 years/\$30.00 3 years/\$45.00

Payment enclosed Bill: Me Master Charge VISA Amerex

Card # _____ Expire Date _____

Signature _____ Interbank # _____

Name/Label _____

Address _____

City _____ State _____ Zip _____

Canadian—\$18.00, 1 year only, US funds. Foreign—\$23.00, 1 year only, US funds. Please allow 6-8 weeks for processing

THIS CARD EXPIRES JULY 18, 1980

KILOBAUD MICROCOMPUTING PO BOX 997 FARMINGDALE NY 11737

306B6

1 GHz For Only \$139.95

8 Digits • 1 PPM TCXO • Factory Wired 500 MHz or 1 GHz

\$139⁹⁵
5510 WIRED
50 Hz to 1 GHz

\$109⁹⁵
5500 WIRED
50 Hz to 512 MHz



• 1 Hz Resolution to 50 MHz.

- 1 Meg Ohm, 50 Ohm, BNC Inputs
- 15 MV Sensitivity at 250 MHz Typ.

With the introduction of the 5510 DSI has filled a long standing void in the frequency counter market place. You now have the choice of selecting a 512 MHz model 5500 for \$110 or for only \$30.00 more you can buy an 8 digit 1 GHz counter model 5510. With this 1 GHz capability, the new world of 960 MHz is immediately available to you. Both the 5500 and 5510 are available with a rechargeable battery pack which includes the AC adapter and battery charger for one low price. Whether you select the 5500 or the 5510, you will receive the best price to quality features ratio in the industry. No wonder DSI has become one of the world's largest manufacturers of freq. counters.

1.2 GHz Only \$199⁹⁵
5612 KIT

512 MHz Only \$169⁹⁵
5600 KIT

- 10 MHz Proportional Oven
- .2 PPM 10° to 40° C Time Base
- .1 Hz Resolution to 50 MHz.
- External 10 MHz inputs outputs.
- 9 Bright .5 inch LED Read-outs.
- 100% Factory Tested
- Kits 95% Factory Assembled.
- 50 Ohm, 1 Meg, BNC Inputs
- 10 MV Sensitivity at 250 MHz Typ.



Whether you select a 5600, 5612 Kit with 95% of the assembly completed by DSI or select a factory wired and calibrated frequency counter, you can count on DSI to solve all those difficult bench or field problems from measuring audio signals to checking a 960 MHz mobil radio (model 5612), servicing a VTR, trouble shooting a PLL signal in a TV or FM radio, etc. The 5600 or 5612 has the sensitivity and accuracy to meet any FCC landmobile, broadcast, RF, or telecommunications requirements. DSI offers a 10 HR rechargeable battery pack (BA56) option, and an audio multiplier (AM56) which will allow you to resolve a 1/1000 Hz signal in only ten seconds or 1/100 Hz signal in one second. DSI 5600 series offers just the right instrument for all your communication RF, TV servicing and industrial testing needs.

FOR INFORMATION — DEALER LOCATION — ORDERS — OEM
CALL 800-854-2049 CALIFORNIA RESIDENTS CALL 800-542-6253

Model	Price	Frequency Range Typ	Accuracy Over Temperature	Sensitivity Typ			Number of Readouts	Power Requirements	Size H W D
				@ 100Hz-25MHz	@ 50-250MHz	@ 250-450MHz			
5600A-Kit	\$169.95	50Hz-550MHz	Proportional Oven 2 PPM 10° - 40° C	10-25mv	10-15mv	15-50mv	9	*115 VAC or 8.2-14.5 VDC	3 1/2" x 9 1/2" x 9"
5600A-Wired	\$199.95			10-25mv	10-15mv	15-50mv			
5612Kit	\$199.95	50Hz-1.2 GHz	Proportional Oven 2 PPM 10° - 40° C	10-25mv	10-15mv	15-50mv	9	*115 VAC or 8.2-14.5 VDC	3 1/2" x 9 1/2" x 9"
5612 Wired	\$239.95			10-25mv	10-15mv	15-50mv			
5500 Wired	\$109.95	50Hz-512MHz	TCXO 1 PPM 17° - 40° C	10-25mv	15-25mv	25-75mv	8	115 VAC or 8.2-14.5 VDC or NICAD PAK.	1 1/2" x 5" x 5 1/2"
5510 Wired	\$139.95	50Hz-1GHz		10-25mv	15-25mv	25-75mv			

Factory wired units carry 1 year limited warranty kits carry a 90 day limited warranty
Prices and/or specifications subject to change without notice or obligation.

*With AC-9 Adapter

Prices effective
March 1, 1980

- 5510 Wired 139.95
 - 5500 Wired 109.95
 - 5510/BAC Wired 164.95
 - 5500/BAC Wired 134.95
 - T600 BNC ANT (all models) 7.95
 - AC-9 AC Adapter(all models) 7.95
 - LC 5000 169.95
- INTERNAL BAT. ONLY AC-9 NOT REQUIRED.



DSI INSTRUMENTS, INC.
9550 Chesapeake Drive
San Diego, California 92123
(714) 565-8402

TERMS: MC — VISA — AE — CHECK — M.O. — COD
in U.S. Funds. Please add 10% to a maximum of \$10.00
for shipping, handling and insurance. Orders outside
of USA & Canada, please add \$20.00 additional to
cover air shipment. California residents add 6% Sales Tax

- 5612 Kit 199.95
- 5612 Wired 239.95
- 5600A Kit 169.95
- 5600A Wired 199.95
- BA56 Rechargeable
- 10 Hr. Bat. Pack 29.95
- AM-56 Audio Multiplier
- .001 Hz Resolution 34.95

Check Chirp with a Choke

— get 599 every time with this quick fix

The choke described here solved the chirp problem I had which resulted from having antenna current on the outside of the coaxial transmission line get into my home-brew vfo. Although the power leads entering the vfo were carefully filtered, chirp was reported when the 3.5-MHz vfo was used on eighty meters, but not when multi-

plying to higher bands. The fact that the vfo was chirp-free on the higher bands indicated that it was stable and suggested that the cause was rf feedback from the transmitter when it was operated straight through.

The first experiment tried was to wind about 30 turns of miniature coax on a large-size oatmeal box and use this coax in the feedline

between the transmitter and antenna tuner. The tuner feeds a short wire antenna in the attic over an apartment and is worked against a ground connection to a pipe which is part of the heating system. In a system of this configuration, current in the antenna wire is balanced by an equal and opposite current which spreads out in the ground system. Since the feedline coax is in a strong rf field, some of this current will flow along the outside of the coax. Winding sufficient coax into a choke will provide a barrier to current on this path. The oatmeal-box choke did the trick: no more chirp on eighty.

An improved choke was conceived when the author espied a large toroidal core in a box of goodies at the local radio club. As shown in the photo, 10 turns of RG-58 foam-dielectric coax were wound through the core. The inductance of this choke is 21 microhenries (less than the oatmeal choke), but also is effective. A measurement of core permeability yielded a value of 120, indicating that it is probably intended for low-frequency use. This leads one to wonder whether much rf power is dissipated

in the core. The output of my old Harvey-Wells transmitter is 25 Watts; if only 2 Watts were dissipated in the core, it would get very warm, but, in fact, there is no perceptible temperature rise.

Similar results would probably be obtained if one used a salvaged core from a TV flyback transformer. Several cores could be stacked to increase the inductance, if necessary. If solid dielectric coax is used rather than foam-type dielectric, the turns should be larger to avoid distorting the coax, which could adversely affect swr or result in breakdown.

The use of low-frequency ferrite material in a high-frequency choke is quite effective and is the basis of the ferrite-bead chokes commonly used in the VHF region. The choke described here might be likened to a giant ferrite-bead choke. Although such a choke has substantial resistance in addition to its inductive reactance, it does not produce appreciable power loss in the present application since rf ground currents find alternate low-impedance paths in the remaining parts of the ground system. ■

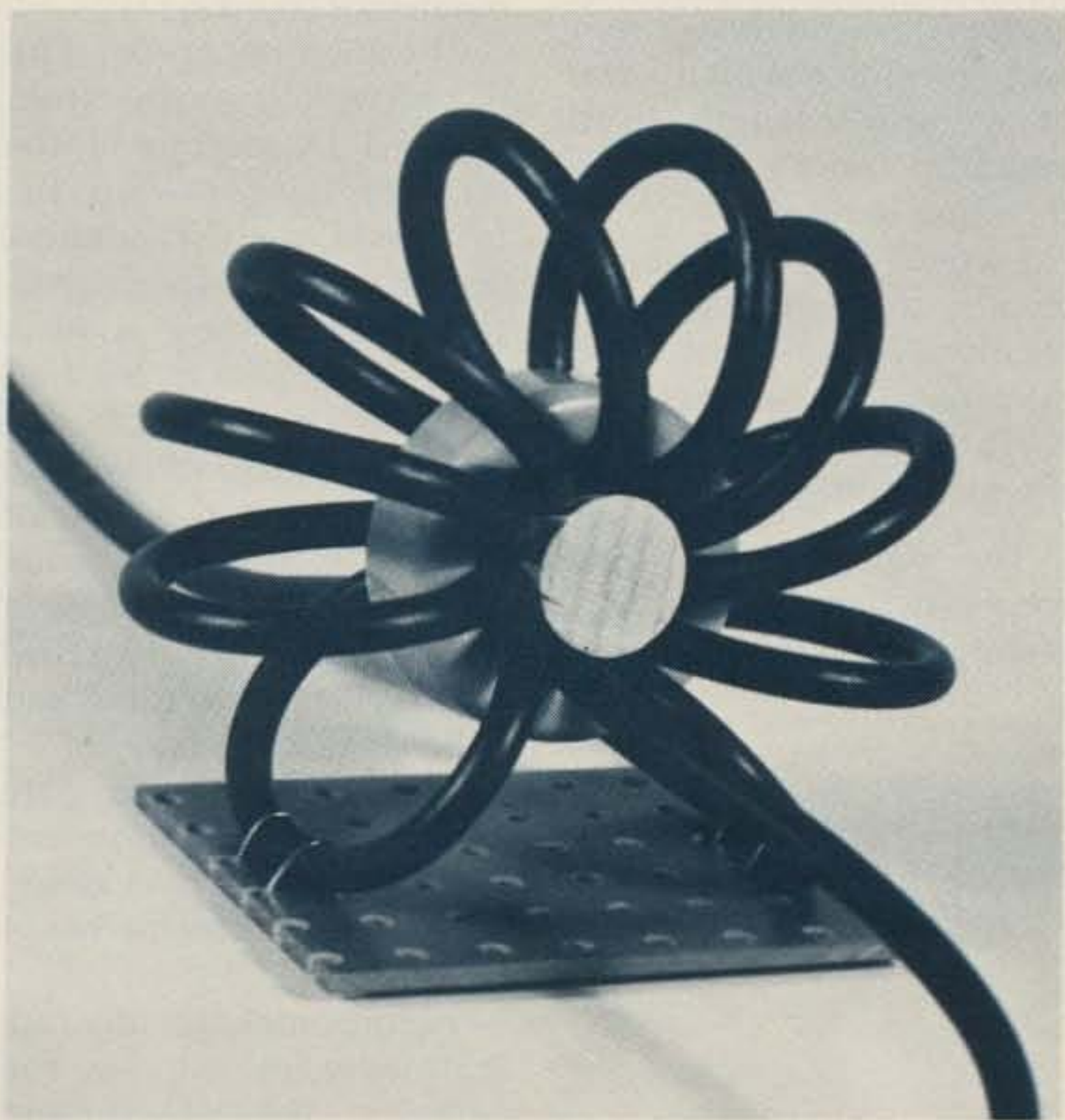

Transmission-line choke wound with RG-58 foam coax on a 1.58-inch ferrite core. Turns are held in place by a cork pressed into the center.

Reawaken that Sleeping Rx

— first steps in receiver alignment

Almost every ham goes through the traumatizing experience of realizing that his or her receiver needs an alignment. Typical signs of this common malady are loss of sensitivity (the receiver is not as "hot" as it used to be), loss of frequency-readout accuracy (for those of us who use a transceiver, the first indication of this problem

very well may be a "what-were-you-doing-out-of-the-band?" admonition from an FCC observer), or what might be described as a general deterioration in the performance of the receiver.

Many amateurs simply let the receiver suffer a protracted and tortuous death. Others, in a fit of panic, thumb through their

logs or notes for the phone number of that celebrated guy "who really knows his stuff." Still others heave a sigh of surrender and tearfully send their receivers out, either to the manufacturer or to a technical lab, musing about the possibility of equipment maintenance someday being covered by Blue Cross.

In any event, like so many aspects of our hobby which so often are considered untouchable, it is, in the last analysis, fear and ignorance which keep us at arm's length from amateur radio's most interesting exotica.

I would like to present a step-by-step procedure for receiver alignment that may make the process a bit more palatable for even the most timid of hams.

The equipment needed for a satisfactory alignment is simple. You will need the

following:

- 1) A VTVM.
- 2) A calibrated rf signal generator whose frequency limits are from about 1.5 MHz to about 30 MHz. The generator must have a provision for modulating its rf signal. (These generators are common enough so that they can be borrowed and cheap enough so that they can be bought.)
- 3) A 50-Ohm resistor.
- 4) A 0.001-uF capacitor.
- 5) An appropriate alignment tool (see Fig. 1).

The alignment procedure is one which moves from the last i-f section of the receiver back toward the front end of the rf section. (Refer to Fig. 2 for orientation.) The starting point is the grid or base of the first stage of the last i-f. (Some receivers have more than one i-f stage.) You will, of course, need a circuit diagram of your receiver. Fig. 3 shows typical starting points for both tube and solid-state circuits.

You will have to prepare a 50-Ohm termination network for the signal generator's lead. Refer to Fig. 4 for this.

Before making any adjustments at all, let the receiver, the VTVM, and the signal generator warm up for at least one-half hour (one hour is preferable).

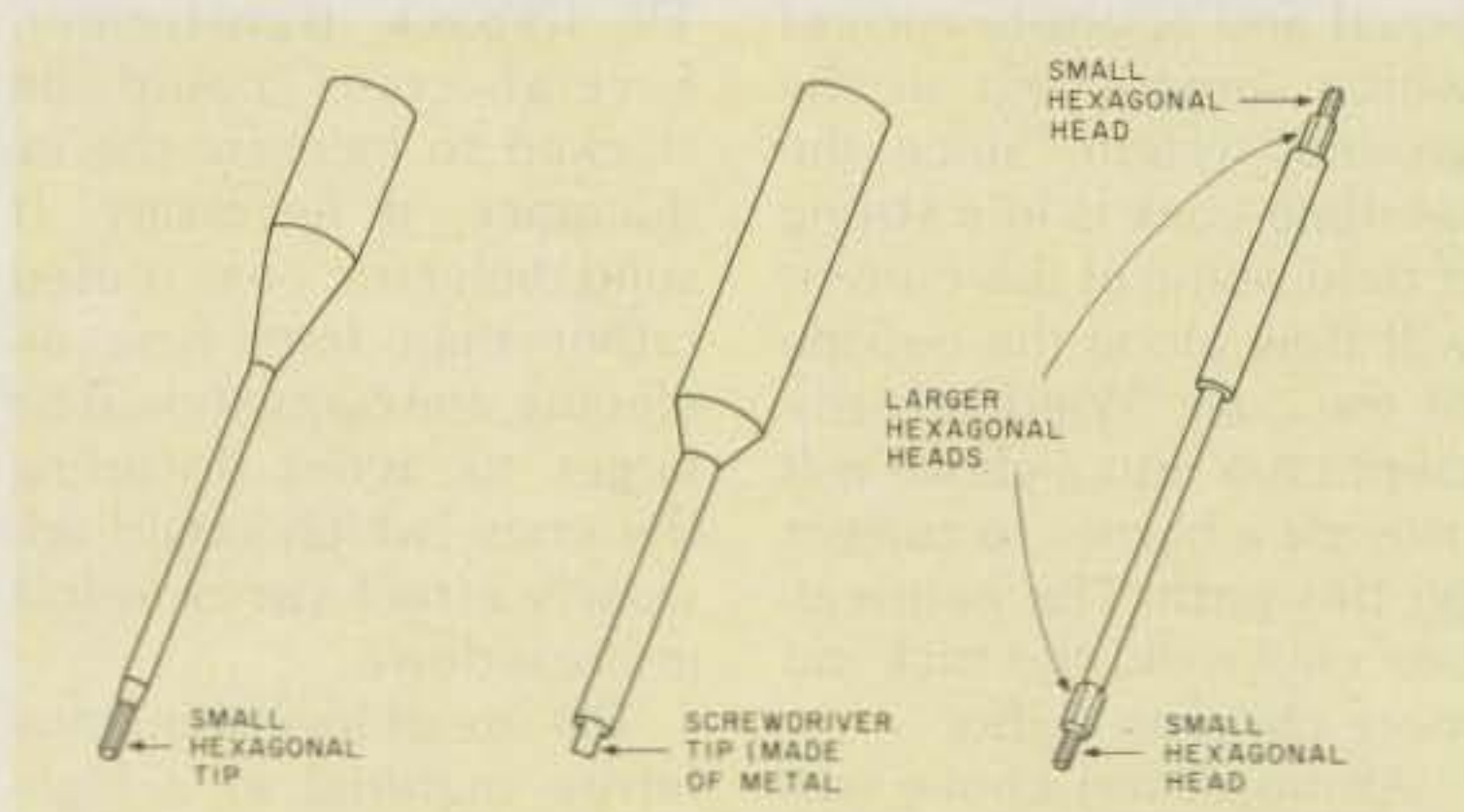

Fig. 1. Several tools used for aligning receivers. Note that except for the screwdriver tip at the end of the center figure, each tool is made of plastic. This prevents the circuit being aligned from being affected by a metal tool.

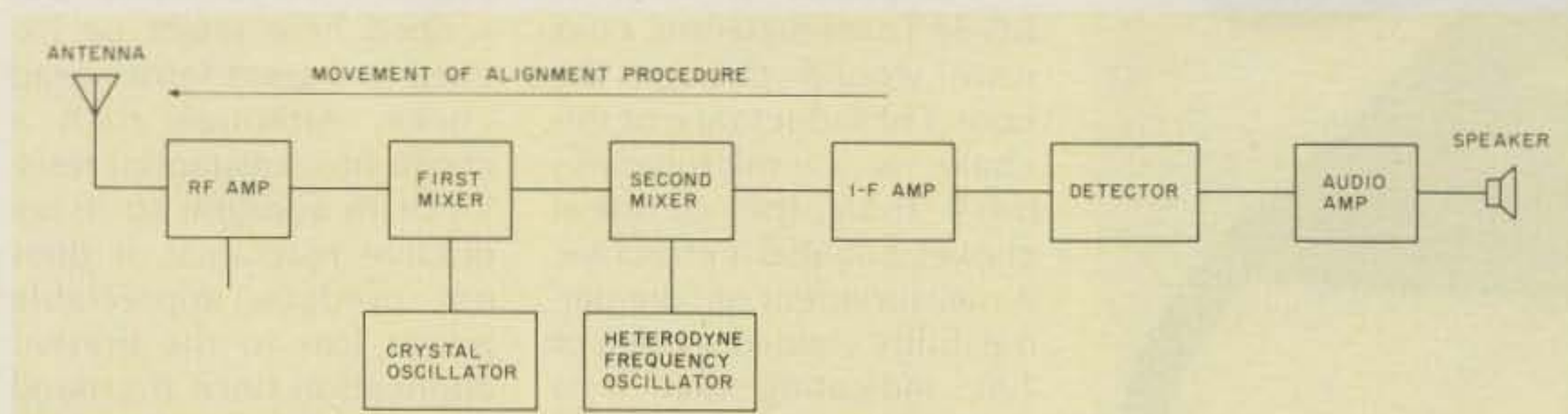

Fig. 2. Illustration of the movement of the alignment procedure. The alignment begins with the first stage of the last i-f amplifier and ends at the rf amplifier. The receiver in the figure is a double-conversion superheterodyne type.

While the gear is simmering, you can look at the schematic of the receiver and locate the following points:

- 1) The grid or base of the last i-f.
- 2) The grid or base of the preceding i-f(s).
- 3) The associated i-f transformers.
- 4) the output of the AM detector.
- 5) The oscillator trimmer capacitors for each band.
- 6) The slug-tuned oscillator coils for each band.

Each of the above-mentioned points or components must be located on the schematic and physically located in the receiver.

The first part of the alignment procedure will be for the last i-f stage.

Procedure—First Part

- 1) Set up the receiver controls for AM reception.
- 2) Clip the VTVM dc probe to the output of the AM detector.
- 3) Connect the signal generator (with the 50-Ohm termination) to the grid or base of the first stage of the last i-f. (Of course, the ground lead of the generator is clipped to the receiver's ground—usually the chassis.)
- 4) Set the frequency of the signal generator very precisely to the frequency of the last i-f of your receiver. This information is in the receiver's manual. It is important that the frequency setting of the signal generator be extremely precise. (A calibrated frequency counter will obviate the need for a precisely-calibrated signal generator. Often, the use of a frequency counter permits a much more accurate setting of frequency than is possible with a signal generator dial.)
- 5) Turn the modulation switch on the generator to internal modulation.
- 6) Feed only enough sig-

nal into the receiver to cause a small deflection on the VTVM. (Set the VTVM's scale appropriately—not at 1000 V dc!)

7) Find the last i-f transformer.

8) The adjustment will start with the transformer winding closest to the AM detector. Stick in a suitable alignment tool and turn it. Don't be afraid. You will see the meter pointer move. Tune the slug for maximum meter deflection.

9) Move your way back toward the input of the i-f section, turning the slugs in the transformers for greatest meter deflection.

10) When you have finished tuning all the slugs, start from the beginning and go through the procedure again. Then do it a third time.

11) If your receiver has an i-f stage (or stages) preceding the one just aligned (double-conversion), follow the same procedure to peak that stage. However, the intermediate frequency will change. Look it up in the manual.

Remember that the accuracy of alignment is a direct function of the accuracy of the signal generator's frequency and peak indication on the VTVM.

We now move to the alignment of the rf stage, or front end, of the receiver. The following preparation is necessary:

- 1) Feed the generated signal (with the 50-Ohm network at the end of the probe) into the antenna jack of the receiver.
 - 2) Again, allow a long warm-up of the gear (the signal generator, the receiver, and the VTVM).
 - 3) Connect the VTVM leads to the speaker terminals.
 - 4) Turn the band selector to the highest band.
- There are three adjustments that will have to be made:

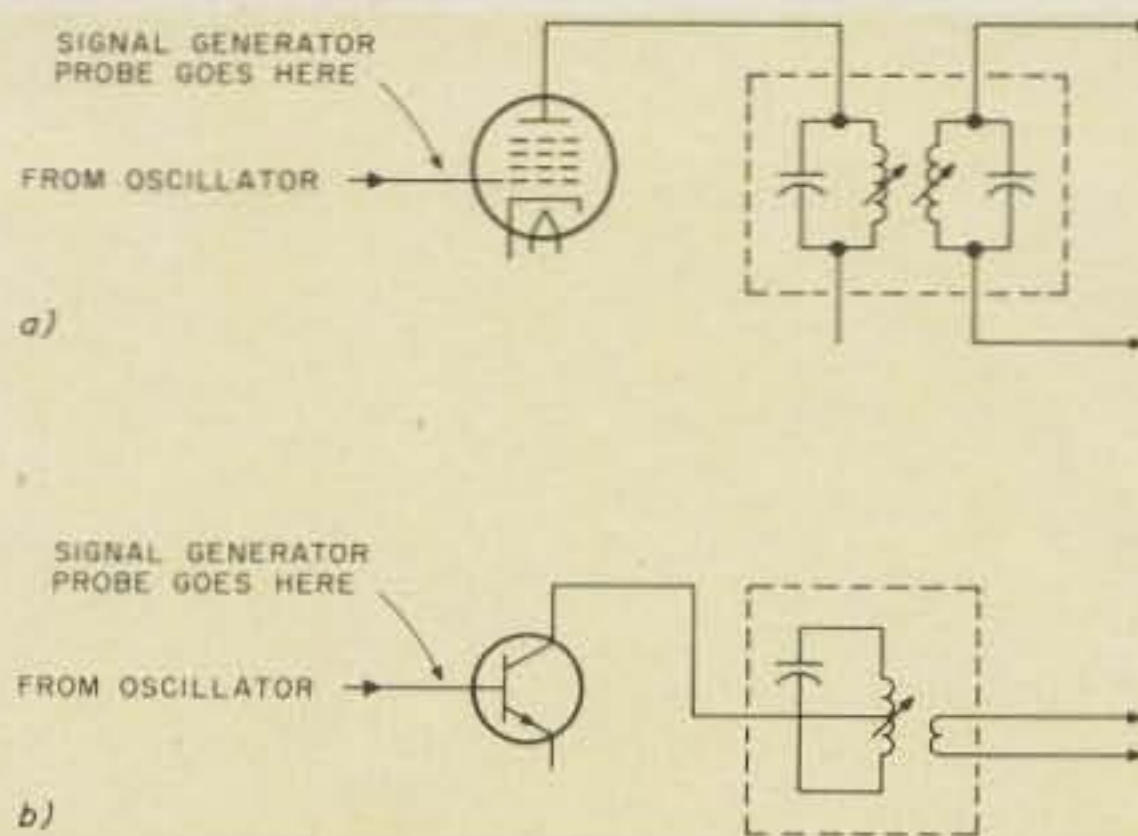

Fig. 3. Starting points for a receiver alignment in a tube (a) and a transistor (b) unit. The circuits diagrammed illustrate the last i-f stages of the receiver.

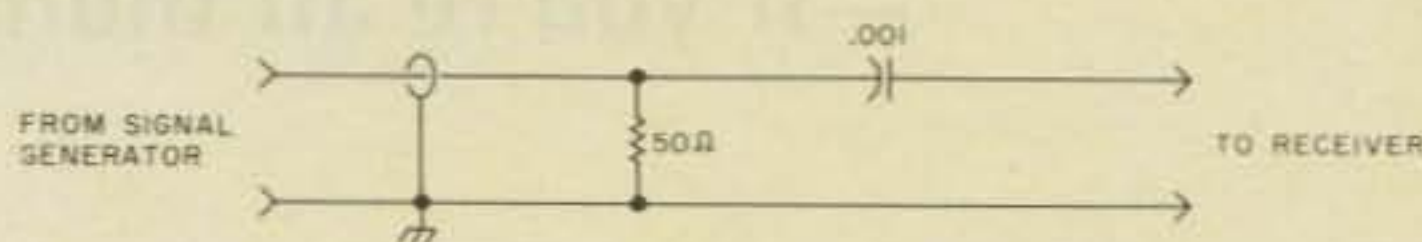

Fig. 4. 50-Ohm termination network. Use shielded cable.

1) Calibrate the high-end dial frequency with the oscillator trimmer capacitor.

2) Calibrate the low-end dial frequency, usually by adjusting a slug in the oscillator coil.

3) Align the tuned rf stages. Some receivers have more than one adjustment for each stage. Check the manual for that information.

Procedure—Second Part

1) Align the dial pointer at both extremes of its excursion.

2) For the high-end adjustment of the top band:

- a) Set the (modulated) rf generator to 30 MHz. Turn the receiver tuning dial in the vicinity of 30 MHz. You should see two meter deflections. One of them represents an image frequency. The one you want is the fundamental frequency, indicated by the greater meter deflection of the two.
- b) Adjust the oscillator trimmer for the highest band so that 30 MHz corresponds to the greatest meter

deflection.

c) Follow the same procedure in adjusting the low end of the band. Set the signal generator to that frequency. Find the fundamental on the receiver and adjust the oscillator coil slug for maximum meter deflection.

d) Make the adjustment several times back and forth between the high end and the low end of the band. Make the last adjustment at the high end.

e) Before going on to the next band, make sure that this one is impeccably tuned.

f) Repeat the high-end and low-end procedure for each band on your receiver.

When you are finished aligning all the bands, go through the procedure again to guarantee optimum performance of your receiver.

And that's it. Obviously, a tune-up procedure on a complex receiver can be tedious (not difficult!). That's why most amateurs save it for a rainy day. Good luck! ■

Rubber Thumbs and Pilot Lamps

— if you're all thumbs, enlighten yourself!

James R. Avoli K3MPJ
239 Foxcroft Road
Pittsburgh PA 15220

If you've ever been on the losing end of a tussle with a snug-fitting pilot lamp of the style that's so common to surplus radio

equipment, you'll appreciate the fun I used to have with the home-brew device shown in Fig. 1. It's a two-level constant-current

nicad battery charger that uses a 100-W lamp to control the 400-mA charging source and a 6-W lamp to control the 25-mA trickle source. It's the latter that used to test my religion.

During one of those dreaded sessions when I was trying to replace the little devil, I was literally clutching at straws to get a grip on the defective lamp without breaking the glass. It was then that I tried a clerk's rubber thumb over it, as pictured in Photo A. The rubber surface grips the glass all around evenly when you gently push down on it. For smaller diameter lamps, simply cut the open end so the whole thing is a little shorter.

Even when we hams overtly try to implement the KISS method (Keep It Simple, Stupid), it's very difficult unless it's by accident! ■

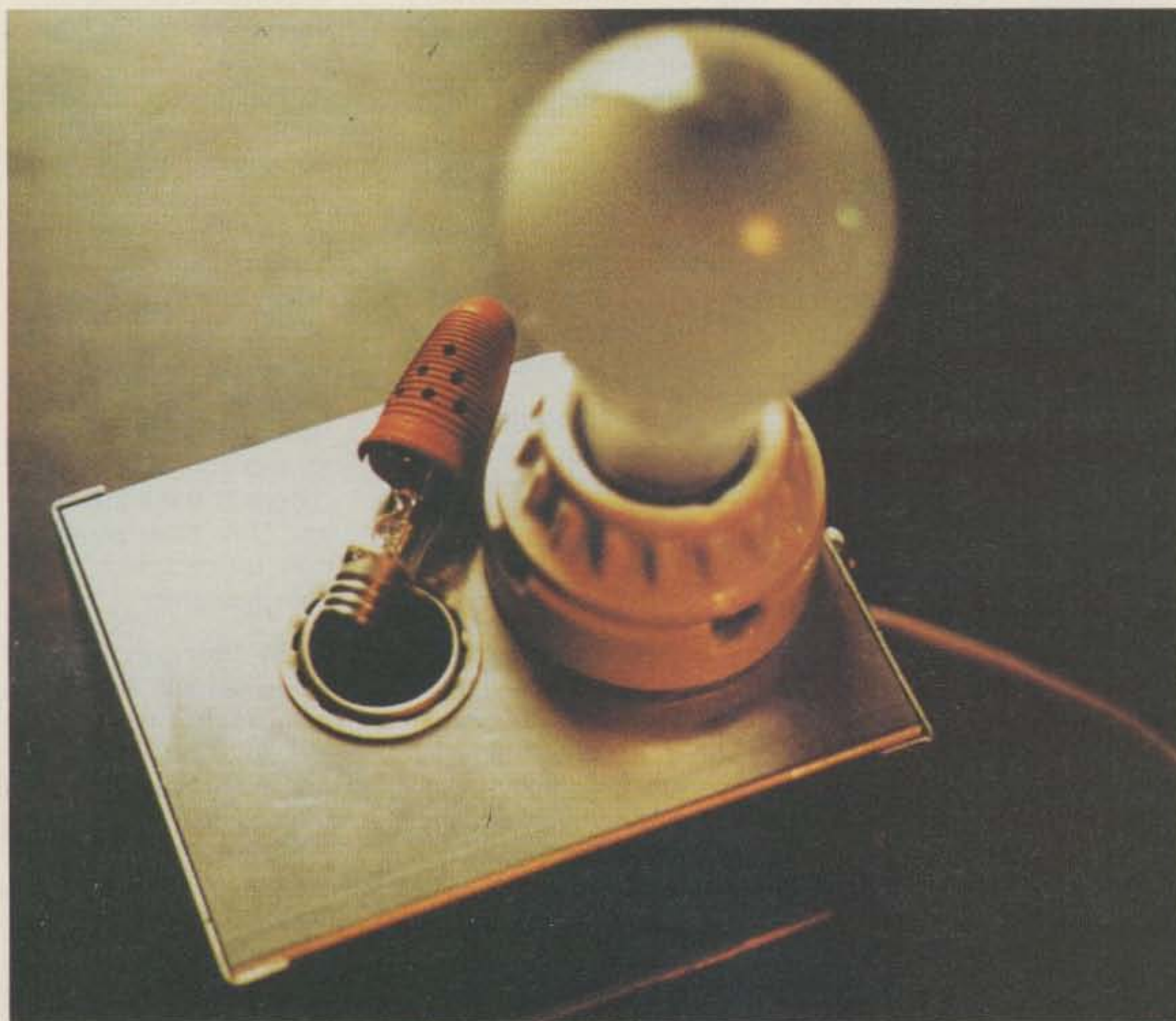

Photo A.

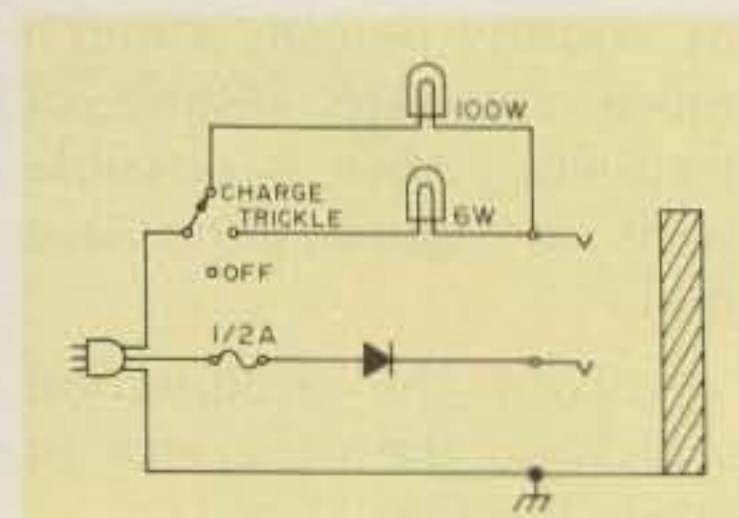

Fig. 1.

73 Magazine

IS GIVING YOU TIME TO FIGHT INFLATION



73 Magazine is increasing its cover price (and subscription price) on July 1, 1980. *BUT* we would like to give you time *TO FIGHT INFLATION* . . . subscribe or renew your present subscription from now until July 18, 1980, and receive 73 at *THE OLD RATES*.

Keep 73 Magazine, with its informative articles and controversial editorials, coming to your doorstep for \$15.00/1 year; \$30.00/2 years and \$45.00/3 years. You could *SAVE* as much as 57% by subscribing (or renewing) for three years at \$1.25 per copy . . . that's \$1.70 *LESS* than the new cover price. With the July issue the new subscription prices will be \$25.00/1 year; \$38.00/2 years and \$53.00/3 years . . . *SO HURRY . . . SEND IN THE COUPON TODAY AND FIGHT INFLATION.*

**ALL PREVIOUS SUBSCRIPTION OFFERS TO 73 MAGAZINE
ARE VOID ON JULY 18, 1980.**

YES, I'LL TAKE THE TIME TO FIGHT INFLATION

- New Subscription Renewal (please affix an address label from your most recent magazine)
 1 year/\$15.00 2 years/\$30.00 3 years/\$45.00
 Payment Enclosed Bill: Me Master Charge VISA Amerex

Card # _____ Expire Date _____

Signature _____ Interbank # _____

Name/Label _____

Address _____

City _____ State _____ Zip _____

73 Magazine

PO BOX 931 • FARMINGDALE NY 11737

Canadian—\$15.00 1 year only, US funds • Foreign—\$26.00 1 year only, US funds

THIS CARD EXPIRES JULY 18, 1980.

306B6

ICM TV-4200

SATELLITE GROUND RECEIVER



International incorporates advanced technology at its best in a fully packaged and assembled receiver covering all satellite channels 3.7-4.2 GHz band. Standard dual audio outputs provided at 6.2 and 6.8 MHz. Other available.

FULLY TUNABLE

Covers all satellite channels 3.7-4.2 GHz band.

DUAL AUDIO OUTPUTS

6.2 and 6.8 MHz audio standard. Others available.

EASY TO USE

Simple tuning
Built-in LNA power supply
Output levels compatible with video monitor or VTR input.

OPTIONS (Availability to be announced)

AFC
Remote tuning
Additional audio frequencies

DIMENSIONS

4½H x 14½W x 12D



The ICM TV-4200 Satellite Receiver is completely assembled and includes power supply, tuner control circuitry and power cable. Available now. Shipping Weight 12 lbs.

PRICE **\$1,995** 1-9 QUANTITY



INTERNATIONAL CRYSTAL MANUFACTURING CO., INC.
10 N. Lee, Oklahoma City, Oklahoma 73102, 405-236-3741

✓ 36

MFJ ✓ 47

SHORTWAVE ACCESSORIES

NEW Indoor Tuned Active Antenna. Rivals, can even exceed reception of outside long wire.

Rivals long wires

\$79⁹⁵



MFJ-1020 NEW INDOOR ACTIVE ANTENNA sits on your desk ready to listen to the world. Rivals, can even exceed reception of outside long wire. Unique **Tuned Active Antenna** minimizes intermod, provides RF selectivity, reduces noise outside tuned band. Also use as preselector for external antenna. Covers 300 KHz to 30 MHz in five bands. Adjustable telescoping antenna. Controls: Tune, Band Selector, Gain, On-Off/Bypass. LED. FET, bipolar circuitry. 110 VAC, 9-12 VDC or 9 V battery for portable use. Phono jack for external ant. 5x2x6 in.



\$99⁹⁵

MFJ-1040 RECEIVER PRESELECTOR. Improves weak signal reception, rejects out-of-band signals, reduces image response, 1.8 to 54 MHz. Up to 20 db gain. Low noise MOSFET. Gain control. Bandswitch. Can use 2 ant., 2 rcvrs. ON-OFF/Bypass. 20 db attenuator. LED. Coax, phono jacks. 110 VAC or 9-18 VDC, 8x2x6 in. Also for XCVRS to 350 watts input. Auto bypass. Delay control. PTT jack. **MFJ-1045, \$69.95.** Same as MFJ-1040, less attenuator, xcvr auto bypass, delay control, PTT. Use 1 ant., 1 rcvr. 5x2x6 in. 9 V bat., 9-18 VDC or 110 VAC with optional AC adapter, \$7.95.

\$89⁹⁵



MFJ-959 RECEIVER ANTENNA TUNER has low noise 20 db preamp for weak stations. Match antenna to receiver for maximum signal. 1.6 to 30 MHz. Can use 2 ant., and 2 rcvrs. Select tuner, tuner with preamp, tuner with 20 db attenuator, bypass. Gain control. Coax, phono jacks. 110 VAC or 9-18 VDC. 9x2x6 in. **MFJ-950, \$59.95.** Same as MFJ-959, less preamp, attenuator, bypass. 6x2x6 in.

MFJ-751 Tunable AM/SSB/CW Filter, \$59.95.
MFJ-200 Freq. Std., \$29.95, more. **Free catalog.**

Order from MFJ and try it. If not delighted, return within 30 days for refund (less shipping).

One year unconditional guarantee.

Order yours today. Call toll free 800-647-1800. Charge VISA, MC. Or mail check, money order. Add \$4.00 each for shipping and handling.

CALL TOLL FREE ... 800-647-1800

Call 601-323-5869 for technical information, order/repair status. Also call 601-323-5869 outside continental USA and in Mississippi.

MFJ ENTERPRISES, INC.

BOX 494, MISSISSIPPI STATE, MS 39762

THE GIANT **AZDEN** COMPANY

REVOLUTIONIZES THE STATE OF THE ART

AWE AND AZDEN. INTRODUCE THE BRILLIANT NEW PCS-2000

**MICROCOMPUTER
CONTROLLED**

**SUPERIOR COMMERCIAL GRADE
2 METER FM TRANSCEIVER**

NOT \$550.00

**SUMMER
SALE**

\$299⁰⁰

REG. \$369.00

NOT \$550.00

**SUMMER
SALE**

\$299⁰⁰

REG. \$369.00



COMPARE THESE FEATURES WITH ANY UNIT AT ANY PRICE



- **FREQUENCY RANGE:** Receive and transmit: 144.00 to 147.995 MHz, 5Khz steps + MARS-CAP CAPABILITY BUILT IN (142-149.995 MHz).
- **ALL SOLID STATE-CMOS PL DIGITAL SYNTHESIZED.**
- **SIZE: UNBELIEVABLE! ONLY 6 3/4" x 2 3/8" x 9 3/4". COMPARE!**
- **MICROCOMPUTER CONTROLLED:** All scanning and frequency-control functions are performed by microcomputer.
- **DETACHABLE HEAD:** The control head may be separated from the radio for use in limited spaces and for security purposes.
- **SIX-CHANNEL MEMORY:** Each memory is re-programmable. Memory is retained even when the unit is turned off.
- **MEMORY SCAN:** The six channels may be scanned in either the "busy" or "vacant" modes for quick, easy location of an occupied or unoccupied frequency. **AUTO RESUME. COMPARE!**
- **FULL-BAND SCAN:** All channels may be scanned in either "busy" or "vacant" mode. This is especially useful for locating repeater frequencies in an unfamiliar area. **AUTO RESUME. COMPARE!**
- **INSTANT MEMORY-1 RECALL:** By pressing a button on the microphone or front panel, memory channel 1 may be recalled for immediate use.
- **MIC-CONTROLLED VOLUME AND SQUELCH:** Volume and squelch can be adjusted from the microphone for convenience in mobile operation.
- **ADDITIONAL OFFSETS:** Provides three additional offset values: +0.4 MHz, +1 MHz and +1.6 MHz. Other offsets may also be obtained.
- **25 WATTS OUTPUT:** Also 5 watts low power for short-distance commun-

- ication.
- **DIGITAL S/RF METER:**LEDS indicate signal strength and power output. No more mechanical meter movements to fall apart!
- **LARGE 1/2-INCH LED DISPLAY:** Easy-to-read frequency display minimizes "eyes-off-the-road" time.
- **PUSHBUTTON FREQUENCY CONTROL FROM MIC OR FRONT PANEL:** Any frequency may be selected by pressing a microphone or front-panel switch.
- **SUPERIOR RECEIVER SENSITIVITY:** 0.28 uV for 20-dB quieting. The squelch sensitivity is superb requiring less than 0.1 uV to open. The receiver radio circuits are designed and built to exacting specifications, resulting in unsurpassed received-signal intelligibility.
- **TRUE FM, NOT PHASE MODULATION:** Transmitted audio quality is optimized by the same high standard of design and construction as is found in the receiver. The microphone amplifier and compression circuits offer intelligibility second to none.
- **OTHER FEATURES:** Dynamic Microphone, built in speaker, mobile mounting bracket, external remote speaker jack (head and radio) and much, much more. All cords, plugs, fuses, microphone hanger, etc. included. Weight: 6 lbs.
- **ACCESSORIES:** 15' REMOTE CABLE.....\$29.95. CS-6R A/C POWER SUPPLY.....\$49.95. TOUCHTONE . MIC. KIT.....\$39.95. EXTERNAL SPEAKER.....\$18.00.

AMATEUR-WHOLESALE ELECTRONICS ORDER NOW TOLL FREE

8817 S.W. 129th Terrace, Miami, Florida 33176

Telephone (305) 233-3631 • Telex: 80-3356

HOURS: 8-6, Mon. - Thur.

U.S. DISTRIBUTOR
DEALER INQUIRIES INVITED

1-800-327-3102

CREDIT CARD HOLDERS MAY USE OUR TOLL FREE ORDERING NUMBER.

Tempo S1 2-Meter Portable

— 800 channels, to go!

Two-meter FM is probably the most popular aspect of ham radio ever to come along. With repeaters in virtually all areas of the country, one can be in touch with police in case of emergency or just wile away the miles on the interstates chewing the rag a bit. However, once at your destination, you either sit in the car with your syn-



The Tempo S1 FM transceiver.

thesized rig (a real pain on hot summer days) or drag out a 12-volt power supply to continue your hamming. That problem has now been solved by the boys at Tempo.

Synthesized HT

Tempo, through Henry Radio, has released their S1 synthesized HT-type portable rig. This nifty little rig, 1.6" x 2.5" x 6.5" (40 x 62 x 165 mm) in size, has all the features of all but the most expensive mobile and base rigs. Its small size and light weight (about one pound) make it very attractive to traveling hams who'd like to stay in touch on two meters but don't want to pack a 12-volt power supply in their baggage. With an upcoming trip to VK2-land, this was extremely important to me. Best of all, it's synthesized in 5-kHz steps from 144.000 MHz to 147.995 MHz for complete coverage of the two-meter band, including the new repeater subband.

The frequency of operation is selected by three thumbwheel switches (1 MHz, 100 kHz, and 10 kHz) and a +5-kHz slide switch located on the top of the

unit. Repeater offsets (−600 kHz, simplex, and +600 kHz) are selected by a slide switch on the back of the unit.

Theory of Operation

The heart of the whole thing is a vco which operates in the range of 44.4333 MHz to 45.765 MHz followed by a tripler which results in a two-meter output minus 10.7 MHz. This frequency is mixed with the incoming two-meter signal for receive in a dual conversion mode, which results in a sensitivity of better than .3 uV for 20-dB SINAD.

For transmit, the tripled vco signal is mixed with either a 10.7-MHz signal for simplex or with 11.3-MHz or 10.1-MHz signals for +600-kHz or −600-kHz repeater offsets, respectively. Three buffer amps and a power amp then kick the signal up to a whopping 1.5 Watts out.

Frequency stability is maintained by a phase-locked loop circuit which really seems to do its job well. The worst frequency deviation I've measured was −80 Hz, and that was at 144.000 MHz. Granted,

this is outside the amateur band, but since phone transmissions aren't authorized below 144.100 MHz, this really isn't anything to worry about unless you get your jollies banging away on the push-to-talk switch and trying to decipher squelch tails as code.

Versatile Operation

Since I live near Chicago, I'm practically within spitting distance of umpteen repeaters and have no trouble hitting most of them within a fifteen-mile radius. As such, my S1 has taken over many of the duties previously dealt out to my other two-meter rig.

For those of you who live out in the boonies, say, forty miles or so away from the nearest machine, don't despair, for Tempo also has 30-Watt and 80-Watt matching amplifiers available. Connection is made through an antenna jack on top of the rig right next to the earphone jack.

And for you autopatch users (I'm probably the only ham left who doesn't use autopatch), a touchtone™ pad is available factory-in-

stalled for an extra half of a C-note.

I've had quite a few QSOs with my rig and have been given nothing but the best reports for audio quality and readability. While listening on my other rig through what pass around here for hi-fi speakers, the transmitted audio sounds more like broadcast quality than any other rig I've ever heard. The received audio is crisp and clean with none of the hollow squawk-box sound so common to other portable rigs.

The S1 is powered by an internal 250 mAh nicad battery pack (supplied) which is charged at a rate of 50 mA by a little plug-in charger (also supplied). According to its label, the charger will work on both 60-Hz and 50-Hz current, needing only a step-down transformer to work on foreign current. This is

another plus for the ham who wants to take his hobby overseas with him.

Unlike its nearest competitor in the synthesized portable field, the S1 can be operated while charging. Therefore, if this is to be your only two-meter rig, you won't be QRT while the batteries are being charged (about 10 hours for a completely dead battery pack). Fortunately, though, dead batteries shouldn't plague you, since the transmit indicator LED also lights up and stays on continuously while receiving when the battery charge is about used up.

A Few Disadvantages

Naturally, nothing is perfect, and this is true even with a neat little rig like this.

The first thing is that you're limited to simplex or standard repeater offsets. If a weird offset is

needed, you either modify the thing or do some fancy thumbwheel flipping. I've opted for the latter, since I hate drilling holes or doing anything else to void the warranty of a new unit. Besides, I'm all thumbs, and the innards are packed in pretty tight. So here's one for the Mod Squad to tackle. All that is necessary is to add another crystal and a four- (or more) position switch to accommodate the oddball repeater offset position(s).

Next, it would be nice to have an external mike for use in the mobile, as picking up the whole thing with both its power and antenna cables dangling could hamper your ability to drive and talk at the same time. Again, the problem is space—where to mount the mike connector. If this were done, though, it would add much more convenience to an already

great rig.

Finally, the Lexan case could stand being made a bit heavier. This really isn't too much of a drawback as long as you don't plan to drop-kick the rig across the room or pitch it off the edge of the Grand Canyon. Still, an ounce of prevention...

Summary

While it might be a bit presumptuous to say that Tempo's S1 transceiver is the greatest thing since the audion tube, just consider the 800 channels, a hot receiver, and the clean 1.5 Watts out of a one-pound rig that fits neatly into your hand. Considering all the options available and a price only slightly higher than that of most six-channel rigs, I'm sure you'll at least rank it right up there among the top ten goodies to come along in recent years. ■

FULL BANDWIDTH FIREWORKS, 144-148 MHz

KLM'S DUAL-DRIVEN ELEMENTS DO IT AGAIN:
SUPER-GAIN ACROSS THE WHOLE BAND for FM, SSB, DX, TROPO, EME, etc.

15.5 dBd

- No tuning or matching
- 1KW balun supplied
- Less weight and windload
- Strong 1 1/2" boom/ no truss needed

VSWR CURVE

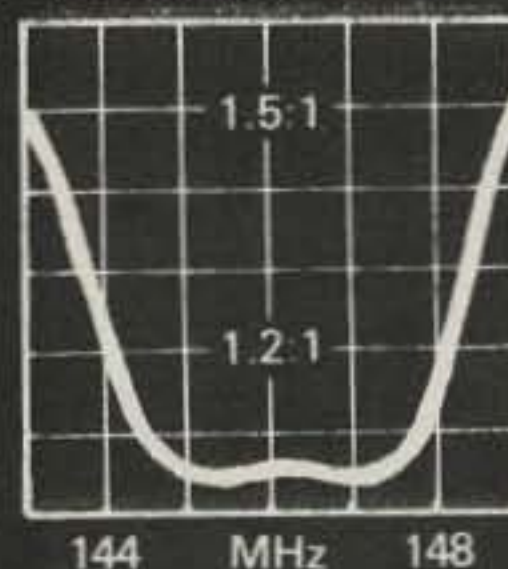

KLM's 144-148-13LB

WORLDS ONLY WHOLE BAND/ALL MODE SUPER-GAIN ANTENNA

KLM P. O. Box 816, Morgan Hill, CA 95037

A Proper Pedestal for PCBs

— handy holder eases circuit board construction and repair

When working with PC boards, either to repair them or to put together kits which use them, it often is handy to have a holder for them so that hands are free for soldering, placing test leads, and other tasks. Many such holders are available commercially but they tend to be a bit expensive. One can, however, with a bit of ingenuity, usually use available parts to home-brew a very satisfactory holder.

This article presents a description of one home-brew holder made out of

available odds and ends. It has some features which even commercial holders do not have—such as pinpoint illumination on the underside of the board so that one can hunt down bad connections, cracks, and so on. You may not wish to duplicate this particular holder exactly, but you can use the ideas presented to develop a holder using available materials.

Photo A shows the completed holder. The circular base is the lead weight from a discarded table lamp, and is about 5 inches in diameter. Any sort of

heavy base is suitable. Another version of the holder was constructed later using a piece of $\frac{1}{4}$ " steel plate about 4 x 8 inches in size as the base. This base proved to be even steadier than the circular one shown. The rest of the holder consists of an arrangement of BNC connector hardware and a gooseneck section. The arrangement of the BNC connector hardware allows the PC board being held to be rotated into any conceivable position. It also can be rotated rapidly around so that one can get at either side of the board. This is a feature which

many commercial holders do not have, and it is extremely convenient when one has to check back and forth frequently between the component and foil sides.

The arrangement of the BNC hardware is shown in Fig. 1. Since each of the connectors can rotate on its axis and the UG-306 right-angle adapter can rotate fully on both of its axes, one can readily appreciate how it is possible to achieve any PC board positioning.

Assembly is extremely simple. The BNC hardware

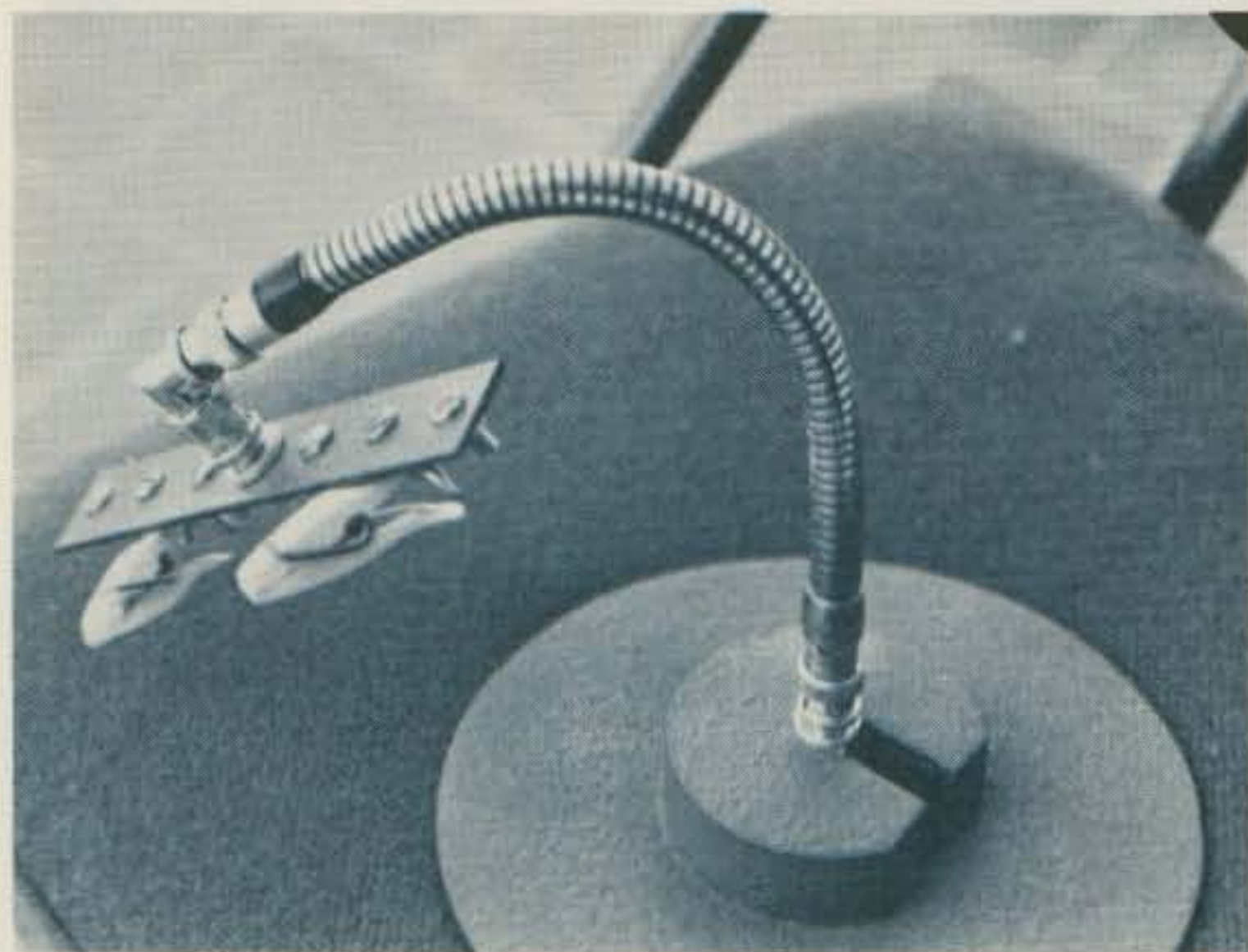

Photo A. This is the completed holder.

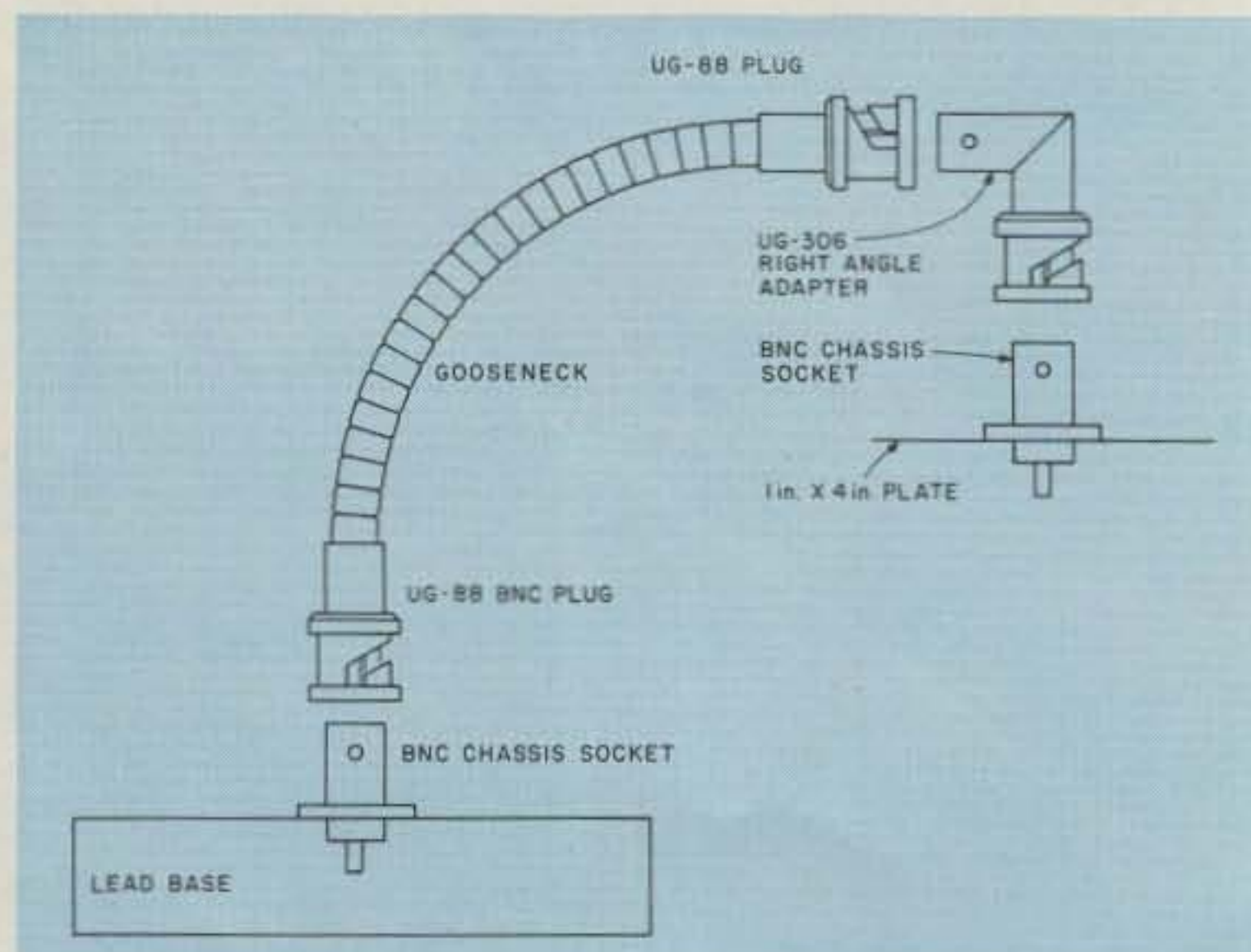

Fig. 1. Simple assembly of the holder using BNC connector hardware.

just connects together and the two female BNC connectors are of the single-hole mounting type. The gooseneck is a standard lamp type approximately 9" long which should be available at any large hardware store. It has a threaded stud on each end which loosely fits into the back of the UG-88 plugs. Epoxy cement can be used to make a firm bond between the studs and the plugs. In fact, the assembly of the gooseneck and the two UG-88 plugs should be prepared first and the epoxy allowed to set thoroughly.

Two plastic clothespins are attached to the plate shown in Fig. 1 using 6 x 32 hardware and wing nuts. The plate can be of aluminum or plastic. The 6 x 32 hardware is placed with equal spaces along the 4"-long plate so that the clothespins can be moved to accommodate any small- to medium-size PC board.

Photo B shows the holder in use, and also illustrates the hardware mounting on the 1-x 4-inch holder plate for the clothespins. As one looks at the photo, the PC board can be rotated fully 360° horizontally and also 360° in and out of the page.

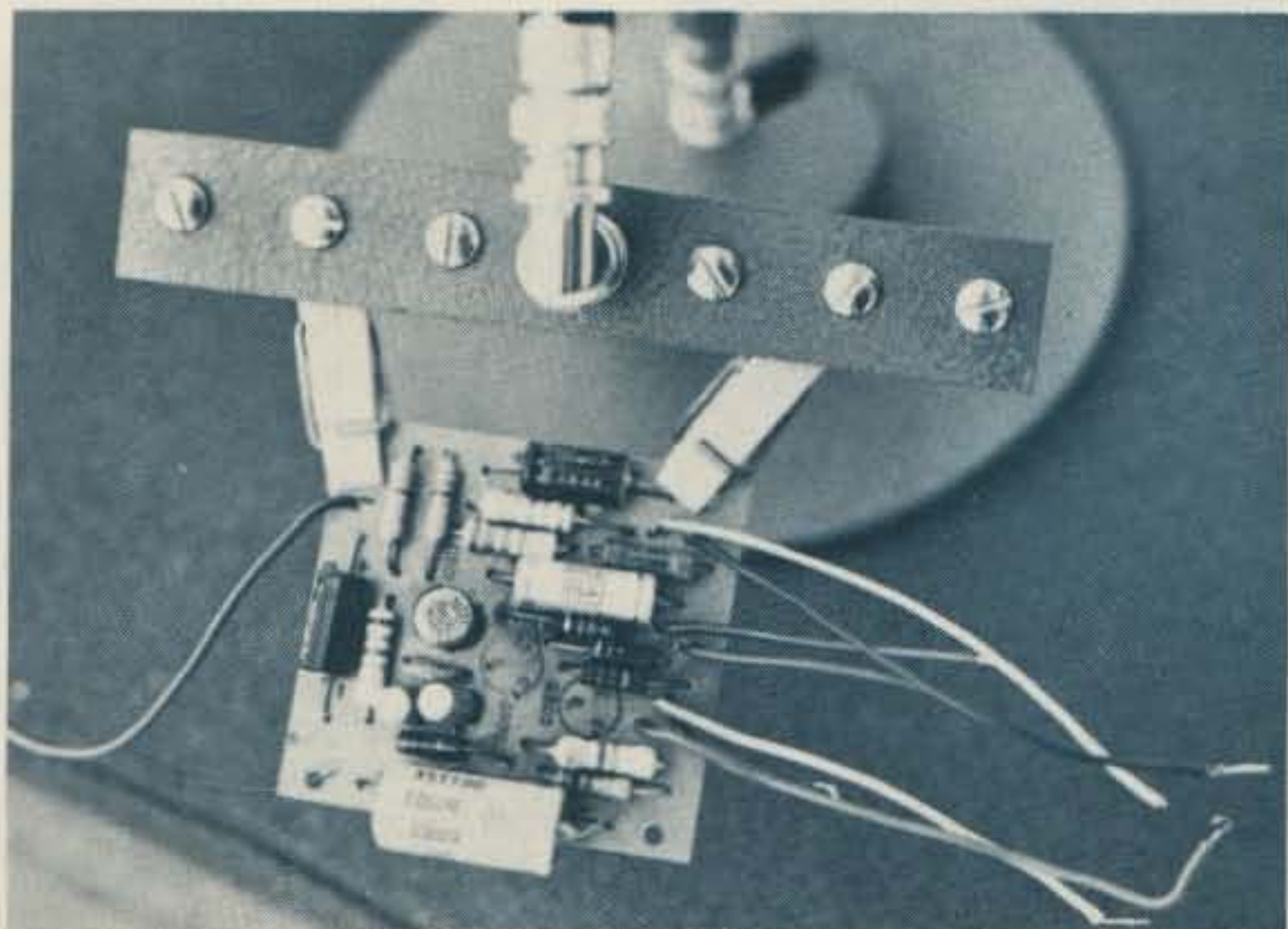

Photo B. This shows the holder in use. Note how the clothespins can be set to accommodate different sizes of PC boards.

Although the holder as shown was used for some time quite satisfactorily, the thought later came to develop also a lamp function since the BNC connectors provide an available electrical connection no matter how the holder is rotated. The unit was disassembled and a wire connection made between the two UG-88 plugs on the ends of the gooseneck. Electric power was run to the female BNC connector in the base of the holder. The lamp was installed on the 1- x 4-inch plate as shown in photo C. In this case, just a simple flashlight bulb was used, with leads soldered to it (covered by shrink tubing) and to the female BNC connector on the 1-x 4-inch plate. Later on, the unit was modified to use one of the 12 volt, high-intensity bulbs as a source of illumination. In any case, the illumination feature has proved to be extremely handy when examining PC boards—particularly complex boards with close-spaced foil patterns. The board is illuminated from the foil side, and then by carefully viewing the board from the component side one can often locate faults (breaks and solder bridges) which otherwise

would not be readily apparent.

There is no need to follow exactly the construction of the holder as described. Possibly, one can devise an even better system using two goosenecks where there is a holder and illumination

source at the end of each gooseneck.

Whatever form the holder may take, however, it can be an extremely useful tool around the shack for even some non-electrical application where a "third hand" would come in handy. ■

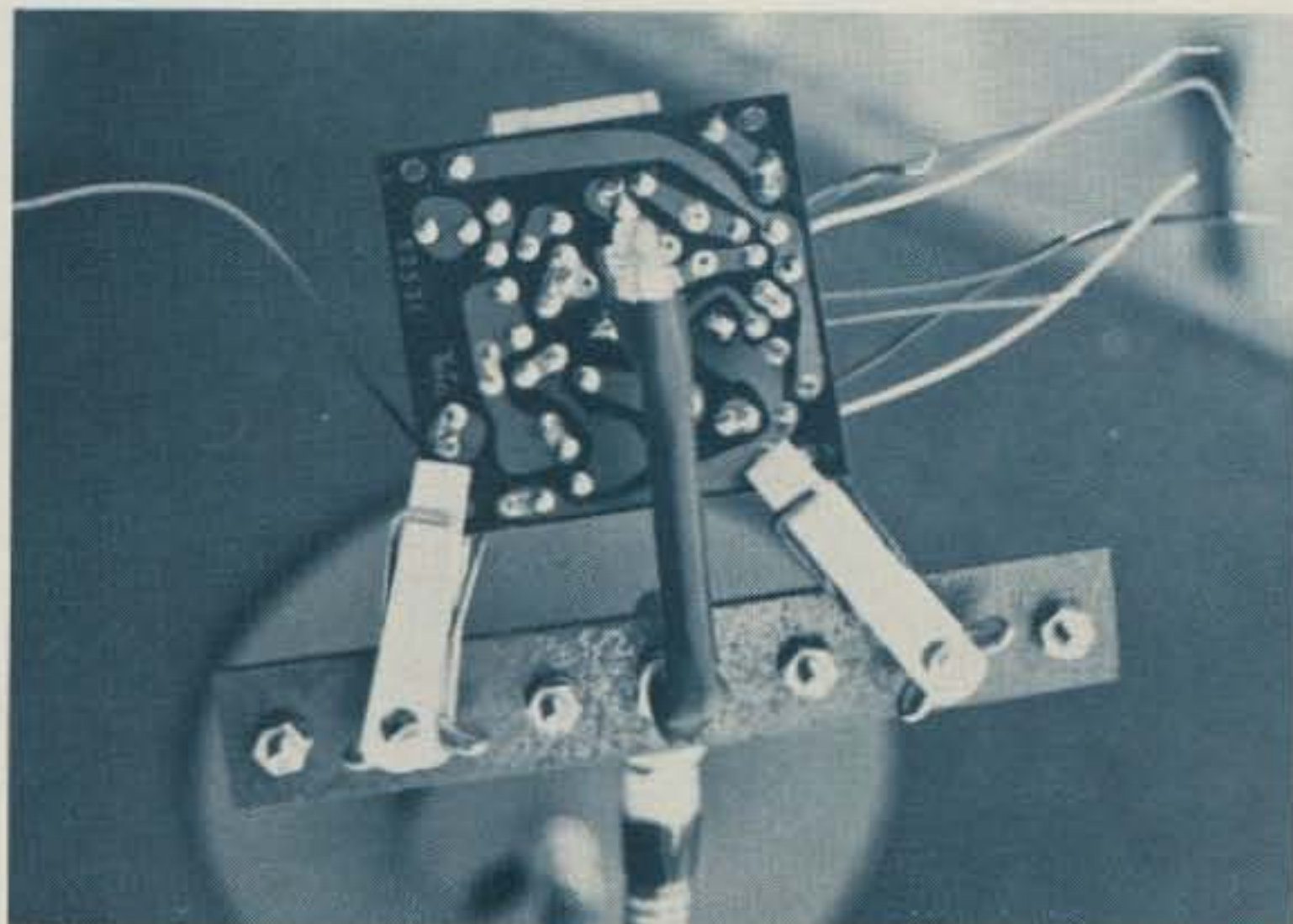

Photo C. A lamp can easily be added to the holder to provide illumination for tracing PC board faults.

"WORLD FRIENDSHIP THROUGH AMATEUR RADIO"

SEANARC '80

SEATTLE NATIONAL AMATEUR RADIO CONVENTION

26th NATIONAL ARRL CONVENTION

July 25 - 27, 1980

Seattle, Washington



ENJOY THE 26th NATIONAL ARRL CONVENTION
IN THE BEAUTIFUL PACIFIC NORTHWEST

SEMINARS, DISPLAYS, LADIES PROGRAMS, FORUMS AND MAJOR
EQUIPMENT EXHIBITORS WILL HIGHLIGHT THIS GATHERING AT
THE SEA-TAC AIRPORT RED LION MOTOR INN.

Roy Neal, K6DUE, of NBC News will be the featured Saturday
night banquet speaker.

Vic Clark, W4KFC will explain the results of WARC-79 and what
it means to the future of amateur radio.

Meet ARRL President Harry Dannels
W2HD, and other ARRL officials.

For Program and Registration Materials
Write:

1980 ARRL NATIONAL CONVENTION COMMITTEE
P. O. Box 68534, SEATTLE, WASHINGTON 98168



Surplus Treasures

— assemble a quality ham station for less than \$200

The price of new ham radio equipment has gotten so high these days that starting or expanding an amateur radio station can be tremendously expensive. State-of-the-art quality has a justifiable premium put on it, but what is state-of-the-art today is run-of-the-mill tomorrow, and the values that are available on the used-equipment market bear this out. The sub-millionaires among us

would do well to consider used (previously owned) equipment for their next purchase. For a newcomer to the hobby, there is a gold mine of excellent gear to be had for a small percentage of what equivalent new gear would cost.

My own experience in this area comes from buying and selling at the local flea markets a few times each year. These outings not only have provided quite a lot of enjoyment,

but they have given me the opportunity to examine a lot of different types of equipment—some ancient, and some not so ancient. The station that I am presently using is built around top quality bargains obtained by utilizing just a bit of patience and experience at these markets.

Although I own a transceiver, I wanted a little more versatility for operating CW and RTTY. My

Swan 300B didn't really fill the bill. Usually a couple of quality rigs show up at each flea market, so I wandered around in search of something suitable that I could afford. What caught my eye was a mint National NC-303 with matching 6- and 2-meter converters and speaker. I was hooked, especially since the asking price was \$125.

For those who don't remember, the NC-303 is a wonderful, large receiver which, in 1964, retailed for about \$450 without accessories. The dial and band-switch mechanism would cost nearly that to duplicate today. So, with nearly 100 pounds of receiver in my trunk, I headed home to try it out. It worked perfectly, and the silky-smooth controls are a pleasure. The NC-303 cannot be accused of being miniature, but it certainly does *feel* good, and signal for signal it equalled or surpassed the performance of my Swan (especially on CW).

Well, that receiver demanded a matching transmitter, so at the next few markets I concentrated on finding a suitable companion for it. The fruit of my labors was a Hallicrafters HT-37 SSB transmitter in



perfect condition for the remarkable price of \$60. (The original price of the HT-37 was also about \$450.) This transmitter was one of the most popular of its day. It uses a phasing-type sideband generator and is very stable and easy to operate. In about 10 minutes I added an FSK circuit to the HT-37 and was on the air. Reports on all modes have been excellent, and the total investment, including speaker and converters, was \$185!

Why buy new super-expensive gear? Possible reasons may be as follows: (1) It is certainly smaller. (2) The new all-solid-state rigs take less time to warm up and, on the average, they drift less. (3) Transceivers, especially broadbanded ones, require less fuss.

My own personal comments on these are, in order: (1) I like big equip-

ment. It somehow feels and looks more substantial. (2) My two units take about 10-15 minutes to come to temperature, after which stability is perfectly acceptable. Not all old gear drifts. (3) The operation of separate receiver and transmitter, while not as simple as a transceiver, allows all sorts of convenience, especially on CW and RTTY. True, in most cases zero-beating the transmitter is a bother, but it quickly becomes part of the routine.

To this I should add the most important point of all. For under \$200 I have assembled a station that can equal the performance of most new gear at 3 to 5 times the price. A slightly less ambitious station could be put together for even less. Novices take note. Cost is certainly no excuse for inferior equipment. ■

Radio Bookshop

NEW FROM 73!



THE MAGIC OF HAM RADIO

by Jerrold Swank / W8HXR

Under various callsigns, Jerry Swank W8HXR has been heard on the ham bands since 1919. He has watched amateur radio grow from the days of Model A spark coils to an era of microprocessors and satellite communications. In *The Magic of Ham Radio*, Jerry gives his account of our hobby during the past six decades.

W8HXR has often been where the action is. Jerry has responded to calls for help from earthquake-stricken Managua and tornado-ravaged Xenia. Antarctica, one of man's loneliest outposts, has been a bit less lonely, thanks to Jerry's tireless phone patching efforts. Drawing on his own colorful experiences and those of many other hams, Jerry has compiled this word-picture of what ham radio was and is.

It has been said that any sufficiently advanced technology is indistinguishable from magic. Ham radio fits this description quite well. In what other activity is it possible to meet people, reunite them with loved ones, even save their lives without actually seeing those you've helped? Yes, there is something magical about ham radio, and we hams are the magicians. Order BK7312 \$4.95.*

*Use the order card in the back of this magazine or itemize your order on a separate piece of paper and mail to: 73 Radio Bookshop • Peterborough NH 03458. Be sure to include check or detailed credit card information, no C.O.D. orders accepted. Add \$1.00 handling charge. Note: Prices subject to change on books not published by 73 Magazine. Questions regarding your order? Please write to Customer Service at the above address. Please allow 4-6 weeks for delivery.

MOVING?

Let us know 8 weeks in advance so that you won't miss a single issue of 73 Magazine.

Attach old label where indicated and print new address in space provided. Also include your mailing label whenever you write concerning your subscription. It helps us serve you promptly. Write to:

73 magazine

Subscription Department
P.O. Box 931
Farmingdale NY 11737

- | | |
|---|---|
| <input type="checkbox"/> Address change only | <input type="checkbox"/> Payment enclosed |
| <input type="checkbox"/> Extend subscription | <input type="checkbox"/> Bill me later |
| <input type="checkbox"/> Enter new subscription | |
| <input type="checkbox"/> 1 year \$18.00 | |

If you have no label handy, print OLD address here.

NAME _____ CALL _____

ADDRESS _____

CITY _____ STATE _____ ZIP _____

print NEW address here:

NAME _____ CALL _____

ADDRESS _____

CITY _____ STATE _____ ZIP _____

301B55

Listen in Secrecy with a Giant Inductive Loop

— monitor your rig from anywhere in the house — without wires

Fred Johnson ZL2AMJ
15 Field Street
Upper Hutt, New Zealand

My late father (Joe ZL2GA) developed a hearing impairment in later life and was outfitted with a number of hearing aids of various types. Several had "telephone" coils fitted in them. These use a pick-up loop or coil which can be switched in place of the normal hearing-aid microphone. The loop is held

alongside the telephone or its earpiece so that stray energy from the induction coil or telephone earpiece can induce a signal into the loop. It is then amplified and fed to the hearing-aid earpiece.

By this means, a deaf person can hear on the telephone far more effectively than with the normal telephone earpiece or with an amplifier-type telephone. The characteristics of the hearing aid can be tailored to fit the hearing deficiency of the individu-

al.

On an occasion when my father visited me, he mentioned that he would like to feed the audio output of his amateur receiver to his hearing aid directly, to avoid the loudspeaker-to-hearing-aid audible link. This would give better acoustic quality for his particular hearing requirement and would eliminate other shack noises from being picked up by the hearing-aid microphone. A simple experiment quickly showed that these hearing

aids are not only useful for the amateur with a hard-of-hearing problem, but are useful for the amateur with good hearing, too. Many useful amateur radio applications are possible, plus some other useful applications, too. This article outlines several uses to which hearing aids with induction or telephone coils can be put.

The Loop Around the House

Five turns of 25-gauge enameled wire were wound around the house. Fig. 1 shows the scheme. The house is two-story over most of its area. The loop was wound around at the upper-floor level by simply winding it around the outside! The number of turns on the loop does not appear to be critical; five to ten have been found to be adequate. The position of the loop is not critical; anywhere between floor and ceiling seems to be satisfactory. Several houses of different styles have been

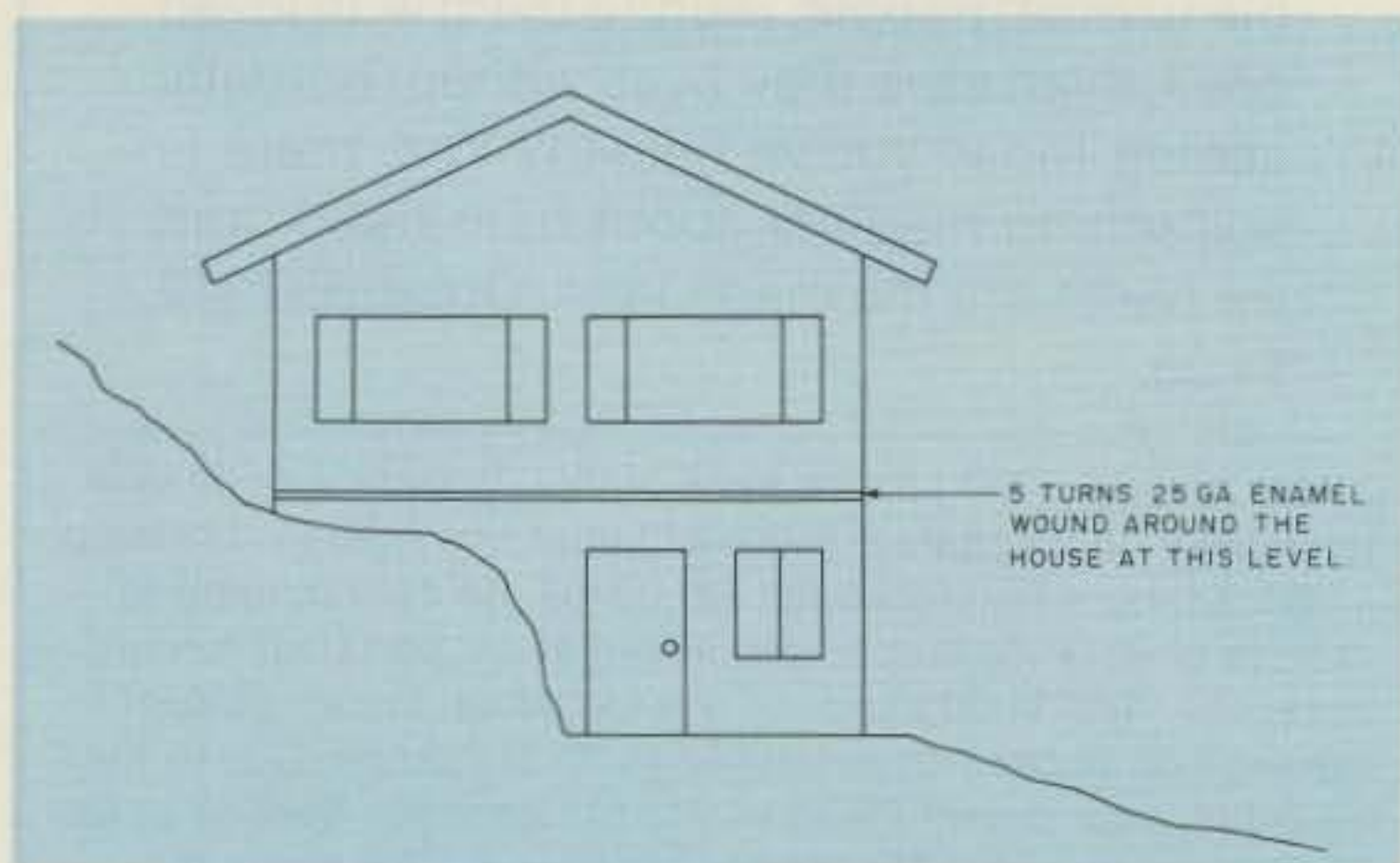

Fig. 1. How one house was wired for induction-wireless.

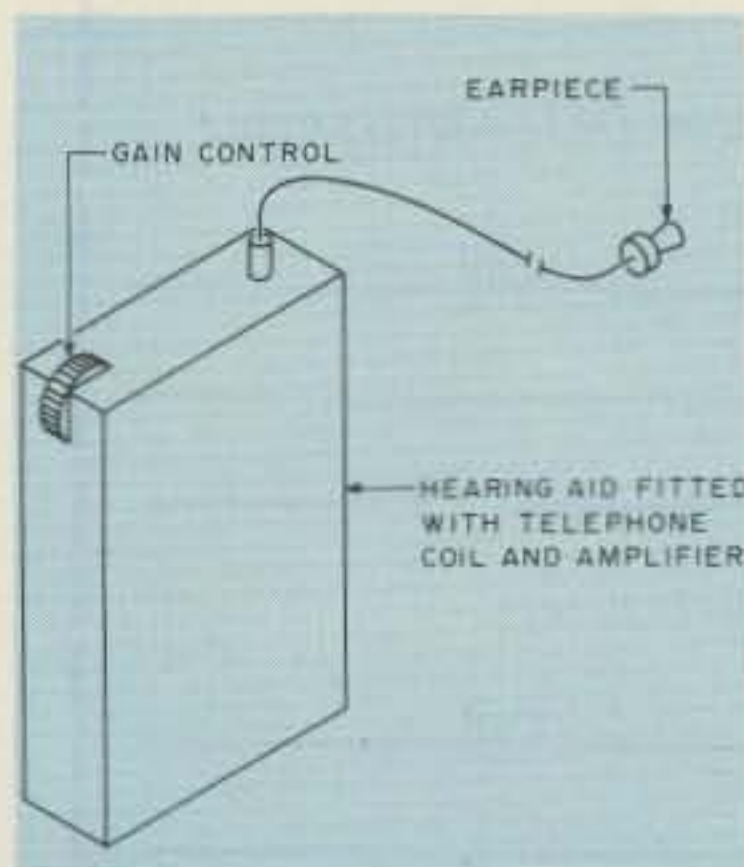

Fig. 2. A simple induction-loop receiver.

fitted, and all installations seem to work effectively.

The loop could be made from one turn of a multi-conductor cable (if you have a suitable length available) by connecting the individual conductors in series to form a multi-turn loop. The gauge of wire used does not seem to be critical.

The two ends of the loop are connected in place of the loudspeaker in the receiver or tape recorder that you wish to monitor. An "external speaker" socket can be used. The audio gain setting should be about the same as that for normal room loudspeaker use. No damage appears to have been done to any audio amplifier by the removal of its usual loudspeaker and replacement with this unusual load. I have used the loop with my two-meter gear for monitoring the local repeater. It can also be used on my FT-101B on the HF bands so that if I have to leave the shack, I can continue to listen to the rig unhindered as I move about the house.

Coverage

Testing coverage from this induction-wireless unit is rather like checking the coverage of a two-meter repeater, but the distances are smaller! There are nulls and peaks and extensive areas of first-class coverage. The signal level falls quite quickly outside the loop, but is usable to about one loop-diameter or more away. My loop covers most of my property. In a two-story house, excellent coverage is obtained across both levels.

The Receiver Units

Hearing aids with telephone coils make excellent monitors. Two general types have been tried. The hearing aid with

separate earpiece (Fig. 2) is a good unit to use for persons with normal hearing. It fits in a pocket and can be carried easily. Quite simply, if you wish to leave the shack, switch from speaker to loop and grab the hearing aid. Push earpiece into ear, switch on, set audio level, and put unit in pocket. You can then wander about the house monitoring the shack receiver as you go.

The spectacle-type aid (Fig. 3) also works very effectively as an induction receiver. It is ideal for persons who are hard-of-hearing and who have spectacles already fitted. Some spectacles have amplifiers fitted into each side-piece but usually only one is fitted with a telephone coil. Spectacle receivers are a bit elaborate for a person with normal hearing to use, but a very good application will be given later.

Power-line hum problems are not serious. The signal-to-hum ratio is generally such that the hum is not noticed. The response characteristics of the hearing aids reject signals at the low-frequency end of the audio spectrum hence minimizing the hum problem.

It is quite uncanny to walk about an absolutely quiet home and monitor amateur signals via a pair of spectacles with no one else listening. Secret listening applications suggest themselves!

Audio-Coupled Listening

Other applications for induction-wireless become possible. It is not always convenient to wind a loop around a house. For short-range and portable use, a ferrite rod (from an old broadcast radio) can be used. It is wound for its full length with 25-gauge enameled wire and connected in place of a speaker in a receiver. The

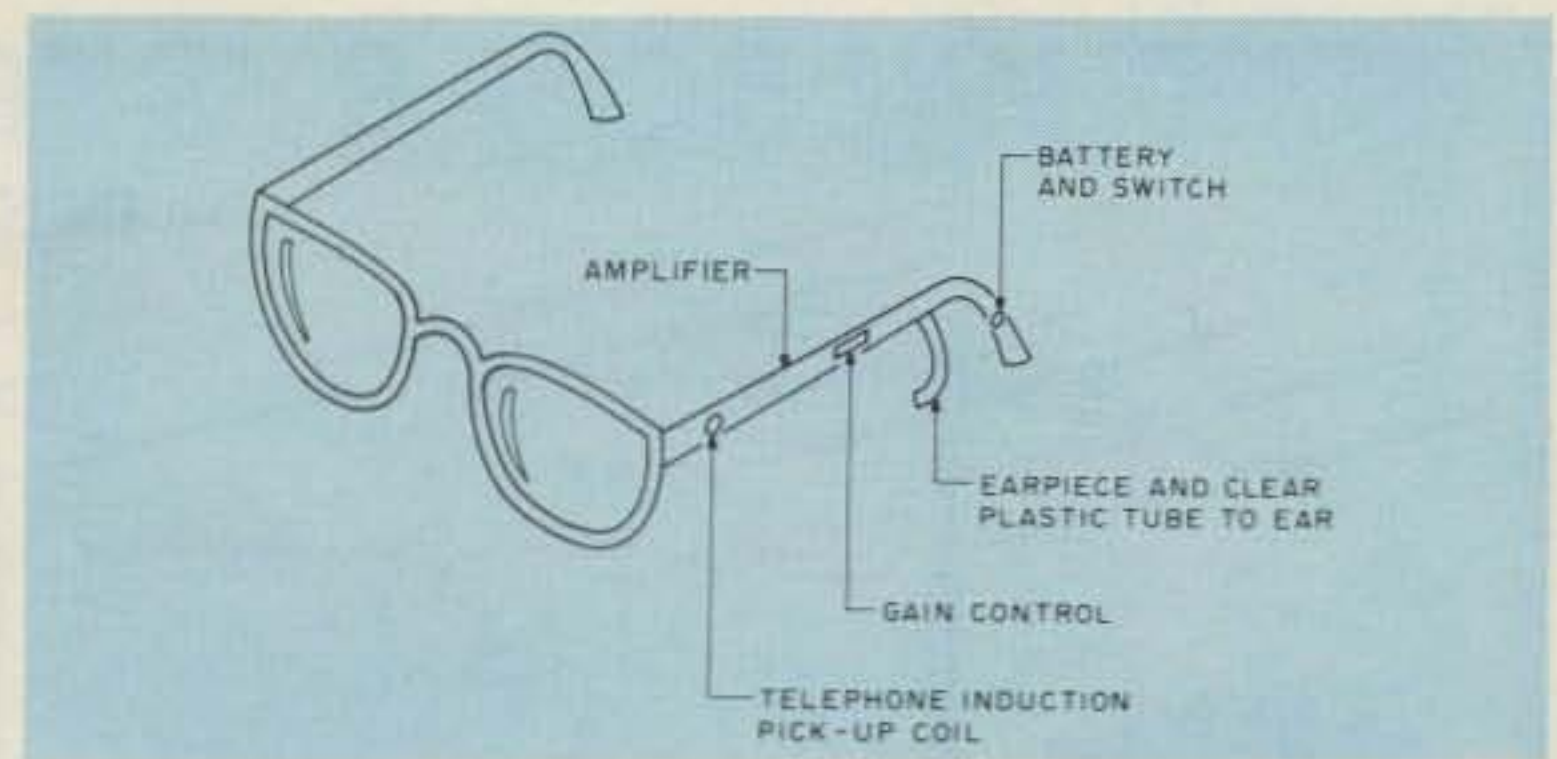

Fig. 3. Hearing-aid spectacles fitted with a telephone coil.

rod can be placed under a shelf above a rig and this gives close-area directional coverage. The number of turns or quality of ferrite used does not seem to be critical. By this means, a deaf person can operate his rig using his spectacles for listening.

Secret Listening

A small broadcast-band radio has been fitted with such an added ferrite rod wound with wire and connected in place of its speaker. It can radiate to spectacles over some six feet or more. This means that "no-wire" private listening to the radio is possible—secret listening with no one else hearing it (see Fig. 4).

I have attended meetings (which I knew were going to be boring) and have listened to a radio located in my briefcase alongside my chair without anyone else hearing it or knowing about it. Anyone spotting the frames of my spectacles would assume I was going deaf—and I probably got undeserved sympathy as a result!

Conclusion

Other applications for induction-wireless soon present themselves. For monitoring the local repeater or a net when you have to leave the shack, it is excellent. It is unfortunate that a multi-channel system is not as simple!

If you have to wear spectacles fitted with a hearing aid, and if your hearing aid

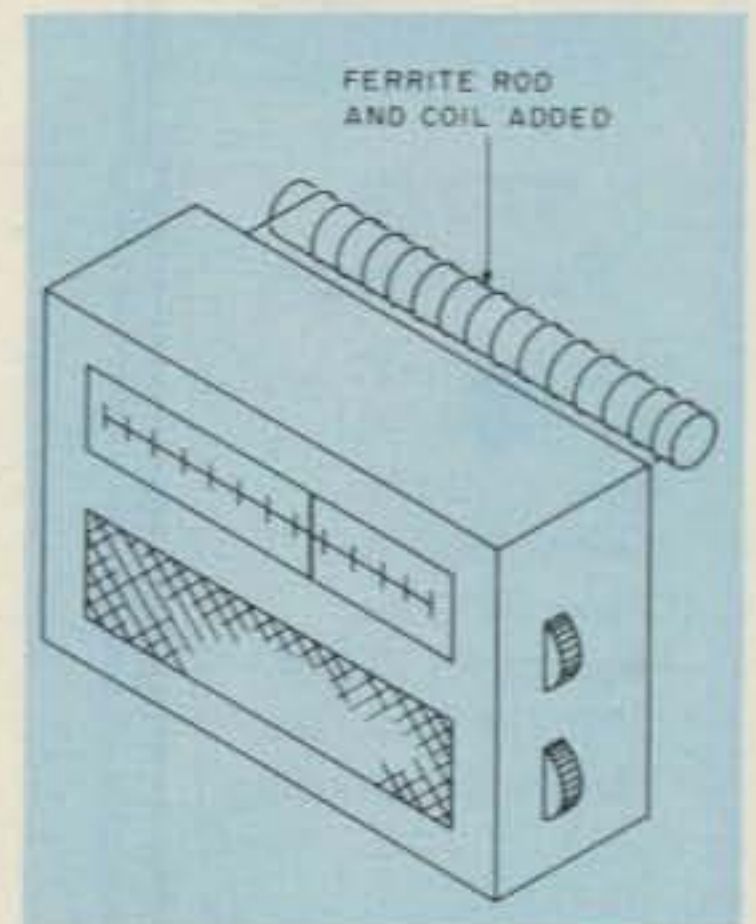

Fig. 4. A receiver fitted for "secret listening."

is fitted with a telephone coil, then I expect that you will be delighted to fit a loop around your shack or house and listen to your receiver through your spectacles. You will find it very convenient, and it does not disturb the other occupants in the house—they hear nothing!

My father, Joe ZL2GA, was intending to write an article on this topic to help others who were hard-of-hearing and whom he considered would gain enormous benefit from this induction-wireless system. He became a silent key before he completed the task, so I have done the job for him. My grandfather was deaf, my father was deaf, and my turn will come. It will not be a handicap if I can put a pair of hearing-aid spectacles to other use!

I am interested in corresponding with others who have experimented with audio-coupled wireless systems of this type. Good listening! ■

WILSON SYSTEMS TOWERS

— IN STOCK —

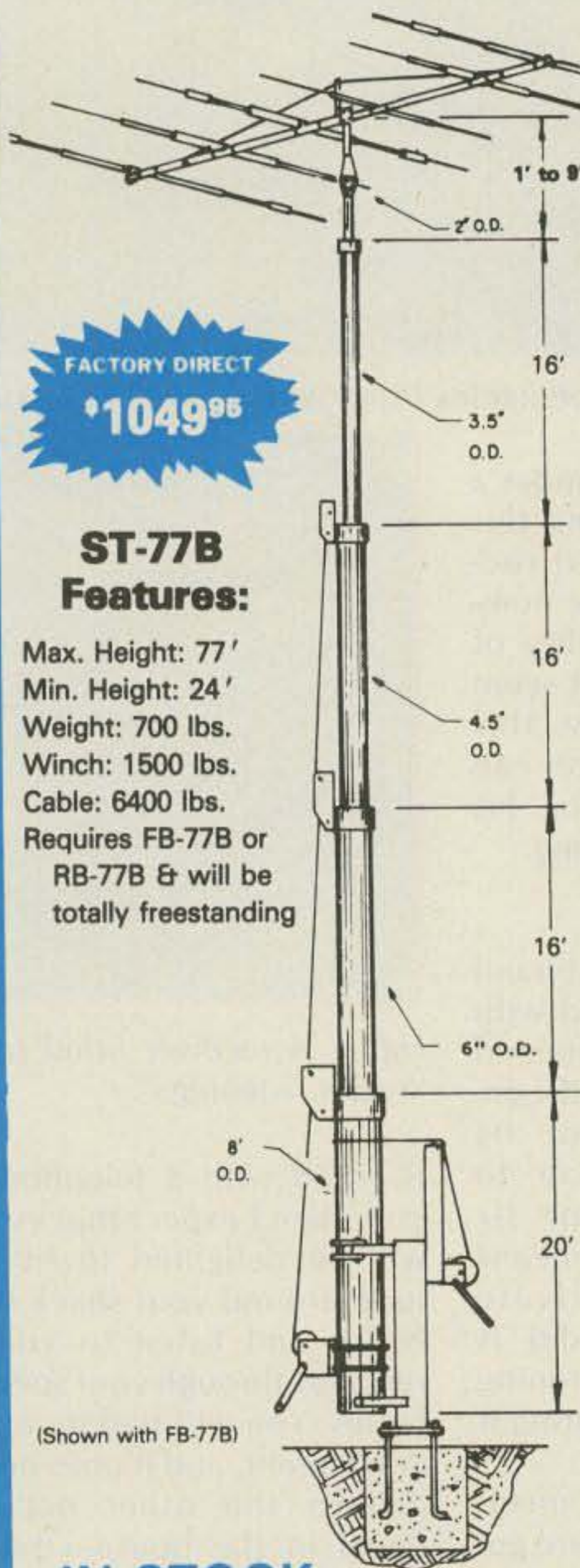

FACTORY DIRECT
\$1049⁹⁵

ST-77B Features:

Max. Height: 77'
Min. Height: 24'
Weight: 700 lbs.
Winch: 1500 lbs.
Cable: 6400 lbs.
Requires FB-77B or RB-77B & will be totally freestanding

(Shown with FB-77B)

IN STOCK

FACTORY DIRECT
\$589⁹⁵

MT-61B Features:

Max. Height: 61'
Min. Height: 23'
Weight: 450 lbs.
Winch: 1200 lbs.
Cable: 4200 lbs.
No Guys required when mounting against house.
For completely freestanding installation, use RB-61B or FB-61B below.

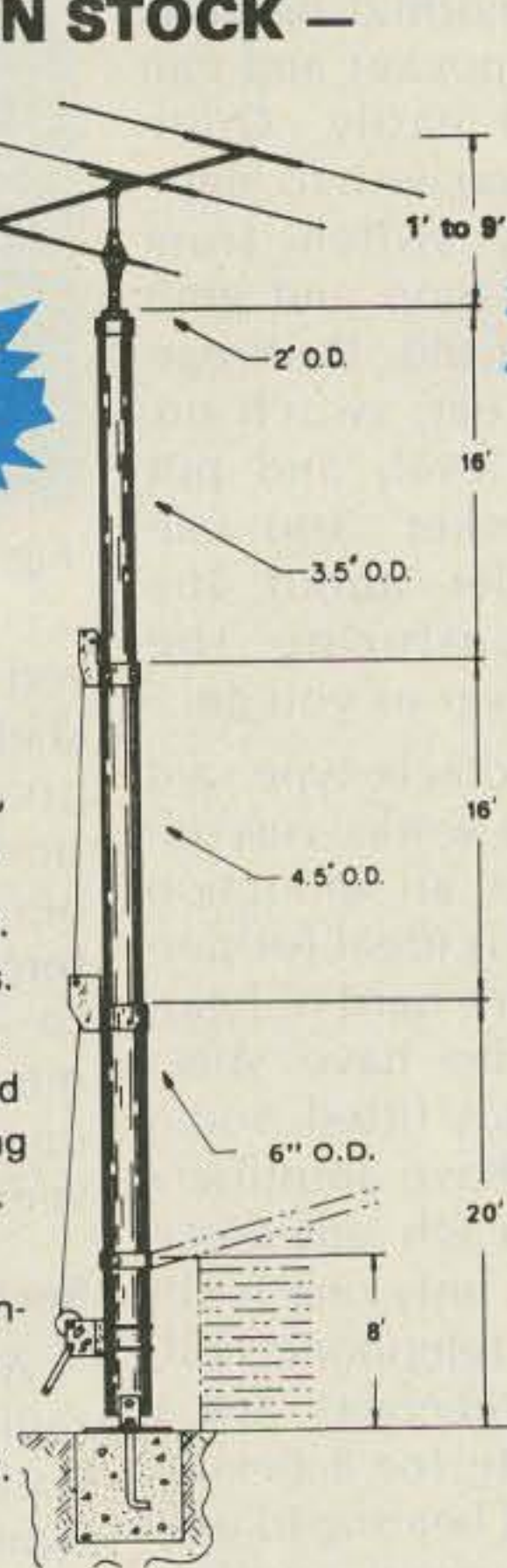

FACTORY DIRECT
\$379⁹⁵

TT-45B Features:

Max Height: 45'
Min. Height: 22'
Weight: 250 lbs.
Winch: 1200 lbs.
Cable: 4200 lbs.
No Guys required when mounting against eve of house.
For completely freestanding installation, use RB-45B or FB-45B below.

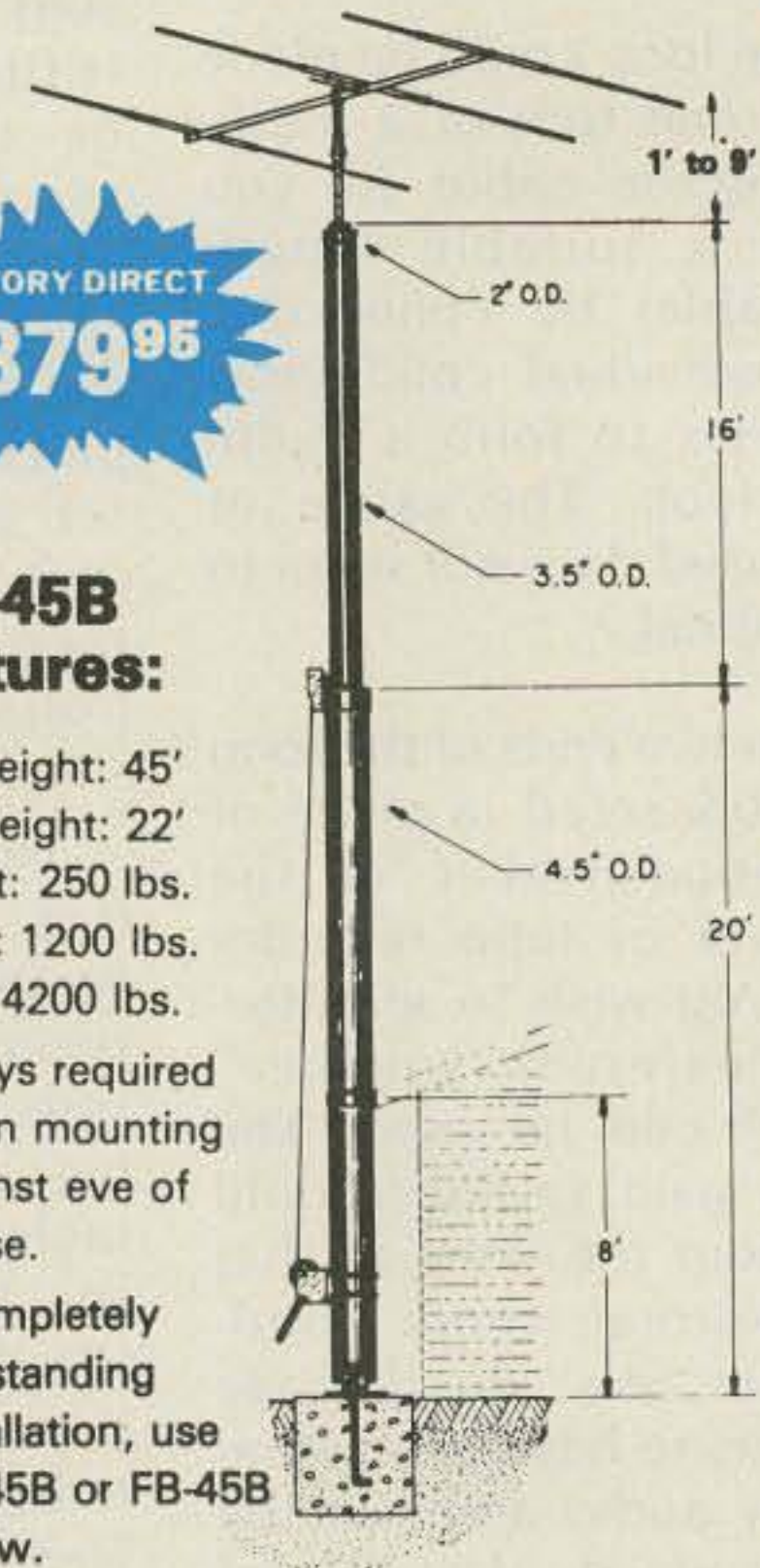

WIND LOADING			
Tower	Height	Sq. Ft.	Square Footage Based on 50 MPH Wind
ST-77B	69	18	
	77	12	
MT-61B	53	18	
	61	12	
TT-45B	37	18	
	45	12	

BASE CHART		
TOWER	WIDTH	DEPTH
TT-45B	12" x 12"	30"
FB-45B	30" x 30"	4 1/2'
RB-45B	30" x 30"	4 1/2'
MT-61B	18" x 18"	4'
FB-61B	3' x 3'	5 1/2'
RB-61B	3' x 3'	5 1/2'
ST-77B	See Below	Bases
FB-77B	3 1/2' x 3 1/2'	6'
RB-77B	3 1/2' x 3 1/2'	6'

Wilson Systems uses a new high strength carbon steel tube manufactured especially for Wilson Systems. It is 25% stronger than conventional pipe or tubing. The tubing size used is: 2" & 3 1/2"-.095; 4 1/2" & 6"-.125; 8"-.134. All tubing is hot dip galvanized. Top section is 2" O.D. for proper rotor and antenna mounting.

The TT-45B and MT-61B come complete with house bracket and hinged base plate for against-house mounting. For totally freestanding installation, use either of the tilt-over bases shown below.

The ST-77B can not be mounted against the house and must be used with the tilt-over base FB-77B or RB-77B shown below.

TILT-OVER BASES FOR TOWERS

FIXED BASE

The FB Series was designed to provide an economical method of moving the tower away from the house. It will support the tower in a completely free-standing vertical position, while also having the capabilities of tilting the tower over to provide an easy access to the antenna. The rotor mounts at the top of the tower in the conventional manner, and will not rotate the complete tower.

FB-45B . . 112 lbs. . . \$174.94
FB-61B . . 169 lbs. . . \$249.95
FB-77B . . 250 lbs. . . \$359.95



ROTATING BASE

The RB Series was designed for the Amateur who wants the added convenience of being able to work on the rotor from the ground position. This series of bases will give that ease plus rotate the complete tower and antenna system by the use of a heavy duty thrust bearing at the base of the tower mounting position, while still being able to tilt the tower over when desiring to make changes on the antenna system.

RB-45B . 144 lbs. . \$239.95
RB-61B . 229 lbs. . \$324.95
RB-77B . 300 lbs. . \$489.95

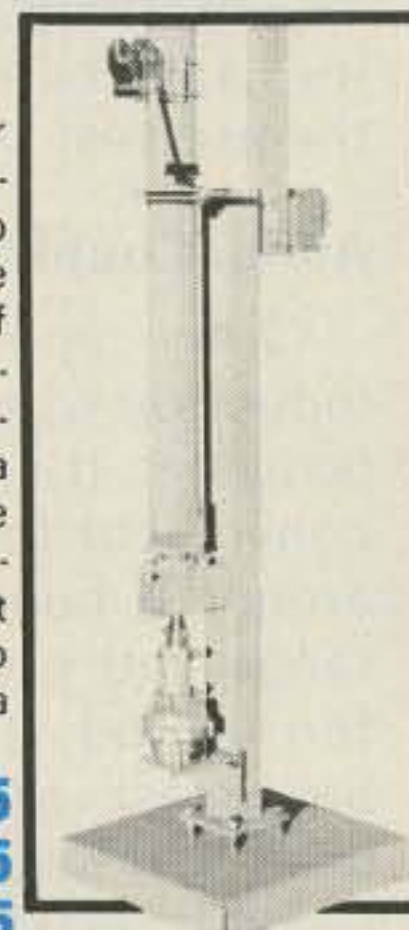

Tilting the tower over is a one-man task with the Wilson bases. (Shown above is the RB-61B. Rotor is not included.)

ORDER
FACTORY DIRECT
1-800-634-6898

W S I WILSON SYSTEMS, INC.

4286 S. Polaris Ave., Las Vegas, Nevada 89103

WILSON SYSTEMS, INC. PRESENTS

THE NEW SYSTEM 40 TRIBANDER

3 MONOBAND ANTENNAS IN ONE — EACH WITH FULL MONOBAND PERFORMANCE

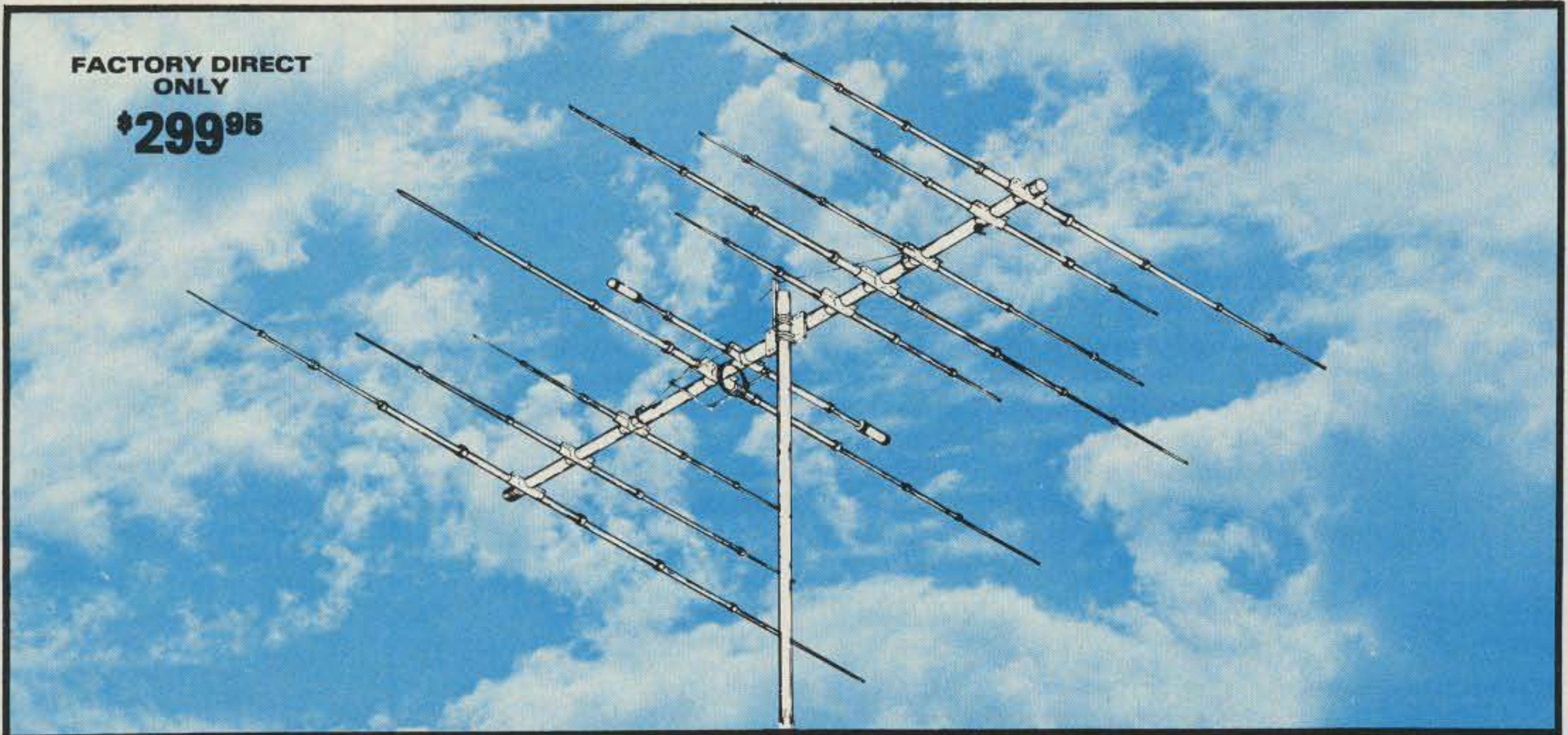

A NEW CONCEPT IN ANTENNA DESIGN USING A 26 FT. BOOM

- FOR THE SERIOUS DXer WHO WANTS MONOBANDERS ON 10-15-20
- FOUR FULL SIZE 20 MTR ELEMENTS WITH 10 dbd GAIN
- THREE WIDE SPACED 15 MTR ELEMENTS WITH 8.2 dbd GAIN
- FOUR WIDE SPACED 10 MTR ELEMENTS WITH 10.2 dbd GAIN
- ONLY ONE FEED LINE REQUIRED
- DESIGNED WITH NO INTERACTIONS BETWEEN ELEMENTS
- ALL DRIVEN ELEMENTS AND DIRECTOR ELEMENTS ARE INSULATED FROM BOOM
- ALL PARASITIC ELEMENTS ARE FULL SIZE
- BROADBAND — NO SEPARATE SETTINGS REQUIRED FOR PHONE OR CW
- SAME QUALITY HARDWARE AS USED IN ALL WILSON ANTENNAS

SPECIFICATIONS

Max. Pwr. Input	Legal Limit	Longest Element	36'
VSWR @ Res	1.2:1	Turning Radius	22' 6"
Impedance	50 ohm	Surface Area	12.1 sq. ft.
Feed Method ..	Coax Balun Supplied	Wind Loading @ 80 mph ..	309 lbs.
Matching Method ..	Modified Beta	Assem. Weight	75 lbs.
F/B Ratio	25 db	Shipping Weight	84 lbs.

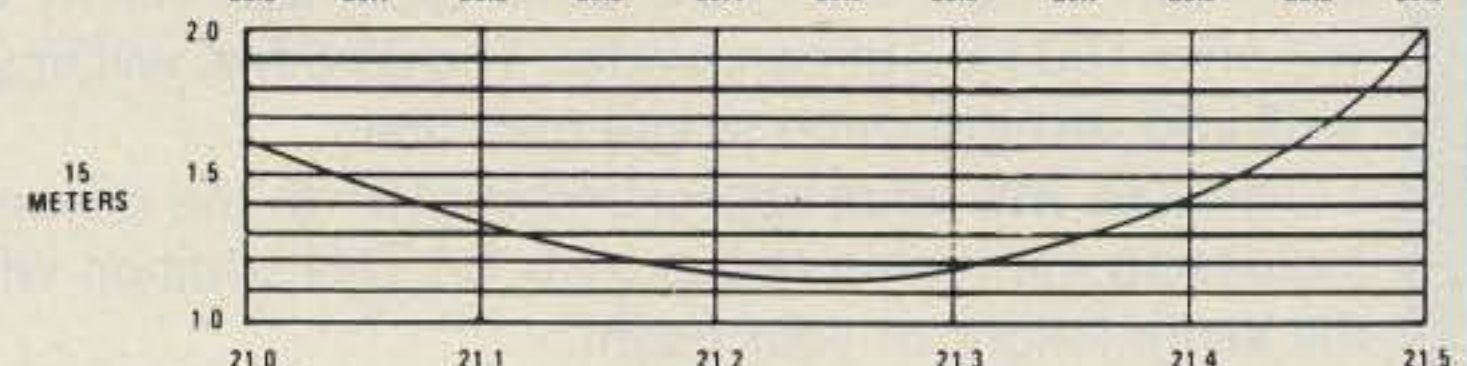
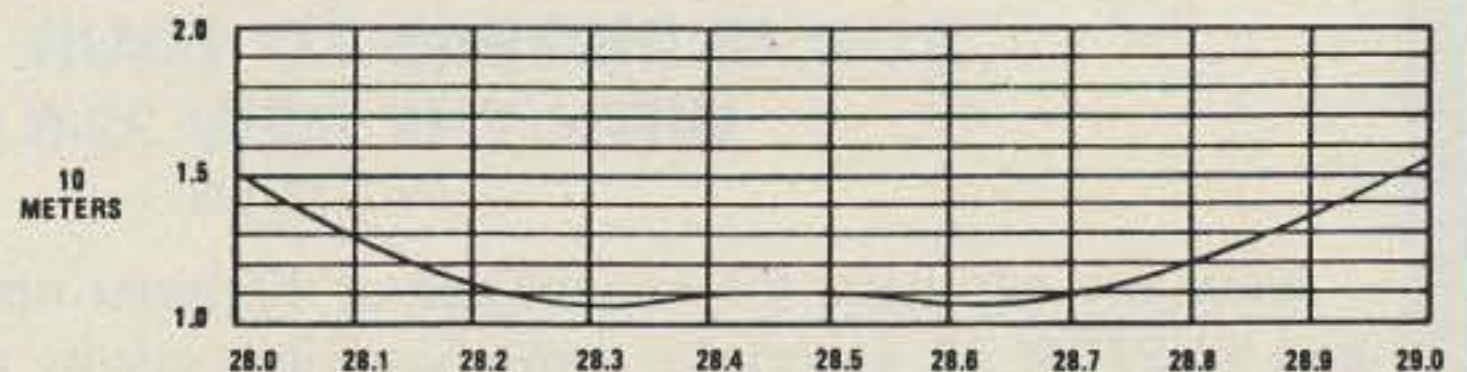
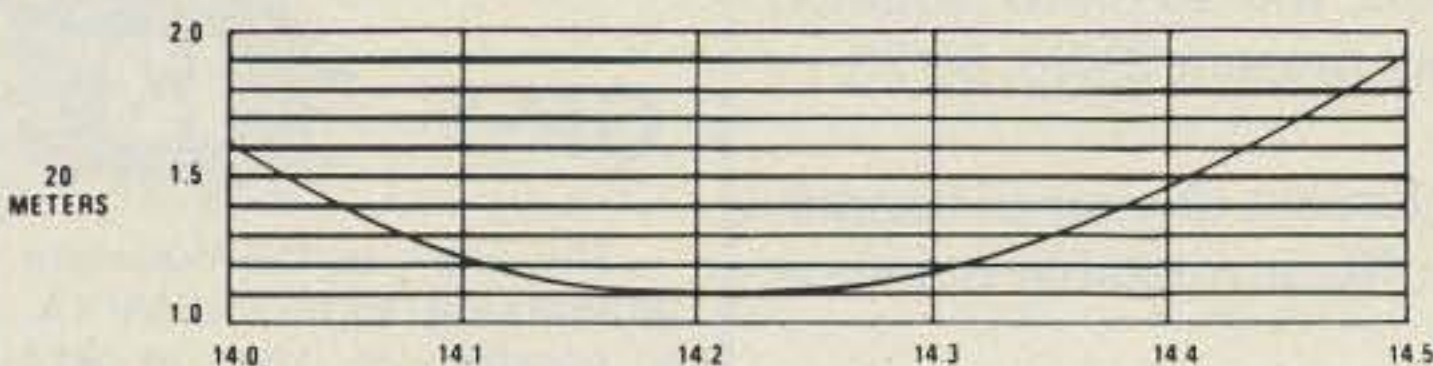

**AVAILABLE ONLY
FACTORY DIRECT
CALL**

1-800-634-6898 TOLL FREE

WSI WILSON SYSTEMS, INC.

4286 S. Polaris Las Vegas, Nevada 89103
PRICES AND SPECIFICATIONS SUBJECT TO CHANGE WITHOUT NOTICE.

SYSTEM 33

\$159⁹⁵

FACTORY DIRECT ONLY

IN STOCK

Capable of handling the Legal Limit, the *SYSTEM 33* is the finest compact tri-bander available to the amateur.

Designed and produced by one of the world's largest antenna manufacturers, the traditional quality of workmanship and materials excels with the *SYSTEM 33*.

New boom-to-element mount consists of two 1/8" thick formed aluminum plates that will provide more clamping and holding strength to prevent element misalignment.

Superior clamping power is obtained with the use of a rugged 1/4" thick aluminum plate for boom to mast mounting.

The use of large diameter High-Q Traps in the *SYSTEM 33* makes it a high performing tri-bander and at a very economical price.

A complete step-by-step illustrated instruction manual guides you to easy assembly and the lightweight antenna makes installation of the *SYSTEM 33* quick and simple.

SPECIFICATIONS

Band MHz.....14-21-28	Boom (O.D. x length) 2" x 14'4"	Wind load @ 80 mph .. 114 lbs
Max. power input... Legal limit	No. elements..... 3	Assembled Wt..... 37 lbs
Gain (dbd)..... Up to 8 dB	Longest element..... 27'4"	Shipping Wt..... 42 lbs
VSWR at resonance..... 1.3:1	Turning radius..... 15'9"	Direct 52 ohm feed
Impedance..... 50 ohms	Max. mast diameter... 2" O.D.	no balun required
F/B ratio..... 20 dB or better	Surface area..... 5.7 sq. ft.	Max wind survival ... 100 mph

ACTUAL SWR CURVES

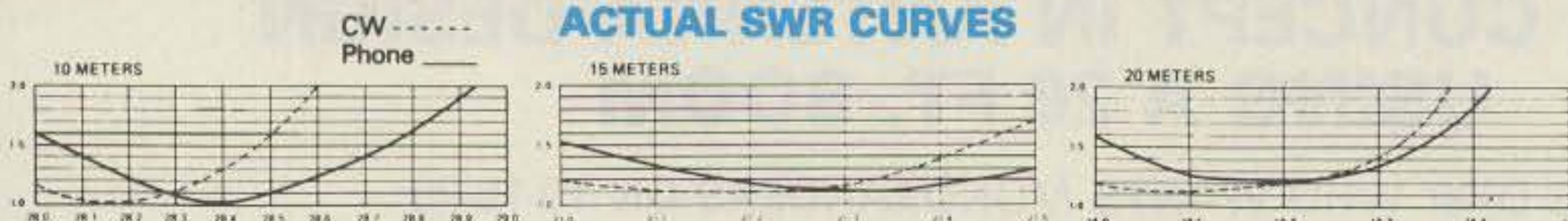

COMPARE THE SY33 WITH OTHERS...

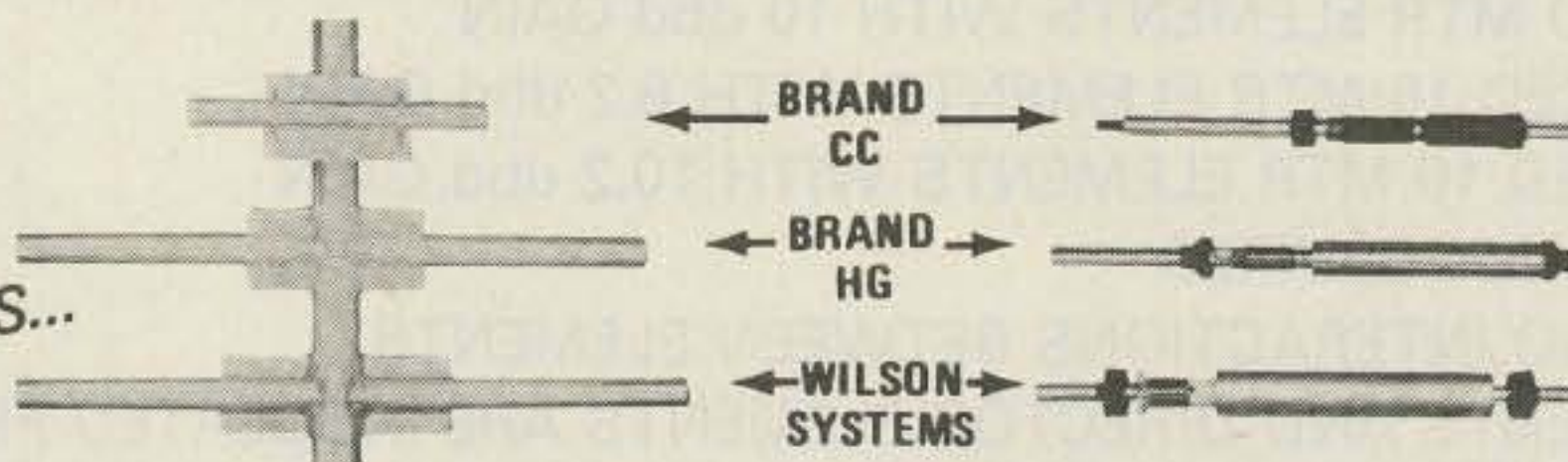

Compare the size and strength of the boom to element clamps. See who offers the largest and heaviest duty. Which would you prefer?

Wilson Systems traps offer a larger diameter trap coil and a larger outside housing, giving excellent Q and power capabilities.

ADD 40 METERS TO YOUR TRI-BAND WITH THE NEW 33-6 MK

— IN STOCK —

\$54⁹⁵

Now you can have the capabilities of 40-meter operation on the *SYSTEM 36* and *SYSTEM 33*. Using the same type high quality traps, the 40-meter addition will offer 150 KHZ of bandwidth. The 33-6 MK will fit your present SY36, SY33, or SY3 and use the same single feed line.

The 33-6 MK adds approximately 15' to the driven element of your tri-bander, increasing the tuning radius by 5'6". This addition will offer a rotatable dipole at the same height of your beam.

W S I WILSON SYSTEMS, INC.

4286 S. Polaris Ave., Las Vegas, Nevada 89103

Prices and specifications subject to change without notice.

ORDER FACTORY DIRECT 1-800-634-6898

\$54⁹⁵

WV-1A

4 BAND TRAP VERTICAL (10 - 40 METERS)

No bandswitching necessary with this vertical. An excellent low cost DX antenna with an electrical quarter wavelength on each band and low angle radiation. Advanced design provides low SWR and exceptionally flat response across the full width of each band.

Featured are the Wilson large diameter High-Q traps which will maintain resonant temperatures with varying temperatures and humidity.

Easily assembled, the WV-1A is supplied with a base mount-bracket to attach to vent pipe or to a mast driven in the ground.

Note: Radials are required for peak operation. (See GR-1 below)

SPECIFICATIONS

- 19' total height
- Self supporting — no guys required
- Weight — 14 lbs.
- Input impedance: 50 Ω
- Powerhandling capability: Legal Limit
- Two High-Q traps with large diameter coils
- Low angle radiation
- Omnidirectional performance
- Taper swaged aluminum tubing
- Automatic bandswitching
- Mast bracket furnished
- SWR: 1.1:1 or less on all bands

GR-1

\$13⁹⁵

The GR-1 is the complete ground radial kit for the WV-1A. It consists of 150' of #12 aluminum wire and heavy duty egg insulators, instructions. The GR-1 will increase the efficiency of the WV-1A by providing the correct counterpoise.

WILSON SYSTEMS, INC.

SYSTEM 36

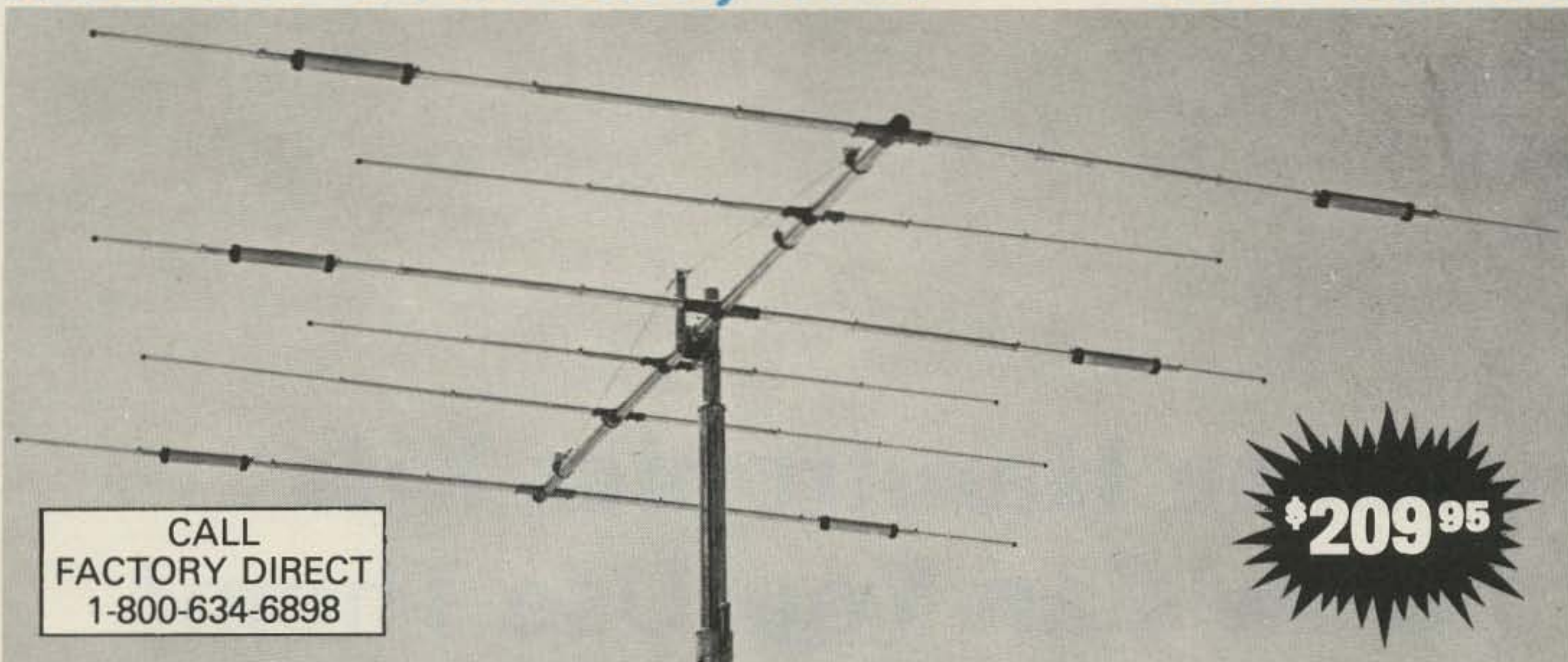

\$209⁹⁵

CALL
FACTORY DIRECT
1-800-634-6898

A trap loaded antenna that performs like a monobander! That's the characteristic of this six element three band beam. Through the use of wide spacing and interlacing of elements, the following is possible: three active elements on 20, three active elements on 15, and four active elements on 10 meters. No need to run separate coax feed lines for each band, as the bandswitching is automatically made via the High-Q Wilson traps. Designed to handle the maximum legal power, the traps are capped at each end to provide a weather-proof seal against rain and dust. The special High-Q traps are the strongest available in the industry.

Compare the SY-36 with others . . .

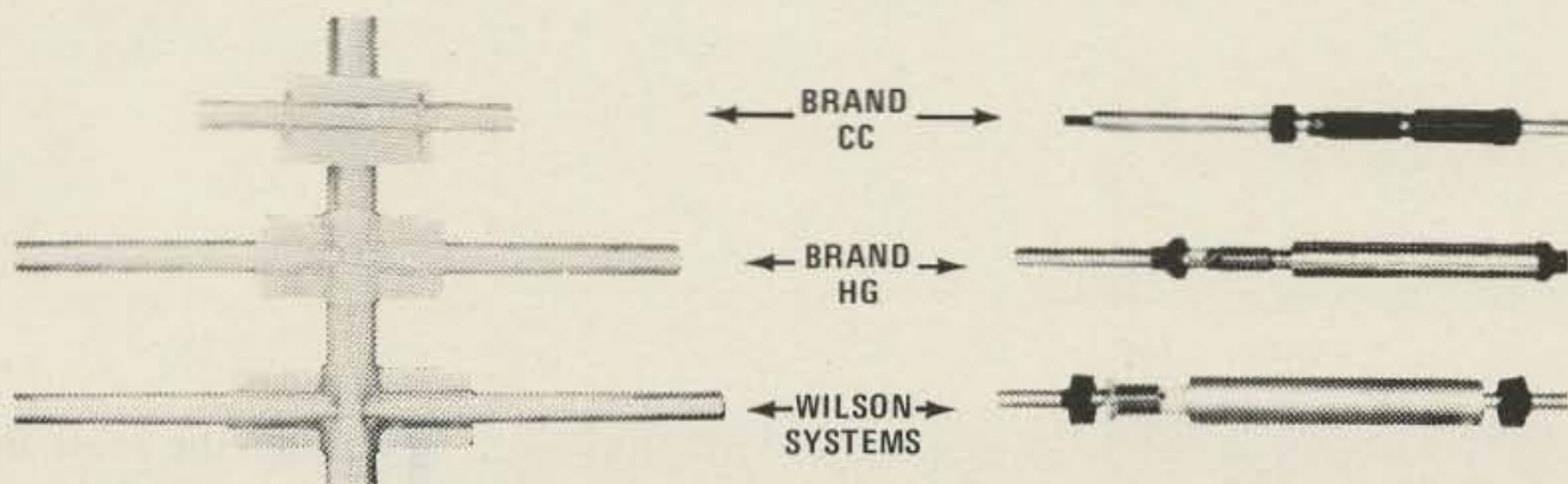

Compare the size and strength of the boom to element clamps. See who offers the largest and heaviest duty. Which would you prefer?

Wilson Systems traps offer a larger diameter trap coil and a larger outside housing, giving excellent Q and power capabilities.

SPECIFICATIONS

Band MGz. 14-21-28
 Maximum power input. Legal Limit
 Gain (dBd) 9 db
 VSWR @ resonance 1.3:1
 Impedance 50 ohm
 F/B Ratio 20 db or Better
 Boom (O.D. x Length) 2" x 24' 2 1/2"
 No. of Elements 6
 Longest Element 28' 2 1/2"
 Turning Radius 18' 6"
 Maximum Mast Diameter 2"
 Surface Area 8.6 sq. ft.
 Matching Method Beta
 Wind Loading @ 80 mph 215 lbs.
 Maximum Wind Survival 100 mph
 Feed Method Coaxial Balun (supplied)
 Assembled Weight (approx.) 53 lbs.
 Shipping Weight (approx.) 62 lbs.

WILSON SYSTEMS, INC. — 4286 S. Polaris
Las Vegas, NV — (702) 739-7401

FACTORY DIRECT ORDER BLANK

Toll-Free Order Number
1-800-634-6898

WILSON SYSTEMS ANTENNAS

Qty.	Model	Description	Shipping	Price
	SY40	10 Ele. Tribander for 10, 15, 20 Mtrs.	UPS	299.95
	SY36	6 Ele. Tribander for 10, 15, 20 Mtrs.	UPS	209.95
	SY33	3 Ele. Tribander for 10, 15, 20 Mtrs.	UPS	159.95
	33-6 MK	40 Mtr. Mod Kit for SY33 & SY36	UPS	54.95
	WV-1A	Trap Vertical for 10, 15, 20, 40 Mtrs.	UPS	54.95
	GR-1	Ground Radials for WV-1A	UPS	13.95
	M-520A	5 Elements on 20 Mtrs.	TRUCK	234.95
	M-420A	4 Elements on 20 Mtrs.	UPS	164.95
	M-515A	5 Elements on 15 Mtrs.	UPS	134.95
	M-415A	4 Elements on 15 Mtrs.	UPS	89.95
	M-510A	5 Elements on 10 Mtrs.	UPS	89.95
	M-410A	4 Elements on 10 Mtrs.	UPS	74.95
ACCESSORIES				
	T*X	Tail Twister Rotor	UPS	269.95
	HD-73	Alliance Heavy Duty Rotor	UPS	109.95
	RC-8C	8/C Rotor Cable	UPS	.12/FT.
	RG-8U	RG-8U Foam-Ultra Flexible Coaxial Cable, 38 strand center conductor, 11 gauge	UPS	.21/FT.

WILSON SYSTEMS TOWERS

Qty.	Model	Description	Shipping	Price
	TT-45B	Freestanding 45' Tubular Tower	TRUCK	379.95
	RB-45B	Rotating Base for TT-45B w/tilt over feature	TRUCK	239.95
	FB-45B	Fixed Base for TT-45B w/tilt over feature	TRUCK	174.95
	MT-61B	Freestanding 61' Tubular Tower	TRUCK	589.95
	RB-61B	Rotating Base for MT-61B w/tilt over feature	TRUCK	324.95
	FB-61B	Fixed Base for MT-61B w/tilt over feature	TRUCK	249.95
	ST-77B	Freestanding 77' Tubular Tower	TRUCK	1049.95
	RB-77B	Rotating Base for ST-77B w/tilt over feature	TRUCK	489.95
	FB-77B	Fixed Base for ST-77B w/tilt over feature	TRUCK	359.95

Prices Effective June 1-30, 1980 Nevada Residents Add Sales Tax
 Ship C.O.D. Check enclosed Charge to VISA MasterCharge

Card No. _____ Expires _____

Bank No. _____ Signature _____

Name _____

Street _____

City _____ State _____ Zip _____

Phone _____

Prices and specifications subject to change without notice.

NOTE:

On Coaxial and Rotor Cable, minimum order is 100' and 50' multiples.
 Prices and specifications subject to change without notice.
 Ninety (90) Day Limited Warranty — All Products FOB Las Vegas, Nevada

Those Hamtronics Kits . . . How Can You Use Them?

— an in-depth look at some electronic bargains

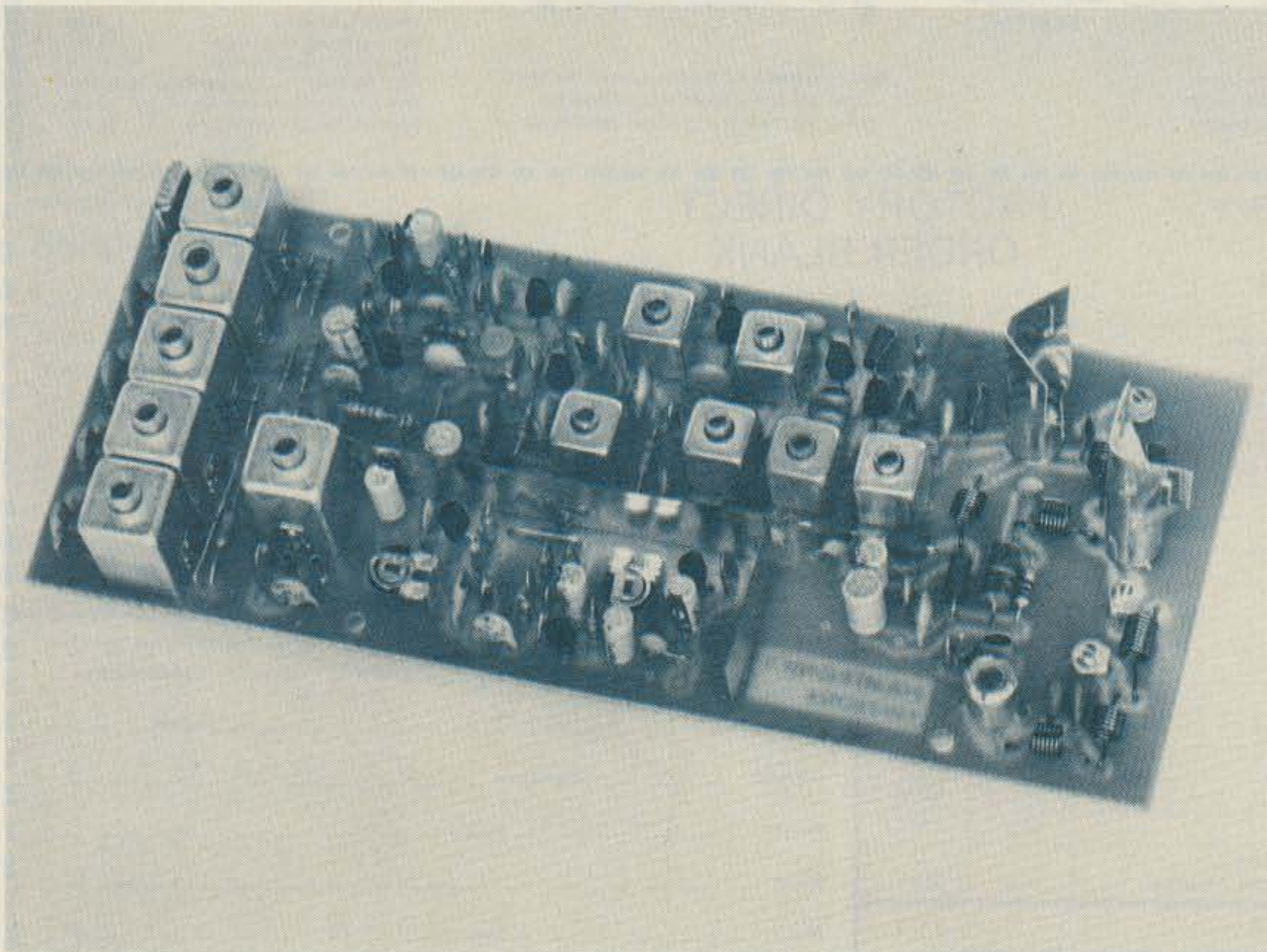

Photo A. T50 FM exciter: a high-quality VHF kit at a low price.

Through the years, many fine companies and products have come and gone in the capricious game of consumer electronics. Ham radio certainly has not escaped its share of casualties. But one company which has been around for a while is Hamtronics, well-known for its quality kits and reasonable prices.

Recently, I decided to have an up-to-date look at their growing catalog to see for myself some of their more recent products. I was so impressed that I decided to take a closer look at some of the kits.

T50 2-Watt VHF Exciter

Designed to put out 2 Watts on any one of three bands (6, 2, or 1¼ meters), this \$44.95 rig will accommodate six crystal-con-

trolled channels. Either narrow-band FM or CW modes may be selected. Individual crystal trimmers allow precise netting for accuracy.

For voice transmission, a trimpot allows adjustment from 0- to 7-kHz deviation. A phase modulator includes audio shaping and filtering for maximum audio punch. Microphone gain is adjustable separately from deviation limitation.

With TVI such a constant problem, I paid particular attention to suppression of unwanted spurious signals. The T50 shielded oscillator and multiplier coils and a three-stage harmonic filter at the output keep harmonics and spurious signals down 60 dB.

The little board measures 3" x 7½" x 2", and requires 13.6 volts dc at 400 mA for full output.

LPA2 Linear Power Amplifier

For the VHF and UHF enthusiast who needs that extra margin of power, I recommend a look at the Hamtronics line of linear power amplifier kits, starting at \$59.95. Requiring only 1- to 2-Watts drive (and thus fully compatible with the T50 exciter and XV2 and XV4 transmitting converters, as well as with most commercial portables), these amplifiers may be ordered for outputs from 15 to 45 Watts! And they may be used on sideband, FM, CW, AM—you name it. They are available for the 50-, 144-, 220-, and 432-MHz bands.

Output transistors are fully vswr protected; they are high-gain, emitter-biased devices.

As with the T50, a 13.6-V dc power supply is required (but at 2 to 8 Amps, depending upon the amplifier chosen and the drive level). Heat sinks are provided with these kits.

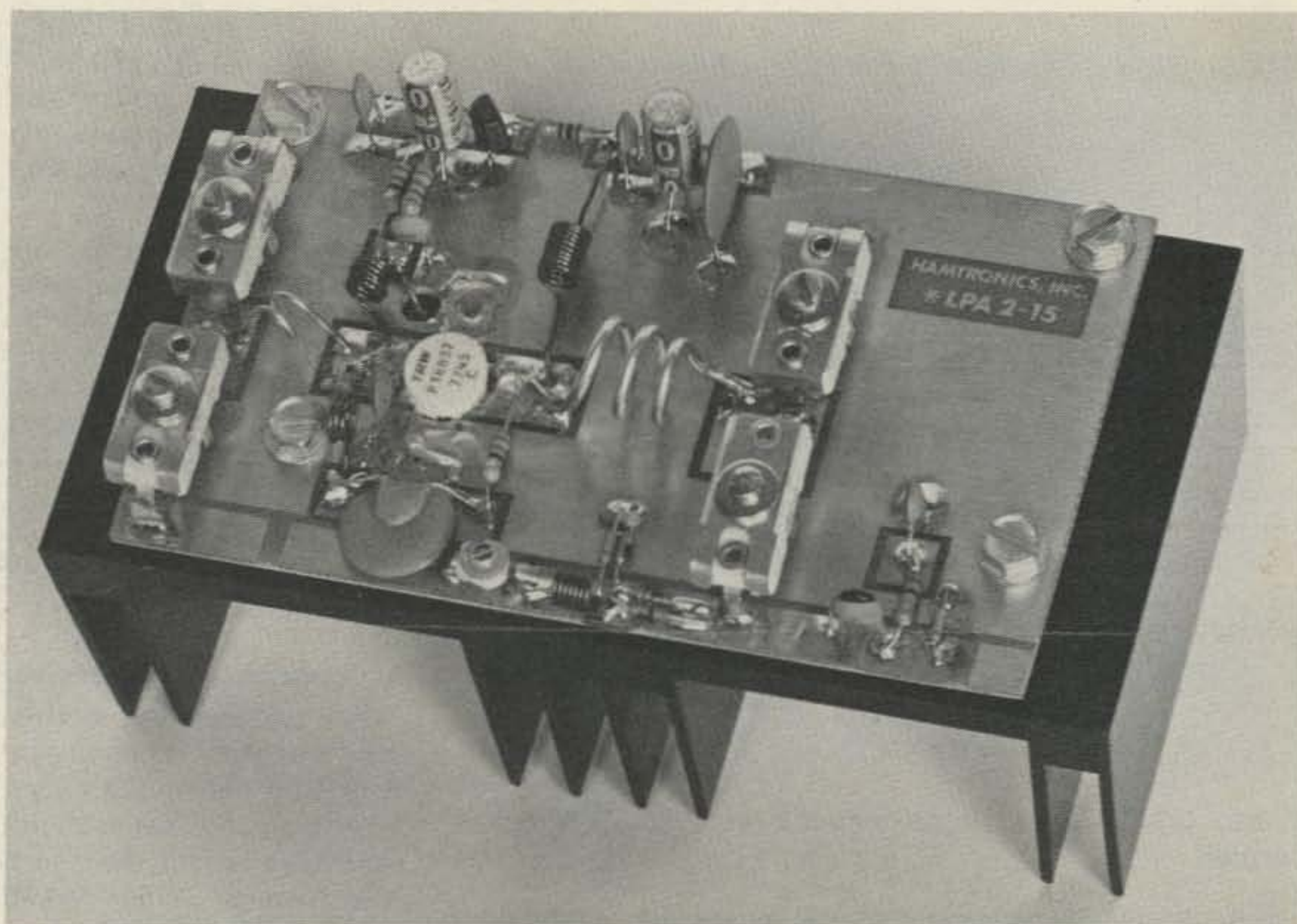

Photo B. LPA2-15 linear amplifier is typical of several Hamtronics power amplifiers for VHF applications.

R75 VHF FM Receiver

For the purist who wants only the best reception on two meters, the R75 single-channel strip receiver should fill the bill. Nominal i-f bandwidth is ± 7 kHz, but filter cascading is available as an option to make passbands very narrow.

Selectivity options for the R75 include 4 increments, from an LC filter (± 30 kHz at 60 dB down) to a razor-sharp 8-pole slicer (± 9 kHz at 60 dB down). Prices are from \$69.95 to \$99.95 for these receiver kits.

I-f boards are available separately for \$20 less than the full kit prices.

Sensitivity is an extraordinary 0.2 microvolts, making the R75 a natural for 136 MHz satellite reception of NOAA/ATS as well as for 143/149 MARS operation.

The low-noise FET front end is gate protected, and shielded double-tuned coils are featured to enhance single-signal reception. The crystal oscillator

is voltage regulated, and a trimmer allows tight calibration.

Built-in test points assure optimum tune-up. The 2-board receiver (rf and i-f/audio) requires 13.6 V dc at 60-150 milliamps and will provide 2 Watts of audio—that's enough for virtually any application!

R85 UHF Receiver

For an additional \$20 over the cost of the R75, you can be the proud owner of a UHF receiver with the same excellent specifications as the VHF version.

This UHF receiver affords an excellent opportunity for those ATV experimenters who don't wish to invest in an expensive commercially-assembled UHF receiver. A matching transmitter will be described shortly.

R110 Aircraft Receiver

With the increased interest among scanner enthusiasts, it isn't surprising that someone has finally offered a VHF aircraft-band receiver. The primary

hitch that has prevented scanner manufacturers from including the aircraft band in their programmable scanners is the fact that while the land mobile services are all FM, aircraft still tenaciously hold on to the AM mode.

While Regency Electronics now offers their Digital Flight Scan receiver, only Bearcat has both land mobile FM and aircraft AM in one receiver (models BC-220 and BC-300).

The Hamtronics R110 receiver kit is an excellent accessory for the owner of FM-only scanners. It is designed for 110- to 130-MHz reception, but can also be used on virtually any frequency from 26- to 220-MHz.

Sensitivity is 0.2 microvolts for 10 dB signal-plus-noise to noise—(S+N)/N. Selectivity is not particularly a problem in the aircraft band, so the receiver has moderate selectivity.

The R110 features 2 Watts of audio, squelch, S-meter output, rf agc circuitry, and a dual-gate MOSFET front end. It is vir-



Photo C. R75 VHF single-channel receiver—a hot performer.

tually the same receiver kit as the R75, and sells for \$74.95.

Pre-amplifier Kits

Not all receivers have the degree of sensitivity we would like. For that reason, Hamtronics offers a fine series of receiving pre-amplifiers to bring up the apparent sensitivities of those questionable front ends. Basically, all a pre-amp needs to do is to bring a weak signal up to a level that can ride over a receiver's inherent noise, and the job is done.

For receiving applications in the 20-to-230-MHz range, the P8 will probably fill the bill. It has two J-FETs in cascade, providing 20- to 25-dB gain with only 2.5 dB of noise! And it will continue to provide that gain within 6 dB with frequency excursions as much as 3% off center frequency.

One possible application of a preamp like the P8 is in the extension of frequency coverage of programmable scanner radios. It is well known that a listener can pick up images of frequencies lower than he can tune, but their signal levels are way down.

Suppose that you would like to hear the ATS satellite at 135.575 MHz; no programmable scanner covers that range in the FM mode. By using the P8 pre-amp tuned to that frequency, you would be able to pick up the image frequency (roughly 21.7-MHz higher) on your scanner! Simply double the i-f frequency and add that number to the received signal frequency. With Regency and Radio Shack programmables (10.7-MHz i-f), simply add 21.4 MHz (ATS would be tuned in at 156.976). For Bearcats, i-fs may be 10.8 or 10.85 MHz, so you would add 21.6 or 21.7 MHz. It's that simple.

The only drawback from such a system is when the preamp also increases signal levels of loud VHF stations on the normal rf pass-band of the receiver. This can cause intermod problems. But the technique is viable in a pinch!

The P8 kit costs only \$10.95; a premium P9 is available for \$12.95 (\$21.95 wired) which boasts lower noise and sharper pass-band (6 dB bandwidth within 2% center frequency).

For UHF, try the P15 pre-amp with 20-dB gain and 5-dB noise figure for any 10-MHz segment between 380 and 520 MHz. (\$18.95 kit; \$27.95 wired).

Scanner enthusiasts may wish to try the image-enhancement receiving technique using this converter to tune in the elusive 406- to 420-MHz government band. As before, add twice the i-f frequency to the desired frequency, and punch up the total on your UHF scanner.

Accessories for the Receiver

For expanding the flexibility of your receiving installation, let me call your attention to several innovative circuits from Hamtronics. Their AS10 scanner adapter permits a four-channel scanning function to be added to any fixed-frequency receiver. Two adapters may be linked for 8 channels, and so on.

The P13 receiving multicoupler allows the use of two receivers simultaneously on one antenna. Any segments of the 26- to 230-MHz range may be selected. The P13 is modeled after the P9 VHF pre-amp, and provides 15-dB gain in each channel.

The A3 multichannel adapter allows a single-channel receiver or transmitter to be multichannelized. It accepts crystal fundamentals from 10 to 20 or 38 to 55 MHz (specify model). The A13 affords six-channel capacity.

XV4 UHF Transmitting Converter

OSCAR Phase III is a snap using this neat little \$99.95 transmitting adapter with your 10-meter transceiver. The XV4 requires a minimum of only 1 milliwatt of drive. (An attenuator will be necessary with most exciters). Output power is 1-1½ Watts on SSB, CW, or FM. Image rejection is down 60 dB.

The circuit utilizes a double-balanced mixer to assure low spurious generation and guarantee easier alignment as well. Two oscillators are provided for remote switching of operating frequency ranges.

Frequency stability is good, too. Thermal drift is less than 200 Hz per hour at constant ambient temperature, or within 1 kHz for 10° F temperature change.

Several options of another version, the model XV2 transmitting converter, are available to allow outputs on 2 or 6 meters as well as 220 MHz. They may be driven by a CB or 10-meter rig.

A novel XV28 transmitter down-converter allows a two-meter rig to serve as an exciter to drive one of the other converters. For example, a two-meter transceiver connected to the XV28 will now have an output in the 28-MHz region. This signal may be injected into an XV4 for 432-MHz operation.

Hams who have not yet had the experience of operating 432 have a treat in store. OSCAR Phase III, amateur fast-scan TV, UHF repeaters, and other operating modes await the newcomer to UHF ham radio. It is especially active in metropolitan areas. The Hamtronics transmitting converters permit one of the most cost-effective ways I know of to get quality hands-on exposure to this interesting portion of the spectrum.

Hamtronics provides an unusual opportunity for the home builder to acquire quality equipment at wholesale prices. Try to buy the parts alone for one of these kits, and you'll see what I mean!

A copy of the new 1980 catalog can be obtained by writing: Hamtronics, 65F Moul Road, Hilton NY 14468. ■



Tempo Handheld!

800 CHANNEL SYNTHESIZED TRANSCEIVERS

- S-1 264.50 2 Meter
- S-1T 299.95 With Tone Pad
- S-2 315.00 220 MHz
- S-2T 359.00 With Tone Pad

Amateur equipment accessories & antennas.
Amateur & commercial repair service.
COD's USA. Export anywhere.



✓ 301

2317 Vance Jackson Rd. San Antonio, TX 78213
(512) 734-7793

AN/APR-4Y AM & FM Receiver—115 Volts 60 Cycle for Frequencies 38 to 4000 megacycles. **\$79.50**
(Tuning Units Available P.U.R.)

AN/ART-13 Transmitter for 80, 40, 20 and 10 meters. 100 Watts Output on AM, CW & MCW.

With all tubes **\$59.50**

SCR-522 TRANSMITTER-RECEIVER 100-156 mc. Crystal Controlled on 4 Channel. Excellent condition.

All tubes **\$42.50**

ARC-5 TRANSMITTER with all tubes and crystal Brand new (BC-457-4.5.3mc. . . . BC-458-5.3-7mc.). **\$16.95**

AC POWER SUPPLY for above transmitter completely wired and tested. New **\$26.50**

R-28/ARC-5 VHF RECEIVER Crystal Controlled on 4 channels. 100-156 MC Excellent used cond. **\$27.50**

T-23/ARC-5 VHF Transmitter. Crystal Controlled on 4 channels. 100-156 mc. **\$29.50**

DM-32 Dynamotor, New **\$3.95**

R-23/ARC-5 RECEIVER 190-550 KC continuous tuning used, with all tubes **\$16.95**

ARR-2 RECEIVER 234-238 MC. New **\$10.95**

Write for catalog — send 50¢ for postage.

Write for low prices on all types of tubes.

Terms: F.O.B. NYC. 25% deposit with order, balance COD or remittance in full. Subject to prior sale and price change.

G&G Radio Electronics CO. ✓ 302
45-47 WARREN ST.
NEW YORK, NY 10007 Ph. 212-267-4605

CB TO 10 METER

10 METER CONVERSION KITS FOR CB RADIOS AM-FM & SSB

- Kits for over 300 Models of CB Radios
- Low Cost from \$10.00
Easy to Install with All Instructions
Tune-Up Procedure Alignment
- KITS FOR MOST POPULAR UNITS
Over 5,000 Satisfied Customers
- Write or Call Today for Our Free
1980 Catalogue

AMERICAN CRYSTAL SUPPLY COMPANY

PO Box 638
W Yarmouth, MA 02673
(617) 771-4634 ✓ 7

SYNTHESIZED SIGNAL GENERATOR



• Covers 100 to 179.999 MHz in 1 kHz steps with thumb-wheel dial • Accuracy .00001% at all frequencies • Internal frequency modulation from 0 to over 100 kHz at a 1 kHz rate • Spurs and noise at least 60dB below carrier • RF output adjustable from 50 to 500mv across 50 ohms • Operates on 12vdc @ 1/2 amp • Price \$299.95 plus shipping.

In stock for immediate shipping. Overnight delivery available at extra cost. Phone: (212) 468-2720.

✓ 311

VANGUARD LABS
196-23 Jamacia Ave. Hollis, NY 11423

New SATELLITE For the TV home.



Supersharpe Reception—Color Like Never Before
Get over 50 channels of television directly from the satellite! HBO, Showtime, the Superstations, and sports from around the world!

Works Anywhere!

Buy complete or build and save. Our book tells everything! Send \$7.95 today or call our 24 hr. C.O.D. Hotline! **(305) 869-4283**

SPACECOAST RESEARCH ✓ 309
P.O. Box 442, Dept. G, Altamonte Springs, FL 32701

Subscription Problem?

73 Magazine does not keep subscription records on the premises, therefore calling us only adds time and doesn't solve the problem.

Please send a description of the problem and your most recent address label to:

73 Magazine
Subscription Dept.
PO Box 931
Farmingdale, NY 11737

Thank you and enjoy your subscription.

Clegg is VHF Headquarters!

SELECTED PRODUCTS FROM CLEGG AND FRIENDS!!

CLEGG FM-88

Fully synthesized
143-148.995 in 5 KHZ steps.
CAP & MARS coverage
Variable power (1-25w)
1 year warranty

CLEGG FM-88S

All of the great features of the FM-88 Plus
800 channel programable scanner

CLEGG MARK-3 & FM-76

12 channel crystal controlled
MARK-3 — 146-148 MHZ
FM-76 — 220-225 MHZ

CLEGG ALL BANDER AB-144

Converts your "ALL-MODE"
2 meter transceiver to General
Coverage Receiver.
100 KHZ to 30 MHZ

CLEGG TT-2

Solid State Touch Tone encoder featuring
automatic transmitter keying.

CLEGG POWER SUPPLIES

Four popular models
PS-7A-7 Amp
PS-12A-12 Amp
PS-20A-20 Amp
RS-35A-35 Amp

ANTENNAS BY:
ASP, CUSHCRAFT, HUSTLER, KLM

POWER METERS BY:
MIRAGE

AMPLIFIERS BY:
MIRAGE AND KLM

SSB TRANSCEIVERS BY:
ICOM

HAND-HELDS BY:
ICOM

ROTATORS, TOWERS & CABLES
ALLIANCE
CONSOLIDATED
TIMES WIRE
BERK-TEK

IF YOU'RE GOING TO DO IT ON VHF YOU'LL DO IT BETTER WITH CLEGG AND FRIENDS!

Clegg

Communications Corp.

1911 Old Homestead Lane
Greenfield Industrial Park East
Lancaster, PA 17601
(717) 299-7221

✓ 13

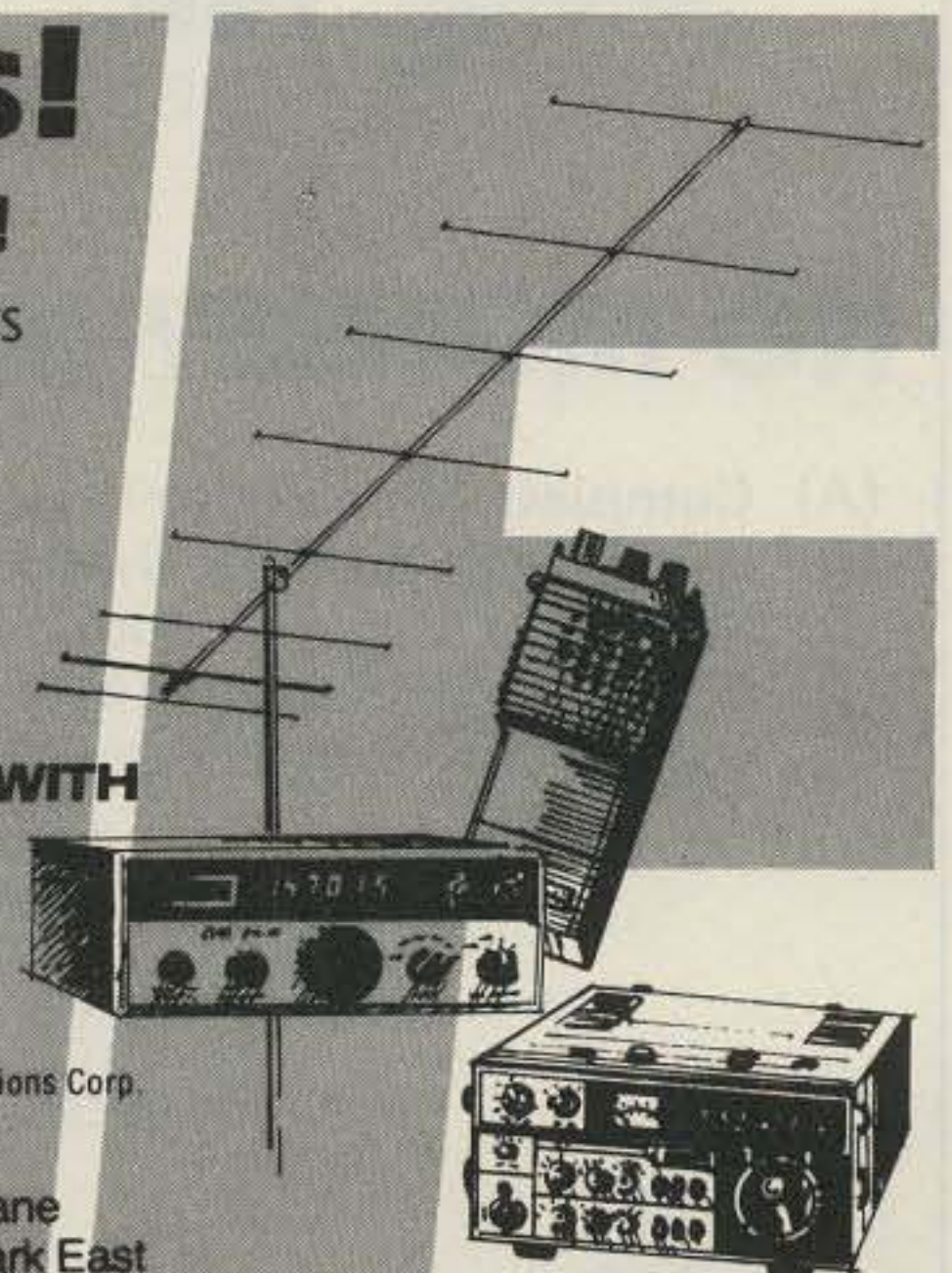

CALL OR WRITE
FOR DESCRIPTIVE LITERATURE:

10 Meters for the SB-221

— add the "missing" band

John P. McNeil WA2KSM
168 Lexington Road
Shirley, L.I. NY 11967

When you finally decide to buy that new Heath amplifier, consider purchasing additional components from the

SB-220 manual. These parts will be substituted into the SB-221 amplifier for TEN-meter operation.

Basically, the SB-221 is the same as the SB-220 amplifier. The tank circuits are similar; only the input network has been changed. What Heath has done to inhibit the 10-meter operation is to remove its input coil, then place low-pass filters across the other coils. In this way, this frequency of operation has been eliminated. When you do come to the input network assembly (SB-221), go to the SB-220 manual, add the additional parts, and wire according to those directions and the schematic.

The band switch must be the SB-220, with the SB-220 plate coil. You finish wiring the SB-221 following the directions of the SB-220 manual.

What I have given you is a direction to follow; from this you can make the necessary front panel modifications for that band we have lost.

It would be interesting for some enterprising individual to come up with a similar article dealing with the feasibility of placing this missing band on the SB-201!

I would like to thank George Sintchak WA2VNV for his assistance in preparation of this article. ■



**Germantown
Amateur
Supply,
Inc.**

MEMPHIS, TENNESSEE

NO MONKEY BUSINESS!

- (A) Complete Service Facilities
- (B) Good Deals on most Brands
- (C) Shipping within 24 Hours
- (D) All inquiries handled by Active Hams with over 20 years experience in ham radio

CALL TOLL FREE
1-800-238-6168

IN TENNESSEE, CALL 901-452-4276
MONDAY - SATURDAY 8:30-5:30
FOR YOUR SPECIAL.

Write: 3202 Summer Ave., Memphis, Tennessee 38112

Parts List			
Quantity	Heath Part	Description	Cost
1	595-1122	SB-220 manual	\$3.00
2	40-964	10/15m input coil	1.00
1	40-966	40m input coil	1.15
1	40-968	Plate coil	5.50
2	20-124	115 pF capacitor	.90
1	20-103	150 pF capacitor	.40
1	20-120	220 pF capacitor	.45
2	20-113	470 pF capacitor	1.20
2	20-99	22 pF capacitor	.80
1	63-562	Rotary switch wafer	6.10
1	63-561	5-position rotary switch	6.90
Total			\$27.40



NOW - THE NEW

AMCODER

IT'S EVEN BETTER!!!

4" x 2 3/8" x 6"

- Still only 40hz wide. Single signal - no QRM/QRN reception. Immune to impulse (ignition) noise.
- Still tape quality audio with TTL compatible signal for computer interface applications. No noise appears in the AMCODER output.
- NOT A FILTER!! Its CW regeneration.
- NOW - dig into the noise for the weak ones without front end overload with our new AGC module. No locking on noise.
- No mods to your gear. Just plug into phone jack. Speaker or phone outputs with bypass switching when not in use. No external power required.
- 26DB dynamic range (5 to 6S unit fade margin) with AGC module when properly adjusted.
- Constant level input to the AMCODER regardless of receiver audio level with either S-1 or 3D over 9 signals. (Works on phone signal levels too) with the AGC module.
- Still reduced operator fatigue, variable frequency acquisition, 400-1400hz and variable frequency output tone (and smoother).
- Still variable output level for station speaker or head phones.

Complete kit (Less AGC option) (Cabinet included)	\$79.95
AGC Module (only FWT) for older AMCODERS	29.95
AGC Module (Only FWT) for new AMCODERS	29.95
New AMCODER Factory wired & tested With AGC Module installed	94.95 119.95
Foreign - Add \$20.00 - all in U.S. Funds. Ship your old AMCODER to AMC for updating and installation of AGC module - we pay for return shipping	32.50

VISA & Mastercharge Accepted
Maryland residents - add 5% Sales Tax.
Write for brochure or check reader info card.
AMC ENGINEERING
P.O. Box 427 ✓ 6
Jessup, Md. 20794
Phone: 301-799-7741

ALDELCO ELECTRONICS COMPANY

RF DEVICES	
2N5913 1.7W 175 MHz	\$1.70
2N3866 1W 400 MHz	1.25
2N5589 3W 175 MHz	4.75
2N5590 10W 175 MHz	7.80
2N5591 25W 175 MHz	10.95
2N6080 4W 175 MHz	5.40
2N6081 15W 175 MHz	8.45
2N6082 25W 175 MHz	10.95
2N6083 30W 175 MHz	11.75
2N6084 40W 175 MHz	13.30

OVERVOLTAGE PROTECTION OV-12 Provides protection from runaway Power Supply Voltage. Triggers @ 16V 25 Amp rated, 1 piece moulded unit for 12 Volt DC fused Power Supply \$8.95 OV-5 for 5 Volt PS triggers at 7V \$9.95

ACCUKEYER KIT. Similar to Handbook version. Includes PC Board, IC's, Sockets & all parts. Includes sidetone on board, Iambic operation dot dash memory. Only \$21.95

NEW MEMORY KIT. 1056 bit memory expandable to 4224 bits. 1 2102 supplied. Additional chips \$1.25 each. Led indicator. Adaptable to other keyers. Uses 5VDC. Only \$21.95

Dual digital 12 or 24 HOUR CLOCK KIT. NOW WITH A NEW WALNUT WOOD GRAIN CABINET. Model ALD 5-W. Six Big 0.5 Displays. Only \$52.95 12 or 24 Hour Operation — Each Clock controlled separately. Freeze Feature for Time Set — Easy assembly for clock and Cabinet.

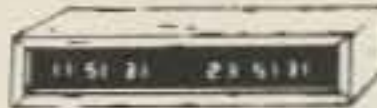

5 x 7 3 dot matrix display 3.95
Handie Talkie collapsible whip ant. BNC 8.95

ALARM CLOCK KIT Six 0.5 LED Display Readouts. Elapsed Time indicator. 12 Hour Format with 24 Hour Alarm Snooze feature. AM/PM indicator. Power Supply power failure indicator. Only \$21.95
12 or 24 Hour Clock Kit. 0.5 Display LED's \$19.95
Wood Grain Cabinet \$4.95

TUNABLE AMATEUR TV CONVERTER. Receive Fast Scan ATV in the 420 MHz Band with any TV Set. Low noise high gain Amplifier stage with Varactor Tuned input and output. Built-in 110 VAC Supply Two Tone Walnut & Beige Cabinet measuring 1-7/8" x 4-1/4" x 4-1/8". Factory Wired & Tested. 2 Year Guaranty. Only \$59.95

Lunch Counter Kit (boards & front panel only)	\$14.50
11C90 Prescaler	\$19.95
1 MHz crystal	\$ 7.95
74C925 Multiplex	\$15.95
10-60 PF trimmer	\$.40
F9368 Drivers (2)	\$15.95
704 displays, each	\$ 1.25
Resistor Kit	\$ 1.75
Capacitor Kit	\$ 6.00

Add 6% for Shipping. Min. Order \$10.00. Out of USA send Certified Check or Money Order. Include Postage.

ALDELCO

2789 A Milburn Avenue, Baldwin, NY 11510
(516) 378-4555

✓ 300 Send 1st class stamp for our catalog.



JAN
CRYSTALS
KEEP
YOU ON
THE AIR

- CB
- CB standard
- 2 meter
- Scanners
- Amateur Bands
- General Communication
- Industry
- Marine VHF
- Micro processor crystals

Send 10¢ for our latest catalog. Write or phone for more details.

Jan Crystals ✓ 39
2400 Crystal Drive
Ft. Myers, Florida 33907
all phones (813) 936-2397



easy to charge



"As You Like It"

SHAKESPEARE AND KENWOOD



Kenwood's big little rig—all solid state with 200 watts input, digital readout, and IF shift. How about five band HF mobile with the available mobile mount? You've heard the quality of this rig on the bands. Join the growing group of hams in the know, running the TS-120S. It's priced at \$699.95, but call for quote!

Here's maximum convenience, maximum performance, and all the features you need for the very best in HF operation. PLL circuitry provides stability, IF shift and available filters provide selectivity, DFC provides versatility and the transmitter provides 200 watts of solid state punch to make you heard. **The retail price is \$1149.99 with DFC, but call for all the information and a quote on this tremendous piece of equipment.**

MADISON

Electronics Supply, Inc. ✓ 45

1508 McKinney • Houston, Texas 77002 • (713) 658-0268



Another Place, Another Time

— working the paranormal band

It was ten years ago that Wayne wondered, in his editorial column, if any ham had ever experienced any supernatural contact in the operation of his hobby. I think I may have snickered at the time, but it wasn't three years later that it happened to me. I have asked Wayne not to release my name or address, as I fear that I would be swamped with letters—letters from parapsychologists right down to the ordinary garden-variety of nuts. I prefer not to get involved. The events I am about to reveal have not been polished into a story; names have been changed.

There were the three of us and our wives. We congregated on two meters every evening—145.1 MHz to be exact. This was back in the AM days, about 1971. How we originally got together, I cannot recall. This triumvirate consisted of Sam, a retired tool and die maker, and his wife, Stella. Then there was Doc, a general practitioner of

medicine, and his wife, Margie. And, me, involved in electronic manufacturing, and my wife, Marian.

It was a rather curious group in that our wives seemed always to be present in the ham shack, offering their comments on the conversations held by the three of us males. At 8 o'clock promptly, you'd hear:

"You there, Doc? How about you, Sam?"

Invariably our QSOs would start in this informal way. Professionally, we could not have been further apart, but from a hobby standpoint we were three typical ham nuts. Over a period of three years we were involved with facsimile, RTTY, fast-scan TV, and just plain yacking into the mike.

Then one evening Sam broke some news. "I'm going to sell this place and head for Oregon. This LA smog is too much for me."

And that's exactly what happened. Sam moved to Oregon, with the comment

that perhaps we'd better move our nightly QSOs to 75 phone so they might be continued.

Well, Doc and I, with the background comments of our wives, continued to prattle on each evening for about six months or so. His wife, Margie, like all Margies I have ever met, was vivacious, peppy, and had a sparkling sense of humor. However, I noticed less and less participation by Margie. One evening at 8 pm the phone rang just as I was about to go on the air. It was Doc.

"Glenn, I thought I had better tell you this on the telephone rather than on the air. Margie is a very sick girl and is in the hospital. It's leukemia and I'm afraid the prognosis is negative." I could hear a sob in his voice as he talked.

Doc was right; a few weeks later, Margie passed on. We, of course, attended the funeral. It was obvious that something within Doc died also when his beloved Margie left this world. I'd

listen at 8 pm, and no Doc. After a few weeks went by, I called him and suggested that ham radio might be a therapy for his mind.

"No, Glenn," said Doc. "I'm selling out and am going to give up the practice of medicine. I'm tired of being a pill dispenser. There are more important things to be done. I'm going to find a cure for leukemia if I have to spend the rest of my life and my savings to do so."

As it turned out, Doc, through his professional friends, was given laboratory space in a large pharmaceutical manufacturing plant. Doc not only worked days, but far into the night. Our contacts were strictly by telephone—and few and far between.

The months rolled by. One day I persuaded Doc to have lunch with me. I was shocked at what he had done to himself, although I said nothing. He had lost a great deal of weight and was just a tired

shadow of himself.

Then it happened. Early one morning the phone rang. It was the plant. The night watchman, making his round about 1:00 am, found Doc on the floor in the laboratory. He detected a faint pulse and immediately called the paramedics. They arrived minutes later and did all they could, but Doc was a goner. He had just worn himself out and his heart gave up.

Doc's wishes for a brief and simple funeral were obeyed. His son and daughter came from back east—the only family he had, aside from a host of professional friends who filled the small church.

When my wife and I arrived home after the funeral, we simply sat down in the living room and stared at each other. We had lost our best friends in just one year's time. Life would not be the same.

Then things began to happen. That night the bedside telephone rang about 1 am. Or, at least, I thought it rang, for something woke me up. Half awake, I lifted the receiver. All I heard was a dial tone. No one was there. Wrong number, I thought.

The next night, and the night after that, it happened again, and always at the time Doc died, although this thought did not occur to me until much later. The morning after the third occurrence, I awoke and sat up, thinking about the bell I had heard ring. It was not a telephone bell, although similar in pitch. So that night I pulled the phone plug from the wall.

So now we have arrived at the weekend. It was a Friday night. We had concluded supper and the dishes were done. I walked into the ham shack, followed by my wife, who

brought the evening paper with her. She sat down and began to read. I sat down at the operating desk and stared at my equipment. Probably from force of habit more than anything else, I flipped on the two-meter receiver and turned on the transmitter filaments. I looked at the receiver dial. 145.1 MHz, just where it had been anchored for more than three years. The S-meter was registering nothing but noise.

Then it happened. A voice seemed to come over the radio. It said: "Glenn... this is Doc... I have been trying so hard to reach you... are you conscious of my voice?"

I was terrified, to say the least. I turned and fairly shouted at my wife who was not more than ten feet away, reading her newspaper. "Did you hear? It's Doc!"

She looked up, staring at me as though I had taken leave of my senses. "I don't hear anything," was her comment.

"Come closer," I shouted, grabbing her by the hand. I no sooner touched her than her expression changed to fright. "I hear him... it's Doc talking... be quiet!"

We sat there in front of the receiver. I had not released my wife's hand. Doc's voice continued.

"Glenn, all my work will be for naught if those notes are lost. I was almost there... just a few more weeks and I would have achieved my goal... it's BCG, I am now sure... find my notes and give them to my doctor friend at the lab... he'll know what to do..." and his voice disappeared. But before that happened, I had looked at the S-meter. It had remained in the noise level.

I think my wife and I must have stared at each other in profound shock for

Sentry Crystals...

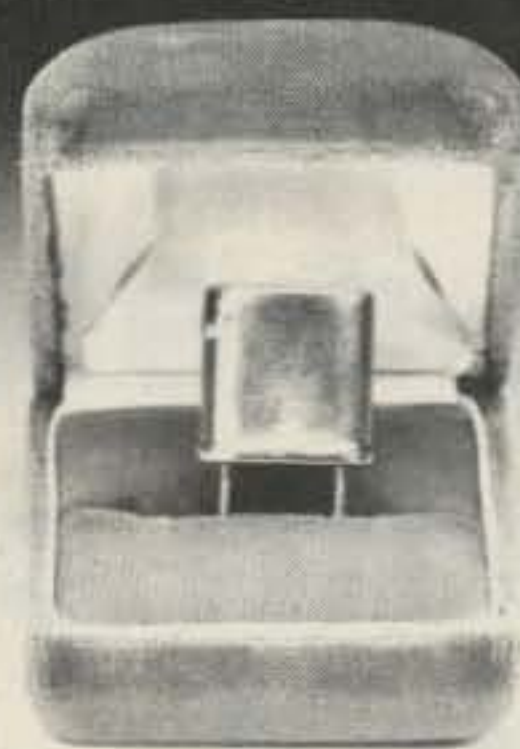

A Work Of Art.

Why settle for an imitation?

Policemen, firemen, E.M.S. and private citizens all depend on good, clear communication. That's why Sentry builds crystals better than they have to be—they're built to exceed Mil-Spec standards. Sentry produces the highest quality, gold-plated crystals available.

You don't have to wait for a Sentry Crystal...
to come halfway around the

world. Just call Sentry's toll free number (800-654-8850) and you're in business with the crystals you need to get the job done right, the first time, in a very short time.



333

Sentry

more than a minute. Finally I said to her, "That was Doc alright, but his voice was not coming through the speaker!"

"That's right," she commented. "And I didn't hear him until you grabbed my hand."

"We didn't hear anything, really, did we, now? That message was a complete and instantaneous thought implanted in our minds. It did not have the variation in tonal quality that one hears when one is talking to you," I observed.

The wife agreed. A message had come through "from the other side" but it was not spoken to us as we had thought. Of that I am positive.

The next morning I called the company where Doc had been spending his time. I talked with the M.D. who was in charge of the laboratory and told him what happened. There was

a silence, and then he asked me to have lunch with him.

"I've got to question you more about what happened," he said. "Please have lunch with me."

I agreed. We met and discussed the events of the previous evening over and over. My knowledge of medicine is restricted to the use of aspirin. I wasn't sure that Doc had said "BCG" or if I had heard just letters of a complete word. However, my host seemed to know what it meant. He thanked me for my time, and we parted, although I think he gave me a very curious over-the-shoulder glance as he left.

In the years that have now passed, I have learned that extensive experimentation with BCG vaccine has been undertaken by various agencies in trying to find a cure for leukemia. I hope they are successful and that Doc was right. ■

YAESU CPU-2500RK

2-meter FM transceiver with central processing unit

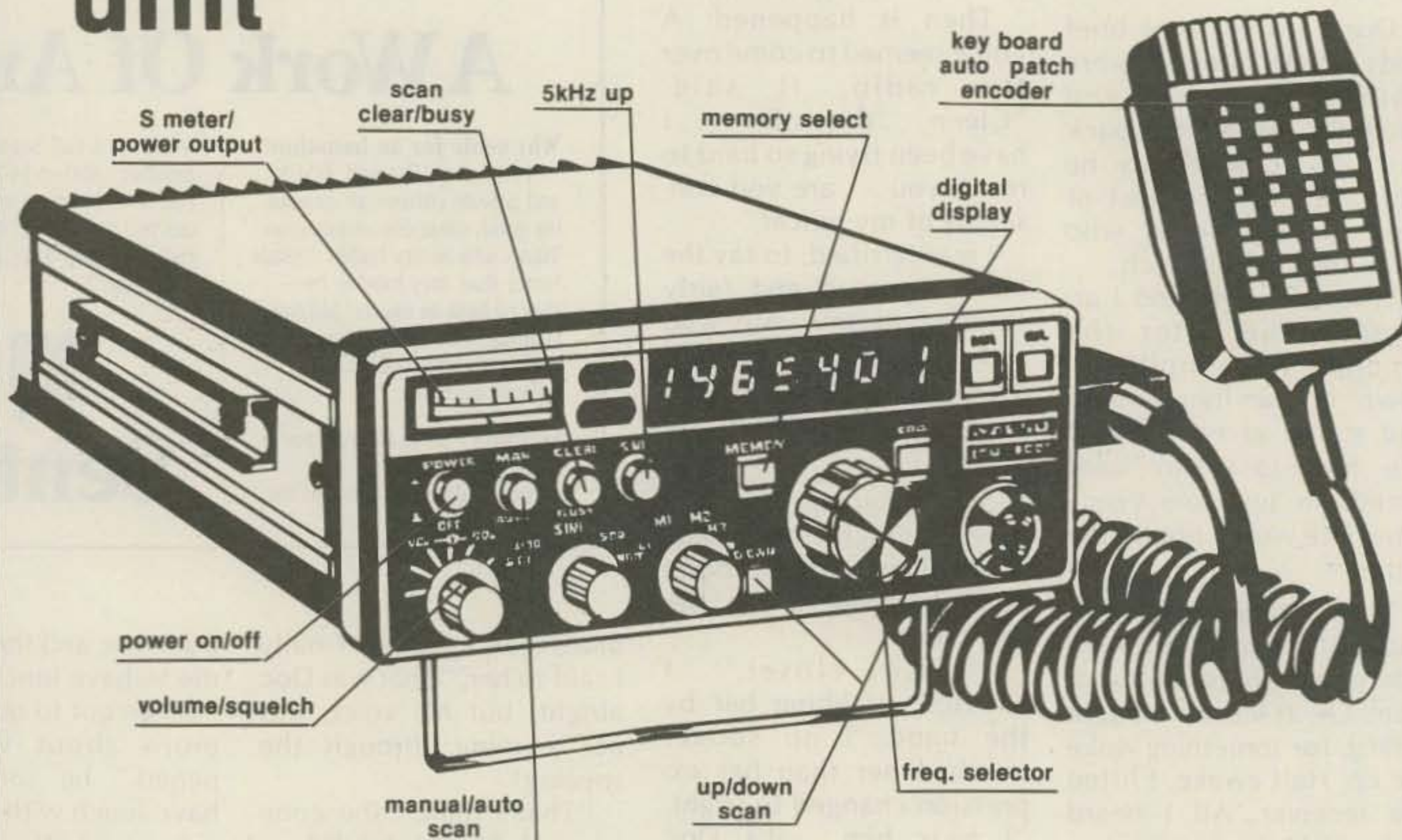

Just flick a switch and the CPU-2500RK will perform complex control operations. The CPU scanner moves you instantly up or down the band, and will search for a busy or clear channel, as desired. In the manual mode, a press of the mic PTT switch will halt the scan instantly. 800 PLL synthesized channels are available in 5 kHz steps over the entire 2-meter band. A photo-interrupter frequency selection technique is used, and full 6-digit frequency display is provided. Four memory channels are available for simplex or repeater operation, and an additional memory channel may be used for a split of up to 4 MHz. The keyboard microphone contains up/down scanner controls, a two-tone encoder for autopatch, and remote provision for dialing in operating or memory frequencies. A dual gate FET front end lets you pull in those weak signals, while the transmitter puts out a solid 25 watts at Hi power. (3 watts Low power) Convenience features include "busy channel" and "on the air" lights, a memory backup feature, single-shaft control for volume and squelch, and manual or automatic tone burst selection. Engineered for performance, using the latest technology, the CPU-2500RK is the dawning of a new age for 2-meter FM transceivers. Mobile mounting bracket included.



Price
419.95

Long's



Use your Master Charge or BankAmericard/VISA when you order.

Ham Radio Department Store

MAIL ORDERS: P.O. BOX 11347 BIRMINGHAM, AL 35202 • STREET ADDRESS: 2808 7TH AVENUE SOUTH BIRMINGHAM, ALABAMA 35233

NEW! ICOM IC-2A 2-meter synthesized hand-held transceiver

NEW!

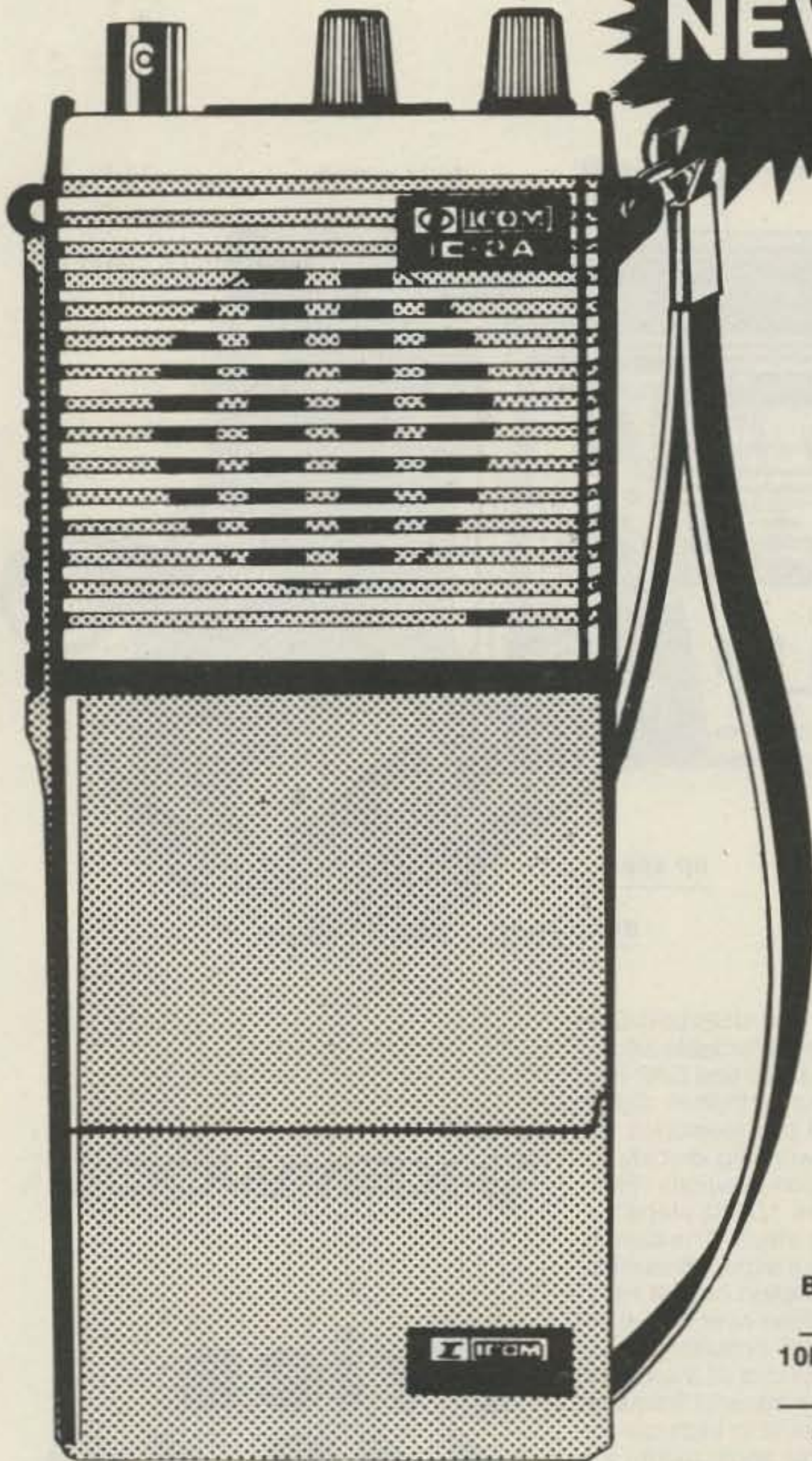

At last, it's here! Icom's answer to hand-held transceivers! Lightweight and compact, about the size of a dollar bill, the IC-2A is loaded with features at a very affordable price. Includes 800 synthesized channels (no crystals!), ± 600 kHz repeater offset, simplex/duplex switch, 1.5 watt output high power switch and battery saving .15 watt low power switch. Frequency selection by thumb wheel switches. The IC-2A has 3 Nicad Power pack sizes available to suit your needs. Easy slip on/slip off bottom Nicad makes it the most compact HT on the market. Also features 5 kHz channel selection, 10 kHz channel selection, transmit indicator, squelch and volume controls, and speaker/mic jack. Built-in speaker and condenser mic included. Optional 600 ohm dynamic mic may be used. Frequency coverage: 144.000 - 147.995 MHz. Transmission power: high: 1.5W at 8.4V, Low: 0.15W. Sensitivity: less than 0.4uV for 20dB Noise quieting. Selectivity: ± 7.5 KHz at -6dB point, ± 15 KHz at the -60dB point. Audio: more than 300mW. Equipped with rubber antenna and belt clip.

Price 189.53

with alkaline battery pack (w/o batteries)

Price 218.03

with Nicad pack and wall charger

Price 237.03

deluxe model with Nicad pack wall charger, and touch tone pad

Back View

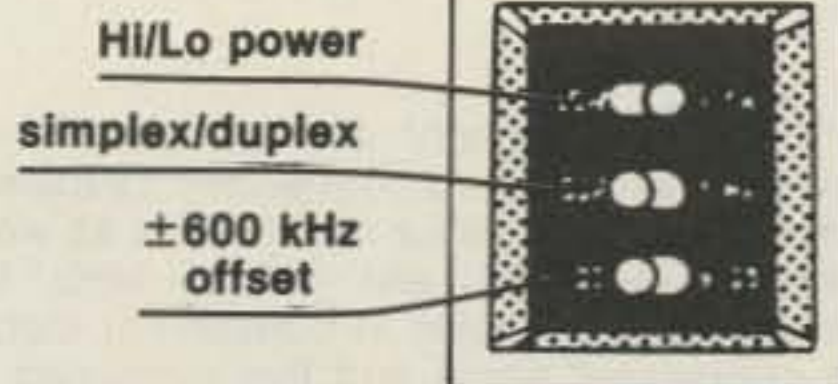

Top View

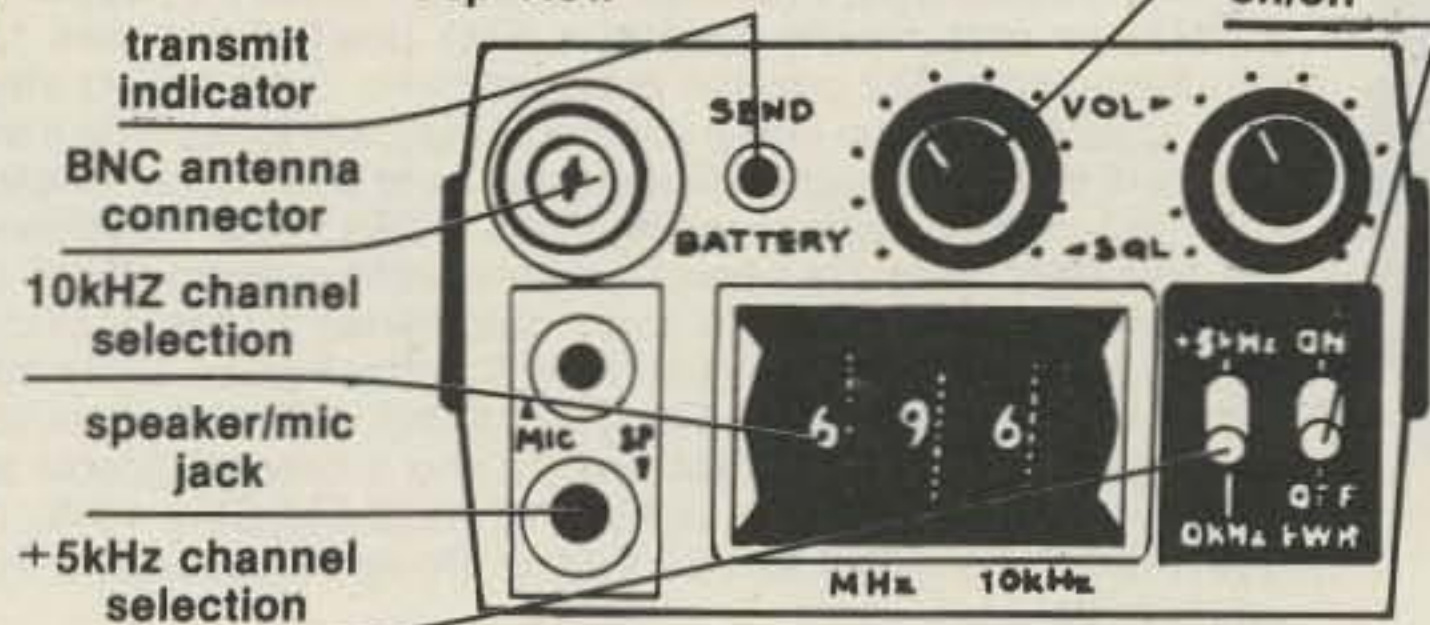

Call Toll Free **1-800-633-3410**

IN ALABAMA CALL 1-800-292-8668 9 AM TIL 5:30 PM CST, MONDAY THRU FRIDAY

KENWOOD'S TR-9000

2-meter all-mode transceiver

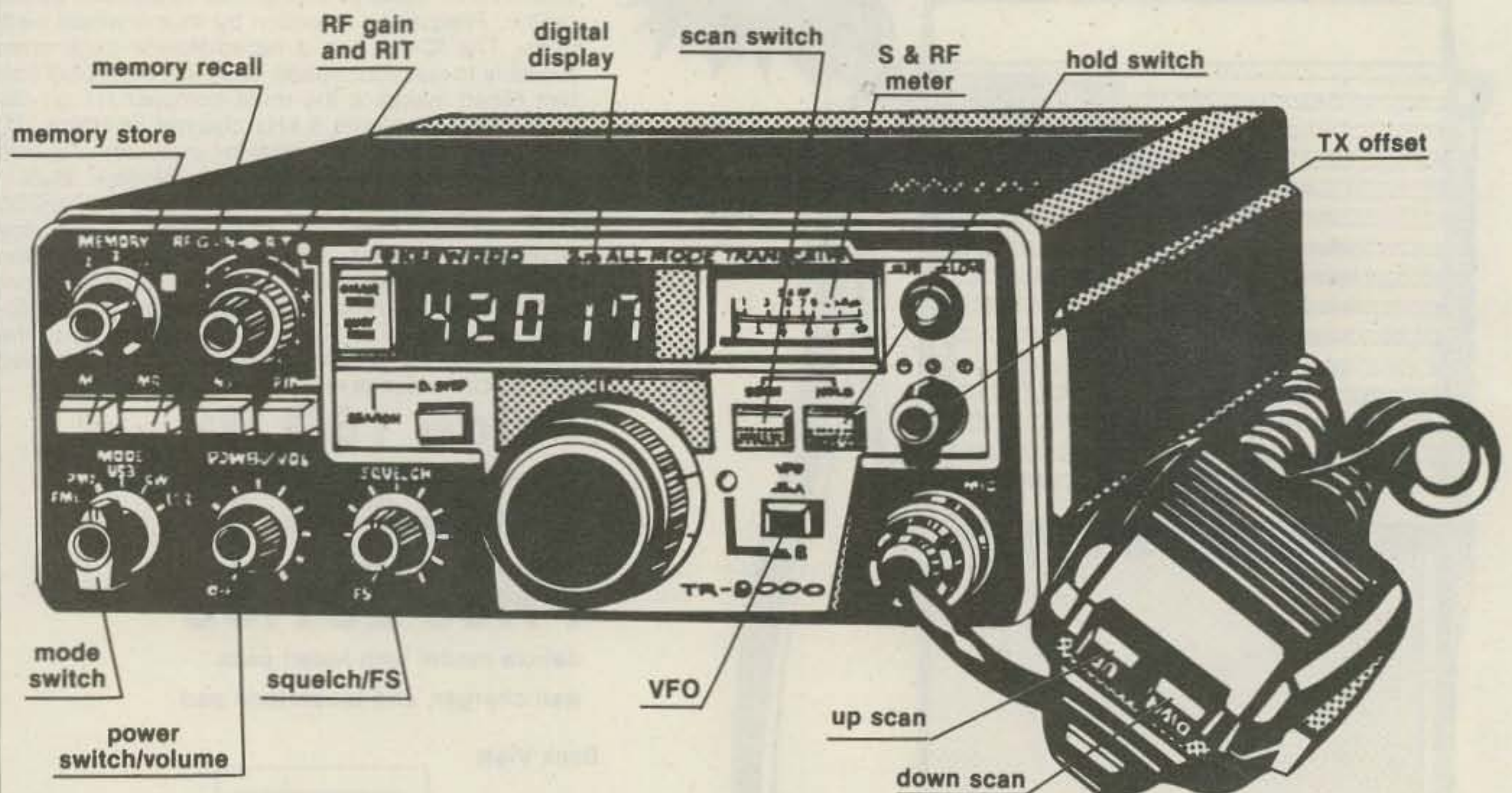

The TR-9000 is a lightweight and compact 2-meter FM/USB/LSB/CW transceiver with advanced and convenient functions at an affordable price. Operates on all 2-meter Amateur frequencies as well as MARS and CAP frequencies between 143.900 and 148.99 MHz. It features built-in digital VFOs for selecting frequencies in convenient steps and five memories for switching in convenient steps and five memories for switching quickly to specific frequencies. FM mode has two frequency selection positions (FM1 & FM2) for easy mobile operation. FM1 position provides 10kHz steps for fast tuning and FM2 position provides 5kHz and 100Hz steps. The built-in busy stop scan of the entire band automatically locks onto a signal. Scanning resumes when the signal disappears. Auto busy scan function only in FM1 and FM2 modes. Free scanning in the USB/LSB/CW position over 4 MHz in the 144 MHz band. New hand-held mic with up-down switch enables convenient frequency changes in steps determined by the positions of the mode and D. Step. Other features include TX offset which shifts transmit frequency for repeater operation, RF gain control, RIT circuit, built-in high quality noise blanker, Hi/Low power switch, and a new adjustable angle mount for mobile installation. Power output: Hi (SSB, FM, CW) 10W, Low (FM, CW) 1W. Freq. range: 144 to 147.9 MHz. Power requirement: 13.8V DC at 2.9 amps hi transmit.

 **KENWOOD**

Price
449.10

Long's



Use your Master Charge or BankAmericard/VISA when you order.

Ham Radio Department Store

MAIL ORDERS: P.O. BOX 11347 BIRMINGHAM, AL 35202 • STREET ADDRESS: 2808 7TH AVENUE SOUTH BIRMINGHAM, ALABAMA 35233

KENWOOD SPECIAL! For a limited time, get a free SSB filter, plus save over \$380 when you buy the TS-180S plus accessories!

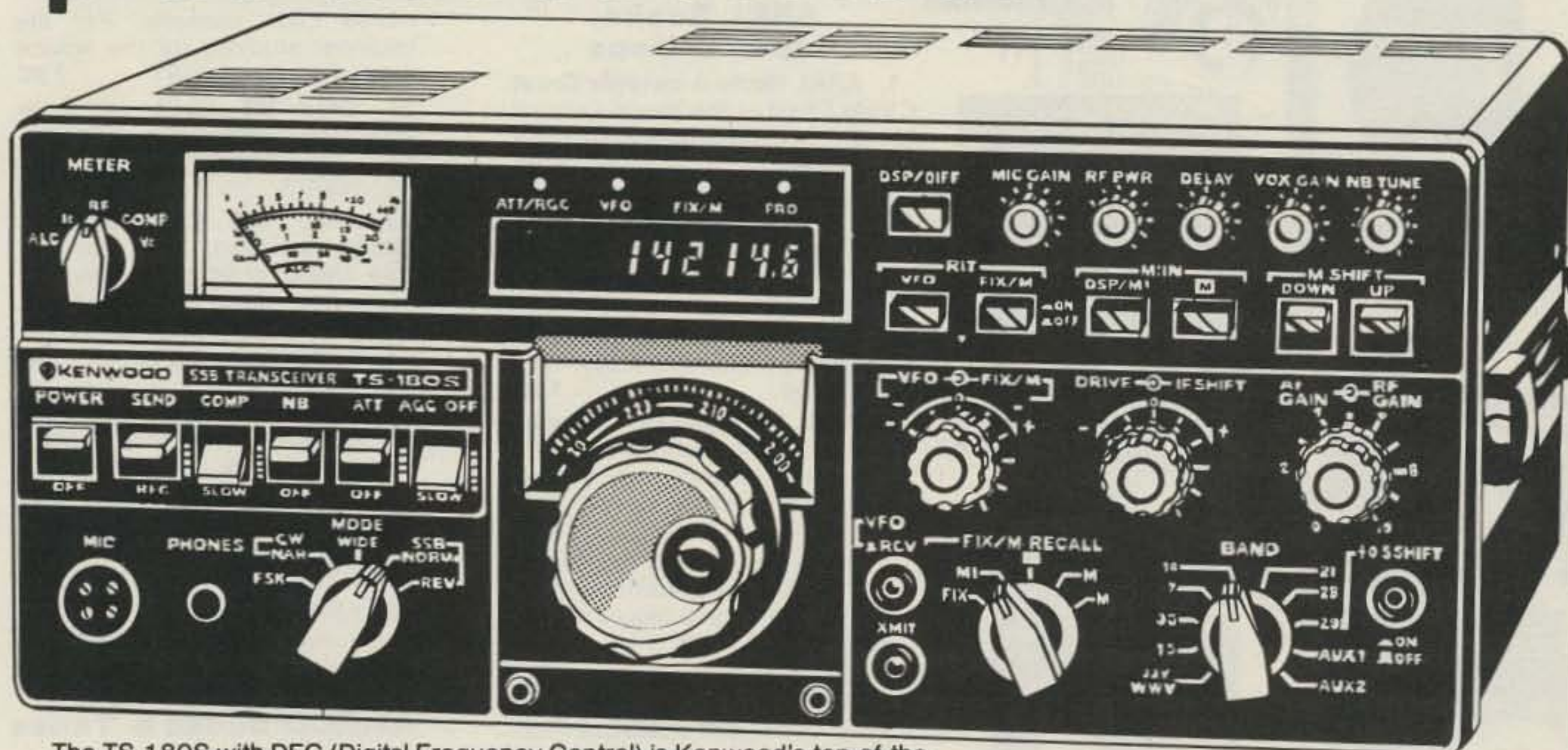

The TS-180S with DFC (Digital Frequency Control) is Kenwood's top-of-the-line all solid state HF SSB/CW/FSK transceiver covering 160 thru 10 meters. Features include four memories with digital up/down paddle-switch tuning. Memories are usable in transceiver or split modes, and can be tuned in 20 Hz steps up or down, slow or fast, with recall of the original stored frequency. Adaptable to three new bands and VFO covers more than 50 kHz above and below each band. Digital display flashes blinking decimal points to indicate "out of band." Other features are tunable noise blanker, dual RIT, RF speech processor, RF attenuator, and VSWR protection circuit. Power: 13.8 VDC at 20 amps. Input: 200W PEP/160W DC on 160-15 meters and 160W PEP/140W DC on 10 meters. Receiver sensitivity: 0.25uV at 10dB S/N. Hurry and get a free YK-88 SSB filter with the purchase of the TS-180S and accessories. That's a 59.95 value!

Price 939.95 TS-180S W/DFC

TS-180S w/o DFC price 799.95

Accessories for TS-180S

- AT -180 matching antenna tuner Price 127.05
- VFO-180 matching remote variable frequency oscillator Price 138.82
- *SP-180 matching external speaker Price 49.95
- *Speaker must be purchased with another Kenwood item worth over \$100.00.

**Buy the TS-180S
and the
accessories and
save \$383.98 plus
get a SSB filter
FREE
(a 59.95 value)!**

Call Toll Free 1-800-633-3410

IN ALABAMA CALL 1-800-292-8668 9 AM TIL 5:30 PM CST, MONDAY THRU FRIDAY

For your books

ARRL Books, Tapes & Maps

1. ARRL Radio Amateurs Great Circle Chart of the World - a must for all ham radio operators. Item No. 10003..... 1.25
2. ARRL Map Library - a complete set of maps, prefix world map, great circle chart, map of North America and world atlas. Item No. 10005 4.50
3. ARRL Prefix Map of North America. Order yours today. Item No. 10004..... 1.25
4. ARRL Novice Q and A book - questions and answers. Your study guide for entry into the exciting world of amateur radio. Item No. 10008..... 2.00
5. ARRL Technician General Q and A book - questions and answers to help you pass the FCC exam. Item No. 10009..... 2.50
6. ARRL 1980 Radio Amateur Handbook - contains valuable theory, circuit and operating information for all levels of amateur interest. Item No. 10011 10.00
7. ARRL Radio Amateur's License Manual - a new and complete study guide. All the latest FCC rules and regulations for the higher class license exam. Item No. 10012..... 4.00
8. ARRL Log Book - large spiral bound book. Item No. 10015 1.75
9. ARRL Understanding Amateur Radio - establishes technical groundwork for all phases of amateur radio. Item No. 10016..... 5.00
10. ARRL Antenna Handbook - a book full of valuable information about antennas for the amateur operator. Item No. 10026 ... 5.00
11. ARRL Tune in the World with Ham Radio - learn all about amateur radio with a text and a morse code cassette. For the beginner studying for the Novice exam. Item No. 10031..... 7.00
12. 1980 US Callbook - order your 1980 edition now with complete up-dated information. Item No. 10033..... 16.95
13. 1980 DX Callbook - new listings included, with standard time charts, great circle bearings, postal information and much more. Item No. 10034 15.95
14. ARRL Code Kit - boost your code speed from 5-13 wpm. For the Novice or Technician going for the General or Advanced license. Item No. 10046 8.00
15. Simple Low Cost Wire Antennas - learn how to build efficient antennas that get out. Item No. 10058..... 5.95
16. ARRL World Map - a must for all amateur radio operators. Item No. 10099..... 3.50

AMECO Books & Tapes

17. AMECO Questions & Answers for Advanced Class Exam - to help you pass your FCC advanced class exam with sample questions and answers. Item No. 24809 1.75
18. AMECO Radio Theory Course - preparation for Novice, Technician, General, Advanced and Extra classes of FCC licenses. Includes FCC-type questions and answers. Item No. 24812..... 5.95
19. AMECO General Class QSO code tape #105-QT-12, 13, 14, & 15 words per minute. Item No. 24827..... 4.95
20. AMECO 701 Question and Answer Guide for the Novice Exam - FCC questions and easy to understand answers with FCC type practice exam. Item No. 24828..... 1.00

Long's

Ham Radio Department Store

MAIL ORDERS: P.O. BOX 11347 BIRMINGHAM, AL 35202 • STREET ADDRESS: 2808 7TH AVENUE SOUTH BIRMINGHAM, ALABAMA 35202



Use your Master Charge or BankAmericard/VISA when you order.

**Mirage
2-meter
amplifiers**

Features include built-in receive preamp, adjustable delay for SSB, and automatic internal or external relay keying. Perfect for your HT! Will handle as little as 1 to 2 watts input. Freq. range: 144-148MHz.
B108 10W in - 80W out..... **152.96**
B1016 10W in - 160W out..... **251.96**
B3016 30W in - 160W out..... **215.96**



NEW! KENWOOD HC-10 World Clock
 With 2 separate digital displays, shows time in both GMT and local, gives date, day of week, and can memorize starting time of QSO. Able to program 2 different time zones of any 2 countries. Displays time of 10 designated cities around the world.
Price 89.95



CDE HAM IV antenna rotor
 A metered communications antenna rotor with electric locking wedge brake. Designed to handle up to 15 sq. ft. of antenna. For in-tower mounting only. Requires 8 conductor cable. Complete with control box.
Price 179.95



CDE T2X Tailtwister antenna rotor
 A super duty metered communications rotor with electric locking wedge brakes. Capable of handling up to 30 sq. ft. of antenna and requires 8 conductor cable for installation. Complete with control box.
Price 249.00

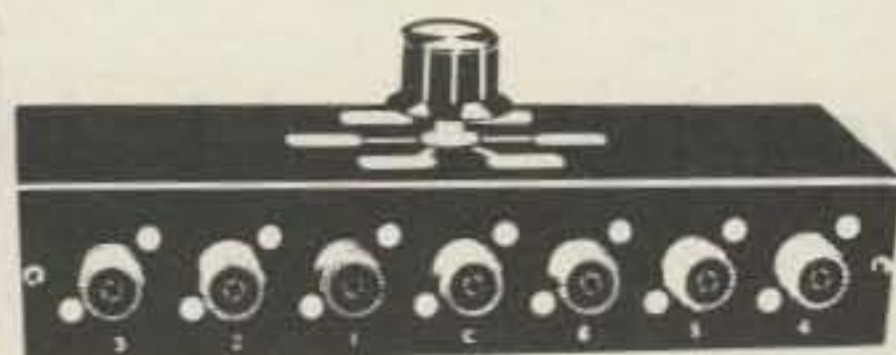

B & W 595 coax switch
 Features 6 outputs, a power rating of 2 KW PEP and VSWR of less than 1.2:1 up to 150 MHz. Grounds all unused antennas.
Price 22.50



MFJ-941B Versa tuner II
 Has SWR and dual range wattmeter, antenna switch, built-in balun and 300W RF output. Has SO-239 connectors and mobile mounting bracket.
Price 79.95

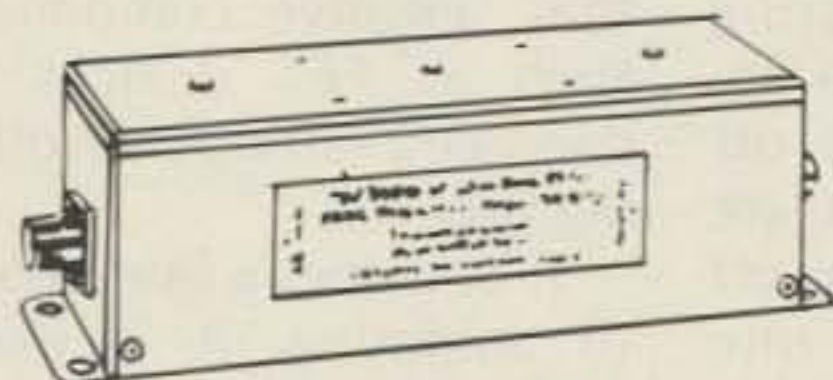

DRAKE TV-3300-LP low pass filter
 Low pass filters, properly attached to transmitters attenuate all harmonics falling in any TV channel or the FM band. 1000W max. below 30 MHz. Attenuation better than 80dB above 41 MHz.
Price 26.60



**SHARP CB-2460
40-channel CB transceiver**
 A full featured 40-channel CB with RF/signal meter, channel 9 priority monitor with LED readout, detachable mic with LED readout, PTT switch, PA operation optional. Also delta tuning, squelch control and automatic noise limiter.
Price 49.95

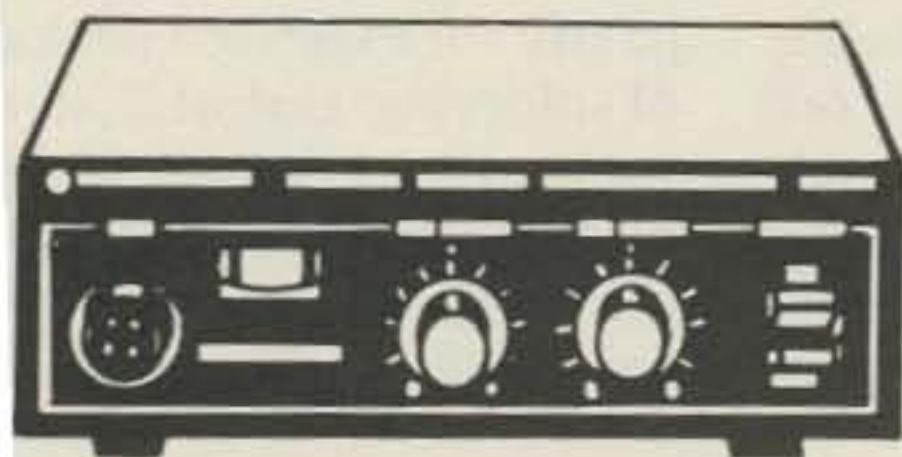

KENWOOD PC-1 phone patch
 The PC-1 features NULL control, RX and TX gain controls and VU meter. Connects between a transceiver and a phoneline.
Price 59.95



BENCHNER BY-1 Iambic paddle
 With solid silver contact points, full range adjustment, non-skid feet and heavy steel black-textured base.
Price 42.95



**DYNAMIC INSTRUMENTS
nickle cadmium rechargeable batteries**
 Never run out of batteries again. Guaranteed for 5 years

Size AA	Price	2 for 4.33
Size C	Price	2 for 5.15
Size D	Price	2 for 5.30
9 volt	Price	9.50 each

Call Toll Free 1-800-633-3410

IN ALABAMA CALL 1-800-292-8668 9 AM TIL 5:30 PM CST, MONDAY THRU FRIDAY

Who Needs a \$40 Soldering Iron?

— here's why you may want to invest in one

73 Magazine Staff

Most amateurs probably start out by ac-

quiring one of the standard, garden-variety soldering irons selling for \$5 or so, and operating directly off 110 V ac. Such irons are probably fine to start off with, especially if one chooses a wattage suitable for the types of components being soldered, but after a period of time, one will start to notice various disadvantages. The tips will usually corrode rather quickly, the temperature of the iron will not be stable, and the heavy line-cord tends to curl or kink, making the iron unhandy to use. In some cases, these irons may even have such poor

isolation from the ac line that sensitive components such as FET devices are damaged during the soldering process.

If one does a fair amount of soldering, it is worthwhile to consider the purchase of a more sophisticated type of soldering iron. Probably the ultimate would be a cordless iron with a constant-temperature regulator of some sort instant heat, and high capacity for extended period of soldering. Unfortunately such an iron does not exist. The cordless irons which are available are excellent for many portable applica-

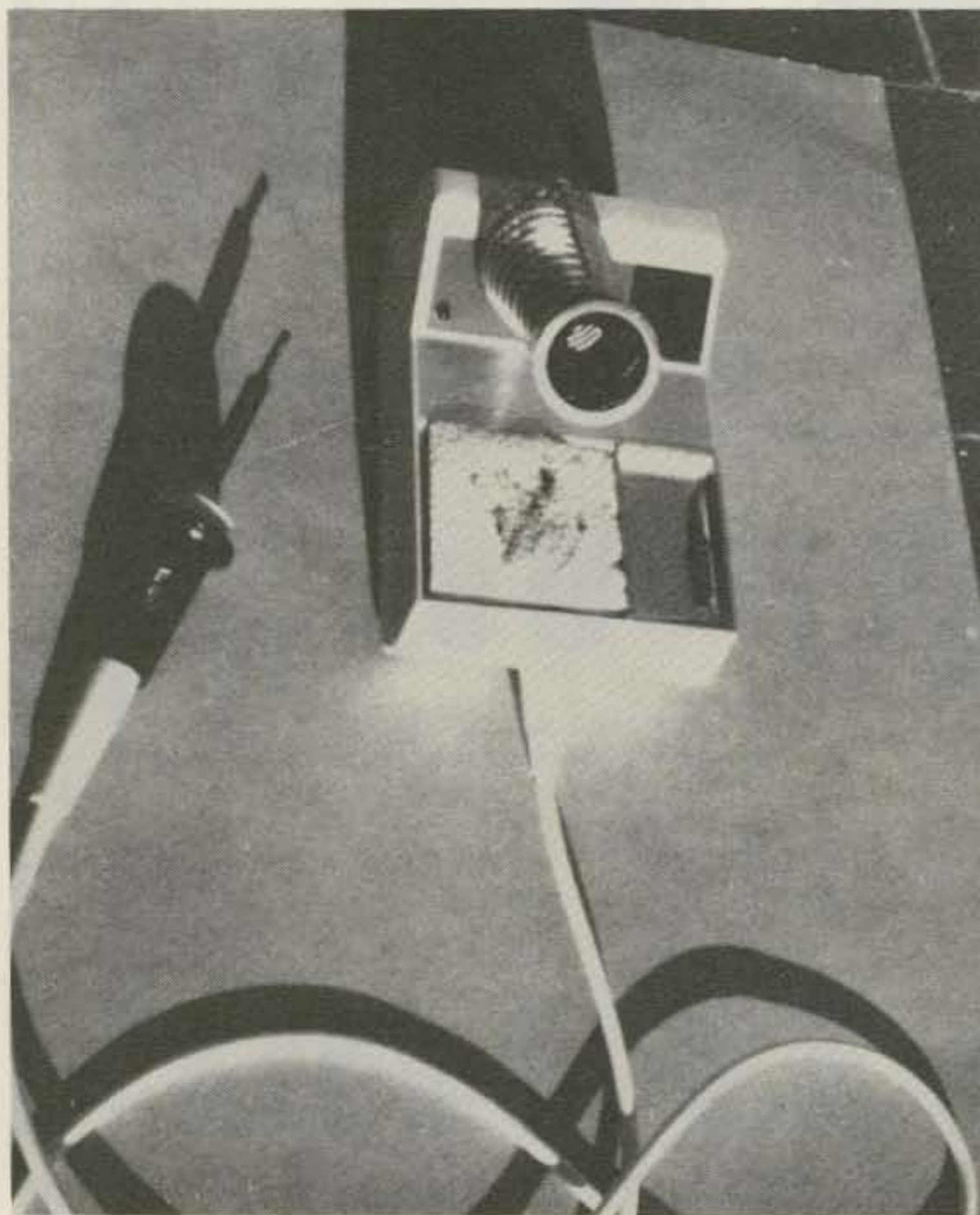

This is the complete Weller "soldering station." The LED indicator which was added can be seen in the lower left-hand corner of the upper, sloping portion of the stand.

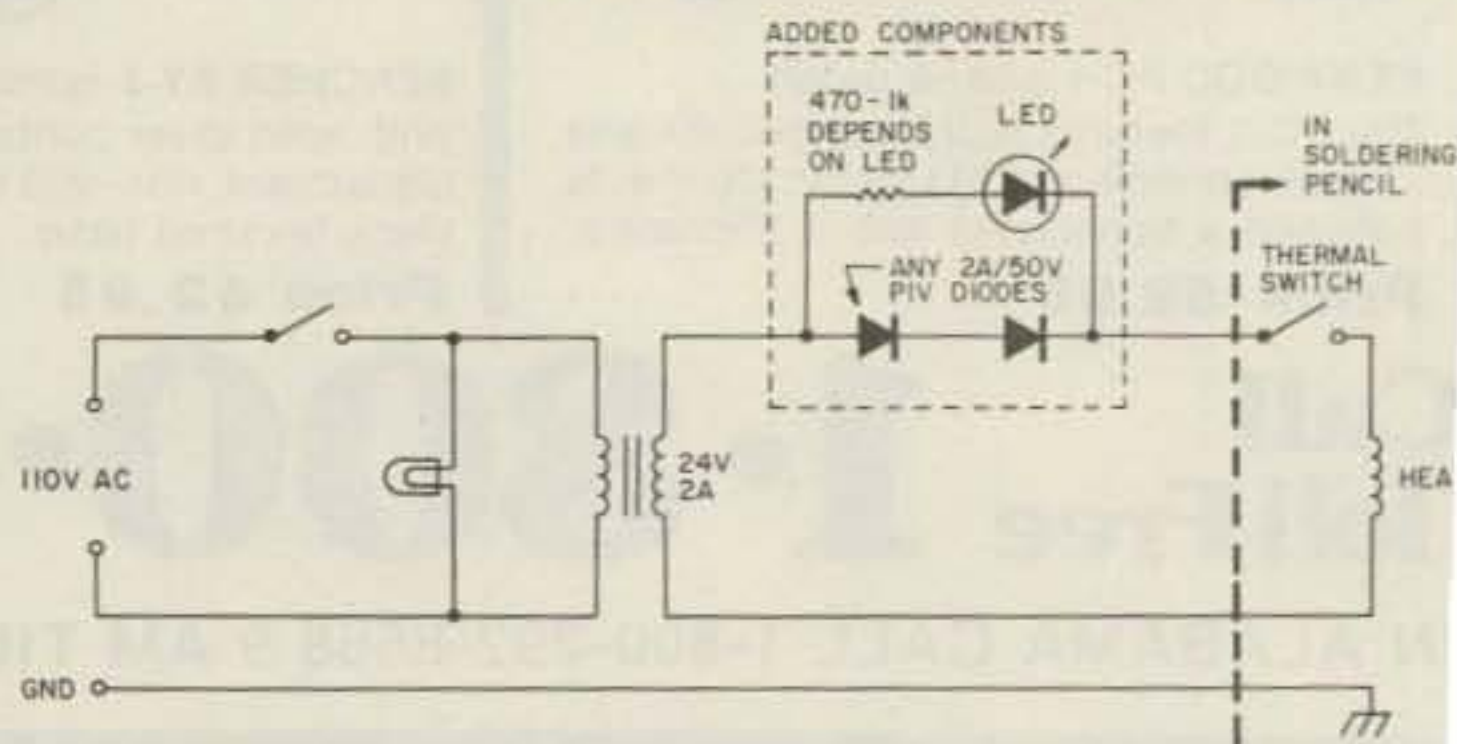

Fig. 1. Diagram of the soldering iron, including components for a heater indicator light.

tions where a small number of connections have to be made. They are not suitable for most bench-type applications, however. The time an on/off sequence is gone through for a soldering operation, and the limited operating time per charge (10 minutes continuous operation for some cordless models), make this type of iron unsuitable.

Probably the best compromise for bench work which is available is one of the low-voltage irons which have a constant-temperature feature. This article describes one such iron, the Weller WTCPN series, and also includes some small modifications the author has found useful.

The Weller WTCPN is available as a "soldering station" for about \$60.00. The station consists of a power unit or stand and a pencil-type soldering unit. The power unit houses a 24-volt, 2-Ampere transformer, a cleaning sponge compartment, and a metal tip tray to store extra tips. These features can be seen in the photograph.

The soldering pencil connects to the power unit via a very flexible, silicon, non-burning cord. One still wishes, of course, that the cord were not present, but one hardly notices its presence, and even after long usage, it will not kink in any manner. We have been using a similar but earlier version of this iron for over five years without any cord problems.

The iron is wired so that the tip is grounded. That is, the ground wire from the ac cord is wired through the pencil so that it connects to the metal frame of the iron which holds the tip in place. One could, of course, access this wire in the stand and connect it to the ground foil on a PC board if some especially sensitive components were being soldered.

A main feature of the iron is its temperature control system. It is rather unique, but won't be described in great detail since it is nothing that can be duplicated by the experimenter. Basically, each interchangeable tip used with the iron has a ferromagnetic disk on its base. The tips do not screw in but are simply dropped in place in front of the iron and held in place with a screw-down collar. The ferromagnetic disk loses its magnetic property when it reaches a specific temperature. This disk interacts with a spring-loaded permanent magnet and switch in the soldering iron assembly to turn on and off the heater element also contained in the assembly. So, one constantly hears a faint clicking noise as the tip calls for heat or shuts off the heating element so that it can maintain a constant temperature. The whole heat-control mechanism is self-contained in the soldering pencil.

A variety of Weller tips is available for the iron and probably will satisfy most needs. We have found on occasion, however, that the miniature screw-in tips made by other manufacturers such as Ungar have advantages. One of the Weller types was modified, therefore, by cutting it off just above the ridge on the tip which fits the hold-down collar. The body of the tip was tapped to accept the screw-in tips. This arrangement has worked very well since the ferromagnetic disk on the bottom of the Weller tip preserves the temperature-control feature while providing added versatility from a wider variety of tips.

Another feature that was found to be useful was the addition of an indicator showing that the heating element in the iron was be-

this publication is available in microform



Please send me additional information.

University Microfilms International

300 North Zeeb Road Dept. P.R. Ann Arbor, MI 48106 U.S.A.	18 Bedford Row Dept. P.R. London, WC1R 4EJ England
--	---

Name _____

Institution _____

Street _____

City _____

State _____ Zip _____

ing sequenced on and off. Such an indicator was added as shown by the dotted lines in Fig. 1. In this case, advantage was taken of the voltage drop across two ordinary power diodes to activate an LED. This scheme also, of course, half-wave rectifies the 24-volt ac supply. The iron possibly has to cycle "on" a bit longer because of this, but absolutely no effect on normal usage has been noted.

Another scheme would be to insert a small resistance in series with the circuit and place a lamp across it. A 1/2-Ohm resistance, composed of several standard 2.7-Ohm resistors in parallel, will produce about 1 volt when the heater is operating and can light a small 1.2-volt flashlight bulb such as a type #211. The LED indicator used was placed in the lower left corner of the upper part of the stand

and can be seen in the photograph.

From an electrical viewpoint, the only thing the stand contains is a 24-volt transformer. One can, therefore, just purchase the soldering pencil and power it with any suitable transformer. The pencil is available separately as item TC-201, sells for about \$20.00, and comes complete with one tip. In fact, we used an earlier iron of this type powered by some old 6.3-volt filament transformers wired in series to produce 18 volts, and it provided excellent service for years. We believe the whole soldering iron/stand assembly is worth the \$40.00, but this way you can have essentially all of it for \$20.00!

Weller products are manufactured by the Cooper Group, Electronics Division, P.O. Box 728, Apex NC 27502. ■

Outboard Power for the 820

— it's easy to connect a second set of ears to the Kenwood transceiver

For working DX, especially on CW and SSB, nothing can beat a separate receiver and transmitter or a transceiver with remote vfo for split-frequency op-

eration. Many DX stations and DXpeditions operate split frequency for a variety of reasons.

If you own a TS-820 and a second receiver (Drake

R-4A, in my case) and don't want to spend the extra bucks for the VFO-820, this change is for you.

Merging the 820 with a

second receiver is simplicity itself and provides real versatility. The cost is minimal and, for most, will only involve the purchase of a connector from Kenwood.

The change is a no-holes modification, taking advantage of the transverter connector on the rear of the 820. At this connector, outputs are available to power the TV-502/506 transverters, antenna inputs, etc. Also included is a normally-closed relay contact.

Modification

1. Purchase a male connector from Trio-Kenwood, 1111 West Walnut Ave. Compton CA 90220. It is part #E09-1272-05 (formerly part #E09-1204-05).

2. Make the following connections to the new connector. All cable should be long enough to reach the external receive

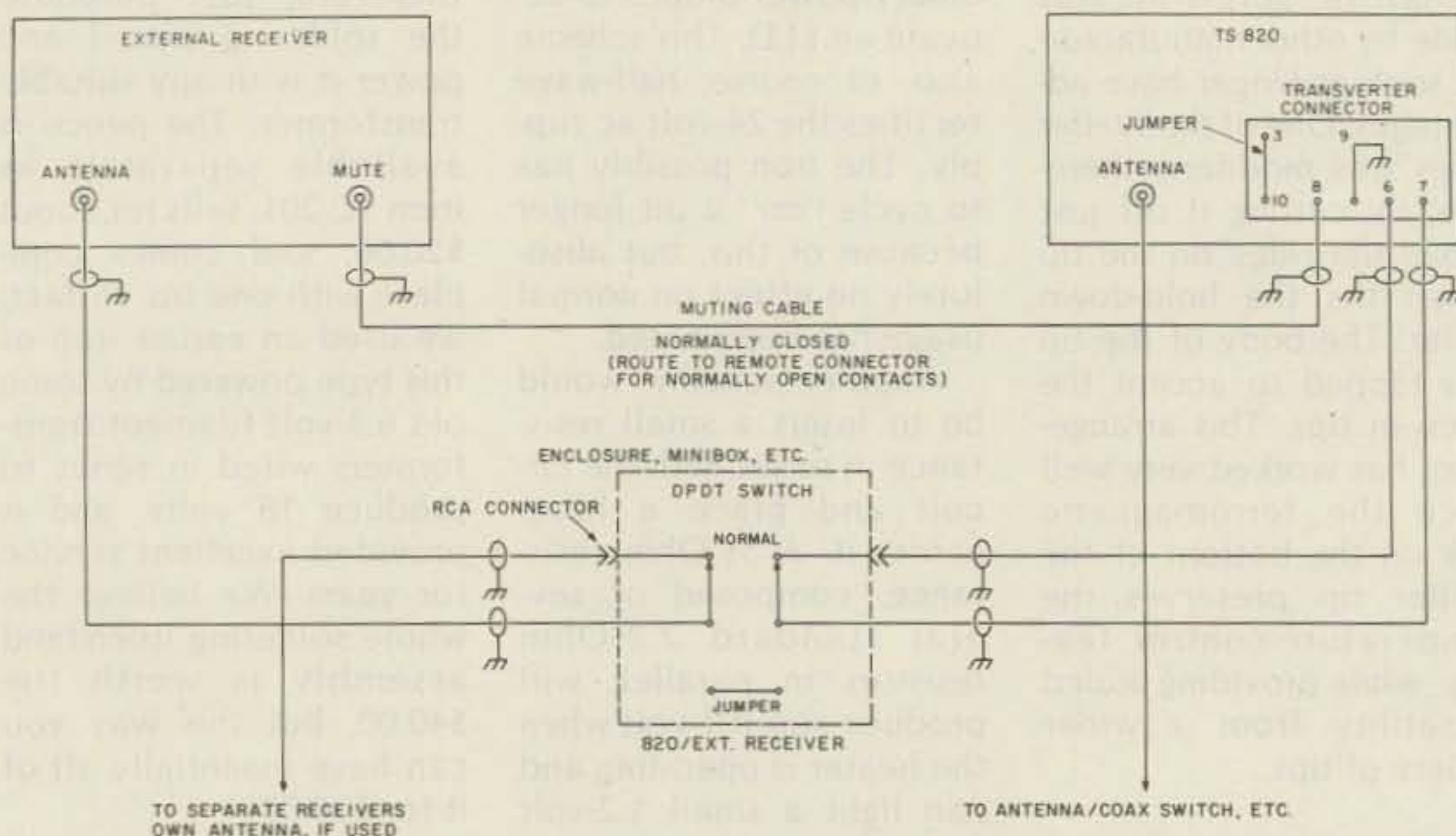

Fig. 1. Showing separate/combine switch, the configuration at KL7GRF/6 uses a separate 4BTV vertical antenna, switched on to the external receiver when the switch is in the NORMAL position. When going to the 820/EXT RECEIVER position, whatever antenna is on the 820 is also used on the external receiver.

BECKMAN 3½-DIGIT MULTIMETER MODEL TECH 310

COMPLETE MULTIMETER CAPABILITY:

DC VOLTS: 100 μ V TO 1500 V
 AC VOLTS: 100 μ V TO 1000 V rms
 RESISTANCE: 0.1 OHMS TO 20 MEGOHMS
 DC CURRENT: 100 nA TO 10 A
 AC CURRENT: 100 nA TO 10 A
 DIODE/SEMICONDUCTOR TEST FUNCTION.
 CONTINUITY FUNCTION - INSTA-OHMS [TM].
 COMPLETE OVERVOLTAGE PROTECTION.
 LOW-POWER OHMS IN ALL RESISTANCE RANGES.

FULLY EQUIPPED WITH THE FOLLOWING:
 9-VOLT BATTERY, A SPARE FUSE, SAFETY-DESIGNED TEST LEAD SET, OPERATOR'S MANUAL AND BECKMAN'S FULL ONE-YEAR WARRANTY.

OPTIONAL ACCESSORIES AND PRICES:

TECH 310 DIGITAL MULTIMETER	\$140.00
DC-202 DELUXE CASE	24.00
VC-201 VINYL CASE	10.00
DL-241 DELUXE TEST LEAD KIT	10.00
TL-242 TEST LEAD SET [AS SUPPLIED]	6.00
RF-221 RF PROBE	35.00

LaRUE ELECTRONICS ✓41
 1112 GRANDVIEW STREET
 SCRANTON, PENNSYLVANIA 18509
 PHONE [717]343-2124



and an externally mounted switch—see Fig. 1.

(a) Small shielded cable (RG-174, etc.), center conductor to pin 8, shield to pin 9. This is the "muting" cable for the external receiver (most receivers use closed-to-ground contacts for "normal" operation and open contacts for "muting"). Check your manual before making this modification. Normally-open contacts, if your receiver needs them, are available on pins 5 and 1 of the remote control socket on the rear of the TS-820.

(b) Shielded cable, center conductor to pin 7, shield to pin 9. This is the receive antenna relay contact output of the TS-820.

(c) Shielded cable, center conductor to

pin 6, shield to pin 9. This is the TS-820 receiver antenna input.

(d) Jumper pins 3 and 10. This maintains 250 V dc within the TS-820.

(e) Close up and secure the connector.

3. Run external connections to a DPDT toggle/slide/rotary switch as desired. Connect as shown in Fig. 1. I mounted the switch in a small minibox, next to the TS-820 for convenience, with RCA connectors for inputs and outputs. The purist may choose to use PL-259, BNC, etc. The impedance bump in the line to the receivers caused by the switch and connectors should be minimal.

4. After making the connections, you are ready to try it out. Place the transmitter switch on the rear of the 820 to ON and plug in the newly-wired connector. Place the external switch to

NORMAL. The 820 receiver should operate normally. The external receiver will switch to its own antenna. Place the switch to 820-EXT RECEIVER. The 820 receiver should go quiet and the antenna on the 820 will be switched to the external receiver. Key the 820 transmitter and ensure that the external receiver mutes correctly (depending on your muting configuration). The external receiver will mute any time the 820 transmitter is keyed, either in normal or combined, guarding against any high incoming rf to the separate receiver.

To return the 820 to normal operation for resale, etc., merely pull out the connector, put the transmitter switch to OFF again, and you are back to normal.

This change could also probably be applied to the TS-520. Check the TS-520 manual. One can still use the VFO-820 in this configura-

tion with the TS-820 with no changes required, providing even more flexibility.

I have been using this change for some time and it works beautifully. Of course, no attempt has been made to make the 820 transceive with an external receiver. This is strictly for split-frequency operation or as a transmitter/receiver operation. My main interest in ham radio is RTTY operation, and this combination certainly makes it a pleasure when working drifting stations. RTTY with a transceiver can be a pain when two stations start leapfrogging down the band because one is drifting.

I claim no originality for this modification. There are any number of ways this could be accomplished and many probably already have done so. This is an economical way to do it and, best of all, involves no holes. ■

CB to 6

— convert a 49-MHz HT into something

Do you need an inexpensive means of communications? Whether you hunt, fish, put up antennas, go to hamfests, or just have a need now and then for a wireless telephone, I think I have just the answer for you.

If you have ever owned or listened to the "toy" variety 100-mW CB handie-talkies, most of which were on channel 14, you probably will agree that they are worthless for doing much of anything—including monitoring channel 14! Well, great new things have happened in the CB handie-talkie 49-MHz band.

I purchased from Radio Shack a pair of Archer transceivers, catalog number 60-4001, with batteries, for just under \$17. That was just before Thanksgiving, 1978. While these are not kW transmitters (50-mW rated, ¼-mile range), at least they are crystal controlled! The receivers are not multi-conversion masterpieces (superregenerative detec-

tors), but they are more than adequate. Now for the bad news—and why I personalized mine.

First of all, the unit has no squelch. Being used to the serene silence of 2-meter FM, the "blowing" noise continually grinding forth from the speaker was going to drive me bananas. Next, to add to the noise problem, there is no volume control, either! Something had to change and fast. Adding a squelch to a radio that has only three transistors and draws 20 mA on receive seemed a bit much then (but open to future thought), so I added the next best thing—a volume control. Less noise is not no noise, but it beats bunches of noise hands down. The next question was where to put it.

If you have not looked at these little rigs, by all means do so. They are much smaller (5¼" x 2-11/16" x 1-5/8") and lighter (0.39 lbs/177 g) than their older, bulky, antique cousins on channel 14. Real shirt-pocket radio is here!

They even use a 2-inch speaker/mic for reasonable quality sound. Not hi-fi, but nice. Small is nice—but crowded. There just was not anywhere to put a shaft-type volume control, miniature, sub-miniature, or otherwise. Therefore, the following compromise ensued.

I did find a corner down under the battery and foam rubber battery pad where I could hide a small screwdriver-type, multi-turn pot. If you use a Bourns trimpot, model 3006P-1-501 (500-Ohm), and follow the drilling diagram in Fig. 1, it just fits nicely. Start the hole with a #50 or smaller bit and finish very slowly with a #25 (or so) bit to just clear a small-blade screwdriver. Use Eastman 910™ adhesive (very few drops) to hold the pot down in the corner as shown—flush with the case side, front, and bottom. This will leave the pot's brass adjustment screw aligned in the hole you drilled, sticking out about half the thickness of the case. This is far enough

to reach easily for adjustment, but not far enough to bump out of adjustment.

Follow the instructions in Fig. 1, and you will do just fine. I modified this part of two transceivers in exactly an hour, including time spent figuring out a place to put the pot, how to route wires, etc. The trimpot is a multi-turn unit, so you have a nice slow change in volume until you reach the level you want. Have a friend move out about 100 feet with one unit and transmit to you while you adjust the pot. You will be quite surprised at how low you can go and still not miss any calls.

Since there is virtually no one else on 49 MHz yet, you can instantly tell when someone calls just by the sudden low-level noise reduction. However, the sound level is now down far enough to make it hard to understand every word without literally holding the radio up to your ear. Break out the screwdriver? Not on your life! Read on.

If the code key on the HT really produced A1 telegraphy there might be a benefit to keeping its function as is, but A2 is what they make do with. It may teach a few kids the code, but for just about anything else, it is worthless. The key is a simple SPST leaf switch formed by a leaf contact in the case and a contact on the board. Fig. 1 includes instructions so you can free it up from its tone function and put it to good use: to short out the volume-control pot you just installed. Voila! We now have a push-to-receive switch for full receiver volume, without having to stand for the full-volume racket all the time!

While I was at it, I added an earphone jack for personal listening with the transceiver clipped down on my belt. This may be tough unless you have a female chassis-mount miniature phone plug close to the size of mine. I stole mine from an old pocket BC-band radio, so I can't really help you with part numbers. A lot of the similar jacks I have seen in stores are just too deep behind the panel to fit. Look around, and you're sure to find something if you want the addition badly enough (and I did!).

It is wired with the pink

speaker wire going to the NC contacts (when no male plug from the earphone is inserted) to complete the speaker function. The center pin gets the audio when the plug is inserted. A new wire goes from where the pink wire was, near the PTT switch, to the jack's common switching pole (not the case or ground) to route audio, during receive, from the area of the PTT switch to either the speaker or earphone. This way the speaker operates normally until an earphone is plugged in.

Another addition was a tab-type belt hook to give hands-off listening ability while working on antennas or trotting around ham-fests. It really goes hand-in-hand with the earphone modification. Be very careful with the mounting hardware and its placement, or you will either short out or break the PC board with the unit all closed up.

The rest of the modifications really make it a ham radio, if you so choose. I am still waiting for the proper crystal to arrive to complete this one myself. A big (too big, physically) crystal was tried on 50.7 MHz in its huge can-type holder (HC-6). The radio tuned right up using a field-

strength meter by holding the radio very steady, and backing off on L2 a bit to get the 840-kHz increase in frequency. The FCC surely was nice when it moved the new CB HTs right next door to 6 meters (chuckle!). That's it—one adjustment and one new crystal of the KSS-T8B type. I'm sure that any of the crystal manufacturers can fix you up if you send the old crystal and the schematic along.

There are many like me who have jumped at the new multi-mode synthesized rigs for 2-meter home use, probably with a crystal rig for the car (unless you drag one rig back and forth), and just

can't find the loot to have a handie-talkie as well. I hope this can be the answer to your personalized radio needs. Get a pair, and get a friend on. While on the 49-MHz CB band, they have to use the built-in antenna (it is nice and short), but once the HTs are moved to 6 meters, a 5/8-wavelength loaded antenna, or even a one- or two-stage trunk-mounted PA, would be legal. Now let's see, where can I fit in another jack for the antenna connector?

If you need any help, just send an SASE, but this one is so simple it should be all done and running before you know it. The

- (1) Remove battery.
- (2) Remove back cover screw.
- (3) Squeeze top and bottom to remove back cover.
- (4) Remove the one screw holding the board in place.
- (5) Remove and keep the blue jumper, A-B.
- (6) Drill #60 hole next to A.
- (7) Solder new 6" leads into A and B and dress toward the battery compartment.
- (8) Remove the brown lead at C and place in A—fold over and solder to A.
- (9) Cut and remove the foil shown.
- (10) Use blue jumper from B to switch pad X.
- (11) Glue the pot in place and connect it to the added leads. Shorten the leads as required. Connect so that resistance decreases with clockwise rotation of the pot screw.
- (12) Dress the foam and cardboard back over the pot connections.
- (13) Check for lead dress clearance, solder bridges, etc.
- (14) Temporarily hook up battery and check out the unit.
- (15) Reverse steps 1 through 4 to re-assemble.
- (16) Push the code button for full volume.

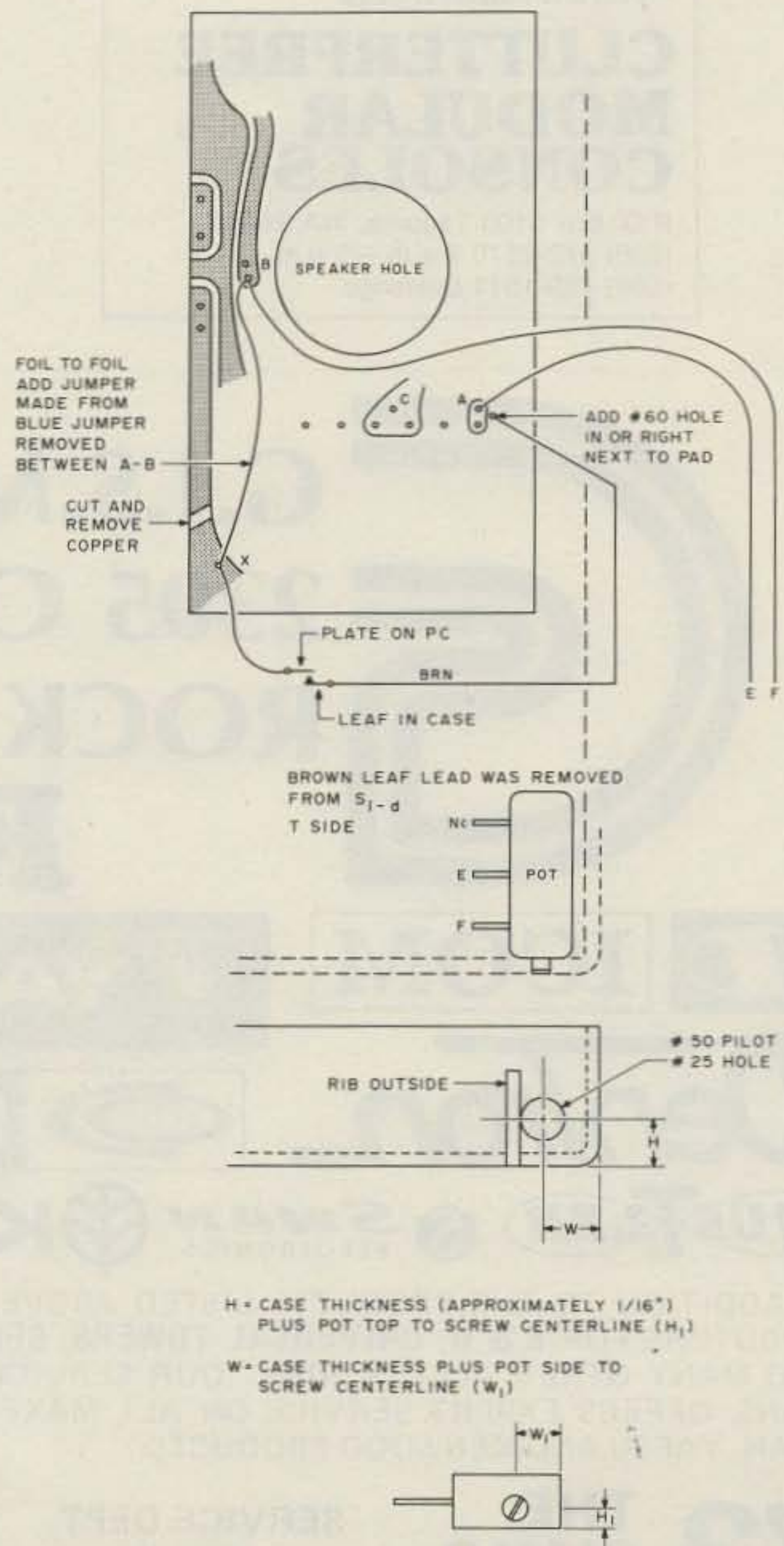

Fig. 1. Volume control and push-to-receive mods.



Organize your shack with a
**CLUTTERFREE MODULAR
 CONSOLE \$179.95**

- Large, 42" H x 57" W x 29" D
- Strong groove-construction
- Mar-resistant wood grain finish
- Options, drawers & face plate
- For ham or home computer
- Visa and Master Charge

**CLUTTERFREE
 MODULAR
 CONSOLES** ✓89

P.O. Box 5103 Tacoma, WA 98405
 (206) 572-8570 9 a.m.—5 p.m.
 (206) 759-1611 Evenings

radios use a common 9-volt transistor radio battery available about anywhere, which is nice, and there are even 9-volt nicad batteries around in the same physical packages now. (Now let's see, if I throw out the radio PC board, I'll have room for one more jack for the charger!) Seriously, since 50.7 MHz was once more or less a standard spot for AM mobile/portable operations, I would like to suggest we all meet there. It would make it nice for hamfests and some QRP fun. Any takers?

Another ham friend of mine and I have contemplated buying another pair of HTs and using the telescoping antenna as a gamma-type rod built right onto a 3-element yagi antenna. We would keep the regular cases as spares for the first pair of radios, and build some kind of

waterproof case (PVC tubing with end caps?) around the radio, mounting the whole thing right on the antenna. We would then add a resistor and zener in place of the battery and a small set of reed relays for T-R switch-over, sending the audio, switch-over control, and power up and down a rotor-type cable. I really think this use meets the letter, but not the spirit, of the FCC regulations on "built-in" antennas, so the FCC can relax!

We are going to 50.7 MHz before we try this part. 50 mW—wow! Anyone who can suggest a means of A1 keying a one-transistor rig like this would find his comments welcomed by me, and if you decide to join us on "flea-power" radio, by all means drop me a letter or card so we can listen for you. At least it shouldn't be a dull year on 6 meters. ■



G.I.S.M.O. ✓27

**2305 CHERRY ROAD
 ROCK HILL, S.C. 29730**

Featuring



IN ADDITION TO THE PRODUCTS LISTED ABOVE, WE ARE ALSO FACTORY AUTHORIZED DEALERS OR DISTRIBUTORS FOR B & W, UNIVERSAL TOWERS, BERK-TEK CABLES, BENCHER PADDLES, THE NEW CES DIALER AND MANY OTHER ACCESSORIES. OUR SERVICE SHOP, STAFFED BY FIRST PHONE, EXTRA CLASS TECHNICIANS, OFFERS EXPERT SERVICE ON ALL MAKES AND MODELS AND FACTORY AUTHORIZED SERVICE ON SWAN, YAESU AND KENWOOD PRODUCTS.

**73 THE
 GISMO
 GANG**

SERVICE DEPT.
 CALL
 803-366-7158

**ORDER TOLL FREE!
 800-845-6183**

Radio World
CENTRAL NEW YORK'S FASTEST GROWING HAM DEALER









Featuring Yaesu, Icom, Drake, Ten-Tec, Swan, DenTron, Midland, KDK, MFJ, Microwave Module, Tempo, Astron, KLM, Hy-Gain, Mosley, Larsen, Cushcraft, Hustler, Mini Products, Bird, DSI, Mirage, Vibroplex, Bencher, Info-Tech, Universal Towers, Callbook, ARRL, Astatic, Shure. We service everything we sell! Write or call for quote. You Won't be Disappointed.
We are just a few minutes off the NYS Thruway (I-90) Exit 32

**ONEIDA COUNTY AIRPORT TERMINAL BUILDING
ORISKANY, NEW YORK 13424**

Warren K2IXN Call Toll Free: 1-800-448-7914 Bob WA2MSH New York State Residents Call: 315-337-2622 or 315-337-0203

**2 watts QRP
go a long way!**

Rockhound®
Two full watts CW output! Choose 40 or 80 meter models. Weighs less than 6 ounces. Crystal control, 12-15 VDC. \$25.95

8040 B
Covers the Novice portions and more on 40 and 80 meters for CW receiving. Only 3" by 5" by 7" and 24 ounces! \$89.95

Freedom®
Free yourself from crystals with this VFO for 40, 80 and 15 meters. Great for many old transmitters! \$64.95

Please add \$2 per order, or \$3 for combinations, for shipping/handling.

Kantronics
(913) 842-7745
1202 E. 23rd Street
Lawrence, Kansas 66044

Microcraft's New Morse-A-Word

Eight character moving display.
Built-in code practice oscillator.
Excellent for learning Morse Code. ✓50
Complete — no CRT or expensive extras needed.
Decodes audio CW signals from your receiver's speaker and displays letters, numbers, punctuation and special Morse characters as the code is received.



MORSE-A-WORD Kit with 4 character readout MAWK-4 \$149.95
MORSE-A-WORD Kit with 8 character readout MAWK-8 \$169.95
MORSE-A-WORD wired & tested with 8 character readout . . . MAWF \$249.95

Send check or money order. Use your VISA or Master Charge. Add \$3.50 shipping and handling for continental U.S. Wisconsin residents add 4% State Sales Tax.

Microcraft Corporation Telephone: (414) 241-8144
P. O. Box 513G, Thiensville, Wisconsin 53092

INSTRUMENTS YOU CAN COUNT ON...

- 4½ DIGIT MULTIMETER/THERMOMETER
- FREQUENCY COUNTERS TO 1.3 GHz
- PRECISION DIGITAL THERMOMETER
- CAPACITANCE METER

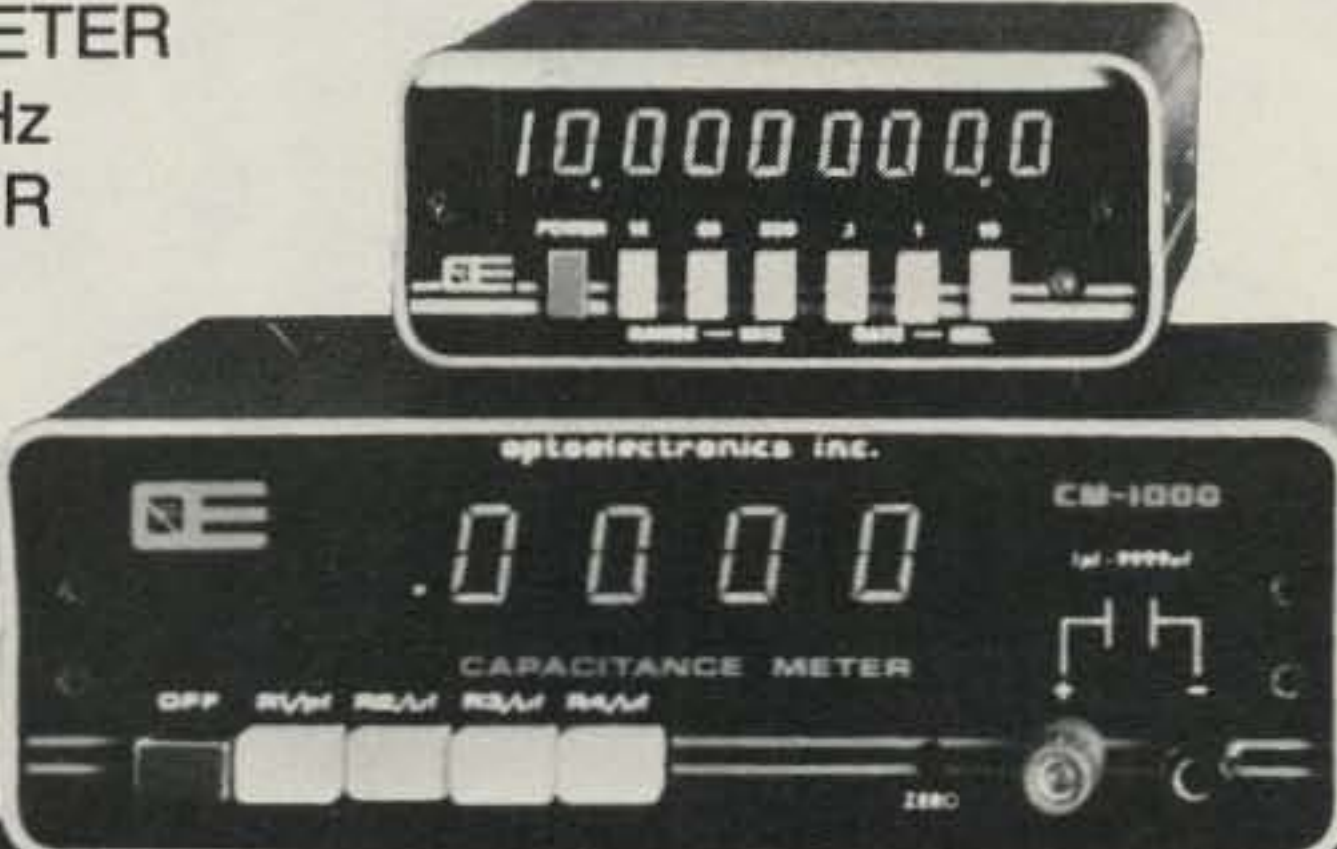
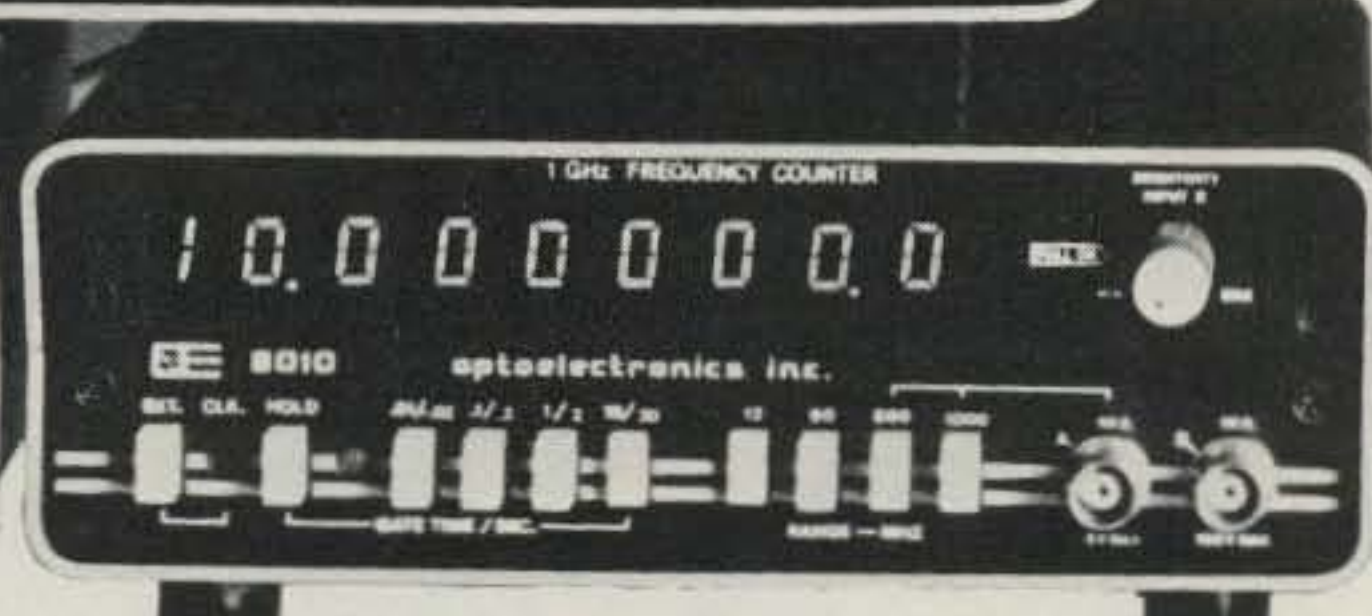
800-327-5912

FOR ORDERS, INFORMATION OR A CATALOG WRITE OR PHONE
FROM FLORIDA PHONE (305) 771-2050/771-2051

Optoelectronics inc ✓55
5821 N.E. 14 AVE. FT. LAUDERDALE, FL. 33334

Digital Boat Anchor

— using pencil, paper, and a frequency counter for receiver readout

A while back, I found a real treasure at a local garage sale. It was an old HQ-145A receiver, a little the worse for wear but in operating condition. Besides, the price was right at \$25 cash-and-carry.

After bringing the gear

home, I found that it had been accumulating dust since it was new around 1960. After cleaning and re-tuning, it proved to be a pretty fine piece of equipment despite its age. The sensitivity was good and the selectivity, due to

crystal phasing and slot filters, was acceptable for general listening.

The one thing that did bug me, however, was that I could not get the dial to read accurately even with its 100-kHz calibrator. On the ham bands, the calibra-

tion was fairly good on the calibrated bandspread for these bands. (At least you could tell where you were within 10 kHz.) But on the other bands there was not a calibrated bandspread, and without a book full of graph paper and the use of the logging scale as a reference, you were never sure just where you were listening.

By the way, the graph paper method has been used for years. It's simple, but time consuming and not as accurate as I really wanted. Besides, a graph has to be made for each band of frequencies because receivers, including the HQ-145A, are not linear in their tuning. As a result, when you get down to the lower frequencies, you can use quite a bit of graph paper. (See Fig. 1.)

The graph-paper method is as follows, in case you are interested in using it before you build a digital readout: First, mark the X axis, or the vertical lines of the graph paper, to correspond to the logging scale of your receiver (usually 0 to 100). Next, on the Y axis, or the horizontal lines along the left side of the paper, mark the frequencies in which you are interested, placing the lowest frequency on the

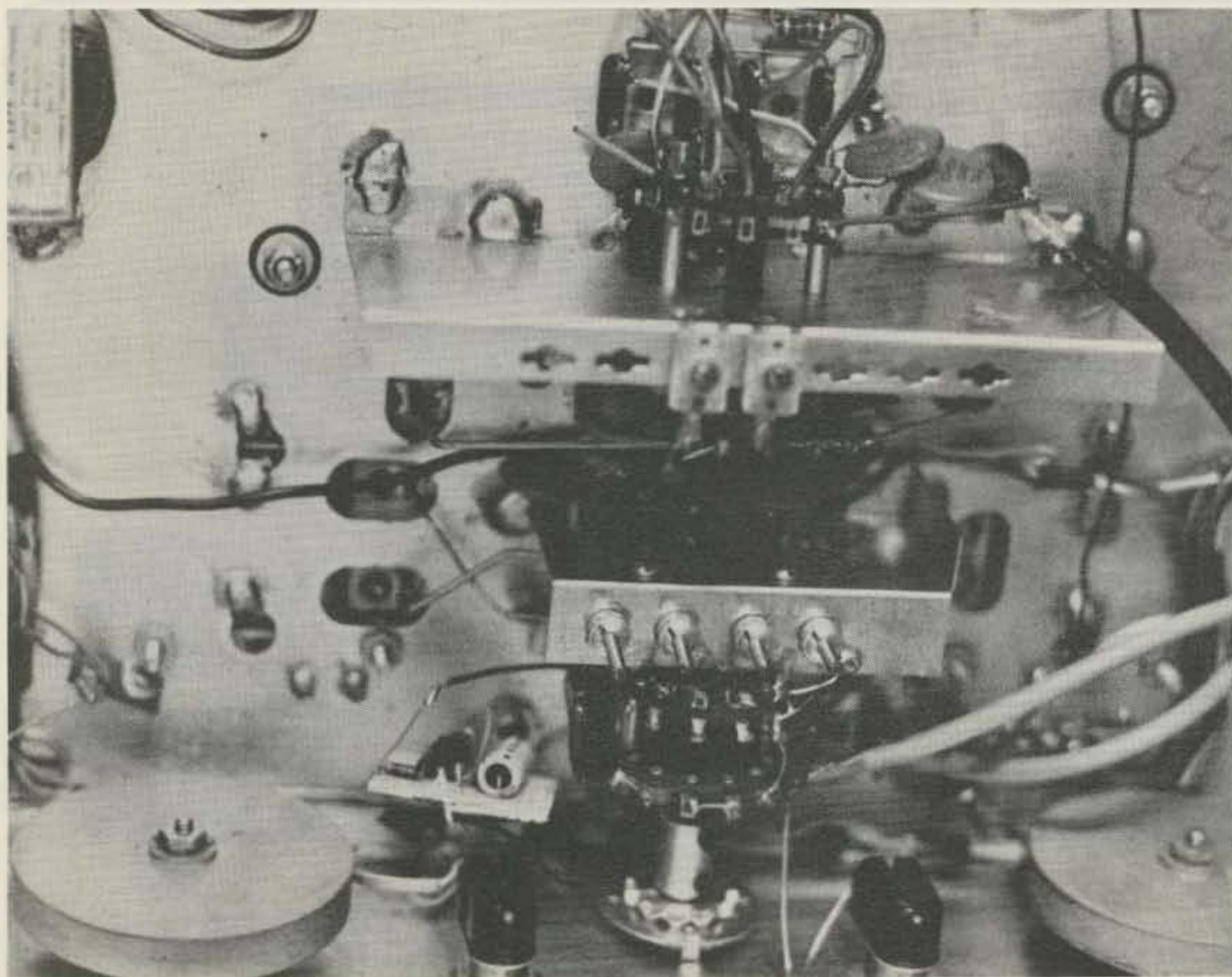

Photo A. The 1½" x 1½" buffer circuit board can be seen to the left of the bandswitch. The output phono jack can be seen below the buffer. Keep the leads from input and output as short as possible. The receiver may have to be realigned slightly after installation of the buffer.

bottom line and proceeding up the paper. When your paper is ready, set your receiver to the lowest frequency on your graph, using your 100-kHz calibrator and the main tuning dial. Keep the bandspread set at 0.

Next, begin tuning up in frequency, using the bandspread dial only. Every time you come to a signal from the 100-kHz calibrator, mark it on the graph paper by finding the coordinates of the frequency and the logging scale number. After you have done this for every 100-kHz point between 0 and 100 on the logging scale, draw a line between the points. Now you can read any frequency in the range off the graph by following the frequency line over to the graph line and then down to the X axis to find the logging scale number. Conversely, you can determine an unknown frequency by following the logging scale number up to the graph line and then over to the frequency. You should be able to tell from the way the points lie on the graph that the receiver tuning is not very linear, even over a narrow band of frequencies. This contributes to the inaccuracy of the method, as does the re-setting of the main tuning knob the next time you want to use the same graph.

Being spoiled after using many pieces of modern electronic gear with bright digital readouts, the calibration drawback to the HQ-145A annoyed me no end. Therefore, I decided something had to be done to fix this problem.

After searching through stacks of old magazines and reading various books, it suddenly dawned on me that to put a direct-reading digital readout on the HQ-145A was going to cost me quite a bit of money. And, let's face it, the receiver cost only \$25.

It suddenly occurred to

me that I did not need a direct-reading readout on the HQ-145A; all I needed was a way to determine what frequency I was listening to. The wheels started turning, and, before long, I had decided to read the oscillator frequency directly with my frequency counter, and to subtract, mathematically, the i-f of 455 kHz to give me the frequency of the received signal.

The first attempt at doing this failed miserably because, as I had expected, the addition of the frequency counter to the load on the oscillator drew the oscillator so far off frequency that I could not re-calibrate the receiver to the frequencies on the main dial. Therefore, I had to add a high-impedance input buffer between the oscillator output and the counter. This stopped the pulling problem completely, and the receiver retained calibration with the counter in or out of the circuit. So, if my counter was doing duty somewhere else, the receiver still functioned as it did before the modification.

The buffer, which is shown in Fig. 2, was built completely out of junk-box parts, but I am sure that if the parts were purchased new they would not cost more than a couple of dollars. It is also small enough to fit into any chassis (1½" x 1½"). The power for the buffer was stolen from the receiver filament supply (Fig. 3). A phono jack was mounted in a vacant spot on the chassis as near as possible to the mixer. This jack was connected to the output of the buffer and had easy access from the top of the receiver for the insertion and removal of the frequency-counter cord.

This scheme will work with any superheterodyne receiver with any i-f, be it 455 kHz, 1600 kHz, or what have you. Just remember to subtract the correct i-f for

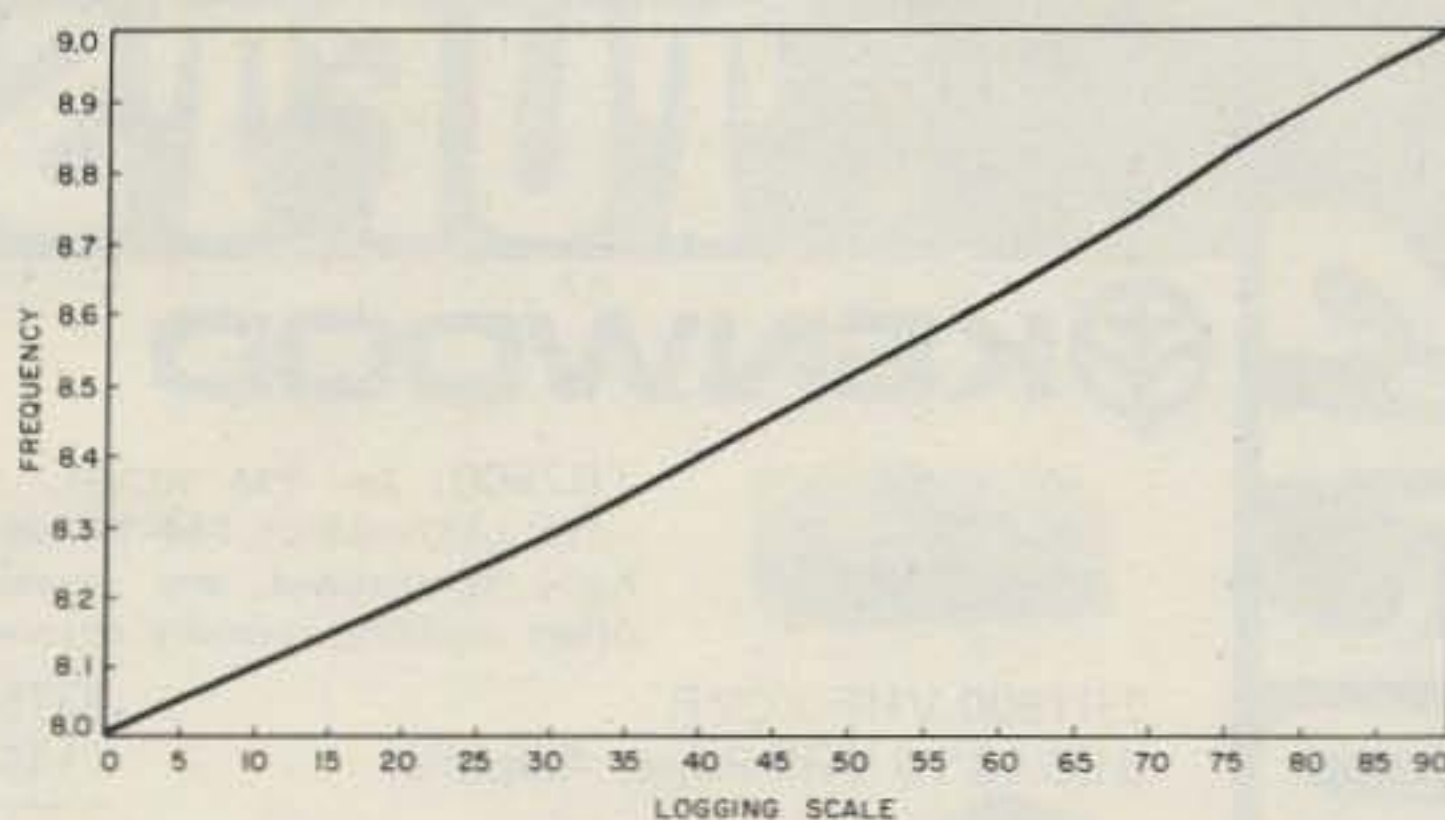

Fig. 1. Graph used to find, roughly, a wanted frequency. As can be seen, the line is not linear due to non-linear tuning of the receiver and to logging scale errors.

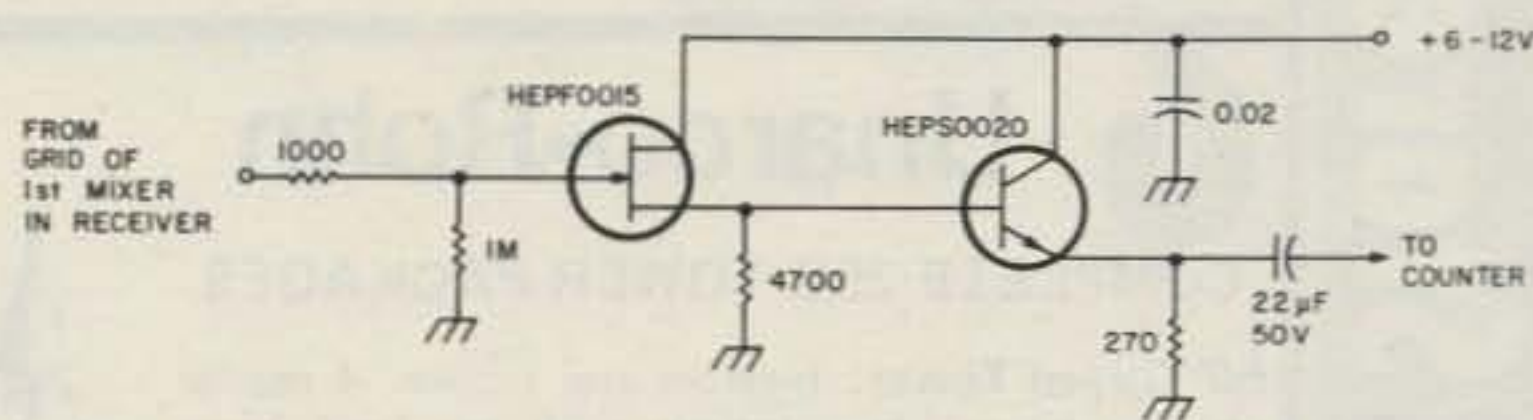

Fig. 2. Buffer circuit.

your receiver. In fact, the highest band of the HQ-145A is double-conversion, and the first i-f is 3035 kHz.

To find the frequency of a signal which is tuned in on the receiver, just subtract the i-f from the displayed figure. To find the frequency of a signal which is tuned in on the receiver, just subtract the i-f from the displayed figure. To set the receiver to a pre-determined frequency, just add the i-f to the frequency desired and then tune the receiver until that figure is displayed on the frequency counter. It's as simple as that. It's nice to be able to pre-tune the receiver for a desired frequency and know that you'll be right on the money.

As an example, suppose you have a receiver with an i-f of 455 kHz and you have a schedule on 7.235 MHz. To find the frequency, you would add the 7.235 MHz and .455 MHz and get the figure 7.690. Tune your receiver until this figure is displayed on the counter, and you will be listening on 7.235 MHz.

Suppose you are tuning across one of the international broadcasting bands and discover a signal which you can't identify. The display reads 10.445. By

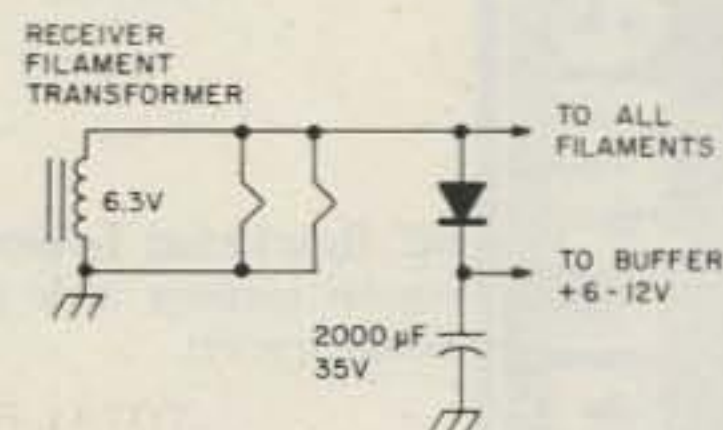

Fig. 3. Power supply for buffer, from the receiver filament supply.

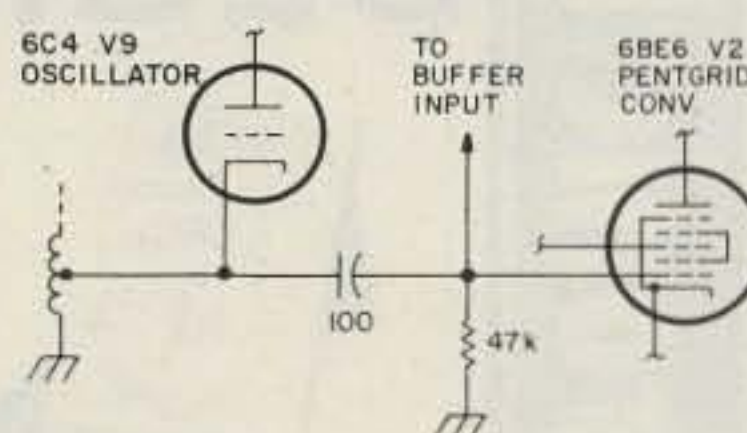

Fig. 4. Take-off point for HQ-145A receiver rf should be taken off the grid of the 1st mixer or converter tube.

subtracting .455 you discover the actual received frequency is 9.990 MHz. You can then turn to a list of international broadcasting frequencies and have a big advantage in identifying the signal by knowing the frequency.

It takes a pencil and paper or a calculator to read the frequency accurately, but the price makes the little additional work seem very much worth it. ■

TUFTS ELECTRONIC

TUFTS Electronic Department Store TUFTS

KENWOOD



TR7600: 2m FM XCVR. 10 watts, LED readout, 144-147.995. Fully synthesized, any repeater offset possible, memory channel.

TR7600 VHF XCVR **\$375.00**
 BLC 10/70 VHF Power Amplifier **149.95**



TOTAL REGULAR PRICE **\$524.95**
 SALE PRICE **\$424.95**

Vhf engineering

SAVE \$100.00

Unarco-Rohn

COMPLETE 25G TOWER PACKAGES

50' Guyed Tower: Includes top section, 4 regular sections, base plate, rotor plate, 50' guy wire, 2 guy assemblies with torque bars, 3 concrete guy anchors and other miscellaneous hardware.

TOTAL REGULAR PRICE **\$594.02**
 SALE PRICE **464.02**

SAVE \$130.00

50' Bracketed Tower: Includes top section, 4 regular sections, base plate, rotor plate and universal house bracket.

TOTAL REGULAR PRICE **\$366.15**
 SALE PRICE **266.15**

SAVE \$100.00



BECKMAN



If you've ever been troubled by a faulty multimeter — or had one that wasn't quite up to the tougher jobs — your troubles are over

Choice of Models
 The TECH 310 has all above features, 7 functions, 29 ranges, plus 0.25% Vdc accuracy.
 The TECH 300 has a 0.5% Vdc accuracy and all the above features, but without Insta-Ohms™ continuity function or the 10 amp current ranges.

Complete Multimeter Capability

DC volts: 100 μ V to 1500V
 AC volts: 100 μ V to 1000V rms
 Resistance: 0.1 Ω to 20M Ω
 DC current: 100nA to 10A (TECH 310)
 100nA to 2A (TECH 300)
 AC current: 100nA to 10A (TECH 310)
 100nA to 2A (TECH 300)
 Diode/Semiconductor test function
 Continuity function (TECH 310)

TECH 300 — \$110
 TECH 310 — \$140

TEN-TEC



574



570

TUFTS NOVICE EXCLUSIVE

Purchase your Century 21 (570 or 574) from us and have up to one year to apply the full purchase price towards a model 540, 544, 545, or 546 when you upgrade your station.

NOVICE SPECIAL

TEMPO KLM YAESU



Syncom S1 with TTP: From Tempo — the world's first synthesized 800 channel handheld transceiver. Includes battery pack, charger, telescoping antenna — and 800 channels!

KLM PA2-25B Power Amplifier: 2 watts in, 25 watts out.

PACKAGE 1

Tempo S1 w/TTP **\$339.00**
 KLM PA2-25B Power Amplifier **92.95**

Total Regular Price **\$431.95**
 SALE PRICE **\$396.95**

SAVE \$35.00

FT207R: From YAESU — 2m FM XCVR. Handheld completely synthesized, digital readout, keyboard access, 2 watts, 4 memories and much more.



PACKAGE 2

FT207R Synthesized 2m handheld **\$399.00**
 KLM PA2-25B Power Amplifier **92.95**

Total Regular Price **\$491.95**
 SALE PRICE **\$441.95**

SAVE \$50.00

KENWOOD

...pacesetter in amateur radio



TS520SE

TS520SE: 160-10 meters, 200 watts P.E.P., speech processor, noise blanker, excellent sensitivity and minimum cross-mod.

5BTV

TS520SE **\$629.95**
 Hustler 5BTV Vertical **139.95**

TOTAL REGULAR PRICE **\$769.90**
 SALE PRICE **\$649.90**

SAVE \$120.00

or

TS520SE **\$629.95**
 ATB34 Cushcraft TriBander **\$289.95**

TOTAL REGULAR PRICE **\$919.90**
 SALE PRICE **\$769.90**

SAVE \$150.00

ATB34



KENWOOD

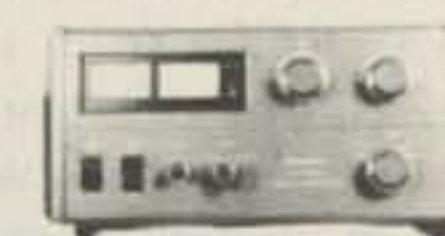

TL922A: 2kW P.E.P., 160-15 meters, 3-500Z tubes.

TL922A: **\$1199.00**
 MBII Tuner **295.00**

Total Regular Price **\$1494.00**
 Sale Price **\$1294.00**

SAVE \$200.00



Model 43



MBII TUNER: 3kW, 160-10 meters.

TL922A: **\$1199.00**
 Bird Model 43

with 2500H element and carrying case **201.00**

Total Regular Price **\$1400.00**
 Sale Price **\$1200.00**

SAVE \$200.00

CALL AND CHECK OUR GREAT DEALS ON ALL YOUR AMATEUR RADIO NEEDS.

DIAL: 1-617-391-3200

Stock items shipped within 24 hours. Prices subject to change. Limited quantity on some items.

TEL. 1-617-391-3200

DEPARTMENT STORE TUFTS



THE IAMBIC KEYSER PADDLE. Features include: adjustable jeweled bearings ("Deluxe" only); tension and contact spacing fully adjustable; large, solid, coin silver contact points; 2½ lb. chrome plated steel base rests on non-skid feet; lifetime guarantee against manufacturing defects. "Standard" model with textured gray base. \$49.50. "Deluxe" model with chrome plated base. \$65.00

THE IMPROVED "ORIGINAL" VIBROPLEX. Suitable for All Classes of Transmitting Work Where Speed and Perfect Morse Are Prime Essentials. This great new Vibroplex is a smooth and easy working BUG. It has won fame on land and sea for its clarity, precision and ease of manipulation. Can be slowed down to 10 words per minute or less or geared to as high rate of speed as desired. Maintains the same high quality signal at whatever speed, insuring easy reception under all conditions. Weight 3 lbs. 8 oz. Standard \$56.95 DeLuxe - Chromium base and top parts, with jeweled movement. \$69.95



THE "LIGHTNING BUG" VIBROPLEX High Quality Signals at All Speeds. Flat pendulum model. Weight 3 lbs. 8 oz. Standard - Polished Chromium top parts, grey base. \$69.95 Standard \$56.95



THE "CHAMPION" VIBROPLEX Weight 3 lbs. 8 oz. Without circuit closer. Standard finish only. Chromium finished top parts, with grey crystal base. \$56.95



VIBRO-KEYER Over the years, we have had many requests for Vibroplex parts to be used for construction of a keying mechanism for an electronic transmitting unit. This beautiful and most efficient "Vibro Keyer" is ideal for this job. **FEATURES OF THE "VIBRO-KEYER"**
 • Beautiful beige colored base, size 3½" x 4½", weight 2½ pounds
 • Same large size contacts as furnished on Deluxe Vibroplex.
 • Same main frame and super finished parts as Deluxe Vibroplex
 Standard — \$49.50; Deluxe Finish \$65.00



No. SSK-1 \$23.95
 No. SSK-1CP Chrome — \$29.95

NYE VIKING SQUEEZE KEY

Extra-long, finger-fitting molded paddles with adjustable spring tension, adjustable contact spacing. Knife-edge bearings and extra large, gold plated silver contacts! Nickel plated brass hardware and heavy, die cast base with non-skid feet. Base and dust cover black crackle finished. SSK-1 — \$23.45. SSK-1CP has heavily chrome-plated base and dust cover. Price — \$32.95

CODE PRACTICE SET

You get a sure, smooth, Speed-X model 310-001 transmitting key, linear circuit oscillator and amplifier, with a built-in 2" speaker, all mounted on a heavy duty aluminum base with non-skid feet. Operates on standard 9V transistor type battery (not included). Price — \$20.75
PHONE PATCH Model No. 250-46-1 measures 6-1/2" wide, 2-1/4" high and 2-7/8" deep. List price, \$36.50. Model 250-46-3, designed for use with transceivers having a built-in speaker, has its own built-in 2" x 6" 2 watt speaker. Measures 6-1/2" wide, 2-1/4" high and 2-7/8" deep. Price — \$46.50



No. 250-46-1 — \$36.50
 No. 250-46-3 — \$46.50



No. 250-46-3 — \$46.50



No. 250-46-3 — \$46.50

NYE VIKING SPEED-X KEYS

NYE VIKING Standard Speed-X keys feature smooth, adjustable bearings, heavy-duty silver contacts, and are mounted on a heavy oval die cast base with black wrinkle finish. Available with standard, or Navy knob, with, or without switch, and with nickel or brass plated key arm and hardware.

Pamper yourself with a Gold-Plated NYE VIKING KEY! Model No. 114-31C-004GP has all the smooth action features of NYE Speed-X keys in a special "presentation" model. All hardware is heavily gold plated and it is mounted on onyx-like jet black plastic sub-base. Price \$50.00

ALL BAND PREAMPLIFIERS

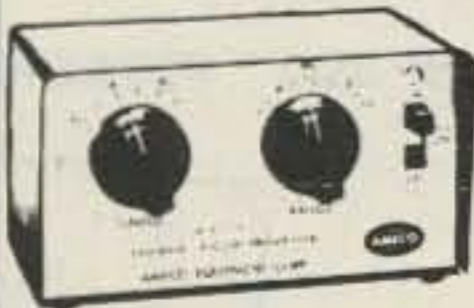

- 6 THRU 160 METERS
- TWO MODELS AVAILABLE
- RECOMMENDED FOR RECEIVER USE ONLY
- INCLUDES POWER SUPPLY

MODEL PLF employs a dual gate FET providing noise figures of 1.5 to 3.4 db., depending upon the band. The weak signal performance of most receivers as well as image and spurious rejection are greatly improved. Overall gain is in excess of 20 db. Panel contains switching that transfers the antenna directly to the receiver or to the Preamp. Model PLF 117V AC, 60 Hz. Wired & Tested \$49.95

Now you can receive the weak signals with the Ameco PT-2 pre-amplifier!

Model PT-2 is a continuous tuning 6-160 meter Pre-Amp specifically designed for use with a transceiver. The PT-2 combines the features of the well-known PT with new sophisticated control circuitry that permits it to be added to virtually any transceiver with no modification. No serious harm can be without one. Price: \$74.95

- Improves sensitivity and signal-to-noise ratio.
- Boosts signals up to 26 db.
- For AM or SSB.
- Bypasses itself automatically when the transceiver is transmitting.
- FET amplifier gives superior cross modulation protection.
- Simple to install. • Advanced solid-state circuitry.
- Improves immunity to transceiver front-end overload by use of its built-in attenuator.
- Provides master power control for station equipment.

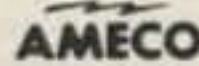

- Handle full 200 watts • low-low V.S.W.R.
- Deliver 3 dB gain and more!
- Pick the one that best fits your needs:

MAGNETIC MOUNT stays put even at 100 mph!

- MM-JM-150 for 144 MHz use } Only \$42.00
- MM-JM-220 for 220 MHz use } complete
- MM-JM-440 for 440 MHz use }

TRUNK LID MOUNT

No holes and low silhouette too!
 TLM-JM-150 for 144 MHz use } Only \$42.00
 TLM-JM-220 for 220 MHz use } complete
 TLM-JM-440 for 440 MHz use }
 And 1/4 wave antenna for trunk and magnetic mount — \$18.50

ROOF or FENDER MOUNT

Goes on quick and easy in 3/8" or 3/4" with fewest parts.
 JM-150-K for 144 MHz use } Only \$34.50
 JM-220-K for 220 MHz use } complete
 JM-440-K for 440 MHz use }
 And 1/4 wave antenna for roof and fender mounts \$11.50

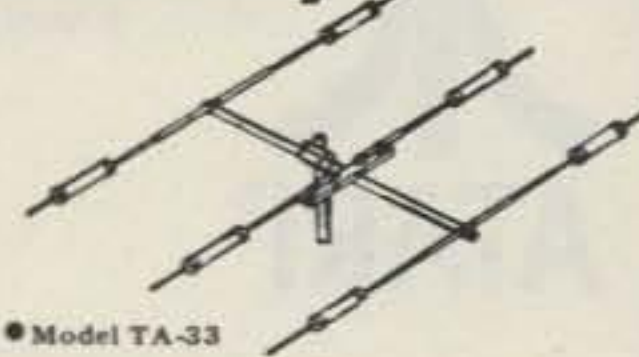

• Model TA-33

- Model TA-33, 3 elements, 10.1 dB forward gain (over isotropic source) — \$264.00
- Model TA-33 Jr., 3 elements, 10.1 dB forward gain (over isotropic source) — \$197.00
- Model MPK-3, 7500 Watts AM/CW and 2000 Watts P.E.P. SSB — \$67.75
- Model TA-36, 6 elements — \$392.75
- AK-60 mast plate adapter — \$14.50
- Model CL-33, 3 elements — \$304.75
- Model CL-36, 6 elements — \$392.75
- Model CL-203, 3 elements — \$290.00
- Model TA-40 KR — 40 meter conversion kit — \$119.50

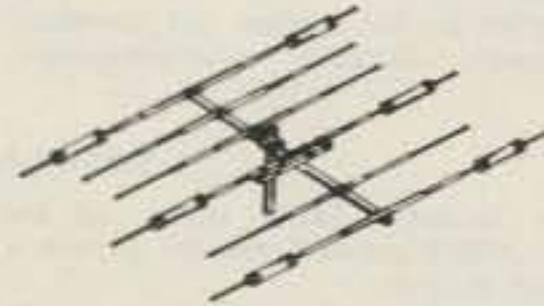

slinky
 \$39.95

Slinky! \$43.95 Kit A LOT of antenna in a LITTLE space New Slinky® dipole* with helical loading radiates a good signal at 1/10 wavelength long!

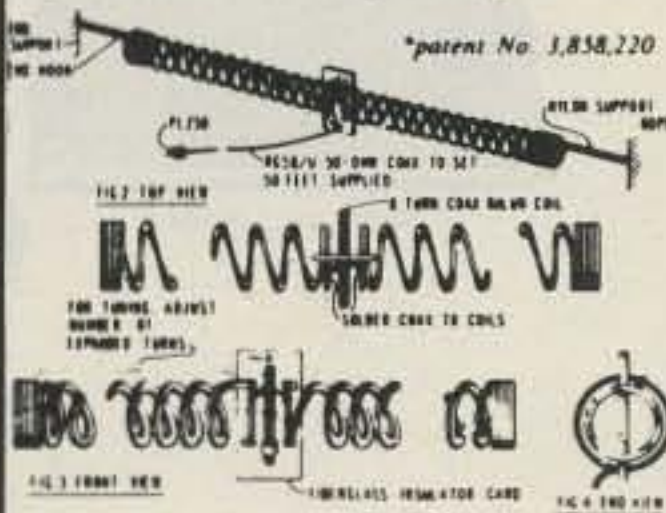

This electrically small 80/75, 40 & 20 meter antenna operates at any length from 24 to 70 ft. • no extra balun or transmatch needed • portable — erects & stores in minutes • small enough to fit in attic or apt. • full legal power • low SWR over complete 80/75, 40 & 20 meter bands • much lower atmospheric noise pick-up than a vertical & needs no radials • kit incl. a pr. of specially-made 4" dia. by 4" long coils, containing 335 ft. of radiating conductor, balun, 50 ft. RG58/U coax, PL259 connector, nylon rope & manual.

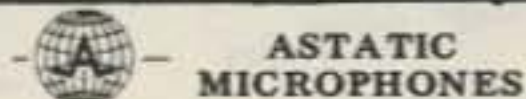

- T-UP9-D104 transistorized w/push bar base \$67.50
- T-UG8-D 104 transistorized. \$55.50
- T-UG9-D 104 "Silver Eagle" transistorized. \$74.40
- UG-D 104 ceramic or crystal . . . \$49.50



P.O. Box 27, Medford, Mass., 02155

TUFTS Electronic Department Store TUFTS

TUFTS ELECTRONIC

TUFTS Electronic Department Store TUFTS



A Warner Communications Company

ATARI® 800™ PERSONAL COMPUTER SYSTEM



\$1080.00

ATARI 800

The ATARI 800 is a top-of-the-line personal computer system. Its expandable memory, advanced peripheral components, comprehensive software library, and modular design assure that it will never become obsolete.

Whether it's for business and household management, education, or entertainment,

the ATARI 800 can be tailored to specific needs and has been designed to change as those needs change. This "timeless" computer system can be used by people with no previous computer experience, although it doesn't compromise capability for the sophisticated user.

SOFTWARE LIBRARY

The hardware which makes up the ATARI 800 Personal Computer System is only half the story.

The other half is ATARI's complete software library. You get a full choice of ROM cartridge, tape cassette, and diskettes that give you complete control in shaping your computer's character and applications. For data management. For problem solving. For education. For fun and games.

You can even create and apply your own programs. ATARI's BASIC Language cartridge gives you direct access to your computer's central processing unit, memory and color, sound and file transfer capabilities. So you can design, write and implement your own programs. Or modify existing ones to suit your needs. Easily. Even if you've never talked to a computer before.



ATARI® 830™ MODE M



ATARI® 850™ INTERFACE MODULE



JOYSTICK CONTROLLERS



PADDLE CONTROLLERS



ROM PROGRAMS



CASSETTE PROGRAMS

The system

The ATARI 800™ system provides easy access to a wide variety of household information. Uses such as music composition, electronic art, and household security control are all planned applications for the ATARI 800 system. The educational and entertainment value built into the system is endless.

For professional use, the ATARI 800 is expandable to keep up with the needs of most small businesses, and with the needs of large businesses where the central computer is overloaded.

Business & household management

- **Personal Financial Management** Income and expense record keeping keyed to rapid retrieval for income tax purposes
- **Record Keeping** Books, records, serial numbers, insurance policies.
- **Charge Account Management** (With check printing)
- **Personal Capital Investment Management** Stocks, bonds, real estate, with stock quotation service
- **Mailing List/Address Book** (With printing)
- **Computerized Appointment Calendar**
- **Inventory Management**
- **Accounts Payable**
- **Touch-typing Trainer**
- **Payroll**

Educational applications

The exclusive ATARI 800 Educational Library on audio/digital cassettes, contains over 20 subjects, including:

- Algebra
- Economics
- Auto Mechanics
- Sociology
- U.S. History
- Zoology
- Counseling
- Procedures
- Vocabulary Builder
- Basic Psychology
- Spelling
- Spanish
- Accounting
- Carpentry
- Great Classics
- Statistics
- Basic Electricity
- World History

Direct interaction with the computer takes place through the keyboard, television screen, and speaker. This running dialogue between the user and the computer is highlighted by immediate feedback on accuracy and understanding.

Entertainment applications

The ATARI 800 is capable of playing sophisticated thinking and action games. The Entertainment Program Library consists of:

- Thinking games**
- Chess
 - Backgammon
 - Business Simulations
 - Stock Market Simulation
 - Space Adventure
 - Strategy Games

- Action games**
- Four-Player Basketball
 - Superbug™ Driving Game
 - Game of Life
 - Super Breakout™

ANNOUNCING A NEW GENERATION OF PERSONAL COMPUTERS BY ATARI®



ATARI 410 Program Recorder

Comes supplied with your ATARI 800 Personal Computer. The program recorder gives you the ability to utilize any ATARI pre-recorded tape cassette program. It also lets you store your own programs on audio cassette tapes. It can store up to 100K bytes per 60 minute tape. **\$89.95**



ATARI Memory Modules (Optional)

Unique 8K and 16K plug-in RAM modules let you instantly expand your computer's internal memory up to 48K.

8K \$124.95
16K \$199.95



ATARI 820 Printer (Optional)

High resolution, dot-matrix impact printer uses inexpensive, standard roll paper. Prints more than 2,000 characters per minute to provide permanent printed records of program listings and program results. **\$599.95**



ATARI 810 DISC DRIVE (Optional)

Uses standard 5 1/4" diskettes to add up to 88K bytes of rapid access information storage for each diskette. As many as four 810 Disk Drive units can be operated simultaneously and accessed individually.

\$699.95

ATARI® 400™ PERSONAL COMPUTER SYSTEM



\$630.00

ATARI 400

The ATARI 400 Personal Computer is just that: a computer that you can use. It's easy to own. And easy to operate. Even if you've never used a computer before.

But don't let its simple operation fool you. The ATARI 400 is a full-fledged general purpose computer that can go a long way towards simplifying your complex life.

All you have to do is pick a program from ATARI's comprehensive library of plug-in cartridge and cassette tape software. Everything from small business management to home finance and computerized education. Plus some of the most challenging, most exciting computer games ever.

TEL. 1-617-391-3200

DEPARTMENT STORE TUFTS



from Barker & Williamson

On this page Tufts
brings you . . .
B&W

5-BAND TRAP DIPOLE (80 thru 10 Meters)



Pre-assembled:
Model 370-11 Kit (illustrated):
- \$64.95 Model 370-12 - \$54.95

Model Number	Dia.	TPI	Wire Size (AWG)	Length of Coils (Inches)	PRICE	Model Number	Dia.	TPI	Wire Size (AWG)	Length of Coils (Inches)	PRICE
404T	1/2	4	18	2	\$2.20	1404T	13/4	4	14	10	\$7.10
406T	1/2	6	18	2	2.33	1406T	13/4	6	14	10	5.01
408T	1/2	8	18	2	2.33	1408T	13/4	8	14	10	5.12
410T	1/2	10	18	2	2.42	1410T	13/4	10	16	10	5.23
416T	1/2	16	20	2	2.53	1416T	13/4	16	18	10	5.36
432T	1/2	32	24	2	2.75	1432T	13/4	32	24	10	5.65
504T	5/8	4	16	2	2.20	1604T	2	4	12	10	9.60
506T	5/8	6	18	2	2.27	1606T	2	6	14	10	9.71
508T	5/8	8	18	2	2.33	1608T	2	8	14	10	9.82
510T	5/8	10	18	2	2.46	1610T	2	10	16	10	9.94
516T	5/8	16	20	2	2.53	1616T	2	16	18	10	10.14
532T	5/8	32	24	2	2.66	2004T	21/2	4	12	10	10.90
604T	3/4	4	16	2	2.10	2006T	21/2	6	12	10	11.01
606T	3/4	6	18	2	2.17	2008T	21/2	8	12	10	11.12
608T	3/4	8	18	2	2.30	2010T	21/2	10	16	10	11.23
610T	3/4	10	18	2	2.37	2404T	3	4	10	10	13.17
616T	3/4	16	20	2	2.42	2406T	3	6	12	10	13.28
632T	3/4	32	24	2	2.61	2408T	3	8	14	10	13.40
804T	1	4	16	3	2.31	2410T	3	10	14	10	13.50
806T	1	6	18	3	2.45	195-1	3	—	—	—	52.38
808T	1	8	18	3	2.52	195-2	3	—	—	—	61.02
810T	1	10	18	3	2.56	3204T	4	4	8	10	69.39
816T	1	16	20	3	2.73	3206T	4	6	10	10	70.74
832T	1	32	24	3	2.78	3208T	4	8	12	10	67.23
1004T	11/4	4	14	10	6.17	3210T	4	10	12	10	68.58
1006T	11/4	6	14	10	6.33	4004T	5	4	8	10	83.16
1008T	11/4	8	16	10	7.17	4006T	5	6	10	10	84.78
1010T	11/4	10	18	10	7.33	4008T	5	8	12	10	86.94
1016T	11/4	16	20	10	7.48	4010T	5	10	12	10	90.45
1032T	11/4	32	24	10	7.89	4804T	6	4	8	10	92.34
1204T	11/2	4	14	10	6.36	4806T	6	6	10	10	99.36
1206T	11/2	6	14	10	6.79	4808T	6	8	12	10	100.98
1208T	11/2	8	16	10	7.17	4810T	6	10	12	10	108.00
1210T	11/2	10	18	10	7.24						
1216T	11/2	16	20	10	7.50						
1232T	11/2	32	24	10	7.82						

PI-DUX® Coils
High-precision, air-wound coils for band-switching, pi-network final amplifiers.

AIR-DUX® Air Wound Coils
Uniform-pitch coils from 1/2 inch to 6 inches diameter, 2 inches to 10 inches long, 4 to 32 turns per inch, no. 8 to no. 24 AWG.

COAXIAL SWITCHES AND ACCESSORIES

for antenna selection and RF switching



MODEL	DESCRIPTION	PRICE
375	SWITCHES PROTAX switch. Grounds all except selected output circuit. 6 Outputs.	\$19.75
376	PROTAX switch. Grounds all except selected output circuit. Sixth switch position grounds all outputs. 5 Outputs.	19.75
377	Coaxial Antenna Relay	22.50
550A	Antenna/RF Coax Switch. 5 Outputs.	17.50
550A-2	Antenna/RF Coax Switch. 2 Outputs.	14.95
551A	Special 2-pole, 2-position switch used to switch any RF device in or out of series connection in a coaxial line. 2 Outputs.	17.95
556	Bracket only, for wall mounting of radial connector switches.	.95
590	Antenna/RF Coax Switch. 5 Outputs.	18.50
590G	Grounds all except selected output circuit. 5 Outputs.	18.50
592	Antenna/RF Coax Switch. 2 Outputs.	17.75
593	Single pole, 3 position Antenna RF/Coax Switch.	17.50
594	D.P.D.T. Antenna /RF Coax Switch. Interchanges two outputs between two inputs.	18.25
595	Grounds all except selected output circuit. 6 Outputs.	21.50



Model 333 dummy load wattmeter - Favorite Lightweight Portable-250 WATT RATING - Air Cooled. Ideal field service unit for mobile 2-way radio - CB, marine, business band. Best for QRP amateur use, CB, with zero to 5 watts full scale low power range.

Frequency Range: DC to 300 MHz
VSWR: Less than 1.3:1 to 230 MHz
Power Range: 250 watts intermittent
Warning light* signals maximum heat limit.
Wattmeter Ranges: 0-5, 0-50, 0-125, 0-250
Connector: SO-239
Size: 4" x 7" x 8"
Shipping Weight: 2 lbs.
Price: \$98.50

Model 374 dummy load wattmeter - Top of the Line - 1500 WATT RATING - Oil Cooled. Our highest power combination unit. Rated to 1500 watts input (intermittent). Meter ranges are individually calibrated for highest accuracy.

Frequency Range: DC to 300 MHz
VSWR: Less than 1.3:1 to 230 MHz
Power Range: 1500 watts DC intermittent. Warning light* signals maximum heat limit.
Wattmeter Ranges: 0-15, 0-50, 0-300, 0-1500
Input Connector: SO-239 (hermetically sealed)
Size: 4 1/2" x 9" x 10 1/2"
Shipping Weight: 12 lbs.
Price: \$225.00

High Power - 1000 WATT RATING - Oil Cooled - model 334A dummy load wattmeter. Our most popular combination unit. Handles full amateur power. Meter ranges individually calibrated. Can be panel mounted.

Frequency Range: DC to 300 MHz
VSWR: 1.3:1 maximum, DC to 225 MHz
Power Range: 1000 watts CW intermittent. Warning light* signals maximum heat limit.
Wattmeter Ranges: 0-10, 0-100, 0-300, 0-1000
Input Connector: SO-239 (hermetically sealed)
Size: 4 1/2" x 9" x 10 1/2"
Shipping Weight: 12 lbs.
Price: \$195.00

Wide range attenuator - Model 371-1. Seven rocker switches provide attenuation from 1 dB to 61 dB in 1-dB steps. Switches are marked in dB, 1-2-3-5-10-20-20. Sum of actuated switches (IN position) gives attenuation. With all switches in OUT position, there is NO insertion loss. Attenuator installs in coaxial line using UHF connectors.

Power Capacity: 1/2 watt
VSWR: 1.3:1 maximum, DC to 225 MHz
Impedance: 50 ohms
Accuracy: 1 dB/dB, DC to 60 MHz
0.1 dB/dB, 70.5 dB, DC to 160 MHz
0.1 dB/dB, 71.0 dB, DC to 225 MHz
Size: 8 1/2" x 2 1/2" x 2 1/2"
Shipping Weight: 1 1/2 lbs.
Price: \$89.50

TUFTS Electronic Department Store TUFTS

P.O. Box 27, Medford, Mass., 02155

TUFTS ELECTRONIC

TUFTS Electronic Department Store TUFTS

On this page Tufts brings you . . .
Tempo
Palomar Engineers

PALOMAR ENGINEERS



\$299.95

ANTENNA TUNER

Here is a new tuner that puts more power into your antenna, works from 160m-10m, handles full legal power and then some, and works with coax, single wire and balanced lines. And it lets you tune up without going on the air.

All tuners lose some rf power, mostly in the inductance coil and the balun core. To avoid this we switched from No. 12 wire for the main inductor to 1/4" copper tubing. It can carry ten times the rf current. And we've moved the balun from the output, where it almost never sees its design impedance, to the input where it always does. Thus more power to your antenna.

The biggest problem with tuners is getting them tuned up. With three knobs to tune on your transceiver and three on the tuner and ten seconds to do it (see the warning in your transceiver manual) that's 1 1/2 seconds per knob. We have a better way; a built-in 50 Ohm noise bridge that lets you set the tuner controls without transmitting. And a switch that lets you tune your transmitter into a dummy load. So you can do the whole tuneup without going on the air. Saves that final; cuts QRM.



TEMPO

TEMPO
the first in synthesized portables gives you the broadest choice at the lowest price

PRICE LIST

Tempo S-5	\$349.00
Tempo S-5 with touch tone pad	399.00
12 Button touch tone pad (not installed)	39.00
16 Button touch tone pad (not installed)	48.00
Tone burst generator	29.95
CTCSS sub-audible tone control	29.95
Rubber flex antenna	8.00
Leather holster	16.00
Cigarette lighter plug mobile charging unit	6.00
Matching 30 watt output 13.8 VCD power amplifier (S30)	89.00
Matching 80 watt output power amplifier (S80)	149.00
Tempo S-2	349.00
Tempo S-2 with touch tone pad	399.00
Tempo S-1	299.00
Tempo S-1 with touch tone pad	339.00

. . . the new S-5

- ★ The only synthesized hand-held offering 5 watts output. (Switchable for 1 or 5 watt operation)
- ★ The same dependability as the time proven S-1. Circuitry that has been proven in more than a million hours of operation.
- ★ Heavy duty battery pack.
- ★ Telescoping whip antenna.
- ★ Ni-cad battery pack, charger.
- ★ External microphone capability.

If you're not on 220 this is the perfect way to get started. With the addition of the S-25 (25W output) or S-75 (75W output) Tempo solid state amplifier it becomes a powerful mobile or base station. If you have a 220 MHz rig, the S-2 will add tremendous versatility. Its low price includes an external microphone capability, heavy duty ni-cad battery pack, charger, and telescoping whip antenna.

the Tempo S-2

- ★ Tempo is first again. This time with a superior quality synthesized 220 MHz hand-held transceiver. With an S-2 in your car or pocket you can use 220 MHz repeaters throughout the U.S. It offers all the advanced engineering, premium quality components and exciting features of the S-1. The S-2 offers 1000 channels in an extremely lightweight but rugged case.

Tempo S-1

- ★ The first and most thoroughly field tested hand-held synthesized radio available. 800 channels in the palm of your hand.
- ★ Simple to operate. (You don't need a degree in computer programming).
- ★ Heavy duty battery pack allows more operating time between charges.
- ★ External microphone capability.

<p>R-X NOISE BRIDGE \$55.00</p> <ul style="list-style-type: none"> Learn the truth about your antenna. Find its resonant frequency. Find R and X off-resonance. Broadband 1-100 MHz. Simple to use. — Self contained. 	<p>VLF CONVERTER \$59.95</p> <ul style="list-style-type: none"> New device opens up the world of VLF radio. Converts VLF to 80 meters. For use with any shortwave receiver covering 3.5-4 MHz. Advanced design for simple operation, high performance. Gives reception of the 1750 meter band. Also covers navigation radiobeacons, WWVB, ship-to-shore, and LF broadcast band. 	<p>LOOP ANTENNA Loop Amplifier \$67.50 Plug-in loops \$47.50 ea.</p> <ul style="list-style-type: none"> Plug-in loops available for: 1600-5000 KHz (160/80 meter amateur bands) 550-1600 KHz (Broadcast Band) 150-550 KHz (VLF, 1750 meter band) 40-150 KHz (WWVB, Loran) 10-40 KHz (Omega) Nulls out interference 	<p>IC KEYER \$97.50</p> <ul style="list-style-type: none"> Sends Manual, Semi-Automatic, Full Automatic, Dot Memory, Dash Memory, Squeeze and Lambic. More Features than any other keyer. Built-in sidetone, speaker, speed and volume controls. Fully Adjustable contact spacing and paddle tension. The perfect paddle touch will Amaze you. Battery Operated. Heavy shielded die-cast metal case. 3-lb. steel base. By the World's oldest manufacturer of electronic keys.
<p>FREQUENCY STANDARD \$42.50</p> <ul style="list-style-type: none"> 100, 50, 25, 10 and 5 KHz. Markers selectable by panel switch. Crystal controlled. A true secondary frequency standard. Square Wave Signal. Rich harmonics usable from 5 kHz to 50 MHz. Sharp Clear Output. Exclusive circuit suppresses unwanted markers. Battery Operated. No line cord. Self contained battery. 	<p>RF TRANSFORMER \$42.50</p> <ul style="list-style-type: none"> Full 2000 watt CW (5-Kw PEP). Matches 32, 28, 22, 18, 12, 8, 5 ohm antennas. For all verticals and mobile whip antennas. Smaller size. Higher efficiency. RF ferrite toroid core. 	<p>500 W. RF TRANSFORMER \$35.00</p> <ul style="list-style-type: none"> Full 500 watt CW capability. No time limit. Convenient switch selection of impedance taps. Small size. High efficiency. RF ferrite toroid core. 	<p>CW FILTER \$39.95</p> <ul style="list-style-type: none"> Steep skirts. No ringing. Simulated-stereo technique filters QRM, improves copyability of CW signals. 80 Hz bandwidth. Eight pole IC filter.
<p>ALL BANDS PREAMPLIFIER \$89.50</p> <ul style="list-style-type: none"> Tunes 1.8 to 54 MHz. Covers ALL amateur bands 160 to 6 meters. ALL shortwave broadcast bands. For receivers AND transceivers. Up to 20 db gain. Peeps up that tired receiver. Reduces image and spurious response. 	<p>BEAM BALUN \$47.50</p> <ul style="list-style-type: none"> 3 Kw CW, 6 Kw PEP input power. U bolt for 2" boom. 1.7 - 30 MHz. 1:1 or 4:1 ratio available. All stainless steel hardware. 	<p>MODEL 2K BALUN \$42.50</p> <ul style="list-style-type: none"> 3 Kw CW, 6 Kw PEP input power. Replaces center insulator. 1.7 - 30 MHz. 1:1 or 4:1 ratio available. 	<p>MODEL 1K BALUN \$22.50</p> <ul style="list-style-type: none"> 1.5 Kw CW, 3 Kw PEP input power. Replaces center insulator. 1.7 - 30 MHz. 1:1 or 4:1 ratio available.

PALOMAR ENGINEERS

TEL. 1-617-391-3200

DEPARTMENT STORE TUFTS

F9FT

ON REMAINING
F9FT ANTENNAS

SALE!

1/3 OFF
REGULAR PRICE!

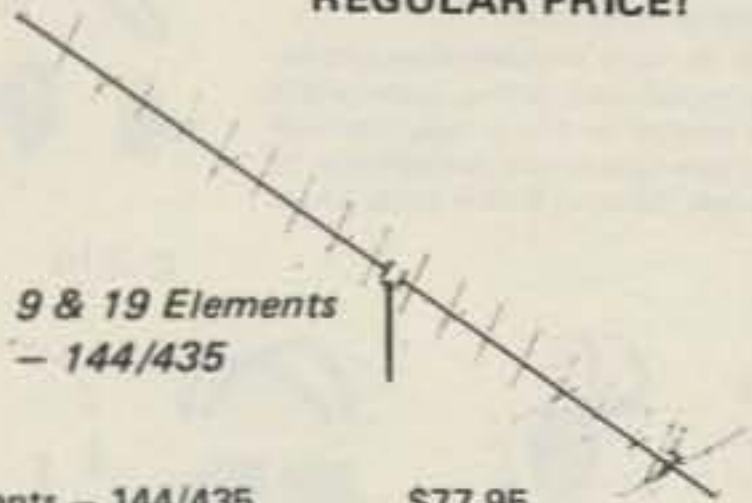

9 & 19 Elements
- 144/435

Special OSCAR - 9 & 19 Elements - 144/435 \$77.95

TECHNICAL DATA

Frequency range MHz	144/146	430/440
Gain ISO	14 dB	17 dB
Horizontal aperture angle*	2 x 19°	2 x 14°
Vertical aperture angle*	2 x 23°	2 x 16°
Front-to-back ratio	15 dB	23 dB
Side lobe attenuation	> 50 dB	> 38 dB
SWR	< 1.3	< 1.2
Impedance	50	50
Weight	1.9 kg	1.1 kg
Physical length	3.3m	3.2 m
Windload*	6.4 kgp	5.4 kgp

*The indicated value is given at -3 dB

9 Elements - 144 MHz



9 Elements - 144 MHz \$39.95

TECHNICAL DATA

Frequency range MHz	144/146
Gain ISO	14 dB
Horizontal aperture angle*	2 x 19°
Vertical aperture angle*	2 x 23°
Front-to-back ratio	15 dB
Side lobe attenuation	> 50dB
SWR	< 1.3
Impedance	50
Weight	1.9 kg
Physical length	3.3m
Windload*	6.4 kgp

*The indicated value is given at -3 dB

21 Elements - 432 MHz

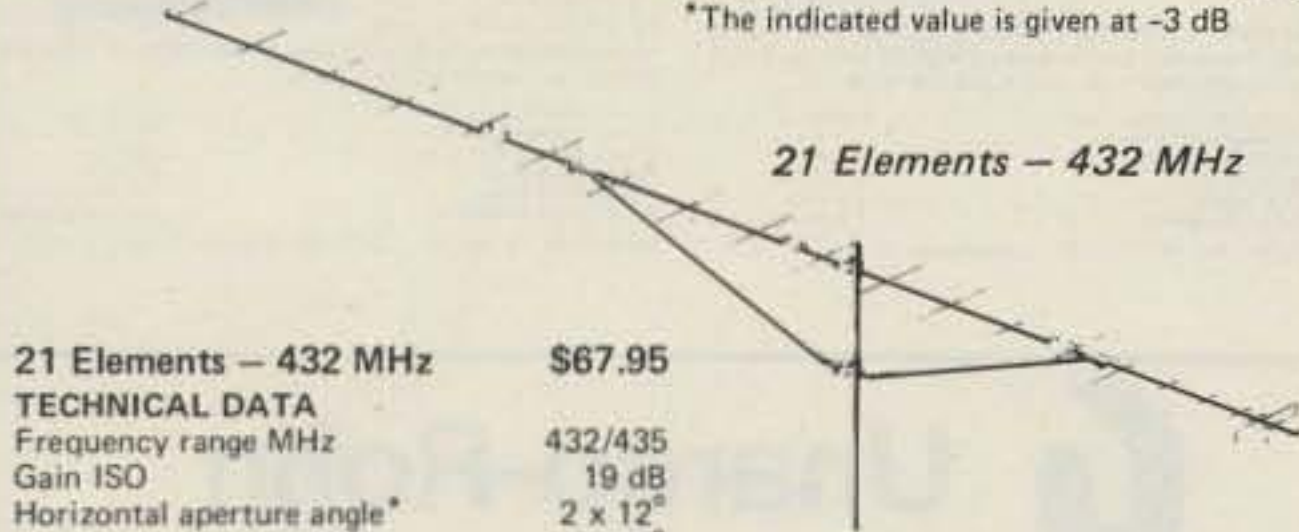

21 Elements - 432 MHz \$67.95

TECHNICAL DATA

Frequency range MHz	432/435
Gain ISO	19 dB
Horizontal aperture angle*	2 x 12°
Vertical aperture angle*	2 x 13°
Front-to-back ratio	23 dB
Side lobe attenuation	> 40 dB
SWR	< 1.1
Impedance	50
Weight	2.6 kg
Physical length	4.6m
Windload*	6.4 kgp

*The indicated value is given at -3 dB

16 Elements - 144MHz

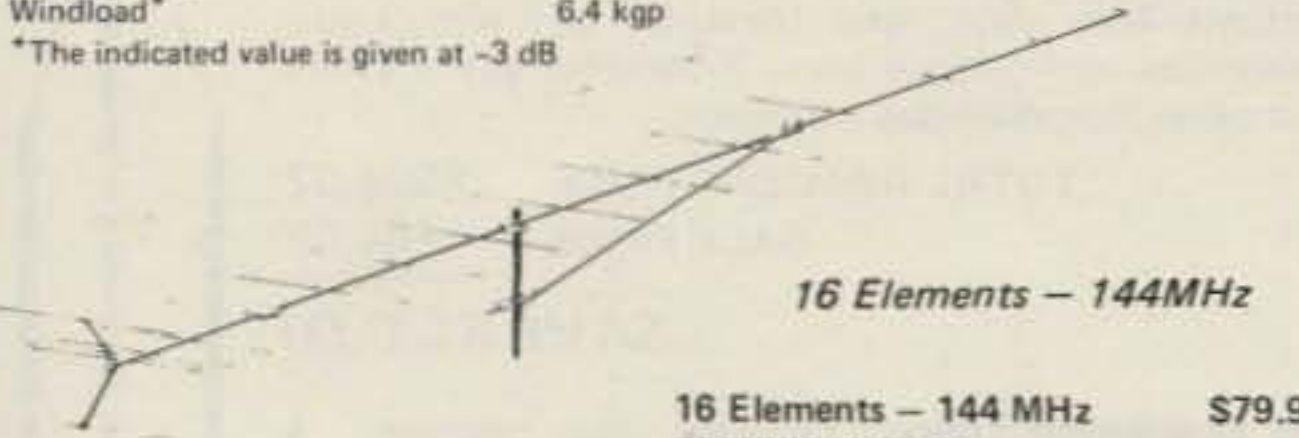

16 Elements - 144 MHz \$79.95

TECHNICAL DATA

Frequency range MHz	144/146
Gain ISO	17.8 dB
Horizontal aperture angle*	2 x 16°
Vertical aperture angle*	2 x 17°
Front-to-back ratio	22 dB
Side lobe attenuation	> 60 dB
SWR	< 1.2
Impedance	50
Weight	4.4 kg
Physical length	6.4m
Windload*	16 kgp

*The indicated value is given at -3 dB

Antennas
for the
Active
Amateur

MICROWAVE MODULES TEXAS RF

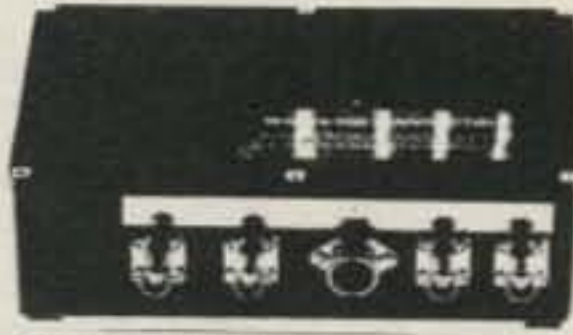

MICROWAVE MODULES
HIGH PERFORMANCE UNITS
FOR 144, 432 and 1296 MHz

**144 MHz MOSFET CON-
VERTER - MMC144/28**
With dual protected gate Mosfet
RF Amplifier and Mixer stages
Input frequency: 144-146 MHz
I.F. output frequency: 28-30 MHz
Typical gain: 30 dB
Guaranteed maximum noise figure: 2.5 dB
Typical image rejection: 65 dB
Crystal oscillator frequency: 116 MHz (tuner controlled)
Maximum frequency error at 144 MHz: 3 KHz
Power requirements: 12 volts DC 75% at 50 mA
Other I.F. output frequencies available:
12-14, 14-16, 18-20, 24-26 MHz

**144 MHz MOSFET CON-
VERTER - MMC144/28 LO**
Similar to the MMC144/28, this
unit features an additional 116
MHz buffer amplifier to provide a
local oscillator signal suitable for
transverter use.

**144 MHz DOUBLE CON-
VERSION MOSFET CONVERTER -
MMC144/2 - MMC144/4**
This unit has been developed to
meet the requirements for a con-
verter suitable for use with re-
ceivers having better performance
at lower frequencies.
Input frequency: 144-146 MHz
I.F. output frequencies available: 2.4, 4.6 MHz
Oscillator frequency: 71 MHz (2.4 MHz IF),
70 MHz (4.6 MHz IF)
Maximum frequency error at 144 MHz: 3 KHz
Typical gain: 30 dB
Guaranteed maximum noise figure: 2.5 dB
Power requirements: 12 volts DC 75% at 30 mA

**144 MHz DUAL OUTPUT MOS-
FET PREAMPLIFIER -
MMA144**
This two-stage mosfet preampli-
fier has two separate isolated out-
puts, for leading two receivers, for
example.
Input frequency: 144-146 MHz
Typical gain: 18 dB
Guaranteed maximum noise figure: 2.5 dB
Bandwidth: 5 MHz at -3 dB, 8 MHz at -10 dB
Power requirements: 12 volts DC 75% at 25 mA

SALE! 1/2 PRICE!
ON REMAINING
MODULES

**432 MHz MOSFET CON-
VERTER - MMC432/144**
Two RF Amplifiers and a Mosfet
Mixer combine high sensitivity
and low cross-modulation charac-
teristics.
Input frequency: 432-434 MHz
I.F. output frequencies available:
14-16, 18-20, 28-30, 144-146
MHz
Typical gain: 30 dB
Guaranteed maximum noise figure: 3.8 dB
Crystal oscillator frequency: 101 MHz (28-30 MHz IF)
(tuner controlled): 96 MHz (144-146 MHz IF)
Maximum frequency error at 432 MHz: 5 KHz
Power requirements: 12 volts DC 75% at 45 mA

**1296 MHz CONVERTER -
MMC 1296/28 - MMC1296/144**
A hybrid ring mixer with a
matched pair of hot-carrier
diodes, driving a dual-gate mosfet
I.F. amplifier.
Input frequency: 1296-1298 MHz
I.F. output frequencies available: 28-30, 144-146 MHz
Typical gain: 25 dB
Guaranteed maximum noise figure: 8.5 dB
Crystal oscillator frequency: 105.666 MHz (28-30 MHz IF)
(tuner controlled): 96 MHz (144-146 MHz IF)
Maximum frequency error at 1296 MHz: 20 kHz
Power requirements: 12 volts DC 75% at 50 mA
Connectors: 50 ohm BNC

TRANSVERTERS:

MMT 144/28	259.95
MMT 144/50	259.95
MMT 432/28S	329.95
MMT 432/50S	329.95
MMT 432/144S	389.95

RECEIVING CONVERTERS:

MMC 144/28	65.95
MMC 144/28LO	70.95
MMC 432/28S	95.95
MMC 432/144	95.95
MMC 1296/28	85.95
MMC 1296/144	85.95

VARACTOR TIPLER:

MMV 1296	110.95
----------	--------

ATTENUATORS:

MAA 16	27.95
--------	-------



Two NEW Rotors from Cornell-Dubilier

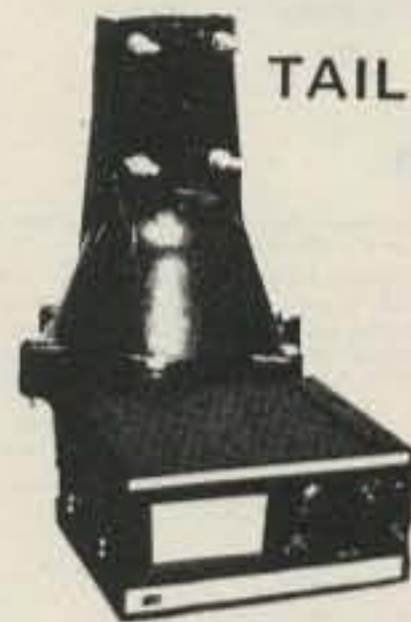

TAIL TWISTER™



HAM IV

- For the New Super Communications Antennas
- New Thickwall Casting
- New Steel Ring Gear
- New Metal Pinion Gear
- New Motor Prebrake
- New Super Wedge Brake
- New L.E.D. Control Box
- Safe 26 Volt Operation

Designed for the newest of the king-size communications antennas, the TAIL TWISTER™ is the ultimate in antenna rotational devices. The TAIL TWISTER™ starts with a deluxe control box featuring snap action controls for brake and directional controls; L.E.D. indicators signal rotation and brake operation, while the illuminated meter provides direction readout. This new control box couples to the newest bell rotor. Using the time tested bell rotor principle, the TAIL TWISTER™ is a brand new design with thickwall castings and six bolt assembly. A brand new motor with prebrake action brings the antenna system to an easy stop, while the massive square front brake wedge locks the assembly in place. A new stainless steel spur gear system provides final drive

into a new steel ring gear for total reliability. Triple race, 138 ball bearing assembly carries dead weight and maintains horizontal stability. An optional heavy duty lower mast adaptor is available for lighter loads with mast mounting. Price: \$279.00

The HAM IV sets new levels of performance. Snap action switched wedge brake and rotational controls brings pinpoint accuracy to large directional arrays popular in communications. A new motor provides pre-brake action to assist in slowing down rotational mass, and the new thicker wedge brake offers far stronger lock-in phase action. To take full advantage of this new design, the HAM III is designed for in-tower mounting. A new optional heavy duty lower mast adaptor is available when the HAM III is to be mast mounted with smaller arrays. A stainless steel spur gear system multiplies the torque into the dual race 98 ball bearing support assembly assuring years of trouble free performance. Price: \$189.00

P.O. Box 27, Medford, Mass., 02155

TUFTS Electronic Department Store TUFTS

TUFTS ELECTRONIC

TUFTS Electronic Department Store

On this page Tufts brings you . . .

Telex
NPC
Unarco-Rohn



Headphone Jack Box

Ham Clubs, field day contest operation. No more jury rigs for multiple headphones. Six 1/4" phone jacks with individual volume controls, 4 foot cord with 1/4" phone plug. **\$14.30**

PROFESSIONAL HEADPHONES & HEADSETS BOOM MIC HEADSETS

For the ultimate in communications convenience and efficiency select a boom mic headset. Long-time favorites of professional communications, boom mic headsets allow more personal mobility while always keeping the mic properly positioned for fast, precise voice transmission. Boom microphones are completely adjustable to allow perfect positioning. And, boom headsets leave both hands free to perform other tasks.

All models are supplied with "close talking" microphones to limit ambient noise pick-up and provide superior intelligibility. Each model as a convenient, inline push-to-talk switch, which can be wired for either push-to-talk relay control or mic circuit interrupt for voice operated transmitters. The switch may be used as a momentary push-button or it can be locked in the down position. All models have tough, flexible, 8 foot cords which are stripped and tinned, unterminated.

TELEX



C-610 C-1210 C-1320



CM-610 CM-1210 CM-1320 CM-1320-S PC-100 HTC-2 HMC-2 HTC-91

MODEL	C-610	SWL-610	C-1210	C-1320	CM-610	CM-1210	CM-1320	CM-1320S	PC-100	HTC-2	HMC-2	HFC-91
Headphone Sensitivity Ref 0002 Dynes/cm ² @ 1mW input, 1kHz	103dB SPL ±5dB	103dB SPL ±5dB	103dB SPL ±3dB	105dB SPL ±5dB	103dB SPL ±5dB	103dB SPL ±3dB	105dB SPL ±5dB	105dB SPL ±dB				
Headphone Impedance	3.2 20 ohms	2000 ohms	3.2 20 ohms	3.2 20 ohms	3.2 20 ohms	3.2 20 ohms	3.2 20 ohms	3.2 20 ohms	8 200 ohms	3.2 20 ohms	3.2 20 ohms	3.2 20 ohms
Microphone Frequency Response					50 8000 Hz	50 8000 Hz	50 8000 Hz	50 8000 Hz	50 1200 Hz	100 3000 Hz	100 3000 Hz	100 3000 Hz
Microphone Impedance					High	High	High	High	Low	Low	Low	Low
Microphone Sensitivity Below 1 volt/microbar at 1 kHz					51 dB ±5 dB	51 dB ±5 dB	51 dB ±5 dB	51 dB ±5 dB				
PRICE:	\$10.45	\$12.25	\$29.70	\$41.80	\$47.20	\$62.75	\$75.25	\$59.95	\$16.95	\$24.50	\$15.50	\$9.90



MODEL	NET PRICE
12V4	\$19.95
102	\$24.95
107	\$28.95
103R	\$39.95
104R	\$49.95
108RA	\$79.95
108RM	\$99.95
109R	\$149.95



MODEL 109R

NPC 25 Amp Regulated Power Supply. 4-Way Protected. Output Voltage and Current Meters.

Extra heavy duty unit quietly converts 115 volts AC to 13.6 volts DC - 200 millivolts. 10 amps continuous, 25 amps max. All solid state. Features dual current overload, overvoltage and thermal protection. Ideally suited for operating mobile Ham radio and linear amplifier in your home or office. Excellent bench power supply for testing and servicing of mobile communications equipment.

	TYPICAL	MAXIMUM
Output Voltage	13.6 - 2VDC	13.6 - 3VDC
Line/Load Regulation	50 mV	100 mV
Ripple/Noise	5 mV RMS	10 mV RMS
Transient Response	20 µSec	
Current Continuous	10 Amp	
Current Limit	25 Amp	
Overvoltage Protection	14.5 V	15 V
Thermal Overload	180 F	

Case 4" (H) x 9" (W) x 8" (D) Shipping Weight: 15 lbs

MODEL 107

NPC 4 Amp Power Supply, 6 Amp Max. Solid State, Overload Protected.



Functions silently in converting 115 volts AC to 12 volts DC. 4 amps continuous, 6 amps max. Enables anyone to enjoy CB radio, car 8-track cartridge, cassette player or car radio in a home or office.

	MAXIMUM
Continuous Current (Full Load)	4 Amp
Output Voltage (No Load)	16 V max
Output Voltage (Full Load)	12 V min
Filtering Capacitor	10,000 µF
Ripple (Full Load)	5 V RMS
Short Circuit Protection	Thermal Breaker

Case 3" (H) x 4" (W) x 5" (D) Shipping Weight: 5 lbs

MODEL 12V4

NPC 1.75 Amp Power Supply, 3 Amp Max.



Functions silently in converting 115 volts AC to 12 volts DC. Ideally suited for most applications including 8-track stereo, burglar alarm, car radio and cassette tape player within power rating.

	MAXIMUM
Continuous Current (Full Load)	1.75 Amp
Output Voltage (No Load)	16 V max
Output Voltage (Full Load)	12 V min
Filtering Capacitor	5,000 µF
Ripple (Full Load)	4 V RMS
Short Circuit Protection	Thermal Breaker

Case 3" (H) x 4" (W) x 5" (D) Shipping Weight: 3 lbs

MODEL 108RM

NPC 12 Amp Regulated Power Supply. Solid State. 3 Way Protected. Current Meter.

This heavy duty unit quietly converts 115 volts AC to 13.6 volts DC - 200 millivolts. 8 amps continuous, 12 amps max. All solid state. Features dual current overload and overvoltage protection. Ideally suited for operating mobile Ham radio 2 meter AM-FM-SSB transceivers in your home or office. Can also be used to trickle-charge 12 volt car batteries.

	TYPICAL	MAXIMUM
Output Voltage	13.6 - 2VDC	13.6 - 3VDC
Line/Load Regulation	20 mV	50 mV
Ripple/Noise	3 mV RMS	5 mV RMS
Transient Response	20 µSec	
Current Continuous	8 Amp	
Current Limit	12 Amp	
Current Foldback	2.5 Amp	
Overvoltage Protection	14.5 V	15 V

Case 4" (H) x 7" (W) x 5" (D) Shipping Weight: 9.5 lbs

ALSO AVAILABLE AS MODEL 108RA WITHOUT METER AND OVERVOLTAGE PROTECTION.



MODEL 103R

NPC 4 Amp Regulated Power Supply. Solid State. Dual Overload Protection.

Converts 115 volts AC to 13.6 volts DC - 200 millivolts. Handles 2.5 amps continuous and 4 amps max. Ideally suited for applications where no hum and DC stability are important such as CB transmission, small Ham radio transmitter, and high quality eight-track car stereos. Can also be used to trickle-charge 12 volt car batteries.

	TYPICAL	MAXIMUM
Output Voltage	13.6 - 2 VDC	13.6 - 3 VDC
Line/Load Regulation	20 mV	50 mV
Ripple/Noise	2 mV RMS	5 mV RMS
Transient Response	20 µSec	
Current Continuous	2.5 Amp	
Current Limit	4 Amp	
Current Foldback	1 Amp	

Case 3" (H) x 4" (W) x 5" (D) Shipping Weight: 4 lbs



MODEL 104R

NPC 6 Amp Power Supply. Regulated. Solid State. Dual Overload Protection.

Converts 115 volts AC to 13.6 volts DC - 200 millivolts. Handles 4 amps continuous and 6 amps max. Ideally suited for applications where excellent DC stability is important, such as CB transmission, small Ham radio transmitter, and high quality eight-track car stereos. Can be used to trickle-charge 12 volt car batteries.

	MAXIMUM	TYPICAL
Output Voltage	13.6 - 2 VDC	13.6 - 3 VDC
Line/Load Regulation	20 mV	50 mV
Ripple/Noise	2 mV RMS	5 mV RMS
Transient Response	20 µSec	
Current Continuous	4 Amp	
Current Limit	6 Amp	
Current Foldback	2 Amp	

Case 3" (H) x 5" (W) x 6" (D) Shipping Weight: 6 lbs



MODEL 102

NPC 2.5 Amp Power Supply, 4 Amp Max. Solid State. Overload Protected.

Functions silently in converting 115 volts AC to 12 volts DC. 2.5 amps continuous, 4 amps max. Enables anyone to enjoy CB radio, car 8-track cartridge, cassette tape player or car radio in a home or office.

	MAXIMUM
Continuous Current (Full Load)	2.5 Amp
Output Voltage (No Load)	16 V max
Output Voltage (Full Load)	12 V min
Filtering Capacitor	5,000 µF
Ripple (Full Load)	6 V RMS
Short Circuit Protection	Thermal Breaker

Case 3" (H) x 4" (W) x 5" (D) Shipping Weight: 4 lbs

Unarco-Rohn

COMPLETE 25G TOWER PACKAGES

50' Guyed Tower: Includes top section, 4 regular sections, base plate, rotor plate, 50' guy wire, 2 guy assemblies with torque bars, 3 concrete guy anchors and other miscellaneous hardware.

TOTAL REGULAR PRICE \$594.02
SALE PRICE 464.02

SAVE \$130.00

50' Bracketed Tower: Includes top section, 4 regular sections, base plate, rotor plate and universal house bracket.

TOTAL REGULAR PRICE \$366.15
SALE PRICE 266.15

SAVE \$100.00



TEL. 1-617-391-3200

DEPARTMENT STORE TUFTS

On this page Tufts brings you . . .

Datong Fox
Bencher Bird

DATONG ELECTRONICS LIMITED



FL1 . . . Frequency-Agile Audio Filter

MODEL FL1

Frequency - Agile Audio Filter

The Datong Frequency-Agile Audio Filter is intended primarily for post-detector signal filtering in RF and LF communications receivers for SSB and CW. It offers an unusually versatile combination of benefits to the user including:

For the SSB operator:

- Fast automatic suppression of interfering heterodyne whistles in the range 280-3000 Hz by a unique search-lock-and-track notch filter. The tracking notch can be left in circuit with no audible effect until a whistle appears in which case the whistle will 'disappear' within typically one second.

- A continuously adjustable audio 'window' or a variable-width notch to improve reception in the presence of other off-tune SSB, RTTY or SSTV signals.

For the CW operator:

- Continuously variable center-frequency (280-3000 Hz) and bandwidth (25-1000 Hz) for perfect matching of receiver passband to changing band conditions, sending speeds, and personal preference.
- Flat-topped, steep-skirted response shape for optimum ease of tuning combined with excellent noise rejection.
- Linear tuning law with bandwidth independent of frequency and gain independent of bandwidth for natural 'feel'.

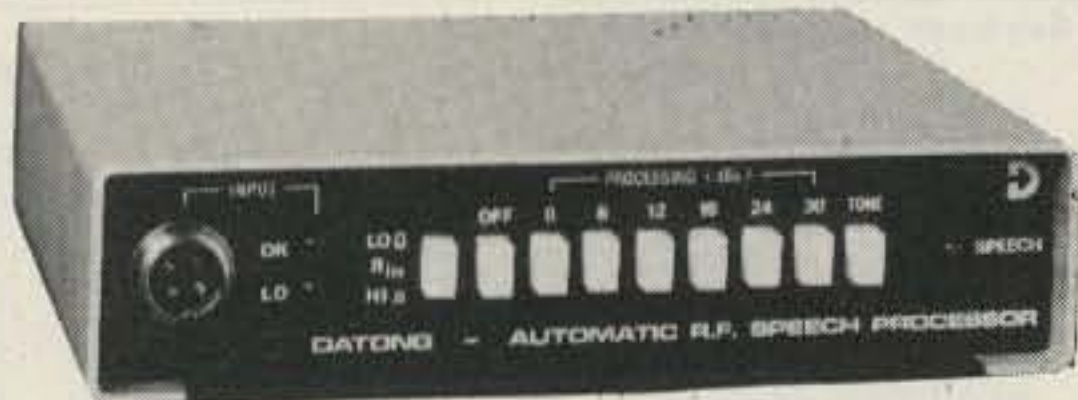

ASP . . . Automatic Speech Processor

ASP

Automatic Speech Processor

The ASP internally generates its own SSB signal and processes it up to 30 db. This processed signal is demodulated and delivered to your rig's mic input with fully automatic AGC control of both input and output level.

ASP Features:

- Installs between mic and transmitter!
- No need to open the rig!
- Push button selection of processing

- Harmonic distortion - less than 0.5% at 1 kHz.
- Internal tone generator allows easy and accurate initial adjustment - no scope needed.
- Selectable HiZ or LoZ mic input.
- Operates from 12 Vdc internal or external.
- Size 7 1/4" x 1 1/4".
- For use in PTT (non-VOX) operation.

MODEL D-70

Morse Tutor

The Morse Tutor provides a highly effective new way to practice Morse code reception at all levels of skill. It provides an unlimited supply of precision Morse at the turn of a switch, plus a built-in oscillator for sending practice.

D70 Features:

- Produces random five character groups. You can choose all letters, all figures, or mixed.
- Calibrated variable speed (6 1/2-37 wpm) and variable delay (up to 3 seconds) between letters for optimum learning efficiency. This delay facility means that right from the start you can learn each letter and number as it ought to be learnt, that is with the dots and dashes within a letter fast enough to form a complete sound pattern, but with a long delay between each letter. As you improve you simply reduce the delay between letters.
- Internal loudspeaker, plus personal ear-piece for private listening.

PRICE

ASP Automatic Speech Processor	\$259.95
FL-1 Frequency Agile Audio Filter	219.95
UC-1 UP Converter	379.95
D-70 Code Tutor	159.95
DATEST I	189.95
DATEST II	169.95
D-75	179.95
RFC M RF Clipper Board Assembly	59.95
M100	20.00

BIRD

Electronic Corporation

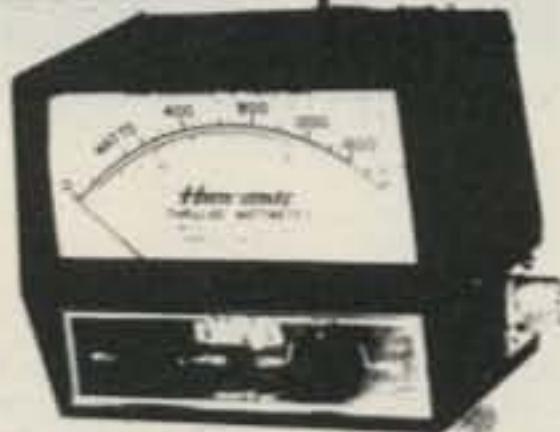

\$99 VHF model 4362 (140-180 MHz)

\$99 HF model 4360 (18-30 MHz)

The 4360, 4362 HAM-MATE Directional Wattmeters are insertion type instruments for measuring forward or reflected power in 50-ohm coaxial transmission lines. They are direct descendants of the model 43 THRULINE® Wattmeter - the professional standard of the industry - and will accurately measure RF power flow under any load condition. Each wattmeter is made up of a precisely machined section of 50-ohm line, a rotatable sensing element and meter calibrated in watts, all mounted in a high-impact plastic housing. It is this type of solid construction and the directional THRULINE coupling circuit, without toroids, that account for the superiority of the HAM-MATE Wattmeters.

the indispensable
BIRD 43
THRULINE
WATTMETER



Power Range	Frequency Bands (MHz)				
	2-30	25-40	100-250	200-500	400-1000
5 watts	—	5A	5C	5D	5E
10 watts	—	10A	10C	10D	10E
25 watts	—	25A	25C	25D	25E
50 watts	50H	50A	50C	50D	50E
100 watts	100H	100A	100C	100D	100E
250 watts	250H	250A	250C	250D	250E
500 watts	500H	500A	500C	500D	500E
1000 watts	1000H	1000A	1000C	1000D	1000E
2500 watts	2500H	2500A	2500C	2500D	2500E
5000 watts	5000H	5000A	5000C	5000D	5000E

MODEL 43

Elements (Table 1) 2-30 MHz	\$135.00
Elements (Table 1) 25-1000 MHz	50.00
Carrying case for Model 43 & 6 elements	42.00
Carrying case for 12 elements	28.00
	17.00

READ RF WATTS DIRECTLY! (Specify Type N or SO239 connectors) 0.45 - 2300 MHz, 1-10,000 Watts ±5%, low insertion VSWR - 1.05. Unequaled economy and flexibility. Buy only the element(s) covering your present frequency and power needs, add extra ranges later if your requirements expand.



The Bencher Ultimate Paddle . . . a dual lever, jambic keyer paddle that will increase your speed, accuracy & operating comfort.

• **ADJUSTABLE CONTACT POINT SPACING** - Precision screw adjustments on each set of contacts make exact settings easy. Contact posts are split and locked by set screws, eliminating the need for locknuts.

• **WIDE RANGE OF TENSION ADJUSTMENT** - Tension on finger knobs is maintained by a long expansion spring. Dual screw adjustments adjust spring tension to match your "fist."

• **SELF ADJUSTING NEEDLE BEARINGS** - Keying shafts pivot in nylon bearings that "float" on machined brass fittings. Spring tension prevents free play and slop; eliminates contact bounce and backlash.

• **SOLID SILVER CONTACT POINTS** - The contact points are solid silver for a lifetime of flawless keying.

• **PRECISION-MACHINED COMPONENTS** - Main frame, contact posts, spring post and bearing ring are all machined from solid brass . . . polished and chrome plated for durability and rich appearance. The Bencher Paddle looks as good as it works!

• **HEAVY STEEL BASE; NON-SKID FEET** - Finished in an attractive black wrinkle finish (chrome plating optional), the base measures 9.5cm x 10.2cm x 1.3cm thick. It weighs 1 kilogram, and with its non-skid rubber feet is as solid as a rock.

Model BY-1 Standard Black Base . . . \$42.95. Model BY-2 Polished Chrome Base . . . \$52.95.

BENCHER, INC.



First is the Fox XK. It reads all bands and tucks away on the visor.



Our remote (RW) unit is "out-of-sight" when installed. Out-of-sight in performance, too.



And now there's Superfox!

The first remote, superheterodyne radar warning system. Superfox has 10 times the sensitivity capability of any conventional radar detector. It is ideal for custom installations.

PRICE LIST

Order No.	Description	Price
60	Fox XK All band detector w/self contained aural/visual alarm	\$109.00
60-2	Fox XK (RW) All band detector w/remote control, waterproof	\$139.00
60-3	Super Fox Super-Heterodyne remote radar warning system	\$299.95

P.O. Box 27, Medford, Mass., 02155

TUFTS Electronic Department Store TUFTS

TUFTS ELECTRONIC

TUFTS Electronic Department Store TUFTS

OMNI



Designed to give you every advantage, every capability, whatever your operating specialty. Totally solid-state, 8 bands, broad-band design, analog and digital readouts, built-in VOX and PTT, built-in adjustable squelch, built-in 4-position CW/SSB filter, 8-pole crystal SSB filter, 2-speed break-in, WWV reception, front panel control of linear or antenna bandswitching, built-in phone patch jacks, built-in "timed" crystal calibrator, built-in zero beat switch, separate receiving antenna capability, built-in SWR bridge, front panel microphone and phone jacks, adjustable automatic level control, built-in adjustable sidetone, dual compression-loaded speakers, automatic sideband selection, plug-in circuit boards, 12VDC, 117VAC (external supply is required for fixed station use), accessories available, much more.

OMNI SPECIFICATIONS:

Frequency Bands: 1.8-2.3, 3.5-4.0, 7.0-7.5, 14.0-14.5, 21.0-21.5, 28.0-28.5, 28.5-29.0, 29.0-29.5, 29.5-30.0 MHz transceive; 10.0-10.5 MHz receive only.
Permeability tuned VFO and receiver rf amplifier.
Vernier Tuning: 18 kHz per revolution, typical.
OMNI-A Accuracy: ±1kHz from nearest 25 kHz calibration point.
Pulsed 25 kHz crystal calibrator in OMNI-A.
OMNI-D Accuracy: ±100 Hz.
OMNI-A Readout: Slide rule dial indicates 100 kHz segment, dial skirt increment to 1 kHz. Three dial scales.
OMNI-D Readout: Six digit, 0.43" LED numerals. Least significant digit indicating 100 Hz green, all others red.
VFO Stability: Less than 15 Hz change per F°, averaged over a 40° change from 70° to 110°, after 30 minute warmup. Less than 10 Hz change from 105 to 125 VAC line voltage when using TEN-TEC power supply.
Automatic sideband selection, reversible.
Provisions for remote VFO, Model 243.
Power switch remotely controls power supply.

NOVICE SPECIAL

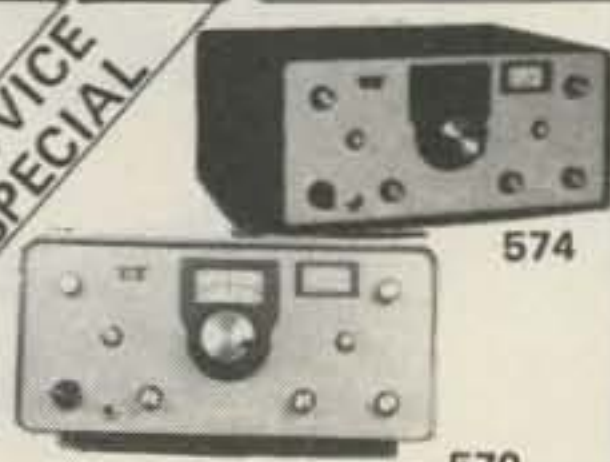

Century 21 (570 or 574)
Novice Exclusive
 Purchase your Century 21 (570 or 574) from us and have up to one year to apply the full purchase price towards a model 540, 544, 545, or 546 when you upgrade your station.

ADDITIONAL CRYSTALS

Extend 10m coverage to 30MHz. Model 212 29.0 to 29.5 MHz. Model 213 29.5 to 30.0 MHz.

MODEL 249 - Noise Blanker

Plug-in PC assembly for either model. Effectively blanks most impulse noise. Blanker is inserted into receiving i-f channel. Disabling switch on front panel.

MODEL 245 - CW Filter

Plug-in PC assembly consists of four active, low Q op-amps. Center frequency of 750 Hz, bandwidth of 150 Hz. Two selectivity responses available with front panel control. Shape factor of 7.2 @ 6/60 dB.

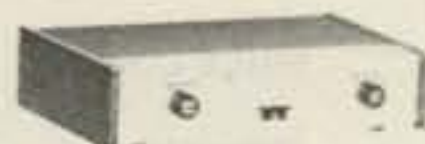

MODEL 240 - 160m Converter
 Provides 160m operation at 75% power level. In addition to using 540/544 VFO for variable transceive operation, one of two owner-selected crystal positions can be used for transmitting while the VFO is used for receiving. This is useful for listening in the DX window and transmitting outside of it. Housed in matching enclosure.

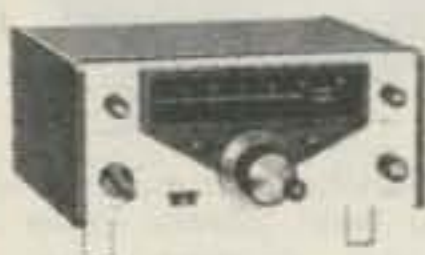

MODEL 242 - Remote VFO
 Duplicate of 540/544 VFO for operation on two frequencies. Switch, with LED indicators, allows selection of six possible modes: TRANSCEIVER transmit and receive; REMOTE transmit and receive; TRANSCEIVER transmit-REMOTE receive; REMOTE transmit-TRANSCEIVER receive; TRANSCEIVER transmit-both receive; REMOTE transmit-both receive. Full break-in is preserved for all modes. Two crystal positions, selected from front panel, for spot frequency or out of band use. Matching enclosure. Plugs into accessory socket on either Model 540 or 544.

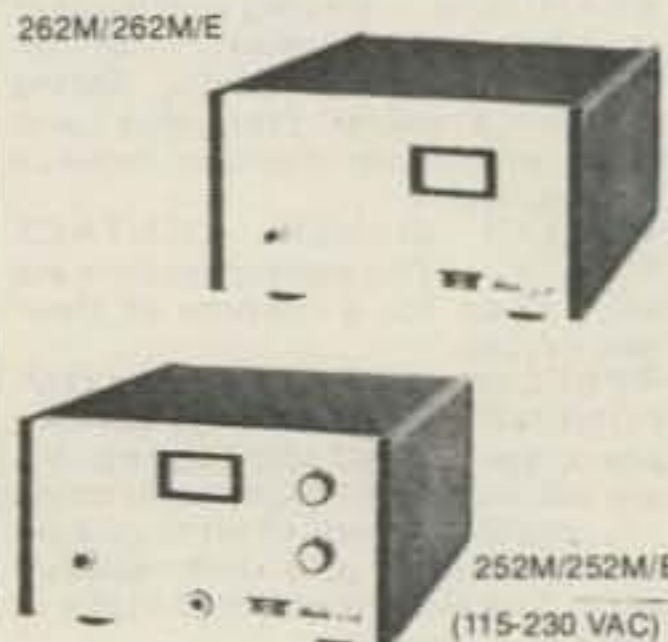

MODEL 262M/262M/E
MODEL 252M/252M/E (115-230 VAC)
AC Power Supplies
 Fully voltage regulated to provide highly stable, pure DC (225W) from 117 VAC. Panel DC ammeter. Instantaneous overload protection circuit prevents damage caused by excessive current drain; reset by momentary turn-off. Model 262M has, in addition, a complete VOX system. VOX controls are located on front panel. Low frequency components in voice, below cut-off frequency of speaker, actuate T/R function.

TEN-TEC

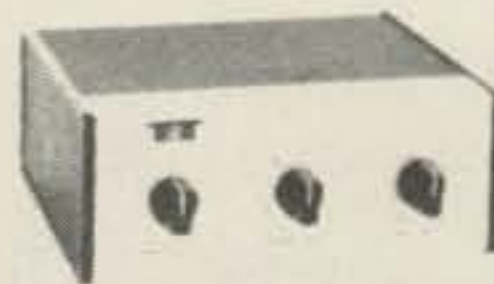

MODEL 247 - Antenna Tuner
 Matches 50 ohm unbalanced output from transmitter to a variety of balanced or unbalanced antenna impedances. Popular universal Transmatch circuit with one kV capacitor spacing and 46-tap silver plated inductor (pat. pending) allows vernier adjustment up to 200W rf rating. Handsome enclosure matches 540/544 transceivers.

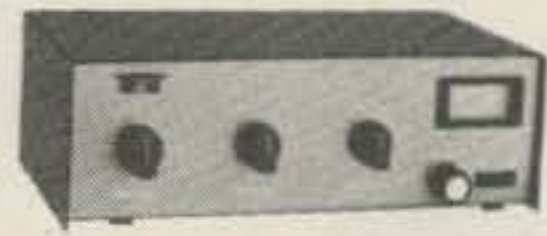

MODEL 277 ANTENNA TUNER/SWR BRIDGE \$85.00
 This versatile antenna tuner offers the same unique features of the model 247 plus the handy addition of a built-in SWR bridge and meter. The SWR meter shows ratios of 1:1 up to 5:1 and values in-between; has panel mounted Sensitivity Control and Forward-Reverse Switch. Makes an ideal accessory to the TEN-TEC Century/21. Size: 3 1/2"H x 10 1/4"W x 6 1/2"D.



MODEL 645 - Electronic Keyer
 The 645 keyer uses transistor switching and is powered by the transceiver (so it is compatible with any TEN-TEC transceiver). Adjustable magnetic paddle return. Self completing characters. Dit and dah memories with defeat switches.



MODEL 241 - Crystal Oscillator
 Six crystal positions allow operating spot frequencies in or out of bands. Will extend range 100 kHz from 80 and 40 meter band edges and 200 kHz on remaining bands. Cannot be used with Models 242 or 244. Plugs into accessories socket. Matching enclosure.

See back cover for specials!

MODEL	DESCRIPTION	PRICE
ACCESSORIES		
206A	Crystal Calibrator	\$34.50
208	CW Filter, for Model 509	34.50
212	Crystal, for Models 540/544, 29.0-29.5 MHz	5.00
213	Crystal, for Models 540/544, 29.5-30.0 MHz	5.00
214	Electret Microphone, for Model 234	39.00
215P	Microphone, Ceramic with plug	29.50
215PC	Microphone, Ceramic with plug and coil-cord	34.50
217	500 Hz 8 Pole Ladder Filter	55.00
218	1.8 kHz 8 Pole Ladder Filter	55.00
234	Speech Processor	124.00
240	One-Sixty Converter, for Models 540/544	110.00
241	Crystal Oscillator, for Models 540/544	35.00
242	Remote VFO, for Models 540/544	179.00
243	Remote VFO, for Models 545/546	139.00
244	Digital Readout/Counter for Models 540/544	197.00
245	CW Filter, for Models 540/544	25.00
247	Antenna Tuner	69.00
248	Noise Blanker, for Models 545/546	49.00
249	Noise Blanker, for Models 540/544	29.00
273	Crystal, for Models 570/574, 28.5-29.0	5.00
276	Crystal Calibrator, for Model 570	29.00
277	Antenna Tuner/SWR Bridge, for Model 570	85.00
1102	Snap-up Legs (pair)	1.00
1140	DC Circuit Breaker, for Models 540/544 and 545/546	8.75
1145	Knob Set for Models 540, 509	5.00
1150	Overvoltage Protector, for Models 252/262 Series	15.00
1170	DC Circuit Breaker, for Model 570	8.75
POWER SUPPLIES		
210	117 VAC, 13 VDC, 1 A	34.00
210/E	Same as Model 210, but 115/230 VAC	39.00
252M	117 VAC, 13 VDC, 18 A	139.00
252M/E	Same as Model 252M, but 115/230 VAC	146.00
252MO	Same as Model 252M, but matches OMNI	139.00
252MO/E	Same as Model 252MO, but 115/230 VAC	146.00
262M	117 VAC, 13 VDC, 18 A. Deluxe, with VOX	159.00
262M/E	Same as Model 262M, but 115/230 VAC	166.00
TRANSCIEVERS		
509	Argonaut, 5 W. SSB/CW, 3.5-30 MHz	389.00
540	Transceiver, 200 W. SSB/CW, 3.5-30 MHz	699.00
544	Transceiver, Digital, 200 W. SSB/CW, 3.5-30 MHz	869.00
545	OMNI-A, Analog, Series B, SSB/CW, 1.8-30 MHz	1119.00
570	Century/21, 70 W. CW, 3.5-29 MHz	349.00
574	Century/21, Digital, 70 W. CW, 3.5-29 MHz	449.00
KEYERS		
645	Ultrasonic, Dual Paddle for 545/546	85.00
670	Single Paddle Keyer, for Model 570/574	34.50
KR-5A	Single Paddle Keyer, 6-14 VDC	39.50
KR-20A	Single Paddle Keyer, 117 VAC/6-14 VDC	69.50
KR-50	Ultrasonic Keyer, Dual Paddle, 117 VAC/6-14 VDC	110.00

TEL. 1-617-391-3200

DEPARTMENT STORE TUFTS

See back cover for specials!



OSCAR



OSCAR Satellite Communications

Cushcraft offers complete antenna systems for OSCAR satellite communications on 2m and 70 cm. On 145 MHz the 10-element twin antenna (5 vertical elements, 5 horizontal) yields up to 10.8 dBd gain; the 20-element 436 MHz beam (10 vertical elements plus 10 horizontal) provides up to 13.8 dBd gain. For greater performance on 2m choose the 20-element 148 MHz beam which offers 13.8 dBd gain. The half-power beamwidth of these antennas has been optimized for reliable satellite communications with minimum tracking requirements. All twin antennas come complete with special matching networks for selectable horizontal, vertical, or circular polarization. Match 50-ohm feedlines.

ATV-5

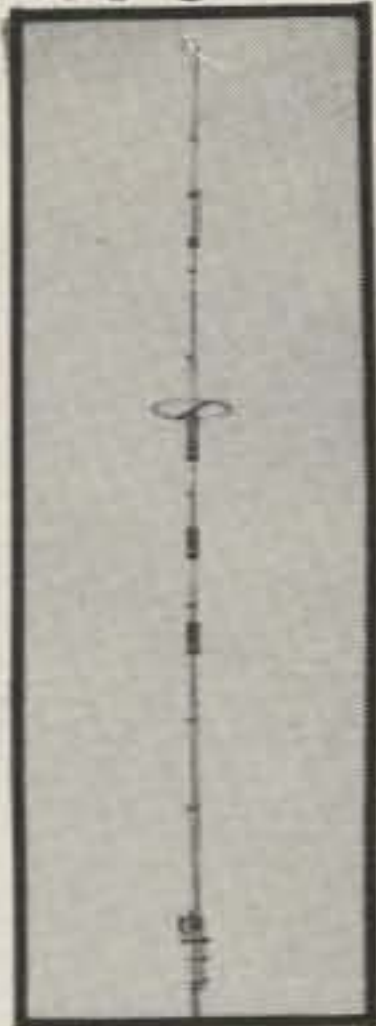

ATV-5

This trapped vertical antenna system has been engineered for five-band operation on 80m-10m. The high Q traps are carefully optimized for wide operating bandwidths: 2:1 SWR bandwidth with 50-ohm feedline is approximately 1 MHz on 10m; more than 500 kHz on 15m and 20m; 180 kHz on 40m; and 75 kHz on 80m. Instructions are provided for adjusting impedance to your preferred part of the band, CW or SSB. Built-in coaxial connector takes PL-259. Nominal height, 293 inches. Rated at 2000 watts PEP on all bands.

Two Meter Boomers

Whether you have the space for the 3.2 x 32-19 or the compact 2.2 x models, 2m Boomers are your best choice. They offer the maximum gain available for their boom length (See 1885 vs. 688). They feature trigon reflectors for additional front-to-back ratio and cleaner patterns. All stainless steel hardware and heavy gauge heat treated aluminum are used throughout. Whatever your choice of 2m activity, the Boomer will fill your needs. For CW/SSB on the low end use 228FB or 214FB. For CW/SSB on the low end use 32-19 or 214B. In EME, DX or just reliable QSOs, Boomer will perform for you.

Six Meter Boomers

The new 6m Yagi offers more boom, more gain and fewer elements. Designed for the low end of the band, the 6m Boomer has Cushcraft's typical attention to detail; the Boomer's balanced feed with balun, and extra heavy duty mechanical construction. The secret behind its super performance and light weight is special element spacing and boom lengths.

Specifications

Model Number	32-19	214B	214FB	228FB	617-6B
Frequency range (MHz)	144-148	144-148	144.5-148	144.5-148	50.5-51
Forward gain (dBd)	16.2	15.2	15.2	16.2	14
Front to back ratio (dB)	24	24	24	24	30
Element Spacing (deg)	2x14	2x17	2x17	2x11	2x19
Element Spacing (deg)	2x11	2x18	2x18	2x9	NA
Side lobe suppression (dB)	-60	-60	-60	-60	-60
SWR into 50 ohm	1.21	1.21	1.21	1.21	1.21
Impedance (ohms)	50	50	50	50	50
Recommended stacking distance (inches)	18	10	10	10	NA
Element (ft)	12	10	10	10	22.5
Weight (lbs)	12	9	9	22	26
Length (ft)	22	15	15	15	34
Largest element (in)	40x	40x	39x	39x	113x
Turning radius (ft)	71	7.5	7.5	8.5	17.7
Windload (psf)	3.5	1.7	1.7	4.0	4.6

On this page Tufts brings you . . .

Cushcraft
Save Your Radio

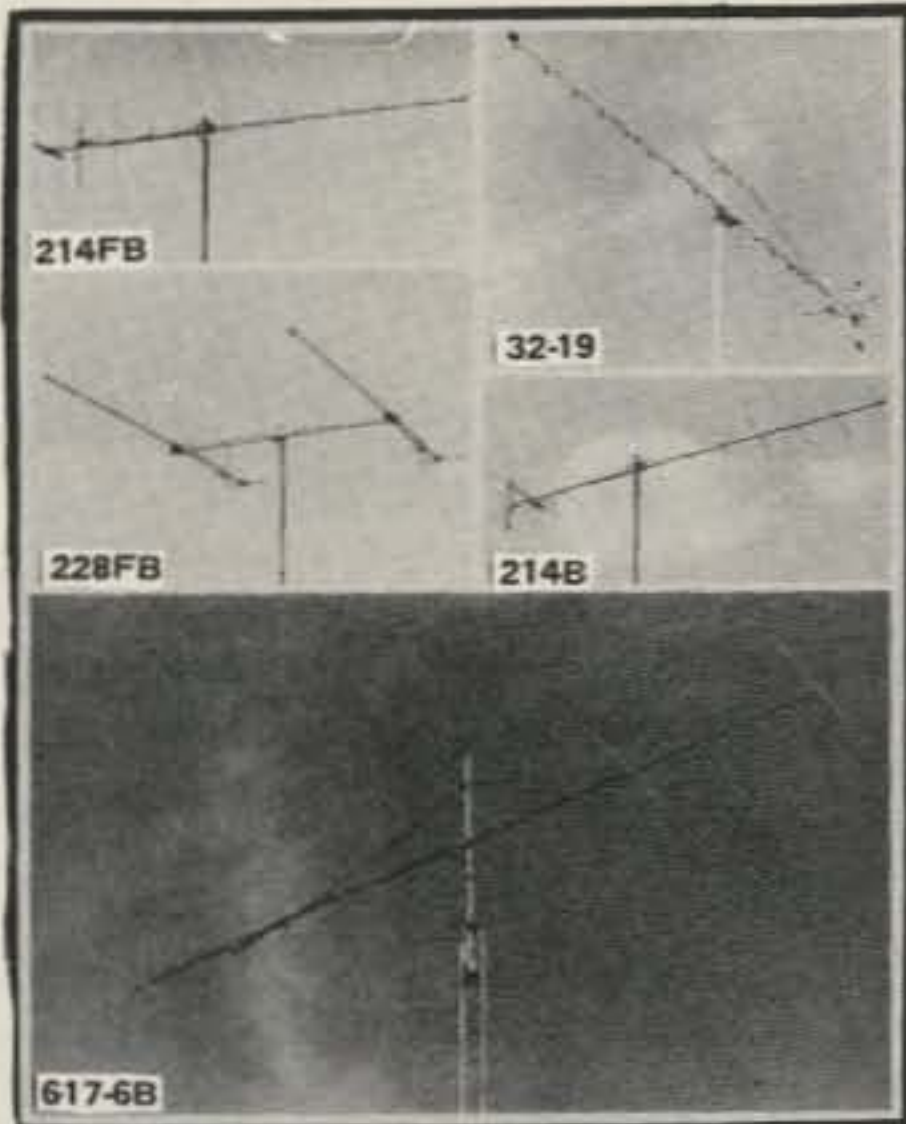

ALL PRICES SHOWN ARE LIST PRICES!
CALL FOR SPECIAL PACKAGE PRICING!

Skywalker

3 and 4 Element Single Band Yagis

Skywalker

More contacts, less waiting, less interference, and a better signal at the other end are yours with the Skywalker series of single band Yagis. The 10dBd forward gain of the 4 element models will put you first in line. See the chart for all the details.

Heavy wall heat treated 6063-T832 aluminum tubing, ruggedly plated steel fasteners, and carefully formed aluminum brackets. Assembly is simple with the new Cushcraft Boom Assembly Marking System.

Specifications

Model Number	30-4CD	20-3CD	15-4CD	10-3CD	10-4CD	10-3CD
Frequency range (MHz)	14.0-14.35	14.0-14.35	21.0-21.45	21.0-21.45	28.0-29.7	28.0-29.7
Forward gain (dBd)	10.0	8.0	10.0	8.0	10.0	8.0
Front to back ratio (dB)	30	30	30	30	30	30
Boom length (ft)	32	18	20	14	17	12
Longest element (ft)	35-10	35-8	23-4	23-0	17-10	17-8
Element Spacing (deg)	60	56	57	56	57	56
Side lobe suppression (dB)	+60	+40	+40	+40	+40	+40
SWR into 50 ohm	1.2	1.2	1.2	1.2	1.2	1.2
Recommended stacking distance (inches)	44	40	33	30	27	21
Turning radius (ft)	20	23	15-4	13-6	14	10
Weight (lbs)	35	30	25	20	18	11
Windload (psf)	6.1	3.5	4.5	3.4	3.1	2.3

ATB-34

ATB-34 - 10-15-20 Meters

The Cushcraft ATB-34[®] 3 band antenna offers the no-compromise performance of a single-band Yagi on 10m, 15m, and 20m, and represents the best in state-of-the-art antenna design. The antenna's rugged construction, broad bandwidth, and four active elements give superb performance. Quality workmanship and the use of the best available materials give an estimated wind survival rating of 90 mph. Forward gain is 7.5 dBd on all bands; front-to-back ratio is nominally 30 dB on 20m; 22 dB on 15m; and 18 dB on 10m. Nominal input impedance is 50 ohms; VSWR is 1.5:1 or less at resonance.

ATB-34



PRICE LIST

MODEL	DESCRIPTION	LIST PRICE	MODEL	DESCRIPTION	LIST PRICE
BOOMER ANTENNAS					
32-19	144-148 MHz, 19 element, 3.2 x	89.95	ARX-2K	135-170 MHz, Rings Ranger	18.95
214B	144-148 MHz, 14 element, 2.2 x	69.95	ARX-220	220-225 MHz, Rings Ranger	35.95
214FB	144.5-148 MHz, 14 element, 2.2 x	69.95	ARX-450	435-450 MHz, Rings Ranger	39.95
228FB	144.5-148 MHz, 28 element, 2.2 x	219.95	FM STACKING KITS		
617-6B	50-51 MHz, 8 element, 1.7 x	199.95	A14-SK	Stacking Kit for two A147-4	18.95
BOOMER STACKING KITS					
32-SK	Stacking Harness & P.D., 2 Boomers	39.95	A18-VPK	Vert. Pol. for two A147-4	28.95
32-OK	Quad Stacking Kit, 4 Boomers	389.95	A21-SK	Stacking Kit for two A220-11	18.95
22-SK	Stacking Harness & P.D., 2 Boomers	38.95	A220-VPK	Vert. Pol. for two A220-11	29.95
22-OK	Quad Stacking Kit, 4 Boomers	249.95	A147-VPK	Vert. Pol. for two A147-11	42.95
22B-VPK	Vert. Pol. Kit, 2 FM Boomers	89.95	A44B-SK	Stacking Kit for two A44B-6 or 11	19.95
PD-2	Power Divider, 2 Boomers	19.95	A44B-VPK	Vert. Pol. for two A44B-6 or 11	29.95
PD-4	Power Divider, 4 Boomers	29.95	BLITZ BUOY		
MULTIBAND HF ANTENNAS					
ATB-34	Three Band 4 element Beam	289.95	LAC-1	Coax Lightning Arrester	4.95
ATV-3	Three Band Trapped Vertical	49.95	LAC-2	Coax Lightning Arrester	4.95
ATV-4	Four Band Trapped Vertical	99.95	TRIST ANTENNAS		
ATV-5	Five Band Trapped Vertical	109.95	A147-10T	145 MHz, 10 element	21.95
SKYWALKER BEAMS					
20-4 CD	14 MHz, 4 element (2 cartons)	299.95	A144-20T	145 MHz, 20 element	69.95
REFLECTORS					
20-3 CD	14 MHz, 3 element, A14-3	199.95	A432-20T	430-436 MHz, 20 element	59.95
15-4 CD	21 MHz, 4 element, A21-4	119.95	VHF/UHF BEAMS		
15-3 CD	21 MHz, 3 element, A21-3	99.95	A50-3	50 MHz, 3 element beam	49.95
10-4 CD	28 MHz, 4 element, A28-4	89.95	A50-5	50 MHz, 5 element beam	69.95
10-3 CD	28 MHz, 3 element, A28-3	69.95	A50-6	50 MHz, 6 element beam	89.95
MOBILE ANTENNAS					
AMS-147	146-148 MHz, Stainless Magnet Mt.	29.95	A50-10	50 MHz, 10 element beam	119.95
ATS-147	146-148 MHz, Stainless Trunk Mt.	29.95	A144-7	144 MHz, 7 element beam	29.95
AMS-220	220-225 MHz, Stainless Magnet Mt.	29.95	A144-11	144 MHz, 11 element beam	39.95
ATS-220	220-225 MHz, Stainless Trunk Mt.	29.95	A430-11	432 MHz, 11 element beam	37.95
FM ANTENNAS					
A147-4	146-148 MHz, 4 element	26.95	VHF/UHF STACKING KITS		
A147-11	146-148 MHz, 11 element	39.95	A11-SK	Stacking Kit for two A144-11	19.95
A147-20T	146-148 MHz, 20 element	67.95	A17-SK	Stacking Kit for two A144-7	19.95
A147-22	146-148 MHz, 22 element	119.95	A41-SK	Stacking Kit for two A430-11	19.95
A220-11	220-225 MHz, 7 element	29.95	A535-SK	Stacking Kit for two A50-3/A50-5	19.95
A220-11	220-225 MHz, 11 element	37.95	A561-SK	Stacking Kit for two A50-6/A50-5	29.95
A44B-6	449 MHz, 6 element	26.95	ADK-144	Stacking Kit for four A144-11 Hbr. Pol.	139.95
A44B-11	449 MHz, 11 element	37.95	ADK-444	Stacking Kit for four A430-11	109.95
AFM-4D	144-148 MHz, Four Pole	69.95	DX ARRAYS - 20 ELEMENT		
AFM-24D	220-225 MHz, Four Pole	84.95	DX-120	144 MHz	59.95
AFM-44D	440-480 MHz, Four Pole	59.95	DX-220	220 MHz	49.95
AR-2	135-170 MHz, Rings	24.95	DX-420	432 MHz	39.95
AR-6	50-54 MHz, Rings	39.95	DX ARRAY BALUNS		
AR-220	220-225 MHz, Rings	24.95	DX-1B75	1:1 Balun for DX-120	15.95
AR-450	440-480 MHz, Rings	24.95	DX-2B11	1:1 Balun for DX-220	15.95
ARX-2	135-170 MHz, Rings Ranger	39.95	DX-4B11	1:1 Balun for DX-420	18.95

STOP THEFT! SAVE YOUR RADIO!



DESIGNED FOR COMMERCIAL USE UP TO 1000 MHZ.
The TUFTS SAVE YOUR RADIO bracket can save you a bundle . . . and a lot of hassle. Why worry about rig theft? The TUFTS SAVE YOUR RADIO bracket mounts quickly and easily in your car and makes it possible to snap your rig out of its bracket when you park and put it out of sight.

The connector system has a special coaxial cable connector which will provide you with a flawless connection right up to 1000 MHz! No loss! In addition to the quick connect connector there are also four power and accessory connectors which are made automatically when the rig is slid into its bracket . . . just what you need for feeding power and loudspeaker connections to the rig.

This is a rugged bracket and connector system . . . it'll take a beating. There is a hole on each side of the 1/8" gauge steel plate for a padlock in case you want to lock the rig for short periods in its bracket. They'll have to rip out the dash to get it . . . and it won't be the first time for that!

With two of these brackets you can bring the mobile rig into the house and use it in seconds. Or it lets you take an AC supply for the rig and use it in your hotel room. Price: **\$34.95**

6 METER BEAMS

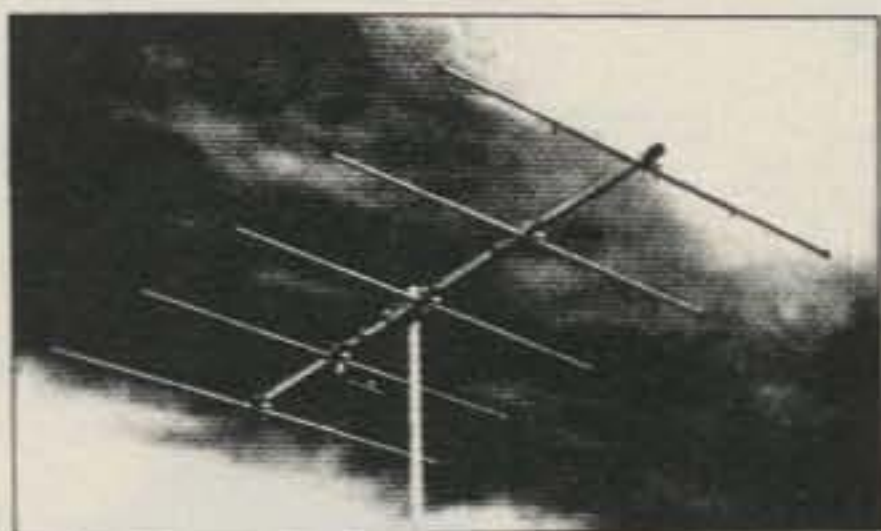

3-5-6-10 ELEMENTS

Description	3 element	5 element	6 element	10 element
Model No.	A50-3	A50-5	A50-6	A50-10
Boom Length	6'	12'	20'	24'
Longest El.	117"	117"	117"	117"
Turn Radius	6'	7' 6"	11'	13'
Fwd. Gain	7.5 dB	9.5 dB	11.5 dB	13 dB
F/B Ratio	20 dB	24 dB	26 dB	26 dB
Weight	7 lbs.	11 lbs.	18 lbs.	25 lbs.

3/4, 1-1/4, 2 METER BEAMS

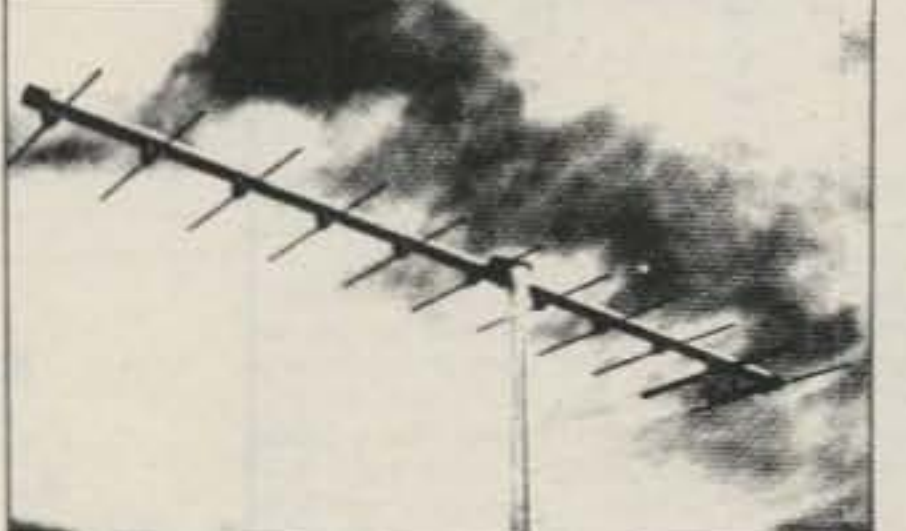

Model No.	A144-7	A144-11	A220-11	A430-11
Description	2m	2m	1 1/4m	1/4m
Elements	7	11	11	11
Boom Length	98"	144"	102"	57"
Weight	4	6	4	3
Fwd. Gain	11 dB	13 dB	13 dB	13 dB
F/B Ratio	26 dB	26 dB	26 dB	26 dB
Fwd. Lobe @ 1/2 pwr. pt.	46	42	42	42
SWR @ Freq.	1 to 1	1 to 1	1 to 1	1 to 1

P.O. Box 27, Medford, Mass., 02155

TUFTS Electronic Department Store TUFTS

TUFTS ELECTRONIC

TUFTS Electronic Department Store

FINCO STINGER VHF/UHF Antennas

On this page Tufts brings you . . .
 Finco Stinger Ham-Key Hitachi
 Alliance



\$62.95

10 meter

STINGER A 10-4 DESCRIPTION
 The model Stinger A 10-4 is a wide spaced, full size, high gain four element 10 meter monopole designed for optimum DX performance. Utilizing the exclusive Stinger Series square boom construction, the A 10-4 is light enough to be easily stacked for an additional 3 dB gain yet strong enough to withstand the most adverse weather conditions. The highly efficient gamma match system easily withstands 2,000 watts P.E.P. of power and maintains a relatively low V.S.W.R. across the entire 10-meter amateur band.

ELECTRICAL - A 10-4		MECHANICAL - A 10-4	
Forward Gain	10dB	Boom Length	16 ft.
Front-to-Back Ratio	25dB	Longest Element	18.2 ft.
V.S.W.R. 1st resonance	1.7:1	Turning Radius	7.4 ft.
Half Power Beam Width	51°	Maximum Surface Area	4.8 sq. ft.
Bandwidth	26 to 30 MHz	Wind Load at 80 MPH	115 lbs.
Impedance	50 Ohms	Weight	17.9 lbs.
Matching System	Adjustable Gamma		

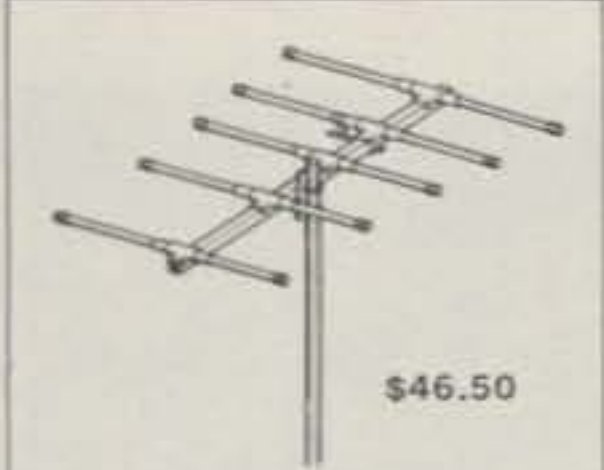

\$46.50

6 meter

STINGER A 6-5 DESCRIPTION
 The model Stinger A 6-5 is a highly directional 6-meter five element beam specifically designed for portable use as it disassembles into a compact package. The elements are constructed of high tensile strength anodized aluminum tubing plus the exclusive Stinger square boom and bracket assemblies. For maximum power transfer and low V.S.W.R., a carefully designed gamma matching assembly capable of withstanding 2,000 watts P.E.P. is incorporated. Wide element spacing assures optimum DX performance and good operating efficiency across the entire 50 to 54 MHz 6-meter band. The square boom of low optical vertical mounting for accessing 6-meter repeaters.

ELECTRICAL - A 6-5		MECHANICAL - A 6-5	
Forward Gain	11dB	Boom Length	12 ft.
Front-to-Back Ratio	21.0dB	Longest Element	10 ft.
V.S.W.R. 1st resonance	1.3:1	Turning Radius	8.3 ft.
Half Power Beam Width	52°	Maximum Surface Area	3.23 sq. ft.
Bandwidth	50 to 54 MHz	Wind Load at 80 MPH	40.2 lbs.
Impedance	50 ohms	Weight	11.3 lbs.
Matching System	Adjustable Gamma		

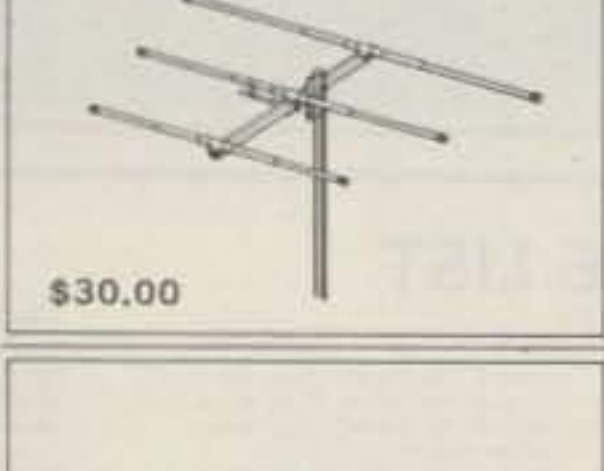

\$30.00

6 meter

STINGER A 6-3 DESCRIPTION
 The model Stinger A 6-3 is a 3-element high gain 6-meter beam similar to the A 6-5 but expressly designed for the casual 6-meter enthusiast. The A 6-3 also finds excellent application for portable use as it disassembles into a compact package. Due to the units light weight and minimal wind load, the antenna is ideal for double stacked and quad stacked arrays for the real 6-meter DXer. The A 6-3 is rated at 2,000 watts P.E.P. and incorporates a square boom and high tensile strength aluminum elements.

ELECTRICAL - A 6-3		MECHANICAL - A 6-3	
Forward Gain	7.0dB	Boom Length	6.0 ft.
Front-to-Back Ratio	21.0dB	Longest Element	10 ft.
V.S.W.R. 1st resonance	1.3:1	Turning Radius	5.4 ft.
Half Power Beam Width	60°	Maximum Surface Area	1.75 sq. ft.
Bandwidth	50 to 54 MHz	Wind Load at 80 MPH	17.6 lbs.
Impedance	50 Ohms	Weight	7 lbs.
Matching System	Adjustable Gamma		

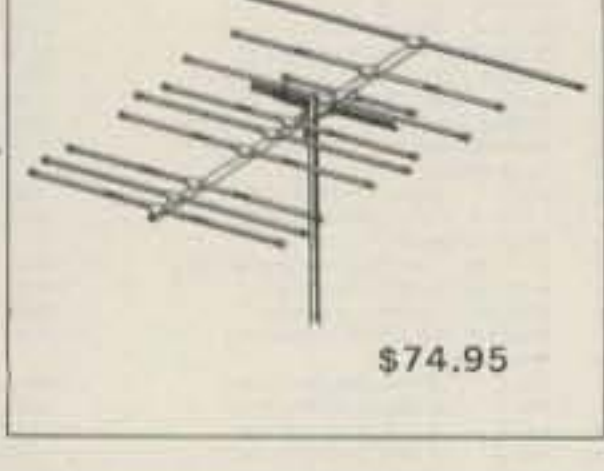

\$74.95

6 and 2 meter

STINGER A 6-2 DESCRIPTION
 The model Stinger A 6-2 is a truly remarkable combination 6 and 2 meter beam designed for optimum performance on both bands yet only requiring ONE transmission line. This is accomplished through the use of exclusive phasing elements to accomplish dual band operation with no sacrifice to either band - NO SWITCHING REQUIRED!
 On 2-meters, the A 6-2 has 6 collinear elements - equivalent to three 1/2 lambda 6-element yags stacked side by side - thus giving outstanding performance. Maximum forward gain is assured on 6-meters through the use of four wide spaced elements. The heavy duty Stinger construction is used throughout so that the antenna will withstand 100 mph plus wind loads.
 The A 6-2 is ideal for mounting on the same mast as your tri-band or other antenna thus easily opening up the world of 6 and 2 meter VHF communication.

ELECTRICAL - A 6-2		MECHANICAL - A 6-2	
Forward Gain	5 meters 9.5dB	Boom Length	10.1 ft.
Front-to-Back Ratio	2 meters 12.0dB	Longest Element	10 ft.
V.S.W.R. 1st resonance	5 meters 1.9:1	Turning Radius	8.7 ft.
Half Power Beam Width	2 meters 22dB	Maximum Surface Area	4.48 sq. ft.
V.S.W.R. 16 & 2 meters	1.1:1	Wind Load at 80 MPH	43 lbs.
Bandwidth	5 meters 50 to 54 MHz	Weight	13.8 lbs.
Impedance	2 meters 144 to 148 MHz		
Matching System	Adjustable Gamma		

2 meter

STINGER A 2-10 DESCRIPTION
 The model Stinger A 2-10 is a high performance wide spaced ten-element 2 meter yag designed for the serious VHF operator. Utilizing the Stinger construction features, the A 2-10 is almost indestructible no matter what weather conditions are encountered. Complete coverage of the 2-meter band and low V.S.W.R. is assured through the use of non-linear spaced elements thus also achieving maximum forward gain. Power rating - 2,000 watts P.E.P.
 The A 2-10 can be mounted for vertical polarization, thereby making the antenna quite useful in repeater service, or mounted for horizontal polarization for station to station VHF DX work. Additional booms of the A 2-10 can be easily stacked for even greater gain and front-to-back ratio.

ELECTRICAL - A 2-10		MECHANICAL - A 2-10	
Forward Gain	13.8dB	Boom Length	10 ft.
Front-to-Back Ratio	25dB	Longest Element	42 in.
V.S.W.R. 1st resonance	1.1:1	Turning Radius	71 in.
Half Power Beam Width	40°	Maximum Surface Area	2.26 sq. ft.
Bandwidth	144 to 148 MHz	Wind Load at 80 MPH	36.2 lbs.
Impedance	50 Ohms	Weight	3.8 lbs.
Matching System	Adjustable Gamma		

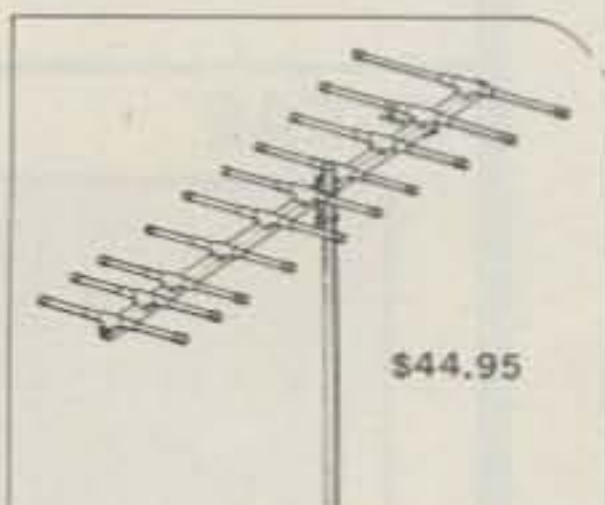

\$44.95

2 meter

STINGER A 2-5 DESCRIPTION
 The model Stinger A 2-5 is a five-element high gain antenna similar to the A 2-10 but having physically less of a profile. The A 2-5 finds excellent application as a portable antenna as it disassembles into a very compact package. Like the A 2-10, the antenna can be mounted for vertical or horizontal polarization for repeater or general coverage work. Constructed of the Stinger heavy duty materials, the A 2-5 is ideal for locations encountering adverse weather conditions. Power rating 2,000 watts P.E.P.

ELECTRICAL - A 2-5		MECHANICAL - A 2-5	
Forward Gain	9.5dB	Boom Length	5.5 ft.
Front-to-Back Ratio	22dB	Longest Element	41 in.
V.S.W.R. 1st resonance	1.1:1	Turning Radius	42 in.
Half Power Beam Width	51°	Maximum Surface Area	1.22 sq. ft.
Bandwidth	144 to 148 MHz	Wind Load at 80 MPH	13.3 lbs.
Impedance	50 Ohms	Weight	6.5 lbs.
Matching System	Adjustable Gamma		



\$27.95

2 meter

STINGER A 2-2 DESCRIPTION
 The model Stinger A 2-2 is a two-element, dual polarization 2-meter antenna designed for OSCAR communications or where switching from horizontal to vertical polarization is required. The A 2-2 can even be phased to operate on both lower orbital and vertical polarizations at the same time. This is not only ideal for OSCAR work but gives your station versatility for ground communications.
 Wide, non-linear element spacing gives the A 2-2 superior gain, however, since it is a five element beam in one gain plane, the half power beam width does not make satellite tracking difficult because of sharp directivity. The dual gamma match assemblies provide for a very low V.S.W.R. and will withstand 2,000 watts P.E.P.
 The Stinger construction features make the A 2-2 extremely heavy duty. Provisions are made for mounting the antenna at the end of the boom - for azimuth control - or at the middle of the boom for normal applications.

ELECTRICAL - A 2-2		MECHANICAL - A 2-2	
Forward Gain	9.5dB	Boom Length	6 ft.
Circular Gain	10.5dB	Longest Element	41 in.
Front-to-Back Ratio	22dB	Turning Radius	5.5 ft.
Half Power Beam Width	52°	End Mount	2.4 ft.
Horizontal Polarization	E Plane 52° H Plane 98°	Maximum Surface Area	1.51 sq. ft.
Vertical Polarization	E Plane 98° H Plane 52°	Wind Load at 80 MPH	13.4 lbs.
Circular Polarization	E Plane 52° H Plane 52°	Weight	11 lbs.
Bandwidth	144 to 148 MHz		
Impedance	50 Ohms		
Matching System	Adjustable Gamma		

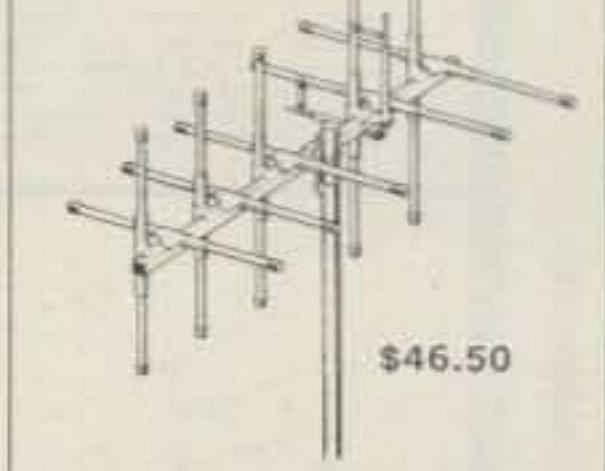

\$46.50

1 1/4 meter

STINGER A 1 1/4 - DESCRIPTION
 The model Stinger A 1 1/4 is a ten element 1 1/4-meter (220 MHz) high performance yag designed for all 220 MHz communication needs. Designed to be mounted in either the vertical or horizontal plane, the A 1 1/4 is adaptable for OSCAR, repeater, or general communication work. Incorporating the Stinger heavy duty elements, boom and boom to mast assemblies, the antenna easily withstands 120 mph wind loads under 1/4" ice conditions. A low loss gamma matching system assures a low V.S.W.R. and is power rated at 1,000 watts.

ELECTRICAL - A 1 1/4		MECHANICAL - A 1 1/4	
Forward Gain	13.8dB	Boom Length	8 ft.
Front-to-Back Ratio	25dB	Longest Element	26 in.
V.S.W.R. 1st resonance	1.1:1	Turning Radius	4.3 ft.
Half Power Beam Width	40°	Maximum Surface Area	1.32 sq. ft.
Bandwidth	220 to 226 MHz	Wind Load at 80 MPH	17.9 lbs.
Impedance	50 Ohms	Weight	8 lbs.
Matching System	Adjustable Gamma		

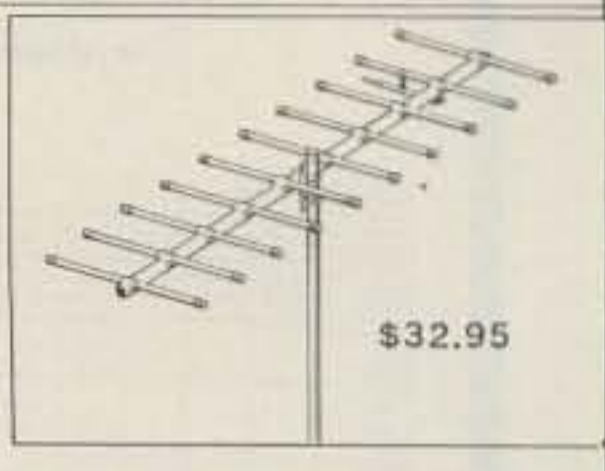

\$32.95

HITACHI OSCILLOSCOPES



Single and dual trace, 15 and 30 MHz. All four high sensitivity Hitachi oscilloscopes are built to demanding Hitachi quality standards and are backed by a 2-year warranty. They're able to measure signals as low as 1mV/division (with X5 vertical magnifier). It's a specification you won't find on any other 15 or 30 MHz scope. Plus: Z-axis modulation, trace rotation, front panel X-Y operation for all four scope models, and X10 sweep magnification. And, both 30 MHz oscilloscopes offer internal signal delay lines. For ease of operation, functionally-related controls are grouped into three blocks on the color coded front panel.

- V-302 30 MHz Dual Trace \$850.50
- V-301 30 MHz Single Trace \$670.50
- V-152 15 MHz Dual Trace \$625.25
- V-151 15 MHz Single Trace \$490.50

HAM-KEY

Model HK-3M



\$19.95

Deluxe straight key
 Anti-rip bracket. Can't tip
 Heavy base. No need to attach to desk
 CC-3P shielded cable & plugs for HK-3M \$2.48
 Model AT 2 anti-rip bracket only. No counter. Only HK-3 to HK-3M \$2.99

Model HK-4



\$44.95

Combination HK-1 & HK-3 on same base
 Straight key may be used conventionally or as a switch to trigger a memory.
 CC-1-3P shielded cable with plugs for HK-4 \$5.99

RADIO TELEGRAPH SENDING DEVICES

Model HK-1



\$29.95

- Dual lever squeeze paddle
- For use with all electronic keyers
- Heavy base with non-slip rubber feet
- Paddles reversible for wide or close finger spacing

CC-1P shielded cable & plugs for HK-1 \$3.75
 Model HK-2, same as HK-1 but less base for incorporation in your own keyer. \$19.95

Model HK-5A Electronic Keyer



\$69.95

- Leads circuit for squeeze keying
- Self-cleaning dots & dashes
- Dot & dash memory
- Battery operated with provision for external power
- Uses Curtis 8044 keyer chip
- Grid block or direct keying
- Speed, volume, tone & weight controls on front panel
- Use with HK-1 or HK-6

ALLIANCE



\$119.95

HD-73 HEAVY-DUTY ROTATOR

with exclusive Dual-Speed Control!
 For antennas up to 10.7 sq. ft. of wind load area. Mast support bracket design permits easy centering and offers a positive drive no-slip option. Automatic brake action cushions stops to reduce inertia stresses. Unique control unit features DUAL-SPEED rotation with one five-position switch. SPECIFICATIONS: Max. wind load bending moment - 10,000 in.-lbs. (side-thrust overturning); Starting torque - 400 in.-lbs.; Hardened steel drive gears; Bearings - 100/3/8" diameter (hardened); Meter - D'Arsonval, taut band (back-lighted). There's much, much more.

TEL. 1-617-391-3200

New Products

from page 23

Government radio communications installations in the 2-420 MHz spectrum as released under the Freedom of Information Act.

The exhaustive volume comprises the entire unclassified computer file for that frequency range. It includes Justice, Treasury, NASA, FCC, FAA, Interior, Army, Navy, Air Force, Coast Guard, and many other

Federal Government agency listings.

The entries are arranged in order of frequency, agency, and geographical location, and include installations in the 50 states, possessions and protectorates, and space satellites.

The *Federal Frequency Directory* is available for \$14.95 postpaid from *Grove Enterprises, Box 156K, Brasstown NC 28902*, and from qualified dealers. Inquiries are invited.

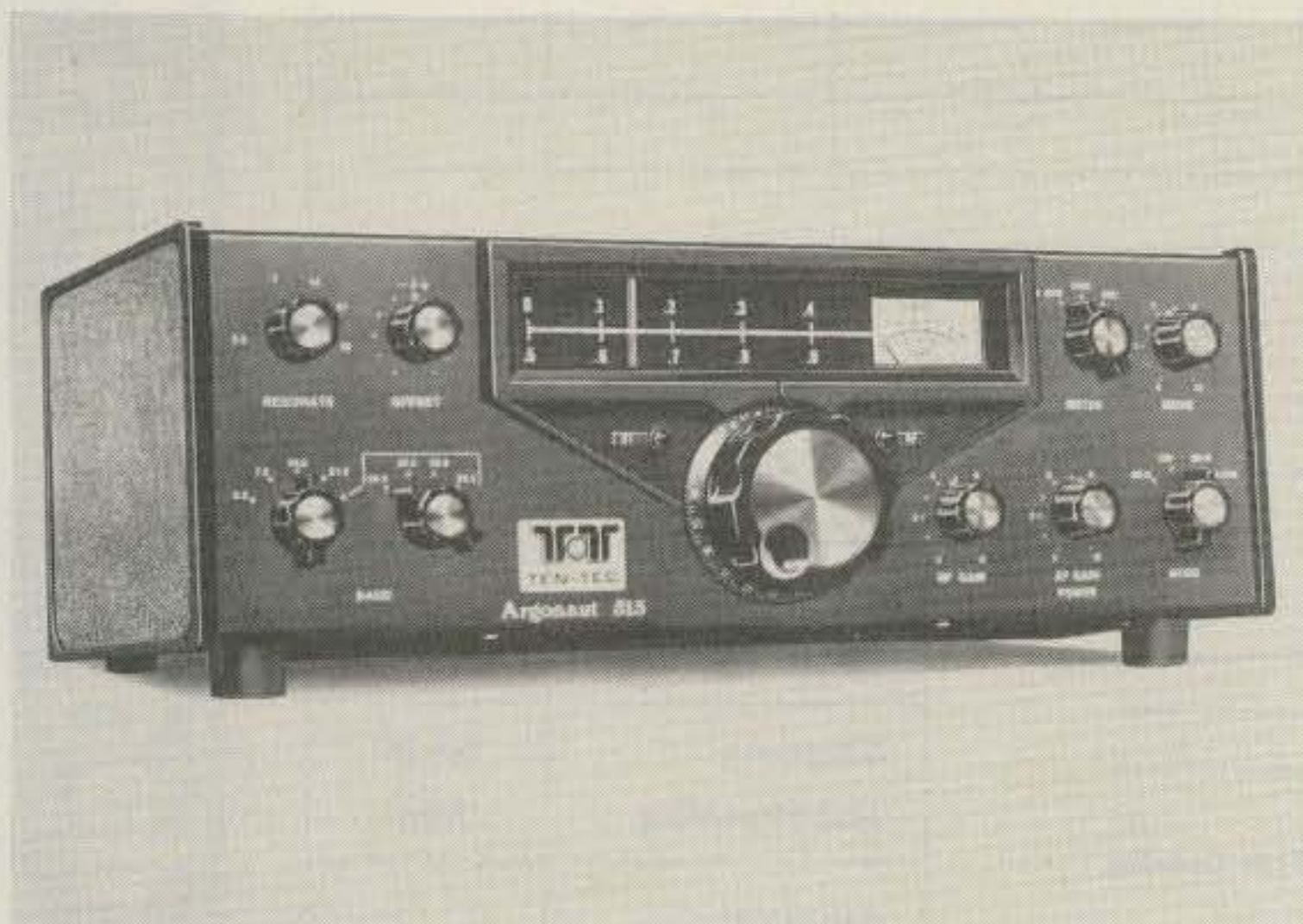

The Argonaut 515 from Ten-Tec.



Icom's new IC-2A.

Reader Service number 481.

NEW TEN-TEC "ARGONAUT" 515 UPDATES WORLD'S MOST POPULAR QRPp RIG

Latest in the famous Ten-Tec "Argonaut" QRPp line, the Model 515 brings the performance level of the '80s to low-power operation.

Featuring a new super-sensitive receiver front end, the 515 has 0.35- μ V sensitivity, a 4-pole crystal lattice filter with 2.4 kHz bandwidth, a unique optional combination CW filter and variable notch filter in an outboard cabinet, and a new heterodyne vfo with a new permeability-tuned oscillator which provides increased calibration accuracy. Argonaut's band coverage (80-10m) has 10 meters split into new 500-kHz segments (others optional). Other features include offset tuning with LED indicator, resonate control, direct frequency readout, QSK instant CW break-in, adjustable sidetone level and pitch, "S"/swr meter, low-distortion audio, and built-in speaker.

The broad band transmitter section features a new design no-tune final for instant band change, 5 Watts input, new LED output indicator set for 2-Watt voice operation, TVI filter, automatic 750-Hz CW offset, automatic sideband selection (reversible), and PTT.

New styling in black and bronze colors with new knob design and new tilt-up bail make the Argonaut 515 a handsome addition to any QRPp enthusiast's operating position.

For full information, see your dealer or write *Ten-Tec, Inc., Highway 411 East, Sevierville TN 37862; (615)-453-7172*.

NEW HAND-HELD FROM ICOM

Icom's new hand-held is finally here! The IC-2A 2-meter hand-held covers 144.000 through 149.995 MHz in 800 synthesized T-R channels with selectable 1.5- or .15-Watt output. This unit is only slightly larger than a dollar bill (35mm thick, though) and weighs 450 grams (1 pound) including batteries and flexible antenna. Power may be supplied via an alkaline or nicad battery pack (8.4 volts). Audio is handled by a built-in speaker and condenser microphone, but an optional 600-Ohm dynamic microphone can be used. Sensitivity is rated at less than 0.4 μ V (0.2 μ V

typical) for 20 dB of quieting. Approximate current requirements on transmit are 400 mA at 1.5 Watts and 160 mA at .15 Watts; on receive, at maximum audio, current drain is 140 mA and 20 mA squelched. Three sizes of snap-on nicad packs (250 mA standard) allow the IC-2A to carry the power you need.

IC-2A packages are available with alkaline battery pack (without batteries), nicad battery pack and wall charger, and nicad battery pack, wall charger, and built-in touch-tone™ pad. Options to the basic unit include a speaker/mike, drop-in desk charger, and leather case. *Icom America, Inc., 3311 Towerwood Dr., Suite 307, Dallas TX 75234; (214)-620-2780*.

Gene Smarte WB6TOV/1
News Editor

HAM SCAN-2

Frequency-scanning adapters for 2-meter radios have been on my mind quite a bit for the past year, especially since a lot of that time was spent designing and constructing two different scanners for the popular Icom IC-22S.

I learned from that experience that all of these scanners go about their business in much the same manner. So, when a friend asked me about scanning his Kenwood 7400A transceiver, I knew that any adapter, whether built by me or someone else, would be based on the principle of counting through the desired range of frequencies digitally — eliminating the need to spin the dials. By letting the little chips supply the necessary electrical bits, one can do other things and let the scanner take some of the drudgery out of life. I opted to purchase a ready-made unit.

Since they all start out the same way, there must be something which sets apart the various scanner products on the market. That something is features. So, after taking in all the literature that I could gather from the manufacturers, the product chosen for the 7400A had to be the Ham Scan-2.

It seems that this unit has all the user features that I would have built into a scanner and more. Furthermore, it is the only one that I could find which has them all.

Among the more important of these operator conveniences are:

IRON POWDER and FERRITE PRODUCTS

AMIDON
Associates ✓ A26

Fast, Reliable Service Since 1963

Small Orders Welcome Free 'Tech-Data' Flyer

Toroidal Cores, Shielding Beads, Shielded Coil Forms
Ferrite Rods, Pot Cores, Baluns, Etc.

12033 OTSEGO STREET, NORTH HOLLYWOOD, CALIFORNIA 91607

50 144 REPEATERS 220 450 Mhz

BASIC AUTO PATCH

*Access, #Disable and adjustable Timer.
COMPLETELY ASSEMBLED—\$75.00.

EXTENSION BOARD

Antifalsing, 3 digit sequential Touch Tone™
decoder with automatic reset, Antifalsing
Ring detector, reverse auto patch capability
for basic auto patch and two, two-watt audio
amplifiers.

COMPLETELY ASSEMBLED—\$140.00

New and Improved
Receiver
and Transmitter

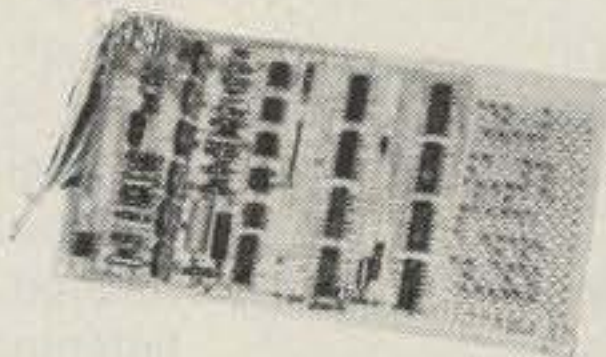

Available Separately:

COR Identifier: All on one board, programmable, Fully ad-
justable, time out (.5-7 min.), hang time (0-1 min.), identifier
(1-10 min.), tone, speed, volume, L.E.D. outputs, low current
drain CMOS logic, plugs for easy installation and removal plus
much more. \$89.95 COMPLETELY ASSEMBLED

Basic Repeater **599.95** COMPLETELY ASSEMBLED

2M 130-175 MHz Basic Repeater for 2 meters with all the features of the HI
Pro Mki less the power supply and front panel controls and accessories.

Hi Pro Mk I
REPEATERS

50 MHz \$889.95 450 MHz 899.95
144 or 220 MHz 799.95

PA Res. add 6% tax
PLUS SHIPPING

✓ 46

Maggiore Electronic Laboratory

845 WESTTOWN RD.
WEST CHESTER, PA. 19380 PHONE 215 436-6051

UNIVERSAL CONVERTER ASCII - BAUDOT - MORSE ABM-200

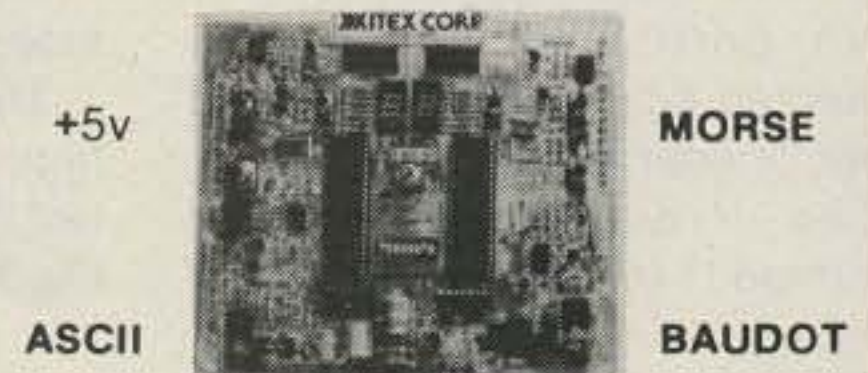

The ABM-200 is a universal code converter
for translating between ASCII and Baudot,
or between Morse and ASCII (or Baudot).
Also used as TTY® speed and line length
converter. Inserts directly between TU and
TTY®, RS232 & current plus 40 char FIFO
buffer. Write for details \$189.

OEM Inquiries Invited.

C.O.D. XITEX Corporation Check
9861 Chartwell Dr. ✓ 82
Dallas, Texas 75243
214-349-2490



"As You Like It"

SHAKESPEARE AND KENWOOD

Kenwood's big little rig—all solid state with 200 watts input, digital
readout, and IF shift. How about five band HF mobile with the available
mobile mount? You've heard the quality of this rig on the bands. Join
the growing group of hams in the know, running the TS-120S. It's
priced at \$699.95, but call for quote!

Here's maximum convenience, maximum performance, and all the
features you need for the very best in HF operation. PLL circuitry pro-
vides stability, IF shift and available filters provide selectivity, DFC
provides versatility and the transmitter provides 200 watts of solid
state punch to make you heard. The retail price is \$1149.99 with
DFC, but call for all the information and a quote on this tremen-
dous piece of equipment.

MADISON
Electronics Supply, Inc. ✓ 45

1508 McKinney • Houston, Texas 77002 • (713) 658-0268

- The front-panel dials on the radio do not have to be zeroed-out to scan through the desired range of frequencies.
- It will go through the whole 2-meter band in an amazing 20 seconds.
- The unique design allows for one channel of memory.
- No portion of the easily-selected scan range is skipped over or omitted.
- The frequency can be "bumped" in 10-kHz steps with

- the scan start/stop switch.
- Scanning cannot be engaged while the transmit button is depressed. This prevents one from accidentally kurchunking every repeater within range. (Repeater users have got to appreciate this benefit greatly.)
- The whole unit fits nicely inside the case of the radio.

The installation justified my high expectations of the product. There are a lot of wires in the frequency-determining sec-

tions of a digital phase-locked loop radio, and, if one is not given precise instruction, digging into them could prove disastrous. The Technical Clinic instructions left nothing out and were set up a la Heathkit®, with one thing being done and checked off at a time. The unit went into the radio without a hitch. The scan start/stop switch mounts in the microphone using existing wiring and a few jumpers. The scan on/off switch is an unused terminal of the 7400A tone selector.

Operation is as smooth as the installation. With the scanner running, an occupied frequency stops it for 3 to 4 seconds, enough time to decide if you want to stay there and monitor/operate for a while. A flick of the start/stop switch is all that is needed. Should you get tired of listening around, a twist of the scan on/off switch brings the previously dialed-in panel frequency back on the radio; nothing to it. Everything is packed into two operator motions.

This particular unit has been in operation for several months without missing a beat, and many hams in my area report having used them for much longer with equal results. The reliability seems to be uniform.

Technical Clinic advises me that they have other types of products on the market and in the works. If these are as completely slick and functional as this unit, I look forward to trying them all.

One more thing: In these days of loophole-filled warranties, a good one is worth the price of the product, and Technical Clinic has a great one: "Should you install one of our units according to our instructions and it fails to work, just send us both pieces. If the unit hasn't been tampered with, you will get your radio back with an operating unit installed. Pronto." How about that? Solid! Just as solid as the product they make. *Technical Clinic, PO Box 636, Sterling Heights MI 48078; (313)-286-4836.* Reader Service number 482.

**Mike Zedan WD8JLW
Attica MI**

PA 1-10, 2-METER CLASS C AMPLIFIER

The PA 1-10 is a solid state VHF power amplifier designed for fixed or mobile operation. The amplifier operates Class C

for FM only. The PA 1-10 provides a nominal 10 Watts output for 1 Watt of input. T-R switching is accomplished by diodes and quarter-wave stubs which are ac-coupled to ground. The amplifier is factory tuned to operate in the 144-148 MHz amateur band plus or minus 1 MHz for MARS or CAP operation. Some retuning may be required for out-of-the-band operation.

This design uses rugged balanced emitter rf power transistors to ensure long life and high swr protection. The size and weight of this amplifier are kept to a minimum without sacrificing performance and reliability.

For more information, contact *THS Electronics, Rt. 1, Box 195, Greene NY 13778; (607)-656-8071.* Reader Service number 476.

LARSEN ELECTRONICS OFFERS FULL LINE OF ANTENNAS FOR HAND-HELD RADIOS

Larsen Electronics, Inc., of Vancouver, Washington, has developed a full line of Kulduckie antennas to mate with all the most commonly used hand-held radios.

Larsen offers eight helical type Kulduckie models which operate on low, high, and UHF band frequencies (136-174 MHz, 406-420 MHz, and 450-512 MHz). Eight quarter-wave models are also available to operate in the 406-420 and 450-512 MHz bands. They are all color coded by frequency for easy identification.

Larsen's Kulduckie antennas mate with Motorola, GE, RCA, REPCO, and many other popular hand-held models.

They are ruggedly constructed to take the rough usage common to this type of antenna. VHF and UHF models are spring-wound for flexibility and plated with high conductivity material for Larsen's maximum radiation efficiency.

They are also all-weather-protected by a tough heavy-duty coating of an exclusive step design which prevents detuning from shorting and adds flexibility. They handle a full 25 Watts and are flexible enough to bend 180 degrees in all directions.

For more information, write *Larsen Electronics, Inc., PO Box 1686, Vancouver WA 98663.* Reader Service number 480.



The PA 1-10 from THS.



Larsen Kulduckie KD-4 antenna.

XITEX INTRODUCES "SMART TU" FOR ASCII/BAUDOT/MORSE

Xitex Corporation has just announced the addition of the UDT-170 (Universal Data Transceiver) to its data products line for RTTY and Morse operation. The UDT-170 connects directly between the user's ASCII or Baudot Teletype® or video terminal and the station transceiver. For the user who does not currently have a teletype or video terminal, the Xitex SKT-100 video terminal is recommended.

The UDT-170 is actually the combination of a microprocessor-based data converter plus a high performance RTTY terminal unit (TU). In the receive mode, the TU takes the RTTY or Morse signal from the receiver audio output and converts it to a dc signal which is fed to the data converter portion of the

UDT-170. Here, two single-chip microcomputers are used to convert the ASCII/Baudot/Morse input signal into an RS-232 or 60-milliamp output signal which has been regenerated to match the mode (ASCII or Baudot), baud rate, and line length of the user's terminal.

In the transmit mode, the serial output signal from the keyboard on the user's terminal is fed into the data converter in the UDT-170 where it is continuously buffered and regenerated in the desired output mode (ASCII, Baudot, or Morse) and data rate.

The UDT-170 will operate at any FSK shift from less than 100 Hz to over 1000 Hz, Baudot rates of 60, 67, 75, and 100 wpm, ASCII rates of 110 or 300 baud, Morse rates from 1 to 150 wpm with "Auto Track," and line lengths from 40 to 80 characters. Other



The UDT-170 from Xitex.

features include a 2-digit LED display for the copy wpm rate (Morse only) and buffer states, and an optional CW "indent" feature for RTTY operation.

The UDT-170 is packaged in an RFI-protected metal enclosure measuring 12" x 7 1/4" x

3 1/2" and operates on either 115 or 230 V ac, 50/60 Hz. For additional information, contact Xitex Corporation, 9861 Chartwell Dr., Dallas TX 75243; (214)-349-2490. Dealer inquiries and overseas orders welcome. Reader Service number 478.

Looking West

from page 10

formed ARC Security employee told me.

"But when I returned to the same checkpoint after seeing my wife onto her plane, I asked the supervising guard under what authority the demand had been made. The supervisor, an ARC sergeant, toned the 'demand' down to a 'request,' which he claimed is routinely made on behalf of the airlines which contract for ARC's services at the Atlanta airport.

"Contacted by mail, Delta Air Lines (the largest carrier headquartered in Atlanta) confirmed that even such a 'request' has no legal basis. Wayne G. Reel, director of Delta's Atlanta station, wrote that 'ARC Security, Incorporated, employees have been advised that there are no laws or statutes presently in force that prevent radio communication on our concourses.'

"ARC management, in a telephone interview, acknowledged that their employees had made errors in the incident both by demanding that the handie-talkie be disabled and in claiming that amateur communications were prohibited beyond the checkpoints. 'Our officers make millions of judgment calls

every month,' said Tom Cleary, regional manager for ARC Security. 'They must assure themselves that any item carried past the checkpoints is okay. Radios are okay. The guard only had to assure himself it was a radio.'

"Cleary said that ARC checkpoint guards do not receive explicit instructions on how to ascertain that a radio is just that and not a bomb or gun. Every guard asked to pass a radio through a checkpoint makes a decision based on his or her own knowledge and experience. 'If a guard is uncertain about an item, he will ask the owner to wait and defer the judgment to a supervising guard, an airline employee, or law enforcement personnel.' In the deadly serious business of searching for harmful items in American airports, such double checks are agreeably endured by most people.

"The ARC executive confirmed that the contracted security guards have no authority to detain anyone. That authority is limited to law enforcement personnel with legal cause. ARC employees can and occasionally do escort persons with suspicious or unusual hand baggage to the gate areas to report that baggage to airline

employees or flight crews. Such a report might be made if a security guard believed a traveler intended to use a radio on board an airliner without proper permission. Such use is banned."

THE WINTER OLYMPICS DEPARTMENT

Amateur radio played a rather important role at the Lake Placid Winter Olympics.

Depending on whom you speak with, any one of three separate groups was the "official" Olympics station. I had an *unofficial* Westlink correspondent covering the games, concentrating his reports on the amateur radio activity related to the event. Thanks to Ray Thill WA9EXP, we were able to ascertain exactly what was going on.

An organization known as the "Winter Olympics Radio Amateur Network" was the official station, operating from the athletes village. There was only one problem. Due to the station location, it was impossible for the average amateur to wander by and utilize the equipment. The main function of WORAN was to handle traffic in and out of the Olympic village, and reports are that Lincoln Dixon and his crew did a splendid job. I do not have a total count of the number of pieces of traffic handled, but I understand it was enormous. Contrary to earlier reports we received, the "torch run communi-

cations" was not a WORAN operation. They were a part of it, but the actual operation was put together by staffers from ARRL headquarters. Dubbed "Operation Rollerball" by those participating, a caravan of amateurs escorted the Olympic torch from the moment it landed in the USA until it entered the Olympic stadium. According to Steve Mendelsohn WA2DHF, one of the amateurs who helped put the network together, the entire operation ran flawlessly, even though the schedule kept changing on a moment's notice.

The final amateur station at the Winter Olympics was actually a joint effort by members of the press corps covering the event—particularly the technical people from the television operations. Since the FCC had stopped issuing special event call signs, the group obtained the call sign VE3OLP from the Canadian DOC and operated it "1/2" from a number of locations as a commemorative station. Their goal was to provide a recreational station that would be accessible to as many amateurs as possible, and for this reason stations were set up at the International Broadcast Center, the Ramada Inn, and Howard Johnson's. If you worked VE3OLP/2 during the Olympics and wish to QSL with them, try sending your own QSL to Box 307, Sunland CA 91504. By the way, if you haven't fig-

ured it out yet, VE3OLP stood for VE3 "Olympics Lake Placid."

As if this were not enough, a group from within this group also provided a number of special event repeaters for the duration of the event. They were built in California with equipment supplied by the Sober Radio Em-

pire of Los Angeles. Both were open systems operating under the callsign WD6DYZ/2/RPT; they were placed in operation by engineers from ABC-TV.

While the Olympics only recognized one of the three, WORAN, as the "official" Winter Olympics amateur station, I

doubt if anyone would really mind if Looking West proclaims all three as having provided a truly outstanding "official" service. We congratulate all on a splendid job.

One closing comment: Plans are already being formulated here in Los Angeles for the 1984

Summer Olympics. The Los Angeles Council of Amateur Radio Clubs has appointed Bill Principe AJ6J to spearhead amateur radio's participation in the event. Amateurs with ideas on the project should write to '84 Olympics Communications, c/o TASMA, PO Box 444, Northridge CA 91328.

Social Events

Listings in this column are provided free of charge on a space-available basis. The following information should be included in every announcement: sponsor, event, date, time, place, city, state, admission charge (if any), features, talk-in frequencies, and the name of whom to contact for further information. Announcements must be received two months prior to the month in which the event takes place. They should be sent directly to Editorial Offices, 73 Magazine, Pine Street, Peterborough NH 03458, Attn: Social Events.

MANASSAS VA JUN 1

The Ole Virginia Hams Amateur Radio Club, Inc., will hold its seventh annual Manassas Hamfest on Sunday, June 1, 1980, at the Prince William County Fairgrounds, Route 234, Manassas VA. Booths are available. Admission is \$3.00, children under 12 are free, and tailgaters are \$2.00. Talk-in on 146.37/146.97 repeater (WB4HHN) and 146.52 simplex. For further information, contact Joseph A. Schlatter K4FPT, Ole Virginia Hams ARC, Inc., PO Box 1255, Manassas VA 22110.

BRAINTREE MA JUN 1

The South Shore Amateur Radio Club will hold its annual auction on Sunday, June 1, 1980, at the Viking Club, 410 Quincy Avenue (Route 53), Braintree MA. A flea market will precede the auction from 10:00 am to 2:00 pm in the Viking Club parking lot, weather permitting. Space is \$3.00; bring your own table. No reservations are necessary. The auction will start at 2:00 pm and admission is free. There will be a 15 percent club commission on auction items only. For further information, contact The South Shore Amateur Radio Club, c/o Kristen

Johnson K1WQ, 86 Alton Road, Quincy MA 02169.

CHELSEA MI JUN 1

The Chelsea Swap and Shop will be held on Sunday, June 1, 1980, at the Chelsea Fairgrounds, Chelsea MI. Gates will open for sellers at 5:00 am and for the public from 8:00 am until 2:00 pm. Admission is \$1.50 in advance or \$2.00 at the gate. Children under 12 and non-ham spouses are admitted free. Talk-in on .52 and .37/1.97. For more information, write William Altenberndt, 3132 Timberline, Jackson MI 49201.

WILMINGTON OH JUN 1

Clinton County area amateurs will sponsor the first annual Clinton County area Hamfest 1980 on June 1, 1980, 8:00 am to 5:00 pm, at the Clinton County Fairgrounds, Wilmington OH. Admission will be \$3.00; 12 and under are free. Flea-market space is free. There will be door prizes and free parking. Food and drinks will be available. Talk-in on .72/1.12. For more info, send an SASE to CCARA c/o Russ Eidemiller WD8NPZ, 310 Bethel Lane, Wilmington OH 45177.

MUNCIE IN JUN 1

The Muncie Area Amateur Radio Club Amateur Spectacular will be held on Sunday, June 1, 1980, on the Ball State University campus with over one acre of indoor space. Advance tickets are \$2.00; \$3.00 at the door, with children under 12 free. Features will include food prices of the 1960s, over \$2,000.00 in prizes, forums on traffic and nets, computers, ARRL, etc. Talk-in on .13/1.73, 223.30/224.90, and .52/1.52. For information and registration,

please contact MAARC, PO Box 3111, Muncie IN 47302.

GUELPH ONT CAN JUN 7

The Guelph Amateur Radio Club will hold the Central Ontario Amateur Radio Fleamarket and Computer Fest on Saturday, June 7, 1980, from 8:00 am until 4:00 pm at the Centennial Arena, College Avenue West, Guelph, Ontario, Canada. Admission is \$1.00, with children 12 years and under admitted free. Admission for vendors is an additional \$2.00. There will be commercial displays, home-computer displays, and the Sidebanders dinner at 5:00 pm (contact Jack Kirby VE3AFN). Refreshments will be available during the day. Talk-in on .52/1.52, .37/1.97 KSR, and .96/1.36 ZMG. For further information, contact Rocco Furfaro VE3HGZ, Guelph Amateur Radio Club, PO Box 1305, Guelph, Ontario, Canada N1H 6N9 or call (519)-824-1157.

GREELEY CO JUN 7

The Northern Colorado Amateur Radio Club will hold its Superfest II hamfest on Saturday, June 7, 1980, from 7:00 am to 4:30 pm in the Weld County Exhibition Building, Greeley CO. Features will include an operating satellite television receiving station, the Colorado Code Contest, and an auction. Additional special events are planned for families. Registration will be \$3.00, with exhibition space and swap tables included at no extra cost. For further information, including details about commercial exhibit space, contact Gus Fox, PO Box 895, Greeley CO 80632.

HUNTINGTON WV JUN 7-8

The Tri-State Amateur Radio Association will hold its 18th annual hamfest on June 7-8, 1980, at the Huntington Civic Center, Huntington WV. Admission is \$3.00 for both days, with additional prize tickets \$1.00 each.

Prizes will be awarded both days. Commercial and flea market spaces are available at reasonable prices. Activities will include forums, hidden-transmitter hunts, a left-footed CW contest, a Saturday-night banquet, and lots of demonstrations and activities for the non-amateurs, XYLs and harmonics. Hotels, restaurants, shopping areas, and a limited number of RV hookups are within walking distance. Talk-in on 146.04/146.64. For more information, contact the Tri-State Amateur Radio Association, c/o Phil Jones WD8OTJ, 309 22nd Street West, Huntington WV 25704.

MAYVILLE ND JUN 8

The Goose River Amateur Radio Club will hold its annual hamfest on June 8, 1980, at Island Park, Mayville ND. Features will include a flea market, an auction, door prizes, free coffee, and camping facilities. For more information, call or write Mary Carlson, Route 2, Hatton ND, (701)-543-3287.

JEFFERSON CITY MO JUN 8

The Missouri Single Side Band Net Picnic will be held on Sunday, June 8, 1980, at Binder Lake, Jefferson City MO. There will be a covered dish dinner served at noon and drinks will be furnished by the Net. For information, contact Benton C. Smith K0PCK, net manager, Prairie Home MO 65068.

ALLENWOOD PA JUN 8

The 9th annual Milton Amateur Radio Club Hamfest will be held on June 8, 1980, rain or shine, at the Allenwood Firemen's Fairgrounds, located on US Route 15, 4 miles north of I-80, Allenwood PA. Hours are from 8:00 am to 5:00 pm. Registration for sellers is \$2.50 in advance or \$3.00 at the gate. XYLs and children are free. Featured will be a flea market, an auction, contests, cash door prizes, a

free portable and mobile FM clinic, and supervised children's activities. There will be an indoor area available, plus food and beverages. Camping and motels are located nearby. Talk-in on .37/.97 and .52 simplex. For further details, write Kenneth E. Hering WA3IJU, RD #1, Box 381, Allenwood PA 17810, or phone (717)-538-9168.

GRANITE CITY IL JUN 8

The Egyptian Radio Club will hold a hamfest and flea market on June 8, 1980, beginning at 8:00 am at the ERC Clubhouse, Slough Road, Granite City IL. Tickets are \$1.50. Refreshments, activities for women and children, and overnight camping are available. Prizes will be awarded. Talk-in on 146.16/.76 and 146.52.

AKRON OH JUN 8

The Goodyear Amateur Radio Club will hold its 13th annual hamfest picnic and flea market on Sunday, June 8, 1980, from 10:00 am to 5:00 pm at Goodyear Wingfoot Lake Park, near Rtes. 224 and 43, east of Akron OH. There will be five main prizes, including a Kenwood TS-120S with PS-30, a Tempo S1, a Hy-Gain TH3-MK3 antenna, a Den-Tron Super Tuner Plus, and a Bird wattmeter. Featured will be a large flea market, auction, and picnic area. Tickets are \$3.00. Talk-in on 146.04/.64. For more information, contact D. W. Rogers WA8SXJ, 161 South Hawkins Avenue, Akron OH 44313.

MONROE MI JUN 8

The annual Monroe County Radio Communications hamfest will be held on June 8, 1980, from 8:00 am to 4:00 pm at the Monroe Community College on Raisinville Road, Monroe MI. Tickets are \$1.50, with XYLs and children free. There will be free parking and plenty of table spaces available. Features will include a contest, an auction, and displays. Talk-in on 146.13/.73 and .52. For information, contact Fred Lux WD8ITZ, PO Box 982, Monroe MI 48161, or call (313)-243-1088.

STEVENS POINT WI JUN 8

The Central Wisconsin Radio Amateurs, Ltd., will hold its 3rd annual swapfest and family pic-

nic on Sunday, June 8, 1980, at Bukolt Park, Stevens Point WI. Admission will be \$2.00 for adults, children will be admitted free. Swap tables and tailgate sales will be \$2.50. At 8:00 am, rolls and coffee will be served and at 11:00 am, a BBQ lunch will begin. At 3:00 pm, a raffle drawing will be held with a grand prize for hams of a Yaesu FT-202R 2-meter HT. Also featured will be a beverage stand, an indoor lodge, outdoor grills, horseshoe courts, picnic tables, and a kiddie korner. Talk-in on .07/.67 and .22/.82 (WB9QFW).

BETHEL OH JUN 8

The Bethel Amateur Radio Klub will hold the second annual Bethel Ham Trade Around on Sunday, June 8, 1980, at the Bethel Middle School grounds, SR 222 Angel Drive, Bethel OH. Activities will begin at noon. There will be a small tailgating fee. Bring your own tables. The flea market will be in a large wooded area and will be for radio and electronic items. If it rains, it will be held inside the school auditorium. There will be prizes, refreshments, restrooms inside, displays, and surprises. Talk-in on 146.825/.225. For further information, contact Russ Canter WB8SID, 129 Morris Street, Bethel OH 45106.

WILLOW SPRINGS IL JUN 8

The Six Meter Club of Chicago, Inc., will sponsor the 23rd annual ABC Hamfest on Sunday, June 8, 1980, at Santa Fe Park, southwest of Chicago, 91st and Wolfe Road, Willow Springs IL. Advance registration is \$1.50 or \$2.00 at the gate. There will be picnic grounds, refreshments, and parking available. Featured will be a large swappers' row, displays in the pavilion, an AFMARS meeting, and prizes of a color TV and IC-215 or Bearcat 210. Talk-in on 146.94 or WR9ABC .37/.97 (PL2A). For more information and advance tickets, contact Val Hellwig K9ZWV, 3420 South 60th Court, Cicero IL 60650.

BARRIE ONT CAN JUN 13-15

The Lake Simcoe Hamfest will be held on June 13-15, 1980, at Molson's Park, Barrie, Ontario, Canada. Doors will open at 12:00 noon on Friday, June 13. Registration at the gate is \$5.00 and pre-registration is \$4.00,

with children under the age of 18 admitted free. Talk-in on VE3LSR 146.85, 146.52 simplex, and 3780 kHz. For information, reservations, or tickets, write to Lake Simcoe Hamfest, PO Box 2283, Orillia ONT, Canada L3V 6S1.

WOLF POINT MT JUN 14-15

The twenty-fifth annual NE Montana Hamfest will be held on Saturday and Sunday, June 14-15, 1980, at the Lewis and Clark Bridge Park, south of Wolf Point MT. Free overnight parking and camping spaces will be available. Features will include a flea market, a used-gear auction, door prizes, and a potluck picnic on Sunday. Talk-in on .52 simplex and 3900 kHz. For more information, contact WB7QDL or WB7QDN.

CROWN POINT IN JUN 15

The Lake County Amateur Radio Club will hold its annual Dad's Day Hamfest on June 15, 1980, at the Lake County Fairgrounds in Crown Point IN. The event will be held indoors again this year in the Industrial Arts Building. Take I-65 to exit S.R. 231 west (Crown Point) to S.R. 55 south and follow the signs. Tickets are \$1.50 in advance and \$2.00 at the door. Talk-in on 147.84/.24 or 146.52 simplex. For more information and tickets, write Tickets, PO Box 1909, Gary IN 46409.

FREDERICK MD JUN 15

The Frederick Amateur Radio Club will hold its 3rd annual hamfest on June 15, 1980, at the Frederick Fairgrounds, East Patrick Street, Frederick MD. Grounds open at 6:00 am for commercial and tailgating; breakfast will be available. The hamfest opens at 8:00 am for general admission. Donation is \$3; \$2 extra for tailgating. YLs and children are free. There will be plenty of on-grounds food, drink, and parking. Talk-in on 146.52 simplex (K3ERM). For more information, contact Mike Staley WB3LJK, New Market MD 21774, or Hamfest Committee, PO Box 1260, Frederick MD 21701.

JACKSONVILLE IL JUN 15

The Jacksonville Area Amateur Radio Club will hold its 15th annual hamfest and flea market

on June 15, 1980, at the Morgan County Fairgrounds, Jacksonville IL. Tickets are \$1.50 each or four for \$5.00. Featured will be free coffee and doughnuts from 8:00 am to 9:00 am, food on the grounds, and indoor facilities. Talk-in on .52/.52.

TERRE HAUTE IN JUN 15

The 34th annual WVARA Hamfest will be held on June 15, 1980, at the Vigo County Fairgrounds, one mile south of I-70 on US 41, Terre Haute IN. Overnight camping will be available. There will be a free outdoor flea market, a covered flea market at \$2.00 for a 12' x 12' space, with some tables and ac available, XYL bingo, food, refreshments, and valuable prizes. Advance ticket sales are \$2.00 or 3 for \$5.00. Tickets at the gate are \$3.00, with children under 12 free. Talk-in on .25/.85 and .52 simplex. For tickets and information, send an SASE to WVARA Hamfest, PO Box 81, Terre Haute IN 47808.

VANDENBERG AFB CA JUN 15

The 1980 Santa Maria Swapfest and BBQ will be held on Sunday, June 15, 1980, at Union Oil's Newlove Picnic Grounds, south of Santa Maria, off US 101. Tickets are \$7.00 for adults and \$3.50 for children 6 to 12, with children under 6 free. Extra drawing tickets are \$1.00 each or 6 for \$5.00. Featured will be prizes, including a new Yaesu FT-707, QLF and QBK contest, and swap tables. Swap tables are \$2.50 each. Talk-in on WR6ASW, 146.34/.94. For tickets or more information, write Santa Maria Swapfest, PO Box 1615, Vandenberg AFB CA 93437, or contact KA6AKC at (805)-734-1380.

MIDLAND MI JUN 21

The Central Michigan Amateur Repeater Association, Inc., will hold its sixth annual Swap and Shop on Saturday, June 21, 1980, from 8:00 am until 2:00 pm at the Midland County Fairgrounds, Midland MI. There will be computer displays and demonstrations, door prizes, and an auction held at 1:00 pm for gear that isn't sold. Tickets are a donation of \$3.00 or 2 for \$5.00, with XYL and junior op free on the OM's ticket. Talk-in on 146.73 WR8ARB and 146.52 simplex. For more information

and tickets, send an SASE to R. L. Wert W8QOI, 309 E. Gordonville Road, Rte. 12, Midland MI 48640.

**DUNELLEN NJ
JUN 21**

The Raritan Valley Radio Club will hold its ninth annual hamfest and flea market on Saturday, June 21, 1980, from 8:30 am to 4:00 pm at Columbia Park, Dunellen NJ. Registration for sellers is \$3.00, donation for lookers is \$2.00, and spouses and children are free. Prizes will be awarded, including a first prize of a Tempo S1 and a second prize of a frequency counter. Refreshments will be available. Talk-in on 146.025/.625 and 146.52. For details, write RVRC, RD #3, Box 317, Somerset NJ 08873, or phone (201)-356-8435.

**BLACKSBURG VA
JUN 23-27**

A workshop entitled, "TRS-80 Interfacing and Programming for Instrumentation and Control" will be held on June 23-27, 1980, at the Virginia Polytechnic Institute and State University, Blacksburg VA. This is a hands-on workshop with the participants working with and designing interfaces for the TRS-80 microcomputer. For more information, contact Dr. Linda Leffel, CEC, Virginia Tech, Blacksburg VA 24061, or phone (703)-961-5241.

**DUNKIRK NY
JUN 28**

The Northern Chautauqua Amateur Radio Club will hold its second annual Lake Erie International Hamfest and Flea Market on Saturday, June 28, 1980, at the Chautauqua County Fairgrounds, Dunkirk NY. Registration is \$3.00 in advance and \$4.00 at the gate. Flea market space is \$1.00. There will be radio dealers, door prizes, and refreshments. Talk-in on hamfest station W2SB, .25/.85 and .52 simplex. For more information and an easy-to-follow map, write Mike Samuelson WB2DFM, General Chairman, PO Box 319, Brocton NY 14716.

**OXFORD ME
JUN 28**

The Yankee Radio Club, Inc., of Maine, will hold its Yankee Hamfest '80 on Saturday, June 28, 1980, at the Oxford County Fairgrounds in Oxford ME. Featured will be computer displays, talks on selected subjects, a

ladies' program, a youth program, swap tables, door prizes, and a buffet dinner in the evening. Registration will be \$8.00, complete with a dinner and door prize chances; \$7.00 for early registrations. For admission only, at the gate, the cost is \$2.50. Camper hookups will be available for Friday and Saturday nights at \$2.00 per night. Talk-in will be on 146.28/.88 and on 146.52. For information and registration, send an SASE to Lynda Mount, 198 Cony Extension, Augusta ME 04330.

**BELLE CENTER OH
JUN 29**

The Champaign-Logan Amateur Radio Club, Inc., will hold its annual hamfest on Sunday, June 29, 1980, at the Memorial Hall in Belle Center OH. A special grand prize, as well as many door prizes, will be given away. Tickets are \$1.50 in advance, \$2.00 at the door, and trunk and table sales space are \$3.00. Talk-in on 146.52 simplex. For more information, contact CLARC, Inc., PO Box 637, Bellefontaine OH 43311.

**BOWLING GREEN OH
JUN 29**

The 16th annual Wood County Ham-A-Rama will be held on Sunday, June 29, 1980, at the Wood County Fairgrounds, Bowling Green OH. Gates will open at 10:00 am, with free admission and parking. Tickets are \$1.50 in advance and \$2.00 at the door. There will be drawings for prizes, and tables and trunk sales space will be available. There will be advance table rentals to dealers only. Talk-in on .52. For more information, write to Wood County ARC, c/o C. Falls, 201 Martendale, Walbridge OH 43465.

**HARRISBURG PA
JUL 4**

The Harrisburg RAC Annual Firecracker Hamfest will be held on Friday, July 4, 1980, at the Shellsville VFW Picnic Grounds. Take exit 27 off I-81 north of Harrisburg at PA route 39, then follow the signs for one mile or call for talk-in information. There are shade trees and a pavilion. Parking for 1,000 cars will be available. Food will be available or bring your own picnic. Admission is \$3.00; XYLs and children are free. Tailgating is \$1.50. Many valuable prizes will be awarded.

**BURLINGTON ONT CAN
JUL 5**

The Burlington Amateur Radio Club will hold its 6th annual Ontario Hamfest 1980 on Saturday, July 5, 1980, at the Milton Fairgrounds, just south of the intersection of Highways 401 and 25 (Exit 39). General admission is \$3.00; children and ladies are free. Pre-registration before June 15, 1980, is \$2.00. Gates will open Friday, July 4, 1980, at 12:00 noon and Saturday, July 5, 1980, at 7:00 am. The flea market opens at 8:00 am and tables are free. There will be camping available and food and prizes. Talk-in on 147.81/.21 VE3RSB. For information, write BARC, Box 836, Burlington ONT, CAN L7R 3Y7.

**OAK CREEK WI
JUL 12**

The South Milwaukee Amateur Radio Club will hold its annual Swapfest '80 on Saturday, July 12, 1980, at the American Legion Post #434, 9327 S. Shepard Avenue, Oak Creek WI. Admission is \$2.00 and includes a happy hour with free beverages. Prizes include a \$100 first prize, a \$50 second prize, and a variety of other prizes. Activities will begin at 7:00 am and continue until 5:00 pm. Parking, a picnic area, and hot and cold sandwiches, as well as liquid refreshments, will be available on the grounds. Overnight camping is also available. Talk-in on 146.94. More details, including a map, may be obtained from the South Milwaukee Amateur Radio Club, Inc., Robert Kastelic WB9TIK, Secretary, PO Box 102, South Milwaukee WI 53172.

**WILKES-BARRE PA
JUL 13**

The Broadcasters' Amateur Radio Club will hold its third annual hamfest on July 13, 1980, from 9:00 am to 4:00 pm at the Pocono Downs Race Track, Rte. 315, Plains Twp., 1½ miles north of Wilkes-Barre PA. Admission is \$2.50, XYLs and children are free, and there will be no additional charge for sellers. Gates will open at 8:00 am for set-up. There will be unlimited outdoor and indoor space, refreshments, prizes, a free FM clinic, and ac power available. Talk-in on 147.66/.06 and 146.52 simplex. For more information, contact Charles Baltimore WA3NUT,

BARC, 62 South Franklin Street, Wilkes-Barre PA 18773, or phone (717)-823-3101.

**INDIANAPOLIS IN
JUL 13**

The Indianapolis Amateur Radio Convention and Hamfest will be held on Sunday, July 13, 1980, at the Marion County Fairgrounds. For further information, write Indianapolis Amateur Radio Association, Box 11086, Indianapolis IN 46201.

**WAUKESHA WI
JUL 19**

The Kettle Moraine Radio Amateur Club (KMRA) will hold its annual hamfest on Saturday, July 19, 1980, beginning at 7:00 am, at the Badger Raceway, Waukesha WI. The Badger Raceway is located west of Dousman on U.S. 18, 3½ miles from the intersection of I-94 and State Highway 67. There will be overnight camping on the grounds on Friday. Tickets are \$1.50 in advance and \$2.00 at the door. Talk-in on 146.52, 52.525, and 28.650 MHz. For additional information and advance tickets, write KMRA Hamfest, 108 Shepard Ct., Mukwonago WI 53149.

**CARY NC
JUL 19**

The Cary Amateur Radio Club will hold its 8th annual Mid-Summer Swapfest on Saturday, July 19, 1980 (rain or shine), at the Cary Lions Club Shelter (next to the Cary Senior High School). Gates will open at 9:00 am. There will be an auction (no fees) from 1:00 pm to 2:00 pm. Prize drawings will be held from 2:00 pm to 2:15 pm and will include a Kenwood TS-520SE, a Yaesu FT-202 with nicads and charger, a CDE Tailtwister® rotor, a Hy-Gain TH3 Sr., and others. Registration is \$3.00. Tables will be rented or bring your own. Talk-in on 146.28/.88 and 146.52/.52. For more information, write CARC, Box 53, Cary NC 27511.

**BLYTHEVILLE AR
JUL 19-20**

The 1980 Arkansas Army MARS Convention will be held on July 19-20, 1980, at the National Guard Armory, Highway 61 south, Blytheville AR. Registration is \$7.50 and includes a catfish supper and pancake breakfast. Talk-in on 148.01 and .07/.67. For more information, contact Richard Duncan

WB5CNV/AAR6SH, 209 Wilson Street, Dell AR 72426.

**BELVIDERE IL
JUL 20**

The annual Big Thunder ARC Hamfest will be held on Sunday, July 20, 1980, at the Boone County Fairgrounds. There will be a large indoor facility and plenty of outdoor space available, as well as camping after 6:00 pm on Saturday. Talk-in on 146.52 simplex and 147.375 repeater. For more information, write Mike George, 6159 Broadview, Belvidere IL 61008.

**CANTON OH
JUL 20**

The Canton Amateur Radio Club and the Tusco Amateur Radio Club will hold the 6th annual Hall of Fame Hamfest on Sunday, July 20, 1980, at the Nimishillen Grange near Louisville OH, just off of Route 62, East of Canton OH. Admission is \$2.50 in advance and \$3.00 at the gate. Talk-in on .52/.52, .19/.79, and .72/.12. for reservations and information, contact Max Lebold WA8SHP, 10877 Hazelview Avenue, Alliance OH 44601, or phone (216)-821-8794.

**DETROIT LAKES MN
JUL 20**

The Detroit Lakes Amateur Radio Club will hold its 4th annual picnic and swapfest on Sunday, July 20, 1980, from 10:00 am to 4:00 pm at Long Lake Park, 1½ miles west of Detroit Lakes on Highway 10. Tickets for the drawing are \$1.00. Picnic and swap tables will be available. Talk-in on 146.22/.82 and 146.52/.52. For additional information, contact Russ Berger N0ARZ, 1406 Long Avenue, Detroit Lakes MN 56501.

**LOGANSPORT IN
JUL 20**

The Cass County Amateur Radio Club's third annual hamfest will be held on Sunday, July 20, 1980, from 7:00 am to 4:00 pm at the 4-H Fairgrounds. Go north of Logansport on Highway 25, turn right at Road 100, and follow the QSY signs. Advance tickets are \$1.50; \$2.00 at the gate. Outside setup is free; undercover is \$1.00. Bring your own tables. Free overnight camping, refreshments, and door prizes will be available. Talk-in on 146.52 and Logansport Repeater 147.78/.18. For in-

formation, write Roy E. Manniko WB9PKN, 530 North Cicott Street, Logansport IN 46947.

**GOLDEN CO
JUL 20**

The RMRL will hold its annual Field Day Demonstration and Swapfest on Sunday, July 20, 1980, at 10:00 am at Karl Ramstetter's (WA0HJZ) Ranch. It is located on top of Guy Hill, Highway 93, Golden CO. Signs will be posted. There will be door prizes. It would be appreciated if everyone would make his contribution to the potluck lunch by bringing his favorite dish and chairs and/or blankets. Soft drinks will be provided. Talk-in on .34 and .94.

**MCKEESPORT PA
JUL 20**

The Two Rivers Amateur Radio Club will hold its annual hamfest on Sunday, July 20, 1980, at the Penn State University, McKeesport Campus, McKeesport PA. A flea market will be held outside on the hard surface and car spaces will be \$5.00. There will be food and drink, door prizes, and free admission. Talk-in on 146.22/.82.

**WASHINGTON MO
JUL 20**

The Zero-Beaters ARC will sponsor the Washington Hamfest on Sunday, July 20, 1980, at the Washington Fairgrounds, Washington MO. There will be prizes and good buys for the ham, and bingo and a candy scramble for other family members. Features will include a commercial dealer exhibit, a large traders' row, and delicious food. Talk-in on .52 simplex. For more information on tickets, prizes, and camping, write ZBARC, Box 24, Dutzow MO 63342.

**MONACA PA
JUL 20**

The Beaver Valley Amateur Radio Association will hold its third annual hamfest on Sunday, July 20, 1980, at the Community College of Beaver County from 9:00 am to 5:00 pm. Registration is \$2.00 each or 3 for \$5.00; children under 12 will be admitted free. Refreshments will be available, as well as free parking, indoor vendor space, and a paved outdoor flea market. There will be a drawing at 4:00 pm and door prizes all

day, including a first prize of a Kenwood TS-520SE transceiver, a second prize of a Kenwood TS-2400 synthesized hand-held, and a third prize of a Cushcraft ATB-34 triband beam. Talk-in on 146.25/.85 WR3AAA, 223.26/.86 WR3AAA, and 146.52 simplex. For further information and advance registration, contact either Gary Mohrbacher WB3FKE, 3417 47th Street, New Brighton PA 15066, (412)-843-9546, or Adam Horniak WB3JZN, 182 Edgewood Street, Aliquippa PA 15001, (412)-378-9667.

**WRIGHTSTOWN NJ
JUL 20**

The West Jersey Radio Amateurs, Inc., hamfest will be held on July 20, 1980, at McGuire AFB, Wrightstown NJ, from 9:00 am to 4:00 pm. Admission is \$2.50 and advance orders receive an additional chance at door prizes. Spouses and children are free. Tailgate or table space is \$2.50 per space; bring your own table. Refreshments and activities will be available. Door prizes will be awarded continuously and a major door prize of a 2-meter transceiver will be drawn at 3:30. Talk-in on .52 and 146.925. Advance tickets are available from club members or send an SASE to Mary Lou Shontz WB2QIU, 107 Spruce Lane, Route 16, Mt. Holly NJ 08060. For additional information, call Mark Millman N2ME at (609)-871-6691.

**RAPID CITY SD
JUL 25-27**

The Black Hills Amateur Radio Club will hold its 1980 South Dakota Hamfest and Picnic on Friday, July 25, through Sunday, July 27, 1980, at the Surbeck Center, South Dakota School of Mines campus, Rapid City SD. Registration will be \$6.50 before July 1st, and \$7.00 after July 1st and at the door beginning at 4:00 pm on Friday, July 25th. Door prizes will be awarded along with a pre-registration prize. There will be forums, tours, exhibits, a transmitter hunt, a flea market, contests, and YL activities. Flea-market tables are free. A Sunday noon meal will be catered and tickets will be available at the door. Assistance will be provided in obtaining lodging or trailer parking facilities. Talk-in on 146.34/.94, or contact W0BLK. To pre-register or obtain further information, contact Black Hills

Amateur Radio Club, PO Box 1014, Rapid City SD 57709.

**OKLAHOMA CITY OK
JUL 25-27**

The Central Oklahoma Radio Amateurs will hold the Oklahoma State ARRL Convention and "Ham Holiday" on July 25-27, 1980, at Lincoln Plaza, 4445 Lincoln Boulevard, Oklahoma City OK. The program will include an ARRL forum and technical talks. In addition, a full program is scheduled for the ladies. Pre-registration will be \$5.00 if received before July 19. After that date, it will be \$6.00. A special award is being given to encourage pre-registration. There will be many other awards. Adequate rooms are available for commercial exhibitors and flea market swappers. Unlimited parking space is also available. Mail your registration to CORA, PO Box 15013, Oklahoma City OK 73155.

**SEATTLE WA
JUL 25-27**

The 26th National ARRL Convention will be held on July 25-27, 1980, at the SEA-TAC Airport Red Lion Motor Inn, 18740 Pacific Highway South, Seattle WA 98188. Basic registration is \$7.00 before July 1, 1980, \$9.00 after that date; additional family registration is \$6.00, \$7.00 after July 1, and student registration is \$7.00. Features will include prize drawings, forums, displays and new equipment exhibits, tours, and much more. Roy Neal K6DUE of NBC News will be the featured Saturday-night banquet speaker. For additional details, write John H. Brown W7CKZ, Promotion Chairman, SEANARC '80, PO Box 68534, Seattle WA 98168.

**NASHVILLE TN
JUL 27**

The Nashville Hamfest will be held on Sunday, July 27, 1980, beginning at 8:00 am CDT at the National Guard Armory, Sidco Drive, Nashville TN. Admission is \$1.00 and tables are \$3.00. Refreshments will be available and the hamfest will be all indoors. Talk-in on .90/.30. For more information, contact Radio Amateur Transmitting Society (RATS), PO Box 2892, Nashville TN 37219.

**WEST FRIENDSHIP MD
JUL 27**

The Baltimore Radio Amateur

Television Society will hold its annual BRATS Maryland Hamfest on Sunday, July 27, 1980, at the Howard County Fairgrounds, just off I-70 and Route 32 at Route 144, West Friendship MD. Beginning at 8:00 am, activities will be held rain or shine. Talk-in on .63/.03, .16/.76, and .52 simplex. For information or table reservations, write BRATS, Box 5915, Baltimore MD 21208.

JACKSONVILLE FL AUG 2-3

The Jacksonville Hamfest Association is pleased to announce that the 1980 Jacksonville Hamfest and ARRL Florida State Convention will be held on August 2-3, 1980, at a new location, The Orange Park Kennel Club at the intersection of I-295 and US Highway 17. Advance registration is \$3.00 and is available from Jacksonville Hamfest, 1249 Cape Charles Avenue, Atlantic Beach FL 32233. Price at the door will be \$3.50. A large indoor swap mart will be featured, with tables available at \$5.00 per day. The table reservations can be ordered from Andy Burton WA4TUB, 5101 Younis Road, Jacksonville FL 32218. Interesting programs and forums are planned and many manufacturer and dealer exhibits will be displayed, as well as new equipment. Plenty of family activities

are available close by and hotels with special rates and a good selection of accommodations are within walking distance. For more information, write JHA, 911 Rio St. Johns Drive, Jacksonville FL 32211.

ANGOLA IN AUG 3

The Steuben County Radio Amateurs will hold their 22nd annual FM Picnic and Hamfest on Sunday, August 3, 1980, at Crooked Lake, Angola IN. Admission is \$2.00. There will be prizes, picnic-style BBQ chicken, inside tables for vendors and exhibitors, and overnight camping (with a fee charged by the county park). Talk-in on 146.52 and 147.81/.21.

NORTH HAVEN CT AUG 16-17

The South Central Connecticut Amateur Radio Association will hold its Super Scarafest '80 on August 16-17, 1980, at the Ramada Inn, at Exit 12 of I-91, North Haven CT 06473. Booths will be available. Features will include a ham and computer flea market, an auction, special events for non-ham spouses and children, and drawings for prizes throughout the show. Prizes will include a solid-state low-band transceiver, a synthesized two-meter HT, a micro-computer, and a 600-MHz fre-

quency counter. Admission will be \$4.00, pre-registration before July 1, and \$5.00 at the door for both days. Talk-in on 146.01/146.61. For further information, write Super Scarafest '80, PO Box 5265, Hamden CT 06518, or call Jeff Wayne K1YLV at (203)-281-6038 between 9:00 am and 9:00 pm EST.

PENSACOLA FL AUG 31

The Five Flags Amateur Radio Association, Inc., will hold its 1980 Ham-A-Rama on August 31, 1980, from 8:00 am to 4:00 pm at the Pensacola Municipal Auditorium, Pensacola FL. Admission will be \$1.00 and swap tables will be available for \$5.00 each. Additional information can be obtained by writing to the FFARA, PO Box 17343, Pensacola FL 32522.

MELBOURNE FL SEP 6-7

The Platinum Coast Amateur Radio Society will hold its 15th annual hamfest and indoor swap-and-shop flea market on September 6-7, 1980, at the Melbourne Civic Auditorium. Admission is \$3.00 in advance and \$4.00 at the door. Swap tables are \$5.00 per day. There will be food and plenty of free parking available, as well as awards, forums, and meetings. Talk-in on .25/.85 and .52/.52. For reser-

vations, tables, and information, write PCARS, PO Box 1004, Melbourne FL 32901.

BOULDER CO SEP 28

The Boulder Amateur Radio Club will hold Barcfest '80 on September 28, 1980, beginning at 9:00 am at the Boulder National Guard Armory, North Broadway, at the city limits, Boulder CO. There will be an auction and a snack bar. Admission is \$2.00 per family and includes a door prize drawing and swap space. Talk-in on 146.10/.70 and .52/.52. For further information, contact Mark Call NØMC, 4297 Redwood Ct., Boulder CO 80301, or phone (303)-442-2616.

CHICAGO IL OCT 16-19

National Computer Shows (formerly Northeast Expositions) will hold the Midwest Personal and Business Computer Show from Thursday, October 16, through Sunday, October 19, 1980, at McCormack Place, Chicago IL. Show hours are: Thursday through Saturday, 11:00 am to 9:30 pm and Sunday, 11:00 am to 6:00 pm. General adult admission is \$5.00. For further information, contact National Computer Shows, PO Box 678 Brookline Village MA 02147, or phone (617)-524-0000.

Ham Help

I'm looking for a dial drum and S-meter for a Heath RX-1 Mohawk receiver.

L. Chapin K8ZJV
10442 Hart Avenue
Huntington Woods MI 48070

I would like to contact any teenagers who are interested in forming a net on the 15-meter Novice band.

Dave Mihelcic
41 Morrison
Belleville IL 62221

I need to locate a source of old callbooks dating back to 1945. Any old odd years would help.

Carl A. Mitchell K1JDJ
Box 1003
Fairfield CT 06430

I need help in altering a Bear-

cat 220 to receive outside of its pre-programmed bands. I have reached only multiple dead ends, so far. If you know a way or have an idea, please let me know. Thanks.

Si Davis
Box 3704
APO NY 09009

I'd appreciate a schematic, manual, or any info on a Hallcrafters Model S-38C communications receiver. I will pay copying charges and postage or do the copying and return to you postpaid. Thanks very much.

R. L. Foster N5BUW
PO Box 1296
Albany TX 76430

I need a 6907 tube for local repeater control (450 MHz), but *not* at \$35! Would anyone like to

trade one for six UX-120 tubes, tested for af and rf oscillation? I'll pay all shipping.

H. Eddy W2BU
3 N. Belmont
Oneonta NY 13820

I have an impedance bridge made by Clough/Brengle, military nomenclature ZM-11. I have not been able to find any sort of instruction manual for it. Does anyone have any information on this unit?

Richard Need WB4YOD
PO Box 248
Waxhaw NC 28173

I'm looking for ham call license plates for my collection. I would like to swap for or buy plates from other states and provinces.

Bryan Hastings KA1HY
64 Concord Street
Peterborough NH 03458
(603)-924-6902

I need a schematic of a filter

(300-3000 Hz), a CW reception method using a simulated stereo technique, and an EIMAC transmitting-tube catalog, 1976 or 1977. I also would appreciate any help from American radio amateurs (books, surplus, etc.).

Santos Henri 6W8HS
ARAS B.P. 971
Dakar, Senegal

I am interested in the future employment opportunities for persons holding a 2nd class radio telegraph ticket with aircraft endorsement (especially in the maritime field). Thanks for any assistance.

SSG. Gary S. O'Neal
138th Ord Co
APO NY 09253

I am trying to start a chess players net, evenings, on 75 meters.

Charles E. Martin AB4Y
PO Box 3370
Bowling Green KY 42101

OSCAR Orbits

Courtesy of AMSAT

Any satellite placed into a near-Earth orbit suffers from the cumulative effects of atmospheric drag. The much publicized descent of the Skylab space station was a graphic demonstration of these effects.

The OSCAR satellites are subject to atmospheric drag, of course, and the present period of intense solar activity has accentuated the problem. During this period, our sun has been expelling huge numbers of charged particles, some of which find their way into the Earth's upper atmosphere, increasing the density (and thus the drag) there. It is through this region that the OSCARs must pass. OSCAR 8, in a lower orbit than OSCAR 7, is the more seriously affected of the two.

If the drag factor is not considered when OSCAR calculations are performed, long-range orbital projections will be in error. For example, by the end of 1979, OSCAR 8 was more than 20 minutes ahead of some published schedules. The nature of orbital mechanics is such that extra drag on a satellite causes it to move into a lower orbit, resulting in a shorter orbital period. Thus, the satellite arrives above a given Earthbound location earlier than predicted.

Using data supplied to us by Dr. Thomas A. Clark W3IWI of AMSAT, the equatorial crossing tables shown here were generated with the aid of a TRS-80™ microcomputer. The tables take into account the effects of atmospheric drag and should be in error by a few seconds at most.

The listed data tells you the time and place that OSCAR 7 and OSCAR 8 cross the equator in an ascending orbit for the first time each day. To calculate successive OSCAR 7 orbits, make a list of the first orbit number and the next twelve orbits for that day. List the time of the first orbit. Each successive orbit is 115 minutes later (two hours less five minutes). The chart gives the longitude of the day's first ascending (northbound) equatorial crossing. Add 29° for each succeeding orbit. When OSCAR is ascending on the other side of the world from you, it will descend over you. To find the

equatorial descending longitude, subtract 166° from the ascending longitude. To find the time OSCAR 7 passes the North Pole, add 29 minutes to the time it passes the equator. You should be able to hear OSCAR 7 when it is within 45 degrees of you. The easiest way to determine if OSCAR is above the horizon (and thus within range) at your location is to take a globe and draw a circle with a radius of 2450 miles (4000 kilometers) from your QTH. If OSCAR passes above that circle, you should be able to hear it. If it passes right overhead, you should hear it for about 24 minutes total. OSCAR 7 will pass an imaginary line drawn from San Francisco to Norfolk about 12 minutes after passing the equator. Add about a minute for each 200 miles that you live north of this line. If OSCAR passes 15° east or west of you, add another minute; at 30°, three minutes; at 45°, ten minutes. Mode A: 145.85-95 MHz uplink, 29.4-29.5 MHz downlink, beacon at 29.502 MHz. Mode B: 432.125-.175 MHz uplink, 145.975-.925 MHz downlink, beacon at 145.972 MHz.

At press time, OSCAR 7 was scheduled to be in Mode A on odd numbered days of the year and in Mode B on even numbered days. Monday is QRP day on OSCAR 7, while Wednesdays are set aside for experiments and are not available for use.

OSCAR 8 calculations are similar to those for OSCAR 7, with some important exceptions. Instead of making 13 orbits each day, OSCAR 8 makes 14 orbits during each 24-hour period. The orbital period of OSCAR 8 is therefore somewhat shorter: 103 minutes.

To calculate successive OSCAR 8 orbits, make a list of the first orbit number (from the OSCAR 8 chart) and the next thirteen orbits for that day. List the time of the first orbit. Each successive orbit is then 103 minutes later. The chart gives the longitude of the day's first ascending equatorial crossing. Add 26° for each succeeding orbit. To find the time OSCAR 8 passes the North Pole, add 26 minutes to the time it crosses the equator. OSCAR 8 will cross the imaginary San Francisco-to-Norfolk line about 11 minutes after crossing the equator. Mode A: 145.85-95 MHz uplink, 29.4-29.50 MHz downlink, beacon at 29.40 MHz. Mode J: 145.90-146.00 MHz uplink, 435.20-435.10 MHz downlink, beacon on 435.090 MHz.

OSCAR 8 is in Mode A on Mondays and Thursdays, Mode J on Saturdays and Sundays, and both modes simultaneously on Tuesdays and Fridays. As with OSCAR 7, Wednesdays are reserved for experiments.

OSCAR 7 ORBITAL INFORMATION FOR JUNE

ORBIT #	DATE	TIME (GMT)	EQ. CROSSING (DEGREES WEST)
25361	1	0131:59	93.7
25373	2	0031:18	78.5
25386	3	0125:33	92.1
25398	4	0024:52	77.0
25411	5	0119:08	90.6
25423	6	0018:26	75.4
25436	7	0112:42	89.0
25448	8	0012:01	73.8
25461	9	0106:16	87.4
25473	10	0005:35	72.3
25486	11	0059:50	85.9
25499	12	0154:06	99.5
25511	13	0053:25	84.3
25524	14	0147:40	97.9
25536	15	0046:59	82.7
25549	16	0141:14	96.3
25561	17	0040:33	81.2
25574	18	0134:48	94.8
25586	19	0034:07	79.6
25599	20	0128:22	93.2
25611	21	0027:41	78.1
25624	22	0121:57	91.6
25636	23	0021:15	76.5
25649	24	0115:31	90.1
25661	25	0014:50	74.9
25674	26	0109:05	88.5
25686	27	0008:24	73.4
25699	28	0102:39	86.9
25711	29	0001:58	71.8
25724	30	0056:13	85.4

OSCAR 8 ORBITAL INFORMATION FOR JUNE

ORBIT #	DATE	TIME (GMT)	EQ. CROSSING (DEGREES WEST)
11416	1	0058:12	66.3
11430	2	0103:03	67.6
11444	3	0107:53	68.8
11458	4	0112:44	70.0
11472	5	0117:34	71.3
11486	6	0122:25	72.5
11500	7	0127:15	73.7
11514	8	0132:05	75.0
11528	9	0136:55	76.2
11542	10	0141:46	77.4
11555	11	0003:24	52.9
11569	12	0008:14	54.1
11583	13	0013:04	55.3
11597	14	0017:54	56.6
11611	15	0022:44	57.8
11625	16	0027:33	59.0
11639	17	0032:23	60.2
11653	18	0037:13	61.5
11667	19	0042:03	62.7
11681	20	0046:53	63.9
11695	21	0051:42	65.2
11709	22	0056:32	66.4
11723	23	0101:21	67.6
11737	24	0106:11	68.9
11751	25	0111:00	70.1
11765	26	0115:50	71.3
11779	27	0120:39	72.5
11793	28	0125:28	73.8
11807	29	0130:17	75.0
11821	30	0135:07	76.2

OSCAR 7 ORBITAL INFORMATION FOR JULY

ORBIT #	DATE	TIME (GMT)	EQ. CROSSING (DEGREES WEST)
25737	1	0150:29	99.0
25749	2	0049:47	83.8
25762	3	0144:03	97.4
25774	4	0043:21	82.3
25787	5	0137:37	95.8
25799	6	0036:56	80.7
25812	7	0131:11	94.3
25824	8	0030:30	79.1
25837	9	0124:45	92.7
25849	10	0024:04	77.6
25862	11	0118:19	91.2
25874	12	0017:38	76.0
25887	13	0111:53	89.6
25899	14	0011:12	74.4
25912	15	0105:27	88.0
25924	16	0004:46	72.9
25937	17	0059:01	86.5
25950	18	0153:17	100.0
25962	19	0052:35	84.9
25975	20	0146:51	98.5
25987	21	0046:09	83.3
26000	22	0140:25	96.9
26012	23	0039:43	81.8
26025	24	0133:59	95.4
26037	25	0033:17	80.2
26050	26	0127:33	93.8
26062	27	0026:51	78.6
26075	28	0121:07	92.2
26087	29	0020:25	77.1
26100	30	0114:41	90.7
26112	31	0013:59	75.5

OSCAR 8 ORBITAL INFORMATION FOR JULY

ORBIT #	DATE	TIME (GMT)	EQ. CROSSING (DEGREES WEST)
11835	1	0139:56	77.4
11848	2	0001:33	52.9
11862	3	0006:22	54.1
11876	4	0011:11	55.3
11890	5	0016:00	56.6
11904	6	0020:49	57.8
11918	7	0025:37	59.0
11932	8	0030:26	60.2
11946	9	0035:15	61.5
11960	10	0040:04	62.7
11974	11	0044:52	63.9
11988	12	0049:41	65.1
12002	13	0054:29	66.4
12016	14	0059:18	67.6
12030	15	0104:06	68.8
12044	16	0108:54	70.0
12058	17	0113:43	71.3
12072	18	0118:31	72.5
12086	19	0123:19	73.7
12100	20	0128:07	74.9
12114	21	0132:55	76.2
12128	22	0137:44	77.4
12142	23	0142:32	78.6
12155	24	0004:08	54.0
12169	25	0008:55	55.3
12183	26	0013:43	56.5
12197	27	0018:31	57.7
12211	28	0023:19	58.9
12225	29	0028:06	60.1
12239	30	0032:54	61.4
12253	31	0037:42	62.6

2 METER AMPLIFIER

CLASS C
PA 1-10

\$79.95



Works with all hand held and portable units. ✓ 324
1-3 watts in, 10-25 watts out, 4MHz band width.

Operates from 12-14 VDC. Solid state RF switching.

THE ELECTRONICS

RD 1, Box 195, Greene, NY 13778
Phone 607-656-8071

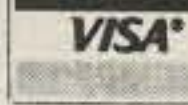

ALL BAND TRAP ANTENNAS!



PRETUNED - COMPLETELY ASSEMBLED - ONLY ONE NEAT SMALL ANTENNA FOR UP TO 6 BANDS! EXCELLENT FOR CONGESTED HOUSING AREAS - APARTMENTS LIGHT - STRONG - ALMOST INVISIBLE!

FOR ALL MAKES & MODELS OF AMATEUR TRANSCIVERS - TRANSMITTERS - GUARANTEED FOR 2000 WATTS SSB 1000 WATTS CW INPUT FOR NOVICE AND ALL CLASS AMATEURS!

COMPLETE AS SHOWN WITH 90 ft. RG58U-52 ohm feedline, and PL259 connector, insulators, 30 ft. 300 lb. test dacron end supports, center connector with built in lightning arrester and static discharge - molded, sealed, weatherproof, resonant traps 1" X 6" - you just switch to band desired for excellent worldwide operation - transmitting and receiving! WT. LESS THAN 5 LBS.

160-80-40-20-15-10 bands 4 trap --- 169 ft. with 90 ft. RG58U - connector - Model 1060BU ... \$99.95
80-40-20-15-10 bands 4 trap --- 91 ft. with 90 ft. RG58U coax - connector - Model 1080BU ... \$95.95
40-20-15-10 bands 4 trap --- 45 ft. with 90 ft. RG58U coax - connector - Model 1040BU ... \$92.95
20-15-10 bands 4 trap --- 23 ft. with 90 ft. RG58U coax - connector - Model 1002BU ... \$89.95

SEND FULL PRICE FOR POST PAID INSURED DEL. IN USA. (Canada is \$5.00 extra for postage - clerical - customs - etc.) or order using VISA Bank Americard - MASTER CHARGE - AMER. EXPRESS. Give number and ex. date. Ph 1-308-236-5333 9AM - 6PM week days. We ship in 2-3 days. ALL PRICES WILL INCREASE ... SAVE - ORDER NOW! All antennas guaranteed for 1 year. 10 day money back trial if returned in new condition! Made in USA. FREE INFO. AVAILABLE ONLY FROM:

WESTERN ELECTRONICS ✓ 80 Dept. A7-6

Kearney, Nebraska, 68847

ALL BAND TRAP ANTENNAS!

RTTY Loop

from page 12

several sample columns were presented to the staff of 73. A favorable reception was enjoyed, and the material was rewritten and the column renamed "RTTY Loop." At about that time, another shift in the club paper resulted in the abolition of "Tele-Tips," so now only the offspring remains.

What's the lesson? Simple. When the editor of your club newsletter sends out a plea for material—and they all do that every month—*answer it!* Without good input, any club or local publication will fold. Give it good stuff and you may find more there than you thought. OK?

Now, where were we? Before interrupting our line for ASCII last month, we were about to conclude our look at home-brew demodulators. Let's start this month with Fig. 1. This was called a "drift-free TU" when J. C. Cain VE7DBK published it in the September, 1977, issue of 73. Why "drift-free"? Well, after limiting and passage through a bandpass filter tuned for 2200 Hz, a phase locked loop (an LM565) is used to decode the audio input. As pointed out several months ago, the PLL has the ability to "track" input, by

"locking on" to the signal. Thus, drift, as a disturbing factor, is minimized. A rather nice feature of this design is the use of a squelch circuit to provide "mark-hold" in the absence of a signal. This locks up mechanical teleprinters to prevent their "running open." A high-voltage transistor is used to directly key the loop, as we are seeing more and more in demodulators designed these days.

Just as integrated circuits can replace discrete circuitry, as with the PLL above, so they can be used to redesign previous techniques. Such is the case with the demodulator presented in the November, 1978, issue of 73. Winford Rister WB4MBL's design uses 741 op amps as active filters to select mark and space signals. Fig. 2 shows the basic circuit, minus required power supplies of +5 V dc, +8 V dc, +160 V dc, and ± 7.5 dc. A sample power supply schematic is illustrated in the original article. All of those various voltages are necessitated by the mix of TTL, op amps, and transistors. Whew! With this demodulator, after selection by the active filters, the derived signal is fed through TTL logic to produce the desired keying waveform. Again, a sturdy transistor does the keying. It is

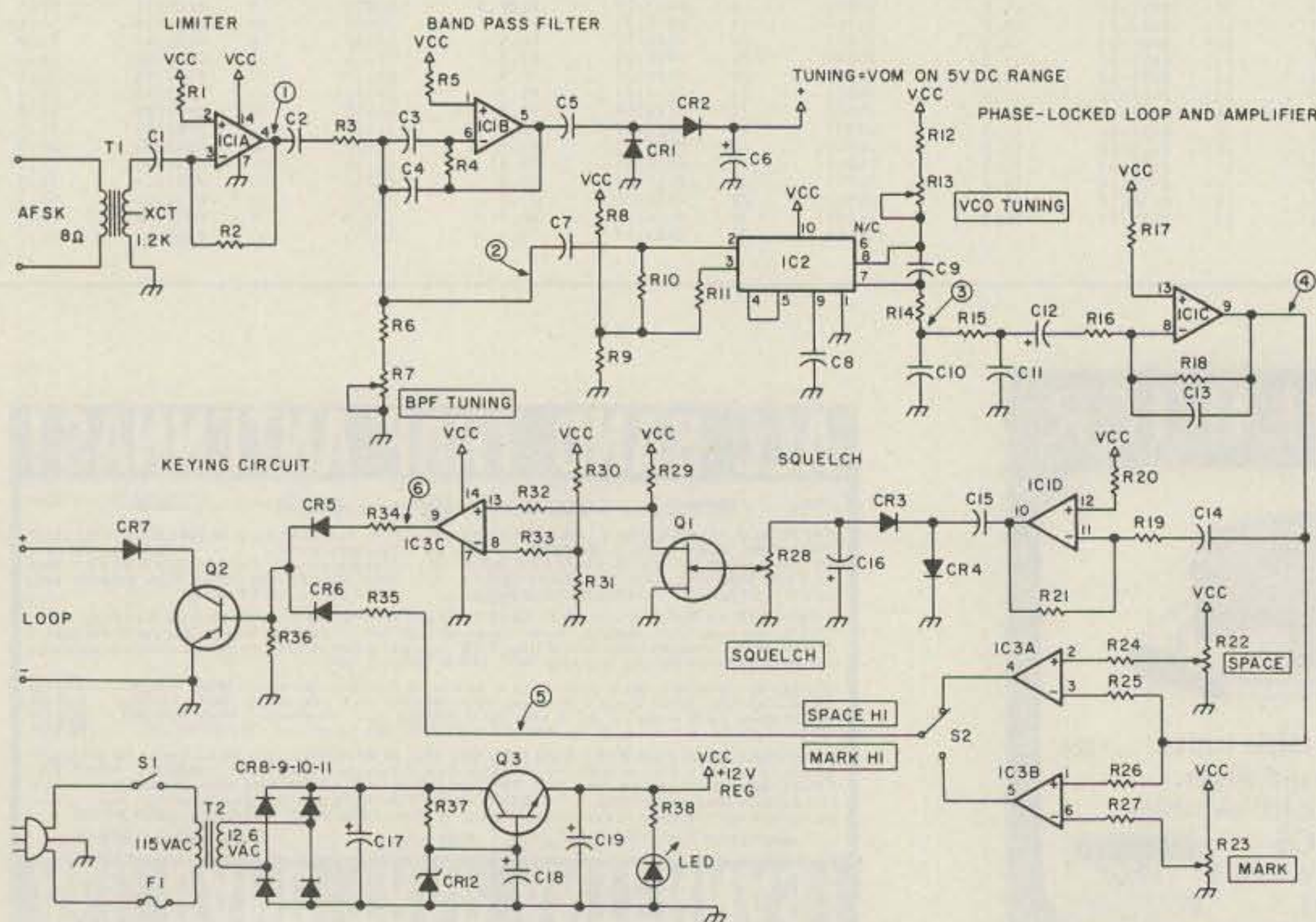

Fig. 2.

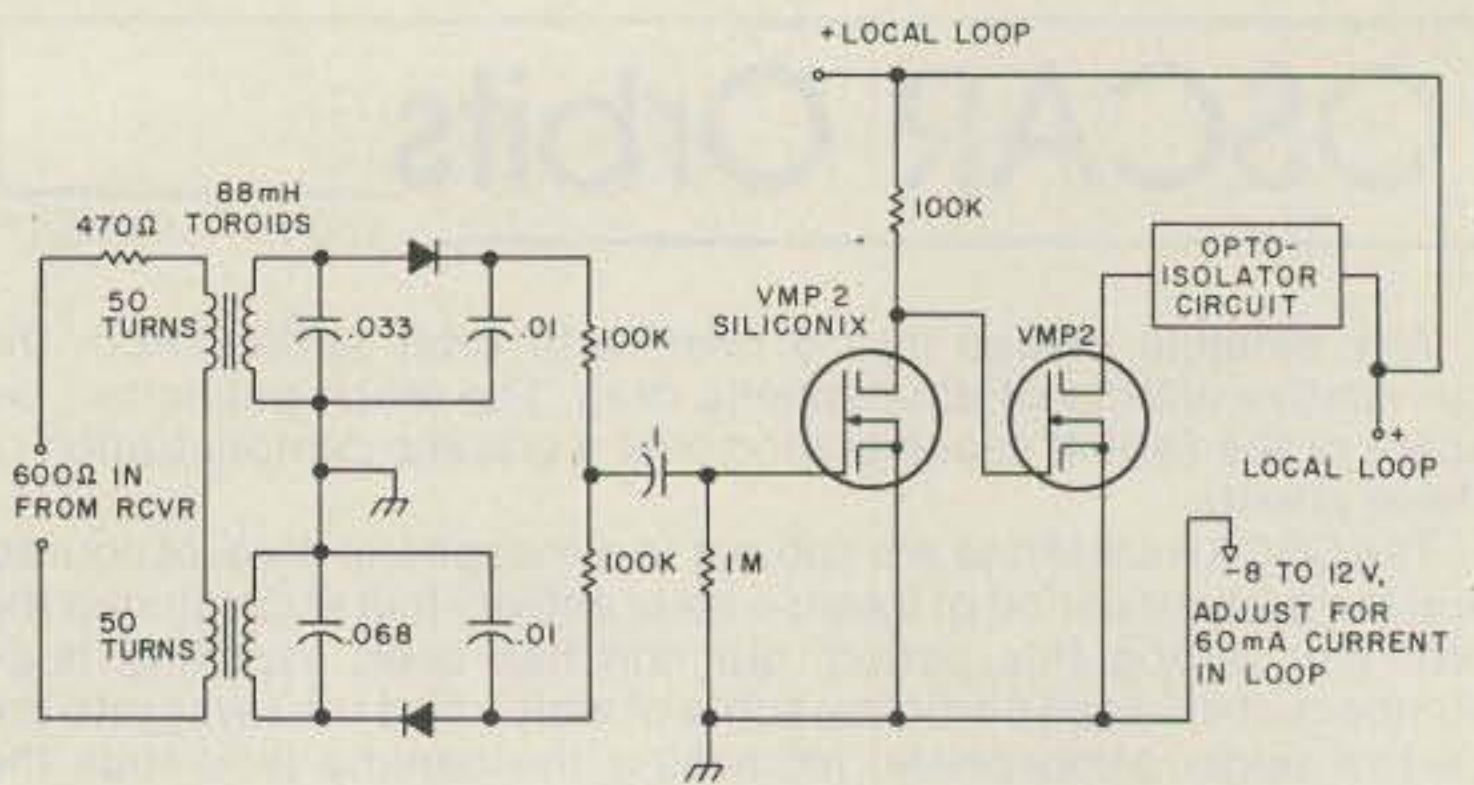

Fig. 3.

interesting to reflect on how we have come—from using the receiver bfo to select the tone, to TV width coils, to toroids (which represented state of the art for a long time), to active filters. Through use of op-amp active filters, selectivity unmatched except by carefully-matched, read "expensive," networks can be achieved cheaply and in a small package.

Speaking of small packages, we will close our look at home-brew (or home-brewable) converters with the demodulator of Fig. 3. Also from the November, 1978, issue of 73, this design by Lauren Colby is one of the most intriguing of all we have looked at. It needs no power supply, won't fry external components, and contains a grand total of two active components, and they are identical! What Lauren did was to couple two standard toroids to a MOSFET discriminator by adding a second coil to each toroid, producing a trans-

former. The discriminator is able to derive power from the loop while keying it. Now, granted, you are not going to key a 150 V, 60 mA loop with this one, but for keying a computer or TVT input, this is not that bad. Sure looks interesting!

And now... ASCII update. Last month, we covered the early information and some speculation about the new ASCII rules and regs. The FCC has released the full wording of the docket, and there is more to it than we originally thought. Not only does the rule allow transmission of ASCII with baud restrictions as outlined last month, but it also frees us from the 60 wpm (45.45 baud) limitation on Baudot communication. Five-level information may now be passed at 60 wpm (45.45 baud), 67 wpm (50 baud), 75 wpm (56.25 baud), or 100 wpm (75 baud). Also, the door has been left open to use of other non-standard modes of data exchange, such as binary-coded decimal or the old IBM favorite, EBCDIC (Extended BCD Decimal Interchange). Maybe even Selectric will be allowed. Now, these are not presently authorized, and international (ITU) regulations may prevent international use until those regulations are updated, but it appears that the FCC is looking into allowing us to use pretty much whatever we want to here.

And now, it's resource time for all the fans of the Loop! I have a note here from Dave Lundquist WA2UWK, who has acquired a Lenkurt model 25-A demodulator. While he would like to get the thing up and running, he is having a time interfacing it with his equipment. He requests any information be forwarded to him at 23 Three Village Lane, Setauket, New York 11733. Drop me a line, too, if you send over anything, OK?

The giant Greater Baltimore Hamboree and Computerfest is now history. Wayne W2NSD/1 gave two talks to the crowd, and one item stood out: RTTY stands alone as the vanguard of new communications techniques. All the skills we have

developed on RTTY can be put to good use on other digital communications circuits. Let us here at 73 know what you are working on. Write up that circuit or program so that more can benefit. If you would like, send RTTY programs to RTTY Loop,

and they will be published for all to benefit.

Next month, the spotlight will remain on reception techniques. We will start to shift our focus, however, toward those many commercial devices available

on the market. I will try to relay information made available from manufacturers, other individuals, and my personal observations on that equipment I have used. I won't forget your questions, either, here in RTTY Loop.

ou moons don't ever proof
lousy manuscripts from bat
bunch of ruck
you liars d
I insist that you print ev
tell Ma Bell that she shou

LETTERS

from page 18

bands. SSB was far preferable except for rare occasions when one might take advantage of the better fidelity of some AM rigs ... and when something more than a four-inch speaker was being used.

3. I found most operators able to cope quite well with SSB after a few minutes instruction. There were problems until they learned the use of the rf gain control, admittedly.

And 4. We could do without some of the signal shaping and processing.

Though I am in most ways a conservative, I think my record of trying new ideas and promoting those with promise is an enviable one. I started building RTTY equipment in 1948 ... got in on NBFM experiments in the very early days of 1946, when that was first invented by a chap not far from me. I was an enthusiastic and early supporter of SSTV, of moonbounce communications, of OSCAR, repeaters, FM ... etc. There are few experiences in amateur radio that I have not personally experienced and enjoyed. And when I find something which I think is good, I do all I can to get others to share this enjoyment with me.

With the work schedule and the traveling I do these days, it is not possible for me to do everything personally as I used to, so yes ... I am "too busy" to set up and spend weeks evaluating new ideas. But I did work closely with Tim on this and read all of the material submitted ... listened to the tests, both on tape and live ... read reports, talked with some of the people involved over the air and on the phone. I recognized the pioneering effort by Henry Radio to

bring this system to the hams and for that reason I was all the more hopeful that it would prove to be all the promoters said it was ... and more. We need new ideas and new modes of communications in amateur radio, for they are fun and help generate enthusiasm. I think Ted Henry should get a lot of credit for putting up the venture money to give this NBVM system a try.

I can be much more critical of the League ... as usual ... but am I unjustified? They apparently promoted the system without even trying it, going on the basis of the claims of the promoters. They sold the idea, without trial, to trusting QST readers through articles and even a chapter in the Handbook! Now, when we checked with the ARRL about this, I understand that they are "unable to find" the equipment in their labs and that the "whole issue is dead."

Tim Daniel did a massive amount of work on the project, funded by 73 Magazine. He worked for many weeks on it last summer and his aim was to try to make it work, not to debunk it. His final report was cautious and conservative, if perhaps discouraging as far as the future of NBVM is concerned. But then the NBVM promoters must be used to that by now, for most of the recent reports I've seen have not been encouraging. I can understand their enthusiasm ... if they had been able to make something work out and then been able to sell it to the industry, they could all have been multimillionaires. Getting hams to prove the worth of new modes of communications is a well tested and proven route. We did it with FM, SSB, NBFM, SSTV, etc. There are some new modes

in the wings and perhaps they will turn out to be more practical than NBVM. Or perhaps the NBVM people will come up with some improvements and yet win the day.

In talking with Ted Henry, I found that a great many of the units he was selling were going to commercial and government labs. They, too, are interested in results and will beat a path to the door of the successful pioneer of useful new techniques. We'll see what comes of their tests of NBVM. — Wayne.

HAM POWER

- 10-meter amplifier ban
- Elimination of club, military, and RACES licenses
- HF CB
- Proposed "type acceptance" of ham gear
- Elimination of secondary station, repeater, and special-event call signs
- Ending of hamfest license examinations
- Crazy call signs
- Quiet zones
- Monitor station protection
- and on and on and on ...

Enough is enough! Where will the FCC stop? When the Amateur Service is a jungle like CB?

After decades of peaceful cooperation with radio amateurs, the FCC has recently embarked on a course committed to destroying amateur radio as we all know and love it. In a series of misguided attempts to rectify problems in another radio service and in a self-centered effort to reduce their own workload, the Commission has seen fit to ransack and pillage the very foundations of amateur radio.

Editorials in QST, CQ, 73, World Radio, and Ham Radio Horizons have all blasted the Commission's treatment of amateur radio. QST even went so far as to title their November, 1979, editorial, "The FCC: Public Servant, or Public Enemy?" While ham magazines have rarely agreed on any topic, all are currently united in their criti-

cism of the FCC.

This letter is being sent by a group of concerned radio amateurs who are fed up with being choked by an insensitive and unresponsive FCC bureaucracy. We think it's time that ham radio operators take their gripes right to the Commission's doorstep. Perhaps, if the FCC had visible proof of the frustration and resentment held by most amateurs today, they wouldn't be so cavalier in their rulings. In the great tradition of the First Amendment to the U.S. Constitution, it's time for hams "peaceably to assemble and to petition the government for a redress of grievances."

On August 23rd, 1980, we want to see hams come to Washington by the bus-, train-, and plane-load for a day-long rally against the FCC's amateur policies. We want to hold a mammoth demonstration somewhere within the Capitol (right outside FCC Headquarters, if we can get the police permit, or on the steps of the Capitol) and publicly express our anger with the Commission.

Just think of the publicity. With, say, 10,000 hams protesting recent FCC rulings, the news media will never again confuse us with CBers. In addition, there will be speakers, entertainment, and a general effort made to educate the public about amateur radio and our plight. We'll even have representatives of our group meet with selected congressmen, senators, and other government officials. By sunset on August 23rd, the entire nation will know what amateur radio is and how the FCC is killing us.

Now, what can you do to help make our plan a reality? We don't want your money; we need your support. Write your ARRL Director and the ARRL President, Vice Presidents, and General Manager. Send letters of support to ham magazines. Most of all, talk up the August 23rd rally on the air.

The farmers do it and war protesters do it — now we can do it, too. There is strength in unity

and unity in numbers. After August 23rd, the FCC will think twice before dreaming up another stupid rule change.

**The August 23rd Rally
Committee
AG2U and WB2IBE,
Co-chairmen
Glendale NY**

Hey, how come one of the chairmen has a funny call? Silver to you, too. But, about the rally . . . if I thought it would do any good, I would be pushing the hell out of it. Actually, I think it would do a lot of harm. Oh, there are some things that should be done, but amassing hams in Washington during August, when everyone is on vacation, is not a priority item. Right now, the main problem that we have is a very serious image problem with the FCC commissioners. Getting the League to can their Washington counsel should be number one on the list of ways to improve the image of amateur radio with the Commission. I've already written about the inexcusable incident where he patronizingly lectured the new commissioners and, to my view, made the linear ban inevitable. The further action to take the Commission into court over it was just more arrogance and hurt us badly. The continuous pressures to get the FCC to try to stem the tide of jamming and bad language on the ham bands should be stopped immediately. We need good vibes, not constant bad ones. A staged media event, which is what you are proposing, is unlikely to bring joy to the commissioners. We should be working on letting them know about our good points and our value to the country, not making their lives miserable. They just have too many ways to get even.
— Wayne.

THE HUMAN FACTOR

I am not yet a ham, the price of most equipment keeping me from being one, but I do occasionally pick up a ham magazine just to keep current in some of the things going on.

My ship was on a port visit to Athens, Greece, and I found myself with nothing to read. I discovered, on one of my wanderings, a bookstore calling itself the "American Bookstore" and, indeed, most of the books carried were in English. Your maga-

zine was among the many on ham radio and electronics in general. If you are interested, right now in Athens, the price for *73 Magazine* is 190 drachmas, or an even \$5.00.

The issue I picked up was the January, 1980, issue, and the articles in it were very interesting. I wish to compliment you on a fine magazine—the best in the field, I feel.

The editorial by Wayne Green has to be one of the most comprehensive ones that I have ever read and I agree wholeheartedly with most of his views. As a naval communicator and as a person interested in ham radio, most of his propositions make a good deal of sense. However, I disagree with him on one point.

In the latter part of his editorial, he discusses the "bandwidth problem." His views on time-sharing, or automated contacts, while being innovative in the technological sense, take much of the human factor out of operating. Sure, the bands may be congested in particular spots, but if DXing rare contacts is reduced to a two-second exchange between machines, what is the point of being a ham? One can get just as much satisfaction and more information exchanged by having a pen pal.

As I said earlier, I am not a ham, so I do not really know the thrill of contacting a remote and hard-to-find station, but I am the shipboard MARS operator and I know the thrill of having my 100-Watt transmitter make a connection good enough for phone patches when we are floating off the coast of Turkey. It must be somewhat similar. I can't see how Wayne can, in the same editorial, speak of the joys of rag chewing and then discuss manners in how one can eliminate same.

If, by some chance, I get lucky and find your February or March issue in one of these backwater Mediterranean ports we pull into, I'll buy it. If not, I will delay my continued readership until we return home. You have a most interesting magazine.

**J. E. Richardson
FPO NY**

Just in case some amateur might not think your letter through and might have the question unanswered about automated contacts, I'd better reply. Anyone who has done

much DXing will tell you that there is little rag chewing going on with DX stations . . . particularly the rare ones. The pressure is on to make contacts as short as possible so that as many stations as desire can make a contact with the rare station. By automating this nonsense, we will end up with a lot more rag chewing and, I think, a much better amateur radio. The country hunters can rack up their silly scores (I have well over 300 countries confirmed) and the hams in rare spots will be able to give these contacts without having to spend months or even years fighting pileups to satisfy the demand. Their automatic station will grind out the thousands of duty contacts, leaving them free to sit back and rag chew when they have the desire. I think amateur radio will grow faster in rare spots if it is fun for the local operator . . . and constant pileups and screaming angry hams demanding QSLs are hardly enjoyable for the long run.— Wayne.

MEDICAL STATION

Under the direction of Dr. Steven H. Posner WB2QET/8, a station has been set up at the United States Public Health Service office in Cleveland OH for the purpose of handling emergency and priority medical traffic from any maritime or land-based station. The station has phone-patch capability to any medical facility in the U.S.

Begun on March 17, 1980, the station operates Monday through Friday, monitoring 28.911 MHz for the first 5 minutes of each hour, 0800 to 1600 hours Eastern Time.

**Dr. Steven H. Posner WB2QET
Lakewood OH**

PURE LIBEL

Allow me to take this time to express to you, Wayne, what a great job you and your staff are doing with *73 Magazine*. Personally, I find that it covers a wide variety of subjects in the greatest of detail. With technology increasing so rapidly, this type of information can be most helpful to today's ham.

Because the quality of *73 Magazine* is so high, I am left disgusted with *Ham Radio Horizons'* comment about your maga-

zine. To me, it seems to be pure libel. Additionally, if I were a newcomer to ham radio and unaware of the true content of *73*, I probably would not subscribe to it after reading those comments.

In conclusion, I would like to say I think *73 Magazine* is great. In fact, I will probably scrape up enough money for a lifetime subscription when renewal time comes. It's too bad that people get away with libelous comments which could have a detrimental effect on others.

**Bradley F. Hardin KB8OC
Sugar Grove WV**

Thanks for the nice letter. The referenced libel has to do with my editorials, which I think have stood the test of time. But, if you think it over, can you point to anyone in history who has tried to move things along who hasn't been put down with petty libel like that?— Wayne.

FULL OF WHAT?

I have a feeling that the New Product Review of John Meshna's Viet Nam surplus transmitters may have something to do with the first day of April.

However, I was impressed by the apparent unintentional play on words in the description of the transmitter's usefulness in detecting "troop movements."

Keep up the good work. I don't mind a little crap in *73* once a year. After all, *QST* is full of it every month!

**Michael W. Babb N4PF
Louisville KY**

BOO AND YEA

It would be interesting to know how many other licensed hams have found that some snake in the grass is using their call letters to work DX. Or is my case unusual?

For hams outside the US, I would like to acknowledge cards received through the 7th District Portland QSL office from TI9CF, IØRDJ, I3GJZ, SM5AQD, DK5AX, and SW listeners OK3-915 and DL-H11/1631274. None of the frequencies or times of contact coincides with the log at W7AR during 1978 and 1979. The only clue to the illegal operation is the

name Doug and the state of Oregon. We may be seeing only the tip of the iceberg.

On the positive side, to counter the bellyaching over shabby sales and service, I'd like to recommend Brodie Electronics, one of your advertisers in Moore OK, for friendly service beyond the call of duty.

**F. W. Anderson W7AR
Seattle WA**

Well, Andy, it wouldn't be so bad if the chap would work some decent DX and get you some rare cards. In the meanwhile, perhaps everyone can keep an ear peeled for "Doug" and his crummy signal. And Doug, if you're reading this, either get your own

call or work some rare stuff for Andy. Regarding Brodie Electronics: Three Cheers!—Wayne.

BLUEBERRY QSL

The Black River Amateur Radio Club will be operating a special event station during the National Blueberry Festival in South Haven MI on July 16-20, 1980 (Monday through Saturday). The call of the station will be WD8AGC and the frequencies used will be on or near 3.975, 7.275, 14.275, 21.375, and 28.375 MHz. CW operations will be conducted randomly throughout the Novice/Techni-

cian subbands. Any station working WD8AGC during this period can receive a colorful postpaid certificate by mailing a QSL card to The National Blueberry Festival, PO Box 224, South Haven MI 49090.

**Charlie Harrell
Secretary, BRARC
Watervliet MI**

117 BIG ONES

Any ham in the world who works a West Virginia amateur the week of the state's 117th birthday celebration will receive a beautiful certificate from the Secretary of State of West Virginia bearing the West Virginia

seal and signed by the Secretary.

Simply send your QSL report of the contact to the attention of the Secretary of State, the Honorable A. James Manchin, Room 157, State Capitol Building, Charleston WV 25305, and simply wish West Virginia a happy 117th birthday. This event starts Flag Day, June 14, and ends at midnight EST June 20, West Virginia's birthday. Look for West Virginia's hams 15 kHz up from the bottom of each General band segment.

**Lovell Webb N8LW
President, Kanawha Amateur
Radio Club
Charleston WV**

Awards

from page 24

NEW ZEALAND AWARD

The NZA award is available to all radio amateurs other than ZL. A total of 101 contacts are required to qualify for this award. All contacts must be made after December 8, 1945.

Applicant must make the following contacts: 35 ZL1 contacts, 35 ZL2 contacts, 20 ZL3 contacts, 10 ZL4 contacts, plus 1 contact with a ZL "territory" (either New Zealand, Antarctica, Chatham Island, Kermadec Island, or Campbell Island). This one contact may be substituted by 20 additional ZL contacts not already claimed.

Fee for this award is US \$.50 or 2 IRCs.

WORKED ALL NEW ZEALAND AWARD

The WAZL Award requires that contact be made with 45 different branches of NZART—except for overseas applicants, for whom only 35 contacts are required.

A special endorsement is given if the WAZL Award is accomplished within a 12-month period of time. Mobiles operating outside their regular branch area must sign the branch from which they are mobile while operating. Endorsements are also given for single band or mode. All contacts must be made after November 1, 1945, to qualify.

NZART branches are as follows:

01 Ashburton, 02 Auckland, 03 Western Suburbs, 04 Cambridge, 05 Christchurch, 06 Dannevirke, 07 Blank, 08 East Southland, 09 Egmont, 10 Franklin, 11 Gisborne, 12 Hamilton, 13 Hastings, 14 Hawera, 15 Hawke's Bay Central, 16 Horowhenua, 17 Huntly, 18 Hutt Valley, 19 Inglewood, 20 Manawatu, 21 Manukau, 22 Marlborough, 23 Marton, 24 Motueka, 25 Napier, 26 Nelson, 27 New Plymouth, 28 Northland, 29 North Shore, 30 Otago, 31 Pahiataua, 32 Rahoitu Coastal, 33 Rotorua, 34 South Canterbury, 35 South Otago, 36 South Westland, 37 Southland, 38 Taumarunui, 39 Tauranga, 40 Te Awamutu, 41 Thames Valley, 42 Titahi Bay, 43 Waihi, 44 Matamata Radio Club, 45 Waimarino, 46 Wairarapa, 47 Waitara, 48 Wanganui, 49 Westland, 50 Wellington, 51 Eastern Bay of Plenty, 52 Wairoa, 53 Te Puke, 54 Patea, 55 Waitomo, 56 Hornby, 57 Tokoroa, 58 Helenville, 59 Mangakino, 60 Taupo, 61 Central Otago, 62 Reefton Buller, 63 Upper Hutt, 64 North Otago, 65 Papakura, 66 Auckland VHF, 67 Kawerau, 68 North Canterbury, 69 Kapiti, 70 Fielding, 71 Rodney, 72 Opotiki, 73 Hobson, 74 Western VHF.

NEW ZEALAND COUNTIES AWARD

The Basic NZC Award requires contacts with 20 different New Zealand counties. Endorsements for 40, 60, 80, and 100 are made with a special certificate

for 112. A map showing the counties is available by writing NZART (ZL2GX) directly. Enclose 10 cents or 1 IRC to cover handling.

The initial award with any or all endorsements costs 45 cents or 3 IRCs. Separate endorsements thereafter cost 10 cents or 1 IRC. The special NZC 112 Award costs 45 cents.

Contacts may be made single band or any mode to qualify. GCR apply. Applicants must provide a list of contacts detailing the usual logbook data.

5 × 5 AWARD

This premier award has been instituted to recognize the increasing interest in 5-band DX operation. The initial award requires that the same station be contacted on 5 bands repeated with 5 different countries.

A certified list with full QSO data and fee of \$1.00 is required. The certificate is outstanding and is overprinted in embossed gold. Contacts must date from 1945.

ZLA AWARD

To qualify for this award, applicants must contact Auckland City ZL1, Wellington City ZL2, Christchurch City ZL3, Dunedin City ZL4, Antarctica ZL5, Campbell Island, Chatham Island, and Kermadec Island. There are endorsements given for single band or mode.

Award fee is 45 cents or 3 IRCs. GCR rules apply.

INDIVIDUAL ZL DISTRICT AWARDS

All ZL district awards are 35 cents each or 3 IRCs. Later en-

dorsements are accessed at 10 cents or 1 IRC apiece. All contacts must be dated post war.

ZL1 Award—Contact 125 different ZL1 stations. Endorsements are recognized for 175 and 250 contacts.

ZL2 Award—Basic award requires contact with 100 different ZL2 stations, with endorsements given for 150 and 200.

ZL3 Award—Basic award requires 50 ZL3 contacts, and endorsements are given applicants claiming 75 and 100.

ZL4 Award—This award requires only 25 ZL4s be worked, with endorsements given for 35 and 50.

CAPTAIN JAMES COOK AWARD

The CJC award, as it is called, is to perpetuate the memory of this world famous navigator and seaman—in three classes. 1. The basic "Sailor" class requires contacts with G in Yorkshire, FO8, ZL2, VK2, and KH6. 2. For "Officer" class, applicant must first possess all the Sailor class contacts plus ZL1, ZL3, ZL4, VK3, VK4, VK9 New Guinea, and any Antarctica station. 3. For "Command" class, both the previous classes must be earned plus five of the following—VE2, VO, A35, YJ8, FK8, CE0, and KL7.

Cost of this award is 45 cents in stamps or IRCs. GCR rules apply.

YL ZL AWARD

The Women Amateur Radio Operator Award (WARO) requires VK and ZL stations to work at least 12 members of the WARO. DX stations must work

at least 5 members. All contacts must be made after June 1, 1969, and must include one each from ZL1, 2, 3, and ZL4.

Net contacts do not qualify. There are no band or mode limitations; however, all contacts must be made from the same QTH for all.

Unlike all the previous awards shown so far, send your list of contacts along with your QSL cards to the Award Custodian, Thelma Souper ZL2LO, 62 Kirk Street, Otaki, New Zealand.

There was no mention of an award fee, but to be safe and courteous, it is advisable to enclose at least an amount for sufficient postage to return your cards.

In the event you missed the address for all applicants for NZART awards, please forward your requests to Mr. Jock White

ZL2GX, 152 Lytton Road, Gisborne, New Zealand. Be sure to tell Jock you heard about the NZART awards from *73 Magazine*.

CANADIAN AWARDS FROM CARF

The Canadian Amateur Radio Federation, Inc. (CARF) is pleased to announce the following radio amateur awards available to operators worldwide.

CANADAWARD

A colorful certificate will be issued to any amateur who confirms two-way contact with all Canadian provinces and territories. Awards will be issued for any band six to one-sixty meters and any mode via OSCAR satellite. Modes may be

mixed, CW, SSB, RTTY, SSTV, or any other authorized emission.

All contacts must be made after July 1, 1977. To qualify, applicant must forward QSL cards with \$2.00 or 10 IRCs plus sufficient funds for the safe return of your cards. CARF members need only submit sufficient funds for returning your QSLs. Mail your fee, application, and QSLs to: CANADAWARDS, PO Box 76752, Vancouver BC, Canada V5R 5S7.

List of Canadian provinces and territories which qualify for this award: VO1/VO2 Newfoundland and Labrador, VE1 Prince Edward Island, VE1 Nova Scotia, VE1 New Brunswick, VE2 Quebec, VE3 Ontario, VE4 Manitoba, VE5 Saskatchewan, VE6 Alberta, VE7 British Columbia, VE8 Yukon Territory, VE8

Northwest Territories. Note: VO1 or VO2 count as one required contact.

5 BAND CANADAWARD

A special plaque will be issued to any amateur who confirms two-way contact with all Canadian provinces and territories on each of five separate bands (12 cards per band for a total of 60 cards). All contacts must be made after July 1, 1977. Submit the 60 cards with \$10.00 or 70 IRCs plus sufficient postage for the safe return of your QSLs. Should you work 6 or 7 bands using the same CANADAWARD criteria, special endorsements will be provided upon proof of your claim. As with the basic CANADAWARD, forward your applications to PO Box 76752, Vancouver BC, Canada V5R 5S7.

DX

from page 15

been worked previously. Four US stations had tried and failed to make contact on Monday; none attempted Tuesday.

Futile attempts to steer the VKØRM crew to some radio equipment purportedly left on Heard some 20 years ago were made on Wednesday, 19 March. VK1PG had been on Heard at that time. P29JS and VKØRM moved to 21205, but no contact was made there. Nothing was heard of VKØRM after about 1300 UTC on Wednesday, 19 March.

Does this story make you start thinking about your solid-state rig and its limitations? What if the Heard boys had taken a Collins KWM-2 or a Drake pair? Better yet, what if they had taken two Kenwood TS-120 radios, one for a spare?

When there's no Radio Shack on an island, having only one rig (with transistors in the final) is risky, at best. Convenient, yes, but...

We began the April column with a comment about the beginning of the new decade ("unless you're progressive and follow the decade-begins-in-'81 theory"). That was bound to bring at least one response, as indeed it did:

Dear Editor:

This letter refers to the first sentence in your article in *73's* issue for April, 1980, and reflects my dismay in discovering that the writer who has earned my respect with his intelligent, pleasurable reports not only holds to an absurd version of the meaning of "decade," but also persists in publishing it. I am dissatisfied in you.

Any dictionary you might consult will tell you that a decade is

a "group, set or collection of ten things, especially a period of ten years." When you count any ten things, even years, you begin your counting with "one" (not "zero") and end with "ten" (and you insist on getting ten singles for a ten-dollar bill, don't you?). When you count your toes, you wind up with ten; if you continue the count on your fingers, you wind up *with twenty*... or, to put it another way, your second decade of digital appendages *includes* the twentieth. Carrying this further: The Christian Era began with the "Year One" (not "Year Zero"), the first century ended with the year 100, the nineteenth century ended with the year 1900, the twentieth century began with the year 1901, its seventy decade ends with 1980, and that its eighth decade begins in '81 (to quote you) is just the most simple, mathematical fact — not "theory."

Will you have the goodness to correct your published statement in one of your subsequent articles, not for me, but for the sake of other readers whose

own misunderstanding may have been enhanced by yours?

Most sincerely,
Herbert Schwartz K2LVU
Professor Emeritus, NYU

Well, darn it, at least my admonishment came from an academic. Nice to hear from you, Herb. I was thinking of things like measuring... a yardstick begins with zero, doesn't it? And if I give you a ten-dollar bill and ask for *change*, don't I start with zero dollars, until you hand me the first one back? And did the sixties end with the murders of Robert Kennedy and Martin Luther King in 1968, or did they end with the pullout from Viet Nam and the abolishing of the Selective Service in 1973?

As you can see, we thrive on letters, opinions, even criticism. And photos for the column, too. Letters make fun reading while scanning the bands for DX. We'd like to hear from you — good, bad, indifferent.

All of the material for this column came from *The DX Bulletin* out of Vernon CT.

Corrections

In my article, "A Micro-Controlled Ham Station" (April, p. 76), Fig. 1 on page 77 inadvertently shows a Small System Hardware TRS-232 Converter between the TRS-80 Expansion Interface and Western I/O Selec-

tric Printer. The TRS-232 Converter is totally unnecessary as the Western I/O printer works *directly* off the expansion interface.

Robert M. Richardson W4UCH/2
Chautauqua Lake NY

In regard to "The Paper, the Station, and the Man" (February, p. 54), a few errors occurred which you might want to correct:

On page 56: The flier's name in the N.Y.-to-Norway flight was Thor Solberg. He later became the owner and operator of an airfield near Morristown NJ.

On page 58: The call letters of

the Louise Boyd Expedition were LA9Z; they operated in the amateur bands.

On page 59: I retired on June 1, 1969, after 69 years with the *Times*.

Incidentally, my name is IVERSEN.

Reginald Iversen K4QZ
St. Petersburg FL

Contests

from page 21

tors.

EXCHANGE:

RST, QSO number from 001, WAB area and county. Book numbers and districts may be requested but are not mandatory as part of the exchange.

SCORING:

Score 5 points for each completed QSO. Stations may be worked on other bands for extra points.

Multipliers for UK contestants are each WAB area and each overseas country (DXCC list). In addition, Alderney, Guernsey, Jersey, and Sark count as separate countries. The remainder of G, GD, GI, GM, and GW count as one multiplier only.

Multipliers for overseas contestants are each WAB area, county, and each G prefix (G, GD, GI, GM, and GW). Multipliers count on each band, i.e., a station worked on three bands = 3 multipliers.

For mobile entries, every contact made from a different area will count five points, but the multiplier counts once only (i.e., mobile station from ten different areas—score is 10 times 5 points, but only one multiplier for the mobile station).

AWARDS:

Certificates for the leading contestant in each class or entry. For awards, each G prefix is separate. There will also be certificates issued to the leading contestants from each DXCC country and also to SWLs. Certificates for 2nd and 3rd will be issued if there are 10 or 25 entries from a particular country or call area.

ENTRIES:

Logs must show the title of the contest, name and full postal address of contestant, QSO details, total points claimed, multipliers claimed, and the full details of all operators when multi-operator entry is submitted. Logs must be sent to the contest manager: R. L. Senter G4BFY, 27 Station Road, Thurnby, Leicester LE7 9PW, England.

Entries must be postmarked not later than one calendar month following the date of the contest and must be received by the contest manager not later than 40 days following the said contest. A signed declaration that the station was operated in accordance with the current licensing conditions must accompany all entries. It is a condition of entry that the decision of the WAB Contest Manager

and the WAB Committee shall be absolute in the case of dispute. For SWLs, all stations logged must be participating in the contest and giving serial numbers which must be logged. The RSGB will be notified of the results and the Contest Manager will supply a detailed result sheet on receipt of an SAE on or after November 1st.

QRP FIELD DAY

Starts: 1800 GMT June 28

Ends: 2100 GMT June 29

(same dates/times as the ARRL contest if they should change!)

Sponsored by the QRP Amateur Radio Club International, Inc., the contest is open to all amateurs and all are eligible for awards. Portable stations may operate the 27-hour span if setup is after the start of the contest. Non-portable stations may operate a 24-hour period only. All modes are accepted, but no repeater QSOs and no pre-arranged contacts. Stations can be worked for credit once per band. No multi-transmitter stations are allowed.

EXCHANGE:

RS(T) and ARRL section.

SCORING:

Each QSO counts 2 points. Bonus points are +500 for portable (in field, non-commercial power source), +100 for all battery power, and +300 for all solar power. Multipliers are as follows: more than 100 Watts dc output power = x1; 30.1 W to

100 Watts dc output = x1.5; 10.1 W to 30 = x2; 3.1 W to 10 = x4; 1.1 W to 3 = x6; 0.1 W to 1 = x10.

Final score is QSO points times power multiplier; then add bonus points. Multi-operator stations divide by the number of operators.

AWARDS:

Certificates to the highest-scoring 1st, 2nd, and 3rd place stations overall.

ENTRIES:

Send full log data, including name, address, and call used. Also equipment, power input only, antennas, and bonus information (battery, solar, portable). Results will be published in the QRP International Newsletter, etc. Entrants desiring results sheet and scores, please enclose a business size SASE. Logs must be received by July 30th to qualify. Address entries to: QRP ARCI Contest Chairman, Edwin R. Lappi WD4LOO, 203 Lynn Drive, Carrboro NC 27510.

CANADA DAY CONTEST

Starts: 0001 GMT July 1

Ends: 2359 GMT July 1

Sponsored by the Canadian Amateur Radio Federation (CARF), the contest is open to all and everybody works everybody. Use all bands from 160 to 2 meters on CW and phone combined. Entry classes include single-operator, allband; single-operator, single band; and multi-

Results

RESULTS OF THE 1979 PENNSYLVANIA QSO PARTY

PENNSYLVANIA STATIONS

Call	County	Total QSOs	PA QSOs	Out-of-State QSOs	Sections	Counties	Score
N3AOT	Perry	687	45	642	62	28	122,202
K3ONW	Adams	359	75	284	61	29	56,547
K3NB	Schuylkill	410	101	309	48	32	49,344
WB3GZV	Columbia	265	69	196	33	27	21,681
WA3UNX*	Erie	187	55	132	37	23	16,687
WB3KCK	Delaware	135	35	100	23	23	7,705
W3HDH	Centre	104	35	69	27	18	6,534
AD8J/3	Allegheny	77	13	64	31	10	6,355
N3RJ	Pike	92	25	67	28	20	6,328
W3ADE	Dauphin	128	53	75	22	22	6,116
K3SWZ	York	125	57	68	21	23	5,481
K3HWL	Crawford	97	32	65	24	16	5,448
W3ZX	Centre	112	44	68	19	24	4,712
KA3DGT	Centre	59	5	54	28	5	4,676
W3CNS	Lancaster	85	25	60	22	12	4,510
AD3O	Tioga	85	30	55	22	19	4,290
K3VX/3	Mercer	80	24	56	21	16	4,032
W3CEI	Dauphin	72	28	44	19	16	3,040
W3TEF	Blair	74	35	39	19	20	2,888
WB3CAI	Luzerne	74	32	42	17	22	2,686
N3ASB	Beaver	37	15	22	15	12	1,215

*Western Pennsylvania Winner

THE TOP TEN OUT OF STATE

Call	QSOs	Counties	Points
VE3DAP	95	33	3135
VE3KK	75	30	2250
W2IMO	75	29	2175
WA2OTC	65	27	1755
W1TEE	64	27	1728
K1ITS	62	26	1612
W3PYZ	55	23	1265
N2RT	52	24	1248
K1VUT	50	23	1150
W5WG	48	21	1008
WA2NPP	48	21	1008

PENNSYLVANIA COUNTIES MISSING

Clarion Potter
Clinton Snyder
Fayette Sullivan
Forest Susquehanna
Fulton Union
Lebanon Warren
McKean Wayne

53 of the 67 counties were represented. Let's hope for a clean sweep next year.

operator, single transmitter, all-band. All contacts with amateur stations are valid. Stations may be worked twice on each band, once on CW and once on phone. **EXCHANGE:**

Signal report and consecutive serial number; VE1 stations should also send their province. **SCORING:**

Score 10 points for each contact with Canada, 1 point for contacts with others. Score 20

points for the first contact with any CARF official news station using the suffix TCA or VCA. Multipliers are the number of Canadian provinces/territories worked on each band and mode (12 provinces/territories \times 8 bands \times 2 modes for a maximum of 192 possible multipliers). Contacts with stations outside Canada count for points but not multipliers.

FREQUENCIES:

Phone — 1810, 3770, 3900, 7090, 7230, 14150, 14300, 21200, 21400, 28500, 50.1, 146.52.

CW — 1810, 7025, 14025, 21025, 28025, 50.1, 144.1.

Since this is a Canadian-sponsored contest, remember to stay within the legal frequencies for your country!

AWARDS & ENTRIES:

The CARF Canada Day Contest Trophy will be awarded to the highest-scoring single-op-

erator entry. Certificates will be awarded to the highest score in each category in each province/territory, US call area, and DX country. Send all logs including dupe sheets, summary sheet, and comments to: Canadian Amateur Radio Federation, Box 76752, Vancouver B.C. V5R 5S7, Canada. Entries should be postmarked before July 31st and include an SASE for a copy of the results.

W2NSD/1

NEVER SAY DIE

editorial by Wayne Green

from page 6

WHISTLING

My interest in police radar detectors should not be news to you, since I have been writing about them off and on for some time now. The array in the 73 mobile office (a Dodge van . . . the performance of which has convinced me that efforts to keep Chrysler in business are against our national interests) has risen to seven these days. Talk about overkill! When a police car is passed, the van lights up like a busy pinball game, with hoots and buzzers sounding and lights of all colors flashing.

I've written about the Cincinnati Microwave Escort unit. It is about 20 dB better than the diode models which have been sold for the last few years. This was put together by some refugees from Drake and was the first superheterodyne receiver for the 10.5- and 26-GHz bands. That 20-dB difference is a big one, amounting to about one hundred times the gain. This means that the receiver detects radar signals substantially before the diode units.

The Whistler company is not far from Peterborough, just over the border, down in Massachusetts. Sherry and I drove down there the other day to see how they were doing with their detectors . . . and in particular their new superheterodyne receiver, the Model Q-1000. Well, they're still selling the diode units in good numbers, with the Q-1000 sales still just a small percen-

tage of the production. I have a feeling that once people understand what is at stake, they will not accept anything less than a superhet.

A couple weeks after the visit, my turn came up to get a test Q-1000 from their production. I went right out and checked it against the Escort. It seemed to be about the same in sensitivity . . . which means that it sounds off as soon as there is a police car anywhere in the neighborhood. With the diode units, you have to develop the ability to instantly brake when the detector sounds, for you often have less than one second to slow down if you happen to be lead-footed (as I am). Radar units are unable to lock on your car if you are changing speed, so a fast response will avoid anything worse than a scowl from the fuzz. If you get a blast from the detector and you start looking to see where the radar unit is, you're in trouble. You really have to develop a completely automatic braking action.

With the superheterodyne models (sometimes called quadradyn), you have the luxury of a few seconds to ponder the location of the radar unit. My reflexes are automatic, so now I ponder as I drive along about ten miles under the speed limit . . . instead of ten miles over. I have read enough about radar units to know that you should leave a healthy margin for their error. Once you get used to the efficiency of the superhet, you feel almost naked with one of the old

diode detector types. I really hate to drive without one of the good detectors.

Whistler called the other day to see if I would be interested in doing some tests on their diode unit in comparison with the brand new and highly touted Fuzzbuster Elite. Sure, I was game for that. They brought up the unit and we set it up in the 73 van alongside the other detectors (Fuzzbuster, Bearfinder, Super Snooper, Fox, Q-1000, Escort, and Micronta). They had a K-band radar unit with them and I got out my X-band Sport Radar Gun (a present from Chuck of Tufts Electronics). We ran tests in the spots where the local police have found their radar units the most effective in generating income for the town . . . such as the hill out in front of our Instant Software building and a sharp road curve a mile beyond that.

There was no question but that the regular diode Whistler unit was able to pick up the radar signals before the new Fuzzbuster Elite . . . about one second ahead under normal driving speeds. Considering the short time you have for slowing down with the diode detectors, this is significant. But none of the units even came close to the warning given by the Q-1000 and the Escort. There is a long hill coming out of the only stoplight in Peterborough. The radar was set up out of sight just over the top of this hill. The Q-1000 picked it up halfway up the hill and the diode unit got it just as the radar car came into view as we crested the hill. The difference between the various diode detectors was a matter of perhaps 100 feet in sounding off, while the Q-1000 got all excited over 1000 feet before that. It was picking up the signals bouncing off traffic signs, passing cars, trees, etc., and announcing the radar from way down the hill . . . and around corners.

The Whistler people feel that the difference in price is such that it will be a lot more difficult to sell the superhet units (they run around \$250-\$300). Considering the expense and the psychological damage of a ticket, not to mention the problems with keeping a driver's license, the cost of the detector is hardly significant. Of course, if you haven't yet gotten a radar-inspired ticket (even if you weren't speeding), you may not really care about all this . . . yet.

The Fuzzbuster Elite certainly was a disappointment. I wonder why they are not getting into business with a superhet instead of coming out with just another diode gadget. The "Elite" name on it may confuse some people with the Escort name. I don't know what's with those people . . . the firm, Electrolert, has done a fantastic job of fighting legal battles over radar detectors and they were one of the first with a detector which worked well enough to be of real value. But since then they have done some disappointing things . . . like that fake "new model" with an Escort unit in it sent to a magazine for test. Their legal kit for people wanting to fight radar tickets is superb.

The Whistler Q-1000 is available from any Whistler dealer. The Escort is only available direct from Cincinnati Microwave, 255 Northland Blvd., Cincinnati OH 45246.

CLEANING UP COMPUTERS

With some 30,000 microcomputers already in the hands of hams, about the only thing that stands between our having 30,000 RTTY fans and reality is the horrendous noise these computers generate and radiate into our radios. It is high time that some hams tackled this problem and solved it.

Despite many warnings, the manufacturers of microcomput-

Completely Free
Standing Towers

TELE TOW'R

PAT. NO.

4,151,534

40' MODEL

Model 40 (extends from 21' to 40')

List \$259.10

55' MODEL

Model 55 (extends from 21' to 55')

List \$473.97

Breakover Model 40

(extends from 23' to 40' with breakover at ground level)

List \$440.62

Breakover Model 55

(extends from 23' to 55' with breakover at ground level)

List \$661.75

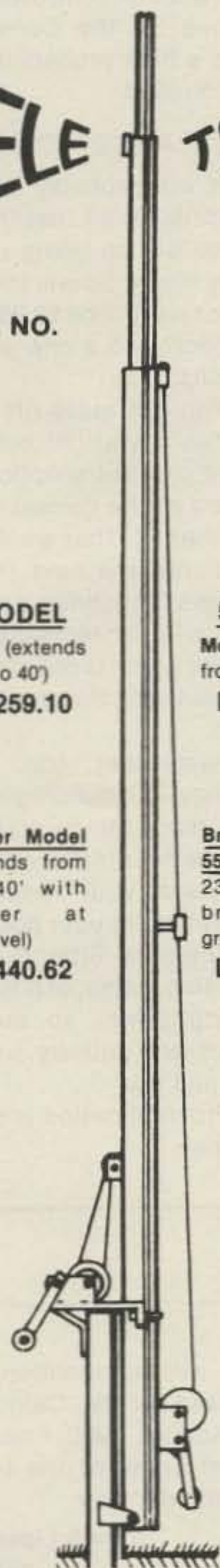

All steel constructed.

Concrete sleeve available for all models.

✓72

TELE-TOW'R MFG. CO., INC.
P.O. Box 3412 • Enid, OK 73701
405-233-4412

Lynda says:

Step up To Tempo

AND SAVE, SAVE ...



That's right . . . buy now the new Tempo S5 handheld and save, save, save! The S5 offers switchable 1 & 5 watts output, 800 channels, external microphone capability, and time proven dependability with so much more.

The world's first synthesized handheld sells for \$399.00 with touch-tone pad, \$349.00 without. Matching accessories include leather case, rubber antenna, 16 button touch-tone pad, cigarette lighter plug, power amplifiers, etc. Call now for your price, brochures. Export inquiries are invited.

Communications for Worldwide Use

CTG

Communications
Technology
Group Incorporated

448 Merrick Road, Oceanside, N. Y. 11572 U.S.A. (516) 536-5724
Telex 640-596/TWX 510-225-7536

✓85

**For your TRS-80
send & receive
CW/RTTY**



FEATURES

- Auto Send & Receive RTTY & CW
- Connects to TRS-80 User Port & Key/head phone jacks
- 10 message memories 255 char. ea
- Uses builtin PLL or external TU

- Includes hardware, cassette & manual
 - Morse tutorial-10 lessons-corrects mistakes Simplest, fastest way to learn the code
 - Morse practice-random 5 letter words
 - Auto numbering contest keyer
 - Interactive graphics custom PIX
 - Autotransmitter control PTT
 - Requires Level II Basic & 16K RAM
 - CM80 In cabinet as illustrated \$279
 - M80 As above minus cabinet \$149
 - M800 Adds advanced RTTY features to M80 \$99
- PET, APPLE, SORCERER versions available

Write or call for complete catalog



MACROTRONICS, inc. ®

1125 N. Golden State Blvd. / Suite G
Turlock, CA 95380 (S)
(209) 667-2888 / 634-8888

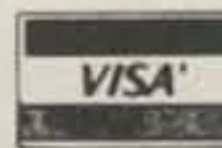

We are experiencing telephone difficulties,
please keep trying.

California residents add 6% tax

✓44

ers took the easy way out and built systems which generated severe radio frequency interference. Noise generation is a logical result of the type of construction used for most computers, where a bus structure is at the heart of the system. This means that there are a bunch of wires going all through the computer which are carrying high-frequency radio signals, so of course they are going to radiate.

One possible approach to the problem is to seal the computer unit in a shielded box, filtering all cables entering the box. The Cromemco computer uses this system with a good deal of success. This does increase the weight, size, and cost of the computer significantly.

Another approach from the manufacturing end is to shield each individual module of the system, which Atari has done with success. This, too, increases the cost of manufacture. And remember that every manufacturing cost is magnified substantially as it goes through the marketing chain, reflecting an increase to the customer on the order of three to five times the increase in manufacturing cost.

There is a need for experimentation in the field of reducing the interference from computers. I'd like to see you tackle this problem and solve it. I don't know how much can be helped by lining the inside of a TRS-80 keyboard box with aluminum foil and grounding it, or whether the only answer is a separate shielded box for the CPU section. I do think that we can work out a reasonable solution which will allow microcomputers to be used in the ham shack.

73 is thus soliciting articles on RFI cures for the various microcomputer systems. We're also interested in further articles on using these computers for RTTY communications, ASCII communications, etc. Here is a subject you can tackle and get your teeth into. If we have any less than ten times the number of articles on this subject than all other ham magazines combined, I am going to be disappointed.

THE FUTURE ARRIVES

Sometimes I get impatient for technological changes which are obviously going to arrive. Last fall, when I finally got my hands on a Yaesu FT-207R, I felt

a great sense of satisfaction... the future had arrived.

Large scale integrated circuits and the resultant microprocessor have made it possible for us to have a radio transceiver which is about the size of our smaller hand transceivers, yet includes the features of a scanner and synthesizer.

Those few FMers who were around ten years ago may remember one of the first FM rigs on the market. It was a unit put out by Galaxy and it had four crystal-controlled receiver and four transmitter channels. The unit had long wires running around and switches which had to be banged now and then to make good contact; in general, the equipment was prehistoric. Stability was not a big feature.

Rigs grew more stable and required vast amounts of crystals through the mid-70s. Finally Icom broke through with the IC-230 synthesized rig. Now we have a hand-held programmable transceiver. It will scan the entire band looking for active channels... or it will scan programmed channels. You can use it with 600-kHz offset or program in the offset you desire for repeaters.

Remember when the first digital readouts arrived? That wasn't very long ago, and now there they are even on my hand unit! The 207 seems to have just about everything the sophisticated base station transceiver would have, plus a belt clip. I think we'll be seeing these used not only for hand use, but also, with a power supply and amplifier, for use in the shack and in the car. I know I've put an amplifier in the car and taken out the old mobile rig. Now I don't have to worry about the rig being ripped out some night or while I'm in doing shopping somewhere.

The 207 has a jack for a remote microphone. That's most useful at hamfests where you don't want to have to wrest it from your belt every time someone calls. I find it handy for skiing, too, where the rig is in a pocket and only the clip-on mike is out there on my coat collar for easy use.

This isn't an advertisement for the 207, so I won't go into all of the features. There are plenty and the rig is incredibly flexible. Frankly, I'm hard put to look a lot further ahead for any significant technological improve-

ments. What is there left to do? I can see some little details which might be added, but when just about everything you can get in the most sophisticated base station is built into a hand transceiver, it seems like a dead end.

You can be sure of one thing... my 207 is with me just about everywhere I go... and, if I'm in your town, I'm listening to your repeaters. There is no way to hide them from a synthesized scanner.

NEW CALLSIGN RUMOR

A letter came in from one of our better authors in the mid-west... and he was all upset. He'd been talking on 40 meters and three of the hams on the round table had personal friends who were Engineers In Charge of local FCC facilities and they all had the same story: In the near future, all call signs would be reassigned by the FCC computer every time a license was renewed. Further, the ARRL was warned about this a year ago, but they ignored it.

My reaction was... balderdash. But, just to make sure, I called the FCC and checked with the horse's mouth. Balderdash was the correct response. This silly rumor probably got started as a result of the policy of the FCC to permit changes of call signs at renewal time if your class of license permits same.

The FCC used to have all sorts of hassles about call signs. Now that almost anything goes, the beefing is almost zero, so it

is highly unlikely that they would go out of their way to stir up that hornet's nest again. They haven't.

Here's a good rule: If you hear a rumor that sounds like baloney, the chances are good that it is. If the rumor would entail a lot of controversy and expense for the Commission, it has a high probability of being unfounded.

PRICE INCREASE

It will probably come as no surprise at all that the 73 cover price will be going up with the July issue. So will the subscription rate. It'll be \$2.95 per copy, I expect, and a one year rate of \$25 (US).

You can stave off the higher prices if you get busy and extend your subscription for three years at the current rate of \$45 (in the US). That would save you \$30 over the next three years, unless it becomes necessary to put another increase in the interim, which is not at all unlikely, considering the rate of our inflation.

Remember, too, that your money is devaluing rapidly, so the more things you buy now, the better off you are. If you try to save your money, it will shrivel up in your pocket.

There is little likelihood of printing, paper, or postage costs going down, so subscription rates are unlikely to go down... just up.

Procrastination is the thief of money.

Ham Help

I am studying for my Technician and have purchased a Hammarlund HQ-110 receiver to help build up my code speed. I need an operating manual and schematic for this rig. I will be glad to pay copying expenses and postage. Thanks very much for any help.

Edward J. Hannigan, Jr.
20551 Salt Air Circle
Huntington Beach CA 92646

I need a 2AC Crystal Calibrator for my Drake 2B. If you can get your hands on a new one, I'll pay the new price. Any help would be appreciated.

Frank M. Shelton W8NYH
Box 156
Jenkinjones WV 24848

I will be vacationing in the Eureka-Arcata, California, area in August, 1980. I would like to meet some of the local hams during my stay.

Herb Lipson W8FBH
17597 Tracey
Detroit MI 48235

Does anyone have a manual or schematic for a National NC-98 receiver? If you can lend me yours, please let me know. I'll send you a mailing envelope, and then burn a copy of yours and return it to you along with reimbursement of your mailing cost. Thanks.

John Yares KA4IMM
9660 Coachman Court
Pensacola FL 32504

Lynda Says . . . We can't thank you enough.

All of you out there. For the year of '79 was great for all of us. I would like to pass along the savings to you. Select one of these fine transceivers with either your credit card, trade-in or cash deal. We want your business and thank you for it. Why not find out why Hams from all over the world come to CTG. We are on the South Shore on Long Island with a real Ham Radio Showroom that can't be beat. Come in, call at any hour or write for free brochures. Export inquiries invited.



Ten-Tec Omni Series B Ten-Tec D Transceiver. 160-10 Mtrs. Digital Readout. Four position CW/SSB Filter. 200 Watts SSB. Regularly sells for \$1,119.00/Now \$995.00.



Swan 100MX Solid-State. 10-80 Mtrs. 235 Watts SSB power with noise blanker. Regularly sells for \$699.95/Now \$549.00.



Kenwood TS120S. 80-10 Mtrs. Digital Readout, Analog Dial, 200 Watts SSB power. Reg. \$699.00/Now \$665.00.



NCX 1000 Transceiver. 10-80 Mtrs. 1 kW SSB, AM, CW, RIT Control. Speech Clipper, Built-in P.S. Much more. Regularly sells for \$1,695.00/Now \$1,495.00.



Kenwood TS180S with DFC. 160-10 Mtrs. 200 Watts, Digitally Tuned Memory. Regularly \$1,149.95/Now \$1,092.46.



Swan Astro 150 VRS Tuning 10-80 Mtrs. 235 Watts SSB. Fully Microprocessor Controlled frequencies. Regularly sells for \$925.00/Now \$765.00.



Drake TR7/DR7. Reg. \$1,395.00/Call for your price.

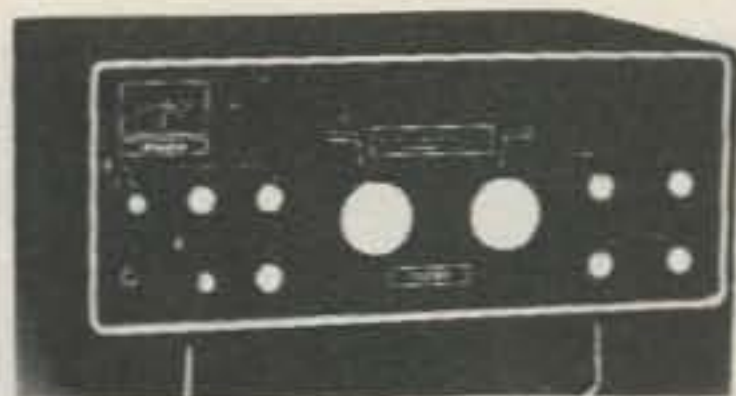

Swan 102BX Transceiver. Dual PTO's 235 Watts SSB & CW. 1.8-30 MHz I.F. Passband Tuning. Tunable Notch filter, much, much more. Regularly sells for \$1,195.00/Now \$995.00.



Kantronics Field Day TTY Code Reader. Reg. \$449.00/Now \$350.00.

CDE Tailtwister Rotor TX2
Reg. \$349.00/Now \$189.00



Communications
Technology
Group, Incorporated®

448 Merrick Road
Oceanside, N. Y. 11572
1708 Rockaway Avenue
Lynbrook, N. Y. 11563
(516) 536-5724
Telex 640-596/TWX 510-225-7536

85 Communications for Worldwide Use

MFJ SWR/ WATTMETERS

NEW Multi-Sensor SWR/Peak Reading Wattmeter. Operate 2 rigs simultaneously:



HF, VHF, QRP.
\$119⁹⁵

MFJ-825 Deluxe Power Sentry is MFJ's exclusive Multi-Sensor SWR/PEAK Wattmeter.

Plug in any 2 sensors: HF, VHF, or QRP (see specs below). Switch selects one of two. Comes with one sensor of your choice. Use remote or mount in cabinet.

Operate 2 rigs simultaneously or alone. Switch selects rig to monitor.

Forward/reflected power in 2 ranges. Dual meters, 2% movements. Peak or average power.

Read SWR directly of either rig from 1:1 to 6:1. Has SWR sensitivity control.

Switch selects sensor A or B or grounds sensors for protection in transit and from minor static discharges.

Lighted meters, battery check. Black steel cabinet. 6-3/4 x 5-3/8 x 5-3/4 inches. 9 V battery or 110 VAC with optional AC adapter, \$7.95.

\$69⁹⁵

BRAND NEW



The NEW MFJ-820 Power Sentry is MFJ's exclusive Multi-Sensor SWR/Wattmeter.

Plug-in sensors for HF, VHF, and QRP (see specs below). Comes with one sensor of your choice. Use remote or mount in cabinet.

Monitor forward/reflected average power, 2 ranges. SWR 1:1 to 6:1. 2% meter movement.

Has range/mode, reflected/forward power switches, SWR sensitivity control.

Lighted meter (requires 12 V). Rugged black steel cabinet. 3-7/8 x 5-3/8 x 4-1/2 inches.

PLUG-IN SENSORS: HF, VHF, QRP. \$29.95 EACH.

Plug up to two in MFJ-825, one in MFJ-820.

MFJ-830 HF SENSOR. 1.8 to 30 MHz. 200 and 2000 watts forward, 20 and 200 watts reflected power, full scale. 5 watt SWR sensitivity.

MFJ-831 VHF SENSOR. 50 to 175 MHz. 20 and 200 watts full scale forward and reflected power. 5 watt SWR sensitivity.

MFJ-832 QRP SENSOR. 1.8 to 30 MHz. 2 and 20 watts full scale forward and reflected power. 500 milliwatt SWR sensitivity.

Aluminum cabinet. SO-239. 2-1/2 x 2-5/8 x 2-1/4 inches. Remote or mount in meter cabinet.

Order from MFJ and try it. If not delighted, return within 30 days for refund (less shipping).

One year unconditional guarantee.

Order yours today. Call toll free 800-647-1800.

Charge VISA, MC. Or mail check, money order. Add \$4.00 each for shipping and handling.

CALL TOLL FREE ... 800-647-1800

Call 601-323-5869 for technical information, order/repair status. Also call 601-323-5869 outside continental USA and in Mississippi.

MFJ ENTERPRISES, INC.

BOX 494, MISSISSIPPI STATE, MS 39762

ATTENTION

EXPERIMENTER DESIGNER MANUFACTURER

HFT OFFERS YOU

ENGINEERING SERVICES - MINIMODULE PRODUCTS
AUDIO THROUGH 250 MHZ

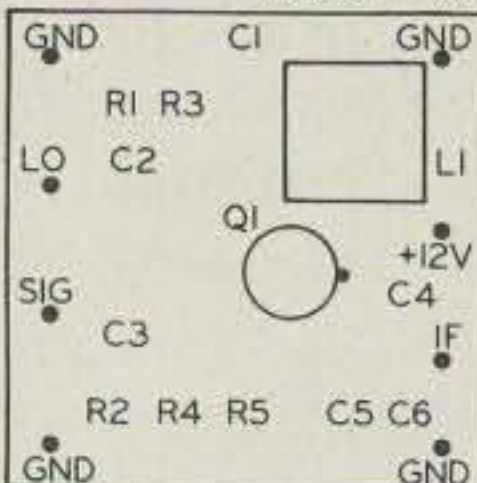

FULL SCALE DUAL GATE MIXER

RF PREAMPLIFIERS
DUAL GATE FET MIXERS
IF AMPLIFIERS
AUDIO AMPLIFIERS
WWV RECEIVERS
VIDEO AMPLIFIERS
COMPRESSIVE AUDIO AMP.
SSB GENERATOR
RF POWER AMPLIFIERS
POWER SUPPLIES

CATALOG ITEMS IN TWO WEEKS OR LESS
QUICK TURN AROUND ON SPECIALS

CATALOG & DESIGN MANUAL \$2.95 REFUND ON 1ST PURCHASE

DETAILED SPECIFICATIONS

APPLICATION NOTES

DESIGN DATA ON:

RF PREAMPLIFIERS, MIXERS,
SPURIOUS SIGNALS, RECEIVER
PARAMETERS, AUDIO COMPRESSION,
& OTHER DATA

SHORT FORM CATALOG ON REQUEST

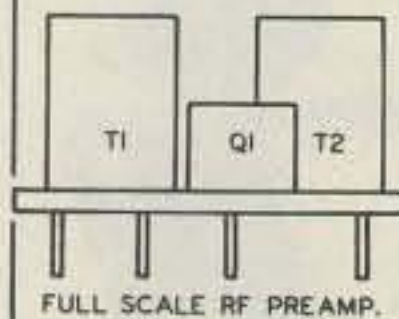

FULL SCALE RF PREAMP.

HFT INC ✓304

158 West 9th St
Deer Park NY 11729

THE LITTLE GIANT BRAKE

BEND & FORM
.060 ALUM. & STL.

CLEAN
SMOOTH
BENDS TO
90°

EASY
TO USE

BUILD CUSTOM
CABINETS YOU'LL BE
PROUD OF! COMMERCIAL
QUALITY AT 1/10 THE COST!

GUARANTEED! 19⁹⁵

ORDER NOW FROM; **+2.00 P&h**

Z ASSOCIATES cont. u.s.
P O BOX 757 ✓336 only. sorry
3050 NE 55 TH AVE. no cods.
SILVER SPRINGS, FLA., 32688

Radio Amateurs!

AZDEN PCS-2000

2 Meter \$299.95 (MARS-CAP KIT SOON)

AZDEN PCS-2800

10 Meter \$299.95

SWAN ASTRO 102BX

160/10 Meters \$1051.60

Astro 150 \$814.00

100 MX \$615.96

TEN-TEC OMNI D

160/10 Meters \$965.25

Six others lower priced



Amateur equipment accessories & antennas.

COD's USA. Export Anywhere.

Amateur & commercial repair service.

2317 Vance Jackson Rd. San Antonio, TX 78213

(512) 734-7793 ✓301

★ For Sale ★

**\$10,000,000
INVENTORY**

The *ultimate* source for electronic components and equipment.

**PRODUCTION OVERRUNS
SURPLUS MATERIALS**

Send us your inquiries. Get on our exclusive mailing list. Inquire in writing or by Telex

TWX: 510-224-6539

Serving domestic and overseas markets.

**Ultima
Electronics, Ltd.**

(516) 423-3770

✓310

73 Sherwood Ct., Huntington, N.Y. 11743 U.S.A.

URFI

(UNIVERSAL RECEIVED
FREQUENCY INDICATOR)



Digitize your receiver's dial with the DIAL SPOTTER. Adapts to most Communication Receivers with simple connection to VFO. From \$149.95 Write for Data Sheet.

**GEMINI
INSTRUMENTS
INCORPORATED**

Box 205, Larchmont, NY 10538 ✓24

MILITARY SURPLUS WANTED

Highest prices ever on recent U.S. Military surplus, especially on Collins equipment or parts. We Pay freight. Call collect for high offer. (201) 440-8787. 35 Ruta Court, S. Hackensack, N.J. 07606

SPACE ELECTRONICS CO.

✓317

Quest

60
ELECTRONICS

Same day shipment. First line parts only. Factory tested. Guaranteed money back. Quality IC's and other components at factory prices.

INTEGRATED CIRCUITS

7400TTL	LM323K-5	5.95	CD4026	2.50
7400N	LM323K-12	1.50	CD4027	.66
7402N	LM323K-15	1.50	CD4028	.85
7404N	LM323T-5	1.35	CD4029	1.35
7409N	LM323T-8	1.35	CD4030	.45
7410N	LM323T-12	1.35	CD4035	1.35
7414N	LM323T-15	1.35	CD4040	1.35
7420N	LM324N	1.40	CD4042	.85
7422N	LM339N	1.00	CD4043	.85
7430N	LM340K-5	1.35	CD4044	.85
7442N	LM340K-8	1.35	CD4046	1.67
7445N	LM340K-12	1.35	CD4049	.45
7447N	LM340K-15	1.35	CD4050	.49
7448N	LM340T-24	1.35	CD4051	1.13
7450N	LM340T-5	1.25	CD4060	1.42
7474N	LM340T-8	1.25	CD4066	.71
7475N	LM340T-12	1.25	CD4068	.40
7485N	LM340T-15	1.25	CD4069	.40
7489N	LM340T-18	1.25	CD4070	.50
7490N	LM340T-24	1.25	CD4071	.45
7492N	LM350	7.50	CD4072	.45
7493N	LM377	3.50	CD4073	.45
7495N	LM399	5.00	CD4075	.45
74100N	LM380N	1.00	CD4076	1.65
74107N	LM381	1.60	CD4078	.40
74121N	LM382	1.60	CD4081	.35
74123N	LM703H	.65	CD4082	.35
74125N	LM709H	.28	CD4116	.47
74145N	LM723H/N	.50	CD4490	5.50
74150N	LM733N	.85	CD4507	1.00
74151N	LM741CH	.35	CD4508	4.25
74154N	LM741N	.38	CD4510	1.02
74157N	LM747H/N	.75	CD4511	.94
74161N	LM748N	.35	CD4515	2.52
74162N	LM1303N	1.75	CD4516	1.10
74163N	LM1304	1.10	CD4518	1.02
74174N	LM1305	1.27	CD4520	1.02
74175N	LM1307	2.00	CD4527	1.51
74190N	LM1310	2.75	CD4528	.79
74192N	LM1458	.47	CD4533	3.50
74193N	LM1800	1.75	CD4586	2.25
74221N	LM1812	7.50	CD4583	2.35
74298N	LM1889	3.00	CD4585	1.10
74365N	LM2111	1.75	CD40192	3.00
74366N	LM2902	2.25	74C00	.35
74367N	LM3900N	.60	74C04	.40
	LM3905	1.75	74C10	.35
	LM3909N	.95	74C14	1.95
	MC1458V	.50	74C20	.35
	NE520N	1.00	74C30	.35
	NE555V	.39	74C48	2.25
	NE566A	.85	74C74	.85
	NE566A	1.00	74C76	1.75
	NE566V	1.50	74C90	1.75
	NE567V	1.00	74C93	1.75
	NE5708	4.75	74C154	3.00
	78L05	.60	74C160	2.00
	78L08	.60	74C175	1.35
	78M05	.85	74C192	2.25
	75108	1.25	74C221	3.50
	75491CN	.50	74C905	6.00
	75492CN	.55	74C906	.75
	75494CN	.89	74C914	1.95
	80388	4.50	74C922	6.00
	80389	4.50	74C923	6.00
	8700CJ	13.95	74C926	6.95
	8701CN	22.00	74C927	6.95
	8750CJ	13.95		
	LD130	9.40		
	8400CJ/VF	4.40		
	ICL7103	9.50		
	ICL7107	14.25		
	CD4011	35		
	CD4012	28		
	CD4013	47		
	CD4014	1.25		
	CD4015	1.00		
	CD4016	55		
	CD4017	1.05		
	CD4018	94		
	CD4019	45		
	CD4020	1.02		
	CD4021	1.35		
	CD4022	1.10		
	CD4023	28		
	CD4024	75		
	CD4025	28		

4116 200ns	9.50
84116 200ns	60.00
25138	6.30
MM5262	4.40
MM5280	3.00
MM5320	9.95
MM5330	5.94
PD411D-3	4.00
PD411D-4	5.00
PS101L	8.95
42D04	9.95
82S25	2.90
91L02A	1.50
HD0165-5	6.95
MM57100	4.50
GIAY38500-1	9.95
MCM86751A	9.95
9368	3.50
4100	10.00
416	16.00
5.50	
MM5311	3.90
MM5312	3.90
MM5314	2.10
MM5369	1.18
MM5841	14.95
MM5965	7.50
CT7001	5.80
CT7010	3.95
CT7015	8.95
MM5375AA/N	3.90
MM5375AG/N	4.90
7207	16.50
7208	7.50
7209	15.95
7210	4.95
DS0026CN	3.75
DS0056CN	3.75
MM53104	2.50
2.4576 MHz	4.50
3.2768 MHz	4.50
3.5795 MHz	1.20
2.0100 MHz	1.95
2.097152 MHz	4.50
2.4576 MHz	4.50
3.2768 MHz	4.50
3.5795 MHz	4.50
5.185 MHz	4.50
5.7143 MHz	4.50
6.5536 MHz	4.50
14.31818 MHz	4.25
18.432 MHz	4.50
22.1184 MHz	4.50
AY5-2376	\$12.50
AY5-3600	17.95
AY5-9100	10.50
AY5-9200	16.50
AY5-9222	5.50
AY5-9200	5.50
AY5-9400	10.50
DB25P	2.95
DB25S	3.95
Cover	1.50
DE9S	1.95
DA15P	2.10
DA15S	3.10
CDP1802CD	19.95
CDP1802D	25.00
CDP1861	12.95
UART/FIFO	5.50
AY5-1013	7.50
AY5-1014	7.50
3341	6.95
1702A	4.95
25138 upper case	6.95
2708	7.75
2716T	24.50
2716 Intel	34.95
2716 Intel	240.00
85	85.00
22.50	22.50
100 per type .015	
1000 per type .012	
350 piece pack	
5 per type 6.75	
1/2 watt 5% per type .05	
10 per type .03	
25 per type .025	
100 per type .015	
1000 per type .012	
350 piece pack	
5 per type 6.75	
7520 Clairex photocells	39
TIL311 Hex	9.50
MAN3640	CC 30 1.10
MAN410	CA 40 1.20
MAN440	CC 40 1.25
MAN470	CA 40 95
MAN4740	CC 40 1.20
MAN6640	CC 58 2.95
MAN6710	CA 60 1.35
MAN6740	CC 60 1.35
MA1002A	8.95
MA1002E	8.95
MA1012A	8.95
102P3 transformer	2.25
MA1012A Transformer	2.25

56 key ASCII keyboard kit	\$67.50
Fully assembled	77.50
53 key ASCII keyboard kit	60.00
Fully assembled	70.00
Enclosure Plastic	14.95
Metal Enclosure	29.95
Red T018	15
Green, Yellow T018	20
Jumbo Red	20
Green, Orange, Yellow Jumbo	25
Cligite LED Mounting Clips	8.51.25
(specify red, amber, green, yellow, clear)	
CONTINENTAL SPECIALTIES in stock	
Complete line of breadboard test equip.	
MAX-100 8 digit Freq. Ctr.	\$128.95
OK WIRE WRAP TOOLS in stock	
Portable Multimeter	\$18.00
Complete line of AP Products in stock.	
SPECIAL PRODUCTS	
MM5865 Stopwatch Timer	
with 10 pg. spec.	9.00
PC board	7.50
Switches Mom. Pushbutton	.27
3 pos. slide	.25
Encoder HD0165-5	6.95
Paratronics 100A Logic	
Analyzer Kit	\$224.00
Model 10 Trigger	
Expander Kit	\$229.00
Model 150 Bus	
Grabber Kit	\$369.00
Sinclair 3 1/2 Digit	
Multimeter	\$59.95
Clock Calendar Kit	\$23.95
2.5 MHz Frequency	
Counter Kit	\$37.50
30 MHz Frequency	
Counter Kit	\$47.75
TRANSFORMERS	
6V 300 ma	3.25
12 Volt 300 ma transformer	1.25
12.6V CT 600 ma	3.75
12V 250 ma wall plug	2.95
12V CT 250 ma wall plug	3.50
24V CT 400 ma	3.95
10V 1.2 amp wall plug	4.85
12V 6 amp	12.95
12V 500 ma wall plug	4.75
12V 1 amp wall plug	6.50
12V 3 amp	8.50
10/15 VAC 8/16 VA wall plug	9.75
KEYBOARD ENCODERS	
AY5-2376	\$12.50
AY5-3600	17.95
AY5-9100	10.50
AY5-9200	16.50
AY5-9222	5.50
AY5-9200	5.50
AY5-9400	10.50
D Connectors RS232	
DB25P	2.95
DB25S	3.95
Cover	1.50
DE9S	1.95
DA15P	2.10
DA15S	3.10
Hickok 3 1/2 Digit LED	
multimeter	69.95
Stopwatch Kit	28.95
Auto Clock Kit	17.95
Digital Clock Kit	14.95
8K/16K Eprom Kit	
(less PROMS)	\$89.00
Motherboard	\$39.00
Extender Board	\$8.99
RESISTORS 1/2 watt 5%	
10 per type .03	
25 per type .025	
100 per type .015	
1000 per type .012	
350 piece pack	
5 per type 6.75	
1/2 watt 5% per type .05	
Televideo	
Terminal 912	\$845.00

NEW PRODUCTS!

Super Color S-100 Video Kit \$129.95
 Expandable to 256 x 192 high resolution color graphics. 6847 with all display modes computer controlled. Memory mapped. 1K RAM expandable to 6K. S-100 bus 1802, 8080, 8085, Z80 etc. Delivery January '80.

1802 16K Dynamic RAM Kit \$149.00
 Expandable to 32K. Hidden refresh w/clocks up to 4 MHz w/no wait states. Addl. 16K RAM \$63

Quest Super Basic

Quest, the leader in inexpensive 1802 systems announces another first. Quest is the first company worldwide to ship a full size Basic for 1802 systems. A complete function Super Basic by Ron Cenker including floating point capability with scientific notation (number range ± 17E⁹⁸), 32 bit integer ± 2 billion; Multi dim arrays; String arrays; String manipulation; Cassette I/O. Save and load, Basic, Data and machine language programs; and over 75 Statements, Functions and Operators.

Easily adaptable on most 1802 systems. Requires 12K RAM minimum for Basic and user programs. Cassette version in stock now. ROM versions coming soon with exchange privilege

Elf II Adapter Kit \$24.95
 Plugs into Elf II providing Super Elf 44 and 50 pin plus S-100 bus expansion. (With Super Expansion). High and low address displays, state and mode LED's optional \$18.00.

Gremlin Color Video Kit \$69.95
 32 x 16 alpha/numerics and graphics; up to 8 colors with 6847 chip; 1K RAM at E000. Plugs into Super Elf 44 pin bus. No high res. graphics.

allowing some credit for cassette version. New improved version with improved speed and accuracy now avail. Source list for I/O now incl.

Super Basic on Cassette \$40.00

Tom Pittman's 1802 Tiny Basic Source listing now available. Find out how Tom Pittman wrote Tiny Basic and how to get the most out of it. Never offered before. \$19.00.

S-100 4-Slot Expansion \$9.95

Super Monitor VI.1 Source Listing \$15.00

Coming Soon: Assembler, Editor, Disassembler, DA/AD, Super Sound/Music, EPROM programmer, Stringy Floppy System.



RCA Cosmac Super Elf Computer \$106.95

Compare features before you decide to buy any other computer. There is no other computer on the market today that has all the desirable benefits of the Super Elf for so little money. The Super Elf is a small single board computer that does many big things. It is an excellent computer for training and for learning programming with its machine language and yet it is easily expanded with additional memory, Full Basic, ASCII Keyboards, video character generation, etc.

Before you buy another small computer, see if it includes the following features: ROM monitor; State and Mode displays; Single step; Optional address displays; Power Supply; Audio Amplifier and Speaker; Fully socketed for all IC's; Real cost of in warranty repairs; Full documentation.

The Super Elf includes a ROM monitor for program loading, editing and execution with SINGLE STEP for program debugging which is not included in others at the same price. With SINGLE STEP you can see the microprocessor chip operating with the unique Quest address and data bus displays before, during and after executing instructions. Also, CPU mode and instruction cycle are decoded and displayed on 8 LED indicators.

An RCA 1861 video graphics chip allows you to connect to your own TV with an inexpensive video modulator to do graphics and games. There is a speaker system included for writing your own music or using many music programs already written. The speaker amplifier may also be used to drive relays for control purposes.

Super Expansion Board with Cassette Interface \$89.95

This is truly an astounding value! This board has been designed to allow you to decide how you want it optioned. The Super Expansion Board comes with 4K of low power RAM fully addressable anywhere in 64K with built-in memory protect and a cassette

Function Generator Kit

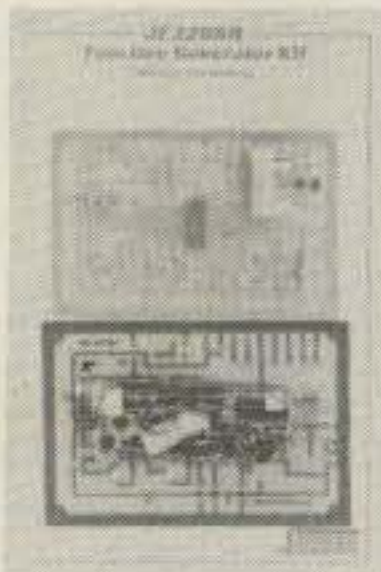

Provides three basic waveforms: sine, triangle and square wave. Frequency range from 1 Hz to 100K Hz. Output amplitude from 0 volts to over 6 volts (peak to peak). Uses a 12V supply or a $\pm 6V$ split supply. Includes chip, P.C. Board, components & instructions.

JE2206B \$19.95

Digital Thermometer Kit



Dual sensors — switching control for indoor/outdoor or dual monitoring. Continuous LED .8" ht. display. Range: $-40^{\circ}F$ to $199^{\circ}F$ / $-40^{\circ}C$ to $100^{\circ}C$. Accuracy $\pm 1^{\circ}$ nominal. Set for Fahrenheit or Celsius. Simulated walnut case. AC wall adapter included. Size: $3\frac{1}{4}''$ h x $6\text{-}5/8''$ w x $1\text{-}3/8''$ d.

JE300 \$39.95

Digital Stopwatch Kit



Use Intersil 7205 Chip. Plated thru double-sided P.C. Board. Red LED display. Times to 59 minutes, 59.59 seconds with auto reset. Quartz crystal controlled. Three stopwatches in one: single event, split (cumulative) and taylor (sequential timing). Uses 3 penlite batteries.

Size: $4.5''$ x $2.15''$ x $.90''$

JE900 \$39.95

4-Digit Clock Kit

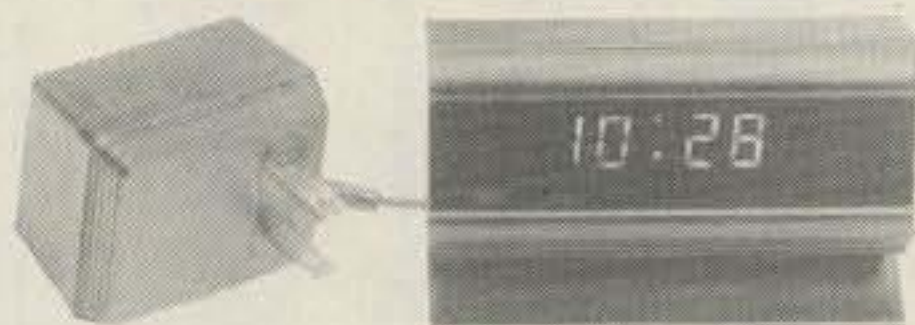

Bright .357" ht. red display. Sequential flashing colon. 12 or 24 hour operation. Black extruded aluminum case. Pressure switches for hours, minutes and hold functions. Includes all components, case and wall transformer. Size: $3\frac{1}{4}''$ x $1\frac{1}{4}''$ x $1\frac{1}{4}''$

JE730 \$14.95

6-Digit Clock Kit



Bright .300 ht. common cathode display. Uses MM5314 clock chip. Switches for hours, minutes and hold functions. Hours easily viewable to 20 ft. Simulated walnut case. 115VAC operation. 12 or 24 hour operation. Includes all components, case and wall transformer. Size: $6\frac{1}{4}''$ x $3\text{-}1/8''$ x $1\frac{1}{4}''$

JE701 \$19.95

Jumbo 6-Digit Clock Kit



Four .630" ht. and two .300" ht. comm. anode displays. Uses MM5314 clock chip. Switches for hrs., mins., and hold functions. Hours viewable to 30 ft. Sim. walnut case. 115VAC operation. 12 or 24 hour operation. Incl. all components, case and wall transformer. Size: $6\frac{1}{4}''$ x $3\text{-}1/8''$ x $1\frac{1}{4}''$

JE747 \$29.95

Regulated Power Supply Kit



Uses LM309K. Heat sink provided. PC board construction. Provides solid 1 amp @ 5 volts. Includes components, hardware & instructions. Size: $3\frac{1}{2}''$ x $5''$ x $2''$ h

JE200 \$14.95

Multi-Voltage Board Kit



ADAPTS TO JE200 SUPPLIES $\pm 5V$, $\pm 9V$ and $\pm 12V$
Independent load rating at single terminal. $\pm 12V$:160mA, $\pm 9V$:200mA, $-5V$:250mA. DC/DC converter with +5V input. Toroidal hi-speed switching XMFR. Short circuit protection. PC board construction. Piggy-back to JE200 board. Size: $3\frac{1}{2}''$ x $2''$ x $9/16''$ h

JE205 \$12.95

Variable Power Supply Kit



Full 1.5 amp @ 5-10V output. Up to .5 amp @ 15V output. Heavy duty transformer. Three-terminal I.C. voltage regulator. Heat sink provided for cooling efficiency. PC board construction. 120VAC input. Size: $3\frac{1}{2}''$ x $5''$ x $2''$ h

JE210 \$19.95

62-Key ASCII Encoded Keyboard Kit



The JE610 ASCII KEYBOARD KIT can be interfaced into most any computer system. The JE610 kit comes complete with an industrial grade keyboard switch assembly (62-keys), IC's, sockets, connector, electronic components and a double-sided printed wiring board. The keyboard assembly requires +5V @ 150mA and $-12V$ @ 10mA for operation. Features: 60 keys generate the full 128 characters, upper and lower case ASCII set. Fully buffered. Two user-define keys provided for custom applications. Caps lock for upper case-only alpha characters. Utilizes a 2376 (40-pin) encoder read-only memory chip. Outputs directly compatible with TTL/DTL or MOS logic arrays. Easy interfacing with a 16-pin dip or 18-pin edge connector.

JE610 \$79.95

Hexadecimal Encoder Kit

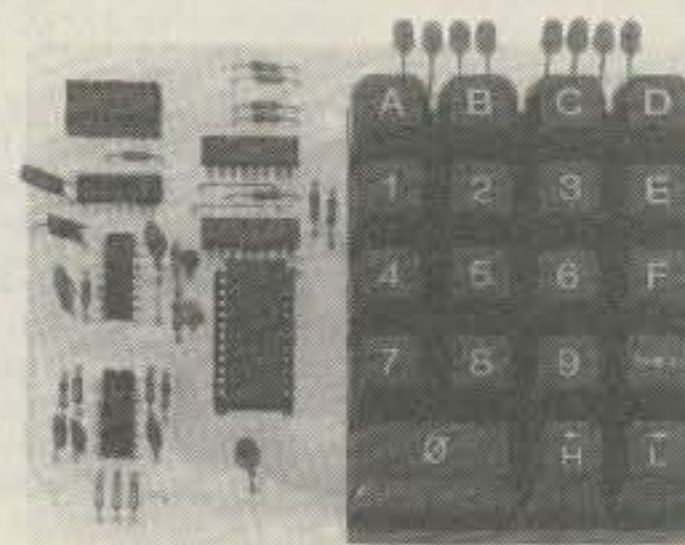

FULL 8-BIT LATCHED OUTPUT — 19-KEY KEYBOARD

The JE600 ENCODER KEYBOARD provides two separate hexadecimal digits produced from sequential key entries to allow direct programming for 8-bit microprocessor or 8-bit memory circuits. Three (3) additional keys are provided for user operations with one having a bistable output available. The outputs are latched and monitored with 9 LED readouts. Also included is a key entry strobe. Features: Full 8-bit latched output for microprocessor use. Three user-define keys with one being bistable operation. Debounce circuit provided for all 19 keys. 9 LED readouts to verify entries. Easy interfacing with standard 16-pin IC connector. Only +5VDC required for operation.

JE600 \$59.95

(Prices Subject To Change)

SEE YOUR LOCAL **Jim-pak** DISTRIBUTOR TODAY!!
electronic components

For Distributor Information, write or phone JIM-PAK, 1355 Shoreway Road, Belmont, CA 94002 (415) 595-5936

OSCAR PHASE III

431-436 MHz R.F. Amplifiers

431-436 MHz (or other 5 MHz in the band) amplifiers are now available for your IC-402 or similar low power exciter and the Echo 70 or similar higher power exciter. These amps are linearized and are aimed at the new satellite operation. They have no rcv. amp. normally but they can be ordered with a very low noise pre-amp. on special request.

Model	Power In	Power Out	DC Cur.	Price	Operating Range	Mode
VAR50A6M	1-6W	30-50W	6A	\$279.95	431-436MHz	SSB-CW
VAR100A6M	3-8W	50-100W	12A	369.96	"	"
VAR100A01M	1-6W	80-100W	18A	399.95	"	"
VAR70A20M	5-20W	20-70W	14A	299.95	"	"
VAR100A15M	5-20W	50-100W	15A	399.95	"	"

CUSHCRAFT TWIST

Complete your station with the Cushcraft "twist" antennas.

A432-20T 20 element (10 horiz. and 10 vert.) has the careful balance of gain and directivity needed for OSCAR work \$59.95

A144-20T similar to the A432-20T except for 2M. This antenna will provide a "gain balanced system", when used with the 432 twist antenna \$69.96

VISTA POWER SUPPLIES

You will need a heavy duty power supply for your amplifier and VISTA can fill the bill.

VISTA X R 8 amps CCS	\$84.95
VISTA XX R 16 amps CCS	\$119.95
VISTA XXX R 30 amps CCS	\$179.95

LUNAR PRE-AMPS

LUNAR pre-amps are also available to help out on the receiving end.

PAE432-5 420-450MHz, ultra low noise	\$69.95
PAF432-2 420-450MHz, w/ input filter	\$54.95
PAI144 2 meter pre amp. (inline)	\$52.95

COMTRONIX

COMTRONIX - KF-1200 1296 MHz FM xcvr. Freq coverage 1294-1296 MHz adjustable. 12 channels w/ 1296 MHz installed. Output power 1W, type N antenna connector. Operating voltage is 12-14VDC. Rcvr. is crystal controlled triple conversion superhet. sensitivity 1 uV for 20dB quieting. \$599.95
Special order allow 4-8 weeks for delivery on this item.

FT-101 TS-520 TS-820

Good news for owners of the TS-820, TS-520 and the FT-101 transceivers! The RM kits have been designed to overcome, as much as practical, the deficiencies in the receivers of these amateur radios. These rigs usually have sufficient sensitivity, but lack selectivity and the capability to handle strong signals without overload. The RM kits deal with these problems in an effective and economical manner. The kits are easily installed in about an hour. A basic tool kit is required, including a small soldering iron.

*"I found the 820's rejection of adjacent channel signals much better than they were before." - WD9****

"The RM-820 is an absolute success. I am hearing stations that I never knew were there. I have already recommended your kit to a couple of 920 owners."

*"My FT-101E sounds better than it ever has; the RM-101 is a real bargain." - K2***

There are just a few of the many reports we have had since the RM kits first went on the market. "RM kits are an excellent investment in improved receiver performance." Now many hams have found what this statement means - performance at a fair price. And now, for your convenience, we have a 24-hour toll free number for your VISA and Master Charge orders only. Just call 1-800-854-2003, extension 873, nationwide, or 1-800-522-1500, extension 873, from California, any time of day with your order. Be sure and tell the operator which rig you have so you can get the kit for your radio (RM-101, RM-820 or RM-520). Remember this line is for orders only. If you have any questions, call direct or write Vineyard Amateur Radio.

The price of the improved RM series kit is \$17.95 (+tax for CA residences).

— CALL OR DROP US A LINE FOR THE EVERY DAY LOW PRICES ON —

Ten-Tec, Cushcraft, Yaesu, ICOM, Superex, Trackkeys, Bencher, Centurion ducks, Ameco, Callbook, Scelbi, ARRL, B & W, Bearcat, Berk-Tek, Lunar, Mirage, "RM" kits, Hanimex calculators, Comtronix, Midland, Phone Mate, Astatic, Turner, Vista, Fuzzbuster, Tri-Ex, Larsen, PIPO, Theft Alert Alarms.

All prices F.O.B. Oxnard, C.O.D. add \$5.50

VAR

VINEYARD AMATEUR RADIO ✓86
Art (WA6OYS) - Sales and Service - Jay (WB6YQN)
4407 Vineyard, Oxnard, CA 93030, (805) 485-0942

BANK AMERICARD

VISA

Orders accepted



FOR YOUR VISA AND MASTER CHARGE ORDERS ONLY CALL
Nationwide 24-hour order line
1-800-854-2003, Ext. 873

California 24-hour order line
1-800-522-1500 ext. 873

7294 N.W. 54 STREET
MIAMI, FLORIDA 33166

SURPLUS ELECTRONICS CORP. ✓69

PHONE: (305) 887-8228

TWX: 810-848-6085

WHOLESALE - RETAIL

<p>SO239</p> <p>10/\$5.00 100/\$35.00 50/\$20.00 1000/\$300.00</p>	<p>CB SPECIAL</p> <p>Brand new printed circuit board assembly. Used in all HyGain 40 Channel CB transceivers. Fits many other manufacturers' units also. Squelch pot/volume control/channel selector switch not included. Board Dimensions 6" x 6 1/2"</p> <p>1-9 - 7.50 ea. 50-99 - 6.00 ea. 10-49 - 6.50 ea. 100-up - 5.50 ea.</p>		<p>TRIMMER CAPS</p> <p>Can fit in your watch 3.5-20 pF & 5-30 pF \$.75 ea., 2/\$1.25 5/\$3.00</p>																																																																						
<p>PL259 Amphenol .60¢ ea.</p>	<p>CB SPECIAL W/40 ch SW same as above</p> <p>1-9 \$10.50 ea. 50-99 \$9.00 ea. 10-49 \$9.50 ea. 100-up \$8.50 ea.</p>		<p>POLY FOAM COAX 50 Ohm</p> <p>Low Loss = to RG174 \$4.95/100' \$3.00/50'</p>																																																																						
<p>E. F. Johnson S Meter</p> <p>Edge Meter 250 UA. Fits in 5/8" x 1-3/8" hole. MTG holes on each end 1-1/4" behind panel. Black scale 0-5 bottom 1-20 top \$1.25 ea. 5/\$5.00</p>	<p>Serviceman Special</p> <p>New Hy-Gain 40ch CB Less Case, Speaker & Knobs (as is) \$14.95 ea</p>		<p>ULTRASONIC TRANSDUCER</p> <p>Detects sound above the range of human hearing! Transmits & receives \$2.50 ea. 5/\$10.00</p>																																																																						
<p>E. F. Johnson Signal Strength Meter 200 UA 2 1/2" x 2 1/2" Sq. mounts in 1 3/4" hole 1" behind panel. Scale: 1-30 db top 0-5 bottom. \$4.95 ea 5/\$20.00</p>	<p>NEW Hy-Gain Remote 40ch CB Less Case, Speaker & Control Mic (as is) \$14.95 ea</p>	<p>NEW E.F. Johnson Power Mic/Less Cord, Desktop Style \$19.95 ea</p>	<p>MAGNETIC PICK UP TRANSDUCER</p> <p>Converts motion to ac voltage without mechanical linkage 3/8" x 2" w/6' shielded cable \$4.95 ea.</p>																																																																						
<p>PANEL METERS</p> <p>\$4.00 ea 2 for \$7.00</p> <p>25-0-25 dc Volts } 2 1/4" x 3" 0-25 dc Volts } 2 1/4" x 2 1/4" 0-50 ac Volts } -Shunt Required-</p>	<p>ASTATIC T-UG8-D104 PREAMP Desktop microphone w/crystal element 3 Pin Plug \$35 ea.</p>	<p>ILEX COPY LENS F:5.6,6.1 Focal Length (155MM) 1 3/4" D, 2 1/16" L, 1 1/16" Fixed iris. \$.75 ea.</p>	<p>CERAMIC IF FILTERS EFC L455K \$3.50 ea.</p>																																																																						
<p>Double Row/Wire Wrap .100</p> <p>25 pins \$3.49 ea 10/\$30.00 30 pins \$3.96 ea 10/\$32.00 50 pins \$5.43 ea 10/\$45.00</p>	<p>8 Position Dip Switches 16 pin (AMP) \$1.50 ea. 10/\$13.50</p>	<p>15' MODEM CABLES 10#22ga wire w/shield, DB25P conn & DB51226-1 cover on one end \$5.50 ea. 10/\$50.00</p>	<p>25' MODEM CABLES 13#22ga wire w/shield, DB25P conn & DB51226-1 cover on one end \$6.50 ea. 10/\$60.00</p>																																																																						
<p>Double Row/Solder Eyelet .156</p> <p>6 pins \$1.10 ea 10/\$ 9.00 15 pins \$1.55 ea 10/\$12.50 22 pins \$2.08 ea 10/\$17.00 43 pins \$3.66 ea 10/\$30.00</p>	<p>12 Vdc RELAY SPST 35 Amp Contacts Open Frame Rugged, great for mobile use \$4.50 ea 5/\$20.00</p>	<p>12 Vdc RELAY SPST Open Frame 5 Amp Contacts Mfg-Magnecraft \$1.50 ea 4/\$5.00</p>	<p>SOLDERLESS TEST PROD (BLACK)</p> <p>Threaded type, molded handle \$.40 ea. 10/\$3.50</p>																																																																						
<p>C & K SWITCHES</p> <p>PART # MOVEMENT</p> <p>7101 ON/NONE/ON SPST 7103 ON/OFF/ON SPST 7108 ON/NONE/(ON) SPST 7201 ON/NONE/ON DPDT \$1.00 EA 6 FOR \$5.00</p>	<p>12 V DC Horn 2" diameter x 1 1/4" deep .75 each 3/\$2.00</p>	<p>100 ASSORTED DISC CAPS (FULL LEADS) 20 EA OF 5 DIFFERENT VALUES \$2.00 PER PACK</p>	<p>USED MUFFIN FANS</p> <p>3 blades, 110VAC, 4 3/4" sq. \$5.95</p>																																																																						
<p>6 TV GAMES ON (1) CHIP Gen Instr AY-3-8500-1 28 Pin Plastic Case EVERYDAY LOW PRICE \$7.50 ea</p>	<p>Autronic Elect Auto Alarm Easy installation independent circuits solid state 12V neg ground \$5.00 ea.</p>	<p>White Porcelain Egg Insulator 1 1/2" x 1" 50¢ ea. 3 for \$1.25</p>	<p>CW MINI SLIDE SW</p> <p>DPDT .15 ea. 10/\$1.25</p>																																																																						
<p>ASSORTED ELECTROLYTICS</p> <table border="1"> <thead> <tr> <th>VALUE/MFD</th> <th>VOLTS</th> <th>DIA</th> <th>LENGTH</th> <th>PRICE</th> </tr> </thead> <tbody> <tr><td>63,000 @</td><td>15V</td><td>3"</td><td>x 5 1/2"</td><td>4.00 ea</td></tr> <tr><td>10,000 @</td><td>20V</td><td>1 1/2"</td><td>x 5 3/4"</td><td>3.00 ea</td></tr> <tr><td>2,700 @</td><td>25V</td><td>1 1/4"</td><td>x 2 1/4"</td><td>2.00 ea</td></tr> <tr><td>2,900 @</td><td>25V</td><td>1 1/4"</td><td>x 2"</td><td>2.00 ea</td></tr> <tr><td>3,000 @</td><td>25V</td><td>1 1/2"</td><td>x 4 1/2"</td><td>2.00 ea</td></tr> <tr><td>18,000 @</td><td>25V</td><td>2"</td><td>x 4"</td><td>3.00 ea</td></tr> <tr><td>21,000 @</td><td>25V</td><td>2 1/2"</td><td>x 3"</td><td>3.00 ea</td></tr> <tr><td>1,000 @</td><td>50V</td><td>1 1/4"</td><td>x 3 1/4"</td><td>2.50 ea</td></tr> <tr><td>34,800 @</td><td>50V</td><td>3"</td><td>x 5 1/2"</td><td>3.00 ea</td></tr> <tr><td>450 @</td><td>75V</td><td>1 1/4"</td><td>x 2 1/4"</td><td>2.00 ea</td></tr> <tr><td>500 @</td><td>100V</td><td>1 1/2"</td><td>x 3 1/2"</td><td>2.00 ea</td></tr> <tr><td>240 @</td><td>300V</td><td>1 1/4"</td><td>x 3 1/4"</td><td>2.00 ea</td></tr> <tr><td>50 @</td><td>450V</td><td>1 1/4"</td><td>x 2"</td><td>2.00 ea</td></tr> </tbody> </table>	VALUE/MFD	VOLTS	DIA	LENGTH	PRICE	63,000 @	15V	3"	x 5 1/2"	4.00 ea	10,000 @	20V	1 1/2"	x 5 3/4"	3.00 ea	2,700 @	25V	1 1/4"	x 2 1/4"	2.00 ea	2,900 @	25V	1 1/4"	x 2"	2.00 ea	3,000 @	25V	1 1/2"	x 4 1/2"	2.00 ea	18,000 @	25V	2"	x 4"	3.00 ea	21,000 @	25V	2 1/2"	x 3"	3.00 ea	1,000 @	50V	1 1/4"	x 3 1/4"	2.50 ea	34,800 @	50V	3"	x 5 1/2"	3.00 ea	450 @	75V	1 1/4"	x 2 1/4"	2.00 ea	500 @	100V	1 1/2"	x 3 1/2"	2.00 ea	240 @	300V	1 1/4"	x 3 1/4"	2.00 ea	50 @	450V	1 1/4"	x 2"	2.00 ea	<p>15' MODEM CABLES 14#22ga wire w/shield, DB25P conn & DB51226-1 cover on one end \$6.00 ea. 10/\$55.00</p> <p>15' MODEM CABLES 10#22ga wire w/shield, DB25S conn & DB51226-1 cover on one end \$6.50 ea. 10/\$60.00</p>	<p>IC SOCKETS Cambion Gold Plated Wire Wrap</p> <p>14 pin .35 ea 10/\$3.00 16 pin .38 ea 10/\$3.30</p>	<p>RED SEVEN SEGMENT DISPLAY</p> <p>TIL 322P \$1.00 ea.</p>
VALUE/MFD	VOLTS	DIA	LENGTH	PRICE																																																																					
63,000 @	15V	3"	x 5 1/2"	4.00 ea																																																																					
10,000 @	20V	1 1/2"	x 5 3/4"	3.00 ea																																																																					
2,700 @	25V	1 1/4"	x 2 1/4"	2.00 ea																																																																					
2,900 @	25V	1 1/4"	x 2"	2.00 ea																																																																					
3,000 @	25V	1 1/2"	x 4 1/2"	2.00 ea																																																																					
18,000 @	25V	2"	x 4"	3.00 ea																																																																					
21,000 @	25V	2 1/2"	x 3"	3.00 ea																																																																					
1,000 @	50V	1 1/4"	x 3 1/4"	2.50 ea																																																																					
34,800 @	50V	3"	x 5 1/2"	3.00 ea																																																																					
450 @	75V	1 1/4"	x 2 1/4"	2.00 ea																																																																					
500 @	100V	1 1/2"	x 3 1/2"	2.00 ea																																																																					
240 @	300V	1 1/4"	x 3 1/4"	2.00 ea																																																																					
50 @	450V	1 1/4"	x 2"	2.00 ea																																																																					
<p>AXIAL LEAD ELECTROLYTIC CAPACITORS</p> <table border="1"> <tbody> <tr><td>2 uF @ 15V</td><td rowspan="5">}</td><td rowspan="5">12 ea. for \$1.00</td></tr> <tr><td>10 uF @ 15V</td></tr> <tr><td>20 uF @ 15V</td></tr> <tr><td>50 uF @ 15V</td></tr> <tr><td>2.2 uF @ 25V</td></tr> <tr><td>3.3 uF @ 25V</td><td rowspan="3">}</td><td rowspan="3">15 ea. for \$2.00</td></tr> <tr><td>1 uF @ 35V</td></tr> <tr><td>2 uF @ 150V</td></tr> <tr><td>25 uF @ 25V</td><td rowspan="5">}</td><td rowspan="5">10 ea. for \$2.00</td></tr> <tr><td>3 uF @ 50V</td></tr> <tr><td>5 uF @ 50V</td></tr> <tr><td>10 uF @ 50V</td></tr> <tr><td>250 uF @ 25V</td></tr> <tr><td>100 uF @ 50V</td><td rowspan="2">}</td><td rowspan="2">10 ea. for \$2.00</td></tr> <tr><td>50 uF @ 75V</td></tr> </tbody> </table>	2 uF @ 15V	}	12 ea. for \$1.00	10 uF @ 15V	20 uF @ 15V	50 uF @ 15V	2.2 uF @ 25V	3.3 uF @ 25V	}	15 ea. for \$2.00	1 uF @ 35V	2 uF @ 150V	25 uF @ 25V	}	10 ea. for \$2.00	3 uF @ 50V	5 uF @ 50V	10 uF @ 50V	250 uF @ 25V	100 uF @ 50V	}	10 ea. for \$2.00	50 uF @ 75V																																																		
2 uF @ 15V	}			12 ea. for \$1.00																																																																					
10 uF @ 15V																																																																									
20 uF @ 15V																																																																									
50 uF @ 15V																																																																									
2.2 uF @ 25V																																																																									
3.3 uF @ 25V	}	15 ea. for \$2.00																																																																							
1 uF @ 35V																																																																									
2 uF @ 150V																																																																									
25 uF @ 25V	}	10 ea. for \$2.00																																																																							
3 uF @ 50V																																																																									
5 uF @ 50V																																																																									
10 uF @ 50V																																																																									
250 uF @ 25V																																																																									
100 uF @ 50V	}	10 ea. for \$2.00																																																																							
50 uF @ 75V																																																																									

TERMS: All material guaranteed • If for any reason you are not satisfied, our products may be returned within 10 days for a full refund (less shipping). Please add \$3 for shipping and handling on all orders. Additional 5% charge for shipping any item over 5 lbs. COD's accepted for orders totaling \$50.00 or more. All orders shipped UPS unless otherwise specified. Florida residents please add 4% sales tax. Minimum order \$15.00.

EQUIPMENT / COMPONENTS / WIRE & CABLE / ACCESSORIES

SEMICONDUCTORS SURPLUS

✓ 64

2822 North 32nd Street/Unit -1 Phoenix, Arizona 85008 (602) 956-9423

We accept checks, MasterCharge, and Visa

Prices subject to change without notice



WE ACCEPT MASTERCHARGE, VISA, CHECKS, AND C.O.D.'s PHONE IN YOUR ORDER
NO ORDERS WILL BE ACCEPTED UNDER \$10.00, NOT INCLUDING SHIPPING!

HAM MICROWAVE RECEIVERS

2100-2400MHz
28dB GAIN
2.5 to 3dB NOISE

Assembled and tested with 90 day guarantee \$299.95
\$5.00 shipping with charge card or money order enclosed. \$10.00 shipping if C.O.D.

RECEIVER KIT \$169.95 Includes antenna, power supply box, P.C.B. and parts,
down converter P.C.B. and parts, and complete instructions.

MISCELLANEOUS PARTS FOR HMR

YAGI antenna	\$ 59.95
Power supply box	12.95
Power supply P.C.B.	4.99
Power supply transformer	3.99
Power supply kit, complete	49.95
Down converter kit	79.95
Down converter assembled and tested	114.95
Power supply assembled and tested	59.95
Down converter P.C.B.	19.95
Instructions	10.00
MRF901	3.99
MRF902	12.50
MRF911	4.29
7812	1.99
MBD101	1.99
MB1101	4.99
2835/1N5711	1.99
1K Pot	3.00
Matching transformers, 75 Ohm - 300 Ohm	1.99
Two-way splitters	2.99
Chassis type F connectors	2/.99
Cable type F connectors	4/.99
Barrel type F connectors	.76
One 6 foot RG59 with connectors and one 50 foot RG59 with connectors	18.99

TOROIDAL CORES

1" radius by
3/8" high
3-30 MHz
\$1.00 each

1 3/8" x 1/2"
3-30 MHz
\$1.25 each

1 7/8" x 3/4"
3-30 MHz
\$3.00 each

MICA INSULATION
T0-3 type
10/\$1.00

SEMICONDUCTOR
MOUNTING HARDWARE
ASSORTMENT 100 pcs.
\$1.99

RG180B/U 75 Ohm
COAX 100 ft./\$6.99

SEMICONDUCTOR
INSULATION MICA
ASSORTMENT
10/\$1.00

CRYSTAL ASSORTMENT
10 assorted \$1.99
25 assorted 5.00
50 assorted 9.00

PANEL FUSEHOLDER
for 3AG type fuses
69¢ each

INLINE FUSEHOLDER
for 3AG type fuses
69¢ each

SEMTECH DIODES
S9HVM 2.5 KV
\$12.99 each

ONE POUND SOLDER
63/37 .032 size
H2=3.5% \$9.95

QUANTITY PRICES AVAILABLE FOR 10 AND UP

ZENERS

1Watt 1N4728 to 1N4764	10%	4/\$1.00
1Watt 1N4728A to 1N4764A	5%	3/\$1.00
500MW 1N751 to 1N759	10%	6/\$1.00
500MW 1N751A to 1N759A	5%	4/\$1.00
500MW 1N957 to 1N978	10%	6/\$1.00
500MW 1N957A to 1N978A	5%	4/\$1.00

AA NICADS

USED/Pull outs from calculators
79¢ each or 100/\$59.00 SOLD AS IS

NICAD BATTERY CHARGER

Will charge 4 AA cells at a time
\$5.95

Low Cost...High Performance

DIGITAL MULTIMETER



\$99.95 WIRED

Low cost, high performance, that's the DM-700. Unlike some of the hobby grade DMMs available, the DM-700 offers professional quality performance and appearance at a hobbyist price. It features 26 different ranges and 5 functions, all arranged in a convenient, easy to use format. Measurements are displayed on a large 3½ digit, ½ inch high LED display, with automatic decimal placement, automatic polarity, and overrange indication. You can depend upon the DM-700, state-of-the-art components such as a precision laser trimmed resistor array, semiconductor band gap reference, and reliable LSI circuitry insure lab quality performance for years to come. Basic DC volts and ohms accuracy is 0.1%, and you can measure voltage all the way from 100 μ V to 1000 volts, current from 0.1 μ A to 2.0 amps and resistance from 0.1 ohms to 20 megohms. Overload protection is inherent in the design of the DM-700, 1250 volts, AC or DC on all ranges, making it virtually goof proof. Power is supplied by four 'C' size cells, making the DM-700 portable, and, as options, a nicad battery pack and AC adapter are available. The DM-700 features a handsome, jet black, rugged ABS case with convenient retractable tilt bail. All factory wired units are covered by a one year limited warranty and kits have a 90 day parts warranty.

Order a DM-700, examine it for 10 days, and if you're not satisfied in every way, return it in original form for a prompt refund.

Specifications

DC and AC volts: 100 μ V to 1000 Volts, 5 ranges
 DC and AC current: 0.1 μ A to 2.0 Amps, 5 ranges
 Resistance: 0.1 Ω to 20 megohms, 6 ranges
 Input protection: 1250 volts AC/DC all ranges fuse protected for overcurrent
 Input impedance: 10 megohms, DC/AC volts
 Display: 3½ digits, 0.5 inch LED
 Accuracy: 0.1% basic DC volts
 Power: 4 'C' cells, optional nicad pack, or AC adapter
 Size: 6"W x 3"H x 6"D
 Weight: 2 lbs with batteries

Prices

DM-700 wired + tested	\$99.95
DM-700 kit form	79.95
AC adapter/charger	4.95
Nicad pack with AC adapter/charger	14.95
Probe kit	3.95

TERMS: Satisfaction guaranteed or money refunded, COD, add \$1.50. Minimum order \$6.00. Orders under \$10.00, add \$.75. Add 5% for postage, insurance, handling. Overseas, add 15%. NY residents, add 7% tax.



600 mHz COUNTER

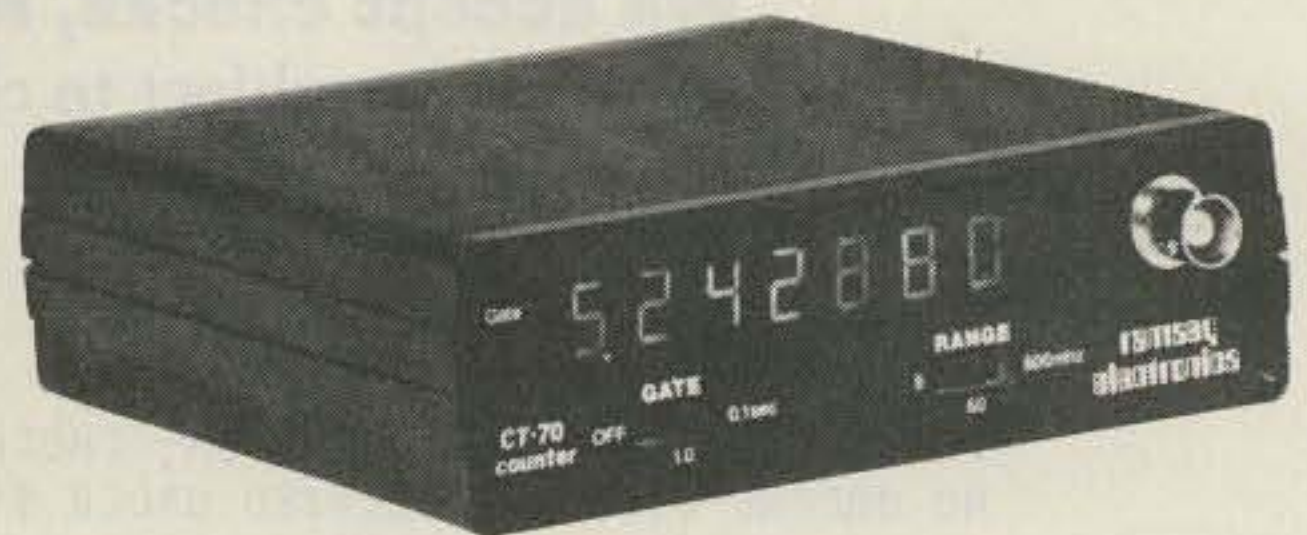

\$99.95 WIRED

The CT-70 breaks the price barrier on lab quality frequency counters. No longer do you have to settle for a kit, half-kit or poor performance, the CT-70 is completely wired and tested, features professional quality construction and specifications, plus is covered by a one year warranty. Power for the CT-70 is provided by four 'AA' size batteries or 12 volts, AC or DC, available as options are a nicad battery pack, and AC adapter. Three selectable frequency ranges, each with its own pre-amp, enable you to make accurate measurements from less than 10 Hz to greater than 600 mHz. All switches are conveniently located on the front panel for ease of operation, and a single input jack eliminates the need to change cables as different ranges are selected. Accurate readings are insured by the use of a large 0.4 inch seven digit LED display, a 1.0 ppm TCXO time base and a handy LED gate light indicator.

The CT-70 is the answer to all your measurement needs, in the field, in the lab, or in the ham shack. Order yours today, examine it for 10 days, if you're not completely satisfied, return the unit for a prompt and courteous refund.

Specifications

Frequency range: 10 Hz to over 600 mHz
 Sensitivity: less than 25 mv to 150 mHz
 less than 150 mv to 600 mHz
 Stability: 1.0 ppm, 20-40°C; 0.05 ppm/°C TCXO crystal time base
 Display: 7 digits, LED, 0.4 inch height
 Input protection: 50 VAC to 60 mHz, 10 VAC to 600 mHz
 Input impedance: 1 megohm, 6 and 60 mHz ranges 50 ohms, 600 mHz range
 Power: 4 'AA' cells, 12 V AC/DC
 Gate: 0.1 sec and 1.0 sec LED gate light
 Decimal point: Automatic, all ranges
 Size: 5"W x 1½"H x 5½"D
 Weight: 1 lb with batteries

Prices

CT-70 wired + tested	\$99.95
CT-70 kit form	75.95
AC adapter	4.95
Nicad pack with AC adapter/charger	9.95
Telescopic whip antenna, BNC plug	7.95
Tilt bail assembly	3.95

ramsey electronics

62 BOX 4072, ROCHESTER, N.Y. 14610
 PHONE ORDERS CALL
 (716) 271-6487



SPECTRONICS, INC.

1009 Garfield St., Oak Park, Illinois • 60304

(312) 848-6777 ✓67

BARGAIN FAVORITES!

OUR BEST-SELLING MULTI-BAND!



AS LOW AS
\$73⁷⁵

- One half the length of conventional half-wave dipoles
- Multi-band, Multi-frequency.
- Maximum efficiency — no traps, loading coils, or stubs
- Fully assembled and pre-tuned — no measuring, no cutting.
- All weather rated — 1 KW AM, 2.5 KW CW or PEP SSB.
- Proven performance — more than 10,000 have been delivered.
- Permit use of the full capabilities of today's 5-band xcvrs.
- One feedline for operation on all bands.

80-40HD/A 80/40 Mtr bands (69) 77.25 c
 75/40HD/A 75/40 Mtr bands (66) 73.75 c
 75-10HD/A 75/40/20/15/10 Mtr (66).... 89.95 c
 80-10HD/A 80/40/20/15/10 Mtr (69).... 94.95 c

Famous "W2AU" Balun

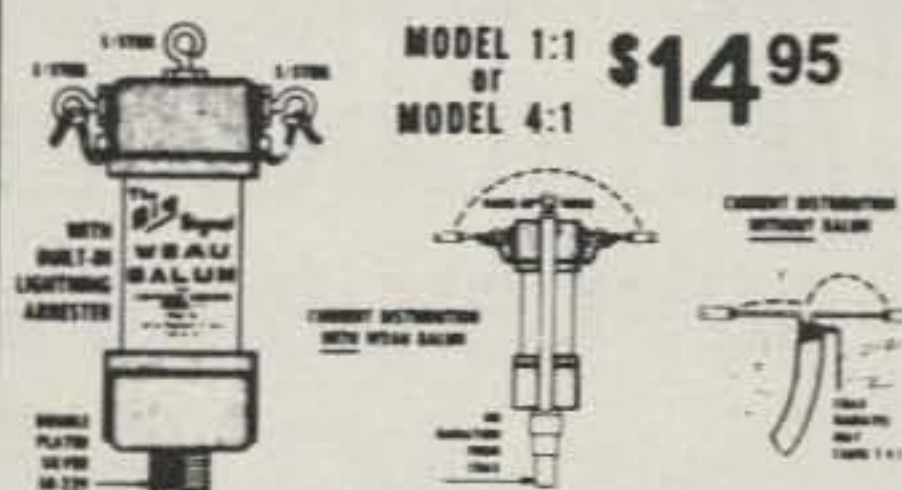

MODEL 1:1 **\$14⁹⁵**
OR
MODEL 4:1

1. HANDLES FULL 2 KW PEP AND THEN SOME. Broad Banded 3 to 40 Mc.
2. HELPS TVI PROBLEMS By Reducing Coax Line Radiation
3. NOW ALL STAINLESS STEEL HARDWARE. S0239 Double Silver Plated
4. IMPROVES F/B RATIO By Reducing Coax Line Pick-Up
5. REPLACES CENTER INSULATOR. Withstands Antenna Pull of Over 600 Lbs.
6. BUILT-IN LIGHTNING ARRESTER. Helps Protect Balun — Could Also Save Your Valuable Gear
7. BUILT-IN HANG-UP HOOK. Ideal For Inverted Vees, Multi-Band Antennas, Dipoles, Beam and Quads

NOW BEING USED BY ALL BRANCHES OF THE U.S. ARMED FORCES, FAA, RCA, CIA, CANADIAN DEFENSE DEPT. PLUS THOUSANDS OF HAMS THE WORLD OVER

Comes in 2 models. 1:1 matches 50 or 75 ohm unbalanced (coax line) to 50 or 75 ohm balanced load. 4:1 model matches 50 or 75 ohm unbalanced (coax line) to 200 or 300 ohm balanced load.

Model 1:1.....\$14.95 Model 4:1.....\$14.95

MODEL 595 **B·W**
\$22⁵⁰

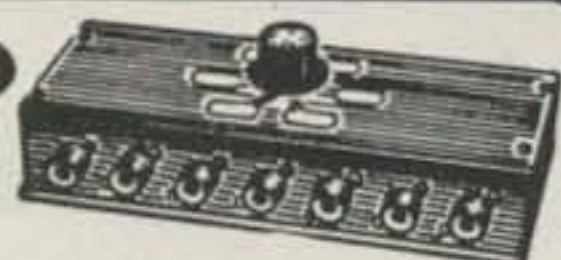

Our most popular switch. 6 position, grounds all except selected output circuit. Can be mounted on wall, on desk, or almost anywhere. Good to 150MHz. Wt. 2 lbs.

IMPROVE YOUR RECEPTION!



MODEL PLF-2 AMECO ALL-BAND
\$49⁹⁵ PREAMP!

- 6-160 Meters
- 20+ dB Gain
- Low Price

MODEL PLF-2 ... Improves weak signals as well as image and spurious rejection of most receivers. Direct switching to rec. or preamp. Includes pwr. supp. 117 VAC wired & tested. \$49.95
 MODEL PLF-2E ... 240 VAC 50-60 Hz operation \$54.95
 MODEL PT-2 ... For transceiver use. Continuously tunable from 6 to 160 meters. Features dual-gate FET transistor amplifier for improved receiver sensitivity and low noise figure. Requires no transceiver modifications and can handle up to 250W transceiver output. 117 VAC 60 Hz. \$74.95
 MODEL PT-2E ... 240 VAC 50-60 Hz operation \$79.95

2 METER ANTENNAS at BARGAIN PRICES!!



3 db GAIN
MAGNETIC MOUNT

ONLY

Model 287
Wt. 2.5 lbs.

\$19.⁹⁵



An economical alternative to drilling a hole. A magnetic antenna by a name you can trust at a low, low price.

Model 286 Same but trunk lid. \$15.95 b

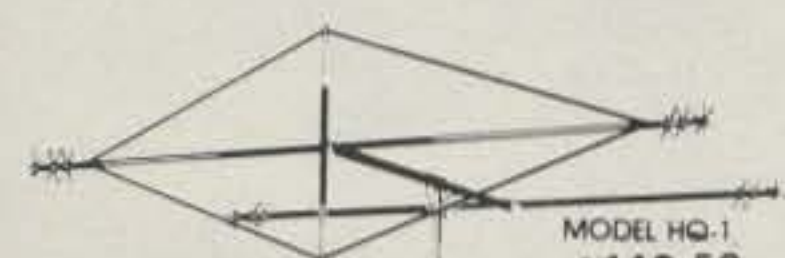

MODEL HQ-1
\$149.50

CRAMPED FOR SPACE?

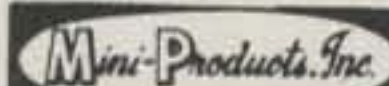

Then you want the antenna that's known around the world for its small size and superior performance. The Multiband HYBRID QUAD for 6-10-15 & 20 meters.

- WING SPAN-11 FT.
- BOOM-54 INCHES LONG
- WIND AREA-1.5 SQ. FT.
- 1200 WATTS P.E.P. INPUT TO FINAL
- FEED LINE-50 OHMS

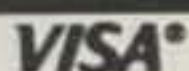
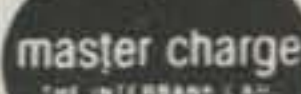

2 MTR DUCKIES

- Model HM-4. Has 5/16"-32 thread. Fits Motorola HT's. ICOM IC215 and Standard 146A \$7.00
- Model HM-5. Same as above, but with PL-259 connector \$7.00
- Model HM-226. Same, with TNC connector for Wilson 1405 \$18.50
- Model HM-227. Same, but with BNC connector termination \$12.00
- Model HM-228. With F connector for Wilson 1402 & Tempo \$11.50

HM-4

HM-5

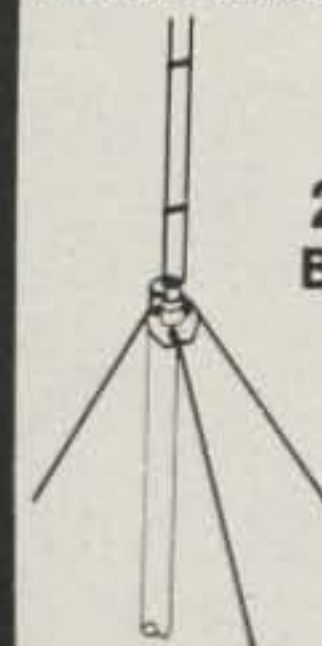

2.8 dbd GAIN
BASE ANTENNA

ONLY

\$9.⁹⁵

Model A2-GP
Wt. 2 lbs.

At last! An inexpensive, omni directional, 144-148 MHz, 1/2 wave antenna. Fits 1 1/4" mast, 50 ohm imp. A good antenna at a very affordable price.



ONLY
\$29⁹⁵

MFJ-101 24 HOUR SOLID STATE DIGITAL CLOCK.

AVERAGE SHIPPING COST GUIDE

(Continental U.S.) Items sent UPS whenever possible.

Please estimate the shipping charges for your order. Any excess payment over 25c will be refunded or credited. Underpayment will be billed or sent collect. For insurance add 25c for each \$100.00 value over the first \$100.00.

WEIGHT	1,2,3,4,5	6,7	8,9	9
1 lb.	.90	1.00	.90	.85
5 lbs.	1.50	2.00	1.35	1.20
10 lbs.	2.25	3.20	1.95	1.70
20 lbs.	3.80	5.60	3.20	2.80
30 lbs.	5.30	8.05	4.40	3.90
50 lbs.	8.40	12.90	6.80	5.35

ESTIMATED WEIGHT CODING

After the price of each item you will find a letter, i.e., 18.95 a. To make it easier to figure shipping costs, these letters indicate the approximate weight of the item as follows:

a. Less than 1 lb.	1.20-30 lbs.
b. 1-3 lbs.	6. 7-10 lbs.
c. 4-8 lbs.	8. 30-40 lbs.
d. 10-20 lbs.	9. 40-50 lbs.

NOTE: INTERNATIONAL ORDERS write for Proforma Invoice. ITEMS MARKED * will be sent truck collect.

AZDEN ★ NEW! ★ AZDEN ★ NEW! ★ AZDEN ★ NEW! ★ AZDEN

THE GIANT **AZDEN**® COMPANY

REVOLUTIONIZES THE STATE OF THE ART

AWE AND **AZDEN**. INTRODUCE THE BRILLIANT NEW **PCS-2800**

MICROCOMPUTER CONTROLLED

SUPERIOR COMMERCIAL GRADE

10 METER
FM TRANSCEIVER

INTRODUCTORY
PRICE

\$299⁰⁰

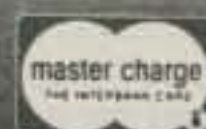

COMPARE THESE FEATURES
WITH ANY UNIT AT ANY PRICE

- **FREQUENCY RANGE:** Receive and transmit: 28.000 to 29.995 MHz, 10KHz steps with built-in +100 KHz repeater offset.
- **ALL SOLID STATE-CMOS PL DIGITAL SYNTHESIZED.**
- **SIZE: UNBELIEVABLE! ONLY 6 3/4" x 2 3/8" x 9 3/4". COMPARE!**
- **MICROCOMPUTER CONTROLLED:** All scanning and frequency-control functions are performed by microcomputer.
- **DETACHABLE HEAD:** The control head may be separated from the radio for use in limited spaces and for security purposes.
- **SIX-CHANNEL MEMORY:** Each memory is re-programmable. Memory is retained even when the unit is turned off.
- **MEMORY SCAN:** The six channels may be scanned in either the "busy" or "vacant" modes for quick, easy location of an occupied or unoccupied frequency. **AUTO RESUME. COMPARE!**
- **FULL-BAND SCAN:** All channels may be scanned in either "busy" or "vacant" mode. This is especially useful for locating repeater frequencies in an unfamiliar area. **AUTO RESUME. COMPARE!**
- **INSTANT MEMORY-1 RECALL:** By pressing a button on the microphone or front panel, memory channel 1 may be recalled for immediate use.
- **MIC-CONTROLLED VOLUME AND SQUELCH:** Volume and squelch can be adjusted from the microphone for convenience in mobile operation.
- **DIRECT FREQUENCY READOUT:** LED display shows operating frequency, **NOT** channel number. **COMPARE!**
- **TEN (10) WATTS OUTPUT:** Also 1 watt low power for shorter distance communications. LED readout displays power selection when transmitting.
- **DIGITAL S/R F METER:** LEDs indicate signal strength and power output. No more mechanical meter movements to fall apart!
- **LARGE 1/2-INCH LED DISPLAY:** Easy-to-read frequency display minimizes "eyes-off-the-road" time.
- **PUSHBUTTON FREQUENCY CONTROL FROM MIC OR FRONT PANEL:** Any frequency may be selected by pressing a microphone or front-panel switch.
- **SUPERIOR RECEIVER SENSITIVITY:** 0.28 uV for 20-dB quieting. The squelch sensitivity is superb, requiring less than 0.1 uV to open. The receiver audio circuits are designed and built to exacting specifications, resulting in unsurpassed received-signal intelligibility.
- **TRUE FM, NOT PHASE MODULATION:** Transmitted audio quality is optimized by the same high standard of design and construction as is found in the receiver. The microphone amplifier and compression circuits offer intelligibility second to none.
- **OTHER FEATURES:** Dynamic Microphone, built in speaker, mobile mounting bracket, external remote speaker jack (head and radio) and much, much more. All cords, plugs, fuses, microphone hanger, etc. included. Weight 6 lbs.
- **ACCESSORIES:** 15' REMOTE CABLE....\$29.95. FMPS-4R A/C POWER SUPPLY....\$39.95. TOUCHTONE MIC. KIT....\$39.95. EXTERNAL SPEAKER....\$18.00.

AMATEUR-WHOLESALE ELECTRONICS ORDER NOW TOLL FREE

8817 S.W. 129th Terrace, Miami, Florida 33176
Telephone (305) 233-3631 • Telex: 80-3356
HOURS: 8-6, Mon. - Thurs.

U.S. DISTRIBUTOR
DEALER INQUIRIES INVITED

1-800-327-3102

CREDIT CARD HOLDERS MAY USE OUR TOLL FREE ORDERING NUMBER.

We now have available a bunch of goodies too good to bypass. Items are limited so order today

Call Your Phone Order in Today

**MINI KITS - YOU HAVE SEEN THESE BEFORE NOW
HERE ARE OLD FAVORITE AND NEW ONES TOO.
GREAT FOR THAT AFTERNOON HOBBY.**

FM MINI MIKE



A super high performance FM wireless mike kit! Transmits a stable signal up to 300 yards with exceptional audio quality by means of its built in electret mike. Kit includes case, mike, on-off switch, antenna, battery and super instructions. This is the finest unit available.

FM-3 Kit **\$14.95**
FM-3 Wired and Tested **19.95**

Color Organ

See music come alive! 3 different lights flicker with music. One light each for, high, mid-range and lows. Each individually adjustable and drives up to 300 W. runs on 110 VAC.

Complete kit, ML-1 **\$8.95**

Video Modulator Kit
Converts any TV to video monitor. Super stable, tunable over ch. 4-6. Runs on 5-15V, accepts std. video signal. Best unit on the market! Complete kit, VD-1 **\$7.95**



Led Blinky Kit
A great attention getter which alternately flashes 2 jumbo LEDs. Use for name badges, buttons, warning panel lights, anything! Runs on 3 to 15 volts. Complete kit, BL-1 **\$2.95**

Super Sleuth
A super sensitive amplifier which will pick up a pin drop at 15 feet! Great for monitoring baby's room or as general purpose amplifier. Full 2 W rms output, runs on 6 to 15 volts, uses 8-45 ohm speaker. Complete kit, BN-9 **\$5.95**

CPO-1
Runs on 3-12 Vdc 1 wall out, 1 KHZ good for CPO, Alarm, Audio Oscillator. Complete kit **\$2.95**

CLOCK KITS

Your old favorites are here again. Over 7,000 Sold to Date. Be one of the gang and order yours today!

Try your hand at building the finest looking clock on the market. Its satin finish anodized aluminum case looks great anywhere, while six .4" LED digits provide a highly readable display. This is a complete kit, no extras needed, and it only takes 1-2 hours to assemble. Your choice of case colors: silver, gold, black (specify).
Clock kit, 12/24 hour, DC-5 **\$24.95**
Clock with 10 min. ID timer, 12/24 hour, DC-10 **\$29.95**
Alarm clock, 12 hour only, DC-8 **\$29.95**
12V DC car clock, DC-7 **\$29.95**

For wired and tested clocks add \$10.00 to kit price. SPECIFY 12 OR 24 HOUR FORMAT

FM Wireless Mike Kit



Transmits up to 300' to any FM broadcast radio, uses any type of mike. Runs on 3 to 9V. Type FM-2 has added sensitive mike preamp stage.

FM-1 kit **\$3.95** FM-2 kit **\$4.95**

Whisper Light Kit

An interesting kit, small mike picks up sounds and converts them to light. The louder the sound, the brighter the light. Includes mike, controls up to 300 W, runs on 110 VAC. Complete kit, WL-1 **\$6.95**

Tone Decoder

A complete tone decoder on a single PC board. Features: 400-5000 Hz adjustable range via 20 turn pot, voltage regulation, 567 IC. Useful for touch-tone burst detection, FSK, etc. Can also be used as a stable tone encoder. Runs on 5 to 12 volts. Complete kit, TD-1 **\$5.95**



Car Clock

The UN-KIT, only 5 solder connections

Here's a super looking, rugged and accurate auto clock, which is a snap to build and install. Clock movement is completely assembled — you only solder 3 wires and 2 switches, takes about 15 minutes! Display is bright green with automatic brightness control photocell — assures you of a highly readable display, day or night. Comes in a satin finish anodized aluminum case which can be attached 5 different ways using 2 sided tape. Choice of silver, black or gold case (specify)

DC-3 kit, 12 hour format **\$22.95**
DC-3 wired and tested **\$29.95**

Universal Timer Kit

Provides the basic parts and PC board required to provide a source of precision timing and pulse generation. Uses 555 timer IC and includes a range of parts for most timing needs.

UT-5 Kit **\$5.95**

Mad Blaster Kit

Produces LOUD ear shattering and attention getting siren like sound. Can supply up to 15 watts of obnoxious audio. Runs on 6-15 VDC. Complete kit, MB-1 **\$4.95**

Siren Kit

Produces upward and downward wail characteristic of a police siren. 5 W peak audio output, runs on 3-15 volts, uses 3-45 ohm speaker. Complete kit, SM-3 **\$2.95**

60 Hz Time Base
Runs on 5-15 VDC Low current (25ma) 1 min/month accuracy TB-7 Kit **\$5.50**
TB-7 Assy **\$9.95**

Calendar Alarm Clock

The clock that's got it all: 6-5" LEDs, 12/24 hour, snooze, 24 hour alarm, 4 year calendar, battery backup, and lots more. The super 7001 chip is used. Size: 5x4x2 inches. Complete kit, less case (not available) DC-9 **\$34.95**

Under Dash Car Clock

12/24 hour clock in a beautiful plastic case features: 6 jumbo RED LEDs, high accuracy (0.01%), easy 3 wire hookup, display blanks with ignition, and super instructions. Optional dimmer automatically adjusts display to ambient light level. DC-11 clock with mtg bracket **\$27.95 kit**
DM-1 dimmer adapter **\$2.50**
Add \$10.00 Assy and Test

Video Terminal

A completely self-contained, stand alone video terminal card. Requires only an ASCII keyboard and TV set to become a complete terminal unit. Features are: single 5V supply, XTAL controlled sync and baud rates (to 9600), complete computer and keyboard control of cursor, parity error control and display. Accepts and generates serial ASCII plus parallel keyboard input. The 6416 is 64 char. by 16 lines with scrolling, upper and lower case (optional) and has RS-232 and 20ma loop interfaces on board. Kits include sockets and complete documentation.
RE 6416 terminal card kit (add \$60.00 for wired unit) **\$189.95**
Lower Case option **\$13.95**
Power Supply **\$14.95**
RF Modulator kit **\$7.95**

PARTS PARADE

IC SPECIALS

LINEAR

301	\$.35
324	\$1.50
380	\$1.50
555	\$.45
556	\$1.00
565	\$1.00
566	\$1.00
567	\$1.25
741	10/\$2.00
1458	\$.50
3900	\$.50
3914	\$2.95
8038	\$2.95

TTL

74S00	\$.40
7447	\$.65
7475	\$.50
7490	\$.50
74196	\$1.35

SPECIAL

CMOS

4011	.50
4013	.50
4046	\$1.85
4049	.50
4059	\$9.00
4511	\$2.00
4518	\$1.35
5639	\$1.75

FERRITE BEADS

With info and specs **15/\$1.00**
6 Hole Balun Beads **5/\$1.00**

Resistor Ass't

Assortment of Popular values - 1/4 watt. Cut lead for PC mounting, 1/2" center, 1/2" leads, bag of 300 or more. **\$1.50**

Switches

Mini toggle SPDT **\$1.00**
Red Pushbuttons N.O. **3/\$1.00**

Earphones

3" leads, 8 ohm, good for small tone speakers, alarm clocks, etc. 5 for \$1.00

Mini 8 ohm Speaker

Approx 2 1/4" diam. Round type for radios, mike etc. 3 for \$2.00

Slug Tuned Coils

Small 3/16" Hex Slugs turned coil. 3 turns. 10 for \$1.00

CAPACITORS

TANTALUM	ALUMINUM	DISK CERAMIC
Dipped Epoxy	Electrolytic	01 16V disk 20/\$1.00
1.5 uF 25V 3/\$1.00	1000 uF 16V Radial \$5.00	1-16V 15/\$1.00
1.8 uF 25V 3/\$1.00	500 uF 20V Axial \$5.00	001 16V 20/\$1.00
.22 uF 25V 3/\$1.00	150 uF 16V Axial 5/\$1.00	100 pF 20/\$1.00
	10 uF 15V Radial 10/\$1.00	047 16V 20/\$1.00

Crystals

3.579545 MHZ	\$1.50
10.00000 MHZ	\$5.00
5.248800 MHZ	\$5.00

AC Adapters

Good for clocks, nicad chargers, all 110 VAC plug one end
8.5 vdc @ 20 mA **\$1.00**
16 vac @ 160mA **\$2.50**
12 vac @ 250mA **\$3.00**

Solid State Buzzers

small buzzer 450 Hz, 86 dB, sound output on 5-12 vdc at 10-30 mA. TTL compatible. **\$1.50**

AC Outlet

Panel Mount with Leads **4/\$1.00**

Audio Prescaler

Make high resolution audio measurements, great for musical instrument tuning, PL tones, etc. Multiplies audio UP in frequency, selectable x10 or x100, gives .01 HZ resolution with 1 sec. gate time! High sensitivity of 25 mv, 1 meg input z and built-in filtering gives great performance. Runs on 9V battery, all CMOS.
PS-2 kit **\$29.95**
PS-2 wired **\$39.95**

600 MHz PRESCALER



Extend the range of your counter to 600 MHz. Works with all counters. Less than 150 mv sensitivity, specify -10 or -100

Wired, tested, PS-1B **\$59.95**
Kit, PS-1B **\$44.95**

30 Watt 2 mtr PWR AMP

Simple Class C power amp features 8 times power gain. 1 W in for 8 out, 2 W in for 15 out, 4W in for 30 out. Max output of 35 W, incredible value, complete with all parts, less case and T-R relay.
PA-1, 30 W pwr amp kit **\$22.95**
TR-1, RF sensed T-R relay kit **6.95**

MRF-238 transistor as used in PA-1

8-10db gain 150 mhz **\$11.95**

Power Supply Kit

Complete triple regulated power supply provides variable 6 to 18 volts at 200 ma and +5 at 1 Amp. Excellent load regulation, good filtering and small size. Less transformers, requires 6.3 V (a 1 A and 24 VCT). Complete kit, PS-3LT **\$6.95**

RF actuated relay senses RF (1W) and closes DPDT relay.

For RF sensed T-R relay TR-1 Kit **\$6.95**

OP-AMP Special

BI-FET LF 13741 - Direct pin for pin 741 compatible, but 500,000 MEG input z, super low 50 pa input current, low power drain.
50 for only **\$9.00** 10 for **\$2.00**

78MG \$1.25

78MG	\$1.25
79MG	\$1.25
723	\$1.50
309K	\$1.15
7805	\$1.00

Regulators

7812	\$1.00
7815	\$1.00
7905	\$1.25
7912	\$1.25
7915	\$1.25

Shrink Tubing Nubs

Nice precut pcs of shrink size: 1" x 1/4" shrink to 1/8". Great for splices **50/\$1.00**

Mini TO-92 Heat Sinks

Thermalloy Brand **5 for \$1.00**
To-220 Heat Sinks **3 for \$1.00**

Opto Isolators - 4N28 type

Opto Reflectors - Photo diode + LED **\$1.00 ea.**

Molex Pins

Molex already precut in length of 7. Perfect for 14 pin sockets. **20 strips for \$1.00**

CDS Photocells

Resistance varies with light, 250 ohms to over 3 meg **3 for \$1.00**

READOUTS

FND 359 4" C.C	\$1.00
FND 507/510 5" C.A	1.00
MAN 72/HP7730 33" C.A	1.00
HP 7651 43" C.A	2.00

TRANSISTORS

2N3904 NPN	15/\$1.00
2N3906 PNP	15/\$1.00
2N4403 PNP	15/\$1.00
2N4410 NPN	15/\$1.00
2N4916 FET	4/\$1.00
2N5401 PNP	5/\$1.00
2N6028 C-F	4/\$1.00
2N3771 NPN Silicon	\$1.50
2N5179 UHF NPN	3/\$2.00
Power Tab NPN 40W	3/\$1.00
Power Tab PNP 40W	3/1.00
MPF 102/2N5484	\$.50
NPN 3904 Type	50/\$2.50
PNP 3906 Type	50/\$2.50
2N3055	\$.80
2N2646 UJT	3/\$2.00

Diodes

5.1 V Zener	20/\$1.00
1N914 Type	50/\$1.00
1KV 2Amp	8/\$1.00
100V 1Amp	15/\$1.00

25 AMP 100V Bridge \$1.50 each

Mini-Bridge 50V 1 AMP 2 for \$1.00

Crystal Microphone

Small 1" diameter 1/4" thick crystal mike cartridge **\$7.75**

Coax Connector

Chassis mount BNC type **\$1.00**

9 Volt Battery Clips

Nice quality clips **5 for \$1.00**
1/2" Rubber Grommets **10 for \$1.00**

Parts Bag

Asst. of chokes, disc caps tant, resistors, transistors, diodes, MICA caps etc. sm. bag (100 pc) **\$1.00** lg. bag (300 pc) **\$2.50**

Connectors

6 pin type gold contacts for mA-1003 car clock module price **.75 ea.**

Leds - your choice, please specify

Mini Red, Jumbo Red, High Intensity Red, Illuminator Red **8/\$1**
Mini Yellow, Jumbo Yellow, Jumbo Green **6/\$1**

Varactors

Motorola MV 2209 30 PF Nominal cap 20-80 PF - Tunable range - **.50 each or 3/\$1.00**

Bargains GALORE !!

SOLDERTAIL SOCKET SPECIAL

14 pin 50/\$4.95 16 pin 50/\$4.95 18 pin 50/\$4.95
 20 pin 40/\$4.95 24 pin 30/\$4.95 28 pin 30/\$4.95
 40 pin 20/\$4.95

TRANSISTORIZED SPECIAL

If you ever needed to stock up on transistors, you had better do it now. General purpose NPN transistors (similar to the 2N3904) are now 100/\$7.95, while general purpose PNP transistors (similar to the 2N3906) are now 100/\$8.95. Quantities are limited at this special price.

THE CLOCK AND CASE SPECIAL CONTINUES

The MA1003 is a great car clock module; it includes a built-in crystal controlled timebase, runs off +12V DC, and features blue-green fluorescent readouts for easy visibility. The case has an optical filter to bring out the best of the readouts, along with mounting hardware to attach the clock under (or on) your dashboard. \$19.95

16K DYNAMIC RAMS: 8/\$69 - SPECIAL LOW PRICE!

Ideal for expanding memory in TRS-80*-I and -II, as well as machines made by Apple, Exidy, Heath, newer PETs, etc. Low power, 250 ns (4 MHz) parts. Add \$3 for two DIP shunts plus TRS-80* installation instructions.

*TRS-80 is a trademark of the Tandy Corporation

WE HAVE THE VOLTAGE REGULATORS YOU NEED

Positive 1A, TO-220 package, 78 series only \$1.38 each. Choose from +5, +6, +8, +12, +15, +18, and +24 Volts. Negative 1A, TO-220 package, 79 series only \$1.49 each. Choose from -5, -6, -8, -12, -15, -18, and -24 Volts.

transistors & FET's

2N2221	NPN TO-18, unmarked	7/\$1.00
2N2222	PNP TO-18, unmarked	5/\$1.00
2N2907A	PNP plastic case, house number	5/\$1.00
2N3055	NPN TO-3, house no. power type	1/\$0.75
2N3904	NPN TO-105, house number	5/\$1.00
2N3906	PNP TO-105, house number	5/\$1.00
2N4124	30V, 200 mA, 350 mW, TO-92 w/ min hFE 120 to 360	3/\$1.00
2N4304	TO-18 plastic N-JFET, gen purp.	2/\$1.00
2N4400	NPN plastic, house number	5/\$1.00
2N4917	PNP TO-106 case	5/\$1.00
2N4946	NPN TO-106 case	6/\$1.00
2N5227	Ideal small signal 3 lead, silicon transistor, PNP, TO-92, 30V	6/\$1.00
2N5306	Silicon transistor, TO-92, Darlington NPN 25V, 300 mA, 400 mW, hFE 7000 to 70000	3/\$1.00
2N5449	Silicon NPN transistor	6/\$1.00
2N5484	RF N-FET	3/\$1.00
D41D1	PNP TO-202, 1A max power type	1/\$0.50
D44C4	TO-220, 4A, 30W, 55V, NPN, minimum hFE 25	1/\$0.75
D45C4	TO-220, 4A, 30W, 55V, PNP, minimum hFE 25	1/\$0.75
D45H8	TO-220, house number, PNP, 10A, 50W, 60V, hFE 60 min.	3/\$2.00
TIP3055	Silicon NPN power, tab case elect.	1/\$0.75
MPS3694	NPN/general purpose	4/\$1.00
FPT100	Phototransistors	1/\$0.50
FET-1	Dual N-JFET VHF/UHF, TO-18	3/\$1.00
FET-2	Dual N-JFET VHF/UHF amp, sim. to 2N4416, TO-18	3/\$1.00
FET-3	Dual N-JFET low noise audio amp, TO-18	2/\$1.00
FET-6	House number, general purpose 631 type dual gate MOSFET. Ideal for RF amp/mixer applications with a dB NF at 200 MHz	3/\$2.00

SPECIAL SPECIAL SPECIAL SPECIAL SPECIAL
 .01 ceramic disc capacitors, with full leads (not cut for PC insertion). Ideal for bypassing TTL and other logic circuits, audio coupling, and audio bypass applications. Available in quantity only: 500/\$16.95 or for even greater savings, 1000/\$30.00. Stock up now!
 SPECIAL SPECIAL SPECIAL SPECIAL SPECIAL

resistors

¼ Watt only; may be 5% or 10%. All resistors may only be ordered in multiples of 100 (i.e. you cannot purchase one 2.7k resistor; you must order 100, 200, 300, etc.).

EACH VALUE: \$1.70/hundred (1 pkg)
 TEN VALUES: \$15.30/thousand (10 pkgs)

1.0 Ohms	47 Ohms	2.0k	82k
1.2	51	2.2k	91k
1.3	56	2.4k	100k
1.5	62	2.7k	110k
1.6	68	3.0k	120k
1.8	75	3.3k	130k
2.0	82	3.6k	150k
2.2	91	3.9k	160k
2.4	100	4.3k	180k
2.7	110	4.7k	200k
3.0	120	5.1k	220k
3.3	130	5.6k	240k
3.6	150	6.2k	270k
3.9	160	6.8k	300k
4.3	180	7.5k	330k
4.7	200	8.2k	360k
5.1	220	9.1k	390k
5.6	240	10k	430k
6.2	270	11k	470k
6.8	300	12k	510k
7.5	330	13k	560k
8.2	360	15k	620k
9.1	390	16k	680k
10	430	18k	750k
11	470	20k	820k
12	510	22k	910k
13	560	24k	1.0M
15	620	27k	1.1M
16	680	30k	1.2M
18	750	33k	1.3M
20	820	36k	1.5M
22	910	39k	1.6M
24	1k	43k	1.8M
27	1.1k	47k	2.0M
30	1.2k	51k	2.2M
33	1.3k	56k	5.6M
36	1.5k	62k	6.8M
39	1.6k	68k	22M
43	1.8k	75k	

TERMS: Cal res add tax. Allow 5% shipping; excess refunded. VISA/Mastercharge call our 24 hour order desk at (415) 562-0636. COD OK with street address for UPS. Special prices good through cover month of magazine while supplies last; other prices subject to change without notice. Add \$1 handling to orders under \$15. Thanks for your business!

SEND FOR OUR CATALOG TODAY!

GODBOUT

GODBOUT ELECTRONICS
 Bldg. 725, Oakland Airport, CA 94614

MINIATURE SCREWDRIVER

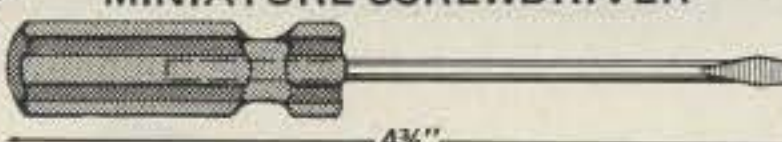

4 3/4"

RUGGED CONSTRUCTION
1000's OF USES - 1/8" TIP

2/\$1.00

MAGNETIC RETRIEVER TOOL



Picks up elusive metal parts or tools in hard-to-reach places.

EXTENDS TO 26 3/4" - ROTATES 360° STRONG, LIFETIME MAGNET

MRT-2281 \$3.95

CSC CONTINENTAL SPECIALTIES

LOGIC PROBE KIT



SPECIFICATIONS

Input Impedance: 300,000 Ohms.
Thresholds: "Lo" 30%Vcc - "Hi" 70%Vcc
Maximum Speed: 300 nsec., 1.5MHz
Input Protection: ±50VDC continuous 117VAC for 15 sec.
Power: 30mA @5V - 40mA @ 15V - 25V max. reverse voltage protected; 36" cable with color coded clips included.
Operating Temp.: 0-50°C.
Dimensions: 5.8L x 1.0W x 0.7D in. (147 x 25 x 18mm)
Weight: 30 oz. (85 gm)
LPK-1 \$21.95/Kit

Proto Clips



14-PIN CLIP	PC-14	\$ 4.50
16-PIN CLIP	PC-16	\$ 4.75
24-PIN CLIP	PC-24	\$10.00
40-PIN CLIP	PC-40	\$16.00

Proto Boards



PB-6	\$17.95
PB-100	19.95
PB-101	22.95
PB-102	26.95
PB-103	44.95
PB-104	55.95
PB-203	99.95
PB-203A	155.00
PB-203A-Kit	131.00

Jumbo 6-Digit Clock Kit



- * Four .630"ht. and two .300"ht. common anode displays
- * Uses MM5314 clock chip
- * Switches for hours, minutes and hold functions
- * Hours easily viewable to 30 feet
- * Simulated walnut case
- * 115VAC operation
- * 12 or 24 hour operation
- * Includes all components, case and wall transformer
- * Size: 6 3/4" x 3 3/8" x 1 3/4"

JE747 \$29.95

JE701



- * Bright .300 ht. comm. cathode display
- * Uses MM5314 clock chip
- * Switches for hours, minutes and hold modes
- * Hrs. easily viewable to 20 ft.
- * Simulated walnut case
- * 115 VAC operation
- * 12 or 24 hr. operation
- * Incl. all components, case & wall transformer
- * Size: 6 3/4" x 3-1/8" x 1 1/4"

6-Digit Clock Kit \$19.95

Regulated Power Supply

Uses LM309K. Heat sink provided. PC board construction. Provides a solid 1 amp @ 5 volts. Can supply up to ±5V, ±9V and ±12V with JE205 Adapter. Includes components, hardware and instructions. Size: 3 1/2" x 5" x 2 1/4"

JE200 \$14.95

ADAPTER BOARD

—Adapts to JE200—
±5V, ±9V and ±12V



DC/DC converter with +5V input. Toroidal hi-speed switching XMFR. Short circuit protection. PC board construction. Piggy-back to JE 200 board. Size: 3 1/2" x 2" x 9/16" H

JE205 \$12.95

MICROPROCESSOR COMPONENTS

8080A/8080A SUPPORT DEVICES		MICROPROCESSOR MANUALS	
8080A CPU	\$ 7.95	M-280 User Manual	\$7.50
8212 8-Bit Input/Output	3.25	M-COP1802 User Manual	7.50
8214 Priority Interrupt Control	5.95	M-2650 User Manual	5.00
8216 8i-Directional Bus Driver	3.49		
8224 Clock Generator/Driver	3.95		
8226 Bus Driver	3.49		
8228 System Controller/Bus Driver	4.95		
8238 System Controller	5.95		
8251 Prog. Comm. 1/0 (USART)	7.95		
8253 Prog. Interval Timer	14.95		
8255 Prog. Periph. 1/0 (PPI)	9.95		
8257 Prog. DMA Control	19.95		
8259 Prog. Interrupt Control	19.95		
6800/6800 SUPPORT DEVICES			
MC6800 MPU	\$14.95		
MC6802CP MPU with Clock and Ram	24.95		
MC6810API 128X8 Static Ram	5.95		
MC6821 Periph. Inter. Adapt (MC6820)	7.49		
MC6828 Priority Interrupt Controller	12.95		
MC6830L8 1024X8 Bit ROM (MC68A30-8)	14.95		
MC6850 Asynchronous Comm. Adapter	7.95		
MC6852 Synchronous Serial Data Adapt.	9.95		
MC6860 0-600 bps Digital MODEM	12.95		
MC6862 2400 bps Modulator	14.95		
MC6880A Quad 3-State Bus. Trans. (MC8T26)	2.25		
MICROPROCESSOR CHIPS—MISCELLANEOUS			
280(780C) CPU	\$13.95		
Z80A(780-1) CPU	15.95		
CDP1802 CPU	19.95		
2650 MPU	19.95		
6502 CPU	11.95		
8035 8-Bit MPU w/clock, RAM, 1/0 lines	19.95		
P8085 CPU	19.95		
TMS9900JL 16-Bit MPU w/hardware, multiply & divide	49.95		
SHIFT REGISTERS			
MM500H Dual 25 Bit Dynamic	\$.50		
MM503H Dual 50 Bit Dynamic	.50		
MM504H Dual 16 Bit Static	.50		
MM506H Dual 100 Bit Static	.50		
MM510H Dual 64 Bit Accumulator	.50		
MM5016H 500/512 Bit Dynamic	.89		
2504T 1024 Dynamic	3.95		
2518 Hex 32 Bit Static	4.95		
2522 Dual 132 Bit Static	2.95		
2524 512 Static	.99		
2525 1024 Dynamic	2.95		
2527 Dual 256 Bit Static	2.95		
2528 Dual 250 Static	4.00		
2529 Dual 240 Bit Static	4.00		
2532 Quad 80 Bit Static	2.95		
3341 Fifo	6.95		
74LS670 4X4 Register File (TriState)	2.49		
UART'S			
A-Y-5-1013 30K BAUD	5.95		

JE600 HEXADECIMAL ENCODER KIT



FEATURES:

- * Full 8 bit latched output for micro-processor use
- * 3 User Define keys with one being bistable operation
- * Debounce circuit provided for all 19 keys
- * LED readout to verify entries
- * Easy interfacing with standard 16 pin 1C connector
- * Only +5VDC required for operations

FULL 8 BIT LATCHED OUTPUT—19 KEYBOARD

The JE600 Encoder Keyboard provides two separate hexadecimal digits produced from sequential key entries to allow direct programming for 8 bit microprocessor or 8 bit memory circuits. Three (3) additional keys are provided for user operations with one having a bistable output available. The outputs are latched and monitored with LED readouts. Also included is a key entry strobe.

JE600 \$59.95
Hexadecimal Keypad only \$14.95

62-Key ASCII Encoded Keyboard Kit



FEATURES:

- * 60 Keys generate the full 128 characters, upper and lower case ASCII set
- * Fully buffered
- * 2 user-define keys provided for custom applications
- * Caps lock for upper case only alpha characters
- * Utilizes a 2376 (40 pin) encoder read only memory chip
- * Outputs directly compatible with TTL/DTL or MOS logic arrays
- * Easy interfacing with a 16-pin dip or 18-pin edge connector

The JE610 62-Key ASCII Encoded Keyboard Kit can be interfaced into most any computer system. The JE610 Kit comes complete with an industrial grade keyboard switch assembly (62 keys), IC's, sockets, connector, electronic components and a double-sided printed wiring board. The keyboard assembly requires +5V @ 150mA and -12V @ 10mA for operation.

JE610 \$79.95
62-Key Keyboard only . . \$34.95

HICKOK LX303 Portable LCD Digital Multimeter



- * Big 3/4 inch high, 3 1/2 Digit Liquid Crystal Display
- * Automatic zero, polarity and overrange indication
- * 19 ranges and functions
- * Rugged Cycloac® case and removable cover, stores test lead set
- * Full one year warranty.

SPECIFICATIONS: DC volts (8 ranges): 0.1mV to 1000V, Accuracy: ±0.5% rdy ±0.5% f.s.; Input imped: 10MΩ Max. input 1A except 500V on 200mV range.
AC Volts (40Hz to 50Hz): 0.1V to 800V, Accuracy: ±1.0% rdy ±0.5% f.s. (-200 max. at 50Hz); Max. input: 600V
Resistance (16 Low Power Ranges): 0.1 to 20MΩ, Accuracy: ±0.5% rdy ±0.5% f.s. (1.5% rdy on 20MΩ range); Input protected to 120VAC at ranges.
DC Current (8 ranges): 0.1mA to 100mA, Accuracy: ±1.0% rdy ±0.5% f.s.
Dimensions and Weight: 3-7/8" x 3-3/8" x 1-3/4" - 8 oz. POWER: 9V battery (not included) or Hickok AC adapter
READ RATE: 3/sec.

LX303	1% ACCURACY	\$74.95
LX304	5% ACCURACY	\$89.95

PART NO. PRICE

RC-3	115V AC ADAPTER	7.50
CC-3	PADDED CARRYING CASE	7.50
VP-10	X10 DC PROBE ADAPTER (Up to 10K)	14.95
VP-40	40kV DC PROBE	35.00
CS-1	10 Amp DC Current Shunt	14.95

\$10.00 Min. Order — U.S. Funds Only
Calif. Residents Add 6% Sales Tax
Postage — Add 5% plus \$1 Insurance (if desired)

Spec Sheets — 25¢
1980 Catalog Available — Send 41¢ stamp

Jameco ELECTRONICS

MAIL ORDER ELECTRONICS — WORLDWIDE
1355 SHOREWAY ROAD, BELMONT, CA 94002
PRICES SUBJECT TO CHANGE

PHONE ORDERS WELCOME
(415) 592-8097

6-80 ✓ 38

The Incredible "Pennywhistle 103"



\$139.95 Kit Only

The Pennywhistle 103 is capable of recording data to and from audio tape without critical speed requirements for the recorder and it is able to communicate directly with another modern and terminal for telephone "hamming" and communications. In addition, it is free of critical adjustments and is built with non-precision, readily available parts.

Data Transmission Method Frequency-Shift Keying, full-duplex (half-duplex selectable)
Maximum Data Rate 300 Baud
Data Format Asynchronous Serial (return to mark level required between each character)
Receive Channel Frequencies 2025 Hz for space; 2225 Hz for mark.
Transmit Channel Frequencies Switch selectable: Low (normal) = 1070 space, 1270 mark; High = 025 space, 2225 mark.
Receive Sensitivity -46 dbm acoustically coupled.
Transmit Level -15 dbm nominal. Adjustable from -6 dbm to -20 dbm.
Receive Frequency Tolerance Frequency reference automatically adjusts to allow for operation between 1800 Hz and 2400 Hz.
Digital Data Interface EIA RS-232C or 20 mA current loop (receiver is optoisolated and non-polar).
Power Requirements 120 VAC, single phase, 10 Watts.
Physical All components mount on a single 5" by 9" printed circuit board. All components included.
Requires a VOM, Audio Oscillator, Frequency Counter and/or Oscilloscope to align

TRS-80 16K Conversion Kit

Expand your 4K TRS-80 System to 16K.
Kit comes complete with:
* 8 each UPD416-1 (16K Dynamic Rams) 250NS
* Documentation for conversion

TRS-16K \$75.00

JUST WRAP™



30 AWG wire • .025" square posts
Daisy chain or point-to-point • Built-in cut off
No stripping or slitting required—just wrap • Includes 50 ft. wire

Part No.	Wire Color	Price
JW-1-B	Blue	\$14.95
JW-1-W	White	14.95
JW-1-Y	Yellow	14.95
JW-1-R	Red	14.95

JUST WRAP™ Replacement Wire

Part No.	Color	Price
R-JW-B	Blue	50 ft. roll \$2.98
R-JW-W	White	50 ft. roll 2.98
R-JW-Y	Yellow	50 ft. roll 2.98
R-JW-R	Red	50 ft. roll 2.98

JUST WRAP™ Unwrap Tool \$3.49



VV-1 \$3.49

Vacuum Vise
Vacuum-based light-duty vise for small components and assemblies. ABS construction. 1 1/2" jaws, 1 1/4" travel. Can be permanently installed.

ADJUSTABLE WRENCH



- * Two Sizes: 6" and 10"
- * Professional Quality
- * Chrome Vanadium Steel

6" — AW-6 .. \$4.95 10" — AW-10 .. \$6.95

JOYSTICK VIDEO CONTROLLER



JVC-40 \$4.95 each

- * IDEAL FOR ALL VIDEO GAMES OR REMOTE CONTROL PROJECTS
- * SMALL CASE SIZE: 1-1/2"H x 2-3/8"W x 4-5/16"L
- * 2 MINIATURE POTENTIOMETERS—40K OHM EACH
- * SPST PUSH BUTTON CONTROL
- * 5-WIRE CONNECTION CABLE — 5 FEET LONG
- * RUGGED PLASTIC CASE

ASSOCIATED RADIO

913-381-5900

8012 CONSER BOX 4327
OVERLAND PARK, KANSAS 66204



CALL US WITH YOUR REQUIREMENTS
AMERICA'S NO. 1 Real Amateur Radio Store



**Associated Wants to TRADE - BUY - SELL
GOT YOUR BEST DEAL? THEN CALL US AT
913-381-5900 - NO TRADE? ASK FOR EXT. 12**

**NOTE: SEND \$1.00 FOR OUR CURRENT CATALOG
OF NEW AND RECONDITIONED EQUIPMENT.**

*** ALSO WE PERIODICALLY PUBLISH A LIST OF
UNSERVICED EQUIPMENT AT GREAT SAVINGS.
A BONANZA FOR THE EXPERIENCED OPERATOR.
TO OBTAIN THE NEXT UNSERVICED BARGAIN LIST,
SEND A SELF ADDRESSED STAMPED ENVELOPE.**



THERE'S GOLD IN THEM THAR PAKS!!

\$2.99'ERS

ARE PAKS EVEN A 49'ER CAN DIG!



- 20-MOTORS MOTORS, asstd. sizes speeds & types, 1.5-12 volts, (#2551A) \$2.99
- 200-LONG LEAD DISCS, prime, marked caps, assorted material, (#2598) 2.99
- 100-PLASTIC TRANSISTORS, untested, TO-92, asst. types (#2604) 2.99
- 50-SLIDE SWITCHES, various shapes, sizes, and types, (#2726) 2.99
- 75-TRANSISTOR ELECTROLYTICS, epoxy encapsulated, asst. values, (#2747) 2.99
- 250-HALF WATTERS, 100%, color-coded resistors, asst. values, (#3046) 2.99
- 25-SLIDE VOLUME CONTROLS, various values & types, for Hi-Fi, etc. (#3057) 2.99
- 50-UPRIGHT ELECTROS, 100%, assorted values & voltages, marked, (#3226) 2.99
- 20-ROCKER SWITCHES, white rockers, DPDT, solder lugs, 125V 4A, (#3302A) 2.99
- 50-MINI POTS, pc style, single turn, assorted values, (#3345) 2.99
- 20-JUMBO RED LEDS, 3V 10 mA, 100% good material, red dome lense, (#3369) 2.99
- 3-SOUND TRIGGERS, sound activated amp, SCR triggered, on 3" board, (#3625) 2.99
- 50-TRANSISTOR SOCKETS, assortment may include; TO-19,5,6,3, etc, (#3845) 2.99
- 100-CABLE TIES, 4" non-slip white plastic, like Ty-wrap, (#5218) 2.99
- 150-FEEDTHRU CAPS, assorted types & sizes, for RF, UHF, etc, (#5668A) 2.99
- 250-1/4 WATT RESISTORS, asstd. carbons, carbo-films, some 5%ers, (#5797A) 2.99
- 100-PLESSY CAPS, ceramic blocks in assorted sizes & vlaues, (#6221) 2.99
- 30-HOBBY LEDS, assorted types & colors, mostly dims, some good, (#6225) 2.99
- 200 PC-SEMICON SPECIAL, assorted semis of all types. Untested material, (#3300) 2.99
- 100-TTLs, 7400 series, incl. gates, flip-flops, etc, untested, (#6226) 2.99
- 5-BRASS LOCKS, with key, 1 1/2" long, for doors, windows, etc, (#6253) 2.99
- 250-MOLEX SOCKETS, "on-a-strip", make your own pc sockets, (#6255) 2.99
- 4-LM-747 OP AMPS, 100% prime, dual linear op amp, DIP package, (#6262) 2.99
- 50-RCA PHONO PLUGS, popular audio/speaker plugs, 100% material, (#3293) 2.99
- 200-PREFORMED HALF WATTERS, resistors, color coded, asst (#6246) 2.99
- 25-CRYSTALS, assorted types, some H6/U, some frequency marked, (#6256) 2.99
- 150-SUBMINI IF TRANSFORMERS, asst. may include; osc. antenna, etc, (#6259) 2.99
- 60-SQUARE OHM RESISTORS, prime resistors, asst. values, grab 'em! (#6261) 2.99
- 30-MICRO MINI REED SWITCHES, 1" long, for alarms, relay systems, etc, (#6263) 2.99
- 200 PC-CAPACITOR SPECIAL, asst. mylars, polys, micas, etc. 100% good, (#6264) 2.99
- 20-PUSHBUTTON ALARM SWITCH, SPST, momentary, NC, w/hardware, (#6267) 2.99
- 500* PC-HARDWARE SURPRISE, (*approx.) 1 lb. asst. screws, washers, etc, (#6271) 2.99
- 30-9V BATTERY CLIPS, snap connector, coded, insulated leads, (#6286) 2.99
- 6-WATCH GUTS, 5-function, LED style, assorted sizes, untested, (#6287) 2.99
- 10-HEAVY DUTY LINE CORDS, white, 2 cond. 6 ft. 16 gauge, (#6292) 2.99
- 20-SINGLE PIN LEDS, green, micro style, 3V 10mA, 100%, (#6293) 2.99
- 40-LED/TRANSISTOR SOCKETS, "snap-in", 3 pc leads, for TO-5,18,46,etc, (#6297) 2.99
- 200 PRECISION RESISTORS, 1/2W, 1%, axial (#2428) 2.99
- 3-25A 50V BRIDGES, "block" type, with four lug-type leads, (#6311) 2.99
- 100-DTL IC's, mostly dual JK flip flops, marked, 100% prime, (#6444) 2.99
- 200-ONE WATTERS, asst. 1W resistors, mostly carbons, some 5%ers, (#6284) 2.99
- 40-INSTRUMENT KNOBS, for half round shafts, some w/pointers, (#6498) 2.99

- 50-SCRs & TRIACS, assorted values, 10 Amp TO-220, untested, (#6337) \$2.99
- 1-CB CONVERTER, receives CB on car radio, 12 VDC operation, (#5193) 2.99
- 40-EDGE CONNECTORS, asst. 4 & 6 pin, 2-sided, pc leads, (#6364) 2.99
- 20-6 CELL BATTERY HOLDERS, for AA size cells, 9V clip receptical, (#6386) 2.99
- 60-THERMAL FUSES, break at 257 F. 14 gauge axial leads, (#6367) 2.99
- 4-0.8" HOBBY READOUTS, 4 digit panels, Com. Cathode, untested, (#6384) 2.99
- 25-TINY SLIDE SWITCH, only 3/7" cube, SPDT, PC leads, (#6385) 2.99
- 50-TO-5 TRIACS, 50-600 prv., 3 lead TO-5 cans, 60%+ yield, (#6321) 2.99
- 30-PLASTIC POWERS, 25 watt, npn & pnp, 50-200 bvcbo, TO-220, (#6237) 2.99
- 100-2 WATT RESISTORS, assorted carbons, films, etc. some 5%ers, (#6238) 2.99
- 150 PC-HEAT SHRINK, like Thermo-Fit, asst. sizes, shrinks 50%, (#6239) 2.99
- 25-MAGNETIC DISCS, Plastalloy 13/16 dia. x 1/8" discs, (#6294) 2.99
- 150-PLUGS & SOCKETS, assorted types & styles, wide variety, (#3527) 2.99
- 15-PA-263 PC BOARDS, for GE PA-263 stereo amps, pre-etched, (#2013) 2.99
- 40-STEREO INDICATORS, tiny red 1.5V bulbs, for Hi-Fi replacement, (#6244) 2.99
- 40-800V 1A RECTIFIERS, type IN4006, epoxy, axial leads, (#6245) 2.99
- 4-2A 500V BRIDGES, silicon, full wave rectifiers, TO-5 case, (#6248) 2.99
- 10-QUAD PHONO JACKS, 4 RCA jacks on 2 x 1 1/2" Bakelite strip, (#6249) 2.99
- 50-MODULAR SWITCHES, by Centralab, "push-on" DPDT, 6PDT, etc., (#3150A) 2.99
- 150-"4000" RECTIFIERS, IN4000 series, may include; 50 to 1000V, (#2417) 2.99
- 15-THUMBWHEEL TRIM POTS, snap-in type, assorted values, (#6299) 2.99
- 50-MAGNIFIED MAN-3's, 7 segment 0. " high, w/"bubble" magnifier, (#6257) 2.99
- 1-I.R. DIODE, 5-9 watts, hetero-junction coax, for Pulse mode, (#6445) 2.99
- 200-BULLPLATES, asst. resistor-capacitor networks, various values, (#6282) 2.99
- 150-METAL CAN TRANSISTORS, asst. 2N #'s in TO-5,1,18, some unmarked, (#2603) 2.99
- 24-LM-340T VOLTAGE REGULATORS, untested TO-220, may incl. 5-24V, (#2635) 2.99
- 150-POLYSTYRENE CAPS, assorted types, styles, & sizes, all good, (#2729) 2.99
- 100-PLASTIC LENSES, assorted styles, & colors, (#6266) 2.99
- 250-CERAMIC CAPS, asst. tubulars, NPO's, temp. coefficient, etc, (#5839) 2.99
- 60-THERMISTORS, various types & styles, neg. coefficient, 100%, (#4089) 2.99
- 25-IC SOCKETS, asst. 24,28, & 40 pin sockets on G-10 board, (#6380) 2.99
- 25-MINI PLUG & CABLE SETS, 3.5mm plug, 6' insulated 2 cond. leads, (#6269) 2.99
- 20-RCA PHONO JACKS, popular Hifi jack on a Bakelit strip, (#6230) 2.99
- 250-PRE-FORMED DISCS, caps w/leads for PC use, mixed values, (#2605) 2.99
- 50-AXIAL ELECTROS, asst. values, volts, sizes, What a buy!, (#3227) 2.99
- 100-METALLIC RESISTORS, mostly 1/2 watters, asst. val. 1-5% tol. (#6280) 2.99
- 100-POWERS POWERS, 3 to 7 watt power resistors, (#6281) 2.99
- 15-IGNITION SUPPRESSION CAPS, for auto radios, decks, etc, 0.5 mf (#6224) 2.99
- 200-COILS & CHOKES, asst. RF, OSC, IF, and peaking types, (#6283) 2.99
- 50-POWER TAB TRANSISTORS, plastic NPN, TO-220, asst. types, untested, (#2425) 2.99
- 24-SKINNY TRIM POTS, multi & single turn, asst. values & types, (#6285) 2.99
- 30-HOBBY OPTO COUPLERS, untested, mini DIP, 1500V isolation, (#2629) 2.99
- 15-LINE CORDS, heavy-duty, 18 gauge, 6', molded plug, 2-cond. (#6499) 2.99



FREE! FREE!

WITH ANY \$30 ORDER, PICK A \$2.99er FREE!



TANK BATTLE

Cat. No. 92CU6526

TV GAME CHIP & BOARD SET

You're commanding Sherman class tank on patrol. Suddenly there's an explosion to your right. You've been sighted by the enemy. Quickly you swing your turret and Fire... Poly Paks brings back the thrill of armored combat in a 28 pin DIP with General Instrument's AY-3-8700-1 Tank Battle Game Chip and board set. The initial response for this item was so phenomenal that we've been searching the world over to replenish our already depleted stock. Finally in the far reaches of Hong Kong... SUCCESS! (But to avoid disappointment, order Now... they sold out before... and they'll sell out again!) Boards have: shielded FM modulator section, (a \$4.95 value alone), IC's, transistors, caps, etc. Chip capabilities: Two independently controllable tanks which explode & fragment when hit by shells or mines, 3 forward & reverse speeds, Realistic tank motor, track squeak, and explosion sounds, automatic on-screen scoring, (in color), and more! Tank game chip is 100% Guaranteed. With a little ingenuity and perhaps a few parts, you can recreate history's great tank battles... in the comfort of your home. Size: 8 1/2 x 6-5/8 x 1 1/4". Wt: 8 oz.

\$14⁸⁸

TANK GAME CHIP LESS BOARD \$995

• General Instruments AY-3-8700-1 Cat. No. 92CU6505

60 MINUTE DIGITAL COUNTDOWN TIMER

- Counts Down To 00 Minutes, 00 Seconds From Any Point Up To 59 Minutes, 59 Seconds
- Alarm Bell Rings Repeatedly When Counter Reaches 00

Truly an item that everyone can use! Versatile countdown timer by Litton makes an ideal darkroom, lab, or workbench accessory. Counts down to 00 Min., 00 Sec. from any desired point up to 59 Min. 59 Sec. Upon reaching 00:00, the alarm bell "dings" softly, and repeats until power is interrupted, or counter is reset. Also includes SPST micro switch which triggers devices up to 115 VAC, 3A, when timer completes it's cycle. 3/8" high white digits on two rollers represent Minutes from 00 to 59. Third roller shows Seconds from 00 to 59. Barrel-type mechanism is completely resettable via 1-3/8" long flattened shaft, and large thumb-wheel control, both front-mounted. Lightweight aluminum frame houses the mechanism. 3W 115 VAC, 60 Hz. motor, Bell, & Microswitch are rear-mounted. Comes with 10' insulated wire leads. Size: 4 x 3 x 2 1/4". Wt: 9 oz.

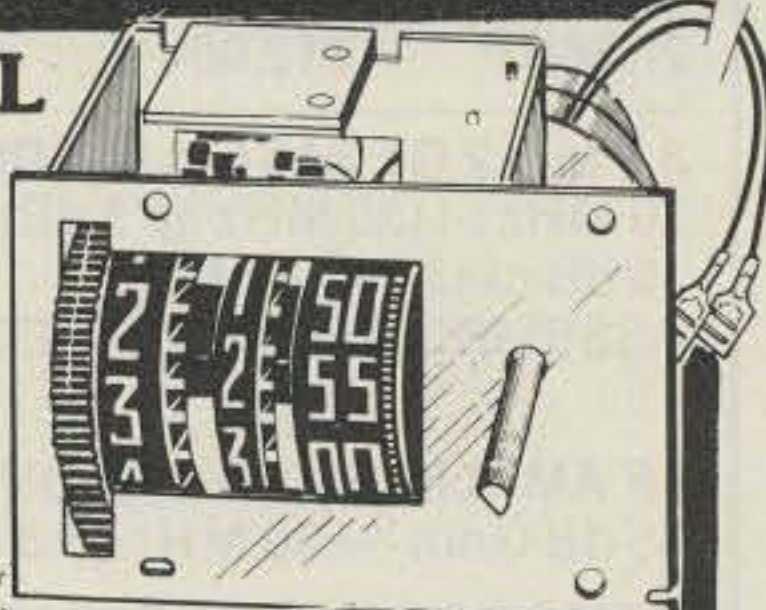

\$995
Cat. No. 92CU6476

ULTRA-SMALL LCD CHRONOGRAPH MODULE STOPWATCH!

ELAPSED TIME INDICATOR!

Hard to believe? Read on! Features include: 3/8" LCD display, AM/PM indicator, Seconds indicator and switchable numeric display. Built-In Alarm circuit with variable Sleep and Snooze modes, Fast Set for Hrs, Minutes, & Seconds. Built-In backlit Lamps, and more! 1-13/16 x 1-1/4" display panel is surrounded by a 2-3/8 x 1-1/4" black faceplate. Fits Anywhere! Comes with complete specs and hookup info. Requires 1.5-5 VDC. Order Now, because never before has so much been offered to so many... for so little!



ALARM CLOCK! DUAL ZONE TIMER!

\$24.50
Cat. No. 92CU6403

COMPACT CONDENSOR BOOM MIKE

- Space Efficient
- Practical Overhead "Boom" Design
- Minimizes Sound Coloration



\$3.50

Supply Voltage: 9V. Sensitivity: -63 dB @ 1 KHz. (typ.) Frequency Response: 10-15 KHz Imped: 3.3K ohms @ 1 KHz. Size: 5/8 (dia.) x 1-1/8". With Specs.

Cat. No. 92CU6374 **3 FOR \$9.**

HOW TO ORDER
We honor MASTERCARD, VISA, check, and C.O.D. (25% down). Order by phone or mail. Minimum Order: \$10 Please state Cat. No. & description, name & month of magazine. POSTAGE: USA; add \$3, CANADIAN; add \$5, FOREIGN; add \$10, (US funds). Excess will be returned. OPEN ACCOUNTS: (must be listed & rated in Dun & Bradstreet) Net - 30 PHONE: (617) 245-3828.

SEND FOR FREE CATALOG

Poly Paks®

P.O. BOX 942, A6 ✓58
SOUTH LYNNFIELD, MASS. 01940

MHz electronics ✓ 48

1900 MHz to 2500 MHz DOWN CONVERTER

This receiver is tunable over a range of 1900 to 2500 mc and is intended for amateur radio use. The local oscillator is voltage controlled (i.e.) making the i-f range approximately 54 to 88 mc (Channels 2 to 7).

PC BOARD WITH CHIP CAPACITORS 13	\$44.99
PC BOARD WITH ALL PARTS FOR ASSEMBLY	\$79.99
PC BOARD ASSEMBLED AND TESTED	\$120.00
POWER SUPPLY KIT	\$44.99
POWER SUPPLY ASSEMBLED AND TESTED	\$69.99
YAGI ANTENNA 4' LONG APPROX. 20 TO 23 dB GAIN	\$59.99
YAGI ANTENNA 4' WITH TYPE (N, BNC, SMA Connector)	\$64.99

2300 MHz DOWN CONVERTER

Includes converter mounted in antenna, power supply, antenna, 75' and 3' RG59 cable with connectors, 75 to 300 ohm adapter, Plus 90 DAY WARRANTY

OPTION #1 MRF902 in front end. (7 dB noise figure)	\$299.99
OPTION #2 2N6603 in front end. (5 dB noise figure)	\$349.99
OPTION #2 2N6603 in front end. (5 dB noise figure)	\$400.00

2300 MHz DOWN CONVERTER ONLY

10 dB Noise Figure 23 dB gain in box with N conn. Input F conn. Output	\$149.99
7 dB Noise Figure 23 dB gain in box with N conn. Input F conn. Output	\$169.99
5 dB Noise Figure 23 dB gain in box with SMA conn. Input F conn. Output	\$189.99
DATA IS INCLUDED WITH KITS OR MAY BE PURCHASED SEPARATELY	\$15.00

Shipping and Handling Cost:

Receiver Kits add \$1.50, Power Supply add \$2.00, Antenna add \$5.00, Option 1/2 add \$3.00, For complete system add \$7.50.

Replacement Parts:

MRF901	\$5.00	MBD101	\$2.00
MRF902	\$10.00	.001 chip caps	\$2.00
2N6603	\$12.00	PC Board only	\$25.00 with data

3.7 to 4.2 Gc SATELLITE DOWN CONVERTER

70 MHz i-f (30 MHz @ 3 dB) 10 dB min. IMAGE REJECTION
15 dB max. Noise Figure 15 dB Gain

ASSEMBLED AND TESTED WITH N OR SMA CONNECTOR FOR INPUT AND F CONNECTOR FOR OUTPUT **\$499.99**

I-F AMPLIFIER FOR ABOVE 70 MHz

45 dB Gain — 30 MHz @ 3 dB — ASSEMBLED AND TESTED F CONNECTOR **\$129.99**

DEMOD FOR ABOVE 70 MHz

COMPOSITE VIDEO OUTPUT (NO RF) — ASSEMBLED AND TESTED **\$159.99**

TERMS:

MASTER CHARGE, MASTERCARD, VISA, BANK AMERICARD. WE CHARGE 5% FOR HANDLING

CARD NUMBER _____ EXP. DATE _____

YOUR SIGNATURE _____ PHONE NUMBER _____

PLEASE SEND POSTAL MONEY ORDER, CERTIFIED CHECK, CASHIER'S CHECK OR MONEY ORDER.
PRICES SUBJECT TO CHANGE WITHOUT NOTICE. WE CHARGE 15% FOR RESTOCKING ON ANY ORDER.
ALL CHECKS AND MONEY ORDERS IN US FUNDS ONLY.
ALL ORDERS SENT FIRST CLASS OR UPS.
ALL PARTS PRIME AND GUARANTEED.

WE WILL ACCEPT COD ORDERS FOR \$25.00 OR OVER, ADD \$1.50 FOR COD CHARGE.
PLEASE INCLUDE \$1.50 MINIMUM FOR SHIPPING OR CALL FOR CHARGES.

(602) 242-2037
(602) 242-8916

WE ALSO ARE LOOKING FOR NEW AND USED TUBES,
TEST EQUIPMENT, COMPONENTS ETC.
WE ALSO SWAP OR TRADE.
FOR CATALOG SEE JANUARY, 1980, 73 Magazine, 10
Pages.

2111 W. Camelback
Phoenix, Arizona 85015

FAIRCHILD VHF AND UHF PRESCALER CHIPS

95H90DC	350 MHz Prescaler Divide by 10/11	\$9.50
95H91DC	350 MHz Prescaler Divide by 5/6	9.50
11C90DC	650 MHz Prescaler Divide by 10/11	16.50
11C91DC	650 MHz Prescaler Divide by 5/6	16.50
11C83DC	1 GHz Divide by 248/256 Prescaler	29.90
11C70DC	600 MHz Flip/Flop with reset	12.30
11C58DC	ECL VCM	4.53
11C44DC/MC4044	Phase Frequency Detector	3.82
11C24DC/MC4024	Dual TTL VCM	3.82
11C06DC	UHF Prescaler 750 MHz D Type Flip/Flop	12.30
11C05DC	1 GHz Counter Divide by 4	74.35
11C01FC	High Speed Dual 5-4 input NO/NOR Gate	15.40

WISPER FANS

This fan is super quiet, efficient cooling where low acoustical disturbance is a must. Size 4.68" x 4.68" x 1.50", impedance protected, 50/60 Hz. 120 Vac.

\$9.99

TRW BROADBAND AMPLIFIER MODEL CA615B

Frequency response 40 MHz to 300 MHz
Gain: 300 MHz 16 dB Min., 17.5 dB Max.
50 MHz 0 to -1 dB from 300 MHz

Voltage: 24 volts dc at 220 ma max. \$19.99

CARBIDE — CIRCUIT BOARD DRILL BITS FOR PC BOARDS

Size: 35, 42, 47, 49, 51, 52	\$2.15
Size: 53, 54, 55, 56, 57, 58, 59, 61, 63, 64, 65	1.85
Size: 66	1.90
Size: 1.25 mm, 1.45 mm	2.00
Size: 3.20 mm	3.58

CRYSTAL FILTERS: TYCO 001-19880 same as 2194F

10.7 MHz Narrow Band Crystal Filter
3 dB bandwidth 15 kHz min. 20 dB bandwidth 60 kHz min. 40 dB bandwidth 150 kHz min.

Ultimate 50 dB: insertion loss 1.0 dB max. Ripple 1.0 dB max. Ct. 0 +/- 5 pf 3600 ohms. \$5.95

MURATA CERAMIC FILTERS

Models: SFD-455D 455 kHz	\$3.00
SFB-455D 455 kHz	2.00
CFM-455E 455 kHz	7.95
SFE-10.7 10.7 MHz	5.95

TEST EQUIPMENT — HEWLETT PACKARD — TEKTRONIX — ETC.

Hewlett Packard:		
491C	TWT Amplifier 2 to 4 Gc 1 watt 30 dB gain	\$1150.00
608D	10 to 420 mc .1 uV to .5 V into 50 ohms Signal Generator	500.00
612A	450 to 1230 mc .1 uV to .5 V into 50 ohms Signal Generator	750.00
614A	900 to 2100 mc Signal Generator	500.00
616B	1.8 to 4.2 Gc Signal Generator	400.00
618B	3.8 to 7.2 Gc Signal Generator	400.00
620A	7 to 11 Gc Signal Generator	400.00
623B	Microwave Test Set	900.00
624C	Microwave Test Set	950.00
3200B	10 to 500 mc vhf Oscillator	450.00
8691A	1 to 2 Gc Plug In For 8690A Sweeper	800.00
8692A	2 to 4 Gc Plug In For 8690A Sweeper	800.00
8693A	4 to 8 Gc Plug In For 8690A Sweeper	800.00
8742A	Reflection Test Unit 2 to 12.4 Gc	1800.00
Tektronix:		
190B	350 kHz to 50 mc Oscillator	150.00
Alitech:		
473	225 to 400 mc AM/FM Signal Generator	750.00
Singer:		
MF5/VR-4	Universal Spectrum Analyzer with 1 kHz to 27.5 mc Plug In	1200.00
Keltek:		
XR630-100	TWT Amplifier 8 to 12.4 Gc 100 watts 40 dB gain	9200.00
Polarad:		
2038/2436/1102A	Calibrated Display with an SSB Analysis Module and a 10 to 40 mc Single Tone Synthesizer	1500.00

RF TRANSISTORS

TYPE	PRICE	TYPE	PRICE	TYPE	PRICE
2N1561	\$15.00	2N5590	\$6.00	MM1550	\$10.00
2N1562	15.00	2N5591	10.35	MM1552	50.00
2N1692	15.00	2N5637	20.00	MM1553	56.50
2N1693	15.00	2N5641	4.90	MM1601	5.50
2N2632	45.00	2N5642	8.63	MM1602/2N5842	7.50
2N2857JAN	2.45	2N5643	14.38	MM1607	8.65
2N2876	12.35	2N6545	11.00	MM1661	15.00
2N2880	25.00	2N5764	27.00	MM1669	17.50
2N2927	7.00	2N5842	8.65	MM1943	3.00
2N2947	17.25	2N5849	19.50	MM2605	3.00
2N2948	15.50	2N5862	50.00	MM2608	5.00
2N2949	3.90	2N5913	3.25	MM8006	2.15
2N2950	5.00	2N5922	10.00	MMCM918	1.00
2N3287	4.30	2N5942	46.00	MMT72	.61
2N3294	1.15	2N5944	7.50	MMT74	.94
2N3301	.75	2N5945	10.90	MMT2857	2.68
2N3302	1.05	2N5946	13.20	MRF304	43.45
2N3304	1.48	2N6080	5.45	MRF420	20.00
2N3307	10.50	2N6081	8.60	MRF450	11.85
2N3309	3.90	2N6082	9.90	MRF450A	11.85
2N3375	8.75	2N6083	11.80	MRF454	20.10
2N3553	1.45	2N6084	13.20	MRF458	18.95
2N3755	7.20	2N6094	5.75	MRF475	5.00
2N3818	6.00	2N6095	10.35	MRF476	5.00
2N3866	1.09	2N6096	19.35	MRF502	.49
2N3866JAN	2.70	2N6097	28.00	MRF504	6.95
2N3866JANTX	4.43	2N6136	18.70	MRF509	4.90
2N3924	3.20	2N6166	36.80	MRF511	8.60
2N3925	6.00	2N6265	75.00	MRF901	5.00
2N3927	11.50	2N6266	100.00	MRF5177	20.70
2N3950	26.25	2N6439	43.45	MRF8004	1.44
2N4072	1.70	2N6459/PT9795	18.00	PT4186B	3.00
2N4135	2.00	2N6603	12.00	PT4571A	1.50
2N4261	14.60	2N6604	12.00	PT4612	5.00
2N4427	1.09	A50-12	25.00	PT4628	5.00
2N4429	7.50	BFR90	5.00	PT4640	5.00
2N4430	20.00	BLY568C	25.00	PT8659	10.72
2N4957	3.50	BLY568CF	25.00	PT9784	24.30
2N4958	2.80	CD3495	15.00	PT9790	41.70
2N4959	2.12	HEP76/S3014	4.95	SD1043	5.00
2N4976	19.00	HEPS3002	11.30	SD1116	3.00
2N5090	6.90	HEPS3003	29.88	SD1118	5.00
2N5108	3.90	HEPS3005	9.95	SD1119	3.00
2N5109	1.55	HEPS3006	19.90	TA7993	75.00
2N5160	3.34	HEPS3007	24.95	TA7994	100.00
2N5179	.60	HEPS3010	11.34	TRWMRA2023-1.5	42.50
2N5184	2.00	HEPS5026	2.56	40281	10.90
2N5216	47.50	HP35831E/		40282	11.90
2N5583	4.43	HXTR5104	50.00	40290	2.48
2N5589	4.60	MM1500	32.20		

CHIP CAPACITORS

1pf	27pf	220pf	1200pf
1.5pf	33pf	240pf	1500pf
2.2pf	39pf	270pf	1800pf
2.7pf	47pf	300pf	2200pf
3.3pf	56pf	330pf	2700pf
3.9pf	68pf	360pf	3300pf
4.7pf	82pf	390pf	3900pf
5.6pf	100pf	430pf	4700pf
6.8pf	110pf	470pf	5600pf
8.2pf	120pf	510pf	6800pf
10pf	130pf	560pf	8200pf
12pf	150pf	620pf	.010mf
15pf	160pf	680pf	.012mf
18pf	180pf	820pf	.015mf
22pf	200pf	1000pf	.018mf

We can supply any value chip capacitors you may need.

PRICES

1 to 10	\$1.99
11 - 50	1.49
51 - 100	1.00
101 up	POR

POR = CALL FOR PRICE

ATLAS CRYSTAL FILTERS FOR ATLAS HAM GEAR

- 5.52-2.7/8
- 5.595-2.7/8/U
- 5.595-.500/4/CW
- 5.595-2.7LSB
- 5.595-2.7USB
- 5.645-2.7/8
- 9.0USB/CW

YOUR CHOICE \$24.95

ALARM CLOCK KITS: 4 Digit .5"

Here it is! The first of several quality kits we have been asked for: Here is what you get — unbelievable as it may sound...

- 1 National - 5375AA Clock Chip
- 1 Bowmar Clock Stick Readout (L.E.D.) 4 digit - 1/2"
- 13 Transistors
- 2 Push Buttons for time set
- 2 Toggle Switches for alarm
- 1 Filter cap
- 4 1N4000 series diodes
- 1 1N4148
- 2 Disc caps
- 29 Resistors
- 1 Transducer (Speaker) for Alarm
- 1 LED Lamp for alarm indicator

ORDER
KIT
CK-100AC

NEW!
\$9.99

P.C. Board \$2.25

Plug In
Transformer \$1.50

CASE \$3.50

D.C. MODEL

Same as above except it includes 60 Hz timebase.

This Kit Includes:

- 1 National 5375AA Clock Chip
- 1 Bowmar Clock Stick Readout - (L.E.D.) 4 digit - 1/2"
- 12 Transistors
- 2 Push Buttons for time set
- 2 Disc caps
- 27 Resistors
- 1 MOV
- 1 60 Hz time base

ORDER
KIT
CK-100DC

NEW!
\$12.75

P.C. Board \$2.25

CASE \$3.50

**MICRO MINI
TOGGLE SWITCHES**
6 for \$5 with hardware.



**99¢
EACH**

***** **CABLE TIES** *****
MAKE YOUR PROJECTS "NEAT + TIDY." 4" CABLE TIES AT A FANTASTIC PRICE. GET THIS BARGAIN AND "TIE" IT DONW. \$2.00 for 100 or better yet \$15.00 for 1000

5-14 V.D.C. BETTER BEEPER

Two audio oscillator—a low frequency pulse oscillator—either or both audio frequencies can be shifted (warbled) or pulsed on and off. Constant tone capability. Any combination of pulses and warbles or tones. 1 7/8" DX 1 3/4" ALARMS—TOYS—TESTING—ETC. Complete kit ... \$3.55 or 3 for \$9

RCA SENSITIVE GATE TRIAC

TO-5 CASE. HOUSE #40531

ALSO SAME AS T2300D.

2.5 AMPS 400 PIV

5 FOR \$1.19

Perfect for Dimmers, Color Organs, etc.
PC LEADS



5 VOLT REED RELAY

An absolutely fantastic item. Compare this price with any advertiser. **While They Last.**

\$1.10

Turns on at 10 MA.

Drops out at 5 MA.



**We bought 350,000 LED's.
And you get the savings.**
Reds, greens, yellows, orange, small, medium, large. Bags of 25 - mixed \$2.75. That's only 11¢ each. Compare this bargain up to twice our price.

FACTORY PRIME

BI - Polar LED 59¢ ea. or 10 for \$5

TOSHIBA POWER AUDIO AMP

5.8 WATTS RMS Typical Output. 50 to 30,000 HZ ± 3 DB. For CB's, tape decks, PA's, etc. Works off of a single supply voltage from 10.5 to 18 VDC. 10 Pin plastic DIP with special built in heat sink tab. Perfect for use on 12VDC. **\$3.99 each** With Data.

CLOCK MODULE OPTIONS MA 1008 A and D MA1013

Switches and pot for all options.
Includes:
5 push buttons
1 toggle
1 10K pot \$2.50
Alarm Parts (including high impedance transducer). Much more efficient than a speaker. \$1.50
Transducer only (unbelievably loud) \$1.10

LAB-BENCH VARIABLE POWER SUPPLY KIT \$15.99 KIT

5 to 20 VDC at 1 AMP. Short circuit protected by current limit. Uses IC regulator and 10 AMP Power Darlington. Very good regulation and low ripple. Kit includes PC Board, all parts, large heatsink and shielded transformer. 50 MV. TYP. Regulation.

16K DYNAMIC RAM CHIP WORKS IN TRS-80 OR APPLE II

16K X 1 Bits. 16 Pin Package. Same as Mostek 4116-4. 250 NS access. 410 NS cycle time. Our best price yet for this state of the art RAM. 32K and 64K RAM boards using this chip are readily available. These are new fully guaranteed devices by a major mfg.

VERY LIMITED STOCK!

"MAGAZINE SPECIAL"

8/\$79.50

60 Hz CRYSTAL TIME BASE \$4.95 (Complete Kit)

Uses MM5369 CMOS divider IC with high accuracy 3.579545 MHZ Crystal. Use with all MOS Clock Chips or Modules. Draws only 1.5 MA. All parts, data and PC Board included. 100 Hz, same as above, except \$5.95

SILICON POWER SOLAR CELLS

2 Inch Dia. Approx. .5 VDC at 500 MA. in sunlight. Factory new units, not rejects as sold by others. Series for higher voltage, parallel for higher current. Converts solar energy directly to electricity. **LIMITED QUANTITY. \$5.99 ea**

NATIONAL SEMICONDUCTOR "COLOSSUS JR." JUMBO CLOCK MODULE

**MA1013
BRAND NEW!**

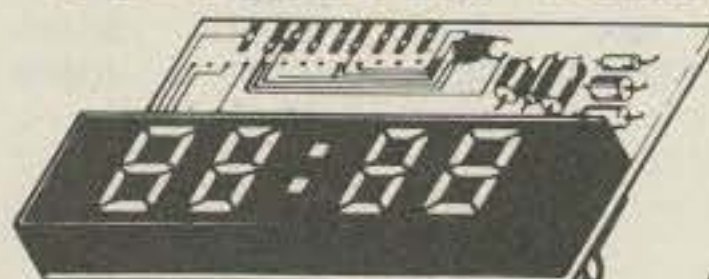

\$8.50

2 FOR \$15

(AC XFMR \$1.95)

ASSEMBLED! NOT A KIT!

MANUFACTURER'S CLOSEOUT!

PERFECT FOR USE WITH A TIMEBASE.

- * Bright 4 digit 0.7" LED Display
- * Complete-Add only Transformer and Switches.
- * 24 Hour Alarm Signal Output
- * 12 Hour Real Time Format
- * 50 or 60 Hz Operation
- * Power Failure Indication
- * LED Brightness Control
- * Sleep and Snooze Timers
- * Alarm "on" and PM Indicators
- * Direct Drive - No RFI
- * Direct Replacement for MA1012
- * Comes with Full Data

SONY 23 WATT AUDIO AMP MODULE

#STK-054. 23 WATTS SUPER CLEAN AUDIO. 20 HZ to 100 KHZ ± 2 DB. HYBRID, SILICON, SELF-CONTAINED MODULE. ONLY 1 3/4 x 2 1/2 IN. WITH DATA.

COMPARE AT UP TO TWICE OUR PRICE! **\$6.50 each**

FAIRCHILD PNP

"SUPER TRANSISTOR"
2N4402. TO-92 Plastic. Silicon PNP Driver. High Current. VCEO-40 HFE-50 to 150 at 150 MA. FT-150 MHZ. A super "BEEFED-UP" Version of the 2N3906.

8 FOR \$1.19

SOUND ACTIVATED SWITCH

Not a kit. Already assembled Clap your hands and turn on lights, music boxes, coffee pots, etc. Full spec. sheet with each unit.

69¢

10 for \$5.50

Digital Research: Parts

(OF TEXAS)

P.O. BOX 401247 • GARLAND, TEXAS 75040 • (214) 271-2461

TERMS: Add 50¢ postage, we pay balance. Orders under \$15 add 75¢ handling. No C.O.D. We accept Visa, MasterCard and American Express cards, Tex. Res. add 5% Tax. Foreign orders (except Canada) add 20% P&H. 90 Day Money Back Guarantee on all items.

GET ON PHASE THREE FOR MUCH LESS THAN YOU THINK!

These Low Cost SSB TRANSMITTING CONVERTERS

Let you use inexpensive recycled 10M or 2M SSB exciters on UHF & VHF!

- Linear Converters for SSB, CW, FM, etc.
- A fraction of the price of other units; no need to spend \$300 - \$400!
- Use with any exciter; works with input levels as low as 1 mW.
- Use low power tap on exciter or simple resistor attenuator pad (instructions included).
- Link osc with RX converter for transceive.

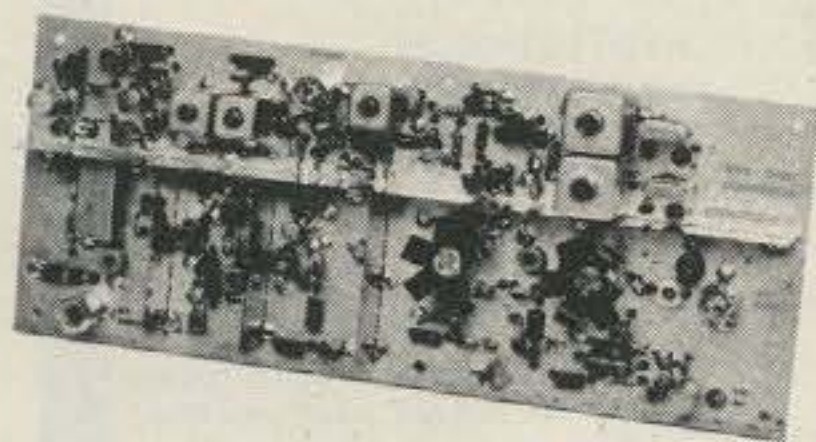

HAMTRONICS DOES IT AGAIN!

NEW XV4 UHF KIT - ONLY \$99.95

28-30 MHz in, 435-437 MHz out; 1W p.e.p. on ssb, up to 1½W on CW or FM. Has second oscillator for other ranges. Atten. supplied for 1 to 500 mW input, use external attenuator for higher levels.

Extra crystal for 432-434 MHz range \$5.95
XV4 Wired and tested \$149.95

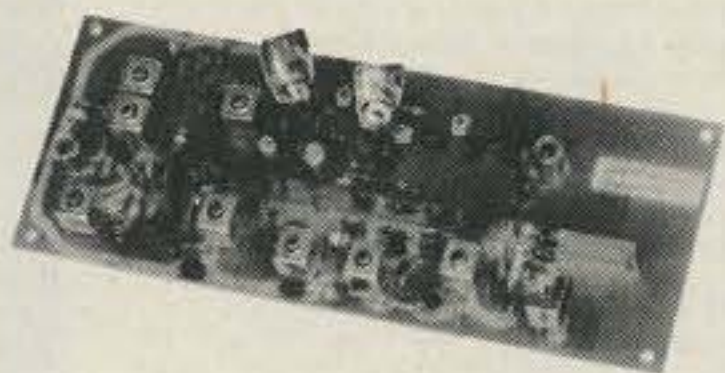

XV2 VHF KIT - ONLY \$69.95

2W p.e.p. output with as little as 1mW input. Use simple external attenuator. Many freq. ranges available.

MODEL	INPUT (MHz)	OUTPUT (MHz)
XV2-1	28-30	50-52
XV2-2	28-30	220-222
XV2-4	28-30	144-146
XV2-5	28-29 (27-27.4 CB)	145-146 (144-144.4)
XV2-7	144-146	50-52
XV2 Wired and tested \$109.95		

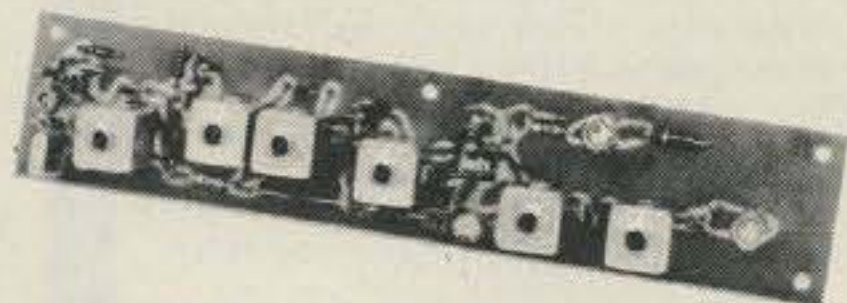

XV28 2M ADAPTER KIT - \$24.95

Converts any 2M exciter to provide the 10M signal required to drive above 220 or 435 MHz units.

Easy to Build FET RECEIVING CONVERTERS

Let you receive OSCAR and other exciting VHF and UHF signals on your present HF or 2M receiver

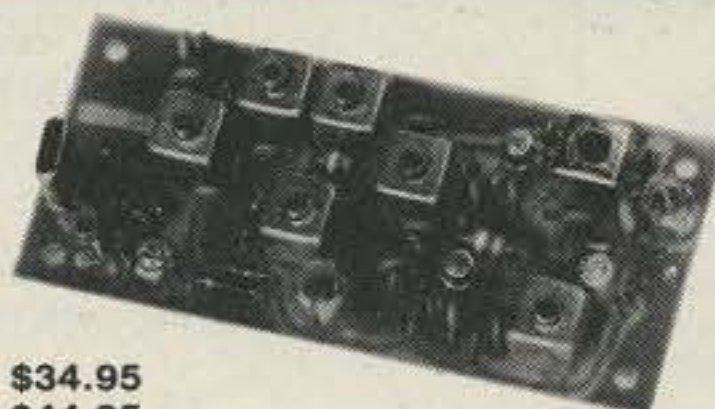

VHF KIT \$34.95
VHF Wired \$44.95

MODEL	RF RANGE	OUTPUT RANGE
CA28	28-32 MHz	144-148 MHz
CA50	50-52	28-30
CA50-2	50-54	144-148
CA144	144-146	28-30
CA145	145-147	28-30
or	144-144.4	27-27.4 (CB)
CA146	146-148	28-30
CA220	220-222	28-30
CA220-2	220-224	144-148
CA110	Any 2MHz of Aircraft Band	26-28 or 28-30
Kit less xtal \$29.95		

UHF KIT \$34.95
UHF Wired \$44.95



MODEL	RF RANGE	OUTPUT RANGE
C432-2	432-434	28-30
C432-5	435-437	28-30
C432-4	432-436	144-148
Kit less xtal \$29.95		

Professional Quality VHF/UHF FM/CW EXCITERS

- Fully shielded designs
- Double tuned circuits for spurious suppression
- Easy to align with built-in test aids

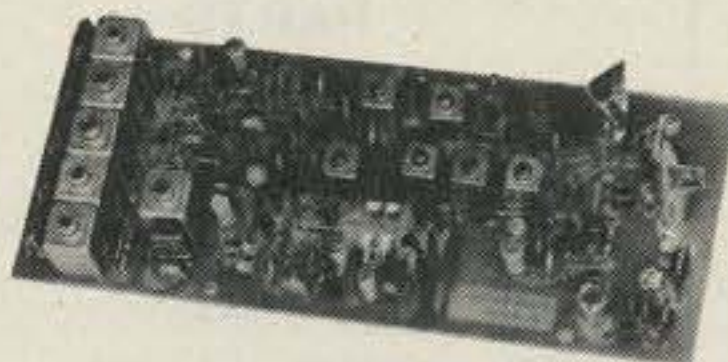

T50-50	6-chan, 6M, 2W Kit.....	\$44.95
T50-150	6-chan, 2M, 2W Kit.....	\$44.95
T50-220	6-chan, 220 MHz, 2W Kit.....	\$44.95
T450	1-chan, 450 MHz, ¼W Kit.....	\$44.95

See our Complete Line of VHF & UHF Linear PA's

- Use as linear or class C PA
- For use with SSB Xmtg Converters, FM Exciters, etc.

LPA2-15	6M, 2M, 220; 15 to 20W.....	\$59.95
LPA2-30	6M, 2m; 25 to 30W.....	\$89.95
LPA2-40	220 MHz; 30 to 40W.....	\$119.95
LPA2-45	6M, 2M; 40 to 45W.....	\$119.95
LPA4-10	430MHz; 10 to 14W.....	\$79.95
LPA4-30	430MHz; 25 to 30W.....	\$119.95

See catalog for complete specifications

FAMOUS HAMTRONICS PREAMPS

Let you hear the weak ones too!
Great for OSCAR, SSB, FM, ATV. Over 14,000 in use throughout the world on all types of receivers.

P9 Kit \$12.95
P14 Wired \$21.95
Specify band when ordering



- Deluxe vhf model for applications where space permits ● 1½" x 3" ● Models available to cover any 4MHz band in the 26 to 230 MHz range ● 12 Vdc ● 2 stages ● Ideal for OSCAR ● 20 dB gain

P8 Kit \$10.95
Specify band when ordering



- Miniature vhf model for tight spaces—size only ½ x 2 ¾ ● Models available to cover any 4MHz band in the range 20 to 230 MHz ● 20 dB gain ● 12 Vdc

P15 Kit \$18.95
P35 Wired \$27.95



- Covers any 10 MHz band in UHF range of 380 to 520 MHz ● 20 dB gain ● 2 stages ● 12 Vdc

NEW VHF/UHF FM RCVRs

Offer Unprecedented Range of Selectivity Options

- New generation
- More sensitive
- More selective
- Low cross mod
- Uses crystal filters
- Smaller
- Easy to align



R75A* VHF Kit for monitor or weather satellite service. Uses wide L-C filter. -60dB at ± 30 kHz. \$69.95

R75B* VHF Kit for normal nbfm service. Equivalent to most transceivers. -60dB at ± 17 kHz, -80dB at ± 25 kHz. ... \$74.95

R75C* VHF Kit for repeater service or high rf density area. -60dB at ± 14kHz, -80dB ± 22kHz, -100dB ± 30kHz. \$84.95

R75D* VHF Kit for split channel operation or repeater in high density area. Uses 8-pole crystal filter. -60dB at ± 9 kHz, -100dB at ± 15 kHz. The ultimate receiver! ... \$99.95

* Specify band: 10M, 6M, 2M, or 220 MHz. May also be used for adjacent commercial bands. Use 2M version for 137 MHz WX satellites.

R85() UHF FM Receiver Kits, triple conversion, include C432 UHF Front End Module. Add \$20 to above prices. (Add selectivity letter to model number.)

A13-45A 6 Channel Adapter for receivers \$13.95
WX-25 Weather Tone Alert \$24.95

NEW R110 VHF AM RCVR

AM monitor receiver kit similar to R75A, but AM. Available for 10-11M, 6M, 2M, 220 MHz, and 110-130 MHz aircraft band. \$74.95

IT'S EASY TO ORDER!

- Write or phone 716-392-9430 (Electronic answering service evenings & weekends)
- Use Credit Card, UPS COD, Check, Money Order
- Add \$2.00 shipping & handling per order

Call or Write to get FREE CATALOG With Complete Details

(Send 4 IRC's for overseas mailing)

hamtronics, inc.

65 E MOUL RD · HILTON, NY 14468

BULLET ELECTRONICS

P.O. Box 401244-E

Garland, TX. 75040

(214) 278-3553

SUPER SUMMER SPECIALS!



SLIDE SWITCH ASSORTMENT

An outstanding bargain. Includes miniature and standard sizes and multiposition units. All new first quality, name brand switches. Try one pack and you'll reorder more: **SPECIAL — 12 for \$1.20** (Assortment)



1/2W RESISTOR ASSORTMENT

A good mix of 5% and 10% values in both full lead and PC lead devices. All new, first quality.



(Asst.) 200 pieces/ 2.00

XAN SUPER DIGITS

.6" JUMBO LED
7 SEGMENT
RED

.99

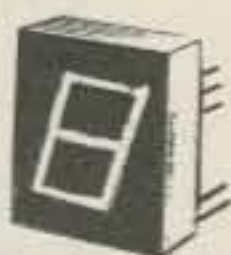

6920 COMMON ANODE
6640 COMMON CATHODE

NOW A SUPER READOUT AT A SUPER BUY! These are factory fresh prime LED readouts, not seconds or rejects as sold by others. Compare our price and send for yours today, but hurry, the supply is limited!

SPECIFY: COMMON ANODE OR COMMON CATHODE

*2N5191
NPN

**SILICON
POWER
TRANSISTOR**

V_{ceo} = 60V
I_C = 4A
H_{fe} 25-100
@ 1.5A
*HSE #



3/\$1.00
100/\$25.00

PN2222 (2N2222A)

**MOST POPULAR NPN
GEN. PURPOSE
TRANSISTOR.**

TO - 90 V_{ceo} = 40V
P_d = .5W
H_{fe} = 100 - 300

10/\$1.00 100/\$9.00

THE PERFECT TRANSFORMER



117VAC primary. 12VAC secondary @ 200ma
Great for all you CMOS, or low power TTL projects. PC board mount.

99¢ ea. 3/\$2.50

Size: 1.5" W x 1.25" D x 1.25" H

AY3-8910 PROGRAMMABLE SOUND GENERATOR

The AY3-8910 is a 40 pin LSI chip with three oscillators, three amplitude controls, programmable noise generator, three mixers, an envelope generator, and three D/A converters that are controlled by 8 BIT WORDS. No external pots or caps required. This chip hooked to an 8 bit microprocessor chip or Buss (8080, Z80, 6800 etc.) can be software controlled to produce almost any sound. It will play three note chords, make bangs, whistles, sirens, gunshots, explosions, bleets, whines, or grunts. In addition, it has provisions to control its own memory chips with two IO ports. The chip requires +5V @ 75ma and a standard TTL clock oscillator. A truly incredible circuit.

\$14.95 W/Basic Spec Sheet (4 pages)

60 page manual with S-100 interface instructions and several programming examples, \$3.00 extra

OVP-2 OVERVOLTAGE PROTECTOR 6.95

Provides cheap insurance for your expensive equipment. Trip voltage is adjustable from 3 to 30 volts. Overvoltage instantly fires a 25A SCR and shorts the output to protect equipment. Should be used on units that are fused. Directly compatible with the PS-12 and PS-14. All electronics supplied. Drilled and plated PC board.

ULTRASONIC RELAY KIT

Invisible Beam Works Like A Photo Electric Eye. **COMPLETE KIT**. All Parts & PC Board. Use Up To 25 Ft. Apart.

\$21.50

Optional entry delay and Alarm Timeout Circuit will source or sink up to 200 MA DC.

\$3.95

AUTO/VAN CLOCK KIT

- 12 Hr. Format
- 6 Digit 1/2" LED Readouts
- Quartz XTAL Timebase
- Alarm & Snooze Options
- Noise Filtering
- Easy Assembly • 12 VDC
- 4 5/8" x 3" x 1 1/2"
- All Parts!

\$16.95

ZULU II CLOCK KIT

WITH CALENDAR
AND NOX™ CIRCUIT

X-RATED!

X-TRA VALUE: All the components and high quality plated G-10 PC Boards are provided.

X-TRA CARE IN DESIGN: Easy Assembly! Large open layout.

X-CELLENCE IN IDEAS: 5 years of designed products for the amateur radio market.

X-CELLENCE IN INSTRUCTIONS: Clear step-by-step instructions with quality illustrations and schematic.

X-TRA FEATURES: There has never been a clock kit with so many features — at any price!

- Unit operates on either 12 VAC or 12 VDC.
- On board QUARTZ XTAL TIMEBASE or 60Hz AC line freq. can be used.
- Automatic BATTERY BACKUP*
- Reads true 24 HOUR TIME and 31 DAY CALENDAR.
- Unique NOX™ CIRCUIT activates readouts with a handclap followed by the date for 4 seconds. Or they can be turned on constantly.
- When used mobile readouts blank when ignition is off.
- Special NOISE SUPPRESSION and battery reversal circuits.
- Bright 1/2" LED's show hours, minute and seconds.

19.95

LESS CASE

ACCESSORIES

Custom High Impact Molded Case with Ruby Lens. Available in Blue or Tan.

\$6.50

117 VAC to 12 VAC Transformer.

\$1.35

*9V Battery Not Included

Sound Effects Kit

The SE-01 Sound Effects Kit is a complete kit, all you need to build a programmable sound effects machine except a battery and speaker. Our kit is designed to really ring out the TI 76477 Sound Chip. Only the SE-01 provides you with additional circuitry that includes a PULSE GENERATOR, MUX OSCILLATOR and COMPARATOR to make more complex sounds a snap. We help you in building the kit with a clear, easy-to-follow construction manual and we show you how to easily program the unit. Other dealers will sell you the chip or a "kit" of parts but you are on your own to do the most difficult part...make neat sounds! Within a short time after you build the SE-01 you can easily create Gunshots, Explosions, Space Sounds, Steam Trains and much more. We think the Bullet SE-01 is the best deal on the market but don't ask us, — ask the 15,000 happy SE-01 owners!

Complete Kit With Quality Plated PC Board \$17.50

(Less battery & speaker)

Users Group Notes: Includes additional programming charts plus quarterly updates \$5.00

7 WATT AUDIO AMP KIT

SMALL SINGLE HYBRID IC AND COMPONENTS FIT ON A 2" x 3" PC BOARD (INCLUDED). RUNS ON 12VDC. GREAT FOR ANY PROJECT THAT NEEDS AN INEXPENSIVE AMP. LESS THAN 3% THD @ 5 WATTS. COMPATIBLE WITH SE-01 SOUND KIT. \$5.95

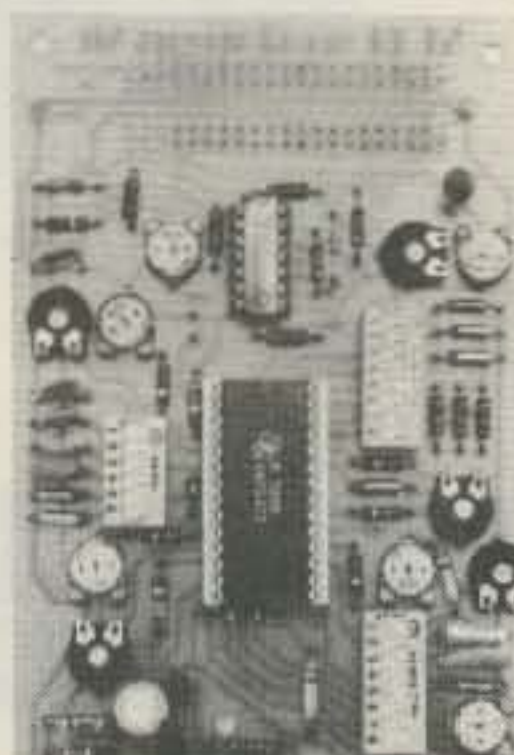

PARTS

LM3046	(CA3046) Xistor Array	.75
RCA 40430	400V 6A TRIAC TO-66	.75
CA3086	RCA Xistor Array	.80
LM567	Tone Decoder	.99
CD4046	PLL CMOS	.99
LM3302	Quad Comparator	.89
2SC 1849	High Freq. NPN TO-92	6/1.00
MPS A 20	NPN General Purpose	6/1.00
TL490	Bar/Graph Driver w/specs	2.50
7812	12V 1A Regulator	.99
7805	5V 1A Regulator	.99
78M05	5V 1/2A Reg. TO-5 (Hse #)	.60
LM3911	Temp. Transducer w/specs	1.10
555	Timer IC	.49
2N6028	P.U.T. w/specs	.50
IL-1	Opto Isolator w/specs	.60
LM380	2W Audio IC w/specs	.50
LM377	Dual LM380 w/specs	1.09
TIP-30	PNP Power TO-220	3/1.00

NEW! MUSIC FOR YOUR EARS

Bullet's Electronic Music Machine™ Kit has a single 28 Pin Microprocessor Chip with ROM that has been programmed to play the first 6 to 10 notes of the 25 popular tunes listed below. Each tune can easily be addressed individually or played sequentially at the push of a button. The 3 chime sequences are activated at any time by separate switch closures so when used as a doorbell, one door can play songs while two others will play different chimes. The unit has a 5 watt audio Amp and will run on either 12VAC or 12VDC. Optional 117VAC transformer is available. Construction is very simple, works with any 8 or 16 ohm speaker, or horn speaker. (Not included.) Tunes can be remotely programmed using a single rotary switch, (not included), if desired.

Complete Kit \$16.95 Transformer \$1.35
For Operation on 117VAC

Tunes: Toreador * William Tell * Hallelujah Chorus * Star Spangled Banner * Yankee Doodle * America, America * Deutschland Leid * Wedding March * Beethoven's 5th and 9th * Hell's Bells * La Vien En Rose * Star Wars Theme * Clementine * Augustine * Jingle Bells * God Save The Queen * Colonel Bogey * Marseillaise * O Sole Mio * Santa Lucia * The End * Blue Danube * Brahms Lullaby * Westminster Chime * Simple Chime * Descending Octave Chime.

★ CALL OR WRITE TODAY FOR FREE CATALOG ★

- * NO C.O.D.
- * SEND CHECK, M.O., OR CREDIT CARD #
- * PHONE ORDERS ACCEPTED ON VISA/MASTER CHARGE ONLY (214) 278-3553

P
O
L
I
C
I
E
S

- * ADD 5% FOR SHIPPING
- * ORDERS UNDER \$10 ADD .75 HANDLING
- * TEX. RES. ADD 5% TAX
- * FOREIGN ORDERS (EXCEPT CANADA ADD 10% (20% FOR AIRMAIL).

RADIO BOOKSHOP

LICENSE STUDY GUIDES & TAPES

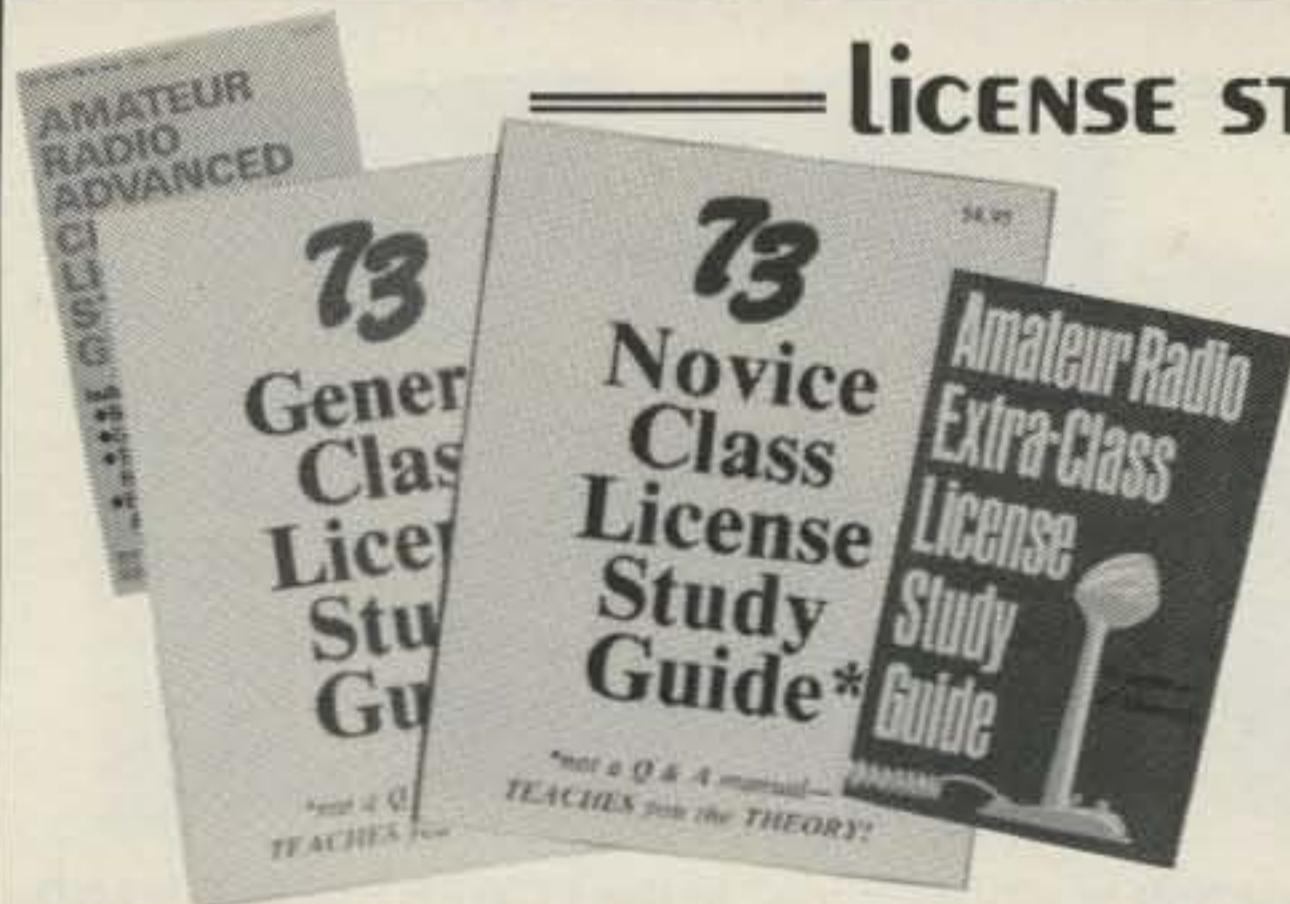

● **NOVICE STUDY GUIDE—SG7357**—Here is a completely new study guide and reference book for the potential ham. This is not a question/answer memorization course. Electronic and radio fundamentals are presented and explained in an easy-to-understand fashion, preparing the beginner for the Novice exam. Includes the latest FCC amateur regulations, as well as application forms. Easily the best path into the exciting world of ham radio! \$4.95.*

● **GENERAL CLASS STUDY GUIDE—SG7358**—A complete theory course for the prospective General or Technician. This reference explains transistor, amplifier, and general radio theory, while preparing the Novice for the "big" ticket. After getting your ticket, you'll use this guide again and again as an electronics reference source. Not a question/answer guide that becomes dated when the FCC updates the amateur exams. \$5.95.*

● **ADVANCED CLASS LICENSE STUDY GUIDE—SG1081**—Ready to upgrade your license? To prevent retaking the FCC theory exam, you need the 73 Advanced theory guide. SSB, antenna theory, transmitters, and electronics measuring techniques are covered in detail in this easy-to-follow study guide. Special modes and techniques, such as RTTY, are also treated. An engineering degree is *not* necessary to master the Advanced theory—try this book before visiting the examiner's office! \$6.95.* (Published by TAB Books previous to recent changes in FCC exam material.)

● **EXTRA CLASS LICENSE STUDY GUIDE—SG1080**—Before going for your 1 x 2 call, it pays to be a master of the Extra class electronics theory. This study guide is the logical extension of the 73 theory course. All the theory necessary to pass the exam is presented. Antennas, transmission lines, swr are discussed, as well as noise, propagation, and specialized communication techniques. This book is not a classroom lecture or memorization guide, but rather a logical presentation of the material that must be *understood* before attempting the Extra exam. Save yourself a return trip to the FCC and try the 73 method first! \$5.95.*

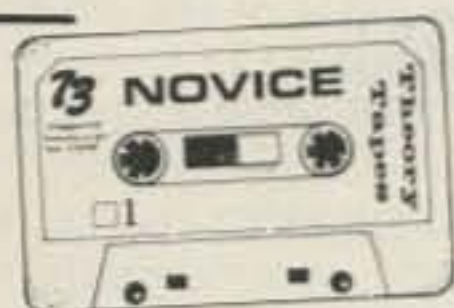

NOVICE THEORY TAPES Startling Learning Breakthrough



● **NOVICE THEORY TAPES—CT7300**—Startling Learning Breakthrough. You'll be astounded at how really simple the theory is when you hear it explained on these tapes. Three tapes of theory and one of questions and answers from the latest Novice exams give you the edge you need to breeze through your exam. 73 is interested in helping get more amateurs, so we're giving you the complete set of our tapes for the incredibly low price of **ONLY \$15.95.***

Scientists have proven that you learn faster by listening than by reading because you can play a cassette tape over and over in your spare time—even while you're driving! You get more and more info each time you hear it. You can't progress without solid fundamentals. These four hour-long tapes give you all the basics you'll need to pass the Novice exam easily. You'll have an understanding of the basics which will be invaluable to you for the rest of your life! Can you afford to take your Novice exam without first listening to these tapes? Set of 4—\$15.95.*

These tapes were made previous to recent changes in FCC rules. These minor changes do not affect the *theory* involved. A new set of tapes reflecting these rule changes is being developed. Expected availability is June 1980.

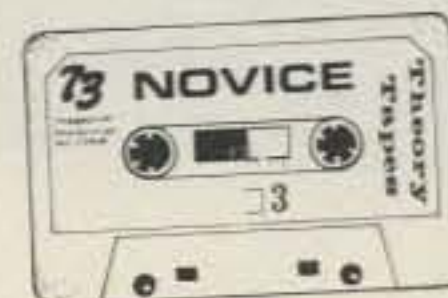

SSTV

● **SLOW SCAN TELEVISION TAPE—CT7350**—Prize-winning programs from the 73 SSTV contest. Excellent for Demo! \$5.95.*



73 CODE TAPES

"GENESIS"

5 WPM—CT7305—This is the beginning tape for people who do not know the code at all. It takes them through the 26 letters, 10 numbers and necessary punctuation, complete with practice every step of the way using the newest blitz teaching techniques. It is almost miraculous! In one hour many people—including kids of ten—are able to master the code. The ease of learning gives confidence to beginners who might otherwise drop out.

"THE STICKLER"

6+ WPM—CT7306—This is the practice tape for the Novice and Technician licenses. It is made up of one solid hour of code, sent at the official FCC standard (no other tape we've heard uses these standards, so many people flunk the code when they are suddenly—under pressure—faced with characters sent at 13 wpm and spaced for 5 wpm). This tape is not memorizable, unlike the zany 5 wpm tape, since the code groups are entirely random characters sent in groups of five.

Any Four Tapes For \$15.95! *
\$4.95 Each! *

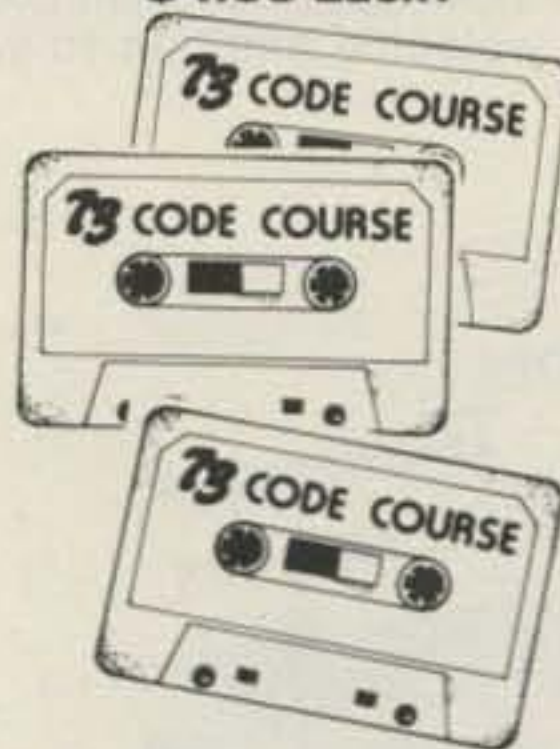

"BACK BREAKER"

13+ WPM—CT7313—Code groups again, at a brisk 13 per so you will be at ease when you sit down in front of the steely-eyed government inspector and he starts sending you plain language at only 13 per. You need this extra margin to overcome the panic which is universal in the test situations. When you've spent your money and time to take the test, you'll thank heavens you had this back-breaking tape.

"COURAGEOUS"

20+ WPM—CT7320—Code is what gets you when you go for the Extra class license. It is so embarrassing to panic out just because you didn't prepare yourself with this tape. Though this is only one word faster, the code groups are so difficult that you'll almost fall asleep copying the FCC stuff by comparison. Users report that they can't believe how easy 20 per really is with this fantastic one hour tape.

"OUTRAGEOUS"

25+ WPM—CT7325—This is the tape for that small group of overachieving hams who wouldn't be content to simply satisfy the code requirements of the Extra Class license. It's the toughest tape we've got and we keep a permanent file of hams who have mastered it. Let us know when you're up to speed and we'll inscribe your name in 73's CW "Hall of Fame."



* Use the order card in the back of this magazine or itemize your order on a separate piece of paper and mail to: 73 Radio Bookshop • Peterborough NH 03458. Be sure to include check or detailed credit card information. * Add \$1.00 handling charge. Note: Prices subject to change on books not published by 73 Magazine. Questions regarding your order? Please write to Customer Service at the above address. Please allow 4-6 weeks for delivery.

FOR TOLL FREE ORDERING CALL 1-800-258-5473

RADIO BOOKSHOP

73 TECHNICAL LIBRARY

● **BEHIND THE DIAL**—BK7307—By Bob Grove. Get more fun out of shortwave listening with this interesting guide to receivers, antennas, frequencies and interference. \$4.95.*

● **THE CHALLENGE OF 160**—BK7309—is the newest book in the 73 technical library, dedicated to 160 meter operating. Si Dunn provides all necessary information to get started on this unique band. The all-important antenna and ground systems are described in detail. The introduction contains interesting photos of Stew Perry's (the King of 160) shack. This reference is a must for new and experienced "Top Band" operators. Price: \$4.95.*

● **IC OP-AMP COOKBOOK**—BK1028—by Walter G. Jung. Covers not only the basic theory of the IC op amp in great detail, but also includes over 250 practical circuit applications, liberally illustrated. 592 pages, 5½ × 8½, softbound. \$12.95.*

● **THE POWER SUPPLY HANDBOOK**—BK7305—Need a power supply for a gadget you're building? In the **POWER SUPPLY HANDBOOK** there are dozens ready-to-build, plus detailed steps for designing your own. There are circuits and parts lists for all kinds of supplies, ranging from simple DC types to highly stable regulated versions. If you need a circuit to convert a DC voltage to a higher or lower voltage, turn DC into AC, or AC to DC—then this is the book you need. With more than 400 pages, you should be able to find just the circuit you need. Without a doubt one of the best power supply source books available, compiled by the editors of 73. \$7.95.*



● **INTRODUCTION TO RTTY**—BK7380—A beginner's guide to radioteletype including teletypewriter fundamentals, signals, distortion and RTTY art. You can be a RTTY artist! A 73 publication. \$2.00.*

● **THE NEW RTTY HANDBOOK**—BK7347—is a new edition and the only up-to-date RTTY book available. The state of the art has been changing radically and has made all previous RTTY books obsolete. It has the latest circuits, great for the newcomer and expert alike. \$5.95.*

● **PROPAGATION WIZARD'S HANDBOOK**—BK7302—by J. H. Nelson. When sunspots riddled the worldwide communications networks of the 1940's, John Henry Nelson looked to the planets for an answer. The result was a theory of propagation forecasting based upon interplanetary alignment that made the author the most reliable forecaster in America today. The book provides an enlightened look at communications past, present, and future, as well as teaching the art of propagation forecasting. \$6.95.*

● **SSB... THE MISUNDERSTOOD MODE**—BK7351—by James B. Wilson. Single Sideband Transmission... thousands of us use it every day, yet it remains one of the least understood facets of amateur radio. J. B. Wilson presents several methods of sideband generation, amply illustrated with charts and schematics, which will enable the ambitious reader to construct his own sideband generator. A must for the technically-serious ham. \$5.50.*

● **MASTER HANDBOOK OF HAM RADIO CIRCUITS**—BK1033—This is an encyclopedia of amateur radio circuits, gleaned from past issues of 73 Magazine and carefully selected according to application. You'll find many you've never seen before, some new twists on the tried and true, and several that have been long forgotten but are well worth remembering. Where your interest ranges from ragchewing to EME, from CW to slow-scan TV, from DX to county nets, this handbook will be a welcome addition to your shack. \$8.95.*



● **WEATHER SATELLITE HANDBOOK**—BK7370—Simple equipment and methods for getting good pictures from the weather satellite. Antennas, receivers, monitors, facsimile you can build, tracking, automatic control (you don't even have to be home). Dr. Taggart WB8DQT. \$4.95.*

● **TOOLS & TECHNIQUES FOR ELECTRONICS**—BK7348—is an easy-to-understand book written for the beginning kit builder as well as the experienced hobbyist. It has numerous pictures and descriptions of the safe and correct ways to use basic and specialized tools for electronic projects as well as specialized metal working tools and the chemical aids which are used in repair shops. \$4.95.*

● **THE CONTEST COOKBOOK**—BK7308—reveals the secrets of the contest winners (Domestic, DX and specialty contests), complete with photos and diagrams of equipment used by the top scorers. Find out how to make 150 contacts in one hour. \$5.95.*



* Use the order card in the back of this magazine or itemize your order on a separate piece of paper and mail to: 73 Radio Bookshop • Peterborough NH 03458. Be sure to include check or detailed credit card information. *Add \$1.00 handling charge. Note: Prices subject to change on books not published by 73 Magazine. Questions regarding your order? Please write to Customer Service at the above address. Please allow 4-6 weeks for delivery.

FOR TOLL FREE ORDERING CALL 1-800-258-5473

RADIO BOOKSHOP

TEST EQUIPMENT

● **RF AND DIGITAL TEST EQUIPMENT YOU CAN BUILD**—BK1044—Rf burst, function, square wave generators, variable length pulse generators—100 kHz marker, i-f and rf sweep generators, audio osc, af/rf signal injector, 146 MHz synthesizer, digital readouts for counters, several counters, prescaler, microwave meter, etc. 252 pages. \$5.95.*

● **VOL. I COMPONENT TESTERS**—LB7359—... how to build transistor testers (8), diode testers (3), IC testers (3), voltmeters and VTVMs (9), ohmmeters (8 different kinds), inductance (3), capacity (9), Q measurement, crystal checking (6), temperature (2), aural meters for the blind (3) and all sorts of miscellaneous data on meters... using them, making them more versatile, making standards. Invaluable book. \$4.95.*

● **VOL. II AUDIO FREQUENCY TESTERS**—LB7360—... jam packed with all kinds of audio frequency test equipment. If you're into SSB, RTTY, SSTV, etc., this book is a must for you... a good book for hi-fi addicts and experimenters, too! \$4.95.*

● **VOL. III RADIO FREQUENCY TESTERS**—LB7361—Radio frequency waves, the common denominator of Amateur Radio. Such items as SWR, antenna impedance, line impedance, rf output and field strength; detailed instructions on testing these items includes sections on signal generators, crystal calibrators, grid dip oscillators, noise generators, dummy loads and much more. \$4.95.*

● **VOL. IV IC TEST EQUIPMENT**—LB7362—Become a troubleshooting wizard! In this fourth volume of the 73 TEST EQUIPMENT LIBRARY are 42 home construction projects for building test equipment to work with your ham station and in servicing digital equipment. Plus a cumulative index for all four volumes of the 73 TEST EQUIPMENT LIBRARY. \$4.95.*



THE WELL-EQUIPPED HAM SHACK

NEW!



● **THE MAGIC OF HAM RADIO**—BK7312—by Jerrold Swank, W8HXR begins with a brief history of amateur radio and of Jerry's involvement in it. Part 2 details many of ham radio's heroic moments. Hamdom's close ties with the continent of Antarctica are the subject of Part 3. In Part 4 the strange and humorous sides of ham life get their due. And what of the future? Part 5 peers into the crystal ball. \$4.95.*

● **A GUIDE TO HAM RADIO**—BK7321—by Larry Kahaner WB2NEL. What's Amateur Radio all about? You can learn the basics of this fascinating hobby with this excellent beginner's guide. It answers the most frequently asked questions in an easy-going manner, and it shows the best way to go about getting an FCC license. A Guide to Ham Radio is an ideal introduction to a hobby enjoyed by people around the world. \$4.95.*

● **HOW TO BUILD A MICROCOMPUTER—AND REALLY UNDERSTAND IT**—BK7325—by Sam Creason. The electronics hobbyist who wants to build his own microcomputer system now has a practical "How-To" guidebook. This book is a combination technical manual and programming guide that takes the hobbyist step-by-step through the design, construction, testing and debugging of a complete microcomputer system. Must reading for anyone desiring a true understanding of small computer systems. \$9.95.*



● **LIBRARY SHELF BOXES**—These sturdy white, corrugated, dirt-resistant boxes each hold a full year of 73, *Kilobaud Microcomputing* or *80 Microcomputing*. With your order, request self-sticking labels for any of the following: 73, *Kilobaud Microcomputing*, *80 Microcomputing*, *CQ*, *QST*, *Ham Radio*, *Personal Computing*, *Radio Electronics*, *Interface Age*, and *Byte*. Order 1—BX1000—for \$2.00*; order 2-7—BX2002—for \$1.50 each*; order 8 or more—BX1002—for \$1.25 each*.



Style Y



Style W

● **QSL CARDS**—73 turns out a fantastic series of QSL cards at about half the cost of having them done elsewhere because they are run as a fill-in between printing books and other items in the 73 Print Shop. 250 Style W—QW0250—for \$8.95*; 500 Style W—QW0500—for \$13.95*; 250 Style X—QX0250—for \$8.95*; 500 Style X—QX0500—for \$13.95*; 250 Style Y—QY0250—for \$8.95*; 500 Style Y—QY0500—for \$13.95.* Allow 6-12 wks. for delivery.



Style X

● **OWNER REPAIR OF RADIO EQUIPMENT**—BK7310—Frank Glass K6RQ shares over 40 years of operating, servicing, and design experience in this book which ranges from the elementary to the highly technical written for the top engineers in the field. It is written in narrative style on the subjects of electronic servicing, how components work, and how they are combined to provide communication equipment. This book will help you understand the concepts required to service your own station equipment. \$7.95.*

● **BACK ISSUES**—Complete your collection; many are prime collectables now, classics in the field! A full collection is an invaluable compendium of radio and electronics knowledge!

Single back issue—ST0000—\$3.00*;

25 our choice—ST2500—\$12.00*;

25 your choice—ST2501—\$25.00*;

5 your choice—ST0500—\$8.75*;

10 your choice—ST1000—\$14.00.*

● **FREE BACK ISSUE CATALOGS** are yours for the asking... specify 73 Magazine and/or *Kilobaud Microcomputing* back issue catalog when you send your name and address to us on a postcard.

* Use the order card in the back of this magazine or itemize your order on a separate piece of paper and mail to: 73 Radio Bookshop • Peterborough NH 03458. Be sure to include check or detailed credit card information. *Add \$1.00 handling charge. Note: Prices subject to change on books not published by 73 Magazine.

Questions regarding your order? Please write to Customer Service at the above address. Please allow 4-6 weeks for delivery.

FOR TOLL FREE ORDERING CALL 1-800-258-5473

Radio Bookshop

● **73 DIPOLE AND LONG-WIRE ANTENNAS**—BK1016—by Edward M. Noll W3FQJ. This is the first collection of virtually every type of wire antenna used by amateurs. Includes dimensions, configurations, and detailed construction data for 73 different antenna types. Appendices describe the construction of noise bridges, line tuners, and data on measuring resonant frequency, velocity factor, and swr. \$5.50.*

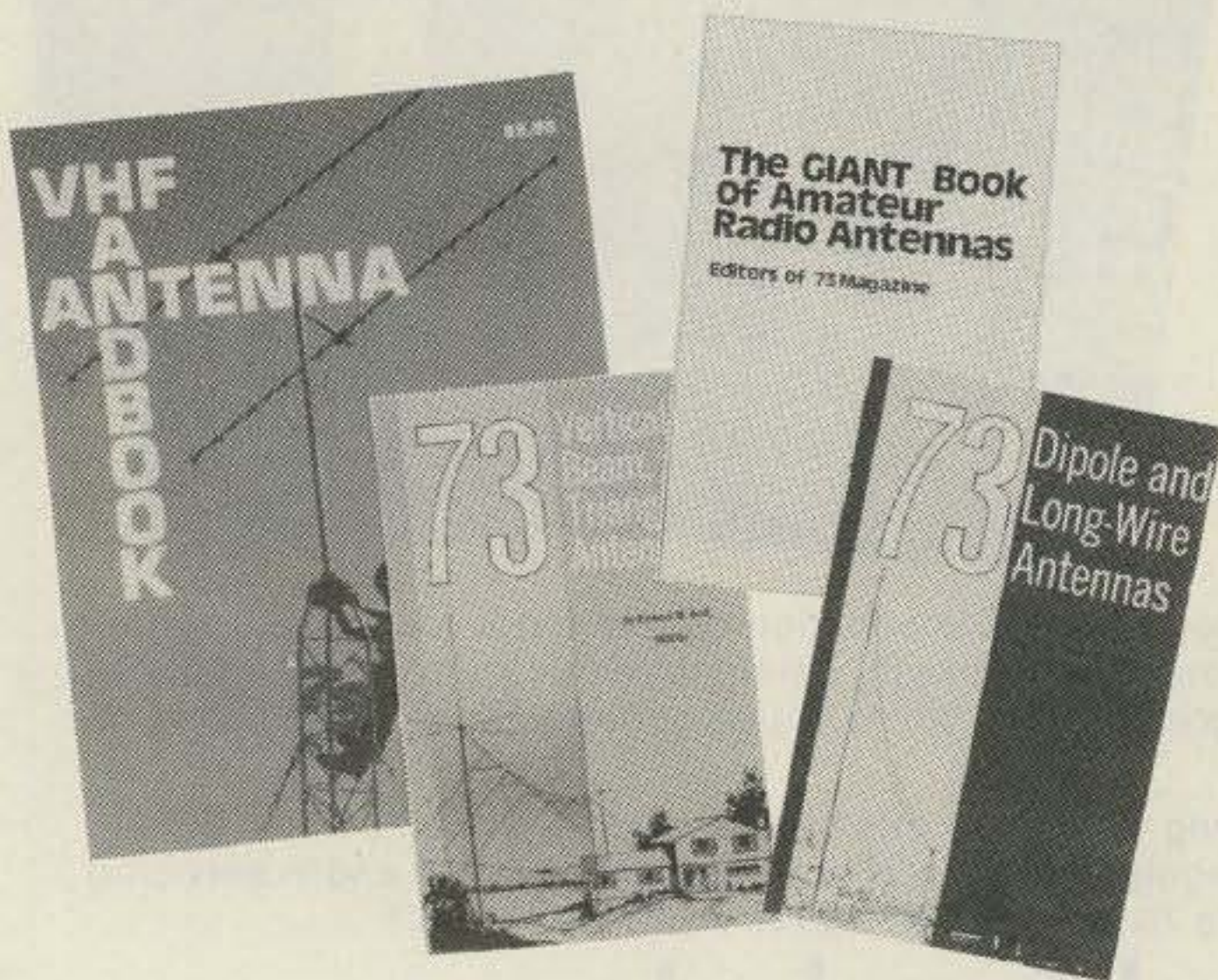

● **THE GIANT BOOK OF AMATEUR RADIO ANTENNAS**—With the **GIANT Book of Amateur Radio Antennas** by your side, antennas will become the least of your worries. Over 450 pages of design ideas, theory and reference data make this book live up to its title. The 7 chapters cover everything from basic antenna theory through designs for DIY accessories, as well as dozens of antenna designs. Whether planning to build or buy, design or admire, test or enjoy a ham antenna—this is the book for you. From the editors of 73; published by Tab Books. \$12.95* hardback—BK7304, \$8.95* paper—BK1104.

● **73 VERTICAL, BEAM AND TRIANGLE ANTENNAS**—BK1069—by Edward M. Noll W3FQJ. Describes 73 different antennas for amateurs. Each design is the result of the author's own experiments covering the construction of noise bridges and antenna line tuners, as well as methods for measuring resonant frequency, velocity factor, and standing-wave ratios. 160 pages. \$5.50.*

● **VHF ANTENNA HANDBOOK**—BK7368—The **NEW VHF Antenna Handbook** details the theory, design and construction of hundreds of different VHF and UHF antennas... A practical book written for the average amateur who takes joy in building, not full of complex formulas for the design engineer. Packed with fabulous antenna projects you can build. \$5.95.*

● **PRACTICAL ANTENNAS FOR THE RADIO AMATEUR**—BK1015—A manual describing how to equip a ham station with a suitable antenna. A wide range of antenna topics, systems, and accessories are presented giving the reader some food for thought and practical data for construction. Designed to aid the experienced ham and novice as well. Only \$9.95.*

● **TTL COOKBOOK**—BK1063—by Donald Lancaster. Explains what TTL is, how it works, and how to use it. Discusses practical applications, such as a digital counter and display system, events counter, electronic stopwatch, digital voltmeter and a digital tachometer. \$9.50.

● **CMOS COOKBOOK**—BK1011—by Don Lancaster. Details the application of CMOS, the low power logic family suitable for most applications presently dominated by TTL. Required reading for every serious digital experimenter! \$10.50.*

● **TVT COOKBOOK**—BK1064—by Don Lancaster. Describes the use of a standard television receiver as a microprocessor CRT terminal. Explains and describes character generation, cursor control and interface information in typical, easy-to-understand Lancaster style. \$9.95.*

● **BASIC NEW 2ND EDITION**—by Bob Albrecht. Self-teaching guide to the computer language you will need to know for use with your microcomputer. This is one of the easiest ways to learn computer programming. \$6.95.* (BK1081)



● **HOBBY COMPUTERS ARE HERE!**—BK7322—If you want to come up to speed on how computers work... hardware and software... this is an excellent book. It starts with the fundamentals and explains the circuits, the basics of programming, along with a couple of TVT construction projects, ASCII-Baudot, etc. This book has the highest recommendations as a teaching aid for newcomers. \$4.95.*

● **THE NEW HOBBY COMPUTERS**—BK7340—This book takes it from where **Hobby Computers Are Here!** leaves off, with chapters on Large Scale Integration, how to choose a microprocessor chip, an introduction to programming, low cost I/O for a computer, computer arithmetic, checking memory boards, a Baudot monitor/editor system, an audible logic probe for finding those tough problems, a ham's computer, a computer QSO machine... and much, much more! \$4.95.*

● **HOW TO MAKE MONEY WITH COMPUTERS**—In 10 information-packed chapters, Jerry Felsen describes more than 30 computer-related, money-making, high profit, low capital investment opportunities. \$15.00.* (BK1003)

● **RTL COOKBOOK**—BK1059—by Donald Lancaster. Explains the how and why of RTL (Resistor-Transistor Logic) and gives design information that can be put to practical use. Gives a multitude of digital applications ranging from the basic switch to the sophisticated counter. 240 pages; \$6.50.*



Use the order card in the back of this magazine or itemize your order on a separate piece of paper and mail to: 73 Radio Bookshop • Peterborough NH 03458. Be sure to include check or detailed credit card information. *Add \$1.00 handling charge. Note: Prices subject to change on books not published by 73 Magazine. Questions regarding your order? Please write to Customer Service at the above address. Please allow 4-6 weeks for delivery.

FOR TOLL FREE ORDERING CALL 1-800-258-5473

DEALER DIRECTORY

Fontana CA

We carry the following: ICOM, Midland, Amcom, DenTron, KLM, Swan, Drake, Ten-Tec, Wilson, SST, MFJ, Hy-Gain, Lunar, Nye-Viking, B&W, Redi-kilowatt, CushCraft, Mosley, Big Signal, Pipa, etc. Full Service Store **Fontana Electronics**, 8628 Sierra Ave., Fontana CA 92335, 822-7710.

San Jose CA

Bay area's newest Amateur Radio store. New & used Amateur Radio sales & service. We feature Kenwood, ICOM, KDK, Yaesu, Ten-Tec, VHF Engineering & many more. **Shaver Radio, Inc.**, 1378 So. Bascom Ave., San Jose CA 95128, 998-1103.

San Leandro CA

Specializing in Amateur Radio Test Guides, F.C.C. Advanced Class test is a snap with our manual. **Bash Educational Services**, 15373 Edgemoor St., P.O. Box 382, San Leandro CA 94577.

Denver CO

Experimenter's paradise! Electronic and mechanical components for computer people, audio people, hams, robot builders, experimenters. Open six days a week. **Gateway Electronics Corp.**, 2839 W. 44th Ave., Denver CO 80211, 458-5444.

New Castle DE

ICOM, Ten-Tec, Swan, KDK, NDI, Tempo, WISNAP. Authorized dealer: 1 mile off I-95. No sales tax. **Delaware Amateur Supply**, 71 Meadow Road, New Castle DE 19720, 328-7728.

Columbus GA

KENWOOD—YAESU—DRAKE

The world's most fantastic amateur showroom! You gotta see it to believe it! **Radio Wholesale**, 2012 Auburn Avenue, Columbus GA 31906, 561-7000.

Boise ID

Adzen, Amidon, Ameco, ARRL, B&W, Callbook, Collins, CushCraft, Dentron, Hustler, ICOM, Jim-Pak, KDK, MFJ, NPC, Nye, Sams, SST, Swan, Ten-Tec, Wanzer, Wilson. **Custom Electronics**, 1209 Broadway, Boise ID 83706, Bob W7SC 344-5084.

Preston ID

Ross WB7BYZ, has the Largest Stock of Amateur Gear in the Intermountain West and the Best Prices. Call me for all your ham needs. **Ross Distributing**, 78 So. State, Preston ID 83263, 852-0830.

Terre Haute IN

Your ham headquarters located in the heart of the Midwest. **Hoosier Electronics, Inc.**, 43B Meadows Shopping Center, P.O. Box 2001, Terre Haute IN 47802, 238-1456.

Littleton MA

The ham store of N.E. you can rely on. Kenwood, ICOM, Wilson, Yaesu, DenTron, KLM amps, B&W switches & wattmeters, Whistler radar detectors, Bearcat, Regency, antennas by Larsen, Wislon, Hustler, GAM. **TEL-COM Inc. Communications & Electronics**, 675 Great Rd., Rt. 119, Littleton MA 01460, 486-3040.

Laurel MD

Kenwood, Drake, ICOM, Ten-Tec, Swan, Dentron, Tempo and many ham accessories. Also computers by Apple and Exidy. Call toll free 1-800-638-4486. **The Comm Center, Inc.**, Laurel Plaza—Rt. 198, Laurel MD 20810.

St. Louis MO

Experimenter's paradise! Electronic and mechanical components for computer people, audio people, hams, robot builders, experimenters. Open six days a week. **Gateway Electronics Corp.**, 8123-25 Page Blvd., St. Louis MO 63130, 427-6116.

Camden NJ

X-band (& other frequencies) Microwave Components & Equipment. Laboratory Grade Test Instruments, Power Supplies, 1000's in stock at all times, BUY & SELL all popular makes—HP, GR, FXR, ESI, Sorensen, Singer, etc. **Lectronic Research Labs**, 1423 Ferry Ave., Camden NJ 08104, 541-4200.

Syracuse—Central NY

We deal, we trade, we discount, we please! Yaesu, Ten-Tec, Cushcraft, Drake, Dentron, KLM, Midland, B&W, ICOM, Hygain, Swan, Amcom, Telco, Mirage, DSI etc. Complete 2-way service shop! **Ham-Bone Radio (Div. Stereo Repair Shop)** 3206 Erie Blvd. East, Syracuse NY 13214, 446-2266.

Syracuse—Rome—Utica NY

Featuring: Yaesu, ICOM, Drake, Atlas, Dentron, Ten-Tec, Swan, Tempo, KLM, Hy-Gain, Mosley, Wilson, Larsen, Midland Southwest Technical Products. You won't be disappointed with equipment/service. **Radio World, Oneida County Airport-Terminal Building**, Oriskany NY 13424, 337-2622.

Phila. PA/Camden NJ

Waveguide & coaxial microwave components & equipment. Laboratory grade test instruments, power supplies. Buy, sell & trade all popular makes, HP, GR, FXR, ESI, Sorensen, Singer, etc. **Lectronic Research Labs**, 1423 Ferry Ave., Camden NJ 08104, 541-4200.

Columbus OH

All major brands featured in the biggest and best ham store for miles around. Come in and twist the knobs before you buy. We ship U.P.S. too. **Universal Amateur Radio, Inc.**, 1280 Aida Dr., Reynoldsburg (Columbus) OH 43068, 866-4267.

Houston TX

Experimenter's paradise! Electronic and mechanical components for computer people, audio people, hams, robot builders, experimenters. Open six days a week. **Gateway Electronics Inc.**, 8932 Clarkcrest, Houston TX 77063, 978-6575.

San Antonio TX

Complete 2 way service shop. Call Dee, W5FSP. Selling Antenna Specialists, Avanti, Azden, Bird, Hy-gain, Standard communications, Genave, Henry, CushCraft, Hustler, ICOM, KDK, MFJ, Nye, Shure, Swan, Tempo, Ten-Tec and others. **Appliance & Equipment Co., Inc.**, 2317 Vance Jackson Road, San Antonio TX 78213, 734-7793.

Port Angeles WA

Mobile RFI shielding for elimination of ignition and alternator noises. Bonding straps. Components for "do-it-yourself" projects. Plenty of free advice. **Estes Engineering**, 930 Marine Drive, Port Angeles WA 98362, 457-0904.

DEALERS

Your company name and message can contain up to 25 words for as little as \$150 yearly (prepaid), or \$15 per month (prepaid quarterly). No mention of mail-order business or area code permitted. Directory text and payment must reach us 60 days in advance of publication. For example, advertising for the August issue must be in our hands by June 1st. Mail to 73 Magazine, Peterborough NH 03458. ATTN: Aline Coutu.

PROPAGATION

by
J. H. Nelson

EASTERN UNITED STATES TO:

	GMT:	00	02	04	06	08	10	12	14	16	18	20	22
ALASKA	14	14	14	7	7	7	7	7	7A	14	14	14	
ARGENTINA	21	21	14	14	14	7	14	21	21	21A	21A	21A	
AUSTRALIA	14A	14	14	14	7B	7B	7	7	7B	7B	14	14	
CANAL ZONE	21	21	14	14	7A	7A	14	21	21	21	21A	21A	
ENGLAND	14	14	7	7	7	14	14	14A	21	21	14	14	
HAWAII	21	14A	14	7A	7	7	7	14	14	14	14A	14A	
INDIA	14	14	7B	7B	7B	7B	14	14	14	14	14	14	
JAPAN	14	14	14	7B	7	7B	7B	7B	14	14	14	14	
MEXICO	14A	14	14	14	7	7	14	14	14	14	21	21	
PHILIPPINES	14	14	14	7B	7B	7B	7B	7B	14	14	14	14	
PUERTO RICO	14	14	14	7	7	7	14	14	14	14	14A	21	
SOUTH AFRICA	14	7B	7B	14	14	21	21	21	21A	21A	21A	14	
U. S. S. R.	14	7A	7A	7	7	14	14	14	14	14	14	14	
WEST COAST	21	14A	14	14	7	7	7A	14	14	14A	21	21	

CENTRAL UNITED STATES TO:

ALASKA	14	14	14	7A	7	7	7	7	14	14	14	14	
ARGENTINA	21	21	14	14	14	7	14	21	21	21A	21A	21A	
AUSTRALIA	21	21	14	14	14	7B	7	7	7B	7B	14	14A	
CANAL ZONE	21	21	14	14	7A	7A	14	21	21	21	21A	21A	
ENGLAND	14	7A	7	7	7	7	7A	14	14A	14A	14	14	
HAWAII	21	21	14A	14	14	7	7	14	14	14A	21	21	
INDIA	14	14	14	7B	7B	7B	7B	14	14	14	14	14	
JAPAN	14	14	14	14	7	7B	7B	7B	14	14	14	14	
MEXICO	14A	14	14	7	7	7	7	14	14	14	14	14A	
PHILIPPINES	14	14	14	14B	7B	7B	7B	7B	14	14	14	14	
PUERTO RICO	21	14A	14	14	7	7	14	14	14A	21	21	21	
SOUTH AFRICA	14	7B	7B	14	14B	14B	14	14	21	21	21	14	
U. S. S. R.	14	7A	7A	7	7	7	7A	14	14	14	14	14	

WESTERN UNITED STATES TO:

ALASKA	14	14	14	7A	7	7	7	7	14	14	14	14	
ARGENTINA	21A	21	14	14	14	7	14	21	21	21A	21A	21A	
AUSTRALIA	21A	21A	21	14A	14A	14	14	7	7B	7B	21	21	
CANAL ZONE	21	21	14	14	7A	7A	14	14	21	21	21A	21A	
ENGLAND	14	7B	7	7	7	7	7	7	14	14A	14	14	
HAWAII	21A	21A	21A	21	14	14	14	14	14A	21	21	21	
INDIA	14	14	14	14	7B	7B	7B	7B	14	14	14	14	
JAPAN	14	14	14	14	14	7A	7B	7B	14	14	14	14	
MEXICO	14A	14	14	14	7	7	7	14	14	14	14A	21	
PHILIPPINES	14	14	14	14	14B	7B	7B	7B	14	14	14	14	
PUERTO RICO	21	14A	14	14	7	7	14	14	14	21	21	21	
SOUTH AFRICA	14	7B	7B	14	14B	7B	14B	14	14	14	21	14	
U. S. S. R.	14	7A	7A	7	7	7	7A	7A	14	14	14	14	
EAST COAST	21	14A	14	14	7	7	7A	14	14	14A	21	21	

A = Next higher frequency may also be useful

B = Difficult circuit this period

F = Fair

G = Good

P = Poor

SF = Chance of solar flares

june

sun	mon	tue	wed	thu	fri	sat
1	2	3	4	5	6	7
G	G	F	G	G	G	G
8	9	10	11	12	13	14
G	G	G	G	G	G	G
15	16	17	18	19	20	21
F	F	F	F	G	G	G
22	23	24	25	26	27	28
G	G	G	G	G	G	G
29	30					
G	G					

List of Advertisers

To receive full information from our advertisers please complete the following postage-paid card.

R.S. No.	Page	R.S. No.	Page	R.S. No.	Page	R.S. No.	Page
9	AR Technical Products Corp. 80	302	G&G Radio Elect. Co. 133	46	Maggiore Electronic Lab. 167	72	Tele-Tow'r Mfg. Co. 183
6	AMC Engineering. 135	24	Gemini Instrument Co. 186	49	Micro Control Specialties. 66	*	Ten-Tec, Inc. 3, 11
2	Advanced Electronic Applications 67	25	Germantown Amat. Supply. 134	313	Micro Management Sys. 97	75	Thomas Comm. 77
483	Advanced Electronic Applications 22	27	G.I.S.M.O. 150	50	Microcraft Corp. 151	76	Trac Electronics. 26
3	AED Electronics. 39	28	Global 23	51	Microlog Corp. 27	335	Tri-Ex Tower. 17
300	Aldelco 135	*	Godbout Electronics. 196	52	Mid Com Electronics, Inc. 66	77	Tufts Radio Electronics. 154-165
5	Amateur-Wholesale Elect. 117, 194	481	Gregory Electronics. 49	318	National Comm. Group Co. 83	310	Ultima Electronics, Ltd. 186
7	American Crystal Supply. 133	304	Grove Enterprises. 23	54	OK Machine & Tool. 99, 101, 105	311	Vanguard Labs. 133
479	Amerex 23	31	HFT, Inc. 186	55	Optoelectronics, Inc. 89, 151	86	Vineyard Amateur Radio. 189
334	Amidon Associates. 167	*	Hal Comm. Corp. 13	57	P.C. Electronics. 59	79	Wacom. 47
301	Appliance & Equip. Co., Inc. 133, 186	31	Hal-Tronix. 59	*	Palomar Engineers. 26	80	Western Electronics. 175
8	Apron Laboratories. 91	30	The Ham-Key Co. 52	*	Partridge Electronics. 47	*	Wilson Sys., Inc. 126-129
*	Associated Radio. 198	32	Ham Radio Center. 45	58	Poly Paks. 199	82	Xitex Corp. 87, 167
*	Atlanta HamFestival. 109	33	Hamtronics, NY. 203	69	Quest Electronics. 187	478	Xitex Corp. 169
10	Avanti Research & Develop. 71	34	Henry Radio. Cov II	63	RF Power Labs, Inc. 86	83	Yaesu Electronics. Cov III, 35, 57
11	Barker-Williamson. 85	37	iRL. 71	61	Radio Amateur Callbook. 52	336	Z Associates. 186
12	Bullet Electronics. 204	*	ICOM. 7, 25	*	Radio World. 151		
13	Clegg. 87, 133	35	Info-Tech, Inc. 53	62	Ramsey Electronics. 192, 195		
89	Clutterfree Modular Consoles 150	337	Instant Software. 92, 93	65	S-F Amateur Radio Services 53, 67		
332	Commerce Tours Internat. Inc. 79	36	International Crystal Mfg. 116	*	Seattle National Amateur Radio Convention. 121		
14	Comm. Center, NE. 63	38	Jameco Electronics. 188, 197	64	Semiconductors Surplus. 191		
15	Comm. Specialists. 8, 9	39	Jan Crystals. 135	333	Sentry Mfg. Co. 137		
85	Comm. Tech. Group. 183, 185	40	KLM Electronics. 119	*	73. 115, 205-208, 210		
16	Crown Micro Prod. 86	*	Kantronics. 151	66	Signalcrafters, Inc. 47		
331	DATAK. 95	*	KB Microcomputing. 109	317	Space Electronics. 186		
330	Debco Electronics. 76	*	Kenwood. Cov IV, 5	309	Spacecoast Research. 133		
*	Digital Research Parts. 202	480	Larsen Antennas. 168	67	Spectronics, Inc. 193		
20	DSI Instruments. 110	41	LaRue Electronics. 147	68	Spectrum Comm. 72, 73		
*	80 Microcomputing. 101	84	Long Path Radio. 86	69	Surplus Electronics. 190		
23	Flesher Corp. 47	42	Long's Electronics. 138-143	70	Swan Electronics. 19		
323	Fox-Tango Corp. 62	47	MFJ Enterprises. 81, 87, 116, 186	73	TET, USA. 40, 41		
		48	MHz Electronics. 200, 201	324	THS Electronics. 175		
		53	MOM's. 102, 103	476	THS Electronics. 168		
		43	M&M RF Distributors. 108	482	Technical Clinic. 166		
		44	Macrotronics. 183				
		45	Madison Electronics Sup. 135, 167				

*Please contact these advertisers directly.

Books, ETC.

To order, complete the following postage-paid card, or itemize your order including detailed credit card information or check and mail to:
73 Magazine/Mail Order Dept./Peterborough NH 03458.

Catalog #	Item	Price	Catalog #	Item	Price	Catalog #	Item	Price
BK1016	73 DIPOLE & LONG WIRE ANTENNAS	\$ 5.50	BK7380	INTRO TO RTTY.	\$ 2.00	SG1081	STUDY GUIDE - ADVANCED CLASS.	\$ 6.95
ST0000	73 BACK ISSUE.	\$ 3.00	BK7312	MAGIC OF HAM RADIO.	\$ 4.95	SG1080	STUDY GUIDE - EXTRA CLASS.	\$ 5.95
ST2500	73 BACK ISSUES - 25 OUR CHOICE.	\$12.00	BK1033	MASTER HANDBOOK OF HAM RADIO CIR-	\$ 8.95	SG7358	STUDY GUIDE - GENERAL CLASS.	\$ 5.95
ST0500	73 BACK ISSUES - 5 YOUR CHOICE.	\$ 8.75	BK7340	THE NEW HOBBY COMPUTERS.	\$ 4.95	SG7357	STUDY GUIDE - NOVICE CLASS.	\$ 4.95
ST1000	73 BACK ISSUES - 10 YOUR CHOICE	\$14.00	CT7300	NOVICE THEORY TAPES.	\$15.95	LB7359	TEST EQUIP LIB V1 - COMP TESTERS	\$ 4.95
ST2501	73 BACK ISSUES - 25 YOUR CHOICE	\$25.00	BK7310	OWNER REPAIR OF RADIO EQUIPMENT	\$ 7.95	LB7360	TEST EQUIP LIB V2 - AUDIO TESTERS	\$ 4.95
BK1081	BASIC NEW 2ND EDITION.	\$ 6.95	BK7305	POWER SUPPLY HANDBOOK.	\$ 7.95	LB7361	TEST EQUIP LIB V3 - RADIO EQUIP.	\$ 4.95
BK7307	BEHIND THE DIAL.	\$ 4.95	BK1015	PRACTICAL ANTENNAS FOR THE RADIO	\$ 9.95	LB7362	TEST EQUIP LIB V4 - IC TEST EQUIP.	\$ 4.95
BK7309	CHALLENGE OF 160.	\$ 4.95	BK7302	PROPAGATION WIZARD'S HANDBOOK	\$ 6.95	BK7348	TOOLS & TECHNIQUES.	\$ 4.95
CT7305	CODE TAPE - 5 WPM.	\$ 4.95	QW0250	QSL CARDS - STYLE W - 250.	\$ 8.95	BK1063	TTL COOKBOOK.	\$ 9.50
CT7306	CODE TAPE - 6+ WPM.	\$ 4.95	QW0500	QSL CARDS - STYLE W - 500.	\$13.95	BK1064	TVT COOKBOOK.	\$ 9.95
CT7313	CODE TAPE - 13+ WPM.	\$ 4.95	QX0250	QSL CARDS - STYLE X - 250.	\$ 8.95	BK1069	VERTICAL BEAM & TRIANGLE ANTNS	\$ 5.50
CT7320	CODE TAPE - 20+ WPM.	\$ 4.95	QX0500	QSL CARDS - STYLE X - 500.	\$13.95	BK7368	VHF ANTENNA HANDBOOK.	\$ 5.95
CT7325	CODE TAPE - 25+ WPM.	\$ 4.95	QY0250	QSL CARDS - STYLE Y - 250.	\$ 8.95	BK7370	WEATHER SATELLITE HANDBOOK.	\$ 4.95
CT7394	CODE TAPES (ANY FOUR ABOVE).	\$15.95	QY0500	QSL CARDS - STYLE Y - 500.	\$13.95			
BK7308	THE CONTEST COOKBOOK.	\$ 5.95	BK1044	RF DIGITAL TEST EQUIPMENT.	\$ 5.95			
BK7304	GIANT BOOK OF AMATEUR RADIO	\$12.95	BK7347	RTTY HANDBOOK.	\$ 5.95			
BK7322	HOBBY COMPUTERS ARE HERE.	\$ 4.95	BK1059	RTL COOKBOOK.	\$ 6.50			
BK7325	HOW TO BUILD A MICROCOMPUTER &	\$ 9.95	BX1000	SHELF BOX - 1.	\$ 2.00			
BK1003	HOW TO MAKE MONEY WITH COMPUT-	\$15.00	BX1001	SHELF BOXES - 2-7	\$1.50 each			
BK1028	IC OP AMP COOKBOOK.	\$12.95	BX1002	SHELF BOXES - 8 AND UP.	\$1.25 each			
			BK7351	SSB THE MISUNDERSTOOD MODE.	\$ 5.50			
			CT7350	SSTV TAPE.	\$ 5.95			

READER SERVICE

73 Magazine, P.O.B. 2739, Clinton, IA 52735

This card is valid until September 30, 1980

Please help us to bring you a better magazine—by answering these questions:

I. What is your age?

- A. under 18
 B. 18-22
 C. 23-40
 D. 41-60
 E. over 60

II. ARRL

1. Love it
 2. Don't care
 3. Hate it

III. If you are not a subscriber please circle number 500.

Reader Service: Return this card to receive full information on the products advertised in this issue. Refer to the ad. You will find numbers near the logo of each advertiser. Each represents the advertiser's individual Reader Service Number. Circle the corresponding numbers on one of the cards on this page, include your name, address & zip, and drop in a mailbox. In 4-6 weeks you'll hear from the advertiser directly.

1	6	11	16	21	126	131	136	141	146	251	256	261	266	271	376	381	386	391	396
2	7	12	17	22	127	132	137	142	147	252	257	262	267	272	377	382	387	392	397
3	8	13	18	23	128	133	138	143	148	253	258	263	268	273	378	383	388	393	398
4	9	14	19	24	129	134	139	144	149	254	259	264	269	274	379	384	389	394	399
5	10	15	20	25	130	135	140	145	150	255	260	265	270	275	380	385	390	395	400
26	31	36	41	46	151	156	161	166	171	276	281	286	291	296	401	406	411	416	421
27	32	37	42	47	152	157	162	167	172	277	282	287	292	297	402	407	412	417	422
28	33	38	43	48	153	158	163	168	173	278	283	288	293	298	403	408	413	418	423
29	34	39	44	49	154	159	164	169	174	279	284	289	294	299	404	409	414	419	424
30	35	40	45	50	155	160	165	170	175	280	285	290	295	300	405	410	415	420	425
51	56	61	66	71	176	181	186	191	196	301	306	311	316	321	426	431	436	441	446
52	57	62	67	72	177	182	187	192	197	302	307	312	317	322	427	432	437	442	447
53	58	63	68	73	178	183	188	193	198	303	308	313	318	323	428	433	438	443	448
54	59	64	69	74	179	184	189	194	199	304	309	314	319	324	429	434	439	444	449
55	60	65	70	75	180	185	190	195	200	305	310	315	320	325	430	435	440	445	450
76	81	86	91	96	201	206	211	216	221	326	331	336	341	346	451	456	461	466	471
77	82	87	92	97	202	207	212	217	222	327	332	337	342	347	452	457	462	467	472
78	83	88	93	98	203	208	213	218	223	328	333	338	343	348	453	458	463	468	473
79	84	89	94	99	204	209	214	219	224	329	334	339	344	349	454	459	464	469	474
80	85	90	95	100	205	210	215	220	225	330	335	340	345	350	455	460	465	470	475
101	106	111	116	121	226	231	236	241	246	351	356	361	366	371	476	481	486	491	496
102	107	112	117	122	227	232	237	242	247	352	357	362	367	372	477	482	487	492	497
103	108	113	118	123	228	233	238	243	248	353	358	363	368	373	478	483	488	493	498
104	109	114	119	124	229	234	239	244	249	354	359	364	369	374	479	484	489	494	499
105	110	115	120	125	230	235	240	245	250	355	360	365	370	375	480	485	490	495	500

Name _____

Address _____

City _____ State _____ Zip _____

73 Magazine • June 1980

BOOKS

73 Magazine, Pine Street, Peterborough, N.H. 03458

Please send me the following 73 products:

Qty.	Catalog #	Title	Unit Price	Total

Add \$1 shipping/handling _____

Total _____

Please allow 4-6 weeks for delivery.

Enclosed \$ _____ Check M.O.

Bill: AE MC Visa

Card # _____ Exp. date _____

Signature _____ Interbank # _____

Name _____

Address _____

City _____

State _____ Zip _____

SUBSCRIPTION

73 Magazine P.O. Box 931 Farmingdale, N.Y. 11737

73 subscribers
Beat the July 1st
Rate Increase
Subscribe now

New subscription Renewal
 1 year—\$15 2 years—\$30 3 years—\$45
 Enclosed \$ _____ Check M.O.
 Bill: MC Visa AE me

This Card Expires July 18, 1980

Card # _____ Exp. date _____

Signature _____ Interbank # _____

Name _____

Address _____

City _____ State _____ Zip _____

Canada: \$15 per year, US funds.
 Other foreign: \$26 one year only, US funds.

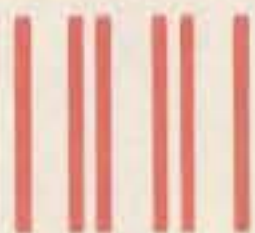

NO POSTAGE
NECESSARY
IF MAILED
IN THE
UNITED STATES

BUSINESS REPLY CARD

FIRST CLASS PERMIT NO. 73 PETERBOROUGH NH 03458

POSTAGE WILL BE PAID BY ADDRESSEE

73 MAGAZINE
Subscription Dept.
POB 931
Farmingdale NY 11737



BUSINESS REPLY CARD

FIRST CLASS PERMIT NO. 217 CLINTON IA 52735

POSTAGE WILL BE PAID BY ADDRESSEE

73 MAGAZINE
POB 2739
Clinton IA 52735

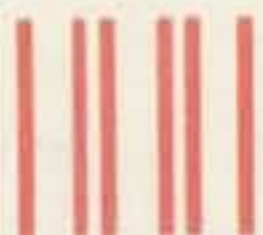

NO POSTAGE
NECESSARY
IF MAILED
IN THE
UNITED STATES

BUSINESS REPLY CARD

FIRST CLASS PERMIT NO. 73 PETERBOROUGH NH 03458

POSTAGE WILL BE PAID BY ADDRESSEE

73 MAGAZINE
Peterborough
NH 03458



NO POSTAGE
NECESSARY
IF MAILED
IN THE
UNITED STATES

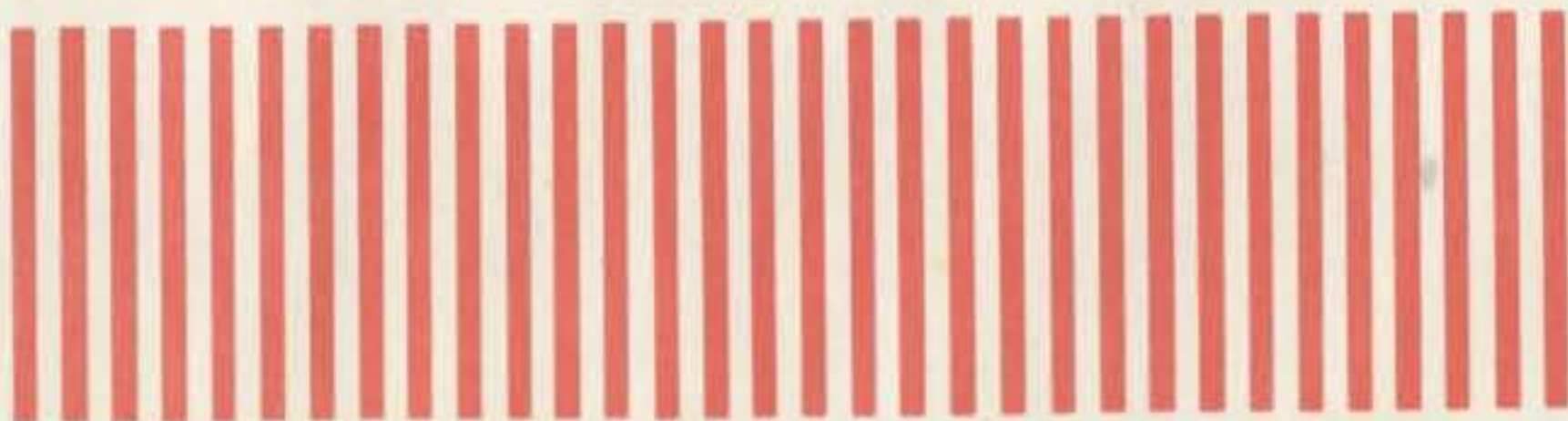

Att. Mail Order

FT-707 is shown with optional FV-707DM VFO & Scanning Microphone



THE FT-707 "WAYFARER"

The introduction of the "WAYFARER" by Yaesu is the beginning of a new era in compact solid state transceivers. The FT-707 "WAYFARER" offers you a full 100 watts output on 80-10 meters and operates SSB, CW, and AM modes. Don't let the small size fool you! Though it is not much larger than a book, this is a full-featured transceiver which is ideally suited for your home station or as a traveling companion for mobile or portable operation.

The receiver offers sensitivity of .25 μ V/10 dB SN as well as a degree of selectivity previously unavailable in a package this small. The "WAYFARER" comes equipped with 16 poles of IF filtering, variable bandwidth and optional crystal filters for 600 Hz or 350 Hz. Just look at these additional features:

FT-707 with Standard Features

- Fast/slow AGC selection
- Advanced noise blanker
- Built-in calibrator
- WWV/JJY Band
- Bright Digital Readout
- Fixed crystal position
- 2 auxiliary bands for future expansion
- Unique multi-color bar metering—monitors signal strength, power output, and ALC voltage.

FT-707 with Optional FV-707DM & Scanning Microphone

- Choice of 2 rates of scan
- Remote scanning from microphone
- Scans in 10 cycle steps
- Synthesized VFO
- Selection of receiver/transmitter functions from either front panel or external VFO
- "DMS" (Digital Memory Shift)

Impressive as the "WAYFARER" is its versatility can be greatly increased by the addition of the FV-707DM (optional). The FV-707DM, though only one inch high, allows the storage of 13 discrete frequencies and with the use of "DMS" (Digital Memory Shift) each memory can be band-spread 500 KHz. These 500 KHz bands may be remotely scanned from the microphone at the very smooth rate of 10 Hz steps.

The FT-707 "WAYFARER" is a truly unique rig. See it today at your authorized Yaesu Dealer.

YAESU
The radio.



New 2-meter direction.



PS-20

TR-9000

BO-9

SP-120

A compact transceiver with FM/SSB/CW plus...

TR-9000

Kenwood's done it again! Now, it's the exciting TR-9000 2-meter all-mode transceiver... complete with a host of new features. Combining the convenience of FM with long distance SSB and CW in a very compact, very affordable package, the TR-9000 is the answer for any serious Amateur Operator! Versatile? You

bet! Because of its compactness, the TR-9000 is ideal for mobile installation. Add on its fixed station accessories and it becomes the obvious choice for your ham shack!

See your Authorized Kenwood Dealer now for details on the TR-9000... the new direction in 2-meter all-mode transceivers!



UP/DOWN microphone (standard)
... "beep" sounds with each frequency step.

Note: Price, specifications subject to change without notice and obligation.

 **KENWOOD**
...pacesetter in amateur radio

TRIO-KENWOOD COMMUNICATIONS INC.
1111 WEST WALNUT/COMPTON, CALIFORNIA 90220