

# 73 Magazine

## for Radio Amateurs

- 40 In Profile: Dick Bash KL7IHP**  
—the father of *The Final Exam* speaks out  
..... N1AUI
- 44 That Mysterious Mode: 10 FM**  
—an examination of propagation phenomena  
..... WB2EQG
- 52 The World Above 430**  
—part II: next stop, 1296..... W9CGI
- 56 Bridge Over Troubled Audio**  
—another method for driving speakers  
..... K4IPV
- 60 Load a Lawn Chair**  
—even if you can't carry a tune, you can build  
this matchbox..... WB5PPV
- 62 The Penultimate CPO**  
—a nondiscrete LSI device..... N6HI
- 64 Get Out and Vote**  
—a grass roots project for this election year  
..... WA9FDP/WR9ACD
- 68 A Wider Windom**  
—broadbanded sans transmatch.... WA4PYQ
- 70 RYRYRYRY**  
—an electronic torture test for RTTY systems  
..... Minchow
- 76 Goin' Mobile**  
—equipment for air-conditioned gypsies  
..... KL7IPE/DA1SM, DF7NM
- 80 Inside Radio Shack's Digital Receiver**  
—SWLing with the DX-300..... W4PGI
- 84 The Two-Meter Monkey**  
—not just another linear..... KL7GLK
- 88 RTTY QSK**  
—break in to RTTY operation with a KOR  
..... CT1EM/PY1AQL
- 90  A Programmer's Potpourri**  
—fifteen practical programs for hams  
..... K2OAW
- 102 CB to 10**  
—part XXIX: put that Hy-Gain CB board to use  
..... W1BG
- 111 Old Receivers Never Die**  
—but occasionally they do get sick.... W4ANL
- 112 The Battery Minder**  
—a real turn-on for chargers..... K4GOK
- 116 Working in Wood**  
—a tilt-over home-brew for \$2 a foot  
..... WB3ICL
- 118 The Two-Hour Audio Amp**  
—quick to construct, easy to use..... K7HKL
- 122 Power × 2... Plus!**  
—an improved two-battery auto electrical  
system..... W4STDT
- 126 The Little Thinker**  
—a quick puzzle project..... WB4RXB
- 130 A Conversion with Gusto**  
—throw your weight around on six... WB2WIK
- 134 The Confidence Builder**  
—a CW speedometer..... WB4TYL

**COMING  
NEXT MONTH:  
OUR GALA  
20TH  
ANNIVERSARY  
ISSUE!**



Never Say Die—4, Looking West—10, DX—12, RTTY Loop—16, Letters—18, Contests—20, Awards—22, Leaky Lines—25, Ham Help—25, 161, 193, OSCAR Orbits—31, New Products—32, Review—153, Social Events—165, Dealer Directory—193, Propagation—193





Shown with optional touch tone pad

## The new improved Tempo S-1

- The first and most thoroughly field tested hand-held synthesized radio available. 800 channels in the palm of your hand.
- Simple to operate. (You don't need a degree in computer programming)
- Heavy duty battery pack allows more operating time between charges.
- External microphone capability
- The lowest price ever...\$259.00
- The S-1T (With touch tone pad installed)...\$289.00

Now available is the expanded line of Tempo commercial hand holds... "big name" quality at affordable prices. The FMH-12 & FMH-15 operate in the 135 to 174 MHz range and the FMH-40 & FMH-44 in the 440 to 480 MHz range. Tempo also offers the FMT-2 & FMT-42. They provide excellent VHF or UHF mobile communications and feature a remote control head for hide-away mounting. Also available is the superb MR-3 pocket receiver... a miniature, 2 channel VHF high band monitor or paging receiver. Please call or write for complete information. Also available from Tempo dealers throughout the U.S. and abroad.



TOLL FREE ORDER NUMBER: (800) 421-6631  
For all states except California.  
Calif. residents please call collect on our regular numbers.

11240 W. Olympic Blvd., Los Angeles, Calif. 90064 213/477-6701  
931 N. Euclid, Anaheim, Calif. 92801 714/772-9200  
Butler, Missouri 64730 816/679-3127

# tempo...

the first in synthesized portables gives you the broadest choice at the lowest price

## ...the new S-5

- \* The only synthesized hand-held offering 5 watts output. (Switchable for 1 or 5 watt operation)
- \* The same dependability as the time proven S-1. Circuitry that has been proven in more than a million hours of operation.
- \* Heavy duty battery pack.
- \* External microphone capability.
- \* The S-5's exciting low price...only \$299.00
- \* With touch tone pad \$339.00

### SPECIFICATIONS

Frequency Coverage: 144 to 148 MHz  
Channel Spacing: Receive every 5 kHz, transmit Simplex or  $\pm 600$  kHz  
Power Requirements: 9.6 VDC  
Current Drain: 17 ma-standby, 900 ma-transmit  
Antenna Impedance: 50 ohms  
Dimensions: 40 mm x 62 mm x 170 mm (1.6" x 2.5" x 6.7")  
Weight: 17 oz.  
Sensitivity: Better than .5 microvolts nominal for 20 db

### SUPPLIED ACCESSORIES

Telescoping whip antenna, ni-cad battery pack, charger.

### OPTIONAL ACCESSORIES

12 Button touch tone pad (not installed): \$39 • 16 Button touch tone pad (not installed): \$48 • Tone burst generator: \$29.95 • CTCSS sub-audible tone control: \$29.95 • Rubber flex antenna: \$8 • Leather holster: \$16 • Cigarette lighter plug mobile charging unit: \$6 • Matching 30 watt output 13.8 VDC power amplifier (S30): \$89 • Matching 80 watt output power amplifier (S80): \$149

## The Tempo S-2

Tempo is first again. This time with a superior quality synthesized 220 MHz hand-held transceiver. With an S-2 in your car or pocket you can use 220 MHz repeaters throughout the U.S. It offers all the advanced engineering, premium quality components and exciting features of the S-1. The S-2 offers 1000 channels in an extremely lightweight but rugged case.

If you're not on 220 this is the perfect way to get started. With the addition of the S-25 (25W output) or S-75 (75W output) Tempo solid state amplifier it becomes a powerful mobile or base station. If you have a 220 MHz rig, the S-2 will add tremendous versatility. Its low price includes an external microphone capability, heavy duty ni-cad battery pack, charger, and telescoping whip antenna. Price...\$349.00 With touch tone pad...\$399.00

### TEMPO VHF & UHF SOLID STATE POWER AMPLIFIERS

Boost your signal... give it the range and clarity of a high powered base station. VHF (135 to 175 MHz)

Drive Power	Output	Model No.	Price
2W	130W	130A02	\$209
10W	130W	130A10	\$189
30W	130W	130A30	\$199
2W	80W	80A02	\$169
10W	80W	80A10	\$149
30W	80W	80A30	\$159
2W	50W	50A02	\$129
2W	30W	30A02	\$ 89

UHF (400 to 512 MHz) models, lower power and FCC type accepted models also available.

# Henry Radio

Prices subject to change without notice



Switch it...  
tune it...  
load it...  
measure it...  
send it...with  
**Heathkit®**  
amateur  
gear



Low SWR and maximum radiation are yours with the SA-2040 2 kW Antenna Tuner.



Measure power and SWR with the HM-2141 Dual Meter VHF Wattmeter you build yourself.

No matter what you are doing to your signal, Heath has the amateur gear to help you do it better...and to save you money, too. Heath is your one-stop headquarters for accessories, antennas and complete, build-it-yourself rigs. And they're all backed by the more than 200 hams at Heath.

The new Heathkit Catalog describes one of the most complete selections of ham gear anywhere. You'll also find the latest in home computers, fine stereo components, color TV's, precision test instruments and innovative electronics for your home...all in easy-to-build, money-saving kits.

It's one catalog you don't want to be without. Write for your free copy today or pick one up at your nearest Heathkit Electronic Center.

The easy-to-build Cantenna™ Dummy Load reduces QRM during tune-up.



Send smooth, easy-to-read CW with the Heathkit HD-1410 Electronic Code Keyer.



#### SEND FOR FREE CATALOG

Write to Heath Company, Dept. 011-694, Benton Harbor, MI 49022. In Canada, write Heath Co., 1480 Dundas Highway East, Mississauga, Ontario L4X 2R7.

#### VISIT YOUR HEATHKIT STORE

In the U.S. and Canada, visit your nearby Heathkit Electronic Center where Heathkit Products are displayed, sold and serviced. See the white pages of your phone book. In the U.S., Heathkit Electronic Centers are units of Veritechnology Electronics Corporation.



Switching antennas is easy with the low-priced SA-1480 Remote Coax Switch.

# Heathkit®



# Info

## Manuscripts

Contributions in the form of manuscripts with drawings and/or photographs are welcome and will be considered for possible publication. We can assume no responsibility for loss or damage to any material. Please enclose a stamped, self-addressed envelope with each submission. Payment for the use of any unsolicited material will be made upon acceptance. All contributions should be directed to the 73 editorial offices. "How to Write for 73" guidelines are available upon request.

### Editorial Offices:

Pine Street  
Peterborough NH 03458  
Phone: 603-924-3873

### Advertising Offices:

Elm Street  
Peterborough NH 03458  
Phone: 603-924-7138

### Circulation Offices:

Elm Street  
Peterborough NH 03458  
Phone: 603-924-7296

### Subscription Rates

In the United States and Possessions:  
One Year (12 issues) \$25.00  
Two Years (24 issues) \$38.00  
Three Years (36 issues) \$53.00

### Elsewhere:

Canada—\$27.00/1 year only, U.S. funds. Foreign surface mail—\$35.00/1 year only, U.S. funds. Foreign air mail—\$62.00/1 year only, U.S. funds.

### To subscribe, renew or change an address:

Write to 73 Magazine, Subscription Department, PO Box 931, Farmingdale NY 11737. For renewals and changes of address, include the address label from your most recent issue of 73. For gift subscriptions, include your name and address as well as those of gift recipients. Postmaster: Send form #3579 to 73 Magazine, Subscription Services, P.O. Box 931, Farmingdale, NY 11737.

### Subscription problem or question:

Write to 73 Magazine, Subscription Department, PO Box 931, Farmingdale NY 11737. Please include an address label.

73 Magazine (ISSN 0098-9010) is published monthly by 73, Inc., 80 Pine Street, Peterborough NH 03458. Second class postage paid at Peterborough NH 03458 and at additional mailing offices. Copyright (c) 1980 by 73, Inc. All rights reserved. No part of this publication may be reprinted or otherwise reproduced without written permission from the publisher. Microfilm Edition—University Microfilm, Ann Arbor MI 48106.

## W2NSD/1 NEVER SAY DIE

editorial by Wayne Green

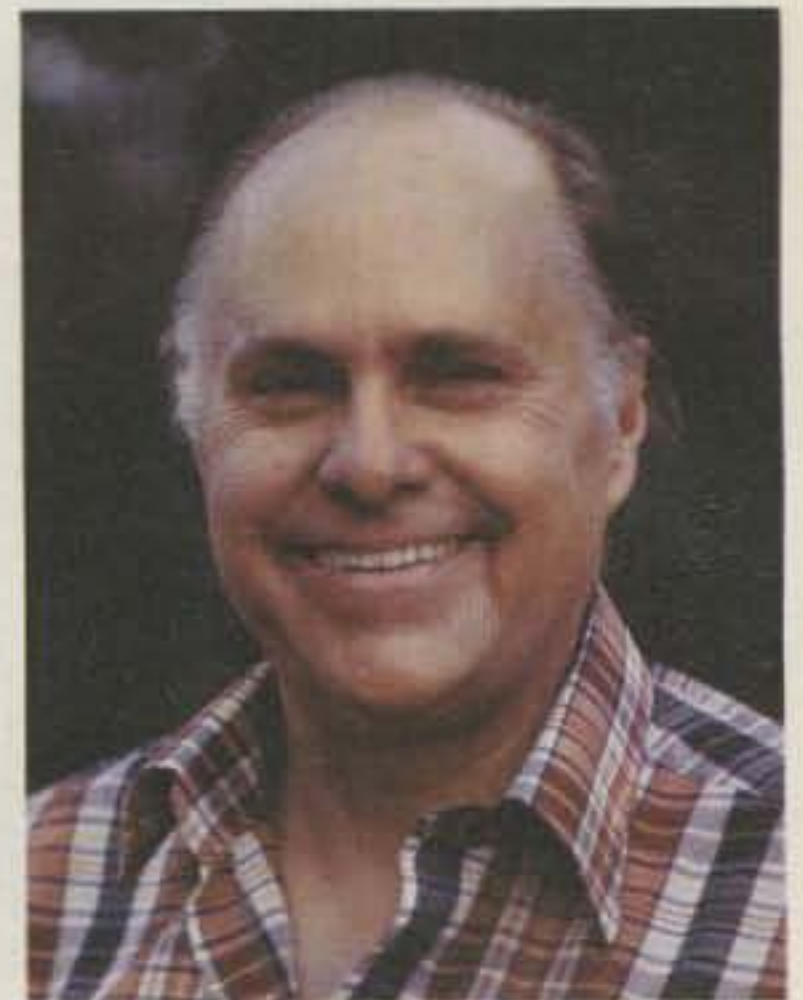

### AUTOMATIC IDENTIFICATION

Just a few years ago, it was a big deal to build a circuit which could allow a car horn to send "hi." The best way to send any repeated code signal was to make a code wheel out of metal and have it operate a microswitch. One long-forgotten firm even had such a device on the market.

When amateurs were first permitted to send frequency-shift Teletype™ signals on the low bands, the rules called for identification in Morse code as well as on RTTY. Lacking any simple way to do this mechanically, amateurs installed hand keys on the sides of their printers and signed on and off each transmission with hand-set code ... hating it.

I think it was around 1951 when I got involved with a beacon station for six meters. I set it up on the standard beacon frequency of 50.1 MHz and had a converted BC-624 (SCR-522 transmitter) perking away (832 final). It was keyed by an aluminum disk on a slow-turning motor. My call letters were hacked out of the periphery of the disk and operated the microswitch, which in turn keyed the transmitter.

Six meters was not very popular in those days and thus beacons were quite helpful. It made it possible to leave your receiver on one channel and spot band openings quickly. A government-sponsored project to investigate six-meter propagation, the Radio Amateur Scientific Observations (RASO), was being run by a chap named Perry Ferrell from down in New Jersey. I got a nice certificate for participating in that project.

Later Perry became the editor of CQ magazine and this paved the way for my CQ column on RTTY. I started a monthly RTTY newsletter in 1951—Perry liked that and thought more hams should be exposed to RTTY. The CQ column led to my taking over the editorship of CQ in 1955 when Perry moved on up to edit *Popular Electronics*.

In those days, I was the only active amateur in all of New York City on six meters! There were a few pioneers out in New Jersey and some up in Westchester, but no one else in New York.

Today, with digital electronics, it is simple to put together an identifier. Indeed, several thousand repeaters have them. I've been a bit surprised that

phone ops have not added a small Morse identifier to their station to take care of the ten-minute identification requirements, sending the call softly in the background.

Now, with the authorization of ASCII coding, the door is open for a radical step forward in amateur operating. I first began to think about this when I was mulling over some possible solutions to the crowding which was expected to develop through the Phase III ham satellite. If we were going to try to use our decades-old techniques of pileups to work through the narrow band available, we could look forward to increasing frustrations and jamming. Something new was badly needed.

This will hold, too, for the eventually coming new DX bands, which are very narrow and will be epics in interference unless new modes of communications are devised.

Speaking of the recently demised satellite, I suspect that the taking over of AMSAT by the League may turn out to be a serious problem. While many amateurs still implicitly trust the ARRL, a large percentage of the amateurs are not so easily convinced that it is much different from any other similar bureaucracy. The AMSAT-ARRL connection may give the impression that satellite funding will be coming from the League and thus discourage donations from amateurs interested in helping ham growth. I'd like to see more written about this so that we can get AMSAT moving again.

Getting back to identification, suppose all ham rigs had a continuous identifier going in the background, sending your call

### NO TAXES!

Looking for a job? 73 is currently seeking applicants for one of its top staff positions. In addition to being a non-smoker, the qualified candidate will be a ham with an outstanding knowledge of electronics, an excellent command of the English language, and experience as a working journalist. We offer a competitive salary, fine fringe benefits, and excellent working conditions—as well as the opportunity to live and work in beautiful, tax-free New Hampshire. Interested parties should respond with resumes to: Director of Personnel, 73 Magazine, Elm Street, Peterborough NH 03458.



# Top-Notch.



## VBT, notch, IF shift, wide dynamic range

### TS-830S

Now most Amateurs can afford a high-performance SSB/CW transceiver with every conceivable operating feature built in for 160 through 10 meters (including the three new bands). The TS-830S combines a high dynamic range with variable bandwidth tuning (VBT), IF shift, and an IF notch filter, as well as very sharp filters in the 455-kHz second IF. Its optional VFO-230 remote digital VFO provides five memories.

#### TS-830S FEATURES:

- **160-10 meters, including three new bands**  
Covers all Amateur bands from 1.8 to 29.7 MHz (LSB, USB, and CW), including the new 10, 18, and 24-MHz bands. Receives WWV on 10 MHz.
- **Wide receiver dynamic range**  
Junction FETs (with optimum IMD characteristics and low noise figure) in the balanced mixer, a MOSFET RF amplifier operating at low level for improved dynamic range (high amplification level not needed because of low noise in mixer), dual resonator for each band, and advanced overall receiver design result in excellent dynamic range.

- **Variable bandwidth tuning (VBT)**  
Continuously varies the IF filter passband width to reduce interference. VBT and IF shift can be controlled independently for optimum interference rejection in any condition.
- **IF notch filter**  
Tunable high-Q active circuit in 455-kHz second IF, for sharp, deep notch characteristics.
- **IF shift**  
Shifts IF passband toward higher or lower frequencies (away from interfering signals) while tuned receiver frequency remains unchanged.
- **Various IF filter options**  
Either a 500-Hz (YK-88C) or 270-Hz (YK-88CN) CW filter may be installed in the 8.83-MHz first IF, and a very sharp 500-Hz (YG-455C) or 250-Hz (YG-455CN) CW filter is available for the 455-kHz second IF.
- **Built-in digital display**  
Six-digit large fluorescent tube display, backed up by an analog dial. Reads actual receive and transmit frequency on all modes and all bands. Display Hold (DH) switch.
- **Adjustable noise-blanker level**  
Built-in noise blanker eliminates pulse-type (such as ignition) noise. Front-panel threshold level control.

- **6146B final with RF NFB**  
Two 6146B's in the final amplifier provide 220 W PEP (SSB)/180 W DC (CW) input on all bands. RF negative feedback provides optimum IMD characteristics for high-quality transmission.
  - **More flexibility with optional digital VFO**  
VFO-230 operates in 20-Hz steps and includes five memories. Also allows split-frequency operation. Built-in digital display. Covers about 100 kHz above and below each 500-kHz band.
  - **Built-in RF speech processor**  
For added audio punch and increased talk power in DX pileups.
  - **RIT/XIT**  
Receiver incremental tuning (RIT) shifts only the receiver frequency, to tune in stations slightly off frequency. Transmitter incremental tuning (XIT) shifts only the transmitter frequency.
  - **SSB monitor circuit**  
Monitors IF stage while transmitting, to determine audio quality and effect of speech processor. Ask your Authorized Kenwood Dealer about the many operating features offered by the TS-830S... at a very reasonable price!
- NOTE:** Price, specifications subject to change without notice and obligation.

#### MATCHING ACCESSORIES FOR FIXED-STATION OPERATION:

- SP-230 external speaker with selectable audio filters
  - VFO-230 external digital VFO with 20-Hz steps, five memories, digital display
  - AT-230 antenna tuner/SWR and power meter
  - MC-50 desk microphone
  - YG-455C (500-Hz) and YG-455CN (250-Hz) CW filters for 455-kHz IF
  - YK-88C (500-Hz) and YK-88CN (270-Hz) CW filters for 8.83-MHz IF
  - HC-10 digital world clock
  - HS-5 and HS-4 headphones
  - MC-30S and MC-35S noise-cancelling hand microphones
- Other accessories not shown:**
- TL-922A linear amplifier
  - SM-220 Station Monitor
  - PC-1 phone patch





# Staff

**EDITOR/PUBLISHER**  
Wayne Green W2NSD/1

**MANAGING EDITOR**  
John Burnett

**ASSISTANT MANAGING EDITOR**  
Susan Philbrick

**EDITORIAL ASSISTANTS**  
Nancy Noyd  
Richard Phenix

**PRODUCTION MANAGER**  
Noel Self WB1ARP

**ART DEPARTMENT**  
Steve Baldwin  
Tedd Cluff  
Robert Drew  
Bruce Hedin  
Kenneth Jackson  
Clare McCarthy  
Michael Murphy  
Dion Owens  
Robert Sawyer  
Patrice Scribner  
Susan Symonds  
John White

**BOOK PUBLICATIONS**  
Jim Perry

**BOOK PRODUCTION**  
Emily Gibbs  
Chris Brown N1AU1

**PHOTOGRAPHY**  
Bill Heydolph  
Terrie Anderson

**TYPESETTING**  
Barbara Latti  
Sara Bedell  
Linda Locke

**EXECUTIVE VICE PRESIDENT**  
Sherry Smythe

**CORPORATE CONTROLLER**  
Alan Thulander

**ASSOCIATE PUBLISHER**  
Edward Ferman

**ASSISTANT PUBLISHER**  
Jeffrey DeTray WB8BTH

**EXECUTIVE ASSISTANT**  
Leatrice O'Neil

**ACCOUNTING MANAGER**  
Knud Keller KV4GG/1

**DATA ENTRY**  
Cathy DeSilva

**CIRCULATION MANAGER**  
Debra Boudrieau

**ASSISTANT CIRCULATION MANAGER**  
Barbara Block

**CIRCULATION**  
Pauline Johnstone

**BULK SALES MANAGER**  
Ginnie Boudrieau

**SHIPPING**  
Phil Rodier  
Bill Barry

**RECEPTIONIST**  
Pat Graham

**ASSOCIATES**  
Robert Baker WB2GFE  
Bill Gosney WB7BFK  
Sanger Green  
Dave Ingram K4TWJ  
Larry Kahaner WB2NEL  
Joe Kasser G3ZCZ  
Bill Pasternak WA6ITF  
John Schultz W4FA  
Peter Stark K2OAW

**ADVERTISING**  
(603) 924-7138

Jim Gray, Mgr.

in subaudible tones with ASCII coding. With this you would be able to tune in a station, whether on sideband or FM, and read out the call letters immediately on your receiver. Being in the audio spectrum below the passband of your receiver, you would not normally hear the ID, but it would continuously read out for you.

For starters, this would make tuning the DX bands a lot more exciting. You would know quickly what station you are copying. But there would be some far more important benefits to this relatively simple system. The subcarrier tones would permit a receiver to tune automatically to each station and zero in on it. Automatic tuning would not be difficult to build into receivers.

The next step is obvious... a microcomputer system to check each station tuned, looking for the station or prefix of your choice. You wouldn't miss those DXpeditions any more, and, with proper programming, your receiver would let you know instantly when *any* unworked prefix was being received.

Skeds? You could set your receiver to tune a segment of the band or check a certain few repeaters looking for a signal from your friends.

The next step beyond that would be simple, too... automatic contact with a desired station, with the whole works recorded for you. In this way, you could work DX without even being home. By getting these automatic contacts down to the bare minimum requirements for certificates, contacts could be made in a second or two... perhaps even including the swapping of the QSL over the air!

But, I hear you say, the rules... the rules... they say you have to be in control of your station. Sure they do. And, if your station is programmed by you to operate in a certain way and has appropriate fail-safe measures, are you *not* in control? No one else is. The rules are suitably vague and should be left alone.

Perhaps, by reducing the value of some certificates and "honors," we will be able to change amateur radio enough so that operators in rare spots around the world will actually be able to sit and chew the rag, without being driven up the wall by DX hunters. You may enjoy being in the rare DX seat for a few days while on a DXpedition,

but after a few weeks of the screaming and pileups, you'd go the route of most other rare DX operators... QRT.

Those obsessed with certificates could work toward faster and faster six-band DXCC. Or even DXCCC... why think small?

## MAKING IT HAPPEN

Hypothesizing and dreaming is one thing... and making it happen is something else. In this case, we are not talking about very much in the way of technical breakthroughs, but mostly of the need for some experimenting and pioneering to make this all happen.

Those of you who have been around amateur radio for twenty years will remember the part 73 *Magazine* played in getting sideband firmly entrenched. I started this push back when I was editor of *CQ* and then followed through with it in 73. More recently, just a bit over ten years ago, I decided that FM and repeaters were just too much fun for the handful of pioneers who were experimenting with it. With no help whatsoever from any other ham magazines, I plunged into promoting FM... with hundreds of articles, books, FM symposia, and even a monthly newsletter.

Within two years, FM took hold and we began to see commercial equipment for it... even commercially-made repeaters. The frequencies were standardized and the usual bunch of fast-buck artists driven out of the field. Today, there are more hams active on 2m than on any other ham band.

With the solid backing of 73, I think we can develop an automatic identification system and make it universally accepted. The equipment for the transmitter is simple, probably using a programmable memory (PROM) with the call in it and a second chip to generate the subaudible tones.

The receiver circuits can be simple, too, at least for starters. I'm sure we will be seeing ever more complex circuits to get more and more out of the system. This will mean opportunities for amateurs who are into being entrepreneurs.

To get started, I'd like to see articles on the subject and simple technical construction projects. I'd like to see a hundred articles... a thousand articles.

Eventually we'll have much of it built into chips, but at first we'll have to work with gates and microprocessors.

## PROTOCOLS

Since we are already authorized to send ASCII at 300 baud, perhaps we should start with that and try later to step up that speed, if possible. Even so, for identification, 300 baud is not bad. In case you are having any problem translating that into more familiar terms, 300 baud means that 300 bits per second are sent. If we use the normal ASCII system of eight bits for each character, one start bit and two stop bits (or one parity bit and one stop bit), we end up being able to send 27 characters per second. If we figure the normal call to be six characters and add a seventh as a space, we come up with about one quarter of a second to send a call.

With a little cunning, we could do a better encoding job and get the call down to four eight-bit groups (32 bits), but the time saved would not be significant and the system would not be compatible with other uses such as sending messages and intercomputer communications. Let's get going with standard ASCII and see what we can do.

At first, I expect we'll be seeing add-on equipment for our stations, but eventually the manufacturers will be building in the digital identification (DI) circuits.

Who will be first with articles on this?

## UNIVERSAL SLOW SCAN

Slow scan television never really caught on with amateurs. Oh, we've had hundreds active at many times in the past, but in general the pattern has been for the enthusiasm for this mode to blow over after a few months of excitement. Pity, because I think slow scan has some valuable uses in amateur radio... but has never really had a chance to seek its rightful place.

The normal pattern, which I went through, along with several thousand other amateurs, was to first get interested... then buy a camera and monitor. It's easy to get set up and the first few contacts are truly exciting. But after a while, the

*Continued on page 155*



# The 2ATouch!

ICOM Quality and Performance in the Most Compact and Economical Hand-Held Designed for Ham Radio.

## IC-2AT Synthesized 2 Meter Hand-Held

### FEATURES YOU'VE WANTED

- Touch Tone® Pad
- 800 T/R Channels. Synthesized.
- 1.5 Watt Output High/Low Power Battery Saving Switch to .15 Watt.
- Separate built in Speaker & Mic. Excellent audio quality.
- Compact. About the size of a dollar bill.
- Variable size NiCd Power Pack, 3 sizes available to suit your needs. (250 MA standard). Makes the IC-2AT the most compact synthesized Hand-Held on the market.
- ICOM level Receiver Performance-ICOM Quality Receiver in a compact package (.2uv/20db typical)
- Optional Leather Case, Mobile Charge Cord, Desk Charger, Speaker/Mic available.
- With slip on/slip off Bottom NiCd Pack, you can vary the size of the Hand-Held from about 116 mm high to 175 mm high. Easy to carry extra Snap-on packs packs with you for extended trips.
- Complete with BP3 NiCd Pak, wall charger, flexible antenna and belt clip.

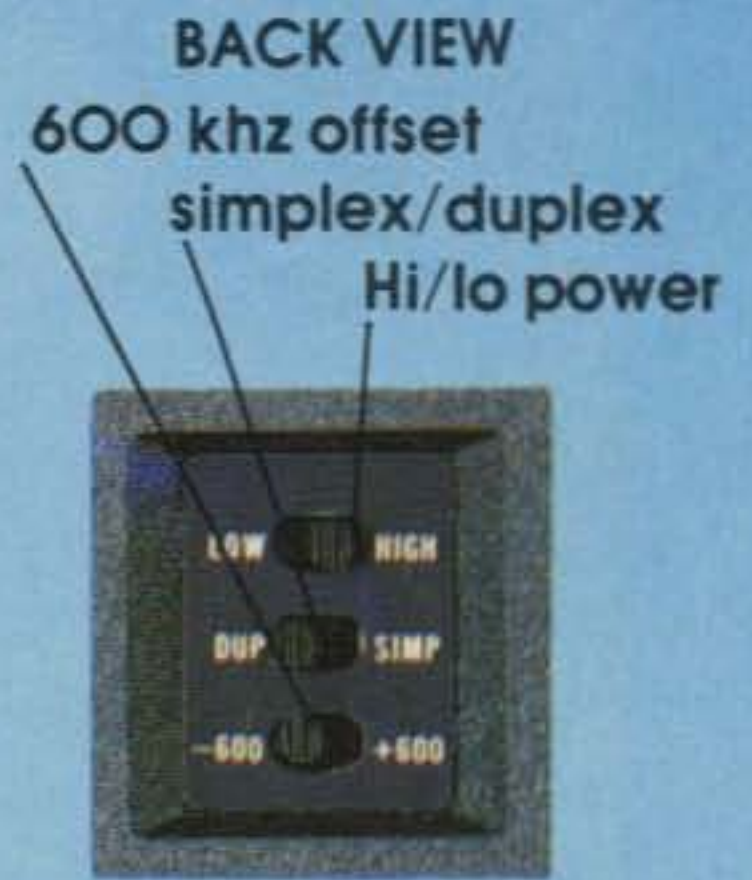

Cut out and put the ICOM IC-2AT in the palm of your hand.



ICOM AMERICA, INC.

2112 - 116th Avenue NE  
Bellevue, WA 98004

3331 Towerwood Dr., Suite 307  
Dallas, TX 75234





114.8	0000	118.8	2100
110.9	041	123.0	2150
107.2	082	127.3	2200
103.5	123	131.8	2250
100.0	164	136.5	2300
97.4	205	141.3	2350
94.8	246	146.2	2400
91.5	287	151.4	2450
88.5	328	156.7	2500
85.4	369	162.2	2550
82.5	410	167.8	2600
79.7	451	173.8	2650
77.0	492	179.9	2700
74.4	533	186.2	2750
71.9	574	192.8	2800
67.0	615	203.5	2850

Communications Specialists TE-64



# Food for thought.

Our new Universal Tone Encoder lends it's versatility to all tastes. The menu includes all CTCSS, as well as Burst Tones, Touch Tones, and Test Tones. No counter or test equipment required to set frequency-just dial it in. While traveling, use it on your Amateur transceiver to access tone operated systems, or in your service van to check out your customers repeaters; also, as a piece of test equipment to modulate your Service Monitor or signal generator. It can even operate off an internal nine volt battery, and is available for one day delivery, backed by our one year warranty.



- All tones in Group A and Group B are included.
- Output level flat to within 1.5db over entire range selected.
- Separate level adjust pots and output connections for each tone Group.
- Immune to RF
- Powered by 6-30vdc, unregulated at 8 ma.
- Low impedance, low distortion, adjustable sinewave output, 5v peak-to-peak.
- Instant start-up.
- Off position for no tone output.
- Reverse polarity protection built-in.

## Group A

67.0 XZ	91.5 ZZ	118.8 2B	156.7 5A
71.9 XA	94.8 ZA	123.0 3Z	162.2 5B
74.4 WA	97.4 ZB	127.3 3A	167.9 6Z
77.0 XB	100.0 1Z	131.8 3B	173.8 6A
79.7 SP	103.5 1A	136.5 4Z	179.9 6B
82.5 YZ	107.2 1B	141.3 4A	186.2 7Z
85.4 YA	110.9 2Z	146.2 4B	192.8 7A
88.5 YB	114.8 2A	151.4 5Z	203.5 M1

- Frequency accuracy,  $\pm .1$  Hz maximum - 40°C to + 85°C
- Frequencies to 250 Hz available on special order
- Continuous tone

## Group B

TEST-TONES:	TOUCH-TONES:	BURST TONES:
600	697 1209	1600 1850 2150 2400
1000	770 1336	1650 1900 2200 2450
1500	852 1477	1700 1950 2250 2500
2175	941 1633	1750 2000 2300 2550
2805		1800 2100 2350

- Frequency accuracy,  $\pm 1$  Hz maximum - 40°C to + 85°C
- Tone length approximately 300 ms. May be lengthened, shortened or eliminated by changing value of resistor

Wired and tested: \$79.95



**COMMUNICATIONS SPECIALISTS** ✓15

426 West Taft Avenue, Orange, California 92667  
(800) 854-0547/ California: (714) 998-3021



# Looking West

Bill Pasternak WA6ITF  
24854-C Newhall Ave.  
Newhall CA 91321

Have you ever thought of writing a book? I mean a real, honest-to-goodness book about something you felt you knew something about? I had never given this idea much thought until about two and a half years ago, when I received a rather unexpected phone call. It was from Ken Sessions K6MVH. Those of you who have been around the FM scene for any length of time will remember Ken. He was one of the mode's pioneers. Ken wrote the first *FM and Repeater Handbook* published by TAB books back in 1969, a book that was for many years the bible of FM and repeater operation. Ken is a truly prolific writer in his own right, as any of you who have read his work will attest. His *Chronicles of .76* is a classic. •

As I said, I had never given any thought to writing a book of any sort. Writing *Looking West* and other assorted articles for *73* and *Worldradio* was more than enough to keep my busy. Anyway, Ken called and asked if I wanted to write a book about amateur FM and repeaters. At that point I could not readily make a decision, so I asked for a few days to think things over. A few days passed, and along came a follow-up letter from Ken on the same matter. Finally, I said to myself: "Why not? Others have done it—why not me?" I called Ken and told him to arrange things with TAB. The book was to be a new version of his original *FM and Repeater Handbook*. At least that was the original intent.

Some 30 months have gone by, and last week a box arrived at my home from TAB. In it were a dozen copies of the new book, aptly titled *The Practical Handbook of Amateur Radio FM and Repeaters*. The original contract called for 300 pages. The published text comes to 538, and weighs almost three quarters of a pound! Writing the book was another of those experiences of a lifetime; I rank it second only to working on the "World of Amateur Radio" film with Dave Bell and Roy Neal. Actually, I worked both projects at the

same time. This was done while I was also working a 5-day-a-week normal job and still devoting a lot of time to producing this column. For the record, I have to state that I have the world's most understanding and supportive wife. I know of very few XYs who would put up with someone as devoted to amateur radio as I am. She kept me going, and the book, film, and everything else are accomplishments that she has had a quiet but important part in.

I said earlier that the original intent of the book was to update Ken's book. As things progressed, a totally different tack developed. Rather than an update, I wound up with what appears to be an almost entirely new book. There are three very good reasons that this happened. In order, they are Mike Morris WA6ILQ, the book's chief technical advisor, Ray Thill WA9EXP/6, its second chief technical advisor, and—most of all—the overall amateur VHF/UHF population of this country. When input or information was needed, it was always forthcoming. Because of this, certain items that most people thought would never reach print are now there for the taking. These include such items as Joe Domke W2MNN/6's simplex autopatch and probably the best touchtone decoder ever designed, that of WA6AWD. In essence, *The Practical Handbook of Amateur Radio FM and Repeaters* is a book for the VHF/UHF FMer derived from national input. Over a hundred individuals, clubs, organizations, and equipment manufacturers provided material for it, and when we finished pre-editing prior to shipment to the publisher, we had enough material left over to begin a second volume.

However, I digress. My purpose in writing about the book is not to get you to buy it. If you need a book of that type, then I think you will find it of value. What's interesting is that I now believe that anyone can write a book on a given topic, given the time and motivation. In my case, it was simple. For years I have been collecting data about VHF, UHF, FM, and repeaters, much of it from first-hand experience. For a long time, I wondered what

to do with this data. How could my experiences benefit others? This couldn't happen unless I could find a way to get this information to those who might need it most. That was the reason I took on the project, and the reason that Mike and I have decided to continue writing books on this and allied topics. We have developed a good working relationship. He handles anything of a technical nature and I do the historical, biographical, operational, and all other peripheral work. The best part is that we can work together for hours at a clip without getting on one another's nerves.

Anyway, I think we have accomplished something with this book, but only you can be the judge. I want to hear from you. I want your opinions and input and your suggestions on future works of this type. I enjoyed writing the book and hope you will enjoy reading it.

## SIX-METER DEREGULATION

As of July 14th, 16F3 and other wide bandwidth modes could operate on the entire six-meter band. This was a result of a change to the regulations announced in late May. The only restricted area is 50.0 to 50.1, which is still CW only. This deregulation is a double-edged sword in that it calls for some judicious planning to protect interests already established on that band, as well as further deregulation to permit a truly viable relay band plan to be established.

Since the day I became an amateur, I have been a devotee of six meters. I went through its DX era in the early 60s, made the switch from AM to SSB in the mid-60s, and have watched its unfortunate deterioration since then. When I first got onto 6 meters, rag-chew sessions were commonplace. Most of us ran 5 to 10 Watts AM in those days, and all-night QSOs were common. With the coming of SSB, QSOs became shorter as DXing grew a bit easier. Then, in the late 60s, the nation went 2-meter-FM happy, and six was all but left to rot. I must admit having been caught up in the FM craze myself, and along about 1970 I abandoned six. There was one very good reason. Though I had one of the best SSB stations on the air from New York, there were very few stations to talk with any more. For the

record, my last big-league six-meter station consisted of a Swan 250C SSB transceiver and a Hammarlund HQ-110A VHF back-up receiver (with a good product detector installed) fed by a Telco low-noise converter. For added kick, the 250C fed a pair of 4-400As in grounded grid configuration, and on the roof were a pair of stacked 6-element Hy-Gain full-size wide-spaced beams. I had my dream station, but with only a handful of people to talk with, my personal interest waned. Remember, that was the low ebb of the DX cycle. By 1968, I was already spending more time on 2, and by 1970 the station was but a memory.

When I moved to California in 1972, I put up antennas not only for two meters, but for six meters as well. Even with a 3-element beam and 100 Watts of AM, contacts were virtually non-existent. I still had the HQ-110 in those days, and listening around 50.110 I counted about as many people using six out here as there were back in New York. Today, the only radio I have that operates on the 50-MHz band is a Polycomm 6. Remember them? Back in the early 60s, having a Polycomm on 6 was akin to owning a Collins S-Line on HF. How things change. I purchased this one mint at a Mt. Wilson Repeater Association swap meet for \$20 about three years ago. It's used only to listen to a local 6-meter repeater using slope detection. Once in a while, I tune it to the low-end and hear some SSB, but not all that much. Six, by and large, is still a deserted band, but it has been far from forgotten by the at least 3700 amateurs who comprise an organization known as SMIRK.

I recently had an opportunity to talk on the telephone with SMIRK's chief officer, Ray Clark K5ZMS (7158 Stone Fence, San Antonio TX 78227). I had called Ray to discuss the recent deregulation with him, and we agreed that judicious planning at this time is essential to the redevelopment of six meters. If our feelings differ at all, it's in where a repeater subband should begin.

While it's now permitted to operate FM below 52.5, repeaters are still restricted to the existing subband. For years, controversy has raged about the best six-meter band plan. In

*Continued on page 162*



# SUPER RIG

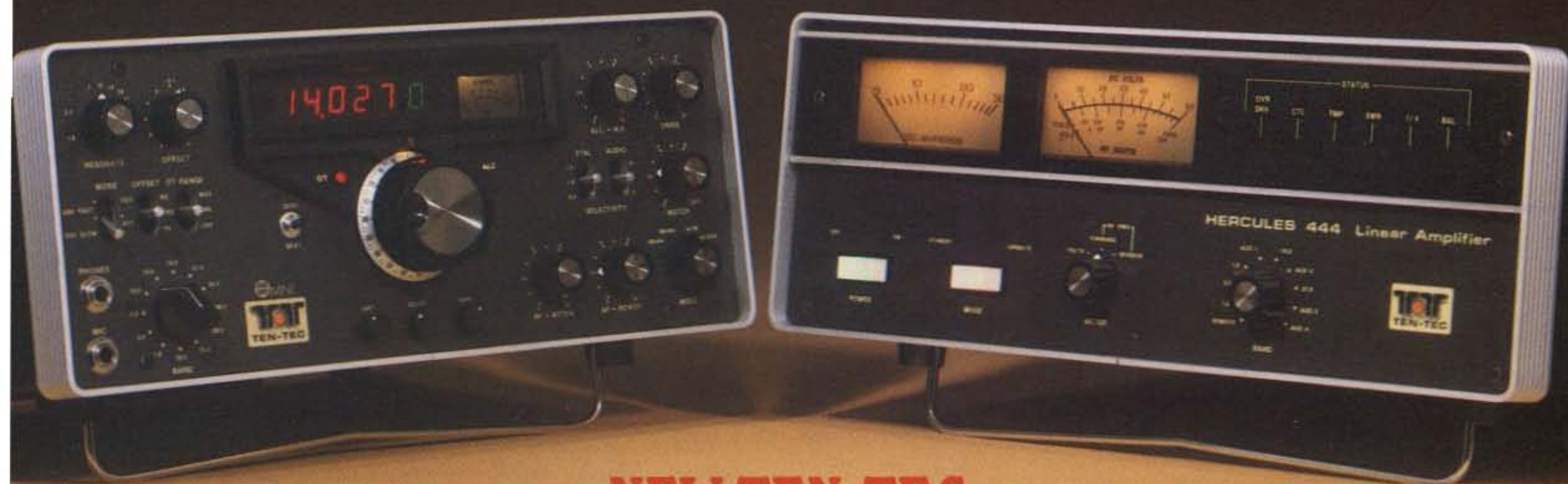

## NEW TEN-TEC

## OMNI-C 9 Band Transceiver + HERCULES Solid-State kW Linear

**TEN-TEC SUPER RIG IS READY.** For every band, every band condition. With the latest in solid-state hf technology, the latest in features. To make communications easier, more reliable — super.

### OMNI-C

The new model in this famous series. With new coverage and new features to make it better than ever!

**All 9 HF Bands.** From 160 through 10 meters, including the new 10, 18 and 24.5 MHz bands. Coverage you can live with—for years and years.

**3-Mode, 2-Range Offset Tuning.** Offset the receiver section or the transmitter section or the entire transceiver! In 2 ranges:  $\pm 500$  Hz or  $\pm 4$  kHz. For complete flexibility in fine tuning, a DX work, or net operations.

**Seven Response Curves.** Four for SSB, three for CW. With new switching to select the standard 2.4 kHz filter, optional 1.8 kHz SSB filter, 500 Hz or 250 Hz CW filters, and standard 450 and 150 Hz CW active audio filters. Up to 16 poles of i-f filtering plus audio filtering to handle any situation.

**Built-In Notch Filter and Noise Blanker.** Notch is variable from 200 Hz to 3.5 kHz with a depth of more than 50 dB. New noise blanker reduces ignition and line noise. Both standard equipment.

**"Hang" AGC.** New, smoother operation.

**Super Specs.** Optimized sensitivity—a balance between dynamic range and sensitivity ( $2 \mu\text{V}$  on 160 to  $0.3 \mu\text{V}$  on 10 meters) Greater dynamic range: better than 90 dB. And a PIN diode switchable 18 dB attenuator. 200 watts input on all bands! 100% duty cycle on all bands for up to 20 minutes.

**Super Convenient.** Built-In VOX with 3 up-front controls. Built-In PTT control at front and rear jacks. Built-In Zero-Beat switch puts you on exact frequency. Built-In Adjustable Sidetone with variable pitch and level. Adjustable ALC for full control from low power to full output. 2-Speed Break-In, fast or slow speeds to fit operating conditions. Built-In Speaker eliminates desk clutter. Automatic Sideband Selection—reversible.

**Super Design.** All Solid-State and Broadbanded—from the pioneer, Ten-Tec. Modular plug-in circuit boards. Functional Styling with convenient controls, full shielding, easy-to-use size ( $5\frac{3}{4}$ "h x  $14\frac{1}{4}$ "w x 14"d).

**Super Hercules Companion.** Styled to match, plus separate receiving antenna capability, plus transceiver front panel control of linear's bandswitching (one knob does it all).

**Full Accessory Line** including filters, remote VFO, power supplies, keyers, microphones, speech processors, antenna tuners—all in matching color.

Model 546 OMNI-Series C . . . \$1189.

### HERCULES

Amateur Radio's first full break-in solid-state kW linear amplifier. With the reliability you'd expect from the pioneer in high-power solid-state technology—TEN-TEC.

**All Solid-State.** No tubes. Instead, HERCULES uses two 500-watt push-pull solid-state amplifier modules with an output combiner. Super solid.

**Broadband Design.** No knobs, no tuning. From the pioneer, TEN-TEC. For fast, effortless changing of bands. Super easy.

**Automatic Bandswitching** when used with OMNI (the OMNI bandswitch also controls HERCULES bandswitching through a motor driven stepping switch). Super convenient.

**Full Break-In.** HERCULES puts the conversation back into high power CW operation—you can hear between every character you send.

**Full Coverage.** 160 through 15 meters plus four "AUX" positions for 10-meter conversion by owner and future band additions.

**Full Gallon.** 1000 watts input on all bands, 600 watts output, typical. Built-in forced-air cooling. Driving power: 50 watts, typical. Adjustable negative ALC voltage. 100% duty cycle for SSB voice modulation; 50% duty cycle for CW/RTTY (keydown time: 5 minutes max.) Continuous carrier operation at reduced output.

**Full Protection.** Six LED status indicators continuously monitor operating conditions and shut down the amplifier whenever any one exceeds set limits (the exciter automatically bypasses the amplifier under amplifier shut-down for barefoot operation). The six parameters monitored are: 1) overdrive; 2) improper control switch setting; 3) heat sink temp.; 4) SWR; 5) overvoltage/overcurrent; 6) rf output balance. Two meters monitor collector current, voltage, and forward/reverse power. And a highly efficient automatic line voltage correction circuit (patent applied for) eliminates the need for selecting transformer taps, prevents applying too high a voltage to final amplifier devices, becomes operative under low line conditions.

**Super Power Supply.** Provides approximately 45 VDC @ 24 amperes, operates on 105/125 VAC or 210/250 VAC. Tape wound transformer and choke reduce weight (50 lbs.) and size ( $7\frac{1}{2}$ "h x  $15\frac{3}{4}$ "w x  $13\frac{1}{2}$ "d). Separate enclosure.

**Super Styling.** Designed to match OMNI, the HERCULES has the same height as OMNI, plus matching bail and matching colors. The front panel is simplicity in itself with two push-button switches (power and mode) plus two knobs (meter and bandswitch), and a "black-out" monitor panel (when unit is off, meters are unobtrusive). Amplifier size is  $5\frac{3}{4}$ "h x 16"w x  $15\frac{1}{2}$ "d.

Model 444, HERCULES amplifier & power supply . . . \$1575.

Experience SUPER RIG at your TEN-TEC dealer, or write for full details.



**TEN-TEC, INC.**  
SEVIERVILLE, TENNESSEE 37862  
EXPORT: 5715 LINCOLN AVE., CHICAGO, ILL. 60646



# DX

Jim Cain K1TN  
306 Vernon Avenue  
Vernon CT 06066

If you read this spot in July ("DXing in the Eighties"), you are probably anxiously awaiting our obvious next move, which would be advocating free radio for all, peoples' rights to the airwaves, and so on. Breathe again, because you won't see that from this writer. Actually, we may already be there with the Novice test now merely code "recognition" and the license lasting five years.

The latest periodical added to the several dozen which we subscribe to was *Mother Earth News*, which started a few years ago as a very small, struggling magazine published by a bunch of hippies in the backwoods of North Carolina. Today, *MEN* is a highly polished, slick magazine with a large circulation published by a bunch of hippies in the backwoods of North Carolina. Their masthead says *MEN* places "heavy emphasis on alternative energy and lifestyles, ecology, working with nature, and doing more with less."

And what do you know, there's a column in *Mother Earth News* entitled "New Directions Radio," written by Copthorne Macdonald VE1BFL, one of the pioneers of slow scan television for amateurs back in the early sixties.

Cop says that "New Directions Radio" is "an international network of radio amateurs con-

cerned with those ways of using ham radio (and related modes of communicating) that promote our own growth as individuals, and which we perceive as helping to create a more aware, more caring, and more responsible human society." Cop's column dealt with the various license classes and methods of getting the knowledge necessary to qualify for them. Particularly intriguing was the tone of the article, which did not make light of the requirements for amateur licensing. Cop says that anyone of reasonable intelligence can do it, but not without some effort. *MEN*'s serious readers, those heating with solar power, growing most of their foodstuffs, and sharing responsibilities in communal living arrangements in some cases, probably aren't attuned to having much handed to them on the old silver platter.

Which brings me to the letter printed in the accompanying box, in which K8DB expresses the view of perhaps a large percentage of the amateur population. Not that we exactly agree with his views entirely, but the point he makes is well taken. It might be added that the new "list and net" DXers on the bands seem to be not the youngsters, in our experience, but rather those getting on toward middle age. On ARRL's Field Day recently, the operators making the hay with expertise were by and large younger hams; not that the old-timers can't do it,

too...we can all learn something by watching a master like W1BIH, for example. But the kids are still coming up through the ranks of *real* traffic nets and the like to develop their operating skills, and many of those kids are reading magazines like *Mother Earth News*. It is reassuring to know that we have hams like VE1BFL introducing normal people (non-hams) to amateur radio in magazines like *MEN*. Unlike the authors of certain "training programs," Macdonald has no vested financial interest or bogus political reasoning behind his desire to encourage would-be hams. Phenomena such as this are not only going to be interesting to watch through the eighties, but interesting to listen to on our bands as well.

Who knows...someday a hippie group from the USA touring Albania may include a licensed radio amateur, and he or she might get permission to operate some radio where the establishment hams have failed. It just could happen!

## DXCC

We have received two "official" reasons for the change in endorsement stickers for DXCC mentioned last month. One says that cost was the factor, due to the general unavailability of the material necessary for producing the transparencies, while the other reason goes like this: "When you take the sticker off your DXCC lapel pin to put a higher numbered one on it, the glue removes some of the enamel coating on the pin. Thus, by switching to an opaque sticker, you can cover up the damage to the pin done by the previous sticker, something you could not accomplish with a transparent sticker."

If you have sentimental attachment to your original DXCC certificate (and who doesn't?), you are going to be very sad when you add the first oddball, out-of-place, opaque sticker to your award.

On the other hand, the folks doing the day-to-day work down at DXCC are pretty efficient and are surely dedicated. The 1979 annual report of the League has some facts and figures on DXCC hinting at the size of the task: Last year, they processed almost 400,000 QSL cards on the way to issuing 2,570 new DXCC certificates, a hundred 5-Band

DXCC awards and almost a half-million credits to us already having the basic DXCC membership. And there were *no* disqualifications in 1979! The long-awaited new batch of 5-Band DXCC plaques has arrived, also, and they are hardwood instead of the previously used Naugahyde backing. Much nicer, like the life member plaques.

## CONVENTIONS

*Worldradio* featured an extensive report on the Fresno DX Convention which was held in April. The affair is 31 years old and is alternately sponsored by the Southern and Northern California DX Clubs. This year, over 400 DXers registered, including many dignitaries and overseas hams. K6LPL was voted "DXer of the Year," and Hugh Cassidy WA6AUD was inducted into CQ's DX Hall of Fame for his eleven-year toil as publisher of the *West Coast DX Bulletin*.

The east coast's answer to Fresno is DXPO 80, which will be held September 27 and 28 at Tysons Corner, Virginia, sponsored as usual by the National Capitol DX Association. Full particulars are in the Social Events column. John Kanode N4MM is NCDXA president and Stu Meyer W2GHK is DXPO 80 chairman.

The other big September event is W9DXCC. The W9DXCC convention is always in the suburban Chicago area and normally falls on the first weekend of September. It is a Friday night/Saturday gathering and has grown over the past quarter century to about 300 registrants.

At the W9DXCC banquet, a feature has always been the "DX Countdown": Everyone stands, the master of ceremonies starts counting up from one hundred in steps of ten, and when your DXCC total is reached you sit down. For as long as we have been going, the last DXer standing has been Ross Hansch W9BG, of Madison WI. Sadly, someone else will take his place this year, as Ross passed away in late June. When the countdown was completed, you always knew that somewhere there in the back of the banquet hall was Ross, every year just a little red-faced at knowing the entire room was looking for him.

## JUNE HAPPENINGS

Gee, what a dull DX month. Merely operations from Libya,

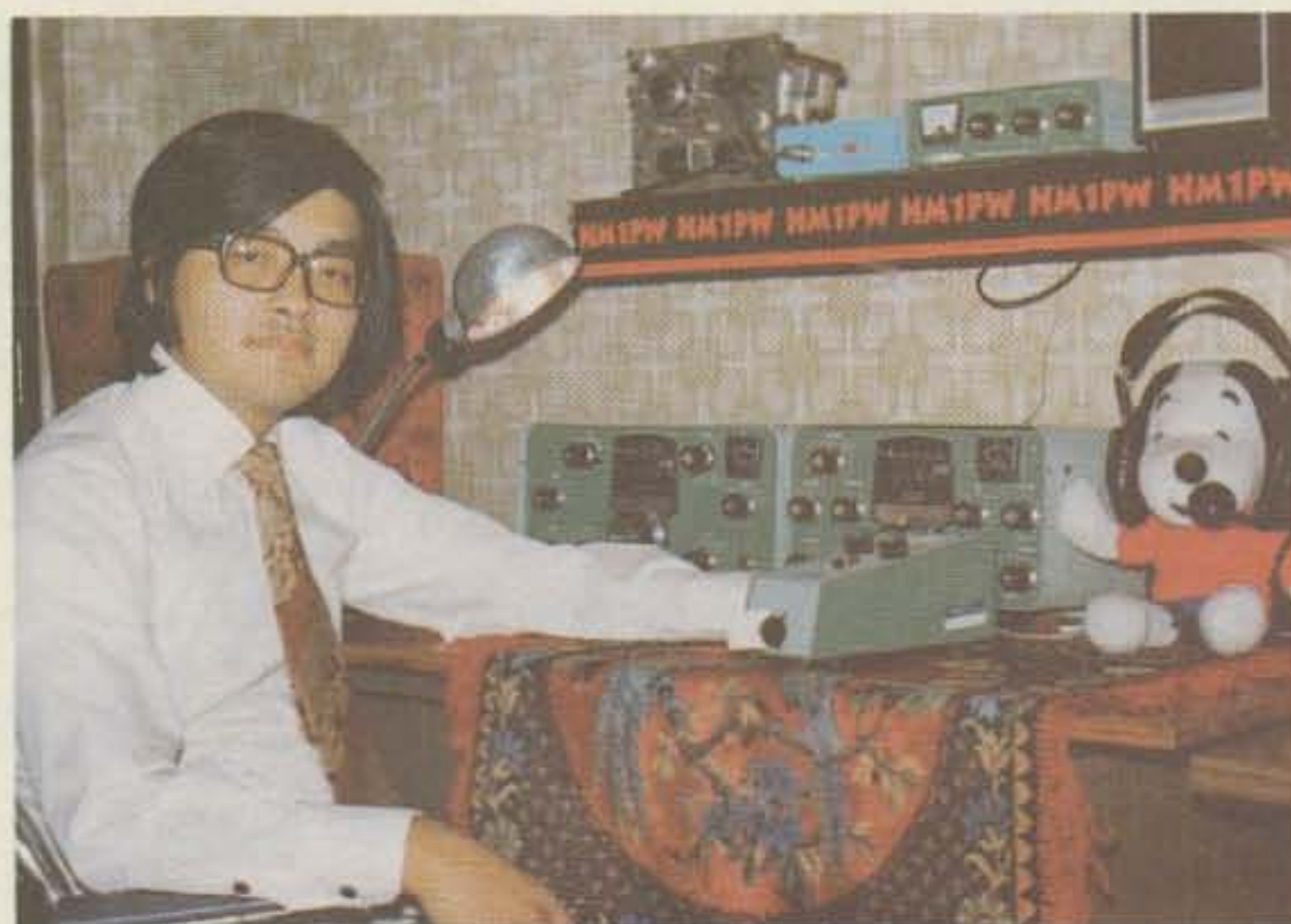

HM1PW can most often be found "Snoopying" around 15- and 20-meter CW from his Seoul shack. (Photo courtesy of W1GWA)



THE GIANT **AZDEN** COMPANY

**REVOLUTIONIZES THE STATE OF THE ART**

**AWE AND AZDEN. INTRODUCE THE BRILLIANT NEW PCS-2000**

**MICROCOMPUTER  
CONTROLLED**

**SUPERIOR COMMERCIAL GRADE  
2 METER FM TRANSCEIVER**

NOT \$550.00  
**SUMMER  
SALE**  
**\$299<sup>00</sup>**  
REG. \$369.00

NOT \$550.00  
**SUMMER  
SALE**  
**\$299<sup>00</sup>**  
REG. \$369.00



COMPARE THESE FEATURES WITH ANY UNIT AT ANY PRICE

- **FREQUENCY RANGE:** Receive and transmit: 144.00 to 147.995 MHz, 5Khz steps + MARS-CAP CAPABILITY BUILT IN (142-149.995 MHz).
- **ALL SOLID STATE-CMOS PL DIGITAL SYNTHESIZED.**
- **SIZE: UNBELIEVABLE! ONLY 6 3/4" x 2 3/8" x 9 3/4". COMPARE!**
- **MICROCOMPUTER CONTROLLED:** All scanning and frequency-control functions are performed by microcomputer.
- **DETACHABLE HEAD:** The control head may be separated from the radio for use in limited spaces and for security purposes.
- **SIX-CHANNEL MEMORY:** Each memory is re-programmable. Memory is retained even when the unit is turned off.
- **MEMORY SCAN:** The six channels may be scanned in either the "busy" or "vacant" modes for quick, easy location of an occupied or unoccupied frequency. AUTO RESUME. **COMPARE!**
- **FULL-BAND SCAN:** All channels may be scanned in either "busy" or "vacant" mode. This is especially useful for locating repeater frequencies in an unfamiliar area. AUTO RESUME. **COMPARE!**
- **INSTANT MEMORY-1 RECALL:** By pressing a button on the microphone or front panel, memory channel 1 may be recalled for immediate use.
- **MIC-CONTROLLED VOLUME AND SQUELCH:** Volume and squelch can be adjusted from the microphone for convenience in mobile operation.
- **ADDITIONAL OFFSETS:** Provides three additional offset values: +0.4 MHz, +1 MHz and +1.6 MHz. Other offsets may also be obtained.
- **25 WATTS OUTPUT:** Also 5 watts low power for short-distance commun-

- ication.
- **DIGITAL S/RF METER:** LEDs indicate signal strength and power output. No more mechanical meter movements to fall apart!
- **LARGE 1/2-INCH LED DISPLAY:** Easy-to-read frequency display minimizes "eyes-off-the-road" time.
- **PUSHBUTTON FREQUENCY CONTROL FROM MIC OR FRONT PANEL:** Any frequency may be selected by pressing a microphone or front-panel switch.
- **SUPERIOR RECEIVER SENSITIVITY:** 0.28 uV for 20-dB quieting. The squelch sensitivity is superb requiring less than 0.1 uV to open. The receiver radio circuits are designed and built to exacting specifications, resulting in unsurpassed received-signal intelligibility.
- **TRUE FM, NOT PHASE MODULATION:** Transmitted audio quality is optimized by the same high standard of design and construction as is found in the receiver. The microphone amplifier and compression circuits offer intelligibility second to none.
- **OTHER FEATURES:** Dynamic Microphone, built in speaker, mobile mounting bracket, external remote speaker jack (head and radio) and much, much more. All cords, plugs, fuses, microphone hanger, etc. included. Weight: 6 lbs.
- **ACCESSORIES:** 15' REMOTE CABLE.....\$29.95. CS-6R A/C POWER SUPPLY.....\$49.95. TOUCHTONE MIC. KIT.....\$39.95. EXTERNAL SPEAKER.....\$18.00.



**AMATEUR-WHOLESALE ELECTRONICS ORDER NOW TOLL FREE**

8817 S.W. 129th Terrace, Miami, Florida 33176  
Telephone (305) 233-3631 • Telex: 80-3356  
HOURS: 8-6, Mon. - Thur.

**1-800-327-3102**

U.S. DISTRIBUTOR  
DEALER INQUIRIES INVITED

✓5

CREDIT CARD HOLDERS MAY USE OUR TOLL FREE ORDERING NUMBER.



Wallis Island, Macao, Sudan, southern Sudan, Aland Islands, Cocos-Keeling, Guinea, and the start of a seven-country expedition in Africa. Americans continued to play less and less a role in expeditions, as only three of these were Yanks.

A. E. Howell G3JKI came on from the British Embassy in Tripoli, Libya, in late June, working with F6CYL on 20 and 15 meters SSB. He left on June 27 with no apparent plans to return

soon. Documentation is awaited in Newington before DXCC credits will be issued for G3JKI/5A. QSLs should be sent to Anne Koloboff F6CYL, 3 R. De l'Etang, 78430 Louveciennes, France.

Ian Ridpath ZL1BCG operated FW0DD June 22-27, after a short stop in Samoa and some air time as 5W1CR. 5W1CR cards should be sent to J. I. Rid-

*Continued on page 154*



*Austrian old-timer OE1UO (first licensed in 1919) mobiles with a vengeance: That's a 20-meter quarter-wave atop his auto. (Photos courtesy of W1GWA)*

## AN OPEN LETTER TO DXERS

A new breed of DXer has emerged in the past few years which has been very detrimental to the art of DXing. For various reasons, a mania has been instilled into DXing which has caused many DXers to sense that there is no tomorrow. It is perplexing to realize that very many amateurs have worked 250 to 275 countries in a relatively short period of time.

If you consider this a noteworthy feat, take a closer look. In years gone by, the idea of making DXCC, 5BDXCC, WAZ, 5BWAZ, and the Honor Roll, etc., involved a dedicated ham with infinite patience, good operating practice and technique, and above all, an excellent station. The responsible and truly competitive DXer was looked upon in a manner similar to the way in which one would view a big game hunter. The tougher the prey was to bag, the more rewarding the win.

By comparison, the new breed of DXer is making a mockery of DXing's most treasured honors by utilizing patently unethical and/or illegal practices to short-cut the process. They are impatient and don't want to "waste time" in pileups. Their motto is "work them any way you can get them," or "let your conscience be your guide." Unfortunately, most of their consciences are so warped, compromised, and otherwise self-rationalized that they have trouble distinguishing right from wrong.

My concerns do not involve DX lists or net operations per se. I have no real gripe with such operations as long as all those who ultimately make the list did it fairly by openly competing with fellow DXers on the HF bands. The honest nets and list operators include a W7 and a DK2. I would like to know of others. In contrast, though, most list and net operations are tainted with political-type favors, prearrangements, phone-ins, etc. Thus, good amateur practice, technique, and station quality take a strong second place to whom you know and your favors-given vs. favors-taken ratio.

All DXers should ask themselves what glory comes from working a rare DX station when their only competition was breaking through a busy signal or accessing a repeater. As a parallel, imagine the big game hunter receiving much acclaim and praise only to find out that he killed his prey in a cage. Tainted accomplishments reap hollow honors.

This brings me to the most serious problems prevalent in the DXing arena today which I believe are the root causes of the QRMing and bad manners so prevalent on the bands. These problems are: 1) rude, unethical, and/or outright illegal practices and 2) the emergence of the DX barons or captains who dole out their DX with partiality so as to reinforce their own importance.

Many of the unethical or illegal practices are easily recognizable by the deserving DXer. They include lists partially or completely taken on a prearranged basis with an on-the-air facade that a list is being taken at that time. In addition, some DXers dump their friends' calls in on a list and/or work the DX station using their friends' calls.

It is my feeling that any time responsible hams hear of these practices, which have a serious impact on amateur radio's image, they should speak up and be heard. In addition, the DX captains and their nets or list operations, if questionable, should be ignored. We as hams have permitted them to come into power, so we should correspondingly be able to defrock them.

Fellow DXers, there are no politics in big game hunting or sport fishing, hobbies which are closely akin to DXing. Let us begin to rid ourselves of this growing political-type malignancy and as a result reestablish the meaningfulness of DX honors. — Dennis M. Burgess K8DB.





**"BRAND NEW"**  
**CHAMPION MESSAGE  
 MEMORY KEYER**  
 Model TE-292  
**\$125.95**

**Features:**

- State-of-the-Art-CMOS Circuitry
- Choice of Message Storage
  - A. Six 50 character messages
  - B. Twelve 25 character messages
  - C. 27 combinations of message C. programming.
- Records at any speed—plays at any speed.
- Memory operating LED
- Use for daily QSO or contests

**PLUS:**

- Self-completing dots and dashes
- Both dot and dash memory
- Iambic Keying with any squeeze paddle
- 5-50 w.p.m.
- Speed, volume, tone, tune and weight controls
- Sidetone and speaker
- Low current drain CMOS battery operation—portable
- Rear panel Jack for auxiliary power
- Deluxe quarter-inch jacks for keying and output
- Keys grid block and solid rigs
- WIRED AND TESTED FULLY GUARANTEED—LESS BATTERY

**\$89.95**

**Features: Model TE-284**

- State-of-the-Art CMOS Circuitry
- Three choices of Message Storage
  - A. Two (50 character each) message storage
  - B. Four (25 character each) message storage
  - C. One 50 character and two 25 character message storage
- Records at any speed—plays at any speed
- Memory operating LED
- Use for daily QSO or contests

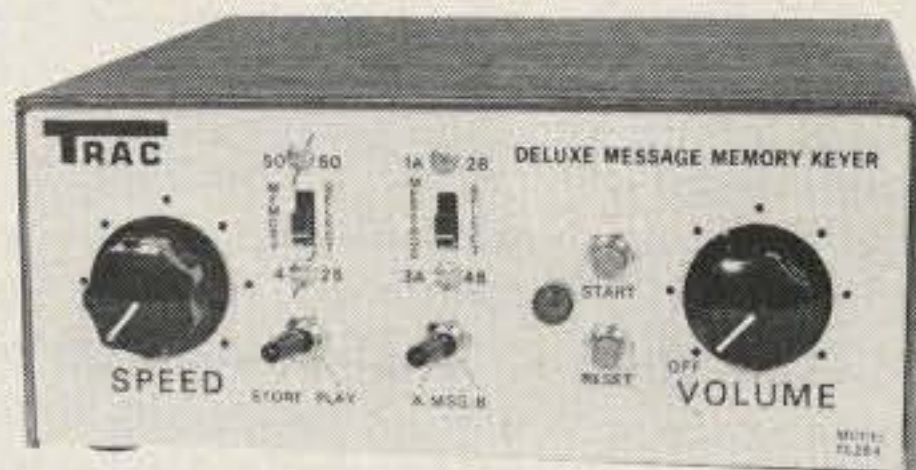

**PLUS:**

- Self-completing dots and dashes
- Both dot and dash memory
- Iambic Keying with any squeeze paddle
- 5-50 w.p.m.
- Speed, volume, tone, tune and weight controls
- Sidetone and speaker
- Low current drain CMOS battery operation—portable
- Deluxe quarter-inch jacks for keying and output
- Keys grid block and solid rigs
- WIRED AND TESTED FULLY GUARANTEED—LESS BATTERY



**MESSAGE  
 MEMORY KEYER**

**Model # TE201**

**\$69.95**

**Features:**

- Advanced CMOS message memory
- Two (50 char. each) message storage
- Repeat function
- Records at any speed—plays back at any speed
- Longer message capacity  
 Example: send CQ CQ CQ DX de WB2YJM WB2YJM K—then play second message on contact—de WB2YJM QSL NY NY 579 579 Paul Paul K
- Use for daily QSOs or contests

**PLUS:**

- State-of-the-art CMOS keyer
- Self completing dots and dashes
- Both dot and dash memory
- Iambic keying with any squeeze paddle
- 5-50 wpm
- Speed, volume, tone, tune and weight controls
- Sidetone and speaker
- Low current drain CMOS battery operation—portable
- Deluxe quarter-inch jacks for keying and output
- Keys grid block and solid state rigs
- WIRED AND TESTED FULLY GUARANTEED—LESS BATTERY



**Model # TE144**

**\$59.95**

**Features: Deluxe CMOS  
 Electronic Keyer**

- State-of-the-art CMOS circuitry
- Self completing dots and dashes
- Both dot and dash memory
- IAMBIC keying with any squeeze paddle
- 5-50 wpm

- Speed, weight, tone, volume tune controls & sidetone and speaker
- Semi-automatic "bug" operation & straight keying—rear panel switch
- Low current drain CMOS battery operation—portable
- Deluxe quarter inch jacks for keying and output
- Keys grid block and solid state rigs
- Wired and tested—fully guaranteed—less battery

MODEL TE133—same as TE144 with wgt and tone control internal, less semi-auto keying. \$49.95  
 MODEL TE122—same as TE133 less wgt, tune, solid state keying \$36.50

**AT YOUR DEALER OR SEND CHECK OR MONEY ORDER.**  
**Plus \$2.00 S/H NY Res add tax**

**TRAC**

**ELECTRONICS, INC  
 1106 RAND BLDG.  
 BUFFALO NY 14203**

✓76

**VLF Converter**



- New device opens up the world of Very Low Frequency radio.
- Gives reception of the 1750 meter band at 160-190 KHz where transmitters of one watt power can be operated without FCC license.
- Also covers the navigation radiobeacon band, standard frequency broadcasts, ship-to-shore communications, and the European low frequency broadcast band.

The converter moves all these signals to the 80 meter amateur band where they can be tuned in on an ordinary shortwave receiver.

The converter is simple to use and has no tuning adjustments. Tuning of VLF signals is done entirely by the receiver which picks up 10 KHz signals at 3510 KHz, 100 KHz signals at 3600 KHz, 500 KHz signals at 4000 KHz.

The VLF converter has crystal control for accurate frequency conversion, a low noise rf amplifier for high sensitivity, and a multipole filter to cut broadcast and 80 meter interference.

All this performance is packed into a small 3" x 1½" x 6" die cast aluminum case with UHF (SO-239) connectors.

The unique Palomar Engineers circuit eliminates the complex bandswitching and tuning adjustments usually found in VLF converters. Free descriptive brochure sent on request.

"VLF Converter \$59.95 in U.S. and Canada. Add \$3.00 shipping/handling. California residents add sales tax."



**ORDER YOURS NOW!**

**Palomar  
 Engineers**

BOX 455, ESCONDIDO, CA 92025  
 Phone: (714) 747-3343



# RTTY Loop

Marc I. Leavey, M.D. WA3AJR  
4006 Winlee Road  
Randallstown MD 21133

About a year and a half ago, I received an announcement from Gilfer Associates, Inc., of a forthcoming new book which would be of interest to the RTTYer. Well, several months down the line, due to illness of the author, the book has been published—it looks rather interesting.

Entitled *Guide To RTTY Frequencies*, the book, by Oliver P. Ferrell, represents itself as a complete guide to press, wireless, government, and other assorted RTTY signals in the high-frequency spectrum. It is all that and more.

An introduction, written by Webb Linzmayer, goes into a brief description of RTTY and the mechanics of sending the code over the air. Standard Baudot code is covered, along with looks at some of the more unusual codes which may be found, such as Cyrillic and Arabic. Although Hebrew transmission is also mentioned, no key to recognition is offered, as are keys to the former two languages. Encryption is also discussed, with some clues to decoding more common forms which may be encountered on the air.

Then comes the meat of the book. Over fifty pages contain more than 3000 entries describing RTTY stations heard reliably on the air. The stations are broken down by frequency band, beginning at 4 MHz and running the spectrum up to 27 MHz, and service, whether fixed,

mobile, or whatever. For each station, the frequency, callsign, location, service, shift, speed, and transmitter power is supplied, whenever possible. At the least, the frequency, shift, and speed information will allow reception, and these are sometimes all that is available, together with an approximate location.

In summary, then, this book appears to be a gold mine for the person looking for interesting print on his (or her) RTTY machine. The *Guide To RTTY Frequencies* costs \$8.95 and is available from Gilfer Associates, Inc., PO Box 239, 52 Park Avenue, Park Ridge NJ 07656. If you drop them a line, be sure to mention 73's RTTY Loop, OK?

The "circuit-of-the-month," if there is such an animal, this month comes from New Jersey, where Joseph A. Maillet K2ODG found RTTY Loop so interesting that he subscribed to 73! Anyway, Joe was playing with some of the demodulator circuits featured a few months ago and lamenting the lack of some kind of tuning indicator. The solution he devised is a simple tuning device that monitors the state of the mark signal and lights two LEDs, one for presence and one for absence of the mark (assumed space). The circuit is shown in Fig. 1 and should be straightforward for anyone but the most severe thumb burner to build. The transistors are specified as 2N2222s, but almost any general purpose NPN should work. The LEDs are the common ten-for-a-buck kind, any color you like. To use the

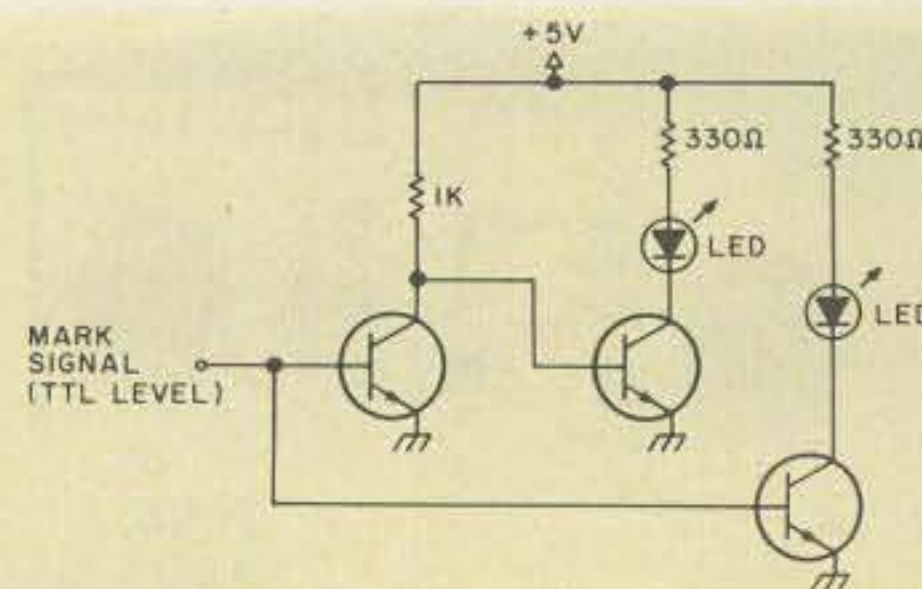

Fig. 1. A simple tuning indicator.

device, feed the decoded mark signal at TTL data levels to the bases of the transistors. With a signal consisting of roughly fifty percent mark, such as an "RY" test, the LEDs should light to about equal brilliance or flicker. Simple!

Hey, all you RTTYers in the northwest, a not-yet-Novice has requested help in completing his station, complete with RTTY gear. Charles McCleary relates that he is disabled and unable to "make order out of this chaos!" If you can help him, drop a line to 5625 N. Campbell Street, Portland OR 97217. I'm sure he will appreciate all the help he can get.

I haven't talked much about computers lately. I'm told it turns some of you off, but as long as we are on the west coast, let's drop down south a bit and see what's happening in California. Well, will you look at that! There are a couple of nets which may be of interest to RTTY/computer types. On 14250 kHz or thereabouts, a group meets on California Sundays (that's really early Monday in GMT) at 0100 in the summer and 0200 in the winter. Up a bit, around 21260 kHz, I am told that ASCII RTTY has been tossed around. They meet around the same time on Friday and Saturday nights (or Saturday and Sunday mornings, if you prefer).

As more of us get on ASCII or other "computer" RTTY, the search for components will become more intense. That is why more and more manufacturers, I suppose, are introducing peripherals priced to appeal to the hobbyist. Continuing our critical look at equipment, let's take a look at a keyboard available from Jameco Electronics, San Carlos CA 94070. The JE-610 ASCII keyboard kit has been featured in ads in 73, *Microcomputing*, and other magazines. At \$79.95, the keyboard represents a good alternative to "surplus specials."

Assembling the kit is not very difficult. Seven integrated circuits stretch across the top of the printed circuit board. The sixty-two-key assembly is received as a unit and slips into place nicely, all pins aligning. Several options are available, such as key-pressed strobe positive or negative, and parity. Two user-defined keys are provided for custom applications. A repeat key is also provided which repeats any key pressed, even control characters, after a brief pause.

There are, however, several problems. There is a "CAPS LOCK" key which, when depressed, forces uppercase for all letters. Numerals and punctuation operate normally, with the shift key, and the shift key has no effect on the already capital letters. However, several non-alphanumerics, such as the brackets, "-", and backslash, are forced into uppercase characters, preventing their use. Also, a key labeled "DELETE" actually sends an underline or delete, depending on CAPS LOCK and shift. And although the ads state "60 keys generate the full 128 character, upper- and lowercase ASCII set," one character, "US", hex 1F, cannot be generated. As some printers use this character for internal functions, this may be a problem. When this defect was brought to the attention of Jameco, the letter of reply stated "The ASC II (sic) keyboard kit was intended to have all 128 characters and codes as shown...The US function as well as the underline function was omitted in error. This was brought to our attention after the units were out." The modification, which is not included with information in the kit, is to change the matrix position of the DELETE key to one which would provide all of the functions. A minor point? Not if you bought the kit and tried to send that *one code* that your device needed.

## 2 METER AMPLIFIER

CLASS C  
PA 1-10

\$79.95

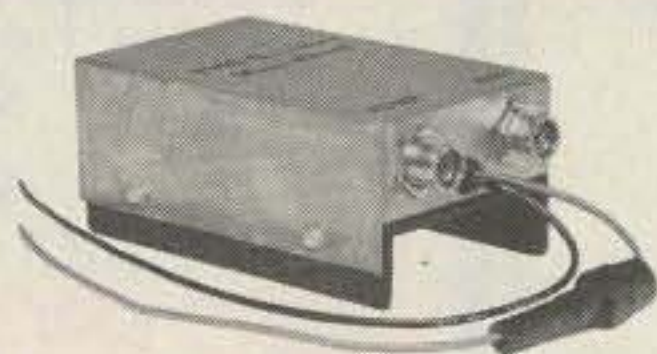

Works with all hand held and portable units. ✓324  
1-3 watts in, 10-25 watts out, 4MHz band width.  
Operates from 12-14 VDC. Solid state RF switching.

THS ELECTRONICS

RD 1, Box 195, Greene, NY 13778  
Phone 607-656-8071





# WHEN OUR CUSTOMERS TALK...WE LISTEN.

## DS3100 ASR

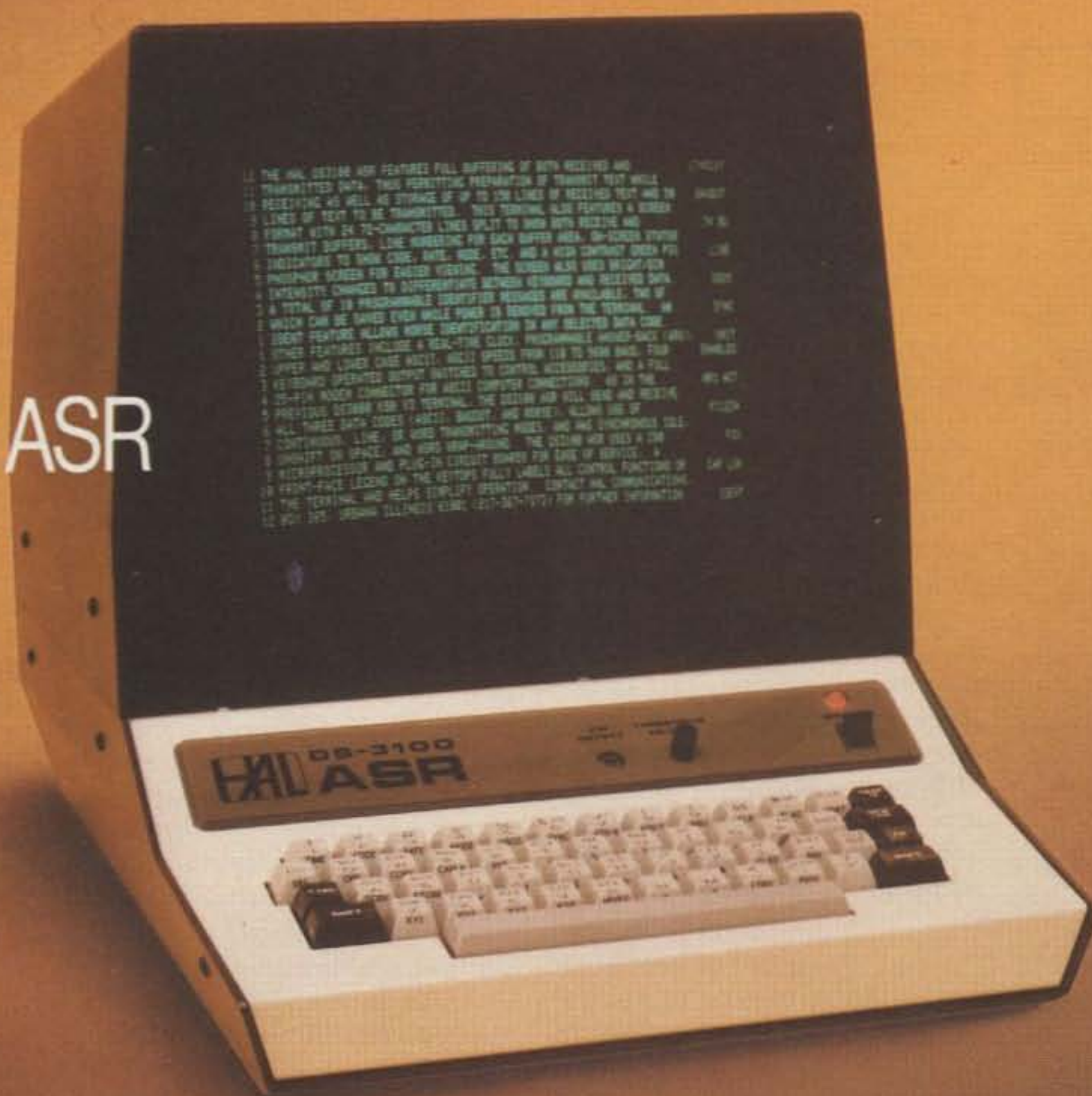

### We've Been Taking Notes.

Combining your ideas with some of our own, we've come up with what has to be the most advanced and convenient terminal available. These are some of the conveniences you can now enjoy by putting the DS3100 ASR in your RTTY and CW station:

### ASR Operation (Compose your transmission *WHILE* receiving)

- 150-line Receiver Buffer
- 50-line Transmit Buffer
- Split Screen to Show Buffers
- Internal Real-Time Clock
- 10 Programmable Messages
- Automatic Answer-Back (WRU)
- Morse, Baudot, or ASCII Operation
- RTTY and CW Identification
- Full 128-Character ASCII
- 110-9600 baud ASCII
- 60-130 WPM Baudot
- 1-175 WPM Morse

Write or call for the DS3100 ASR specifications and see how ***YOU*** have helped design the new standard in amateur radio terminals.



HAL COMMUNICATIONS CORP.  
Box 365  
Urbana, Illinois 61801  
217-367-7373

For our European Customers Contact:  
Richter & Co., Hannover  
I.E.C. Intereico, Bissone



# LETTERS

## EXPLORING

This letter is a letter of thanks to two very special persons I have become acquainted with. This is not a letter thanking someone for helping another person on a certain class of license, but it's just a vote of thanks for a lot of time and dedication. These two very special persons are Chris W4WRJ and Jay WA4RQP. Last March, these two came to a Boy Scout meeting (which I was a part of) to talk to interested persons about amateur radio and forming an Explorer Post specializing in ham radio. Well, to make a long story short, a month and half or so after that meeting we had our charter, with seven boys and five advisors registered. It's now been well over a year since then. We have had many activities, from going to hamfests to camping and working portable (I imagine someone will recognize the calls W4WRJ/4, KA4EPE/4, WA4RQP/

4, W4LFO/4, KA4LOX/4...) since starting this Explorer Post; we have been contacted just recently about providing communications for the Boy Scout National Jamboree next summer to be held at Fort A. P. Hill here in Virginia.

Exploring is probably the most unknown part of Boy Scouts today (I had to explain what it is many times over the air); that's sad, because it could help so many young people in trouble. To summarize this letter, I would like to thank Chris and Jay and all the other advisors we have for their time and devotion. They spend every Thursday evening with us instead of their families, and then there are all of those weekends.

Well, thanks Chris and Jay, Chuck, Tony...you are what make Exploring and amateur radio go.

**Scott C. Mellott**  
President of Post 1159  
Sponsored by St. James  
Episcopal Church  
Leesburg VA

## JEDDAH REPORT

Just a few weeks ago, in the spring of 1952, I went to the home of a schoolmate to find out why he didn't want to participate in a beach party with the rest of our class. When I entered his house, I heard weird sounds coming from the next room. Being the curious type, I asked what it was. I have never quite recovered from the experience of that day and find myself eagerly anticipating going home from work to listen to my own weird sounds: CW and RTTY.

After 28 years of ham radio, I, like Wayne, occasionally reflect upon the glorious past and the changes that have been wrought since that fateful day for me in 1952.

Several times I went the 6L6 + 6L6 route and even tried 117L7GTs and 6V6s with chassis of foil-lined cigar boxes, Mom's baking pans, and even a piece of 2" x 4" with the components nailed down. I worked stations for several miles around with an old Heathkit signal generator, keying the antenna directly. My favorite, though, was the battery-powered 1U4/1R5 combo in a pie pan with another pie pan on top that looked like a flying saucer. That was in 1956. I stood on the roof of a four-story apartment

building in Newport News, Virginia, and worked PY7EE in Pernambuco, Brazil, with a 50-foot wire draped across the roof and a clothespin CW key screwed to the top pie pan.

Soon after that, I obtained my first store-bought rigs, a Heathkit DX20 and a Hallicrafters S40A, from a local pawn shop, both for \$35.00. At about three-year intervals, I upgraded through horsetrading for a DX40, a Viking Ranger, a National NC125, a Hammarlund SP600, and a Gonset G76 transceiver. Finally, around 1960, I settled on a Johnson 200 W Invader and Collins R388, still hanging on to the SP600 to use with the Kleinschmidt TT119 Teletype™ setup. After 20 years with those, I traded the Invader for a newfangled transistor rig, the Triton IV by Ten-Tec. Just between you and me, I still like the old bottle rigs, but there just might be something to these transistors and integrated circuits after all.

I've been into 2 meters for about ten years now and have worn out several Motorola boat anchors. I still use one for a base station but have the Amcom 2-25 in the motor home for mobile operation. I have driven all over the United States and 2 meters really makes for some enjoyable conversation anywhere I go.

I tried 6 meters for awhile with an old Gonset "Gooney Box" AM rig with dual vfo's. I lost interest in 6 meters, though, because it seemed that everyone else did, too. At least the long silent periods made it seem that was the case. Most of the 6ers moved to 2 meters.

Back in 1965, I happened into a QSO with old K or W -5BLB — don't recall the prefix off-hand — up in Midwest City, Oklahoma. We got to talking about how some Connecticut pressure group was trying to take away the operating privileges that we had worked so hard for and had enjoyed for so many years, the good DX part of the CW frequencies and a healthy chunk of the voice frequencies. All to promote something they called incentive licensing. In a very few minutes, there was quite a roundtable going as more and more hams dropped into the QSO. The general attitude was the same as if the police had



Exploring and ham radio go hand in hand in Leesburg VA.

Continued on page 156



Specializing in Central and South American trade

# N&G

Direct Factory Distributors

At our new main headquarters, adjacent to Miami Int'l Airport

7201 N.W. 12th Street., Miami, FL 33126

Dade(305) 592-9685

Broward (305) 763-8170

Nosotros Si Hablamos Español

Special Export Prices.

We accept VISA and MASTER CHARGE.

Hey . . . O.M.  
Come visit our facility  
. . . the most modern in  
the South. . .



## SWAN ASTRO 150



HF SSB Transceivers are designed to provide the mobile or fixed base operator with the ultimate in power, stability, versatility, reliability, and ease of operation. All this human engineered into a rugged, compact, attractive package.

### IF Gain Control

To complement the exceptionally wide dynamic range front end.

### MIC Gain

Also sets CW for tuning power output (even to QRP levels)

### Dual Scale Meter

Calibrated in watts for true PEP output, and "S" units in receive (60 db over S-9)

Provides for continuous coverage between 100 Hz steps for critical frequency setting.

### RIT Control

provides approximately  $\pm$  500 Hz tuning independent of transmitter frequency

### Tuning Mic

Allows the operator to change frequency up or down in PRECISE 100 Hz steps, independent of VRS™. Constant pressure allows frequency scanning at a fixed rate.

### "VRS"™

"Variable Rate Scanning" allows you to tune up or down at any rate with only a "twist of the wrist!" No more knob cranking to get from here to there. VRS™ does all the work for you with no effort, and incredible precision!

### Digital Readout

In high intensity orange with non-glare smoke filter for superb day or night visibility without eye fatigue. During synthesizer lock-up, audio is muted and a full series of decimals appear.

### Mode Select

Gives you USB, LSB, CW normal filter AND a narrow XTAL filter for optimum CW performance — standard!

### Band Switch

Selects full primary "HAM" bands (all of ten meters) PLUS the extended ranges detailed in the specifications. A unique feature remembers the last tuned frequency on every band. For example if one operated 7141.2 MHz and switched to 20 meters, when switched back to 40M, you would still be tuned to 7141.2 Hz

### Switch Selectors

To provide full or semi-break in, noise blanker, on-off, VOX or PTT and a standby position to remember the LAST TUNED FREQUENCY on each band with only millamps of power drain.

 **SWAN**  
ELECTRONICS

355



Matching power supply (PSU-5) and antenna tuner (ST-3) provide the necessary additional units for a complete base station.



# Contests

Robert Baker WB2GFE  
15 Windsor Dr.  
Atco NJ 08004

## WORLDWIDE RTTY ART CONTEST September 1 through November 30

All worldwide licensed radio amateurs and members of their immediate families (except as otherwise provided in the rules) are eligible to participate in this contest. Sponsored by the Southern Counties Amateur Teleprinter Society of Southern California, the contest rules are as follows:

Entries must have been originated by means of manual inputs to a teleprinter using a standard communications keyboard and may be submitted only by the originator of the art or by the amateur on behalf of a family member. Submitted art may be of any subject suitable for transmission via amateur radio. Entrants may submit as many entries as desired. Each entry shall be given a short title. Submitted art may contain over-

line shading.

Tapes of entries shall be formatted to permit a reasonably short running time and to be compatible with machines which do and do not downshift on space. Compatibility with machines which interchange the bell and apostrophe is not required. At least three functions must be used between each line, normally: carriage return, line feed, and letters.

Each line of the art shall be limited to a maximum of 72 characters (including spaces). Prints must be in one single part, with no splices. Tapes must be limited to a maximum running time of 40 minutes at 60 words per minute for the art itself, exclusive of any other information on the tape, and contain no splices.

Each entry must have been transmitted the first time via amateur radio after September 1st and must be accompanied by a confirmation of at least one receipt of its transmission, identifying the title of the art and the call letters of the receiving and

transmitting stations. All confirmation must be in writing (not by RTTY transmission) and must have been obtained by the entrant from the receiving station. Entrants may obtain necessary transmission of their entry by any amateur radio station.

The tape and prints of each entry shall carry the full name of the author, call letters of the submitting station, and mailing address. This information shall be both written upon a beginning leader of the tape and also punched in the tape to appear on page copy when reproduced. Entrants must submit one five-level paper tape and five prints of each entry and by such submission agree that the tapes and prints may be used, duplicated, or published for any purpose. Tape submissions shall be of the 11/16th inch width only. Tape, prints, and transmission confirmation information should be securely packaged and sent to: RTTY Art Contest, c/o Norm Koch K6ZDL, PO Box 1351, Torrance CA 90505. Entries must be postmarked on or before November 30th. Entries will not be acknowledged after the closing date. Since mail-damaged tapes will be of little value, it is suggested that tapes

be wound tightly upon a hard core.

Entries will be judged on the originality of the author in selection of subject matter, on excellence of technique in producing the art and formatting the tape, on overall appearance of the art from a distance, on suitability for publication, and on the entrant's compliance with the rules. If an individual is the first place winner in a given year, he will not be eligible for nor considered for first place in the immediate following year. This does not preclude a station from entering and being considered for second, third, or honorable mention places.

A committee of judges, made up from those amateurs who have exhibited an interest in RTTY art, will select first, second, third, and honorable mention winners. Winning entrants will receive a plaque for their places. Winning entries will be published in various amateur radio journals. The decisions of the judges shall be final, and no correspondence will be entered into regarding their decisions.

Officials and judges of this contest and members of their

*Continued on page 150*

## Calendar

Sep 1-Nov 30	Worldwide RTTY Art Contest
Sep 13-14	European DX Contest - Phone
Sep 13-14	ARRL VHF Contest
Sep 13-14	Pennsylvania QSO Party
Sep 13-14	CAN-AM Contest - Phone
Sep 13-15	Washington State QSO Party
Sep 14	North American Sprint
Sep 27	DARC Corona 10-Meter RTTY Contest
Sep 27-28	Delta QSO Party
Sep 27-28	CAN-AM Contest - CW
Sep 27-28	Ex-KZ5 Reunion
Oct 4-5	California QSO Party
Oct 4-5	VK/ZL/Oceania DX Contest - Phone
Oct 11-12	ARRL CD Party
Oct 18-19	ARRL Simulated Emergency Test
Oct 18-19	VK/ZL/Oceania DX Contest - CW
Oct 18-19	Scouting Jamboree
Oct 18-20	QRP October QSO Party
Oct 25-26	CQ Worldwide DX Contest - Phone
Nov 1-2	ARRL Sweepstakes - CW
Nov 8-9	European DX Contest - RTTY
Nov 8-9	IPA Contest
Nov 9	International OK DX Contest
Nov 15	DARC Corona 10-Meter RTTY Contest
Nov 15-16	ARRL Sweepstakes - Phone
Nov 29-30	CQ Worldwide DX Contest - CW
Dec 6-7	ARRL 160-Meter Contest
Dec 13-14	ARRL 10-Meter Contest
Jan 18	FRACAP Worldwide Contest
Mar 7-8	1981 SSTV Contest

## Results

1980 SPRING CONTEST RESULTS BRITISH AMATEUR RADIO TELEPRINTER GROUP				
<i>Single Operator Section</i>				
No.	Call	Points	Total QSOs	Countries
1.	W3FV	592012	325	37
2.	F9XY	506456	314	32
3.	I5FZI	498456	284	32
4.	K7BV	454940	258	32
5.	SM6ASD	417648	252	29
6.	W4CQI	413354	249	35
7.	I2OLW	410416	270	32
8.	I2WEG	389850	248	30
9.	K0PJ/6	385556	254	32
10.	G3HJC	351430	199	23
<i>Multiple Operator Section</i>				
No.	Call	Points	Total QSOs	Countries
1.	9A1ONU	644160	408	32
2.	G3ZRS	490048	288	31
3.	I5MYL	456246	305	30
<i>Shortwave Listener Section</i>				
No.	Name/Call	Points	QSOs	Countries
1.	H. Ballenberger	403862	259	45
2.	OK1 11857	382506	227	36
3.	IV3 13018	309430	251	32



# Good-bye RFI

With the compact ATR-6800, you can forget about RFI . . . Add silent RTTY/CW/SSTV capability to your station with equipment that's designed to be ham gear! Unlike plastic-cased home computers, your ATR-6800 will sit right next to your kilowatt and ignore it! (And your receiver won't know it's there either!) By combining everything in one rugged aluminum enclosure, we have eliminated another source of RFI — all those boxes and assorted cables. The ATR-6800 is really complete; the AFSK-terminal unit, keying circuits, video drive, computer . . . everything's inside for direct connection and control of your transceiver. To get the full story, write for our ten page brochure or pick one up at your local dealer. Microlog Corporation, 4 Professional Drive, Suite 119, Gaithersburg, MD 20760. Telephone (301) 948-5307.



**MICROLOG** ✓ 51

Innovators in Digital Communications



# Awards

Bill Gosney WB7BFB  
2665 North 1250 East  
Whidbey Island  
Oak Harbor WA 98277

This is the second of our two-part series featuring the 73 Magazine awards portfolio; we now learn of the six domestic awards being sought by award seekers the world over.

These awards were not meant to be an overnight venture nor were they designed to duplicate any in existence today. Each offers its own degree of difficulty and creates a sense of accomplishment among those who are happy recipients.

## WORKED ALL USA AWARD

Sponsored by the editors of 73 Magazine, the Worked All USA Award is available to licensed amateurs throughout the world. To be valid, all contacts must have been made on or after January 1, 1979. There are no band or mode restrictions; however, single band and single mode accomplishments will be recognized.

If you're looking for an award with challenge, this definitely is one. To qualify, applicants must work each of the 50 US states within the same calendar year (January 1 through December 31). Annual endorsements will be awarded applicants who can verify their claim.

To apply, make a self-prepared list of claimed contacts in alphabetical order by US state, beginning with the state of Alabama. List the state, the callsign of the station worked, the date and time in GMT, and the band and mode of operation.

Do not send QSL cards! Have your list of contacts verified by two amateurs, a local radio club secretary, or a notary public.

The fee for the basic award is \$3.00 or 8 IRCs. Endorsements are \$1.50 or 4 IRCs. Send your application and award fee(s) to: Bill Gosney WB7BFB, 73 Awards Editor, 2665 North Busby Road, Oak Harbor, Whidbey Island WA 98277 USA.

The Worked All USA Award, with its 12-month limitation, separates the men from the boys. To date, only a few have mastered the 80-meter band, while 10, 15, and 20 have become the more popular bands

accomplished. Only one applicant has mastered all states on 6 meters and 160 meters has yet to be conquered. Does your station have what it takes to WORK ALL USA in a calendar year?

## THE Q-5 AWARD OF EXCELLENCE

If you frequent the American Novice bands, we are pleased to announce an exclusive award for these bands. Sponsored by the editors of 73 Magazine, the Q-5 Award of Excellence is offered to amateurs worldwide who meet the requirements this Novice band award dictates.

To be valid, all contacts must have been made on or after January 1, 1979. All contacts must have been made in the CW mode on those frequencies assigned the American Novice. Applicants are cautioned that the power limitation is 250 Watts input. There are no band restrictions; however, applicants may request special band endorsements on the award if the request is made at the time of application.

To qualify, applicants must work all ten (10) US call districts and receive no less than a Q-5 report. A valid RST might be 559, 539, 579, etc., while an RST of 449, 349, or 479 would not qualify the applicant for this award.

This award is not meant to be an overnight accomplishment. Stations meeting the challenge of these requirements will be proud to display this unique award depicting the excellence and superiority of their transmitted signal.

To apply, prepare a list of claimed contacts, logging each contact in order of the US call district. Include the station callsign, date and time in GMT, the frequency utilized, and, most important, the RST as noted on your confirmation card. Also required is a brief description of the station equipment and antenna system utilized to complete this award.

Do not send QSL cards! Have your list verified by two amateurs, a local radio club secretary, or a notary public. Send your application with \$3.00 or 8 IRCs to: Bill Gosney WB7BFB, 73 Awards Editor, 2665 North

Busby Road, Oak Harbor, Whidbey Island WA 98277 USA.

## SPECIALTY COMMUNICATIONS ACHIEVEMENT AWARD — CLASS A

A significant number of amateurs throughout the world find their primary interest in the operation and development of specialty-type communications. It is the efforts of these many pioneers in their respective fields which have created many state-of-the-art improvements which we know in technology today. The editors of 73 wish to recognize those amateurs who make positive steps toward expanding the use of their respective mode or type of amateur operation. As a result, in the paragraphs to follow, learn of our latest communications award, dedicated to "communicator specialists."

To be eligible for the Specialty Communications Achievement Award, all contacts must have been made on or after January 1, 1980. In addition, only communications via SSTV, RTTY, EME (Earth-moon-Earth), and/or OSCAR will be recognized for this award. Contacts between stations on OSCAR or EME may be made using any authorized mode allowed in your country. Applicants are cautioned, however, that mixed mode contacts are not valid.

To qualify, applicants must work and confirm contact with each of the 50 US states. There are no band requirements; however, specific band accomplishments will be recognized if requested at the time of application.

To apply, applicants must prepare a list of claimed contacts in alphabetical order by state. Include the date and time in GMT, the band and mode of operation, and a signed description of equipment and antenna system utilized.

Do not send QSL cards! Have your list verified by two amateurs, a local radio club secretary, or a notary public. Send your application with a \$3.00 award fee or 8 IRCs to: Bill Gosney WB7BFB, 73 Awards Editor, 2665 North Busby Road, Oak Harbor, Whidbey Island WA 98277 USA.

## DISTRICT ENDURANCE AWARD

If any of our readers feel our

awards are too soft, they should take a hard look at this one. It was designed to appear fairly simple at first glance, but will drive you right up the wall with frustration as it is pursued. Known as the District Endurance Award, in order to get it you'll need to find yourself an accurate timepiece, as you'll have exactly sixty (60) minutes to work all (10) ten US call districts. Simple, huh? Can you beat the best time to date — 45 minutes?

Sponsored by the 73 Magazine editors, the District Endurance Award is offered to licensed amateurs throughout the world. To be valid, all contacts must have been made on or after January 1, 1979. There are no band or mode restrictions; however, if you are fortunate enough to work these requirements on a single band, we would be happy to recognize this feat when processing your award.

One of the most important rules applicable to this award is that all contacts must be made independent of nets of any kind and not while any contest is underway.

To qualify, applicants must work all ten US call districts in one hour or less. The time will commence the moment the first contact is established and end with the time logged for the last district required.

To apply, applicants must prepare a signed declaration that all contacts were independent of net or contest operation. Applications should also include a list of stations worked in callsign order by district, the date and time worked in GMT, the band and mode of operation, and the state.

Do not send QSL cards! Have your list of contacts verified by two amateurs, a local radio club secretary, or a notary public. Forward your application along with a \$3.00 award fee or 8 IRCs to: Bill Gosney WB7BFB, 73 Awards Editor, 2665 North Busby Road, Oak Harbor, Whidbey Island WA 98277 USA.

## TEN-METER 10-40 AWARD

What would an awards program be like without a QRP incentive? With 10 meters at an all-time high, the editors of 73 Magazine take pride in announcing the Ten-Meter 10-40 Award.

Continued on page 158



An Extraordinary Offer to introduce you to the benefits of Membership in

# ELECTRONICS BOOK CLUB

take any **4** (UP TO 6 BOOKS) ✓321 of these 22 unique electronics selections (values to \$115.<sup>65</sup>) for only **\$1<sup>99</sup>** for **ALL FOUR**

with a Trial Membership in the Book Club that guarantees to save you 25% to 75% on a wide selection of electronics books



2 BOOKS COUNT AS 1 SELECTION—1224/1182: 672 p.—The Complete Handbook of Radio Transmitters and The Complete Handbook of Radio Receivers (\$19.95)

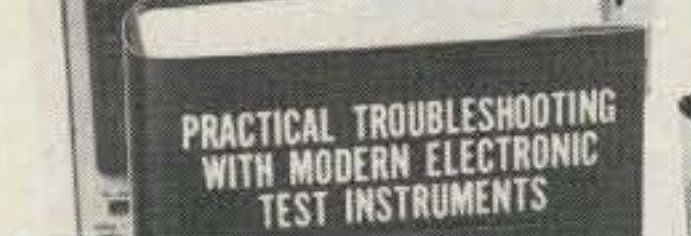

2 BOOKS COUNT AS 1 SELECTION—1162/1177: 592 p.—Practical Troubleshooting With The Modern Oscilloscope and Practical Troubleshooting With Modern Electronic Test Instruments (\$25.90)



1212-532 p.—The Practical Handbook of Amateur Radio FM & Repeaters (\$15.95)



1146-504 p.—Radio Propagation Handbook (\$17.95)



1225-322 p.—Master Handbook of Electronic Tables & Formulas—3rd Edition (\$14.95)



1189-140 p.—10-Meter FM for the Radio Amateur (\$9.95)

1152-266 p.—Antenna Data Reference Manual—including dimension tables (\$12.95)



1136-540 p.—Practical Electronics Math (\$15.95)

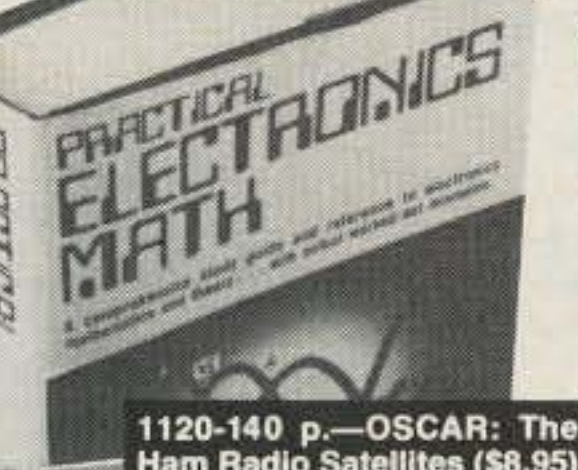

1194-448 p.—How to Troubleshoot & Repair Amateur Radio Equipment (\$14.95)



1066-868 p.—The Illustrated Dictionary of Electronics (\$19.95)

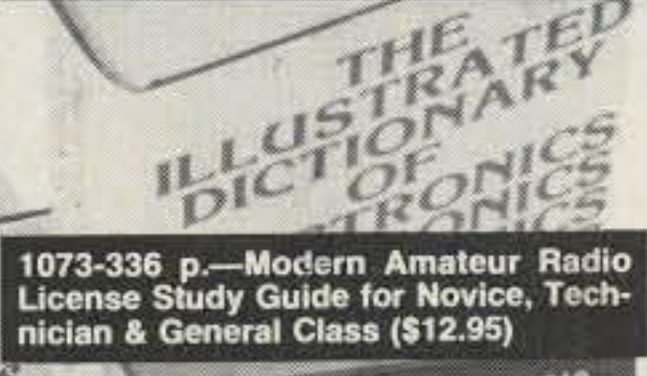

955-308 p.—Modern Digital Communications (\$10.95)



1073-336 p.—Modern Amateur Radio License Study Guide for Novice, Technician & General Class (\$12.95)

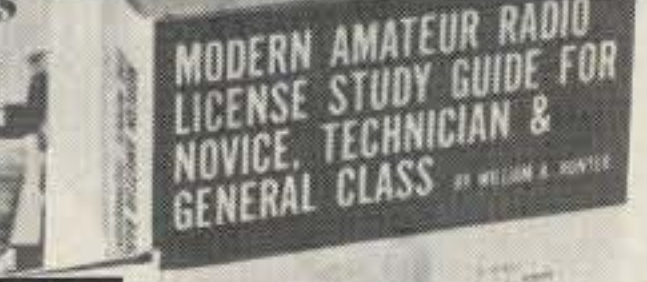

1120-140 p.—OSCAR: The Ham Radio Satellites (\$8.95)



802-462 p.—The Giant Book of Amateur Radio Antennas (\$8.95)



1132-280 p.—Handbook of Electrical Noise: Measurement and Technology (\$10.95)

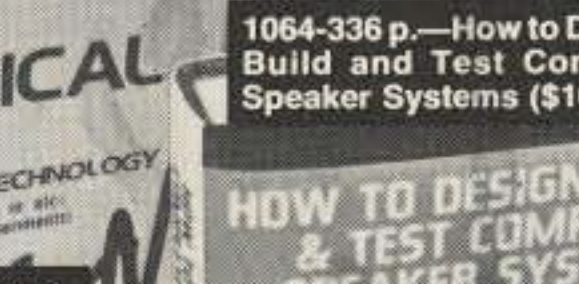

1064-336 p.—How to Design, Build and Test Complete Speaker Systems (\$10.95)

805-378 p.—99 Test Equipment Projects You Can Build (\$12.95)



1255-308 p.—The Complete Shortwave Listener's Handbook—2nd Edition (\$14.95)



1005-196 p.—The Handbook of Solar Flare Monitoring & Propagation Forecasting (\$9.95)



1070-406 p.—Digital Interfacing with an Analog World (\$12.95)



## Facts About Club Membership

- The 4 introductory books of your choice carry publisher's retail prices of up to \$115.65. They are yours for only \$1.99 for all 4 (plus postage/handling) with your Trial Membership.
- You will receive the **Club News**, describing the current Selections, Alternates, and other books, every 4 weeks (13x a year).
- If you want the Selection, do nothing, it will be sent to you automatically. If you do not wish to receive the Selection, or if you want to order one of the many Alternates offered, you simply give instructions on the reply form (and in the envelope) provided, and return it to us by the date specified. This date allows you at least 10 days in which to return the form. If, because of late mail delivery, you do not have 10 days to make a decision and so receive an unwanted Selection, you may return it at Club expense.
- To complete your Trial Membership, you need buy only four additional monthly Selections or Alternates during the next 12 months. You may cancel your Membership any time after you purchase these four books.
- All books—including the Introductory Offer—are fully returnable after 10 days if you're not completely satisfied.
- All books are offered at low Member prices, plus a small postage and handling charge.
- **Continuing Bonus.** If you continue after this Trial Membership, you will earn a Dividend Certificate for every book you purchase. Three Certificates plus payment of the nominal sum of \$1.99 will entitle you to a valuable Book Dividend of your choice which you may choose from a list provided Members.

May we send you your choice of 4 of these practical time-and-money-saving books as part of an unusual offer of a Trial Membership in Electronics Book Club?

Here are quality hardbound volumes, each especially designed to help you increase your know-how, earning power, and enjoyment of electronics. Whatever your interest in electronics, you'll find Electronics Book Club offers practical, quality books that you can put to immediate use and benefit.

This extraordinary offer is intended to prove to you through your own experience, that these very real advantages can be yours...that it is possible to keep up with the literature published in your areas of interest, and to save substantially while so doing. As part of your Trial Membership, you need purchase as few as four books during the coming 12 months. You would probably buy at least this many anyway, without the substantial savings offered through Club Membership.

To start your Membership on these attractive terms, simply fill out and mail the coupon today. You will receive the 4 books of your choice for 10-day inspection. YOU NEED SEND NO MONEY. If you're not delighted, return the books within 10 days and your Trial Membership will be cancelled without cost or obligation.

ELECTRONICS BOOK CLUB, Blue Ridge Summit, Pa. 17214

## ELECTRONICS BOOK CLUB

Blue Ridge Summit, Pa. 17214

Please open my Trial Membership in ELECTRONICS BOOK CLUB and send me the 4 books circled below. I understand the cost of the books I have selected is only \$1.99 for all 4, plus a small shipping charge. If not delighted, I may return the books within 10 days and owe nothing, and have my Trial Membership cancelled. I agree to purchase at least four additional books during the next 12 months after which I may cancel my membership at any time.

802 805 955 1005 1064 1066 1070  
1073 1120 1132 1136 1146 1152 1162/1177  
1189 1194 1212 1224/1182 1225 1255

Name \_\_\_\_\_ Phone \_\_\_\_\_

Address \_\_\_\_\_

City \_\_\_\_\_

State \_\_\_\_\_ Zip \_\_\_\_\_

(Valid for new Members only. Foreign and Canada add 15%.) ST-980



# WHEN OUR CUSTOMERS TALK... WE LISTEN.



Jim Clouse, K5JN  
Oklahoma City, OK



Phil Litchfield, WA1OFP  
New Canaan, CT



Colin Richards, 9M2CR  
Singapore

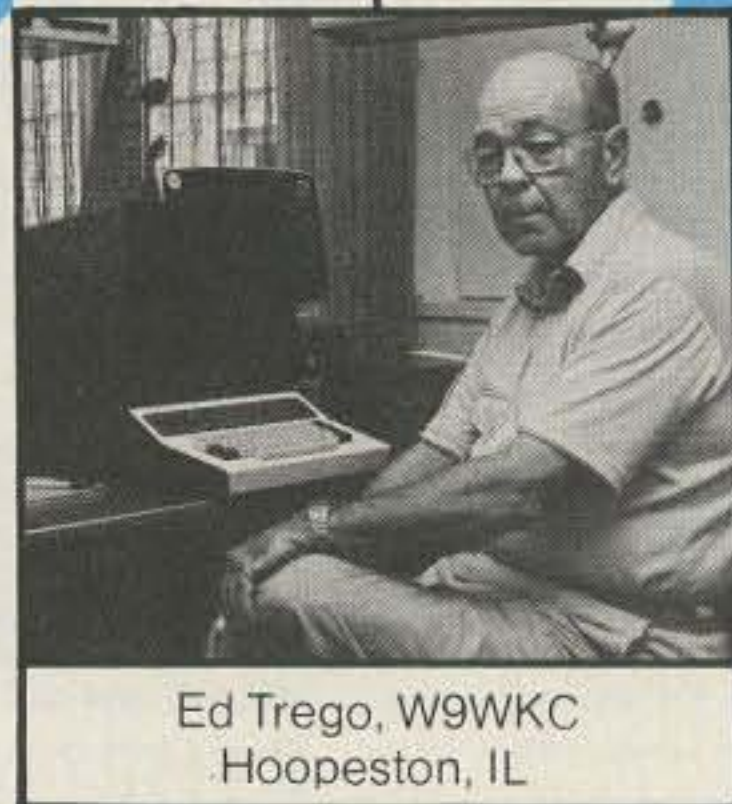

Ed Trego, W9WKC  
Hoopeston, IL

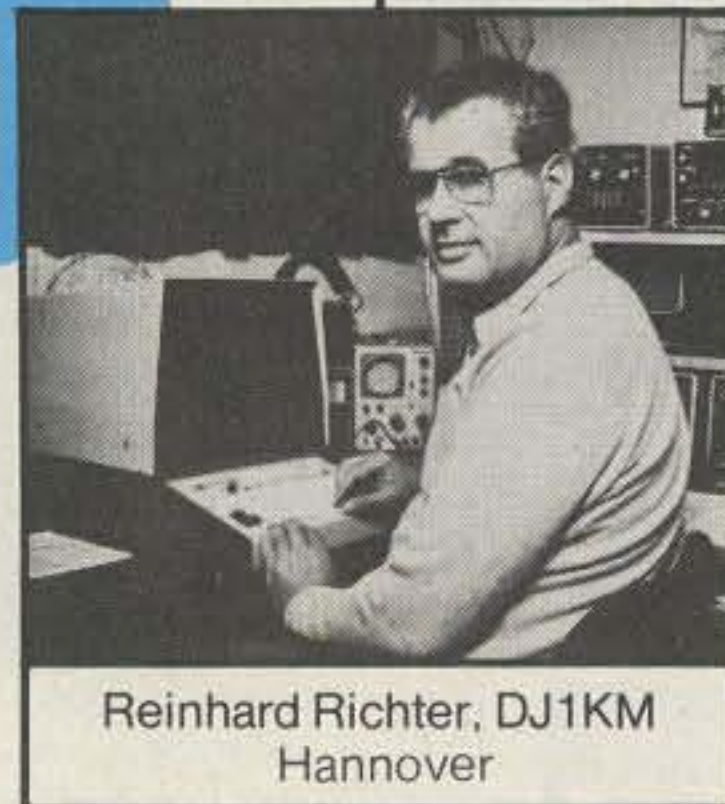

Reinhard Richter, DJ1KM  
Hannover

## From around the world their RTTY messages read loud and clear.

At HAL we *want* to hear what our customers have to say about RTTY practices, problems, and possibilities. So when they talk . . . we listen . . . and respond.

The result is that HAL Communications equipment

stays at the leading edge of RTTY design with . . . features that open up new capabilities for greater enjoyment of RTTY operation. And with performance reliability so certain, we offer a full one-year warranty.

**Write or give us a call. We'll be glad to send you our new RTTY catalog.**



**HAL COMMUNICATIONS CORP.**  
Box 365  
Urbana, Illinois 61801  
217-367-7373

✓ 345

For our European Customers Contact:  
Richter & Co., D3000 Hannover 1  
Transradio SA, 6816 Bissone/Lugano



# Leaky Lines

Dave Mann K2AGZ  
3 Daniel Lane  
Kinnelon NJ 07405

This may cause the eggs to hit the fan, but so be it. And if I get my head handed to me, I've got to say it anyway.

Just as driving a car was once a pleasure but has now become a harrowing and tedious bore and a task to be avoided, so have repeater operations on 2 meters become an onerous and disagreeable jejune. It is not merely that the band, like our highways, has become overcrowded and impossibly congested, but that like many drivers, some ham operators display such immaturity and thoughtlessness. There is hardly a repeater you can name that doesn't have its own resident bore... a guy or group of guys who can be found at almost any hour of the day, holding forth with an endless stream of unremitting, meaningless drivel.

Just as brevity is the soul of wit, is it also the hallmark of courtesy and tact. In a situation where the facility must be fairly shared among thousands who are entitled to its use, what is this strange compulsion that causes certain people to push the mike switch whenever they are behind the wheel, whether they're driving a hundred miles or just down to the corner drugstore? Why must some people find it so necessary to access a repeater fifteen or twenty times a day whether they have something to communicate or not?

Every repeater, it seems, has its own long-playing big mouth... a fellow who delivers endless monologues with the monotony and regularity of Old Faithful! He can be found holding forth for hours on end. This can be highly intimidating to those who are newly licensed or inclined toward unaggressiveness. They would rather just listen than try to compete with the self-assured marathon talker who seems to dominate at all hours, day or night. But it is not only the newcomers who feel intimidated or turned off. Many old-timers are also repulsed at this arrant hoggishness. I know scores who just don't bother to transmit at all any more, and it is likely that

they avoid it because they don't want to get trapped in a long, ear-bending encounter with these resident big mouths.

If you live in a large metropolitan area, check this out for yourself. You will find that the simplex frequencies are being used more and more each day, for increasing numbers are finding repeaters unsatisfactory. In less congested areas of the country, of course, things are much better.

Strangely enough, in crowded places where repeaters have memberships of hundreds, you are likely to hear the nonstop monologist, but out in the hinterlands where club rosters don't compare in size, it is rare to encounter one.

There are those who place the blame squarely on the repeaters themselves, but I disagree. This is like blaming the victim for enticing the rapist. It makes very little sense. Perhaps those in charge of repeater operations are responsible for dealing with such problems when they arise, but that is after the fact. They are no more culpable for the excesses of the garrulous member than for the occasional jammer who fouls up the works. It is what is done to deal with the problem that counts. I have attended many a repeater club meeting, and invariably the subject of the jammer will be raised. But I've never heard anyone broach the matter of the member in good standing who never shuts his @\$%&\* mouth and who monopolizes the machine to the utter disgust of all other members.

Unlike the characters in that famous cigarette commercial, many repeater members would rather switch than fight! The first stage is a gradual reduction in their activity, and ultimately they just leave for less annoying, more fruitful frequencies. This is not always noticed because new members come in to keep the total membership figures fairly constant in level. But a great number of stalwart, steadfast members are now leaving repeater clubs because they feel a real sense of frustration about the way two or three guys with long-playing mouths have taken over the machines.

Many people are rediscovering the fact that round tables, rag chews and net-type QSOs properly belong on other frequencies... not on repeaters. And if they must be conducted on 2 meters, there are more than enough simplex channels to accommodate them.

Hams, who ought to know better, seem to think that the FCC can solve all the problems of amateur radio. The fact is that our service lies at the very bottom of the Commission's priority list. No matter who our spokespersons and representatives happen to be—the ARRL or whomever—the Amateur Service is not of prime concern to the agency.

There are times when this fact is acknowledged so openly that it boggles the mind. I was watching a TV interview with a certain member of the FCC some time ago. When the interviewer asked him to summarize briefly his duties, he answered to the effect that his sole function was to try to get as many radio and television stations licensed to minority people as he could. To say that I was shocked at his candor is a rank understatement. But I was even more astonished at the realization that he regards his post not as one of service to the Commission so much as an opportunity to further his own political and social hopes and ideas.

I believe that one of the most important goals for those involved in communications and committed to its future within the framework of a free nation should be to strive to influence the selection of FCC Commissioners from among those who are best qualified by virtue of experience, competence, and commitment. It is an outrage when persons are awarded such posts as a reward for political favors or their work in election campaigns. Certainly no FCC Commissioner should be chosen who is not at least somewhat conversant with the complex nature of communications in today's world.

If the President of the United States wishes to reward some politician with a post in some bureau or agency, let it be one in which his lack of expertise does not result in such fiascoes as the ban on the manufacture of linear amplifiers for 28 MHz or the apparent unwillingness of the present Commission to deal in any way with the illegal commandeering of unassigned frequencies by unauthorized users in that same section of the radio spectrum.

How can amateurs possibly rely upon any administrative agency which displays such inability to enforce its own rules and regulations? It is pathetic—and it is absurd!

## Ham Help

It is with deep regret that I inform you of the passing of my beloved husband of 45 years, Robert H. Kastle K4TQW, on March 19, 1980.

Please note that I have a complete library of QST starting from 1974. I also have 73s (all of 1977 through current), as well as numerous other amateur books. I would like very much to find a worthwhile club or library that could take them all and use them as a memorial to Bob.

**Mrs. Robert H. Kastle**  
3896 46th Avenue North  
St. Petersburg FL 33714

I am looking for a crystal-controlled mobile 220 rig at a good price.

**Kenneth Hunt**  
6519 Valhalla  
Klamath Falls OR 97601

I need a boat-anchor tube-type 2-meter rf amplifier—the bigger, the better. I need to saturate all the canyons and gullies in order to break a repeater over in the valley.

**Mickey McDaniel W6FGE**  
940 Temple St.  
San Diego CA 92106

I have a Teletype™ in a rack and need to locate manuals for this or similar equipment. The units are marked:

Data Prep Set DOD Model 35  
1) AN/GGC 15(V)1; Typing unit in which is UA28 printer (code LK806ATN, also marked LP821TM/ATX);  
2) Tape punch;  
3) Switch and code wheel set.

**Alan H. Nielsen K3GRO**  
22 Woodland Place  
Pompton Plains NJ 07444



# WILSON SYSTEMS INC.

## SYSTEM 33

**\$164<sup>95</sup>**

**FACTORY DIRECT ONLY**

Capable of handling the Legal Limit, the *SYSTEM 33* is the finest compact tri-bander available to the amateur.

Designed and produced by one of the world's largest antenna manufacturers, the traditional quality of workmanship and materials excels with the *SYSTEM 33*.

The boom-to-element mount consists of two 1/8" thick formed aluminum plates that will provide more clamping and holding strength to prevent element misalignment.

Superior clamping power is obtained with the use of a rugged 1/4" thick aluminum plate for boom to mast mounting.

The use of large diameter High-Q Traps in the *SYSTEM 33* makes it a high performing tri-bander and at a very economical price.

A complete step-by-step illustrated instruction manual guides you to easy assembly and the lightweight antenna makes installation of the *SYSTEM 33* quick and simple.

### SPECIFICATIONS

Band MHz. . . . . 14-21-28  
Max. power input . . . Legal limit  
Gain (dbd) . . . . . 8  
VSWR at resonance . . . . . 1.3:1  
Impedance . . . . . 50 ohms  
F/B ratio . . . . . up to 20

Boom (O.D. x length) 2" x 14'4"  
No. elements . . . . . 3  
Longest element . . . . . 27'4"  
Turning radius . . . . . 15'9"  
Max. mast diameter . . . 2" O.D.  
Surface area . . . . . 5.7 sq. ft.

Wind load @ 80 mph . . 114 lbs  
Assembled Wt. . . . . 37 lbs  
Shipping Wt. . . . . 42 lbs  
Direct 52 ohm feed  
no balun required  
Max wind survival . . . 100 mph

### ACTUAL SWR CURVES

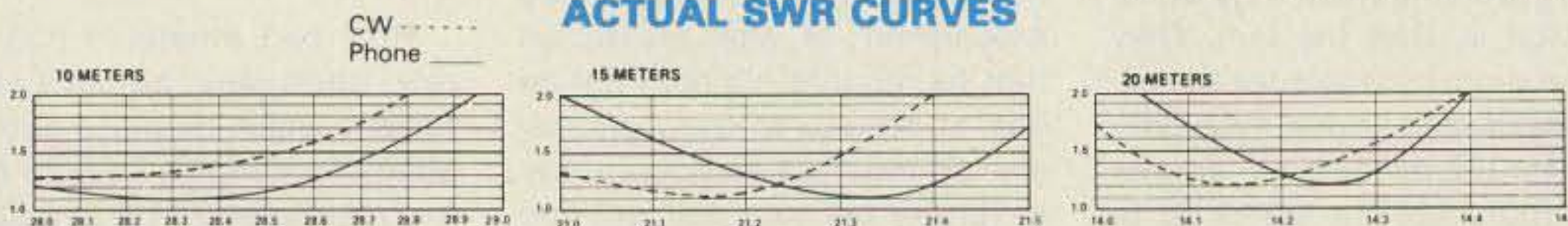

**COMPARE THE SY33 WITH OTHERS...**

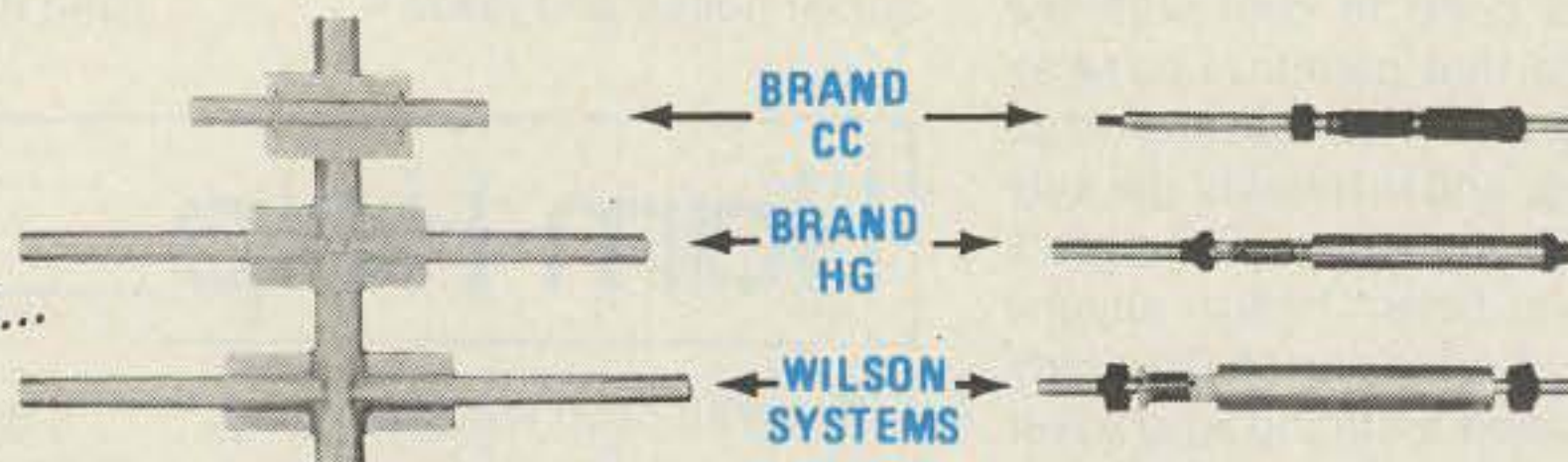

Compare the size and strength of the boom to element clamps. See who offers the largest and heaviest duty. Which would you prefer?

Wilson Systems traps offer a larger diameter trap coil and a larger outside housing, giving excellent Q and power capabilities.

## ADD 40 METERS TO YOUR TRI-BAND WITH THE 33-6 MK

— IN STOCK —

**\$64<sup>95</sup>**

Now you can have the capabilities of 40-meter operation on the *SYSTEM 36* and *SYSTEM 33*. Using the same type high quality traps, the 40-meter addition will offer 150 KHZ of bandwidth. The 33-6 MK will fit your present SY36, SY33, or SY3 and use the same single feed line.

The 33-6 MK adds approximately 15' to the driven element of your tri-bander, increasing the tuning radius by 5 to 6 feet. This addition will offer an effective rotatable dipole at the same height of your beam.

**W S I WILSON SYSTEMS, INC.**

4286 S. Polaris Ave., Las Vegas, Nevada 89103  
Prices and specifications subject to change without notice

**ORDER FACTORY DIRECT 1-800-634-6898**

**\$64<sup>95</sup>**

## WV-1A

**4 BAND TRAP VERTICAL (10 - 40 METERS)**

No bandswitching necessary with this vertical. An excellent low cost DX antenna with an electrical quarter wavelength on each band and low angle radiation. Advanced design provides low SWR and exceptionally flat response across the full width of each band.

Featured is the Wilson large diameter High-Q traps which will maintain resonant points with varying temperatures and humidity.

Easily assembled, the WV-1A is supplied with a base mount bracket to attach to vent pipe or to a mast driven in the ground.

**NOTE:**  
Radials are required for peak operation or above ground mounting. (See GR-1 below)

### SPECIFICATIONS

- 19' total height
- Self supporting — no guys required
- Weight — 14 lbs.
- Input impedance: 50 Ω
- Powerhandling capability: Legal Limit
- Two High-Q traps with large diameter coils
- Low angle radiation
- Omnidirectional performance
- Taper swaged aluminum tubing
- Automatic bandswitching
- Mast bracket furnished
- SWR: 1.1:1 or less on all bands

## GR-1

**GROUND RADIAL KIT**

**\$14<sup>95</sup>**

The GR-1 is the complete ground radial kit for the WV 1A. It consists of 150' of 7/14 stranded aluminum wire, heavy duty egg insulators and instructions. The GR-1 will increase the efficiency of the WV-1 by providing the correct counterpoise.



# WILSON SYSTEMS, INC.

## the SYSTEM 36

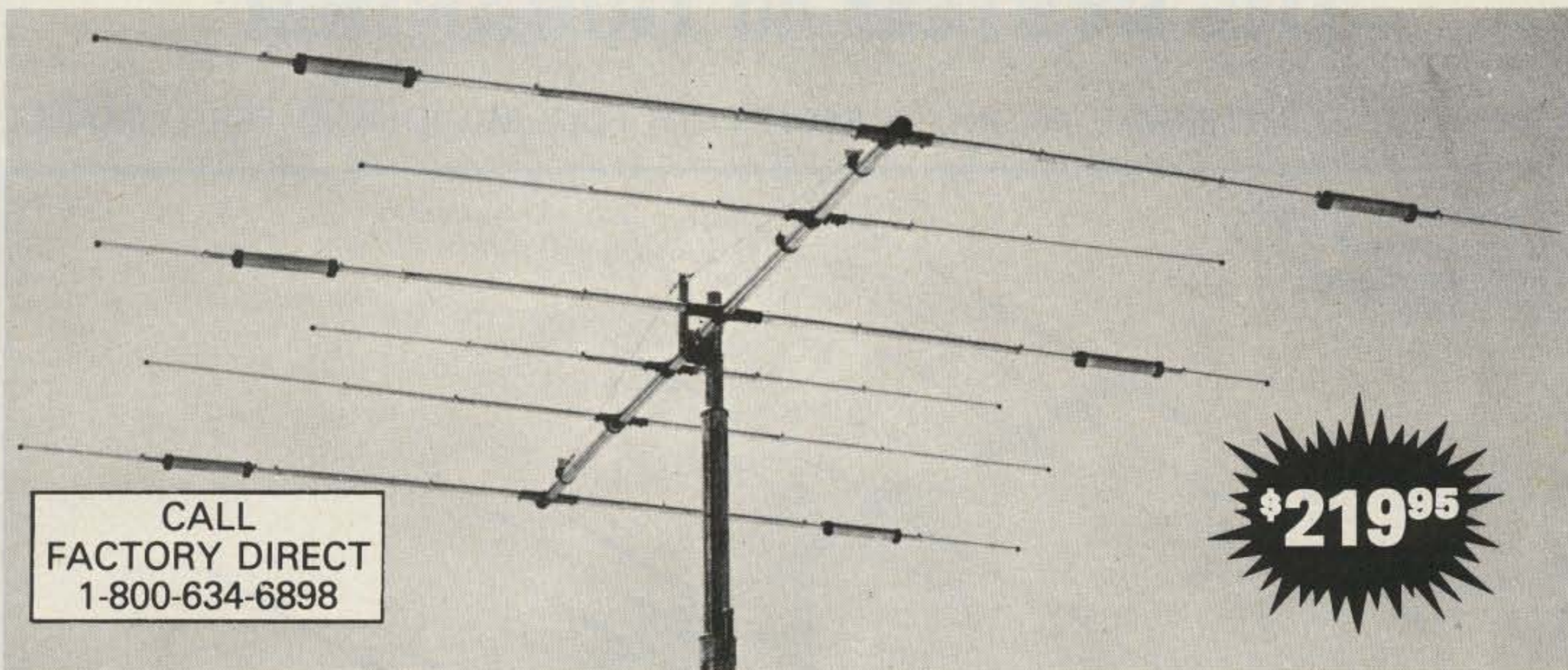

CALL  
FACTORY DIRECT  
1-800-634-6898

**\$219<sup>95</sup>**

A trap loaded antenna that performs like a monobander! That's the characteristic of this six element three band beam. Through the use of wide spacing and interlacing of elements, the following is possible: three active elements on 20, three active elements on 15, and four active elements on 10 meters. No need to run separate coax feed lines for each band, as the bandswitching is automatically made via the High-Q Wilson traps. Designed to handle the maximum legal power, the traps are capped at each end to provide a weather-proof seal against rain and dust. The special High-Q traps are the strongest available in the industry today.

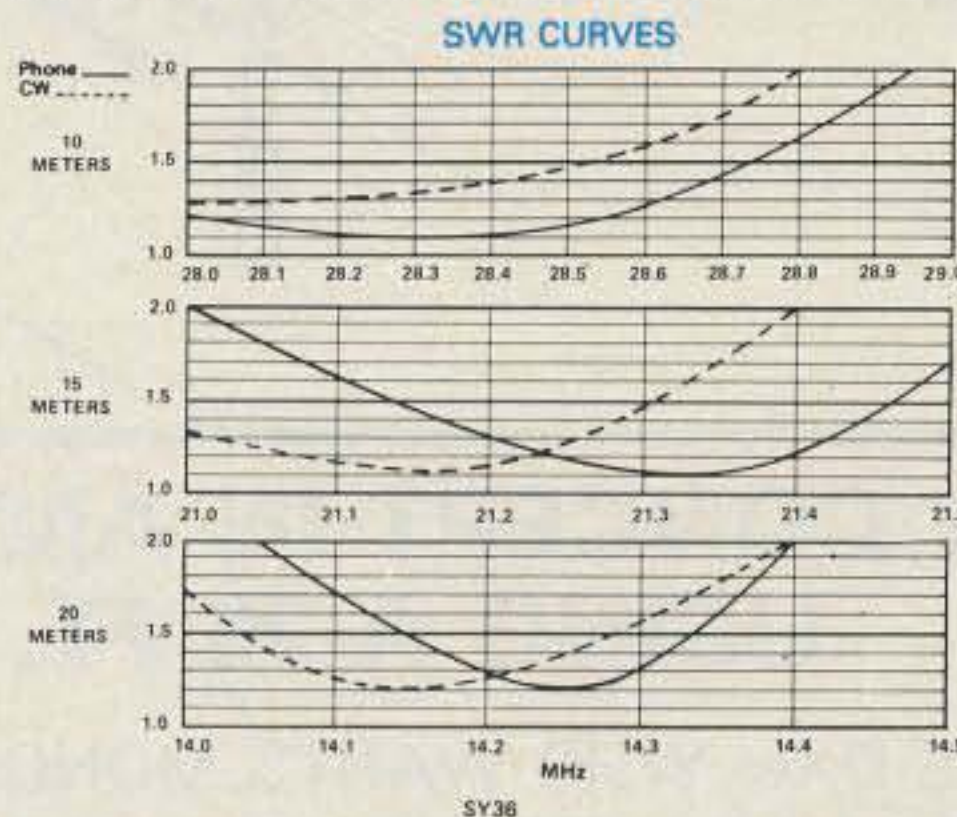

### SPECIFICATIONS

Band MGz	14-21-28
Maximum power input	Legal Limit
Gain (dbd)	9 db
VSWR @ resonance	1.3:1
Impedance	50 ohm
F/B Ratio	20 db or Better
Boom (O.D. x Length)	2" x 24' 2 1/2"
No. of Elements	6
Longest Element	28' 2 1/2"
Turning Radius	18' 6"
Maximum Mast Diameter	2"
Surface Area	8.6 sq. ft.
Matching Method	Beta
Wind Loading @ 80 mph	215 lbs.
Maximum Wind Survival	100 mph
Feed Method	Balun (Supplied)
Assembled Weight (approx.)	53 lbs.
Shipping Weight (approx.)	62 lbs.

## Compare the SY-36 with others . . .

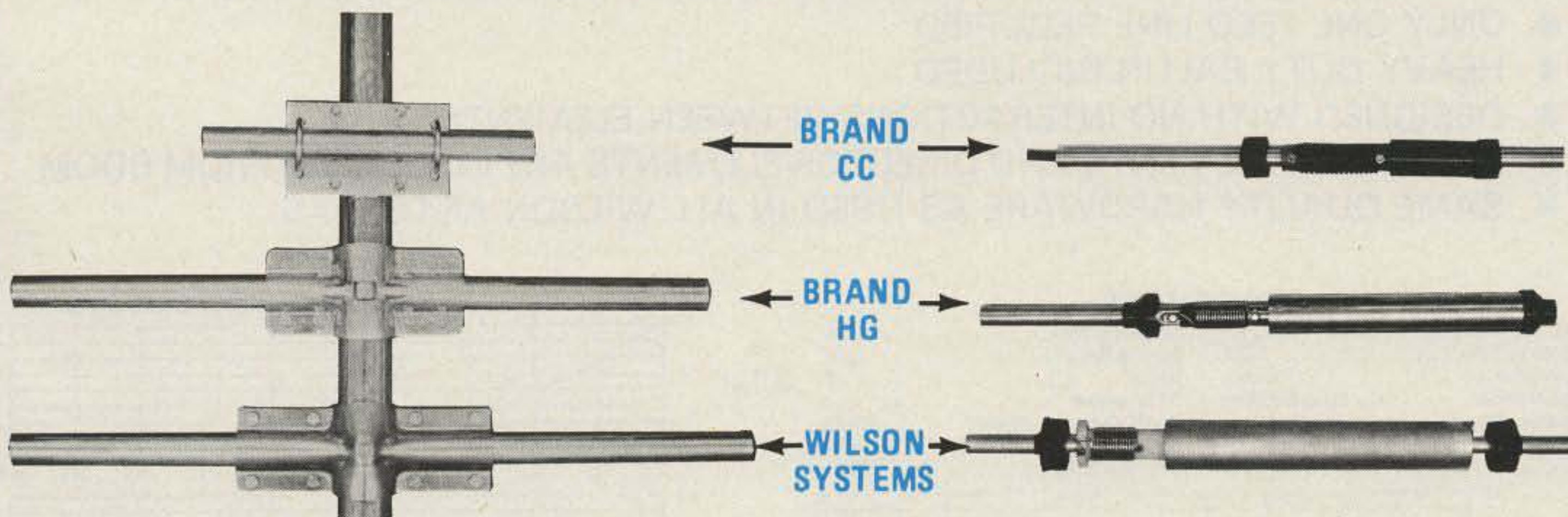

Compare the size and strength of the boom to element clamps. See who offers the largest and heaviest duty. Which would you prefer?

Wilson Systems traps offer a larger diameter trap coil and a larger outside housing, giving excellent Q and power capabilities.

CALL  
FACTORY DIRECT  
1-800-634-6898

**W S I WILSON SYSTEMS, INC.**

4286 S. Polaris Ave., Las Vegas, Nevada 89103

Prices and specifications subject to change without notice.



**WILSON SYSTEMS, INC. PRESENTS**

# THE SYSTEM 40 TRIBANDER

3 MONOBAND ANTENNAS IN ONE — EACH WITH FULL MONOBAND PERFORMANCE

**FACTORY DIRECT  
ONLY  
\$374<sup>95</sup>**

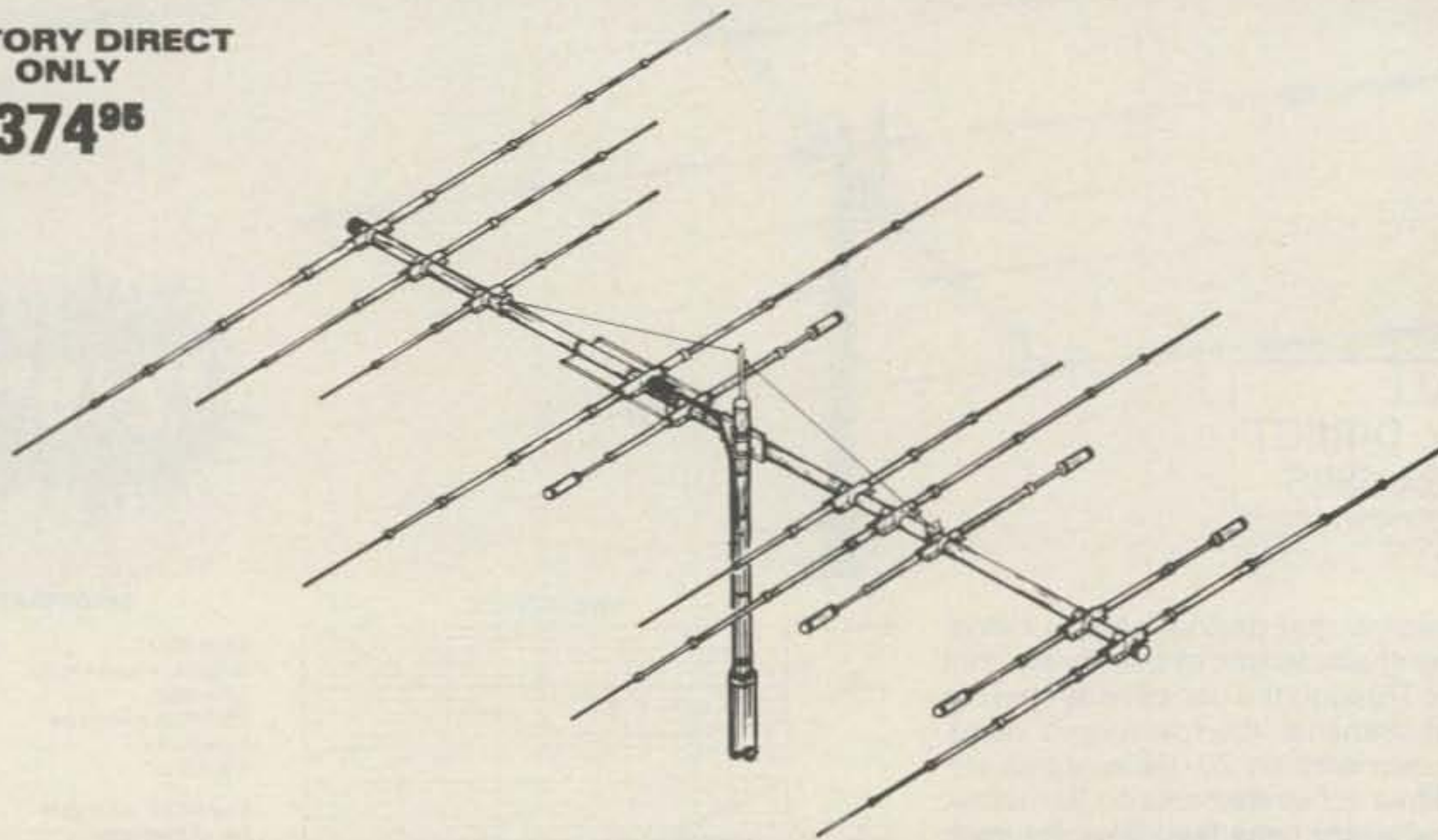

## A NEW CONCEPT IN ANTENNA DESIGN USING A 26 FT. BOOM

- FOR THE SERIOUS DXer WHO WANTS MONOBANDERS ON 10-15-20
- FOUR FULL SIZE 20 MTR ELEMENTS WITH 10 dbd GAIN & 25 db F/B
- FOUR WIDE SPACED 15 MTR ELEMENTS WITH 10 dbd GAIN & 20 db F/B
- FIVE WIDE SPACED 10 MTR ELEMENTS WITH 11.5 dbd GAIN & 20 db F/B
- ONLY ONE FEED LINE REQUIRED
- HEAVY DUTY BALUN INCLUDED
- DESIGNED WITH NO INTERACTIONS BETWEEN ELEMENTS
- ALL DRIVEN ELEMENTS AND DIRECTOR ELEMENTS ARE INSULATED FROM BOOM
- SAME QUALITY HARDWARE AS USED IN ALL WILSON ANTENNAS

—SPECIFICATIONS—

Max. Pwr. Input.....	Legal Limit	Longest Element.....	36'
VSWR @ Res.....	1.2:1	Turning Radius.....	22'6"
Impedance.....	50 ohm	Boom.....	26'
Feed Method.....	Coax Balun Supplied	Surface Area.....	12.1 sq. ft.
Matching Method.....	Modified Beta	Wind Loading @ 80 mph.....	309 lbs.
F/B Ratio.....	See Above	Assem. Weight.....	75 lbs.
Gain.....	See Above	Shipping Weight.....	99 lbs.

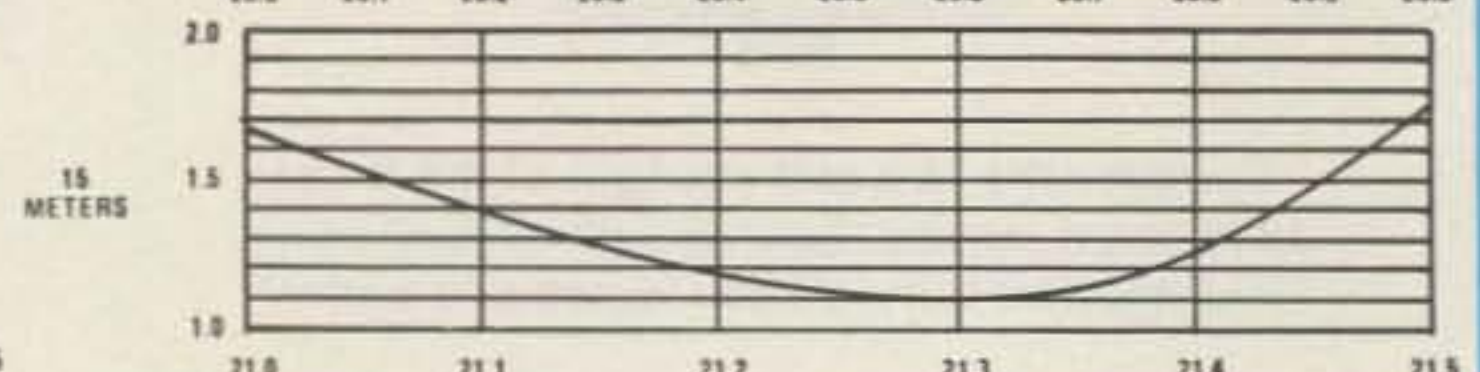
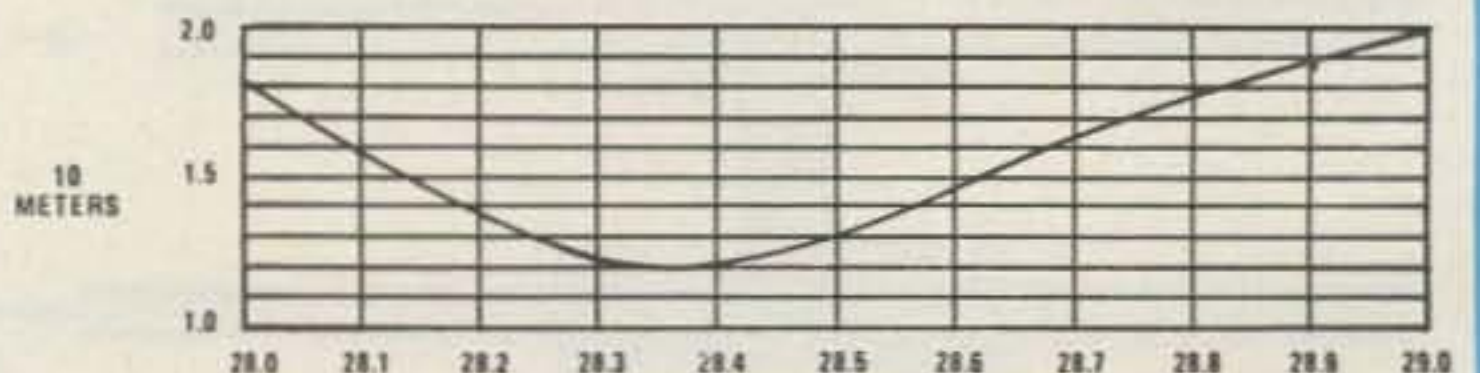
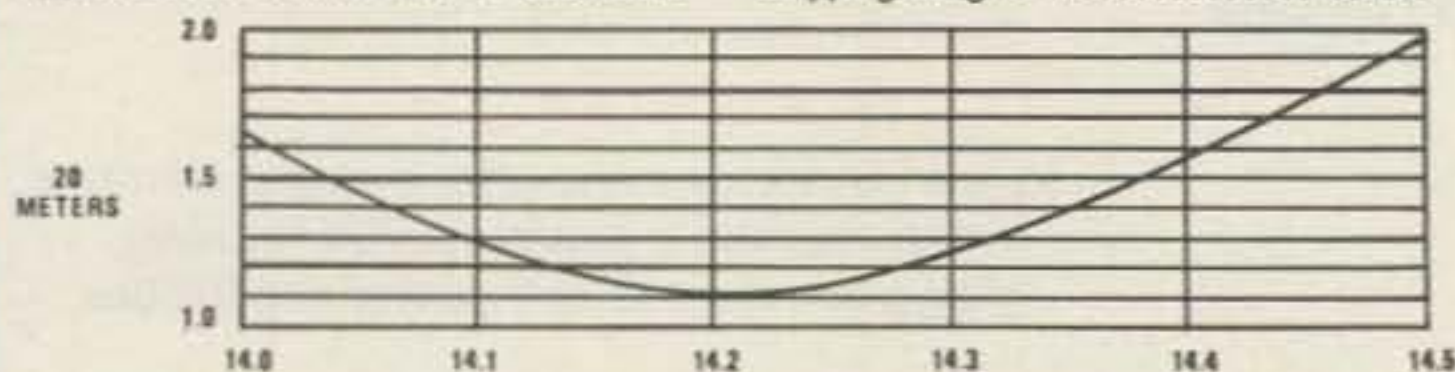

**AVAILABLE ONLY  
FACTORY DIRECT**

CALL

**1-800-634-6898 TOLL FREE**

**W S I WILSON  
SYSTEMS, INC.**

4286 S. Polaris Ave., Las Vegas, Nevada 89103

PRICES AND SPECIFICATIONS SUBJECT TO CHANGE WITHOUT NOTICE.



# WILSON SYSTEMS TOWERS

— FACTORY DIRECT —

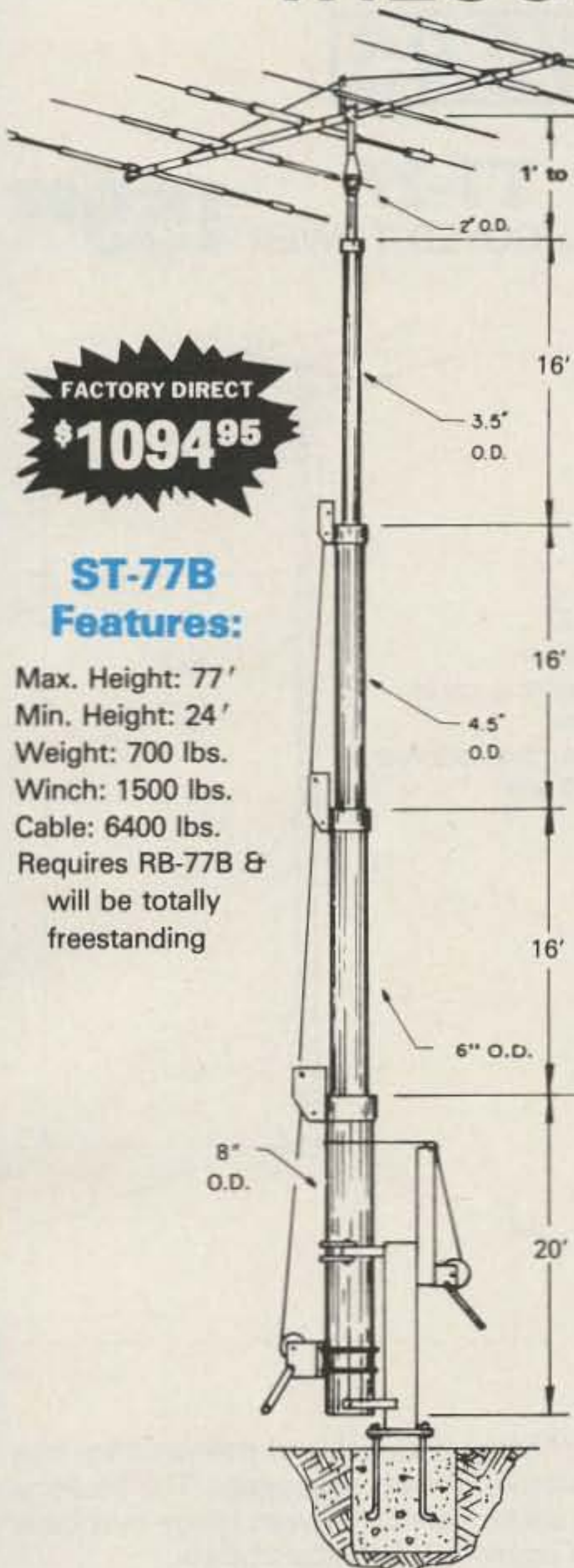

**FACTORY DIRECT**  
**\$1094<sup>95</sup>**

## ST-77B Features:

Max. Height: 77'  
Min. Height: 24'  
Weight: 700 lbs.  
Winch: 1500 lbs.  
Cable: 6400 lbs.  
Requires RB-77B & will be totally freestanding

**FACTORY DIRECT**  
**\$614<sup>95</sup>**

## MT-61B Features:

Max. Height: 61'  
Min. Height: 23'  
Weight: 450 lbs.  
Winch: 1200 lbs.  
Cable: 4200 lbs.  
No Guys required when mounting against house.  
For completely freestanding installation, use RB-61B or FB-61B below.

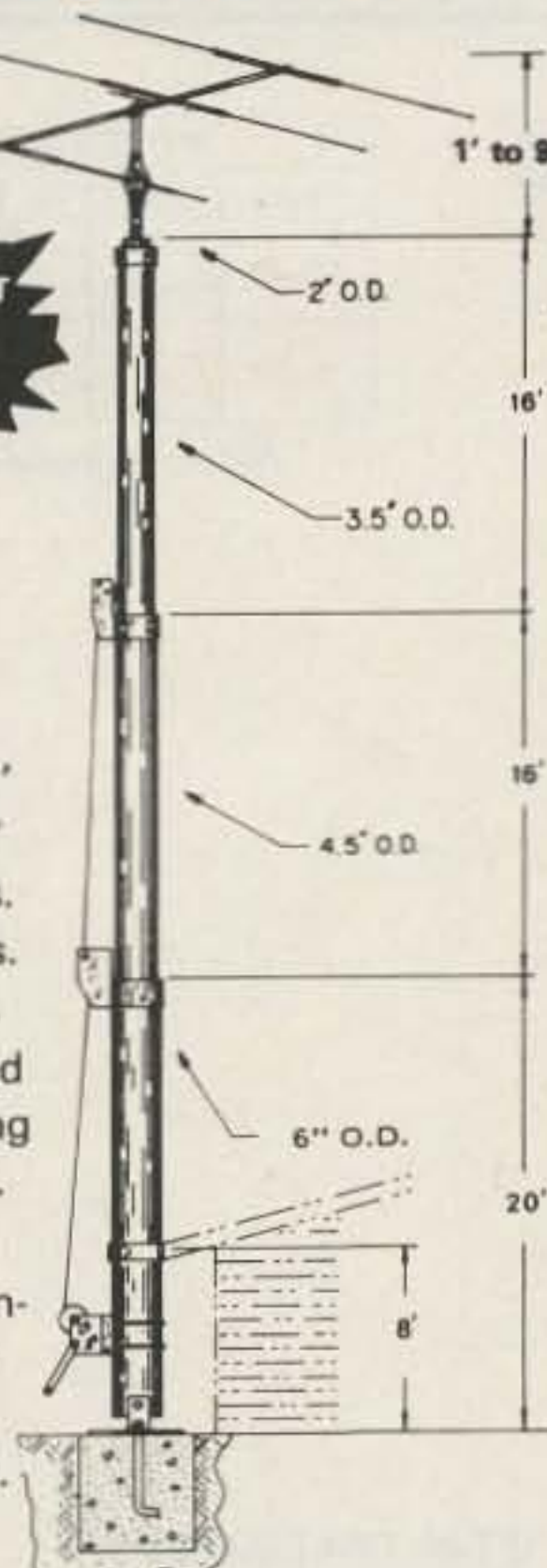

**FACTORY DIRECT**  
**\$399<sup>95</sup>**

## TT-45B Features:

Max Height: 45'  
Min. Height: 22'  
Weight: 250 lbs.  
Winch: 1200 lbs.  
Cable: 4200 lbs.

No Guys required when mounting against eave of house.

For completely freestanding installation, use RB-45B or FB-45B below.

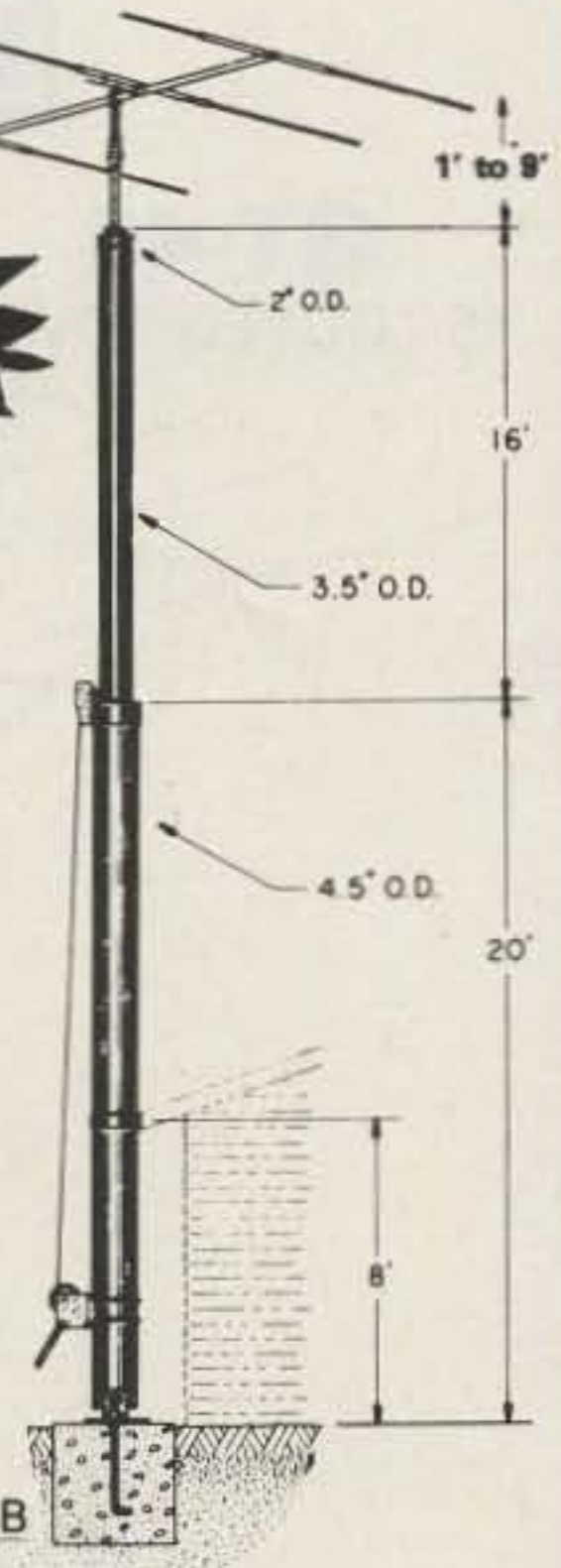

## NEW! Wilson Electric Winch



Now you can raise and lower your Wilson Tower electrically. The electric winch will replace the hand operated winch. Available for use on the TT-45, MT-61 and ST-77 towers.

EW-45 (TT-45)  
EW-61 (MT-61)  
EW-77 (ST-77)

**\$249<sup>95</sup>**

WIND LOADING			Square Footage Based on 50 MPH Wind
Tower	Height	Sq. Ft.	
ST-77B	69	16	
	77	10	
MT-61B	53	18	
	61	12	
TT-45B	37	18	
	45	12	

BASE CHART		
TOWER	WIDTH	DEPTH
TT-45B	12" x 12"	30"
FB-45B	30" x 30"	4 1/2'
RB-45B	30" x 30"	4 1/2'
MT-61B	18" x 18"	4'
FB-61B	3' x 3'	5 1/2'
RB-61B	3' x 3'	5 1/2'
ST-77B	See Below	
RB-77B	3 1/2' x 3 1/2'	6'

Wilson Systems uses a high strength carbon steel tube manufactured especially for Wilson Systems. It is 25% stronger than conventional pipe or tubing. The tubing size used is: 2" & 3 1/2"-.095; 4 1/2" & 6"-.125; 8"-.134. All tubing is hot dip galvanized. Top section is 2" O.D. for proper rotor and antenna mounting.

The TT-45B and MT-61B come complete with house bracket and hinged base plate for against-house mounting. For totally freestanding installation, use either of the tilt-over bases shown below.

The ST-77B cannot be mounted against the house and must be used with the rotating tilt-over base RB-77B shown below.

# TILT-OVER BASES FOR TOWERS

## FIXED BASE

The FB Series was designed to provide an economical method of moving the tower away from the house. It will support the tower in a completely free-standing vertical position, while also having the capabilities of tilting the tower over to provide an easy access to the antenna. The rotor mounts at the top of the tower in the conventional manner, and will not rotate the complete tower.

**FB-45B.. 112 lbs... \$189<sup>95</sup>**  
**FB-61B.. 169 lbs... \$269<sup>95</sup>**



## ROTATING BASE

The RB Series was designed for the Amateur who wants the added convenience of being able to work on the rotor from the ground position. This series of bases will give that ease plus rotate the complete tower and antenna system by the use of a heavy duty thrust bearing at the base of the tower mounting position, while still being able to tilt the tower over when desiring to make changes on the antenna system.

**RB-45B.. 144 lbs... \$269<sup>95</sup>**  
**RB-61B.. 229 lbs... \$344<sup>95</sup>**  
**RB-77B.. 300 lbs... \$514<sup>95</sup>**

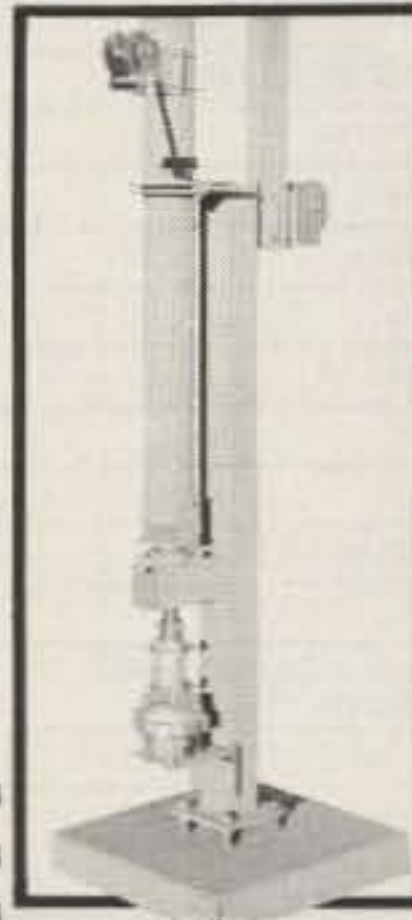

Tilting the tower over is a one-man task with the Wilson bases. (Shown above is the RB-61B. Rotor is not included.)

**ORDER**  
**FACTORY DIRECT**  
**1-800-634-6898**

**W S I WILSON**  
**SYSTEMS, INC.**

Prices Effective 9-1-80 to 9-30-80

4286 S. Polaris Ave., Las Vegas, Nevada 89103



# WILSON SYSTEMS, INC.

## WILSON GUYED TOWERS

**GT-46**  
46' GUYED TOWER **234<sup>95</sup>**

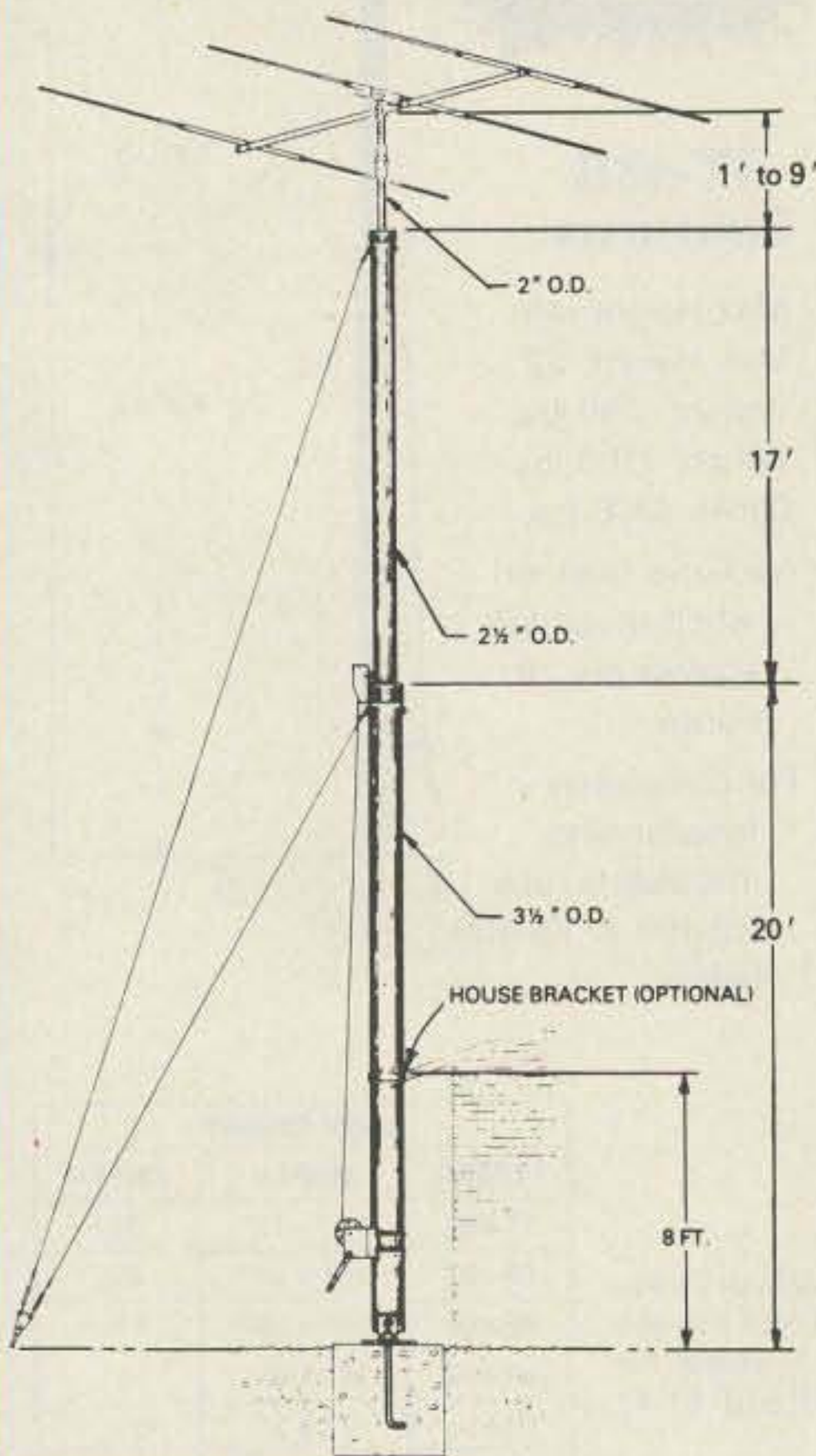

**GT-46 FEATURES:**

- Maximum height, 46'.
- 800 lb. capacity winch.
- 2,000 lb. capacity raising cable.
- Only one cubic ft. of cement required.
- Total weight, 117 lbs.

WIND LOADING			
Tower	Height	Sq. Ft.	Square Footage Based on 50 MPH Wind
GT-46	46	6	
	41	8	
	38	10	
TT-27	27	6	
	22	8	
	18	10	

(When Properly Guyed)

**TT-27**  
27' GUYED TOWER **159<sup>95</sup>**

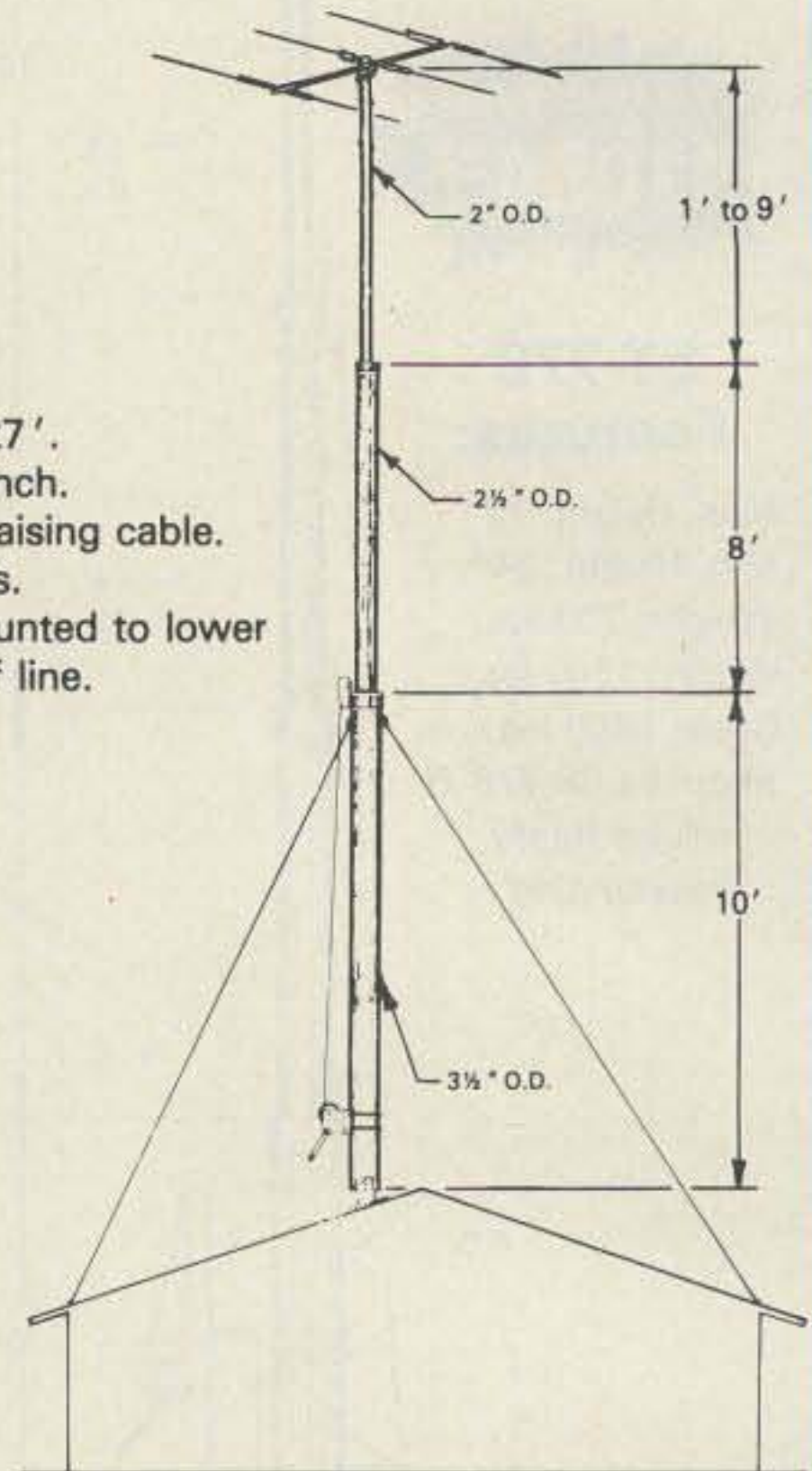

**TT-27 FEATURES:**

- Maximum height, 27'.
- 800 lb. capacity winch.
- 2,000 lb. capacity raising cable.
- Total weight, 84 lbs.
- Can be ground mounted to lower antenna below roof line.

**GENERAL FEATURES**

All towers use high strength heavy galvanized steel tubing that conforms to ASTM specifications for years of maintenance free service. The large diameters provide unexcelled strength. All welding is performed with state-of-the-art equipment. Top sections are 2" O.D. for proper antenna/rotor mounting. A 9' push-up mast is included in the top section of each tower. Hinge-over base plates are standard with each tower. The high loads of today's antennas make Wilson crank-ups a logical choice.

WILSON SYSTEMS, INC. — 4286 S. Polaris  
Las Vegas, NV 89103 — (702) 739-7401

**FACTORY DIRECT  
ORDER BLANK**

Toll-Free Order Number  
**1-800-634-6898**

Qty.	Model	Description	Shipping	Price	Qty.	Model	Description	Shipping	Price
	SY40	10 Ele. Tribander for 10, 15, 20 Mtrs.	UPS	374.95		GT-46	46' Guyed Tower	TRUCK	234.95
	SY36	6 Ele. Tribander for 10, 15, 20 Mtrs.	UPS	219.95		TT-27	27' Guyed Tower	TRUCK	159.95
	SY33	3 Ele. Tribander for 10, 15, 20 Mtrs.	UPS	164.95		TT-45B	Freestanding 45' Tubular Tower	TRUCK	399.95
	33-6 MK	40 Mtr. Mod Kit for SY33 & SY36	UPS	64.95		RB-45B	Rotating Base for TT-45B w/tilt over feature	TRUCK	259.95
	WV-1A	Trap Vertical for 10, 15, 20, 40 Mtrs.	UPS	64.95		FB-45B	Fixed Base for TT-45B w/tilt over feature	TRUCK	189.95
	GR-1	Ground Radials for WV-1A	UPS	14.95		MT-61B	Freestanding 61' Tubular Tower	TRUCK	614.95
	M-420A	4 Elements on 20 Mtrs.	UPS	174.95		RB-61B	Rotating Base for MT-61B w/tilt over feature	TRUCK	344.95
	M-515A	5 Elements on 15 Mtrs.	UPS	139.95		FB-61B	Fixed Base for MT-61B w/tilt over feature	TRUCK	269.95
	M-415A	4 Elements on 15 Mtrs.	UPS	99.95		ST-77B	Freestanding 77' Tubular Tower	TRUCK	1094.95
	M410A	4 Elements on 10 Mtrs.	UPS	74.95		RB-77B	Rotating Base for ST-77B w/tilt over feature	TRUCK	514.95
	<b>ACCESSORIES</b>					GK-46	Guying Kit for GT-46	UPS-TRK	74.95
	T <sup>2</sup> X	Tail Twister Rotor	UPS	274.95		GK-45B	Guying Kit for TT-45B	UPS-TRK	69.95
	HD-73	Alliance Heavy Duty Rotor	UPS	109.95		GK-61B	Guying Kit for MT-61B	UPS-TRK	79.95
	RC-8C	8/C Rotor Cable	UPS	.12/ft.		GK-77B	Guying Kit for ST-77B	UPS-TRK	99.95
	RG-8U	RG-8U Foam-Ultra Flexible Coaxial Cable. 38 strand center conductor, 11 gauge	UPS	.21/ft.		WTB-1	Thrust Bearing for Top of Rotating Towers	UPS-TRK	59.95
	EW-45	Wilson Electric Winch for TT-45B	UPS	249.95					
	EW-61	Wilson Electric Winch for MT-61	UPS	249.95					
	EW-77	Wilson Electric Winch for ST-77	UPS	249.95					

**NOTE:**

On Coaxial and Rotor Cable, minimum order is 100' and 50' multiples.  
Prices and specifications subject to change without notice.  
Ninety (90) Day Limited Warranty — Shipping Not Included in Above

Prices Effective Sept. 1-30, 1980

Nevada Residents add Sales Tax

Ship C.O.D.  Check enclosed  Charge to VISA  MasterCard

Card No. \_\_\_\_\_ Expires \_\_\_\_\_

Bank No. \_\_\_\_\_ Signature \_\_\_\_\_

Name \_\_\_\_\_ Phone \_\_\_\_\_

Street \_\_\_\_\_

City \_\_\_\_\_ State \_\_\_\_\_ Zip \_\_\_\_\_

Prices and specifications subject to change without notice.



# OSCAR Orbits

Courtesy of AMSAT

Any satellite placed into a near-Earth orbit suffers from the cumulative effects of atmospheric drag. The much publicized descent of the Skylab space station was a graphic demonstration of these effects.

The OSCAR satellites are subject to atmospheric drag, of course, and the present period of intense solar activity has accentuated the problem. During this period, our sun has been expelling huge numbers of charged particles, some of which find their way into the Earth's upper atmosphere, increasing the density (and thus the drag) there. It is through this region that the OSCARs must pass. OSCAR 8, in a lower orbit than OSCAR 7, is the more seriously affected of the two.

If the drag factor is not considered when OSCAR calculations are performed, long-range orbital projections will be in error. For example, by the end of 1979, OSCAR 8 was more than 20 minutes ahead of some published schedules. The nature of orbital mechanics is such that extra drag on a satellite causes it to move into a lower orbit, resulting in a shorter orbital period. Thus, the satellite arrives above a given Earthbound location earlier than predicted.

Using data supplied to us by Dr. Thomas A. Clark W3IWI of AMSAT, the equatorial crossing tables shown here were generated with the aid of a TRS-80™ microcomputer. The tables take into account the effects of atmospheric drag and should be in error by a few seconds at most.

The listed data tells you the time and place that OSCAR 7 and OSCAR 8 cross the equator in an ascending orbit for the first time each day. To calculate successive OSCAR 7 orbits, make a list of the first orbit number and the next twelve orbits for that day. List the time of the first orbit. Each successive orbit is 115 minutes later (two hours less five minutes). The chart gives the longitude of the day's first ascending (northbound) equatorial crossing. Add 29° for each succeeding orbit. When OSCAR is ascending on the other side of the world from you, it will descend over you. To find the

equatorial descending longitude, subtract 166° from the ascending longitude. To find the time OSCAR 7 passes the North Pole, add 29 minutes to the time it passes the equator. You should be able to hear OSCAR 7 when it is within 45 degrees of you. The easiest way to determine if OSCAR is above the horizon (and thus within range) at your location is to take a globe and draw a circle with a radius of 2450 miles (4000 kilometers) from your QTH. If OSCAR passes above that circle, you should be able to hear it. If it passes right overhead, you should hear it for about 24 minutes total. OSCAR 7 will pass an imaginary line drawn from San Francisco to Norfolk about 12 minutes after passing the equator. Add about a minute for each 200 miles that you live north of this line. If OSCAR passes 15° east or west of you, add another minute; at 30°, three minutes; at 45°, ten minutes. Mode A: 145.85-.95 MHz uplink, 29.4-29.5 MHz downlink, beacon at 29.502 MHz. Mode B: 432.125-.175 MHz uplink, 145.975-.925 MHz downlink, beacon at 145.972 MHz.

At press time, OSCAR 7 was scheduled to be in Mode A on odd numbered days of the year and in Mode B on even numbered days. Monday is QRP day on OSCAR 7, while Wednesdays are set aside for experiments and are not available for use.

OSCAR 8 calculations are similar to those for OSCAR 7, with some important exceptions. Instead of making 13 orbits each day, OSCAR 8 makes 14 orbits during each 24-hour period. The orbital period of OSCAR 8 is therefore somewhat shorter: 103 minutes.

To calculate successive OSCAR 8 orbits, make a list of the first orbit number (from the OSCAR 8 chart) and the next thirteen orbits for that day. List the time of the first orbit. Each successive orbit is then 103 minutes later. The chart gives the longitude of the day's first ascending equatorial crossing. Add 26° for each succeeding orbit. To find the time OSCAR 8 passes the North Pole, add 26 minutes to the time it crosses the equator. OSCAR 8 will cross the imaginary San Francisco-to-Norfolk line about 11 minutes after crossing the equator. Mode A: 145.85-.95 MHz uplink, 29.4-29.50 MHz downlink, beacon at 29.40 MHz. Mode J: 145.90-146.00 MHz uplink, 435.20-435.10 MHz downlink, beacon on 435.090 MHz.

OSCAR 8 is in Mode A on Mondays and Thursdays, Mode J on Saturdays and Sundays, and both modes simultaneously on Tuesdays and Fridays. As with OSCAR 7, Wednesdays are reserved for experiments.

## OSCAR 7 ORBITAL INFORMATION FOR SEPTEMBER

ORBIT #	DATE	TIME (GMT)	EQ. CROSSING (DEGREES WEST)
26513	1	0025:08	79.1
26526	2	0119:23	92.7
26538	3	0018:41	77.6
26551	4	0112:56	91.2
26563	5	0012:14	76.0
26576	6	0106:29	89.6
26588	7	0005:47	74.5
26601	8	0100:02	88.0
26614	9	0154:17	101.6
26626	10	0053:35	86.5
26639	11	0147:50	100.1
26651	12	0047:08	84.9
26664	13	0141:23	98.5
26676	14	0040:41	83.3
26689	15	0134:56	96.9
26701	16	0034:14	81.8
26714	17	0128:29	95.4
26726	18	0027:47	80.2
26739	19	0122:02	93.8
26751	20	0021:20	78.6
26764	21	0115:35	92.2
26776	22	0014:53	77.1
26789	23	0109:08	90.7
26801	24	0008:26	75.5
26814	25	0102:40	89.1
26826	26	0001:59	74.0
26839	27	0056:13	87.5
26852	28	0150:28	101.1
26864	29	0049:46	86.0
26877	30	0144:01	99.6

## OSCAR 8 ORBITAL INFORMATION FOR SEPTEMBER

ORBIT #	DATE	TIME (GMT)	EQ. CROSSING (DEGREES WEST)
12700	1	0133:36	77.3
12714	2	0138:25	78.6
12727	3	0000:02	54.0
12741	4	0004:51	55.2
12755	5	0009:40	56.4
12769	6	0014:29	57.7
12783	7	0019:18	58.9
12797	8	0024:06	60.1
12811	9	0028:55	61.4
12825	10	0033:44	62.6
12839	11	0038:33	63.8
12853	12	0043:22	65.0
12867	13	0048:10	66.3
12881	14	0052:59	67.5
12895	15	0057:48	68.7
12909	16	0102:36	70.0
12923	17	0107:25	71.2
12937	18	0112:13	72.4
12951	19	0117:02	73.6
12965	20	0121:50	74.9
12979	21	0126:38	76.1
12993	22	0131:27	77.3
13007	23	0136:15	78.5
13021	24	0141:03	79.8
13034	25	0002:40	55.2
13048	26	0007:28	56.4
13062	27	0012:16	57.6
13076	28	0017:04	58.9
13090	29	0021:52	60.1
13104	30	0026:40	61.3

## OSCAR 7 ORBITAL INFORMATION FOR OCTOBER

ORBIT #	DATE	TIME (GMT)	EQ. CROSSING (DEGREES WEST)
26889	1	0043:19	84.4
26902	2	0137:34	98.0
26914	3	0036:52	82.8
26927	4	0131:07	96.4
26939	5	0030:25	81.3
26952	6	0124:39	94.9
26964	7	0023:58	79.7
26977	8	0118:12	93.3
26989	9	0017:30	78.2
27002	10	0111:45	91.7
27014	11	0011:03	76.6
27027	12	0105:18	90.2
27039	13	0004:36	75.0
27052	14	0058:51	88.6
27065	15	0153:05	102.2
27077	16	0052:24	87.0
27090	17	0146:38	100.6
27102	18	0045:56	85.5
27115	19	0140:11	99.1
27127	20	0039:29	83.9
27140	21	0133:44	97.5
27152	22	0033:02	82.3
27165	23	0127:16	95.9
27177	24	0026:35	80.8
27190	25	0120:49	94.4
27202	26	0020:07	79.2
27215	27	0114:22	92.8
27227	28	0013:40	77.7
27240	29	0107:55	91.2
27252	30	0007:13	76.1
27265	31	0101:27	89.7

## OSCAR 8 ORBITAL INFORMATION FOR OCTOBER

ORBIT #	DATE	TIME (GMT)	EQ. CROSSING (DEGREES WEST)
13118	1	0031:28	82.6
13132	2	0036:16	83.8
13146	3	0041:04	85.0
13160	4	0045:52	86.2
13174	5	0050:40	87.5
13188	6	0055:28	88.7
13202	7	0100:16	89.9
13216	8	0105:04	91.1
13230	9	0109:51	92.4
13244	10	0114:39	93.6
13258	11	0119:27	94.8
13272	12	0124:14	96.0
13286	13	0129:02	97.3
13300	14	0133:50	98.5
13314	15	0138:37	99.7
13327	16	0000:13	55.1
13341	17	0005:00	56.3
13355	18	0009:47	57.6
13369	19	0014:35	58.8
13383	20	0019:22	60.0
13397	21	0024:10	61.2
13411	22	0028:57	62.5
13425	23	0033:44	63.7
13439	24	0038:31	64.9
13453	25	0043:18	66.1
13467	26	0048:06	67.4
13481	27	0052:53	68.6
13495	28	0057:40	69.8
13509	29	0102:27	71.0
13523	30	0107:14	72.2
13537	31	0112:01	73.5



**10% DISCOUNT**  
Off List

64K 1 Drive \$3499.00

No Taxes on Out Of State Shipments

Immediate Shipment From Stock.

## AUTHORIZED TRS-80® DEALER A301

COMPUTER SPECIALISTS

Popular 16K Level II System.....	\$700.00
26-1145 RS-232 Board.....	84.00
26-1140 "O" K Interface.....	254.00
26-1160 Mini Disk.....	424.00
26-1171 Telephone Modern.....	169.00
Fast 100 CPS Centronics 730 Printer.....	675.00
Highly Reliable Lobo 5 1/4" Drives.....	375.00
Versatile Lobo Interface, 8" Drives and IMI Hard Drives.....	Call For Prices

**1-800-841-0860 Toll Free Order Entry**  
MICRO MANAGEMENT SYSTEMS, INC. ✓ 313

DOWNTOWN PLAZA SHOPPING CENTER  
115 C SECOND AVE. S.W.  
CAIRO, GEORGIA 31728  
GA. PHONE NO. (912) 377-7120

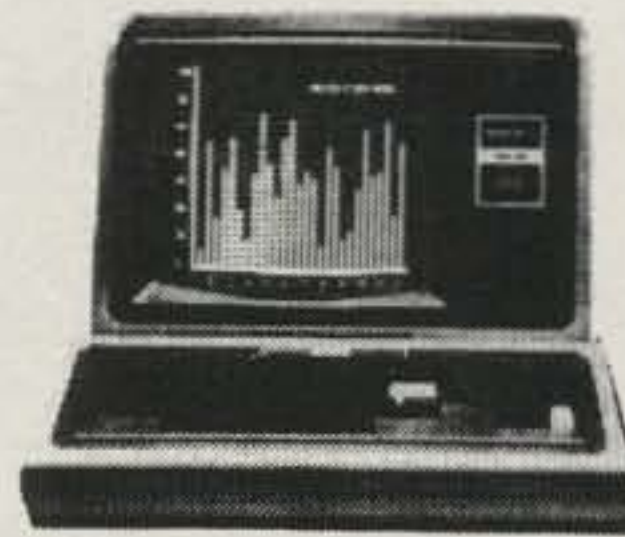

**15% DISCOUNT**  
Off List

4K Level 11 \$527.00

Full Factory Warranty on All Items Sold.

Largest Inventory in the S.E. U.S.A.



# New Products

## SWAN'S ASTRO 102BX TRANSCEIVER

The best single-word description of Swan's new HF transceiver, the Astro 102BX, is that it is *different*. Swan does not attempt to give you a radio that is a carbon copy of those coming from overseas. Instead, they have packed this rig with an unusual set of features, unlike those found in any other amateur transceiver, domestic or foreign.

The Astro 102BX offers solid-state no-tune-up SSB and CW operation on the 160- through 10-meter amateur bands. It is packaged in a black wrinkle finish with silver trim cabinet that is 6.4" high, 14.25" wide, and 13.75" deep, and weighs in at 23.5 pounds. Designed for both mobile and base station use, the 102BX requires a 12 to 14 V dc supply capable of providing 20 Amperes. The PSU-6 serves as a matching power supply and contains an external speaker and headphone jack.

### Receiver Versatility

One of the Astro 102BX's distinguishing features is the two permeability-tuned oscillators (PTOs), each with a large tuning knob on the front panel. This amounts to having an external vfo built right in. You can operate using either oscillator

"A" or "B" exclusively or you can select one PTO for receive and the other for transmitting. This is not a digital tuning arrangement. Frequency coverage is continuous and the digital display is based on a frequency counter. Thus, if the RIT (receiver incremental tuning) feature is used, the display will show the shift in frequency.

The PTO circuitry may be a throwback to earlier days, but the band switching uses a state-of-the-art phase-locked-loop circuit. The bandswitch acts as an address selector for a read only memory that sets a +N counter used by the PLL. With a bit of imagination and some retuning, this rig could probably be put on the new ham bands.

The Astro 102BX, in keeping with Swan tradition, uses a single conversion receiver. Eight of the 19 front panels are devoted solely to receiver functions. Included are the standard rf and af gain controls, RIT, and a noise blanker. Among the unusual features are passband tuning, an i-f gain control, continuously variable agc decay, and an audio notch filter.

The passband tuning sets the i-f bandwidth. The user can select either high- or low-pass action. Anyone who has operated on a crowded phone band will find this helpful. When someone

starts a QSO one kHz up, all you have to do is shift the passband so that the upper portion is cut off. The resulting passband is shown by eight LEDs located below the frequency readout. If you are a CW fan, you'll like the 300-Hz bandwidth filter that can be tuned across the 2.4-kHz i-f bandwidth.

The notch filter becomes very useful when some lid decides to spend half an hour tuning without using a dummy load. Since the filter is narrow, the control must be turned slowly or you're likely to pass right over the offending signal.

Perhaps I am not enough of a receiver fanatic to appreciate the i-f gain function. I found myself turning it to the maximum level and then leaving it alone. In normal operation, the i-f gain and agc decay don't need to be adjusted often. If, however, you like operating when conditions are noisy or the other station's signal doesn't fall in the normal category, then these two controls can be helpful. You need to spend some time experimenting with various combinations of settings before the Astro 102BX's flexibility becomes apparent.

### Transmitter Features

The Astro 102BX, like just about any other new radio worth its salt, does not need to be tuned up before you transmit. There are preset output networks for each band. If the swr is greater than 1.7:1, the power

output is automatically reduced, protecting those expensive final transistors. I found that the two MRF458 finals produced 100 Watts on all bands, just as advertised. However, if you want to operate SSTV or RTTY at full power, an external fan will be needed to cool the heat sink.

Rather than providing metering for a bunch of transmitter functions as some rigs do, the 102BX has provisions to read only forward and reflected output power and the ALC voltage. It doesn't take long to gain an intuitive notion of what your swr is by using the FWD and REFL power positions. Just keep in mind the fact that the meter reads 100 Watts full scale in the forward position and 10 Watts full scale when measuring reflected power.

I doubt if any ham manufacturer would produce a transceiver that did not have some kind of speech processor. Swan's Astro 102BX is no exception. When processing is selected by the front-panel switch, the microphone amplifier becomes a simple logarithmic compressor. The processor level control, along with the VOX adjustments, lies on the rig's left side, recessed behind holes in the cabinet. Since a screwdriver is needed for adjustment, these controls are less than conveniently located for operators who like to tinker with different settings.

Swan definitely kept the CW user in mind when they designed this radio. It is the only rig I have seen that has a front-panel switch allowing you to select "hard" or "soft" CW rise and decay times. Swan suggests that by using a soft waveform for slow speed code a more pleasing sound is produced. Similarly, selecting the hard position results in better clarity at speeds greater than 25 wpm.

The hard/soft switch might be considered a frill, but the Astro 102BX's full break-in capability can be a real asset. The unique T-R switch causes the transmitter output to be continuously connected to the antenna. In the receive mode, the transmitter appears as an open circuit. The receiver is coupled to the antenna through a transformer and reed relay. When you transmit, there are no loud relay contacts banging into place—just a soft click. This circuit allows full



Swan's Astro 102BX transceiver.



Move over imports, here's the new TEN-TEC

# DELTA

the notable change in hf transceivers



## All new, all **nine** hf bands and only \$849!

**DELTA** — the symbol of change—the name of a great new TEN-TEC transceiver. A transceiver for changing times, with new features, performance, styling, size and value.

**TOTAL SOLID-STATE.** By the world's most experienced manufacturer of hf solid-state amateur radio equipment.

**ALL 9 HF BANDS.** First new transceiver since WARC. 160-10 Meters including the three new hf bands (10, 18 & 24.5 MHz). Ready to go except for plug-in crystals for 18 and 24.5 MHz segments (available when bands open for use).

**SUPER RECEIVER.** New, low noise double-conversion design, with 0.3  $\mu$ V sensitivity for 10 dB S+N/N.

**HIGH DYNAMIC RANGE.** 85 dB minimum to reduce overload possibility. Built-in, switchable, 20 dB attenuator for extreme situations.

**SUPER SELECTIVITY.** 8-pole monolithic SSB filter with 2.4 kHz bandwidth, 2.5 shape factor at 6/60 dB points. And optional 200 Hz and 500 Hz 6-pole crystal ladder filters. Eight pole and 6-pole filters cascade for 14 poles of near ultimate skirt selectivity. Plus 4 stages of active audio filtering. To sharpen that i-f response curve to just 150 Hz bandwidth. 4-position selectivity switch.

**BUILT-IN NOTCH FILTER.** Standard equipment. Variable, 200 Hz to 3.5 kHz, with notch depth down to -50 dB. Wipes out interfering carriers or CW.

**OFFSET TUNING.** Moves receiver frequency up to  $\pm 1$  kHz to tune receiver separately from transmitter.

**"HANG" AGC.** For smoother, clearer, receiver operation.

**OPTIONAL NOISE BLANKER.** For that noisy location, mobile or fixed.

**WWV RECEPTION.** Ready at 10 MHz.

**"S"/SWR METER.** To read received signal

strength and transmitted standing wave ratio. Electronically switched.

**SEPARATE RECEIVER ANTENNA JACK.** For use with separate receiving antenna, linear amplifier with full break-in (QSK) or transverters.

**FRONT PANEL HEADPHONE AND MICROPHONE JACKS.** Convenient.

**DIGITAL READOUT.** Six 0.3" red LEDs.

**BROADBAND DESIGN.** For easy operation. Instant band change—no tuneup of receiver or final amplifier. From the pioneer, TEN-TEC.

**SUPER TRANSMITTER.** Solid-state all the way. Stable, reliable, easy to use.

**200 WATTS INPUT.** On all bands including 10 meters (with 50 ohm load). High SWR does not automatically limit you to a few watts output. Proven, conservatively rated final amplifier with solid-state devices warranted fully for the first year, and pro-rata for five more years.

**100% DUTY CYCLE.** All modes, with confidence. 20 minutes max. key-down time. Brought to you by the leader in solid-state finals, TEN-TEC.

**QSK — INSTANT BREAK-IN.** Full and fast, to make CW a real conversation.

**BUILT-IN VOX AND PTT.** Smooth, set-and-forget VOX action plus PTT control. VOX is separate from keying circuits.

**ADJUSTABLE THRESHOLD ALC & DRIVE.** From low level to full output with ALC control. Maximum power without distortion. LED indicator.

**ADJUSTABLE SIDETONE.** Both volume and pitch, for pleasant monitoring of CW.

**SUPER STABILITY.** Permeability tuned VFO with less than 15 Hz change per  $F^\circ$  change over 40° range after 30 min. warmup—and

less than 10 Hz change for 20 Volt AC line change with TEN-TEC power supply.

**VERNIER TUNING.** 18 kHz per revolution, typical.

**SUPER AUDIO.** A TEN-TEC trademark. Low IM and HD distortion (less than 2%). Built-in speaker.

**SUPER STYLING.** The '80s look with neat, functional layout. "Panelized" grouping of controls nicely human engineered for logical use. New, smaller size that goes anywhere, fixed or mobile (4 $\frac{3}{4}$ "h x 11 $\frac{3}{8}$ "w x 15"d). Warm, dark front panel. Easy-to-read contrasting nomenclature. Black "clam-shell" aluminum case. Tilt bail.

**MODULAR/MASS-TERMINATION CONSTRUCTION.** Individual circuit boards with plug-in harnesses for easy removal if necessary. Boards are mailable.

**FULL ACCESSORY LINE.** All the options: Model 282 200 Hz CW filter \$50; Model 285 500 Hz CW Filter \$45; Model 280 Power Supply \$139; Model 645 Dual Paddle Keyer \$85; Model 670 Single Paddle Keyer \$34.50; Model 247 Antenna Tuner \$69; Model 234/214 Speech Processor & Condenser Microphone \$163; Model 215 PC Ceramic Microphone \$34.50. Model 283 Remote VFO, Model 287 Mobile Mount, and Model 289 Noise Blanker available soon.

Experience The Notable Change In HF Transceivers, Experience DELTA. See your TEN-TEC dealer or write for full details.

**TEN-TEC, INC.**  
SEVIERVILLE, TENNESSEE 37862  
EXPORT: 5715 LINCOLN AVE., CHICAGO, ILL. 60646



break-in on CW or, if you want, conventional semi-break-in is available.

### Brickbats and Kudos

One unpleasant aspect of operating the 102BX is the appearance of the frequency read-out. Red LED displays are used, but no filter is placed in front of them to screen out the stray light which reflects from the unlit segments. This annoyance can be partially eliminated by looking at the display from an angle and controlling the room lighting.

The 102BX owner who uses his rig at home with an external supply and speaker is not likely to notice that the internal speaker is very small and anemic. Serious mobile operators would be well advised to use an external speaker.

An idea of the care that goes into the design and construction of a rig can be obtained by disconnecting the antenna, turning up the volume, and tuning across the bands, listening for "birdies." These mixing products are very difficult to eliminate, so every attempt should be made for them to fall away from the frequencies of interest and be at extremely low levels. When testing the Astro 102BX, we found six noticeable birdies within the amateur bands. Correspondence from Swan acknowledges the presence of these mixer products and suggests that they are below the .5- $\mu$ V level. Our own on-the-air tests indicate that when noise levels are low, several of these heterodynes

are detectable—but at a low enough amplitude to cause interference to only the weakest of signals.

Evaluating a piece of equipment as complex and expensive as the Astro 102BX can be a tough job. The evaluator has to be careful that insignificant shortcomings don't dominate the review. Every rig has its faults, but they must be weighed against the larger pool of good points.

Each Astro 102BX is shipped with a Performance Check Sheet. It gives the receiver sensitivity and power out on each band for that particular radio. Every 102BX also receives a 72-hour elevated temperature burn-in during which the rig is cycled between transmit and receive. It is comforting to know that quality control is a reality that occurs before shipping rather than in the new owner's shack.

This may be the age of appliance operating, but there are a few hams who still like to repair or modify their store-bought gear themselves. Swan has made the 102BX in such a way that this can be done with a minimum of gymnastics. Fifteen circuit boards are used, with most of the interconnections made at a distribution board. Dip-style jumpers are used rather than plug-in cards. The documentation is excellent; there are individual one-page schematics and parts placement diagrams for each board. For once you don't have to buy an extra service manual to find out what is where.

The styling of the American-made Astro 102BX runs counter to the military-like appearance popularized by such firms as Kenwood, Icom, and Yaesu. Features such as dual PTOs and a single conversion receiver are among Swan's symbols of an independence from the everyday world of amateur radio products. Priced at \$1195, the 102BX joins a growing list of transceivers costing a kilobuck or more. The accessory power supply lists at \$179.95. As Swan's premier transceiver, the Astro 102BX is intended for the discerning amateur, one who can appreciate its styling and versatility.

Swan, a division of Cubic Communications, Inc., 305 Airport Rd., Oceanside CA 92054; (714)-757-7525. Reader Service number 476.

Tim Daniel N8RK  
73 Staff

### THE CON-PUTER 1

Con-puter 1 is a new type of memory keyer for amateur radio CW contest or casual operation. It permits the operator to store contest exchange messages which contain serial numbers. Such exchanges are required in the Sweepstakes, WAE, VK/ZL, and many other CW contests.

After initial storing of desired contest messages by the operator, Con-puter 1 automatically inserts the correct serial number. This number is also displayed. Each time the message is initiated, the serial number automatically increases by one, and the complete message,

with number, is sent without further attention from the operator. Numbers up to 9999 can be accommodated.

Con-puter 1 also contains a leading zero option which, when activated, automatically places lead zeros in front of numbers less than 100. The memory and address locations are digitally displayed for loading convenience.

Con-puter 1's front panel is purposely kept simple for operating ease. Con-puter 1 operates like a regular memory keyer when the serial number feature is not needed. Approximately 200 characters may be stored in the 4 primary and 4 secondary message locations.

Con-puter 1 has built-in sidetone and speaker. A regular or iambic key paddle may be used. Continuously adjustable keying speed is 5-60 wpm. Power requirements are 120 volts ac, 60 Hz or 12 volts dc. Memory contents may be protected against power loss by connecting an external battery to terminals provided for that purpose on the rear panel.

The heavy-duty aluminum cabinet measures 12" wide x 3½" high x 10" deep. The unit weighs 8 lbs.

For further information, contact *Con-puter 1*, 3006 Lockheed, Midland TX 79701. Reader Service number 481.

### THE ICOM IC-2AT SYNTHESIZED TALKIE

Miniaturization techniques and frequency synthesizers are creating some radical and exciting innovations in the world of 2-meter hand-held transceivers. Large, crystallized handies capable of operation on 5 or 6 discrete channels are giving way to pocket-sized equivalents capable of 800-channel operation, two-tone encoding and much more. The mass clamor for these palm-sized gems and their accessories is extensive, with almost every active amateur wanting to get in on the action. The capability of carrying a full communications system comfortably in one hand has a distinct advantage which is, indeed, hard to beat.

In addition to their everyday use through one's local repeaters, frequency-synthesized handies are particularly useful when traveling via airlines and rental cars. (I don't advocate us-

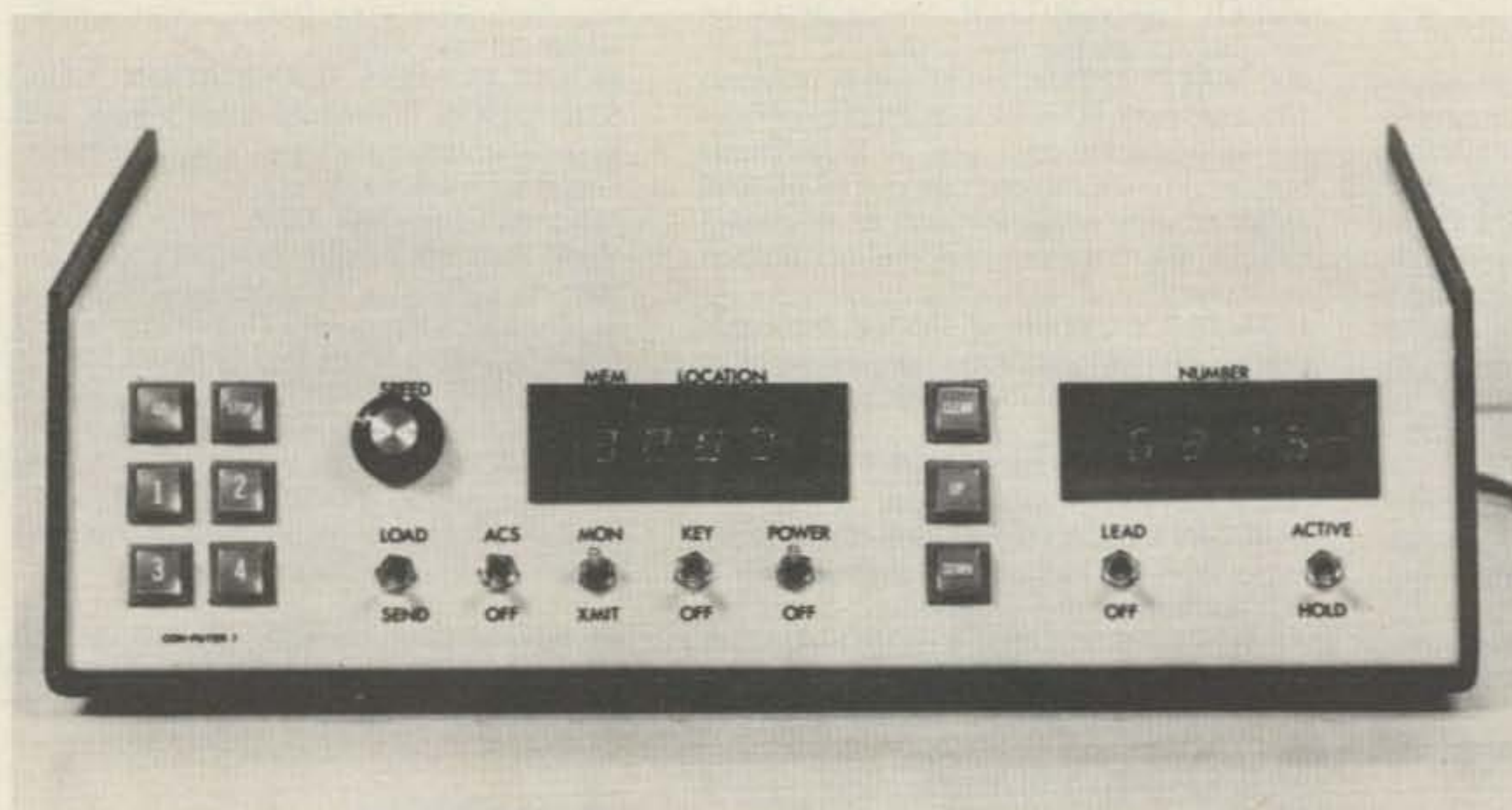

The Con-puter 1.



# hy-gain®

## DX'ER, CONTESTER, or RAG-CHEWER

With the sunspot cycle nearing its peak, and traffic on 10, 15 and 20 meters at an all-time high, you need a tri-band beam that really delivers. You'll find that there are more Hy-Gain Tri-Banders on the air than any other brand, and that says a lot! All of Hy-Gain's Tri-Banders feature separate High-Q, high-efficiency traps that ensure maximum F/B ratio and gain and minimum VSWR on ALL THREE bands. Hy-Gain's "no-compromise" construction features; taper-swaged 6063-T832 thick-wall aluminum tubing for maximum strength and minimum wind resistance; a rugged boom-to-mast bracket that adjusts from 1 1/4" to 2 1/2"; heavy gauge, machine formed, element-to-boom brackets that won't allow the elements to twist on the boom; and improved element compression clamps that allow greater tightening ability and easier readjustment.

Hy-Gain's unique Beta-Match is factory pre-tuned to ensure minimum VSWR and maximum gain on all three bands. All Hy-Gain beams are fed with 52 ohm coaxial cable and deliver less than 1.5:1 VSWR at resonance.

Write for full details today!

**TELEX hy-gain**

TELEX COMMUNICATIONS, INC.

1800 Airport Ave. St. Louis, Mo. 63114 U.S.A.  
Europe: 22, rue de la Loge d'Orléans, 92010 St. Denis, France

## Hy-Gain has the right Tri-Bander for you!

Antenna shown is:

**TH6DXX**  
6-Element  
Tri-Band Beam

Other Tri-Banders in the  
Hy-Gain line:

**TH5DX**  
5-Element  
Tri-Band Beam

**TH3MK3**  
3-Element  
Tri-Band Beam

Tower shown is  
The NEW Hy-Gain  
**HG-52SS**  
Self Supporting  
Crank-Up Tower

ing the HT aboard a commercial airline, but its emergency capability is reassuring.) Once clear of airport hassles, the HT can be set on an area repeater and placed on the rental car's seat. This pleasure is proving its worth to HT owners every day.

Hand-held talkies also make ideal mobile rigs when used with a 25- or 50-Watt amplifier and a gain antenna mounted on the auto's roof. When leaving the auto, the handie can be carried right along and used portable.

During recent years, I've used almost every hand-held, transceiver on the market. Every unit was an exceptional performer, each exhibiting some special feature or features unique to that manufacturer. Recently, however, I secured what seems the most enjoyable and logical talkie I've owned—a new Icom IC-2AT.

### The Rig

Two models of the Icom handie are available in the US: the IC-2A and the IC-2AT. The difference between these units is that the IC-2AT includes a touchtone encoder which is molded into its front case. The encoder adds only 1/16" to the case thickness, its inner area is rubberized, and the buttons have a positive snap action. The rubberized area is slightly recessed to provide some protection from pocket edges, etc. There are two unique features in the Icom's encoder. When punching numbers, the tones can be heard on the handie's speaker. The loudness of these tones follows the handie's volume control setting. After punching a single digit and hearing those two tones in return, the handie's push-to-talk can be released. A VOX circuit in the unit holds the rig on transmit until approximately 1 second after the tones are completed. This delay will follow almost any dialing speed one cares to use. Next, the transmit LED atop the unit will extinguish and the handie will automatically return to receive mode.

The Icom handie is smaller and lighter than other hand-helds, and it can actually be slipped into pockets where other units won't fit. In fact, the Icom can be comfortably carried in the vest pocket of a suit coat all day without evidencing itself by a bulge or pull from weight.

Frequency selection with the



Conditions	Total Current
Receiver on, squelched	12 mA
Receiver on, signal present, low volume	25 mA
Receiver on, signal present, high volume	35 mA
Transmitter on, low power	200 mA
Transmitter on, high power	400 mA

Table 1. Current drains measured on the IC-2AT. Battery voltage was 8.7 volts.

Icom handie is done with small thumbwheel switches mounted atop the unit. Two main advantages of this arrangement are the ability to change frequencies by merely feeling and counting steps rather than looking at the rig (very beneficial when mobiling in rush-hour traffic) and the fact that this mechanical memory doesn't require battery current or reprogramming during periods of minimal use. An LED mounted beside the thumbwheel switch/frequency display indicates transmit mode and battery condition. Three small switches are submounted on the Icom's back for selecting high/low power, simplex or duplex operation, and +600- or -600-kHz transmitter offset. Odd splits and 1-MHz splits are not provided in the Icom. A belt clip is also furnished with the Icom; it can be used or removed, as desired.

Internally, the Icom handie consists of layered PC boards which open book-style for servicing. The receiver is double conversion with a first i-f on 10.695 MHz and a second on 455 kHz. Through actual on-the-air use, I've found sensitivity and selectivity comparable to other

quality handies on the market. The transmitter uses a conventional and popular varicap/frequency multiplier arrangement to achieve a crisp, clean transmitted signal. A voltage regulator circuit applies +5 and +6 volts to all stages except the transmitter's driver and final amplifier. Those stages receive full battery voltage for producing maximum transmitted rf energy. The handie's LED monitors voltage to the regulator during transmit mode.

#### The Power Source

Power for the Icom handie is supplied by a slide-on battery pack on the unit's bottom section. Mating is accurate and positive, without "play" or loose edges. The standard battery pack supplied with the Icom is a 250-mAH unit of relatively small size. This pack is no slouch, however; it powers my unit to 2.4 Watts output when normally charged. The output power drops to 1.3 Watts when the batteries are almost depleted. (These measurements were conducted using a dummy load and a Bird wattmeter.) Battery life when using this 250-mAH pack depends on the amount of transmitting, receiving and

squelched time employed. Obviously, this situation varies with individual applications. You can calculate HT use time for your particular type of activity with the aid of Table 1. If, for example, you listen for 1 hour (approximately 30 mA) and transmit for a total of 3½ minutes (approximately 60 mA), a fully charged 250-mAH pack will be dropped to approximately 160 mAH. Speaking from a more non-technical standpoint, the Icom (with its 250-mAH pack) exhibits the same battery life as the Yaesu FT-207R. Several optional battery packs should soon be marketed for the Icom handie, although the manufacturer is back-ordering them as this report is being written. The BP5 pack will contain nine 450-mAH nicads and power the HT to an advertised 2.3 Watts output. The BP2 pack will contain six 450-mAH nicads and power the unit to a solid 1-plus Watt output. Finally, the BP4 case looks particularly appealing and useful. This is a blank case which can be loaded with 6 alkalines or 6 nicads of the 450- or 500-mAH variety. When this case is used in conjunction with the standard 250-mAH pack (BP3), continuous operation is possible by alternately swapping and charging packs. The slide on/off feature permits this option without missing a single QSO.

#### Personal Evaluation

I've personally found the Icom handie perfectly adaptable to my particular needs and

pleasures. Its small size and light weight are, in my opinion, definitely a worthwhile trade-off for the scanning feature of my previous frequency-synthesized HT, and the slide on/off battery packs are an ideal means of keeping the unit operating continuously. The microphone is placed midway along the unit and opposite the antenna. This allows the unit to be canted back during use to prevent rf from radiating broadside into the eyes. Both transmit and receive audio are exceptionally crisp and clean. I think it's a great little transceiver and recommend it heartily. The U.S. distributor is Icom, Inc., 3331 Towerwood Drive, Suite 307, Dallas, TX 75234.

Dave Ingram K4TWJ  
Birmingham AL

#### SOUNDPOWER SP100 SPEECH PROCESSOR

Every ham dreams of having the loudest signal on the band. Some amateurs make an obsession out of this. They build or buy gain antennas, amplifiers, and now speech processors. Of course, these signal boosters do have some drawbacks. Antennas require a lot of real estate and amplifiers have final tubes that are expensive to replace. Speech processors, on the other hand, are usually inexpensive and don't require more than a few inches of desk space. Is it any wonder that many of the signals heard today are clipped, compressed, amplified, expanded, and so forth?

Enter the SP100 speech processor made by Soundpower. The SP100 is advertised as increasing the "effective voice power output well over ten times." Packaged in a 5¼" W × 2½" H × 2½" D cabinet, the SP100 uses only two eight-pin integrated circuits and a handful of common resistors and capacitors to give you a 10-dB increase in talk power. The user must supply 6 to 13 volts dc. A small plug-in supply, the PS9, is available as an accessory.

The Soundpower processor eliminates unneeded frequency components so that the system voice power can be concentrated in the high articulation frequencies. The result is an adjustable constant amplitude signal containing only the frequency components needed to make the human voice intelligible.



Soundpower's SP100 speech processor.



Our bench and on-the-air tests confirmed that the SP100 does selectively amplify parts of the complex audio signal coming from your microphone. We used a D104 microphone which plugged into the standard 4-pin connector on the processor. A short cable runs from the SP100 to the rig. In our case, it was a Kenwood TS-820 and we were able to use the spare 4-pin connector supplied with the SP100.

Two trimpots were adjusted according to the instructions and on-the-air feedback. If you succumb to the temptation to crank up the processor's gain, the result may be a loud signal but also an unintelligible one. The S-meter on a nearby station's receiver showed a 9- to 12-dB improvement over unprocessed speech. This agrees with the claim of a voice power output increase of about 10 times.

There is no free lunch when it comes to using the Soundpower unit. The gain in talk power is accompanied by a loss of fidelity. The low frequency parts of speech are dropped, so the natural resonance that accompanies the human voice is lost. The result is signal that is far less pleasing to listen to. One station expressed his amazement at the substantial increase in signal strength provided by the SP100, then he asked me to turn it off. Unprocessed speech is likely to be preferred by just about everyone you meet. Of course there are situations when your normal signal won't break through the noise and interference. In such cases, the SP100 can help you out, but don't expect the operator on the other end to praise your audio.

When properly operated, the SP100 should not cause your rig to splatter. The duty cycle imposed on the transmitter section is likely to increase, so the rig is going to run a bit hotter. Costing \$79.95, the SP100 is an inexpensive way to boost your SSB signal. Don't forget that you sacrifice some audio quality, too.

Soundpower, PO Box 426, Bergenfield NJ 07621. Reader Service number 477.

Tim Daniel N8RK  
73 Staff

#### RTTY READER

A new radioteletype code

# hy-gain<sup>®</sup>

## 18HT The World's Finest Multiband Vertical

The 18HT "Hy-Tower" is the only full size, automatic band-switching vertical antenna for 80 thru 10 meters on the market today! It features a unique stub decoupling system which effectively isolates various sections of the antenna so that an electrical  $\frac{1}{4}$  wavelength (or odd multiple of a  $\frac{1}{4}$  wavelength) appears on all bands. As a result, the VSWR is less than 1.5:1 at resonance 80 thru 10 meters.

#### Typical 2:1 VSWR Bandwidths are:

- 700 kHz on 10 meters
- 300 kHz (or better) on 15, 20, and 40 meters
- 250 kHz on 80 meters

**With the addition of a base loading coil, the 18HT also provides exceptional 160 meter performance!**

Many 18HT's have been in service for 15 years or more and they still deliver "original spec" performance. This enviable record is the result of Hy-Gain's no-compromise attitude toward materials and construction. The 18HT is complete with a 24 foot galvanized tower that supports the entire system without guys in winds up to 75 mph. The top section consists of dependable 6063-T832 taper swaged aluminum tubing that extends the antenna to an overall height of 50 feet. A special hinged base allows complete assembly on the ground and permits easy raising and lowering.

Hy-Gain offers a wide selection of vertical antennas as well as a complete line of beams and crank-up towers. Write for detailed information today!

**TELEX hy-gain**

TELEX COMMUNICATIONS, INC.

8600 Aldrich Ave. So., Minneapolis, MN 55420 U.S.A.  
Europe: 22, rue de la Légion d'Honneur, 93200 St. Denis, France.

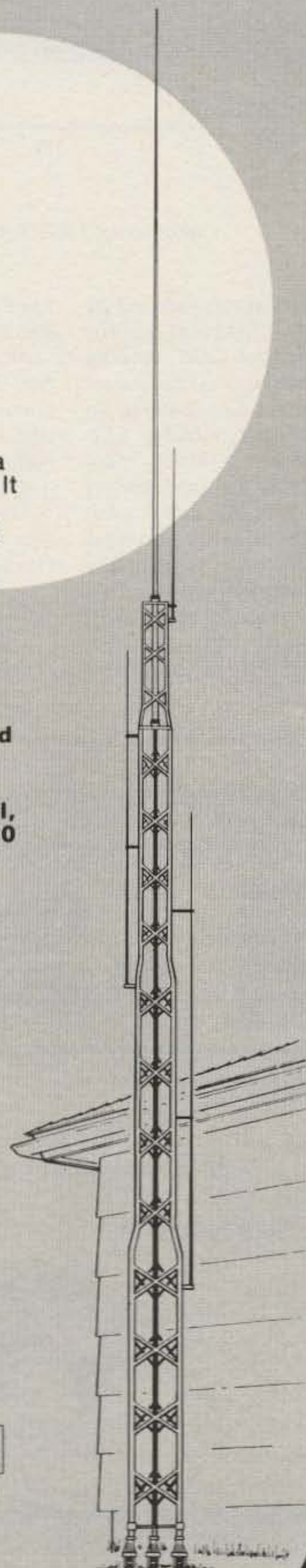





Microcraft's RTTY Reader.

reader has been introduced by Microcraft Corporation for SWLs, Novices and veteran radio operators. It is completely self-contained and features an eight-character moving LED display, separate active mark and space filters, and tuning LEDs. All text characters—letters, numbers and punctuation—are shown sequentially on the display. It features an extremely versatile decoding system capable of handling 170, 425 and 850 Hz FSK with RTTY

speeds of 60, 67, 75 and 100 Baudot and 100 ASCII.

All that is required is to connect it to the loudspeaker of a communications receiver—no CRT is needed. It is compact, measuring 7.375" W x 5.75" D x 3.375" H, and weighs 4 lbs.

Microcraft Corporation, PO Box 513, Thiensville WI 53092. Reader Service number 479.

#### INSTANT SOFTWARE'S "QSL MANAGER"

While tuning across the ham

bands have you ever said to yourself, "I've worked that guy before; it was on 15 meters about a month ago, or was it 40 meters?" You could make a mad dash for the logbook and furiously flip pages in hopes of finding the QSO. If your memory is like mine, though, chances are that you won't find the entry in time.

The "QSL Manager," a disk-based program from Instant Software, Inc., turns your 32K TRS-80 Level II computer into a video logbook, one that can find a record of any past QSO with that "familiar" callsign in just a few seconds. No more log sheets are needed; just load the program and choose one of the five functions: view log, add entry, print summary, search entries, and end.

The program can be used with a single disk drive system, but this will limit the number of entries to about 400 since the disk must hold both that program and data. With a dual drive system, one disk can store the program and the other has room for about 1400 entries if the TRS-80 has 48K of memory. Computers with 32K are limited to approximately 1000 entries.

In order to make the most of the disk storage, each QSO entry is limited to the date, time, call, band, mode, name, remarks/QTH, and a record of QSL exchange. When the data is loaded at the beginning of each session, the callsigns are stored in the computer's random access memory. If a search is initiated, the computer scans the memory, which points to the appropriate location on the disk. This results in fast search times, even when your log contains hundreds of QSOs.

The "QSL Manager" package is more than 6000 bytes long. It contains a title program, the manager program, and an auxiliary program that allows convenient start-up. You can customize the program to include your callsign in the heading and, if you want, other changes can be made to tailor the program to your specific needs.

This type of video log is intended for rag chewing rather than contest use. It allows you to keep track of stations that have forgotten to send a QSL, something that is handy if you are trying for a multiband Worked All States or DX award. A hard copy of your entire log (or

selected entries) can be made if your system includes a printer.

A computer costing hundreds of dollars may seem to be an expensive way to keep a log. The "QSL Manager," however, represents the tip of an iceberg of potential ham radio applications for the TRS-80. The "QSL Manager" costs \$19.95 and is available from many computer stores or direct from the publisher.

Instant Software, Inc., Peterborough NH 03458. Reader Service number 482.

Tim Daniel N8RK  
73 Staff

#### REPEATER "TAIL CHOPPER"

Circuit Specialists has introduced a repeater squelch tail eliminator called the "Tail Chopper." Both models of the "Tail Chopper" maintain normal squelch hysteresis to 0.1 mV and feature adjustable sensitivity.

Model TC-2100 is a universal module for use with most repeaters. It has a built-in enable/disable function which can be connected to the tone control system of the repeater. The TC-2000 is designed to plug into the Regency U10R UHF repeater to improve its squelch operation and eliminate the squelch tail.

Completely assembled units as well as PC boards and parts are available from Circuit Specialists, Inc., 621 Bishop, Salina KS 67401. Reader Service number 484.

#### SOUNDS OF SHORTWAVE

How do you describe the notorious Russian woodpecker to a friend who has never heard it? Words just do not do the job when you want to tell someone about the unusual squawks and buzzes you hear on your ham or shortwave receiver.

Now you don't have to settle for words—you can produce those strange sounds any time you want with Grove Enterprises' cassette tape, *Sounds of Shortwave*.

One half of this 60-minute tape is devoted to explaining and listening to dozens of on-the-air sounds. You'll hear everything from common RTTY signals to the rare and unexplainable English "number" transmissions.

Side two helps the listener select the best shortwave receiver and design an effective antenna. To an experienced

## Instant Software™ Inc.

Designed for use on  
TRS-80\*  
32K  
LEVEL II

# QSL Manager

\*A trademark of Tandy Corporation.



SEE REVERSE SIDE FOR PROGRAM INFORMATION

© Instant Software Inc. 1980 © Peterborough, N.H. 03458  
ALL RIGHTS RESERVED

0151RD

Instant Software's "QSL Manager."



SWL or ham, much of this will be old news. The tape is intended for the listener who is new to the hobby.

The tape's interesting and useful content could be enhanced by better quality production and a less sing-song narration. However, don't skip over this tape if you are looking for a novel way to introduce a friend or relative to shortwave listening. *Sounds of Shortwave* costs \$5.95 postpaid and is available from *Grove Enterprises, Route 1, Box 156K, Brasstown NC 28902*. Reader Service number 480.

**Tim Daniel N8RK**  
73 Staff

### HY-GAIN ADDS THREE NEW PRODUCTS TO TOWER LINE

Hy-Gain, a division of Telex Communications, Inc., has announced the addition of three new products to its tower line. The HG-70HD, a new 70-foot self-supporting crank-up tower, is the tallest of seven towers now offered by Telex/Hy-Gain. The tower is all steel, has four sections, and features an improved guide system providing rigid, close-tolerance structural support while leaving the tube ends open for complete surface galvanizing and unrestricted moisture drainage. This heavy-duty tower was designed for antenna loads of up to 16 square feet in winds of up to 60 mph. The top section is predrilled for thrust bearing bolts; a rotor mounting plate is included.

Hy-Gain has also developed a new electric winch system, Model HG-EW, that fits the new HG-70HD as well as the existing 54-foot HG-54HD and the 52-foot HG-52SS. The winch control box can be locked, which allows the tower to be secure in either the extended or retracted position. It has a limit switch which prevents a possible overload at the upper stop position. A manual crank is also supplied in the event of an electrical power failure. The HG-EW is equipped with an automatic brake which is always in positive engagement when the winch is not operating.

This winch system can be converted at any time to remote control operation by adding the new Hy-Gain tower control (HG-EWRC) which has been specifically designed as a

# hy-gain®

## HG-52SS Self-Supporting Crank-Up Tower

The Hy-Gain Model HG-52SS is a 52 foot self-supporting crank-up tower designed for antenna loads of up to 9.0 square feet in winds up to 50 mph. This all steel constructed tower is hot dip galvanized after fabrication to ASTM specifications. Features include extra-strength diamond web bracing and an improved guide system for the telescoping sections, which provides rigid, close tolerance structural support while leaving the tube ends open for complete surface galvanizing and unrestricted moisture drainage. Rotators, including the Hy-Gain 300 and CDE Tailtwister, can be mounted inside the top section on the rotor mounting plate included with the tower. The HG-52SS is easily raised and lowered by manual or optional electric winch system. A thrust bearing is available which bolts to the top section and accommodates masts up to 2 inches in diameter. The HG-52SS is easily erected on a limited area site, and can be readily retracted to a 21 foot height for service of the antenna. Hy-Gain manufactures a complete line of Crank-Up towers from 33 to 70 feet. Write for complete details today.

Antenna shown  
is Hy-Gain  
**TH6DXX**  
Tri-Band Beam



Hy-Gain  
Diamond Web  
Bracing for the  
ultimate in  
structural  
strength.

**TELEX hy-gain**

TELEX COMMUNICATIONS, INC.

8800 Aldrich Ave. So., Minneapolis, MN 55410 U.S.A.  
Europe: 28, rue de la Légion-d'Honneur, 92030 St. Denis, France

Continued on page 160



# In Profile: Dick Bash KL7IHP

## — the father of The Final Exam speaks out

*Dick Bash KL7IHP has created a furor by publishing FCC test questions, verbatim, in a series of controversial license manuals called The Final Exam. Individual manuals exist for the Advanced, General, and Extra class tests and will be released soon for the Novice class test. Controversy has arisen because many hams feel that these manuals are nothing more than elaborate cheat sheets and, as such, should be suppressed. The following profile is drawn from an interview I conducted with Dick Bash at the 1980 Dayton Hamvention.*

**"M**orality? Man, who am I to judge morality? Who can address moral issues in these changing times? Legality? Now that's something else, altogether."

As he speaks, the intensity in Dick Bash's steel-blue eyes is meant to telegraph the high seriousness of his positions on various issues. But whether discoursing on the controversial nature of

his license manuals or on his vision of the future of the ham radio hobby, he exudes the smooth confidence that's so often present in the laid-back, sunny California personality.

"The FCC won't mess with me. I've got some high-priced legal talent in San Francisco ready and waiting to take them on. They haven't got a case, and they know it. A thing called the Freedom of Information Act is involved."

The format for the controversial manuals is straightforward. Actual test questions and multiple-choice answers are reproduced exactly as they appear on the official government tests. Bash suggests in the General class guide that some outside reading be done to supplement his information. In the Advanced class guide, however, he indicates that simple memorization of his material will be sufficient preparation to allow one to pass the test.

Bash solicits the test questions appearing on the FCC exams from cooperative hams who have recent-

ly taken the tests.

"Every day, I go down to the examining station, stand outside the door, and wait for them to come out: all the young kids and old-timers who have failed the Advanced class test three and four times. I say, 'Hi buddy. Did you pass?' Most say no." (I have it from Commission insiders that the failure rate on the Advanced test is a whopping 69%.)

"When they tell me they have failed, I say, 'Well, maybe you should have used my book.' Then I ask them if they remember any of the questions. Usually they can come up with one or two.

"I also get lots of questions in the mail from guys who have heard of me and are fed up with the BS way the FCC writes its exams. It's as simple as that."

Bash maintains that test aids similar to his are available for many other federally-administered tests where licensing is involved. His examples include FCC commercial radio exams and the certifica-

tion tests the FAA periodically requires of pilots. He is upset that the ham radio establishment has not been more receptive of his efforts at making its own tests easier to pass.

More than altruism is involved. What began as a ten-meter, self-help net for San Francisco-area General class hams trying to upgrade to Advanced has become a full-time business for Dick Bash. He estimates that approximately 8,000 copies of his books have been sold during the past four months. Most of the substantial inventory in his booth at the Dayton Hamvention was depleted by the close of business on Sunday afternoon. He seems to have an enthusiastic market for his product.

"I'll tell you something else. Today's ham is not an engineer, he's an appliance operator. And there is not a damn thing wrong with that. How many Kenwood, Yaesu, and Ten-Tec rigs do you think are on the air? Lots, that's how many. These guys just want to get on and shoot the bull. So



why not let them? Why make such a damn game of it?"

Bash, a TS-820S owner/operator, feels that current FCC amateur tests favor technically-oriented hams—many of whom are professionally involved with the electronics industry—at the expense of socially-motivated hams. This perception provides the rationale for the publishing of his test guides. Bash suggests that anyone who questions this premise read Part 97.1, Subpart A—General, Basis and Purpose. He feels that this section indicates that, officially, the social aspects of the hobby are at least on an equal footing with technological aspects.

In Bash's opinion, the situation is compounded by the fact that the ARRL has abandoned the Novice. He also feels that much of the ham media (*QST*, *73*, and *Ham Radio Magazine*) has nothing at all to offer the beginner. Further, he will tell you that the East Coast Establishment soon will sound the death knell of ham radio if allowed to continue its domination of the hobby.

"But you know what? Ham radio is alive and well on the West Coast. You guys from back east ought to come out to the real world sometime and see what has been happening."

Like most California true believers, his faith in the "west is best" ethic is strong. And, believing the sweep of trends in America to be a west-to-east phenomenon, he places himself in the vanguard of a new ham movement.

"I'm gonna have five thousand new Novices on the air next year alone. They are all going to use my Novice guide to get their tickets and they're all going to pass the test on the first try."

Whether or not one feels that the declining ranks of US amateurs would benefit from 5,000 new recruits next year, the prospect of the instant existence of 5,000 new, Bash-prepared amateurs is an interesting one to speculate upon. Would today's already crowded bands plunge into chaos? Would the declining domestic ham industry receive the shot-in-the-arm it sorely needs? Would there be any impact at all? The debate is raging among those familiar with Dick Bash.

Bash does allow that an operator must know enough theory to run his station in a legal manner, within qualitatively acceptable limits: no out-of-band operation, no splatter, etc. To him, expecting more than this is unnecessary and unfair.

Bash perceives the ranks of amateur operators with a simple dualism. Old/young, east/west, have/have not. The lack of cooperation and communication which he feels exists within the amateur fraternity has resulted from the unwillingness of the privileged class of operators to share their bands and privileges with others: an "I've got mine, you get yours" situation, where maintaining the status quo is the rule. For Bash, the end result is the loss of new talent and stagnation of the hobby. He feels that eventually his manuals may rectify this inequity and, for that reason, are threatening to a great many old guard operators.

A Jerry Brown liberal, he often seems to be subject to the same confusion of goals and vagueness of purpose that appeared to plague his governor's presidential election campaign. Though his social theory may be simplistic and his solutions short-term, he has begun to have an impact on amateur licensing proce-

dures as well as on the hobby itself. And, like the governor he admires, he has accrued his share of detectors.

His relationship with the ARRL is, predictably, stormy. To him, it represents everything that is wrong with ham radio today. By refusing to run an ad for his manuals in its monthly journal, *QST*, the League has given Bash a slap in the face that he finds particularly infuriating.

The federal government does not get very high marks from Dick Bash either. He feels that it has failed in its responsibility to oversee the ham licensing procedure and has buried its sense of purpose in the bureaucratic quagmire known as Washington DC. Rather than encourage the development of the hobby, he feels that the government has inhibited development by placing obstructions in the path of people trying to upgrade. These obstructions take the form of licensing tests which feature

needlessly vague questions on esoteric subjects, all cleverly phrased to trick the reader into answering incorrectly.

Recently, Bash has asserted that the Personal Radio Division of the FCC has been exerting pressure on those magazines which do advertise and sell his manuals. The pressure, he claims, comes in the form of threats of lack of Commission cooperation with the ham media. His assertion, while startling, is true. One national magazine, regularly advertising and selling his books, has ceased doing so for the reason he cites. This probably indicates that the FCC has either recognized the legality of what Bash has been doing or has given up hope of prosecuting him in the anti-regulatory atmosphere existing in Washington today. In either case, the FCC's use of coercion is a questionable (but not unheard of) tactic for a federal agency to employ.

The issue of Dick Bash's

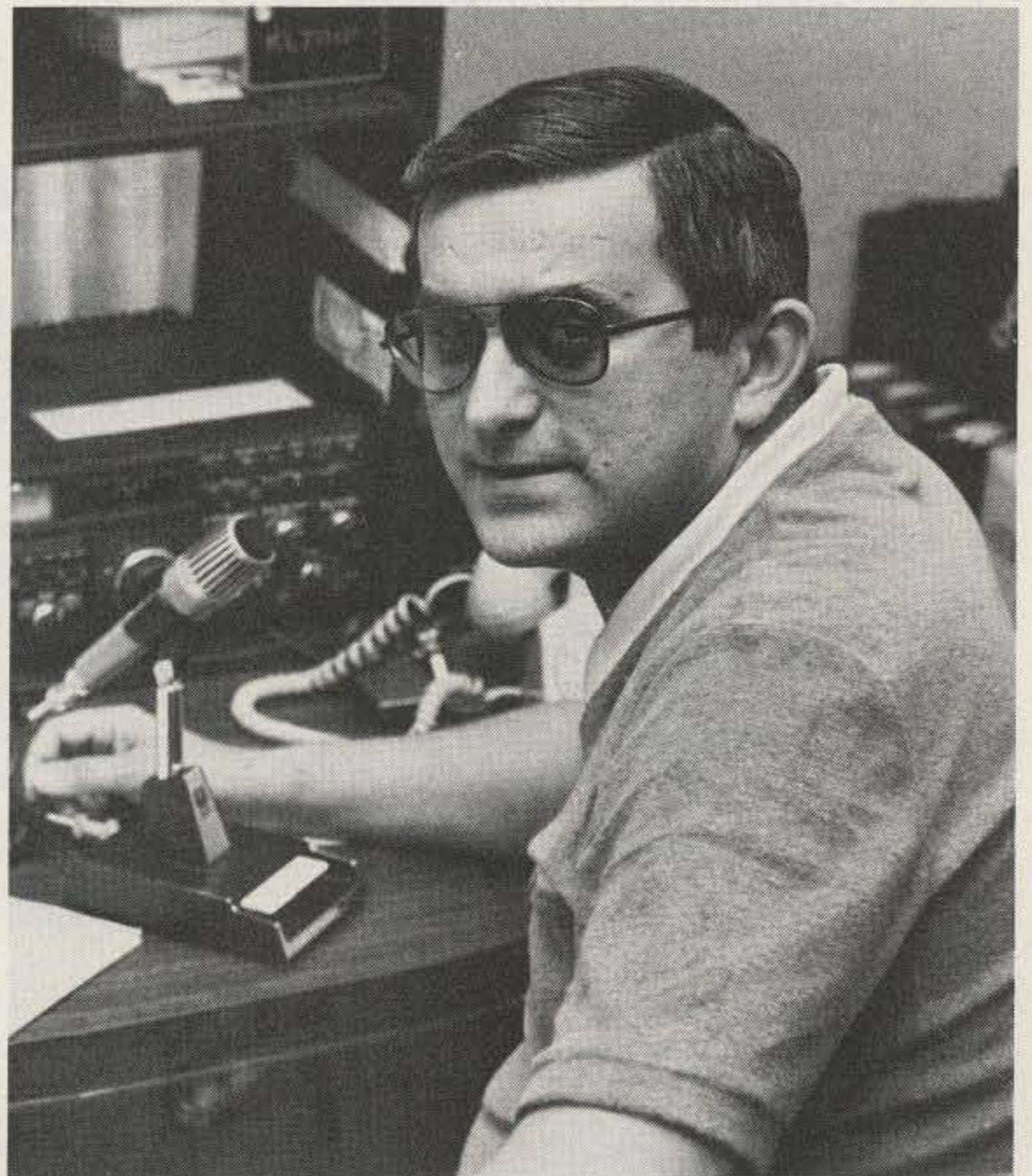

Dick Bash KL7IHP. (Photo by Frank Novac.)





# Germantown Amateur Supply, Inc.

MEMPHIS, TENNESSEE

## NO MONKEY BUSINESS!

- (A) Complete Service Facilities
- (B) Good Deals on most Brands
- (C) Shipping within 24 Hours
- (D) All inquiries handled by Active Hams with over 20 years experience in ham radio

CALL TOLL FREE  
1-800-238-6168

IN TENNESSEE, CALL 901-452-4276  
MONDAY - SATURDAY 8:30-5:30  
FOR YOUR SPECIAL.

Write: 3202 Summer Ave., Memphis, Tennessee 38112

manuals goes beyond what is merely legal or illegal, moral or immoral. Dick Bash's manuals are a response to a malaise existing within ham radio today. While it is unrealistic to assume that the hobby will greatly benefit from an influx of non-technical operators, it would seem that an examination may be called for of just what qualities an amateur operator should embody.

If there is a place within ham radio for rag chewers, bull throwers, and social butterflies, then maybe current licensing tests with their emphasis on things technical are not valid indicators of the ability to use the ham bands effectively. If there is no place within our hobby for these people, then possibly Part 97.1, as it applies to the basis and purpose of the hobby, should be revised. As Bash points out, the ability to run the dB

calculation does not mean one is able to enhance international goodwill.

Dick Bash and his manuals will not go away. In fact, he intends to step up his publishing activities with more frequent updates of his entire line of manuals to coincide with changing FCC exams. In addition, he is planning a series of licensing seminars around the country using his manuals. He guarantees a 95% passing rate for seminar attendees, the first time around.

It is obvious that a head-in-the-sand approach to dealing with him is not realistic. While national magazines may choose to ignore him and the federal government may try to subvert him, his manuals continue to sell briskly. There is a reason for this, and concerned hams, old and young, east and west, should start wondering why. ■

## INSTRUMENTS YOU CAN COUNT ON...

- 4½ DIGIT MULTIMETER/THERMOMETER
- FREQUENCY COUNTERS TO 1.3 GHz
- PRECISION DIGITAL THERMOMETER
- CAPACITANCE METER

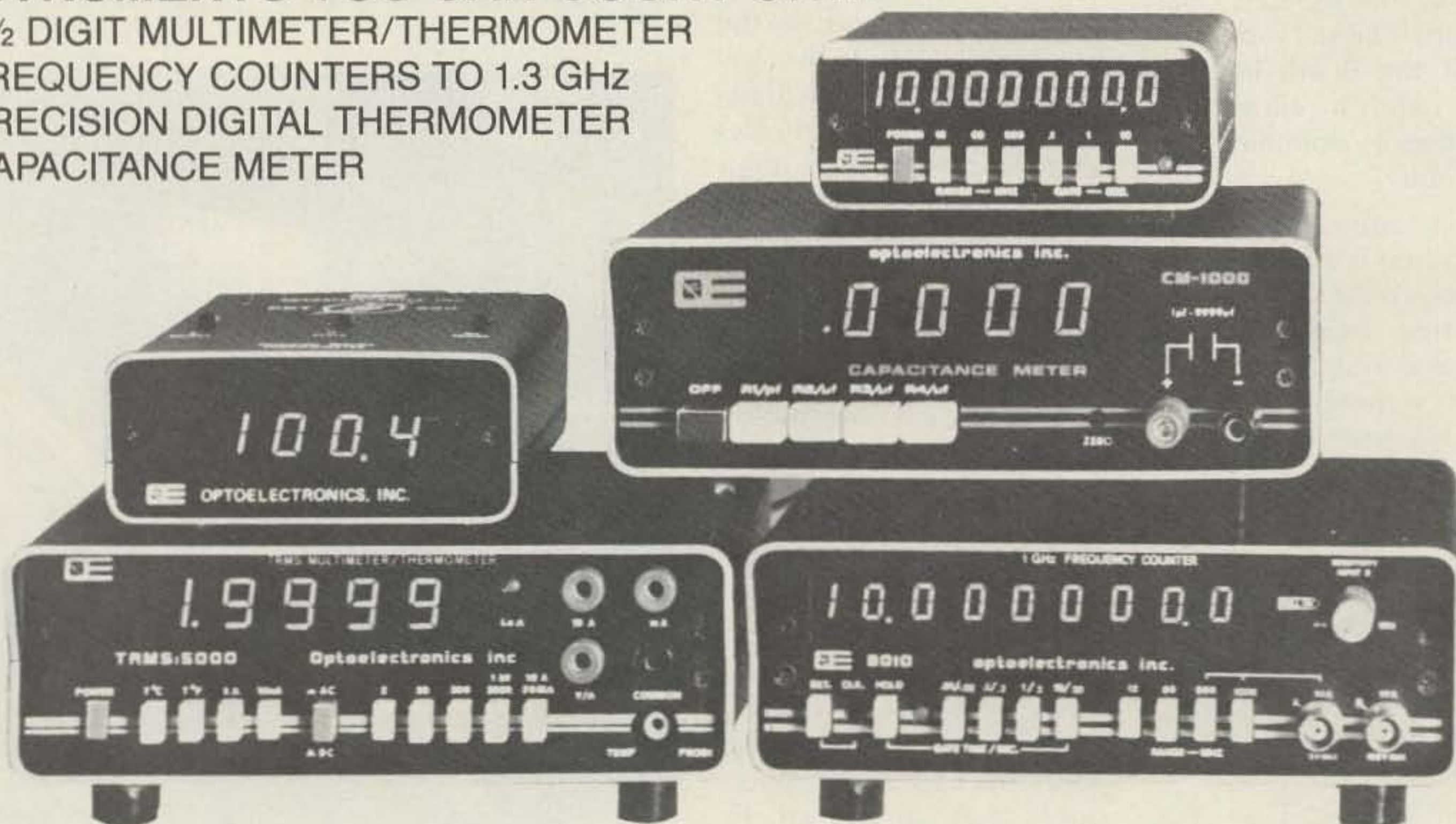

FOR ORDERS, INFORMATION OR A CATALOG WRITE OR PHONE

# 800-327-5912

FROM FLORIDA PHONE (305) 771-2050/771-2051



## Optoelectronics inc

5821 N.E. 14 AVE. FT. LAUDERDALE, FL. 33334



# DOUBLE YOUR PLEASURE

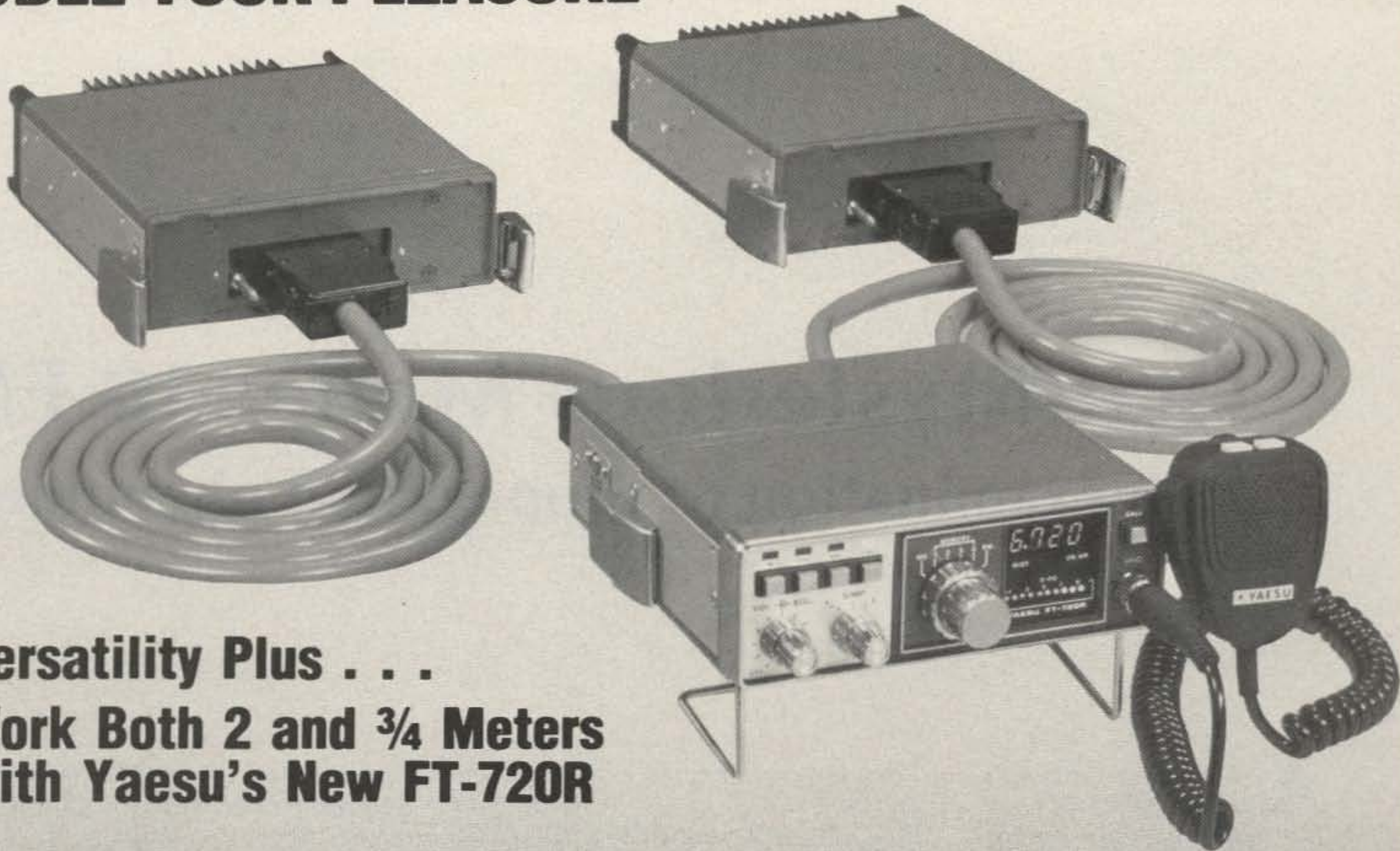

## Versatility Plus . . . Work Both 2 and 3/4 Meters With Yaesu's New FT-720R

The FT-720R series is a compact VHF/UHF mobile transceiver that harnesses the incredible power of the microprocessor to bring you top-operating flexibility. Start with the FT-720R Control Head, then add either the 10 watt FT-720RU 440 MHz or 25 watt FT-720RVH 2 meter RF Deck. You can clamp the Control and RF Deck together or use an optional remote cable to hide the RF Deck. The best news is still to come! By using the optional S-72 Switching Box and two remote cables, you can use a single Control Head for operation with both the 440 MHz and 2 meter decks, giving you a high-performance two band FM station for your car or home. Compare the features below, then ask your dealer for a demonstration of the fabulous FT-720R series. . . another winner from the performance leader . . . Yaesu.

- Four simplex/repeater memory channels, plus receive-only memory channel.
- Scanning controls on microphone with search for busy or clear channel.
- Optional 32 tone CTCSS module for accessing private repeaters.
- Colorful, easy-to-read LED power output/S meter.
- Built-in 1800 Hz tone generator.
- Priority channel with search-back feature.
- Pause feature that holds, then restarts scan, on busy or clear channels.
- Digital display of last four digits of operating frequency.
- Single Control Head may be used for operation on both 440 MHz and 2 meters via optional switching box and remote cables.
- Extremely compact size, light weight.

FT-720RVH	Specifications	FT-720RU
144.00-147.99 MHz	Frequency Coverage	440.00-449.975 MHz
10 kHz	Synthesizer Steps	25 kHz
25 watts	Power Output	10 watts
.32 uV for 20 dB	Sensitivity	0.5 uV for 20 dB
quieting		quieting
±6 kHz (-6dB)	Selectivity	±12 kHz (-6dB)
±12 kHz (-60 dB)		±24 kHz (-60 dB)

Price And Specifications Subject To  
Change Without Notice Or Obligation

**YAESU**  
*The radio.*



480

YAESU ELECTRONICS CORP., 6851 Walthall Way, Paramount, CA 90723 ● (213) 633-4007  
YAESU ELECTRONICS Eastern Service Ctr., 9812 Princeton-Glendale Rd., Cincinnati, OH 45246



# That Mysterious Mode: 10 FM

## — an examination of propagation phenomena

As a 10-meter aficionado I've spent most of my operating time during the last few years on the FM portion of that band, which lies between 29.5 and 29.7 MHz. Use of the FM mode (narrowband,  $\pm 5$  kHz deviation) is allowed above 29 MHz, just as on the VHF and UHF bands. The mix of long-distance propagation together with FM-receiving characteristics is most interesting, and one hears effects not noticed during either HF-SSB or VHF-FM operation.

The propagation anomalies which I've noticed can

be divided roughly into three types.

*Type I.* Discovering that two different 10-meter FM QSOs can be heard on the same frequency at the same time by switching the receiver from a vertical to a horizontal antenna. The band is "open" when this occurs.

*Type II.* A strong FM signal is received which, when unmodulated, is typically at full-quieting. During modulation it becomes almost unintelligible, sounding like an SSB signal received on an AM receiver (no bfo). On the air, this ef-

fect is referred to commonly as "phase distortion." It often happens just before the band is about to shift or close, and is accompanied by deep QSB. The lower audio frequencies seem to be the most distorted.

*Type III.* A weak FM signal is received which shows a fair degree of quieting when unmodulated. In this case, modulation also distorts the signal but not at all like Type II. Instead, the audio quality becomes completely "fuzzed-up" during modulation to the point of being unreadable. At the same time, the degree of quieting goes to zero and the receiver's squelch may chop up the signal. This type of signal distortion seems to be associated with "backscatter" propagation conditions.

### Some Detective Work

As an aid to observing what was happening during these conditions, two different meters were installed in the receiver's FM i-f strip. The first one acts as a signal strength indicator, showing how much signal energy is present in the receiver's

bandpass by reading first-limiter current. It is analogous to an S-meter and then some. The second meter shows the degree of quieting on a signal by sampling the amount of "supersonic" noise on it. This supersonic noise energy is found above the usual communications audio range (about 6 kHz and up) where audio energy does not normally lie. This noise spectrum also is used to activate the noise-operated squelch circuits found in most FM receivers.

Now, from VHF-FM experience you might reasonably expect that the signal strength and quieting indications would correlate at all times, i.e., a strong signal should display a large degree of quieting, but this is not always so on 10 meters, as we'll see. In fact, let's see just what the meters tell us under Type I, II, and III conditions.

With Type I conditions, we see relatively equal signal strengths from the two different signals but only a fair amount of quieting on them. Under Type II conditions, signal strength and quieting are good on the un-

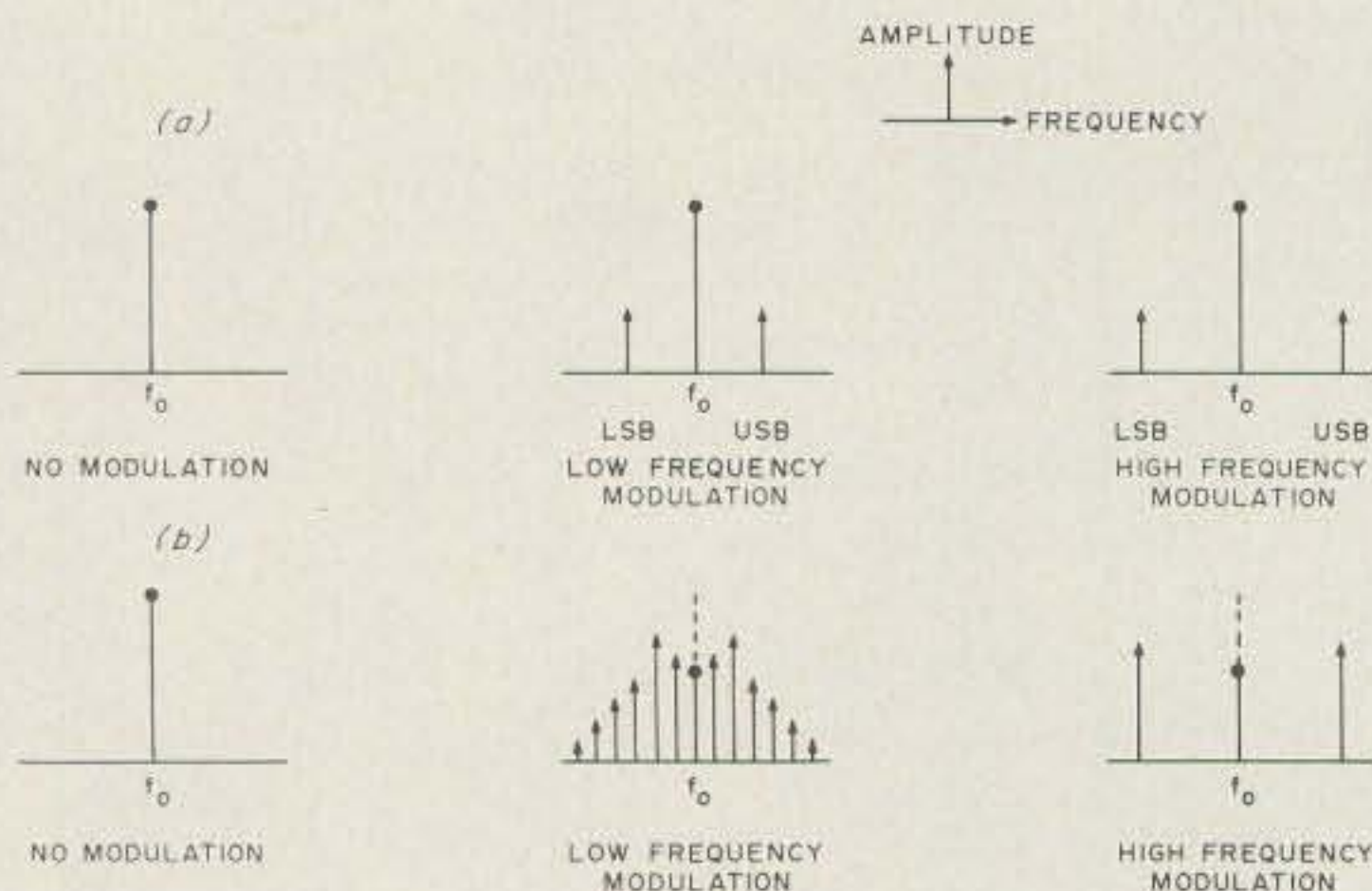

Fig. 1. (a) AM and (b) FM modulation spectra. Carrier is shown at  $f_0$  in all cases.



modulated signal, but with modulation signal strength drops sharply in step with the modulation; quieting remains adequate. Type III signals produce the opposite effect: Signal strength holds steady with modulation (as it normally should) but the quieting falls to zero on modulation peaks, letting noise bursts through. In other words, a great deal of supersonic energy is being generated during modulation and is responsible for causing the noise-operated squelch to drop.

### Amplitude vs. Frequency Modulation

At this point, it would be useful to review briefly the difference between amplitude- and frequency-modulated signals. Fig. 1(a) shows the frequency spectra for three cases of an AM signal: with no modulation, with low-frequency modulation, and with high-frequency modulation. Note that with AM there is always only one set of sidebands, that the sidebands move further away from the carrier for higher audio-modulating frequencies (bandwidth increases), and that the carrier level stays constant during modulation.

By contrast, the narrow-band ( $\pm 5$ -kHz deviation) FM case is shown in Fig. 1(b), using the same audio modulation frequencies as before. Notice that the lower audio-modulation frequency produces numerous, closely-spaced sidebands, whereas only one set is found for the higher audio frequency. Also, the bandwidth of the FM signal does not vary with modulating frequency and the carrier amplitude drops during modulation.

This carrier energy is not lost, however, as it reappears in the FM sidebands, i.e., the average power level of an FM signal remains constant during modulation. This is not so with AM,

where the modulator must supply additional power during modulation—up to 50% of the carrier power level. Typical bandwidths using speech modulation (3 kHz maximum audio frequency) are 6 kHz for AM and about 13.6 kHz for FM.

You may wonder why the bandwidth of a  $\pm 5$ -kHz FM signal is not just 10 kHz. It is because there are additional, lower amplitude sidebands accompanying an FM signal. For narrow-band FM, the second set of sidebands might have only about 13% of the total signal energy. While these sidebands must be passed by the receiver for correct demodulation, in the interests of clarity we will ignore the extra sidebands for our discussions.

One of the most attractive properties of FM is, of course, its noise-reducing capabilities. As usual, however, there is a price to be paid for this advantage: FM's performance at very low signal levels is inferior to AM and SSB. As can be seen in Fig. 2, at low carrier-to-noise ratios (CNR), under 9 dB, the AM signal-to-noise ratio (SNR) is better than with FM. At these low levels, the FM signal suppression effect occurs, i.e., the FM signal's modulation becomes increasingly swamped by noise and finally abruptly disappears. On the other hand, at greater CNRs (above 9 dB), FM begins to show its superior SNR qualities, and at 12 dB of CNR, the threshold of full improvement is reached, beyond which the FM signal will have an SNR of about 10 dB better than an equal-strength AM signal. Greater FM deviation ratios will yield more startling improvements, e.g., broadcast FM uses  $\pm 75$  kHz of deviation which can provide an ultimate SNR of around 75 dB!

### Receivers

Next, take a quick look at

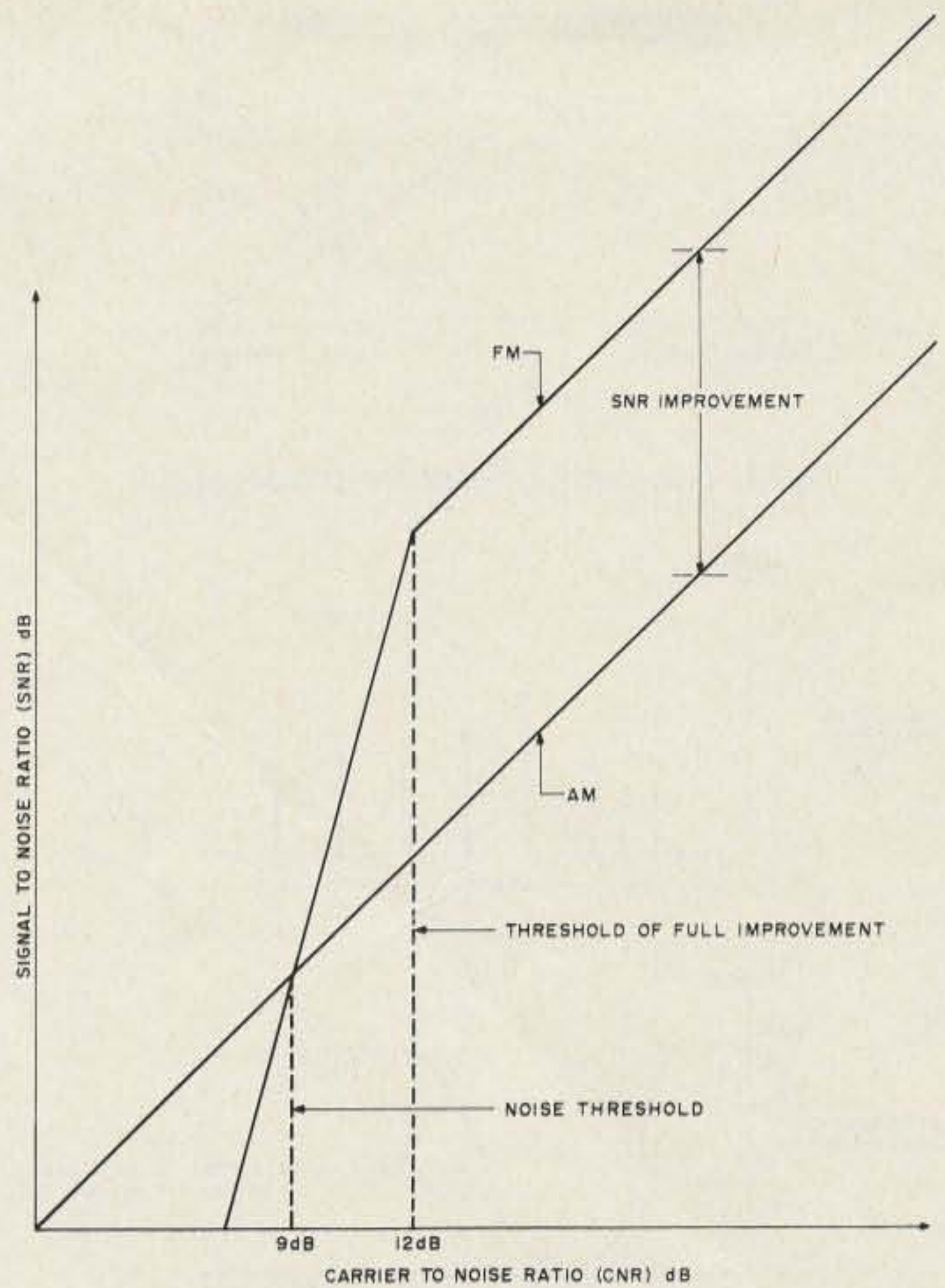

Fig. 2. Signal-to-noise ratio improvement in FM systems.

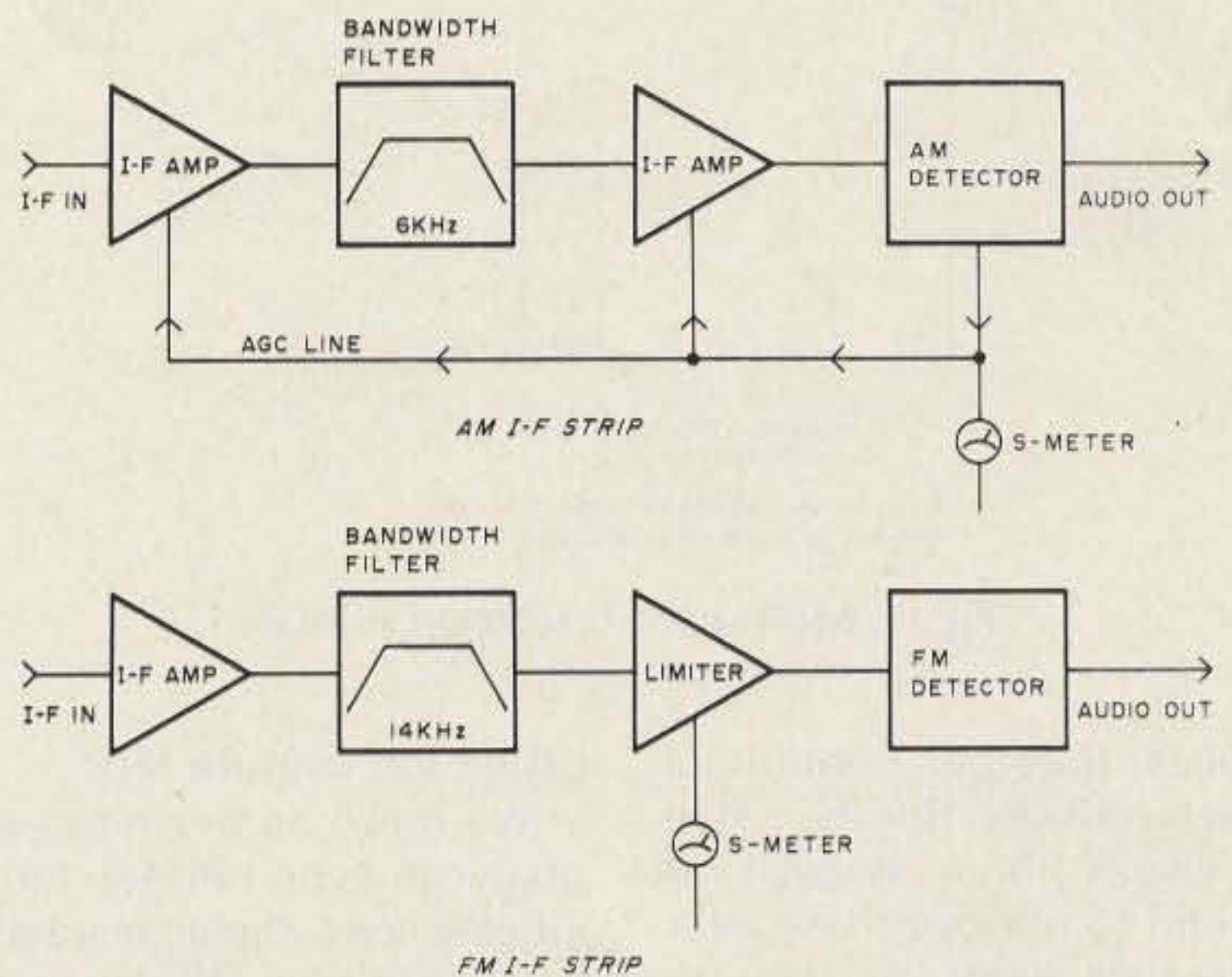

Fig. 3. Comparison of AM and FM receiver i-f strip design.

the typical AM and FM i-f strips shown in Fig. 3. Aside from using a different detector, the FM receiver also has a limiter whose function is to remove any amplitude variations (including amplitude modulation) from the incoming signal, leaving only the frequency variations for the FM detector to demodulate. Since most QRN is

amplitude in nature, static can be reduced markedly when using FM.

What about the situation where two different FM signals occupy the same frequency simultaneously (co-channel QRM)? Well, just as when two AM signals sit on top of one another and interfere, the FM carriers and sidebands also will



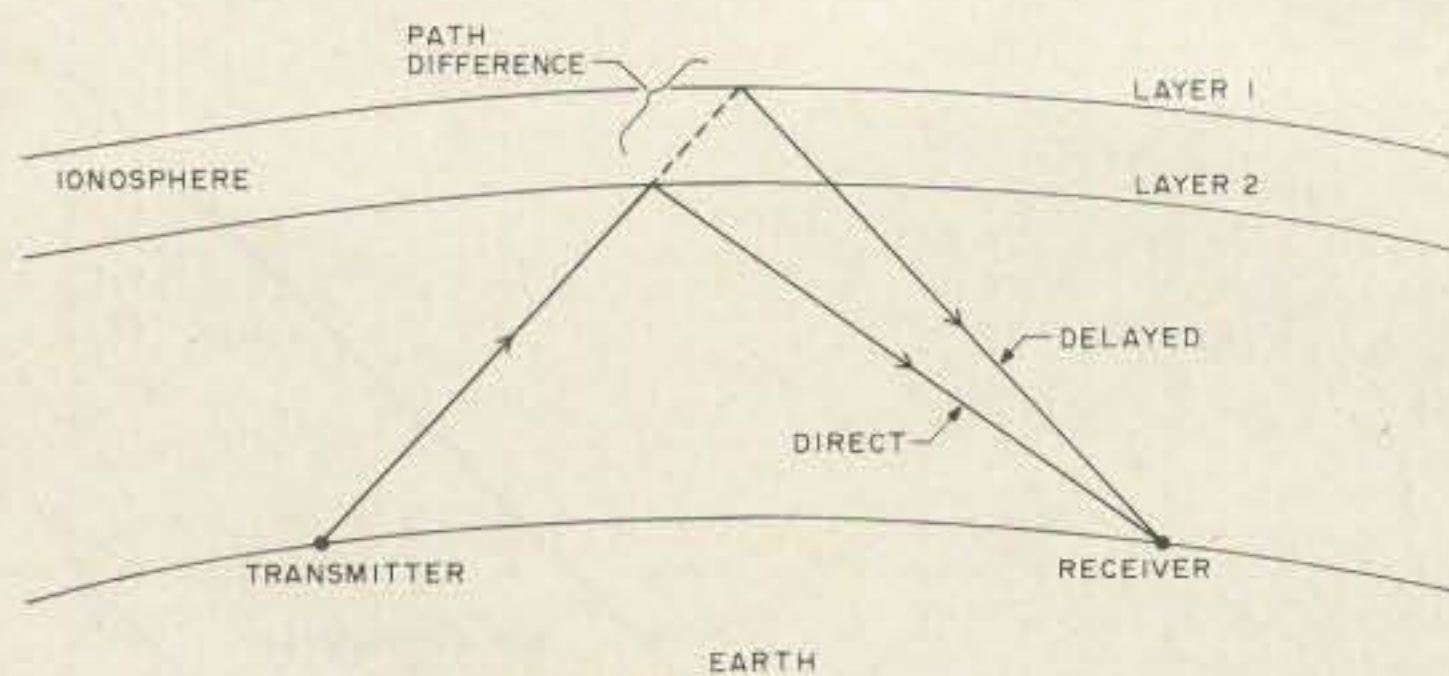

Fig. 4. Two-path ionosphere propagation.

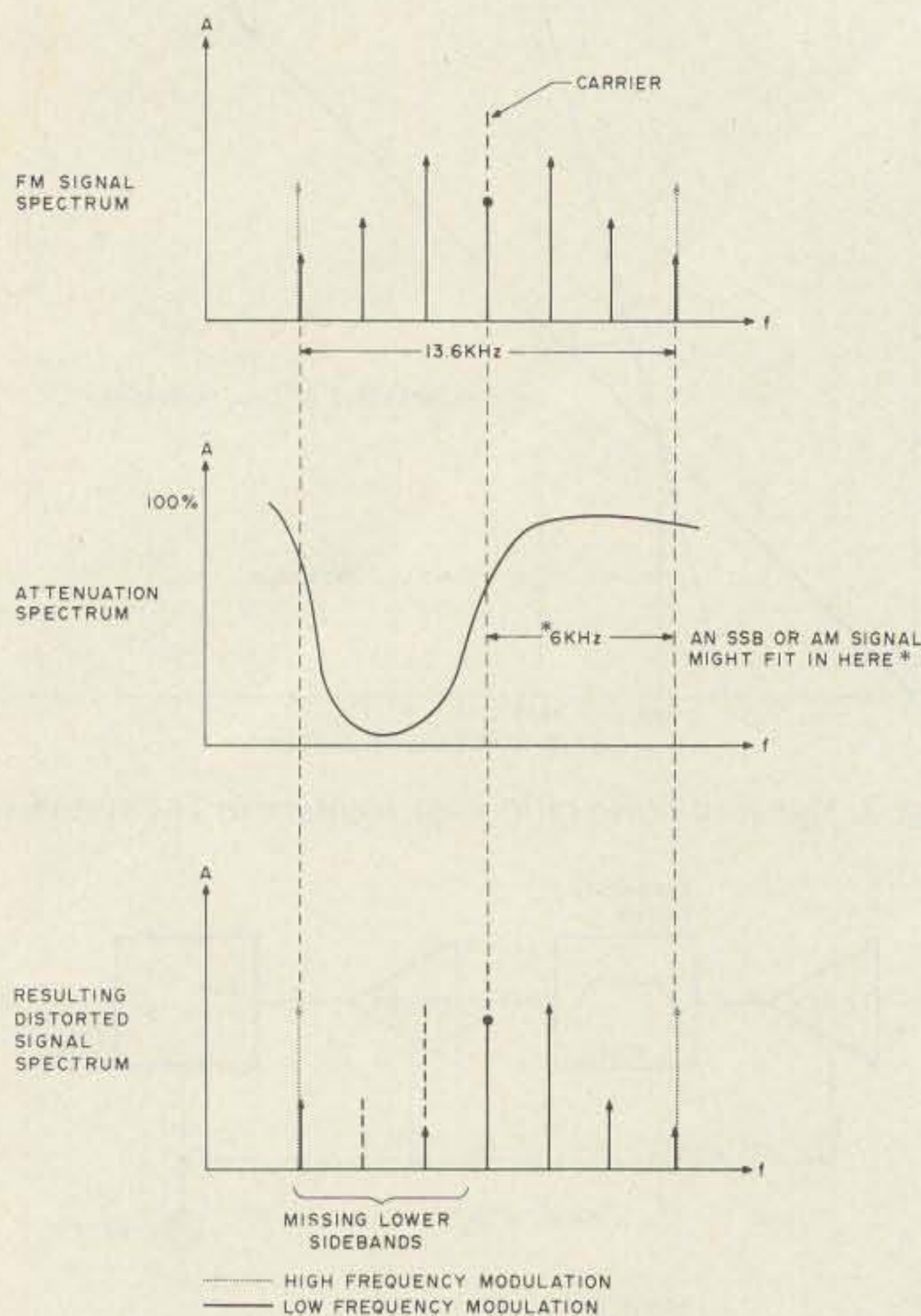

Fig. 5. Multi-path distortion effects.

beat together, producing heterodynes. But the FM receiver's limiter stage(s) will tend to remove these interference beats, as they are amplitude modulated, thus leaving only the stronger FM signal to be detected. This is known as the FM "capture effect"—one signal need be only a few dB stronger than the other to capture the FM receiver and produce an interference-free output. The minimum difference (in dB) in signal strength between two co-channel signals which completely suppresses the weaker one is

called the capture ratio.

We now can begin to explain the Type I effect: Obviously, one signal needed to be only a few dB stronger than the other in its respective antenna to capture the appropriate receiver. Some interference from higher-order beats still will remain in the supersonic region, causing the quieting meter to act up a bit, as noted. Why the two antennas heard different signals still must be explained.

#### Propagation Primer

We now can leave the receivers behind us and begin

to look at some typical HF propagation mechanisms. Of course, we're all familiar with the usual skip propagation modes on HF, i.e., signal reflection from various ionospheric layers such as the F<sub>1</sub> and F<sub>2</sub> (longer skip distance, multihops) and the E layer (shorter skip distance, sporadic-E).

Most of us are willing to accept the reason for fading on skip signals as being a temporary loss of reflective properties in the ionosphere, but this is not quite accurate. Actually, the ionospheric layers are not just single, mirror-like reflectors but are each composed of many closely-spaced sub-layers whose relative and absolute heights are constantly shifting in a random manner. Any one signal, therefore, often will be reflected from two or more sub-layers at the same time. Since reflection from slightly higher sub-layers results in a slightly longer path from transmitter to receiver, both direct and delayed signals will arrive at the receiving antenna—see Fig. 4. This is known as multi-path propagation.

Now, if the delayed signal's path is just one-half wavelength (or odd multiple thereof) longer than the direct signal's path, the two signals will arrive at the receiving antenna 180° out of phase (this corresponds to a half-wavelength) and will cancel each other out, thus producing a down-fade. Moments later, as the reflecting sub-layers shift to different relative heights, the path length difference might become one whole wavelength or a multiple thereof; the two signals then would arrive in phase (0° phase shift) producing a fade-up. It is this constantly changing behavior of the ionosphere which produces most short-term HF fading. On 10 meters for example, one half wavelength amounts to only 15 feet—

peanuts, when compared to a 3000-mile trip through the ionosphere—so QSB is not a surprising phenomenon. Experiments have shown that in most cases of selective fading only two propagation paths are involved, the direct and the delayed, both having similar strengths.

In addition to reflecting signals, the ionosphere also plays tricks with a signal's polarization, rotating it in a random fashion. It matters not what polarization sense the transmitted wave has during skip propagation, as it may arrive at a distant location with any polarization—vertical, horizontal, or any angle in between, and will change from moment to moment. Some HF fading is due to the arriving signal's polarization not matching that of the receiving antenna. Further, I would suspect that there are differences in polarization between the direct and delayed signals, producing circular and even elliptical polarization. Polarization shifts do not ordinarily take place during ground-wave propagation; in this case, therefore, transmitting and receiving antenna polarization should be matched or up to 20-dB cross-polarization loss may result. No such consistent penalty results from sky-wave contacts.

Returning to our Type I observation, the two different signals that we heard must have arrived with predominantly different polarizations: one mostly vertical, producing the strongest output from the vertical antenna, and the other mostly horizontal, producing the strongest output from the horizontal antenna. Because cross-polarization losses come to about 20 dB, the signal whose polarization was "wrong" in a particular antenna would be attenuated more than enough to exceed the FM capture ratio and thus



be suppressed.

Current communications satellites use the same technique, running two separate channels on the same frequency by using horizontal polarization for one and vertical for the other. The video channels are frequency-modulated to take full advantage of the FM capture effect and superior SNR, and achieve very high co-channel isolation. I think that Major Armstrong would have been pleased!

A logical question at this point might be: Wouldn't the direct and delayed signals interfere with one another just as two different co-channel signals would? Yes, because the delayed signal's modulation is no longer identical to the direct signal's—its modulation lags behind due to the extra time delay. It's just like one word of a sentence which, when shouted into an echo canyon, comes back just in time to interfere with the next word of the (direct) sentence. This is an important multi-path propagation effect which can produce great amounts of signal distortion in addition to signal fading.

Up to now, our explanation of propagation and fading has assumed a signal of only one discrete frequency, i.e., a carrier of zero bandwidth. However, modulated signals also have sidebands whose frequencies (and wavelengths) are different from the carrier. Because these sidebands are of slightly larger and smaller wavelengths, they will not all fade simultaneously due to half-wavelength ( $180^\circ$  phase shift) cancellation effects. For example, the path difference might be such that only the carrier fades, leaving the upper and lower sidebands relatively intact. This would, of course, distort a signal severely. An AM signal, for example, would be unintelligible if its carrier faded, sounding like an SSB

signal received on an AM receiver. Since the sidebands lie very close to the carrier frequency, percentage-wise, only very small shifts in the ionosphere (on the order of inches) are necessary for cancellation to take place. This so-called "selective fading" literally punches holes in the propagated rf spectrum of a signal, selectively eliminating certain portions of it.

SSB's superiority over AM is due in part to the fact that it has no carrier or other sideband to fade out; the SSB receiver provides a steady, fade-proof carrier (the bfo) for demodulation.

Fig. 5 depicts another possible case of selective fading. Here, the spectrum is attenuated in the vicinity of the lower sideband. An AM signal would be quite receivable with its lower sideband missing; indeed, some AM stations transmit the carrier with only one sideband to save spectrum space. By way of contrast, an FM signal is shown under the same conditions of selective fading, using both low- and high-frequency audio modulation.

It is clear that the lower audio frequencies, which produce many more FM sidebands, are much more susceptible to selective fading since almost all of the FM signal's low-frequency, lower sidebands have been lost. Unlike AM, both sidebands must be present for distortion-free FM demodulation. The FM signal with higher frequency audio modulation would come through relatively unscathed since it has only one set of sidebands. This, then, explains why the lower audio frequencies were more distorted during Type II conditions.

Selective fading also shows us why our S-meter indications dropped during modulation. When a carrier is frequency modulated, energy disappears from the

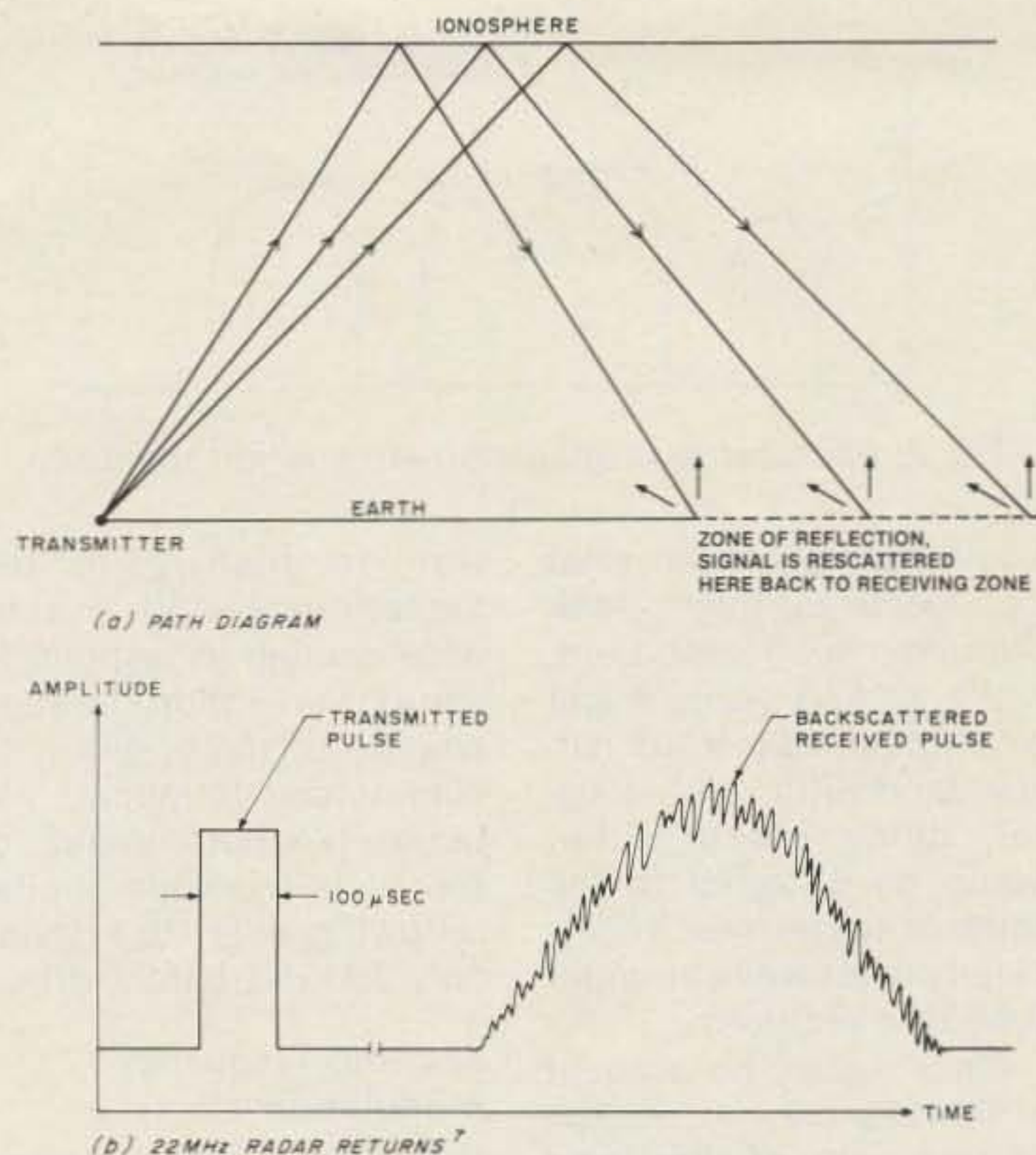

Fig. 6. Backscatter propagation.

carrier but shows up in the sidebands, keeping the average signal power constant. In the case of selective fading, some of the carrier energy is being distributed to sidebands which are being attenuated; the received signal power drops with modulation, and the S-meter kicks downward, i.e., some energy "disappears" during modulation.

A partial analogy can be noted when an over-deviated FM signal is received on a selective FM receiver—the first limiter current drops during modulation because such over-deviation produces extra energy-laden sidebands lying outside of the receiver's bandpass, i.e., total energy within the passband is reduced during this time.

Quieting is maintained because the signal is still strong enough for limiter saturation. Better limiting in the receiver will have no effect on selective distortion because no amount of limiting can possibly restore the missing sidebands or carrier.

Well, two down and one to go; now for Type III. The

key to this one is the observation of backscatter-type propagation conditions. We've all heard backscattered SSB signals on 10 meters. Typically, a station beyond ground-wave range but inside the minimum skip distance is heard weak and fluttery with odd sounding (hollow or echo-like) audio quality.

Fig. 6 shows how backscatter propagation takes place along with a pulse sent out and returned to a 22-MHz radar set. Notice how that clean, rectangular pulse came back ragged and about five times wider than it was originally. This occurred because a large area of ground rescattered the original, point-source signal, thereby generating a very large number of differently delayed signals. In other words, we see here a terrible case of multi-path distortion! Any additional ionosphere multi-path propagation will only compound the effect.

If a two-path situation can produce the attenuation spectrum of Fig. 5, just imagine what 10 or 20 paths (as with backscatter)



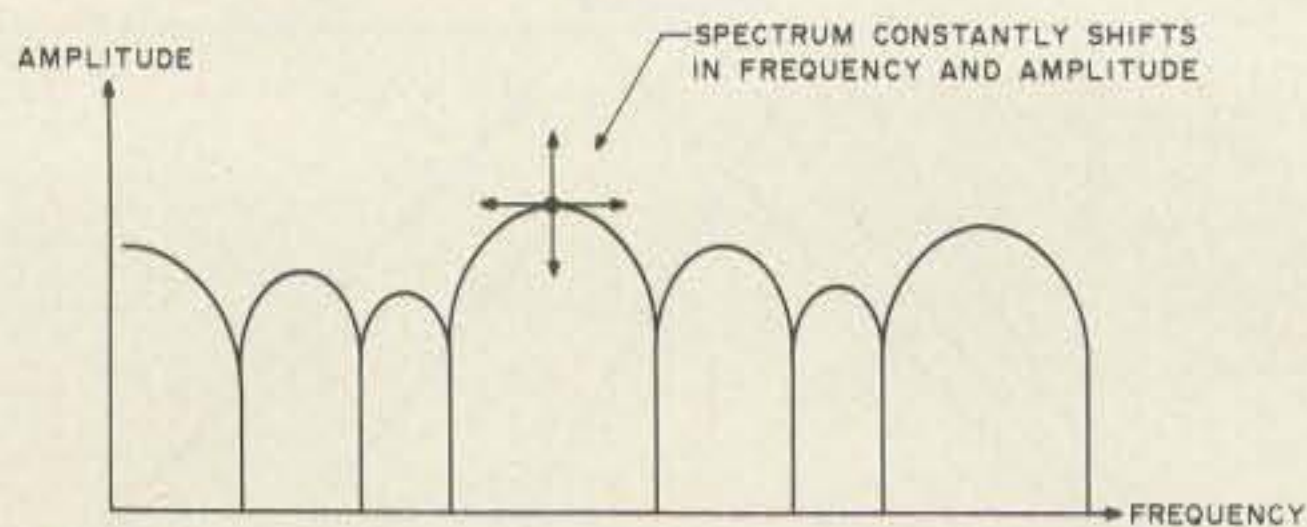

Fig. 7. Backscatter propagation attenuation spectrum.

would do. Fig. 7 shows what the spectrum might look like under such conditions. While an SSB signal might get through due to its narrow bandwidth, an FM signal, being much wider, would be distorted to the point of uselessness. This is exactly what we hear under Type III conditions.

Once again, no amount of limiting can restore the missing parts of the signal spectrum although certain other improvements can be effected. We still don't know why the quieting went to zero on modulation, though, so we'll have to look a little deeper into the theory of FM multi-path distortion.<sup>2,3,4</sup>

### Spurious Amplitude Modulation

First, a large amount of spurious amplitude modulation—up to 100%—may be impressed on the FM signal under adverse multi-path conditions. This type of distortion becomes progressively worse for larger amounts of deviation, more numerous propagation paths, and/or greater time delays. Here is where overall receiver performance can help—limiter characteristics in particular. Adequate receiver sensitivity and i-f strip gain will ensure that the limiter(s) will always have enough signal to saturate, even though spurious amplitude modulation may drop the instantaneous signal amplitude toward zero. If the limiter is allowed to drop out of saturation at these points, noise bursts will accompany the FM signal's modulation. In addition

to high gain, the limiter's bandwidth must be wide enough to respond to (limit) very short-duration amplitude fluctuations. In commercial broadcast FM radios, it is not common to see a 1-MHz-wide limiter following an i-f strip having only 200-kHz bandwidth.

### Spurious Frequency Modulation

Second, there is the more difficult-to-cure case of spurious frequency-modulated distortion. Multi-path effects cause the instantaneous frequency of the received signal to vary spuriously during modulation, i.e., the distortion is itself frequency-modulated in nature. Here, the limiter can have no effect on reducing the distortion because it can eliminate only amplitude fluctuations. The FM detector cannot, of course, distinguish between the desired frequency modulation and the spurious, distortion-producing frequency modulation, and will respond to both.

As a result, the detector's audio output may contain, along with the desired signal, large amounts of odd-order harmonic distortion, to the extent of completely obliterating the desired signal—i.e., 100% distortion. The spectrum of this harmonic distortion extends through and beyond the audio range, into the supersonic region. Fig. 8 illustrates this result.

It's now evident that our quieting meter was responding to these higher-order harmonics in the supersonic region during Type III conditions, in-

dicating the relative amount of multi-path distortion on the signal. Theory tells us that this type of distortion becomes much worse when many delayed paths are present, which is just what backscatter consists of. Once again, greater deviation aggravates the problem and higher audio frequencies contribute more to distortion than the low ones, to the point where the spurious frequency modulation's deviation can be twice that of the original, undistorted signal.

### For Skeptics

Lest you doubt the existence of multi-path propagation, you can see its effects in other ways, too. The traditional ghosting on television screens is due to multi-path propagation of ground waves. Small path delays produce only "fringing" effects on the trailing edges of images. Longer delays will shift an entire scene or place a vertical bar in the middle of the picture. Sometimes the video may be obliterated completely by multiple ghosting to the point where picture stability may be lost as the arrival of multiple sync pulses fools the receiver's synchronization circuits. And, of course, the sound channel also may suffer distortion, as it uses  $\pm 25$ -kHz deviation FM.

While it is not so easy to determine exactly how long the time delays are in HF propagation (experiments show a range from 1 to 100 microseconds), you can do it easily for TV ghosting. Given the scanning frequencies used for TV (the horizontal frequency is 15,750 Hz), we know that it takes about 60 microseconds for the cathode ray tube to "paint" just one line from left to right on the screen. Since the radio waves travel at about 186,000 miles per second, you can figure out that the

duration of one scanning line would allow a radio wave to travel about 11 miles. If you see a vertical ghost bar about halfway across your screen, therefore, the ghost signal was delayed 30 microseconds (60 microseconds  $\div 2$ ) because it traveled an extra  $5\frac{1}{2}$  miles.

If you have an FM broadcast radio in your car, you've probably noticed periods of "fuzzed-up" reception even in cities where signal strengths are high but multi-path effects abound. Commercial FM broadcast uses  $\pm 75$ -kHz deviation, making it highly vulnerable to such distortion. On nearby 2 meters, where deviation is only  $\pm 5$  kHz, you'll hear lots of things on signals but not much multi-path distortion at all unless signals are very weak. Such weak signals are often subject to squelch chopping, which can be alleviated somewhat by backing off from the mike. In this case, the multi-path distortion is generating harmonic distortion components in the supersonic range, which the noise-operated squelch is mistaking for noise. Reducing the deviation by speaking more softly cuts down on these distortion components, as our theory predicts, and squelch chopping is reduced.

Interesting side-note: Simultaneous observation of amateur FM skip signals on 10 and 6 meters over the same paths reveals that the 6-meter signals are consistently "cleaner" with fewer multi-path effects. I would suspect that the ionosphere looks less "rough" (more specular) for the reflection of 6-meter signals since their wavelengths are only 60% of the size of 10-meter signals.

### Some Suggested Cures

Based on observations and theoretical considerations, certain simple tech-



niques can be used to minimize the extent of multi-path distortion on FM signals.

1) Reduce the FM transmitter's low-frequency audio response since the lows are much more prone to distortion. Recall that the lower frequencies produced many more sidebands, rendering such a signal more susceptible to spectral distortion caused by multi-path propagation.

2) Use sufficient pre-emphasis in the speech amplifier—about 6 dB per octave—to suppress the lows and boost the highs. This ensures that the harmonic distortion arising from the lower frequencies will be masked and covered by the boosted higher frequency speech energy. For example, the odd-order harmonics of 500-Hz energy would lie at 1.5 and 2.5 kHz, which would be masked by the boosted part of the speech range (see Fig. 8).

A graphic example of not following this advice is provided by a certain commercial 10-meter FM transceiver whose transmit audio response is notoriously muffled (high frequencies too sharply rolled off). When received under multi-path conditions, the harmonics from the predominant lower audio frequencies fall right into the upper half of the audio passband. Since there is little high frequency speech energy to mask this distortion, intelligibility is severely degraded.

3) Roll off the speech amplifier frequency response above about 3 kHz. This should be done to reduce the generation of the spurious frequency modulation mentioned before. It turns out that this unwanted FM component can itself have a deviation of up to twice that of the original signal when sufficient high frequency audio is present in the signal. Ironically, this effect may cause more

problems on a high-selectivity FM receiver as the excessive spurious deviation would place extra, energy-robbing FM sidebands outside of the normal receiver passband.

4) Reduce deviation levels to decrease the number of sidebands and reduce signal bandwidth. By concentrating the FM signal into a smaller bandwidth, the effects of spectrum "hole-punching" are reduced, resulting in less spurious amplitude- and frequency-modulated distortion. However, reducing deviation will make the signal sound less loud at the receiving end and thus degrade SNR.

Audio clipping could be used profitably to raise the average deviation level, therefore, even though the peak (most distortion-producing) deviation has been cut. If done correctly, the reduced-deviation, audio-clipped FM signal might sound subjectively as loud as before. During multi-path conditions, the benefits of a reduction in distortion would far outweigh the small loss of SNR. After all, what is the purpose of a good SNR when the signal is 100% distorted? A deviation ratio of 1.0 ( $\pm 2.4$ -kHz deviation) would provide a signal bandwidth of 6 kHz (equal to an AM signal) and sacrifice only about 6 dB of SNR.

On a casual basis, when operating under difficult multi-path conditions using FM, try backing off from the mike to reduce deviation and, consequently, distortion. I know this certainly goes against the grain of the typical phone op—the tougher it gets, the more you shout!

5) On the receiver side, high gain and hard limiting to produce adequate sensitivity and capture characteristics are fundamentally important, of course. But beyond that, I've found

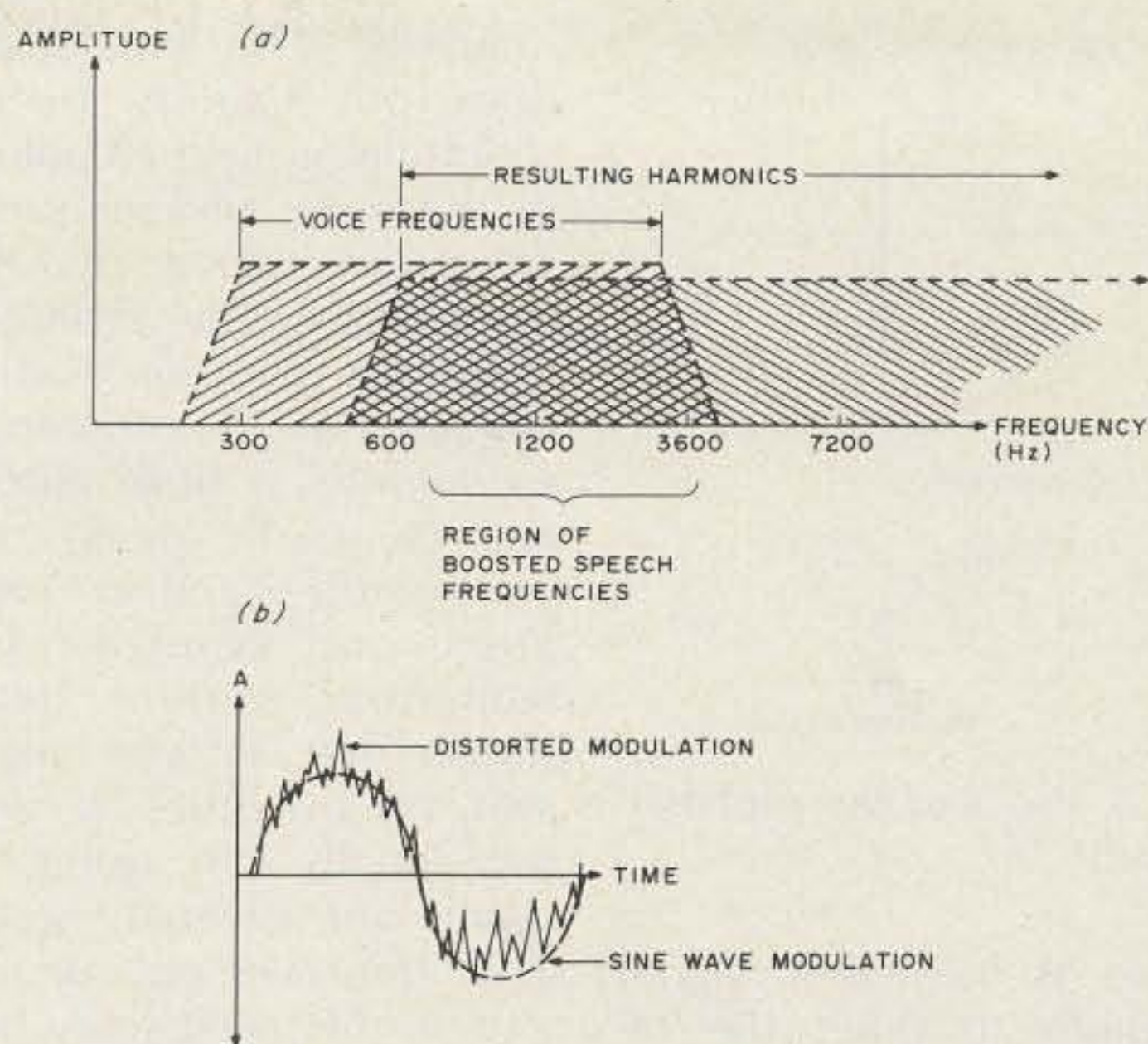

Fig. 8. Resultant waveform distortion.

that tailoring the receiver's audio response carefully by using de-emphasis can be beneficial. One of my 10-meter FM radios originally had a rather extended audio response (high fidelity?) that let all sorts of crud and distortion come through. By selecting the right amount of de-emphasis, one can strike a good balance among (a) having sufficient high frequency response for good intelligibility, (b) suppressing the higher-order harmonic distortion components of the lower frequency speech sounds, and (c) restoring at least some of the lows lost in the transmitter due to pre-emphasis. In my particular receiver, I've found 100 microseconds of de-emphasis to be about right. See Fig. 9 for details of pre- and de-emphasis circuit design.

6) Some studies have shown that even the seemingly insoluble problem of frequency-modulated distortion (the FM detector can't discriminate between such distortion and the desired signal) may be improved by use of certain receiver configurations. In particular, an FM i-f strip consisting of several cascaded stages of wide-band, hard limiters each followed by a sharp bandpass filter,

has been shown to reduce multi-path distortion effects. Its principle of operation has to do with the output spectrum of a limiter in FM service: The distortion-producing components tend to lie further away from the signal, and repeated limiter/filter-stage action eventually cleans things up.<sup>5</sup>

This technique should not be confused with the usual FM i-f strip design which does not have any post-limiter filtering. Similar work using this idea has been done on RTTY demodulators to process FSK (Frequency Shift Keying) signals under multi-path conditions. FSK is, of course, a special form of frequency modulation.

The two 10-meter FM receivers used in my shack are quite different in i-f strip design: One is a tube-type with two stages of limiting and a quadrature detector; the other is solid state—all limiting and detection is accomplished on one IC chip. Yet both behave very similarly when copying multi-path-distorted signals.

Oddly enough, the time-honored tradition of increasing transmitter power is of only limited benefit on FM under adverse multi-path conditions. As long as



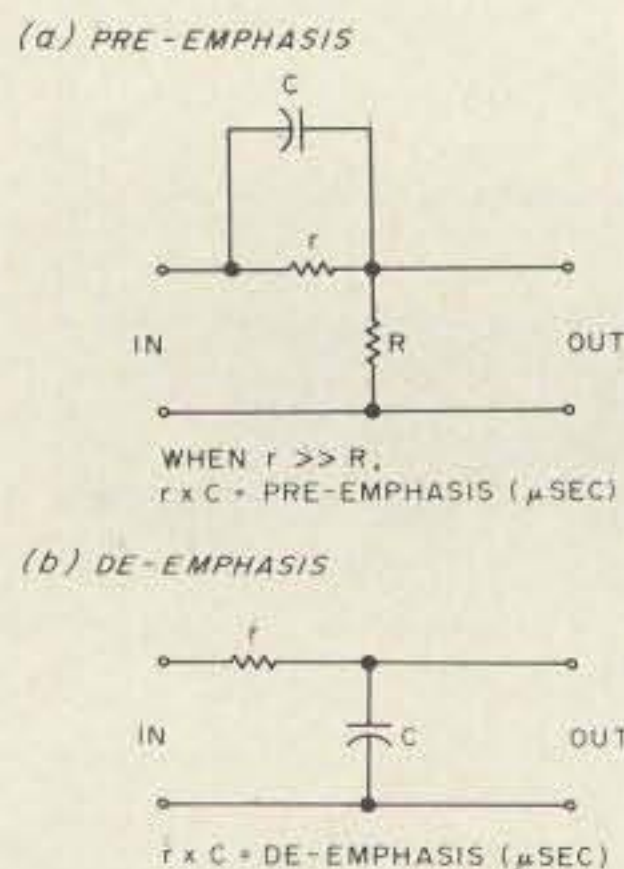

Fig. 9. Pre- and de-emphasis circuits.

there is sufficient signal strength to quiet the receiver, further increases in signal strength will have little effect on reducing distortion—the amplitude ratio of the direct and delayed signals will not change at all with power levels and the distortion will remain.

#### Diversity Reception for 10-Meter FM

Originally, the Type I effect was discovered quite by accident. Two 10-meter FM receivers were present in the shack but only one 10-meter antenna was available, a roof-mounted, half-wavelength vertical. The only other antenna was an 80-meter inverted vee with its apex about 45 feet high, located 60 feet south of the vertical antenna; it was pressed into service to drive the second receiver. Surprisingly good reception resulted from operating in the inverted vee's 7th harmonic mode.

In addition to the occasional Type I effect, also noted was the reception advantage of having two receivers during periods of QSB. Oftentimes, when a signal faded from one antenna it was still copyable on the other. Using two physically separated antennas driving separate receivers is known as diversity reception. The excellent article of Reference 6 gives a review of the subject.

Briefly, sky-wave fading does not usually occur simultaneously at all points in the zone of reception. Therefore, when two or more physically separate antennas are used, the chances of simultaneous signal-fade at both antennas is small unless, of course, the band or path goes out completely. Numerous studies have shown that antenna spacings of as little as one wavelength can result in significant diversity gain. This improvement is not gain in the usual sense but represents the increase in average signal strength levels obtained from two antennas over that from a single antenna, in the face of QSB. It has been shown that not much extra diversity gain occurs beyond spacings of  $2\frac{1}{2}$  wavelengths, when using two antennas. On 10 meters, one wavelength works out to be only 30 feet for appreciable gain, which may approach 6 dB at two-wavelength spacing.

Since FM suffers an inherent disadvantage over AM at low signal levels (the threshold effect), diversity reception offers a workable way of making up for it to some extent as well as reducing the effects of QSB in general. As 10-meter FM activity is all channelized, tuning two receivers to the same frequency is not as critical a factor as it would be on SSB. At present, I use two converted CB/FM scanner combination transceivers for 10-meter operation; they are set up to scan the two simplex frequencies (29.5 and 29.6 MHz) as well as the four repeater-output channels (29.62, .64, .66, and .68 MHz). The scanner logic is set up to drive the PLL frequency synthesizer in the converted CB for frequency selection; a second, identical transceiver is slaved to the first by paralleling the PLL divide-by- $n$  lines of

both rigs. In this way, both receivers scan together while listening to two different antennas. Due to the FM capture effect and tight squelch action, signals pop back and forth between receivers in a rather pronounced fashion but rarely fade in both receivers simultaneously.

The antenna arrangement described above combines both space and polarization diversity. Sixty feet of separation provides two wavelengths of spacing, and the inverted vee responds primarily to horizontally polarized radiation. I suspect that vertical angle-of-signal-arrival discrimination effects also occur. Whereas the half-wave vertical is a strongly low-angle radiator, the inverted vee, operated on its 7th harmonic as a longwire antenna, no doubt displays numerous lobes in both azimuth and elevation. Signals arriving at higher vertical angles, such as short-skip or sporadic-E, will favor this antenna rather than the vertical one. Longer skip tends to favor the vertical antenna, as expected.

For example, when Type I conditions occur, the more distant of the two stations usually is heard on the vertical, whereas the closer in signal favors the horizontal antenna. Before the band fades over a particular F-layer path to the west in the evening, signal strengths usually rise greatly just prior to drop out and are accompanied by deep QSB with lots of Type II distortion. At this point, the horizontal antenna often provides the best signal. My guess is that as the sun sets, the Earth's shadow shields increasingly higher-altitude layers of the ionosphere. Thus, just prior to complete propagation circuit failure, only the uppermost layer still would be capable of supporting communications and any signal re-

flected off it necessarily would arrive at higher-than-usual vertical angles.

Interestingly, some casual diversity observations using a pair of 2-meter FM receivers and ground-plane antennas spaced about 10 feet apart have shown reductions in both mobile signal chopping and distant-signal slow QSB.

#### Repeaters

The existence of a local 10-meter FM repeater has allowed me to make some extended-spacing diversity reception tests. This repeater's 10-meter receiver is remote-sited, about 15 miles from my QTH. Listening to both the repeater's output signal and my own local receiver shows little improvement for short-term (half-second to a minute) QSB conditions. Rather, long-term (several minutes) effects are noticed, mostly on DX stations, i.e., the signal is not swapped back and forth between receivers as quickly as when using two-wavelength spacing.

There are presently about a half-dozen 10-meter FM repeaters (and one AM repeater) on the air in the continental United States. No matter how sensitive their receivers are, though, they all suffer mightily from the same problem of fading. Skip stations don't always know whether (a) the path between themselves and repeater has faded, (b) the path between the repeater and the other station has faded, or (c) they've timed the machine out. This leads to some confusion.

Space and/or polarization diversity would seem a good way to gain 3 to 6 dB of effective repeater-system sensitivity. High-speed solid-state or reed-relay switching could be used to select the quietest receiver's audio output for repeating. Such "voter logic" techniques already



are used for VHF and UHF repeaters having satellite receivers.

### Stampede to FM DX? Nah!

Believe it or not, under certain conditions FM can do a better job than even SSB on 10 meters! To wit, during a recent FM QSO with a Japanese station, it was decided to switch over to SSB for comparison purposes. On this occasion, there was the usual amount

of heavy, erratic QSB but fair peak signal strengths and not too much multipath. The FM audio levels were very steady, with no trace of the QSB due to the limiter's action. On SSB though, the rapid signal flutter made copy very tough as the agc was not able to follow the QSB; contact, therefore, was re-established on FM and the QSO continued. How about them apples? ■

### References

1. Edwin H. Armstrong, "A Method of Reducing Disturbances in Radio Signaling by a System of Frequency Modulation," *Proceedings of the IRE*, v. 24, May, 1936.
2. Murray G. Crosby, "Frequency Modulation Propagation Characteristics," *Proceedings of the IRE*, v. 24, June, 1936.
3. Murray G. Crosby, "Observations of Frequency-Modulation Propagation of 26 Megacycles," *Proceedings of the IRE*, v. 27, January, 1939.

4. Murlan S. Corrington, "Frequency-Modulation Distortion Caused by Multi-Path Transmission," *Proceedings of the IRE*, December, 1945.
5. E. J. Baghdadady, "Theory of Stronger-Signal Capture in FM Reception," *Proceedings of the IRE*, v. 46, April, 1958.
6. John J. Nagel K4KJ, "High Frequency Diversity Reception," *Ham Radio*, November, 1979.
7. Abel & Edwards, "Source of Long-Distance Backscatter," *Proceedings of the IRE*, December, 1951.

# FREE RF TESTER DESIGN

You may be losing up to half the output from your vertical, omnidirectional antenna simply because of RF spillover. We'll send you a design for a simple RF tester that can help you find out. We'll also send you details on the amazing AEA Isopole that virtually eliminates RF spillover and can help multiply your power in all directions on the horizon relative to an ideal half-wave dipole or other non-decoupled "gain" antennas.

## Get the Facts.

Contact Advanced Electronic Applications, Inc., P.O. Box 2160, Lynnwood, WA 98036. Call 206/775-7373.

✓ 349

# AEA Brings you the Breakthrough!



## September

### Specials

**11C05 1 GHz, pre.**  
Special \$59.95



**ATF 417 pre-amp net** Special \$19.95  
**MRF 901 UHF transistors, 1 GHz** Special \$ 3.95

**COMPLETE KITS:** CONSISTING OF EVERY ESSENTIAL PART NEEDED TO MAKE YOUR COUNTER COMPLETE. **HAL-600A** 7-DIGIT COUNTER WITH FREQUENCY RANGE OF ZERO TO 600 MHz. FEATURES TWO INPUTS: ONE FOR LOW FREQUENCY AND ONE FOR HIGH FREQUENCY. AUTOMATIC ZERO SUPPRESSION. TIME BASE IS 1.0 SEC OR 1 SEC GATE WITH OPTIONAL 10 SEC GATE AVAILABLE. ACCURACY ± .001%. UTILIZES 10-MHz CRYSTAL 5 PPM.

**COMPLETE KIT**.....\$129

**HAL-300A** 7-DIGIT COUNTER WITH FREQUENCY RANGE OF ZERO TO 300 MHz. FEATURES TWO INPUTS: ONE FOR LOW FREQUENCY AND ONE FOR HIGH FREQUENCY. AUTOMATIC ZERO SUPPRESSION. TIME BASE IS 1.0 SEC OR 1 SEC GATE WITH OPTIONAL 10 SEC GATE AVAILABLE. ACCURACY ± .001%. UTILIZES 10-MHz CRYSTAL 5 PPM.

**COMPLETE KIT**.....\$109

**HAL-50A** 8-DIGIT COUNTER WITH FREQUENCY RANGE OF ZERO TO 50 MHz OR BETTER. AUTOMATIC DECIMAL POINT. ZERO SUPPRESSION UPON DEMAND. FEATURES TWO INPUTS: ONE FOR LOW FREQUENCY INPUT, AND ONE ON PANEL FOR USE WITH ANY INTERNALLY MOUNTED HALTRONIX PRE-SCALER FOR WHICH PROVISIONS HAVE ALREADY BEEN MADE. 1.0 SEC AND 1 SEC TIME GATES. ACCURACY ± .001%. UTILIZES 10-MHz CRYSTAL 5 PPM.

**COMPLETE KIT**.....\$109

#### PRE-SCALER KITS

**HAL 300 PRE**.....\$14.95  
(Pre-drilled G10 board and all components)

**HAL 300 A/PRE**.....\$24.95  
(Same as above with preamp)

**HAL 600 PRE**.....\$29.95  
(Pre-drilled G10 board and all components)

**HAL 600 A/PRE**.....\$39.95  
(Same as above but with preamp)

#### TOUCH TONE DECODER KIT

HIGHLY STABLE DECODER KIT. COMES WITH 2 SIDED, PLATED THRU AND SOLDER FLOWED G-10 PC BOARD, 7-567's, 2-7402, AND ALL ELECTRONIC COMPONENTS. BOARD MEASURES 3 1/2 x 5 1/2 INCHES. HAS 12 LINES OUT. ONLY \$39.95

**DELUXE 12-BUTTON TOUCHTONE ENCODER KIT** utilizing the new ICM 7206 chip. Provides both VISUAL AND AUDIO indications! Comes with its own two-tone anodized aluminum cabinet. Measures only 2 3/4 x 3 3/4". Complete with Touch-Tone pad, board, crystal, chip and all necessary components to finish the kit.

**PRICED AT**.....\$29.95

For those who wish to mount the encoder in a hand-held unit, the PC board measures only 9/16" x 1 3/4". This partial kit with PC board, crystal, chip and components.

**PRICED AT**.....\$14.95

**ACCUKEYER—MEMORY OPTION KIT** THIS ACCUKEYER MEMORY KIT PROVIDES A SIMPLE, LOW COST METHOD OF ADDING MEMORY CAPABILITY TO THE WB4VVF ACCUKEYER. WHILE DESIGNED FOR DIRECT ATTACHMENT TO THE ABOVE ACCUKEYER, IT CAN ALSO BE ATTACHED TO ANY STANDARD ACCUKEYER BOARD WITH LITTLE DIFFICULTY. \$16.95

**ACCUKEYER (KIT)** THIS ACCUKEYER IS A REVISED VERSION OF THE VERY POPULAR WB4VVF ACCUKEYER ORIGINALLY DESCRIBED BY JAMES GARRETT, IN QST MAGAZINE AND THE 1975 RADIO AMATEURS HANDBOOK. \$16.95

**ACCUKEYER—MEMORY OPTION KIT—TOGETHER ONLY \$32.00**

#### 6-DIGIT CLOCK • 12/24 HOUR

COMPLETE KIT CONSISTING OF 2 PC G10 PRE-DRILLED PC BOARDS, 1 CLOCK CHIP, 6 FND 359 READOUTS, 13 TRANSISTORS, 3 CAPS, 9 RESISTORS, 5 DIODES, 3 PUSH-BUTTON SWITCHES, POWER TRANSFORMER AND INSTRUCTIONS. DON'T BE FOOLED BY PARTIAL KITS WHERE YOU HAVE TO BUY EVERYTHING EXTRA.

**PRICED AT**.....\$12.95

**CLOCK CASE** Available and will fit any one of the above clocks. Regular Price... \$6.50 But Only \$4.50 when bought with clock

**SIX-DIGIT ALARM CLOCK KIT** for home, camper, RV, or field-day use. Operates on 12-volt AC or DC, and has its own 60-Hz time base on the board. Complete with all electronic components and two-piece, pre-drilled PC boards. Board size 4" x 3". Complete with speaker and switches. If operated on DC, there is nothing more to buy.

**PRICED AT**.....\$16.95

Twelve-volt AC line cord for those who wish to operate the clock from 110-volt AC. \$2.95

#### SHIPPING INFORMATION

ORDERS OVER \$15.00 WILL BE SHIPPED POSTPAID EXCEPT ON ITEMS WHERE ADDITIONAL CHARGES ARE REQUESTED. ON ORDERS LESS THAN \$15.00 PLEASE INCLUDE ADDITIONAL \$1.00 FOR HANDLING AND MAILING CHARGES. SEND SASE FOR FREE FLYER.



"HAL" HAROLD C. NOWLAND  
WBZXH

## HAL-TRONIX

P. O. BOX 1101  
SOUTHGATE, MICH. 48195  
PHONE (313) 285-1782





# The World Above 430

## — part II: next stop, 1296

This article deals with getting more activity going on the UHF and higher bands. Part 1 (*73 Magazine*, August, 1980) dealt with a very special modulation scheme to allow simple rf equipment running class C to be used and multiplying the frequency to get to 432 MHz and 1296 MHz. As promised, this part of the article will deal with the rf part of the scheme, starting with the rig I used to get to 432 MHz, a section of a commercial FM transmitter, the Motorola T-44. If your only wish is to get to 432 MHz, as I initially did for OSCAR, that's it—no modification is required beyond getting the T-44 tripler and final aligned on 432 MHz. Some may require a bit of padding, but mine went on as is.

I removed the final section from the T-44 main strip and remounted them on a good, sturdy Premier chassis base with a self-contained power supply. The supply really isn't much, and any article covering the conversion of the T-44 to amateur FM use

probably provides power-supply information. The *FM Digest* series also covers it well. Remember, you will be running class C just like FM, so no fancy bias or screen supplies are needed to keep things linear. If you run the audio deck into a 2-meter transceiver and run FM, you should be done—fire it up and run. You will have to come up with appropriate connectors and plugs to match your rig and the chassis with the T-44 parts, but there is no major circuit hacking.

For 1296-MHz operation, things get somewhat tougher, and this is where our only remaining buy remains in the rf sections. You need a good, efficient, and easily-tuned circuit to replace the plate circuit of the last 2C39 that was your 432-MHz final. It must tune to 1296 MHz and somehow couple energy at that frequency over to the APX-6 transmitter tube cathode. The 432-MHz final now runs as a tripler, so the 2C42 or 2C43 APX-6 transmitter tube can run straight through for maximum pow-

er gain and efficiency. Due to the cavity layout and other considerations, this tube will run class C grounded grid in our setup. As in any grounded-grid amplifier, any power to the cathode is added on to the power gain in the tube. Using the grounded-grid configuration avoids having to use pads, and mechanically change the existing grounded-grid circuit in the APX-6. Fig. 1 shows the mechanical layout I am now using. It works, but not extremely well. Somewhere along the line I think that the system can be made cleaner, have more power output, and certainly be more efficient. I am open for suggestions in the area of the 1296-MHz circuits, since I am sort of new here once again. If you come up with a classy circuit, please write it up or let me know about it. It seems to be our biggest bug at this time.

The system as described did work, but the same distortion-type products still seem to prevail. It was not until recently that I discovered a major error on

my part. I had been trying to add back in all of the AM component at audio before the 2-meter transceiver. Since I was trying to evaluate SSB at the time, the class C amplifiers were still attacking (distorting) even the AM component—just as Karl had stated it would. The AM part was obviously going to have to be added, at least in part, at the end. I have considered partial screen modulation, or a scheme used quite successfully by Globe for years called Heising or choke modulation. These trials are still in progress, but look very promising in clearing up the last of our modulation problems. On the T-44 and APX-6 units, if you go that way in the rf section, you can just modulate the B+ to the final with the AM component, as well as the audio final. It seems to work out to be somewhat of the same answer to AM modulating a solid-state transmitter by modulating more than just the final stage. The modulation required at the final rf stage appears to be far from



100%, but a fair amount sure seems to clean things up!

On some APX-6 models, you will still need to carefully remove a bit from the transmitter cavity plunger. On one of mine, I did not have to do anything but tune. On the other, it required trimming, but someone else did it for me (on a lathe), so I suggest you obtain copies of the articles in the bibliography and digest them well before chopping away. The modification of the cavity plunger would make an article in itself (as it did several times in the past) and mine was done strictly using their technique and only after trying to run it stock, first.

All of this brings us down to having our transmit signal on 432 or 1296 MHz, but I have not mentioned the receiver. On 432 MHz you are somewhat on your own, but many converters are available to convert to 2-meters, or to a low-band receiver for receive. On 1296 MHz, where I was headed, it is simpler, since you already have the converter—the APX-6. Instead of hacking up the rest of the cavities and plungers to raise the APX-6 to the 1296-MHz range, I plan to cheat and ignore their noisy and ineffective 60-MHz i-f in the APX-6. The local oscillator cavity and oscillator will cover a wide range of frequencies, one of which is 1152 MHz. Mine did it with the stock cavity and plunger. Taking 1296 MHz minus 1152 MHz equals 144 MHz, or just right for the input to the receiver of the 2-meter transceiver you started with for transmit. You can rig the 1152-MHz oscillator to be tunable from 1152 to 1148 MHz for outputs from 144 to 148 MHz on receive. That is touchy at best, and I wanted to tower-mount the APX-6 part of the system

near the antennas. Therefore, for the time being anyway, I am settling for using a Hamtronics 2-meter converter into the 14-MHz i-f of my TR-6 and using 0.5-MHz coverage per converter crystal.

There are some places the system happens to work out just right using the transceive idea and APX-6 alone. At 144.0 MHz, you have  $144 \times 3 \times 3 = 1296$  MHz and  $1296 \text{ MHz} - 1152 \text{ MHz} = 144 \text{ MHz}$ . That's fine, but now try 144.1 MHz!  $144.1 \times 3 \times 3 = 1296.9 \text{ MHz}$  and  $1296.9 \text{ MHz} - 1152 \text{ MHz} = 144.9 \text{ MHz}$ . Oops! That's an 800-kHz offset, and thus requires a separate converter and receiver for simplex operation. If you try FM on one of the multi-mode rigs like my KLM 2700, you can also cheat and use the repeater offset at one frequency. At  $144.07 + 5$ , or 144.075 MHz, you have  $144.075 \times 3 \times 3 = 1296.675 \text{ MHz}$  and  $1296.675 - 1152 = 144.675$ , a natural 600-kHz offset normally used for repeaters. I'd like to suggest that frequency as a simplex FM location, so we can all have some coordination.

The APX-6 cavity is broad, but not the 4 MHz necessary to cover the entire 1296 to 1300 MHz, so why not use the 144 MHz start point for CW-SSB and a 1296-MHz output, and the 144.075-MHz start point for FM and a 1296.675-MHz output? It's not so crowded up there that we couldn't all live together and a lot more contacts might be the result of it. Later, we could worry about separate receiver-converter combinations and then spreading out a bit. In some ways, I hate to see channelization of any band, but even when it comes, I hope it is in .010-MHz increments at the 2-meter frequency or .090-MHz at the 1296-MHz fre-

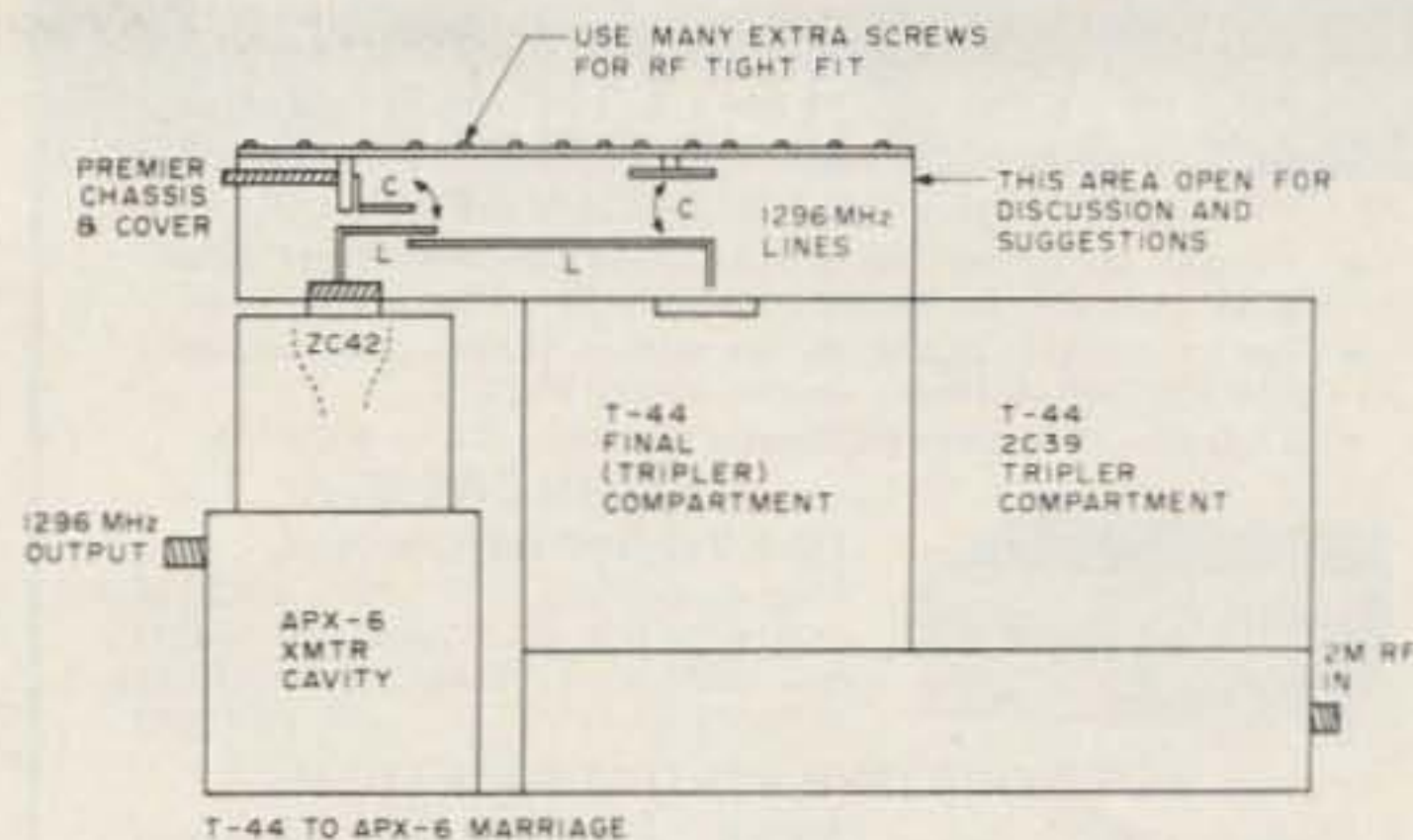

Fig. 1.

quency. It would make looking for each other a lot easier until the population up there increases. Please, let's hear your ideas and suggestions concerning this band and my ways of reaching it. GE and RCA gear like the Progress line and CMU-15s should work just as well as the tripler/amplifiers and there is a large quantity now available cheap, along with articles on getting them on the 432-MHz band. I just had the Motorola, so I used it! Ideas from the stripline, cavity, and plumbing group of hams would sure be appreciated to eliminate our biggest bug in getting from 432 MHz to 1296 MHz. It would also help to see more receiver, preamplifier, and antenna ideas specifically for 1296 MHz, instead of everyone trying to extend 432-MHz article ideas to work up there.

If you can help with an article or two, please do, but be realistic about it. Give up a precious dB or two and stay away from the gold-plated antennas and \$50 solid-state devices few can find or afford. Some of the UHF TV tuner solid-state devices surely must work up there or how about a modified UHF tuner?

1296 MHz does not have to be a short-range band! Remember when 2 meters would get you across town—maybe? I have 11 states confirmed on 2 meters now using SSB and the barefoot KLM 2700 in

the 1-Watt position. I'm not saying this for ego, but to show you what a little population will do for a band. When the 1 Watt runs out, I'll go to the 10-Watt position and wring it out, and only then will I go back to building the 100-Watt 5894 amplifier I started to build when I bought the KLM. QRP has turned out to be too much fun. I do run decent antennas in the form of an 8 over 8 J-slot with a screen relector, but even it is homebrew, and was an article in *73 Magazine*, June, 1978, p. 140. The same sort of homebrewing can happen for 1296 MHz if only a bit of help starts appearing in the way of articles.

I hope, most of all, that this article has stirred up a renewed interest in 1296 MHz. I could not find a single article on this band and its use over the last 5 years in my files (*73*, *CQ*, *QST*, and *Ham Radio*) with the exception of the solid-state peanut whistles suitable as lab bench items or beacons, or if your DX interest lies with the guy next door! I'm not knocking any of these articles, believe me, because it at least reminded me that 1296 MHz was still around.

Remember Wayne's "220—use it or lose it"? Don't laugh—it could happen to 1296 MHz more easily, and we almost lost the 220-MHz portion as it is. The sting of that one should still be sharp in everyone's mind, and it wasn't the hams that



# FAST SCAN ATV

## WHY GET ON FAST SCAN ATV?

- You can send broadcast quality video of home movies, video tapes, computer games, etc, at a cost that is less than sloscan.
- Really improves public service communications for parades, RACES, CAP searches, weather watch, etc.
- DX is about the same as 2 meter simplex — 15 to 100 miles.

### ALL IN ONE BOX



**TC-1 Transmitter/Converter . . . . .**  
Plug in camera, ant., mic, and TV and you are on the air. Contains AC supply, T/R sw, 4 Modules below . . . . . \$ 399 ppd

### PUT YOUR OWN SYSTEM TOGETHER



**TXA5 ATV Exciter** contains video modulator and xtal on 434 or 439.25 MHz. All modules wired and tested . . . . . \$85 ppd

**PA5 10 Watt Linear** matches exciter for good color and sound. This and all modules run on 13.8 vdc. . . . . \$ 79 ppd

**TVC-1B Downconverter** tunes 420 to 450 MHz. Outputs TV ch 2 or 3. Contains low noise MRF901 preamp. . . \$ 49.50 ppd

**FMA5 Audio Subcarrier** adds standard TV sound to the picture . . . . . \$ 25 ppd

**PACKAGE SPECIAL** all four modules \$ 225 ppd

### SEND FOR OUR CATALOG, WE HAVE IT ALL

Modules for the builder, complete units for the operator, antennas, color cameras, repeaters, preamps, linears, video ider and clock, video monitors, computer interface, and more. 19 years in ATV.

Credit card orders call (213) 447-4565. Check, Money Order or Credit Card by mail.

## P.C. ELECTRONICS ✓ 57

Maryann  
WB6YSS

2522 PAXSON  
ARCADIA, CA 91006

Tom  
W6ORG



stopped the loss from happening! I am only saying that if we give the band the honest chance it deserves, it should reward us just as the others have. Let's go for 10- to 20-Watt rf equipment, reasonable receivers, and see just how much reward the band can provide. ■

### Bibliography

1. Karl Meinzer DJ4ZC, "A frequency multiplication technique for VHF and UHF SSB," *QST*, October, 1970.
2. Don Stoner W6TNS, VHF Column, "Let's get technical—The APX-6," *CQ*, May, 1962.
3. Allen Katz K2UYH (staff), "APX-6 Radiators," *The VHF Amateur*, December, 1962.
4. Les Maurer W6OSA, "Notes on the APX-6 Transponder," *Ham Radio*, April, 1968.
5. Gianni Lovisolo I1LOV, "Conversion of the APX-6 to 1290 MHz operation," *73 Magazine*, October, 1964.
6. Jim Fisk W1DTY, "A 1296 Grid Dipper (a GDO for 1050 to 1320 MHz)," *73 Magazine*, June, 1967.

7. Other sources for this article (non-articles) taken from USAF, T.O. 12 P 4-2, APX 25-2 by W9CGI. The APX-25 and APX-6 are identical for your purposes, so bear that in mind when shopping for a unit. The APX-25 has an additional keyer modification to the pulse circuits that you discard anyway.

### Notes

1. The normal APX-6 frequencies are: Receiver — 990 to 1050 MHz and local oscillator — 1050 to 1110 MHz.
2. The plunger cutting specification on the transmitter cavity per *73 Magazine*, reference 5, above, was, "remove 9/16" from the cavity plunger," for those unable to obtain the article.
3. Further, I will copy (for a small fee to cover my expenses) any of the above or other articles I might have for those who are seriously interested. Please try to obtain them from the magazines wherever possible, but I realize some of the above and others are no longer in business so I will try to help. As for any other help I can provide, just send an SASE and I'll try.

# HAM-KEY™ RADIO TELEGRAPH SENDING DEVICES



Model **HK-3M**

**\$19<sup>95</sup>**

Add \$2.00 Shipping & Handling.

- \* Deluxe straight key
- \* Anti-tip bracket. Can't tip
- \* Heavy base. No need to attach to desk

- \* Navy type knob
- \* Smooth action

CC-3P shielded cable & plug for HK-3M \$2.49.

Add \$ .50 Shipping & Handling.

Model AT-B anti-tip bracket only, to convert any HK-3 to HK-3M. \$2.99 Postpaid



Model **HK-1** **\$29<sup>95</sup>**

Add \$2.00 Shipping & Handling.

- \* Dual lever squeeze paddle
- \* For use with all electronic keyers
- \* Heavy base with non-slip rubber feet
- \* Paddles reversible for wide or close finger spacing

CC-1P shielded cable & plug for HK-1 \$3.75

Add \$ .75 Shipping & Handling.

Model HK-2, same as HK-1 but less base for incorporation in your own keyer. \$19.95

Add \$1.00 Shipping & Handling.

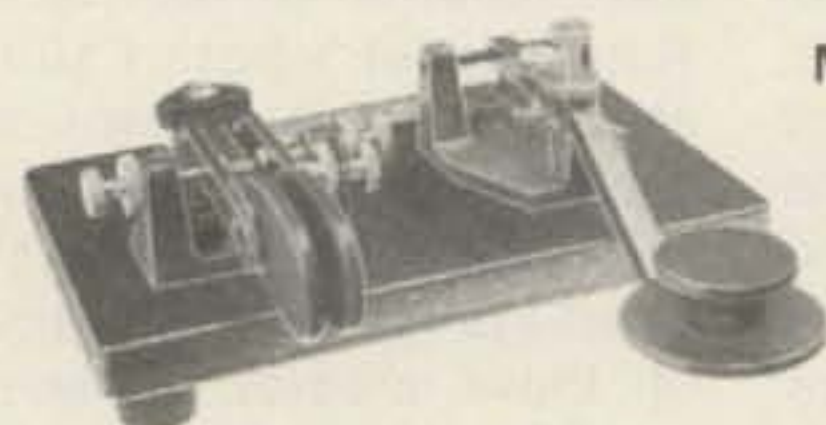

Model **HK-4**

**\$44<sup>95</sup>**

Add \$2.00 Shipping & Handling.

- \* Combination HK-1 & HK-3 on same base
- \* Straight key may be used conventionally or as a switch to trigger a memory.

CC-1/3P Shielded cable with plugs for HK-4 \$5.99.

Add \$1.00 Shipping & Handling



Model **HK-5A** Electronic Keyer

**\$69<sup>95</sup>**

Add \$2.00 Shipping & Handling.

- \* Iambic circuit for squeeze keying
- \* Self completing dots & dashes
- \* Dot & dash memory
- \* Built-in sidetone
- \* Battery operated with provisions for external power
- \* Uses Curtis 8044 keyer chip
- \* Grid block or direct keying
- \* Speed, volume, tone & weight controls on front panel
- \* Use with HK-1 or HK-4

Order direct or from your favorite dealer. ✓ 30

**The HAM-KEY Co.**

P.O. Box 28271

St. Louis, MO 63132

Phone TOLL-FREE 1-800-325-3651

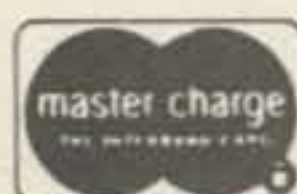



**YOU ARE LOOKING AT  
EVERYTHING  
THAT IS NOT ON SALE  
THIS MONTH  
AT HAM RADIO CENTER**

**FOR BEST PRICE – FAST DELIVERY  
CALL TOLL - FREE**

**1-800-325-3636**

**HAM RADIO CENTER** <sup>32</sup>  
8340-42 Olive Blvd. • P.O. Box 28271 • St. Louis, MO 63132





# Bridge Over Troubled Audio

## — another method for driving speakers

Most low- to medium-power audio amplifiers operate with an unbalanced output stage in which the load, i.e., the loudspeaker, is grounded. Fig. 1 shows a typical audio power amplifier output stage. This type of circuit is sometimes called the

totem-pole amplifier because the transistors appear "stacked" (i.e., series connected) on top of each other in the schematic. Transistors Q1 and Q2 are a matched pair fed out of phase with each other.

Output is taken from the junction (A) between tran-

sistors, so that Q1 contributes power on one half-cycle and Q2 contributes on the other half-cycle.

But a problem exists: Point A has a dc potential approximately equal to half of the supply voltage. This potential necessitates the use of capacitor C1 to block dc and prevent it from being applied to the voice coil of the loudspeaker. If C1 were not used, or if it becomes shorted, then a potential of  $\frac{1}{2} V+$  is applied to the loudspeaker, causing its destruction.

Capacitor C1 must have a very large value so that its reactance at the lowest frequency passed by the amplifier is negligible. If there were a significant reactance, then there would be significant output power reduction and phase shift at low frequencies. Audio amplifier designers have solved that problem in the past by making C1 a very large value capacitor, with values as low as 500  $\mu\text{F}$  in some car radios and up to 10,000  $\mu\text{F}$  in some hi-fi amplifiers. Capacitors in these values tend to be physically very large and bulky, which in car radios and other mobile audio ap-

plications becomes a distinct disadvantage.

Delco Electronics, the General Motors division responsible for making car radios and other auto audio products as well as being a manufacturer of transistors and ICs, solved the problem of the large capacitor with a unique integrated circuit audio power amplifier—see Fig. 2—using a circuit technique called *bridge audio*. The IC is shown in Fig. 2(a), while its pinouts are shown in Fig. 2(b). This device is designed to be operated from a single power supply up to +16 volts dc. (The usual automotive battery has a potential of about 14 volts dc when the engine is running, not 12 volts dc as is commonly believed.) The heat sink is the power supply negative terminal, so it is compatible with the standard negative-ground electrical system used in US-made automobiles.

Delco uses the bridge audio IC (under the type number DM84) in their car radio products, but offers it under the type number DA101 through their distributors. The current price of the DA101 in 1-10 quan-

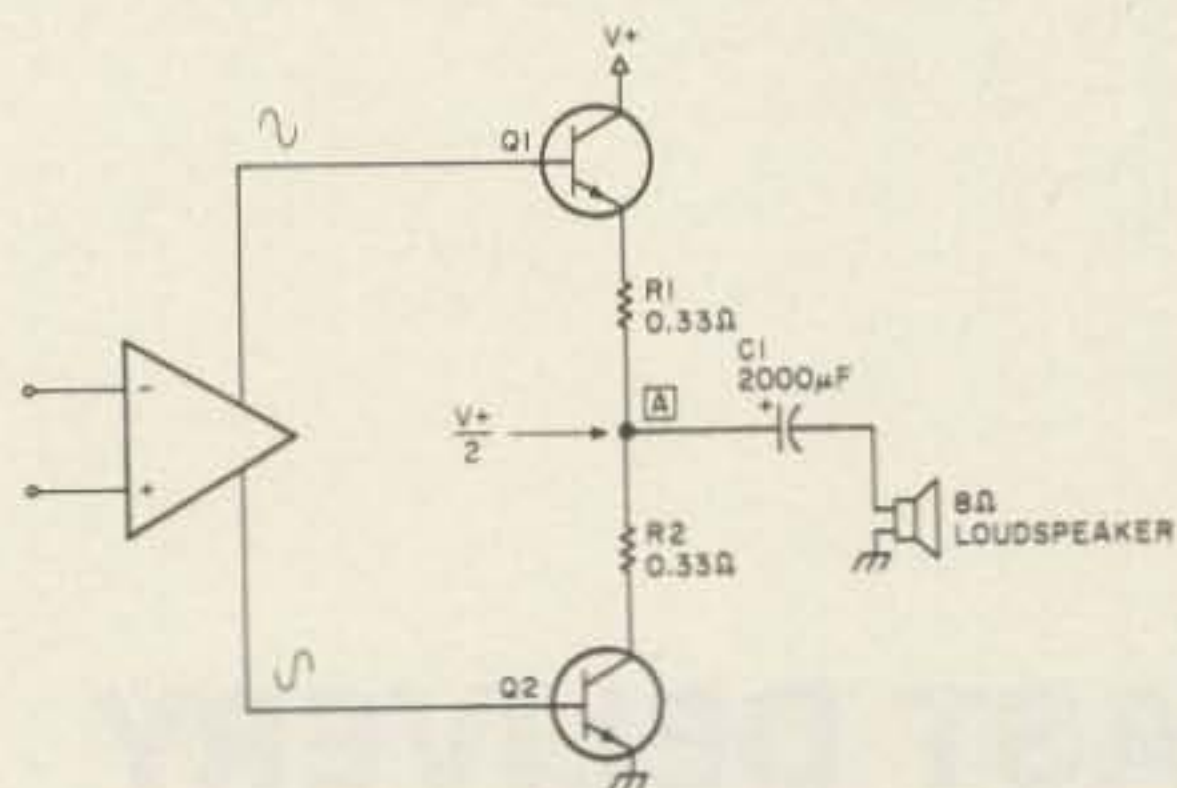

Fig. 1. Totem-pole audio power amplifier circuit.

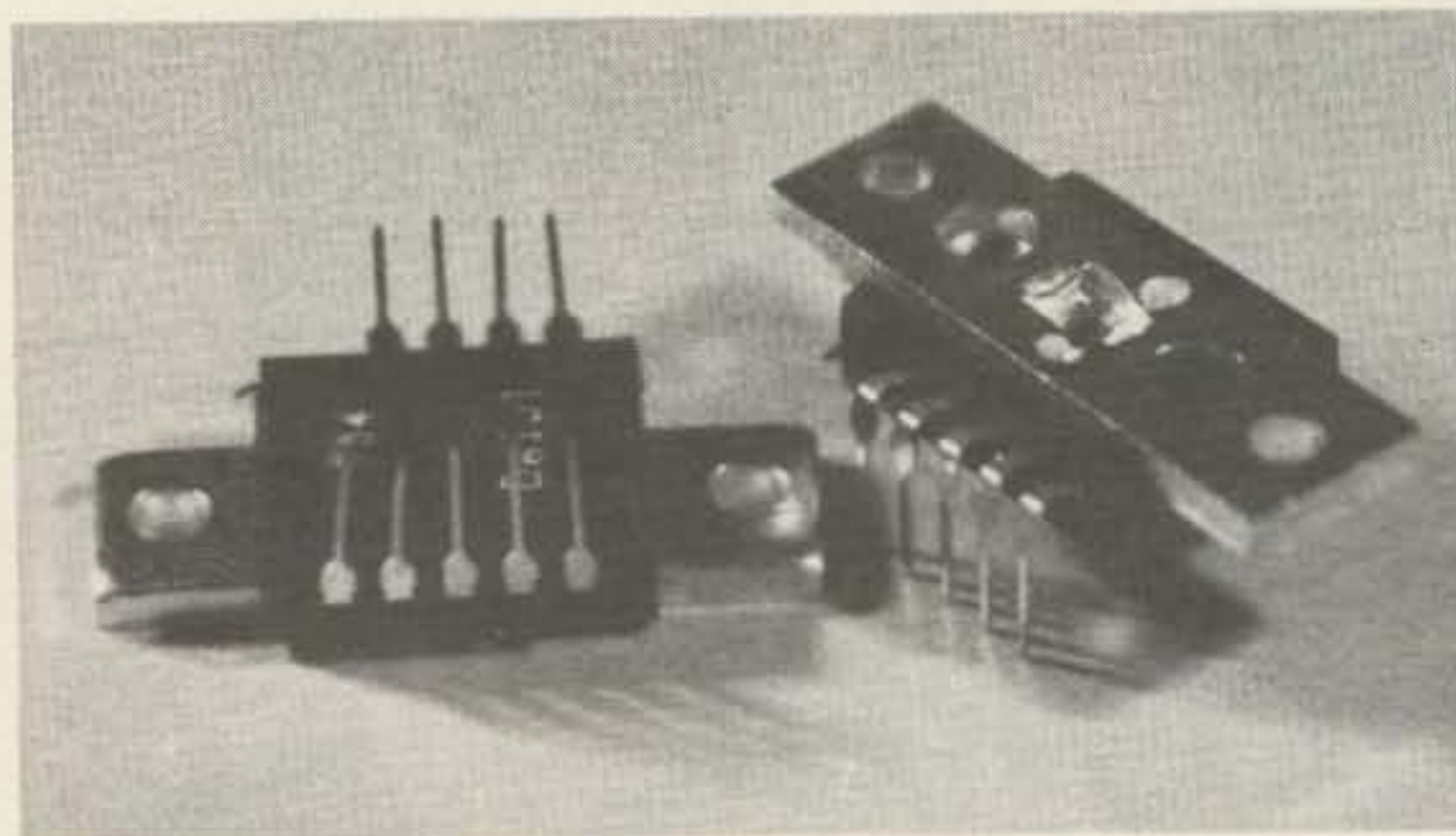

Fig. 2(a). The DA101 power amplifier chip.



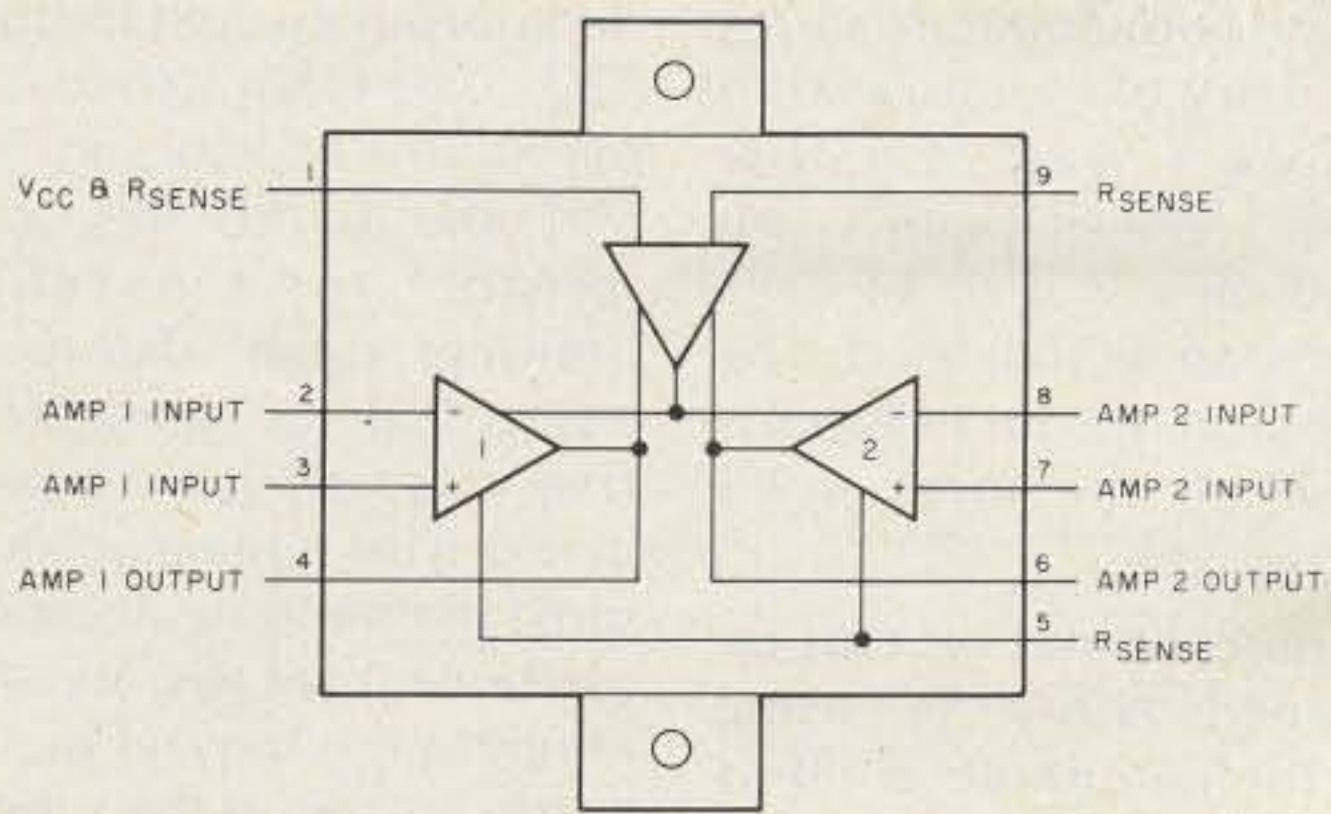

Fig. 2(b). Pinouts for the DA101.

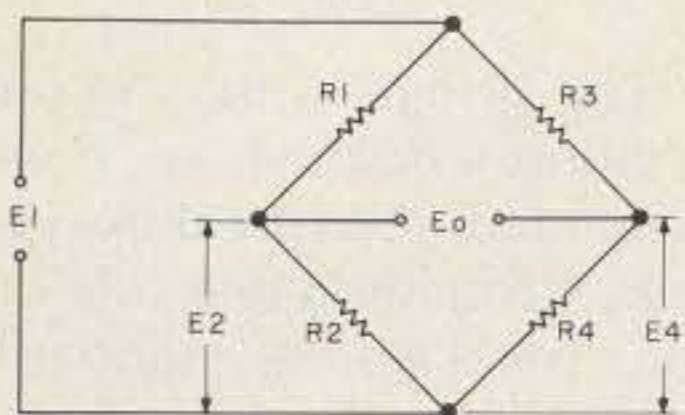

Fig. 3(a). Wheatstone bridge.

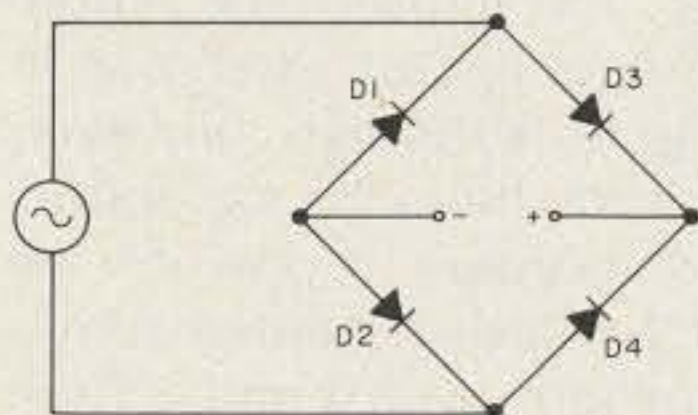

Fig. 3(b). Bridge rectifier.

tities is about \$7.

### What Is Bridge Audio?

Bridge circuits are used extensively in electronics; two common examples are shown in Fig. 3. The operation of the audio bridge can be more easily understood if the simple dc Wheatstone bridge of Fig. 3(a) also is understood.

We may view the bridge in Fig. 3(a) as a pair of resistor voltage dividers connected in parallel across the same power supply (E1). The output voltage,  $E_o$ , is the difference between E2 and E4:  $E_2 = E_1 \times [R_2 / (R_1 + R_2)]$ , and  $E_4 = E_1 \times [R_4 / (R_3 + R_4)]$ .

When  $E_2 = E_4$ , the bridge is balanced and  $E_o$  is zero; therein lies the beauty of the audio bridge (Fig. 4). In the audio bridge, circuit transistors Q1 through Q4 replace the resistors. Under zero-signal conditions, the collector-emitter resistances of Q1-Q4 are approximately equal, so  $E_o$  is zero, or has, at worst, a very small value. This means that a loudspeaker can be connected across the bridge output terminals without capacitor coupling! No harm will come to the loudspeaker.

The circuitry provided in

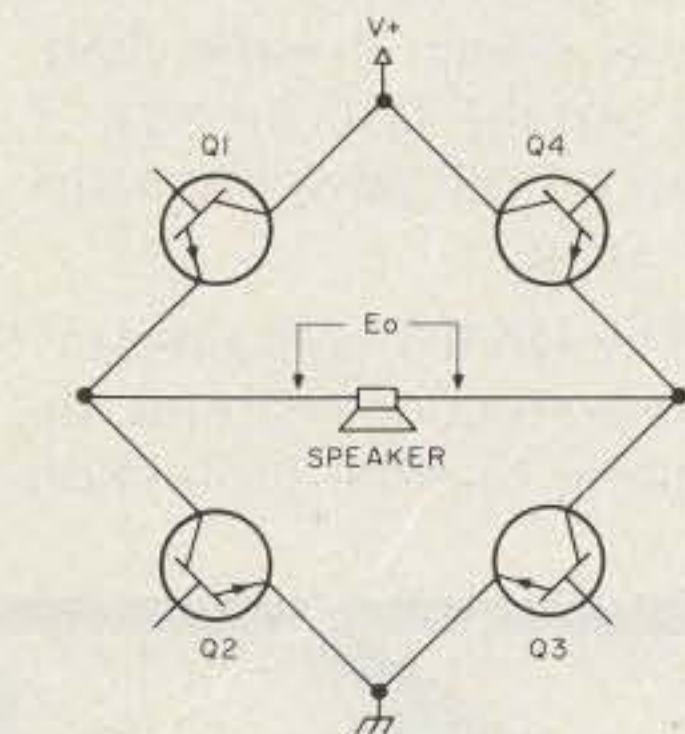

Fig. 4. Audio bridge is similar to circuits in Fig. 3, except that power transistors form the bridge elements.

the DA101 IC consists of a pair of power operational amplifiers, each similar to the circuit in Fig. 1, less the output capacitor, of course.

Fig. 5 shows how the two totem-pole sections inside the DA101 can be connected together to form a bridge audio power amplifier. Pins 4 and 6 are the output junctions, each corresponding to point A in Fig. 1. These pins are both at a potential of  $\frac{1}{2} V+$  under zero-signal conditions, so in the car radio (where  $V+$  is 14 V dc), the potential between each of these pins and ground is +7 volts dc. But the loudspeaker is connected *between* pins 4 and 6, so it is not grounded. The dc potential across the

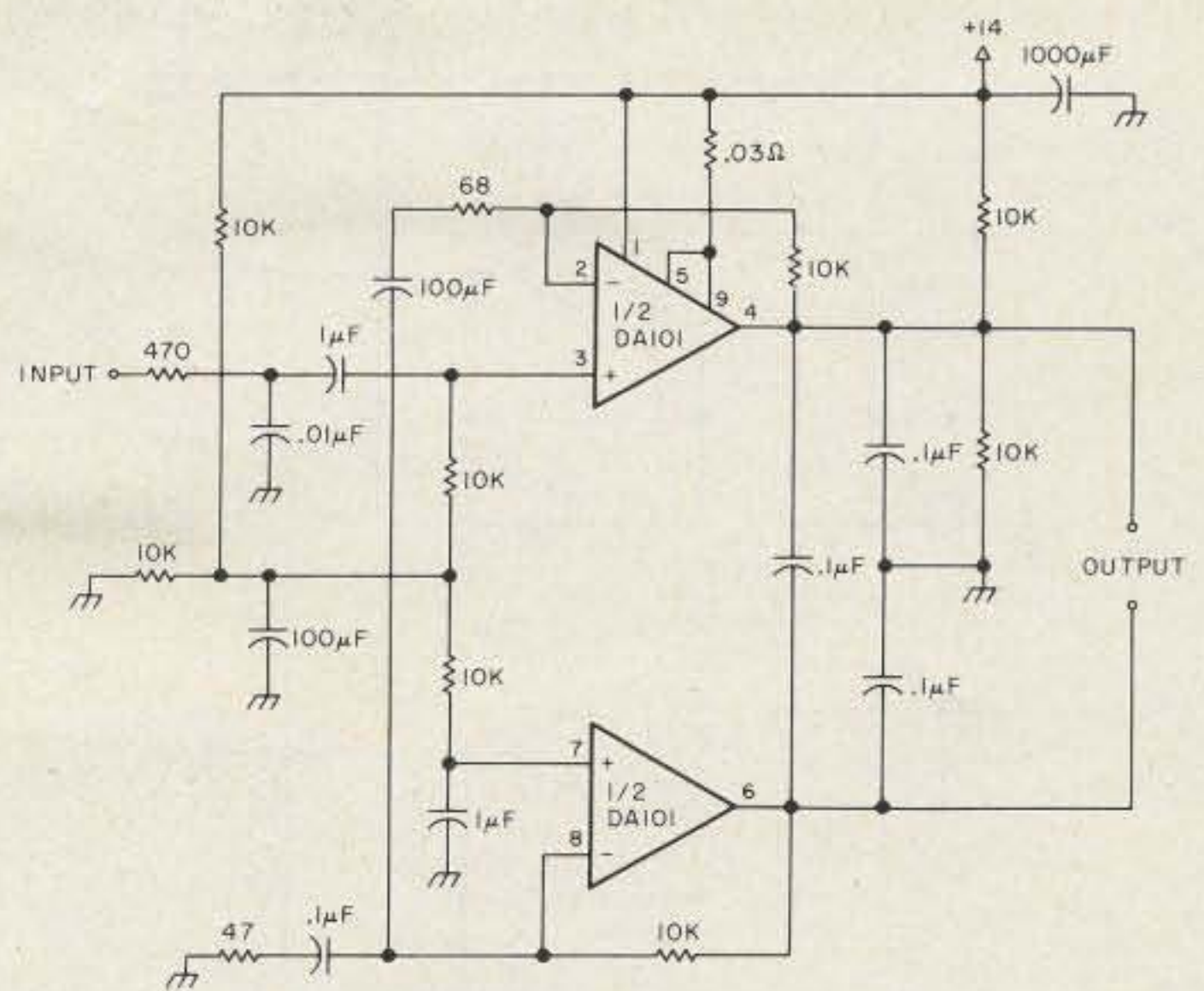

Fig. 5(a). Delco bridge audio circuit features balanced output. Actual circuit.

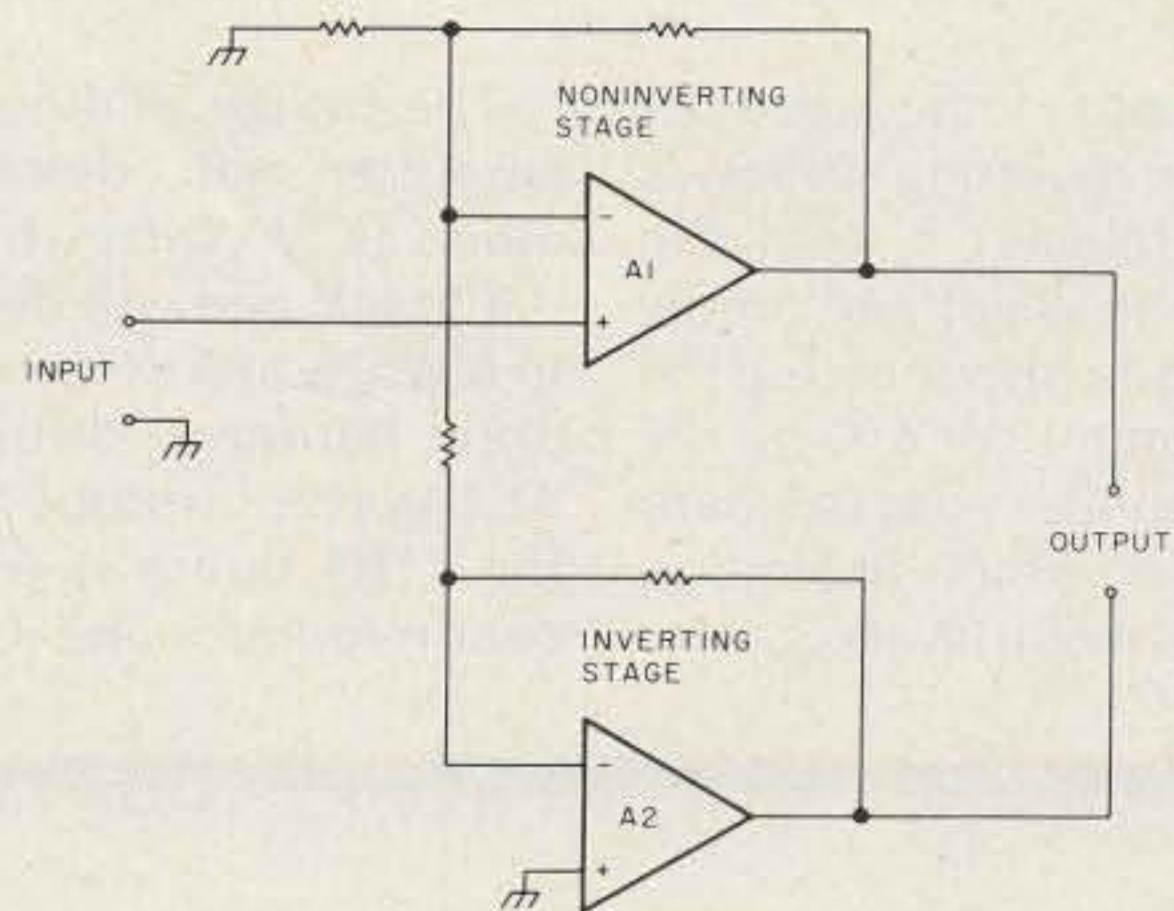

Fig. 5(b). Simplified circuit.

loudspeaker is 7-7, or 0 volts.

Driving the audio bridge requires one of the amplifiers to be used in the inverting mode and the other to be in the non-inverting mode, to ensure the proper  $180^\circ$  phase-angle difference required of any push-pull amplifier. One is tempted to solve this problem by tying together the - and + inputs of the two amplifiers, but this tactic will not work because the low input impedance of the inverting amplifier will pull the overall input impedance too low.

Delco engineers solved this problem—see simplified schematic in Fig. 5(b)—by taking advantage of one of the elementary properties of an operational amplifier: Both inputs tend to

stay together. This means that a voltage, either a signal or a dc bias, that is applied to one input will also be found on the other input terminal! In the standard inverting follower circuit, the input is grounded, so the - input is at a potential of 0 volts; this is the fact that leads to the confusing misnomer, "virtual ground."

Similarly, if you apply a dc potential, E, to the + input, then a voltmeter at the - input will read E. The non-inverting follower, A1, has a very high input impedance, and input potential  $E_{in}$  is applied to this input terminal. This situation means that  $E_{in}$  also appears on the - input terminal of A1, and that signal can be used to drive the inverting follower circuit, A2. The result is that we retain the



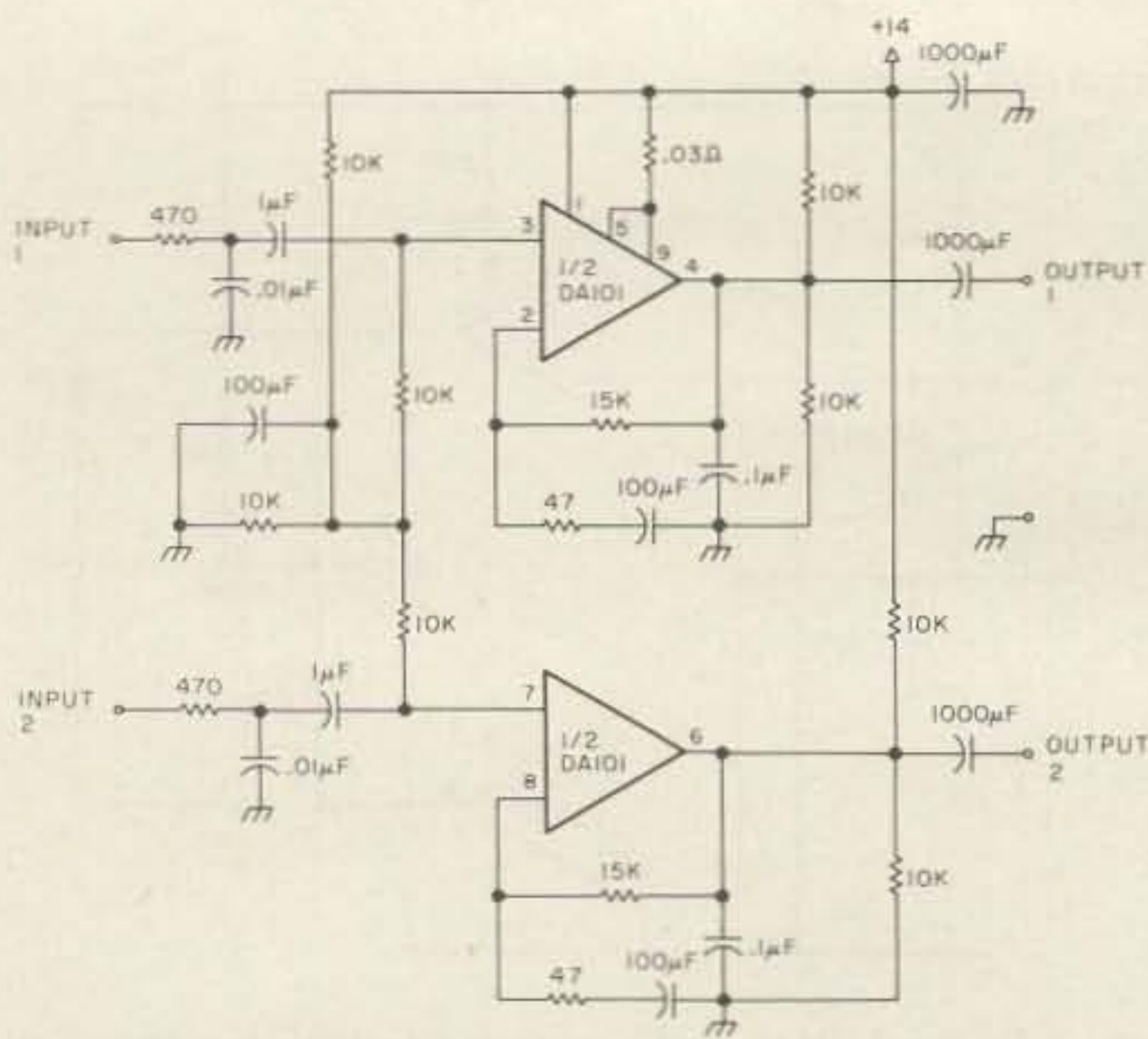

Fig. 6. Using the DA101 as a single-ended totem-pole stereo amplifier.

high input impedance of the non-inverting follower circuit (always a desirable feature in a voltage amplifier) while also meeting the requirement for driving the two amplifiers out of phase with each other. Ingenious, those Kokomo Kids.

The bridge audio power amplifier will deliver as much as 12 Watts when  $E_{in}$  is 100 mV and will deliver 5 to 6 Watts at 5 percent THD (total harmonic distortion). At 1 Watt of output power, the THD figure is 0.7 percent minimum and 1.5 per-

cent maximum. It requires only 9 mV of input signal to produce 1 Watt of output power. These figures are based on a  $V+$  of 14 volts dc and an 8-Ohm load. The maximum output power exists when the load is 4-5 Ohms.

Stereo operation can be obtained either by using two bridge circuits such as in Fig. 5(a) or by connecting a single DA101 in the classic totem-pole (i.e., non-bridge) circuit as shown in Fig. 6. Note well, however, that dc-blocking capacitors are needed to prevent the +7-volt dc potential at output terminals 4 and 6 from damaging the loudspeakers. This circuit results in lower maximum output power ratings in each channel, but the THD rating at 1 Watt output power remains the same.

The DA101 contains several protection features, including thermal protection

and output current limiting. The 0.03-Ohm (that's 30 milliohms) resistors in Figs. 5(a) and 6 are the sense resistors for the current limiting stage. These resistors can be made from fine wire, using data given in any wire table (such as in most elementary electricity textbooks), or by parallel-connecting low-value "fusistors" used in the emitter circuits of power transistors.

The bridge audio circuit requires a floating, i.e., non-grounded, loudspeaker system. Grounding one side of the speakers is standard practice in auto electronics, so be wary of connecting an audio bridge into an existing speaker system. All Delco models that are equipped with bridge audio have a label on the chassis warning the service technician not to ground the loudspeakers either in the vehicle or on the test bench. ■



# GET DELIVERED

# 1-800-325-3609

MO. RESIDENTS CALL (314) 961-9990

**We have it!**  
And we'll get it to you fast.

To our extensive list of major brands; we proudly announce the addition of:

- Bearcat scanners
- Regency scanners
- Vibroplex

One call will let you know why we're "The Direct Connection" for delivery too.

## MIDCOM ELECTRONICS, INC.

2506 S. BRENTWOOD BOULEVARD  
ST. LOUIS, MISSOURI 63144  
Hours: 9-7 Mon.-Fri. 9-5 Sat.







# FORMULA FOR 2 METER FM ENJOYMENT

4  
x RELIABILITY



## CLEGG FM-88

\$329.95

143-149 MHz

.25 uv sensitivity

mobile mount & microphone included

25 Watts (variable)

Provisions for non-standard splits  
(CAP, MARS, etc.)

Optional AC power supply available

### THAT'S CORRECT!!!

We are convinced that the FM-88 is four times more reliable than the other 2 meter rigs being offered. To prove it to you, we are supplying the FM-88 with *four times* more warranty than supplied with other models—One full year instead of the normally expected 90 days.

While there are radios on the market that offer lots of "gadgets"—our past experience

has been that simplicity of operation & elimination of unnecessary "Bells & Whistles" actually removes the causes of many failures being experienced with such transceivers.

If you are shopping for a new 2 meter transceiver, don't you owe it to yourself to go with a radio that has proven itself with thousands of hours of reliable, "On the Air" operation?

Phone 1 (800) 233-0250 today to order your FM-88 or to request a detailed brochure describing this fantastic transceiver & related accessories.

The FM-88 is also available with an 800 channel, programmable scanner—order model FM-88S—\$429.95



# Clegg

Communications Corp.  
1911 Old Homestead Lane  
Greenfield Industrial Park East  
Lancaster, PA 17601  
(717) 299-7221



# Load a Lawn Chair

— even if you can't carry a tune,  
you can build this matchbox

This here's a project for all you folks who have a yen for one of those thirty-, forty-, or even fifty-buck matchboxes that will let you load your transmitter into a lawnchair, but who know that those hard-earned shekels have to be spent elsewhere.

Now, I realize that there's been plenty written about tuners already, but there seems to be a shortage of articles on versions that are simple enough and cheap enough so that one does not have to go out and buy it ready-built.

Well, this one has no hard-to-find parts, is simple to build, and will give an excellent match into almost anything that even vaguely resembles a longwire. The icing on the cake is that the sum cost of all the parts in it will probably be less than the cost of the box that you choose to put it in. That could get pretty cheap!

## The Parts

The capacitor is straight out of a junked AM or AM/FM tube-type radio. The only care in choosing

one lies in making sure the plates aren't bent to the point of scraping one another. The plates we want to connect are always the larger set (in multi-ganged versions); just ignore any others. Plate spacing in these older radios was pretty much standardized, and all that I've seen will work at the 150-200-Watt level for SSB and at slightly less for CW. The frame of the capacitor is already connected to the rotating set of plates, so all you have to do is make one connection to the stationary set.

The inductor is home-wound, which solves that procurement problem. It consists of 48 turns of about 18 gauge (not critical) insulated or bare hookup wire wound on a one-inch diameter form, 16 turns to the inch, for a total of three inches of coil. Some hookup wire that Radio Shack sells in three-packs has insulation over it that makes it wind at 16 turns to the inch when close-spaced, so you might use some of that if you have any. If not, just wind the wire you have, close-

spaced, and then stretch it out until it is three inches long.

What you wind the inductor on is up to you. A piece of plastic pipe (ABS is preferable to PVC, but again, this is not critical), a tube that solder comes in, a couple of pill bottles glued end-to-end, or a Plexiglas™ X-shaped frame—which would be ideal. Lacking any of these, just about any non-metallic, one-inch diameter by at least three-inch long form would be satisfactory since we don't intend to run kilowatts of power through it. Any minor difference in inductance due to the form material would be compensated for by the infinitely variable capacitor.

After you have completed winding the inductor, solder short pieces of wire to the third, tenth, nineteenth, and twenty-ninth turns on the coil, taking care to avoid making electrical contact with any adjacent turns. These wires will be connected to the inductance-selector switch later.

The inductance-selector

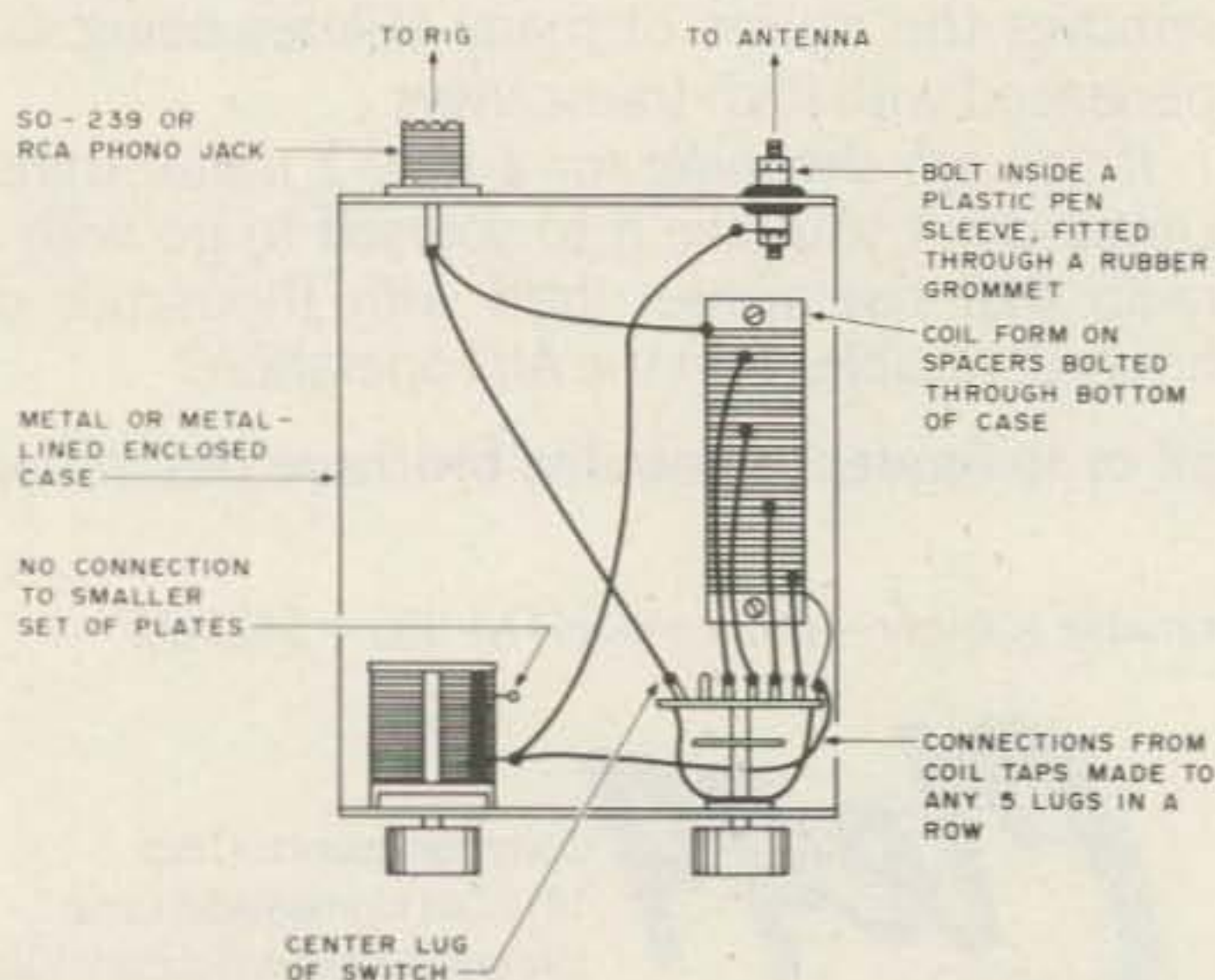

Fig. 1. Suggested layout.



rotary switch is stock Radio Shack; either the 6-position or the 12-position type will work just fine. I know that using these runs afoul of the tradition of using rf ceramic switches in this application, and if you have a ceramic version, by all means use it. I didn't use one in any of the tuners I built and thus far have had no problems. The 12-position switch has the advantage of allowing you to add extra taps to the inductor if you want to experiment, while the 6-position is less cumbersome in the original version.

### Construction Hints

Something along the lines of a metal enclosure should be used to house the tuner; otherwise, hand capacitance could cause the settings to not stay put when anything near the tuner is moved. That

means that if you were planning to build a plywood, fiberboard, or even cardboard box to house the thing, make sure the inside of the box is completely lined with tin foil or the equivalent. That also prevents TVI and gives a ground return path for the rotary plates on the capacitor.

When transmitting, the antenna end of the tuner can have some pretty high rf voltages present on it, so be sure to use a connector that has some insulation to it. A bolt through a plastic pen sleeve on a vinyl grommet would be one suitable example. Try to keep the individual wires separated and away from the case to avoid flashovers, and keep wire lengths down to the minimum needed to make the connections. That last precaution will help avoid stray inductance.

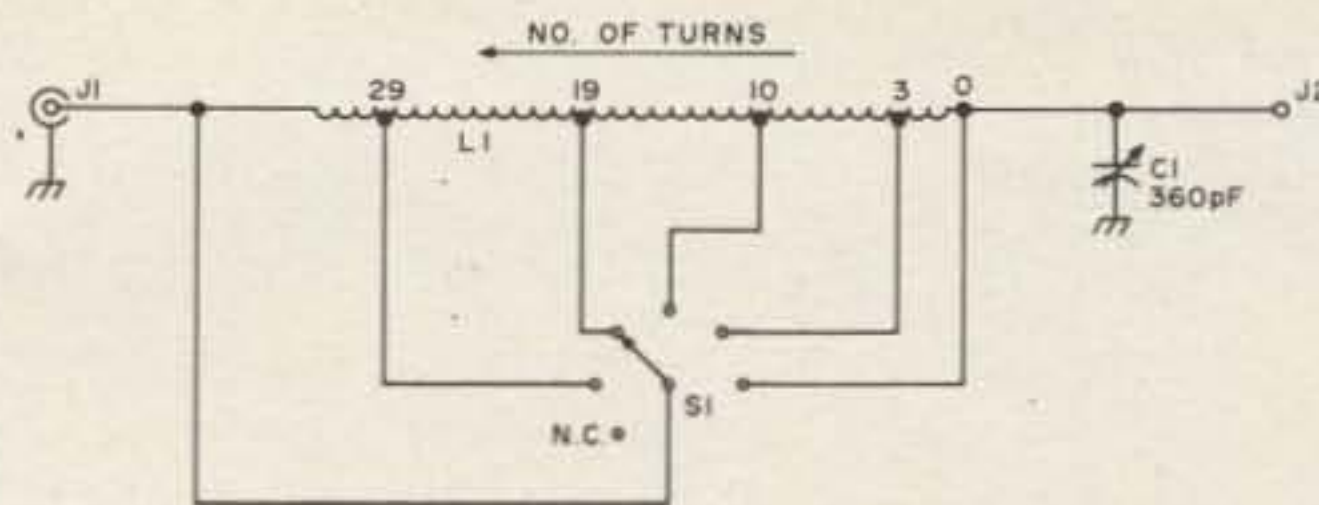

Fig. 2. Schematic. See Parts List.

### Summary

Before I built my first longwire tuner, my activities were confined to one or two bands due to the lack of a good all-band antenna. Now I operate wherever I want, with capability for really quick band change, thanks to the tuner and a handy knob-

setting log. It's also kind of nice not to have to worry about bad weather knocking out my antenna, since the tuner would be loaded quickly into a makeshift wire thrown up for the occasion. All in all, having one is a heck of an asset to my station. I hope you enjoy yours as much as I do mine. ■

### Parts List

- J1—SO-239 connector or RCA-type phono plug
- J2—Feedthrough antenna insulator, commercial or homemade
- L1—Home-brew inductor—see text
- S1—6- or 12-position rotary switch, Radio Shack or equivalent
- C1—Approx. 360-pF variable capacitor, salvaged out of tube-type radio, AM or AM/FM type
- Miscellaneous: cabinet, 2 knobs

CAN 20% BE WRONG?



A recent survey showed that 20% of the 73 subscribers also read Kilobaud MICROCOMPUTING magazine . . . and enjoy it. This is the best way to learn and keep up with the rapidly developing world of microcomputers. There's nothing to be afraid of, you just have to read an interesting magazine and you'll learn. Try a subscription to Kilobaud MICROCOMPUTING and see for yourself.

- New subscription
- Renewal
- 12 issues for \$25.00
- Payment enclosed \$ \_\_\_\_\_
- 24 issues for \$38.00
- VISA
- MC
- AE
- Bill me
- 36 issues for \$53.00

Card # \_\_\_\_\_ Interbank # \_\_\_\_\_

Signature \_\_\_\_\_ Exp. date \_\_\_\_\_

Name \_\_\_\_\_

Address \_\_\_\_\_

City \_\_\_\_\_ State \_\_\_\_\_ Zip \_\_\_\_\_

—for even faster ordering service call toll free (800) 258-5473

Canadian: \$27, one year only, U.S. funds. Other foreign: \$35, one year only, U.S. funds. Please allow 6-8 weeks for delivery. 308B6

MICROCOMPUTING • POB 997 • Farmingdale NY 11737

TRS 80\*  
OWNERS

ARISE!



Arise and subscribe to 80 MICROCOMPUTING, the newest and fastest growing microcomputer magazine. This is full of news about programs, accessories and theory on the world's largest selling computer, the TRS-80\*. Definitely beginner level and includes lots of program listings. Find out what all the fuss is about.

- New subscription
- Renewal
- 12 issues for \$18
- Payment enclosed \$ \_\_\_\_\_
- 24 issues for \$30
- VISA
- MC
- AE
- Bill me
- 36 issues for \$45

Card # \_\_\_\_\_

Interbank # \_\_\_\_\_ Exp. date \_\_\_\_\_

Signature \_\_\_\_\_

Name \_\_\_\_\_

Address \_\_\_\_\_

City \_\_\_\_\_ State \_\_\_\_\_ Zip \_\_\_\_\_

80 microcomputing™

• P.O.B. 981 • Farmingdale N.Y. 11737

\*TRS-80 is a trademark of Tandy Corporation.

Please allow 6 to 8 weeks for delivery  
Canadian: 1 yr. only/\$20 in U.S. Funds  
Foreign: 1 yr. only/\$28 in U.S. Funds

308B6



# The Penultimate CPO

## — a nondiscrete LSI device

It has been my observation that most code-practice oscillators in use these days—both commercial and home-built—leave a lot to be desired. Many of these are actually buzzers—or sound like one!

I enjoy teaching the code to prospective Novices, and it is my contention that a good code-practice oscillator ought to sound like the real thing. That is, it should sound just the way a CW signal received off the air sounds! A perfect CW signal should—and does—sound like a perfect-keyed sine wave, with no clicks or thumps as the key makes or breaks contact, and with no frequency shift when the oscillator starts up.

Building a perfect sine-wave oscillator is easy. The trick is to build one that won't produce clicks or shift frequency as it is turned on and off. This is next to impossible with less than a very complicated and elaborate circuit. However, there is another and

simpler way to do the job (see Fig. 1). It is much easier to build a square-wave oscillator, which is easily keyed, and filter its output with a narrow bandpass filter so that only the fundamental frequency is passed to the output. The result is a perfect-keyed sine-wave oscillator, with no clicks, thumps, or chirps.

Fig. 2, the schematic diagram, shows the results of my attempts to design the ultimate code-practice oscillator. The circuit is truly state of the art, using no discrete transistors. All active components are commonly-available ICs. This circuit will produce a sine-wave tone with no clicks or chirps and with sufficient audio-power output to drive a speaker to room-filling volume at very low distortion.

### Circuit Description

Referring to Fig. 2, the power-supply circuitry is straightforward, employing a bridge rectifier, capacitor-

input filter, and a 3-terminal voltage regulator (IC1). An LED is included as a pilot lamp to indicate when power is on.

The oscillator circuit, IC2a, is a classic op-amp square-wave oscillator, modified to provide for a frequency (tone) adjust and on-off keying. It is followed by a narrow bandpass filter, IC2b, with a center-fre-

quency adjust to provide for matching the filter-pass frequency to the oscillator-output frequency.

The output from the bandpass filter, a keyed sine wave, is passed on to the audio-power amplifier, IC3. I chose an LM380 IC amplifier for the audio-output stage because it is a high-quality, low-distortion audio amplifier capable of

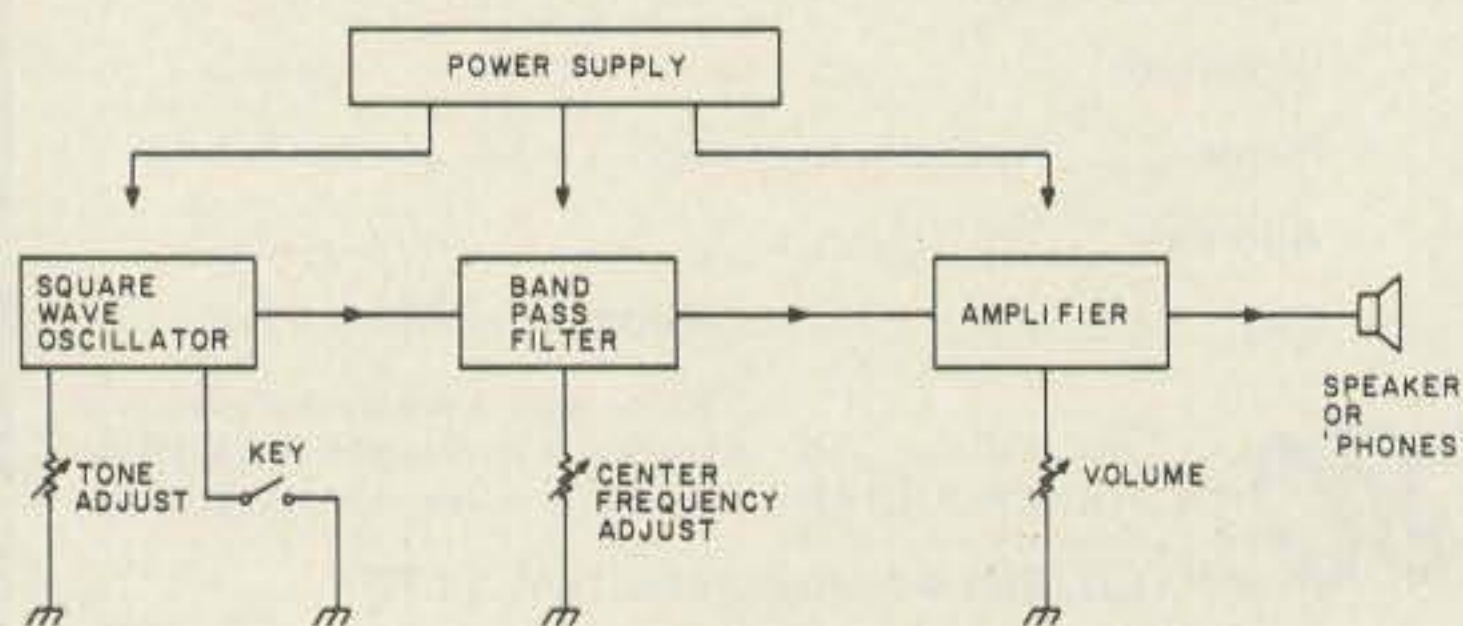

Fig. 1. Block diagram.

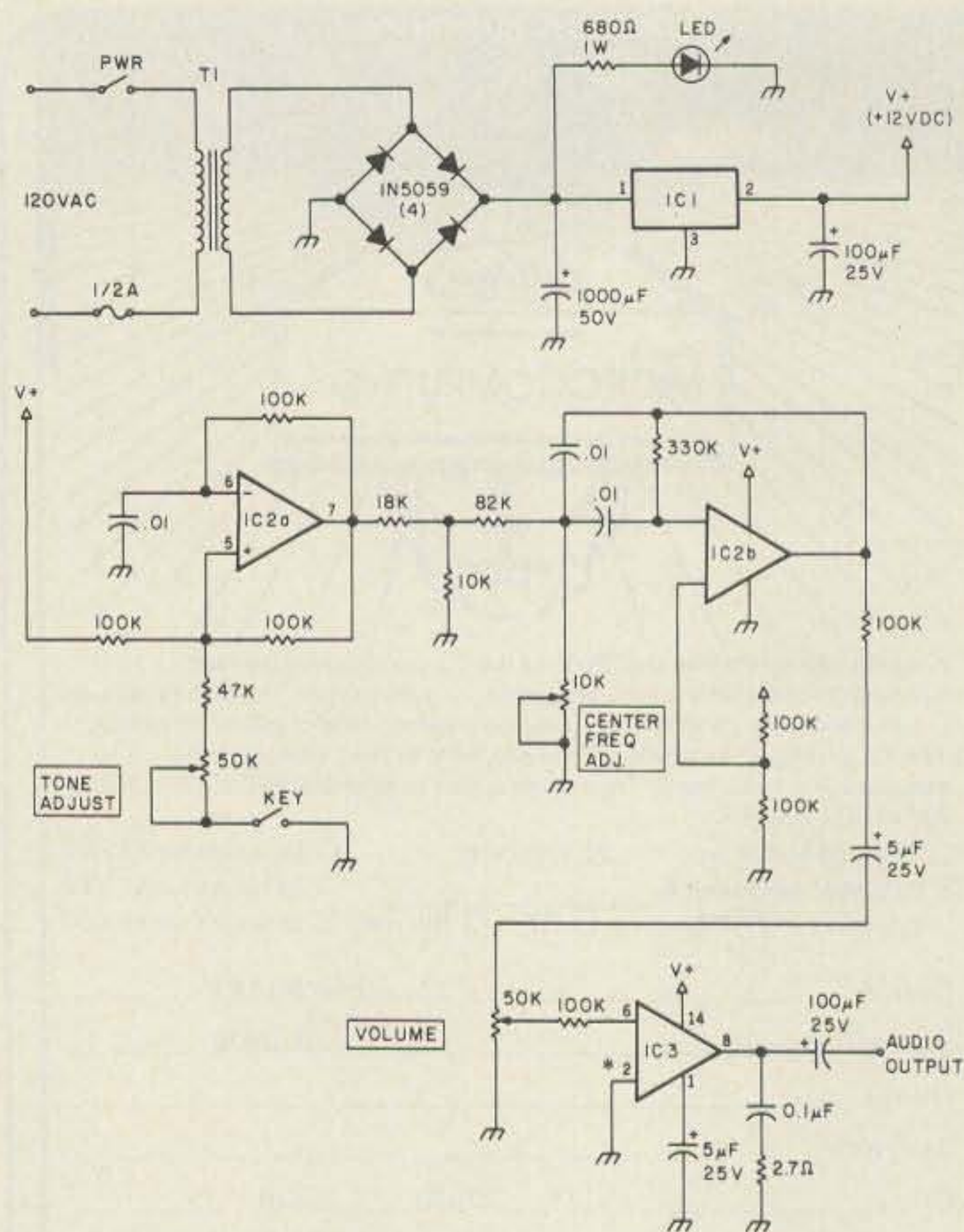

Fig. 2. Schematic diagram. T1=120-V primary, 18-V (300-mA) secondary; IC1=uA7812UC 12-V regulator; IC2=LM358N dual op amp; IC3=LM380N power amp; \*IC3 ground pins: 2, 3, 4, 5, 7, 10, 11, 12.



driving anything from a 4-Ohm speaker to high-impedance headphones.

### Construction

This circuit is so simple that the time required to produce a PC board for it did not seem justified. I built my unit on a small piece of perfboard. Although I used trimmer pots for the tone-adjust and filter center-frequency-adjust controls, these could be front-panel-mounted-type controls if you feel that frequent tone adjustments are desirable. I built my unit into a small Ten-Tec enclosure and mounted the power switch, pilot light LED, and volume control on the front panel, with the key jack, headphone/speaker jack, and ac fuse holder on the rear panel. You may wish to eliminate the power-supply circuitry if you have a source of 12 V dc available

to power the unit and do not desire a built-in power supply.

### Initial Adjustment

To adjust the controls, proceed as follows: Plug the unit in, turn on the power switch, and advance the volume about a third of the full rotation. Center the tone and center-frequency controls. Plug a key into the key jack and key the unit. Holding the key down, adjust the tone control for the desired pitch. Next, adjust the bandpass control for the loudest volume and clearest tone. The unit is now ready to operate.

You will find that this oscillator will produce a tone that remarkably resembles the quality of a CW signal received off the air. It is easy to build and a pleasure to use. If you are learning or teaching the code, this project is for you! ■

**NEW!!** **ATTENTION MOBILE HAMS**  
**15 METER MOBILE TRANSCEIVER**  
**CW & USB**  
**NCG 15SB**



THE QRP RIG WITH THE **BIG RIG SOUND** ACTIVE NOISE BLANKER—RF GAIN—CW SWITCH—SQUELCH—MIC GAIN—DIGITAL FREQUENCY DISPLAY—HI/LO POWER SWITCH—13.8 VDC 5A POSITIVE OR NEGATIVE GROUND.

See your dealer for a demonstration.  
 DEALER INQUIRY INVITED.

**NCG Co.** 318 **NEW** 438 to 450 MHz  
 PLL mobile  
 Memory-Scan

1275 N. GROVE ST.  
 ANAHEIM, CALIF. 92806 (714) 630-4541

# ASCII MORSE RTTY

## MONITOR \$149.

(12" B&W)  
 (Optional)

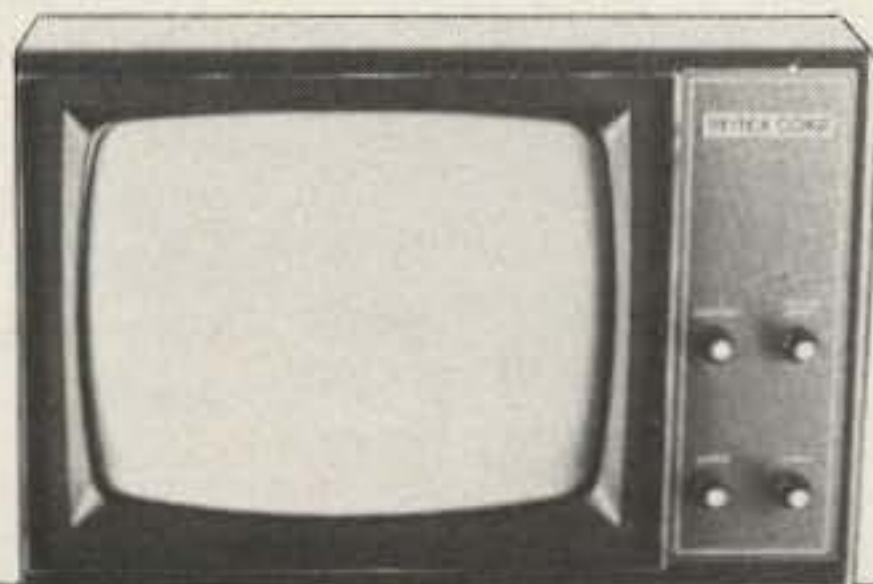

## SKT-100 COMPLETE KEYBOARD TERMINAL

\$375. Kit  
 (Less Monitor)  
 Assembled \$430

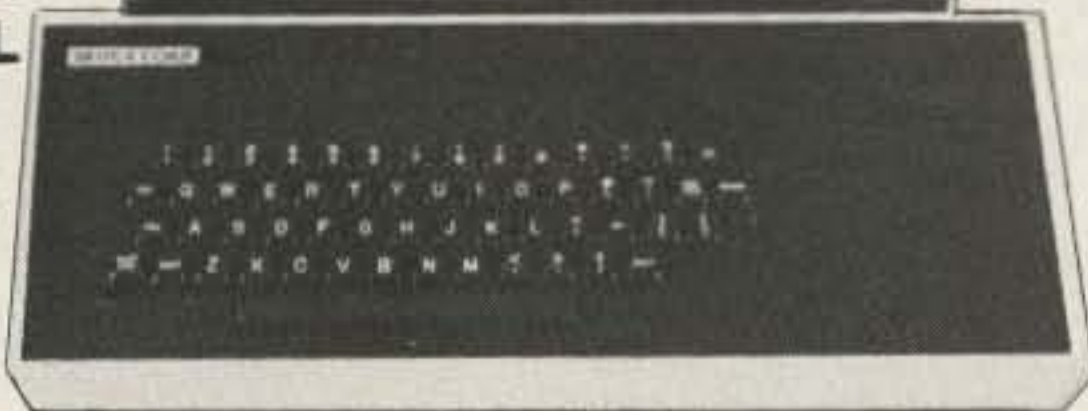

ALSO AVAILABLE:

## SCT-100 STAND ALONE VIDEO BOARD

Assembled & Tested \$215.

Full Kit \$175. Partial Kit \$115.

## ABM-200 ASCII BAUDOT MORSE CONVERTER \$189.

# XITEX CORP.

9861 Chartwell Drive  
 Dallas, Texas 75243 (214)349-2490

MC/VISA ORDER BY PHONE

Prices subject to change without notice.

## COMPUTER

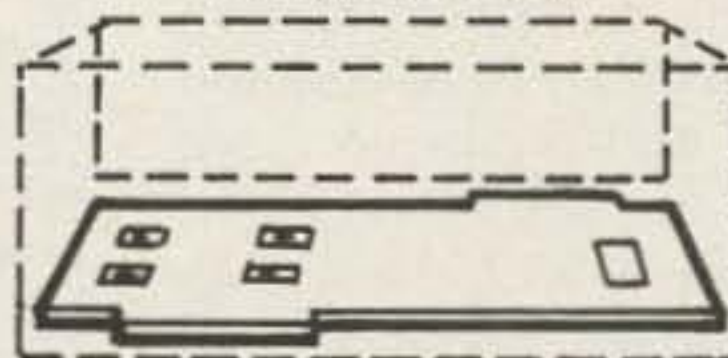

SERIAL  
 LOOP or RS232

## Features

- ASCII & BAUDOT
- Auto Sync. 1-150 WPM CW
- Narrow & Wide Shift TU
- Microcomputer Interface

## TRANSCEIVER



AFSK/KEY  
 (SEND)

AUDIO  
 (COPY)

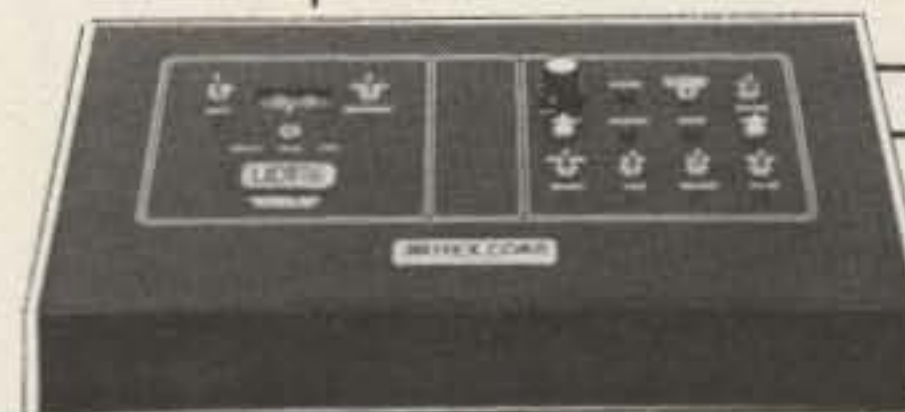

Key  
 Input



Key Optional

## UDT 170 UNIVERSAL DATA TRANSCEIVER

Converts any ASCII or Baudot TTY\* or Video Terminal into a multiple baud rate data transceiver for RTTY and Morse operation. (Boards sold separately)

PRICE \$549



# Get Out and Vote

— a grass roots project for this election year

This system was designed to allow two or more remote receivers to be fed into one repeater transmitter. The system is very inexpensive and is simple to build (Fig. 1).

I originally designed this circuit to be used with four remote receivers and a four-frequency scanner at the transmitter. The scanner I had would not scan fast enough to satisfy me. We are using Midland 13-509 220-MHz rigs split apart for our links. I had a receiver for each transmitter, so I put a separate re-

ceiver in for each link. These four receivers are tied together and fed into the transmitter with a circuit to be explained later.

## What It Does

This circuit causes a delay on link key-up. The length of the delay is determined by the signal strength at the receiver.

When a mobile station keys his mike to access the system and brings up more than one remote receiver, the receiver with the strongest signal will come on first. The COR on the link receiver

er at the repeater transmitter also will come on first. The positive voltage from the COR will cause the audio latching board to lock the audio from that receiver to the transmitter.

## How It Works

This system uses a 555 timer (IC1) to give a delay on the remote link transmitter key-up (Fig. 2). This delay time varies from no delay with a strong signal to up to a one-second delay on a weak signal. This is done by varying the voltage on pin 5 of the 555 delay timer. Varying the voltage on pin 5 will change delay time independently of the RC network. As the voltage on pin 5 is decreased, the delay time will decrease. This is done with Q1 and Q2. Q1 simply amplifies the voltage from the first limiter of a Motorola Motran receiver. The first limiter voltage varies from 0 with no, or a weak, signal, to about a minus 1.5 volts with a strong signal. D1 is used to raise the base voltage on Q1 enough for it to function. The average (silicon) diode has a 0.7-volt drop across it. This 1N270 (ger-

manium) has only a 0.3-volt drop. I have not tried a silicon diode, but if a 1N270 is not available, I believe the only difference would be in sensitivity adjustment.

As the signal gets stronger, the collector voltage of Q1 rises, causing the collector voltage of Q2 to lower. This pulls the voltage of pin 5 of IC1 down. This, in turn, decreases the delay time. The amount of delay with a weak signal may be varied with R3 of IC1. I have our system set at about half a second.

The basic voting system is Q1, Q2, and IC1. I have incorporated a 3-minute time-out timer (IC2) on the same board. The COR (Fig. 4) is not mounted on the board—but look at the connections. When the COR is relaxed, it pulls pins 2 and 4 of both timers through a diode to ground. This resets both timers. The COR then applies 12 V dc when keyed to the circuit.

Q8 is a U56 and gives you a high output (+12) with delay and time-out. Q9 is a U06 and will pull in just about any push-to-talk circuit. It also has delay on

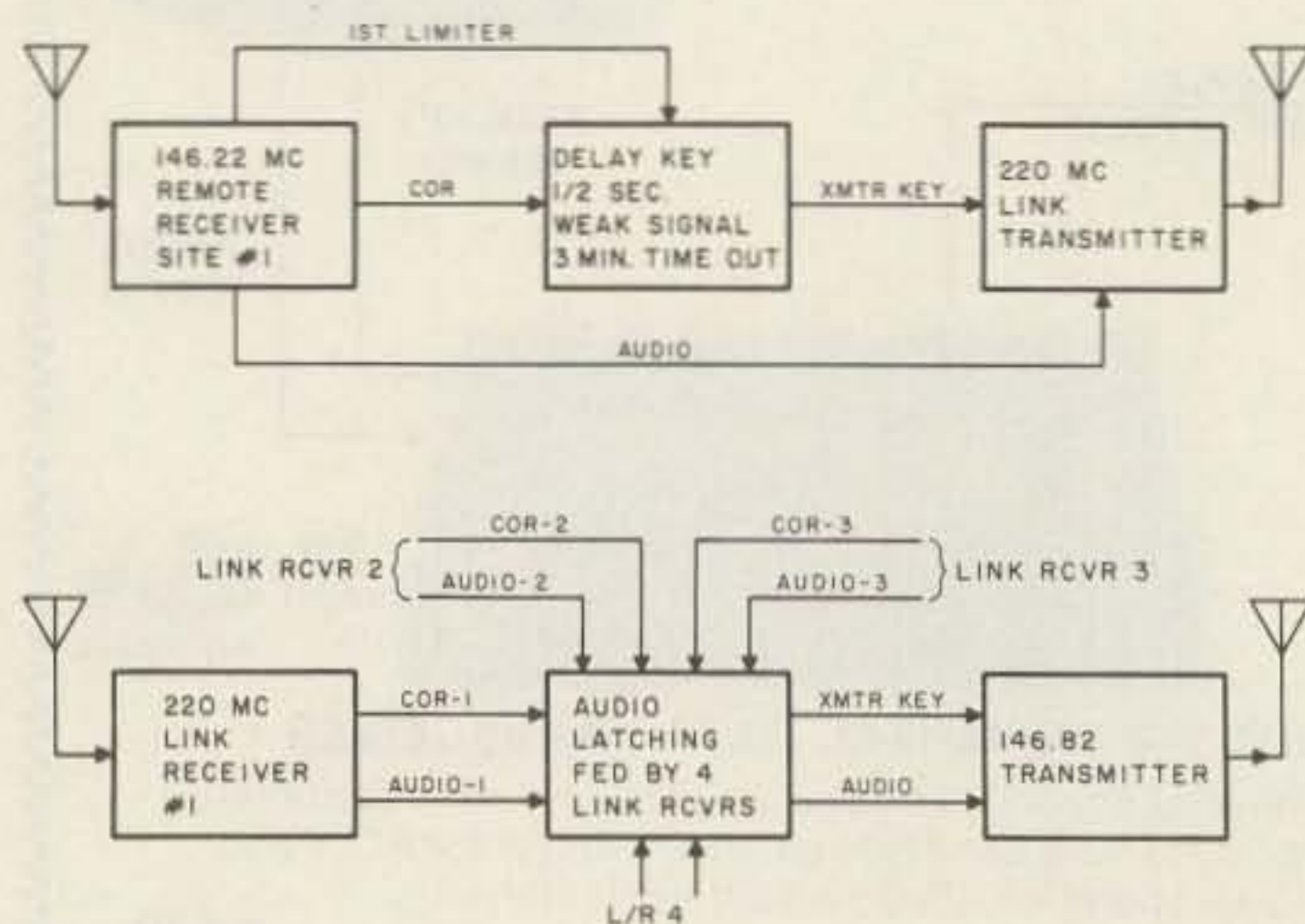

Fig. 1. Voting system block diagram.



and time-out.

You should notice that a large number of bypass capacitors are used. These are needed to prevent oscillation and rf problems. I have never shielded any of these boards, but it may not be a bad idea if it will be near a strong rf field.

With the exception of D1 (1N270), the diodes are not critical.

### Alignment

Alignment is simple. All voltage readings are taken from pin 5 of IC1. To start the alignment procedure, set R1 to maximum sensitivity and R2 to ground. Adjust R4 of IC2 for maximum time. Make all connections and apply voltage. Adjust R3 for about a one-second delay on key-up. This can be set to whatever delay you want later. At this point, pin 5 of IC1 should be about 0.7 to 1 volt below Vcc. The voltage should not vary when a full saturating signal is applied to the receiver. Apply a fully-saturating signal to the receiver and adjust R2 until pin 5 of IC1 reads 0.25 volts.

While the signal is still applied, adjust R1 to decrease sensitivity. Decrease R1 just enough to raise pin 5 voltage by 0.1 to 0.2 volts, giving you a total voltage on pin 5 of 0.35 to 0.45, with a strong signal. Do not exceed 0.5 volts. With no signal, pin 5 will read about 3.7. This reading will depend on Vcc. I had 4.8 volts on this circuit. Exactly 5 volts is not necessary, but the readings may vary a little. It is very important to have well-regulated voltage on pin 8 of IC1 and Q1 and Q2. I use LM309 regulators. Adjust R3 to the desired delay, R4 to time-out time, and that is it!

I have built four of these delay boards and was very surprised to find that they all tuned exactly the same and all worked well. The voltage readings did vary a

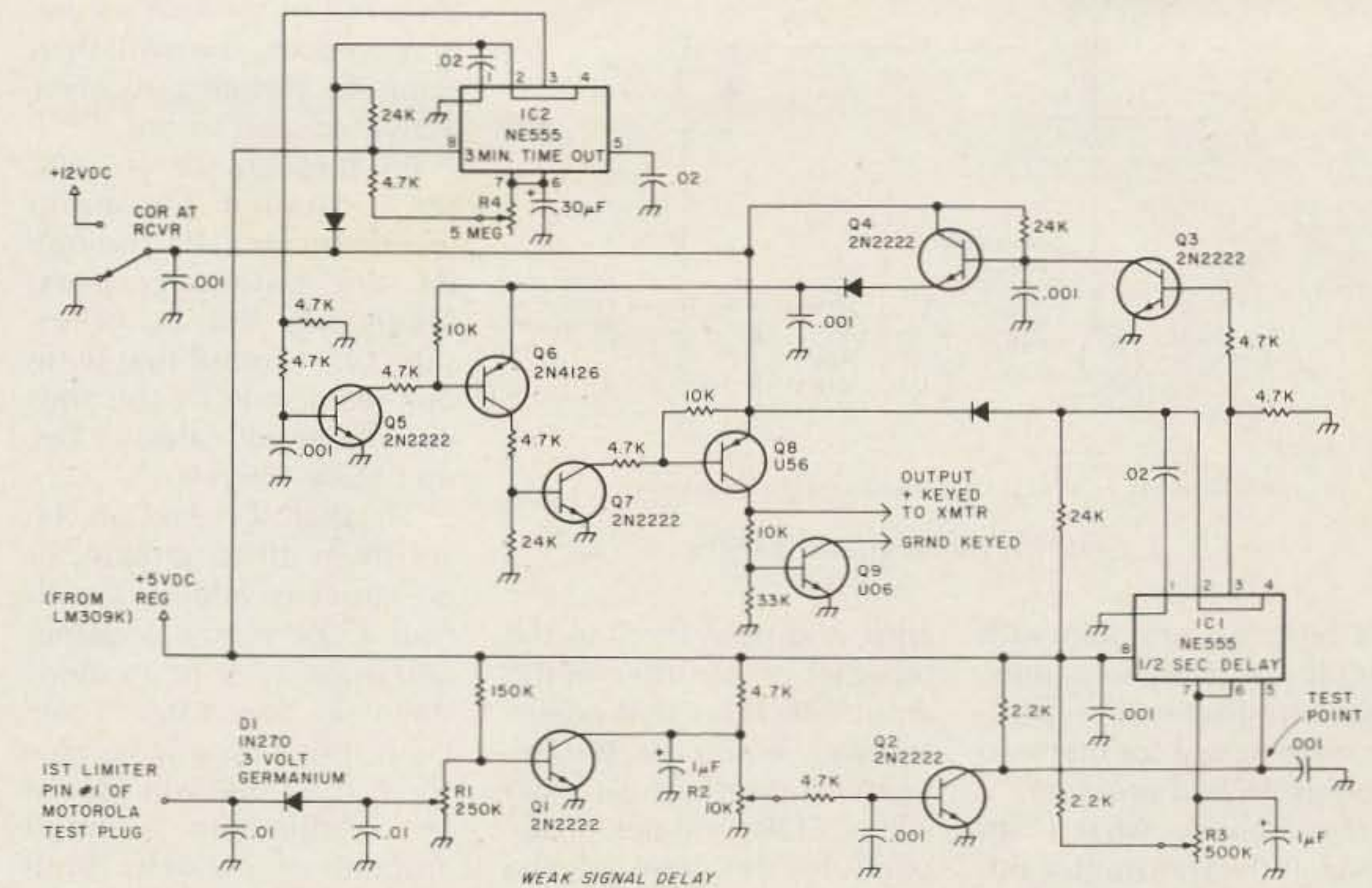

Fig. 2. Link-signal delay and 3-minute time-out board.

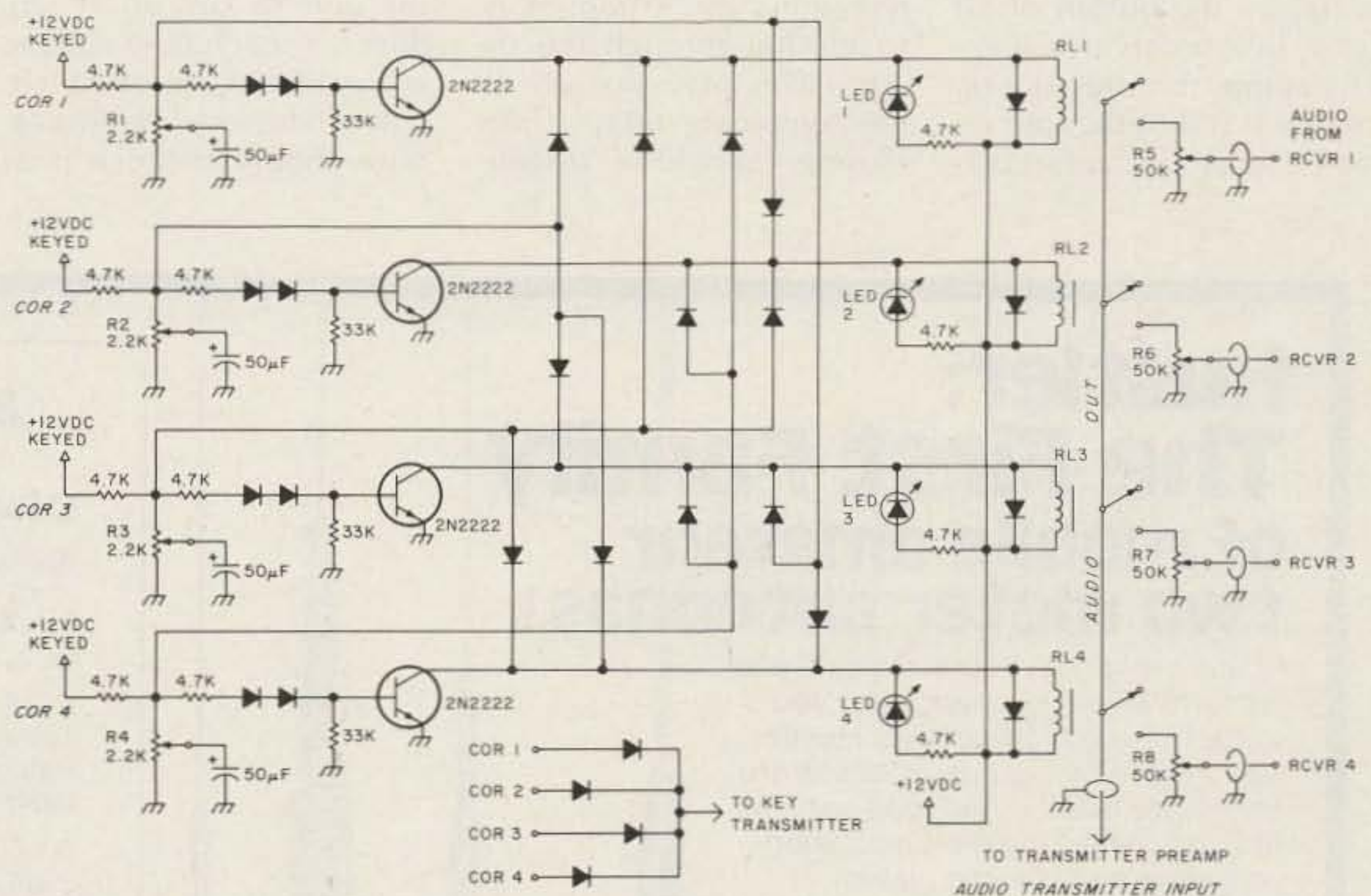

Fig. 3. Audio latching board.

small amount due to the fact that all four had just a little different input voltage. The difference really was not enough to mention.

Bob Heil K9EID, of Marrison, Illinois, is working with this system also, on his club's .81/.21 machine. He seems to be very happy with it. As far as I know, he has had no problems with it.

I have been working on

this circuit for about three years. I knew it had to be possible, but did not know just how when I began. I have had this circuit in use for about a year on the Gillespie, Illinois, .22/.82 machine. We have two remote receivers on now, with a third one just about ready to go. The receiver sites are about 25 miles apart. Everyone seems to be well satis-

fied with its operation. It does a good job for mobiles and hand-helds.

I have found that running the repeater receiver squelch and COR adjustments just a little tighter than normal helps the fading base stations. This way, the signal does not have to get so noisy before the system switches to another receiver site. This switching



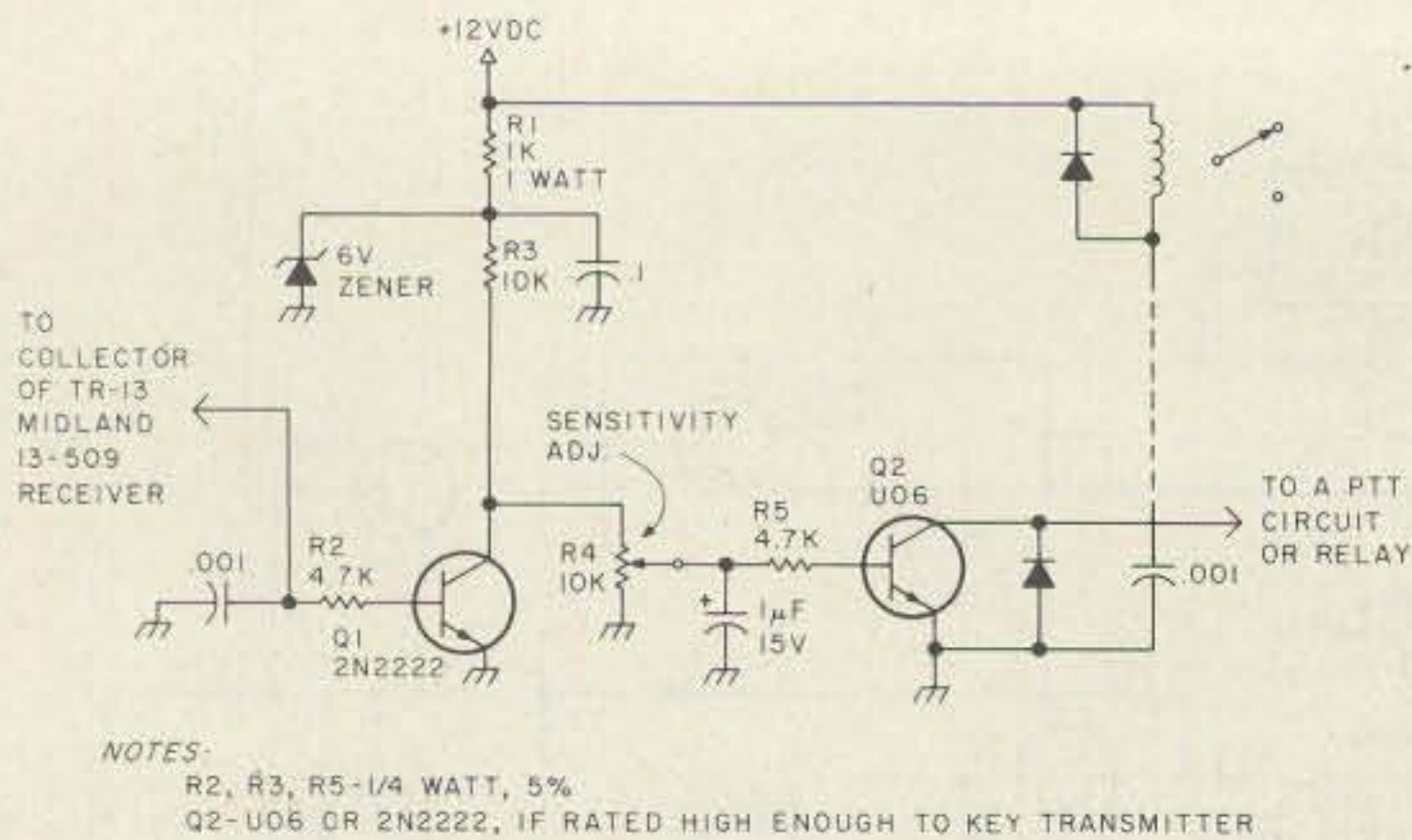

Fig. 4. COR for the Midland 13-509.

has been no problem with mobiles or hand-held units. I am sure that most repeaters were meant for them, so there is no real problem.

Fig. 3 shows what I am doing at the transmitter site to pick out the receiver site that comes on first or the strongest signal. This circuit is fed by the output of all four link-receiver CORs. The audio from the four receivers is fed to the four relays, then to an audio pre-

amp, and from there to the repeater transmitter audio input. The relay that passes receiver audio to the repeater transmitter is closed when COR voltage is applied to the base of the relay-keying transistor. The collector of that transistor then pulls the base of the remaining three transistors to ground through the diodes. This prevents any of the remaining relays from closing. Should a mobile

drop out of the first receiver keyed up, he will then jump to the next receiver activated, and so on.

R5 through R8 are 50k pots installed for audio level matching. R1 through R4 are balancing pots. These may not be necessary, but I found that without them, one of the four circuits would always key up before the rest.

To align R1 through R4, set them all to ground, or no capacity added. Tie all four COR inputs together and pulse 12 V dc to all of them at the same time. Each time you put voltage to all four, one will always key. Adjust in a small amount of capacity until the next one does the same. By adjusting R1-R4 in this manner, you soon will get the unit to key up at random, i.e., each time voltage is applied, a different circuit will lock on. This procedure should balance it as

well as ever needed.

The diodes are not critical. As long as all values are close to the same for each of the four relay circuits, I am sure the resistors are not critical. I used the values marked on the diagram. The resistors are 1/4-Watt, 5%. The four transistors are 2N2222s.

This COR circuit was originally designed for the Midland 13-509 receiver. We are using the Midland and this COR for our link setup on the Gillespie, Illinois, 22/82 repeater. The input of the COR is connected to the collector of TR-13. The collector voltage goes low with a signal.

This COR is very stable and sensitive. There are no critical parts, but I did use 5% resistors and a good grade of wire-wound 10k pot.

This COR also has been installed on other FM receivers with good results. ■

## Hustler: The First Family of mobile amateur two meter antennas!

Maximum range, improved gain and better SWR at resonance put you ahead on the highway with Hustler. Our mobile two meter antennas are known for quality. And long service life, too. Featuring the finest stainless steel and chrome plated components.

It's quality and performance like this that make Hustler the mobile amateur two meter antenna you should be riding with!

Most models available  
in 1-1/4 meters.

CGT-144  
\$42.95



HT-144  
\$27.95



BBLT-144A  
\$34.95



SPS-144  
\$28.95



Clearly the choice of those who know quality.

**HUSTLER** INC. ✓ 305

3275 North B. Ave. • Kissimmee, Florida 32741

**HUSTLER**

### DEALERS

Appliance & Equipment Co., Inc.  
2317 Vance Jackson Rd.  
San Antonio, TX 78213  
(512) 734-7793

Electronic Sales, Inc.  
100 West Mercury Blvd.  
Hampton, VA 23669  
(804) 722-9824

G.I.S.M.O. Communications  
2305 Cherry Rd.  
Rock Hill, SC 29730  
(803) 366-7157  
WATS (800) 845-6183

Iris La Communications  
7149 S.W. Eighth St.  
Miami, FL 33144  
(305) 264-4636

Mid-Com Electronics, Inc.  
2506 S. Brentwood Blvd.  
St. Louis, MO 63144  
(314) 961-9990

Route Electronics, Inc.  
220 Route 46  
Totowa, NJ 07512  
(201) 256-8555



CALL TOLL FREE  
**1-800-228-4097**

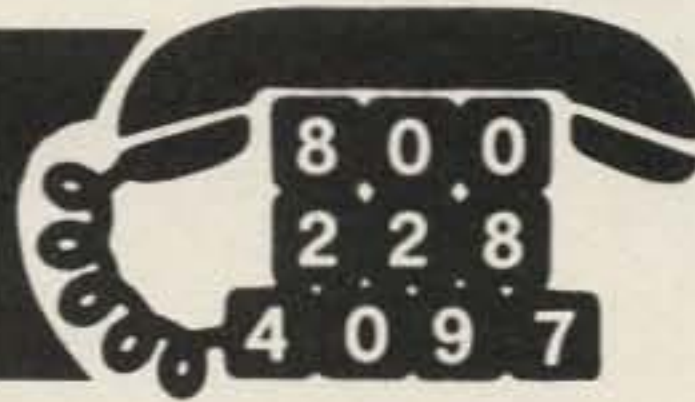

*Another Great Buy!*

**FEATURES**

- No Crystals to buy
- Lo Band 32-50 MHZ
- Ham Band 146-148 MHZ
- High Band 148-174 MHZ
- UHF Band 450-470 MHZ
- "T" Band 470-512 MHZ
- Auto Search
- Delay Scan
- Automatic Lock Out
- AC/DC Operation
- Simple Programming
- Scan Rate 20 ch./sec.
- Ext. Antenna Jack
- Ext. Speaker Jack
- Big 3" Front Mounted Speaker
- UL Listed / FCC Certified

**Bearcat® 210**  
 PROGRAMMABLE SCANNER

**LIMITED SPECIAL  
 ONLY  
 \$199.95**



**PANASONIC RF-2900**

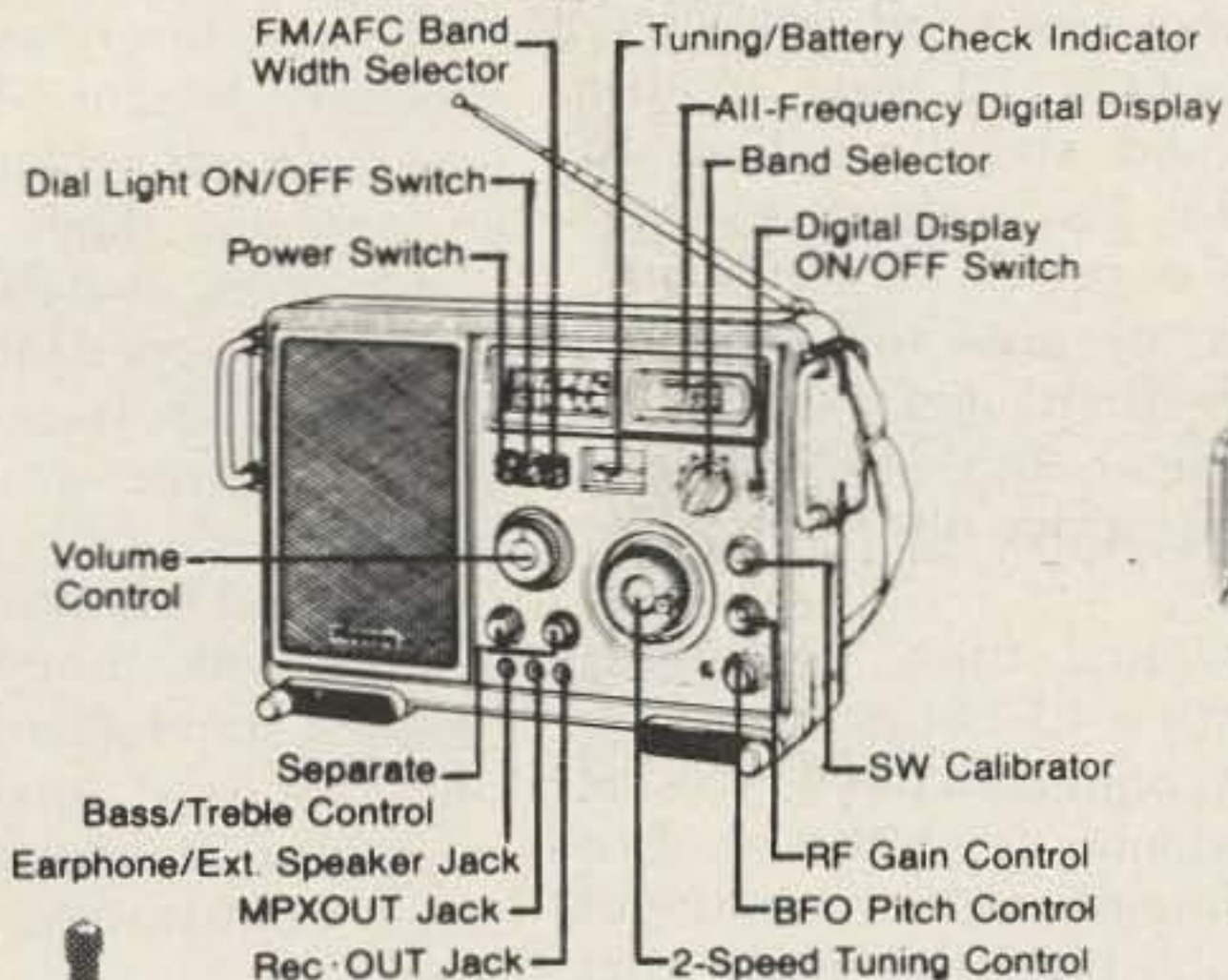

**Suggested List \$329.95  
 SPECIAL \$219.95**



**PANASONIC RF-4900**  
 General Coverage Receiver  
 List \$549.95  
 Ours \$399.95



**NEW SHURE 444D**  
 Dual Impedance  
 Normal/Vox Slide Switch  
 Adjustable Height  
 Mfg. List \$90.00  
**SAVE AT ONLY \$49.95**

**KENWOOD TR-7800**  
 2 Mtr. Transceiver  
**CALL for Discount Price**



**KENWOOD TR-2400**  
 2 Mtr. Hand Held  
 144-148 MHZ  
 List \$395.00  
**CALL FOR PRICE**

Call for **LOWEST PRICES** on Antennas and Towers

*New QTH*

**We Export**

PRICES SUBJECT TO CHANGE AND AVAILABILITY

**Communications Center**

1840 "O" STREET LINCOLN, NEBRASKA 68508  
 In Nebraska Call 402/476-7331

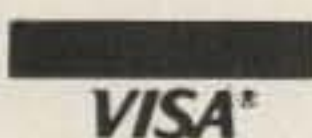



# A Wider Windom

## —broadbanded sans transmatch

It has been nearly fifty years since Loren Windom W8GZ started experimenting with an off-centered dipole which would catch the fancy of generations of hams.

The principle was simple: While a centered dipole exhibits a 75-Ohm resonant response on its half-wave frequency and near that on the third harmonic, it is far from an allband antenna. Would it be possible to locate a feedpoint other than the center which would show a common impedance on several harmonically-related ham bands? Loren Windom decided to find out.

After considerable experimentation, he determined that a point 14% away from the center of the antenna (that is, 36% from the end) exhibited a nearly identical feedpoint impedance on

even multiples of the half-wave frequency. Rf signals at 3.5, 7, 14, 21, and 28 MHz would see an impedance of approximately 400 Ohms under ideal free-space conditions. Early amateurs used single-wire feed, approximating the correct feedpoint impedance. Later, 300-Ohm open-wire line was used, as was TV twinlead.

But, as many amateurs have found out, longwire antennas cut for the CW portion of the bands begin to balk at signals in the higher portions of the phone bands.

With these limitations in mind, I decided to see if the off-centered antenna could be reconfigured to accommodate phone operation without the use of an external tuner.

Dozens of individual experiments were devised,

each involving a gradual change in feedpoint, feedline length, total dipole length, and individual lengths of each dipole leg. Results were frustrating. When one band would represent a 1:1 swr, another would show a zillion to one! The problem was not so severe on 75 and 40 meters because subtle dimensional changes were not so critical, but at 20 meters and above the roof came in!

Initial trials were done with a 4:1 balun transformer connected directly at the antenna feedpoint. I then remembered a comment published somewhere that it is often better to isolate the balun with a length of balanced line first. The literature reported that a length of 44 feet, or multiples thereof, seemed to be ideal.

I could not get that length to work. Nor did I find a harmonically-related 67-foot length to be of advantage. But at 47-48 feet of 300-Ohm feedline, the antenna tamed down considerably. Swr readings were reasonable on all bands, and with some judicious pruning of antenna length, the swr was reduced even further.

The magical combination, at least at my location, with the antenna elevated about 25 feet above ground, seems to be a 134-

foot dipole divided into 90- and 44-foot sections. This combination results in a feedpoint 17% off center (33% from one end).

Early versions of 300-Ohm-fed antennas were generally matched by running the feedline directly to an antenna tuner in the shack or by matching the feedpoint impedance with a 4:1 balun transformer. The transformer was almost always made from two bifilar-wound B & W self-supporting coils mounted on ceramic standoff insulators and secured inside an aluminum Bud box. It was a large contrivance, but it worked!

Nowadays, with the ready availability of ferrite core materials, the physical size and the balun may be reduced considerably. Kits may be ordered from advertisers found in the pages of *73 Magazine*, and commercial units are available already assembled.

The balun transformer which we used was the world-famous W2AU, marketed by Unadilla (Microwave Filter Company, 6743 Kinne Street, East Syracuse NY 13057) for \$14.95 and carried by many amateur radio supply houses.

Ferrite-core balun transformers typically perform uniformly from 3-40 MHz, but ours seemed to work well down to 160 meters.

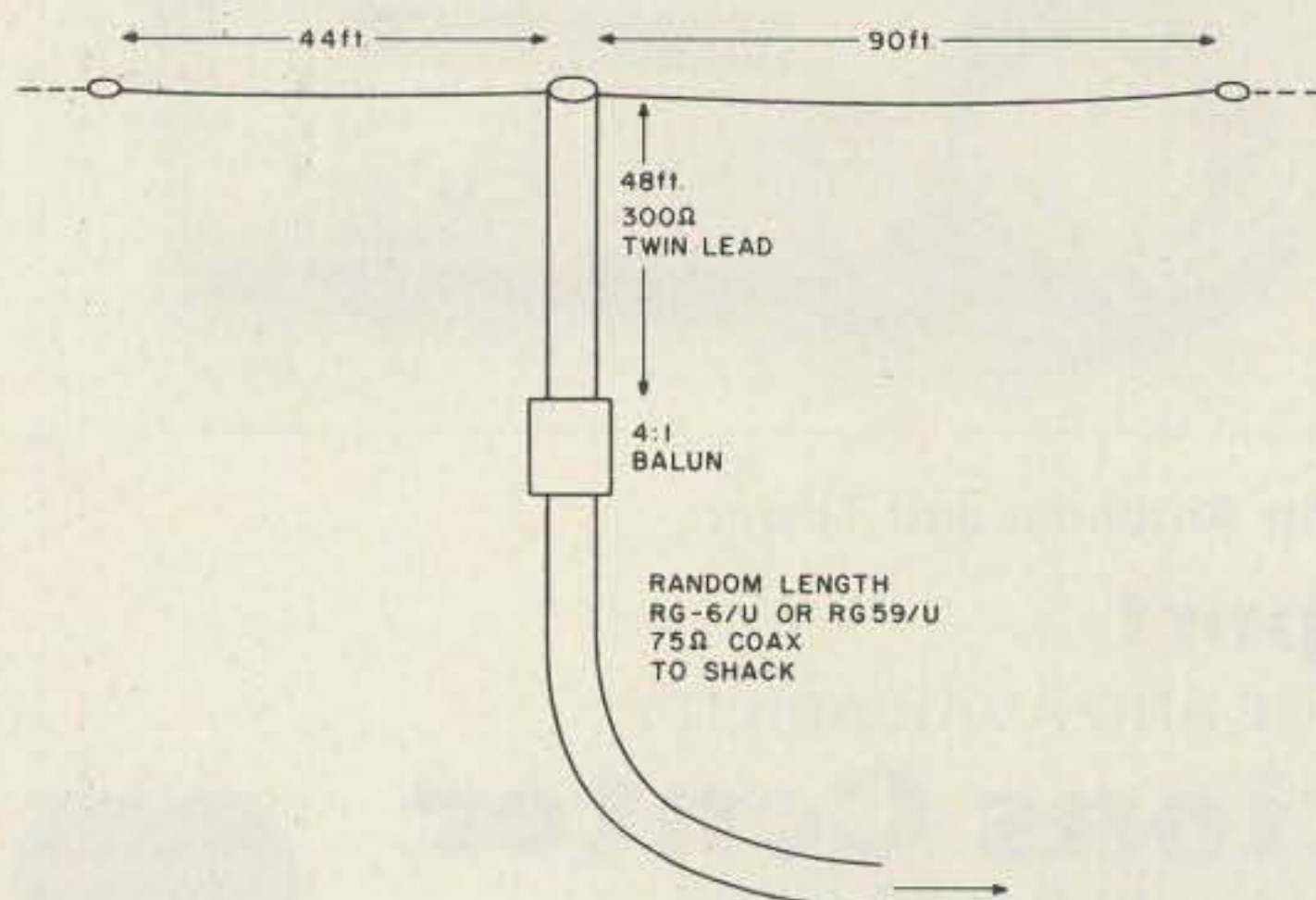

Fig. 1. Construction details of the phone man's Windom.



We did not try transmitting on 6 meters, but reception from 100 kHz to 50 MHz was phenomenal!

It is recommended that the experimenter who intends to put up one of these modified Windoms should start with measurements slightly long and prune the antenna down to proper performance. Begin with a 48-foot feedline, 93 feet of wire for the long end of the antenna, and 46 feet for the short end.

Three strain insulators will be needed, one for the middle and one on each end. Galvanized stranded-steel guy wire is probably the best all-around antenna wire for this purpose. It is strong, corrosion resistant, inexpensive, and easily soldered. It is readily available at most hardware stores.

After passing the antenna wire through the end insulators, wrap it lightly around itself so that it can easily be changed in length for tests.

For feedline, use a 48-foot length of outdoor 300-Ohm TV twinlead to start with. It may be trimmed to 47 feet if juggling the antenna length does not bring the swr down to a satisfactory level.

For the run to the shack, 75-Ohm coaxial cable is recommended. Unless transmit power is to exceed 300 Watts, RG-59/U will work just fine. If you have a length of RG-6/U cable-TV coax, it will work just as well. Its slightly larger diameter may require some vinyl jacket shaving at the ends to accommodate a conventional adapter sleeve for the PL-259 connectors.

I found the easiest way to erect the antenna was to tie a rock to the end of a roll of nylon twine, unwind thirty feet or so, and heave it over an upper limb of a tree. The twine is cut from the roll and tied to an end insulator. It is easily hoisted over the branches. The process is re-

peated at another tree at the far end of the antenna. Such an arrangement makes it easy to lower and raise the antenna during tuning procedures, as well as provides access to the antenna for repair or severe weather protection. The lower end of the twine may be tied to an inconspicuous nail driven into the tree trunk.

A typical chart of swr versus frequency for one off-centered antenna, which I personally use, is shown below. The antenna is 134 feet in total length, fed at a point which divides it into 90- and 44-foot lengths by a 48-foot length of heavy-duty outdoor 300-Ohm TV twinlead. A Unadilla 4:1 balun transformer connects the twinlead to a random length of RG-6/U, 75-Ohm TV coax to the shack.

FMHz	SWR
1.8	2.0
3.5	1.3
3.6	1.4
3.7	1.3
3.8	1.3
3.9	1.4
4.0	1.3
7.0	1.5
7.1	1.3
7.2	1.1
7.3	1.1
14.0	2.7
14.25	2.4
14.35	2.0
21.0	3.5
21.25	1.8
21.45	1.2
28.0	3.0
28.5	1.8
29.0	2.5
29.5	1.9

Signal reports have been outstanding. Even with less than 100 Watts input to the rig, it was hard to call CQ without receiving a reply, often from several stations, commenting on the strength of the signal.

Carefully pruned, the phone man's Windom antenna is an inexpensive way for any ham to get top performance on all HF bands without having to resort to a transmatch. ■

# TIMETRAC

By Comus

the microcomputer-controlled  
appointment clock

**NEW**  
First Time Offer

— NOT A KIT —

Limited Offer by  
**HAL-TRONIX**  
only \$49.95  
plus \$2.00



Shipping & handling charge

## FEATURES:

- Sleek modern styling to complement any home or office decor.
- Tells the time.
- Tells the date and year.
- Up-timer to 60 minutes, 59 seconds with pause.
- Alarm to ring at the same time everyday.
- Daily appointment sets appointments for the next 23 hours, 59 minutes.
- Future appointments up to one year.
- Dimmer switch for display.
- Memory will hold up to 30 appointments.
- Lithium power cell to retain memory during power outage.
- Appointments entered out of chronological order will be stored in chronological order.
- Colon flashes once each second.
- A.M./P.M. indicator.
- Plugs into any wall outlet.
- Easy to read vacuum fluorescent display.
- Extremely accurate quartz crystal clock.

EFFICIENT. REMARKABLE.

TimeTrac sold and distributed by HAL-TRONIX. Dealers welcome.

Send 15¢ stamp or S.A.S.E. for information and flyer on other HAL-TRONIX products. To order by phone: 1-313-285-1782.



"HAL" HAROLD C. NOWLAND  
WBZXH

**HAL-TRONIX**

P.O. Box 1101  
Southgate, MI 48195

SHIPPING  
INFORMATION:

ORDERS OVER \$15.00 WILL BE SHIPPED POSTPAID EXCEPT ON ITEMS WHERE ADDITIONAL CHARGES ARE REQUESTED. ON ORDERS LESS THAN \$15.00 PLEASE INCLUDE ADDITIONAL \$1.00 FOR HANDLING AND MAILING CHARGES.



# R Y R Y R Y

## — an electronic torture test for RTTY systems

Here is an electronic "RY" tape for those who don't have a mechanical transmitter-distributor (TD) for their Teletype® system or who have become tired of making paper tapes. It is useful for on-the-air transmissions, as well as for adjusting and troubleshooting your own teletype system. The solid-state RY tape has to be superior to a paper tape if only because it can send an

unlimited number of RYs. The solid-state unit uses eight integrated circuits and can be built to operate on any of the teletype circuit speeds. It always starts by sending an R as the first letter and will shut off only after sending a Y. One of the prototype units was tested with an expensive teletype distortion tester and was found to have had zero distortion without requiring any adjustment to

the unit. It was built for 100-wpm operation, used a reed relay to control the teletype loop, and had been set to speed with a homemade frequency counter.

The solid-state RY tape in this article is designed for 60-wpm operation, although the builder can change it to any speed by changing the RC values in the clock circuit. The unit can be made using TTL ICs or CMOS ICs. A unit made with TTL ICs requires that a well-regulated 5-volt power supply be used. The TTL output IC is capable of sinking 48 mA, so it is able to drive most 5-volt reed relays.

an R and a Y. One pulse is used as a start signal, another is used as a stop signal, and the remaining five contain the coded information for each letter. The teletype pulses are called mark and space pulses. A space indicates the circuit is open and a mark means a closed circuit. The start pulse and the five code pulses are the same length, but the stop pulse is 1.42 times as long as one of the other pulses. For this reason, the teletype code is often referred to as a 7.42-unit code.

The stop pulse is longer in order to synchronize the machines on a teletype circuit. The stop pulse gives machines that are running slightly slow an opportunity to catch up after each letter or function and thereby start in synchronization at the beginning of each new letter. If the stop pulse is longer or shorter than 1.42 units, most teletype machines are not affected, but the rate at which information is handled on the circuit is slowed or speeded up. The actual rate of information transmittal on the so-called 60-wpm circuit is 61.33 wpm. If the stop

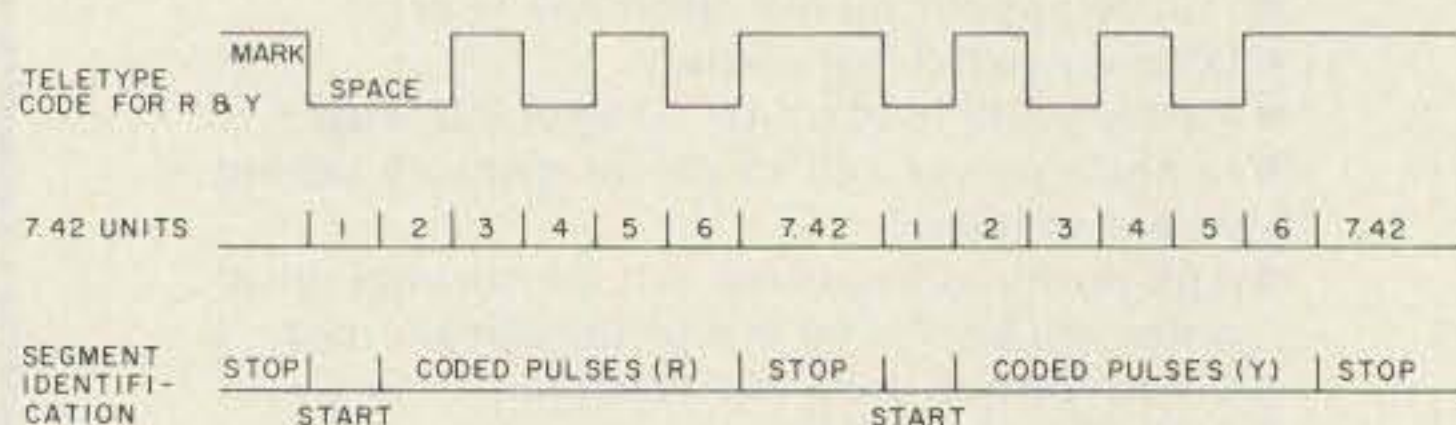

Fig. 1. R and Y Teletype® coding.

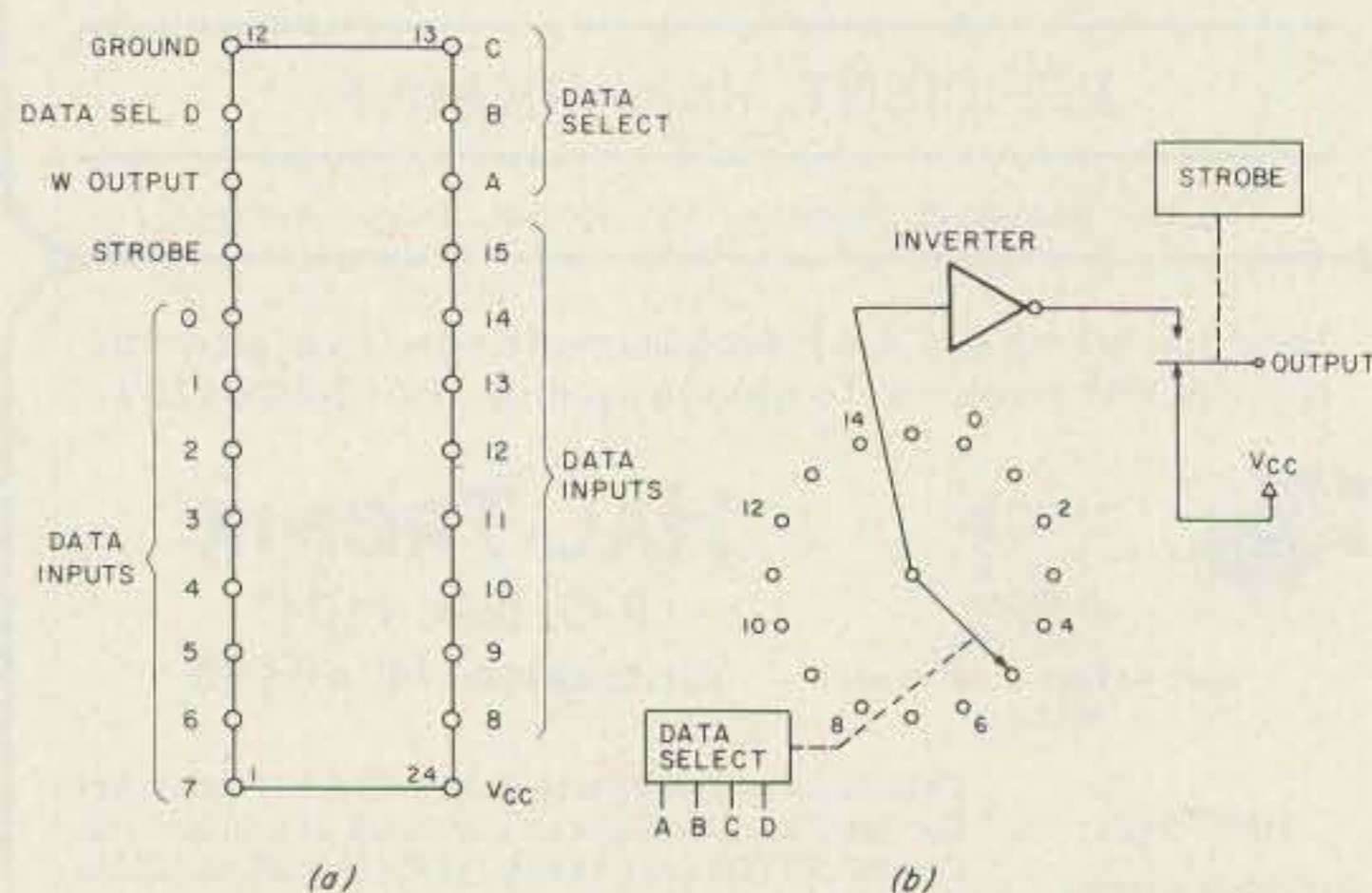

Fig. 2. The 74150 pinout and function.



pulse were made 1.50 units long with the other pulses remaining 1 unit in length, the transmission rate would decrease about 0.65 wpm and the circuit would transmit information at the rate of 60.68 wpm. Such a small difference would not affect the machines nor be noticeable to the operators.

Increasing the stop pulse to 2.0-unit lengths would decrease the rate by 4.44 wpm and slow the circuit speed to 56.89 wpm. While not harming the machines, the loss of speed is noticeable to the users. The solid-state RY tape uses a 7.50-unit code as a compromise between the cost of building a unit with exactly the correct stop pulse length and one that may do the job but obviously runs slow. Several more ICs would be necessary if the stop pulse were to be made 1.42 units long.

Accepting that a 7.50-unit code is satisfactory, the design of the solid-state RY tape can be based on an 74150 IC, which can be used to form the teletype code for the R and Y letters. The 74150 is a 16-line-to-1-line data selector/multiplexer, which means, in simple language, that it has 16 inputs and only one output. Fig. 2(a) shows a bottom view of the 74150 pins and their designations. The output pin of the 74150 can be switched to any of the input data pins, just as if the IC were a single pole, 16-position rotary switch. See Fig. 2(b). The position of the switch is controlled by the binary code present at the data-select pins of the 74150.

For example, if the binary code for 5 were present at the data-select pins, the output pin would be connected to data input pin number 5. There are two important differences between the 74150 and a mechanical switch. The IC

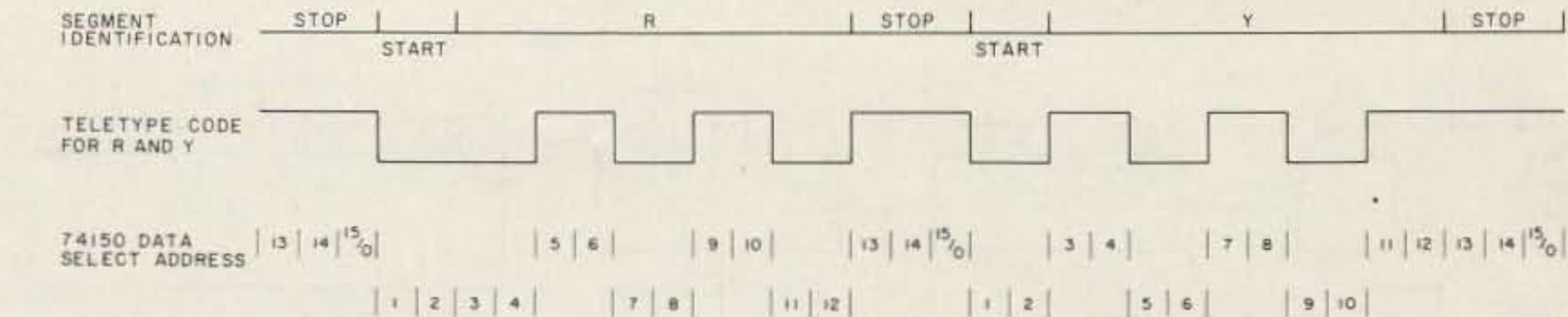

Fig. 3. Relationship between positions of 74150 and the codes for R and Y.

inverts the information between the data inputs and the output pin. That is, if the data at input pin 5 was a high, it will appear at the output pin as a low. The other difference is that the output of the 74150 has to be "strobed," which means that the output has to be turned on by a signal at its strobe pin. In the absence of the strobe signal, the output pin is at the high level. True output data is available only when the strobe signal is applied.

To cause the 74150 to form the teletype codes for the letters R and Y, the data-input pins are connected to high and low sources so that the 7.50-unit code for each letter appears at the output pin as it is connected in turn to each of the input data pins. To simplify the formation of the 7.50-unit code, the 74150 data inputs are connected to the external sources in such a manner that all 16 positions are used to form one letter. After a letter has been scanned, the external data-input sources are changed so that the other letter is generated the next time the data inputs are scanned. Using all 16 positions to form one letter allows the use of two data inputs or switch positions for each unit pulse, and three data inputs for the stop pulse, thereby making the stop pulse 1.50 times the length of the other pulses. Actually, only 15 of the 16 positions of the 74150 are used to generate a letter; the remaining position is discarded by forcing the data-select counter to

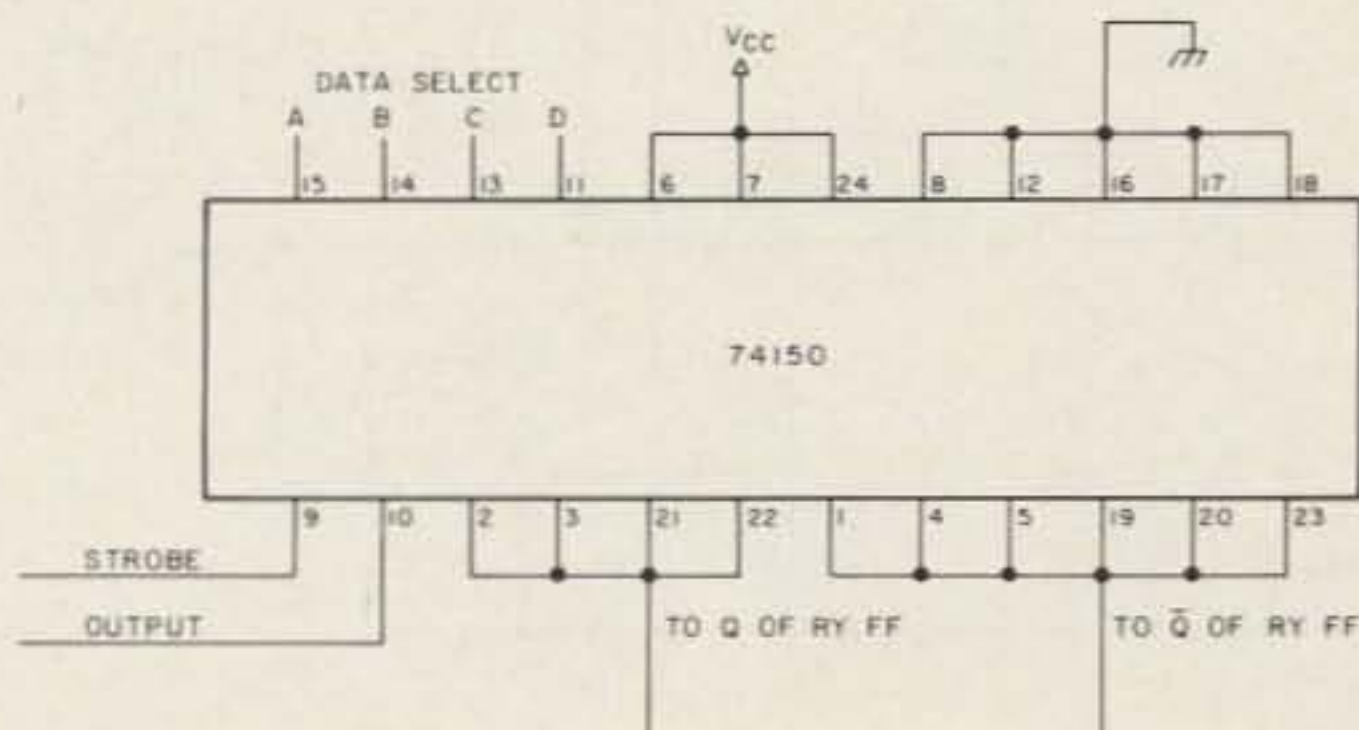

Fig. 4. External connections to 74150.

rapidly advance over the unused position.

Fig. 3 illustrates the relationship between the positions of the 74150 and the codes for R and Y. Data-select positions 13, 14, 15, and 0 are used for the stop pulse. Positions 1 and 2 are used for the start pulse. Positions 3 and 4 are for the first coded pulse, 5 and 6 are for the second coded pulse, 7 and 8 are for the third coded pulse, 9 and 10 are for the fourth coded pulse, and 11 and 12 form the fifth coded pulse. Position 15 is the position that is skipped over by forcing the data-select counter to go to a count of 0 whenever it attempts to stop on 15. More on this later.

The high and low source connections for each data input pin of the 74150 can be determined from Fig. 3. Since 13, 14, 15, and 0 are always used to form the stop pulses, they are connected to a low source. (The 74150 inverts the input signal so that the output from these pins becomes a high at the output pin.) Data inputs 1 and 2 always form the start pulse, so these pins connect to a high source. Data inputs 3, 4, 7, 8, 11, and 12 should be high to

produce an R and low to form a Y. Data inputs 5, 6, 9, and 10 have to be low for an R and high to form a Y. Fig. 4 shows the external connections to the data-input pins of the 74150 to form the teletype code for R and Y.

The alternating high-low sources for the coded pulses are obtained from the outputs of a flip-flop which is caused to change states each time the data-select inputs skip position 15. This flip-flop is a 7473, IC2a, as shown in Fig. 5.

The data-select information for the 74150 is furnished by a 7493 binary counter, IC3. The 7493 counts to 16 and its outputs are connected to the data-select inputs of the 74150 to drive the IC through its 16 positions. (The positions are numbered 0 through 15.) IC4b, a 7420, is used to detect the number 15 when the binary counter, IC3, arrives at that count. When the 7493 reaches 15, its four outputs are all high. Since the four inputs of IC4b are wired to the counter outputs, the output of the 7420 goes low. The output is inverted by IC4a and is used to reset the 7493 binary counter to zero, thereby



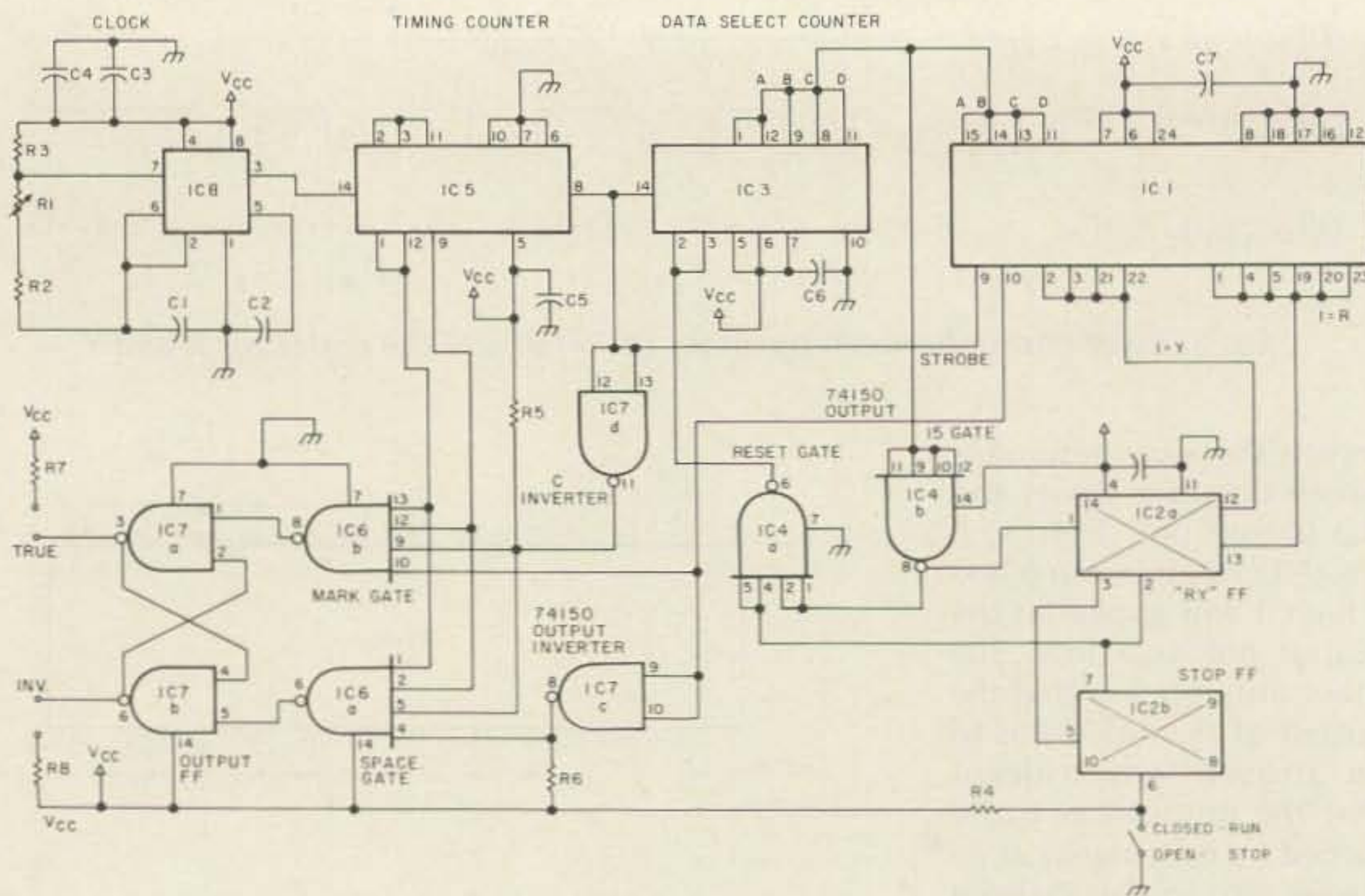

Fig. 5. Solid-state RY tape generator schematic.

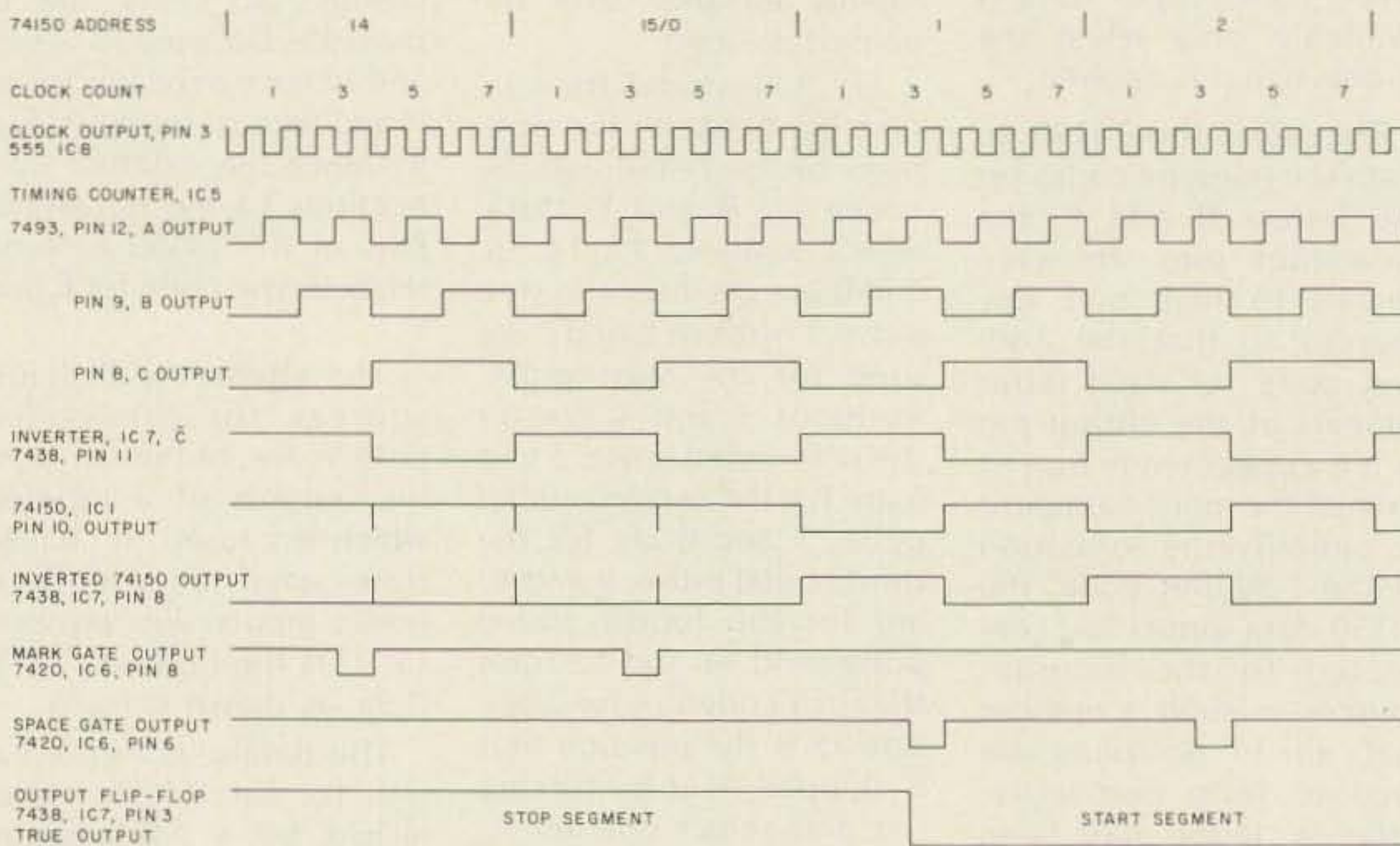

Fig. 6. Solid-state timing chart.

skipping position 15 of the 74150. The output of IC4b is also connected to the clock input of IC2a, causing the RY flip-flop to change states each time the output of IC4b goes low. Since this action takes place during the stop pulse, the new letter code is present at the data input pins long before it is needed.

The binary counter, IC3, is driven by another counter, IC5. This counter can be either a 7490 or a 7493, as the wiring in the schematic

of Fig. 5 is arranged so that either IC can be used. This counter is used to generate the timing signals for the RY tape unit in addition to driving the data-select counter, IC3. The timing signals are formed from the ABC outputs of IC5. The C output of IC5 (pin 8) is connected to the clock input of the data-select counter IC3, so the data-select counter advances one number for each eight counts for the timing counter.

Count three of the timing

counter is used to examine the output of the 74150 and determine whether the code is a mark or a space. This is done by using a pair of 4-input NAND gates, IC6a and 6b, to detect the level of the 74150 output. The A and B outputs of the timing counter, IC5, are connected directly to two inputs of 6a and 6b. The C output is inverted by IC7d, one section of a 7438, and connected to a third input of IC6a and 6b. When the timing counter is on the

count of three, the A and B outputs of the counter are high and the C output is low. The inputs of IC6a and 6b are all high because the C output was inverted by IC7d. If the fourth input of either gate becomes high, its output will become low.

The output of the 74150 is connected directly to the fourth input of IC6b. The output of the 74150 is inverted by IC7c and then is connected to the fourth input of IC6a. The C output of IC5 is used as the strobe. It turns on the output of the 74150 when the timing counter, IC5, is on counts 0, 1, 2, and 3. With a true output from the 74150 on timing count three, one of the IC6 gates will have all highs on its four inputs and a low on its output. If the output of the 74150 is high, gate 6b will have a low at its output. IC6b is the mark gate. If the output of the 74150 is low, the output of IC6a will be low. Gate 6a is the space gate.

The output stage of the solid-state RY tape is a flip-flop made up of the two remaining gates of IC7, 7a and 7b. The flip-flop is connected as an S-R type of flip-flop, with the outputs of the mark and space gates setting and resetting the flip-flop. The 7438 is an open-collector type of NAND gate and requires an external load for each gate output. The external load can be a resistor or a relay. Each of the collectors of the 7438 is capable of sinking 48 mA at 5 volts, which is more than adequate to operate 5-volt reed relays. Both collectors in the flip-flop have to have a load, so the collector not used to drive a relay has to be connected to a load resistor. If the solid-state RY tape is to be used to drive other ICs or transistors instead of a reed relay, the 7438 can be replaced with a 7400 IC, and the load resistors for all four gates can be eliminated since the 7400 is



not an open-collector IC.

One output of the flip-flop is a true output whose waveform is shown in Fig. 3, while the other output of the flip-flop is inverted. If the RY tape unit is used to drive a relay whose contacts are in series with the teletype loop current, the relay has to be connected to the inverted output of the flip-flop in order to key the line current correctly. The other (true) output of the flip-flop has to be connected to a load resistor.

A 555 IC timer is used for the clock generator. The 555, IC8, is a very stable oscillator and the circuit requires few components. The clock frequency for the solid-state RY tape used on a 60-wpm teletype circuit is 727.2 pulses per second. The usual rate for a mechanical TD is 45.45 pulses per second, but the circuit of the RY tape unit requires a much higher clock speed to arrive at the 60-wpm teletype circuit speed.

Two of the data-select positions are used for each teletype code segment. This doubles the internal clock speed from 45.45 to 90.90 pps. The timing counter divides the clock by eight, so 8 times 90.90 equals 727.2 pulses per second.

The clock can be set without a counter if necessary, if an operating teletype printer is available. With the solid-state RY tape unit connected in your local teletype loop, adjust the frequency control until the machine prints RYs. Refine the adjustment until the rangefinder on the printer can be set to the normal reading for your loop, using the solid-state RY tape as the source for checking the rangefinder. The 100k adjustable resistor in the clock circuit is adequate to compensate for the tolerance of the components in the timing circuit so that the clock

easily can be adjusted to the right frequency.

The slightly longer stop pulse used in the solid-state RY tape does not change the required clock speed nor influence the setting of the rangefinder. The only pulse lengths bearing on clock frequency or rangefinder setting are the start and coded pulses. They have to be 22 milliseconds long for a 60-wpm teletype circuit. The stop pulse affects just the rate of information transmittal.

The circuit which causes the solid-state RY tape to start with an R and end the transmission after sending a Y includes a 7473 flip-flop, IC2b, and the reset gate, IC4a. The clear or reset, pin 6, of IC2b is connected to 5 volts through a 1k resistor. Pin 6 is also connected to a

switch identified as the Stop-Run switch. This switch connects the reset to ground when the switch is closed. The switch is closed in the Run position and the low on the reset pin holds the flip-flop in the reset condition. The  $\bar{Q}$  output of IC2b is held high and fed to the reset of IC2a, allowing IC2a, the RY flip-flop, to respond to signals on its clock input. The high from the  $\bar{Q}$  output is applied also to input pins 4 and 5 of the reset gate, IC4a, enabling the 15 gate, IC4b, to control the reset signal to the data-select counter, IC3. Under these conditions, the solid-state tape runs, coding teletype RYs, until the Stop-Run switch is opened.

When the Stop-Run switch is opened, the unit stops running after a com-

plete Y is sent. With the switch open, there is a high from the 5-volt supply through the 1k resistor on the reset pin of IC2b. This enables the Stop flip-flop to respond to negative-going signals on its clock input, pin 5. Following the completion of a coded Y, the 15 gate clocks the RY flip-flop to a reset condition where the Q output becomes low. The low from the Q output of the RY flip-flop clocks the input of IC2b, causing the flip-flop to assume the set state. The  $\bar{Q}$  output of the Stop flip-flop is now low. This low is fed to the reset, pin 2, of the RY flip-flop, holding IC2a in the reset condition. The RY flip-flop is held in the state which will cause an R to be sent as the first letter of the next sequence. The low is

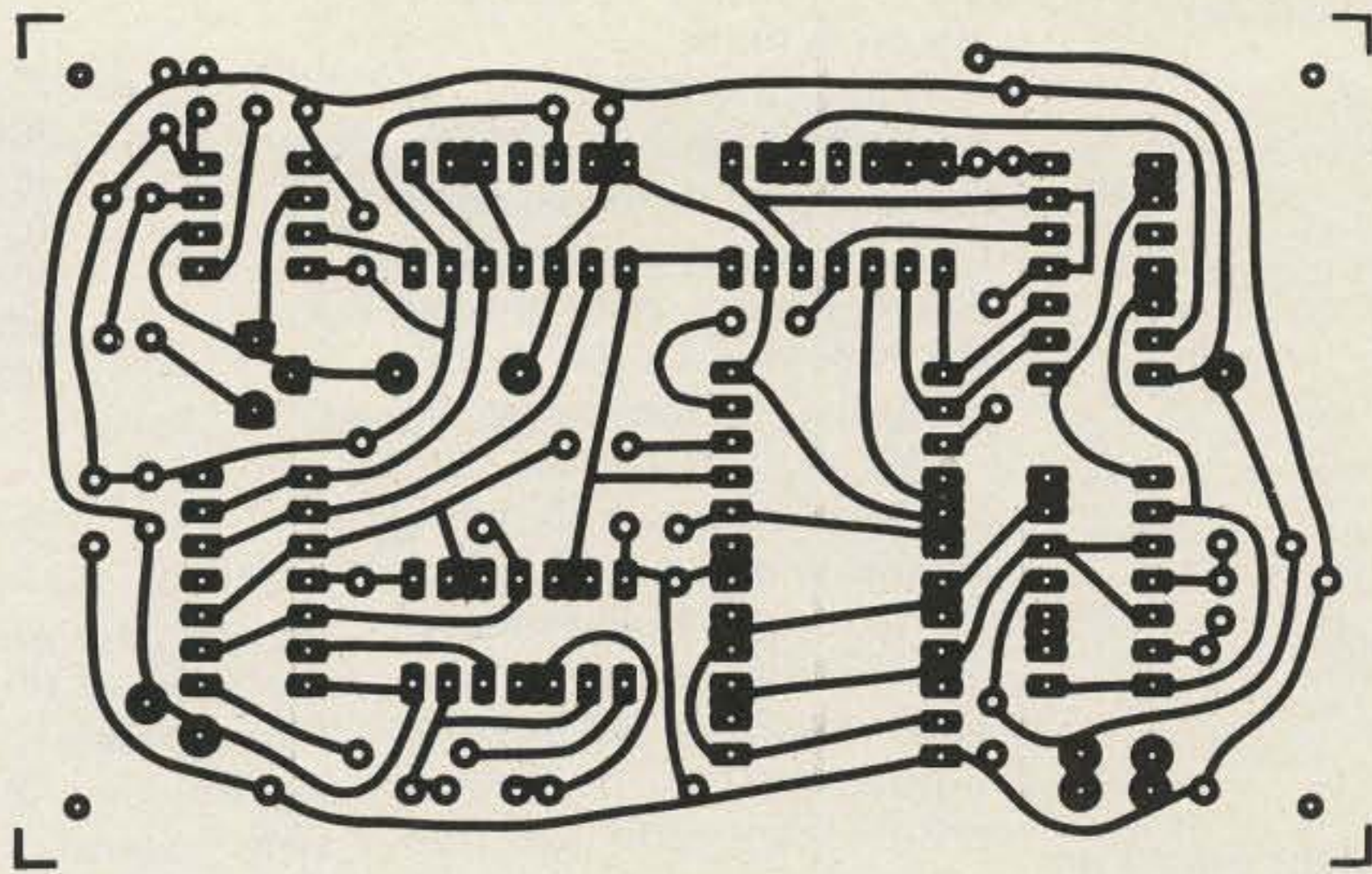

Fig. 7. PC board layout.

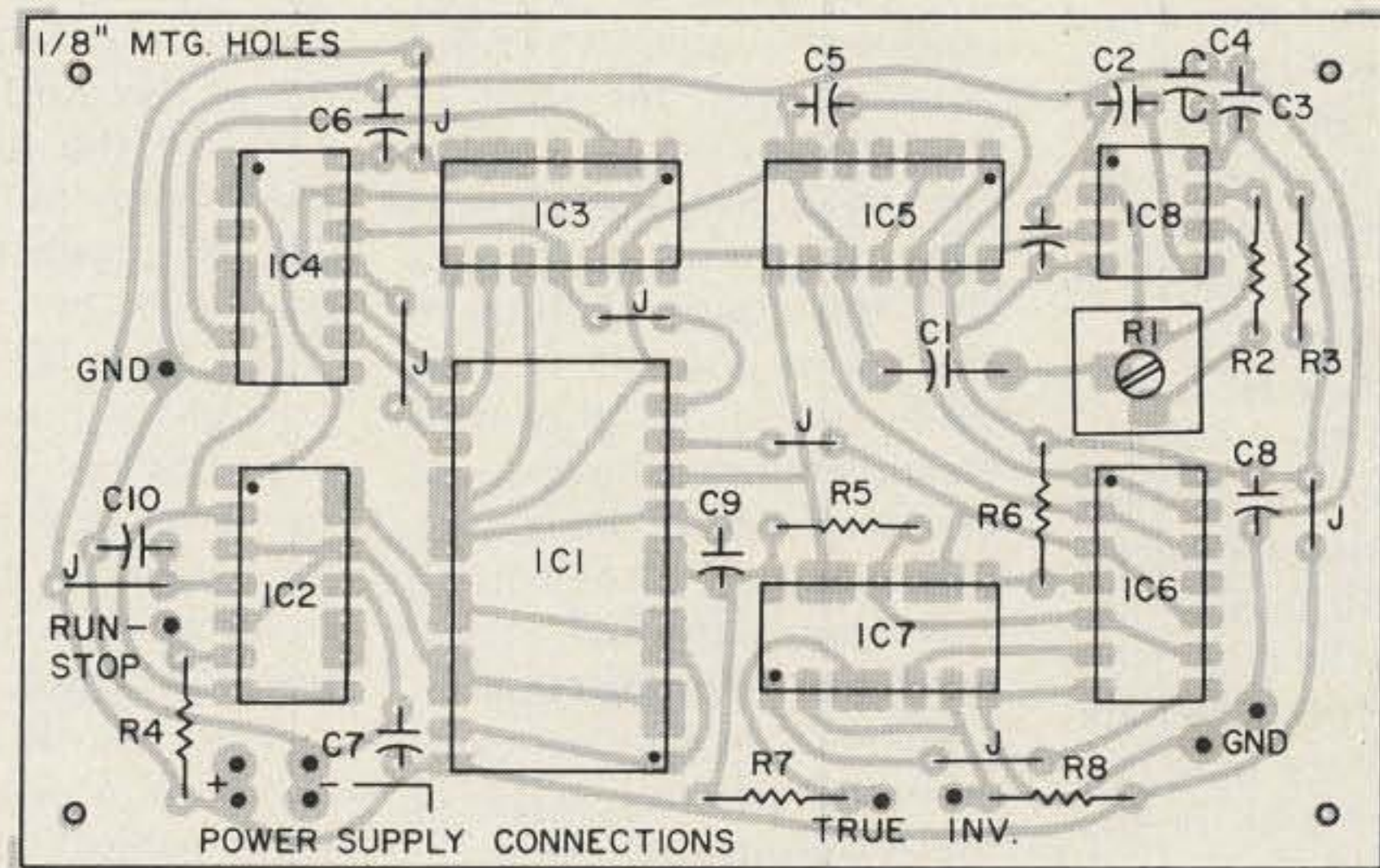

Fig. 8. Component location.



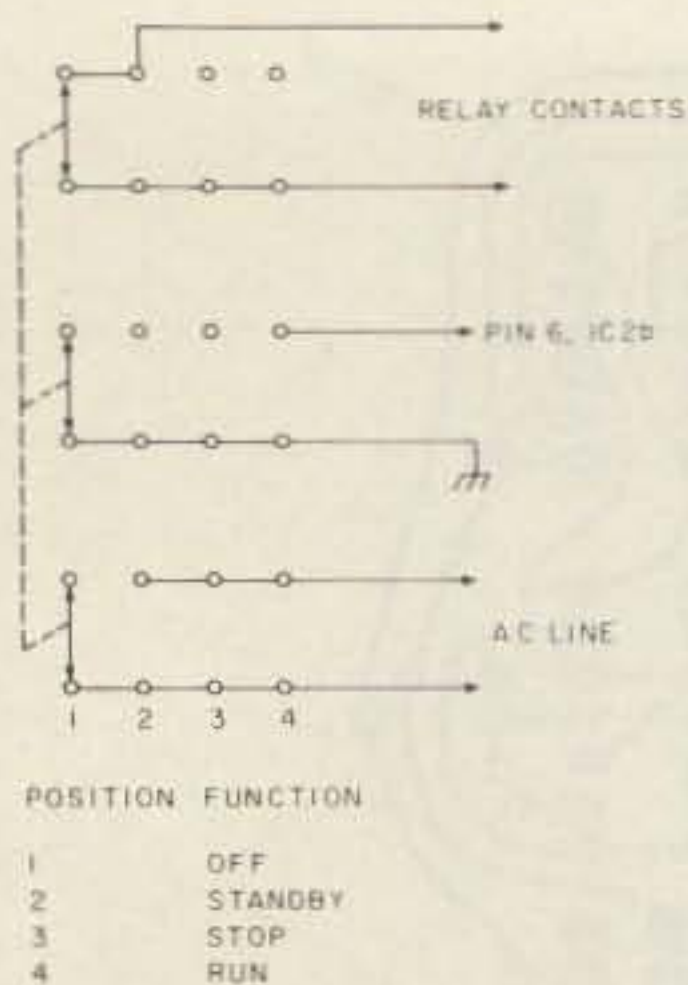

Fig. 9. Alternate Stop-Run switch arrangement.

also fed to input pins 4 and 5 of the reset gate, IC4a. The output of IC4a becomes high and holds the data-select counter, IC3, in the reset condition with its output on number zero.

The solid-state RY tape is stopped until the Stop-Run switch is placed in the Run position. Closing the switch resets the Stop flip-flop. This removes the reset from the data-select counter and the solid-state RY tape runs beginning with R as the first letter transmitted.

Fig. 6 is a timing chart of the solid-state RY tape unit. It illustrates the waveforms of the important circuits during part of the stop segment and part of the start pulse. This action takes place during the time the 74150 IC is advancing through positions 14, 15/0, 1, and 2. As shown, the 74150 data-select count is advanced one position for each eight clock pulses. The A, B, and  $\bar{C}$  outputs combine with the output of the 74150 in the mark and space gates each time the count in timing counter IC5 is three. During the time the 74150 is on positions 14 and 15/0, the output of the IC is a high. This causes the mark gate output to become low during the time the timing counter count is three. The low triggers the output flip-flop and causes the true output of the flip-flop to remain high. The stop pulse is

always a mark.

When the 74150 is on positions 1 and 2, the output of the IC is low. Notice that the true output of the 74150 occurs only during the time the strobe is low (output C of IC5). Now the inverted output of the 74150 combines with the A, B, and  $\bar{C}$  outputs of IC5 in the space gate to generate a low at the output of the gate. This low triggers the output flip-flop to the opposite state, and the true output now is a low or space.

Notice that the teletype pulses or segments do not coincide with the start of the 74150 positions. The beginning or end of each teletype segment coincides with the count of three in the timing counter. At that time, three of the four waveforms that have to be in coincidence have stabilized and the fourth waveform is the high at output A of the timing counter. The mark or space begins with the positive edge of the A output waveform.

While there are two triggers or lows developed during each teletype segment (three in the case of the stop pulse), only the first will cause a change in the state of the output flip-flop.

Fig. 7 is the foil pattern of the printed circuit board for the solid-state RY tape. It is a single-sided board with seven jumpers completing the pattern. The spacing between ICs is sufficient so that sockets can be used, although they are not recommended. It's preferable to solder the ICs to the PC board.

Fig. 8 is the layout of components on the board. All the components shown in Fig. 5, except the Stop-Run switch, mount on the PC board. Four external connections to the board are required to make use of the RY tape unit. The four connections are: Vcc, Stop-Run switch, output, and

	TTL	CMOS
IC1	74150	74C150
IC2	7473	74C73
IC3	7493	74C93
IC4	7420	74C20
IC5	7490 or 7493	74C90 or 74C93
IC6	7420	74C20
IC7	7438 or 7400	74C00

Table 1.

ground. Several extra ground pads are located on the edge of the board pattern for convenience in wiring the unit into the teletype system.

There also are solder pads in the pattern so that the load resistor can be connected in the unused output of the output flip-flop.

While the discussion of the RY tape unit referred to TTL IC numbers only, the unit can be constructed with CMOS ICs if the lower cost of the power supply is important or if it is desired to share an existing power supply of suitable voltage. In either case, a 555 IC will be used at IC8.

The TTL ICs and their CMOS equivalents are listed in Table 1.

IC5 can be a 7490 or 7493 TTL IC or a 74C90 or 74C93 CMOS IC, as the PC board foil pattern is made so that either type of IC can be placed in this position. The counter is used only to count to eight, so either a decade or binary counter will work.

The table of TTL ICs shows a 7438 or a 7400 TTL IC at IC7. If the unit is to be used to drive a power-consuming load such as a relay, the 7438 IC should be used as it can sink 48 mA. If the RY tape unit is used as a signal source, a 7400 IC can be used at IC7. The 1k load resistors are not required if

the 7400 is used.

If the unit is built using CMOS ICs, the load resistors are not needed and the IC used at IC7 will not drive a load. If it is necessary for the unit to operate a relay, a transistor can be added as the relay driver.

If the tape unit is to be installed permanently in the teletype loop, the simple Stop-Run switch can be replaced with a 3P4T rotary switch, as in Fig. 9. One pole of the switch is used to place a short across the relay contacts of the RY tape unit in the Off and Standby positions. This keeps the teletype loop closed so that the other equipment attached to the loop can function when the relay contacts are open during the time the power is off to the RY tape unit. When the power is applied by switching to the Standby position, it is possible, depending on the ICs in the unit, that a letter or part of a letter will be generated. The short on the contacts in the Standby position will prevent the unwanted transmission from appearing in the loop.

Another pole is used to turn the ac power on and off and the third pole is the Stop-Run switch. It operates just as in the previous description of the SPST Stop-Run switch action. ■

#### Parts List

C1	2000-pF, 5% mica
C4	6.8-uF, 25-volt, tantalum
C2, C3,	
C5-C10	0.02-uF, 50-volt
R1	100k trimmer, cermet, 63P104
R2	390k
R3	120k
R4-8	1k



**new**

# Looking For a VHF/UHF FM Link System? With or Without Autopatch?

- For Remote Autopatch Hookup
- To Link 2 Repeaters. (W/or W/O Autopatch).
- To Reach a Remote Station
- Other Special Purpose Application!



Spectrum is proud to announce that we are now supplying a wide line of VHF & UHF Link equipment such as Full Duplex or Half Duplex/Simplex link transceivers and rack mount Link Receivers, etc. These units are typically made up from our SCR1000/4000 Repeater Mainframes, but they are specially modified for Link Transceiver use.

The link units typically operate "cross band", e.g. 2M to 220MHz, or 2M to 450MHz, or vice versa, etc. We normally supply complete systems, including rack mount Link Transceivers, possibly a main Repeater, plus any duplexers, antennas, cable, cabinets, etc. However, we can also supply shielded receiver & transmitter subassemblies (w/ or w/o rack mount panel), as well as COR, ID and Touch Tone Control Boards, etc.

SCR1000 Link Transceiver

These systems are often used to link a very remote mountain-top Repeater (which has no access to a phone line), to a site in the valley where there is access to a phone line. The Autopatch unit is then located at the valley site, and is "linked" to the mountain-top repeater which has "tremendous coverage", thereby providing wide area Autopatch service! There are also many other applications for Link Systems. Call or write us today to discuss your particular requirements!

## COMMERCIAL MOBILE & BASE TRANSCEIVERS - For U.S. or Export Markets

*"Professional Communications Line"*

(225-240 MHz Commercial Export)

- Very attractive woodgrain housing.



PCL250 30W. Min. Mobile Unit

- 136-174 MHz & 220-240 MHz (450 soon).
- 6 channels.
- 0.35 uV Rcvr.
- 8 Pole Crystal Fltr.
- Beautiful Audio—RX & TX.
- Very Reasonable Price!



- "Super Rugged" Housing. Solid 1/8" Thk. Aircraft Aluminum!



PCL300 30W. Base Station

- Built-in AC Power Supply.
- Front Panel Status Indicator Lights. ("Busy," Xmit, & AC Power.)
- Optional Rcvr. Scanning Function Available.

FCC TYPE ACCEPTED — PARTS 21, 81, 90



# SPECTRUM COMMUNICATIONS

Commercial Business Radio Write or call for Data Sheets, prices, etc. • Export orders—Contact our International Dept. Dealer Inquiries Invited 1055 W. Germantown Pk., Dept. S8 • Norristown PA 19401 • (215) 631-1710



# Goin' Mobile

## — equipment for air-conditioned gypsies

SSG James T. Ashcraft  
 KL7IPE/DAISM  
 261st Signal Company  
 DCS Station Breitsol  
 APO NY 09162

Dieter W. Potzel DF7NM  
 Gartenstrasse #2  
 8751 Dammbach O.T. Kr  
 West Germany

**"K** P4I, this is DA1SM/mobile."

"DA1SM/mobile, this is KP4I; you are 5 and 3 here, old man . . ."

Not too bad for a converted CB from central Germany on a homebrew helical whip. If you like excitement, this little rig can deliver!

"Hey, Dieter, I just got a 1979 Cobra 140 GTL SSB CB rig. Will you help me convert it to 10 meters?"

So, in the true ham spirit, we jumped into something about which we knew very little. Since *73 Magazine* is just about the only link we have with current technical information and trends in amateur radio, I read every article printed during 1978 pertaining to CB-to-10 conversion with PLL frequency synthesis. From this information, it was apparent that we would be looking at two crystal-controlled oscillators in the Cobra. They are controlled by crystals X1 and X4. Crystal X1 runs the programmable divider, IC2, operat-

ing at 10.240 MHz. The other, X4, operates at 11.1125 MHz, and that is the one we are going to change.

So, the first thing to do was figure out what's the first thing to do! Since the bulk of 10-meter DX in Europe is between 28.450

MHz and 28.700 MHz, we decided to put channel 1 at 28.450 MHz, with channel 40 ending up at 28.890 MHz.

Fig. 1.

### FREQUENCY SYNTHESIZER ALIGNMENT

Test Equipment	Test Point	Transceiver Controls	Adjust	Remarks
Frequency counter	TP12	Ch. 19, AM	—	Check for 10.240 MHz (we got 10.2385 MHz).
Oscilloscope or rf mV meter	TP16 (L18 secondary)	Ch. 19, AM voice lock mid-range	L18	Adjust for maximum rf.
dc voltmeter	TP9	Ch. 40, AM	L13	Adjust for 5.00 volts.
Oscilloscope or rf mV meter	TP1	Ch. 19, USB	L14	Adjust for maximum rf.
Frequency counter	TP1	Ch. 19, USB voice lock mid-range	CT3	Adjust for 36.4725 MHz $\pm$ 20 Hz. Check all channels. See Fig. 2. If no reading, readjust L18 and L14 until they have more than one peak. Use maximum peak.
Frequency counter	TP1	Ch. 19, LSB voice lock mid-range	L19	Adjust for 36.4675 MHz $\pm$ 20 Hz. Check all channels. See Fig. 2.
Frequency counter	TP1	Ch. 19, AM voice lock mid-range	L20	Adjust for 36.4700 MHz $\pm$ 20 Hz.
Frequency counter	TP1	Ch. 19, LSB Transmit	VR3	Adjust for 36.4675 MHz $\pm$ 20 Hz.
Frequency counter	TP10	Ch. 1, USB	—	Check for 1.430 MHz. Check all channels. See Fig. 2.
Frequency counter	TP3	Ch. 19, USB	CT1	Adjust for 7.8025 MHz.
Frequency counter	TP3	Ch. 19, LSB	CT2	Adjust for 7.7975 MHz.
Frequency counter (disconnect TP7 and TP8)	TP3	Ch. 19, AM Transmit	L17	Adjust for 7.800 MHz $\pm$ 5 Hz.

### RECEIVER ALIGNMENT

Connect an ac VTVM or high-Z FET VOM (ac) across the speaker coil and adjust the volume control for a suitable indication. Keep the rf signal generator output level as low as possible to prevent agc limiting. If you do not have a generator, you can use another transmitter operating AM or CW into a dummy load on low power at the operating frequency for Ch. 19, and then adjust the "rf cans," in sequence as listed below, for maximum noise. Mode AM, rf-gain maximum, squelch minimum, voice lock mid-range, NB off.

Test Equipment	Transceiver Controls	Adjust	Remarks
Output of signal generator through	Ch. 19, AM	L3, L4	Adjust for maximum output on







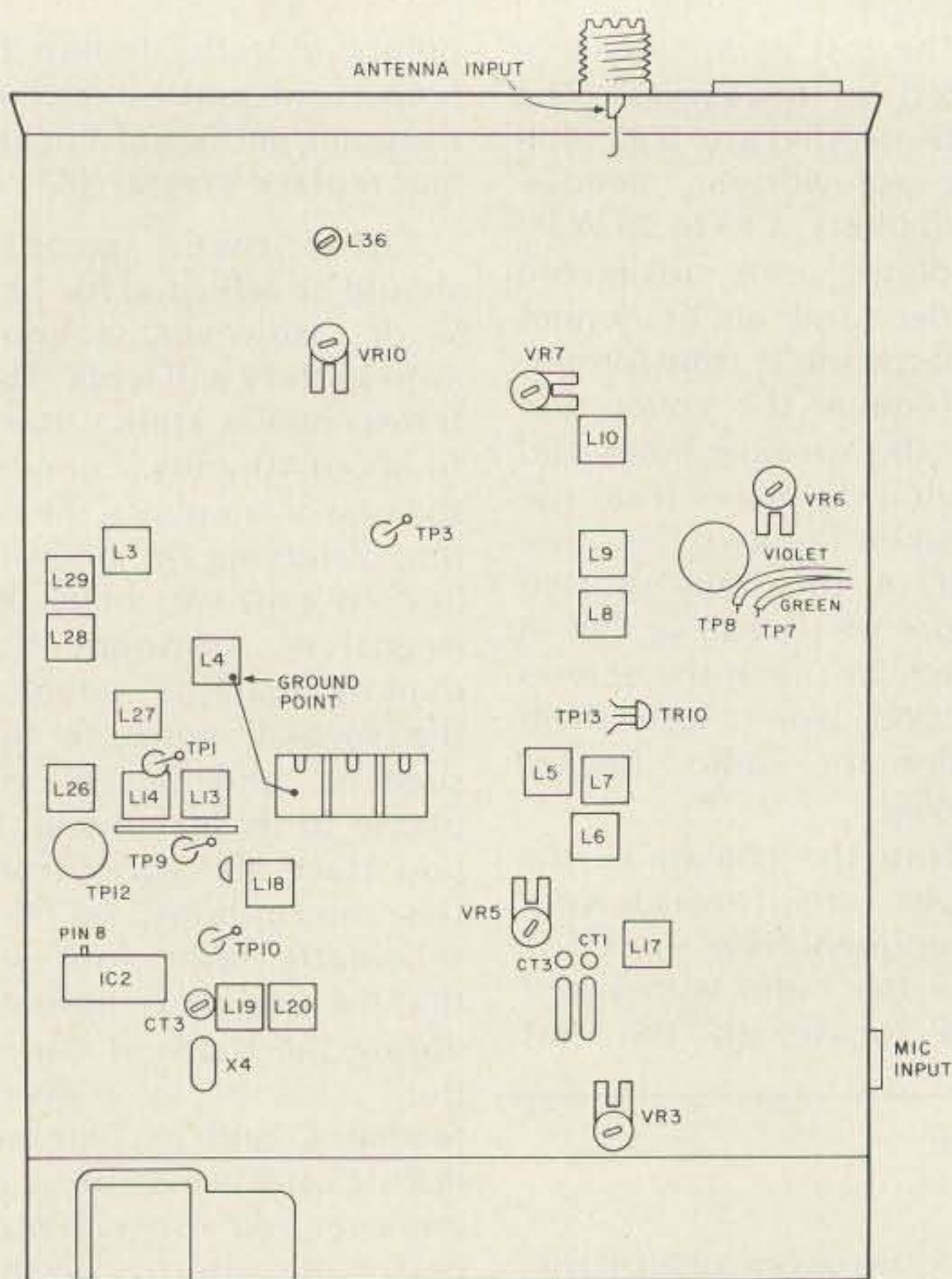

Fig. 2. Control knobs.

the time was spent finding out that L14 and L18 have more than one peak indication, and that only the correct peaks would produce the correct indication on the frequency counter at TP10. The second unit took only 40 minutes. So, take your time and follow the directions carefully. Watch out for the front panel settings. We also spent a lot of time backtracking by not having the correct transceiver control settings.

What do you think about 10 kHz transceiver incremental tuning—and still

have RIT operate normally? I just couldn't take it when some station was just far enough off frequency that I could hear him/her, but I wasn't able to transmit on the same frequency. Now we have almost continuous tuning from channel 1 to 40. But that's another story, and I love it!

Dieter and I usually monitor channel 9 (that's 28.550 MHz) or USB when we're mobile 5 days a week (any five days) between 0500 and 0600 GMT and 1700 and 1800 GMT. If the band is good, see you there. 73 and good DX. ■

Channel	Operating Frequency(MHz)	Divider Input TP10 (MHz)	AM Rec, vco out TP1 (MHz)
1	28.450	1.4300	36.2500
2	28.460	1.4400	36.2600
3	28.470	1.4500	36.2700
4	28.490	1.4700	36.2900
5	28.500	1.4800	36.3000
6	28.510	1.4900	36.3100
7	28.520	1.5000	36.3200
8	28.540	1.5200	36.3400
9	28.550	1.5300	36.3500
10	28.560	1.5400	36.3600
11	28.570	1.5500	36.3700
12	28.590	1.5700	36.3900
13	28.600	1.5800	36.4000
14	28.610	1.5900	36.4100
15	28.620	1.6000	36.4200
16	28.640	1.6200	36.4400
17	28.650	1.6300	36.4500
18	28.660	1.6400	36.4600
19	28.670	1.6500	36.4700
20	28.690	1.6700	36.4900
21	28.700	1.6800	36.5000
22	28.710	1.6900	36.5100
23	28.740	1.7200	36.5400
24	28.720	1.7000	36.5200
25	28.730	1.7100	36.5300
26	28.750	1.7300	36.5500
27	28.760	1.7400	36.5600
28	28.770	1.7500	36.5700
29	28.780	1.7600	36.5800
30	28.790	1.7700	36.5900
31	28.800	1.7800	36.6000
32	28.810	1.7900	36.6100
33	28.820	1.8000	36.6200
34	28.830	1.8100	36.6300
35	28.840	1.8200	36.6400
36	28.850	1.8300	36.6500
37	28.860	1.8400	36.6600
38	28.870	1.8500	36.6700
39	28.880	1.8600	36.6800
40	28.890	1.8700	36.6900

To make a chart for the 73 channelization plan when X4 is 11.7792 MHz, just start channel 1 at 28.965. TP10 will not change, TP1 will be 36.7650, and go from there. Channel 23 frequencies are not a mistake.

Fig. 3. Frequency chart when X4 is 11.6075 MHz.

**MODEL TR70A**  
**ATV RECEIVING CONVERTER, 420-450 MHz**

- **TUNABLE**-vernier tuned, 420 to 450 MHz
- **HIGH PERFORMANCE**-low noise RF preamp., mosfet mixer, mosfet IF amp. [Ch2 or 3 out]
- **SELF-CONTAINED**-including power supply
- **1 YEAR WARRANTY**
- **PRICE: \$ 88.00** [includes shipping. Add \$ 1.15 for COD shipment]

To order, or receive detailed information, write us or call us at 1-812-336-4775

**APTRON LABORATORIES** ✓8  
 PO BOX 373, BLOOMINGTON, INDIANA, 47402



**FREE!**  
**RADIO AMATEURS**  
**WORLD ATLAS**  
 with purchase of famous  
**CALLBOOK**  
**MAP LIBRARY!**

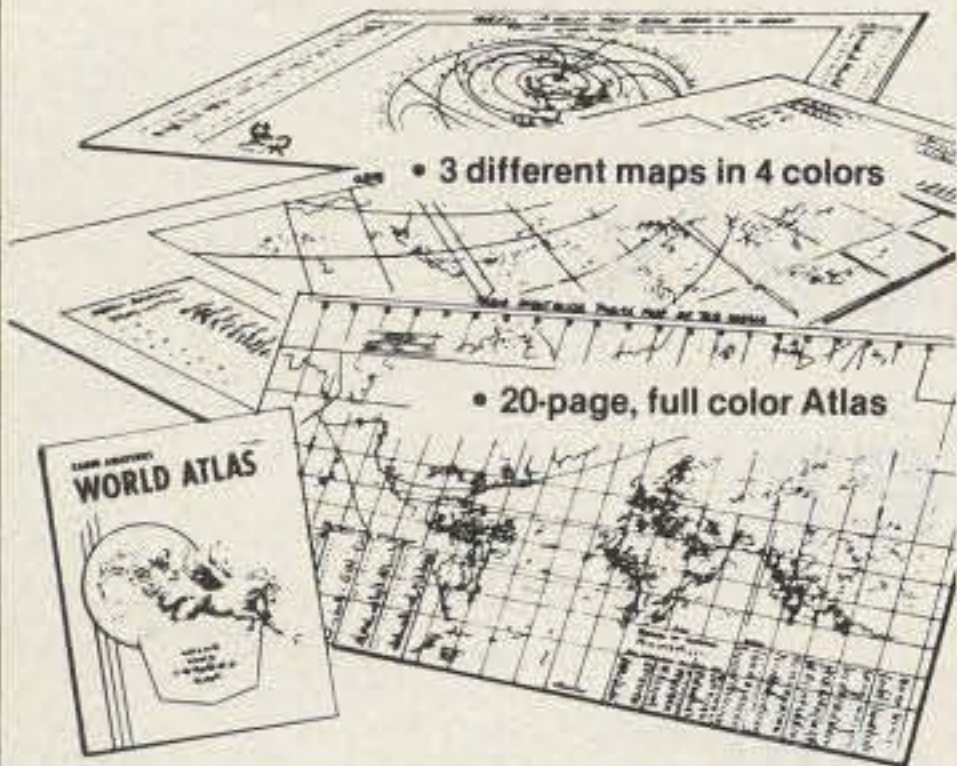

Here's an offer you can't refuse! You receive three, information-packed, Amateur Callbook maps, folded, plus the World Atlas for only \$4.50 plus \$1.50 shipping and handling. If purchased separately, total value of map/atlas offer would be \$7.50 plus shipping. You save \$3.00 and get these invaluable radio amateur aids!

- 1. Prefix Map of the World, folded.**  
 World-wide prefixes. Shows 40-zone map on one side, 90-zone map on the other. Size 40" x 28"
- 2. Map of North America, folded.**  
 Includes Central America and Caribbean to the Equator. Shows call areas, zone boundaries, prefixes, etc. Size 30" x 25"
- 3. Great Circle Chart of World, folded**  
 Centered on 40°N, 100°W. Shows cities, latitude, longitude, great circle bearings and more! Size 30" x 25"

**Plus special FREE bonus!**  
 The Callbook's own **Radio Amateur World Atlas**, FREE with the purchase of the 3 maps. Contains eleven full color maps of the world, looking at things from the radio amateurs point of view.

Callbook Map Library	\$4.50
Shipping	1.50
<b>Total</b>	<b>\$6.00</b>



**Special Offer!**  
**Amateur Radio**  
**Emblem Patch**  
**only \$2.50 prepaid**

Pegasus on blue field, red lettering. 3" wide x 3" high. Great on jackets and caps. Sorry, no call letters.

**ORDER TODAY!**

Order from your favorite electronics dealer or direct from the publisher. All direct orders add \$1.50 for shipping. Illinois residents add 5% Sales Tax.

**RADIO AMATEUR**  
**callbook INC.** ✓61  
 Dept. BN  
 925 Sherwood Drive  
 Lake Bluff, ILL 60044

**APPLE Owners**  
**send & receive**  
**CW/RTTY**



**FEATURES**

- Send & Receive MORSE, BAUDOT, ASCII
- Connects to APPLE game I/O port.
- Split Screen - edit while receiving.
- Uses builtin PLL or external TU.

- Includes hardware, cassettes & manual
- Word Oriented Editor
- Instant Break operation—preserve type-ahead buffer
- Eight message memories—255 char. ea.
- Auto transmitter control—PTT
- Diddle, Replay, Cassette Save, CW ID (RTTY only)
- Random Practice, Beacon, change spacing (Morse only)
- CA650 In cabinet as illustrated \$259
- TA650 FSD-1 active filter HTTY demodulator, XTL-1 xtal controlled AFSK and AC power supply installed in CA650 (assembled/tested) \$499
- A6500 adds disk-based RTTY to CA650/TA650 \$50

**Write or call for complete catalog**



**MACROTRONICS, inc.®**

1125 N. Golden State Blvd. / Suite G  
 Turlock, CA 95380 (S)  
 (209) 667-2888 / 634-8888



*We are experiencing telephone difficulties, please keep trying.*

California residents add 6% tax

**NEW MFJ SOLID STATE**  
**24 HOUR DIGITAL CLOCK**

Eliminate converting to GMT. Pleasant **BLUE** easy-on-eyes display. Bright .6 inch digits. **ID timer**. Alarm, snooze, lock functions. Power out, alarm on indicators. Assembled.

**Pleasant Blue Display**  
**is easy-on-eyes.**  
**Bright .6 inch digits.**  
**Built-in ID timer.**

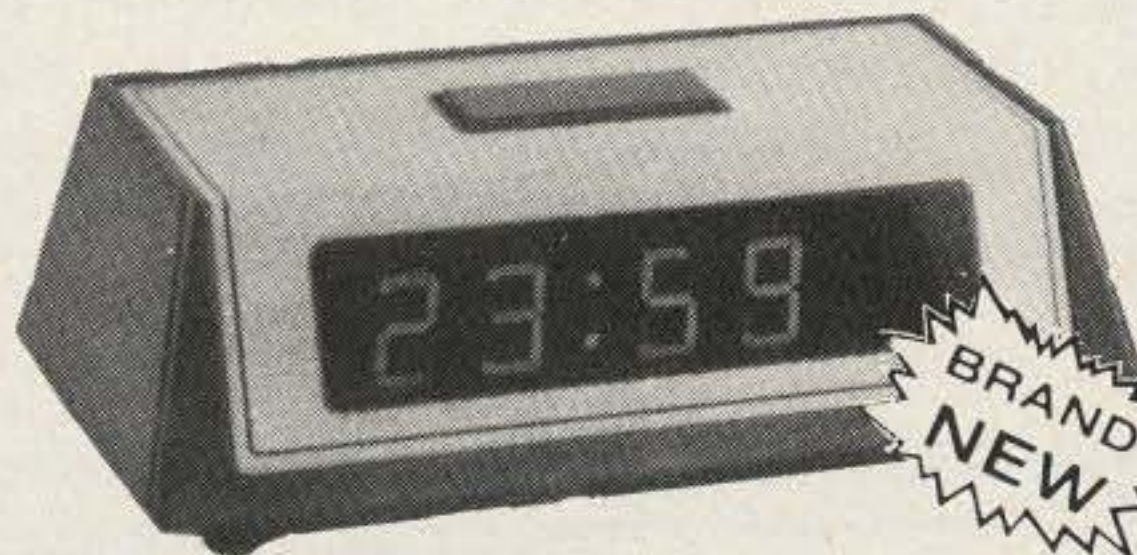

**BRAND NEW**

**\$29<sup>95</sup>**

The MFJ-101 is a new all solid state 24 hour digital clock. Just set it to GMT and forget about converting to GMT.

Pleasant **blue .6 inch digits** (like TS-820S) are easy-on-eyes and bright enough to see clear across your room.

**ID timer** alerts you every 9 minutes after you tap ID/doze button.

**Set alarm** to remind you of SKED or simply to wake you up in morning. Has alarm on indicator.

**Fast/slow set buttons** make setting time and alarm simple.

**Lock function** prevents missetting time/alarm. Digits flash if power is interrupted. Rugged black plastic case. Brush aluminum front/top panel.

**UL approved.** 110 VAC. 50/60 HZ switch for USA, Europe, Japan and other countries. Use

220/240 VAC with optional AC adapter. 6x2x3 in.

**Order from MFJ and try it — no obligation.** If not delighted, return it within 30 days for refund (less shipping). One year limited warranty by MFJ.

**Order today.** Call toll free 800-647-1800. Charge VISA, MC or mail check, money order for \$29.95 plus \$3.00 shipping/handling for MFJ-101.

**Don't wait any longer** to enjoy the convenience of reading GMT time directly.

**CALL TOLL FREE ... 800-647-1800**

Call 601-323-5869 for technical information, order/repair status. Also call 601-323-5869 outside continental USA and in Mississippi.

**MFJ ENTERPRISES, INC.**  
 BOX 494, MISSISSIPPI STATE, MS 39762



# Inside Radio Shack's Digital Receiver

## — SWLing with the DX-300

If you have been around communications equipment for at least the past ten years or so, you will recall literally drooling over a receiver whose digital display of frequency was so accurate that you could dial up a frequency and listen. If nothing was heard, you were assured that the transmitter was not on the air. This selfsame receiver had controls for audio bandwidth and rf/af gain and cost a pretty penny unless you were o.d. in color

and eligible to have government property.

Well, as I unpacked Radio Shack's new model DX-300 receiver, that old feeling crept up on me. The receiver is everything you have always wanted to ask for in a receiver, and more. The more is the LED digital frequency display and the price, which is less than \$400.00. Considering the fact that frequency coverage extends from 10 kHz to 30 MHz, the DX-300 would appear to be that single

multi-purpose receiver suitable for both the Novice ham and the Advanced ham, with the shortwave listener thrown in for good measure.

Naturally, I was a doubting Thomas—several of us were: The price, the way the receiver looked, and the specifications contained in the manufacturer's literature seemed like a dream come true. But true skeptics that we were, we subjected the DX-300 to a

series of tests, using a likewise diverse series of testers. The receiver was used portable (on its internal eight C-cell batteries), plugged into a car's cigar lighter, and fixed, operating off conventional 120 V ac. During the long periods of portable operation, the battery-saving dial light switch was used to conserve the battery, but, considering the efficient design and extensive use of solid-state devices, we didn't notice any appreciable loss in battery life during the test.

The DX-300 covers from 10 kHz through 30 MHz in thirty bands and shares a very efficient preselector which is switchable and tuneable in six stages: 0.01-0.15, 0.15-0.5, 0.5-1.6, 1.6-4.5, 4.5-12, and 12-30 MHz. Literally any frequency you might be interested in from the submarines to the CBers will be covered in these ranges.

The basic frequency determination is via the main tuning control with the LED display. Each frequency is displayed and carried





through in MHz and kHz (e.g., 12.000-12.999 MHz with a 1-kHz fine tune for better reception of SSB and CW signals). Examining the more-than-complete block diagram, we note that we have triple conversion—quartz controlled with the first i-f, 54.5-55.5 MHz, second i-f, 3-2 MHz, and the third i-f, at 455 kHz.

Following an incoming rf signal from the antenna, it travels to the rf section with attenuation capabilities (20-0-40 dB) switch selectable and into the preselector. The signal is amplified by Q201 and mixed down in the 1st mixer, Q202-203, by means of the 55.5-81.5-MHz local oscillator, Q401 (MHz tuning). The MHz tuning converts the antenna input signals up to 30 MHz into 55.5-54.5 MHz at 1-MHz separation into amplifiers Q205-214 and 206 (first i-f). Also at this time, the first local oscillator of MHz tuning is mixed down with  $\frac{1}{4} \times N$  integer harmonics of 4 MHz (3-32 MHz) produced by the second oscillator, Q507, in the third mixer, IC201, and amplified by a 52.5-MHz amplifier, Q207, 208, 209, and the second mixer, Q206 (3-32 MHz), signals are produced by harmonic generator D501-502.

The resulting signal from the first i-f (55.5-54.5 MHz) is mixed down with the 52.5 MHz of the second mixer and converted to 3-2 MHz for the second i-f. From this point we have a conventional and rather ordinary single superheterodyne circuit which converts the signal to the third i-f of 455 kHz and then to a detector and audio output.

For example, assuming we have tuned to 26.965 MHz, the first local oscillator is at 81.5 MHz and the first mixer output is  $81.6 - 26.965$  or 54.635 MHz.

The second oscillator 29-MHz output is used in the third mix to produce:

Description	Condition	Nominal Spec.	Limit Spec.
Frequency coverage	Band A	10-150 kHz	10-150 kHz
	Band B	150-500 kHz	150-500 kHz
	Band C	500-1600 kHz	500-1600 kHz
	Band D	1.6-4.5 MHz	1.6-4.5 MHz
	Band E	4.5-12 MHz	4.5-12 MHz
	Band F	12-30 MHz	12-30 MHz
Sensitivity (S + N)/N = 10 dB Output = 50 mW	10-50 kHz	Not specified	Not specified
		AM SSB	AM SSB
	100 kHz	10 uV 10 uV	50 uV 50 uV
	300 kHz	2 uV 1 uV	10 uV 5 uV
	900 kHz	2 uV 1 uV	10 uV 5 uV
	3.1 MHz	0.5 uV 0.3 uV	2 uV 1 uV
	7.1 MHz	0.5 uV 0.3 uV	2 uV 1 uV
	15.1 MHz 28.1 MHz	0.5 uV 0.3 uV 0.5 uV 0.3 uV	2 uV 1 uV 2 uV 1 uV
Selectivity	± 10 kHz	70 dB	60 dB
Image ratio	10-50 kHz	Not specified	
	100 kHz	60 dB	50 dB
	300 kHz	60 dB	50 dB
	900 kHz	60 dB	50 dB
	3.1 MHz	60 dB	50 dB
	7.1 MHz	60 dB	50 dB
	15.1 MHz	60 dB	50 dB
	28.1 MHz	60 dB	50 dB
Signal to noise ratio	At 7.1 MHz 1 mV 30% Mod.	40 dB	35 dB
Intermediate frequency	1st	54.5-55.5 MHz	
	2nd	2-3 MHz	
	3rd	455 kHz	
Spurious rejection	At 7.1 MHz	40 dB	30 dB
1 MHz harmonics	At 7 MHz	0.5 uV	3 uV
Audio output power	Less than 10% T.H.D.	1.8 W	1.2 W
Phone jack output power	At 0.5 W speaker output	100 mV	50-200 mV
Tape output voltage	At 7.1 MHz, 1 mV 30% Mod. af output 0.5 W	300 mV	150-600 mV
Meter sensitivity	S-9 at 7.1 MHz	100 uV ± 6 dB	
Rf attenuator	0, 20, and 40 dB		
Frequency display	5-digit LED display (MHz/kHz)		
Frequency stability	Within ± 1 kHz after one hour warm up		
Antenna impedance	50-Ω unbalanced type		
Power source	ac 120 V, 60 Hz, dc 12 V negative ground only or internal cells		
Operation temperature	0° C to 40° C		

Table 1. Specifications.

$81.6 - 29 = 52.6$  MHz. The second mix produces  $54.635 - 52.6 = 2.035$  MHz which is free of drift. The receiver is fully state of the art and makes a maximum use of integrated circuitry and LED displays for both status and frequency indi-

cation.

While the DX-300 comes with a complete operating manual, technically-minded owners may want the optional Service Manual (Radio Shack Part No. 20-204). For the first time—at least in my experi-

ence of some twenty years in ham radio—a service manual equals or exceeds the quality of the equipment. Not only do you have full technical data and specifications, but alignment instructions, suggested test equipment, and



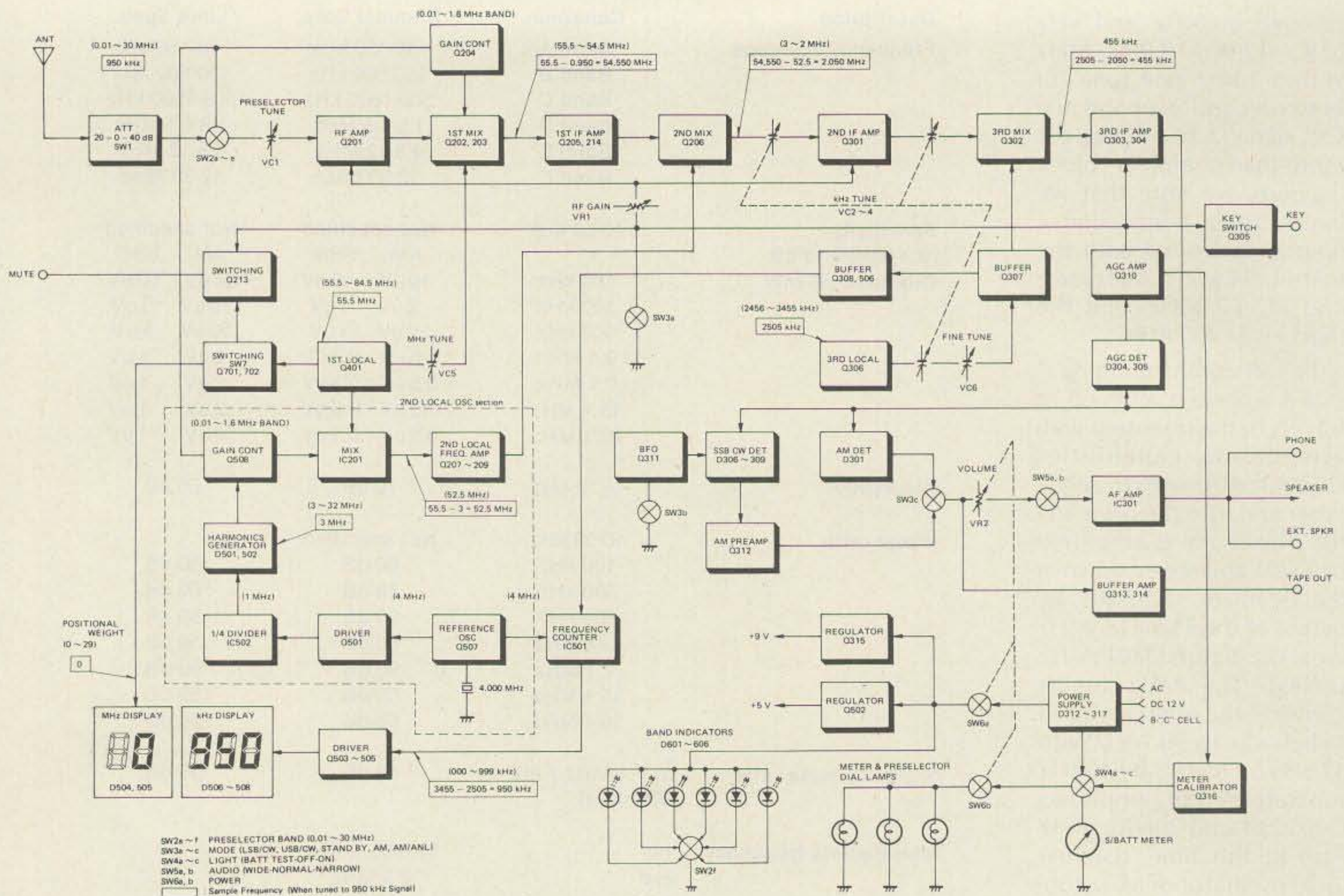

Fig. 1. Block diagram.

a series of tests which use the diagnostic troubleshooting decision-tree approach rarely found with equipment for the home or hobbyist market. Nothing is left to chance; a brief schematic or block representation shows the correct manner to hook up test equipment to the receiver and what points to either measure or inject a corresponding frequency or voltage.

The manual triggered the same positive thoughts and comparisons of that "dream-receiver" we alluded to in the beginning of this review. In a nutshell, the manual is everything you have always wanted to know about repairing and recalibrating but were afraid to ask for because, until now, the methodology was not clear enough. The manual is so clear that I would not hesitate to take the DX-300 to far-off DX locations where I couldn't

be assured of parts or of an adequate repair facility. Even the parts list is complete, and included are base diagrams for solid-state devices and a complete set of top and bottom views for the six PC boards which make up the DX-300. As well, there are mechanical drawings and wiring interconnects.

On-the-air tests proved that the receiver sounds as good as it looks. The quality of audio through the internal speaker was clear and undistorted. The attenuator, when used with a coaxial antenna, provided ample rejection of high-powered intruders operating around the frequencies we were interested in. In fact, the audio quality was so good that Radio Shack included a TAPE OUT jack on the rear panel for those broadcasts which one may want to save; during our tests, we were able

to make several excellent tapes using a variety of antennas from the enclosed whip to a random-length longwire. In CW modes, the audio bandwidth control functioned better than we anticipated. While it's not a full-blown CW filter and isn't specified as one, it does a more than creditable job on the 40- and 80-meter ham bands.

Considering the price, its frequency range, and other features, it would be hard to define any single segment of the market that the DX-300 is targeted for. Our tests and use showed it to be an excellent ham station receiver, with the facility of full general coverage. Maybe the operator's manual says it all. In a nutshell, the manual is a complete course in the installation, use, selection of an antenna, and a guide to listening. Radio Shack has long been absent

from the ham marketplace, and this new receiver would seem to be the first of what we hope will be many more ham products.

We tried to wring out this receiver and find its shortcomings, but with a total of four hams and one XYL testing it, we could arrive at only two points of contention: the lack of a crystal calibrator (WWV tests found it right on frequency), and a bassy tone with the internal speaker (a subjective opinion at best, and limited to only one evaluator).

If you haven't already guessed, we compared the receiver against what a number of us remember fondly as a workhorse in the military, the R-390; believe me, the DX-300 does it all, with LED display and stability, not to mention cost and weight. And besides, the R-390 didn't offer a built-in code practice oscillator—the DX-300 does! ■



# COMPACT RETN

TU-170

\$169.95 buys a terminal unit kit with capabilities beyond your expectations for the price. And

the Flesher Corp TU-170 won't devour your precious space. Wired units are available at \$249.95. Call or write today for our free 1980 catalog of affordable kits, wired units and accessories.



✓23

**FLESHER CORP**

P.O. Box 976 • Topeka, Kansas 66601 • 913 • 234 • 0198

Distributors in Canada and Australia

## Directional RF Wattmeter

Dielectric wattmeters are your best choice for making accurate RF measurements. These rugged, dependable wattmeters can discriminate between forward and reflected power in all types of 50 ohm coaxial transmission lines and RG type cables.

In addition, they:

- Measure from 100mW to 5kW
- Have ± 5% full scale accuracy
- Measure from 2MHz to 1GHz
- Have an easy-to-read 4½" mirrored meter scale
- Feature a taut-band meter movement for longer life
- RF Elements available for all measurements

The 1000-A from Dielectric —you can't buy an easier reading, more accurate RF wattmeter.

A complete line of RF loads are also available.

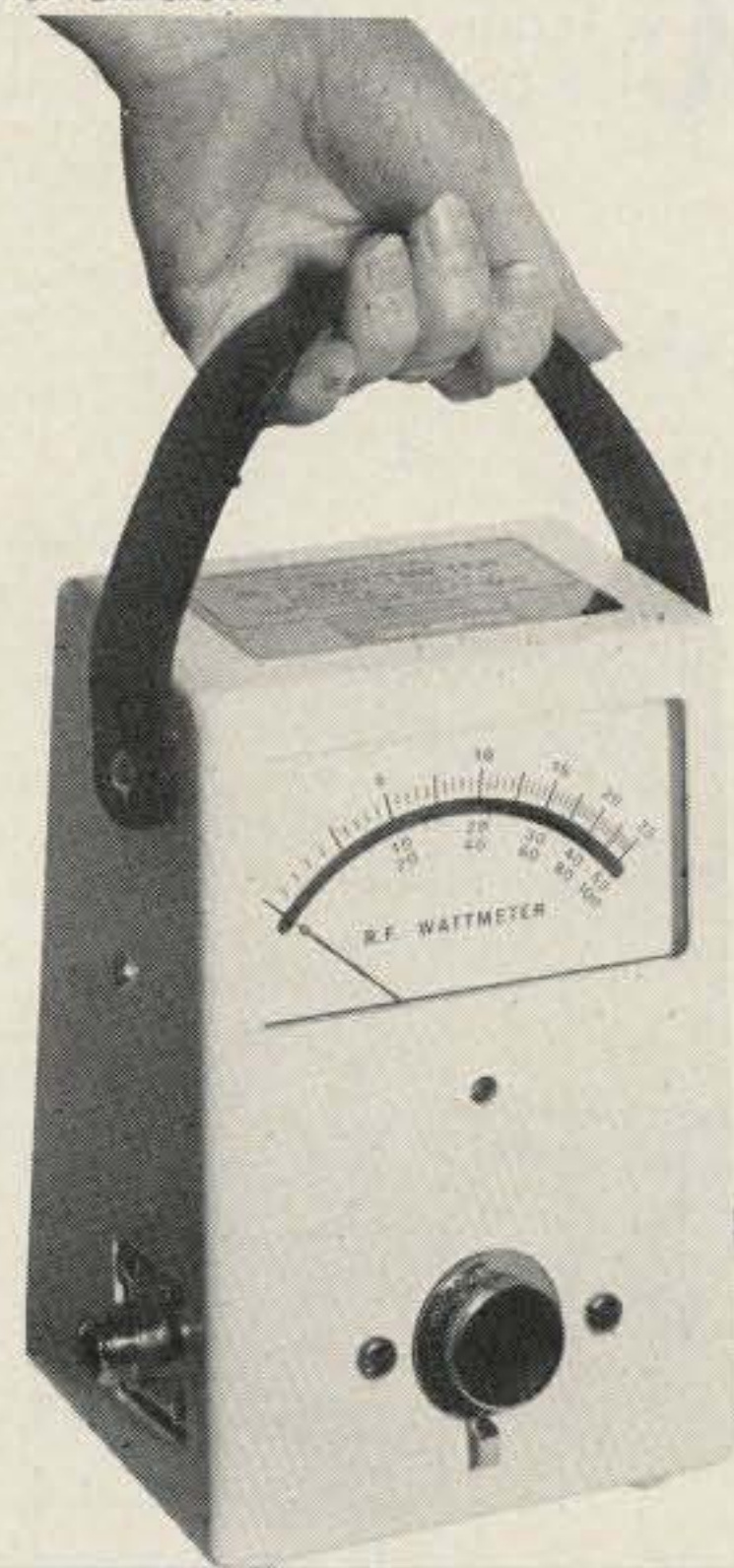

A UNIT OF GENERAL SIGNAL **GS**

**DIELECTRIC**

RAYMOND, MAINE 04071 ✓17  
TEL. 207/655-4555 • 800/341-9678

## SCANNERS:

KENWOOD TR7400A, TR7600, & TR7625,  
TEMPO (preassembled only), KDK 2015R, KDK 2016A,  
ICOM IC22S, MIDLAND 13-510, 13-513,  
CLEGG FM-28, COMTRONIX, YAESU FT227R

- AED continues to expand its line of quality scanners.
- All of AED's scanners are custom designed to install completely inside of their respective rigs.
- Installation is simple. Unlike other competitive products all AED scanners are designed so that it is totally unnecessary to cut any wires inside your rig during installation.
- All P.C.B.s are silk-screened and tin plated for easier and more effective soldering.
- The kit comes complete with all parts and a detailed instruction manual including schematics.
- In the scanner OFF mode the rig operates normally. In the scanner ON mode the scanner locks on an occupied frequency, pauses for a preset time (about 5 sec.) and then resumes scanning (except 22S).
- The frequency being scanned is displayed on the digital readout (except 22S and Tempo).
- This gives you the ability to eavesdrop all over the band without lifting a finger. When you hear something interesting, you flip the switch to the LOCK mode and the rig is ready to transmit.

KIT PRICE ..... 39.95  
PREASSEMBLED, REG. .. 59.95  
SPECIAL, NOW ..... 49.95

## 10 METER FM —THE NEW FRONTIER

The AED FM ADAPTER is now available

- The AED adapter converts existing HF transceivers to transmit on 10 meter FM.
- To use the adapter you are required to have an HF SSB transceiver and a 2 M FM transceiver or receiver.
- The AED kit consists of 2 P.C. boards. Both boards are designed to fit entirely inside your HF rig. (Each board measures 1" x 2")
- One board serves as the modulator which FM's your existing HF transceiver's VFO.
- The second board is a receiver adapter which converts your HF transceiver's I.F. to a 2M frequency. This will allow you to receive noise free 10M FM on your 2M transceiver.
- This modification can be disabled with the on-off switch supplied with the kit.
- The kit comes complete with all parts and a detailed instruction manual (crystal not included).

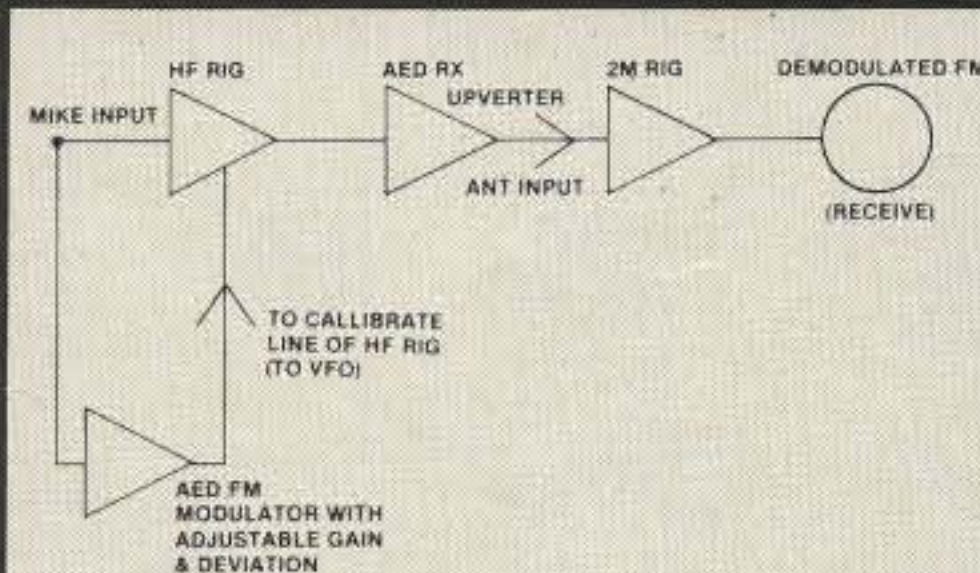

KIT PRICE ..... 39.95  
PREASSEMBLED, REG. .... 59.95  
SPECIAL, NOW ..... 49.95

**AED ELECTRONICS** ✓3

750 LUCERNE RD., SUITE 120 DEPT. A  
MONTREAL, QUEBEC, CANADA H3R 2H6  
TEL. 514-737-7293

INCLUDE \$1.50 FOR  
POSTAGE AND HANDLING PER ITEM





# The Two-Meter Monkey

## — not just another linear

**M**y Icom IC-202 is a nice little two-meter SSB radio. Unfortunately, it's rated at only three Watts, which limits it to all but local contacts. This

quickly became apparent after several attempts to work long distances and was the natural inspiration for this linear amplifier.

Building the amplifier was settled upon easily when it was clear that I couldn't afford to buy a commercial one. A more difficult decision was whether it should be solid-state "state of the art" or tubes. Again, economics came into the decision-making. In comparing the price of parts for a sixty-Watt transistorized amplifier and its power supply (all of which I'd have to buy) against my large 1960s junk box (parts I wouldn't have to buy), the conclusion I drew was that old technology isn't necessarily bad technology. I went with the tubes.

The amplifier described below was built for two meters for the 202. It is hoped that the reader will notice that the basic cir-

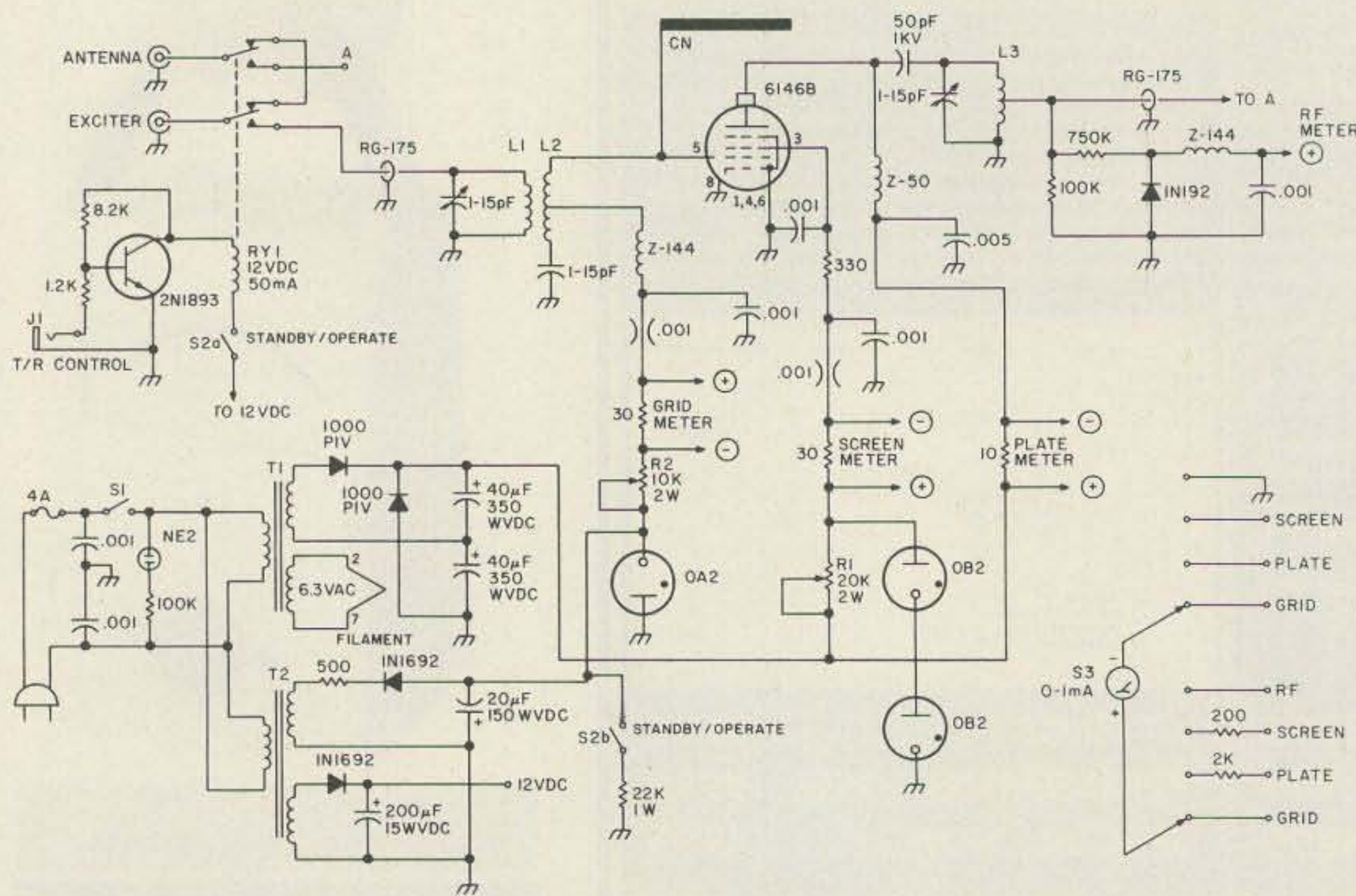

Fig. 1. Two-meter linear amplifier. All resistors 1/4 Watt unless noted. T1—pri: 115 V ac; secs: 220 V ac, 250 mA and 6.3 V ac, 2 A. T2—pri: 115 V ac; secs: 115 V ac, 50 mA and 12 V ac, 500 mA. L1—3T, #14, 1/2" dia., 5/8" long. L2—6 T, #14, 1/2" dia., 7/8" long with center tap. L3—1T, #14, 3/4" dia.; tap 1/4 to 1/3 turn from ground. CN—see text.



circuit will also lend itself to other transceivers and frequencies.

**Circuit**

The amplifier is a basic 6146B, biased class AB<sub>1</sub> for SSB, at about sixty Watts of input power. The layout of the components is detailed in the line drawing. The amplifier is neutralized by CN, a piece of #14 insulated copper wire five inches long which encircles the base of the 6146. The grid circuits are enclosed within a small minibox which also holds the 6146 socket. Two OB2 voltage regulators keep the screen voltage stiff, which is necessary for linear operation. S2b switches out a resistor, dropping the grid bias from a cut-off -120 V dc in Standby to -50 V dc for Operate. The whole unit is housed in a 10" x 10" x 3 1/2" cabinet.

So far, the circuit is straightforward and not unlike other VHF amplifiers. Just another linear amplifier? A unique part of the design, however, is how this amplifier is switched in and out of the transceiver's antenna line. There are several ways that this could be done, like using rf-sensing diodes or tapping a control voltage out of the transceiver. The first method is okay for modes like FM, but things tend to get

messy with anything other than a continuous carrier. Tapping off a control voltage to operate a T-R relay works, too, but you show me a good, safe spot in an Icom to do this (or in almost any other solid-state rig, for that matter). Besides, the following method works much better and doesn't "invade" any of the radio's internal circuits.

There are four wires in the Icom microphone cord, if the mic shield is included. Rearranging these wires as shown in Figs. 2 and 3 will allow the unused side of the microphone PTT switch to be used to control the amplifier. The earphone jack was sacrificed as it is a convenient place to tie the amplifier to

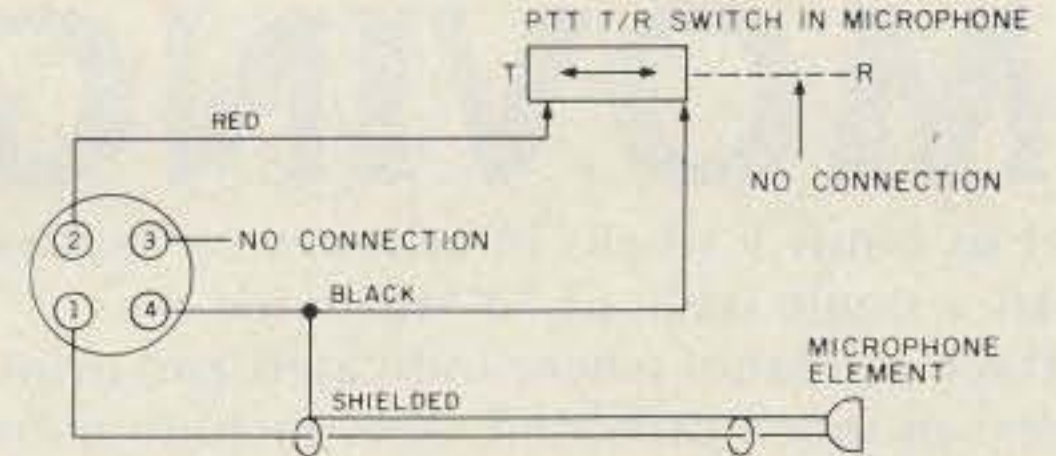
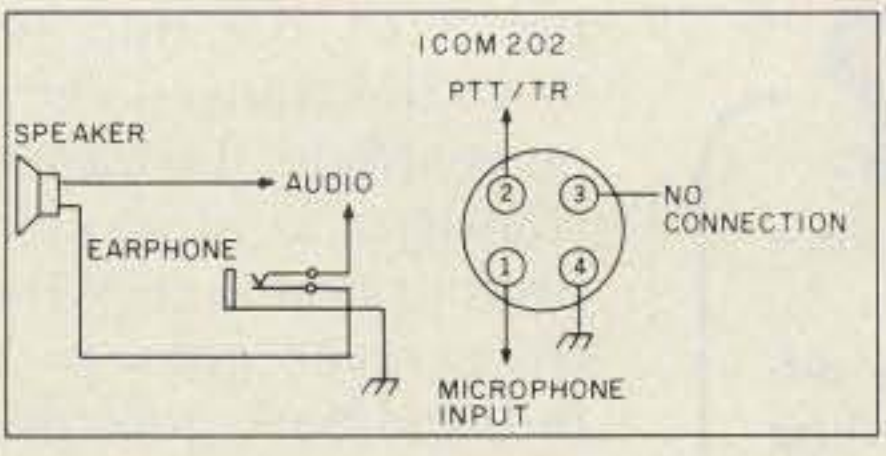

Fig. 2. Unmodified Icom IC-202 transceiver and microphone.

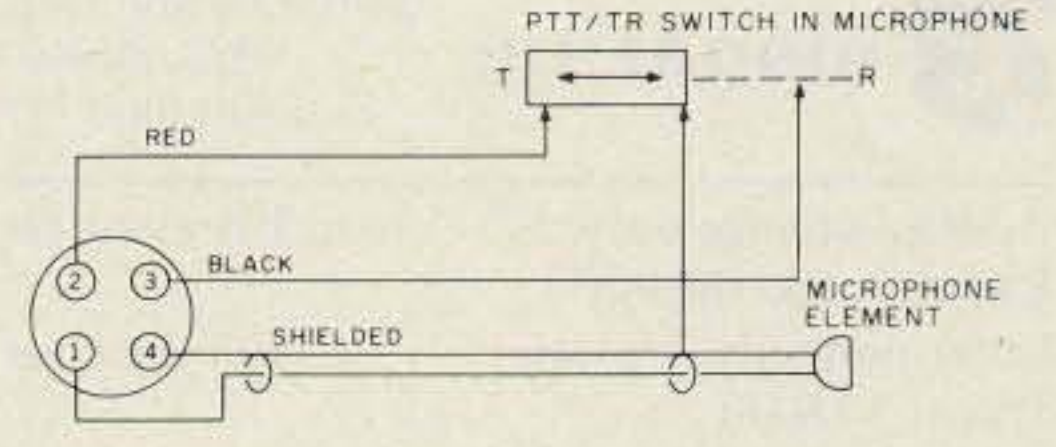
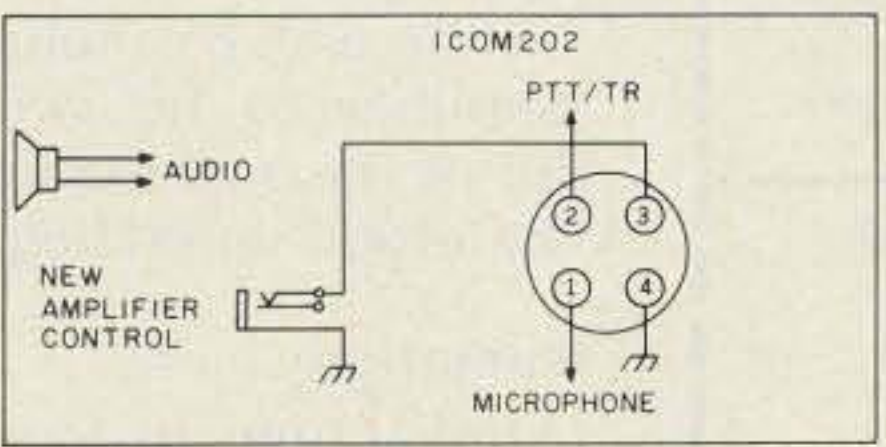

Fig. 3. Modified transceiver and microphone.

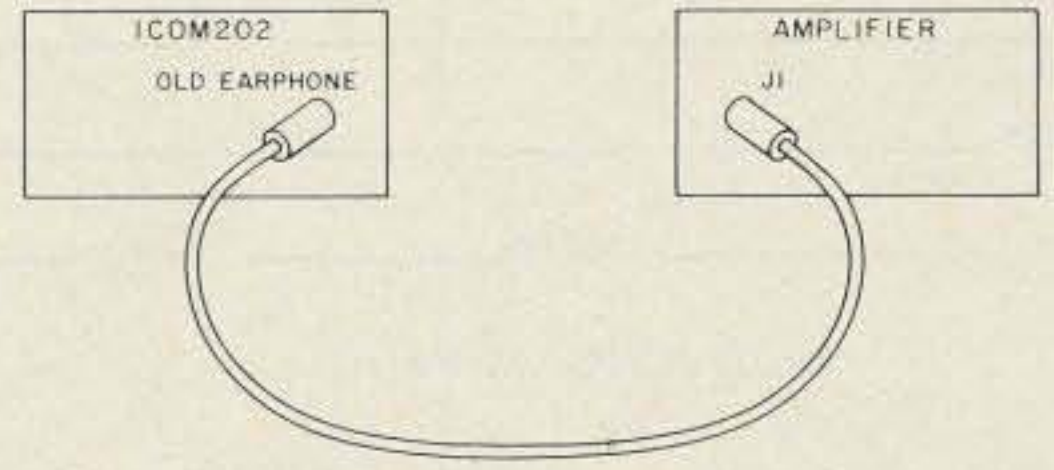
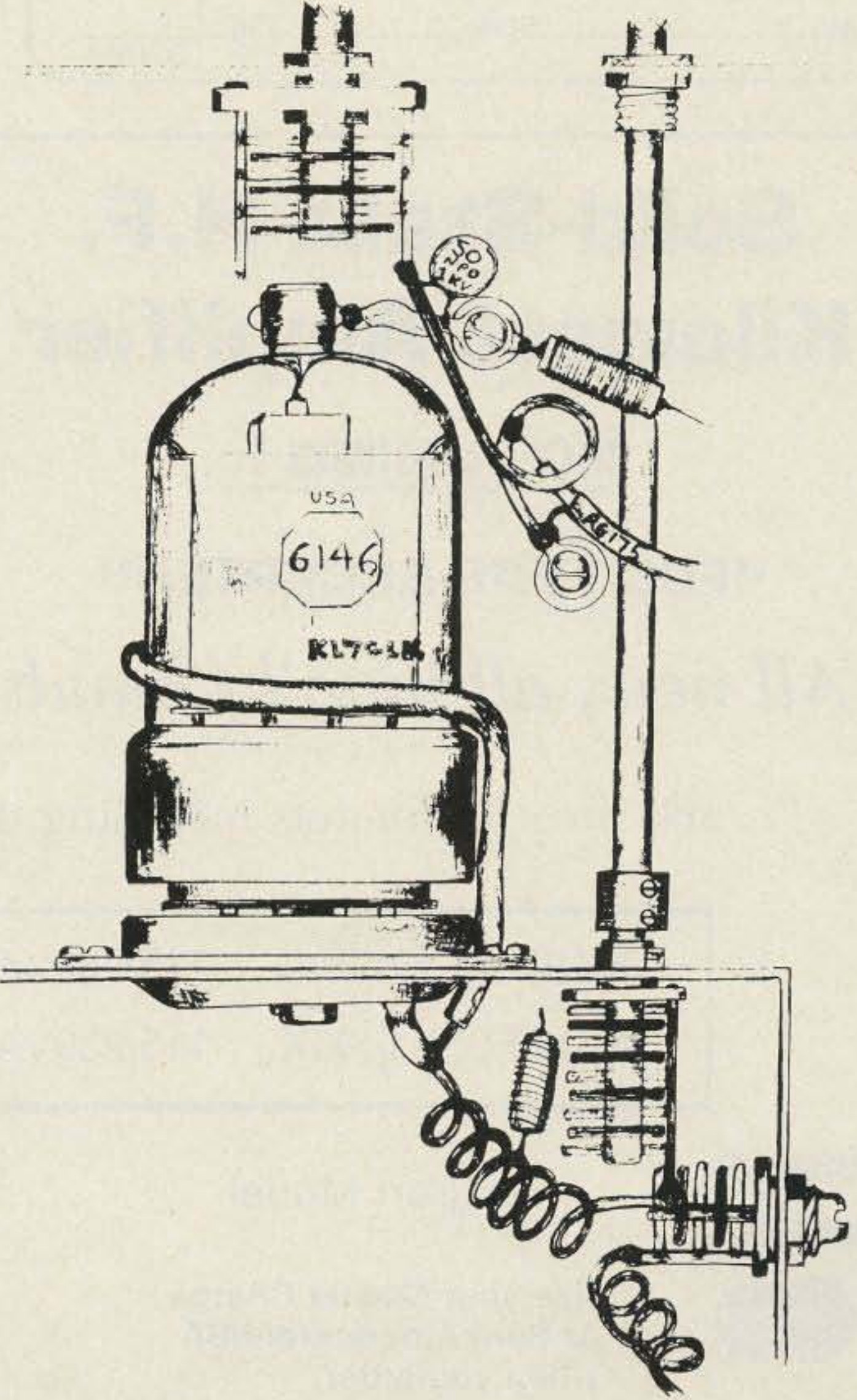
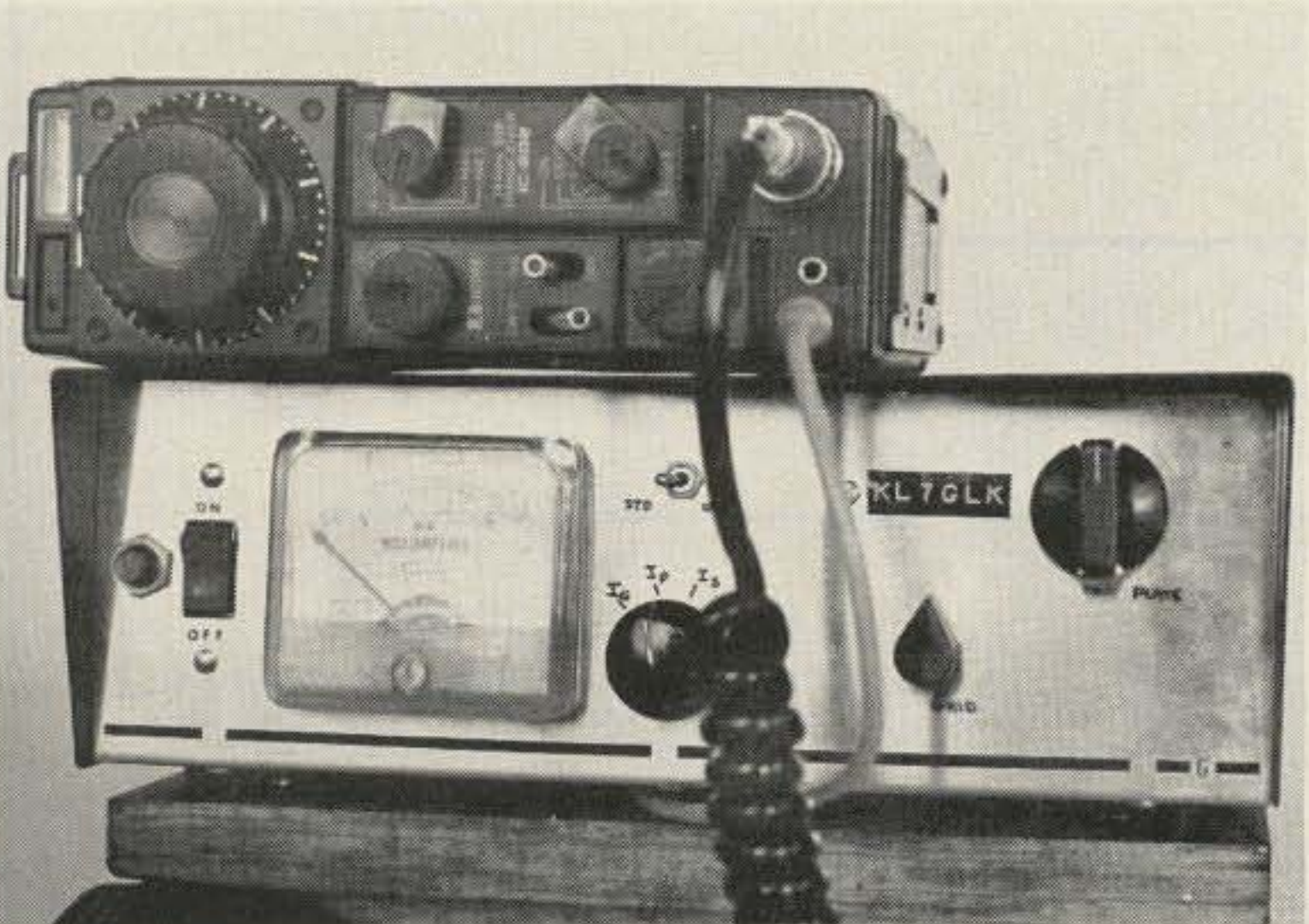

Fig. 4. Hookup between the 202 and the amplifier.



Line drawing detailing component layout.



Two-meter linear amplifier with the Icom IC-202.



# MOVING?

Let us know 8 weeks in advance so that you won't miss a single issue of 73 Magazine.

Attach old label where indicated and print new address in space provided. Also include your mailing label whenever you write concerning your subscription. It helps us serve you promptly. Write to:

**73 magazine**

Subscription Department  
P.O. Box 931  
Farmingdale NY 11737

- |   |   |
|---|---|
| <input type="checkbox"/> Address change only    | <input type="checkbox"/> Payment enclosed |
| <input type="checkbox"/> Extend subscription    |   |
| <input type="checkbox"/> Enter new subscription | <input type="checkbox"/> Bill me later    |
| <input type="checkbox"/> 1 year \$18.00         |   |

If you have no label handy, print OLD address here.

AFFIX LABEL

Name \_\_\_\_\_ Call \_\_\_\_\_

Address \_\_\_\_\_

City \_\_\_\_\_ State \_\_\_\_\_ Zip \_\_\_\_\_

print NEW address here:

Name \_\_\_\_\_ Call \_\_\_\_\_

Address \_\_\_\_\_

City \_\_\_\_\_ State \_\_\_\_\_ Zip \_\_\_\_\_

301B55

pin 3 of the mic socket. With the transceiver in Receive mode, the base of the transistor is at ground and doesn't conduct. When the transceiver goes to transmit, the base goes positive and the transistor conducts, closing the T-R relay, RY1. S2 is a DPDT switch which allows the amplifier to be switched out of the antenna line for "barefoot" operation.

## Operation

Initial tune-up operation involves applying power with S2 in Standby. R2 is adjusted to produce 190 V dc at the screen. Without applying a two-meter drive, the amplifier is placed in Operate and R2 adjusted to -50 V dc at the grid. The plate current should idle around 20 mA and the screen at 1-2 mA. Rotate the plate and grid capacitors through their ranges and look for any

change in grid current. If neutralization is necessary, reposition CN to another area around the 6146 until no combination of adjustments to either plate or grid produces any change in grid current. Now apply a two-meter carrier and adjust the grid and plate capacitors for maximum rf output. For linear operation on SSB, back off the grid drive to a point that grid current just starts to be drawn. Repositioning the tap on L3 may be necessary to achieve an optimum loading to a particular antenna.

Once tuned up, the amplifier doesn't require re-tuning over at least a 200-kHz bandspread. The amplifier has given good accounts of itself in the signal reports received. It has proven a good, easy way to extend the communications range of the Icom IC-202. ■

## Solid-State H.F. Kilowatt Amplifier

**NO TUNING !**

**"FCC TYPE ACCEPTED"**

*All new, all nine hf bands*



160 thru 10\* meters including the new 10, 18 and 24 MHz bands.

MODEL: A1000      115/230VAC, 50-100W Input      \$1395.00

\*MODEL: A1000X      115/230VAC, 15-35W Input      \$1395.00



\*Export Model



Use your Master Charge or BankAmericard/VISA when you order.

✓ 63

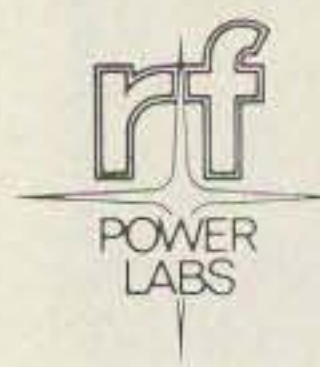

DEALER INQUIRIES INVITED  
**RF POWER LABS, INC.**

21820 87th S.E., Maltby Industrial Village,  
Woodinville, WA 98072, (206) 481-8833  
Telex No. 32-1042



# SOMETHING DIFFERENT

## The FT-107 Series with "DMS"\*

*"It's A Cut Above The Rest"*

\* **OPTIONAL DIGITAL MEMORY SHIFT ("DMS")**  
12 discrete memories. Stores individual frequencies or use as 12 full coverage VFOs (500 kHz each)

- Solid State
- 240 watts DC SSB/CW
- 160-10 meters, WWV  
(2 auxiliary band positions are available for future expansion)
- RF Speech Processor
- SSB, CW, AM, FSK
- Built-in SWR Meter
- Excellent Dynamic Range
- Audio Peak/Notch Filter
- Variable Bandwidth
- Full Line of Accessories



The FT-107 has been created as a result of a blending of technologies — computer, solid state and RF design. By careful utilization of these disciplines and the experience gained from our FT-301 series, YAESU has achieved an HF transceiver which offers unique features (e. g. "Digital Memory Shift"), efficient operation and a level of performance that has been previously unattainable.

### (Receiver Section) FT-107 TRANSCEIVER SPECIFICATIONS (Transmitter Section)

**Sensitivity:** 0.25 uV for 10dB S/N, CW/SSB, FSK  
1.0 uV for 10dB S/N, AM

**Image Rejection:** 60dB except 10 meters (50dB)

**IF Rejection:** 70dB

**Selectivity:** SSB 2.4 kHz at -6dB, 4.0 kHz at -60dB.  
\*CW 0.6 kHz at -6dB, 1.2 kHz at -60dB.  
\*AM 6 kHz at -6dB, 12 kHz at -60dB  
Variable IF Bandwidth

**20dB RF Attenuator**

**Peak/Notch Audio Filter**

**Audio Output:** 3 watts (4-16 ohms)

**Accessories:** FV-107 VFO (standard not synthesized)  
FTV-107 VHF (UHF Transverter)  
FC-107 Antenna Tuner  
SP-107 Matching Speaker  
FP-107 AC Power Supply

\*CW/AM Filters Optional

**Power Input:** 240W DC (SSB/CW) 80W DC (AM/FSK)

**Opposite Sideband Suppression:** Better than 50dB

**Spurious Radiation:** -50dB.

**Transmitter Bandwidth** 350-2700 hz (-6dB)

**Transmitter:** 3rd IMD -31dB neg feedback 6dB

**Transmitter Stability:** 300 hz after 10 min. warmup  
less than 100 hz after 30 min.

**Antenna Input Impedance:** 50 ohms

**Microphone Impedance:** 500 ohms

**Power Required:** 13.5V DC at 20 amps  
\*\* 100/110/117/200/220/234V AC at 650 VA  
\*\*FP-107 or FP-107E Optional

**YAESU** <sup>83</sup>  
*The radio.*



1179RR

And Specifications Subject To  
Without Notice Or Obligation

**YAESU ELECTRONICS CORP., 6851 Walthall Way, Paramount, CA 90723 • (213) 633-4007**  
**YAESU ELECTRONICS Eastern Service Ctr., 9812 Princeton-Glendale Rd., Cincinnati, OH 45246**



# RTTY QSK

## —break in to RTTY operation with a KOR

In its issue of October, 1978, the *RTTY Journal* published an article, "Keyboard Operated Relay," that immediately attracted my attention.

The author, VE3DCX, wrote that "... this gadget will put such luxuries as VOX for SSB or break-in for CW in the hands of RTTY enthusiasts..." That was no wild claim, as I found out later.

Being basically a lazy person and averse to unnecessary work and effort (except when deliberately engaged in some kind of physical exercise), I lost no time breadboarding and testing two versions of this

KOR adapted to my microprocessor-based RTTY setup.

An analysis of the original circuitry revealed that, at least in my case, the circuit was unnecessarily complicated.

The basic idea, as adapted to my uP system, is shown in Fig. 1, illustrating two different configurations: (a) for systems that give a level one for mark, and (b) for systems that give a level zero for mark. It should be clear now that the idea is to have no charge going to the timing capacitor when the rig is in mark-hold condition, and, therefore, the transmitter relay should drop. As soon as transmission begins, the low bits (or the high bits, depending on the case) will cause the circuitry to provide charging current to the timing capacitor, and the relay pulls in.

The circuit shown in Fig. 2 was tested and found per-

fectly satisfactory for my Digital Group uP, which outputs a level one for mark.

In the schematic, connections are shown for the Kenwood TS-820. If you have a different rig, the collector and emitter of Q2 will have to be inserted in series with the holding coil circuit of the transmitter relay: The collector goes to the hot side and the emitter goes to the cold side of the circuit.

Also, depending on the voltage and resistance already in the circuit, it may be necessary to insert a series resistor to limit the collector current to a safe value for the transistor, but sufficiently high for the relay. However, this is unlikely to be necessary because this circuit must already be limited to a safe value for the coil. For the Kenwood TS-820, this resistor is not necessary, and pins 2 and 3 of the MIC plug

may be connected directly to Q2 as shown in the figure.

The timing for dropping the relay will depend on the values of C1 and R1—the higher those values, the longer the delay. The capacitor is charged through the diode (any signal-type diode) and discharged through R1 and the base of Q2. "Fudging" those values, you can adjust the delay to a convenient length. Please note that too high a value for R1 will prevent Q2 from outputting sufficient current to make the relay work. Alternatively, you could use a trimpot for R1. Suggested values are 100k and 5 uF, respectively, for a start.

After breadboarding and testing the circuit of Fig. 2 and finding that it worked to my complete satisfaction, it suddenly occurred to me that using an optocoupler would be cheap insurance against rf feedback into the microprocessor. The circuit of Fig. 3, therefore, was developed. It can be seen that it is basically similar to Fig. 2 except that now the collector current of Q2 will fire up the LED inside the optocoupler, and its phototransistor, in turn, will complete

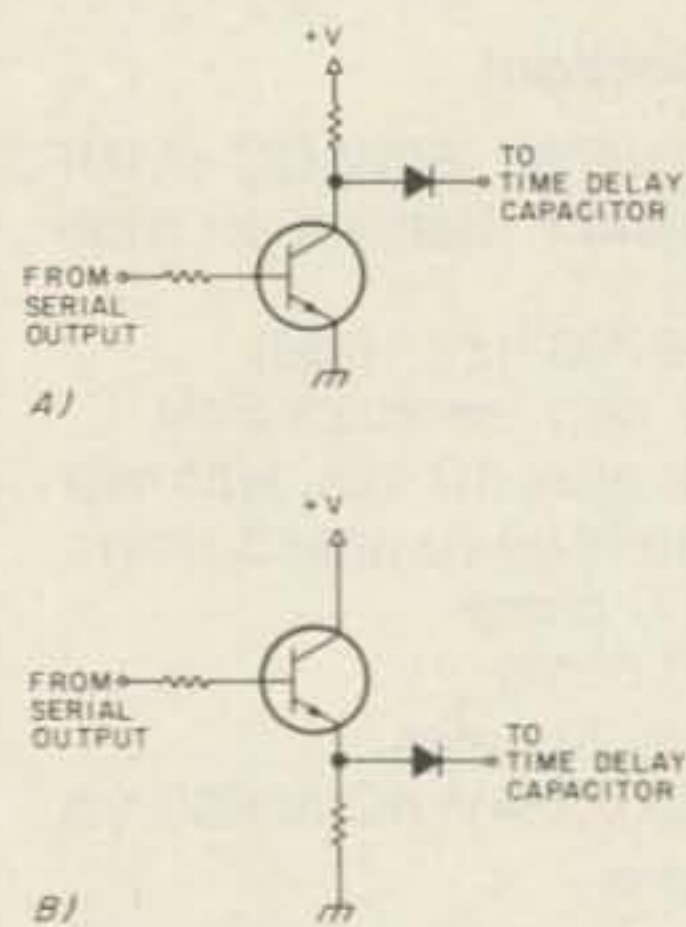

Fig. 1. How to derive the signal from a serial output. (a) Mark is level 1; (b) mark is level 0.

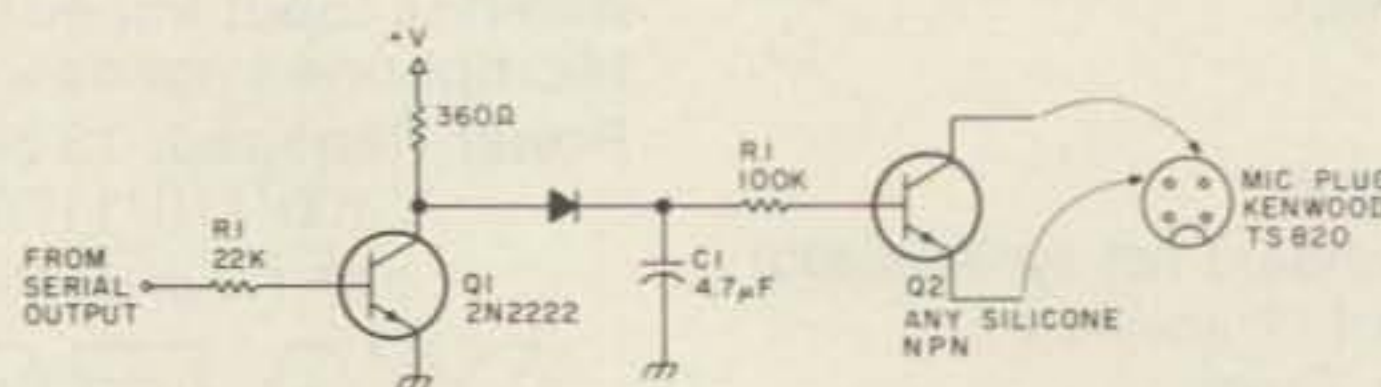

Fig. 2. A simple circuit for microprocessors having level one for mark. For level zero for mark, use Q1 as per (b) in Fig. 1.



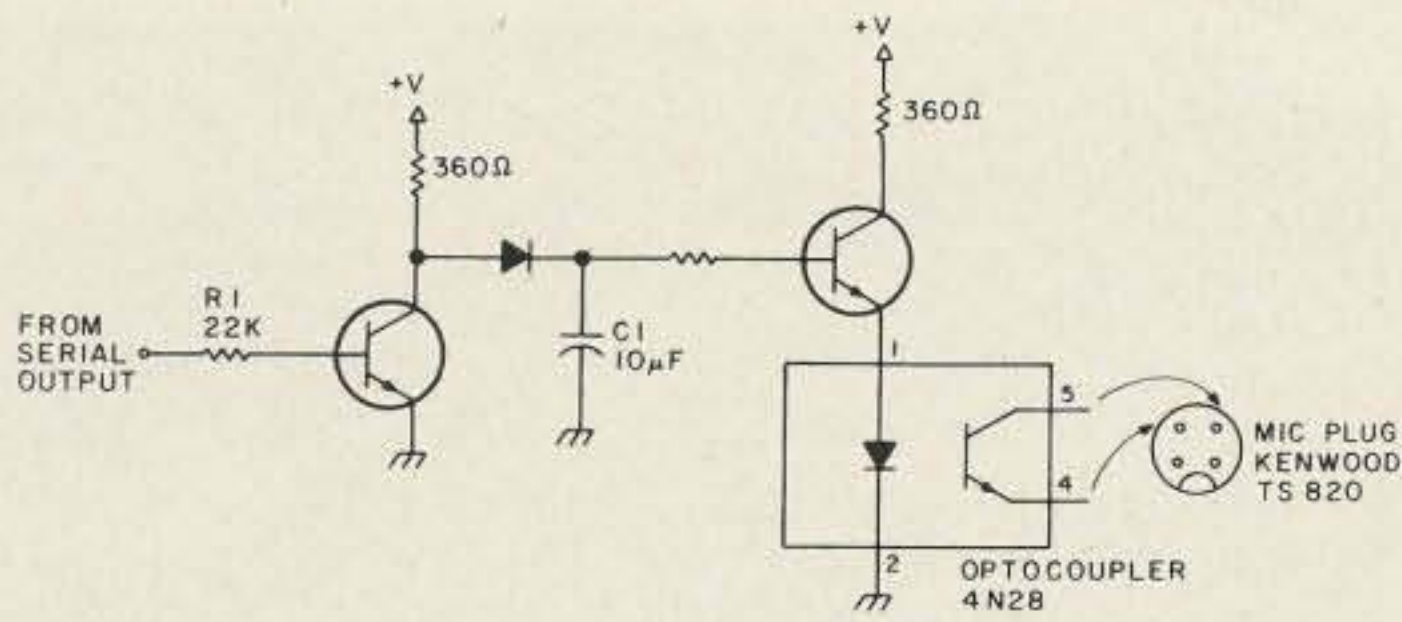

Fig. 3. Guarding against rf feedback. For systems giving level zero for mark, use Q1 as per (b) in Fig. 1.

the circuit for the relay coil. I used an unknown device with the Motorola logo and a house number that was supposed to be similar to the 4N28. I treated it as such, and the device did not disappoint me.

Again, the timing will be adjusted by means of C1 and R1, but now we face a different situation. Whereas in the circuit of Fig. 1 we could use virtually any NPN transistor, now we need a relatively high current to keep the LED glowing. Therefore, in order to avoid

having to use very large values for C1 which might cause other complications, we will have to use a transistor with a current gain of 200 or more, like the 2N2222. I used a BC109C with a gain of 365 and suggest 10 uF and 120k, respectively, for C1 and R1.

The use of this gadget couldn't be simpler: Start typing and the relay pulls in; stop typing and about three seconds after the buffer has stopped outputting signals, the relay drops. That is all! ■

# RF POWER

ONE BILLION WATTS IN STOCK



Your One Stop Source for RF Power Tubes and Transistors

### RF IS BUSTING OUT ALL OVER

8877/3CX1500A7 .....	\$300.00	6MJ6 .....	\$4.50
811A .....	10.00	6146B .....	6.00
572B .....	30.00	8950 .....	6.50
3-500Z .....	95.00	5894B .....	58.00

### RF Transistors

SD1451 — 60W 2-30Mhz 12.5V Flange	14.00	(excellent for 100W linears = to MRF 453)
RF 13 — 50W 2-175Mhz 12.5V Stud type	13.00	(Premium replacement for MRF 450A and 2N6084)
RF 33 — 70W 2-30Mhz 12.5V Stud Type	15.00	(Premium replacement for MRF 455A)

MINIMUM ORDER \$30.00

CALL TOLL-FREE 800-645-2322 (N.Y. State 516-536-8868)



## RF Gain, Ltd.

100 Merrick Road

Rockville Centre, New York 11570

# close encounter



## Dateline Dayton Hamvention . . .

To demonstrate the selectivity of our Mark 3CR repeater we keyed a transmitter 15 KHz off frequency and set it directly against the receiver input. Our Mark 3CR didn't even notice the close encounter.

Sure the Mark 3CR can withstand severe interference. . . it uses both crystal filtering and double conversion. And that's just the beginning. Its performance continues with a transmitter that meets commercial specs plus a microprocessor controller that gives you 39 functions and 13 Morse messages. For peak performance have your own close encounter with a Mark 3CR / Repeater or Mark 3C Controller.



call or write for specifications ✓ 49

**MICRO CONTROL SPECIALTIES**  
23 Elm Park, Groveland, Ma. 01834  
(617) 372-3442



# A Programmer's Potpourri

## — fifteen practical programs for hams

Here's a collection of fifteen programs to run on your computer once you tire of playing yet another game of Star Trek. These programs will help you calculate parts values for several popular circuits, print out fancy-looking purchase orders for your parts orders, and even prepare a complete wire list for wire-wrapping or just checking out a printed circuit board layout.

All of these programs are written in BASIC and most can, with just minor changes, be run on most popular computer systems.

The wire-list program is written for disk systems, but can be adapted for cassette use with a little work.

### 555 Timer Calculator

The 555 timer is a popular IC which is used in a variety of ways. Possibly the most popular circuit is the oscillator circuit of Fig. 1. The oscillation frequency is determined by R1, R2, and C, and the output is a square wave whose high (positive) part is always longer than its low part; that is, its duty cycle (the percentage of the time that it is high as compared to the time for one whole cycle) is

always greater than 50 percent.

There are two kinds of calculations we often have to do—find the parts values for R1, R2, and C based on what we want the oscillator to do, or figure out what it is supposed to do from the parts values we already have. Program 1 will do either job.

When you start it, the program first asks which you want to do—calculate component values or find out what it is doing with known parts values.

Program 1(b) is a sample run to calculate component values. Since resistors are more easily changed (and a pot can be used to make an

adjustable resistance), we always assume a known value for C, but the program is set up so that it repeats itself so that you can try several values for C. If C is too small, the resistor values will be too large to be practical; the sum of R1 and R2 should be less than 5 megohms with a 5-volt supply. In the sample, we find that for a frequency of 1000 Hz at a 75 percent duty cycle (output high  $\frac{3}{4}$  of the time), we should use resistors of approximately 7215 and 3607 Ohms with a 0.1-microfarad capacitor.

Program 1(c) is a sample run to find the frequency and duty cycle when the resistor and capacitor val-

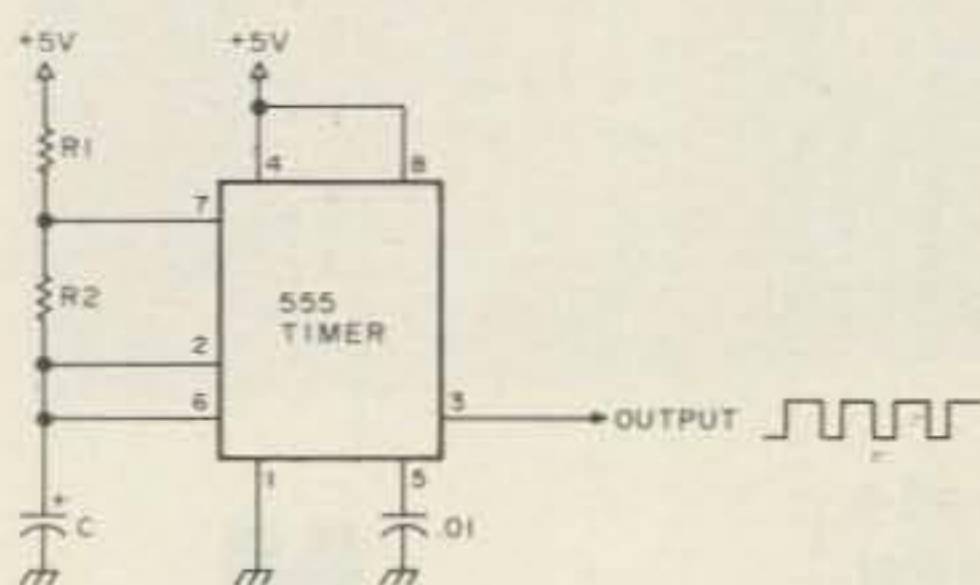

Fig. 1. 555 oscillator circuit.

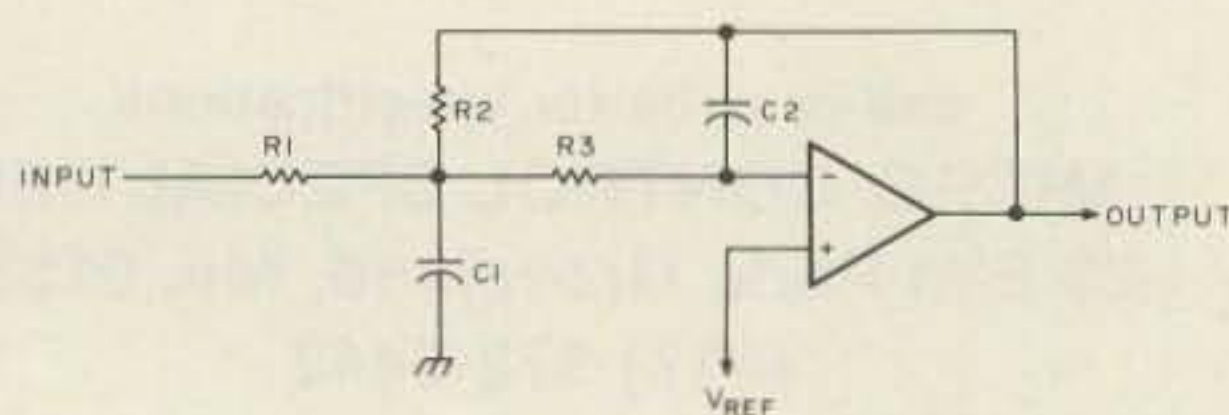

Fig. 2. Low-pass active filter.

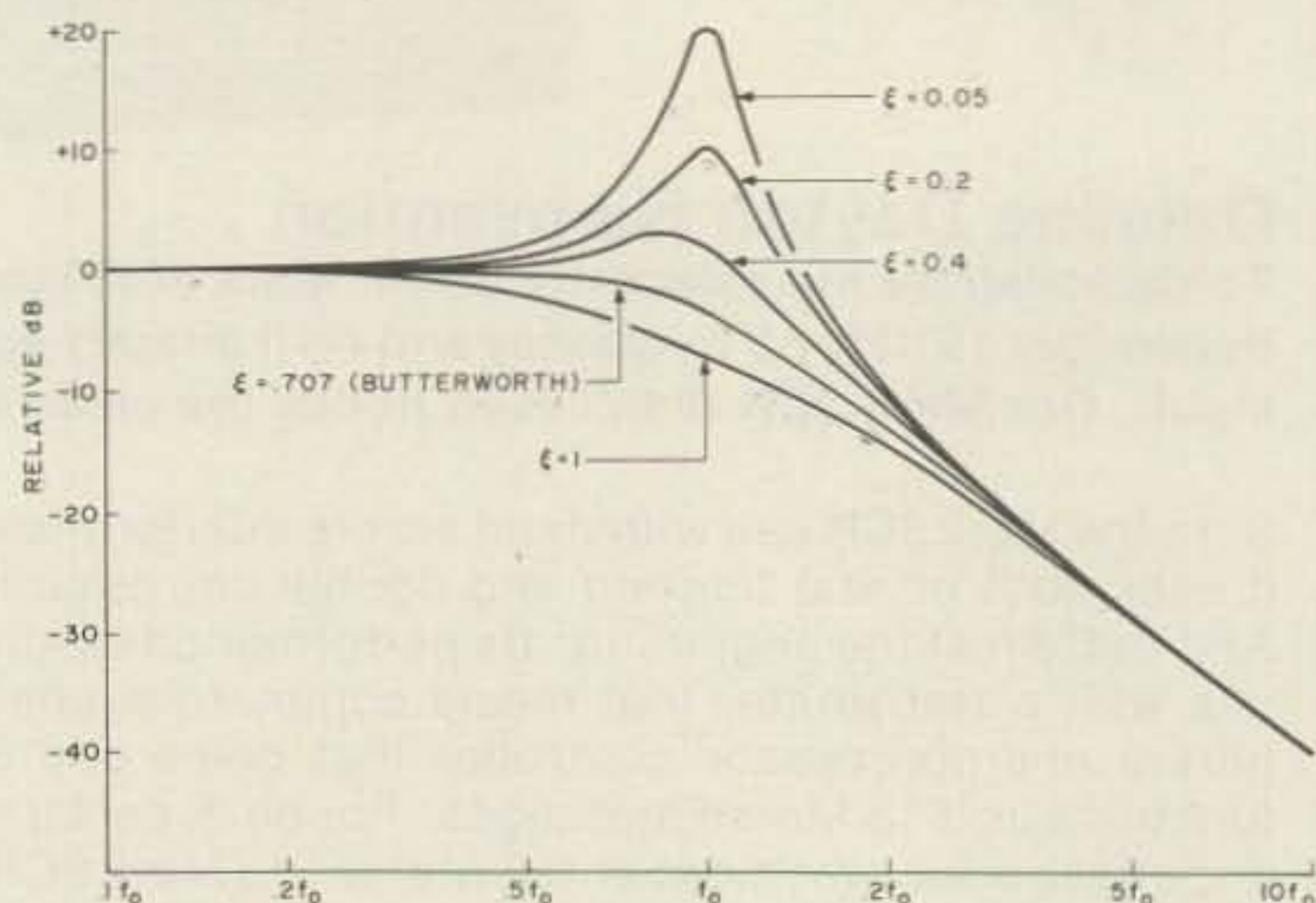

Fig. 3. Comparison of different filters.



ues are known. Thus, with R1 at 10k, R2 at 470 Ohms, and C at 0.1 microfarad, we find an oscillation frequency of 1319 Hz and a duty cycle of almost 96 percent. The program also tells us how long the output is on (high) and off (low).

### Low-Pass Active Filter

Fig. 2 is the circuit of a low-pass active filter. An active filter is one that uses just RC components and an amplifier to do what would normally require an LC circuit. (See my article entitled "Low-Pass Filter Primer" in 73 Magazine, October, 1978, page 98, for a fuller explanation.) This amplifier can have different characteristics depending on the values chosen for the three resistors and two capacitors.

The amplifier is usually an operational amplifier, or op amp, such as a 741. The input shown as going to Vref is grounded if the op-amp power supply consists of a positive and a negative supply, or is connected to a voltage divider if the op amp has just one power supply. The output of the voltage divider should be halfway between ground and the power-supply voltage.

In any case, a low-pass filter is one which passes low-frequency signals, but stops high-frequency signals from getting through. The exact shape of its frequency response curve depends on a quantity called the damping coefficient, represented by the greek letter  $\zeta$ , zeta. As shown in Fig. 3, if zeta is 1, then the response drops off very gradually near the cutoff frequency, shown as  $f_0$  in Fig. 3. On the other hand, if zeta is close to 0, then the response peaks right at frequency  $f_0$ .

A filter which has a zeta equal to 0.707 is called a Butterworth filter, or "maximally-flat." This is a filter

which is as flat as it can be in the pass region (to the left of  $f_0$ ), without having any peaking. If zeta is just a bit larger, then the response drops off too soon; if it is just a drop smaller than 0.707, then the response starts to have a tiny peak.

Although the Butterworth filter has this very neat characteristic of maximum flatness, there are many times when we intentionally accept a little peaking in the interests of extending the frequency response with a steeper skirt (steeper drop-off). In any case, the active filter can provide either type of response.

Program 2 allows us to calculate parts values based on the desired stage gain, cutoff frequency, and zeta. Since there are many different combinations which will work, the value of C2 is selected manually first and input into the program. The sample run in (b) shows that for a gain of 5, cutoff frequency of 100 Hz, and a Butterworth filter with zeta equal to 0.707 and C2 equal to 0.5 microfarads, useful values would be approximately: R1 = 450 Ohms; R2 = 2250 Ohms; R3 = 375 Ohms; C1 = 6 uF.

The program calculates these to many digits of precision, but obviously the accuracy depends a lot on available components. We can usually round off to the nearest commercially-available components without affecting the frequency response, although this does often change the stage gain by a small amount.

### High-Pass Active Filter

The high-pass active filter is essentially the opposite of the low-pass filter. It, too, has gain and can provide a variety of response curves, depending on its zeta. The frequency response for a high-pass filter would look just like the

```
(a)
0010 PRINT "555 TIMER DESIGN PROGRAM"
0020 REM COPYRIGHT 1979 BY P. STARK

0030 PRINT "DO YOU WANT TO CALCULATE COMPONENTS, OR FIND OUT"
0040 PRINT "WHAT THE TIMER IS DOING? - TYPE C OR F"
0050 INPUT A$
0060 IF A$="C" GO TO 110
0070 IF A$="F" GO TO 260
0080 GOTO 30

0090 REM FOLLOWING PART CALCULATES RESISTOR VALUES, GIVEN
0100 REM OPERATING FREQ., DUTY CYCLE, AND CAPACITOR VALUE

0110 INPUT "WHAT IS THE OSCILLATION FREQUENCY F?", F
0120 INPUT "WHAT DUTY CYCLE (MORE THAN 50 PERCENT)?", D
0130 IF D<=50 GO TO 120
0140 IF D=100 GO TO 120
0150 T1=1/F * D/100 :REM HIGH PORTION OF CYCLE
0160 T2=1/F - T1 :REM LOW PORTION OF CYCLE
0170 INPUT "WHAT VALUE OF C (IN MICROFARADS)", C
0180 R2=T2/(0.693 * C/1000000)
0190 R1=T1/(0.693 * C/1000000) - R2
0200 PRINT "RESISTOR FROM +V TO PIN 7 IS "; R1; "OHMS"
0210 PRINT "RESISTOR FROM PIN 7 TO PINS 2 & 6 IS "; R2; "OHMS"
0220 IF R1+R2>5000000 THEN PRINT "RESISTORS ARE TOO BIG"
0230 GOTO 170

0240 REM FOLLOWING PART CALCULATES OUTPUT ON TIME, OFF TIME,
0250 REM AND FREQUENCY GIVEN RESISTOR AND CAPACITOR VALUES

0260 INPUT "ENTER CAPACITOR VALUE IN MICROFARADS", C
0270 INPUT "ENTER RESISTOR FROM +V TO PIN 7 (OHMS)", R1
0280 INPUT "ENTER RESISTOR BETWEEN PINS 7 AND 2/6 ", R2
0290 T1=0.693 * C/1000000 * (R1+R2)
0300 T2=0.693 * C/1000000 * R2
0310 D=T1/(T1+T2) * 100
0320 F=1/(T1+T2)
0330 PRINT "TIME ON (SECONDS) "; T1
0340 PRINT "TIME OFF "; T2
0350 PRINT "DUTY CYCLE "; D; "PERCENT"
0360 PRINT "OSCILLATING FREQUENCY "; F; "HZ"
```

```
(b)
RUN
555 TIMER DESIGN PROGRAM
DO YOU WANT TO CALCULATE COMPONENTS, OR FIND OUT
WHAT THE TIMER IS DOING? - TYPE C OR F
? C
WHAT IS THE OSCILLATION FREQUENCY F? 1000
WHAT DUTY CYCLE (MORE THAN 50 PERCENT)? 75
WHAT VALUE OF C (IN MICROFARADS)? .1
RESISTOR FROM +V TO PIN 7 IS 7215.0072 OHMS
RESISTOR FROM PIN 7 TO PINS 2 & 6 IS 3607.5036 OHMS
WHAT VALUE OF C (IN MICROFARADS)? .01
RESISTOR FROM +V TO PIN 7 IS 72150.072 OHMS
RESISTOR FROM PIN 7 TO PINS 2 & 6 IS 36075.036 OHMS
WHAT VALUE OF C (IN MICROFARADS)?
READY
#
```

```
(c)
RUN
555 TIMER DESIGN PROGRAM
DO YOU WANT TO CALCULATE COMPONENTS, OR FIND OUT
WHAT THE TIMER IS DOING? - TYPE C OR F
? F
ENTER CAPACITOR VALUE IN MICROFARADS? .1
ENTER RESISTOR FROM +V TO PIN 7 (OHMS)? 10000
ENTER RESISTOR BETWEEN PINS 7 AND 2/6 ? 470
TIME ON (SECONDS) 0.000725571
TIME OFF 0.000032571
DUTY CYCLE 95.7038391 PERCENT
OSCILLATING FREQUENCY 1319.01411 HZ
READY
#
```

Program 1. 555 timer calculator. (a) Program. (b) Sample run to calculate component values. (c) Sample run to find frequency and duty cycle.

one shown in Fig. 3, except for being flipped left-to-right. The equations are also somewhat different.

Program 3 allows us to calculate the component values for the desired gain, cutoff frequency, and damping coefficient. This time, the input capacitor, C2, would also be determined manually.

Part (b) of the printout shows a sample run; for a gain of 5, cutoff frequency of 1000 Hz, and a Butterworth filter (zeta = 0.707), we have: C2 = 0.1 uF; R1 = 12381 Ohms; R2 = 1022

Ohms; C1 = 0.02 uF.

### Bandpass Active Filter

When high-pass and low-pass filtering are combined in one circuit, the result is a bandpass filter which allows a band of frequencies to pass, but stops frequencies above and below that band. (The full analysis and design of bandpass filters can get quite sticky; for more info, see my article entitled "Design an Active RTTY Filter" in 73 Magazine, September, 1977, page 38.)

Rather than use zeta,



```
(a)
0010 PRINT "LOW PASS ACTIVE FILTER STAGE DESIGN"
0020 REM COPYRIGHT 1979 BY P. STARK

0030 PRINT "STAGE GAIN SHOULD BE BELOW 10 FOR BEST RESULTS."
0040 INPUT "ENTER THE DESIRED STAGE GAIN", M
0050 INPUT "ENTER CUTOFF FREQUENCY IN HZ", F
0060 PRINT "ENTER THE DAMPING COEFFICIENT; ENTER 0.707 FOR A
0070 INPUT "BUTTERWORTH OR MAXIMALLY-FLAT FILTER", Z
0080 INPUT "ENTER FEEDBACK CAPACITOR IN MICROFARADS", C2
0090 C2=C2/1000000
0100 R2=Z/(2 * 3.14159 * F * C2)
0110 R3=R2/(M+1)
0120 R1=R2/H
0130 C1=(1 + M) * C2 / Z.2
0140 C1=C1*1000000
0150 PRINT "R1 IS "; R1; "OHMS"
0160 PRINT "R2 IS "; R2; "OHMS"
0170 PRINT "R3 IS "; R3; "OHMS"
0180 PRINT "C1 IS "; C1; "MICROFARADS"
0190 GOTO 80
```

```
(b)
LOW PASS ACTIVE FILTER STAGE DESIGN
STAGE GAIN SHOULD BE BELOW 10 FOR BEST RESULTS.
ENTER THE DESIRED STAGE GAIN? 5
ENTER CUTOFF FREQUENCY IN HZ? 100
ENTER THE DAMPING COEFFICIENT; ENTER 0.707 FOR A
BUTTERWORTH OR MAXIMALLY-FLAT FILTER? 0.707
ENTER FEEDBACK CAPACITOR IN MICROFARADS? .5
R1 IS 450.090558 OHMS
R2 IS 2250.45279 OHMS
R3 IS 375.075465 OHMS
C1 IS 6.00181254 MICROFARADS
ENTER FEEDBACK CAPACITOR IN MICROFARADS?
```

Program 2. Low-pass active filter. (a) Program. (b) Sample run.

```
(a)
0010 PRINT "HIGH PASS ACTIVE FILTER STAGE DESIGN"
0020 REM COPYRIGHT 1979 BY P. STARK

0030 PRINT "STAGE GAIN SHOULD BE BELOW 10 FOR BEST RESULTS."
0040 INPUT "ENTER THE DESIRED STAGE GAIN", M
0050 INPUT "ENTER CUTOFF FREQUENCY IN HZ", F
0060 PRINT "ENTER THE DAMPING COEFFICIENT; ENTER 0.707 FOR A
0070 INPUT "BUTTERWORTH OR MAXIMALLY-FLAT FILTER", Z
0080 INPUT "ENTER INPUT CAPACITOR C2 IN MICROFARADS", C2
0090 C2=C2/1000000
0100 R1=(2*M+1) / (4*3.14159*F*C2)
0110 R2=Z/(3.14159*F*C2*(2+1/H))
0120 C1=C2/H
0130 C1=C1*1000000
0140 PRINT "R1 IS "; R1; "OHMS"
0150 PRINT "R2 IS "; R2; "OHMS"
0160 PRINT "C1 IS "; C1; "MICROFARADS"
0170 GOTO 80
```

```
(b)
HIGH PASS ACTIVE FILTER STAGE DESIGN
STAGE GAIN SHOULD BE BELOW 10 FOR BEST RESULTS.
ENTER THE DESIRED STAGE GAIN? 5
ENTER CUTOFF FREQUENCY IN HZ? 1000
ENTER THE DAMPING COEFFICIENT; ENTER 0.707 FOR A
BUTTERWORTH OR MAXIMALLY-FLAT FILTER? 0.707
ENTER INPUT CAPACITOR C2 IN MICROFARADS? .1
R1 IS 12381.2295 OHMS
R2 IS 1022.93308 OHMS
C1 IS 0.02 MICROFARADS
ENTER INPUT CAPACITOR C2 IN MICROFARADS?
```

Program 3. High-pass active filter. (a) Program. (b) Sample run.

```
(a)
0010 PRINT "BAND PASS ACTIVE FILTER STAGE DESIGN"
0020 REM COPYRIGHT 1979 BY P. STARK
0030 PRINT "STAGE GAIN SHOULD BE BELOW 10 FOR BEST RESULTS."
0040 INPUT "ENTER THE DESIRED STAGE GAIN", M
0050 INPUT "ENTER CENTER FREQUENCY IN HZ", F
0060 W=2*3.14159*F
0070 INPUT "ENTER DESIRED Q", Q
0080 INPUT "ENTER INPUT CAPACITOR C2 IN MICROFARADS", C2
0090 C2=C2/1000000
0100 INPUT "ENTER FEEDBACK CAPACITOR C1 IN MICROFARADS", C1
0110 C1=C1/1000000
0120 R1=Q/(H*M*C1)
0130 T=R1/(Q*(C1+C2)*W)
0140 B=R1 - 1/(Q*(C1+C2)*W)
0150 R2=T/B
0160 R3=Q*(C1+C2)/(C1+C2*W)
0170 PRINT "R1 IS "; R1; "OHMS"
0180 PRINT "R2 IS "; R2; "OHMS"
0190 PRINT "R3 IS "; R3; "OHMS"
0200 GOTO 80
```

```
(b)
RUN
BAND PASS ACTIVE FILTER STAGE DESIGN
STAGE GAIN SHOULD BE BELOW 10 FOR BEST RESULTS.
ENTER THE DESIRED STAGE GAIN? 5
ENTER CENTER FREQUENCY IN HZ? 2100
ENTER DESIRED Q? 10
ENTER INPUT CAPACITOR C2 IN MICROFARADS? .1
ENTER FEEDBACK CAPACITOR C1 IN MICROFARADS? .1
R1 IS 1515.26264 OHMS
R2 IS 38.8657088 OHMS
R3 IS 15157.6264 OHMS
ENTER INPUT CAPACITOR C2 IN MICROFARADS?
READY
#
```

Program 4. Bandpass active filter. (a) Program. (b) Sample run.

```
(a)
0010 PRINT "BUTTERWORTH LC LOW PASS FILTER DESIGN"
0020 REM COPYRIGHT 1979 BY P. STARK

0030 INPUT "HOW MANY LC STAGES", N
0040 INPUT "ENTER SOURCE RESISTANCE", R
0050 INPUT "ENTER CUTOFF FREQUENCY IN HZ", F
0060 FOR I=1 TO N
0070 PRINT "STAGE "; I
0080 C=1/(3.14159*F*R)*SIN((4*I-3)*3.14159/(4*N))
0090 C=C*1000000
0100 L=R/(3.14159*F)*SIN((4*I-1)*3.14159/(4*N))
0110 L=L*1000
0120 PRINT " C IS "; C; "MICROFARADS"
0130 PRINT " L IS "; L; "MILLIHENRIES"
0140 NEXT I
```

```
(b)
RUN
BUTTERWORTH LC LOW PASS FILTER DESIGN
HOW MANY LC STAGES? 2
ENTER SOURCE RESISTANCE? 600
ENTER CUTOFF FREQUENCY IN HZ? 2500
STAGE 1
C IS 0.0812079444 MICROFARADS
L IS 70.5792315 MILLIHENRIES
STAGE 2
C IS 0.196053632 MICROFARADS
L IS 29.2352725 MILLIHENRIES
READY
#
```

Program 5. Butterworth LC filter. (a) Program. (b) Sample run.

```
(a)
0010 PRINT "RESISTIVE T AND PI ATTENUATORS"
0020 REM COPYRIGHT 1979 BY P. STARK

0030 INPUT "ENTER INPUT IMPEDANCE IN OHMS", Z1
0040 INPUT "ENTER OUTPUT IMPEDANCE IN OHMS", Z0
0050 T=(SQRT(Z1/Z0)+SQRT(Z1/Z0-1))2
0060 M=10*LOG(T)/2.3025
0070 PRINT "THE MINIMUM PAD LOSS IS "; M; "DB"
0080 PRINT "WHAT DB LOSS DO YOU WANT? (MUST BE GREATER"
0090 INPUT "THAN MINIMUM ABOVE", L
0100 L=10*(L/10)
0110 PRINT "T PAD ATTENUATOR:"
0120 R3=2*SQRT(L*Z1*Z0)/(L-1)
0130 R1=Z1*(L+1)/(L-1)-R3
0140 R2=Z1*(L+1)/(L-1)-R3
0150 GOSUB 240
0160 PRINT "PI PAD ATTENUATOR:"
0170 R3=(L-1)/2*SQRT(Z1*Z0/L)
0180 T=(L+1)/(L-1)/Z1-1/R3
0190 R1=1/T
0200 T=(L+1)/(L-1)/Z0-1/R3
0210 R2=1/T
0220 GOSUB 240
0230 END
0240 PRINT "RESISTOR R1 IS "; R1; "OHMS"
0250 PRINT " R2 IS "; R2; "OHMS"
0260 PRINT " R3 IS "; R3; "OHMS"
0270 RETURN
```

```
(b)
RUN
RESISTIVE T AND PI ATTENUATORS
ENTER INPUT IMPEDANCE IN OHMS? 600
ENTER OUTPUT IMPEDANCE IN OHMS? 600
THE MINIMUM PAD LOSS IS 0 DB
WHAT DB LOSS DO YOU WANT? (MUST BE GREATER
THAN MINIMUM ABOVE? 3
T PAD ATTENUATOR:
RESISTOR R1 IS 102.59851 OHMS
R2 IS 102.59851 OHMS
R3 IS 1703.11415 OHMS
PI PAD ATTENUATOR:
RESISTOR R1 IS 3508.82782 OHMS
R2 IS 3508.82782 OHMS
R3 IS 211.377475 OHMS
```

Program 6. T and pi attenuators. (a) Program. (b) Sample run.

```
(a)
0010 PRINT "SWR CALCULATOR PROGRAM"
0020 REM COPYRIGHT 1979 BY P. STARK

0030 INPUT "ENTER FORWARD POWER IN WATTS", F
0040 INPUT "ENTER REVERSE POWER IN WATTS", R
0050 F1=SQRT(F)
0060 R1=SQRT(R)
0070 S=(F1+R1)/(F1-R1)
0080 PRINT "THE SWR IS "; S; " : 1"
```

```
(b)
RUN
SWR CALCULATOR PROGRAM
ENTER FORWARD POWER IN WATTS? 50
ENTER REVERSE POWER IN WATTS? 10
THE SWR IS 2.61803422 : 1
READY
#
```

Program 7. Swr calculator. (a) Program. (b) Sample run.

bandpass filters are usually characterized by their Q, which describes the sharpness of the filter response. A response which is very broad and passes a wide range of frequencies has a low Q, while a very sharp response which passes only a narrow range of frequencies has a high Q.

As you can see from Fig. 5, the diagram of an active bandpass filter is very similar to the low-pass and high-pass filters; the only difference is that each filter has its resistors and capacitors in a slightly different place.

Program 4 is used to calculate component values from desired response data. There is a lot of interplay between capacitor and resistor values, and so the program assumes that you choose the capacitors and it calculates the resistors.

For instance, to get a gain of 5, center frequency of 1000 Hz, and a Q of 10, we need these approximate values: C1 = C2 = 0.1 uF; R1 = 1515 Ohms; R2 = 38 Ohms; R3 = 15157 Ohms.

#### Butterworth LC Filters

Filters don't have to be active—they can also be

passive. That is, instead of using amplifiers and fancy circuitry, they can also use plain LC circuits. Fig. 6 shows a popular LC low-pass filter. Though a passive filter is somewhat bulkier and more difficult to trim than an active filter, it is simpler and can handle large power levels. Moreover, active filters are only useful at relatively low frequencies; they cannot be used at rf frequencies because the amplifiers required to make them work at such high frequencies are simply not available.

This kind of filter will on-

ly work properly when the input and output resistances are correct; the equations used in our program assume that the source and load resistances are equal.

As shown in Fig. 6, one stage of the filter consists of one capacitor and one inductor; the filter shown is a two-stage filter, but could really have any number of stages. Each stage adds two poles to the response (see the bandpass filter article mentioned before for an explanation of how poles affect the response curve).

Program 5 is specifically



set up for Butterworth filters. The program shows how calculations are made for a two-stage Butterworth filter for a 600-Ohm line, 2500-Hz cutoff frequency, and two stages.

### T and Pi Attenuators

Attenuators or pads are often inserted into a signal path to attenuate the signal going through it. Although a plain pot, connected as a volume control, will often do the job, special circuits called T and pi attenuators are needed when the circuit is required to maintain input and output resistances equal to the line impedance. A common application is in a 600-Ohm telephone line or 16-Ohm speaker system. Broadcast stations, which use 600-Ohm lines for almost all audio paths, use attenuators or pads a lot.

In many cases, an attenuator is used not only to attenuate, but also to match impedances; in this case, it is designed to have unequal input and output resistances.

Fig. 7 shows why these attenuators are called T and pi; the T pad looks like the letter T, while the pi circuit looks like the greek letter pi ( $\pi$ ).

Program 6 allows us to calculate all the resistor values for both pads, starting with the desired input and output impedances and the pad loss. The pad loss indicates how much attenuation the circuit should provide and is measured in decibels (dB).

When the input and output line impedances are equal, a zero loss (loss of 0 dB) could be achieved by simply connecting the input and output by wires; hence the minimum pad loss possible is 0 dB, and the attenuator can provide anything above that. When the input and output impedances are not equal, however, then some loss is always neces-

sary because of the impedance-matching requirements of the pad. The sample run indicates that after the input and output resistances are entered, the program outputs the minimum pad loss possible with those impedances. It then asks for a desired loss, which has to be equal to or greater than the minimum, and then computes all resistor values for the two circuits.

### Swr Calculator

If you have a "forward and reflected power meter" in your antenna line, you often want to do a calculation of the swr from the forward and reflected powers. Program 7 is a very simple (almost trivial) program which does just this. For instance, it shows that if the forward power going to the antenna is about 50 Watts while the reflected power is 10 Watts, the swr is about 2.6 to 1.

### Intermodulation Spurs

Still on the subject of rf, here is a program useful to repeater users and operators. Very often, two repeater signals will combine in some non-linear circuit to produce an output frequency which interferes with some other signal. This is based on the same summing or differencing that we're familiar with in mixers, except that in this case the signals involved may be either the fundamental or a harmonic of one or both of the signals.

That sounds quite abstract, so look at this example. Suppose that two 2-meter FM transmitters are interacting; one of these is at 146.94, the other at 147.00. If the second harmonic of the 146.94 transmitter (which is at 293.88) beats with the 147.00 signal, we get a difference frequency of  $293.88 - 147.00 = 146.88$ , which is often called an "intermod spur" and which could easily

cause interference to still another repeater.

The problem, though, is that higher harmonics may be involved than just the second; for instance, the third harmonic of one signal might be beating with the seventh of the other. Sometimes it's hard to find the right harmonic to use in this calculation, especially when we work the problem backwards—we know where the interference is and are trying to find the cause.

Program 8 is a general-purpose program to find causes of intermod spurs. Rather than requiring specific input and output frequencies, it will accept a range of frequencies; if you want to use just a single frequency, enter the same value for both the lower and upper frequency of each range.

The sample run shows an interesting example. Suppose you run a 146.34-146.94 MHz repeater and find that your own 146.94-MHz output is mixing with the output of some other 2-meter repeater to produce an intermod spur on the 146.34-MHz input frequency of your own repeater. Enter 146.94 as the lower and upper limits of input 1, enter a range of frequencies (146.60 - 147.00) as input 2, and enter the 146.34 frequency as the output range. Then run the

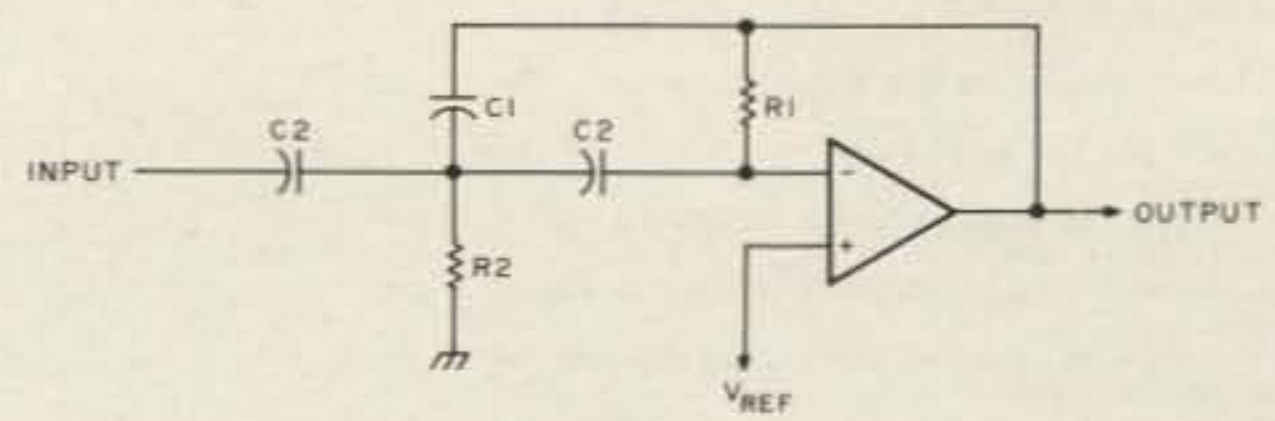

Fig. 4. High-pass active filter.

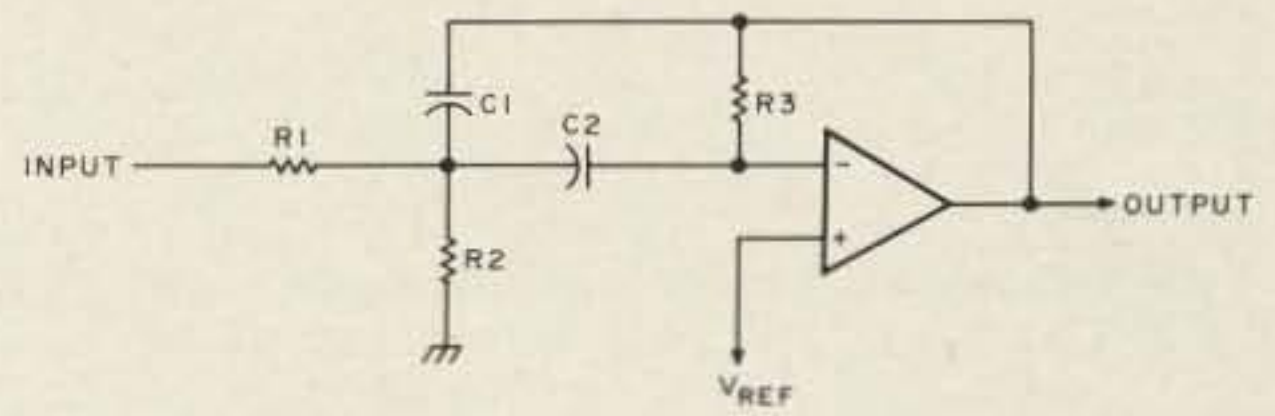

Fig. 5. Bandpass active filter.

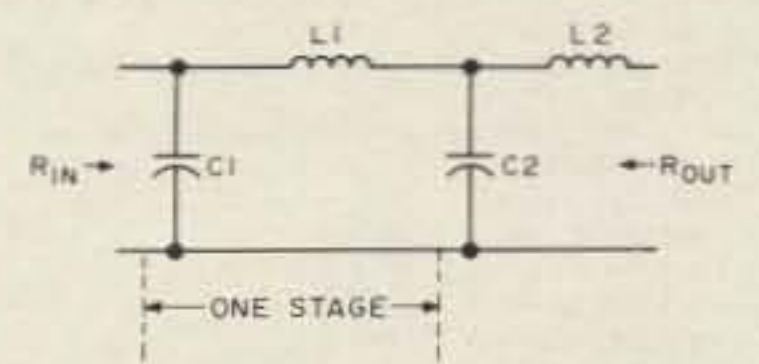
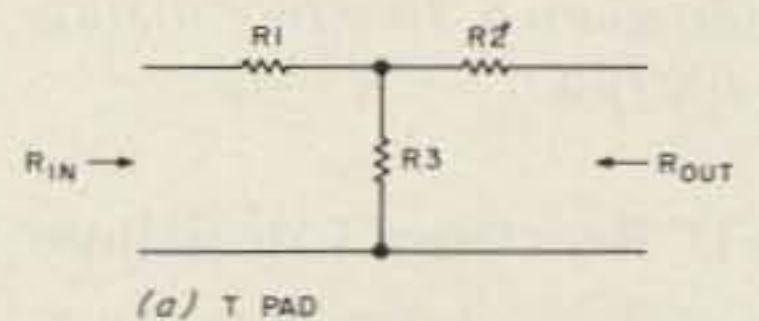
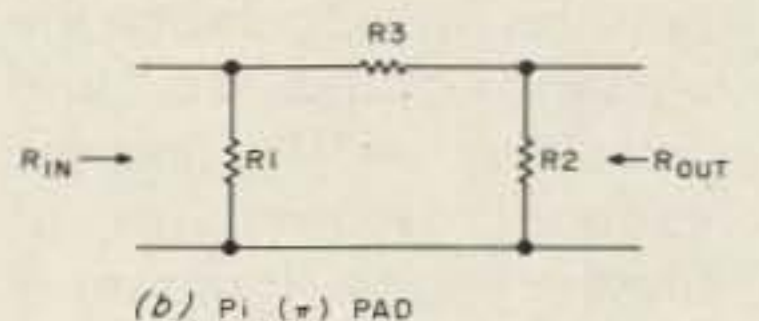

Fig. 6. Passive (LC) filter.



(a) T PAD



(b) Pi (π) PAD

Fig. 7. T and pi attenuators. (a) T pad. (b) Pi ( $\pi$ ) pad.

program, and you get the five output lines shown at the bottom.

The last line, for example, says  $5 * \text{FREQ } 1$ , and  $6 * \text{FREQ } 2$  (\* means times in the BASIC language) is one of the intermod products. This means that the fifth harmonic of your own transmitter might be beating with the sixth harmonic of another to produce an intermod spur. Sure enough, when you sit down with a calculator, you find that this occurs when  $(6 * 146.84) - (5 * 146.94) = 146.34$ . If you know that there is no repeater output in your area on 146.84 MHz, you can disregard this possibility and look at the other four.



```
(a)
0010 PRINT "INTERMODULATION SPUR ANALYSIS PROGRAM"
0020 REM COPYRIGHT 1979 BY P. STARK

0030 PRINT "ENTER THE LOWER AND UPPER FREQUENCIES FOR INPUT 1"
0040 INPUT L1,H1
0050 PRINT "ENTER THE LOWER AND UPPER FREQUENCIES FOR INPUT 2"
0060 INPUT L2,H2
0070 PRINT "ENTER THE LOWER AND UPPER FREQUENCIES OF THE"
0080 PRINT "OUTPUT RANGE"
0090 INPUT L0,H0
0100 Q0=0
0110 M2=0
0120 M2=M2+1
0130 M1=Q0-M2
0140 IF M1<=0 GO TO 250
0150 S1 =M1*L1-M2*H2
0160 S2=M1*H1-M2*L2
0170 IF L0-S2<=0 GO TO 210
0180 G4=-S1
0190 S1=-S2
0200 S2=G4
0210 Z=(S2-L0)+(S1-H0)
0220 IF Z>0 GO TO 120
0230 PRINT M1;"* FREQ 1, AND "; M2;"* FREQ 2"
0240 GOTO 120
0250 Q0=Q0+1
0260 M2=0
0270 GOTO 130
```

```
(b)
RUN
INTERMODULATION SPUR ANALYSIS PROGRAM
ENTER THE LOWER AND UPPER FREQUENCIES FOR INPUT 1
? 146.94, 146.94
ENTER THE LOWER AND UPPER FREQUENCIES FOR INPUT 2
? 146.80, 147.00
ENTER THE LOWER AND UPPER FREQUENCIES OF THE
OUTPUT RANGE
? 146.34, 146.34
1 * FREQ 1, AND 2 * FREQ 2
2 * FREQ 1, AND 3 * FREQ 2
3 * FREQ 1, AND 4 * FREQ 2
4 * FREQ 1, AND 5 * FREQ 2
5 * FREQ 1, AND 6 * FREQ 2

READY
#
```

Program 8. Intermodulation analyzer. (a) Program. (b) Sample run.

### LC Reactance Calculations

There is a whole set of formulas for calculating the reactance of inductors and capacitors and finding the resonant frequencies of tuned circuits. Program 9 puts them all together into one program which can find any quantity when the others are known.

The program has three parts, for tuned circuits, inductors, or capacitors. Once you choose one of these (see the sample run in Program 9), the program asks for the known data; simply answer 0 for the unknown quantity. It then calculates the unknown and prints it out.

### Series-Parallel Calculations

Series or parallel resistors, capacitors, and inductors don't require a computer to find equivalent values, but the program is so simple that it makes a good demonstrator. Program 10 shows how it's done.

### Power-Supply Calculations

Calculating the output

voltage and ripple for a given transformer/rectifier/filter combination is also very easy, but it's easy to make a mistake by doing the wrong computation. Thus Program 11 is a very useful one.

This program assumes that silicon diodes with a voltage drop of .7 volts are used and is especially useful for low-voltage power supplies. It asks for the secondary voltage of the power transformer and then for the type of rectifier—half-wave, full-wave, or bridge. From these, it computes the peak output voltage from the rectifier, before filtering.

Either a single-capacitor filter or a choke-input filter can be specified. The output voltage and ripple depend on the load current, and the program computes that from the load resistance. It assumes that the transformer and/or choke resistance is very low in comparison with the load resistance and then outputs the dc output voltage and

the ripple voltage.

The two sample runs are interesting because they are related to 5-volt power supplies used in digital circuits. Sample run (b) assumes a 12.6-volt CT transformer with a full-wave rectifier, 1000-uF capacitor filter, and a load resistance of 25 Ohms. This gives an output voltage of 6.25 volts with a peak-to-peak ripple of 2.5 volts; this translates to an output which goes 1.25 volts above and below the average dc voltage, so that the ripple goes from 5 volts to 7.5 volts. Since most 5-volt regulators go out of regulation if their input drops below about 7 volts, this circuit would not be suitable for a regulated 5-volt power supply.

In sample run (c), on the other hand, an 8-volt transformer, bridge rectifier, and 5000-uF filter would be good enough for a power supply with a much lower load resistance.

### Printing Purchase Orders

Many parts suppliers don't like to deal with individual purchasers. This is so for a variety of reasons, but you can soothe them a lot—and possibly get better service—by sending them an official-looking purchase order rather than a hastily scribbled sheet of paper. If your computer has a printer, you can use it to print up those purchase orders for you, using Program 12. The best way to get acquainted with the program is to look at the sample run in (b).

When the program starts, it asks you to enter the quantity, stock or part number, description, and price for each item, separated by commas. The quantity must be a number, but the stock part number can be a string such as 2N2222 or 74LS00.

If a whole series of items have the same description—the following, for instance—

5, 10k, ¼ W resistor, .10  
10, 22k, ¼ W resistor, .10  
10, 47k, ¼ W resistor, .10  
then entering a period instead of a description will simply repeat the same description as in the previous item.

The price entered is the price each; for instance, in the above example, the price for each resistor. Often, though, there is a group price, like "3 for \$1." Rather than try to break this up into \$0.33 each and then have the computer print it out as a total of \$0.99, you can enter a group price rather than an individual price by entering it as a minus number. For example, the second item on the sample run is entered as -27 to show that it is for the entire group of 10 pieces.

Enter -10,0,0,0 to end your order entry. The program now prints out the total dollar amount of the order, not including sales tax and shipping, and asks whether you'd like a print-out of your order.

In the printout, each item is numbered at the left. Once finished, the program asks whether you'd like to make changes. This part is not shown in the sample, but if the answer is YES, it will then ask for the item number and allow you to reenter the entire line again. If the quantity is entered as 0, that item will be deleted from the order.

Once the order has been corrected, the program asks whether there is sales tax on the order; the sales tax applies on in-state purchases, but not on out-of-state deals. The percentage is set in line 750 of the program at 5 percent; change it to your local rate.

Also requested at this point is the date, estimated shipping cost, type of payment, and transportation method desired. The latter two may be strings; you can specify, for instance, COD



```
(a)
0010 PRINT "INDUCTANCE-CAPACITANCE PROGRAM"
0020 REM COPYRIGHT 1979 BY P. STARK
0030 PRINT
0040 PRINT "WHICH PROBLEM DO YOU WANT TO DO?"
0050 PRINT "  1. TUNED CIRCUIT"
0060 PRINT "  2. INDUCTIVE REACTANCE"
0070 PRINT "  3. CAPACITIVE REACTANCE"
0080 INPUT A
0090 PRINT "ENTER THE FOLLOWING; ENTER 0 IF NOT KNOWN."
0100 PRINT "FREQUENCY IN HERTZ?";
0110 INPUT F
0120 IF A = 1 GO TO 270
0130 PRINT "REACTANCE IN OHMS?";
0140 INPUT X
0150 IF A = 2 GO TO 180
0160 IF A = 3 GO TO 270
0170 GOTO 30
0180 PRINT "INDUCTANCE IN HENRYS";
0190 INPUT L
0200 IF F = 0 THEN F = X / (2 * 3.14159 * L)
0210 IF L = 0 THEN L = X / (2 * 3.14159 * F)
0220 IF X = 0 THEN X = 2 * 3.14159 * F * L
0230 PRINT "INDUCTANCE IN HENRYS IS "; L
0240 PRINT "REACTANCE IN OHMS IS "; X
0250 PRINT "FREQUENCY IN HERTZ IS "; F
0260 GOTO 30
0270 PRINT "CAPACITANCE IN MICROFARADS?";
0280 INPUT C
0290 C = C / 1000000
0300 IF A = 1 GO TO 370
0310 IF X = 0 THEN X = 1 / (2 * 3.14159 * F * C)
0320 IF C = 0 THEN C = 1 / (2 * 3.14159 * F * X)
0330 IF F = 0 THEN F = 1 / (2 * 3.14159 * X * C)
0340 C = C * 1000000
0350 PRINT "CAPACITANCE IN MICROFARADS IS "; C
0360 GOTO 240
0370 PRINT "INDUCTANCE IN HENRYS?";
0380 INPUT L
0390 IF F = 0 THEN F = 1 / (2 * 3.14159 * SQR(L * C))
0400 IF L = 0 THEN L = 1 / (4 * 3.14159^2 * F^2 * C)
0410 IF C = 0 THEN C = 1 / (4 * 3.14159^2 * F^2 * L)
0420 C = C * 1000000
0430 PRINT "CAPACITANCE IN MICROFARADS IS "; C
0440 X = 0
0450 GOTO 220
```

```
(b)
RUN
INDUCTANCE-CAPACITANCE PROGRAM

WHICH PROBLEM DO YOU WANT TO DO?
  1. TUNED CIRCUIT
  2. INDUCTIVE REACTANCE
  3. CAPACITIVE REACTANCE
? 1
ENTER THE FOLLOWING; ENTER 0 IF NOT KNOWN.
FREQUENCY IN HERTZ? 2025
CAPACITANCE IN MICROFARADS? 0
INDUCTANCE IN HENRYS? .088
CAPACITANCE IN MICROFARADS IS 0.0791952681
INDUCTANCE IN HENRYS IS 0.088
REACTANCE IN OHMS IS 1119.66267
FREQUENCY IN HERTZ IS 2025

WHICH PROBLEM DO YOU WANT TO DO?
  1. TUNED CIRCUIT
  2. INDUCTIVE REACTANCE
  3. CAPACITIVE REACTANCE
? 2
ENTER THE FOLLOWING; ENTER 0 IF NOT KNOWN.
FREQUENCY IN HERTZ? 2295
REACTANCE IN OHMS? 0
INDUCTANCE IN HENRYS? .088
INDUCTANCE IN HENRYS IS 0.088
REACTANCE IN OHMS IS 1268.95103
FREQUENCY IN HERTZ IS 2295
```

```
WHICH PROBLEM DO YOU WANT TO DO?
  1. TUNED CIRCUIT
  2. INDUCTIVE REACTANCE
  3. CAPACITIVE REACTANCE
?
READY
*
```

Program 9. Reactance and tuned circuits. (a) Program. (b) Sample run.

or CHECK ENCLOSED for payment type, and UPS or BEST WAY or some other means for the other.

Finally, the program asks for a supplier address of up to five lines, as well as a purchase-order number. Enter as many address lines as needed, and enter a blank for the last. Then make up a purchase-order number.

The purchase order or PO number is important, because suppliers always

file your order by your PO number. Their invoicing program also references that number. Besides, it makes the whole thing look official. So make up a PO number and include it.

The very last request is for the number of the output port which has the printer. This is then followed by the PO at the bottom. You must admit that it looks good.

The program itself was written in Percom 6800

```
(a)
0010 PRINT "RESISTORS, INDUCTORS, OR CAPACITORS, IN"
0020 PRINT "SERIES OR PARALLEL"
0030 REM COPYRIGHT 1979 BY P. STARK
0040 PRINT "USE OPTION 1 FOR"
0050 PRINT "  RESISTORS OR INDUCTORS IN SERIES, OR"
0060 PRINT "  CAPACITORS IN PARALLEL"
0070 PRINT "USE OPTION 2 FOR"
0080 PRINT "  RESISTORS OR INDUCTORS IN PARALLEL, OR"
0090 PRINT "  CAPACITORS IN SERIES"
0100 PRINT " *** IMPORTANT ***"
0110 PRINT "MAKE SURE TO USE THE SAME UNITS FOR EACH ELEMENT"
0120 PRINT "  FOR INSTANCE, ALL MUST BE IN OHMS, K, ETC."
0130 INPUT "WHICH OPTION DO YOU WANT? "; O
0140 INPUT "HOW MANY ELEMENTS ARE THERE? "; N
0150 S=0
0160 REM ENTER ALL THE ELEMENTS
0170 FOR I=1 TO N
0180   PRINT "ELEMENT NO. "; I
0190   INPUT V
0200   IF O=1 THEN S=S+V
0210   IF O=2 THEN S=S+1/V
0220 NEXT I
0230 REM CALCULATE THE TOTAL
0240 IF O=2 THEN S=1/S
0250 PRINT "TOTAL OF ALL "; N; "ELEMENTS IS "; S
```

```
(b)
RUN
RESISTORS, INDUCTORS, OR CAPACITORS, IN
SERIES OR PARALLEL
USE OPTION 1 FOR
  RESISTORS OR INDUCTORS IN SERIES, OR
  CAPACITORS IN PARALLEL
USE OPTION 2 FOR
  RESISTORS OR INDUCTORS IN PARALLEL, OR
  CAPACITORS IN SERIES
*** IMPORTANT ***
MAKE SURE TO USE THE SAME UNITS FOR EACH ELEMENT
  FOR INSTANCE, ALL MUST BE IN OHMS, K, ETC.
WHICH OPTION DO YOU WANT? 1
HOW MANY ELEMENTS ARE THERE? 2
ELEMENT NO. 1
? 10000
ELEMENT NO. 2
? 27000
TOTAL OF ALL 2 ELEMENTS IS 37000
READY
*
```

```
(c)
RUN
RESISTORS, INDUCTORS, OR CAPACITORS, IN
SERIES OR PARALLEL
USE OPTION 1 FOR
  RESISTORS OR INDUCTORS IN SERIES, OR
  CAPACITORS IN PARALLEL
USE OPTION 2 FOR
  RESISTORS OR INDUCTORS IN PARALLEL, OR
  CAPACITORS IN SERIES
*** IMPORTANT ***
MAKE SURE TO USE THE SAME UNITS FOR EACH ELEMENT
  FOR INSTANCE, ALL MUST BE IN OHMS, K, ETC.
WHICH OPTION DO YOU WANT? 2
HOW MANY ELEMENTS ARE THERE? 3
ELEMENT NO. 1
? 100
ELEMENT NO. 2
? .01
ELEMENT NO. 3
? .05
TOTAL OF ALL 3 ELEMENTS IS 0.00833263894
READY
*
```

Program 10. Series-parallel calculator. (a) Program. (b) Sample run for series resistors. (c) Sample run for parallel resistors.

```
(a)
0010 PRINT "POWER SUPPLY AND FILTERING CALCULATIONS"
0020 REM COPYRIGHT 1979 BY P. STARK
0030 INPUT "ENTER FULL SECONDARY RMS VOLTAGE? "; V
0040 PRINT "WHAT KIND OF RECTIFIER?"
0050 PRINT "  H = HALF-WAVE"
0060 PRINT "  F = FULL-WAVE"
0070 PRINT "  B = BRIDGE"
0080 INPUT A$
0090 IF A$="H" THEN P=V*1.414-0.7
0100 IF A$="F" THEN P=V*1.414-1.4
0110 IF A$="B" THEN P=V*1.414-1.4
0120 IF P=0 GO TO 30
0130 PRINT "WHAT KIND OF FILTER?"
0140 PRINT "  C = CAPACITOR ONLY"
0150 PRINT "  LC = CHOK INPUT ONE STAGE"
0160 INPUT B$
0170 IF B$="LC" THEN INPUT "ENTER CHOK INDUCTANCE IN HENRYS?";L
0180 INPUT "ENTER FILTER CAPACITANCE IN MICROFARADS?"; C
0190 C=C/1000000
0200 INPUT "ENTER LOAD RESISTANCE IN OHMS?"; R
0210 IF B$="C" THEN IF A$="H" THEN H=P/(60*R*C)
0220 IF B$="C" THEN IF A$="F" THEN H=P/(120*R*C)
0230 IF B$="C" THEN IF A$="B" THEN H=P/(3*3.14159*3*F*2*L*C)
0240 IF B$="LC" THEN IF A$="H" THEN H=P/(16*3.14159*3*F*2*L*C)
0250 IF H=0 GO TO 130
0260 IF B$="C" THEN V=P/H-0.2
0270 IF B$="LC" THEN V=P/2*P/3.14159
0280 PRINT "DC OUTPUT VOLTAGE IS "; V; "VOLTS"
0290 PRINT "PEAK-TO-PEAK RIFPLE IS "; H; "VOLTS"
```

```
(b)
RUN
POWER SUPPLY AND FILTERING CALCULATIONS
ENTER FULL SECONDARY RMS VOLTAGE? 12.6
WHAT KIND OF RECTIFIER?
  H = HALF-WAVE
  F = FULL-WAVE
  B = BRIDGE
? F
WHAT KIND OF FILTER?
  C = CAPACITOR ONLY
  LC = CHOK INPUT ONE STAGE
? C
ENTER FILTER CAPACITANCE IN MICROFARADS? 1000
ENTER LOAD RESISTANCE IN OHMS? 25
DC OUTPUT VOLTAGE IS 6.25683334 VOLTS
PEAK-TO-PEAK RIFPLE IS 2.50273333 VOLTS
READY
*
```

```
(c)
RUN
POWER SUPPLY AND FILTERING CALCULATIONS
ENTER FULL SECONDARY RMS VOLTAGE? 8
WHAT KIND OF RECTIFIER?
  H = HALF-WAVE
  F = FULL-WAVE
  B = BRIDGE
? B
WHAT KIND OF FILTER?
  C = CAPACITOR ONLY
  LC = CHOK INPUT ONE STAGE
? C
ENTER FILTER CAPACITANCE IN MICROFARADS? 5000
ENTER LOAD RESISTANCE IN OHMS? 10
DC OUTPUT VOLTAGE IS 9.086 VOLTS
PEAK-TO-PEAK RIFPLE IS 1.652 VOLTS
READY
*
```

Program 11. Power-supply design. (a) Program. (b) Sample run for full-wave rectifier/capacitor filter. (c) Sample run for bridge rectifier/capacitor filter.

Super BASIC and contains only standard BASIC statements. The only feature which may need change for your BASIC is its way of specifying output ports. In line 920, we input a port number Z. Lines 940 and on then use that in a PRINT statement as PRINT #10. If Z equals 1, then printing is done to port number 1 and so on.

Lines 1020-1040 should be modified to contain your shipping address. Please

don't send out your orders with mine!

### Printing Wire Lists

A wire list is simply a listing of all wires in a system. It is used in industry during system manufacture to allow little old ladies to wire up a system without knowing what it's all about.

See the last few lines of Program 16 for an example of a simple wire list. In the list, each signal gets a name like 5 V, GROUND, or IN-



```

(a)
0100 PRINT "PURCHASE ORDER PROGRAM"

0110 REM COPYRIGHT 1980 BY PETER A. STARK

0120 C=100 :REM ALLOW UP TO 100 ITEMS PER ORDER
0130 DIM Q(C),N$(C),D$(C),P(C)
0140 DIM T(C),S$(C)
0150 LINE=0
0160 PRINT "ENTER QUANTITY, STOCK/PART NUMBER, DESCRIPTION,";
0170 PRINT " AND PRICE EACH."
0180 PRINT "IF GROUP PRICE EXISTS, ENTER THE TOTAL AS MINUS."
0190 PRINT "ENTER 0 QUANTITY TO DELETE AN ITEM"
0200 PRINT "ENTER QUANTITY BETWEEN -1 AND -9 TO BACKSPACE"
0210 PRINT "WHEN DONE, ENTER -10,0,0,0"
0220 L=0
0230 K=1
0240 PRINT K;
0250 INPUT Q(K),N$(K),D$(K),P(K)
0260 IF K>L THEN L=K
0270 T(K)=Q(K)*P(K)
0280 IF P(K)<0 THEN T(K)=-P(K)
0290 IF Q(K)=0 THEN T(K)=0
0300 IF D$(K)="" THEN D$(K)=D$(K-1)
0310 IF Q(K)=-10 GO TO 400
0320 IF Q(K)=0 GO TO 350
0330 K=K+Q(K) :REM BACKSPACE 0 ITEMS IF 0 IS NEGATIVE
0340 GOTO 240
0350 K=K+1
0360 IF K<>C GO TO 240 :REM CHECK FOR OVERFLOW
0370 PRINT "ENOUGH ITEMS; NO MORE."

0380 REM ALL ITEMS HAVE BEEN ENTERED; NOW TOTAL BILL
0390 REM AND CONTINUE

0400 M=0
0410 FOR K=1 TO L-1
0420 M=M+T(K)
0430 NEXT K
0440 PRINT "TOTAL OF ORDER (NOT INCLUDING SHIPPING ETC) $";
0450 PRINT M
0460 PRINT "WANT LISTING OF YOUR ORDER?";
0470 INPUT A$
0480 IF A$="NO" GO TO 570
0490 FOR K=1 TO L-1
0500 IF Q(K)=0 THEN GO TO 530 :REM SKIP DELETED ITEMS
0510 PRINT K;TAB(4);Q(K);TAB(10);N$(K);TAB(20);P(K);
0520 PRINT TAB(28);T(K);TAB(36);D$(K)
0530 IF (K-INT(K/10)*10)<10 GO TO 560
0540 PRINT "HIT C/R TO CONTINUE";
0550 INPUT A$ :REM STOP AND WAIT EVERY 10 LINES
0560 NEXT K
0570 PRINT "ANY CHANGES?";
0580 INPUT A$
0590 IF A$="NO" GO TO 710
0600 IF A$<>"YES" GO TO 460
0610 PRINT "WHICH ITEM?"; :REM ALLOW CORRECTIONS
0620 INPUT K;
0630 PRINT K;
0640 INPUT Q(K),N$(K),D$(K),P(K) :REM INPUT CORRECTED ITEM
0650 T(K)=Q(K)*P(K) :REM CALCULATE NEW TOTAL PRICE
0660 IF P(K)<0 THEN T(K)=-P(K)
0670 IF Q(K)=0 THEN T(K)=0
0680 IF K>L THEN L=K+1 :REM UPDATE COUNTER IF ADDED ITEM
0690 GOTO 400

0700 REM ALL ITEMS ENTERED AND CORRECTED; GET MORE INFO

0710 PRINT "SALES TAX -- YES OR NO?";
0720 INPUT A$
0730 S=0
0740 IF A$<>"YES" GO TO 770
0750 S=M*.05 :REM .05 IS FOR 5% - CHANGE IF NEEDED
0760 S=INT(S*100+.5)/100 :REM ROUND TO NEAREST PENNY
0770 PRINT "SALES TAX IS $";S
0780 INPUT "ENTER DATE", Y$
0790 INPUT "ENTER SHIPPING COST", U
0800 INPUT "ENTER TYPE OF PAYMENT", P$
0810 INPUT "ENTER TYPE OF TRANSPORTATION", T$
0820 PRINT "ENTER ADDRESS OF SUPPLIER (UP TO 5 LINES)"
0830 FOR K=1 TO 5
0840 PRINT "LINE ";K;
0850 INPUT S$(K)
0860 IF S$(K)="" THEN GOTO 890 :REM CHECK FOR LAST LINE
0870 S$=K :REM COUNT NUMBER OF LINES
0880 NEXT K
0890 INPUT "ENTER PURCHASE ORDER NUMBER", P$
0900 PRINT "ENTER PORT NUMBER FOR OUTPUT AND TURN ON PRINTER"
0910 PRINT "IF NECESSARY."
0920 INPUT Z

0930 REM FINALLY READY TO PRINT ON PORT Z.

0940 PRINT W$
0950 PRINT W$,TAB(23);"PURCHASE ORDER No. ";P$
0960 PRINT W$; :PRINT W$
0970 PRINT W$,TAB(12);S$(1);TAB(45);Y$
0980 FOR K=2 TO 55
0990 PRINT W$,TAB(12);S$(K)
1000 NEXT K
1010 PRINT W$
1020 PRINT W$,TAB(12);"SHIP TO:";TAB(12);"PETER A. STARK"
1030 PRINT W$,TAB(12);"P. O. BOX 209"
1040 PRINT W$,TAB(12);"MT. KISCO, N. Y. 10549"
1050 PRINT W$

```

```

1060 PRINT W$,TAB(12);P$;TAB(45);"SHIP VIA: ";T$
1070 PRINT W$; :PRINT W$
1080 PRINT W$,TAB(12);"QUANT. PART NO. DESCRIPTION";
1090 PRINT W$,TAB(50);"EACH EXT."
1100 PRINT W$,TAB(50);"-----";
1110 PRINT W$,TAB(50);"-----"
1120 PRINT W$

1130 REM NOW PRINT OUT EACH ITEM ORDERED

1140 FOR K=1 TO L-1
1150 IF Q(K)=0 THEN GO TO 1280
1160 L$=STR$(Q(K)) :REM CONVERT QUANTITY TO A STRING
1170 L1=LEN(L$) :REM USE INSTEAD OF PRINT USING
1180 PRINT W$,TAB(5-L1);Q(K);TAB(8);N$(K);TAB(20);D$(K);
1190 DIGITS=2 :REM USE INSTEAD OF PRINT USING
1200 IF P(K)<0 THEN GO TO 1240 :REM PRINT WITH 2 DIGITS AFTER DECIMAL POINT
1210 L$=STR$(P(K)) :REM CONVERT PRICE TO STRING
1220 L1=LEN(L$) :REM USE INSTEAD OF PRINT USING
1230 PRINT W$,TAB(54-L1);P(K); :REM ALIGN PRICE AND PRINT
1240 L$=STR$(T(K))
1250 L1=LEN(L$) :REM REPEAT FOR EXTENSION
1260 PRINT W$,TAB(63-L1);T(K)
1270 DIGITS=0 :REM CANCEL 2-DIGIT PRINT
1280 NEXT K

1290 REM ALL ITEMS NOW PRINTED; PRINT TOTALS ETC.

1300 PRINT W$
1310 DIGITS=2
1320 L$=STR$(M)
1330 L1=LEN(L$)
1340 PRINT W$,TAB(40);"SUBTOTAL:";TAB(63-L1);M
1350 L$=STR$(S)
1360 L1=LEN(L$)
1370 PRINT W$,TAB(40);"SALES TAX:";TAB(63-L1);S
1380 L$=STR$(U)
1390 L1=LEN(L$)
1400 PRINT W$,TAB(40);"SHIPPING/INS.:";TAB(63-L1);U
1410 PRINT W$
1420 L$=STR$(M+S+U)
1430 L1=LEN(L$)
1440 PRINT W$,TAB(40);"TOTAL:";TAB(63-L1);M+S+U
1450 PRINT W$
1460 DIGITS=0
1470 PRINT W$,TAB(10);"*****PLEASE EXPEDITE THIS ORDER*****"
1480 GOTO 900

```

```

(b)
PURCHASE ORDER PROGRAM
ENTER QUANTITY, STOCK/PART NUMBER, DESCRIPTION, AND PRICE EACH.
IF GROUP PRICE EXISTS, ENTER THE TOTAL AS MINUS.
ENTER 0 QUANTITY TO DELETE AN ITEM
ENTER QUANTITY BETWEEN -1 AND -9 TO BACKSPACE
WHEN DONE, ENTER -10,0,0,0
1 ? 1,2N222,TRANSISTOR NPN,.25
2 ? 10,N525-01,5" DISKETTE,-27
3 ? 3,74LS00,SCHOTTKY HAND GATE,.20
4 ? -10,0,0,0
TOTAL OF ORDER (NOT INCLUDING SHIPPING ETC) $27.85
WANT LISTING OF YOUR ORDER? YES
1 1 2N222 0.25 0.25 TRANSISTOR NPN
2 10 N525-01 -27 27 5" DISKETTE
3 3 74LS00 0.2 0.6 SCHOTTKY HAND GATE
ANY CHANGES? NO
SALES TAX -- YES OR NO? YES
SALES TAX IS $1.39
ENTER DATE? 1-18-80
ENTER SHIPPING COST? 1
ENTER TYPE OF PAYMENT? C.O.D.
ENTER TYPE OF TRANSPORTATION? UPS OR BEST WAY
ENTER ADDRESS OF SUPPLIER (UP TO 5 LINES)
LINE 1 ? MONUMENTAL COMPUTER WORKS
LINE 2 ? P. O. BOX 1200
LINE 3 ? WASHINGTON D.C. 20020
LINE 4 ?
ENTER PURCHASE ORDER NUMBER? 11880
ENTER PORT NUMBER FOR OUTPUT AND TURN ON PRINTER
IF NECESSARY.
? 1

```

	PURCHASE ORDER	No. 11880		
TO:	MONUMENTAL COMPUTER WORKS P. O. BOX 1200 WASHINGTON D.C. 20020	1-18-80		
SHIP TO:	PETER A. STARK P. O. BOX 209 MT. KISCO, N. Y. 10549			
PAYMENT:	C.O.D.	SHIP VIA: UPS OR BEST WAY		
QUANT.	PART NO.	DESCRIPTION	EACH	EXT.
1	2N222	TRANSISTOR NPN	0.25	0.25
10	N525-01	5" DISKETTE		27.00
3	74LS00	SCHOTTKY HAND GATE	0.20	0.60
		SUBTOTAL:		27.85
		SALES TAX:		1.39
		SHIPPING/INS.:		1.00
		TOTAL:		30.24

\*\*\*\*\*PLEASE EXPEDITE THIS ORDER\*\*\*\*\*

## Program 12. Purchase-order program. (a) Program. (b) Sample run.

PUT. Next to that name is a listing of all points to which that signal goes. For example, the sample wire list shows that 5 V goes to IC1, pin 5, and to R1, terminal 1.

A wire list turns out to be very useful in many ham

radio projects. I have used a wire list when wire-wrapping a computer project; the list gave me a printed listing of every connection to be made, and I simply checked off each as it was made. The result was a proj-

ect with several hundred wires and not a single error.

I have also used it in checking out a printed circuit board layout. Once the board was laid out, I went back over it and checked off each connection on the

list. Again, it allowed me to spot a few layout errors which I had missed on prior checks.

My wire-list programs are written for a disk system. This happens to be the most convenient, since you can



```

0100 REM WENTER - WIRE LIST PROGRAM 1
0110 REM ENTER CONNECTIONS REQUIRED AND STORE ON DISK
0120 REM COPYRIGHT (C) 1979 BY PETER A. STARK
0130 REM ALL RIGHTS RESERVED

0140 INPUT "ENTER FILE NAME", F$
0150 INPUT "ENTER DRIVE NUMBER", D
0160 IF D=1 GO TO 190
0170 IF D=2 THEN F$="2/"+F$ : GO TO 190
0180 GOTO 150 :REM IF DRIVE NUMBER IN ERROR
0190 PRINT "NOW ENTER EACH CONNECTION IN THIS ORDER:"
0200 PRINT " SIGNAL NAME, IC OR REF NO., PIN NO."
0210 PRINT "ENTER 'ZZZ' TO END."
0220 OPEN #10, F$
0230 S$="" : R$="" : P$="" :REM INIT NAME, REF, PIN BLANK
0240 FOR I=1 TO 500
0250 PRINT "WIRE NO. "; I;
0260 INPUT A$,B$,C$
0270 IF A$="ZZZ" GO TO 360 :REM AT END OF DATA
0280 IF A$="" THEN S$=A$
0290 IF B$="" THEN R$=B$
0300 IF C$="" THEN P$=C$
0310 N=N+1 :REM KEEP COUNT
0320 PRINT #10, S$;R$;P$ :REM STORE ON DISK FILE
0330 NEXT I

0340 REM IF FILE FULL, PRINT ERROR MESSAGE

0350 PRINT "ERROR - FILE FULL AT ";
0360 PRINT N; "ITEMS."
0370 CLOSE #10
0380 END

```

### Program 13. WENTER program.

easily set up a disk file with all the connections, edit it to make changes and corrections as needed, and produce a latest printout as needed. If your system does not have a disk, then it can be modified for cassette files; that part is up to you.

There are actually three wire-list programs, all written in BASIC. WENTER (Program 13) is used to enter each connection from the keyboard and store in the disk file. WSORT (Program 14) then reads that file and sorts it by signal name to get all like connections grouped together. (If you have a text editor, you can edit the sorted or unsorted file with that.) Finally, WPRINT (Program 15) produces a printed listing of the sorted list.

Except for the disk commands (which are for a Percom LFD-400 disk system using Percom Super BASIC on an SWTP 6800 computer), the rest of the programs are just standard BASIC. To aid in converting to a different disk system or to cassette, let's look at the special disk statements.

In Program 13, a file-name F\$ and drive number D are entered in lines 140 and 150. If drive 2 is specified, then a 2/ is added to the beginning of the file name and the resulting name is used to open a disk file in line 220. That file is

numbered 10, and the PRINT #10 in line 320 outputs to that file. A maximum of 500 connections is allowed by the FOR statement in line 240; the reason is that the sort routine in WSORT is limited to that number.

The WSORT program of Program 14 then sorts that file. It reads the file into array N\$ which is dimensioned as (250,2), which leaves room for 500 connections. The reason it is broken up into a two-dimensional array is that this BASIC has a limit of 255 on subscript size; this is a trick to get around that limitation. In any case, depending on the memory size of your computer, you may have to cut the array size down even more; the 500-connection limitation is for a fairly large computer. (If you have a different sort routine, you can use that to sort your file and either get around the 500-connection limitation or get even faster sorting.)

Line 250 reads the signal name, reference or IC number, and pin number into A\$, B\$, and C\$. The 380 after the reverse slash means the program will go to line 380 (to close the open disk file) when it reaches the end of data.

Lines 270 through 300 shorten A\$, B\$, and C\$ and then combine them into

```

0100 REM WSORT - WIRE LIST PROGRAM 2
0110 REM SORT WIRE LIST DISK FILE BY SIGNAL NAME
0120 REM COPYRIGHT (C) 1979 BY PETER A. STARK
0130 REM ALL RIGHTS RESERVED

0140 INPUT "ENTER FILE NAME", F$
0150 INPUT "ENTER DRIVE NUMBER", D
0160 IF D=1 GO TO 190
0170 IF D=2 THEN F$="2/"+F$ : GO TO 190
0180 GOTO 150 :REM IF DRIVE NUMBER IN ERROR
0190 DIM N$(250,2) :REM DIMENSION ARRAY FOR DATA SORT

0200 REM READ DATA INTO N$ ARRAY

0210 R=1 : C=1 :REM NEXT ROW AND COLUMN
0220 OPEN #10, F$ :REM OPEN DATA FILE
0230 PRINT "READING SOURCE FILE"
0240 FOR I=1 TO 500 :REM READ UP TO 500 CONNECTIONS
0250 READ #10, A$,B$,C$ \ 380 :REM READ LINE
0260 PRINT A$,B$,C$
0270 A$=LEFT$(A$,15) :REM COMPRESS TO FIT INTO ONE STRING
0280 B$=LEFT$(B$,15)
0290 C$=LEFT$(C$,5)
0300 N$(R,C)=A$+" "+B$+" "+C$ :REM SAVE ALL IN ONE
0310 R=R+1 :REM INCREMENT ROW POINTER
0320 IF R>250 THEN R=1 : C=C+1 :REM CHECK FOR OVERFLOW
0330 N=I :REM TOTAL NUMBER OF CONNECTIONS
0340 NEXT I
0350 PRINT "ERROR - TOO MANY CONNECTIONS." : END
0360 PRINT "ERROR - END OF FILE." : END

0370 REM FILE READ, NOW SORT IT

0380 CLOSE #10
0390 PRINT "SORTING ... PLEASE WAIT"
0400 M=N
0410 M=INT(M/2)
0420 IF M=0 GO TO 610
0430 K=M-N
0440 J=1
0450 I=J
0460 L=I+M :REM INIT POINTERS FOR I
0470 R1=I : C1=1 :REM INIT POINTERS FOR L1
0480 IF R1>250 THEN R1=R1-250 : C1=C1+1 : GOTO 480 :REM INIT POINTERS FOR L1
0490 R2=L1 : C2=1
0500 IF R2>250 THEN R2=R2-250 : C2=C2+1 : GOTO 500
0510 IF N$(R1,C1)<N$(R2,C2) GO TO 570
0520 A$=N$(R1,C1)
0530 N$(R1,C1)=N$(R2,C2) :REM SWITCH IF OUT OF ORDER
0540 N$(R2,C2)=A$
0550 I=I-M
0560 IF I>=1 GO TO 460
0570 J=J+1
0580 IF J>K GO TO 410
0590 GOTO 450

0600 REM N$ IS NOW SORTED, SO WRITE BACK TO DISK

0610 R=1 : C=1 :REM SET UP ROW AND COLUMN AGAIN
0620 F$=F$+"S" :REM CHANGE FILE NAME TO NEW NAME
0630 OPEN #10, F$ :REM OPEN DISK FILE NAME
0640 FOR I=1 TO N :REM WRITE BACK N RECORDS
0650 PRINT #10, N$(R,C) :REM NEXT ITEM IN SORTED TABLE
0660 PRINT N$(R,C)
0670 R=R+1 :REM INCREMENT ROW POINTER
0680 IF R>250 THEN R=1 : C=C+1 :REM CHECK FOR OVERFLOW
0690 NEXT I
0700 CLOSE #10
0710 PRINT "FILE WRITTEN BACK"

```

### Program 14. WSORT program.

```

0100 REM WPRINT - WIRE LIST PROGRAM 3
0110 REM PRINT OUT WIRE LIST ARRANGED BY SIGNAL NAME
0120 REM COPYRIGHT (C) 1979 BY PETER A. STARK
0130 REM ALL RIGHTS RESERVED

0140 INPUT "ENTER FILE NAME", F$
0150 INPUT "ENTER DRIVE NUMBER", D
0160 IF D=1 GO TO 190
0170 IF D=2 THEN F$="2/"+F$ : GO TO 190
0180 GOTO 150 :REM IF DRIVE NUMBER IN ERROR
0190 INPUT "PRINT ON WHICH PORT", P
0200 LINE=0
0210 IF P<>INT(P) GO TO 190
0220 IF P<0 GO TO 190
0230 IF P>1 GO TO 190
0240 OPEN #10, F$ :REM OPEN DISK FILE
0250 S$="" :REM PREVIOUS SIGNAL NAME INIT BLANK
0260 FOR I=1 TO 500 :REM READ NEXT SIGNAL
0270 READ #10, A$,B$,C$ \ 380 :REM READ NEXT SIGNAL
0280 IF A$=S$ GO TO 330
0290 PRINT #P
0300 PRINT #P, A$; TAB(15); :REM SKIP TO NEW LINE IF NEW
0310 S$=A$ :REM PRINT NEW NAME
0320 P7=15 :REM MEMORIZE CURRENT SIGNAL NAME
0330 IF P7>70 THEN PRINT #P : PRINT #P, TAB(15); :REM CURRENT PRINTHEAD POSITION
0340 PRINT #P, B$;"-";C$;" "
0350 P7=POS
0360 NEXT I
0370 PRINT "ERROR - END OF FILE." : END
0380 CLOSE #10
0390 END

```

### Program 15. WPRINT program.

one string, separated by commas. Having the entire connection data in one string makes the sorting much easier and faster than if the three pieces of data were handled separately.

This combined string will eventually get written back out to an output file; when it is read back later by WPRINT, the commas will break up the string back into three separate strings.



```

LOAD "WENTER"

READY
RUN
ENTER FILE NAME? SAMPL
ENTER DRIVE NUMBER? 1
NOW ENTER EACH CONNECTION IN THIS ORDER:
SIGNAL NAME, IC OR REF NO., PIN NO.
ENTER "ZZZ" TO END.
WIRE NO. 1 ? 5V,R1,1
WIRE NO. 2 ? INPUT,,2
WIRE NO. 3 ? SWITCH,1
WIRE NO. 4 ? GROUND,,2
WIRE NO. 5 ? INPUT,IC1,14
WIRE NO. 6 ? 5V,,5
WIRE NO. 7 ? GROUND,,10
WIRE NO. 8 ? IC1-A,,1
WIRE NO. 9 ? ,,12
WIRE NO. 10 ? IC2,7
WIRE NO. 11 ? IC1-B,IC1,9
WIRE NO. 12 ? IC2,1
WIRE NO. 13 ? IC1-C,IC1,8
WIRE NO. 14 ? IC2,2
WIRE NO. 15 ? IC1-D,IC1,11
WIRE NO. 16 ? IC2,6
WIRE NO. 17 ? IC3,14
WIRE NO. 18 ? ZZZ
17 ITEMS.

```

```

READY
WLOAD "WSORT"

READY
RUN
ENTER FILE NAME? SAMPL
ENTER DRIVE NUMBER? 1
READING SOURCE FILE
5V R1 1
INPUT R1 2
INPUT SWITCH 1
GROUND SWITCH 2
INPUT IC1 14
5V IC1 5
GROUND IC1 10
IC1-A IC1 1
IC1-A IC1 12
IC1-A IC2 7
IC1-B IC1 9
IC1-B IC2 1
IC1-C IC1 8
IC1-C IC2 2
IC1-D IC1 11
IC1-D IC2 6
IC1-D IC3 14
INPUT IC1 14
INPUT R1 2
INPUT SWITCH 1
FILE WRITTEN BACK

```

```

SORTING ... PLEASE WAIT
5V,IC1,5
5V,R1,1
GROUND,IC1,10
GROUND,SWITCH,2
IC1-A,IC1,1
IC1-A,IC1,12
IC1-A,IC2,7
IC1-B,IC1,9
IC1-B,IC2,1
IC1-C,IC1,8
IC1-C,IC2,2
IC1-D,IC1,11
IC1-D,IC2,6
IC1-D,IC3,14
INPUT,IC1,14
INPUT,R1,2
INPUT,SWITCH,1
FILE WRITTEN BACK

```

```

READY
WLOAD "WPRINT"

```

```

READY
RUN
ENTER FILE NAME? SAMPLS
ENTER DRIVE NUMBER? 1
PRINT ON WHICH PORT? 1
5V IC1-5 R1-1
GROUND IC1-10 SWITCH-2
IC1-A IC1-1 IC1-12 IC2-7
IC1-B IC1-9 IC2-1
IC1-C IC1-8 IC2-2
IC1-D IC1-11 IC2-6 IC3-14
INPUT IC1-14 R1-2 SWITCH-1
READY
#

```

### Program 16. Sample run of wire-list preparation programs.

The middle part of Program 14, lines 370 through 600, is a Shell-Metzner sort, and the last part of the program writes the file back on the disk. To avoid erasing the previous file, line 620 adds an "S" to the end of the previous file name to produce a new file name and therefore a new file. (For instance, the sample printout of Program 16 sorts

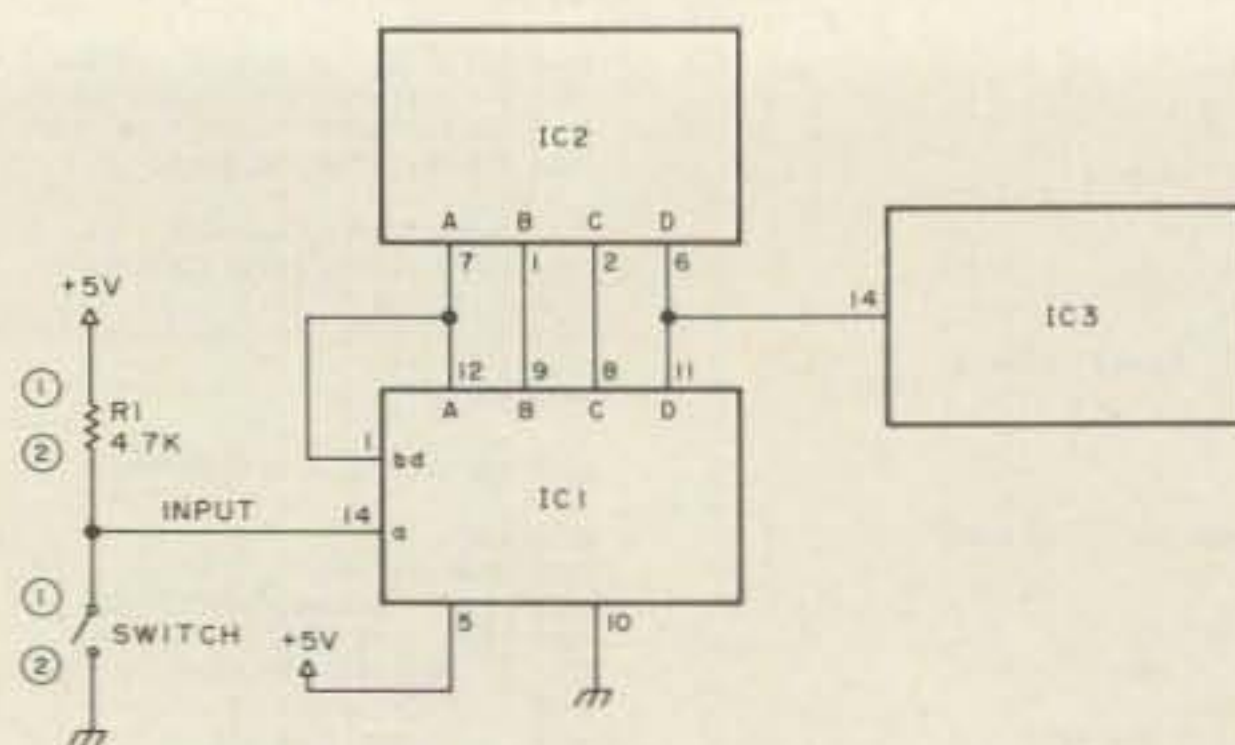

Fig. 8. Sample circuit for preparing a wire list.

a file called SAMPL into a new file called SAMPLS.)

The WPRINT program (Program 15) is used last to read the sorted disk file and print the actual wire list. Whenever a connection has the same signal name as the previous connection, it gets listed on the same line; otherwise, it goes on a new line. In this way, all connections with the same signal name get grouped together on a line. The only new non-standard statement is: 350 P7=POS. POS is a BASIC function which returns the present position of the printhead on the paper. It is used to keep the printout from going into the right margin. Whenever P7 is greater than 70, line 330 forces a carriage return/line feed and goes to a new line.

The best way to understand the working of these three programs is to try an example. Fig. 8 shows a very simple circuit for which we want a wire list; Program 16 is the sample run which shows how the three programs are used to generate it.

Before starting, we have to give each component of the diagram a name. The ICs are simply labelled IC1, IC2, and IC3. The resistor is labelled R1, and the switch could be called SW1 or just plain SWITCH. (In industrial lingo, terms like C1, R1, SW1, and IC3 are called "reference designations.") Any string name could be used, but the shorter the better.

Next, every terminal of

every device has to be identified. ICs have pin numbers; switches, resistors, and other components get terminal numbers. These are shown on Fig. 8 as circled—the top terminal of R1 is terminal 1, the bottom is terminal 2. A good convention is to make the top or left terminals number 1, the bottom or right number 2. On transistors, terminals can be called C, B, and E; on diodes, they can be CATH and ANODE, or C and A. Any number or letter code can be used, up to five characters. In digital circuits, this is easy, since most components are ICs and are already numbered.

Third, every signal has to be given a name. This is also very easy to do in digital circuits, a bit tougher to do in others. Names like GROUND and 5 V are easy; the input from the switch is called INPUT. For want of a better name, we call IC1's outputs IC1-A through IC1-D.

All of this looks like a lot of extra work; actually, it is a help because it makes you look critically at your circuit and become more familiar with it. With all this out of the way, we are finally ready to enter all our data into the computer as in Program 16.

First, we run WENTER to enter all data. The program asks for the file name which, in our example, was SAMPL, and the drive number. Next it prompts for the signal name, IC or reference number, and pin number

for each connection. For example, for the very first wire we enter 5 V, R1, 1, meaning that terminal 1 of R1 connects to 5 volts. We simply go through the circuit, one component at a time, listing each connection. The program is set up so that any item which is not entered (that is, which is left blank) is simply copied from the previous line. Thus, wire 2 is entered as INPUT,,2, which means that the middle entry should be the same as the R1 on the previous line. This can save a lot of typing.

When we are finished, we are asked to type in ZZZ, which is the code for "end of data." WENTER then finishes the file and stops.

Next, we load WSORT and run it. After giving the program the name of our file and the disk drive number, the program reads the file and prints it out so we can check it. The sort takes a few seconds, followed by printout of the sorted data in the exact form it is in on the disk.

If you have a text editor, by the way, the resulting file could be edited and changed at this point. If, for example, you discover some errors in the listing, you can easily go back and fix them.

The last step is to run WPRINT to print out the actual wire list. As you can see at the bottom of Program 16, all connections are grouped by signal name. If you are wire-wrapping a board, it is a simple matter to just start at the top of the list and work your way down, one connection at a time, until you reach the bottom.

I can't recommend this system too highly. Although there is some preparation to be done before you can prepare the wire list, the savings in troubleshooting time that this allows is much greater. Try it... you'll like it. ■



MAKE  
MONEY...  
SELL  
73 MAGAZINE

Selling 73 Magazine, the ham radio magazine that offers quality and quantity, brings the ham into your store. Once through the door you can sell him anything.

Plus... you make a profit selling "73". Newsstand price is \$2.95 and you pay only \$1.97 an issue (that's the standard dealer discount of 33 $\frac{1}{3}$ %). You make 98¢ on each issue sold.

Our dealers are telling us that "73" outsells them all... so call today and join the dealers who make money with 73 Magazine.

For information on selling 73 Magazine call 603-924-7296 and speak with Ginnie Boudrieau, our Bulk Sales Manager. Or write to her at:

73 MAGAZINE  
80 PINE STREET  
PETERBOROUGH NH 03458

ok



### Wire Wrapping Kit

Model WK-5 is a unique new Wire Wrapping Kit that contains a complete range of tools and parts for prototype and hobby applications, all conveniently packaged in a handy, durable plastic carrying case.

The kit includes Model BW-630 battery wire wrapping tool complete with bit and sleeve; Model WSU-30, a remarkable new hand wire-wrapping/unwrapping/stripping tool; a universal PC board; an edge connector with wire-wrapping terminals, a set of PC card guides and brackets; a mini-shear with safety clip; industrial quality 14, 16, 24 and 40 pin DIP sockets; an assortment of wire-wrapping terminals; a DIP inserter; a DIP extractor and a unique 3-color wire dispenser complete with 50 feet each of red, white and blue Kynar® insulated, silver plated solid AWG 30 copper wire.

**\$74.95\***

**OK Machine & Tool Corporation** ✓54  
3455 Conner St., Bronx, N.Y. 10475 U.S.A.  
Tel. (212) 994-6600 Telex 125091

\*Minimum billings \$25.00, add shipping charge \$2.00  
New York State residents add applicable tax

® Pennwalt



# SPECIAL SUPER SAVINGS

NO CREDIT CARD ORDERS ACCEPTED

## VERBATIM MINI DISKETTES

FOR TRS-80, PET, APPLE, HEATH

(Please specify which computer)

#P007XS

5 1/4" 10 PACK...ONLY \$24  
Plus shipping & handling

FOR TRS-80 MOD II

8" 10 PACK.....ONLY \$36  
Plus shipping & handling

### ASK MOM BEFORE YOU BUY TRS EQUIPMENT

from anybody . . . prices are changing daily and if possible, we'll beat prices anywhere.



#### MAGIC LIGHT BULB SAVER

If you've got a light bulb you need our MAGIC L.B.S. which increases the life expectancy of a new bulb 93 times! . . . and saves you 44% on energy costs. Regularly \$2.50 . . . MOM's price is \$1.99 each. #LS001.

5%

#### PANASONIC TAPE DECKS

Panasonic RS261 US Stereo Cassette Decks—with auto-stop, record level adjust, VU meters, used condition; all have had heads replaced and aligned. #T001-\$50.

5%

**SPECIAL SUPER SAVINGS SALE PRICES GOOD THRU COVER MONTH OF MAGAZINE—OTHER Prices Subject to Change Without Notice.**

# MOM'S

MAIL ORDER MICROS ✓53

Dept. 973 • PO Box 427 • Marlboro NH 03455

Phone: (603) 924-3041\*

### BRAND NEW TRS-80's and accessories at FANTASTIC SAVINGS

LEVEL II 16K COMPLETE.....	\$690	#TRS-001XISI
16K EXPANSION UNIT.....	\$400	#TRS-002SISI
32K EXPANSION UNIT.....	\$525	#TRS-003ISI
DISK DRIVES (Specify which drive you want)		
\$425	each	#TRS-004ISI
FRICTION MODEL PRINTER.....	\$870	#TRS-005SISI
TRACTOR FED MODEL PRINTER.....	\$1350	#TRS-006ISI
LINE PRINTER III (AND CABLE).....	\$1750	#TRS-007ISI
MOD II 64K.....	\$3400	#TRS-008
MOD II 2 DISK DRIVE EXPANSION SYSTEM.....	\$1625	#TRS-00

FREE INSTANT SOFTWARE CASSETTE VALUE \$7.95 YOUR CHOICE WITH ANY TRS ORDER

**TRS TERMS:** Shipment normally within one week of receipt of your order (with cashier's check or money order) for microcomputer and three weeks for accessories (checks take two weeks extra to clear bank). ADD \$2.50 PER ITEM for HANDLING. Everything will be sent to you with UPS or other freight charges COLLECT. Sorry, no credit card purchases or extra discounts on TRS-80 items.

**BRAND SPANKING NEW TRS-80's IN FACTORY CARTONS WITH FULL FACTORY WARRANTY! COMPARE PRICES AND QUALITY AND ORDER FROM MOM'S.**

\*A registered trademark of Tandy Corp.

FREE INSTANT SOFTWARE APPLE \$7.95 CASSETTE — YOUR CHOICE — (SEE INSTANT SOFTWARE AD)

### APPLE II

16K.....\$965 32K.....\$1040

### ATARI

MODEL 400.....\$490

MODEL 800.....\$775

#820 PRINTER.....\$445

#810 DISK DRIVE.....\$520

TERMS: Same as "TRS TERMS." No extra discounts for Apple or Atari items

### \*CAUTION

Our phone is usually answered by machine. Orders taken with credit cards. Questions answered by mail. Please leave your name and address clearly.

### TRS-80 MODEL II 64K

**\$3400<sup>00</sup>**

(with full factory warranty)

SEE TRS TERMS



# MOM'S

MAIL ORDER MICROS ✓53

Dept 973 • PO Box 427 • Marlboro NH 03455

Phone: (603) 924-3041\*



# SALE

5% EXTRA DISCOUNT  
for orders with checks or money  
orders (see "TERMS" for details).

ORDER NOW—  
Prices subject to change without notice.

## SCOTT ADAMS ADVENTURES

SPECIAL 10% OFF  
REGULAR PRICES  
(Reg \$14.95)

ONLY \$13.45 each

### #1 ADVENTURELAND

YOU'LL WANDER THROUGH AN ENCHANTED LAND ENCOUNTERING WILD ANIMALS AND MAGICAL BEINGS WHILE YOU TRY TO RECOVER LOST TREASURES.  
Order #SA001T for TRS Level II 16K, #SA001S for Sorcerer 16K, #SA001A for Apple 24K—\$13.45 each, on cassette.

### #2 PIRATE ADVENTURE

SAIL TO TREASURE ISLAND AND TRY TO RECOVER LONG JOHN SILVER'S LOST TREASURES.  
Order #SA002T for TRS Level II 16K, #SA002S for Sorcerer 16K, #SA002A for Apple 24K—\$13.45 each, on cassette.

### #3 MISSION IMPOSSIBLE ADVENTURE

SAVE THE WORLD'S FIRST AUTOMATED NUCLEAR REACTOR WHEN YOU COMPLETE YOUR MISSION.  
Order #SA003T for TRS Level II 16K, #SA003S for Sorcerer 16K, #SA003A for Apple 24K—\$13.45 each, on cassette.

### #4 VOODOO CASTLE

SAVE COUNT CRISTO FROM THE FIENDISH CURSE OR FOREVER BE DOOMED—BEWARE THE VOODOO MAN.  
Order #SA004T for TRS Level II 16K, #SA004S for Sorcerer 16K, #SA004A for Apple 24K—\$13.45 each, on cassette.

### #5 THE COUNT

LOVE AT FIRST BYTE FROM YOUR BIG BRASS BED IN TRANSYLVANIA.  
Order #SA005T for TRS Level II 16K, #SA005S for Sorcerer 16K, #SA005A for Apple 24K—\$13.45 each, on cassette.

### #6 STRANGE ODYSSEY

YOU'RE MAROONED AT THE GALAXY'S EDGE AND DISCOVER RUINS OF AN ANCIENT ALIEN CIVILIZATION AND TRY TO COPE WITH UNEARTHLY TECHNOLOGIES WHILE YOU AMASS FABULOUS TREASURES.  
Order #SA006T for TRS Level II 16K, #SA006S for Sorcerer 16K, #SA006A for Apple 24K—\$13.45 each, on cassette.

### #7 MYSTERY FUN HOUSE

FIND YOUR WAY THROUGH THE STRANGEST FUN HOUSE BEFORE THE WEIRD PARK CLOSES.  
Order #SA007T for TRS Level II 16K, #SA007S for Sorcerer 16K, #SA007A for Apple 24K—\$13.45 each, on cassette.

### #8 PYRAMID OF DOOM

AN EGYPTIAN TREASURE HUNT THROUGH A NEWLY UNCOVERED PYRAMID. COMPLETE WITH AN ANCIENT CURSE.  
Order #SA008T for TRS Level II 16K, #SA008S for Sorcerer 16K, #SA008A for Apple 24K—\$13.45 each, on cassette.

# COMPU CRUISE



## DRIVING COMPUTER

... from \$99.99

COMPUCRUISE has added some fantastic new products to their popular line of driving computers and we're selling everyone of them at a drastic price reduction. Whether you choose the Super Deluxe Model #44 with 44 features including cruise control, the Deluxe Model #41 with 41 features (without cruise control), or the fantastic new Model #28 with 28 of the most used functions (without cruise control), you're bound to cut driving costs and boost your driving pleasure. Model #44 will be shipped with a silver dashboard panel unless you specify the new black panel when you order, no extra charge; Models #41 and #28 have silver panel only. These driving computers will work on any car not having diesel, mechanical or CIS injection systems (ELECTRONIC fuel injection okay when you use the special kit #P1300). Kit #P1312 makes installation easier and neater if you have a tiny car with very little excess space under the hood for extra gadgets. All fit into most dashboards and make every trip like flying a 747. Check the chart to see which driving computer suits your needs best and order today.

MODEL #44 order #P002 regular price \$199.50... MOM's price \$159.95

MODEL #41 order #P003 regular price \$159.50... MOM's price \$127.95

MODEL #28 order #P028 regular price \$118.95... MOM's price \$ 99.99

SPECIAL OPTIONS:

Front Wheel Drive Kit #P001 MOM's price \$4.40

ELECTRONIC FUEL INJECTION KIT #P1300 MOM's price \$20.95

FUEL RETURN LINE SYSTEM KIT #P1283 MOM's price \$8.35

CRUISE CONTROL INSTALLATION AND ACCESSORY KIT WITH CABLE DRIVE #P1312

MOM's price \$14.00

5%

5%

## CASIO'S NEW C-80 CALCULATOR CHRONOGRAPH



has lightweight attractive ruggedly built black plastic water-tight case and band, regular digital watch features of hours, minutes, seconds, AM/PM and day on display PLUS two time zones, calendar and a 4 function calculator! You've seen it advertised in the Wall Street Journal for \$75... MOM's price is only \$49.95. Hurry our supply is limited... order #PC80 now.

5%

## WAMECO S-100 Bare Computer Boards

			Retail	MOM'S Price	
10 ea	CPU-1	8080 CPU Board	26.95	22.95	#LP001
10 ea	MEM-1A	8K Memory Board (2102)	25.95	21.95	#LP002
10 ea	EPM-2	2708/2716 EPROM Board	25.95	21.95	#LP004
10 ea	EPM-1	1702 EPROM Board	25.95	21.95	#LP005
10 ea	RTC-1	Real Time Clock	23.95	20.50	#LP006
10 ea	QM-9	The Little Mother (9 slot)	30.95	26.50	#LP007
10 ea	QM-12	The Quiet Mother (12 slot)	34.95	29.95	#LP008
5 ea	FDC-1	Floppy Disk Board	42.95	36.95	#LP009
7 ea	FPB-1	Front Panel (MSAI size)	44.50	37.95	#LP010
1 ea	EPM-1	1702 EPROM Board (asmbld) without EPROMS	49.95	42.50	#LP011

5%

### COMPU CRUISE CHART

FEATURE	Model 44	Model 41	Model 28
1. Current fuel eff/mph	X	X	X
2. Current fuel eff/L/100	X	X	X
3. Av fuel eff/mph	X	X	X
4. Av fuel eff/L/100km	X	X	X
5. Fuel used since fillup/gal	X	X	X
6. Fuel used since fillup/L	X	X	X
7. Distance since fillup	X	X	X
8. Distance since fillup/Km	X	X	X
9. Time of day	X	X	X
10. Time to empty	X	X	X
11. Distance to empty/miles	X	X	X
12. Distance to empty/Km	X	X	X
13. Fuel to empty/gal	X	X	X
14. Fuel to empty/L	X	X	X
15. Current vehicle speed/mph	X	X	X
16. Current vehicle speed/Km/h	X	X	X
17. Av vehicle speed/mph	X	X	X
18. Av vehicle speed/Km/h	X	X	X
19. Night time display/dimming	X	X	X
20. Error display	X	X	X
21. Elapsed time hr:min:sec	X	X	X
22. Trip driving time	X	X	X
23. Time to arrival	X	X	X
24. Alarm	X	X	X
25. Distance traveled on trip/mi	X	X	X
26. Distance traveled on trip/Km	X	X	X
27. Distance to arrival/mi	X	X	X
28. Distance to arrival/Km	X	X	X
29. Fuel used on trip/gal	X	X	X
30. Fuel used on trip/L	X	X	X
31. Fuel to arrival/gal	X	X	X
32. Fuel to arrival/L	X	X	X
33. Current fuel consumption/gph	X	X	X
34. Current fuel consumption/L/h	X	X	X
35. Av fuel consumption/gph	X	X	X
36. Av fuel consumption/L/h	X	X	X
37. Inside temp/F	X	X	X
38. Inside temp/C	X	X	X
39. Outside temp/F	X	X	X
40. Outside temp/C	X	X	X
41. Battery voltage	X	X	X
42. Cruise control set	X	X	X
43. Cruise control resume	X	X	X
44. Cruise control program	X	X	X



MOM's cleaning house... these items must go... prices listed are last advertised prices... MAKE OFFER... any reasonable amount will be accepted... first come, first serve... now's your chance to get some really great savings... you name the price... hurry supplies are limited.

### HEAD ALIGNMENT KIT

Best cassette recorder tape head alignment kit available. Solves loading problems. #K001-only

\$9.95

5%

### COMPUCOLOR HARDWARE

Compucolor Computer 8001 (use as computer or 75 MHZ Color Monitor)—8K RAM, BASIC and DOS in ROM, good condition. #S025X-\$1200 each. SPECIAL PRICE.

Compucolor MiniFloppy—5 1/4 inch, good condition. #S026X-\$475 each. SPECIAL PRICE.

Compucolor 8K RAM card—Static RAM, good condition. #S027X-\$180 each. SPECIAL PRICE.

Compucolor Floppy Tape Drive—Uses eight-track cartridges, good condition. #S028X-\$55 each. SPECIAL PRICE.

### HONEYWELL

Honeywell ASR-33 Communications Consoles with TTY, paper tape reader and punch. Used, working when removed from service. Shipped freight collect or you pick up. Weight 300 lbs. \$325. Order #P006X.

### PROCESSOR TECH SOL

SOL Computers—8K RAM Monitor, S-100, excellent condition. #D004X-\$850.00 each.

TREK-80 on cassette for SOL—This is one of the best real time space games available today; needs 8K. #D005X-\$9 each.

### PROCESSOR TECH SOFTWARE

Processor Tech Extended Disk BASIC—This is full disk BASIC on 8" disk for HELIOS II disk controllers with PTDOS and greater than 16K. #D015S-\$70 each.

BASIC 5 from Processor Tech—This is a simple BASIC for a SOLOS, CUTTER, or CONSOL Monitor and 8K of RAM. #D013-\$11.60 each.

Processor Tech GAMEPAC for above BASIC—Various simple games. #D014-\$10.00 each

### VECTOR GRAPHIC S-100

Vector Graphic ROM/RAM card—12K empty ROM sockets, 1K RAM, excellent condition. No documentation. (Make offer—we may surprise you and accept!) #D0078X-\$95.

TERMS OF SALES: We accept MC, VISA or AMEX but do not allow extra discounts on credit card purchases. We'll ship UPS or insured mail if possible. Extra 5% discount allowed only on items that have a "5%" symbol in their description box only when orders accompanied by cashiers check, personal check, or money order. No COD's please. ADD \$2.50 for each equipment item for Apple, Atari or Radio Shack and we'll ship these items freight collect.

ALL OTHERS USE THIS CHART FOR SHIP/HANDLING COSTS:

\$1-\$24.99 add \$2.50; \$25-\$49.99 add \$2.85; \$50-\$74.99 add \$3.75; \$75-\$99.99 add \$4.50; \$100-\$124.99 add \$5.25; \$125 and over add \$6.25.

### TDL SOFTWARE-DISK

TDL FDOS & SuperBASIC on 8" Disk—This requires an ICOM Disk Controller and at least 20K of memory, plus a ZAP-APPLE Monitor in an S-100 Cabinet (Altair, IMSAI, etc.) #D0065SX-\$120.

TDL System Software on 5 1/4" disk—This set of system software requires a North Star Disk Controller, and a TDL Systems Monitor Board I, and consists of 12K BASIC, Relocator/Linking Loader, Z-80 Editor, and Text Processor. #D0066X-\$160.

TDL System Software on 5 1/4" disk—This is the same as above, but does not require the Systems Monitor Board I. #D0067X-\$180.

TDL System Software on 5 1/4" disk—Again, as above, but requires a HELIOS Disk Controller and the TDL Systems Monitor Board II (not I). #D0068X-\$160.



## CB to 10

### — part XXIX: put that Hy-Gain CB board to use

Penn Clower W1BG  
459 Lowell Street  
Andover MA 01810

If you've read a ham magazine at all recently, the chances are that you've seen an article about con-

verting a CB set to ten meters. Most of these articles tell you which crystals to replace to move the

channels up to some portion of the ham band.

This article is different because it will tell you how to put one CB set on ten meters without buying a crystal. In fact, this rig can be purchased and put on ten meters in a single weekend for a total cash outlay of less than \$15—and that isn't just one 40-channel strip of the band, but at least two overlapping segments covering the bottom MHz of the phone band. Also described is what may be the world's simplest bfo addition (two additional components) for CW and SSB reception plus an easy way to put the transmitter on CW down in that end of the band.

The reason the rig is so inexpensive is that you buy the main circuit board, with maybe a few controls, as surplus—the remnants of the Hy-Gain CB operation. These boards are appearing in quantity on the market for prices around \$10, but they require initial check-out plus the addition of controls, a microphone, a power supply, and a speaker before they're complete

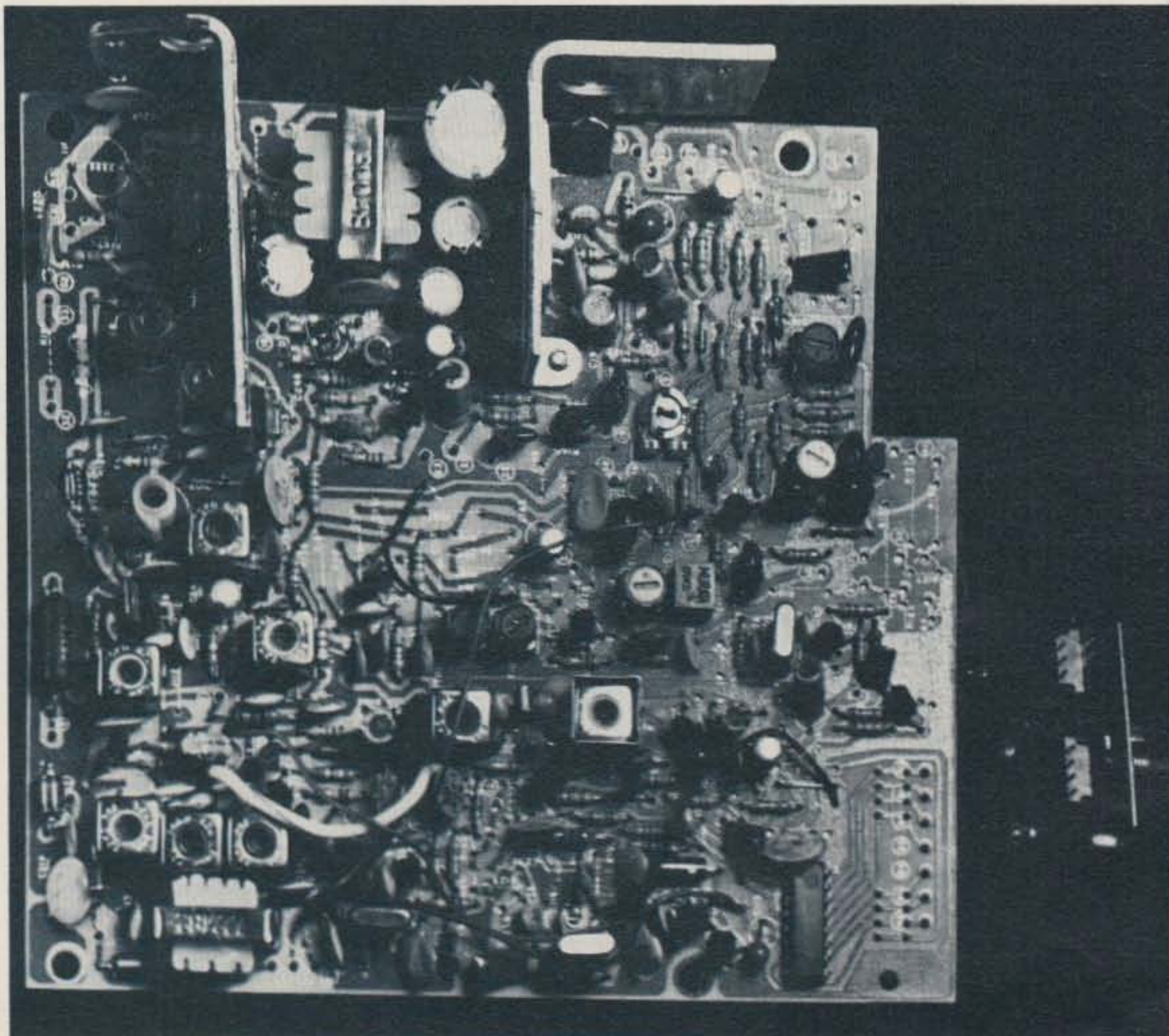

Photo A. The Poly Paks board and channel switch as purchased.



radios. The basic conversion described in these pages requires a two-transistor circuit addition (but no exotic parts) and a few easy hours. The whole secret to the conversion lies in making use of the flexibility designed into the set's phase-locked loop (PLL) synthesizer. The PLL is quite common in two-meter equipment, but few hams have had the opportunity to play with one enough to realize how really easy they are to modify—and that probably explains why earlier conversion articles on sets using this board require a crystal change.<sup>1,2</sup>

I bought my first board for \$9.00 from John Meshna, Inc. (PO Box 62, 19 Allerton St, E. Lynn MA 01904). That unit was destined to be a trunk-mounted Hy-Gain model 2679A, and in surplus form consisted of the main circuit board surrounded on three sides by a U-shaped metal support bracket to which is mounted the antenna connector, external speaker jack, fuse holder, and the strain relief grommets for the power leads and external microphone/control unit. Also included was the smaller circuit board which contains the circuitry interfacing between the remote microphone and the main board functions.

For another \$5.00, I was able to purchase (minus its cord) the remote microphone (which contains the volume, squelch, channel selection, and channel display functions). A word about this control unit: Having all of the controls in your hand is a nice feature, but contrary to some advertising claims, the unit cannot just be hooked up to any set. The interface board contains four ICs, one of them customized and not available, and two of the remaining three are pre-programmed PROMs. If you do not have this board, you

can use the control unit only after a lot of design and construction work, so make sure if you want the remote control that you also buy the interface card.

The first unit that I converted worked so well and was so much fun that in November, 1979, I bought two boards, each with a 40-channel switch, from Poly Paks (PO Box 942, South Lynnfield MA 01940) for \$12.51. These boards were a different prospect because they were considerably less finished than the first unit. Hy-Gain used the basic circuit board in a whole series of sets (models 2679, 2680, 2681, 2682, and 2683, at least), and, during the manufacturing process, the board apparently was first built to one state of completeness and then held until it was installed in a particular set. Then, depending on that model number, the various functions were connected or added or modified as necessary.

The boards purchased from Poly Paks were of the unfinished variety. Included with each was the 40-

channel switch, and that certainly made it easier to get the board running since the switch coding is a diffi-

cult function to home brew in a convenient form. To get the board working as a CB set required connecting

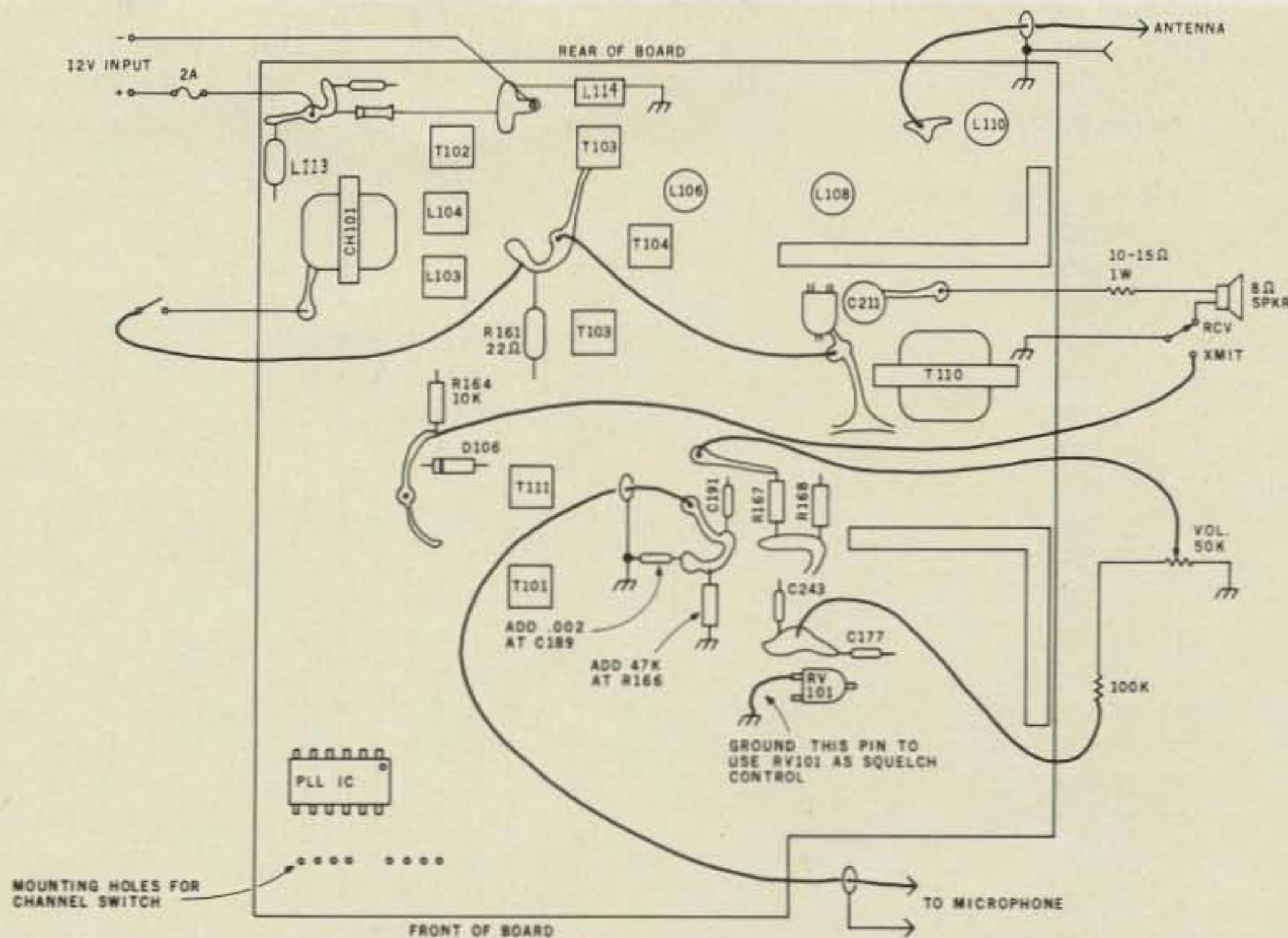

Fig. 1. Board layout showing connections for CB operation.

## INTIMIDATED BY MORSE CODE?

**\$99.95**

INTRODUCTORY PRICE

**THE NEW AEA  
MODEL MT-1  
COMPUTERIZED  
MORSE TRAINER  
MAKES MORSE  
CODE EASY AND  
FUN TO LEARN.**



- Automatic Speed Increase, User May Program: Starting Speed, Ending Speed, Practice Duration; 5 Letter code Groups or Random Space; Common or All Characters.
- Precise Speed Control 1 to 99 WPM (Tailor to Your Exact Requirements).
- 24,000 Character Answer Book Available (\$2.00) For 10 Starting Positions.
- Random Mode For Practice (No Answers).

*KT-1 Computerized Keyer With All Features of Above Trainer is Also Available in Same Package For \$129.95.*

Advanced Electronic Applications, Inc., P.O. Box 2160, Lynnwood, WA 98036. Call 206/775-7373.

**AEA** <sup>350</sup> **Brings you the  
Breakthrough!**



IC input name:	P0	P1	P2	P3	P4	P5	P6	P7	P8		
Pin number:	15	14	13	12	11	10	9	8	7		
Freq. Shift value (kHz):	10	20	40	80	160	320	640	1280	2560		
Channel—Frequency											
1 26.965			0	0	0	0	0	1	1	1	0
2 26.975			1	0	0	0	0	1	1	1	0
3 26.985			0	1	0	0	0	1	1	1	0
4 27.005			0	0	1	0	0	1	1	1	0
5 27.015			1	0	1	0	0	1	1	1	0
6 27.025			0	1	1	0	0	1	1	1	0
7 27.035			1	1	1	0	0	1	1	1	0
8 27.055			1	0	0	1	0	1	1	1	0
9 27.065			0	1	0	1	0	1	1	1	0
10 27.075			1	1	0	1	0	1	1	1	0
11 27.085			0	0	1	1	0	1	1	1	0
12 27.105			0	1	1	1	0	1	1	1	0
13 27.115			1	1	1	1	0	1	1	1	0
14 27.125			0	0	0	0	1	1	1	1	0
15 27.135			1	0	0	0	1	1	1	1	0
16 27.155			1	1	0	0	1	1	1	1	0
17 27.165			0	0	1	0	1	1	1	1	0
18 27.175			1	0	1	0	1	1	1	1	0
19 27.185			0	1	1	0	1	1	1	1	0
20 27.205			0	0	0	1	1	1	1	1	0
21 27.215			1	0	0	1	1	1	1	1	0
22 27.225			0	1	0	1	1	1	1	1	0
23 27.255			1	0	1	1	1	1	1	1	0
24 27.235			1	1	0	1	1	1	1	1	0
25 27.245			0	0	1	1	1	1	1	1	0
26 27.265			0	1	1	1	1	1	1	1	0
27 27.275			1	1	1	1	1	1	1	1	0
28 27.285			0	0	0	0	0	0	0	0	1
29 27.295			1	0	0	0	0	0	0	0	1
30 27.305			0	1	0	0	0	0	0	0	1
31 27.315			1	1	0	0	0	0	0	0	1
32 27.325			0	0	1	0	0	0	0	0	1
33 27.335			1	0	1	0	0	0	0	0	1
34 27.345			0	1	1	0	0	0	0	0	1
35 27.355			1	1	1	0	0	0	0	0	1
36 27.365			0	0	0	1	0	0	0	0	1
37 27.375			1	0	0	1	0	0	0	0	1
38 27.385			0	1	0	1	0	0	0	0	1
39 27.395			1	1	0	1	0	0	0	0	1
40 27.405			0	0	1	1	0	0	0	0	1
									*	*	*

Note: The three digits above the asterisks are always the same and are the inverse of the last digit.

Table 1. PLL programming—CB frequencies.

that switch, routing 12 volts from a power supply through a filter on the board, and then adding jumpers to get the B+ to various portions of the circuit not reached by printed circuit foil. I also had to add in a volume control, squelch control, and antenna and speaker jacks.

For my convenience, I also added the diodes and resistors necessary to get an S-meter. This job was aided considerably by having converted the previous set.

Also indispensable was a Sams Photofact® booklet covering the trunk-mounted version. A good readable schematic is necessary for a successful conversion: A troubleshooting manual may cost several dollars but it is a good investment despite the fact that it adds significantly to the cost of the project.

#### Firing Up the Basic Board

The connections required to turn the board on are shown in Fig. 1. The

channel switch needs to be mounted in the front right-hand corner of the board. The switch that came with my Poly Paks boards had two extra contact pins on the front of the unit that were not needed; they must have had something to do with 23-channel-only operation. I bent them back out of the way and soldered in the switch by the remaining eight pins which fit in the holes provided on the board.

The 12-volt power line

enters the board at the rear right-hand corner, goes through a filter, and comes off the board to the power switch. After the switch, the 12 volts goes back to two spots on the board: the supply point for the audio IC (located next to the output transformer, T110) and the supply point for the rest of the radio at the rear end of R161. This resistor is a largish 22-Ohm unit mounted just to the left of T103.

The next step is to route the audio signals around on the board. The squelch-range-adjust control, RV101, has one unconnected terminal. If this terminal is grounded, the small trimmer will work as a squelch control. (Squelch isn't too useful on ten meters, so I just turned it off.) If you want a real control, then find the center arm of RV101 and connect a 10k pot wired as a variable resistor from there to ground.

The receiver's detector output is located at the junction of C177 and C243. This signal is routed through an external 100k resistor and 50k pot to ground, with the pot wiper returning the signal to the circuit board on the rearward end of R167 (27k). The receiver has, if anything, too much audio output, so if you have only a 10 or 25k pot, don't be afraid to use it as the volume control. If for some reason you want more gain, you can always replace the 100k resistor with a smaller value.

The microphone audio goes into the board on the front end of C191. You should add two components in the spaces provided at this point: a .002-uF cap at C189 and a 47k resistor at R166. These spaces were left empty because the trunk-mounted units have a transformer (on the remote control interface board) which drives a slightly different circuit here.

The speaker audio comes



from the output transformer through C211 and goes to the speaker through a 10- or 15-Ohm, 1-Watt (at least) resistor. There is a resistor on the rear of the circuit board to use for this purpose if you wish: R194, an 8.2-Ohm, 3-Watt unit. The speaker audio returns to ground through one side of the push-to-talk switch. The other switch contact is used to turn on the transmitter during transmit, and this connection is made to the junction of R164 (10k) and D106.

The antenna is connected to the output side of L110, and the outer conductor of the coax is tied to the foil ground either directly or through a .005-uF capacitor. (In mobile operation, of course, the unit may be used in either a positive- or negative-ground car, and, for this reason, the practice is to have any external metal parts—antenna connector, metal case, shaft controls, etc.—isolated for dc from the “ground” on the circuit board. Otherwise, you risk losing at least a fuse when you install the unit in your car.)

With these connections made, the unit should operate on CB. If it doesn't, then get out the schematic and start checking to see that all the stages are getting power. Make sure that the squelch is turned off (the wiper of RV101 is grounded). You can check the PLL synthesizer for proper operation by measuring the dc voltage at the junction of R113, R114, and R115 as detailed later. Once the board is off and running, you can start to think about the ten-meter conversion steps, and that means starting with the PLL.

### The Basic PLL

Phase-locked-loop operation has been covered elsewhere in more detail than I intend to go into here.<sup>3</sup> The first thing you need to know is how the PLL basically

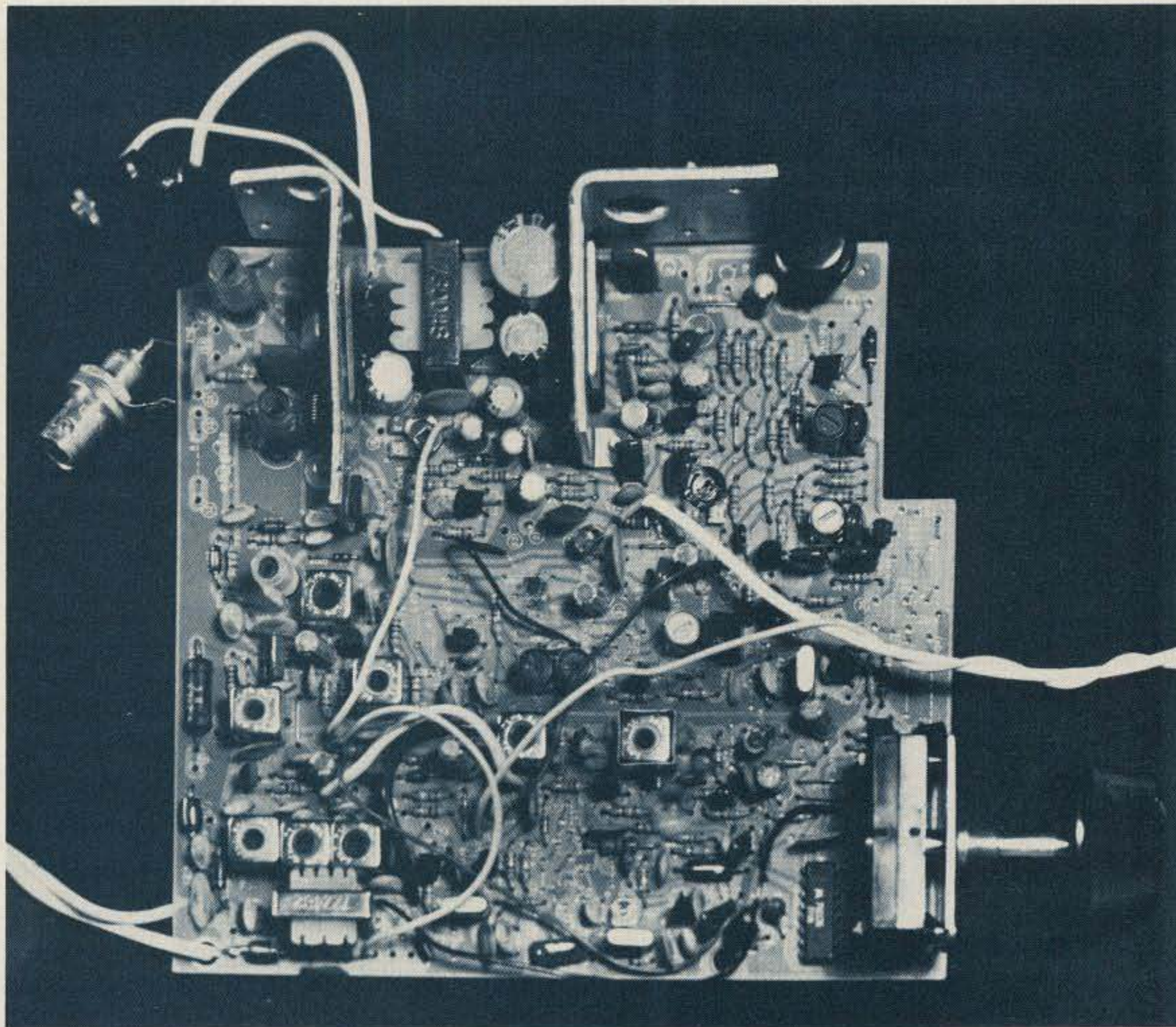

Photo B. The Poly Paks board set up and operating on (gulp!) 11 meters. The twisted wire coming out the front of the board is the mike/transmit cable. The black knob on the lower right is a volume control.

works, and that is diagrammed in Fig. 2. The loop shown there serves to control the voltage-controlled oscillator (or vco—which is just a voltage-tuned vfo) so that it has the same stability as the crystal oscillator even though it is running on a different frequency. The heart of the loop is the phase detector.

If the word “phase” bothers you, think of it for the moment as a frequency detector. When the loop is operating normally, the two signals going into the phase detector will be of the same frequency. Coming out of the detector is a signal whose dc value goes up or down if one of the input frequencies starts to get higher or lower than the other. This output signal goes through a low-pass filter and dc amplifier and eventually is applied to the terminal which controls the

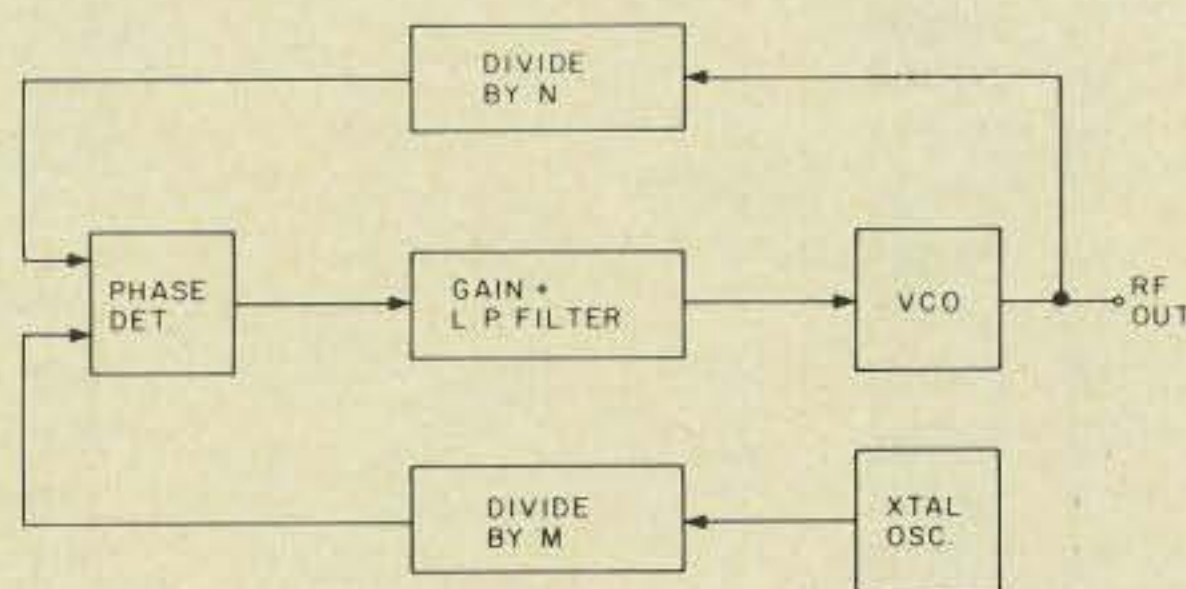

Fig. 2. A basic phase-locked loop.

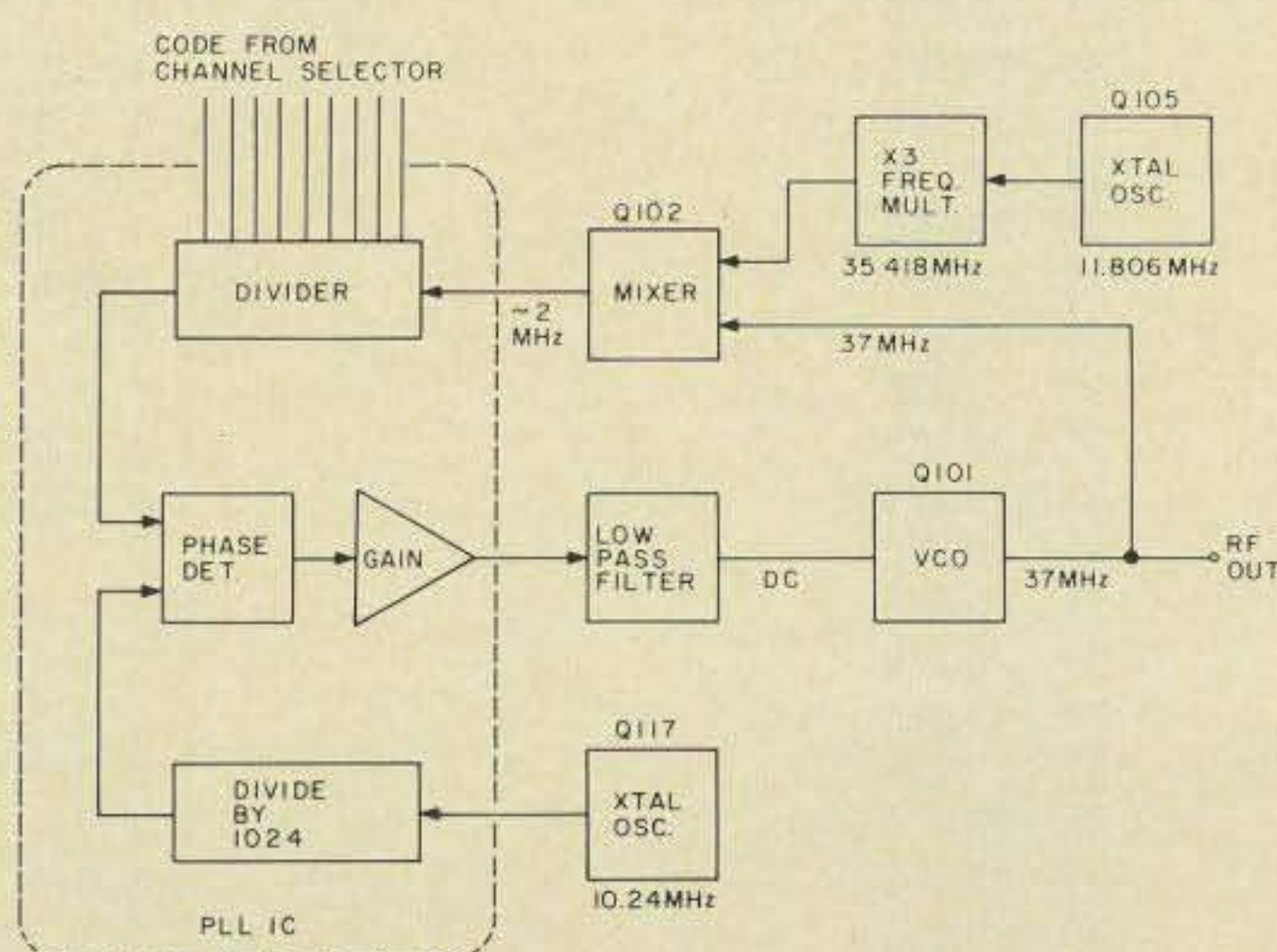

Fig. 3. The Hy-Gain phase-locked loop.



frequency of the vco. The vco output (which in the CB set will be the local oscillator frequency) goes through a digital frequency divider and then becomes one of the phase-detector input signals. That frequen-

cy divider is important and we'll consider it in a moment, but, for now, realize that when the vco frequency goes up, the output frequency of the divider (which is  $f_{VCO}/N$ ) also goes up.

Meanwhile, a crystal oscillator whose frequency is divided by M in another divider provides a stable input frequency to the other side of the phase detector. When the loop is operating properly, the two phase-detector input signals are on exactly the same frequency, and that means that  $f_{VCO}/N$  must equal  $f_{xtal}/M$ . Now suppose that because of a temperature or voltage change, the vco frequency starts to drift upwards. The corresponding input frequency to the phase detector also has to drift upwards, and, of course, the phase detector senses this

and its dc output voltage changes. This voltage change, after being amplified and applied to the vco input terminal, forces the vco back to the right frequency. Because of the high gain in the dc amplifier and the sensitivity of the phase detector, this correction takes place practically before the drift gets started. In fact, the vco can for all purposes be made as stable as the crystal oscillator.

Now, suppose that the crystal oscillator frequency and the size of digital frequency division M are chosen so that the phase detector reference input is 10 kHz. Then, because the other input in the operating loop must also be 10 kHz, the vco frequency must be exactly N times higher. If, for example, N is 100, then the vco will be on 1 MHz, and if N is changed to 101, then the vco will shift to 1.01 MHz. Clearly, the vco can be moved around in 10-kHz steps simply by changing divider value N, and that's just how it is done in the CB sets. It is a very nice system, since with the PLL guts on a single chip, the whole set of 40 channels can be generated with a single crystal and a cheap switch.

### The Hy-Gain PLL

The block diagram of the Hy-Gain PLL system shows differences from the simple loop just described. The real loop is shown in Fig. 3 and the dotted lines circle the parts of the system which are included in the PLL 02A (or MC145109) IC: the top two dividers, the phase detector, and the amplifier. The major change is that in this case the vco output is mixed down to a lower frequency before driving the divider.

The other mixer input is a 35.4-MHz signal derived from the third harmonic of an 11.806-MHz crystal oscillator. This is the crystal

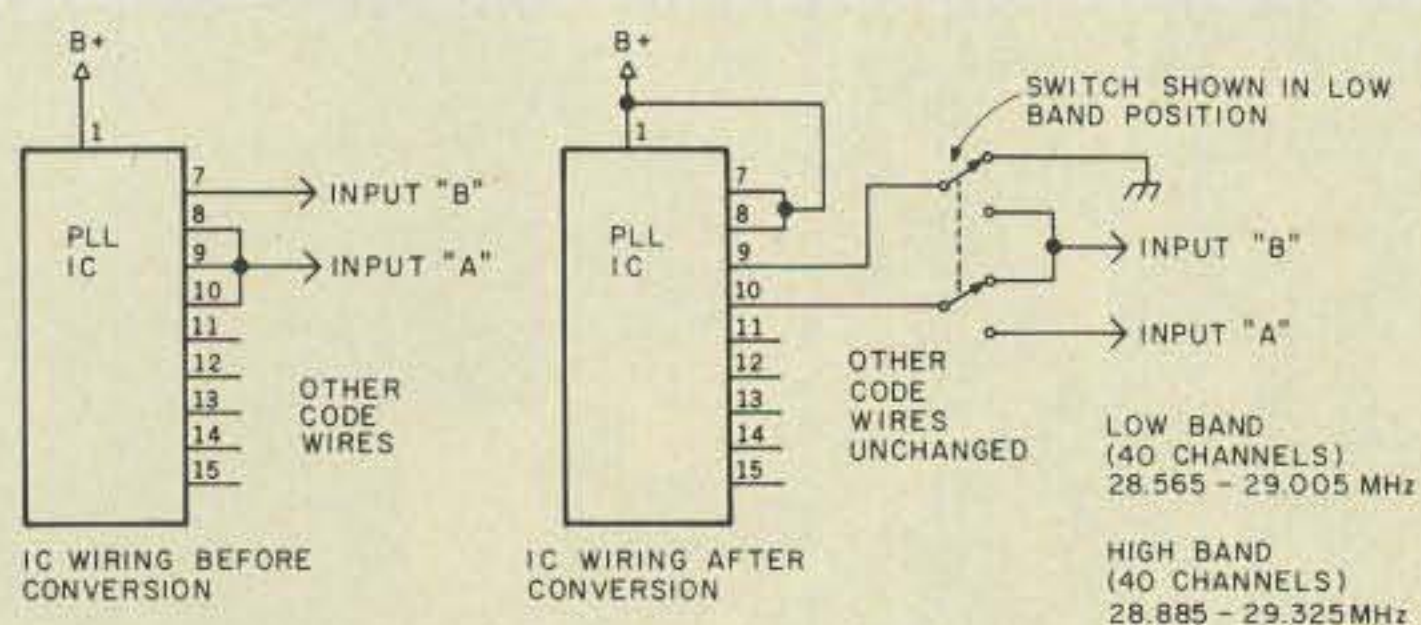

Fig. 4. Modifications in the PLL coding.

IC input name:	P0	P1	P2	P3	P4	P5	P6	P7	P8
Pin number:	15	14	13	12	11	10	9	8	7
Freq. Shift value (kHz):	10	20	40	80	160	320	640	1280	2560
Channel—Frequency									
1 28.885					0	1	0	1	1
2 28.895					1	0	0	0	1
3 28.905					0	1	0	0	1
4 28.925					0	0	1	0	0
5 28.935					1	0	1	0	0
6 28.945					0	1	1	0	0
7 28.955					1	1	1	0	0
8 28.975					1	0	0	1	0
9 28.985					0	1	0	1	0
10 28.995					1	1	0	1	0
11 29.005					0	0	1	1	0
12 29.025					0	1	1	1	0
13 29.035					1	1	1	1	0
14 29.045					0	0	0	0	1
15 29.055					1	0	0	0	1
16 29.075					1	1	0	0	1
17 29.085					0	0	1	0	1
18 29.095					1	0	1	0	1
19 29.105					0	1	1	0	1
20 29.125					0	0	0	1	1
21 29.135					1	0	0	1	1
22 29.145					0	1	0	1	1
23 29.175					1	0	1	1	1
24 29.155					1	1	0	1	1
25 29.165					0	0	1	1	1
26 29.185					0	1	1	1	1
27 29.195					1	1	1	1	1
28 29.205					0	0	0	0	1
29 29.215					1	0	0	0	1
30 29.225					0	1	0	0	1
31 29.235					1	1	0	0	1
32 29.245					0	0	1	0	1
33 29.255					1	0	1	0	1
34 29.265					0	1	1	0	1
35 29.275					1	1	1	0	1
36 29.285					0	0	0	1	1
37 29.295					1	0	0	1	1
38 29.305					0	1	0	1	1
39 29.315					1	1	0	1	1
40 29.325					0	0	1	1	1

Table 2. PLL programming—28.885 to 29.325 MHz.



that is usually replaced for 10-meter conversion. If the crystal frequency is moved upwards by 2/3 MHz, then the mixer input frequency moves up by 2 MHz and the vco must move upwards by the same 2 MHz in order for the mixer output to stay the same. The approach used here is to change only the divider programming so that the vco has to move upwards because the divider input frequency must move upwards to maintain a 10-kHz output frequency.

The divider input consists of nine wires, as shown in Fig. 3, although in the CB setup three are tied together so that only seven switched lines are needed. The code on these seven wires is predetermined by the mechanical construction of the channel switch or, in the case of the trunk-mounted version, by the information stored in a read-only memory. What can be changed easily is the wiring between the channel selector and the nine input terminals on the PLL chip. The coding for the original setup is shown in Table 1. With the chip used on the Hy-Gain boards, a logic 1 placed on a particular input causes the divider to divide by whatever binary value that input represents. The frequency value of each of the nine inputs is shown at the top of the table, and if you study the change in frequency that results from a change in coding, the overall scheme of things will quickly become clear.

If, for example, the set is on channel 14 and you want to go up 10 kHz to channel 15, then the code on the P<sub>0</sub> line is changed from a 0 to a 1. To go up 90 kHz to channel 21, both the P<sub>0</sub> and P<sub>3</sub> inputs are set to 1. Note that the most significant input, P<sub>8</sub>, has a value of 2.56 MHz, so if the set were on channel 1 but you had taken a soldering iron and wired P<sub>8</sub> to five volts instead of the low level com-

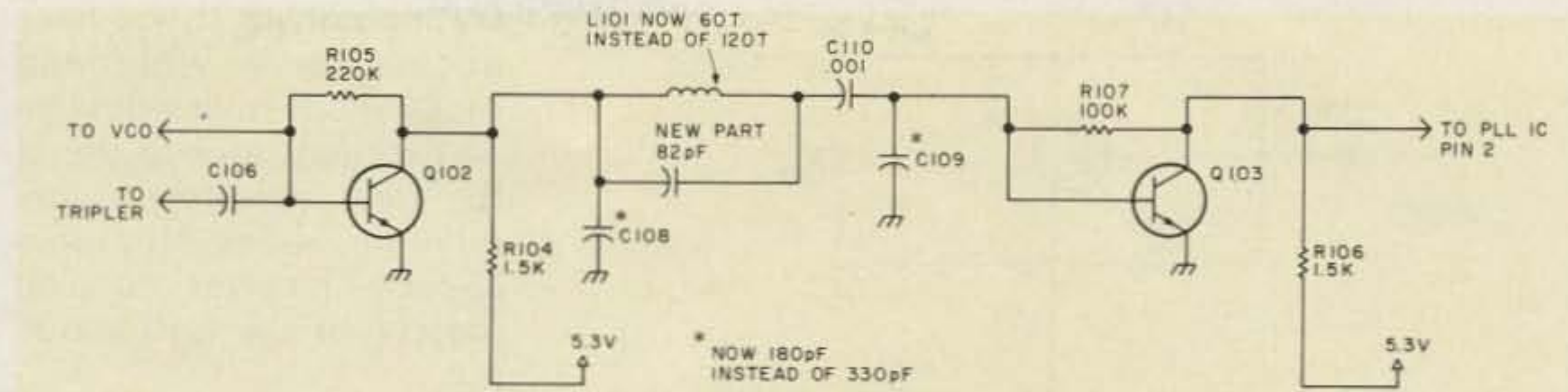

Fig. 5. Mixer output filter modification.

ing out of the switch, then the PLL would try to move the vco (and with it the rig's operating frequency) exactly 2.56 MHz higher to 29.925 MHz. Also note that three inputs, P<sub>5</sub>, P<sub>6</sub>, and P<sub>7</sub>, are connected together on the printed circuit board and always have exactly the opposite value from P<sub>8</sub>.

To command the rig to ten meters, all that is required is to cut apart these three inputs and rewire the coding driving them. The change in the wiring is shown in Fig. 4. On my unit, I included a switch so that two overlapping sections of the band could be covered —this gives a continuous range of channels from 28.565 to 29.325 MHz. I don't use the lower band much since the AM activity stays between 29.0 and 29.1 MHz for the most part, but I had the switch in my junk box and the addition was certainly easy enough.

The PLL coding inputs after the modification is made are shown in Table 2 for the "high band," or 28.885 to 29.325 MHz. It is easy to calculate the new frequencies by looking at the change in coding between Tables 1 and 2. For example, on channel 35, the P<sub>6</sub> and P<sub>7</sub> bits have been changed from 0 to 1 for an operating frequency increase of  $.64 + 1.28$ , or 1.92 MHz, from 27.355 to 29.275 MHz. This modification is quick and simple, partly because the old channel switching circuitry is retained and only the wiring is changed. It has the disadvantage of skipping an occasional frequency, and

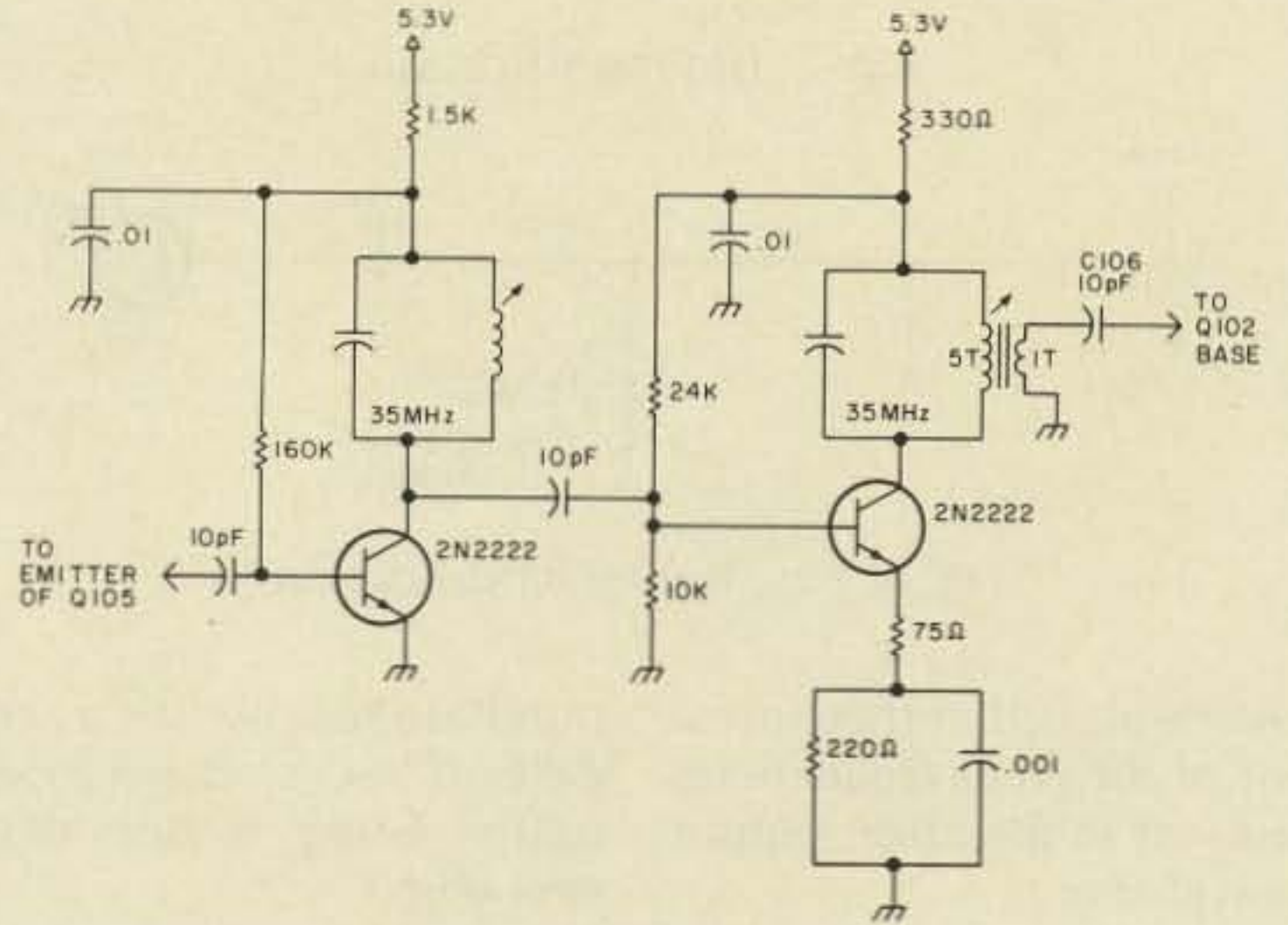

Fig. 6. New circuit—11.8- to 35.4-MHz tripler-buffer.

if that is a detriment or if you want more than 40 channels, you could use external toggle switches or thumbwheel switches or whatever your junk box contains to code in any frequencies you wish.

Now that the programmable division has been increased, the frequency coming out of the loop mixer (Q102) has also been increased by some 2 MHz. For reasons discussed later, there are many frequencies present in the output of this mixer stage; to reject the unwanted ones, the mixer is followed by the low-pass filter consisting of C108, L101, and C109. This filter must be changed to accommodate the higher frequency. The new circuit is shown in Fig. 5. The two capacitors have been reduced to 180 pF each, the coil has been reduced from 120 to 60 turns, and an 82-pF capacitor has been added in parallel with the coil to increase the sharpness of the filter roll-off. In some of the units, the coil is mounted in

a small white plastic box, but the cover slides off fairly easily so the turns can be removed without damaging the unit physically.

### The Catch

The changes outlined above are all that are necessary to command the phase-locked loop to the desired frequency. Unfortunately, it won't lock there until you remove a shortcut that Hy-Gain got away with in its design. Fig. 3 shows a tripler following the 11.806-MHz crystal oscillator. In fact, this tripler is not shown on the schematic because it is part of the mixer.

A mixer is a nonlinear circuit—that's why it mixes two frequencies instead of just adding the voltages together. When the loop mixer is fed the 11.806-MHz signal from the crystal oscillator, it internally generates the second, third, fourth, and so on harmonics of that basic frequency. It does the same with the 37-MHz vco signal also, and



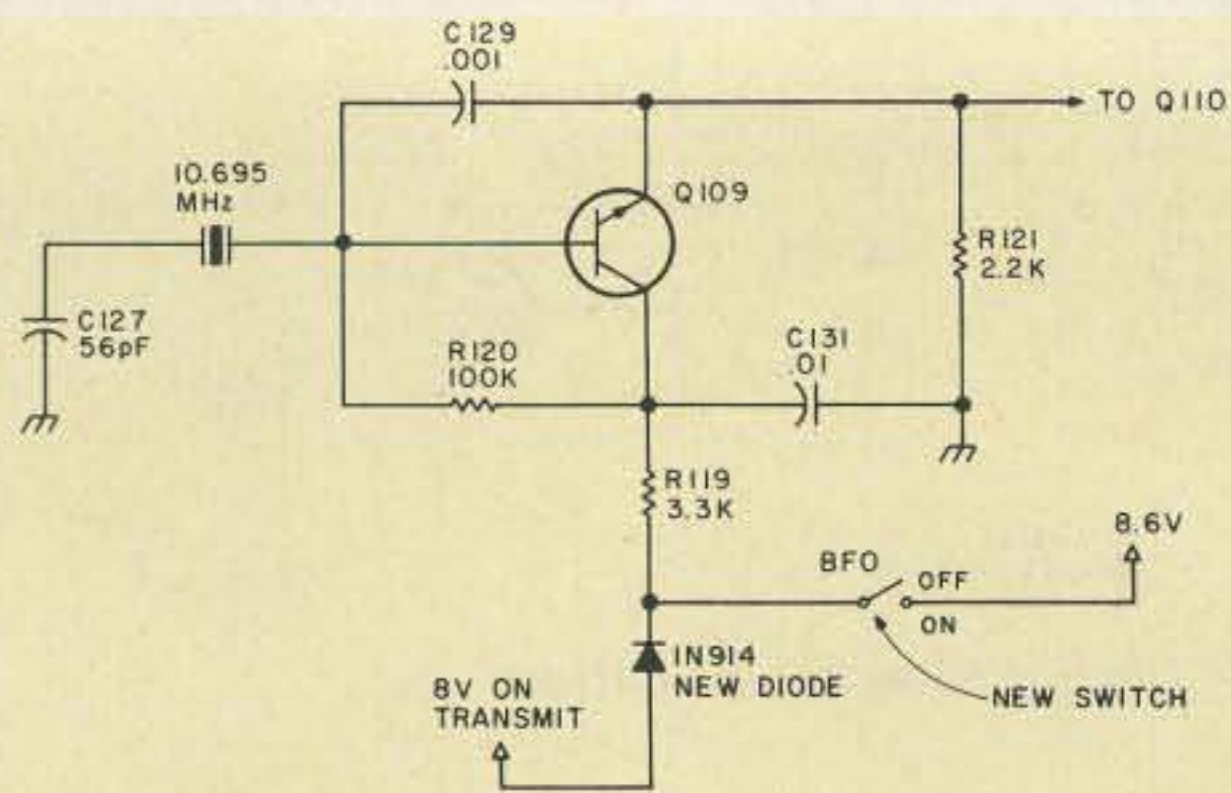

Fig. 7. Bfo modification.

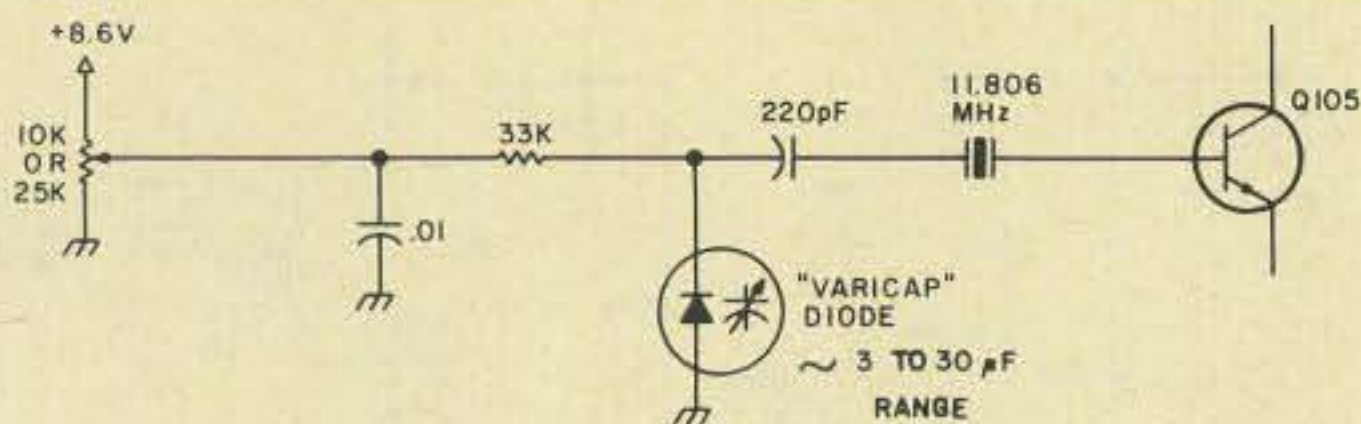

Fig. 8. Fine tuning modification.

the result is that there are a lot of different frequencies present in the mixer output waveform.

The designers at Hy-Gain were careful in picking the right frequencies so that the loop locks on the one they wanted and not on some spurious mixer product. Unhappily, the shift to ten meters upsets things enough so that the loop gets confused and doesn't operate properly. This is where the two transistors mentioned earlier come into the picture, since they are used in the circuit of Fig. 6 to generate a nice, clean 35.4-MHz signal which is fed into the mixer in place of the lower frequency. The circuit is a straightforward tripler-buffer using commonly available parts.

The tuned circuits could be modified i-f transformers or any other small adjustable coils capable of being tuned to the 35-MHz range. The transistors also could be salvaged from an old FM radio if you don't have any 2N2222s on hand. In fact, I make it a practice to collect broken and discarded transistor radios, as I find the parts they contain are often smaller than any I could

purchase locally. It's a rare case of recycled parts actually being better than new ones.

The circuit can be constructed on a small circuit board and mounted in any convenient manner close to the mixer (Q102) on the mother board. I was able to fit the addition into the open space existing between the 10.695- and 11.806-MHz crystals. In any case, if you use the transformers, they must be modified so that they resonate on 35 MHz, and this requires some careful work. The easiest thing to do is to remove turns from the coils since the capacitor inside the transformer is very small and it is unlikely that your junk box would have a smaller value in a similar physical size. The coil will have perhaps 7 to 10 turns of very fine wire, and you need about half that number—4 or 5 turns.

To tune the two coils, you need some way of monitoring the 35-MHz output of the second stage. I used a grid-dip meter as a rough guide to resonance while cutting down the coil, and then, in the wavemeter mode, as an indicator of the buffer's output in the op-

erating circuit. If you have access to a wideband oscilloscope, that would be an excellent tool to use in the final adjustment. Another possibility is to use a 35-MHz receiver coupled loosely to the buffer output.

With the addition of the tripler and buffer stages, the loop should lock readily on the proper frequency. The best way to check for proper locking is to monitor the dc error signal controlling the vco, and this signal is available at the common junction of R113, R114, and R115. You might want to watch this voltage a bit while the set is still set up on the CB frequencies so that you can get a feel for proper operation. With my sets, this voltage can be anywhere between 1 and 4.5 volts during normal operation, and the voltage will hold a steady dc value on any particular channel.

When the channel selector calls for a new frequency, the voltage changes since the loop is forcing the vco to a different frequency. As the channel selector is switched progressively higher from 1 to 40, the voltage at this point will smoothly change from its lowest to its highest value—about a 2-volt change in all. There will be a slight bump in the response near mid-scale since channels 24 and 25 are below channel 23 in frequency. The position of the 2-volt excursion within the 3.5-volt operating range can be varied by adjusting the slug in the vco tank coil, T101: This action changes the vco's free-running frequency and so requires the loop to pull by a different amount in getting the vco back on frequency. If this vco adjustment is too far off, the loop is unable to lock and the error voltage will stay at either the high or low limit.

There are some points at

which the loop apparently locks on a spurious mixer product. In these cases, the error voltage sits at mid-range and doesn't track the changes of the channel selector. If the tripler or buffer tank circuits are mistuned drastically, the error voltage may bounce around on the upper channels instead of holding steady. Remember that this voltage is the electrical equivalent of a vfo knob and should be rock steady in normal operation, showing only a very slow drift as the loop compensates for temperature or B+-induced vco drift. For the final vco adjustment, select a channel near the middle of the frequency range and set T101 so that the error voltage is around 2 volts. In my sets, the loop can control the oscillator over about a MHz, so that once adjusted, T101 need not be touched up.

With the PLL moved to the proper frequency, the only other adjustments required are in the front-end rf circuits. In receive, the antenna and rf amplifier slugs on T103 and T104 are screwed out a turn or so to peak up the received signals. The local oscillator injection tuning for the mixer, T111, also should be peaked up to the new vco frequency range. This can be accomplished as before with a grid-dip meter, receiver, or oscilloscope. In this case, the frequency change is only about 5%, so you might get away with simply a half-turn counter-clockwise of the slug.

On the transmitter side, there are more tweaks to make. The vco signal is mixed with the output of a 10.695-MHz crystal oscillator to produce the ten-meter output frequency. The output of that mixer is cleaned up by a three-stage filter consisting of L103, L104, and T102. The easiest way to adjust these three



coils is with the aid of another ten-meter receiver. Tune it to the transmit frequency and, with a dummy load on the rig, push the transmit button. You should hear a signal, maybe a weak one, in the receiver. As you adjust those three coils, the signal should peak up noticeably although it may still be a bit weak since the output stages are still on 27 MHz. Don't, by the way, hold the key down for long periods until the output stages are resonated. The output tuning is fairly broad and noncritical: Simply adjust T103, L106, L109, and L110 for maximum output. For my rig, that is 3.5 to 4 Watts with a 13.5-volt power supply.

At this point, you should be able to start making contacts. As mentioned before, most of the AM activity is between 29 and 29.1 MHz, and if you don't hear anyone there, don't be afraid to call CQ for awhile.

If you hear some sideband stations on the lower channels, you can be sure that the band is open, so persevere. The AM activity doesn't crowd up its band segment the way the SSB gang does, and people are out there listening. Many of the stations you work will be using CB sets, and you will be amazed at how well your low power gets out.

### Sideband Reception

There are plenty of AM contacts to be had, but without a doubt, there is more activity on SSB—how about a bfo to detect them? It's already there waiting to be turned on. During transmit, the output frequency is created by mixing the vco signal with the output of a crystal oscillator on 10.659 MHz—the receiver first i-f frequency. If that oscillator is turned on during receive, it provides enough bfo injection to demodulate the SSB signals you are hearing. Technically, it is a bad ap-

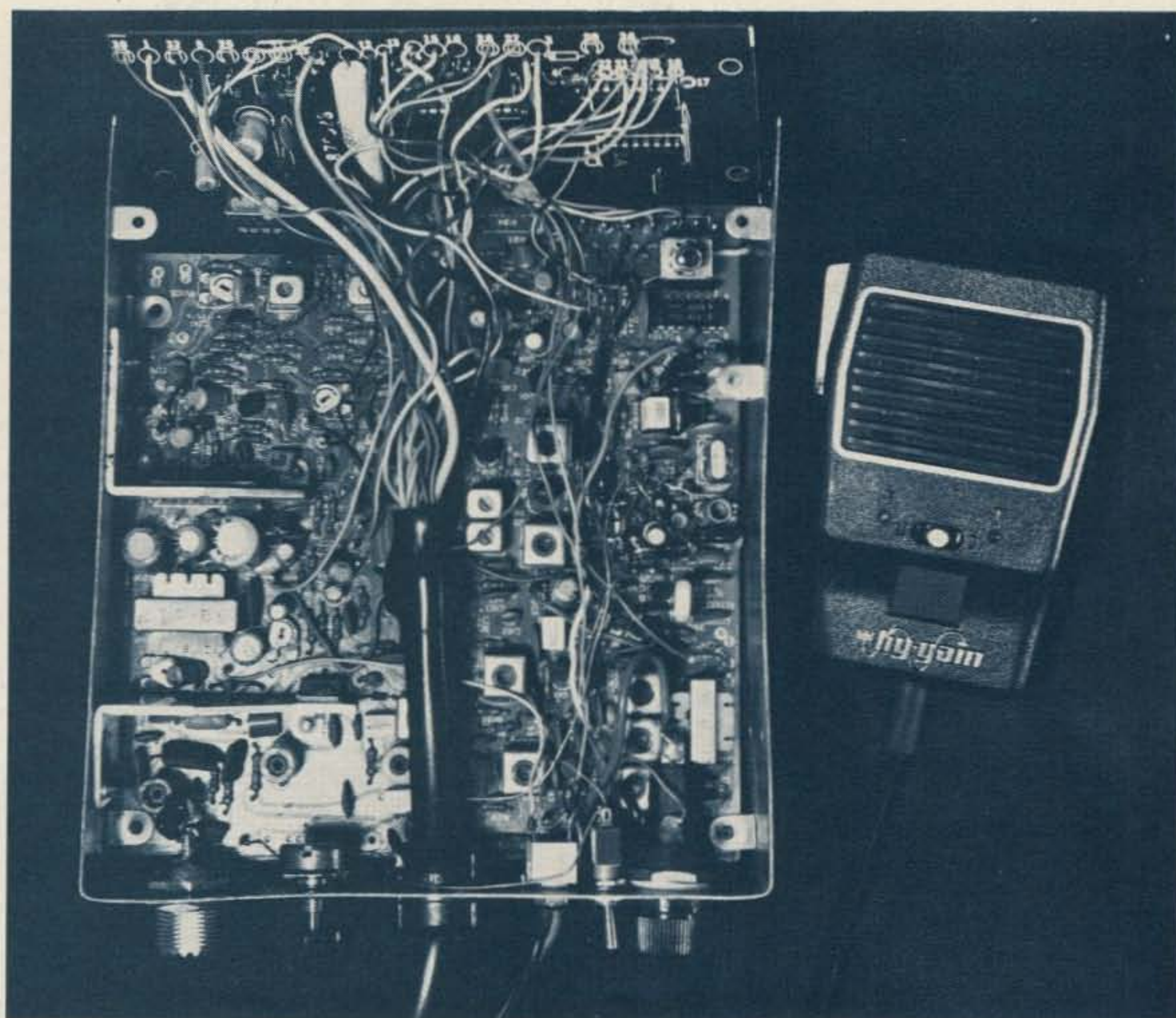

*Photo C. The modified trunk-mount rig with remote microphone/control unit. The control-unit interface board has been folded back to show the position of the bandswitch next to the PLL IC. Mounted next to the antenna jack is the  $\pm 4$ -kHz fine-tuning pot; the switch next to the fuse holder is for the bfo.*

proach because the bfo signal is injected ahead of most of the i-f gain so that it gets into the agc circuitry and most likely desensitizes the receiver. Practically, it works just fine, especially considering that all the modification requires is the single diode and switch shown in Fig. 7.

### Fine Tuning

Once the bfo is working, the difficulty with sideband stations is that few of them are exactly on one of the 40 channel frequencies and the receiver has no provision for fine tuning. There is a trimmer, CT101, that can move the transmit and receive frequencies around by a kHz or so; it was put there to allow adjusting the CB channels to their assigned slots. The easiest way to add fine tuning to the rig is to replace this

trimmer with a panel-mounted unit of the 5-to-35-pF variety. Once this is done and the 39-pF fixed capacitor that was in parallel with CT101 is removed, the variable range is between 8 and 10 kHz.

A much neater modification will result if the trimmer is replaced with a diode designed to operate as a variable capacitor. I was able to purchase eight such diodes for \$1.30. (Try Solid State Sales, 139 Hampshire Street, Cambridge MA 02139.) As with all surplus components, there was some variation in performance between parts, but I was able to find several diodes which would give a 7-kHz shift when used in the circuit shown in Fig. 8.

After this modification, you will find that it is

even possible to contact sideband stations after you zero beat them, and that often the SSB operator won't realize you are on AM unless you tell him. It's only courteous to stay out of the congested end of the band, however, since your other sideband could cause some unnecessary QRM. The technique can be useful, though, when you can't scare up an AM contact and the band isn't too crowded.

### CW Modifications

Once the set has a bfo and fine-tuning capability, why not CW? There is a lot of activity on the CW end of the band, and a low-power signal is at a lot less of a disadvantage when using that mode. Two changes are required: The PLL must be reprogrammed, and some means of keying the carrier must be installed.



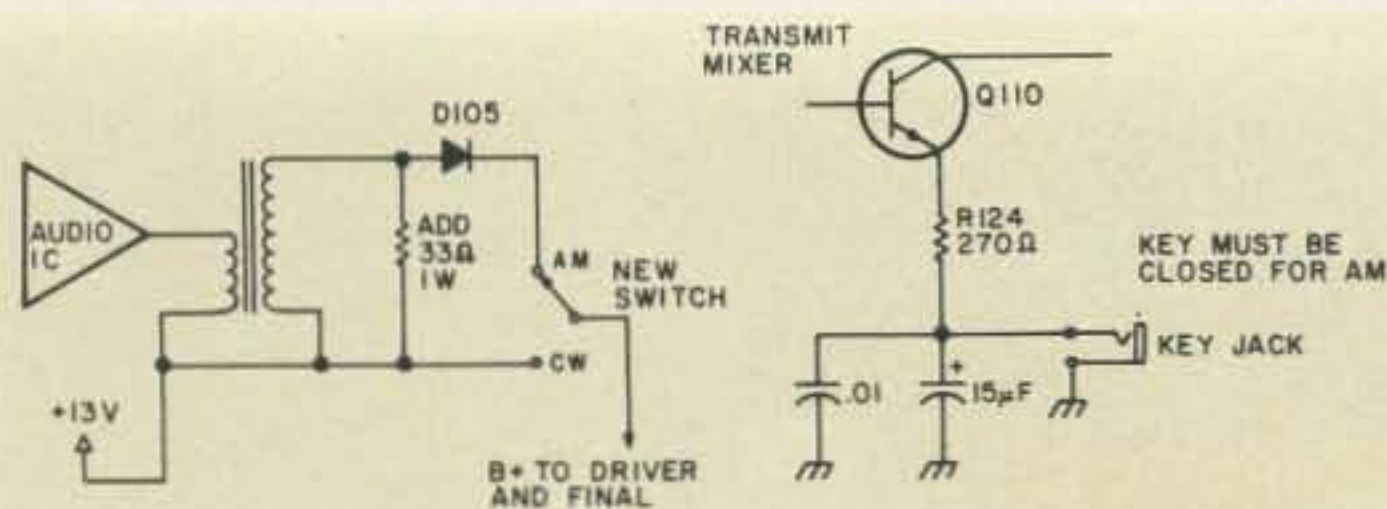

Fig. 9. Modifying the transmitter for CW keying.

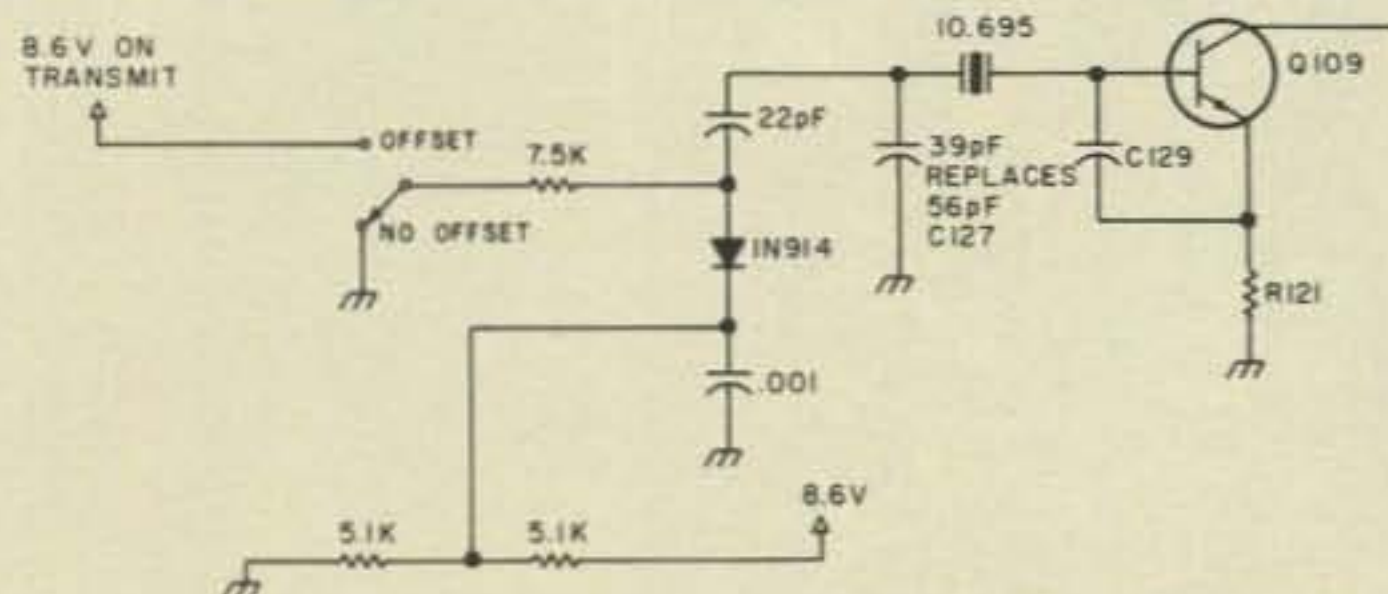

Fig. 10. Transmit frequency offset modification.

One minor disadvantage of the frequency modification is that 28.1 MHz is far enough from 29.1 MHz so that both the receiver and transmitter will have to be re-peaked for proper operation. In my particular board, the vco would just make the transition, but it really required a slight adjustment to ensure stable operation. The necessary retuning is easy enough until you mount the board in some kind of enclosure (it's a nice fit in a 7" x 7" x 2" chassis, by the way), so if you plan on a lot of CW operation, you might include access holes in any box you use to allow quick circuit peaking.

Modifying the PLL coding to get the set operating on the CW end is pretty simple. First, the switch shown in Fig. 4 should be in the Low Band position so that channel 1 is on 28.565 MHz. Then, simply tie pin 8 to ground instead of 5 volts, and connect pin 9 to 5 volts instead of ground. This operation moves all the channel frequencies lower by 640 kHz, so channel 8 is now on 28.015 MHz. The lower seven channels can be used for monitoring the illegal operation below the band when you get the urge.

After making these coding changes, go back and check for proper PLL operation by monitoring the error voltage at the junction of R113, R114, and R115. Once again, T101 should be adjusted until the error voltage on channel 20 is about 1.5 to 2 volts. Then peak up the receiver front end and you should start hearing some signals.

Modifying the transmitter for CW is also pretty simple: The changes are shown in Fig. 9. The B+ feeding the driver and final is connected directly to the 12-volt line, thus disabling the modulator, and the carrier is keyed at the emitter of the transmit mixer, Q110. The 15- $\mu$ F capacitor across the keying lead is a simple but effective means of shaping the waveform to prevent key clicks. One disadvantage of this modification is that the receiver is always zero beat with the transmitter. Since the other operator has a tendency to zero beat with you, he keeps disappearing from your audio, and unless you are aware of what is happening, you may lose the contact or maybe start leap-frogging the other station down the band.

Offsetting the transmitter during CW operation

isn't too difficult, however, and the circuit shown in Fig. 10 will move the CW transmit frequency about a kHz below the receive frequency. The switch could be made part of a Phone-CW mode switch or it could be left as a separate control. The amount of offset is fixed by the size of the capacitor added to the oscillator circuit, and this size may need to be varied depending on the desired shift and particular crystal characteristics.

### Afterthoughts

Most of the existing CB-to-ten modifications require the purchase of a crystal, and while that is a perfectly valid approach, it means you have to wait for the crystal to be made and accept the band segment that that crystal gives you. I feel that the added flexibility and lower cost of the PLL modification outlined here is well worth considering as an alternative. Not only does it get you on the air quicker, but also you have the freedom of easily putting the 40 channels anywhere you want at a moment's notice.

That freedom opens the door to a lot of weekend experimenting, only some of which I've tried. How about an OSCAR monitor for higher in the band? Or ten-meter FM? The variable tuning modification shown in Fig. 8 could be applied to the 10.695-MHz oscillator, and with an audio controlling signal instead of the potentiometer, the transmitter would be on FM. If the 455 crystal filter were removed, the receiver would probably slope-detect pretty well. It should be possible also to gang-tune the rf stages, maybe with the capacitor diodes, for example. The tuning could be via a front-panel potentiometer or maybe even ganged with a band-switch that changes the PLL coding. Such a setup would

make changing from the AM to CW end of the band easier. For CW operation, a sidetone oscillator could be included. The 40-channel switch could be replaced with thumb-wheels or other switches so that no channels would be missing (as in the CB sequencing) or to provide more channels without bandswitching. How about programming the PLL from a digital counter running at some slow rate? Then the band, or some segment, could be scanned automatically for activity just like a VHF scanner. With a little effort, the channel spacing could be changed to 5 kHz (divide the 10.24 input to the PLL by two with a flip-flop and double the values of C113, C114, and C115). Belong to a radio club? You couldn't think of a better or cheaper club project. How about a club net or monitoring frequency on ten?

Have fun, and see you on ten.

### Acknowledgements

I owe a thank-you to John Brownhill (almost a Novice at this writing) for introducing me to the bargains available in these CB boards, and also for the loan of his Sams Photofact information. My special thanks to Steve Finberg W1GSL for his suggestions on the text and his help with the photography. Finally, I must give credit for the bfo modification to the unknown local ham using the technique who worked me while I was on ten with my SSB CB set. He was on AM, and sure enough, I didn't realize it until he told me; I'm sorry only that I didn't note the incident in my log so that I could give him proper credit. ■

### References

1. Paul Schmidt K9PS, "CB to Ten—part XVIII," 73, May, 1979.
2. Cliff Wiginton WB5BSG, "CB to Ten—part XI," 73, Sept., 1978.
3. Lester Earnshaw, "PLL Techniques," 73, October, 1978.







## The Battery Minder

— a real turn-on for chargers

A car battery with an ac charger is an easy way to power those all-solid-state rigs. Such an arrangement is not expensive and

can deliver the often-required high peak currents. It also makes a nice emergency supply when the ac fails, as it often does

here during the winter.

One question that keeps coming up is when to charge the battery. It is a nuisance to have to check

the battery voltage and connect and disconnect the charger accordingly. The circuit presented here was designed to make life with such a supply just a little bit easier. It is a simple, reliable circuit that is easy and quick to build. There are no difficult or tricky "gimmicks." All parts are readily available; substitutions can be made with good results.

The circuit is based on the LM339 voltage comparator. (See Fig. 1.) A 6-volt zener and a 4.7k resistor form a reference voltage for the 339's minus input. The 339's plus input is connected to the tap of a 10k pot that is connected across the battery. This pot is set so that the plus input is near 6 volts.

Now, as the battery voltage falls, the plus input will fall below the reference 6 volts at the minus input and the 339 output will go low and turn the transistor and relay on. Note that

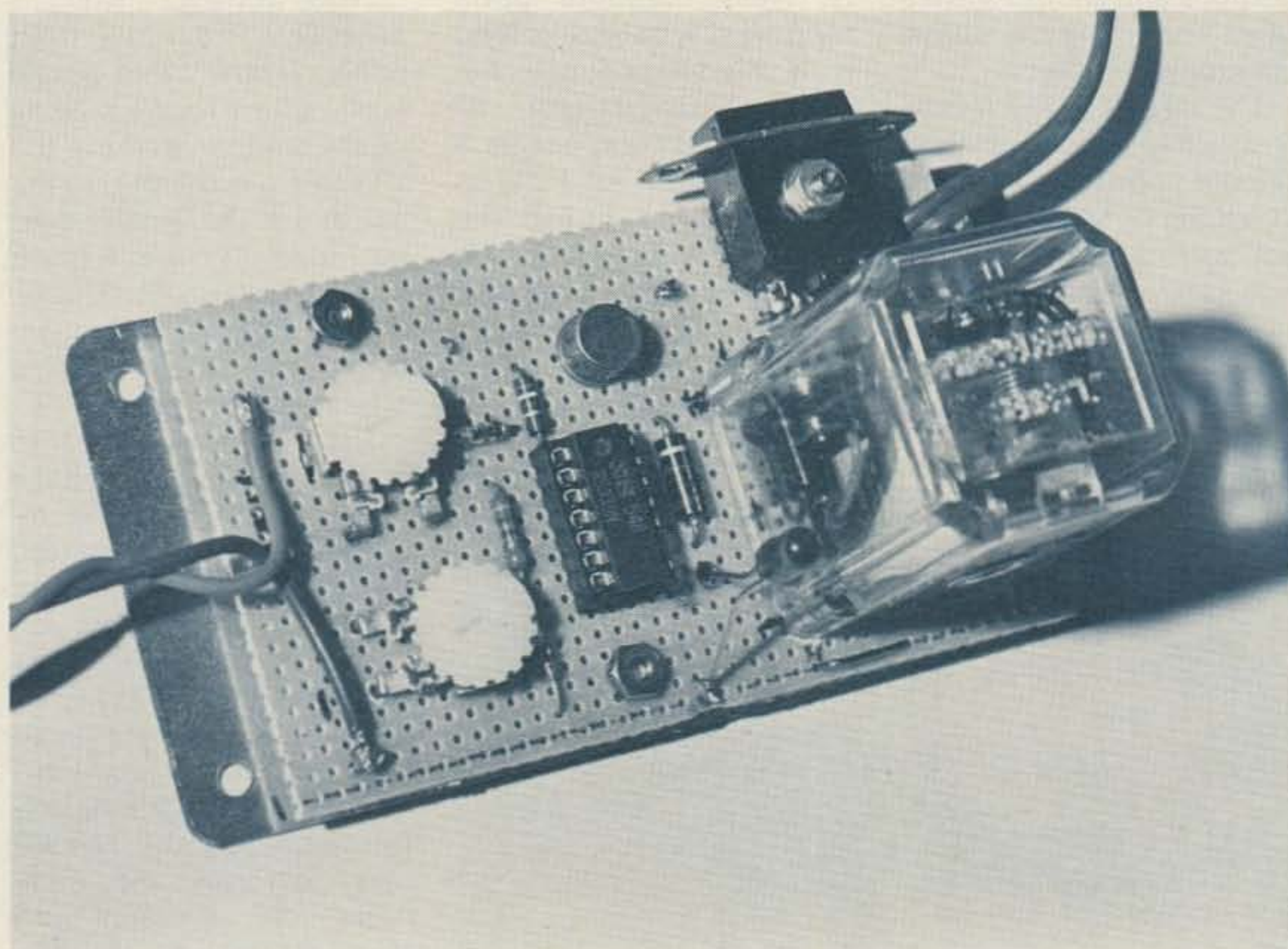

*The Battery Minder.*



# RIGHT FROM THE START, YOU CAN TELL WHY **73** IS THE #1 BARGAIN!

73 Magazine doesn't hide what's inside with a fancy cover. *The table of contents is the cover.* Right from the start, you know that inside 73 are the quality and quantity of articles you've been looking for in an amateur radio magazine.

73 Magazine has *articles on everything*, from the new ham bands to moonbouncing to mountaintopping. Plus, 73 has the *most thought-provoking editorials* of any amateur radio magazine—you may not agree with them, but you'll never be bored. And, 73 has (because of its active ham readership) *the best mail-order advertising*—to give you more places to shop for lower prices.

June 1988 \$2.50

## 73 Magazine for Radio Amateurs

<p>28 One Stop at a Time: Designing Your Own Ham Gear <span style="float: right;">W4ENL</span> —part 1</p> <p>36 Down with Interpolation <span style="float: right;">W4QJ</span> —a digital display for the Triton and others</p> <p>42 Hooray! An AFSK Auto IDer! <span style="float: right;">K3J</span> —a clean and legal way for RTTY transmitters</p> <p>44 Let's QSY to 52 <span style="float: right;">W4RVA</span> —oh, technology</p> <p>46 Five Test Equipment Bargains from Heath <span style="float: right;">W2QJC</span> —the 500 series features plenty of measuring power per dollar</p> <p>48 The Phoenix Fix <span style="float: right;">W4JAM</span> —an alarming digital-to-digital conversion for out-of-time clock radios</p> <p>50 QRQ, QRS—By the Numbers! <span style="float: right;">W7BKX</span> —a digital C-M25 code-speed indicator</p> <p>54 Adding a Scanner to Your 2m Rig <span style="float: right;">W4H89</span> —here's a method that works with most scanner receivers</p> <p>56 Digital Transistor Checker <span style="float: right;">W4QUP/728G</span> —a "hand-on" tester</p> <p>58 CB to 10 <span style="float: right;">A188</span> —part 2: using those surplus 400 channel searchers</p> <p>60 The Steals Rig Retriever <span style="float: right;">W4ABM</span> —built on gallego substrate the search goes on with every transmission</p> <p>64 Constructing QRP Dummy Loads <span style="float: right;">W10LP</span> —useful and inexpensive</p> <p>68 The IC-211 Cookbook <span style="float: right;">K1VCJ</span> —tips and tricks to optimize performance</p> <p>74 Take a Hike <span style="float: right;">K4ID</span> —backpack rig with an ICOM</p> <p>78 Tuning Antenna-Mounted Preamps <span style="float: right;">K4H</span> —do it without additional wiring</p> <p>80 PC Artwork Made Easy <span style="float: right;">W7RHS</span> —off layouts from the page with transparent ink</p> <p>82 Electronic Dice—a Family Pleaser <span style="float: right;">W7RHS</span> —Las Vegas, look out!</p> <p>84 Fun with Fuzzie <span style="float: right;">W7RHS</span></p> <p>88 The Demise of Component Stores <span style="float: right;">VE3IE</span> —parts prices are just one price</p>	<p>90 Priority Frequency Power-Up for the FT-227R <span style="float: right;">W4ALM</span> —the right of a course tone</p> <p>94 Computerize Your Contest Paperwork <span style="float: right;">W4RWA</span> —from BASIC programs to a kit</p> <p>98 Emulate an Elephant <span style="float: right;">K4AB</span> —but let your rig be the leader</p> <p>104 Prelix Challenge <span style="float: right;">AL6P</span> —is this white-powder waiting for the lead to open up?</p> <p>111 Check Chirp with a Choke <span style="float: right;">W4MJA</span> —get QRP every time with the open book</p> <p>112 Eradicate that Sleeping Rx <span style="float: right;">K4H</span> —best steps in its short alignment</p> <p>114 Rubber Thumbs and Pilot Lamps <span style="float: right;">K1MP1</span> —a special all-thumbs collection</p> <p>118 Tempo 51 2-Meter Portable <span style="float: right;">W4H8V</span> —800 channels, 100 gr</p> <p>120 A Proper Pedestal for PCBs <span style="float: right;">K4H</span> —helps hold your rig in the heat</p> <p>122 Surplus Treasures <span style="float: right;">K1VICJ</span> —available in quality lots, nation for less than \$200</p> <p>124 Listen in Secrecy with a Giant Inductive Loop <span style="float: right;">ZL1AM</span> —without using any iron anywhere in the house</p> <p>130 Three Hamtronics Kits...How Can You Use Them? <span style="float: right;">W4PQJ</span> —an in-depth look at some of the best bargains</p> <p>134 10 Meters for the 5B-221 <span style="float: right;">W4NSM</span> —the missing link</p> <p>136 Another Place, Another Time <span style="float: right;">A4H</span> —working the peripheral bands</p> <p>144 Who Needs a \$40 Soldering Iron? <span style="float: right;">K4H</span> —here's why you may want to re-examine your</p> <p>146 Outboard Power for the 820 <span style="float: right;">K1GFB</span> —it's easy to install and we end up of men to the Komrad!</p> <p>148 CB to 6 <span style="float: right;">W4CC1</span> —convert a 40-WATT CB into something</p> <p>152 Digital Boat Anchor <span style="float: right;">W4YAL</span> —using just 6 paper and a frequency counter to do your job</p>
--	--



Never Say Die—4, Looking West—10, RTTY Loop—12, DX—14, Leaky Lines—16, Ham Help—16, 174, 184, Letters—18, Contests—20, New Products—22, Awards—24, Social Events—170, OSCAR Orbits—175, Corrections—180, Dealer Directory—209, Propagation—209

## SUBSCRIBE TO **73** MAGAZINE TODAY!

**AND  
FIND OUT WHY  
WHEN YOU'RE  
THE #1 BARGAIN,  
YOU DON'T HAVE  
TO HIDE IT!**

OK, I'll take the #1 Bargain

1 year—\$25       2 years—\$38       3 years—\$53

Payment enclosed       Bill me

Bill my:  Master Charge       VISA       Amex

Card # \_\_\_\_\_ Expire Date \_\_\_\_\_

Signature \_\_\_\_\_ Bank # \_\_\_\_\_

Name \_\_\_\_\_

Address \_\_\_\_\_

City \_\_\_\_\_ State \_\_\_\_\_ Zip \_\_\_\_\_

**73 MAGAZINE—POB 931—FARMINGDALE NY 11737**

Canada—1 year—\$27 in US funds Foreign—1 year—\$35 in US funds

Please allow 6 to 8 weeks for delivery

308B6



when the 339 output is low, the plus input is pulled even lower through the 100k feedback pot. It now will require a higher voltage across the 10k pot (and battery) to make the relay go off. The amount of this hysteresis is set by the 100k pot. It should be set to turn the charger on and off at the voltage the builder desires.

A bit of experimenting may be required to get the on and off voltages best for your battery. The settings will depend on the condition of the battery and the output voltage of the charger. The low-voltage turn-on point is set with the 10k pot while the 100k pot is at its maximum resistance. Then the high-voltage turn-off point is set by adjusting the 100k pot. I set my Battery Minder to turn on at 11.5 volts and to turn off at 13.3 volts. The relay controls the

110 ac to the charger. An LED indicates when the battery is being charged.

The parts used in my Battery Minder were those on hand. Just about any voltage comparator will work if it will operate from a single-ended power supply. The zener diode can be any voltage from about 4 to 8 volts, with an appropriate adjustment of the 10k pot. The 10k and 100k pots can be just about any value that does not load the circuit. As a starting place, the feedback pot should be about 10 times the value of the voltage divider pot. The relay can be just about any one that will handle 110 ac, but note that it must be able to operate at the lowest voltage to which the battery is allowed to discharge. It could be an SPST relay. The transistor is any general-purpose PNP type that will handle the relay and LED current. The total

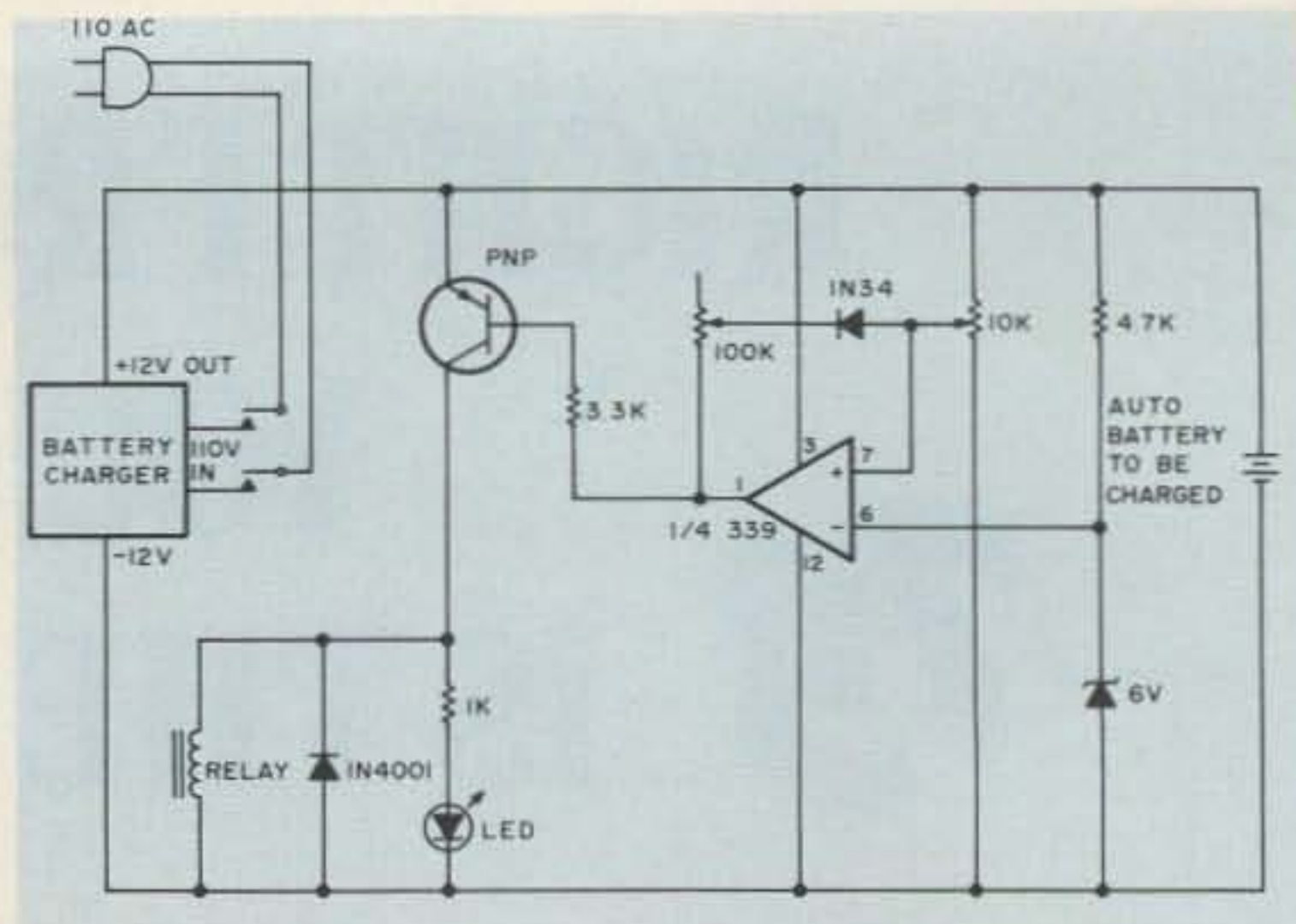

Fig. 1. Schematic diagram.

current through mine was about 45 mA.

Construction of the Minder is very simple using perfboard. The photo shows the parts placement that I used. Wiring was simply point-to-point using component leads. It is recommended that the relay be one of the enclosed types; they go much longer

without the points fouling. My unit was mounted in a plastic box, with a 110-volt receptacle into which to plug the charger.

The Battery Minder keeps the "power supply" charged at all times, reduces the nuisance factor, and ensures that the 2-meter rig has emergency power when the ac fails. ■

X-RATED

**OUTPERFORMS**  
**ALL** commercially  
 available tribanders  
**AND** many monoband  
 systems, too!

KLM's KT-34X

20, 15, & 10M — FOR THE MATURE HAM ONLY

KT-34 UPGRADE KITS AVAILABLE  
 WRITE FOR COMPLETE DETAILS OR  
 SEE YOUR LOCAL KLM DEALER

**KLM** 17025 LAUREL RD., MORGAN HILL, CA 95037, (408) 779-7363



CALL TOLL FREE  
**1-800-228-4097**

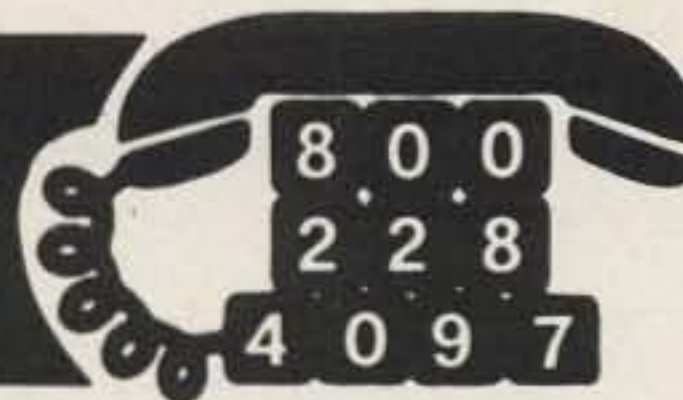

*They won't last long* AT THIS INTRODUCTORY PRICE

16 Channels  
 30-54 MHZ  
 140-180 MHZ  
 410-514 MHZ  
 Digital Clock  
 Date Display  
 110 V. AC or 12-16 V. DC  
 1 Year Warranty  
 Seek Rate: Fast 10ch/sec  
 Slow 5 ch/sec



INTRODUCING THE  
**J.I.L. SX-100 SCANNER**

BRIGHT GREEN 9 DIGIT  
 FREQUENCY DISPLAY

Ext. Antenna Jack  
 Ext. Speaker Jack  
 Large Top Mounted Speaker  
 Mobile Mounting Bracket  
 Scan Rate: Fast 8 ch/sec  
 Slow 4 ch/sec  
 Scan delay time variable 0-4 sec.

**HURRY**

ONLY 102 UNITS TO SELL AT THIS PRICE ALL UNITS FACTORY FRESH  
 Mfg. List \$399.00 UNBELIEVABLY PRICED AT A LOW \$179.95

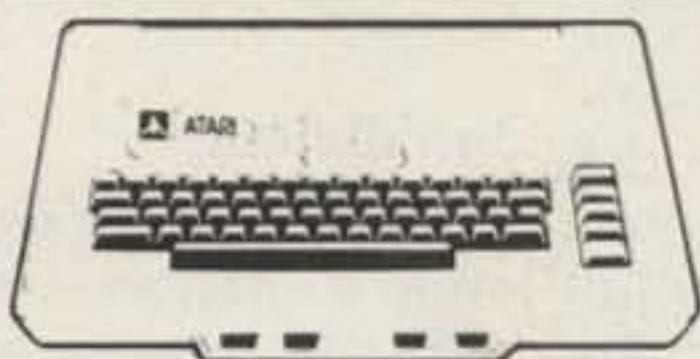

**IN 1970 A COMPUTER THIS  
 POWERFUL COST \$125,000.  
 NOW, TEN YEARS LATER  
 YOU CAN OWN IT  
 FOR LESS THAN \$1,000.**

Not only has the price of computers come well within the reach of most people the computers themselves have improved remarkably.

With the Atari 800 Personal Computer System, you'll be running programs yourself in just a few hours.

You'll be able to evaluate your investment options with confidence. Organize your family finances. Simplify all sorts of bookkeeping and accounting activities. And have endless fun playing computer games.

**LIST \$999 CALL FOR PRICE**



**NEW SHURE 444D**  
 Dual Impedance  
 Normal/Vox Slide Switch  
 Adjustable Height  
 Mfg. List \$90.00  
**SAVE AT ONLY \$49.95**



**PANASONIC RF-4900**  
 General Coverage Receiver  
 List \$549.95  
 Ours \$399.95



**KENWOOD TR-2400**  
 2 Mtr. Hand Held  
 144-148 MHZ  
 List \$395.00  
**CALL FOR PRICE**

**CUSHCRAFT**

ATB-34	4-Element Triband Beam	\$ 219.95
ATV-4	40-10 mtr Trap Vertical	84.95
ATV-5	80-10 mtr Trap Vertical	89.95
ARX-2	2-mtr "Ringo Ranger"	32.95
A-3219	19-Element 2-mtr "Boomer"	74.95
A-214B	14-Element 2-mtr "Boomer"	56.95
A-214FB	14-Element 2-mtr FM "Boomer"	56.95
A-228FB	28-Element 2-mtr FM Power Pack	179.95
A-147-11	11-Element 2-mtr FM Beam	32.95
A-147-22	22-Element 2-mtr FM Power Pack	95.95
ARX-450	450 MHz "Ringo Ranger"	32.95
A-144-10T	10-Element 2-mtr "Oscar" ant.	39.95
A-144-20T	20-Element 2-mtr "Oscar" ant.	56.95
A-432-20T	20-Element 432 MHz "Oscar" ant.	49.95

**HY-GAIN**

		Regular	Special
TH80XX	Super Thunderbird	\$329.95	\$239.95
TH3MK3	3 el. 10-15-20M beam	222.95	189.95
TH3JR	3 el. 10-15-20M beam	169.95	129.95
Hy-Quad	2 el. 10-15-20M Quad	274.95	209.95
205BA	5 el. "Long John" 20M beam	329.95	239.95
155BA	5 el. "Long John" 15M beam	199.95	149.95
105BA	5 el. "Long John" 10M beam	129.95	99.95
204BA	4 el. 20M beam	249.95	189.95
204MK5	5 el. conversion kit	99.95	79.95
153BA	3 el. 15M beam	89.95	79.95
103BA	3 el. 10M beam	74.95	59.95
402BA	2 el. 40M beam	239.95	189.95
BN-86	Balun for beam antennas	15.95	15.95
TH2MK3	2 el. 10-15-20M beam	149.95	119.95
18HT	Hy-Tower 80-10M vertical	\$359.95	\$289.95
18AVT/WB	80-10M Trap vertical	105.95	84.95
14AVO/WB	40-10M Trap vertical	69.95	57.00
12AVO	20-10M Trap Vertical	42.95	34.95
14RMO	Roof Mounting kit (verticals)	33.95	29.95
58DO	80-10M Trap doublet	109.95	89.95
28DO	80-40M Trap doublet	59.95	49.95
66B	6 el. 6M beam	119.95	99.95
203	3 el. 2M beam	15.95	
205	5 el. 2M beam	21.95	
208	8 el. 2M beam	29.95	
214	14 el. 2M beam	34.95	
LA-1	Deluxe lightning arrestor	59.95	49.95
TH5DX	5 el. 10-15-20 M. Beam	269.95	199.95

LOWEST PRICES IN THE COUNTRY ON ANTENNAS  
 HY-GAIN - CUSHCRAFT - MOSLEY - HUSTLER

*New QTH*

**We Export**

PRICES SUBJECT TO CHANGE AND AVAILABILITY

**Communications Center**

1840 "O" STREET LINCOLN, NEBRASKA 68508  
 In Nebraska Call 402/476-7331

VISA





# Working in Wood

## — a tilt-over home-brew for \$2 a foot

**H**aving the good fortune to be the recipient of a quad-antenna gift, my thoughts naturally turned to how best to support it. My requirements were: (1) accessibility of the antenna for installation, tuning, repairs, etc.; (2) an antenna at least one-quarter wavelength and preferably a half-wavelength above ground at 20 meters; and (3) expenses for this which would be easy on the wallet.

Commercially-available towers met the first two requirements but not the last. A search of available literature showed several designs, but none that appeared as an economical or practical possibility. I therefore decided to design my own, and the result is shown in Fig. 1.

### Construction

The base of the tower is a rough-cut 6 x 6, 24 feet long,

with its bottom 5 to 6 feet anchored in a block of concrete approximately 1½' square. The base of the 6 x 6 is mounted on a 1"-thick concrete block to help keep moisture out of the beam.

The tilt-over part of the tower is made up of 2 x 4s having a total length of thirty-eight feet, as shown in Fig. 2. A steel pipe was added at the top, along with a rotator, to put the boom of the quad up at about forty-three feet. Also, note in Fig. 1 that there are stay wires that run the entire length of the tilt-over portion to form a truss. The eyebolts in the center should be as long as possible for this truss. Don't omit the truss, as the tower will not handle the tilt-over load without it.

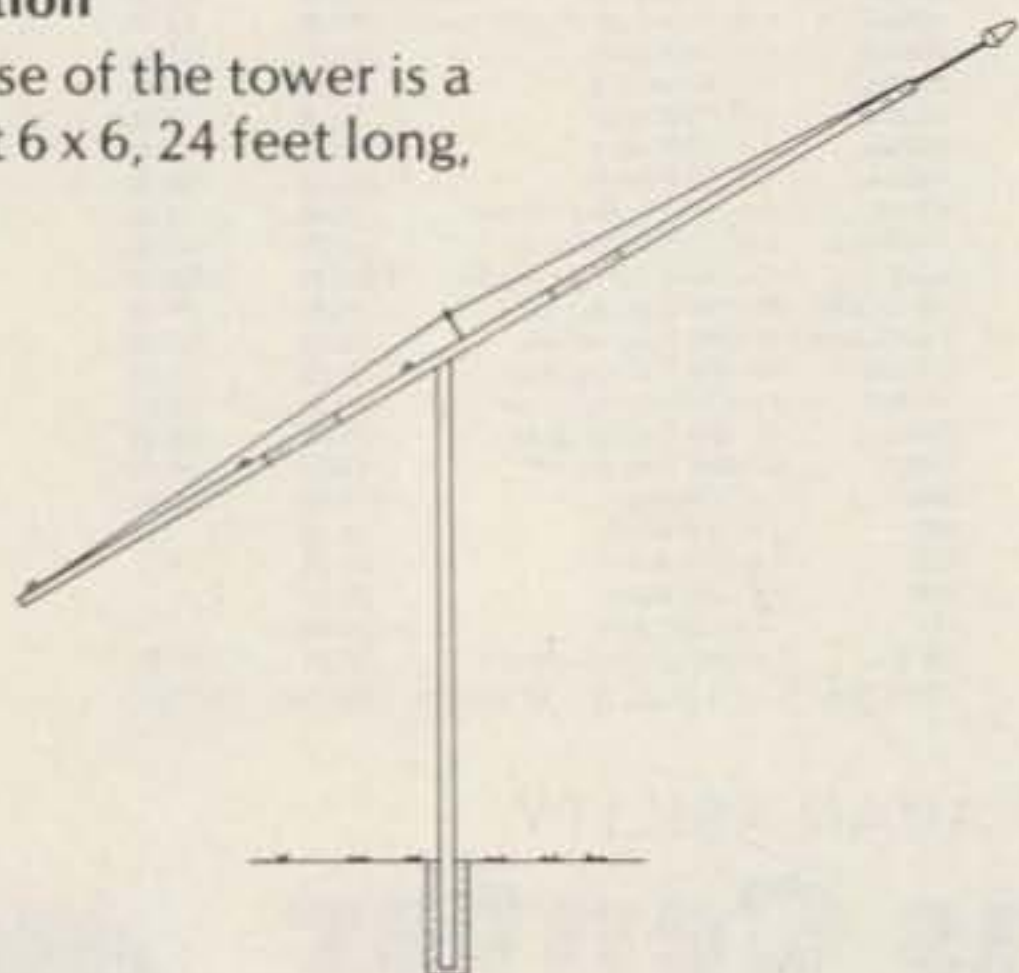

Fig. 1. The completed all-wood, tilt-over tower.

The tower is bolted and glued together, with the exception of the 2 x 4 cross supports which are screwed and glued to the 2 x 4 frame. The 2 x 4s are spliced together with about a three-foot brace piece at the splice. Along with the glue, five 1/4-inch round-head bolts with washers and two nuts are used on each side of the butt joint.

The pipe mast is anchored to both 2 x 4s by using U-bolts around the pipe and through the 2 x 4s. Alternate these to each side for a total of about 8 U-bolts. The tilt-over section is pivoted on a ½" carriage bolt with washers and two nuts. Another similar bolt was used at the bottom to pin the tower in place.

It goes without saying that the best grade of wood you can get should be used, within cost constraints, of course. Douglas fir was used as it was within my budget, available, and reasonably strong. Oak would be better, but probably out of sight costwise.

In the interest of aesthetics and neighborhood goodwill, I stained my tower with some dark oak stain which I had available. It was then covered with three coats of polyurethane spar varnish for weather protection. (The lower part

of the 6 x 6 also was treated with a wood preservative before varnishing and received an extra three coats of the polyurethane varnish.)

### Installation

Putting up the 6 x 6 was a simple matter—with the aid of three friends. It was dropped into the hole, centered, and guyed in a vertical position. I used approximately 1,000 pounds of concrete and allowed it to cure over about a week's time; then the tilt-over section was erected using muscle power (again, friends or a crane are necessary).

The method used was to place the base of the tilt-over section at ground level of the 6 x 6, where one person held it. A line was placed over the top of the 6 x 6 from a point above the pivot point of the tilt-over section and run out to another person, who pulled. Two others then were able to walk the tilt-over section up into position. The cross supports and the person at the bottom kept it from going past the vertical. It then was raised about a foot, and a ladder was used to climb to the pivot point and insert the pivot carriage bolt.

With the addition of a ro-



tator and the antenna, it is not easy to tilt the tower back to vertical. To help, I strapped a large cement block to the base of the tilt-over section as a counterweight. This helped ease the effort immeasurably. Future plans call for a small boat winch to be added at the bottom of the 6 x 6 for even easier raising and lowering. Another recommended addition is some form of guying as near to the top as possible, for protection in high winds. Using nylon lines to my house and two convenient trees, my tower has remained firm through some recent gusty winds of up to 60 knots.

My total investment for the tower was less than \$100 (using some items on hand), which is a lot less than the \$400 plus for a comparable commercial unit. It works, looks good, and best of all, I can say I made it myself. ■

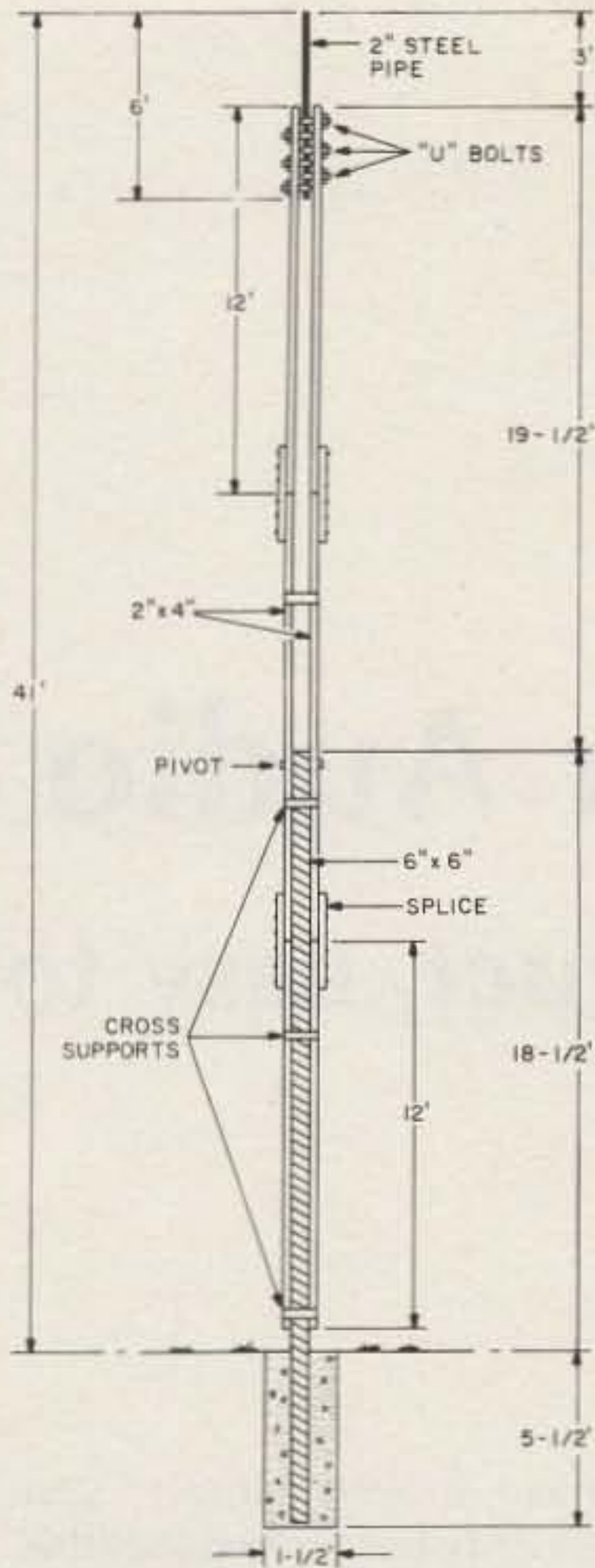
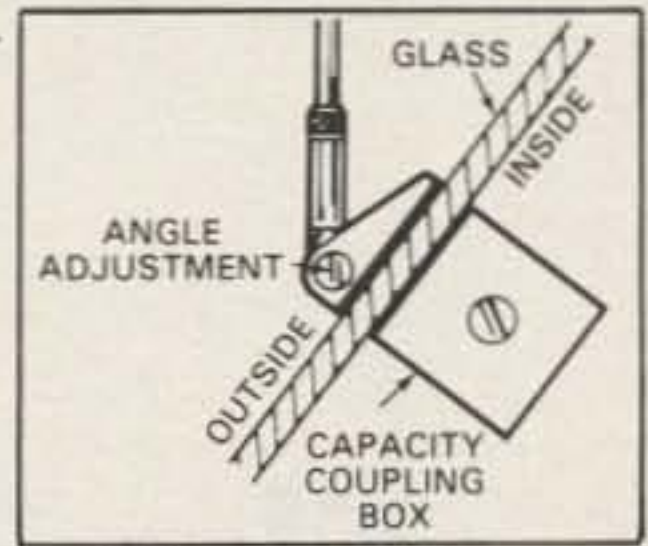

Fig. 2. Construction details.

## New Improved Adhesive Mount for the 2 Meter Avanti Mobile Antenna.

Mounts on glass — no holes!

- Receives and transmits through glass.
- Superior performance equivalent to 5/8 wave.
- Superior radiation full Omni-Directional.



It's easy to install — No holes to drill, no magnet to scratch the paint, no clamps. Uses an especially developed silicone adhesive that secures antenna to window. The capacity coupling box is simply attached with a special adhesive tape to inside of window. Worried about crimping or corroding coaxial cables? It's all inside and out of sight.

Models also available for 220 MHz and 450 MHz.

See Avanti's other new mobile and base antennas. Write for new catalog today. Send 50¢ for handling and postage.

avanti® antennas

Avanti Research and Development, Inc.  
340 Stewart Ave., Addison, IL 60101 (312) 628-9350  
In Canada: Lenbrook Ind., Scarborough, Ontario M1H 1H5

### RAPID MOBILE CHARGER

The DEB-TED Rapid Mobile Charger is a constant voltage charger that will charge your batteries off a 12 Volt source in 4-6 hours. You may use the charger at all times, this includes transmit and receive periods. It is equipped with a cigarette lighter plug on the input side and the appropriate charging plug on the output side. Models available now for the Kenwood TR2400, Yaesu 207R, Tempo S1, S2, S5 and the Wilson Mark II and IV. Other models available also please call or write for info . . . . . \$34.95.



COMING SOON THE NEW AC VERSION

### VEHICLE INTRUSION ALARM

An easy to assemble and install kit that offers options not normally found in other alarm systems. Hidden switch mounts under the dash. Kit has provisions for sensors and remote control switch. Programmable time delays for exit, entry and alarm periods. Basic hook-up utilizes dome light circuit activating when doors are opened. The alarm will drive a siren or pulse horn at a 1HZ rate. Not prone to false alarm do to reliable CMOS circuitry. No external switch required! Complete kit with easy to follow instructions and diagrams . . . . . \$12.95  
Wired and Tested . . . . . \$19.95

### "SEE THE WORKS" CLOCK

OUR EASIEST CLOCK TO ASSEMBLE!

6 Digits 12 or 24 Hour Format Clock rests between two pieces of clear plexiglas A GREAT CONVERSATION PIECE!

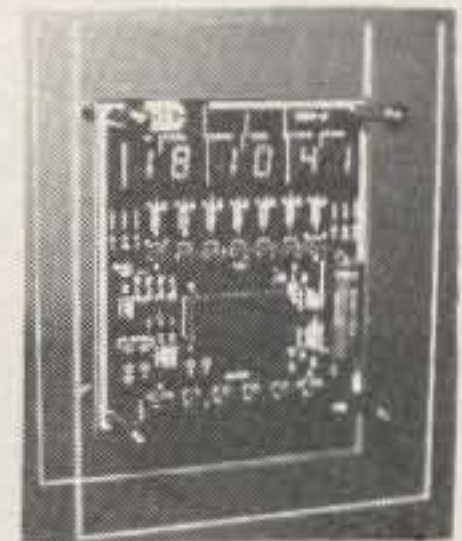

Kit is complete including top quality PC board, all componets, pre-cut and drilled plexiglas and all hardware . . . . . \$29.95  
Wired and Tested . . . . . \$39.95

SPECIAL



SPECIAL

MODEL 5314 CLOCK KIT 12 or 24 hour format 6 large "5 Digits. Kit is complete with all parts, pc board and custom designed cabinet. (Specify Whit or Black) \$29.95



DEBCO ELECTRONICS  
P.O. BOX 9169  
CINCINNATI, OHIO 45209

330

Phone: (513) 731-7220

- Add 5% Shipping for U.S. & Canada
  - All foreign orders add 10%
  - COD orders add \$1.25
  - Master Charge and Visa Welcome
  - Orders under \$20.00 add \$1.00 handling
  - Ohio residents add 4½% Tax
- CALL OR WRITE FOR CATALOG



# The Two-Hour Audio Amp

## — quick to construct, easy to use

Arvid G. Evans K7HKL  
6400 Trajan Drive  
Orangevale CA 95662

**D**o you ever have need for an audio output stage which can be assembled from your junk box, yet will provide several Watts of clean audio? This is not a weekend project—it should not take over two hours to assemble, test, and appreciate this unit!

The heart of the design is an op amp (preferably a dual type) and a complementary pair of transistors (2 A, 30 V) which do not

need to be matched. If you have a selection of power transistors available, the two which exhibit the highest current gain will make life easier for the op amp, but anything with a gain of 40 or more is adequate.

Fig. 1 shows the basic design. The op amp is used as a unity gain driver for the complementary pair. This transistor pair is included inside the feedback loop of the op amp to minimize the crossover distortion introduced by the deadband condition which exists at  $0 \pm 0.7$  volts. In fact, it compensates so well that you will find no visible crossover anomaly with your scope on the output! If you

have looked closely, you already have noted that this circuit is dc-coupled in and out. There are no capacitors to affect the frequency response!

The design in Fig. 2 shows how gain may be introduced in the single op amp version. The conventional dual-supply layout is shown

in (a), and (b) demonstrates a method of operation utilizing a single supply. The penalty paid for use of this single power source is that coupling capacitors must be used here for dc isolation. This increases the component count and allows the chance of frequency roll-off unless ade-

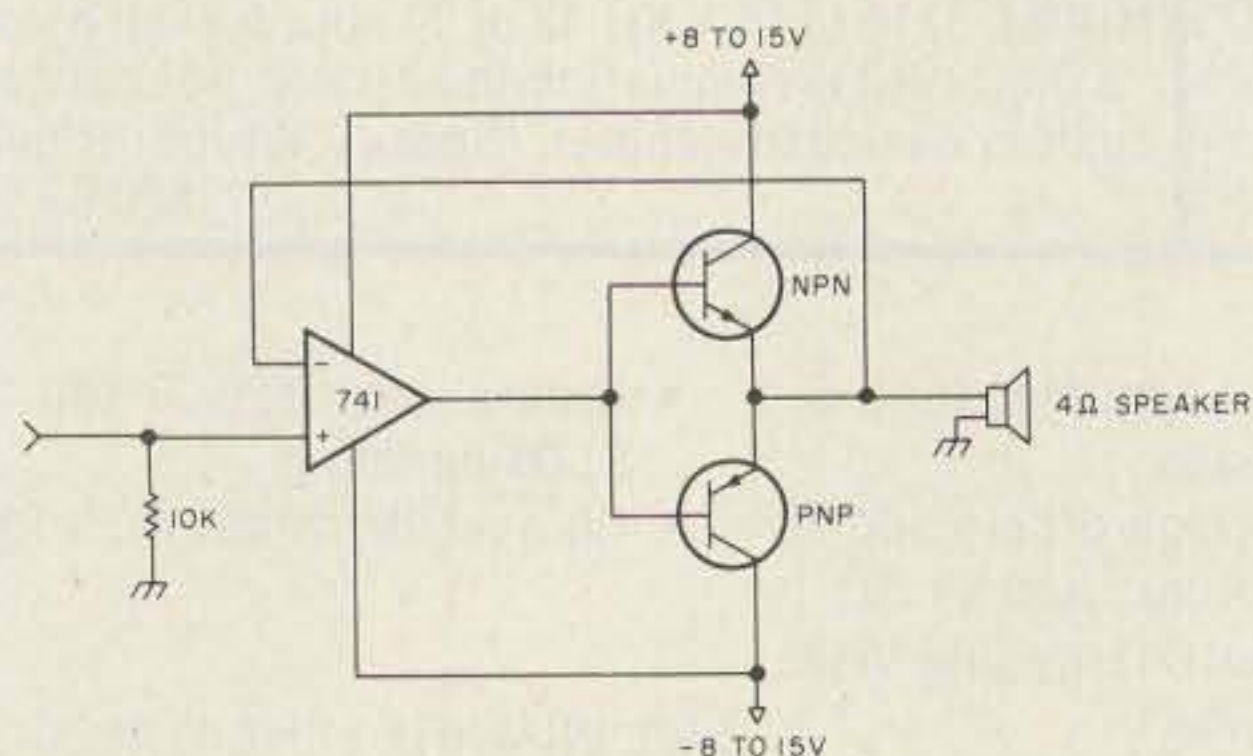

Fig. 1.

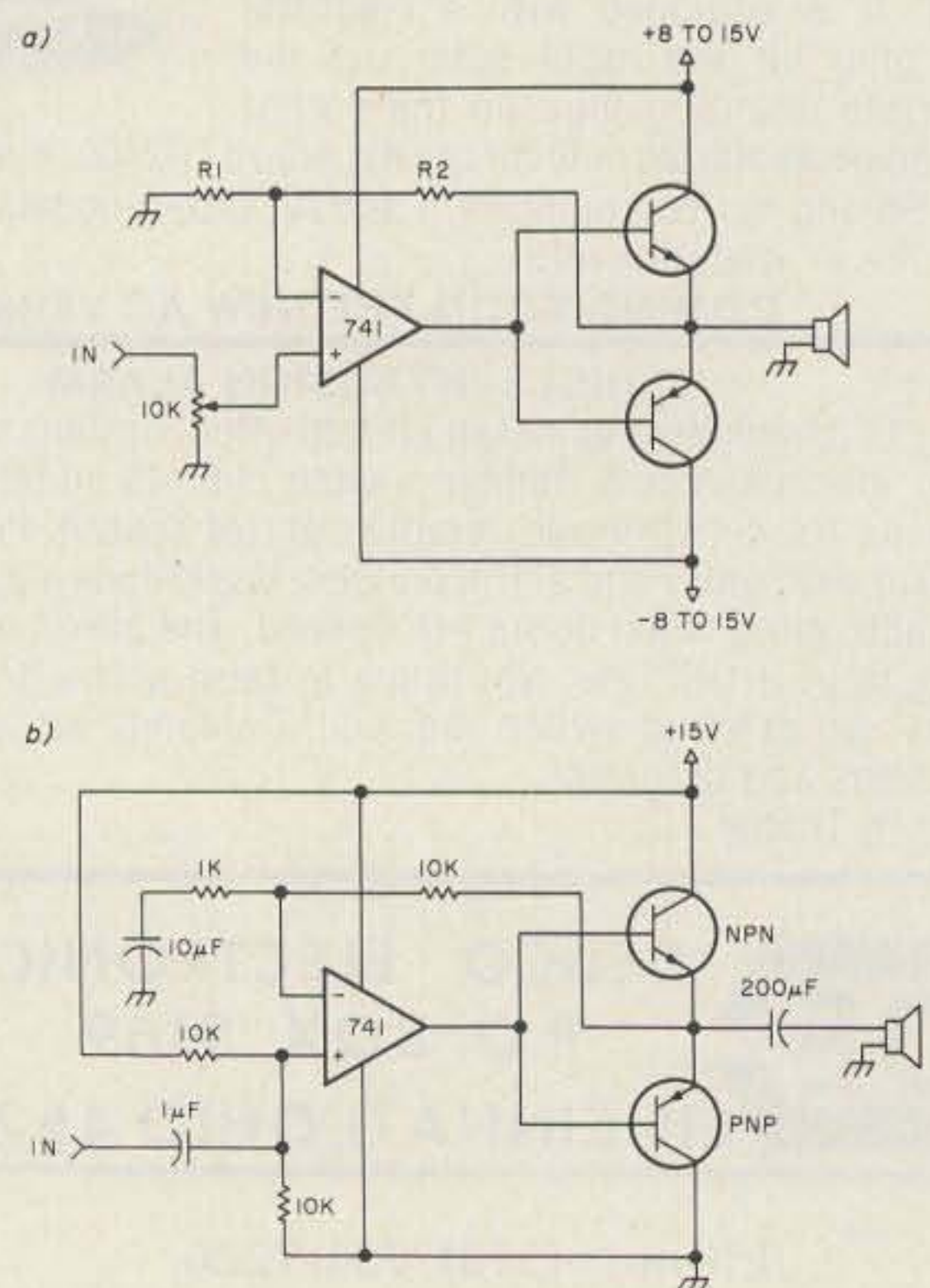

Fig. 2.



# This NEW MFJ Versa Tuner II . . .

has SWR and dual range wattmeter, antenna switch, efficient airwound inductor, built in balun. Up to 300 watts RF output. Matches everything from 1.8 thru 30 MHz: dipoles, inverted vees, random wires, verticals, mobile whips, beams, balanced lines, coax lines.

## MFJ LOWER PRICES!

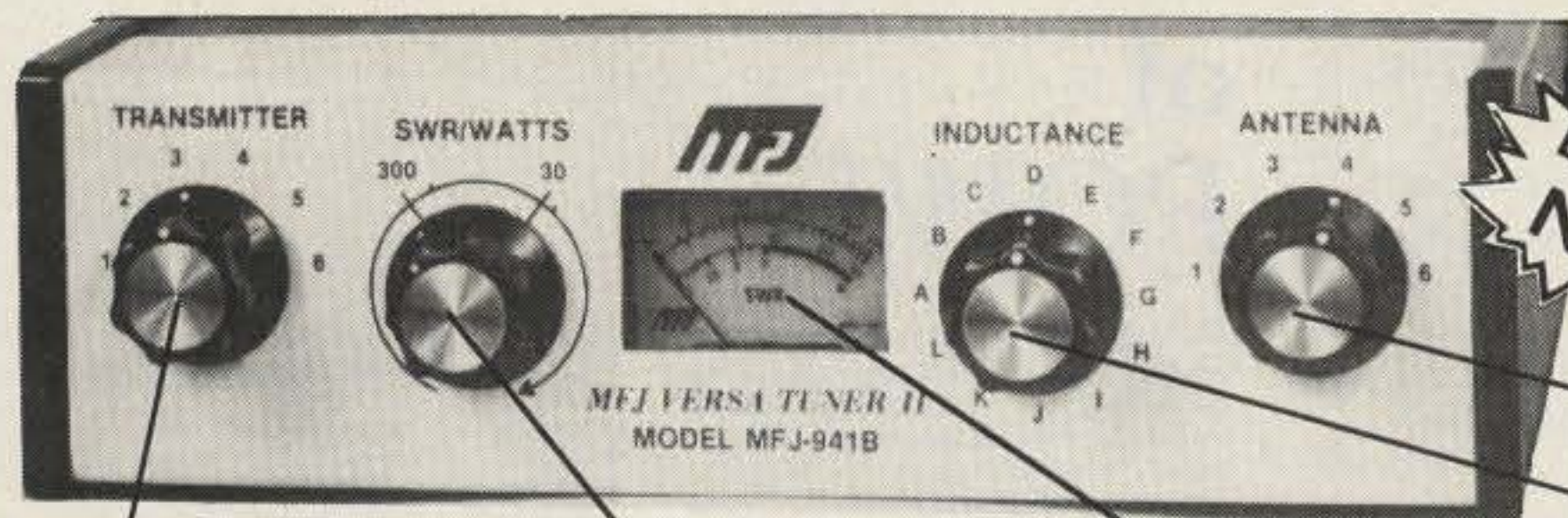

NEW, IMPROVED MFJ-941B HAS . . .

- More inductance for wider matching range
- More flexible antenna switch
- More sensitive meter for SWR measurements down to 5 watts output

NEW LOWER PRICE

# \$79<sup>95</sup>

**Transmitter matching capacitor.** 208 pf. 1000 volt spacing.

**Sets power range,** 300 and 30 watts. Pull for SWR.

**Meter reads SWR and RF watts** in 2 ranges.

**Efficient airwound inductor** gives more watts out and less losses.

**Antenna matching capacitor.** 208 pf. 1000 volt spacing.

Only MFJ gives you this MFJ-941B Versa Tuner II with all these features at this price:

A SWR and dual range wattmeter (300 and 30 watts full scale) lets you measure RF power output for simplified tuning.

An antenna switch lets you select 2 coax lines direct or thru tuner, random wire/balanced line, and tuner bypass for dummy load.

A new efficient airwound inductor (12 positions) gives you less losses than a tapped toroid for more watts out.

A 1:4 balun for balanced lines. 1000 volt capacitor spacing. Mounting brackets for mobile installations (not shown).

With the NEW MFJ Versa Tuner II you can run your full transceiver power output — up to 300 watts RF power output — and match your



**ANTENNA SWITCH** lets you select 2 coax lines direct or thru tuner, wire/balanced line, dummy load.

transmitter to any feedline from 160 thru 10 Meters whether you have coax cable, balanced line, or random wire.

You can tune out the SWR on your dipole, inverted vee, random wire, vertical, mobile whip, beam, quad, or whatever you have.

You can even operate all bands with just

one existing antenna. No need to put up separate antennas for each band.

Increase the usable bandwidth of your mobile whip by tuning out the SWR from inside your car. Works great with all solid state rigs (like the Atlas) and with all tube type rigs.

It travels well, too. Its ultra compact size 8x2x6 inches fits easily in a small corner of your suitcase.

This beautiful little tuner is housed in a deluxe eggshell white Ten-Tec enclosure with walnut grain sides.

S0-239 coax connectors are provided for transmitter input and coax fed antennas. Quality five way binding posts are used for the balanced line inputs (2), random wire input (1), and ground (1).

## NEW 300 WATT MFJ VERSA TUNER II'S: SELECT FEATURES YOU NEED.

NEW MFJ-945 HAS SWR AND DUAL RANGE WATTMETER. NEW LOWER PRICE

**\$69<sup>95</sup>**



Same as MFJ-941B but less 6 position antenna switch.

NEW MFJ-944 HAS 6 POSITION ANTENNA SWITCH ON FRONT PANEL. NEW LOWER PRICE

**\$69<sup>95</sup>**



Same as MFJ-941B but less SWR/Wattmeter.

NEW MFJ-943 MATCHES ALMOST ANYTHING FROM 1.8 THRU 30 MHz. NEW LOWER PRICE

**\$59<sup>95</sup>**



Same as MFJ-941B, less SWR/Wattmeter, antenna switch, mounting bracket. 7x2x6 in.

## ULTRA COMPACT 200 WATT VERSA TUNERS FOR ALL YOUR NEEDS.

MFJ-901 VERSA TUNER MATCHES ANYTHING, 1.8 THRU 30 MHz. NEW LOWER PRICE

**\$49<sup>95</sup>**



Efficient 12 position air inductor for more watts out. Matches dipoles, vees, random wires, verticals, mobile whips, beams, balanced lines, coax. 200 watts RF, 1:4 balun, 5x2x6 in.

MFJ-900 ECONO TUNER MATCHES COAX LINES/RANDOM WIRES. NEW LOWER PRICE

**\$39<sup>95</sup>**

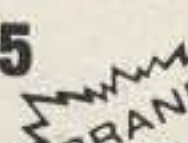

Same as MFJ-901 but less balun for balanced lines. Tunes coax lines and random lines.

MFJ-16010 RANDOM WIRE TUNER FOR LONG WIRES. NEW LOWER PRICE

**\$29<sup>95</sup>**



1.8 thru 30 MHz. Up to 200 watts RF output. Matches high and low impedances. 12 position inductor. S0-239 connectors. 2x3x4 inches. Matches 25 to 200 ohms at 1.8 MHz. Does not tune coax lines.

For Orders Call toll-free **800-647-1800**

Order any product from MFJ and try it. If not delighted, return within 30 days for a prompt refund (less shipping).

Order today. Money back if not delighted. One year unconditional guarantee. Add \$3.00 shipping/handling. For technical information, order/repair status, in Mississippi, outside continental USA, call 601-323-5869.

Order By Mail or Call TOLL FREE 800-647-1800 and Charge It On



**MFJ ENTERPRISES, INC.**

P. O. BOX 494  
MISSISSIPPI STATE, MISSISSIPPI 39762



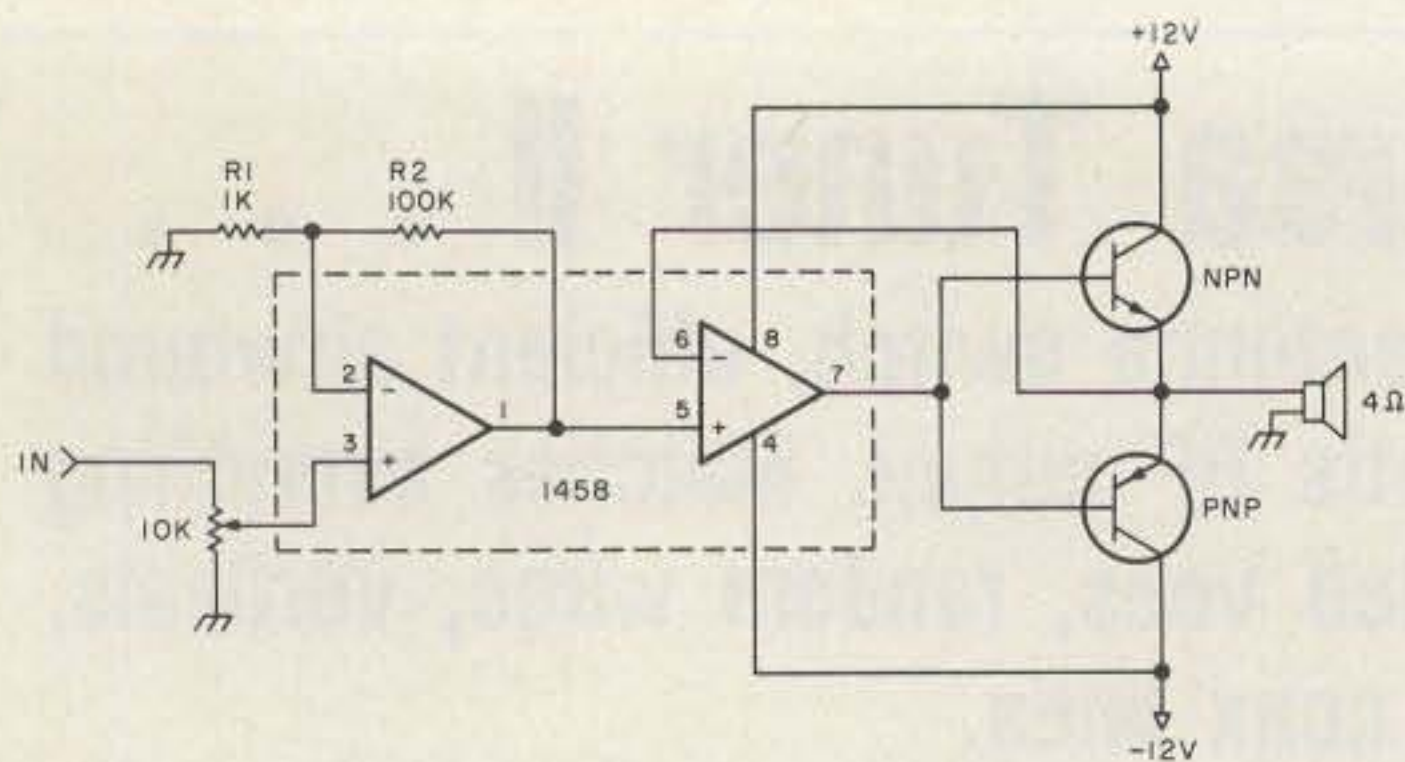

Fig. 3.

quate capacitance is employed.

Fig. 3 shows the method to which I have graduated. Since dual amps (1458 type) are becoming inexpensive and readily available, I use the first stage as a programmable gain unit and the second stage as the voltage follower/driver for the complementary pair.

Here at my location, you will find this circuit in several units including a signal tracer, two experimental re-

ceivers, and a heterodyne frequency meter.

If this has inspired your interest in this type of audio output stage (you will like the wide frequency response and unconditional stability), but you feel the need to upgrade to a larger unit, like 50 Watts, then you might contact Intersil, Inc. (10710 N. Tantau Ave., Cupertino CA 95014), for information on their ICL8063 power transistor driver-amplifier. ■



## Handful of POWER

Give your low-power 2-meter rig real punch by delivering a potent 25-watt signal with only two watts of drive (also available set up for 200 milliwatts drive). Compact and convenient to mount, VoCom's Model 2C025 is ideal for car, boat or anywhere you've got a 12 VDC source. At only \$84.95 (\$99.95 for 200 mW drive), it's the perfect companion for your Drake, Encomm, Henry, Icom, Kenwood, Motorola, Standard, Wilson, Yaesu or other 2-meter FM portable!

- 2 or 2 watt nominal drive (specify)
- 2 watt model delivers 15-20 watts with only one watt of drive
- 10 MHz bandwidth for CAP or MARS
- Harmonic and spurious down more than 70 dB
- 200 mW drive model permits operating Icom IC-2A or Yaesu FT-207R on their battery-saving low-power mode
- Only \$84.95 (\$99.95 for 200 mW drive)

Ask about our 50 and 100 watt amplifiers for use with low-power hand-held radios!

Available now from your local amateur radio dealer or order direct:

**VoCom** Box 219, Prospect Heights, IL 60070  
**PRODUCTS CORPORATION** (312) 870-8060

# FALL TUNE UP TIME

Check-Tune your rig for maximum power with a B & W Dummyload-Wattmeter



### Model 334A

Freq. Range: DC-300 MHz  
 VSWR: Less than 1.3:1  
 Power Range: Up to 1000 watts

### Model 374

Freq. Range: DC-300 MHz  
 VSWR: Less than 1.3:1  
 Power Range: Up to 1500 watts



### Model 333 Medium Power Model

Freq. Range: DC-300 MHz  
 VSWR: Less than 1.3:1  
 Power Range: Up to 250 watts



11

Barker & Williamson, Inc.  
 10 Canal Street,  
 Bristol, Pa. 19007





**G.I.S.M.O.** ✓27

**2305 CHERRY ROAD**

**ROCK HILL, S.C. 29730**

## *Featuring*



**ICOM**



**YAESU**



**Cushcraft**



**Wilson**

**BIRD**



**KDK**



**Larsen**

**TEMPO**

*Henry Radio*

*Dentron*

**HUSTLER**



**SWAN  
ELECTRONICS**



**KENWOOD**



**DRAKE**®

IN ADDITION TO THE PRODUCTS LISTED ABOVE, WE ARE ALSO FACTORY AUTHORIZED DEALERS OR DISTRIBUTORS FOR B & W, UNIVERSAL TOWERS, BERK-TEK CABLES, BENCHER PADDLES, THE NEW CES DIALER AND MANY OTHER ACCESSORIES. OUR SERVICE SHOP, STAFFED BY FIRST PHONE, EXTRA CLASS TECHNICIANS, OFFERS EXPERT SERVICE ON ALL MAKES AND MODELS AND FACTORY AUTHORIZED SERVICE ON SWAN, YAESU AND KENWOOD PRODUCTS.

SERVICE DEPARTMENT CALL 803-366-7158

**73,** THE  
GISMO  
GANG

**ORDER TOLL FREE!**  
**800-845-6183**



# Power $\times$ 2... Plus!

## — an improved two-battery auto electrical system

For several years I have used dual batteries in my Chevrolet van. In a short article in the February, 1979, issue of 73, Harry Miller described a simple system for adding that second battery. The system I have used for over four years has some additional features which I have found to be handy.

The charging system is essentially unchanged from that described by Miller, except that my vehicle has a voltage regulator within the alternator. Fig. 1 reflects how the diode assembly and the second battery can be connected to this type of charging system.

I have a half-dozen electronic devices in my van, including three rather power-hungry General Electric

Progress Line™ transceivers, and more than once I have experienced the inevitable by forgetting to turn one of them off. Besides, I hate to spend ten minutes or so turning all of my radios on and off each time I enter and exit the vehicle.

To allow all of my equipment to be turned on and off with the flick of a single switch, I installed a solenoid-type relay (K1, Fig. 1) with the contacts placed in series with the output of the second battery (B1) ahead of the radio equipment. The positive terminal of the coil of the relay is connected to a switch (S1) at a convenient location in the vehicle, and S1 is connected to the positive terminal. Make S1 a key-operated switch, and the key can be re-

moved at car washes, garages, etc., to prevent unauthorized use of the equipment as required by FCC regulations!

I also placed a red panel light (L1) in the dash and wired it, as shown in Fig. 1, to indicate when power is on. If that is enough to remind you, great! It wasn't enough for me, so I added an audible warning device (Z1) to the circuit so that if the radio circuits are energized when the driver's door is open (S3 closed), the device will give me a not-too-gentle warning. Any kind of buzzer or other alerting device can be used—I used a small 12-volt buzzer marketed by Radio Shack. An automotive buzzer of the type used for ignition-key-removal warning can be used if you prefer a softer warning. For those who need something guaranteed to wake the dead, a Sonalert™ would be perfect.

Other interesting additions for those who like ex-

tra gadgets would be two ammeters, one in series with each line from the diode assembly to each battery, and a voltmeter connected to each positive battery terminal so that the respective status of each battery can be monitored.

Now that you have your second battery to keep your radios from running down your primary vehicle battery, the first thing you'll do is leave your headlights on and run it down anyway! It's embarrassing to have a fully-charged secondary battery and no jumper cables to start your car. While you are wiring in that second battery, therefore, buy a Ford starter relay (K2) and connect it in series between the positive terminals of B1 and B2.

Theory says that the connection between the two batteries should be as short as possible and that the wire used should have the same or a larger cross section than that of the original battery cables. My secondary battery is mounted just ahead of the left rear wheel, and the original battery is at the right front of the vehicle, requiring a cable run of 12 feet. The cable I used was a #2, and I have had no problems with that installation. As with K1, the positive terminal of the coil of K2 is

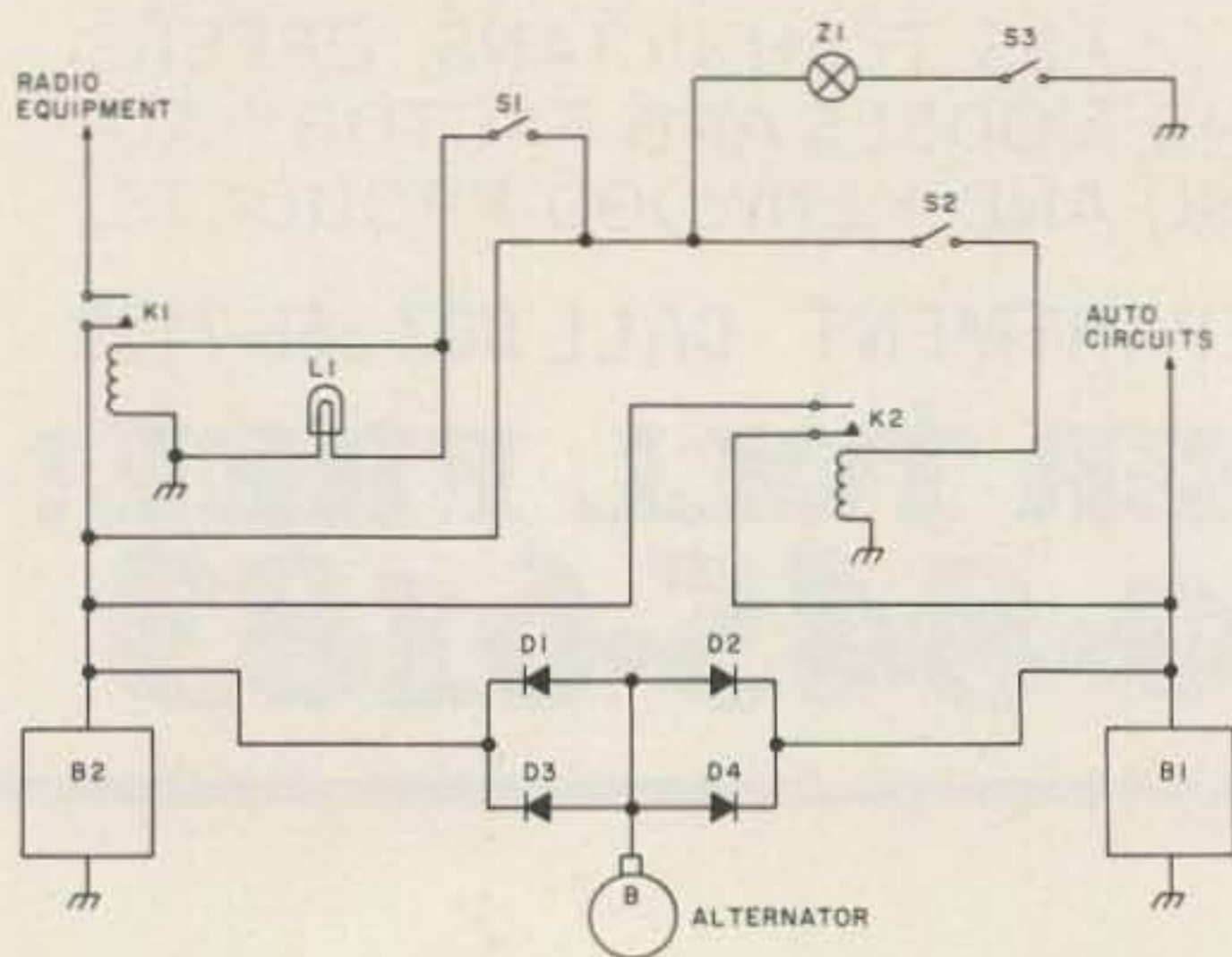

Fig. 1.

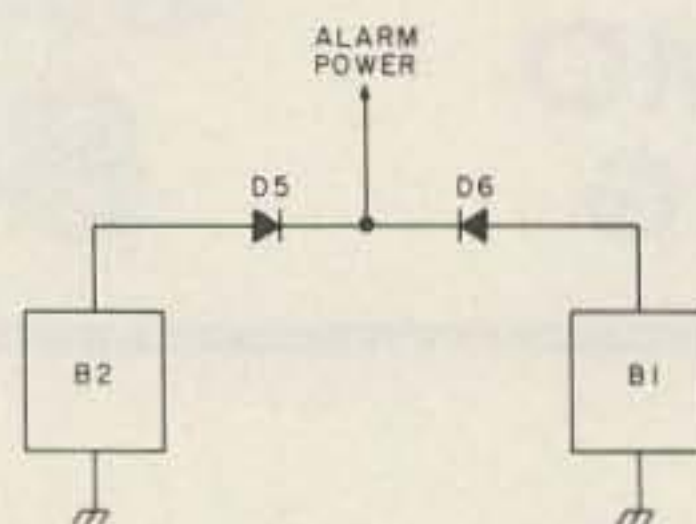

Fig. 2.



# TET<sup>®</sup>

## ANTENNA SYSTEMS

### 1-800-654-3231

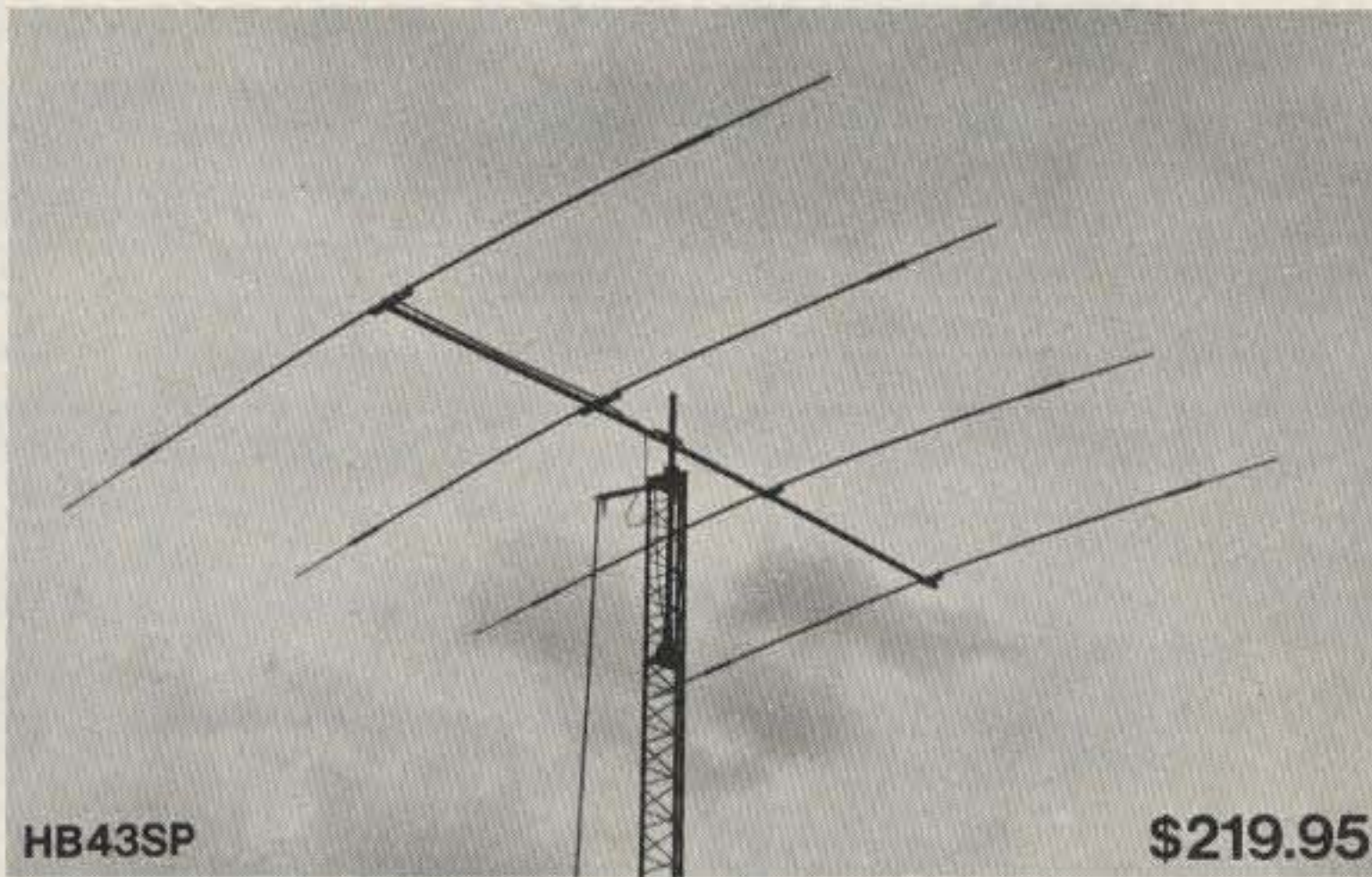

HB43SP

**\$219.95**

TET, THE LEADER IN WIDEBAND ANTENNA DESIGN, introduces another new triband antenna to provide unmatched wideband performance on the 10, 15 and 20 meter amateur bands. This radical departure from conventional triband antenna design employs TWO DRIVEN ELEMENTS with a rigid phasing line to couple power from the radiator element to the reflector. Phase relationships have been carefully engineered to provide extremely high gain figures without neglecting the need for high front to back ratio. The two element drive system is coupled to one parasitic director on the model HB33SP; two parasitic directors on a longer boom with the model HB43SP.

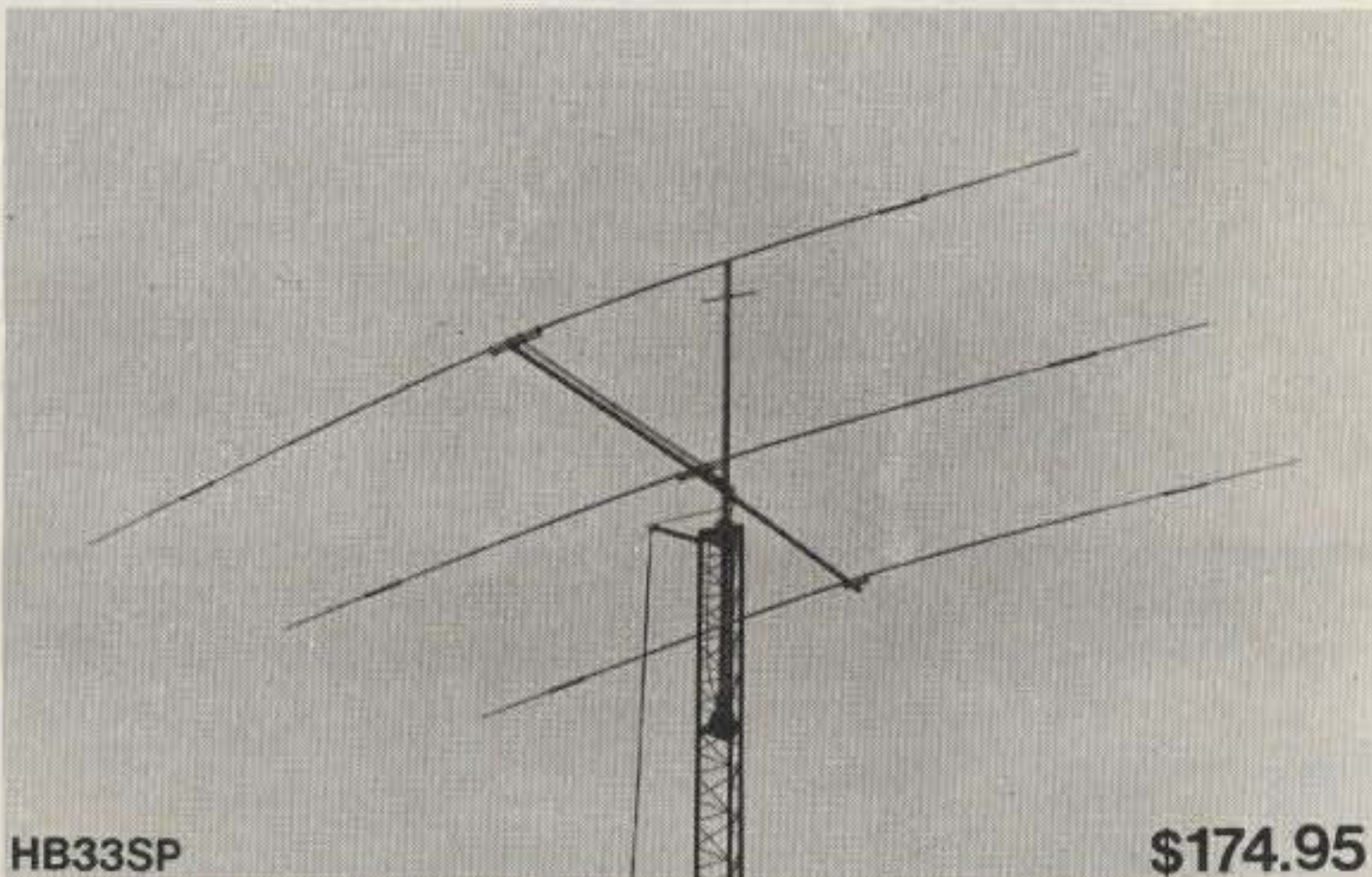

HB33SP

**\$174.95**

**FULL BAND COVERAGE** is possible without the need for antenna tuners or separate CW and phone antenna adjustments. The 1.5:1 VSWR bandwidth covers the entire 20 and 15 meter amateur bands, with a little extra for MARS operation. On 10 meters, coverage is in excess of 1 MHz.

**QUALITY CONSTRUCTION** and repeatable performance permit TET to deliver an antenna package without need for any tuning adjustments. All tubing is cut and pre-drilled to precision tolerances. The phasing harness and feed assembly for the two driven elements are pre-assembled to insure ease of construction and reliable performance.

**MOVE UP** with the performance oriented leader in antenna technology. Order your new high performance wideband triband antenna system from TET today.

MODEL	BANDS	ELE- MENTS	ELE- MENTS PER BAND	MAX PWR	VSWR	IMPEDANCE	MAX ELEMENT LGTH	BOOM LGTH	TURN- ING RADIUS	WIND SURFACE AREA	WIND LOAD @80 mph	BOOM DIA- METER	MAST SIZE	WT
HB43SP	14/21/28	4	4	2KW	BELOW 1.5	50 Ohm	27'	19' 8"	16' 9"	6.62 sq.ft.	131.3 lb.	2"	1½-2"	38 lb.
HB33SP	14/21/28	3	3	2KW	BELOW 1.5	50 Ohm	27'	13' 2"	15'	4.73 sq.ft.	102 lb.	1 9/16"	1½-2"	27 lb.

Call Factory for ANTENNA GAIN dBd and FRONT TO BACK RATIO.

TET FACTORY DIRECT PRICE

HB43SP \$219.95  
HB33SP \$174.95

## Call Toll FREE 1-800-654-3231



# TET U.S.A., INC.



425 HIGHLAND PARKWAY, NORMAN, OKLAHOMA 73069 TEL: 405-360-6410



connected to switch S2, and S2, in turn, is connected to battery positive. A momentary switch must be used to avoid the possibility of forgetting to disconnect the batteries after starting. Now you have a space-age backup system, and it may be hoped that you never again will have to get a boost from someone else on those cold winter mornings.

If your vehicle has an alarm system, a diode arrangement as shown in Fig. 2 will provide full power to the alarm even if only one

battery has a charge, or if a thief disconnects one battery! A note of caution if you don't already own a second battery and plan to buy one: If a standard auto battery is repeatedly and fully discharged, the plates will warp and the battery will soon be useless. The best battery for use as a secondary is one sold for that purpose; it's called a "deep-cycle" battery. The deep-cycle battery is made for recreational vehicles and fishermen's trolling motors, and will stand use and abuse much better. ■

#### Parts List

- D1-D6 - Silicon diodes, stud-mounted, 60 piv, 25 Amp
- S1 - SPST toggle switch or key-operated SPST
- S2 - SPST normally-open, momentary, push-button
- S3 - SPST normally-closed, dome-light switch
- K1 - Any heavy-duty relay rated 25% above the maximum current draw of all radios used
- K2 - Ford solenoid-operated starter relay, Borg-Warner S-63 (or any heavy-duty relay rated 100 Amps or more)
- B1 - Original battery
- B2 - Deep-cycle secondary battery
- Z1 - Buzzer - Radio Shack #273-051, #273-060, or Sonalert™.



**FOX-TANGO CORP.**

Box 15944S, West Palm Beach, FL 33406

Visa/MC welcomed. Money back if not satisfied.

#### 8-POLE FILTER BANDWIDTHS IN STOCK

CRYSTAL FILTER	CW (Hz)						SSB-AM (kHz)				
	125	250	400	500	600	800	1.8	2.1	2.4	6.0	8.0
<b>YAESU</b>	<b>\$55 EACH</b>										
*FT-101/F/FR-101	✓	✓	✓	✓	✓	✓	✓	✓	✓	✓	✓
*FT-301/FT-7B/620	✓	✓	✓	✓	✓	✓	✓	✓	✓	✓	✓
*FT-901/101ZD/107	✓	✓	✓	✓	✓	✓	✓	✓	✓	✓	✓
FT-401/560/570	✓	✓	✓	✓	✓	✓	✓	✓	✓	✓	✓
FT-200/TEMPO 1	✓	✓	✓	✓	✓	✓	✓	✓	✓	✓	✓
<b>KENWOOD</b>	<b>\$55 EACH</b>										
*TS-520/R-599	✓	✓	✓	✓	✓	✓	✓	✓	✓	✓	• 2nd IF \$125 for R-820 only
*TS-820/R-820	✓	✓	✓	✓	✓	✓	✓	✓	✓	✓	• 2nd IF \$125 for R-820 only
<b>HEATH</b>	<b>\$55 EACH</b>										
<b>ALL HF</b>	✓	✓	✓	✓	✓	✓	✓	✓	✓	✓	✓
<b>DRAKE</b>	<b>FOR PRICES SEE NOTES</b>										
R-4C	GUF-1 Broad 1st IF Superior Shape Factor/Ult Rej \$65										✓
	GUF-2 Narrow 1st IF										✓
	56H125										✓
	GUD Product Detector - w pcb w relay										✓
	Very sharp 2nd IF - Plug in type - \$90										✓
	double balanced type \$30										✓
<b>COLLINS:</b>	<b>SPECIAL \$125 EACH</b>										
75S-3B/C	✓	EQUALS OR EXCELS \$400 COLLINS UNIT									

\*DIODE SWITCHING BOARDS available to permit 1, 2 or more filters than those for which manufacturer provides room. SPECIFY make and model.

Single-filter type: \$12 Airmail postpaid  
Dual-filter type: \$21 Airmail postpaid

Florida residents add 4% (sales tax) (FOREIGN ADD \$3 per filter)



BROCHURE ON REQUEST  
Dealer Inquiries Welcomed



✓ 323

# RTTY Demodulators

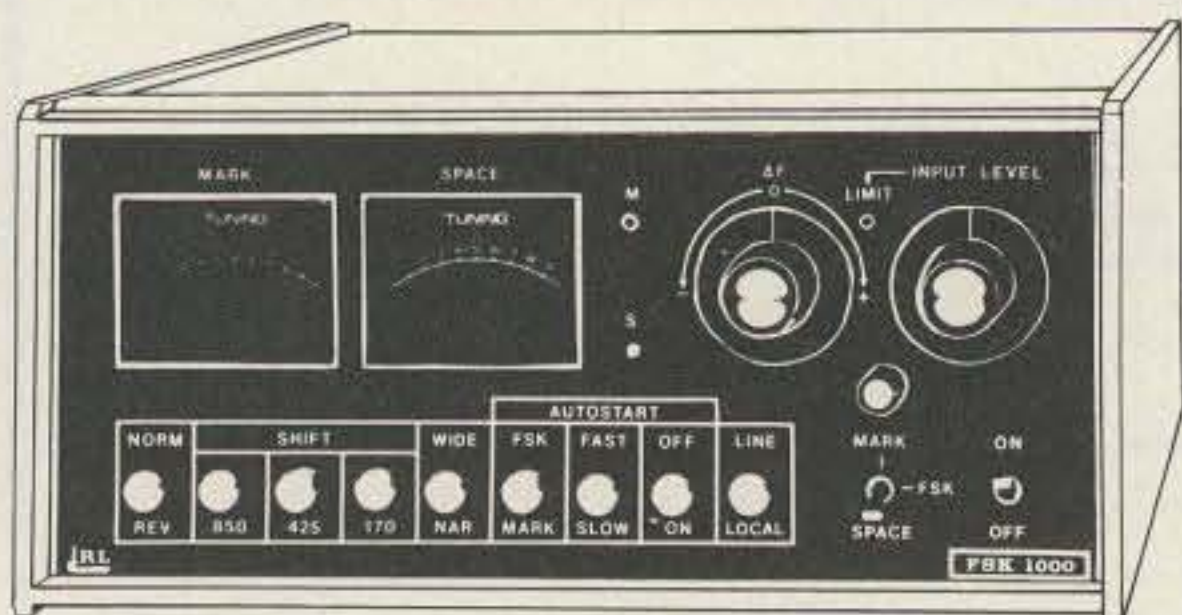

\$449.00 Ham net

**FSK-1000** T.M.



\$197.00 until Nov. 1, \$229.00 after

**FSK-500** T.M.

**IRL**

T.M. Call (614) 864-2464

Order direct on Visa or MC  
700 Taylor Road  
Columbus, Ohio 43230

Here is no compromise design and construction:

- Unparalleled selectivity achieved with sophisticated limiterless design utilizing ultrasharp active filters and decision level correction circuits
- The most flexible interface system available to computers and high voltage loops
- Built in 170 volt loop supply
- Selectable bandwidths of 55 and 100 Hz. (copies 110 Baud ASCII)
- Continuously tunable shift coverage
- Rugged construction - commercial quality throughout
- Full complement of rear panel connectors for easy interface
- Keyboard activated switch for break in operation
- Individual tuning meters and LED's for quick, accurate tuning

This RTTY demodulator is designed for computer interface but is a fine stand alone unit:

- Easy computer interface with RS-232 or 5 volt logic signals
- Three shift coverage without straddle tuning
- Selectable bandwidths give you optimal Baudot or 110 Baud ASCII copy
- Input bandpass preselector using active filters
- High voltage loop keyer output
- Autostart built in
- Three shift AFSK keyer plus narrow shift CW ID
- Fully wired and tested: ready to copy!
- The FSK-500 is the best demodulator available for under \$500.00 (Except for our FSK-1000!)
- Positive tuning with meter and LED's





**S-F Amateur Radio Services**  
(213) 837-4870  
4384 KEYSTONE AVE.,  
CULVER CITY, CA. 90230

**the W6TOG**  
RECEIVER MODIFICATION KITS  
INCREASE SELECTIVITY  
IMPROVE SENSITIVITY  
LOWER INTERNAL NOISE  
COMBAT BLOCKING  
FROM LOCAL SIGNALS

TS-520 KIT	\$27.50
TS-520S KIT	32.50
TS-820 & 820S KIT	34.50
TS-820 MIXER KIT	27.50
TS-120S KIT	32.50
FT-101 SERIES KIT	32.50
FT-101ZD KIT	34.50
FR-101 SERIES KIT	34.50
FT-301 SERIES KIT	34.50
FT-901 SERIES KIT	34.50

**MAGICOM**  
RF PROCESSOR

INCREASES AUDIO PUNCH  
IMPROVES  
PROCESSED SPEECH QUALITY

TS-520/S	42.50
TS-820/S	27.50
NEW	
TS-120/S	42.50
DRAKE T4XC	52.50
DRAKE TR7	42.50

The "MAGICOM" provides up to 6dB increase in output with smooth, clean, non-distorted audio and more penetration for those pile-ups. Easy installation. (No front panel alteration)

**HI POWER**  
KITS

INCREASE OUTPUT POWER BY 30%

Set of (2) 6146-W final tubes  
Plate rating 40W per tube

GET MORE DRIVE FOR  
THOSE HI POWER AMPLIFIERS!!!

TS-520 / 520S QRO KIT	\$41.50
TS-820 / 820S QRO KIT	41.50

Prices subject to change without notice.

SEND FOR PRICING  
AND INFORMATION

ALL PRICES POSTPAID  
IN CALIF. ADD 6% SALES TAX  
MASTERCARD & VISA ACCEPTED  
SATISFACTION GUARANTEED  
OR MONEY REFUNDED



**JAN CRYSTALS**  
HOLD THE FREQUENCY

- CB
- CB standard
- 2 meter
- Scanners
- Amateur Bands
- General Communication
- Industry
- Marine VHF
- Micro processor crystals

Send 10¢ for our latest catalog. Write or phone for more details.

**JAN CRYSTALS**   easy to charge ✓39

2400 Crystal Drive  
Ft. Myers, Florida 33907  
all phones (813) 936-2397

NOW - THE NEW



**AMCODER**  
IT'S EVEN BETTER!!!

4" x 2 3/8" x 6"

- Still only 40hz wide. Single signal - no QRM/QRN reception. Immune to impulse (ignition) noise.
- Still tape quality audio with TTL compatible signal for computer interface applications. No noise appears in the AMCODER output.
- NOT A FILTER!! Its CW regeneration.
- NOW - dig into the noise for the weak ones without front end overload with our new AGC module. No locking on noise.
- No mods to your gear. Just plug into phone jack. Speaker or phone outputs with bypass switching when not in use. No external power required.
- 26DB dynamic range (5 to 6S unit fade margin) with AGC module when properly adjusted.
- Constant level input to the AMCODER regardless of receiver audio level with either S-1 or 30 over 9 signals. (Works on phone signal levels too) with the AGC module.
- Still reduced operator fatigue, variable frequency acquisition, 400-1400hz and variable frequency output tone (and smoother).
- Still variable output level for station speaker or head phones.

Complete kit (Less AGC option) (Cabinet included)	\$79.95
AGC Module (only FWT) for older AMCODERS	29.95
AGC Module (Only FWT) for new AMCODERS	29.95
New AMCODER Factory wired & tested	94.95
With AGC Module installed	119.95

Foreign - Add \$20.00 - all in U.S. Funds.  
Ship your old AMCODER to AMC for updating and installation of AGC module - we pay for return shipping 32.50

VISA & Mastercard Accepted  
Maryland residents - add 5% Sales Tax.  
Write for brochure or check reader info card.  
**AMC ENGINEERING**  
P.O. Box 427 ✓6  
Jessup, Md. 20794  
Phone: 301-799-7741

**MFJ SUPER CW/SSB FILTERS**



✓47  
**\$59<sup>95</sup>**  
MFJ-721

**MFJ-721 SUPER SELECTOR CW/SSB FILTER** gives 80 Hz BW, steep SSB skirts, noise limiting. **CW Filter** gives 80 Hz BW. No ringing. 8 poles give super steep skirts (60 dB down one octave from center freq. of 750 Hz). No tunable filter can match performance. BW: 80, 110, 150, 180 Hz. Reduces noise up to 15 dB. **SSB Filter** improves readability. Reduces splatter, hiss, static, noise, hum. IC active filter has 375 Hz highpass cutoff; 2.5, 2.0, 1.5 KHz (36 dB/octave) lowpass cutoffs. **Works with any rig.** AM, SSB, CW. Plugs into phone jack. 2 watts for speaker. Inputs for 2 rigs. Speaker and phone jacks. Phones disable speaker. OFF bypasses filter. 9-18 VDC, 300 ma. 5x2x6 inches. Optional AC adapter, \$7.95. **Switchable noise limiter** for impulse noise; trough clipper removes background noise. **Simulated stereo for CW** lets ears, brain reject QRM. Yet, hear off frequency calls.

**Tunable Filter**  
Instantly zero in SSB/CW signals with tunable peak, notch, lowpass filter.



✓47  
**\$59<sup>95</sup>**  
MFJ-751

**MFJ-751. Peak, notch or lowpass signals, zero in with freq. control, adjust bandwidth for minimum QRM. Double tuned for extra steep skirts. Linear freq. control tunes 300 to 3000 Hz. Output is constant as bandwidth is varied flat to 40 Hz. Tight notch to 70 db. 5x2x6 in. Hear off frequency calls with simulated stereo. Works with any rig. Plugs in phone jack. 2 watts for speaker. 110 VAC or 9-18 VDC, 300 ma. One year unconditional guarantee.**

**MFJ-721** has 4 CW stages for super steep skirts. Best for CW. **MFJ-751** is best for general use when versatility is more important.

Order from MFJ and try it. If not delighted return within 30 days for refund (less shipping). One year unconditional guarantee. **Order today. Call toll-free 800-647-1800, charge VISA, MC. Or mail check, money order. Add \$3.00 shipping.**

**CALL TOLL FREE ... 800-647-1800**  
Call 601-323-5869 for technical information, order/repair status. Also call 601-323-5869 outside continental USA and in Mississippi.

**MFJ ENTERPRISES, INC.**  
BOX 494, MISSISSIPPI STATE, MS 39762



# The Little Thinker

## — a quick puzzle project

Photos by Kris Thorp

**B**ack in '62 (when we lived in New Jersey), one summer evening I met my dad at the bus stop. He worked in New York City, and he always gave me a smile as he got off that bus.

That night, I got more than his smile. He brought me a book—green, black, and white cover, paperback, Gernsback Library No. 70.\*

"Thought you might enjoy this; picked it up in Port Authority," Dad said. "It's titled *Electronic Puzzles*

\**Electronic Puzzles and Games*, Matthew Mandel, Gernsback, January, 1961.

and Games. What do you think?"

Now, to be honest, a twelve-year-old would rather covet a large silver box of Big Bang Roll Caps, an old piece of mechanical gadgetry his office was discarding or that a building handyman "donated," or additions to the foreign coins I had squirreled away that he had gotten in change at Nedick's or Chock Full o' Nuts, but a book? I thanked him and thumbed through the stiff, heavy pages.

I read the book at the dinner table. You made the

game boards from wood, the switches from tin cans, and the buzzers and bells from magnet wire wound on a large bolt. The games were simple but devious and could outwit a grown-up. That book started to look real good as its pages frayed.

After eating, I was down in the cool basement hunting up the components of the game that really had me dreaming. It was "The Little Thinker," and the introduction read like this: "An interesting type of puzzle in which the player is pitted against the puzzle and where specific moves must be made by the player in order to win. The player has a choice of removing one, two, or three pegs at a time. When he has done so, the machine will indicate how many pegs it wants removed. Whoever is left with the last peg loses."

I was hooked! I read on. "Either the player or the machine can have the first move. If the player moves first, he removes up to three pegs, as desired. He then depresses the button at the bottom of the panel. One of the lights at the

right (marked one, two or three) will then light up, indicating the machine's choice. The number of pegs requested by the machine are then removed. The player then removes his selection of pegs and again depresses the button to indicate that he has made his choice. This continues until either the player or the machine is left with only one peg."

The machine was diabolical, though, and you really only had one chance to win, but this wizard of tin and wood and telephone wire wouldn't give you the pleasure. It would "know" before you and it were half way through and lit a Concede lamp!

By sundown I had sawed up a berry crate from the Newark Farmers' Market for the game board, located the spider's nest of telephone wire scraps Dad had brought home from the office one day, and borrowed tin snips from a neighbor to transform a Hi-C can into switches. The nuts, bolts, and wood screws (no two the same) were found under the workbench in my kid brother's used baby food jars.

The only things I bought



Fig. 1. Little Thinker Puzzle.



were the bulbs, sockets, and a piece of wood dowel from the lumberyard (for the pegs). The holes for the pegs were drilled by Dad with bit and brace; otherwise I flew solo. It wasn't the fanciest little thinker, but we had fun!

The book never lost its appeal for me, and years later while I studied digital electronics, it stimulated a game using the same principle with an integrated circuit as the "brain." Of course, the game board was done on a milling machine, the switches slide now, and the bulbs and start button are up to military specs. The integrated circuit sits in a wire-wrap socket, and the resistors are low-noise types. However, you can make the game in a cigar box with the ingredients from a "grab bag" and it'll still work. In fact, if you have a berry crate and a Hi-C can...

Play the game using Matthew Mandel's instructions for the original game. Use LEDs with a 300-Ohm (or thereabouts) current-limiting resistor, if you can't scrounge 5- or 6-volt low-current lamps. I would try to stay close to the 330-Ohm hold-down resistors on the inputs of the 7438 IC. You can use any switches that will electrically move one contact (or pole) between two others. Single pole-double throw slide switches are fine and cheap.

The normally open switch (NO) starts the game and chooses how many switches to slide down for the machine. If you want to go first, slide down one, two, or three switches and push the start switch for the machine's choice. Push the switch first if you want the machine to move first, and push down the number of switches it requests.

You can't win if you go first, but I should have let

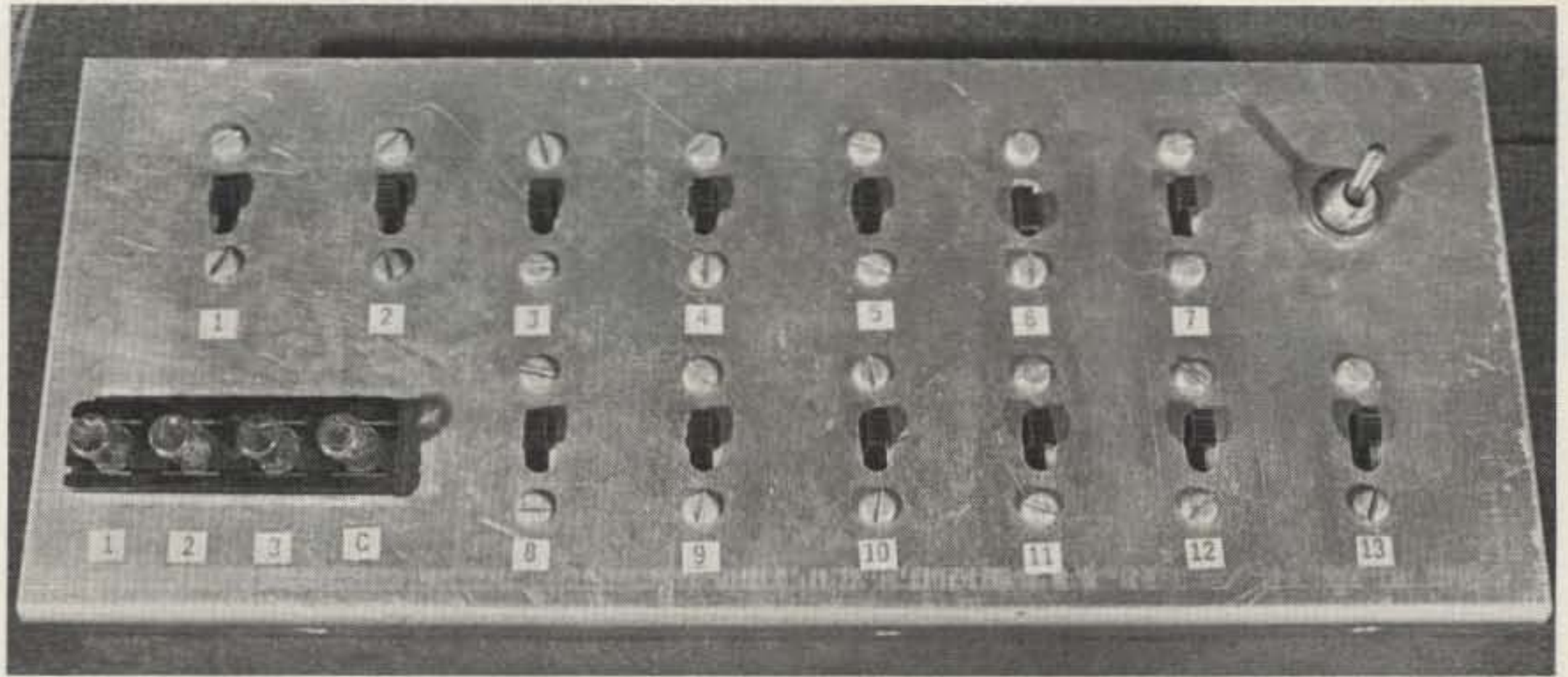

Photo A. The Logic Game.

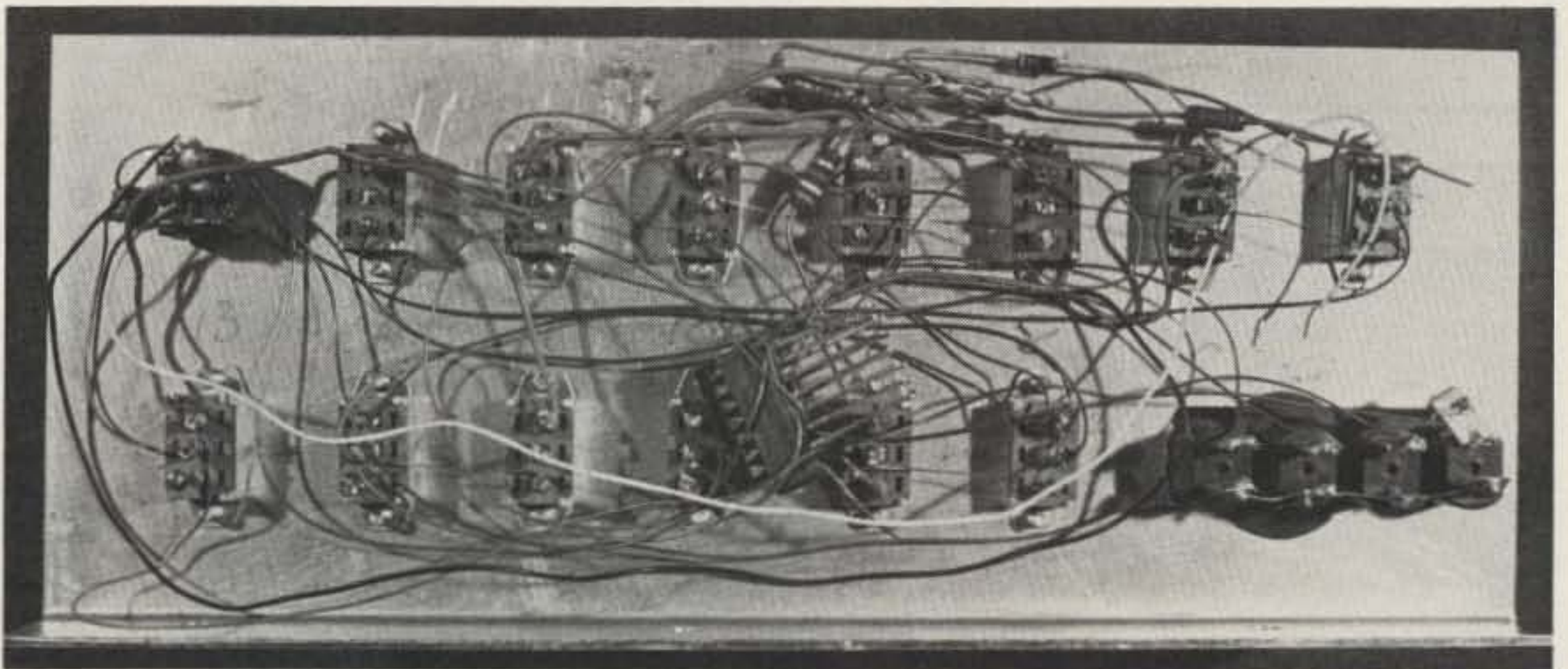

Photo B. Rear view of the Logic Game.

you find that out! If you are going to win, the Concede light will admit that

you're good... or just lucky?

By building the game

you will learn about ICs, but by playing it I'll confess you'll only have fun! ■

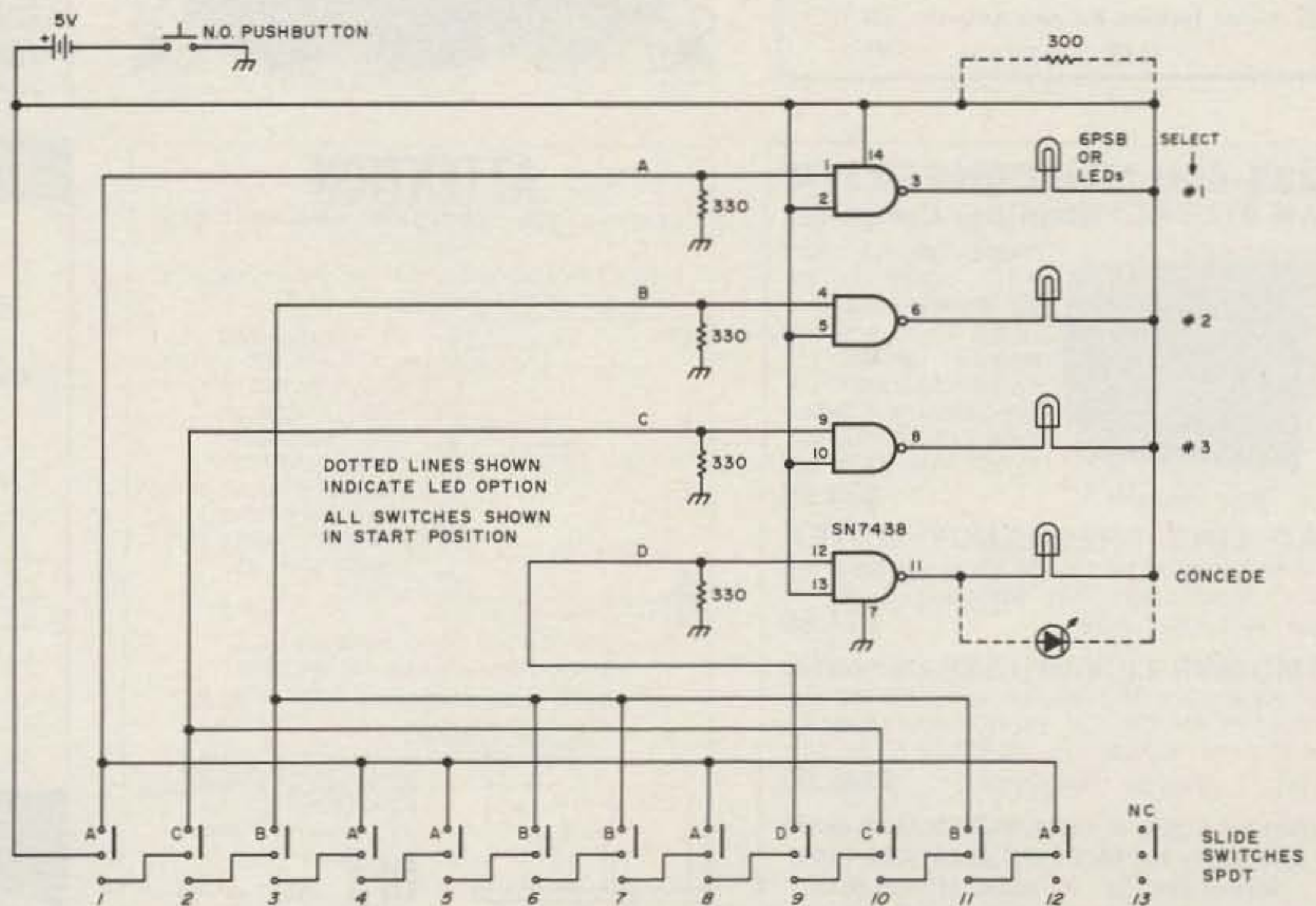

Fig. 2. Logic Game circuits.



## Stretch

YOUR HAM RADIO-\$\$\$

•• WE SELL SATISFACTION  
At a **DISCOUNT!**

Call or Write: ✓ 339

**J-T ELECTRONICS SUPPLY, INC.**  
14 JUPITER PLACE # 117  
PLANO, TEXAS 75074  
(214) 424-0515

•TEN-TEC • MFJ • BENCHER • JANEL  
•RAMSEY 600 Mhz COUNTERS  
•KLM AMPLIFIERS  
•B & W, MANY OTHERS

OPEN: 12:00 - 8:00 WEEKDAYS  
9:00 - 5:00 SATURDAY

**SIDEWALK SALE -**  
LAST SAT OF EVERY MONTH

## SYNTHESIZED SIGNAL GENERATOR



• Covers 100 to 179.999 MHz in 1 kHz steps with thumb-wheel dial • Accuracy .00001% at all frequencies • Internal frequency modulation from 0 to over 100 kHz at a 1 kHz rate • Spurs and noise at least 60dB below carrier • RF output adjustable from 50 to 500mv across 50 ohms • Operates on 12vdc @ 1/2 amp • Price \$299.95 plus shipping.

In stock for immediate shipping. Overnight delivery available at extra cost. Phone: (212) 468-2720.

✓ 311

## VANGUARD LABS

196-23 Jamacia Ave. Hollis, NY 11423

## CB TO 10 METER

10 METER CONVERSION KITS  
FOR CB RADIOS AM-FM & SSB

- Kits for over 300 Models of CB Radios
- Low Cost from \$10.00  
Easy to Install with All Instructions  
Tune-Up Procedure Alignment
- KITS FOR MOST POPULAR UNITS  
Over 5,000 Satisfied Customers
- Write or Call Today for Our Free  
1980 Catalogue

## AMERICAN CRYSTAL SUPPLY COMPANY

PO Box 638  
W Yarmouth, MA 02673  
(617) 771-4634 ✓ 7

## Radio Amateurs!

### Tempo Handheld!

S-1	\$232.80	2 Meter
S-1T	\$260.90	With Tone Pad
S-2	\$315.00	220 MHz
S-2T	\$359.00	With Tone Pad
S-5	\$264.50	2 Meter 5 Watt
S-5A	\$299.95	With Tone Pad

### AZDEN PCS-2000

2 Meter \$289.95 MARS CAPABILITY WITH MOD.

### AZDEN PCS-2800

10 Meter \$289.95

### SWAN ASTRO 102BX

160/10 Meters \$995.00

Astro 150 \$777.00

100 MX \$600.00

TEN-TEC OMNI C NEW! \$1025.50

TEN-TEC OMNI D \$795.00

Six others lower priced Limited Quantities.



Amateur equipment accessories & antennas.

COD's USA. Export Anywhere.

Amateur & commercial repair service.

2317 Vance Jackson Rd. San Antonio, TX 78213  
(512) 734-7793 ✓ 301

## MILITARY SURPLUS WANTED

Highest prices ever on recent U.S. Military surplus, especially on Collins equipment or parts. We Pay freight. Call collect for high offer. (201) 440-8787. 35 Ruta Court, S. Hackensack, N.J. 07606

Our 18th Year  
**SPACE ELECTRONICS CO.** ✓ 317

## URFI

(UNIVERSAL RECEIVED  
FREQUENCY INDICATOR)



Digitize your receiver's dial with the DIAL SPOTTER. Adapts to most Communication Receivers with simple connection to VFO. From \$149.95 Write for Data Sheet.

## GEMINI INSTRUMENTS INCORPORATED

Box 205, Larchmont, NY 10538 ✓ 24

## 225-400 Mhz CONVERTER AM-914/TRC Amplifier-Converter



Originally used with military R-417 receiver for the 225-400 Mhz range. Continuous tuning of RF and oscillator; 30 Mhz I.F. Has tubes 5670 and 4/6J4. See 7/80 CQ for R. Grove's conversion of this unit. 7 1/2 x 6 1/2 x 9 1/2. 17 lbs. sh.

wt. Used, repairable \$34.95

### AC LINE FREQUENCY METER

48-52 and 58-62 Hz 100-150 VAC using ten reeds. 3 1/2" round; sealed. H.H. Sticht mfg. 2 lbs. sh. wt. #974-9364, unused \$27.95

### TMC MSR-4 (CV-591) SSB Converter

for use with 2-32 Mhz receivers having 455 KHz IF's. USB, LSB, AM, CW, FSK, and FAX. Input voltage 0.1 to 10 V-rms. Requires 115/230 VAC 50-60 Hz. 5 1/4 x 19 x 13 1/2. 28 lbs. sh. Used, repairable \$145.00

Prices F.O.B. Lima, O. • VISA, MASTERCARD Accepted.  
Send for our New FREE SURPLUS CATALOG Today!  
Address Dept. 73 • Phone: 419/227-6573

**FAIR RADIO SALES** ✓ 22  
1016 E. EUREKA • Box 1105 • LIMA, OHIO • 45802

## ATTENTION

EXPERIMENTER DESIGNER MANUFACTURER

HFT OFFERS YOU

ENGINEERING SERVICES - MINIMODULE PRODUCTS  
AUDIO THROUGH 250 MHz

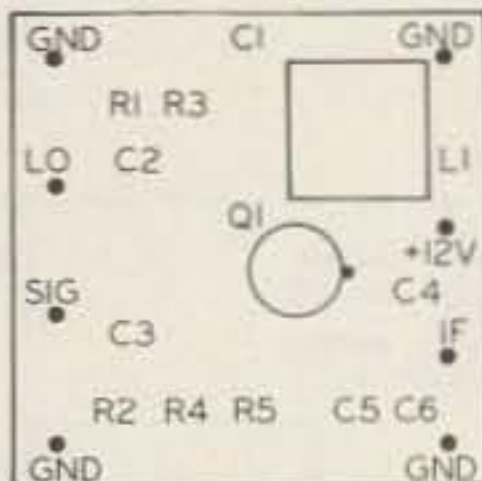

FULL SCALE DUAL GATE MIXER

RF PREAMPLIFIERS  
DUAL GATE FET MIXERS  
IF AMPLIFIERS  
AUDIO AMPLIFIERS  
WWV RECEIVERS  
TIMING GENERATOR  
COMPRESSIVE AUDIO AMP.  
SSB GENERATOR  
RF POWER AMPLIFIERS  
POWER SUPPLIES  
KITS

CATALOG ITEMS IN TWO WEEKS OR LESS  
QUICK TURN AROUND ON SPECIALS

CATALOG & DESIGN MANUAL \$3.95 REFUND ON 1ST PURCHASE

DETAILED SPECIFICATIONS  
APPLICATION NOTES  
DESIGN DATA ON:

RF PREAMPLIFIERS, MIXERS,  
SPURIOUS SIGNALS, RECEIVER  
PARAMETERS, AUDIO COMPRESSION,  
& OTHER DATA

SHORT FORM CATALOG ON REQUEST

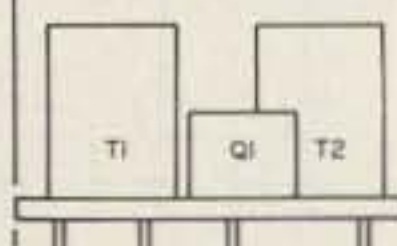

FULL SCALE RF PREAMP.

**HFT INC** ✓ 304  
158 West 9th St  
Deer Park NY 11729

## COPY CW. RTTY. ASCII

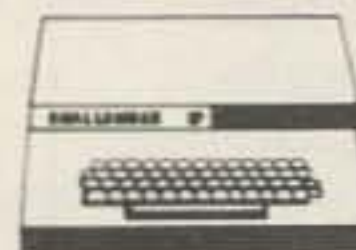

with OHIO SCIENTIFIC'S  
C1-P Computer

- Send & Receive CW
- Retain All Functions  
of C1-P 8K Computer

RTTY Receive Program ..... \$19.95  
CW Transcieve Program ..... 19.95  
ASCII Transcieve Program .. Coming

• All Programs Supplied On Cassette  
Complete With Interfacing Schematics  
and Instructions.

Parts Kit for Interface ..... 19.95  
C1-P 8K RAM Computer ..... 379.00  
C1-P 8K Complete with Interface  
Installed, Wired, and Tested .. 429.00

## COMPUTER SYSTEMS

3763 Airport Blvd. • Mobile, AL 36608

(205) 344-7448 ✓ 340

Dealer Inquiries Invited

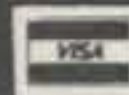
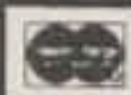



## MICROWAVE ANTENNAS & KITS

- MICROWAVE TRANSISTORS
- AZ-EL OPTION KITS
- MICROWAVE DIODES
- PARABOLIC REFLECTORS
- ALUMINUM FEED-HORNS



Your source of supplies for the fastest growing field of communications. Here is a low cost entry into the fascinating area of microwave technology. We offer a complete line of antennas, receivers, pre-amps, power supplies, etc..... Call or write for details.



**DATA SERVICE COMPANY**  
3110 Evelyn Street ✓ 346  
Roseville, MN 55113  
612-636-9469

## FREE CATALOG



**NEW!**  
CATALOG OF  
HARD-TO-FIND  
PRECISION TOOLS

✓ 354

**Also contains test equipment  
plus wide selection of  
tool kits and cases**

Jensen's new catalog is jam-packed with more than 2000 quality items. Your single source for hard-to-find precision tools and tool kits used by electronic technicians, scientists, engineers, instrument mechanics, schools, laboratories and government agencies. Send for your free copy today!



**JENSEN TOOLS INC.**  
1230 S PRIEST DR. TEMPE, AZ 85281

## AUXILIARY POWER for Emergency or Portable Operation

Generac

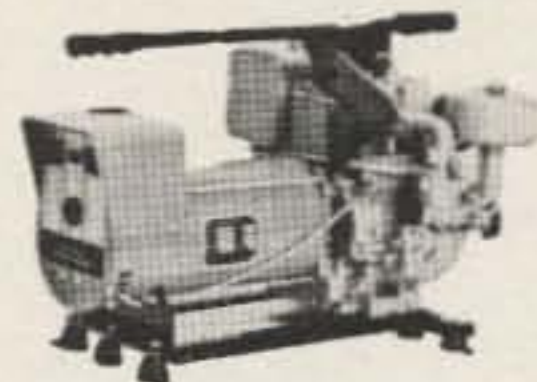

Light wt. Portable Alternator. Stand-by power for Ham Equipment, household needs during power outages or operation in remote areas. Operates lighting, refrigerators, heating systems or other appliances including freq. sensitive loads such as TV sets, induction motors and fluorescent lights. Solid-state voltage regulation. 25% surge capacity. B&S engine. Alternator draws just enough engine output to meet load resulting in up to 25% fuel savings. Low interference. Advanced design. Drip-proof construction protects windings from rain and dirt assuring long life.

One year warranty by manufacturer.

Models available with 1350 to 7000 watt ratings.  
Write for our quote and additional information.

**Mastercharge or VISA accepted**

## OUTDOOR OUTFITTERS ✓ 325

705 Elm St. • Waukesha, WI 53187  
Ph. 1-414-542-7772 • Ken, N9KS—Mgr.

**Louis N. Anciaux,  
WB6NMT**  
stands behind  
every product  
he makes  
at **Lunar  
Electronics.**



2785 Kurtz Street, Suite 10  
San Diego, CA 92110  
(714) 299-9740 Telex 181747

## Satellite TV

FOR THE HOME

Sick of Network TV?

Our receiver lets you get over 75 channels of television directly from earth-orbiting cable TV satellites: HBO, Showtime, super stations, sports and movies from around the world.



**We don't just sell information!  
We Manufacture Hardware!**

Our 75-page catalog and information book tell the whole story! Inexpensive dishes, high pro-feeds, computer aiming software! Specs, Kits and more! Send \$7.95 today!

24-hour C.O.D Hotline  
(305) 339-7600



**SPACECOAST RESEARCH** ✓ 310  
Dept. S, P.O. Box 442, Altamonte Springs, FL 32701

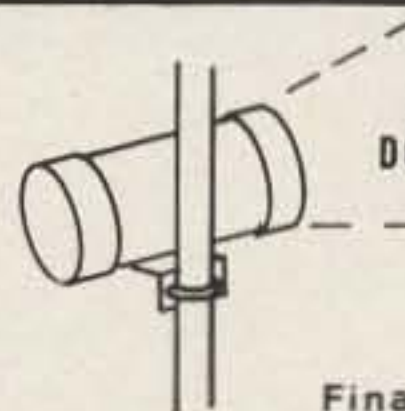

**2300 MHZ  
DOWN CONVERTER**

Finally a proven design with a small size. PC board mounts on back of coffee can. PC board contains a Rf amp, Mixer, Lo, and an If amp.

Kit supplied with a 5 page brochure, PC board, Diodes, Chip Caps, Transistors, and all parts to complete a working board.

512132-138

**\$35.00**

Money Order, Cod. or Check ✓ 351  
mail or phone

**UNIVERSAL COMMUNICATIONS**

1825 JOCYLE; ARLINGTON, TEX. 76010  
817-265 0391

Now with courtesy  
beep and beacon  
capability.

**144**

# REPEATERS

**220**

New and Improved  
Receiver  
and Transmitter

(Included in All Repeaters)



**COR Identifier:** All on one band, programmable. Fully adjustable, time out (.5-7 min.), hang time (0-1 min.), identifier (1-10 min.), tone, speed, volume, I.E.D. outputs, low current drain CMOS logic, plugs for easy installation and removal plus much more. \$99.95.

Basic Repeater \$649.95

2M 130-175 MHz/ Basic Repeater for 2 meters with all the features of the HI Pro MkI less the power supply and front panel controls and accessories.

### OPTIONS

- Duplexers
- Basic auto patch
- Matching cabinet
- .0005% High stability crystals

**Hi Pro Mk I**

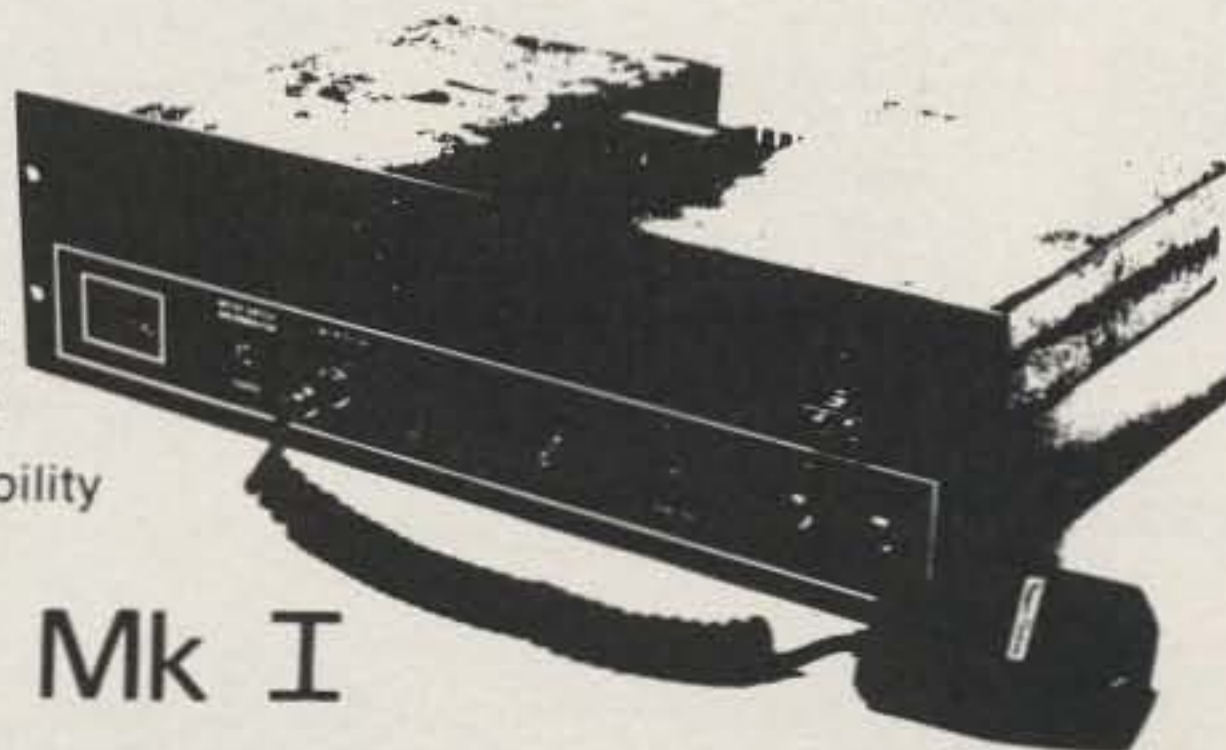

**Maggiore Electronic Laboratory**

845 WESTTOWN RD. ✓ 46  
WEST CHESTER, PA. 19380 PHONE 215 436-6051

144 or 220 MHz \$849.95

PLUS SHIPPING  
PA Res. add 6% tax



# A Conversion with Gusto

## — throw your weight around on six

It is my observation, after DXing on 50 MHz for several years, that the most likely way to be enthralled by what may be achieved on VHF is to erect the largest, highest antenna possible and then run a kW into it. Honestly, there is no way one can fully appreciate the 50-MHz band, especially during this peak in Cycle

21, without running QRO. As I write this, six meters is open from the eastern US to Europe—as it has been nearly every day for the past several weeks—and in another few hours we'll be hearing W6s and KL7s. A few hours after that, the West Coast gang will be working JA. The fellows running kilowatts will be

the ones heard longest and best, to be sure!

Even during quiet sun years, a kW and a large antenna allow one the privilege of working long-haul tropo nightly, and meteor-scatter work, one of my favorite pastimes, is a breeze with high power.

Although I have built a few high-powered VHF amplifiers from scratch, I cannot avoid being intrigued by the prospect of modifying commercially available gear to operate in the six-meter band. One superbly suited amplifier which is owned by dozens of hams here in the Northeast (and hundreds nationally) is the now-extinct National NCL-2000, marketed for several years as a companion amplifier to the famous NCX-5 transceiver. The NCL-2000 is a husky amplifier capable of running 1-kW dc input power nearly indefinitely; this, coupled with the fact that

the original design calls for RCA 8122 tetrodes, forced-air cooled, external-anode types rated for full input to 500 MHz, compelled me to use an NCL-2000 as a well-conceived frame around which I could build a 2-kW PEP amplifier for 50 MHz.

Once I commenced the modification, I found it to be extraordinarily uncomplicated, and the completed, modified amplifier worked so well that I could hardly keep the news to myself!

As NCL-2000 amplifiers seem to be readily obtainable second-hand at very reasonable prices (the one purchased for this modification was about \$300 in 1972), I would recommend that the prospective six-meter QRO operator purchase one with the sole intention of converting it for 50-MHz use. Following is a complete, step-by-step procedure for those fellows who really wish to be heard on six meters.

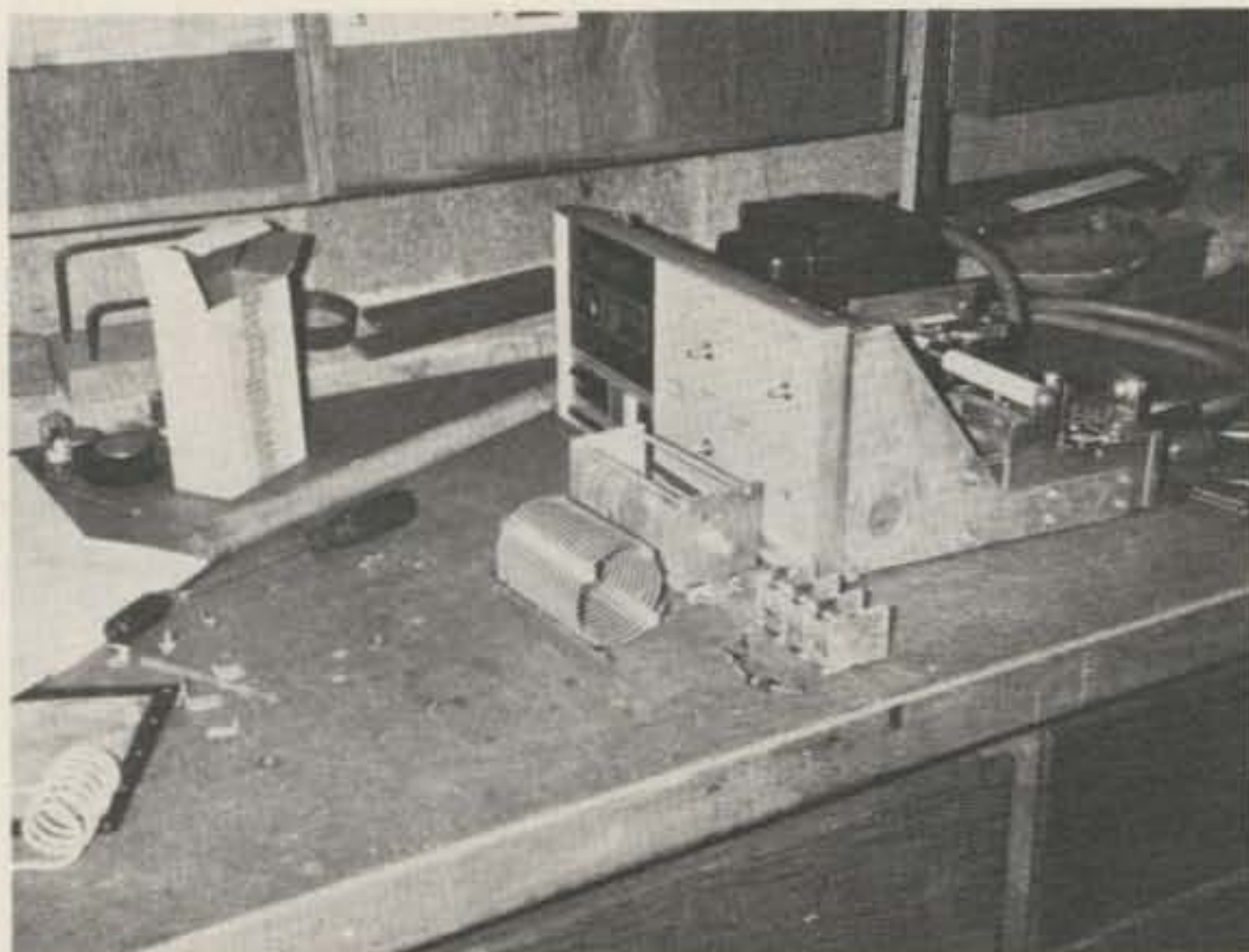

Photo A. The NCL-2000 with old tank components removed.



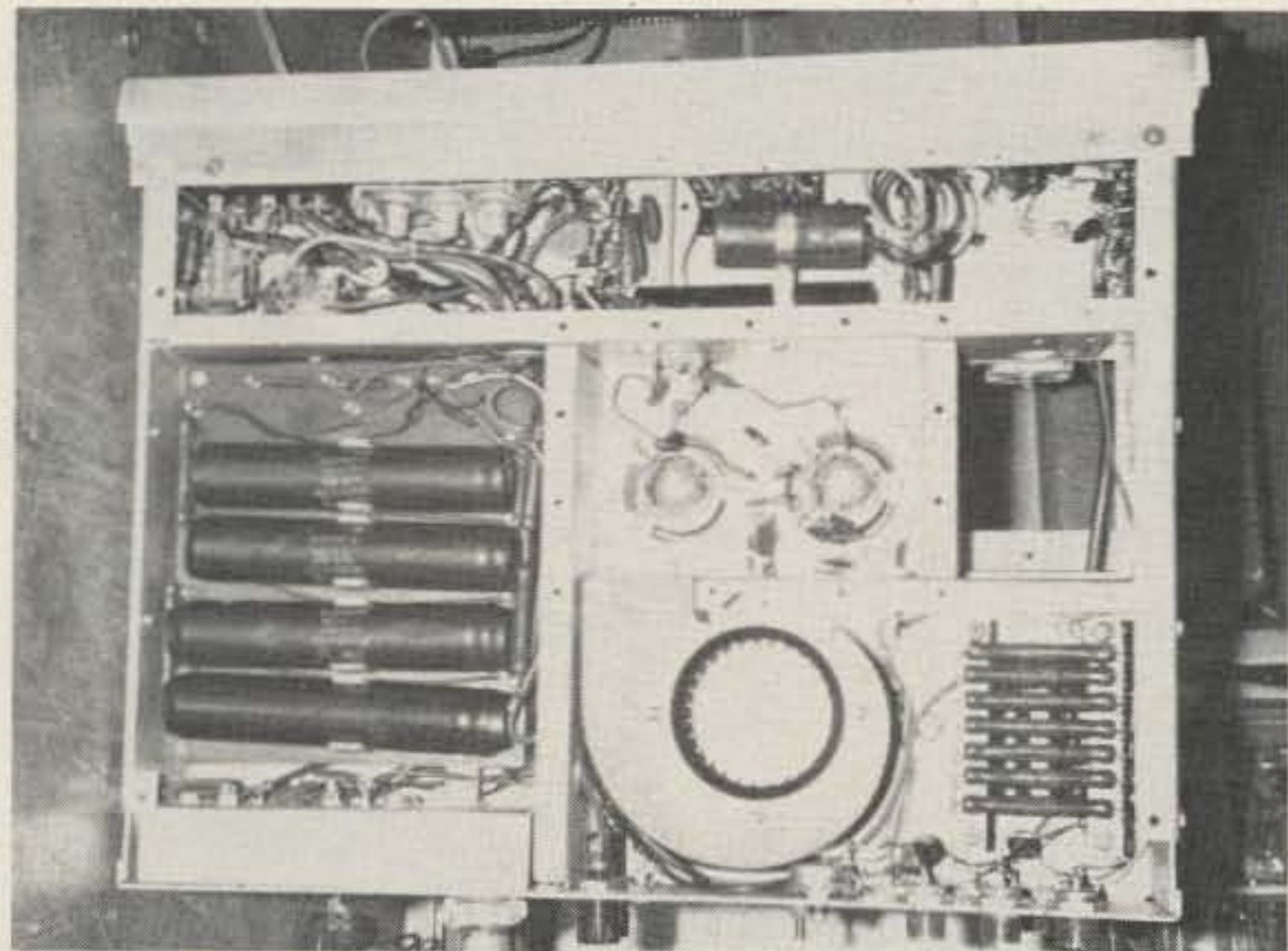

Photo B. NCL-2000 bottom view. The screen bypass caps, C24-C29, must be replaced.



Photo C. The new plate-tune and -load capacitors and modified choke L2 are installed.

1. Completely remove the entire amplifier plate-tank circuit assembly, including C42 (Plate Tune), C43 (Plate Load), and L4. Also remove bandswitch S5 and auxiliary loading "door-knob" capacitors C45, C46, and C47.

2. Remove Z1 and Z2, the plate parasitic suppressor assemblies. Temporarily remove the 8122s (V1 and V2) and the delay-relay tube (K4) and store in a safe place. If necessary, polish the 8122 anode areas with silver polish such as "Twinkle" silver cleaner. The same may be done for the 8122 plate connector rings, if they are very discolored. Remove and store the 8122 ceramic chimneys in a safe place: They are fragile.

3. Carefully remove the plate choke (L2) by dismounting it from its brackets and unsoldering both end connections.

4. Unwind choke L2 carefully, leaving only  $\frac{3}{4}$ " of winding on the ceramic form. If you have access to an inductance bridge, then measure the inductance of L2. It should be about 15  $\mu$ H, but this isn't very critical. Store L2 for future installation.

5. Unsolder and remove C24 through C29, the six 500-pF, 1-kV ceramic screen

bypass capacitors; be very careful not to damage the tube sockets or pins.

6. Install six new 220-pF, 1-kV ceramic disc capacitors in place of the six just removed. Use high-quality X7R dielectric capacitors; avoid type Z5U or Y5V or other very high-K dielectrics, as they tend to drift in value with temperature and age. Use the shortest possible leads on these capacitors! I was able to clip off all but  $\frac{1}{8}$ " of each capacitor lead and still install the new bypasses satisfactorily. If you can see the capacitor leads after the parts are installed, they are too long!

7. Inspect your work thus far: You should have removed *all* original plate-tank circuit wiring. There should be nothing mounted to the front panel but the meter function switch, S4, the meters, power switches, and indicator lamps.

8. Clip off any remaining bus wires interconnecting components in the 8122 plate area. The chassis in the original plate-tank area should be bare but for a few ceramic standoff pillars and the bias-regulator transistors, Q1 and Q2. Be sure you have removed the shaft which originally coupled to the Plate Load capacitor, C43; in fact, you may now remove the panel bearing,

as it will not be used.

9. Install three #6 solder lugs beneath the blocking capacitor, C48 (a .001- $\mu$ F, 5-kV "doorknob" type). Reinstall C48, screwing it tightly into its ceramic pillar. Atop C48 install one #6 solder lug with the lug body facing the front panel, and tighten a #6  $\frac{1}{4}$ " screw into the top of C48.

10. Reinstall the 8122 plate rings after fitting a ceramic chimney above each socket between the ceramic pillars. Under each #8 bolt head (those which hold the plate rings to the ceramic standoff pillars) install a #8 solder lug.

11. Remove and discard the plate-ring clamping screw assemblies (which consist of a long #6 bolt, a short metal pillar, and a wing-nut). Use in their places a #6-32  $\frac{1}{2}$ " plated bolt and lock-nut for each ring assembly.

12. Install plate choke L2 in the same manner as it was originally installed, dressing the high-voltage feed end along the ceramic form down to the high-voltage feedpoint which is the junction of R43 (15 Ohms, 12 Watts) and C44 (.001  $\mu$ F, 6 kV). Strip the new end with a sharp knife, tin the exposed conductor, and solder to the high-voltage feedpoint lug near the high-

voltage interlock. Then use "Q-Max," or high temperature coil dope, to hold the remaining choke winding in position.

13. Use #20 bus wire to connect the tube end of L2 to one of the three solder lugs beneath C48, the plate blocking capacitor. Using  $\frac{1}{4}$ " wide copper strap or the braid from RG-58/U, complete the connections from the other two solder lugs to the two 8122 plating solder lugs nearest the center pillar. Keep these straps fairly short; mine were about 1" long.

14. Install an E. F. Johnson-type #167-12, 200-pF variable capacitor in the hole previously used for the plate-tune capacitor, C42. Install a Hammarlund MC-20-SX, 20-pF, 2.5-kV variable capacitor in the hole previously used for the band-switch, S5. Be sure to use internal-tooth lockwashers on both capacitor bushings, and tighten bushing nuts until they're very tight. Note: The capacitors called for here are not the only types which will work, but they *do* work well, and I happened to find them at a local flea market. Avoid large, bulky, air-variable caps such as those originally used by National for 80-10 meter operation, as they tend to cause prob-



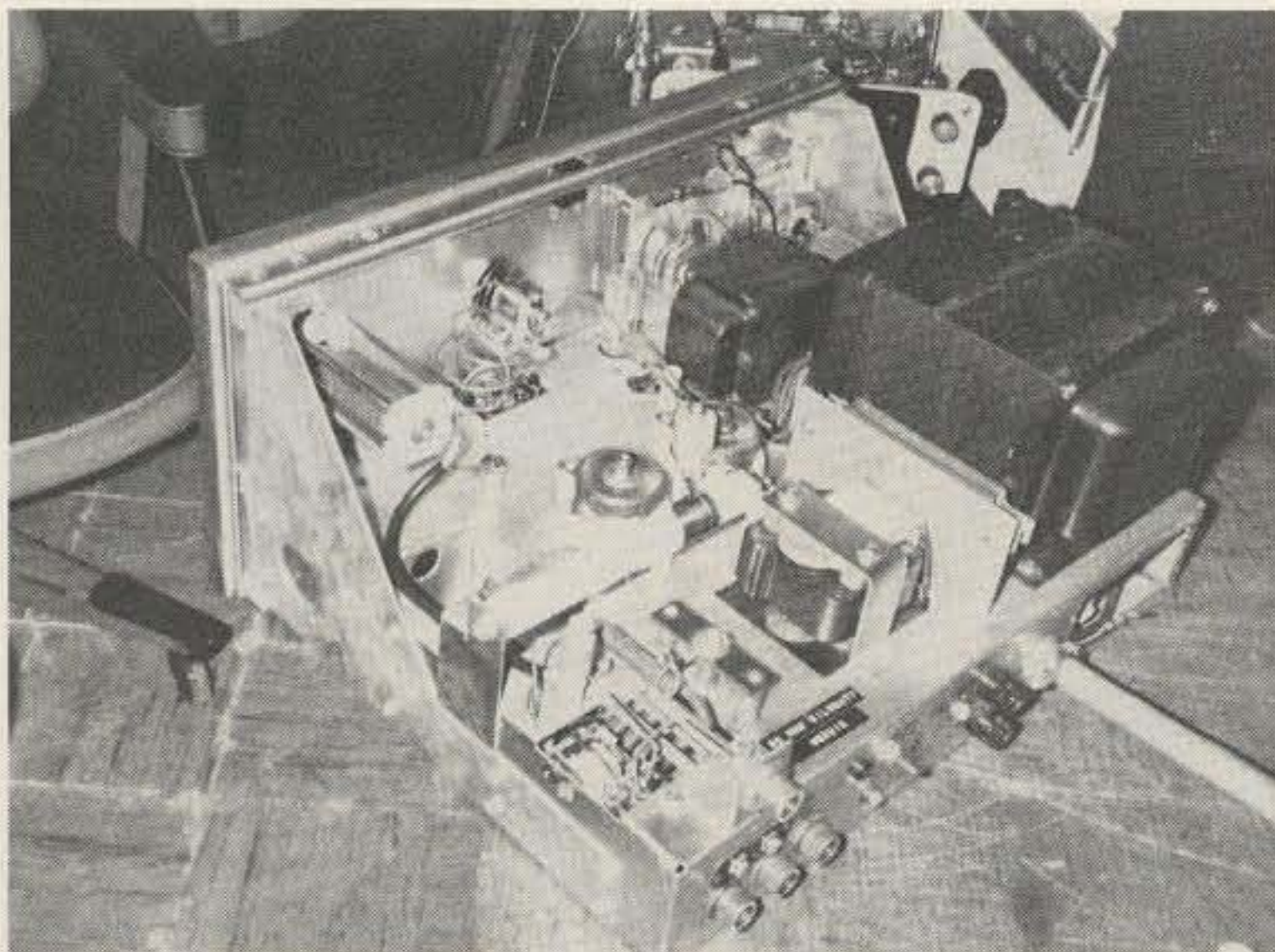

Photo D. The tank inductor, output straps, and output cable (connected to plate-load capacitor) are installed.

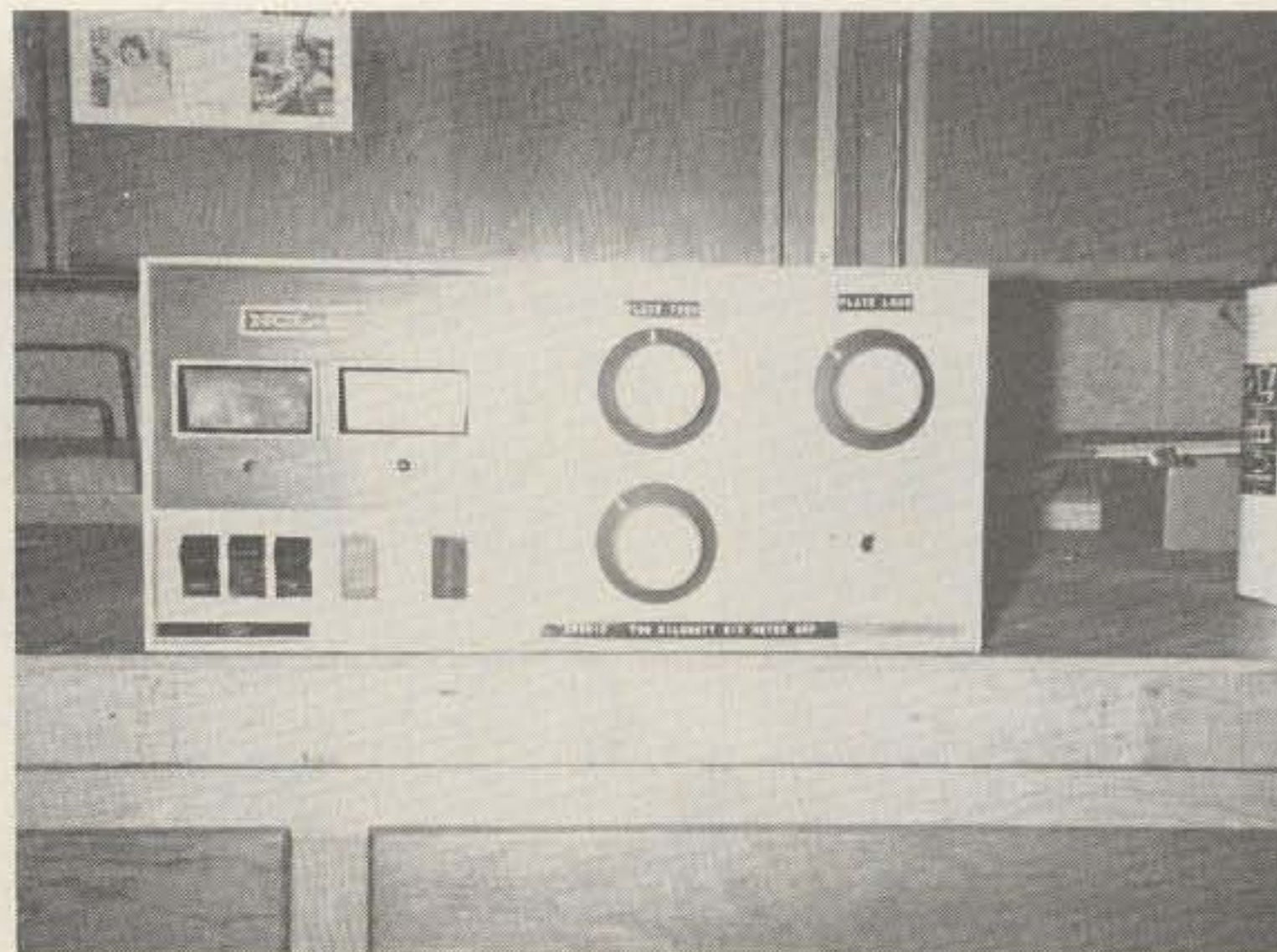

Photo E. Front panel of six-meter kilowatt. Plate tune is on the left, plate load on the right. You can always cement a knob over the remaining hole!

lems with parasitic resonances, intermittent ground paths, etc. A pair of 3" teflon-insulated copper or brass discs would be a good substitute for the MC-20-SX.

15. Install the plate conductor as shown in the photographs, from the top of C48 to the right-hand (as viewed from the rear of the amp) stator lug of the MC-20-SX plate tuning capacitor. This conductor should be at least 1/4" wide strap, about five inches long. I used the flattened braid from RG-59/U; the braid from RG-8/U might be a better choice. Half-inch wide copper flashing also would work well.

16. The plate inductor may now be built; mine is 3 1/4 turns of #10 solid copper wire, 1 1/2" diameter, 2 1/2" long. This size coil, used with the capacitors specified, will resonate the plate tank at about 50 MHz. My design values for the tank circuit were for an output impedance of 50 Ohms and a Q of 12. These goals were obtained with the subject amplifier. For your final trial, install the 8122s in their sockets and tighten plate-ring assemblies. Install the tank inductor, soldering it between the stator posts of the new tuning and loading capacitors.

Allow the coil to self-sup-

port, hanging in the air about three inches above the chassis. Check tank resonance by setting the plate-tuning capacitor at mid-range, then coupling a gdo to the tank coil; tuning the plate-loading capacitor through its range should yield a dip at about 50 MHz. Spread or compress the turns of the tank inductor until the plate-tuning capacitor can resonate the tank above and below 50 MHz. You may wish to use a larger conductor than #10 wire for the tank coil; I suggest using nothing smaller. A good hint regarding the dimensions of the inductor: Use a winding length that does not much exceed the winding diameter, to keep Q high.

17. Solder the output coaxial cable to the stator post of the new plate-loading control and a nearby ground lug. Install delay-relay tube K4. Check all wiring. *Install amplifier chassis in its cabinet before attempting to apply plate voltage!* The interlocks will only blow fuses, anyway.

It should be mentioned that the NCL-2000, with its passive grid circuit, may create high IMD products if overdriven; also, its rf second and third harmonics will be disgracefully high (down less than 20 dB) if the

grids of the 8122s are driven to conduction. This is typical of any class AB2 amplifier, and for this reason I recommend operation in the AB1 region only (no grid current). The slight increase in output power derived from class AB2 operation is not worth the troubles which might be created, both with your fellow hams for in-band "splatter," and with your neighbors for TVI.

Running the modified NCL-2000 at 50.1 MHz into a Heath "Antenna" through a Bird model 43 coupler/meter using a type 1000B slug, I recorded the data shown in Table 1. It works!

Note that the 80 Watts drive power does not appear at the 8122 grids; the NCL-2000 has an internal resistive attenuator which absorbs most of the signal. I used a Heath SB-110A transceiver as the exciter for these tests, and it happens to have 80 Watts output. Any exciter in the 25-to-

100-Watt (output) region should work quite well.

Remember to keep grid current low (0 to 1 mA) for the nicest sounding signal, and keep screen current low (per NCL-2000 instruction manual) to ensure long tube life. You may note that the new plate-load control has quite an effect on screen current; tune it for the most output which coincides with the lowest possible screen current. In the model amplifier, I was able to achieve over 700 Watts rf output with nearly no screen current.

I invite further inquiries related to this article and shall be glad to help prospective builders in any way I can. Unfortunately, the amplifier I modified does not belong to me, so it is no longer available for me to look at; however, the memories of this modification are vivid enough so that I probably can be of help to anyone needing it.

Good DXing on six! ■

SSB/CW	
Switch	SSB
Ep	2.8 kV no-load/2.2 kV full-load
Ip	225 mA idling/535 mA driven (2-tone)
Ig	0
Is	5 mA (driven)
Pin	80 Watts to rf connector
Pout	760 Watts rf

Table 1. NCL-2000 controls/meter readings.



# Microcraft's New Morse-A-Word

Eight character moving display.  
Built-in code practice oscillator.  
Excellent for learning Morse Code. ✓50  
Complete — no CRT or expensive extras needed.

Decodes audio CW signals from your receiver's speaker and displays letters, numbers, punctuation and special Morse characters as the code is received.



MORSE-A-WORD Kit with 4 character readout ..... MAWK-4 \$149.95  
MORSE-A-WORD Kit with 8 character readout ..... MAWK-8 \$169.95  
MORSE-A-WORD wired & tested with 8 character readout ... MAWF \$249.95

Send check or money order. Use your VISA or Master Charge. Add \$3.50 shipping and handling for continental U.S. Wisconsin residents add 4% State Sales Tax.

**Microcraft Corporation** Telephone: (414) 241-8144  
P. O. Box 513G, Thiensville, Wisconsin 53092

# TWO REALLY GREAT ANTENNAS

**THE JOYSTICK VFA** (Variable Freq. Antenna) claims unbeaten scoring over commercial and/or conventional antennae.

• Simple, rapid erection • Not only 6-band but CONTINUOUS 0.5 - 30Mhz., incl. BC & MARS • Omni-directional • Substantially Harmonic FREE • 1,000,000 miles per watt, world record! • Poor QTH's enhanced! CLIFF DWELLERS DREAM ANTENNA! • QUOTE from RADIO ZS (South Africa) "A remarkable antenna with great possibilities. Its physical size makes confined space operation a practical proposition".

## SYSTEM 'A' \$110.00

150 W.P.E.P. &/or Receiving only

## SYSTEM 'J' \$130.00

500 W.P.E.P. &/or Improved Q Factor Receive

## UP-DATE FOR THE EIGHTIES NEW JOYMASTER

You get all the JOYSTICK VFA top-notch capability plus the JOYMASTER BONUS of EARTH INDEPENDENCE. This new system gives you TUNED ARTIFICIAL EARTH radials on ham bands 80 thru' 10. Now snap your fingers at 99% of QTH problems!

## SYSTEM 'JM1' \$147.00

150 W.P.E.P. &/or Receiving only

## SYSTEM 'JM2' \$162.00

500 W.P.E.P. &/or improved Q Factor Receive

JOYSTICK VFA OWNERS, update your system to JM1/JM2 for \$86.00 and \$101.00, respectively. Rush Master-charge/Visa no. or check or request FREE literature. All goods assemble easily from the pack — then you have your REALLY COMPACT ANTENNA SYSTEM. Matching ATU's. Air mail cost incl.

## PARTRIDGE ELECTRONICS LTD

8, Partridge House,  
G3CED Broadstairs, Kent, England. G3VFA  
Tel: 011 44 0843 62535

Please send all reader enquiries directly

# Radio World

CENTRAL NEW YORK'S FASTEST GROWING HAM DEALER

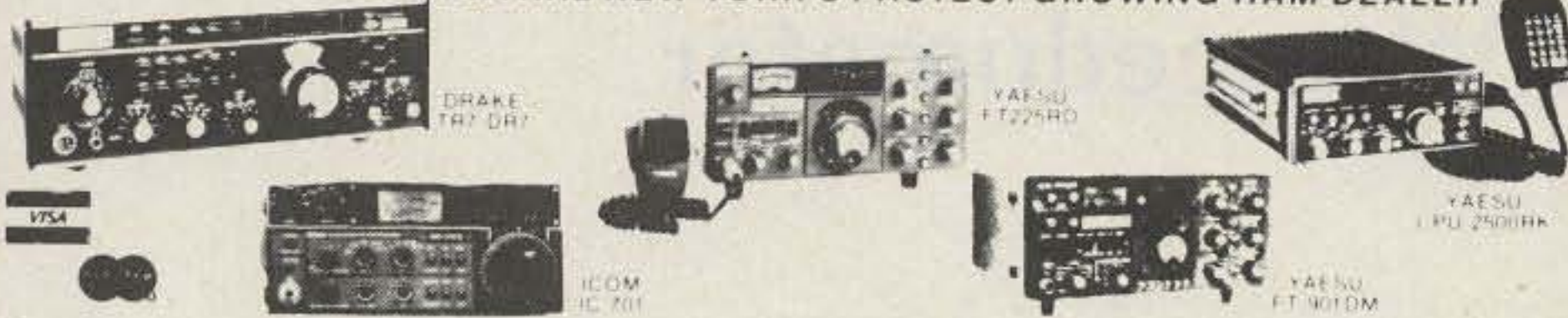

Featuring Yaesu, Icom, Drake, Ten-Tec, Swan, DenTron, Kenwood, KDK, MFJ, Microwave Module, Tempo, Astron, KLM, Hy-Gain, Mosley, Larsen, Cushcraft, Hustler, Mini Products, Bird, DSI, Mirage, Vibroplex, Bencher, Info-Tech, Universal Towers, Callbook, ARRL, Astatic, Shure. We service everything we sell! Write or call for quote. You Won't be Disappointed.

We are just a few minutes off the NYS Thruway (I-90) Exit 32

ONEIDA COUNTY AIRPORT TERMINAL BUILDING  
ORISKANY, NEW YORK 13424

Warren  
K2IXN

Call Toll Free: 1-800-448-7914

Bob  
WA2MSH

New York State Residents Call: 315-337-2622 or 315-337-0203

# FEDERAL FREQUENCY DIRECTORY

2 - 420 MHz Inclusive

OVER 100,000 FREQUENCY ALLOCATIONS FROM OFFICIAL U.S. GOV'T RECORDS.

UNCLASSIFIED UNDER THE FREEDOM OF INFORMATION ACT

AIR FORCE	JUSTICE	STATE DEPT.
ARMY	TREASURY	FAA
NAVY	NASA	INTERIOR
COAST GUARD	FCC	AGRICULTURE

ALL LISTINGS ARRANGED BY FREQUENCY, AGENCY AND LOCATION

A BIBLE FOR SHORTWAVE BUFFS AND SCANNER LISTENERS

Order Now..

Only.. \$14.95

✓352 Grove Enterprises, Inc.  
Route 1, Box 156 K  
Brasstown, NC 28902

Postage Paid within continental U.S.

Add \$2.00 if mailed overseas.

All payments must equal U.S. Exchange.

Dealer Inquiries Invited

# S-100 S-100 S-100 S-100

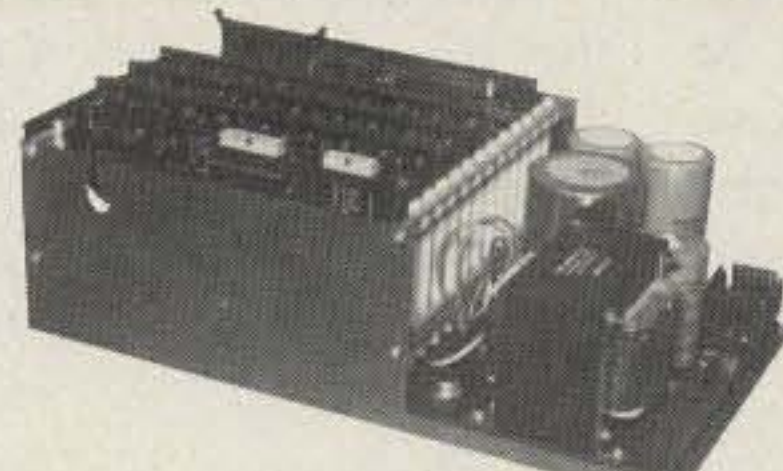

\*\$249<sup>00</sup>

IN STOCK NOW

INTRODUCTORY OFFER

PLACE QUANTITY ORDERS NOW, SAVE!

\*Less Boards and Fans, Assembled Add \$45.00, 6 Slots Populated with Connectors

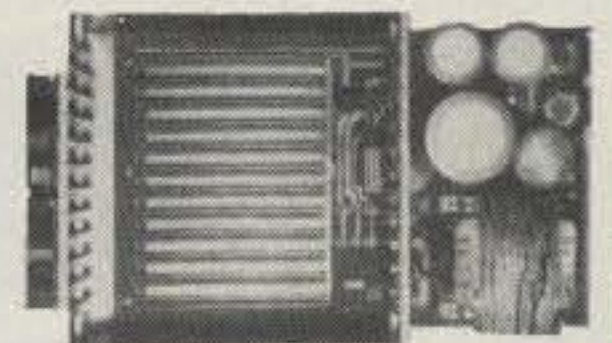
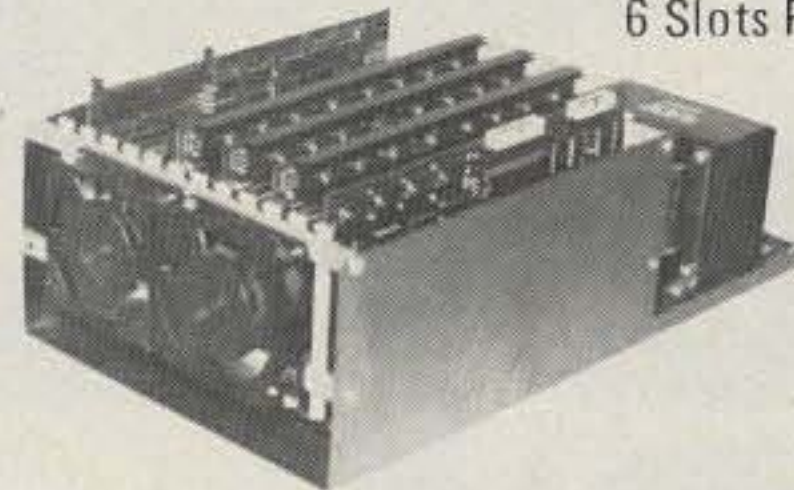

COMPLETE S-100 SYSTEM ALL NECESSARY POWER SUPPLIES

\*12 Slot Motherboard Fully Terminated

\*30A of +8V  
6A of ±16V

\*Disc Power Supply  
6A of +24V  
5A of +5V  
1A of -5V

\*All Steel Frame

\*220VAC or 110VAC  
50 or 60 Cycle Operation

\*Low Voltage Tap

\*Nylon Card Guides

\*Connectors Supplied for up to 4 Drives

\*Optional Fans Mount Neatly on One Side

DELTA PRODUCTS ✓357

15392 Assembly Lane, Huntington Beach, CA 92649

(714) 898-1492



# The Confidence Builder

## — a CW speedometer

**S**o you've been building your code speed by copying signals "off-the-air"? But you can't get W1AW much because of QRW or perhaps you have to be elsewhere while the code-practice session is on? How will you ever know

just how fast you are, or whether you're quite ready to face the examiner?

Why don't you try this little fun box—my "Confidence Machine"? It not only is an excellent code-practice oscillator, but it also can tell you the num-

ber of words per minute being sent or received. On top of that, it filters out pops, snorts, whistles, roars, and other background noises so that you hear only an easy-to-copy, clean musical tone. If you can get the signal at all, you'll hear only 599s from each station.

Even more, once the parts are assembled, this is a one-evening construction project with a cost running less than \$10 if you use your junk box. The values of the resistors and capacitors are not sacred, so if your junk box has something within 25%, use it. An assumption has been made that the people most interested in building this project will be Novices or Techs looking for their General tickets. For this reason, construction details are kept as simple as possible. Also, there is no attempt at scholarly discussion about how everything works. Just build it and have fun!

### How It Works—An "Unscholarly" Discussion

The Confidence Machine is a simple counter which counts the number of taps of the key and then translates the count into words per minute. In sending everyday English by Morse code, you must tap the key an average of  $2\frac{1}{2}$  times for each letter and  $12\frac{1}{2}$  times for each average 5-letter word. Count the taps for a minute, divide by  $12\frac{1}{2}$ , and you have the number of words per minute. (Sounds like that old Texas joke about the midget who figured the number of cows in a herd by counting legs and dividing by 4!)

Design of an electronic device that will divide numbers by  $12\frac{1}{2}$  is complicated, but dividing *time* by the use of a 555 IC timer is easy. This means that we can divide a minute by  $12\frac{1}{2}$ , and the number of taps during this shortened period represents the number of words per minute.

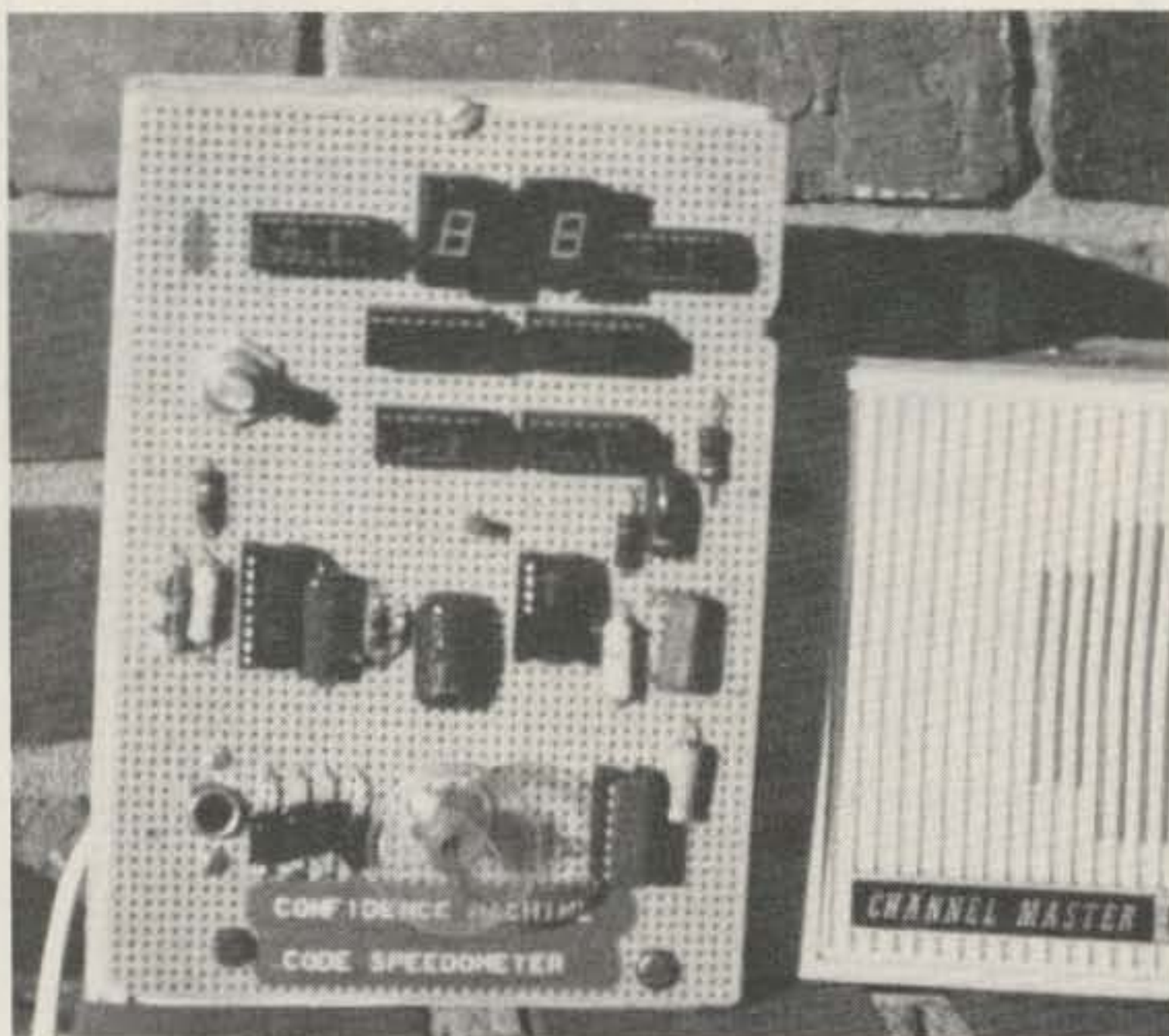

Photo A.



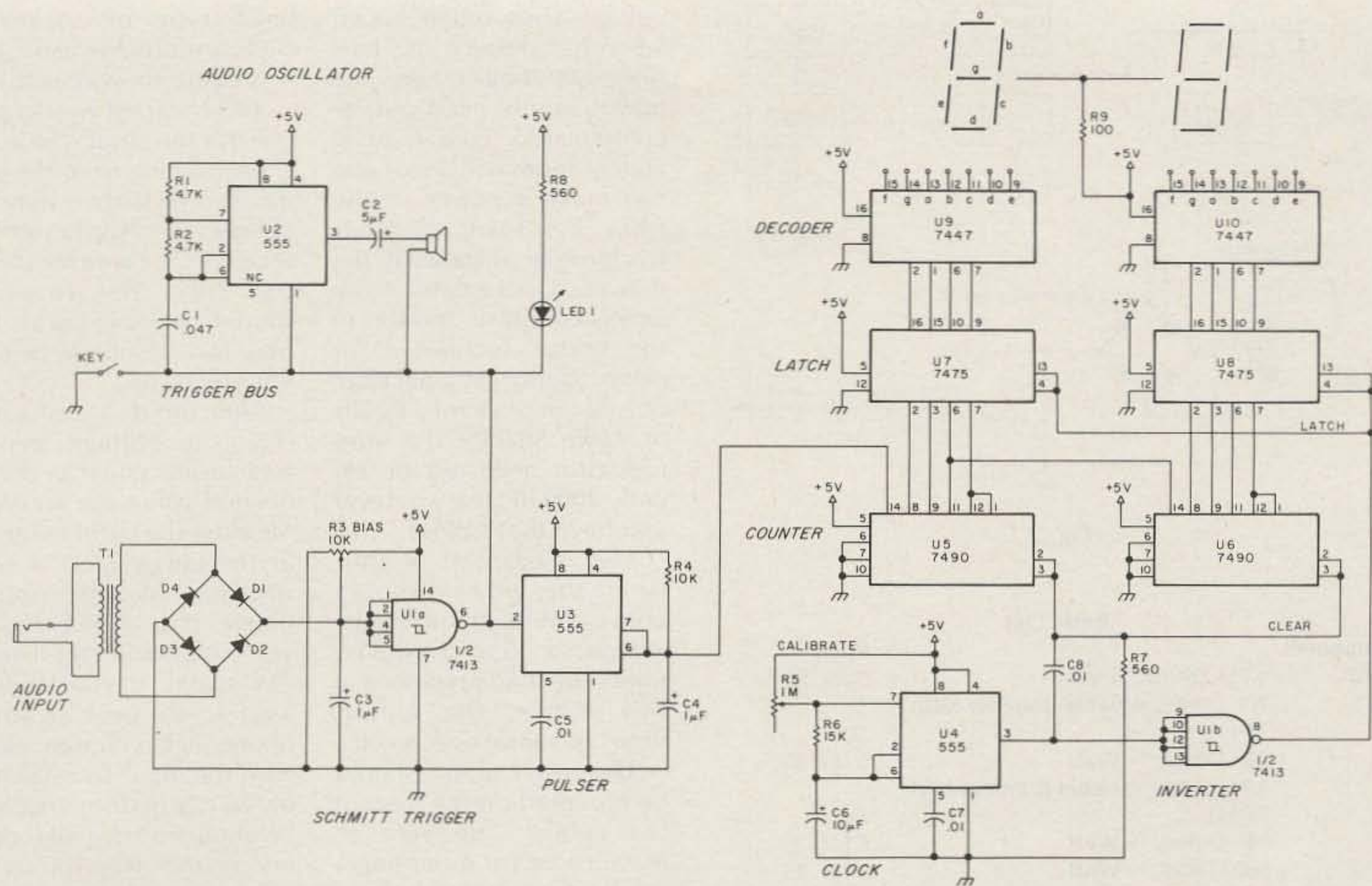

Fig. 1. The "Confidence Machine," a code-practice oscillator with code speedometer.

(Don't spend a lot of time trying to think about that, George. Just trust me and read on.)

We can count either the taps of the key or the bursts of CW tone from a receiver. If we are going to count the dots and dashes coming out of a receiver, we'll need something which will convert each burst of sound into a single electrical pulse. Since the receiver puts out varying levels of alternating current at the phone jack, we can rectify this current and apply the positive pulses to the input of a NAND gate Schmitt trigger. The Schmitt trigger can then trigger the audio oscillator and the pulser the same as a key does. (A NAND gate is an inverter. If all inputs are positive, the output is zero—it turns off. But if any one of the inputs is zero, the output is positive—it turns on.)

So, when we apply a positive pulse to the input of the NAND gate Schmitt

trigger, the output drops to zero (ground), triggering both the audio oscillator and the pulser. The audio oscillator produces a tone, and the pulser produces a positive pulse which goes to the counter chain.

Each of the counter chains has a decade counter, a latch (for temporary storage of the count), and a BCD-to-seven-segment decoder (to translate the binary-coded count into a readable number in the display).

The decade counters are controlled by pins 2 and 3. They will count when either pin 2 or 3 is at ground, and they will clear when both pins 2 and 3 are made positive. In a similar fashion, the latches are controlled by their pins 4 and 13. A positive pulse at these control pins causes the latches to store or remember what the count was at the time the positive pulse arrived. A second pulse will cause the latches to forget the

previous count and store a new count.

The pulses which cause the counters to clear and the latches to store the count are generated by the clock (U4). This is a 555 IC timer set up to deliver a positive output for 4.8 seconds followed by a drop to zero (or ground) for about .1 seconds. As the output of the clock goes positive, a positive pulse is delivered to the control pins of the counters (through C8), clearing the counters. The voltage to the control pins immediately drops low through R7 and the counters are able to start counting again.

Part of the output from the clock is fed to the inverter, shown as U1B. A positive input to a NAND gate causes a zero output from the gate. On the other hand, a zero input causes a positive output. During the tenth of a second that the clock has a zero output, the output of the inverter is

positive. This positive pulse is delivered to the control pins of the latches and the count is stored.

The combination of all this action causes the device to count continuously, and at the end of each 4.9-second period, it will display the count made during the previous period.

The LED tied to the trigger bus serves no really useful purpose, but it does provide visual monitoring. You may want to eliminate it, but every science-fiction movie fan knows that all computers are supposed to have blinking red lights on the front. Besides, it does look impressive when you're showing off to visitors in the shack.

### Construction Hints

Construction should begin with the power supply. The requirement is for about 240 mA at 5 volts. ICs in the 7400 series require at least 4.5 volts and simply will not operate if the



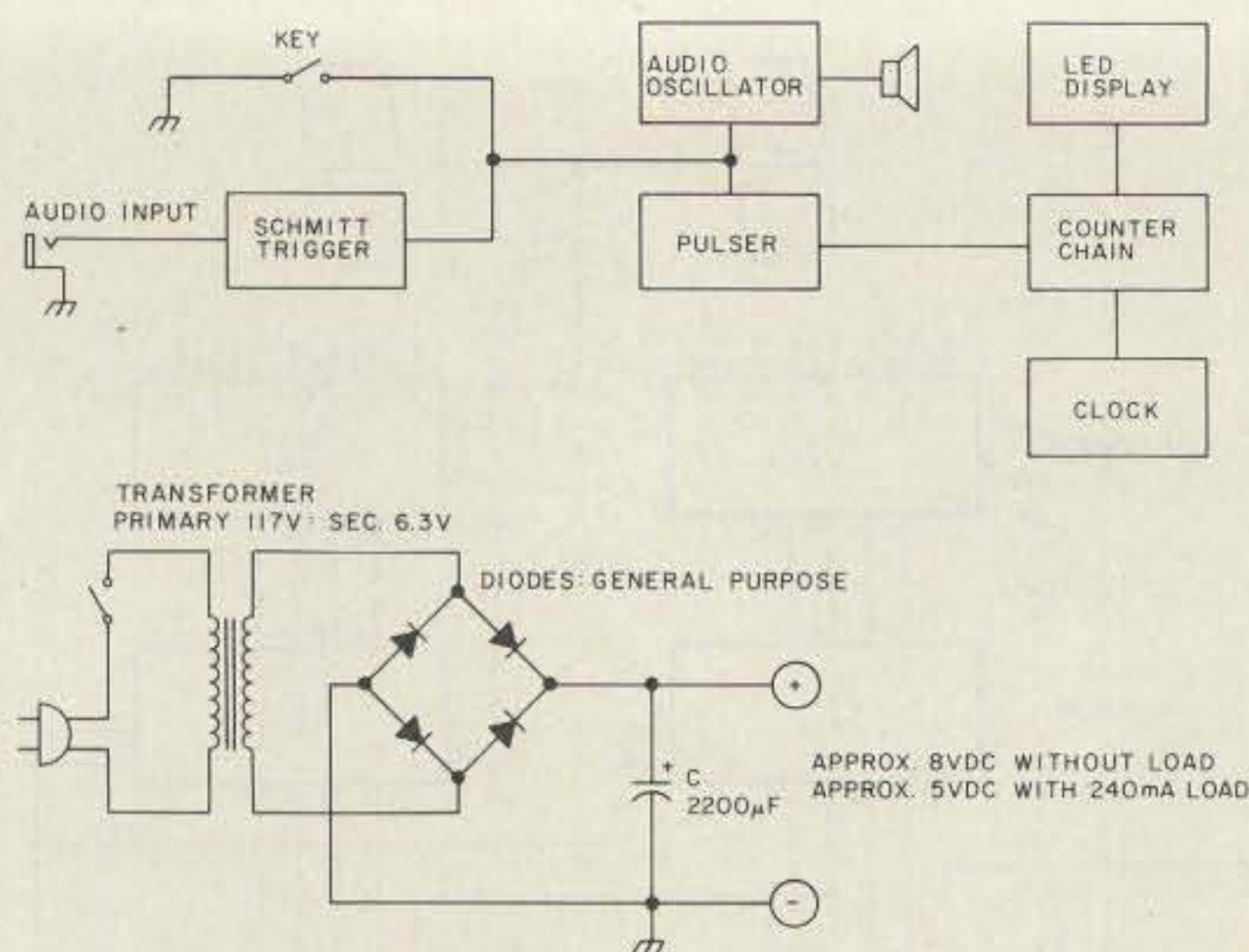

Fig. 2.

### Parts List

Component		Price*
R1,R2	4.75k Ohms, 1/4 Watt	5 for .25
R3	10k Ohms, variable (trimmer MDL TR11)	.35
R4	10k Ohms, 1/4 Watt	5 for .25
R5	1 megohm, variable (trimmer MDL TR11)	.35
R6	15k Ohms, 1/4 Watt	5 for .25
R7,R8	560 Ohms, 1/4 Watt	5 for .25
R9	100 Ohms, 1/4 Watt	5 for .25
C1	.047-µF disc	5 for .30
C2	4.7 µF/16 V	.14
C3,C4	1 µF/16 V	2 @ .15 = .30
C5,C7,C8	.01-µF disc	5 for .30
C6	10 µF/16 V	.14
D1-D4	diodes 1N4006	10 for 1.00
U1	SN 7413 dual Schmitt trigger	.40
U2,U3,U4	LM555 timer	3 @ .39 = 1.17
U5,U6	SN7490 decade counter	2 @ .45 = .90
U7,U8	SN7475 quad latch	2 @ .49 = .98
U9,U10	SN7447 BCD-to-7-segment	2 @ .59 = 1.18
Readouts	MAN-81 common anode	2 @ .99 = 1.98
Speaker	2"-3" Radio Shack 40-247	1.89

### Options

LED 1	LED monitor may be any small LED	
Perfboard	.10 spacing 4½ × 6, Radio Shack 276-1394	1.29
Input Transformer	Radio Shack 273-1380	.99
IC sockets:	8-pin wire-wrap	3 @ .39 = 1.17
	14-pin wire-wrap	3 @ .39 = 1.17
	16-pin wire-wrap	4 @ .43 = 1.72

### Parts for Power Supply

Filter capacitor	2200 µF/16 V	
Filament transformer	117/6.3 V Radio Shack 273-1384	1.99
Diodes — any general-purpose diodes		

\*Except where Radio Shack parts are specified, all prices are from the 1979 catalog of Jameco Electronics, 1021 Howard St., San Carlos CA 94070. (Add 5% for shipping and 75¢ for insurance. Minimum order, \$5.00.) Delivery time 8-10 days.

Keep your cost down by substituting when possible. For instance, you need only one of the .047-µF disc capacitors, but you must order a minimum of five. Use the balance of them for C5, C7, and C8 instead of the .01 µF called for. Also, the Radio Shack catalog lists 1/2-Watt resistors at 2 for 19¢. This is a slightly higher cost per resistor, but you can buy a minimum of two.

voltage rises much above 5.5 volts. Despite this narrow operating range, the power supply need not be complicated. Four C or D cells in series will do, or you can make a power supply from a 6.3-volt filament transformer as shown in the drawing. Use just about any general-purpose diodes in the bridge rectifier. (You can probably get a package of a dozen or so for a dollar at Radio Shack.) The filter capacitor need not be exactly 2000 µF; use whatever you have that's close.

The measured output from the power supply above will be about 8 volts without a load. However, under the load presented in this device, the output drops to a little over 5 volts.

The power supply should be mounted on the base of the cabinet. Be sure to leave room for mounting a small input transformer—as will be discussed later.

Construction will be greatly simplified by using a perforated board with .10-inch spacing. The ICs can be mounted on this board without drilling. The input terminals, the speaker, the readouts, and the LED monitor will need to be mounted on the face of the cabinet. In my own construction, I used the perf-board as the face of the cabinet and mounted everything in plain sight.

However you may decide to do it, you may lay the parts out in much the same configuration as is shown in the schematic. You will need to provide for three common points of connection: a positive bus, a negative or ground bus, and a trigger bus.

Except for R5 and C6, the values of the resistors and capacitors may be varied up to 25% without seriously affecting performance. Use your junk box. I strongly recommend the use of IC sockets. They make construction and troubleshooting much easier. The wire-

wrap type of socket is slightly more expensive, but it is easier to work with.

The cheapest way to provide for the input is to leave wires hanging from the two inputs which then may be connected to the key or the receiver. The wire for the input from the receiver should be provided with a plug for the phone jack of your receiver.

The input transformer (T1) is a voltage step-up transformer and may not be needed with your receiver. Measure the output voltage at the phone jack of your receiver by inserting a phone plug connected to your volt ohmmeter. Tune a CW signal. If you have at least 3 volts peak ac at the phone jack, you may eliminate the input transformer, but better performance will be obtained from all receivers if the transformer is used. If a transformer is needed, use any step-up transformer you have. I used an output transformer from an old receiver, connected backwards so that it stepped up the voltage.

The bias control (R3) and the calibrate control (R5) need be set only once, so they may be mounted inside the cabinet.

Put a 100-Ohm resistor in series with the common anode or common cathode of the LED displays. Be sure to determine whether you are using a common-anode or a common-cathode type of display before ordering your BCD-to-seven-segment decoders. A common anode requires a 7447 and a common cathode requires a 7448. Of course, the common anode is tied to the positive bus (through the limiting resistor) and the common cathode is tied to the negative bus (through the limiting resistor).

The choice of LED displays should be governed by cost and availability. The MAN-71 (red) or MAN-81 (yellow) fit nicely into a 14-pin IC socket and



cost about a buck each. The FND-70 costs about 70 cents, but is available only in the common-cathode type.

### Calibration and Operation

Turn the power on and rotate the bias control (R3) until a continuous sound is heard from the speaker. Then reverse the rotation of the bias control until the sound just stops. Leave the control set here.

If no tone is heard, check wiring to U1 and U2. If the volume is too low, increase the value of C2; if it is too high, decrease the value of C2. If you desire to raise the pitch of the tone, you may place another resistor in parallel with R2.

Connect a key to the key input and tap it a few times. There should be an audio output and a reading should appear. After a few seconds more, the reading should drop to zero. This in-

dicates all systems are working.

Begin tapping the key with a steady rhythm, counting the taps for a full minute. Multiply the count by .08 and this will be the number of words per minute. (For instance, if the count is 77, multiply 77 by .08 to arrive at 6.16 or 6 words per minute.) Again tap the key with the same steady rhythm and rotate the calibrate control (R5) until the readings correspond to the computed words per minute. (Using the above example, the readings should show 6. If the machine is set perfectly, and if the timing of the taps is perfect, the machine should read 6 most of the time. But, since we obviously are not dealing with exactly 6 wpm, the reading should jump up to 7 a couple of times during the test minute.) You can get better calibration by trying several

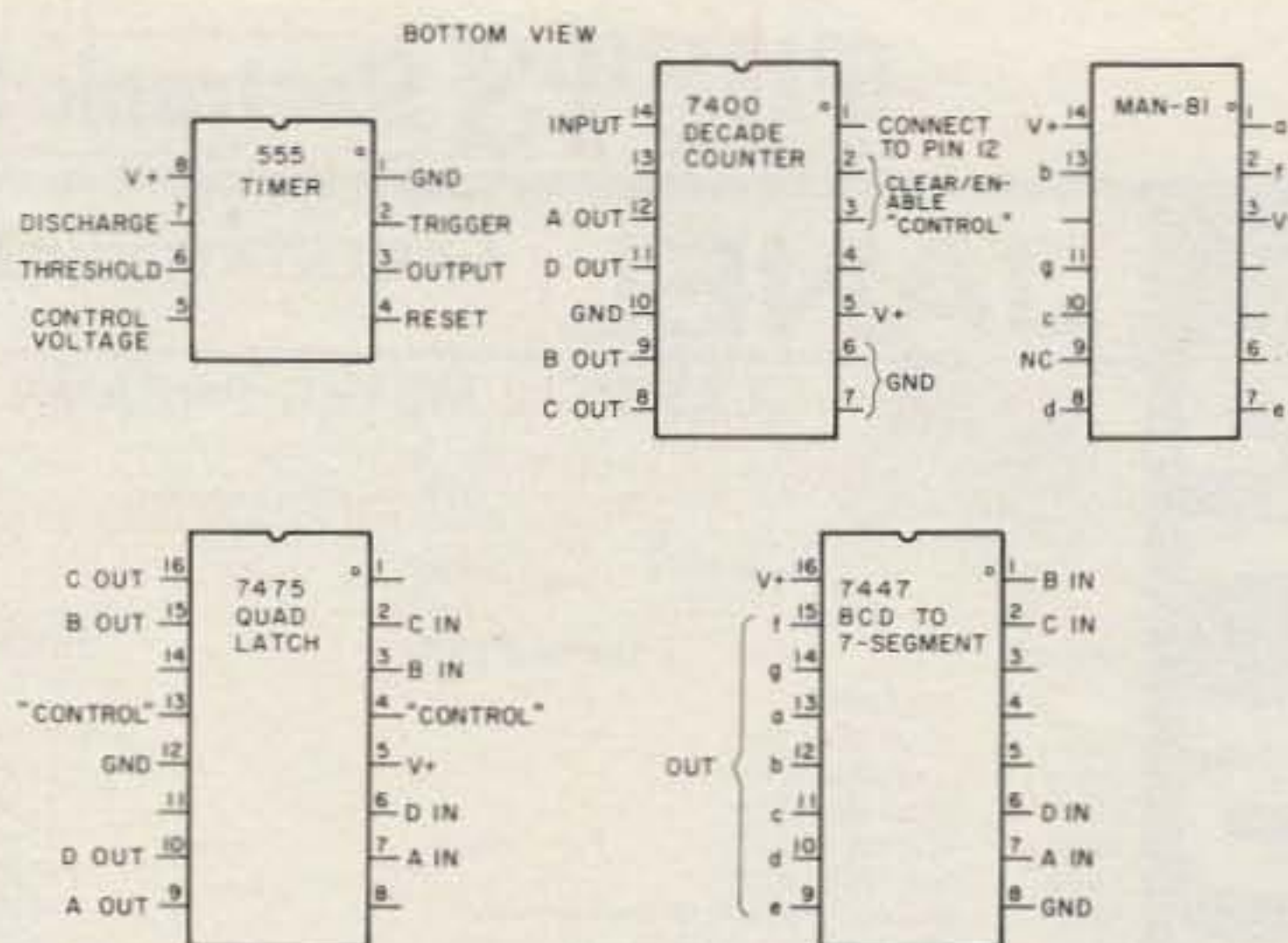

Fig. 3.

times at different speeds.

Now turn on the receiver and tune a good CW signal. Connect the receiver input of the Confidence Machine to the phone jack of the receiver. Start with the volume low and increase it until you begin hearing clean dots and dashes. Too high a setting of the volume will cause a continuous

tone and also cause the trigger to be tripped by noise. This gives a false count. So keep the volume as low as possible.

The Confidence Machine is intended to be a learning tool only, and it is doubtful if it can be used in an actual QSO. However, it is fun to build and is certainly fun to use. Try it; you'll like it! ■

\*\*\*\*\*  
 Available IMMEDIATELY  
 Write for Features/Specs  
 ☆ **TRS-80/RTTY** ☆  
 THE CROWNING TOUCH  
**ROM-116**  
 THE COMPLETE AMATEUR RTTY OPERATING SYSTEM  
 CROWN MicroProducts  
 P. O. BOX 892  
 Marysville, Wa. 98270  
 206-659-4279/206-659-9512  
 ✓16



Organize your shack with a  
**CLUTTERFREE MODULAR  
 CONSOLE \$179.95**

- Large, 42" H x 57" W x 29" D
- Strong groove-construction
- Mar-resistant wood grain finish
- Options, drawers & face plate
- For ham or home computer
- Visa and Master Charge

**CLUTTERFREE  
 MODULAR  
 CONSOLES** ✓89

P.O. Box 5103 Tacoma, WA 98405  
 (206) 572-8570 9 a.m.—5 p.m.  
 (206) 759-1611 Evenings

IRON POWDER and FERRITE PRODUCTS

**AMIDON**  
 Associates ✓334

Fast, Reliable Service Since 1963

Small Orders Welcome Free 'Tech-Data' Flyer

Toroidal Cores, Shielding Beads, Shielded Coil Forms  
 Ferrite Rods, Pot Cores, Baluns, Etc.

12033 OTSEGO STREET, NORTH HOLLYWOOD, CALIFORNIA 91607



TUFTS Electronic Department Store TUFTS

## JANEL LABORATORIES



### CLASSIC 2 METER PREAMP

This widely used 2 meter preamp is probably the most sensitive available today. One model provides a uniformly low noise figure across the full band. Equally applicable for DX, AM, SSB, FM and OSCAR. 18 dB gain, 2 dB noise figure, 12 vdc power (5mA) BNC connectors. Aluminum box is 1 1/2"x2 1/2"x2 1/2".  
**Model 144PB 144-148MHz**

MODEL	DESCRIPTION	PRICE
<b>PREAMPS</b>		
30PB	28-30 MHz (BNC)	\$ 21.95
50PB	50-52 MHz (BNC)	21.95
53PB	52-54 MHz (BNC)	21.95
137PB	135-139 MHz (BNC)	21.95
144PB	144-148 MHz (BNC)	21.95
PM-1	2m Preamp Module (Solder Terminals)	16.95
QSA 5	144-148 MHz for Transceivers (SO-239)	41.95
QSA 6	50-52 MHz (SO-239)	43.95
220PB	220-225 MHz (BNC)	21.95
432PA	420-450 MHz (BNC) 3.5 dB maximum NF	33.00
432PC	420-450 MHz (BNC) 2.0 dB maximum NF	54.95
432PE	1.0 dB typical NF	90.00
PB	Any single frequency between 30 and 50, or 148-174 MHz (BNC)	27.00
<b>CONVERTERS</b>		
144CF	144-146 MHz IN, 28-30 MHz OUT (BNC)	\$ 79.95
	2nd crystal for 144CF (146-148 IN, 28-30 OUT)	12.00
432CF	432-434 MHz IN, 28-30 MHz OUT (BNC)	79.95
	2nd crystal for 432CF (434-436 IN, 28-30 OUT)	10.00
	(Also available with 434-436 MHz IN and 28-30 MHz OUT, (Oscar 8, Mode J)	79.95
<b>OSCILLATORS</b>		
O1-A	Precision, Specify 4 or 10 MHz	\$ 79.95
D1-A	10 to 1 Digital Divider	11.95
D8-A	Eight, 10 to 1 Dividers	27.95
<b>USEFUL ACCESSORIES</b>		
17013	BNC to BNC, 36" RG-58C/U Cable	\$ 6.00
17010	BNC to UHF, 36" RG-58C/U Cable	6.00
17014	BNC to RCA Phono, 36" RG-58C/U Cable	6.00
03005	Adaptor, BNC Plug to UHF Jack	4.00
03006	BNC Connector, UG-88/U for RG-58 size cable	1.25
<b>MISCELLANEOUS</b>		
ISOLINE	Antenna Isolator, 144-174 MHz (SO-239)	\$ 14.95
432FA	Cavity Filter, .5 dB loss	105.00
432FA .2	Cavity Filter, .2 dB maximum loss	115.00



### UHF PREAMPS \$33.00

Low Cost All Around Favorite

This two stage amplifier provides high sensitivity across the full 420 to 450 MHz band. A low 3.5 dB noise figure makes this preamp ideal for most amateur applications. Can be used for all modes: 17dB gain, 12vdc power (10mA). BNC connectors (50 ohms) aluminum box 1 1/2"x4x2".  
**Model 432PA 420-450MHz**

### Extremely Sensitive \$54.95

This preamp provides a low noise figure required for demanding applications. A premium state-of-the-art transistor is used to provide extremely high sensitivity. Two stages, 20 dB gain, 2 dB maximum noise figure (1.7 dB typical). 12 volt dc power BNC connectors.  
**Model 432PC 420-450MHz**

### QSA5 PREAMP For Transceivers

The QSA 5 preamp is a high performance, low noise preamp for improving the receiving sensitivity of 2 Meter transceivers. This preamp features easy installation with no modification to the transceiver required. This preamp can be used with virtually all 2 meter transceivers and on all modes — FM, SSB, CW or AM. Relays in the QSA 5 automatically bypass the preamp when transmit power is sensed. A LED indicator shows the status of the QSA 5. A front panel switch allows the preamp to be bypassed while receiving. The low noise figure of the QSA 5 provides for exceptional sensitivity. The gain has been set to optimize the performance with 2 meter transceivers.



Model PM-1

### PREAMP MODULE

This low noise preamp is designed to be easily incorporated into new or existing 2 meter equipment. Solder pins are provided for mounting to a PC board or for connection to wire or coax. Uses low noise JANEL MOSFET circuitry. Each unit is fully tested for gain and noise figure. Quantity prices are available for OEM's.



### For 6 Meter Transceivers \$43.95

All of the features of our popular QSA-5 but for 6 meters. Fully compatible with transceivers running 30 watts or less. All mode use. Noise Figure 2dB. Gain, 15dB. VSWR (transmit) 1.2. Available for 50-52 or 52-54MHz (specify when ordering). UHF connectors. **Model QSA-6.**



### \$90.00

### Our Finest UHF Preamp—1.0 dB NF

This outstanding 432 MHz preamp provides the lowest practical noise figure. The finest transistors available today are combined with the ultimate in construction and alignment. Single stage Gain 15dB (min) Noise Figure 1.2dB (max including measurement uncertainty). 0.8 to 1.0dB typical. Bandwidth 100 MHz. 12 volts at about 7 mA. Type N connectors. Size 1 1/2"x3x1 1/2" inches. Center Frequency 400 to 512 MHz (specify when ordering). **Model 432PE.**



### 10 METER PREAMP Oscar Special

Ideal for pulling weak satellite signals out of the noise. This preamp has been responsible for producing many "impossible" OSCAR QSO's. 18 dB gain, 2 dB noise figure, 12vdc power (5mA). BNC connectors. Aluminum box is 1 1/2"x2 1/2"x2 1/2".  
**Model 30 PB 28-30MHz.**

### 6 METER PREAMP \$21.95

### Ideal for DX

This low noise preamp significantly improves the sensitivity of most 6 meter receivers. Available in two frequency versions to cover DX and FM portions of the band. 18 dB gain, 2 dB noise figure, 12 vdc power. BNC connectors.  
**Model 50PB 50-52MHz, Model 53PB 52-54MHz.**

### 220 MHz \$21.95

### Low Noise Preamp

1 1/4 Meters-Covers full 220-225 MHz range with 15 dB gain, 3 dB noise figure, 12 volt power and BNC connectors. **Model 220PB.**

\$65.95



## DAIWA

\$105.00 RF-660



RF-440 \$135.95

Coaxial Switches  
 2 Position/Model CS-201  
 4 Position/Model CS-401

### SWR & Power Meters

Models CN-720, CN-620 and CN-630

Professionally engineered cavity construction. Power Rating: 2.5kW PEP, 1kW CW. Impedance: 50 Ohms. Connectors: SO-239. Insertion Loss: Less than 2 dB. VSWR: 1:1.2. Maximum Frequency: 500 MHz. Isolation: Better than 50 dB at 300 MHz; better than 45 dB at 450 MHz; adjacent terminal. Unused Terminals grounded.



CN-720 \$166.95

**RF Speech Processor**  
 Models RF-400 & RF-660  
 Increases talk power with splatter free operation. RF clipping assures low distortion. Simply install between microphone and transmitter.  
 Talk Power: Better than 6 dB.  
 Frequency Response: 300-3000 Hz at 12 dB down.  
 Distortion: Less than 3% at 1 kHz, 20 dB clipping.  
 Power Requirement: RF-440 self contained. AC power supply: RF-660 13.5Vdc external supply.

**CN-720 and CN-620**  
 Frequency Range: 1.8-150 MHz  
 SWR Detection Sensitivity: 5W min.  
 Power: 3 Ranges (Forward, 20/200/100W) (Reflected, 4/40/200W)



\$140.50 CN-620

### Interference Filters from J. W. Miller

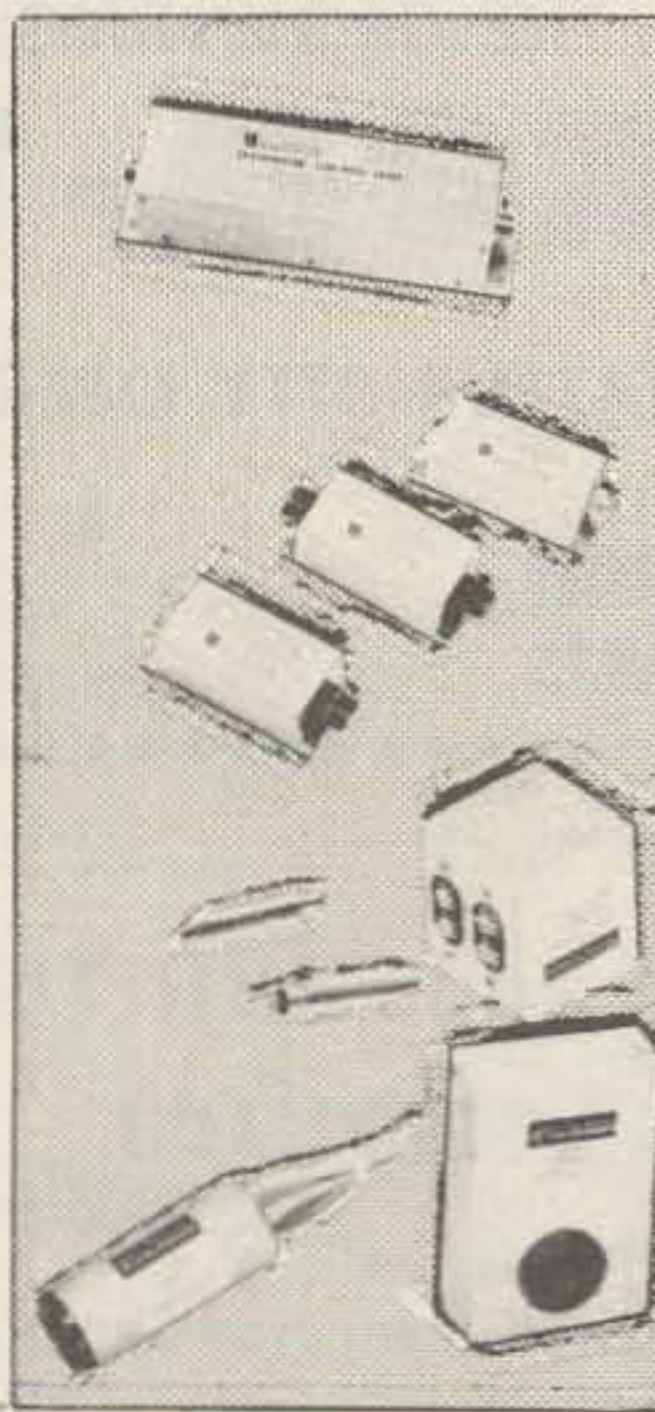

### Low Pass Filters

Eliminate or greatly reduce interference to TV receivers by radio amateur stations when installed in antenna lines of those transmitters. Input and output impedance 50 ohms. Insertion loss .3 dB max. / VSWR 1.2:1. Attenuation greater than 75 dB above 41 MHz.  
 C-511-T: 25 W AM 50 W PEP SSB \$19.50  
 C-514-T: 1000 W AM 2000 W PEP SSB \$26.80

### High Pass Filters

When installed in the antenna, eliminate or greatly reduce front end overload interference to TV or FM receivers caused by amateur radio transmitters and other high frequency radio services. Filter attenuates signals below 40 MHz by a power factor greater than 1,000,000:1. Impedance C-513-T 1.75/300 ohm \$10.18  
 C-513-T2: 75/75 ohm; C-513-T3: 300/300 ohm \$10.18

### Audio Interference Filters

Eliminate interference caused in your audio equipment by radio amateur transmitters and other radio services. C-505-R installs in the input lines of audio equipment. Consists of 1 pair. C-506-R installs in speaker lines. Unit will take care of stereo speaker system. \$5.07  
 C-506-R \$6.67

### AC Power Line Filters

Eliminate or reduce interference to radio amateur receivers, TV's and radios, and prevent radio signals from entering power line.  
 C-508-L: 3-section LC filter, 3 A max. \$ 8.33  
 C-509-L: 5-section LC filter (for more severe interference), 5 A max. \$18.35

**CN-630**  
 Frequency Range: 140-450 MHz  
 Power: 2 Ranges (Forward 20/200W) (Reflected 4/40W)

CN-630 \$139.00





## BIRD Electronic Corporation

\$99 VHF model 4362 (140-180 MHz)  
\$99 HF model 4360 (18-30 MHz)

The 4360, 4362 HAM-MATE Directional Wattmeters are insertion type instruments for measuring forward or reflected power in 50-ohm coaxial transmission lines. They are direct descendants of the model 43 THRULINE® Wattmeter — the professional standard of the industry — and will accurately measure RF power flow under any load condition. Each wattmeter is made up of a precisely machined section of 50-ohm line, a rotatable sensing element and meter calibrated in watts, all mounted in a high-impact plastic housing. It is this type of solid construction and the directional THRULINE coupling circuit, without toroids, that account for the superiority of the HAM-MATE Wattmeters.

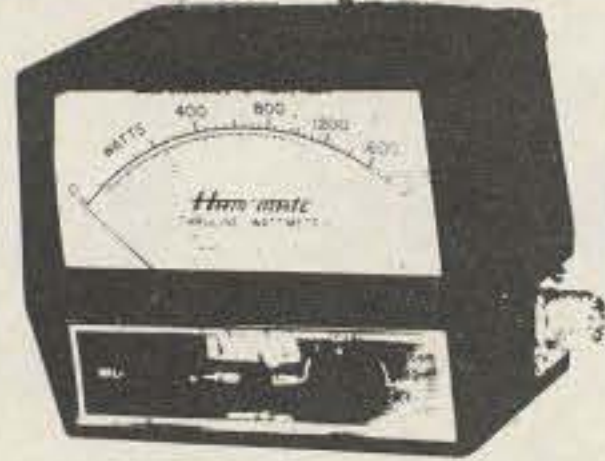

the indispensable  
**BIRD 43**  
THRULINE  
WATTMETER



Power Range	Frequency Bands (MHz)				
	2-30	25-60	100-250	200-500	400-1000
5 watts	—	5A	5C	5D	5E
10 watts	—	10A	10C	10D	10E
25 watts	—	25A	25C	25D	25E
50 watts	50H	50A	50C	50D	50E
100 watts	100H	100A	100C	100D	100E
250 watts	250H	250A	250C	250D	250E
500 watts	500H	500A	500C	500D	500E
1000 watts	1000H	1000A	1000C	1000D	1000E
2500 watts	2500H	—	—	—	—
5000 watts	5000H	—	—	—	—

MODEL 43  
Elements (Table 1) 2-30 MHz \$135.00  
Elements (Table 1) 25-1000 MHz 50.00  
Carrying case for Model 43 & 6 elements 42.00  
Carrying case for 12 elements 28.00  
Carrying case for 12 elements 17.00

READ RF WATTS DIRECTLY! (Specify Type N or SO239 connectors) 0.45 — 2300 MHz, 1-10,000 Watts ±5%, low insertion VSWR — 1.05. Unequalled economy and flexibility. Buy only the element(s) covering your present frequency and power needs, add extra ranges later if your requirements expand.

## AMPHENOL BUNKER RAMO

**SERIES 31 — BNC CONNECTORS**  
Amphenol's BNC connectors are small, lightweight, weatherproof connectors with bayonet action for quick disconnect applications.

Shells, coupling rings and male contacts are accurately machined from brass. Springs are made of beryllium copper. All parts in turn are ASTRO-plated® to give you connectors that can take constant handling, high temperatures and resist abrasion.

**BNC BULKHEAD RECEPTACLE 31-221-385 UG-1094**  
Mates with any BNC plug. Receptacle can be mounted into panels up to 1/4" thick. \$1.25



**BNC (M) TO UHF (F) ADAPTER 309-2900-385 UG-255**  
Adapts any BNC jack to any UHF plug. \$3.63



**DOUBLE MATE ADAPTER 83-877-385**  
Both coupling rings are free turning. Connects 2 female components. \$2.72



**JACK ADAPTER 575-102-385**  
Adapts 83-1SP-385 to Motorola type auto antenna jack or pin jack. \$1.95



**PANEL RECEPTACLE 83-1R-385 SO239**  
Mounts with 4 fasteners in 21/32" diameter hole. \$1.17



**BNC (F) TO UHF (M) ADAPTER 31-028-385 UG-273**  
Adapts any BNC plug to any UHF jack. \$2.39



**PUSH-ON 83-5SP-385**  
Features an unthreaded, springy shell to push fit on female connectors. \$2.27



**LIGHTNING ARRESTOR 575-105-385**  
Eliminates static build-up from antenna. Protects your valuable equipment against lightning damage. \$4.80



**BNC PLUG 31-002-385 UG-88**  
Commonly used for communications antenna lead cables. For RG 55/U & RG 58/U cables. \$1.59



**BNC STRAIGHT ADAPTER 31-219-385 UG-914**  
1 9/32" long, allows length of cables to be joined. Mates with BNC plugs. \$2.12

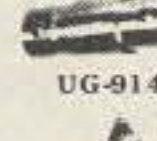

**BNC PANEL RECEPTACLE 31-003-385 UG-290**  
Mounts with 4 fasteners in 29/64" diameter hole. \$1.74

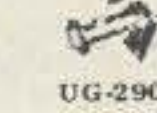

**83-878-385 SO239SH**  
Mounts in single 21/32" diameter hole. Knurled lock nuts prevent turning. \$1.59



**BNC ANGLE ADAPTER 31-009-385 UG-306**  
Adapts any BNC plug for right angle use. \$4.23



**BNC TEE ADAPTER 31-008-385 UG-274**  
Adapts 2 BNC plugs to 31-003-385 or other female BNC type receptacle. \$4.56



First is the Fox XK. It reads all bands and tucks away on the visor.



Our remote (RW) unit is "out-of-sight" when installed. Out-of-sight in performance, too.



**And now there's Superfox!**  
The first remote, superheterodyne radar warning system. Superfox has 10 times the sensitivity capability of any conventional radar detector. It is ideal for custom installations.

### PRICE LIST

Order No.	Description	Price
60	Fox XK All band detector w/self contained aural/visual alarm	\$109.00
60-2	Fox XK (RW) All band detector w/remote control, waterproof	\$139.00
60-3	Super Fox Super-Heterodyne remote radar warning system	\$299.95

## HITACHI OSCILLOSCOPES

SPECIAL!  
15% OFF ALL  
HITACHI SCOPES

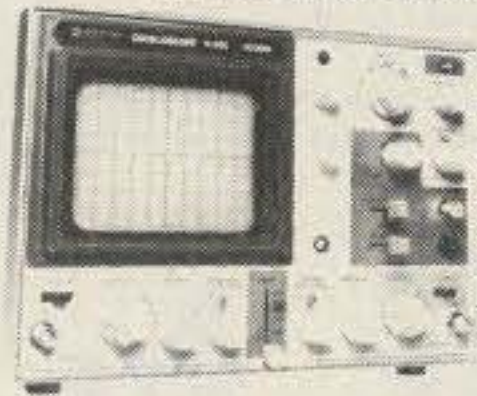

Single and dual trace, 15 and 30 MHz. All four high sensitivity Hitachi oscilloscopes are built to demanding Hitachi quality standards and are backed by a 2-year warranty. They're able to measure signals as low as 1mV/division (with X5 vertical magnifier). It's a specification you won't find on any other 15 or 30 MHz scope. Plus: Z-axis modulation, trace rotation, front panel X-Y operation for all four scope models, and X10 sweep magnification. And, both 30 MHz oscilloscopes offer internal signal delay lines. For ease of operation, functionally-related controls are grouped into three blocks on the color coded front panel.

- V-302 30 MHz Dual Trace \$850.50
- V-301 30 MHz Single Trace \$670.50
- V-152 15 MHz Dual Trace \$625.25
- V-151 15 MHz Single Trace \$490.50

## ALLIANCE



\$99.00

### HD-73 HEAVY-DUTY ROTATOR

with exclusive Dual-Speed Control!

For antennas up to 10.7 sq. ft. of wind load area. Mast support bracket design permits easy centering and offers a positive drive no-slip option. Automatic brake action cushions stops to reduce inertia stresses. Unique control unit features DUAL-SPEED rotation with one five-position switch. SPECIFICATIONS: Max. wind load bending moment — 10,000 in.-lbs. (side-thrust overturning); Starting torque — 400 in.-lbs.; Hardened steel drive gears; Bearings — 100-3/8" diameter (hardened); Meter — D'Arsonval, taut band (back-lighted). There's much, much more.



## Two NEW Rotors from Cornell-Dubilier

### TAIL TWISTER™

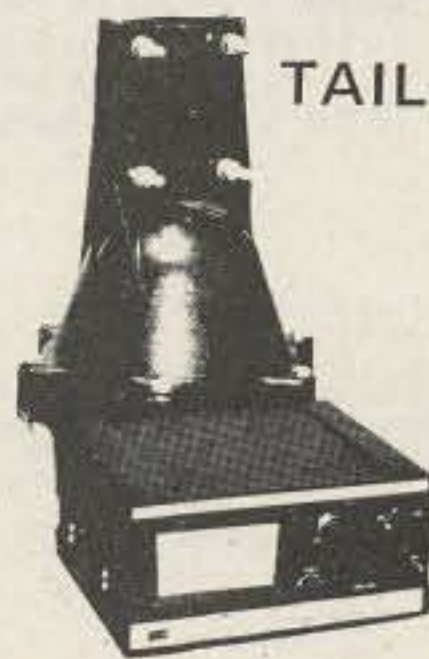

### HAM IV



- For the New Super Communications Antennas
- New Thickwall Casting
- New Steel Ring Gear
- New Metal Pinion Gear
- New Motor Prebrake
- New Super Wedge Brake
- New L.E.D. Control Box
- Safe 26 Volt Operation

Designed for the newest of the king-size communications antennas, the TAIL TWISTER™ is the ultimate in antenna rotational devices. The TAIL TWISTER™ starts with a deluxe control box featuring snap action controls for brake and directional controls; L.E.D. indicators signal rotation and brake operation, while the illuminated meter provides direction readout. This new control box couples to the newest bell rotor. Using the time tested bell rotor principle, the TAIL TWISTER™ is a brand new design with thickwall castings and six bolt assembly. A brand new motor with prebrake action brings the antenna system to an easy stop, while the massive square front brake wedge locks the assembly in place. A new stainless steel spur gear system provides final drive

into a new steel ring gear for total reliability. Triple race, 138 ball bearing assembly carries dead weight and maintains horizontal stability.

An optional heavy duty lower mast adaptor is available for lighter loads with mast mounting. Price: \$279.00

The HAM IV sets new levels of performance. Snap action switched wedge brake and rotational controls brings pinpoint accuracy to large directional arrays popular in communications. A new motor provides pre-brake action to assist in slowing down rotational mass, and the new thicker wedge brake offers far stronger lock-in phase action. To take full advantage of this new design, the HAM III is designed for in-tower mounting. A new optional heavy duty lower mast adaptor is available when the HAM III is to be mast mounted with smaller arrays. A stainless steel spur gear system multiplies the torque into the dual race 98 ball bearing support assembly assuring years of trouble free performance. Price: \$189.00

TUFTS Electronic Department Store TUFTS



## PROFESSIONAL HEADPHONES & HEADSETS BOOM MIC HEADSETS

For the ultimate in communications convenience and efficiency select a boom mic headset. Long-time favorites of professional communications, boom mic headsets allow more personal mobility while always keeping the mic properly positioned for fast, precise voice transmission. Boom microphones are completely adjustable to allow perfect positioning. And, boom headsets leave both hands free to perform other tasks.

All models are supplied with "close talking" microphones to limit ambient noise pick-up and provide superior intelligibility. Each model as a convenient, inline push-to-talk switch, which can be wired for either push-to-talk relay control or mic circuit interrupt for voice operated transmitters. The switch may be used as a momentary push-button or it can be locked in the down position. All models have tough, flexible, 8 foot cords which are stripped and tinned, unterminated.

## TELEX



C-610 C-1210 C-1320



**Headphone Jack Box**  
Ham Clubs, field day contest operation. No more jury rigs for multiple headphones. Six 1/4" phone jacks with individual volume controls, 4 foot cord with 1/4" phone plug.  
**\$14.30**

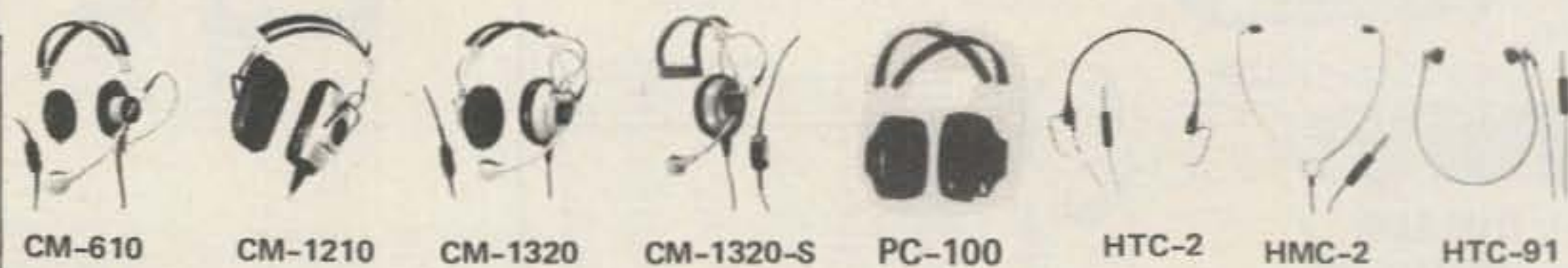

CM-610 CM-1210 CM-1320 CM-1320-S PC-100 HTC-2 HMC-2 HTC-91

MODEL	C-610	SWL-610	C-1210	C-1320	CM-610	CM-1210	CM-1320	CM-1320S	PC-100	HTC-2	HMC-2	HFC-91
Headphone Sensitivity Ref 0002 Dynes/cm <sup>2</sup> @ 1mW input. 1kHz	103dB SPL ±5dB	103dB SPL ±5dB	103dB SPL ±3dB	105dB SPL ±5dB	103dB SPL ±5dB	103dB SPL ±3dB	105dB SPL ±5dB	105dB SPL ±dB				
Headphone Impedance	3.2 20 ohms	2000 ohms	3.2 20 ohms	3.2 20 ohms	3.2 20 ohms	3.2 20 ohms	3.2 20 ohms	3.2 20 ohms	8 200 ohms	3.2 20 ohms	3.2 20 ohms	3.2 20 ohms
Microphone Frequency Response					50 8000 Hz	50 8000 Hz	50 8000 Hz	50 8000 Hz	50 1200 Hz	100 3000 Hz	100 3000 Hz	100 3000 Hz
Microphone Impedance					High	High	High	High	Low	Low	Low	Low
Microphone Sensitivity Below 1 volt/microbar at 1 kHz					51 dB ±5 dB	51 dB ±5 dB	51 dB ±5 dB	51 dB ±5 dB				
PRICE:	\$10.45	\$12.25	\$29.70	\$41.80	\$47.20	\$62.75	\$75.25	\$59.95	\$16.95	\$24.50	\$15.50	\$9.90

**THOMSON-CSF NPC ELECTRONICS**

MODEL	PRICE	MODEL	PRICE
12V4	\$19.95	104R	\$ 59.95
102	26.95	108RA	89.95
107	36.95	108RM	99.95
103R	42.95	109R	159.95



**MODEL 109R**  
NPC 25 Amp Regulated Power Supply. 4-Way Protected Output Voltage and Current Meters.  
Extra heavy-duty unit quietly converts 115 volts AC to 13.6 volts DC - 200 millivolts, 10 amps continuous, 25 amps max. All solid state. Features dual current overload, overvoltage and thermal protection. Ideally suited for operating mobile Ham radio 2 meter AM-FM-SSB transceivers in your home or office. Excellent bench power supply for testing and servicing of mobile communications equipment.

	TYPICAL	MAXIMUM
Output Voltage	13.6 ±2VDC	13.6 - 3VDC
Line/Load Regulation	50 mV	100 mV
Ripple/Noise	5 mV RMS	10 mV RMS
Transient Response	20 µSec	
Current Continuous	10 Amp	
Current Limit	25 Amp	
Overvoltage Protection	14.5 V	15 V
Thermal Overload	180 F	

Case: 4" (H) x 5" (W) x 8" (D). Shipping Weight: 15 lbs.

**MODEL 107**

NPC 4 Amp Power Supply, 6 Amp Max. Solid State, Overload Protected



Functions silently in converting 115 volts AC to 12 volts DC; 4 amps continuous, 6 amps max. Enables anyone to enjoy CB radio, car 8-track cartridge, cassette player or car radio in a home or office.

	4 Amp	1.75 Amp
Continuous Current (Full Load)	4 Amp	1.75 Amp
Output Voltage (No Load)	16 V max	16 V max
Output Voltage (Full Load)	12 V min	12 V min
Filtering Capacitor	10,000 µF	5,000 µF
Ripple (Full Load)	5 V RMS	4 V RMS
Short Circuit Protection	Thermal Breaker	Thermal Breaker

Case: 3" (H) x 4" (W) x 5" (D). Shipping Weight: 5 lbs.

**MODEL 12V4**

NPC 1.75 Amp Power Supply, 3 Amp Max.



Functions silently in converting 115 volts AC to 12 volts DC. Ideally suited for most applications including 8-track stereo, burglar alarm, car radio and cassette tape player within power rating.

	1.75 Amp
Continuous Current (Full Load)	1.75 Amp
Output Voltage (No Load)	16 V max
Output Voltage (Full Load)	12 V min
Filtering Capacitor	5,000 µF
Ripple (Full Load)	4 V RMS
Short Circuit Protection	Thermal Breaker

Case: 3" (H) x 4" (W) x 5" (D). Shipping Weight: 3 lbs.

**MODEL 108RM**  
NPC 12 Amp Regulated Power Supply. Solid State. 3-Way Protected. Current Meter.

This heavy-duty unit quietly converts 115 volts AC to 13.6 volts DC - 200 millivolts, 8 amps continuous, 12 amps max. All solid state. Features dual current overload and overvoltage protection. Ideally suited for operating mobile Ham radio 2 meter AM-FM-SSB transceivers in your home or office. Can also be used to trickle-charge 12-volt car batteries.

	TYPICAL	MAXIMUM
Output Voltage	13.6 ±2VDC	13.6 - 3VDC
Line/Load Regulation	20 mV	50 mV
Ripple/Noise	2 mV RMS	5 mV RMS
Transient Response	20 µSec	
Current Continuous	8 Amp	
Current Limit	12 Amp	
Current Feedback	2.5 Amp	
Overvoltage Protection	14.5 V	15 V

Case: 4" (H) x 7" (W) x 5" (D). Shipping Weight: 9.5 lbs.

ALSO AVAILABLE AS MODEL 108RA WITHOUT METER AND OVERVOLTAGE PROTECTION.



**MODEL 104R**

NPC 6 Amp Power Supply. Regulated. Solid State. Dual Overload Protection.

Converts 115 volts AC to 13.6 volts DC - 200 millivolts. Handles 4 amps continuous and 6 amps max. Ideally suited for applications where excellent DC stability is important, such as CB transmission, small Ham radio transmitter, and high quality eight-track car stereos. Can be used to trickle-charge 12-volt car batteries.

	MAXIMUM	TYPICAL
Output Voltage	13.6 ± 2 VDC	13.6 ± 3 VDC
Line/Load Regulation	20 mV	50 mV
Ripple/Noise	2 mV RMS	5 mV RMS
Transient Response	20 µSec	
Current Continuous	4 Amp	
Current Limit	6 Amp	
Current Feedback	2 Amp	

Case: 3" (H) x 5" (W) x 6" (D). Shipping Weight: 8 lbs.

**MODEL 103R**  
NPC 4 Amp Regulated Power Supply. Solid State. Dual Overload Protection.

Converts 115 volts AC to 13.6 volts DC - 200 millivolts. Handles 2.5 amps continuous and 4 amps max. Ideally suited for applications where no hum and DC stability are important such as CB transmission, small Ham radio transmitter, and high quality eight-track car stereos. Can also be used to trickle-charge 12-volt car batteries.

	TYPICAL	MAXIMUM
Output Voltage	13.6 ± 2 VDC	13.6 ± 3 VDC
Line/Load Regulation	20 mV	50 mV
Ripple/Noise	2 mV RMS	5 mV RMS
Transient Response	20 µSec	
Current Continuous	2.5 Amp	
Current Limit	4 Amp	
Current Feedback	1 Amp	

Case: 3" (H) x 4" (W) x 5" (D). Shipping Weight: 4 lbs.



**MODEL 102**

NPC 2.5 Amp Power Supply, 4 Amp Max. Solid State. Overload Protected.

Functions silently in converting 115 volts AC to 12 volts DC; 2.5 amps continuous, 4 amps max. Enables anyone to enjoy CB radio, car 8-track cartridge, cassette tape player or car radio in a home or office.

	2.5 Amp
Continuous Current (Full Load)	2.5 Amp
Output Voltage (No Load)	16 V max
Output Voltage (Full Load)	12 V min
Filtering Capacitor	5,000 µF
Ripple (Full Load)	6 V RMS
Short Circuit Protection	Thermal Breaker

Case: 3" (H) x 4" (W) x 5" (D). Shipping Weight: 4 lbs.

## Unarco-Rohn

### COMPLETE 25G TOWER PACKAGES

**50' Guyed Tower:** Includes top section, 4 regular sections, base plate, rotor plate, 50' guy wire, 2 guy assemblies with torque bars, 3 concrete guy anchors and other miscellaneous hardware.

TOTAL REGULAR PRICE \$594.02  
SALE PRICE 464.02  
**SAVE \$130.00**

**50' Bracketed Tower:** Includes top section, 4 regular sections, base plate, rotor plate and universal house bracket.

TOTAL REGULAR PRICE \$366.15  
SALE PRICE 266.15  
**SAVE \$100.00**







**THE IAMBIC KEYSER PADDLE.** Features include: adjustable jeweled bearings ("Deluxe" only); tension and contact spacing fully adjustable; large, solid, coin silver contact points; 2 1/2 lb. chrome plated steel base rests on non-skid feet; lifetime guarantee against manufacturing defects. "Standard" model with textured gray base. \$49.50. "Deluxe" model with chrome plated base. \$65.00

**THE IMPROVED "ORIGINAL" VIBROPLEX.** Suitable for All Classes of Transmitting Work Where Speed and Perfect Morse Are Prime Essentials. This great new Vibroplex is a smooth and easy working BUG. It has won fame on land and sea for its clarity, precision and ease of manipulation. Can be slowed down to 10 words per minute or less or geared to as high rate of speed as desired. Maintains the same high quality signal at whatever speed, insuring easy reception under all conditions. Weight 3 lbs. 8 oz. Standard \$56.95 DeLuxe - Chromium base and top parts, with jeweled movement. \$69.95



**THE "LIGHTNING BUG" VIBROPLEX** High Quality Signals at All Speeds. Flat pendulum model. Weight 3 lbs. 8 oz. Standard - Polished Chromium top parts, grey base. \$69.95 Standard \$56.95



**THE "CHAMPION" VIBROPLEX** Weight 3 lbs. 8 oz. Without circuit closer. Standard finish only. Chromium finished top parts, with grey crystal base. \$56.95



**VIBRO-KEYER**  
Over the years, we have had many requests for Vibroplex parts to be used for construction of a keying mechanism for an electronic transmitting unit. This beautiful and most efficient "Vibro Keyer" is ideal for this job.  
**FEATURES OF THE "VIBRO-KEYER"**  
• Beautiful beige colored base, size 3 1/2" x 4 1/2", weight 2 1/2 pounds  
• Same large size contacts as furnished on Deluxe Vibroplex.  
• Same main frame and super finished parts as Deluxe Vibroplex  
Standard - \$49.50; Deluxe Finish \$65.00



No. SSK-1 \$23.95  
No. SSK-1CP Chrome - \$29.95

**NYE VIKING SQUEEZE KEY**  
Extra-long, finger-fitting molded paddles with adjustable spring tension, adjustable contact spacing. Knife-edge bearings and extra large, gold plated silver contacts! Nickel plated brass hardware and heavy, die cast base with non-skid feet. Base and dust cover black crackle finished. SSK-1 - \$23.45. SSK-1CP has heavily chrome-plated base and dust cover. Price - \$32.95

**CODE PRACTICE SET**

You get a sure, smooth, Speed-X model 310-001 transmitting key, linear circuit oscillator and amplifier, with a built-in 2" speaker, all mounted on a heavy duty aluminum base with non-skid feet. Operates on standard 9V transistor type battery (not included). Price - \$20.75  
**PHONE PATCH Model No. 250-46-1** measures 6-1/2" wide, 2-1/4" high and 2-7/8" deep. List price, \$36.50. Model 250-46-3, designed for use with transceivers having a built-in speaker, has its own built-in 2" x 6" 2 watt speaker. Measures 6-1/2" wide, 2-1/4" high and 2-7/8" deep. Price - \$46.50



No. 114-320-003 - \$11.70  
No. 114-322-003 - Brass - \$12.10  
No. 114-320-001 - \$9.70  
No. 114-322-001 - Brass - \$10.15  
No. 114-310-003 - \$9.65  
No. 114-312-003 - Brass - \$10.25

**NYE VIKING SPEED-X KEYS**

NYE VIKING Standard Speed-X keys feature smooth, adjustable bearings, heavy-duty silver contacts, and are mounted on a heavy oval die cast base with black wrinkle finish. Available with standard, or Navy knob, with, or without switch, and with nickel or brass plated key arm and hardware.

**Pamper yourself with a Gold-Plated NYE VIKING KEY!**  
Model No. 114-31C-004GP has all the smooth action features of NYE Speed-X keys in a special "presentation" model. All hardware is heavily gold plated and it is mounted on onyx-like jet black plastic sub-base. Price \$50.00

**ALL BAND PREAMPLIFIERS**



- 6 THRU 160 METERS
- TWO MODELS AVAILABLE
- RECOMMENDED FOR RECEIVER USE ONLY
- INCLUDES POWER SUPPLY

MODEL PLF employs a dual gate FET providing noise figures of 1.5 to 3.4 db., depending upon the band. The weak signal performance of most receivers as well as image and spurious rejection are greatly improved. Overall gain is in excess of 20 db. Panel contains switching that transfers the antenna directly to the receiver or to the Preamp. Model PLF 117V AC, 60 Hz. Wired & Tested . . . . . \$49.95

Now you can receive the weak signals with the Ameco PT-2 pre-amplifier!

Model PT-2 is a continuous tuning 6-160 meter Pre-Amp specifically designed for use with a transceiver. The PT-2 combines the features of the well-known PT with new sophisticated control circuitry that permits it to be added to virtually any transceiver with no modification. No serious ham can be without one. Price: \$74.95.

- Improves sensitivity and signal-to-noise ratio.
- Boosts signals up to 26 db.
- For AM or SSB.
- Bypasses itself automatically when the transceiver is transmitting.
- FET amplifier gives superior cross modulation protection.
- Simple to install. • Advanced solid-state circuitry.
- Improves immunity to transceiver front-end overload by use of its built-in attenuator.
- Provides master power control for station equipment.



**Larsen Kulrod Antennas**

- Handle full 200 watts • low-low V.S.W.R.
- Deliver 3 dB gain and more!
- Pick the one that best fits your needs:

**MAGNETIC MOUNT**

stays put even at 100 mph!  
MM-JM-150 for 144 MHz use } Only \$42.00 complete  
MM-JM-220 for 220 MHz use }  
MM-JM-440 for 440 MHz use }



**TRUNK LID MOUNT**

No holes and low silhouette too!  
TLM-JM-150 for 144 MHz use } Only \$42.00 complete  
TLM-JM-220 for 220 MHz use }  
TLM-JM-440 for 440 MHz use }  
And 1/4 wave antenna for trunk and magnetic mount - \$18.50



**ROOF or FENDER MOUNT**

Goes on quick and easy in 3/8" or 3/4" with fewest parts.  
JM-150-K for 144 MHz use } Only \$34.50 complete  
JM-220-K for 220 MHz use }  
JM-440-K for 440 MHz use }  
And 1/4 wave antenna for roof and fender mounts \$11.50



**TRAC \$89.95 "BRAND NEW"**

**DELUXE MESSAGE MEMORY KEYS**

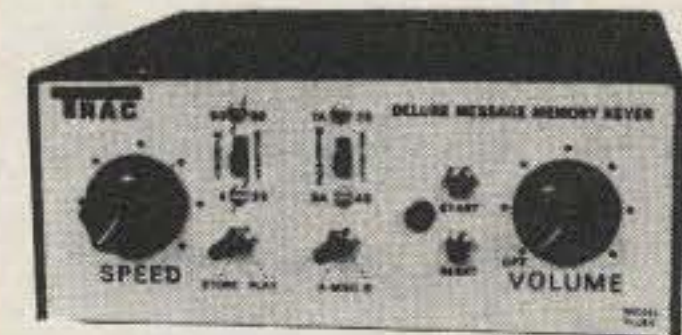

- Features: Model TE-284**
- State-of-the-Art CMOS Circuitry
  - Three choices of Message Storage
    - A. Two (50 character each) message storage
    - B. Four (25 character each) message storage
    - C. One (50 character and two 25 character message storage)
  - Records at any speed plays at any speed
  - Memory operating LED
  - Use for daily QSO or contests
- PLUS:**
- Self-completing dots and dashes
  - Both dot and dash memory
  - Iambic Keying with any squeeze paddle
  - 5-50 wpm
  - Speed, volume, tone, tune and weight controls
  - Sidetone and speaker
  - Low current drain CMOS battery operation-portable
  - Deluxe quarter-inch jacks for keying and output
  - Keys grid block and solid state rigs
  - WIRED AND TESTED FULLY GUARANTEED-LESS BATTERY

**MESSAGE MEMORY KEYS**

**Model # TE201 \$69.95**



- Features:**
- Advanced CMOS message memory
  - Two (50 char. each) message storage
  - Repeat function
  - Records at any speed—plays back at any speed
  - Longer message capacity
  - 5-50 wpm
  - Speed, volume, tone, tune and weight controls
  - Sidetone and speaker
  - Low current drain CMOS battery operation—portable
  - Deluxe quarter-inch jacks for keying and output
  - Keys grid block and solid state rigs
  - WIRED AND TESTED FULLY GUARANTEED-LESS BATTERY

**"BRAND NEW" Model # TE144 59.95**



- Features: Deluxe CMOS Electronic Keyer**
- State-of-the-art CMOS circuitry
  - Self completing dots and dashes
  - Both dot and dash memory
  - IAMBIC keying with any squeeze paddle 5-50 wpm
  - Speed, weight, tone, volume tune controls & sidetone and speaker
  - Semi-automatic "bug" operation & straight keying—rear panel switch
  - Low current drain CMOS battery operation—portable
  - Deluxe quarter inch jacks for keying and output
  - Keys grid block and solid state rigs
  - Wired and tested—fully guaranteed—less battery

MODEL TE133—same as TE144 with wgt and tone control internal, less semi-auto keying. \$49.95

MODEL TE122—same as TE133 less wgt, tune, solid state keying. \$36.50

**ASTATIC MICROPHONES**

- T-UP9-D104 transistorized w/push bar base . . . \$67.50
- T-UG8-D 104 transistorized. \$55.50
- T-UG9-D 104 "Silver Eagle" transistorized. \$74.40
- UG-D 104 ceramic or crystal . . . \$49.50



TUFTS Electronic Department Store TUFTS



## Weller Industrial & Service Equipment, Soldering Equipment, Accessories, & Other Tools for the Professional or Hobbyist



**Model D550 Heavy-Duty Gun (260/200 Watts) \$24.65**

Highest output gun with 2-position trigger selection of dual heats. Heavy gauge, high efficiency pre-finned copper tip comes up to temperature in 6 seconds. Balanced pistol-grip design with twin lights to illuminate work. Complete with "Soldering Hints" booklet. 120V, 60Hz, 2-wire cord. UL-listed. Boxed.



**Model 8200W All-Purpose Gun (140/100 Watts) \$18.13**

Fingertip trigger selection of high or low output from this instant-heat gun that's ready to solder in 6 seconds. High efficiency tip of pre-finned pure copper. Light illuminates work. Compact, balanced pistol-grip design. "Soldering Hints" booklet included. 120V, 60Hz, 2-wire cord. UL-listed.



**Model 250K Electronic Tool Kit \$35.58**

Ideal 12-piece kit for the budding technician or for general use in countless electronic jobs. UL-listed. Housed in a compact, convenient plastic carrying case storage tray and contains the following professional quality Weller and Xcelite tools:

- WP25 Soldering Iron with 1/4" screwdriver tip 750°F
- ST2 Extra sp. 1/32" screwdriver Soldering Aid Tool Rosin-Core Solder
- #8 1/4" Nutdriver
- #R184 1/4" Blade driver for slotted screws
- #X101 No. 1 Phillips-type Screwdriver
- #41CG 4" Short Chain-Nose Pliers with cushion-grip
- #54CG 4" Diagonal Cutting Pliers with cushion-grip
- #100 Wire Stripper/Cutter with cushion-grip

**Replacement and extra soldering tips**  
Same as for Model WP25 iron.



**Model WTCPN, Controlled-Output Soldering Station \$70.80**

Exclusive Weller closed loop, low-voltage circuit automatically controls output and temperature in three ranges: 600°F, 700°F, and 800°F. Temperature selected simply by changing the grounded heat-sensing tip with knurled thumbscrew. Safe for IC soldering. Comfortable, lightweight pencil iron has heat shield, non-burnable silicone rubber cord, and locking design for easy interchangeability. Power unit, with contemporary, impact-resistant case, has unitized on/off toggle switch and neon indicator light, non-heat-sinking iron holder, storage tray for extra tips, and tip-clearing sponge with receptacle. 3-wire 6 ft. long cord. 120V, 60 Hz, 60W. Furnished with 1/4" screwdriver tip. 700°F. PTA7. UL-listed.

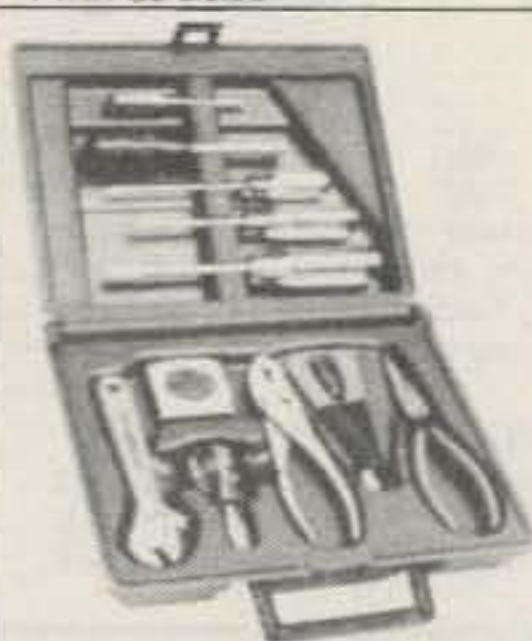

**TKX-11 Multi-Purpose Tool Kit \$36.70**

The versatile kit contains 11 quality tools, perfect for all types of routine repair and simple do-it-yourself projects. Everything comes neatly packaged in an attractive, easy to store case.

- Tool Kit includes**
- R144 1/4" x 4" Round Blade Screwdriver
  - R184 3/8" x 4" Round Blade Screwdriver
  - X101 #1 Phillips x 3" Screwdriver
  - 8 1/4" Hex Nutdriver
  - P12S #0 Phillips x 2" Screwdriver
  - 51CG 6" Long Nose Plier w Side Cutter
  - 46CG 6" Adjustable Wrench
  - S-141 1/4" x 1 1/4" Stubby Square Blade Screwdriver
  - 100-X Wire Stripper & Cut. Adj. Screw Stop
  - TM120 1/2" x 10" Metric English Tape Rule
  - 76C 6" Combination Plier Chrome Plated

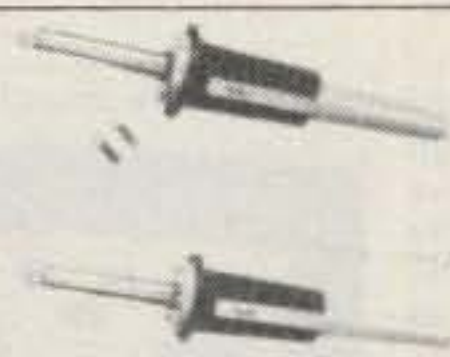

**Models WP25 and WP40 Professional Soldering Irons**

Top quality, industrial grade tools develop 750°F temperature. Rugged stainless steel barrel construction. Long life double coated tips. High efficiency. Popular pencil styling. Light blue handle with black heat shield. Only 7 1/2" long. 1 1/4 oz. 120V, 50/60 Hz. 4 Ft. Cord. UL-listed.

Model	Description	Tip	
WP25	25W	ST1, 1/4"	<b>\$13.35</b>
WP25-3	25W	screwdriver	
	3-Wire Cord		
WP40	40W	ST3, 1/4"	<b>\$16.40</b>
WP40-3	40W	screwdriver	
	3-Wire Cord		

**Replacement and extra soldering tips**  
Top quality, iron plated tips with anti-wetting chrome coating. All tips are pre-finned.

Cat. No.	Tip Size	Description
ST1	1/4"	Screwdriver
ST2	1/32"	Screwdriver
ST3	1/4"	Screwdriver
ST4	3/16"	Screwdriver
ST5	1/32"	Single Flat
ST6	1/32"	Screwdriver
ST7	1/32"	Conical
ST8	1/16"	Narrow Screwdriver

## Xcelite Versatile Series 99

Series 99\* Service Kits and Sets  
Series 99 service kits and sets are made up primarily of various screwdriver, nutdriver, and other blades which can be used interchangeably in Series 99 handles. This saves space offers utmost economy.

All blades are high carbon steel with highly polished nickel chrome finish except Bristol and Allen Hex types which are precision-formed of alloy steel. Hex head sockets are precision-formed, cold drawn, case hardened steel. Plastic handles have a unique spring device that holds blades firmly, yet permits quick, easy insertion and removal. All handles accommodate all blades.



**99SMW Service Kit \$84.24**

Plastic-coated cover holds 26-piece set of handles and interchangeable screwdriver, nutdriver and other blades plus wire stripper and cutter and Weller\* soldering iron.

**Contents:**  
WP25 — Soldering Iron  
ST3 — Tip  
100-X — Wire Stripper and cutter  
52CG — 6" Long Nose Cushion Grip Plier  
55CG — 5" Diagonal Cushion Grip Plier

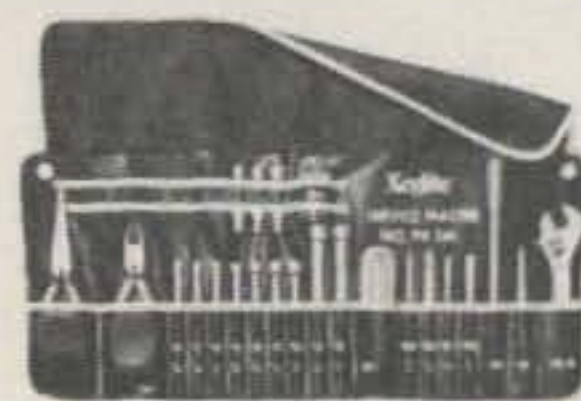

**99SM Service Kit \$64.71**

This versatile 23-piece set of quality tools in a durable, roll-up plastic-coated canvas case weighs only 2 1/2 pounds. Provides a variety of quick-change tools and tool combinations to speed up assembly and service work. Set includes:

- 52CG — 6" Long Nose Cushion Grip Plier
- 55CG — 5" Diagonal Cushion Grip Plier
- 46CG — 6" Thin-pattern Cushion Grip Adjustable Wrench
- 99-1 — Regular Handle
- 99-3 — Stubby Handle
- 99-6 thru 99-16 — Regular Nutdrivers (9)
- 99-58, 99-510, 99-512 — Stubby Nutdrivers
- 99-821, 822 — Phillips Screwdrivers
- 99-811, 99-250 — Slotted Screwdrivers
- 99-38 — Reamer
- 99-X10 — Extension Blade
- 99SMK — Canvas Case



**46CG — 6" Thin-pattern Cushion Grip Adjustable Wrench**

- 99-1 — Regular Handle
- 99-3 — Stubby Handle
- 99-6 thru 99-16 — Regular Nutdrivers (9)
- 99-821, 99-822 — Phillips Screwdrivers
- 99-58, 99-510, 99-512 — Stubby Nutdrivers
- 99-811, 99-250 — Slotted Screwdrivers
- 99-38 — Reamer
- 99-X10 — Extension Blade
- 99MVK — Canvas Case



**Model D550PK Kit \$28.68**

8-piece heavy-duty soldering kit featuring the versatile Weller Model D550 soldering gun with pre-finned heavy copper tip. Kit also includes 2 spare un-finned tips, tip-changing wrench, flux brush, soldering aid tool, coil of 60/40 rosin-core solder, and sturdy plastic carrying case, plus "Soldering Hints" booklet. UL-listed.



**Model 8200 PK Kit \$21.15**

8-piece kit includes Weller Model 8200 dual-heat soldering gun with pre-finned copper tip, 2 extra un-finned copper tips, tip-changing wrench, flux brush, soldering aid tool, coil of 60/40 rosin-core solder, and sturdy plastic carrying case, plus "Soldering Hints" booklet. UL-listed.



**MP Series Miniature Controlled-Output Soldering Stations \$47.22**

Especially designed for printed circuit electronic work. The famous Weller closed-loop temperature control circuit and grounded tip protect sensitive components from heat damage. Tip temperature of 650°F or 750°F is selected by changing the plug-in iron, which operates on low voltage and has non-burnable silicone rubber cord for added safety and longer life. High impact-resistant housing has non-heat-sinking iron holder plus tip-clearing sponge and receptacle. Variety of tips available for special applications. 3-wire cord. 120V, 60/40Hz, 22W. Furnished with .020" conical tip. MP131. UL-listed. Power Cord 6 Ft. Iron Cord 4 Ft.



**Model 230K Hobby Kit \$14.58**

Complete kit for hobbyists contains SP23 Soldering Iron in carrying case and tool tray, with 6 tips; cone soldering screwdriver, chisel, smoothing, hot knife, and cone burning. Work sponge. Hot iron rest. Soldering aid tool. Rosin core solder. Instruction Booklet. UL-listed. Carton weight 8 1/2 lbs. Carton quantity 6.



## Tools, Parts, Accessories

### Diagonal Pliers

**\*54CG**  
Midget 4" size for close quarter work.  
**\$6.60**

**\*55CG**  
5" Plier for most cutting needs.  
**\$7.13**

**\*64CG**  
4" long, for fast, clean, easy tip cutting of fine wires in close quarters.  
**\$8.87**

**\*66CG**  
6" all-purpose diagonal plier.  
**\$7.48**

**\*67CG**  
7" diagonal pliers for heavy duty cutting.  
**\$7.33**

### Needle-Nose Pliers

**\$8.37**  
**\*56CG**  
6" size Long, slim serrated jaws permit entry inaccessible to regular long nose plier.

**\$8.27**  
**\*57CG**  
5 1/2" size with fine serrated jaws and coil spring for firm gripping and looping of wire.

### Long-Nose Pliers

**\$6.85**  
**\*41CG**  
Midget 4" pliers, serrated jaws, without side cutters.

**\$7.92**  
**\*51CG**  
6" long-nose pliers with side cutters.

**\$6.37**  
**\*52CG**  
6" long-nose pliers without side cutters.

### XST-5 — Super-Tru Tip (Phillips type) Screwdriver Set

Contains 5 pieces — all Phillips.

**\$13.97**



### SDS-44 — Square Blade Screwdriver Set

Contains 5 Square Blade Screwdrivers for slotted screws. Catalog Nos S-141, S-3164, S-144, S-5166, S-388.

**\$14.76**

### Adjustable Wrenches

Xcelite's exclusive thin-pattern design permits access where regular adjustables will not fit. Rugged construction, chrome-plated, polished heads, with quick one-hand adjustment and Cushion-Grip (CG).

**\*44CG** — 4" length, 1/2" opening **\$6.38**

**\*46CG** — 6" length, 3/4" opening **\$6.45**

**\*48CG** — 8" length, 1 1/8" opening **\$7.28**

### Wire Strippers & Cutters

With Cushion Grip Handles

**\*100-X** **\$2.63**

Has adjustable screw stop for different wire sizes, and cushion grips. Cuts and strips both solid and stranded wire cleanly, neatly. Hardened with ground blades.

**\*101-S** **\$3.32**

Specifications same as 100, except with spring-equipped self-opening handles.

**\*103-S** **\$4.12**

Has unique cam stop adjustment for different wire sizes. Cam adjustment stays put, won't move, even with screw loose. Fine for industrial use.

### 104CG Wire Stripper and Cutter

Cutter, stripper and crimper for all types and sizes of wire, with a wide-size-range bolt cutter. Features scissor action-up front wire cutting and wire stripping, bolt cutters, cushion grips, plier nose, hardened pivot joint bushing and crimp stations.

**\$10.08**

## Quality Coaxial Cable for All Applications

- LOW LOSS CABLE • NON TARNISHING CONNECTORS
- FACTORY ASSEMBLED, TESTED FOR 100% RELIABILITY

### RG58/U Type

PART NUMBER	DESCRIPTION	APPLICATIONS
581-58018 *	18" length with UHF CB plugs on both ends.	Used as patch cords for mobile & base station SWR & power meters, antenna switches, and SWR matchers.
<b>\$3.20</b>		
581-583 *	3' length with UHF CB plugs on both ends.	Used to connect mobile CB sets to trunk, mirror, gutter or bumper mount antennas using spade lug terminations to the antenna.
<b>\$3.70</b>		
581-585L *	5' length with UHF CB plug & spade lugs.	Used to connect mobile CB sets to trunk, mirror, gutter or bumper mount antennas requiring a UHF CB plug termination to the antenna.
<b>\$4.10</b>		
581-5812L *	12' length with UHF CB plug & spade lugs.	Used where smaller diameter cable is required and signal loss is not critical.
<b>\$4.10</b>		
581-5820L *	20' length with UHF CB plug & spade lugs.	Used to connect base station CB sets with base antennas. Where loss is critical, these cables will out perform RG 58/U cables of the same length.
<b>\$4.99</b>		
581-5812 *	12' length with UHF CB plugs on both ends.	Used to connect mobile or base stations with antennas requiring a UHF CB plug termination at the antenna.
<b>\$4.99</b>		
581-5820-259 *	20' length with UHF CB plugs on both ends.	Used to connect base station CB sets with base antennas. Where loss is critical, these cables will out perform RG 58/U cables of the same length.
<b>\$5.49</b>		
581-5850-420	50' length with UHF CB plugs on both ends.	Used to connect base station CB sets with base antennas. Where loss is critical, these cables will out perform RG 58/U cables of the same length.
<b>\$7.25</b>		
581-5875-420	75' length with UHF CB plugs on both ends.	Used to connect base station CB sets with base antennas. Where loss is critical, these cables will out perform RG 58/U cables of the same length.
<b>\$9.29</b>		
581-58100-420	100' length with UHF CB plugs on both ends.	
<b>\$10.99</b>		

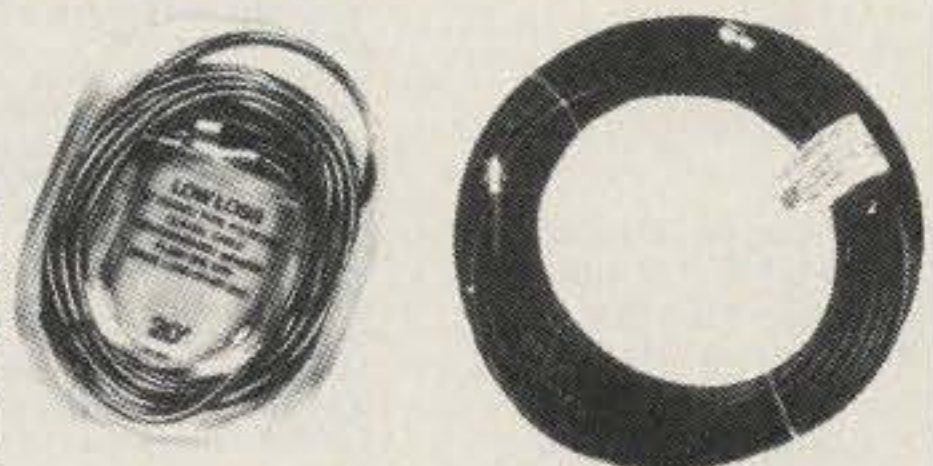

RG 58/U Type      RG 8/U Low Loss Type

### RG8/U Low Loss Type

PART NUMBER	DESCRIPTION	APPLICATIONS
581-83 *	3' lengths with UHF CB plugs on both ends.	Used as patch cords for mobile and base station SWR and power meters, antenna switches & SWR matchers.
<b>\$4.10</b>		
581-820	20' length with UHF CB plugs on both ends.	Used to connect mobile or base stations with antennas requiring a UHF CB plug termination at the antenna.
<b>\$8.50</b>		
581-850-420	50' length with UHF CB plugs on both ends.	Used to connect base station CB sets with base antennas. Where loss is critical, these cables will out perform RG 58/U cables of the same length.
<b>\$14.99</b>		
581-875-420	75' length with UHF CB plugs on both ends.	Used to connect base station CB sets with base antennas. Where loss is critical, these cables will out perform RG 58/U cables of the same length.
<b>\$22.50</b>		
581-8100-420	100' length with UHF CB plugs on both ends.	
<b>\$26.50</b>		

### LAB QUALITY CABLES

#### BNC Test Voltage

1500 vac; Frequency: 0-4 GHz; Impedance: 50 Ohms nominal; Cable Retention Force: 60 lbs. minimum (RG-58C/U)

#### UHF Test Voltage

1500 vac; Frequency: 0-500 MHz; Impedance: Non Constant; Cable Retention Force: 60 lbs. minimum (RG-58C/U)

**50 ohm UHF Plug to UHF Plug**

**50 ohm BNC Plug to UHF Plug**

**50 ohm BNC Plug to BNC Plug**

No. 651	3 feet	\$ 6.52	No. 651	3 feet	\$ 6.52
No. 652	5 feet	\$ 7.05	No. 652	5 feet	\$ 7.05
No. 653	10 feet	\$ 8.34	No. 653	10 feet	\$ 8.34
No. 657	1 foot	\$ 7.20	No. 657	1 foot	\$ 7.20
No. 658	3 feet	\$ 7.72	No. 658	3 feet	\$ 7.72
No. 656	5 feet	\$ 8.24	No. 656	5 feet	\$ 8.24
No. 668	3 feet	\$ 8.91	No. 668	3 feet	\$ 8.91
No. 662	5 feet	\$ 9.43	No. 662	5 feet	\$ 9.43
No. 666	10 feet	\$10.73	No. 666	10 feet	\$10.73

TUFTS Electronic Department Store TUFTS



TUFTS Electronic Department Store TUFTS

## hy-gain<sup>®</sup> TOWERS Crank-ups<sup>™</sup>

As a leading manufacturer of CB, Amateur Radio, Marine, Land Mobile, Industrial and Military antennas for world-wide communications, Hy-Gain also provides a wide selection of antenna towers with high structural integrity. These all-steel towers feature torsion resistant "W" bracing with a diamond web at the lap joints for superior strength with minimum wind load. After fabrication, towers are hot-dip galvanized by full submergence. Open end tubing assures 100% rust resistant plating and provides moisture drainage when the tower is erected. Welded base assemblies facilitate tower installation and provide a rigid, close tolerance support for the tower legs. Hy-Gain towers are designed and made of certified materials and processes to conform with industrial standards and national code requirements. As with antennas, the selection of a Hy-Gain tower assures you of the best value you can buy. The serious CB base station operator will be served well by the towers shown here.

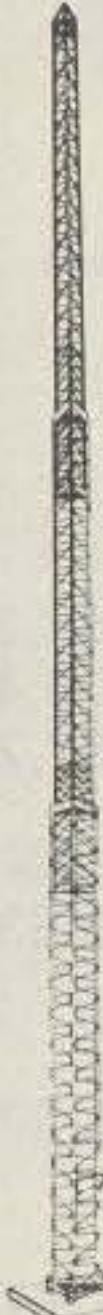

PRICES	
HG-35MT2	\$345
HG-50MT2	\$588
HG-52SS	\$889

**Model HG-35MT2** - two sections  
**Model HG-50MT2** - three sections  
 These are side-supported towers of 35 and 50 feet height (10.66m and 15.24m) respectively. Telescoping sections raise and lower uniformly with a manual safety winch or optional motorized winch. The top section mast plate accommodates direct rotor mounting. The base mount provides a tilt-over feature for convenient tower erection and antenna maintenance. Either model is easily erected on a limited area site.

	HG-35MT2	HG-50MT2
Height Extended	35 feet (10.66m)	50 feet (15.24m)
Height Nested	20 feet (6.27m)	21 feet (6.4m)
Wind Survival, fully extended with max. load	50 mph (80 kmph)	50 mph (80 kmph)
Antenna Load Limits	9.5 sq. feet (0.882 sq.m)	6 sq. feet (0.557 sq.m)

**Model HG-52SS**  
 A 52 foot (15.24m) self-supporting crank-up tower that requires no guy wiring. A safety winch and improved guide system provides positive control in manual crank-up or down mode. An electric motor is optional. A thrust bearing can be bolted to the top section to accommodate a 2" (50mm) mast. A rotor mounting plate is included as is the base mount with tilt-over feature for convenient tower erection or antenna servicing. The HG-52SS tower is easily erected on a limited area site.

Height, Extended	52 feet (15.24m)
Height, Nested	21 feet (6.4m)
Wind Survival, fully extended with max. load	50 mph (80 kmph)
Antenna Load Limits	9 sq. feet (0.837 sq.m)

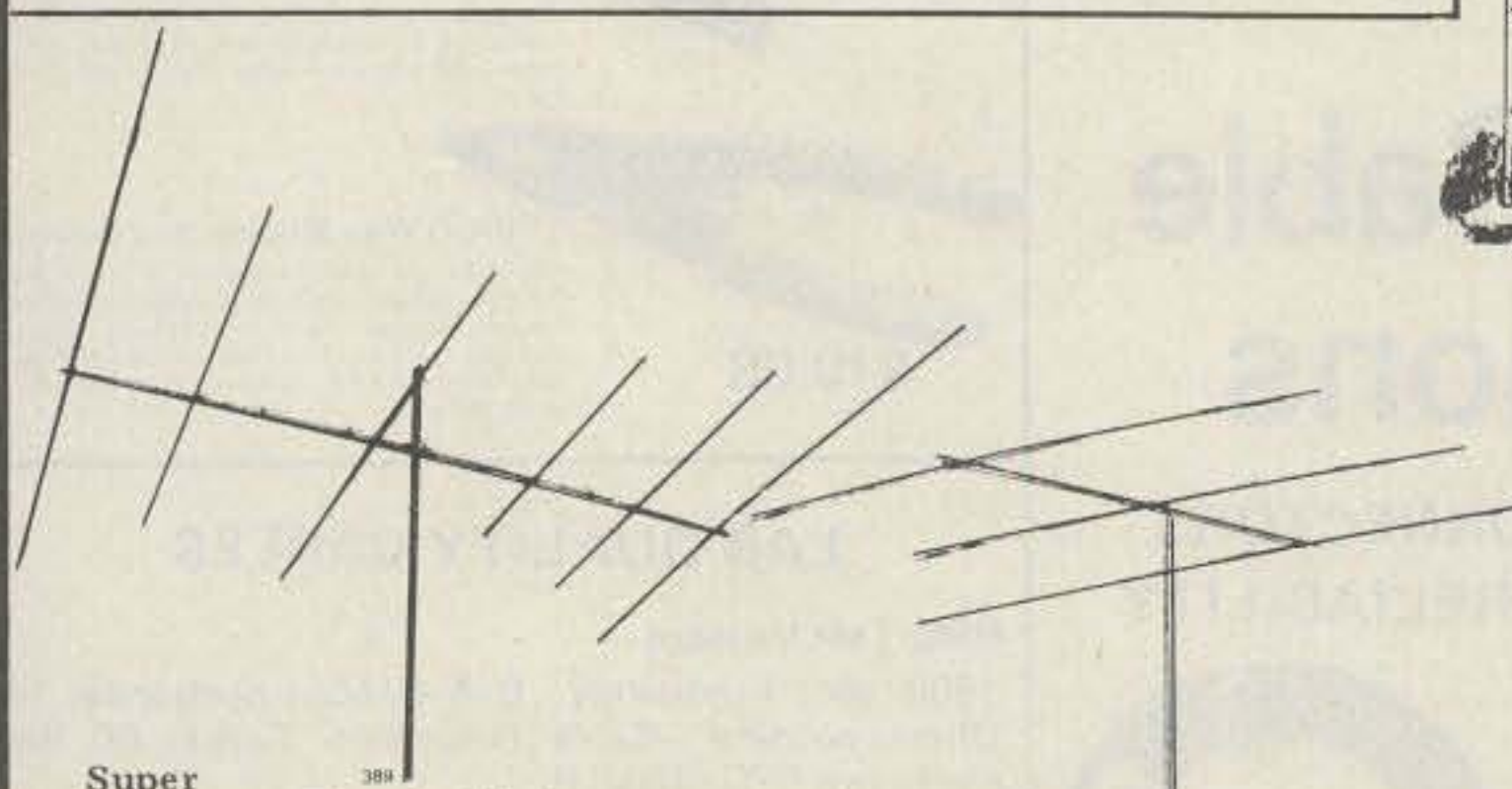
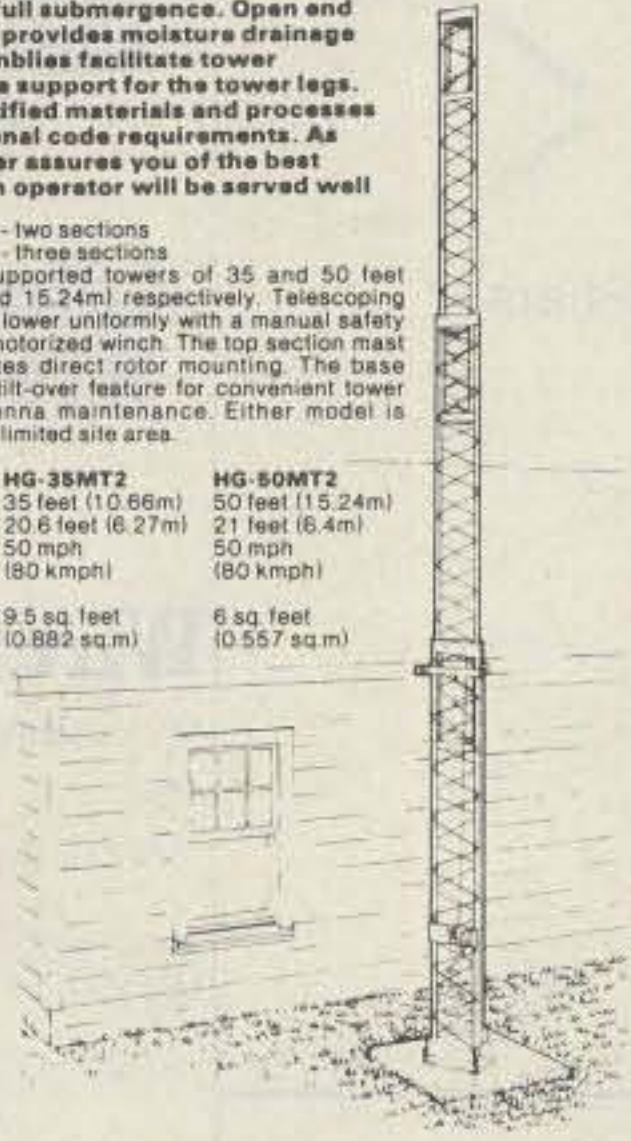

**Super 3-Element Thunderbird for 10, 15 and 20 Meters Model TH3Mk3 - \$199.95**

Hy-Gain's Super 3-element Thunderbird delivers outstanding performance on 10, 15 and 20 meters. The TH3Mk3 features separate and matched Hy-Q traps for each band, and feeds with 52 ohm coax. Hy-Gain Beta Match presents tapered impedance for most efficient 3 band matching, and provides DC ground to eliminate precipitation static. The TH3Mk3 delivers maximum F/B ratio, and SWR less than 1.5:1 at resonance on all bands. Its mechanically superior construction features taper swaged slotted tubing for easy adjustment and larger diameter. Comes equipped with heavy tiltable boom-to-mast clamp. Hy-Gain ferrite balun BN-86 is recommended for use with the TH3Mk3.

Electrical	TH6DXX	TH3Mk3
Gain—average	8.7dB	8dB
Front-to-back ratio	25dB	25dB
SWR (at resonance)	Less than 1.5:1	Less than 1.5:1
Impedance	50 ohms	50 ohms
Power rating	Max legal	Max legal

Mechanical	TH6DXX	TH3Mk3
Longest element	31.1'	27'
Boom length	24'	14'
Turning radius	20'	15.7'
Wind load at 80 MPH	156 lbs.	103.2 lbs.
Maximum wind survival	100 MPH	100 MPH
Net weight	57 lbs.	36 lbs.
Mast diameter accepted	1 1/4" to 2 1/2"	1 1/4" to 2 1/2"
Surface area	6.1 sq. ft.	4.03 sq. ft.

**6-Element Super Thunderbird DX for 10, 15 and 20 Meters Model TH6 DXX \$249.95 Separate HY-Q traps, featuring large diameter coils that develop an exceptionally favorable L/C ratio and very high Q, provide peak performance on each band whether working phone or CW. Exclusive Hy-Gain beta match, factory pretuned, insures maximum gain and F/B ratio without compromise. The TH6DXX feeds with 52 ohm coaxial cable and delivers less than 1.5:1 SWR on all bands. Mechanically superior construction features taper swaged, slotted tubing for easy adjustment and readjustment, and for larger diameter and less wind loading. Full circumference compression clamps replace self-tapping sheet metal screws. Includes large diameter, heavy gauge aluminum boom, heavy cast aluminum boom-to-mast clamp, and heavy gauge machine formed element-to-boom brackets. Hy-Gain's ferrite balun BN-86 is recommended for use with the TH6DXX.**

Hy-Gain's Super 3-element Thunderbird delivers outstanding performance on 10, 15 and 20 meters. The TH3Mk3 features separate and matched Hy-Q traps for each band, and feeds with 52 ohm coax. Hy-Gain Beta Match presents tapered impedance for most efficient 3 band matching, and provides DC ground to eliminate precipitation static. The TH3Mk3 delivers maximum F/B ratio, and SWR less than 1.5:1 at resonance on all bands. Its mechanically superior construction features taper swaged slotted tubing for easy adjustment and larger diameter. Comes equipped with heavy tiltable boom-to-mast clamp. Hy-Gain ferrite balun BN-86 is recommended for use with the TH3Mk3.

## HY-GAIN'S INCOMPARABLE HY-TOWER FOR 80 THRU 10 METERS

- Model 18HT**
- Outstanding Omni-Directional Performance
  - Automatic Band Switching
  - Installs on 4 sq. ft. of real estate
  - Completely Self-Supporting

By any standard of measurement, the Hy-Tower is unquestionably the finest multi-band vertical antenna system on the market today. Virtually indestructible, the Model 18HT features automatic band selection on 80 thru 10 meters through the use of a unique stub decoupling system which effectively isolates various sections of the antenna so that an electrical 1/4 wavelength (or odd multiple of a 1/4 wavelength) exists on all bands. Fed with 52 ohm coax, it takes maximum legal power ... delivers outstanding performance on all bands. With the addition of a base loading coil, it also delivers outstanding performance on 160 meters. Structurally, the Model 18HT is built to last a lifetime. Rugged hot-dipped galvanized 24 ft. tower requires no guyed supports. Top mast, which extends to a height of 50 Ft., is 6061ST6 tapered aluminum. All hardware is iridite treated to MIL specs. If you're looking for the epitome in vertical antenna systems, you'll want Hy-Tower, Shpg. Wt., 96.7 lbs. Order No. 182, Price: \$279.95

NEW Special hinged base assembly on Model 18HT allows complete assembly of antenna at ground level ... permits easy raising and lowering of the antenna.



## BROAD BAND DOUBLET BALUN for 10 thru 80 meters Model BN-86 \$15.95



The model BN-86 balun provides optimum balance of power to both sides of any doublet and vastly improves the transfer of energy from feedline to antenna. Power capacity is 1 KW DC. Features weatherproof construction and built-in mounting brackets. \$15.95 Shpg. Wt. 1 lb. Order No. 242

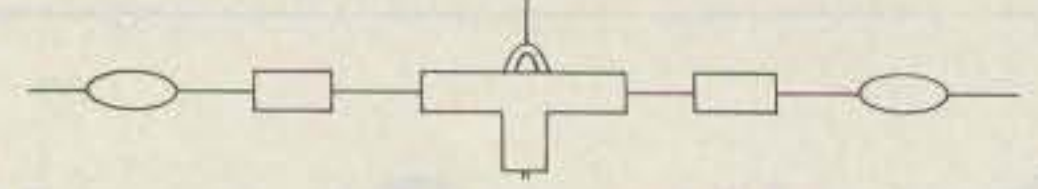

## MULTI-BAND HY-Q TRAP DOUBLETS Hy-Q Traps

- Install Horizontally or as Inverted V
- Super-Strength Aluminum Clad Wire
- Weatherproof Center and End Insulators

Installed horizontally or as an inverted V, Hy-Gain doublets with Hy-Q traps deliver true half wavelength performance on every design frequency. Matched traps, individually pretuned for each band feature large diameter coils that develop an exceptionally favorable L/C ratio and very high Q performance. Mechanically superior solid aluminum trap housings provide maximum protection and support to the loading coil. Fed with 52 ohm coax, Hy-Gain doublets employ super-strength aluminum clad single strand steel wire elements that defy deterioration from salt water and smoke ... will not stretch ... withstand hurricane-like winds. SWR less than 1.5:1 on all bands. Strong, lightweight, weatherproof center insulators are molded from high impact cyolac. Hardware is iridite treated to MIL specs. Heavily serrated 7-inch end insulators molded from high impact cyolac increase leakage path to approximately 12 inches.

**MODEL 2BDQ for 40 and 80 meters. 100' 10 1/2" overall. Takes maximum legal power. Shpg. Wt., 7.5 lbs \$49.95**

Order No. 380

**MODEL 5BDQ for 10, 15, 20, 40 and 80 meters. 94' overall. Takes maximum power. Shpg. Wt., 12.2 lbs. \$79.95**

Order No. 383

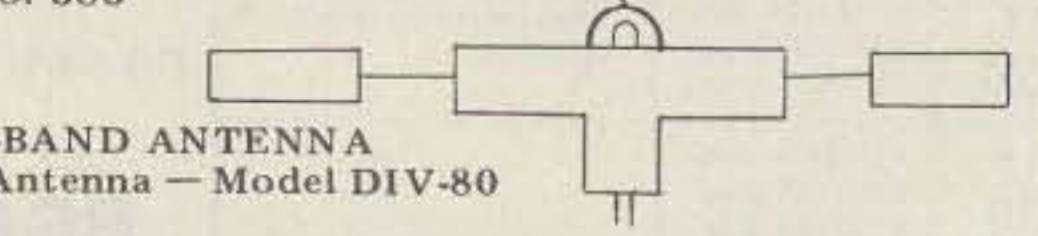

## MULTI-BAND ANTENNA Dipole Antenna - Model DIV-80 \$13.95

For 10 thru 80 meters - choice of one band

A dipole antenna for the individuals who prefer the "do-it-yourself" flexibility of custom-designing an antenna for your specific needs. (Work the frequencies you wish in the 10 through 80 meters bands).

The DIV-80 features: Durable Copperweld wire for greater strength. Mosley Dipole Connector (DPC-1) for RG-8/U or RG-58/U coax and all the technical information you will need to construct your custom-designed antenna.

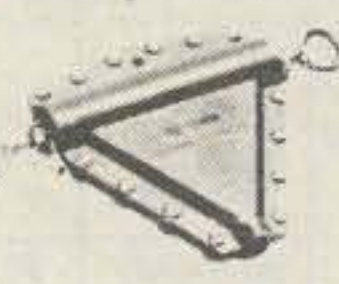

## CENTER INSULATOR for Multi-Band Doublets Model CI

Strong lightweight, weatherproof Model CI is molded from high impact cyolac. Hardware is iridite treated to MIL specs. Accepts 1/4" or 3/8" coaxial. Shpg. Wt., 0.6 lbs. \$5.95 Order No. 155



## END INSULATORS for Doublets Model EI

Rugged 7-inch end insulators are molded from high impact cyolac that is heavily serrated to increase leakage path to approximately 12 inches. Available in pairs only. Shpg. Wt., 0.4 lbs. \$3.95 Order No. 156



## WIDE BAND VERTICAL for 80-10 Meters Hy-Gain's 18 AVT/WB

Take the wide band, omni-directional performance of Hy-Gain's famous 14AVQ/WB, add 80 meter capability plus extra-heavy duty construction - and you have the unrivalled new 18AVT/WB. In other words, you have quite an antenna.

- Automatic switching, five band capability is accomplished through the use of three beefed-up Hy-Q traps (featuring large diameter coils that develop an exceptionally favorable L/C ratio).
- Top loading coil.
- Across-the-band performance with just one furnished setting for each band (10 through 40).
- True 1/4 wave resonance on all bands.
- SWR of 2:1 or less at band edges.
- Radiation pattern has an outstandingly low angle whether roof top or ground mounted.



**CONSTRUCTION** ... of extra-heavy duty tapered swaged seamless aluminum tubing with full circumference, corrosion resistant compression clamps at slotted tubing joints... is so rugged and rigid that, although the antenna is 25' in height, it can be mounted without guy wires, using a 12" double grip mast bracket, with recessed coax connector.

Order No. 386 Price: \$97.00

## The Versatile Model 18V for 80 thru 10 Meters

The Model 18V is a low-cost, highly efficient vertical antenna that can be tuned to any band 80 thru 10 meters, by a simple adjustment of the feed point on the matching base inductor. Fed with 52 ohm coax, this 18 ft. radiator is amazingly efficient for DX or local contact. Constructed of heavy gauge aluminum tubing, the Model 18V may be installed on a short 1 1/2 inch mast driven into the ground. It is also adaptable to roof or tower mounting. Highly portable, the Model 18V can be quickly knocked down to an overall length of 5 ft. and easily re-assembled for field days and camping trips. Ship. Wt. 5 lbs.

Order No. 193 Price \$24.95

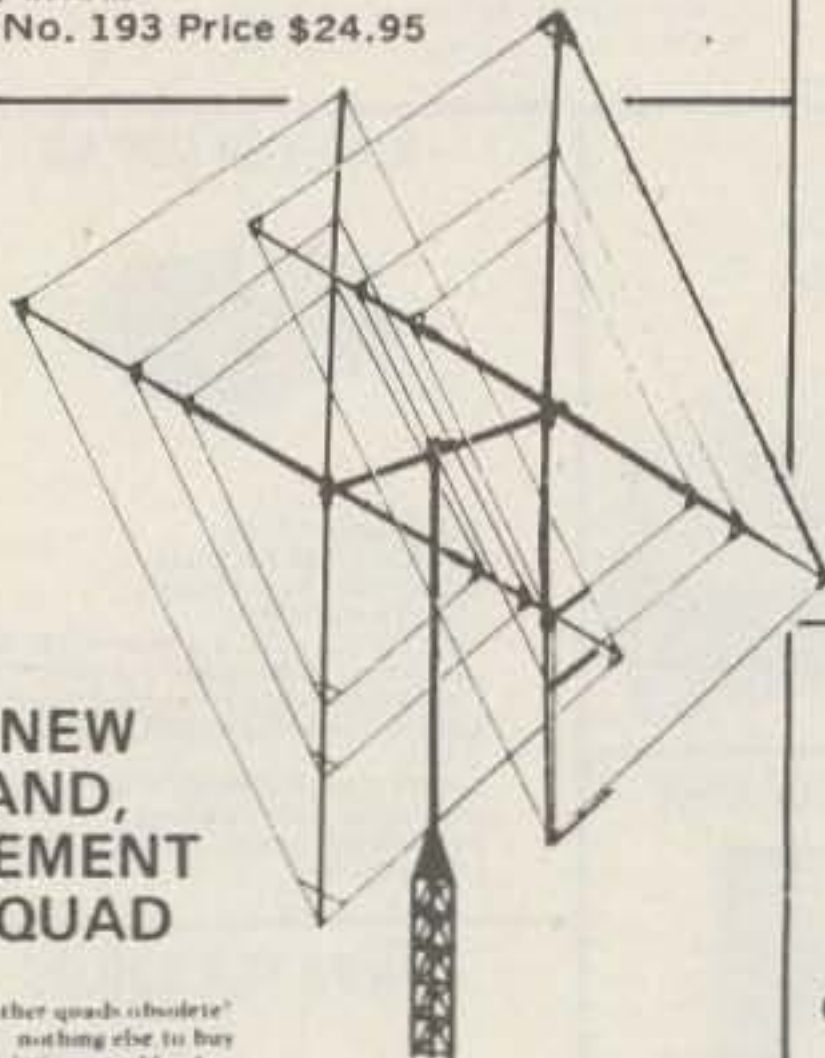

## ALL NEW 3-BAND, 2 ELEMENT HY-QUAD

- Makes all other quads obsolete!
  - Complete - nothing else to buy
  - High strength, low wind load
- The Hy-Quad from Hy-Gain makes all other quads obsolete! Here's why. First, it's the only quad that is complete. There is nothing more to shop for or buy.
- Secondly, it is uniquely designed so that it overcomes all of the previously undesirable features inherent in quads.
- The all aluminum structure stays up! The single feed line and diamond shape simplifies feed line routing.
- Hy-Gain's all new Hy-Quad will outdo all other quads because it's engineered to do just that. The Hy-Quad is new, it's superior, it's complete. It's the first quad to have everything spreaders are broken up at strategic electrical points with Cycloc insulation / tri-band 2 element construction with individually resonated elements with no interaction / Hy-Quad requires only one feed line for all three bands / individually tuned gamma matches on each band with Hy-Gain exclusive vertex feed / full wave element loops require no tuning coils, traps, loading coils or baluns / heavy duty mechanical construction of strong swaged aluminum tubing and die formed spreader-to-boom clamps / extra heavy duty universal boom-to-mast clamp that fits and mounts on any mast 1 1/2" to 2 1/2" in diameter / aluminum stranded wire. You can open and close the bands with this antenna. You'll experience the thrill of real DX.

Order No. 244 Price \$229.95

### SPECIFICATIONS

Overall length of spreaders	25.5	Forward gain	8.5 db
Tuning radius	13.5	Input impedance	52 ohms
Weight	42 lbs	VSWR	1.2:1 or better at resonance on all bands
Boom diameter	2"	Power	Maximum legal
Boom length	8'	Front to back ratio	25:35 db depending upon electrical height
Mast diameter	1 1/2" to 2 1/2"	Polarization	Horizontal
Wind survival	100 mph		
Surface area	6.4 sq ft		
Wind load at 100 mph	256.0 lbs		



For 10, 15, and 20 Meters  
New Hy-Gain Model 12 AVQ

Completely self-supporting, the Model 12AVQ features Hy-Q traps...12" double-grip mast bracket...taper swaged seamless aluminum construction with full circumference compression clamps at tubing joints. It delivers outstanding low angle radiation. SWR is 2:1 or less on all bands. Overall height is 13'6". Shipping weight 7.2 lbs. Price: \$47.00  
Order No. 384

New, improved successor to the world's most popular vertical!  
Hy-Gain Model 14 AVQ/WB for 40-10 Meters.

- Wide band performance with one setting (optimum settings for top performance furnished)
- New Hy-Q Traps • New 12" Double-Grip Mast Bracket • Taper Swaged Seamless Aluminum Construction

The Model 14AVQ/WB, new improved successor to the world famous Model 14AVQ, is a self-supporting, automatic band switching vertical that delivers omni-directional performance on 40 through 10 meters. Three separate Hy-Q traps featuring large diameter coils that develop an exceptionally favorable L/C ratio and a very high Q, provide peak performance by effectively isolating sections of the antenna so that a true 1/4 wave resonance exists on all bands. Outstandingly low angle radiation pattern makes DX and other long haul contacts easy. Superior mechanical features include solid aluminum housing for traps using air dielectric capacitor...heavy gauge taper swaged seamless aluminum radiator...full circumference compression clamps at tubing joints that are resistant to corrosion and wear...and a 12" double-grip mast bracket that insures maximum rigidity whether roof-top or ground mounted. The Model 14AVQ/WB also delivers excellent performance on 80 meters using Hy-Gain Model LC-80Q Loading Coil. Overall height is 18 feet. Shipping weight 9.2 lbs. Unsurpassed portability - outstanding for permanent installations. Price: \$67.00  
Order No. 385

### TYPICAL 14AVQ/WB VSWR CURVES

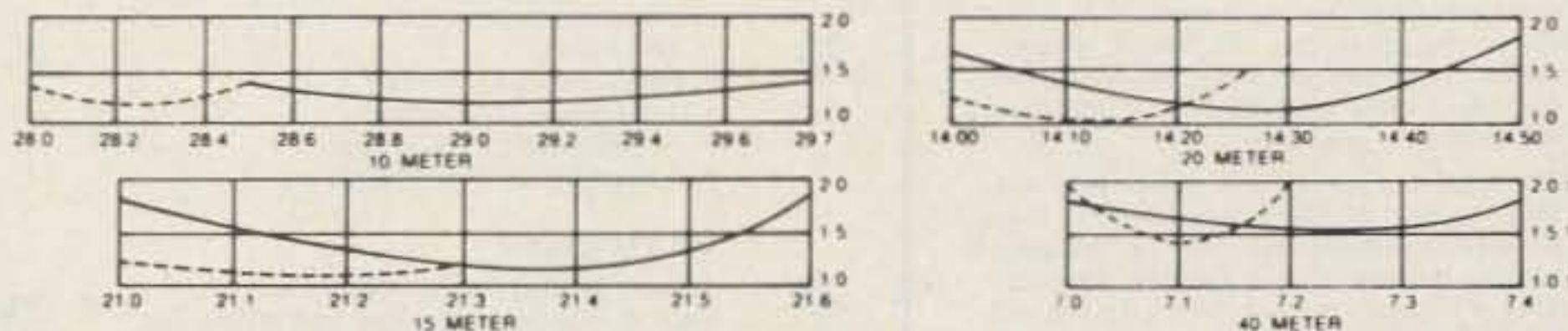

ROOF MOUNTING KIT - Model 14RMQ provides rugged support for Model 14AVQ/WB.

Order No. 184. Price: \$28.95

## Hy-Gain REEL TAPE PORTABLE DIPOLE for 10 thru 80 Meters Model 18TD

The most portable high performance dipole ever...

The Model 18TD is unquestionably the most foolproof high performance portable doublet antenna system ever developed. It has proven invaluable in providing reliable communications in vital military and commercial applications throughout the world. Two stainless steel tapes, calibrated in meters, extend from either side of the main housing up to a total distance of 132 feet for 4.5 mc operation. 25 ft. lengths of polypropylene rope attached to each tape permits installation to poles, trees, buildings... whatever is available for forming a doublet antenna system. Integrated in the high impact housing is a frequency to length conversion chart calibrated to meter measurements on the tapes - makes installation foolproof. Feeds w/ 52 ohm coax. Delivers outstanding performance as a portable or permanent installation. Measures 10x5 1/2x2 inches retracted. Wt., 4.1 lbs.  
Order No. 228 Price: \$94.95



BE PREPARED FOR CYCLE 21  
GET HY-GAIN'S NEW LONG-JOHNS  
"THE STACKABLES"

Specifications:	377 205BA	376 115BA	375 105BA
SWR (at resonance)	Less than 1.5:1	Less than 1.5:1	Less than 1.5:1
Impedance	50 ohms	50 ohms	50 ohms
Power rating	Maximum Legal	Maximum Legal	Maximum Legal
2:1 VSWR Bandwidth	400 KHz	500 KHz	1.5 MHz
Longest Element	36 1/2"	24 1/2"	18 1/2"
Boom Length	34"	26"	24"
Boom Diameter	2"	2"	2"
Turning Radius	25'	17 1/2'	15'
Surface Area	9.0 sq. ft.	5.2 sq. ft.	3.9 sq. ft.
Wind Load at 80 mph	230 lbs.	133 lbs.	100 lbs.
Maximum Wind Survival	80 mph	100 mph	100 mph
Mast DIA Accepted	1 1/4" to 2 1/2"	1 1/4" to 2 1/2"	1 1/4" to 2 1/2"

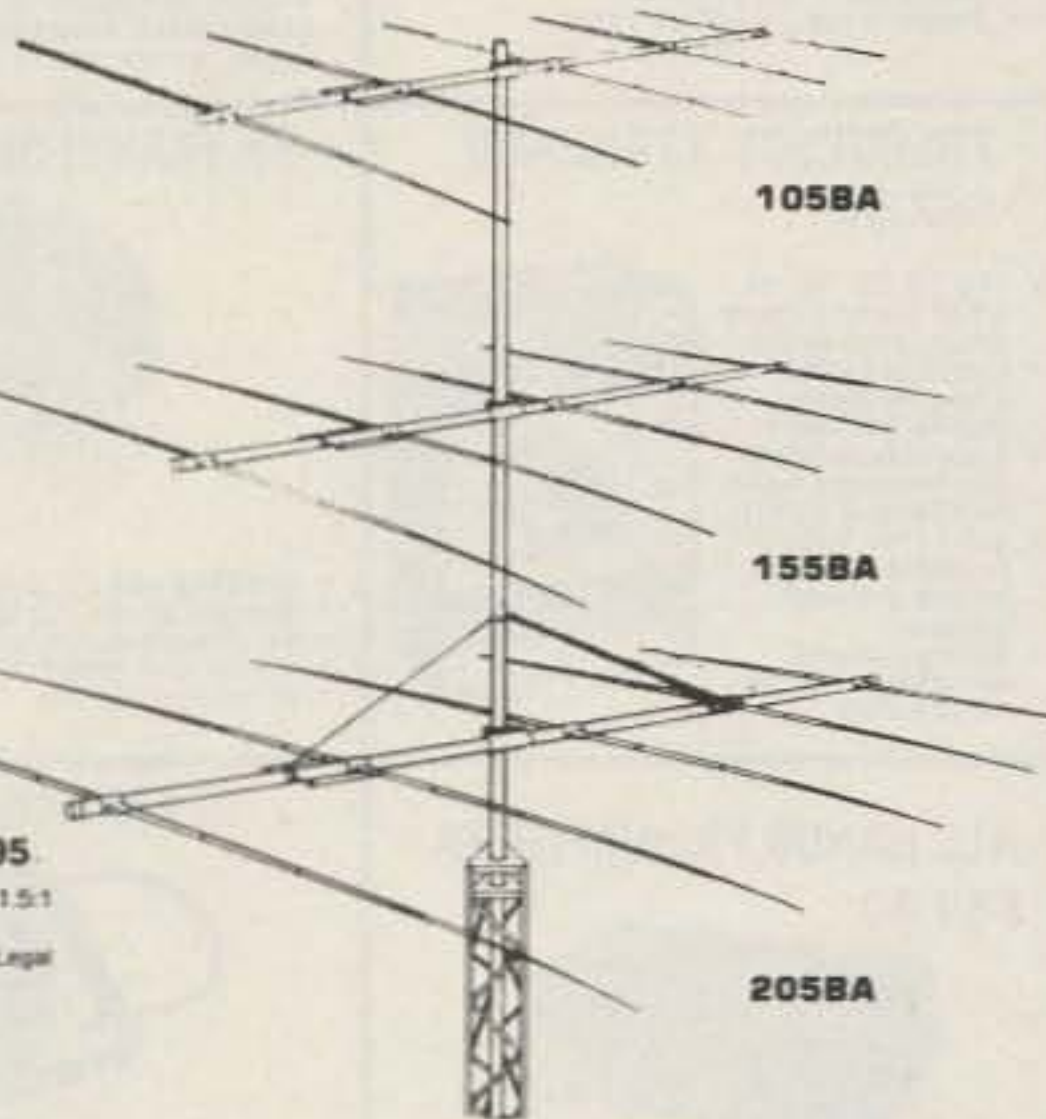

5 Element Maximum Performance Monoband Beams for 10, 15, and 20 meters

With sunspot cycle 21 now in the upswing, you should be prepared for the DX available on the 3 top HF bands, if not, our new "Long-Johns" are for you. The new 5 element "Long-John" monobanders are ideal for the serious DX'er. Each utilizes Hy-Gain's unique Beta-match for optimum power transfer. Also each antenna uses taper-swaged tubing for minimum wind load and maximum strength. For maximum durability each "Long-John" uses Hy-Gain's rugged boom-to-mast clamp.

TUFTS Electronic Department Store TUFTS



## PALOMAR ENGINEERS



\$299.95

### ANTENNA TUNER

Here is a new tuner that puts more power into your antenna, works from 160m-10m, handles full legal power and then some, and works with coax, single wire and balanced lines. And it lets you tune up without going on the air.

All tuners lose some rf power, mostly in the inductance coil and the balun core. To avoid this we switched from No. 12 wire for the main inductor to 1/4" copper tubing. It can carry ten times the rf current. And we've moved the balun from the output, where it almost never sees its design impedance, to the input where it always does. Thus more power to your antenna.

The biggest problem with tuners is getting them tuned up. With three knobs to tune on your transceiver and three on the tuner and ten seconds to do it (see the warning in your transceiver manual) that's 1 1/2 seconds per knob. We have a better way; a built-in 50 Ohm noise bridge that lets you set the tuner controls without transmitting. And a switch that lets you tune your transmitter into a dummy load. So you can do the whole tuneup without going on the air. Saves that final; cuts QRM.



TEMPO  
the first in synthesized portables gives you the broadest choice at the lowest price

## TEMPO

### PRICE LIST

Tempo S-5	\$299.00
Tempo S-5 with touch tone pad	339.00
12 Button touch tone pad (not installed)	39.00
16 Button touch tone pad (not installed)	48.00
Tone burst generator	29.95
CTCSS sub-audible tone control	29.95
Rubber flex antenna	8.00
Leather holster	16.00
Cigarette lighter plug mobile charging unit	6.00
Matching 30 watt output 13.8 VDC power amplifier (S30)	89.00
Matching 80 watt output power amplifier (S80)	149.00
Tempo S-2	349.00
Tempo S-2 with touch tone pad	399.00
Tempo S-1	259.00
Tempo S-1 with touch tone pad	289.00

### ... the new S-5

- ★ The only synthesized hand-held offering 5 watts output. (Switchable for 1 or 5 watt operation)
- ★ The same dependability as the time proven S-1. Circuitry that has been proven in more than a million hours of operation.
- ★ Heavy duty battery pack.
- ★ Telescoping whip antenna.
- ★ Ni-cad battery pack, charger.
- ★ External microphone capability.

### the Tempo S-2

- ★ Tempo is first again. This time with a superior quality synthesized 220 MHz hand-held transceiver. With an S-2 in your car or pocket you can use 220 MHz repeaters throughout the U.S. It offers all the advanced engineering, premium quality components and exciting features of the S-1. The S-2 offers 1000 channels in an extremely lightweight but rugged case.

If you're not on 220 this is the perfect way to get started. With the addition of the S-25 (25W output) or S-75 (75W output) Tempo solid state amplifier it becomes a powerful mobile or base station. If you have a 220 MHz rig, the S-2 will add tremendous versatility. Its low price includes an external microphone capability, heavy duty ni-cad battery pack, charger, and telescoping whip antenna.

### Tempo S-1

- ★ The first and most thoroughly field tested hand-held synthesized radio available. 800 channels in the palm of your hand.
- ★ Simple to operate. (You don't need a degree in computer programming).
- ★ Heavy duty battery pack allows more operating time between charges.
- ★ External microphone capability.

### R-X NOISE BRIDGE \$55.00



- Learn the truth about your antenna.
- Find its resonant frequency.
- Find R and X off-resonance.
- Broadband 1-100 MHz.
- Simple to use. — Self contained.

### VLF CONVERTER \$59.95



- New device opens up the world of VLF radio.
- Converts VLF to 80 meters. For use with any shortwave receiver covering 3.5-4 MHz.
- Advanced design for simple operation, high performance.
- Gives reception of the 1750 meter band.
- Also covers navigation radiobeacons, WWVB, ship-to-shore, and LF broadcast band.

### LOOP ANTENNA

Loop Amplifier \$67.50  
Plug-in loops \$47.50 ea.

- Plug-in loops available for:  
1600-5000 KHz (160/80 meter amateur bands)  
550-1600 KHz (Broadcast Band)  
150-550 KHz (VLF, 1750 meter band)  
40-150 KHz (WWVB, Loran)  
10-40 KHz (Omega)
- Nulls out interference



### IC KEYS \$97.50



- Sends Manual, Semi-Automatic, Full Automatic, Dot Memory, Dash Memory, Squeeze and lmbic.
- More Features than any other keyer. Built-in sidetone, speaker, speed and volume controls.
- Fully Adjustable contact spacing and paddle tension. The perfect paddle touch will Amaze you.
- Battery Operated. Heavy shielded die-cast metal case. 3-lb. steel base.
- By the World's oldest manufacturer of electronic keys.

### FREQUENCY STANDARD \$42.50

- 100, 50, 25, 10 and 5 KHz. Markers selectable by panel switch.
- Crystal controlled. A true secondary frequency standard.
- Square Wave Signal. Rich harmonics usable from 5 kHz to 50 MHz.
- Sharp Clear Output. Exclusive circuit suppresses unwanted markers.
- Battery Operated. No line cord. Self contained battery.



### RF TRANSFORMER \$42.50



- Full 2000 watt CW (5-Kw PEP).
- Matches 32, 28, 22, 18, 12, 8, 5 ohm antennas.
- For all verticals and mobile whip antennas.
- Smaller size. Higher efficiency.
- RF ferrite toroid core.

### 500 W. RF TRANSFORMER \$35.00



- Full 500 watt CW capability. No time limit.
- Convenient switch selection of impedance taps.
- Small size. High efficiency.
- RF ferrite toroid core.

### CW FILTER \$39.95



- Steep skirts. No ringing.
- Simulated-stereo technique filters QRM, improves copyability of CW signals.
- 80 Hz bandwidth.
- Eight pole IC filter.

### ALL BANDS PREAMPLIFIER \$89.50



- Tunes 1.8 to 54 MHz. Covers ALL amateur bands 160 to 6 meters. ALL shortwave broadcast bands.
- For receivers AND transceivers.
- Up to 20 db gain.
- Peps up that tired receiver.
- Reduces image and spurious response.

### BEAM BALUN \$47.50



- 3 Kw CW, 6 Kw PEP input power.
- U bolt for 2" boom.
- 1.7-30 MHz.
- 1:1 or 4:1 ratio available.
- All stainless steel hardware.

### MODEL 2K BALUN \$42.50



- 3 Kw CW, 6 Kw PEP input power.
- Replaces center insulator.
- 1.7-30 MHz.
- 1:1 or 4:1 ratio available.

### MODEL 1K BALUN \$22.50



- 1.5 Kw CW, 3 Kw PEP input power.
- Replaces center insulator.
- 1.7-30 MHz.
- 1:1 or 4:1 ratio available.

PALOMAR ENGINEERS



\$299.00



### BEARCAT 220

Aircraft, Marine, Public Service. The 220 adds features and advanced sophistication.

- Aircraft and Marine — press button to search entire Aircraft Band, another for Marine
- 7 Bands — Low, High, UHF, UHF-T, 2m amateur and 75 CM Ham — plus the Aircraft Band
- 20 Channels — scan up to 20 frequencies or either of two banks of 10 channels each
- Automatic Search — Selective Scan Delay — Automatic Lock-Out — Patented Track Tuning — Manual Scan Control — Single Antenna
- Priority — automatically samples designated channel every two seconds
- AC/DC operation

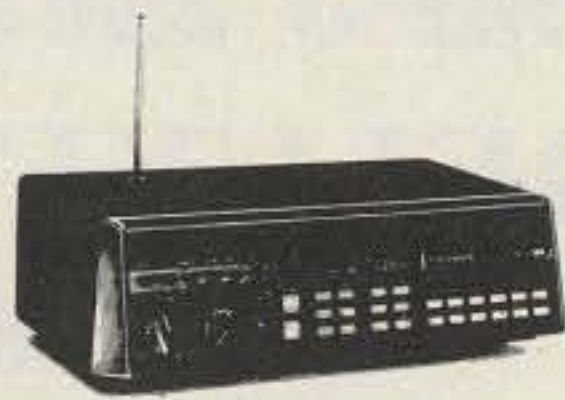

### BEARCAT 300 \$499.95

Service Search  
Over 2100 pre-programmed frequencies.

- 11 Service Search categories arrange stored frequencies into "interest" groups — Police, Fire, Marine, HAM, Emergency, Telephone, Government, Forestry, Industrial, Transportation and Aircraft.
- 50 Channels/5 bands
- 7 Bands (Low & High VHF, UHF, and UHF-T, AM Aircraft, 2m & 75 CM Amateur)
- Non-volatile memory, AC/DC
- Automatic Search with Hold & Resume functions
- Patented Selective Scan Delay
- Vacuum Fluorescent Decimal-Display with Dimmer Control
- Speed Control
- Quartz Clock
- Patented Track Tuning
- Direct Channel Access
- Automatic Squelch

# Bearcat®

NEW!

\$149.95



BEARCAT®  
FOUR-SIX  
THIN SCAN™

More bands, more channels — more scanning capabilities than other Hand-Helds.

- 4 Bands (Low, High, UHF and UHF-T)
- 6 Channels — more monitoring capacity
- "Rubber Ducky" Antenna
- Belt Clip frees hands while monitoring
- 8 channels per second scan speed
- Automatic or manual scanning
- Individual channel lock-outs
- Portable — weighs only 12 ounces
- Battery operated (6 Vdc)

\$219.55



### BEARCAT 210

The one that pioneered synthesized scanning — and unlocks new channels of communication.

- No crystals to buy — full 6-band coverage.
- Keyboard programming makes frequency selection as easy as punching a push-button telephone.
- Decimal display and exclusive rolling zeros to show what's being programmed and monitored.
- Automatic search for finding new frequencies.



PUNCHES THROUGH LOUD and CLEAR



Only \$179.00

**Cobra 29GTL Recognized Industry Standard**  
Cobra's most popular CB mobile—the "Truckers' choice":  
• Delta tune • "DynaMike" • Antenna warning indicator • Illuminated S/R/F/SWR meter • Switchable automatic noise limiting and noise blanking



Only \$89.95  
Cobra 78X Dollar Saver

Talk to the best of them with this economy-sized, economy-priced CB. • Large illuminated tuning dial • Sensitive squelch control • Full range volume control • PA jack • Legal maximum output of four watts



Only \$124.95

**Cobra 25GTL Full Feature Compact**  
You'll know your voice is out there being heard: • "DynaMike" • LED channel display with brightness control • LED transmit/receive indicator • PA/external speaker jacks • RF gain control



Only \$96.00

**Cobra 21GTL Command Performance "Mini" Size**  
Has all the beef to punch through loud and clear: • Digital LED channel display • "DynaMike" • Switchable automatic noise limiting • Illuminated S/R/F Meter and much more



Only \$249.95

The Cobra 140GTL mobile gives you maximum distance with 12 full watts of power, plus quieter communications and 120 channels (80 on sideband). A perfect match for the Cobra 142GTL!



Only \$359.95

### Cobra 142GTL CB Base Station

The COBRA 142GTL SSB/AM Base Station is for CB-ers who want extra distance, full 12 watts of power, quieter communications due to elimination of AM "clutter," and 120 channels — 80 of them on sideband.

## avanti® antennas

## base stations

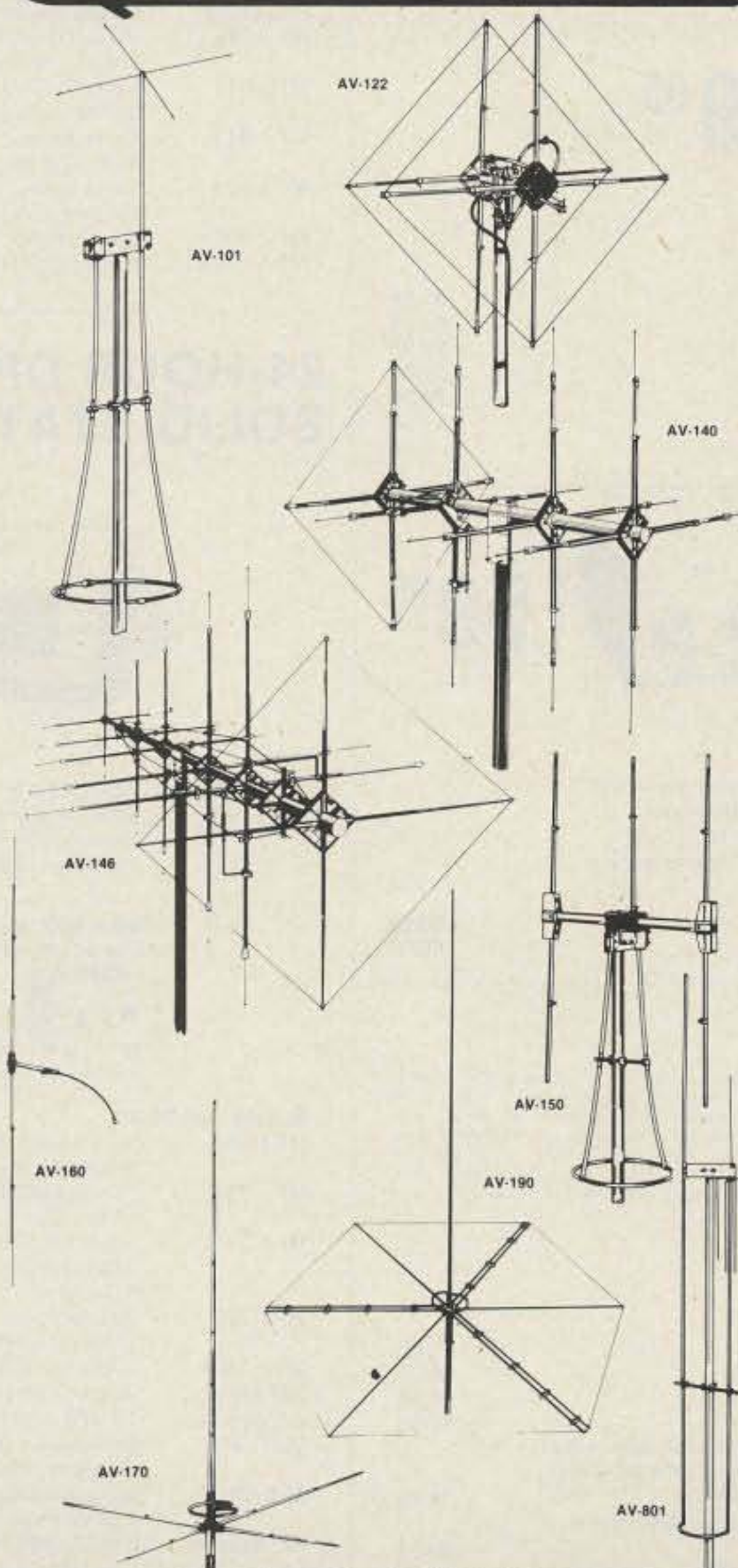

### CB Antennas

**AV-101 ASTRO PLANE™** — Patented performance. Best value available today in an omni directional base antenna. **\$47.95**

**AV-122 PDL II™** — Patented design dual polarity antenna with orbital gamma match. Light weight and long range communication in a beam antenna. Five elements on each polarity. **\$515.95**

**AV-140 MOONRAKER®** — America's most popular and most imitated CB antenna design in a dual polarity beam. Includes cast aluminum hubs, stainless steel tip wires and many other Avanti quality features. **\$199.95**

**AV-146 MOONRAKER®** — King of CB antennas. All the quality features of Avanti Moonraker 4 plus the exclusive 4-way boom support that protects against structural failures common to competitor's super big beam antennas. **\$99.95**

**AV-150 ASTRO BEAM™** — Big power in a small package. Unprecedented 40 dB front-to-back ratio in a three element vertical beam. **\$29.95**

**AV-160 RAMROD™** — The versatile all purpose antenna • CB • low or high band Business radio • short wave listening • monitor • TV-FM • civil defense • amateur • aircraft • marine • experimenting • a no nonsense full 1/2 wave antenna that is fully adjustable from 25 to 175 MHz (adjustment chart provided). **\$89.95**

**AV-170 SIGMA II™** — Second generation 5/8 wave with incredibly low S.W.R., 5.14 dBi gain. New static arrestor system. Easy installation. New H.D. mounting tube. Aircraft quality aluminum. New low price. **\$89.95**

**AV-190 SATURN™** — New scientific breakthrough. Now vertical and horizontal polarity in an omni directional antenna. Strong, long distance power in a unique dual polarity design. Unsurpassed omni power gain and SWR characteristics. Static arrestor system for clearest possible communications in all weather conditions. Easy assembly — aero space light, high strength construction tested to withstand years of wind and weather. Switchbox included. **\$199.95**

### Tri-Band Monitor Antenna

**AV-801 ASTRO SCAN™** — A patented Tri-band base monitor design with no compromises. Unmatched gain over the whole tri-band range from 25 MHz to 512 MHz, including the new "T" band. Aerospace light construction of aircraft quality aluminum and stainless steel is well balanced on the mast to withstand years of severe wind and weather. **\$34.95**

TUFTS Electronic Department Store TUFTS



TUFTS Electronic Department Store TUFTS

## NEW! GRANDMASTER MEMORY KEYERS

At \$139.95 this MFJ-484 GRANDMASTER memory keyer gives you more features per dollar than any other memory keyer available — and Here's Why . . .



- MEMORY KEYERS**
- MFJ-484 Grandmaster Memory Keyer. Up to twelve 25 character messages plus a 100, 75, 50, or 25 character message. **139.95**
  - MFJ-482 Grandmaster Memory Keyer. Four 25 or a 50 and two 25 character messages. **99.95**
  - MFJ-481 Grandmaster Memory Keyer. Two 50 character messages. **79.95**
  - HK-1 Optional Squeeze Key. **29.95**

- PROFESSOR MORSE**
- MFJ-410 Professor Morse, Random code generator/keyer. Morse code teaching computer. Sends alpha only or alphanumeric, full feature Curtis keyer, speed readout, delay for spacing letters up to three seconds. **149.95**

- TELEPHONE PATCHES**
- MFJ-624 Crisp clear professional sounding audio, Vu meter for monitoring line level and for nulling for maximum separation of transmitter and receiver, easy patch in patch out connections. **59.95**
  - MFJ-620 Same as MFJ-624 except without meter. **49.95**



- MISCELLANEOUS**
- MFJ-202 RF Noise Bridge. **59.95**
  - MFJ-1030BX Receiver Preselector. **49.95**
  - MFJ-200BX Frequency Standard. **29.95**
  - MFJ-40T QRP Transmitter. **29.95**
  - MFJ-40V Companion QRP VFO for 40T. **29.95**
  - CPO-555 Code Practice Oscillator. **17.95**
  - TK-555 Optional Telegraph Key. **1.95**



- SPEECH PROCESSOR**
- MFJ-525 RF Speech Processor. Plugs between microphone and rig. Powerful natural sounding speech. Vu meter for adjustment of processing, 4 pin mic jack, 6 dB more average SSB power, use with any rig and any mic, push button on-off/bypass. **119.95**
  - LSP-520BX II Logarithmic Speech Processor. Deluxe model. **59.95**
  - LSP-520BX Logarithmic Speech Processor. **49.95**



**CMOS-8043 Electronic Keyer**  
State of the art design uses CURTIS-8043 Keyer-on-a-chip.

- ELECTRONIC KEYERS**
- MFJ-8044IC Deluxe Keyer. Dot and dash memory. **69.95**
  - MFJ-404 Econo Keyer. Built-in paddle, plus extras. **59.95**
  - MFJ-402 Econo Keyer. Built-in paddle. **44.95**
  - MFJ-400 Econo Keyer. External Key. **49.95**
  - MFJ-408 New Deluxe Electronic II, speed readout meter, socket for: Memory, random code generator, keyboard. 8044IC keyer chip dot and dash memory. Up to 50 WPM. **79.95**
  - BY-1 Bencher Deluxe Iambic Paddles. Heavy steel base, non-skid feet. **39.95**

## MFJ ENTERPRISES DELUXE Versa Tuner II



- MFJ-984 Deluxe 3kW Versa Tuner IV. SWR, forward-reflected wattmeter, rf ammeter, dummy load, antenna switch, balun, 3kW PEP. **299.95**
- MFJ-982 3kW Versa Tuner IV. 7 position antenna switch, balun, 3kW PEP. **199.95**
- MFJ-981 3kW Versa Tuner IV. SWR, forward-reflected wattmeter, balun, 3kW PEP. **199.95**
- MFJ-980 3kW Versa Tuner IV. Built-in balun, 3kW PEP. **169.95**
- MFJ-962 1.5 kW Versa Tuner III. SWR, forward-reflected wattmeter, 6 position antenna switch, balun, 1.5kW PEP. **169.95**
- MFJ-961 1.5kW Versa Tuner III. 6 position antenna switch, balun for balanced lines, 1.5kW PEP. **149.95**
- MFJ-949 Deluxe Versa Tuner II. Ultimate in antenna tuners: SWR, dummy load, forward-reflected wattmeter, front panel antenna switch, balun, 300W output. **129.95**
- MFJ-941B Versa Tuner II. Improved model with SWR/wattmeter, antenna switch, balun, mobile mounting bracket, 300W output. **79.95**
- MFJ-940 Versa Tuner II. SWR/wattmeter, antenna switch, no balun, no mobile mount, 300W. **69.95**
- 700-0014 Mobile mount for MFJ-940. **3.00**
- MFJ-945 Versa Tuner II. With SWR/wattmeter and mobile mounting bracket, less 6 position antenna switch, 300W. **69.95**
- MFJ-944 Versa Tuner II. With antenna switch and mobile mounting bracket, less SWR/wattmeter, 300W output. **69.95**
- MFJ-943 Versa Tuner II. Less SWR/wattmeter, antenna switch mounting bracket, 300W output. **59.95**
- MFJ-901 Versa Tuner. Matches anything. Coax, random wires, balance lines, 200W output. **49.95**
- MFJ-900 Econo Tuner. Matches coax and random wires. 200W. **39.95**
- MFJ-16010 Random Wire Tuner. For random and long wires, 200W. **29.95**

## 24-HOUR DIGITAL CLOCK SOLID-STATE



- 24 HOUR DIGITAL CLOCK**
- MFJ-101 24 hour digital clock, totally solid state, .6" blue display (like TS-820S), ID time, lock function (prevents accidental missetting of time). **29.95**

These MFJ active filters are the most copied in industry.



- SSB/CW FILTERS**
- MFJ-752 Dual tunable SSB/CW active filter Signal Enhancer II. 2 noise limiters, inputs for 2 rigs, 110VAC or 12 VDC. **79.95**
  - MFJ-751 Tunable SSB/CW active filter Signal Enhancer. 110VAC or 12 VDC. **59.95**
  - MFJ-721 Super CW/SSB Filter. 2W amplifier, noise limiters, inputs for 2 rigs. 12VDC or 110VAC with optional AC adapter. **59.95**
  - MFJ-720 Deluxe Super CW Filter. 2W amplifier, 12VDC or 110VAC with optional AC adapter. **44.95**
  - CWF-2BX Super CW Filter. **29.95**
  - SBF-2BX Single Sideband Filter. **29.95**
  - AC Adapter 12 VDC, 200 mA. **7.95**
  - CWF-2PC Same wired and tested PC board as in CWF-2BX with 4 position switch. **19.95**
  - SBF-2PC Same wired and tested PC board as in SBF-2BX with 4 position switch. **19.95**
  - AC Adapter 6 VDC, 300 mA. **7.95**







# Contests

from page 20

families shall not be eligible to participate herein.

## WASHINGTON STATE QSO PARTY

0100 GMT September 13 to  
0700 GMT September 13  
1300 GMT September 13 to  
0700 GMT September 14  
1300 GMT September 14 to  
0100 GMT September 15

The fifteenth annual contest sponsored by the Boeing Em-

ployees' Amateur Radio Society (BEARS) is divided into 3 operating periods as shown. All amateurs are invited to participate. Use all bands and modes, but no CW QSOs are allowed in the phone bands. Stations may be worked once on each band and mode for contact points and more than once each band/mode if they are additional multipliers.

### EXCHANGE:

QSO number, RS(T), and state, province, country, or

Washington county.

### FREQUENCIES:

Phone — 1815, 3925, 7260, 14280, 21380, 28580; CW — 1805, 3560, 7060, 14060, 21060, 28160; Novice — 3725, 7125, 21150, 28160.

### SCORING:

Washington stations score 2 points for each phone contact and 3 points for each CW contact, including contacts with

other Washington stations. Multiply QSO points by the total number of different states, Canadian provinces, and other foreign countries worked. All others score 2 points for each phone contact and 3 points for each CW contact with a Washington station. Multiply QSO points by the total number of different Washington counties worked (39 maximum). There will

## Results

### RESULTS OF THE 1980 MARAC COUNTY HUNTERS SSB CONTEST

#### Fixed Station Scores

N7TT/2	4,469,304
K1NWE	3,820,064
AG9S	2,069,262
WA3YEY	1,555,200
WD5EYM	1,466,059
WD4FGW	960,918
K5IID	603,120
W3ARK	280,434
WB3CFD	263,493
W7JYW	239,760
VE1RQ	206,976
K9DAF	199,906
N8BGF	117,420
WA0RJJ	49,470
WA2WCW	30,960
WB8MDG	8,723
WD8QOY	5,130
WB9SMU	4,104
WB8WEZ	1,955
K9GTQ	1,491
K9GDF	333
K5XY	250

#### Mobile Scores

N4UF	575,340
W0QWS	343,295
WB5BBS	234,360
K3KX	135,125
W5VQR	131,376
W4OWY	54,240
WB4FBS	27,186
VE3IR	1,566
K4ZT	1,554
W1EXZ	540
K9DAF	243

#### DX Scores

WB5KEA/KP4	1,787,832
G2AFQ	206,778
I2PHN	83,681
VK4VU	72,900
CT4SL	9,460
JH1BBU	6,322
SM0CHA	2,600

## Results

### RESULTS OF APRIL 1980 QSO PARTY SPONSORED BY QRP ARCI

State/ Prov./ Country	Call	Points	Mult.	Score
Ala	K4JXS	69	16	5,520
Ark	AD5F	116	28	3,248
Cal	WA6POC*	359	81	87,237
Col	WB0QQW	151	37	16,761
Conn	WA1TRY	150	38	33,500
Del	KA3CDB	30	13	585
Fla	WA4PHM	282	62	34,968
Ga	AA4RF	241	52	25,064
Ill	WB9HPV***	343	69	71,001
Ind	W4JKC/9**	360	69	74,520
Ia	WB0URA	272	61	48,708
Ky	WD4IVF	97	29	8,439
La	AB5N	35	9	945
Me	WB2GNX	167	36	18,036
Md	N3PM	425	69	29,325
Mass	W1PWK	195	46	26,910
Mich	WD8MFP	399	60	47,880
Minn	KB0N	281	62	52,266
Mo	WB0WIW	321	61	58,743
Mont	KL7FDO/7	28	9	756
Neb	KA0O	128	33	6,336
Nev	KA7DVR	122	31	5,673
N. J.	WA2GTJ	247	53	39,273
N. Mex	W5VBO	272	47	38,352
N. Y.	W2EZ	467	80	56,040
N. Car	W4OMW	261	66	25,839
N. Dak	KB0L	116	34	7,888
Ohio	W8AC	119	27	9,639
Ore	WA7ZBL	153	19	8,721
Penn	WB3FLK	218	35	22,090
R. Is	KA1EGZ	32	10	320
Tenn	K4EXC	229	54	37,098
Tex	N5QQ	348	63	65,772
Utah	N7ARE	261	30	23,490
Vir	K4KMS	146	45	19,710
Wash	AA7O	123	23	8,487
W. Va	WA8CNN	298	64	28,608
Wisc	WB7OJV/9	554	89	49,306
Alta	VE6ER	107	39	12,519
B. C.	VE7EMX	60	17	3,060
N. S.	VE1BQQ****	162	37	17,982
Sask	VE5AAD	137	29	11,946
England	G4BUE	139	46	19,946
Puerto Rico	KP4DJ	140	29	12,180

\*Overall winner

\*\*2nd place overall

\*\*\*3rd place overall

\*\*\*\*overall winner in Canada



be an extra multiplier of one for each group of 8 contacts with the same Washington county for all non-Washington stations.

**AWARDS:**

Certificates will be awarded to the highest scoring station (both single and multi-operator) in each state, Canadian province, foreign country, and Washington county. Additional certificates may be issued at the discretion of the Contest Committee. Worked Five BEARS awards are also available to anyone working 5 club members before, during, or after the QSO party (unless previously issued). All QSO party entries will be screened by the Contest Committee for possible Worked Five BEARS awards. Worked Three BEAR Cubs awards are also available for working 3 Novice members.

**ENTRIES:**

Logs must show dates/times in GMT, stations worked, exchanges sent and received, bands and modes used, and scores claimed. Include a dupe sheet for entries with more than 100 QSOs. Each entry must include a signed statement that the decision of the Contest Committee will be accepted as final. No logs can be returned. Results of the QSO party will be mailed to all entrants and an SASE is *not* required. Log sheets and summary sheets must be postmarked no later than October 15th and sent to: Boeing Employees' Amateur Radio Society, c/o Contest Committee, Willis D. Propst K7RS, 18415 38th Avenue S., Seattle WA 98188.

**EUROPEAN DX CONTEST — PHONE**

**Starts: 0000 GMT September 13**  
**Ends: 2400 GMT September 14**

Sponsored by the Deutscher Amateur Radio Club (DARC). Only 36 hours of operations out of the 48-hour period are permitted for single operator stations. The 12 hours of non-operation may be taken in one period (but not more than three) at any time during the contest. Operating classes include single operator, allband and multi-operator, single transmitter. Multi-operator, single transmitter stations are only allowed to change band one time within a 15-minute period, except for making a new multiplier. Use all amateur bands from 3.5 through 28 MHz. A con-

test QSO can only be established between a non-European and a European station. Each station can be worked only once per band.

**EXCHANGE:**

Exchange the usual five-digit number consisting of RS and progressive QSO number starting with 001.

**SCORING:**

Each QSO counts 1 point. Each QTC (given or received) counts 1 point. The multiplier for non-European stations is determined by the number of European countries worked on each band. Europeans will use the last ARRL countries list. In addition, each call area in the following countries will be considered a multiplier: JA, PY, VE, VO, VK, W/K, ZL, ZS, UA9/UA0. The multiplier on 3.5 MHz may be multiplied by 4, on 7 MHz by 3, and on 14 through 28 MHz by 2. The final score is the total QSO points plus QTC points multiplied by the sum total multipliers.

**QTC TRAFFIC:**

Additional point credit can be realized by making use of the QTC traffic feature. A QTC is a report of a confirmed QSO that has taken place earlier in the contest and later sent back to a European station. It can only be sent from a non-European station to a European station. The general idea is that after a number of European stations have been worked, a list of these stations can be reported back during a QSO with another station. An additional 1 point credit can be claimed for each station reported.

A QTC contains the time, call, and QSO number of the station being reported, e.g., 1300/DA1AA/134. This means that at 1300 GMT you worked DA1AA and received number 134. A QSO can be reported only once and not back to the originating station. Only a maximum of 10 QTCs to a station is permitted. You may work the same station several times to complete this quota, but only the original contact has QSO point value. Keep a uniform list of QTCs sent. QTC 3/7 indicates that this is the 3rd series of QTCs sent and that 7 QSOs are reported. Europeans may keep the list of the received QTCs on a separate sheet if they clearly indicate the station who sent the QTCs.

**AWARDS:**

Certificates to the highest

scorer in each classification in each country, reasonable score provided. Continental leaders will be honored with plaques. Certificates will also be given stations with at least half the score of the continental leader or with at least 250,000 points. The minimum requirements for a certificate or a trophy are 100 QSOs or 10,000 points.

**ENTRIES:**

Violation of the rules or unsportsmanlike conduct or taking credit for excessive duplicate contacts will be deemed sufficient cause for disqualification. The decisions of the Contest Committee are final. It is suggested to use the log sheets of the DARC or equivalent. Send a large SASE to get the wanted

# Results

**RESULTS OF THE 20TH ALL ASIAN DX CONTEST — CW**  
**Continental Winners**

*(Multiband, Single Operator)*

Africa	EL2FY	7332
Europe	UR2QI	136240
Oceania	VK3AEW	18270
S. America	LU8DQ	234220
N. America	N6RO	151632
Asia	UV9AX	219432

**Continental Leaders**  
*(Multiband, Multi-Operator)*

Europe	UK4WAR	299468
Oceania	DU1MRC	95432
S. America	LU1DZ	212256
N. America	K7FD	15939
Asia	UK9OAC	182710

**USA**

	Entries	Pts.	Mult.	Score
AE6U	1.9	6	5	30
W7DRA	3.5	27	12	324
K7WA	7	258	37	9546
K4RZ	14	103	44	4532
K5GA	14	83	34	2822
WA6VNR	14	45	18	810
W6NNV	14	57	11	627
WB7SQM	14	29	15	435
W1OPJ	14	7	6	42
K6LL	21	257	41	10537
AI6E	21	89	31	2759
W6SZN	21	79	30	2370
K1KI	21	74	23	1702
AA1M	21	49	28	1372
N6RO	M	972	156	151632
K6NA	M	897	157	140829
N6AW	M	685	140	95900
N5JB	M	509	117	59553
K3TW	M	474	108	51192
K5RC	M	435	109	47415
K4JYS	M	333	87	28971
W8UVZ	M	280	94	26320
WA0TKJ	M	354	70	24780
K2CL	M	238	78	18564
N7AM	M	251	72	18072
W9OA	M	222	75	16650
W4MM	M	176	70	12320
N8FU	M	147	56	8232
K3VW	M	147	54	7938
W5OB	M	104	56	5824
WA4QMQ	M	93	48	4464
K4BAI	M	46	28	1288
K7FD	Mop	231	69	15939
W7DG	Mop	221	68	15028



number of logs and summary sheets (40 QSOs or QTCs per sheet). SWLs apply the rules accordingly. Entries should be sent no later than October 15th; North American residents may send their applications and logs to: Hartwin E. Weiss W3OG, PO Box 440, Halifax PA 17032 USA.

#### EUROPEAN COUNTRY LIST:

C31, CT1, CT2, DL, DM, EA, EA6, EI, F, FC, G, GC Guer, GC Jer, GD, GI, GM, GM Shetland, GW, HA, HB9, HB0, HV, I, IS, IT, JW Bear, JW, JX, LA, LX, LZ, M1, OE, OH, OH0, OJ0, OK, ON, OY, OZ, PA, SM, S, SV, SV Crete, SV Rhodes, SV Athos, TA1, UA1346, UA2, UB5, UC2, UN1, UO5, UP2, UQ2, UR2, UA Franz Josef Land, YO, YU, ZA, AB2, 3A, 4U1, 9H1.

#### CAN-AM CONTEST

##### Phone

**Starts: 1800 GMT September 13**

**Ends: 1800 GMT September 14**

##### CW

**Starts: 1800 GMT September 27**

**Ends: 1800 GMT September 28**

Multi-operator stations can operate the full 24-hour period. Single operator stations can operate a maximum of 20 hours with a maximum of two rest periods totaling a minimum of 4 hours.

The contest is sponsored by the Ontario Contest Club and Canadian DX Association to increase the friendship among Canadian and American amateurs and to provide a means of measuring the performance of their operating skills and equipment.

Operating categories include: 1) single operator—all bands with station operated by the station licensee; 2) multi-operator, single transmitter—stations operated by more than one operator, or single operator other than the licensee, or club station; 3) club competition.

Use all bands, 160 through 10 meters. USA General portion of the bands is recommended. The same station can be contacted once on each band. Stations operating from outside of their own call area must sign slash and the area they are operating from.

#### EXCHANGE:

RS(T) plus sequential QSO number starting with 001 and multiplier (MX) area abbreviation (in that order). Multiplier area abbreviation is the usual two letter postal abbreviation for 50 US states, CN—for Caribbean (KC4, KG4, KP1, KS4, KV4),

PC—for Pacific (rest of US possessions). Canadians will use: NF = VO1 and VO2; NB = VE1 New Brunswick; NS = Nova Scotia; PE = Prince Edward Isl.; SI = Sable and St. Paul I.; PQ = VE2; ON = VE3; MB = VE4; SK = VE5; AT = VE6; BC = VE7; NW = VE8 NWT; and YU = VY1 Yukon.

#### SCORING:

The multipliers are the 50 US states, 2 US possessions (Caribbean and Pacific), 10 Canadian provinces, 2 territories (NWT and YU), and 1 island (Sable or St. Paul). Total of 65 multipliers per band; maximum possible on all 6 bands is 390.

QSO points for Americans to Americans or Canadians to Canadians is 2 points per QSO. American to Canadian and vice versa counts 3 points per QSO. The final score is the result of the total QSO points from all bands multiplied by the sum of the multipliers from all bands. Phone and CW sections of the contest are considered separate contests. However, combined score for phone and CW will be used for overall competition. Combined scores will be calculated by the contest committee as a result of the addition of the phone and CW scores.

#### AWARDS:

First place certificates will be awarded in each multiplier area on both modes in single operator categories. Top five multi-operator stations will receive certificates for high claimed phone and CW scores. All scores will be published in *CQ Magazine*. Free one year subscription to *Long Skip*, the CANADX bulletin, will be awarded to the 5 US stations. Additional trophies and plaques will be awarded the overall winners for the Canadian and American champion on phone, CW, and combined. Also, an award for the club having the highest score as a result of adding the 5 best scores on phone and CW by its members. A club officer must submit the summary showing the callsigns and scores. Each station is eligible for one trophy only. In cases where one station qualifies for another trophy, the less significant trophy goes to the next eligible station.

#### ENTRIES:

All times must be kept in GMT. Indicate multipliers the first time only on each band. Log must be checked for duplicate contacts, correct QSO points,

and multipliers. Do not use separate logs for each band. Rest periods must be clearly marked in the log. Each entry must consist of log sheets, summary sheet showing all scoring information, category of competition, operator's name and callsign, address of the station, and signed declaration. Entries with over 200 QSOs must include check sheets for each band. Official logs, check sheets, and summary sheets with multiplier tables are available from the contest chairman; a large SASE with Canadian stamps (or US stamps *not glued* to the envelope) will bring you samples. Usual disqualification rules apply and the decisions or actions of the CAN-AM Contest Committee are official and final. All entries must be postmarked not later than 30 days after the contest and mailed to: VE3BMV, PO Box 292, Don Mills, Ontario, Canada M3C 2S2.

As a trial, certificates will be issued to high scoring QRP stations running less than 10 W input and also to the monoband entries. Any band can be selected; all monoband entries will be lumped together. You are encouraged to use the official forms—they considerably help with "bookkeeping" and processing the results. Please send logs regardless of how small!

#### PENNSYLVANIA QSO PARTY

**1700 GMT September 13 to**

**0400 GMT September 14**

**1300 GMT September 14 to**

**2200 GMT September 14**

Sponsored by the Nittany Amateur Radio Club, this is the 23rd annual event. Stations may be worked once on each band and on each mode. Mobiles may be reworked as they change counties. Repeater contacts *do not count*.

#### EXCHANGE:

RS(T), 3-digit sequential serial number, and ARRL section or PA county.

#### FREQUENCIES:

SSB—3980, 7280, 14280, 21380, 28580; CW—50 kHz up from bottom of CW bands.

#### SCORING:

Count 1 point for SSB QSOs, 1.5 points for CW QSOs, and 2 points for 80-meter CW QSOs. PA stations multiply QSO points by the total number of sections plus the total number of PA counties worked. Mobiles in PA calculate their total for each county then add these county

totals together for the final score.

#### AWARDS:

Handsome plaques will be awarded to the top PA entrant and the top out-of-state entrant. Certificates for section winners and the 10 top PA entrants with a minimum of 10 QSOs. Special club award—an engraved gavel donated by W1PL will be awarded to the PA club whose members score the highest aggregate scores in the contest. Be sure to indicate club affiliation on your logs!

#### ENTRIES:

Dupe sheets are required for entries with 100 QSOs or more, except for mobiles who are exempt from this rule. Mail logs, dupe sheets, comments, and SASE (for results) by October 15th to: Douglas R. Maddox W3HDH, 1187 S. Garner Street, State College PA 16801.

#### NORTH AMERICAN SPRINT

**Starts: 0100 GMT September 14**

**Ends: 0500 GMT September 14**

Sponsored by the *National Contest Journal*, the contest is open to all licensed radio amateurs. The object is to work as many North American stations (and/or other stations if you are in North America) as possible and as many multipliers as possible during the 4-hour contest period. Entries must be single operator only—no helpers or spotting nets are permitted. All contacts must be made on the 80-, 40-, or 20-meter bands using CW only. A station may be worked once on each band. If any station solicits a call by sending CQ, QRZ, etc., he is permitted to work only one station in response to that solicitation. He must thereafter move at least 1 kHz before he works any other station, or at least 5 kHz before he again solicits other calls. Regardless of the number of licensed callsigns issued to a given operator, one and *only* one callsign shall be utilized during the contest by that operator. For the purposes of this contest, a North American station is as defined by the rules of the CQ Worldwide DX Contest.

#### EXCHANGE:

To have a valid exchange, you must send all of the following information: his call, your call, serial number (starting at 001), your name, and your state (or VE province/country).

#### FREQUENCIES:

Suggested frequencies are:



3530-3550, 7030-7050, and 14030-14050.

#### SCORING:

Multiply the total valid contacts by the sum of states, VE provinces, and other North American countries to get the final score (do not count USA and VE as countries). KH6 is not counted as a state and is not a North American country. VE multipliers are maritime (VE1, VO1, and VO2) and VE2 through VE8 (8 total). Non-North American countries do not count as multipliers.

#### AWARDS:

A trophy shall be awarded to the highest scoring entrant. Certificates of merit shall be awarded to the highest scoring entrant from each USA call area, Canada, and other country; to each of the ten highest scoring entrants; to each member of the winning team; and to the highest entrant on each team.

#### ENTRIES:

Entries must be sent to: Rusty Epps N6SF, 235 Montgomery Street, Suite 2600, San Francisco CA 94104.

Entries must be received not later than 30 days after the Sprint to be eligible for trophies and awards. An entry consists of 1) a summary sheet showing valid contacts by band, total multipliers, total score, name, callsign and address of the operator, station callsign, and station location; 2) a complete, legible log of all contacts (including dupes marked as such) with indication by numbered sequence of each multiplier claimed; and 3) a separate check sheet for each band. Logs, summary sheets, and check sheets may be home-made or patterned after those shown in the *National Contest Journal (NCJ)*.

Team competition is limited to a maximum of 10 operators as a single entry unit. Clubs having more than 10 members may submit more than one team entry. To qualify as a team entry, the name, callsign of each operator, and callsign of the station operated (should the operator be a guest at a station other than his own) must be registered with N6SF. The team information may be contained either in a letter, which must be received by N6SF before the start of the Sprint, or it may be contained in a Western Union mailgram dated at least 24 hours before the start of the Sprint. There are neither distance limitations nor

meeting requirements for a team entry. The only requirement is pre-registration of the team.

Any entry may be disqualified for illegibility, incorrectness, or illegal or non-ethical operation. Such disqualification is at the discretion of the NCJ Contest Review Committee.

#### DARC CORONA 10-METER RTTY CONTEST

##### Contest Period:

**1100 to 1700 GMT September 27**

This is the third of four tests during the year sponsored by the DARC eV to promote RTTY activity on the 10-meter band. Each of the four tests is scored separately. Use the recommended portions of the 10-meter band.

#### EXCHANGE:

RST, QSO number, and name.

#### SCORING:

Each station can be contacted only once. Each completed 2X RTTY QSO is worth 1 point. Multipliers include the WAE and DXCC lists and each district in W/K, VE/VO, and VK. Also count each different prefix as a multiplier. The final score is the total number of QSOs times the total multiplier.

#### AWARDS:

Plaques will be awarded to the leading stations in each class with a reasonable score present. Operating classes include Class A for single or multi-op and Class B for SWLs.

#### ENTRIES:

Logs must contain name, call, and full address of participant. Also show class, times in GMT, exchange, and final score. SWLs apply the rules accordingly. Logs must be received within 30 days after each test. Send all entries to: Klaus K. Zielski DF7FB, PO Box 1147, D-6455 Erlensee, West Germany.

The last contest period is on November 15th.

#### EX-KZ5 REUNION

**Starts: 0001 GMT September 27**

**Ends: 2400 GMT September 28**

An on-the-air reunion, sponsored by the Canal Zone Amateur Radio Association, Panama, to foster continued friendship among former KZ5s. Use A1 and A3 modes only; no cross-mode operation allowed. No power limitations within legal limits.

Two categories of participants. Former KZ5s licensed

under authority of the Panama Canal Zone Government will count only contacts with other former KZ5s. Total points will be based on 2 points for each A1 contact and 1 point for each A3 contact. All other stations wishing to participate are encouraged to contact a minimum of 5 current CZARA members to qualify for the Balboa Award.

#### EXCHANGE:

Former KZ5 operators will send signal report, the last two digits of the first year licensed as a KZ5, and former KZ5 callsign. Others will provide signal report and state/country.

#### FREQUENCIES:

Listen within the lowest 25 kHz of the CW and Phone seg-

ments of the US General class portion on each band.

#### AWARDS:

Prizes for the top three former KZ5s currently operating from the Republic of Panama as an HP-licensed operator. Also, prizes for the top three former KZ5s currently operating elsewhere, worldwide. Certificates for all other former KZ5 entries.

#### ENTRIES:

Send extract of contest logs by October 31st marked either "Reunion" or "Balboa Award" to: John B. Barham HP1XOG, PSC Box 4481, APO Miami FL 34001. Former KZ5s who choose not to submit entries are encouraged to provide current callsign and address via QSL or postal card to the above address.

## Review

### HIGH FREQUENCY CIRCUIT DESIGN

by James Hardy

Depending on publications written expressly for amateur radio operators is frustrating if you are seeking information about the more theoretical aspects of our hobby. On the other hand, many "theory" books are filled with mathematical proofs and long-winded technical descriptions of "ideal" circuits that are of little use. *High Frequency Circuit Design* by James Hardy is one book that falls somewhere in between application-oriented amateur texts and rigorous theory books. Although it is intended primarily for electronics technology students, the author expresses his hope that it may be of use to practicing rf designers and radio amateurs.

Many hams consider rf circuit design to be a sort of black magic that is practiced by a few experts. Instead of trying to understand the workings of an oscillator or amplifier, we often build a project hoping for the best but not really knowing why it was designed the way it was. *High Frequency Circuit Design* concentrates on the basics that make up any rf circuit, whether it is centered around tubes or the latest power FET device. First the terminology needed to understand noise, amplitude, and phase is discussed. Then the author describes how simple components like resistors and

capacitors behave when used in rf circuits. Once the fundamentals are taken care of, the book explains the secrets of impedance matching, filter design, amplifiers, and oscillators.

There is no way to gain a thorough understanding of rf circuitry unless you are exposed to the mathematics that governs it. The author does not expect his readers to be experts in calculus—all the math is at an algebra level.

The latest FCC Extra class study outline lists items like preselector design and the use of Smith charts. Your favorite amateur references may have a paragraph or two on these topics, but *High Frequency Circuit Design* has many pages. If you are looking for a schematic diagram for a high-powered amplifier, you will be disappointed, but if you are genuinely interested in what makes an rf amplifier work, this book just might hold the answer.

If theory is not your bag, then this 340-page book will probably sit on your shelf unread. If, however, you already have a solid background in circuit fundamentals but are still itching to find out how the "magicians" designed your rig, then *High Frequency Circuit Design* may be of interest. Published by Prentice-Hall, a hardcover copy costs \$19.95.

Tim Daniel N8RK  
73 Staff



from page 14

path, 50 David Ave., Manurewa, New Zealand; FW0DD confirmations come from Canad-X Club Station VE3ODX, PO Box 717, Postal station Q, Toronto, Ontario M4T 2N5, Canada.

John Ackley KP2A completed his Asian operations as CR9A the last three weeks of June, under the auspices of the International DX Foundation, which provides just the QSL support and publicity for Ackley's work. The considerable travel costs

are not picked up by IDXF. CR9A cards to WB2KXA.

Incidentally, IDXF's East Malaysia 9M6MU operation in May turned out almost 20,000 contacts in six days of operation. About 25% were on CW, about 30% overall with North America. And band conditions were abysmal then, too.

OH2BH and OH2MM appeared right on schedule from the Sudan, signing 6T1YP from

the Children's Youth Palace. They then drove south with Mr. Fadul Kabbar ST2FF to put the south Sudan on for several days as ST2FF/ST0. Martti OH2BH and Willi OH2MM were invited to Khartoum to discuss amateur radio training in the Sudan and to make final adjustments to the 6T1YP station, which was a gift of North Korea.

George Wagner K5KG vacationed in Finland's Aland

## GLORIOSO

*Editor's note: This article is published unedited in order to retain its special flavor.*

Do you remember your last DX adventure, when you reached right away HB0XXX on your first call in the biggest pileup? Quite a success! How about following us on our DX-pedition — but a bit further — just turn your beam toward the Indian Ocean, northeast of Madagascar. The island of Glorioso is even on sea maps only a small spot.

We thought, with our licenses, we would have no further difficulties. Bull! On arrival our difficulties started. Nobody of the local authorities could be reached. Hours and days passed, and we were still sitting on the island of Mayotte. No wonder that hours before we departed and even after our return there were doubts that we had been there.

Everybody who listened to our traffic on the "Safari Frequency" could feel how exciting the last days had been, before we went on our trip. All of the "Safari Family" know each other and they wanted us on Glorioso and Geysers Reef for any price (donations are welcome!).

Anne DF3KX got the call FR0ACB/Iles Glorieuses; this call should give the YL-hunters and CW freaks worldwide their points. FR0ACC/Iles Glorieuses was DK9KX, Hans-Walter, who handled the SSB traffic...he was a main operator. Gero DJ3NG held FH0FLP and FR0FLP/Iles Glorieuses, and used also FR0ACC. Wilfried DJ5RT was also along and the doctor of the expedition.

Our main CW operator was Baldur DJ6SI, member of FOC who also used FR0ACB/G. Help was given by many OMs of the "Safari Round" from Cologne over Kenya to Mayotte.

Special thanks to the Northern California DX foundation and all the other donators who helped to get us there.

Our outfit included 5 HF transceivers of different makes, as well as two beams, several dipoles, and a DX-Butternut. All the antennas were donations. Last but not least, we should not forget our pilot, Rainer FH8OM, and our airplane "Bongo Banjo," a Partenavia P68V, with two engines and six seats, an ideal plane for short runways. Special thanks to an OM from Condor Airways in Frankfurt who got us VIP treatment; the antennas were not only bulky but heavy as well.

On arrival in the morning of April 12, 1980, in Mombasa, we got our first feeling of the hot and tropical climate of Africa. That's where our difficulties started. Just before the airport was closed due to a visit of a foreign statesman, Rainer landed at the airport with "5 Y BBE" which was a borrowed replacement for his own plane, which had engine failure.

So we had to stay for one night in Mombasa in the Castle Hotel, with slow-turning fans and a temperature of 95 degrees F (35° C) in the shade. We put up the Butternut 6P antenna and contacted the OMs in Germany and told them of our delay. We were not finished yet as already the first CW calls came in. Then we handled the first calls under 5Z4NG/4, the call of DJ3NG, on CW! We could only get Baldur DJ6SI away from his key by putting a plate of excellent food under his nose.

Next day we left for Mayotte, a five hour flight above open sea. We arrived on Mayotte April 14, 1980. On April 16, we finally left for the Island of Glorioso, direction Geysers Reef. Understandably, we could not land on Geysers Reef, but we used it as a marker to get to Glorioso. The maps did not show the position correctly. We had to fly 20 minutes in several directions to find it. In fact, we found three small sandbanks where we could dock with a boat. But we did not have any luck; the only available boat had an engine break down, so "1G" next time!

Now further direction Glorioso. We were told there had to be a beacon. No good! No beacon to hear. It was out of order, so we had to fly visual. After 25 minutes, still no Glorioso. We got nervous.

Finally, there was a flat island to see and after 32 minutes we landed on Glorioso Island. The four people on the island without contacts (except radio) for 120 days were obviously pleased to see us. Two hours after our arrival, stations and beams were ready and we could make our first contact. First reaction on the band: "Are you really there?"

Now we got the first congrats approximately 1400 GMT under the call FR0ACB/G. Conditions were hard, 100% humidity, 98 degrees F in the shade. The one and only policeman was soon assured that we were not spies and we got on friendly terms.

Baldur gets up to his best and works 180 stations per hour. The commercial operator of the island group gives up after ten minutes of listening. SSB was not much lower; one op at the mike, one at the logbook, we worked within two hours 120 stations per hour on 10 and 20 meters. The 28-MHz band was open 14 hours a day, especially to the Pacific area during the daytime and Europe in the morning. 40 and 80 we did not have any luck; no contacts.

Discipline was generally good, with few exceptions. We worked mostly split frequency, and we had signals as high as S9 + 40 dB spread for 40 kHz.

Sorry we could not reach all the OMs calling us; we would have needed weeks to do that, but we did work 15,000 stations within the four and a half days we could stay on Glorioso Island. Two stations were always operating. Weather was not always good, so that our allowed stay (3 days) had to be extended for 36 hours. Storms, lots of water, and thunderstorms did not make our job easier.

Three times a day we had to recharge our batteries with the big generator. Even so, our sixty Amps battery was out of order after our fourth day. After that we had to work with reduced power.

On the morning of the 22nd of April, we left the island and our new friends, the next expedition in mind for September. So watch your DX infos. With your QSL card or SWL card and a few IRCs or a small donation to our manager, DK9KD, you would help us get there. Until then, good DX! — Dieter Löffler DK9KD.

*(Reprinted from The DX Bulletin, Vernon CT)*



Islands, making over 3,000 contacts as K5KG/OH0. He stayed at the home of Kee OH0NA, who was the lighthouse keeper for neighboring Market Reef from 1965 to 1977, and who now accompanies each expedition to the reef to ensure ham operations don't interfere with the reef's solid-state control systems for the lighthouse.

Cocos-Keeling VK9 appears all too infrequently, and always for a very short duration. VK9CCT made some contacts early in June, using the usual setup—low power and a 20-meter dipole. The Australian Air Force runs missions to Cocos, always unannounced, sometimes having a ham technician on board, occasionally affording time for a few hours of ham radio. VK5CT comes on 14195 the day a mission leaves to make the announcement if a ham is making the trip, but it is not known if an amateur radio operation will take place until the crew has done its work on Cocos and time remains. When the sunspots go back to wherever they come from (in a couple of years), the VK9CCT signal (weak in '79-'80) will probably just not make it at all. But

VK5CT has been working on some sort of "package station" to be taken along each time, possibly with a small breakdown beam for 20 meters.

LA5KC was in the Republic of Guinea to set up some commercial radios in early June and made a handful of contacts on 15 SSB. This may have been using the commercial radios themselves, as taking amateur equipment into Guinea is virtually impossible due to mistrust on the part of officials. LA5KC just may be back there early in September and if he operates, it would likely be at 21250-21300 on SSB.

Bob Dreher W6RZO departed from California on June 22 to operate from a number of Asian spots, including (tentatively) VS6 Singapore Aug. 15-21, YB Indonesia through Aug. 28, W3WYP/DU2 Philippines through Sept. 4, Peking, China through Sept. 11, and JH1ARJ Tokyo, Japan through Sept. 18. If you work any of the callsigns listed during the time frames above it was probably Bob, and QSLs go to him: R. Dreher, USICA MGT/TCE, Rm. 320, 1776 Penn Avenue, Washington DC 20547 USA.

Jim Hewitt W8LMB, an associate of W6RZO, left in mid-July for Africa, hoping to operate from some spots. His itinerary included 5N2 Nigeria, TY Benin, TN8 Congo, TJ Camerouns, TL8 Central African Republic, 9Q5 Zaire, TT8 Chad, 9U5 Burundi, 9X5 Rwanda, 5Z4 Kenya, S79 Seychelles, ET3 Ethiopia, and 6O1 Somalia. The lengths of stay at various stops was not known. QSLs for any operations go to W2TK.

Finally, Karl Renz K4YT also left for Africa in mid-July, with planned stops at 5T5DX, K4YT/6W8, D4, J5, C5ACO, 3X, 9L1, 9G1, TU2, TY9ER, TZ, XT, 5U7AG, and 5V. QSLs for these operations also go to W2TK. These fellows in many cases will have no idea if they can operate the radio until they arrive and make contacts with the authorities in the various countries. The only hope of catching them is to listen constantly and/or get one of the weekly published DX bulletins. W1AW's on-the-air bulletin on Friday morning UTC (Thursday evening in North America) may also carry late developments. Check QST for the schedule.

Next month we will carry the results of a countries-needed survey conducted by *The DX Bulletin*, reflecting the needs of over 900 subscribers. If you don't have it it's rare, but the top spots on the list should make for good dreaming by would-be expeditioners.

You'll be getting *that* issue of 73 just as radio conditions pick up from the summer slump they're now in. Does it seem to you that this summer's doldrums are worse than those of the past couple of summers? Sure gives that impression here, but I think it is our imagination. Back when there were no sunspots and wintertime conditions were marginal at best, when 10 died and 15 went flaky in the summer it wasn't much of a change from the rest of the year. Now, 10 is dead and 15 is flaky and it's a big letdown from the spectacular conditions of the winter of '79-'80. Oh, well, a little abstinence never hurts, and it will feel so good to hear those JAs on 10 again come October!

Meanwhile, keep letters and photos coming. Hope your summer has been a good one, DX-and otherwise.

---

# W2NSD/1 NEVER SAY DIE

editorial by Wayne Green

---

from page 6

eight second waits for pictures to unfold can get boring... particularly if it is the third time you've seen those girl photos from Miami or the *Playboy* centerfolds from Venezuela. The pits is waiting for someone with a slow scan typewriter to put a dozen words on your screen.

The first few days you point your camera at yourself and smile at your contacts. This gets old by the second contact with each chap. Then you rig up a menu board so you can send a QSL over the air for the contact. This keeps you hopping, putting the other station's call on the board...then changing it for calling CQ...etc.

It doesn't take long before

you get the impulse to work up a program for the fellows. You get together pictures of your wife, children, home, ham shack, yourself, etc., and put them all on tape. It takes several days of work, but eventually it looks pretty good. Now you get on the air and show off the program. Great! Everyone enjoys it. But a funny thing happens... interest in repeat performances is minimal.

Eventually, when you've seen everyone else's programs and they have seen yours, you go back to DXing or RTTY...and SSTV fades away for you. It is just too much work getting new programs together and it kills the fun.

Suppose we could get the cost of SSTV equipment down

...way down. And then suppose we got away from trying to make complete contacts with slow scan and just used it as a way to swap a picture or two... no more? I'd like to see what the person I'm talking with looks like... and so might you.

Slow scan is sent by means of a series of audio tones, so there is nothing very complicated about it. Much of the cost of the equipment has been due to the small production quantities made rather than the complexity of the circuits. Just by way of getting this concept across, may I remind you that eight-inch television (black and white) sets cost \$250 back in 1948. That's equivalent to about \$3,500 in today's dollarettes. You can buy a much better set today for \$59 (saw an ad on TV last night).

The slow scan camera could be replaced by a simple PROM which could be made by your nearby ham dealer. He would sit you down in front of his camera (or use a glossy photo) and pop a PROM, putting your photo in the memory chip. One or two chips more would give you a simulated SSTV camera, all for a

few bucks.

The monitor is simple, as I said. In quantity most of the circuitry needed could be put on a single chip, leaving only the small CRT and power supply required. It could come well below \$100. First costs will be higher since we will be needing a 16K memory chip to hold the slow scan picture and display it with fast scan for easy seeing.

Once we build the system into a transceiver, we can use the scope not only for seeing the people we are working, but also to tune in stations, as a display for a panoramic view of the band, as a way of monitoring your transmitter quality, etc. Even the call letters could be displayed on the scope. By adding a cassette recorder to the system...or an output for one...we can save pictures of the people we work on tape.

## BUS-ORIENTED RIGS

If our ham transceivers were built-in modules like computers, we would be able to buy a rig and then add to it as money and interest dictated. By the use of a



common bus structure for the system, it might be possible to build a rig with end panels which are removable so further modules could be added.

For instance, the DI module could have a small panel space for its control and just screw on to the end of your transceiver, interfacing with it automatically via the power and audio lines.

Next, we might want to add a Morse keyer/converter... then a RTTY keyer/converter. This would have output for a printer via RS-232C standard or to a TV monitor. If you later added the slow scan scope system, it would read the RTTY or Morse code, if you desired.

This type of design would allow a ham rig to be almost infinitely expandable, interfacing with your computer, the phone

lines, other control units, etc.

Needless (I hope) to say, articles are hereby solicited for any developments along this line. It would be nice to work up a standard bus structure for ham gear so that small firms could be formed to make esoteric additions, much as the S-100 bus system has made it possible for hundreds upon hundreds of boards to be made for S-100 oriented computer systems.

Let's see what you can do!

### THINK SOLAR

With 73 growing, it is getting time for us to plan for a headquarters building which will hold everything we are doing. The old mansion, though it has forty rooms, filled up and overflowed into the town's largest motel. Now that, too, is full and some-

thing has to give.

Peterborough has run out of office space so we're going to have to start thinking in terms of a new building. Keeping in mind the problems of heating and cooling, my inclination is to plan on something which would be built into the side of a hill, facing south so that it could be heated entirely... or almost entirely... via solar energy. The ground temperature year around, once you get down a few feet, is 57°, so it shouldn't be difficult to keep a building like that warm enough or cool enough.

Getting information on similar buildings is not simple, so if you come across anything comparable, I'd appreciate knowing about it. Should we allow for skylights, or would we do better to be further under the ground

and use sunlight-type fluorescents? I've seen some interesting buildings which have solar panels which automatically fill with tiny plastic beads at night to prevent radiation of the heat.

With a projected staff of about 200, we would need a minimum of 50,000 square feet of space. This would not only provide space for the growth of our computer publications, but would also allow for room for a headquarters for lobbying for amateur radio on both a national and international basis... something which has been badly needed.

It may be that government regulations would not permit something new like this to be built, but if it is possible and practical, I'd like to tackle it.

# LETTERS

from page 18

come around and told us it didn't matter that we had worked hard and long and done our best at driving for 20 years, but we could no longer drive on the freeway and had to take the back streets only from now on. That the freeway was being set aside now for automotive engineers and designers to have exclusive use of and unless we could pass engineers' and designers' types of examinations, we might as well forget about the long trips (DX) and be happy they still let us use the back streets.

To make a long story short, after about a week of discussing it on the air, the pileup on our QSOs began to sound worse than the Clipperton DXpedition. So was born the AARA, American Amateur Radio Association. Since I was then in the Army at Fort Benning GA and centrally located in the southeast, I was elected to be the director of the AARA effort for the southeastern states. It was a completely nonprofit, loose-knit, nationwide group of several hundred amateurs who were interested

in keeping the integrity of the bands as they were. We worked at it as hard as we could. We made hundreds of tapes of our aims and goals to put on the nightly nets and mailed thousands of cards all over the country to be signed and sent to the FCC. Those of us actively involved in the AARA effort took the entire expense in time and money, equipment, and postage out of our own pockets. We even tried to get Barry Goldwater to go to bat for us in Washington. He was sympathetic to our cause but was unable to become involved for various reasons.

The big guns in Connecticut won out and about the time I shipped out to go fight the war in Viet Nam, the hammer fell. We lost. Amateur radio lost. There were other good options for incentive licensing besides segregating the bands. I, for one, am still "unhappy" with it and there will be rain forests in Siberia before I'll knuckle under and join the elite. There are still a lot of us Generals working the unsegregated parts of the bands who can rock along at 35-40 wpm even though it does get a little

crowded once in awhile. We manage because we are darn good operators with darn good technique and at least it's some consolation to know that the big guns with their "California kilowatts" are off at the edges of the band where they won't be clobbering us with their 20-kHz-wide signals.

I sure am sorry I missed Field Day this year. First time in 15 years. No amateur radio here in Saudi Arabia. It's banned. Guess they're afraid somebody will QSO an Israelite or something. If I'm lucky, I may get to give someone a good DX shot. I am a pilot here and get an air mobile crack at it once in awhile on the HF SSB rig in the aircraft. 500 Watts to a 50-foot long-wire up 15,000 feet gets an occasional laugh.

I'm not a subscriber. 73 is on the newsstand here a month before I could get it in the mail. I'll subscribe when I get back to the States.

Keep up the good work. You're the only ones in print who really know what amateur radio is all about.

**Orvill B. Wolf WA4IXN  
Jeddah, Saudi Arabia**

### FORGOTTEN?

Your views in 73 seem to reflect mine up to a point. Your view on 220 MHz is a bit narrow; however, it seems justified when you see what happened to the last band of frequencies

taken from hams. Look, though, at the possibilities of a compromise on the issue.

Let the CBers have 220 MHz and give us back 27 MHz. All that is on 220 is a glorified CB operation anyhow. Let them run their illegal power on 220 rather than on 27 MHz. They won't get into the TVs and toasters and tape recorders quite so bad, and they won't get around the block either.

If, as you say, we are going to lose it, then let's put a few strings on it, such as when the 220 MHz CB band opens, the 27 MHz band closes in 365 days. Don't say it can't be done — just remember what happened to double sideband marine communications a few years back.

Then put in the stipulation that 730 days after 220 MHz CB starts, the 27 MHz band becomes an amateur band. This will give us a shot at regulating our testing. The US was built on the idea of a compromise, so instead of getting mad and starting a big uproar, let's sit down and work things out a bit.

The other view is one that I am surprised to see you print. You actually agree with the ARRL's position of going out and getting more amateurs. I also agree — but put a string or two on that idea. If you do bring someone into ham radio, at least spend the time to teach him the do's and don'ts. The next time I hear an "old-timer" complain about the WDs or KAs, I'll give him a piece of my mind,



since they were the ones who got us interested, helped us get licensed, and then forgot us. If you have no background and no one will tell you, how in the hell do you find out?

I hear the old-timers grumble and say, "Oh, well, I'll just turn it off or go do something else." If you ignore a problem, it will only get worse — that is a proven fact. If you hear something wrong, pull the man over to the side and tactfully tell the man the right way. We "newcomers" look up to you "old-timers" and all we see is closed eyes, deaf ears, and mute mouths. If you don't tell us, how will we know? We want to enjoy your company.

**John F. Hauser KA4DLC**  
Pensacola FL

### BUY AMERICAN

I just read your FB editorial in the July, 1980, issue of 73 and noted the enjoyment and kindly thoughts that occurred to you in carrying and contemplating your fine Casio calculator watch.

I also just re-read some 1952 and subsequent issues of *QST*. It's fascinating reading.

I don't think that it was just Kahn's or Orr's personal whims that gave us incentive licensing. The idea was in (and on) the air for years before it happened, as the result of a logical, quite gradual, and rather sane development. (The way the democratic process worked then, as it is now, is well illustrated by Docket 10237 of ill fame which proposed "calling and listening" frequencies and related in-anities. It was soundly rejected and defeated, as, I am sure, you well know.)

It was unfortunate that American ham radio had to "stagnate" for so long when incentive licensing came into formal existence in 1963. But it was only natural that, after such painful surgery, the stunned patient had to rest, to pause, to recover, and to work through what had happened.

And true enough, there have been casualties. Some proud names have suffered or perished. Some wounds perhaps will never heal.

But where would amateur radio be today without incentive licensing? No Extras, no Advanceds. Why go through the trouble of shooting for 20 wpm

plus if you can comfortably tag along at 13 plus (or minus!)? Why go through all the "fun" of learning the theory if no tangible rewards ("incentives") are offered? Well, yes, I know. It might have been just as well. The Europeans with their comparatively less complicated licensing structure seem comfortable enough — but, then, they can't take and retake (and retake...) their exams, once failed, every 30 days for free...

Let's face it. All things considered, the patient seems alive and well today. What hasn't killed him has made him stronger. And never mind those diligent island people and their delightful toys. They want to make a living, too, and labor very hard (as I am sure you fully appreciate) so that we can use and enjoy their Sonys, Sanyos, and, yes, your Casio calculator watch. But then, if you insist and *want* to "buy American," what's keeping you, or me, or anyone? Those who want, prefer, and opt for the quality and service American electronic firms have to offer us today can most certainly do so at their discretion. I know I did — and shall continue to do so.

**F. Paul Kosbab N4AZN**  
Hampton VA

### BIG E

Thanks for the tip on the Casio C-80. It is a great piece of "gear"! I read your article in the July, 1980, issue of 73, mentioned the watch to my XYL, and several days later she purchased a C-80 in a local discount department store. It keeps perfect time, all functions work FB, and the price was right.

Thanks, too, for the fine code tapes and study guides. I'm here (Big E) because your team's there.

**William J. Switoyus AJ3Z**  
Shickshinny PA

### TAKING EXCEPTION

I must take exception to Wayne's comments in the NSD column on page 4 of the June issue of 73, wherein he showed a photograph of the Yaesu engineering department and stated, "I suspect there are more development engineers and technicians in this one lab than all of

the American ham manufacturers have combined."

Cubic Corporation, who markets ham gear under the Swan label, employs more than 900 engineers with a BS or higher degree, plus more than 350 technicians. This does not include degreed management personnel.

The all-new team at Cubic Communications (ex-Swan) in Oceanside where the Swan gear is produced operates on a free technical interchange with all Cubic divisions and subsidiaries to draw or give technical support and facilities whenever necessary.

I am sure the same is true at Rockwell Collins, and I don't think Drake, Ten-Tec, and others are to be sold short.

American technology does not have to take a back seat to any country in the world and, in fact, it is "borrowed" by every country.

To my way of thinking, the sooner we Americans stop touting and purchasing imported equipment of all types, the sooner the American economy and American way of life will return to some semblance of normalcy.

**Sam F. Arn K6TSD**  
President  
Cubic Communications, Inc.  
Oceanside CA

### HBO

As I am sure you know and I informed WD9IVY, the FCC has authorized cable systems to use a set of "special" channels between 6 and 7. The frequencies of these channels include 144-148 MHz. When I heard about this, I was very skeptical. I have been waiting for this very problem to surface.

What is happening is that the converter attached to the TV is actually receiving at or near the 3m band, so there is little or nothing a ham can do to filter the TV antenna to remove interference (short of also blocking HBO transmissions).

The cable companies have agreed to provide sufficient shielding to prevent pickup of ham (and other) transmissions by their converters operating in these bands. So it is their problem. However, I feel that every ham who has this problem should notify the FCC of it so that they will understand how

well(?) this system works. (I feel sorry for any ham running a full gallon on "2" in an HBO area.)

**W. D. Rhodes WB2JMX**  
Webster NY

### MDA

Amateur station KA8COI will be operating as a special event station this Labor Day, September 1, 1980 (0330 to 2230 GMT, 7.230 MHz SSB), during the course of the annual Muscular Dystrophy Telethon hosted by Jerry Lewis.

A numbered certificate will be available to all stations making contact with KA8COI during this period. There will be no charge or fee for the certificate, although stations are requested to send an SASE with their QSL. They also should mention their QSO number (which will be given them on the air).

No third-party traffic will be handled on behalf of the Muscular Dystrophy Association and no solicitations for donations will be made over the air. Anyone wishing to donate to the MDA is urged to do so through their local telethon station. The MDA is a nonprofit charity, so donations would be tax-deductible. The Muscular Dystrophy Association has been contacted about this operation and has issued their formal approval. The certificates will bear the signature of Jerry Lewis, National Chairman for the MDA.

QSL information, QSO number, and SASE should be sent to:

**Al Graff KA8COI**  
PO Box 332  
South Webster OH 45682

### KING OF BOGUS

The article appearing in the July, 1980, issue of your magazine concerning the Dayton Hamvention was quite well done. Too bad the local news media tends to look upon the Hamvention as just another cause of traffic congestion and an increase in the practice of the oldest trade.

However, I must take exception to your remarks about "some nut" dressed in an Arabian sheik's garb.

That "nut" was my good friend and former fellow-employee, Vince Barman. Vince is also Ash-sheik Abu Ibn al Heeshash, Emir of the principality of



Bogus and once Vice Omnipotens to the King of Bogus, Curtis Long.

For those who might not know, Bogus is one of those tiny islands of the mind, not unlike Hay, Abaco, and Espiritu Santo, where the common dreamers go in search of refuge from engineers, politicians, and the ARRL. Most of its inhabitants are former employees of the R. L. Drake company. Some wish they were.

Vince, as he is known to fellow Bogusites, is also N8ASQ. A contact with him is worth 2 points toward the coveted "Worked All Bogus" award. He is intelligent, clean, and not taken to malevolence. He knows four phrases in Arabic. He fixes radios and likes cats. I do not think he is a "nut."

For a nut, you have to look to the other guy in the picture. That's John Wallace WD8OQS. John is the Lord High Sheboygandoski of the Lower Dingus. Now, John is a nut. He plugs S-meters into the 110-ac line.

So maybe next time you can pick on John. He deserves it.

**Nils R. Bull Young WB8IJN**  
Grand Bumpkin  
Awards Chairman  
Director of International Gizmos  
New Carlisle OH

## LIGHTEN UP

As a newly-licensed ham and a new subscriber to 73, I have been disturbed by your occasional potshots at the ARRL and its leadership. Maybe I don't know enough to understand the basis for this, but I do know that I don't like it one bit.

Your editorial in the July issue takes the cake. Now we are asked to believe that the machinations of Mort Kahn and Bill Orr are responsible for the explosive growth of the Japanese electronics industry, to the detriment of American companies.

First of all, I am unconvinced. Secondly, I don't think this sort of thing serves amateur radio very well. Aren't there enough things to write about without sniping at other hams?

The name of your magazine exemplifies the best that amateur radio has to offer as a hobby: the communication of friendship and goodwill from one person to another. How ironic that 73 should occasionally become the vehicle for promulgating divisiveness and negativism. I for one am tired of reading this sort of thing.

Come on, lighten up. Bury the hatchet.

**John W. Baker N5BSZ**  
Houston TX

## COMPETITION

I read with interest your editorial in the July issue of 73 and noted the mention of Kahn and Orr and their activities regarding phone band restrictions. This is a subject that arouses my ire rather quickly—and not in favor of their theories. I would like to see the artificial restrictions on our bands put to a vote or poll to see how many of our amateurs today agree with them.

There are several things I would like to see stopped or deregulated; among them, incentive licensing and stipulated phone and CW bands quickly come to mind. I would rather see the bands open for any emission type anywhere with areas marked only by common usage. It seems rather apparent that the present regulations cause much QRM due to crowding and leave some favored few with all the allocations.

If the aims of amateur radio really do include making friends

and promoting worldwide understanding among all people, why are these restrictions necessary? No one has ever explained to my satisfaction why we are restricted from certain areas on phone for the benefit of the Canadians and the Mexicans, for example (as mentioned in the letter you published, by George K0WTM).

If we are truly the bastion of freedom in the eyes of the world, why do these restrictions exist? I suspect that if there were another organization, devoted to amateur radio operating parallel with the League, many of these ghosts and skeletons would be examined under a de facto "sunshine" law.

I would like to see such an alternative organization started. I think you could get the ball rolling quite easily with a request in 73 for interested people to contact the magazine.

I don't think the ARRL is all bad, let me clearly state, but as in business, competition is good in order that all may benefit fairly. And, I have an idea that many people would quickly muster to join such an organization if you would provide a starting point. Put my name on the list!

**Noell "Dusty" Reed KJ5A**  
Lafayette LA

# Awards

from page 22

Designed specifically for owners of converted Citizens Band equipment, the Ten-Forty Award is probably the roughest worked-all-states award program in existence. Ask those who have tried numerous times and failed!

Available to licensed amateurs the world over, the Ten-Meter 10-40 Award offers a challenge second to none. To be valid, all contacts must be made on the ten-meter band using only "channelized" Citizens Band equipment or similar commercial units. Power is limited to 15 Watts PEP output. External amplifiers are prohibited.

To be eligible, all contacts must have been made on or after October 1, 1978, in the AM, SSB, CW, or FM modes. Mixed-mode contacts are not valid.

To qualify for this award, the

applicant must work and confirm at least forty (40) of the 50 US states. An endorsement will be issued if all 50 states are worked.

To apply, make a list of contacts in alphabetical order by US state beginning with Alabama. Include the call of the station worked, the date and time in GMT, the band and mode of operation, and a brief description of the equipment and antenna system utilized.

Do not send QSL cards! Have your list verified by two amateurs, a radio club secretary, or a notary public. Send your application along with the award fee of \$3.00 or 8 IRCs to: Bill Gosney WB7BFBK, 73 Awards Editor, 2665 North Busby Road, Oak Harbor, Whidbey Island WA 98277 USA.

Though the title may be deceiving, this next award is probably the ultimate in the domes-

tic awards offered by this magazine. A look at the requirements will clearly show the degree of difficulty one will experience in attaining the goals of this award. Luckily, we were sympathetic enough to eliminate any time limitations.

## CENTURY CITIES AWARD

The editors of 73 Magazine designed the Century Cities Award as a dual-Worked-All-USA effort. The applicant who applies for this achievement realizes he has accomplished what is probably the greatest feat available in award programs today.

All contacts must have been made on or after January 1, 1979. To qualify, the applicant must work and confirm a minimum of two cities or towns in each of the fifty (50) US states, for a total of 100 US cities.

To apply, prepare a list of claimed contacts, listing each one in alphabetical order by state. As shown below, include the full callsign of the station

worked, the date, the band, and the city. Beginning with Alabama, your list will look something like the following example:

Alabama—W4ZZZ, March 31, 1979, 14 MHz, Decatur; N4XXY, February 1, 1979, 21 MHz, Mobile. Alaska—KL7AB, January 22, 1979, 7 MHz, Anchorage; WL7WW, May 19, 1979, 28 MHz, Fairbanks, etc.

Do not send QSL cards! Have your list of claimed contacts verified by two amateurs, a radio club secretary, or a notary public. Send this list along with an award fee of \$3.00 or 8 IRCs to: Bill Gosney WB7BFBK, 73 Awards Editor, 2665 North Busby Road, Oak Harbor, Whidbey Island WA 98277 USA.

For applicants for the awards offered by 73 Magazine, I would like to present some insight on how we process the paperwork. Upon receipt of an application, each award requirement is carefully scrutinized to see that the applicant has met each one to the letter. If approved, a three-



# TET<sup>®</sup>

## ANTENNA SYSTEMS 1-800-654-3231

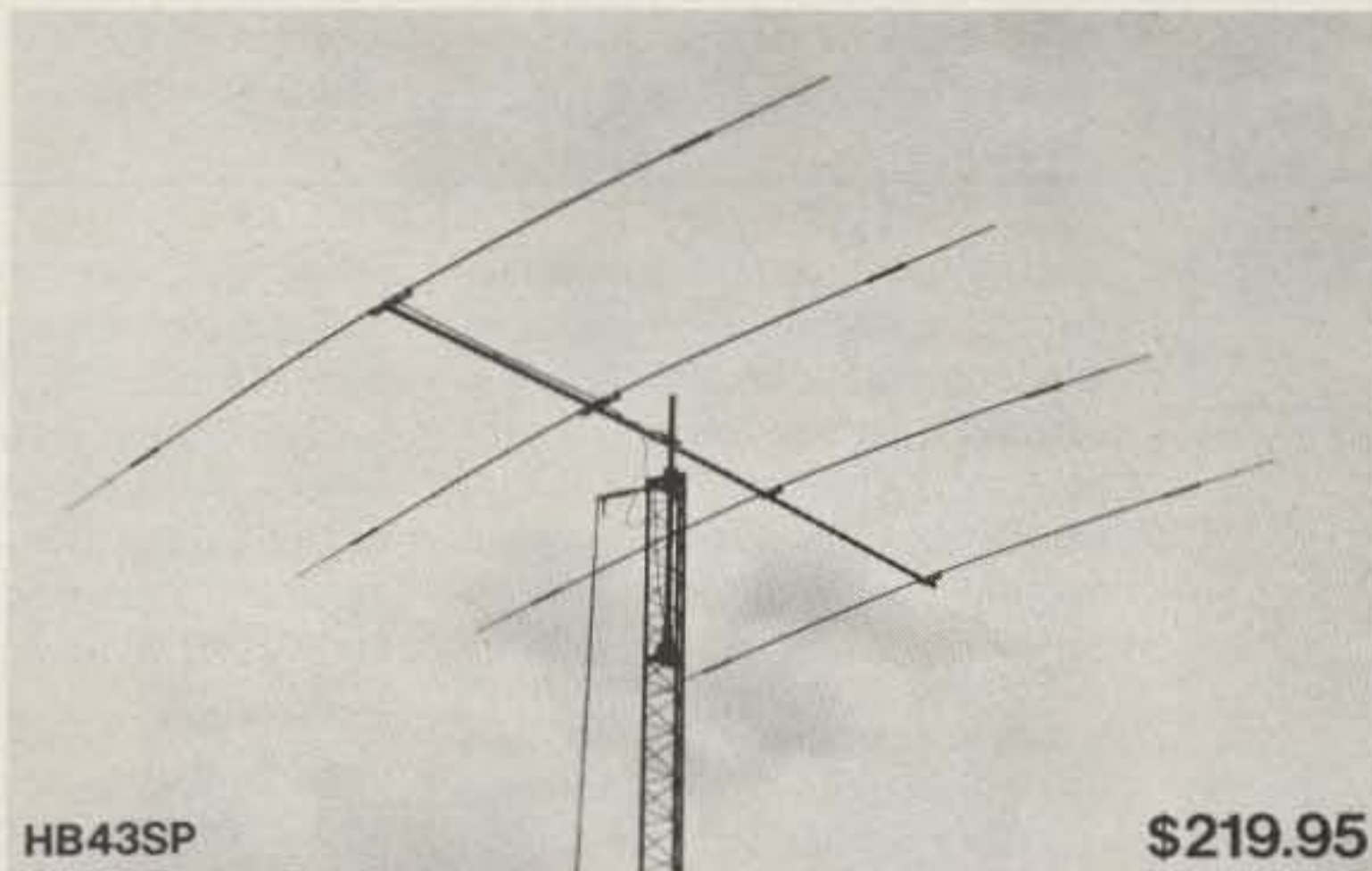

HB43SP

**\$219.95**

**TET, THE LEADER IN WIDEBAND ANTENNA DESIGN**, introduces another new triband antenna to provide unmatched wideband performance on the 10, 15 and 20 meter amateur bands. This radical departure from conventional triband antenna design employs **TWO DRIVEN ELEMENTS** with a rigid phasing line to couple power from the radiator element to the reflector. Phase relationships have been carefully engineered to provide extremely high gain figures without neglecting the need for high front to back ratio. The two element drive system is coupled to one parasitic director on the model HB33SP; two parasitic directors on a longer boom with the model HB43SP.

**FULL BAND COVERAGE** is possible without the need for antenna tuners or separate CW and phone antenna adjustments. The 1.5:1 VSWR bandwidth covers the entire 20 and 15 meter amateur bands, with a little extra for MARS operation. On 10 meters, coverage is in excess of 1 MHz.

**QUALITY CONSTRUCTION** and repeatable performance permit TET to deliver an antenna package without need for any tuning adjustments. All tubing is cut and pre-drilled to precision tolerances. The phasing harness and feed assembly for the two driven elements are pre-assembled to insure ease of construction and reliable performance.

**MOVE UP** with the performance oriented leader in antenna technology. Order your new high performance wideband triband antenna system from TET today.

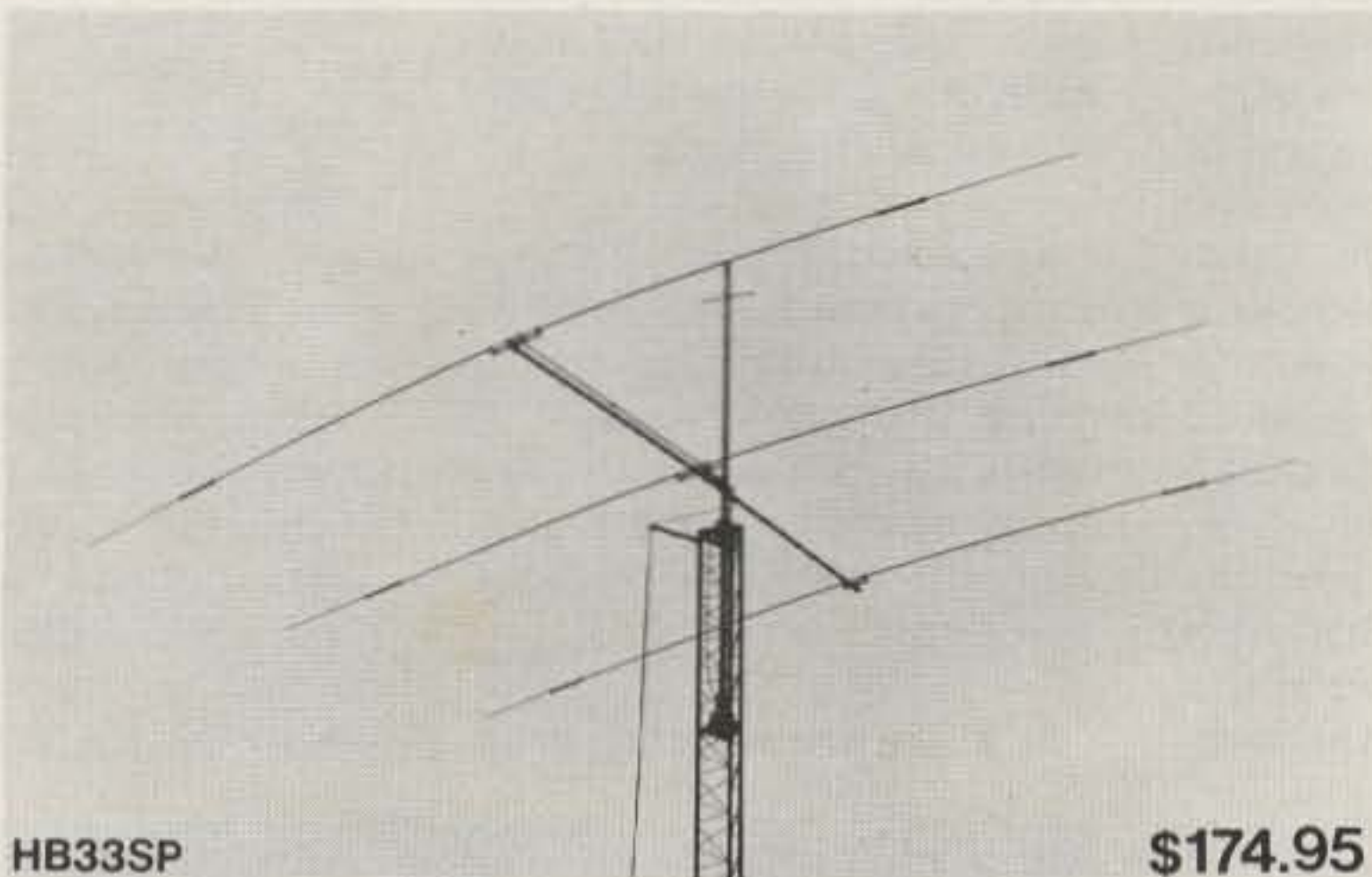

HB33SP

**\$174.95**

MODEL	BANDS	ELE- MENTS	ELE- MENTS PER BAND	MAX PWR	VSWR	IMPEDANCE	MAX ELEMENT LGTH	BOOM LGTH	TURN- ING RADIUS	WIND SURFACE AREA	WIND LOAD @80 mph	BOOM DIA- METER	MAST SIZE	WT
HB43SP	14/21/28	4	4	2KW	BELOW 1.5	50 Ohm	27'	19' 8"	16' 9"	6.62 sq.ft.	131.3 lb.	2"	1 1/2"-2"	38 lb.
HB33SP	14/21/28	3	3	2KW	BELOW 1.5	50 Ohm	27'	13' 2"	15'	4.73 sq.ft.	102 lb.	1 9/16"	1 1/2"-2"	27 lb.

Call Factory for ANTENNA GAIN dBd and FRONT TO BACK RATIO.

TET FACTORY DIRECT PRICE

HB43SP \$219.95  
HB33SP \$174.95

## Call Toll FREE 1-800-654-3231



# TET U.S.A., INC.



425 HIGHLAND PARKWAY, NORMAN, OKLAHOMA 73069 TEL: 405-360-6410



part award worksheet is prepared. The original copy and applicable award fee is mailed to the Peterborough offices for 73 to process. It is there that your award is given a personal touch; from there, it is later mailed to your door. In the meantime, a copy of the award worksheet is mailed to the applicant to acknowledge that the applica-

tion has been received. Should the applicant feel it necessary to follow up on the application, he or she should write a letter to the Assistant Publisher, 73 Magazine, Peterborough NH 03458. Writing directly to 73 headquarters will speed your efforts since I no longer retain your paperwork once a request for issuance is mailed.

We hope you enjoy the challenges of the 73 Awards Program and will share its rules with your amateur friends. While we hope you all will pursue the objectives these awards have to offer, we also hope that you will send any information you might have on other award programs which have never appeared between the covers of this maga-

zine. Looking through my files, I see that we have gone many, many months without duplicating a single award. Our files are getting bare, however, and it is the input of our readers that will keep the image of this column original and creative. If your club has an award it sponsors, why not share it with our thousands of readers?

## New Products

from page 39

Reader Service number 478.

modular addition to the HG-EW winch. This remote control unit allows the operator to conveniently raise and lower the tower from a remote location such as a ham shack. The control displays upper and lower limit positions, up or down operating direction, and also provides a fail-safe sensor and indicator which automatically shuts off the winch should extreme side loads affect tower telescoping. Both the winch and the remote control are available for 110- and 200-volt operations.

For further information, contact Hy-Gain, Division of Telex Communications, Inc., 8601 Northeast Highway Six, Lincoln NE 68505; (402)-467-5321.

### ARCHER ENGINEER'S NOTEBOOK

Just published by Radio Shack is a new handbook of 415 electronic circuits for electronics hobbyists, experimenters, technicians, and engineers.

The Archer Engineer's Notebook contains 128 pages of useful and thought-provoking circuitry in a unique hand-executed style that resembles a master circuit designer's notebook. Applications are included for most of the popular integrated circuits sold by Radio Shack.

Dozens of handy problem-solving circuits ranging from straightforward building blocks to never-before-published novel-

ties, including a generous selection of warbling, flashing, and howling fun circuits, are described. Tips and techniques for beginners are included in the introduction which precedes each section.

Following a brief review of basic electronics, the book is divided into two major sections: digital and linear. The digital section is further subdivided into CMOS and TTL/LS chips. Each chip gets at least a full page, and some get four pages of application circuits.

According to Radio Shack, using the book is easy since the chips are organized by function rather than part number. All CMOS gate packages, combinational logic chips, and sequential logic chips are placed in their respective groups.

In a like manner, the linear

section includes separate subsections for voltage regulators, operational amplifiers, LED flashers and dot/bar drivers, timers, tone decoders, voltage-to-frequency converters, voltage-controlled oscillators, and audio amplifiers.

The book was compiled and hand-executed on engineering grid paper by Forrest M. Mims III, an electronics writer who has written hundreds of articles and 36 books covering topics ranging from electronics and lasers to computers and CB radio.

Many of the circuits in Engineer's Notebook came from Mims's personal notebooks and his project articles. Others are from manufacturers' data books or were designed by Mims specifically for this book.

Radio Shack, a division of Tandy Corp., 1300 One Tandy Center, Ft. Worth TX 76102. Reader Service number 483.

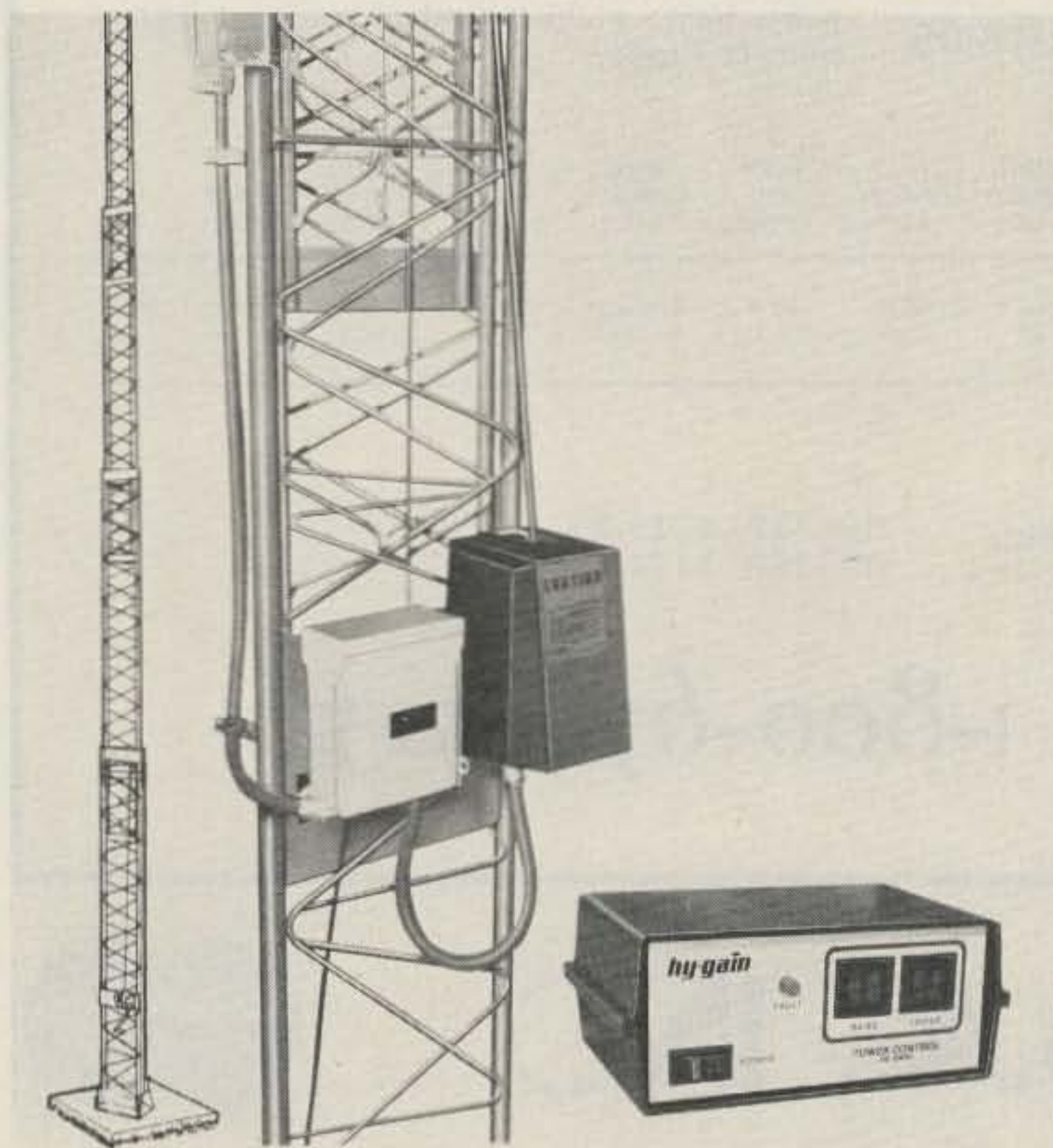

New products from Telex/Hy-Gain (l to r): HG-70HD, HG-EW, HG-EWRC.

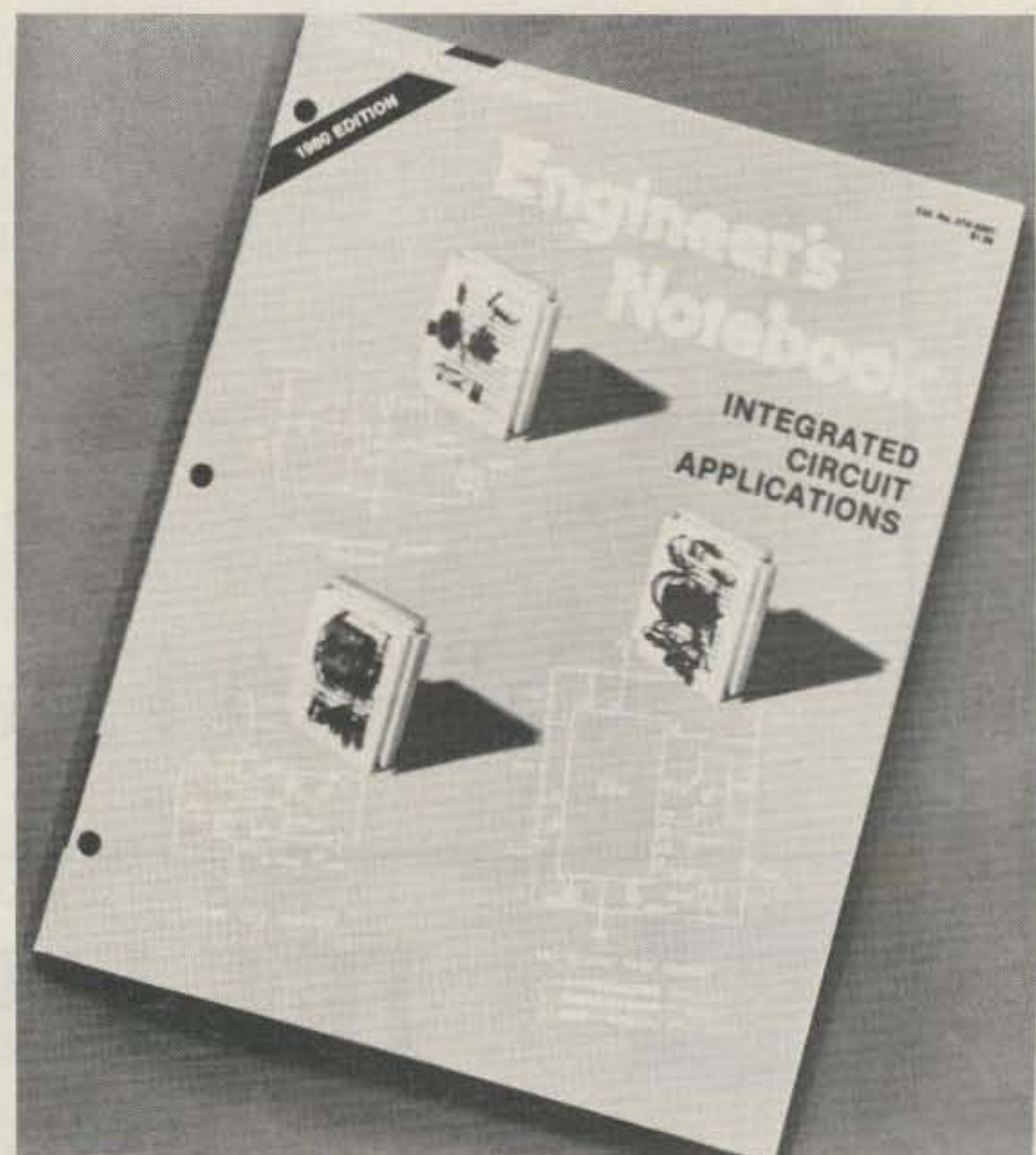

The Archer Engineer's Notebook.



## ALDELCO ELECTRONICS COMPANY

**RF DEVICES**  
 2N5913 1.7W 175 MHz \$1.70 2N6080 4W 175 MHz 5.40  
 2N3866 1W 400 MHz 1.25 2N6081 15W 175 MHz 8.45  
 2N5589 3W 175 MHz 4.75 2N6082 25W 175 MHz 10.95  
 2N5590 10W 175 MHz 7.80 2N6083 30W 175 MHz 11.75  
 2N5591 25W 175 MHz 10.95 2N6084 40W 175 MHz 13.30

**OVERVOLTAGE PROTECTION OV-12** Provides protection from runaway Power Supply Voltage. Triggers @ 16V 25 Amp rated, 1 piece moulded unit for 12 Volt DC fused Power Supply \$8.95 OV-5 for 5 Volt PS triggers at 7V \$9.95

**ACCUKEYER KIT.** Similar to Handbook version. Includes PC Board, IC's, Sockets & all parts. Includes sidetone on board, lmbic operation dot dash memory. Only \$21.95

**NEW MEMORY KIT.** 1056 bit memory expandable to 4224 bits. 1 2102 supplied. Additional chips \$1.25 each. Led indicator. Adaptable to other keyers. Uses 5VDC. Only \$21.95

**Dual digital 12 or 24 HOUR CLOCK KIT.** NOW WITH A NEW WALNUT WOOD GRAIN CABINET Model ALD 5-W Six Big 0.5 Displays. Only \$52.95 12 or 24 Hour Operation

Each Clock controlled separately  
 Freeze Feature for Time Set — Easy assembly for clock and Cabinet.

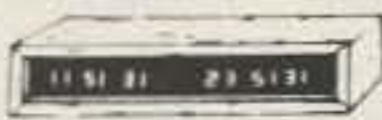

5 x 7 3 dot matrix display 3.95  
 Handie Talkie collapsible whip ant. BNC 8.95

**ALARM CLOCK KIT** Six 0.5 LED Display Readouts Elapsed Time indicator 12 Hour Format with 24 Hour Alarm Snooze feature AM/PM indicator Power Supply power failure indicator. Only \$21.95  
 12 or 24 Hour Clock Kit 0.5 Display LED's \$19.95  
 Wood Grain Cabinet \$4.95

**TUNABLE AMATEUR TV CONVERTER** Receive Fast Scan ATV in the 420 MHz Band with any TV Set. Low noise high gain Amplifier stage with Varactor Tuned input and output. Built-in 110 VAC Supply Two Tone Walnut & Beige Cabinet measuring 1-7/8" x 4-1/4" x 4-1/8" Factory Wired & Tested. 2 Year Guaranty. Only \$59.95

**Lunch Counter Kit (boards & front panel only)** \$14.50  
 11C90 Prescaler \$19.95 1 MHz crystal \$ 7.95  
 74C925 Multiplex \$15.95 10-60 PF trimmer \$ .60  
 F9368 Drivers (2) \$15.95 704 displays, each \$ 1.25  
 Resistor Kit \$ 1.75 Capacitor Kit \$ 6.00

Add 6% for Shipping. Min. Order \$10.00. Out of USA send Certified Check or Money Order. Include Postage.

# ALDELCO

2789 A Milburn Avenue, Baldwin, NY 11510  
 (516) 378-4555

✓ 300 Send 1st class stamp for our catalog

## Subscription Problem?

73 Magazine does not keep subscription records on the premises, therefore calling us only adds time and doesn't solve the problem.

Please send a description of the problem and your most recent address label to:

73 Magazine  
 Subscription Dept.  
 PO Box 931  
 Farmingdale, NY 11737

Thank you and enjoy your subscription.

## Ham Help

I need a schematic and/or a service manual with power requirements for a Galaxy SSB Comm 1.

H.E. Roby K5JMI  
 317 Driftwood  
 San Antonio TX 78239

I need a circuit diagram and/or instruction book for a

Simpson #311 VTVM. I will pay for copying and postage.

Nate Bushnell KA0DGN  
 7175 S. Grant St.  
 Littleton CO 80122

I am looking for a vfo or a schematic for one with sufficient output to drive a World Radio Labs SB-175 tube-type

transmitter. I will pay a reasonable price for the vfo or for the schematic. I will reimburse the cost of copying or return the schematic after copying.

Rex D. Faulkner KA3FTN  
 3416 Brinkley Rd. #102  
 Temple Hills MD 20031

I would like to hear from anyone who has successfully tinkered with a CPU 2500 R/K (Yaesu) so as to unlock the PLL in order to be able to listen to lower and higher frequencies.

Mine is factory wired for 144 to 148 MHz. Thanks.

Hubert Melin PY1VLY  
 PO Box 551  
 20.000 Rio de Janeiro  
 Brazil

I need to contact individuals who are familiar with permits, regulations, etc., for the marine radio bands—especially VLF, MF, and HF.

Gary Mitchell WA1GXE  
 Box 1003  
 Fairfield CT 06430

## STAINLESS STEEL WHIP—FIBERGLASS LOADING COIL—NO COIL HEATING

### MOBILE OPERATORS

LOOKING FOR VALUE, HIGH PERFORMANCE, AND EASE OF OPERATION? The MT-1 MOBILE ANTENNA, GENERAL COVERAGE, 3.2 to 30 MHz. 750 WATTS C.W., 1500 P.E.P., CENTER LOADED, Tune to EXACT RESONANCE. NO COIL HEATING. 50 OHMS INPUT. FULL OUTPUT from SOLID STATE FINALS. BASE TUNED WITH LOGGING SCALE and correlation chart for ease of resetting. Max. length 116 inches at 3.2 MHz, 92.5 inches at 30 MHz. Fits any STD. MOUNT (3/8 x 24 THREAD.) Send for free brochure.  
 MAX. DIA. OF COIL 1.125 INCH

CHECK WITH YOUR LOCAL DEALER OR ORDER DIRECT. \$129.95 PLUS UPS  
 MT-1A HEAVY DUTY STAINLESS STEEL MARINE UNIT. \$179.95 PLUS UPS



**ANTECK, Inc.**

Phone (208) 423-4100  
 Box 415, Route 1  
 Hansen, Idaho 83334

BASE TUNED WITH LOG—

NO COILS TO CHANGE—POSITIVE TUNING LOCK. LESS THAN 1.5 VSWR. ✓ 356

RESETTABLE TO EXACT FREQUENCY

NO TUNERS REQUIRED—

**ICOM • BIRD • BECKMAN • CUSHCRAFT  
 AEA • B&W • VIBROPLEX • CDE • CES  
 HAM-KEY • ANTENNA SPECIALISTS  
 ASTRON • BELDEN • ARRL • W2AU/W2VS  
 AMECO • SHURE • AVANTI • AMPHENOL  
 SANKYO 24-HOUR DIGITAL CLOCKS  
 WELLER SOLDERING STATIONS  
 RADIO AMATEUR CALLBOOKS**

**LaRUE ELECTRONICS**

1112 GRANDVIEW STREET, SCRANTON, PA. 18509 - Ph. [717]343-2124

## ALL BAND TRAP ANTENNAS!



PRE-TUNED - COMPLETELY ASSEMBLED - ONLY ONE NEAT SMALL ANTENNA FOR UP TO 7 BANDS! EXCELLENT FOR CONGESTED HOUSING AREAS - APARTMENTS LIGHT - STRONG - ALMOST INVISIBLE!

FOR ALL MAKES & MODELS OF AMATEUR TRANSCEIVERS - TRANSMITTERS - GUARANTEED FOR 2000 WATTS SSB 1000 WATTS CW. INPUT FOR NOVICE AND ALL CLASS AMATEURS!

COMPLETE AS SHOWN with 90 ft. RG58U-52 ohm feedline, and PL259 connector, insulators, 30 ft. 300 lb. test dacron end supports, center connector with built in lightning arrester and static discharge - molded, sealed, weatherproof, resonant traps 1" X 6" - you just switch to band desired for excellent worldwide operation - transmitting and receiving! Low SWR over all bands including 80/75 (Pat. Pend. Broadband design). Works on 160 too! (Instruction incl.) - THE ONLY ANTENNA YOU WILL EVER NEED FOR ALL BANDS - WITH ANY TRANSCEIVER - NEW - EXCLUSIVE!

80-40-20-15-10-6 Meter --- 106 ft. long - with 90 ft. of RG58U - connector - Model 999BU ... \$79.95

SEND FULL PRICE FOR POSTPAID INSURED. DEL. IN USA. (Canada is \$5.00 extra for postage - clerical - customs etc.) or order using VISA - MASTER CHARGE - CARD - AMER. EXPRESS. Give number and ex. date. Ph 1-308-236-5333 9AM - 6PM week days. We ship in 2-3 days. ALL PRICES WILL INCREASE . . . SAVE - ORDER NOW! All antennas guaranteed for 1 year. 10 day money back trial if returned in new condition! Made in USA. FREE INFO. AVAILABLE ONLY FROM  
 WESTERN ELECTRONICS Dept. A7-9 Kearney, Nebraska, 68847



# Looking West

from page 10

southern California they utilize 220-kHz input-to-output separation, while other areas have 600, 800, 900, 1 MHz, or any combination thereof. Frankly, none of these has proven truly viable, especially for single-site installations. With a bit more deregulation, though, the answer to developing a solid relay subband is within our grasp. In my opinion, the answer will come from petitioning the Commission to permit FM repeater operation from 51 through 54 MHz and then adopting the now-proven 220-MHz band plan to six meters. This would yield a total of 69 repeater pairs with 1.8-MHz input-to-output separation and a minimum of 20-kHz spacing between repeaters, and would make for easier system construction. To implement it would first take convincing the FCC to open 51 through 54 MHz to repeaters and then convincing the manufacturers of amateur equipment that we meant business this time. One of the reasons that so few 6-meter FM transceivers were ever developed for amateur use is that manufacturers who attempted this, especially with synthesized units, found that without an established national band plan there was little interest in their product. Unless we show good faith by conforming to a national relay band plan, I don't think you will see all that much FM-only equipment coming to the six-meter market. For the manufacturer, the multi-mode transceiver is a better product to market since it covers all bases.

Let's take a closer look at the band plan (Table 1) and then discuss its pros and cons.

On the surface, the concept looks almost too good to be true. The technology has been proven and, from a standpoint of spectral efficiency, the plan makes more sense than anything to date. There are drawbacks, and they must be brought out before we go any further.

First, as Ray points out, there now exists a Pacific DX window from 52.0 to 52.1 MHz. That's because VKs are restricted to operation above 52 MHz, and

many, many DX QSOs are made in that slot. While judicious coordination could minimize impact on this window, FM repeaters operating near it, in both proximity and frequency, will have a detrimental effect and cause definite degradation in that spectral parcel. The actual bandwidth of an FM signal is infinite. As noted on page 530 of my own book, the bandwidth (of an FM transmitted carrier) is determined by Carson's Rule as  $B_t = 2(f/W + 1)W = 2f + 2W$ , where  $f$  is the modulating frequency and  $W$  is the deviation.

I cannot take credit for discovering the existence of Carson's Rule or its application to amateur FM. In fact, what has just been stated is part of a paper originally prepared by someone far more technically inclined than I, Bob Thornburg WB6JPI. While Bob wrote his original thesis to deal with the problem of 15-kHz tertiary split repeaters, its application is even more important here. Take out your pocket calculators, plug some numbers in for  $f$  and  $W$ , and see what you get. As you can see, implementation of a band plan for FM relay service such as described herein would spell disaster for the Pacific DX window.

There is yet another problem, one more psychological than technical. Many will ask why FM and FM repeater operation should be given what amounts to the lion's share of the band, even though most of 6 lies unused. This feeling comes from years of established 6-meter tradition, I suspect. The concept is "even though nobody else uses it, it's mine and I like it the way it is!" I can only point to 2 meters, 220 MHz and 450 MHz, and say that I firmly believe that if any mode becomes dominant it will be FM. Look at the number of 2-meter FM radios in the hands of amateurs these days as opposed to the number of radios which operate other modes. Sure, we can go through some more growing pains with which FM relay technology will slowly inch its way into a position of power, or we can start to work together now to protect vested interests. I favor the latter approach. This means get-

ting whatever further deregulation is necessary underway now. Even if we petition the FCC to permit FM repeater operation from 51.0 up and have such deregulation granted, there is no reason why we cannot on a voluntary basis build safeguards into our band plan simply by keeping all FM signals out of a region from 51.9 to 52.2. One of the nice things about Carson's Rule is that while the bandwidth of an FM signal is technically infinite, thankfully levels dissipate in strength very quickly outside the design bandwidth. Nonetheless, a certain amount of degradation will occur in the ambient noise floor of the band. How much? There is no way to know for sure till it happens. It's for this reason and based upon this premise that a good-sized guard band to protect the Pacific DX corridor must be part of any national 6-meter band plan, and even now, with only simplex FM permitted throughout the band, it's wise to keep FM clear of that spectral parcel.

Now that I have punched holes in my own proposal, let's look at the positive side of things. First, and most important, a band plan such as this, if implemented along with regulatory expansion permitting FM relay operation as low as 51 MHz, would make it easy to get a 6-meter repeater into operation. Regardless of the band, one truism holds: The greater the input-to-output separation, the better the system will perform. So, for the sake of argument, let's assume that we can obtain that further deregulation. If we were to adopt the proven national band plan for 220 MHz and apply its technology to 6 meters, we come up with 1.6 MHz between a repeater's input and its output, and a minimum of 20 kHz between systems. This is far better than the 146-148-MHz spectrum where we are dealing with 600-kHz input-to-output separation and 15 kHz between systems. Again, plug some numbers into Carson's Rule if you need any more proof.

Another problem that will be minimized is desensitization. The greater input-to-output separation handles that. Finally, there is the old 6-meter bugaboo, TVI. The reason that the band plan is low-in/high-out is that most of the time repeater

transmitters are located in high places removed at least to some degree from humanity. Conversely, repeater users are usually in fairly inhabited areas, and therefore are more prone to causing unwanted twitches on the local one-eyed monster.

Sure, the repeater transmitter will cause TVI. I've yet to run into a 6-meter transmitter that won't. If you're one of those who claims never to have received a TVI complaint when operating 6 meters, then you are either the luckiest person in the world, have the most understanding neighbors, or are surrounded by so many CBers in your neighborhood that your TVI blends in with the rest. I've lived through my share, and it's never been much fun. Since the repeater transmitter will be the immobile object creating the greatest possibility of TVI (but in most cases will be remote from humanity), put it at the high end and keep the user transmitters as far from 54 MHz as possible. Also, don't do what one group I know of did. They rented space at a location shared with a cable TV head end. I guess I don't have to tell you the rest. Rule of thumb: Keep static 6-meter transmitters as far removed from humanity and humanity's visual link to the world as possible.

Thus far we have not mentioned the fact that many model builders have obtained amateur licenses for the sole purpose of flying their model planes or running their model boats in spectra far removed from the 27-MHz CB mess. Obviously, the band plan as outlined would put a crimp in this established operation. However, they need not be displaced from the 6-meter band. In fact, this band plan could hold good vibes for them since provision is made to move them to spectra below 51 MHz and give them a lot more room. Note that 50.6 to 51 MHz is allocated to AM and experimental modes. There is no reason why the remote-control model enthusiast could not relocate within that spectral parcel. In reality, I doubt if AM is going to make a comeback, and the few AMers left could easily live with the remote-control model enthusiasts and vice versa. Keep in mind that most truly wide-band, high-utilization-density modes are kept above 51 MHz in this voluntary band plan. That



is the reason for the next part of this discussion, on the special simplex frequency listing.

Let's go there for a moment. There are four reserved simplex channels to meet specific needs. Obviously, if this band plan were to be adopted, it would negate the current national calling frequency. Since amateurs seem to like things to be symmetrical, I suggest that 52.52 MHz, derived from its companion 146.52-MHz counterpart, become the primary national FM simplex calling channel. Likewise, 52.50 could become the 6-meter counterpart to 323.50. That might be called the secondary national calling frequency or, possibly, the regional calling frequency. The same anomaly holds true for 52.46 MHz as a national remote base 6-meter counterpart to the already established 146.46.

This brings us to the last special simplex frequency of 52.56 MHz which is totally dedicated to ASCII RTTY point-to-point communication. If we are going to build a subband for everyone, then the computer-buff ham operator is an important consideration. Another channel could be reserved for conventional RTTY as well, although I suspect that within a few years the traditional green keys may well be a thing of the past.

With ASCII having been approved, with its inherently higher efficiency as opposed to the Baudot we have been utilizing for years, I suspect that by the time a band plan of this sort could be implemented the model 28s would be naught but collectors' items. Prediction: Computers will replace traditional RTTY in a very short time.

#### ARCH '80 DEPARTMENT

Last month I told you the gruesome details of the flight to St. Louis for the 1980 Amateur Radio Computer Hobbyist convention. I had planned a picture story about ARCH '80 this month, but made one big mistake. In order to travel light, I took along one of those mini 110 pocket cameras. That's the last time I will ever depend on one of those. Out of 20 photos, only four came out. Of those four, none really shows what I want. Therefore, I will have to use the proverbial 1,000 words in lieu of the photos.

ARCH '80 drew about 4,000 attendees to the city of St. Louis for Memorial Day weekend. By all standards, it was a successful outing. Credit for this must be given to an organization known as the Gateway Amateur Radio Association. GARA is a conclave of 17 St. Louis regional clubs which banded together to put on the event. The organization's president is Bob Heil K9EID, and it was Bob who inspired the ARCH convention idea originally. The first one, in 1979, was put together in 90 days and was deemed one of the best of that year. I would give this year's outing at least equal billing.

GARA was able to get just the right mix of everything to hold

everyone's interest. It was billed as a family convention, and to that end an outing to a baseball game at Busch Stadium was set up as the opening event and a day at "Six Flags" was the close. In between there was something for everyone. There were seminars galore, covering both amateur radio and computer hobbyist interests, as well as a couple that tied the two together. There were some great bargains to be found at their indoor flea market (which might best be called a mini indoor Dayton). There were some excellent buys in video equipment, as well as the expected amateur radio and computer hardware/software. I make it a practice to leave my checkbook at home

when attending these events since I am one of those who will purchase things on the spur of the moment. In fact, I guess I am one of the very few who has attended the 10-acre Dayton flea market and come away dry! After seeing some of the video equipment being offered at almost ridiculously low prices, I wanted to kick myself. Oh well, there's always next year, hopefully.

I spoke with a number of the dealers and distributors, and while most said that business was off a bit this year, the comment was made that this was indicative of almost every show they had attended. I suspect this is also indicative of the overall economy. Just about every one of those I spoke with had high praise for the way that the GARA organization had worked with them on the planning and setup of booths.

In the guest speaker department, there were some big names on hand. Harry Dannals W2HD came in from New York to represent the ARRL. At the last minute, it was announced that the FCC would not be able to send a representative; however, a pretty good FCC/regulatory forum took place with Lou McCoy W1ICP filling in as seminar leader. Personal Communications Foundation President Joe Merdler N6AHU put on an excellent presentation despite the fact that he had only an hour or so's sleep on the flight in from Los Angeles. He drew one of the biggest of the audiences I noted. However, the true highlight of ARCH '80 came at the Saturday night banquet which featured NBC News correspondent Roy Neal K6DUE. Roy spoke on the past, present, and future of both amateur radio and the broadcast industry, doing so from a personal viewpoint that kept the audience literally spellbound. I got so wrapped up in listening to Roy's talk that I almost forgot to turn the cassette over in the machine when side one ran out. I only wish I had room to reprint Roy's entire presentation for you to read — it is a talk that every amateur, old-timer or newcomer, could appreciate.

Above all, ARCH '80 was a fun convention. Not a Dayton Hamvention in size or scope, but rather the kind of intimate get-together of hams that you could really enjoy.

#### PROPOSED SIX-METER BAND PLAN BASED UPON FUTURE DEREGULATION OF REPEATER OPERATION TO 51.0 MHZ

Frequency (MHz)	Utilization
50.0-50.025	CW beacons
50.025-50.05	Weak-signal CW operations
50.05-50.1	General CW
50.1-50.25	Weak-signal SSB (50.110 calling)
50.25-50.6	Other SSB operations (rag-chew, nets)
50.6-51.0	AM and experimental modes, including radio model remote control
51.0-53.99999	Voluntary FM subband for simplex and repeater operation

#### VOLUNTARY SUBBAND

The concept for division of the upper three MHz of 6 meters to FM operation is directly based upon the premise of future deregulation to permit FM relay operations on 51 MHz, and is derived directly from the current 220-MHz national band plan. It uses 1.6-MHz input-to-output separation, repeating "UP", i.e., low in, high out. Initial spacing could be 40 kHz between repeater systems, with 20-kHz splits available as the band utilization increased. This would yield 35 initial repeater pairs, with 40-kHz separation and a maximum of 69 repeater pairs with 20-kHz separation (between systems).

Even-numbered pairs would be utilized beginning with 51.02 MHz as the lowest input matched to 52.62 MHz output. The highest channel pair after all 20-kHz splits were implemented would be 52.38 in, 53.98 out.

The current national simplex calling channel would be negated and simplex would be as follows:

52.42
52.44
52.46 — Proposed national remote-base intercom
52.48
52.50 — Proposed regional FM calling simplex
52.52 — Proposed national FM calling simplex
52.54
52.56 — Proposed ASCII/RTTY calling and intercom
52.58
52.60

#### Exceptions

51.9 through 52.2 would be initially reserved and kept clear of FM for use as a Pacific SSB DX corridor.

Table 1.



## Signalcrafters Presents The Most Advanced Automatic Computing Power Meters In Amateur Radio!



### MODELS 31 and 32\*

Our portable Models 31 and 32 feature the same state-of-the-art technology that is incorporated in their Big Brother, the Model 30. Never again will you have to bother with SWR "calibrate" controls and switches! Signalcrafters' custom integrated circuit makes power and SWR measurement a "hands-off" operation by automatically computing SWR. The result is unparalleled accuracy and ease of operation.

#### FEATURES:

- **CUSTOM IC**—Computes SWR from the level sensed on the transmission line independent of the power level. This analog computer operates over a range of only one watt to the full scale of the meter with unequalled accuracy.
- **RUGGED TAUT-BAND METERS**—Provide accuracy and readability that must be seen to be appreciated.
- **HEAVY DUTY CABINETS**—Handsome heavy duty metal cabinets complement virtually every transceiver on the market today.
- **TWO MODES—PEAK OR AVERAGE**—The amateur may choose between either peak or average power readings.
- **POWER REQUIREMENTS**—Due to the advanced low current design, battery life is truly outstanding, making this meter a natural for portable or field day operation. Uses standard 9 volt battery or 120V AC with optional AC adaptor.
- **ATTRACTIVE AFFORDABLE PRICING**  
\*Model 31A (0 to 200w)  
31B (0 to 20w)  
.....only **\$149.00**  
Model 32A (0 to 200w, 0 to 2000w)  
32B (0 to 20w,  
0 to 200w)  
✓66 .....only **\$169.00**

**SIGNALCRAFTERS, INC.**  
5460 BUENA VISTA DRIVE  
SHAWNEE MISSION, KANSAS 66205  
913/262-6565; TELEX 42-4171

All Signalcrafters products are designed, engineered, and produced in the U.S.A. Prices include shipping to all U.S.A. VISA and Master Charge accepted. Kansas Residents please add 3% percent.

## For your TRS-80 send & receive CW/RTTY



#### FEATURES

- Auto Send & Receive RTTY & CW
  - Connects to TRS-80 User Port & Key / head phone jacks
  - 10 message memories 255 char ea
  - Uses builtin PLL or external TU
  - Includes hardware, cassette & manual
  - Morse tutorial-10 lessons-corrects mistakes simplest, fastest way to learn the code
  - Morse practice-random 5 letter words
  - Auto numbering contest keyer
  - Interactive graphics custom PIX
  - Autotransmitter control PTT
  - Requires Level II Basic & 16K RAM
  - M80 Software, PC Board, Manual \$149
  - CM80 As above in Cabinet \$279
  - TM80 As above plus demodulator & AFSK \$499
  - M800 Adds advanced RTTY to M80 / CM80 / TM80 \$99
- PET, APPLE, SORCERER versions available  
Write or call for complete catalog



**MACROTRONICS, inc.** ✓44

1125 N. Golden State Blvd. / Suite G  
Turlock, CA 95380 (S)  
(209) 667-2888 / 634-8888

California residents add 6% tax

We are experiencing telephone difficulties, please keep trying.

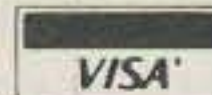

## NEW MFJ-525

# RF SPEECH PROCESSOR

**True RF Speech Processing. Up to 4 times more average SSB power. Powerful natural sounding speech punches thru QRM. Works with any rig. Plugs between mic and rig.**



**Powerful natural sounding processed speech punches thru QRM. Plugs between mic and rig.**

# \$119<sup>95</sup>

BRAND  
NEW

The MFJ-525 gives you up to four times (6db) more average SSB power on all bands with true RF Speech Processing. Powerful natural sounding speech punches thru QRM and DX pile ups.

**Gives you more average SSB power increase** per dollar than a linear or beam. Combine with linear and beam for ultimate.

**Ideal for mobile and QRP.** Vastly improves phone patching. Eliminates flat-topping, splatter.

**Complete SSB transmitter-receiver system:** Microphone audio is converted to SSB, clipped, filtered and converted back to audio for rig's mic input.

**Plugs between mic, rig.** No internal connections.

**Two color VU meter** aids in setting clipping level.

**Clipping level control.** Output level control.

**ON-OFF/BYPASS switch.** LED indicates power on.

**4 pin mic jack.** Shielded output cable has push-to-talk line. Uncommitted 4 pin mic plug supplied.

**Input, output RFI filtering,** ferrite beads, careful layout, PC ground plane, RFI coating on side panels. **110 VAC or 12 to 18 VDC.** 6x2x6 inches.

**Order from MFJ and try it — no obligation.** If not delighted, return it within 30 days for refund (less shipping). **One year unconditional guarantee.**

**Order today.** Call toll free 800-647-1800. Charge VISA, MC or mail check, money order for \$119.95 plus \$3.00 shipping for MFJ-525.

**Don't wait to punch thru QRM with powerful natural sounding processed speech,** order today.

**CALL TOLL FREE ... 800-647-1800**

Call 601-323-5869 for technical information, order/repair status. Also call 601-323-5869 outside continental USA and in Mississippi. ✓47

**MFJ ENTERPRISES, INC.**  
BOX 494, MISSISSIPPI STATE, MS 39762



# Social Events

Listings in this column are provided free of charge on a space-available basis. The following information should be included in every announcement: sponsor, event, date, time, place, city, state, admission charge (if any), features, talk-in frequencies, and the name of whom to contact for further information. Announcements must be received two months prior to the month in which the event takes place. They should be sent directly to Editorial Offices, 73 Magazine, Pine Street, Peterborough NH 03458, Attn: Social Events.

## ATLANTIC CITY NJ AUG 30-SEP 8

Station K2BR will be operating from the Miss America Pageant headquarters in Atlantic City from August 30-September 8, 1980. It will be sponsored by Southern Counties Amateur Radio Association on the following approximate frequencies: CW—3560, 7060, 14060, 21060; Novice—3730, 7130, 21130; phone—3935, 7235, 14280, 21380. QSL to K2BR, Box 121, Linwood NJ 08221 with an SASE. Traffic to and from the Miss America contestants will be accepted.

## AUGUSTA NJ SEP 6

The Sussex County Amateur Radio Club will hold its second annual hamfest on Saturday, September 6, 1980, at the Sussex County Farm and Horse Show grounds, Plains Road off Route 206, Augusta NJ. Admission for sellers at the outside flea market is \$5.00 at the door and \$4.00 in advance. Admission for indoor sellers is \$6.00 at the door and \$5.00 in advance. Admission for buyers is free and a door prize ticket is \$1.00. Talk-in on 147.90/.30 and 146.52. For pre-registration and information, write Sussex County Amateur Radio Club, PO Box 11, Newton NJ 07860, or call Ed Woznicki AC2A at (201)-852-3268.

## MENA AR SEP 6-7

The Queen Wilhelmina Hamfest Association will hold its 11th annual get-together on September 6-7, 1980, at the Queen Wilhelmina State Park

Inn, atop Rich Mountain near Mena AR. Registration is \$2.50 at the door. Campsites will be available. Features will include a flea market and a banquet. Talk-in on .19/.79 and .52/.52. For details, write Albert C. Petrasert AD5J, General Chairman, Rt. 4, Box 612, Mena AR 71953.

## GRAYSLAKE IL SEP 6-7

The Chicago FM Club will hold Radio Expo '80 on September 6-7, 1980, at the Lake County Fairgrounds, Rtes. 45 and 120, Grayslake IL from 9:00 am to 4:00 pm both days. The flea market is open from 6:00 am to 6:00 pm. Tickets, good for both days, are \$2.00 each before September 1st and \$3.00 at the gate. Indoor flea market space is free with an admission ticket on a first-come basis. Bring your own table and chair. Outside are many acres of available space. Features will include commercial exhibitors in ham radio and computers, ladies' programs, hourly door prizes with a super drawing at 3:00 pm on Sunday with prizes worth thousands of dollars. Food, nearby hotels, free parking, and camping with some hookups will be available. Talk-in on 146.16/.76 or 222.50/224.10 WA9ORC. For advanced tickets, send an SASE to Radio Expo Ticket, PO Box 1532, Evanston IL 60204. For more information, call (312)-BST-EXPO.

## MELBOURNE FL SEP 6-7

The Platinum Coast Amateur Radio Society will hold its 15th annual hamfest and indoor swap-and-shop flea market on September 6-7, 1980, at the Melbourne Civic Auditorium. Admission is \$3.00 in advance and \$4.00 at the door. Swap tables are \$5.00 per day. There will be food and plenty of free parking available, as well as awards, forums, and meetings. Talk-in on .25/.85 and .52/.52. For reservations, tables, and information, write PCARS, PO Box 1004, Melbourne FL 32901.

## FINDLAY OH SEP 7

The Findlay Radio Club will hold its 38th annual Findlay Hamfest on Sunday, September 7, 1980 (not September 27, as

previously published), at a new location, the Hancock Recreational Center, just east of I-75 exit 161, on the north edge of Findlay, 40 miles south of Toledo. Tickets are \$2.00 in advance and \$2.50 at the door. Reserved tables are \$2.50 per half. There will be forums on Saturday evening and setup Sunday at 5:00 am. Main prizes are a TS-120S with supplies, two TR-2400s, and an AT-120 matcher. For tickets, information, and reservations, send an SASE to PO Box 587, Findlay OH 45840.

## PENNSAUKEN NJ SEP 7

The South Jersey Radio Association will hold its 32nd annual hamfest on Sunday, September 7, 1980, on the grounds of the Pennsauken Senior High School, Hylton Road (1½ miles SE on Rte. 73 from the Tacony Palmyra Bridge), Pennsauken NJ. Admission is \$3.00 and tailgate or booth space is \$5.00 per seller. Features will include a flea market, prize drawings, contests, bingo for the ladies, and games for the children. Talk-in on 146.52 or 146.22/.82. For more information, contact Edwin T. Kephart W2SPV, Hamfest Chairman, 4309 Willis Avenue, Pennsauken NJ 08109.

## PORT JEFFERSON NY SEP 7

The Suffolk County Radio Club will hold its third annual Electronic Flea Market on September 7, 1980, with a rain date of September 14, 1980. The site is the Odd Fellows Hall, Jane Boulevard, Port Jefferson LI NY. Walk-ins will be \$1.50 and sellers will be \$3.00. Gates will open at 7:00 am. Bargains, prizes, food, and friendship will be available. Talk-in on .52, .94, and 223.50. For further information, contact Floyd Davis WA2SDI at (516)-234-9376.

## SOUTH DARTMOUTH MA SEP 7

The South Eastern Massachusetts Amateur Radio Association will hold its annual picnic and flea market on Sunday, September 7, 1980, from 9:00 am until 4:00 pm at the Stackhouse Fairgrounds, Faith Street, South Dartmouth MA. The rain date will be September 14, 1980. Sales space is \$6.00 and tables for rent are \$4.00. There will be free parking, entertainment, and

food and beverages for sale. Talk-in on 147.60/147.00 or CB channel 11. For information, write SEMARA, PO Box P-105, South Dartmouth MA 02748, or phone (617)-997-3674 or (617)-994-4838.

## MONTGOMERY AL SEP 7

The Central Alabama Amateur Radio Association will hold its 3rd annual hamfest on Sunday, September 7, 1980, at the Civic Center, downtown Montgomery AL. There will be free admission, free parking, and 22,000 square feet of air-conditioned activities including a flea market. Setup will be at 0600, doors will be open from 0800 to 1500, and a prize drawing will be held at 1400 CST. Restaurants and a motel are located nearby and refreshments will be available in the Civic Center. Talk-in on 146.04/.64 or 146.52, rag chew on 146.31/.91, 147.18/.78, or 147.045/.645. For further information or market reservations, write Hamfest Committee, PO Box 3141, Montgomery AL 36109.

## BUTLER PA SEP 7

The Butler County Amateur Radio Association, Inc., will hold its Butler Hamfest on Sunday, September 7, 1980, at the Butler Farm Show Grounds at Roe Airport, Butler PA, from 9:00 am to 4:00 pm. Admission is a \$1.00 donation which includes drawings for small prizes. Parking is free. Children under 12 will be admitted free. Overnight campers will be welcome and handicap parking will be available. Featured will be a free outside flea market, an indoor flea market with 8-foot tables for \$3.00 each, refreshments, a fly-in to Butler Farm Show Airport (with a fly-in prize awarded), and a mobile check-in on .96/.36 (W3UDX) and .52 (with a mobile prize awarded). The first of 5 main prizes is a Kenwood TS-520SE transceiver. For a special ticket, a 13" portable color TV is first prize. For more details, write Dan Metrick WA3GDS, 130 Rieger Road, Butler PA 16001, or phone 283-1719.

## HAMBURG NY SEP 12-13

The 9th annual Ham-O-Rama '80 hamfest will be held on September 12-13, 1980, at the Erie County Fairgrounds. Ad-



vance tickets are \$3.00. There will be exhibits, tech programs, prizes, flea markets, plenty of free parking, and free RV hookups. For more information and tickets, contact Ron Brodowski KC2P, 260 Hilltop Drive, Elma NY 14059, or phone (716)-652-6754.

#### **VALPARAISO IN SEP 14**

The Porter County Amateur Radio Club, Inc., will hold its annual hamfest on September 14, 1980, at the Porter County Fairgrounds, Valparaiso IN. Featured will be a flea market, technical sessions, door prizes, and bingo. Food will be available. Advance tickets are \$1.50 and tickets at the gate are \$2.00. There will be dealers and commercial exhibitors, as well as free indoor and outdoor space. Gates will open at 6:00 am. Talk-in on 147.96/.36 and 146.52. For tickets and information, write Charles Baker W9SJM, PO Box 251, Portage IN 46368.

#### **WHITESTONE NY SEP 18**

The Tu-Boro ARC will hold its annual auction on September 18, 1980, at the Odd Fellows Hall, 149-14 14th Avenue, Whitestone NY. Doors will open at 6:00 pm for sellers and at 7:00 pm for buyers. Donation is \$1.00 per person. Beer and soda will be available. Talk-in on 146.52. For information, call Walt WB2PFO at (212)-539-5732 nights, and Ed WB2IBQ at (212)-746-4082.

#### **PEORIA IL SEP 20-21**

Peoria Superfest '80 will be held on September 20-21, 1980, at Exposition Gardens, W. Northmoor Road, Peoria IL. Advance tickets are \$2.00 and at the gate \$3.00. Full camping facilities will be available. Featured will be the latest amateur and computer product displays, forums and product demonstrations, a free flea market, ladies' programs, and children's activities. On Saturday evening, there will be an informal get-together at the Heritage House Smorgasbord, 8209 N. Mt. Hawley Road. No reservations are necessary. Talk-in on .16/.76 W9UVI. For tickets and more information, write Superfest '80, 5808 N. Andover Ct., Peoria IL 61615, or phone (309)-692-8763.

#### **GRASS VALLEY CA SEP 21**

The Golden Empire Flying Club, in cooperation with Radio Systems Technology, announces the third annual Fly-In and Avionics Swap Meet on September 21, 1980, at Nevada County Airport, Grass Valley CA. The event is free to dealers and individuals alike and runs from 10:00 am until dusk. Pilots of antiques or homebuilts flying in are invited free of charge to an authentic old-time miner's luncheon. There is no registration or tie-down fee for either the fly-in or the Avionics Swap Meet. Pilots are requested to use the new Unicom frequency, 123.0 MHz. For further information, contact Fran Mitchell, c/o Radio Systems Technology, 10985 Grass Valley Avenue, Grass Valley CA 95945, or phone (916)-272-2203.

#### **ISLIP LI NY SEP 21**

The Long Island Mobile Amateur Radio Club, Inc., will hold its ARRL Hamfair '80 on September 21, 1980, at the Islip Speedway, one block south of Southern State Parkway, Exit 43, Islip LI NY. There will be over 350 exhibitors on hand and food and refreshments will be available at the track. Admission is \$2.00 and \$3.00 per exhibitor's space. No reservations are necessary. Many awards will be given throughout the day. The heavy rain date is September 28, 1980. For more information, call (nights) Sid Wolin K2LJH at (516)-379-2861, Nick Bellmann KA2CAO at (516)-223-1076, or Hank Wener WB2ALW at (516)-484-4322.

#### **FLINT MI SEP 21**

The Genesee County Radio Club, along with the Bay Area Amateur Radio Club, the Lapeer County Amateur Radio and Repeater Club, the Saginaw Valley Amateur Radio Association, and the Shiawassee Amateur Radio Association, will hold their Five-County Swap-N-Shop on Sunday, September 21, 1980, from 7:30 am to 4:00 pm at Southwestern High School, 1420 W. Twelfth Street (south off 69 on Hammerberg Road, then turn left at 12th Street), Flint MI. Tickets are \$2.00 per person in advance and \$3.00 at the door, with children under 12 free.

There will be food concessions, free parking, and prizes. Talk-in on 146.52. For information, write Bob Ross, PO Box 7671, Flint MI 48507, or call (313)-239-0397.

#### **HARRISBURG PA SEP 21**

The Central Pennsylvania Repeater Association will hold its seventh annual High Rise Hamfest on September 21, 1980, from 8:00 am to 3:00 pm at the Park & Shop Garage, 200 block of Walnut Street, Harrisburg PA. Admission is \$3.00 and \$1.00 for tailgating. Spouses and children will be admitted free. Door prizes will be awarded, and protected parking will be available for 1100 cars. Talk-in on 144.87/145.47, 146.16/.76, and 146.34/.94. For more information, write CPRA, PO Box 6284, Harrisburg PA.

#### **LOWER BURRELL PA SEP 21**

The Skyview Radio annual swap and shop will be held on September 21, 1980, at Sokol Camp, Lower Burrell PA, from 12:00 noon to 4:00 pm. Registration is \$1.00 per ham, and XYs, Ys, and children are free. There will be plenty of parking and lots of shade. Talk-in on .04 and .64. For more information, send an SASE to Jim Jackson K3VRU, RD 1, Box 7A, Apollo PA 15613.

#### **ROSS OH SEP 21**

The Greater Cincinnati Amateur Radio Association, Inc., will hold its 44th annual Cincinnati Hamfest on Sunday, September 21, 1980, at Stricker's Grove on Ohio State Rte. 128, one mile west of Ross (Venice) OH. Exhibits, prizes, food, and refreshments will be available. Featured will be a flea market with radio-related products only, music and good fellowship, a hidden transmitter hunt, and a sensational air show. Admission and registration are \$4.00. For further information, write Lillian Abbott K8CKI, 1424 Main Street, Cincinnati OH 45210.

#### **ELMIRA NY SEP 27**

The 5th annual Elmira International Hamfest will be held at the Chemung Country Fairgrounds on September 27, 1980. Featured will be an ARRL Forum and talk by Atlantic Division Director Jesse Bieberman

W3KT. Also on the agenda is a similar forum and discussion with officials from the Federal Communications Commission's Buffalo NY office. There will be a free outdoor flea market and some indoor space, as well as several electronics dealers from across the northeast. The usual abundance of prizes and good food will be part of this year's event once again. Gates open at 8:00 am. Advance sale tickets are available from John Breese WA2FJM, 340 West Avenue, Horseheads NY 14845 at \$2.00 each (save a dollar per ticket off the gate price!). Talk-in on 147.96/.36, 146.10/.70, and .52 simplex.

#### **TYSONS CORNER VA SEP 27-28**

The National Capitol DX Association will sponsor DXPO 80 on Saturday and Sunday, September 27-28, 1980, at the Ramada Inn, junction of Rte. 7 and I-495, Tysons Corner VA. Saturday's half-day session will include Phase I of the DXPO Program, an Attitude Adjustment Party, and a banquet with prizes and surprises. Sunday's session will feature Phase II of the DXPO Program. Unless you have previously attended DXPO, write to Dick Vincent K3AO, Rte. 1, Box 230, Bryantown MD 20617, for more information. If you have any program suggestions, contact John Boyd W4WG, 8424 Reflection Lane, Vienna VA 22180.

#### **BOYSTOWN NE SEP 27-28**

Fremont NE hams will be operating from Father Flanagan's Boys' Home at Boystown NE on amateur bands from 75 meters through 10 meters for a 24-hour period from 1700Z on September 27, 1980, to 1700Z on September 28, 1980. Frequencies used will be plus or minus 5 kHz from 3.905, 7.235, 14.305, 21.405, and 28.605. Special commemorative QSL cards in envelopes post-marked Boystown will be mailed for all contacts upon receipt of an SASE or IRCs. QSL direct to W0RCH, Pioneer Amateur Radio Club, RFD 3, Fremont NE 68025.

#### **ANNISTON AL SEP 27-28**

The Calhoun County Amateur Radio Association will hold its first annual hamfest on September 27-28, 1980, from 9:00 am to



5:00 pm on Saturday and from 9:00 am to 3:00 pm on Sunday at the Municipal Auditorium, 1128 Gurnee Avenue, Anniston AL. Admission is free and there will be daily parking as well as overnight self-contained RV parking. Features will include a large air-conditioned exhibit area, bingo, hourly drawings, and a final drawing on Sunday to award a Ten-Tec Delta Model 580 plus many more prizes. Donations are \$1.00 or 6 for \$5.00. Tables are \$3.00 for one day or \$5.00 for both days. Talk-in on .69/.09. For more information, contact Bill Ward W4PCK, c/o CCARA, PO Box 1624, Anniston AL 36202, or phone (205)-820-3619.

#### **GAINESVILLE GA SEP 28**

The Lanierland Amateur Radio Club will hold its seventh annual Hamnic at Lake Lanier Islands on September 28, 1980. There will be a large covered pavilion and a large parking area for the swap shop and exhibits. Food will be available. There will be no entry fee for Hamnic; however, Lanier Islands charges a \$2.50 entry fee per car. Picnicking, hiking, and swimming will be available for the kids. Trailer hookups and camping will be available on site. Many prizes will be awarded. Talk-in on .07/.67 (WR4AER). For further information, write Fred Runkle K4KAZ, 25 Stonehedge Drive, Buford GA 30518.

#### **ADRIAN MI SEPT 28**

The Adrian Amateur Radio Club will hold its 8th annual hamfest on Sunday, September 28, 1980, at the Lenawee County Fairgrounds, Adrian MI. Featured will be prizes, games and programs. Tables are available for \$5.00 per 8-foot space, \$3.00 per 4-foot space, \$1.00 per 8-foot trunk space, and \$2.00 for an inside space for your table. Talk-in on 146.31/.91 and 146.52. For ticket and table information, write Adrian Amateur Radio Club, Inc., PO Box 26, Adrian MI 49221, or call Bob and Sally Fay of Sword Enterprises at (517)-263-3592.

#### **NEW BERLIN IL SEP 28**

The Sangamon Valley Radio Club will hold its fifth annual hamfest on Sunday, September 28, 1980, at the Sangamon

County Fairgrounds, New Berlin (12 miles west of Springfield on Rt. 36) IL. The ticket donation is \$1.50 in advance, \$2.00 at the hamfest, and 3 for \$5.00. First prize is a Kenwood TR-2400 synthesized hand-held. (Club members and families are ineligible to win prizes.) Randy Rowe NØTG will talk on the Navassa DXpedition. There will be a covered pavilion, an indoor display area, and exhibits, as well as food and camping available on the grounds. Talk-in on 146.28/.88 and 146.52. For additional information, contact Joe Suarez WB9RFC, c/o SVRC, 1020 S. 6th Street, Springfield IL 62703.

#### **BOULDER CO SEP 28**

The Boulder Amateur Radio Club will hold Barcfest '80 on September 28, 1980, beginning at 9:00 am at the Boulder National Guard Armory, North Broadway, at the city limits, Boulder CO. There will be an auction and a snack bar. Admission is \$2.00 per family and includes a door prize drawing and swap space. Talk-in on 146.10/.70 and .52/.52. For further information, contact Mark Call NØMC, 4297 Redwood Ct., Boulder CO 80301, or phone (303)-442-2616.

#### **ERIE PA SEP 28**

The Radio Association of Erie, Inc., will hold its HAMJAM 1980 on Sunday, September 28, 1980, at the Rainbow Gardens at Waldameer Beach Park, Erie PA. Hours are from 9:00 am to 5:00 pm. The \$3.00 admission fee includes a chance for the main prizes, hourly door prizes, and a free cup of coffee. Featured will be commercial displays, huge outdoor flea market (\$1.00 per car space), large indoor display area (tables available at \$5.00). Food will be available on site. Talk-in on 146.34/.94 (primary) and 146.22/.82 (secondary). For information about overnight parking and other details, write Lee Robinson WA3HJC, HAMJAM Chairman, PO Box 844, Erie PA 16512.

#### **SUTTON NH SEP 28**

The Connecticut Valley FM Association will hold its hamfest on September 28, 1980, from 9:00 am to 5:00 pm at the King Ridge ski area, Exit 11 off

I-89, Sutton NH. Admission is \$3.00 per person over 16. Festivities include an indoor/outdoor flea market, a floral exhibit, a frisbee toss, a horseshoe competition, dealers' exhibits, food, overnight camping available for self-contained units only, and a consignment room. Door prizes will be awarded, including a grand prize; there will be a raffle at 5:00 pm. Talk-in on .52/.52, .16/.76, and .24/.84. For further information, contact C. A. Breuning, 54 Myrtle Street, Newport NH 03773.

#### **CORNWALL NY OCT 4**

The Orange County Amateur Radio Club will hold its annual auction on Saturday, October 4, 1980, at Munger Cottage, Cornwall NY. Admission is \$1.00. The auction begins at 11:00 am. Talk-in on 146.52. For more information, contact William Lazzaro N2CF, 11 Jefferson Street, Highland Mills NY 10930.

#### **BILOXI MS OCT 4-5**

The Mississippi Coast Amateur Radio Association will hold its 4th annual Ham-SwapFest on Saturday and Sunday, October 4-5, 1980, at the International Plaza, Biloxi MS. Admission is free. Features will include a prize drawing Saturday afternoon, an old-time shrimp boil Saturday night, main prize drawings on Saturday afternoon, a flea market, commercial displays, forums, and prizes for YLs, XYLs, and harmonics. Talk-in on 146.13/.73 and .52. For further information, contact Bob Wyatt WB5VCI, Hamfest Chairman, Box 114, Whispering Pines Drive, Waveland MS 39576.

#### **VIRGINIA BEACH VA OCT 4-5**

The ARRL Virginia State Convention and the fifth annual Tidewater Hamfest, Computer Show, and Flea Market will be held on October 4-5, 1980, in the Arts and Conference Center, Virginia Beach VA. Take Highway 64 to Highway 44, which passes right by the door and also into the beach resort area. Featured are ARRL, traffic, DX, and technical forums, as well as free bingo and a lounge for XYLs. Admission is \$3.50 and flea market spaces are \$3.00 per day. There will be an advance ticket drawing for a Kenwood FM transceiv-

er. For tickets and more information, send an SASE to TRC, PO Box 7101, Portsmouth VA 23707.

#### **WARRINGTON PA OCT 4-5**

The Pack Rats fourth annual Mid-Atlantic States VHF Conference will be held on October 4, 1980, from 9:00 am to 5:00 pm at the Warrington Motor Lodge, Rte. 611, Warrington PA. Registration is \$3.00 in advance or \$4.00 at the door. The price includes admission to the ninth annual Hamarama flea market on October 5, 1980, from 8:00 am to 4:00 pm, rain or shine, at the Bucks County Drive-In Theatre, also on Rte. 611. The Saturday conference will include a cocktail hour and get-together at 6:30 pm and a buffet dinner, at \$9.00 each, at 7:30 pm. The cost for the flea market alone is \$2.00 and tailgating is \$2.00 per space (bring your own table). Featured will be amateur radio equipment, electronic parts, surplus, and door prizes. Talk-in on 146.52 (W3CCX). For information about both events, write Ron Whitsel WA3AXV, PO Box 353, Southampton PA 18966, or phone (215)-355-5730.

#### **NEW YORK NY OCT 5**

The Kings County Radio Club will hold its Hamfest 1980 on October 5, 1980 (rain date is October 12, 1980), at Manhattan Beach Park Brooklyn NY. Take the Ocean Avenue exit from the belt parkway and follow the signs. Admission for sellers is \$3.00, buyers' admission is \$1.00, and spouses and children will be admitted free. There will be a large outdoor electronic flea market and plenty of parking. Sellers can bring their own tables or tailgate. Prizes will be awarded and a color TV will be raffled. Talk-in on .52.

#### **BENTON HARBOR MI OCT 5**

The 1980 Blossomland Blast will be held on Sunday, October 5, 1980, from 8:00 am to 3:30 pm EDT at the Lake Michigan College Convention Center, one mile off exit 30 on I-94 near Benton Harbor MI. Prepaid tickets are \$2.00 each (\$3.00 at the door). XYLs, YLs, and children under the age of 16 are free.

*Continued on page 193*



**NEW!**



**Tunable 420 MHz Fast Scan TV Converter**

Receive Fast Scan Amateur TV in the 420 to 450 MHz Band with any TV set. Low noise, high gain rf Amp with Varactor tuned input and outputs. Built in AC supply. Comes in two tone walnut & beige cabinet measuring 1-7/8" x 4-1/4" x 4-1/8". Factory wired with 2-year guarantee. ATVC-10 \$49.95

Basic Varactor Tuner & PS Kit w/instructions  
ATVC-10K \$39.95

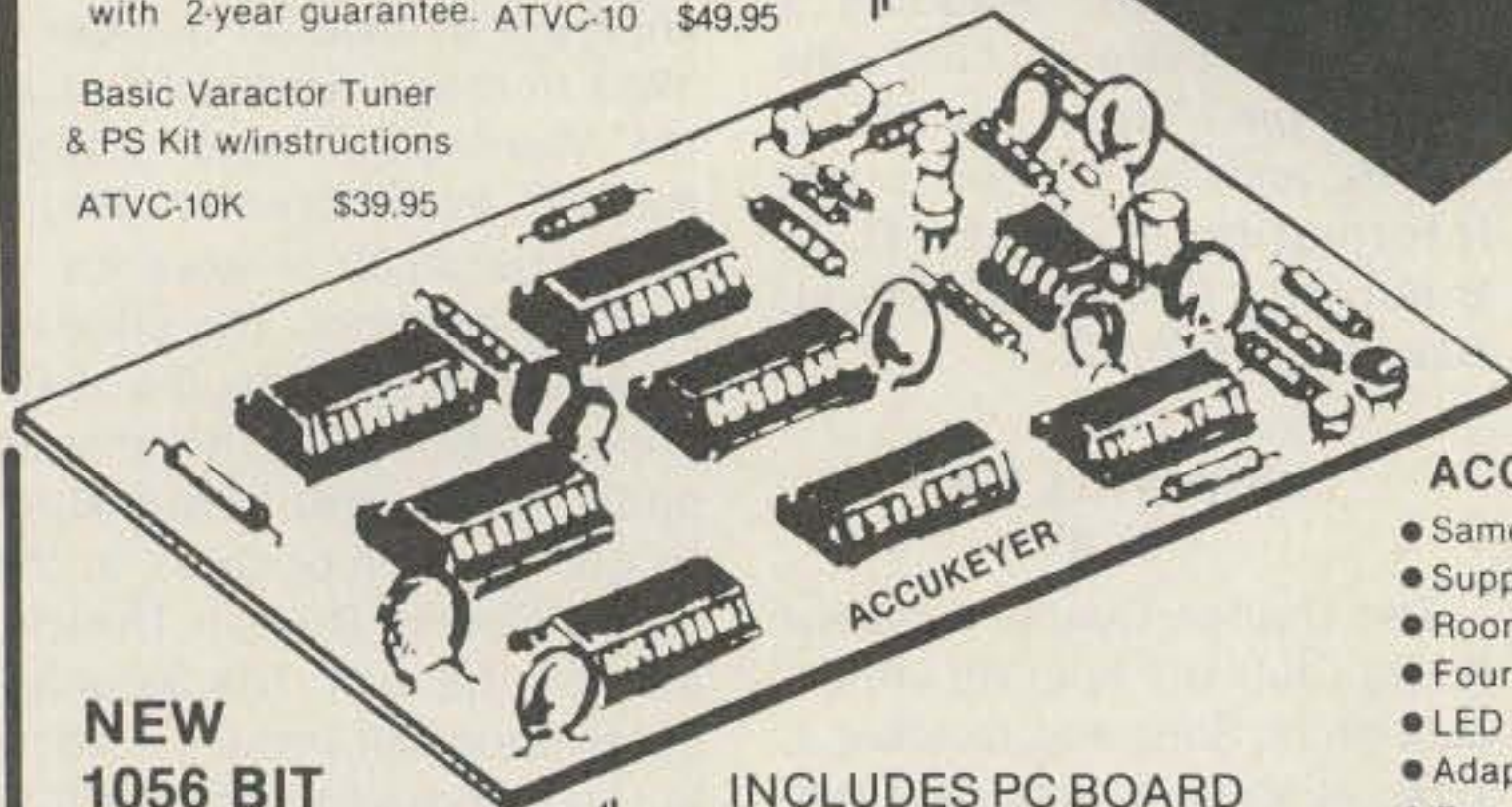

**NEW 1056 BIT EXPANDABLE MEMORY KIT**

INCLUDES PC BOARD AND PARTS STILL ONLY  
**\$19.95**

**ALDELCO ELECTRONIC COMPANY**

**THE VERY POPULAR**

**TOPE ACCUKEYER KIT**

- Self Completing Dots & Dashes
- Iambic Operation
- Single Dot & Dash Memories
- Provision for Attachment of Memory for DX or Contest Work

Revised version of the Accukeyer featured in the ARRL Handbook. Has more logical IC Layout and ON Board sidetone Oscillator. Includes PC Board, TTL ICs, 555 Timer, IC Sockets, Switch, Speaker, Transistors, capacitors and resistors. Requires 5 VDC **\$19.95**  
Use our PS-5 Power supply kit to power keyer & Memory only \$7.95

**MEMORY ADD ON KIT**

Four Position Switch 3-2102s, sockets, and resistors \$5.00

OV-12 Crow Bar Overvoltage Protection Circuit. Triggers App. 16 to 18 volts \$8.95  
5 to 8 volts 9.95

**ACCUKEYER MEMORY KIT**

- Same size PC Board as Accukeyer
- Supplied with one 2102 Memory Chip
- Room on the board for three more
- Four chips will total 4224 BITS
- LED indicator for Programming
- Adaptable to other keyers
- Requires 5 volts DC

**SEVEN DIGIT HAND HELD FREQUENCY COUNTER KIT**

**Accuracy:** ± 0.0002%  
**Gate Times:** 1 or 0.1 Seconds  
**Frequency:** Typical to 148 Mhz  
**Sensitivity:** 5.5 mv @ 27 Mhz  
5 mv @ 50 Mhz  
12 mv @ 135 Mhz  
**Power Required:** 5 VDC (4 AA nicads)  
Has input for batt. charger diode protected.  
P.C. board measures 2 3/4" x 4"  
Adelco supplies:  
ICs, sockets, P.C. board crystal capacitors, resistors, battery holder wat. A1188A readouts 0.100" and instructions  
(case & batteries not included)  
**\$49.00**

RF TRANSISTORS											
SD1018-4	40W	4.5db	450MHz	380-4LFL	15.25	2N3375	3.0W	400 MHz TO60	5.60		
SD1074	50W	11db	30MHz	500-6LFL	21.15	2N3553	2.5W	175 MHz TO39	1.40		
SD1076	75W	13	50	500-6LFL	24.00	2N3866	1.0W	400 MHz TO39	1.25		
SD1088	25W	6	450	500-6LFL	23.25	2N4427	1.0W	175 MHz TO39	1.35		
SD1089	40W	5	450	500-6LFL	27.15	2N5589	3.0W	175 MHz MT71	4.75		
SD1143	10W	10	200	MT72	10.95	2N5590	10W	175 MHz MT72	7.80		
SD1158	12W	5.3	200	TO117	12.30	2N5591	25W	175 MHz MT72	10.25		
SD1272	30W	6	220	MT72	9.60	2N5913	1.75W	175 MHz TO39	1.70		
SD1278	50W	10	50	MT72	16.30	2N6080	4.0W	175 MHz MT72	5.40		
SD1416	70W	6.7	175	500-6LFL	26.80	2N6081	15W	175 MHz MT72	8.45		
SD1428	45W	6.5	175	500-6LFL	22.65	2N6082	25W	175 MHz MT72	11.70		
SD1433	8W	7.5	450	MT90	9.50	2N6083	30W	175 MHz MT72	11.70		
SD1434	50W	5	450	500-6LFL	34.00	2N6084	40W	175 MHz MT72	13.50		
SD1451	50	14	50	500-6LFL	18.10	2N6094	4.0W	175 MHz X106	6.60		
SD1477	100W	6	175	500-6LFL	52.85	2N6095	15W	175 MHz X106	8.50		
2N5945	4W	8	450	MT90	10.75	2N6096	30W	175 MHz X106	10.35		
2N5946	10W	6	450	MT90	13.00	2N6097	40W	175 MHz X106	20.00		

**ALDELCO JOINS - THE GLOBAL SPECIALTIES FAMILY**  
(formerly Continental Specialties)

**MAX 100 8 DIGIT 5 TO 100 MHZ COUNTER**



3.579545 MHz Crystal Oscillator. Size 1.75" x 7.38" x 5.63". Requires 7.5 to 10 VDC. Operates on AA nicads or alkaline's (not supplied). \$134.95

**PS500 PRESCALER**



Extends range 10 times compatible with most counters. Requires 7.5 - 10 VDC \$70.00.

**ACCESSORIES**

Charger adaptor 110V mod. 100 CA1. \$12.45  
Mobile charger adaptor mod. 100 CLA \$5.95.

**LP2 LOGIC PROBE**



Use to 300 nsec 1.5 MHz. Shows logic state at a glance. Easy to use. Only \$24.95

**LP1**

Use up to 50nsec. 10 MHz. Memory feature. \$44.95

For complete GSC catalog send 50c handling & shipping.

**PROTO CLIPS**

14 pin PC 14 \$4.50

16 pin PC 16 \$4.75

24 pin PC 24 \$10.00

**EXPERIMENTER SERIES BREAD BOARDS**

EXP 600 \$10.95

EXP 300 \$9.95

EXP 4B \$4.00

EXP 650 \$6.25

EXP 350 \$5.50

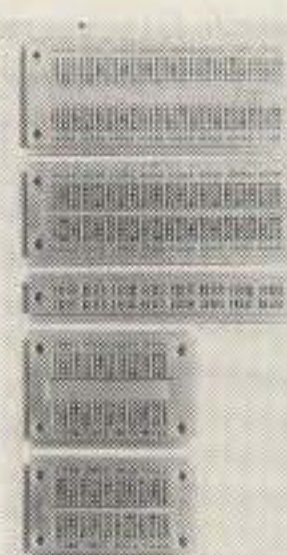
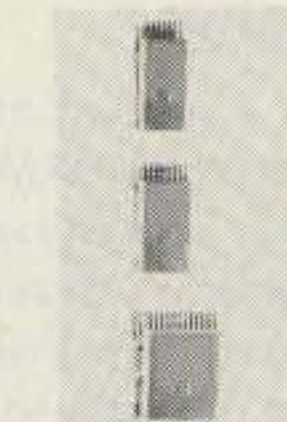

**TWO METER TELESCOPING WHIP ANTENNA**

with BNC male \$8.95 angle whip with BNC male \$9.50 (also good for freq. counters)

**MODEL 951 ADAPTER \$2.95**

UG255U BNC male to VHF female

**12 or 24 HOUR DIGITAL CLOCK KIT**

Uses 0.5 Display LED, 5314 Clock Chip. Freeze feature for accurate set, fits our standard cabinet. **ONLY \$19.95**

**CLOCK CABINETS**

Woodgrain or black leather ea. \$4.95

**CRYSTAL TIME BASE KIT**

Includes PC Board, Crystal, all parts and instructions. \$4.95

**BASIC 600 MHZ PRESCALER KIT**

**Includes:** PC board 11C90, capacitors, diodes and instructions requires 5VDC \$29.95  
12VDC option \$1.75

**ALDELCO KITS**

**DUAL DIGITAL 12/24 HOUR CLOCK KIT NOW WITH A NEW WALNUT GRAIN WOOD CABINET**

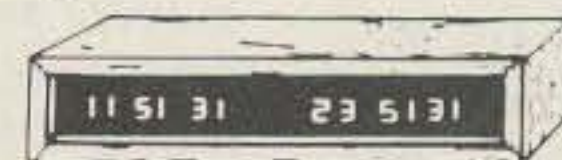

**ONLY \$49.95**

**MODEL ALD 5-W 0.5 LEDs**

- Features
- 12 or 24 Hour Operation on either clock
  - Each Clock separately controlled
  - Freeze feature for time set
  - Easy assembly for clock and cabinet

**ADJUSTABLE POWER SUPPLY KITS**

5-15 Volts 500 MA Model PS5.....\$7.95  
12-20 Volts 500 MA Model PS12.....7.95

**ALDELCO** 300

2789A MILBURN AVE, BALDWIN, N.Y. 11510  
516-378-4555

Add 6% shipping. Add \$1.00 for orders under \$10.00. Out of U.S.A. add 15% shipping and certified check or money order in U.S. funds.





P.O. Box 4430M  
Santa Clara, CA 95054  
Will calls: 2322 Walsh Ave.  
(408) 988-1640

Same day shipment. First line parts only. Factory tested.  
Guaranteed money back. Quality IC's and other components at factory prices.

INTEGRATED CIRCUITS

7400TL	LM323K-5	5.95	CD4026	2.50	4116 200ns	7.95	CONNECTORS	KEYBOARDS
7400N	LM320K-12	1.50	CD4027	66	84116 200ns	49.00	30 pin edge	56 key ASCII keyboard kit
7402N	LM320K-15	1.50	CD4028	85	2513B	6.30	44 pin edge	Fully assembled
7404N	LM320T-5	1.35	CD4029	1.35	MMS262	4.00	100 pin edge	53 key ASCII keyboard kit
7409N	LM320T-8	1.35	CD4030	45	MMS280	3.00	100 pin edge WW	Fully assembled
7410N	LM320T-12	1.35	CD4035	1.35	MMS320	9.95		Enclosure Plastic
7414N	LM320T-15	1.35	CD4040	1.35	MMS330	5.94		Metal Enclosure
7420N	LM324N	1.40	CD4042	85	PD4110-3	4.00		
7422N	LM339N	1.00	CD4043	85	PD4110-4	5.00		
7430N	LM340K-5	1.35	CD4044	85	PS101L	8.95		
7442N	LM340K-8	1.35	CD4046	1.67	4200A	9.95		
7445N	LM340K-12	1.35	CD4049	45	82S25	2.90		
7447N	LM340K-15	1.35	CD4050	49	91L02A	1.50		
7448N	LM340K-20	1.35	CD4051	1.13	HD0165-5	6.95		
7450N	LM340T-5	1.25	CD4060	1.42	MMS7100	4.50		
7474N	LM340T-8	1.25	CD4066	71	GA138900-1	9.95		
7475N	LM340T-12	1.25	CD4068	40	MCMM66751A	9.95		
7485N	LM340T-15	1.25	CD4069	40	9368	3.50		
7489N	LM340T-18	1.25	CD4070	50	4100	10.00		
7490N	LM340T-24	1.25	CD4071	45	416	15.00		
7492N	LM350	7.50	CD4072	45				
7493N	LM377	3.50	CD4073	45				
7495N	LM379	5.00	CD4075	45				
74100N	LM390N	1.00	CD4076	1.65				
74107N	LM381	1.60	CD4078	40				
74121N	LM382	1.60	CD4081	35				
74123N	LM703H	65	CD4082	35				
74125N	LM709H	28	CD4116	47				
74145N	LM723H/N	5.00	CD4490	5.00				
74150N	LM733N	85	CD4507	1.00				
74151N	LM741CH	35	CD4508	4.25				
74154N	LM741N	38	CD4510	1.02				
74157N	LM747H/N	75	CD4511	94				
74161N	LM748N	35	CD4515	2.52				
74162N	LM1303N	1.75	CD4516	1.10				
74163N	LM1304	1.10	CD4518	1.02				
74174N	LM1305	1.27	CD4520	1.02				
74175N	LM1307	2.00	CD4527	1.51				
74190N	LM1310	2.75	CD4528	79				
74192N	LM1458	47	CD4553	3.50				
74193N	LM1812	7.50	CD4566	2.25				
74221N	LM1809	3.00	CD4583	2.35				
74258N	LM2111	1.75	CD4586	1.10				
74365N	LM2902	2.00	CD40192	3.00				
74366N	LM3900N	60	74C00	35				
74367N	LM3905	1.75	74C04	40				
	LM3909N	95	74C10	35				
	MC1458B	50	74C14	1.95				
74LS00 TTL	NE550N	1.00	74C20	35				
74LS00N	NE555V	39	74C30	35				
74LS04N	NE568A	85	74C48	2.95				
74LS05N	NE568A	1.00	74C74	85				
74LS08N	NE568V	1.50	74C76	1.75				
74LS10N	NE567V	1.00	74C90	1.75				
74LS13N	NE570B	4.75	74C93	1.75				
74LS14N	78L05	60	74C154	3.00				
74LS20N	78L08	60	74C160	2.00				
74LS22N	78M05	85	74C175	1.35				
74LS26N	75108	1.75	74C192	2.25				
74LS30N	75191CN	2.50	74C221	2.50				
74LS33N	75192CN	55	74C909	6.00				
74LS38N	75194CN	89	74C906	75				
74LS47N			74C914	1.95				
74LS75N			74C922	6.00				
74LS90N			74C923	6.00				
74LS93N			74C925	7.50				
74LS95N			74C926	6.95				
74LS107N			74C927	6.95				
74LS112N			74C927	6.95				
74LS113N			74C927	6.95				
74LS132N			74C927	6.95				
74LS136N			74C927	6.95				
74LS151N			74C927	6.95				
74LS155N			74C927	6.95				
74LS170N			74C927	6.95				
74LS162N			74C927	6.95				
74LS163N			74C927	6.95				
74LS174N			74C927	6.95				
74LS190N			74C927	6.95				
74LS221N			74C927	6.95				
74LS258N			74C927	6.95				
74LS367N			74C927	6.95				
LINEAR								
CA3045								
CA3046								
CA3081								
CA3082								
CA3089								
LM301AN/AH								
LM3059P								
LM307N								
LM309N								
LM309R								
LM311H/N								
LM317T/K								
LM318								
LM320K-5								

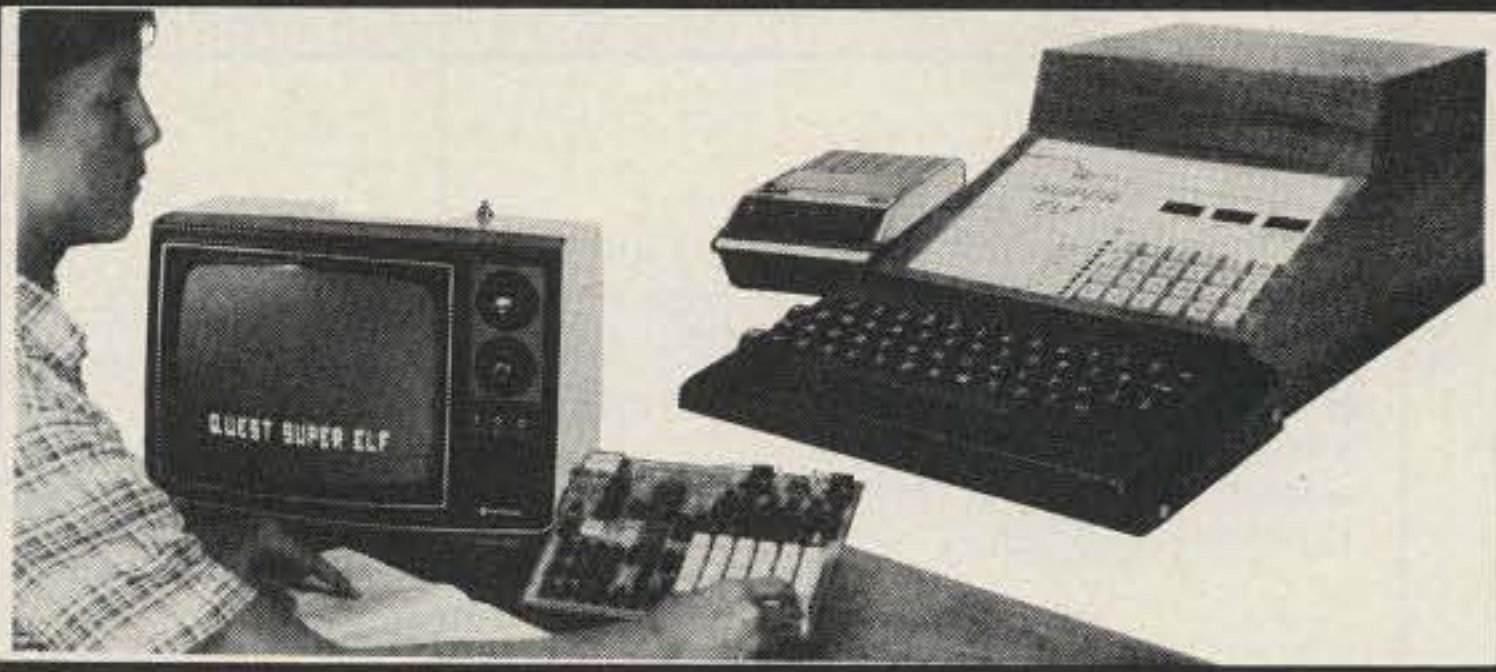

RCA Cosmac 1802 Super Elf Computer \$106.95

Compare features before you decide to buy any other computer. There is no other computer on the market today that has all the desirable benefits of the Super Elf for so little money. The Super Elf is a small single board computer that does many big things. It is an excellent computer for training and for learning programming with its machine language and yet it is easily expanded with additional memory, Full Basic, ASCII Keyboards, video character generation, etc.

plus load, reset, run, wait, input, memory protect, monitor select and single step. Large, on board displays provide output and optional high and low address. There is a 44 pin standard connector slot for PC cards and a 50 pin connector slot for the Quest Super Expansion Board. Power supply and sockets for all IC's are included in the price plus a detailed 127 pg. instruction manual which now includes over 40 pgs. of software info, including a series of lessons to help get you started and a music program and graphics target game. Many schools and universities are using the Super Elf as a course of study. OEM's use it for training and R&D.

Before you buy another small computer, see if it includes the following features: ROM monitor; State and Mode displays; Single step; Optional address displays; Power Supply; Audio Amplifier and Speaker; Fully socketed for all IC's; Real cost of in warranty repairs; Full documentation.

Remember, other computers only offer Super Elf features at additional cost or not at all. Compare before you buy. Super Elf Kit \$106.95, High address option \$8.95, Low address option \$9.95. Custom Cabinet with drilled and labelled plexiglass front panel \$24.95. All metal Expansion Cabinet, painted and silk screened, with room for 5 S-100 boards and power supply \$57.00. NiCad Battery Memory Saver Kit \$6.95. All kits and options also completely assembled and tested.

The Super Elf includes a ROM monitor for program loading, editing and execution with SINGLE STEP for program debugging which is not included in others at the same price. With SINGLE STEP you can see the microprocessor chip operating with the unique Quest address and data bus displays before, during and after executing instructions. Also, CPU mode and instruction cycle are decoded and displayed on 8 LED indicators.

Questdata, a software publication for 1802 computer users is available by subscription for \$12.00 per 12 issues. Single issues \$1.50. Issues 1-12 bound \$16.50.

An RCA 1861 video graphics chip allows you to connect to your own TV with an inexpensive video modulator to do graphics and games. There is a speaker system included for writing your own music or using many music programs already written. The speaker amplifier may also be used to drive relays for control purposes.

Tiny Basic Cassette \$10.00, on ROM \$38.00, original Elf kit board \$14.95. 1802 software; Moewls Video Graphics \$3.50. Games and Music \$3.00, Chip 8 Interpreter \$5.50.

A 24 key HEX keyboard includes 16 HEX keys

Super Expansion Board with Cassette Interface \$89.95

This is truly an astounding value! This board has been designed to allow you to decide how you want it optioned. The Super Expansion Board comes with 4K of low power RAM fully addressable anywhere in 64K with built-in memory protect and a cassette interface. Provisions have been made for all other options on the same board and it fits neatly into the hardwood cabinet alongside the Super Elf. The board includes slots for up to 6K of EPROM (2708, 2758, 2716 or TI 2716) and is fully socketed. EPROM can be used for the monitor and Tiny Basic or other purposes.

points can be used with the register save feature to isolate program bugs quickly, then follow with single step. If you have the Super Expansion Board and Super Monitor the monitor is up and running at the push of a button.

A 1K Super ROM Monitor \$19.95 is available as an on-board option in 2708 EPROM which has been preprogrammed with a program loader/editor and error checking multi file cassette read/write software, (relocatable cassette file) another exclusive from Quest. It includes register save and readout, block move capability and video graphics driver with blinking cursor. Break

Other on board options include Parallel Input and Output Ports with full handshake. They allow easy connection of an ASCII keyboard to the input port. RS 232 and 20 ma Current Loop for teletype or other device are on board and if you need more memory there are two S-100 slots for static RAM or video boards. Also a 1K Super Monitor version 2 with video driver for full capability display with Tiny Basic and a video interface board. Parallel I/O Ports \$9.85, RS 232 \$4.50, TTY 20 ma I/F \$1.95, S-100 \$4.50. A 50 pin connector set with ribbon cable is available at \$15.25 for easy connection between the Super Elf and the Super Expansion Board.

Announcing Quest Super Basic— SECOND GENERATION

A new enhanced version of Super Basic now available. Quest was the first company worldwide to ship a full size Basic for 1802 Systems. A complete function Super Basic by Ron Cenko including floating point capability with scientific notation (number range ± 17E<sup>99</sup>), 32 bit integer ± 2 billion; multi dim arrays, string arrays; string manipulation; cassette I/O; save and load, basic, data and machine language programs; and over 75 statements, functions and operations.

Power Supply Kit for the complete system (see Multi-volt Power Supply).

Gremlin Color Video Kit \$69.95

32 x 16 alpha/numerics and graphics; up to 8 colors with 6847 chip; 1K RAM at E000. Plugs into Super Elf 44 pin bus. No high res. graphics. On board RF Modulator Kit \$4.95

Enhancements include increased speed, built-in provisions for Stringy Floppy, Floppy Disc, Printer Driver, I/O, user definable command library and statement renumbering.

Easily adaptable to most 1802 systems. Requires 16K RAM minimum for Basic and user programs. Source listing for both Serial and Parallel I/O included.

Super Basic on Cassette \$40.00.

1802 16K Dynamic RAM Kit \$149.00

Expandable to 32K. Hidden refresh w/clocks up to 4 MHz w/no wait states. Addl. 16K RAM \$63.00 Super Elf 44 pin expansion board; 3 female and 1 male bus. Board plus 3 connectors \$22.95

Elf II Adapter Kit \$24.95

Plugs into Elf II providing Super Elf 44 and 50 pin plus S-100 bus expansion. (With Super Expansion). High and low address displays, state and mode LED's optional \$18.00.

Tiny Basic Extended on Cassette \$15.00

(added commands include Stringy, Array, Cassette I/O etc.)

Super Color S-100 Video Kit \$129.95

Expandable to 256 x 192 high resolution color graphics. 6847 with all display modes computer controlled. Memory mapped. 1K RAM expandable to 6K. S-100 bus 1802, 8080, 8085, Z80 etc.

S-100 4-Slot Expansion \$ 9.95

Super Monitor V1.1 Source Listing \$15.00

Editor Assembler \$25.00

(Requires minimum of 4K for E/A plus user source)

1802 Tiny Basic Source listing \$19.00

Super Monitor V2.0/2.1 Source Listing \$20.00

PROM Eraser

assembled. 25 PROM capacity \$37.50 (with timer \$69.50). 6 PROM capacity OSHA/UL version \$69.50 (with timer \$94.50).

Z80 Microcomputer

16 bit I/O, 2 MHz clock, 2K RAM, ROM Breadboard space. Excellent for control. Bare Board \$28.50. Full Kit \$99.00. Monitor \$20.00. Power Supply Kit \$35.00. Tiny Basic \$30.00

S-100 Computer Boards

8K Static Godbout Econo IIA Kit 145.00  
16K Static Godbout Econo XIV Kit 285.00  
24K Static Godbout Econo VIIA-24 Kit 435.00  
32K Static Godbout Econo X-32 Kit 575.00  
16K Dynamic RAM Kit 199.00  
32K Dynamic RAM Kit 310.00  
64K Dynamic RAM Kit 470.00  
Video Interface Kit \$135.00

80 IC Update Master Manual \$55.00

Comp. IC data selector, 2700 pg. master reference guide. Over 51,000 cross references. Free update service through 1980. Domestic postage \$3.50.

Modem Kit \$60.00

State of the art, orig., answer. No tuning necessary. 103 compatible 300 baud. Inexpensive acoustic coupler plans included.

LRC 7000 + Printer \$389.00

40/20 column dot matrix impact, std. paper. Interface all personal computers. 64/40/32/20 version \$405.00. Optional cables available.

LRC 7000 printer interface cable for Super Elf with software \$26.00

NiCad Battery Fixer/Charger Kit

Opens shorted cells that won't hold a charge and then charges them up, all in one kit w/full parts and instructions. \$7.25

Rockwell AIM 65 Computer

6502 based single board with full ASCII keyboard and 20 column thermal printer. 20 char. alphanumeric display, ROM monitor, fully expandable. \$375.00. 4K version \$450.00. 4K Assembler \$85.00. 8K Basic Interpreter \$100.00.

Special small power supply for AIM65 assem. in frame \$54.00. Complete AIM65 in thin briefcase with power supply \$499.00. Molded plastic enclosure to fit both AIM65 and power supply \$47.50. Special Package Price: 4K AIM, 8K Basic, power supply, cabinet \$599.00



<p><b>W2AU Balun</b> World famous W2AU Balun. Full legal power - no TVI from your coax - built in lightning arrester - 3-40 MHz broadbanded - use on vees, doublets, quads, yagis, folded dipoles. Specify 1 to 1 or 4 to 1 models, both types are \$15.95.</p>	<p><b>BENCHER</b> Bencher paddles are dual lever iambic keyer paddles that will increase your speed, accuracy, &amp; operating comfort. Black base \$39.95, chrome base \$49.95.</p>	<p><b>SUPEREX HEADPHONES</b> Superex headphones - APS-II features high sensitivity, crisp clear speech clarity, and comfort oriented design. \$29.95. The AVNS-7 "noise shield" headphones provide for improved communications by shutting out noises that interfere with reception - These comfortable headphones are designed with the purist in mind. \$59.95. The APS-M3 comms headphone is a useful all around headphone, at home in the ham shack or out on field day. This rugged model is \$34.95.</p>
<p><b>B&amp;W COAX SWITCHES</b> Model 375 5 position pill box configuration with coax conn on the back \$19.98, 376 five position with ground, radial configuration \$19.98, 550A five position radial basic \$17.98, 590G five position high reliability \$18.98, 593 square configuration with three positions and coax connectors at the top of the box, \$17.95, other B&amp;W equipment available upon request.</p>	<p><b>73 CODE COURSES</b> The excellent code tapes that "get you over the top". These tapes take you from just enough to a comfortable margin above the speeds required for the FCC exams. 6 + W.P.M. \$4.45; 13 + W.P.M. \$4.45.</p>	<p><b>AMECO      DRAKE      NYE</b> Ameco - PLF-2 Preamp 160 through 6 Meters \$49.95. Drake - Low pass filters: 100W \$14.95 1000W \$26.95. Nye - 1000W low pass filter, \$22.95</p>
<p><b>TRAC</b> <b>DELUXE MESSAGE MEMORY KEYS</b> This full featured memory keyer is only \$89.98. The Message Memory keyer with less features is \$69.95 but still is the best memory keyer available at V.A.R. at this low price.</p>	<p><b>RM KITS</b> "RM" kits - are receiver improvement kits for the TS-520, TS-820, TS -820s and the FT-101 through the F models. The kit includes replacement parts for critical sections of your receiver and alignment instructions where applicable. The kits install in about one hour and require a small tool kit including a low wattage soldering iron. The improved "RM" kits are \$17.95. Order now for free delivery.</p>	<p><b>THEFT ALERT</b> Pager type auto alarm system, can either be silent or set off alarm at the vehicle. Your expensive equipment deserves the best protection you can get. One mile model \$129.95. The EIGHT MILE RANGE model for maximum protection is only \$189.95. Includes transmitter/interface and belt pager with full instructions.</p>
<p><b>MIRAGE</b> MP1 HF or MP2 VHF precision wattmeter-SWR meters \$119.95. B108 10 in 80 out with pre-amp (2M) \$179.95, B1016 10 W in for 160 WATTS out with receive pre-amp \$279.95, B3016 30 watts in 160 watts out with pre-amp \$239.95.</p>	<p><b>PIPO TTP</b> The Best Concept in touch tone pads (encoders) Pipo features reliability, ease of installation and high quality parts. Snap action push buttons eliminate mis-encoding due to intermittent switch contacts. PP-1 basic 12 key pad \$49.95 PP-1K with relay \$55.95, PP-2 basic 16 key pad \$58.00, PP-2K \$69.00, P-3 electronics and keyboard only \$39.95, P-3 16 key is \$43.95.</p>	<p><b>CUSHCRAFT</b> Boomer antennas: 214FB (the FM boomer) \$69.95, A32-19 \$79.95, ATB-34 (tri-band beam) \$239.95, ARX-2 \$35.95 ARX-220 \$35.95. While stock lasts.</p>
<p><b>ASTATIC</b> MICROPHONES - Astatic TUG-8-D104 \$55.95, TUG-9-D104 GOLD \$159.95, Turner + 2 \$54.95, Turner + 3B \$59.95, Turner 360DM-6 \$24.95.</p>	<p><b>RADAR DETECTORS</b> SUPERFOX - superheterodyne dual band really gives you the time to react. Much more sensitive than the cheaper diode type. \$299.95, Whistler Q-1000 another superhet with dual alarms - \$329.95, Fuzzbuster Elite \$199.95, Long Range Super Snooper - \$189.95.</p>	<p><b>ROTORS</b> AR-40 \$79.95, HD-73 \$109.95, CD-45 \$129.95, Ham 4 \$169.95, T2X \$229.95. Mast bracket for Ham 4 - \$29.95.</p>

Prices available only while stock on hand lasts!

REMEMBER - V.A.R. PAYS THE SHIPPING (48 States)

Ten-Tec, Cushcraft, Yaesu, ICOM, Superex, Trackeys, Bencher, Centurion ducks, Ameco, Callbook, Scelbi, ARRL, B & W, Bearcat, Berk-Tek, Lunar, Mirage, "RM" kits, Hanimex calculators, Comtronix, Midland, Phone Mate, Astatic, Turner, Vista, Fuzzbuster, Tri-Ex, Larsen, PIPO, Theft Alert Alarm.

C.O.D. add \$5.50



VINEYARD AMATEUR RADIO

Art(WA60YS) - Sales and Service - Jay (WB6YQN)

4407 Vineyard, Oxnard, CA 93030, (805) 485-0942

FOR YOUR VISA AND MASTER CHARGE ORDERS ONLY CALL

Nationwide 24-hour order line  
1-800-854-2003, Ext. 873

California 24-hour order line  
1-800-522-1500, Ext. 873

BANK AMERICA

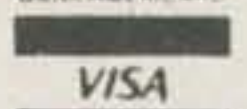

Orders accepted





7294 N.W. 54 STREET  
MIAMI, FLORIDA 33166

# SURPLUS ELECTRONICS CORP. ✓69

PHONE: (305) 887-8228

TWX: 810-848-6085

WHOLESALE - RETAIL

### SO239

10/\$5.00      100/\$35.00  
50/\$20.00    1000/\$300.00

### PL259 Amphenol .60¢ ea.

### E. F. Johnson S Meter

Edge Meter 250 UA. Fits in 5/8" x 1-3/8" hole. MTG holes on each end 1-1/4" behind panel. Black scale 0-5 bottom 1-20 top \$1.25 ea.      5/\$5.00

**E. F. Johnson Signal Strength Meter** 200 UA 2 1/2" x 2 1/2" Sq. mounts in 1 3/4" hole 1" behind panel. Scale: 1-30 db top 0-5 bottom. \$4.95 ea      5/\$20.00

### PANEL METERS

\$4.00 ea      2 for \$7.00

25-0-25 dc Volts } 2 1/4" x 3"

0-25 dc Volts } 2 1/4" x 2 1/4"  
0-50 ac Volts }  
-Shunt Required-

### Double Row/Wire Wrap .100

25 pins    \$3.49 ea    10/\$30.00  
30 pins    \$3.96 ea    10/\$32.00  
50 pins    \$5.43 ea    10/\$45.00

### Double Row/Solder Eyelet .156

6 pins      \$1.10 ea      10/\$ 9.00  
15 pins     \$1.55 ea      10/\$12.50  
22 pins     \$2.08 ea      10/\$17.00  
43 pins     \$3.66 ea      10/\$30.00

### C & K SWITCHES

PART #	MOVEMENT	
7101	ON/NONE/ON	SPST
7103	ON/OFF/ON	SPST
7108	ON/NONE/(ON)	SPST
7201	ON/NONE/ON	DPDT

\$1.00 EA      6 FOR \$5.00

6 TV GAMES ON (1) CHIP  
Gen Instr AY-3-8500-1  
28 Pin Plastic Case  
EVERYDAY LOW PRICE \$7.50 ea

### CB SPECIAL

Brand new printed circuit board assembly. Used in all HyGain 40 Channel CB transceivers. Fits many other manufacturers' units also. Squelch pot/volume control/channel selector not included. Board Dimensions 6" x 6 1/2"

1-9 - 7.50 ea.      50-99 - 6.00 ea.  
10-49 - 6.50 ea.    100-up - 5.50 ea.

### CB SPECIAL W/40 ch SW same as above

1-9 \$10.50 ea.      50-99 \$9.00 ea.  
10-49 \$9.50 ea.    100-up \$8.50 ea.

### Serviceman Special

New Hy-Gain 40ch CB Less Case, Speaker & Knobs (as is) \$14.95 ea

**NEW Hy-Gain Remote 40ch CB** Less Case, Speaker & Control Mic (as is) \$14.95 ea

### ASTATIC T-UG8-D104

PREAMP Desktop microphone w/crystal element 3 Pin Plug \$35 ea.

**NEW E.F. Johnson Power Mic/Less Cord.** Desktop Style \$19.95 ea

**ILEX COPY LENS F:5.6,6.1**  
Focal Length (155MM) 1 1/4" D,  
2 1/16" L, 1 1/16" Fixed iris.  
\$7.50 ea.

**CERAMIC IF FILTERS**  
EFC L455K  
\$3.50 ea.

8 Position Dip Switches  
16 pin (AMP) \$1.50 ea.  
10/\$13.50

**15' MODEM CABLES**  
10#22ga wire w/shield,  
DB25P conn & DB51226-1  
cover on one end  
\$5.50 ea. 10/\$50.00

**25' MODEM CABLES**  
13#22ga wire w/shield,  
DB25P conn & DB51226-1  
cover on one end  
\$6.50 ea. 10/\$60.00

**12 Vdc RELAY**  
**SPST 35 Amp Contacts**  
Open Frame  
Rugged, great for mobile use  
\$4.50 ea      5/\$20.00

**12 Vdc RELAY**  
SPST Open Frame  
5 Amp Contacts  
Mfg-Magnecraft  
\$1.50 ea      4/\$5.00

22 pins/Double Row/Dipped Solder  
.156 \$2.08 ea    10/\$17.00

22 pins/Double Row/Wire Wrap  
.156 \$2.44 ea    10/\$19.00

12 V DC Horn  
2" diameter x 1 1/4" deep  
.75 each  
3/\$2.00

100 ASSORTED DISC CAPS  
(FULL LEADS) 20 EA OF 5  
DIFFERENT VALUES \$2.00  
PER PACK

**Autronic Elect Auto Alarm**  
Easy installation independent cir-  
cuits solid state 12V neg ground  
\$5.00 ea.

**White Porcelain**  
**Egg Insulator**  
1 1/2" x 1" 50¢ ea.    3 for \$1.25

**CAPS RADIAL LEADS**  
2200 uF @ 16V  
.25 ea. 10/\$2.00

**SOLDER LUG-TYPE CAPS**  
50 uF @ 350V 1" D x 3" L  
50 uF @ 450V 1" D x 2 1/2" L  
50 uF @ 450V 1" D x 3" L  
60¢ EA.    5 FOR \$2.50

**EFJ CRYSTAL OVENS**  
6V/12V 75°  
\$5.00 ea.

**IC SOCKETS**  
**Cambion**  
**Gold Plated Wire Wrap**  
14 pin .35 ea    10/\$3.00  
16 pin .38 ea    10/\$3.30

**COMCO XTAL FILTER**  
23/8" x 1" x 3/4"  
13KC BW \$10.00 ea.

**Coax Connectors**  
UG-273/U BNC-F/UHF-M 2.50  
UG-255/U BNC-M/UHF-F 3.00  
UG-146A/U N-M/UHF-F 4.50  
UG-83B/U N-F/UHF-M 4.50  
UG-175 RG-58 Adapt. .20  
UG-176 RG-59 Adapt. .20

### TRIMMER CAPS

Can fit in your watch  
3.5-20 pF & 5-30 pF  
\$.75 ea., 2/\$1.25  
5/\$3.00

### POLY FOAM COAX 50 Ohm

Low Loss = to RG174  
\$4.95/100' \$3.00/50'

### ULTRASONIC TRANSDUCER

Detects sound above the range of human hearing! Transmits & receives  
\$2.50 ea. 5/\$10.00

### MAGNETIC PICK UP TRANSDUCER

Converts motion to ac voltage without mechanical linkage  
3/8" x 2" w/6' shielded cable  
\$4.95 ea.

### SOLDERLESS TEST PROD (BLACK)

Threaded type, molded handle  
\$.40 ea. 10/\$3.50

**USED MUFFIN FANS**  
3 blades, 110VAC, 4 3/4" sq.  
\$5.95

### CW MINI SLIDE SW

DPDT .15 ea. 10/\$1.25

### ALL STAR AIR VARIABLE

24-275 pF .75 ea.

### RED SEVEN SEGMENT DISPLAY

TIL 322P \$1.00 ea.

### BOURNS' EDGE MOUNTING

5K pot single turn  
3345W series \$1.50 ea.

### 12 VOLTS @ 1/2 AMP

Filament transformer  
1 5/8" x 2" x 1" \$1.50 ea.

### CTS DP6P ROT SWITCH

.50 ea. 5/\$2.00

### ASSORTED ELECTROLYTICS

VALUE/MFD		VOLTS	DIA		LENGTH	PRICE
63,000	@	15V	3"	x	5 1/2"	4.00 ea
10,000	@	20V	1 1/2"	x	5 3/4"	3.00 ea
2,700	@	25V	1 1/4"	x	2 1/4"	2.00 ea
2,900	@	25V	1 1/4"	x	2"	2.00 ea
3,000	@	25V	1 1/2"	x	4 1/2"	2.00 ea
18,000	@	25V	2"	x	4"	3.00 ea
21,000	@	25V	2 1/2"	x	3"	3.00 ea
1,000	@	50V	1 1/4"	x	3 1/4"	2.50 ea
34,800	@	50V	3"	x	5 1/2"	3.00 ea
450	@	75V	1 1/4"	x	2 1/4"	2.00 ea
500	@	100V	1 1/2"	x	3 1/2"	2.00 ea
240	@	300V	1 1/4"	x	3 1/4"	2.00 ea
50	@	450V	1 1/4"	x	2"	2.00 ea

### AXIAL LEAD ELECTRO- LYTIC CAPACITORS

2 uF @ 15V	}	12 ea. for \$1.00
10 uF @ 15V		
20 uF @ 15V		
50 uF @ 15V		
2.2 uF @ 25V		
3.3 uF @ 25V	}	15 ea. for \$2.00
1 uF @ 35V		
2 uF @ 150V	}	10 ea. for \$2.00
25 uF @ 25V		
3 uF @ 50V		
5 uF @ 50V		
10 uF @ 50V		
250 uF @ 25V	}	10 ea. for \$2.00
100 uF @ 50V		
50 uF @ 75V		

All material guaranteed • If for any reason you are not satisfied, our products may be returned within 10 days for a full refund (less shipping). Please add \$3 for shipping and handling on all orders. Additional 5% charge for shipping any item over 5 lbs. COD's accepted for orders totaling \$50.00 or more. All orders shipped UPS unless otherwise specified. Florida residents please add 4% sales tax. Minimum order \$15.00.

EQUIPMENT / COMPONENTS / WIRE & CABLE / ACCESSORIES



**THE ZULU IS BACK!**  
NATIONAL SEMICONDUCTOR MILITARY TIME FORMAT  
**JUMBO CLOCK MODULE**

**MA1001C  
BRAND NEW!**



**\$4.95**

- FEATURES
- FOUR JUMBO 1 INCH LED DISPLAYS
  - 12 HR REAL TIME FORMAT
  - 24 HR ALARM SIGNAL OUTPUT
  - 50 OR 60 HZ OPERATION
  - LED BRIGHTNESS CONTROL
  - POWER FAILURE INDICATOR
  - SLEEP & SNOOZE TIMERS
  - DIRECT LED DRIVE (LOW RFI)
  - COMES WITH FULL DATA

Add \$1.95 for AC XFMR

ASSEMBLED! NOT A KIT!

COMPARE AT UP TO TWICE  
OUR PRICE!

**ZULU**

PERFECT FOR USE  
WITH A TIMEBASE.

MANUFACTURER'S CLOSEOUT!

# Video-Volley

Introductory Offer

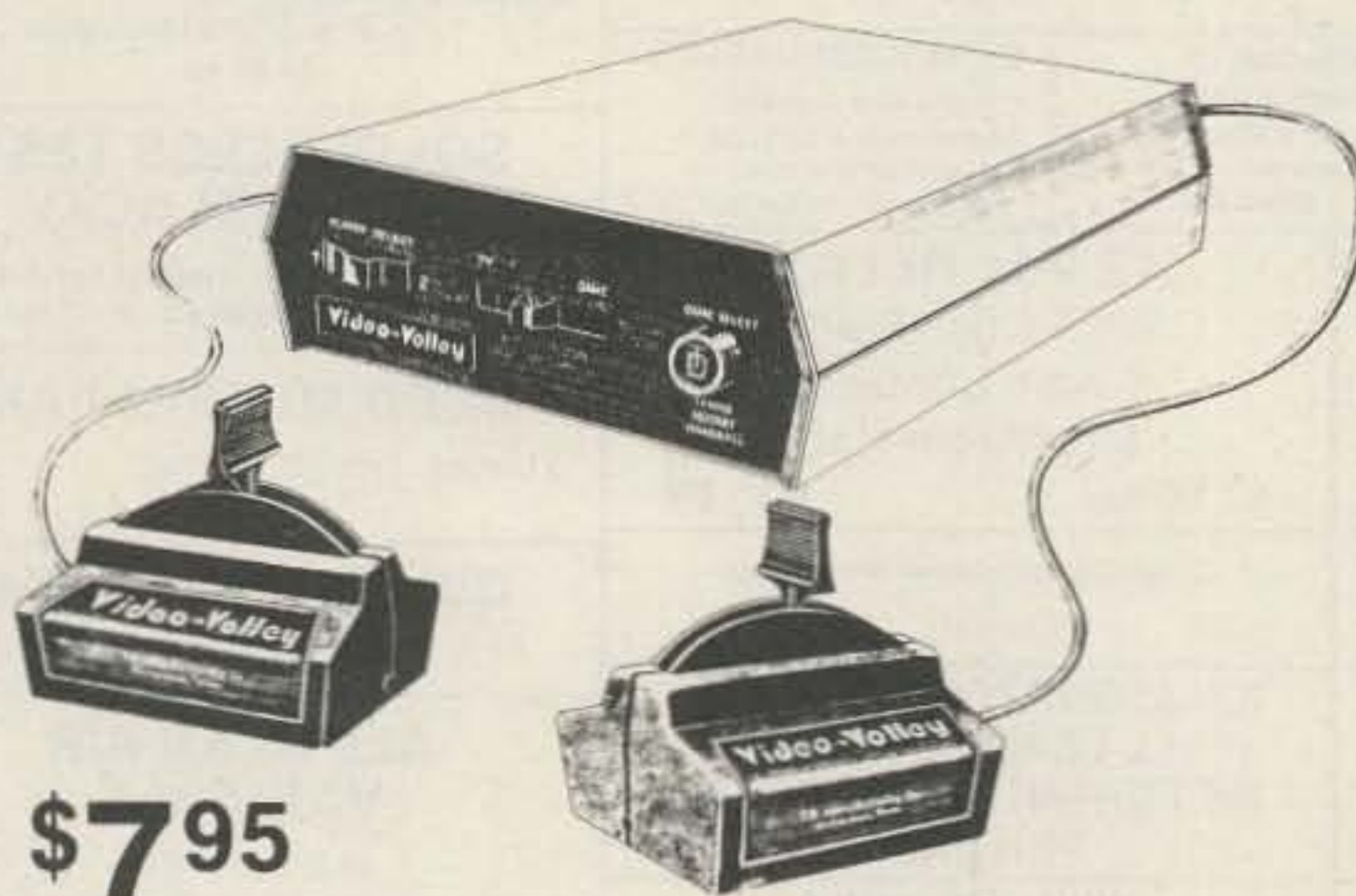

**\$7.95**

**TD Manufacturing Co.**  
Richardson, Texas

**MICRO MINI  
TOGGLE SWITCHES**  
6 for \$5 with hardware.



**99¢  
EACH**

\*\*\*\*\* **CABLE TIES** \*\*\*\*\*

MAKE YOUR PROJECTS "NEAT & TIDY." 4" CABLE TIES AT A FANTASTIC PRICE. GET THIS BARGAIN AND "TIE" IT DOWN. **\$2.00 for 100 or better yet \$15.00 for 1000**

**A Full Color\* TV Game For The Family**

Six exciting TV Games — Hockey, Tennis and Handball with one or two player capability for each game. Ball velocity doubles after the fourth player hit for an increasingly competitive game.

Adjustable paddle size for each player allows for handicapped play if desired. Paddles can give automatic ball spin with seven possible angles of ball deflection.

Automatic digital scoring appears after each point is scored. Game ceases automatically after one player scores 15 points. Serving is from the paddle of player who scored the last point, thus server can "place" his shot.

Video-Volley is designed to be installed, with a minimum of effort, to any standard television receiver, either color or black and white. Batteries are not required.

Small hand-held player modules with 15 foot cord length provides more comfort and versatility for players.

The compact command module sits atop the television receiver and has front panel control allowing effortless change from normal television reception to game play. Easy disconnection of the player hand-held modules facilitates easy set-up and take-down for storage.

**NON POLARIZED CAPS**

200 UF/50 VNPS **4 FOR \$1.25**

**5 VOLT REED RELAY**

An absolutely fantastic item. Compare this price with any advertiser. **While They Last.**

**\$1.10**

Turns on at 10 MA.

Drops out at 5 MA.



**FACTORY PRIME.**

5BI - Polar LED 59¢ ea. or 10 for \$5

**INTERSIL 8038 FUNCTION GENERATOR**

Produces sine, square wave, and triangular wave forms. **\$3.00 ea.**  
14 PIN DIP **5/\$12.50**

**VARO BRIDGE**

In a Mini Dip Package

1A 50 VOLT

**2/\$1.19**

**10/\$4.90**

**LAB-BENCH VARIABLE POWER SUPPLY KIT**

**\$12.00 KIT**

5 to 20 VDC at 1 AMP. Short circuit protected by current limit. Uses IC regulator and 10 AMP Power Darlington. Very good regulation and low ripple. Kit includes PC Board, all parts, large heatsink and shielded transformer. 50 MV. TYP. Regulation.

**16K DYNAMIC RAM CHIP**

WORKS IN TRS-80 OR APPLE II  
16K X 1 Bits. 16 Pin Package. Same as Mostek 4116-4 250 NS access. 410 NS cycle time. Our best price yet for this state of the art RAM. 32K and 64K RAM boards using this chip are readily available. These are new fully guaranteed devices by a major mfg.

**VERY LIMITED STOCK!  
"MAGAZINE SPECIAL"  
8/\$59.95**

**60 Hz CRYSTAL TIME BASE**

**\$4.95 (Complete Kit)**

Uses MM5369 CMOS divider IC with high accuracy 3.579545 MHZ Crystal. Use with all MOS Clock Chips or Modules. Draws only 1.5 MA. All parts, data and PC Board included. 100 Hz, same as above, except \$5.95

**D.C. HORN**

**VERY LOUD!**  
6-12 VDC  
Like Used In  
Smoke Alarms.  
**FANTASTIC SAVINGS.**  
Compare this true value  
**.60 ea. 4 For \$2.00**

NATIONAL SEMICONDUCTOR  
**"COLOSSUS JR." JUMBO CLOCK MODULE**

**MA1013  
BRAND NEW!**

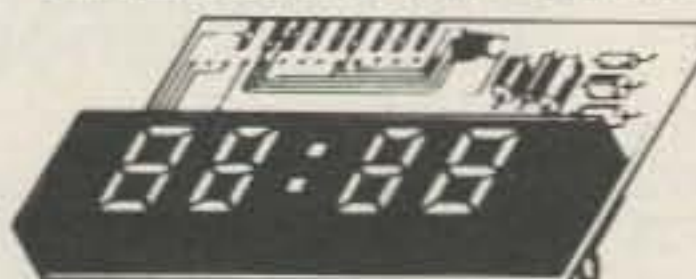

**\$8.50**

- Bright 4 digit 0.7" LED Display
- Complete-Add only Transformer and Switches
- 24 Hour Alarm Signal Output
- 12 Hour Real Time Format
- 50 or 60 Hz Operation
- Power Failure Indication
- LED Brightness Control
- Sleep and Snooze Timers
- Alarm "on" and PM Indicators
- Direct Drive - No RFI
- Direct Replacement for MA1012
- Comes with Full Data

ASSEMBLED! NOT A KIT!

(AC XFMR \$1.95)

MANUFACTURER'S CLOSEOUT!

PERFECT FOR USE  
WITH A TIMEBASE.

**PMD-11K-60**

60 Volts  
HFE 800-20K  
12 Amps

150 Watts  
By Lambda  
Brand New!

**\$1.50**

**REPEAT OF A SELL-OUT!**

VECO PRECISION THERMISTOR. GLASS TYPE. VECO #41A72. 8.2K OHMS AT ROOM TEMP. **VERY SENSITIVE.** INDIVIDUALLY PACKAGED IN PLASTIC VIALS. \$3.00 VALUE

**\$1.00 each or 3 FOR \$2.50**

## Digital Research: Parts

(OF TEXAS)

P.O. BOX 401247 • GARLAND, TEXAS 75040 • (214) 271-2461

**TERMS:** Add 50¢ postage, we pay balance. Orders under \$15 add 75¢ handling. No C.O.D. We accept Visa, MasterCard and American Express cards. Tex. Res. add 5% Tax. Foreign orders (except Canada) add 20% P&H. 90 Day Money Back Guarantee on all items.

**SEND FOR CATALOG WITH SUPER SAVINGS!!**



# These Low Cost SSB TRANSMITTING CONVERTERS

Let you use inexpensive recycled 10M or 2M SSB exciters on UHF & VHF!

- Linear Converters for SSB, CW, FM, etc.
- A fraction of the price of other units; no need to spend \$300 - \$400!
- Use with any exciter; works with input levels as low as 1 mW.
- Use low power tap on exciter or simple resistor attenuator pad (instructions included).
- Link osc with RX converter for transceiver.

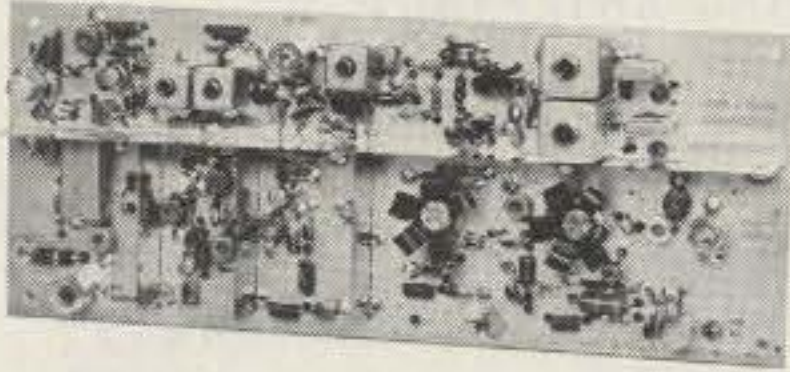

## XV4 UHF KIT — ONLY \$99.95

28-30 MHz in, 435-437 MHz out; 1W p.e.p. on ssb, up to 1½W on CW or FM. Has second oscillator for other ranges. Atten. supplied for 1 to 500 mW input, use external attenuator for higher levels.

Extra crystal for 432-434 MHz range..... \$5.95  
XV4 Wired and tested ..... \$149.95

## XV2 VHF KIT - ONLY \$69.95

2W p.e.p. output with as little as 1mW input. Use simple external attenuator. Many freq. ranges available.

MODEL	INPUT (MHz)	OUTPUT (MHz)
XV2-1	28-30	50-52
XV2-2	28-30	220-222
XV2-4	28-30	144-146
XV2-5	28-29 (27-27.4 CB)	145-146 (144-144.4)
XV2-7	144-146	50-52

XV2 Wired and tested ..... \$109.95

## XV28 2M ADAPTER KIT - \$24.95

Converts any 2M exciter to provide the 10M signal required to drive above 220 or 435 MHz units.



## NEW! COMPLETE TRANSMITTING CONVERTER AND PA IN ATTRACTIVE CABINET

Far less than the cost of many 10W units!

Now, the popular Hamtronics® Transmitting Converters and heavy duty Linear Power Amplifiers are available as complete units in attractive, shielded cabinets with BNC receptacles for exciter and antenna connections. Perfect setup for versatile terrestrial and OSCAR operations! Just right for phase 3! You save \$30 when you buy complete unit with cabinet under cost of individual items. Run 40-45 Watts on VHF or 30-40 Watts on UHF with one integrated unit! Call for more details.

MODEL	KIT	WIRED and TESTED
XV2/LPA2-45/Cabt (6M or 2M)	\$199.95	\$299.95
XV4/LPA4-30/Cabt (for UHF)	\$229.95	\$349.95

# Easy to Build FET RECEIVING CONVERTERS

Let you receive OSCAR and other exciting VHF and UHF signals on your present HF or 2M receiver



- NEW LOW-NOISE DESIGN
- ATTRACTIVE WOODGRAIN CASE
- Less than 2dB noise figure, 20dB gain

MODEL	RF RANGE	OUTPUT RANGE
CA28	28-32 MHz	144-148 MHz
CA50	50-52	28-30
CA50-2	50-54	144-148
CA144	144-146	28-30
CA145	145-147-or-144-144.4	28-30 27-27.4 (CB)
CA146	146-148	28-30
CA220	220-222	28-30
CA220-2	220-224	144-148
CA110	Any 2MHz of Aircraft Band	26-28 or 28-30
CA432-2	432-434	28-30
CA432-5	435-437	28-30
CA432-4	432-436	144-148

Easily modified for other rf and if ranges.

STYLE	VHF	UHF
Kit less case	\$34.95	\$49.95
Kit with case	\$39.95	\$54.95
Wired/Tested in case	\$54.95	\$64.95

## Professional Quality VHF/UHF FM/CW EXCITERS

- Fully shielded designs
- Double tuned circuits for spurious suppression
- Easy to align with built-in test aids



T50-50	6-chan, 6M, 2W Kit.....	\$44.95
T50-150	6-chan, 2M, 2W Kit.....	\$44.95
T50-220	6-chan, 220 MHz, 2W Kit.....	\$44.95
T450	1-chan, 450 MHz, ¾W Kit.....	\$44.95

## See our Complete Line of VHF & UHF Linear PA's

- Use as linear or class C PA
- For use with SSB Xmtg Converters, FM Exciters, etc.

LPA2-15	6M, 2M, 220; 15 to 20W.....	\$59.95
LPA2-30	6M, 2m; 25 to 30W.....	\$89.95
LPA2-40	220 MHz; 30 to 40W.....	\$119.95
LPA2-45	6M, 2M; 40 to 45W.....	\$119.95
LPA4-10	430MHz; 10 to 14W.....	\$79.95
LPA4-30	430MHz; 30-40W.....	\$119.95

See catalog for complete specifications

## FAMOUS HAMTRONICS PREAMPS

Let you hear the weak ones too! Great for OSCAR, SSB, FM, ATV. Over 14,000 in use throughout the world on all types of receivers.



- NEW LOW-NOISE DESIGN
- Less than 2 dB noise figure, 20 dB gain
- Case only 2 inches square
- Specify operating frequency when ordering

MODEL P-30 VHF PREAMP, available in many versions to cover bands 18-300 MHz.

MODEL P432 UHF PREAMP, available in versions to cover bands 300-650 MHz.

STYLE	VHF	UHF
Kit less case	\$12.95	\$18.95
Kit with case	\$18.95	\$26.95
Wired/Tested in Case	\$27.95	\$32.95

## NEW VHF/UHF FM RCVRs

Offer Unprecedented Range of Selectivity Options

- New generation
- More sensitive
- More selective
- Low cross mod
- Uses crystal filters
- Smaller
- Easy to align



R75A\* VHF Kit for monitor or weather satellite service. Uses wide L-C filter. -60dB at ± 30 kHz..... \$69.95

R75B\* VHF Kit for normal nbfm service. Equivalent to most transceivers. -60dB at ± 17 kHz, -80dB at ± 25 kHz... \$74.95

R75C\* VHF Kit for repeater service or high rf density area. -60dB at ± 14kHz, -80dB ± 22kHz, -100dB ± 30kHz.... \$84.95

R75D\* VHF Kit for split channel operation or repeater in high density area. Uses 8-pole crystal filter. -60dB at ± 9kHz, -100dB at ± 15 kHz. The ultimate receiver!... \$99.95

\* Specify band: 10M, 6M, 2M, or 220 MHz. May also be used for adjacent commercial bands. Use 2M version for 137 MHz WX satellites.

R450( ) UHF FM Receiver Kits, similar to R75, but for UHF band. New low-noise front end. Add \$10 to above prices. (Add selectivity letter to model number as on R75.)

A14 5 Channel Adapter for Receivers..... \$9.95

## NEW R110 VHF AM RCVR

AM monitor receiver kit similar to R75A, but AM. Available for 10-11M, 6M, 2M, 220 MHz, and 110-130 MHz aircraft band \$74.95. (Also available in UHF version.)

## IT'S EASY TO ORDER! ✓ 33

- Write or phone 716-392-9430 (Electronic answering service evenings & weekends)
- Use Credit Card, UPS COD, Check, Money Order
- Add \$2.00 shipping & handling per order

Call or Write to get FREE CATALOG With Complete Details

(Send 4 IRC's for overseas mailing)

HAMTRONICS® IS A REGISTERED TRADEMARK

# hamtronics, inc.

65J MOUL RD • HILTON, NY 14468



# SEMICONDUCTORS SURPLUS

2822 North 32nd Street/Unit -1 Phoenix, Arizona 85008 (602) 956-9423

We accept checks, MasterCharge, and Visa

Prices subject to change without notice



FOR OUT OF STATE USE OUR NEW 800 NUMBER FOR PHONE ORDERS 800 528-3611

NO ORDERS WILL BE ACCEPTED UNDER \$10.00, NOT INCLUDING SHIPPING!

NO C.O.D.'s. PHONE IN YOUR ORDER

## NEW PRIME RF POWER TRANSISTORS

2N2270	\$ 1.00	2N6094	\$ 7.15	MRF901	\$ 3.99
2N2857	1.57	2N6095	11.77	MRF902	12.55
2N2857JAN	2.54	2N6097	29.54	MRF904	3.00
2N2947	17.25	2N6166	38.60	MRF911	4.29
2N3227	3.25	2N6368	26.52	MRF5177	21.62
2N3261	2.32	2N6439	45.77	MRF8004	1.60
2N3375/MM3375	9.32	40280	3.00	CD3495	19.99
2N3553	1.80	40281	11.90	CD3435	29.95
2N3818	8.00	40282	12.90	A50-12	29.95
2N3866	1.20	40894	1.20	BFR96	2.00
2N3866JAN	2.80	PT3551C/2N6082NS	5.00	MWA110	6.92
2N3866JANTX	4.49	(no stud)		MWA120	7.38
2N3925/M9477	8.00	PT3563	5.00	MWA130	8.08
2N3948	2.00	PT4571A	1.50	MWA210	7.46
2N3950	26.86	PT3607	5.00	MWA220	8.08
2N3959	3.88	PT3123E	5.00	MWA230	8.62
2N4072	2.00	MRF216	22.46	MWA310	8.08
2N4427	1.20	MRF221	10.08	MWA320	8.62
2N4429	9.00	MRF227	3.00	MWA330	9.23
2N4877	1.00	MRF238	10.00		
2N4959	2.23	MRF240	14.62	MICROWAVE DIODES	
2N5108	4.03	MRF245	33.30	1N21	\$ 2.85
2N5109	1.66	MRF247	33.30	1N21B	3.85
2N5179	1.05	MRF314	14.08	1N21D	3.85
2N5177/MRF5177	21.62	MRF412	23.83	1N21WE	2.85
2N5214	20.00	MRF421	31.38	1N23CR	4.85
2N5583	4.55	MRF422A	44.14	1N23F	5.50
2N5589	6.83	MRF426A	10.24	1N23WE	4.00
2N5590	8.15	MRF432	11.23	1N23FMR	6.95
2N5591	11.85	MRF449A	10.61	1N25	6.50
2N5635	6.86	MRF450	11.77	1N78	8.63
2N5636	13.38	MRF450A	11.77	1N446	12.00
2N5637	22.15	MRF452	15.00	1N3655A	3.85
2N5641/PT4132D	6.00	MRF452A	15.00	1N5711/2835	1.99
2N5642	12.38	MRF454	21.83	MBD101	1.99
2N5643	15.82	MRF454A	21.83	MB1101	4.99
2N5645	12.38	MRF455	14.08	IS1544A	3.00
2N5842/MM1607	8.78	MRF455A	14.08	P40075	3.85
2N5847	11.15	MRF474	3.00	1N41SEMR	7.85
2N5919	30.00	MRF475	3.25	MA41482	3.00
2N5946	14.69	MRF476	2.25	MA41482R	5.00
2N5849/MM1620	21.29	MRF477	10.06		
2N5862	51.91	MRF479	4.68	MOTOROLA RF MODULES	
2N6080	7.74	MRF485	3.50	MHW602	
2N6082	11.30	MRF502	1.08	20 W output at 174 MHz	
2N6083	13.23	MRF604	2.00	12.5 VDC 20.6 dB Gain	
2N6084	14.66	MRF629	3.00	\$42.00	



# SEMICONDUCTORS SURPLUS

2822 North 32nd Street/Unit -1 Phoenix, Arizona 85008 (602) 956-9423

We accept checks, MasterCharge, and Visa

Prices subject to change without notice



## HAM MICROWAVE RECEIVERS

2100-2400 MHz  
28 dB Gain  
2.5 to 3 dB Noise

Assembled and tested with 90 day guarantee \$269.95

\$5.00 shipping with charge card or money order.

**RECEIVER KIT** \$169.95 Includes Yagi antenna, power supply box, P.C.B. and parts, down converter P.C.B. and parts, and complete instructions.

## MISCELLANEOUS PARTS FOR HMR

Yagi antenna	\$ 59.95
Power supply box	12.95
Power supply P.C.B.	4.99
Power supply transformer	3.99
Power supply kit	49.95
Power supply assembled and tested	59.95
Down converter P.C.B.	19.95
Down converter kit	79.95
Down converter assembled and tested	114.95
Complete Instructions	10.00
MRF901	3.99
MRF902	12.50
MRF911	4.29
7812	1.99
MBD101	1.99
MB1101	4.99
2835/1N5711	1.99
1 K Pot	3.00
Matching transformers, 75 Ohm - 300 Ohm	1.99
Two-way splitters	2.99
Chassis type F connectors	2/.99
Cable type F connectors	4/.99
Barrel type F connectors	.76
One 6 foot RG59 with connectors and one 50 foot RG59 with connectors	18.99

QUANTITY PRICES AVAILABLE FOR 10 AND UP

## TUBES

2E26	\$ 5.00	12BY7A	\$ 4.50
3-500Z	100.00	811A	12.95
3B28	7.00	6146	5.00
3X2500A3	125.00	6146A	5.25
3X3000F1	200.00	6146B	7.95
4-65A	30.00	6146W	12.95
4-125A	40.00	6360	7.95
4-250A	60.00	6939	8.00
4-400A	80.00	8072	45.00
4-1000A	200.00	8295/PL172	300.00
4CX250B	43.00	8950	10.00
4CX250R	45.00	8877 OUT	300.00
4CX350A	50.00	7289	6.99
4CX1000A	150.00	6KD6	6.00
4X150A	20.00	6LF6	6.00
4X150G	30.00	6LQ6/6JE6	6.00
572B/T160L	39.00	8908	13.00
		6550A	8.00

Other numbers on request

**NEW ELECTRICAL POWER STRIP**  
9 OUTLETS WITH BUILT IN CIRCUIT  
BREAKER AND INDICATOR LAMP  
\$21.95 each

Check, money order, or credit cards. (MasterCharge and VISA only) NO C.O.D.'s. No personal checks or certified personal checks for foreign countries accepted. Money order or cashier's check in U.S. funds only. Letters of credit are not acceptable. Minimum shipping by UPS is \$2.00 plus 35¢ insurance per \$100.00. Please allow extra shipping charges for heavy items. All parts returned due to customer error will be subject to a 15% restock charge.

If we are out of an item ordered we will try to replace it with an equal or better part unless you specify not to, or we will back order the item. **PRICES ARE SUBJECT TO CHANGE WITHOUT NOTICE.** Prices superseade all previously published. Some items offered are limited to small quantities and are subject to prior sale. **FOR OUT OF STATE USE OUR NEW 800 NUMBER FOR PHONE ORDERS. 800 528-3611 (For charge orders only, NO C.O.D.)**



**ramsey**

**the first name in Counters!**



**9 DIGITS 600 MHz \$129<sup>95</sup> WIRED**

**PRICES:**

CT-90 wired, 1 year warranty	\$129.95
CT-90 Kit, 90 day parts warranty	109.95
AC-1 AC adapter	3.95
BP-1 Nicad pack + AC Adapter/Charger	12.95
OV-1, Micro-power Oven time base	49.95
External time base input	14.95

The CT-90 is the most versatile, feature packed counter available for less than \$300.00! Advanced design features include; three selectable gate times, nine digits, gate indicator and a unique display hold function which holds the displayed count after the input signal is removed! Also, a 10MHz TCXO time base is used which enables easy zero beat calibration checks against WWV. Optionally; an internal nicad battery pack, external time base input and Micro-power high stability crystal oven time base are available. The CT-90, performance you can count on!

**SPECIFICATIONS:**

Range:	20 Hz to 600 MHz
Sensitivity:	Less than 10 MV to 150 MHz Less than 50 MV to 500 MHz
Resolution:	0.1 Hz (10 MHz range) 1.0 Hz (60 MHz range) 10.0 Hz (600 MHz range)
Display:	9 digits 0.4" LED
Time base:	Standard-10,000 mHz, 1.0 ppm 20-40°C. Optional Micro-power oven-0.1 ppm 20-40°C
Power:	8-15 VAC @ 250 ma

**7 DIGITS 525 MHz \$99<sup>95</sup> WIRED**



**SPECIFICATIONS:**

Range:	20 Hz to 525 MHz
Sensitivity:	Less than 50 MV to 150 MHz Less than 150 MV to 500 MHz
Resolution:	1.0 Hz (5 MHz range) 10.0 Hz (50 MHz range) 100.0 Hz (500 MHz range)
Display:	7 digits 0.4" LED
Time base:	1.0 ppm TCXO 20-40°C
Power:	12 VAC @ 250 ma

The CT-70 breaks the price barrier on lab quality frequency counters. Deluxe features such as; three frequency ranges - each with pre-amplification, dual selectable gate times, and gate activity indication make measurements a snap. The wide frequency range enables you to accurately measure signals from audio thru UHF with 1.0 ppm accuracy - that's .0001%! The CT-70 is the answer to all your measurement needs, in the field, lab or ham shack.

**PRICES:**

CT-70 wired, 1 year warranty	\$99.95
CT-70 Kit, 90 day parts warranty	84.95
AC-1 AC adapter	3.95
BP-1 Nicad pack + AC adapter/charger	12.95

**7 DIGITS 500 MHz \$79<sup>95</sup> WIRED**



**PRICES:**

MINI-100 wired, 1 year warranty	\$79.95
MINI-100 Kit, 90 day part warranty	59.95
AC-Z Ac adapter for MINI-100	3.95
BP-Z Nicad pack and AC adapter/charger	12.95

Here's a handy, general purpose counter that provides most counter functions at an unbelievable price. The MINI-100 doesn't have the full frequency range or input impedance qualities found in higher price units, but for basic RF signal measurements, it can't be beat! Accurate measurements can be made from 1 MHz all the way up to 500 MHz with excellent sensitivity throughout the range, and the two gate times let you select the resolution desired. Add the nicad pack option and the MINI-100 makes an ideal addition to your tool box for "in-the-field" frequency checks and repairs.

**SPECIFICATIONS:**

Range:	1 MHz to 500 MHz
Sensitivity:	Less than 25 MV
Resolution:	100 Hz (slow gate) 1.0 KHz (fast gate)
Display:	7 digits, 0.4" LED
Time base:	2.0 ppm 20-40°C
Power:	5 VDC @ 200 ma

**8 DIGITS 600 MHz \$159<sup>95</sup> WIRED**



**SPECIFICATIONS:**

Range:	20 Hz to 600 MHz
Sensitivity:	Less than 25 mv to 150 MHz Less than 150 mv to 600 MHz
Resolution:	1.0 Hz (60 MHz range) 10.0 Hz (600 MHz range)
Display:	8 digits 0.4" LED
Time base:	2.0 ppm 20-40°C
Power:	110 VAC or 12 VDC

The CT-50 is a versatile lab bench counter that will measure up to 600 MHz with 8 digit precision. And, one of its best features is the Receive Frequency Adapter, which turns the CT-50 into a digital readout for any receiver. The adapter is easily programmed for any receiver and a simple connection to the receiver's VFO is all that is required for use. Adding the receiver adapter in no way limits the operation of the CT-50, the adapter can be conveniently switched on or off. The CT-50, a counter that can work double-duty!

**PRICES:**

CT-50 wired, 1 year warranty	\$159.95
CT-50 Kit, 90 day parts warranty	119.95
RA-1, receiver adapter kit	14.95
RA-1 wired and pre-programmed (send copy of receiver schematic)	29.95



**DIGITAL MULTIMETER \$99<sup>95</sup> WIRED**

**PRICES:**

DM-700 wired, 1 year warranty	\$99.95
DM-700 Kit, 90 day parts warranty	79.95
AC-1, AC adaptor	3.95
BP-3, Nicad pack + AC adapter/charger	19.95
MP-1, Probe kit	2.95

The DM-700 offers professional quality performance at a hobbyist price. Features include; 26 different ranges and 5 functions, all arranged in a convenient, easy to use format. Measurements are displayed on a large 3 1/2 digit, 1/2 inch LED readout with automatic decimal placement, automatic polarity, overrange indication and overload protection up to 1250 volts on all ranges, making it virtually goof-proof! The DM-700 looks great, a handsome, jet black, rugged ABS case with convenient retractable tilt bail makes it an ideal addition to any shop.

**SPECIFICATIONS:**

DC/AC volts:	100uV to 1 KV, 5 ranges
DC/AC current:	0.1uA to 2.0 Amps, 5 ranges
Resistance:	0.1 ohms to 20 Megohms, 6 ranges
Input impedance:	10 Megohms, DC/AC volts
Accuracy:	10.1% basic DC volts
Power:	4 'C' cells

**AUDIO SCALER**

For high resolution audio measurements, multiplies UP in frequency.

- Great for PL tones
- Multiplies by 10 or 100
- 0.01 Hz resolution!

\$29.95 Kit \$39.95 Wired

**ACCESSORIES**

Telescopic whip antenna - BNC plug	\$ 7.95
High impedance probe, light loading	15.95
Low pass probe, for audio measurements	15.95
Direct probe, general purpose usage	12.95
Tilt bail, for CT 70, 90, MINI-100	3.95
Color burst calibration unit, calibrates counter against color TV signal	14.95

**COUNTER PREAMP**

For measuring extremely weak signals from 10 to 1,000 MHz. Small size, powered by plug transformer-included.

- Flat 25 db gain
  - BNC Connectors
  - Great for sniffing RF with pick-up loop
- \$34.95 Kit \$44.95 Wired

**ramsey electronics**

BOX 4072 • ROCHESTER, NY 14610

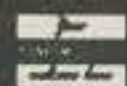

PHONE ORDERS  
CALL 716-586-3950

**TERMS**

Satisfaction guaranteed - examine for 10 days, if not pleased, return in original form for refund. Add 5% for shipping + insurance to a maximum of \$10. Overseas add 15%. COD, add \$2. Orders under \$10., add \$1.50. NY residents, add 7% tax.



ATTENTION IC-2A OWNERS:  
**IC-2A TONE DECKS ARE HERE!**

CUSTOM DESIGNED TO FIT WITH NO TROUBLE!

**IT'S HERE NOW!**

The question used to be, "When is Icom coming out with a hand-held?"...Now that it's become one of the hottest two meter rigs around, the big question now is, "When will a sub-audible tone option be available for my IC-2A?" The answer is: Spectronics has it now!



**FULLY TUNABLE!**

We are proud to be first in offering you a fully tunable miniature sub-audible tone deck specifically designed to fit the Icom IC-2A hand-held transceiver. If you own one of the other synthesized hand helds, you'll be delighted to know that you can put it in your unit as well.



**QUALITY TO LAST!**

This unit is manufactured by Transcom, Inc., to their exacting standards, and is guaranteed to be stable to within  $\pm 1$  Hz, after proper tuning. All units are pre-set to your specified tone, and require no further adjustment for frequency.

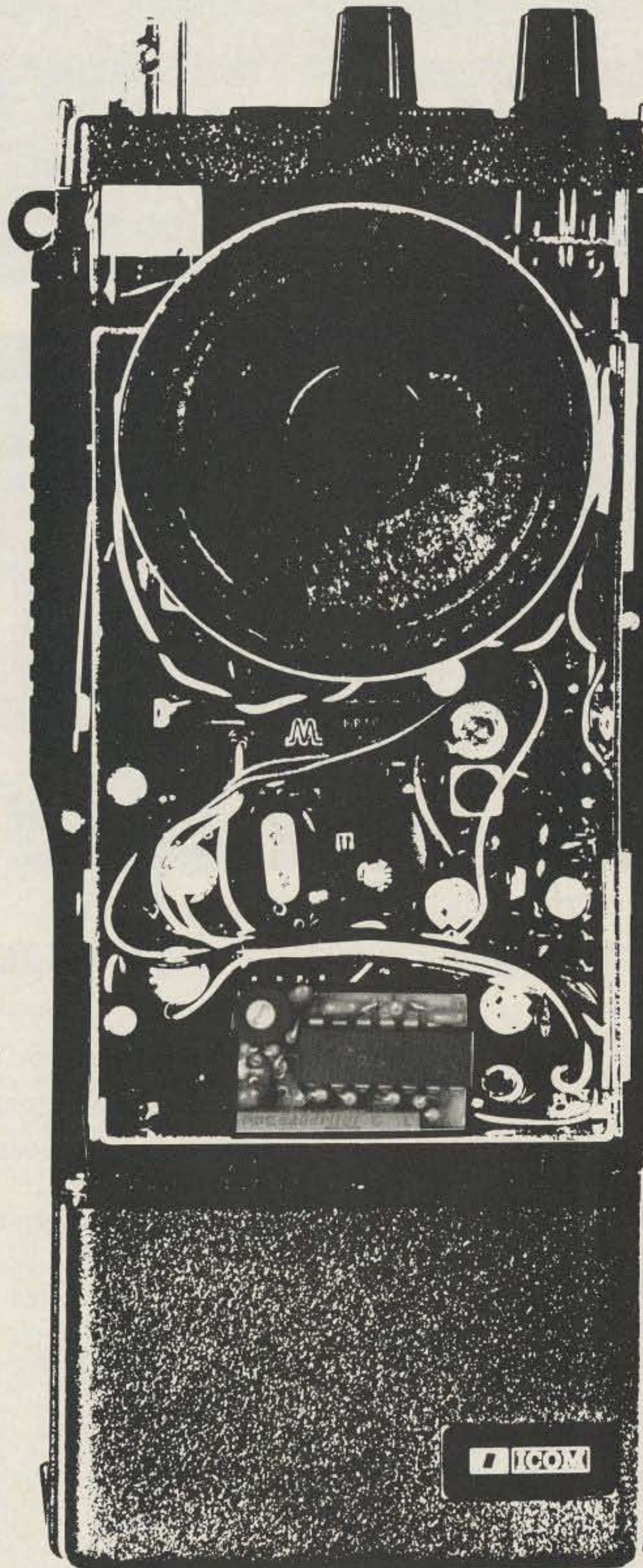

ANOTHER  
**SPECTRONICS  
 FIRST!**



TOP VIEW



SIDE VIEW

- Fits plain or TT.
- Fully tunable!  
No tone elements to buy - ever!
- Also fits other synthesized hand-helds as well.
- Easy to install; no cutting, chopping, or remote parts!
- Accurate to  $\pm 1$  Hz.

\$ **29**<sup>95</sup>  
 Plus \$2.00  
 S & H



PHONE: (312) 848-6777



**SPECTRONICS, INC. — 1009 GARFIELD ST.  
 OAK PARK, ILL.-60304** ✓67



AZDEN ★ NEW! ★ AZDEN ★ NEW! ★ AZDEN ★ NEW! ★ AZDEN

THE GIANT **AZDEN**® COMPANY  
**REVOLUTIONIZES THE STATE OF THE ART**  
**AWE AND AZDEN.** INTRODUCE THE BRILLIANT NEW **PCS-2800**  
**MICROCOMPUTER CONTROLLED**  
**SUPERIOR COMMERCIAL GRADE**  
**10 METER**  
**FM TRANSCEIVER**

FALL  
 SALE  
**239.00**



COMPARE THESE FEATURES  
 WITH ANY UNIT AT ANY PRICE

- **FREQUENCY RANGE:** Receive and transmit: 28.000 to 29.995 MHz, 10KHz steps with built-in +100 KHz repeater offset.
- **ALL SOLID STATE-CMOS PL DIGITAL SYNTHESIZED.**
- **SIZE: UNBELIEVABLE! ONLY 6 3/4" x 2 3/8" x 9 3/4". COMPARE!**
- **MICROCOMPUTER CONTROLLED:** All scanning and frequency-control functions are performed by microcomputer.
- **DETACHABLE HEAD:** The control head may be separated from the radio for use in limited spaces and for security purposes.
- **SIX-CHANNEL MEMORY:** Each memory is re-programmable. Memory is retained even when the unit is turned off.
- **MEMORY SCAN:** The six channels may be scanned in either the "busy" or "vacant" modes for quick, easy location of an occupied or unoccupied frequency. **AUTO RESUME. COMPARE!**
- **FULL-BAND SCAN:** All channels may be scanned in either "busy" or "vacant" mode. This is especially useful for locating repeater frequencies in an unfamiliar area. **AUTO RESUME. COMPARE!**
- **INSTANT MEMORY-1 RECALL:** By pressing a button on the microphone or front panel, memory channel 1 may be recalled for immediate use.
- **MIC-CONTROLLED VOLUME AND SQUELCH:** Volume and squelch can be adjusted from the microphone for convenience in mobile operation.
- **DIRECT FREQUENCY READOUT:** LED display shows operating frequency, **NOT** channel number. **COMPARE!**
- **TEN (10) WATTS OUTPUT:** Also 1 watt low power for shorter distance communications. LED readout displays power selection when transmitting.
- **DIGITAL S/R F METER:** LEDs indicate signal strength and power output. No more mechanical meter movements to fall apart!
- **LARGE 1/2-INCH LED DISPLAY:** Easy-to-read frequency display minimizes "eyes-off-the-road" time.
- **PUSHBUTTON FREQUENCY CONTROL FROM MIC OR FRONT PANEL:** Any frequency may be selected by pressing a microphone or front-panel switch.
- **SUPERIOR RECEIVER SENSITIVITY:** 0.28 uV for 20-dB quieting. The squelch sensitivity is superb, requiring less than 0.1 uV to open. The receiver audio circuits are designed and built to exacting specifications, resulting in unsurpassed received-signal intelligibility.
- **TRUE FM, NOT PHASE MODULATION:** Transmitted audio quality is optimized by the same high standard of design and construction as is found in the receiver. The microphone amplifier and compression circuits offer intelligibility second to none.
- **OTHER FEATURES:** Dynamic Microphone, built in speaker, mobile mounting bracket, external remote speaker jack (head and radio) and much, much more. All cords, plugs, fuses, microphone hanger, etc. included. Weight 6 lbs.
- **ACCESSORIES:** 15' REMOTE CABLE...\$29.95. FMPS-4R A/C POWER SUPPLY...\$39.95. TOUCHTONE MIC. KIT...\$39.95. EXTERNAL SPEAKER...\$18.00.

**AMATEUR-WHOLESALE ELECTRONICS** ORDER NOW TOLL FREE  
 8817 S.W. 129th Terrace, Miami, Florida 33176  
 Telephone (305) 233-3631 • Telex: 80-3356  
 HOURS: 8-6, Mon. - Thurs.  
 U.S. DISTRIBUTOR  
 DEALER INQUIRIES INVITED ✓ 5  
**1-800-327-3102**  
 CREDIT CARD HOLDERS MAY USE OUR TOLL FREE ORDERING NUMBER.



We now have available a bunch of goodies too good to bypass. Items are limited so order today

Call Your Phone Order in Today

TERMS: Satisfaction guaranteed or money refunded. COD add \$1.50. Minimum order \$6.00. Orders under \$10.00 add \$.75. Add 5% for postage insurance handling. Overseas add 15%. NY residents add 7% tax.

**MINI KITS - YOU HAVE SEEN THESE BEFORE NOW HERE ARE OLD FAVORITE AND NEW ONES TOO. GREAT FOR THAT AFTERNOON HOBBY.**

<p><b>FM MINI MIKE</b></p>  <p>A super high performance FM wireless mike kit! Transmits a stable signal up to 300 yards with exceptional audio quality by means of its built in electret mike. Kit includes case, mike, on-off switch, antenna, battery and super instructions. This is the finest unit available.</p> <p>FM-3 Kit <b>\$14.95</b> FM-3 Wired and Tested <b>19.95</b></p>	<p><b>Color Organ</b></p> <p>See music come alive! 3 different lights flicker with music. One light each for, high, mid-range and lows. Each individually adjustable and drives up to 300 W. runs on 110 VAC.</p> <p>Complete kit, ML-1 <b>\$8.95</b></p>	<p><b>Video Modulator Kit</b></p> <p>Converts any TV to video monitor. Super stable, tunable over ch 4-6. Runs on 5-15V, accepts std video signal. Best unit on the market! Complete kit, VD-1 <b>\$7.95</b></p>	<p><b>Super Sleuth</b></p> <p>A super sensitive amplifier which will pick up a pin drop at 15 feet! Great for monitoring baby's room or as general purpose amplifier. Full 2 W rms output, runs on 6 to 15 volts, uses 8-45 ohm speaker. Complete kit, BN-9 <b>\$5.95</b></p>
<p><b>FM Wireless Mike Kit</b></p>  <p>Transmits up to 300' to any FM broadcast radio, uses any type of mike. Runs on 3 to 9V. Type FM-2 has added sensitive mike preamp stage.</p> <p>M-1 kit <b>\$3.95</b> FM-2 kit <b>\$4.95</b></p>	<p><b>Whisper Light Kit</b></p> <p>An interesting kit, small mike picks up sounds and converts them to light. The louder the sound, the brighter the light. Includes mike, controls up to 300 W, runs on 110 VAC. Complete kit, WL-1 <b>\$6.95</b></p>	<p><b>Tone Decoder</b></p> <p>A complete tone decoder on a single PC board. Features: 400-5000 Hz adjustable range via 20 turn pot, voltage regulation, 567 IC. Useful for touch-tone burst detection, FSK, etc. Can also be used as a stable tone encoder. Runs on 5 to 12 volts. Complete kit, TD-1 <b>\$5.95</b></p>	<p><b>Siren Kit</b></p> <p>Produces upward and downward wail characteristic of a police siren. 5 W peak audio output, runs on 3-15 volts, uses 3-45 ohm speaker. Complete kit, SM-3 <b>\$2.95</b></p>
<p><b>Universal Timer Kit</b></p> <p>Provides the basic parts and PC board required to provide a source of precision timing and pulse generation. Uses 555 timer IC and includes a range of parts for most timing needs.</p> <p>UT-5 Kit <b>\$5.95</b></p>	<p><b>Mad Blaster Kit</b></p> <p>Produces LOUD ear shattering and attention getting siren like sound. Can supply up to 15 watts of obnoxious audio. Runs on 6-15 VDC. Complete kit, MB-1 <b>\$4.95</b></p>	<p><b>60 Hz Time Base</b></p> <p>Runs on 5-15 VDC. Low current (2.5ma). 1 min/month accuracy. TB-7 Kit <b>\$5.50</b> TB-7 Assy <b>\$9.95</b></p>	<p><b>Calendar Alarm Clock</b></p> <p>The clock that's got it all! 6-5" LEDs, 12/24 hour, snooze, 24 hour alarm, 4 year calendar, battery backup, and lots more. The super 7001 chip is used. Size: 5x4x2 inches. Complete kit, less case (not available) <b>\$34.95</b> DC-9 <b>\$3.95</b></p>

**CLOCK KITS**

Your old favorites are here again. Over 7,000 Sold to Date. Be one of the gang and order yours today!

Try your hand at building the finest looking clock on the market. Its satin finish anodized aluminum case looks great anywhere, while six .4" LED digits provide a highly readable display. This is a complete kit, no extras needed, and it only takes 1-2 hours to assemble. Your choice of case colors: silver, gold, black (specify).

Clock kit, 12/24 hour, DC-5 **\$24.95**  
Clock with 10 min. ID timer, 12/24 hour, DC-10 **\$29.95**  
Alarm clock, 12 hour only, DC-8 **\$29.95**  
12V DC car clock, DC-7 **\$29.95**

For wired and tested clocks add \$10.00 to kit price. SPECIFY 12 OR 24 HOUR FORMAT

**Car Clock**

The UN-KIT, only 5 solder connections

Here's a super looking, rugged and accurate auto clock, which is a snap to build and install. Clock movement is completely assembled — you only solder 3 wires and 2 switches, takes about 15 minutes! Display is bright green with automatic brightness control photocell — assures you of a highly readable display, day or night. Comes in a satin finish anodized aluminum case which can be attached 5 different ways using 2 sided tape. Choice of silver, black or gold case (specify).

DC-3 kit, 12 hour format **\$22.95**  
DC-3 wired and tested **\$29.95**

**Under Dash Car Clock**

12/24 hour clock in a beautiful plastic case features 6 jumbo RED LEDs, high accuracy (.001%), easy 3 wire hookup, display blanks with ignition, and super instructions. Optional dimmer automatically adjusts display to ambient light level!

DC-11 clock with mtg bracket **\$27.95 kit**  
DM-1 dimmer adapter **\$2.50**  
Add \$10.00 Assy. and Test

**Video Terminal**

A completely self-contained, stand alone video terminal card. Requires only an ASCII keyboard and TV set to become a complete terminal unit. Features are: single 5V supply, XTAL controlled sync and baud rates (to 9600), complete computer and keyboard control of cursor, parity error control and display. Accepts and generates serial ASCII plus parallel keyboard input. The 6416 is 64 char by 16 lines with scrolling upper and lower case (optional) and has RS-232 and 20ma loop interfaces on board. Kits include sockets and complete documentation.

RE 6416 terminal card kit (add \$60.00 for wired unit) **\$189.95**  
Lower Case option **\$13.95**  
Power Supply **\$14.95**  
RF Modulator kit **\$7.95**

**PARTS PARADE**

<p><b>IC SPECIALS</b></p> <p><b>LINEAR</b></p> <p>01 <b>\$ .35</b> 24 <b>\$1.50</b> 30 <b>\$1.50</b> 55 <b>\$ .45</b> 56 <b>\$1.00</b> 55 <b>\$1.00</b> 56 <b>\$1.00</b> 57 <b>\$1.25</b> 58 <b>\$ .50</b> 59 <b>\$ .50</b> 914 <b>\$2.95</b> 938 <b>\$2.95</b></p> <p><b>CMOS</b></p> <p>11 <b>.50</b> 13 <b>.50</b> 46 <b>\$1.85</b> 49 <b>.50</b> 59 <b>\$9.00</b> 11 <b>\$2.00</b> 18 <b>\$1.35</b> 39 <b>\$1.75</b></p>	<p><b>TTL</b></p> <p>74S00 <b>\$ .40</b> 7447 <b>\$ .65</b> 7475 <b>\$ .50</b> 7490 <b>\$ .50</b> 74196 <b>\$1.35</b></p> <p><b>SPECIAL</b></p> <p>11C90 <b>\$15.00</b> 10116 <b>\$1.25</b> 7208 <b>\$17.50</b> 7207A <b>\$ 5.50</b> 7216D <b>\$21.00</b> 7107C <b>\$12.50</b> 5314 <b>\$ 2.95</b> 5375AB/G <b>\$ 2.95</b> 7001 <b>\$ 6.50</b></p> <p><b>FERRITE BEADS</b></p> <p>With info and specs <b>15/\$1.00</b> 6 Hole Balun Beads <b>5/\$1.00</b></p>	<p><b>Resistor Ass't</b></p> <p>Assortment of Popular values - 1/4 watt. Cut lead for PC mounting, 1/2" center, 1/8" leads, bag of 300 or more. <b>\$1.50</b></p> <p><b>Switches</b></p> <p>Mini toggle SPDT <b>\$1.00</b> Red Pushbuttons N.O. <b>3/\$1.00</b></p> <p><b>Earphones</b></p> <p>3" leads, 8 ohm, good for small tone speakers, alarm clocks, etc. <b>5 for \$1.00</b></p> <p><b>Mini 8 ohm Speaker</b></p> <p>Approx 2 1/4" diam Round type for radios, mike etc. <b>3 for \$2.00</b></p> <p><b>Slug Tuned Coils</b></p> <p>Small 3/16" Hex Slugs turned coil, 3 turns. <b>10 for \$1.00</b></p>	<p><b>Crystals</b></p> <p>3.579545 MHZ <b>\$1.50</b> 10.00000 MHZ <b>\$5.00</b> 5.248800 MHZ <b>\$5.00</b></p> <p><b>AC Adapters</b></p> <p>Good for clocks, nicad chargers, all 110 VAC plug one end</p> <p>8.5 vdc @ 20 mA <b>\$1.00</b> 16 vac @ 160mA <b>\$2.50</b> 12 vac @ 250mA <b>\$3.00</b></p> <p><b>Solid State Buzzers</b></p> <p>small buzzer 450 Hz, 86 dB sound output on 5-12 vdc at 10-30 mA, TTL compatible. <b>\$1.50</b></p> <p><b>AC Outlet</b></p> <p>Panel Mount with Leads <b>4/\$1.00</b></p>	<p><b>Audio Prescaler</b></p> <p>Make high resolution audio measurements, great for musical instrument tuning, PL tones, etc. Multiplies audio UP in frequency, selectable x10 or x100, gives .01 HZ resolution with 1 sec gate time! High sensitivity of 25 mv, 1 meg input z and built-in filtering gives great performance. Runs on 9V battery, all CMOS.</p> <p>PS-2 kit <b>\$29.95</b> PS-2 wired <b>\$39.95</b></p>	<p><b>600 MHz PRESCALER</b></p>  <p>Extend the range of your counter to 600 MHz. Works with all counters. Less than 150 mv sensitivity, specify -10 or -100</p> <p>Wired, tested, PS-1B <b>\$59.95</b> Kit, PS-1B <b>\$44.95</b></p>
<p><b>READOUTS</b></p> <p>D 359 4" C.C. <b>\$1.00</b> D 507/510 5" C.A. <b>1.00</b> N 72/HP7730 33" C.A. <b>1.00</b> 7651 43" C.A. <b>2.00</b></p>	<p><b>Sockets</b></p> <p>8 Pin <b>10/\$2.00</b> 14 Pin <b>10/\$2.00</b> 16 Pin <b>10/\$2.00</b> 24 Pin <b>4/\$2.00</b> 28 Pin <b>4/\$2.00</b> 40 Pin <b>3/\$2.00</b></p>	<p><b>DC-DC Converter</b></p> <p>+5 vdc input prod -9 vdc @ 30ma +9 vdc produces -15 vdc @ 35ma <b>\$1.25</b></p> <p>25K 20 Turn Trim Pot <b>\$1.00</b> 1K 20 Turn Trim Pot <b>\$.50</b></p>	<p><b>Ceramic IF Filters</b></p> <p>Mini ceramic filters 7 kHz B.W. 455 kHz <b>\$1.50 ea.</b></p> <p><b>Trimmer Caps</b></p> <p>Sprague - 3-40 pf Stable Polypropylene .50 ea.</p>	<p><b>30 Watt 2 mtr PWR AMP</b></p> <p>Simple Class C power amp features 8 times power gain, 1 W in for 8 out, 2 W in for 15 out, 4W in for 30 out. Max output of 35 W, incredible value, complete with all parts, less case and T-R relay.</p> <p>PA-1, 30 W pwr amp kit <b>\$22.95</b> TR-1, RF sensed T-R relay kit <b>6.95</b></p> <p>MRF-238 transistor as used in PA-1 8-10db gain 150 mhz <b>\$11.95</b></p>	<p><b>Power Supply Kit</b></p> <p>Complete triple regulated power supply provides variable 6 to 18 volts at 200 ma and +5 at 1 Amp. Excellent load regulation, good filtering and small size. Less transformers, requires 6.3 V tra 1 A and 24 VCT. Complete kit, PS-3LT <b>\$6.95</b></p>
<p><b>TRANSISTORS</b></p> <p>3904 NPN <b>15/\$1.00</b> 3906 PNP <b>15/\$1.00</b> 4403 PNP <b>15/\$1.00</b> 4410 NPN <b>15/\$1.00</b> 4916 FET <b>4/\$1.00</b> 5401 PNP <b>5/\$1.00</b> 5028 C-F <b>4/\$1.00</b> 3771 NPN Silicon <b>\$1.50</b> 5179 UHF NPN <b>3/\$2.00</b> wer Tab NPN 40W <b>3/\$1.00</b> wer Tab PNP 40W <b>3/1.00</b> F 102/2N5484 <b>\$.50</b> N 3904 Type <b>50/\$2.50</b> P 3906 Type <b>50/\$2.50</b> 3055 <b>\$.80</b> 2646 UJT <b>3/\$2.00</b></p>	<p><b>Diodes</b></p> <p>5.1 V Zener <b>20/\$1.00</b> 1N914 Type <b>50/\$1.00</b> 1KV 2Amp <b>8/\$1.00</b> 100V 1Amp <b>15/\$1.00</b></p> <p><b>25 AMP 100V Bridge \$1.50 each</b></p> <p><b>Mini-Bridge 50V 1 AMP 2 for \$1.00</b></p>	<p><b>Crystal Microphone</b></p> <p>Small 1" diameter 1/4" thick crystal mike cartridge <b>\$.75</b></p> <p><b>Coax Connector</b></p> <p>Chassis mount BNC type <b>\$1.00</b></p> <p><b>Parts Bag</b></p> <p>Asst of chokes, disc caps, tant resistors, transistors, diodes, MICA caps etc sm. bag (100 pc) <b>\$1.00</b> lg. bag (300 pc) <b>\$2.50</b></p> <p><b>Leds - your choice, please specify</b></p> <p>Mini Red, Jumbo Red, High Intensity Red, Illuminator Red <b>8/\$1</b> Mini Yellow, Jumbo Yellow, Jumbo Green <b>6/\$1</b></p>	<p><b>9 Volt Battery Clips</b></p> <p>Nice quality clips <b>5 for \$1.00</b> 1/8" Rubber Grommets <b>10 for \$1.00</b></p> <p><b>Connectors</b></p> <p>6 pin type gold contacts for mA-1003 car clock module price <b>.75 ea.</b></p> <p><b>Varactors</b></p> <p>Motorola MV 2209 30 PF Nominal, cap 20-80 PF - Tunable range - <b>.50 each or 3/\$1.00</b></p>	<p><b>Regulators</b></p> <p>78MG <b>\$1.25</b> 79MG <b>\$1.25</b> 723 <b>\$.50</b> 309K <b>\$1.15</b> 7805 <b>\$1.00</b></p> <p>7812 <b>\$1.00</b> 7815 <b>\$1.00</b> 7905 <b>\$1.25</b> 7912 <b>\$1.25</b> 7915 <b>\$1.25</b></p> <p><b>Shrink Tubing Nubs</b></p> <p>Nice precut pcs of shrink size: 1" x 1/4" shrink to 1/8" Great for splices. <b>50/\$1.00</b></p> <p><b>Opto Isolators - 4N28 type \$1.00 ea.</b></p> <p><b>Opto Reflectors - Photo diode + LED \$1.00 ea.</b></p> <p><b>Molex Pins</b></p> <p>Molex already precut in length of 7. Perfect for 14 pin sockets. <b>20 strips for \$1.00</b></p>	<p><b>Mini TO-92 Heat Sinks</b></p> <p>Thermalloy Brand <b>5 for \$1.00</b> To-220 Heat Sinks <b>3 for \$1.00</b></p> <p><b>CDS Photocells</b></p> <p>Resistance varies with light, 250 ohms to over 3 meg <b>3 for \$1.00</b></p>







### 7400 TTL

SN7400N	.20	SN7470N	.29	SN74150N	.89
SN7401N	.20	SN7471N	.29	SN74151N	.89
SN7402N	.20	SN7472N	.29	SN74152N	1.95
SN7403N	.20	SN7473N	.35	SN74153N	.89
SN7404N	.25	SN7474N	.35	SN74154N	.89
SN7405N	.20	SN7475N	5.00	SN74155N	.89
SN7406N	.29	SN7476N	.35	SN74156N	1.25
SN7407N	.29	SN7477N	.69	SN74157N	1.95
SN7408N	.20	SN7478N	.89	SN74158N	1.59
SN7409N	.20	SN7479N	.35	SN74159N	6.00
SN7410N	.18	SN7480N	1.75	SN74160N	1.25
SN7411N	.25	SN7481N	.45	SN74161N	1.00
SN7412N	.25	SN7482N	.59	SN74162N	1.00
SN7413N	.40	SN7483N	.43	SN74163N	.79
SN7414N	.70	SN7484N	.43	SN74164N	.79
SN7416N	.25	SN7485N	.65	SN74165N	1.95
SN7417N	.25	SN7486N	.65	SN74166N	.79
SN7420N	.20	SN7487N	.65	SN74167N	1.95
SN7421N	.29	SN7488N	3.00	SN74168N	1.95
SN7422N	.39	SN7489N	1.25	SN74169N	1.95
SN7423N	.25	SN7490N	.35	SN74170N	1.95
SN7425N	.29	SN7491N	.59	SN74171N	1.25
SN7426N	.29	SN7492N	1.95	SN74172N	6.00
SN7427N	.25	SN7493N	.35	SN74173N	1.25
SN7429N	.39	SN7494N	.43	SN74174N	1.00
SN7430N	.20	SN7495N	.65	SN74175N	1.00
SN7432N	.25	SN7496N	.65	SN74176N	.79
SN7433N	.25	SN7497N	.79	SN74177N	.79
SN7434N	.40	SN7498N	.65	SN74178N	1.95
SN7435N	.25	SN7499N	.65	SN74179N	.79
SN7440N	.20	SN7500N	3.00	SN74180N	1.95
SN7441N	.89	SN7501N	1.25	SN74181N	1.95
SN7442N	.75	SN7502N	1.25	SN74182N	.79
SN7443N	.75	SN7503N	1.25	SN74183N	1.95
SN7444N	.75	SN7504N	1.25	SN74184N	1.95
SN7445N	.75	SN7505N	1.25	SN74185N	1.95
SN7446N	.89	SN7506N	1.25	SN74186N	9.95
SN7447N	.79	SN7507N	1.25	SN74187N	3.95
SN7448N	.59	SN7508N	1.25	SN74188N	3.95
SN7449N	.20	SN7509N	1.25	SN74189N	1.25
SN7450N	.20	SN7510N	1.25	SN74190N	1.25
SN7451N	.20	SN7511N	1.25	SN74191N	1.25
SN7452N	.20	SN7512N	1.25	SN74192N	.79
SN7453N	.20	SN7513N	1.25	SN74193N	.79
SN7454N	.20	SN7514N	1.25	SN74194N	.89
SN7455N	.20	SN7515N	1.25	SN74195N	.69
SN7456N	.20	SN7516N	1.25	SN74196N	.89
SN7457N	.20	SN7517N	1.25	SN74197N	.89
SN7458N	.20	SN7518N	1.25	SN74198N	1.49
SN7459N	.20	SN7519N	1.25	SN74199N	1.49
SN7460N	.20	SN7520N	1.25	SN74200N	4.95
SN7461N	.20	SN7521N	1.25	SN74201N	1.49
SN7462N	.20	SN7522N	1.25	SN74202N	1.49
SN7463N	.20	SN7523N	1.25	SN74203N	1.49
SN7464N	.20	SN7524N	1.25	SN74204N	1.49
SN7465N	.20	SN7525N	1.25	SN74205N	1.49
SN7466N	.20	SN7526N	1.25	SN74206N	1.49
SN7467N	.20	SN7527N	1.25	SN74207N	1.49
SN7468N	.20	SN7528N	1.25	SN74208N	1.49
SN7469N	.20	SN7529N	1.25	SN74209N	1.49
SN7470N	.20	SN7530N	1.25	SN74210N	1.49
SN7471N	.20	SN7531N	1.25	SN74211N	1.49
SN7472N	.20	SN7532N	1.25	SN74212N	1.49
SN7473N	.20	SN7533N	1.25	SN74213N	1.49
SN7474N	.20	SN7534N	1.25	SN74214N	1.49
SN7475N	.20	SN7535N	1.25	SN74215N	1.49
SN7476N	.20	SN7536N	1.25	SN74216N	1.49
SN7477N	.20	SN7537N	1.25	SN74217N	1.49
SN7478N	.20	SN7538N	1.25	SN74218N	1.49
SN7479N	.20	SN7539N	1.25	SN74219N	1.49
SN7480N	.20	SN7540N	1.25	SN74220N	1.49
SN7481N	.20	SN7541N	1.25	SN74221N	1.49
SN7482N	.20	SN7542N	1.25	SN74222N	1.49
SN7483N	.20	SN7543N	1.25	SN74223N	1.49
SN7484N	.20	SN7544N	1.25	SN74224N	1.49
SN7485N	.20	SN7545N	1.25	SN74225N	1.49
SN7486N	.20	SN7546N	1.25	SN74226N	1.49
SN7487N	.20	SN7547N	1.25	SN74227N	1.49
SN7488N	.20	SN7548N	1.25	SN74228N	1.49
SN7489N	.20	SN7549N	1.25	SN74229N	1.49
SN7490N	.20	SN7550N	1.25	SN74230N	1.49
SN7491N	.20	SN7551N	1.25	SN74231N	1.49
SN7492N	.20	SN7552N	1.25	SN74232N	1.49
SN7493N	.20	SN7553N	1.25	SN74233N	1.49
SN7494N	.20	SN7554N	1.25	SN74234N	1.49
SN7495N	.20	SN7555N	1.25	SN74235N	1.49
SN7496N	.20	SN7556N	1.25	SN74236N	1.49
SN7497N	.20	SN7557N	1.25	SN74237N	1.49
SN7498N	.20	SN7558N	1.25	SN74238N	1.49
SN7499N	.20	SN7559N	1.25	SN74239N	1.49
SN7500N	.20	SN7560N	1.25	SN74240N	1.49



### JE608 PROGRAMMER

2704/2708 EPROM PROGRAMMER

43 segment Display Register, 8 LED's for Hex Key status, 16 LED's (2" x 2") for Address Register and 8 LED's for Data Memory Register. The Data Memory Register displays the content of the RAM's from the EPROM Chip.

Development of microprocessor systems by means of a ribbon cable from the programmer panel test socket to the EPROM socket on the microprocessor board.

Rapid storage verification of programmed data changes.

After any change data from a master to RAM's or write into RAM's with keyboard entries.

Allows manual stepping microprocessor (up and down) at any address location.

Stand alone EPROM Programmer consisting of:

- A 16-key Hexadecimal Keyboard assembly, Programmer Board assembly with 4 power supplies and a LED/Hex Socket Panel Board assembly. The Test Socket is a zero force insertion type. Power requirements: 115VAC, 60Hz, 50.
- Compact desk-top enclosure. Color-coded designer's case with light top panel and control and green in front bottom. Size: 2" x 11" x 11". Weight: 5 lbs.

The JE608 EPROM Programmer is a completely self-contained unit which is independent of computer control and requires no additional systems for its operation. The EPROM can be programmed from the Hexadecimal Keyboard or from a pre-programmed EPROM. The JE608 Programmer can emulate a programmed EPROM by the use of its internal RAM circuit. This will allow the user to test or protect a program for a system, prior to programming a chip. Any changes in the program can be entered directly into the memory circuits with the Hexadecimal Keyboard so that re-writing the entire program will not be necessary. The JE608 Programmer contains a Programmer Board with 26 IC's and including power supplies of -5V, +5V, +12V and +20V. The Hexadecimal Keyboard and LED/Hex Socket Panel Board are separate assemblies within the system.

**JE608 KIT** ..... \$399.95  
**JE608 Assembled and Tested** ..... \$499.95

### DISCRETE LEDs

XC556R	.200" red	5/51	MV50	.085" red	6/51	XC111R	.190" red	5/51
XC556G	.200" green	4/51	XC209R	.125" red	5/51	XC111G	.190" green	4/51
XC556Y	.200" yellow	4/51	XC209G	.125" green	4/51	XC111Y	.190" yellow	4/51
XC556C	.200" clear	4/51	XC209Y	.125" yellow	4/51	XC111C	.190" clear	4/51
XC22R	.200" red	5/51	XC526R	.185" red	5/51			
XC22G	.200" green	4/51	XC526G	.185" green	4/51			
XC22Y	.200" yellow	4/51	XC526Y	.185" yellow	4/51			
MV10B	.170" red	4/51	XC526C	.185" clear	4/51			

INFRA-RED LED  
 1/4" x 1/4" x 1/16" flat 5/51

### DISPLAY LEDs

TYPE	POLARITY	HT	PRICE	TYPE	POLARITY	HT	PRICE
MAN 1	Common Anode-red	270	2.95	MAN 6730	Common Anode-red ± 1	560	.99
MAN 2	5 x 7 Dot Matrix-red	300	4.95	MAN 6740	Common Cathode-red-D.D.	560	.99
MAN 3	Common Cathode-red	125	2.55	MAN 6750	Common Cathode-red ± 1	560	.99
MAN 4	Common Cathode-red	187	1.95	MAN 6760	Common Anode-red	560	.99
MAN 7G	Common Anode-green	300	1.25	MAN 6780	Common Cathode-red	560	.99
MAN 7Y	Common Anode-yellow	300	.99	DL701	Common Anode-red ± 1	300	.99
MAN 7Z	Common Anode-red	300	.75	DL704	Common Cathode-red	300	.99
MAN 74	Common Cathode-red	300	1.25	DL707	Common Anode-red	300	.99
MAN 82	Common Anode-yellow	300	.49	DL728	Common Cathode-red	500	1.49
MAN 84	Common Cathode-yellow	300	.99	DL741	Common Anode-red	600	1.25
MAN 3820	Common Anode-orange	300	.49	DL746	Common Anode-red ± 1	630	1.49
MAN 3630	Common Anode-orange ± 1	300	.99	DL747	Common Anode-red	600	1.49
MAN 3640	Common Cathode-orange	300	.99	DL749	Common Cathode-red ± 1	630	1.49
MAN 4610	Common Anode-orange	300	.99	DL750	Common Cathode-red	600	1.49
MAN 4640	Common Cathode-orange	400	.99	DL338	Common Cathode-red	110	.35
MAN 4710	Common Anode-red	400	.99	FND70	Common Cathode	250	.69
MAN 4730	Common Anode-red ± 1	400	.99	FND358	Common Cathode ± 1	357	.99
MAN 4740	Common Cathode-red	400	.99	FND359	Common Cathode	357	.75
MAN 4810	Common Anode-yellow	400	.99	FND503	Common Cathode(FND500)	500	.99
MAN 4840	Common Cathode-yellow	400	.99	FND507	Common Anode (FND510)	500	.99
MAN 6610	Common Anode-orange-D.D.	560	.99	5082-7730	Common Anode-red	300	.99
MAN 6630	Common Anode-orange ± 1	560	.99	HOSP-3400	Common Anode-red	800	1.50
MAN 6640	Common Cathode-orange-D.D.	560	.99	HOSP-3403	Common Cathode red	800	1.50
MAN 6650	Common Cathode-orange ± 1	560	.99	5082-7300	4 x 7 Sgl. Digit-RHDP	600	19.95
MAN 6660	Common Anode-orange	560	.99	5082-7302	4 x 7 Sgl. Digit-LHDP	600	19.95
MAN 6680	Common Cathode-orange	560	.99	5082-7304	Overrange character (±1)	600	15.00
MAN 6710	Common Anode-red-D.D.	560	.99	5082-7340	4 x 7 Sgl. Digit-Hexadecimal	600	22.50

### RCA LINEAR

CA3013T	2.15	CA3082N	2.00
CA3023T	3.25	CA3083N	1.60
CA3035T	2.48	CA3086N	.85
CA3039T	1.35	CA3089N	3.75
CA3046N	1.30	CA3130T	1.39
CA3059N	3.25	CA3140T	1.25
CA3060N	3.25	CA3150T	1.25
CA3080T	1.25	CA3160N	.59
CA3081N	2.00	CA3600N	3.50

### CALCULATOR CHIPS/DRIVERS

MMS725	\$2.95
MMS738	2.95
DM8864	2.00
DM8865	1.00
DM8867	.75
DM8869	.75
9374 7-seg.	
LED driver	1.50
MMS309	4.95

### CLOCK CHIPS

MMS309	4.95
MMS311	4.95
MMS312	4.95
MMS314	4.95
MMS316	6.95
MMS318	9.95
MMS365	2.95
MMS387/1996a	4.95
CT 7001	6.95

### MOTOROLA

MC1408L7	4.95
MC1408L8	5.75
MC1439L	2.95
MC3022P	2.95
MC3061P	3.50
MC4016 (P446)	17.50
MC4024P	3.95
MC4040P	6.95
MC4044P	4.50

### LOW PROFILE (TIN) SOCKETS

1-24	25-49	50-100
8 pin LP	.17	.15
14 pin LP	.20	.19
16 pin LP	.22	.21
18 pin LP	.29	.28
20 pin LP	.34	.32
22 pin LP	.37	.36
24 pin LP	.38	.37
28 pin LP	.45	.44
36 pin LP	.60	.59
40 pin LP	.63	.62

### SOLDERTAIL STANDARD (TIN)

1-24	25-49	50-100
14 pin ST	.27	.25
16 pin ST	.30	.27
18 pin ST	.35	.32
24 pin ST	.49	.45
28 pin ST	.99	.90
36 pin ST	1.39	1.26
40 pin ST	1.59	1.45

### WIRE WRAP SOCKETS (GOLD) LEVEL #3

1-24	25-49	50-100
8 pin WW	.59	.54
10 pin WW	.69	.63
14 pin WW	.75	.73
16 pin WW	.85	.77
18 pin WW	.99	.90
20 pin WW	1.19	1.08
22 pin WW	1.49	1.35
24 pin WW	1.39	1.26
28 pin WW	1.69	1.53
36 pin WW	2.19	1.99
40 pin WW	2.29	2.09

### SOLDERTAIL (GOLD) STANDARD

1-24	25-49	50-100
8 pin SG	.39	.35
14 pin SG	.49	.46
16 pin SG	.54	.49
18 pin SG	.55	.53
24 pin SG	.79	.75
28 pin SG	1.10	1.00
36 pin SG	1.65	1.40
40 pin SG	1.75	1.59

### 1/4 WATT RESISTOR ASSORTMENTS - 5%

ASST. 1	5 ea.	10 OHM	12 OHM	15 OHM	18 OHM	22 OHM	50 PCS	\$1.75
ASST. 2	5 ea.	27 OHM	33 OHM	39 OHM	47 OHM	56 OHM	50 PCS	1.75
ASST. 3	5 ea.	68 OHM	82 OHM	100 OHM	120 OHM	150 OHM	50 PCS	1.75
ASST. 4	5 ea.	180 OHM	220 OHM	270 OHM	330 OHM	390 OHM	50 PCS	1.75
ASST. 5	5 ea.	470 OHM	560 OHM					



# ASSOCIATED RADIO

913-381-5900

8012 CONSER BOX 4327  
OVERLAND PARK, KANSAS 66204



CALL US WITH YOUR REQUIREMENTS  
**AMERICA'S NO. 1 Real Amateur Radio Store**



**Associated Wants to TRADE - BUY - SELL  
GOT YOUR BEST DEAL? THEN CALL US AT  
913-381-5900 - NO TRADE? ASK FOR EXT. 12**

**NOTE: SEND \$1.00 FOR OUR CURRENT CATALOG  
OF NEW AND RECONDITIONED EQUIPMENT.**

**\* ALSO WE PERIODICALLY PUBLISH A LIST OF  
UNSERVICED EQUIPMENT AT GREAT SAVINGS.  
A BONANZA FOR THE EXPERIENCED OPERATOR.  
TO OBTAIN THE NEXT UNSERVICED BARGAIN LIST,  
SEND A SELF ADDRESSED STAMPED ENVELOPE.**



# BACK TO SCHOOL SALE

58



TAKE 20% OFF ANY ORDER TOTALING \$30 OR MORE!



- 10-QUAD PHONO JACKS, 4 RCA jacks on 2 x 1 1/2" Bakelite strip, (#6249) ..... 2.99
- 50-RCA PHONO PLUGS, popular audio/speaker plugs, 100% material, (#3293) ..... 2.99
- 25-MINI PLUG & CABLE SETS, 3.5mm plug, 6' insulated 2 cond. leads, (#6269) ..... 2.99
- 25-MAGNETIC DISCS, Plastalloy 13/16 dia. x 1/8" discs, (#6294) ..... 2.99
- 250-PRE-FORMED DISCS, caps w/leads for PC use, mixed values, (#2605) ..... 2.99
- 30-PLASTIC POWERS, 25 watt, npn & pnp, 50-200 hvcb, TO-220, (#6237) ..... 2.99
- 100-2 WATT RESISTORS, assorted carbons, films etc. some 5%ers, (#6238) ..... 2.99
- 24-LM-340T VOLTAGE REGULATORS, untested TO-220, may incl. 5-24V, (#2635) ..... 2.99
- 150-POLYSTYRENE CAPS, assorted types, styles, & sizes, all good, (#2729) ..... 2.99
- 200-COILS & CHOKES, asst. RF, OSC, IF, and peaking types, (#6283) ..... 2.99
- 50-POWER TAB TRANSISTORS, plastic NPN, TO-220, asst. types, untested, (#2425) ..... 2.99
- 100-2 WATT RESISTORS, assorted carbons, films etc. some 5%ers, (#6238) ..... 2.99
- 24-SKINNY TRIM POTS, multi & single turn, asst. values & types, (#6285) ..... 2.99
- 3-25A 50V BRIDGES, "block" type, with four lug-type leads, (#6311) ..... 2.99
- 100-TTLs, 7400 series, incl. gates, flip-flops, etc. untested, (#6226) ..... 2.99
- 5-BRASS LOCKS, with key, 1 1/2" long, for doors, windows, etc. (#6253) ..... 2.99
- 250-MOLEX SOCKETS, "on-a-strip", make your own pc sockets, (#6255) ..... 2.99
- 50-MINI POTS, pc style, single turn, assorted values, (#3345) ..... 2.99
- 20-JUMBO RED LEDS, 3V 10 mA, 100% good material, red dome lense, (#3369) ..... 2.99
- 3-SOUND TRIGGERS, sound activated amp, SCR triggered, on 3" board, (#3625) ..... 2.99
- 50-TRANSISTOR SOCKETS, assortment may include; TO-19,5,6,3, etc. (#3845) ..... 2.99
- 100-CABLE TIES, 4" non-slip white plastic, like Ty-wrap, (#5218) ..... 2.99
- 150-FEEDTHRU CAPS, assorted types & sizes, for RF, UHF, etc. (#5668A) ..... 2.99
- 250-1/4 WATT RESISTORS, asst. carbons, carbo-films, some 5%ers, (#5797A) ..... 2.99
- 100-PLESSY CAPS, ceramic blocks in assorted sizes & values, (#6221) ..... 2.99
- 30-HOBBY LEDS, assorted types & colors, mostly dims, some good, (#6225) ..... 2.99

- 150-PC-HEATSHRINK, slip-over type, shrinks 50%, like Thermo-fit, (#6239) ..... 2.99
- 30-NE-2 BULBS, neon, for 110 VAC, requires resistor, (not incl.) (#2613) ..... 2.99
- 100-METALLIC RESISTORS, mostly 1/2 watters, asst. val. 1-5% tol. (#6280) ..... 2.99
- 100-POWER POWERS, 3 to 7 watt power resistors, (#6281) ..... 2.99
- 25-CRYSTALS, assorted types, some H6/U, some frequency marked, (#6256) ..... 2.99
- 150-SUBMINI IF TRANSFORMERS, asst. may include; osc. antenna, etc. (#6259) ..... 2.99
- 60-SQUARE OHM RESISTORS, prime resistors, asst. values, grab 'em! (#6261) ..... 2.99
- 30-MICRO MINI REED SWITCHES, 1" long, for alarms, relay systems, etc. (#6263) ..... 2.99
- 200-PC-CAPACITOR SPECIAL, asst. mylars, polys, micas, etc. 100% good, (#6264) ..... 2.99
- 20-PUSHBUTTON ALARM SWITCH, SPST, momentary, NC, w/hardware, (#6267) ..... 2.99
- 500" PC-HARDWARE SURPRISE, ("approx.") 1 lb. asst. screws, washers, etc. (#6271) ..... 2.99
- 30-9V BATTERY CLIPS, snap connector, coded, insulated leads, (#6286) ..... 2.99
- 6-WATCH GUTS, 5-function, LED style, assorted sizes, untested, (#6287) ..... 2.99
- 10-HEAVY DUTY LINE CORDS, white, 2 cond. 6 ft. 16 gauge, (#6292) ..... 2.99
- 20-SINGLE PIN LEDS, green, micro style, 3V 10mA, 100%, (#6293) ..... 2.99
- 40-LED/TRANSISTOR SOCKETS, "snap-in", 3 pc leads, for TO-5,18,46,etc. (#6297) ..... 2.99
- 200-PRECISION RESISTORS, 1/2W, 1%, axial (#2428) ..... 2.99
- 15-MOTORS MOTORS, asst. sizes speeds & types, 1.5-12 volts, (#2551A) ..... 2.99
- 150-LONG LEAD DISCS, prime, marked caps, assorted material, (#2598) ..... 2.99
- 100-PLASTIC TRANSISTORS, untested, TO-92, asst. types (#2604) ..... 2.99
- 50-SLIDE SWITCHES, various shapes, sizes, and types, (#2726) ..... 2.99
- 75-TRANSISTOR ELECTROLYTICS, epoxy encapsulated, asst. values, (#2747) ..... 2.99
- 250-HALF WATTERS, 100%, color-coded resistors, asst. values, (#3046) ..... 2.99
- 25-SLIDE VOLUME CONTROLS, various values & types, for Hi-Fi, etc. (#3057) ..... 2.99
- 50-UPRIGHT ELECTROS, 100%, assorted values & voltages, marked, (#3226) ..... 2.99



## TANK BATTLE TV GAME CHIP & BOARD

Poly Paks brings back the thrill of armored combat in a 28 pin DIP with General Instrument's AY-3-8700-1 Tank Battle Game Chip & board set. High quality Boards have: shielded FM demodulator section, (a \$4.95 value alone), IC's, transistors, caps, etc. Chip capabilities: Two independantly controllable tanks which explode & fragment when hit by shells or mines, 3 forward & reverse speeds, Realistic tank motor, track squeek, and explosion sounds, automatic on-screen scoring, (in color), and more! Tank game chip is 100% Guaranteed. With a little ingenuity and perhaps a few parts, you can recreate history's great tank battles in the comfort of your home. Size: 8 1/2 x 6-5/8 x 1 1/4". Wt: 8 oz.

**\$14.88**  
Cat. No. 92CU6526

**TANK GAME CHIP LESS BOARD**  
• General Instruments AY-3-8700-1  
Cat. No. 92CU6505 Wt. 1 oz. **\$9.95**



**PET COMPUTER KEYBOARDS**  
**\$39.95**  
Cat. No. 92CU6671  
• Includes;  
53-Key Alphanumeric, PLUS 20-Key Hexadecimal Arrays!  
• ASCII Compatible  
Original Factory Keyboard



Complete 73-Key PET keyboards include all Alphabetical, Numeric, Graphics, Game, and Command legends commensurate with the PET 8K microcomputer. 64 ASCII characters are available without shift and all 64 graphic & reverse field characters are accessible from keyboard (with shift). Keys are color-coded for quick reference, and are precision mounted in a compact 9 1/2" x 3-7/8" high-impact plastic frame. Terminates in standard 18-contact single-sided edge connection. Plugs directly into PET systems, and can be soldered to for interface with other makes. Adds a versatile, professional touch to any microcomputer system. Removed from equipment. 100% functional. Wt: 10 oz.



**MOTOROLA**  
"Factory Installed" Quality at a "Do-It-Yourself" Price!  
**\$49.95**  
• 5 Station Pushbutton Tuning!  
**AM-FM STEREO AUTO RADIO**  
Cat. No. 92CU6551



Protect Your Home & Family with **The Ultimate Ultrasonic Alarm**

**\$79.95**  
Cat. No. 92CU6556

• Dependable, Professional Quality Security with No Installation!  
• Covers up to 20' x 30' Area!  
**Ultrasonic™**

Ultras is remarkably easy to use - just plug it into any AC outlet, and adjust the sensitivity to the room being protected. Ultrasonic arms at the touch of a button, and features a factory-preset 3-digit code, so only you can shut it off. If tripped, the alarm resets after a 3 minute sounding, and a memory light remains on to report the intrusion. Unit incorporates a 60 second exit delay and a 30 second entry delay, thus allowing time to punch in the shut-down code. Ultrasonic accepts "C" size batteries for use in the event of a power failure. It's great for homeowners, apartment dwellers, even security areas in small businesses. 100% Factory Guaranteed! Size: 10 1/2 x 6 1/2 x 3". Wt: 5 lbs.

Use Your T.V. As Monitor For:  
• Audio or Video Recorders  
• CCTV Cameras  
• Data Displays  
**Computer Interface R.F. CONVERTER/MODULATOR**  
Cat. No. 92CU6527

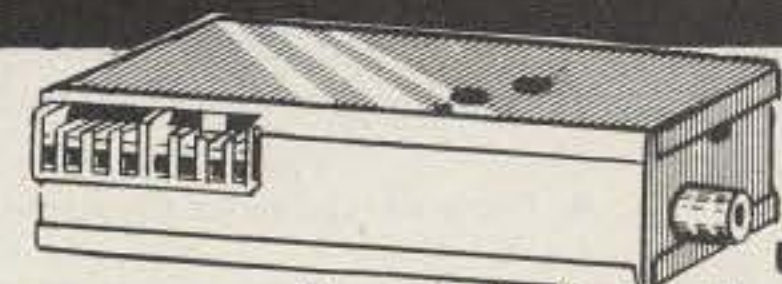

**\$39.95**  
Wt. 13 ozs.

**"SPACE SHOT" AUDIO GAME BOARD**  
IC controlled programmable game board electronically simulates several realistic "Outer Space" type sound effects, including: Rocket Blasts, Phaser Fire, Space Man Breathing, "Clear the Launchpad" Alarm Gong... even 21st century Music! Also features: 7 synchronized red LEDs which flash in sequence with the various sounds, tactile contact switches for programming, 9V battery clip, and more! Requires 8 ohm speaker and 9V transistor radio-type battery. Size: 4 1/2" x 1 1/2" x 1". Wt: 2 oz.  
Cat. No. 92CU6707 **\$4.95**  
Provides Authentic "Outer Space" Sound Effects

Return of a Repeated Sellout!  
**40 Channel CB BOARD**  
Cat. No. 92CU5554

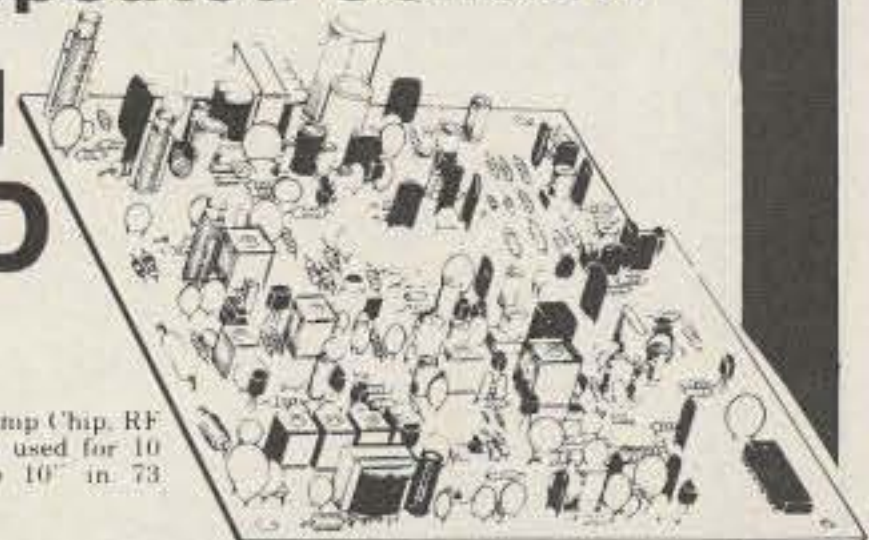

From Hy-Gain! Boards have: Heatsinked 9 Watt Amp Chip, RF & Mod. transistors, and PLL selector IC. May be used for 10 meter conversion. See continuing series CB to 10" in 73 magazine. Size: 6" x 6" x 2 1/2". Wt: 9 oz.

Only **\$14.88**

**Could Convert To 10 Meters**

**\*SALE ENDS: NOVEMBER 1, 1980**  
Discount To Be Taken BEFORE Postage Is Added.  
SEND FOR FREE CATALOG  
**POLY PAKS INC.**  
P.O. BOX 942-A9  
SO. LYNNFIELD, MA 01940  
PHONE: (617) 245-3828

We honor MASTERCARD, VISA, Check, & C.O.D. Order by Phone or Mail. Min. Order: USA & Canada: \$10, Foreign: \$20. Please state Cat. No. & Description, Name & Month of magazine. Please Enclose for POSTAGE & HANDLING: USA: \$5, Canadian: \$8, Foreign: \$20, (US Funds). OPEN ACCOUNTS: (Must be listed & rated in D&B Net-30, \$25 minimum). C.O.D. ORDERS: Payment must be made via Cash, Postal Money Order, or Certified Check. C.O.D. charges will be added to the order.





## The RF Line

### MRF454

\$21.83

#### NPN SILICON RF POWER TRANSISTORS

... designed for power amplifier applications in industrial, commercial and amateur radio equipment to 30 MHz.

- Specified 12.5 Volt, 30 MHz Characteristics —
  - Output Power = 80 Watts
  - Minimum Gain = 12 dB
  - Efficiency = 50%

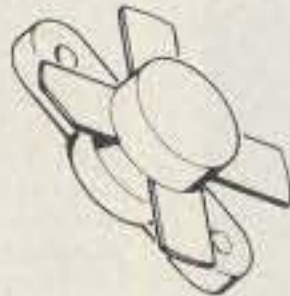

### MRF458

\$20.68

#### NPN SILICON RF POWER TRANSISTOR

... designed for power amplifier applications in industrial, commercial and amateur radio equipment to 30 MHz.

- Specified 12.5 Volt, 30 MHz Characteristics —
  - Output Power = 80 Watts
  - Minimum Gain = 12 dB
  - Efficiency = 50%
- Capable of Withstanding 30:1 Load VSWR @ Rated P<sub>out</sub> and V<sub>CC</sub>

#### NPN SILICON RF POWER TRANSISTOR

... designed primarily for use in large-signal output amplifier stages. Intended for use in Citizen-Band communications equipment operating at 27 MHz. High breakdown voltages allow a high percentage of up-modulation in AM circuits.

- Specified 12.5 V, 27 MHz Characteristics —
  - Power Output = 4.0 Watts
  - Power Gain = 10 dB Minimum
  - Efficiency = 65% Typical



### MRF472

\$2.50

#### NPN SILICON RF POWER TRANSISTOR

... designed primarily for use in single sideband linear amplifier output applications in citizens band and other communications equipment operating to 30 MHz.

- Characterized for Single Sideband and Large-Signal Amplifier Applications Utilizing Low-Level Modulation.
- Specified 13.6 V, 30 MHz Characteristics —
  - Output Power = 12 W (PEP)
  - Minimum Efficiency = 40% (SSB)
  - Output Power = 4.0 W (CW)
  - Minimum Efficiency = 50% (CW)
  - Minimum Power Gain = 10 dB (PEP & CW)
- Common Collector Characterization



\$5.00

### MHW710 - 2

\$46.45

440 to 470MC

#### UHF POWER AMPLIFIER MODULE

... designed for 12.5 volt UHF power amplifier applications in industrial and commercial FM equipment operating from 400 to 512 MHz.

- Specified 12.5 Volt, UHF Characteristics —
  - Output Power = 13 Watts
  - Minimum Gain = 19.4 dB
  - Harmonics = 40 dB
- 50 Ω Input/Output Impedance
- Guaranteed Stability and Ruggedness
- Gain Control Pin for Manual or Automatic Output Level Control
- Thin Film Hybrid Construction Gives Consistent Performance and Reliability



## Tektronix Test Equipment

B	Wideband High Gain Plug In	\$ 51.00
CA	Dual Trace Plug In	150.00
K	Fast Rise DC Plug In	63.00
N	Sampling Plug In	200.00
R	Transistor Rise-time Plug In	116.00
W	High Gain Differential Comparator Plug In	283.00
TU-2	Test Load Plug In for 530/540/550 Main Frames	50.00
1A2	Wideband Dual Trace Plug In	216.00
151	Sampling Unit With 350PS Rise-time DC to 1GHZ	730.00
2A61	AC Differential Plug In	133.00
353	Dual Trace Sampling DC to 1GHZ Plug In	250.00
3576	Dual Trace Sampling DC to 875MHZ Plug IN	250.00
3777A	Sampling Sweep Plug In	250.00
3L10	Spectrum Analyzer I to 36MHZ Plug IN	1000.00
50	Amplifier Plug In	50.00
51	Sweep Plug In	50.00
53B	Wideband High Gain Plug In	25.00
53/54B	Wideband High Gain Plug In	45.00
53/54C	Dual Trace Plug In	112.50
53/54D	High Gain DC Differential Plug In	38.00
53/54G	Wideband DC Differential Plug In	68.00
53/54L	Fast Rise High Gain Plug In	68.00
84	Test Plug In For 580/581 Main Frames	75.00
107	Square Wave Generator .4 to 1MHZ	48.00
RM122	Preamplifier 2Hz to 40KHZ	63.00
123	AC Coupled Preamplifier	25.00
127	Power Supply For 2 Plug In's	148.00
131	Current Probe Amplifier	50.00
184	Time Mark Generator	363.00
R240	Program Control Unit	150.00
280	Trigger Countdown Unit	84.00
455	Portable Dual Trace 50MHZ Scope	2000.00
465	Portable Dual Trace 100MHZ Scope	2500.00
503	DC to 450KHZ Scope Rack Mount	250.00
535A	DC to 15MHZ Scope Rack Mount	263.00
543	DC to 33MHZ Scope	300.00
561	DC to 10MHZ Scope Rack Mount	150.00
561A	DC to 10MHZ Scope Rack Mount	200.00

## Scopes with Plug-in's

567	Digital Readout Scope with a 6R1A Digital Unit and a 3S3 Dual Trace DC to 1GHZ Sampling Plug In and a 3T77A Sweep Plug In.	750.00
561A	DC to 10MHZ Scope with a 3576 Dual Trace DC to 875MHZ Sampling Plug In and a 3T77A Sweep Plug In. Rack Mount	600.00
565	DC to 10MHZ Dual Beam Scope with a 2A63 Diff. and a 2A61 Diff. Plug In's	900.00
581	DC to 80MHZ Scope with a 82 Dual Trace High Gain Plug In	650.00
661	Sampling Scope with a 5T3 Timing Plug In and a 4S2 Dual Trace DC to 3.5GHZ Sampling Plug In.	575.00

## Tubes

2E26	\$ 5.00	4CX350FJ	\$116.00	6146W	12.00
3-500Z	102.00	4CX1000A	300.00	6159	10.60
3-1000Z	268.00	4CX1500B	350.00	6161	75.00
3B2B/866A	5.00	4CX15000A	750.00	6293	18.50
3X2500A3	150.00	4E27	50.00	6360	6.95
4-65A	45.00	4X150A	41.00	6907	40.00
4-125A	58.50	4X150D	52.00	6939	14.75
4-250A	68.50	4X150G	74.00	7360	12.00
4-400A	71.00	572B/T160L	39.00	7984	10.40
4-1000A	184.00	6LF6	5.00	8072	49.00
5-500A	145.00	6LQ6	5.00	8106	2.00
4CX250B	65.00	811A	12.95	8156	7.85
4CX250F/G	55.00	813	29.00	8226	127.70
4CX250K	113.00	5894/A	42.00	8295/PL172	328.00
4CX250R	92.00	6146	5.00	8458	25.75
4CX300A	147.00	6146A	6.00	8560A/AS	50.00
4CX350A	107.00	6146B/8298A	7.00	8908	9.00
				8950	9.00



## MICROWAVE COMPONENTS

### ARRA

2416	Variable Attenuator	\$ 50.00
3614-60	Variable Attenuator 0 to 60dB	75.00
KU520A	Variable Attenuator 18 to 26.5 GHz	100.00
4684-20C	Variable Attenuator 0 to 180dB	100.00
6684-20F	Variable Attenuator 0 to 180dB	100.00

### General Microwave

Directional Coupler 2 to 4GHz 20dB Type N	75.00
---	-------

### Hewlett Packard

H487B	100 ohms Neg. Thermistor Mount (NEW)	150.00
H487B	100 ohms Neg. Thermistor Mount (USED)	100.00
477B	200 ohms Neg. Thermistor Mount (USED)	100.00
X487A	100 ohms Neg. Thermistor Mount (USED)	100.00
X487B	100 ohms Neg. Thermistor Mount (USED)	125.00

J468A	100 ohms Neg. Thermistor Mount (USED)	150.00
478A	200 ohms Neg. Thermistor Mount (USED)	150.00
8478A	200 ohms Balanced Neg. Thermistor Mount (USED)	175.00
J382	5.85 to 8.2 GHz Variable Attenuator 0 to 50dB	250.00
X382A	8.2 to 12.4 GHz Variable Attenuator 0 to 50dB	250.00

X885A	8.2 to 12.4 GHz Phase Shifter +/- 360°	250.00
394A	1 to 2 GHz Variable Attenuator 6 to 120dB	250.00
NK292A	Waveguide Adapter	65.00
K422A	18 to 26.5 GHz Crystal Detector	250.00
K375A	18 to 26.5 GHz Variable Attenuator	300.00
8436A	Bandpass Filter 8 to 12.4 GHz	75.00

8439A	2 GHz Notch Filter	75.00
8471A	RF Detector	50.00
342A	VHF Noise Source	100.00
X347A	8.2 to 12.4 GHz Noise Source	250.00
H532A	7.05 to 10 GHz Frequency Meter	300.00
G532A	3.95 to 5.85 GHz Frequency Meter	300.00
J532A	5.85 to 8.2 GHz Frequency Meter	300.00

809A	Carriage with a 444A Slotted Line Untuned Detector Probe and 809B Coaxial Slotted Section 2.6 to 18 GHz	175.00
809B	Carriage with a 442B Broadband Probe 2.6 to 12.4 GHz and a X810B Slotted Section	200.00
809B	Carriage with a X810B Slotted Section and a PRD 250A Detector Mount 2.4 to 12.4 GHz	200.00

### Merrimac

AU-25A/	801115 Variable Attenuator	100.00
AU-26A/	801162 Variable Attenuator	100.00

### Microlab/FXR

Y410A	Frequency Meter 12400 - 18000 MC	250.00
N414A	Frequency Meter 3950 - 11000 MC	350.00
X638S	Horn 8.2 - 12.4 GHz	60.00
601-B18	X to N Adapter 8.2 - 12.4 GHz	35.00
Y610D	Coupler	75.00

### Narda

3095/	22909 Directional Coupler 7 to 12.4 GHz 10dB Type N	250.00
4013C-10/	22540A Directional Coupler 2 to 4 GHz 10dB Type SMA	90.00
4014-10/	22538 Directional Coupler 3.85 to 8 GHz 10dB Type SMA	90.00
4014C-6/	22876 Directional Coupler 3.85 to 8 GHz 6dB Type SMA	90.00
4015C-10/	22539 Directional Coupler 7.4 to 12 GHz 10dB Type SMA	95.00
4015C-30/	23105 Directional Coupler 7 to 12.4 GHz 30dB Type SMA	95.00
3044-20	Directional Coupler 4 to 8 GHz 20dB Type N	125.00
3040-20	Directional Coupler 240 to 500 MC 20dB Type N	125.00
3041-20	Directional Coupler 500 to 1000 MC 20dB Type N	125.00
3043-20/	22006 Directional Coupler 1.7 to 4 GHz 20dB Type N	125.00
3003-10/	22011 Directional Coupler 2 to 4 GHz 10dB Type N	75.00
3003-30/	22012 Directional Coupler 2 to 4 GHz 30dB Type N	75.00
3042-20	Directional Coupler 950 to 2 GHz 20dB Type N	125.00
3043-30/	22007 Directional Coupler 1.7 to 3.5 GHz 30dB Type N	125.00
22574	Directional Coupler 2 to 4 GHz 10dB Type N	125.00
3033	Coaxial Hybrid 2 to 4 GHz 3dB Type N	125.00
3032	Coaxial Hybrid 950 to 2 GHz 3 dB Type N	125.00
784/	22380 Variable Attenuator 1 to 90dB 2 to 2.5 GHz Type SMA	550.00
22377	Waveguide to Type N Adapter	35.00
720-6	Fixed Attenuator 8.2 to 14.4 GHz 6 dB	50.00
3503	Waveguide	25.00

### PRD

U101	12.4 to 18 GHz Variable Attenuator 0 to 60dB	300.00
X101	8.2 to 12.4 GHz Variable Attenuator 0 to 60dB	200.00
C101	Variable Attenuator 0 to 60dB	200.00
205A/367	Slotted Line with Type N Adapter	100.00
195B	8.2 to 12.4 GHz Variable Attenuator 0 to 50dB	100.00
185B51	7.05 to 10 GHz Variable Attenuator 0 to 40dB	100.00
196C	8.2 to 12.4 GHz Variable Attenuator 0 to 45dB	100.00
170B	3.95 to 5.85 GHz Variable Attenuator 0 to 45dB	100.00
588A	Frequency Meter 5.3 to 6.7 GHz	100.00
140A,C,D,E	Fixed Attenuators	25.00
109J,I	Fixed Attenuators	25.00
WEINSCHL ENG.	2692 Variable Attenuator +30 to 60dB	100.00

## COMPUTER I.C. SPECIALS

### MEMORY

DESCRIPTION	PRICE
2708	1K x 8 EPROM \$ 7.99
2716/2516	2K x 8 EPROM 5Volt Single Supply 20.00
2114/9114	1K x 4 Static RAM 450ns 6.99
2114L2	1K x 4 Static RAM 250ns 8.99
2114L3	1K x 4 Static RAM 350ns 7.99
4027	4K x 1 Dynamic RAM 3.99
4060/2107	4K x 1 Dynamic RAM 3.99
4050/9050	4K x 1 Dynamic RAM 3.99
2111A-2/8111	256 x 4 Static RAM 3.99
2112A-2	256 x 4 Static RAM 3.99
2115AL-2	1K x 1 Static RAM 55ns 4.99
6104-3/4104	4K x 1 Static RAM 320ns 14.99
7141-2	4K x 1 Static RAM 200ns 14.99
MCM6641L20	4K x 2 Static RAM 200ns 14.99
9131	1K x 1 Static RAM 300ns 10.99

### C.P.U.'s ECT.

MC6800L	Microprocessor	13.80
MCM6810AP	128 x 8 Static RAM 450ns	3.99
MCM68A10P	128 x 8 Static RAM 360ns	4.99
MCM68B10P	128 x 8 Static RAM 250ns	5.99
MC6820P	PIA	8.99
MC6820L	PIA	9.99
MC6821P	PIA	8.99
MC68B21P	PIA	9.99
MCM6830L7	Mikbug	14.99
MC6840P	PTM	8.99
MC6845P	CRT Controller	29.50
MC6845L	CRT Controller	33.00
MC6850L	ACIA	10.99
MC6850P	ACIA	4.99
MC6852P	SSDA	5.99
MC6852L	SSDA	11.99
MC6854P	ADLC	22.00
MC6860CJCS	D-600 BPS Modem	29.00
MC6862L	2400 BPS Modem	14.99
MK3850N-3	F8 Microprocessor	9.99
MK3852P	F8 Memory Interface	16.99
MK3852N	F8 Memory Interface	9.99
MK3854N	F8 Direct Memory Access	9.99
8008-1	Microprocessor	4.99
8080A	Microprocessor	8.99
Z80CPU	Microprocessor	14.99
6520	PIA	7.99
6530	Support For 6500 series	15.99
2650	Microprocessor	10.99
TMS1000NL	Four Bit Microprocessor	9.99
TMS4024NC	9 x 64 Digital Storage Buffer (FIFO)	9.99
TMS6011NC	UART	9.99
MC14411	Bit Rate Generator	11.99
AY5-4007D	Four Digit Counter/Display Drivers	8.99
AY5-9200	Repertory Dialler	9.99
AY5-9100	Push Button Telephone Diallers	7.99
AY5-2376	Keyboard Encoder	19.99
AY3-8500	TV Game Chip	5.99
TR1402A	UART	9.99
PR1472B	UART	9.99
PT1482B	UART	9.99
8257	DMA Controller	9.99
8251	Communication Interface	9.99
8228	System Controller & Bus Driver	5.00
8212	8 Bit Input/Output Port	5.00
MC14410CP	2 of 8 Tone Encoder	9.99
MC14412	Low Speed Modem	14.99
MC14408	Binary to Phone Pulse Converter	12.99
MC14409	Binary to Phone Pulse Converter	12.99
MC1488L	RS232 Driver	1.00
MC1489L	RS232 Receiver	1.00
MC1405L	A/D Converter Subsystem	9.00
MC1406L	6 Bit D/A Converter	7.50
MC1408/6/7/8	8 Bit D/A Converter	4.50
MC1330P	Low Level Video Detector	1.50
MC1349/50	Video IF Amplifier	1.17
MC1733L	LM733 OP Amplifier	2.40
LM565	Phase Lock Loop	2.50

# MHz <sup>✓48</sup> electronics

(602) 242-3037  
(602) 242-8916

2111 W. Camelback  
Phoenix, Arizona 85015



### FAIRCHILD VHF AND UHF PRESCALER CHIPS

95H90DC	350 MHz Prescaler Divide by 10/11	\$9.50
95H91DC	350 MHz Prescaler Divide by 5/6	9.50
11C90DC	650 MHz Prescaler Divide by 10/11	16.50
11C91DC	650 MHz Prescaler Divide by 5/6	16.50
11C83DC	1 GHz Divide by 248/256 Prescaler	29.90
11C70DC	600 MHz Flip/Flop with reset	12.30
11C58DC	ECL VCM	4.53
11C44DC/MC4044	Phase Frequency Detector	3.82
11C24DC/MC4024	Dual TTL VCM	3.82
11C06DC	UHF Prescaler 750 MHz D Type Flip/Flop	12.30
11C05DC	1 GHz Counter Divide by 4	74.35
11C01FC	High Speed Dual 5-4 input NO/NOR Gate	15.40

### WISPER FANS

This fan is super quiet, efficient cooling where low acoustical disturbance is a must. Size 4.68" x 4.68" x 1.50", Impedance protected, 50/60 Hz. 120 Vac. **\$9.99**

### TRW BROADBAND AMPLIFIER MODEL CA615B

Frequency response 40 MHz to 300 MHz  
Gain: 300 MHz 16 dB Min., 17.5 dB Max.  
50 MHz 0 to -1 dB from 300 MHz  
Voltage: 24 volts dc at 220 ma max. **\$19.99**

### CARBIDE — CIRCUIT BOARD DRILL BITS FOR PC BOARDS

Size: 35, 42, 47, 49, 51, 52	\$2.15
Size: 53, 54, 55, 56, 57, 58, 59, 61, 63, 64, 65	1.85
Size: 66	1.90
Size: 1.25 mm, 1.45 mm	2.00
Size: 3.20 mm	3.58

### CRYSTAL FILTERS: TYCO 001-19880 same as 2194F

10.7 MHz Narrow Band Crystal Filter  
3 dB bandwidth 15 kHz min. 20 dB bandwidth 60 kHz min. 40 dB bandwidth 150 kHz min.  
Ultimate 50 dB: Insertion loss 1.0 dB max. Ripple 1.0 dB max. Ct. 0 +/- 5 pf 3600 ohms. **\$5.95**

### MURATA CERAMIC FILTERS

Models: SFD-455D 455 kHz	\$3.00
SFB-455D 455 kHz	2.00
CFM-455E 455 kHz	7.95
SFE-10.7 10.7 MHz	5.95

### TEST EQUIPMENT — HEWLETT PACKARD — TEKTRONIX — ETC.

<b>Hewlett Packard:</b>		
491C	TWT Amplifier 2 to 4 Gc 1 watt 30 dB gain	\$1150.00
608D	10 to 420 mc .1 uV to .5 V into 50 ohms Signal Generator	500.00
616B	1.8 to 4.2 Gc Signal Generator	400.00
618B	3.8 to 7.2 Gc Signal Generator	400.00
620A	7 to 11 Gc Signal Generator	400.00
623B	Microwave Test Set	900.00
624C	Microwave Test Set	950.00
614A	900 to 2100 MC. Signal Generator	\$500.00
8691A	1 to 2 Gc Plug In For 8690A Sweeper	800.00
8692A	2 to 4 Gc Plug In For 8690A Sweeper	800.00
8693A	4 to 8 Gc Plug In For 8690A Sweeper	800.00
8742A	Reflection Test Unit 2 to 12.4 Gc	1800.00
695A	12.4 to 18Gc Sweep Generator	900.00
1702A	Storage Oscilloscope	1800.00
<b>Alltech:</b>		
473	225 to 400 mc AM/FM Signal Generator	750.00
<b>Singer:</b>		
MF5/VR-4	Universal Spectrum Analyzer with 1 kHz to 27.5 mc Plug In	1200.00
<b>Keltek:</b>		
XR630-100	TWT Amplifier 8 to 12.4 Gc 100 watts 40 dB gain	9200.00
<b>Polarad:</b>		
2038/2438/1102A	Calibrated Display with an SSB Analysis Module and a 10 to 40 mc Single Tone Synthesizer	1500.00

### ATLAS CRYSTAL FILTERS FOR ATLAS HAM GEAR

5.52-2.7/B	<b>YOUR CHOICE \$24.95</b>
5.595-2.7/B/U	
5.595-.500/4/CW	
5.595-2.7LSB	
5.595-2.7USB	
5.645-2.7/B	
9.0USB/CW	

### RF TRANSISTORS

TYPE	PRICE	TYPE	PRICE	TYPE	PRICE
2N1561	\$15.00	2N5590	8.15	MM1550	\$10.00
2N1562	15.00	2N5591	11.85	MM1552	50.00
2N1692	15.00	2N5637	22.15	MM1553	56.50
2N1693	15.00	2N5641	6.00	MM1601	5.50
2N2632	45.00	2N5642	10.05	MM1602/2N5842	7.50
2N2857JAN	2.52	2N5643	15.82	MM1607	8.65
2N2876	12.35	2N6545	12.38	MM1661	15.00
2N2880	25.00	2N5764	27.00	MM1669	17.50
2N2927	7.00	2N5842	8.78	MM1943	3.00
2N2947	18.35	2N5849	21.29	MM2605	3.00
2N2948	15.50	2N5862	51.91	MM2608	5.00
2N2949	3.90	2N5913	3.25	MM8006	2.23
2N2950	5.00	2N5922	10.00	MMCM918	20.00
2N3287	4.30	2N5942	46.00	MMT72	1.17
2N3294	1.15	2N5944	8.92	MMT74	1.17
2N3301	1.04	2N5945	12.38	MMT2857	2.63
2N3302	1.05	2N5946	14.69	MRF304	43.45
2N3304	1.48	2N6080	7.74	MRF420	20.00
2N3307	12.60	2N6081	10.05	MRF450	11.85
2N3309	3.90	2N6082	11.30	MRF450A	11.85
2N375	9.32	2N6083	13.23	MRF454	21.83
2N3553	1.57	2N6084	14.66	MRF458	20.68
2N3755	7.20	2N6094	7.15	MRF472	2.50
2N3818	6.00	2N6095	11.77	MRF475	5.00
2N3866	1.09	2N6096	20.77	MRF476	5.00
2N3866JAN	2.80	2N6097	29.54	MRF502	1.08
2N3866JANTX	4.49	2N6136	20.15	MRF504	6.95
2N3924	3.34	2N6166	38.60	MRF509	4.90
2N3927	12.10	2N6265	75.00	MRF511	8.15
2N3950	26.86	2N6266	100.00	MRF901	3.00
2N4072	1.80	2N6439	45.77	MRF5177	21.62
2N4135	2.00	2N6459/PT9795	18.00	MRF8004	1.60
2N4261	14.60	2N6603	12.00	PT4186B	3.00
2N4427	1.20	2N6604	12.00	PT4571A	1.50
2N4429	7.50	A50-12	25.00	PT4612	5.00
2N4430	20.00	BFR90	5.00	PT4628	5.00
2N4957	3.62	BLY568C	25.00	PT4640	5.00
2N4958	2.92	BLY568CF	25.00	PT8659	10.72
2N4959	2.23	CD3495	15.00	PT9784	24.30
2N4976	19.00	HEP76/S3014	4.95	PT9790	41.70
2N5090	12.31	HEPS3002	11.30	SD1043	5.00
2N5108	4.03	HEPS3003	29.88	SD1116	3.00
2N5109	1.60	HEPS3005	9.95	SD1118	5.00
2N5160	3.49	HEPS3006	19.90	SD1119	3.00
2N5179	1.05	HEPS3007	24.95	TA7993	75.00
2N5184	2.00	HEPS3010	11.34	TA7994	100.00
2N5216	47.50	HEPS5026	2.56	TRWMRA2023-1.5	42.50
2N5583	4.55	HP35831E/		40281	10.90
2N5589	6.82	HXTR5104	50.00	40282	11.90
		MM1500	32.20	40290	2.48

### CHIP CAPACITORS

	1pf	27pf	220pf	1200pf
	1.5pf	33pf	240pf	1500pf
	2.2pf	39pf	270pf	1800pf
	2.7pf	47pf	300pf	2200pf
	3.3pf	56pf	330pf	2700pf
	3.9pf	68pf	360pf	3300pf
	4.7pf	82pf	390pf	3900pf
	5.6pf	100pf	430pf	4700pf
	6.8pf	110pf	470pf	5600pf
	8.2pf	120pf	510pf	6800pf
	10pf	130pf	560pf	8200pf
	12pf	150pf	620pf	.010mf
	15pf	160pf	680pf	.012mf
	18pf	180pf	820pf	.015mf
	22pf	200pf	1000pf	.018mf

We can supply any value chip capacitors you may need.

**PRICES**  
1 to 10 \$1.99  
11-50 1.49  
51-100 1.00  
1 0 1 - 1 0 0 0 .75  
1001 up .50

POR = CALL FOR PRICE

### HAMLIN SOLID STATE RELAYS ✓ 48

120vac at 40Amps.  
Input Voltage 3 to 32vdc.  
  
240vac at 40Amps.  
Input Voltage 3 to 32vdc.  
Your Choice \$4.99



# MHz electronics ✓48

## 1900 MHz to 2500 MHz DOWN CONVERTER

This receiver is tunable over a range of 1900 to 2500 mc and is intended for amateur radio use. The local oscillator is voltage controlled (i.e.) making the i-f range approximately 54 to 88 mc (Channels 2 to 7).

PC BOARD WITH CHIP CAPACITORS 13 .....	\$44.99
PC BOARD WITH ALL PARTS FOR ASSEMBLY .....	\$79.99
PC BOARD ASSEMBLED AND TESTED .....	\$120.00
PC BOARD FOR 3.7 TO 4.2 GC SATELLITE CONVERTER WITH DATA.....	\$100.00
PC BOARD FOR I-F AMPLIFIER WITH DATA .....	40.00
PC BOARD FOR DEMOD WITH DATA .....	55.00
POWER SUPPLY KIT .....	\$44.99
POWER SUPPLY ASSEMBLED AND TESTED .....	59.99
YAGI ANTENNA 4' LONG APPROX. 20 TO 23 dB GAIN .....	\$59.99
YAGI ANTENNA 4' WITH TYPE (N, BNC, SMA Connector) .....	\$64.99
<b>2300 MHz DOWN CONVERTER</b>	
Includes converter mounted in antenna, power supply, antenna, 75' and 3' RG59 cable with connectors, 75 to 300 ohm adapter, Plus 90 DAY WARRANTY .....	\$299.99
OPTION #1 MRF902 in front end. (7 dB noise figure) .....	\$349.99
OPTION #2 2N6603 in front end. (5 dB noise figure) .....	\$400.00
<b>2300 MHz DOWN CONVERTER ONLY</b>	
10 dB Noise Figure 23 dB gain in box with N conn. Input F conn. Output.....	\$149.99
7 dB Noise Figure 23 dB gain in box with N conn. Input F conn. Output.....	\$169.99
5 dB Noise Figure 23 dB gain in box with SMA conn. Input F conn. Output.....	\$189.99
DATA IS INCLUDED WITH KITS OR MAY BE PURCHASED SEPARATELY .....	\$15.00
2 FOOT DISH WITH FEED AND MOUNT .....	59.99
PC BOARD WITH ALL PARTS FOR ASSEMBLY PLUS 2N6603 .....	89.00

### Shipping and Handling Cost:

Receiver Kits add \$1.50, Power Supply add \$2.00, Antenna add \$5.00, Option 1/2 add \$3.00, For complete system add \$7.50.

### Replacement Parts:

MRF901	\$5.00	MBD101	\$2.00
		.001 chip caps	\$2.00
2N6603	\$12.00	PC Board only	\$25.00 with data

## 3.7 to 4.2 Gc SATELLITE DOWN CONVERTER

70 MHz i-f (30 MHz @ 3 dB) 10 dB min. IMAGE REJECTION

15 dB max. Noise Figure 15 dB Gain

ASSEMBLED AND TESTED WITH N OR SMA CONNECTOR FOR INPUT AND F CONNECTOR FOR OUTPUT

\$499.99

## I-F AMPLIFIER FOR ABOVE 70 MHz

45 dB Gain — 30 MHz @ 3 dB — ASSEMBLED AND TESTED F CONNECTOR

\$129.99

## DEMOM FOR ABOVE 70 MHz

COMPOSITE VIDEO OUTPUT (NO RF) — ASSEMBLED AND TESTED

\$179.99

# We no longer accept Bank Cards.

PLEASE SEND POSTAL MONEY ORDER, CERTIFIED CHECK, CASHIER'S CHECK OR MONEY ORDER.  
 PRICES SUBJECT TO CHANGE WITHOUT NOTICE. WE CHARGE 15% FOR RESTOCKING ON ANY ORDER.  
 ALL CHECKS AND MONEY ORDERS IN US FUNDS ONLY.  
 ALL ORDERS SENT FIRST CLASS OR UPS.

ALL PARTS PRIME AND GUARANTEED.

WE WILL ACCEPT COD ORDERS FOR \$25.00 OR OVER, ADD \$1.50 FOR COD CHARGE.

PLEASE INCLUDE \$1.50 MINIMUM FOR SHIPPING OR CALL FOR CHARGES.

**(602) 242-3037**

**(602) 242-8916**

WE ALSO ARE LOOKING FOR NEW AND USED TUBES,  
 TEST EQUIPMENT, COMPONENTS ETC.

WE ALSO SWAP OR TRADE.

FOR CATALOG SEE JANUARY, 1980, 73 Magazine, 10  
 Pages.

**2111 W. Camelback  
 Phoenix, Arizona 85015**



# BULLET ELECTRONICS

P.O. Box 401244-E

Garland, TX. 75040

(214) 278-3553

*Special Buy!*

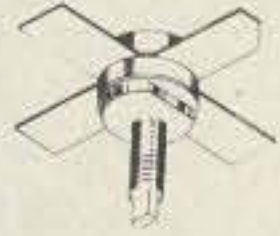

### RF POWER TRANSISTORS

**2N5591** 25 W @ 13.6 VDC to 240 mhz. minimum gain 4.4 db. **6.95**

**Limited Qty.**  
Limit 5 of each type per customer

**2N6081 / MRF221**  
15W @ 13.6 VDC to 240 mhz. Minimum gain 6.3 db. **4.95**

Units are marked with special mfg's. part number, however, all are new and guaranteed.

### TO-3 P.C. BOARD HEATSINK

Perfect for power transistors, or 309 and 340K series voltage regulators.

**3/1.10**



Thermoloy H6014 Black Anodized

**LM395** High gain power transistor with built in current limiting, power limiting and thermal overload making it virtually impossible to destroy with overload. VCEO = 36V IC = 2A HFe 3000. Will drive directly off TTL and CMOS. **1.65**

\*2N5191 NPN

Vceo = 60V  
IC = 4A  
Hfe 25-100 @ 1.5A  
\*HSE #

### SILICON POWER TRANSISTOR



Pd 40W  
**3/\$1.00**  
**100/\$25.00**

PN2222 (2N2222A)

MOST POPULAR NPN GEN. PURPOSE TRANSISTOR.  
TO - 90 Vceo = 40V  
Pd = .5W  
Hfe = 100 - 300  
**10/\$1.00 100/\$9.00**



### THE PERFECT TRANSFORMER

117VAC primary. 12VAC secondary @ 200ma Great for all you CMOS, or low power TTL projects. PC board mount.

**99¢ ea. 3/\$2.50**

Size: 1.5" W x 1.25" D x 1.25" H

### AY3-8910 PROGRAMMABLE SOUND GENERATOR

The AY3-8910 is a 40 pin LSI chip with three oscillators, three amplitude controls, programmable noise generator, three mixers, an envelope generator, and three D/A converters that are controlled by 8 BIT WORDS. No external pots or caps required. This chip hooked to an 8 bit microprocessor chip or Buss (8080, Z80, 6800 etc.) can be software controlled to produce almost any sound. It will play three note chords, make bangs, whistles, sirens, gunshots, explosions, bleets, whines, or grunts. In addition, it has provisions to control its own memory chips with two IO ports. The chip requires +5V @ 75ma and a standard TTL clock oscillator. A truly incredible circuit.

**\$14.95** W/Basic Spec Sheet (4 pages)

60 page manual with S-100 interface instructions and several programming examples, **\$3.00 extra**

### OVP-2 OVERVOLTAGE PROTECTOR **6.95**

Provides cheap insurance for your expensive equipment. Trip voltage is adjustable from 3 to 30 volts. Overvoltage instantly fires a 25A SCR and shorts the output to protect equipment. Should be used on units that are fused. Directly compatible with the PS-12 and PS-14. All electronics supplied. Drilled and plated PC board.

### ULTRASONIC RELAY KIT

Invisible Beam Works Like A Photo Electric Eye. **COMPLETE KIT**. All Parts & PC Board. Use Up To 25 Ft. Apart. **\$21.50**

Optional entry delay and Alarm Timeout Circuit will source or sink up to 200 MA DC. **\$3.95**

### AUTO/VAN CLOCK KIT

- 12 Hr. Format
- 6 Digit 1/2" LED Readouts
- Quartz XTAL Timebase
- Alarm & Snooze Options
- Noise Filtering
- Easy Assembly • 12 VDC
- 4 5/8" x 3" x 1 1/2"
- All Parts!

**\$16.95**

## X-RATED!

### ZULU II CLOCK KIT

WITH CALENDAR AND NOX™ CIRCUIT

**19.95**

LESS CASE

### ACCESSORIES

Custom High Impact Molded Case with Ruby Lens. Available in Blue or Tan. **\$6.50**

117 VAC to 12 VAC Transformer. **\$1.35**

\*9V Battery Not Included

**X-TRA VALUE:** All the components and high quality plated G-10 PC Boards are provided.

**X-TRA CARE IN DESIGN:** Easy Assembly! Large open layout.

**X-CELLENCE IN IDEAS:** 5 years of designed products for the amateur radio market.

**X-CELLENCE IN INSTRUCTIONS:** Clear step-by-step instructions with quality illustrations and schematic.

**X-TRA FEATURES:** There has never been a clock kit with so many features — at any price!

- Unit operates on either 12 VAC or 12 VDC.
- On board QUARTZ XTAL TIMEBASE or 60Hz AC line freq. can be used.
- Automatic BATTERY BACKUP\*
- Reads true 24 HOUR TIME and 31 DAY CALENDAR.
- Unique NOX™ CIRCUIT activates readouts with a handclap followed by the date for 4 seconds. Or they can be turned on constantly.
- When used mobile readouts blank when ignition is off.
- Special NOISE SUPPRESSION and battery reversal circuits.
- Bright 1/2" LED's show hours, minute and seconds.

### Sound Effects Kit **\$18.50**

The SE-01 Sound effects Kit is a complete kit; all you need to build a programmable sound effects machine except a battery and speaker. Our kit is designed to really ring out the TI 76477 Sound Chip. Only the SE-01 provides you with additional circuitry that includes a PULSE GENERATOR, MUX OSCILLATOR and COMPARATOR to make more complex sounds a snap. We help you in building the kit with a clear, easy-to-follow construction manual and we show you how to easily program the unit. Other dealers will sell you the chip or a "kit" of parts but you are on your own to do the most difficult part...make neat sounds! Within a short time after you build the SE-01 you can easily create Gunshots, Explosions, Space Sounds, Steam Trains and much more. We think the Bullet SE-01 is the best deal on the market but don't ask us. — ask the 15,000 happy SE-01 owners!

Complete Kit With Quality Plated PC Board **\$18.50**  
(Less battery & speaker)

Users Group Notes: Includes additional programming charts plus quarterly updates **\$5.00**

### 7 WATT AUDIO AMP KIT

SMALL SINGLE HYBRID IC AND COMPONENTS FIT ON A 2" x 3" PC BOARD (INCLUDED) RUNS ON 12VDC GREAT FOR ANY PROJECT THAT NEEDS AN INEXPENSIVE AMP. LESS THAN 3% THD @ 5 WATTS COMPATIBLE WITH SE-01 SOUND KIT. **\$5.95**

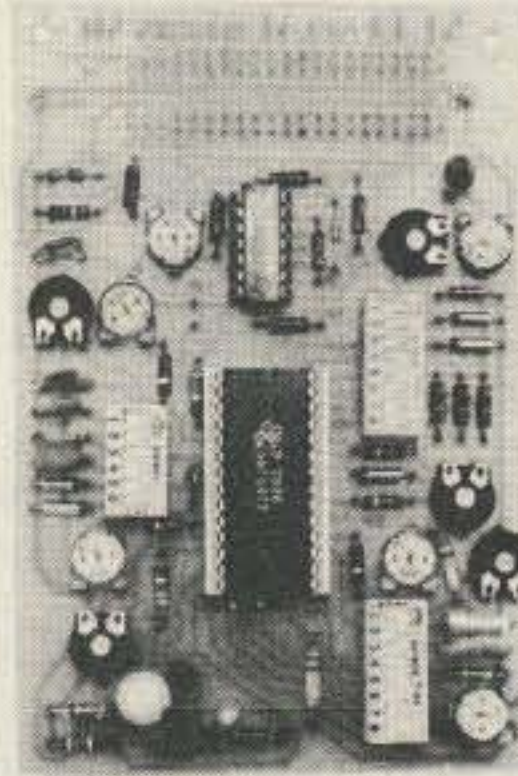

### PARTS

LM3046	(CA3046) Xistor Array	.75
RCA 40430	400V 6A TRIAC TO-66	.75
LM567	Tone Decoder	.99
CD4046	PLL CMOS	.99
LM3302	Quad Comparator	.89
2SC 1849	High Freq. NPN TO-92	6/1.00
MPS A 20	NPN General Purpose	8/1.00
TL490	Bar/Graph Driver w/specs	2.50
7812	12V 1A Regulator	.99
7805	5V 1A Regulator	.99
78M05	5V 1/2A Reg. TO-5 (Hse #)	.60
LM3911	Temp. Transducer w/specs	1.10
555	Timer IC	.49
2N6028	P.U.T. w/specs	.50
IL-1	Opto Isolator w/specs	.60
LM380	2W Audio IC w/specs	.50
LM377	Dual LM380 w/specs	1.09
TIP-30	PNP Power TO-220	3/1.00
SCR	Sensitive Gate 200V 4A	7/1.00
SCR	Sensitive Gate 600V	
	4A RCA	3/1.00
LM317	Variable Reg. 3-35V 1A w/specs	1.69
	Trigger diode for triacs in AC phase control operation	.29
DIAC		

### NEW!

### MUSIC FOR YOUR EARS

Bullet's Electronic Music Machine™ Kit has a single 28 Pin Microprocessor Chip with ROM that has been programmed to play the first 6 to 10 notes of the 25 popular tunes listed below. Each tune can easily be addressed individually or played sequentially at the push of a button. The 3 chime sequences are activated at any time by separate switch closures so when used as a doorbell, one door can play songs while two others will play different chimes. The unit has a 5 watt audio Amp and will run on either 12VAC or 12VDC. Optional 117VAC transformer is available. Construction is very simple, works with any 8 or 16 ohm speaker, or horn speaker. (Not Included.) Tunes can be remotely programmed using a single rotary switch, (not included), if desired.

Complete Kit **\$16.95** Transformer **\$1.35**  
For Operation on 117VAC

Tunes: Toreador \* William Tell \* Hallelujah Chorus \* Star Spangled Banner \* Yankee Doodle \* America, America \* Deutschland Leid \* Wedding March \* Beethoven's 5th and 9th \* Hell's Bells \* La Vien En Rose \* Star Wars Theme \* Clementine \* Augustine \* Jingle Bells \* God Save The Queen \* Colonel Bogey \* Marseillaise \* O Sole Mio \* Santa Lucia \* The End \* Blue Danube \* Brahms Lullaby \* Westminster Chime \* Simple Chime \* Descending Octave Chime.

### ★ CALL OR WRITE TODAY FOR FREE CATALOG ★

- ★ NO C.O.D.
- ★ SEND CHECK, M.O., OR CREDIT CARD #
- ★ PHONE ORDERS ACCEPTED ON VISA/MASTER CHARGE ONLY (214) 278-3553

P  
O  
L  
I  
C  
I  
E  
S

- ★ ADD 5% FOR SHIPPING
- ★ ORDERS UNDER \$10 ADD .75 HANDLING
- ★ TEX. RES. ADD 5% TAX
- ★ FOREIGN ORDERS (EXCEPT CANADA ADD 10% (20% FOR AIRMAIL))



# RADIO BOOKSHOP

## LICENSE STUDY GUIDES & TAPES

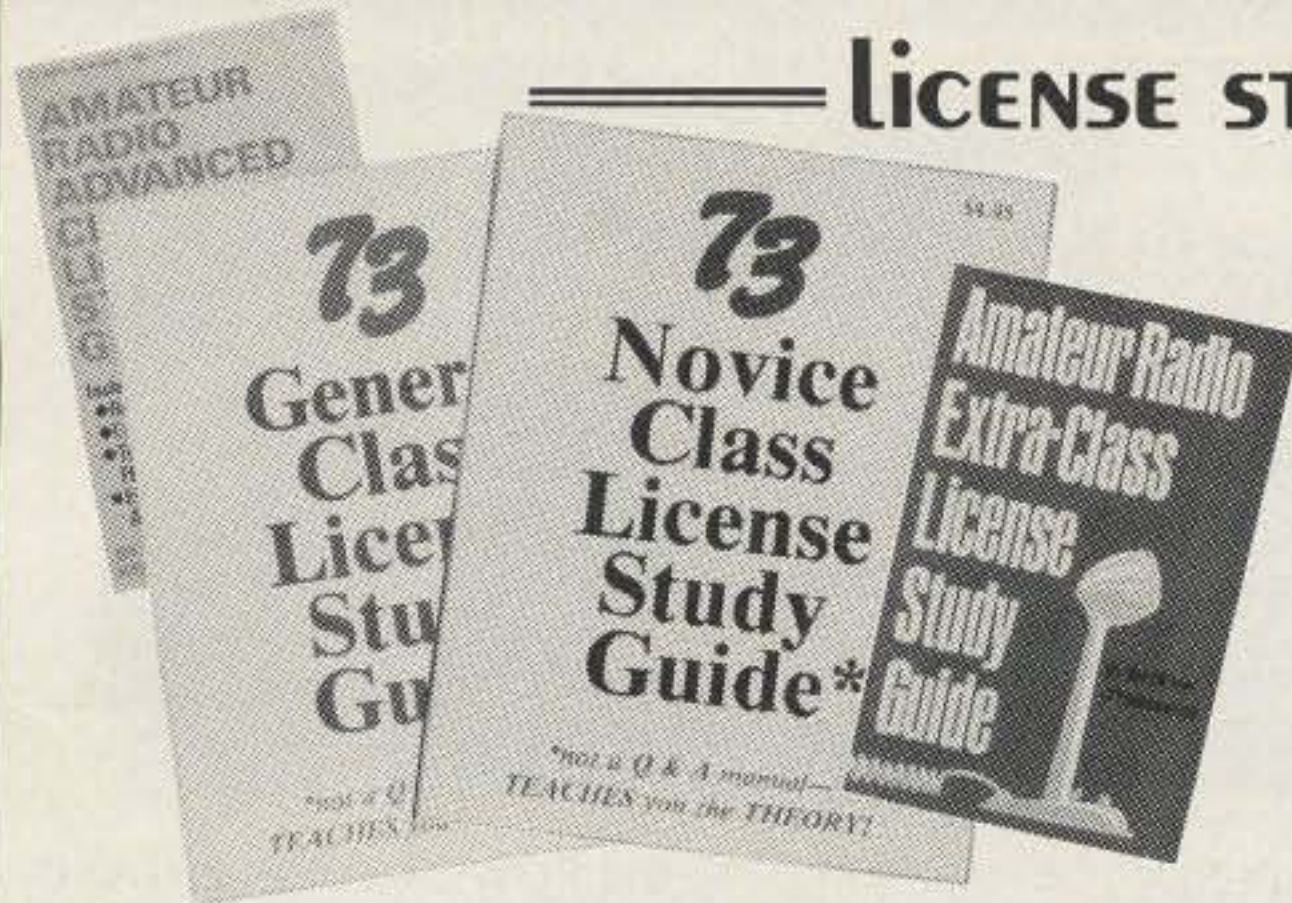

• **NOVICE STUDY GUIDE**—SG7357—Here is a completely new study guide and reference book for the potential ham. This is not a question/answer memorization course. Electronic and radio fundamentals are presented and explained in an easy-to-understand fashion, preparing the beginner for the Novice exam. Includes the latest FCC amateur regulations, as well as application forms. Easily the best path into the exciting world of ham radio! \$4.95.\*

• **GENERAL CLASS STUDY GUIDE**—SG7358—A complete theory course for the prospective General or Technician. This reference explains transistor, amplifier, and general radio theory, while preparing the Novice for the "big" ticket. After getting your ticket, you'll use this guide again and again as an electronics reference source. Not a question/answer guide that becomes dated when the FCC updates the amateur exams. Under revision, expected availability is December 1980. \$5.95\*

• **ADVANCED CLASS LICENSE STUDY GUIDE**—SG1081—Ready to upgrade your license? To prevent retaking the FCC theory exam, you need the 73 Advanced theory guide. SSB, antenna theory, transmitters, and electronics measuring techniques are covered in detail in this easy-to-follow study guide. Special modes and techniques, such as RTTY, are also treated. An engineering degree is *not* necessary to master the Advanced theory—try this book before visiting the examiner's office! \$6.95.\* (Published by TAB Books previous to recent changes in FCC exam material.)

• **EXTRA CLASS LICENSE STUDY GUIDE**—SG1080—Before going for your 1 x 2 call, it pays to be a master of the Extra class electronics theory. This study guide is the logical extension of the 73 theory course. All the theory necessary to pass the exam is presented. Antennas, transmission lines, swr are discussed, as well as noise, propagation, and specialized communication techniques. This book is not a classroom lecture or memorization guide, but rather a logical presentation of the material that must be *understood* before attempting the Extra exam. Save yourself a return trip to the FCC and try the 73 method first! \$5.95.\*



## NOVICE THEORY TAPES Startling Learning Breakthrough



• **NOVICE THEORY TAPES**—CT7300—Startling Learning Breakthrough. You'll be astounded at how really simple the theory is when you hear it explained on these tapes. Three tapes of theory and one of questions and answers from the latest Novice exams give you the edge you need to breeze through your exam. 73 is interested in helping get more amateurs, so we're giving you the complete set of our tapes for the incredibly low price of **ONLY \$15.95.\***

Scientists have proven that you learn faster by listening than by reading because you can play a cassette tape over and over in your spare time—even while you're driving! You get more and more info each time you hear it. You can't progress without solid fundamentals. These four hour-long tapes give you all the basics you'll need to pass the Novice exam easily. You'll have an understanding of the basics which will be invaluable to you for the rest of your life! Can you afford to take your Novice exam without first listening to these tapes? Set of 4—\$15.95.\*



These tapes were made previous to recent changes in FCC rules. These minor changes do not affect the *theory* involved. A new set of tapes reflecting these rule changes is being developed. Expected availability is December 1980.

## SSTV

• **SLOW SCAN TELEVISION TAPE**—CT7350—Prize-winning programs from the 73 SSTV contest. Excellent for Demo! \$5.95.\*



## 73 CODE TAPES

Any Four Tapes For \$15.95! \*  
\$4.95 Each! \*

### "GENESIS"

5 WPM—CT7305—This is the beginning tape for people who do not know the code at all. It takes them through the 26 letters, 10 numbers and necessary punctuation, complete with practice every step of the way using the newest blitz teaching techniques. It is almost miraculous! In one hour many people—including kids of ten—are able to master the code. The ease of learning gives confidence to beginners who might otherwise drop out.

### "THE STICKLER"

6+ WPM—CT7306—This is the practice tape for the Novice and Technician licenses. It is made up of one solid hour of code, sent at the official FCC standard (no other tape we've heard uses these standards, so many people flunk the code when they are suddenly—under pressure—faced with characters sent at 13 wpm and spaced for 5 wpm). This tape is not memorizable, unlike the zany 5 wpm tape, since the code groups are entirely random characters sent in groups of five.

### "BACK BREAKER"

13+ WPM—CT7313—Code groups again, at a brisk 13 per so you will be at ease when you sit down in front of the steely-eyed government inspector and he starts sending you plain language at only 13 per. You need this extra margin to overcome the panic which is universal in the test situations. When you've spent your money and time to take the test, you'll thank heavens you had this back-breaking tape.

### "COURAGEOUS"

20+ WPM—CT7320—Code is what gets you when you go for the Extra class license. It is so embarrassing to panic out just because you didn't prepare yourself with this tape. Though this is only one word faster, the code groups are so difficult that you'll almost fall asleep copying the FCC stuff by comparison. Users report that they can't believe how easy 20 per really is with this fantastic one hour tape.

### "OUTRAGEOUS"

25+ WPM—CT7325—This is the tape for that small group of overachieving hams who wouldn't be content to simply satisfy the code requirements of the Extra Class license. It's the toughest tape we've got and we keep a permanent file of hams who have mastered it. Let us know when you're up to speed and we'll inscribe your name in 73's CW "Hall of Fame."

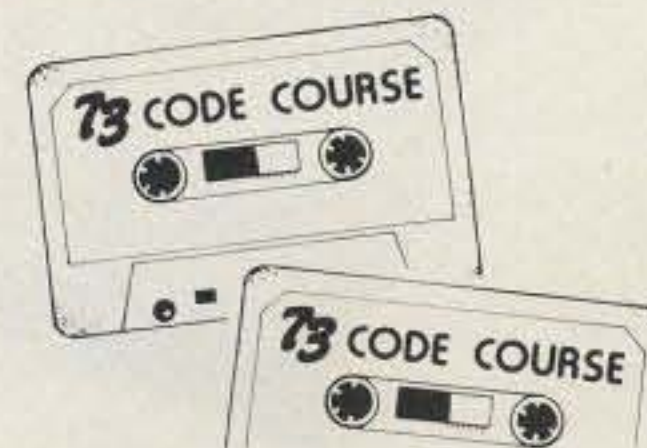
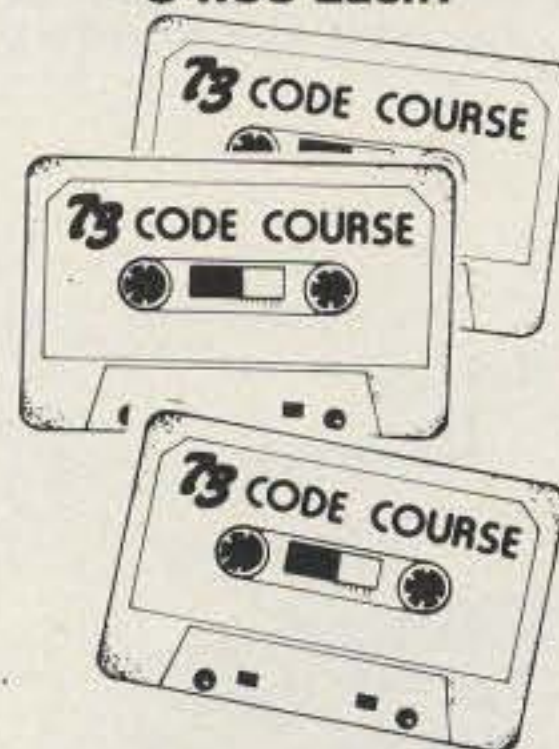

\*Use the order card in the back of this magazine or itemize your order on a separate piece of paper and mail to: 73 Radio Bookshop • Peterborough NH 03458. Be sure to include check or detailed credit card information. No C.O.D. orders accepted. \*Add \$1.00 handling charge. Note: Prices subject to change on books not published by 73 Magazine. Questions regarding your order? Please write to Customer Service at the above address. Please allow 4-6 weeks for delivery.

**FOR TOLL FREE ORDERING CALL 1-800-258-5473**



# RADIO BOOKSHOP

## 73 TECHNICAL LIBRARY

● **BEHIND THE DIAL**—BK7307—By Bob Grove. Get more fun out of shortwave listening with this interesting guide to receivers, antennas, frequencies and interference. \$4.95.\*

● **THE CHALLENGE OF 160**—BK7309—is the newest book in the 73 technical library, dedicated to 160 meter operating. Si Dunn provides all necessary information to get started on this unique band. The all-important antenna and ground systems are described in detail. The introduction contains interesting photos of Stew Perry's (the King of 160) shack. This reference is a must for new and experienced "Top Band" operators. Price: \$4.95.\*

● **IC OP-AMP COOKBOOK**—BK1028—by Walter G. Jung. Covers not only the basic theory of the IC op amp in great detail, but also includes over 250 practical circuit applications, liberally illustrated. 592 pages, 5½ × 8½, softbound. \$12.95.\*

● **THE POWER SUPPLY HANDBOOK**—BK7305—Need a power supply for a gadget you're building? In the **POWER SUPPLY HANDBOOK** there are dozens ready-to-build, plus detailed steps for designing your own. There are circuits and parts lists for all kinds of supplies, ranging from simple DC types to highly stable regulated versions. If you need a circuit to convert a DC voltage to a higher or lower voltage, turn DC into AC, or AC to DC—then this is the book you need. With more than 400 pages, you should be able to find just the circuit you need. Without a doubt one of the best power supply source books available, compiled by the editors of 73. \$9.95.\*

● **WEATHER SATELLITE HANDBOOK**—BK7370—Simple equipment and methods for getting good pictures from the weather satellite. Antennas, receivers, monitors, facsimile you can build, tracking, automatic control (you don't even have to be home). Dr. Taggart WB8DQT. \$4.95.\*

● **THE NEW RTTY HANDBOOK**—BK7347—is a new edition and the only up-to-date RTTY book available. The state of the art has been changing radically and has made all previous RTTY books obsolete. It has the latest circuits, great for the newcomer and expert alike. \$5.95.\*

● **PROPAGATION WIZARD'S HANDBOOK**—BK7302—by J. H. Nelson. When sunspots riddled the worldwide communications networks of the 1940's, John Henry Nelson looked to the planets for an answer. The result was a theory of propagation forecasting based upon interplanetary alignment that made the author the most reliable forecaster in America today. The book provides an enlightened look at communications past, present, and future, as well as teaching the art of propagation forecasting. \$6.95.\*

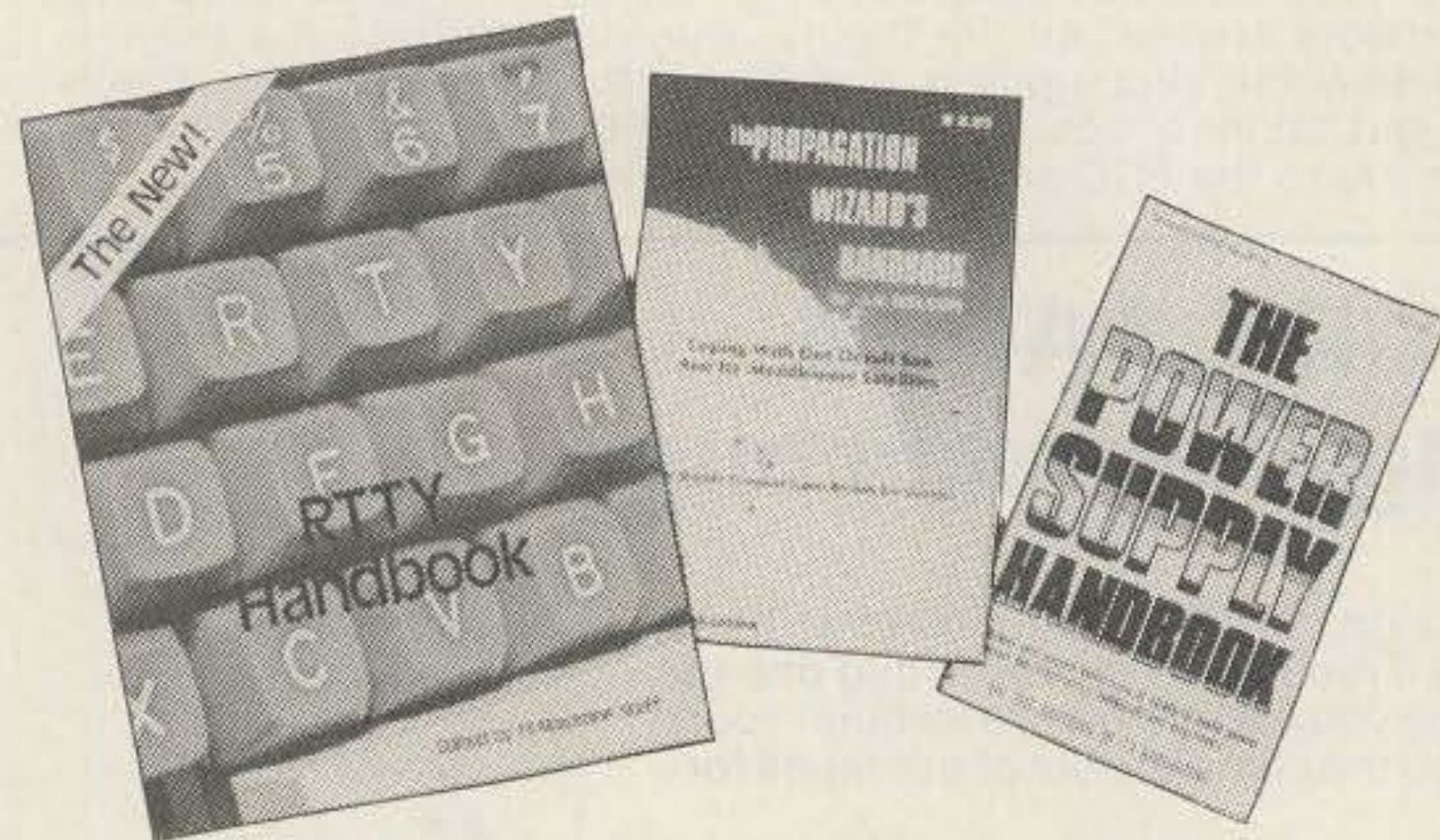

● **SSB . . . THE MISUNDERSTOOD MODE**—BK7351—by James B. Wilson. Single Sideband Transmission . . . thousands of us use it every day, yet it remains one of the least understood facets of amateur radio. J. B. Wilson presents several methods of sideband generation, amply illustrated with charts and schematics, which will enable the ambitious reader to construct his own sideband generator. A must for the technically-serious ham. \$5.50.\*

● **MASTER HANDBOOK OF HAM RADIO CIRCUITS**—BK1033—This is an encyclopedia of amateur radio circuits, gleaned from past issues of 73 Magazine and carefully selected according to application. You'll find many you've never seen before, some new twists on the tried and true, and several that have been long forgotten but are well worth remembering. Where your interest ranges from ragchewing to EME, from CW to slow-scan TV, from DX to county nets, this handbook will be a welcome addition to your shack. \$8.95.\*



● **OWNER REPAIR OF RADIO EQUIPMENT**—BK7310—Frank Glass K6RQ shares over 40 years of operating, servicing, and design experience in this book which ranges from the elementary to the highly technical written for the top engineers in the field. It is written in narrative style on the subjects of electronic servicing, how components work, and how they are combined to provide communication equipment. This book will help you understand the concepts required to service your own station equipment. \$7.95.\*

● **TOOLS & TECHNIQUES FOR ELECTRONICS**—BK7348—is an easy-to-understand book written for the beginning kit builder as well as the experienced hobbyist. It has numerous pictures and descriptions of the safe and correct ways to use basic and specialized tools for electronic projects as well as specialized metal working tools and the chemical aids which are used in repair shops. \$4.95.\*

● **THE CONTEST COOKBOOK**—BK7308—reveals the secrets of the contest winners (Domestic, DX and specialty contests), complete with photos and diagrams of equipment used by the top scorers. Find out how to make 150 contacts in one hour. \$5.95.\*

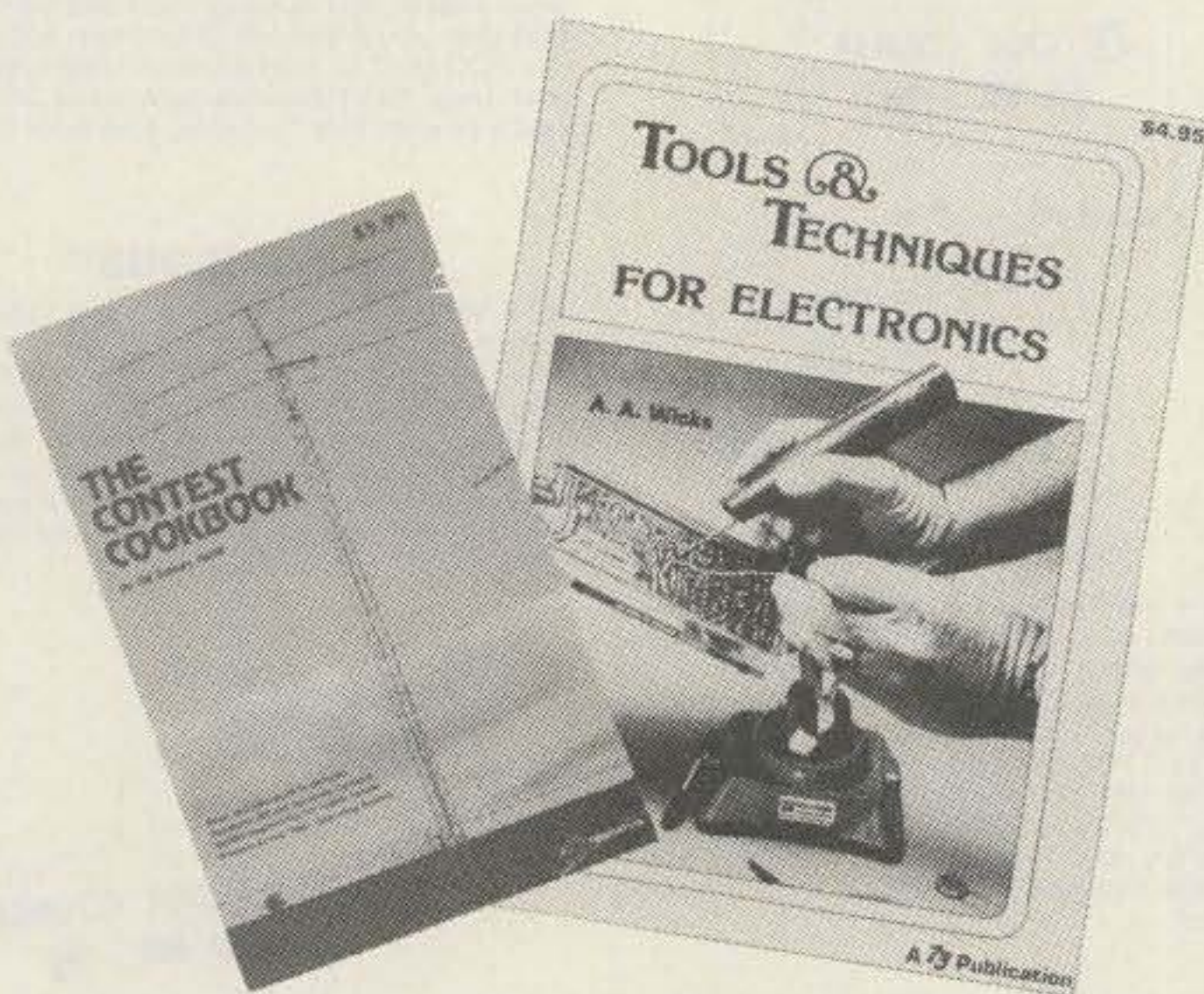

\*Use the order card in the back of this magazine or itemize your order on a separate piece of paper and mail to: 73 Radio Bookshop • Peterborough NH 03458. Be sure to include check or detailed credit card information. No C.O.D. orders accepted. \*Add \$1.00 handling charge. Note: Prices subject to change on books not published by 73 Magazine. Questions regarding your order? Please write to Customer Service at the above address. Please allow 4-6 weeks for delivery.

**FOR TOLL FREE ORDERING CALL 1-800-258-5473**



# Radio Bookshop

## TEST EQUIPMENT

● **RF AND DIGITAL TEST EQUIPMENT YOU CAN BUILD**—BK1044—Rf burst, function, square wave generators, variable length pulse generators—100 kHz marker, i-f and rf sweep generators, audio osc, af/rf signal injector, 146 MHz synthesizer, digital readouts for counters, several counters, prescaler, microwave meter, etc. 252 pages. \$5.95.\*

● **VOL. I COMPONENT TESTERS**—LB7359—... how to build transistor testers (8), diode testers (3), IC testers (3), voltmeters and VTVMs (9), ohmmeters (8 different kinds), inductance (3), capacity (9), Q measurement, crystal checking (6), temperature (2), aural meters for the blind (3) and all sorts of miscellaneous data on meters ... using them, making them more versatile, making standards. Invaluable book. \$4.95.\*

● **VOL. II AUDIO FREQUENCY TESTERS**—LB7360—... jam packed with all kinds of audio frequency test equipment. If you're into SSB, RTTY, SSTV, etc., this book is a must for you ... a good book for hi-fi addicts and experimenters, too! \$4.95.\*

● **VOL. III RADIO FREQUENCY TESTERS**—LB7361—Radio frequency waves, the common denominator of Amateur Radio. Such items as SWR, antenna impedance, line impedance, rf output and field strength; detailed instructions on testing these items includes sections on signal generators, crystal calibrators, grid dip oscillators, noise generators, dummy loads and much more. \$4.95.\*

● **VOL. IV IC TEST EQUIPMENT**—LB7362—Become a troubleshooting wizard! In this fourth volume of the 73 TEST EQUIPMENT LIBRARY are 42 home construction projects for building test equipment to work with your ham station and in servicing digital equipment. Plus a cumulative index for all four volumes of the 73 TEST EQUIPMENT LIBRARY. \$4.95.\*



## THE WELL-EQUIPPED HAM SHACK

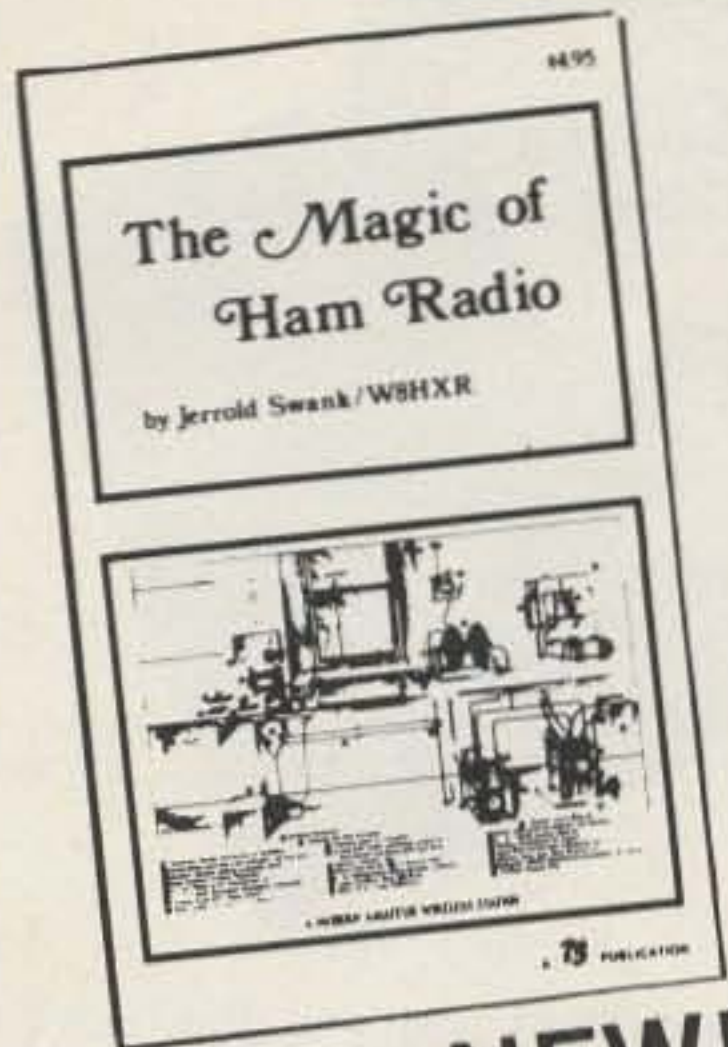

**NEW!**

● **THE MAGIC OF HAM RADIO**—BK7312—by Jerrold Swank, W8HXR begins with a brief history of amateur radio and of Jerry's involvement in it. Part 2 details many of ham radio's heroic moments. Hamdom's close ties with the continent of Antarctica are the subject of Part 3. In Part 4 the strange and humorous sides of ham life get their due. And what of the future? Part 5 peers into the crystal ball. \$4.95.\*

● **A GUIDE TO HAM RADIO**—BK7321—by Larry Kahaner WB2NEL. What's Amateur Radio all about? You can learn the basics of this fascinating hobby with this excellent beginner's guide. It answers the most frequently asked questions in an easy-going manner, and it shows the best way to go about getting an FCC license. A Guide to Ham Radio is an ideal introduction to a hobby enjoyed by people around the world. \$4.95.\*

● **HOW TO BUILD A MICROCOMPUTER—AND REALLY UNDERSTAND IT**—BK7325—by Sam Creason. The electronics hobbyist who wants to build his own microcomputer system now has a practical "How-To" guidebook. This book is a combination technical manual and programming guide that takes the hobbyist step-by-step through the design, construction, testing and debugging of a complete microcomputer system. Must reading for anyone desiring a true understanding of small computer systems. \$9.95.\*



● **LIBRARY SHELF BOXES**—These sturdy white, corrugated, dirt-resistant boxes each hold a full year of 73, *Kilobaud Microcomputing* or *80 Microcomputing*. With your order, request self-sticking labels for any of the following: 73, *Kilobaud Microcomputing*, *80 Microcomputing*, *CQ*, *QST*, *Ham Radio*, *Personal Computing*, *Radio Electronics*, *Interface Age*, and *Byte*. Order 1—BX1000—for \$2.00\*; order 2-7—BX2002—for \$1.50 each\*; order 8 or more—BX1002—for \$1.25 each\*.



Style Y



Style W

● **QSL CARDS**—73 turns out a fantastic series of QSL cards at about half the cost of having them done elsewhere because they are run as a fill-in between printing books and other items in the 73 Print Shop. 250 Style W—QW0250—for \$8.95\*; 500 Style W—QW0500—for \$13.95\*; 250 Style X—QX0250—for \$8.95\*; 500 Style X—QX0500—for \$13.95\*; 250 Style Y—QY0250—for \$8.95\*; 500 Style Y—QY0500—for \$13.95.\* Allow 6-12 wks. for delivery.

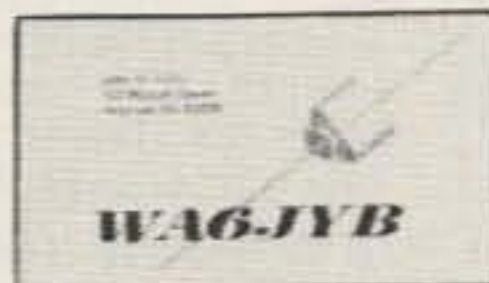

Style X

● **BACK ISSUES**—Complete your collection; many are prime collectables now, classics in the field! A full collection is an invaluable compendium of radio and electronics knowledge!

Single back issue—ST0000—\$3.00\*;  
25 our choice—ST2500—\$12.00\*;  
25 your choice—ST2501—\$25.00\*;  
5 your choice—ST0500—\$8.75\*;  
10 your choice—ST1000—\$14.00.\*

● **FREE BACK ISSUE CATALOGS** are yours for the asking ... specify 73 Magazine and/or *Kilobaud Microcomputing* back issue catalog when you send your name and address to us on a postcard.

## 73 MAGAZINE BINDERS

● Preserve and protect your collection for a lifetime! Order these handsome red binders with gold lettering. \$7.50 for 1, 3 for \$21.75, 6 for \$42.00. (Postpaid within USA, please add \$2.50 per order outside USA.) Check or money orders only, no phone or C.O.D. orders. 73 Binders, P.O. Box 5120, Philadelphia, PA 19141.

\*Use the order card in the back of this magazine or itemize your order on a separate piece of paper and mail to: 73 Radio Bookshop • Peterborough NH 03458. Be sure to include check or detailed credit card information. No C.O.D. orders accepted. \*Add \$1.00 handling charge. Note: Prices subject to change on books not published by 73 Magazine. Questions regarding your order? Please write to Customer Service at the above address. Please allow 4-6 weeks for delivery.

**FOR TOLL FREE ORDERING CALL 1-800-258-5473**



# Radio Bookshop

● **73 DIPOLE AND LONG-WIRE ANTENNAS**—BK1016—by Edward M. Noll W3FQJ. This is the first collection of virtually every type of wire antenna used by amateurs. Includes dimensions, configurations, and detailed construction data for 73 different antenna types. Appendices describe the construction of noise bridges, line tuners, and data on measuring resonant frequency, velocity factor, and swr. \$5.50.\*

● **THE GIANT BOOK OF AMATEUR RADIO ANTENNAS**—With the **GIANT Book of Amateur Radio Antennas**—BK1104—by your side, antennas will become the least of your worries. Over 450 pages of design ideas, theory and reference data make this book live up to its title. The 7 chapters cover everything from basic antenna theory through designs for DIY accessories, as well as dozens of antenna designs. Whether planning to build or buy, design or admire, test or enjoy a ham antenna—this is the book for you. From the editors of 73; published by Tab Books. Hardcover \$12.95.\*

● **73 VERTICAL, BEAM AND TRIANGLE ANTENNAS**—BK1069—by Edward M. Noll W3FQJ. Describes 73 different antennas for amateurs. Each design is the result of the author's own experiments covering the construction of noise bridges and antenna line tuners, as well as methods for measuring resonant frequency, velocity factor, and standing-wave ratios. 160 pages. \$5.50.\*

● **VHF ANTENNA HANDBOOK**—BK7368—The **NEW VHF Antenna Handbook** details the theory, design and construction of hundreds of different VHF and UHF antennas . . . A practical book written for the average amateur who takes joy in building, not full of complex formulas for the design engineer. Packed with fabulous antenna projects you can build. \$5.95.\*

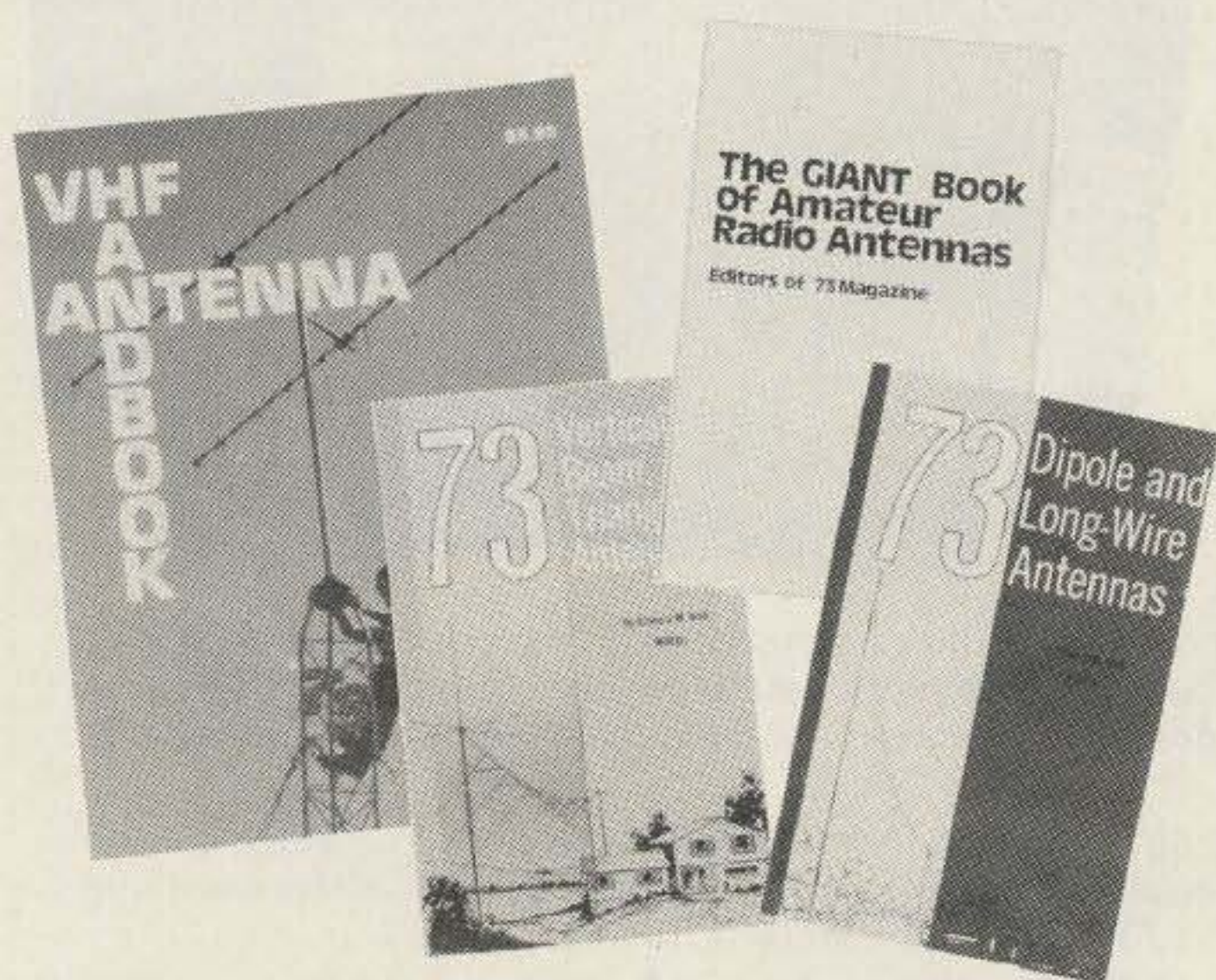

● **PRACTICAL ANTENNAS FOR THE RADIO AMATEUR**—BK1015—A manual describing how to equip a ham station with a suitable antenna. A wide range of antenna topics, systems, and accessories are presented giving the reader some food for thought and practical data for construction. Designed to aid the experienced ham and novice as well. Only \$9.95.\*

● **TTL COOKBOOK**—BK1063—by Donald Lancaster. Explains what TTL is, how it works, and how to use it. Discusses practical applications, such as a digital counter and display system, events counter, electronic stopwatch, digital voltmeter and a digital tachometer. \$9.50.

● **CMOS COOKBOOK**—BK1011—by Don Lancaster. Details the application of CMOS, the low power logic family suitable for most applications presently dominated by TTL. Required reading for every serious digital experimenter! \$10.50.\*

● **TVT COOKBOOK**—BK1064—by Don Lancaster. Describes the use of a standard television receiver as a microprocessor CRT terminal. Explains and describes character generation, cursor control and interface information in typical, easy-to-understand Lancaster style. \$9.95.\*

● **RTL COOKBOOK**—BK1059—by Donald Lancaster. Explains the how and why of RTL (Resistor-Transistor Logic) and gives design information that can be put to practical use. Gives a multitude of digital applications ranging from the basic switch to the sophisticated counter. 240 pages; \$6.50.\*

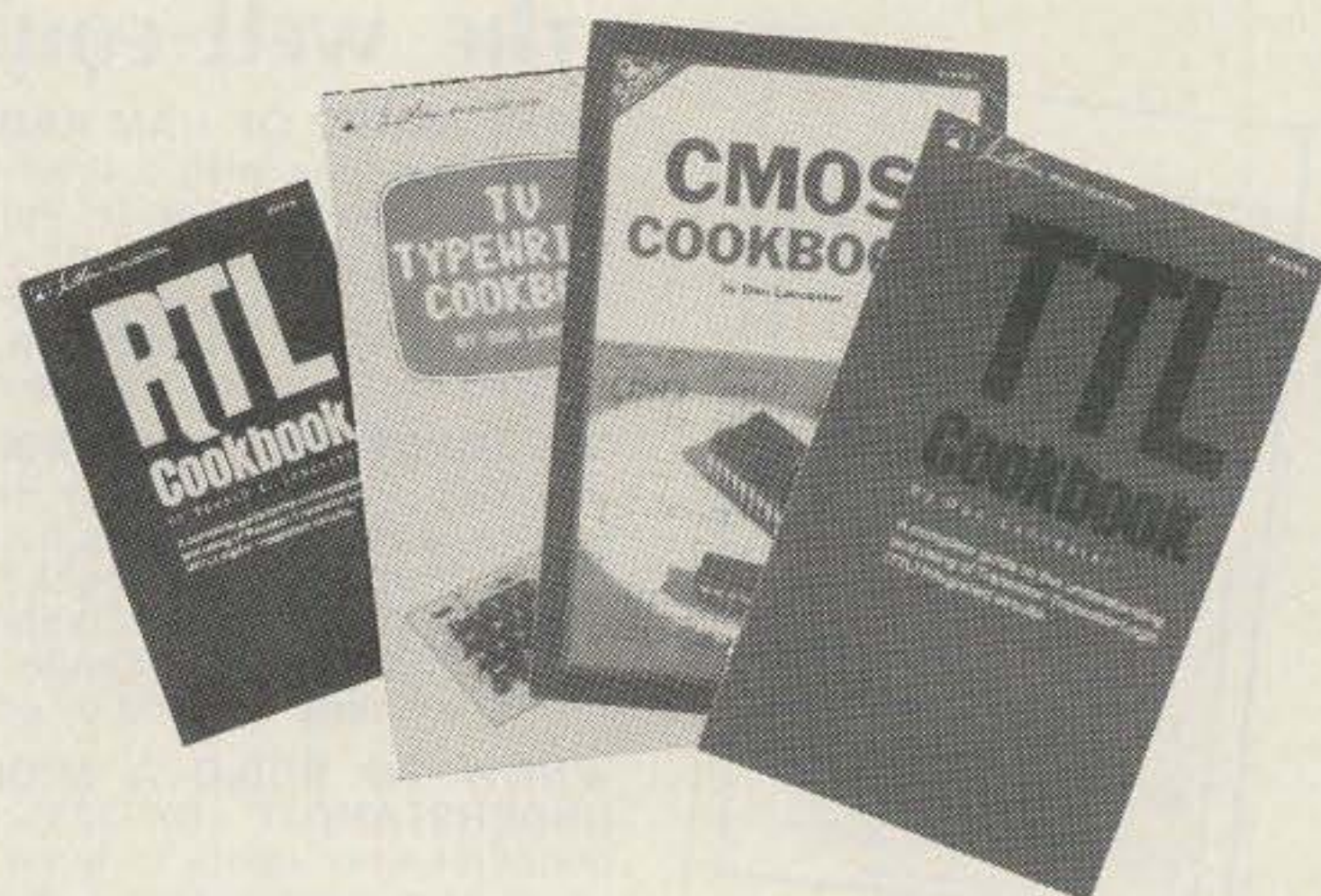

**NEW** ● **40 COMPUTER GAMES FROM KILOBAUD MICROCOMPUTING**—BK7381—Forty games in all in nine different categories. Games for large and small systems, and even a section on calculator games. Many versions of BASIC used and a wide variety of systems represented. A must for the serious computer gamesman. \$7.95\*

**NEW** ● **UNDERSTANDING AND PROGRAMMING MICROCOMPUTERS**—BK7382—A valuable addition to your computing library. This two part text includes the best articles that have appeared in 73 and Kilobaud Microcomputing magazines on the hardware and software aspects of the new microcomputing hobby. Well known authors and well structured text helps the reader get involved in Americas fastest growing hobby. \$10.95\*

● **HOBBY COMPUTERS ARE HERE!**—BK7322—If you want to come up to speed on how computers work . . . hardware and software . . . this is an excellent book. It starts with the fundamentals and explains the circuits, the basics of programming, along with a couple of TVT construction projects, ASCII-Baudot, etc. This book has the highest recommendations as a teaching aid for newcomers. \$4.95.\*

● **THE NEW HOBBY COMPUTERS**—BK7340—This book takes it from where **Hobby Computers Are Here!** leaves off, with chapters on Large Scale Integration, how to choose a microprocessor chip, an introduction to programming, low cost I/O for a computer, computer arithmetic, checking memory boards, a Baudot monitor/editor system, an audible logic probe for finding those tough problems, a ham's computer, a computer QSO machine . . . and much, much more! \$4.95\*

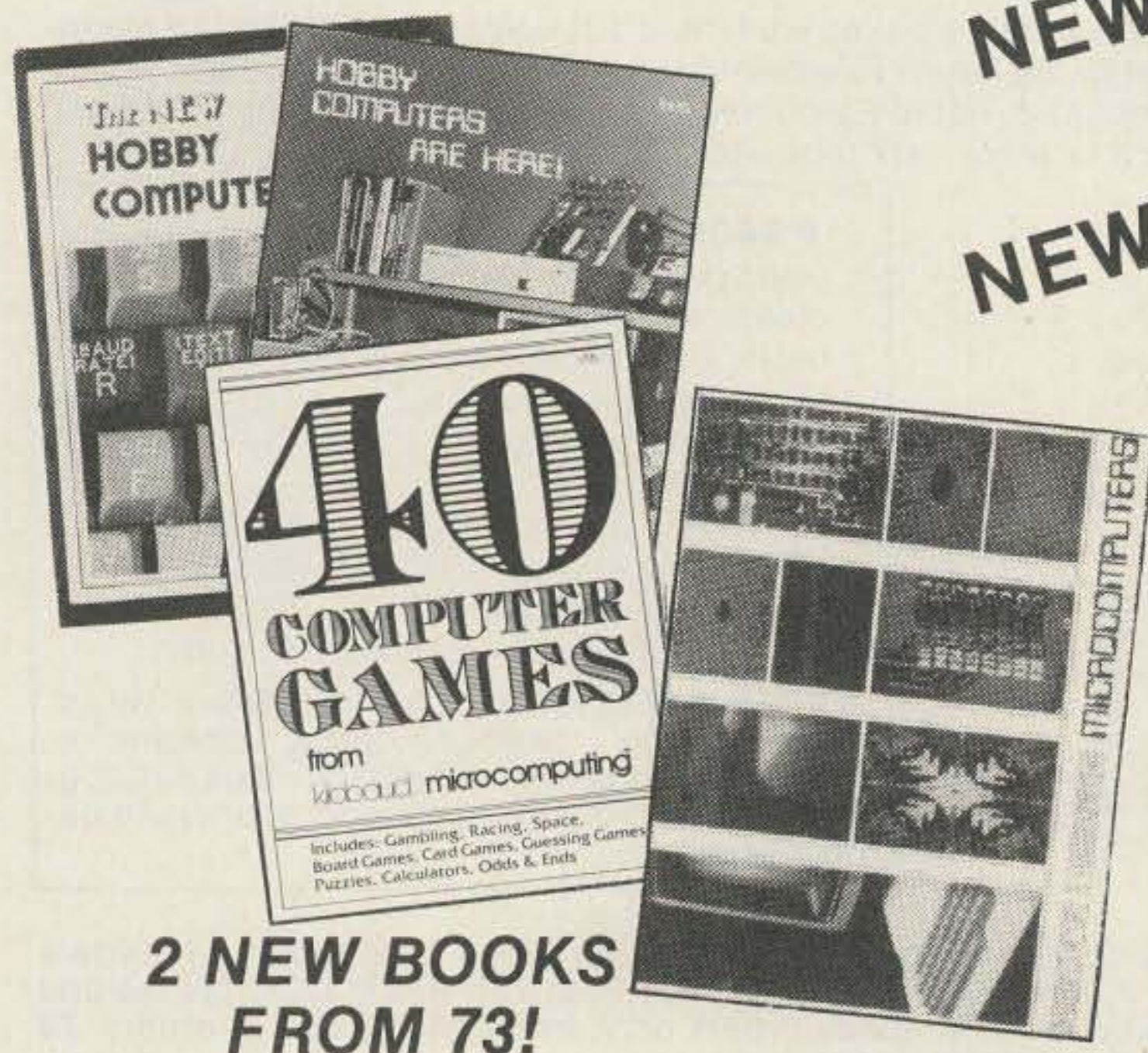

**2 NEW BOOKS FROM 73!**

\*Use the order card in the back of this magazine or itemize your order on a separate piece of paper and mail to: 73 Radio Bookshop • Peterborough NH 03458. Be sure to include check or detailed credit card information. No C.O.D. orders accepted. \*Add \$1.00 handling charge. Note: Prices subject to change on books not published by 73 Magazine. Questions regarding your order? Please write to Customer Service at the above address. Please allow 4-6 weeks for delivery.

**FOR TOLL FREE ORDERING CALL 1-800-258-5473**



# DEALER DIRECTORY

## San Leandro CA

Specializing in Amateur Radio Test Guides, F.C.C. Advanced Class test is a snap with our manual. **Bash Educational Services, 15373 Edgemoor St., P.O. Box 382, San Leandro CA 94577.**

## Denver CO

Experimenter's paradise! Electronic and mechanical components for computer people, audio people, hams, robot builders, experimenters. Open six days a week. **Gateway Electronics Corp., 2839 W. 44th Ave., Denver CO 80211, 458-5444.**

## Uncasville CT

Cushcraft, Bencher, Hy-Gain, Telex, Barker & Williamson, Nye-Viking, Hustler, MFJ, Callbook, Murch, Unadilla, OK, Saxton, ARRL Books, Used equipment, Electronic parts and accessories, free catalog. **Donovan Electronics, Inc., 2510 Norwich, New London Tpke, Uncasville CT 06382, 848-3434.**

## New Castle DE

ICOM, Ten-Tek, Swan, KDK, NDI, Tempo, Wilson; Authorized dealer; 1 mile off I-95. No sales tax. **Delaware Amateur Supply, 71 Meadow Road, New Castle DE 19720, 328-7728.**

## Columbus GA

### KENWOOD—YAESU—DRAKE

The world's most fantastic amateur show-room! You gotta see it to believe it! **Radio Wholesale, 2012 Auburn Avenue, Columbus GA 31906, 561-7000.**

## Boise ID

Adzen, Amidon, Ameco, ARRL, B&W, Callbook, Collins, CushCraft, Dentron, Hustler, ICOM, Jim-Pak, KDK, MFJ, NPC, Nye, Sams, SST, Swan, Ten-Tec, Wanzer, Wilson. **Custom Electronics, 1209 Broadway, Boise ID 83706, Bob W7SC 344-5084.**

## Preston ID

Ross WB7BYZ, has the Largest Stock of Amateur Gear in the Intermountain West and the Best Prices. Call me for all your ham needs. **Ross Distributing, 78 So. State, Preston ID 83263, 852-0830.**

## Terre Haute IN

Your ham headquarters located in the heart of the midwest. **Hoosier Electronics, Inc., 43B Meadows Shopping Center, P.O. Box 2001, Terre Haute IN 47802, 238-1456.**

## Littleton MA

The ham store of N.E. you can rely on. Kenwood, ICOM, Wilson, Yaesu, DenTron, KLM amps, B&W switches & wattmeters, Whistler radar detectors, Bearcat, Regency, antennas by Larsen, Wilson, Hustler, GAM. **TEL-COM Inc. Communications & Electronics, 675 Great Rd., Rt. 119, Littleton MA 01460, 486-3040.**

## Laurel MD

Kenwood, Drake, ICOM, Ten-Tec, Swan, Dentron, Tempo and many ham accessories. Also computers by Apple and Exidy. Call toll free 1-800-638-4486. **The Comm Center, Inc., Laurel Plaza—Rt. 198, Laurel MD 20810.**

## St. Louis MO

Experimenter's paradise! Electronic and mechanical components for computer people, audio people, hams, robot builders, experimenters. Open six days a week. **Gateway Electronics Corp., 8123-25 Page Blvd., St. Louis MO 63130, 427-6116.**

## Syracuse-Rome-Utica NY

Featuring: Yaesu, ICOM, Drake, Atlas, Dentron, Ten-Tec, Swan, Tempo, KLM, Hy-Gain, Mosley, Wilson, Larsen, Midland Southwest Technical Products. You won't be disappointed with equipment/service. **Radio World, Oneida County Airport-Terminal Building, Oriskany NY 13424, 337-2622.**

## Phila. PA/Camden NJ

Waveguide & coaxial microwave components & equipment. Laboratory grade test instruments, power supplies. Buy, sell & trade all popular makes, HP, GR, FXR, ESI, Sorensen, Singer, etc. **Lectronic Research Labs., 1423 Ferry Ave., Camden NJ 08104, 541-4200.**

## Columbus OH

All major brands featured in the biggest and best ham store for miles around. Come in and twist the knobs before you buy. We ship U.P.S. too. **Universal Amateur Radio, Inc., 1280 Aida Dr., Reynoldsburg (Columbus) OH 43068, 866-4267.**

## Houston TX

Experimenter's paradise! Electronic and mechanical components for computer people, audio people, hams, robot builders, experimenters. Open six days a week. **Gateway Electronics Inc., 8932 Clarkcrest, Houston TX 77063, 978-6575.**

## San Antonio TX

Complete 2 way service shop. Call Dee, W5FSP. Selling Antenna Specialists, Avanti, Azden, Bird, Hy-gain, Standard communications, Genave, Henry, CushCraft, Dielectric, Hustler, ICOM, MFJ, Nye, Shure, Swan, Tempo, Ten-Tec and others. **Appliance & Equipment Co., Inc., 2317 Vance Jackson Road, San Antonio TX 78213, 734-7793.**

## DEALERS

*Your company name and message can contain up to 25 words for as little as \$150 yearly (prepaid), or \$15 per month (prepaid quarterly). No mention of mail-order business or area code permitted. Directory text and payment must reach us 60 days in advance of publication. For example, advertising for the November issue must be in our hands by September 1st. Mail to 73 Magazine, Peterborough NH 03458. ATTN: Nancy Ciampa.*

# PROPAGATION

by  
J. H. Nelson

Due to unforeseen circumstances, J. H. Nelson's "Propagation" was unavailable this month. His column will resume soon.

## Social Events

from page 167

Features will include a gigantic flea market, an ARRL movie, an audio/visual tour of a Heathkit factory, a Novice forum, an XYL program, and a CW contest. Talk-in on 146.22/.82. For tickets or an information package, send an SASE to Box 164, St. Joseph MI 49085.

### REVERE MA OCT 19

The 19-79 Repeater Association of Malden MA will hold its first annual flea market on Sunday, October 19, 1980, from 11:00 am to 4:00 pm (sellers will be admitted at 10:00 am) at the Beachmont VFW Post, 150 Bennington Street, Revere MA. Admission is \$1.00. Sellers' tables are \$5.00 in advance and \$7.50 at the door, if available. Talk-in on

.19/.79 and .52. For table reservations, send a check to 19-79 Repeater Association, PO Box 221, Malden MA 02148.

### SO GREENSBURG PA NOV 8

The Foothills ARC will hold its annual Swap & Shop on Saturday, November 8, 1980, at the St. Bruno's Church in South Greensburg PA. Doors will be open from 9:00 am until 5:00 pm. Dealers are welcome. The main prize is a complete HF antenna system, including a triband beam, a 40-foot tower, a rotor, thrust bearing, and cable. Second prize is an Icom IC-2A handheld. Talk-in on 146.07/.67 and .52. For advance table reservations, phone Jim Yex WB3CQA at (412)-256-3531. For more information, phone Chuck Hamman WB3HJM at (412)-837-9194.

## Ham Help

I'm looking for a Heath HW-8 transceiver. Please include description and prepaid prices. Thanks.

**Dante Ventriere KA4JRE  
17831 NW 81 Ave.  
Hialeah FL 33015**

Has anyone made any improvements to the Heathkit SW-717 receiver? I would like to include them on mine.

**Jose Faginas LU7AIM  
Conde 2556 PB DTO D  
Buenos Aires  
Argentina**

I am in need of the schematic, parts manual, and alignment instructions for an EICO 235 professional VTVM. If needed, I will copy and return any materials.

**R.L. Wood WA7DNN/KH2  
51 Betel Palm Rd. (NCS)  
FPO San Francisco 96630**

I would be happy to pay postage both ways if someone would loan me a copy of the manual for an EICO 723 60-Watt CW transmitter.

**Greg Magarie WA1VIL  
33 Barnesdale Rd.  
Natick MA 01760**

I am a subscriber to your magazine, and new to ham radio. I have a question: Is there a way (simple) to add a sidetone to my Heathkit DX-60A transmitter? I quite frankly don't see how. CW is impossible without it!! How can you tell what you are sending????

If anyone can help, I would appreciate it.

**John Comney  
Box 1248  
AFAF  
Gila Bend AZ 85337**



# List of AdvertisERS

To receive full information from our advertisers please complete the following postage-paid card.

R.S. No.	Page	R.S. No.	Page	R.S. No.	Page	R.S. No.	Page
349	AEA/Advanced Elect. Applica.....51	25	Germantown Amat. Supply.....42	313	Micro Management Systems.....31	316	Telex Comm., Inc.....35, 37, 39
350	AEA/Advanced Elect. Applica.....103	28	Godbout Electronics.....180	50	Microcraft Corp.....133	478	Telex Comm., Inc.....39
3	AED Electronics.....83	352	Grove Enterprises.....133	479	Microcraft Corp.....37	*	Ten-Tec, Inc.....11, 33
6	AMC Engineering.....125	480	Grove Enterprises.....38	51	Microlog Corp.....21	76	Trac Electronics.....15
300	Aldelco.....161, 168	304	HFT, Inc.....128	52	MidCom Electronics, Inc.....58	77	Tufts Radio Electronics.....138-149
5	Amateur-Wholesale Elect.....13, 178	345	Hal Comm.....17, 24	355	N&G Distributing Corp.....19	351	Universal Comm.....129
7	American Crystal Supply.....128	31	Hal-Tronix.....51, 69	318	National Comm. Group Co.....63	311	Vanguard Labs.....128
334	Amidon Associates.....137	30	The Ham-Key Co.....54	54	OK Machine & Tool.....99	86	Vineyard Amateur Radio.....170
356	Anteck, Inc.....161	32	Ham Radio Center.....55	55	Optoelectronics, Inc.....42	90	VoCom Products Corp.....120
301	Appl. & Equip. Co., Inc.....128	33	Hamtronics, NY.....173	325	Outdoor Outfitters.....129	80	Western Electronics.....161
8	Apron Laboratories.....78	303	Heath Co.....3	57	P.C. Electronics.....54	*	Wilson Systems, Inc.....26-30
*	Associated Radio.....182	34	Henry Radio.....Cov II	*	Palomar Engineers.....15	82	Xitex Corp.....63
10	Avanti Research & Develop.....117	305	Hustler, Inc.....66	*	Partridge Electronics.....133	83	Yaesu Elect. Corp.....Cov III, 43, 87
11	Barker-Williamson.....120	316	Hy-Gain Div. of Telex Comm., Inc. .....35, 37, 39	58	Poly Paks.....183		
12	Bullet Electronics.....188	478	Hy-Gain Div. of Telex Comm., Inc. .....39	60	Quest Electronics.....169		
484	Circuit Specialists.....38			342	RF Gain, Ltd.....89		
13	Clegg.....59	*	IRL.....124	63	RF Power Labs, Inc.....86		
89	Clutterfree Modular Consoles.....137	*	ICOM.....7, 34	61	Radio Amateur Callbook, Inc.....79		
14	Comm Center, NE.....67, 115	482	Instant Software.....38	483	Radio Shack.....160		
15	Comm Specialists.....8, 9	339	J-T Electronics Supply, Inc.....128	*	Radio World.....133		
340	Computer Systems.....128	38	Jameco Electronics.....181	62	Ramsey Electronics.....176, 179		
481	Con-puter 1.....34	39	Jan Crystals.....125	65	S-F Amateur Radio Services.....125		
16	Crown Micro Prod.....137	354	Jensen Tools, Inc.....129	64	Semiconductors Surplus.....174, 175		
330	Debco Electronics.....117	40	KLM Electronics.....114	*	73 Magazine.....99, 113, 161, 189-193		
346	Data Service.....129	*	KB Microcomputing.....61	66	Signalcrafters, Inc.....164		
357	Delta Products.....133	*	Kenwood.....Cov IV, 5	477	Soundpower.....36		
17	Dielectric Comm.....83	*	LaRue Electronics.....161	317	Space Electronics.....128		
*	Digital Research Parts.....172	43	Lunar Electronics.....129	309	Spacecoast Research.....129		
*	80 Microcomputing.....61	47	MFJ Enterprises.....79, 119, 125, 164	67	Spectronics.....177		
71	Electronics Book Club.....23	48	MHz Electronics.....184-187	68	Spectrum Comm.....75		
22	Fair Radio Sales.....128	53	MOM'S.....100, 101	69	Surplus Electronics.....171		
23	Flesher Corp.....83	44	Macrotronics.....79, 164	355	Swan Electronics.....19		
323	Fox-Tango Corp.....124	46	Maggiore Electronic Lab.....129	476	Swan Electronics.....32		
27	G.I.S.M.O.....121	49	Micro Control Specialties.....89	73	TET, USA.....123		
24	Gemini Instrument Co.....128			324	THS Electronics.....16		

\*Please contact these advertisers directly.

## 73 magazine peterborough, n.h. 03458

### Books, ETC.

To order, complete the following postage-paid card, or itemize your order including detailed credit card information or check and mail to:  
73 Magazine/Mail Order Dept./Peterborough NH 03458.

Catalog #	Item	Price	Catalog #	Item	Price	Catalog #	Item	Price
BK1016	73 DIPOLE & LONG WIRE ANTENNAS	\$ 5.50	BK1033	MASTER HANDBOOK OF HAM RADIO CIRCUITS	\$ 8.95	SG1080	STUDY GUIDE—EXTRA CLASS.....	\$ 5.95
ST0000	73 BACK ISSUE.....	\$ 3.00	BK7340	THE NEW HOBBY COMPUTERS.....	\$ 4.95	SG7358	STUDY GUIDE—GENERAL CLASS..	\$ 5.95
ST2500	73 BACK ISSUES—25 OUR CHOICE..	\$12.00	CT7300	NOVICE THEORY TAPES.....	\$15.95	SG7357	STUDY GUIDE—NOVICE CLASS.....	\$ 4.95
ST0500	73 BACK ISSUES—5 YOUR CHOICE..	\$ 8.75	BK7310	OWNER REPAIR OF RADIO EQUIPMENT	\$ 7.95	LB7359	TEST EQUIP LIB V1—COMPONENT TESTERS.....	\$ 4.95
ST1000	73 BACK ISSUES—10 YOUR CHOICE	\$14.00	BK7305	POWER SUPPLY HANDBOOK.....	\$ 7.95	LB7360	TEST EQUIP LIB V2—AUDIO TESTERS	\$ 4.95
ST2501	73 BACK ISSUES—25 YOUR CHOICE	\$25.00	BK1015	PRACTICAL ANTENNAS FOR THE RADIO AMATEUR.....	\$ 9.95	LB7361	TEST EQUIP LIB V3—RADIO EQUIP..	\$ 4.95
BK7307	BEHIND THE DIAL.....	\$ 4.95	BK7302	PROPAGATION WIZARD'S HANDBOOK	\$ 6.95	LB7362	TEST EQUIP LIB V4—IC TEST EQ....	\$ 4.95
BK7309	CHALLENGE OF 160.....	\$ 4.95	QW0250	QSL CARDS—STYLE W—250.....	\$ 8.95	BK7348	TOOLS & TECHNIQUES.....	\$ 4.95
CT7305	CODE TAPE—5 WPM.....	\$ 4.95	QW0500	QSL CARDS—STYLE W—500.....	\$13.95	BK1063	TTL COOKBOOK.....	\$ 9.50
CT7306	CODE TAPE—6 + WPM.....	\$ 4.95	QX0250	QSL CARDS—STYLE X—250.....	\$ 8.95	BK1064	TVT COOKBOOK.....	\$ 9.95
CT7313	CODE TAPE—13 + WPM.....	\$ 4.95	QX0500	QSL CARDS—STYLE X—500.....	\$13.95	BK7382	UNDERSTANDING & PROGRAMMING MICROCOMPUTERS.....	\$10.95
CT7320	CODE TAPE—20 + WPM.....	\$ 4.95	QY0250	QSL CARDS—STYLE Y—250.....	\$ 8.95	BK1069	VERTICAL BEAM & TRIANGLE ANTNS	\$ 5.50
CT7325	CODE TAPE—25 + WPM.....	\$ 4.95	QY0500	QSL CARDS—STYLE Y—500.....	\$13.95	BK7368	VHF ANTENNA HANDBOOK.....	\$ 5.95
CT7394	CODE TAPES (ANY FOUR ABOVE).....	\$15.95	BK1044	RF & DIGITAL TEST EQUIPMENT.....	\$ 5.95	BK7370	WEATHER SATELLITE HANDBOOK..	\$ 4.95
BK7308	THE CONTEST COOKBOOK.....	\$ 5.95	BK7347	RTTY HANDBOOK.....	\$ 5.95			
BK7381	40 COMPUTER GAMES.....	\$ 7.95	BK1059	RTL COOKBOOK.....	\$ 6.50			
BK7304	GIANT BOOK OF AMATEUR RADIO ANTENNAS.....	\$12.95	BX1000	SHELF BOX—1.....	\$ 2.00			
BK7322	HOBBY COMPUTERS ARE HERE.....	\$ 4.95	BX1001	SHELF BOXES—2-7.....	\$1.50 each			
BK7325	HOW TO BUILD A MICROCOMPUTER & REALLY UNDERSTAND IT.....	\$ 9.95	BX1002	SHELF BOXES—8 AND UP.....	\$1.25 each			
BK1028	IC OP AMP COOKBOOK.....	\$12.95	BK7351	SSB THE MISUNDERSTOOD MODE..	\$ 5.50			
BK7312	MAGIC OF HAM RADIO.....	\$ 4.95	CT7350	SSTV TAPE.....	\$ 5.95			
			SG1081	STUDY GUIDE—ADV. CLASS.....	\$ 6.95			



# Tomorrow's Technology—Here Today!

## THE YAESU FT-207R

The "horse-and-buggy" days of crystal-controlled handies are gone! Yaesu's engineers have harnessed the power of the microprocessor, bringing you 800 channels, digital display, memory, and scanning from a hand-held package. Only with Yaesu can you get these big performance features in such a compact package.

**FALL \$349 SPECIAL!**

includes  
FT-207R

**NBP-9 BATTERY PACK  
NC-9B WALL CHARGER  
AND MINI EARPHONE**



### SPECIFICATIONS:

#### GENERAL

**Frequency coverage:** 144-148 MHz  
**Number of channels:** 800  
**Emission type:** F3  
**Batteries:** NiCd battery pack  
**Voltage requirement:** 10.8 VDC  
 $\pm 10\%$ , maximum  
**Current consumption:**  
 Receive: 35 mA squelched (150 mA unsquelched with maximum audio)  
 Transmit: 800 mA (full power)  
**Case dimensions:** 68x181x54 mm (HWD)  
**Weight (with batteries):** 680 grams

#### RECEIVER

**Circuit type:** Double conversion superheterodyne  
 Intermediate frequencies.  
 1st IF = 10.7 MHz  
 2nd IF = 455 kHz  
**Sensitivity:** 0.32  $\mu$ V for 20 dB quieting  
**Selectivity:**  $\pm 7.5$  kHz at 60 dB down  
**Audio Output:** 200 mW at 10% THD

Price And Specifications Subject To Change Without Notice Or Obligation

#### TRANSMITTER

**Power Output:** 2.5 watts minimum /200mW  
**Deviation:**  $\pm 5$  kHz  
**Spurious radiation:** -60 dB or better  
**Microphone:** Condenser type (2000 ohms)

#### OPTIONS

LC-C7 Leather Carrying Case  
 YM-24 Remote Speaker/Microphone  
 Tone Squelch Unit

**YAESU**  
The radio.



180



# Small wonder.

Processor, N/W switch, IF shift, DFC option



## TS-130S/V

An incredibly compact, full-featured, all solid-state HF SSB/CW transceiver for both mobile and fixed operation. It covers 3.5 to 29.7 MHz (including the three new Amateur bands!) and is loaded with optimum operating features such as digital display, IF shift, speech processor, narrow/wide filter selection (on both SSB and CW), and optional DFC-230 digital frequency

controller. The TS-130S runs high power and the TS-130V is a low-power version for QRP applications.

Ask your Authorized Kenwood Dealer about the compact, full-featured, all solid-state TS-130 Series.

**NOTE:** Price, specifications subject to change without notice and obligation.



...pacesetter in amateur radio

TRIO-KENWOOD COMMUNICATIONS INC.  
1111 WEST WALNUT / COMPTON, CA 90220



### Optional DFC-230 Digital Frequency Controller

Allows frequency control in 20-Hz steps with UP/DOWN microphone (supplied with DFC-230). Includes four memories (handy for split-frequency operation) and digital display. Covers 100 kHz above and below each 500-kHz band. Very compact.