

June 1981 \$2.95

# **73** MAGAZINE

*FOR RADIO AMATEURS*

**Plain Language Rules:  
Disaster Area?**

**Direction-Finding:  
Open Season on Turkeys**



# tempo does it again



## THE WORLD'S FIRST 440 MHz SYNTHESIZED HAND HELD RADIO

Tempo was the first with a synthesized hand held for amateur use, first with a 220 MHz synthesized hand held, first with a 5 watt output synthesized hand held...and once again first in the 440 MHz range with the S-4, a fully synthesized hand held radio. Not only does Tempo offer the broadest line of synthesized hand holds, but its standards of reliability are unsurpassed...reliability proven through millions of hours of operation. No other hand held has been so

thoroughly field tested, is so simple to operate or offers so much value. The Tempo S-4 offers the opportunity to get on 440 MHz from where ever you may be. With the addition of a touch tone pad and matching power amplifier its versatility is also unsurpassed.

The S-4...\$349.00  
With 12 button touch tone pad...\$399.00  
With 16 button touch tone pad...\$419.00  
S-40 matching 40 watt output  
13.8 VDC power amplifier...\$149.00



### Tempo S-1

The first and most thoroughly field tested hand held synthesized radio available today. Many thousands are now in use and the letters of praise still pour in. The S-1 is the most simple radio to operate and is built to provide years of dependable service. Despite its light weight and small size it is built to withstand rough handling and hard use. Its heavy duty battery pack allows more operating time between charges and its new lower price makes it even more affordable.



### Tempo S-5

Offers the same field proven reliability, features and specifications as the S-1 except that the S-5 provides a big 5 watt output (or 1 watt low power operation). They both have external microphone capability and can be operated with matching solid state power amplifiers (30 watt or 80 watt output). Allows your hand held to double as a powerful mobile or base radio.

S-30...\$89.00\* S-80...\$149.00\*

\*For use with S-1 and S-5



### Tempo S-2

With an S-2 in your car or pocket you can use 220 MHz repeaters throughout the U.S. It offers all the advanced engineering, premium quality components and features of the S-1 and S-5. The S-2 offers 1000 channels in an extremely lightweight but rugged case. If you're not on 220 this is the perfect way to get started. With the addition of the S-20 Tempo solid state amplifier it becomes a powerful mobile or base station. If you have a

220 MHz station, the S-2 will add tremendous versatility. Price...\$349.00 (With touch tone pad installed...\$399.00)

S-20...\$89.00

#### Specifications:

Frequency Coverage: 440 to 449.995 MHz  
Channel Spacing: 25 KHz minimum  
Power Requirements: 9.8 VDC  
Current Drain: 17 ma-standby 400 ma-transmit (1 amp high power)  
Antenna Impedance: 50 ohms  
Sensitivity: Better than .5 microvolts nominal for 20 db  
Supplied Accessories: Rubber flex antenna 450 ma ni-cad battery pack, charger and earphone  
RF output Power: Nominal 3 watts high or 1 watt low power  
Repeater Offset: ± 5 MHz

#### Optional Accessories for all models

12 button touch tone pad (not installed): \$39 • 16 button touch tone pad (not installed): \$48 • Tone burst generator: \$29.95  
• CTCSS sub-audible tone control: \$29.95 • Leather holster: \$20 • Cigarette lighter plug mobile charging unit: \$6

#### TEMPO VHF & UHF SOLID STATE POWER AMPLIFIERS

Boost your signal... give it the range and clarity of a high powered base station. VHF (135 to 175 MHz)

Drive Power	Output	Model No.	Price
2W	130W	130A02	\$209
10W	130W	130A10	\$189
30W	130W	130A30	\$199
2W	80W	80A02	\$169
10W	80W	80A10	\$149
30W	80W	80A30	\$159
2W	50W	50A02	\$129
2W	30W	30A02	\$ 89

UHF (400 to 512 MHz) models, lower power and FCC type accepted models also available.



✓ 34

# Henry Radio

2050 S. Bundy Dr., Los Angeles, CA 90025 (213) 820-1234  
931 N. Euclid, Anaheim, CA 92801 (714) 772-9200  
Butler, Missouri 64730 (816) 679-3127

TOLL FREE ORDER NUMBER: (800) 421-6631  
For all states except California.  
Calif. residents please call collect on our regular numbers.  
Prices subject to change without notice.

Please note, as of Dec. 1, 1980 we will occupy our new world headquarters building with a new Los Angeles address and phone number.

# FIVE STORE BUYING POWER! SPRING SPECIALS

SHIPPING REGULARLY TO COUNTRIES IN ALL CONTINENTS.

**SERVING HAMS  
BETTER.**

North...south...east...west.



Bob Ferrero, W6RJ/K6AHV,  
Jim Rafferty, N6RJ  
other well known hams  
give you courteous,  
personalized  
service.

**FREE PHONE**

**800  
854-6046**

CALIF. CUSTOMERS PLEASE  
CALL OR VISIT LISTED STORES

**FREE  
SHIPMENT**

(UPS Brown)

CONTINENTAL  
U.S.A.



**HAM  
RADIO  
OUTLET™**

**ANAHEIM, CA 92801**

2620 W. La Palma,  
(714) 761-3033 (213) 860-2040  
Between Disneyland & Knott's Berry Farm

**BURLINGAME, CA 94010**

999 Howard Ave., (415) 342-5757  
5 miles south on 101 from S.F. Airport.

**OAKLAND, CA 94609**

2811 Telegraph Ave., (415) 451-5757  
Hwy 24 Downtown. Left 27th off-ramp.

**SAN DIEGO, CA 92123**

5375 Kearny Villa Road (714) 560-4900  
Hwy 163 & Clairemont Mesa Blvd.

**VAN NUYS, CA 91401**

6265 Sepulveda Blvd., (213) 988-2212  
San Diego Fwy at Victory Blvd.

**OVER-THE-COUNTER**

Mon. thru Sat. 10AM to 5:30PM

AEA • ALLIANCE • ALPHA • AMECO • AMPHENOL • ARRL • ASTRON  
• AVANTI • BENCHER • BERK-TEK • BIRD • B&W • CALLBOOK • CDE  
• COLLINS • CUBIC • CURTIS • CUSHCRAFT • DAIWA • DATONG  
• DENTRON • DRAKE • DX ENGINEERING • EIMAC • HUSTLER  
• HY-GAIN • ICOM • J.W.MILLER • KENWOOD • KLM • LARSEN  
• LUNAR • METZ • MFJ • MICRO-LOG • MINI-PRODUCTS  
• MIRAGE • NYE • PALOMAR • ROBOT • ROHN • SHURE • SWAN  
• TELEX • TELREX • TEMPO • TEN-TEC • TRISTAO  
• YAESU and many more!



**77DX**  
REGULAR  
\$4945 \*

**78**  
REGULAR  
\$3185 \*



\* CALL NOW FOR YOUR SPRING SPECIAL PRICES



**76PA**  
REGULAR  
\$2195 \*

**374A**  
REGULAR  
\$2395 \*



**YAESU FT-207R  
HANDIE**  
REGULAR  
\$299 \*

Includes:  
NBP-9  
battery pack.  
NC-9B wall charger.  
FEP-1 earphone,  
rubber flex. ant.

\*ASK FOR YOUR PRICE



**MIRAGE B-1016 2M  
AMPLIFIER**  
160 W OUTPUT  
SSB, FM, CW.

Freq. range: 144-148MHz • RF out: 160W nom.  
(10W in). • RF power in: 5-15W • DC operating  
pwr: 13.8VDC @ 20-25A • Intermittent duty  
cycle • Built-in receiver pre-amp. Auto-  
matic internal or external relay keying.

REGULAR  
\$279.95 YOUR PRICE **\$249.95**

**R.L. DRAKE TR-7/DR-7**



REGULAR \$1549

ASK FOR YOUR PRICE

**COLLINS KWM-380**



NEW REGULAR PRICE \$3496

LIMITED NUMBER AT OLD PRICE **\$2695**

# KENWOOD



**TS-130S**  
REGULAR \$759.95

**TR-2400**



**TS-830S**  
REGULAR \$929.95



REGULAR  
\$395



**TR-7800**  
REGULAR \$399.95

**CALL NOW FOR YOUR  
SPRING SPECIAL PRICES**

Prices, specs subject to change without notice

Calif. residents please add sales tax.

# INFO

## Manuscripts

Contributions in the form of manuscripts with drawings and/or photographs are welcome and will be considered for possible publication. We can assume no responsibility for loss or damage to any material. Please enclose a stamped, self-addressed envelope with each submission. Payment for the use of any unsolicited material will be made upon acceptance. All contributions should be directed to the 73 editorial offices. "How to Write for 73" guidelines are available upon request.

## Editorial Offices:

Pine Street  
Peterborough NH 03458  
Phone: 603-924-3873, 924-3874

## Advertising Offices:

Elm Street  
Peterborough NH 03458  
Phone: 603-924-7138

## Circulation Offices:

Elm Street  
Peterborough NH 03458  
Phone: 603-924-7296

## Subscription Rates

In the United States and Possessions:  
One Year (12 issues) \$25.00  
Two Years (24 issues) \$38.00  
Three Years (36 issues) \$53.00

## Elsewhere:

Canada—\$27.00/1 year only, U.S. funds. Foreign surface mail—\$35.00/1 year only, U.S. funds. Foreign air mail—\$62.00/1 year only, U.S. funds.

## To subscribe, renew or change an address:

Write to 73 Magazine, Subscription Department, PO Box 931, Farmingdale NY 11737. For renewals and changes of address, include the address label from your most recent issue of 73. For gift subscriptions, include your name and address as well as those of gift recipients. Postmaster: Send form #3579 to 73 Magazine, Subscription Services, P.O. Box 931, Farmingdale, NY 11737.

## Subscription problem or question:

Write to 73 Magazine, Subscription Department, PO Box 931, Farmingdale NY 11737. Please include an address label.

73 Magazine (ISSN 0098-9010) is published monthly by 73, Inc., 80 Pine Street, Peterborough NH 03458. Second class postage paid at Peterborough NH 03458 and at additional mailing offices. Copyright (c) 1981 by 73, Inc. All rights reserved. No part of this publication may be reprinted or otherwise reproduced without written permission from the publisher. Microfilm Edition—University Microfilm, Ann Arbor MI 48106.

# SWAN METERS

## THE TOP OF THE LINE

**PEAK READING WATT METER WM-2000A** reads power in 200, 1000, 2000 watt ranges. 3.5-30 MHz. Reads average or PEP power output. Includes expanded VSWR scale.



**IN-LINE WATT METER WM-2000** reads power in 200, 1000, 2000 watts. 3.5-30 MHz. Incl. expanded VSWR scale.



**MOBILE WATT METER HFM-200** with remote directional coupler reading 20 or 200 watts. 3.5-30 MHz. Illuminated, with VSWR scale.



**SWR BRIDGE SWR 1A** with dual reading meters. 1000 watts RF. 3.5-150 MHz. Reads relative power output.



Available only through authorized dealers.

**CUBIC COMMUNICATIONS, INC.**

305 Airport Rd. • Oceanside, Ca. 92054  
(714) 757-7525

## 2 Meter Quad

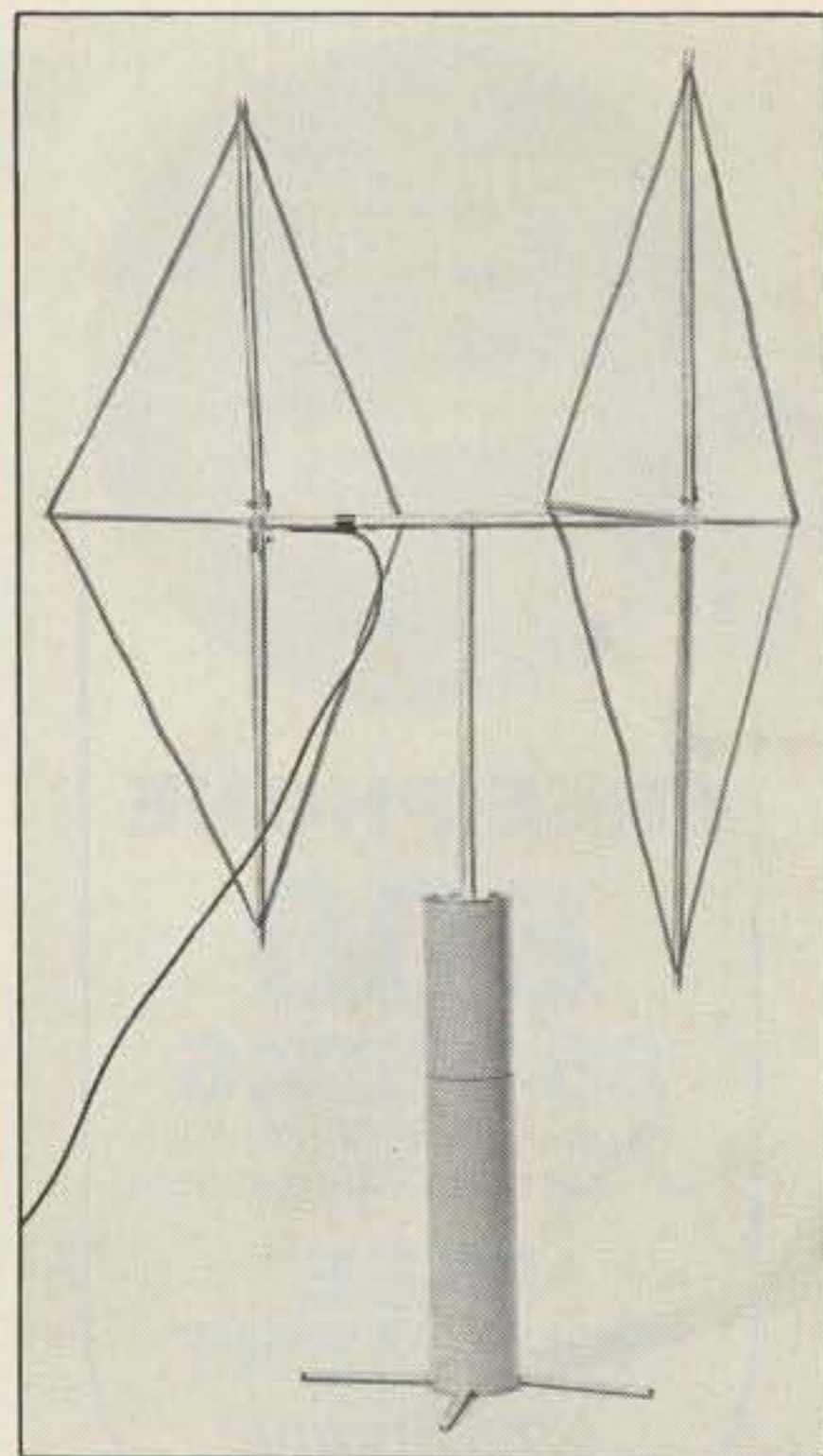

- Portable. Collapsible.
- Folds into its own base for portability.
- For boating, backpacking, mountaintopping, OSCAR.

New portable quad extends the range of low power two meter transceivers by providing the gain and front-to-back discrimination of a two element quad. Gives the gain of a linear amplifier but does not require additional battery power.

The entire beam slips into an 18" carrying case to go in your suitcase. For use, it unfolds to form a two element full size quad complete with stabilized mounting stand. Patented design lets you set it up or take it down in minutes. See the cover article QST September 1980 for full details.

Order direct or from your favorite dealer. Model A-502 portable 2-meter quad \$87.50 Add \$3 shipping/handling. Calif. residents add sales tax.



# Palomar Engineers

1520-G Industrial Ave., Escondido, CA 92025  
Phone: [714] 747-3343

### Repeater at 102,000 Feet!

—Canadian hams go up, up, and away  
.....VE4FK 12

### Digital Control for the Ham III Rotor

—good-bye manual switching!  
.....WAØPBQ 18

#### Review:

### The Doppler Systems DDF-3003

—a review of the latest in direction-finding equipment from Doppler Systems  
.....KA1LR 28

### About the Beverage

—when you say longwire, mean it. Use the remarkable beverage!.....W2XQ 68

### Design-a-Dish

 —produce a proper home-brew parabola with this BASIC program.....W3KH 72

### Mayday!

—help locate downed aircraft with your local repeater.....W2FJT, K2JXU, K2UZS 78

### An 820S Remote Vfo

—using the rig's counter and display  
.....VE5PZ 84

### Maximize That Multimeter

—add a few features the manufacturer forgot.....Staff 88

# 73 MAGAZINE

June 81



102,000 Feet!—12



Turkeys—32

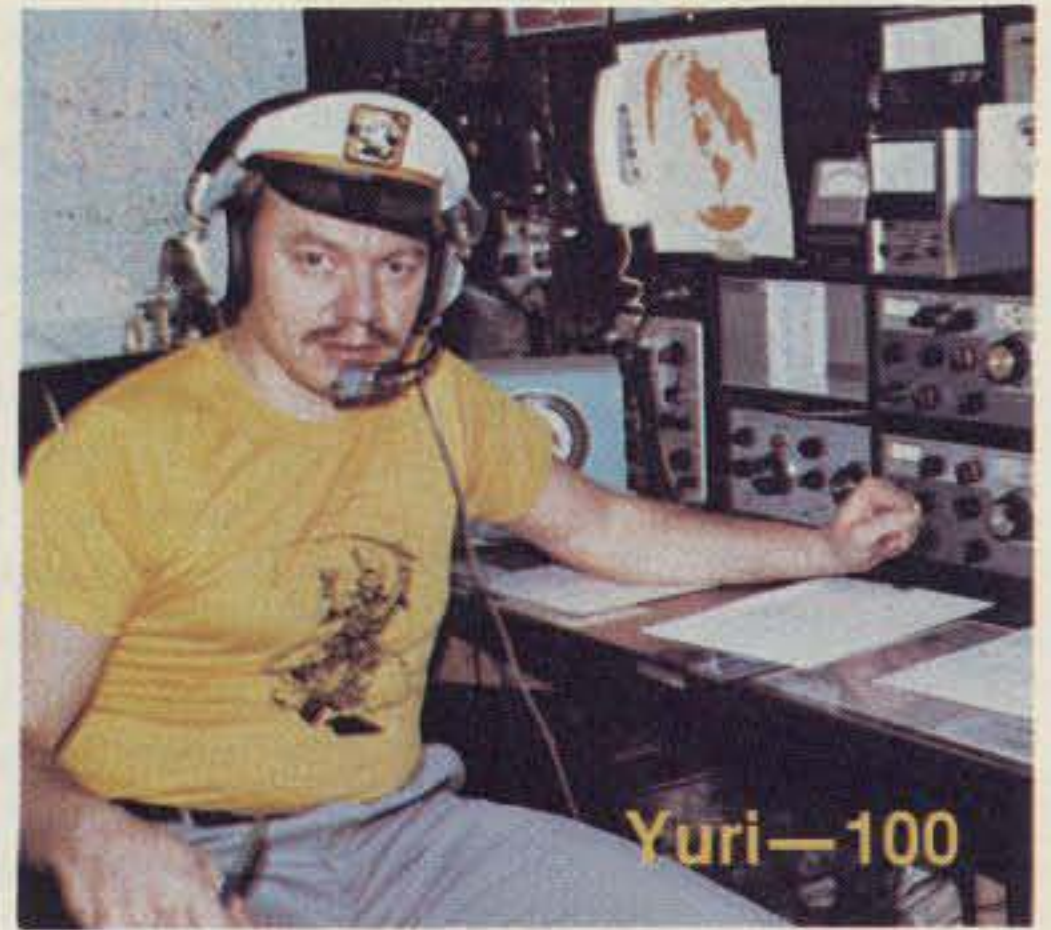

Yuri—100

### DF Breakthrough!

—the “turkey” tracker we’ve all been waiting for.....W7BEP 32

### The History of Ham Radio

—part XV.....W9CI 48

#### Review:

### The VoCom Two-Meter Monkey

—30 Watts out from a mighty small package.....N1BEJ 52

### The Solid-Copy RTTY TTL

—state-of-the-art performance you can afford.....K1VIC/2 54

#### Review:

### The CES Simplex Autopatch

—some hot new hardware for two  
.....KA1LR 62

#### Review:

### Amateur Radio, Super Hobby!

—a breezy new intro to the world of hamming.....KA1D 96

#### Review:

### A Guide to Amateur Radio

—book review of an English import  
.....N1BEJ 97

#### Review:

### Get Your Shack Together

.....K4TWJ 98

### Plain Talk on Plain Language Rules

.....N8RK 125

#### Review:

### A Timely New Product

—the MFJ-102 digital clock.....WA4PYQ 130

Never Say Die—6, DX—100, Fun!—101, Contests—103, Ham Help—104, 122, 130, 135, New Products—105, Kahaner Report—107, Awards—115, Looking West—117, FCC—118, 120, RTTY Loop—119, Letters—123, Social Events—127, OSCAR Orbits—136, Dealer Directory—162

Cover: Photo by James Boesch WB3DBV, East Greenville PA.

# W2NSD/1 NEVER SAY DIE

editorial by Wayne Green

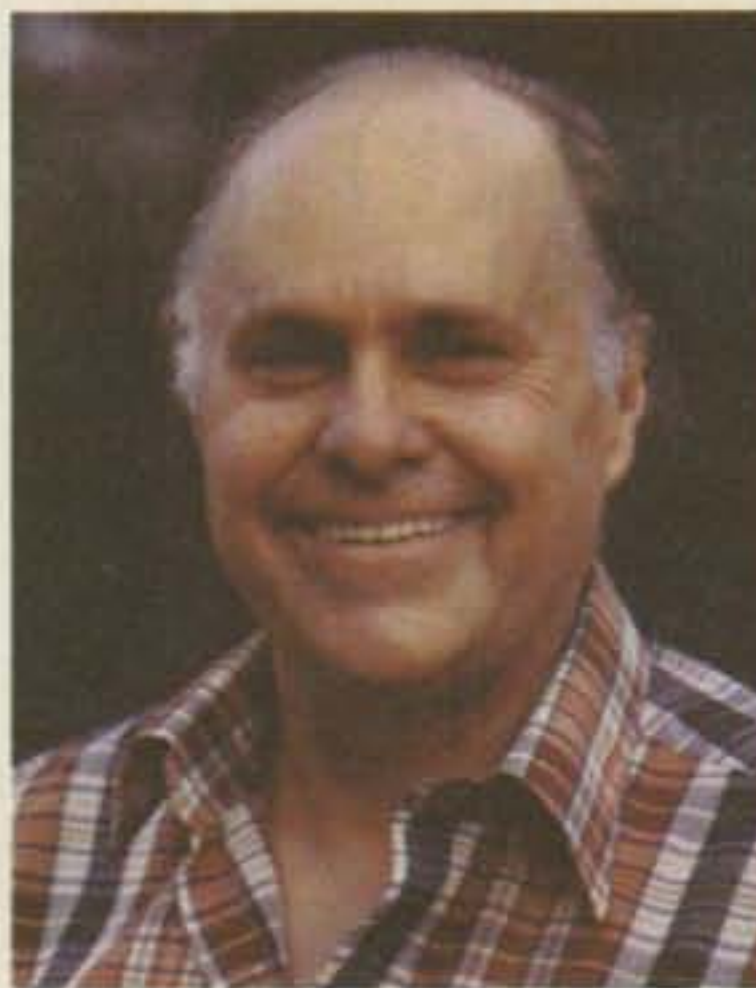

## CQ'S BOO-BOO

The cover article on the April CQ was about the OH2BH trip to Sudan. Inside was a three-page article on the "expedition." Marty OH2BH, who has made such trips to many interesting places, pulled a serious boner with this one. The QSL card for the operation, which was *not* shown in the article, but was mentioned, had a picture of a starving child. To say that this was in bad taste is an understatement.

A card managed to get to the Sudan government people very quickly and the result was a serious black eye for amateur radio. It wasn't that anyone wanted to hide starvation; it was that, as far as I am able to determine, it doesn't exist in that country at present.

I talked with a ham recently back from the Sudan who had operated in both Khartoum and in Southern Sudan; he said that he had not seen anything like that anywhere he had been. The government officials were astounded and furious, because they know of no such starvation in the Sudan.

Amateur radio really doesn't need that sort of foreign relations.

## HARTFORD CANCELLED

Things are really hurting, apparently. The ARRL New England Convention was cancelled recently. I gather that the reason was a lack of interest on the part of the usual exhibitors. Unfortunately, the show was cancelled far too late for the chaps who run the Boxboro (Mass.) convention to pick up the ball. So, at a time when the infusion of spirit that a convention brings is so desperately

needed, there will be no New England convention at all!

Everything was going well with New England until their place for the hamfest (in Swampscott) burned down a few weeks before the show several years ago. They tried holding it in Boston, but that was not popular. Parking was expensive and cars are often stolen or vandalized if not parked off the streets in Boston.

They tried Cape Cod, but that was too far away and attendance was low. The site at Boxboro turned out to be a good one, but by the time that had been found, another group in Hartford had started putting on shows there and there was a good deal of push and shove. They settled down to alternating years. Unfortunately, Hartford did not have the right kind of area for a good hamfest. The hotel where they have been showing is too small, with little area for exhibitors...and an almost impossible situation as far as setting up exhibits is concerned. Parking is very expensive, etc.

The Civic Center at Hartford has more space, but it is far too large and too expensive, so there has been a lot of frustration all around. Perhaps the collapse of the Hartford convention will enable the Boxboro group to get into a regular yearly show. Our hobby needs this.

## ARRL SURVEY

The recent ARRL survey, re-

ported in QST, showed a readership of *73 Magazine* of 141,000. Since that about covers the active amateur population, that's not bad. This is certainly consistent, within the limits of their sampling method, with the results *73* surveys have shown, which indicated that about 150,000 licensed amateurs were reading *73*.

## ORLANDO

Since I'm as popular as a mongoose in a cage of snakes at an ARRL convention, others of the *73* staff ran our booth at this event. The reports are that there was a good crowd, though they apparently brought very little money. Estimates run from 2,000 to 5,000, depending on the bias of the reporter.

Dannals was reported to have given his speech on how great the ham satellite communications would be if we had not lost 99% of our satellite channels ten years ago at Geneva. I'm sorry I missed that, for I really did enjoy it at St. Paul some years ago...and at other conventions. It left me really energated.

Baldwin announced his approaching retirement, leaving members to wonder who will be his replacement. Speculation is that the top job will probably go Lee Aurick, known around HQ as "Mr. Nice Guy." Several directors hinted that Dannals, too, will be retired soon, with Mary Lewis being mentioned as the possible new president.

## ANOTHER WINNER

Congratulations to Larry Groppi of Elk Grove IL, winner of a life subscription to *73 Magazine* at the March 14-15 Orlando Hamcation.

Another topic of discussion was some of the recent lawsuits brought against the League. Apparently more and more outraged members are aware that the League can be sued in their local area and not just in Connecticut. They can be sued wherever they do business. These suits are being won... look for details in QST. Go on and look.

There is some speculation as to whether the picture of directors Metzger and Bergman, both sound asleep during the board meeting, will be published in QST. Metzger got in when Don Miller was suddenly forced to resign the day before the ballot count. The hams in Indiana are really upset over what they consider the screwing of Miller... and do not seem to appreciate Metzger getting elected in spite of their vote against him.

Just in case I am unable to come up with anything positive about the ARRL in June, as promised, I do have a firmly positive thing to say about the League. I hope this will shut up those pinheads who are saying that I am anti-League. ARRL observers, who are privy to the inside skinny, assure me that there are now *two* good guys on the board of directors. Two out of 16 is fantastic and I think a round of huzzahs is in order. If this sort of thing keeps up, who knows what marvelous things we may eventually see.

In case the above does not completely satisfy the League brainwashed, I'll keep reading my mail, asking everyone in the industry, and in general making a pest of myself trying to come up with something really positive for June...or at least July. Keep your fingers crossed.

## ARE THINGS GOOD?

No, not really. The recent QST editorials bemoaning their poverty have shaken a lot of complacent League members. The disappearance of a growing number of previously visible ham dealers has not gone completely unnoticed. The sudden demise of *Ham Horizons* was another clear indication. The panic dumping of ham gear at discount rates which are barely above wholesale prices by some ham dealers is another clear clue.

Those discount prices have been raising hell throughout the industry, by the way. The

# "Cents-ational."



## IF shift, digital display, narrow-wide filter switch

### TS-530S

The TS-530S SSB/CW transceiver is designed with Kenwood's latest, most advanced circuit technology, providing wide dynamic range, high sensitivity, very sharp selectivity with selectable filters and IF shift, built-in digital display, speech processor, and other features for optimum, yet economical, operation on 160 through 10 meters.

#### TS-530S FEATURES:

- **160-10 meter coverage, including three new bands**  
Transmits and receives (LSB, USB, and CW) on all Amateur frequencies between 1.8 and 29.7 MHz, including the new 10, 18, and 24 MHz bands. Receives WWV on 10 MHz.
- **Built-in digital display**  
Large, six-digit, fluorescent-tube display shows actual receive and transmit frequencies on all modes. Backed up by analog subdial.
- **IF shift**  
Moves IF passband around received signal and away from interfering signals and sideband splatter.

#### • Narrow/wide filter combinations

Any one or two of three optional filters . . . YK-88SN (1.8 kHz) SSB, YK-88C (500 Hz) CW, YK-88CN (270 Hz) CW . . . may be installed for selecting (with "N-W" switch) wide and narrow bandwidths on CW and/or SSB.

#### • Wide receiver dynamic range

Greater immunity to strong-signal overload, with MOSFET RF amplifier operating at low level for improved IMD characteristics, junction FETs in balanced mixer with low noise figure, and dual resonator for each band.

#### • Built-in speech processor

Combines an audio compression amplifier with change of ALC time constant for extra audio punch and increased average SSB output power, with suppressed sideband splatter.

#### • Two 6146B's in final

Runs 220 W PEP/180 W DC input on all bands.

#### • Advanced single-conversion PLL system

Improved overall stability and improved transmit and receive spurious characteristics.

#### • Adjustable noise-blanker level

Pulse-type (such as ignition) noise is eliminated by built-in noise blanker, with front-panel threshold level control.

#### • RF attenuator

The 20-dB RF attenuator may be switched in for rejecting IMD from extremely strong signals.

#### • Optional VFOs for flexibility

VFO-240 allows split-frequency operation and other applications. VFO-230 digital VFO operates in 20-Hz steps and includes five memories and a digital display.

#### • RIT/XIT

Front-panel RIT (receiver incremental tuning) shifts only the receiver frequency, for tuning in stations slightly off frequency. XIT (transmitter incremental tuning) shifts only the transmitter frequency, for calling a DX station listening off frequency.

More information on the TS-530S is available from all authorized dealers of Trio-Kenwood Communications, Inc., 1111 West Walnut Street, Compton, California 90220.

#### Matching accessories for fixed-station operation:

- SP-230 external speaker with selectable audio filters
- VFO-240 remote VFO
- AT-230 antenna tuner/SWR and power meter
- MC-50 desk microphone

#### Other accessories not shown:

- VFO-230 remote digital VFO with 20-Hz steps, five memories, digital display
- TL-922A linear amplifier
- SM-220 Station Monitor
- KB-1 deluxe VFO knob
- PC-1 phone patch
- HS-5 and HS-4 headphones
- HC-10 digital world clock
- YK-88C (500 Hz) and YK-88CN (270 Hz) CW filters and YK-88SN (1.8 kHz) SSB narrow filter
- MC-30S and MC-35S noise-canceling hand microphones



**KENWOOD**  
...pacesetter in amateur radio

Specifications and prices are subject to change without notice or obligation.

# STAFF

**PUBLISHER/EDITOR**  
Wayne Green W2NSD/1

**EXECUTIVE VICE PRESIDENT**  
Sherry Smythe

**ASSISTANT PUBLISHER/EDITOR**  
Jeff DeTray WB8BTH

**ASSOCIATE PUBLISHER/DIRECTOR OF PUBLICATIONS**  
Edward Ferman WA1UFY

**MANAGING EDITOR**  
John Burnett

**ASST. MANAGING EDITOR**  
Susan Philbrick

**NEWS EDITOR**  
Gene Smarte WB6TOV

**EDITORIAL ASSISTANTS**  
Nancy Noyd  
Richard Phenix

**CONTRIBUTING EDITORS**  
Chris Brown KA1D  
Alyson Grupp N1BEJ  
Paul Grupp KA1LR  
Larry Kahaner WB2NEL

**ADMINISTRATIVE ASSISTANT**  
Pat Graham

**ASSOCIATES**  
Robert Baker WB2GFE  
Bill Gosney KE7C  
Sanger Green

Dave Ingram K4TWJ  
Joe Kasser G3ZCZ  
Dr. Marc Leavey WA3AJR  
Dave Mann K2AGZ  
Bill Pasternak WA6ITF  
John Schultz W4FA  
Peter Stark K2OAW

**PRODUCTION MANAGER/PUBLICATIONS**  
Nancy Salmon

**ASST. PRODUCTION MANAGER/PUBLICATIONS**  
Michael Murphy

**ART DIRECTOR**  
Diana Shonk

**ADVERTISING GRAPHICS MANAGERS**  
Robert Drew  
Steve Baldwin  
Bruce Hedin

**PRODUCTION**  
Joan Ahern  
Frances Benton  
Fiona Davies  
Linda Drew  
Bob Dukette  
Kenneth Jackson  
Ross Kenyon KA1GAV  
Maryann Metevier  
Theresa Ostebo  
Jane Preston  
Susan Symonds  
Thomas Villeneuve

**PHOTOGRAPHY**  
William Heydolph  
Terrie Anderson  
Bill Suttentfield  
Paul Babick

**TYPESSETTING**  
Barbara Latti  
Sara Bedell  
Mary Kinzel  
Karen Stewart  
Michele DesRochers  
Linda Locke  
Luann Keddy

**CORPORATE CONTROLLER**  
Charles Garniss, Jr.

**EXECUTIVE ASSISTANT**  
Leatrice O'Neil

**ACCOUNTING MANAGER**  
Knud Keller KV4GG/1

**CIRCULATION MANAGER**  
Debra Boudrieau

**CIRCULATION**  
Doris Day  
603-924-7296  
Pauline Johnstone

**BULK SALES MANAGER**  
Ginnie Boudrieau

**ADVERTISING**  
603-924-7136  
Jim Gray W1XU, Mgr.  
Nancy Ciampa, Asst. Mgr.

manufacturers swear that they are not shipping much gear to these discounters, so there is no way in the world for them to fill orders once their past stock is out. Calls to some of them have shown clearly that they do *not* have the equipment to ship, so all they are doing, really, is keeping anyone from selling equipment. We hams, being dedicated skinflints, would rather die than spend an extra buck for a rig, even if we have to wait until hell freezes over to get it.

It appears that the importers of ham gear have responded to this situation by diverting much of their normal supply to take care of the increased need in Japan, where amateur radio is growing far more rapidly than it is here. Indeed, Japan has over twice as many active hams as we have right now and they are stepping up their push for new hams. Their leading ham magazine had over 40 pages of pictures of ham club activities last

month . . . while I have yet to get one single such picture for 73, despite editorials asking for them. I guess our clubs are pretty much dead . . . particularly in comparison with the Japanese.

73 has had to thin down to cope with the drop in equipment sales. To keep a magazine viable, you have to run about 40% advertising. *Ham Horizons* got down into the 20s . . . the kiss of death. *CQ* ran in the 30s last year, causing much concern in the field. *HR* was also in the 30s . . . low 30s . . . another disaster was possible. Publishers watch things like that with an eagle eye.

Rather than sit back passively, I have some ideas which could revitalize amateur radio. Those of you who were around ten years ago can testify as to the results of my push for FM and repeaters . . . with no help whatever from any of the other magazines . . . and vigorous op-

position from the ARRL. Despite that, FM went from the private province of perhaps 2,000 hams to the single most active aspect of the hobby. It can be done again.

Though my initial approaches to Radio Shack were rebuffed, I have by no means given up with them. Never Say Die, remember? I am going to keep after them until they at least give my idea a test and prove it won't work. I'm going to see what I can do with Heath and their 50+ stores . . . all of the ham dealers in the country . . . and so on. Once we have our new 73 training series ready, I'll be pushing every club I can find as hard as I can to get hopping to get amateur radio back into a strong growth mode. In case you don't know it, we lost over 50% of the people we tried to get into amateur radio through inferior teaching materials.

*Continued on page 99*

## Well . . . I Can Dream, Can't I?

by Bandel Linn K4PP



"The meeting will be in Vegas—wives excluded—and the all-expense cost, including air fare, is just five dollars and seventeen cents . . ."



# ICOM IC-290

The Latest State of the Art in 2 Meter Mobile



## 5 Memories/Priority/ Scan/Squelch on SSB.

### FM Ease.

- Five memories + 2 VFO'S - store your favorite repeaters.
- Priority channel - check your most important frequency automatically.
- Programmable offsets - for odd repeater splits.
- 5 KHz or 1 KHz tuning.

### SSB/CW Convenience.

- Squelch on SSB - silently scan for signals.
- 2 VFO's with equalizing capability - mark you signal frequency with the touch of a button.
- RIT - receiver incremental tuning.
- 1 KHz or 100 Hz tuning.
- CW sidetone.
- AGC - selectable slow or fast in SSB and CW.
- NB - Noise blanker - suppresses pulse type noises on SSB/CW.

### Full Capability Scanning.

- Scan the whole band/scan between VFO's/scan memories and VFO's.
- Automatic stop and automatic resume scan after carrier drop or predetermined adjustable delay.
- Adjustable scan rate.
- 15 KHz or 5 KHz FM scanning steps.
- Stop on busy or empty channels.

### ICOM Performance.

- 143.8 to 148.199.9 MHz coverage.
- Remote tuning from optional HM 10 microphone.
- Digital frequency display - significant digits only.
- Hi/low power switch.
- LED indicators - REC/SND/PRIO/DUP
- LED bar meter.
- Provision for retention of memory with optional NiCd battery system.
- Touch Tone® with optional HM8 microphone.
- Compact size - 6 11/16W x 2 1/2H x 8 5/8D.



2112 116th Avenue N.E., Bellevue, WA 98004  
3331 Towerwood Dr., Suite 307, Dallas TX 75234

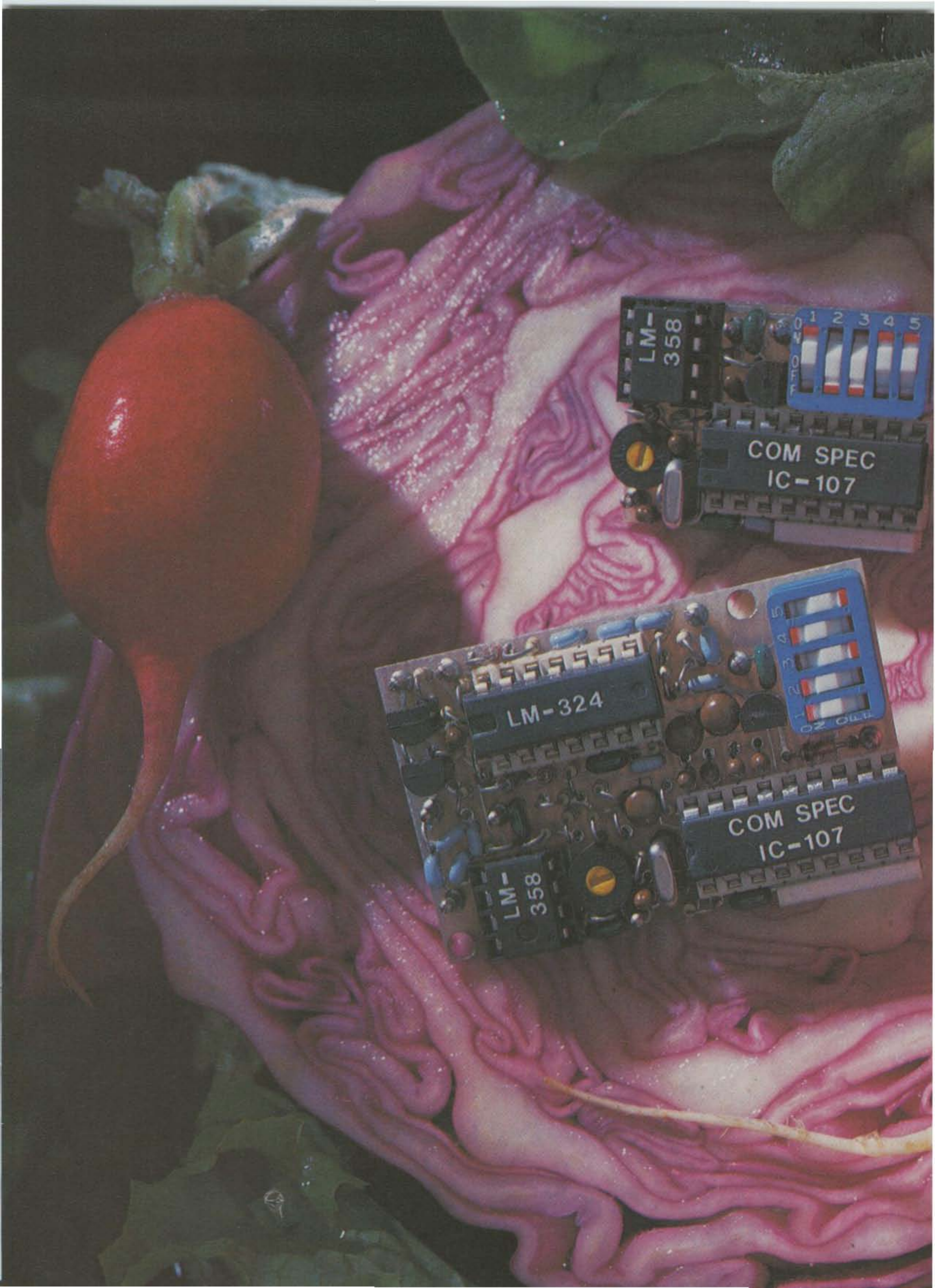

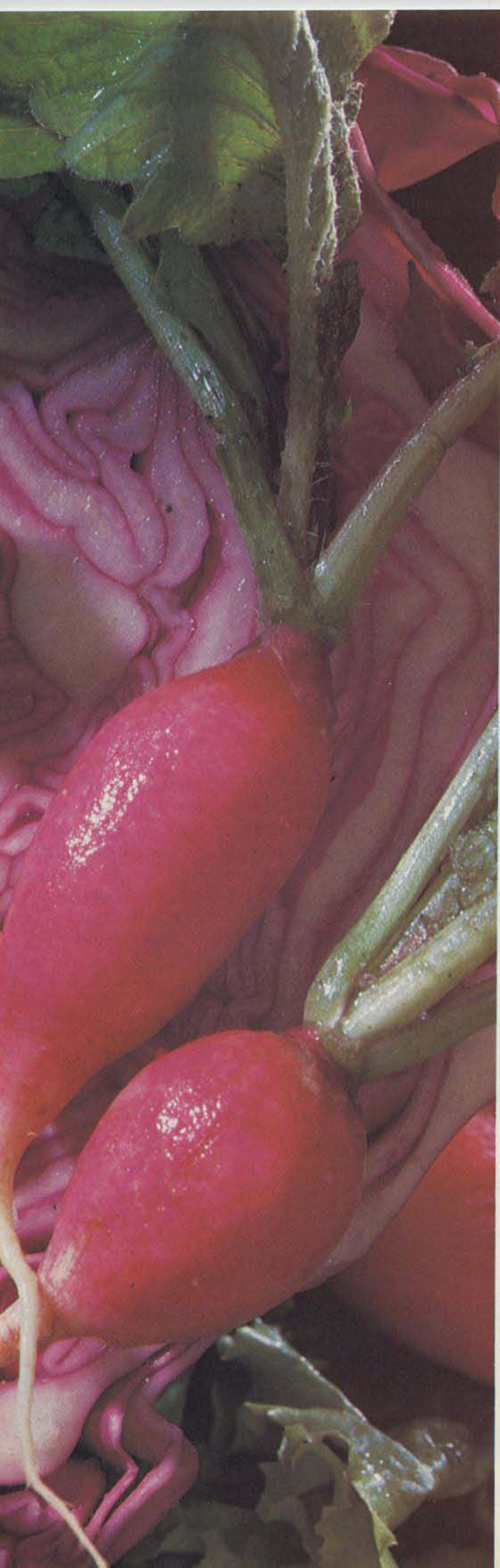

# A fresh idea!

Our new crop of tone equipment is the freshest thing growing in the encoder/decoder field today. All tones are instantly programmable by setting a dip switch; no counter is required. Frequency accuracy is an astonishing  $\pm .1$  Hz over all temperature extremes. Multiple tone frequency operation is a snap since the dip switch may be remoted. Our SS-32 encode only model is programmed for all 32 CTCSS tones or all test tones, touch-tones and burst-tones. And, of course, there's no need to mention our 1 day delivery and 1 year warranty.

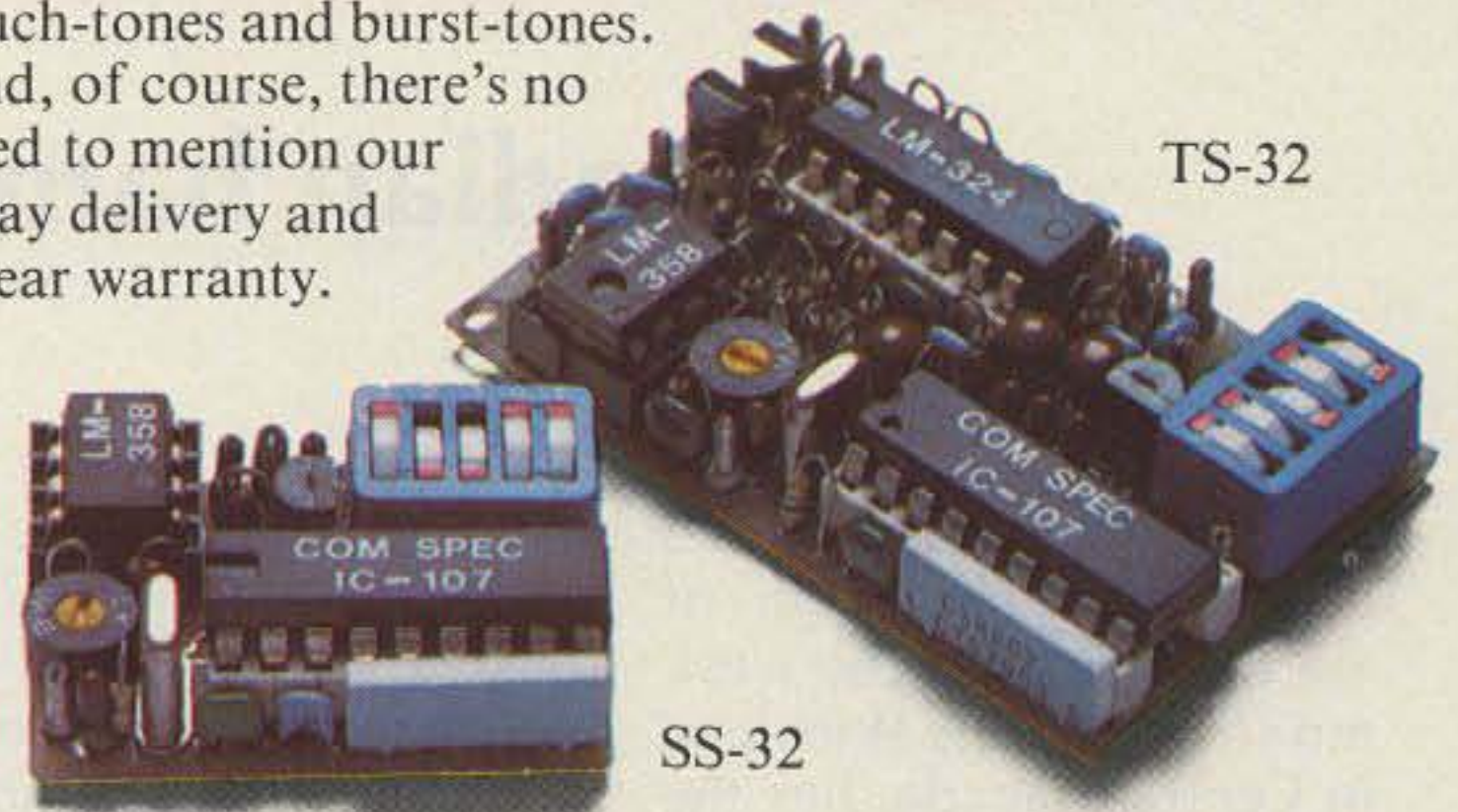

## TS-32 Encoder-Decoder

- Size: 1.25" x 2.0" x .40"
- High-pass tone filter included that may be muted
- Meets all new RS-220-A specifications
- Available in all 32 EIA standard CTCSS tones

## SS-32 Encoder

- Size: .9" x 1.3" x .40"
- Available with either Group A or Group B tones

### Frequencies Available:

Group A			
67.0 XZ	91.5 ZZ	118.8 2B	156.7 5A
71.9 XA	94.8 ZA	123.0 3Z	162.2 5B
74.4 WA	97.4 ZB	127.3 3A	167.9 6Z
77.0 XB	100.0 1Z	131.8 3B	173.8 6A
79.7 SP	103.5 1A	136.5 4Z	179.9 6B
82.5 YZ	107.2 1B	141.3 4A	186.2 7Z
85.4 YA	110.9 2Z	146.2 4B	192.8 7A
88.5 YB	114.8 2A	151.4 5Z	203.5 M1

- Frequency accuracy,  $\pm .1$  Hz maximum  $-40^{\circ}\text{C}$  to  $+85^{\circ}\text{C}$
- Frequencies to 250Hz available on special order
- Continuous tone

Group B						
TEST-TONES:	TOUCH-TONES:		BURST-TONES:			
600	697	1209	1600	1850	2150	2400
1000	770	1336	1650	1900	2200	2450
1500	852	1477	1700	1950	2250	2500
2175	941	1633	1750	2000	2300	2550
2805			1800	2100	2350	

- Frequency accuracy,  $\pm 1$  Hz maximum  $-40^{\circ}\text{C}$  to  $+85^{\circ}\text{C}$
- Tone length approximately 300ms. May be lengthened, shortened or eliminated by changing value of resistor

Wired and tested: TS-32 \$59.95, SS-32 \$29.95



**COMMUNICATIONS SPECIALISTS**

426 West Taft Avenue, Orange, California 92667  
(800) 854-0547 / California: (714) 998-3021



# Repeater at 102,000 Feet!

## — Canadian hams go up, up, and away

**S**eventy miles north of Winnipeg, on the western shore of Lake Winnipeg in Central Canada, lies the small fishing village of Gimli. The town's main claim to fame is in being the oldest existing Icelandic community in Canada.

Gimli Air Force Station, now an industrial park, was for years a pilot training school, and for a short time was home for many World War II pilots and, later, for pilot trainees from NATO countries.

During the spring of 1979, the Space Research Facilities Branch of the Na-

tional Research Council (the Canadian equivalent of NASA) reopened the deactivated airport as a launching base for high altitude scientific balloons, its two long runways making it an ideal site.

The initial launches were partly to train launch crews and partly to investigate any effects on launch procedures due to the proximity of a large body of water. Later, high-altitude balloons launched from this site would carry various scientific experiments into the lower stratosphere, these balloons being de-

signed to cruise at 100,000 to 150,000 feet, or 20 to 30 miles.

At this time, Larry Toms VE4VX and his brother Max worked as instrumentation technologists with the contractor operating the launch facility for NRC. The possibility of an amateur radio experiment hitching a ride on one of the training flights occurred to Larry and Max, and enquiries were made through NRC official channels. Hopes were not high as no firm plans of what the experiment configuration might be had been formulated, and there-

fore no formal proposal could be made. Only a request was made that a 2-meter repeater, the design of which would evolve as construction proceeded, was to be flown.

On June 21st the cruncher came! Yes, permission was granted to fly an amateur radio experiment on balloon flight number 7907B scheduled for launch on or after July 18th! Only 26 days to go and only a vague concept of what the experiment would be—no hardware, no money, no work force...!

Much thought and head-



*Balloon being inflated. Radio package can be seen hanging from the truck on the extreme left.*

### Flight Payload Specifications

<b>Weight:</b>	250 lb.
<b>Repeater</b>	Transmitter Power: 1 Watt Frequency: 147.33 MHz Modulation: FM, 3.5-kHz deviation Antenna: Modified ground plane Mode: Simplex/duplex, commandable
<b>Link:</b>	Transmitter Power: 1 Watt Frequency: 144.33 MHz Modulation: FM, 3.5-kHz deviation Antenna: Modified ground plane
<b>Beacon:</b>	Transmitter Power: 80 milliwatts Frequency: 432 MHz Mode: CW Antenna: Turnstile
<b>Power Supplies:</b>	+ 16 V dc, 35 Ampere/hour + 15 V dc, 1 Ampere/hour
<b>Total Current Drain:</b>	1 Ampere/hour
<b>Command Signals:</b>	+ 24-volt pulse, 80-ms duration

scratching followed, during which time the matter was chatted up on the air with anyone who would listen. Ron Nurnberg VE4KA became interested and, after some discussion, it was decided that a "simplex" repeater would be flown. Although the title "simplex repeater" seemed incredible to some amateurs who heard last-minute publicity announcements some time later, the concept was fairly straightforward. Two repeaters would be constructed back-to-back. One would accept input on 144.33 MHz from the ground control station and retransmit on 147.33 MHz. The other would accept input from amateur stations on 147.33 MHz and retransmit on 144.33 MHz. This would be our "simplex" mode using a common simplex channel. A solid-state relay system would ensure that when either transmitter was operating, the receiver of the opposite pair would be muted. Normal duplex repeater operations on 144.33/147.33 or 147.33/144.33 were also possible upon command. The 3-MHz spacing was selected to give protection against desensing of the unmuted receiver. This was necessary as it would not be

possible, due to restricted space, to include a duplexer for a normal 2-meter repeater split.

The word started to get around about the crazy things being planned out at Gimli! Barry Malowanchuk VE4MA came forward with a plan to include a low-power 432-MHz beacon in the package. As an L-band radar reflector was mounted on the balloon, it was suggested by members of the group that "balloon-bounce" communications might be attempted. The ideas were coming forward, but still the problems of components and hardware remained. The slowly growing team of helpers began to chip in equipment and bucks where they could. A massive scrounging spree for expensive or hard-to-get items was directed towards local electronics stores and other businesses. Larry and Max reworked two Marconi DT-85 transceivers for use as the repeaters, and Ron VE4KA set to work on the control circuitry.

Because of the anticipated current drain, power was a problem! Numerous suggestions were made ranging from dry cells to gel batteries, but due to the high

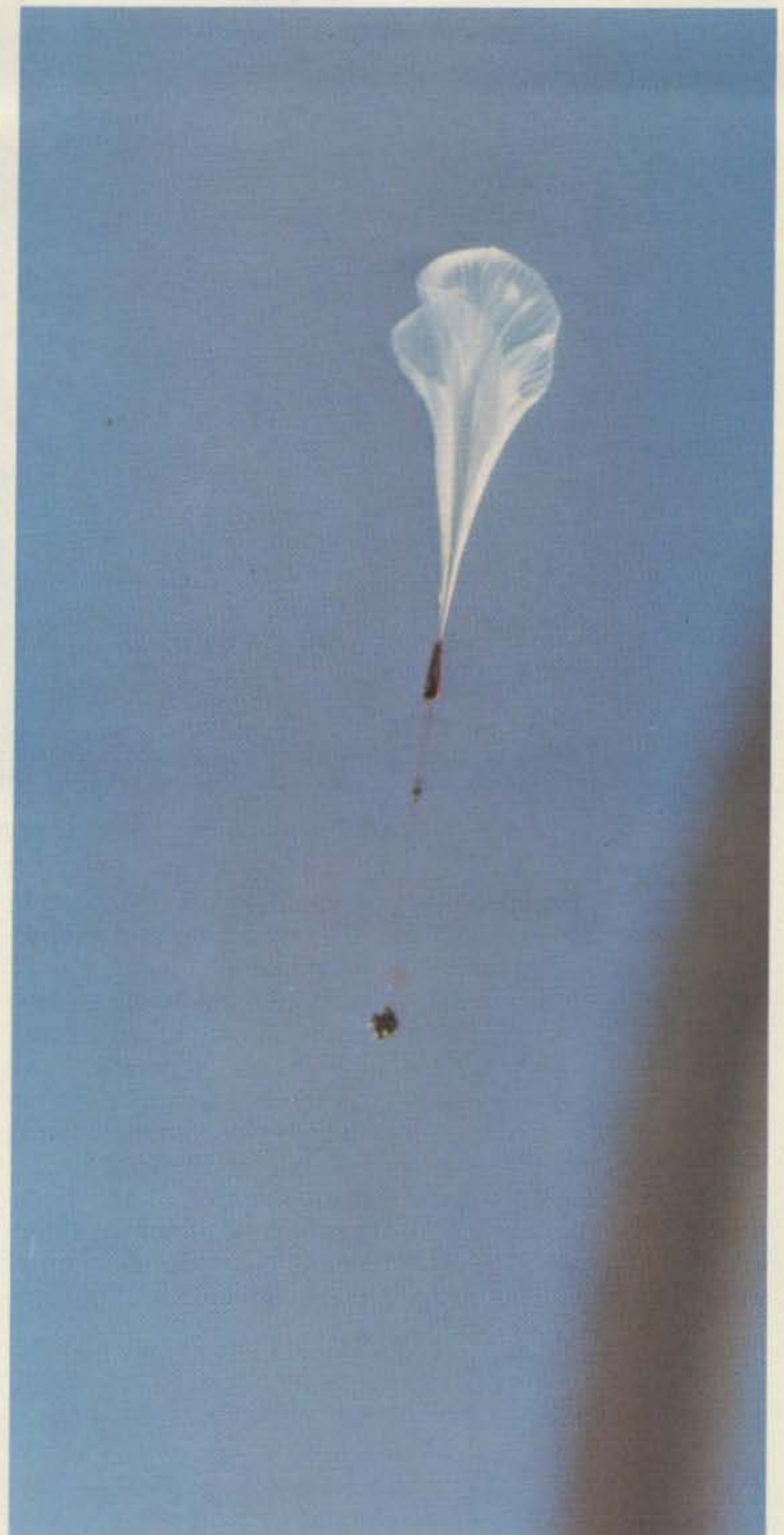

"Skyhook" balloon at about 1000 feet, just after lift-off.

costs, these ideas were discarded in favor of a bank of silver cells which had been formerly used for rocket experiments. Hugh McKay VE4HC was given the somewhat tedious task of charging and discharging the battery pack to a very strict program to ensure that the maximum battery life would be available "come the day."

Because the design operating altitude was to be

about 100,000 feet, the package would have to be insulated against the extremely low temperatures and sealed against the rarified atmosphere as none of the equipment had been originally designed to operate in a partial vacuum. One local amateur worked for a company which used explosion-proof electrical junction boxes. These were made of 3/4"-thick aluminum alloy, with inside di-



Ron VE4KA working on the repeater package.

mensions approximately 19" x 12" x 12" and weighing an incredible 95 pounds each! Two such boxes were diverted to the project and became the air-tight equipment enclosures we needed.

Thus, most of the equipment was acquired and assembly of the flight package began during the first week of July. The radio

equipment was installed in a compartmented aluminum box 12" x 17" x 3" with two receivers in one compartment and the transmitters in separate compartments. Connections between the compartments was via feedthrough capacitors. Control of the package was of paramount concern. No control equipment, either digital or tone,

was readily available. However, on each high-altitude experimental balloon, several command functions are required, such as to open a helium valve to cause the balloon to descend or to dump ballast to cause it to ascend. Command functions for on-board experiments also are provided. A Command Instrument Package (CIP) is

flowed for this purpose. A system had to be devised which would convert the CIP output, consisting of a +24-volt pulse of 80-ms duration to a logic level which would actuate the specific functions of our experiment. Ron VE4KA, being responsible for the control circuitry, with assistance from Keith Jonas VE4YA, constructed a system of optical isolators and digital latches which effected the required command sequences. In addition, op amps and digitally-actuated relays were used in the repeater when operating in the duplex mode. Failing to manufacture a suitable bipolar supply to operate from the battery pack, we were forced to rely on Radio Shack D-cells hastily wired together to provide the  $\pm 15$  volts required for these op amps. This proved to be the Achilles heel of the whole operation! Fig. 1 shows a block diagram of the repeaters and command system.

During the later part of the assembly period, Bill Bowman VE4AFO had been busy assisting with assembly of the equipment, helping to prepare the deactivated airport control tower for use as the ground station, building antennas for HF communications, and running errands for the constructors. He also managed to spend some time on the local 2-meter repeaters advertising the Gimli activity, arranging for the loan of equipment, and recruiting help where he could find it.

I was recruited at this time and did some publicity work on 20 meters and on the various 75-meter nets in the adjoining states and provinces. This I found a little frustrating. After accepting the information I had to offer, sometimes a little skeptically, most people would ask for a launch date and time. This I was not able to give! The problem

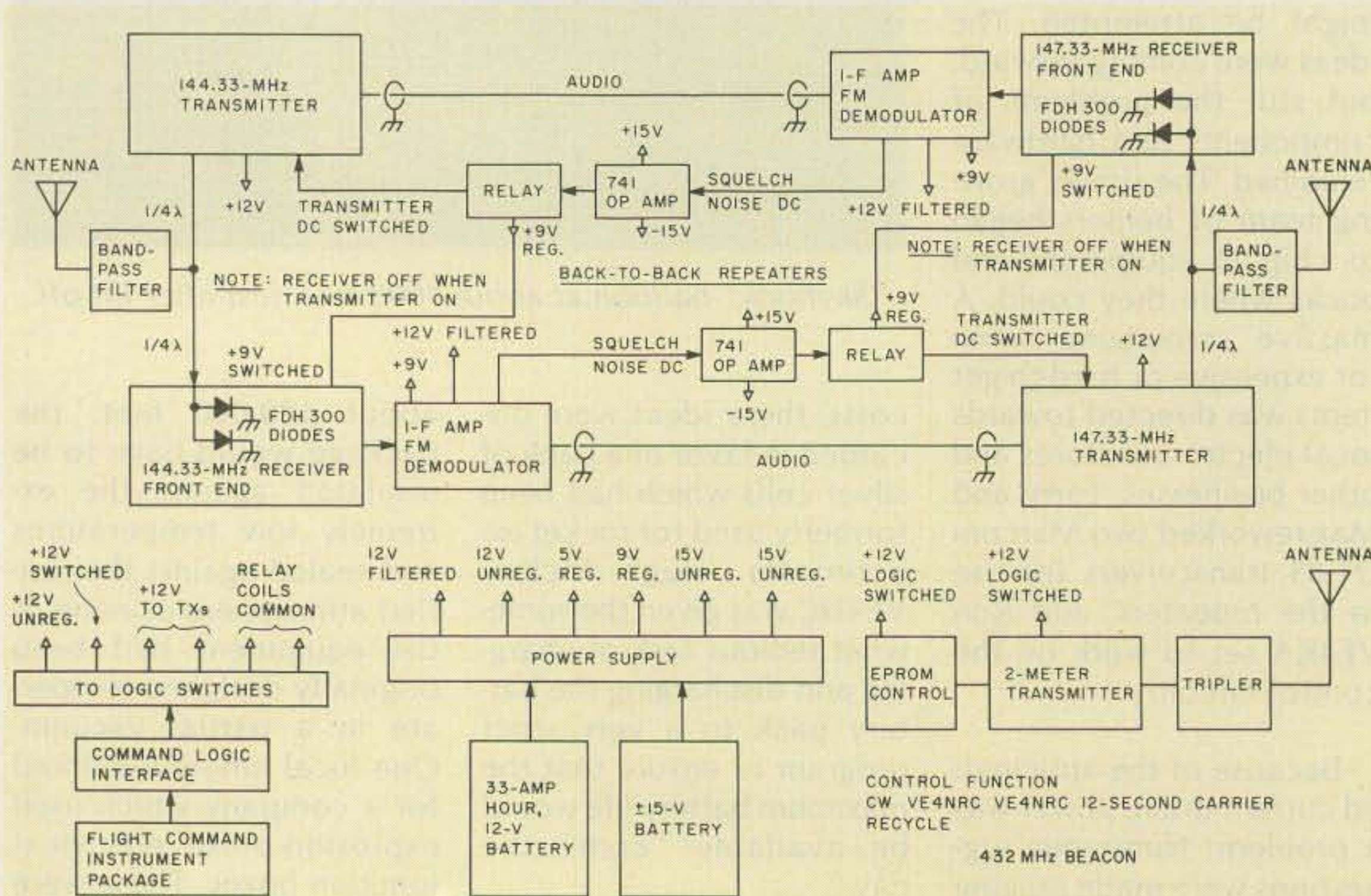
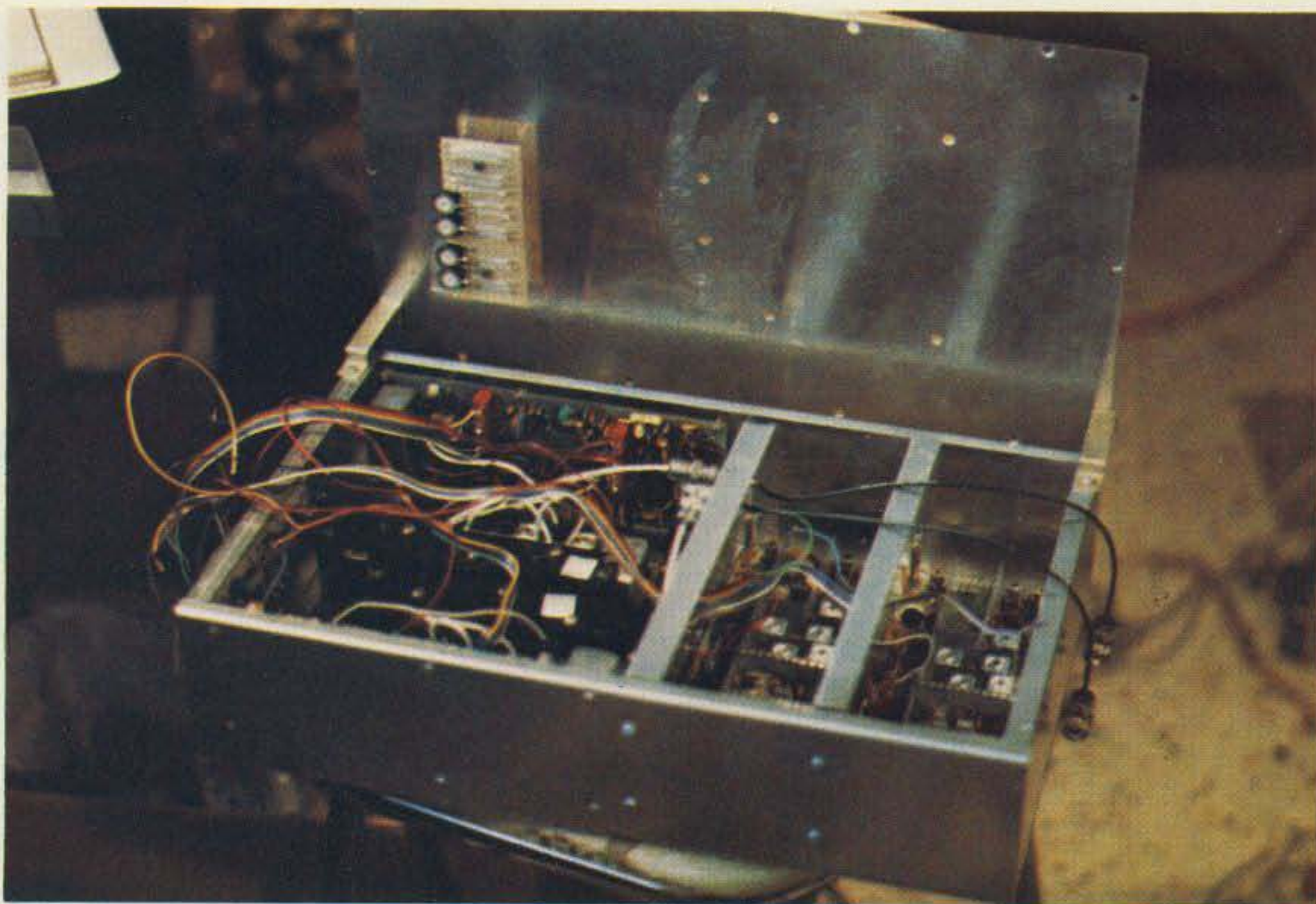

Fig. 1. Flight package.

was that this balloon would be a real monster! It would have an inflated volume of 1.5 million cubic feet, and the combined length of the balloon, payload, and flight train, consisting of the ladder structure and collapsed parachute, would be 600 feet. It was therefore necessary that, at launch time, there be no more than a 5-mph wind velocity difference between ground level and 400 feet, or else the balloon could be damaged. Thus the launch date and time were highly dependent on local weather conditions. Regarding the size of the balloon/package combination, one of the group described it as "like flying a large condominium to a height of 22 miles."



The repeater package with two receivers in the left-hand compartment and the transmitters in two separate compartments on the right.

During the later stages of the airborne package construction, the ground station was being prepared. Most of this equipment was obtained on loan from various amateur and business sources, while some specialized equipment was obtained from NRC. Dick McGuire VE4HK ran a courier service between Winnipeg and Gimli! He delivered purchased and scrounged equipment to the construction team. The ground 2-meter transceiver was an Icom 280 driving a KLM 70-Watt linear amplifier. The main tracking antenna, a 4 × 6-element yagi array, was jointly constructed by Vic Grant VE4VG and Joe DeLaronde. It was mounted on an Andrew pedestal for manual control of azimuth and elevation. Also mounted on the pedestal was a remote receiver agc meter to assist the antenna operator in tracking the balloon. Fig. 2 is a block diagram of the ground station equipment used.

The Federal Department of Communications had been kept informed of our plans at all times and had approved the call VE4NRC for use during the flight, the

sponsor being Kathy Toms VE4YI. Sponsorship was later transferred to VE4KA in order that Advanced class privileges would be available.

At last the day came, after many days of payload checks, weather briefings, false alarms, and final preparation of the ground station. At 0012Z on July 27, 1979, the balloon was launched, not looking like a

conventional hot-air balloon, round and graceful, as I for one expected, but more like a sad sausage skin which someone had forgotten to fill! At first, as I watched from the balcony of the control tower along with dozens of local amateurs who had heard that the launch was imminent, the balloon went straight up, then it drifted off to the southeast over Lake Winni-

peg. It appeared to hang motionless over the southern end of the lake for several hours. Later, under the influence of upper winds and the Earth's rotation, it would travel westward across Manitoba and into Saskatchewan.

Amateur operations commenced at 0025Z, thirteen minutes after lift-off when the balloon was at about 15,000 feet, the first contact

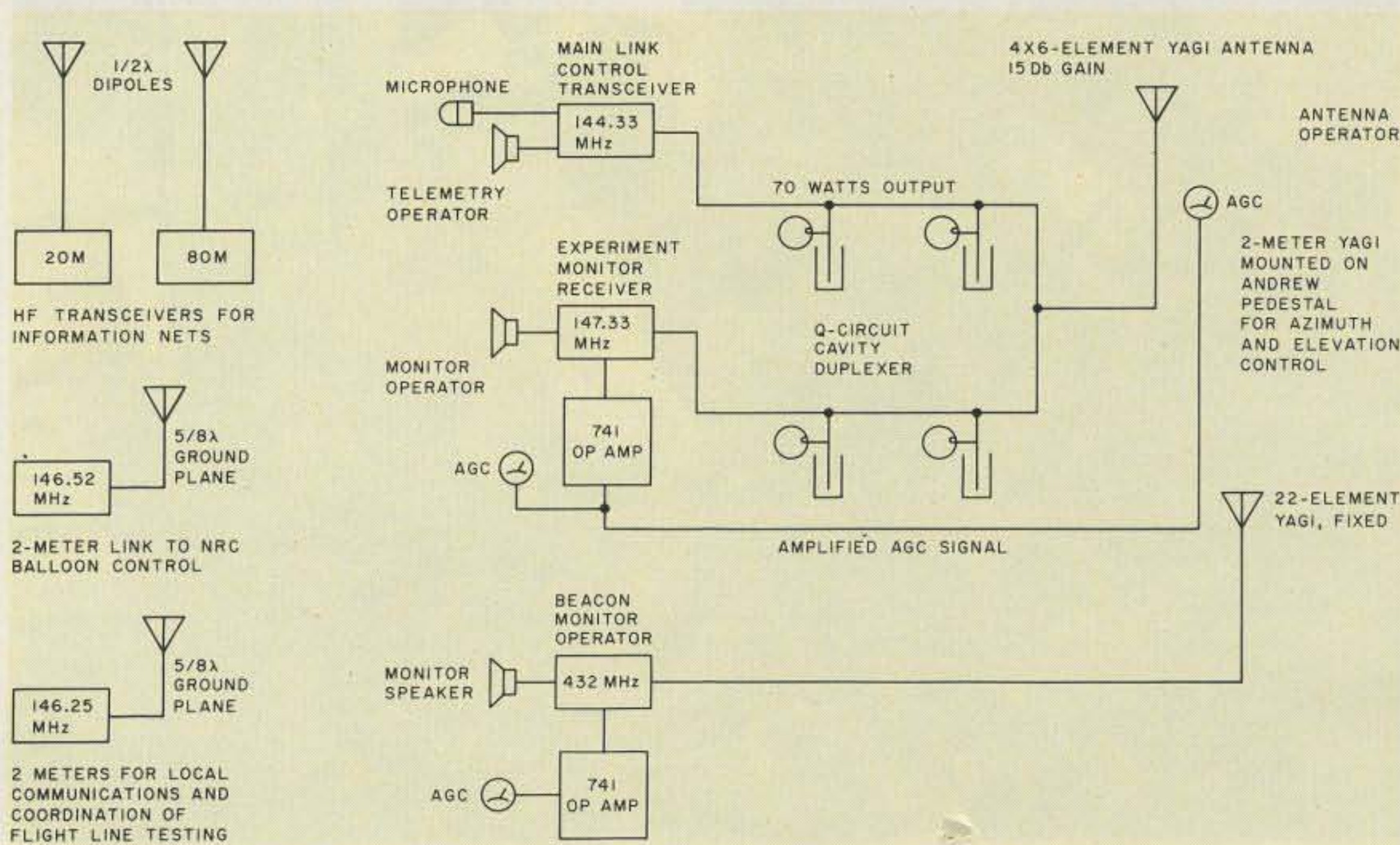

Fig. 2. Ground station.



*Balloon package prepared for flight.*

being VE4BE at 0027Z. Bill VE4AFO was in his element, feeling like a DX operator in a pileup! Alas, it did not take long for the amateur community to find the ground control input frequency, but this was being monitored and no station attempting contact on the control frequency was acknowledged. We had little

to fear! With 2000 Watts ERP from the base station through its antenna system, we could certainly "capture" the flight uplink receiver! Although some interference continued, a great many contacts were made until the experiment was temporarily shut down at 0830Z.

There were a few amus-

ing contacts. While I was putting out the word on 75 meters, I ran into two amateurs in Minnesota and I broke into their QSO to tell them what was taking place. A few minutes later I heard them make contact with the control station, and a short time later, again on 75 meters, I heard the following:

"How high did that guy say the balloon was?"

"102,000 feet, but no one in his right mind would put a repeater on a free balloon. It must be tethered."

Short pause.

"Where the devil would they get a rope 20 miles long?"

Long pause!

My favorite story is the one about the amateur in northern Nebraska who was called by nature in the early hours of the morning. Noticing that the scanner on his handie-talkie by his bedside was stuck on one frequency, he took it with him. Perhaps to this day he doesn't believe that he spoke to an operator 500 miles away on 147.33 simplex, with a 1-Watt handie-talkie with a rubber ducky antenna while sitting on his own john!

Many similar tales made our 30-hour day more bearable!

The experiment was turned on again at 1010Z, but insufficient power remained in the  $\pm 15$ -volt power supply to operate the repeater in the simplex mode. The 147.33-MHz transmitter was commanded on continuously and successful operation continued in the 144.33/147.33 duplex mode until termination at 1529Z. During the 15-hour, 17-minute flight, over 500 contacts were made in 5 states and 3 provinces. From calculations and a Fresnel plot, the theoretical radio range from 102,000 feet was 451.6 miles. Information provided by the NRC weather service indicated that there were no significant inversions during the period of the flight. Analysis of the actual contacts made indicates that the actual radio range was indeed very close to the theoretical.

It was also noted that differences in polarization at ground stations, e.g., verti-



*Hugh VE4HC and the 432-MHz monitors.*



cal, horizontal, or circular, had no apparent effect on the received signal strength.

A drop in signal strength of about 30 dB occurred approximately every 74 minutes. The regularity of this phenomenon leads us to suspect that balloon rotation resulted in eclipsing of the flight antenna system. Rotation was confirmed by telescopic sightings.

The 432-MHz beacon experiment was not successful as the unit was inadvertently turned off by the balloon command officer and it was only just before termination that, when supposedly switching it off, it was in fact switched on, and we could hear the signal clearly from almost 400 miles away. No reception reports were received.

The flight was terminated near Broadview, Saskatchewan, and a search team quickly located and recovered the amateur package which was safely returned, undamaged, to Gimli the next day.

As a result of this flight and the professional attitude of the amateur fraternity, amateurs in general, and the recently formed Canadian Amateur Radio Research Club (CARRC) in particular, have gained a measure of credibility and recognition from the scientific and industrial communities.

At present, members from the Greater Winnipeg area, together with an Ottawa chapter, are working on a flight experiment expected to be included as a passenger on a balloon flight during the summer of 1981. The design of the package calls for:

1. A microprocessor which will act as the control center for other experiments on board. This will demonstrate that programming and execution can be controlled from the ground. Commands will be transmitted from the ground to

activate various functions of the experiment, e.g., to turn equipment on or off, etc. Command verification and analog data from the experiment (temperatures, supply voltages, etc.) will be transmitted back to the ground via Pulse Code Modulation (PCM).

The data transmissions will be decommutated at the ground station and the data will be analyzed in real time. Magnetic tape recordings will preserve data for further analysis at a later time.

PCM format: 1.5 kilobits per second, bi-phase level; mainframe length—20 words; word length—9 bits (8 data bits + 1 bit); sync word length—18 bits. The PCM will be transmitted on an FM subcarrier, frequency modulated on the main telemetry down-link.

2. The radio experiments will consist of:

(a) a 2-meter duplex repeater with input on 144.33 MHz and output on 147.33 MHz.

(b) a 10-meter-to-2-meter transponder. This will consist of a 10-meter SSB input with a 2-meter FM output.

(c) a UHF beacon, tone modulated.

We have been informed that, as we would be passengers on the flight, we must keep the package weight down to 50 pounds and the size down to 1 cubic foot. Ah, well, the impossible just takes a little longer!

It is hoped that we will be able to publicize the next flight rather better than the last. Our publicity man will probably send information to local net managers in Canadian provinces and the northern United States, so perhaps you should monitor your local net frequencies for up-to-date news on the progress of our next venture. The results of the proposed experiment may



The Gimli control tower. The 4 × 6-element yagi for 2 meters is seen to the right and the 432-MHz beam can be seen to the left.

be published in a future article. Meanwhile, any further information is avail-

able from CARRC, Box 473, Pinawa, Manitoba, Canada R0E 1L0. ■



Fig. 3. Dotted envelope shows the theoretical maximum coverage throughout the flight.

# Digital Control for the Ham III Rotor

## —good-bye manual switching!

Don Inbody WA0PBQ  
8413 Riggs  
Overland Park KS 66212

Shortly after I installed my new CDE Ham III™ rotator, I decided that there just had to be a more convenient method of operation. Being basically lazy, I am fundamentally opposed to the manual manipulation of switches required. (Press brake lever and hold, press rotation switch and hold until antenna is at de-

sired heading, release rotation switch, and release brake switch a few seconds later.) With the state-of-the-art of electronics, I knew that there should be a better way.

I contemplated the matter for several weeks and even sketched out a few designs on paper. Nothing really jelled until I read a 73

article by Randy Kaeding K8TMK (September, 1979). The article described how he developed a digital readout for the CDE AR-44™ rotator. With his modification, manual manipulation of switches is still required, but he showed me how to produce digital information which can be used to control rotator operation.

I can operate my rotator by selecting the desired heading with thumbwheel switches and momentarily pressing one of two push-buttons, depending on whether clockwise or counterclockwise rotation is desired. I can go back to operating while the antenna rotates to the new heading and stops. A few seconds later the brake solenoid engages. The heading is shown by a three-digit LED readout.

The block diagram (Fig. 1) shows the general operation of the control. A voltage which varies according to the antenna heading is produced across the potentiometer in the rotator assembly. That voltage is



Photo A. Front view of the digital rotator control. Thumbwheel switches for selecting the desired heading are at upper left. LED readouts are behind a red plastic filter at upper right. At lower left are three push-buttons for ccw and cw rotation manually. Discrete LEDs above each push-button indicate the status of the control.

translated into digital information by an analog-to-digital converter. The A/D converter output is fed to decoder/drivers and LED displays. The A/D output is also compared with the settings of thumbwheel switches. When the values agree, rotation stops. A delay timer keeps the brake released for a few seconds to allow the antenna to coast to a full stop.

Fig. 2 shows the logic circuit. U9 is a 3½-digit analog-to-digital converter designed for voltmeter applications and provides a full-scale reading of 2.0 volts. A voltage divider (R34 and R35) furnishes 0.36 volts across the 500-Ohm pot in the rotator assembly; thus, at complete rotation, a readout of 360 is provided. Pins 20-23 provide binary-coded-decimal (BCD) outputs for all digits. Pins 16-19 are digit-enable lines. To obtain information needed by the 7485 comparators (U3 and U4), the output must be de-multiplexed. I used a 74175 (U7) and a 7474 (U6). As explained later, only two digits are used, so the outputs of pins 16 and 19 are disregarded.

The largest number to be shown in the hundreds position is 3, so the binary 4 and 8 outputs are ignored for that digit. The BCD outputs go to the memory chips (U6 and U7) which are clocked by the digit-enable lines. U6 and U7 require positive-going pulses for clocking, so the outputs of pins 17 and 18 must be inverted. I tried various types of inverters, but I could get dependable clocking only by using a 7414, a hex Schmitt trigger. The Schmitt trigger has a very quick snap action, responds with less variation between high and low values, and is fairly tolerant of noisy signals.

U6 and U7 remember the BCD information for each digit until a new clock pulse

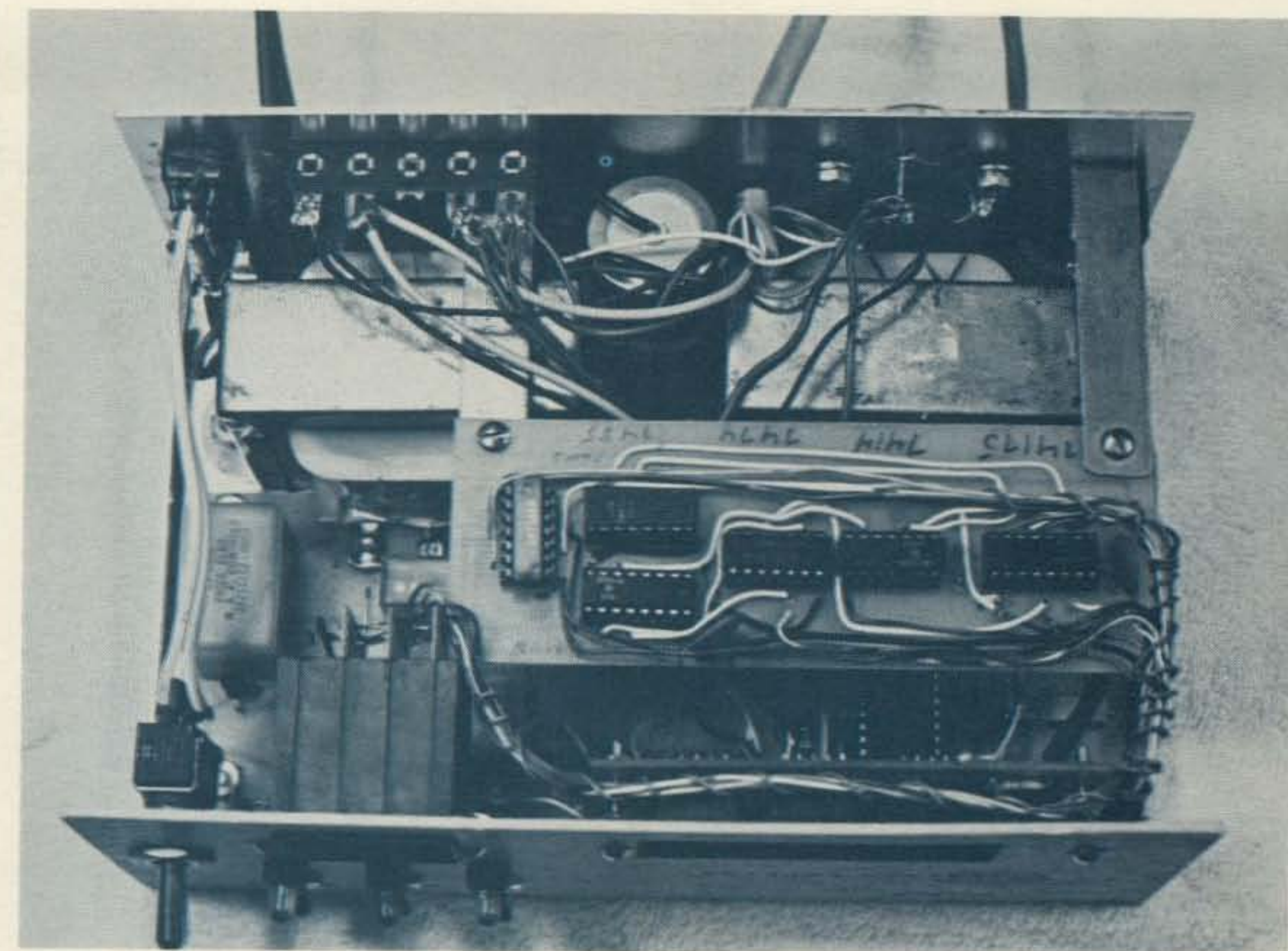

Photo B. Interior view. A 25.2-V transformer at upper left provides ac for rotator operation. At upper right is a 12.6-V transformer for control operation. Connections to the rotator assembly are made on the terminal strip at upper left. After the photo was taken, I installed a molex connector and eliminated the terminal strip. The ac power switch and thumbwheel switches are at lower left. The six ICs mounted on a separate circuit board which is double-decked over the main board are the de-multiplexers, comparators, and inverters.

is provided by the digit-enable lines. This allows the 7485s to compare the values being shown on the readout with those set on the thumbwheel switches. When the values agree, pin 6 of U3 goes high, resets the control flip-flops, and starts the brake-delay timer.

Antenna rotation is accomplished by three set-reset flip-flops and three relays. There is one each for clockwise and counterclockwise rotation and one for operating the brake solenoid. For example, when counterclockwise rotation is desired, momentarily pressing S5 drives pin 1 of U11 high, which closes K1, an SPST relay, and provides 25.2 V ac to the brake solenoid.

At the same time, pin 10 of U10 goes high, which closes K2 and provides 25.2 V to the ccw winding in the rotator motor.

When the desired head-

ing is reached, pin 6 of U3 goes high and resets the ccw flip-flop, which releases K2 and stops rotation. Also, the delay timer is triggered. About three seconds later, the stop flip-flop is reset and K1 is released, allowing the brake to engage. Operation for clockwise rotation is the same, using S4.

S3 provides a manual method of stopping rotation before the desired setting is reached. (This is also useful if you press ccw when you mean to press cw!) LEDs (D4 and D5) light when the antenna is turn-

ing. Another LED (D6) lights when the brake solenoid is energized (brake released). These are not really necessary, but they give a visual indication of action and impress the tourists.

To get more dependable triggering, I routed the output of U3 through two inverters of U8. This may not be necessary, but the inverters were available and they do provide a very clean, fast trigger pulse. D7 blocks the +5-V dc supply from the output of the inverter when the stop button is pressed.

Brake delay is accom-

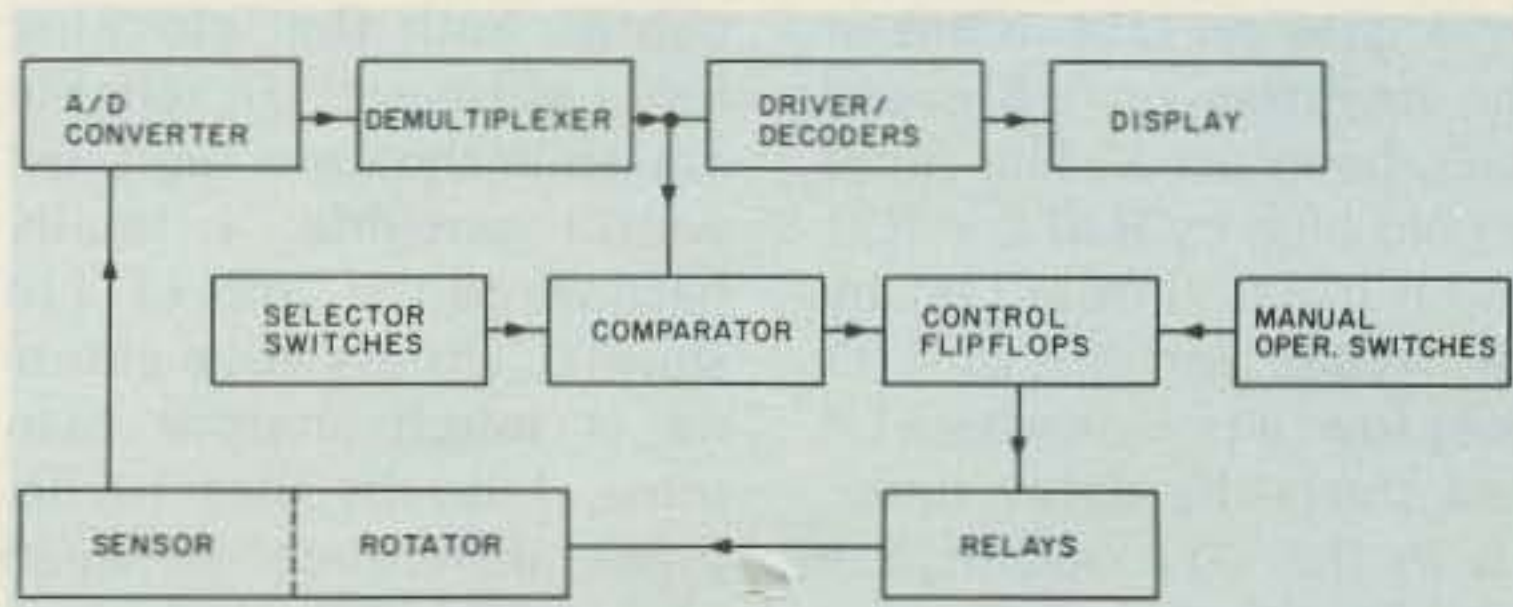

Fig. 1. Automatic rotator control block diagram.

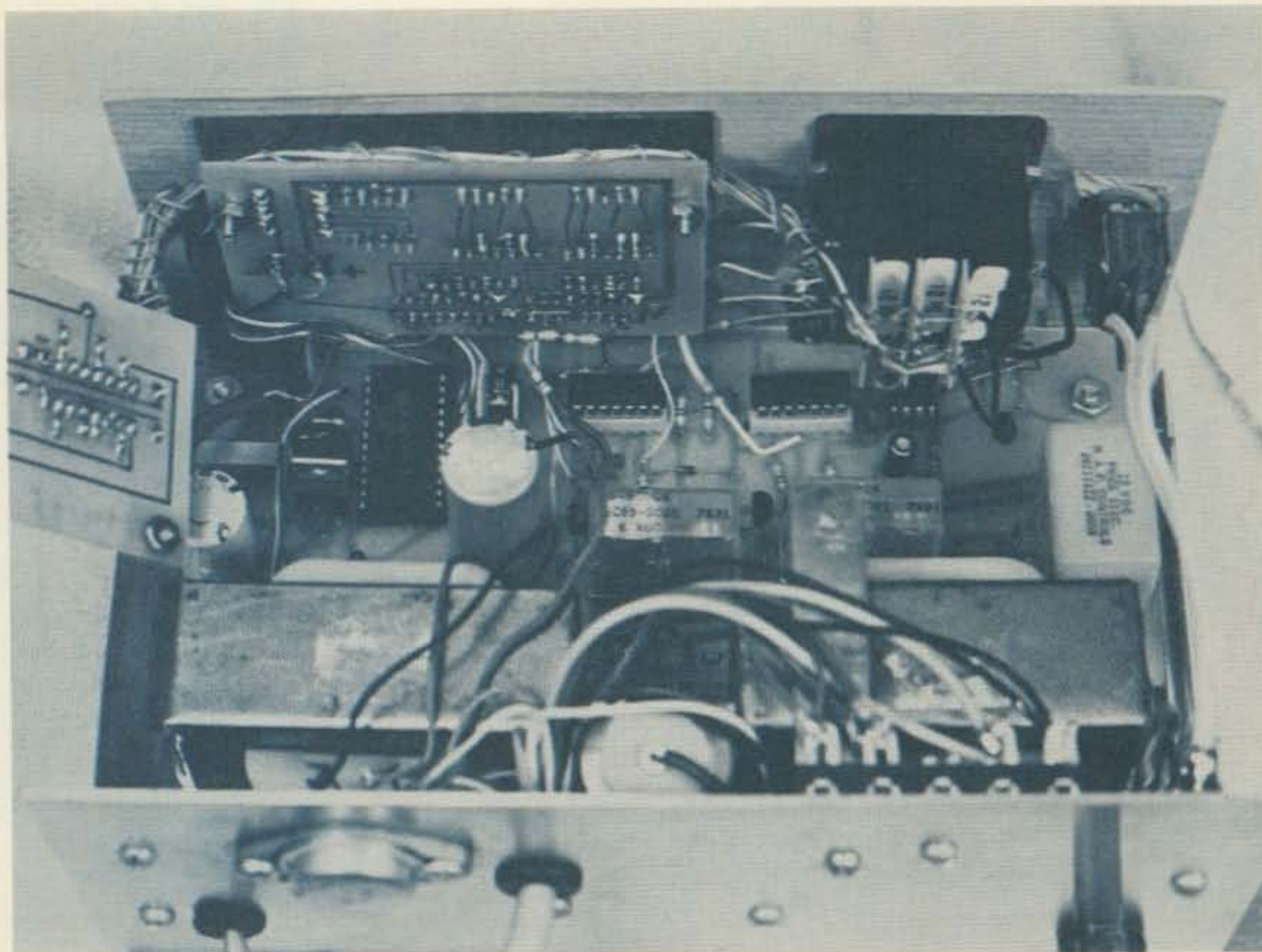

Photo C. The double-decked board has been rotated away to show layout of the main board. The displays and drivers are mounted on the board at upper left. Thumbwheel switches are at upper right. The A/D converter is the large chip at left center. Motor control and brake relays are at right center. The tops of the transformers can be seen near the bottom. At the left is a separate two-conductor shielded cable for the sensor circuit. At left center is the main rotator cable. These have been replaced by a nine-conductor molex connector.

plished by U12, a 555 timer. The values of C5 and R32 shown in Fig. 3 hold the brake released for about three seconds after the motor is turned off. The time can be altered by changing the values of C5 and/or R32 to provide the amount of delay needed for any particular installation. The delay can be any amount from a small fraction of a second to several minutes.

The trigger input of a 555 must be a negative pulse and must be held high between triggerings. The high output from U3 is inverted by a gate on U11. (One of the inverters on U8 could have been used.) The timer is held high by R30 and R31 and is isolated from U11 by C4. When pin 13 of U11 goes low, a pulse crosses C4 and starts the delay timer. C6 in the U12 output line (pin 3) also improves triggering.

The external components around the A/D converter (U9) were chosen according to the manufacturer's application sheet. R16 and R17 are used to set the reference voltage at +2.0 V dc. Other components establish internal operation of the chip.

As shown on the schematic, the rotator control reads out only the hundreds and tens digits. I tried several ways to get more precise readings, but I finally gave up. Because of the method of picking up the sensing voltage, a long rotator cable, and the clocking times of U6 and U7, reliable action in the units digit just wasn't possible. I finally hard-wired the units LED to show 0. Unless your antenna is much sharper than mine, I doubt that 10 degrees difference between actual and indicated heading will be noticeable. If you

know of a way to get a more precise readout, please let me hear from you.

I got the control working well on the breadboard using a 500-Ohm trimpot to simulate the pot in the rotator assembly. When I connected it to the rotator, the readout was totally erratic. After a great deal of checking, consultation, head scratching (and maybe just a little cussing), I found the problem. Instead of 0.36 V dc across terminals 3 and 7 of the rotator, I had about 12 V ac. Apparently, an ac voltage was being induced within the approximately 100 feet of rotator cable. I tried several types of filters and chokes, but nothing worked. A separate two-conductor shielded cable from the shack to the rotator assembly solved that problem.

Another source of diffi-

culty was the nature of the wiring of the rotator assembly. The wiper of the indicator pot in the rotator is connected to earth ground. As that is the source of voltage for U9, all control circuitry must be insulated from earth ground. Also, as I learned the hard way, grounded test instruments cause erratic and meaningless readouts.

I used PC board construction. Perfboard or wire-wrap should work just as well. There are three boards. On one are the power supply, the flip-flops, the relays, and the A/D converter with its associated components. A second board holds the readouts and drivers. The de-multiplexers, Schmitt trigger, and comparators are on a third board, which is double-decked over the main board.

The whole works is mounted in a Radio Shack (#270-269) cabinet, including the transformers. The fit is pretty tight, but it does work, and it looks nice. Wood-grained self-adhesive paper was used to cover the bare aluminum.

The thumbwheel switches provide BCD output. The 7485 comparators require BCD complement, so the switch outputs must be inverted. As only the 1 and 2 outputs are used by the hundreds digit, one 7405 (U5) provides the needed 6 inverters.

The power supply as shown in Fig. 4 is conventional. U13, an LM309K regulator, is mounted on the rear of the cabinet to dissipate the heat. No heat sink is needed for U14, a 7905 regulator, which provides -5 V dc for U9. C10 and C11 are needed to prevent oscillation. They should be installed very near the output terminals of the regulators.

I used 6-volt relays for motor operation and a 12-volt relay for brake oper-

The right design — for all the right reasons. In setting forth design parameters for ARGOSY, Ten-Tec engineers pursued the goal of giving amateurs a rig with the right features at a price that stops the amateur radio price spiral.

The result is a unique new transceiver with selectable power levels (convertible from 10 watts to 100 watts at the flick of a switch), a rig with the right bands (80 through 10 meters including the new 30 meter band), a rig with the right operational features plus the right options, and the right price for today's economy—just \$549.

Low power or high power, ARGOSY has it. Now you can enjoy the sport and challenge of QRPp operating, and, when you need it, the power to stand up to the crowds in QRM and poor band conditions. Just flip a switch to move from true QRPp power with the correct bias voltages to a full 100 watt input.

New analog readout design. Fast, easy, reliable, and efficient. The modern new readout on the ARGOSY is a mechanical design that instantly gives you all significant figures of any frequency. Right down to five figures ( $\pm 2$  kHz). The band switch indicates the first two figures (MHz), the linear scale with lighted red bar-pointer indicates the third figure (hundreds) and the tuning knob skirt gives you the fourth and fifth figures (tens and units). Easy. And efficient—so battery operation is easily achieved.

The right receiver features. Sensitivity of  $0.3 \mu\text{V}$  for 10 dB S+N/N. Selectivity: the standard 4-pole crystal filter has 2.5 kHz bandwidth and a 2.7:1 shape factor at 6/50 dB.

Other cw and ssb filters are available as options, see below. I-f frequency is 9 MHz, i-f rejection 60 dB. Offset tuning is  $\pm 3$  kHz with a detent zero position in the center. Built-in notch filter has a better than 50 dB rejection notch, tunable from 200 Hz to 3.5 kHz. An optional noise blanker of

utes on all bands. 3-function meter shows forward peak power on transmit, SWR, and received signal strength. PTT on ssb, full break-in on cw. PIN diode antenna switch. Built-in cw sidetone with variable pitch and volume. ALC control on "high" power only where needed, with LED indicator.

Automatic normal sideband selection plus reverse. Normal 12-14V dc operation plus ac operation with optional power supply.

The right styling, the right size. Easy-to-use controls, fast-action push buttons, all located on raised front panel sections. New meter with lighted, easy-to-read scales. Rigid steel chassis, molded front panel with matching aluminum top, bottom and back.

Stainless steel tilt-up bail. And it's only 4" high by 9½" wide by 12" deep (bail not extended) to go anywhere, fit anywhere at home, in the field, car, plane or boat.

The right accessories—all front-panel switchable.

Model 220 2.4 kHz 8-pole ssb filter \$55; Model 218 1.8 kHz 8 pole ssb filter \$55; Model 217 500 Hz cw filter \$55; Model 219 250

Hz cw filter \$55; Model 224 Audio cw filter \$34; Model 223 Noise blanker \$34; Model 226 internal Calibrator \$39; Model 1125 Dc circuit breaker \$10; Model 225 117/230V ac power supply \$129; Model 222 mobile mount, \$25; Model 1126 linear switching kit, \$15.

Model 525 ARGOSY — \$549. Make the right choice, ARGOSY—for the right reasons and low price. See your TEN-TEC dealer or write.

## Here's a Concept You Haven't Seen In Amateur Radio For A Long Time— Low Price.



## New TEN-TEC Argosy \$549

the i-f type has 50 dB blanking range. Built-in speaker is powered by low-distortion audio (less than 2% THD)

The right transmitter features. Frequency coverage from 80 through 10 meters, including the new 30 meter band, in nine 500 kHz segments (four segments for 10 meters), with approximately 40 kHz VFO overrun on each band edge. Convertible power: 100 or 10 watts input with 100% duty cycle for up to 20 min-

**TEN-TEC, INC.**  
SEVIERVILLE, TENNESSEE 37862  
EXPORT 5715 LINCOLN AVE., CHICAGO, ILL. 60646

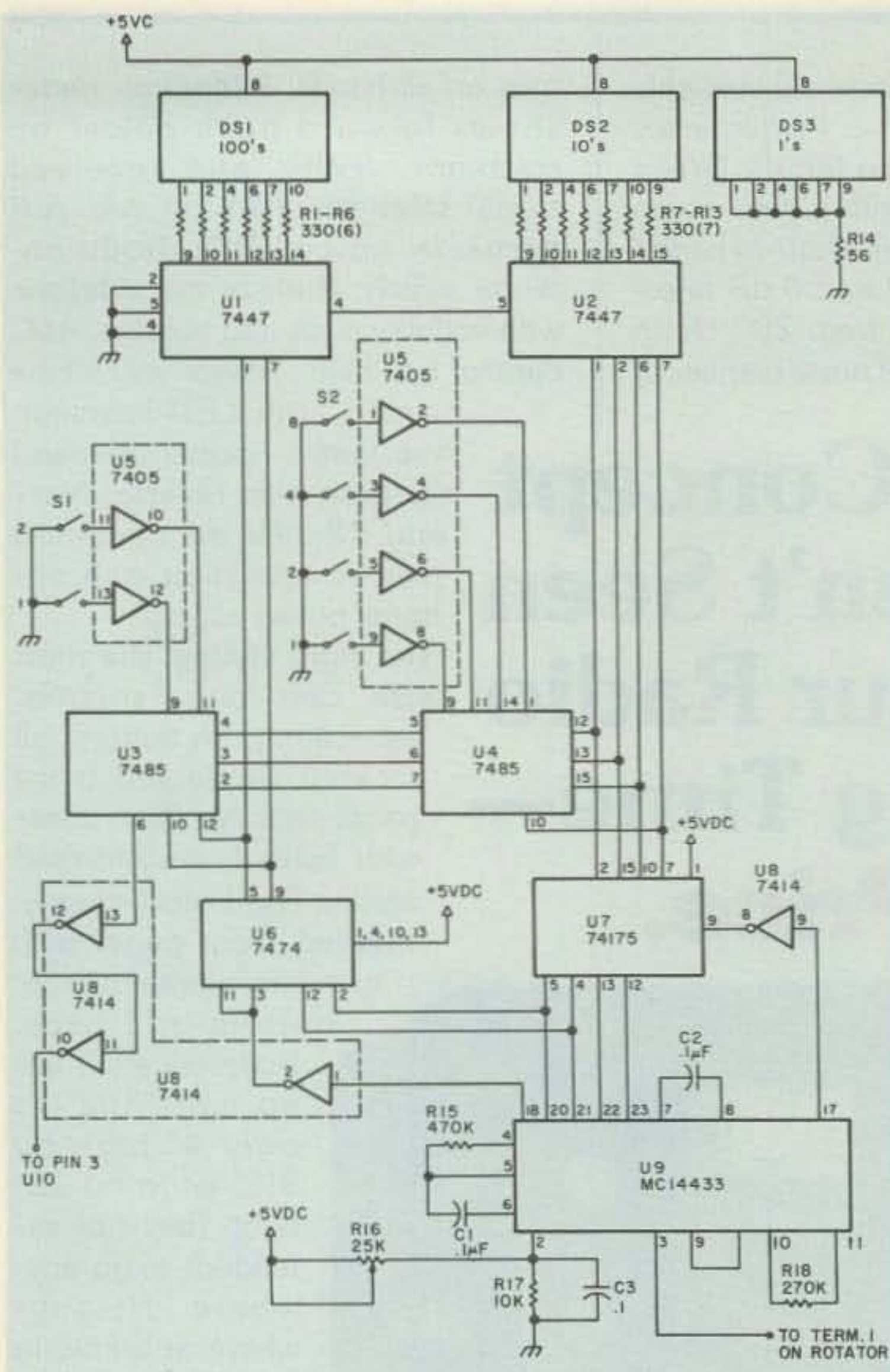

Fig. 2. Readout and logic schematic. All circuitry must be insulated from earth ground.

ation because they were on hand. The motor relays are not especially critical as the current is relatively small. The brake relay must handle about 2 Amps plus the amount required by the motor. Note that the motor relay contacts are in series with the brake relay contacts. This ensures that the motor will not run unless the brake is released.

My 6-volt relays would not operate from the 5-volt power supply, so I included D12, a 6-volt zener, ahead of the positive regulator with R35 in series. The power supply voltage ahead of the positive regulator was near enough to 12 volts to operate the brake relay. Different relays will, of course, have different power requirements.

Almost any general-purpose NPN switching transistors should work for Q1-Q3. D1-D3 across the relay coils help prevent voltage spikes which occur when the coils are switched out.

If you build this project, don't forget C7, a 120-140-uF unpolarized electrolytic capacitor. It is necessary for rotator operation. I got mine from CDE.

There are only two adjustments to make. R16 must be set to provide 2.0 V dc at pin 2 of U9. R34 is adjusted to provide a 360 reading at full rotation of the antenna and will need to be readjusted if the control cable length is changed.

All parts used in the control are readily available. Except for the motor capacitor, I got all my parts from

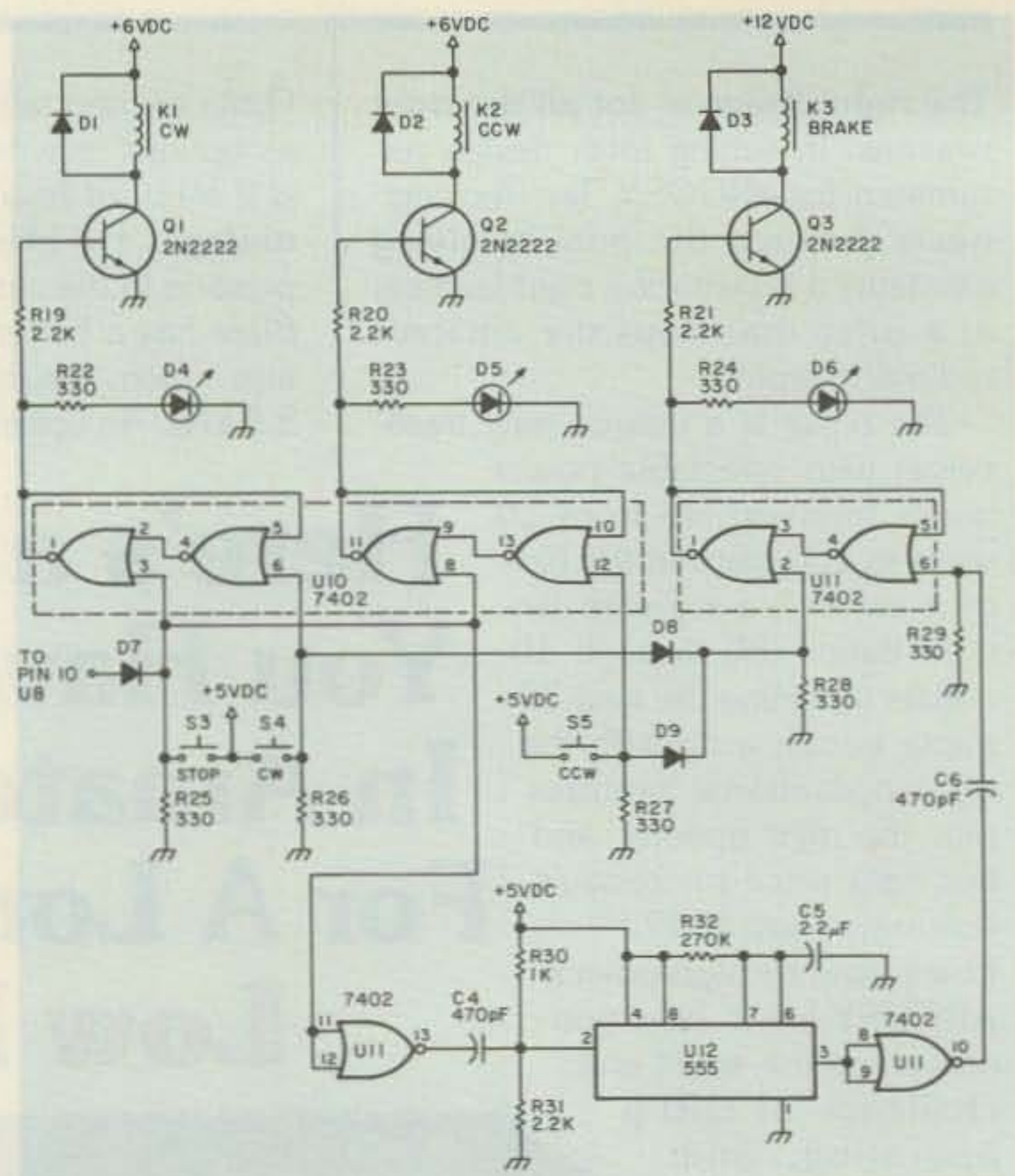

Fig. 3. Control schematic. All circuitry must be insulated from earth ground.

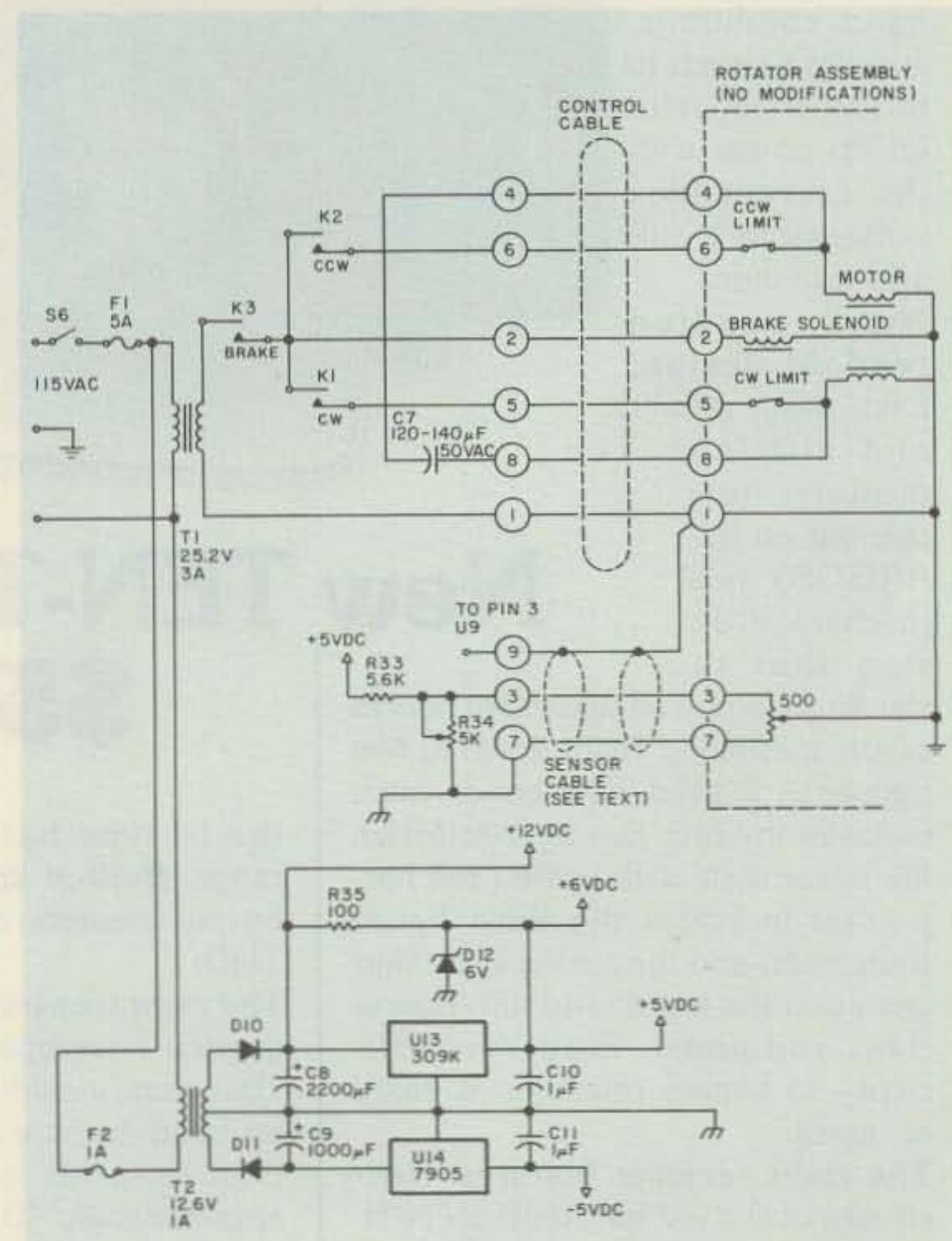

Fig. 4. Power supply and connections to rotator assembly. All circuitry must be insulated from earth ground except potentiometer wiper and motor in the rotator assembly and the cabinet ground on the 115-V ac line.



# Rickerson Returns

*A print by a famous American space-age artist offers you a chance to help launch the AMSAT satellite.*

The response was great. A few months ago JS&A offered a limited edition print by American artist, Mark Rickerson, in a similar style to the print shown above.

## THE SUCCESS

There were only 300 prints available. Although we expected to get more orders than we had prints, we did not expect the several thousand responses we eventually received.

## THE FAILURE

Another famous program, however, was not successful. A satellite, built by world amateur radio operators in 1980 and placed on a European rocket, crashed into the ocean almost immediately after take-off. The AMSAT satellite and the rocket were lost, along with the hopes of amateurs who had worked for years building their satellite.

The JS&A program was a success. But JS&A's program and the AMSAT failure have something in common—a great opportunity for the public. Let us explain.

AMSAT was a private venture based strictly on donations. No government money was used. In addition to the thousands of man hours contributed by amateurs world-wide, there was a total of \$250,000 raised to buy materials.

Why do amateurs even need a satellite? Amateurs or ham radio operators (not to be confused with citizen band operators) are always the first on a scene in a major disaster. During the Italian earthquake, for example, amateurs were first to direct relief efforts.

But occasionally a disturbance in the ionosphere will interrupt this communication and render all radio communications inoperative, as was the case in the Alaskan earthquake. That's only one of the many reasons for

AMSAT—positive communications in times of emergencies and not dependent on the ionosphere. JS&A thinks the venture deserves the support of all Americans, and we are providing our full financial and creative support to a program to help raise funds to build and launch a new AMSAT satellite.

## THE PROGRAM

JS&A commissioned Mark Rickerson to paint "AMSAT"—a painting to be used exclusively for this space effort. From this painting, JS&A has arranged with Rickerson to produce limited edition prints signed by the artist. JS&A will contribute all prints and the full costs to produce these prints to the program. Only the cost to run the advertisement in a magazine will be covered by the initial proceeds.

Each print has a 26" x 35" image size on a 34" x 42" piece of museum-quality PH balanced 100% rag content paper. The print will be shipped in a well-protected circular cardboard double container. Your contribution of \$300 will also entitle you to a handsome certificate suitable for framing to acknowledge your active participation in the new AMSAT launch. A certificate of authenticity will also accompany the print should you wish to sell or donate it to someone in the future.

Each color of this multi-colored painting will be faithfully reproduced in a special colotype process utilizing a continuous tone printing process, several printing plates and the artist's supervision and approval to provide an almost three dimensional reproduction.

Dr. Tom Clark, a NASA scientist and president of the AMSAT organization, says, "We need the cooperation of the American citizen to make this program a success. I urge all Americans to participate. Not only is the

reproduction a beautiful piece of art, but the contribution is to a very worthwhile cause. In addition to its use during emergencies, we will be using AMSAT for educational purposes to train many of the potential young scientists in our country."

The edition will be limited to those who subscribe before the deadline date of June 30, 1981. The publication you are reading has helped us in this program by giving us a good position in their magazine and allowing us every available discount to keep the expense of this program low.

To order, send your check or money order for \$300 made payable to AMSAT to Dept. ST, JS&A Group, Inc., One JS&A Plaza, Northbrook, Illinois 60062. If for any reason you are not satisfied with your print, you may return it anytime this year for a prompt and courteous refund.

JS&A had a success with its limited edition print program earlier this year. The AMSAT program suffered a failure. Why not join with us to make their launch a huge success? Order your Rickerson AMSAT print, today.



Dept. ST One JS&A Plaza  
Northbrook, Ill. 60062 (312) 564-7000  
© JS&A Group, Inc., 1981

## Parts List

C1	0.1-uF mylar®
C2,3	0.1-uF ceramic disc
C4,6	470-pF ceramic disc
C5	2.2-uF tantalum
C7	120-140-uF ac electrolytic
C8	2200-uF electrolytic
C9	1000-uF electrolytic
C10,11	1-uF tantalum
D1-3,7-9	1N914/1N4148, etc.
D4-6	LED
D10,11	1N4001
D12	6-volt zener
DS1-3	FND-510
K1,2	SPST 1-A relay
K3	SPST 3-A relay
Q1-3	2N2222 or equivalent
R1-13,22-29	330 Ohms (all fixed resistors are 1/4 Watt)
R14	56 Ohms
R15	470k
R16	25k trimpot
R17	10k
R18,32	270k
R19-21,31	2.2k
R30	1k
R33	5.6k
R34	5k,10-turn trimpot
R35	100 Ohms
S1,2	BCD thumbwheel switch*
S3-5	NO push-button
S6	SPST toggle
T1	25.2 V, 3 A
T2	12.6 V, 1 A
U1,2	7447
U3,4	7485
U5	7405
U6	7474
U7	74175
U8	7414
U9	MC14433
U10,11	7402
U12	555
U13	LM309K
U14	7905

### Other:

Cabinet  
Power cord  
5-A fuse and holder  
1-A fuse and holder  
IC sockets  
2-conductor shielded cable  
9-pin molex connectors  
(2 male, 1 female)  
Despiking capacitors  
(0.01-0.1-uF ceramic)

\*Thumbwheel switches are available from Jameco Electronics, 1355 Shoreway Road, Belmont CA 94002. This project uses 2 SR21 BCD switches and 1 pair SREP end plates.

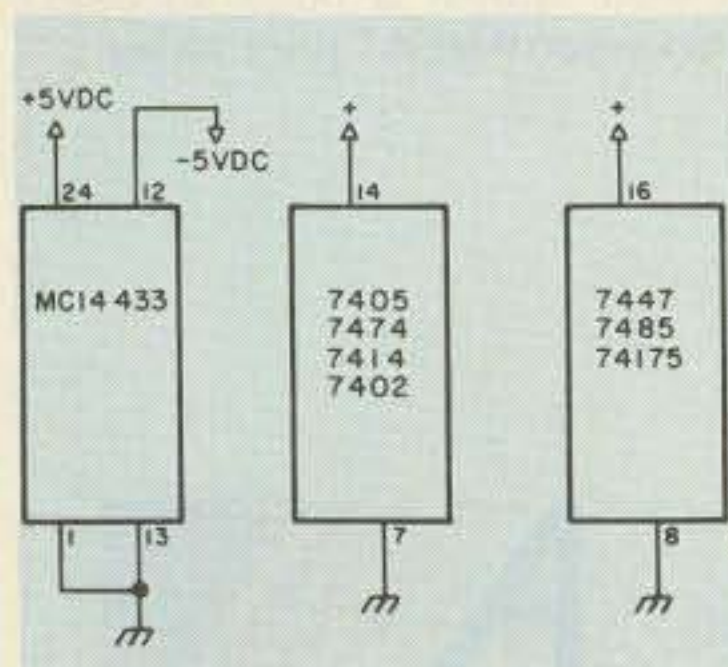

Fig. 5. Supply connections for integrated circuits.

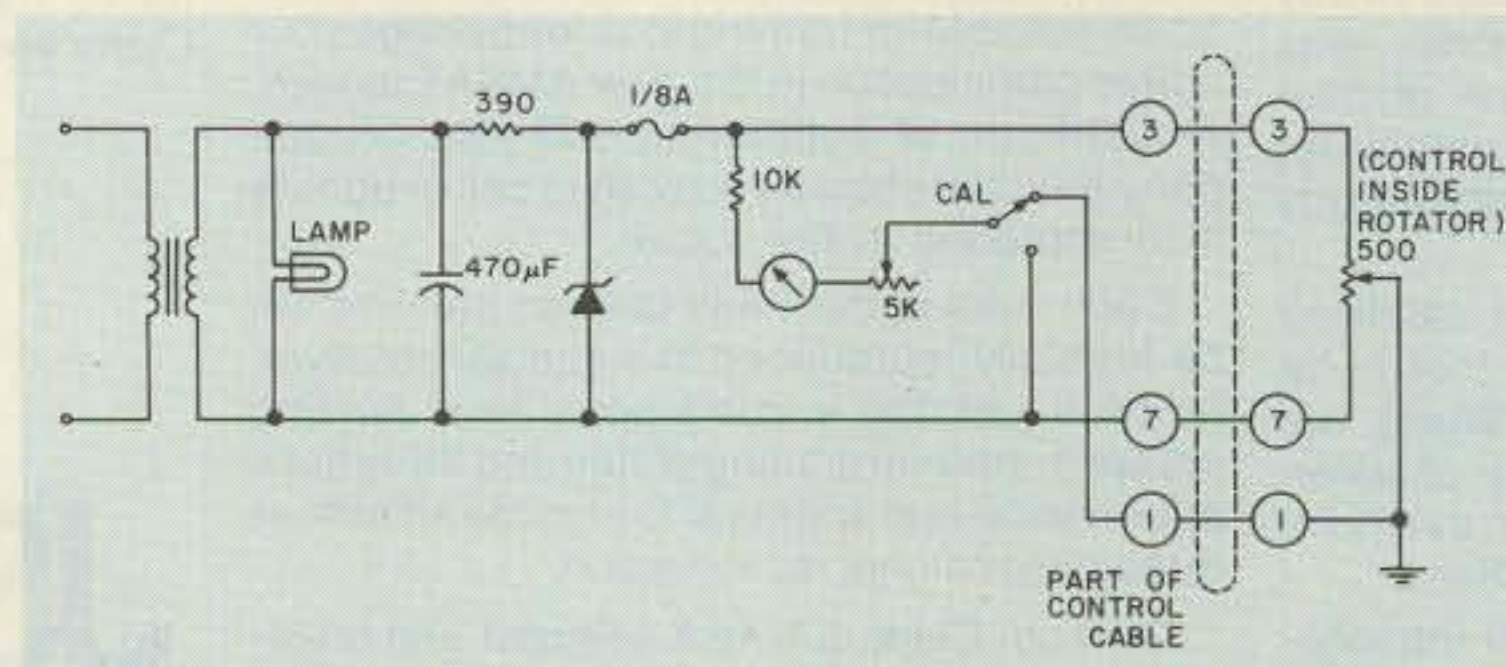

Fig. 6. Unmodified sensing circuit of the Ham III rotator. Wiper of control in rotator is connected to earth ground.

Radio Shack, 73 advertisers, and my junk box. Prices vary, so it pays to do some comparison shopping. Except for the timing of the brake release delay and the external components around the A/D converter, nothing in the circuit is especially critical. The 330-Ohm resistors are typical for TTL circuits, but any value from 100 Ohms to 560 Ohms will work, although lower values will increase the power supply demand. Diodes D1-D3 and D7-D9 can be just about any general-purpose diodes you have available.

Good TTL design requires liberal use of despiking capacitors. They are not shown on the schematics, but several 0.01-uF ceramic discs were installed at various locations where +5-V dc lines were near ground buses. There should be one for every three ICs and one at each place a supply line enters a circuit board. Any value from 0.01 uF to 0.1 uF will work in a circuit such as this one. Supply connections for most ICs have been omitted from the schematics. See Fig. 5 for connections required.

The readouts are FND-510s. They are large (0.5") and can be bought for \$1.00 or less. Almost any 7-segment LEDs could be used. The 510 is a common-anode device. If common-cathode displays are used, substitute 7448 drivers for the 7447s and connect the common pins to ground instead of to +5 V dc.

As mentioned before,

this project was developed to adapt my Ham III. Other CDE rotators have basically the same circuit, so adaptation to other models should be possible. Fig. 6 shows the sensing circuit of the Ham III. If you have a different model, you can check the circuit shown in your owner's manual to learn if any changes are needed.

With this control, the antenna will have to be shifted 180 degrees. The standard dial on CDE rotators has 0 and 360 degrees at the center of the meter scale. With the digital control described here, mid-rotation provides a 180-degree reading. As I wanted to be able to continue using my CDE control box as a backup, I changed the marking on the meter plate. A south-centered meter plate is available from CDE.

I also provided both control boxes and the rotator cable with molex™ connectors. This allows me to switch controls easily. Incidentally, this quick-disconnect feature provides a safety factor. When lightning threatens and I disconnect my antennas, I also can disconnect the rotator cable and remove one more possible source of lightning in the shack.

The digital rotator control has been in operation in my shack for several months without any problems. It certainly is more convenient to use than the standard control. During net or contest operation, I can change the antenna heading quickly by dialing the new heading and pressing a button. I can immediately go on operating without waiting for the antenna to complete its rotation.

There are probably better and simpler ways to accomplish the same results. I will be interested in hearing about your efforts. If you have questions, write to me and include an SASE. I will try to answer. ■



# A superb frequency counter is frequently not counted—just because it doesn't have a high price-tag.



The truth is, our 8000B 1 Gigahertz is an excellent counter. In fact, it's preferred by many engineers, technicians, and electronic enthusiasts. Not a single competitor on the market today can surpass our price/performance ratio.

And we've deliberately kept our prices down. First, we've refused to join everybody else in their high mark ups. Instead of "charge what the market will bear," for us it's "charge a fair price." Second, we sell what we manufacture, directly to you. So extra costs of extra steps are automatically eliminated. Third, we have to build a lot of frequency counters to meet the demand. Because we do sell so many, we don't have to charge a high price to make a profit.

And about quality . . . Sabtronics frequency counters always have the most innovative features available. For example, our 8000B 1 Gigahertz Frequency Counter has a 10 Megahertz precision crystal timebase. But most important, the 8000B, using the most advanced LSI circuitry, has a guaranteed sensitivity of 30 millivolts up to 1 Gigahertz, with 20 millivolts typical. The three-stage differential amplifier IC makes this possible. Altogether, the 8000B uses only 6 IC's, making the chance of failure virtually nonexistent.

Three selectable gate times provide the measurement speed you need — and greater resolution. The resolution is further enhanced by our counter's 9-digit display.

Like the 8000B, Sabtronics' 8610B is a high-quality precision frequency counter. It features only 4 IC's, and offers a frequency range up to 600 Megahertz.

The cases of both counters are high strength impact-resistant ABS plastic. Elegant but very rugged. Sabtronics doesn't believe in skimping on the high quality construction that brings excellent performance. But we're not about to charge a high price just because we could get it!

Send in the coupon and order your new frequency counter now. Credit card holders may call.

## BRIEF SPECIFICATIONS:

**Frequency Range:** 10 Hz to 1 GHz (Model 8000B), 10 Hz to 600 MHz (Model 8610B); **Timebase:** Frequency: 10 MHz, Stability:  $\pm 1$  ppm (20 to 40°C.), Aging Rate:  $< 1$  ppm/year; **Sensitivity** (adjustable): Input A  $< 15$  mV to 100 MHz, Input B  $< 30$  mV, 100 MHz to 1 GHz (Model 8000B),  $< 30$  mV, 100 MHz to 600 MHz (Model 8610B); **Gate Times:** .1 sec., 1 sec., 10 sec.; **Resolution:** 0.1 Hz to 10MHz, 1 Hz to 100 MHz, 10 Hz to 1 GHz; **Display:** 9-digit LED 0.4"; **Power Requirements:** 4.5 to 6.5 VDC (4 C-cells) or optional AC adapter; **Dimensions:** 8" wide X 6.5" deep X 3" high (203 X 165 X 76 mm), 1.3 pounds (590 g) excluding battery.

Making Performance Affordable

**sabtronics**   
INTERNATIONAL INC.

Sabtronics International, Inc., 5709 N. 50th Street, Tampa, FL 33610, (813) 623-2631.

Please send me the following:

\_\_\_\_\_ Model 8000B 1 GHz Frequency Counter(s), Assembled @ \$199.00 each ..... \$ \_\_\_\_\_

\_\_\_\_\_ Model 8610B 600 MHz Frequency Counter(s), Assembled @ \$149.00 each ..... \$ \_\_\_\_\_

Shipping and handling, \$6.00 per unit\* ..... \$ \_\_\_\_\_

10% deposit for C.O.D. orders ..... \$ \_\_\_\_\_

Florida residents add 4% Sales Tax ..... \$ \_\_\_\_\_

I enclose  check  money order. (Allow two to three weeks for personal checks to clear.)

Charge:  Visa  Master Charge

Account No. \_\_\_\_\_ Exp. Date \_\_\_\_\_

Name \_\_\_\_\_

Address \_\_\_\_\_

City \_\_\_\_\_ State \_\_\_\_\_ ZIP \_\_\_\_\_

\*U.S. only. Canada \$7.50; overseas air mail \$25.00.



# SCR1000 VHF—SCR4000 UHF

*If You Want a Fantastic Repeater or Link System - Go With the Finest  
Go With Spec Comm!*



**2 Mtr.  
220 MHz  
450 MHz**

- 30W Output.
- Low Noise/Wide Dynamic Range Front End for Excellent Sensitivity & IM Rejection.
- Sensitivity: 0.3uV Typ.
- 12 Pole IF Filter, & 8 Pole Front End Filter.
- Full Metering, Lighted Status Indicators/Control Push-buttons, Btry. Power Input, AC Pwr. Supply, CW IDer, etc., etc.

SCR1000  
& SCR4000  
ARE FCC TYPE  
ACCEPTED  
for Commercial  
Services

Available with all of the features you want—Full Autopatch/Reverse Patch/Land-Line Control; Touch Tone Control of various repeater functions; "PL"; "Emergency Pwr. I.D."; various Tone & Timer Units, etc. PLUS—the finest Duplexers, Cabinets, Antennas, Cables, etc. Our Repeaters are sold factory direct only, or through Foreign Sales Reps. Get your order in A.S.A.P.!

If you plan to install a new Repeater or VHF/UHF Link System (with or w/o Auto-patch), you'll find that you can't find better quality, more reliable equipment, with all of the features and options you want at anywhere near our prices—if you can find it at all!

For many years now, we have specialized specifically in the field of VHF/UHF Repeaters, Links, Transceivers and all of the accessories to make up a complete system. We now have hundreds of repeater and link systems operating successfully all over the world!

When you buy Spec Comm gear, you get the benefit of all of these years of experience—you get the best! And, years from now, you'll still be glad you went with Spec Comm!

Shown in Optional Cabinet

**30 or 70 WATTS  
on 2 Mtrs.!**

Made In U.S.A.

*Commercial Business Radio Dealer Inquiries Invited*

180 Day Warranty

Call or write today and get the details!



## **SPECTRUM**

Export Orders — Contact our International Dept.

1055 W. Germantown Pk., Dept. S6

# COMMERCIAL MOBILE & BASE TRANSCEIVERS

**new**

Spec Comm "Professional Communications Line"

**136-174 MHz**

## Features

- 6 channels.
- 0.23 uV Rcvr. Sens.
- 8 Pole Crystal & 4 Pole Ceramic IF Filtrs.
- Beautiful Audio—RX + TX.
- Provision for CTCSS.
- Panel LEDs for PWR, Xmt; Busy
- Very Reasonable Price!

### PCL250 40 Wt. Mobile Unit

• "Super Rugged" Housing

Solid 1/8" Thk. Aircraft Aluminum!



**220-240 MHz** (Commercial Export and Amateur)

• Very attractive woodgrain housing.



- Built-in AC Power Supply.
- Front Panel Status Indicator Lights ("AC PWR.", "Transmit," "RX BUSY")
- Optional Rcvr. Scanning Function Available.

### PCL300 40 Wt. Base Station

▶ FCC TYPE ACCEPTED — PARTS 21, 81, 90 ◀

## SPEC COMM REPEATER BOARDS & SUB-ASSEMBLIES

These are Professional "Commercial Grade" Units—Designed for Extreme Environments (−30 to +60° C).

All equipment assembled & tested. For 2M, 220 MHz & New 450 MHz!

### SCR450 BOARD



### SCR100 VHF Receiver Board

- Wide dynamic range! Reduces overload, desense, and IM.
- Sens. 0.3 uV/12dB SINAD typ.
- Sel. -6dB @ ± 6.5 KHz. -110dB @ ± 30KHz. (8 Pole Crystal Filtr.) 10 Pole—Optional
- 'S Meter' Output.
- Exc. audio quality! Fast squelch! w/0.0005% Crystal.

### SCR100 Receiver Assembly

- SCR100 mounted in shielded housing
- Completely asmbld. w/F.T. caps, SO239 conn., AF GAIN POT, etc.

### SCR450 UHF Receiver Bd. or Assy.

- Similar to SCR100, except with 12 Pole IF Filtr. & 8 Resonator Front End Filtr.!
- Discriminator & Deviation Mtr. Outputs
- **Totally New Advanced Design!**

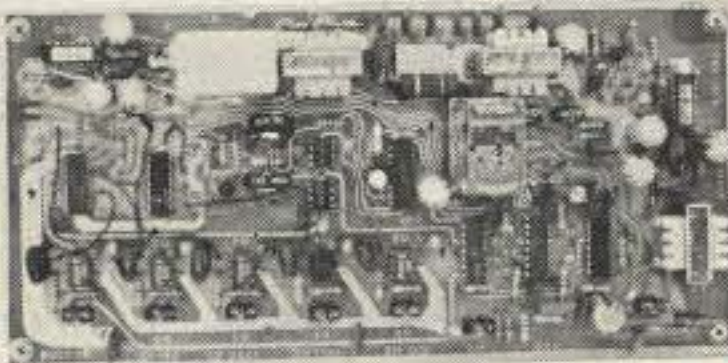

### SCAP Autopatch Board

- Provides all basic autopatch functions
- Secure 3 Digit Access; 1 Aux On-Off function, Audio AGC; Built-in timers; etc. Beautiful Audio!
- 0/1 inhibit bd. also available
- Write/call for details and a data sheet

### RPCM Board

- Used w/SCAP board to provide "Reverse Patch" and Land-Line Control of Repeater.
- Includes land line "answering" circuitry

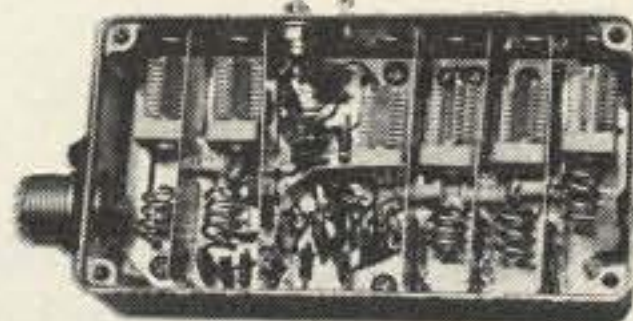

FL-6

### FL-6 Rcvr. Front-End Preselector

- 6 Hi Q Resonators with Lo-Noise Transistor Amp (2M or 200MHz).
- Provides tremendous rejection of "out-of-band" signals w/out the usual loss! Can often be used instead of large, expensive cavity filters.
- Extremely helpful at sites with many nearby VHF transmitters to "filter-out" these 'out-of-band' signals.

### CTC100 Rptr. COR Timer/Control Bd.

- Complete solid state control for rptr. COR, "Hang" Timer, "Time-Out" Timer, TX Shutdown/Reset, etc.
- Includes Inputs & Outputs for panel controls & lamps

### Repeater Tone & Control Bds.—For SCR1000/4000 & CTC100/ID250 only

#### TRA-1 "Courtesy Tone Beeper" Board

- Puts out a tone beep apx. 1 sec. after RX sig. drops—thus allowing time for breakers
- Resets T.O. Timer after "beep"

#### TMR-1 "Kerchunker Killer" or "Time Out Warning Tone" Bd.

- For One of above 2 functions
- "Kerchunker Killer" provides adj. delay (0-10 sec.) for initial rptr. access. Auto-Reset at end of QSO.
- T.O. Warning Tone provides alerting "warble tone" apx. 10 sec. before "time out."

### PSM-1 Repeater Power Supply Mod Kit

- For SCR-1000 or SCR-4000
- Replaces Darlington Pass Tr.—for improved reliability
- Includes new overvoltage "Crowbar" shutdown circuit.
- Complete kit, w/assembled PC board. \$19.50 + \$2.50 SH.

### ID250 CW ID & Audio Mixer Board

- Adjustable ID tone, speed, level, timing cycle.
- 4 Input AF Mixer & Local Mic amp.
- COR input & xmtr. hold circuits.
- CMOS logic; PROM memory—250 bits/channel.
- Up to 4 different ID channels!
- Many other features Factory Programmed



SCT410 XMTR. ASSY.

### SCT110 VHF Xmtr/Exciter Board

- 7 or 10 Wts. Output, 100% Duty Cycle!
- Infinite VSWR proof
- True FM for exc. audio quality
- Designed specifically for continuous rptr service
- Very low in "white noise"
- Spurious - 70 dB. Harmonics - 60 dB.
- With .0005% xtal.
- BA-10 30 Wt. Amp board & Heat Sink, 3 sec. L.P. Filter & rel. pwr. sensor.

### SCT110 Transmitter Assembly

- SCT110 mounted in shielded housing
- Same as used on SCR1000
- Completely asmbld. w/F.T. caps, SO239 conn.
- 7, 10 or 30 Wt. unit.

### SCT410 UHF Transmitter Bd. or Assy.

- Similar to SCT110. 10 Wts. nom.
- Avail. w/ or w/o OS-18 Super High Stability Crystal Osc./Oven.
- BA-40 30W. min. UHF Amp. Bd. & Heat Sink.

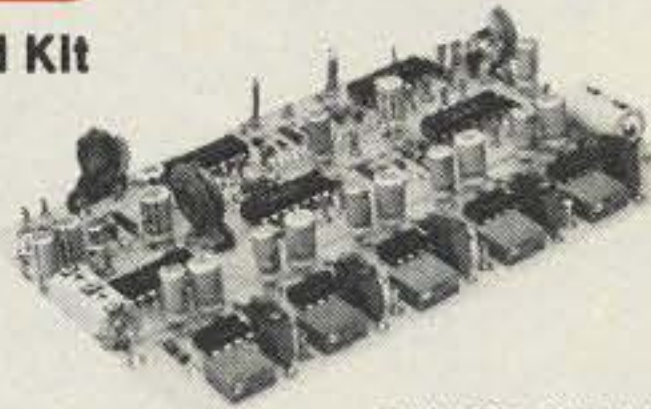

TTC100 Touchtone

### Control Board

- 3 digit ON, 3 digit OFF control of a single repeater function. Or, (optional) 2 functions (2 digits ON/OFF each).
- Can be used to pull in a relay, trigger logic, etc.
- Typically used for Rptr. ON/OFF, HI/LO Pwr., P.L. ON/OFF, Patch Inhibit/Reset, etc.
- Stable, anti-falsing design. 5s Limit on access.
- For Add'l Function(s)—Add a "Partial TTC" Board.

# COMMUNICATIONS CORP.

Send for Data Sheets!

Norristown, PA 19401 • (215) 631-1710

# The Doppler Systems DDF-3003

## — a review of the latest in direction-finding equipment from Doppler Systems

Paul Grupp KA1LR  
73 Magazine Staff

One rather unfortunate by-product of the boom in repeater activity is the large flock of wild

turkeys that has accompanied it. For the uninitiated, a wild turkey is an uncivilized lout who manifests various and sundry antisocial behaviors while firmly clutching the PTT switch on the microphone of an FM transceiver. As an avid FM operator, I have developed a fairly well-tested hypothesis which I

call the wild-turkeys-per-square-mile factor.

In any given population center, there will be a certain number of wild turkeys per square mile. The greater the population density of a specific geographical area, the greater the number of wild turkeys in that area. By the same token, the wider the coverage of a particular

repeater, the larger the number of wild turkeys that will be operating within its coverage area.

Now, whatever the coverage of a particular repeater, it can only carry so much traffic. A repeater with a very small coverage area in a location with a low population density will probably be able to laugh off the feeble efforts of the .325 wild turkeys within its coverage area. The matter gets a bit more serious as the coverage of the repeater increases. A wide-area-coverage repeater in a metropolitan area will have no more hours in its operating day than the rural repeater, yet the flock of wild turkeys using its time will be much larger, causing a level of interference that often cannot be tolerated.

It is on this fertile ground that sophisticated direction-finding equipment has begun to get a foothold in the amateur market. At some point, the operators of a repeater grow tired of the activities of the wild-turkey contingent, and they

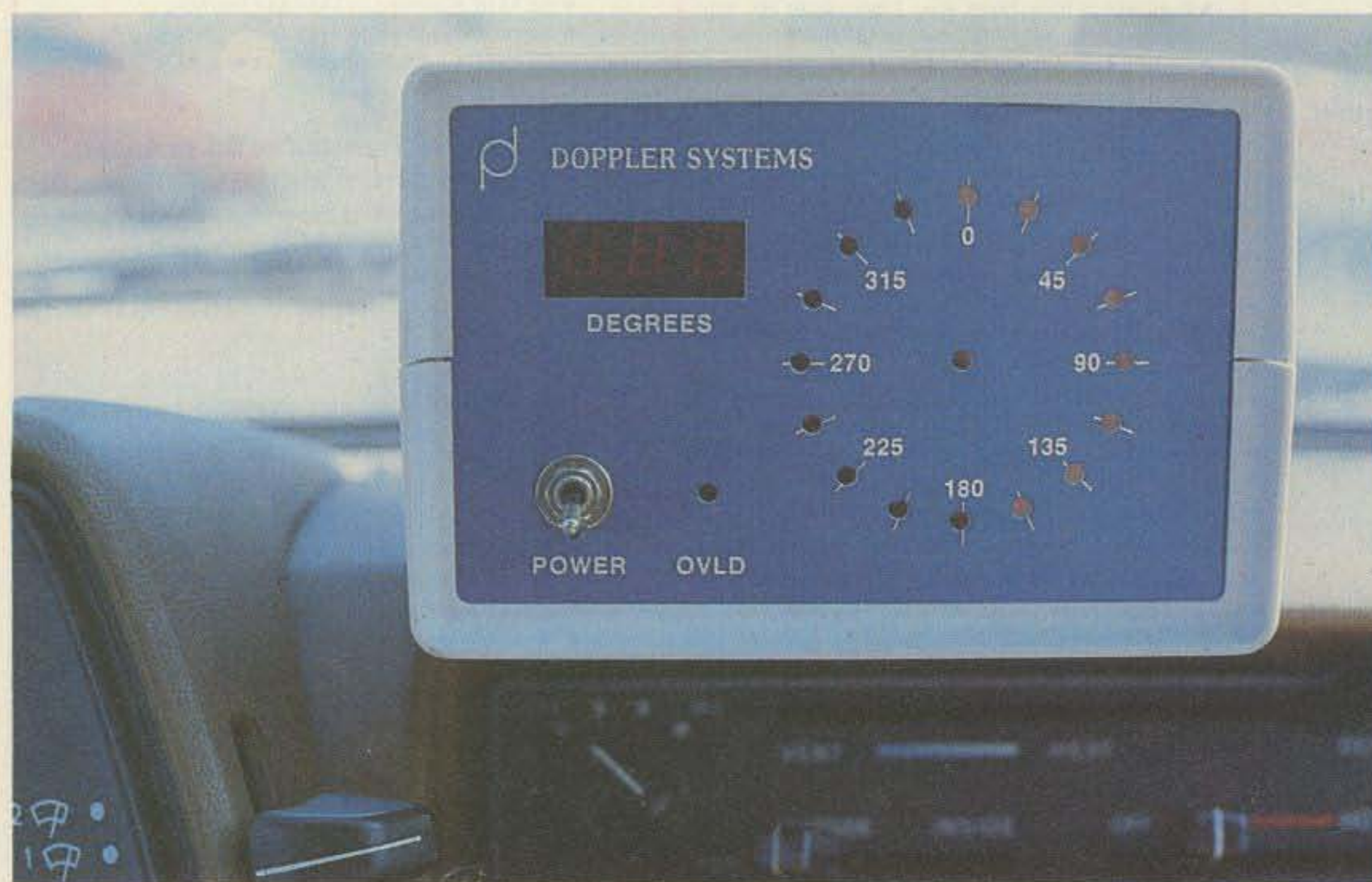

The Doppler Systems DDF-3003 radio direction-finder.

# New! AZDEN® PCS 3000

## BLAZING THE FRONTIER OF

# MICROCOMPUTER COMMUNICATIONS



**SUPERIOR  
COMMERCIAL GRADE  
2-METER FM TRANSCEIVER**

INTRODUCTORY PRICE

**\$339<sup>00</sup>**  
**FREE** TOUCH-TONE®  
PAD KIT INCLUDED

### COMPARE THESE FEATURES WITH ANY UNIT AT ANY PRICE

- **8 MHZ FREQUENCY COVERAGE, INCLUDING CAP/MARS BUILT IN:** Receive and transmit 142.000 to 149.995 MHz in selectable steps of 5 or 10 kHz. **COMPARE!**
- **SIZE:** Unbelievable! Only 6 3/4" by 2 1/2" by 9 3/4". **COMPARE!**
- **MICROCOMPUTER CONTROL:** All frequency control is carried out by a microcomputer.
- **MUSICAL TONE ACCOMPANIES KEYBOARD ENTRIES:** When a key is pressed, a brief musical tone indicates positive entry into the microcomputer. **COMPARE!**
- **PUSHBUTTON FREQUENCY CONTROL FROM MICROPHONE OR PANEL:** Frequency is selected by buttons on the front panel or microphone.
- **8 CHANNEL MEMORY:** Each memory channel is reprogrammable and stores the frequency and offset. Memory is backed up by a NICAD battery when power is removed.
- **INSTANT MEMORY 1 RECALL:** By pressing a button on the microphone or front panel, memory channel 1 may be accessed immediately.
- **MEMORY SCAN:** Memory channels may be continuously scanned for quick location of a busy or vacant frequency.
- **PROGRAMMABLE BAND SCAN:** Any section of the band may be scanned in steps of 5 or 10 kHz. Scan limits are easily reprogrammed.
- **DISCRIMINATOR SCAN CONTROL (AZDEN EXCLUSIVE PATENT):** The scanner stops by sensing the channel center, so the unit always lands on the correct frequency. **COMPARE** this with other units that claim to scan in 5-kHz steps!
- **THREE SCAN MODES WITH AUTO RESUME:** "Sampling" mode pauses at busy channels, then resumes. "Busy" mode stops at a busy channel, then resumes shortly after frequency clears. "Vacant" mode stops at a vacant channel and resumes when signal appears. If desired, auto resume may be prevented by pressing one button. **COMPARE!**
- **REMOVABLE HEAD:** The control head may be located as much as 15 feet away from the main unit using the optional connecting cable. **COMPARE!**

- **PL TONE OSCILLATOR BUILT IN:** Frequency is adjustable to access PL repeaters.
- **MICROPHONE VOLUME/FREQ. CONTROL:** Both functions may be adjusted from either the microphone or front panel.
- **NON-STANDARD OFFSETS:** Three accessory offsets can be obtained for CAP/MARS or unusual repeater splits. CAP and Air Force MARS splits are **BUILT IN!** **COMPARE!**
- **25 WATTS OUTPUT:** Also 5 watts low power to conserve batteries in portable use.
- **GREEN FREQUENCY DISPLAY:** Frequency numerals are green LEDs for superior visibility.
- **RECEIVER OFFSET:** A channel lock switch allows monitoring of the repeater input frequency. **COMPARE!**
- **SUPERIOR RECEIVER:** Sensitivity is better than 0.28 uV for 20-dB quieting and 0.19 uV for 12-dB SINAD. The squelch sensitivity is superb, requiring less than 0.1 uV to open. The receiver audio circuits are designed for maximum intelligibility and fidelity. **COMPARE!**
- **ILLUMINATED KEYBOARD:** Keyboard backlighting allows it to be seen at night.
- **TRUE FM, NOT PHASE MODULATION:** Transmitted audio quality is optimized by the same high standard of design and construction as is found in the receiver. The microphone amplifier and compression circuits offer intelligibility second to none.
- **OTHER FEATURES:** Dynamic microphone, built-in speaker, mobile mounting bracket, external remote speaker jack (head and radio) and much, much more. All cords, plugs, fuses, microphone hanger etc. included. Weight: 6 lbs.
- **ACCESSORIES:** CS-ECK 15-foot remote cable . . . \$39.95. CS-6R 6-amp ac power supply . . . \$59.95. CS-AS remote speaker . . . \$18.00. CS-TTK touch-tone® microphone kit (wired and tested) . . . \$39.95.

✓5

**AMATEUR-WHOLESALE ELECTRONICS** ORDER NOW TOLL FREE

8817 S.W. 129th Terrace, Miami, Florida 33176  
Telephone (305) 233-3631 • Telex: 80-3356  
HOURS: 9 - 5 Monday thru Friday  
• U.S. DISTRIBUTOR • DEALER INQUIRIES INVITED



# 800-327-3102

CREDIT CARD HOLDERS MAY USE OUR TOLL FREE ORDERING NUMBER.

begin to cast about for methods of silencing the cretins. The FCC does what it can, but a problem has to get awfully serious before the Commission can get its ponderous machine into motion. Enter the direction-finding committee.

For the DF committee to do its job, it needs good direction-finding equipment, and really good DFing equipment has been neither plentiful nor cheap. Some of the best DFing units are those that operate on the Doppler principle, but the complexity and expense of these devices has kept them out of the reach of most repeater groups.

Doppler Systems of Phoenix, Arizona, is trying to change this situation. The Doppler Systems DDF-3003 is a radio direction-finder that works on the Doppler principle using a relatively compact antenna array. It is designed to work with almost any VHF FM receiver and is suitable for either mobile or fixed operation. Doppler Systems has been kind enough to present complete engineering data and construction information for their direction-finder in another article in this issue. That article gives you enough information to build a DFer on your own, or Doppler Systems will sell you a complete unit, in kit form or assembled. This review will not repeat the material presented in the article, but instead will attempt to give you an idea of what the completed unit is capable of and how well it works.

### Description

Doppler Systems offers their DFing unit in three different configurations. The DDF-3001 is the basic unit and reads out the bearing of a transmitter with an array of sixteen LEDs spaced 22½ degrees apart. Model DDF-3002 adds a digital display

that gives a numeric readout with one degree resolution. The DDF-3003 includes all the features of the other two models and adds a serial AFSK interface which can be used for remote readout, telemetry, tape recording, etc. As this is written, the price of the 3001 is \$235 in kit form, \$335 assembled. The 3002 is \$295 kit, \$470 assembled, and the 3003 is \$325 kit, \$470 assembled. For the truly cautious ham who doesn't rush into anything, the assembly and operation manual is available for \$12.50.

For this review I obtained a DDF-3003 and an antenna built to the specifications detailed in the manual. The antenna can either be mast-mounted or mounted atop a car—I opted for the mobile installation. New Hampshire's mountains are beautiful for everything but direction-finding. Reflections being so plentiful and unpredictable, I thought I would have better luck with mobile DFing than with operation from a fixed location.

### The Manual

The DDF-3003 I tested was supplied assembled, so I really can't comment on the assembly instructions other than to say that they appear to be well thought out and complete. The theory of operation, installation, and troubleshooting sections are some of the best I've seen anywhere, but the operation and use section isn't too hot—in fact, it is almost nonexistent! According to the manufacturer, the DDF-3003 has seen a lot of action in competitive transmitter hunts. It would be nice if the experience gained in this activity could be passed along to the customer. I'd like to see Doppler Systems add a section on how to interpret readings or at least suggest an-

other publication that offers general information on DFing.

### Installation and Use

Installation was fairly simple, involving audio and antenna connections to a VHF receiver and a source of 12 V dc. Four RG-174 cables from the antenna atop the car also plug into the back of the DDF-3003. Audio and power connect through an Amphenol "D" connector; antennas use phone jacks and plugs.

Once everything is installed and connected, the real fun begins. You flatlanders have it easy! The object of the game is to aim the front of the DFer-equipped car directly at a transmitter and have the DFer read 0 degrees at the same time. A multi-turn pot inside the case gives a 90-degree range of adjustment. If proper calibration is out of this range of adjustment, you simply plug the antennas into the DFer in a different order. Calibration isn't complicated, but it can be annoying. It took me several hours to get the thing aligned correctly, because of reflections from surrounding mountains. I would zero the display, move the car backwards or forwards a few feet, and the display would go totally berserk. This unit can teach you some good lessons about multipath!

I finally found a location that was relatively free of reflections, and thereafter things went smoothly. After careful calibration, I drove the car in a circle and the display tracked perfectly, always showing the location of the transmitter in relation to the nose of my car. Things were looking up! I took a nice long drive around the transmitter and was soon reassured that the DFer was indeed calibrated correctly. Over the next few days I spent a lot of time

taking bearings on several different transmitters, and it was quite an education. The DDF-3003 is at best only a smart machine, and it will occasionally display the bearing of a reflection of a signal rather than the signal itself. However, once you get to know the little beast, it will rarely fool you. I found that when it was tracking reflections, the display would "box the compass," with the LEDs flicking around erratically. When it was on to the real thing, it would lock onto a single heading, occasionally flicking back and forth between two 22½-degree increments. Only when I attempted to track a very distant transmitter while I was deep in a valley did I get incorrect readings that appeared to be correct.

### Conclusions

The DDF-3003 will tell you where a transmitter is, but you sometimes have to use a little common sense when interpreting readings. I didn't have another type of unit to compare it with, but it didn't seem to have any serious shortcomings. The accuracy was such that a single unit installed in a vehicle could be used to track down a reasonably long-winded wild turkey. More units, handled properly, will pinpoint the gobbler far more quickly. A repeater group could install a set of DDF-3003s to monitor their repeater's coverage area and use the serial AFSK outputs to feed the information into a microcomputer. Such a network could accurately locate a wild turkey in a very short period of time. What you do with him after you find him is another story, but this DFer will find him for you!

For further information, contact *Doppler Systems*, 111 E. Moon Valley Drive, Phoenix AZ 85022. Reader Service number 479. ■



## Stuck with a problem?

Our TE-12P Encoder might be just the solution to pull you out of a sticky situation. Need a different CTCSS tone for each channel in a multi-channel Public Safety System? How about customer access to multiple repeater sites on the same channel? Or use it to generate any of the twelve tones for EMS use. Also, it can be used to access Amateur repeaters or just as a piece of versatile test equipment. Any of the CTCSS tones may be accessed with the TE-12PA, any of the audible frequencies with the TE-12PB. Just set a dip switch, no test equipment is required. As usual, we're a stickler for 1 day delivery with a full 1 year warranty.

- Output level flat to within 1.5db over entire range selected.
- Immune to RF.
- Powered by 6-30vdc, unregulated at 8 ma.
- Low impedance, low distortion, adjustable sinewave output, 5v peak-to-peak.
- Instant start-up.

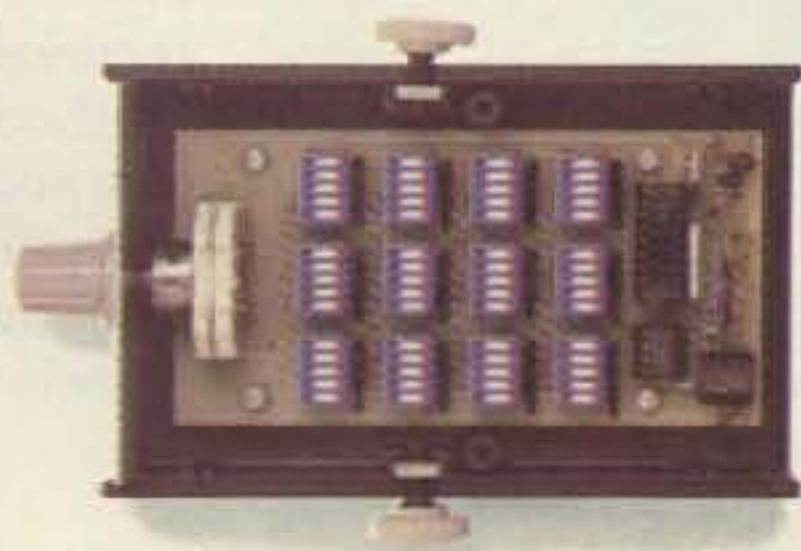

### TE-12PA

67.0 XZ	85.4 YA	103.5 1A	127.3 3A	156.7 5A	192.8 7A
71.9 XA	88.5 YB	107.2 1B	131.8 3B	162.2 5B	203.5 M1
74.4 WA	91.5 ZZ	110.9 2Z	136.5 4Z	167.9 6Z	
77.0 XB	94.8 ZA	114.8 2A	141.3 4A	173.8 6A	
79.7 SP	97.4 ZB	118.8 2B	146.2 4B	179.9 6B	
82.5 YZ	100.0 1Z	123.0 3Z	151.4 5Z	186.2 7Z	

- Frequency accuracy,  $\pm 0.1$  Hz maximum  $-40^{\circ}\text{C}$  to  $+85^{\circ}\text{C}$
- Frequencies to 250 Hz available on special order.
- Continuous tone

### TE-12PB

TEST-TONES:	TOUCH-TONES:	BURST TONES:
600	697 1209	1600 1850 2150 2400
1000	770 1336	1650 1900 2200 2450
1500	852 1477	1700 1950 2250 2500
2175	941 1633	1750 2000 2300 2550
2805		1800 2100 2350

- Frequency accuracy,  $\pm 1$  Hz maximum  $-40^{\circ}\text{C}$  to  $+85^{\circ}\text{C}$
- Tone length approximately 300 ms. May be lengthened, shortened or eliminated by changing value of resistor

**\$89.95**

✓ 443

**COMMUNICATIONS SPECIALISTS**

426 West Taft Avenue, Orange, California 92667  
(800) 854-0547/California: (714) 998-3021



# DF Breakthrough!

## — the “turkey” tracker we’ve all been waiting for

A U.S. Patent is pending on the direction-finding system described in this article. For further information, contact the author.

**R**adio direction-finding (RDF) systems tend to fall into two general categories depending on whether or not they use the Doppler shift principle. Most non-Doppler RDFs employ directional antennas which produce peaks or nulls in the received signal amplitude as they are rotated. Doppler-type systems, on the other hand, detect the phase modulation imparted to the received signal by translational motion of the receiving antenna. As a consequence of the “capture effect” of the FM receiver which detects the

phase modulation, Doppler-type systems generally are less sensitive to site errors than amplitude measurement systems. The first known RDF based on detecting the Doppler shift was patented by H.T. Budenbom and used a motor driven antenna. Doppler RDFs today do not mechanically rotate an antenna, but instead rely on sequential switching between a series of antennas placed in a circular array to approximate the continuously rotating single element.

In 1969, W7KWB and I

built one of the earliest adaptations of this system for amateur use. That system employed 16 switched antennas housed in a 4-foot-diameter wooden “hat box” and was used successfully in local transmitter hunts during 1970-1972. The antenna itself was heavy (115 pounds) and the system required an external oscilloscope for display. DTL logic was used. Other systems were subsequently built in the Phoenix area which operated on essentially the same basis but incorporated improved mechanical construction

and utilized the more sophisticated TTL and CMOS integrated circuits then becoming available.

A serious drawback to these systems was the drastic loss in sensitivity which occurred during operation. A second problem which was equally vexing was the appearance of mysterious false bearing vectors apparently due to off-channel frequencies being shifted onto the received frequency by something in the commutation (electrical rotation) process. Both of the above problems would disappear whenever the antenna commutation was halted, i.e., on-channel stations would immediately regain their signal strength into the receiver and off-channel carriers would disappear.

Several techniques were tried unsuccessfully to eliminate these problems. Theorizing that the switching transients related to turning on and off the various antennas were causing receiver desensitization and, in addition, were modulating off-channel signals into the receiver passband, several methods were investigated to smooth out the switching transients. These included:

(1) overlapping the antenna selection so that at least

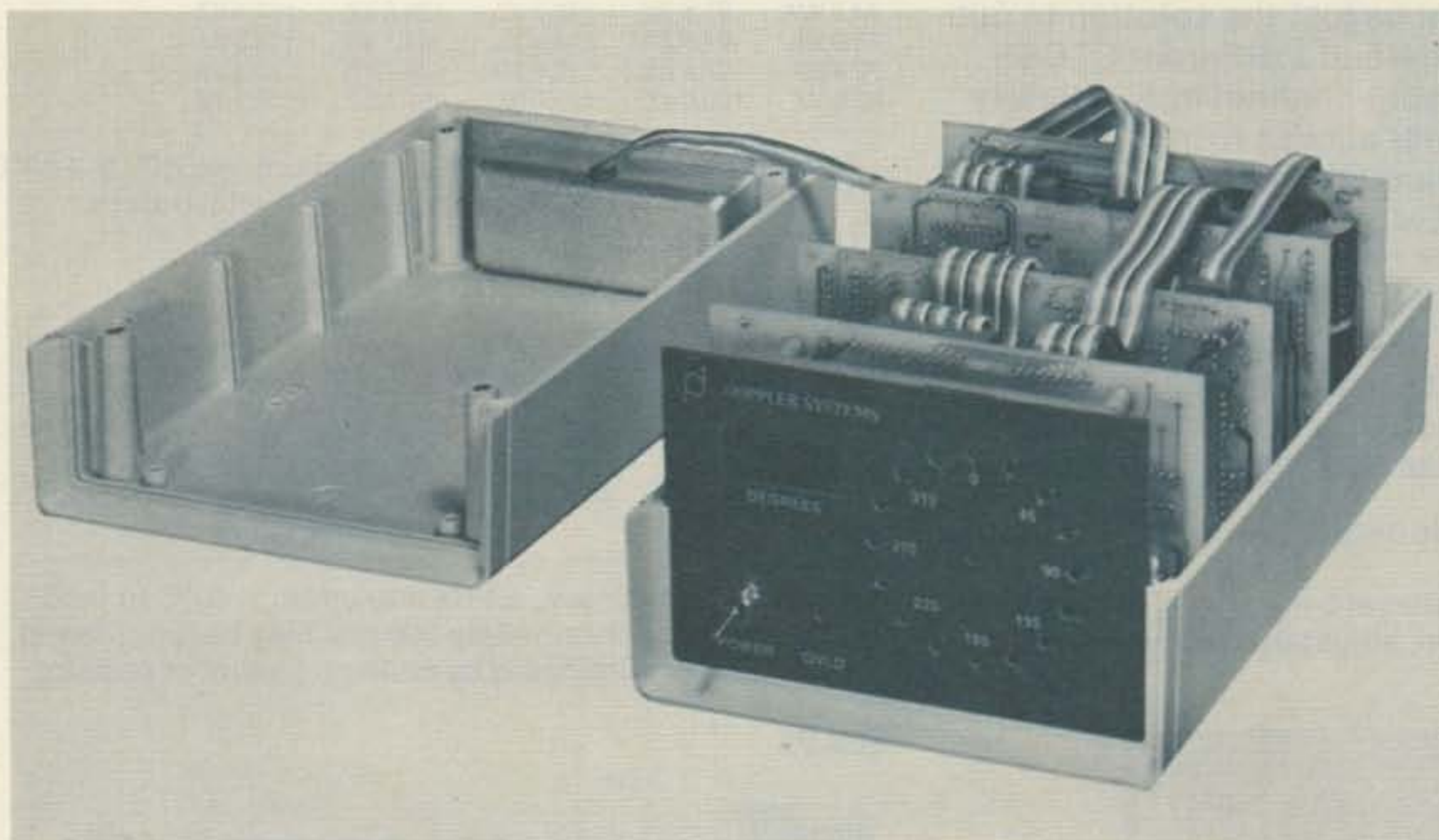

Photo A. Fully expanded version of the electronics available in kit form from Doppler Systems.



one antenna was always connected to the receiver;

(2) rounding the antenna switching waveforms and using PIN diodes to create a more gradual on/off transition; and

(3) generating a complex analog control waveform matched to the gain characteristics of the PIN diodes to further reduce switching transients.

None of these solutions produced especially noteworthy results. In addition, it was felt that an antenna array of the size being used was impractical, especially for mobile use. Reducing the number of elements would help this problem, but with discrete commutation, the linearity of the system deteriorates as the number of antennas decreases.

The solution which ultimately was discovered uses only four antennas which are located in a square pattern, the sides of which are typically 1/4 wavelength long. The received signal induced into all four antennas is continuously mixed in a precision summing circuit in such a manner that the resultant rf voltage produced is very nearly identical to that which would be induced in a single antenna rotating at a uniform rate around the circle which inscribes the square formed by the four actual antennas. Tests have demonstrated that this system does not possess the loss of gain or off-channel susceptibility problems of previous designs. Antenna size for VHF applications is very compact. Electronic processing is relatively involved, but considering the performance which is obtained, it is justified for serious direction-finding applications. The system to be described works with any FM receiver to detect the Doppler-induced phase modulation and does not require any modification of the receiver.

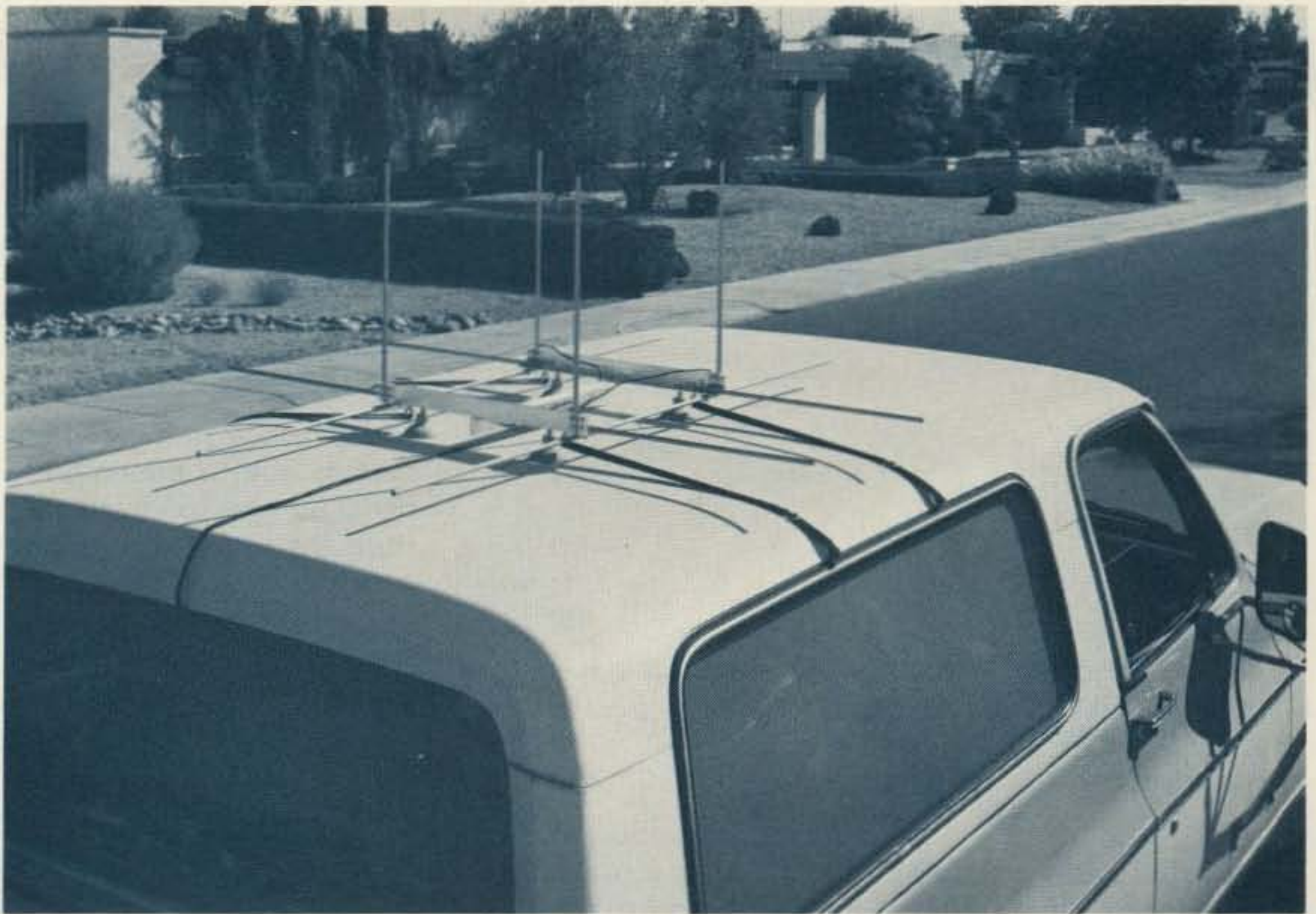

Photo B. Antenna mounted to a 1974 Blazer. The ground plane formed by the radials is particularly useful with non-metallic roofs.

er. It is relatively broadband and has been tested over the frequency range of 135 to 165 MHz.

Depending on the application, three different outputs are available. For mobile application, a circular array of 16 light-emitting diodes (LEDs) provides an immediate analog bearing relative to the vehicle's direction. For more demanding mobile or fixed station applications, a 3-digit panel display provides the bearing directly in degrees. Finally, a serial interface is available in a format suitable for remote-display (utilizing the same or similar electronics for readout),

recording the bearing data on an ordinary audio tape recorder, or connection to a microprocessor. The linking of several remotely-located direction finders into a common microprocessor for automatic station triangulation and logging should be straightforward.

A simplified functional block diagram of the complete system is shown in Fig. 1. The rf summer combines the output of the four antennas in a manner which phase-modulates the rf signal to the receiver. As explained on the next section, the phase modulation contains the bearing information. A conventional FM receiver provides the audio input to the Doppler signal processor via connection to the external speaker output. Synchronous filtering removes the normal voice content leaving a sine wave having the same frequency as was used to modulate the antenna signals and a phase angle equal to the bearing angle. This sine wave acts as a trigger to latch the outputs of counters for display of the bearing in either a circular LED array and/or a 3-digit decimal display. An optional serial interface transmits the bearing data displayed by the unit or receives external bearing data as input for the display.

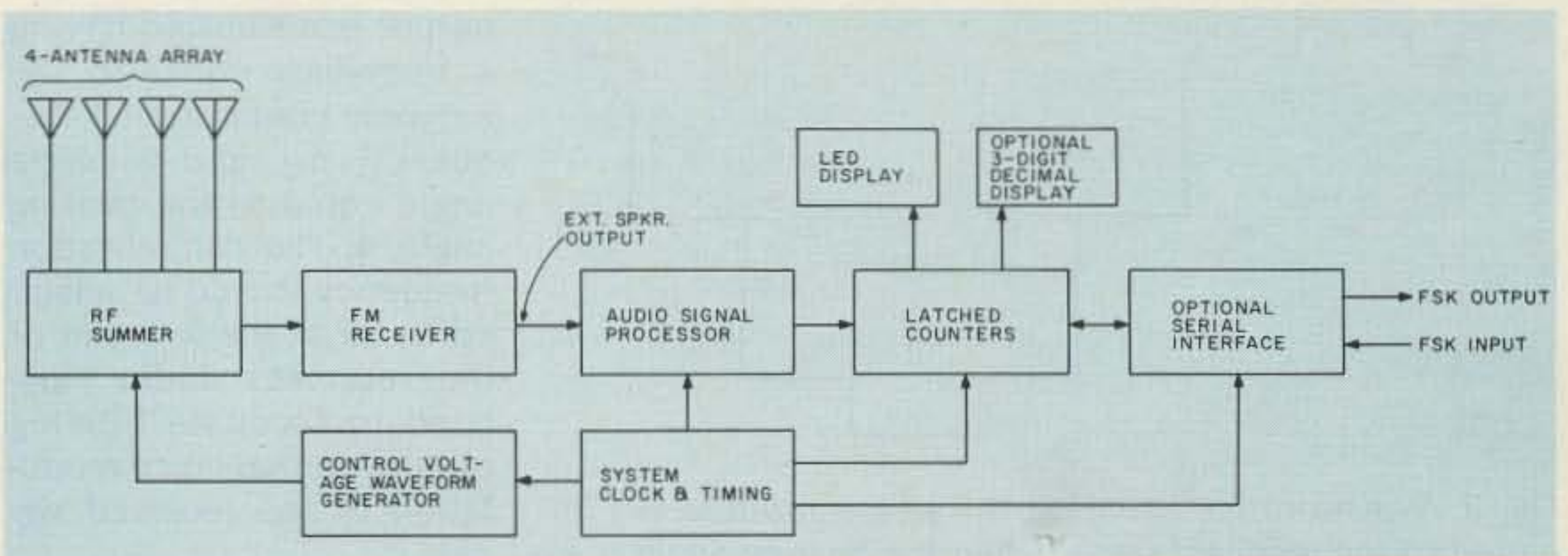

Fig. 1. Block diagram of the complete direction-finding system.

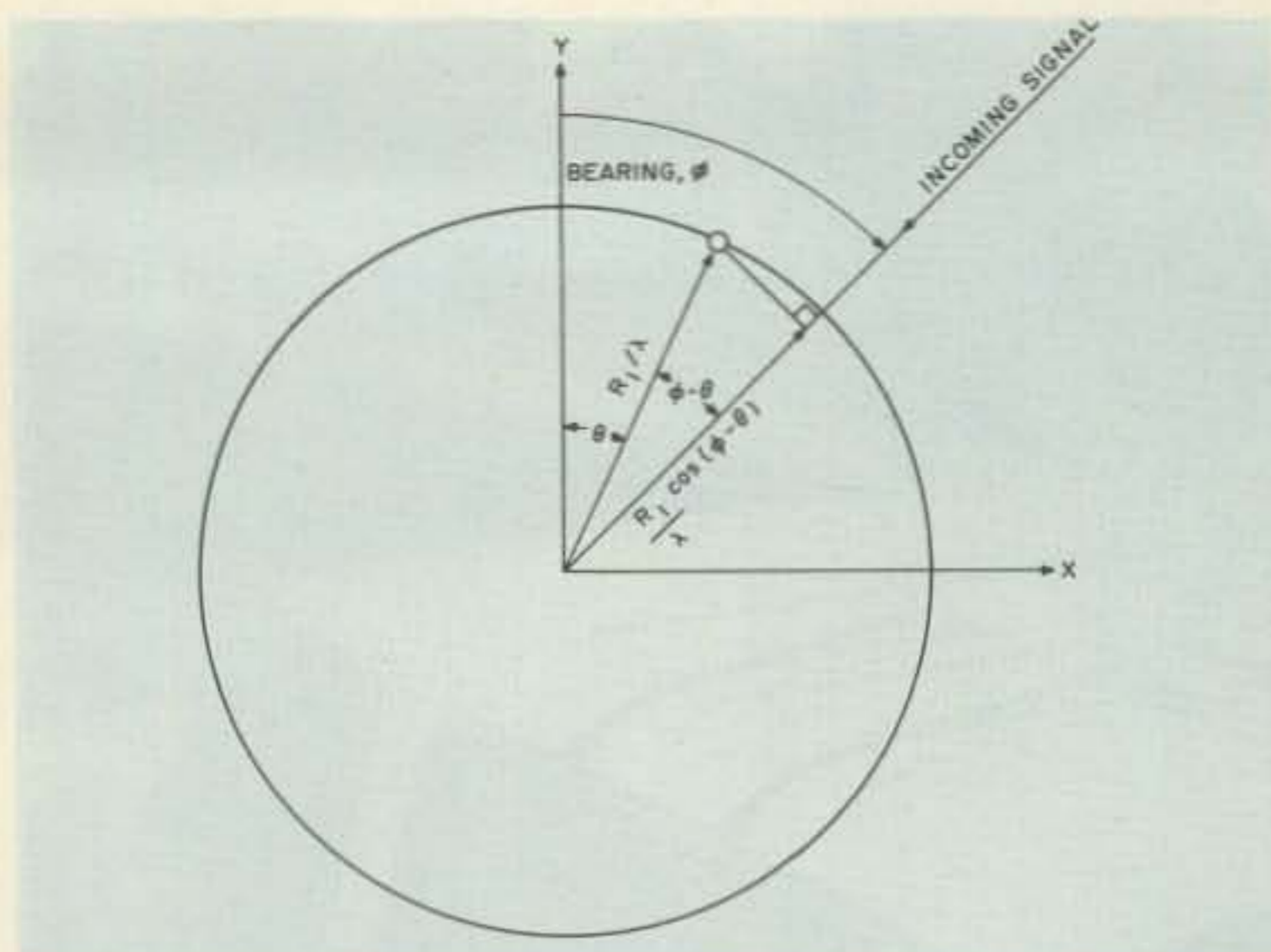

Fig. 2. Geometry used to derive the signal received by a rotating antenna.

### Theory

Fig. 2 illustrates a simple antenna located at distance  $R_1/\lambda$  and angle  $\theta$  from the

reference position. Assume the incoming signal is located far (relative to the wavelength,  $\lambda$ ) from the receiving

antenna at the bearing  $\phi$  shown. Then the voltage induced in the antenna can be written as shown in Equation (1), where  $A$  is the received amplitude in volts,  $\omega_c$  is the carrier frequency in radians per second,  $t$  is the time in seconds and is selected to start with a zero crossing of  $E_R$  at the origin, and  $\psi$  is the phase shift in radians due to the antenna being closer to or further from the transmitter. If the antenna is closer to the source,  $\psi$  would be positive, indicating a phase lead, etc. For the geometry shown, see Equation (2).

Now suppose the receiving antenna is permitted to rotate with velocity  $\omega_d$  in a circular path of radius  $R_1/\lambda$ . Then  $\theta = \omega_d t$  and the phase of the received signal is as shown in Equation (3).

Equation (3) indicates that the rotating antenna has caused the incoming carrier to become phase (and frequency) modulated. The modulation frequency is the same as the rotation frequency,  $\omega_d$ , so the frequency deviation which is equal to the rate of change of the phase is as shown in Equation (4) or Equation (5).

A standard FM receiver with de-emphasis will produce an audio output equal to the phase which is modulating the received signal (assuming the deviation is small compared to the discriminator full-scale range). See Equation (6).

Thus the receiver's audio output is a sinusoid having a frequency equal to the antenna commutation frequency,  $\omega_d$ , and a phase angle equal to the bearing angle,  $\phi$ . The commutation frequency should be selected to be at the low end of the receiver's audio pass-band to facilitate filtering out the normal voice modulation of the received signal.

Another way of looking

at the problem is to consider the situation when the rotating antenna is at the angle where it is directly approaching the incoming signal. The maximum relative velocity causes an apparent increase in the carrier frequency at this point. Similarly, when the antenna has moved 180 degrees to the point where it is traveling away from the transmitter, the relative velocity is a minimum and the carrier frequency appears to be lower. This is the familiar Doppler shift phenomenon, but here the rotation of the antenna produces a periodic up/down shift, the phase of which is set by the bearing angle between receiver and transmitter.

Fig. 3(a) shows Equation (3) plotted against time for an assumed bearing angle of 45 degrees. Instead of physically rotating a single antenna, present-day Doppler systems discretely switch between adjacent antennas located in a circular array. To indicate graphically what sort of waveforms are generated by discretely commutated antenna arrays, the theoretical audio output for a system of 16 and 8 antennas is plotted in Figs. 3(b) and 3(c), respectively. The antenna, of course, receives many different signals in addition to the channel of interest. The phase modulation of all of these signals by a complex waveform such as shown in Fig. 3(b) or 3(c) may generate a variety of frequency components within the receiver pass-band. It is believed that these spurious frequencies are responsible for the false bearing problems noted earlier.

The technique for electronically producing the phase modulation of Fig. 3(a) with four antennas will now be described. Consider the system of antennas A, B, C, and D shown in Fig. 4 and assume for the moment

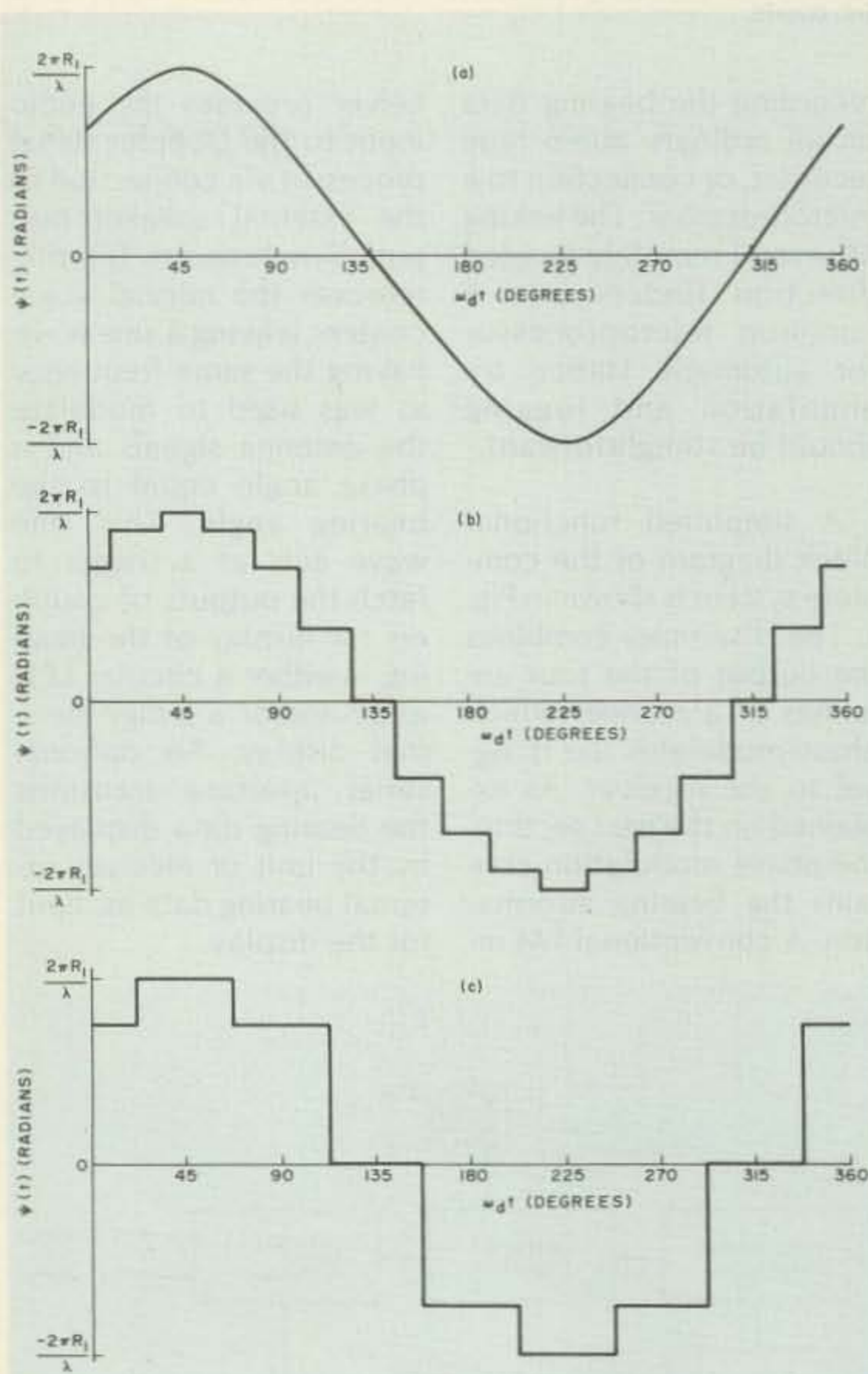

Fig. 3. Waveforms illustrating the phase modulation imparted to the received signal when the bearing angle is 45 degrees.

that the antennas are not coupled, i.e., there is no mutual impedance between them. The signals received by the four antennas can be summed electronically as shown in Equation (7), where  $K_A, K_B, K_C, K_D$  are gains and  $E_A, E_B, E_C, E_D$  are the rf voltages induced in the four antennas. We wish to find the value of the four gains which will create a voltage  $E_S$  equal to that induced in an antenna  $S$  located on the inscribed circle of radius  $R_1/\lambda$  at the angle  $\theta$  shown in Fig. 4.

If an incoming signal were arriving from the left or right in Fig. 4, the phase at  $A$  and  $B$  would be equal, and the phase at  $C$  and  $D$  would also be equal. As long as the array is less than  $1/2$  wavelength on a side, the phase at point  $S$  may be computed by interpolating linearly between the phases to the left and right as indicated in the plot directly below the sketch of the antenna array in Fig. 4. See Equation (8).

For example, if  $S$  is midway between  $A$  and  $D$ ,  $\theta = 0^\circ$ ,  $K_X = 1/2$ ,  $(1-K_X) = 1/2$ , and the phase is the simple average of the phases measured at  $A$  and  $D$ . If we now consider a signal originating from the top in Fig. 4, the phase at  $S$  can be com-

puted from that at  $A$  or  $D$  and that at  $B$  or  $C$  by interpolating along the  $Y$  direction. Referring to the graph to the left of the antenna in Fig. 4 see Equation (9).

Equations (8) and (9) may be combined to give a two dimensional interpolation of phase. From similarity, Equation (7) can then be written as in Equation (10).

The mixing is not perfect since rf voltages rather than phase angles are being mixed; the errors, however, are small, as discussed below. The gain for antenna  $A$  is given in Equation (11), which is shown plotted in Fig. 5 over one cycle of rotation in  $\theta$ . Note that the gain peaks, as would be expected, at 45 degrees where the imaginary antenna is closest to antenna  $A$ . A second small gain increase also occurs 180 degrees from this location. The other antenna gains,  $K_B, K_C,$  and  $K_D$ , have identical shapes to  $K_A$ , but are displaced 90 degrees in phase ( $K_B$  lags  $K_A$  by  $90^\circ$ , etc.).

To evaluate the accuracy of the mixing given by (10), the instantaneous amplitude and phase of  $E_S$  was computed for antennas of different size with various bearing angles,  $\phi$ . A typical result is shown in Fig. 6 for an antenna of dimension  $2R_1/\lambda = 1/4$  on each side. In

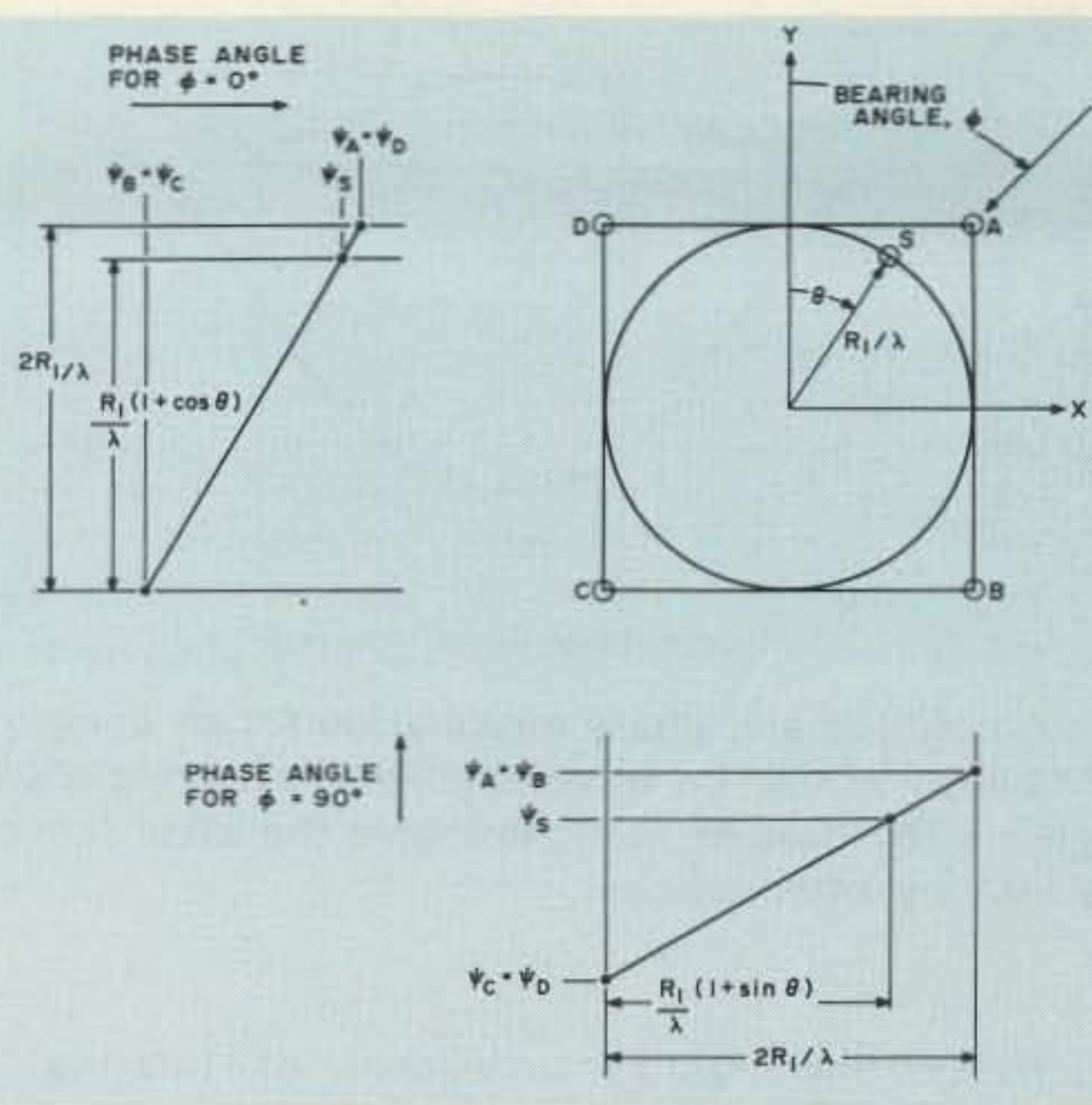

Fig. 4. Top view of a four-antenna array showing the interpolation of phase angle between opposite sides of the array.

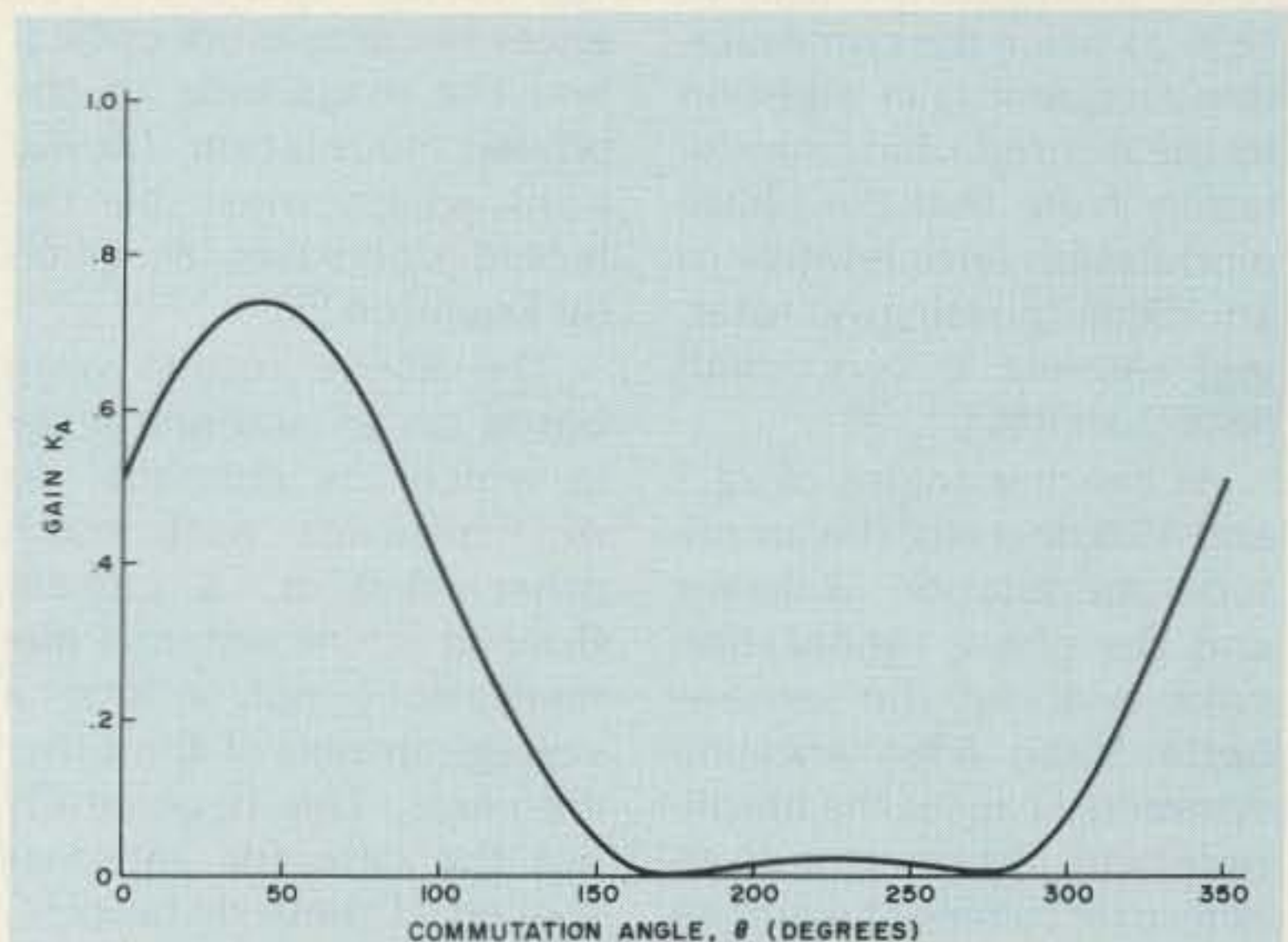

Fig. 5. Theoretical gain variation for antenna "A" required to produce an equivalent continuously rotating antenna signal.

### EQUATIONS

Equation (1):  $E_R = A \sin(\omega_c t + \psi)$

Equation (2):  $\psi = \frac{2\pi R_1}{\lambda} \cos(\phi - \theta)$

Equation (3):  $\psi(t) = \frac{2\pi R_1}{\lambda} \cos(\phi - \omega_d t)$

Equation (4):  $\omega_{\text{deviation}} = \frac{2\pi R_1 \omega_d}{\lambda}$  radians/second

Equation (5):  $f_{\text{deviation}} = \frac{R_1 \omega_d}{\lambda}$  Hz

Equation (6):  $E_{\text{audio}} = K_A \frac{2\pi R_1}{\lambda} \cos(\phi - \omega_d t)$

Equation (7):  $E_S = K_A E_A + K_B E_B + K_C E_C + K_D E_D$

Equation (8): Phase at  $S = \psi_S = \psi_{C \text{ or } D} + \left[ \frac{(1 + \sin \theta) R_1 / \lambda}{2 R_1 / \lambda} \right] (\psi_{A \text{ or } B} - \psi_{C \text{ or } D})$

$= K_X \psi_{A \text{ or } B} + (1 - K_X) \psi_{C \text{ or } D}$   
where  $K_X = (1 + \sin \theta) / 2$

Equation (9):  $\psi_S = \psi_{B \text{ or } C} + \left[ \frac{(1 + \cos \theta) R_1 / \lambda}{2 R_1 / \lambda} \right] (\psi_{A \text{ or } D} - \psi_{B \text{ or } C})$

$= K_Y \psi_{A \text{ or } D} + (1 - K_Y) \psi_{B \text{ or } C}$   
where  $K_Y = (1 + \cos \theta) / 2$

Equation (10):  $E_S = K_X K_Y E_A + K_X (1 - K_Y) E_B + (1 - K_X) (1 - K_Y) E_C + (1 - K_X) K_Y E_D$

Equation (11):  $K_A = K_X K_Y = 1/4 (1 + \sin \theta) (1 + \cos \theta)$

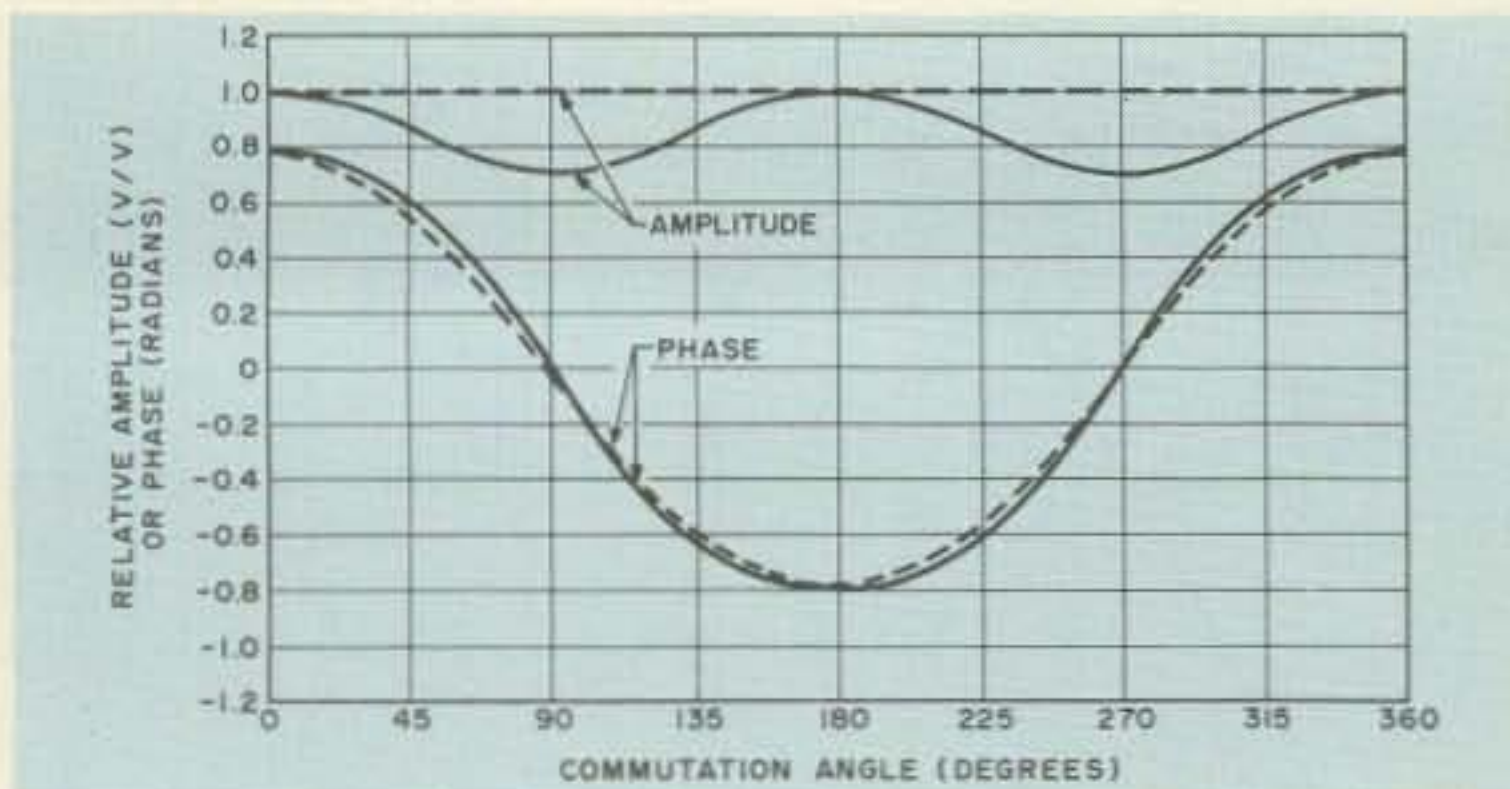

Fig. 6. Amplitude and phase modulation for an uncoupled antenna array of size  $1/4$  wavelength and a bearing angle of  $0$  degrees. The dashed lines represent the ideal (continuously rotating antenna) case.

Fig. 6, the bearing angle  $\phi$  is  $0$  (signal coming from top in Fig. 4). The composite rf signal contains some amplitude modulation (about 18% at twice the commutation frequency) in addition to the desired phase modulation. Note that the phase modulation error relative to an ideal (physically rotating) antenna is very small (less than 8%).

At bearing angles of  $22.5$  and  $45.0$  degrees, the amplitude modulation is lower and the phase modulation error is about the same—better than 8%. Antenna symmetry causes the amplitude and phase error characteristic to repeat every 45

degrees of bearing. Decreasing the antenna size improves the error characteristic over that shown in Fig. 6, but antenna tolerances become more critical and the magnitude of the phase modulation (deviation) which must be detected decreases as given by Equation (5).

The above results were based on an antenna array in which the elements do not interact with each other—that is, a current flowing in one antenna element does not induce a voltage in one of the other elements. This is generally not the case for antennas spaced at these distances.

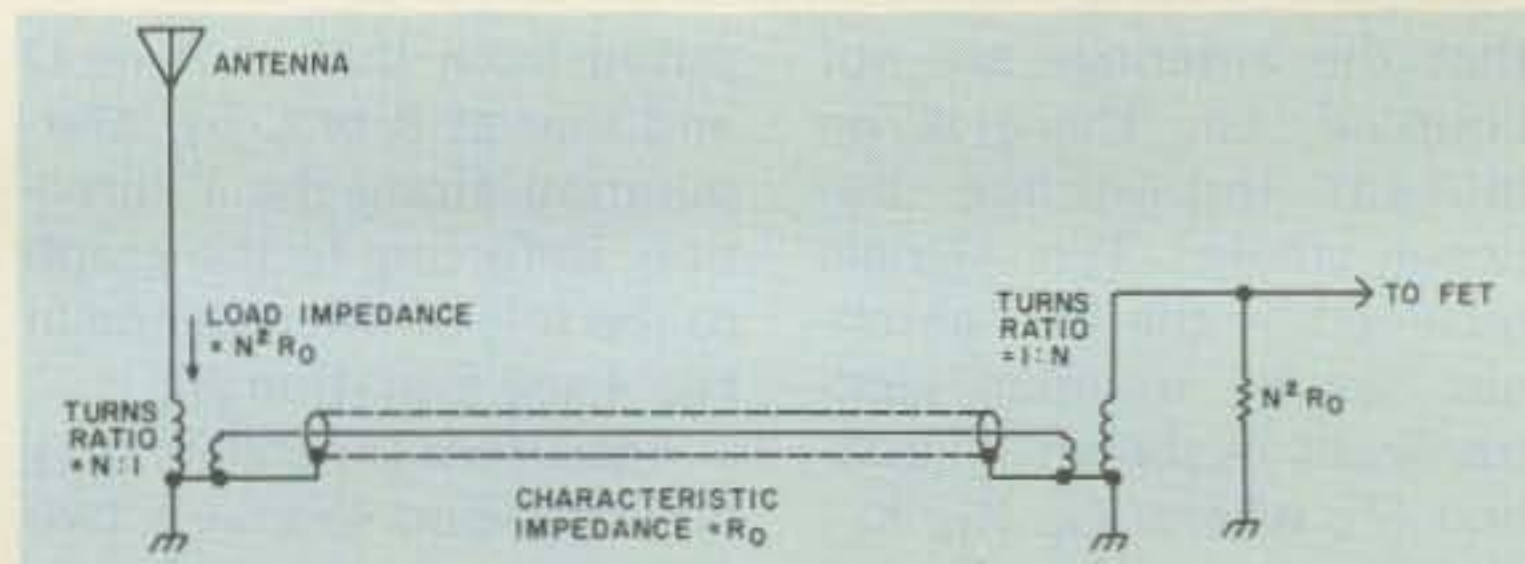

Fig. 7. Use of impedance transformers to minimize the effect of mutual impedance coupling between array antennas.

A detailed analysis has been made which takes into account the actual coupling between elements (mutual impedance). If each antenna element is terminated into a 50-Ohm load, the antenna currents and hence the coupling between elements are significant and the rf output voltage to the receiver is affected. For the  $1/4$ -wavelength array, amplitude modulation increases to about 65% and the phase modulation waveform becomes noticeably distorted. The situation is considerably better with smaller antennas. For example, if the array size is  $1/8$  wavelength on a side, the amplitude modulation is only 19% and the phase modulation is very nearly sinusoidal.

An alternate to reducing the array size is to increase the effective load impedance across each antenna element. This may be accomplished using an impedance step-down transformer at the antenna and an impedance step-up transformer at the receiving end of the transmission line. See Fig. 7. It should be kept in mind that in a receiving application, the antenna is acting as the source and the receiver (or rf summer here) is the load. We wish to minimize standing waves on the transmission line to prevent rf pickup other than from the antenna. Therefore, the line must be matched to the rf summer. At the antenna, we are interested in having the maximum voltage de-

veloped across the antenna terminals. This is obviously obtained by presenting a high impedance load to the antenna. An impedance match between line and antenna is generally regarded as essential to proper system operation, but that is the case only for transmitting where the antenna acting as the load determines the line swr and maximum power transfer occurs when line and load are matched.

At this point, it might be asked just how significant amplitude modulation and phase modulation distortion are in this system. The receiver provides limiting which will remove most of the AM, and the phase detector provides synchronous filtering which will remove most of the harmonic distortion in the phase modulation. Initially, it was feared that any amplitude modulation would cause modulation products from adjacent channel signals to be formed which might appear on the selected channel and cause interference. Also, distortion of the phase modulation could lead to bearing errors at specific bearing angles. Neither of these problems has been observed in either the testing or the field use of this system. Therefore, while a solution is at hand, the need to employ it has not been evidenced and the design to be discussed in the remainder of this article does not include impedance transformers. The subject

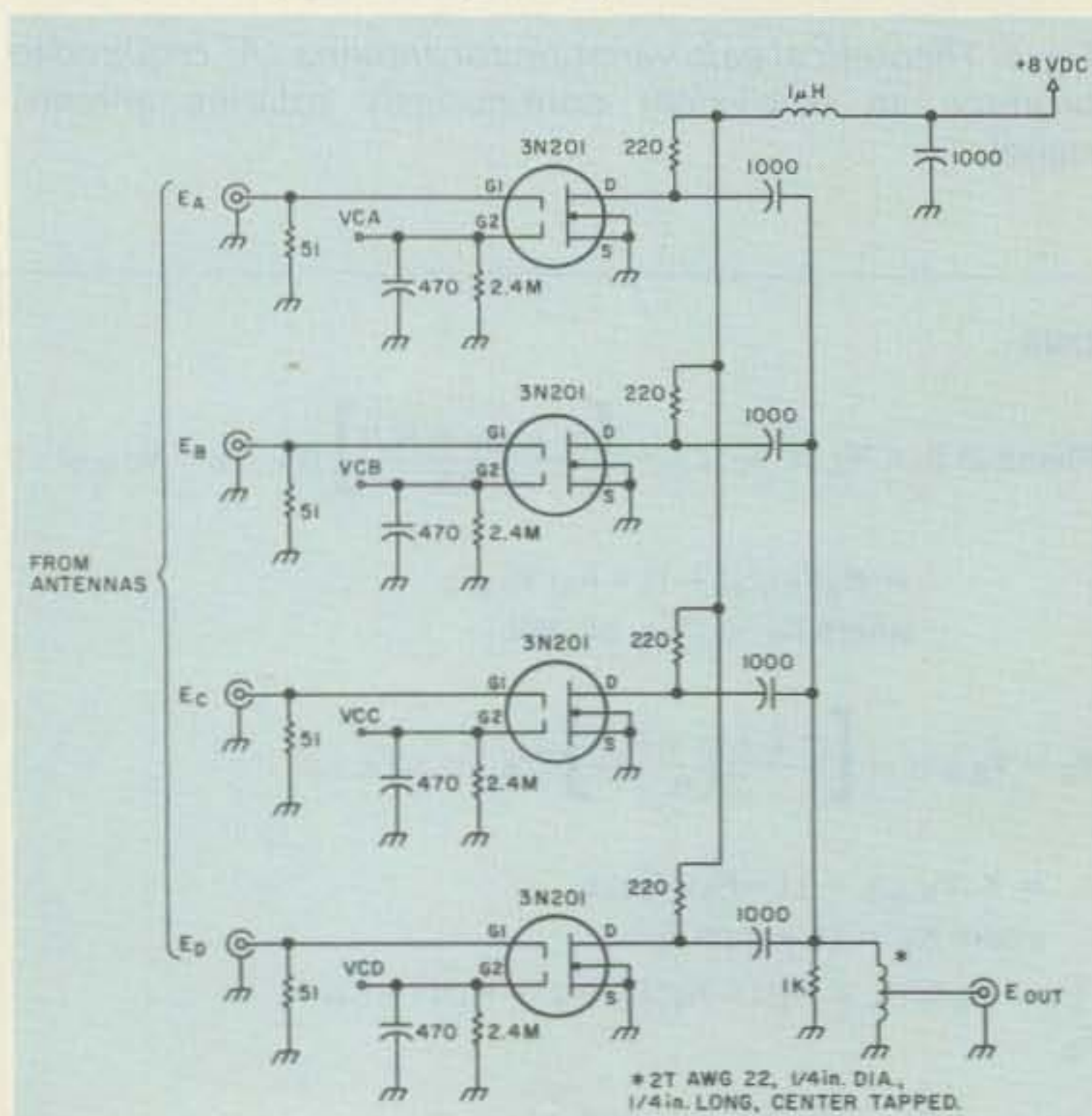

Fig. 8. Rf summer circuit schematic.

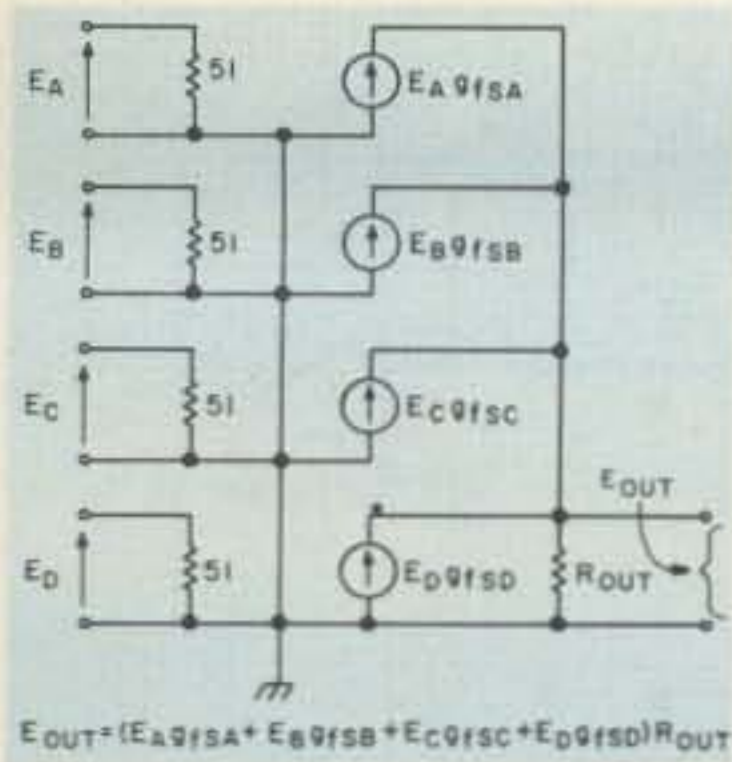

Fig. 9. Equivalent circuit of the rf summer.

of antenna array optimization and coupling for this system is an area for much additional experimentation and development.

### Rf Summer

The circuit to be used for antenna summing should provide a low insertion loss, provide a stable and electronically-controlled gain characteristic, have negligible phase-shift variation with the control voltage, be compatible with a 50-Ohm unbalanced input, and lend itself to operating into a 50-Ohm unbalanced output.

PIN diodes and voltage-controlled FET resistor devices were tried and eventually rejected for one or more incompatibilities with the above requirements. The dual-gate MOSFET operating in a common-source configuration was found to provide an excellent choice. Fig. 8 shows the circuit configuration.

The rf equivalent circuit is given in Fig. 9. Each MOSFET acts as a current source into a common output impedance. The single, tapped inductor is used to cancel the combined output susceptance of the four MOSFETs. Device input impedance is extremely high, and the circuit is broadbanded by the use of relatively low value resistors for line impedance termination at all inputs and the output. Some gain is lost, but it is quite acceptable

(less than 6 dB) and could easily be made up with a preamplifier stage at the output if desired. The output voltage is the weighted sum of the four antenna voltages with the weighting determined by the transconductance of the FETs. Since the transconductance can be varied by the second gate control voltage, this provides the means for electronically combining the rf voltages.

Fig. 10 plots the measured circuit gain ( $E_{out}/E_{in}$ ) of four randomly selected devices together with a 7th order polynomial fit to the data. By combining the MOSFET rf gain characteristic of Fig. 10 with the desired antenna gain variation given in Fig. 5, the control voltage waveform for antenna A can be found. This is plotted in Fig. 11. The control waveforms for channels B, C, and D are identical in shape, but delayed by 90, 180, and 270 degrees respectively.

### Control Voltage Waveform Generator

Two inexpensive PROMs are used to store the waveform plotted in Fig. 11. The PROM address is multiplexed in multiples of 90 degrees commutation angle, and the PROM output, after conversion to an analog voltage, is demultiplexed at the same time so that the entire PROM memory is utilized to generate each of the four control voltages. Fig. 12 shows the schematic of the control voltage waveform generator.

The CD4040 is a 12-stage ripple-carry binary counter that produces an 8-bit incrementing address to the PROMs. When driven at a frequency of 1,228,800 Hz, the PROM address will cycle at a rate of 300 Hz, which is the commutation frequency of the system. To multiplex the PROM, the two most significant bits

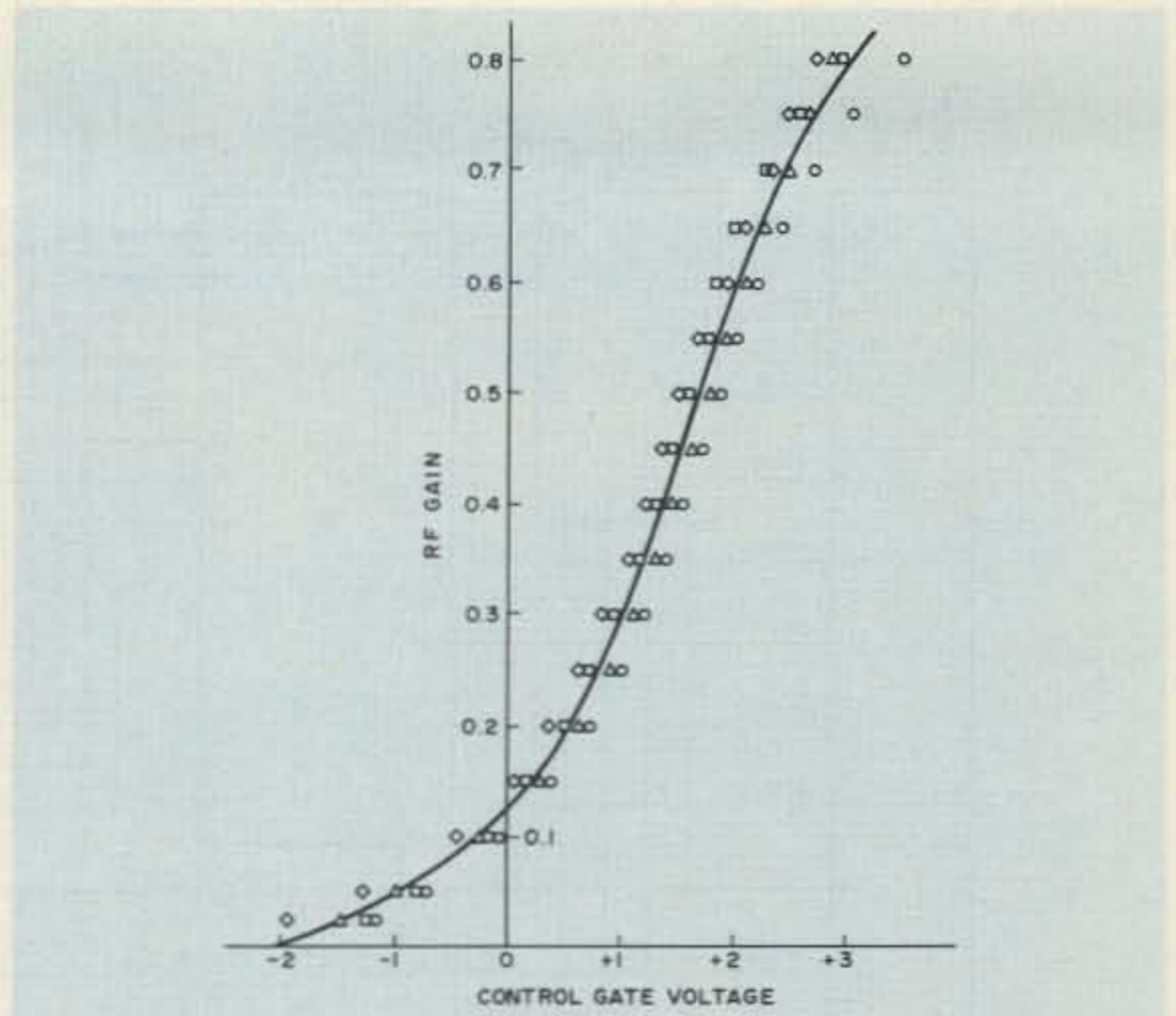

Fig. 10. Rf gain variation with control gate voltage for four typical field-effect transistors. The curve is a seventh-order polynomial fit to the measured data.

are modified by adding a 0, 1, 2, and 3 sequentially to each of the PROM addresses using a CD4008 full adder. The resulting address is held temporarily in the 8-bit 74LS273 latch which synchronizes the otherwise skewed output of the ripple counter.

Together, the two 74S287 PROMs provide an 8-bit address by 8-bit output memory for the control waveform. Each address corresponds to 360/256 or 1.40625 degrees of commutation, while the output is scaled to cover the range -2.5 to +3.5 volts dc which provides a resolution of  $6.0/256 = 0.0234$  volts/step. The MC1408 digital-to-analog

converter is used with a CA3240 BIMOS operational amplifier to minimize offset and noise. The CD4051 is an 8-channel analog demultiplexer which directs the converter output into one of the four dual-gate MOSFETs. A small RC filter formed by the 10-kilohm resistors and 470-pF capacitors in the rf summer is sufficient to hold the demultiplexed control voltage between updates. NAND gates A and B are used to inhibit the demultiplexer except during that portion of the cycle when the D/A output is stable. They also provide the synchronizing pulse to the 74LS273 octal latch.

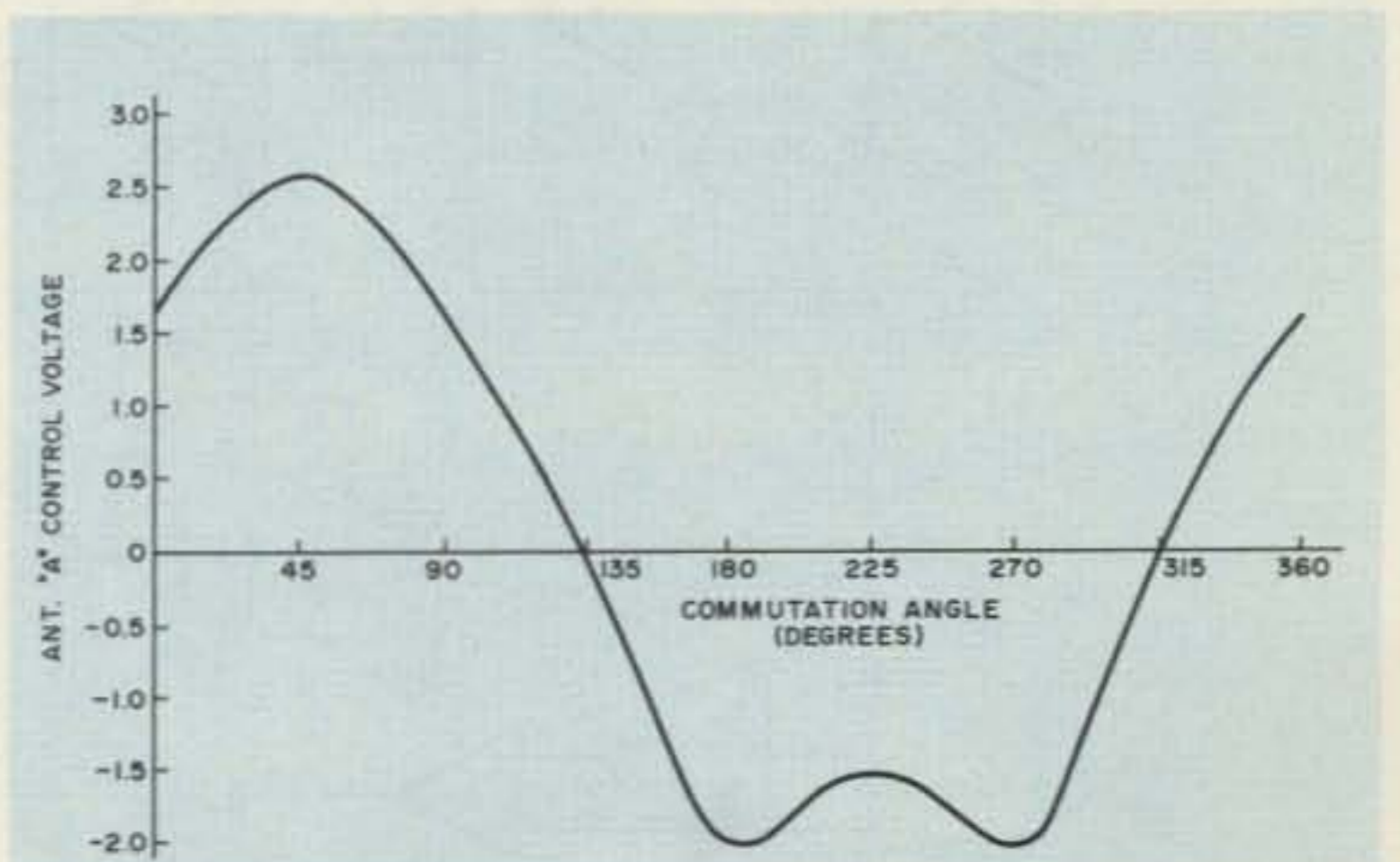

Fig. 11. FET control voltage required to produce the amplitude variation shown in Fig. 5.

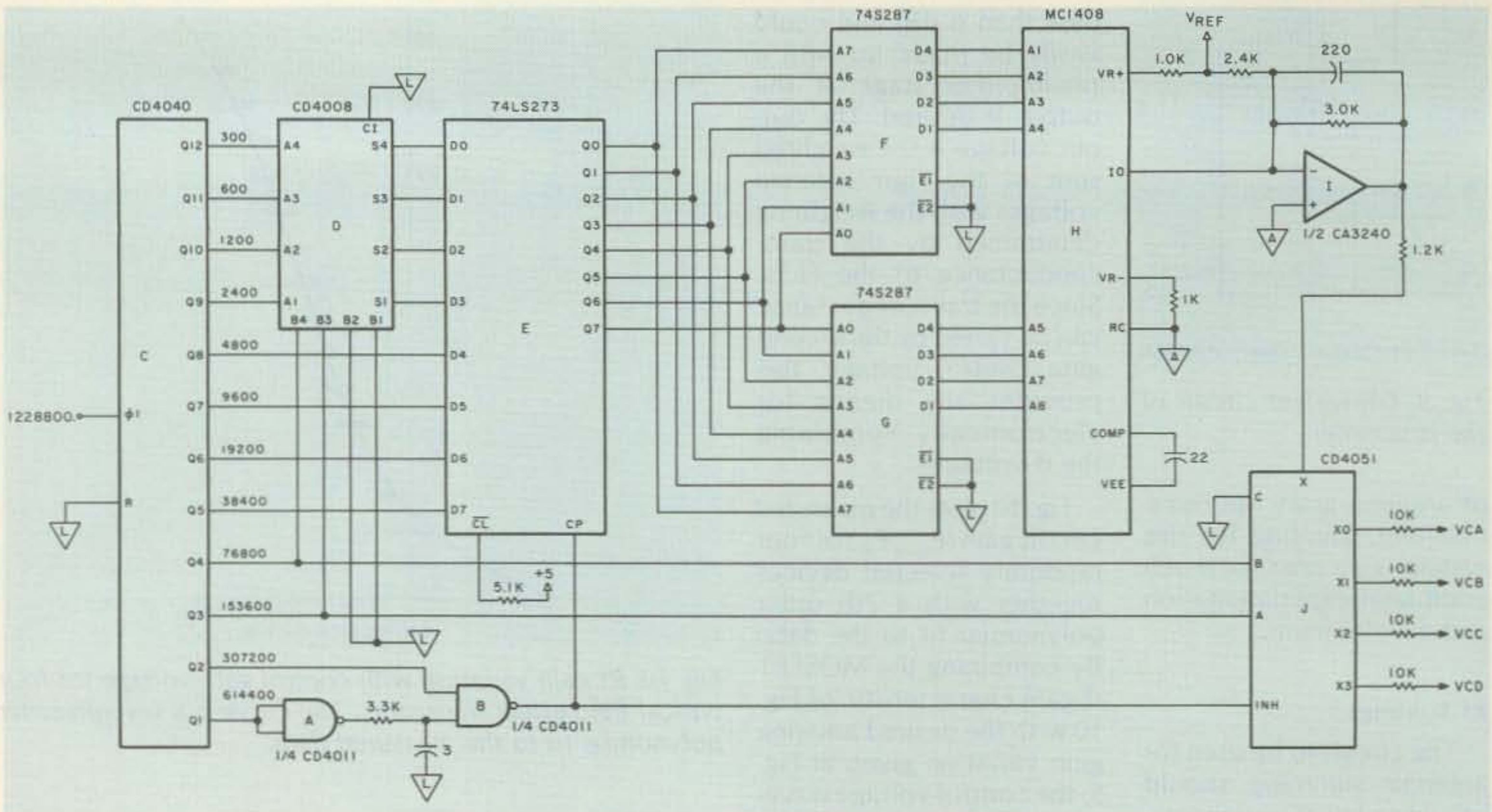

Fig. 12. Circuit schematic of the control voltage waveform generator. Notes: Logic power is  $V_{cc} = V_{dd} = +5$ ,  $V_{ee} = -6$ ,  $V_{ss} = GND = \text{L}$ . Op amp power is  $+5$  and  $-6$  V dc.

### Audio Signal Processor

Fig. 13 shows the circuitry used to extract the 300-Hz Doppler modulation frequency from the receiver's audio output and generate a logic signal synchronized

to the phase of this signal. Threshold detectors are also provided to give an overload indication to assist in setting up the audio gain of the circuit

and to blank the display when no signal is present.

Preamplifier A is ac coupled to the receiver and contains a gain adjustment variable over the range 0.2

to 10. Frequencies below 142 Hz are attenuated by the input filter and frequencies above 664 Hz are reduced by the feedback compensation. Amplifier B provides an additional gain

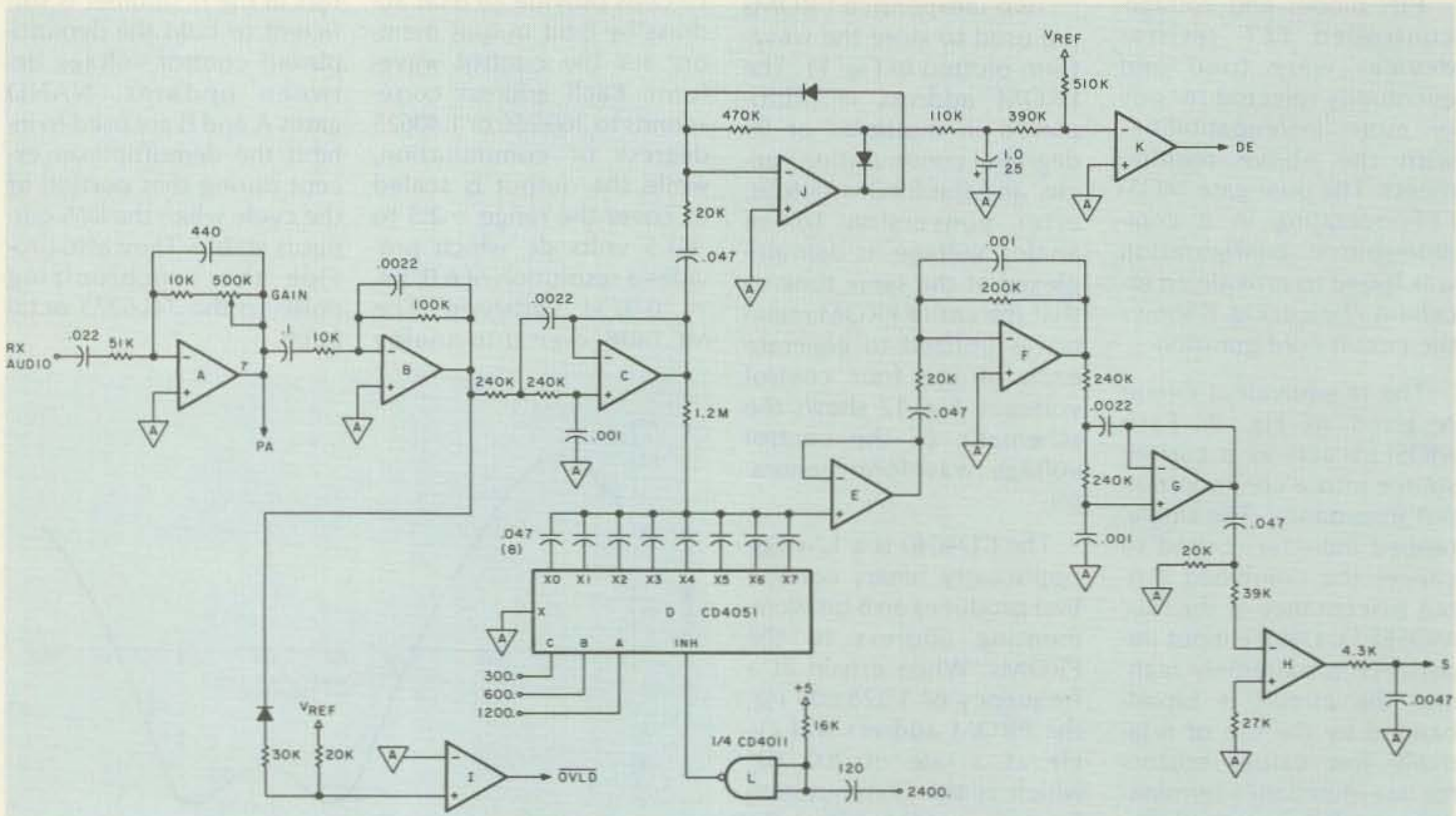

Fig. 13. Audio signal processor circuit schematic. Notes: All op amps are 1/2 LM1458 except H, which is 1/2 CA3240. All diodes are 1N4148. Logic power is  $V_{dd} = +5$ ,  $V_{ee} = -6$ ,  $V_{ss} = \text{L}$ . Op amp power is  $+5$  and  $-6$  V dc.

of 10 and further filtering above 724 Hz.

Amplifiers C and G are identical second-order low-pass filters tuned to a frequency of 469 Hz with critical damping. These filters and the commutative filter described below were designed using the methods given in "Get Notch Qs in the Hundreds," by Mike Kaufman, *Electronic Design* 16, August 2, 1974, pp. 96-101.

The 8-section commutative filter, composed of multiplexer D and follower amplifier E, provides a 300-Hz bandpass synchronized to the antenna waveform frequency with a Q of 7540 RC where R is the series input resistor and C is the value of each of the switched capacitors. In Fig. 13,  $R = 1.2$  megohms and  $C = .047$  uF, providing a Q of 425. Since the Q of this circuit determines the speed of response of the system as well as the selectivity, a trade-off can be made in the selection of resistor R. The value shown provides a good compromise, but individual users may prefer a somewhat faster or slower responding display. The one-shot formed with NAND gate L is used to inhibit switching of the multiplexer during transition of its logic-select inputs.

Amplifier F provides an additional gain of 10 and helps to attenuate harmonics produced in the commutative filter above 796 Hz. Ac coupling is used to attenuate frequencies below 169 Hz because the commutative filter does pass dc. Amplifier H is used as a comparator to produce a square wave sync signal for the display generator. A CA3240 operational amplifier is used here instead of the LM1458s used elsewhere for its very high slew rate. Ac coupling is employed to remove any dc offsets from the previous

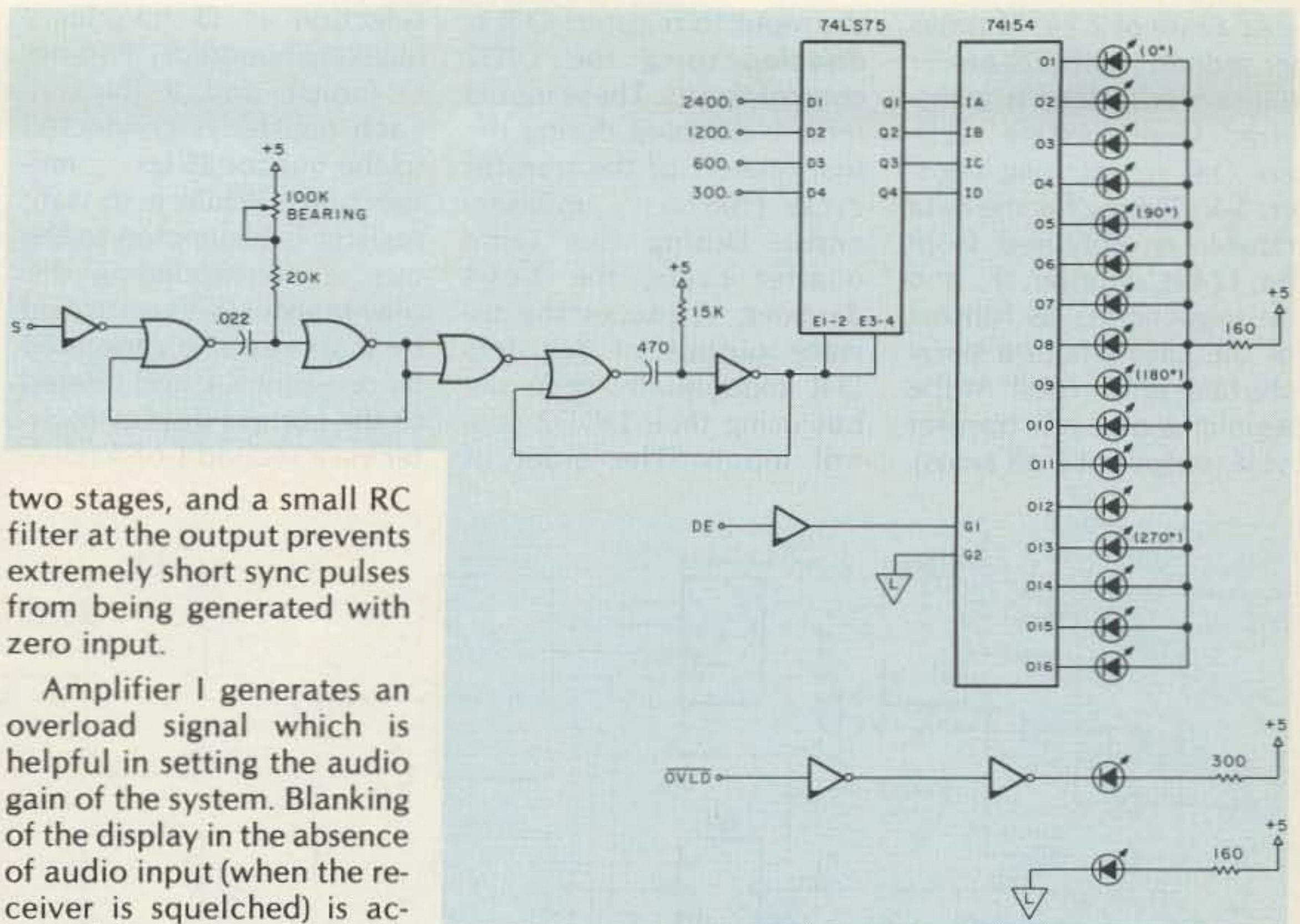

two stages, and a small RC filter at the output prevents extremely short sync pulses from being generated with zero input.

Amplifier I generates an overload signal which is helpful in setting the audio gain of the system. Blanking of the display in the absence of audio input (when the receiver is squelched) is accomplished by the half-wave rectification of amplifier J and the comparator operation of amplifier K. A blanking delay of approximately 100 milliseconds is provided by the electrolytic capacitor.

### Display

The circuitry required for a simple LED display is shown in Fig. 14. Two one-shot circuits are used to convert square wave sync signal S to a short positive clock pulse which is used to latch the binary clock count into the 74LS75 quad latch. The first one-shot has an adjustable delay time to permit calibration of the display over a 90-degree bearing angle. (Rotation of the four antenna inputs is used for greater correction.) The second one-shot generates the 10-microsecond latching pulse.

A 74154 decoder drives the 16-LED circular display directly. Two additional LEDs are used to indicate audio overload in the signal processing circuit and the power-on status.

When both LED and three-digit decimal bearing readouts are required, the circuit of Fig. 15 is used in

Fig. 14. Simple LED display circuit schematic. Notes: All LEDs are MIL32 R. Logic power is  $V_{cc} = V_{dd} = +5$ ,  $V_{ss} = GND = \nabla$ . NOR gates are 1/4 CD4001. Inverters are 1/6 74C903.

place of Fig. 14. This circuit is designed for compatibility with the optional serial interface to be described below and uses a 4-bit data bus to transfer data between temporary holding registers and the display latches. If the serial interface is omitted, the two signals SEND and MS must be tied to logic ground.

BCD counter latches H, I, and J are driven by a 108,026-Hz clock signal and their contents are latched into tri-state latches O, P, and Q by the delayed sync pulse. The binary clock count is simultaneously strobed into latch R by the same sync pulse. Since the maximum count is (decimal) 359, the maximum BCD count required for the hundreds digit is 3 (binary 0011). Since the two most significant bits of this digit are always zero, these bits are used to transfer the overload (MSB) and the display enable (MSB-1) information. A one-shot is used to stabilize the overload flag for sampling.

Selection of the system clock frequency and dividers was made so as to produce compatible binary and BCD counter frequencies. Over a complete commutation interval of 1/300 second, the 4-bit binary input to register R will increment through  $2400/300 \times 2 = 16$  counts. Each of these counts then corresponds to 1/16th of a revolution on the LED circular display. Over the same time interval, the clock input to the BCD counters generates  $108026.3736/300 = 360.0879$  counts, or approximately one count per degree. Although the error is very small (less than 0.1 degree), it will accumulate rapidly unless the BCD counter is periodically synchronized back to the binary counter. The circuit consisting of flip-flop A and the surrounding gates is used to reset the three BCD counters every complete cycle (as defined by the binary counter) so that the BCD and binary counts remain synchronized.

At a rate of 2.34375 times per second (each 426.66... millisecond), data is transferred from tri-state registers O-R to latching registers S-V. Timing for the data transfer is obtained from the 12-bit counter, F, and the sequence is as follows for the case where a serial interface is not used. At the beginning of each transfer cycle (output of F all zeros),

the input to registers O-R is disabled using the DID2 control inputs. These inputs remain disabled during the first quarter of the transfer cycle (106.66... milliseconds). During this same quarter cycle, the 1-of-4 decoder, Y, places the tri-state output of registers O-R sequentially onto the bus using their DOD2 control inputs. The order of

selection is Q (overload/blanking/hundreds), P (tens), O (units), and R (binary). Each register is connected to the bus for 26.66... milliseconds. While a tri-state register is connected to the bus, a corresponding display register (S-V) is strobed by one-shot K-L and steered to the correct display register via a second 1-of-4 selec-

tor (Z). The data transferred to the display registers is held until the next update (426.66... milliseconds later). Consequently, the display appears stable, but is still reasonably responsive to changes in the bearing data. Also, the data displayed is consistent (i.e., the binary and BCD data displayed are sampled simultaneously even though they

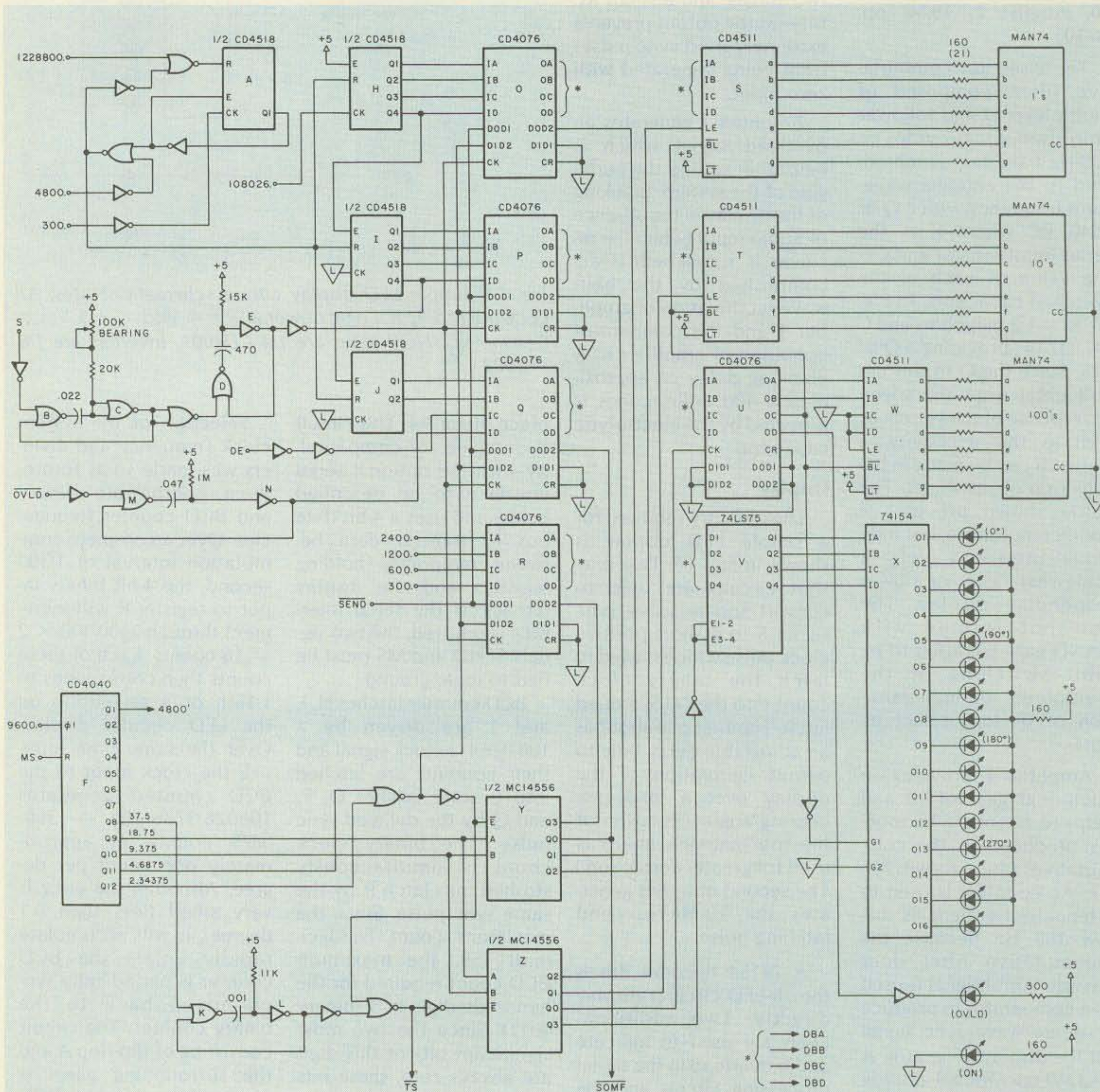

Fig. 15. Schematic of the circuit used to provide circular LED display and a three-digit decimal display. A data bus technique is employed which is compatible with the optional serial interface. Notes: Connect 4-bit data bus \*. All LEDs are MIL32 R. Digital logic power is  $V_{dd} = V_{cc} = +5$ ,  $V_{ss} = GND = \text{ground symbol}$ . All NOR gates are 1/4 CD4001. All inverters are 1/6 CD4069 except  $\nabla$  are 1/6 74C903. Schematic is drawn for operation with serial interface. For no serial interface, add jumpers SEND to  $\nabla$ , MS to  $\nabla$ .



are transferred sequentially).

Registers S and T are CD4511 BCD-to-7-segment latching drivers which drive the units and tens displays directly. Latch U is a holding register which provides the 2 bits of hundreds data to the third CD4511 driver (W). The blanking information and overload data are also available from outputs C and D of latch U. Quad latch V provides the binary LED data to the 1-of-16 selector X.

### Serial Interface

An optional serial interface is shown in Fig. 16 which permits remote transmission or reception of the displayed data using standard 300 baud audio frequency shift tones. This data rate and the FSK tones used are compatible with data recording and playback using an inexpensive tape recorder so that this interface may also be used whenever unattended operation is desired.

The universal asynchronous receiver transmitter (UART), A, is shown programmed for five data bits, no parity, and 1-1/2 stop bits per character. The first four data bits of each character are simply the four data bus bits transferred to the display registers S-V in Fig. 15. The fifth bit is used to signal the first character of the four-character message; a zero represents the first character (overload/blanking/hundreds).

When locally received data is to be displayed, the UART operates in its transmit mode. The data transfer across the data bus operates exactly as explained above, and the data bus is strobed into the UART transmit buffer whenever any of the display registers is clocked. Thus, a four-character word of data is

sent every 426.66... milliseconds. At 300 baud, it requires  $(5 + 1-1/2)/300$  seconds or 21.66... milliseconds to send each character. Since data is taken from the bus each 26.66... milliseconds, this creates a gap of 5 milliseconds between consecutive characters.

When display of remote data is selected, the timing changes somewhat. All of the tri-state registers are removed from the data bus using their DOD1 control inputs, and the UART tri-state received data output is connected to the bus ( $\overline{RDE} = 0$ ). When a first character has been received (bit 5 = 0 and UART data available), a pulse is generated at MS which resets 12-bit counter F in Fig. 15. Data transfer into the display registers then

proceeds as usual except that the UART supplies the data. The first data character is clocked into display register U at 13.333... milliseconds following data reception. Therefore, a large skew can be tolerated between local and remote clocks without affecting system operation.

In the local data display mode, digital data at 300 baud from the UART serial output is used to select which of two clock frequencies, 9600 or 19200, is applied to the 4-bit Johnson counter, E. The counter outputs are applied through summing resistors to inverter F configured to work as an operational amplifier. The weighting of the three summing resistors is chosen such that the filtered output of F approximates a sine wave of frequency

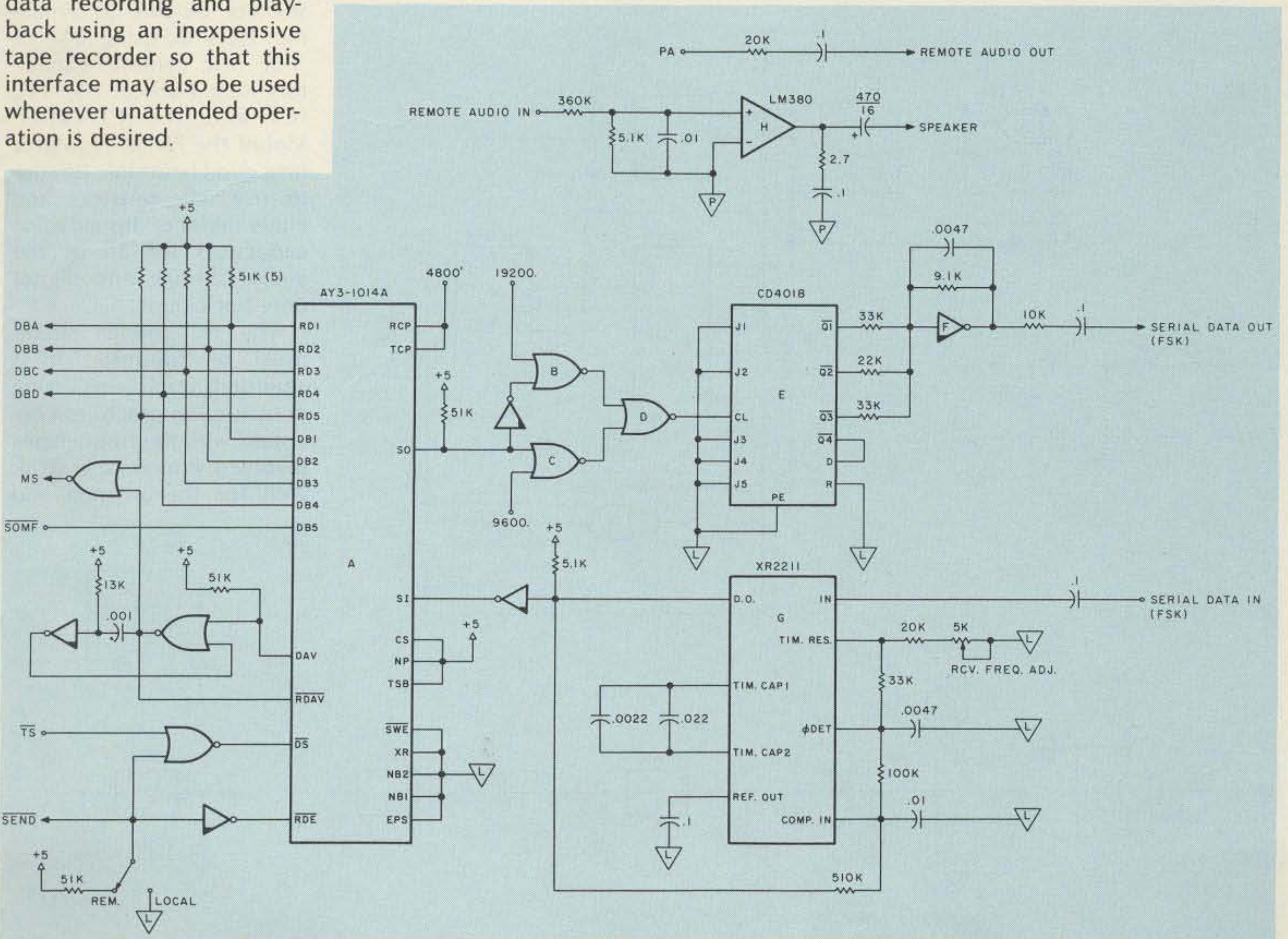

Fig. 16. Optional serial interface circuit schematic. Notes: NOR gates are 1/4 CD4001. Inverters are 1/6 74C903. Digital logic power is  $V_{cc} = V_{dd} = +5$ ,  $V_{ss} = GND = \nabla$ . Amplifier H power is +13 switched (sw); ground is  $\nabla$ .

1200 Hz when the UART output is "0" or 2400 Hz when the UART output is a "1". Sine-wave distortion is below 5% with this arrangement, and the FSK frequencies are as accurate as the system clock (which is crystal controlled).

When the system is in the remote data display mode, FSK input is demodulated in the XR2211 decoder, G. The component values shown are optimized for 300-baud, 1200/2400-Hz operation using the procedure given in EXAR's specification sheet for the XR2211.

The audio circuitry shown at the top of Fig. 16 is included as a convenience when using the system with a two-channel tape recorder. FSK data can be placed on one channel, and the received audio out of pre-amplifier A in Fig. 13 can be

coupled through the RC circuit shown to the second channel for simultaneous recording. On playback, this audio is amplified by the LM380 (amplifier H) to drive a loudspeaker so that bearing data can be easily correlated with the received signal.

### Power Supply and Clock

The entire system is designed to operate from a single unregulated supply voltage between 11.5 and 14.5 V dc negative ground for mobile operation. Total input current is approximately one Ampere with the display enabled. Fig. 17 shows the power supply and clock circuits.

Gates A and B are connected for linear operation and form a crystal-controlled oscillator. The

74LS197 is used to divide the 9.8304-MHz clock frequency by 8 to generate 1.2288 MHz for the antenna control waveform generator and binary display. Two 74LS193 counters are connected to divide the clock frequency by 91 to generate 108026 Hz for the BCD display. Gates F and G and the 74LS74 flip-flop are used to load a count of  $256 - 91 = 165$  into the two 4-bit counters. If the BCD display is not used, ICs D, E, and H may be omitted.

A 7805K regulator provides +5 V dc for the digital logic, operational amplifiers, and the displays. The 7808 regulator provides +8 V dc for the MOSFETs used in the rf summer.

Negative voltage is generated by a switching inverter/voltage doubler circuit that produces approxi-

mately -8 V dc at the input to a 7906 regulator. The -6 V dc is used as the negative analog supply voltage.

Operational amplifier K generates the +2.0 V dc reference used for D/A conversion and threshold comparison.

### Electronics Construction

If you wish to build the electronics from scratch, your best bet is to use wire-wrap sockets for all of the DIP integrated circuits and the discrete components (resistors, diodes, and small capacitors). Individual wire-wrap pins may be used for the larger components such as the electrolytic capacitors. All circuitry except the rf summer may be constructed on open perforated board with 0.1" spacing to accept the wire-wrap sockets. Be sure to bypass the +5 V dc using .047- or .1- $\mu$ F disc ceramic capacitors near each of the TTL ICs and the CD4511s. Mount the 7805K regulator on a good heat sink. Be sure to use 5% resistors and either mylar or dipped mica capacitors for all of the audio filtering and digital one-shot circuits.

The rf summer circuit must be mounted in a shielded enclosure using construction practices consistent with the frequencies involved. Phono jacks work well for the antenna and

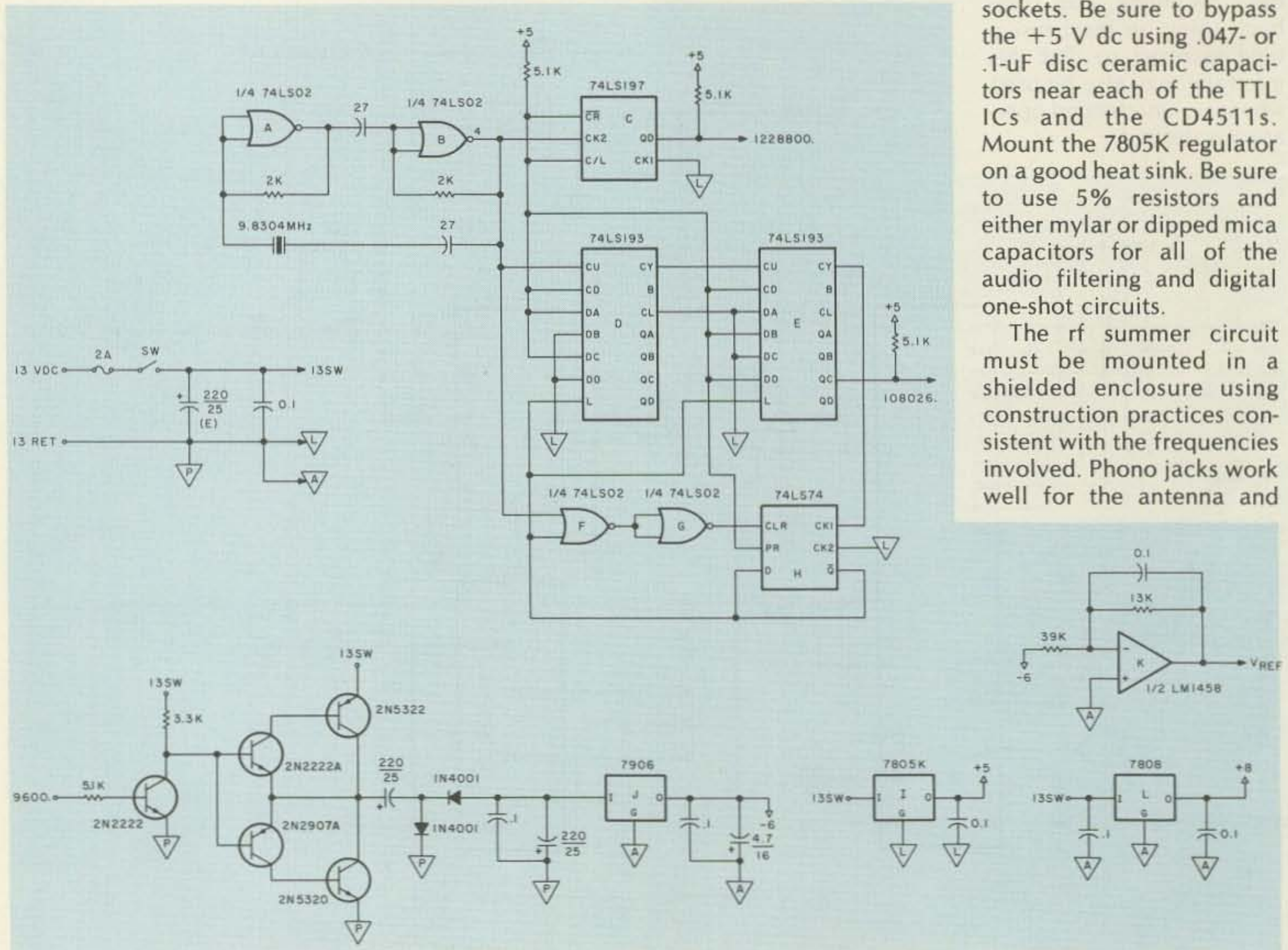

Fig. 17. Schematic of the power supply and clock circuitry. Notes: Power to LM1458 is +5 and -6 V dc. Logic power is  $V_{cc} = +5$ ,  $GND = \text{ground}$ .

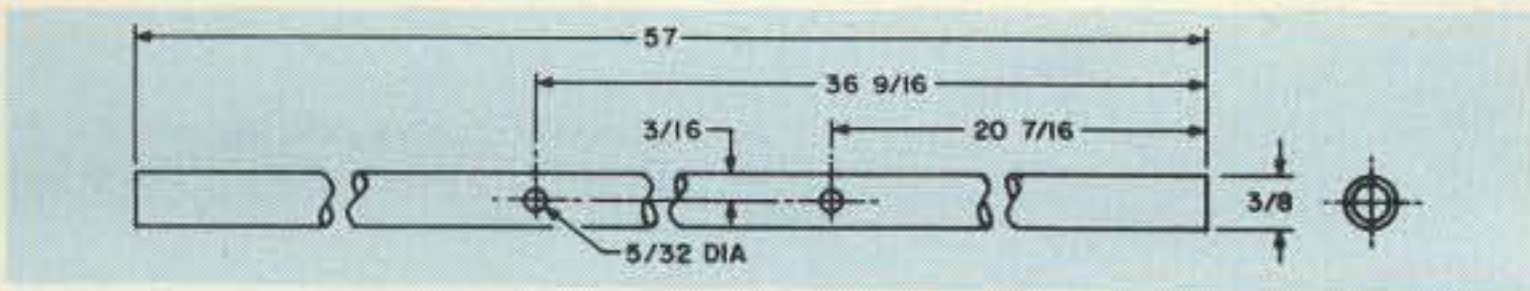

Fig. 18. Construction detail of the long radial. Two are required.

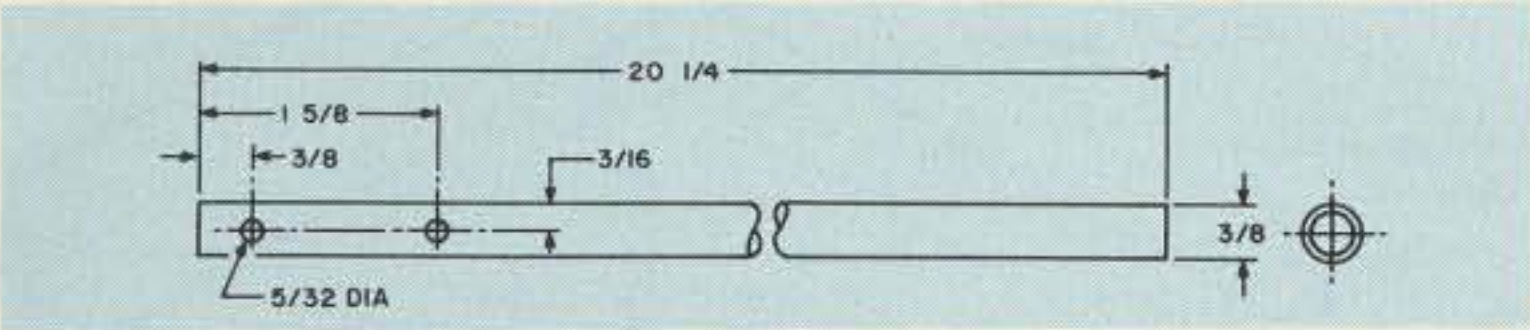

Fig. 19. Construction detail of the short radial. Four are required.

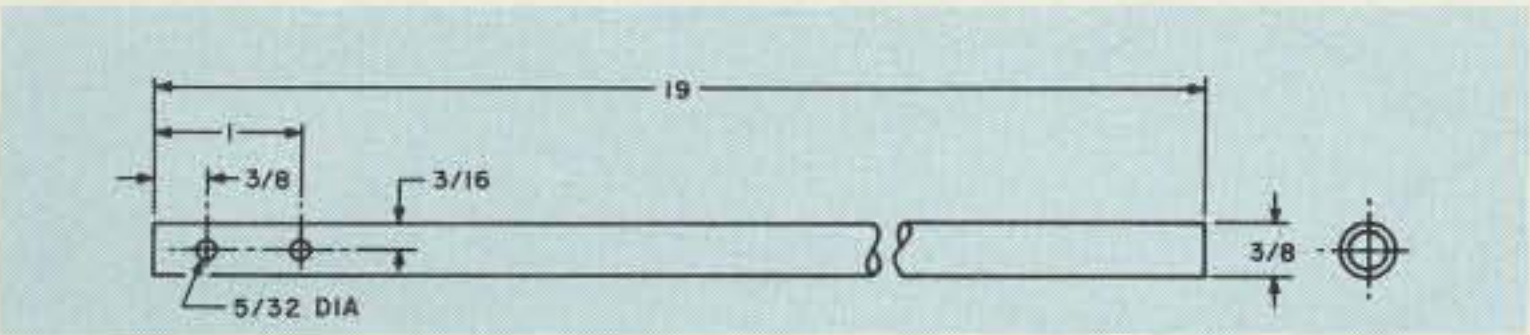

Fig. 20. Vertical element dimensions. Four are required.

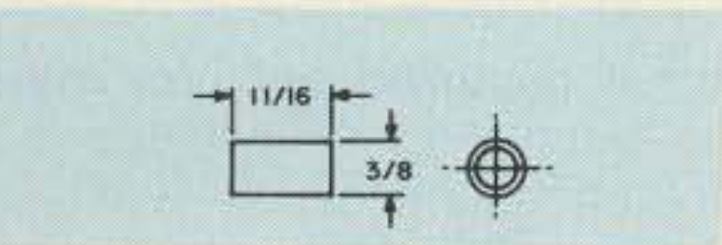

Fig. 21. Suction cup spacer. Four of these are required for mounting the antenna on a car roof.

receiver connectors. Keep all leads short and arrange the parts symmetrically.

A professionally designed unit utilizing double-sided printed wiring boards with plated-through holes and an attractive enclosure is available from Doppler Systems in either kit form or fully assembled and tested. Photo A shows the interior construction of the fully expanded version of the system (digital readout and serial interface).

### Antenna Construction

The antenna array must contain four identical elements located in the corners of a square array having sides less than one-half wavelength. Analysis shows, however, that the best performance can be expected with an array size between  $1/16$  and  $5/16$  wavelength. Each element must be vertically polarized and non-directional in the horizontal plane. Antenna impedance and matching to the transmission lines is not

especially important; however, each of the four lines must be of the same electrical length. For this reason, and to prevent excessive signal loss, the antenna should not be located too far from the electronics.

Element length may be increased to provide greater capture area and may be either balanced or unbalanced using a ground plane composed of radials. Mechanical stability is important, however, especially in a mobile application.

A good basic design suitable for either fixed or mobile use is given below. Elements are approximately  $1/4$  wavelength long and

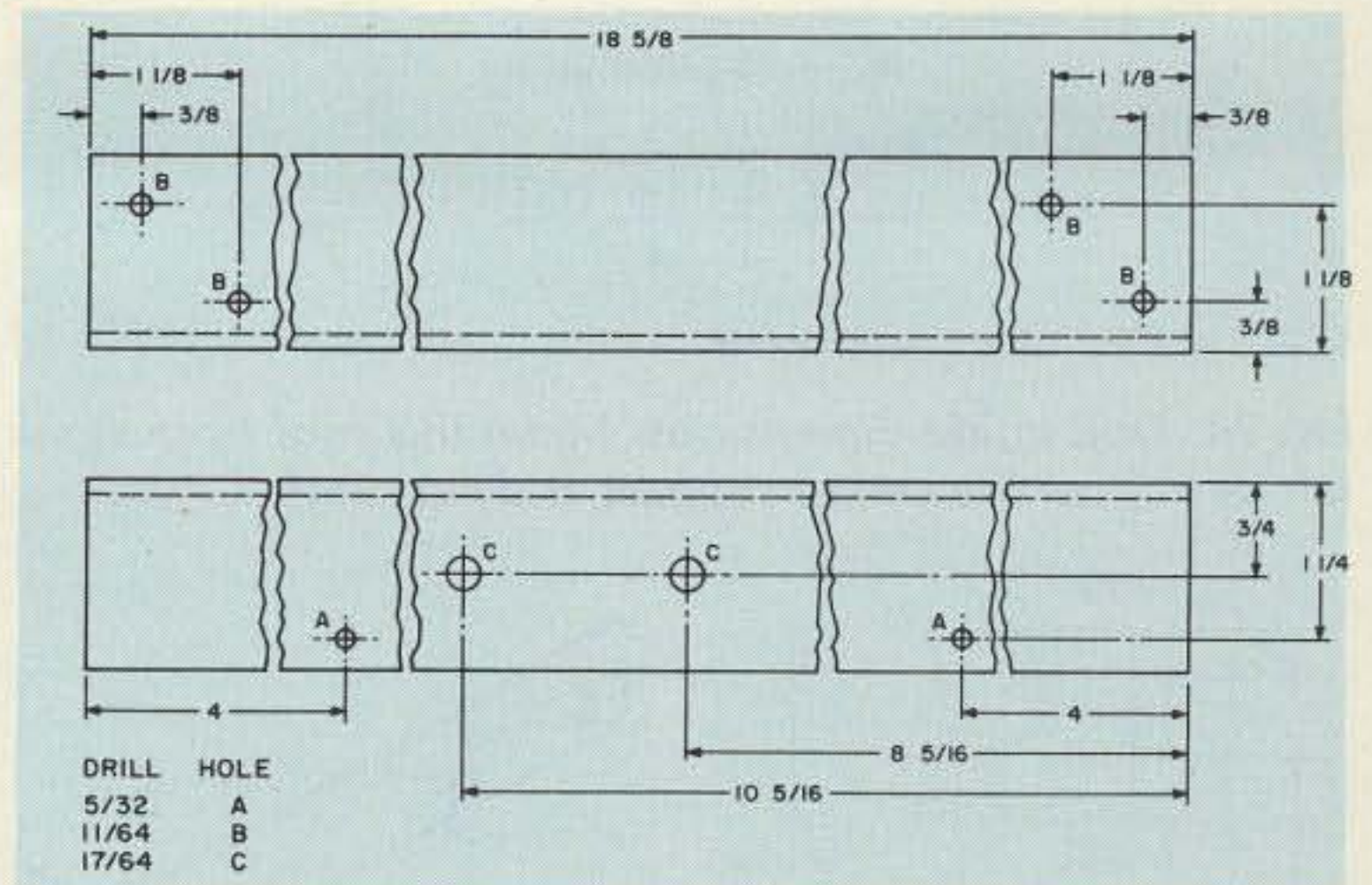

Fig. 22. Center support detail. Only one is required.

are spaced  $1/4$  wavelength apart at 2 meters. Radials extend an additional  $1/4$  wavelength beyond the elements, giving the antenna compact and sturdy characteristics. All material should be available from local suppliers. Alternatively, specific items may be ordered from Doppler Systems.

#### Aluminum Stock

- (1)—6'  $\times$  1-1/2"  $\times$  1-1/2"  $\times$  1/8" angle
- (2)—12'  $\times$  3/8" o.d.  $\times$  .035"-wall tubing

#### Teflon

- (1)—1'  $\times$  1-1/2"  $\times$  1/8" rectangular bar

#### Hardware

- (16)—6-32  $\times$  1/2" round head machine screws
- (16)—6-32  $\times$  3/4" round head machine screws
- (4)—6-32  $\times$  1" round head

machine screws

- (24)—No. 6 flat washers
- (32)—No. 6 split-type lock-washers
- (40)—6-32 hex nuts
- (8)—No. 6 locking-type solder lugs
- (4)—8-32  $\times$  1/2" round head machine screws
- (4)—No. 8 split-type lock-washers
- (4)—8-32 hex nuts
- \*(4)—1/4-20  $\times$  2" eye bolts
- \*(8)—1/4-20 hex nuts
- \*(8)—1/4" split-type lock-washers
- \*(4)—1/4-20  $\times$  1-1/2" bolts
- \*(4)—1/4" flat washers
- \*(4)—1/4-20 insert suction cups
- \*(4)—adjustable straps with gutter clips
- \*\* (1)—5/16  $\times$  2" center-to-center  $\times$  3" long U-bolt
- \*\* (2)—5/16 split-type lock-washers
- \*\* (2)—5/16 hex nuts

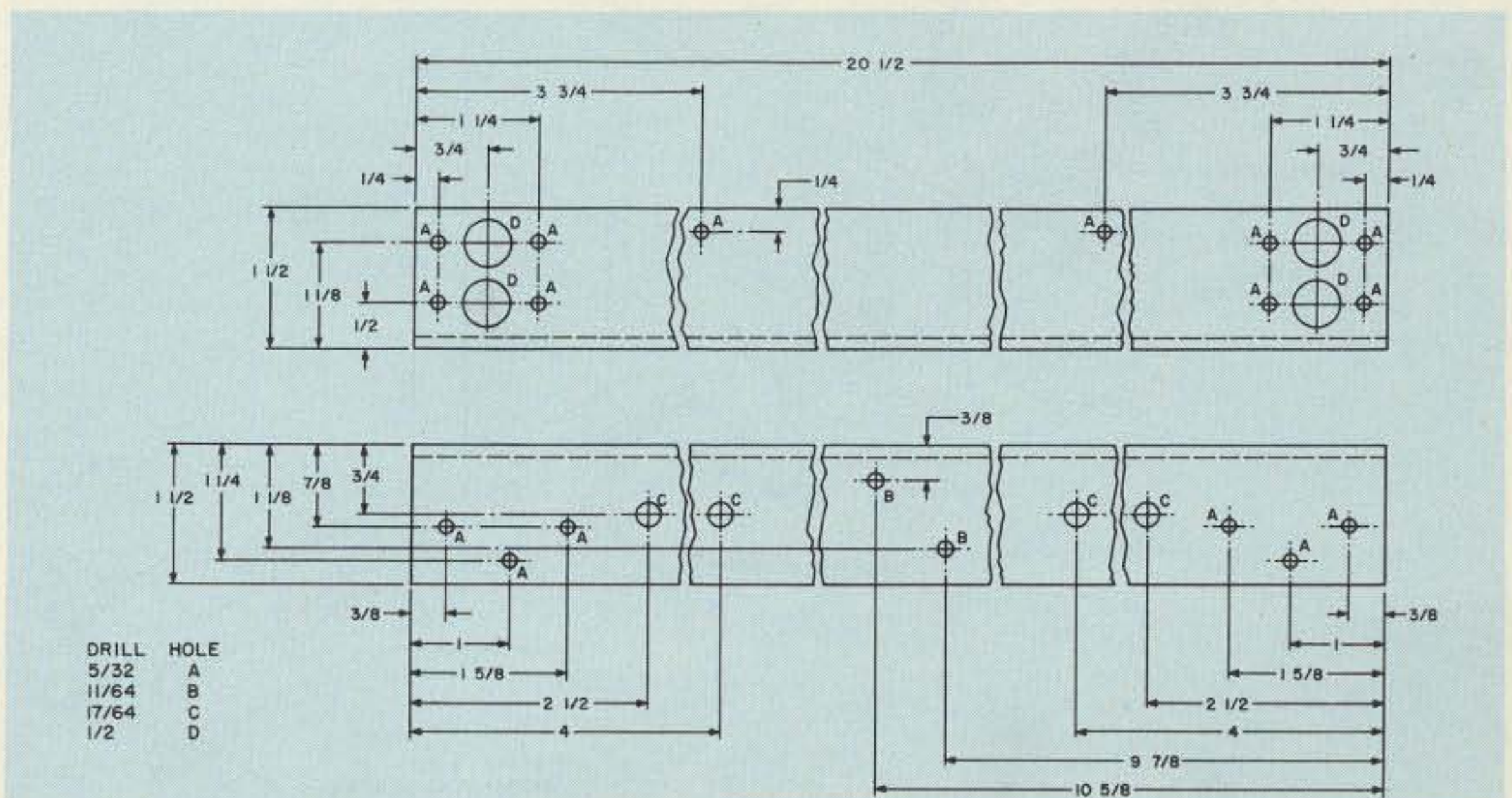

Fig. 23. Side arm construction detail. Two are required.

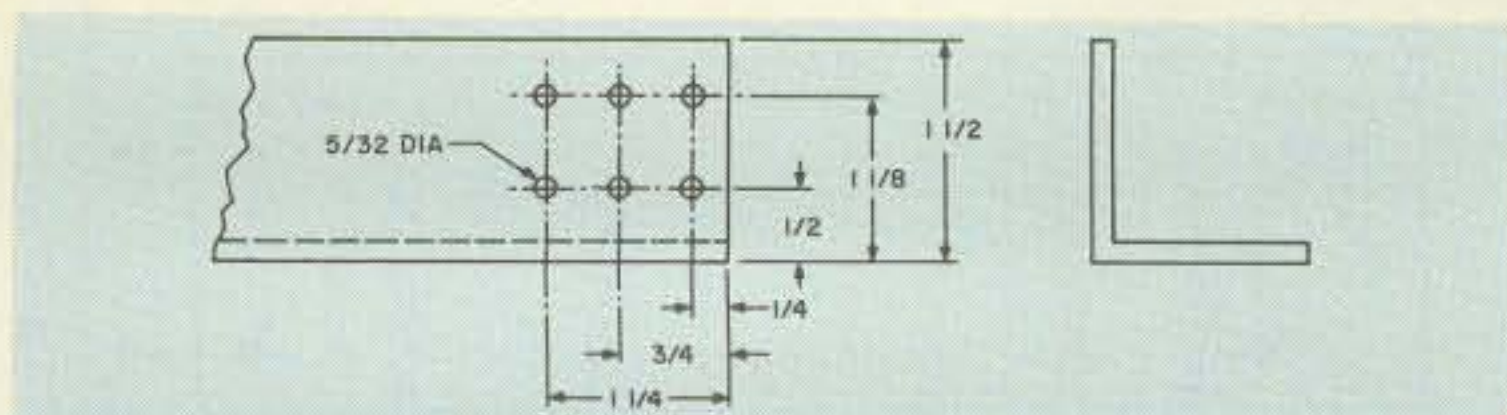

Fig. 24. Drill guide dimensions. Make this tool from stock left over from the center support and side arms.

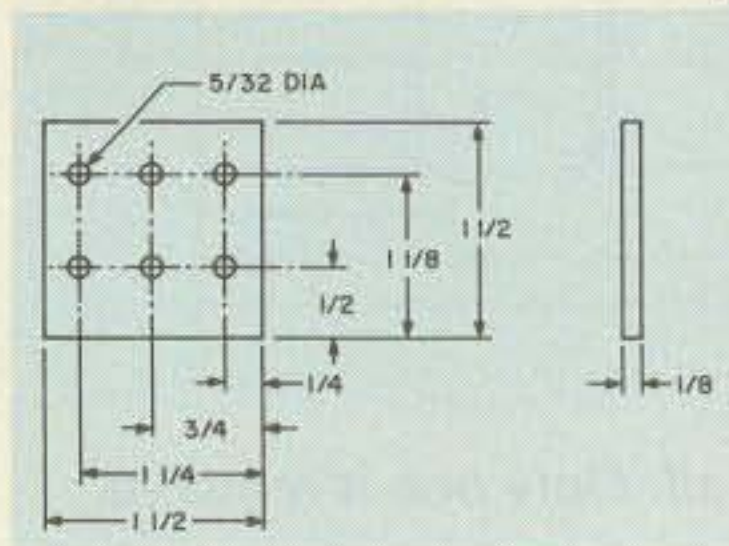

Fig. 25. Teflon insulator construction. Use the drill guide and a block of wood when drilling this material.

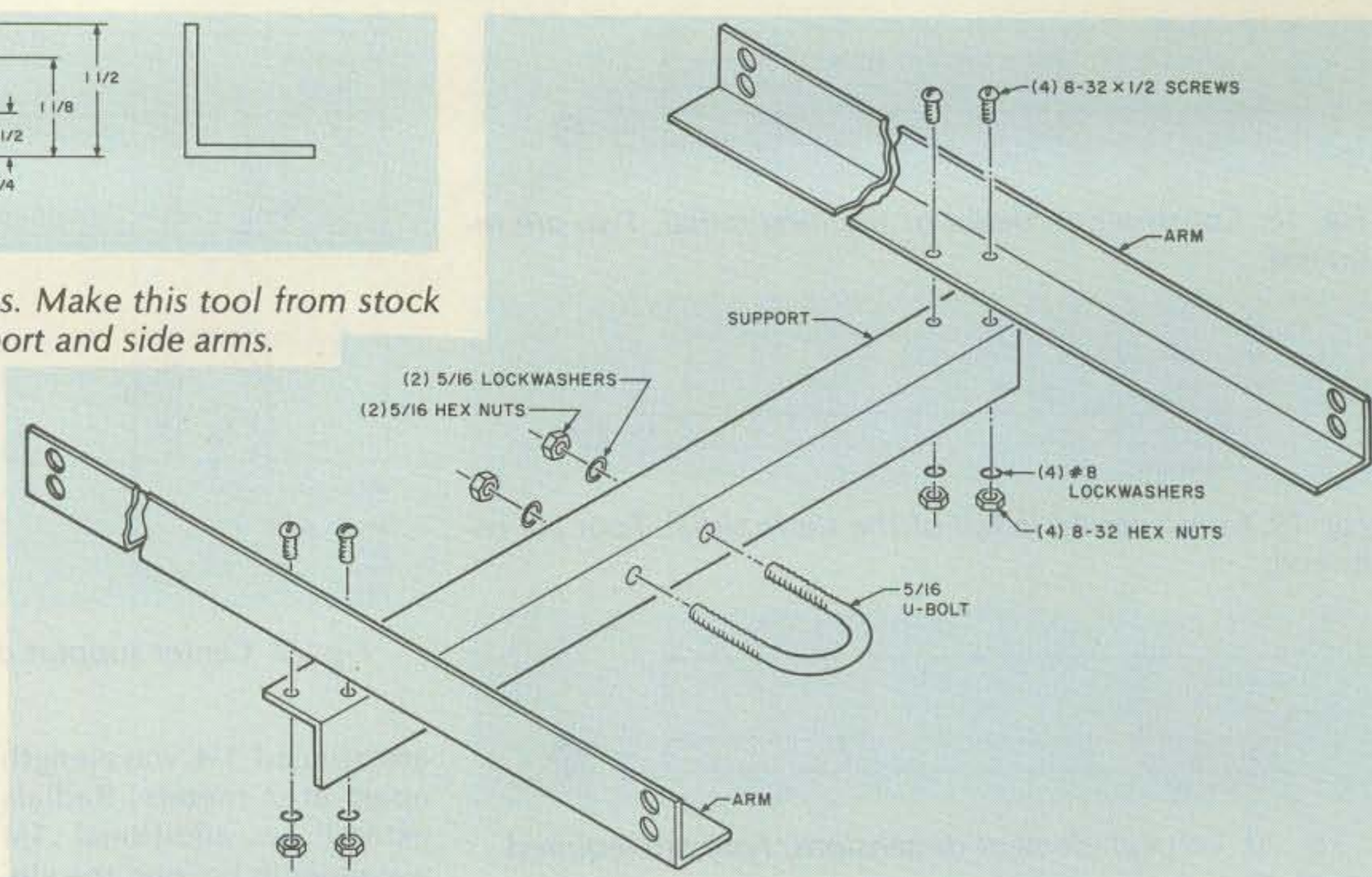

Fig. 26. Assembly of center support and side arms. The U-bolt is required only for mast mounting.

### Electrical

RG-174/U coax cable (length depends on installation)

(4)—phono plugs (shielded type)

\*Required for mobile mounting.

\*\*Required for mast mounting.

Cut two pieces 20-1/2" long and one piece 18-5/8" long from the aluminum angle. Save the remaining short length for use as a drill template with the teflon. Be sure to file all ends smooth after cutting.

From each of the 12-foot pieces of tubing, cut one

piece 57" long, two pieces 20-1/4" long, and two pieces 19" long. If you are making the antenna for mobile mounting, cut four additional pieces 11/16" long from the remaining short length of tubing. File all ends smooth after cutting.

Mark and drill all of the holes shown in Figs. 18 through 24. Use a counter-sink to deburr all of the holes after drilling.

Cut the teflon into four

pieces 1-1/2" long as shown in Fig. 25. Clamp the four teflon pieces together between a piece of wood and the end of the drill guide. Drill the six 5/32"-diameter holes through all four pieces.

Prepare four lengths of coax cable by soldering No. 6 solder lugs to both the inner conductor and the shield at one end, and a phono plug at the other. Be sure that the four pieces are

cut to the same length.

Assemble the two arms to the support bracket using the 8-32 hardware as shown in Fig. 26. Use a square to align the arms perpendicular to the support before tightening the screws.

At each end of the two arms, assemble a vertical element using the 6-32 hardware and teflon insulator as shown in Fig. 27. Check that the element is perpendicular to the arm and that the element mounting hardware does not touch the aluminum arm. Tighten the screws sufficiently to compress the lockwashers, but do not overtighten so as to crush the tubing or the teflon insulator. Connect the coax cable and tie it as shown as a strain relief.

Attach the short and long radials to the ends of each arm using the 6-32 hardware shown in Fig. 28. If the antenna will be used on a car, also mount the suction cups and eye bolts as shown. Align the "eyes" so that they face outward from the suction cups. Photo B shows a typical installation.

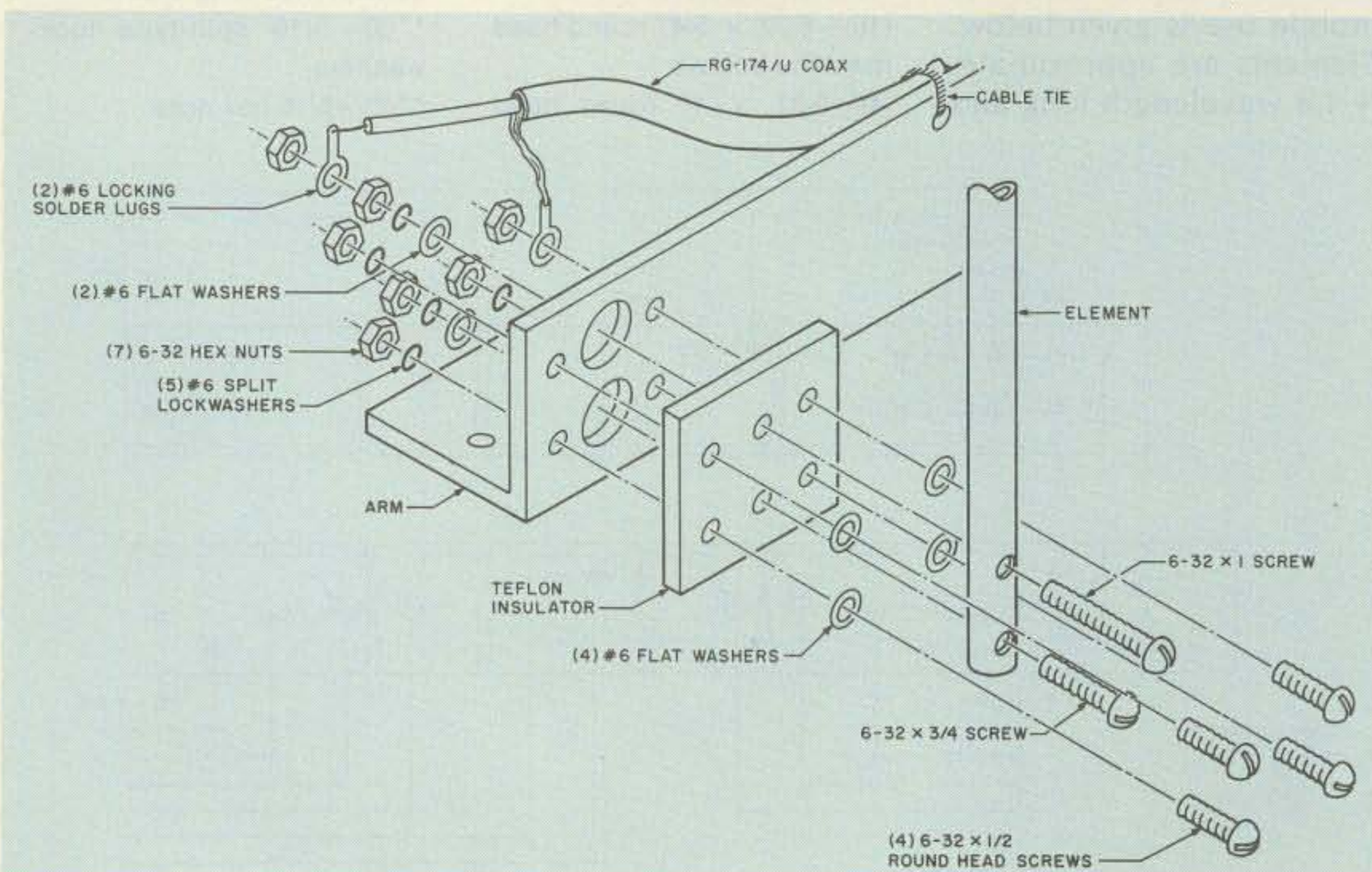

Fig. 27. Vertical element installation on the antenna side arms.

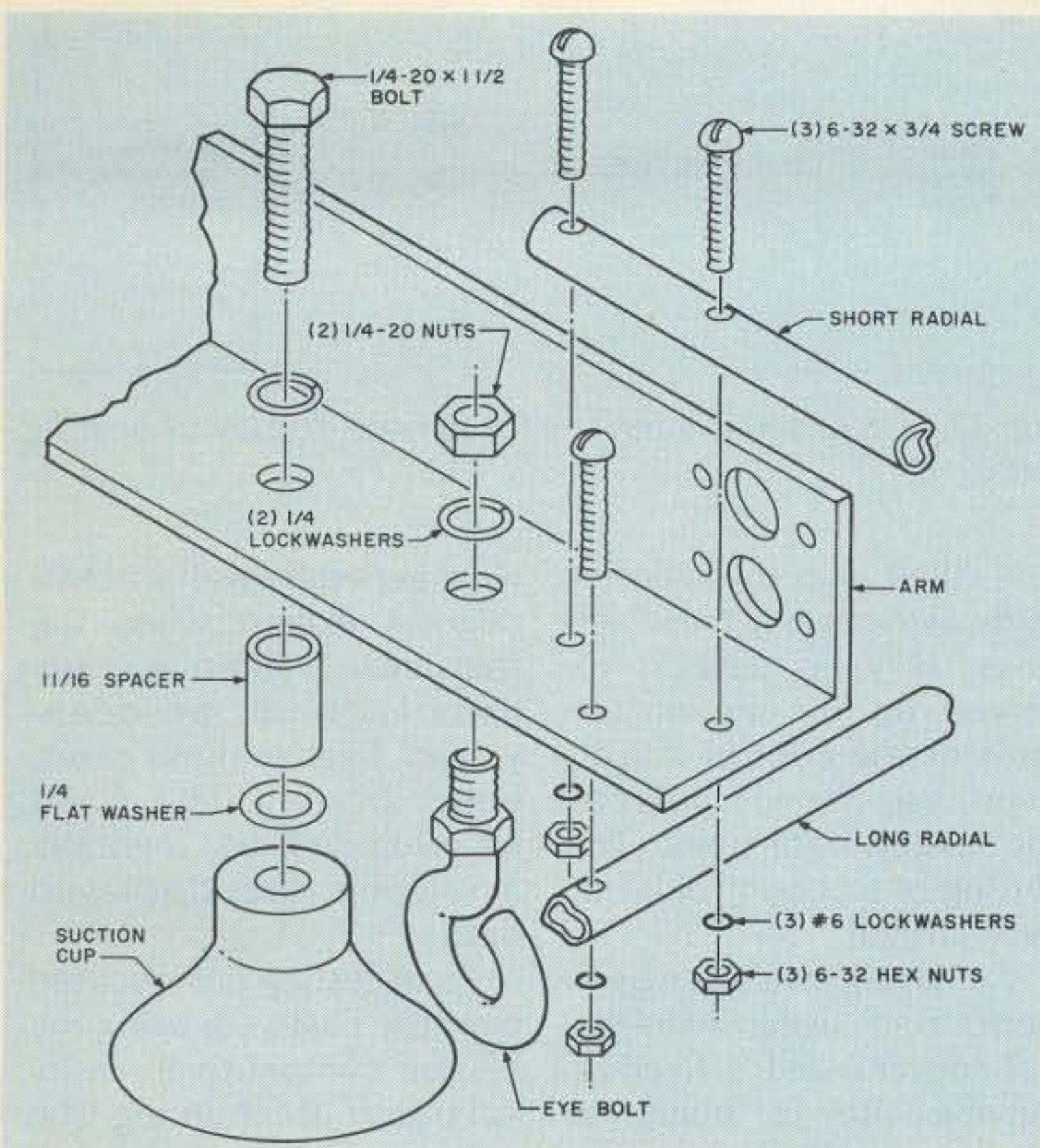

Fig. 28. Radial element assembly. The eye bolt and suction cups are required only for car mounting.

Mark the phono jack ends of the coax cable "A", "B", "C", and "D" according to Fig. 29. Mark antenna "A" also for ease in aligning the system later.

### Installation and Adjustment

Primary power requirements for the electronics is 11.5 to 13.5 V dc negative ground at 1 Ampere maximum. Ordinary 12-V dc automobile battery power may be used, or, for fixed operation, an inexpensive 12.6-V dc power supply may be used, such as Radio Shack Model 22-127.

System interconnection without the serial interface is particularly simple as indicated in Fig. 30. While the external speaker connection can be used, you will probably find a more convenient connection to be the high and low ends of the receiver's volume control. This will enable the listening level of the receiver to be adjusted without affecting the audio input level to the direction finder.

The serial interface can be used in several ways as

indicated in Figs. 31 and 32. Bearing data and receiver audio may be recorded simultaneously as shown in Fig. 31. Virtually any audio tape recorder is adequate for this application because of the low baud rate and wide FSK shift used for serial data transmission. A stereo system is recommended so that the normal receiver audio (voice) information may be recorded with the bearing data.

Two systems may be connected as shown in Fig. 32 for remote data display. A switch could be installed at the central site to enable a single monitor point to display the bearing data received at two or more remote sites for triangulation. The possibilities for more complex system interconnects using digital processing for automatic triangulation and logging are exciting.

Calibration adjustments are very simple and should not be required after initial setup unless the antenna orientation is changed or a different receiver is used.

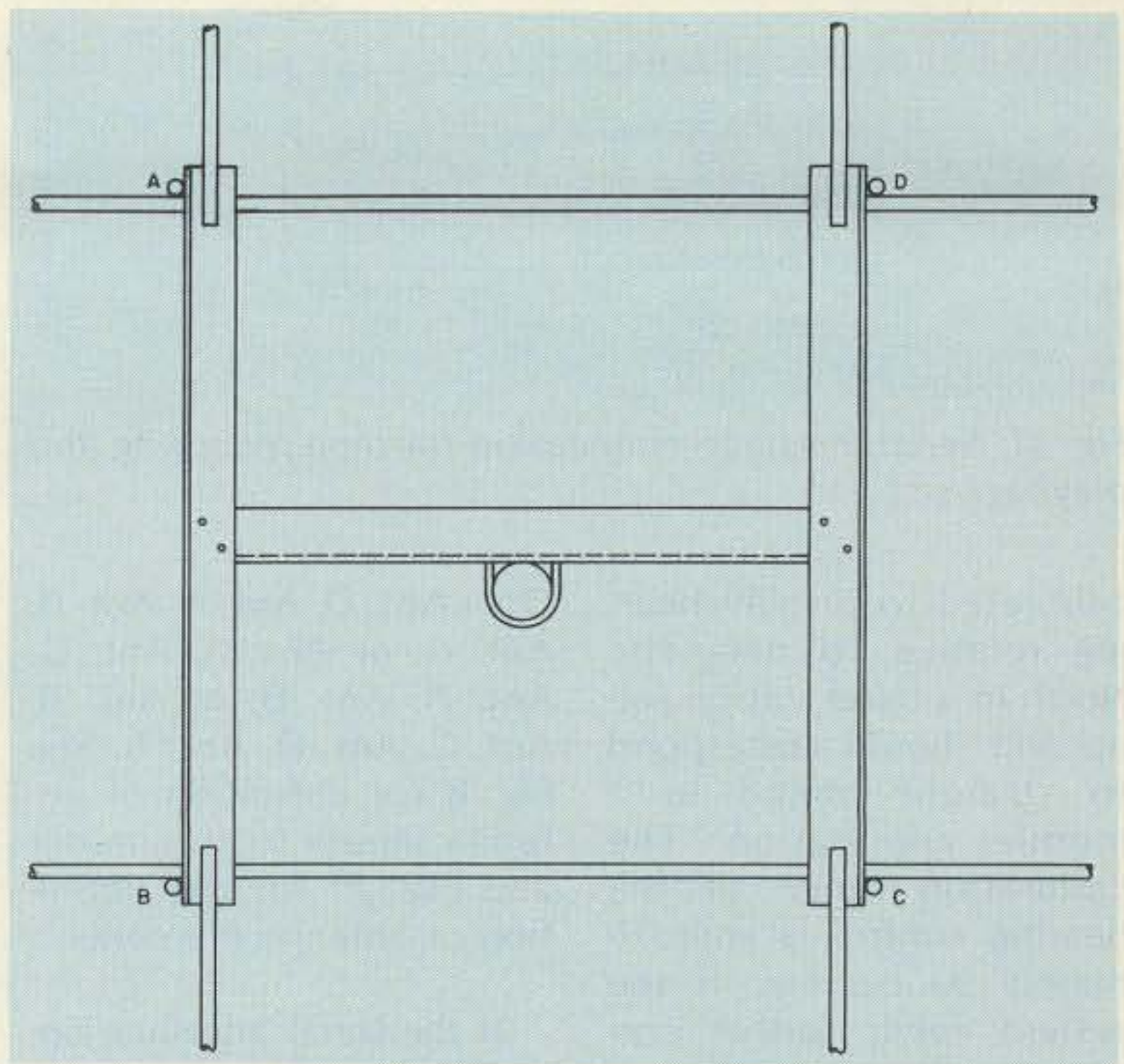

Fig. 29. Antenna top view showing marking of phono plugs required for proper calibration.

Allow the receiver and direction finder to warm up before making final calibration adjustments, however.

After setting the receiver's volume control, the direction-finder gain adjustment is made. Increase the gain until the overload LED flashes on voice peaks. (If this adjustment is very low, the display will remain blanked.) Setting is not critical, but the overload LED should blink with a duty cycle between about 10 and 50 percent during normal speech.

The direction-finder bearing control should then be adjusted so that the correct bearing is displayed for a known transmitted signal. Do not use a nearby handie-talkie for this calibration as local reflections are sure to result in an error. A repeater station which is within the line of sight of the antenna makes the best calibration source. Changing channels will have very little effect on system calibration, so any convenient station within the band may be used. The display should be

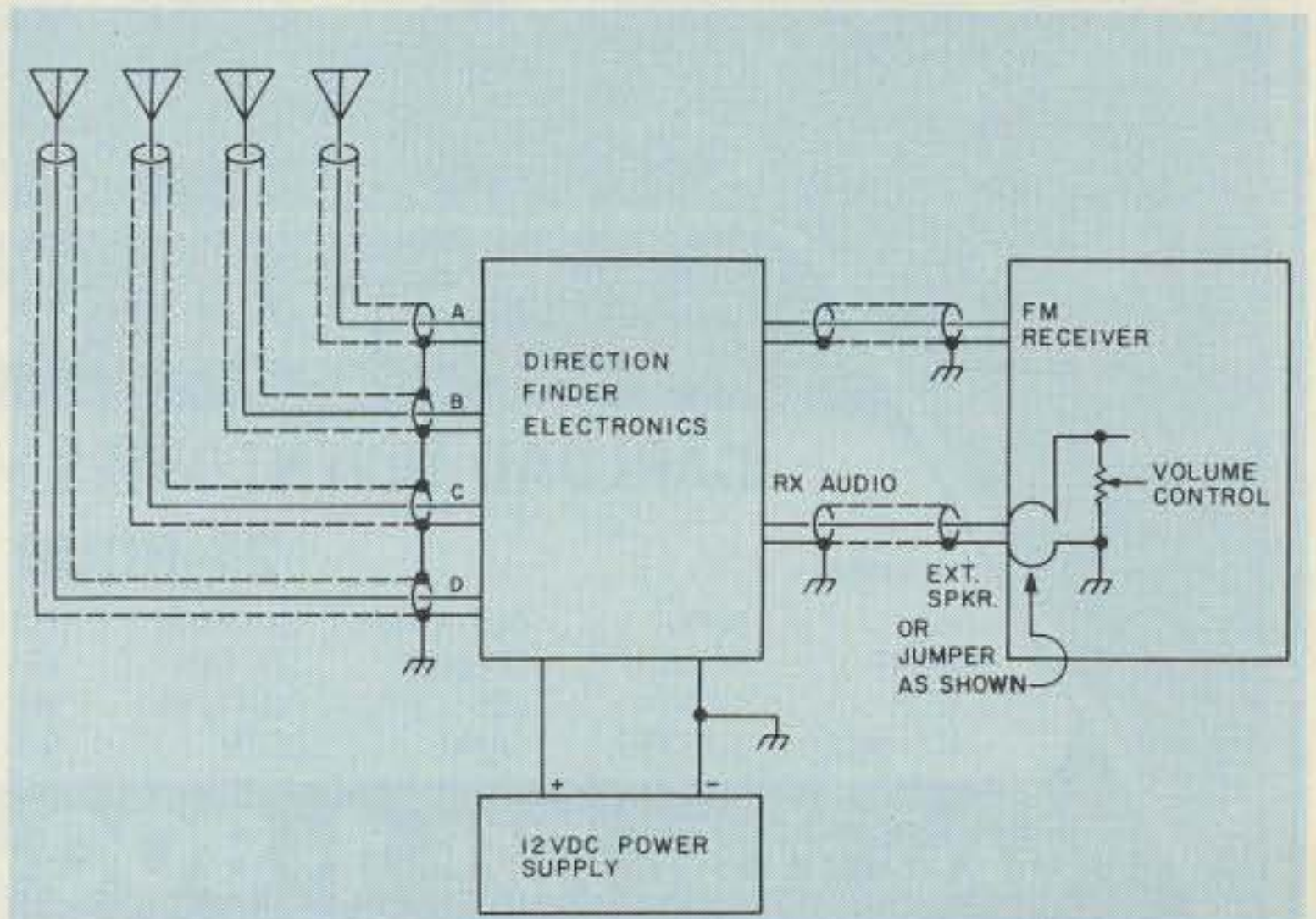

Fig. 30. Basic system connection to antenna, power source, and FM receiver. If a transceiver is used, be sure to disable the transmitter to prevent inadvertent transmission into the RDF electronics.

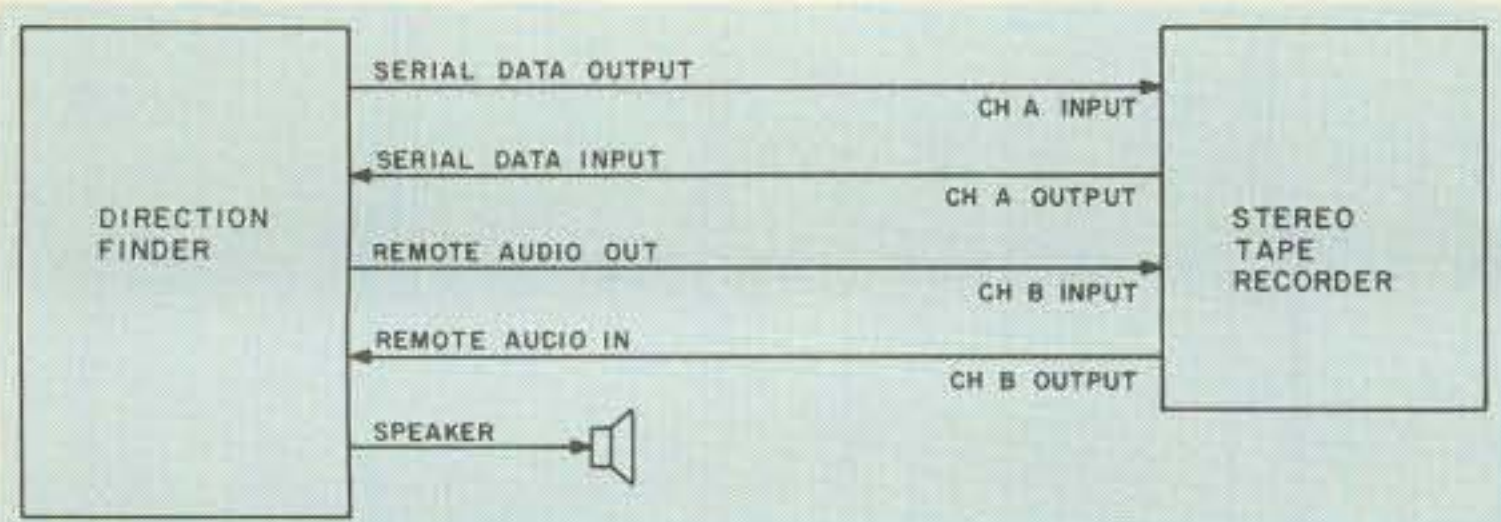

Fig. 31. Serial interface connection for tape recording and playback.

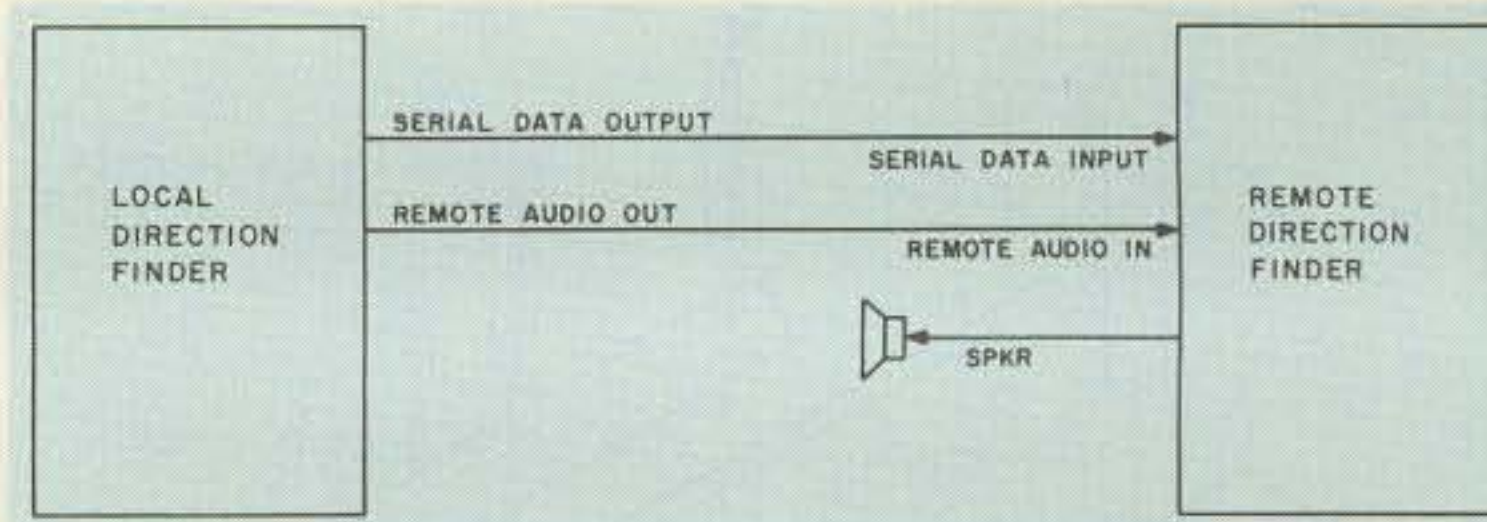

Fig. 32. Use of serial interface for remote display of bearing data.

calibrated to display bearing relative to magnetic North in a fixed station set-up and should correspond to straight ahead in a mobile application. The calibration range of the bearing control is approximately 90 degrees. If the system needs further correction, either rotate the antenna physically or switch the antenna inputs to the electronics. Be sure not to reverse the order of antenna rotation, however. The acceptable combinations for inputs A, B, C, and D are: Ant. A, Ant. B, Ant. C, Ant.

D; or Ant. D, Ant. A, Ant. B, Ant. C; or Ant. C, Ant. D, Ant. A, Ant. B; or Ant. B, Ant. C, Ant. D, Ant. A. See Fig. 8 for definition of antenna inputs to rf summer and Fig. 29 for the definition of antenna elements.

If the serial interface option is to be used, the receive frequency adjustment can be made by recording a few minutes of data, then playing it back in the Remote Display Mode while making this adjustment. Note the control settings where invalid data oc-

cur, then set the control midway between these settings. If valid data is received up to one of the ends of the control adjustment, use the end point as the invalid data point. The setting of this control is not very critical.

Accuracy tests have been performed using fixed-signal sources and a fixed-receiving site to eliminate changing reflection paths. The antenna was rotated on a calibrated turnstile and errors measured between the true bearing and the displayed bearing. These

were generally well within 5 degrees except when the transmitted audio was unusually loud or deep-voiced. Even in those cases, better bearing data could be obtained by mentally averaging the displayed data.

Field testing has occurred over the past year using the system competitively in local transmitter hunting. The success record achieved to date has been very impressive considering the high expertise in transmitter hunting which exists in the Phoenix area. ■

# MIDCOM

## DEAL WITH #1!

### CARLOAD INVENTORIES • ROCK BOTTOM PRICES

### 24-HOUR SERVICE

LINES:

AEA	ALPHA	CUSHCRAFT	DENTRON	KLM	MOR GAIN	PALOMAR ENG.	UNIVERSAL
AVANTI	BEARCAT	COLLINS	HY GAIN	KENWOOD	MIRAGE	REGENCY	UNARCO-ROHN
ASTRON	BIRD	CDE	HUSTLER	MICROLOG	MFJ	SWAN	VIBROPLEX
ALLIANCE	BENCHER	DRAKE	ICOM	MINI-PRODUCTS	NYE	TEN TEC	Kantronics

CALL TOLL FREE **1-800-325-3609**

IN MISSOURI  
**314-961-9990**

MID-COM ELECTRONICS • 8516 MANCHESTER ROAD • BRENTWOOD, MO 63144



✓ 52

WE BACK EVERYTHING  
WE SELL WITH OUR  
PERSONAL GUARANTEE

PRICES F. O. B.  
HOUSTON

PRICES SUBJECT TO  
CHANGE WITHOUT  
NOTICE

ITEMS SUBJECT TO  
PRIOR SALE

# MADISON Electronics Supply



NEW NIGHTTIME LINE

TOLL FREE

1-800-231-3057

MON, WED, FRI, 6 PM-10 PM CT

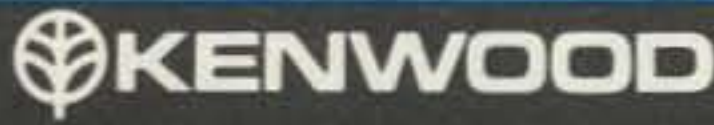

**TS530 INTRODUCED**

Digital readout built in. Fits TS830 accessories. Replaces TS520 SE. Call for quote and intro package.

UNDER \$800.00



**ICOM**

IC2 AT  
\*\$269.95  
BP-5-  
49.95  
BC-30-  
69.95

**NEW IC-22U**

List - 329.00  
INTRODUCTORY  
PRICE  
289.00

IC255-A \*389.00

**ACCESSORIES**

HM-8 49.95  
HM-9 34.50  
HM-10 39.95  
PS-15 149.00  
PS-20 229.00

**DONS CORNER**

Best new buy in HF AC Transceivers—Kenwood TS830S. Reports are great, failures low, deliveries steady.

Best used buy—Collins KWM2. Excellent backup rig or primary station at cheap prices if you look hard. Suggestion; buy Round Emblem if possible, they were built in the 70's.

Try the new Mini RG-8 from Belden or other quality brands. Good for a KW to 30MHZ. RG-59 outer diameter. Flexible and clearer than RG-8. 95% braid, foam, easy to put connectors on.

Be sure to try Coax-Seal. New product on market for wrapping coax connectors. Works great on air leaks on my truck!

New items/ideas. Watch for radios with more features at cheaper prices to come along. Example; TS820S replaced by TS830S which is a better set.

One notable exception, the Rockwell KWM 380, the quality is there regardless of price.

Come see your favorite manufacturer/dealer in Houston, August 2-4, 1981.

See you next month!

**THE KWM-380  
SOME AT OLD  
PRICES - CALL QUICK**

**KENWOOD**

TS-130S Deal  
TRANSCEIVER 759.00  
AT - 130 (139.00)

—FREE—

TS130S & AT130 759.00

**ETO-ALPHA**

ALPHA 78 \* 2707.00  
ALPHA 374A \* 2036.00  
ALPHA 76A \* 1585.00  
ALPHA 76PA \* 1866.00

**DRAKE**

TR7/DR7 \* 1349.00

**ICOM**

720A W/PS \* 1498.00

**BELDEN**

RG8/u Dbl. Shield	Part Number	MHz	db/100 ft.	db/100 m.	
	9888	50	1.2	3.9	8448 27 c/ft.
		100	1.8	5.9	
		200	2.6	8.5	
		300	3.3	10.8	
RG8/u Foam .81VF		400	3.8	12.5	
	8214	50	1.2	3.9	9405 45 c/ft.
		100	1.8	5.9	
		200	2.6	8.5	
		300	3.3	10.8	
RG8/u Regular .66VF		400	3.8	12.5	
	8237	100	2.0	6.8	Belden Mini RG-8 (9258)-19c/ft.
		200	3.0	9.8	
		400	4.7	15.4	
		900	7.8	25.4	
RG 213 Non-contaminating		100	2.0	6.8	
	8267	200	3.0	9.8	
		400	4.7	15.4	
		900	7.8	25.4	

Belden Mini RG-8 (9258)-19c/ft.

**ET CETERA**

- Cubic-Swan 102BXA ..... \$999.00
- Astro 150A ..... 849.00
- Robot 800A ..... 749.00
- Cushcraft A4 Tribander ..... 219.00
- Bird 43, Slugs ..... Stock
- CDE Ham-4 Rotor ..... 199.00
- Ham X ..... 269.00
- FDK Palm 2 Handie with BP/AC ..... 149.00
- GE 572B ..... 38.00
- GE 6146B ..... 9.95
- Fits Kenwood Yaesu
- Kenwood Service Manuals
- Stock ..... 10.00 ea.
- Telrex TB5EM ..... 425.00
- Belden #148000 Stranded
- Antenna Wire ..... 10c/ft.
- Adel Nibbling Tool ..... 8.95
- Jonel QSAS ..... 41.95
- AEA Morsematic ..... 169.00
- Alliance Hd73 Rotor ..... 109.95
- Amphenol Silverplate PL259 ..... 1.00
- ICOM 255A 2M Synthesized ..... 339.00
- W/TT Mike
- ICOM 260A 2M SSB/FM/CW ..... 449.00
- Kenwood TS 180S/DFC/SSB ..... 899.00
- NEW-Icom IC 720 W/AC/Mike ..... Call
- Bearcat 220-[329.00] ..... 300-399.00
- Manual Typewriters ..... 35.00
- Guaranteed to Work
- Mallory 2.5A/1000 PIV
- Epoxy Diode ..... 19c ea.
- Antique Tubes ..... Call
- Bash Books ..... 9.95
- 2 Guaranteed Service Techs on
- Collins KWM-2/KWM-380/S-Line Call!

**ASTRO 103**

- 100 WATT OUTPUT
- AGC DYNAMIC RANGE GREATER THAN 100 dB
- SELECTIVITY 16 POLE CRYSTAL FILTER  
2.7kHz at -6dB;  
3.78 kHz at -100dB.



\$1395.00 LIST\*

**HANDIES**

**KENWOOD**  
TR-2400 \* 399.00

**SANTEC**  
HT 1200 \* 299.00

**MOBILE 2M**

**KENWOOD**  
TR9000  
ALL MODE \* 499.00

**ICOM**  
IC-260A  
ALL MODE \* 499.00

713-658-0268

\* CALL FOR QUOTES \*

1508 MCKINNEY  
HOUSTON, TEXAS 77010

# The History of Ham Radio

## — part XV

Reprinted from QCC News, a publication of the Chicago Area Chapter of the QCWA.

There had been no changes in radio legislation in fourteen years, and by 1926 there were over 700 applications on file with the Department of Commerce for radio broadcast station licenses and about 16,000 licensed radio amateurs operating in the United States. Of special interest to all was the allocation of frequencies above 2000 kc de-

ecided upon by the Fourth National Radio Conference. (See Table 1.)

Broadcasters had 95 available frequencies with ten-kc separation, with six reserved exclusively for Canada.

### Mounting Listener Resentment

The listening audiences

generally agreed that there were too many high-powered broadcast stations operating in the lower wavebands with too little information and entertainment of high-class value. In addition, the problem of regenerative whistles from neighboring radio sets was a bugaboo. The receivers on the market in 1926 lacked good design and circuitry devel-

opment, so they oscillated and produced spurious signals. By 8 pm every night, when the squealers and howlers started, the time for receiver shutoffs had arrived. Enjoyment of radio listening began to wane.

Licenses and frequency assignments for radio broadcasting, as well as all other associated regulation, still rested with the Department of Commerce, with Secretary Hoover in charge. As more conflicts arose, the Department's authority was seriously questioned. Several broadcasters, notably WJAZ in Chicago, challenged the legality of the regulations pertaining to "time on the air" assignments. They asserted that The Freedom of the Air gave everyone the right to choose . . . where and when he operated . . . that the people of the country were the ones who had The Freedom of the Air. In consequence, the division of time among

Kilocycles	Meters	Service
500-550	545-600	CW, ICW, phone, aircraft
550-1,500	200-545	Broadcast
1,500-2,000	150-200	Amateur phone, CW, ICW
2,000-3,500	85.7-105	Aircraft, point-to-point, mobile relay
3,500-4,000	75-85.7	Amateur, army mobile, navy vessels with aircraft
4,000-7,000	42.8-75	Public toll, mobile, point-to-point, relay
7,000-8,000	37.5-42.8	Amateur, army mobile
8,000-14,000	21.4-37.5	Point-to-point, relay
14,000-16,000	18.7-21.4	Amateur
16,000-56,000	5.35-18.7	Public toll, mobile, government, point-to-point, experimental
56,000-64,000	4.69-5.35	Amateur
64,000-400,000	.7496-4.69	Experimental
400,000-401,000	.7477-.7496	Amateur

Table 1. 1926 frequency allocations.



## SUMMER SPECIALS

HAL 2304 MHz downconverters (frequency range: 2000-2500 MHz). Model #1 kit: discontinued. 2304 Model #2 kit (with preamp): \$59.95. 2304 Model #3 kit (with high-gain preamp) \$69.95. 2304 Model #4 kit coming soon! All of the above kits came with coax fittings IN and OUT, and with weatherproofed diecast housing. Factory wired and tested, for all of the above: \$50 additional. Power supply kit: \$24.95; wired and assembled: \$34.95.  
**FREE: 11-PAGE MANUAL WITH EACH KIT**

## FREQUENCY COUNTERS

**COMPLETE KITS:** CONSISTING OF EVERY ESSENTIAL PART NEEDED TO MAKE YOUR COUNTER COMPLETE. **HAL-800A** 7-DIGIT COUNTER WITH FREQUENCY RANGE OF ZERO TO 600 MHz. FEATURES TWO INPUTS: ONE FOR LOW FREQUENCY AND ONE FOR HIGH FREQUENCY; AUTOMATIC ZERO SUPPRESSION. TIME BASE IS 1.0 SEC OR .1 SEC GATE WITH OPTIONAL 10 SEC GATE AVAILABLE. ACCURACY  $\pm 001\%$ . UTILIZES 10-MHz CRYSTAL 5 PPM.

COMPLETE KIT.....\$129

**HAL-300A** 7-DIGIT COUNTER WITH FREQUENCY RANGE OF ZERO TO 300 MHz. FEATURES TWO INPUTS: ONE FOR LOW FREQUENCY AND ONE FOR HIGH FREQUENCY; AUTOMATIC ZERO SUPPRESSION. TIME BASE IS 1.0 SEC OR .1 SEC GATE WITH OPTIONAL 10 SEC GATE AVAILABLE. ACCURACY  $\pm 001\%$ . UTILIZES 10-MHz CRYSTAL 5 PPM.

COMPLETE KIT.....\$109

**HAL-50A** 8-DIGIT COUNTER WITH FREQUENCY RANGE OF ZERO TO 50 MHz OR BETTER. AUTOMATIC DECIMAL POINT. ZERO SUPPRESSION UPON DEMAND. FEATURES TWO INPUTS: ONE FOR LOW FREQUENCY INPUT, AND ONE ON PANEL FOR USE WITH ANY INTERNALLY MOUNTED HALTRONIX PRE-SCALER FOR WHICH PROVISIONS HAVE ALREADY BEEN MADE. 1.0 SEC AND .1 SEC TIME GATES. ACCURACY  $\pm 001\%$ . UTILIZES 10-MHz CRYSTAL 5 PPM.

COMPLETE KIT.....\$109

### PRE-SCALER KITS

**HAL 300 PRE**.....\$14.95  
 (Pre-drilled G10 board and all components)

**HAL 300 A/PRE**.....\$24.95  
 (Same as above with preamp)

**HAL 600 PRE**.....\$29.95  
 (Pre-drilled G10 board and all components)

**HAL 600 A/PRE**.....\$39.95  
 (Same as above but with preamp)

### TOUCH TONE DECODER KIT

HIGHLY STABLE DECODER KIT. COMES WITH 2 SIDED, PLATED THRU AND SOLDER FLOWED G-10 PC BOARD, 7-567's, 2-7402, AND ALL ELECTRONIC COMPONENTS. BOARD MEASURES 3 1/2 x 5 1/2 INCHES. HAS 12 LINES OUT. ONLY \$39.95

**DELUXE 12-BUTTON TOUCHTONE ENCODER KIT** utilizing the new ICM 7206 chip. Provides both VISUAL AND AUDIO indications! Comes with its own two-tone anodized aluminum cabinet. Measures only 2 3/4 x 3 3/4". Complete with Touch-Tone pad, board, crystal, chip and all necessary components to finish the kit.

PRICED AT.....\$29.95

For those who wish to mount the encoder in a hand-held unit, the PC board measures only 9/16" x 1 3/4". This partial kit with PC board, crystal, chip and components.

PRICED AT.....\$14.95

**ACCUKEYER—MEMORY OPTION KIT** THIS ACCUKEYER MEMORY KIT PROVIDES A SIMPLE, LOW COST METHOD OF ADDING MEMORY CAPABILITY TO THE WB4VVF ACCUKEYER. WHILE DESIGNED FOR DIRECT ATTACHMENT TO THE ABOVE ACCUKEYER, IT CAN ALSO BE ATTACHED TO ANY STANDARD ACCUKEYER BOARD WITH LITTLE DIFFICULTY. \$16.95

**ACCUKEYER (KIT)** THIS ACCUKEYER IS A REVISED VERSION OF THE VERY POPULAR WB4VVF ACCUKEYER ORIGINALLY DESCRIBED BY JAMES GARRETT, IN QST MAGAZINE AND THE 1975 RADIO AMATEURS HANDBOOK. \$16.95

ACCUKEYER—MEMORY OPTION KIT—TOGETHER ONLY \$32.00

### 6-DIGIT CLOCK • 12/24 HOUR

COMPLETE KIT CONSISTING OF 2 PC G10 PRE-DRILLED PC BOARDS, 1 CLOCK CHIP, 6 FND 359 READOUTS, 13 TRANSISTORS, 3 CAPS, 9 RESISTORS, 5 DIODES, 3 PUSH-BUTTON SWITCHES, POWER TRANSFORMER AND INSTRUCTIONS.

DON'T BE FOOLED BY PARTIAL KITS WHERE YOU HAVE TO BUY EVERYTHING EXTRA.

PRICED AT.....\$12.95

**CLOCK CASE** Available and will fit any one of the above clocks. Regular Price...\$6.50 But Only \$4.50 when bought with clock

**SIX-DIGIT ALARM CLOCK KIT** for home, camper, RV, or field-day use. Operates on 12-volt AC or DC, and has its own 60-Hz time base on the board. Complete with all electronic components and two-piece, pre-drilled PC boards. Board size 4" x 3". Complete with speaker and switches. If operated on DC, there is nothing more to buy.\*

PRICED AT.....\$16.95

Twelve-volt AC line cord for those who wish to operate the clock from 110-volt AC. \$2.95

### SHIPPING INFORMATION

ORDERS OVER \$20.00 WILL BE SHIPPED POSTPAID EXCEPT ON ITEMS WHERE ADDITIONAL CHARGES ARE REQUESTED. ON ORDERS LESS THAN \$20.00 PLEASE INCLUDE ADDITIONAL \$1.50 FOR HANDLING AND MAILING CHARGES. SEND SASE FOR FREE FLYER.



**HAL-TRONIX** ✓31

P. O. BOX 1101  
 SOUTHGATE, MICH. 48195  
 PHONE (313) 285-1782

"HAL" HAROLD C. NOWLAND  
 W8ZXH

# The HD-73 Rotator by Alliance

## A precision instrument built to last.

The HD-73 combines Dual-Speed rotation and a single 5-position switch with the clear visibility of a backlit D'Arsonval meter. So you get precise control for fast and fine tuning.

And the advanced technology of HD-73 is backed by quality construction. Heavy duty aluminum casings and hardened steel drive gears. Lifetime factory lubrication that

withstands -20°F. to 120°F. temperatures.

The superior design of the HD-73 mast support bracket, with optional no-slip positive drive, assures perfect in-tower centering with no special tools.

Automatic braking minimizes inertia stress.

Easy to install, a pleasure to use.

The HD-73 is on your wavelength.

Write for performance details today.



I want to tune in on HD-73.

Send complete details

Give me the name of my nearest dealer.

NAME \_\_\_\_\_

ADDRESS \_\_\_\_\_

CITY \_\_\_\_\_ STATE \_\_\_\_\_ ZIP \_\_\_\_\_



The Alliance Manufacturing Company, Inc.,  
 Alliance, Ohio 44601 ✓314

the powerful stations, known as Class B stations, was challenged and legal action resulted.

### The New Radio Bills

The radio legislative situation in Congress brought about important stipulations through the enactment of two long-overdue bills. The House's White Bill, H.R. 9971, one of many previously considered by committee, was finally voted on favorably March 15, 1926, placing the control of radio in the Department of Commerce. In the Senate, the Dill Bill, S.4027 (Fig. 1), introduced April 19, 1926, provided for an independent regulatory commission. These two bills went to a joint compromise conference committee, but were not acted upon until the 70th Session. The new law emerged in final form February 23, 1927, after being signed by President Cal-

vin Coolidge and designated *The Radio Act of 1927*.

Henceforth, available licenses were granted to license-seekers on request on the basis of priority of demand. The new Radio Act provided for dividing the United States into five radio zones to facilitate parceling out available radio channels as applications for licenses and renewals were received. It was implied that the Secretary of Commerce should make an equitable distribution of frequencies and power among the zones and issue licenses accordingly. Also provided for in the Act was the appointment of a five-member commission, one member for each zone, to constitute an advisory body to aid the Secretary in the designation of channels, etc. President Coolidge made the committee appointments on March 1, 1927.

With radio and other associated regulations still in the hands of the Department of Commerce, Senator Dill had the following remarks to contribute:

*The question has arisen during consideration of the bill as to whether the regulation of radio should be entrusted to the Secretary of Commerce, or to any other one man. It is my belief that at the present stage of development the details of administration should remain with the Department of Commerce, but that a nonpartisan commission should be established with authority to pass finally upon questions which may be referred to it by the Secretary of Commerce or anyone else. The decision of this commission should, of course, be subject to review by the courts.*

In all the fourteen years of radio control under Sec-

retary Hoover, no serious criticism was aimed at his method of administration . . . referred to in a passing remark by Dill. During the debate in Congress, there emerged criticism concerning one-man control with the observation that "such arrangement would give the President the final say while political opposition would be deprived the use of the ether! Control must be non-partisan!!"

The several committees, in their long debates before reaching compromises, recognized the need for extension of broadcast into the higher frequencies, but did not want to encroach upon the major bands used by the amateurs. The extensive progress continuously made by amateur and experimental "wireless" was clearly exemplified in the assignments made to the frequency bands for amateur use. ■

60TH CONGRESS  
1ST SESSION

S. 4057

FROM THE LIBRARY OF  
ERIC G. SHALKHAUSER

IN THE SENATE OF THE UNITED STATES

APRIL 19 (calendar day, APRIL 22), 1926

Mr. DILL introduced the following bill; which was read twice and referred to the Committee on Interstate Commerce.

A BILL

For the regulation of radio communications, and for other purposes.

1 *Be it enacted by the Senate and House of Representatives*  
 2 *of the United States of America in Congress assembled,*  
 3 (A) That it is hereby declared and reaffirmed that  
 4 the ether within the limits of the United States, its Territories  
 5 and possessions, is the inalienable possession of the  
 6 people thereof, and that the authority to regulate its use  
 7 in interstate and foreign commerce is conferred upon the  
 8 Congress of the United States by the Federal Constitution.

9 No person, firm, company, or corporation shall use or  
 10 operate any apparatus for the transmission of energy or  
 11 communications or signals by radio (a) from one place in

Fig. 1.

THERE'S ALWAYS SOMETHING NEW IN AMATEUR RADIO!

OUTSTANDING FEATURES OF THE PAST 20 YEARS PICTURED BY BUX

<p>1908</p> <p>THE GALENA DETECTOR CAME INTO USE.</p>	<p>1909</p> <p>AN IMPROVEMENT IN TUNING DEVICES</p>	<p>1910</p> <p>VARIABLE CONDENSER TUNING OF SECONDARIES BECAME POPULAR.</p>	<p>1911</p> <p>SOME TONE! EH? WOT? THE ROTARY GAP</p>
<p>1912</p> <p>NOW YOU'LL HAVE TO GET RADIO LICENSES.</p>	<p>1913</p> <p>THE OSCILLATION TRANSFORMER</p>	<p>1914</p> <p>THE AUDION IN GENERAL USE.</p>	<p>1915</p> <p>ORGANIZED RELAYING COMMENCES</p>
<p>1916</p> <p>THE SHORT WAVE REGENERATORS APPEAR</p>	<p>1917</p> <p>STATIONS DISMANTELED ACCOUNT OF WAR</p>	<p>1918</p> <p>THOUSANDS OF HAMS SERVE AS SKILLED RADIO OPERATORS IN THE SERVICE</p>	<p>1919</p> <p>OPENED AGAIN 20,000 AMATEURS YELLING TO GO ON BOY JUST WANT TILL GET SHING AGAIN!</p>
<p>1920</p> <p>CW WITH WHIP TUBES 200 METERS</p>	<p>1921</p> <p>THE SYNCHRONOUS GAP REMEMBER THESE BABIES?</p>	<p>1922</p> <p>BIGGER TUBES FOR CW HONESTLY SECURED 50 WATT BOTTLE</p>	<p>1923</p> <p>SHORT WAVE CW INTERNATIONAL DX</p>
<p>1924</p> <p>LOW LOSS</p>	<p>1925</p> <p>HOPS THAT LITTLE PIECE OF QUARTZ GOING TO KEEP MY WAVE STEADY? CRYSTAL CONTROLLED TRANSMITTERS</p>	<p>1926</p> <p>LOOK ME OVER BOYS I'M NOW A TRANSMITTING TUBE. W-199</p>	<p>1927</p>

# DELTA RIG



## THE TEN-TEC STATION FOR CHANGING TIMES

**DELTA—symbol of change—and the first HF transceiver with all nine bands—offers more of the features you need for these changing times.**

### Tennessee Technology Leads The Way.

Today's operating demands the changes a DELTA station offers. All nine HF bands in all solid-state design with optimized receiver sensitivity and selectivity, 200 watt, 100% duty cycle no-tune transmitter, QSK, VOX, PTT, ALC, Notch, Offset, and more. All in a compact, ready-to-go-anywhere functional design that offers light weight, thorough shielding, and operating ease. And a price that permits affording the full complement of accessories. TEN-TEC put it all together—in DELTA—for you.

### For The Change in Bands.

DELTA with all nine bands—another TEN-TEC "first." 160 through 10 meters, including the new 10, 18 and 24.5 MHz bands. (Crystals optional for 18 & 24.5 MHz). DELTA is ready.

### For The Change in Band Conditions.

Optimized design for the ideal balance between sensitivity (0.3  $\mu$ V for 10 dB S+N/N) and dynamic range (85 dB or better) plus switchable 20 dB attenuator that puts you in control of even extreme situations. No matter where you live or what power your neighbor is running, DELTA can handle it.

Super selectivity permits narrowing DELTA bandpass to suit the crowds. The four-position switch selects the standard 2.4 kHz SSB filter, adds a section of the 4-stage active audio filter, cascades an optional CW filter (for 14 poles of filtering), and cascades both filters with 4 stages of audio filters to give you the passband window you need with the virtually ultimate skirt selectivity required to knife through strong adjacent signals.

Built-ins to quiet the world. A variable notch filter is standard on DELTA. Vary from 200 to 3500 Hz to notch out interfering carriers or CW signals to a depth of 50 dB or more. Offset tuning for moving the receiver frequency  $\pm$ 1 kHz to reach that DX or to fine tune. "Hang" AGC to give you smoother receiver operation.

### For The Change in Operating Styles.

Variety is the word for today, and DELTA offers it.

For a rag-chew with an old friend, 200 watts of SSB to the proven solid-state amplifier (designed by the leader, TEN-TEC) with built-in VOX and PTT.

For the fun of operating 200 watts CW with QSK—full, fast break-in that makes CW a conversation, saves time, and opens a window on DX.

Power up or down. Adjustable threshold ALC and drive let you choose power levels with full ALC control.

DELTA accepts what you have, what you want... from separate antennas to linears, transverters, remote VFO, 12 VDC, keys and more—just plug in.

### For The Change In Lifestyles.

DELTA moves with you. "At home" anywhere—on your operating desk, in the field, on a boat, plane, camper, wherever. Its neat small size (4 $\frac{3}{4}$ "h x 11 $\frac{3}{8}$ "w x 15"d) and light weight (12 $\frac{1}{2}$  lbs.) make it a good traveling companion. Yet compact as it is, DELTA panel size and knob spacing make it comfortable to use hour after hour in your home station.

### For The Change In Economics.

These days, everyone wants more value for his money. And DELTA offers it. More features and performance per dollar. Quality that's American-made. Service you can count on. A solid warranty—one year on the transceiver plus an extra five year pro-rata warranty on the amplifier transistors. And low prices!

### The DELTA Rig

Model 580 DELTA Transceiver .....	<b>\$869.00</b>
Model 283 DELTA Remote VFO .....	<b>189.00</b>
Model 280 DELTA Power Supply .....	<b>169.00</b>
Model 282, 250 Hz CW Filter .....	<b>50.00</b>
Model 285, 500 Hz CW Filter .....	<b>45.00</b>
Model 234 RF Speech Processor .....	<b>139.00</b>
Model 214 Electret Microphone .....	<b>39.00</b>
Model 645 Dual Paddle Keyer .....	<b>85.00</b>

### Other Optional Accessories

Model 670 Single Paddle Keyer .....	<b>39.00</b>
Model 227 Antenna Tuner .....	<b>79.00</b>

Isn't it time for you to change? Check the DELTA rig at your dealer or write for full details.

**TEN-TEC, INC.**  
SEVIERVILLE, TENNESSEE 37862  
EXPORT: 5715 LINCOLN AVE., CHICAGO, ILL. 60646

# The VoCom Two-Meter Monkey

— 30 Watts out from a mighty small package

Alyson Grupp N1BEJ  
73 Magazine Staff



VoCom's 2CO25-2 2m amp.

Through the wonder of integrated circuits, you can now buy a hand-held two-meter transceiver that will do almost everything a larger rig will do. Today, many hams are using the new synthesized hand-helds in their cars. The only drawback to this arrangement is the limited power output of the hand-held—sometimes you *need* those extra Watts! VoCom has come up with an ideal solution. The 2CO25-2 two-meter power amplifier will provide you with thirty Watts out for a mere two Watts in and is small enough to fit almost anywhere.

The amp is housed in a classy gold-colored metal case, measuring 3.37" x 3" x 1.56" high (2" high including the bracket). The bracket is a typical U-shaped strip of metal which can be positioned either over or under the amplifier. Finding a place for this little gem is not too difficult, even in a small car. Excellent installation instructions are given in the manual. Any questions that arise concerning what to use to hook the amp up are easily answered by consult-

ing the complete charts provided which list properties of various sizes of stranded hookup wire and coax. Also covered in the well-written manual are the selection of a proper location and the vital importance of adequate heat dissipation.

The front panel has an on/off toggle switch for power and a power-status LED. The switch is on the horizontal axis rather than the usual vertical axis, which takes some getting used to. The back panel sports two SO-239 coax connectors, one for the antenna and the other to hook the amplifier up to the transceiver. Exiting the back panel via a grommeted hole is a short, heavy power cable, a reminder of the relatively high current requirements of such an amplifier.

Being insatiably curious, I had to know what was inside the box, and getting inside proved a bit difficult. The screws are apparently secured with some sort of shellac and require a lot of torque to remove. Operation of the amplifier does not require opening the

case, but two of the six screws that hold the case together also hold the bracket on. These, naturally, must be removed for installation.

Once you do get a peek inside, it is obvious that the amplifier is carefully planned and well laid out. Its kick is supplied by an MPSA13 which is bolted to the thick aluminum plate that serves both as a heat sink and as the bottom of the cabinet.

I tested the amplifier on a 12.25-volt power supply, which is some 1.55 volts less than the recommended 13.8 volts. Even at this low voltage, the amplifier performs above the manufacturer's rating. Specifically, with an input power of 1/2 a Watt, the output is 7 Watts; at 1 Watt, output jumps to 25 Watts. Either 1 1/2 or 2 Watts will give you about 27 Watts out, while at 5 Watts in (the maximum rec-

ommended by the manufacturer), the output was 31 Watts.

Gripes? Only one. The cabinet is not rf-tight, which may or may not be a problem in your installation. Otherwise, I found the amplifier to be a superb performer. T/R switching is fast and silent, and use of the amplifier had no effect on the audio quality of my transceiver. The model I tested was designed for a rated drive of two Watts; there is also a model available that achieves full output with a battery-saving 200 mW. If you'd like to give your hand-held a little more punch, at home or in your car, take a good look at the VoCom amps!

For more information, contact VoCom Products Corporation, 65 East Palatine Road, Suite 111, Prospect Heights IL 60070; (312)-459-3680. Reader Service number 480. ■

# TUNE OUT SCANNER INTERMOD!



**GROVE FTR-2 SCANNER FILTER**  
... WORTH A CLOSER LOOK!

FOR PRODUCT INFORMATION AND CATALOG, WRITE:



**GROVE ENTERPRISES INC**

DEPT. K

Brasstown, North Carolina 28902

## ... at last ... your shack organized!

A beautiful piece of furniture — your XYL will love it!

### \$16450 S-F RADIO DESK Deluxe - Ready to Assemble

Designed with angled rear shelf for your viewing comfort and ease of operation.

FINISHES: Walnut or Teak Stain.

Floor Space: 39" Wide by 30" Deep

Additional Information on Request.

Checks, Money Orders, BankAmericard and Master Charge Accepted.

F.O.B. Culver City. (In Calif. Add 6% Sales Tax.)

DEALER INQUIRIES INVITED

**S-f Amateur Radio Services**

**Sf**

✓65

4384 KEYSTONE AVENUE • CULVER CITY, CALIF. 90230 — PHONE (213) 837-4870



Radio equipment  
not included

Also Available ...

Floor Space: 51" Wide by 30" Deep  
\$192.50

## WE'RE ROLIN IN CRYSTALS!

✓418

**2 Meter Crystals — \$3.95 each**  
**(10 or More — \$3.50 each)**



### We Stock Crystals For:

Clegg	Drake	Icom
Kenwood	Midland	Regency
Standard	Wilson	Yaesu
Lafayette	Tempo	VHF Eng

(We Also Accept Orders For Custom Crystals.)

### Rolin Distributors

P.O. Box 436 Department 7  
Dunellen, N.J. 08812  
201-469-1219



### Organize your shack with a CLUTTERFREE MODULAR CONSOLE \$179.95

- Large, 42" H x 57" W x 29"D
- Strong groove-construction
- Mar-resistant wood grain finish
- Options, drawers & face plate
- For ham or home computer
- Visa and Master Charge

## CLUTTERFREE MODULAR CONSOLES

P.O. Box 5103 Tacoma, WA 98405  
(206) 759-1611 ✓89

# The Solid-Copy RTTY TU

— state-of-the-art performance  
you can afford

**R**TTY can be one of the most enjoyable aspects of amateur radio. Though outwardly it may seem complex to the un-

initiated, the concepts involved are easily mastered by anyone acquainted with CW. The September, 1977, issue of 73 is probably the

best introduction, and it was after reading it that I became interested. RTTY had always seemed rather mysterious and untouch-

able, but a clear explanation was all that was needed to remedy that situation. I will describe here the top-quality terminal unit

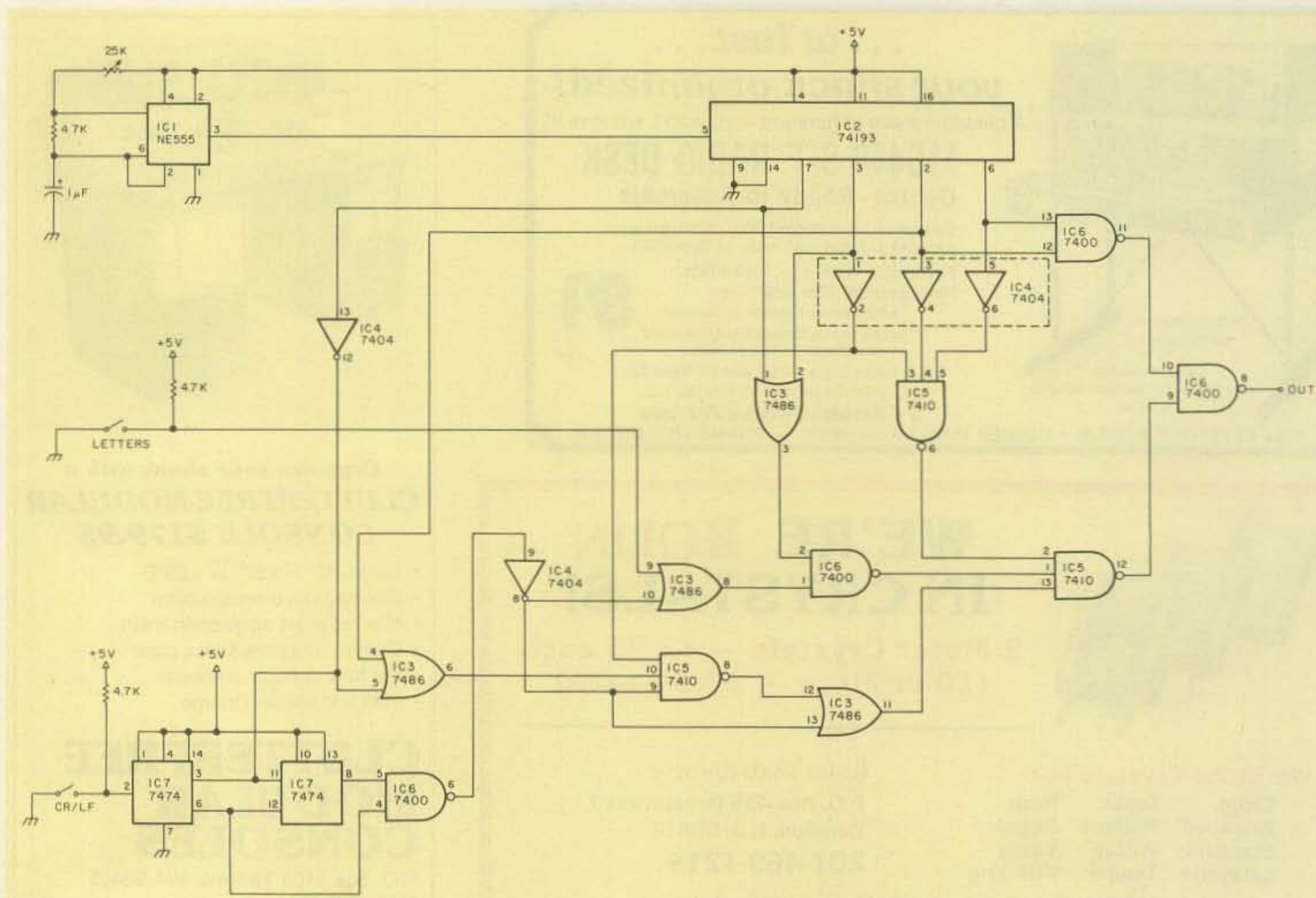

Fig. 1. The W2FJT RY generator.

**KLM KLM KLM KLM KLM KLM KLM**

★ All New! ★

2 and 3 el. 40 meter monobanders

2 meter  
hi-performance vertical

Available  
NOW!

Super Gain

6 Meter  
Long Boomer

Broadband 2 meter 4 el.

★  
Also featuring:

Select KLM performance-oriented UHF/VHF Power Amplifiers, and antennas, 1.8 to 520 MHz: monobanders, tribanders, log-periodics, verticals, dipoles, circulars and stacked arrays.

**KLM** P.O. Box 816, Morgan Hill, CA 95037 (408) 779-7363

that I have been using with excellent results for over a year now. It is simple to assemble and provides real state-of-the-art performance.

The heart of my TU is the Flesher DM-170. The price of \$39.95 and excellent reviews<sup>1</sup> made this the logical choice for the best low-cost demodulator. The DM-170 has easily-tuned active filters (for 170-Hz shift), auto-start, a tuning meter, and an oscilloscope output.

After using it for a while, I decided to try the Flesher PS-170 bandpass filter. The whole filter is contained on a 2" x 2-3/8" PC board and consists of four stagger-tuned active filters. I was skeptical about any increase in performance, but in situations of heavy QRM, the filter really helps. Watching the signals on a scope with and without the PS-170 switched in is convincing evidence that the unit really performs. The output of the filter can be taken before or after a stage of hard limiting, providing even more flexibility.

Having the Flesher demodulator and filter up and running, I added an auto-start relay board to the set-up. Actually, since I do little VHF RTTY work here, I haven't used this feature, but since the Flesher has an autostart output, it seemed easy enough to include it. The relay will turn on the ac power to the TTY in the presence of a RTTY signal and turn it off in its absence. The delay time for turning on the power is about 3 seconds and the delay for turning it off is adjustable by an external pot. Flesher also sells a relay board kit, incidentally, but it is simple enough to home-brew one.

In use, it is sometimes nice to be able to test the demodulator and teleprint-



Photo A. TU with Baudot/ASCII converter on top.

er without the necessity of using signals from the receiver. For this purpose, I included in my terminal unit an RY generator. The characters RYRY... are sent continuously until the Return/Line Feed switch is depressed. This allows any adjustments to be made off the air. The RY generator I used is extremely simple; it was described in *73 Magazine*.<sup>2</sup> I have included a schematic in Fig. 1.

My teleprinter is a Model 33 ASR and uses the ASCII code. A code converter is used with the 33 to convert to Baudot code. The code converter also was described in *73*.<sup>3</sup> One very nice feature of this setup is that the code converter utilizes two UARTs to con-

vert the serial code to parallel code which can be processed by the converter. The UARTs provide signal regeneration and possible speed conversion as a side benefit. The TTY is much more reliable when operating on a regenerated signal. In addition, the converter includes the unshift-on-space feature which inserts a letters character after a space if you are in the figures mode. This helps the copy very much when conditions are bad.

A block diagram of the TU is shown in Fig. 2. A bottom view is shown in Photo B. On the right are the DM-170 and PS-170. In the center near the front panel is the RY generator, and behind it is the relay board.

The left-hand side is filled with the  $\pm 12$ -volt supplies for the demodulator and filter and the +5-volt supply for the RY generator and code converter. The tuning meter on the front is useful, but not nearly so much as an external scope. Originally, I had planned on including a small scope in the same chassis, but things got a little too cramped. The scope outputs can be seen in the rear view, Photo C. They are the BNC connectors. Also shown in that photo are the plugs for the code converter and the TTY outlet.

The receiver here is an NC-303 which I use in the 500-Hz bandwidth position. The bfo is offset so that the passband is centered about

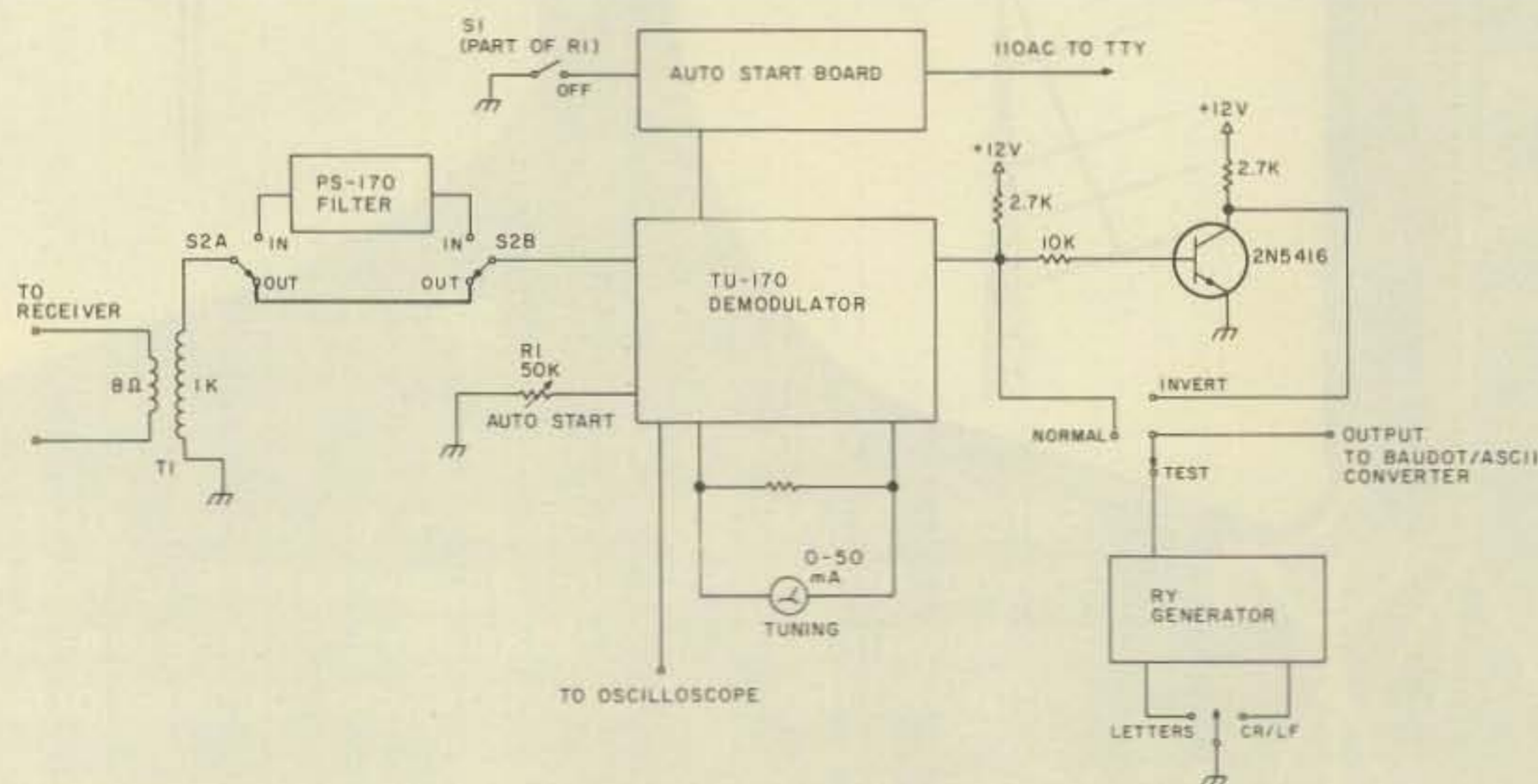

Fig. 2. Block diagram of the TU.



# N&G

Call TOLL FREE  
1-800-327-3364



## DISTRIBUTING

7201 N.W. 12th ST.  
MIAMI, FLORIDA 33126  
1-305-592-9685 • 1-305-763-8170

WE ALSO CARRY MANY  
MARINE & AIRCRAFT RADIOS

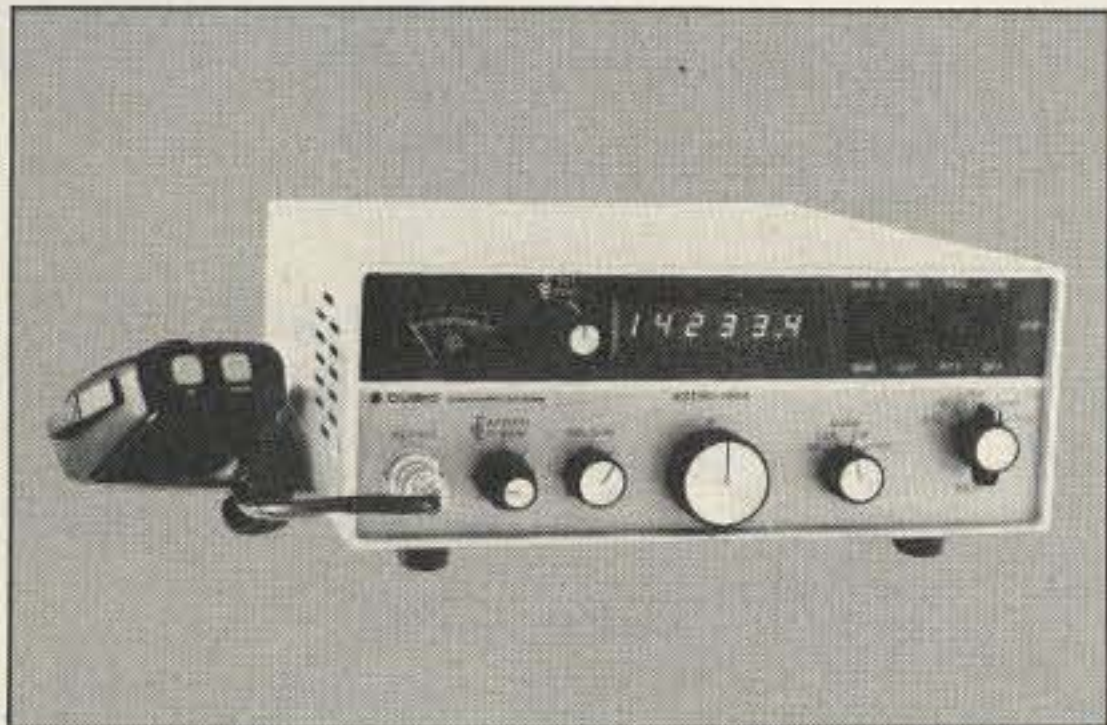

ASTRO 150 \$975.00  
MATCHING POWER SUPPLY 179.95  
MATCHING ANTENNA TUNER 169.95

General Frequency Range  
160 Meter Band - 1.8-2.4 MHz†  
80 Meter Band - 3.0-4.5 MHz  
40 Meter Band - 6.0-8.3 MHz  
20 Meter Band - 13.8-16.0 MHz  
15 Meter Band - 20.8-23.0 MHz  
10 Meter Band - 28.0-30.0 MHz††  
† Model 151 only  
†† Model 150 only

HF/SSB  
PORTABLE  
RADIO STATION  
100 WATT  
115/230V  
50/60 Hz AC  
OR 12V DC  
IS AVAILABLE

# CUBIC



DIPLOMAT 150



BATTERY PACK CHARGER



ST 2 TUNER  
ASTRO 150  
PSU 5 POWER SUPPLY  
1500Z Amp.  
LIST PRICE 3000.00

### BIRD WATT METERS & ACCESSORIES LARGEST SELECTION IN THE EAST

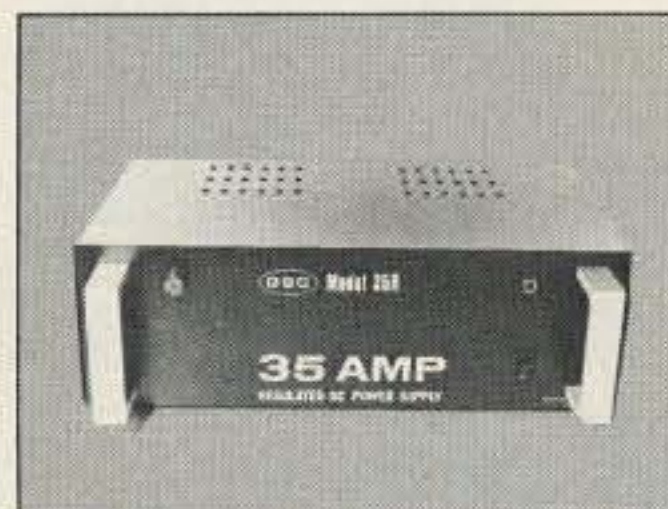

35 AMP Reg. P.S.  
LIST 250.00  
N&G PRICE 149.00

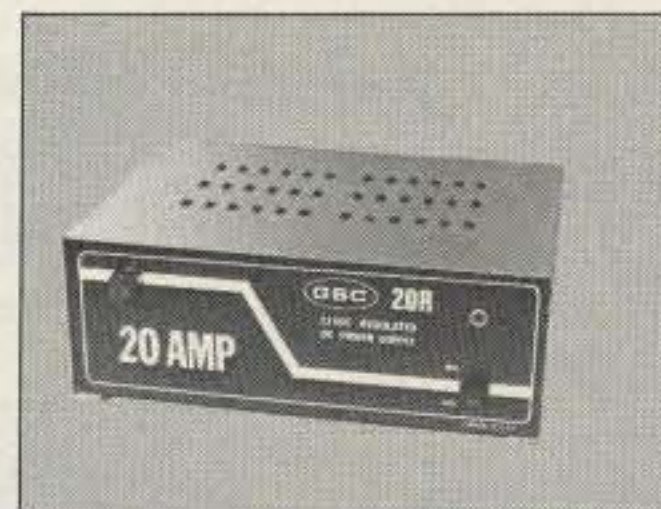

20 AMP Reg.  
LIST 129.00  
N&G PRICE 79.95

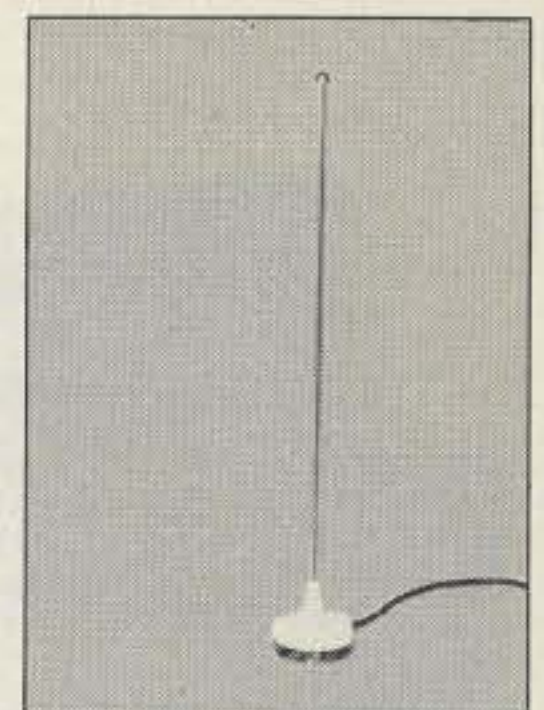

WAVE MAG  
LIST 24.95  
N&G PRICE 15.00



6 AMP Reg.  
LIST 89.95  
N&G PRICE 39.95



MA 25B  
LIST 279.00  
N&G PRICE 249.95



BIRD 43 142.00  
All Bird Prod. in Stock

ALL PRICES ARE SUGGESTED RETAIL PRICES • PLEASE CALL FOR QUOTES.

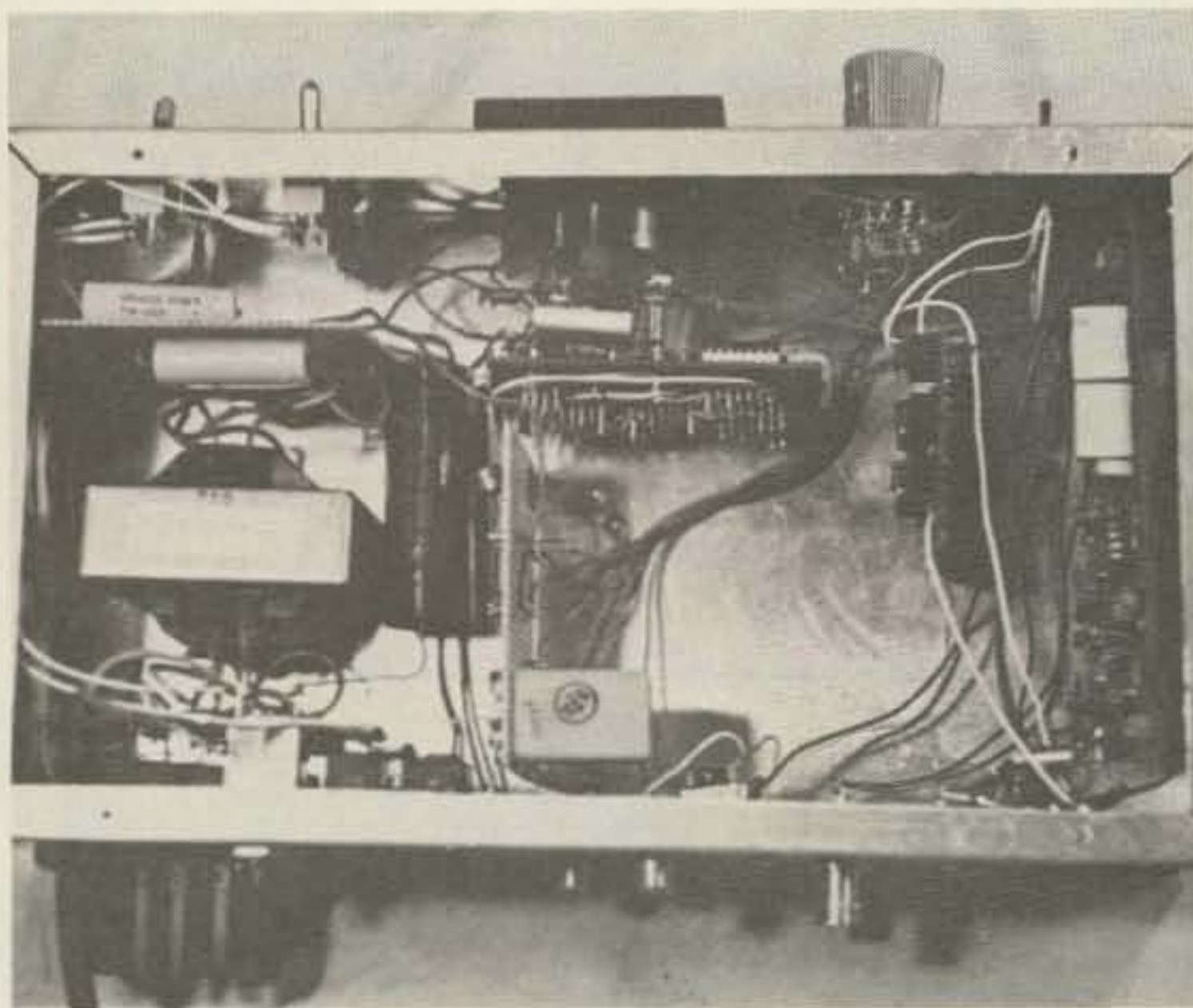

Photo B. Bottom view of the TU. DM-170 is on the far right, with PS-170 on its left. The RY generator is behind the meter.

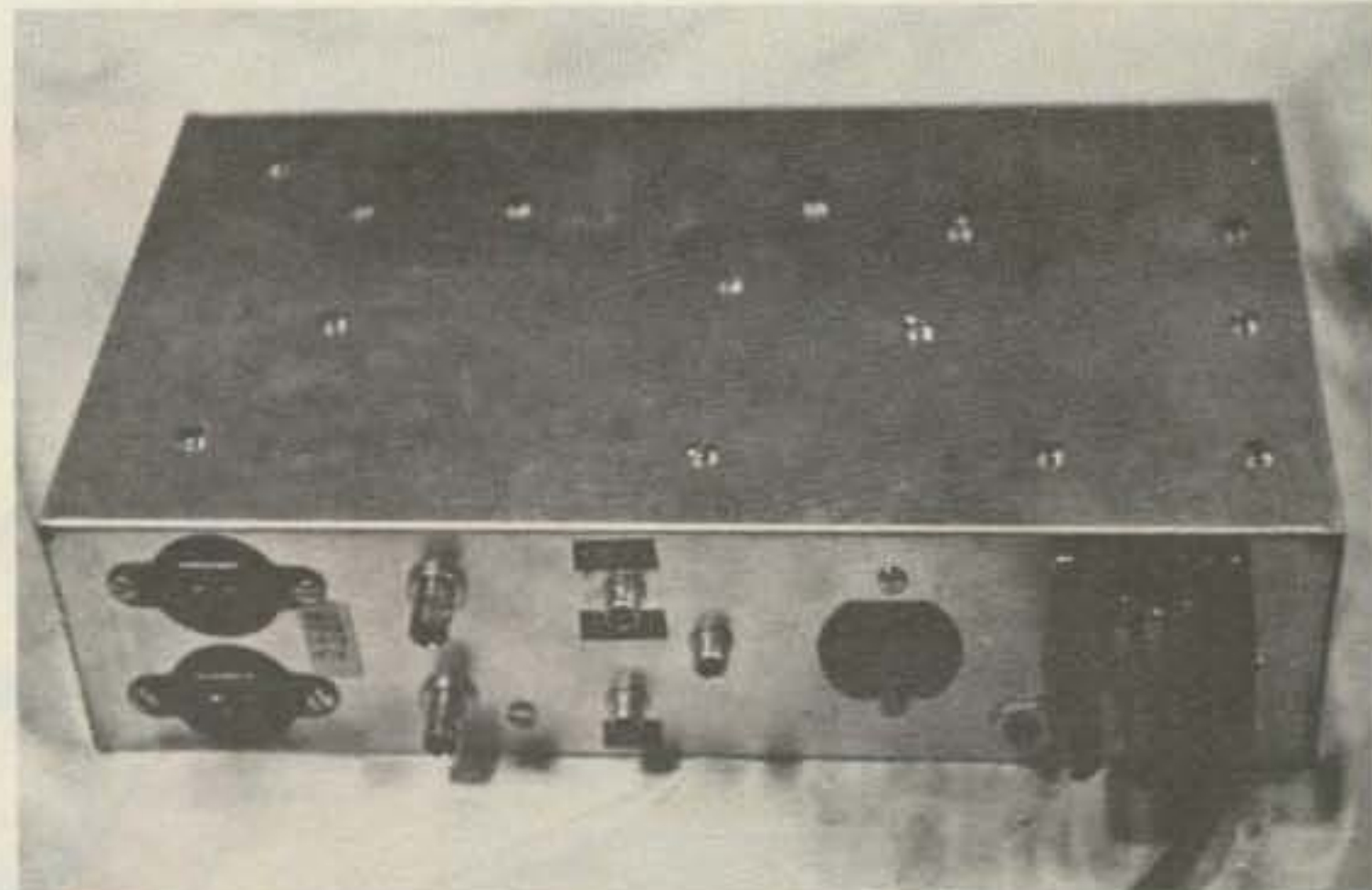

Photo C. Rear view. BNC jacks are for the tuning scope.

2200 Hz from zero beat of the incoming signal. This allows full advantage to be taken of the selectivity offered by the receiver. Audio is coupled into the TU through a small transistor output transformer

which matches the 8-Ohm audio to the 1000-Ohm input impedance of the DM-170.

This compact TU has shown itself to be very sensitive, easy to use, and reliable under real operating

conditions. Sometimes a totally unrecognizable signal (to the human ear) will provide perfect copy. Under marginal conditions, copy becomes garbled, occasionally, but only at the point where the signal is either buried under the noise or an interfering station is too close in frequency. Considering that the total cost was under

\$100 (excluding the code converter), the performance is outstanding.

Build one and see! ■

#### References

1. New Products, *73 Magazine*, September, 1977, page 14.
2. E. H. Sommerfield, "RTTY Test Station," *73 Magazine*, September, 1977, page 104.
3. J. G. Mills, "Baudot to ASCII Converter," *73 Magazine*, September, 1977, page 80.

## ASSOCIATED RADIO

8012 CONSER BOX 4327  
OVERLAND PARK, KANSAS 66204

913-381-5900

# BUY—SELL—TRADE

## All Brands New & Reconditioned



We Want to DEAL—Call Us—We'll Do It Your Way.  
**WE'RE #1**



NOTE: SEND \$1.00 FOR OUR CURRENT CATALOG OF NEW AND RECONDITIONED EQUIPMENT.

★ ALSO WE PERIODICALLY PUBLISH A LIST OF UNSERVICED EQUIPMENT AT GREAT SAVINGS.  
A BONANZA FOR THE EXPERIENCED OPERATOR.

TO OBTAIN THE NEXT UNSERVICED BARGAIN LIST SEND A SELF ADDRESSED STAMPED ENVELOPE.

# SADELTA is only for SUPERHAMS

New desk and hand microphones from SPAIN. SADELTA mics have a longer range and are designed for amateurs who want the best.

**BRAVO** (desk) and *fine* (hand) offer you more features for less money. If you try them, you'll fall in love with their performance, their texture and attractive color. Finally you'll fall in love with their special TURBOCOMPRESSION.

Once you try them, you'll shout:

**"BRAVO, THESE ARE *fine* MICS"**

Main Specifications	BRAVO			FINE
	MP-20	MP-21	MP-22	HM-20
Element Type	DYNAMIC			
Impedance	From 50 to 100 K Ohms.			
Gain	(*) 50 dB			46 dB
Compression	(*) 20 dB at 30 microbar			16 dB at 30 mbar
Cable	4 cond. (1 shielded) for connector from 3 to 7 pins			
Meters	0	1	2	0
Switch	Normal/Vox			

(\*) Adjustable

SEND FOR FREE CATALOG OR SEND FOR SAMPLES (check \$ 50 each, freight prepaid)

DEALER INQUIRIES WELCOME

CONTACT  **SADELTA**

Avda. Jordan, 12 - BARCELONA-35  
tel. 3-212 00 16 Tx. 50023 SPAIN.

✓ 432



**TRY THEM!**

*fine*  
HM-20

BRAVO  
MP-22

SEE FOR YOURSELF: WE ARE THE BEST!

## Valor's omni-gain™ ...base station antennas for professional performance!

Listen to Valor when it comes to the omni-gain base station antenna. Featuring 5/8 wavelength and 3dB gain, this antenna is power rated 200 watts, high efficiency, low VSWR. Construction is of quality materials, including 17-7 stainless steel, 6061-T6 aluminum, chrome-plated brass. No copper coil to burn out. Listen to the leader in amateur products — Valor Enterprises — and choose the omni-gain for better performance.

Visit Booth #90 at "The 1981 Atlanta Hamfestival," June 20-21, 1981



**VALOR ENTERPRISES, INC.** ✓ 422  
185 West Hamilton Street  
West Milton, Ohio 45383  
(513) 698-4194 or 698-4195  
Outside Ohio: 1-800-543-2197

Model OG146B  
144-148 MHZ

Model OG220B  
220-225 MHZ  
(Not Illustrated)



Mast & Cable not included.



**FREE!**  
1981  
DISCOUNT  
ELECTRONICS  
CATALOG

JOIN THE PAK!

Send for our Free catalog and become a member of our exclusive Pak. Our members receive Poly Paks' exciting catalog several times a year. We offer: Penny Sales, Free Premiums and Low, Low Prices on a wide variety of Electronic Products such as Computer Peripherals, Integrated Circuits, Speakers, Audio Equipment, Rechargeable Batteries, Solar Products, Semiconductors, and much, much more! Take advantage of our 25 years as America's foremost Supplier of discount electronics.

Over  
4.5 Million  
Satisfied  
Customers

RUSH ME YOUR FREE DISCOUNT CATALOG!

NAME: \_\_\_\_\_

ADDRESS: \_\_\_\_\_

CITY: \_\_\_\_\_

STATE: \_\_\_\_\_ ZIP: \_\_\_\_\_

CLIP AND MAIL COUPON TODAY TO:  
**POLY PAKS, INC.** ✓ 58

P.O. BOX 942, ST6  
S. LYNNFIELD, MA. 01940 (617) 245-3828

When it comes to  
**AMATEUR  
RADIO QSL's...**

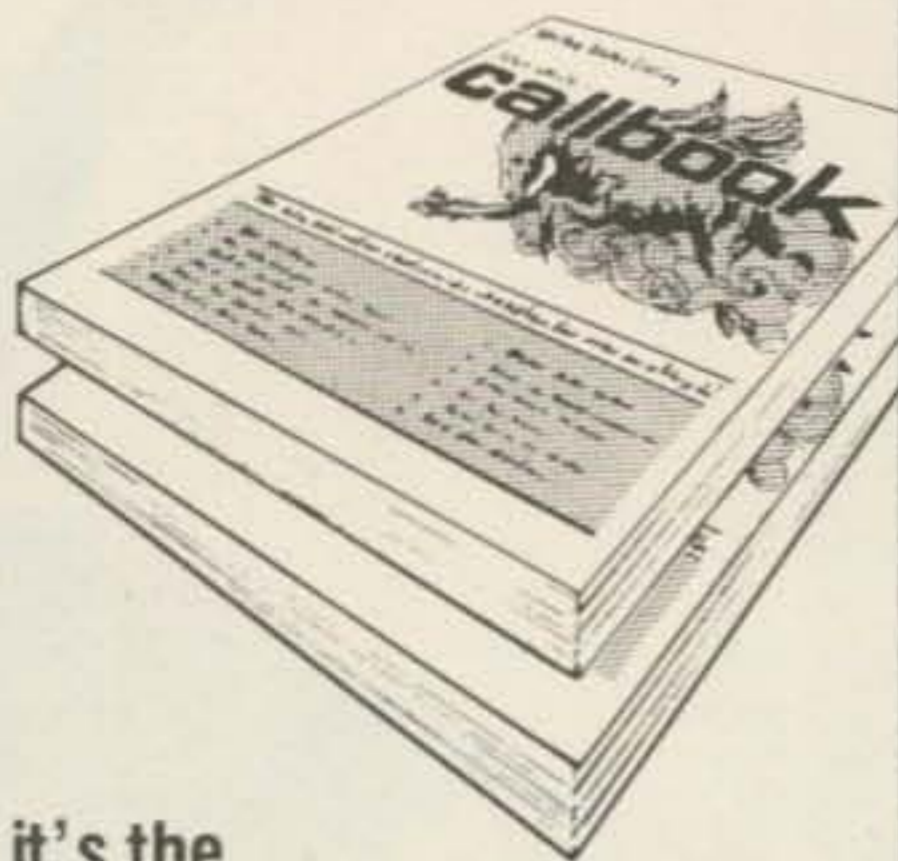

it's the  
**ONLY BOOK!**  
US or DX Listings

1981  
**callbooks**

Here they are! The latest editions. World-famous Radio Amateur Callbooks, the most respected and complete listing of radio amateurs. Lists calls, license classes, address information. Loaded with special features such as call changes, prefixes of the world, standard time charts, worldwide QSL bureaus, and more. The U.S. Edition features over 400,000 listings, with over 100,000 changes from last year. The Foreign Edition has over 300,000 listings, over 90,000 changes. Place your order for the new 1981 Radio Amateur Callbooks, available now.

	Each	Shipping	Total
<input type="checkbox"/> US Callbook	\$17.95	\$2.55	\$20.50
<input type="checkbox"/> Foreign Callbook	\$16.95	\$2.55	\$19.50

Order both books at the same time for \$37.45 including shipping.

Order from your dealer or directly from the publisher. All direct orders add \$2.55 for shipping. Illinois residents add 5% sales tax.



**SPECIAL LIMITED OFFER!**  
Amateur Radio  
Emblem Patch  
only \$2.50 postpaid

Pegasus on blue field, red lettering. 3" wide x 3" high. Great on jackets and caps. Sorry, no call letters.

**ORDER TODAY!**

✓61

RADIO AMATEUR  
**callbook** INC.  
Dept. B  
925 Sherwood Drive  
Lake Bluff, IL 60044, USA

**Radio World**

CENTRAL NEW YORK'S MOST COMPLETE HAM DEALER



Featuring Kenwood, Yaesu, Icom, Drake, Ten-Tec, Swan, Dentron, Alpha, Robot, MFJ, Tempo, Astron, KLM, Hy Gain, Mosley, Larsen, Cushcraft, Hustler, Mini Products, Bird, Mirage, Vibroplex, Bencher, Info-Tech, Universal Towers, Callbook, ARRL, Astatic, Shure. *We service everything we sell!*

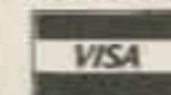

Write or call for quote. **You Won't Be Disappointed.**  
We are just a few minutes off the NYS Thruway (I-90) Exit 32



OUT OF STATE CALL TOLL FREE **800-448-9338**  
ONEIDA COUNTY AIRPORT TERMINAL BUILDING  
ORISKANY, NEW YORK 13424  
N.Y. Res. Call (315) 337-0203 or 736-0470  
Warren - K2IXN  
Bob - WA2MSH

**Handful  
of  
POWER**



Give your low-power 2-meter rig real punch by delivering a potent 25-watt signal with only two watts of drive (also available set up for 200 milliwatts drive). Compact and convenient to mount, VoCom's Model 2C025 is ideal for car, boat or anywhere you've got a 12 VDC source. At only \$84.95 (\$99.95 for 200 mW drive), it's the perfect companion for your Drake, Encomm, Henry, Icom, Kenwood, Motorola, Standard, Wilson, Yaesu or other 2-meter FM portable!

- 2 or 2 watt nominal drive (specify)
- 2 watt model delivers 15-20 watts with only one watt of drive
- 10 MHz bandwidth for CAP or MARS
- Meets all applicable FCC specifications
- 200 mW drive model permits operating Icom IC-2A or Yaesu FT-207R on their battery-saving low-power mode
- Only \$84.95 (\$99.95 for 200 mW drive)

**Even More  
POWER**

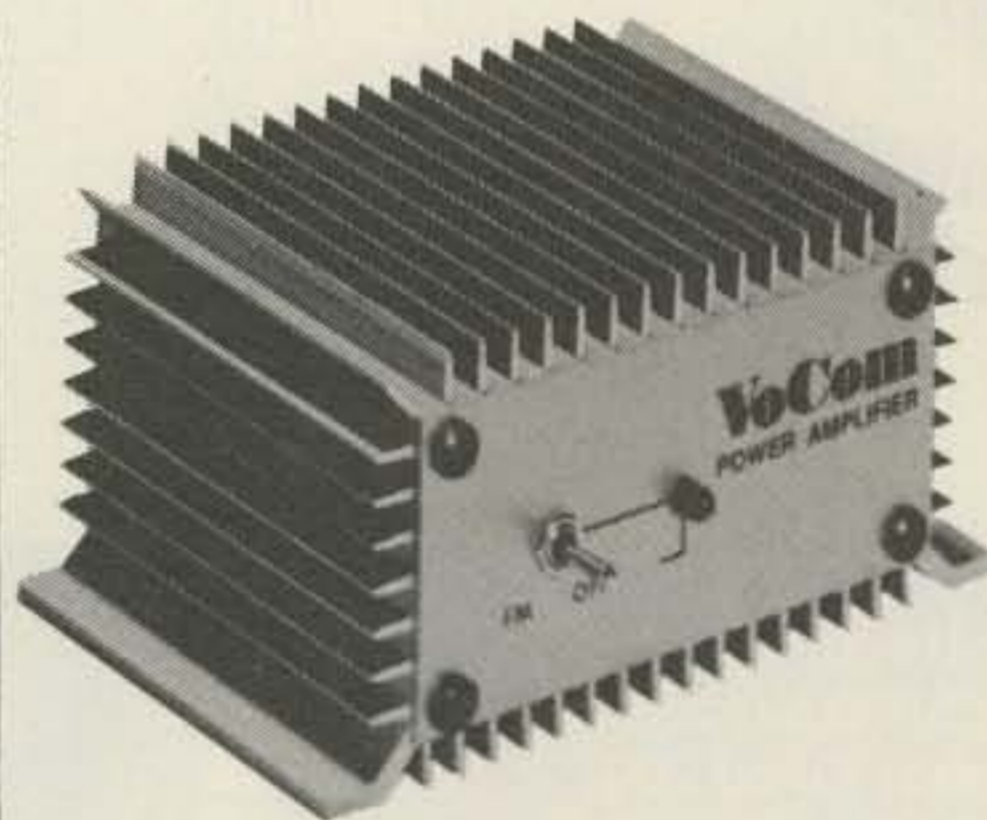

Give your 2-meter hand-held 50 watts of punch with the Model 2C050, or 100 watts with the Model 2C100 amplifiers. Or use the Model 2C100 with your 25-watt output 2-meter rig, by plugging in the appropriate drive-programming module.

Compact and reliable, all VoCom power amplifiers feature front-panel on-off switching for convenient shut down when they're not needed for short hauls, plus an LED status indicator.

See your dealer or contact VoCom today for a copy of our detailed four-page catalog.

**ANTENNAS for 2-meter Hand-Helds**

**5/8-Wave Gain Antenna**

Provides nearly 10-dB gain over a rubber ducky when extended to its full 47", yet telescopes to only 8" for listening or carrying. Works with any BNC equipped radio... **Only \$24.95**

**NEW! Short, Compact  
"UGLY DUCKLING"**

Only 4 1/2" short, yet performs like a "full size" ducky. Available for either BNC or threaded mounts.  
**Only \$14.95 (BNC), \$12.95 (threaded)**

Available now from your local amateur radio dealer or order direct:

**VoCom** PRODUCTS CORPORATION  
65 East Palatine Road, Suite 111, Prospect Heights, IL 60070  
(312) 459-3680

✓90

# AFFORDABLE CW KEYBOARD



Transmits perfect Morse Code \* Built-in 16 character buffer \* Internal speaker and sidetone \* Reed relay output eliminates keying problems \* All solid state circuits and sockets for reliability \* Speed range 5-45 WPM \* Perfect companion to our MORSE-A-WORD CW code reader.

- MORSE-A-KEYER KIT, model MAK-K, Complete kit of parts & manual . . . . . \$159.95
  - MORSE-A-KEYER, model MAK-F, Factory wired & tested . . . . . \$205.00
  - MORSE-A-KEYER ESSENTIAL PARTS KIT, model EPK-K. . . . . \$ 69.95
- (Essential parts kit for home-brewers consists of pc board, board parts and manual. You supply ASCII keyboard, cabinet, power supply & miscellaneous parts.)

Send check or money order. Use your VISA or MasterCard. Add \$5.00 shipping and handling for Continental U.S. Wisconsin residents add 4% Wisconsin State Sales Tax.

*Microcraft*

Corporation Telephone: (414) 241-8144  
Post Office Box 513G, Thiensville, Wisconsin 53092

# Now — the industry's first truly **super keyboard**

## INFO-TECH M-300C TRI-MODE KEYBOARD

A microprocessor controlled keyboard that generates: Morse, RTTY, & ASCII.



Best of all, \$450<sup>00</sup>  
still only  
F.O.B. Factory

### Morse Features:

- 4 to 125 W.P.M. in 1 W.P.M. increments.
- 9 adjustable weight levels
- relay keying
- sidetone with tone and level adjustments
- special keys: AS, BK, BT, AR, SK, CQ, DE

### RTTY Features:

- 4 speeds
- 2 shifts (170 & 850 hz)
- built in AFSK
- built in CWID
- built in RY generation

### ASCII Features:

- 110 & 300 Baud
- 2 shifts (170 & 850 hz)

### Other Features:

- Built in quick brown for generator on all modes
- Automatic CR/LF
- 700 Character Running Buffer
- 10 recallable, user programmable message memories of 120 characters each
- CQ & DE special keys on all modes
- Keyboard control of all functions
- 4 row keyboard eliminates figures/letters shifting on RTTY
- Many more features.

### Order direct or from these dealers:

**Cohoon Amateur Supply**  
307 McLean Avenue  
Hopkinsville, Kentucky 42240  
(502) 886-4534

**Colmay Products**  
14903 Beachview Ave.  
White Rock, B.C. Canada V4B1N8  
(604) 536-3058

**Dialta Amateur Radio Supply**  
212 48th Street  
Rapid City, South Dakota 57701  
(605) 343-6127

**Germantown Amateur Supply**  
3202 Summer Avenue  
Memphis, Tennessee 38112  
1-800-238-6168

**Gilfer Associates, Inc.**  
52 Park Avenue  
Park Ridge, New Jersey 07656  
(201) 391-7887

**Global Communications**  
606 Cocoa Isles Blvd.  
Cocoa Beach, Florida 32931  
(305) 783-3624

**Ham Radio Center**  
8342 Olive Blvd.  
St. Louis, Missouri 63132  
1-800-325-3636

**Michigan Radio**  
38270 Mast  
Mt. Clemens, Michigan 48045  
(313) 469-4656

**N & G Distributing**  
7285 NW 12th Street  
Miami, Florida 33126  
(305) 592-9685, 763-8170

**Radio World**  
Terminal Building  
Oneida County Airport  
Oriskany, New York 13424  
(315) 736-0470  
1-800-448-9338

**Ray's Amateur Radio**  
1590 U.S. Highway 19 South  
Clearwater, Florida 33516  
(813) 535-1416

**Universal Amateur Radio**  
1280 Aida Drive  
Reynoldsburg, Ohio 43068  
(614) 866-4267

**INFO-TECH ELECTRONIC EQUIPMENT**

Manufactured by:  
**DIGITAL ELECTRONIC SYSTEMS, INC.**  
1633 Wisteria Court • Englewood, Florida 33533 • 813-474-9518

# HUSTLER HF MOBILES DELIVER FIXED STATION PERFORMANCE

Hustler HF antennas deliver outstanding signal reports — wherever you're mobile!

Design your own HF mobile from a full selection of top-quality; U.S.-made stainless steel ball mounts, quick disconnects, masts, springs, and resonators. You can cover any 6-to-80-meter band. Choose from medium or high power resonators with broadest bandwidth and lowest SWR for optimum performance on any band. Easy band change and garaging with Hustler's fold-over mast, too.



Ask any ham — the best HF mobiles on the road come from: Hustler — still the standard of performance.

**HUSTLER**

3275 North "B" Avenue  
Kissimmee, Florida 32741

An **ARMSTRONG** Company

# The CES Simplex Autopatch

— some hot new hardware for two

One of the most controversial devices in a well-equipped repeater is its autopatch. Some hams use autopatch facilities frequently, as part of their daily life, while others are very uncomfortable with autopatch usage for routine communications. Many re-

peater groups permit their autopatch to be used only for emergency calls or set strict time limits for routine calls. Whatever your views on autopatching are, you have to admit that in congested areas where repeaters receive heavy use, autopatching can create prob-

lems. Users trying to carry on a conversation grow tired of being interrupted by people needing the patch, and many a stranded motorist has increased his blood pressure to dangerous levels while trying to break into a long-winded monologue to call for help.

Communications Electronics Specialties, Inc., best known in amateur circles for their microphone-mounted tone pads and autodialers, has come up with a fascinating solution to the autopatch problem, the CES 500SA. The 500SA is a simplex autopatch unit which interfaces an amateur transceiver to a standard phone line. No cavities or other hardware are required. You access the patch just as you would access the patch on a repeater: "\*" brings the patch up and "#" disconnects it from the phone line. Now if you think about this for a moment, you might get a little confused. How in the world can you operate an autopatch on a single frequency? It's not as difficult as it first seems.

## How It Works

When the autopatch is not in use, it sits there waiting, patiently listening in the receive mode. When it receives a "\*", it connects the patch to the phone line and switches the transceiv-



CES Model 500SA simplex autopatch.

er over to transmit. You hear a dial tone just as you would with a normal autopatch, with one important difference. Once per second, the patch samples its receiver for a "window" of anything from 5 to 100 milliseconds, depending on the squelch characteristics of the receiver. If there is a carrier present during this sampling window, the logic locks the system in the receive mode and doesn't switch back to transmit until the carrier drops. This ensures that the party on the other end of the phone line can't capture the transmitter.

It doesn't take much of an imagination to conclude that the constant switching between receive and transmit will be audible, and indeed it is. How audible it is depends on how long it takes the autopatch's transceiver to switch from transmit to receive and back again, and how good the squelch is on the transceiver you use to access the patch. CES provides information on how to modify your own transceiver to work with the patch, or they will sell you a Clegg FM-88 synthesized two-meter transceiver that is already modified. The most important change required for a transceiver to work with the 500SA is a simple mod that allows the receiver to stay on all the time. Using the modified Clegg FM-88 on the patch end and a standard Kenwood TR-7600 in the car, we found that the sampling window is audible, but never interferes with intelligibility. The sampling window makes the 500SA sound different than repeater autopatches, but in practice it works just as well.

In the past, some hams have put together systems that used a VOX circuit and stayed in the transmit mode whenever the person on the

telephone was talking. When they stopped talking, the system switched back to receive, allowing the ham to talk. These systems were not legal. The person on the other end of the phone line was clearly in control of the transmitter, and if that person chose to talk about things that made you uncomfortable, you and every other ham on frequency had no choice but to listen. With the CES system, the ham is in control of the autopatch transmitter, because he can cause the patch's transmitter to shut down whenever he chooses, in one second or less.

#### **Advantages of Simplex Autopatch**

The advantages of a simplex autopatch are pretty obvious, but they are worth mentioning anyway. First of all, the patch only occupies one frequency, rather than a pair. In our increasingly congested amateur allocations, this becomes an important consideration. The ability to use a normal synthesized transceiver with the patch is positively enticing. Since the costs involved are negligible compared to a complete repeater, an individual or small group could easily put such a system on the air, or a repeater group could move autopatching activities off the repeater and onto a simplex frequency, freeing the repeater for normal QSOs.

A simplex autopatch could be extremely useful in an emergency situation when telephone communications fail. Just plug the 500SA into the phone system outside of the affected area, and police, fire, and medical teams can be given access to the phone system.

As it is presently configured, the 500SA cannot be accessed through a repeater, but the manufacturer is developing some modifications to allow that use.

Many repeaters are located in remote areas where it is impossible to bring in a phone line, and the 500SA could provide autopatch facilities for these systems.

While the concept of a simplex autopatch is revolutionary, it is only fair to mention that a similar system is presented in Bill Pasternak's and Mike Morris's epic tome, *The Practical Handbook of FM and Repeaters*, and has probably been discussed elsewhere as well. Simplex autopatches have been in use for several years, but the introduction of this commercially-built unit by CES will certainly increase the popularity of the simplex autopatch. With no further ado, let's take a good look at the 500SA.

#### **Description**

Physically speaking, there isn't much to the 500SA. It is a well-finished metal box that measures 1-1/2 inches high by 9 inches deep by 10-1/2 inches wide. The front panel is a model of simplicity. On the far right-hand side is a toggle switch marked "Toll Restrict," and it does just that. Inside the patch is a circuit board with 10 spaces available for the insertion of diodes. Our unit had diodes in the "0" and "1" slots. Numbers starting with a 0 or 1 are consequently ignored by the decoder when the Toll Restrict switch is on.

Next to the Toll Restrict switch is a two-position rotary switch marked "Base" and "Patch". This allows you to completely bypass the patch electronics and use the transceiver as a normal base station. Next to this switch are two momentary-contact push-buttons marked "Disconnect" and "Connect" for manual testing of the patch. The last item sharing the front panel is a row of LEDs, to keep you informed of the

status of the system's various functions.

Inside, construction is uniformly excellent. The glass-epoxy circuit board, high-quality components, and careful layout all serve as reminders that CES produces a wide range of equipment for the commercial radio services.

Moving to the back of the patch, we find a neatly grommeted hole with telephone wire exiting it. The wire is equipped with a standard modular phone plug, so interfacing the patch to the phone line is not traumatic. Also on the rear panel are two multi-pin connectors for interfacing the unit with transceiver and IDer.

#### **Installation and Use**

We used a modified Clegg FM-88 as the transceiver for the patch, and setting up the system couldn't be simpler. CES thoughtfully wired up all the necessary functions to the accessory socket of the Clegg and provided an interface cable as well. Installation consequently took less than five minutes and consisted of hooking up the transceiver to a 12 V dc power supply, an antenna, and the autopatch, and plugging the autopatch into a phone jack. Power is supplied to the patch through the interface cable from the transceiver. The patch can be configured to work with either pulse or touchtone™ phone systems; touchtone is a far-off dream in our area, so we had the optional pulse dialer installed.

Operation of the simplex autopatch is even less challenging than its installation. As with any phone interconnect system that is not full duplex, you have to remind people that if they talk at the same time you're talking, you won't hear them. Because of the once-per-

# Orbit



**ORBIT** is the Official Journal for the Radio Amateur Satellite Corporation (AMSAT), P.O. Box 27, Washington, DC 20047. Please write for application.

For a **FREE SAMPLE COPY** please send \$1 to cover First Class Postage and handling to: Orbit, 221 Long Swamp Road, Wolcott, CT 06716.

second sampling of the patch's receiver, you also have to be careful not to cut off the first part of a transmission, particularly when dialing. If you have a fancy tone pad or autodialer with automatic push-to-talk, you'll have to forego the pleasures of that particular feature. Good operating practice with a simplex autopatch requires the transmitter to be keyed a couple of seconds before the first tone is sent, to allow the patch's logic to lock into the receive mode.

The 500SA is equipped with a time-out timer that gives warning beeps after 80% of timeout. The timer can be programmed to reset with a carrier, a "\*\*\*", or no reset at all. Our unit was programmed to reset with a "\*\*\*", which seems a good compromise.

One feature of the 500SA

that you may not wish to use is its reverse autopatch capability. When someone calls the autopatch, it transmits a beep to let you know that a call is waiting. If you wish to talk to the caller, you simply press the "\*\*\*" on your tone pad to connect the phone line to the patch. Since this system does not allow a control operator to screen the call before the caller goes on the air, it is doubtful that the reverse autopatch function is legal under present FCC rules and regulations. If you choose not to use this feature, it is easily disabled.

### Legal Considerations

Many people I have talked with about the simplex autopatch have questioned the system's legality. After several phone calls to the FCC, I came to the conclusion that within the following limitations, the 500SA is legal. For any auto-

patch to be legal, simplex or otherwise, a control operator has to be present at a control point for the transmitter. This rather dashes any hopes of simply plugging the thing in at home and having your own private autopatch. A ham will either have to be present in the room with the patch, or you'll have to arrange a control link to turn the patch on and off that is independent of the input frequency of the patch. If you monitor the patch whenever it is up and can shut the thing down if a wild turkey brings up the system, you'll be well on your way to being legal.

The other thing you'll need if you want to be legal is an IDer. CES offers one as an option for the 500SA, and at about 50 dollars, it's well worth the investment. The reverse autopatch feature? As mentioned above, the legality of reverse autopatch is doubtful at best, so you might as well disable that feature right away.

### Applications

So how is the average ham going to use the 500SA? Well, the possibilities are almost endless! You could just plug the thing in at a good site and hope that the FCC never catches you operating it without a control operator. That's just asking for trouble, and besides, there are some far more intriguing possibilities that are still within the capabilities of an individual ham.

Install the 500SA at a good site, hook up a 220- or 430-MHz control receiver, and bring in a phone line. Designate anybody you wish as a control operator, and leave the patch normally disabled. Whenever one of the control operators wants to use the patch, he or she can activate it via the control link and then use it normally. This has the ad-

vantage of giving instant accessibility, yet it stays well within the letter and intent of the law.

The only disadvantage is that you need to have a transmitter for 220 or 430 as well as two meters to use the patch, since control functions cannot be performed on two meters. The obvious solution is to put both the patch and its control receiver on the same band, say 220 MHz. Install a 220-MHz transceiver in your car or use a handheld, and the one rig can handle both control and operating functions. Dial in the control frequency, bring up the patch, and then flip to the patch's operating frequency to place your call.

This approach seems ideal for the individual or small group with a closed system in mind. If the group grows or decides to make its facility available on an open basis, the patch could be left on all the time, as long as a control operator is monitoring the frequency.

### Conclusions

However you use it, the CES 500SA is a versatile and innovative new product. The concept is a logical one, and CES has produced an autopatch system that should give dependable, trouble-free operation at a fraction of the cost of a repeater and its associated autopatch equipment.

If you or your group has ever wanted to have an autopatch system, as a convenience or for emergency use, you owe it to yourself to check out the CES 500SA!

For further information, contact *Communications Electronics Specialties, Inc.*, 260 W. New England Avenue, Winter Park FL 32789. Reader Service number 478. ■



# Plug-in Transistor Oscillators

## HIGH FREQUENCY (20 MHz — 160 MHz)

- Signal Generators For Receiver Alignment
  - Quick-Change Plug-In Oscillators
- Five transistor oscillators covering 20 MHz-160 MHz. Standard 77°F calibration tolerance  $\pm .0025\%$ . The frequency tolerance is  $\pm .0035\%$ . Oscillator output is .2 volts (min.) across 51 ohms. Power requirement: 9 vdc @ 10 ma. max.

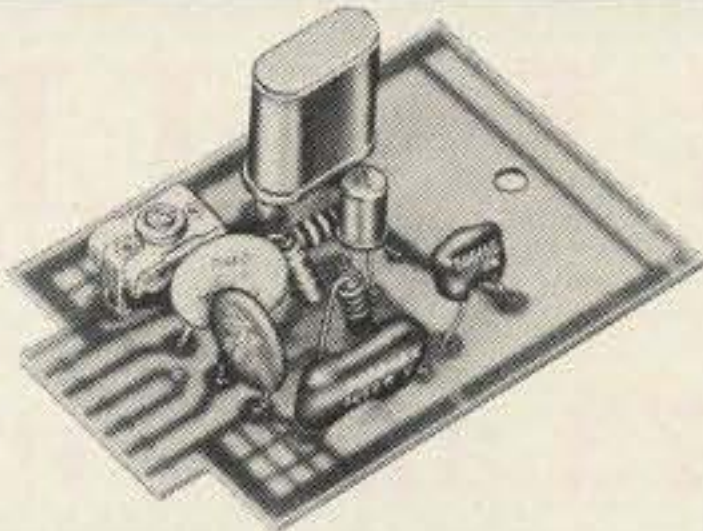

Catalog Number	Oscillator Type	Oscillator Range	Temperature Tol. -40°F to 150°F	Oscillator (Less Crystal) Price
035200	OT-124	20-40 MHz	$\pm .0035\%$	\$10.21
035201	OT-146	40-60 MHz	$\pm .0035\%$	10.21
035202	OT-161	60-100 MHz	$\pm .0035\%$	10.21
035203	OT-1140	100-140 MHz	$\pm .0035\%$	10.21
035204	OT-1160	145-160 MHz	$\pm .0035\%$	10.21

## LOW FREQUENCY (70 KHz - 20,000 KHz)

- Band Edge Markers
- Frequency Markers For Oscilloscopes
- Portable Signal Standards
- Accessory Cases

Four transistor oscillators covering 70 KHz — 20,000 KHz. Trimmer capacitor for zeroing crystal. When oscillator is ordered with crystal the standard will be  $\pm .0025\%$ . Oscillator output is 1 volt (min.) across 470 ohms. Power requirement: 9 vdc @ 10 ma. max.

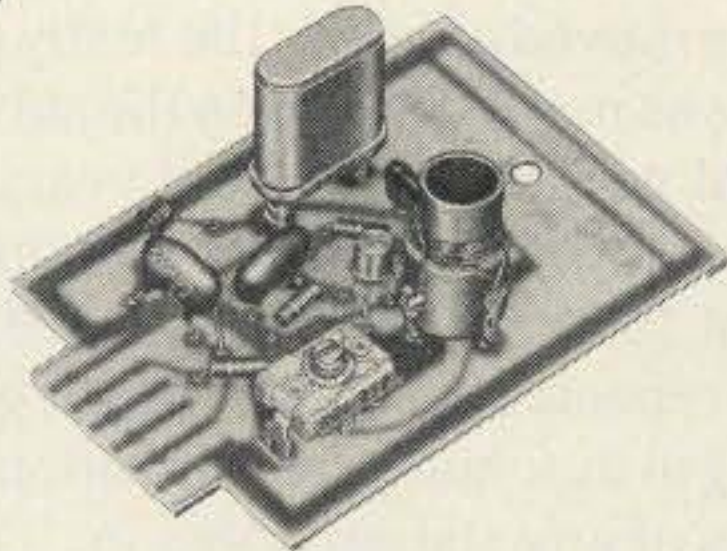

Catalog Number	Oscillator Type	Oscillator Range	Temperature Tol. -40°F to 150°F	Oscillator (Less Crystal) Price
035205	OT-11	70-150 KHz	$\pm .015\%$	\$10.21
035206	OT-12A	150-400 KHz	200-600 KHz $\pm .01\%$	10.21
035207	OT-12	400-5,000 KHz	600-5,000 KHz $\pm .0035\%$	10.21
035208	OT-13	2,000-12,000 KHz	$\pm .0035\%$	10.21
035209	OT-14	10,000-20,000 KHz	$\pm .0035\%$	10.21

## SUPPLEMENTAL CRYSTAL ORDERING INFORMATION FOR ICM OSCILLATORS

Please refer to the "4" Series Crystal Specification Sheets. (Available on request.) Prices on crystals will vary with frequency being ordered.

### CALIBRATION TEMPERATURE:

Customer's choice, usually 26°C.

**RANGE:** Depends on crystal frequency being ordered.

**TYPE:** CS ② is recommended.

### HOLDER:

F-605 ① for all except crystals below 160 KHz.

F-13 ③ required for crystals below 160 KHz.

### LOAD:

OT-11, OT-12, OT-12A ... 24PF ④  
OT-13, OT-14 ... 20PF ③

OT-124, OT-146, OT-161,  
OT-1140, OT-1160 ..... SERIES ①  
ALIGNMENT OSCILLATORS,  
Models 812, 814 ..... 32PF ⑤

Note: Circled numbers refer to numbers on Crystal Specification Sheets.

### EXAMPLES

OT-11 Catalog Number = 4 1 1 2 8 4  
(75 KHz\*, CS, F-13 Holder, 24PF)

OT-14 Catalog Number = 4 3 3 2 1 3  
(10.5 MHz\*, CS, F-605 Holder, 20PF)

OT-1140 Catalog Number = 4 7 4 2 1 0  
(120 MHz\*, CS, F-605 Holder, Series)

\*All "4" Series Catalog Numbers require crystal frequency specified by Customer.

FOR ADDITIONAL INFORMATION WRITE:



✓ 36

INTERNATIONAL CRYSTAL MFG. CO. INC. • 10 NORTH LEE • OKLAHOMA CITY, OKLA. 73102

# CALL TOLL FREE

For the best deal on

- AEA • Alliance • Ameco • Apple • ASP
- Avanti • Belden • Bencher • Bird • CDE
- CES • Communications Specialists
- Collins • Cushcraft • Daiwa • DenTron
- Drake • Hustler • Hy-Gain • Icom • IRL • KLM
- Kenwood • Larsen • Macrotronics • MFJ
- Midland • Mini-Products • Mirage • Mosley
- NPC • Newtronics • Nye • Panasonic
- Palomar Engineers • Regency • Robot
- Shure • Standard • Swan • Tempo
- Ten-Tec • Transcom • Yaesu

## SPRING SPECIALS!

STANDARD C7800 synthesized 440-450 MHz Xcvr with memory/scan intro \$399.95

COLLINS KWM-380... call for Erickson's superb cash price!

DRAKE TR-7/DR-7... call for great spring price

TENTEC Delta 580 9-band super transceiver — only \$759.95

KENWOOD TS-830S new all band (including WARC) Xcvr: Now in stock... call for price!

APPLE Disk Based System: Apple II or II Plus with 48k RAM installed and DOS 3.3, only \$1849

APPLE Game Paddles available

Quantities limited... all prices subject to change without notice

Erickson is accepting late model amateur radio equipment for service: full time technician on duty

## CALL TOLL FREE

(outside Illinois only)

# (800) 621-5802

HOURS: 9:30-5:30 Mon., Tues., Wed. & Fri.

9:30-9:00 Thursday  
9:00-3:00 Saturday

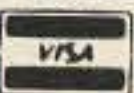

## ERICKSON COMMUNICATIONS

Chicago, IL 60630  
5456 North Milwaukee Ave.  
(312) 631-5181 (within Illinois)

# WHAT WILL YOUR NEW RIG BE LIKE?

## Read 73 and Find Out

The magic of digital electronics is coming to ham gear . . . and you'll be able to read about these developments in 73. There probably will be more changes in ham equipment in the next few years than ever before in history. You'll see these changes coming in 73, where you'll read about the experiments and pioneering. 73 has more articles than any other ham magazine . . . often more than all the others combined.

When sideband got started, it was moved along by the many pioneering articles in 73. In the 60s it was solid state, with several times as many articles on the subject than in all the other magazines combined. When repeaters and FM got going about ten years ago there were over five times as many articles on the subject published in 73 as in all other ham magazines combined . . . and you can see what changes that brought to hamming. Now we're looking at exciting developments such as narrow band sideband for repeaters . . . which might give us six times as many repeaters in our present bands. We're looking at automatic identification systems which may make it possible for us to read out the call letters of any station tuned in . . . and even the development of self-tuning receivers.

Will stereo double sideband techniques make it possible to have up to 30 times as many stations within a given HF band as is now possible? Hams will be experimenting and reporting on these developments in 73. 73 is an encyclopedia of hamming . . . present and future . . . and just a bit of the past, too.

Without the endless fillers on station activities and club news, 73 is able to publish far more information . . . valuable information . . . on hamming and ham equipment.

You may or may not be a pioneer, but you certainly will want to keep up with what is happening and what the new rigs are going to be like. And, frankly, your support of 73 is needed to keep this type of information coming.

Yes, bill me for 1 year of 73 Magazine at \$25.00

316B6

Name \_\_\_\_\_

Address \_\_\_\_\_

City \_\_\_\_\_ State \_\_\_\_\_ Zip \_\_\_\_\_

Canadian \$27/1 year only, US funds. Foreign \$35/1 year only, US funds

Please allow 4 to 6 weeks for delivery

73 Magazine • PO Box 931 • Farmingdale, NY 11737



# Yesterday you could admire all-band digital tuning in a short wave receiver.\* Today you can afford it.



RF-4900

Tune in the Panasonic Command Series™ top-of-the-line RF-4900. Everything you want in short wave at a surprisingly affordable price. Like fluorescent all-band readout with a five-digit frequency display. It's so accurate (within 1 kHz, to be exact), you can tune in a station even before it's broadcasting. And with the RF-4900's eight short wave bands, you can choose any broadcast between 1.6 and 31 MHz. That's all short wave bands. That's Panasonic.

And what you see on the outside is just a small part of what Panasonic gives you inside. There's a double superheterodyne system for sharp reception stability and selectivity as well as image rejection. An input-tuned RF amplifier with a 3-ganged variable tuning capacitor for excellent sensitivity and frequency linearity. Ladder-type ceramic filters to reduce frequency interference. And even an antenna trimmer that changes the front-end capacitance for reception of weak broadcast signals.

To help you control all that sophisticated circuitry, Panasonic's RF-4900 gives you all these sophisticated controls. Like an all-gear-drive

tuning control to prevent "backlash." Separate wide/narrow bandwidth selectors for crisp reception even in crowded conditions. Adjustable calibration for easy tuning to exact frequencies. A BFO pitch control. RF-gain control for improved reception in strong signal areas. An ANL switch. Even separate bass and treble controls.

And if all that short wave isn't enough. There's more. Like SSB (single sideband) amateur radio. All 40 CB channels. Ship to shore. Even Morse communications. AC/DC operation. And with

Panasonic's 4" full-range speaker, the big sound of AM and FM will really sound big. There's also the Panasonic RF-2900. It has most of the features of the RF-4900, but it costs a lot less.

The Command Series from Panasonic. If you had short wave receivers as good. You wouldn't still be reading. You'd be listening.

\*Short wave reception will vary with antenna, weather conditions, operator's geographic location and other factors. An outside antenna may be required for maximum short wave reception.



RF-2900

**Panasonic**  
just slightly ahead of our time.

# About the Beverage

— When you say longwire, mean it. Use the remarkable beverage!

No, a beverage is not a drink! This beverage is a super longwire receiving antenna that is absolutely worth all the time and effort that it takes to put it up.

The advantages of a beverage antenna are that it is highly directional, has extremely low noise pickup, and produces excellent signal-to-noise ratios. Its disadvantage is that it requires a lot of ground to put it up in the direction that you want to listen.

The beverage antenna was invented in the early 1920s by Harold H. Beverage. It was first discussed in a paper titled "The Wave Antenna—A New Type of Highly Directive Antenna," written by Beverage, Chester W. Rice, and Edward W. Kellogg for the journal of the American Institute of Electrical Engi-

neers (Volume 42, 1923, page 215 ff). Other writings on the subject are found only periodically thereafter as an editor or writer "rediscovers" the antenna. The several *Radio Engineering Handbooks* edited by Keith Henney and published by McGraw-Hill also have discussions of the antenna.

## Results

As a medium-wave DXer in the late 1950s and through the 1960s, I had heard of beverages. Several National Radio Club DXers used them to good advantage. Probably the most spectacular example was Jerry Conrad's 1500' beverage in an orange grove in southern Florida. I heard one tape of 1550 kHz on which 50-kW CBE, Windsor, Ontario, normally is the dominant North American clear-channel station, but,

changing from a random wire to the beverage, 50-kW 4QD in Queensland, Australia, completely took over the frequency! As it was later explained, normal daytime reception included regional-frequency stations from Texas and Oklahoma, and twilight reception normally included California and Hawaii stations.

It was not until my wife and I moved to a new location in 1980 that I had the room to put up a beverage. Despite summertime static, St. Pierre et Miquelon on 1375 kHz was readable most evenings on the beverage, yet there was no trace of a carrier on a random length 120' wire. Europeans on the standard medium-wave band were present most evenings throughout the fall, and Saudi Arabia on 1521 kHz often put a strong heterodyne on

WKBW, 1520, Buffalo, New York. Daytime reception of central and northern New England stations on the regional and local frequencies is commonplace.

The results on 75 meters have been equally satisfying. In the fall and winter of 1980, more than 20 new countries have been added to the log just because I can hear them! The best ones include Faroe Islands, Maldivian Islands, Reunion, and Djibouti.

Under normal conditions, the beverage scrubs at least 25 dB and sometimes as much as 40 dB off signals to the sides and to the rear of the antenna. In no-signal conditions, the typical atmospheric noise drops from an S6 or S7 on the dipole to an S2 on the beverage.

## What is a Beverage?

The beverage is a very long longwire run in the direction in which you intend to listen. To be effective, a beverage should normally be at least two wavelengths long on the lowest frequency on which it will be used. For example, two wavelengths at 1.8 MHz is 1100 feet; at 3.5 MHz, 600 feet.

At less than two wavelengths, the property of high directionality will be lessened. At less than a wavelength, signals to the sides and rear will not significantly be reduced. The

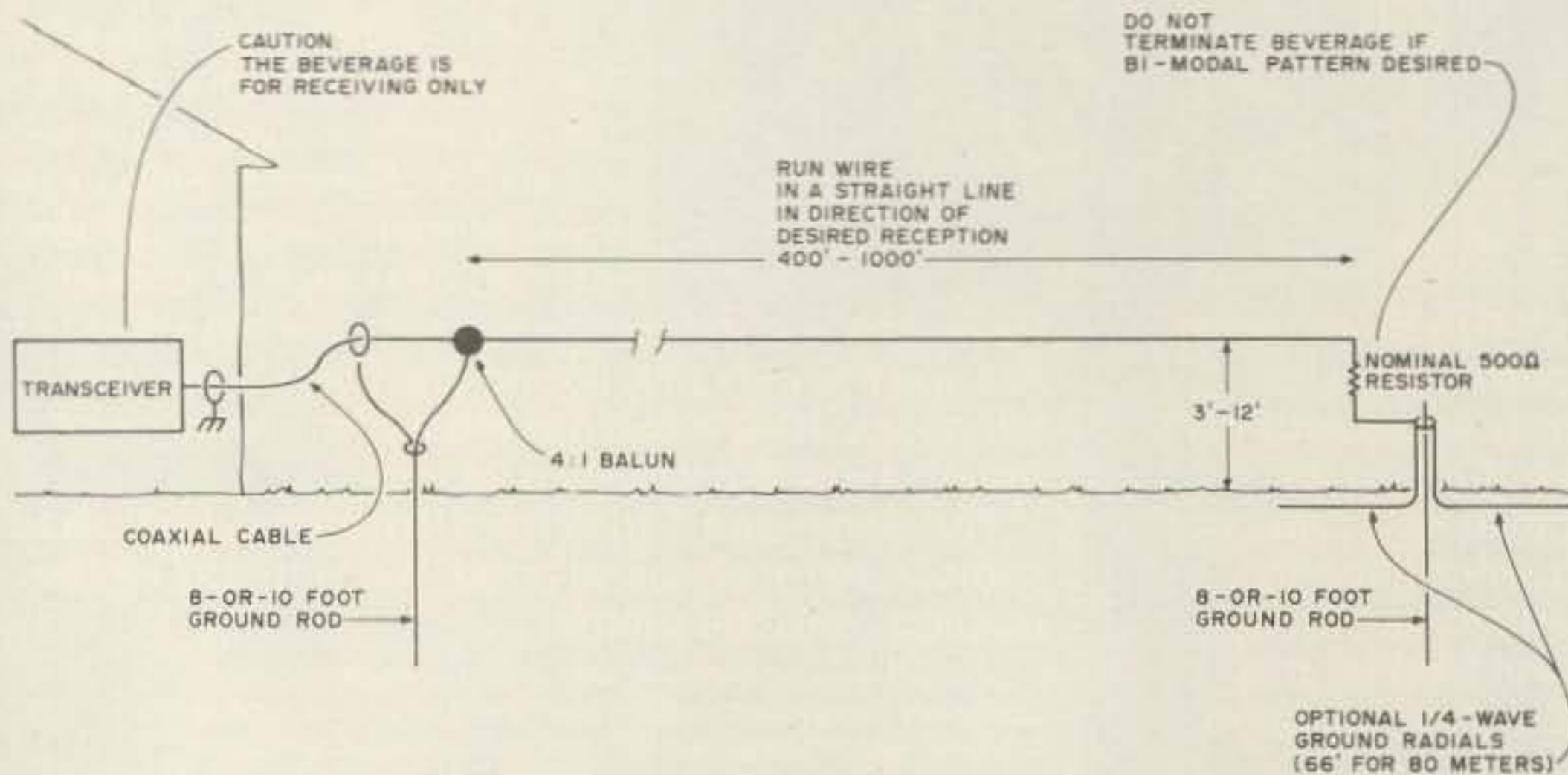

Fig. 1. Installation of the beverage antenna.

# BY POPULAR REQUEST...

The Best Features Of Two Proven HAL RTTY Models  
Are Now Available In ONE Convenient New Unit—

The

## DS2050 KSR



**DS2050—\$649.00**

(Available April 24, 1981)

- Self contained RTTY and CW terminal —RTTY demodulator is now internal!
- Best features of BOTH the DS2000 and ST5000 in one package.
- Simplified connections to your transceiver with standard phono connectors.
- Front panel tuning meter (rear panel scope connectors).
- Both 170Hz and 850Hz shifts for receive and transmit.
- Full high voltage loop<sup>1</sup> compatible for printers, keyboards, and tape transmitters (TD's).
- Full length 72 character lines—24 line screen.
- Pretype either 255 character transmit buffer or the full 1728 character screen.
- Two programmable HERE IS messages with CW ID.
- Keyboard Operated Switch (KOS) for automatic TX/RX control.
- Bright-dim display of received or transmitted text.
- 1-100 wpm CW; 60, 66, 75, 100, 133 wpm Baudot RTTY; 110 or 300 baud<sup>2</sup> ASCII RTTY.
- Word wrap-around, Unshift On Space (USOS), and Synchronous Idle Transmit.
- Edit as you type with WORD transmit mode.
- Built-in demodulator is a proven ST5000 demodulator, not a simple compromise.

<sup>1</sup>Use your own high voltage loop supply.

<sup>2</sup>External modem recommended for 300 baud.

WHEN OUR CUSTOMERS TALK WE LISTEN



HAL COMMUNICATIONS CORP.

BOX 365 ✓335

URBANA, ILLINOIS 61801

217-367-7373

DS2050 .....\$649.00  
MR2000 .....\$169.00  
ESM914.....\$169.00

advantage of improved signal-to-noise ratio will be retained, however.

Increasing the number of wavelengths on the wire is not normally effective when the number exceeds eight to ten. The front acceptance angle also becomes smaller. That was exemplified here by back-to-back QSOs on October 5, 1980, with XT2AW, Upper Volta, on 40 and 75 meters. Whereas my beverage, running northeast, offered no advantage over the dipole on 40, on 75 it was significantly better and provided solid copy. XT2AW was just barely audible on the dipole.

At certain times, particularly in the twilight hours, the beverage will not appear to be functioning. The changing, tilting ionospheric layers in transition tend to produce high-angle signals without any worthwhile low-angle components.

### How It Works

The long antenna wire pointed in the direction of a passing radio wave has a high degree of exposure to the horizontal component of the wave. This induces a continuously building series of voltages that are propagated along the antenna from one end toward the receiver. The effects are cumulative over the long length. Energy collected from a radio wave traveling in the opposite direction is dissipated in a terminating resistor and so does not enter the receiver. Radio waves arriving from the sides have relatively little effect on the receiver.

### Installation

Installing a beverage is relatively simple. As a minimum, you will need antenna wire, a 4:1 balun, a ground rod, a 500-Ohm 1- or 2-Watt carbon resistor, and coaxial cable to feed the receiver.

I used a surplus 1000' roll

of insulated #18 hook-up wire. Others use copper-weld; almost anything will suffice. The wire should be installed at a more-or-less uniform height 3' to 12' off the ground. Mine averages about 8' so that deer walking through the area won't snag the wire and pull it down.

Run the wire—at least 400' and preferably 600'-1000'—in a straight line. A few degrees of bending over the course is acceptable but anything more than a 10- or 20-degree bend should be avoided. Run the antenna wire in the direction of primary interest.

At the far end, install an 8' or 10' ground rod. Connect the end of the beverage to the ground rod with a nominal 500-Ohm resistor in series. Use a non-inductive resistor if one is readily available, otherwise a small carbon resistor will be fine. The value of the resistor is subject to experimentation; values ranging between 200 and 600 Ohms are normally found to be best.

If you need to improve the effectiveness of the ground because of poor conductivity at the point of the ground rod, connect some 66' radials to the ground rod. Run one of them away from the ground rod, continuing in the direction that the beverage was pointed.

A terminated beverage is unidirectional in the direction that the beverage runs, i.e., from the receiver end to the terminated end. If you want the antenna to be bi-directional along its axis, leave the far end unterminated.

The beverage is a high-impedance antenna. It will perform by connecting the receiver end of the beverage antenna wire to the inner conductor of the coaxial cable feeding the receiver. I'll leave it to the

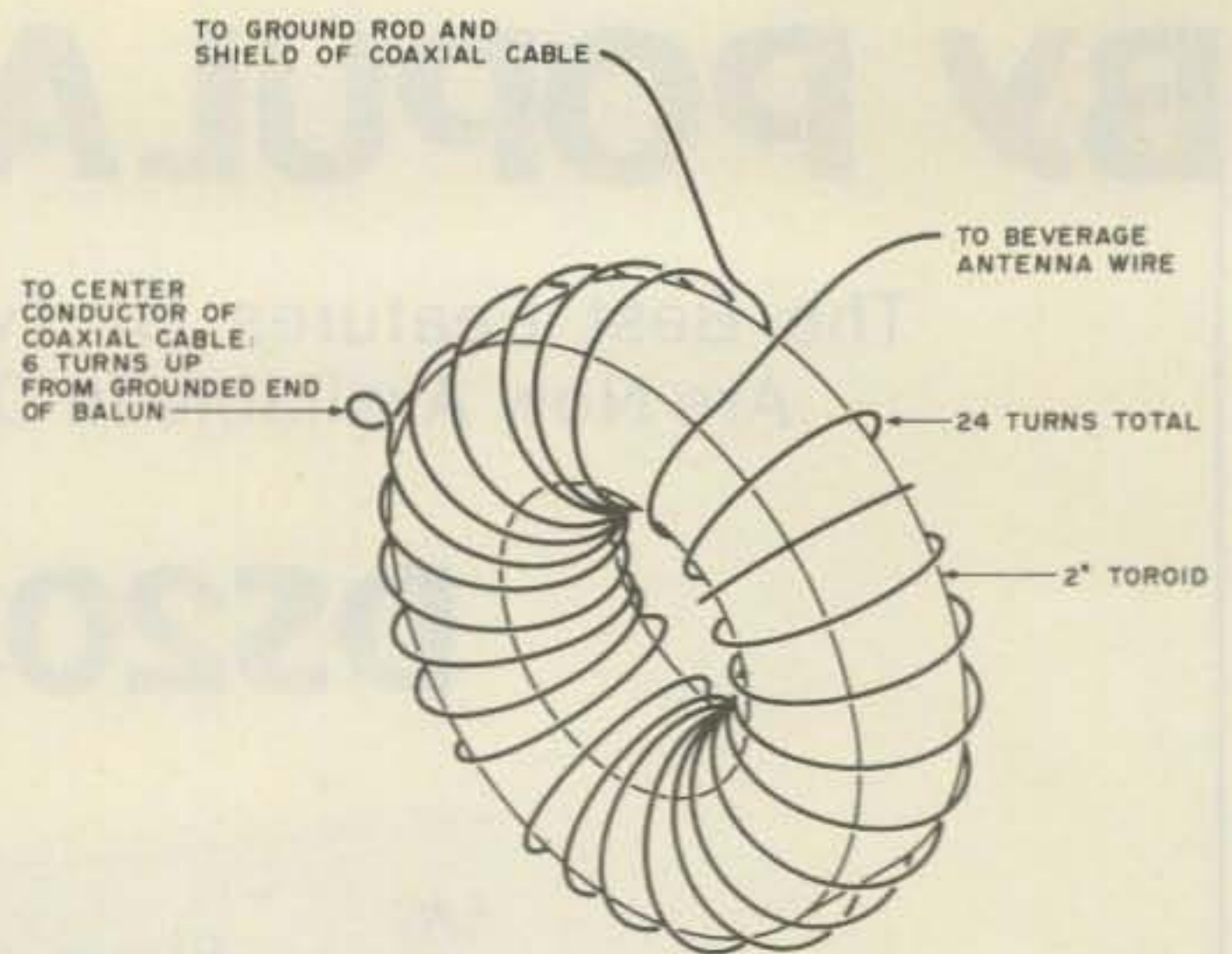

Fig. 2. A homemade 4:1 balun.

engineers to do the calculations on exact impedances and tell you to install either a commercial or homemade 4:1 balun. Almost anything to get the impedance match into the ball park will do.

I wound 24 turns of hook-up wire onto a surplus 2" toroid, tapping it at 6 turns for the coaxial center conductor (see Fig. 2); it works just fine. If the beverage is only for amateur band use, i.e., above 160 meters, one of the small antenna tuners, such as marketed by Den-Tron or MFJ, will perform equally well. A fixed balun should be mounted at the receiver end of the beverage wire, whereas an antenna tuner should be placed by the receiver.

Although this beverage antenna is a *receiving-only* antenna, some users will adjust the antenna tuner for maximum by loading a small amount of power (less than 5 or 10 Watts) into the beverage. Don't forget the terminating resistor!

At the receiver, install switches or relays to listen with the beverage and transmit on your normal antenna(s). If you have a separate receiver and transmitter, that task is simple.

If you have a second ground rod available, install it at the end of the beverage wire. Tie the ground side of the fixed balun and

the coaxial shield to ground with a short piece of wire.

Some final installation notes are in order here. An ohmmeter connected in series between the receiver end of the beverage wire (temporarily disconnected from the balun) and the second ground rod should read 10k to 15k Ohms, assuming the far end of the beverage is terminated. The circuit is completed through the earth. An infinite reading indicates a break in the beverage antenna wire.

If you install multiple beverages for multiple listening directions, the antenna selection device should ground the beverages not being used. Otherwise, signals built up on the other beverages (or random wires) in the area will be inductively coupled to the beverage in use, causing extraneous signal pickup and blunting of the nulls.

### Conclusion

The beverage has opened new vistas for me despite a very modest station installation. The ability to hear is of paramount importance, and I attribute some excellent DX on 80 and 40 meters to that antenna. If you have the room to install a beverage, go ahead and do so. You'll be surprised at what comes out of the noise levels! ■

COMPLETE - ASSEMBLED AND TESTED - READY TO INSTALL - NOT A KIT - ONE FULL YEAR WARRENTY

### AMATEUR TELEVISION

### MICROWAVE RECEIVER DOWNCONVERTER

Cavity Tuned Front End  
H.P. Low Noise Transistor  
H.P. Hot Carrier Mixer Diodes  
Voltage Tuned Oscillator  
Easily Installed

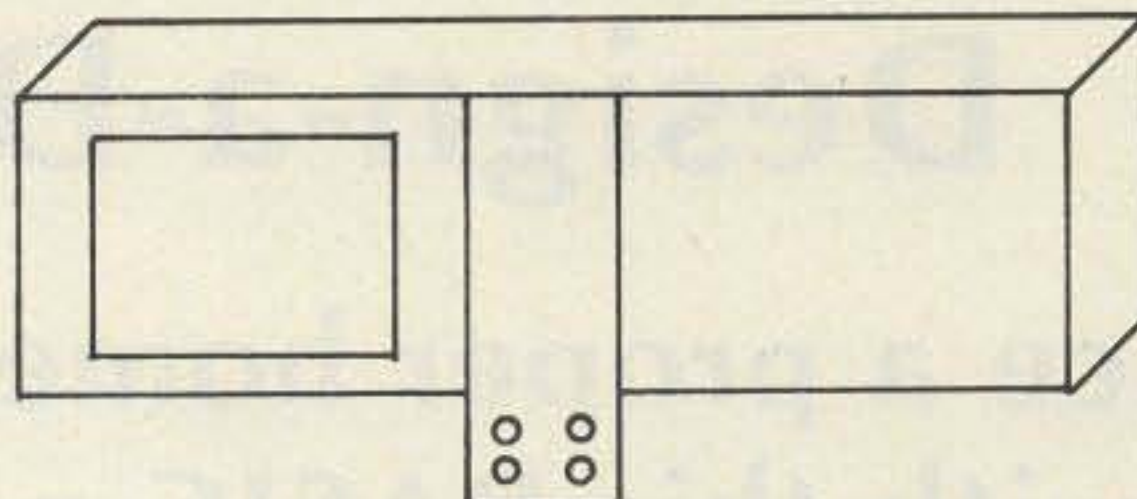

Compact  
Low Wind Resistance  
Weather Tight Case  
Chromate Coated Al  
Resists Corrosion

**ELECTRONIC HOBBY INNOVATIONS** is proud to present to the Amateur Radio Market a high gain, low noise, modern technology S-Band Microwave receiver converter. This converter will let you explore the unknown frontier of Amateur and commercial radio, for your personal enjoyment. In this region of line-of-sight reception, tune in the band of Amateur, digital, FM, AM, or TV modes of transmission using the downconverter and your own television set.

**Caution:** This unit was designed for Amateur use, reception of other TV signals is the responsibility of the owner.

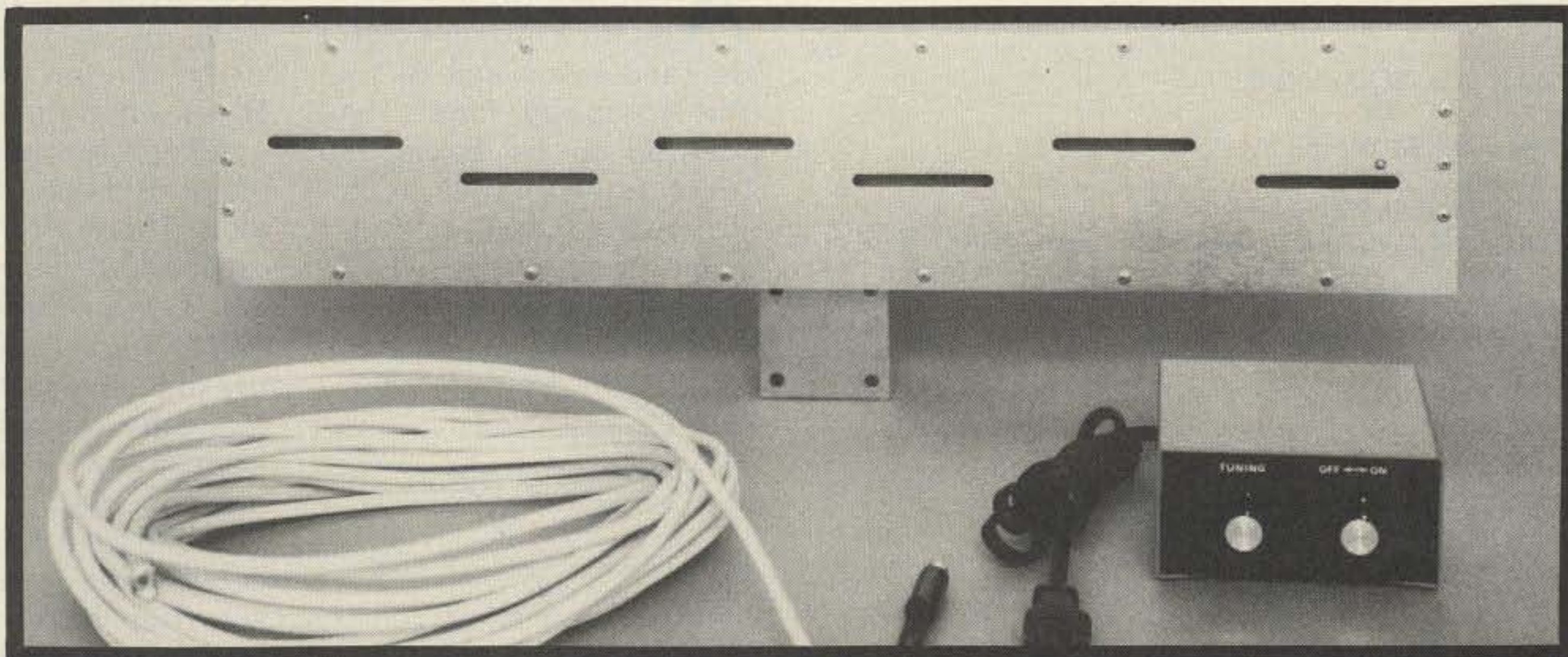

#### SPECS :

Preamplifier: guaranteed 10 dB @ 2.5 dB noise figure  
Mixer: Hewlett-Packard 5082-2835 quality Hot Carrier Diodes for optimum performance  
IF Amplifier: 25 dB minimum gain @ 1.5 dB noise figure  
Output Impedence: Nominal 75 Ohms or 300 Ohms (matching transformer supplied)

Guaranteed Superior Performance : Your choice of guarantee

- 1) Return for refund less 10% restocking fee or
- 2) Show us a better commercial converter within 2 weeks of receiving unit and return order for a full refund plus a \$20.00 gift certificate, good towards next purchase.

**AMATEUR SPECIAL \$179.95 Including shipping (UPS)**

**VISA and MASTERCARD** charges accepted, call (804)-489-2156

Virginia residents please add 4% state sales tax, COD orders 20% deposit required

Coming soon 900 Mhz. and 1296 Mhz. versions - Parts available separately

Special pricing for club projects.

**ELECTRONIC HOBBY INNOVATIONS** ✓447

7510 GRANBY STREET SUITE 207

NORFOLK, VIRGINIA 23505

# Design-a-Dish

— produce a proper home-brew parabola with this BASIC program

```

1 PRINT"DISH AND FEEDHORN DESIGN PROGRAM * RUPERTO W3KH 4/79"
2 GOSUB300
10 PRINT"PARABOLIC DISH DESIGN PROGRAM."
15 PRINT:PRINT
20 INPUT "DESIRED DIAMETER IN FEET:";D
30 INPUT"DESIRED F/D RATIO";Z
40 PRINT:PRINT"THE FOCUS IN FEET IS";Z*D:F=Z*D
45 PRINT "INPUT RATE OF PLOT ALONG Y AXIS. EVERY ? INCHES:";INPUT M
50 PRINT:PRINT"COORDINATE VALUES FOR HALF DISH SIZE ARE AS FOLLOWS:"
60 PRINT TAB(15)"Y";TAB(30)"X"
70 FOR Y=0 TO .5*D*12 STEP M:X=Y*Y/(4*(F*12))
80 PRINT TAB(15)Y;TAB(30)X
90 NEXT Y
100 S=(D/2)[2/(4*F)]
110 PRINT "THE SAGITTA OF THE DISH IS";S;"FEET"
114 INPUT"INPUT DISH OPERATING FREQ IN MHZ FOR GAIN FIGURE";T
115 L=11811/T
116 G=.59*((3.14159*D*12)/L)[2]
117 H=LOG(G)/LOG(10)*10
118 PRINT:PRINT"THE GAIN AT";T;"IS";H;"DB"
119 GOSUB 300
201 PRINT:PRINT"THIS PROGRAM CALCULATES THE PARAMETERS FOR A"
202 PRINT"CIRCULAR WAVEGUIDE TO COAX TRANSITION DEVICE."
203 PRINT:PRINT"ALL OUTPUTS ARE METRIC."
208 INPUT"INPUT DESIGN FREQ OF OPERATION IN MHZ. ";F
210 O=30000*(10)[6/(F*(10)[6]
212 D1=O/1.71:D2=O/1.31
214 CS=(D1+D2)/2:D3=CS*1.71
216 G=O/(SQRT(1-((O/D3)[2]))
218 PRINT"CUTOFF DIA. FOR DOMINANT MODE IS:";D1;"CM."
220 PRINT:PRINT"CUTOFF DIAMETER FOR NXT LWR MODE:";D2;"CM."
225 PRINT:PRINT"GUIDE DIAMETER SHOULD BE BETWEEN";D2;"&"D1
228 PRINT"AVERAGE IS";CS
230 PRINT:PRINT"THE PHYSICAL GUIDE LENGTH, (G/2) IS:";G/2;"CM."
235 PRINT:PRINT"THE FREE-SPACE WAVELENGTH AT";F;"MHZ. IS";O;"CM."
240 PRINT:PRINT"THE PROBE LENGTH IS:";O*10/4;"MM."
245 PRINT"THIS IS ALSO THE DISTANCE FROM PROBE TO CLOSED END.":GOSUB300
246 PRINT"TO FIND THE CUTOFF FREQ OF A CIRCULAR GUIDE"
247 INPUT"INPUT DIAMETER IN CM. ";X:Z=X/2.54
260 Y=X*1.71:PRINT"CUTOFF FOR DIA";X;"CM. IS";Y;"CM. OR";Y/2.54;"IN."
261 PRINT"FREQ. IS.":30000/Y"MHZ."
300 PRINT"INPUT A FOR DISH PARA. B FOR HORN DESIGN. C FOR DIA VSCUTOFF FREQ"
301 INPUT A$:IF A$="A" THEN10 ELSE 302
302 IF A$="B" THEN 201 ELSE303
303 IF A$="C"THEN 246 ELSE 301
304 RETURN
  
```

Program listing.

After months of chatter on the club repeater, I decided last week to join the computer nuts. They seemed to be having so much fun with their microprocessors that I didn't want to be left out. I bought a TRS-80 with Level II BASIC and 4K of mem-

ory, saving a few bucks by using my SSTV monitor instead of buying Radio Shack's monitor.

After a few hours on the manuals, I was off and running. Then, after a couple of hundred games of "Lunar Lander" and "Blackjack," I put something in the machine that ran more along my lines of interest: I wanted my TRS-80 to help me construct a parabolic dish and feed system for receiving the geostationary weather satellites that transmit facsimile on 1691 MHz. Amateur interests (including my own) range from moonbounce to Gunnplexers and even to domestic satellite TV reception (TVRO), so it appeared that the ham without a dish would be missing out on a lot of fun.

If you like to roll your own, you can save a few bucks, learn something about dishes, and not have

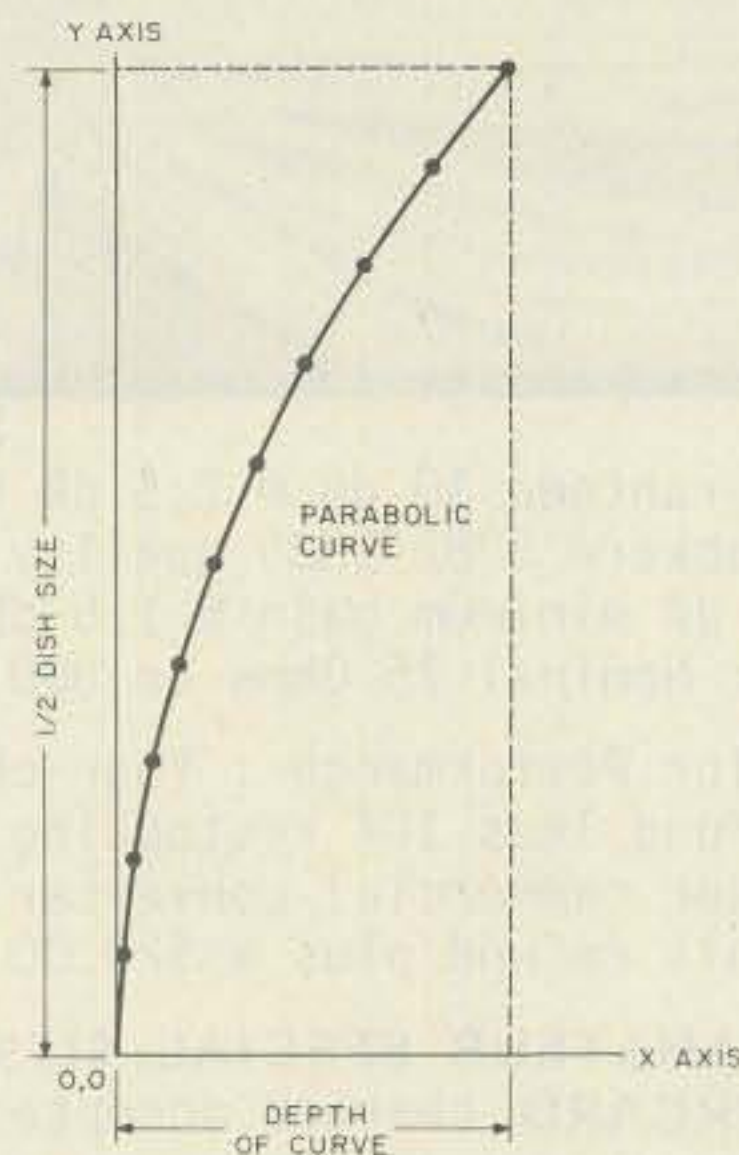

Fig. 1.

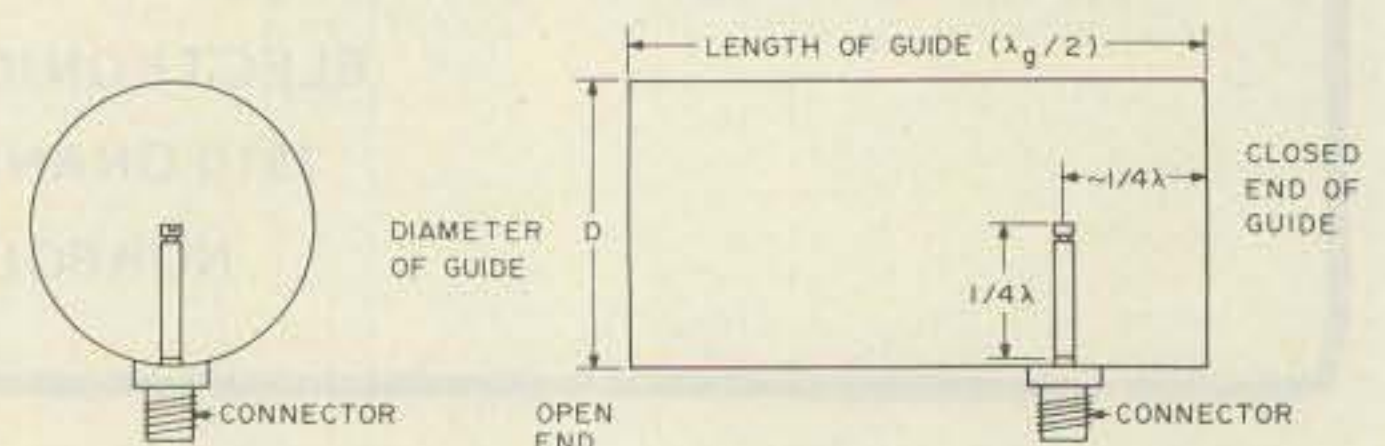

Fig. 2.



to worry about transporting a surplus ten-foot dish across town on the roof of the family Volkswagen. Many good dishes have been constructed using plywood ribs and screen or formed aluminum tubing, but most articles written in the amateur journals usually specified one size of dish and one or, at the most, two frequencies of operation. If after reading them you found that your particular application didn't fall in this category, you looked up a microwave expert or did a lot of reading on the subject.

This program, written in Radio Shack Level II BASIC, takes the drudgery out of the calculations. The hardest things it performs are square root and logarithm conversions, so it should be applicable to Level I BASIC or any other language with little or no modification. It requires the user to select one of three options: A—parabolic dish design, B—feed-horn design, or C—cutoff versus frequency for a specific diameter of waveguide. The program variables are shown in Table 1.

#### Program A

Program A (lines 10 to

119) allows the user to select dish size and f/d ratio independently. Then it prints out the X and Y coordinates in inches and the focal length and depth of the dish in feet. This allows you to select a specific dish diameter and play around with different f/d ratios while plotting X and Y coordinates for each change. This was always a pain even with a calculator. It then asks the user to specify the desired frequency of operation for a gain figure at this frequency. The computer will give a gain figure in dBi based on a 56-percent dish efficiency; this may be a bit optimistic but it is a good ballpark figure. It may be changed by entering your own percent figure at line 116.

The curve formula is derived from the basic  $Y^2=4AX$  definition of a parabolic curve where, in this case, the known Y axis represents one half of the dish size (the other half of the dish is the same curve),  $4A$  is a constant where  $A$  represents the focus, and  $X$  is our unknown.  $X$  represents the depth of the curve along the Y axis. We appropriately substituted  $F$  for  $A$  in the program. The

program asks the user for the number of plots along the Y axis by saying, "INPUT RATE OF PLOT ALONG Y AXIS. EVERY ? INCHES". Depending on the curve perfection desired or your skill with the sabre saw, use whatever value you think necessary. I used every four inches for large dishes and scaled it down for the smaller dishes. See Fig. 1 for curve design.

#### Program B

Program B (lines 201 to 245) specifies the diameter and length of a circular waveguide-to-coax transition device<sup>1</sup> used by a number of amateurs with great success. Basically, it takes the form of a tin can open at one end and closed at the other. A quarter-wavelength rod is mounted approximately a quarter wavelength from the closed end, perpendicular to the longitudinal axis of the can and mounted on a connector suitable for coax cable. The dominant mode (the one we're interested in) is the  $TM_{11}$  mode; it lies between  $1.71d$  and  $1.31d$ , where  $d$  is the guide diameter,  $1.71$  is the cutoff for the dominant mode, and  $1.31$  is the cutoff for

the next mode to develop (the  $TE_{01}$  mode). The diameter is based on the  $H_{11}$  and  $TE_{01}$  limits for the desired frequency of use which is input to the computer by the user. This is done by the prompt, "INPUT DESIGN FREQ OF OPERATION IN MHZ."

For example, we type in "1691", hit the enter key, and the computer prints out "CUTOFF DIA. FOR DOMINANT MODE IS: 10.535 CM." "CUTOFF DIAMETER FOR NXT LWR MODE: 15.212 CM." Aha, my 12-cm diameter lard can will do the trick!

These limits are mathematically depicted in the formulas. The program calculates and prints both limits and their average in cm, thereby giving the user

#### Formulas Used in Calculations By the Computer

$$\lambda_0 = 30,000/F$$

Where  $F$  = Frequency in MHz;  $\lambda_0$  is the free-space operating frequency in centimeters (cm).

$$D = \lambda_0/1.71 \text{ to } 1.31$$

Where  $D$  is the diameter of the guide expressed in cm,  $\lambda_0$  is the free-space operating frequency expressed in cm,  $1.71$  is the cutoff for  $TM_{11}$  mode, and  $1.31$  is cutoff for  $TE_{01}$  mode expressed in cm. This gives the limits of the guide diameter.

$$\lambda_g = \lambda_0 \sqrt{1 - (\lambda_0/\lambda_{CO})^2}$$

Where  $\lambda_g$  is the length of the guide in cm,  $\lambda_{CO}$  is cutoff wavelength expressed in cm, and  $\lambda_0$  is the operating wavelength in cm.

$$\lambda_{CO} = 1.71 \text{ to } 1.31(D)$$

Where  $\lambda_{CO}$  is the cutoff frequency expressed in cm. See Fig. 2.

$$Y^2 = 4AX$$

Where  $X$  is the X-axis plot of dish and  $Y$  is the Y-axis plot of dish; both are expressed in inches.  $Y$  represents one half the dish diameter, input to the computer in feet. Output to the user as "X" and "Y", in inches. See Fig. 1.

$G_{dB} = 10 \log (.59 [12\pi D/\lambda_0]^2)$   
Where  $G$  = gain of the dish in dB,  $D$  is dish diameter in feet, and  $\lambda_0$  is the operating frequency in inches.

Program Line #	Program Variables
20	D = Diameter of dish in feet.
30	Z = f/d ratio.
40	F = Focus of dish.
70	Y = Vertical axis; half dish size, in inches.
70	X = Horizontal axis; plot points of dish depth along Y axis, in inches.
45	M = Input variable to plot a point every (?) inches along the Y axis.
100	S = Dish depth in feet.
114	T = Operating frequency of dish in MHz.
115	L = Operating frequency in inches.
116	G = Gain calculation (dBi).
117	H = Log multiplier for dB. (RS Level II uses only natural logs.)
212	D1 = Cutoff calculation for $TM_{11}$ wave in cm (dominant mode).
212	D2 = Cutoff calculation for $TE_{01}$ mode in cm.
214	CS = Wavelength limit average of D1 and D2 in cm.
210	O = Alpha character denoting operating frequency calculation in cm.
216	G = Physical length of guide calculation; (G/2) gives actual printout in cm.
247	X = Input diameter of guide to computer for cutoff and length calculations in cm.
260	Y = Output to user: frequency of cutoff in cm.
247	Z = Conversion of Y figure to inches.
300	A,B,C = Program selection variables.

Table 1. Program variables. Notice that some variables are duplicated, but due to user input they do not conflict in the program.

# AEA

Brings you the breakthroughs!

## MODEL MM-1 MORSEMATIC

### COMPUTERIZED KEYS

### GREAT FOR CONTESTING, DX OR CODE PRACTICE.

## \$199.95



- CK-1 CONTEST KEYS \$129.95
- MK-1 STANDARD KEYS \$79.95
- MT-1 MORSE TRAINER \$99.95
- KT-1 MORSE KEYS/TRAINER \$129.95
- ME-1 MEMORY EXPANSION BOARD FOR MM-1 KEYS \$59.95
- AC-1 600 Ma. A.C. SUPPLY FOR MM-1 KEYS \$14.95
- AC-2 350 Ma. A.C. SUPPLY FOR ALL OTHER KEYS \$9.95

WRITE FOR COMPLETE SPECIFICATIONS WE STOCK KENWOOD, ICOM AND YAESU. WRITE FOR COMPLETE CATALOG

### HAND HELD TRANSCEIVERS:

- YAESU FT-207R 2 METER \$269.95
- ICOM IC-2AT 2 METER \$242.50
- KENWOOD TR-2400 2 METER \$375.00
- TEMPO S1T 2 METER \$275.00

### ISOPOLE VHF ANTENNAS

- ISOPOLE-144 JR. BASE ANTENNA \$39.95
- ISOPOLE-144 BASE ANTENNA \$49.95

No Sales Tax in Montana.

Finally — a properly decoupled antenna with superior performance at a reasonable cost. Raise more repeaters or increase your simplex distance!

## CALL TODAY 406-259-9554 CONLEY RADIO SUPPLY

318 N. 16th St. Billings, Montana 59101

some leeway on diameter for that particular frequency. The guide length, however, is based on the computer-derived average of these limits. The actual guide length is one half the theoretical guide length, which gives a broader frequency response when tuning the vertical radiator. This was based on work done by DJ1SL.<sup>2</sup> It also prints out the free-space operating wavelength in cm for reference and gives the probe length and distance from the closed end of the guide in millimeters. The program begins at line 201. See Fig. 2 for a schematic of guide and dimensions.

### Program C

This program (lines 246 to 261) is designed for the guy who always wanted to know the cutoff frequency of a tomato paste can in the TM<sub>11</sub> mode and also to

know the operating frequency in centimeters and inches, depending on what type of ruler he has in his pocket. I was too lazy to program the input for both inches and cm, so this program looks for only one thing: "INPUT DIAMETER IN CM." All outputs are as advertised. The program begins at line 246.

Initially, after the computer has requested the user to select program A, B, or C and has performed its task, it returns in this configuration for another program selection. This is done at the subroutine on line 300. ■

### References

1. Vilardi WA2LTM, *QST*, March, 1973, "Simple and Efficient Feed Systems for 1296 and 2304."
2. Griem DJ1SL, *VHF Communications*, Vol. 8, April, 1976, "Tubular radiator for parabolic antennas on the 13 cm band."
3. FAA manual DFR-33, "Transmission lines and wave guides."

## FAST SCAN ATV

### WHY GET ON FAST SCAN ATV?

- You can send broadcast quality video of home movies, video tapes, computer games, etc. at a cost that is less than sloscan.
- Really improves public service communications for parades, RACES, CAP searches, weather watch, etc.
- DX is about the same as 2 meter simplex — 15 to 100 miles.

### ALL IN ONE BOX



TC-1 Transmitter/Converter . . . . Plug in camera, ant., mic, and TV and you are on the air. Contains AC supply, T/R sw, 4 Modules below . . . . . \$ 399 ppd

### PUT YOUR OWN SYSTEM TOGETHER

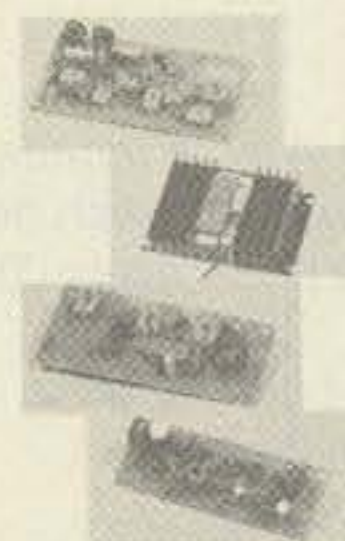

TXA5 ATV Exciter contains video modulator and xtal on 434 or 439.25 MHz. All modules wired and tested . . . . . \$ 89 ppd

PA5 10 Watt Linear matches exciter for good color and sound. This and all modules run on 13.8 vdc. . . . . \$89 pdd

TVC-2 Downconverter tunes 420 to 450 MHz. Outputs TV ch 2 or 3. Contains low noise MRF901 preamp. . . . . \$ 55 ppd

PACKAGE SPECIAL all four modules \$249 ppd

FMA5 Audio Subcarrier adds standard TV sound to the picture . . . . . \$ 29 ppd

### SEND SELF-ADDRESSED STAMPED ENVELOPE FOR OUR LATEST CATALOG INCLUDING:

Info on how to best get on ATV, modules for the builder, complete units, b&w and color cameras, antennas, monitors, etc. and more. 20 years experience in ATV. Credit card orders call (213) 447-4565. Check, Money Order or Credit Card by mail.



### P.C. ELECTRONICS

Maryann  
WB6YSS

2522 PAXSON  
ARCADIA, CA 91006

Tom  
W6ORG





# INSTANT SOFTWARE DOES

With our latest in HAM radio, electronics and utility programs, Instant Software proposes to: 1) organize you 2) keep you up-to-date 3) solve your microcomputing problems (well . . . some of them) 4) entertain you, and 5) save you money. Sound too good to be true? Read on!

## ELECTRONICS I

If you're still designing circuits the old-fashioned way, let the Electronics I package introduce the latest way to go:

**Tuned Circuits & Coil Winding**—Design tuned circuits for audio and radio frequencies. This two-part program will find the two missing values from any two of the following: frequency, capacitance, inductance, or reactance. The coil-winding section will calculate the number of turns and wire gauge required for a close-wound, air-, or slug-tuned coil from the inductance, diameter, length, and permeability of the coil.

**555 Timer Circuits**—Timers, both monostable (one-shot) and astable (oscillator), can be easily designed with this two-part program. The program will also draw a complete schematic on the screen of your TRS-80.

**LM 381 Pre-Amp Design**—You too can quickly design an IC preamp. With this program all you need to do is enter the parameters of the performance you want, and the program does the rest—right down to drawing a detailed schematic of your circuit on the screen!

**Order No. 0008R \$7.95.**

## QSL MANAGER

Did you remember to send a QSL card to the op you worked last week? Maybe you sent a QSL, but can't recall getting one in return. The QSL Manager program will help you set up a computerized log book for instant access to your records.

Make complete log entries which include: date, time, callsign, name, band, both the Sent and Received signal reports, the mode, QSL sent/received, and any remarks you may want to add.

No more fumbling with index cards during a QSO, because the QSL Manager has a built-in search function to locate and display information on any callsign in your records. You can even list all the QSO's for a particular date, time, band worked, mode or a specific signal report. Up to 1400 entries can be accessed

from your disk (depending on how many disk drives you have).

The program has built-in editing features that help you keep your log book up-to-date.

There's also a command that lets you output your log entries to a printer for hard copy.

In that next QSO, knock their socks off with your infallible memory. (T2)

**No. 0151RD \$19.95 Disk.**



## HOME ELECTRONICS TROUBLESHOOTER

The three programs in this package will help us non-technical types to locate the most common problems in home electronic equipment. You'll be shown step-by-step procedures for:

1. Analyzing common problems
2. The simple and logical solution to the problem
3. A general cost-guide to commercial repairs

It can be used to diagnose problems with these types of consumer electronic equipment: B&W and Color TV's, Stereo Receivers/Amplifiers, Turntables, Cassette and Eight-Track Decks, Portable and Table Radios, Portable Phonographs and Handheld Cassette Recorders.

In some cases the repair may be relatively simple and you may wish to fix it yourself. Other times, you might locate a general problem area, but you may not be able to correct the fault. In this event, the repair should be referred to a qualified service shop. Even if your appliance needs professional help, the repair cost may be reduced by informing the shop of what you have learned by using this program. (T1)

**No. 0169R \$9.95.**

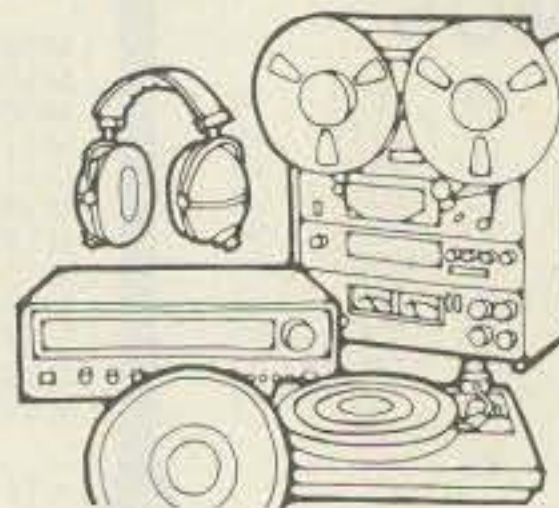

## BASIC PROGRAMMING ASSISTANT

The BASIC Programming Assistant utility program helps you to code and debug BASIC programs. Writing and debugging can be a frustrating, time-consuming process, especially for lengthy programs. BPA helps you control and track the variables, BASIC words, and line numbers in your programs. It reduces the time and effort needed to get a program running properly.

BPA does three things for you:

1. BPA will list the variables used in a BASIC program. You can have BPA list only a particular variable, list all the variables, or list all the multiple letter variables that begin with a specific letter. If you wish, it will also list the line numbers where each variable appears; the variable-type symbol (string, integer, single, or double precision); whether or not the variable is a dimensioned array; and where the variable is changed.

2. BPA will produce a cross-reference list of line numbers for GOTO's, GOSUB's, and IF . . . THEN statements.

3. BPA will list the line numbers where a selected BASIC function word (such as INPUT, PRINT, etc.) is used. Optionally, it lists only the lines where the BASIC word appears with a specified variable.

The minimum system required for BPA is TRS-80 Level II 16K computer, although it will operate on the 32K and 48K versions as well as in Disk BASIC (both TRS-DOS and NEWDOS).

**Order No. 0203R \$14.95.**

## HAM PACKAGE I

Use this versatile package to solve many problems commonly encountered in electronics design. It's ideal for technicians who must frequently apply fundamental electronic formulas.

**Ohm's Law**—Easily performs calculations involving voltage, current, resistance, and power.

**Series and Parallel Calculations**—Find the value for capacitors or resistors in parallel or series circuits.

**Voltage Dropping and Voltage Dividing**—This will give you the value of a dropping resistor and the effective resistance of the load.

\*TRS-80 is a trademark of Tandy Corporation.

# Instant Software Inc.™

PETERBOROUGH, NEW HAMPSHIRE 03458 603-924-7296

# IT WITH FREQUENCY

**R/C Time Constants**—This section will calculate the resistance, capacitance, or the time delay of an R/C circuit.

**Dipole and Yagi Antennas**—These two programs will compute the dimensions of an antenna to your exact frequency and give you an on-screen display—complete with all measurements! (T1)

**No. 0007R \$9.95.**

## AMATEUR RADIO ADVANCED CLASS STUDY GUIDE

Now you can use your TRS-80 to help you prepare for your Advanced Class license test. You can take 100 sample questions designed to test your knowledge of all the areas of skill required to be an Advanced Class operator. The study guide shows you, based on how you answer the questions, which knowledge areas you need to examine more closely, while it familiarizes you with the format of the exam given by the FCC. The program will serve to see how well prepared you are for the exam, and hopefully, make the exam easier for you. It will not take the place of hours of dedicated study, but it will help you determine when you are ready to take the exam. This program is a valuable tool for radio amateurs striving to upgrade their licenses. (T1)

**No. 0252R \$14.95.**



## TO ORDER:

See your local  
Instant Software dealer.

If these packages are  
unavailable, order direct.

CALL TOLL FREE

1-800-258-5473

Orders Only

In New Hampshire Dial

1-603-924-7296

(T1) = TRS-80 Model I, Level II, 16K RAM.

(T2) = TRS-80 Model I, Level II 16K, Expansion Interface 16K + 1 disk drive.

All these programs are Model III compatible except Basic Programming Assistant and Dynamic Device Drivers.

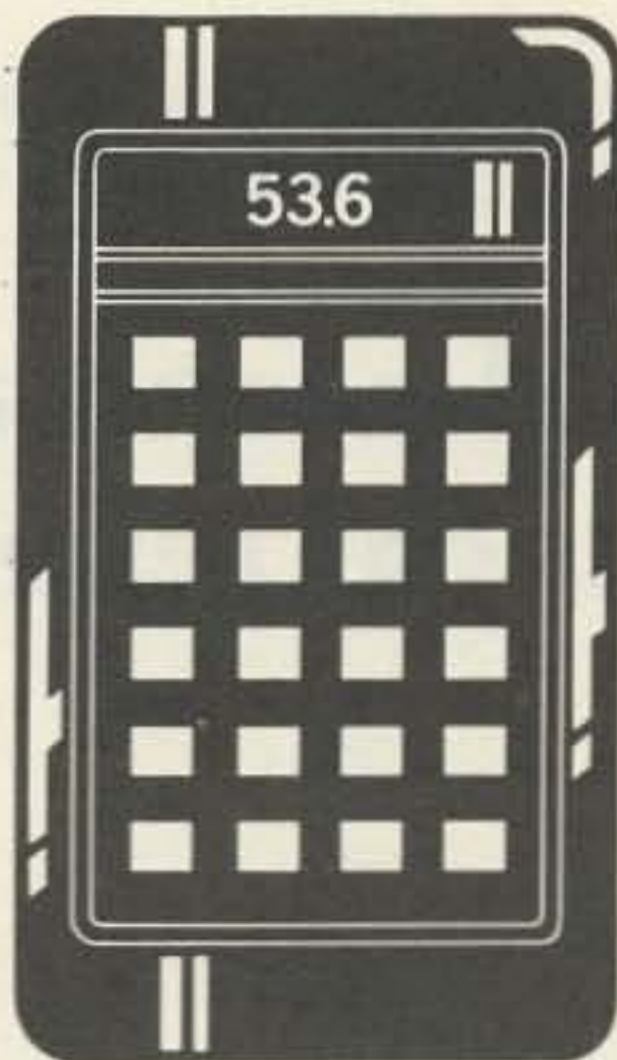

## ELECTRONIC DESIGN CALCULATOR

Electronics is a busy and creative field. Even the best technicians and theoreticians can use some help with the myriad calculations necessary to develop new products. That help has arrived!

The Electronic Design Calculator from Instant Software makes your TRS-80 the hardest worker in your lab (next to you, of course).

The Electronic Design Calculator brings dozens of complex calculations down to size in seconds. It can calculate two of the four possible values of Ohm's Law for A.C. and D.C., given the other two. It can also produce calculations for reactance, resonant frequency, resistors and capacitors in parallel and series, frequency and wavelength, decibel formulas and over two dozen others.

Free yourself from the drudgery of endless calculating. Make your work simpler and more accurate with the Electronic Design Calculator. (T1)

**No. 0204R \$9.95.**

## DYNAMIC DEVICE DRIVERS

Are you tired of working around all of the little "obstacles" that are built into your TRS-80? Ever wish that there was some way to "repair" those imperfections?

Well here it is! The Dynamic Device Drivers package has all of these features:

**Programmable Key Debounce:** Your keyboard can be "tuned" to your typing style.

**Programmable Repeating Key Function:** Every key has a repeat function.

**Lowercase Modification Support:** You have a choice of standard or shift-for-lowercase letters. (A lowercase hardware modification must be installed.)

**Better Than Nothing Graphics:** Graphics characters will be converted to the closest ASCII character.

**Printer/Screen Auto Switching:** If your printer is accidentally turned off, your program won't bomb.

**Programmable Printer Forms Control:** You control the format for printer output.

**Programmable Keyboard Lock:** Only you will know the secret code to unlock your keyboard.

With the Dynamic Device Drivers package, you can look forward to working WITH your TRS-80, instead of against it! (T1)

**No. 0228R \$19.95.**

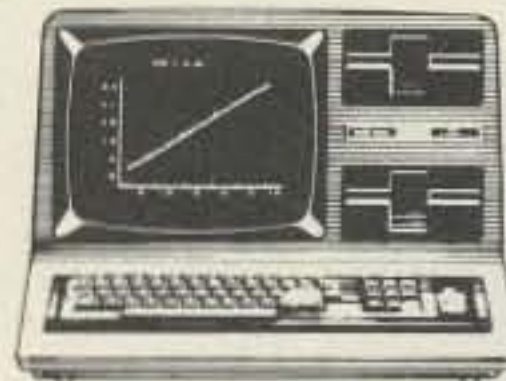

## TRS-Tests

TRS-Tests: three TRS-80 diagnostics will tell you if there are any problems with your computer. This machine-language utility checks Level II ROMs for dropped or defective bits by performing 128 consecutive checksums on each of the three ROM chips.

The Keybounce test helps to identify dirty or defective keys.

The RAM test tells you if your computer has a defective RAM chip, and will identify the chip according to the standard TRS-80 schematics.

Whether you repair computers for a living or only want to check out your own computer, you need TRS-TESTS. (T1)

**No. 0184R \$9.95.**

445

# Instant Software™ Inc.

PETERBOROUGH, NEW HAMPSHIRE 03458 603-924-7296

# Mayday!

— help locate downed aircraft with your local repeater

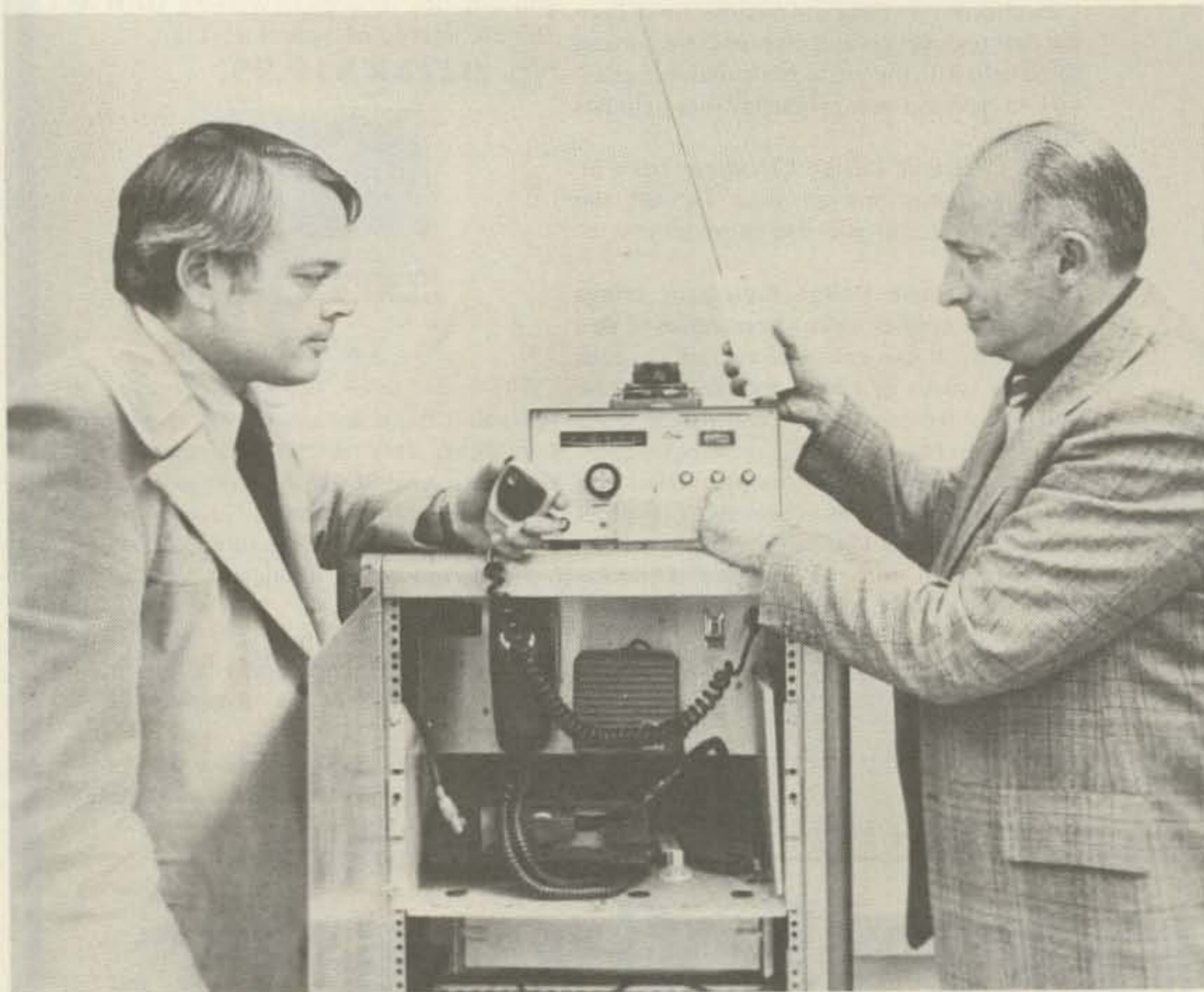

Photo A. Clifford Williams K2UZS (left) and Ed Sommerfield W2FJT check out ELT alert system.

Edward Sommerfield W2FJT  
49 Spring Road  
Poughkeepsie NY 12601

Richard Whatham K2JXU  
Box 1644  
Poughkeepsie NY 12601

Clifford Williams K2UZS  
5 Tanglewood Lane  
Poughkeepsie NY 12603

The public, from the beginning of the era of the Wright brothers, has been enthralled with almost all activities related to the airplane. Incidents related to aircraft disasters, especially the rescue of survivors, have always captured front-page headlines. Amateur radio, therefore, is presented with a rare opportunity to demonstrate our active involvement in public service with a project that first and foremost is of lifesaving benefit, and second is

most visible, in a positive light, to our community.

This project is the early detection and subsequent location of downed aircraft by use of the ELT (Emergency Locator Transmitter) beacon transmitter carried by law in all aircraft, and activated under crash conditions.

The MBARC (Mt. Beacon Amateur Radio Club) of Poughkeepsie, New York, was already involved in RDF (Radio Direction Finding), using it to rid ourselves of jammers. A proposal was put before the membership to channel the RDF experience and enthusiasm into the ELT lifesaving program. This proposal was unanimously accepted and within 3 weeks a modified Clegg 22'er was installed and operating at our local repeater site. Since our repeater is microprocessor controlled, we were able to experiment with various control and time functions. As a matter of fact, one of our engineering problems led to an especially humorous innovation as will be explained later.

### Implementation

The FCC prohibits the direct rebroadcasting of signals on the amateur frequencies other than those received by the repeater input. We contacted the FCC, and were advised that we could indicate the presence of an ELT signal by altering our CW ID.

Referring to Fig. 1, when an ELT signal is received, the increased agc on the Clegg 22'er, amplified by the interface, energizes K1. K1 provides an isolated closure to a digital input port on the microprocessor. If K1 remains energized for 5 minutes, our ID is varied to include an alerting 8 dots followed by a Morse code "ELT" (. . - . -). This modified alerting signal repeats every 2 minutes. Any ham

who hears this signal calls a predetermined list of personnel who, in turn, validate that it is indeed an ELT transmission and not a noise signal and subsequently notify RDF-equipped hams and the FAA.

After this has been done, the ELT mode is "controlled" off and not "controlled" back on until either the FAA advises us that the ELT has been located, or 48 hours have elapsed, whichever comes first. The ELT normal battery life is 48 hours and we don't want a continuous alerting signal, and phone calls, after the FAA has been notified. RDF-equipped hams then track the ELT to its source and take appropriate action. (See Table 1 for complete beacon specifications.)

### Electrical Interface

The electrical interface (Fig. 3) is very simple. The Clegg 22'er was modified for 121.5 MHz (Fig. 2) and RCA interface jacks added. One jack is for the agc line, and the other for 12.6 V ac to power the interface. The interface isolates and amplifies the dc agc level up to 5 times via Q1A, and feeds

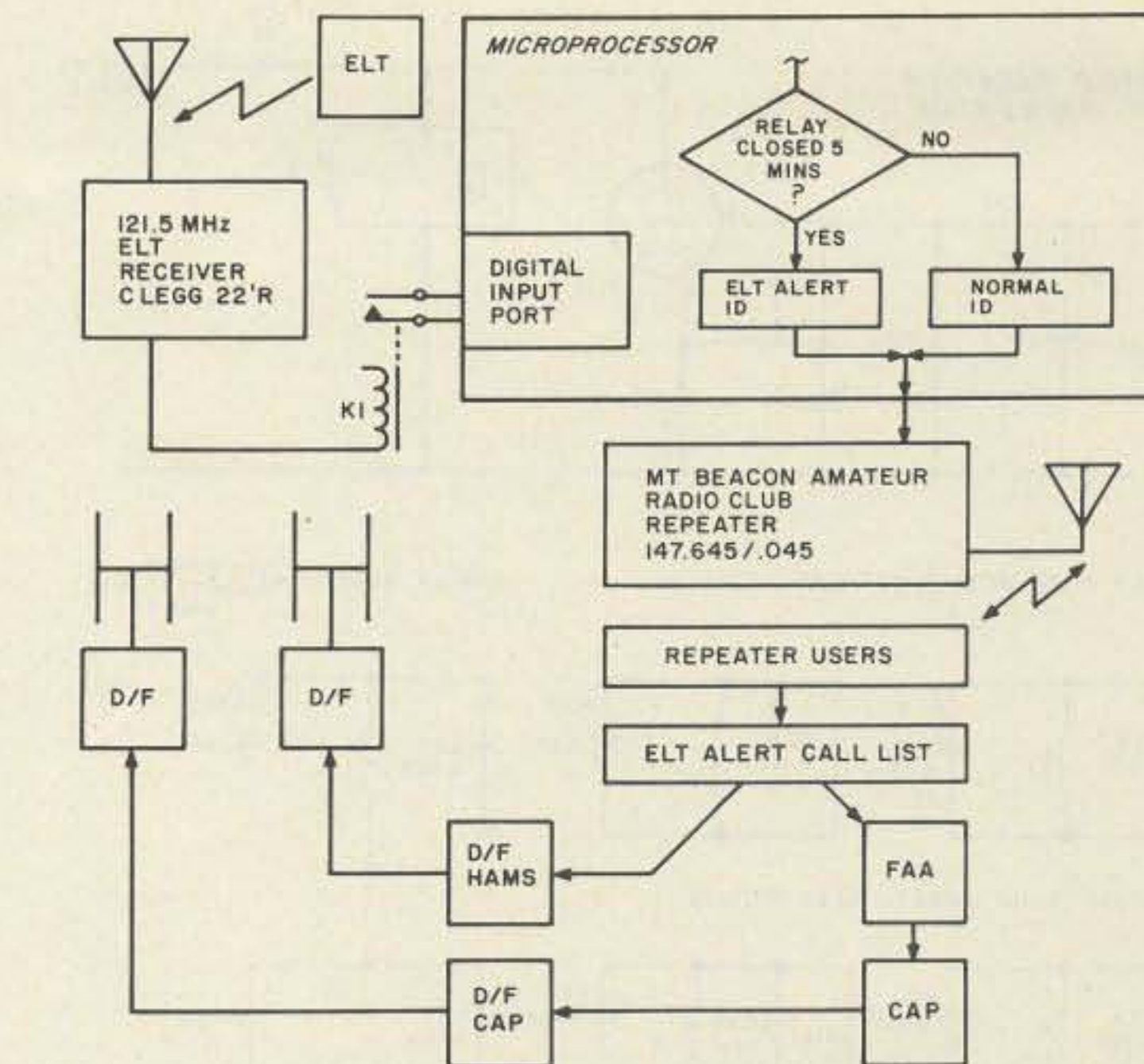

Fig. 1. Emergency Locator Transmitter (ELT) alerting system.

it to the inverted input of voltage comparator Q1B. The voltage comparator is adjusted, via R3, such that Q1B output is at -12 volts under no-ELT-signal conditions. This level ensures that Q2, the relay driver, is off.

When an ELT carrier is received, the Clegg 22'er agc voltage becomes more negative, causing the Q1B inverted input level to go more negative than the adjustable non-inverted level

as set by R3. The comparator output under these conditions goes to +5 volts. This positive voltage disconnects diode D1 and allows current to flow into the base of Q2 via diode D2, turning on Q2, and in turn K1. The activation of K1 presents a contact closure to the microprocessor digital input.

The flowchart in Fig. 4(a) shows that this digital input port is sampled every second and if all samples in a

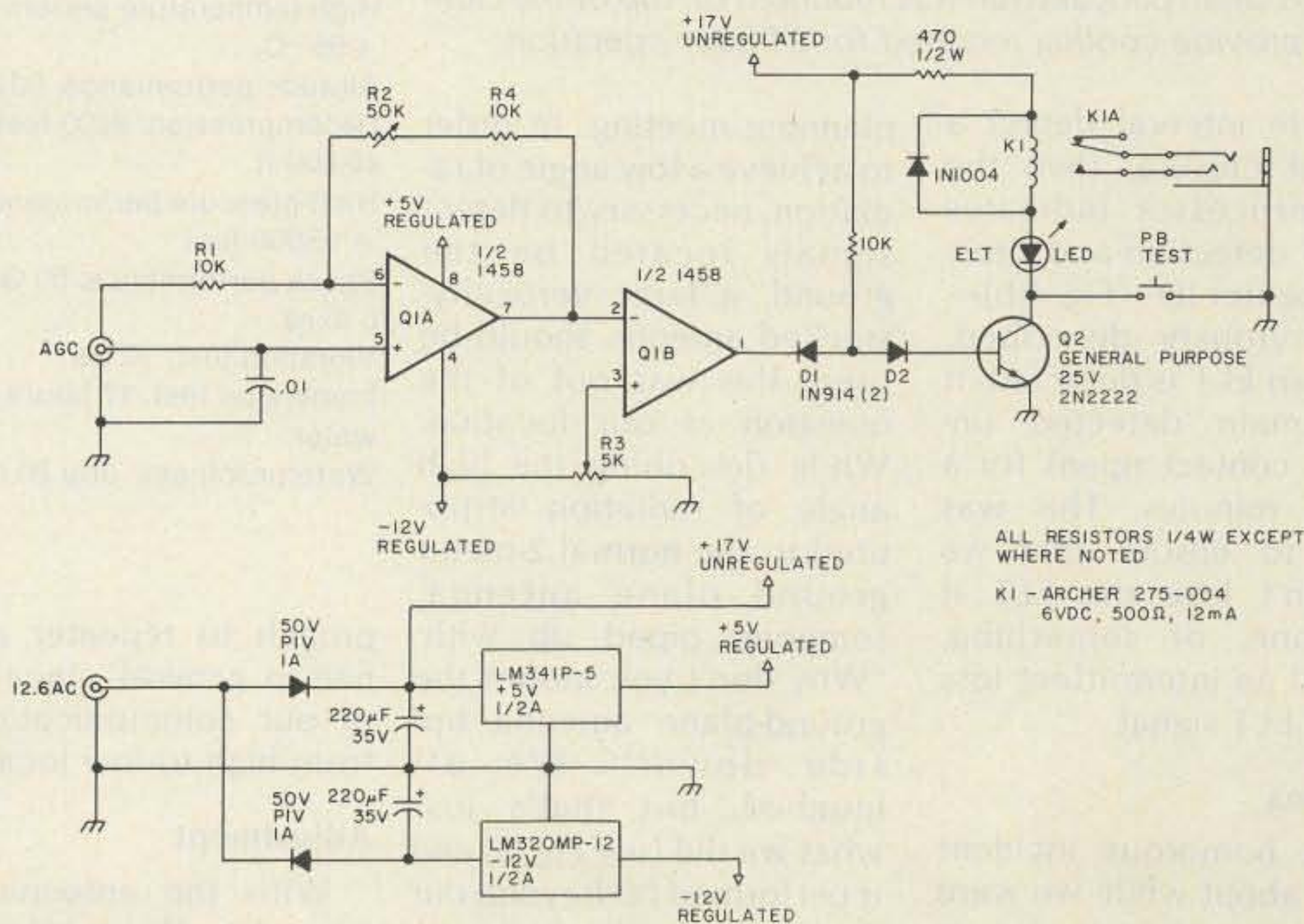

Fig. 2. Interface from Clegg 22'er to microprocessor.

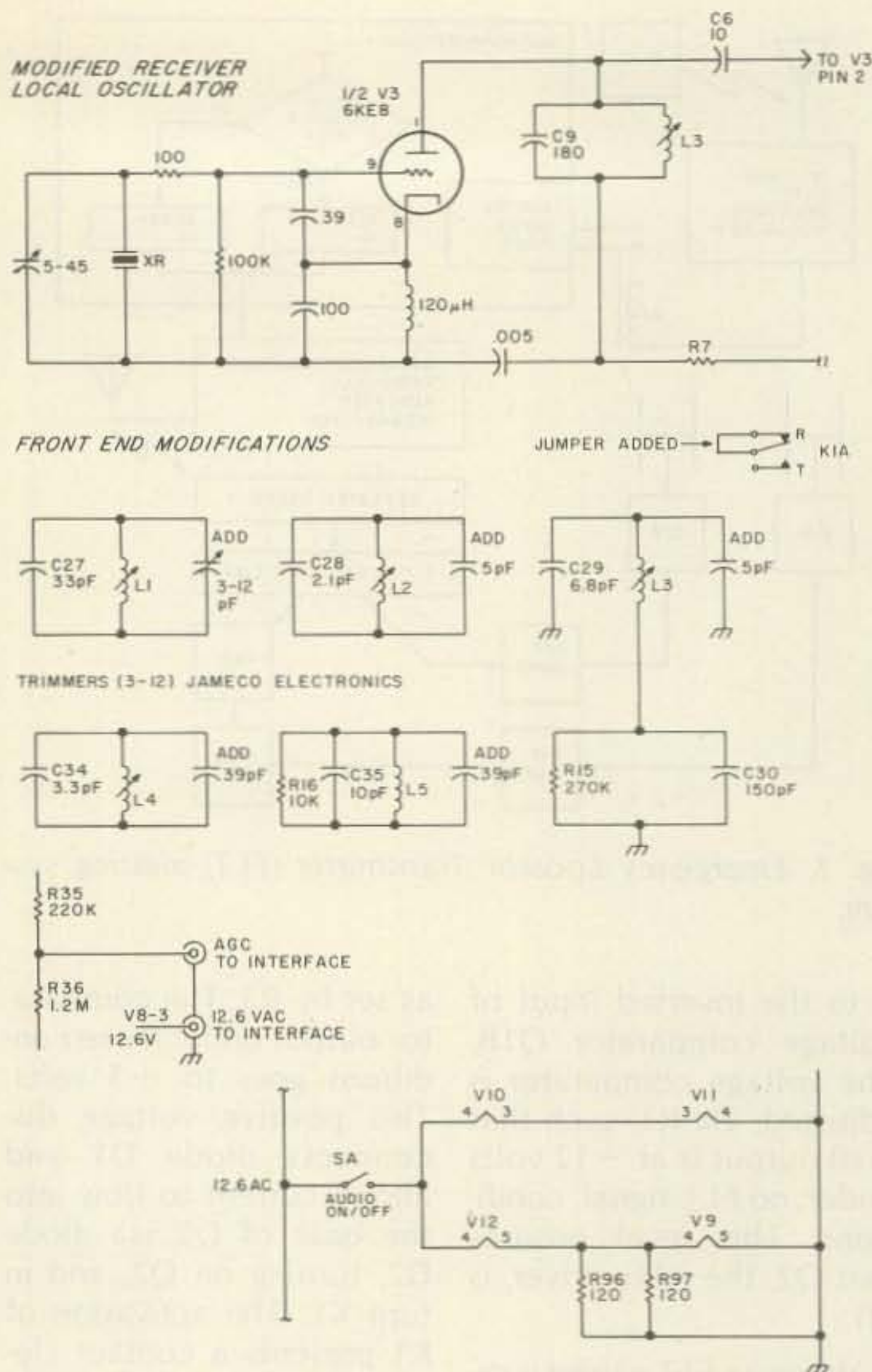

Fig. 3. Modifications to Clegg 22'er for 121.5-MHz ELT reception. XR = 8.262500 MHz for 121.5-MHz input, use International Crystal Manufacturing Co. catalog #433478 (10 North Lee, Oklahoma City OK 73102). Modifications include removal of V13, V14, and V15. Do not remove V12. This turns off audio and reduces heat generated by unused tubes. A small pancake fan was mounted on top of the cabinet to provide cooling required for 24-hour operation.

5-minute interval detect a contact closure, then the microprocessor indicates an ELT detection and alters the repeater ID—Fig. 4(b)—as previously described. Once an ELT is detected, it will remain "detected" until the contact opens for a full 5 minutes. This was done to ensure that we wouldn't lose the ELT if someone, or something, caused an intermittent loss of the ELT signal.

**Antenna**

The humorous incident came about while we were discussing the antenna installation at an engineering

planning meeting. In order to achieve a low angle of radiation, necessary to detect signals located on the ground, a large vertically-stacked antenna should be used; this was out of the question at our location. While describing the high angle of radiation attributed to the normal 2-meter ground plane antenna, someone piped up with: "Why don't you mount the ground-plane antenna upside down?" We all laughed, but that's just what we did (see Fig. 5) and it performed far beyond our expectations. In fact, we are considering this ap-

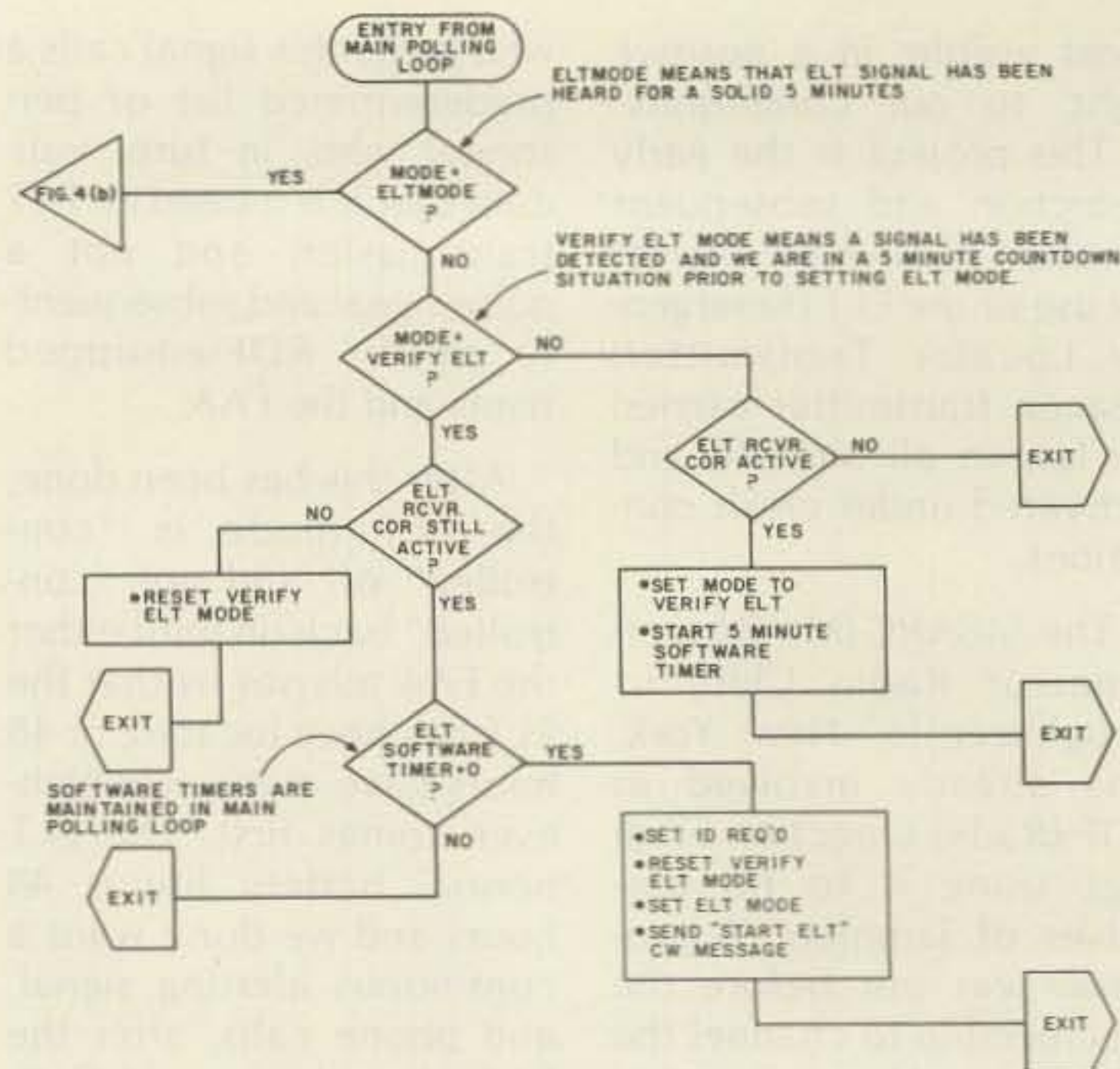

Fig. 4(a). System flowchart.

**ELT Beacon Specifications (EBC-102A Data Sheet)**

Operating life, room temperature	—Greater than 48 hours
Operating frequency	—121.500 MHz ± .005% and 243.000 MHz ± .005%
Modulation percentage	—100%
Sweep range	—1300 Hz to 400 Hz
Sweep rate	—3 Hz
Modulation duty cycle	—45%
Transmitter duty cycle	—100%
Peak effective radiant power	—Greater than 75 mW on both frequencies
Automatic activation	—Minimum 5 Gs for 12 ms Maximum 7 Gs for 15 ms
Temperature variation test	—Frequencies within ± .005% after exposure
—40° C. to +55° C.	
Low-temperature performance:	
—20° C.	
High-temperature performance:	
+55° C.	
Altitude performance:	
50,000 ft.	
Decompression:	
8200 feet to 40,000 ft.	
High-pressure performance:	
—15,000 feet	
Shock performance:	
50 Gs, 6 axes	
Vibration test:	
10 Gs	
Immersion test:	
17 hours in salt water	
Waterproofness:	
drip 20 minutes	

Table 1.

proach to repeater antennae in general, since most of our communications is from high to low locations.

**Adjustment**

With the antenna connected to the receiver, initially adjust R2 to maxi-

imum resistance, and R3 to ground level. Then, adjust R3 until the ELT LED in the collector circuit of Q2 just turns off. Adjust R3 an additional 1/8 turn in the same direction. If the ELT LED cannot be turned off, adjust R2 to a lower resistance,



and repeat the R3 adjustment.

### Problems

We have encountered only one problem so far. The second harmonic of TV channel 3 is in the 120-to-132-MHz range. TV games on channel 3, incorrectly connected to a TV set with its outside antenna attached, will radiate in the 120-MHz range. We advised our close-in neighbor of this problem, and interference to the ELT receiver stopped.

### Operating Experience

ELT transmitters may legally be tested during the first five minutes of every hour. We installed the ELT detector system on a Thursday evening. The following Friday a call was received that the repeater detected an ELT at 1330, which is not within an allowable 5 minute ELT testing period. A call to the FAA confirmed the ELT signal, but before any action could be taken, the ELT was shut off—they thought no one was listening! A second similar incident occurred within 2 weeks. We hope that we never have to hear the 8 dots and the ELT alerting signal, but we routinely test the detector during the legal test time, using a private aircraft transmitter.

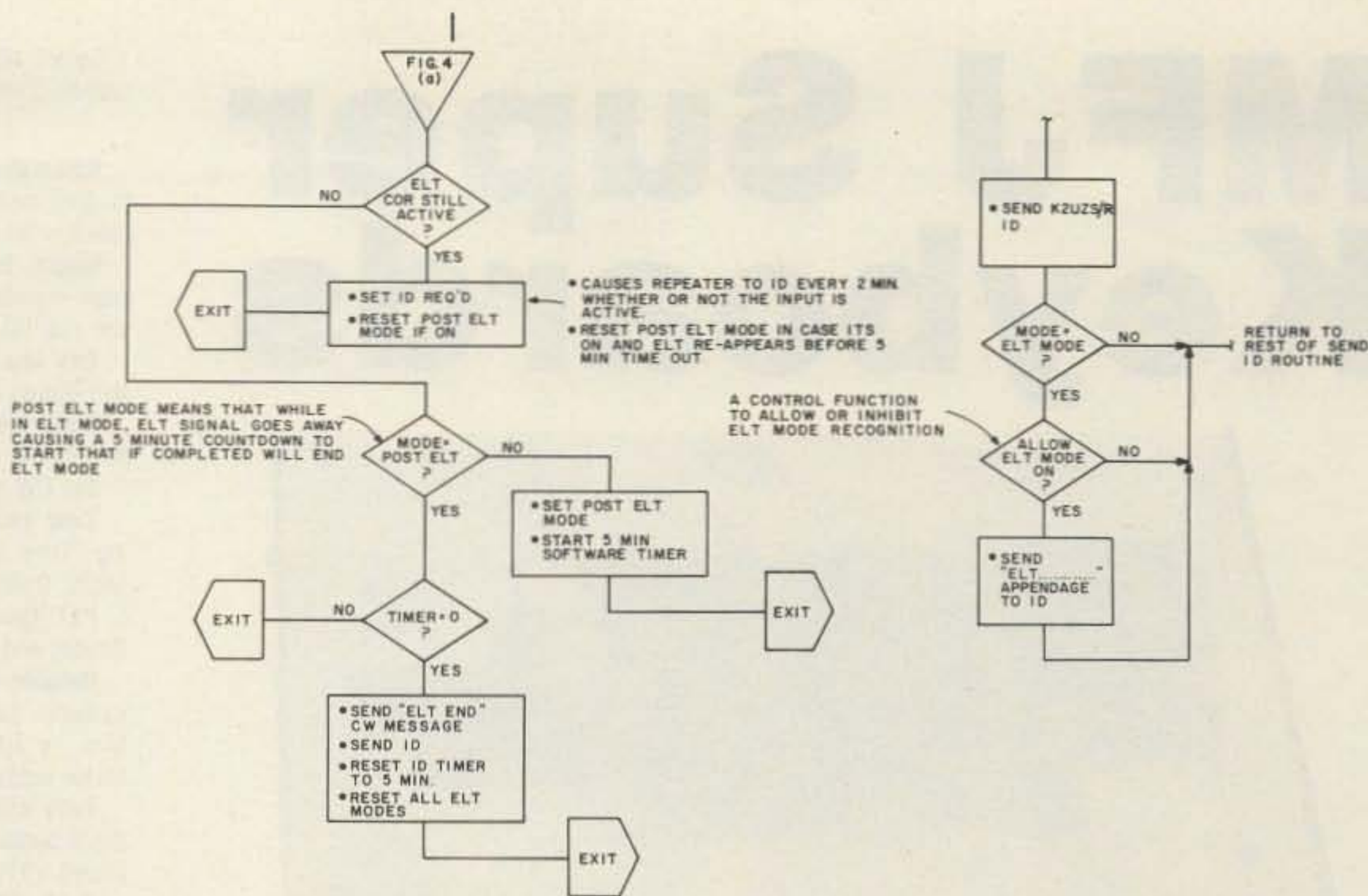

Fig. 4(b). Detail of ELT ID.

### Conclusion

Future plans include upgrading the ELT detector installation from the omni-directional antenna to a controlled directional antenna such that triangulation between 2 or more repeaters would point out the initial direction to search. This would cut the search time considerably. Ideally, if we could equip every repeater station with an ELT detector, help could be on the way within 5 minutes after the ELT is detected.

No other organization

has the equivalent of an umbrella of actively monitored radio stations, located ideally at high elevations. Also, there are very few organizations

around that have the quantity of equipment and number of trained RDF personnel that hams can assemble to detect and search for ELTs. ■

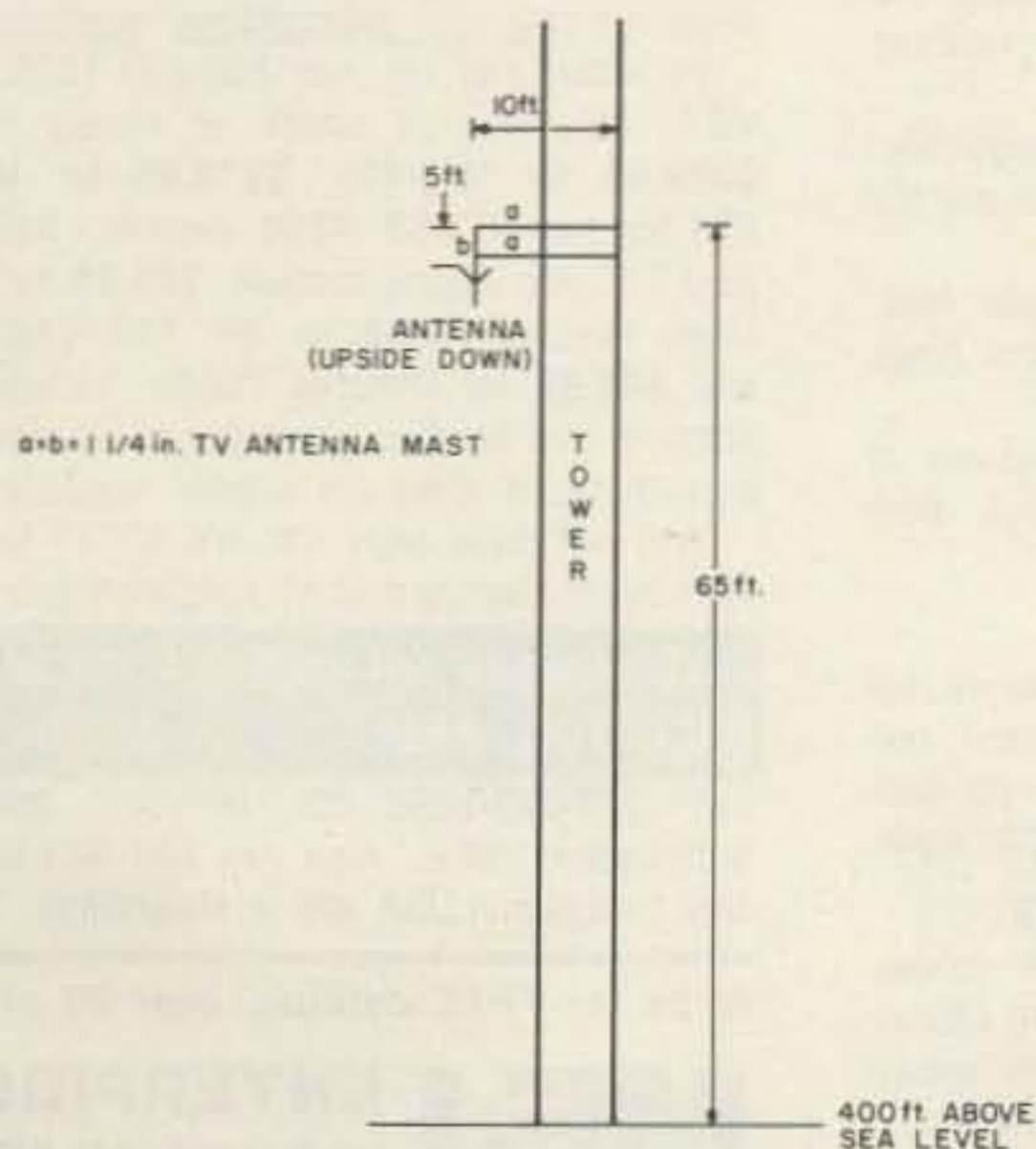

Fig. 5. Antenna mounting details.

**73, THE GISMO GANG**

**G.I.S.M.O.** (803) 366-7157  
**2305 CHERRY ROAD**  
**ROCK HILL, S.C. 29730**

Service Department  
Call 803-366-7158

Order Toll Free! ✓27  
**800•845•6183**

# MFJ Super Keyboards



**5 MODES:** CW, Baudot, ASCII, memory keyer, Morse code practice. **TWO MODELS:** MFJ-496, \$339.95. 256 character buffer, 256 character message memory, automatic messages, serial numbering, repeat/delay. MFJ-494, \$279.95. 50 character buffer, 30 character memory, automatic messages.

MFJ brings you a pair of 5 Mode Super Keyboards that gives you more features per dollar than any other keyboard available. You can send CW, Baudot, ASCII. Use it as a memory keyer and for MORSE code practice.

You get text buffer, programmable and automatic message memories, error deletion, buffer preload, buffer hold, plus much more.

#### MODE 1: CW

The 256 character (50 for 494) text buffer makes sending perfect CW effortless even if you "hunt and peck."

You can preload a message into the buffer and transmit when ready. For break-in, you can stop the buffer, send comments on key paddles and then resume sending the buffer content.

Delete errors by backspacing.

A meter gives buffer remaining or speed. Two characters before buffer full the meter lights up red and the sidetone changes pitch.

Four programmable message memories (2 for 494) give a total of 256 characters (30 for 494). Each message starts after one ends for no wasted memory. Delete errors by backspacing.

To use the automatic messages, type your call into message A. Then by pressing the CQ button you send CQ CQ DE (message A).

The other automatic messages work the same way: CQ TEST DE, DE, QRZ.

Special keys for KN, SK, BT, AS, AA and AR.

A lot of thought has gone into human engineering these MFJ Super Keyboards.

For example, you press only a one or two key sequence to execute any command.

All controls and keys are positioned logically and labeled clearly for instant recognition.

Pots are used for speed, volume, tone, and

weight because they are more human oriented than keystroke sequences and they remember your settings when power is off.

Weight control makes your signal distinctive to penetrate QRM.

#### MODE 2 & 3 (RTTY): BAUDOT & ASCII

5 level Baudot is transmitted at 60 WPM. Both RTTY and CW ID are provided.

Carriage return, line feed, and "LTRS" are sent automatically on the first space after 63 characters on a line. This gives unbroken words at the receiving end and frees you from sending the carriage return. After 70 characters the function is initiated without a space.

All up and down shift is done automatically. A downshift occurs on every space to quickly clear garbled reception.

The buffer, programmable and automatic messages, backspace delete and PTT control (keys your rig) are included.

The ASCII mode includes all the features of Baudot. Transmission speed is 110 baud. Both upper and lower case are generated.

#### MODE 4: MEMORY KEYS

Plug in a paddle to use it as a deluxe full feature memory keyer with automatic and programmable memories, iambic operation, dot-dash memories, and all the features of the CW mode.

#### MODE 5: MORSE CODE PRACTICE

There are two Morse code practice modes. Mode 1: random length groups of random characters. Mode 2: pseudo random 5 character groups in 8 separate repeatable lists (with answers).

Insert space between characters and groups to form high speed characters at slower speed for easy character recognition.

Select alphabetic or alphanumeric plus punctuation. You can even pause and then resume.

#### MORE FEATURES

Automatic incrementing serial number from 0 to 999 can be inserted into buffer or message memory for contests.

Repeat function allows repetition of any message memory with 1 to 99 seconds delay. Lets you call CQ and repeat until answered.

Two key lockout operation prevents lost characters during typing speed bursts.

Clock option (496 only) send time in CW, Baudot, ASCII. 24 hour format.

Set CW sending speed before or while sending.

Tune switch with LED keys transmitter for tuning. Tune key provides continuous dots to save finals. Built-in sidetone and speaker.

PTT (push-to-talk) output keys transmitter for Baudot and ASCII modes.

Reliable solid state keying for CW: grid block, cathode, solid state transmitters (-300V, 10 ma Max, +300V, 100 ma Max). TTL and open collector outputs for RTTY and ASCII.

Fully shielded. RF proof. All aluminum cabinet. Black bottom, eggshell white top. 12"Dx7"Wx1 1/4"H (front) x3 1/2"H (back). Red LED indicates on.

9-12 VDC or 110 VAC with optional adapter.

MFJ-494 is like MFJ-496 less sequential numbering, repeat/delay functions. Has 50 character buffer, 30 character message memory. Clock option not available for MFJ-494.

Every single unit is tested for performance and inspected for quality. Solid American construction.

#### OPTIONS

MFJ-53 AFSK PLUG-IN MODULE. 170 and 850 Hz shift. Output plugs into mic or phone patch jack for FSK with SSB rigs and AFSK with FM or AM rigs. \$39.95 (+ \$3).

MFJ-54 LOOP KEYING PLUG-IN MODULE. 300V, 60 ma loop keying circuit drives your RTTY printer. Opto-isolated. TTL input for your computer to drive your printer. \$29.95 (+ \$3).

MFJ-61 CLOCK MODULE (MFJ-496 only). Press key to send time in CW, Baudot or ASCII. 24 hour format. \$29.95 (+ \$3).

110 VAC ADAPTER. \$7.95 (+ \$3).

BENCHER IAMBIC PADDLE. \$42.95 (+ \$4).

#### A PERSONAL TEST

Give the MFJ-496 or MFJ-494 Super Keyboard a personal test right in your own ham shack.

Order one from MFJ and try it — no obligation. See how easy it is to operate and how much more enjoyable CW and RTTY can be. If not delighted, return it within 30 days for refund (less shipping). One year unconditional guarantee.

To order, call toll free 800-647-1800. Charge VISA, MC, or mail check or money order for \$339.95 for MFJ-496, \$279.95 for MFJ-494, \$39.95 for MFJ-53 AFSK module, \$29.95 for MFJ-54 Loop Keying module, \$29.95 for MFJ-61 Clock module, \$7.95 for the 110 VAC adapter and \$42.95 for Bencher Paddle. Include \$5.00 shipping and handling per order or as indicated in parentheses if items are ordered separately.

Why not really enjoy CW and RTTY? Order your MFJ Super Keyboard at no obligation today.

**TO ORDER OR FOR YOUR NEAREST DEALER  
CALL TOLL FREE . . . . 800-647-1800**

Call 601-323-5869 for technical information, order/repair status. Also call 601-323-5869 outside continental USA and in Mississippi.

Write for FREE catalog, over 80 products

**MFJ ENTERPRISES,  
INCORPORATED**

Box 494, Mississippi State, MS 39762

# MFJ

# ANTENNA TUNERS

16  
MODELS

## MFJ-941C 300 Watt Versa Tuner II

Has SWR/Wattmeter, Antenna Switch, Balun. Matches everything 1.8-30 MHz: dipoles, vees, random wires, verticals, mobile whips, beams, balanced lines, coax lines.



*Ham Radio's most popular antenna tuner. Improved, too.*

# \$89<sup>95</sup>

Fastest selling MFJ tuner . . . because it has the most wanted features at the best price.

Matches everything from 1.8-30MHz: dipoles, inverted vees, random wires, verticals, mobile whips, beams, balanced and coax lines.

Run up to 300 watts RF power output.

SWR and dual range wattmeter (300 & 30 watts full scale, forward/reflected power). Sensitive meter measures SWR to 5 watts.

Flexible antenna switch selects 2 coax lines, direct or through tuner, random wire/balanced line, or tuner bypass for dummy load.

12 position efficient airwound inductor for lower losses, more watts out.

Built-in 4:1 balun for balanced lines. 1000V capacitor spacing.

Works with all solid state or tube rigs.

Easy to use, anywhere. Measures 8x2x6", has

S0-239 connectors, 5-way binding posts, finished in eggshell white with walnut-grained sides.

4 Other 300W Models: MFJ-940B, \$79.95 (+ \$4), like 941C less balun. MFJ-945, \$79.95 (+ \$4), like 941C less antenna switch. MFJ-944, \$79.95 (+ \$4), like 945, less SWR/Wattmeter. MFJ-943, \$69.95 (+ \$4), like 944, less antenna switch. Optional mobile bracket for 941C, 940B, 945, 944, \$3.00.

### MFJ-900 VERSA TUNER



MFJ-900

**\$44<sup>95</sup>** (+ \$4)

Matches coax, random wires 1.8-30 MHz.

Handles up to 200 watts output; efficient air-wound inductor gives more watts out. 5x2x6"

Use any transceiver, solid-state or tube.

Operate all bands with one antenna.

2 OTHER 200W MODELS:

MFJ-901, \$54.95 (+ \$4), like 900 but includes 4:1 balun for use with balanced lines.

MFJ-16010, \$34.95 (+ \$4), for random wires only. Great for apartment, motel, camping, operation. Tunes 1.8-30 MHz.

### MFJ-949B VERSA TUNER II



MFJ-949B

**\$139<sup>95</sup>** (+ \$4)

MFJ's best 300 watt Versa Tuner II.

Matches everything from 1.8-30 MHz, coax, randoms, balanced lines, up to 300W output, solid-state or tubes.

Tunes out SWR on dipoles, vees, long wires, verticals, whips, beams, quads.

Built-in 4:1 balun. 300W, 50-ohm dummy load. SWR meter and 2-range wattmeter (300W & 30W).

6 position antenna switch on front panel, 12 position air-wound inductor; coax connectors, binding posts, black and beige case 10x3x7".

### MFJ-962 VERSA TUNER III



MFJ-962

**\$199<sup>95</sup>** (+ \$4)

Run up to 1.5 KW PEP, match any feed line from 1.8-30 MHz.

Built-in SWR/Wattmeter has 2000 and 200 watt ranges, forward and reflected.

6 position antenna switch handles 2 coax lines, direct or through tuner, plus wire and balanced lines.

4:1 balun. 250 pf 6KV cap. 12 pos. inductor. Ceramic switches. Black cabinet, panel.

ANOTHER 1.5 KW MODEL: MFJ-961, \$179.95 (+ \$10), similar but less SWR/Wattmeter.

### MFJ-984 VERSA TUNER IV

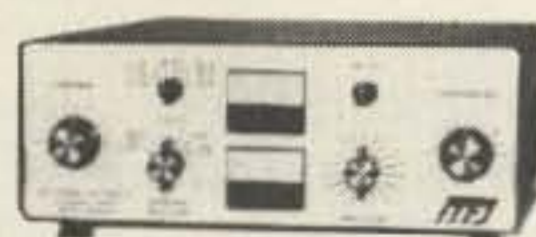

MFJ-984

**\$299<sup>95</sup>** (+ \$10)

Up to 3 KW PEP and it matches any feedline, 1.8-30 MHz, coax, balanced or random.

10 amp RF ammeter assures max. power at min. SWR. SWR/Wattmeter, for./ref., 2000/200W.

18 position dual inductor, ceramic switch.

7 pos. ant. switch. 250 pf 6KV cap. 5x14x14"

300 watt dummy load. 4:1 ferrite balun.

3 MORE 3 KW MODELS: MFJ-981, \$209.95 (+ \$10), like 984 less ant. switch, ammeter.

MFJ-982, \$209.95 (+ \$10), like 984 less ammeter, SWR/Wattmeter. MFJ-980, \$179.95 (+ \$10), like 982 less ant. switch.

### MFJ-989 VERSA TUNER V



MFJ-989

**\$319<sup>95</sup>** (+ \$10)

New smaller size matches new smaller rigs — only 10-3/4Wx4-1/2Hx14-7/8D".

3 KW PEP. 250 pf-6KV caps. Matches coax, balanced lines, random wires 1.8-30 MHz.

Roller inductor, 3-digit turns counter plus spinner knob for precise inductance control to get that SWR down.

Built-in 300 watt, 50 ohm dummy load.

Built-in 4:1 ferrite balun.

Built-in lighted 2% meter reads SWR plus forward/reflected power. 2 ranges (200 & 2000W).

6 position ant. switch. Al. cabinet. Tilt bail.

To order or for your nearest dealer

CALL TOLL FREE  
800-647-1800

For tech. info., order or repair status, or calls outside continental U.S. and inside Miss., call 601-323-5869.

- All MFJ products unconditionally guaranteed for one year (except as noted).
- Products ordered from MFJ are returnable within 30 days for full refund (less shipping).
- Add shipping & handling charges in amounts shown in parentheses.

Write for FREE catalog, over 80 products

## MFJ ENTERPRISES, INCORPORATED

Box 494, Mississippi State, MS 39762

# An 820S Remote Vfo

## — using the rig's counter and display

**W**hile the Clipperton DXpedition was in operation, a friend of mine down the street, Ari VE5AAO, was becoming very frustrated trying to work the split frequency with his Kenwood TS-820S. It was then we realized that

an outboard vfo was a necessity for DX work and we set about putting something together from the junk box.

It turned out to be extremely simple, and another friend, Lorne VE5NO, urged (nagged) me to write

it up for 73 because of the many 820S owners who might wish to build this simple project. What makes it so simple in this case is that you need not bother making any kind of frequency-readout dial—the Kenwood counter and display

do it for you. Other remote vfos that I have built required the construction of some kind of dial and, even with tedious hours of calibration and dial marking (I had no counter then), the resolution and accuracy left a lot to be desired.

All this is eliminated when using the Kenwood with digital readout. When transceiving with the remote vfo, the frequency displayed on the Kenwood will be that of the remote. When transmitting with the Kenwood and receiving on the remote vfo, the display will read the Kenwood vfo when transmitting and the remote vfo when receiving. A front-panel LED indicator shows when the remote vfo is active. So you can see that a mechanical dial on the remote unit would be redundant.

The Transceive/Separate switch allows one to transceive with the remote vfo or, in the Separate position, to receive with the remote and transmit with the TS-820S. The Remote/820 switch allows one to choose which vfo will exercise main control.

The heart of this very stable circuit is the Seiler oscillator; the output level



Photo A. The completed remote vfo.

# IF YOU DIDN'T CALL THIS NUMBER

TOLL-FREE

# 1-800-325-3636

BEFORE BUYING

- Collins
- Dentron
- Drake
- ICOM
- Kenwood
- Tempo
- Ten-Tec
- Swan
- Yaesu

# YOU

PROBABLY

# PAID TOO MUCH !!

**HAM RADIO CENTER**  
8340-42 Olive Blvd. • P.O. Box 28271 • St. Louis, MO 63132 ✓32



varies little when the vfo is tuned through its range, and resettability is excellent. The buffer stage uses an FET operated in class A to minimize loading on the vfo. The emitter-follower provides a low-impedance output for driving the Kenwood circuits.

Temperature compensation requirements are minimal because of the high stability of the variable oscillator circuitry. In this circuit, stability is primarily a function of the tuned-circuit components and is only slightly affected by the active device. Although not used in my unit, a negative-temperature-coefficient capacitor could be used in the tank circuit to take care of any temperature-induced drift.

Construction is straightforward but consistent with good vfo construction techniques. My vfo was built inside a 12.7 cm x 17.8 cm (5" x 7") aluminum chassis on a 6 cm x 10 cm epoxy PC board. If you prefer not to use a circuit board, any wiring method should work equally well. Mechanically, everything should be rigid.

C2 should be a good quality variable; mine came from surplus equipment complete with a good gear-reduction drive, a necessity for slow SSB tuning. L1 should be wound on a ceramic form and capacitor C4 should be a silver mica. The values of the tuning circuit components were arrived at experimentally to achieve a vfo frequency of 5.0 to 5.5 MHz. I did not use C3 for calibration purposes in my unit, but simply pruned L1 until the desired range was obtained. Depending on the capacity of your variable, the value of C4 may need altering to bring the vfo into the desired range.

I would encourage you to use parts you have available and experiment a little. In some cases, I have even pulled plates out of the var-

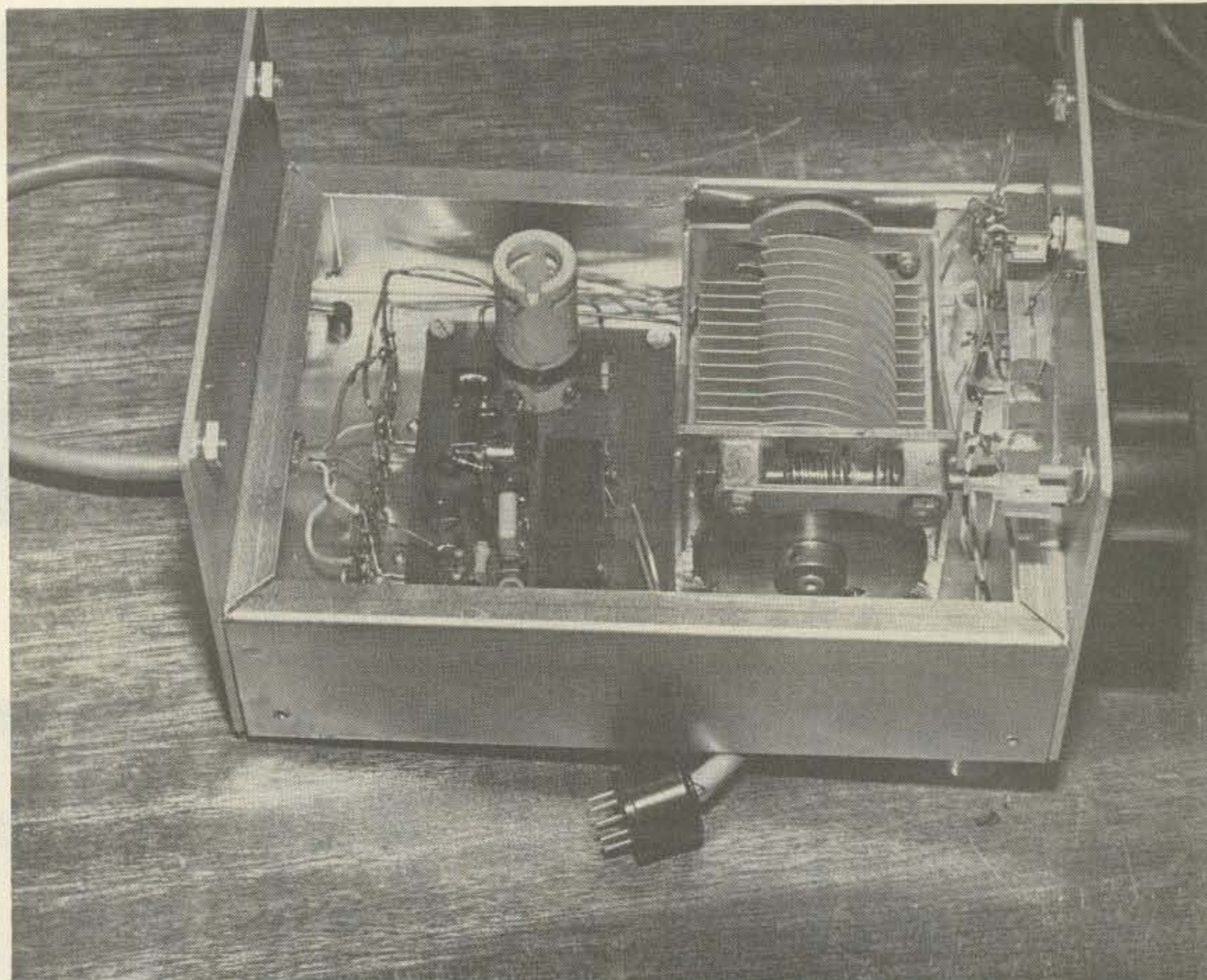

Photo B. Construction details. Oscillator board is mounted at back of chassis. Surplus capacitor (front) includes gear drive.

iable capacitor to arrive at the range I wanted—just go slowly, and remember, you can't put the plates back in!

It is not necessary to regulate the voltage to this vfo because the voltage supplied by the Kenwood socket is regulated. The

whole unit is connected to the Kenwood transceiver by a 9-pin plug which mates a 9-pin tube socket in the Kenwood rear panel.

Stability has been found to be good. From a cold start my vfo drifts 80 Hz in the first five minutes, and

less thereafter. This amount of drift is really not detectable without the aid of a counter.

Good luck with your project and good DX—on split frequencies. My thanks to Brian Dunn for the photography. ■

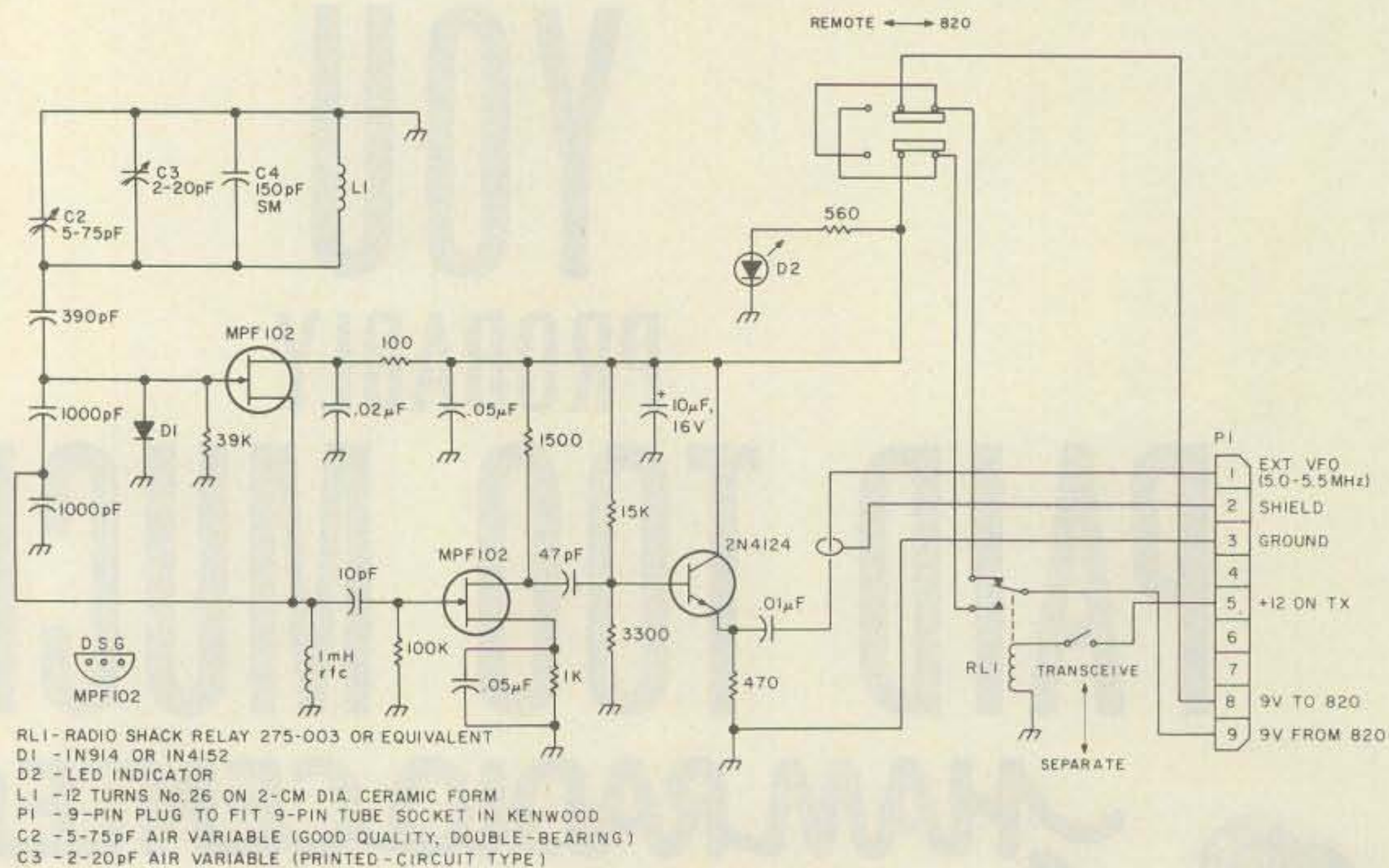

Fig. 1. Schematic for the Kenwood TS-820S remote vfo.

electronic mail

aerospace

press

satellite

training aids

embassy/diplomatic

maritime

government

emergency/disaster

meteorological

oceanographic

handicapped

civil defense

# CONSIDER THE

# ATR-6800

You know of its reputation in Amateur Radio. But did you know of its world-wide uses in commercial/industrial communications networks? ATR-6800's are communicating over land-lines, via satellite, and on HF/VHF radio links all over the world. They're teaching Morse Code on military bases around the country and operating as TELEX & TWX terminals. We offer engineering expertise for your particular requirement be it Data Encryption, Computerized Training or any special interest. ATR-6800 with 9" video monitor and one plug-in Applications Module . . . \$2495. Companion MX-80 printer . . . \$699. Contact the "REAL-WORLD" at MICROLOG CORP. 4 Professional Drive, Suite 119, Gaithersburg, Md. 20760. TEL: (301) 948-5307. TELEX: 908778. You'll be pleasantly surprised.



✓51

## MICROLOG

INNOVATORS IN DIGITAL COMMUNICATION

# Maximize That Multimeter

## — add a few features the manufacturer forgot

Most amateurs probably have relatively inexpensive solid-state multimeters that fall somewhere in the class between old tube-type VTVMs and the digital generation of multimeters. Such "middle generation" multimeters can still suffice for many noncritical applications around any shack. After all, for occasional troubleshooting one does not need an auto-zeroing, auto-polarity, and auto-ranging digital marvel. So don't look forlornly at your multimeter and wish it were a digital with one-inch readouts; why not add a few little

convenience features to it and enjoy the instrument as being a good buy at yesteryear's prices?

This article presents a potpourri of ideas which I have tried on my Heath IM-17. They can be used on almost any multimeter to improve the instrument's performance and convenience in actual use.

One thing that was all too easy to do with the Heath IM-17 was to leave it turned on when not being used and thus run down the three-dollar mercury batteries the manufacturer recommends to power the transistor circuitry. So, one of

the first items added was an LED flasher circuit to indicate that the meter was turned on. The LM3909 circuit (Fig. 1) was used. The LED itself was mounted on the front panel of the meter and can be seen in Photo A, just under the letter "M" in "voltmeter".

The LM3909 itself was mounted on a piece of perforated board stock inside the meter. In the Heath IM-17, the on-off switch also switches the 1.5-volt battery used for the Ohms circuit, so pin 5 of the LM3909 was simply connected to this circuit. The LM3909 can be used with any battery voltage, however, simply by connecting a suitable series resistor to pin 5 (experiment with 1 kilohm for a 9-volt battery). Considering that the whole LM3909 circuitry cost around \$1.50, its installation has paid for itself many times over in battery savings.

The IM-17 was housed originally in a plastic carrying case that folded shut. The case was fine for field work, but very awkward for bench work. So, as shown in Photo B, it was rehoused in a home-built Plexiglas™

case. One need not construct such an elaborate housing if a standard-size metal enclosure can be found. However, the Plexiglas was on hand and it is a relatively easy material to work with, using ordinary hand tools.

The next step was to modify the awkward test lead setup in the IM-17. Like many multimeters, it had three test leads: a common lead, one lead for ac/Ohms, and one lead for dc voltage measurements. The number of leads was awkward and the types of leads supplied were more suited to 10-Ampere battery circuits than transistor circuitry. As shown in Fig. 2(a), the only reason for having a separate dc lead was so that a 1-megohm isolating resistor could be used in the dc probe. Most modern multimeters do not have such a resistor, and the usefulness of such a resistor is debatable.

As shown in Fig. 2(b), the resistor was moved back into the inside of the IM-17 circuitry and this resulted in there being only two test leads needed for all functions. The resistor was re-



Photo A. Front panel of the IM-17.



# MORE PERFORMANCE FOR YOUR DOLLAR! COMPETITORS KNOW ABOUT THE ISOPOLE™

## DO YOU? STUDY THE FACTS ...

The IsoPole is building a strong reputation for quality in design and superior performance. The IsoPole's acceptance has already compelled another large antenna producer to make a major design modification to his most popular VHF Base Station antenna. Innovative IsoPole conical sleeve decouplers (pat. pend.) offer many **new** design advantages.

All IsoPole antennas yield the **maximum gain attainable** for their respective lengths and a zero degree angle of radiation. Exceptional decoupling results in simple tuning and a significant reduction in TVI potential. Cones offer greater efficiency over obsolete radials which radiate in the horizontal plane and present an unsightly bird's roost with an inevitable "fallout zone" below. The IsoPoles have the broadest frequency coverage of any comparable VHF base station antenna. This means no loss of power output from one end of the band to the other, when used with SWR protected solid state transceivers. **Typical SWR is 1.4 to 1 or better across the entire band!**

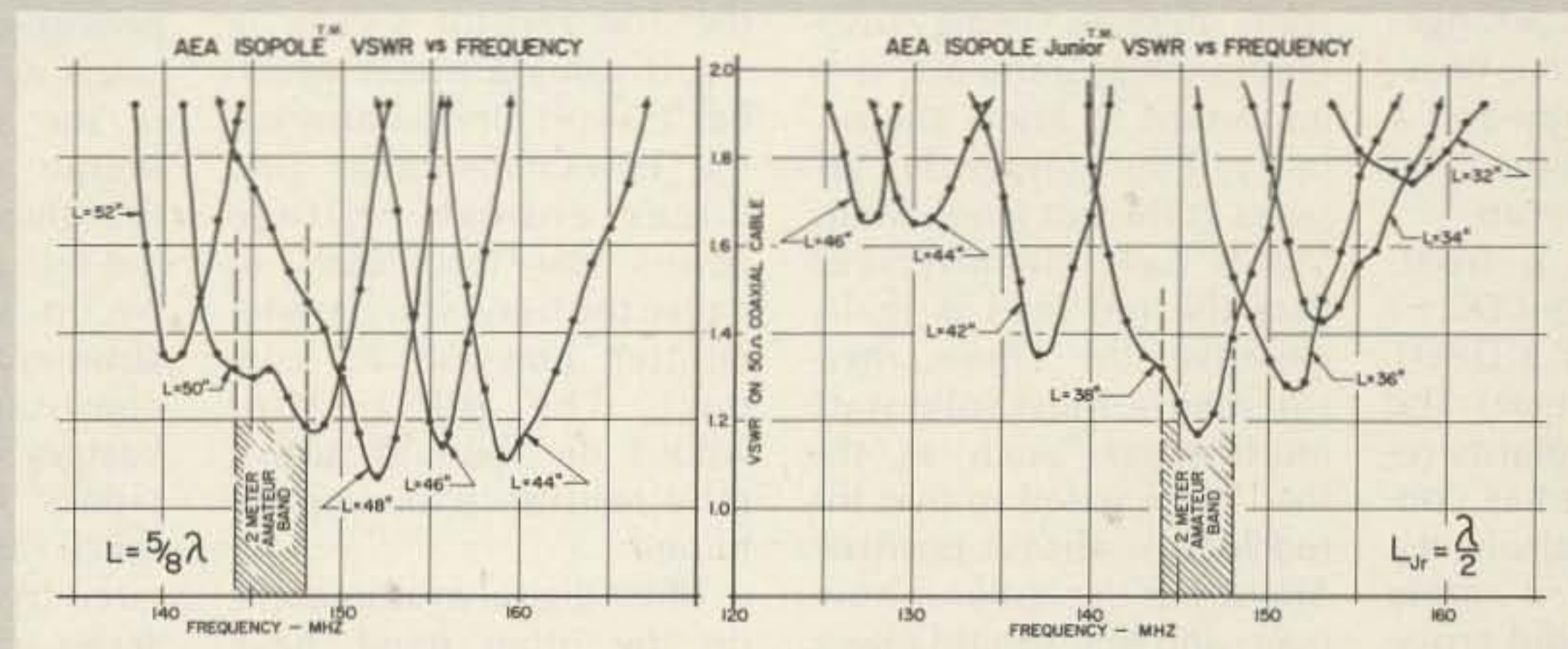

Outstanding mechanical design makes the IsoPole the only logical choice for a VHF base station antenna. A standard 50 Ohm SO-239 connector is recessed within the base sleeve (fully weather protected). With the IsoPole, you will not experience aggravating deviation in SWR with changes in weather. The impedance matching network is weather sealed and designed for maximum legal power. The insulating material offers superb strength and dielectric properties plus excellent long-term ultra-violet resistance. All mounting hardware is stainless steel. The decoupling cones and radiating elements are made of corrosion resistant aluminum alloys. The aerodynamic cones are the only appreciable wind load and are attached directly to the support (a standard TV mast which is **not supplied**)

Operating on MARS or CAP? The IsoPole and IsoPole Jr. antennas will typically operate at least  $\pm 2$  MHz outside the respective ham band without re-tuning. However, by simple length adjustment, the IsoPoles can be tuned over a wider range outside the ham bands.

Our competitors have reacted to the IsoPole, maybe you should too! Order your IsoPole or IsoPole Jr. today from your favorite Amateur Radio Distributor. For more information on other exciting AEA products, contact

Advanced Electronic Applications, Inc., P.O. Box 2160,  
Lynnwood, WA 98036.  
Call 206/775-7373

# AEA Brings you the Breakthrough!

PRICES AND SPECIFICATIONS SUBJECT TO CHANGE WITHOUT NOTICE OR OBLIGATION.

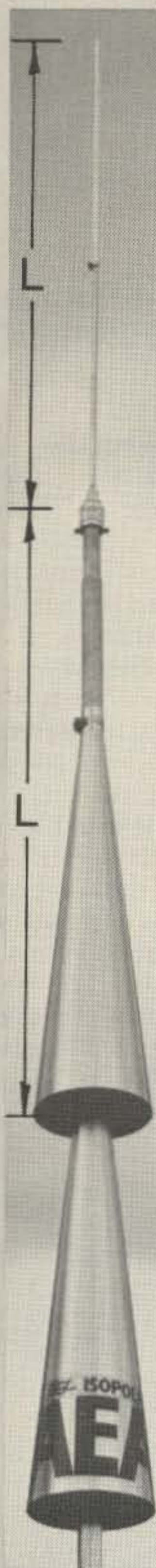

ISOPOLE 144  
\$49.95  
ISOPOLE 220  
\$44.95  
MAST NOT  
SUPPLIED



ISOPOLE  
144JR  
ISOPOLE  
220JR  
\$39.95  
MAST NOT  
SUPPLIED

tained in the circuitry so as not to upset the input impedance of the dc-measuring circuitry. The accessory jack on the front panel was used for connection to the test leads. The use of the jack allows one to use a variety of test leads, shielded or unshielded, and test leads permanently connected to accessory probes.

The ordinary test leads used are small, flexible wire types with grabber-type test clips at the ends of the leads (Radio Shack 278-1160). However, there are instances when a test prod is useful. So, as shown in Photo C, a regular test prod can be used with one of the grabber test clips by means of a short length of wire attached to the test prod. A piece of insulating tubing is slipped over the grabber test clip when it is used with the test prod. This arrangement of test leads has proven to be very handy and a vast improvement over the original test lead setup.

The IM-17 has a front-panel switch marked DC+/DC-. It is simply a DPDT switch which reverses the dc test leads for polarity reversal in case one has connected the leads falsely in a circuit. In reality, I rarely used it. But what did prove to be annoying was the constant need to open and short the test leads several

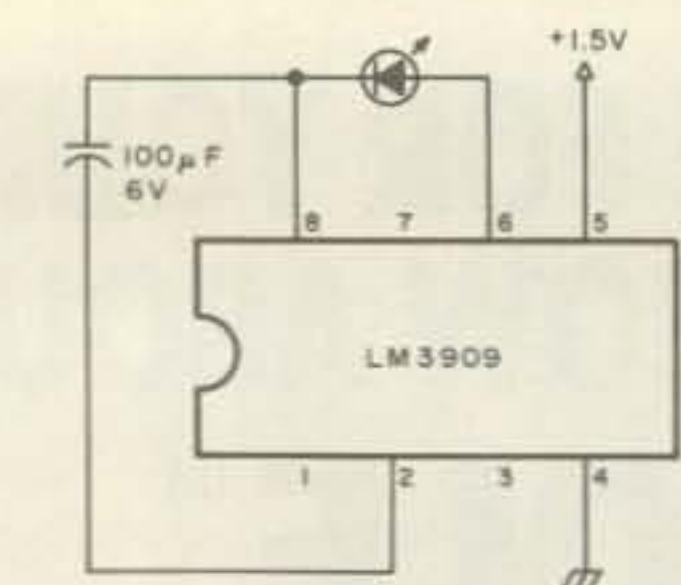

Fig. 1. An LED flasher guards against leaving the battery circuit turned on in a multimeter. The flashing rate is about 1 Hz.

times when making Ohms measurements, so that the ZERO and OHMS controls could be used to set the meter deflection. The polarity reversal switch was simply rewired to short the test leads, when desired, for Ohms adjustments; and it really does get some use in this application.

When testing any solid-state devices using resistances measurements, it is important to know the polarity of the voltage that appears at the test leads. Many VOMs have circuitry such that the red lead is really negative for Ohms measurements. Most solid-state multimeters, such as the IM-17, are wired so that the red lead is always positive. There are exceptions, however, and one should check a given instrument.

A disadvantage of most multimeters for solid-state

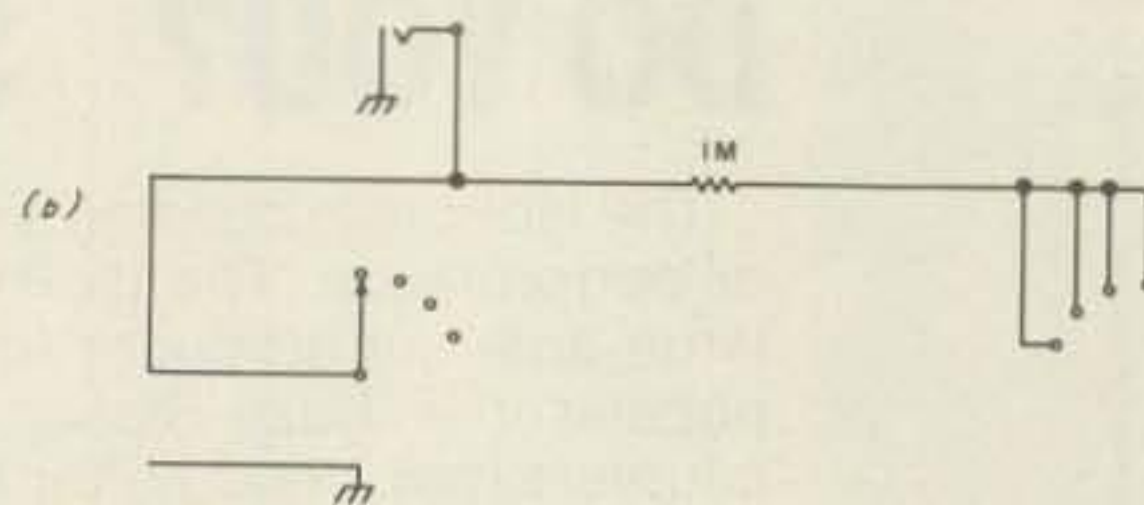
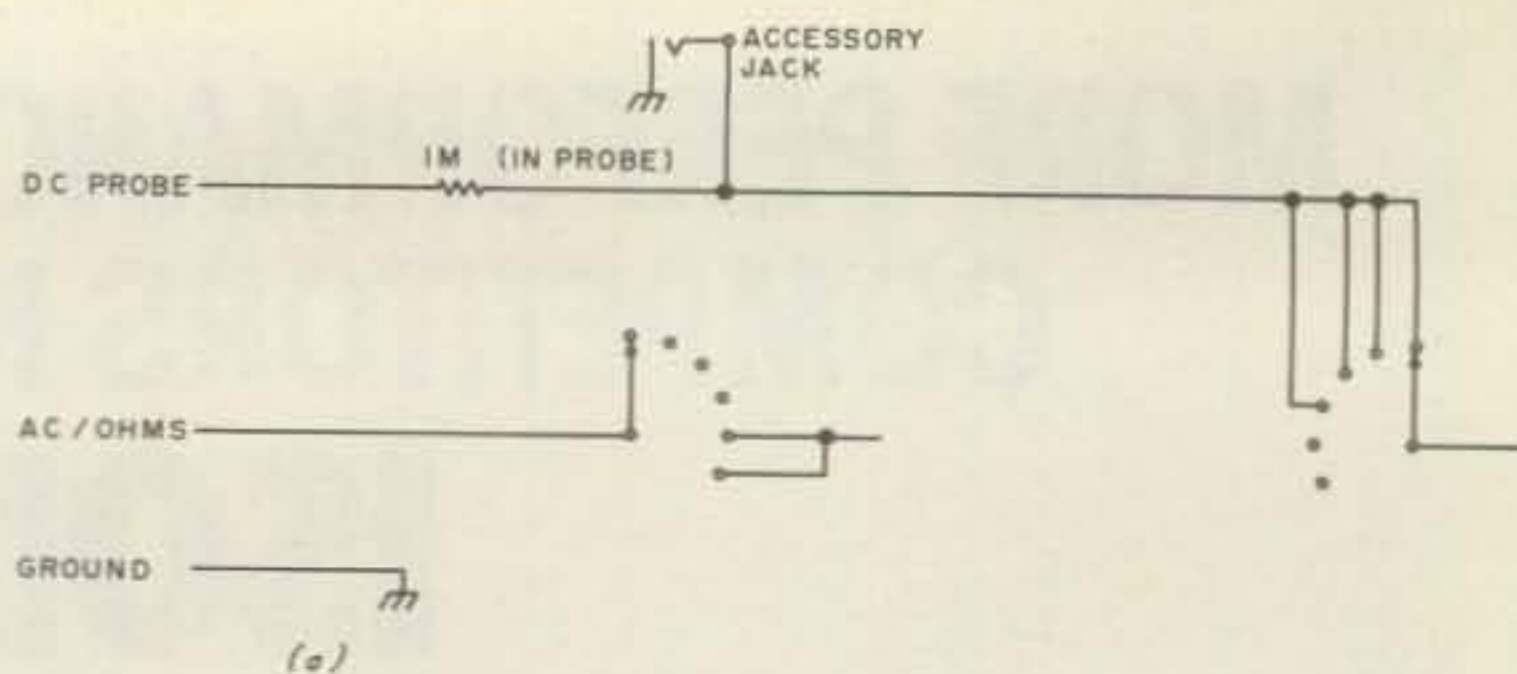

Fig. 2. Moving the 1M resistor inside the IM-17 allows two test leads (plugged into the accessory jack) to be used for all functions.

work is that they place too much voltage across the test leads. For instance, when in-circuit measuring the 10k resistor shown in Fig. 3 using a meter which has 1.5-volt Ohms batteries, the Low-Ohms range produces enough voltage across the test leads to cause the transistor base-to-emitter junction to conduct. The 10k resistor would be shunted and a false resistance reading obtained.

Most digital multimeters, on the other hand, have low-power Ohms ranges where only 0.1 volt appears across the test leads, so that

transistor junctions can't conduct. There is no sense in rebuilding an existing multimeter to obtain low-power-Ohms operation, since we can obtain some of the advantages of this feature in other ways. The first thing to do is to study the resistance measurement circuit used in a given instrument. It will normally consist of the usual 1.5-volt battery with series resistances for different resistance ranges and the meter circuitry placed across the series circuit. The series range resistors determine the current that flows and, therefore, the voltage that

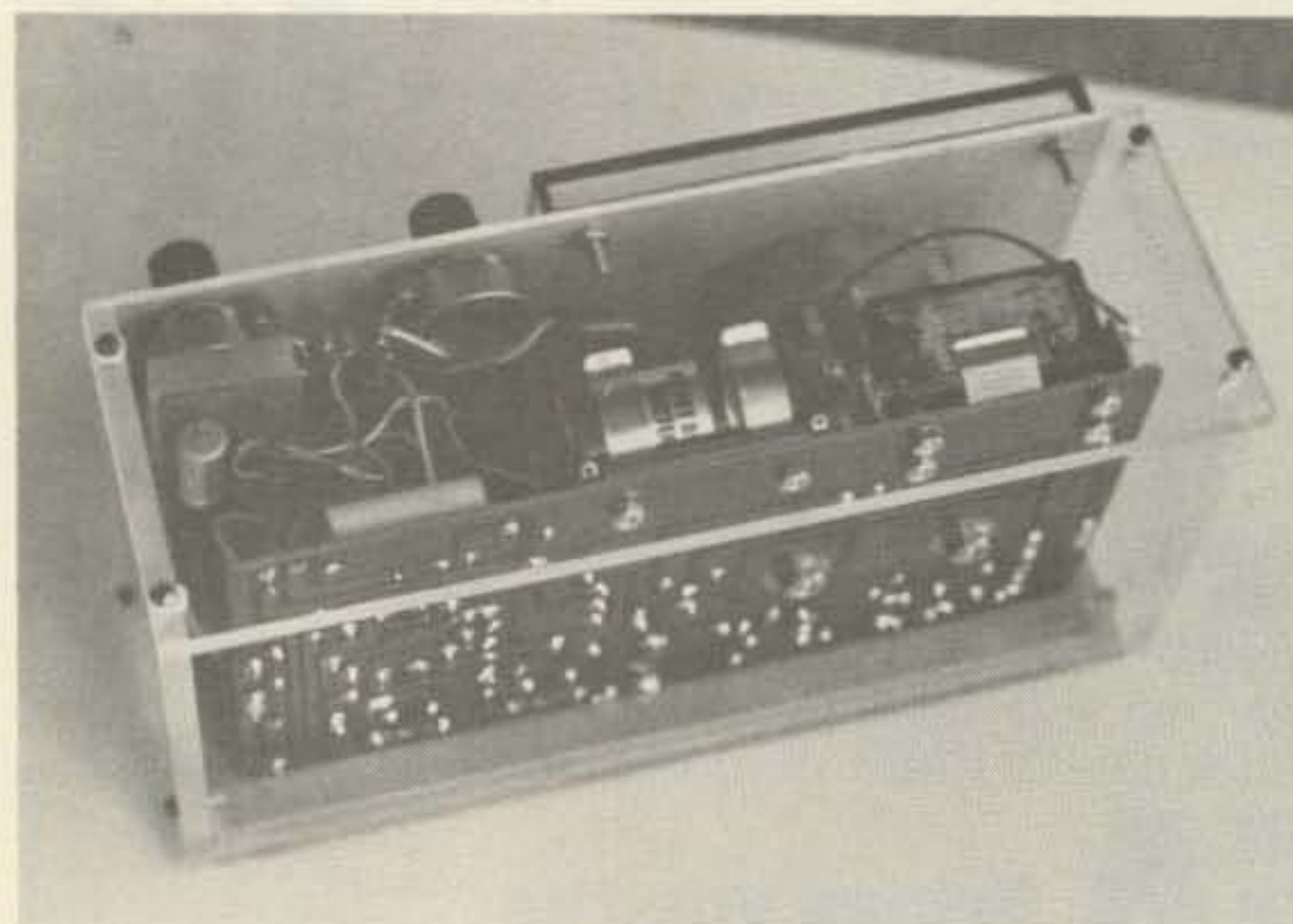

Photo B. The IM-17 mounted in a home-built Plexiglas housing.

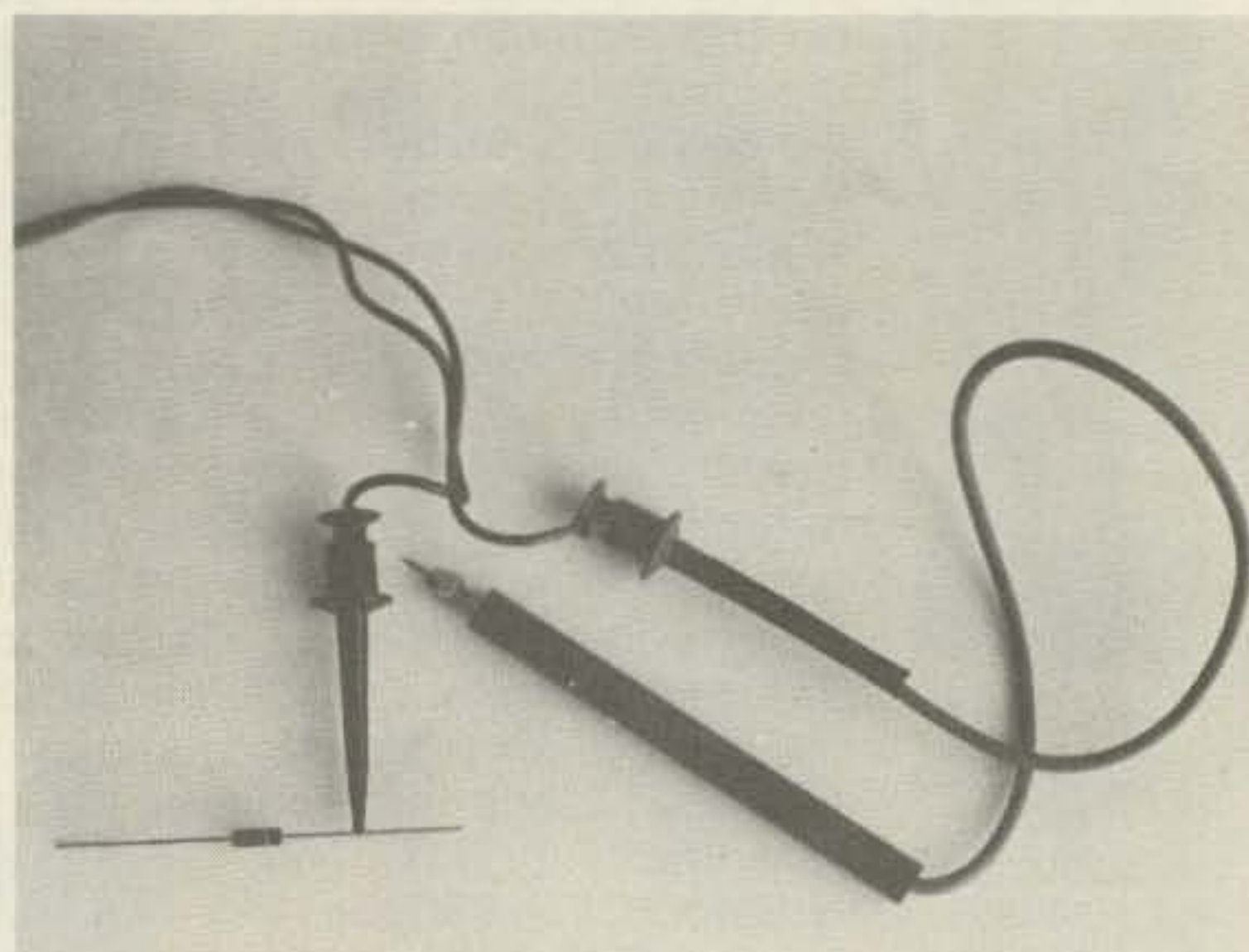

Photo C. New test leads as discussed in the text.

# TERMINALL

The communications terminal that does it all!



**TERMINALL** is a hardware and software system which converts your TRS-80 (Model I or III) into a state of the art communications terminal. **TERMINALL** is simple to use. **TERMINALL** has superior performance. **TERMINALL** works with a general purpose computer and is expandable. **TERMINALL** has it all!

## Simplicity

**TERMINALL** was designed from the outset to be easy to connect to your radio and easy to use. Plug into your receiver headphone jack and copy Morse code, Baudot or ASCII. Plug into your CW key jack and send Morse code. Attach a microphone connector and send Baudot or ASCII using audio tones (AFSK). That's all there is to hooking it up.

The software may be loaded into your computer from cassette or disk. Enter your callsign and the time and you will start receiving immediately. No settings or adjustments are necessary to receive Morse code—it's fully automatic—and it works! You may type your message while receiving or transmitting.

You will be on the air, receiving and transmitting any mode in minutes. As we said, **TERMINALL** is simple.

## Superior Performance

**TERMINALL** can do so much that it's simply not possible to list all the features in this limited space. Here are just some of the highlights:

■ **Multi-Level Displays:** Edit window on top to enter transmit text or program messages. Status window displays mode, operating parameters, prompts and error messages. Dialogue window displays received and transmitted text in chronological order. Review window allows examining and editing historical text while receiving or transmitting.

■ **Fantastic Morse reception:** Six stage active filter demodulator copies the weak ones. Auto adaptive Morse algorithm copies the sloppy ones. Keyboard selectable noise threshold. Received code speed displayed on status line.

■ **Hardware clock:** Maintains correct time during all operations, including cassette I/O. User programmable time/date format.

■ **Full ASCII capabilities:** Upper and Lower case, control codes, even/odd/no parity, 6, 7 or 8 data bits, 75 or 110 baud.

■ **Multiple user-defined WRU:** For each of four WRU functions, you can select any combination of (1) Initiate sequence, (2) Terminate sequence (including none or timeout), (3) What to transmit back (if anything—including ID in any mode, message, serial number, time/date), and (4) Whether to save on tape or not. WRU functions work in all modes (Morse, Baudot, ASCII).

■ **Buffered ASCII** parallel printer output: Select: edited historic text, all text, or WRU activated ("AUTO START") text.

■ **Word wrapping,** word mode editing, diddle, ignore carriage returns, user programmable end of line sequence, adjustable carriage width, Transmit delay (fixed, none, or auto adaptive), Break mode, Keyboard selectable: baud rate, shift, CW ID keying, unshift-on-space, signal invert.

■ **Flexible interfacing:** Builtin: Separate CW and RTTY demodulators, AFSK, CW and PTT keying, 20/60 mil loop interconnect, RS232 IN and OUT, hand-key input, sidetone output, and jumper selectable 110/220 volt AC power supply.

## General Purpose vs Dedicated

**TERMINALL** has capabilities far surpassing other "dedicated terminal" systems. And yet, since it works on a general purpose computer, the majority of your investment (the TRS-80) is spread out over many different applications—not just radio communications. And your system is expandable. For example, Disk based mailbox software may be added at any time.

**Simplicity of Operation. Superior Performance. General Purpose Computer. What are you waiting for? This is the way to go!**

Complete with software on cassette (including disk loading version), assembled and tested hardware, and extensive instruction manual. Specify Model I or Model III. Level II 16K required. \$499.

15 Day Money Back Trial Period. One year parts and labor limited warranty. Add \$4 shipping in U.S.A. CA residents add 6% sales tax.

We continue to experience telephone difficulties, please keep trying.

\*Recognized trademark of Tandy Corporation.



✓ 44

**MACROTRONICS, inc.®**

1125 N. Golden State Blvd.  
Turlock, CA 95380  
(209) 667-2888 / 634-8888



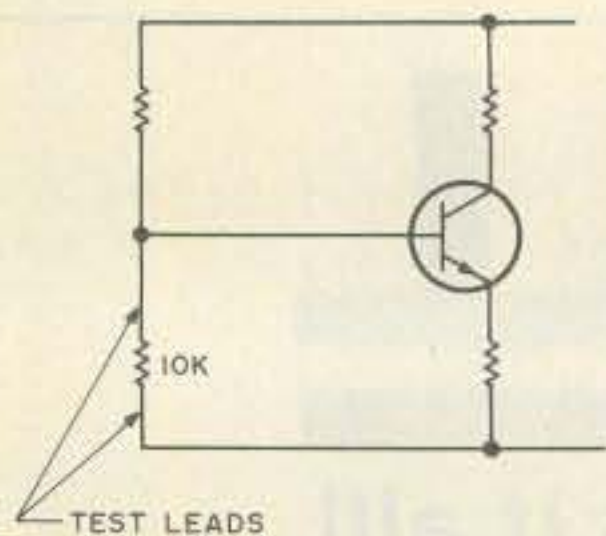

Fig. 3. If the voltage across the test leads causes the transistor base-to-emitter junction to conduct, the 10k resistor cannot be measured in-circuit.

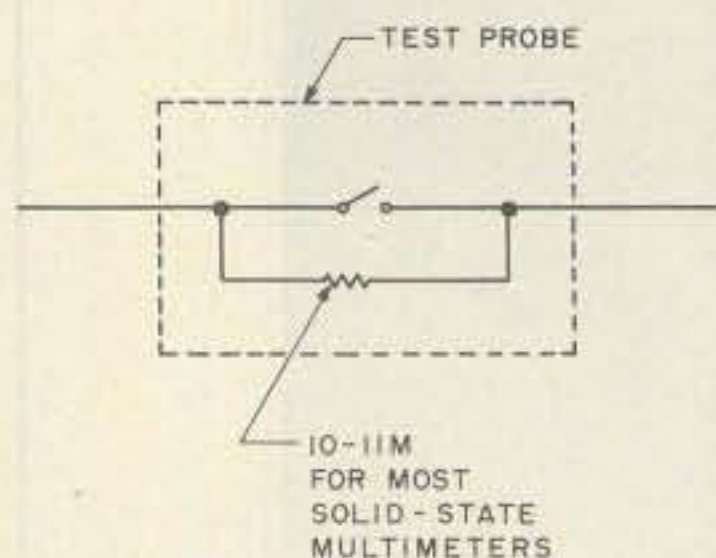

Fig. 4. A simple switchable resistor can add a 2X range extension feature to a multimeter for dc voltage measurements.

appears across an external resistance being measured.

By exercising Ohm's law a bit, one can readily determine the maximum resistance that can be measured before the voltage across the external resistor exceeds 0.1-0.2 volts. In the case of the IM-17 on the 10X R range, it is about 75 kilohms. So, if one has a general idea of the value of in-circuit resistors one is trying to measure, a suitable resistance range can be chosen to prevent too much voltage from appearing across the test leads. Another approach is to place a resistor across the test leads which is dimensioned to keep the voltage across it to about 0.1-0.2 volts. Then external resistors are measured as paralleled resistors. Admittedly, this is an awkward procedure but it does work where great accuracy is not needed.

A nice feature of many digital multimeters is an

overrange capability when making voltage measurements. So, if one is measuring a voltage just slightly greater than that for which the range switch is set, a reading will still be obtained. Usually one doesn't err that much when setting a range switch. For instance, one might think that a voltage is 9 volts and have it turn out to be 12 volts. So, a range switch might be set to 10 volts, and not to the next step of 100 volts.

A simple way to add an overrange feature to an analog instrument is by means of a series resistor in a test lead as shown in Fig. 4. The value of the resistor has to be found by experiment to suit the input impedance of a given instrument. For the IM-17 on the dc voltage ranges, it is about 11 megohms. When the resistor is in the circuit, the voltage ranges are doubled. The 0-1-volt range be-

comes a 0-2-volt range, etc. Having the resistor and switch mounted in a test prod housing makes operation very convenient and fast.

Finally, it is often useful to display a brief summary of an instrument's specifications on its front panel. Often when confusing test readings are obtained, the cause is that the loading characteristics of the instrument are affecting the measurement. Note on the front panel of the IM-17 (Photo A) that the ac/dc loading characteristics are shown using a small taped label below the meter. If a given instrument has ac/dc current ranges, don't neglect to note the voltage drop across the various current ranges. Some meters have significant voltage drops on their current ranges which can lead to false readings when measuring currents in low voltage circuits. ■



**MORSE  
RTTY  
ASCII**



**QUALITY AT AN AFFORDABLE PRICE**

**MKB-2000**

- Complete set of alphanumeric, punctuation, and special function keys
- 512 character text buffer
- 10 reprogrammable 50 character message memories
- 5-99 WPM, keyboard selectable
- Built-in sidetone with adjustable tone and volume
- Buffer/Memory fullness indicators
- 1 year warranty on parts and labor
- Attractive anodized brushed aluminum and gray wrinkle finish case, only 13.3 x 9.4 x 3.5 in.
- RTTY/ASCII option includes—"Brag Tape" interface, CW ID, QBF and RY test messages, auto CR/LF and LTR/FIG shift
- Other options—Memory expansion, AFSK modulator

MKB-2000 (Morse Only)	<b>\$319.00</b>
RTTY/ASCII Option	<b>75.00</b>

**MVD-1000**

- Copies Morse Code directly from your receiver
- Automatic speed tracking with self calibration
- 6-60 WPM speed range
- Manual speed tracking to give operator more control
- Active filters and digital sampling for increased noise rejection
- Operates with any TV set, no expensive monitor needed
- Two page display with 16 lines of 32 characters per page
- Attractive anodized brushed aluminum and gray wrinkle finish case, only 3 x 10 x 10 in.
- RTTY/ASCII option includes demodulator

MVD-1000 (Morse Only)	<b>\$369.00</b>
RTTY/ASCII Option	<b>89.00</b>

Add \$5.00 per unit for shipping U.S.A.

**Send For**

**Free Information**





**787 BRIAR LANE, BELOIT, WISCONSIN 53511 (608) 362-0410**



# HI-Q BALUN

- For dipoles, yagis, inverted vees & doublets
- Replaces center insulator
- Puts power in antenna
- Broadbanded 3-40 MHz
- Small, lightweight and weatherproof
- 1:1 impedance ratio
- For full legal power and more
- Helps eliminate TVI
- With SO-239 connector



**\$10.95**

## HI-Q ANTENNA CENTER INSULATOR

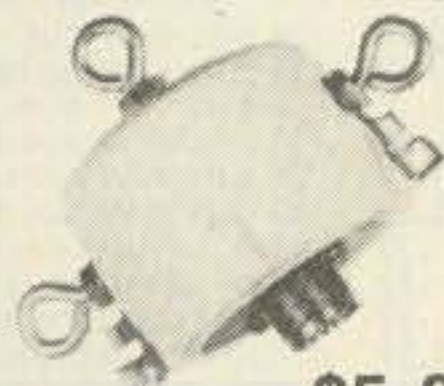

Small, rugged, lightweight, weatherproof  
Replaces center insulator  
Handles full legal power and more

**\$5.95** With SO-239 connector

## HI-Q ANTENNA END INSULATORS

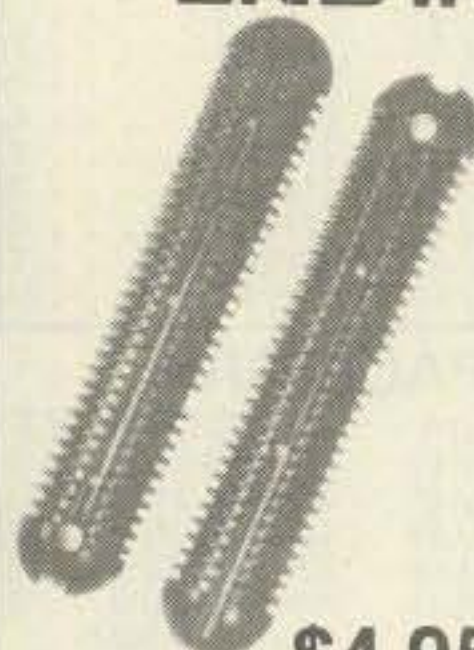

Rugged, lightweight, injection molded of top quality material, with high dielectric qualities, and excellent weatherability. End insulators are constructed in a spiral unending fashion to permit winding of loading coils or partial winding for tuned traps.

- May be used for
- Guy wire strain insulators
  - End or center insulators for antennas

**\$4.95** • Construction of antenna loading coils or multiband traps

Patent No. 4,091,350

# DIPOLES

MODEL	BANDS	LENGTH	PRICE WITH HI-Q BALUN	WITH HI-Q CENTER INSULATOR
<b>Dipoles</b>				
D-80	80/75	130'	\$28.95	\$24.95
D-40	40/15	66'	25.95	21.95
D-20	20	33'	24.95	20.95
D-15	15	22'	23.95	19.95
D-10	10	16'	22.95	18.95
<b>Shortened dipoles</b>				
SD-80	80/75	90'	31.95	27.95
SD-40	40	45'	28.95	24.95
<b>Parallel dipoles</b>				
PD-8010	80,40,20,10/15	130'	39.95	35.95
PD-4010	40,20,10/15	66'	33.95	29.95
PD-8040	80,40/15	130'	35.95	31.95
PD-4020	40,20/15	66'	29.95	25.95
<b>Dipole shorteners - only, same as indicated in SD models</b>				
S-80	80/75		\$11.95/pr.	
S-40	40		\$10.95/pr.	

All antennas are complete with HI-Q Balun or HI-Q Antenna Center Insulator, No. 14 antenna wire, ceramic insulators, 100' nylon antenna support rope (SD models only 50'), rated for full legal power. Antennas may be used as an inverted V, and may also be used by MARS or SWLs.

**Antenna accessories** — available with antenna orders  
Nylon guy rope, 450# test, 100 feet \$3.49  
Ceramic (Dogbone Type) antenna insulators .70/pr  
SO-239 coax connectors .55

All prices are postpaid USA 48  
Available at your favorite dealer or order direct from:

**Van Gorden Engineering**  
BOX 21305, S. EUCLID, OHIO 44121

✓ 373

Dealer Inquiries Invited

## C.B. TO 10 METER KITS AMERICA'S #1 SOURCE FOR 10 METER C.B. KITS

**IN STOCK**—Kits for most C.B. Models—A.M. and S.S.B.

**COMPLETE KITS**—Includes all parts and detailed instructions for both crystal and P.L.L. synthesizers.

**CUSTOM ENGINEERED**—For easy installation with minimum amount of time and test equipment.

**FLEXIBLE BAND COVERAGE**—To provide 1 MHz coverage for most P.L.L. chassis and up to 2 MHz on special order for some types.

**LOW COST**—Kit prices range from \$10.00 to \$50.00, according to parts required. Average kit price under \$25.00.

**Free catalog**—write or call today for our free 10 meter catalog. Includes details on kits and our many other products.

**AMERICAN CRYSTAL SUPPLY COMPANY**  
P.O. BOX 638  
WEST YARMOUTH, MA. 02673  
(617) 771-4634

## MICROWAVE DOWN CONVERTERS 2000-2500 MHZ

NO CHIP CAPS TO MESS WITH!

FEWER COILS TO WIND!

Converter Kit..... 35.00  
Complete with PC board parts, and ten page instruction brochure

Printed Circuit Board & 10 page Instruction Brochure..... 15.95  
Complete Board..... 60.00

Assembled and tested Adjustable Power Supply Kits..... 25.00  
Adjustable Power Supply

Assembled and tested, with case . . . 40.00  
Yagi Cigar Antenna ..... 35.00  
MRF 901 transistor..... 3.50

Down Converter, Assembled and tested, encased and waterproofed, with yagi antenna, 50 feet RG59 coaxial cable, and 3 feet RG59 with 75 to 300 ohm adapter, and power supply ..... 170.00

TERMS: CASHIER CHECK, MONEY ORDER, BANK CARD, PERSONAL CHECK.



**HIGH FREQUENCY TECHNOLOGY SYSTEMS**

10 a.m. - 7 p.m. CST  
Mon. thru Fri.

7308 AMY STREET  
DALLAS, TEXAS 75217  
(214) 343-1017

# SIGNALCRAFTER® Automatic Computing Power Meter

- Automatic SWR Reading
- Precision Power Measurement

The new SIGNALCRAFTERS computing SWR/POWER METERS are in a class by themselves. SIGNALCRAFTERS EXCLUSIVE integrated circuit CHIPS compute SWR automatically, thus eliminating the need for any "set" or "sensitivity" control. The built-in analog computer operates over a power range of one watt to several kilowatts. All models feature: —Selectable Peak or Average Power response—Self-indicating Push Buttons —Rugged taut-band meters —Interchangeable Plug-in directional couplers that can be remote mounted if desired —Handsome heavy-duty low profile metal cabinets that compliment the latest transceiver designs —D.C. Output Receptacle supplies a voltage that follows meter readings. These outputs are used to drive many different possible accessories, such as A-D converters, remote meters, alarm and control devices.



The Model 30 SWR/POWER METER dual display unit. Both Power and SWR are handled automatically. Auto-ranging automatically selects the proper power range according to the level detected on the transmission line and indicates the range on front panel LED's. Operator can override this feature if desired by selecting

any of the three basic ranges manually. Two large taut-band meters indicate forward power and SWR. Complete hands-off operation! And there is more! Self-indicating front panel push-buttons allow antenna selection as well. Full scale accuracy is  $\pm 6\%$  at 1 to 1 SWR. Selection of three antennas and a dummy load is possible. Accessory jack on rear panel provides 12 volts 60 Hz AC for any remote antenna relays. (Operates from 110 volts 60 Hz AC.) Width: 8½", Height: 4¼", Depth: 6".  
Model 30 (less coupler) .....\$250.00

The Models 31 and 32 are both single meter units —each in a class by itself. They are portable battery operated micro power instruments. A single meter displays either SWR or POWER as desired. The Model 31 has a single power range. The Model 32 features

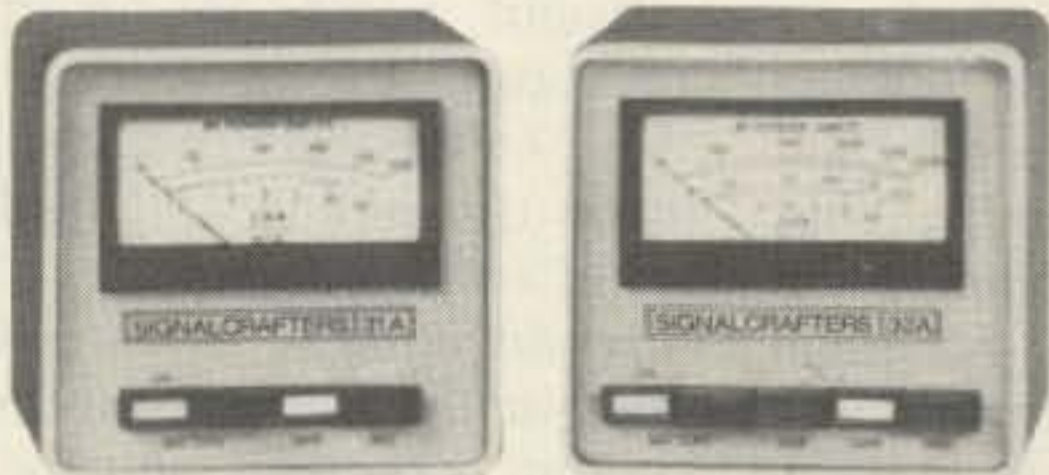

dual power ranges and both have an instant battery check feature. Both models perform with the same accuracy and precision as the Model 30 and an advanced low current design provides battery life that is truly outstanding. The units operate from a standard, easily available, 9-volt battery which is included or can be operated from a standard 110 volts 60Hz AC to 9 volts DC adapter (available as an optional unit). Width: 4½", Height: 4¼", Depth: 5".

Model 31 (31A—0 to 200W) (less coupler) .....\$175.00  
Model 31 (32A—0 to 200W, 0 to 2000W) (32B—0 to 20W, 0 to 200W) (less coupler) .....\$200.00

## SIGNALCRAFTER DIRECTIONAL COUPLERS

**MODEL HF 231 (1.8 to 30 MHz) for use with 50 ohm coaxial cable.** Less than 1.05 dB insertion SWR (max.) Equipped with two SO-239 UHF connectors (1 input-1 output) which plugs directly into rear of Models 30, 31, and 32, or can be remote mounted.

Model HF 231 .....\$66.00

**MODEL HF 231A (1.8 to 30 MHz) for use with 75 ohm coaxial cable, otherwise same as HF 231**

Model HF 231A .....\$66.00

**MODEL UV900 (50 to 900 MHz) for use with 50 ohm coaxial cable.** Less than 1.1 dB insertion SWR. Response:  $\pm .5$  dB over complete range of 50 to 550 MHz,  $\pm 1.0$  dB from 30 to 1000 MHz. Equipped with type "N" connectors. Plugs into Models 30, 31 or 32 by using any length remote cable. RCA phono-type receptacles used (2).

Model UV900 .....\$90.00

OTHER COUPLERS AND ACCESSORIES AVAILABLE — contact factory.

## SIGNALCRAFTERS INC.

5460 BUENA VISTA DRIVE, SHAWNEE MISSION, KANSAS 66205

913/236-7300; TELEX: 42-4171

Prices include shipment to all U.S.A. Kansas residents add 3½ percent  
VISA and MasterCard accepted

✓66

## Alaska Microwave Labs

4335 E. 5TH STREET — DEPT. 73  
ANCHORAGE, ALASKA 99504  
(907) 338-0340

✓406

### TRANSISTORS

MRF901	FT4.5GHZ	\$3.00
MRF911	FT5.0GHZ	\$4.00
BFR90	FT5.0GHZ	\$3.00
BRF91	FT5.0GHZ	\$3.50
NEC 02137	FT4.5GHZ	\$3.25
NEC 02135	FT4.5GHZ	
TYPE NF 2.7DB MAG 12DB	@ 2.0GHZ	\$5.00
NEC 64535	FT8.5GHZ	
NF 2.0DB MAG 15DB	@ 2.0GHZ	\$14.00

### HOT CARRIER DIODES

MBD101	UHF-MICRO	\$1.50
ND4131 4GHZ	NF 5.75DB	\$21.00
HN-1 4GHZ	NF 6.5DB	\$2.00

### CHIP CAPACITORS

1.2, 2.2, 3.3, 4.7, 6.8, 10, 18, 22, 27, 47, 100, 120, 180, 220, 270, 330, 390, 470, 560, 680, 820, 1K, 1.2K, 1.8K, 3.9K, 8.2K, 10K, 100K		\$ .60
---	--	--------

### TEFLON CIRCUIT BOARD

APPROX 3.25" x 5.0" x .010	\$5.50
APPROX 3.25" x 5.0" x .312	\$6.50
APPROX 3.25" x 5.0" x .0625	\$10.50

### FEED-THRU CAPACITORS

1000 PF SOLDER TYPE	\$ .50
470 PF SOLDER TYPE	\$ .50

### DUAL GATE MOSFET

RCA 40673	\$1.50
-----------	--------

### GaAs FETS

MGF1400 NF 2.0DB @ 4GHZ MAG 15DB	\$28.50
MGF1412 NF 0.8DB @ 4GHZ MAG 18 DB	\$75.00

### CHIP RESISTORS

SET OF 3 1% CHIP RESISTORS FOR 50 OHM T NETWORK 3DB PAD	\$6.00
--	--------

### COAX CONNECTORS

SMA Chassis Mount Square Flange	\$6.10
SMA Chassis Mount Plug sq. Flange	\$8.50
SMA Chassis Mount Strip-line Tab	\$6.75
SMA Plug for RG-58	\$6.75
SMA Plug for RG-174	\$6.75
SMA Plug for 141 Semi-rigid	\$3.98

### X BAND COMPONENTS

GUNN SOURCE 10.525 GHZ 10 <sup>-5</sup> MW WR-90 WAVEGUIDE MOUNTING	\$37.00
IMPATT SOURCE 10.5 to 10.55GHZ 50 <sup>-</sup> 20MW WR-90 MOUNTING	\$39.00
FILTER/MIXER 8.2 to 12.4GHZ WR90 MOUNTING	\$30.00
HORN ANTENNA 18 <sup>-</sup> 1DB GAIN AT 10.525GHZ WR-90 MOUNTING	\$13.75
WAVE GUIDE FLANGE WR-90	\$4.00

### SILVER PLATING KIT

Will plate Copper, Brass, Bronze, Nickel, Tin, Pewter, Gold and most white metal alloys.	\$30.00
--	---------

### RF CABLE

141 Semi-rigid Cable, Approx. 24 DB Loss per 100 ft @ 4GHZ. Price is per ft +/- inch max length is 5 ft. Other lengths by special order	\$4.00
--	--------

### PISTON TRIMMERS

TRIKO 201-01M .3-1.8 pf .5-3 pf 1-8 pf	\$2.50
--	--------

NO WARRANTY ON SEMI-CONDUCTORS



OPEN AT 8PM EST  
CLOSED AT 8PM PST

IF YOU DO NOT SEE  
WHAT YOU WANT ASK

ORDERS ARE POSTAGE PAID  
COD-VISA-MASTERCHARGE

# Amateur Radio, Super Hobby!

— a breezy new intro to the world of hamming

Amateur Radio, Super Hobby! by Vince Luciani K2VJ. Cologne Press (PO Box 682, Cologne NJ 08213), 139 pages, \$8.95 softcover, \$14.95 hardcover.

You're trying to interest a friend at work in ham radio. You cast about for an adequate definition of what the hobby is like and what it means to you. More often than not, you can't put the right words together. You find it hard to express exactly what it is you get out of hamming. So, you do the next best thing and try to recommend some reading material. Nothing stuffy or technical and certainly none of those frightening license manuals. What you need is a breezy introduction to the world of recreational radio. Unfortunately, breezy introductions to ham radio are hard to find. Most introductory texts get mired in details, hung up on technology, and in a rut over regulations.

Your friend, her interest waning, is beginning to question the appeal of a leisure-time activity that requires tough licensing exams, a fortune spent on equipment, and an affinity for self-abuse. Eventually, she buys a membership in a racquetball club, plays once a month, and avoids the weird electronics freak

she works with. You blew it.

What you should have done is given her a copy of *Amateur Radio, Super Hobby!* by Vince Luciani K2VJ. This new book is the easy reading overview all Elmers have been waiting for. Within its 144 pages, most of the aspects and appeal of hamming are isolated, identified, and examined. More importantly, the book keeps its focus on the most intriguing element of our hobby, the people. Almost 1/3 of the book is devoted to interviews with and stories about people who also happen to be hams.

The book contains 42 short chapters. The chapters present the detailed vignettes that make up the larger canvas of ham radio. Chapters cover a broad range of topics, and titles include: What Is It?, Who Can Join, How to Join, DX, Then And Now, Big People—Little People, The Benefits, Ladies in Amateur Radio, Equipment Costs, The Shack, Amateur Magazines, The Novice Exam, FCC Gettysburg, Roll Your Own, and many more.

In a particularly poignant chapter called "The First Time Through," Luciani isolates the moment of the first successful Novice QSO, a moment most of us have experienced but many have forgotten. As I read his

account, I, too, remembered.

He writes, "You have stumbled your way through your first CQ call... When you finish, you stand by with fingers gripped unfeeling around a pencil you intend to write with... You almost hope no one will respond so that you might put this off for another, more relaxed, time... and then you find out. 'That's my callsign! Someone heard! Someone is answering!' May I suggest that you savor the moment? It will never come again."

In an equally vivid passage in the same chapter, Luciani captures another moment familiar to most hams but totally alien to the non-ham, the late-night QSO.

"The hour is well past midnight. The house is perfectly quiet... Lights are out, even in your ham shack, except for the soft, reassuring glow of dial lights. This is the supreme moment in which to seek the companionship of another hobby member—one who also is awaiting the predestined crossing of your lives. This, you will find, is a moment in time when the distant world seems entirely at peace. When life itself seems to hang loose and when all seems right within the

security of your den. This is the moment in which to make a new friend... This, to me, is truly what amateur radio is about."

*Amateur Radio, Super Hobby!* is full of such moments. It is one of the few books I've read that successfully telegraphs the enjoyment and excitement of our usually misrepresented hobby in a way the non-ham can understand. As an added plus, the book provides the neophyte with sound advice on the easiest and least expensive ways to get involved with ham radio.

It is written with feeling, adequately illustrated with cartoons, carefully laid out, and produced with attention to quality and detail. It is unique in its people-oriented approach to the subject and, at present, has no equal in the area of introductory amateur literature.

If you have a potential convert to the cause of ham radio within your grasp, this book might just bring them over. At the reasonable price of \$8.95, it's certainly worth the investment. And, as you yourself read it, you may find that it evokes some fond and long forgotten memories of your own ham career. It is thoroughly enjoyable and I highly recommend it. ■



# A Guide to Amateur Radio

— book review of an English import

A Guide to Amateur Radio by Pat Hawker G3VA. 18th edition, 144 pages, paperback, £2.99 (including postage and handling) from RSGB (35 Doughty Street, London WC1N 2AE, Great Britain) worldwide, published July 25, 1980.

After a steady diet of American radio books, it can be quite illuminating to read a book written from an English amateur's point of view. *A Guide to Amateur Radio* (published by the Radio Society of Great Britain) offers insights into hamming in another country and is an excellent all-around book on ham radio, no matter which side of the pond you stand on. While many American books im-

mediately overwhelm the reader with facts and formulas, this book gives information in a conversational style. The author assumes that your goal is to own and operate your own radio station, not just pass an exam. Theory is described in different terms than American books use, and the fresh approach can lead to a new understanding of technical matters.

The first chapter answers many questions asked by newcomers to ham radio. Subjects covered include cost, callsigns, and how to become an amateur. The second chapter is called "Getting Started," and it prepares the reader to do just that. Propagation and the construction of listening antennas are subjects of

special interest to someone who is just beginning to listen to both amateur and shortwave transmissions. Also discussed are station layout, test equipment, and different modes of transmission. Theory is consistently worked into the text at places where questions naturally arise.

A well-illustrated section on the history and development of radio gear is included, and there are short notes on about 250 pieces of radio gear in current use. A chapter entitled "Workshop Practice" covers all aspects of construction. The author describes in detail everything from materials and tools to the aesthetics of a finished product. With this background, the home-brewer can construct

a project that is attractive as well as functional.

At the end of the book are tables and charts of, among other things, Q signals, callsign assignments, band allotment, and common abbreviations. There is also a sample of questions from the British license exam, which is not all that different from the US tests.

Rather than a list of abstract theories you must memorize in order to pass an exam, this book offers enticement and encouragement. It concentrates on the practical things you'll want to know as you assemble and operate your own station. After you read this book, you will be prepared to get your license, but more importantly, you'll be ready to actually use it! ■

**PEOPLE WHO KNOW QUALITY**  
AND NEED RELIABILITY  
Demand **FOX-TANGO Filters**



**WANT TO KNOW WHY?**  
Send for descriptive brochure and information  
**FOX-TANGO OWNERS: JOIN FOX-TANGO CLUB**

323 \$8.00 US, \$9.00 CANADA—\$12 OVERSEAS  
Dealer Inquiries Welcomed Full FT Catalog \$1.00 Refundable

**FOX-TANGO CORPORATION**  
Box 15944S, West Palm Beach, Florida 33406

**ALL BAND TRAP ANTENNAS!**



PRETUNED - COMPLETELY ASSEMBLED - ONLY ONE NEAT SMALL ANTENNA FOR UP TO 7 BANDS! EXCELLENT FOR CONGESTED HOUSING AREAS - APARTMENTS LIGHT - STRONG - ALMOST INVISIBLE!

FOR ALL MAKES & MODELS OF AMATEUR TRANSCEIVERS - TRANSMITTERS - GUARANTEED FOR 2000 WATTS SSB 1000 WATTS CW. INPUT FOR NOVICE AND ALL CLASS AMATEURS!

COMPLETE AS SHOWN with 90 ft. RG58U-52 ohm feedline, and PL259 connector, insulators, 30 ft. 300 M. test dacron end supports, center connector with built in lightning arrester and static discharge - molded, sealed, weatherproof, resonant traps 1"X6"-you just switch to band desired for excellent worldwide operation - transmitting and receiving! Low SWR over all bands - Tuners usually NOT NEEDED! Can be used as inverted V's - sloopers - in attics, on building tops or narrow lots. The ONLY ANTENNA YOU WILL EVER NEED FOR ALL DESIRED BANDS - WITH ANY TRANSCEIVER - NEW - EXCLUSIVE! NO BALUNS NEEDED!

90-40-20-15-10-6 meter - 2 trap --- 104 ft. with 90 ft. RG58U - connector - Model 998BUA ..... \$79.95  
40-20-15-10 meter --- 2 trap --- 54 ft. with 90 ft. RG58U - connector - Model 1008BUA ..... \$76.95  
20-15-10 meter --- 2 trap --- 26ft. with 90 ft. RG58U - connector - Model 1007BUA ..... \$77.95

SEND FULL PRICE FOR POSTPAID INSURED. DEL. IN USA. (Canada is \$5.00 extra for postage - clerical - customs etc.) or order using VISA - MASTER CHARGE - CARD - AMER. EXPRESS. Give number and ex. date. Ph 1-308-236-5333 9AM - 6PM week days. We ship in 2-3 days. ALL PRICES WILL INCREASE . . . SAVE - ORDER NOW! All antennas guaranteed for 1 year. 10 day money back trial if returned in new condition! Made in USA. FREE INFO. AVAILABLE ONLY FROM

WESTERN ELECTRONICS Dept. A7-6 80 Kearney, Nebraska, 68847

**ALL BAND TRAP ANTENNAS!**

Dave Ingram K4TWJ  
Associate Editor  
Eastwood Village #1201 So.  
Rte. 11, Box 499  
Birmingham AL 35210

## Get Your Shack Together

There are few occasions when a certain accessory or item comes along which I personally find overwhelmingly exciting; however, the S-F radio desk is something worthy of considerable excitement! Advertisement photos don't do justice to this item; it's a beautiful and sturdy desk which could set you thinking about remodeling the complete ham shack to match this enclosure.

My first exposure to the S-F desk was at the Atlanta Convention. Its warm pe-

can finish attracted me like a magnet from several booths' distance. I tried everything short of taking an ax to the desk, and it maintained its sturdiness. Armspan to desk width and height was perfect, and the cutaway sides allowed me to sit sideways and stretch out at an angle I personally enjoy. Here, finally, was a desk I could live with regardless of future equipment changes, operating style changes, physical positions, etc.

Before the S-F desk ar-

rived at my home, my gear had been spread on a 7-foot table (a door between sets of file drawers) and stuffed into a shelf unit behind the desk. Although two low-band kilowatt rigs, a QRP rig, an OSCAR rig, 2-meter FM, and two SSTV setups were included, I could only operate one setup without banging knees into drawers or moving gear each day.

My need for numerous drawers coupled with my desire for massive air circulation around a large rf amplifier ruled out the larger S-F desk (48 inches wide, rather than the standard 36-inch version; other dimensions identical). Finally the solution evolved: Install the S-F desk against a wall adjacent to the other desk, shorten the 7-foot desk to 3 feet, and use the area between desks for rf amplifier power supplies and incoming antenna leads. The station's SSTV camera also was placed in this area, permitting it to view either operating position. Then a Yucca tree was added purely for decor. The final result is two complete setups which can be operated independently or simultaneously as desired—without moving gear or banging knees.

The S-F desk is shipped in two approximately 3-foot by 1-foot packages for ease of handling. It goes together in around an hour's time, with S-F furnishing everything but the furniture polish. The desk's bottom struts and braces affix to rear sections, and

are thus out of the way regardless of leg position. A small strip also is included for providing "stops" for gear in the angled rear area. Incidentally, I found the simple assembly instructions easy to follow (I'm not mechanically inclined), and all sections were a perfect fit.

Like many amateurs, I do not like to enclose radio gear or obstruct air circulation. Open areas on the S-F desk (particularly around the sides) ensure equipment cooling while also providing room for installing and removing the plastic covers I keep on my gear during periods of nonuse. What else could one ask! Since adding the S-F desk to my shack, I've begun truly enjoying the pleasures of comfortable operating and the benefits of a second desk for working on projects or articles while also tuning the bands. More than once I've fallen asleep at the S-F desk merely because of the new comfortable position never obtainable with other desks. In fact, I've even been thinking of using another S-F desk for the upcoming home office. They're great!

If you're looking for a way to package that prized equipment while also providing an extra measure of in-shack comfort, check out the S-F radio desk.

For further information, contact S-F Amateur Radio Services, 4384 Keystone Avenue, Culver City CA 90230. Reader Service number 477. ■

INTERESTED IN AMATEUR TELEVISION ON 70 cm?

WHY NOT SHOW WITH THE BEST ?!!

### TXR70A ATV Transceiver

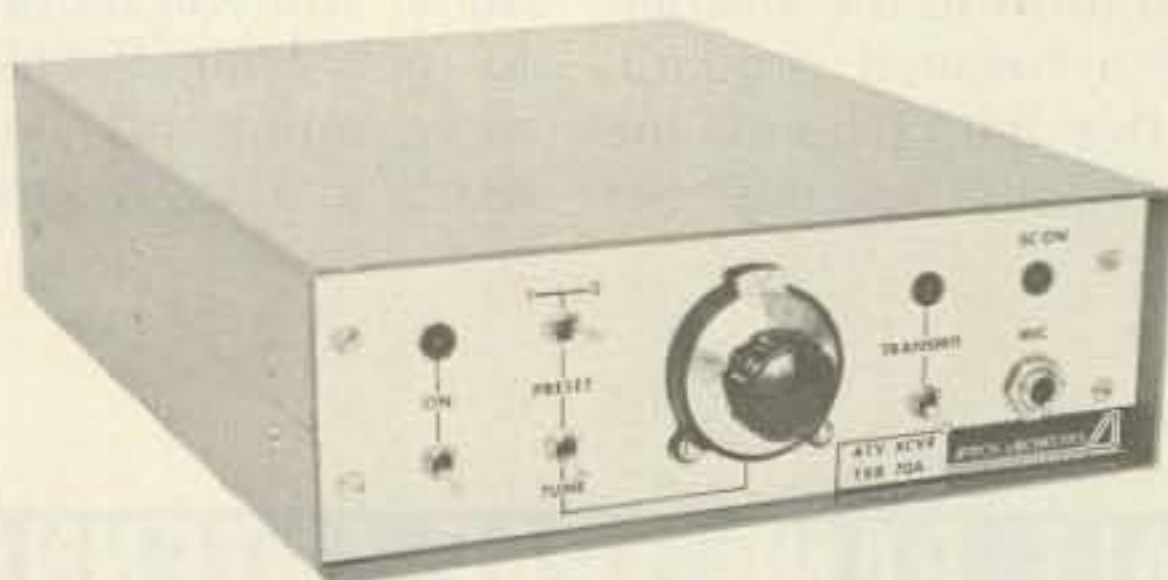

- BROADCAST QUALITY TRANSMITTER—VIDEO and AUDIO
- TUNEABLE + 2 CHANNEL PRESET RECEIVING CONVERTER
- EXTERNAL DC POWERED—12 to 14 VDC
- SMALL and COMPACT for BASE STATION and PORTABLE OPERATION
- ONE YEAR WARRANTY + 30 DAY MONEY BACK GUARANTEE

PRICE—\$ 390.

FOR DETAILED INFORMATION or TO ORDER,  
CALL US at 1-812-336-4775, or WRITE to:



APTRON LABORATORIES INC.

P.O. Box 323, Bloomington, Indiana 47402 • (812) 336-4775

✓8

# W2NSD/1 NEVER SAY DIE

editorial by Wayne Green

from page 8

Several of the new modes of communication which I have written about recently have the possibilities for getting amateur radio growing again, the way FM did. I'm most anxious to have ham experimenters get going on these and keep us up to date via 73 on progress. The recent FCC announcement that they would at long last encourage experimentation was a fantastic boost for us. Can someone at the FCC actually be listening? And reading?

## MAKING MONEY

Every now and then I hear from a reader who is not making a lot of money. This is a pity when you consider the opportunities out there for making money these days. We are getting into the age of electronics, and certainly radio amateurs have a golden opportunity to take advantage of this change in the world.

A few years back, I wrote in my editorials about the possibilities for getting into the security business. A few readers paid attention to this and went for it, starting, as I suggested, on a part-time basis. Many of them have built large security businesses as a result, some going into millions of dollars.

This is still a very good business for hams to get into. It does not take an electronics genius, and some of our ham equipment is immediately applicable. For instance, while you can buy most of the accessories you need from a few major suppliers, you should know how to tackle any radio links you might want to use for a silent and very secure alarm. This is particularly good for merchants wanting to know when someone has broken into their store.

An understanding of slow scan will enable you to set up systems which will let store owners see what is going on in their place of business over the telephone. This is also invaluable

for small businessmen who want to see their offices, warehouses, etc., from afar.

An understanding of microcomputers will enable you to take the next step and have the slow-scan signals processed for change to provide an alarm. The microwave and ultrasonic systems are fine for this, too. With crime increasing, there is an ever-growing need for security for businesses and homes. This is still an infant industry.

The microcomputer business is another natural for hams. The same perversity of human nature which gets people interested in hamming seems to attract people to computers. Our polls show that over 20% of the hams have microcomputers already!

In this new field there are plenty of opportunities...to open and run computer stores, to service computers, to write programs, to get into repping, distribution, designing new circuits, manufacturing, writing books and articles, advertising...it's endless. I know that I am in serious need of a wide variety of skills and interests...needing people for documentation, program evaluation, editing, proofreading, typesetting, drafting, advertising, ad sales, repping, data processing, financial management, legal organization, marketing, packaging, distribution...and so on.

The micro field, which has been growing at a rate of over 300% per year for over five years, shows no sign of slowing down. Micros are now getting into businesses and schools as well as to hobbyists and homes. The big firms are starting to wake up, which will mean all the more sales as IBM, DEC, and others plunge in. There are still abundant opportunities to make a lot of money in this field.

Another field which shows signs of unlimited growth is the satellite communications industry. Like the micro field, it started out with hobbyists,

growing initially on their interest. But the big use for satellites will very soon be for data communication, and this means more opportunities for entrepreneurs. Hams, who have plenty of opportunity to experiment with microwaves, are in a beautiful position to take advantage of this growth.

My own recent experiments with 10-GHz communications gave me a lot of insight into the use of these microwave frequencies. If you remember, I spent a few months working with Chuck Martin WA1KPS, and we established the still-firm record of communications between New Hampshire and six other states...seven in all. All contacts were made on paths of over 50 miles and our New Hampshire contact was over 100 miles! Most were made with simple antennas, though climbing to the top of my local mountain was the most grueling part. That was not easy!

The reception of satellite TV for homes is an exciting and fast-growing business. Prices are tumbling as mass production techniques and large-scale integration are applied to this new service. A couple years ago you had to figure perhaps \$15,000 or so for a workable installation. Now they have that down to around \$5,000. Our own KLM, maker of ham antennas, is one of the pioneers in this field. Many of the pioneers are hams!

As microcomputers proliferate, it will not be long before they are being used for electronic mail. Now, while a one-page message can be encoded so it can be sent over the phone wires in about one second, this still will not speed up the slowness of the phone dialing system. As more and more messages are routed over phone lines, the delays in using the dialing system are going to bog down Ma Bell.

Cool heads tried many years ago to get Bell to use separate signaling systems for dialing up numbers. This would have been much more efficient than using the communications lines. It also would have avoided all of this nonsense Bell is having with customers getting into their switching circuits with blue boxes and such. Well, the Bell folks ignored the wiser heads and now they are in trouble.

The most obvious answer to

the coming congestion of the Bell lines will be to go to satellites. First we will be using radio techniques, but I think that it won't be long before the volume of traffic will dictate the use of laser links, since each of them can carry incredible bandwidths of information.

With satellite-system inventing, manufacturing, selling, servicing, installing, and so on becoming one of the biggest industries in the world, and with the ground floor wide open for you, what better business to get into right away? Much of the needed inventing can be done on the ham bands, so this is a particularly valuable opportunity for us. We can invent and pioneer the equipment they are going to be using in ten and twenty years.

Yes, Bell may be able to expand their service by using glass lines instead of wires, but I think the need for communications is going to grow much faster than Bell will be able to cope with. So much of their equipment is hopelessly obsolete...and with a need for a complete redesigning and rebuilding of their switching system, we are looking at 20 years...and satellites are there right now, ready to handle the needed capacity.

## THOSE UGLY AMERICANS

A few years ago, shortly before my first visit to Jordan, I was called on 20m by an American visiting in Israel. I mentioned that I expected to be in Jordan in a few days. He said that he and his wife were touring in Israel and would like to go to Jordan. I suggested that this was not exactly a bright idea, Jordan at that time being almost an occupied country by the PLO. He brushed that aside.

A few days later, after I'd arrived in Amman, I found a note in my hotel mailbox to the effect that this chap had arrived and would like to get together with me. I called his hotel and found that he had come by way of Cyprus. I was scheduled to have dinner with His Majesty that evening and to present my plan for the setting up of amateur radio in Jordan to the government the next day, so I suggested we get together the next evening.

It didn't take long for trouble to erupt. The next day I got word that he had been downtown and

gotten into a fight with the PLO. I'd suggested that he *not* go downtown, as I had been advised. The PLO troops were everywhere and spoiling for trouble, driving around by the truckload. The American library had just been burned out and the American Embassy compound stormed (unsuccessfully, except for a lot of broken windows and a fire-gutted car), so there was a definite strain between the US and the PLO.

Later, I found that two main things had gone wrong. First, his wife had been wearing a miniskirt, despite this being a flat no-no for Arab countries. Second, he had apparently been taking pictures of the PLO and their trucks. These two circumstances led a PLO soldier to get irritated, which quickly escalated to our ham friend being hit over the head with a rifle.

Cooler heads prevailed and the PLO later offered to take our ham and his wife on a tour of the country at their expense, but he was so upset that he told them where they could go and boarded the next plane out of the country.

It took a lot of chutzpah for a Jewish chap to come to Jordan at that particular time... just days before the civil war between the PLO and King Hussein's government. It took more to flaunt the miniskirt in an Arab country... and more, yet, to walk around downtown during the tense time between the PLO and the government... and particularly the PLO vs. the US. Openly taking pictures kind of capped it.

The next thing I heard about this charmer was a rash of complaints from India, where he had gone from Jordan. The Indian

amateurs were absolutely furious because he had managed to screw up their long-planned DXpedition to the Laccadive Islands. Apparently he had bragged over the air that he had permission to go to the Laccadives, while the Indian amateurs had been unable to get such permission. The government officials were not amused and canceled the Indian trip, which had been years in the arranging.

As this chap went on around the world, I got similar reports from other countries. He was a moving ham disaster area.

Many of the transgressions of Americans came to roost when the ITU meeting was held in Geneva in 1971 to discuss the amateur use of satellites. Our group (the ARRL) found, much to its surprise, that a situation had built up in the Third World where radio amateurs had a very bad name. The confrontation could have been avoided if representatives of amateur radio had bothered to find out where we stood before the meeting. Much of the built-up frustration could have been vented and ironed out by such preliminary meetings. But, as the president of the League said, "We didn't do our homework."

The fact is that American amateurs have a long history of being arrogant, lying, devious, and ignoring the interests of other countries. One of the reasons that amateur radio is still not legal in Turkey stems from the Americans who operated there after WWII. The Turkish government allowed them to operate, but stipulated that they were *not* to indulge in message handling. So what did they do? Phone patches by the gross.

They were repeatedly warned and went right on with phone patches... and amateur radio was lost for over 30 years in Turkey. Yes, those were *American* hams.

In other African countries, we have had DXpeditions come in and ask for special permission to operate, promising propagation studies in return for the permission. These were never delivered... nor were they ever intended for delivery.

Other US amateurs abused countries all over the world by operating without licenses, by signing calls of other countries, by running more power than permitted, and so on. One American ham sat in Casablanca and signed the calls of at least four other countries... contacts that are still honored by the ARRL for their awards. No one knows how many of Don Miller's contacts were invalid—for another example—but they are still accepted by the League.

Another well-known DXpeditioner signed the calls of many African countries he never visited... and even some islands. These cards are all just fine for DXCC.

Well, these transgressions get around and undermine the honor of amateur radio. They came to roost at Geneva when we lost over 99% of our satellite frequencies. They will continue to come to roost if we don't get on the stick and see that they stop. DXers, frantic for a contact with a DXpedition at any cost, do not help. DXpeditions soon discover that they can charge \$50 to \$100 or more for a "new" country and that everyone on the Honor Roll *has* to go along with the payment. If they don't, they lose their place on the list

and the chances are good that they will never again get back where they were.

In case you want to find some uglies closer to home, just tune our DX band any evening or weekend and hear the jamming of rare DX stations by US amateurs. Every DXpedition or operator in a rare country will tell you all about it.

I operated recently from Provo Island in the Turks and Caicos Islands. That's only fairly rare, not real rare. Still, a dozen or so amateurs took the time to try to jam signals... US amateurs. I don't think there is any way to shame the people who are so unfeeling of the fun of others, so perhaps we need a different approach to this. I'm thinking in terms of a jamming certificate for the most enthusiastic jammers. In this way they will get recognition for their skills and nastiness. Also, we'll know just who they are in case we ever come up with vigilante committees, complete with tar and feathers.

I have an advantage when I go on a short DXpedition in that there are many other things which I can do if the jamming gets to be a problem. There are scuba diving trips to the coral reefs, snorkling, going around the islands taking pictures, visiting with local hams, talking with the governments about amateur activity, and eating... ever popular with me. I enjoy hamming, but I also enjoy all the other things there are to do. Chaps who go on a DXpedition and nothing else can only try to jump from one band to another to get away from the harassment.

If anyone has any good ideas on ways for amateurs to clean up our act on a worldwide basis, this forum is open.

## DX



Yuri Blanarovich VE3BMV  
Box 292  
Don Mills  
Ontario M3C 2S2  
Canada

73 has selected as its new DX Editor Yuri Blanarovich VE3BMV. First licensed in 1958, Yuri has held the callsigns OK3-5292, OK3BU, OK5BU, F0SY, and VE3BMV/VP9, and has operated OK3KGH, OK3KAG, 4U1ITU, CJ3DCB, and XJ3ZZ/1. He is a four-time world champion and the all-time world record holder in the CQ WW and WPX Contests, and also holds a number of Canadian and North American records. As a result of his 300,000-plus contacts, Yuri has worked all DXCC countries, holds 5BDXCC, and has col-

lected more than 200 awards.

Yuri is the founder of the Canadian Contest Championship, CAN-AM contest, and CANADX Net. He also has been president of CANADX, the IBM Radio Club, and the Ontario Contest Club, and chairman of the CANADX and CAN-AM contests, as well as a member of the CQ contest committee.

We welcome Yuri on board and ask our readers to furnish him directly with as much and as varied DX information as possible.

# FUN!



John Edwards KI2U  
78-56 86th Street  
Glendale NY 11385

## THE POSTMAN ALWAYS RINGS 612 TIMES

From every state you answered—612 responses in all—and told us what you think about amateur radio. Now the forms have been tabulated and the results are printed below.

Were there any surprises? Well, the number of you responding was a shock—about twice as many as we projected. We were also pleasantly surprised at the time and care most of you devoted to answering the survey. If letter writing is a dying art, we have tons of evidence to the contrary.

In all, the poll seemed to touch a very responsive chord. A number of letters expressed thanks at being included in a poll for the first time (How come Mr. Gallup never comes to my door?) and urged us to run regular surveys in the future. All of your comments are being given due consideration, but our mailman won't put up with another poll for some time. Come to think of it, with an office full of completed response forms, it'll be some time before we're ready again, too.

## ELEMENT 1—BACKGROUND

- 1) Sex:  
A) Male—94%    B) Female—6%

*No surprises here; ham radio continues to remain a predominantly male hobby. One interesting footnote: Most YL response forms were included in the same envelope with their OMs. Very few were independently mailed.*

- 2) Age:  
A) 15 or below—0%    B) 16-21—4%    C) 22-39—52%  
D) 40-59—25%    E) 60 and above—19%

*What happened to the kids? Are postage rates too high or maybe they just don't know how to write? I hope this particular question doesn't reflect amateur radio in general, or we're doomed.*

- 3) License class:  
A) Novice—8%    B) Technician—10%    C) General—35%  
D) Advanced—31%    E) Extra—16%

*About par for the course.*

- 4) Number of years licensed:  
A) 1 year or less—6%    B) 1-5 years—38%    C) 6-10 years—6%  
D) 11-20 years—23%    E) 21 years and up—27%

*Seems about right.*

- 5) Do you have a new (post-March '78) call?  
A) Yes—37%    B) No—63%

*With more than a third of all responses indicating "new" calls, they shouldn't seem strange anymore. Okay, so tell me why a huge number of replies were directed to "K-twelve-U?" That's not a "one," guys, it's an "eye."*

- 6) How many hours a week do you devote to amateur radio?  
A) 0-1 hour—6%    B) 2-5 hours—27%    C) 6-10 hours—42%  
D) 11-20 hours—19%    E) 21 or more hours—6%

*On the whole, a pretty active bunch.*

- 7) Which HF bands do you use most?

- A) 80-75 meters—14%    B) 40 meters—18%    C) 20 meters—12%  
D) 15 and/or 10 meters—44%    E) Don't operate HF—12%

*Only 12% on 20 meters? Sure doesn't sound that way. Eighty meters seems a bit on the low side, too. But those sunspots really seem to be helping 15 and 10.*

- 8) Which VHF/UHF band do you use most?  
A) 6 meters—6%    B) 2 meters—68%    C) 220 MHz—4%  
D) 420 MHz and/or up—0%    E) Don't operate VHF/UHF—22%

*This question asked which VHF/UHF band you used most, not which band you're on. That might explain why hardly anyone picked D, since most UHF ops are probably also on 2. Nevertheless, the apparent lack of UHF activity is disturbing.*

- 9) Which mode do you use most?  
A) SSB—44%    B) CW—24%    C) FM—26%  
D) AM—2%    E) Other—4%

*SSB is still tops, with FM narrowly squeezing ahead of CW for second place.*

- 10) How much money have you spent on amateur radio within the past year? (Include QSL expenses, magazine subscriptions, club dues, and other incidental expenditures.)

- A) 0-\$250—32%    B) \$251-\$500—27%    C) \$501-\$1,000—25%  
D) \$1,001-\$2,500—8%    E) \$2,501 and up—8%

*Soft market.*

## ELEMENT 2—SOCIAL CHARACTERISTICS

- 11) Has amateur radio influenced your career choice?  
A) Greatly—23%    B) Somewhat—25%    C) Not at all—52%

*Even though 52% chose C, try to think of another hobby with as great an influence on its users.*

- 12) If a Novice sent you a QSL after a QSO with no return package (sic), would you answer it?  
A) Yes—96%    B) No—4%

*Return package? Sorry about the typo; we meant, of course, postage. In any event, the old ham spirit still lives.*

- 13) Do you routinely look up the license class of the person you're talking to in the *Callbook*?  
A) Yes—21%    B) No—79%

*A longtime practice, still apparently used, to self-police our bands. Unfortunately, out-of-date Callbooks can sometimes lead to embarrassing situations.*

- 14) Do you think amateur radio was better 10 years ago?  
A) Much better—19%    B) Somewhat better—32%  
C) The same—32%    D) Somewhat worse—17%  
E) Much worse—0%

*A question of perception, since many respondents weren't active 10 years ago.*

- 15) Do you think amateur radio was better 20 years ago?  
A) Much better—27%    B) Somewhat better—23%  
C) The same—27%    D) Somewhat worse—14%  
E) Much worse—9%

*Oh, for the good old days!*

- 16) Did you ever use a "cheat book" to upgrade your license?  
A) Yes—12%    B) No—88%

*A slightly misleading result, since many cited the old ARRL License Manual as a "cheat book." Your FUN! columnist takes no stand on this issue.*

- 17) If someone offered you a million dollars, tax free, on the condition that you give up amateur radio forever, would you?  
A) Yes—61%    B) No—39%

*Thirty-nine percent say no. Either they're already rich, have a very deep love for amateur radio, or a million bucks doesn't mean much these days. Probably the latter.*

- 18) Has ham radio ever interfered in your personal relationships (i.e., time with your wife, husband, children, lover, etc.)?  
A) Yes—54%    B) No—46%

*Confirming what was widely suspected.*

- 19) Have you ever tried to interest a family member in amateur radio?  
A) Yes—88% B) No—12%

*An amateur's evangelical urges know no bounds.*

- 20) Do you think most hams have a sense of humor?  
A) Yes—90% B) No—10%

*Then why are so many QSOs as sharp as a sledgehammer?*

- 21) Do you get upset when you hear hams "kidding around" on the air?  
A) Yes—8% B) No—92%

*Save the bicarb!*

- 22) Have you ever intentionally jammed a repeater or otherwise purposely interfered with a QSO?  
A) Yes—14% B) No—86%

*My goodness! Fourteen percent admit it! Heaven save us!*

- 23) Do you think amateur radio lowers your neighbor's opinion of you?  
A) Yes—6% B) No—94%

*Sure, neighbors just love antenna towers and TVI. That's why they're always trying to pass laws down at Town Hall to limit our hobby. Guess they're just trying to get us to spend more time with them.*

- 24) If your closest ham friend beat you in a major contest, how would you feel?  
A) He must be a better operator than me—76%  
B) Contesting is just luck—6%  
C) The contest was set up unfairly—0%  
D) It was easy for him to win; he has better equipment—14%  
E) He must have cheated—4%

*A response that would have made Jack Armstrong proud.*

- 25) Do you make most of your friends through amateur radio?  
A) Yes—25% B) No—75%

*See, we do talk to other people besides hams.*

- 26) When attending a ham club meeting, flea market, or convention, do you wear a callsign badge?  
A) Yes—76% B) No—24%

*Hi! My Name is John, KI2U!*

- 27) If you answered yes to the above question, what size is your badge?  
A) 1 line—10% B) 2 lines—72% C) 3 lines—15%  
D) 4 lines—0% E) Larger—3%

*Wonder what the 3% who indicated E wear? Billboards? Must keep an eye out for them.*

- 28) If your closest friend won a Collins KWM-380 in a contest, would you feel jealous?  
A) Yes—37% B) No—63%

*What a bunch of liars.*

### ELEMENT 3—OPERATING HABITS

- 29) Do you depend on a Morse code reader or microcomputer code display for most of your CW QSOs?  
A) Yes—6% B) No—94%

*The ear wins!*

- 30) What sort of CW sending device do you use most?  
A) Straight key—51% B) Regular keyer—29%  
C) Memory keyer—4% D) Keyboard—8%  
E) Never send CW—8%

*I'm sorry; I'm sorry; I'm sorry. Yes, a thousand apologies for leaving out everybody's favorite CW sending device—the semi-automatic keyer (commonly known as "The Bug"). Please don't pin my coax or set fire to my house. I confess my sin and promise to genuflect daily in front of an ad from the Vibroplex Company.*

- 31) If required, could you solidly copy CW at the speed at which you were licensed?  
A) Yes—79% B) No—21%

*Hah! I'll bet that all you people who circled B used to dishonestly*

*sign your renewal 610 back when the FCC made you attest to your code speed.*

- 32) Have you ever purposely operated in an amateur subband you weren't licensed to use?  
A) Yes—10% B) No—90%

*On the whole, fairly respectable.*

- 33) Do you think the FCC affects amateur radio in a positive manner?  
A) Yes—44% B) No—55%

*Washington, are you listening?*

- 34) What do you think of the new ham exams? (Answer this even if you have never personally taken one of these new tests.)  
A) Excellent—6% B) Good—30% C) Fair—38%  
D) Poor—18% E) Terrible—8%

*So-so marks.*

- 35) Just for the heck of it, have you ever talked to a friend on the wrong sideband (e.g., LSB on 20 meters)?  
A) Yes—33% B) No—67%

*Give it a try sometime; it's fun.*

- 36) Do you ever speak to foreign, non-English-speaking hams, in their own language?  
A) Always—2% B) Sometimes—14%  
C) I attempt it—20% D) Rarely—10% E) Never—54%

*¿Que? Imagine if those foreign hams had the same attitude.*

- 37) Do you think "gentlemen's agreements" have any value?  
A) Always—35% B) Sometimes—63% C) Never—2%

*No wonder our bands are in the shape they're in.*

- 38) Do you feel you are competent to replace the finals in a tube-type rig?  
A) Yes—88% B) No—12%

*And 10% probably can't change a light bulb.*

- 39) Do you feel you are competent to replace the finals in a transistor-type rig?  
A) Yes—79% B) No—21%

*This 21% probably doesn't own a soldering iron.*

- 40) Have you ever built an electronic project from a kit?  
A) Yes—96% B) No—4%

*No, wait; most hams do own a soldering iron, but obviously need instructions on how to use it.*

- 41) Have you ever home-brewed an electronic project from a book or magazine?  
A) Yes—77% B) No—23%

*There's hope yet.*

- 42) Have you ever designed your own electronic project?  
A) Yes—62% B) No—38%

*Pretty good.*

- 43) After meeting a ham radio acquaintance in person for the first time, do you usually think:  
A) He is better looking than you thought—6%  
B) He is worse looking than you thought—27%  
C) He is about what you expected—67%

*To me, it's always a shock: "You don't look like a 'BQV!' "*

- 44) On the whole, compared to the general public, do you think:  
A) Hams are much better looking—4%  
B) Hams are somewhat better looking—8%  
C) Hams are average looking—62%  
D) Hams are somewhat worse looking—20%  
E) Hams are much worse looking—6%

*No matter what the survey shows, hams are ugly. Why do you think most aren't interested in ATV?*

- 45) Have you ever operated a specialized mode (i.e., RTTY, slow scan, etc.)?  
A) Yes—40% B) No—60%

*Too bad.*

- 46) What do you think of contesting?  
 A) Great—12% B) Good—17% C) Okay—38%  
 D) Don't like it—27% E) Despise it—6%

A split decision.

- 47) What do you think of DXing?  
 A) Great—27% B) Good—36% C) Okay—25%  
 D) Don't like it—8% E) Despise it—4%

Seems popular.

- 48) What do you think of repeaters?  
 A) Great—38% B) Good—38% C) Okay—20%  
 D) Don't like them—4% E) Despise them—0%

Best thing since sliced bread.

- 49) What do you think of traffic handling?  
 A) Great—15% B) Good—35% C) Okay—35%  
 D) Don't like it—11% E) Despise it—4%

What's to hate?

- 50) Do you ever secretly hope that a mild disaster will strike your community just so you could display your amateur radio skills?  
 A) Yes—25% B) No—75%

Let's move this 25% to low ground.

#### ELEMENT 4—A CLOSER LOOK

To conclude our poll, we've taken a closer look at these three questions:

- 12) If a Novice sent you a QSL after a QSO with no return postage, would you answer it? (Poll respondents who spent over \$1,001 on amateur radio in the past year, only.)

A) Yes—87% B) No—13%

On the whole, worse than the average respondent. Maybe that's how many get their money—saving on QSL expenses.

- 19) Have you ever tried to interest a family member in amateur radio (YLs)?

A) Yes—67% B) No—33%

Not as evangelical as OMs.

- 42) Have you ever designed your own electronic project (Extra-class licensees)?

A) Yes—63% B) No—37%

Virtually the same result as given by hams in general. Are Extras really that much smarter?

Many and deep thanks to everyone who participated. Special thanks to AF2M and WB2LWJ for suggesting questions and counting the results.

## CONTESTS



Robert Baker WB2GFE  
 15 Windsor Dr.  
 Atco NJ 08004

#### SCORING:

As per CARTG Zone Chart, multiplied by the number of countries worked, multiplied by the number of continents worked (6 max.). After the above calculations, world stations add 100 points for each VK/ZL station worked on 20 meters, 200 points for each on 15 meters, and 300 points for each on 10 meters. Countries count as per the ARRL list of countries, except that each VK, ZL, JA, VE, VO, and W/K district counts as a separate country. Contacts with one's own country count as zero points for multipliers.

#### AWARDS:

Awards will be issued for 1st, 2nd, and 3rd on a world basis and also on a country basis.

#### ENTRIES:

Logs must show in this order: date and time (GMT), callsign of station worked, serial number sent and received, points claimed. Logs of multi-operator stations must be signed by all operators, together with a list of their callsigns. Logs of SWL listeners must contain both numbers sent and received by the station logged. Incomplete loggings are not eligible for scoring. Logs must be received by the Contest Committee by October 1st. Address all logs to: W. J. Storer VK2EG, 55 Prince Charles

#### VK/ZL/OCEANIA RTTY DX CONTEST

Contest periods:  
 0000 to 0800 GMT Saturday,  
 June 6  
 1600 to 2400 GMT Saturday,  
 June 6  
 0800 to 1600 GMT Sunday,  
 June 7

This contest is now being organized and conducted by the Australian National Amateur Radio Teleprinter Society. Entry classes include: single-operator, multi-operator, and SWL. Each station may be worked only once per band, but may be worked on another band for further multipliers.

#### EXCHANGE:

Serial number consisting of RST, zone number, and time in GMT.

Road, French's Forest, 2086,  
 N.S.W., Australia.

Summary sheet must show callsign of station, name of operator(s), and address of same, bands used (a separate log is required for each band), the points claimed for each band, number of VK/ZL stations worked, total points claimed, and signature(s).

The judges' decision regarding the placings in the contest will be final and no correspondence will be entered into regarding the same. The logs become the property of the Contest Committee on completion of checking.

#### NEW YORK STATE QSO PARTY

Contest Periods:  
 1700 GMT June 6 to  
 0500 GMT June 7  
 1200 to 2359 GMT June 7

The contest is sponsored by the University of Buffalo Amateur Radio Society. Mobiles and portables changing counties may be worked again. NY stations may work each other.

#### EXCHANGE:

RS(T), serial number, and QTH consisting of state, province, country, or NY county.

#### FREQUENCIES:

Phone—3900, 7275, 14285,  
 21375, 28550.

## CALENDAR

Jun 6-7	VK/ZL/Oceania RTTY DX Contest
Jun 6-7	New York State QSO Party
Jun 14-15	ARRL VHF Contest
Jun 19-20	Summer SMIRK Party Contest
Jun 24	The Wednesday Night Contest
Jun 28-29	ARRL Field Day
Jul 1	CARF Canada Contest
Jul 17-23	SWOT QSO Party
Aug 8-9	European DX Contest—CW
Aug 15-16	SARTG Worldwide RTTY Contest
Aug 15-17	Rhode Island QSO Party
Aug 22-23	Ohio QSO Party
Sep 12-13	European DX Contest—Phone
Sep 12-13	G-QRP Club CW Activity Weekend
Sep 12-14	Washington State QSO Party
Sep 26	DARC Corona—10-Meter RTTY
Nov 8	DARC Corona—10-Meter RTTY
Nov 8	OK DX Contest
Nov 14-15	European DX Contest—RTTY
Dec 26-31	G-QRP Club Winter Sports

CW—1810, 3560, 7060, 14060, 21060, 28060.

Novice—3725, 7125, 21125, 28125.

**SCORING:**

Score 5 points per QSO. NY stations multiply by the number of states, provinces, and countries worked. Others multiply by number of NY counties worked, 62 maximum.

**ENTRIES:**

Mail logs by July 10th to: Scott J. Bauer WA2LCC, 816 East Fillmore Ave., East Aurora NY 14052. Include an SASE for results and any possible awards.

**SUMMER SMIRK PARTY CONTEST**

**Starts: 0000 GMT June 20**

**Ends: 2400 GMT June 21**

Sponsored by the Six-Meter International Radio Klub (SMIRK). No crossband contacts, multi-operators, or partial contacts. Check logs or dupe sheets are not needed.

# RESULTS

**RESULTS OF THE 3RD  
VK/ZL/OCEANIA RTTY  
DX CONTEST 1980**

**Single-Operator**

1. DJ6JC 793,282
2. VK5RY 774,996
3. JA6GIJ 611,038
4. VK3KF 539,435
5. VK8HA 481,184
6. VK4AHD 388,080
7. F8XT 352,432
8. I1TXD 320,082
9. W5HEZ 266,900
10. DF2OK 253,680
11. VK1GM 228,756
12. G3HJC 227,028
13. ZL2BR 204,536
14. JA8ADQ 179,800
15. VK2AHB 137,984
16. K0PJ/6 113,164
17. VK2AJT 122,720
18. Y43ZK 102,436
19. JR2TZL 91,484
20. ZL2ALW 83,424

**Multi-Operator Stations**

1. VK2TTY 1,207,340
2. VK2DGA 520,352
3. HB9Z 422,900
4. DK0MM 180,420
5. OZ8JYL 99,200
6. LZ1KDP 95,300
7. OK3VSZ 79,308
8. DF5LK 37,555

**SWL Stations**

1. Horst Ballenberger  
DLSWL 64,472
2. Jaroslav Dedic 62,864

**EXCHANGE:**

SMIRK number and state, province, or country.

**SCORING:**

Count 2 points for each SMIRK contact, 1 point for non-SMIRK QSOs. Add QSO points and multiply by number of states, provinces, and countries worked for final score.

**AWARDS:**

Trophy for overall high score. Certificates for high score in each state, province, or country. Note: Unless there are fewer than 3 active 6-meter operators in a state or country, a minimum of 3 valid entries must be received from that state/country or none will qualify for an award.

**ENTRIES:**

Entries must be submitted on the Fall, 1980, edition of the official SMIRK log. Single copies are available for an SASE and photocopies may be used. Entries received without all requested information, legibly written, will be disqualified. A return address is also requested. Send log requests and entries postmarked by August 1st to: Don Abell WB5SND, 6821 West Avenue, San Antonio TX 78213.

**WEDNESDAY NIGHT CONTEST**

**Starts: 2100 local time, June 24**

**Ends: 0200 local time, June 25**

Submit your best single hour of operation! This contest is sponsored by the Bluegrass Amateur Radio Federation. Any station may contact any other station on any band below 30 MHz. Crossmode contacts are OK.

**EXCHANGE:**

Signal report and color of your eyes.

**SCORING:**

WVE stations count 1 point each; DX stations count 2 points each. Add bonus points of 25 for WAC, 1000 for WAS, and 10,000 for DXCC and WAZ.

**FREQUENCIES:**

Phone—3890, 7225, 14275, 21350, 28600.

CW—3705, 7105, 14060, 21105, 27105.

All  $\pm 10$  kHz.

**ENTRIES AND AWARDS:**

Any log form may be used as long as the QSO time (GMT), exchange, callsign of station worked, and point value is given. Dupe sheet is not required. A certificate will be awarded to the top 3 entries. Disqualifications for claiming a duplicate contact or (and I quote the contest spon-

sor!) "logging on toilet paper." Logs must be postmarked within 10 days of the contest and sent to: Scott Wills WA4YOF, 340 Eagle Creek Drive, Lexington KY 40502.

**CANADA CONTEST**

**Starts: 0001 GMT July 1**

**Ends: 2359 GMT July 1**

Sponsored by the Canadian Amateur Radio Federation (CARF), the contest is open to all and everybody works everybody. Use all bands from 160 to 2 meters on CW and phone combined. Entry classes include single-operator, all band; single-operator, single-band; and multi-operator, single-transmitter, all band. All contacts with amateur stations are valid. Stations may be worked twice on each band, once on CW and once on phone. No crossmode contacts, and no CW contacts in the phone bands are allowed.

**EXCHANGE:**

Signal report and consecutive serial number starting with 001. VE1 stations should also send their province (NS, NB, PEI).

**SCORING:**

Score 10 points for each contact with Canada, 1 point for contacts with others. Score 10 points for each contact with any CARF official news station using the suffix TCA or VCA. Multipliers are the number of Canadian provinces/territories worked on each band and mode (12 provinces/territories  $\times$  8 bands  $\times$  2

modes for a maximum of 192 possible multipliers). Contacts with stations outside Canada count for points but not multipliers.

**FREQUENCIES:**

Phone—1810, 3770, 3900, 7070, 7230, 14150, 14300, 21200, 21400, 28500, 50.1, 146.52.

CW—1810, 3525, 7025, 14025, 21025, 28025, 50.1, 144.1.

Suggest phone on the even hours (GMT), CW on the odd hours (GMT). Since this is a Canadian-sponsored contest, remember to stay within the legal frequencies for your country!

**AWARDS:**

The CARF Canada Contest Trophy will be awarded to the highest score single-operator entry. Certificates will be awarded to the highest score in each category in each province/territory, US call area, DX country, and to the highest score from a Canadian non-Advanced amateur.

**ENTRIES:**

A valid entry must contain log sheets, dupe sheets, and a summary sheet showing a chart of multipliers per band/mode and score calculations. Send entry with comments to: Canadian Amateur Radio Federation, 203-1946 York Avenue, Vancouver, B.C. V6J 1E3, Canada.

Results will be published in TCA, the Canadian amateur magazine. Non-subscribers may include an SASE for a copy of the results.

## HAM HELP

I want to talk with someone who has successfully solved ignition noise problems in a 1977 Honda Accord which interfere with 2-meter operation.

**Jim Weitzman K3JW**  
11417 Hounds Way  
Rockville MD 20852

I have a power inverter/charger, model # KG-666 by Knight Kit, and need a schematic or owner's manual. I will pay any reasonable fee for a copy. Thank you.

**Lowell G. Wilson**  
1104 Wentland Drive  
Mason MI 48854

I have a model 210 Bearcat scanner and it doesn't go lower than 146 MHz. My need is from 142 MHz up. If anyone has made a modification of this kind, I would appreciate the help. Thanks.

**Wm. Green W0GVT**  
22055 Cook Lane  
Morrison CO 80465

I am interested in finding other hams with a passion for the Middle Ages/Society for Creative Anachronism.

**Charles E. Martin AB4Y**  
PO Box 3370  
Bowling Green KY 42101



# NEW PRODUCTS

## AEA'S PFDF RADIO DIRECTION-FINDER

AEA has announced the first product in a new line of radio direction-finders. The AEA Model PFDF is a highly accurate rf direction-finder using the Doppler spun array technique and featuring a self-contained and preprogrammed computer.

The PFDF offers 1° resolution with a 3-digit LED display. A ring of discrete LED indicators surrounding the 3-digit display gives the operator instant course bearing information.

The PFDF will work with virtually any FM receiver (including the popular scanners) by simply plugging into the receiver external speaker jack. The receiver audio gain control is set for proper level as indicated by the PFDF front-panel level indicators. A built-in audio amplifier and speaker in the PFDF allow the operator to independently adjust the monitor level. The Doppler sample tone gives the experienced operator a good indication of when multipath signals are being received. An audio filter is provided to reduce the amplitude of the tone for more pleasant monitoring.

Antenna positioning is not an arduous mechanical task with the PFDF. A calibration offset bearing may be programmed into the PFDF to calibrate the antenna on a known transmitting source. This feature is

especially effective in extending the frequency range of a single antenna system. It also allows calibration when the PFDF is used with more than one receiver, each having different phase delays. The offset information is stored with a separate battery keep-alive circuit when the main power switch is turned off.

Three sample modes are offered by the PFDF. A slow sample mode gives an updated bearing once per second. The fast sample mode updates the bearing three times per second on a continuous basis. The sample and hold mode is activated after pressing the function button so that the next time a signal is present (even for a fraction of a second), the PFDF will determine the bearing and display it until reset.

The PFDF is supplied with a VHF high-band antenna that will operate over a frequency range of 130 to 175 MHz. The antenna consists of four dipoles that are switched with PIN diodes driven by the PFDF computer. Other mating antennas will be made available in the future for other frequency bands.

Power for the PFDF can be derived from any 12 V dc source or from an optional internal rechargeable sealed Gel Cell battery pack. BCD output of the three-digit bearing information is available for such things as feeding another computer from



Grove Enterprises' Code Breaker descrambler.

more than one source for triangulation purposes.

For further information, contact *Advanced Electronic Applications, Inc.*, PO Box 2160, Lynnwood WA 98036; (206)-775-7373.

## CODE BREAKER DESCRAMBLER

A product claimed to be the most advanced consumer voice descrambler ever made available to the public has been announced by Grove Enterprises.

The Code Breaker contains an internal speaker and a tunable notch filter. Simply by plugging the Code Breaker into the external speaker jack of a scanner, the listener can restore normal speech to the vast majority of scrambled speech encountered by scanner listeners. Tone masking, frequently used to thwart reception by conventional competitive descramblers, is easily eliminated by the tunable notch filter.

When conventional communications are being monitored, the Code Breaker filter circuit may be used to reject interference

from the squeals, whines, and irritating sounds which commonly plague the busy communications spectrum. The Code Breaker is optimized for voice frequencies, improving intelligibility when used with existing receivers.

For further information, contact *Grove Enterprises, Dept. K*, Brasstown NC 28902; (800)-438-8155.

## CONDUCTIVE WRIST STRAP PROTECTS DEVICES AND USERS

A new, conductive wrist strap that features an integral resistor to safely ensure constant grounding in static sensitive areas has been introduced by Charleswater Products, Inc. The CP401R conductive wrist strap features a 1-megohm fixed resistor for optimum static dissipation and user safety. Comfortable and lightweight, it attaches with a Velcro® fastener and uses a swivel snap to conveniently disconnect from the ground cord.

Provided with a battery clip

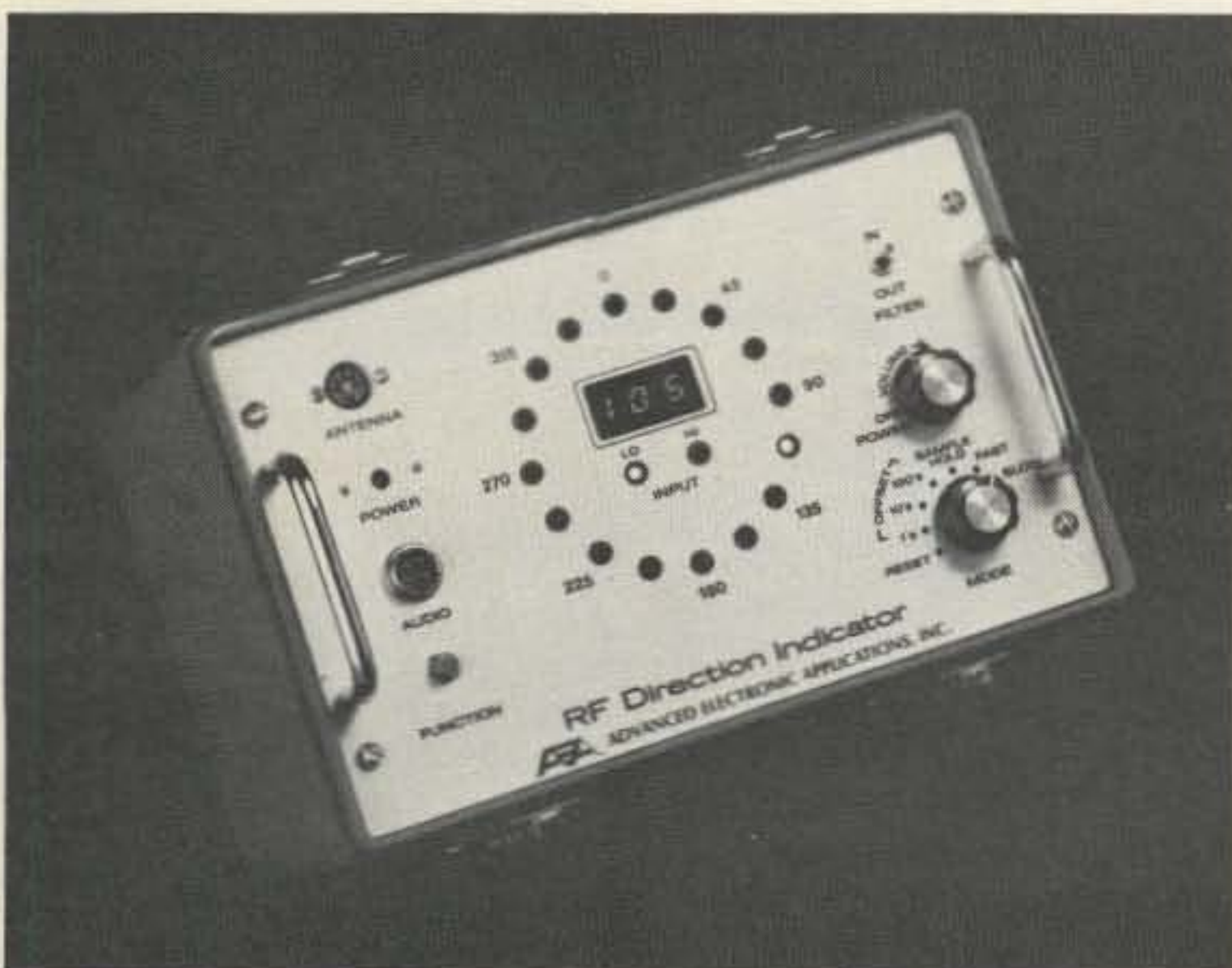

AEA's PFDF radio direction-finder.

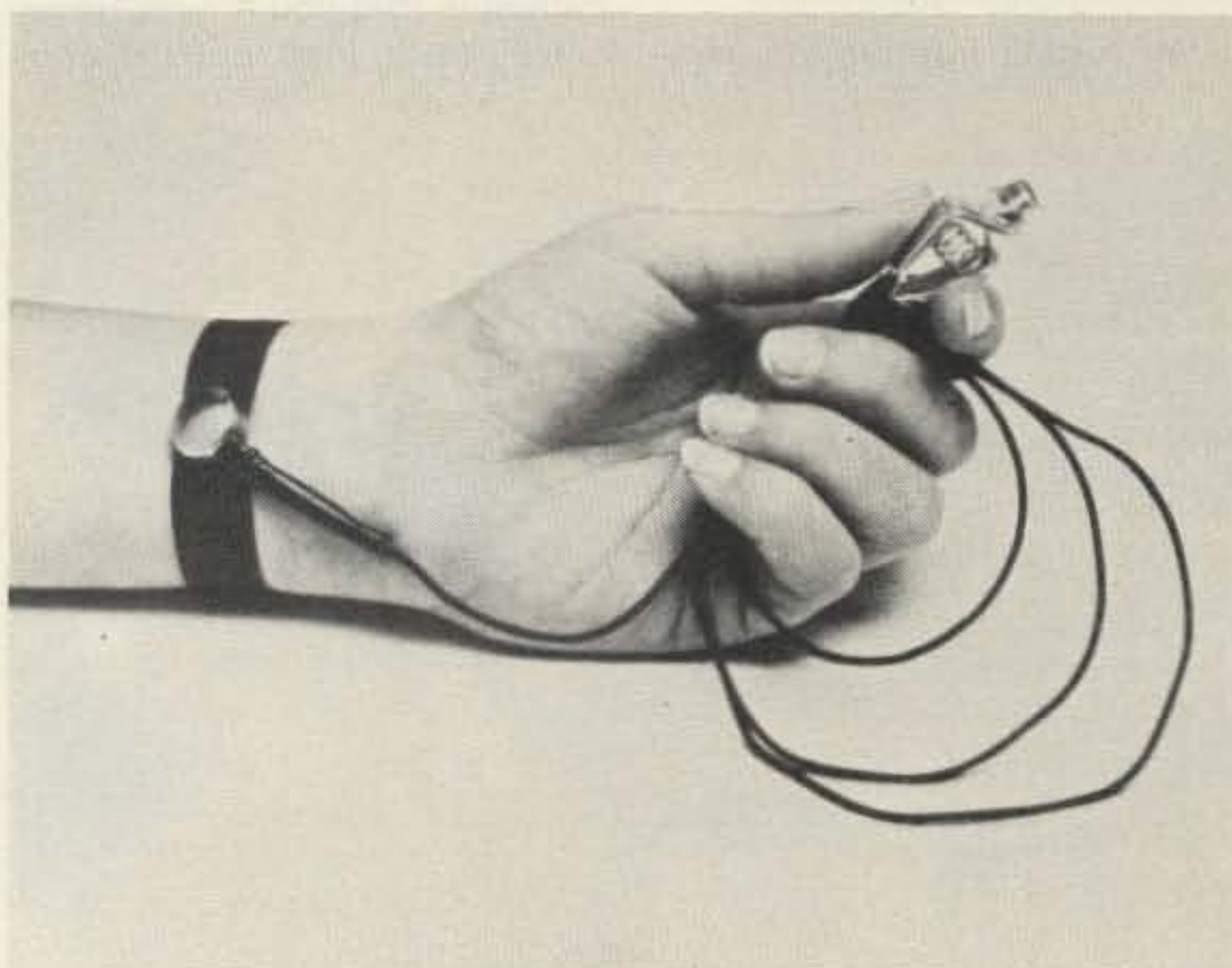

Charleswater Products' CP401R conductive wrist strap.

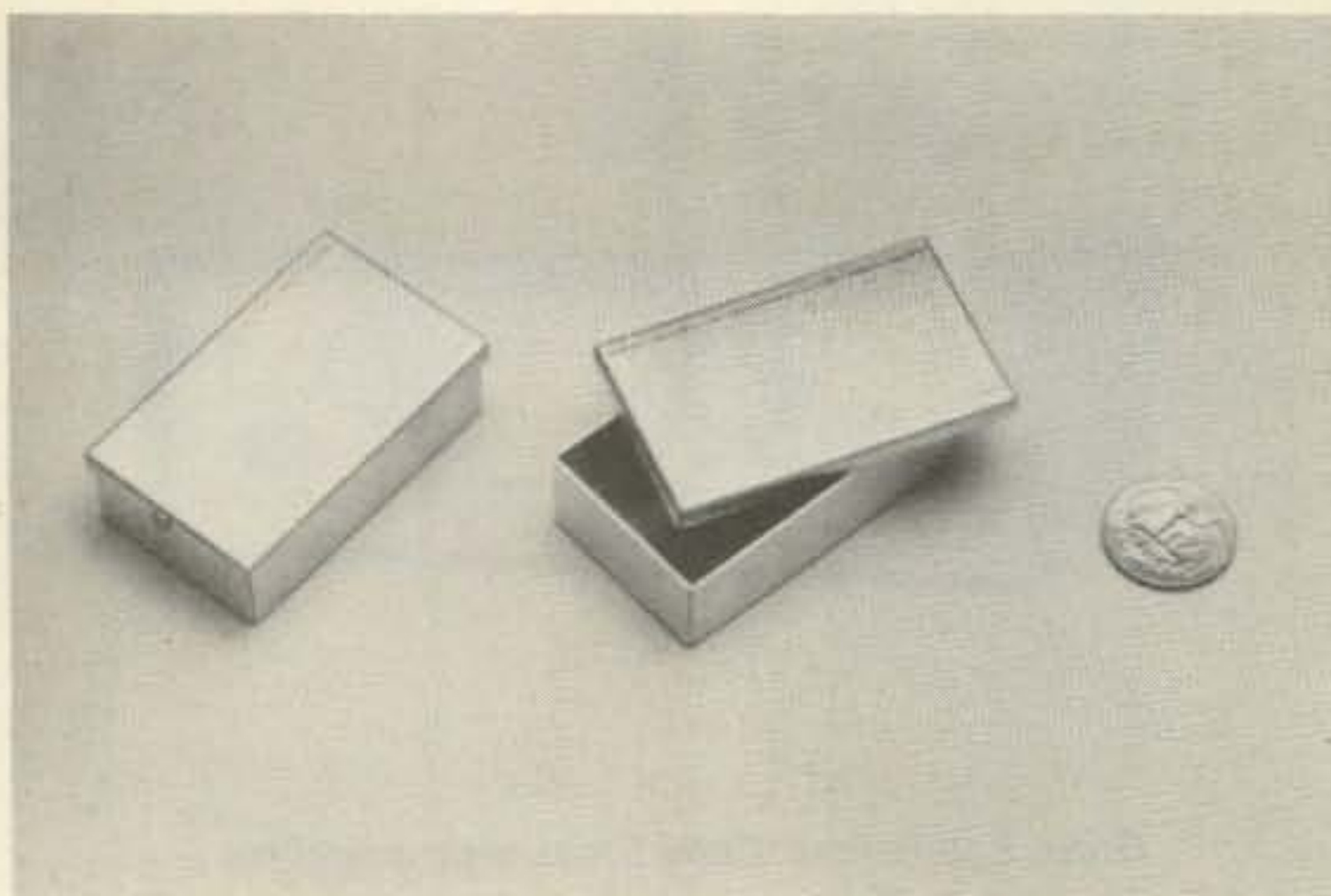

Nordal Electronics' precision packages.

for easy grounding. The CP401R has a polyester band and an insulated copper wire cord. The resistor is located close to the band for safety and the strap comes in 4' and 6' lengths.

For further information, contact Charleswater Products, Inc., 87 Crescent Road, Needham MA 02194; (617)-449-1811. Reader Service number 482.

#### PRECISION ALUMINUM ELECTRONIC PACKAGES

Nordal Electronics has introduced a new line of precision aluminum boxes for electronic packaging which can be made in any size with no tooling or setup charges. The boxes and removable covers are made of .032 aluminum and can be used to package rf circuits, amplifiers, filters, oscillators, magnetics, and other electronic circuits. They can be used alone or mounted on a PC board to provide a shielded package with a removable cover. Special packages can be made with holes for connectors, feedthroughs, stand-offs, or mounting brackets.

For further information, con-

tact Nordal Electronics Company, 9995 Monroe Dr. #205, PO Box 20175, Dallas TX 75220; (214)-350-9515. Reader Service number 487.

#### MFJ'S NEW POLICE/FIRE EXPLORER

The MFJ Police/Fire Explorer, Model MFJ-311, will convert any two-meter synthesized or vfo rig to cover the VHF high-band police and fire frequencies. If your rig covers 144-148 MHz, just insert the MFJ-311 in line with the antenna, connect power, turn on the converter, and you are ready to receive 154-158 MHz. If your rig covers a larger or smaller section of the band, then with the MFJ-311 you can receive a correspondingly larger or smaller section of the VHF police and fire band. The frequencies between 154 and 158 MHz contain nearly all FCC-allocated VHF high-band police and fire activity.

You have direct frequency readout from your rig. If your rig indicates that you are receiving 145.55 MHz, just turn the con-



MFJ's Police/Fire Explorer.

verter on and you are receiving 155.55 MHz.

A push-button switch turns the MFJ-311 on and off. In the off position, the converter is bypassed and you are ready to transmit (very low insertion swr). If you forget and transmit with the converter on, it won't burn out (up to 25 Watts).

The new Police/Fire Explorer is small (only 3" x 4" x 1") and has a mobile mounting bracket for installation in your car. It is black and eggshell white and operates on 9-18 V dc.

For further information, contact MFJ Enterprises, Inc., PO Box 494, Mississippi State MS 39762; (800)-647-1800. Reader Service number 483.

#### CURTIS 8044M ADDS SPEEDMETER OUTPUT

An interesting enhancement of the popular 8044 CMOS keyer has been introduced by Curtis Electro Devices. Called the 8044M, this new integrated circuit adds an output designed to

drive an analog meter for speed indication. Speed indication from 6 wpm to as high as 100 wpm can be accomplished by simply adding two capacitors, a resistor, and a 100-uA meter. The meter indication can be calibrated to be well within a 5% tolerance. The reading is stable, even at the lowest speeds.

The addition of two extra pins at the end of the package allows a pin-for-pin fit with the standard 8044. One of the pins is used for a timing capacitor and the other drives the meter directly. This allows retrofitting in many existing keyers with relative ease.

For further information, contact Curtis Electro Devices, Inc., Box 4090, Mountain View CA 94040; (415)-494-7223. Reader Service number 481.

#### IC FOR VOICE COMMUNICATIONS INTRODUCED BY MOTOROLA

Motorola now offers an FM i-f circuit with exceptionally high

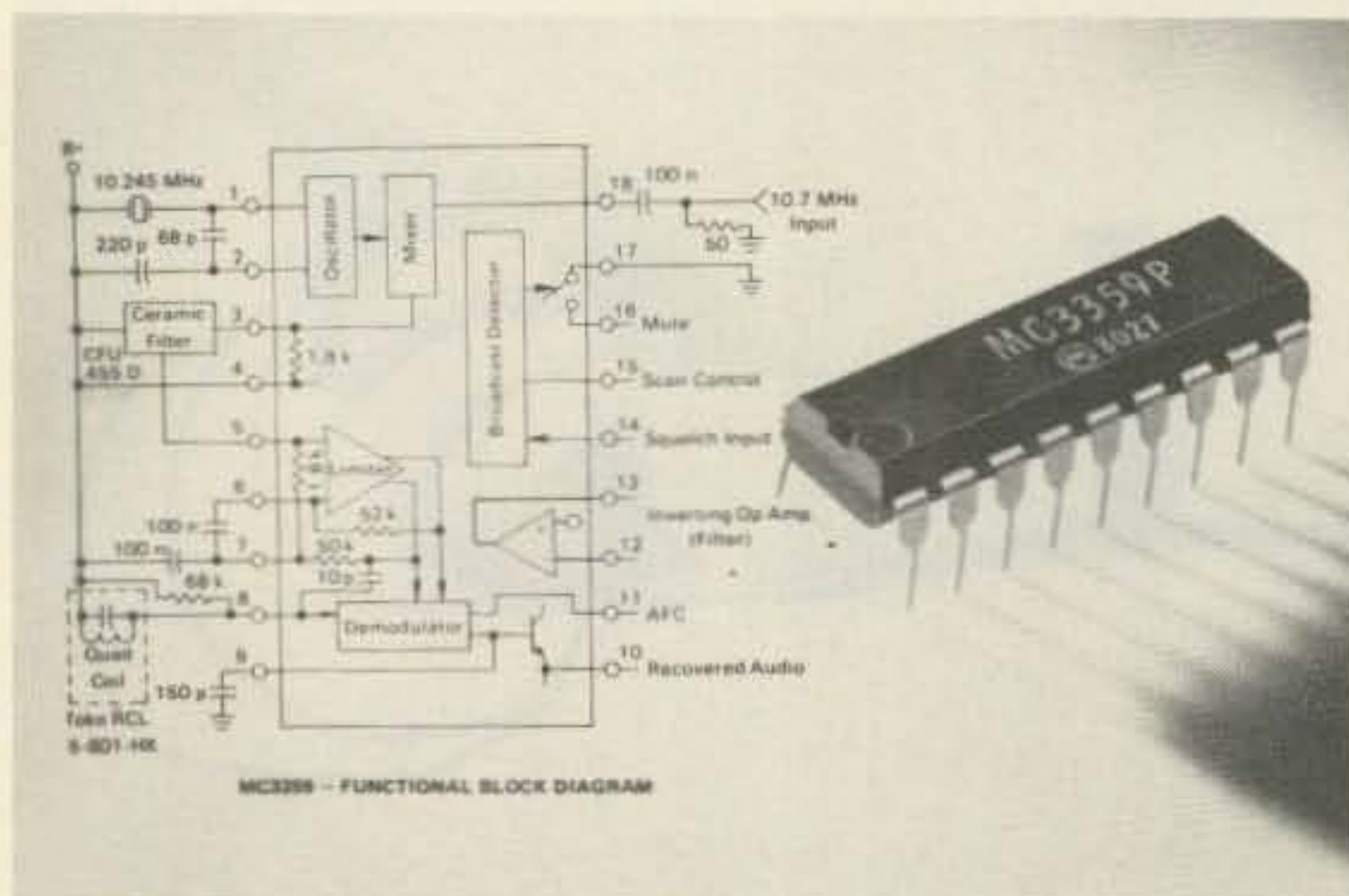

Motorola's MC3359 voice communications IC.

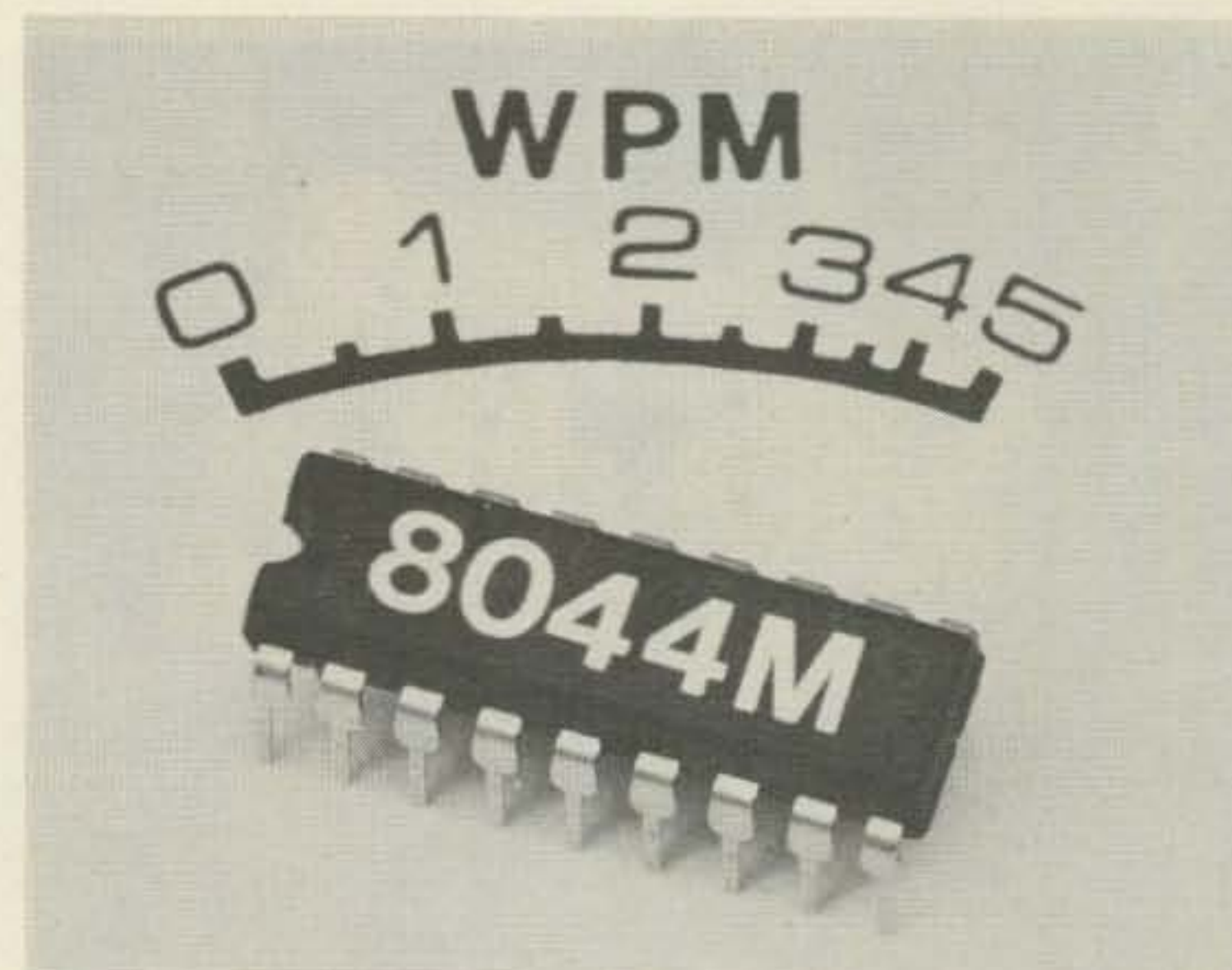

Curtis Electro Devices' 8044M speedmeter chip.

gain and low power consumption for narrowband FM receivers and transceivers found in voice-communications and energy-management systems. It is designated the MC3359, and includes oscillator, mixer, limiting amplifier, afc, quadrature detector, squelch scan control, and op-amp (active filter) circuits.

The MC3359 provides a recovered audio output voltage (typical) of 700 mV. Current drain remains low—at 3.0 mA (typical) from a 6.0-V power supply—and the sensitivity is 2.0  $\mu$ V (typically) for -3.0-dB input limiting.

In actual operation, the mixer-oscillator combination converts the input frequency down to 455 kHz, where, after external band-pass ceramic filtering, most of the amplification is done. The audio is recovered using a conventional quadrature FM detector. The absence of an input signal is indicated by the presence of noise above the desired audio frequencies. This "noise band" is monitored by an active filter and a detector. A squelch-trigger circuit indicates the presence of noise (or a tone) by an output which can be used to control scanning. At the same time, an internal switch is operated, which can be used to mute the audio.

Use of the MC3359 allows the elimination of many discrete components which would normally be employed in a similar voice communications or energy-management system and results in a considerable cost savings.

For further information, contact *Motorola Semiconductor Products, Inc., PO Box 20912, Phoenix AZ 85036*. Reader Service number 488.

#### SWITCHCRAFT PUBLISHES NEW CONNECTOR CATALOG

Switchcraft, Inc., has published a new 36-page catalog on audio and general-purpose connectors and ac receptacles. The catalog (No. C502f) includes product descriptions, full engineering specifications, detailed drawings, and mating charts showing connecting compatibility with similar products.

The catalog includes such Switchcraft products as Tini "Q-G" miniature connectors and accessories; "Q-G" audio connectors (including a variety of panel and wall-plate receptacles, adapters, inserts and accessories); "Slim-Line" audio connectors and accessories; various other microphone connectors, CB connectors, and phone plugs and jacks; and ac receptacles for electrical/electronic applications.

For further information, contact *Switchcraft, Inc., 5555 N. Elston Ave., Chicago IL 60630*. Reader Service number 486.

#### FOUR-CHANNEL REMOTE CONTROL SYSTEM

Advanced Analog Systems, Inc., has announced a four-channel remote control system kit with radio frequency carrier. It is capable of two channels of analog and two channels of digital control through the use of a pulse code modulation technique. The transmitter modulates the rf carrier with a unique series of pulses and the receiver decodes the pulses and generates appropriate analog and digital signals for the devices being controlled.

The analog information is represented

by pulses of varying duration, while digital information is encoded and decoded by means of a pulse-counting technique. The pulse-counting technique was chosen to avoid the costly timing circuitry required at both the transmitter and receiver with other digital encoding schemes. The digital commands are implemented via open/short connections (SPST switches, relays, etc.). The analog information is encoded by varying a control potentiometer.

The rf carrier is modulated to produce a pulse train which consists of one long pulse (for synchronization) followed by several shorter pulses. The first two shorter pulses are pulsewidth modulated and contain the analog information for channels 1 and 2. Following the two analog-encoded (PWM) pulses, there will be either 1, 2, 3, or 4 short pulses representing the 4 possible combinations of the two digital inputs (2 SPST switches, open or closed).

A unique feature of the transmitter is a regulator which keeps the radiated output power constant even under varying supply voltages. This is very desirable in battery-powered remote control applications. Maximum output power is achieved when the transmitter is operated from a 9-V battery. The rf output is down only about 1 dB when the supply voltage drops as low as 5 V. Typical sideband amplitudes 10 kHz from the center frequency are 50 dB down, allowing close physical proximity on closely-spaced channels.

The receiver provides latched outputs for the digital information. Two bidirectional servo

amplifiers with internal pulse-width detection completely decode the two analog channels. The servo amp's output is capable of bidirectional operation yet still requires only a single supply. Each servo amplifier output is capable of a 400-mA load. The dead band of each servo amp can be modified independently by changing one capacitor on the receiver card.

Amplitude modulation of the pulse-modulated waveform of up to 60% results in continued error-free transmission and decoding of the signal. The AM rejection provides a high degree of protection from interfering signal sources. This feature is extremely important for operation in industrial environments. Typical operating "radio range" is 150 to 200 feet. The digital outputs of the receiver card are capable of sinking 100 mA—sufficient for driving small lamps, buzzers, relays, etc.

Typical applications include remote switching, data recovery systems, medical data monitoring, toys and games, alarm systems, remote temperature sensing, carrier current systems, remote peripheral monitoring, environmental controls, remote motor control, communications systems, etc. The kit includes a transmitter and a receiver PC board and all components necessary to develop a complete 4-channel remote control system (antenna and battery clips are not included).

For further information, contact *Advanced Analog Systems, Inc., 790 Lucerne Dr., Sunnyvale CA 94086; (408)-730-9786*. Reader Service number 484.

## KAHANER REPORT

Larry Kahaner WB2NEL  
PO Box 39103  
Washington DC 20016

### POWER PLAYS, PLOYS, AND PARLEYS

By the time you read this, the whole thing might be resolved. The FCC would have consolidated its offices and moved into new surroundings. Although they wanted to move just across

the Potomac to Rosslyn VA and the idea seemed like a shoe-in, it ran into a little trouble.

You may have heard or read about the Rosslyn incident, how the FCC decided at the last minute to reconsider the move. This was all true. But here's the story your newspaper didn't tell you.

It all started last year when the FCC decided it needed more

office space. Believe me—it does. Not only that, but it's scattered over five buildings in downtown Washington DC, making communications between some bureaus difficult.

So the Commission did what it's supposed to do. It asked the General Services Administration for help in finding new digs. That's the GSA's job, procuring everything from paper clips to real estate.

But the GSA, according to FCC officials, wasn't responsive. It dragged its red-taped feet and kept the situation in abeyance. Why? Who knows. Maybe just bureaucracy. In any

event, the FCC got angry, enlisted some friends in high places, and got a rider attached to an 11th-hour Congressional appropriation bill that gave the FCC special dispensation to find its own property within two miles of the District, sign the lease, and move in.

Now the FCC doesn't know much about finding property, so they did what they thought was right. They used contacts, friends of contacts, uncles of friends of contacts. They used consultants, \$680-a-day consultants, and they used newspaper ads. They received about ten offers, narrowed it down to two

choices, and finally decided upon a beautiful piece of land known as Rosslyn Towers. It's a beautiful place, great view of the District, and besides, most of the commissioners live in Virginia.

So, when it came time to sign the lease, they were ready. However, a new administration took control and some congressmen took a dim view of the way the FCC cut the deal.

For one thing, they believed the FCC's actions might set a bad precedent. After all, you can't have an agency getting things done quickly and efficiently—albeit a little unorthodox and perhaps straddling the ethical fence just a tad. Also, the new representatives didn't get a piece of the action and neither did their friends.

The Subcommittee on Buildings and Grounds held a hearing on the move to Rosslyn. Representing the FCC were Acting Chairman Lee, Commissioners Jones and Washburn, staff, and their lawyer.

Lee did most of the talking, related his tale of woe, and told subcommittee members that the FCC planned to vote on the move the next day and he would recommend to his fellow commissioners that they OK the lease. Subcommittee members didn't like that at all and asked Lee to hold off for a while until further studies could be undertaken.

Lee said the Commission was tired of waiting and would go ahead with the move. Subcommittee members didn't take to that either, and Representative Solomon (R-NY) asked, "Even if we brought legal actions to stop the move?"

Lee said he would stick to his guns.

Solomon didn't like that even more and said: "If you meet tomorrow and sign that lease a few days later, I guarantee that legal actions will be taken."

Lee said he would still do it.

Then Solomon, his face a little red, said: "This is a threatened injunction!"

And Lee, swallowing just a bit harder, said he would still recommend to his colleagues that they sign the lease and move in.

You can't just say that to a congressman and get away with it. These guys have egos, you know.

So, the subcommittee chairman, Representative Fary (D-IL), listening coolly, put on his best tough high-school principal face and said he wanted to see *all* the commissioners at a special meeting of the subcommittee tomorrow at 9:30 sharp. But Lee said that the FCC's meeting was at that time, and Fary said: "OK, after the meeting; 2:30."

And the gavel hit the wood. Hard.

Never before has a congressional subcommittee threatened a governmental agency with an injunction. Nobody even knows if they can. But it really didn't matter because the next day the FCC, in closed session, voted 3-2 not to sign any leases until the new chairman, Mark Fowler, takes office. Incidentally, Commissioners Lee and Jones voted against the measure. And the special subcommittee meeting in which the other commissioners were supposed to attend was canceled.

And that, ladies and gentlemen, is how things are done at the Center of the Empire.

#### SOME MORE FRIENDS IN HIGH PLACES

The Capitol Hill Amateur Radio Society, which not only has friends in high places but has members in high places, petitioned the FCC to repeal recent rules that disallow new club licenses.

Sitting at the March 19 Commission meeting, you hardly noticed the commissioners say "dismissed." They said it so fast you barely heard it. You could, however, hear them say: "Next on the agenda."

#### BILLS, BILLS, MORE BILLS

Every year, hundreds of bills are introduced in Congress and most of them never make it out of committee. You usually get a newsletter from your representative saying that he submitted this bill and that, and "Hey, it's not my fault if they didn't go along with my proposal to cut taxes 50%."

Such might be the case with H.R. 2203. It's not a new idea. It was submitted last session as H.R. 8445.

The new bill amends the Communications Act of 1934, permitting the FCC to use volunteers—hams and CBers—for purposes of monitoring violations of the Act by hams and CBers. It also would permit hams to adminis-

ter license tests to the "least privileged class of amateur stations operator license." If I'm not mistaken, don't we already do the testing portion?

The bill got a positive response from Gerald Reese, executive director of REACT, whose letter of praise for the bill was written into the *Federal Register* but not orated on the House floor.

The ARRL also had its response to H.R. 2203 read into the *Federal Register*. The group supports the bill.

#### GOOD NEWS FOR BAD GUYS

HFers take note: At last word, the FCC was running fast, trying to escape Reagan's budget ax. The dust hasn't cleared, but Acting Chairman Lee said that the FY '81 budget included a program to phase out five special enforcement teams and reallocate their resources to establish ten smaller offices. Two were just opened—Little Rock and St. Louis—and they must be closed due to lack of funds. The following, that were to be opened, won't be: Phoenix, Des Moines, Salt Lake City, Tulsa, Nashville, Greensboro, Spokane, and Albuquerque.

In addition, two heavies, special enforcement teams in Detroit MI and Powder Springs GA are being closed.

Lee also said that the current program of traveling to about 77 cities on a monthly, quarterly, or annual basis to give ham and commercial license tests would be cut to an annual basis only.

How much of this will really happen is anyone's guess. All agencies plead "worst case" when their budgets are about to be reduced. However, it's fairly certain that proposed cuts will curtail FCC services, especially in Private Radio which takes a back seat to other bureaus like Broadcast or Common Carrier. If it means the FCC will leave us alone more, perhaps we should be thankful.

#### SOME INTERESTING THINGS

—The FCC is receiving complaints from hams that bootleggers are riding the high seas. It seems that amateur radio is so efficient for long-haul marine traffic that some private mariners toss out the HF marine band and check into maritime mobile nets for phone patches sans ham licenses.

—A firm in Vienna VA is bouncing signals off meteor trails, using them as reflectors. Links are available 24 hours a day even though bursts are random. The key is the number of burst—billions every day! Operating under an FCC test license in the 30-50-MHz range, Telcom, Inc. is sending data on a regular basis between its Virginia headquarters and the Watts Bar TN office, about 700 km away.

The company uses a computer-controlled uplink to automatically scan the sky for a usable meteor trail. When it's found, the company "illuminates" the trail with rf. Then data transmission begins.

Trails hover around 90 to 110 km above the Earth, each with a useful life of about 0.2 seconds. Data is sent at 4,800 bits per second. The system can't be used for voice but is full duplex.

Experiments show best results at 1 kW with a 5-element yagi. The system is cheap and easy to use, the company says. One kink is that sometimes you have to wait several minutes for a usable trail. Telcom says the system is no longer in the prototype phase and is all set for commercial application.

—In the first legal decision that long-term microwave exposure can cause death, NY State Workers' Compensation Board has awarded a \$30,000 settlement to the widow of a Bell Telephone supervisor. Samuel Yannon of Staten Island died as a result of working near microwave towers atop the Empire State Building for eight years.

He left work in 1970 and filed a workers' compensation claim in 1971 saying that exposure led to his illness and inability to hold his job. He died in 1974, and his widow filed for death benefits. Bell will appeal the decision.

—In case you think teletext, the system in which words and graphics appear on your TV screen after you push the decoder box buttons, is still in the Buck Rogers mode, you're wrong. More than 25 different tests worldwide are in the works, but those tests will become part of everyday life very soon. Everyone's got a different name for it: Viewtron, Viewdata, Telidon, Antiope, Data Vision, Bildschmirtext,

*Continued on page 115*

# ICOM IC-720A



**Multi mode operation** includes CW/AM/SSB/RTTY — Normally used side band selected automatically.

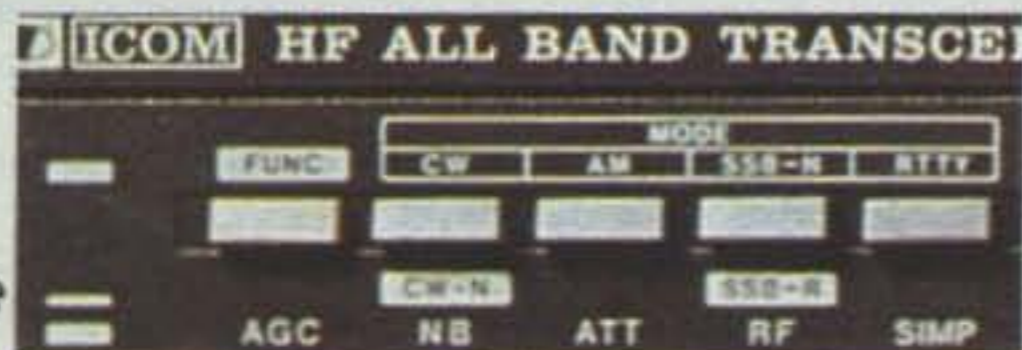

**Simple to use Dual VFO's** standard Data transfer button for marking a frequency of interest and storing it in unused VFO.



**Continuously variable power** from 10W to full power — speech processor — LDA channeling module included provides auto band changing capability when increasing your power using the IC-2KL broadbanded solid state linear.



**Broadbanded solid state transceiver operation** on the 9 amateur HF bands — Readout of mode in use and VFO — Status LEDs for push button functions.

**General coverage receiver** from a 0.1KHz to 29.999.9MHz — Split VFO operation — Frequency memorized in standby VFO.



**Use of RF/ALC switch** in conjunction with the internal top hatch cover switches allows monitoring relative RF Out, SWR, collector current and ALC.



## The ICOM HF System. We Have You Covered.



HF/VHF/UHF AMATEUR AND MARINE COMMUNICATION EQUIPMENT



# ICOM

ICOM AMERICA, INCORPORATED

Sales Service Centers located at:

2112 116th Avenue NE  
Bellevue, WA 98004  
Phone (206) 454-8155

3331 Towerwood Dr., Suite 307  
Dallas, TX 75234  
Phone (214) 620-2780

**MAKE  
MONEY...  
SELL  
73 MAGAZINE**

Selling 73 Magazine, the ham radio magazine that offers quality and quantity, brings the ham into your store. Once through the door you can sell him anything.

Our dealers are telling us that "73" outsells them all...so call today and join the dealers who make money with 73 Magazine.

For information on selling 73 Magazine call 603-924-7296 and speak with Ginnie Boudrieau, our Bulk Sales Manager. Or write to her at:

**73 MAGAZINE**  
80 PINE STREET  
PETERBOROUGH NH 03458

# Radio Bookshop

**NEW** from **73**

**THE  
NEW  
WEATHER  
SATELLITE  
HANDBOOK**



**BY DR. RALPH E. TAGGART**

Here is the completely updated and revised edition of the best-selling **Weather Satellite Handbook**—containing all the information on the most sophisticated and effective spacecraft now in orbit. Dr. Taggart has written this book to serve both the experienced amateur satellite enthusiast and the newcomer. The book is an introduction to satellite watching, providing all the information required to construct a complete and highly effective ground station. Not just ideas, but solid hardware designs and all the instructions necessary to operate the equipment are included. For the thousands of experimenters who are operating stations, the book details all procedures necessary to modify their equipment for the new series of spacecraft. Amateur weather satellite activity represents a unique blend of interests encompassing electronics, meteorology and astronautics. Join the privileged few in watching the spectacle of earth as seen from space on your own monitoring equipment. Order BK7383 \$8.95

**SAVE \$2.95**

**WEATHER SATELLITE  
HANDBOOK (first edition)**

By Dr. Ralph E. Taggart WB8DQT. Valuable information in this first edition is *not included* in Dr. Taggart's just published book, **The New Weather Satellite Handbook** (see above). Chapters such as "How to Build an Electric Timer for Satellite Tracking" and "Building an Automatic Control for the Satellite Receiving Station" will no longer be available when this edition is out of print. This is a good entry level text for those discovering the exciting new use of weather satellites. Regular price: \$4.95. **SPECIAL PACKAGE PRICE--BOTH BOOKS FOR ONLY \$10.95, SAVE \$2.95!** (This offer available only while supplies last.) Order WS7300 and receive both editions of the Weather Satellite Handbook for only \$10.95 (plus \$1.00 shipping and handling charge).

\*Use the order card in this magazine or itemize your order on a separate piece of paper and mail to: 73 Radio Bookshop • Peterborough NH 03458. Be sure to include check or detailed credit card information. Add \$1.00 handling charge. Note: Prices subject to change on books not published by 73 Magazine. Questions regarding your order? Please write to Customer Service at the above address. Please allow 4-6 weeks for delivery. No C.O.D. orders accepted. For Toll Free ordering call 1-800-258-5473.

# RADIO BOOKSHOP

## FOR THE NOVICE

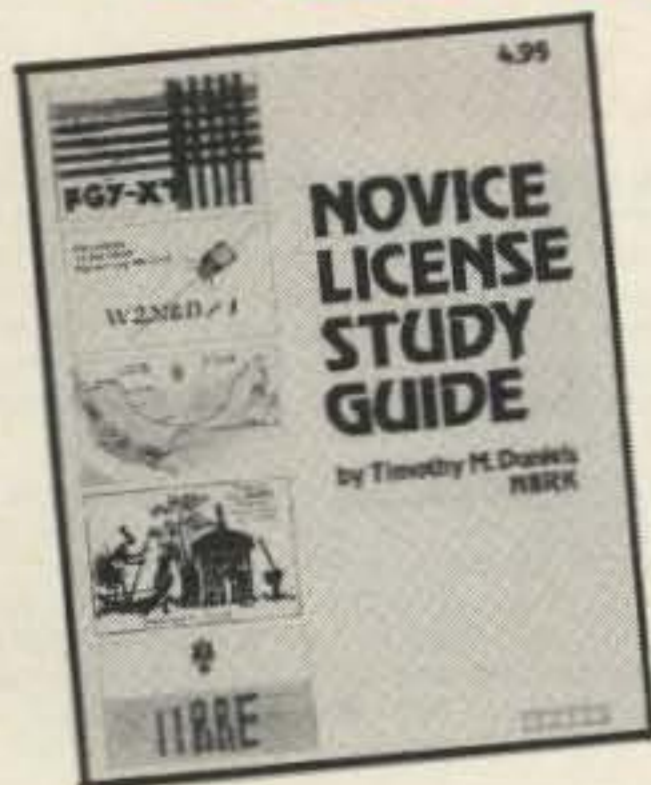

### NEW, UPDATED EDITIONS OF OUR FAMOUS NOVICE CLASS STUDY GUIDE AND NOVICE THEORY TAPES

● **NOVICE STUDY GUIDE—SG7357**—Here is a completely new study guide and reference book for the potential ham. This is not a question/answer memorization course. Electronic and radio fundamentals are presented and explained in an easy-to-understand fashion, preparing the beginner for the Novice exam. Includes the latest FCC amateur regulations, as well as application forms. Easily the best path into the exciting world of ham radio! \$4.95.\*

● **NOVICE THEORY TAPES—CT7300**—Startling Learning Breakthrough. You'll be astounded at how really simple the theory is when you hear it explained on these tapes. Three tapes of theory and one of questions and answers from the latest Novice exams give you the edge you need to breeze through your exam. 73 is interested in helping get more amateurs, so we're giving you the complete set of our tapes for the incredibly low price of **ONLY \$15.95.\***

Scientists have proven that you learn faster by listening than by reading because you can play a cassette tape over and over in your spare time—even while you're driving! You get more and more info each time you hear it. You can't progress without solid fundamentals. These four hour-long tapes give you all the basics you'll need to pass the Novice exam easily. You'll have an understanding of the basics which will be invaluable to you for the rest of your life! Can you afford to take your Novice exam without first listening to these tapes? Set of 4—\$15.95.\*

**SPECIAL OFFER! Both Novice Class Study Guide and Novice Theory Tapes \$20.00 Order NP7300.**

## OTHER STUDY GUIDES

● **EXTRA CLASS LICENSE STUDY GUIDE—SG1080**—Before going for your 1x2 call, it pays to be a master of the Extra class electronics theory. This study guide is the logical extension of the 73 theory course. All the theory necessary to pass the exam is presented. Antennas, transmission lines, swr are discussed, as well as noise, propagation, and specialized communication techniques. This book is not a classroom lecture or memorization guide, but rather a logical presentation of the material that must be understood before attempting the Extra exam. Save yourself a return trip to the FCC and try the 73 method first! \$5.95.\*

● **ADVANCED CLASS LICENSE STUDY GUIDE—SG1081**—Ready to upgrade your license? To prevent retaking the FCC theory exam, you need the 73 Advanced theory guide. SSB, antenna theory, transmitters, and electronics measuring techniques are covered in detail in this easy-to-follow study guide. Special modes and techniques, such as RTTY, are also treated. An engineering degree is *not* necessary to master the Advanced theory—try this book before visiting the examiner's office! \$6.95.\* (Published by TAB Books previous to recent changes in FCC exam material.)

## FOR YOUR HAMSHACK

● **QSL CARDS**—73 turns out a fantastic series of QSL cards at about half the cost of having them done elsewhere because they are run as a fill-in between printing books and other items in the 73 Print Shop. 250 Style W—QW0250—for \$8.95\*; 500 Style W—QW0500—for \$13.95\*; 250 Style X—QX0250—for \$8.95\*; 500 Style X—QX0500; 250 Style Y—QY0250—for \$8.95\*; 500 Style Y—QY0500—for \$13.95.\* Allow 6-12 wks. for delivery.

● **LIBRARY SHELF BOXES**—These sturdy white, corrugated, dirt-resistant boxes each hold a full year of 73, *Kilobaud Microcomputing* or *80 Microcomputing*. With your order, request self-sticking labels for any of the following: 73, *Kilobaud Microcomputing*, *80 Microcomputing*, *CQ*, *QST*, *Ham Radio*, *Personal Computing*, *Radio Electronics*, *Interface Age*, and *Byte*. Order 1—BX1000—for \$2.00\*; order 2-7—BX2002—for \$1.50 each\*; order 8 or more—BX1002—for \$1.25 each\*.

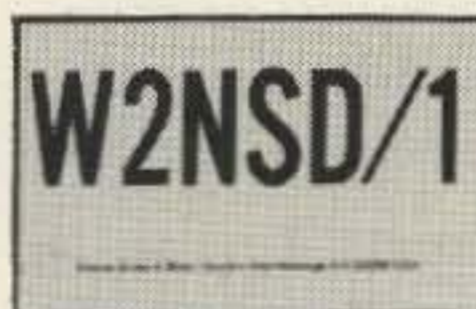

Style Y



Style W



Style X

● Preserve and protect your collection for a lifetime! Order these handsome red binders with gold lettering. \$7.50 for 1, 3 for \$21.75, 6 for \$42.00. (Postpaid within USA, please add \$2.50 per order outside USA.) Check or money orders only, no phone or C.O.D. orders. 73 Binders, P.O. Box 5120, Philadelphia, PA 19141.

\*NOTE—Above address for Binders only.

\*Use the order card in this magazine or itemize your order on a separate piece of paper and mail to: 73 Radio Bookshop • Peterborough NH 03458. Be sure to include check or detailed credit card information. No C.O.D. orders accepted. All orders add \$1.00 handling. Please allow 4-6 weeks for delivery. Questions regarding your order? Please write to Customer Service at the above address. (Prices subject to change on books not published by 73 Magazine.)

## 73 CODE TAPES ANY FOUR TAPES FOR \$15.95! \$4.95 EACH

### "GENESIS"

5 WPM—CT7305—This is the beginning tape for people who do not know the code at all. It takes them through the 26 letters, 10 numbers and necessary punctuation, complete with practice every step of the way using the newest blitz teaching techniques. It is almost miraculous! In one hour many people—including kids of ten—are able to master the code. The ease of learning gives confidence to beginners who might otherwise drop out.

### "THE STICKLER"

6+ WPM—CT7306—This is the practice tape for the Novice and Technician licenses. It is made up of one solid hour of code, sent at the official FCC standard (no other tape we've heard uses these standards, so many people flunk the code when they are suddenly—under pressure—faced with characters sent at 13 wpm and spaced for 5 wpm). This tape is not memorizable, unlike the zany 5 wpm tape, since the code groups are entirely random characters sent in groups of five.

### "BACK BREAKER"

13+ WPM—CT7313—Code groups again, at a brisk 13 per so you will be at ease when you sit down in front of the steely-eyed government inspector and he starts sending you plain language at only 13 per. You need this extra margin to overcome the panic which is universal in the test situations. When you've spent your money and time to take the test, you'll thank heaven you had this back-breaking tape.

### "COURAGEOUS"

20+ WPM—CT7320—Code is what gets you when you go for the Extra class license. It is so embarrassing to panic out just because you didn't prepare yourself with this tape. Though this is only one word faster, the code groups are so difficult that you'll almost fall asleep copying the FCC stuff by comparison. Users report that they can't believe how easy 20 per really is with this fantastic one hour tape.

### "OUTRAGEOUS"

25+ WPM—CT7325—This is the tape for that small group of overachieving hams who wouldn't be content to simply satisfy the code requirements of the Extra Class license. It's the toughest tape we've got and we keep a permanent file of hams who have mastered it. Let us know when you're up to speed and we'll inscribe your name in 73's CW "Hall of Fame."

## SSTV TAPE

● **SLOW SCAN TELEVISION TAPE—CT7350**—Prize-winning programs from the 73 SSTV contest. Excellent for Demo! \$5.95.\*

## BACK ISSUES

● **BACK ISSUES**—Complete your collection; many are prime collectables now, classics in the field! A full collection is an invaluable compendium of radio and electronics knowledge!

ST0000—Single back issue before July 1980.....\$3.00  
ST0250—Single back issue after July 1980.....\$3.50  
ST0500—5 your choice.....\$8.75  
ST1000—10 your choice.....\$14.00  
ST2500—25 our choice.....\$12.00  
ST2501—25 your choice.....\$25.00

● **FREE BACK ISSUE CATALOGS** are yours for the asking... specify 73 Magazine, *Kilobaud Microcomputing*, and/or *80 Microcomputing* back issue catalog when you send your name and address to us on a postcard.

## 73 MAGAZINE BINDERS

FOR TOLL FREE ORDERING CALL 1-800-258-5473

# RADIO BOOKSHOP

## THE 73 TECHNICAL LIBRARY

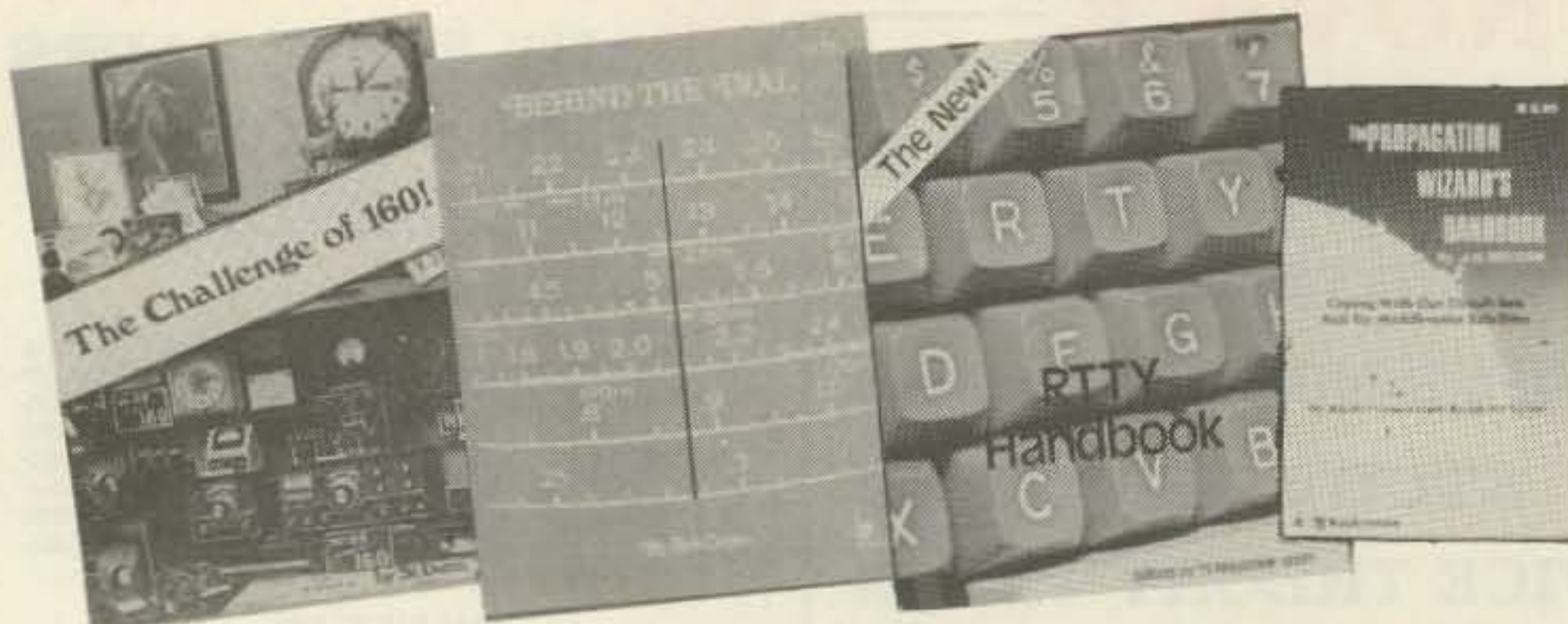

● **BEHIND THE DIAL**—BK7307—By Bob Grove. Get more fun out of shortwave listening with this interesting guide to receivers, antennas, frequencies and interference. \$4.95.\*

● **THE CHALLENGE OF 160**—BK7309—is the newest book in the 73 technical library, dedicated to 160 meter operating. Si Dunn provides all necessary information to get started on this unique band. The all-important antenna and ground systems are described in detail. The introduction contains interesting photos of Stew Perry's (the King of 160) shack. This reference is a must for new and experienced "Top Band" operators. Price: \$4.95.\*

● **SSB... THE MISUNDERSTOOD MODE**—BK7351—by James B. Wilson. Single Sideband Transmission... thousands of us use it every day, yet it remains one of the least understood facets of amateur radio. J. B. Wilson presents several methods of sideband generation, amply illustrated with charts and schematics, which will enable the ambitious reader to construct his own sideband generator. A must for the technically-serious hams. \$5.50.\*

● **PROPAGATION WIZARD'S HANDBOOK**—BK7302—by J. H. Nelson. When sunspots riddled the worldwide communications networks of the 1940's, John Henry Nelson looked to the planets for an answer. The result was a theory of propagation forecasting based upon interplanetary alignment that made the author the most reliable forecaster in America today. The book provides an enlightened look at communications past, present, and future, as well as teaching the art of propagation forecasting. \$6.95.\*

● **TOOLS & TECHNIQUES FOR ELECTRONICS**—BK7348—by A. A. Wicks is an easy-to-understand book written for the beginning kit builder as well as the experienced hobbyist. It has numerous pictures and descriptions of the safe and correct ways to use basic and specialized tools for electronic projects as well as specialized metal working tools and the chemical aids which are used in repair shops. \$4.95.\*



## FOR THE CONTESTER

● **THE CONTEST COOKBOOK**—BK7308—reveals the secrets of the contest winners (Domestic, DX and specialty contests), complete with photos and diagrams of equipment used by the top scorers. Find out how to make 150 contacts in one hour. \$5.95.\*

● **THE NEW RTTY HANDBOOK**—BK7347—is a new edition and the only up-to-date RTTY book available. The state of the art has been changing radically and had made all previous RTTY books obsolete. It has the latest circuits, great for the newcomer and expert alike. \$5.95.\*



**PUBLISHER'S CLOSE-OUT SPECIAL SALE 50%**

● **WEATHER SATELLITE HANDBOOK**—BK7370—By Dr. Ralph E. Taggart WB8DQT. Valuable information in this edition will not be included in the newest edition of the Weather Satellite Handbook (available in Spring 1981). Chapters such as "How to Build an Electronic Timer for Satellite Tracking" and "Building an Automatic Control for the Satellite Receiving Station" will no longer be available when this edition is out of print. This is a good entry level text for those discovering the exciting new use of weather satellites. Regularly \$4.95, SPECIAL SALE PRICE \$2.50.

● **MASTER HANDBOOK OF HAM RADIO CIRCUITS**—BK1033—This is an encyclopedia of amateur radio circuits, gleaned from past issues of 73 Magazine and carefully selected according to application. You'll find many you've never seen before, some new twists on the tried and true, and several that have been long forgotten but are well worth remembering. Where your interest ranges from ragchewing to EME, from CW to slow-scan TV, from DX to county nets, this handbook will be a welcome addition to your shack. \$8.95.\*

● **OWNER REPAIR OF RADIO EQUIPMENT**—BK7310—Frank Glass K6RQ shares over 40 years of operating, servicing, and design experience in this book which ranges from the elementary to the highly technical written for the top engineers in the field. It is written in narrative style on the subjects of electronic servicing, how components work, and how they are combined to provide communication equipment. This book will help you understand the concepts required to service your own station equipment. \$7.95.\*

● **IC OP-AMP COOKBOOK**—BK1028—by Walter G. Jung. Covers not only the basic theory of the IC op amp in great detail, but also includes over 250 practical circuit applications, liberally illustrated. 592 pages, 5 1/2 x 8 1/2, softbound. \$14.95.\*

● **THE POWER SUPPLY HANDBOOK**—BK7305—Need a power supply for a gadget you're building? In the **POWER SUPPLY HANDBOOK** there are dozens ready-to-build, plus detailed steps for designing your own. There are circuits and parts lists for all kinds of supplies, ranging from simple DC types to highly stable regulated versions. If you need a circuit to convert a DC voltage to a higher or lower voltage, turn DC into AC, or AC to DC—then this is the book you need. With more than 400 pages, you should be able to find just the circuit you need. Without a doubt one of the best power supply source books available, compiled by the editors of 73. \$9.95.\*

## HANDBOOKS FOR THE HAMSHACK

● **THE TEN METER FM HANDBOOK**—BK1190—by Bob Heil K9EID. This handbook has been published to help the ten meter enthusiast learn more about the many methods of conversions and tricks that are used to make existing units work better. Join the great "tinkerers" of the world on ten FM and enjoy the fantastic amount of fun in communicating with amateur stations worldwide on ten meter FM. \$4.95.\*

● **THE PRACTICAL HANDBOOK OF AMATEUR RADIO FM REPEATERS**—BK1185—by Bill Pasternak WA6ITF (author of 73 Magazine's monthly column "Looking West") This is the book for the VHF/UHF FMer, compiled from material submitted by over a hundred individuals, clubs, organizations and equipment manufacturers. A "must have" for your ham shack shelf. \$9.95.

## The 73

## Test Equipment Library



● **VOL. I COMPONENT TESTERS**—LB7359—... how to build transistor testers (8), diode testers (3), IC testers (3), voltmeters and VTVMs (9), ohmmeters (8 different kinds), inductance (3), capacity (9), Q measurement, crystal checking (6), temperature (2), aural meters for the blind (3) and all sorts of miscellaneous data on meters... using them, making them more versatile, making standards. Invaluable book. \$4.95.\*

● **VOL. II AUDIO FREQUENCY TESTERS**—LB7360—... jam packed with all kinds of audio frequency test equipment. If you're into SSB, RTTY, SSTV, etc., this book is a must for you... a good book for hi-fi addicts and experimenters, too! \$4.95.\*

● **VOL. III RADIO FREQUENCY TESTERS**—LB7361—Radio frequency waves, the common denominator of Amateur Radio. Such items as SWR, antenna impedance, line impedance, rf output and field strength; detailed instructions on testing these items includes sections on signal generators, crystal calibrators, grid dip oscillators, noise generators, dummy loads and much more. \$4.95.\*

● **VOL. IV IC TEST EQUIPMENT**—LB7362—Become a troubleshooting wizard! In this fourth volume of the 73 TEST EQUIPMENT LIBRARY are 42 home construction projects for building test equipment to work with your ham station and in servicing digital equipment. Plus a cumulative index for all four volumes for the 73 TEST EQUIPMENT LIBRARY. \$4.95.\*

● **RF AND DIGITAL TEST EQUIPMENT YOU CAN BUILD**—BK1044—Rf burst, function, square wave generators, variable length pulse generators—100 kHz marker, i-f and rf sweep generators, audio osc, af/rf signal injector, 146 MHz synthesizer, digital readouts for counters, several counters, prescaler, microwave meter, etc. 252 pages. \$5.95.\*

\*Use the order card in this magazine or itemize your order on a separate piece of paper and mail to: 73 Radio Bookshop • Peterborough NH 03458. Be sure to include check or detailed credit card information. No C.O.D. orders accepted. All orders add \$1.00 handling. Please allow 4-6 weeks for delivery. Questions regarding your order? Please write to Customer Service at the above address. (Prices subject to change on books not published by 73 Magazine.)

**FOR TOLL FREE ORDERING CALL 1-800-258-5473**



# RADIO BOOKSHOP

## ANTENNA BOOKS

## 5 NEW ANTENNA BOOKS

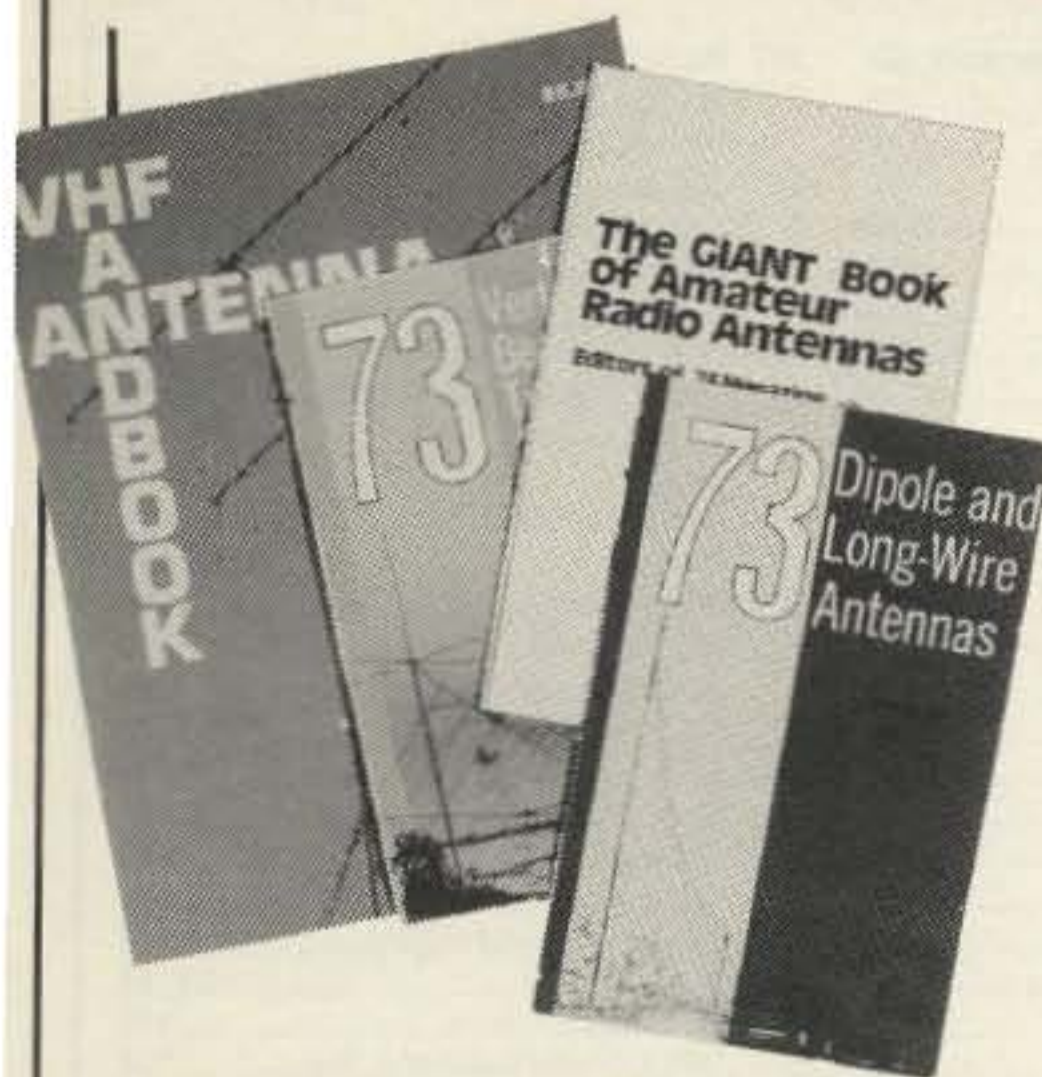

- **ALL ABOUT CUBICAL QUAD ANTENNAS** (2nd edition)—BK1196—The "Classic" on Quad design, theory, construction, and operation. New 2nd edition contains new feed and matching systems and new data. \$4.75\*
- **BEAM ANTENNA HANDBOOK** (New 5th edition)—BK1197—Yagi beam theory, construction and operation. Information on wire beams, SWR curves and matching systems. A "must" for serious DXers. \$5.95\*
- **VHF HANDBOOK FOR RADIO AMATEURS**—BK1198—Contains information on FM theory, operation and equipment, VHF antenna design and construction, satellite-EME, and the newest solid-state circuits. \$6.95\*
- **THE RADIO AMATEUR ANTENNA HANDBOOK**—BK1199—All about wire antennas, beams, tuners, baluns, coax, radials, SWR and towers. Clear and complete information. \$6.95\*
- **SIMPLE, LOW-COST WIRE ANTENNAS FOR RADIO AMATEURS**—BK1200—All new data and everything you want to know about low-cost, multi-band antennas, inexpensive beams, "invisible" antennas for hams in "tough" locations. \$6.95\*

## COOK BOOKS

- **TTL COOKBOOK**—BK1063—by Donald Lancaster. Explains what TTL is, how it works, and how to use it. Discusses practical applications, such as a digital counter and display system, events counter, electronic stopwatch, digital voltmeter and a digital tachometer. \$9.50.
- **CMOS COOKBOOK**—BK1011—by Don Lancaster. Details the application of CMOS, the low power logic family suitable for most applications presently dominated by TTL. Required reading for every serious digital experimenter! \$10.50.\*
- **TVT COOKBOOK**—BK1064—by Don Lancaster. Describes the use of a standard television receiver as a microprocessor CRT terminal. Explains and describes character generation, cursor control and interface information in typical, easy-to-understand Lancaster style. \$9.95.\*

**Save over 50%  
SALE PRICE \$3.00**

- **RTL COOKBOOK**—BK1059—by Donald Lancaster. Explains the how and why of RTL (Resistor-Transistor Logic) and gives design information that can be put to practical use. Gives a multitude of digital applications ranging from the basic switch to the sophisticated counter. 240 pages; Regular price \$6.50, Sale price \$3.00!

### SPECIAL OFFER

#### Chart of UNITED STATES AMATEUR RADIO PRIVILEGES

by class of license, emission type, and frequency from 160 thru 2 meters, including provision for the new 30, 17, and 12 meter bands. This 22 x 28 in. twelve-color chart is the first of its kind to be both informative and decorative. \$3.00 value, only \$1.95 with the purchase of 1 or more books from the Radio Bookshop. (Supplies limited, order now.)  
CH7300 \$1.95.

## THE WELL EQUIPPED HAM SHACK

**NEW  
COMPLETELY  
UPDATED**

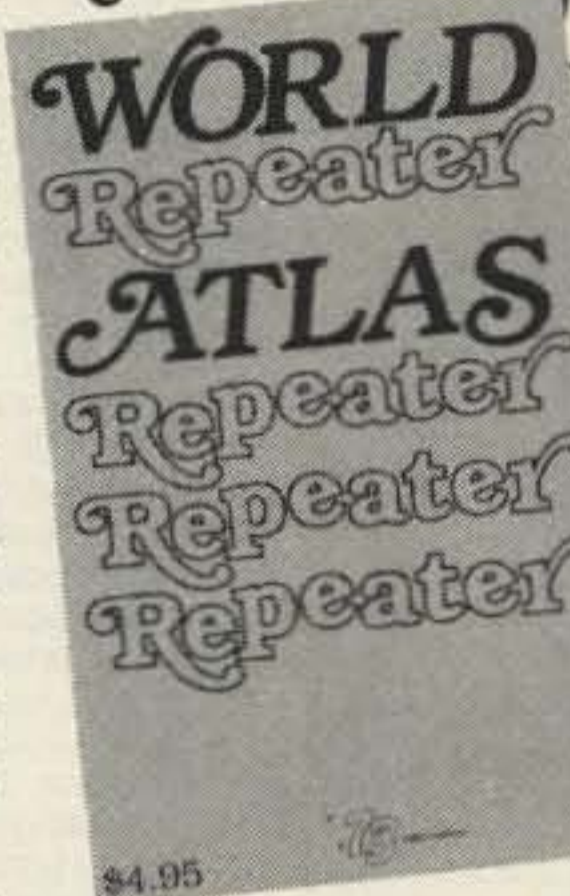

**WORLD REPEATER ATLAS**—BK7315—Completely updated, over 230 pages of repeater listings are indexed by location and frequency. More than 50 maps pinpoint 2000 repeater locations throughout the USA. Foreign listings include Europe, the Middle East, South America, and Africa. \$4.95.

● **THE MAGIC OF HAM RADIO**—BK7312—by Jerrold Swank, W8HXR begins with a brief history of amateur radio and of Jerry's involvement in it. Part 2 details many of ham radio's heroic moments. Hamdom's close ties with the continent of Antarctica are the subject of Part 3. In Part 4 the strange and humorous sides of ham life get their due. And what of the future? Part 5 peers into the crystal ball. \$4.95.\*

● **A GUIDE TO HAM RADIO**—BK7321—by Larry Kahaner WB2NEL. What's Amateur Radio all about? You can learn the basics of this fascinating hobby with this excellent beginner's guide. It answers the most frequently asked questions in an easy-going manner, and it shows the best way to go about getting an FCC license. A Guide to Ham Radio is an ideal introduction to a hobby enjoyed by people around the world. \$4.95.\*

● **WORLD RADIO TV HANDBOOK 1981, 35TH EDITION**—BK1184—This book is the bible of international broadcasters, providing the only authoritative source of exact information about broadcasting and TV stations world wide. This 1981 edition is completely revised, giving comprehensive coverage of short, medium and long wave, 560 pages of vital aspects of world listening. \$16.50.

● **VHF ANTENNA HANDBOOK**—BK7368—The NEW VHF Antenna Handbook details the theory, design and construction of hundreds of different VHF and UHF antennas... A practical book written for the average amateur who takes joy in building, not full of complex formulas for the design engineer. Packed with fabulous antenna projects you can build. \$5.95.\*

● **THE GIANT BOOK OF AMATEUR RADIO ANTENNAS**—Over 450 pages of design ideas, theory and reference data make this book live up to its title. The 7 chapters cover everything from basic antenna theory through designs for DIY accessories, as well as dozens of antenna designs. Whether planning to build or buy, design or admire, test or enjoy a ham antenna—this is the book for you. Hardcover \$12.95.\*

● **73 VERTICAL, BEAM AND TRIANGLE ANTENNAS**—BK1069—by Edward M. Noll W3FQJ. Describes 73 different antennas for amateurs. Each design is the result of the author's own experiments covering the construction of noise bridges and antenna line tuners, as well as methods for measuring resonant frequency, velocity factor, and standing-wave ratios. 160 pages. \$5.50\*

● **73 DIPOLE AND LONG-WIRE ANTENNAS**—BK1016—by Edward M. Noll W3FQJ. This is the first collection of virtually every type of wire antenna used by amateurs. Includes dimensions, configurations, and detailed construction data for 73 different antenna types. Appendices describe the construction of noise bridges, line tuners, and data on measuring resonant frequency, velocity factor, and swr. \$5.50.\*

● **PRACTICAL ANTENNAS FOR THE RADIO AMATEUR**—BK1015—A manual describing how to equip a ham station with a suitable antenna. A wide range of antenna topics, systems, and accessories are presented giving the reader some food for thought and practical data for construction. Designed to aid the experienced ham and novice as well. Only \$9.95.\*

## MICROCOMPUTER BOOKS FROM 73



● **SOME OF THE BEST FROM KILOBAUD/MICROCOMPUTING**—BK7311—A collection of the best articles that have recently appeared in Kilobaud/ MICROCOMPUTING. Included is material on the TRS-80 and PET systems, CP/M, the 8080/8085/Z80 chips, the ASR-33 terminal. Data base management, word processing, text editors and file structures are covered too. Programming techniques and hardware construction projects for modems, high speed cassette interfaces and TVTs are also included in this large format, 200 plus page edition. \$10.95.\*

● **40 COMPUTER GAMES**—BK7381—Forty games in all in nine different categories. Games for large and small systems, and even a section on calculator games. Many versions of BASIC used and a wide variety of systems represented. A must for the serious computer gamesman. \$7.95\*

● **THE NEW HOBBY COMPUTERS**—BK7340—This book takes it from where "HOBBY COMPUTERS ARE HERE!" leaves off, with chapters on Large Scale Integration, how to choose a microprocessor chip, an introduction to programming, low cost I/O for a computer, computer arithmetic, checking memory boards...and much, much more! Don't miss this tremendous value! Only \$4.95.\*

● **UNDERSTANDING AND PROGRAMMING MICROCOMPUTERS**—BK7382—A valuable addition to your computing library. This two-part text includes the best articles that have appeared in 73 and Kilobaud Microcomputing magazines on the hardware and software aspects of microcomputing. Well-known authors and well-structured text helps the reader get involved. \$10.95\*

● **HOW TO BUILD A MICROCOMPUTER—AND REALLY UNDERSTAND IT**—BK7325—by Sam Creason. The electronics hobbyist who wants to build his own microcomputer system now has a practical "How-To" guidebook. This book is a combination technical manual and programming guide that takes the hobbyist step-by-step through the design, construction, testing and debugging of a complete microcomputer system. Must reading for anyone desiring a true understanding of small computer systems. \$9.95.\*

● **HOBBY COMPUTERS ARE HERE!**—BK7322—If you want to come up to speed on how computers work... hardware and software... this is an excellent book. It starts with fundamentals and explains the circuits, and the basics of programming, along with a couple of TVT construction projects, ASCII-Baudot, etc. This book has the highest recommendations as a teaching aid. \$4.95.\*

\*Use the order card in this magazine or itemize your order on a separate piece of paper and mail to: 73 Radio Bookshop • Peterborough NH 03458. Be sure to include check or detailed credit card information. No C.O.D. orders accepted. All orders add \$1.00 handling. Please allow 4-6 weeks for delivery. Questions regarding your order? Please write to Customer Service at the above address. (Prices subject to change on books not published by 73 Magazine.)

**FOR TOLL FREE ORDERING CALL 1-800-258-5473**

# List of AdvertisERS

\*Please contact these advertisers directly.

To receive full information from our advertisers please complete the following postage-paid card.

R.S. No.	Page	R.S. No.	Page	R.S. No.	Page	R.S. No.	Page
* AEA/Advanced Elect. Applica., Inc.	89, 105	* Digital Research Parts	159	384 Jim-Pak Electronic Components	93	397 Radio World	60
484 Advanced Analog Systems	107	425 Doppler Systems	145	* KLM Electronics	55	62 Ramsey Electronics	153, 158
406 Alaska Microwave Labs	95	479 Doppler Systems	28	* Kantronics	141	418 Rolin Distributors	53
314 Alliance Mfg. Co.	49	* 80 Microcomputing	131	* KB Microcomputing	131	378 SMP	139
429 Amateur Accessories	145	447 Electronic Hobby Innovations	71	* Kenwood	CovIV, 7	* Sabtronics International, Inc.	25
5 Amateur-Wholesale Electronics	29	419 Electronic Specialties	132	424 LCC Engineering	134	432 Sadelta	59
7 American Crystal Supply	94, 146	400 Engineering Consulting Service	144	434 M & M Electronics	139	65 S-F Amateur Radio Services	53
* Appl. & Equip. Co., Inc.	140, 145	413 Equipment Exchange	134	47 MFJ Enterprises	82, 83	477 S-F Amateur Radio Services	98
8 Apron Labs	98	* Erickson Comm.	65	476 MFJ Enterprises	130	64 Semiconductors Surplus	154-156
* Associated Radio	58	439 Ben Franklin Electronics	144	483 MFJ Enterprises	106	* 73 Magazine	66, 110-114, 131, 134, 145
358 Astron Corp.	141	323 Fox-Tango Corp.	97	48 MHz Electronics	148-151	66 Signalcrafters	95
* Atlanta Hamfestival	138	27 G.I.S.M.O.	81	44 Macrotronics	91	433 Skytec	144
402 BNF Enterprises	144	* Gilfer Shortwave	143	45 Madison Electronics	47	367 Slep Electronics	135
11 Barker & Williamson	142	* Global Electronics	144	49 Micro Control Specialties	133	360 Soundpower	140
440 Rex Bassett Electronics, Inc.	133	393 H.M. Goodwin	146	313 Micro Management Systems	136	309 Spacecoast Research	144
420 Benjamin Michael Industries	131	417 Gotham Antenna	138, 140	50 Microcraft Corp.	61, 138	* Spectronics	138, 160
426 Bilal Co.	139	* Grove Enterprises	53, 105	383 Micro-80, Inc.	145	68 Spectrum Comm.	26, 27
428 Bright Electronic Corp.	144	345 Hal Comm.	69	51 Microlog Corp.	87	436 Spectrum International	132
482 Charleswater Products	105	31 Hal-Tronix	49	395 Microverter, Inc.	139	403 Stewart Quads	142
13 Clegg	142	30 The Ham-Key Co.	137	52 MidCom Electronics, Inc.	46	486 Switchcraft	107
89 Clutterfree Modular Consoles	53	32 Ham Radio Center	85	488 Motorola	106	430 TEM Microwave Corp.	146
332 Commerce Tours	134	* Ham Radio Outlet	3	355 N & G Distributing	57	* Ten-Tec, Inc.	21, 51
435 Comm. Concepts, Inc.	146	33 Hamtronics, NY	157	318 National Comm. Group Co.	132	76 Trac Electronics	140
377 Communications Electronics	147	34 Henry Radio	CovII	412 Nema Electronics	144	37 UPI Comm. Systems, Inc.	134
478 Communications Electronics Specialties	62	* High Frequency Techn. Systems	94	487 Nordal Electronics	106	* Universal Communications	133
15 Comm. Specialists	10, 11	446 Home Science Experiments	145	* Orbit Magazine	64	422 Valor Enterprises	59
443 Com. Specialists	31	* Hustler, Inc.	61	* P.B. Radio Service	141	311 Vanguard Labs	146
444 Computer Plus	145	* ICOM	9, 109	* P.C. Electronics	74	373 Van Gorden Engineering	94
* Conley Radio Supply	74	35 Info-Tech, Inc.	61	* Palomar Engineers	4	90 VoCom Products Corp.	60
* Crown Micro Products	143	414 Inotek Engineering	146	380 Panasonic	67	480 VoCom Products Corp.	52
70 Cubic Comm.	4	445 Instant Software	76, 77	421 Phillips Tech. Electronics	146	79 Wacom Products	143
481 Curtis Electro Devices	106	36 International Crystal Mfg. Co.	65	* Pecos Valley Amateur Radio Supply	135	398 Wawasee Electronics	139, 143
330 Decco Electronics	137	409 JDR Microdevices	75	58 Poly Paks	59	80 Western Electronics	97
411 DGM Electronics, Inc.	92	* JS & A	23	60 Quest Electronics	152	83 Yaesu Electronics Corp.	CovIII
346 Data Service	145, 146	38 Jameco Electronics	161	61 Radio Amateur Callbook, Inc.	60	336 Z Associates	146
		39 Jan Crystals	142	381 Radio Systems Techn.	145		
		354 Jenson Tools, Inc.	144				

## 73 MAGAZINE

# Books, ETC.

To order, complete the following postage-paid card, or itemize your order including detailed credit card information or check and mail to: 73 Magazine/Mail Order Dept./Peterborough NH 03458.

Catalog #	Item	Price	Catalog #	Item	Price	Catalog #	Item	Price
BK1016	73 DIPOLE & LONG WIRE ANTENNAS	\$ 5.50	BK7312	MAGIC OF HAM RADIO	\$ 4.95	BX1002	SHELF BOXES—8 AND UP	\$1.25 each
ST0000	Single back issue before July 1981	\$ 3.00	BK1033	MASTER HANDBOOK OF HAM RADIO CIRCUITS	\$ 8.95	BK7311	SOME OF THE BEST FROM KILOBAUD	\$ 10.95
ST2500	25 our choice	\$ 12.00	BK7340	THE NEW HOBBY COMPUTERS	\$ 4.95	BK7351	SSB THE MISUNDERSTOOD MODE	\$ 5.50
ST0500	5 your choice	\$ 8.75	CT7300	NOVICE THEORY TAPES	\$ 15.95	CT7350	SSTV TAPE	\$ 5.95
ST1000	10 your choice	\$ 14.00	BK7310	OWNER REPAIR OF RADIO EQUIPMENT	\$ 7.95	SG1081	STUDY GUIDE—ADV. CLASS	\$ 6.95
ST0250	Single back issue after July 1981	\$ 3.50	BK7305	POWER SUPPLY HANDBOOK	\$ 9.95	SG1080	STUDY GUIDE—EXTRA CLASS	\$ 5.95
ST2501	25 your choice	\$ 25.00	BK1015	PRACTICAL ANTENNAS FOR THE RADIO AMATEUR	\$ 9.95	SG7357	STUDY GUIDE—NOVICE CLASS	\$ 4.95
BK7307	BEHIND THE DIAL	\$ 4.95	BK1185	THE PRACTICAL HANDBOOK OF FM REPEATERS	\$ 9.95	LB7359	TEST EQUIP LIB V1—COMPONENT TESTERS	\$ 4.95
BK7309	CHALLENGE OF 160	\$ 4.95	BK7302	PROPAGATION WIZARD'S HANDBOOK	\$ 6.95	LB7360	TEST EQUIP LIB V2—AUDIO TESTERS	\$ 4.95
CT7305	CODE TAPE—5 WPM	\$ 4.95	QW0250	QSL CARDS—STYLE W—250	\$ 8.95	LB7361	TEST EQUIP LIB V3—RADIO EQUIP.	\$ 4.95
CT7306	CODE TAPE—6+ WPM	\$ 4.95	QW0500	QSL CARDS—STYLE W—500	\$ 13.95	LB7362	TEST EQUIP LIB V4—IC TEST EQ.	\$ 4.95
CT7313	CODE TAPE—13+ WPM	\$ 4.95	QX0250	QSL CARDS—STYLE X—250	\$ 8.95	BK7348	TOOLS & TECHNIQUES	\$ 4.95
CT7320	CODE TAPE—20+ WPM	\$ 4.95	QX0500	QSL CARDS—STYLE X—500	\$ 13.95	BK1063	TTL COOKBOOK	\$ 9.50
CT7325	CODE TAPE—25+ WPM	\$ 4.95	QY0250	QSL CARDS—STYLE Y—250	\$ 8.95	BK1064	TVT COOKBOOK	\$ 9.95
CT7394	CODE TAPES (ANY FOUR ABOVE)	\$ 15.95	QY0500	QSL CARDS—STYLE Y—500	\$ 13.95	BK7382	UNDERSTANDING & PROGRAMMING MICROCOMPUTERS	\$ 10.95
BK7308	THE CONTEST COOKBOOK	\$ 5.95	BK1044	RF & DIGITAL TEST EQUIPMENT	\$ 5.95	BK1069	VERTICAL BEAM & TRIANGLE ANTNS	\$ 5.50
BK7381	40 COMPUTER GAMES	\$ 7.95	BK7347	RTTY HANDBOOK	\$ 5.95	BK7368	VHF ANTENNA HANDBOOK	\$ 5.95
BK7304	GIANT BOOK OF AMATEUR RADIO ANTENNAS	\$ 12.95	BK1059	RTL COOKBOOK	\$ 6.50	BK7370	WEATHER SATELLITE HANDBOOK	\$ 2.50
BK7321	A GUIDE TO HAM RADIO	\$ 4.95	BX1000	SHELF BOX—1	\$ 2.00	BK1184	WORLD RADIO TV HANDBOOK	\$ 16.50
BK7322	HOBBY COMPUTERS ARE HERE	\$ 4.95	BX1001	SHELF BOXES—2-7	\$ 1.50 each	BK7315	WORLD REPEATER ATLAS	\$ 4.95
BK7325	HOW TO BUILD A MICROCOMPUTER & REALLY UNDERSTAND IT	\$ 9.95						
BK1028	IC OP AMP COOKBOOK	\$ 12.95						

# KAHANER REPORT

from page 108

Electronic Information Service II, but it's all the same. Some travel over phone lines, others are broadcast by TV stations.

Right now, wars are predicted in Chicago where WGN and

WFLD are in competition for their piece of the videotext pie. And in Texas, the Texas Newspaper Publishers are trying their darndest to keep Bell from testing their own information system, afraid that it will eventually cut into their classified ad rev-

enues. (You not only can present news on videotext, but shopper's ads, movie listings, yellow pages—anything.)

Perhaps the most fascinating confrontation is between WGN in Chicago and United Video in Tulsa. UV receives WGN, one of those satellite superstations, and retransmits it to their cable customers. However, in the process they "strip" the empty, unused TV lines that WGN uses for its teletext test. Now, that doesn't bother the folks receiv-

ing the station directly, but those who pick it up on cable won't be able to receive the teletext information.

WGN is claiming copyright infringement in that the unused lines are still part of their transmission and that UV alters it without permission. UV claims that unused lines aren't part of a bona fide signal and since they have permission to retransmit the picture, they can do what they like. The courts will decide that one.

## AWARDS

Bill Gosney WB7BFK  
Micro-80, Inc.  
2665 North Busby Road  
Oak Harbor WA 98277

### WORKED CYPRUS AWARD

This award is available to all licensed amateurs and requires the applicant to work 5B4 and ZC4 stations representing Cyprus. Based on the point system (see Table 1), all contacts must be made on and after July 1, 1962, to be valid.

Applicants outside Cyprus require 32 points if all contacts were on one band, 24 points if on two bands, and only 16 points if three bands were utilized. A total of 12 points must be earned for a four-band accomplishment. Stations may be worked only once per band. There are no mode endorsements.

To apply for this award, prepare your list of contacts and have it verified by at least two fellow amateurs. Forward this list and 10 IRCs to Cyprus Amateur Radio Society, Andy Panayotious 5B4BM, PO Box 1267, Limassol, Cyprus.

### WORKED FAEROE ISLANDS AWARD

Known as the WAQY Award, applicants in Europe must attain a total of 35 points while all others must accumulate 20 points. To be valid, all contacts must be made on and after April 11, 1965. Mixed-mode and cross-band contacts are not allowed.

For European stations, each Faeroe Radio Association member contacted counts one point for each band, and club stations OY6FRA and OY6NRA count

two points on each band. For stations outside Europe, each FRA station counts one point on 28, 21, and 14 MHz and two points each on the 7- and 3.5-MHz bands. OY6FRA and OY6NRA club stations count 4 points on each band.

Applicants are asked to have their list of contacts verified by at least two radio amateurs. Forward this list along with an award fee of 10 IRCs to FRA Awards Manager, Post Box 184, Torshavn, Faeroe Islands.

### DANISH CROSS COUNTRY AWARD

Tage Eilman OZ1WL has sent us details for the Danish Cross Country Award. To be valid, all contacts must be made on or after April 1, 1970. The award is issued for either all CW or all phone. There are no band restrictions.

European stations find that the callsign is the basis for this award. Each call prefix OZ1-OZ9 and OX3 must be contacted. Two contacts with each prefix are permitted on each band with the exception of OX3 where nine contacts may be made on each band. For amateur applicants outside Europe, three contacts are permitted in each of the OZ call districts. OX3 may be

Zone	1.8 MHz	3.5 MHz	7 MHz	14 MHz	21 MHz	28 MHz	144 MHz	432 MHz
20	4	2	0	1	2	4	16	32
1, 2, 3, 6, 7, 10, 12, 19, 24, 25, 26, 27, 28, 29, 30, 31, 32	16	8	4	2	4	8	—	—
All other zones	8	4	2	1	2	4	16	32

Table 1. Points for Cyprus Award.

worked nine times on each band. Each contact counts one point. Only OX3 stations in Greenland count for this award.

That's only the basis for the award. As for the requirements, European amateurs need to make contacts totaling 50 points while applicants outside Europe must obtain a 40-point total.

To apply, make a list of contacts and have it verified by at least two amateurs. Enclose this application and an award fee of \$2.00 or five IRCs to Diploma Manager of EDR, PO Box 213, 5100 Odense, Denmark.

### 9G1 AWARD OF GHANA

Applicants the world over are encouraged to work toward the Ghana Award. Confirmed contacts are required with five different 9G1 prefix stations of Ghana using a minimum of two amateur bands. There are no band or mode restrictions, but this award is available for all CW, all phone, or mixed modes.

To be valid, all contacts must be made on or after January 1, 1958. The QSL cards must be submitted with your application, along with an award fee of seven IRCs. Forward your request to 9G1 Awards Manager, Postbox 3773, Accra, Ghana.

### 4 x 4 = 16 AWARD

Members of the Israel Amateur Radio Club are proud to announce the requirements of their four-by-four award. There

are no band, mode, or time restrictions for this award, but to qualify applicants must work a minimum of 16 stations in Israel with four bands represented. Four stations on four bands each will meet the minimum requirements.

Do not send QSL cards. Prepare a list of claimed contacts and have them verified by at least two amateurs or a local radio club official. Enclose this application and an awards fee of \$2.00 or 10 IRCs to the Israel Amateur Radio Club, Postbox 4099, Tel Aviv, Israel.

### 5N AWARD FROM NIGERIA

The Nigerian Amateur Radio Society wishes to announce its very popular 5N Award. To qualify for this award, applicants are required to work a minimum of five separate 5N stations of Nigeria. This award also is available to SWL stations on a heard basis. This award is issued for all CW, all phone, and mixed-mode contacts. There are no band or mode limitations or time restrictions.

Once you have attained the required number of contacts, have your list verified by at least two local amateurs and forward your list with an award fee of five IRCs to the Nigerian Amateur Radio Society, Oyekunie Ajayi 5N0NAS, PO Box 2873, Lagos, Nigeria.

### 9H1 AWARD FROM MALTA

A couple months ago, I listed awards from Malta and failed to

Zone	1.8 MHz	3.5 MHz	7 MHz	14 MHz	21 MHz	28 MHz	All other bands
14, 15, 16, 33, 34	5	3	2	1	3	5	25
All other areas	15	12	6	2	6	10	45

Table 2. Band points per 9H1 contact.

mention probably their most popular award program. Sponsored by the Malta Amateur Radio Society, all contacts for the 9H1 Award must be made on or after September 21, 1964 (Malta Independence Day).

The same station may be counted only once per band; only five bands may be used. Fifty points are required for one-band achievements. Forty points for two bands; 30 points for three bands; 20 points for four bands. (See Table 2.)

To apply, prepare your list of contacts and have it verified by at least two fellow amateurs. Forward this list along with your award fee of \$2.00 and 10 IRCs to L. Smith 9H1BB, Malta Amateur Radio Society, Doreen House, New St. off Ganu, B'Kara, Malta.

#### BUDAPEST AWARD

From Hungary, we receive word about the Budapest Award being offered by BRAL (Budapest Radio Amateur League). Only contacts made after January 1, 1976, will be valid. European stations must work a total of 75 different HA5 or HG5 stations to qualify for this award. Duplicate QSOs do not count. There are no band, mode, or time limitations. Endorsements will be made if requested at the time application is made.

Have your confirmed contacts verified by at least two amateurs or a local radio club official. Send your list and award fee of 10 IRCs to BRAL Award Manager, Dezso Tarcsay HA5HA, PO Box 2, H-1553 Budapest, Hungary.

#### WORKED RAAG MEMBERS OF GREECE

Sponsored by the Radio Amateur Association of Greece, this award is made available to amateurs in three categories. Class 1—European stations must work 100 RAAG members, DX stations need to work 50 stations; Class 2—Europeans must work 75 SV RAAG members, DX stations require 30 member stations; Class 3—Europeans must work 50 SV RAAG members, DX stations must work 15 SV RAAG members. There are no band or mode restrictions. The club sta-

tion SV1SV counts three award points and five contacts for European stations in all three classes.

Do not send QSL cards. Prepare a list of contacts and have it verified by two radio amateurs or a local club secretary. Enclose this list with an award fee of \$2.00 or 12 IRCs to RAAG Awards Manager, Anastasios Panos SV1IG, PO Box 564, Athens, Greece.

#### PAAC AWARD

From The Netherlands, we learn of an awards program being made available by the very popular organization known as VERNON.

Sponsored by VERNON, this award requires all contacts to be made on or after June 1, 1945, to be valid. The basic PACC Award requires that the applicant establish contact with at least 100 separate PA/PI stations from The Netherlands. Endorsements also are made available for each increment of 100 stations worked.

Do not send QSL cards! VERNON asks applicants to prepare a list of qualifying contacts and have it verified by two amateurs or a local radio organization. Forward your application and the award fee of seven IRCs to Traffic Manager, VERNON, A. Sanderse PA0MOD, Obdammerdijk 2, 1713 RA Obdam, The Netherlands.

#### 4-2-70 SQUARES AWARD

In the stack of mail received last week, I found a very interesting letter explaining a unique award being offered by our friends in England.

While this award may be impossible to achieve for the majority of western stations, operators throughout Europe who read this column might find the rules extremely challenging and within reach.

To qualify for the award, all contacts must be made after December 31, 1978, to be valid. QSL cards must be submitted at the time of application and be arranged in alphabetical order along with a checklist of the QTH squares claimed. There is no award fee, but adequate postage is required for the safe

return of your QSL cards. All applicants must be RSGB members.

Awards are issued in four categories: fixed stations, alternative stations, portable stations, and mobile stations. These categories cannot be mixed. Award requirements are:

- 70 MHz—20 squares, 4 countries
- 25 squares, 6 countries
- 30 squares, 8 countries
- 35 squares, 10 countries
- 144 MHz—40 squares, 10 countries
- 60 squares, 10 countries
- 80 squares, 18 countries
- 100 squares, 20 countries
- 432 MHz—30 squares, 6 countries
- 40 squares, 10 countries
- 50 squares, 13 countries
- 60 squares, 15 countries

Forward your award claim to Award Manager J. Hum G5UM, 27 Ingarsby Lane, Houghton-on-the-Hill, Leicester LE7 9JJ, England.

#### MAN ON MOON

We will once again be operating from the Neil Armstrong Air and Space Museum in Wapakoneta OH, the home town of Neil Armstrong, first man to set foot on the moon.

This is the 12th anniversary operation in commemoration of Neil Armstrong's historic feat [feet, too—yuk, yuk—Ed.]. The dates and times of operation are as follows: July 18-19, from 9:00 am July 18 to 8:00 pm July 19.

We will be operating two stations on the following frequencies depending on propagation conditions.

- CW—7.075 to 7.125
- phone—7.250 to 7.300
- phone—3.950 to 4.000
- CW—14.1 ± 10 kHz.
- phone—14.300 to 14.350
- phone—21.400 to 21.450

All frequencies may not be used, but we will operate on as many as possible. We will use

the callsign WD8RVZ. A commemorative QSL will be available, SASE required.

US and Canadian amateurs QSL direct to WD8RVZ, all others please use the bureau. Visiting amateurs may check in on 147.93/33. "The World of Amateur Radio" will be shown. For further information, contact Gary W. Stolzenburg WD8RVZ, 717 W. Benton Street, Wapakoneta OH 45895.

#### HIGHLAND GAMES AWARD

Local amateurs in Midlothian IL will be operating a Special Event Station during the Scottish Highland Games in that community.

A commemorative certificate suitable for framing will be issued for any contact made with a Midlothian station during the Games. Look for them on 10 through 80 meters Novice and phone, 0000 GMT June 13 until 2400 GMT June 14, 1981.

To receive this certificate, send QSL and postage—no envelope—to the amateur contacted. For further information, contact Bill McGreevy KA9DES, 14820 Trumbull, Midlothian IL 60445.

#### FIELD DAY AWARD

The Puget Sound Council of Amateur Radio Clubs will issue a handsome certificate for contacting any three of the six participating council clubs in the 1981 Field Day. Those clubs and their calls are: Boeing Employees Amateur Radio Society (K7NWS); Hams Amateur Mobile Service Club (WA7LAW); Mike & Key Amateur Radio Club (K7LED); Mt. Baker Amateur Radio Club (K7SKW); N. Seattle Amateur Radio Club (W7DA); Radio Club of Tacoma (W7DK).

To qualify for the certificate, you must exchange QSL cards with those three Field Day stations you have contacted. Send those QSLs and one dollar to Scotty Huntley K7CYZ, 802 S. Lawrence St., Tacoma WA 98405. Your QSLs will be returned with the certificate.

#### TOM SAWYER DAYS

The Hannibal Amateur Radio Club, Inc., will issue a special events certificate from the National Tom Sawyer Days celebration operating from Mark Twain's boyhood home town, Hannibal MO, on July 4-5, 1981. Hours: 1500-2100 UTC on Satur-

day, July 4, and 1700-2100 UTC on Sunday, July 5. Frequencies: 7.245, 14.290, 21.390 MHz, and Novice CW on 7.125 and 21.125 MHz. To receive the certificate, send a large 9" x 12" SASE and your personal QSL card confirming the contact to Hannibal Amateur Radio Club, Inc., W0KEM, 2108 Orchard Avenue, Hannibal MO 63401. For information, contact Clifford H. Ahrens N0BQN, President, Hannibal Amateur Radio Club, Inc., (314)-221-4060 or (314)-221-8618.

### FORT NECESSITY

The Uniontown Amateur Radio Club (W3PIE) will be sponsoring a special event on July 4, 1981, starting at 1201 GMT through 2100 GMT to commemorate the historic Fort Necessity American Revolutionary War battlefield. A commemorative certificate will be available to amateurs sending an SASE (4" x 9" or larger) and postmarked not

later than July 31, 1981. The operating frequencies ( $\pm$  QRM) will be: CW—21,145 MHz; phone—14,345 and 28,545. Please send correspondence to Uniontown Amateur Radio Club, PO Box 433, Republic PA 15475; Attention: John Cermak WB3DOD.

### GLENDIVE MT CENTENNIAL

In observance of the Glendive MT centennial, the Lower Yellowstone ARC will be operating a special event station on July 4, 1981, amidst the festivities in the downtown area. Operating period will be from 1600Z to 2300Z on 7240 and 14280-290, and exchange will be name and signal report. Send a 4" x 9 1/2" SASE to Larry Melton KB7BO, 711 Snyder Ave., Glendive MT 59330, for commemorative QSL.

### THREE RIVERS FESTIVAL

The Fort Wayne Radio Club of Fort Wayne IN will have on the air special event stations to

celebrate the annual Three Rivers Festival. There will be two operating stations on the air simultaneously, using the calls W9TE and W9IWX. At the time of this writing, 10, 15, and 20 will be used.

A special certificate will be offered to all amateurs contacting these stations during the special event. All amateurs wishing a certificate should send QSLs and a self-addressed, stamped business-size envelope to Fort Wayne Radio Club, PO Box 15127, Fort Wayne IN 46885.

The dates of the special event stations' operation will be July 18-19, 1981. Transmission times are constant during the two days, including the nighttime hours on the 18th.

### FRIENDSHIP DAY

Friendship Day 1981 is being celebrated this year by the Allegany Highlands Amateur Radio Club by setting up a commemo-

orative station (KA2CGV) in Friendship NY. This station will be on the air to make as many QSOs as possible on August 2 from 1700 UTC to 2400 UTC. KA2CGV will operate on the following frequencies: phone—7.280, 21.380, and 28.680; CW—7.060, 21.060, and 28.060. To get your special commemorative certificate, send a QSL card and an SASE to Allegany Highlands Amateur Radio Club, PO Box 373, Friendship NY 14739.

Allow me to remind readers of this column that the 73 Magazine Awards Portfolio is in full swing. If you are interested in learning about one of the most comprehensive programs available, experience the challenge offered by more than twenty individual award incentives, then turn to the September and October, 1980, editions of 73 Magazine. There's something in it for everyone!

## LOOKING WEST

Bill Pasternak WA6ITF  
c/o The Westlink Radio Network  
Suite 718  
7046 Hollywood Blvd.  
Hollywood CA 90028

There is a rather important piece of legislation before the US Congress right now. It's titled H.R. 2203, and it has a direct bearing on the future of the US Amateur Service. Its purpose is actually twofold: First, it permits the FCC to legally utilize the talents of volunteer amateur radio operators as "auxiliary ears for the FCC" in monitoring both the Amateur and Citizens Radio Service for those who violate the rules of either.

The bill also addresses another important problem, that of legally continuing the Novice Licensing Program using volunteer examiners. You might remember that an FCC lawyer found the latter to be an illegal program since the current law strictly forbids the use of non-FCC personnel to perform FCC duties. While the Commission has continued to issue Novice class licenses using volunteer examiners, it has been looking for a permanent solution.

The bill you are about to read is the answer. It deals with both problems in a simple, uncomplicated way. It makes use of the talent available within the amateur community, while keeping ultimate authority on regulatory matters within the purview of the Commission itself.

Ray Frost WA6TEY has worked closely with Congressman Dannemeyer's staff in regard to its preparation. To that end, Frost had solicited input from the amateur community. The result of many months of preparation is now before Congress itself. The bill reads as follows:

### H.R. 2203

A bill to amend the Communications Act of 1934 to permit the Federal Communications Commission to employ voluntary services for purposes of monitoring violations of the Act by amateur and citizens band radio service station operators and for purposes of preparing and administering examinations for certain amateur station operator licenses.

*Be it enacted by the Senate and House of Representatives*

*of the United States of America in Congress assembled, That section 4(f) of the Communications Act of 1934 (47 U.S.C. 154(f)) is amended by adding at the end thereof the following new paragraph:*

"(4)(A) For purposes of monitoring any violation of any provision of this Act, and of any regulation made by the Commission pursuant to this Act, relating to amateur station transmissions, the Commission, without regard to part III of title 5, United States Code, may (i) recruit and train any individual licensed by the Commission to operate an amateur station: and (ii) accept and employ voluntary and uncompensated services of such individual. For purposes of recruiting and training such individual, the Commission, without regard to part III of title 5, United States Code, may accept and employ voluntary and uncompensated services of any amateur station operator organization.

"(B) For purposes of monitoring any violation of any provision of this Act, and of any regulation made by the Commission pursuant to this Act, relating to transmissions of any citizens band radio service station, the Commission, without regard to part III of title 5, United States Code, may (i) recruit and train any individual licensed by the Commission to operate a citi-

zens band radio service station: and (ii) accept and employ voluntary and uncompensated services of such individual. For purposes of recruiting and training such individual, the Commission, without regard to part III of title 5, United States Code, may accept and employ voluntary and uncompensated services of any citizens band radio service station operator organization.

"(C) For purposes of preparing or administering any examination for the least privileged class of amateur station operator license established under section 303(1) of this Act, the Commission, without regard to part III of title 5, United States Code, may accept and employ voluntary and uncompensated services of any individual who is licensed by the Commission to operate an amateur station and whose license is not of such class.

"(D) Any person who provides voluntary and uncompensated services under this paragraph shall not be considered, by reason of having provided such services, a Federal employee for any purpose.

"(E) For purposes of this paragraph, the term 'citizens band radio service station' has the meaning given such term in sections 95.401 and 95.603 of title 47, Code of Federal Regulations, including any amendment

to such term as hereafter may be made by the Commission."

Sec. 2. Section 605 of the Communications Act of 1934 (47 U.S.C. 605) is amended by adding at the end thereof the following new sentence: "This section shall not apply to any receipt, divulgence, publication, or utilization of the contents of any amateur or citizens band radio service station transmission by any individual in the course of providing voluntary and uncompensated monitoring services to the Commission under subparagraph (A) or (B) of section 4(f)(4) of this Act."

From my point of view, H.R. 2203 is a necessity. First, it's a very cost-effective measure in these inflationary times. If passed, it will mean that the FCC will no longer be able to cry poverty in regard to the enforcement of its rules. This is especially important in regard to cases of chronic malicious interference. Cutbacks in the FCC's budget already have been announced.

In mid-March, retiring FCC Chairman Robert E. Lee told a congressional subcommittee that the Reagan budget ax will force a 25% reduction in the agency's Compliance Program, and Field Operations Bureaus in

Beaumont TX, Savannah GA, Cincinnati OH, Pittsburgh PA, and Washington DC will be closed down in fiscal 1982. Also, the Monitoring Station in Anchorage AK will be terminated, as will a number of the Commission's Special Enforcement Teams.

The FCC also is dropping quarterly travel to 77 cities for the administration of amateur and commercial exams. In fiscal 1982, these trips will become *annual* occurrences. Some sources say that they may be terminated entirely if monies are not available. This would mean that obtaining an amateur ticket other than Novice could become almost an impossible task for some. Either travel whatever distance is necessary at your own expense or wait for "next year" should you fail! And, if all this were not enough, Lee predicts that the processing time for an amateur license, which is currently 41 days or less, will increase significantly. Expect it to become a minimum of 65 days at best.

Obviously, the Reagan budget places the FCC in a bind. It also places the amateur community in a similar position since these cutbacks seriously endanger the vitality of our ser-

vice. At least in part, H.R. 2203 offers some relief from this. If enacted, it will take part of the burden off the Commission's shoulders. It will mean continuance of Novice license testing. It will mean that we can expand our efforts to self-regulate our service, and that those who violate the terms of their licenses will not be permitted to continue their activities just because the Commission doesn't have the funding to weed them out. It can help keep our amateur bands from becoming carbon copies of the 11-meter band.

Whether you like or dislike the measure, I urge that you reread it several times and voice your opinion on it. In regard to the latter, your comments should be addressed to the members of the Congressional Subcommittee on Telecommunications, Consumer Protection and Finance. A complete list of all those involved with this committee appears at the end of this column. Also, if you find yourself in support of the measure, why not drop a QSL card to its sponsor, Congressman William E. Dannemeyer, 1032 Longworth Bldg., Washington DC 20515. This as a way of saying thanks to the congressman for his active interest on our behalf.

Also, another QSL to Ray Frost WA6TEY, 14421 Hope St., Garden Grove CA 92643, might be apropos in this case. Without Ray's input, there is no telling what H.R. 2203 might have read like. Thanks to him, it's a rather positive step that helps foster a vital Amateur Service while helping to continue the deregulation process. As you can guess, I support the bill. You must make up your own mind.

**Subcommittee on Telecommunications, Consumer Protection, and Finance  
Room B-333**

**Rayburn Office Bldg.  
Washington DC 20515**

**Congressmen**

Timothy E. Wirth, Chairman  
Ronald M. Mottl  
James H. Markey  
Thomas A. Luken  
Al Swift  
Henry A. Waxman  
Cardiss Collins  
W. J. Billy Tauzin  
John D. Dingell, Chairman, 97th Congress  
James M. Collins  
Matthew J. Rinaldo  
Carlos J. Moorhead  
Marc L. Marks  
Thomas J. Tauke  
Thomas J. Bliley  
James T. Broyhill

## FCC

### FCC ENCOURAGES AMATEUR RADIO EXPERIMENTATIONS

Consistent with a recent Commission amateur radio definition that, "The Amateur Radio Service is for technically-inclined persons who wish to learn about and experiment with radio communications equipment and operating techniques" (Commission Order of November 6, 1980), interested radio amateurs are encouraged to experiment with new methods of transmission and new radio technologies.

The Commission realizes that in certain instances proposed experiments may conflict with existing rules, and may therefore require a Commission rule waiver. The Commission is willing to grant rule waivers for many different experimental purposes, including:

- Spread-spectrum modulation techniques
- Packet-switching networks
- Radioteletype codes, other than ASCII and Baudot
- "Beacons" for propagation studies
- Medium-scan television
- Frequency and/or amplitude "companding"
- Digitized voice techniques
- Digitized video techniques
- "Trunked" repeater systems
- EME communications

For example, on March 6, 1981, the Private Radio Bureau granted Special Temporary Authority (STA) to 25 radio amateurs affiliated with the Amateur Radio Research and Development Corporation (AMRAD) to experiment with spread-spectrum transmission. (Spread-spectrum is an application of broadband transmission that

appears to make more efficient use of congested frequency bands than does conventional narrowband transmission.)

On August 15, 1980, an STA was granted for two years to a radio amateur to conduct experiments in digital phase-shift keying in the HF phone band, where slow-scan television is authorized. During November, 1980, four amateur licensees were granted a rule waiver to permit transmissions of the digital teleprinter code for the purpose of conducting experiments to develop an error-free mode of amateur teleprinter communications. These recent examples represent only a small segment of the many avenues of experimentation open to licensees in the Amateur Radio Service.

Licensees wishing to conduct experiments within the amateur bands should first refer to the Commission's rules to determine if a Commission rule waiver is required. If the experiment may be conducted in accordance with the rules, no communication with the Commission is

required. However, if a proposed experiment will conflict with any of the Commission's rules, the licensee conducting the experiment must write to the Commission and request a waiver of the specific rule(s). Waiver request letters should be addressed to: Federal Communications Commission, 334 York Street, Gettysburg PA 17325; Attention: Technical Section.

The content of the waiver request letter should cover complete details of the proposed experiment, including all technical parameters, specific frequencies to be used, and a justification for the project. The Commission will approve or deny your request in writing, and no experimentation may commence until the written approval is received.

### FCC NO LONGER ISSUES LICENSES TO NEW AMATEUR RADIO CLUB, MILITARY RECREATION, OR RACES STATIONS

Due to the large number of inquiries the Commission is re-

ceiving pertaining to the licensing of club, military recreation, and RACES stations in the Amateur Radio Service, the following information is provided.

In May, 1980, the FCC adopted a Third Report and Order amending Part 97 of the Commission's rules. This action simplified the licensing and call-sign assignment system for such stations in the Amateur Radio Service. Section 97.37 was amended with a new paragraph (b) which reads as follows:

(b) Only modification and/or renewal station licenses will be issued for club and military recreation stations. No new licenses will be issued for these types of stations.

The text of Section 97.171 was amended also, with the addition of a new paragraph (b) which reads as follows:

(b) Only modification and/or

renewal station licenses will be issued for RACES stations. No new licenses will be issued for RACES stations.

A change in the trustee of a club, person in charge of the military recreation station, or responsible civil defense official will be treated as a modification to the existing station license.

In addition, a change in the station location or a change in the name of an existing station will be construed as a license modification. No new call sign will be assigned.

The desire for a new license seems to arise most often in connection with club stations. The club members can select a licensed amateur radio operator as a trustee for the station and then use the trustee's primary call sign as the club's call sign. This would be considered as a modification to an existing license.



The Federal Communications Commission Private Radio Bureau Chief, Carlos V. Roberts (second from right), presents a Special Temporary Authority to experiment with spread-spectrum transmission to Hal L. Feinstein WB3KDU (far left) and Paul L. Rinaldo W4RI. Dr. Michael J. Marcus (far right), Chief, Technical Planning Staff of the Commission's Office of Science and Technology, witnesses the ceremonial occasion at the Commission's offices, March 6, 1981. Messrs. Feinstein and Rinaldo are two of 25 amateurs affiliated with the Amateur Radio Research and Development Corporation granted the Special Temporary Authority for experimentation.

## RTTY LOOP

Marc I. Leavey, M.D. WA3AJR  
4006 Winlee Road  
Randallstown MD 21133

It's June! And with the month come all kinds of good things, not the least of which is this month's edition of RTTY Loop, which marks the beginning of our fifth year!

I sincerely appreciate the interest you all have expressed in RTTY, and in this column, over the past four years. Many newcomers have asked about the availability of older material from the column. Art Galvez KA7GTP of Eugene OR is one who writes that he received an old copy of 73 as a gift, and was interested by the magazine's contents, especially RTTY Loop. He wonders if an index to old columns is available, or if we plan to publish a compilation of old columns in book form.

Well, Art, that is exactly what is planned. Over the next few months I hope to extract what I can from the first few years of RTTY Loop, and we hope to offer it in book form to those who may have missed it or who want to add it to their libraries. Watch

this column for details. Don't forget the other 73 Radio Bookshop publications on RTTY, which are advertised in the magazine. They provide a valuable source of RTTY information. Above all, I hope you plan to continue reading 73, where more articles of interest appear than anywhere else, not to mention the continuing saga of RTTY Loop.

Moving right along, another big item in June is Field Day. I know that many of the clubs are gearing up for that big weekend, June 27-28, but how many of them are actively courting the press? One of the biggest complaints I hear at gatherings of hams is that this paper or that magazine carried an article that somehow cast a bad light on amateur radio.

One of our boosters, the Stark RTTY Group out in Massillon OH, did a bang-up job of publicity in last year's effort, as Fig. 1 shows.

Why don't you try it? Write up a press release, five hundred words or so, describing your club and its efforts and send it off to local publications. Don't

just concentrate on the big daily papers—send one to the neighborhood weeklies and shopping center giveaways. They are all eager to receive news of local activities, and something like this is that much good news for the readership. Send it in early, don't forget to provide some means of contacting an individual for clarification or more detail, and enjoy the spotlight.

Way back when, it took a boat-anchor transmitter and a clunky old grease-monger machine to get on RTTY. Now, with computer-controlled stations and video terminals, more and more hams will be giving it a fling. To this end, Dr. R. B. Gober

W5ZNN, a dentist who is the Mayor of Corsicana TX, sends in a letter with several questions. "Will," he writes, "interference from automatic, computer-controlled RTTY stations become a problem when these stations come on the air with no operator present?" Much as nets now declare certain frequencies in the 75-meter phone band unto themselves, he wonders about claims of frequency ownership by mailboxes, ASCII groups, and the like. He also wonders about providing DX windows, and possibly revamping the band segments.

I really don't know the answer to these questions. I would hope

### Stark RTTY to participate in nationwide ham radio field day



Fig. 1. Samples of positive amateur radio publicity by the Stark RTTY Group of Massillon OH.

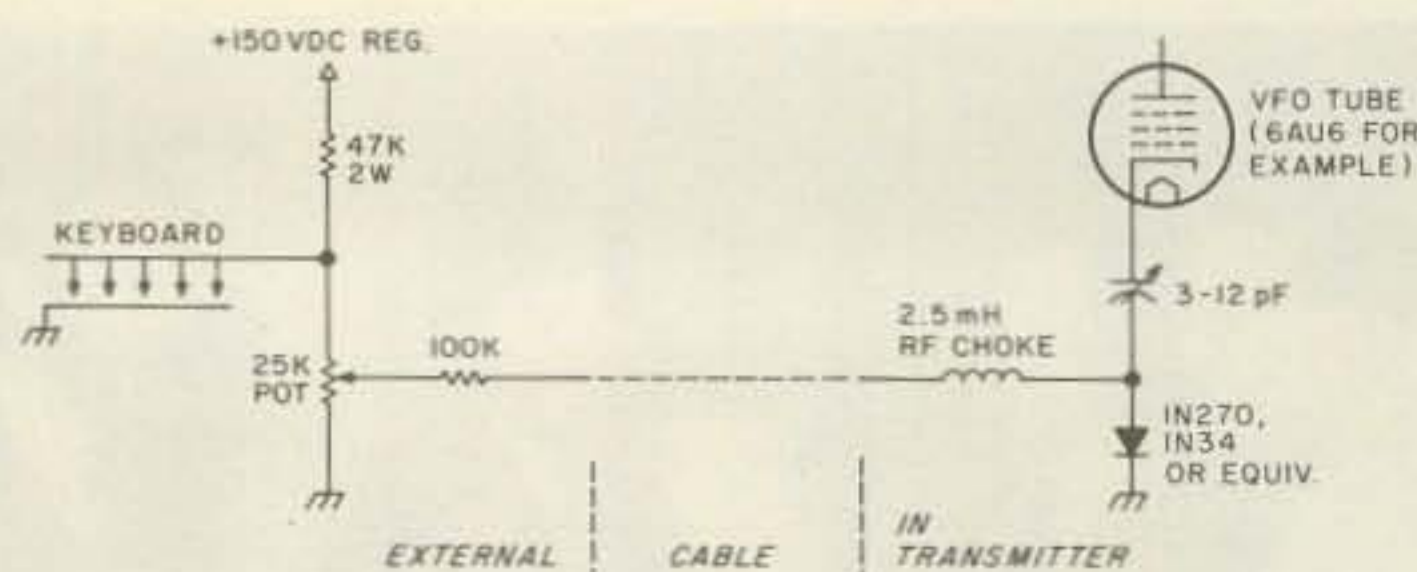

Fig. 2. Shift-pot circuit.

that as RTTY becomes more common, and I have no doubt that with the popularization of ASCII it will, some form of band plan will emerge that will keep everybody happy. It would seem as though a frequency hog is a frequency hog, whether operating SSB on 75 or RTTY on 20, and that to solve that problem we have to deal with the basic relationships hams have with hams, rather than trying to put down this group or that.

Clearly, when and if automatic stations become common, it will still be the operator, present or not, who will be responsible for preventing interference. I am afraid that if we do have a proliferation of interference-causing automatic stations, the powers that be will step in and we won't have the problem any more, because we won't have the privilege of running such a station. I would encourage anyone developing an automatic station to provide for ample monitoring to prevent stepping on others.

Okay, gang, let's get practical now, and down to basics. Francis W. Sorovec WD9HPA from Fort Wayne IN is frustrated as the devil in his attempts to get

onto RTTY. Francis states that he currently operates upside down on 20 meters, with his Swan 350. He got an old Ranger II transmitter and would like to know how to hook the whole thing together.

The shift-pot circuit has been covered before in this column, back in January, 1978. It uses a diode switch to place a small capacitance on the frequency-determining circuit of a vfo, thus lowering the frequency. By applying the bias voltage during space, a correct (low—space; high—mark) FSK signal is produced. Because of the characteristics of the circuit, you can vary the voltage applied to the diode, and thus vary the apparent capacitance, changing the obtained shift. A simple diagram of such a circuit is shown in Fig. 2.

The transmitter in question, the Ranger II, resembles many other transmitters of its era in that it uses a pentode, a 6AU6, as the vfo tube. Connecting the high end of the capacitor to pin 7 of the 6AU6, the cathode, will enable the circuit to shift the frequency appropriately. Why a trimmer? Different circuits need different amounts of capaci-

tance. Once it is adjusted, the trimmer need never be touched again, and I have built these shifters using a small, fixed mica capacitor in the 12-pF range. The potentiometer, located external to the capacitor-diode assembly, should have enough range to allow adjustment to either 170-Hz or (shudder) 850-Hz shift. Hope this helps, and maybe we will work on the air.

As I write this column, the second Greater Baltimore Ham-boree and Computerfest has just ended. Last year's meeting was highlighted by the appearance of Wayne Green; the ARRL graced this year's group. I was quite impressed by the increased showing of digital equipment among the flea-market offerings. We are, at long last, beginning to see an end to the World War II boat anchors, and more and more of the "first-generation" computer equipment, circa 1975, is showing up for secondhand purchase. I was stunned by what many of the guys were asking, though. It will take some time for the market for recycled computer hardware to develop, but it will only do so if items are offered for what they are worth, not what they cost originally or what it would cost to replace them now.

For example, I saw several older computer terminals being offered for close to what they cost *new* during the mid 1970s. Now, I know that a new fancy terminal may cost five or six hundred dollars, or more, but

that does not mean that an old one that cost \$250 new is still worth it.

Flea-market and secondhand equipment provides a valuable function in amateur radio, getting newcomers started with a minimum of investment. Much of the equipment is used for a year or two, then resold to another ham down the line to get him started. I am afraid that offering equipment five years old and several levels out of date at nearly new prices does little to encourage such trade. That's my opinion. Any comments?

In the way of new equipment, I have purchased several items, and a few things have become available, for review in the future. I hope to examine more than the "strict" RTTY equipment, that is, terminals, demodulators, and the like. Any or all equipment that is of interest to the RTTYer is fair game here, and, hopefully, I will be able to cast some light where none was before. In the planning stage now, for example, are reviews of several items usually ignored by the magazines, but vital to the functioning of a RTTY station. More on that in the months to come.

Next month I will conduct my annual (it seems) session on how to get your computer onto RTTY. Many of you have written with interesting experiences in computer RTTY, and I hope to share many of them with the readership and pass along a few tips of my own. Where's that gonna be? Why, right here, in RTTY Loop!

# FCC

Reprinted from the Federal Register

## Amendment of the Commission's Rules To Provide for Exception to the 50-Watt Power Limitation in Two Additional Military Areas, and To Provide for Communications With Satellites by Amateur Radio Stations Within Certain Military Areas

AGENCY: Federal Communications Commission.

ACTION: Final rules.

SUMMARY: The Commission is adopting rules in the Amateur Radio Service to relax a limitation to allow stations located in restricted areas near designated military installations and operating, in the future, in the Amateur-

Satellite Service to communicate with satellites with power up to 1,000 watts (equivalent isotropically radiated power). The Table of Frequency Allocations is also amended to specify two additional areas. Amateur-Terrestrial communication in the restricted areas will remain subject to a 50-watt power limit.

EFFECTIVE DATE: April 8, 1981.

ADDRESS: Federal Communications Commission, Washington, D.C. 20554.

FOR FURTHER INFORMATION CONTACT: John B. Johnston or Maurice J. DePont, Private Radio Bureau, (202) 632-4964.

SUPPLEMENTARY INFORMATION: Adopted: February 11, 1981.

Released: February 28, 1981.

In the matter of amendment of § 97.61(b)(7) of the Amateur Radio Service Rules to provide for exception to the 50 watt power limitation in two additional military areas, and to provide for communications with satellites by amateur radio stations within certain military areas; amendment of § 2.106, Table of Frequency Allocations.

By the Commission: Chairman Ferris not participating.

1. The Commission received a letter from the Radio Amateur Satellite Corporation (AMSAT), requesting the Commission's assistance in removing the 50 watt transmitter power limitation, in § 97.61(b)(7) of the Rules, applicable to amateur radio stations in certain parts of the country operating in the 420-450 MHz band. AMSAT states that, in order to use any new satellites that will be launched in the future, user stations will require 500-1,000 watts effective radiated power, an order of magnitude higher than that required to use previous amateur satellites. As a consequence, it anticipates that there will be as many as several thousand amateur radio stations using the new

Phase III-A satellite that will require a waiver of § 97.61(b)(7) to permit higher power than 50 watts. AMSAT feels that amendment of the rule would eliminate the need for rule waivers.

2. The Frequency band 420-450 MHz is allocated to the Amateur Radio Service on a non-interference basis to the Government Radiolocation Service (See § 2.106 of the Commission's rules, Table of Frequency Allocations and Footnote US 35 thereto). Within this band, the frequencies 435-438 MHz are allocated to the Amateur-Satellite Service (ASAT), on condition that no harmful interference is caused to the other services, Government Radiolocation and Amateur Radio (See § 97.415, Footnote 1). Section 97.61(b)(5) requires that amateur radio stations operating in the frequency band 420-450 MHz not cause interference to the Government Radiolocation Service. Section 97.61(b)(7) identifies certain areas of the United States where amateur radio stations must have special authorization from the FCC Engineer in Charge (EIC) and the Military Area Frequency Coordinator (MAFC) before the station may transmit



in the 420-450 MHz band with more than 50 watts input power.

3. In its request for assistance, AMSAT suggests that the Commission pursue the matter with the Interdepartment Radio Advisory Committee (IRAC) to determine whether the military would have any objection to deletion of the 50 watt power limitation. AMSAT offers three alternatives that it would consider to be suitable. They are:

A. Modify § 97.61(b)(7) to increase the transmitter power limit from the present 50 watts to 250 or 500 watts in the 420-450 MHz band.

B. Modify § 97.61(b)(7) to delete the 50 watt limit in the 435-438 MHz ASAT frequency band. Then the 1,000 watt limit specified in § 97.67(a) would apply between 435-438 MHz.

C. Modify § 97.61(b)(7) to apply only to amateur stations transmitting with antenna radiation patterns below elevation angles of 10 degrees, thus removing the 50 watt power limit for amateur radio stations communicating with the satellite.

4. The Commission took the matter up with IRAC. IRAC reported that the current restrictions, upon which § 97.61(b)(7) is based, are valid and are required by the military services. In addition, IRAC determined that two additional areas must be added to those now specified in § 97.61(b)(7) where power must be limited to 50 watts, unless, as mentioned in paragraph 2, special authorization has been obtained. The first area is within a 50 mile radius around Otis Air Force Base, Massachusetts. The other is within a 50 mile radius around Beale Air Force Base, California.

5. IRAC also said that it could permit amateur radio stations within any of the military restricted areas to communicate with satellites, on ASAT band frequencies 435-438 MHz, with power not to exceed 1,000 watts equivalent isotropically radiated power. However, those amateur radio stations would have to maintain a minimum transmitting antenna elevation angle of 10 degrees.

6. Amateur radio users who engage in amateur satellite operations will benefit from the relaxation of the rules herein ordered. Even though they are within any of the military restricted areas they can use 1,000 watts power as long as their antennas comply with the elevation angle specified. However, amateur radio users whose stations are located in the specified military areas and who engage solely in terrestrial operations will be required to accept the 50 watt power limit (unless waived) since amateur usage of frequencies in the 420-450 MHz band is predicated on a non-interference basis to the Government Radiolocation Service in that band.

7. We are also amending § 2.106, Table of Frequency Allocations, Footnote U.S. 7, to reflect in that rule section the two additional military areas.

8. The specific rule amendments that we are adopting are set forth in the Appendix. Authority for the amendments is contained in Sections 4(i) and 303 of the Communications Act of 1934, as amended. We are dispensing with the prior notice and public procedure provisions of the Administrative Procedure Act as unnecessary (see 5 U.S.C. 553(b)(3)(B)) since the military services: (1) require a power restriction for terrestrial communications of amateur radio stations located near military installations; and, (2) could not permit, because of potential interference to military activities, any further concessions for amateur satellite operations.

9. Accordingly, it is ordered, effective April 8, 1981, that Parts 2 and 97 of the Commission's Rules are amended as set forth in the attached Appendix.

10. It is further ordered That this proceeding is terminated.

11. Information concerning these rule changes may be obtained from John B. Johnston or Maurice J. DePont, (202) 632-4964.

(Secs. 4, 303, 307, 48 Stat., as amended, 1066, 1082, 1083; 47 U.S.C. 154, 303, 307)

Federal Communications Commission.

William J. Tricarico,

Secretary.

A. Part 2 of Chapter I of Title 47 of the Code of Federal Regulations is amended, as follows:

Section 2.106 is amended by adding new paragraphs (e) and (f) to Footnote U.S. 7 to read as follows:

§ 2.106 Table of frequency allocations.

\* \* \* \* \*

U.S. Footnotes

\* \* \* \* \*

U.S. 7 \* \* \* \*

(e) In the State of Massachusetts within an 80-kilometer (50 mile) radius around locations at Otis Air Force Base, Massachusetts (latitude 41°45' N., longitude 70°32' W.).

(f) In the State of California within an 80-kilometer (50 mile) radius around locations at Beale Air Force Base, California (latitude 39°08' N., longitude 121°26' W.).

B. Part 97 of Chapter I of Title 47 of the Code of Federal Regulations is amended, as follows:

1. In § 97.61, paragraph (b)(7) is amended by adding new subparagraphs (v) and (vi), as follows:

§ 97.61 Authorized frequencies and emissions.

\* \* \* \* \*

(b) \* \* \*

(7) \* \* \*

(v) In the State of Massachusetts within an 80-kilometer (50 mile) radius of 41°45' N., 70°32' W.

(vi) In the State of California within an 80-kilometer (50 mile) radius of 39°08' N., 121°26' W.

2. In § 97.421, a new paragraph (c) is added as follows:

§ 97.421 Telecommand operation.

\* \* \* \* \*

(c) Stations in telecommand operation may transmit from within the military areas designated in § 97.61(b)(7) in the frequency band 435-438 MHz with a maximum of 611 watts effective radiated power (1,000 watts equivalent isotropically radiated power). The transmitting antenna elevation angle between the lower half-power (-3 decibels relative to the peak or antenna bore sight) point and the horizon must always be greater than 10°.

3. A new § 97.422 is added to Subpart H of Part 97, as follows:

§ 97.422 Earth operation.

Stations in earth operation may transmit from within the military areas designated in § 97.61(b)(7) in the frequency band 435-438 MHz with a maximum of 611 watts effective radiated power (1,000 watts equivalent isotropically radiated power). The transmitting antenna elevation angle between the lower half-power (-3 decibels relative to the peak or antenna bore sight) point and the horizon must always be greater than 10°.

[FR Doc. 81-0860 Filed 3-3-81; 8:45 am]

BILLING CODE 6712-01-M

Type Acceptance of Equipment Marketed for Use in the Amateur Radio Service

AGENCY: Federal Communications Commission.

ACTION: Final rule (second report and order).

SUMMARY: This document extends the effective date of the existing regulations that require type acceptance of all external radio frequency power amplifiers and amplifier kits capable of operation below 144 MHz, affecting primarily those amplifiers used in the Amateur Radio Service. This extension

is necessary as the present regulations are due to expire on April 28, 1981. The expiration of these regulations would allow the marketing of external amplifiers designed for illegal operation in and around the Citizens Band Radio Service.

DATES: The effective date of the order is April 28, 1981.

ADDRESS: Federal Communications Commission, Washington, D.C. 20554.

FOR FURTHER INFORMATION CONTACT: John A. Reed, Office of Science and Technology, Washington, D.C. 20554 (202) 653-6288.

SUPPLEMENTARY INFORMATION: In the matter of amendment of Parts 2 and 97 of the Commission's Rules to require type acceptance of equipment marketed for use in the Amateur Radio Service.

Second Report and Order

Adopted: March 23, 1981.

Released: March 26, 1981.

By the Commission: Chairman Ferris not participating; Commissioner Jones absent.

1. On March 20, 1978, the Commission released a Report and Order in the above entitled matter (FCC 78-107, 43 FR 12682). That document implemented type acceptance procedures and certain technical requirements for external radio frequency power amplifiers and amplifier kits that are designed for operation below 144 MHz. The effect of that order was to require type acceptance for the majority of amplifiers used in the Amateur Radio Service (ARS). Type acceptance is a procedure whereby the Commission approves radio transmitting equipment as being capable of complying with the necessary technical specifications. Such approval, where required, is necessary before the equipment may be marketed. See 47 CFR 2.901 *et seq.* In this specific case, the type acceptance procedure allows the Commission to determine whether the external amplifiers are capable of meeting those FCC technical standards that are designed to minimize the possibility of interference and, also, to determine whether the amplifiers are intended for use only in the ARS and not in or around the Citizens Band (CB) Radio Service.

2. As noted above, compliance with the revised technical standards to allow for the commercial manufacture and marketing of these external amplifiers is enforced, in part, through our type acceptance procedures. The standards were implemented due to the large number of amplifiers being marketed and promoted for illegal operation in and around the CB Radio Service. Such illegal use of external amplifiers created a severe interference problem to television reception and to the reception of other radio services. It was estimated that in fiscal year 1978 that about four million persons and perhaps as many as ten million persons experienced interference to televisions reception from CB radio stations. About half of this interference was caused by or intensified by the illegal use of these amplifiers. It was also predicted that this interference would significantly increase unless countered by Commission action.

3. These interference problems are detailed in earlier reports, as cited in the reference Report and Order in paragraph one and in the Notice of Proposed Rule Making (released February 28, 1977) for this docket, and will not be further repeated here. It was clear that when the Commission issued its Order on the subject in 1978, it was faced with resolving a serious national problem. In fact, the interference caused by the illegal use of external amplifiers was so severe as to require immediate implementation of the technical standards and type acceptance requirement by this Commission. Because of this rapid implementation, the technical regulations and the type acceptance requirement were made

effective for only three years so that the effects of this action would be subject to a mandatory review prior to the expiration date of April 28, 1981. It was expected that this three year period would allow the Commission additional time to investigate other methods of controlling the promotion and use of external amplifiers in radio services other than the ARS and to monitor the effectiveness of the new regulations.

4. During this three year investigation period, other methods of controlling the manufacture and marketing of external amplifiers were studied. One such method was to require the showing of an appropriate amateur license prior to the purchase of amateur transmitting equipment (FCC 79-586). However, as we concluded in our first Report and Order in this Docket, no other method was considered to offer the effectiveness provided under the current type acceptance program. The problem with attempting to require retailers to ask potential buyers of amateur equipment to display their amateur licenses before they may make a purchase is that it is uncertain whether this Commission has the legal authority to impose this requirement.<sup>1</sup> Even if the Commission had such authority, there are two other problems. First, this type of regulation would be burdensome for retailers. Second, it is more effective for the Commission to enforce its regulations through contact with a limited number of manufacturers (i.e., through type acceptance) than with a vast number of sellers.

5. The effectiveness of the current type acceptance program in halting the promotion of external amplifiers for illegal applications has led this Commission to believe that the program should be continued. Numerous manufacturers and distributors of amplifiers designed for illegal operation in and around the CB service have ceased manufacture and marketing, although legal action was required in some instances. The majority of this litigation has already been detailed in previous Commission releases and will not be repeated in this item. Other cases are still under investigation with court actions pending and, therefore, will not be discussed. However, certain manufacturers are still promoting their non-type accepted amplifiers for illegal operations. Some U.S. Attorneys have questioned the advisability of prosecuting these manufacturers for violation of the existing type acceptance requirement due to the impending cut-off date of the regulations. These U.S. Attorneys feel that it would be inappropriate to prosecute a manufacturer for violation of a temporary regulation. Instead, most prosecutions have been for violations of the regulation that prohibits the manufacture and marketing of any external amplifier with amplification capability between 24.00 MHz and 35.00 MHz § 2.815(b) of the Commission's regulations. This form of prosecution would be sufficient provided all of the amplifiers promoted for CB operation operated within that banned frequency range. Unfortunately, many do not operate within that frequency range as manufactured. For example, without the type acceptance requirement, manufacturers would have no restrictions on producing amplifiers that can be easily altered by purchasers to operate with CB radio equipment even though those amplifiers are designed to operate above or below the prohibited frequency range. Thus, it is necessary to invoke a violation of the type

<sup>1</sup>The provision in the Communications Act of 1934, as amended, that provides the chief support for this requirement is Section 302(a) (47 U.S.C. 302(a)). This Section authorizes the Commission to " \* \* \* make reasonable regulations governing the interference potential of devices \* \* \*" and further states that these regulations apply to the sale of devices. This Section has been relied on by the Commission to establish standards for radio "devices" and to prohibit retailers from selling noncomplying devices.

acceptance regulation to cover all of the available amplifier models. That action requires a removal of the cut-off date for type acceptance in order for these regulations to be more generally effective. In light of this and the information contained in the preceding paragraphs, a continuation of the present type acceptance requirement would be in the public interest.

6. The Administrative Procedure Act permits federal agencies to forgo the usual notice and comment procedures in rule makings if " \* \* \* public procedures thereon are \* \* \* unnecessary." (5 U.S.C. 553(b)(3)(B)). Prior notice and comment procedures concerning a continuation of the current type acceptance requirement are unnecessary for a variety of reasons. First, the possibility of a permanent type acceptance requirement was previously subject to public comments in this Docket in the original Notice of Proposed Rule Making, 42 FR 12204, released February 28, 1977. It is not anticipated that requesting additional comments on the subject would provide the Commission with further useful information. Second, in our Report and Order in Docket No. 21117, adopted February 16, 1978, released March 20, 1978, 43 FR 12682, we indicated that the Commission might make the temporary type acceptance requirement permanent. In paragraph 12 of that Order, we stated "If at the end of this three year period it is determined that the type acceptance requirement is still necessary and that it has indeed reduced the problems caused by these amplifiers, this program can be continued by further Commission action." During this three year period, we have not received any adverse comments regarding the type acceptance requirement. Third, in our Report and Order in Docket No. 21117, we found that the type acceptance requirement itself imposed only a slight burden on manufacturers.

In paragraph 13 of that Order (while discussing § 2.1005(b) of our regulations), we stated:

" \* \* \* No piece of radio equipment from any service should be marketed before a number of samples are tested to determine that the equipment is in compliance with our regulations. As these tests should be performed regardless of the requirement for type acceptance, the only additional expense that type acceptance would cost the manufacturer or supplier is the few hours of paperwork to compile the application and the time delay in marketing during which the Commission processes this application.

Fourth, all the Commission is now doing is making a rule permanent that was found to be in the public interest in our Report and Order in Docket No. 21117. Since we are merely continuing an existing rule, there will be no additional impact on manufacturers. Finally, as discussed above, after extensive and protracted consideration, we do not believe that there are any viable alternatives to a continuation of the type acceptance requirement.

7. The enforcement actions by the U.S. Attorneys and the Commission's Field Operations Bureau against the manufacturers of those amplifiers intended for operation around the CB service and the reduction in the availability of these amplifiers to the public have demonstrated that this method of controlling the illegal operation of these amplifiers is effective. However, the continued, though smaller, illegal market necessitates retaining these regulations. Therefore, the expiration date of the type acceptance requirement for external radio frequency power amplifiers and amplifier kits is deleted, as shown in the attached appendix.

8. Other changes to these regulations, as also shown in the appendix, will be made in accordance with the provisions of Subsections 553(b)(3)(A) and 553(b)(3)(B) of the Administrative Procedure Act (5 U.S.C. 553). These

subsections allow the Commission to finalize regulations without the necessity of providing prior notice or seeking comments when the changes involve interpretative rules or " \* \* \* when the agency for good cause finds (and incorporates the finding and a brief statement of reasons therefor in the rules issued) that notice and public procedure thereon are \* \* \* unnecessary, or contrary to the public interest." When the regulations establishing type acceptance requirements for external amplifiers were implemented, there was a considerable rush in their preparation in order to place them into effect at the earliest possible time. This rush was due to the large number of manufacturers promoting their amplifiers for illegal operation and because of the severity of the interference problems resulting from the use of those amplifiers. As a result, some editorial errors in the regulations occurred and some regulations that were either awkward or unclear were adopted. The language of these regulations has therefore been reworded to correct the editorial errors, to clarify the requirements and to refine the statement of the requirements. Since the meaning of the regulations remains unchanged, it is considered unnecessary to issue a further Notice of Proposed Rule Making on this matter.

Additionally, the prompt clarification of the existing regulations is in the public interest since the changes will make the regulations more understandable and encourage compliance. Any new problems which may arise in the specific wording of the Part 97 regulations can be considered under Docket No. 80-729 which looks toward a rewrite of the amateur regulations into a "plain language" format.

9. It should also be noted that the Commission's policy concerning waivers of the amplifier technical requirements or the type acceptance requirement is unchanged. The type acceptance requirement may still be waived for those amplifiers designed for industrial, scientific or medical (ISM) applications. Additionally, waivers of the technical requirements will be considered for those amplifiers designed to operate within the frequency range of 50.00 MHz to 54.00 MHz as long as the amplifiers can not be easily converted to operate at lower frequency ranges.

10. In view of the foregoing, this Commission is of the opinion that the amended regulations, as described above and in the attached appendix, are in the public interest, convenience and necessity. The authority for these amendments is contained in Sections 4(i), 302, 303(e), 303(f) and 303(r) of the Communications Act of 1934, as amended. Accordingly, it is ordered, effective April 28, 1981, that Parts 2 and 97 of the Commission's Rules and Regulations are amended as set out in the attached appendix. It is further ordered that this proceeding is continued.

(Secs. 4, 303, 307, 48 Stat., as amended, 1066, 1082, 1083; 47 U.S.C. 154, 303, 307)

Federal Communications Commission.

William J. Tricarico,

Secretary.

#### Appendix

#### PART 2—FREQUENCY ALLOCATIONS AND RADIO TREATY MATTERS; GENERAL RULES AND REGULATIONS

A. 47 CFR Part 2 is amended as follows:

1. Section 2.815 is amended by revising paragraph (c) to read as follows:

#### §2.815 External radio frequency power amplifiers.

(c) No person shall manufacture, sell or lease, offer for sale or lease (including advertising for sale or lease) or import, ship or distribute for the purpose of

selling or leasing or offering for sale or lease, any external radio frequency power amplifier or amplifier kit capable of operation on any frequency or frequencies below 144 MHz unless the amplifier has received a grant of type acceptance in accordance with Subpart J of this Part and Subpart C of Part 97 or other relevant Parts of this Chapter. No more than 10 external radio frequency power amplifiers or amplifier kits may be constructed for evaluation purposes in preparation for the submission of an application for a grant of type acceptance.

Note.—For the purposes of this part, an amplifier will be deemed incapable of operation below 144 MHz if the amplifier is not capable of being easily modified to increase its amplification characteristics below 120 MHz, and either:

(1) The mean output power of the amplifier decreases, as frequency decreases from 144 MHz, to a point where 0 decibels or less gain is exhibited at 120 MHz and below 120 MHz; or

(2) The amplifier is not capable of even short periods of operation below 120 MHz without sustaining permanent damage to its amplification circuitry.

2. Section 2.1001 is amended by revising paragraph (f)(2) to read as follows:

#### §2.1001 Changes in type accepted equipment.

(f) \* \* \*

(2) Modifications made pursuant to this Paragraph are limited to equipment used at licensed amateur radio stations.

3. Section 2.1005 is amended by revising the introductory text of paragraph (c) and paragraph (d) to read as follows:

#### §2.1005 Equipment for use in the Amateur Radio Service.

(c) Any supplier of an external radio frequency power amplifier kit as defined by § 97.3(z) of this Chapter shall comply with the following requirements:

(1) \* \* \*

(2) \* \* \*

(3) \* \* \*

(4) \* \* \*

(5) \* \* \*

(d) Type acceptance of external radio frequency power amplifiers and amplifier kits may be denied when denial serves the public interest, convenience and necessity by preventing the use of these amplifiers in services other than the Amateur Radio Service. Other uses of these amplifiers; such as in the Citizens Band Radio Service, are prohibited (CB Rule 21 of this Chapter). Examples of features which may result in the denial of type

acceptance are contained in § 97.77 of this Chapter.

#### PART 97—AMATEUR RADIO SERVICE

B. 47 CFR Part 97 is amended as follows:

1. Section 97.75 is amended by revising the introductory text of paragraph (a) to read as follows:

#### §97.75 Use of external radio frequency (RF) power amplifiers.

(a) Any external radio frequency (RF) power amplifier used or attached to any amateur radio station shall be type accepted in accordance with Subpart J of Part 2 of the FCC's Rules for operation in the Amateur Radio Service, unless one or more of the following conditions are met:

2. Section 97.76 is amended by revising the introductory text of paragraph (a) and subparagraphs (a)(1) and (a)(5) to read as follows:

#### §97.76 Requirements for type acceptance of external radio frequency (RF) power amplifiers and external radio frequency power amplifier kits.

(a) Any external radio frequency (RF) power amplifier or external RF power amplifier kit marketed (as defined in § 2.815 of this Chapter), manufactured, imported or modified for use in the Amateur Radio Service shall be type accepted for use in the Amateur Radio Service in accordance with Subpart J of Part 2 of the FCC's Rules. This requirement does not apply if one or more of the following conditions are met:

(1) The amplifier is not capable of operation on any frequency or frequencies below 144 MHz. For the purposes of this part, an amplifier will be deemed to be incapable of operation below 144 MHz if the amplifier is not capable of being easily modified to increase its amplification characteristics below 120 MHz, and either:

(i) The mean output power of the amplifier decreases, as frequency decreases from 144 MHz, to a point where 0 decibels or less gain is exhibited at 120 MHz and below 120 MHz; or

(ii) The amplifier is not capable of even short periods of operation below 120 MHz without sustaining permanent damage to its amplification circuitry.

(2) \* \* \*

(3) \* \* \*

(4) \* \* \*

(5) The amplifier is purchased in used condition by an equipment dealer from a licensed amateur radio operator who constructed or modified the equipment in accordance with § 2.1001 of the regulations and the amplifier is further sold to another amateur radio operator for use at their licensed amateur radio station.

[FR Doc. 81-9480 Filed 3-26-81; 8:45 am]  
BILLING CODE 6712-01-M

## HAM HELP

\$5 reward for information leading to the successful conversion of a Hallicrafters SR-42A to FM.

Neil Johnson WA4ZTN  
PO Box 154  
Glenwood FL 32722

Needed: schematic and/or manual for a Dumont Model 304-A oscilloscope. I will reim-

burse copying cost or purchase manual.

S. Capasso  
67 Perkins St.  
New Haven CT 06513

I need an ac power supply for a Gonset G-76 transceiver.

R. L. Wartburg K0LLO  
1425 N. Harwood  
Orange CA 92667

# LETTERS

## QUASIMODO

Cal Ritchey's story in the January issue ("Over the Hump and into History") was good reading. Aircraft crews were indeed scattered over several countries, including India, Nepal, Bhutan, Burma, and what is now Bangladesh, while flying the Hump from India to China, during WWII. Stories that today sound like amusing after-dinner anecdotes once were crises in the lives of flying personnel of the Air Transport Command.

The ATC carried war supplies from India to fighting bases in Burma and China from July, 1942, until August, 1945. More than 650,000 tons of critical material were airlifted from India to beleaguered China. This incredible feat kept China in the war, a reality which kept more than one million Japanese troops in occupied China until the end of hostilities. The irony of political developments in that area of the world since WWII can never diminish the accomplishments of the relative few who wrote the ATC chapter in the chronicle of the Hump.

The Army Airways Communications System (AACS) with 4th Wing headquarters at Hastings Mill near Calcutta, India, played a very important part in the history of Hump flight communications. Col. Mandelbaum commanded from early 1942 until the end of 1945 when the remaining squadrons were transferred to European Wings. During this period, AACS provided the equipment, men, and services to install, maintain, and operate flight facilities, including control towers, homing beacons, radio ranges, and instrument landings systems, at some of the larger airfields. Point-to-point facilities, (voice, CW, and radioteletype) were also AACS activities. At some bases, in India, all Army Air Force administrative and operational communications were handled by AACS.

Many of the men in AACS were amateurs before they came into that service. Many be-

came hams after leaving the Air Force. The AACS operation under the 4th Wing covered India, Burma, China, and Thailand, and immediately after Japan's surrender, French Indo-China (Vietnam) and Singapore.

The 4th AACS Wing had four groups, each with several squadrons. The squadrons had a large number of detachments, with operational and maintenance personnel varying from 6 to 25 men. They were radio transmitter, receiver, power-generator, maintenance, and installation people, as well as operators for CW, voice, and radioteletype. Crypto equipment was also in many of these installations. Operational personnel were mostly involved in control-tower and point-to-point communications. Squadrons had their own aircraft for transportation and flight checks of navigational aids.

Having worked in the 128th AACS Squadron of the 4th Wing, as assistant operations officer, I can appreciate Cal Ritchey's story of flights over the Hump with 19-year-old kids, in the C-46, C-47, DC-6, and the infamous B-24/C-87! The 128th was scattered over the Assam Valley and was operational in all the ATC bases closest to the Hump. Therefore, it handled all of the bad flight mishap contacts from the three established air routes from India to Kunming, China, and one to Chengtu, China.

But there were fun times also. As CO of the detachments located in Saigon, Bangkok, and Singapore, we used the Collins 2-kW point-to-point transmitters (with rhombics!) on 20-meter phone and CW in early 1946! At Bangkok, we had HS1SS (*Here Siamese One Sad Sack*) and at Singapore, VS1QEU. About 300 stateside contacts were made, with traffic to next of kin, mostly about returning back to Uncle Sugar!

AACS continued as an Air Force operation until July 1, 1961, when it was changed in name to Air Force Communications Command, with headquarters at Scott Air Force Base, Illinois. The old AACS veterans now enjoy annual re-

unions and a weekly ham net. Those interested in the '81 get-together or getting on the AACS mail roster should contact me.

Peter K. Onnigian W6QEU  
1236 40th Avenue  
Sacramento CA 95822

## CODE OR LATIN?

I just finished reading Leaky Lines from the April issue and thought I'd pass along my thoughts regarding no-code requirements.

I have no objections to a no-code requirement as long as the theory exam is tough as nails. I think a ham should be more proficient in the theory of electronics and radio than the average ham is now and I see no profit in making someone learn the code to get a license, if he never intends to use it, as long as he is very technically proficient. An exam similar in difficulty to the FCC 2nd Class Radiotelephone exam would suit me just fine as an alternative to someone learning code. As a matter of fact, I would prefer to talk on the air (verbally) with someone who was technical rather than someone who "knew the code once" and memorized the technical exam.

The statistics are that only one in three passes the 2nd Class Radiotelephone exam, this in spite of the tremendous number of Q & A manuals available for memorization purposes. I tried to memorize a Q & A manual to get my First Class license but gave that up and enrolled in a CIE course and passed my license exam on the first try because I had learned, not memorized, the theory. This also makes me not care if Dick Bash wants to help out the memorizers with his Q & A books. I don't really see much difference between his books and other Q & As for the commercial ticket.

I am not in favor of making it easier to get a license by removing the code requirement if at the same time the theory exam is not made much tougher. Perhaps a two-class system similar to the telephone vs. telegraph licenses of the commercial portion of the FCC licenses would be an idea. If you want to send via telegraphy, you have to take a code test in addition to the comprehensive theory exam.

This way, we might start eliminating those who talk to the backside of the mike, those who constantly hold the mike 2 feet away to cure "over-deviation" on 2-meter FM, and those who think that if the swr is 1:1 the antenna must be radiating.

Do you really see much advantage in making doctors learn Latin in this day and age?

Thom Page W6KXS  
Los Angeles CA

## WEEDING OUT

The April 73 article by Andrea Favara HR1ADF, "The Honeymoon is Over—hints and kinks for ham husbands" (p. 98), is good advice and may help a wayward male ham.

Now having been single for eight years after being married for eight should qualify, to address the subject of introducing a girl friend to your mistress: the amateur radio fraternity. The article by Andrea did not address the dating picture. I was not a ham when I was married, lest any Monday-morning quarter-back thought *that* caused the little Ms. to depart our modest home.

When I meet a lady who seems to enjoy my company as much as I like hers, I don't get into the hobby until we have found other common ground like biking, hiking, plays, or whatever it might be. Soon thereafter I will say that I have a mistress in my basement I would like her to meet.

Usually they just leave—never to be seen again. Simple phone calls go unreturned. This is part of the "weeding-out" process. Now the confident and self-assured lady follows me down the steps and meets my shack. I fire up the low-band rig and chat a few moments with a fellow ham. Then I pull the plug and prepare to close down the shack and head upstairs.

Now the real moment of truth is near. Some have said, "Gee, that's neat, but isn't it expensive?" Just a few have asked me why we were leaving and insisted we stay and make more contacts. They ask how the keyer works and press for a demonstration. "Let's see the antenna." "What's this two-meter stuff?" "What are you building over here?" "Gee, these cards are neat?" "Did you read all these books?" "What's a ham-

fest?" and on and on. One beloved friend brought an expensive bottle of wine after an upgrade.

At least these are women with whom my hobby would not hinder a more serious relationship. I never badger them into the hobby. They know they are invited at anytime into my strange radio world. All of these women I have met who appreciate my hobby themselves have hobbies of a similar intensity.

I would consider it a great honor to be with a woman who might say to me, "Today I'll be in the studio painting. No phone calls. Don't bother with lunch and don't stay up for me. I'll be out when I am done. And, yes, I love you."

I could understand, appreciate, and respect a woman with such a drive!

**Tim Skoning KB9PA  
Dundee IL**

### WRINKLES

"The Great Aluminum Cover-Up," March, 1981, by Don Stauffer WB0YTH was read with interest. But I do not plan to abandon the simple, easy processes I have developed in this shack, over the past 25 years as a ham.

When we take a mini-box that is crappy, cruddy, painted-over, ratty looking, or whatever, we give that box a brand-new professional finish, quick as one, two, three.

All surfaces of the old box are thoroughly sanded with a swirling motion, then dried with either a paper towel or shop towel. Then we simply take G.C.'s "Wrinkle Finish," either grey or black, and give it a good even coat. Momma's oven force-dries and wrinkles our work beautifully!

We set the oven on the lowest temperature, which is a tad under 200°, put the work into the oven, and close the door, peeking in around ten minutes later to see how the cracking is coming along.

When the entire piece has wrinkled evenly and beautifully, we simply slip the plate holding the box from the oven and then cool it on top of the cooktop of her kitchen stove.

God only knows how many beat up boxes we have turned into new pieces, a delight to behold. We also have thoroughly cleaned with detergent some

of the Heathkit® cabinetry, sprayed them with black wrinkle finish, and baked them into new pieces. I guess I have the only black, wrinkled Heathkit cabinetry in the world—unless some other hams happened to dream up the idea used by the quickie car painting firms, where they run your newly-sprayed car through a bank of heat lamps and promptly dry the newly painted finish.

I experimented with a scrap piece of metal many years ago, and when this turned into a beautiful wrinkle job, other projects followed. Microphone cases and bases, anything and everything around the shack that needs a *new look* is now re-sprayed and shoved into the oven.

A final helpful hint, though, if you plan to re-crackle or re-wrinkle any of the Heathkit wrap-around cabinetry. Take a new drill bit and re-perforate the top and bottom areas of the cabinetry above and under the rf cage. Your Heath gear will run much, much cooler.

**Paul Marlowe K4SDW  
Altamonte Springs FL**

### SELFISH ATTITUDE?

Last year, 1980, the ARRL executives made a submission to the FCC requesting an extension of phone privileges to certain grades of American radio amateurs in the 20-meter band. In my opinion, this will merely extend the California kilowatt QRM further down the band at the expense of "rest-of-world amateurs." It may be considered a selfish attitude, but I hope the FCC rejects this proposal because I think that rest-of-world amateurs are entitled to some spectrum space free from "American kilowatt SSB."

If radio amateurs outside the United States wish to work American amateurs on SSB, it is only necessary to operate in the American phone band. However, to work rest-of-world amateurs on SSB, it is usually necessary for rest-of-world amateurs to operate between 14100 and 14200. The proposed expansion of US phone operations will increase the difficulties of rest-of-world amateurs when working DX stations outside the US, and I wonder if the ARRL executives considered this when they put forward the proposal.

Remember, the whole band is available for CW, and I personally see no reason to increase the number of SSB operations in that portion of the 20-meter band, i.e., 14100 to 14200.

**R. J. Jeffers ZL2AAQ  
Tauranga, New Zealand**

### NEXT WEEK

I'm taking this moment to thank you for your help in my getting my Novice license. What help?—you might ask. I'm referring to the Beginning and 6+ code tapes.

Six weeks ago, I was despairing with regard to the International Radiotelephone Code, as it is known in much of the world (I don't hear the term used here), and then I received your tapes. I was then enrolled in a ham class the next day and my instructor said that if I had the 73 tapes, I should have no problem and would not need to purchase the tapes that the class had.

How true! On the fifth week of class—surprise! It was time for the Novice exam, and I had thought it was "next week"! I was certain that I could not pass the code exam that night, and I almost postponed it a week. I am very glad I did not! I took both elements of the exam, and now I'm waiting for my call! I'm also continuing my class and should be a Technician in another month or so.

I'm so enthusiastic about the 73 code tapes that I'm going to buy a set for my brother when he gets back home on leave, and my girl friend is using my tapes to learn the code. Also, let me add that I tried—and failed—learning the code ten years ago using (I believe) both the ARRL and USN courses (all those tapes!), but the 73 tapes made me feel comfortable with code immediately.

Once again, thank you.

**Keith Glen Littlejohn  
Huntington Beach CA**

### WRITE

In the November, 1980, issue of *73 Magazine*, as part of Wayne's editorial, the ham community was told about the House of Representatives Bill 7747. I, being a congressional letter writer since Mr. Carter put a 5.5% pay cap on the military (I was on a Fleet Ballistic Missile

Submarine, the *USS Stonewall Jackson SSBN 634*, at the time), have become quite good at it.

I wrote to every congressman listed in your editorial. The best reply that I received came from a congressman that I didn't write to, by the way. I believe you should continue through your editorials to tell the hams what became of H.R. 7747, and thank those who wrote for making the system work. That might make it easier for them to write next time.

**Thomas I. Nofsinger KA2ERV  
Virginia Beach VA**

### INVERSION!

There have been a number of band plans discussed in *73's* pages in recent months, but none so simple and effective as the one that occurred to me last night: Invert the 40m band! Rather than have Extra CW from 7.000 to 7.025, Advanced/General CW from 7.025 to 7.300, Novice CW from 7.150 to 7.200, and any phone from 7.150 to 7.300, put the Extras on 7.300 to 7.275, the Advanced/General CW on 7.275 to 7.000, the Novice band on 7.200 to 7.150, and phone operation from 7.150 to 7.000.

The benefits are enormous! SSB activity, requiring more bandwidth and therefore wider filters, is now operating free from the ravages of the megawatt foreign broadcast stations. The CW operators would be able to work around the broadcasters with much less significant QRM problems.

The drawbacks to such a plan are not as important, but need to be enumerated: 1) Any change must overcome inertia, a serious potential difficulty. 2) The most likely change to existing antennas will be lengthening—harder to do than shortening. 3) Crystal users will be displaced—hopefully not significant. 4) Our overseas friends, presently able to use the lower portion of the band for phone operation, will have more company they may not like. 5) The 40m band plan would then be a maverick, different than the other HF bands.

I feel that these drawbacks are very minor in comparison to the gain: a usable 40m phone band. I am quite serious in this proposal. What do you think?

**Larry Franks N7BGZ  
Issaquah WA**

# Plain Talk on Plain Language Rules

Tim Daniel N8RK  
73 Magazine Staff

*Editor's Note: The opinions expressed in this article do not necessarily reflect those of 73 Magazine.*

In 1963, the amateur radio community was stunned by RM-499. This FCC proposal resulted in a furious debate over the merits of "incentive licensing." For many hams, these changes were a bitter pill to swallow. It was the mid 1970s before many old-timers accepted the inevitability of incentive licensing that RM-499 brought about.

A few years ago, the CB craze swept the nation and it was time for yet another FCC bombshell to arrive. The prospect of a no-code license reared its ugly head in Docket 20282. Other proposals included a simplified "dual-ladder" license structure and a new way to measure transmitter power. With the implications of incentive licensing in the back of many minds, ama-

teurs presented overwhelming opposition to 20282 and the no-code license.

Enter the 1980s, and a sweeping proposal to convert the present rules into "plain-language" form. Because of Docket 80-672's length, it cannot be reproduced here in its entirety. Instead, this article will present an overview of how the plain-language rules came about and what substantive changes are proposed.

The obvious question is: "Why do hams need new rules?" The Commission's answer is: "The existing rules are not written to take into account the wide range of applicants and licenses. For this reason, the rules are not as useful as they should be." Are the current rules "unnecessarily complex and difficult to understand"? The FCC thinks so, how about you?

## First CB, Now Amateur Radio

The drive to remove gobbledegook from FCC regulations began in December, 1976, when Part 95 was di-

vided into four subsections, encompassing mobile radio, radio control, Citizens Band, and technical standards. By early 1978, the Carter administration's executive order to make all government regulations understandable to John Q. Public had begun to sink in. Among the first examples of "FCCese" to be rewritten were the CB rules.

According to John Johnston of the Private Radio Bureau, the CB rewrite was the product of cooperation between involved citizens and FCC staffers. The final version was, in the words of the Commission, "met with widespread acclaim." The new CB rules now serve as an example for other government departments.

The style and format of the new Citizens Band rules were duplicated when a plain-language version of the radio control rules was proposed. When the Commission turned its attention to the amateur rules, they were convinced that their formula was a proven success. The exact details of

who authored Docket 80-672 and how long it took are not known. However, the Commission does claim that direct citizen involvement was not needed nor used in preparing the proposed rules.

## New Words for Old Rules

The basic format for the plain-language rules involves presenting a rather general question, followed by a detailed answer. The new rules are oriented to a target audience that is probably younger and less educated than the average ham. Simplifying the rules so that they could be more easily understood involved using the grammatical first and second person. To emphasize the difference between required actions and permissible actions, the Commission makes heavy use of the words "may" and "must."

The proposed rules contain a total of 111 questions and answers. The majority of the questions fall under Subpart A—Amateur Radio Service. Subparts B and C deal with RACES and ASAT,

the Amateur Satellite Service. The fourth subpart, D, offers an explanation of the technical standards that your amateur station must meet. Topics include the 10-meter amplifier ban, power measurement, and standards for video or digital emissions.

In order to make the new rules consistent with international regulations, the proposed title for Part 97 is "Amateur Telecommunications Services." If you have recovered from the shock of a new name for your hobby, then you might want to consider the suggested description of amateur radio.

#### PROPOSED RULE

##### § 97.1 (AR Rule 1) What is the Amateur Radio (AR) Service?

The AR Service is for persons interested in the technical side of radio communications. They use the service only for their own personal satisfaction and get no financial benefit from its use. They learn about radio, communicate with other operators around the world, and find better ways to communicate by radio.

For some unexplained reason, the new definition offers no mention of enhancing international goodwill or the valuable role that amateurs play when there is a disaster. These two areas shouldn't be overlooked.

In almost the same breath that the FCC claims that "we do not propose to change the structure of the Amateur Radio Service in this rulemaking," they give details about three changes that are found in the new rules.

#### Eliminate Logging

"First, we propose to eliminate all logging requirements. We are substituting for the existing logging rule a new rule requiring licensees to keep certain items in their station records."

#### PROPOSED RULE

##### § 97.57 (AR Rule 57) What do I have to keep in my station records?

(a) You must keep the following items in your station records for all types of operation:

- (1) A copy of each letter telling the FCC of your name or address change;
- (2) Your license (or other authorization) or a photocopy;
- (3) A current copy of the Amateur Telecommunications Services Rules, with amendments;
- (4) A copy of each response to an FCC discrepancy notification;
- (5) Each written permission you receive from the FCC; and
- (6) A copy of any other correspondence to or from the FCC about your AR station license or your license (or other authorization).

(b) When your AR station is in repeater operation, you must keep a computation of its AHAAT and ERP (see AR Rule 44) in your station records.

(c) When your AR station is being remotely controlled (see AR Rule 43), you must keep the following items in your station records:

(1) The names, addresses and AR station call signs of all control operators you have authorized;

(2) A functional block diagram and a technical explanation that describe operation of the control link; ("Control link" is the equipment that accomplishes remote control between a control point and a remotely controlled station.)

(3) A description of measures taken to protect the station from access by unauthorized persons;

(4) A description of the measures taken to prevent unauthorized operation by activating the control link or by some other means;

(5) A description of the measures for shutting down the station if the control link stops working correctly; and

(6) A description of the means used to monitor the transmitting frequencies.

(d) You must keep your station records for the term of your license (or other authorization).

#### Rules Must Be On Hand

"We propose to require licensees to keep an up-to-date copy of the Amateur Telecommunication Service Rules. This proposed requirement should help licensees know and understand the rules better and promote self-regulation by licensees. This, in turn, will result in better radio operation and more efficient use of the limited radio spectrum."

#### PROPOSED RULE

##### § 97.51 (AR) Rule 51) Do I need to have a copy of the Amateur Telecommunications Services Rules?

(a) You must keep a current copy of Part 97, FCC Rules for the Amateur Telecommunications Services, in your AR station records. The Amateur Telecommunications Services Rules are published periodically by the Government Printing Office.

(b) You must stay up to date with changes to the Amateur Telecommunications Services Rules. Changes are found in the *Federal Register* and in other publications.

#### Station Inspections Detailed

"Finally we propose to exercise the authority

granted in Section 303(n) of the Communications Act and require that licensees make their stations available for inspection by an FCC representative. We think that this requirement is necessary to encourage compliance with the rules."

#### PROPOSED RULE

##### § 97.56 (AR Rule 56) Do I have to make my AR station and its records available for inspection?

(a) If an authorized FCC representative requests to inspect your AR station and its records, you or the control operator must make the station and its records available for inspection.

(b) The FCC may inspect your station and its records at reasonable times. The FCC considers that a reasonable time to inspect your station is any time during the business day or any time your station is transmitting or has just finished transmitting.

#### Unnecessary and Unintended Hardships

The proposed changes that are acknowledged by the FCC are just part of the story. Unfortunately, the authors of the plain-language rules changed key words and phrases that result in some very different meanings than you find in the old rules. Unless these areas are clarified, the operation of many amateur radio stations could be adversely affected. Because of the varied nature of ham radio, it is almost impossible for any one individual to spot all the slipups. Here are several problem rules that have been brought to the attention of 73:

Proposed AR Rule 41 requires that "at the end of two-way AR communications, you must also transmit the callsign of the station you were communicating with." WA8MHO points out that this rule does not account for the needs of roundtables or nets. The present rule (97.84) allows the use of a "generally accepted network identifier." In this case, the simplified rule ends up being a hindrance for some amateurs.

W2JTP notes that proposed rule AR 33 takes away the privilege to "retransmit either live or de-

layed, transmissions of any AR station, except when your station is in repeater operation or auxiliary operation."

This rule would eliminate the storage and retransmission of RTTY and slow-scan TV pictures. It would put an end to the practice of having another station record and then retransmit your audio for test purposes. This rule would also eliminate the retransmission of ARRL and other bulletins.

The existing rules prohibit only the *automatic* retransmission of signals from a nonrepeater or non-auxiliary station. Drop the word "automatic" and a new and bothersome regulation is born.

A third example of the attempt to simplify gone sour can be found in AR Rule 30 as noted by both WA8MHO and W2JTP. The existing rules allow antennas to be as high as 200 feet unless you live near an airport. If you want antennas higher than 200 feet, then, in some instances, a special application is needed. The proposed rule is worded such that it discourages the installation of any antenna that will be more than 20 feet higher than the building it is attached to. This new rule amounts to little more than a poor imitation of the Citizens Band rule governing antennas.

The proposed Technical Standards give a lengthy description of the technique the FCC will use to measure power levels and bandwidth. There is no mention of the techniques that the average ham can use to ensure that he or she operates legally. To be absolutely certain that your emissions do not exceed the power or bandwidth limits, you need the same kinds of sophisticated test equipment the Commission uses.

## Your Vote Counts

Many, if not all, of Docket 80-672's flaws could have been eliminated if the FCC had involved the public (i.e., active hams) in an advisory capacity. Instead, we have been presented with rules that are a near carbon copy of the appliance operator approach the Commission used with CB.

Declaring the proposed rules to be a total loss is un-

fair. In many cases, the process of simplification has rid the rules of ambiguities. Docket 80-672 goes a long way to eliminate the phenomenon of three FCC officials giving three different interpretations of the same rule. It would be foolish to criticize the idea of reducing the complex jargon that confuses people instead of informing them. While it is hard to challenge the motive behind the new rules, it is unfortunate that the

methodology and resulting proposal leave something to be desired.

Rather than condemn or accept the proposal in its entirety, you should scrutinize every rule that affects your operation. Ask questions. Does the new rule make sense? Will it hinder my enjoyment of ham radio? Is unofficial FCC policy being turned into an official rule?

Let the FCC know what

you think. The deadline for comments is June 19, 1981. To be a formal participant, you should file the original and five copies of your comments by the June 19 deadline. If you would like each Commissioner to get your remarks, file 11 copies. The FCC will consider all input, regardless of the number of copies submitted. If you have something to say, now is the time to speak out. Be sure to let 73 Magazine know, too. ■

# SOCIAL EVENTS

Listings in this column are provided free of charge on a space-available basis. The following information should be included in every announcement: sponsor, event, date, time, place, city, state, admission charge (if any), features, talk-in frequencies, and the name of whom to contact for further information. Announcements must be received two months prior to the month in which the event takes place. They should be sent directly to Editorial Offices, 73 Magazine, Pine Street, Peterborough NH 03458, Attn: Social Events.

## ROCHESTER NY MAY 15-16

The Atlantic Division/New York State Convention, combined with the Rochester Hamfest, will be on Friday and Saturday, May 15-16, at the Monroe County Fairgrounds, Rte. 15A, Rochester NY. Commercial exhibits will be open from 1:00-9:00 pm Friday and from 8:30 am until 6:00 pm Saturday. A huge outdoor flea market will open at 1:00 pm Friday and run continuously until closing Saturday evening.

Programs include an NTS Forum with Bob Halprin K1XA, Asst. Comm. Mgr., ARRL; a League Forum with Pres. Harry Dannals W2HD, Directors Jesse Bieberman W3KT, Stan Zak K2SJO, and others. Other programs will be on antennas, transmitters, VHF, and for beginners, presented by Bill Myers K1GQ, Pete O'Dell KB1N, and Ray

Heaton WA0DYZ. There will also be an ARES forum and section and local net meetings. A highlight of the day will be the 2nd annual W2RUF Memorial Code Contest. Ladies' programs will be presented all day at hamfest hotel headquarters, the Marriott Thruway. Bus transportation will be provided from the fairgrounds to the hotel and to shopping malls.

The annual awards banquet will be Saturday evening at the Marriott. At midnight the Wouff Hong ceremony will be presented. All are welcome to participate.

Registration is \$5 at the gate. The banquet will be \$11. Flea market permits will be \$2 per parking space. For info, write PO Box 1388, Rochester NY 14603 or call (716)-424-1100.

## RICHLAND WA MAY 30-31

The Tri-City Hamfest Council will hold its second annual Tri-City Hamfest and Computer Fair on May 30-31, 1981, beginning at 9:00 am at the Community House, Richland WA. Admission is \$3.00 and children under 15 will be admitted free. The Saturday evening banquet will feature as speaker the NW ARRL Director, Mary Lewis; tickets are \$15.00 each. Other features will include seminars, a door prize and raffle, a swap shop, antiques, vendors, and computer demonstrations. Talk-in on .04/.64, .16/.76 and .52.

## MUNCIE IN MAY 31

The Muncie Area Amateur Radio Club will hold its second annual hamfest on Sunday, May 31, 1981, at the Field and Sports Building on the Ball State University Campus, Muncie IN. Tickets are \$3.00 at the door and tables are \$2.00. There will be over \$2,000 in prizes, and plenty of parking and hamfest space.

## GRAND RAPIDS MI JUN 6

The Independent Repeater Association will hold the Grand Rapids Spring Swap & Shop on Saturday, June 6, 1981, at the National Guard Armory, 44th Street, just 1/4 mile west of US 131. There will be door prizes, dealers, food, and indoor swap area, forums, and trunk sales. Reserved dealer area is available. Doors open at 8:00 am. Tickets are \$2.00 and indoor tables are \$5.00. Talk-in on 147.765. For further information, contact David Jenista WD8NZZ, 437 Airview SE, Wyoming MI 49508.

## MANASSAS VA JUN 7

The Ole Virginia Hams Amateur Radio Club, Inc., will hold its annual Manassas Hamfest on Sunday, June 7, 1981, at the Prince William County Fairgrounds, Route 234, Manassas VA. Booths are available. Admission is \$3.00, children under 12 will be admitted free, and tailgaters will be charged an additional \$2.00. Features will include a ladies' program, indoor and outdoor exhibit areas, a full breakfast and lunch, children's entertainment, CW proficiency awards, and QSL bureaus. Talk-in on 146.37/146.97 repeater

(W1CRO) and 146.52 simplex. For booth reservations, contact Joseph A. Schlatter K4FPT, Ole Virginia Hams ARC, Inc., PO Box 1255, Manassas VA 22110.

## CHELSEA MI JUN 7

The Chelsea Swap and Shop will be held on Sunday, June 7, 1981, at the Chelsea Fairgrounds, Chelsea MI. Gates will open for sellers at 5:00 am and for the public from 8:00 am until 2:00 pm. Admission is \$1.50 in advance or \$2.00 at the gate. Children under 12 and non-ham spouses are admitted free. Talk-in on 146.52 simplex and the 147.855 Chelsea repeater. For more info, write to William Altenberndt, 3132 Timberline, Jackson MI 49201.

## ROME NY JUN 7

The Rome Radio Club, Inc., will hold its 29th annual Ham Family Days on June 7, 1981, beginning at 9:00 am at Beck's Grove, 10 miles west of Rome, just off Route 49 adjoining Beck's Grove Airport. There will be a flea market and displays. Talk-in on 146.28/.88, 146.34/.94 and 146.52.

## CIRCLEVILLE OH JUN 7

The Teays Amateur Radio Club will hold the fourth annual King of the Pumpkin Hamfest on Sunday, June 7, 1981, from 9:00 am to 5:00 pm at the fairgrounds coliseum, Circleville OH. Advance admission is \$2.00; at the door, \$3.00. Tables are available at \$3.00 per 8-foot space and tailgating is \$2.00. There will be an indoor and outdoor flea market, new and used equipment, door prizes, refreshments,

and free parking. For advance reservations and further information, contact Dan Grant W8UCF, 22150 Smith Hulse Road, Circleville OH 43113, or phone (614)-474-6305.

#### SHARONVILLE OH JUN 12

The Hamilton County Amateur Radio Public Service Corp. will sponsor the first annual Cincinnati ARRL '81 Convention at the Scarlet Oaks Vocational Campus, Sharonville OH, on Saturday, June 12, 1981. This event will *not* be replacing the Cincinnati Hamfest which will be held on Sunday, September 20, 1981, at the usual location at Stricker's Grove, Ross OH.

#### STATEN ISLAND NY JUN 13

The Staten Island Amateur Radio Association will hold its flea market on June 13, 1981, from 9:00 am to 4:00 pm on the grounds of All Saints Episcopal Church, Victory Boulevard and Wooley Avenue (take I-278 to the Victory Boulevard exit, then go 1/2 mile east on Victory Boulevard). There will be no admission charge for buyers. Sellers' admission is \$3.00 and sellers must provide their own tables. Talk-in on 146.28/.88 and 146.52. For further information, send an SASE to WA2AMJ, PO Box 495, Staten Island NY 10314.

#### MIDLAND MI JUN 13

The Central Michigan Amateur Repeater Association will hold its seventh annual hamfest on June 13, 1981, from 8:00 am to 2:00 pm at its new location in the "Great Hall" in the Valley Plaza complex, just off US Rte. 10 in Midland, Michigan. Tickets are \$3.00; children under 12 will be admitted free. Tables are available for \$6.00 (\$3.00 for half a table). Trunk sales will be \$2.00 in a designated area. There will be plenty of free parking. The Valley Plaza Complex offers motel accommodations, RV hook-ups, swimming, dining, a bowling alley, theaters, and a picnic area. The major prize drawing will be at 1:30 (for an HT); there will be hourly drawings for other prizes. Videotapes of the Saturn fly-by will be shown. Talk-in will be on 146.13/.73 and 146.52 simplex. For information, contact Carol Hall WD8DQG, 4651 Cardinal Drive, Mt. Pleasant MI 48858; (517)-772-0363.

#### GUELPH ONT CAN JUN 13

The Guelph Amateur Radio Club will hold the 6th annual Central Ontario Amateur Radio Fleamarket and Computer Fest on Saturday, June 13, 1981, at the Centennial Arena, College Avenue West, Guelph, Ontario, Canada. Admission is \$1.00, with children 12 years and under admitted free. Admission for vendors is an additional \$2.00. Tables are \$5.00 each on a first-come basis. The hours are 8:00 am to 4:00 pm; vendors may begin setting up at 6:00 am. There will be commercial displays, computer software and hardware, surplus dealers, indoor and outdoor displays, and door prizes. The refreshment concession will open at 12:00 noon. Talk-in on .52/.52, .37/.97 (VE3KSR), and .96/.36 (VE3ZMG). For further information, contact Dennis Gore VE3DGA at (519)-836-6226 or Andy Janosik VE3GDY at (519)-824-3227.

#### BELLEFONTAINE OH JUN 14

The Champaign Logan Amateur Radio Club, Inc., will hold its annual hamfest on Sunday, June 14, 1981, at a new location, The Logan County Fairgrounds, South Main Street and Lake Avenue, Bellefontaine OH. Admission is \$1.50 in advance and \$2.00 at the door; trunk and table sales are \$3.00. Available this year will be a bid table, door prizes (grand prize is \$300.00), and free parking. Talk-in on 146.52 and Hi-Point repeater. For more information, contact John L. Wentz W8HFK, Box 102, West Liberty OH 43357, or Paul F. Amerine WD8NEB, Box 185, West Mansfield OH 43358.

#### WILMINGTON OH JUN 14

The Clinton and Highland County Radio Clubs will sponsor their annual hamfest and flea market on June 14, 1981, rain or shine, at the Clinton County Fairgrounds, State Route 22, Wilmington OH, from 1200 to 2100 UTC. Admission is \$3.00 and flea market space is free with admission ticket. There will be a sheltered display area, a food concession, an auction, and door prizes. Camping is available at nearby Cowan Lake State Park, as well as at private campgrounds and motels. King's Island Park is

also nearby. Talk-in on 147.72/.12, 147.81/.21, or 146.52. For further information, contact Bob Lewis KE8E, 192 Northview Road, Blanchester OH 45107, or phone (513)-783-2740 evenings.

#### SANTA MARIA CA JUN 14

The Satellite Amateur Radio Club will hold the Santa Maria Amateur Radio Swapfest at the Newlove picnic grounds (Union Oil Company), Santa Maria CA. For information on prizes, swap tables, dinner tickets, etc., mail inquiries to Santa Maria Swapfest, 1600 E. Clark #49, Santa Maria CA 93455.

#### AKRON OH JUN 14

The 14th annual Goodyear A.R.C. Hamfest will be held on Sunday, June 14, 1981, from 10:00 am to 5:00 pm at Goodyear Wingfoot Lake Park, near Rtes. 224 and 43, east of Akron OH. Family admission and donation is \$3.00, which includes flea-market and dealer-area spaces. Features will include major prizes as well as ladies' and hourly door prizes, a picnic area, concession stands, and ample free parking. Talk-in on .04/.64. For further information, contact Don Rodgers WA8SXJ, 161 S. Hawkins Avenue, Akron OH 44313.

#### WILLOW SPRINGS IL JUN 14

The Six Meter Club of Chicago, Inc., will sponsor the 24th annual ABC Hamfest on Sunday, June 14, 1981, at Santa Fe Park, southwest of Chicago, 91st and Wolfe Road, Willow Springs IL. Advance registration is \$1.50; the cost is \$2.00 at the gate. There will be picnic grounds, refreshments, and parking available. Featured will be a large swappers' row, displays in the pavillion, and AFMARS meeting, and prizes of a color TV and an IC-2A or Bearcat 210. Talk-in on 146.52 or WR9ABC .37/.97 (PL2A). For more information and advance tickets, contact Val Hellwig K9ZWV, 3420 South 60th Court, Cicero IL 60650.

#### GRANITE CITY IL JUN 14

The Egyptian Radio Club will hold their annual hamfest on Sunday, June 14, 1981, at their clubhouse in Granite City II. The events begin at 8:00 am and include main prizes (your choice

of a TRS-80 Level III, Kenwood TS-130S, or Panasonic PV-1200 video tape recorder), many other prizes, free coffee and doughnuts, flea market, bingo, and children's activities. Admission is \$1.00 advance and \$2.00 at the door. Talk-in on 146.16/.76, .52, and 3993. For tickets or info, write Bess J. Nelson KB0PG, 4 Covey Court, Florissant MO 63031, and include an SASE.

#### MONROE MI JUN 14

The annual Monroe County Radio Communications Hamfest will be held on June 14, 1981, from 8:00 am to 3:00 pm at the Monroe Community College on Raisinville Road, Monroe MI. Tickets are \$2.00 at the gate, \$1.50 in advance, and XYLs and children will be admitted free. There will be free parking, contests, an auction, displays, and plenty of table space. Talk-in on 146.13/.73 and .52. For more information, contact Fred Lux WD8ITZ, PO Box 982, Monroe MI 48161, or call (313)-243-1088.

#### ALLENWOOD PA JUN 14

The 10th annual Milton Amateur Radio Club Hamfest will be held on June 14, 1981, rain or shine, at the Allenwood Firemen's Fairgrounds, located on US Route 15, 4 miles north of I-80, Allenwood PA. Hours are from 8:00 am to 5:00 pm. Registration for sellers is \$2.50 in advance or \$3.00 at the gate. XYLs and children will be admitted free. Featured will be a flea market, an auction, contests, cash door prizes, a free portable and mobile FM clinic, and supervised children's activities. An indoor area will be available for food and beverages. Talk-in on .37/.97 and .52 simplex. For further details, write Harold C. Denin AC3Q, c/o Milton Amateur Radio Club, PO Box 235, Milton PA 17847, or phone (717)-538-5455.

#### OXFORD ME JUN 20

The Yankee Radio Club will hold its Yankee Hamfest '81 on Saturday, June 20, 1981, at the Oxford County Fairgrounds, Oxford ME. Features will include computer displays, talks on selected subjects, a ladies' program, a youth program, swap tables, a flea market, manufacturers' booths, a CW contest, many prizes, and a buffet dinner



in the evening. Registration at the door will be \$8.00 for dinner and prizes (\$7.00 for early registration). Admission at the gate is \$2.50 and includes prizes. Camper hookups will be available for Friday and Saturday nights at \$2.00 per night. Talk-in on 146.28/88 and 146.52 by W1BYK. For more information and registration, send an SASE to Edward M. Fahey, Jr., W1OKS, 19 Farwell Street, Lewiston ME 04240.

#### **DUNELLEN NJ JUN 20**

The Raritan Valley Radio Club (W2QW) will hold its 10th annual hamfest and flea market on Saturday, June 20, 1981, from 8:30 am to 4:00 pm, rain or shine, at Columbia Park, Dunellen NJ. There will be door prizes and a snack bar. Admission is \$3.00 for sellers and \$2.00 for lookers. Talk-in on 146.625/.025 (W2QW) and 146.52. For further information, call KB2EF (201)-369-7038, 9:00 am to 4:00 pm.

#### **SIDNEY MT JUN 20-21**

The Sidney, Montana, ARC will hold the 26th annual Eastern Montana Hamfest on June 20-21, 1981, at the Richard County Fairgrounds in Sidney MT. Activities include overnight parking, flea market, used gear auction, prizes, and contests for all. A potluck lunch will be held on Sunday. Talk-in .52 and 7240 kHz. Contact Ron Martini N7BMR, Box 449, Sidney MT 59270.

#### **TORRINGTON CT JUN 20-21**

The C.Q. Radio Club will hold a two-day ham-radio flea market on June 20-21, 1981, at the Torrington Drop-In Center, East Albert Street, Torrington CT, from 9:00 am to 5:00 pm. There will be indoor tables for sellers, an outdoor tailgater area, bake-sale items, refreshments, prizes, raffles, and plenty of free parking. The entrance fee of \$2.00 includes one chance for a door prize. There will be two separate raffles; the winner need not be present for either raffle prize. One raffle prize will be a portable black and white TV set and the other raffle prize will be an Icom IC-2AT synthesized 2-meter hand-held. Raffle tickets for either prize are \$1.00 each or a book of 12 for \$10.00. Table

space will cost \$5.00 per table, or \$3.00 per half-table; tailgate space will cost \$2 per space. Talk-in on 146.25/.85, 147.84/.24, and 146.52. For table or tailgate reservations, raffle tickets, or more information, contact Gil Donovan WB1DVD, 50 Wood Street, Torrington CT 06790; Dave Johnstone WB1COB, 19 Margerie Street, Torrington CT 06790; or The C.Q. Radio Club, PO Box 692, Torrington CT 06790.

#### **CROWN POINT IN JUN 21**

The Lake County Amateur Radio Club will hold its ninth annual hamfest on June 21, 1981, at the Lake County Fairgrounds, Crown Point IN. The gate will open at 8:00 am, and all tickets are \$2.00. Talk-in on 147.84/.24 and 146.52. For further information, contact "Mike" Evanson KA9COM, 8037 Monaldi Drive, Munster IN 46321.

#### **LANCASTER OH JUN 21**

The Lancaster and Fairfield County ARC 1981 Family Hamfest will be held on June 21, 1981, from 9:00 am to 5:00 pm at The P&R Party Barn, 4 miles west of Lancaster OH, off Rte. 188. Advance tickets are \$2.00 and tickets at the gate are \$3.00. Flea market tables are \$2.00 and out-of-the-auto selling is \$1.00. Features will include prizes, an R/C model aircraft demonstration, and many outdoor activities for everyone. Refreshments and overnight camping will be available. Talk-in on 147.63/.03 or .52. For more information or tickets, write C. Ted Riley WB8VOA, PO Box 3, Lancaster OH 43130, or phone (614)-653-8222.

#### **TERRE HAUTE IN JUN 21**

The 35th annual WVARA Hamfest will be held on June 21, 1981, at the Vigo County Fairgrounds, one mile south of I-70 on US 41, Terre Haute IN. Overnight camping will be available. There will be a free outdoor flea market, a covered flea market at \$2.00 for a 12' x 12' space (with some tables and ac available). Other features include XYL bingo, refreshments, valuable prizes, and a giant shopping mall nearby. Advance sale tickets are \$2.00 or 3 for \$5.00.

Tickets at the gate are \$3.00, with children under 12 admitted free. Talk-in on .25/.85 and .52. For more information and tickets, send an SASE to WVARA Hamfest, PO Box 81, Terre Haute IN 47808.

#### **FREDERICK MD JUN 21**

The 4th annual Frederick Hamfest will be held on Sunday, June 21, 1981, from 8:00 am to 4:00 pm at the Frederick Fairgrounds, Frederick MD. Admission is \$3.00; \$2.00 extra for tailgating. YLs and children will be admitted free. Features include prizes, demonstrations, exhibits, flea-market tables, tailgating, and an FM clinic. Food and drink services and free parking will be provided. Talk-in on 146.52. For additional information, contact Rick N3RO or Peg N3AIJ, Hamfest Directors, 9425 Glade Avenue, Walkersville MD 21793, or phone (301)-898-3233.

#### **MAPLE RIDGE BC CAN JUL 4-5**

The Maple Ridge ARC will hold its Hamfest '81 on July 4-5, 1981, at the Maple Ridge Fairgrounds, located 30 miles east of Vancouver, Maple Ridge BC. Registration for hams is \$4.50, a program with a ticket for a drawing is \$2.50, and the dinner and dance is \$10.00. Registration for non-hams over 12 years old is \$2.00; non-hams under 12 will be admitted free. There will be food and camper space (without hookups) available. Features will include prizes, a swap and shop, a bunny hunt, a ladies' program, and much more. Talk-in on 146.34/.94 and 146.19/.79. For more information and advanced registration, contact Bob Haughton VE7BZH, Box 292, Maple Ridge BC V2X 7G2.

#### **OAK CREEK WI JUL 11**

The South Milwaukee Amateur Radio Club, Inc., will hold its annual swapfest on Saturday, July 11, 1981, at the American Legion Post #434, 9327 South Shepard Avenue, Oak Creek WI. Admission is \$2.00 and includes a happy hour with free beverages. Prizes include a \$100 first prize and a \$50 second prize. Activities will begin at 7:30 am and continue until 5:00 pm. Parking, a picnic area, hot and cold sandwiches, as well as liquid refreshments, will be available on the grounds. Overnight

camping is also available. Talk-in on 146.94. More details, including a map, may be obtained from The South Milwaukee Amateur Radio Club, PO Box 102, South Milwaukee WI 53172.

#### **PITTSFIELD MA JUL 11-12**

The Northern Berkshire Amateur Radio Club will hold its annual hamfest on Saturday and Sunday, July 11-12, 1981, at the Cummington Fairgrounds, Cummington MA (off Rte. 9). General admission is \$3.00 in advance, and \$4.00 at the gate. Family admission is \$5.00 in advance and \$6.00 at the gate. Dealers are welcome. Talk-in on 146.31/.91. For further information, contact Herb Blake, PO Box 567, North Adams MA 01247.

#### **MOUNT SINAI LI NY JUL 12**

Radio Central ARC will hold its 3rd annual hamfest on Sunday, July 12, 1981, from 9:00 am to 4:00 pm on the grounds of Mount Sinai Elementary School, Rte. 25A, Mount Sinai LI NY. Admission for buyers is \$1.50; XYLs and harmonics will be admitted free. Sellers' spaces are \$3.00. There will be door prizes, a grand prize drawing at 3:00 pm, a contest, and refreshments. Talk-in on 145.15 (WA2UEC) and 146.52. For more information, contact Lew Franklin at (516)-265-5614.

#### **INDIANAPOLIS IN JUL 12**

The Indianapolis Amateur Radio State Convention and Hamfest will be held on Sunday, July 12, 1981, at the Marion County Fairgrounds. For further information, write Indianapolis Amateur Radio Association, Box 11086, Indianapolis IN 46201.

#### **CHARLESTON SC JUL 18-19**

The Charleston Amateur Radio Society, Inc., will hold its eighth annual Charleston Hamfest on July 18-19, 1981, at the Omar Shrine Temple, 44E Battery Street, Charleston SC. There will be overnight security guards and refreshments available. For more information, contact the Charleston Hamfest Committee, PO Box 30643, Charleston SC 29407, or phone (803)-747-2324/496-3660.

## A Timely New Product

### — the MFJ-102 digital clock

While inexpensive digital clocks are plentiful on the marketplace, the new MFJ-102 is a step above the average.

Featuring a low-profile aluminum-accented black cabinet, the clock functions around a brilliant fluorescent display. The 5/8-inch characters are clearly visible across the largest room,

even in bright ambient light.

For the ham shack, a simple switch setting selects the 24-hour mode. Hours and minutes are always displayed; seconds may be called up by pressing the top bar.

The 102 also may be switched to display 12-hour time, complete with an

AM/PM illuminated indicator, for local nets and routine domestic use.

The clock also has an internal alarm complete with snooze button. The alarm doubles as a handy 9-minute ID timer—great for those who conveniently forget those legal IDs!

Time synchronization with WWV is a snap. Fast

and slow set buttons allow easy reset, and to prevent accidental bumping of the reset buttons, a lock switch is provided.

Power interruption is always a problem for accurate-time buffs, but the MFJ-102 first-digit display segments will blink repeatedly until reset following a power-line interruption.

Although the clock comes set for American 120 V ac, 60-Hz line power, foreign 50-Hz operation is possible by merely shorting a pair of circuit pads on the PC board. 220- and 240-volt operation may be accommodated with the use of an external voltage-dropping transformer.

We found the MFJ-102 to be flexible, reliable, and easy to read. At \$32.95, it represents a good value for the ham shack. For further information, contact MFJ Enterprises, Inc., PO Box 494, Mississippi State MS 39762; (601)-323-5869. Reader Service number 476. ■

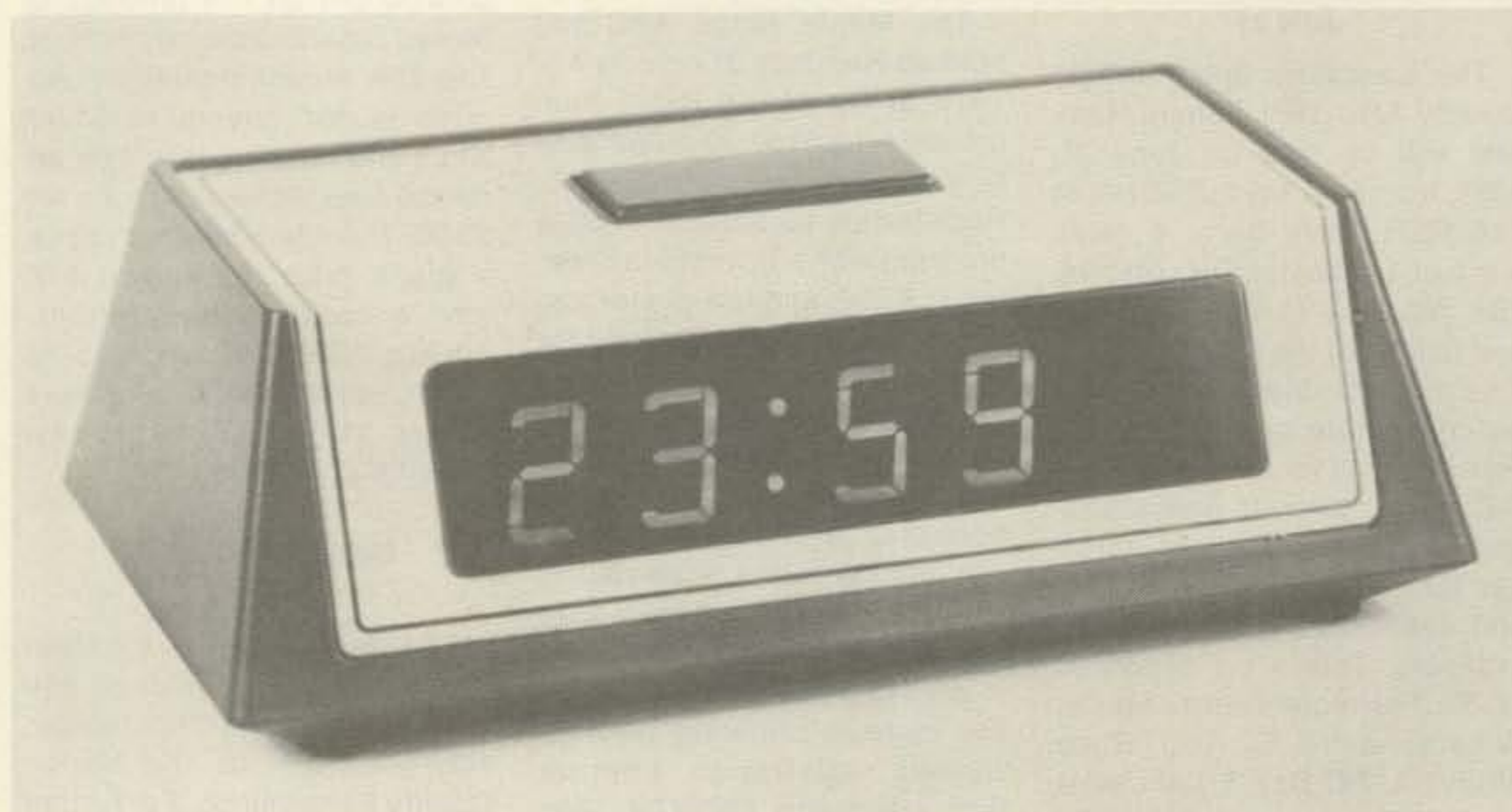

The MFJ-102 digital clock.

## HAM HELP

I am interested in obtaining a schematic or any other information on an old TV Analyzer Scope, model #1076, manufactured by B & K Mfg. Company, Chicago IL. Thanks.

A. B. Wells WA5COH  
PO Box 50  
Tunica LA 70782

I am looking for an FV-401 external vfo and/or matching speaker to buy at a reasonable price. Also, does anyone know anything about PI2MN or 5N20/HB9BVL?

Todd D. Greenleaf KA1CFQ  
108 Edward Ave.  
Pittsfield MA 01201

I need a MITS manual on Altair 8800 BASIC which I can purchase or copy and return.

Carl S. Peterson N6CSI  
219 E. Ashland Ave.  
Visalia CA 93277

Need wiring diagram package No. WDP-0203 for a 32ASR with Centralized Selective Calling System and SA150 Accessory/Interface Unit. Will pay copy costs and/or mailing.

Terry Simonds WB4FXD/1  
PO Box 1558  
Edgartown MA 02539

I am writing an expanded history of Wake Island and would like to hear from anyone who has operated from Wake/Peale/Wilkes Islands as a ham, commercial, or military radio op.

I am also interested in converting/repackaging a Gonset 6-meter Communicator for CW/FM/SSB, as well as borrowing the manual/schematics for the rig (I will pay postage).

Frank P. Nollette, SMSGT, USAF  
KA0AOJ/KH6  
7702C Kikanai Loop  
Hickam AFB HI 96818

# MOVING?

Let us know 8 weeks in advance so that you won't miss a single issue of 73 Magazine.

Attach old label where indicated and print new address in space provided. Also include your mailing label whenever you write concerning your subscription. It helps us serve you promptly. Write to:

**73 magazine**

Subscription Department  
P.O. Box 931  
Farmingdale NY 11737

- |   |   |
|---|---|
| <input type="checkbox"/> Address change only    | <input type="checkbox"/> Payment enclosed |
| <input type="checkbox"/> Extend subscription    | <input type="checkbox"/> Bill me later    |
| <input type="checkbox"/> Enter new subscription |   |
| <input type="checkbox"/> 1 year \$25.00         |   |

If you have no label handy, print OLD address here.

AFFIX LABEL

Name \_\_\_\_\_ Call \_\_\_\_\_  
Address \_\_\_\_\_  
City \_\_\_\_\_ State \_\_\_\_\_ Zip \_\_\_\_\_

print NEW address here:

Name \_\_\_\_\_ Call \_\_\_\_\_  
Address \_\_\_\_\_  
City \_\_\_\_\_ State \_\_\_\_\_ Zip \_\_\_\_\_ 301B55

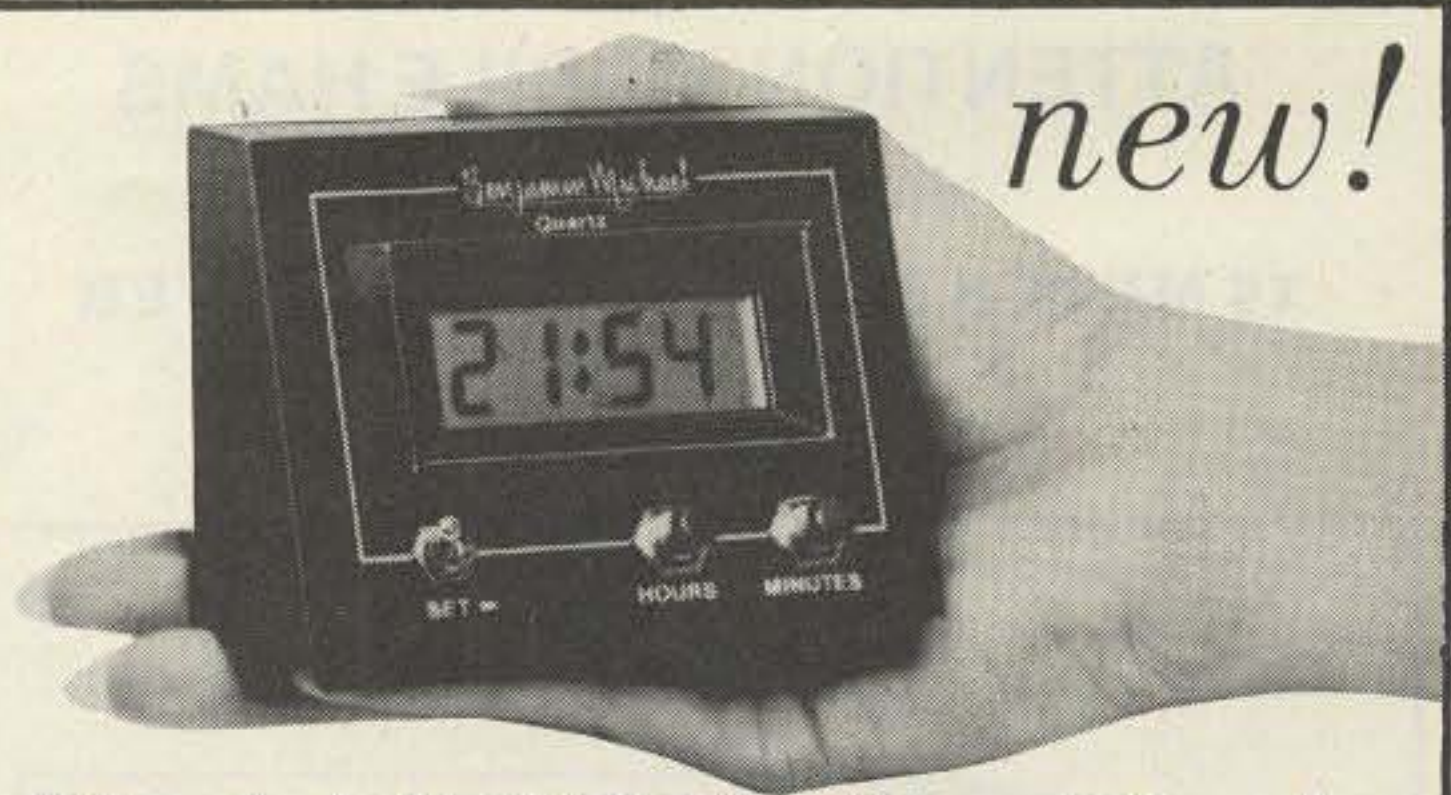

*new!*

## Model 173B Station Clock

- 24 hour military time for proper logging
- quartz crystal accuracy
- large, easy to read LCD display
- push button back lighting for night operation
- one year operation from single penlight cell; no inconvenient and unsightly line cord
- no resetting after power failure
- attractive aircraft instrument styling
- front mounted controls with hold switch that permits precise setting to time standard

Model 173B only \$34.95 plus \$3 shipping from your favorite dealer or

**BMI** Benjamin Michael Industries  
INC.  
65 East Palatine Rd., Suite 105,  
Prospect Heights, IL 60070  
(312) 459-5760

CAN 20% BE WRONG?



A recent survey showed that 20% of the 73 subscribers also read Kilobaud MICROCOMPUTING magazine . . . and enjoy it. This is the best way to learn and keep up with the rapidly developing world of microcomputers. There's nothing to be afraid of, you just have to read an interesting magazine and you'll learn. Try a subscription to Kilobaud MICROCOMPUTING and see for yourself.

- |  |                                  |  |
|--|----------------------------------|--|
| <input type="checkbox"/> New subscription          | <input type="checkbox"/> Renewal | <input type="checkbox"/> 12 issues for \$25.00 |
| <input type="checkbox"/> Payment enclosed \$ _____ |                                  | <input type="checkbox"/> 24 issues for \$38.00 |
| <input type="checkbox"/> VISA                      | <input type="checkbox"/> MC      | <input type="checkbox"/> AE                    |
| <input type="checkbox"/> Bill me                   |                                  | <input type="checkbox"/> 36 issues for \$53.00 |

Card # \_\_\_\_\_ Interbank # \_\_\_\_\_  
Signature \_\_\_\_\_ Exp. date \_\_\_\_\_  
Name \_\_\_\_\_  
Address \_\_\_\_\_  
City \_\_\_\_\_ State \_\_\_\_\_ Zip \_\_\_\_\_

—for even faster ordering service call toll free (800) 258-5473

Canadian: \$27, one year only, U.S. funds. Other foreign:  
\$35, one year only, U.S. funds. Please allow 6-8 weeks for delivery. 316B6

MICROCOMPUTING • POB 997 • Farmingdale NY 11737

# TRS 80\* OWNERS ARISE!



Arise and subscribe to 80 MICROCOMPUTING, the newest and fastest growing microcomputer magazine. This is full of news about programs, accessories and theory on the world's largest selling computer, the TRS-80\*. Definitely beginner level and includes lots of program listings. Find out what all the fuss is about.

- |  |                                  |   |
|--|----------------------------------|---|
| <input type="checkbox"/> New subscription          | <input type="checkbox"/> Renewal | <input type="checkbox"/> 12 issues for \$18 |
| <input type="checkbox"/> Payment enclosed \$ _____ |                                  | <input type="checkbox"/> 24 issues for \$30 |
| <input type="checkbox"/> VISA                      | <input type="checkbox"/> MC      | <input type="checkbox"/> AE                 |
| <input type="checkbox"/> Bill me                   |                                  | <input type="checkbox"/> 36 issues for \$45 |

Card # \_\_\_\_\_  
Interbank # \_\_\_\_\_ Exp. date \_\_\_\_\_  
Signature \_\_\_\_\_  
Name \_\_\_\_\_  
Address \_\_\_\_\_  
City \_\_\_\_\_ State \_\_\_\_\_ Zip \_\_\_\_\_

**80** microcomputing™

• P.O.B. 981 • Farmingdale N.Y. 11737

\*TRS-80 is a trademark of Tandy Corporation.

Please allow 6 to 8 weeks for delivery  
Canadian: 1 yr. only/\$20 in U.S. Funds  
Foreign: 1 yr. only/\$28 in U.S. Funds

316B6

## ATTENTION MOBILE HAMS

Vehicles—Aircraft—Marine

### 15 METER MOBILE TRANSCEIVER CW & USB NCG 15SB



THE QRP RIG WITH THE **BIG RIG SOUND** ACTIVE NOISE BLANKER—RF GAIN—CW SWITCH—SQUELCH—MIC GAIN—DIGITAL FREQUENCY DISPLAY—HI/LO POWER SWITCH—13.8 VDC 5A POSITIVE OR NEGATIVE GROUND. 9.5" x 8.5" x 2.5"

AVAILABLE SOON: 10-meter AM/FM/SSB.

DEALER INQUIRY INVITED.

# NCG Co.

1275 N. GROVE ST.  
ANAHEIM, CALIF. 92806 (714) 630-4541

## WORK THE U.H.F. BANDS

Add a transverter or converter to your existing 10m, 6m or 2m equipments. Choose from the largest selection of modules available for DX, OSCAR, EME, ATV.

### TRANSVERTERS



MMT 432-28 (S) \$339.95  
MMT 439-ATV \$369.95  
MMT 1296-144 \$425.95

### CONVERTERS

Choose from many models to suit your needs.  
Examples: MMC 432-28, MMC 426/439—ATV  
MMK 1296-144, MMC 1280—ATV

Write for details and available options.

### 10FILTERS



Prevent OSCAR 8 Mode J desense  
Use MMF200-7 \$42.95  
Stop receiver IMD birdies  
Use PSF432 \$59.95

### ANTENNAS

420-450 MHz J-beams  
48 el. 15.7 dBd \$75.75  
88 el. 18.5 dBd—Ask  
1250-1300 MHz loop yagi 1296-LY \$49.75

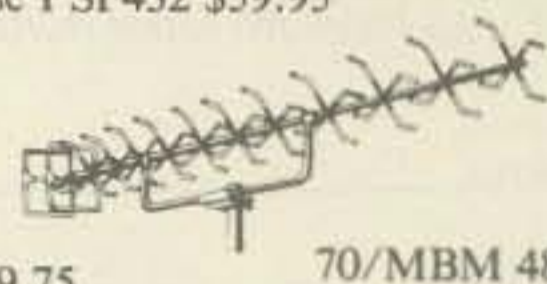

70/MBM 48

Send 36¢ stamps for full details of all our VHF/UHF items.

Pre-selector filters  
Low-pass filters  
Varactor triplers  
Pre-amplifiers

Transverters  
Converters  
Antennas  
Crystals



# si

Spectrum International, Inc.  
Post Office Box 1084S  
Concord, Mass. 01742 USA

## BUILD THIS SSB TRANSCEIVER FROM OUR MODULES

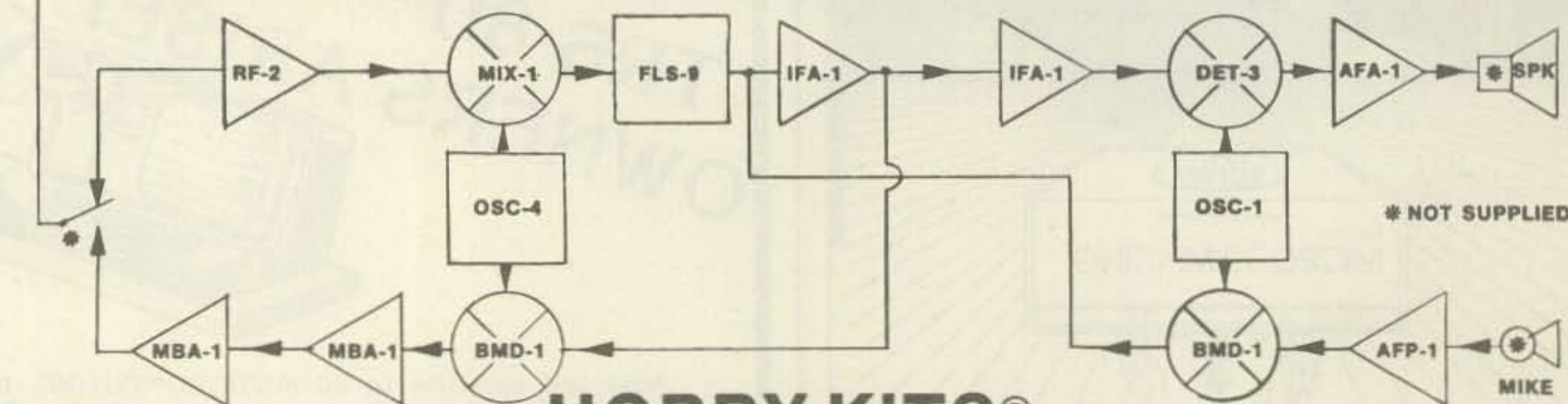

## HOBBY KITS®

EXPERIMENT — LEARN ELECTRONICS; BUILD AND DESIGN YOUR OWN AM, FM, CW, OR SSB RECEIVERS, TRANSMITTERS AND ETC. WITH OUR MINI-LINEAR CIRCUIT KITS

All kits Come Complete With Etched and Drilled Circuit Boards and All Parts Needed To Function As Described

AFA-1 AUDIO AMP. LM-380 1-2 Watts 4-16 OHM Output .....	\$4.95	MBA-1 FREQ. MULT. Tuned Output Buffer-Mult.-Amplifier To 250 MHz .....	\$5.95
AFP-1 AUDIO PREAMP. Dual Audio Preamp — For Mike Etc. ....	\$3.95	OSC-1 CRYSTAL OSC. 100 KHZ — 20 MHz Not Tuned .....	\$3.95
BMD-1 BAL. MIX. LM 1496 Mixer — S.B. Modulator Tuned Output .....	\$9.95	OSC-2 CRYSTAL OSC. Ov. 18-200 MHz Tuned Output .....	\$4.95
DET-1 AM DET. Am Envelope Detector With AGC Output .....	\$3.95	OSC-3 VARIABLE FREQ OSC Varactor Tuned 455KHZ .....	\$5.95
DET-2 FM DET. LM 3065 FM Detector (455 KHZ or 4-11 MHz) .....	\$7.95	OSC-4 VARIABLE FRFY OSC Varactor Tuned 4-11 MHz .....	\$5.95
DET-3 SSB DET. LM 1496 SSB Detector (Needs OSC-1 or OSC-4) .....	\$9.95	PSV-1 POWER SUPPLY LM 723 With Pass Transistor, 3 amps max. ....	\$7.95
IFA-1 IF AMP. CA 3028 30 DB Gain, Optional AGC (455 KHZ or 9-11 MHz) ..	\$6.95	PLL-2 TONE DETECTOR LM567 PLL Tone Detector .....	\$5.95
FLS-9 SSB FILTER 9 MHz/2.1 KHZ BW with USB XAL for OSC-1 .....	\$49.95	RF/MIX-1 RF-AMP/MIXER CA 3028 — Tuned RF AMP/Mixer 1-100 MHz ..	\$7.95
IFA-2 IF AMP. CA 3028 30 DB Gain 1-100 MHz Optional AGC .....	\$6.95	RF/MIX-2 RF-AMP/MIXER 3N204 Tuned RF AM/Mixer 1 — 250 MHz .....	\$7.95

MANY OTHER MODULES AVAILABLE

TERMS: CASH WITH ORDER  
OR 25% DEPOSIT FOR C.O.D.

SEND \$2.00 FOR FULL CATALOG  
WITH CIRCUIT DIAGRAMS AND  
TYPICAL RECEIVER AND  
TRANSMITTER HOOK-UPS

✓ 419

## ELECTRONICS SPECIALTIES SALES CO.

P. O. BOX 2122 • MIAMI, FLORIDA 33152 • PHONE 305-759-2318

COMPLETE SET OF MODULES TO BUILD A  
1-WATT SSB/CW MONO-BAND TRANSCEIVER  
LESS CASE, CONTROLS, PWR SUPPLY  
(12 VDC), SPK AND MIKE

\$149.95 (Specify Band)

**Universal Communications**



**2300** MHz

CONVERTER KIT..... **38.50**  
 COMPLETE WITH PC BOARD, PARTS,  
 AND 10 PAGE BROCHURE

COMPLETE BOARD..... **65.00**  
 ASSEMBLED AND TESTED

POWER SUPPLY..... **19.50**

CIGAR ANT..... **30.00**  
 33 ELEMENTS, PHYSICALLY STRONGER  
 THAN LOOP YAGI, EQUAL IN GAIN.

PREAMP, SUPERVERTER, AND  
 2300 MHZ TRANSMITTER

THE STOPSIGN BOARD WAS DEVELOPED AT OUR LAB FOR OPTIMUM PERFORMANCE WITH LOW COST. THIS IS NOT A COPY (ALTHOUGH WE ARE COPIED) WE STRIVE TO MAINTAIN THE ORIGINAL QUALITY. UNDERSTANDING OUR PRODUCTS MAKES SERVING YOU BETTER. T.V.R.O. RECEIVERS & ACCESSORIES AVAILABLE.

TERMS: COD—MO. BANK CARD, CHECK

HOURS: 8:30 AM—4:30 PM C.S.T. M.—F.



P.O. BOX 339 ARLINGTON, TEX. 76010  
 817-265-0391

★ **YOU ASKED FOR IT** ★

**A COMPLETE REPEATER STARRING THE MARK 3C SUPERCONTROLLER**



ALL the unique features which make Mark 3C the acclaimed leader in repeater control —

- Autopatch
- Reverse patch
- Autodial
- 40 Functions
- 13 Morse messages
- Custom tail messages
- Digital tone decoding
- Microprocessor control

AND NOW, even the repeater is built in —

- Receiver sens. 0.25 UV
- Super crisp audio
- Transmitter output 2W

PLUS options —

- Power amplifiers (pick your level)
- Sub-audible tone
- Control receivers

MARK 3CR REPEATER  
 144-220 \$1645.

MARK 3-C CONTROLLER \$1095

Call or write for specifications  
**MICRO CONTROL SPECIALITIES (617) 372-3442**  
 23 Elm Park, Groveland, Ma. 01834

**BASSETT HELIUM TRAP ANTENNAS**



**BASSETT HELIUM MOBILE ANTENNAS**

**NEW!**



Heavy duty inductors with transparent tube covers.

The result of nearly two years of continuous development and nearly fifty years of amateur and commercial antenna design and manufacture Bassett helium filled antennas are for the amateur who demands the very best in American made automatic bandchange systems and mobile antennas that are compatible with all transceivers including the new "no tune" units. Trap systems are fundamental dipoles on each band and do not require antenna tuners.

- Helium filled traps impervious to all weather
- Maintains precise resonance and efficiency
- Systems easily handle legal amateur power
- Multiband amateur and MARS with one coax
- Fully compatible with "no tune" transceivers
- Short enough to fit on a small 50' by 100' lot
- Rugged white traps only 1" diameter, 5" long
- Uses your RG-8 or RG-58 coax in any length
- Center "isolator" equipped to accept a PL-259
- Solid Copperweld, stainless, nylon end lines

- Helium filled for a lifetime of high efficiency
- Completely adjustable to precise resonance
- Power handling capability to 750 watts PEP
- Beautiful white 32" Fiberglass lower section
- Stainless 38" 17-7 tapered top whip section
- Very low weight. VAC-20 weighs 6.5 ounces
- Low wind drag. Holds vertical at high speed
- All chrome plated polished brass hardware
- Models for all bands with a 2 meter collinear
- Mates with any standard 3/8-24 mobil mount

**MULTIBAND BROADSIDE DIPOLES**

VAC-40/75--\$69.50	VAC-20/40/75--\$89.50	VAC-10/15/20/40-----\$119.50
VAC-20/40--\$69.50	VAC-15/20/40--\$89.50	VAC-15/20/40/75-----\$119.50
VAC-15/20--\$69.50	VAC-10/15/20--\$89.50	VAC-10/15/20/40/75--\$149.50

**SINGLE-BAND MOBILES**

VAC-2 collinear for 2 meter mobile---\$39.50
VAC-6, VAC-10, VAC-15, VAC-20 ---\$39.50
VAC-40---\$44.50      VAC-75 ---\$49.50

**NEW!** VAC-10m/18m/24m-----\$89.50  
 For the 3 new amateur bands

Postpaid to 48 States. Florida residents add 4% Fla. sales tax. Prices and specs subject to change without notice or obligation. Special systems available for any use. Write for price quotes.

440



**REX BASSETT ELECTRONICS, INC.**

1633 N.E. 14th AVENUE, FORT LAUDERDALE, FLORIDA 33305 TEL: 305-561-1400

## "ONV SAFETY BELT"

A "must" for Safety!

'73 Bill Salerno



W20NV  
President



OSHA Approved



**NOW AVAILABLE  
ONV TOOL POUCH  
DESIGNED FOR ONV SAFETY BELT  
\$9.95 EACH**

Shipping & Handling Prepaid



Immediate UPS Del'y

### UPI Communication Systems, Inc.

Mail To: P.O. Box 902 • Saddle Brook, N.J. 07662  
N.J. (201) 279-7528 • (800) 526-5277  
(Office) 481 Getty Ave. • Paterson, N.J. 07503  
Cable: Unipage Telex: 642597

At last!! — a safety belt designed to meet the safety needs of radio amateurs, radio stations, TV stations, boat owners, painters, construction workers, maintenance people — anyone with the need to climb — now at an affordable price.

Our "ONV Safety Belt" is fitted with two drop forged steel "D" rings. Onto one is spliced a 3 foot length of 1/2" diameter nylon rope fitted with a drop forged steel snap hook. The 3" wide nylon body comfort pad is secured to 1 3/4" wide, 9500 lb. test nylon webbing, which is resin or latex treated for abrasion resistance. The belt is adjustable up to size 46" waist.

Only \$39.95 plus \$3.00 for postage and handling. NJ residents add 5% sales tax.

#### Looking for gear?

You know that dealers sell used gear at highly inflated prices. Classifieds are risky: you may pay before you see, may get a lemon, may even be ripped-off!!

#### Don't use all your gear?

Is it just sitting there, collecting dust? Think of what cash could do for you in its place!

#### Upgrading your station?

Dealers give poor trade-in allowances. If they give any at all!

#### Starting out?

Don't know what to get? Dealers often steer you to the gear that will net them the biggest commission!

✓ 413



602-326-1105

Equipment Exchange

QSL or business SASE to:

Radio  
Equipment  
Brokerage

Suite 73  
2509 N. Campbell Ave.  
Tucson, Arizona 85719

HERE AT LAST! THE ALL NEW

## AZDEN PCS-3000

2 METER TRANSCEIVER

AND PCS-300 2 METER HT

We'll Beat Any Price in This Issue

✓ 424

### LCG engineering

116 Country Farms Rd., Box 140, Marlton NJ 08053  
609-983-8844 DAILY 6 PM-MIDNIGHT

this publication  
is available in  
microform



#### University Microfilms International

300 North Zeeb Road  
Dept. P.R.  
Ann Arbor, MI 48106  
U.S.A.

18 Bedford Row  
Dept. P.R.  
London, WC1R 4EJ  
England

## 1981 FAR EAST ELECTRONICS TOUR

The Electronics Tour for Marketing, Purchasing, Engineering, Manufacturing, & Product Development Managers and Executives to Meet with Foreign Distributors, Reps, Suppliers, & Buyers, and to Develop Foreign Business Contacts Through Individual and Group Meetings.

Date: October 7-21, 1981

and

October 8-23, 1981

### HIGHLIGHTS

Japan Electronics Show in Osaka

Korea Electronics Show in Seoul

Taiwan Electronics Show in Taipei

Hong Kong Consumer Electronics Show

★ Arrangements for Group and Individual Business Meetings ★ Daily Program for Participants Interested in Importing ★ Daily Program for Participants Interested in Exporting  
★ Business Briefings by Local Governments, Chambers of Commerce, and U.S. Embassy Commercial Officers ★ Free Time for Individual Appointments ★ First Class Hotel Accommodations ★ Daily Show Transportation

### PRICE

From West Coast \_\_\_\_\_ \$2,290  
From East Coast \_\_\_\_\_ \$2,655

Price includes: airfare, hotels (double occupancy), land transportation, daily American breakfast, dinners, cocktails & city tours in each country, . . . and more!

For more information and brochure, call or write to:

Ellen Heather  
Commerce Tours International ✓ 332  
870 Market Street, Suite 742  
San Francisco, CA 94102  
(415) 433-3072 or 433-3408

# HAM HELP

I want a circuit and construction article for a 4-250A in grounded-grid for HF. I will pay for copying and postage, or I will copy and return. Thank you.

**Gary Kriss VE7CGK**  
20776 114th Ave.  
Maple Ridge B.C.  
Canada V2X 1K1

I have an electronic voltmeter model 302C made by Ballantine Laboratories. I would like a schematic or service manual or any information on this.

**J. Humphrey KB3T**  
618 Magee Ave.  
Patton PA 16668

I am looking for instruction books for a KAAR Mfg. Co. TR-505N UHF FM base station and a NAVY RBM-4 series HF receiver. I also have available a fairly comprehensive library of GE, Motorola, and RCA FM manuals and will try to help anyone who

includes an SASE with information on these makes.

**Geoff Fors WB6NVH**  
PO Box 2946  
Carmel CA 93921

I am still searching for a Collins 32S1 transmitter in any condition that is not being used and is cheap. Please state condition and price.

**H. F. Schnur**  
115 Intercept Ave.  
North Charleston SC 29405

I need any information, including the schematic, on "Communications Receiver Made for Department of Commerce, Civil Aeronautics Administration, Type RCP, Made by National Co., Malden, Mass. Modified by Schuttig and Co., Washington, DC. Dated 10-30-45."

**Bob Hughes KX4A**  
PO Box 29044  
Richmond VA 23233

## TEST EQUIPMENT RECONDITIONED AND LAB CALIBRATED

<b>HP 608C</b> SIGNAL GENERATOR, 10 MHZ THRU 480 MHZ. AM/CW OR PULSE MODULATION, CALIBRATED ATTENUATOR, METERED OUTPUT, AN EXCELLENT LAB GENERATOR	<b>\$375.00</b>
<b>HP 614</b> SIGNAL GENERATOR, 900 MHZ THRU 2100 MHZ. CALIBRATED AND METERED OUTPUT, PERFECT FOR AIRCRAFT OR MICROWAVE WORK	<b>345.00</b>
<b>HP 606A</b> SIGNAL GENERATOR 50 KHZ THRU 65 MHZ. CALIBRATED AND METERED OUTPUT, AM/CW. GREAT FOR IF ALIGNMENT AND GENERAL HF USE.	<b>550.00</b>
<b>SG-13/U</b> VOR-ILS MILITARY SIGNAL GENERATOR, 108-135.9 MHZ AND 329.9 TO 335 MHZ. OUTPUT SIGNALS INCLUDE VOR, LOC, GLIDESLOPE AND 1000 C/P'S, SAME AS COLLINS 479T-2. OPERATES FROM 28VDC AT 317 AMP'S, PORTABLE OR BENCH POWER SOURCE. IDEAL FOR AIRCRAFT RADIO REPAIR.	<b>265.00</b>
<b>AN/URM-26</b> MILITARY SIGNAL GENERATOR 4 MHZ THRU 405 MHZ AM/CW, CALIBRATED ATTENUATOR, METERED OUTPUT, 400/1000 MODULATION, AN EXCELLENT SMALL COMPACT SIG GEN. SIZE 11 x 11 x 14. PERFECT FOR FIELD OR BENCH SERVICE WORK	<b>285.00</b>
<b>AN/UPM-84</b> SPECTRUM ANALYZER, FREQUENCY RANGE 10 MHZ THRU 40.8 GHZ IN 6 BANDS. AM/CW/SSB RADIO SIGNALS ARE DISPLAYED AS A SPECTRUM ON A 5" CRT SCREEN WITH POWER AMPLITUDE PLOTTED ON THE VERTICAL AXIS, AGAINST FREQUENCY ON THE HORIZONTAL AXIS. EXCELLENT FOR LAB USE IN RADIO, RADAR, MICROWAVE AND SATELLITE TV ANALYSIS.	<b>695.00</b>
<b>OS-121/USM-140</b> OSCILLOSCOPE WITH MX-3078/USM HORIZ CHANNEL PLUG-IN AND MX2930 DUAL TRACE PLUG-IN, 5" CRT INTERNAL SWEEP, 24 CALIBRATED RANGES WITH SWEEP EXPANSION, TRIGGER MODES, DC-22 MHZ, CALIBRATOR, HOUSED IN VENTED AIR COOLED CABINET, SIZE 22" L x 14" H x 19" W. ORIGINAL COST \$2,800.00. A BEAUTIFUL MILITARY O'SCOPE.	<b>295.00</b>
<b>TEKTRONIX</b> PLUG-INS TYPE A, B, D, H, K, L, R (EACH)	<b>65.00</b>
<b>TEKTRONIX</b> IL-30 SPECTRUM ANALYZER PLUG-IN, 925 MHZ THRU 10.5 GHZ. USED FOR RADAR, MICROWAVE, SATELLITE TV AND TRANSPONDER ANALYSIS. USING 500 SERIES TEKTRONIX O'SCOPIES	<b>650.00</b>
<b>HP 431C</b> POWER METER	<b>225.00</b>
<b>GR-1556</b> NOISE ANALYZER, 5HZ-20KHZ	<b>95.00</b>
<b>HP 431C</b> POWER METER	<b>225.00</b>
<b>GR-1556</b> NOISE ANALYZER, 5HZ-20KHZ	<b>95.00</b>
<b>HP-5261A</b> VIDEO AMP PLUG-IN FOR 5245/46 FREQ COUNTER	<b>125.00</b>

WE SHIP BEST WAY FOB OTTO, N.C. 30 DAY MONEY BACK GUARANTEE. WE ACCEPT VISA, MASTER CARD, OR CHECK. PHONE BILL SLEEP 704-524-7519.



Electronic  
Distributors

**Slep Electronics Company**

P. O. BOX 100, HWY 441, DEPT. 73  
OTTO, NORTH CAROLINA 28763

CALL  
TOLL  
FREE

# 800-545-7814

CALL  
NOW



Contest Keyer

**AEA** Brings you the  
Breakthrough!

All AEA in stock for quick delivery  
Call for quote on Morsematic, Contest  
Keyer, Keyers & Trainers. Special Pack-  
age Deals available with Bencher Paddles  
CALL NOW!!! TOLL FREE!!!

Also Stocking: AZDEN-ICOM-BENCHER-HYGAIN-KANTRONICS-LARSEN-MIRAGE-AVANTI  
KENWOOD-SANTEC-MFJ-CUSHCRAFT-TENTEC-ASTRON

## Pecos Valley Amateur Radio Supply

112 W. First St., Roswell, NM 88201 • (505) 623-7388 in New Mexico, Evenings, & Sundays



# ICOM

IN STOCK - CALL FOR YOUR PRICE  
TOLL FREE!!!

We have the lowest prices, fast delivery,  
free shipping most items, & TOLL FREE  
Orderline.

OPEN 10-5 M-F &  
10-4 Sat  
MC & VISA Welcome

# OSCAR ORBITS

Courtesy of AMSAT

The OSCAR satellites are subject to atmospheric drag, of course, and the present period of intense solar activity has accentuated the problem. During this period, our sun has been expelling huge numbers of charged particles, some of which find their way into the Earth's upper atmosphere, increasing the density (and thus the drag) there. It is through this region that the OSCARs must pass. OSCAR 8, in a lower orbit than OSCAR 7, is the more seriously affected of the two.

If the drag factor is not considered when OSCAR calculations are performed, long-range orbital projections will be in error. For example, by the end of 1979, OSCAR 8 was more than 20 minutes ahead of some published schedules. The nature of orbital mechanics is such that extra drag on a satellite causes it to move into a lower orbit, resulting in a shorter orbital period. Thus, the satellite arrives above a given Earthbound location earlier than predicted.

Using data supplied to us by Dr. Thomas A. Clark W3IWI of AMSAT, the equatorial crossing tables shown here were generated with the aid of a TRS-80™ microcomputer. The tables take into account the effects of atmospheric drag and should be in error by a few seconds at most.

The listed data tells you the time and place that OSCAR 7 and OSCAR 8 cross the equator in an ascending orbit for the first time each day. To calculate successive OSCAR 7 orbits, make a list of the first orbit number and the next twelve orbits for that day. List the time of the first orbit. Each successive orbit is 115 minutes later (two hours less five minutes). The chart gives the longitude of the day's first ascending (northbound) equatorial crossing. Add 29° for each succeeding orbit. When OSCAR is ascending on the other side of the world from you, it will descend over you. To find the

equatorial descending longitude, subtract 166° from the ascending longitude. To find the time OSCAR 7 passes the North Pole, add 29 minutes to the time it passes the equator. You should be able to hear OSCAR 7 when it is within 45 degrees of you. The easiest way to determine if OSCAR is above the horizon (and thus within range) at your location is to take a globe and draw a circle with a radius of 2450 miles (4000 kilometers) from your QTH. If OSCAR passes above that circle, you should be able to hear it. If it passes right overhead, you should hear it for about 24 minutes total. OSCAR 7 will pass an imaginary line drawn from San Francisco to Norfolk about 12 minutes after passing the equator. Add about a minute for each 200 miles that you live north of this line. If OSCAR passes 15° east or west of you, add another minute; at 30°, three minutes; at 45°, ten minutes. Mode A: 145.85-95 MHz uplink, 29.4-29.5 MHz downlink, beacon at 29.502 MHz. Mode B: 432.125-.175 MHz uplink, 145.975-.925 MHz downlink, beacon at 145.972 MHz.

At press time, OSCAR 7 was scheduled to be in Mode A on odd numbered days of the year and in Mode B on even numbered days. Monday is QRP day on OSCAR 7, while Wednesdays are set aside for experiments and are not available for use.

OSCAR 8 calculations are similar to those for OSCAR 7, with some important exceptions. Instead of making 13 orbits each day, OSCAR 8 makes 14 orbits during each 24-hour period. The orbital period of OSCAR 8 is therefore somewhat shorter: 103 minutes.

To calculate successive OSCAR 8 orbits, make a list of the first orbit number (from the OSCAR 8 chart) and the next thirteen orbits for that day. List the time of the first orbit. Each successive orbit is then 103 minutes later. The chart gives the longitude of the day's first ascending equatorial crossing. Add 26° for each succeeding orbit. To find the time OSCAR 8 passes the North Pole, add 26 minutes to the time it crosses the equator. OSCAR 8 will cross the imaginary San Francisco-to-Norfolk line about 11 minutes after crossing the equator. Mode A: 145.85-95 MHz uplink, 29.4-29.50 MHz downlink, beacon at 29.40 MHz. Mode J: 145.90-146.00 MHz uplink, 435.20-435.10 MHz downlink, beacon on 435.090 MHz.

OSCAR 8 is in Mode A on Mondays and Thursdays, Mode J on Saturdays and Sundays, and both modes simultaneously on Tuesdays and Fridays. As with OSCAR 7, Wednesdays are reserved for experiments.

## OSCAR 7 ORBITAL INFORMATION FOR JUNE

ORBIT #	DATE	TIME (GMT)	EQ. CROSSING (DEGREES WEST)
29933	1	0007:01	80.7
29946	2	0101:16	94.3
29958	3	0000:34	79.2
29971	4	0054:48	92.8
29984	5	0149:03	106.3
29996	6	0048:21	91.2
30009	7	0142:35	104.8
30021	8	0041:53	89.6
30034	9	0136:08	103.2
30046	10	0035:26	80.1
30059	11	0129:40	101.6
30071	12	0028:58	86.5
30084	13	0123:13	100.1
30096	14	0022:31	84.9
30109	15	0116:45	98.5
30121	16	0016:03	83.3
30134	17	0110:18	96.9
30146	18	0009:36	81.8
30159	19	0103:50	95.4
30171	20	0003:08	80.2
30184	21	0057:23	93.8
30197	22	0151:37	107.4
30209	23	0050:55	92.2
30222	24	0145:10	105.8
30234	25	0044:28	90.7
30247	26	0138:42	104.2
30259	27	0038:00	89.1
30272	28	0132:14	102.7
30284	29	0031:32	87.5
30297	30	0125:47	101.1

## OSCAR 8 ORBITAL INFORMATION FOR JUNE

ORBIT #	DATE	TIME (GMT)	EQ. CROSSING (DEGREES WEST)
16509	1	0054:24	74.2
16523	2	0059:05	75.4
16537	3	0103:46	76.6
16551	4	0108:26	77.8
16565	5	0113:07	79.0
16579	6	0117:48	80.2
16593	7	0122:28	81.3
16607	8	0127:09	82.5
16621	9	0131:50	83.7
16635	10	0136:30	84.9
16649	11	0141:11	86.1
16662	12	0002:40	61.5
16676	13	0007:20	62.7
16690	14	0012:00	63.9
16704	15	0016:41	65.1
16718	16	0021:21	66.3
16732	17	0026:01	67.5
16746	18	0030:42	68.6
16760	19	0035:22	69.8
16774	20	0040:02	71.0
16788	21	0044:42	72.2
16802	22	0049:22	73.4
16816	23	0054:03	74.6
16830	24	0058:43	75.8
16844	25	0103:23	77.0
16858	26	0108:03	78.2
16872	27	0112:43	79.3
16886	28	0117:23	80.5
16900	29	0122:03	81.7
16914	30	0126:43	82.9

## OSCAR 7 ORBITAL INFORMATION FOR JULY

ORBIT #	DATE	TIME (GMT)	EQ. CROSSING (DEGREES WEST)
30309	1	0025:05	86.0
30322	2	0119:19	99.5
30334	3	0018:37	84.4
30347	4	0112:52	98.0
30359	5	0012:10	82.8
30372	6	0106:24	96.4
30384	7	0005:42	81.2
30397	8	0059:56	94.8
30410	9	0154:11	108.4
30422	10	0053:29	93.3
30435	11	0147:43	106.8
30447	12	0047:01	91.7
30460	13	0141:15	105.3
30472	14	0040:33	90.1
30485	15	0134:48	103.7
30497	16	0034:06	88.6
30510	17	0128:21	102.1
30522	18	0027:38	87.0
30535	19	0121:52	100.6
30547	20	0021:10	85.4
30560	21	0115:25	99.0
30572	22	0014:43	83.8
30585	23	0108:57	97.4
30597	24	0008:15	82.3
30610	25	0102:29	95.9
30622	26	0001:47	80.7
30635	27	0056:02	94.3
30648	28	0150:16	107.9
30660	29	0049:34	92.7
30673	30	0143:48	106.3
30685	31	0043:06	91.2

## OSCAR 8 ORBITAL INFORMATION FOR JULY

ORBIT #	DATE	TIME (GMT)	EQ. CROSSING (DEGREES WEST)
16928	1	0131:23	84.1
16942	2	0136:03	85.3
16956	3	0140:42	86.5
16969	4	0002:11	61.9
16983	5	0006:51	63.1
16997	6	0011:30	64.2
17011	7	0016:10	65.4
17025	8	0020:50	66.6
17039	9	0025:29	67.8
17053	10	0030:09	69.0
17067	11	0034:49	70.2
17081	12	0039:28	71.4
17095	13	0044:08	72.5
17109	14	0048:47	73.7
17123	15	0053:27	74.9
17137	16	0058:06	76.1
17151	17	0102:46	77.3
17165	18	0107:25	78.5
17179	19	0112:04	79.7
17193	20	0116:44	80.9
17207	21	0121:23	82.0
17221	22	0126:02	83.2
17235	23	0130:42	84.4
17249	24	0135:21	85.6
17263	25	0140:00	86.8
17276	26	0001:28	62.2
17290	27	0006:07	63.3
17304	28	0010:46	64.5
17318	29	0015:25	65.7
17332	30	0020:04	66.9
17346	31	0024:43	68.1

### MODEL II



**\$459<sup>00</sup> DISCOUNT**  
Off List  
**64K 1 DRIVE \$3440.00**

No Taxes on Out of State Shipments.  
Immediate Shipment On Most Items

### \$DISCOUNTS

# TRS-80®

DEALER A301

26-3001 4K Color.....	\$353.00
26-1145 RS-232 Board.....	84.00
26-1140 "O" K Interface.....	249.00
26-1160 Mini Disk.....	419.00
26-1172 Modem.....	135.00
Fast 100 CPS Centronics 730 Printer.....	577.00
Text Quality Centronics 737 Printer.....	737.00

**1-800-841-0860 Toll Free Order Entry**  
**MICRO MANAGEMENT SYSTEMS, INC.** 313

DOWNTOWN PLAZA SHOPPING CENTER  
115 C SECOND AVE. S.W.  
CAIRO, GEORGIA 31728  
GA. & EXPORT PHONE NO. (912) 377-7120

FREE  
COMPUTER  
CATALOG  
UPON  
REQUEST



26-1061 4K I.....	\$629.00
26-1062 16K III.....	865.00
26-1063 32K III	
2 Drives, RS232.....	2225.00

Largest Inventory in S.E. U.S.A.



### RAPID MOBILE CHARGER

The DEB-TED Rapid Mobile Charger is a constant voltage charger that will charge your batteries off a 12 Volt source in 4-6 hours. You may use the charger at all times, this includes transmit and receive periods. It is equipped with a cigarette lighter plug on the input side and the appropriate charging plug on the output side. Models available now for the Kenwood TR2400, Yaesu 207R, Tempo S1, S2, S5 and the Wilson Mark II and IV. Other models available also please call or write for info..... \$34.95.



**NEW AC VERSION NOW AVAILABLE**

### "SEE THE WORKS" CLOCK

OUR EASIEST CLOCK TO ASSEMBLE!

6 Digits 12 or 24 Hour Format Clock rests between two pieces of clear plexiglas A GREAT CONVERSATION PIECE! Kit is complete including top

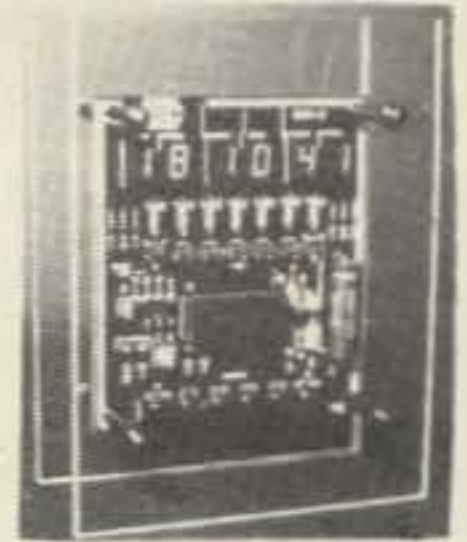

quality PC board, all components pre-cut and drilled plexiglas and all hardware. \$29.95  
Wired and Tested.....\$39.95

### VEHICLE INTRUSION ALARM

An easy to assemble and install kit that offers options not normally found in other alarm systems. Hidden switch mounts under the dash. Kit has provisions for sensors and remote control switch. Programmable time delays for exit, entry and alarm periods. Basic hook-up utilizes dome light circuit activating when doors are opened. The alarm will drive a siren or pulse horn at a 1HZ rate. Not prone to false alarm do to reliable CMOS circuitry. No external switch required! Complete kit with easy to follow instructions and diagrams..... \$12.95  
Wired and Tested..... \$19.95

SPECIAL



SPECIAL

MODEL 5314 CLOCK KIT 12 or 24 hour format 6 large "5 Digits. Kit is complete with all parts, pc board and custom designed cabinet. (specify white or black)..... \$29.95



**DEBCO ELECTRONICS**  
P.O. BOX 9169  
CINCINNATI, OHIO 45209

✓330

Phone: (513) 531-4499

- Add 5% Shipping for U.S. & Canada
  - All foreign orders add 10%
  - COD orders add \$1.40
  - Master Charge and Visa Welcome
  - Orders under \$20.00 add \$1.00 handling
  - Ohio residents add 5½% Tax
- CALL OR WRITE FOR CATALOG

## HAM-KEY® ✓30 RADIO TELEGRAPH SENDING DEVICES

**New Lower Prices**



Model **HK-3M** ~~\$19.95~~  
**Now \$15.95**

Add \$2.00 Shipping & Handling. (U.S.A.)

- \* Deluxe straight key
- \* Anti-tip bracket. Can't tip
- \* Heavy base. No need to attach to desk

- \* Navy type knob
- \* Smooth action

Model AT-B anti-tip bracket only, to convert any HK-3 to HK-3M. \$1.50 Postpaid

CC-3P shielded cable & plug for HK-3M \$1.50

Add \$ .50 Shipping & Handling.



Model **HK-1** ~~\$29.95~~ **Now \$24.95**

Add \$2.00 Shipping & Handling. (U.S.A.)

- \* Dual lever squeeze paddle
- \* For use with all electronic keyers
- \* Heavy base with non-slip rubber feet
- \* Paddles reversible for wide or close finger spacing

Model HK-2, same as HK-1 but less base for incorporation in your own keyer. \$16.95

Add \$1.00 Shipping & Handling

CC-1P shielded cable & plug for HK-1 \$2.00

Add \$ .50 Shipping & Handling.

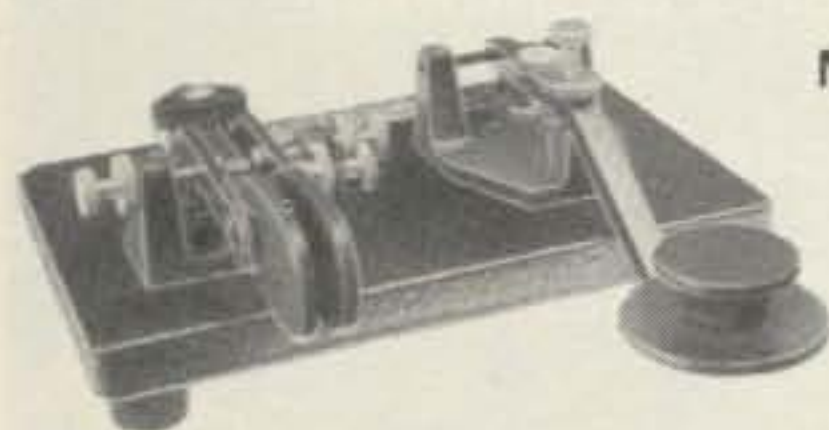

Model **HK-4** ~~\$44.95~~  
**Now \$37.95**

Add \$2.00 Shipping & Handling. (U.S.A.)

- \* Combination HK-1 & HK-3 on same base
- \* Straight key may be used conventionally or as a switch to trigger a memory.

CC-1/3P Shielded cable with plugs for HK-4 \$3.50

Add \$1.00 Shipping & Handling



Model **HK-5A** Electronic Keyer

~~\$69.95~~ **Now \$54.95**

Add \$2.00 Shipping & Handling. (U.S.A.)

- \* Iambic circuit for squeeze keying
- \* Self completing dots & dashes
- \* Dot & dash memory
- \* Built-in sidetone
- \* Battery operated with provisions for external power
- \* Uses Curtis 8044 keyer chip
- \* Grid block or direct keying
- \* Speed, volume, tone & weight controls on front panel
- \* Use with HK-1 or HK-4

IF NOT IN STOCK AT YOUR DEALER, ORDER DIRECT FROM



P.O. Box 28271

**The HAM-KEY Co.**  
Phone TOLL - FREE 1-800-325-3651

St. Louis, MO 63132



# GOTHAM ANTENNAS

(813) 584-8489



## SMALL LOT TRAP DIPOLES ✓ 417

MODEL	BANDS	LGTH	PRICE
TSL 8040	80,40	78'	\$49.95
TSL 4020	40,20,15	40'	\$47.95

## SMALL LOT SHORTENED DIPOLES

SL-8010	80,40,20, 15,10	75'	\$59.95
SL-160	160	130'	\$36.95
SL-80	80	63'	\$35.95
SL-40	40,15	33'	\$34.95

## FULL SIZE PARALLEL DIPOLES

FPD-8010	80,40,20, 15,10	130'	\$49.95
FPD-4010	40,20,15,10	63'	\$44.95

## NEW! PORTABLE VERTICAL! IDEAL FOR APARTMENTS, CAMPING, TRAILERS!

Folds to 5' Package. No Radials. Required. Fully Assembled. Full Legal Limit. 1:1 VSWR

MODEL	BANDS	HGHT	PRICE
PV-8010	80-10	13'	\$59.95

## PROVEN DESIGN - GOTHAM ALL BAND VERTICALS

V-160	160,80,40,20, 15,10,6	23'	\$39.95
V-80	80,40,20, 15,10,6	23'	\$37.95
V-40	40,20,15,10,6	23'	\$35.95

## FAMOUS GOTHAM QUADS

2 Elements — 3 Bands Complete \$119.95

## CHAMPIONSHIP GOTHAM BEAMS

Full Size Complete from \$79.95

CALL OR SEND LARGE SASE FOR CATALOG. Shipping: Dipoles & Verticals \$2.50 USA; \$7.00 Canada; \$5.00 FPO. APO Beams & Quads Shipped UPS or Freight Collect. Fla. add 4% Sales Tax

P.O. Box 776 • Largo, FL 33540

# Microcraft's New Morse-A-Word

Eight character moving display.  
Built-in code practice oscillator.  
Excellent for learning Morse Code.  
Complete — no CRT or expensive extras needed.

Decodes audio CW signals from your receiver's speaker and displays letters, numbers, punctuation and special Morse characters as the code is received.



MORSE-A-WORD Kit with 4 character readout . . . . . MAWK-4 \$149.95  
MORSE-A-WORD Kit with 8 character readout . . . . . MAWK-8 \$169.95  
MORSE-A-WORD wired & tested with 8 character readout . . . MAWF \$249.95

Send check or money order. Use your VISA or Master Charge. Add \$3.50 shipping and handling for continental U.S. Wisconsin residents add 4% State Sales Tax.

Microcraft Corporation Telephone: (414) 241-8144  
P. O. Box 513G, Thiensville, Wisconsin 53092

**AMATEUR RADIO**

**SHORTWAVE**

**SCANNERS**

**SPECTRONICS**

Specialists in Amateur Radio,  
Short-Wave Listening  
And Contemporary  
Electronic Gear.

**SPECTRONICS INC**  
1009 GARFIELD ST. OAK PARK, IL. 60304  
(312) 848-6777

HOURS  
MON, TUES, WED.: 9:30-6:00 PM  
THURS, FRI.: 9:30-8:00 PM  
SAT.: 9:30-3:00 PM  
CLOSED SUNDAYS, HOLIDAYS

OVER 70 BRANDS IN STOCK  
LAND-MOBILE RADIO  
HYGAIN • ARRL  
BEARCAT • MORGAIN • MANY MORE

Full Service Shop • Spectrum Analysis • Antennas  
New and Used Equipment • CW-SSB-FM, Etc. • Towers  
FCC Study Guides • Code Tapes • Books • Accessories

DRAKE ICOM TEN-TEC B&W • CDE  
SEE OUR CENTRAL U.S. EARTH STATION PROJECT

# The 1981 Atlanta Ham Festival and Georgia State ARRL Convention June 20-21, 1981

Downtown Atlanta Marriott Hotel

- GIANT covered Fleamarket/Swapshop!
- More than 25 Forums/Meetings!
- FCC Exams!
- Parking for thousands of cars!
- 140 Major Exhibits!
- Special MICROPROCESSOR Section!
- Programs for Ladies & Children
- Activities Galore!

Registration: \$4 per person IN ADVANCE, \$6 at the door  
Children FREE!

If you do not receive a Preregistration Packet by May 15th, write:

Atlanta Hamfestival 1981

P.O. Box 45183

Atlanta, GA 30320

Hotel Rates: \$44 per day single OR double!

Write for Hotel Reservations to:

Marriott Hotel • Courtland at International Blvd. • Atlanta, GA 30303

or phone: Area 404/659-6500 and hurry, hurry, hurry!

## THE BEST HAMFEST IN THE WORLD!

SMP 2300 MHZ

**MICROWAVE**

UCC-1 Basic downconverter, \$40.00 includes PC board, PC board parts and brief instructions. PC board designed and manufactured by Universal Communications to exacting standards required for microwave performance.

SMC-1 Deluxe Introduction \$51.95 to Microwave package. Includes UCC-1, very detailed step by step assembly manual, extra parts, Microwave Antenna Cookbook. Lots of information on performance and system improvements.

SMC-2 SMC-1 package with \$63.95 a high performance front end transistor.

PER-1 Broadband IF \$11.95 Amplifier, compensates for long coax runs and poor TV front end noise figure.

ANT-1 2300 MHz Microwave \$7.95 Antenna Cookbook. 2nd revision, greatly expanded. Includes coupon worth \$5.00 towards purchase of SMC-1 or SMC-2. The Original.

ANT-2 Disks and spacers \$20.00 for 32 element, 22db gain antenna

HOT-1 High performance RF \$15.00 amplifier transistor, spec sheet, improves UCC-1 or SMC-1.

TU-8 Deluxe PS kit, \$44.95 includes case. PER-1 will mount inside.

New 4 page catalog SASE

All prices postpaid in US. VISA & MC on orders over \$40. COD add \$3. Va residents add 4% sales tax. Orders (703) 255-2918 9-12 EST M-F

SMP 376

Superior Microwave Products, Inc.  
P.O. Box 1241  
Vienna, Va. 22180



**New from BLACKCAT**

**Antenna Sw./Wattmeter/SWR Meter \$169.50 ppd.**

BlackCat JB-4000SW—every shack needs it, every ham can afford it.

**4-position Antenna Switch.** Heavy duty coax switch rated at 2 kW PEP. Three positions for antennas (AUX may be used for dummy load). Fourth position parallels positions 1 and 2 for receive use only.

**Dual-reading RF Power Meter.** Switch to RMS or Peak. Three ranges: 20, 200, and 2000 watts, full scale.

**Built-in SWR Meter.** Shows SWR from 1:1 to 7:1. Two-position "Set/SWR" switch plus RF level control. Calibrated for 80-10 meters, 50 ohm non-inductive load.

And more! Those of us who still enjoy occasionally operating AM appreciate the Modulation-Percent meter scale and earphone monitor jack. And the rugged metal cabinet with black vinyl-clad steel cover and black anodized aluminum panel has white nomenclature for easy reading. Size: 9½"W x6"H x5½"D.

**JB-1000 KW Dummy Load**



50 ohm oil-cooled, temperature-stable, resistive load handles up to 1 kW with low SWR. Less oil. \$29.95 ppd.



**WAWASEE ELECTRONICS 398**  
Dept. 752 Box 36, Syracuse, IN 46567  
Phone: 219/457-3191

Enclosed is \$ (UPS shipping prepaid)  
(No CODs. Indiana res. add 4% sales tax.)  
Please send Model(s)

Charge It:  Visa  Mastercard  
Exp. Date: \_\_\_\_\_ Card No. \_\_\_\_\_

Name \_\_\_\_\_ (please print)  
Address \_\_\_\_\_

City \_\_\_\_\_  
State \_\_\_\_\_ Zip \_\_\_\_\_

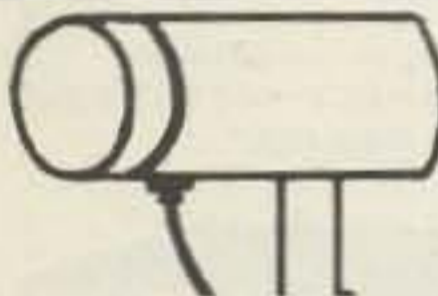

Pre Summer Sale 25% Off

**1800 to 2500 MHZ DOWN CONVERTER**

- Down Converter Kit Printed Circuit Board with all parts for assembly..... \$38.50
- Yagi Antenna Kit 22 db gain with weatherproof Shielded enclosure..... \$40.00
- Tunable Power Supply Kit..... \$34.95
- Antenna Cookbook Tested and proven designs..... \$ 9.95
- Assembled and Tested Down Converter with 50' RG59 cable with 75 to 300 ohm adaptor ready to install..... \$175.00



\*Deluxe Assembled and Tested Down Converter with 50' RG-59 cable, antenna, power supply, and adaptor (30 dB gain) 3 rf amps on board \$249.95

\*Deluxe Converter Kit PCB with all parts including preamp on board \$49.95

TERMS: We will accept COD orders for \$25.00 and over. All orders sent First Class on UPS. Prepaid orders we pay shipping.

**Microverter, Inc.**

617-329-7493

395

P.O. BOX 1267

DEDHAM, MA 02026

**MSB-1 AUDIO FILTER**

**SSB / CW / RTTY \$84.95**



8-Pole Tunable Lowpass Filter  
Tunable Bandpass Filter

Tunable Notch Filter  
6-Pole Fixed Highpass

Audio Amplifier

Power Requirements

FLP = 300-3000 Hz.  
FBP = 300-3000 Hz.  
Bandwidth—Less than 75 Hz. to greater than 1500 Hz.

F Notch = 300-3000 Hz., Notch depth-50 dB

FHP = 300 Hz.

1 Watt

12-14 VDC @300 MA  
110 Vac with optional adapter (\$8.95)

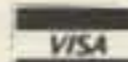

ORDER TODAY. If not completely satisfied, return within 15 days for a prompt refund (less shipping and handling). Add \$2.50 shipping and handling. SEND TODAY for complete list of products. Dealer inquiries welcome.

**M&M ELECTRONICS, INC.**

P. O. BOX 1206/BREWTON, ALABAMA 36427/PHONE (205) 867-2496

432

**Isotron Antennas**

THE ULTIMATE space savers...  
for 80, 40, and 20 meters

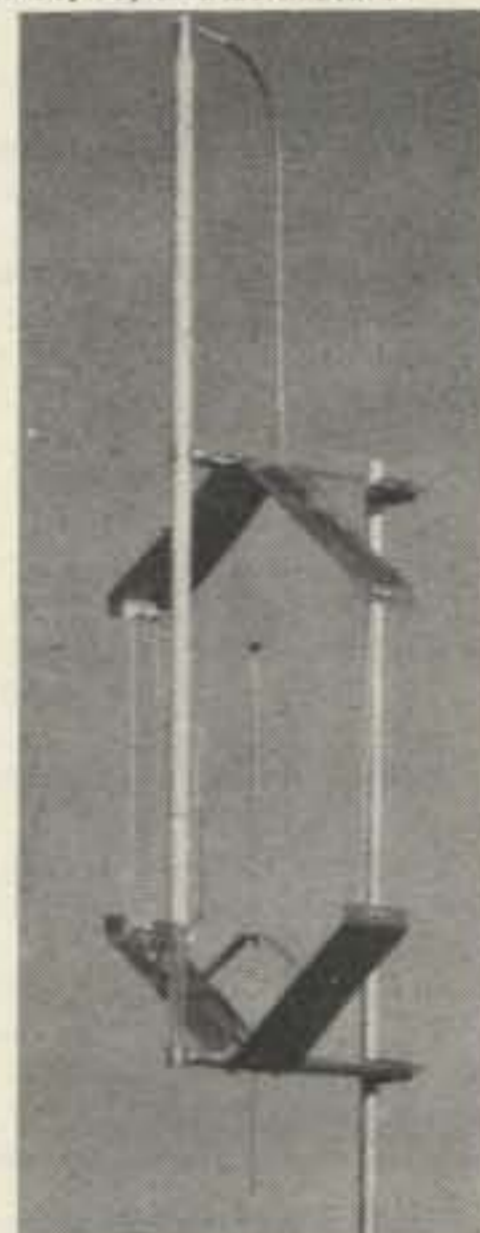

Isotron 80 Ht. 4½' Isotron 40 31" Isotron 20 17"

THIS HIGH PERFORMANCE ANTENNA IS DIRECTLY FED WITH 50Ω COAX. RADIALS OR MATCHING DEVICES ARE NOT USED. WHETHER YOU ARE LIMITED IN SPACE OR NOT, THE ISOTRONS WILL GIVE YOU THE PERFORMANCE YOU EXPECT FROM A HARMONIC ANTENNA. CALL OR WRITE:

DEALERSHIPS AVAILABLE 426

**BILAL COMPANY**

(303) 687-3219

STAR ROUTE

FLORISSANT, CO. 80816

# AMATEUR SPECIALISTS

## HUSTLER

4BTV.....	10 thru 40 Meter Vertical.....	\$72.60
5BTV.....	10 thru 80 Meter Vertical.....	92.40
G6144B.....	2 Meter Base Colinear 6db.....	66.00
G7-144.....	7db 2 Meter Base Colinear.....	99.00
2MB5.....	5 Element 2 meter beam.....	29.75
2MB11.....	11 element 2 meter beam.....	44.10

Complete line of Hustler—Call for prices

## HY-GAIN

TH3JR.....	Tri-Band Beam 750W PEP.....	129.00
64B.....	4 Element 6 Meter beam.....	42.87
103BA.....	3 Element 15 Meter Mono.....	60.45
155BA.....	Long John 5 element 15 meter.....	144.00
205BA.....	Long John 5 element 20 meter.....	233.07
204BA.....	4 Element 20 Meter.....	181.41
402BA.....	2 Element 40 Meter.....	167.97
TH3MK3.....	3 Element Thunderbird.....	174.70
TH6DXX.....	Super Thunderbird 6 element.....	228.57
TH5DX.....	Thunderbird 5 element.....	208.77
18HT.....	Hy Tower 10-80 meters.....	268.49
66B.....	6 Element 6 meter beam.....	82.77

## HY-GAIN CRANK UP TOWERS & ACCESSORIES

HG52SS.....	Self Supporting 52 ft.....	824.18
HG50MTZ.....	Side Supporting 50 ft.....	686.81
HG35MTZ.....	Side Supporting 35 ft.....	445.20
HG37SS.....	Self Supporting 37 ft.....	499.50
HG54HD.....	Self Supporting 54 ft.....	1623.00
HG70HD.....	Self Supporting 70 ft.....	2372.63
HG33MTZ.....	Side Supporting 33 ft.....	624.38
HE-EW.....	Electric Motor w/limit switch.....	487.00
HG-RME.....	Remote System for HE-EW.....	487.00
HG-T-2-129.....	Tower & Trailer Using HG-37SS.....	2951.25
HG-T-2-127.....	Tower & Trailer Using HG-35MTZ2851.30	
HG-T-2-126.....	Tower & Trailer Using HG-50MTZ3034.50	
HGT-2-125.....	Tower & Trailer Using HG52SS.....	3300.00

## ROTORS

HD73.....	Alliance.....	95.00
HDR300.....	Hy-Gain Deluxe Digital.....	377.95
AR22XL.....	Cornell-Dubilier.....	49.00
AR40.....	Cornell-Dubilier.....	60.00
AVR-1.....	Avanti Solid State Control.....	113.78

Cables Available—Call for Prices

## VHF MARINE RADIOS

MT5500.....	Regency Synthesized Transceiver.....	317.89
Horizon 25.....	Standard Comm. 12 + 2 Channels.....	299.95

## TEMPO HANDHELD

S-1.....	2 Meter.....	247.25
S-1T.....	2 Meter with Tone Pad.....	273.70
S-2.....	220 MHz.....	315.00
S-2T.....	220 MHz with Tone Pad.....	359.00
S-4.....	440 MHz.....	314.10
S-4-T12.....	440 MHz w/12 Button Tone Pad.....	359.10
S-4-T16.....	440 MHz w/16 Button Tone Pad.....	377.10
S-5.....	2 Meter, 5 watt output.....	273.70
S-5T.....	2 Meter, 5 watt output w/tone pad.....	308.20

Azden PCS-3000 2 Meter	NEW NEW NEW NEW	339.00
Azden PCS 3800 10 Meter		CALL

Cubic/Swan Astro 102BX.....	978.46
Ten-Tec Omni C.....	1044.22
Ten-Tec Omni D.....	795.00
Ten-Tec Hercules 444 Amplifier.....	1323.00

Six Other Ten Tec's Lower Priced—Limited Quantities



Amateur equipment accessories & antennas.  
COD's USA. Export Anywhere.  
Amateur & commercial repair service.

2317 Vance Jackson Rd. San Antonio, TX 78213

(800)531-5405 (512)734-7793 in Texas

F.O.B. ORIGIN

# GOTHAM ANTENNAS

(813) 584-8489

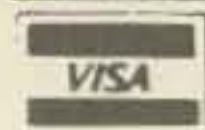

## SMALL LOT TRAP DIPOLES

MODEL	BANDS	LGTH	PRICE
TSL 8040	80,40	78'	\$49.95
TSL 4020	40,20,15	40'	\$47.95

## SMALL LOT SHORTENED DIPOLES

SL-8010	80,40,20,15,10	75'	\$59.95
SL-160	160	130'	\$36.95
SL-80	80	63'	\$35.95
SL-40	40,15	33'	\$34.95

## FULL SIZE PARALLEL DIPOLES

FPD-8010	80,40,20,15,10	130'	\$49.95
FPD-4010	40,20,15,10	63'	\$44.95

## NEW! PORTABLE VERTICAL! IDEAL FOR APARTMENTS, CAMPING, TRAILERS!

Folds to 5' Package. No Radials. Required. Fully Assembled. Full Legal Limit. 1:1 VSWR

MODEL	BANDS	HGHT	PRICE
PV-8010	80-10	13'	\$59.95

## PROVEN DESIGN · GOTHAM ALL BAND VERTICALS

V-160	160,80,40,20,15,10,6	23'	\$39.95
V-80	80,40,20,15,10,6	23'	\$37.95
V-40	40,20,15,10,6	23'	\$35.95

## FAMOUS GOTHAM QUADS

2 Elements — 3 Bands Complete \$119.95

## CHAMPIONSHIP GOTHAM BEAMS

Full Size Complete from \$79.95

CALL OR SEND LARGE SASE FOR CATALOG. Shipping: Dipoles & Verticals \$2.50 USA; \$7.00 Canada; \$5.00 FPO, APO Beams & Quads Shipped UPS or Freight Collect. Fla. add 4% Sales Tax

P.O. Box 776 • Largo, FL 33540

# DXERS... BOOST POWER 10X +



## MODEL SP100

WITH THE FIELD PROVEN SOUND-POWER MODEL SP100 AUDIO SPEECH PROCESSOR (Patent Pending)

Uses new techniques to increase effective talk power over 10X—vastly improve intelligibility—punch through pile-ups using the outer sidebands

Easily installed—15 day money back guarantee if not satisfied—1 year warranty

ONLY \$79.95 add \$3.00 handling and shipping.

Optional AC power supply Model PS9 only \$5.95

Send check or money order or, FOR MORE INFORMATION WRITE  
Soundpower-P.O. Box 426  
17 Clinton Park Dr.  
Bergenfield, N.J. 07621 ✓360

# TRAC



## TRAC\*ONE + DELUXE CMOS KEYSER

# \$119.95

### Features:

Model TE-464

- \* True CW signal reproduction—Single signal reception
- \* Removes all QRM and QRN
- \* Digs out CW signal, decodes it with Phased Lock Loop Tone Decoder then reproduces it with full operator control over Gain, Freq, Tone, Delay.
- \* All controls on front panel
- \* Freq control variable 300 Hz to 2500 Hz will match any rig.
- \* LED flashes during decoder operation
- \* Operates in line with rig audio—leave in line on OFF/BYPASS
- \* Built in speaker
- \* Headphones jack rear panel
- \* Battery or AC-adaptor, 9VDC operation

### PLUS:

- \* Deluxe CMOS Keyer—“State-of-the-art” CMOS circuitry
- \* Self-completing dots and dashes
- \* Both dot and dash memory
- \* Iambic keying with any squeeze paddle
- \* 5-50 w.p.m.
- \* Speed, Volume, Tone, Tune and Weight controls
- \* Sidetone and speaker
- \* Semi-auto switch for bug or straight key
- \* Deluxe quarter-inch jacks for keying and output
- \* Keys grid block or solid state rigs



## TRAC\*ONE CW PROCESSOR

# \$89.95

### Features:

Model TE-242

- \* True CW signal reproduction—Single signal reception
- \* Removes all QRM and QRN
- \* Digs out CW signal, decodes it with Phased Lock Loop Tone Decoder then reproduces it with full operator control over Gain, Freq, Tone, Delay.
- \* All controls on front panel
- \* Freq control variable 300 Hz to 2500 Hz will match any rig.
- \* LED flashes during decoder operation
- \* Operates in line with rig audio—leave in line on OFF/BYPASS
- \* Built-in speaker
- \* Headphones jack rear panel
- \* Battery or AC-adaptor, 9 VDC operation ✓76

SEND FOR BROCHURE ON OUR FULL PRODUCT LINE  
ELECTRONICS, INC.  
1106 RAND BLDG.  
BUFFALO, NY 14203  
(716) 852-8188



# 2300 MHz MICROWAVE DOWNCONVERTERS

## DOWNCONVERTERS

KIT*	35 <sup>00</sup>
ASSEMBLED	65 <sup>00</sup>
<b>2300 MHz PREAMPS</b>	
PREAMP #1	
KIT*	28 <sup>50</sup>
ASSEMBLED	48 <sup>50</sup>
<b>SUPER AMP (Commercial Quality)</b>	
KIT*	48 <sup>50</sup>
ASSEMBLED	68 <sup>50</sup>
<b>POWER SUPPLY KIT*</b>	19 <sup>50</sup>

\*All kits include P.C. board, parts, and detailed instructions.

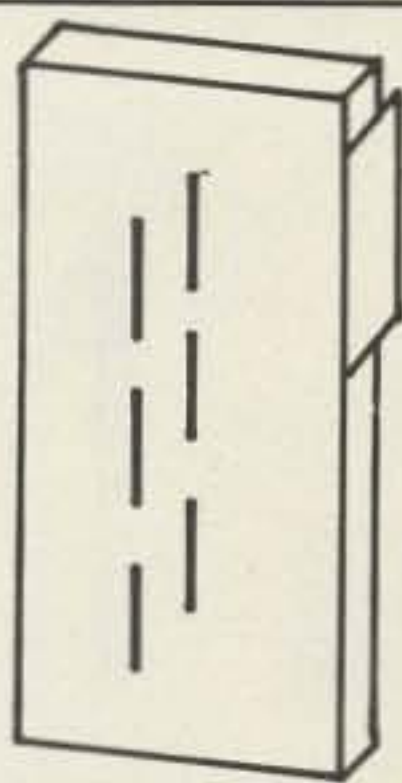

(with box for down converter)

**SLOTTED ARRAY ANTENNA 35<sup>00</sup>**

**ALSO AVAILABLE: COMMERCIAL SYSTEMS,  
BOGNER ANTENNAS, PARABOLIC ANTENNAS,  
MICROWAVE PARTS AND SATELLITE T.V. KITS**

## P.B. Radio Service

1950 E. Park Row • Arlington, TX 76010

Call Order Dept. Toll Free



For Information Call

1-800-433-5169



1-817-460-7071

## ASTRON POWER SUPPLIES

• HEAVY DUTY • HIGH QUALITY • RUGGED • RELIABLE •

### SPECIAL FEATURES

- SOLID STATE ELECTRONICALLY REGULATED
- FOLD-BACK CURRENT LIMITING Protects Power Supply from excessive current & continuous shorted output.
- CROWBAR OVER VOLTAGE PROTECTION on Models RS-7A, RS-12A, RS-20A, RS-35A, RS-20M & RS-35M
- MAINTAIN REGULATION & LOW RIPPLE at low line input Voltage.
- HEAVY DUTY HEAT SINK • CHASSIS MOUNT FUSE
- THREE CONDUCTOR POWER CORD
- ONE YEAR WARRANTY • MADE IN U.S.A.
- VOLT & AMP METER ON MODELS RS-20M & RS-35M

### PERFORMANCE SPECIFICATIONS

- INPUT VOLTAGE: 105 - 125 VAC
- OUTPUT VOLTAGE: 13.8 VDC ±0.05 volts  
(Internally Adjustable: 11-15 VDC)
- RIPPLE: Less than 5mv peak to peak (full load & low line)
- REGULATION: ±0.05 volts no load to full load & low line to high line

Other popular POWER SUPPLIES also available: (Same features and specifications as above)

Model	Continuous Duty (amps)	ICS* (amps)	Size (in.) H x W x D	Shipping Wt. (lbs.)	Price
RS-35M	25	35	5 x 11 x 11	29	\$179.95
RS-35A	25	35	5 x 11 x 11	29	\$159.95
RS-20M	16	20	5 x 9 x 10½	20	\$124.95
RS-20A	16	20	5 x 9 x 10½	20	\$104.95
RS-12M	9	12	4½ x 8 x 9	13	\$ 99.95
RS-12A	9	12	4½ x 8 x 9	13	\$ 79.95
RS-7A	5	7	3¾ x 6½ x 9	10	\$ 59.95
RS-4A	3	4	3¾ x 6½ x 9	5	\$ 43.95

\*ICS — Intermittent Communication Service (50% Duty Cycle)  
If not available at your local dealer, please contact us directly.



ASTRON 20 AMP REGULATED POWER SUPPLY Model RS-20M

16 Amps continuous  
20 Amps ICS\*  
5" (H) x 9" (W) x 10.5" (D)  
Shipping Weight 20 lbs.  
Price ..... \$117.95



Inside View — RS-12A

**ASTRON CORPORATION**

2852 Walnut Unit E  
Tustin, CA 92680  
(714) 832-7770

✓358

Code reading  
makes ham radio  
more fun!



## Field Day 2

A code reader can add to the fun of ham radio by allowing you to copy many signals that are too complex or too fast to decode by ear.

You can get in on such things as news-wire service transmissions, weather information and financial reports that are sent by radioteletype (RTTY), ASCII computer language or Morse code.

Some code readers only copy one or two types of signals, but the **Kantronics Field Day 2™** allows you to copy RTTY at 60, 67, 75 and 100 WPM, ASCII at 110 and 300 (if sent as it is typed) Baud and Morse at 3 to 80 WPM.

The **Field Day 2** even has an editing program to improve sloppy Morse. You get more of the message and fewer illegal character signs than with other code readers. With a **Field Day 2** you also get a 24-hour clock, code speed display and TTL compatible demodulator output.

The **Field Day 2** is a complete unit in one package with a large, easy-to-read, 10-character display and is backed with a full-year limited warranty.

Code reading makes ham radio more fun, and now you can get started with one compact, versatile unit, at \$449.95, suggested price, the **Field Day 2**.

Call or visit your Authorized Kantronics Dealer for a demonstration!

**Kantronics**

(913) 842-7745  
1202 E. 23rd Street  
Lawrence, Kansas 66044



## 10 METER RIG? CB BOARD

Hygain 40 channel CB board, with PLL IC, 9W amp w/heat sink, RF & modulator xistors, lots more! A few connections and alterations makes a 10 meter rig (as described in a 73 Mag series). With typical schematics. 12 oz., #D1KS0007. . . \$9.88 each!

## ASC11 ENCODED KEYBOARD

Sanders 720 surplus keyboard, with parallel output. This nice unit has been written up for projects numerous times in 73 and other computer mag's. Sh. Wt. 5 Lbs. . . #1A30126 . . . \$39.95 ea.

LOTS MORE SURPLUS COMPUTER PERIPHERAL EQUIPMENT AVAILABLE! CIRCLE READER SERVICE FOR OUR CATALOG

Terms: Add Postage. MC / VISA / AE Welcome! Phone orders welcome on credit card orders!

✓402

## FREE GIANT CATALOG of ELECTRONIC BARGAINS

SPEAKER KITS/COMPUTER MAT'L/KITS/GADGETS TOOLS/POWER SUPPLIES/SEMI'S/TRANSFORMERS 1,000's of Electronic Parts! Use Reader Service Card!

## BNF Enterprises

119 Foster St. Peabody, MA. 01960 (617) 531-5774

## COAXIAL CABLE SALE

### POLYETHYLENE DIELECTRIC

RG213 noncontaminating 95% shield mil spec. 35¢/ft.  
RG11AU 75 ohms 97% shield mil spec. 27¢/ft.  
RG62U 93 ohms. 10¢/ft.  
RG8U 80% shield. 18¢/ft.  
RG58U 80% shield. 08¢/ft.

### LOW LOSS FOAM DIELECTRIC

RG-8X (mini 8) 95% shield. Blue Jacket 22¢/ft.  
RG8U 97% shield white jacket. 29¢/ft.  
RG58U 95% shield. 10¢/ft.  
RG58AU stranded center 80% shield. 11¢/ft.

Rotor cable 2-18ga 6-22ga. 19¢/ft.  
\* Cable—shipping \$2.50 1st 100 ft., \$2.00 each add'l 100 ft.

### CONNECTORS

PL-259 push-on adapter shell. 10/\$3.89  
PL-259 & SO-239. 10/\$5.89  
Double Male Connector. \$1.79  
1 ft. patch cord w/RCA type plugs each end. 3/\$1.00  
Reducer UG-175 or 176. 10/\$1.89  
UHF T (M358). \$2.59  
Elbow (M359). \$1.79  
F59A (TV type). 10/\$1.99

Connectors—shipping 10% add'l, \$1.25 minimum

FREE CATALOG—VISA/MASTER CHARGE—C.O.D. ADD \$1.50—FLA. RES. ADD 4%

✓412

## NEMAL ELECTRONICS

5685 S.W. 80th ST., DEPT. RLO, MIAMI, FLORIDA 33143  
TELEPHONE (305) 681-5534

## Enjoy Satellite TV Now



Better than Cable TV—Over 200 TV and radio services. Why waste money? Learn the whole story and build a video system the family can enjoy. No commercials. FREE movies, sports and Vegas shows—worldwide, crystal clear reception connects to any TV set. Big (8 x 11 in.) book loaded with details, photos, plans, kits—TELLS EVERYTHING! Satisfaction Guaranteed.

Send \$7.95 TODAY! Add \$2.00 for 1st class (air mail) or call our 24 hour C.O.D. rush order line (305) 862-5068.

GLOBAL ELECTRONICS, P.O. Box 219-H, Maitland, Florida 32751

## S-LINE OWNERS ENHANCE YOUR INVESTMENT

### with TUBESTERS™

Plug-in, solid state tube replacements

- S-line performance—solid state!
- Heat dissipation reduced 60%
- Goodbye hard-to-find tubes
- Unlimited equipment life

TUBESTERS cost less than two tubes, and are guaranteed for so long as you own your S-line.

✓433

## SKYTEC

Box 535  
Talmage, CA 95481

Write or phone for specs and prices.  
(707) 462-6882

## RED HOT SPECIALS!!

Icom IC2A Handheld	215.00
with Touchtone Pad	235.00
Icom IC720A XCVR	1199.00
Icom IC730 XCVR	699.00
Icom IC255A W/TTMIKE	325.00
Icom 551D 80W 6M	599.00
Icom 2KL Linear Amp	1599.00
Icom IC260 2m All Mode	415.00
Azden PCS 3000 2m	315.00
Janel QSA 5 Preamp	36.50
Bearcat 220 Scanner	269.00
Kantronics FDII Code Reader	360.00
Santec HT1200 Handheld	315.00

Price subject to change without notice.  
SASE for other RED HOT SPECIALS, new and used.

## Ben Franklin Electronics

115½ N Main Hillsboro KS 67063  
316-947-2269

✓439

## FREE CATALOG



### NEW! CATALOG OF HARD-TO-FIND PRECISION TOOLS

✓354

Also contains test equipment plus wide selection of tool kits and cases

Jensen's new catalog is jam-packed with more than 2000 quality items. Your single source for hard-to-find precision tools and tool kits used by electronic technicians, scientists, engineers, instrument mechanics, schools, laboratories and government agencies. Send for your free copy today!



JENSEN TOOLS INC.

1230 S PRIEST DR. TEMPE, AZ 85281

## Satellite TV

### FOR THE HOME

### Sick of Network TV?

Our receiver lets you get over 75 channels of television directly from earth-orbiting cable TV satellites: HBO, Showtime, super stations, sports and movies worldwide.



### We don't just sell information! We Manufacture Hardware!

From offshore oil rigs, data links to hotels and backyard installations, we wrote the book. Constantly updated, our 94 Page technical information book and catalog gives you all the facts. Inexpensive dishes, feeds, telemetry software, kits and more. Recommended reading by NASA, The Office of Consumer Affairs and quality companies like Rockwell/Collins. Send \$7.95 today!

CALL ✓309

24-hr. C.O.D. Hotline  
(305) 339-7600

## SPACECOAST

RESEARCH CORPORATION

P.O. Box 442-D, Altamonte Spgs, FL 32701



## BRIGHT FREQ COUNTERS



A500 229.00 (INCL. ANTENNA & AC SUPPLY)

- VOICE FREQUENCY ANNUNCIATION AVAILABLE
- MEASURE ALL BANDS
- USE WITH ANY TRANSMITTER
- HIGH ACCURACY 10MHz TIME BASE
- FULLY TESTED & CALIBRATED

The A500 series counters are a real must for all hamshacks. Because the bands are crowded, gud ops must know precisely their frequency. BRIGHT counters give fast and accurate read outs. Ask about the BRIGHT 1.1 GHz and commercial models.

TO ORDER CALL 404-952-0968

BRIGHT ELECTRONICS

TERMS: We gladly accept MC, VISA, AMEX and C.O.D. All orders over \$100 add \$7.50 shipping handling and insurance. Delivery dates given when order is placed.

P.O. Box 76972 • Atlanta Georgia 30326

We repair DSI counters Write for free info package ✓428

## YAESU FT-207R OWNERS

AUTO SCAN MODULE AND BATTERY SAVER KIT



15 minutes to install; scan restarts when carrier drops off; busy switch controls automatic scan on-off; includes module and instructions.

Model AS-i. \$25.00

new

FT-207R BATTERY SAVER KIT MODEL BS-1 \$14.95

- \* No more dead batteries due to memory backup
- \* 30% less power drain when squelched
- \* Simple to install; step-by-step instructions and parts included
- \* 4 mA memory backup reduced to 500 uA.
- \* 45 mA receiver drain reduced to 30 mA.
- \* Improved audio fidelity and loudness

## ENGINEERING CONSULTING

P. O. BOX 94355

✓400

RICHMOND, B. C. V6Y2A8, CANADA

# GILFER SHORTWAVE

## GILFER Custom Yaesu FRG-7700



All the features for less. Covers from 0.15 to 29.999 MHz with PLL synthesized up-conversion circuitry — crystal lattice filter 48 MHz first IF. 12-channel memory. Dual readouts. Clock and timer. RF attenuator. Noise blanker. GILFER selectivity of 2.4, 4.0 and 6.0 kHz (at -6 dB). Receives AM, USB, LSB, CW, NBFM with 0.5  $\mu$ V sensitivity. 100/117/200/230 VAC, 12 VDC.

\$725+shipping

New Catalog—25¢



North America's Shortwave Mail Order Place

- Receivers ■ Converters
- Antennas ■ Preselectors
- Clocks ■ Filters ■ Lists
- World Radio TV Handbook

**GILFER SHORTWAVE**  
Dept. 736 Box 239  
Park Ridge, NJ 07656



## Check your signal.

**BLACKCAT Monitor Scope \$209.95 ppd.**

**Blackcat JB-4001S**—for continuous monitoring of your transmitting quality at low cost.

**The dedicated monitor.** Leave it in the line and you'll always know what's happening with your rig. Operates from 160-10 meters.

**Versatile.** With familiarity you'll be able to interpret the scope patterns to determine power output, distortion, audio noise, ALC action, carrier suppression, SWR effects, linearity, spurious signals, flat topping, plus AM modulation characteristics. Provides

both sine and trapezoid patterns. Built-in audio generator for modulation and transmitter testing purposes.

**3" green phosphor scope tube** with printed reference graticule (useful for calculating percentages). Black vinyl-clad steel case with black anodized aluminum panel with white nomenclature. Size: 10½"W x 6¼"H x 11½"D.

### 2 KW Coax Antenna Switch



4-positions (three for ants. & dummy load, fourth for receive only). Coax connectors, black case with white nomenclature measures 3-7/16"H x 4-3/32"W x 4"D.

Model JB-1007SW, only \$24.95 ppd.



**WAWASEE ELECTRONICS** ✓ 398  
Dept. 751 Box 36, Syracuse, IN 46567  
Phone: 219/457-3191

Enclosed is \$ \_\_\_\_\_ (UPS shipping prepaid)  
(No CODs. Indiana res. add 4% sales tax.)  
Please send Model(s) \_\_\_\_\_

Charge It:  Visa  Mastercard  
Exp. Date: \_\_\_\_\_ Card No. \_\_\_\_\_

Name \_\_\_\_\_ (please print)

Address \_\_\_\_\_

City \_\_\_\_\_

State \_\_\_\_\_

Zip \_\_\_\_\_

## DUPLEXERS



US PATENT  
4080601

✓ 79

OUR NEW BANDPASS-REJECT DUPLEXERS WITH OUR EXCLUSIVE

### BpBr CIRCUIT\*

... provides superior performance, especially at close frequency spacing.

Models available for all Ham bands. Special price for Amateur Repeater Clubs

CALL OR WRITE FOR DETAILS:

**WACOM PRODUCTS, INC.**



P. O. Box 7127  
Waco, Texas 76710  
817/848-4435

✓ 79

## RTTY/CW FOR THE TRS-80\*

### ROM-116

RTTY/CW Operating System

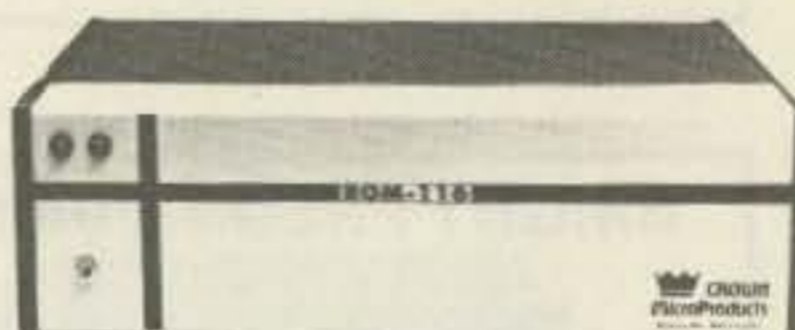

#### FEATURING:

- ASCII-BAUDOT-CW
- SPLIT-SCREEN VIDEO
- REAL TIME CLOCK

#### PLUS:

- Word-wrapping
- Two serial ports  
45.45 to 9600 Baud



**CROWN**  
**MicroProducts**

P O Box 892  
Marysville, Washington 98270  
(206) 659-4279

- Serial ports use USARTS
- Automatic CW/ID
- Program status  
continuously displayed
- Instantly change:  
program status  
Baud rates  
ASCII/Baudot modes
- Transmitter under  
program control
- Self tracking CW speed
- LLIST & LPRINT usable  
on any serial printer
- All software easily  
transferred to disk
- Requires LEVEL II 16K RAM  
Model I or Model III,  
external terminal unit
- Includes pc board, cabinet,  
software & manual
- Unconditionally guaranteed  
for 30 days
- Limited parts & labor  
warranty for 90 days
- ASSEMBLED & TESTED \$325  
Washington residents add 5.3% sales tax

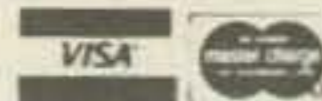

\*A Trademark of the Tandy Corp



## Human Ingenuity vs. Human Aging

Human ingenuity will either affect the aging process or not.

At home, participate in our studies of the chemistry of human aging. For example, which cosmetics, foods, vitamins, etc. are best for your own unique body chemistry? A specific photographic record of a person's physical changes compared with their diet etc. might be useful if coordinated by us. If thoughtful people voluntarily devote themselves to these and other studies we have planned, as part of a systematic hobby at home, we might discover many things sooner than otherwise.

With dedication, the results of your home investigations, sent to us for evaluation and safekeeping, may prove valuable to all mankind.

For further details, send a self-addressed stamped envelope to:

The Exact Chemical Institute  
Home Science Experiments®  
11759 San Vicente Blvd.  
Los Angeles, California 90049  
The United States of America  
Copyright 1981. Edward G. Ampere

✓ 446

**LOWEST POSSIBLE PRICES  
BEST POSSIBLE WARRANTY**



model III 16K

**\$859**

color  
computer 4K

**\$310**



✓ 444 call TOLL FREE 1-800-343-8124

**computer  
plus**

245A Great Road  
Littleton, MA 01460  
617 • 486 • 3193

Write for your  
free catalog.

TRS-80 is a registered trademark of Tandy Corp.

# PILOTS



Build your own aircraft radios.

✓ 381 FREE CATALOG.

OUT OF STATE? CALL TOLL FREE.

800  
824-5978  
OTHERWISE  
916  
272-2203

**Radio Systems  
Technology, Inc.**

10985-G GRASS VALLEY AVE.  
GRASS VALLEY, CA 95945

## HEAVY DUTY ROOF TOWER

OUR 10' & 15' HEAVY-DUTY ROOF TOWERS HAVE BEEN DESIGNED FOR AMATEUR & COMMUNICATION ANTENNAS

— UPS SHIPPABLE! —

- Accommodates masts up to 1 3/4"
- Complete with all hardware
- Includes integral ladder
- 90% Pre-assembled
- Easily assembled
- Heavy duty

MODEL	HEIGHT	LIST	NET
HDT-120	10'	\$69.95	\$49.95
HDT-180	15'	\$95.95	\$74.95

Let us show you how to obtain 30' to 55' of antenna height for \$2.00 per foot without sacrificing quality or mechanical stability.

Call, write or ✓ for additional information.

**DATA SERVICE COMPANY**  
3110 EVELYN STREET ✓ 346  
ROSEVILLE, MN 55113  
612-636-9469



## DIRECTION FINDING?



**New Technology** (patent pending) converts any VHF FM receiver into a modern Doppler Radio Direction Finder. **No receiver mods required.** See June 1981 issue of 73 for technical description. Kits available from \$235. Write for full details and prices.



✓ 425  
**DOPPLER SYSTEMS**  
111 E. Moon Valley Drive  
Phoenix, Arizona 85022

## UPGRADE SUCCESSFULLY!

— PASS THE FCC EXAM —

### ANNOUNCING

the New 1981

LICENSE THEORY REVIEWS

FOR THE

TRS-80 16K Computer

- 12 Programs Per License Class
- Each Comprehensive Package Totals 98,000 Bytes.
- General, Advanced or Extra.

**\$19.95** or **\$39.95**  
each or for all 3 ✓ 383

μ80™

**MICRO-80™ INC.**  
S-2665 No. Busby Road  
Oak Harbor, WA 98277

## Subscription Problem?

73 Magazine does not keep subscription records on the premises, therefore calling us only adds time and doesn't solve the problem.

Please send a description of the problem and your most recent address label to:

73 Magazine  
Subscription Dept.  
PO Box 931  
Farmingdale, NY 11737

Thank you and enjoy your subscription.

## 2 Meter Avanti Mobile Antenna.

Mounts on glass — no holes!

- Receives and transmits through glass.
- Superior performance
- Superior radiation, true Omni-Directional pattern

Mounting on glass is easy and effective using new Duo-Bond method which combines quick "drive away" with rugged durability. No holes to drill, no magnet to scratch paint, no clamps. Takes only minutes to install, without tools. No ground plane required. Electrical connections are inside and out of sight to prevent crimping or corroding coaxial cable.

Models also available for 30-50 MHz, 220 MHz and 450 MHz

**avanti antennas**

"Helping the World Communicate"



2317 Vance Jackson Rd. San Antonio, TX 78213  
(800)531-5405 (512)734-7783 in Texas

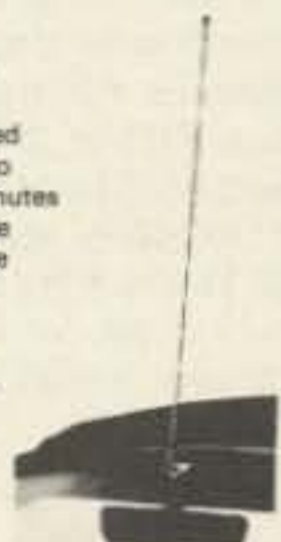
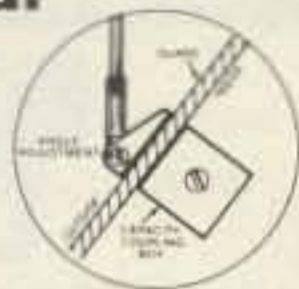

OUR NAME SAYS IT ALL!

## Amateur Accessories

The new and ACTIVE dealer in Richmond/Tidewater for quality Amateur Radio products you know and trust:

MFJ	NYE VIKING
HYGAIN/TELEX	VAN GORDEN
VOCOM	ASTRON POWER SUPPLIES
AZDEN (new PCS 3000)	ALLIANCE
BENCHER	MINI PRODUCTS
HAM KEY	AKIGAWA METERS
PALOMAR	B&W

Watch us add more lines in the near future!

CALL or WRITE for our price on:

KEYERS & PADDLES	COAX SWITCHES
HEADPHONES	ROTATORS
MICROPHONES	SPEECH PROCESSORS
TUNERS	PHONE PATCHES
2M RIGS & AMPLIFIERS	CW/SSB FILTERS
ANTENNAS—HF, VHF	MORE—NOW & FUTURE

We look forward to quoting your needs. Ask about delivery to the Richmond/Tidewater areas!

13817 BARNES SPRING ROAD  
MIDLOTHIAN, VIRGINIA 23113  
(804) 744-3861

✓ 429



## PRO-25 MICROWAVE ANTENNAS 2.0-3.0 Ghz

### FEATURES:

- Precision 25" parabolic reflector
- Seamless aluminum feed-horn
- Sturdy "spyder" mount
- All metal construction
- Easy assembly
- Superior gain

Only Data Service Co. antennas offer the superior mechanical and electrical performance of antennas manufactured to commercial standards at a residential price!

Call, write or ✓ for our data sheets.

AMPEX T-120 and L-500 VTR tapes in stock.



✓346

Data Service Company  
3110 Evelyn Street  
Roseville, MN 55113  
612-636-9469

## THE BRAKE LITTLE GIANT

BEND & FORM  
.060 ALUM.  
& STEEL!



EASY TO USE!  
BUILD CUSTOM CABINETS YOU'LL BE PROUD OF! COMMERCIAL QUALITY at 1/10 THE COST!!

**GUARANTEED!** clamps not incl.  
NO COD OR CREDIT CARDS.  
ALL ORDERS IN US FUNDS.  
ALL FOREIGN ORDERS ADD  
\$5.50 SHIPPING IN ADDITION  
TO P&H. ✓336

**21<sup>95</sup>**

**Z ASSOCIATES +2<sup>00</sup>  
P&H**  
P O BOX 757  
3050 NE 55 TH AVE.  
SILVER SPRINGS, FLA. 32688

## INOTEK ENGINEERING PRESENTS: RTTY!

✓414

GOT THOSE METER TUNING BLUES??

NOW YOU CAN SEE WHETHER THAT SIGNAL HAS DRIFTED, AND WHICH WAY. BRIGHT, SOLID STATE LED ARRAY. INSTANTLY IDENTIFIES 170HZ, 425HZ, AND 850HZ SHIFTS. REQUIRES ONLY +5 AND ±12 VOLT REGULATED POWER SUPPLY. JUST ANOTHER "SIMPLE" RTTY PROJECT  
**"SIMPLE RTTY TUNER"**

drilled p.c. board with documentation - \$13.95  
complete kit \$60.00

P.O. Box 110  
Spanish Fork  
Ut. 84660

**ONLY:  
\$69.95**  
assembled and aligned

## CB TO 10 METER 10 METER CONVERSION KITS FOR MOST C.B. MODELS

- Kits for over 300 Models of CB Radios
- Low Cost from \$10.00  
Easy to Install with All Instructions  
Tune-Up Procedure Alignment
- KITS FOR MOST POPULAR UNITS  
Over 5,000 Satisfied Customers
- Write or Call Today for Our Free  
10 meter catalog

### AMERICAN CRYSTAL SUPPLY COMPANY

PO Box 638  
W Yarmouth, MA 02673  
(617) 771-4634 ✓7

## QUALITY MICROWAVE SYSTEMS

2100 TO 2600 MHz ANTENNAS  
MINIMUM 24 db GAIN OR GREATER

Complete System as pictured (6 month warranty)	\$199.95
PC board, assembled and tested	\$79.95
Power Supply, assembled & tested	\$69.95
PC board with parts, unassembled	\$59.95
Data Information (plans)	\$9.95

Send cash, check or money order to:

### Phillips-Tech Electronics

Dept. SP-73 ✓421  
5025 N. 68th St.  
Scottsdale,  
Arizona 85253

For special quantity pricing, C.O.D.'s, Mastercharge, and VISA call:  
(602)  
945-7419



## SYNTHESIZED SIGNAL GENERATOR

made in U.S.A. model SG-100C \$329.95



- Covers 100 to 179.999 MHz in 1 kHz steps with thumb-wheel dial
- Accuracy .00001% at all frequencies
- Internal frequency modulation from 0 to over 100 kHz at a 1 kHz rate
- Spurs and noise at least 60dB below carrier
- RF output adjustable from 5 to 500mv across 50 ohms
- Operates on 12vdc @ 1/2 amp • Price \$329.95 plus shipping.

In stock for immediate shipping. Overnight delivery available at extra cost. Phone: (212) 468-2720. ✓311

**VANGUARD LABS**  
196-23 Jamacia Ave. Hollis, NY 11423



## BE HEARD! WITH THESE LOW-COST 2-METER AMPLIFIERS.

Anyone who can operate a 2-meter rig can assemble these low cost amplifiers. Our detailed, step-by-step instructions allow you to build these 2-meter kits without an SWR bridge, wattmeter or other type of equipment.

**Model 225** Designed to allow any 2-meter, hand-held FM transceiver, with an output of 350 milliwatts or more, to produce an output of 25 watts. Input BNC connector allows your hand-held to be connected and disconnected easily.

**Model 335** Operate up to 35 watts on FM with an input of only 3 watts. Also operates with less power: 2 watts yields 30 watts, and 1 watt yields 15 watts. Current drain of 4-5 amps @ 13.6 VDC.

**Model 875** Full 75 watts on FM or SSB with 10 watts input. **Model KEB 430 MHz 100 Watt Linear Amplifier** This high power kit is designed for ATV, SSB or FM operation in the 420 to 450 MHz band.

Write or call for our latest brochure. ✓435

### Communication Concepts Inc.

2648 North Aragon Avenue • Dayton, Ohio 45420 • (513) 296-1411

## MICROWAVE DOWNCONVERTER RX-2300

SPECIAL INTRODUCTORY OFFER — \$140

- Quality metal enclosure w/hardware
- Fully assembled, NOT a kit!
- Temperature compensated
- Low noise preamplifier
- 90-day warranty

The RX-2300 downconverter is a state-of-the-art microwave converter that converts 1900 - 2700 Mhz microwave signals down to VHF. It is especially suited for line-of-sight reception of amateur and TV transmissions and will drive either a VHF receiver or a standard television.

Call, write or ✓ for additional data.

### ✓430 TEM MICROWAVE CORP.

22518 - 97th Avenue North, Route 1  
Corcoran, MN 55374  
612-498-8014

## 2300 MHZ Antenna



This antenna is for your 2300 MHZ down converter. Design gain of up to 20DB. Some assembly required. Variable voltage, 150MA power supply for down converters, 8V-15V.

	PRICE	SHIP. & HNDL.
2300 MHZ antenna only	45.00	5.00
Power supply kit	35.00	2.00
Power supply PC board only	5.00	PPD
2300 MHZ PC Board w/Data	15.00	PPD

Complete system: 230 MHZ convertor, antenna, power supply, 18" coax, 50' coax. Ready to hook up and turn on. \$225.00 PLUS \$5.00 shipping.

No C.O.D. Cash only in money order or cashier check

H.M. GOODWIN W5EEY  
11421 FERNALD AVE.  
DALLAS, TX 75218 ✓393

# Why use their flexible discs:

Ampex, Athana, BASF, Caelus, Control Data, Dyan, IBM, Inmac, K-Line, Maxell, Nashua, Scotch, Shugart, Syncom, 3M, Verbatim or Wabash

when you could be using

# MEMOREX

for as low as \$1.99 each?

Find the flexible disc you're now using on our cross reference list... then write down the equivalent Memorex part number you should be ordering.

Product Family	Product Description	Memorex Part Number (3201-1)	CE quant. 100 price per disc(\$)	Ampex	Athana	BASF	Caelus	Dyan	IBM	K-Line	Maxell	Nashua	Scotch 3M	Shugart	Syncom	Verbatim	Wabash	Inmac	Control Data
Flexible Disc 1/2	IBM Compatible (128 B/S, 28 sectors)	3080	2.19	SFD-111110	473071	53428	CM-F11	800506	3305830	40013	FD1-128	FD-1	780-0	S/A-100	15003	FD34-1000	F111111X	7870-K	421603
	IBM Compatible (128 B/S, 28 sectors) w/ W.P.N.	3062	2.24	--	--	--	--	--	--	--	--	--	780-0	--	--	--	--	--	--
	IBM Compatible (128 B/S, 28 sectors) w/ W.P.N. & Hub Ring	3064	2.55	--	--	--	--	--	--	--	--	--	--	--	--	--	--	--	--
	IBM Compatible (128 B/S, 28 sectors) REVERSIBLE	1729	3.35	SFD-112110	473072	54431	--	--	--	40015	--	FD-2	740-2-D	--	15155	FD34-2000	F121111X	7880-K	--
	IBM System 8 Compatible	3066	2.19	--	473077	54561	--	800509	1669999	40014	--	--	740-0-006	--	15003	FD60-1000	F118111X	--	--
	IBM Compatible (256 B/S, 19 sectors)	3109	2.19	SFD-111210	473073	--	--	800584	2305849	40040	--	--	740-3600	--	15005	FD36-1000	F121111X	7961-K	--
	IBM Compatible (512 B/S, 8 sectors)	3110	2.19	--	473074	--	--	800585	1669994	40044	--	--	--	--	15004	FD60-1000	F113111X	7889-K	--
	Shugart Compatible, 32 hard sector	3015	2.19	SFD-211010	475901	53809	CM-F21	10111	--	40018	FH1-32	FD-132	740-32	S/A-101	19029	FD32-1000	--	7890-K	421322
	Shugart Compatible, 32 hard sector REVERSIBLE	3025	3.35	SFD-213010	--	--	--	--	--	40017	--	--	740-0-32	--	15151	FD32-2000	--	7880-K	--
	Wang Compatible, 32 hard sector w/Hub Ring	3067	2.50	--	--	54891	--	--	--	--	--	--	740-32RM	--	--	--	F37A411X	--	--
CPT 8000 Compatible	3045	2.79	--	--	--	--	--	--	--	--	--	--	--	15228	--	--	--	--	
Flexible Disc 1/4	IBM Compatible (128 B/S, 28 sectors)	3090	2.95	SFD-121010	474071	54888	--	3740110	--	40041	FD1-128/M2100	FD-10	741-0	--	--	FD34-8000	F131111X	7887-K	423001
	Soft Sector (128 B/S, 28 sectors) REVERSIBLE	3093	3.99	--	--	--	--	--	--	--	--	--	--	--	--	--	--	--	--
	Shugart Compatible, 32 hard sector	3091	2.95	SFD-221010	476001	54896	--	101110	--	40024	FH1-32D	--	741-32	S/A-103	15079	FD32-8000	F33A410X	7887-K	423322
	Shugart Compatible, 32 hard sector REVERSIBLE	3094	3.99	--	--	--	--	--	--	--	--	--	--	--	--	--	--	--	--
Wang Compatible, 32 hard sector w/Hub Ring	3098	3.20	--	--	--	--	--	--	--	--	--	--	--	--	--	--	F22A411X	--	
Flexible Disc 5/8	Soft Sector (Unformatted)	3101	3.84	--	--	--	--	--	--	--	--	--	--	--	--	--	--	--	--
	Soft Sector (128 B/S, 28 sectors)	3113	3.84	--	--	54426	--	800614	1766870	--	--	--	--	S/A-150	15153	FD10-4026	F121111X	--	--
	Soft Sector (256 B/S, 15 sectors)	3106	3.84	--	473477	54328	--	800615	2736700	40043	FD2-256D	--	742-0	--	15154	FD10-4015	F122111X	7886-K	424612
	32 Hard Sector	3108	3.84	--	--	--	--	--	--	--	FH2-32	--	--	--	--	--	--	--	--
Flexible Disc 3/4	Soft Sector (Unformatted)	3102	3.49	--	473485	--	--	07110	--	40038	FD2-256M	FD-20	743-0	--	15103	FD34-4001	--	--	425002
	Soft Sector (128 B/S, 28 sectors)	3115	3.49	--	--	--	--	--	--	--	--	--	S/A-150	--	--	--	--	--	--
	Soft Sector (256 B/S, 15 sectors)	3103	3.49	--	473471	54326	--	800817	1766872	40038	FD2-256D	--	743-0-256	--	15101	FD34-4026	F144111X	7886-K	429802
	Soft Sector (512 B/S, 15 sectors)	3114	3.49	--	473472	54479	--	800818	1689044	40039	--	--	743-0-512	--	15100	FD34-4015	F145111X	--	429812
	Soft Sector (1024 B/S, 8 sectors)	3104	3.49	--	473473	54455	--	800819	1689045	40020	--	--	743-0-1024	--	15102	FD34-4008	F147111X	7889-K	425622
	32 Hard Sector	3105	3.49	SFD-321010	476051	--	--	101120	--	40021	FH2-32D	--	743-32	S/A-151	15125	FD32-4000	F34A411X	7881-K	425322
	Burnough 8-80 Compatible 32 Hard Sector	3092	3.49	--	--	--	--	--	--	--	--	--	--	--	--	--	F3AA411X	--	--
	Soft Sector (1024 B/S, 8 sectors) w/Hub Ring	3116	3.75	--	--	--	--	--	--	--	--	--	--	--	--	--	--	--	--
Flexible Disc 8D	Memorex 851 or Equiv. Discs Compatible	30112003	2.95	--	476881	--	CM-F31	FD30	--	40032	--	FD-165	811-0	--	15028	FD65-1000	F81A111X	7910	--
Mini Flexible Disc 1/2	Soft Sector (Unformatted)	3421	1.99	--	475021	54258	--	10411	--	40030	MD1	MD-1	744-0	S/A-104	15300	MD525-01	M11A211X	7897	441302
	10 Hard Sector	3403	1.99	--	475010	54257	--	10711	--	40001	--	MD-110	744-10	S/A-107	15305	MD525-10	M41A211X	7898	441102
	16 Hard Sector	3405	1.99	--	475016	54258	--	10511	--	40503	MH1	MD-116	744-16	S/A-105	15308	MD525-16	M51A211X	7899	441162
	Soft Sector (Unformatted) W/Hub Ring	3431	2.19	--	--	--	--	--	--	--	--	--	--	--	--	--	MD525-01	--	--
	10 Hard Sector, w/Hub Ring	3433	2.19	--	--	--	--	--	--	--	--	--	--	--	--	--	MD525-10	--	--
16 Hard Sector, w/Hub Ring	3435	2.19	--	--	--	--	--	--	--	--	--	--	--	--	--	MD525-16	--	--	
Mini Flexible Disc 1/4	Soft Sector	3417	2.24	--	--	54848	--	10410	--	--	--	--	--	--	--	--	MD540-01	--	--
	10 Hard Sector	3418	2.24	--	--	54849	--	10510	--	--	--	--	--	--	--	--	MD540-10	--	--
	16 Hard Sector	3419	2.24	--	--	54850	--	10510	--	--	--	--	--	--	--	--	MD540-16	--	--
Mini Flexible Disc 5/8	Soft Sector	3421	2.74	--	--	54824	--	10410	--	--	MD2-D	--	745-0	S/A-154	--	--	MD550-01	--	--
	10 Hard Sector	3423	2.74	--	--	54827	--	10710	--	--	--	--	745-10	S/A-157	--	--	MD550-10	--	--
	16 Hard Sector	3425	2.74	--	--	54830	--	10510	--	--	MH2-D	--	745-16	S/A-155	--	--	MD550-16	--	--

## Memorex Flexible Discs...The Ultimate in Memory Excellence

**Quality**  
Memorex means quality products that you can depend on. Quality control at Memorex means starting with the best materials available. Continual surveillance throughout the entire manufacturing process. The benefit of Memorex's years of experience in magnetic media production, resulting, for instance, in proprietary coating formulations. The most sophisticated testing procedures you'll find anywhere in the business.

**100 Percent Error Free**  
Each and every Memorex Flexible Disc is certified to be 100 percent error free. Each track of each flexible disc is tested, individually, to Memorex's stringent standards of excellence. They test signal amplitude, resolution, low-pass modulation, overwrite, missing pulse error and extra pulse error. They are torque-tested, and competitively tested on drives available from almost every major drive manufacturer in the industry including drives that Memorex manufactures. Rigid quality audits are built into every step of the manufacturing process and stringent testing result in a standard of excellence that assures you, our customer, of a quality product designed for increased data reliability and consistent top performance.

**Customer-Oriented Packaging**  
Memorex's commitment to excellence does not stop with a quality product. They are proud of their flexible discs and they package them with pride. Both their packaging and their labeling have been designed with your ease of identification and use in mind. The desk-top box containing ten discs is convenient for filing and storage. Both box labels and jacket labels provide full information on compatibility, density, sectoring, and record length. Envelopes with multi-language care and handling instructions and color-coded removable labels are included. A write-protect feature is available to provide data security.

**Full One Year Warranty -- Your Assurance of Quality**  
Memorex Flexible Discs will be replaced free of charge by Memorex if they are found to be defective in materials or workmanship within one year of the date of purchase. Other than replacement, Memorex will not be responsible for any damages or losses (including consequential damages) caused by the use of Memorex Flexible Discs.

### Quantity Discounts Available

Memorex Flexible Discs are packed 10 discs to a carton and 10 cartons to a case. Please order only in increments of 100 units for quantity 100 pricing. We are also willing to accommodate your smaller orders. Quantities less than 100 units are available in increments of 10 units at a 10% surcharge. **Quantity discounts** are also available. Order 500 or more discs at the same time and deduct 1%; 1,000 or more saves you 2%; 2,000 or more saves you 3%; 5,000 or more saves you 5%; 10,000 or more saves you 7%; 25,000 or more saves you 8%; 50,000 or more saves you 9% and 100,000 or more discs earns you a 10% discount off our super low quantity 100 price. Almost all Memorex Flexible Discs are immediately available from CE. Our warehouse facilities are equipped to help us get you the quality product you need, when you need it. If you need further assistance to find the flexible disc that's right for you, call the Memorex compatibility hotline. Dial 800-538-8080 and ask for the *flexible disc hotline* extension 0997. In California dial 800-672-3525 extension 0997.

**Buy with Confidence**  
To get the fastest delivery from CE of your Memorex Flexible Discs, send or phone your order directly to our Computer Products Division. Be sure to calculate your price using the CE prices in this ad. Michigan residents please add 4% sales tax. Written purchase orders are accepted from approved government agencies and most well rated firms at a 10% surcharge for net 10 billing. All sales are subject to availability. All sales are final. Prices, terms and specifications are subject to change without notice. Out of stock items will be placed on backorder automatically unless CE is instructed differently. International orders are invited with a \$20.00 surcharge for special handling in addition to shipping charges. All shipments are F.O.B. Ann Arbor, Michigan. No COD's please. Non-certified and foreign checks require bank clearance.

Mail orders to: **Communications Electronics**, Box 1002, Ann Arbor, Michigan 48106 U.S.A. Add \$8.00 per case or partial-case of 100 8-inch discs or \$6.00 per case of 100 5 1/4-inch mini-discs for U.P.S. ground shipping and handling in the continental U.S.A. If you have a Master Charge or Visa card, you may call anytime and place a credit card order. **Order toll-free** in the United States. Call anytime 800-521-4414. If you are outside the U.S. or in Michigan, dial 313-994-4444. **Dealer inquiries invited.** All order lines at **Communications Electronics** are staffed 24 hours.  
Copyright ©1981 Communications Electronics™

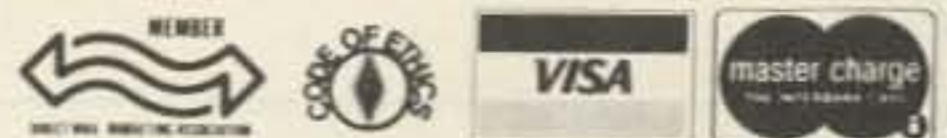

Order Toll-Free!  
(800) 521-4414

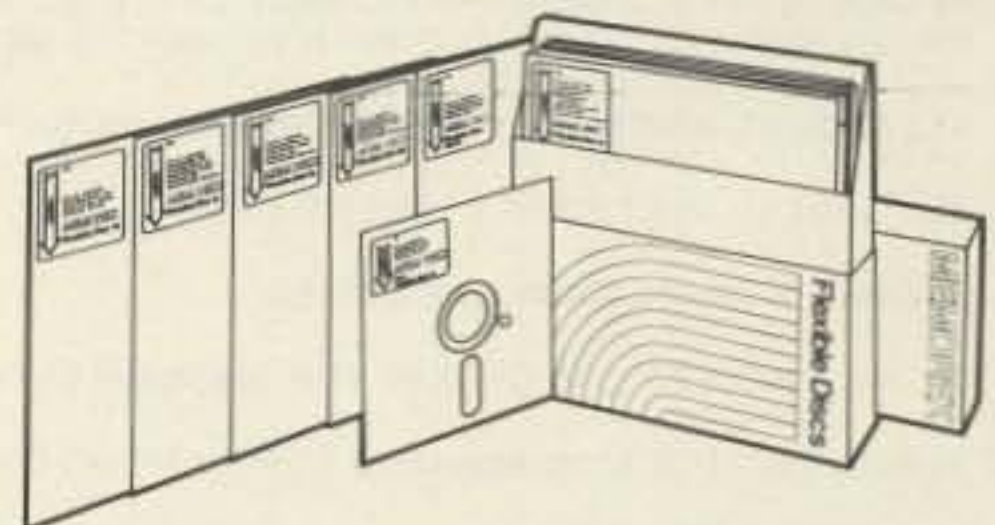

For Data Reliability—Memorex Flexible Discs

**COMMUNICATIONS ELECTRONICS™**

**Computer Products Division**

854 Phoenix □ Box 1002 □ Ann Arbor, Michigan 48106 U.S.A.  
Call TOLL-FREE (800) 521-4414 or outside U.S.A. (313) 994-4444

# MHz electronics

Toll Free Number  
800-528-0180  
(For orders only)

## 1900 MHz to 2500 MHz DOWN CONVERTER

This receiver is tunable a range of 1900 to 2500 mc and is intended for amateur radio use. The local oscillator is voltage controlled (i.e) making the i-f range approximately 54 to 88 mc (Channels 2 to 7).

PC BOARD WITH DATA .....	\$19.99
PC BOARD WITH CHIP CAPACITORS 13 .....	\$44.99
PC BOARD WITH ALL PARTS FOR ASSEMBLY .....	\$69.95
PC BOARD WITH ALL PARTS FOR ASSEMBLY PLUS 2N6603 .....	\$89.00
PC BOARD ASSEMBLED AND TESTED .....	\$79.99
PC BOARD WITH ALL PARTS FOR ASSEMBLY, POWER SUPPLY AND ANTENNA .....	\$159.99
POWER SUPPLY ASSEMBLED AND TESTED .....	\$49.99
YAGI ANTENNA 4' LONG APPROX. 20 TO 23 dB GAIN .....	\$39.99
YAGI ANTENNA 4' WITH TYPE (N, BNC, SMA Connector) .....	\$64.99
2300 MHz down converter HMR11, with dish antenna six month warranty .....	\$200.00
OPTION #1 MRF902 in front end. (7 dB noise figure) .....	\$299.99
OPTION #2 2N6603 in front end. (5 dB noise figure) .....	\$359.99
<b>2300 MHz DOWN CONVERTER ONLY</b>	
10 dB Noise Figure 23 dB gain in box with N conn. Input F conn. Output .....	\$149.99
7 dB Noise Figure 23 dB gain in box with N conn. Input F conn. Output .....	\$169.99
5 dB Noise Figure 23 dB gain in box with SMA conn. Input F conn. Output .....	\$189.99
DATA IS INCLUDED WITH KITS OR MAY BE PURCHASED SEPARATELY .....	\$15.00

### Shipping and Handling Cost:

Receiver Kits and \$1.50. Power Supply add \$2.00. Antenna add \$5.00. Option 1/2 add \$3.00. For complete system add \$7.50.

## HOWARD/COLEMAN TVRO CIRCUIT BOARDS

<b>DUAL CONVERSION BOARD</b> .....	\$25.00
This board provides conversion from the 3.7-4.2 band first to 900 MHz where gain and bandpass filtering are provided and, second, to 70 MHz. The board contains both local oscillators, one fixed and the other variable, and the second mixer. Construction is greatly simplified by the use of Hybrid IC amplifiers for the gain stages. Bare boards cost \$25.	
<b>.47 pF CHIP CAPACITORS</b> .....	\$6.00
For use with dual conversion board. Consists of 6-.47 pF	
<b>70 MHz IF BOARD</b> .....	\$25.00
This circuit provides about 43 dB gain with 50 ohm input and output impedance. It is designed to drive the HOWARD/COLEMAN TVRO Demodulator. The on-board band pass filter can be tuned for bandwidths between 20 and 35 MHz with a passband ripple of less than 1/2 dB. Hybrid ICs are used for the gain stages. Bare boards cost \$25.	
<b>.01 pF CHIP CAPACITORS</b> .....	\$7.00
For use with 70 MHz IF Board. Consists of 7-.01 pF	
<b>DEMODULATOR BOARD</b> .....	\$40.00
This circuit takes the 70 MHz center frequency satellite TV signals in the 10 to 200 millivolt range, detects them using a phase locked loop, deemphasizes and filters the result and amplifies the result to produce standard NTSC video. Other outputs include the audio subcarrier, a DC voltage proportional to the strength of the 70 MHz signal, and AFC voltage centered at about 2 volts DC. The bare board cost \$40.	
<b>SINGLE AUDIO</b> .....	\$15.00
This circuit recovers the audio signals from the 6.8 MHz frequency. The Miller 9051 coils are tuned to pass the 6.8 MHz subcarrier and the Miller 9052 coil tunes for recovery of the audio.	
<b>DUAL AUDIO</b> .....	\$25.00
Duplicate of the single audio but also covers the 6.2 range	
<b>DC CONTROL</b> .....	\$15.00
This circuit controls the VTO's, AFC and the S Meter	

### TERMS:

WE REGRET WE NO LONGER ACCEPT BANK CARDS.

PLEASE SEND POSTAL MONEY ORDER, CERTIFIED CHECK, CASHIER'S CHECK OR MONEY ORDER.  
PRICES SUBJECT TO CHANGE WITHOUT NOTICE. ALL RETURN ORDERS ARE SUBJECT TO PRIOR APPROVAL BY MANAGEMENT

ALL CHECKS AND MONEY ORDERS IN US FUNDS ONLY.

ALL ORDERS SENT FIRST CLASS OR UPS.

ALL PARTS PRIME AND GUARANTEED.

WE WILL ACCEPT COD ORDERS FOR \$25.00 OR OVER. ADD \$2.50 FOR COD CHARGE.

PLEASE INCLUDE \$2.50 MINIMUM FOR SHIPPING OR CALL FOR CHARGES.

WE ALSO ARE LOOKING FOR NEW AND USED TUBES,  
TEST EQUIPMENT, COMPONENTS ETC

WE ALSO SWAP OR TRADE

FOR CATALOG SEE JANUARY, 1980, 73 Magazine, 10 Pages

(602) 242-8916

2111 W. Camelback  
Phoenix, Arizona 85015

### FAIRCHILD VHF AND UHF PRESCALER CHIPS

95H90DC	350 MHz Prescaler Divide by 10/11	\$9.50
95H91DC	350 MHz Prescaler Divide by 5/6	9.50
11C90DC	650 MHz Prescaler Divide by 10/11	16.50
11C91DC	650 MHz Prescaler Divide by 5/6	16.50
11C83DC	1 GHz Divide by 248/256 Prescaler	29.90
11C70DC	600 MHz Flip/Flop with reset	12.30
11C58DC	ECL VCM	4.53
11C44DC/MC4044	Phase Frequency Detector	3.82
11C24DC/MC4024	Dual TTL VCM	3.82
11C06DC	UHF Prescaler 750 MHz D Type Flip/Flop	12.30
11C05DC	1 GHz Counter Divide by 4	50.00
11C01FC	High Speed Dual 5-4 input NO/NOR Gate	15.40

### TRW BROADBAND AMPLIFIER MODEL CA615B

Frequency response 40 MHz to 300 MHz  
Gain: 300 MHz 16 dB Min., 17.5 dB Max.  
50 MHz 0 to -1 dB from 300 MHz  
Voltage: 24 volts dc at 220 ma max. **\$19.99**

### CARBIDE — CIRCUIT BOARD DRILL BITS FOR PC BOARDS

Size: 35, 42, 47, 49, 51, 52	\$2.15
Size: 53, 54, 55, 56, 57, 58, 59, 61, 63, 64, 65	1.85
Size: 66	1.90
Size: 1.25 mm, 1.45 mm	2.00
Size: 3.20 mm	3.58

### CRYSTAL FILTERS: TYCO 001-19880 same as 2194F

10.7 MHz Narrow Band Crystal Filter  
3 dB bandwidth 15 kHz min. 20 dB bandwidth 60 kHz min. 40 dB bandwidth 150 kHz min.  
Ultimate 50 dB: Insertion loss 1.0 dB max. Ripple 1.0 dB max. Ct. 0 +/- 5 pf 3600 ohms. **\$5.95**

### MURATA CERAMIC FILTERS

Models: SFD-455D 455 kHz	\$3.00
SFB-455D 455 kHz	2.00
CFM-455E 455 kHz	7.95
SFE-10.7 10.7 MHz	5.95

### TEST EQUIPMENT — HEWLETT PACKARD — TEKTRONIX — ETC.

**Hewlett Packard:**

491C TWT Amplifier 2 to 4 Gc 1 watt 30 dB gain	\$1150.00
608C 10 mc to 480 mc .1 uV to .5V into 50 ohms Signal Generator	500.00
608D 10 to 420 mc .1 uV to .5V into 50 ohms Signal Generator	500.00
612A 450 to 1230 mc .1 uV to .5V into 50 ohms Signal Generator	750.00
614A 900 to 2100 mc. Signal Generator	500.00
616A 1.8 to 4.2 Gc Signal Generator	400.00
616B 1.8 to 4.2 Gc Signal Generator	500.00
618A 3.8 to 7.2 Gc Signal Generator	400.00
618B 3.8 to 7.2 Gc Signal Generator	500.00
620A 7 to 11 Gc Signal Generator	500.00
623B Microwave Test Set	900.00
626A 10 Gc to 15 Gc Signal Generator	2500.00
695A 12.4 to 18 Gc Sweep Generator	900.00

**Alltech:**

473 225 to 400 mc AM/FM Signal Generator	750.00
--	--------

**Singer:**

MF5/VR-4 Universal Spectrum Analyzer with 1 kHz to 27.5 mc Plug In	1200.00
--	---------

**Keltek:**

XR630-100 TWT Amplifier 8 to 12.4 Gc 100 watts 40 dB gain	9200.00
---	---------

**Polarad:**

2038/2436/1102A Calibrated Display with an SSB Analysis Module and a 10 to 40 mc Single Tone Synthesizer	1500.00
--	---------

### HAMLIN SOLID STATE RELAYS:

120vac at 40 Amps.  
Input Voltage 3 to 32vdc.  
240 vac at 40 Amps.  
Input Voltage 3 to 32 vdc.

**YOUR CHOICE \$4.99**

### RF TRANSISTORS

TYPE	PRICE	TYPE	PRICE	TYPE	PRICE
2N1561	\$15.00	2N5590	\$8.15	MM1550	\$10.00
2N1562	15.00	2N5591	11.85	MM1552	50.00
2N1692	15.00	2N5637	22.15	MM1553	56.50
2N1693	15.00	2N5641	6.00	MM1601	5.50
2N2632	45.00	2N5642	10.05	MM1602/2N5842	7.50
2N2857JAN	2.52	2N5643	15.82	MM1607	8.65
2N2876	12.35	2N6545	12.38	MM1661	15.00
2N2880	25.00	2N5764	27.00	MM1669	17.50
2N2927	7.00	2N5842	8.78	MM1943	3.00
2N2947	18.35	2N5849	21.29	MM2605	3.00
2N2948	15.50	2N5862	51.91	MM2608	5.00
2N2949	3.90	2N5913	3.25	MM8006	2.23
2N2950	5.00	2N5922	10.00	MMCM918	20.00
2N3287	4.30	2N5942	46.00	MMT72	1.17
2N3294	1.15	2N5944	8.92	MMT74	1.17
2N3301	1.04	2N5945	12.38	MMT2857	2.63
2N3302	1.05	2N5946	14.69	MRF245	33.30
2N3304	1.48	2N6080	7.74	MRF247	33.30
2N3307	12.60	2N6081	10.05	MRF304	43.45
2N3309	3.90	2N6082	11.30	MRF420	20.00
2N3375	9.32	2N6083	13.23	MRF450	11.85
2N3553	1.57	2N6084	14.66	MRF450A	11.85
2N3755	7.20	2N6094	7.15	MRF454	21.83
2N3818	6.00	2N6095	11.77	MRF458	20.68
2N3866	1.09	2N6096	20.77		
2N3866JAN	2.80	2N6097	29.54		
2N3866JANTX	4.49	2N6136	20.15	MRF502	1.08
2N3924	3.34	2N6166	38.60	MRF504	6.95
2N3927	12.10			MRF509	4.90
2N3950	26.86			MRF511	8.15
2N4072	1.80	2N6439	45.77	MRF901	3.00
2N4135	2.00	2N6459/PT9795	18.00	MRF5177	21.62
2N4261	14.60	2N6603	12.00	MRF8004	1.80
2N4427	1.20	2N6604	12.00	PT4186B	3.00
2N4957	3.62	A50-12	25.00	PT4571A	1.50
2N4958	2.92	BFR90	5.00	PT4612	5.00
2N4959	2.23	BLY568C	25.00	PT4628	5.00
2N4976	19.00	BLY568CF	25.00	PT4640	5.00
2N5090	12.31	CD3495	15.00	PT8659	10.72
2N5108	4.03	HEP76/S3014	4.95	PT9784	24.30
2N5109	1.66	HEPS3002	11.30	PT9790	41.70
2N5160	3.49	HEPS3003	29.88	SD1043	5.00
2N5179	1.05	HEPS3005	9.95	SD1116	3.00
2N5184	2.00	HEPS3006	19.90	SD1118	5.00
2N5216	47.50	HEPS3007	24.95	SD1119	3.00
2N5583	4.55	HEPS3010	11.34		
2N5589	6.82	HEPS5026	2.56		
		HP35831E/		TRWMRA2023-1.5	42.50
		HXR5104	50.00	40281	10.90
		MM1500	32.20	40282	11.90
				40290	2.48

### CHIP CAPACITORS

1pf	27pf	220pf	1200pf
1.5pf	33pf	240pf	1500pf
2.2pf	39pf	270pf	1800pf
2.7pf	47pf	300pf	2200pf
3.3pf	56pf	330pf	2700pf
3.9pf	68pf	360pf	3300pf
4.7pf	82pf	390pf	3900pf
5.6pf	100pf	430pf	4700pf
6.8pf	110pf	470pf	5600pf
8.2pf	120pf	510pf	6800pf
10pf	130pf	560pf	8200pf
12pf	150pf	620pf	.010mf
15pf	160pf	680pf	.012mf
18pf	180pf	820pf	.015mf
22pf	200pf	1000pf	.018mf

We can supply any value chip capacitors you may need.

### PRICES

1 to 10	1.49
11 - 50	1.29
51 - 100	.89
101 - 1,000	.69
1,001 up	.49

### ATLAS CRYSTAL FILTERS FOR ATLAS HAM GEAR

5.52-2.7/8  
5.595-2.7/8/U  
5.595-.500/4/CW  
5.595-2.7LSB  
5.595-2.7USB  
5.645-2.7/8  
9.0USB/CW

**YOUR CHOICE \$24.95**

**MRF454**

\$21.83

**NPN SILICON RF POWER TRANSISTORS**

... designed for power amplifier applications in industrial, commercial and amateur radio equipment to 30 MHz.

- Specified 12.5 Volt, 30 MHz Characteristics -
  - Output Power = 80 Watts
  - Minimum Gain = 12 dB
  - Efficiency = 50%

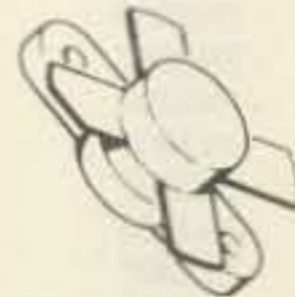

**MRF458**

\$20.68

**NPN SILICON RF POWER TRANSISTOR**

... designed for power amplifier applications in industrial, commercial and amateur radio equipment to 30 MHz.

- Specified 12.5 Volt, 30 MHz Characteristics -
  - Output Power = 80 Watts
  - Minimum Gain = 12 dB
  - Efficiency = 50%
- Capable of Withstanding 30:1 Load VSWR @ Rated P<sub>out</sub> and V<sub>CC</sub>

**NPN SILICON RF POWER TRANSISTOR**

... designed primarily for use in large-signal output amplifier stages. Intended for use in Citizen-Band communications equipment operating at 27 MHz. High breakdown voltages allow a high percentage of up-modulation in AM circuits.

**MRF472**

\$2.50

- Specified 12.5 V, 27 MHz Characteristics -
  - Power Output = 4.0 Watts
  - Power Gain = 10 dB Minimum
  - Efficiency = 65% Typical

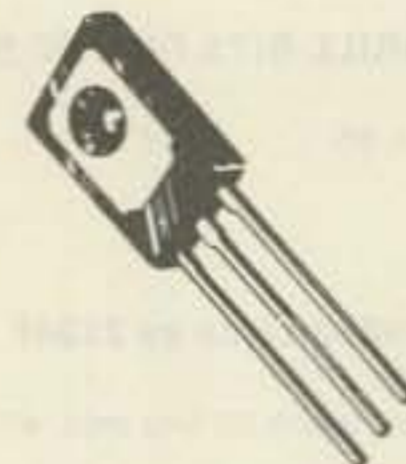

**MRF475**

**NPN SILICON RF POWER TRANSISTOR**

... designed primarily for use in single sideband linear amplifier output applications in citizens band and other communications equipment operating to 30 MHz.

- Characterized for Single Sideband and Large-Signal Amplifier Applications Utilizing Low-Level Modulation.
- Specified 13.6 V, 30 MHz Characteristics -
  - Output Power = 12 W (PEP)
  - Minimum Efficiency = 40% (SSB)
  - Output Power = 4.0 W (CW)
  - Minimum Efficiency = 50% (CW)
  - Minimum Power Gain = 10 dB (PEP & CW)



\$5.00

- Common Collector Characterization

**MHW 710 - 2**

\$46.45

440 to 470MC

**UHF POWER AMPLIFIER MODULE**

... designed for 12.5 volt UHF power amplifier applications in industrial and commercial FM equipment operating from 400 to 512 MHz.

- Specified 12.5 Volt, UHF Characteristics -
  - Output Power = 13 Watts
  - Minimum Gain = 19.4 dB
  - Harmonics = 40 dB
- 50 Ω Input/Output Impedance
- Guaranteed Stability and Ruggedness
- Gain Control Pin for Manual or Automatic Output Level Control
- Thin Film Hybrid Construction Gives Consistent Performance and Reliability



**Tektronix Test Equipment**

B	Wideband High Gain Plug In	\$ 51.00
CA	Dual Trace Plug In	120.00
K	Fast Rise DC Plug In	61.00
N	Sampling Plug In	200.00
R	Transistor Risetime Plug In	116.00
W	High Gain Differential Comparator Plug In	283.00
TU-2	Test Load Plug In for 530/540/550 Main Frames	50.00
1A2	Wideband Dual Trace Plug In	216.00
151	Sampling Unit With 350PS Risetime DC to 1GHZ	730.00
2A61	AC Differential Plug In	133.00
353	Dual Trace Sampling DC to 1GHZ Plug In	250.00
3576	Dual Trace Sampling DC to 875MHz Plug In	250.00
3T77A	Sampling Sweep Plug In	250.00
3L10	Spectrum Analyzer I to 36MHz Plug In	1000.00
50	Amplifier Plug In	50.00
51	Sweep Plug In	50.00
53/54B	Wideband High Gain Plug In	45.00
53/54C	Dual Trace Plug In	112.50
53/54D	High Gain DC Differential Plug In	38.00
53/54G	Wideband DC Differential Plug In	68.00
84	Test Plug In For 580/581 Main Frames	75.00
107	Square Wave Generator 4 to 1MHz	48.00
RM122	Preamplifier 2Hz to 40KHz	63.00
123	AC Coupled Preamplifier	25.00
131	Current Probe Amplifier	50.00
184	Time Mark Generator	363.00
R240	Program Control Unit	150.00
280	Trigger Countdown Unit	84.00
535A	DC to 15MHz Scope Rack Mount	2000.00
543	DC to 33MHz Scope	2500.00
561	DC to 10MHz Scope Rack Mount	250.00
561A	DC to 10MHz Scope Rack Mount	263.00

**Scopes with Plug-in's**

561A	DC to 10MHz Scope with a 3576 Dual Trace DC to 875MHz Sampling Plug In and a 3T77A Sweep Plug In. Rack Mount.	600.00
565	DC to 10MHz Dual Beam Scope with a 2A63 Diff. and a 2A61 Diff. Plug In's	900.00
581	DC to 80MHz Scope with a R2 Dual Trace High Gain Plug In	650.00

**Tubes**

2E26	\$ 5.00	4CX350FJ	\$116.00	6146W	12.00
3-500Z	102.00	4CX1000A	300.00	6159	10.60
3-1000Z	268.00	4CX1500B	350.00	6161	75.00
3B2N/866A	5.00	4CX1500A	750.00	6293	18.50
3X2500A3	150.00	4E27	50.00	6360	6.95
4-65A	45.00	4X150A	41.00	6907	40.00
4-125A	58.50	4X150D	52.00	6939	14.75
4-250A	68.50	4X150G	74.00	7360	12.00
4-400A	71.00	572B/T160L	39.00	798A	10.40
4-1000A	184.00	61F6	5.00	8072	49.00
5-500A	145.00	61Q6	5.00	8106	2.00
4CX250B	65.00	811A	12.95	8156	7.85
4CX250F/G	55.00	813	29.00	8226	127.20
4CX250R	113.00	5894/A	42.00	8295/PL172	328.00
4CX250R	92.00	6146	5.00	8458	25.75
4CX300A	147.00	6146A	6.00	8560A/A1	50.00
4CX350A	107.00	6146B/8295A	7.00	8908	9.00
				8950	9.00

## MICROWAVE COMPONENTS

### ARRA

2416	Variable Attenuator	\$ 50.00
3614-60	Variable Attenuator 0 to 60dB	75.00
KU520A	Variable Attenuator 18 to 26.5 GHz	100.00
4684-20C	Variable Attenuator 0 to 180dB	100.00
6684-20F	Variable Attenuator 0 to 180dB	100.00

### General Microwave

Directional Coupler 2 to 4GHz 20dB Type N	75.00
---	-------

### Hewlett Packard

H487B	100 ohms Neg. Thermistor Mount (NEW)	150.00
H487B	100 ohms Neg. Thermistor Mount (USED)	100.00
477B	200 ohms Neg. Thermistor Mount (USED)	100.00
X487A	100 ohms Neg. Thermistor Mount (USED)	100.00
X487B	100 ohms Neg. Thermistor Mount (USED)	125.00
J468A	100 ohms Neg. Thermistor Mount (USED)	150.00
478A	200 ohms Neg. Thermistor Mount (USED)	150.00
J382	5.85 to 8.2 GHz Variable Attenuator 0 to 50dB	250.00
X382A	8.2 to 12.4 GHz Variable Attenuator 0 to 50dB	250.00
NK292A	Waveguide Adapter	65.00
8436A	Bandpass Filter 8 to 12.4 GHz	75.00
8471A	RF Detector	50.00
H532A	7.05 to 10 GHz Frequency Meter	300.00
G532A	3.95 to 5.85 GHz Frequency Meter	300.00
J532A	5.85 to 8.2 GHz Frequency Meter	300.00
809A	Carriage with a 444A Slotted Line Untuned Detector Probe and 809B Coaxial Slotted Section 2.6 to 18 GHz	175.00
X347A	8.2 to 12.4 GHz noise source	\$500.00
S 347A	2.6 to 3.95 GHz noise source	\$600.00
G 347A	3.95 to 5.85 GHz noise source	\$500.00
J 347A	5.85 to 8.2 GHz noise source	\$500.00
H 347A	7.05 to 10 GHz noise source	\$540.00
349A	400 to 4000 MHz noise source	\$310.00
P 532A	12.4 to 18 GHz Frequency meter	\$400.00
M 532A	Frequency meter	\$500.00
P 382A	0 to 50 DB attenuator	\$520.00
355C	0.5 Watts 50 OHMs DC to 1000 MC attenuator	\$132.50
NK292A	Adapter	\$100.00
3503	Microwave switch	\$100.00
3300IC	Pin absorption modulator	\$295.00
11680A	Tracking generator shunt	\$50.00
M 048C	Feed-through termination	\$25.00
10100B	Termination	\$25.00
H 421A	7.05 to 10 GHz Crystal Detector	\$75.00
H 421A	7.05 to 10 GHz matched pair	\$200.00

### Merrimac

AU-26A/	801162 Variable Attenuator	100.00
---------	----------------------------	--------

### Microlab/FXR

X6385	Horn 8.2 - 12.4 GHz	60.00
601-B18	X to N Adapter 8.2 - 12.4 GHz	35.00
Y610D	Coupler	75.00

### Narda

4013C-10/	22540A Directional Coupler 2 to 4 GHz 10db Type SMA	90.00
4014-10/	22538 Directional Coupler 3.85 to 8 GHz 10dB Type SMA	90.00
4014C-6/	22876 Directional Coupler 3.85 to 8 GHz 6dB Type SMA	90.00
4015C-10/	22539 Directional Coupler 7.4 to 12 GHz 10dB Type SMA	95.00
4015C-30/	23105 Directional Coupler 7 to 12.4 GHz 30dB Type SMA	95.00
3044-20	Directional Coupler 4 to 8 GHz 20dB Type N	125.00
3040-20	Directional Coupler 240 to 500 MC 20dB Type N	125.00
3043-20/	22006 Directional Coupler 1.7 to 4 GHz 20dB Type N	125.00
3003-10/	22011 Directional Coupler 2 to 4 GHz 10dB Type N	75.00
3003-30/	22012 Directional Coupler 2 to 4 GHz 30dB Type N	75.00
3043-30/	22007 Directional Coupler 1.7 to 3.5 GHz 30dB Type N	125.00
22574	Directional Coupler 2 to 4 GHz 10dB Type N	125.00
3033	Coaxial Hybrid 2 to 4 GHz 3dB Type N	125.00
3032	Coaxial Hybrid 950 to 2 GHz 3 dB Type N	125.00
784/	22380 Variable Attenuator 1 to 90dB 2 to 2.5 GHz Type SMA	550.00
22377	Waveguide to Type N Adapter	35.00
720-6	Fixed Attenuator 8.2 to 14.4 GHz 6 dB	50.00
3503	Waveguide	25.00

### PRD

U101	12.4 to 18 GHz Variable Attenuator 0 to 60dB	300.00
X101	8.2 to 12.4 GHz Variable Attenuator 0 to 60dB	200.00
C101	Variable Attenuator 0 to 60dB	200.00
205A/367	Slotted Line with Type N Adapter	100.00
195B	8.2 to 12.4 GHz Variable Attenuator 0 to 50dB	100.00
185B51	7.05 to 10 GHz Variable Attenuator 0 to 40dB	100.00
196C	8.2 to 12.4 GHz Variable Attenuator 0 to 45dB	100.00
170B	3.95 to 5.85 GHz Variable Attenuator 0 to 45dB	100.00
588A	Frequency Meter 5.3 to 6.7 GHz	100.00
140A,C,D,E	Fixed Attenuators	25.00
109J,I	Fixed Attenuators	25.00
WEINSCHEL ENG.	2692 Variable Attenuator +30 to 60dB	100.00

## COMPUTER I.C. SPECIALS

### MEMORY

	DESCRIPTION	PRICE
2708	1K x 8 EPROM	\$ 7.99
2716/2516	2K x 8 EPROM 5Volt Single Supply	20.00
2114/9114	1K x 4 Static RAM 450ns	6.99
2114L2	1K x 4 Static RAM 250ns	8.99
2114L3	1K x 4 Static RAM 350ns	7.99
4027	4K x 1 Dynamic RAM	3.99
4060/2107	4K x 1 Dynamic RAM	3.99
4050/9050	4K x 1 Dynamic RAM	3.99
2111A-2/8111	256 x 4 Static RAM	3.99
2112A-2	256 x 4 Static RAM	3.99
2115AL-2	1K x 1 Static RAM 55ns	4.99
6104-3/4104	4K x 1 Static RAM 320ns	14.99
7141-2	4K x 1 Static RAM 200ns	14.99
MCM6641L20	4K x 2 Static RAM 200ns	14.99
9131	1K x 1 Static RAM 300ns	10.99

### C.P.U.'s ECT.

MC6800L	Microprocessor	13.80
MCM6810AP	128 x 8 Static RAM 450ns	3.99
MCM68A10P	128 x 8 Static RAM 360ns	4.99
MCM68B10P	128 x 8 Static RAM 250ns	5.99
MC6820P	PIA	8.99
MC6820L	PIA	9.99
MC6821P	PIA	8.99
MC68B21P	PIA	9.99
MCM6830L7	Mikbug	14.99
MC6840P	PTM	8.99
MC6845P	CRT Controller	29.50
MC6845L	CRT Controller	33.00
MC6850L	ACIA	10.99
MC6852P	SSDA	5.99
MC6852L	SSDA	11.99
MC6854P	ADLC	22.00
MC6860CJCS	D-600 BPS Modem	29.00
MC6862L	2400 BPS Modem	14.99
MK3850N-3	F8 Microprocessor	9.99
MK3852P	F8 Memory Interface	16.99
MK3852N	F8 Memory Interface	9.99
MK3854N	F8 Direct Memory Access	9.99
8008-1	Microprocessor	4.99
8080A	Microprocessor	8.99
Z80CPU	Microprocessor	14.99
6520	PIA	7.99
6530	Support For 6500 series	15.99
2650	Microprocessor	10.99
TMS1000NL	Four Bit Microprocessor	9.99
TMS4024NC	9 x 64 Digital Storage Buffer (FIFO)	9.99
TMS6011NC	UART	9.99
MC14411	Bit Rate Generator	11.99
AY5-4007D	Four Digit Counter/Display Drivers	8.99
AY5-9200	Repertory Dialler	9.99
AY5-9100	Push Button Telephone Diallers	7.99
AY5-2376	Keyboard Encoder	19.99
AY2-8500	TV Game Chip	5.99
TR1402A	UART	9.99
PR1472B	UART	9.99
PT1482B	UART	9.99
8257	DMA Controller	9.99
8251	Communication Interface	9.99
8228	System Controller & Bus Driver	5.00
8212	8 Bit Input/Output Port	5.00
MC14410CP	2 of 8 Tone Encoder	9.99
MC14412	Low Speed Modem	14.99
MC14408	Binary to Phone Pulse Converter	12.99
MC14409	Binary to Phone Pulse Converter	12.99
MC1488L	RS232 Driver	1.00
MC1489L	RS232 Receiver	1.00
MC1405L	A/D Converter Subsystem	9.00
MC1406L	6 Bit D/A Converter	7.50
MC1408/6/7/8	8 Bit D/A Converter	4.50
MC1330P	Low Level Video Detector	1.50
MC1349/50	Video IF Amplifier	1.17
MC1733L	LM733 OP Amplifier	2.40
LM565	Phase Lock Loop	2.50

# MHz <sup>48</sup> electronics

Toll Free Number

800-528-0180

(For orders only)

(602) 242-8916

2111 W. Camelback  
Phoenix, Arizona 85015



P.O. Box 4430S  
Santa Clara, CA 95054

Will calls: 2322 Walsh Ave.  
(408) 988-1640 TWX 910-338-2139

Same day shipment. First line parts only. Factory tested.  
Guaranteed money back. Quality IC's and other components at factory prices.

### INTEGRATED CIRCUITS

7400TL	LM320K-5	1.35	CD4028	2.50	2114L 450ns	4.00	CONNECTORS	KEYBOARDS
7401N	LM320K-12	1.35	CD4027	.96	4116 200ns	4.50	30 pin edge	56 key ASCII keyboard kit
7402N	LM320K-15	1.35	CD4028	.85	84116 200ns	25.95	44 pin edge	56 key ASCII keyboard kit
7404N	LM320T-5	.96	CD4029	1.35	MM3282	.40	86 pin edge	53 key ASCII keyboard kit
7405N	LM320T-8	.96	CD4030	.45	MM3280	3.00	100 pin edge	53 key ASCII keyboard kit
7410N	LM320T-12	.96	CD4035	1.00	MM3320	2.95	100 pin edge WW	Enclosure Plastic
7414N	LM320T-15	.96	CD4040	1.35	MM3330	3.94	100 pin edge WW	Metal Enclosure
7420N	LM323N-5	5.90	CD4042	.85	PD4110-3	4.00		
7422N	LM323N-1	1.00	CD4043	.85	P04110-4	5.00		
7430N	LM323N	1.00	CD4044	.85	PS101L	8.35		
7442N	LM340K-5	1.35	CD4048	1.67	4200A	9.95	8 15 22 30	
7445N	LM340K-8	1.35	CD4049	.45	8252S	2.90	14 14 24 35	
7447N	LM340K-12	1.35	CD4050	.60	91102A	1.50	16 16 28 42	
7448N	LM340K-15	1.35	CD4051	1.13	H00165-5	4.95	18 27 36 54	
7450N	LM340K-24	1.35	CD4060	1.47	MM37100	4.50	20 29 40 57	
7474N	LM340T-5	.85	CD4066	.71	DAV3850G-1	9.95	2 level 14 pin w/ 28	
7475N	LM340T-8	.85	CD4068	.40	MCAM6751A	9.95		
7485N	LM340T-12	.85	CD4069	.40	9368	3.50		
7489N	LM340T-15	.85	CD4070	.50	4100	10.00		
7490N	LM340T-18	.85	CD4071	.45	416	16.00		
7492N	LM340T-24	.85	CD4072	.45				
7493N	LM350	5.10	CD4073	.45				
7495N	LM377	2.95	CD4075	.45				
74100N	LM379	5.00	CD4076	.40				
74107N	LM380	1.00	CD4079	.40				
74121N	LM381	1.80	CD4081	.35				
74123N	LM382	1.80	CD4083	.35				
74125N	LM390H	.50	CD4118	.47				
74145N	LM723H	.50	CD4490	5.00				
74150N	LM733N	.85	CD4502	1.00				
74151N	LM741CH	.35	CD4508	2.85				
74154N	LM741E	.38	CD4510	1.00				
74157N	LM749N	.75	CD4511	.34				
74161N	LM749N	.75	CD4511	2.52				
74162N	LM1300N	1.75	CD4516	1.10				
74163N	LM1304	1.10	CD4518	1.50				
74174N	LM1305	1.27	CD4520	1.07				
74175N	LM1307	2.00	CD4527	1.51				
74190N	LM1310	1.95	CD4528	1.60				
74192N	LM1458	.55	CD4553	3.50				
74193N	LM1812	2.50	CD4566	2.45				
74221N	LM1889	3.00	CD4583	2.35				
74298N	LM2111	1.75	CD4585	1.10				
74365N	LM2902	2.25	CD40192	3.00				
74366N	LM3900N	.60	74000	.35				
74367N	LM3905	1.75	74004	.40				
	LM3909N	.95	74010	.65				
	MCI458V	.55	74014	.69				
	NE555N	1.35	74020	.35				
	NE555N	.39	74030	.35				
	NE555A	.85	74048	1.95				
	NE555A	1.00	74074	.85				
	NE556N	1.30	74078	1.25				
	NE557V	1.00	74080	1.25				
	NE570H	4.75	74083	1.25				
	74625	.60	74084	1.30				
	74625	.60	74085	1.30				
	74625	.60	74086	2.75				
	74625	.60	74087	1.65				
	74625	.60	74088	1.80				
	74625	.60	74089	6.00				
	74625	.60	74090	7.5				
	74625	.60	74091	1.95				
	74625	.60	74092	5.00				
	74625	.60	74093	5.50				
	74625	.60	74094	17.95				
	74625	.60	74095	17.95				
	74625	.60	74096	9.50				
	74625	.60	74097	89.95				
	74625	.60	74098	26.95				
	74625	.60	74099	17.95				
	74625	.60	74100	14.95				
	74625	.60	74101	3.99				
	74625	.60	74102	3.82				
	74625	.60	74103	5.20				
	74625	.60	74104	5.20				
	74625	.60	74105	1.95				
	74625	.60	74106	2.10				
	74625	.60	74107	2.10				
	74625	.60	74108	3.10				
	74625	.60	74109	9.50				
	74625	.60	74110	89.95				
	74625	.60	74111	26.95				
	74625	.60	74112	17.95				
	74625	.60	74113	14.95				
	74625	.60	74114	3.99				
	74625	.60	74115	3.82				
	74625	.60	74116	5.20				
	74625	.60	74117	5.20				
	74625	.60	74118	1.95				
	74625	.60	74119	2.10				
	74625	.60	74120	2.10				
	74625	.60	74121	3.10				
	74625	.60	74122	9.50				
	74625	.60	74123	89.95				
	74625	.60	74124	26.95				
	74625	.60	74125	17.95				
	74625	.60	74126	14.95				
	74625	.60	74127	3.99				
	74625	.60	74128	3.82				
	74625	.60	74129	5.20				
	74625	.60	74130	5.20				
	74625	.60	74131	1.95				
	74625	.60	74132	2.10				
	74625	.60	74133	2.10				
	74625	.60	74134	3.10				
	74625	.60	74135	9.50				
	74625	.60	74136	89.95				
	74625	.60	74137	26.95				
	74625	.60	74138	17.95				
	74625	.60	74139	14.95				
	74625	.60	74140	3.99				
	74625	.60	74141	3.82				
	74625	.60	74142	5.20				
	74625	.60	74143	5.20				
	74625	.60	74144	1.95				
	74625	.60	74145	2.10				
	74625	.60	74146	2.10				
	74625	.60	74147	3.10				
	74625	.60	74148	9.50				
	74625	.60	74149	89.95				
	74625	.60	74150	26.95				
	74625	.60	74151	17.95				
	74625	.60	74152	14.95				
	74625	.60	74153	3.99				
	74625	.60	74154	3.82				
	74625	.60	74155	5.20				
	74625	.60	74156	5.20				
	74625	.60	74157	1.95				
	74625	.60	74158	2.10				
	74625	.60	74159	2.10				
	74625	.60	74160	3.10				
	74625	.60	74161	9.50				
	74625	.60	74162	89.95				
	74625	.60	74163	26.95				
	74625	.60	74164	17.95				
	74625	.60	74165	14.95				
	74625	.60	74166	3.99				
	74625	.60	74167	3.82				
	74625	.60	74168	5.20				
	74625	.60	74169	5.20				
	74625	.60	74170	1.95				
	74625	.60	74171	2.10				
	74625	.60	74172	2.10				
	74625	.60	74173	3.10				
	74625	.60	74174	9.50				
	74625	.60	74175	89.95				
	74625	.60	74176	26.95				
	74625	.60	74177	17.95				
	74625	.60	74178	14.95				
	74625	.60	74179	3.99				
	74625	.60	74180	3.82				
	74625	.60	74181	5.20				
	74625	.60	74182	5.20				
	74625	.60	74183	1.95				
	74625	.60	74184	2.10				
	74625	.60	74185	2.10				



We now have available a bunch of goodies too good to bypass. Items are limited so order today

716-586-3950

Call Your Phone Order in Today

TERMS: Satisfaction guaranteed or money refunded. C.O.D. add \$2.00. Minimum order \$6.00. Orders under \$10.00 add \$1.50. Add 5% for postage, insurance, handling. Overseas add 15%. N.Y. residents add 7% tax.

**MINI KITS - YOU HAVE SEEN THESE BEFORE NOW HERE ARE OLD FAVORITE AND NEW ONES TOO. GREAT FOR THAT AFTERNOON HOBBY.**

**FM MINI MIKE**

A super high performance FM wireless mike kit! Transmits a stable signal up to 300 yards with exceptional audio quality by means of its built in electret mike. Kit includes case, mike, on-off switch, antenna, battery and super instructions. This is the finest unit available.

FM-3 Kit **\$14.95**  
FM-3 Wired and Tested **19.95**

**Color Organ**  
See music come alive! 3 different lights flicker with music. One light each for, high, mid-range and lows. Each individually adjustable and drives up to 300 W. runs on 110 VAC.

Complete kit, ML-1 **\$8.95**

**Video Modulator Kit**  
Converts any TV to video monitor. Super stable, tunable over ch. 4-6. Runs on 5-15V. accepts std video signal. Best unit on the market! Complete kit, VD-1 **\$7.95**

**Led Blinky Kit**  
A great attention getter which alternately flashes 2 jumbo LEDs. Use for name badges, buttons, warning panel lights, anything! Runs on 3 to 15 volts. Complete kit, BL-1 **\$2.95**

**Super Sleuth**  
A super sensitive amplifier which will pick up a pin drop at 15 feet! Great for monitoring baby's room or as general purpose amplifier. Full 2 W rms output, runs on 6 to 15 volts, uses 8-45 ohm speaker. Complete kit, BN-9 **\$5.95**

**CPO-1**  
Runs on 3-12 Vdc 1 wall out, 1 KHZ good for CPO. Alarm, Audio Oscillator. Complete kit **\$2.95**

**CLOCK KITS**

Your old favorites are here again. Over 7,000 Sold to Date. Be one of the gang and order yours today!

Try your hand at building the finest looking clock on the market. Its satin finish anodized aluminum case looks great anywhere, while six .4" LED digits provide a highly readable display. This is a complete kit, no extras needed, and it only takes 1-2 hours to assemble. Your choice of case colors: silver, gold, black (specify).  
Clock kit, 12/24 hour, DC-5 **\$24.95**  
Clock with 10 min. ID timer, 12/24 hour, DC-10 **\$29.95**  
Alarm clock, 12 hour only, DC-8 **\$29.95**  
12V DC car clock, DC-7 **\$29.95**

For wired and tested clocks add \$10.00 to kit price. SPECIFY 12 OR 24 HOUR FORMAT

**FM Wireless Mike Kit**

Transmits up to 300' to any FM broadcast radio, uses any type of mike. Runs on 3 to 9V. Type FM-2 has added sensitive mike preamp stage.

FM-1 kit **\$3.95** FM-2 kit **\$4.95**

**Whisper Light Kit**

An interesting kit, small mike picks up sounds and converts them to light. The louder the sound, the brighter the light. Includes mike, controls up to 300 W, runs on 110 VAC.

Complete kit, WL-1 **\$6.95**

**Tone Decoder**

A complete tone decoder on a single PC board. Features: 400-5000 Hz adjustable range via 20 turn pot, voltage regulation, 567 IC. Useful for touch-tone burst detection, FSK, etc. Can also be used as a stable tone encoder. Runs on 5 to 12 volts. Complete kit, TD-1 **\$5.95**

**Universal Timer Kit**

Provides the basic parts and PC board required to provide a source of precision timing and pulse generation. Uses 555 timer IC and includes a range of parts for most timing needs.

UT-5 Kit **\$5.95**

**Mad Blaster Kit**

Produces LOUD ear shattering and attention getting siren like sound. Can supply up to 15 watts of obnoxious audio. Runs on 6-15 VDC.

MB-1 Kit **\$4.95**

**Siren Kit**

Produces upward and downward wail characteristic of a police siren. 5 W peak audio output, runs on 3-15 volts, uses 3-45 ohm speaker. Complete kit, SM-3 **\$2.95**

**60 Hz Time Base**  
Runs on 5-15 VDC. Low current (2.5ma) 1 min/month accuracy TB-7 Kit **\$5.50**  
TB-7 Assy **\$9.95**

**Car Clock**

The UN-KIT, only 5 solder connections

Here's a super looking, rugged and accurate auto clock, which is a snap to build and install. Clock movement is completely assembled — you only solder 3 wires and 2 switches. Takes about 15 minutes! Display is bright green with automatic brightness control photocell — assures you of a highly readable display, day or night. Comes in a satin finish anodized aluminum case which can be attached 5 different ways using 2 sided tape. Choice of silver, black or gold case (specify).

DC-3 kit, 12 hour format **\$22.95**  
DC-3 wired and tested **\$29.95**

**Calendar Alarm Clock**

The clock that's got it all: 6-5" LEDs, 12/24 hour, snooze, 24 hour alarm, 4 year calendar, battery backup, and lots more. The super 7001 chip is used. Size: 5x4x2 inches. Complete kit, less case (not available) DC-9 **\$34.95**

**Under Dash Car Clock**

12/24 hour clock in a beautiful plastic case features 6 jumbo RED LEDs, high accuracy (0.01%), easy 3 wire hookup, display blanks with ignition, and super instructions. Optional dimmer automatically adjusts display to ambient light level.  
DC-11 clock with mtg. bracket **\$27.95 kit**  
DM-1 dimmer adapter **\$2.50**  
Add \$10.00 Assy. and Test

**Video Terminal**

A completely self-contained, stand alone video terminal card. Requires only an ASCII keyboard and TV set to become a complete terminal unit. Features are: single 5V supply, XTAL controlled sync and baud rates (to 9600), complete computer and keyboard control of cursor, parity error control and display. Accepts and generates serial ASCII plus parallel keyboard input. The 6416 is 64 char by 16 lines, with scrolling, upper and lower case (optional) and has RS-232 and 20ma loop interfaces on board. Kits include sockets and complete documentation.  
RE 6416 terminal card kit (add \$60.00 for wired unit) **\$189.95**  
Lower Case option **\$13.95**  
Power Supply **\$14.95**  
RF Modulator kit **\$7.95**

**PARTS PARADE**

**IC SPECIALS**

LINEAR	TTL
301 <b>\$ .35</b>	74S00 <b>\$ .40</b>
324 <b>\$1.50</b>	7447 <b>\$ .65</b>
380 <b>\$1.50</b>	7475 <b>\$ .50</b>
555 <b>\$ .45</b>	7490 <b>\$ .50</b>
556 <b>\$1.00</b>	74196 <b>\$1.35</b>
565 <b>\$1.00</b>	
566 <b>\$1.00</b>	
567 <b>\$1.25</b>	
741 <b>10/\$2.00</b>	
1458 <b>\$ .50</b>	
3900 <b>\$ .50</b>	
3914 <b>\$2.95</b>	
8038 <b>\$2.95</b>	
CMOS	SPECIAL
4011 <b>\$.50</b>	11C90 <b>\$15.00</b>
4013 <b>\$.50</b>	10116 <b>\$ 1.25</b>
4046 <b>\$1.85</b>	7208 <b>\$17.50</b>
4049 <b>\$.50</b>	7207A <b>\$ 5.50</b>
4059 <b>\$9.00</b>	7216D <b>\$21.00</b>
4511 <b>\$2.00</b>	7107C <b>\$12.50</b>
4518 <b>\$1.35</b>	5314 <b>\$ 2.95</b>
5639 <b>\$1.75</b>	5375AB/G <b>\$ 2.95</b>
	7001 <b>\$ 6.50</b>
	FERRITE BEADS
	With info and specs <b>15/\$1.00</b>
	6 Hole Balun Beads <b>5/\$1.00</b>

**Resistor Ass't**

Assortment of Popular values - 1/4 watt. Cut lead for PC mounting. 1/8" center, 1/2" leads, bag of 300 or more. **\$1.50**

**Switches**  
Mini toggle SPDT **\$1.00**  
Red Pushbuttons N.O **3/\$1.00**

**Earphones**  
3" leads, 8 ohm, good for small tone speakers, alarm clocks, etc. **5 for \$1.00**

**Mini 8 ohm Speaker**  
Approx 2 1/4" diam. Round type for radios, mike etc. **3 for \$2.00**

**Slug Tuned Coils**  
Small 3/16" Hex Slugs turned coil, 3 turns **10 for \$1.00**

**CAPACITORS**  
TANTALUM Dipped Epoxy  
1.5 uF 25V **3/\$1.00**  
1.8 uF 25V **3/\$1.00**  
.22 uF 25V **3/\$1.00**  
ALUMINUM Electrolytic  
1000 uF 16V Radial **\$.50**  
500 uF 20V Axial **\$.50**  
150 uF 16V Axial **5/\$1.00**  
10 uF 15V Radial **10/\$1.00**  
DISK CERAMIC  
01 16V disk **20/\$1.00**  
1 16V **15/\$1.00**  
001 16V **20/\$1.00**  
100 pF **20/\$1.00**  
047 16V **20/\$1.00**

**Crystals**

3.579545 MHz **\$1.50**  
10.00000 MHz **\$5.00**  
5.248800 MHz **\$5.00**

**AC Adapters**  
Good for clocks, nicad chargers, all 110 VAC plug one end  
8.5 vdc @ 20 mA **\$1.00**  
16 vac @ 160mA **\$2.50**  
12 vac @ 250mA **\$3.00**

**Solid State Buzzers**  
small buzzer 450 Hz, 86 dB, sound output on 5-12 vdc at 10-30 mA, TTL compatible. **\$1.50**

**AC Outlet**  
Panel Mount with Leads **4/\$1.00**

**READOUTS**

FND 359 4" C.C. **\$1.00**  
FND 507/510 5" C.A. **1.00**  
MAN 72/HP7730 33" C.A. **1.00**  
HP 7651 43" C.A. **2.00**

**Sockets**

8 Pin **10/\$2.00**  
14 Pin **10/\$2.00**  
16 Pin **10/\$2.00**  
24 Pin **4/\$2.00**  
28 Pin **4/\$2.00**  
40 Pin **3/\$2.00**

**DC-DC Converter**

+5 vdc input prod. -9 vdc @ 30ma  
+9 vdc produces -15 vdc @ 35ma **\$1.25**

25K 20 Turn Trim Pot **\$1.00**  
1K 20 Turn Trim Pot **\$.50**

**Ceramic IF Filters**

Mini ceramic filters 7 kHz B.W. 455 kHz **\$1.50 ea.**

**Trimmer Caps**  
Sprague - 3-40 pf Stable Polypropylene **.50 ea.**

**TRANSISTORS**

2N3904 NPN C-F **15/\$1.00**  
2N3906 PNP C-F **15/\$1.00**  
2N4403 PNP C-F **15/\$1.00**  
2N4410 NPN C-F **15/\$1.00**  
2N4916 FET C-F **4/\$1.00**  
2N5401 PNP C-F **5/\$1.00**  
2N6028 C-F **4/\$1.00**  
2N3771 NPN Silicon **\$1.50**  
2N5179 LHF NPN **3/\$2.00**  
Power Tab NPN 40W **3/\$1.00**  
Power Tab PNP 40W **3/\$1.00**  
MPF 102/2N5484 **\$.50**  
NPN 3904 Type T-R **50/\$2.50**  
PNP 3906 Type T-R **50/\$2.50**  
2N3055 **\$.80**  
2N2646 UJT **3/\$2.00**

**Diodes**

5.1 V Zener **20/\$1.00**  
1N914 Type **50/\$1.00**  
1KV 2Amp **8/\$1.00**  
100V 1Amp **15/\$1.00**

**25 AMP 100V Bridge \$1.50 each**  
**Mini-Bridge 50V 1 AMP 2 for \$1.00**

**Crystal Microphone**

Small 1" diameter 1/4" thick crystal mike cartridge **\$.75**

**Coax Connector**  
Chassis mount BNC type **\$1.00**

**Parts Bag**  
Asst of chokes disc caps tant resistors transistors, diodes, MICA caps etc. sm bag (100 pc) **\$1.00** lg bag (300 pc) **\$2.50**

**Mini RG-174 Coax**

10 ft. for **\$1.00**

**9 Volt Battery Clips**  
Nice quality clips **5 for \$1.00**  
1/4" Rubber Grommets **10 for \$1.00**

**Connectors**  
6 pin type gold contacts for mA-1003 car clock module price **.75 ea.**

**Leds - your choice, please specify**  
Mini Red, Jumbo Red, High Intensity Red, Illuminator Red **8/\$1**  
Mini Yellow, Jumbo Yellow, Jumbo Green **6/\$1**

**Varactors**  
Motorola MV 2209 30 PF Nominal cap 20-80 PF - Tunable range - **.50 each or 3/\$1.00**

**Audio Prescaler**

Make high resolution audio measurements, great for musical instrument tuning, PL tones, etc. Multiplies audio UP in frequency, selectable x10 or x100, gives .01 Hz resolution with 1 sec gate time! High sensitivity of 25 mv, 1 meg input z and built-in filtering gives great performance. Runs on 9V battery, all CMOS.  
PS-2 kit **\$29.95**  
PS-2 wired **\$39.95**

**600 MHz PRESCALER**

Extend the range of your counter to 600 MHz. Works with all counters. Less than 150 mv sensitivity, specify -10 or -100  
Wired, tested, PS-1B **\$59.95**  
Kit, PS-1B **\$44.95**

**30 Watt 2 mtr PWR AMP**

Simple Class C power amp features 8 times power gain, 1 W in for 8 out, 2 W in for 15 out, 4W in for 30 out. Max output of 35 W, incredible value, complete with all parts, less case and T-R relay.  
PA-1, 30 W pwr amp kit **\$22.95**  
TR-1, RF sensed T-R relay kit **6.95**

**Power Supply Kit**

Complete triple regulated power supply provides variable 6 to 18 volts at 200 ma and +5 at 1 Amp. Excellent load regulation, good filtering and small size. Less transformers, requires 6.3 V 1 x 1 A and 24 VCT  
Complete kit, PS-3LT **\$6.95**

**RF actuated relay senses RF (1W) and closes DPDT relay.**

For RF sensed T-R relay TR-1 Kit **\$6.95**

**OP-AMP Special**

BI-FET LF 13741 - Direct pin for pin 741 compatible, but 500,000 MEG input z, super low 50 pa input current, low power drain  
50 for only **\$9.00** 10 for **\$2.00**

**Regulators**

78MG **\$1.25**  
79MG **\$1.25**  
723 **\$.50**  
309K **\$1.15**  
7805 **\$1.00**

**Mini TO-92 Heat Sinks**

Thermalloy Brand **5 for \$1.00**  
To-220 Heat Sinks **3 for \$1.00**

**Shrink Tubing Nubs**

Nice precut pcs of shrink size 1" x 1/4" shrink to 1/8" Great for splices **50/\$1.00**

**Opto Isolators - 4N28 type**

Opto Reflectors - Photo diode + LED **\$1.00 ea.**

**Molex Pins**

Molex already precut in length of 7. Perfect for 14 pin sockets. **20 strips for \$1.00**

**CDS Photocells**

Resistance varies with light. 250 ohms to over 3 meg **3 for \$1.00**

# SEMICONDUCTORS SURPLUS

2822 North 32nd Street, #1 • Phoenix, Arizona 85008 • Phone 602-956-9423

## MEMORY

	Description	Price
2708	1K x 8 Eprom	\$ 5.00
2716/2516	2K x 8 5V single supply	9.99
2114/9114	1K x 4 Static	5.00
4027	4K x 1 Dynamic Ram	2.99
2117/4116	16K x 1 Dynamic Ram	5.00
2732-6	32K Eprom	39.95

## C.P.U.'s, Etc.

MC6800P	Microprocessor	9.99
MC68B21P	PIA	6.99
MC6845P	CRT Controller	25.00
MC6850P	ACIA	4.99
MC6852P	SSDA	5.00
8008-1	Microprocessor	5.00
8080A	Microprocessor	5.00
Z80A	Microprocessor	10.99
Z80	Microprocessor	8.99
Z80A	PIO	9.99
Z80	SIO/O	22.50
Z80	SIO/I	22.50
8212	8 Bit input/output part	3.99
8251	Communication Interface	6.99
TR1602/AY5-1013	UART	6.99
TMS1000NL	Four Bit Microprocessor	4.99
PT1482B	PSAT	5.99
8257	DMA Controller	8.99
3341	64 x 4 FIFO	3.00
MM5316/F3817	Clock with alarm	5.99
8741		60.00
8748	8 Bit Microcomputer with programmable/erasable EPROM	60.00
MC1408L/6	6 Bit D/A	3.25
COM2502		9.99
COM2601		9.99

## CRYSTAL FILTERS

TYCO 001-19880 Same as 2194F  
 10.7 MHz narrow band  
 3 dB bandwidth 15 KHz min.  
 20 dB bandwidth 60 KHz min.  
 40 dB bandwidth 150 KHz min.  
 Ultimate 50 dB insertion loss 1 dB max.  
 Ripple 1 dB max. Ct. 0+/-5 pf 3600 Ohms  
 \$3.99 each

MRF454, same as MRF458 12.5 VDC, 3-30 MHz  
 80 Watts output, 12 dB gain \$17.95 each

## MRF472

12.5 VDC, 27 MHz  
 4 Watts output, 10 dB gain  
 \$1.69 each

CARBIDE CIRCUIT BOARD DRILL BITS  
 for PCB Boards  
 5 mix for \$5.00

## MURATA CERAMIC FILTERS

SFD 455D	455 KHz	\$2.00
SFB 455D	455 KHz	1.60
CFM 455E	455 KHz	5.50
SFE 10.7 MA	10.7 MHz	2.99

## ATLAS CRYSTAL FILTERS FOR ATLAS

HAM GEAR  
 5.52 - 2.7/8  
 5.595 - 2.7/8/U  
 5.645 - 2.7/8  
 5.595 - .500/4/CW YOUR CHOICE  
 5.595 - 2.7 USB \$12.99 each  
 5.595 - 2.7/8/L  
 5.595 - 2.7 LSB  
 9.0 - USB/CW

J310 N-CHANNEL J-FET 450 MHz  
 Good for VHF/UHF Amplifier,  
 Oscillator and Mixers 3/\$1.00

## AMPHENOL COAX RELAY

26 VDC Coil SPDT #360-11892-13  
 100 Watts Good up to 18 GHz  
 \$19.99 each

78M05 Same as 7805 but only 1/2 Amp @  
 5 VDC 49¢ each or 10/\$3.00

## NEW TRANSFORMERS

F-18X	6.3 VCT @ 6 Amps	\$6.99 ea
F-46X	24 V @ 1 Amp	5.99 ea
F-41X	25.2 VCT @ 2 Amps	6.99 ea
P-8380	10 VCT @ 3 Amps	7.99 ea
P-8604	20 VCT @ 1 Amp	4.99 ea
P-8130	12.6 VCT @ 2 Amps	4.99 ea
K-32B	28 VCT @ 100 MA	4.99 ea
E30554	Dual 17V @ 1Amp ea.	6.99 ea

EIMAC FINGER STOCK #Y-302  
 36 in. long x 1/2 in. \$4.99 each

NO ORDERS UNDER \$10

# SEMICONDUCTORS SURPLUS

2822 North 32nd Street, #1 • Phoenix, Arizona 85008 • Phone 602-956-9423

MRF203	\$P.O.R.	BFW92A	\$ 1.00
MRF216	19.47	BFW92	.79
MRF221	8.73	MMCM913	14.30
MRF226	10.20	MMCM2222	15.65
MRF227	2.13	MMCM2369	15.00
MRF238	10.00	MMCM2484	15.25
MRF240	14.62	MMCM3960A	24.30
MRF245	28.87	MWA110	6.92
MRF247	28.87	MWA120	7.38
MRF262	6.25	MWA130	8.08
MRF314	12.20	MWA210	7.46
MRF406	11.33	MWA220	8.08
MRF412	20.65	MWA230	8.62
MRF421	27.45	MWA310	8.08
MRF422A	38.25	MWA320	8.62
MRF422	38.25	MWA330	9.23
MRF428	38.25		
MRF428A	38.25	TUBES	
MRF426	8.87	6KD6	\$ 5.00
MRF426A	8.87	6LQ6/6JE6	6.00
MRF449	10.61	6MJ6/6LQ6/6JE6C	6.00
MRF449A	10.61	6LF6/6MH6	5.00
MRF450	11.00	12BY7A	4.00
MRF450A	11.77	2E26	4.69
MRF452	15.00	4X150A	29.99
MRF453	13.72	4CX250B	45.00
MRF454	21.83	4CX250R	69.00
MRF454A	21.83	4CX300A	109.99
MRF455	14.08	4CX350A/8321	100.00
MRF455A	14.08	4CX350F/J/8904	100.00
MRF472	2.50	4CX1500B/8660	300.00
MRF474	3.00	811A	20.00
MRF475	2.90	6360	4.69
MRF476	2.25	6939	7.99
MRF477	10.00	6146	5.00
MRF485	3.00	6146A	5.69
MRF492	20.40	6146B/8298	7.95
MRF502	.93	6146W	12.00
MRF604	2.00	6550A	8.00
MRF629	3.00	8908	9.00
MRF648	26.87	8950	9.00
MRF901	3.99	4-400A	71.00
MRF902	9.41	4-400C	80.00
MRF904	3.00	572B/T160L	44.00
MRF911	4.29	7289	9.95
MRF5176	11.73	3-1000Z	229.00
MRF8004	1.39	3-500Z	129.99
BFR90	1.00		
BFR91	1.25	TO-3 TRANSISTOR SOCKETS	
BFR96	1.50	Phenolic type 6/\$1.00	

UHF/VHF RF POWER TRANSISTORS  
 CD2867/2N6439  
 60 Watts output  
 Reg. Price \$45.77  
**SALE PRICE \$19.99**

1900 MHz to 2500 MHz DOWNCONVERTERS  
 Intended for amateur radio use  
 Tunable from channel 2 thru 6  
 34 dB gain 2.5 - 3 dB noise  
 Warranty for 6 months  
 Model HMR II with dish antenna  
 Complete Receiver and Power Supply  
 \$225.00 (does not include coax)  
 4 foot Yagi antenna only  
**\$39.99**

Downconverter Kit - PCB and parts  
**\$69.95**  
 Power Supply Kit - Box, PCB and parts  
**\$49.99**  
 Downconverter assembled  
**\$79.99**  
 Power Supply assembled  
**\$59.99**  
 Complete Kit with Yagi antenna  
**\$109.99**

#### REPLACEMENT PARTS

MRF901 \$ 3.99  
 MBD101 1.29  
 .001 Chip Caps 1.00  
 Power supply PCB 4.99  
 Downconverter PCB 19.99

Bogner down converter, industrial version. 1  
 year guarantee \$225.00

86 PIN MOTOROLA BUS EDGE CONNECTORS  
 Gold plated contacts  
 Dual 43/86 pin .156 spacing  
 Solder tail for PCB \$3.00 each

#### CONTINUOUS TONE BUZZERS

12 VDC \$2.00 each

#### 110 VAC MUFFIN FANS

New \$11.95 Used \$5.95

PL-259 TERMINATION 52 Ohm 5 Watts  
 \$1.50 each

NO ORDERS UNDER \$10

# SEMICONDUCTORS SURPLUS

2822 North 32nd Street, #1 • Phoenix, Arizona 85008 • Phone 602-956-9423 ✓64

2N2857JAN	\$ 2.50	2N6097	\$28.00
2N2949	3.60	2N6166	38.00
2N2947	15.00	2N6368	22.99
2N2950	4.60	2N6439	40.00
2N3375	8.00	A210/MRF517	2.00
2N3553	1.57	BLY38	5.00
2N3818	5.00	40280/2N4427	1.10
2N3866	1.00	40281/2N3920	7.00
2N3866JAN	2.50	40282/2N3927	10.48
2N3866JANTX	4.00		
2N3925	10.00	NE555V TIMERS	
2N3948	2.00	39¢ each or 10/\$3.00	
2N3950	25.00		
2N3959	3.00	NEW DUAL COLON LED	
2N3960JANTX	10.00	69¢ each or	
2N4072	1.60	10/\$5.00	
2N4427	1.10		
2N4429	7.00	HEP170 1000 PIV	
2N4877	1.00	2.5 Amps 25¢ each or	
2N4959	2.00	100/\$15.00	
2N4976	15.00		
2N5070	8.00	HIGH VOLTAGE CAPS	
2N5071	15.00	420 MFD @ 400 VDC <u>OR</u>	
2N5108	4.00	600 MFD @ 400 VDC	
2N5109	1.50	\$6.99 each	
2N5179	1.00		
2N5583	4.00	NEW ROTRON BISCUIT FANS	
2N5589	6.00	Model BT2A1 115 VAC	
2N5590	8.00	\$12.99 each	
2N5591	11.00		
2N5635	5.44	TORIN TA700 FANS NEW	
2N5636	11.60	Model A30340	
2N5637	20.00	230 VAC @ .78 Amps	
2N5641	5.00	Will also work on 115 VAC	
2N5643	14.00	\$29.99 each	
2N5645	10.00		
2N5842	8.00	DOOR KNOB CAPS	
2N5849	20.00	470 pf @ 15 KV \$3.99 each	
2N5942	40.00	Dual 500 pf @ 15 KV 5.99 each	
2N5946	14.00	680 pf @ 6 KV 3.99 each	
2N5862	50.00	800 pf @ 15 KV 3.99 each	
2N6080	7.00	1000 pf @ 20 KV 5.00 each	
2N6081	10.00	2700 pf @ 40 KV 5.99 each	
2N6082	11.00		
2N6083	13.00	NEW & USED BCD SWITCHES	
2N6084	14.00	3 switch with end plates	
2N6095	11.00	New \$8.99	
2N6096	20.00	Used \$6.95	

## ORDERING INSTRUCTIONS

Check, money order, or credit cards welcome. (Mastercharge and VISA only) No personal checks or certified personal checks for foreign countrys accepted. Money order or cashiers check in U.S. funds only. Letters of credit are not acceptable.

Minimum shipping by UPS is \$2.35 with insurance. Please allow extra shipping charges for heavy or long items.

All parts returned due to customer error will be subject to a 15% restock charge.

If we are out of an item ordered, we will try to replace it with an equal or better part unless you specify not to, or we will back order the item, or refund your money.

PRICES ARE SUBJECT TO CHANGE WITHOUT NOTICE. Prices superseade all previously published. Some items offered are limited to small quantities and are subject to prior sale.

We now have a toll free number but we ask that it be used for CHARGE ORDERS ONLY. If you have any questions please use our other number. We are open from 8:00 a.m. - 5:00 p.m. Monday thru Saturday.

Our toll free number for orders only is 800-528-3611.

## JUMBO LED's

Red	8/\$1.00
Clear	6/\$1.00
Yellow	6/\$1.00
Green	6/\$1.00
Amber	6/\$1.00

## MEDIUM LED's

Red	6/\$1.00
Green	6/\$1.00

NEW G.E. OPTO COUPLERS 4N26  
69¢ each or 10/\$5.00

MICRO-MINI WATCH CRYSTALS  
32.768 Hz \$3.00 each

NEW 2 inch ROUND SPEAKERS  
100 Ohm coil 99¢ each

PLASTIC TO-3 SOCKETS 4/\$1.00

NO ORDERS UNDER \$10

# Quality VHF/UHF Kits at Affordable Prices ~

## These Low Cost SSB TRANSMITTING CONVERTERS

Let you use inexpensive recycled 10M or 2M SSB exciter on UHF & VHF!

- Linear Converters for SSB, CW, FM, etc.
- A fraction of the price of other units; no need to spend \$300 - \$400!
- Use with any exciter; works with input levels as low as 1 mW.
- Use low power tap on exciter or simple resistor attenuator pad (instructions included).
- Link osc with RX converter for transceive.

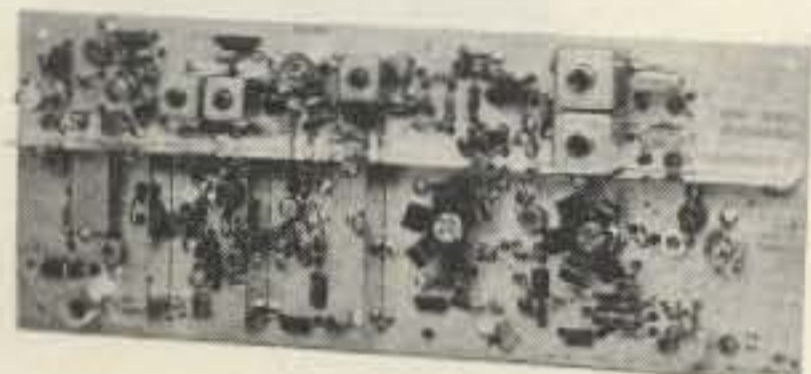

## XV4 UHF KIT — ONLY \$99.95

28-30 MHz in, 435-437 MHz out; 1W p.e.p. on ssb, up to 1½W on CW or FM. Has second oscillator for other ranges. Atten. supplied for 1 to 500 mW input, use external attenuator for higher levels.

Extra crystal for 432-434 MHz range..... \$5.95  
 XV4 Wired and tested ..... \$149.95

## XV2 VHF KIT - ONLY \$69.95

2W p.e.p. output with as little as 1 mW input. Use simple external attenuator. Many freq. ranges available.

MODEL	INPUT (MHz)	OUTPUT (MHz)
XV2-1	28-30	50-52
XV2-2	28-30	220-222
XV2-4	28-30	144-146
XV2-5	28-29 (27-27.4 CB)	145-146 (144-144.4)
XV2-7	144-146	50-52

XV2 Wired and tested ..... \$109.95

## XV28 2M ADAPTER KIT - \$24.95

Converts any 2M exciter to provide the 10M signal required to drive above 220 or 435 MHz units.



## NEW! COMPLETE TRANSMITTING CONVERTER AND PA IN ATTRACTIVE CABINET

For less than the cost of many 10W units!

Now, the popular Hamtronics® Transmitting Converters and heavy duty Linear Power Amplifiers are available as complete units in attractive, shielded cabinets with BNC receptacles for exciter and antenna connections. Perfect setup for versatile terrestrial and OSCAR operations! Just add phase 3! You save \$30 when you buy complete kit with cabinet under cost of individual items. Run 45 Watts on VHF or 30-40 Watts on UHF with one integrated unit! Call for more details.

MODEL	KIT	WIRED and TESTED
2/LPA2-45/Cabt (6, 2, or 220)	\$199.95	\$349.95
4/LPA4-30/Cabt (for UHF)	\$229.95	\$399.95

## IT'S EASY TO ORDER!

Write or phone 716-392-9430  
 Electronic answering service evenings & weekends)  
 Use Credit Card, UPS COD, Check, Money Order  
 Add \$2.00 shipping & handling per order

## Easy to Build FET RECEIVING CONVERTERS

Let you receive OSCAR and other exciting VHF and UHF signals on your present HF or 2M receiver



- NEW LOW-NOISE DESIGN
- ATTRACTIVE WOODGRAIN CASE
- Less than 2dB noise figure, 20dB gain

MODEL	RF RANGE	OUTPUT RANGE
CA28	28-32 MHz	144-148 MHz
CA50	50-52	28-30
CA50-2	50-54	144-148
CA144	144-146	28-30
CA145	145-147-or-144-144.4	28-30
CA146	146-148	27-27.4 (CB)
CA220	220-222	28-30
CA220-2	220-224	144-148
CA110	Any 2MHz of Aircraft Band	26-28 or 28-30
CA432-2	432-434	28-30
CA432-5	435-437	28-30
CA432-4	432-436	144-148

Easily modified for other rf and if ranges.

STYLE	VHF	UHF
Kit less case	\$34.95	\$49.95
Kit with case	\$39.95	\$54.95
Wired/Tested in case	\$54.95	\$64.95

## Professional Quality VHF/UHF FM/CW EXCITERS

- Double tuned circuits for spurious suppression
- Easy to align with built-in test aids



T51-30	10 Meter, 2W Kit.....	\$44.95
T51-50	6 Meter, 2W Kit.....	\$44.95
T51-150	2 Meter, 2W Kit.....	\$44.95
T51-220	220 MHz, 2W Kit.....	\$44.95
T450	450 MHz, 3/4W Kit....	\$44.95
T451	450 MHz, 3 W Kit.....	\$59.95
A14T	5 Chan Adapter (T51&T451)	\$9.95

## See our Complete Line of VHF & UHF Linear PA's

- Use as linear or class C PA
- For use with SSB Xmtg Converters, FM Exciters, etc.

LPA2-15	6M, 2M, 220; 15 to 20W.....	\$59.95
LPA2-30	6M, 2m; 25 to 30W.....	\$89.95
LPA2-40	220 MHz; 30 to 40W.....	\$119.95
LPA2-45	6M, 2M; 40 to 45W.....	\$119.95
LPA4-10	430MHz; 10 to 14W.....	\$79.95
LPA4-30	430MHz; 30-40W.....	\$119.95

See catalog for complete specifications

## FAMOUS HAMTRONICS PREAMPS

Let you hear the weak ones too!  
 Great for OSCAR, SSB, FM, ATV. Over 14,000 in use throughout the world on all types of receivers.



- NEW LOW-NOISE DESIGN
- Less than 2 dB noise figure, 20 dB gain
- Case only 2 inches square
- Specify operating frequency when ordering

MODEL P-30 VHF PREAMP, available in many versions to cover bands 28-300 MHz.

MODEL P432 UHF PREAMP, available in versions to cover bands 300-650 MHz.

STYLE	VHF	UHF
Kit less case	\$12.95	\$18.95
Kit with case	\$18.95	\$26.95
Wired/Tested in Case	\$27.95	\$32.95

## NEW VHF/UHF FM RCVRs

Offer Unprecedented Range of Selectivity Options

- New generation
- More sensitive
- More selective
- Low cross mod
- Uses crystal filters
- Smaller
- Easy to align



R75A\* VHF Kit for monitor or weather satellite service. Uses wide L-C filter. -60dB at ± 30 kHz..... \$69.95

R75B\* VHF Kit for normal nbfm service. Equivalent to most transceivers. -60dB at ± 17 kHz, -80dB at ± 25 kHz... \$74.95

R75C\* VHF Kit for repeater service or high rf density area. -60dB at ± 14kHz, -80dB ± 22kHz, -100dB ± 30kHz.... \$84.95

R75D\* VHF Kit for split channel operation or repeater in high density area. Uses 8-pole crystal filter. -60dB at ± 9kHz, -100dB at ± 15 kHz. The ultimate receiver!... \$99.95

\* Specify band: 10M, 6M, 2M, or 220 MHz. May also be used for adjacent commercial bands. Use 2M version for 137 MHz WX satellites.

R450( ) UHF FM Receiver Kits, similar to R75, but for UHF band. New low-noise front end. Add \$10 to above prices. (Add selectivity letter to model number as on R75.)

A14 5 Channel Adapter for Receivers..... \$9.95

## NEW R110 VHF AM RCVR

AM monitor receiver kit similar to R75A, but AM. Available for 10-11M, 6M, 2M, 220 MHz, and 110-130 MHz aircraft band \$74.95. (Also available in UHF version.)

# hamtronics, inc.

65N MOUL RD • HILTON, NY 14468

Call or Write to get **FREE CATALOG** With Complete Details  
 (Send 4 IRC's for overseas mailing)

HAMTRONICS® IS A REGISTERED TRADEMARK

ramsey

# the first name in Counters!



## 9 DIGITS 600 MHz \$129<sup>95</sup> WIRED

**PRICES:**

CT-90 wired, 1 year warranty	\$129.95
CT-90 Kit, 90 day parts warranty	
BP-1 Nicad pack + AC Adapter/Charger	109.95
OV-1, Micro-power Oven time base	3.95
External time base input	12.95
	49.95
	14.95

The CT-90 is the most versatile, feature packed counter available for less than \$300.00! Advanced design features include: three selectable gate times, nine digits, gate indicator and a unique display hold function which holds the displayed count after the input signal is removed! Also, a 10MHz TCXO time base is used which enables easy zero beat calibration checks against WWV. Optionally, an internal nicad battery pack, external time base input and Micro-power high stability crystal oven time base are available. The CT-90, performance you can count on!

**SPECIFICATIONS:**

Range:	20 Hz to 600 MHz
Sensitivity:	Less than 10 MV to 150 MHz Less than 50 MV to 500 MHz
Resolution:	0.1 Hz (10 MHz range) 1.0 Hz (60 MHz range) 10.0 Hz (600 MHz range)
Display:	9 digits 0.4" LED
Time base:	Standard-10.000 MHz, 1.0 ppm 20-40°C Optional Micro-power oven-0.1 ppm 20-40°C
Power:	8-15 VAC @ 250 ma

## 7 DIGITS 525 MHz \$99<sup>95</sup> WIRED



**SPECIFICATIONS:**

Range:	20 Hz to 525 MHz
Sensitivity:	Less than 50 MV to 150 MHz Less than 150 MV to 500 MHz
Resolution:	1.0 Hz (5 MHz range) 10.0 Hz (50 MHz range) 100.0 Hz (500 MHz range)
Display:	7 digits 0.4" LED
Time base:	1.0 ppm TCXO 20-40°C
Power:	12 VAC @ 250 ma

The CT-70 breaks the price barrier on lab quality frequency counters. Deluxe features such as: three frequency ranges - each with pre-amplification, dual selectable gate times, and gate activity indication make measurements a snap. The wide frequency range enables you to accurately measure signals from audio thru UHF with 1.0 ppm accuracy - that's .0001%! The CT-70 is the answer to all your measurement needs, in the field, lab or ham shack.

**PRICES:**

CT-70 wired, 1 year warranty	\$99.95
CT-70 Kit, 90 day parts warranty	84.95
AC-1 AC adapter	3.95
BP-1 Nicad pack + AC adapter/charger	12.95



## 7 DIGITS 500 MHz \$79<sup>95</sup> WIRED

**PRICES:**

MINI-100 wired, 1 year warranty	\$79.95
MINI-100 Kit, 90 day part warranty	59.95
AC-Z Ac adapter for MINI-100	3.95
BP-Z Nicad pack and AC adapter/charger	12.95

Here's a handy, general purpose counter that provides most counter functions at an unbelievable price. The MINI-100 doesn't have the full frequency range or input impedance qualities found in higher price units, but for basic RF signal measurements, it can't be beat! Accurate measurements can be made from 1 MHz all the way up to 500 MHz with excellent sensitivity throughout the range, and the two gate times let you select the resolution desired. Add the nicad pack option and the MINI-100 makes an ideal addition to your tool box for "in-the-field" frequency checks and repairs.

**SPECIFICATIONS:**

Range:	1 MHz to 500 MHz
Sensitivity:	Less than 25 MV
Resolution:	100 Hz (slow gate) 1.0 KHz (fast gate)
Display:	7 digits, 0.4" LED
Time base:	2.0 ppm 20-40°C
Power:	5 VDC @ 200 ma

## 8 DIGITS 600 MHz \$159<sup>95</sup> WIRED

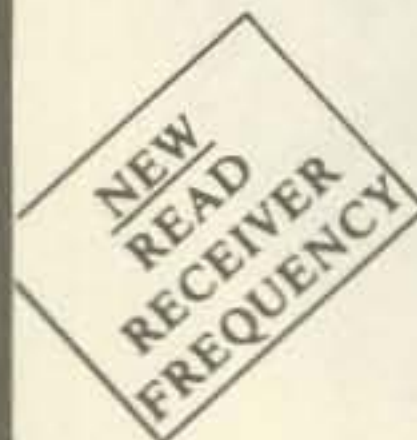

**SPECIFICATIONS:**

Range:	20 Hz to 600 MHz
Sensitivity:	Less than 25 mv to 150 MHz Less than 150 mv to 600 MHz
Resolution:	1.0 Hz (60 MHz range) 10.0 Hz (600 MHz range)
Display:	8 digits 0.4" LED
Time base:	2.0 ppm 20-40°C
Power:	110 VAC or 12 VDC

The CT-50 is a versatile lab bench counter that will measure up to 600 MHz with 8 digit precision. And, one of its best features is the Receive Frequency Adapter, which turns the CT-50 into a digital readout for any receiver. The adapter is easily programmed for any receiver and a simple connection to the receiver's VFO is all that is required for use. Adding the receiver adapter in no way limits the operation of the CT-50, the adapter can be conveniently switched on or off. The CT-50, a counter that can work double-duty!

**PRICES:**

CT-50 wired, 1 year warranty	\$159.95
CT-50 Kit, 90 day parts warranty	119.95
RA-1, receiver adapter kit	14.95
RA-1 wired and pre-programmed (send copy of receiver schematic)	29.95



## DIGITAL MULTIMETER \$99<sup>95</sup> WIRED

**PRICES:**

DM-700 wired, 1 year warranty	\$99.95
DM-700 Kit, 90 day parts warranty	79.95
AC-1, AC adaptor	3.95
BP-3, Nicad pack + AC adapter/charger	19.95
MP-1, Probe kit	2.95

The DM-700 offers professional quality performance at a hobbyist price. Features include: 26 different ranges and 5 functions, all arranged in a convenient, easy to use format. Measurements are displayed on a large 3 1/2 digit, 1/2 inch LED readout with automatic decimal placement, automatic polarity, overrange indication and overload protection up to 1250 volts on all ranges, making it virtually goof-proof! The DM-700 looks great, a handsome, jet black, rugged ABS case with convenient retractable tilt bail makes it an ideal addition to any shop.

**SPECIFICATIONS:**

DC/AC volts:	100uV to 1 KV, 5 ranges
DC/AC current:	0.1 uA to 2.0 Amps, 5 ranges
Resistance:	0.1 ohms to 20 Megohms, 6 ranges
Input impedance:	10 Megohms, DC/AC volts
Accuracy:	10.1% basic DC volts
Power:	4 'C' cells

### AUDIO SCALER

For high resolution audio measurements, multiplies UP in frequency.

- Great for PL tones
- Multiplies by 10 or 100
- 0.01 Hz resolution!

\$29.95 Kit \$39.95 Wired

### ACCESSORIES

Telescopic whip antenna - BNC plug	\$ 7.95
High impedance probe, light loading	15.95
Low pass probe, for audio measurements	15.95
Direct probe, general purpose usage	12.95
Tilt bail, for CT 70, 90, MINI-100	3.95
Color burst calibration unit, calibrates counter against color TV signal	14.95

### COUNTER PREAMP

For measuring extremely weak signals from 10 to 1,000 MHz. Small size, powered by plug transformer-included.

- Flat 25 db gain
- BNC Connectors
- Great for sniffing RF with pick-up loop

\$34.95 Kit \$44.95 Wired

ramsey electronic's, inc.  
2575 Baird Rd. Penfield, NY 14526



PHONE ORDERS  
CALL 716-586-3950

**TERMS:** Satisfaction guaranteed - examine for 10 days if not pleased return in original form for refund. Add 5% for shipping insurance to a maximum of \$10. Overseas add 15% COD add \$2. Orders under \$10 add \$1.50. NY residents add 7% tax.

## National Semiconductor Clock Modules

12VDC AUTOMOTIVE/INSTRUMENT CLOCK



APPLICATIONS:

- In-dash autoclocks
- After-market auto/RV clocks
- Aircraft-marine clocks
- 12VDC oper. instru.
- Portable/battery powered instruments.

Features: Bright 0.3" green display. Internal crystal time-base.  $\pm 0.5$  sec./day accur. Auto display brightness control logic. Display color filterable to blue, blue-green, green & yellow. Complete - just add switches and lens.

**MA1003 Module ..... \$16.95**

### CLOCK MODULES

MA1023	.7" Low Cost Digital LED Clock Module	8.95
MA1026	.7" Dig. LED Alarm Clock/Thermometer	18.95
MA5036	.3" Low Cost Digital LED Clock/Timer	6.95
MA1002	.5" LED Display Dig. Clock & Xformer	9.95

### TRANSFORMERS

XFMR1023	Xformer for MA1023 Clock Modules	3.49
XFMR1026	Xformer for MA1026 Clock Modules	3.49
XFMR5036	Xformer for MA5036 Clock Modules	3.49

## Transistor Checker

The ASI Transistor Checker is capable of checking a wide range of transistor types, either "in circuit" or out of circuit. It has been specially designed to take advantage of the newer concept of dynamic testing under current amplifier conditions. To operate, simply plug the transistor to be checked into the front panel socket, or connect it with the alligator clip test leads provided. No preliminary set-up is needed. The unit safely and automatically identifies low, medium and high power PNP and NPN transistors. The ASI Transistor Checker also permits matching similar transistors in actual operating circuits, and provides a reliable GO/NO-GO test at practical collector currents (from 5mA on small signal types to 50mA and more on power types.) Match similar type transistors by observing and comparing their readings; the higher the reading, the higher the gain. Completely assembled - battery operated. ("C" cell battery not included.)



**Trans-Check ..... \$9.95**

## EPROM Erasing Lamp



- Erases 2708, 2716, 1702A, 5203Q, 5204Q, etc.
- Erases up to 4 chips within 20 minutes.
- Maintains constant exposure distance of one inch.
- Special conductive foam liner eliminates static build-up.
- Built-in safety lock to prevent UV exposure.
- Compact - only 7-5/8" x 2-7/8" x 2"
- Complete with holding tray for 4 chips.

**UVS-11E ..... \$79.95**

## JOYSTICKS

JS-6K	6K Linear Taper Pots	\$6.25
JS-100K	100K Linear Taper Pots	\$4.95
JVC-40	40K (2) Video Controller in case	\$5.95

## 6-Digit Clock Kit

Bright .300 ht. comm. cathode display. Uses MM5314 clock chip. Switches for hours, minutes and hold modes. Hrs. easily viewable to 20 ft. Simulated walnut case. 115 VAC operation. 12 or 24 hr. operation. Incl. all components, case & wall transformer. Size: 6 1/2" x 3 1/8" x 1 1/4"

**JE701 ..... \$19.95**

## JE215 Adjustable Dual Power Supply

General Description: The JE215 is a Dual Power Supply with independent adjustable positive and negative output voltages. A separate adjustment for each of the supplies provides the user unlimited applications for IC current voltage requirements. The supply can also be used as a general all-purpose variable power supply.

**JE215 Adj. Dual Power Supply Kit (as shown) . . . \$24.95**

(Picture not shown but similar in construction to above)  
 JE200 Reg. Power Supply Kit (5VDC, 1 amp) . . . \$14.95  
 JE205 Adapter Brd. (to JE200)  $\pm 5$ ,  $\pm 9$  &  $\pm 12$ V. \$12.95  
 JE210 Var. Pwr. Sply. Kit, 5-15VDC, to 1.5amp. \$19.95

# MICROPROCESSOR COMPONENTS

8080A/8080A SUPPORT DEVICES		DATA ACQUISITION (CONTINUED)			
IN5880A	CPU	4.95	ADC0809CCN	8-BIT A/D Converter (8-Ch. Multi.)	3.25
DP8212	8-Bit Input/Output	2.25	ADC0817CCN	8-BIT A/D Converter (16-Ch. Multi.)	18.95
DP8214	Priority Interrupt Control	3.95	DAC1080LCN	10-BIT D/A Conv. Micro. Comp. (0.05%)	13.95
DP8215	BI-Directional Bus Driver	2.49	DAC1081LCN	10-BIT D/A Conv. Micro. Comp. (0.20%)	8.95
DP8216	Clock Generator/Driver	3.95	DAC1082LCN	10-BIT D/A Converter (0.80% Lin.)	5.95
DP8217	Bus Driver	1.49	DAC1222LCN	12-BIT D/A Converter (0.20% Lin.)	9.95
DP8218	System Controller/Bus Driver	4.95	CD4851H	8-Channel Multiplexer	1.19
DP8219	System Controller	3.95	AV-5-1011	3M. BAUD UART	5.95
IN5824	I/O Expander for 48 Series	35.95	-RAM'S-		
IN5825	Asynchronous Comm. Element	7.95	1301	256x1 Static	1.49
DP8251	Prog. Comm. I/O (USART)	14.95	1302	1024x1 Dynamic	.99
DP8252	Prog. Peripheral I/O (PPI)	9.95	2101 (8001)	256x4 Static	3.95
DP8253	Prog. DMA Control	14.95	2102	1024x1 Static	1.75
DP8254	Prog. Interrupt Control	14.95	2110	1024x1 Static	1.95
DP8255	Prog. CRT Controller	49.95	2111 (8111)	256x4 Static	3.95
DP8256	Prog. Keyboard/Display Interface	14.95	3112	256x4 Static MOS	2.95
DP8257	Octal Bus Receiver	6.95	3114	1024x1 Static 40ns	4.95
DP8258	System Timing Element	6.95	2114L	1024x4 Static 300ns Low Power	4.95
DP8259	8-BIT Bi-Directional Receiver	1.95	2114-2	1024x4 Static 300ns	4.95
DP8260	8-BIT Bi-Directional Receiver	1.95	2114-3	1024x4 Static 300ns Low Power	5.95
DP8261	8-BIT Bi-Directional Receiver	1.95	2117	16,384x1 Dynamic 300ns (Housemarked)	4.95
DP8262	8-BIT Bi-Directional Receiver	1.95	4126 (UPD4126)	256K Dynamic 250ns	3.95
DP8263	8-BIT Bi-Directional Receiver	1.95	4364	512K Dynamic 250ns	49.95
DP8264	8-BIT Bi-Directional Receiver	1.95	MM234J	4096x1 Fast 70ns	19.95
DP8265	8-BIT Bi-Directional Receiver	1.95	5101	256x4 Static	7.95
DP8266	8-BIT Bi-Directional Receiver	1.95	MM5261	1024x1 Dynamic Fairly Decoded	.99
DP8267	8-BIT Bi-Directional Receiver	1.95	MM5262	2Kx1 Dynamic	.25
DP8268	8-BIT Bi-Directional Receiver	1.95	MM5263/2307	4096x1 Dynamic	4.95
DP8269	8-BIT Bi-Directional Receiver	1.95	MM5264-2(416)	8K Dynamic 100ns	5.25
DP8270	8-BIT Bi-Directional Receiver	1.95	MM5265-3A	8K Dyn. 200ns (lower % of MM5265)	4.95
DP8271	8-BIT Bi-Directional Receiver	1.95	UPD44/44K40ET	4K Dynamic 30-60ns	4.95
DP8272	8-BIT Bi-Directional Receiver	1.95	TM5494-45N/L	8K Static	14.95
DP8273	8-BIT Bi-Directional Receiver	1.95	TM5495	16K Static	14.95
DP8274	8-BIT Bi-Directional Receiver	1.95	-PROMS/EPROMS-		
DP8275	8-BIT Bi-Directional Receiver	1.95	1702A	2K UV Erasable PROM	5.95
DP8276	8-BIT Bi-Directional Receiver	1.95	2708	8K EPROM	5.95
DP8277	8-BIT Bi-Directional Receiver	1.95	TM5276	8K EPROM (+5V, +5V, +12V)	19.95
DP8278	8-BIT Bi-Directional Receiver	1.95	2716 (2516)	16K EPROM (Single +5V)	19.95
DP8279	8-BIT Bi-Directional Receiver	1.95	27216 (25216)	32K EPROM	19.95
DP8280	8-BIT Bi-Directional Receiver	1.95	2706	8K EPROM (40ns) (Single +5V)	7.95
DP8281	8-BIT Bi-Directional Receiver	1.95	5102	256 EPROM	14.95
DP8282	8-BIT Bi-Directional Receiver	1.95	82523 (85188)	128 EPROM (Open Collector)	4.95
DP8283	8-BIT Bi-Directional Receiver	1.95	825115	4096 Bipolar PROM	29.95
DP8284	8-BIT Bi-Directional Receiver	1.95	825122 (85284)	32K Tri-State Bipolar PROM	4.95
DP8285	8-BIT Bi-Directional Receiver	1.95	825188	8K PROM	29.95
DP8286	8-BIT Bi-Directional Receiver	1.95	-ROM'S-		
DP8287	8-BIT Bi-Directional Receiver	1.95	2613 (2142)	Character Generator (Upper Case)	9.95
DP8288	8-BIT Bi-Directional Receiver	1.95	2613 (2613)	Character Generator (Lower Case)	9.95
DP8289	8-BIT Bi-Directional Receiver	1.95	2310N	Character Generator	10.95
DP8290	8-BIT Bi-Directional Receiver	1.95	MM5266N	2048-Bit Read Only Memory	1.95
DP8291	8-BIT Bi-Directional Receiver	1.95	-NROM READ ONLY MEMORIES-		
DP8292	8-BIT Bi-Directional Receiver	1.95	MCN86120P	128x17 ASCII 5x11x15 128x17	13.50
DP8293	8-BIT Bi-Directional Receiver	1.95	MCN86140P	128x17 Math Symbol & Pictorial	13.50
DP8294	8-BIT Bi-Directional Receiver	1.95	MCN86150P	128x17 Alpha, Control Char. Gen.	13.50
DP8295	8-BIT Bi-Directional Receiver	1.95	-MICROPROCESSOR MANUALS-		
DP8296	8-BIT Bi-Directional Receiver	1.95	M-290	User Manual	7.95
DP8297	8-BIT Bi-Directional Receiver	1.95	M-CDP3802	User Manual	7.95
DP8298	8-BIT Bi-Directional Receiver	1.95	M-3030	User Manual	7.95
DP8299	8-BIT Bi-Directional Receiver	1.95	-SPECIAL FUNCTION-		
DP8300	8-BIT Bi-Directional Receiver	1.95	DS0825CN	Dual MOS Clock Driver (SMZ)	3.00
DP8301	8-BIT Bi-Directional Receiver	1.95	DS0826CN	Dual MOS Clock Driver (SMZ)	3.00
DP8302	8-BIT Bi-Directional Receiver	1.95	IN5171N-1	Floppy Disk Controller	24.95
DP8303	8-BIT Bi-Directional Receiver	1.95	IN5283N	Communication Chip	29.95
DP8304	8-BIT Bi-Directional Receiver	1.95	MM5361N	Microprocessor Real Time Clock	6.95
DP8305	8-BIT Bi-Directional Receiver	1.95	MM5362N	Microprocessor Compatible Clock	11.95
DP8306	8-BIT Bi-Directional Receiver	1.95	COP4024	Microcontroller with 8-Digit RAM and Direct LED Drive	6.95
DP8307	8-BIT Bi-Directional Receiver	1.95	COP4024N	Microcontroller with 8-Digit RAM & Direct LED Drive w/N Buss Int.	7.49
DP8308	8-BIT Bi-Directional Receiver	1.95	COP4024V	10-Seq. VAC Fluor. Driver (29-pin pkg.)	5.25
DP8309	8-BIT Bi-Directional Receiver	1.95	-TELEPHONE/KEYBOARD CHIPS-		
DP8310	8-BIT Bi-Directional Receiver	1.95	AV-5-4100	Push Button Telephone Dialer	14.95
DP8311	8-BIT Bi-Directional Receiver	1.95	AV-5-1000	Rotary Dialer	14.95
DP8312	8-BIT Bi-Directional Receiver	1.95	AV-5-2200	CMOS Clock Generator	4.95
DP8313	8-BIT Bi-Directional Receiver	1.95	HD0305-9	Keyboard Encoder (36 keys)	11.95
DP8314	8-BIT Bi-Directional Receiver	1.95	HC322	Keyboard Encoder (36 keys)	7.95
DP8315	8-BIT Bi-Directional Receiver	1.95	HC323	Keyboard Encoder (36 keys)	5.49
DP8316	8-BIT Bi-Directional Receiver	1.95	MM5100N	Push Button Pulse Dialer	7.95
DP8317	8-BIT Bi-Directional Receiver	1.95	MM5100N	9/14-Key Serial Keyboard Encoder	6.95

## Bourns Potentiometer

3/4 Watt Single Turn (TOP ADJUSTMENT)

Values: 500Ω 1K 2.5K 5K 10K 25K 50K 100K 250K 500K 5Meg

INDIVIDUAL PRICING:

1-49	50-99	100-999	1K-up
.19	.17	.15	.12

**GB174 ..... \$1.95/lot**  
(25 pieces all 11 asst. values)

To order: Specify Bourns 3355 - (Value desired)

## AC and DC Wall Transformers



Ideal for use with clocks, games, power supplies or any other type of AC or DC application.

Part No.	Input	Output	Price
AC 250	117V/60Hz	12 VAC 250mA	\$3.95
AC 500	117V/60Hz	12 VAC 500mA	\$4.95
AC1000	117V/60Hz	12 VAC 1 amp	\$5.95
AC1700	117V/60Hz	9 VAC 1.7 amp	\$6.95
DV 9200	117V/60Hz	9 VDC 200mA	\$3.25
DC 900	120V/60Hz	9 VDC 500mA	\$3.95

## CONNECTORS



DB25P	D-Subminiature Plug	\$2.95
DB25S	D-Subminiature Socket	\$3.50
DB51226	Cover for DB25P/S	\$1.75
22/44SE	P.C. Edge (22/44 Pin)	\$2.95
UG88/U	BNC Plug	\$1.79
UG89/U	BNC Jack	\$3.79
UG175/U	UHF Adapter	\$ .49
SO239	UHF Panel Recp.	\$1.29
PL258	UHF Adapter	\$1.60
PL259	UHF Plug	\$1.60
UG260/U	BNC Plug	\$1.79
UG1094/U	BNC Bulkhead Recp.	\$1.29

## TRS-80 16K Conversion Kit

Expand your 4K TRS-80 System to 16K.

Kit comes complete with:

- 8 ea. MM5290 (UPD416/4116) 16K Dyn. Rams (\*\*NS)
- Documentation for Conversion

**TRS-16K2 \*150NS ..... \$39.95**  
**TRS-16K4 \*250NS ..... \$29.95**

## GLOBAL SPECIALTIES EXPERIMENTOR SOCKETS



Model	Length	Width	Center Channel	5 Tie Point Terminals	Bus Strips	Price
EXP48	6.0"	1.0"	n/a	n/a	4(160)	\$ 4.75
EXP300	6.0"	2.1"	.3"	94(470)	2(80)	\$12.00
EXP325	1.8"	2.1"	.3"	22(110)	2(20)	\$ 3.50
EXP350	3.6"	2.1"	.3"	46(230)	2(40)	\$ 6.75
EXP600	6.0"	2.4"	.5"	94(470)	2(80)	\$14.75
EXP650	3.6"	2.4"	.5"	48(230)	2(40)	\$ 8.75

### Quick Test Sockets & Bus Strips

Model	Length	Hole to Hole	Terminals	Unit Price \$
QT-595	6.5"	6.2"	118	\$12.25
QT-598	6.5"	6.2"	20	\$ 2.75
QT-475	5.3"	5.0"	94	\$ 9.75
QT-478	5.3"	5.0"	16	\$ 2.50
QT-355	4.1"	3.8"	70	\$ 7.25
QT-358	4.1"	3.8"	12	\$ 2.20
QT-185	2.4"	2.1"	36	\$ 4.50
QT-125	1.8"	1.5"	24	\$ 3.75
QT-85	1.4"	1.1"	16	\$ 3.00
QT-75	1.3"	1.0"	14	\$ 2.75

## ELECTRONIC TOY MOTORS

Typical Power Source	Operating Voltage Range	TYPICAL CHARACTERISTICS							
		NO LOAD				AT MAXIMUM EFFICIENCY			
		Speed RPM	Current AMP	Speed RPM	Current AMP	Torque OZ. IN.	Output W	Eff. %	Small Torque OZ. IN.
DRY CELL	1.5-6.0	3.0	0.20	6,750	0.00	0.260	1.30	67.0	0.07

**MABUCHI RE280 \$ .99 each . . . 10/\$7.50 . . . 100/\$50.00**

## DESIGNERS' SERIES

### Blank Desk-Top Electronic Enclosures



**CONSTRUCTION:**  
 The "DTE" Blank Desk Top Electronic Enclosures are designed to blend and complement today's modern computer equipment and can be used in both industrial and home. The end pieces are precision molded with an internal slot (all around) to accept both top and bottom panels. The panels are then fastened to 1/4" thick tabs inside the end pieces to provide maximum rigidity to the enclosure. For ease of equipment servicing, the rear/bottom panel slides back on slotted tracks while the rest of the enclosure remains intact. Different panel widths may be used while maintaining a common profile outline. The molded end pieces can also be painted to match any panel color scheme.

Enclosure Model No.	Panel Width	PRICE
DTE-8	8.00"	\$29.95
DTE-11	10.65"	\$32.95
DTE-14	14.00"	\$34.95

**\$10.00 Min. Order - U.S. Funds Only**  
 Calif. Residents Add 6% Sales Tax  
 Postage - Add 5% plus \$1 Insurance

Spec Sheets - 25¢  
 Send 52¢ Postage for your  
**FREE 1981 JAMECO CATALOG**

**Jameco ELECTRONICS**  
 PHONE ORDERS WELCOME (415) 592-8097

MAIL ORDER ELECTRONICS - WORLDWIDE  
 1355 SHOREWAY ROAD, BELMONT, CA 94002 ✓ 38  
 PRICES SUBJECT TO CHANGE

# DEALER DIRECTORY

## San Jose CA

Bay area's newest Amateur Radio store. New & used Amateur Radio sales & service. We feature Kenwood, ICOM, Azden, Yaesu, Ten-Tec, Santee & many more. Shaver Radio, Inc., 1378 So. Bascom Ave., San Jose CA 95128, 998-1103.

## Denver CO

Experimenter's paradise! Electronic and mechanical components for computer people, audio people, hams, robot builders, experimenters. Open six days a week. Gateway Electronics Corp., 2839 W. 44th Ave., Denver CO 80211, 458-5444.

## Columbus GA

**KENWOOD—YAESU—DRAKE**  
The world's most fantastic amateur showroom! You gotta see it to believe it! Radio Wholesale, 2012 Auburn Avenue, Columbus GA 31906, 561-7000.

## Preston ID

Ross WB7BYZ, has the Largest Stock of Amateur Gear in the Intermountain West and the Best Prices. Call me for all your ham needs. Ross Distributing, 78 So. State, Preston ID 83263, 852-0830.

## Terre Haute IN

Your ham headquarters located in the heart of the midwest. Hoosier Electronics, Inc., 43B Meadows Shopping Center, P.O. Box 3300, Terre Haute IN 47803, 238-1456.

## Littleton MA

The ham store of N.E. you can rely on. Kenwood, ICOM, Wilson, Yaesu, DenTron, KLM amps, B&W switches & wattmeters, Whistler radar detectors, Bearcat, Regency, antennas by Larsen, Wilson, Hustler, GAM, TEL-COM Inc. Communications & Electronics, 675 Great Rd., Rt. 119, Littleton MA 01460, 486-3040.

## St. Louis MO

Experimenter's paradise! Electronic and mechanical components for computer people, audio people, hams, robot builders, experimenters. Open six days a week. Gateway Electronics Corp., 8123-25 Page Blvd., St. Louis MO 63130, 427-6116.

## Phila. PA/Camden NJ

Waveguide & coaxial microwave components & equipment. Laboratory grade test instruments, power supplies. Buy, sell & trade all popular makes, HP, GR, FXR, ESI, Sorensen, Singer, etc. Electronic Research Labs., 1423 Ferry Ave., Camden NJ 08104, 541-4200.

## Syracuse-Rome-Utica NY

Featuring: Kenwood, Yaesu, ICOM, Drake, Ten-Tec, Swan, DenTron, Alpha, Robot, MFJ, Tempo, Astron, KLM, Hy Gain, Mosley, Larsen, Cushcraft, Hustler, Mini Products. You won't be disappointed with equipment/service. Radio World, Oneida County Airport-Terminal Building, Oriskany NY 13424, 337-0203.

## Winston-Salem NC AMATEUR RADIO REPAIR

Professional service, reasonable rates, all brands, USA KDK repair center. Amateur Radio Repair Center, 1020 Brookstown Ave., Winston-Salem, NC 27101, 725-7500.

## Columbus OH

All major brands featured in the biggest and best ham store for miles around. Come in and twist the knobs before you buy. Universal Amateur Radio, Inc., 1280 Aida Dr., Reynoldsburg (Columbus) OH 43068, 866-4267.

## Scranton PA

ICOM, Bird, CushCraft, Beckman, Fluke, Larsen, Hustler, Antenna Specialists, Astron, Avanti, Belden, W2AU/W2VS, CDE, AEA, Vibroplex, Ham-Key, CES, Amphenol, Sony, Fanon/Courier, B&W, Ameco, Shure. LaRue Electronics, 1112 Grandview St., Scranton PA 18509, 343-2124.

## Houston TX

Experimenter's paradise! Electronic and mechanical components for computer people, audio people, hams, robot builders, experimenters. Open six days a week. Gateway Electronics Inc., 8932 Clarkcrest, Houston TX 77063, 978-6575.

## San Antonio TX

Complete 2 way service shop. Call Dee, W5FSP. Selling Antenna Specialists, Avanti, Azden, Bird, Hy-gain, Standard, Vibroplex, Midland, Henry, CushCraft, Dielectric, Hustler, ICOM, MFJ, Nye, Shure, Cubic, Tempo, Ten-Tec and others. Appliance & Equipment Co., Inc., 2317 Vance Jackson Road, San Antonio TX 78213, 734-7793.

## DEALERS

Your company name and message can contain up to 25 words for as little as \$150 yearly (prepaid), or \$15 per month (prepaid quarterly). No mention of mail-order business or area code permitted. Directory text and payment must reach us 60 days in advance of publication. For example, advertising for the August issue must be in our hands by June 1st. Mail to 73 Magazine, Peterborough NH 03458. ATTN: Nancy Ciampa.

# PROPAGATION

J. H. Nelson  
4 Plymouth Dr.  
Whiting NJ 08759

## EASTERN UNITED STATES TO:

GMT:	00	02	04	06	08	10	12	14	16	18	20	22
ALASKA	14	14	7A	7	7	7	7	7	7A	14	14	14
ARGENTINA	21	14A	14	7	7	7	7A	14	21	21A	21A	21
AUSTRALIA	14A	14	14	7B	7B	7B	7	7	7B	7B	14	21
CANAL ZONE	21	14	14	14	7	7	14	14	21	21	21A	21A
ENGLAND	14	7A	7	7	7	7A	14	21	21	21	14	14
HAWAII	21	14	7A	7	7	7	7A	14	14	14	14	14A
INDIA	14	7A	7B	7B	7B	7B	7A	14	14	14	14	14
JAPAN	14	14	7A	7B	7B	7B	7B	7B	14	14	14	14
MEXICO	14A	14	14	7	7	7	7A	14	14	14	21A	21
PHILIPPINES	14	14	7A	7B	7B	7B	7B	7B	14	14	14	14
PUERTO RICO	14	14	7	7	7	7	7A	14	14	14	21	14A
SOUTH AFRICA	14	7B	7B	7	7	14	14	21	21A	21A	21	14
U. S. S. R.	14	7A	7	7	7	7	14	14	14A	14A	14	14
WEST COAST	21	14	14	7	7	7	7A	14	14	14A	21	21

## CENTRAL UNITED STATES TO:

ALASKA	14	14	14	7	7	7	7	7	14	14	14	14
ARGENTINA	21	21	14	14	7	7	7	14	21	21A	21A	21
AUSTRALIA	21	21	14	14	7	7B	7	7	7B	7B	14	14A
CANAL ZONE	21	14	14	7	7	7	14	14	21	21	21A	21A
ENGLAND	14	7	7	7	7	7	7A	14	14	21	14	14
HAWAII	21	14A	14	7A	7	7	7A	14	14	14	21A	21A
INDIA	14	14	7A	7B	7B	7B	7B	7B	14	14	14	14
JAPAN	14	14	14	7	7	7B	7B	7B	14	14	14	14
MEXICO	14	14	7	7	7	7	7	14	14	14	14A	14A
PHILIPPINES	14	14	14	7B	7B	7B	7B	7B	14	14	14	14
PUERTO RICO	21	14	14	7	7	7	7A	14	14	14A	21	21
SOUTH AFRICA	14	7B	7B	7B	7B	7B	14	14	21	21A	21	14
U. S. S. R.	14	7A	7	7	7	7	7	14	14	14A	14	14

## WESTERN UNITED STATES TO:

ALASKA	14	14	14	7	7	7	7	7	14	14	14	14
ARGENTINA	21A	21	14	14	7	7	7A	14	21	21	21A	21A
AUSTRALIA	21A	21	14A	14	7	7	7	7	7B	7B	14	21
CANAL ZONE	21	14	14	7	7	7	14	14	21	21	21A	21A
ENGLAND	14	7B	7	7	7	7	7	7	14	14A	14	14
HAWAII	21A	21A	14A	14	14	7	7	14	14	21	21	21
INDIA	14	14	14	7A	7B	7B	7B	7B	14	14	14	14
JAPAN	14	14	14	14	7	7	7B	7B	14	14	14	14
MEXICO	14A	14	14	7	7	7	7	14	14	14	14A	14A
PHILIPPINES	14	14	14	14	7B	7B	7B	7B	14	14	14	14
PUERTO RICO	21	14	14	7	7	7	7	14	14A	21	21A	21
SOUTH AFRICA	14	7B	7B	7B	7B	7B	7B	14	14	14	21	14
U. S. S. R.	14	7	7	7	7	7	7B	7A	14	14	14	14
EAST COAST	21	14	14	7	7	7	7A	14	14	14A	21	21

First letter = day waves      Second = night waves  
A = Next higher frequency may also be useful  
B = Difficult circuit this period      F = Fair  
G = Good      P = Poor      \* = Chance of solar flares

## JUNE

SUN	MON	TUE	WED	THU	FRI	SAT
	1 G/G	2 G/G	3 G/G	4 G/G	5 G/G	6 G/F
7 G/G	8 G/G	9 G/F	10 G/G	11 G/G	12 G/G	13 G/G
14 G/G	15 G/F	16 G/F	17 G/G	18 G/G	19 G/G	20 G/G
21 G/G	22 G/F	23 G/G	24 G/G	25 F/F*	26 F/F*	27 F/F
28 G/G	29 G/G	30 G/G				



# WARC BANDS FACTORY INSTALLED!

FT-707 is shown with optional FV-707DM VFO & Scanning Microphone



## THE FT-707 "WAYFARER"

The introduction of the "WAYFARER" by Yaesu is the beginning of a new era in compact solid state transceivers. The FT-707 "WAYFARER" offers you a full 100 watts output on 80-10 meters and operates SSB, CW, and AM modes. Don't let the small size fool you! Though it is not much larger than a book, this is a full-featured transceiver which is ideally suited for your home station or as a traveling companion for mobile or portable operation.

The receiver offers sensitivity of .25  $\mu$ V/10 dB SN as well as a degree of selectivity previously unavailable in a package this small. The "WAYFARER" comes equipped with 16 poles of IF filtering, variable bandwidth and optional crystal filters for 600 Hz or 350 Hz. Just look at these additional features:

### FT-707 with Standard Features

- Fast/slow AGC selection
- Advanced noise blanker
- Built-in calibrator
- WWV/JJY Band
- Bright Digital Readout
- Fixed crystal position
- Factory-installed WARC bands
- Unique multi-color bar metering—monitors signal strength, power output, and ALC voltage.

### FT-707 with Optional FV-707DM & Scanning Microphone

- Choice of 2 rates of scan
- Remote scanning from microphone
- Scans in 10 cycle steps
- Synthesized VFO
- Selection of receiver/transmitter functions from either front panel or external VFO
- "DMS" (Digital Memory Shift)

Impressive as the "WAYFARER" is its versatility can be greatly increased by the addition of the FV-707DM (optional). The FV-707DM, though only one inch high, allows the storage of 13 discrete frequencies and with the use of "DMS" (Digital Memory Shift) each memory can be band-spread 500 KHz. These 500 KHz bands may be remotely scanned from the microphone at the very smooth rate of 10 Hz per step.

The FT-707 "WAYFARER" is a truly unique rig. See it today at your authorized Yaesu Dealer.

**YAESU**  
*The radio.*



381

83

YAESU ELECTRONICS CORP., 6851 Walthall Way, Paramount, CA 90723 • (213) 633-4007  
YAESU ELECTRONICS Eastern Service Ctr., 9812 Princeton-Glendale Rd., Cincinnati, OH 45246

# Power up.



## 40 W, 15 memories/offset recall, scan, priority, DTMF touch-pad

### TR-7850

Kenwood's remarkable TR-7850 2-meter FM mobile transceiver provides all the features you could desire, including a powerful 40 watts RF output. Frequency selection is easier than ever, and the rig incorporates new memory developments for repeater shift, priority, and scan, and includes a built-in autopatch touch-pad (DTMF) encoder. A 25-watt output version, the TR-7800, is also available.

#### TR-7850 FEATURES:

- **Powerful 40 watts power output**  
Selectable high or low power operation. High 40-watt output provides reliable signal for wide area coverage.
- **15 multifunction memory channels, easily selectable with a rotary control**  
M1-M13... memorize frequency and offset ( $\pm 600$  kHz or simplex). M14... memorize transmit and receive frequencies independently for nonstandard offset. M0... priority channel, with simplex,  $\pm 600$  kHz, or nonstandard offset operation.
- **Internal battery backup for all memories**  
All memory channels (including transmit offset) are retained when four AA NiCd batteries (not Kenwood supplied) are installed in battery holder inside TR-7850. Batteries are automatically charged while transceiver is connected to 12-VDC source.
- **Extended frequency coverage**  
143.900-148.995 MHz, in switchable 5-kHz or 10-kHz steps.

- **Priority alert**  
M0 memory is priority channel. "Beep" alerts operator when signal appears on priority channel. Operation can be switched immediately to priority channel with the push of a switch.
- **Built-in autopatch touch-pad (DTMF) encoder**  
Front-panel touch pad generates all 12 telephone-compatible dual tones in transmit mode, plus four additional DTMF signaling tones (with simultaneous push of REV switch).
- **Front-panel keyboard**  
For frequency selection, transmit offset selection, memory programming, scan control, and selection of autopatch encoder tones.
- **Autoscan**  
Entire band (5-kHz or 10-kHz steps) and memories. Automatically locks on busy channel; scan resumes automatically after several seconds, unless CLEAR or mic PTT button is pressed to cancel scan.
- **Up/down manual scan**  
Entire band (5-kHz or 10-kHz steps) and memories, with UP/DOWN microphone (standard).

- **Repeater reverse switch**  
Handy for checking signals on the input of a repeater or for determining if a repeater is "upside down."
- **Separate digital readouts**  
To display frequency (both receive and transmit) and memory channel.
- **LED bar meter**  
For monitoring received signal level and RF output.
- **LED indicators**  
To show: +600 kHz, simplex, or -600 kHz transmitter offset; BUSY channel; ON AIR.
- **TONE switch**  
To actuate subaudible tone module (not Kenwood-supplied).
- **Compact size**  
Depth is reduced substantially.
- **Mobile mounting bracket**  
With quick-release levers.

More information on the TR-7850 is available from all authorized dealers of Trio-Kenwood Communications, Inc., 1111 West Walnut Street, Compton, California 90220.

 **KENWOOD**  
...pacesetter in amateur radio

#### Matching accessory for fixed-station operation:

- KPS-12 fixed-station power supply for TR-7850

#### Other accessories not shown:

- KPS-7 fixed-station power supply for TR-7800
- SP-40 compact mobile speaker



Specifications and prices are subject to change without notice or obligation.