

January 1982 \$2.95

73 MAGAZINE

FOR RADIO AMATEURS

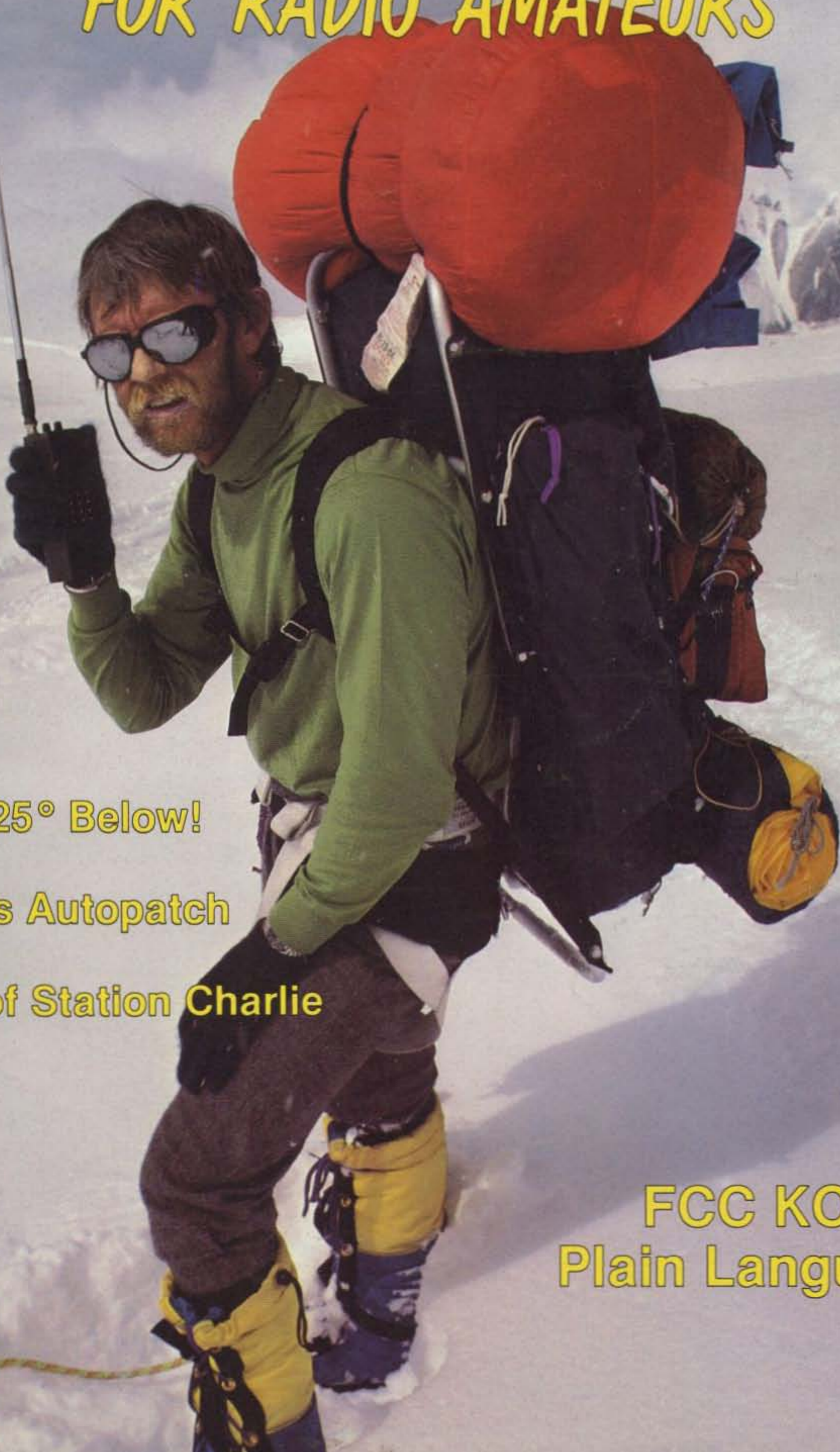

Rescue at 25° Below!

Everybody's Autopatch

The Saga of Station Charlie

FCC KO's
Plain Language!



What's better than one ICOM in the hand?

Meet the new ICOM 220 MHz IC-3AT. Providing full coverage of the 220 MHz band, the IC-3AT is similar in appearance and size to the popular IC-2AT. All accessories, including battery packs, chargers, microphone, etc., are completely compatible between the two series.

The IC-3AT includes a 16 button Touchtone® Pad and covers 220 to 224.99 MHz both simplex and duplex operation. The IC-3AT system comes complete with IC-BP3 NiCd battery pack, AC wall charger, belt clip, "rubber duckie" and wrist strap all standard at no extra cost.



IC-2AT
2 Meter FM

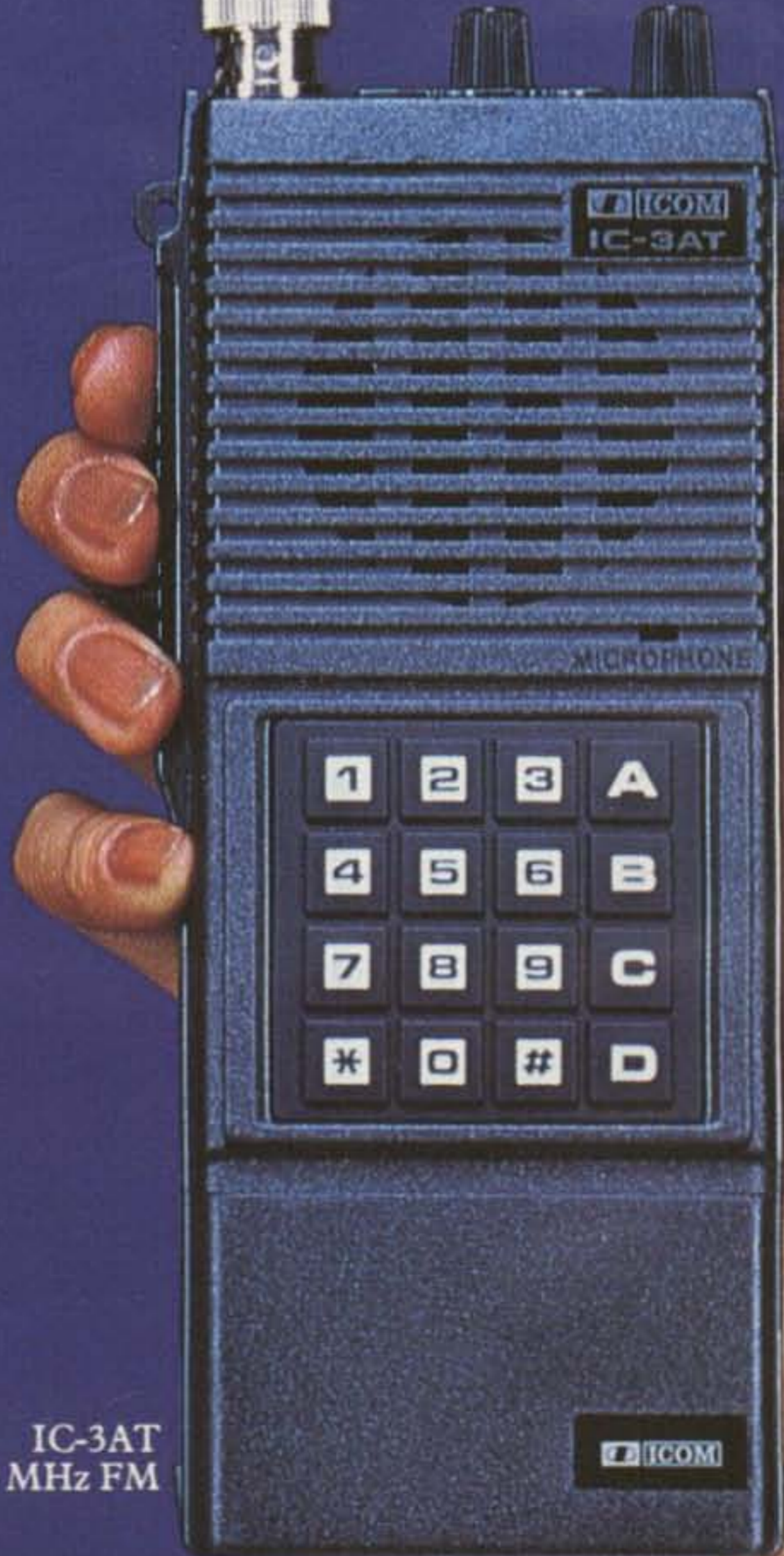

IC-3AT
220 MHz FM



FIVE STORE BUYING POWER!

Fast shipment popular items from huge stocks! And 5 to 1 odds (your favor), that scarcer items are available within multi-store complex! Quantity buying means top discounts, best prices. Call us first.

Amateurs world-wide are taking advantage of our fast service and special prices.

SERVING HAMS BETTER.

North...south...east...west.

Bob Ferrero, W6RJ/K6AHV, Jim Rafferty, N6RJ other well known hams give you courteous, personalized service.



FREE PHONE

**800
854-6046**

CALIF. CUSTOMERS PLEASE CALL OR VISIT LISTED STORES

FREE SHIPMENT

(UPS Brown)

CONTINENTAL U.S.A.



**HAM
RADIO
OUTLET™**

ANAHEIM, CA 92801

2620 W. La Palma,
(714) 761-3033 (213) 860-2040
Between Disneyland & Knott's Berry Farm

BURLINGAME, CA 94010

999 Howard Ave., (415) 342-5757
5 miles south on 101 from S.F. Airport.

OAKLAND, CA 94609

2811 Telegraph Ave., (415) 451-5757
Hwy 24 Downtown. Left 27th off-ramp.

SAN DIEGO, CA 92123

5375 Kearny Villa Road (714) 560-4900
Hwy 163 & Clairemont Mesa Blvd.

VAN NUYS, CA 91401

6265 Sepulveda Blvd., (213) 988-2212
San Diego Fwy at Victory Blvd.

OVER-THE-COUNTER

Mon. thru Sat. 10AM to 5:30PM

AEA • ALLIANCE • ALPHA • AMECO • AMPHENOL • ARRL • ASTRON
• AVANTI • BENCHER • BERK-TEK • BIRD • B&W • CALLBOOK • CDE
• COLLINS • CUBIC • CURTIS • CUSHCRAFT • DAIWA • DATONG
• DENTRON • DRAKE • DX ENGINEERING • EIMAC • HUSTLER
• HY-GAIN • ICOM • J.W.MILLER • KENWOOD • KLM • LARSEN
• LUNAR • METZ • MFJ • MICRO-LOG • MINI-PRODUCTS
• MIRAGE • NYE • PALOMAR • ROBOT • ROHN • SHURE • SWAN
• TELEX • TELREX • TEMPO • TEN-TEC • TRISTAO
• YAESU and many more!

KENWOOD

**NEW
TR-2500
HAND-
HELD**
ASK FOR
PRICES, DETAILS



TS-130S



TR-7850



TS-830S

SAVE substantially!
Call now for
your price

Sensational savings!

COLLINS / ROCKWELL KWM-380



We are offering you
KWM-380 at a price
lower than current
dealer wholesale!

*Limited quantity at this great saving.
Prices are increasing. Call immediately.*

BRAND NEW FROM YAESU • HF TRANSCEIVER

ASK FOR DETAILS, PRICES

• HAND-HELD

ETD ALPHA SUPERLATIVE AMPLIFIERS



77DX REGULAR \$4945
YOUR PRICE \$4199



76PA
REGULAR \$2195

YOUR PRICE \$1799

78

REGULAR \$3185

YOUR PRICE \$2599



Prices, specifications, descriptions subject to change without notice.

Calif. residents please add sales tax.

INFO

Manuscripts

Contributions in the form of manuscripts with drawings and/or photographs are welcome and will be considered for possible publication. We can assume no responsibility for loss or damage to any material. Please enclose a stamped, self-addressed envelope with each submission. Payment for the use of any unsolicited material will be made upon acceptance. All contributions should be directed to the 73 editorial offices. "How to Write for 73" guidelines are available upon request.

Editorial Offices:

Pine Street
Peterborough NH 03458
Phone: 603-924-3873, 924-3874

Advertising Offices:

Elm Street
Peterborough NH 03458
Phone: 603-924-7138

Circulation Offices:

Elm Street
Peterborough NH 03458
Phone: 603-924-7296

Subscription Rates

In the United States and Possessions:
One Year (12 issues) \$25.00
Two Years (24 issues) \$38.00
Three Years (36 issues) \$53.00

Elsewhere:

Canada—\$27.00/1 year only, U.S. funds. Foreign surface mail—\$35.00/1 year only, U.S. funds. Foreign air mail—\$62.00/1 year only, U.S. funds.

To subscribe, renew or change an address:

Write to 73 Magazine, Subscription Department, PO Box 931, Farmingdale NY 11737. For renewals and changes of address, include the address label from your most recent issue of 73. For gift subscriptions, include your name and address as well as those of gift recipients. Postmaster: Send form #3579 to 73 Magazine, Subscription Services, P.O. Box 931, Farmingdale, NY 11737.

Subscription problem or question:

Write to 73 Magazine, Subscription Department, PO Box 931, Farmingdale NY 11737. Please include an address label.

73 Magazine (ISSN 0098-9010) is published monthly by 73, Inc., 80 Pine Street, Peterborough NH 03458. Second class postage paid at Peterborough NH 03458 and at additional mailing offices. Copyright (c) 1981 by 73, Inc. All rights reserved. No part of this publication may be reprinted or otherwise reproduced without written permission from the publisher. Microfilm Edition—University Microfilm, Ann Arbor MI 48106.

T-1 RANDOM WIRE ANTENNA TUNER



All bands (160-10 m.) with any wire — 200W output — Any transceiver — Home or portable — Neon tune-up indicator.
Only \$32.95

T-2 ULTRA TUNER

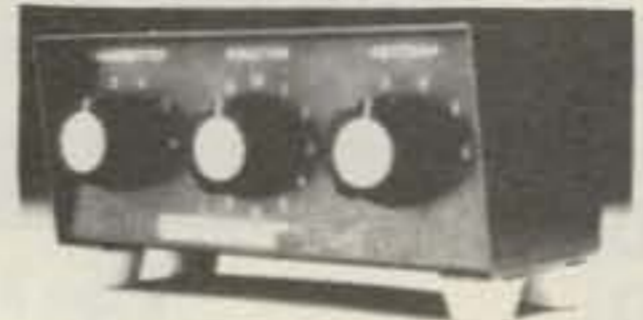

Tunes out SWR on any antenna — coax fed or random wire (160-10 meters). Any rig — up to 200 watts RF output. Rugged, yet compact: 5 1/4" x 2 1/4" x 2 1/2".
Only \$43.95

T-6 ULTRA TUNER



Most versatile antenna tuner available. Any antenna — coax fed or random wire (160-10m.). Front panel function switch selects between two circuits — a Pi or L network — or tuner bypass. Front panel antenna switch. Relative output meter. 200w output — will work with virtually any transceiver. 6 1/2" x 3" x 3". Attractive bronze finished enclosure.
Only \$64.95

T-3 MOBILE IMPEDANCE TRANSFORMER



Matches 52 ohm coax to the lower impedance of a mobile whip. Taps between 3 and 50 ohms. 3-30 MHz. 300 watts output. 2 3/4" x 2" x 2 1/4".
Only \$24.95

DL-1 K4RLJ DUMMY LOAD



The DL-1 is a unique chemical dummy load. Unlike messy oil-filled dummy loads, it will not leak. Sealed ready to use. Max. 1000 watts PEP for 15 sec. SWR less than 1.5:1 1-225 MHz. Portable — only 3 1/8" x 4 3/8".
Only \$19.95

VAN GORDEN ENGINEERING
P.O. BOX 21305
S. EUCLID, OHIO 44121

VLF Converter



The famous Palomar Engineers VLF Converter with new added features.

- New attractive cabinet.
- Antenna bypass when turned off.
- LED power indicator.
- Special amateur and SWL models.

The VLF Converter shifts all the signals in the 10 to 500 KHz band up to the 80 meter band so you can tune them on your receiver.

Model VLF-A converts to 3510-4000 KHz for use with ham-band-only receivers and transceivers.

Model VLF-S converts to 4010-4500 KHz for general coverage short wave receivers. With digital readout receivers the last three digits read the frequency exactly.

All the features that have made the Palomar Engineers VLF Converter a favorite have been kept: crystal control stability, low-noise RF amplifier, multipole filter, and the unique circuit that eliminates the bandswitching and tuning adjustments usually found in VLF converters.

Now you can hear the 1750 meter band, navigation radiobeacon band, standard frequency broadcasts, ship-to-shore communications, and the European low frequency broadcast band just by tuning across 80 meters on your receiver.

Normal 80 meter signals are blocked by the converter during VLF reception. But when the converter is turned off reception is normal.

Explore the interesting world of VLF! Order your converter today!

Model VLF-A (3510-4000 KHz output)
or
Model VLF-S (4010-4500 KHz output)



\$79.95

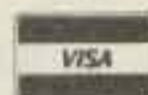

+ \$3 shipping/handling in U.S. & Canada.
California residents add sales tax.

Palomar Engineers

1924-F West Mission Road
Escondido, CA 92025
Phone (714) 747-3343

Egad! A Nine-Tube Linear
 —results from the W7CSD test bed
 W7CSD 12

Drama on Mt. McKinley
 —ice, snow, and amateur radio
 W7KUF 18

TVRO Signal Source
 [TV] —tuner-based test gear. . . . N1BEP 46

Satellite Television Glossary
 [TV] —part II
 *Satellite Television Handbook* 54

Going Bird Hunting?
 [TV] —Satellite Central, part III
 Gibson 60

Micro-Programmed Controllers
 [IO] —bridging the gap between TTL
 and microprocessors. . . . K2OAW 68

jan. 82
73 MAGAZINE



The Simplex Autopatch
 —a telephone interface for everyone's
 two-meter rig!..... WA7VZR 26

The Cheapskate
 —a checker for bargain diodes. . . . K9QLL 30

**Constant Current
 from a Voltage Regulator**
 WA4WDL 39

**The Hesitator:
 A Windshield Wiper Control**
 —a rainy day project. . . . N4UH 40

Messages from Station Charlie
 —when wireless meant life or death
 Phenix 88

The Great Compromiser
 —Henry Clay, eat your heart out
 W5JJ 104

Touch-Tune with Thumbwheels
 —cast away darkness. . . . ZL4LM/VK3CIT 110

Put Talking Time on Your Repeater
 —a Sharp idea. . . . WA4VYR 116

Never Say Die—6, Ham Help—58, 126, 133, 161, Social Events—118, Review—119, FCC—126, Reader Service—130, OSCAR Orbits—132, DX—134, Awards—135, Contests—140, Fun!—144, Corrections—146, New Products—152, RTTY Loop—154, Kahaner Report—155, Letters—156, Dealer Directory—194, Propagation—194

Cover: Photo by Bob Bonar.

W2NSD/1 NEVER SAY DIE

editorial by Wayne Green



milking every dollar it can from the members, whose average age is increasing and who are heading towards retirement and a fixed, low income.

Amateur radio...and the League...needs a general manager who is respected...one with brains and foresight...with a long history of coming up with good ideas and helping the League to prosper. One of the last things we need is a stuffed shirt who is pompous and self-important, complete with jacket and tie. Amateur radio is a hobby...it's for fun, despite our ability to provide many services. So our national organization should be headed by a relaxed, technically-expert ham, one who has gone into every aspect of the hobby personally...DXpeditioned, has a high DX score...into SSTV...RTTY...and so on. Let's all hear it for Harry.

Remember that Harry is getting on in years...and that a union steward doesn't make a lot of money. As General Manager, he might be able to make around \$100,000 a year...which is in line with the importance of the job. I think that a lot of people would like to see Harry really make it big for a change. And that's certainly a reasonable salary for someone running something as big as the ARRL. That would help make up, too, for all of the years he has put in at no salary as president of the League. It's the least we owe him...right?

A few years as General Manager and then he will be able to retire again (I understand he is retiring soon from the union) and live the good life on one of the legendarily-generous League pensions.

POWER STRUGGLE

Yes, there definitely *is* a war going on within the ARRL board of directors. The war is over who will control headquarters, with one side loyal to the power group which has run the League ever since Maxim died in 1936 and the other trying to get the political machine out and replace it with some professionals who, they feel, will run the League for the benefit of the members instead of the clique.

I've always been amused at the blind loyalty of tens of thousands of amateurs to this small group which holds the loyal in utter disdain. Perhaps followers who question not, who

DANNALS NEW GENERAL MANAGER!

That's the headline that's coming up next year for League members. Oh, there is an underground movement to upset the well-laid plans of Baldwin and his decreasing number of loyal supporters on the board of directors, but nothing really serious is expected to come of it.

These malcontents are fomenting unrest in several areas, but League headquarters has met that problem before and surmounted it, so it is confident that all will go as planned this time.

Indeed, anyone with a knowledge of the history of the League has to appreciate the years of devotion that Dannals has given and his adherence to maintaining the continuance of tradition. He is in the mold of the outstanding leaders of the past such as...by golly, let me think a minute...er...Huntoon and...who was that guy before him?...oh yes, Budlong.

We have to remember that Harry stood graciously aside so that Mort Kahn could be elected as Hudson Division director in what turned out to be a major turning point for both amateur radio and for our country. Mort, being a very strong person, took over the League for several years...forcibly retiring Budlong, organizing the building fund coup, and initiating the proposed return to pre-WWII licensing in 1963.

We can certainly chalk up the tremendous success of the amateur exhibits at both the Coca-Cola and Venezuelan exhibits at the World's Fair in New York to Harry and his tireless work for the League.

Getting facts on Harry's background is not easy, but my recollection is that he started from a position at a company in New York which made radio equipment and first became the president of the Hudson Amateur Radio Council. From there he was so supportive of the League that the rules prohibiting people making radios professionally from becoming League officers was ignored and he was permitted to run for ARRL director, anyway.

Though the betting was that Harry would be decisively defeated, the vote, if I remember right, was a tie! The opposition, showing poor sportsmanship, accused HQ of voting irregularities and there was talk of trying to initiate envelopes for the ballots which could not be shadow-sorted before the official counting. The vote rerun saw Dannals elected.

Again, we are seeing poor losers in the directors' sweepstakes griping for piddling reasons. Lyndon Johnson showed us that it really didn't

matter *how* you won, it was what you did afterward that counted...for those of you who are up on your history of LBJ's first election win.

After all, it is the prerogative of HQ to edit the brief histories of the contenders on division ballots, so if almost all of the background of someone who looks like they are not going to be a team player has to be edited out, that's the breaks of the game and it is poor potatoes to beef about it. Many feel that Harry is absolutely right to want to sweep that sort of bickering under the rug where it belongs.

When it comes to running something as big as the League, loyalty and devotion to the HQ mystique are far more important than business experience, so many are hoping that the rather obscure ads for candidates for the General Manager's job will go unnoticed. The League isn't supposed to be a commercial business anyway...it is a membership club to promote amateur radio's growth and health. We don't need some big outfit

FCC DUMPS PLAIN LANGUAGE!

The FCC has decided to drop its proposed major rewrite of the Amateur Radio Service rules due to overwhelming opposition from the amateur community. In taking the unanimous action on November 12, the Commission noted that, should the amateur community at a later date wish to pursue on its own a general rewrite of the rules, the Plain Language docket might prove helpful.

Although amateurs objected to many specific parts of the Plain Language proposal, it was the general tone of the docket that bothered most hams. The proposed elimination of the five-part Basis and Purpose of amateur radio in section 97.1 of the rules, along with a change in name from the "Amateur Radio Service" to the "Amateur Telecommunications Service," were seen as diminishing the status of the service.

Look for more on the FCC's decision to drop the Plain Language proposal in next month's Kahaner Report.—WB8BTH.

New 2-meter direction.



A compact transceiver with FM/SSB/CW plus...

TR-9000

The exciting TR-9000 2-meter all-mode transceiver combines the convenience of FM with long-distance SSB and CW in a very compact, affordable package, ideal for mobile installation. With its fixed-station accessories it becomes the obvious choice for your ham shack.

TR-9000 FEATURES:

- **FM, USB, LSB, and CW**
All the popular 2-meter modes.
- **Extended frequency range**
Covers all 2-meter Amateur frequencies as well as MARS and CAP frequencies (simplex and any repeater split) between 143.9000 and 148.9999 MHz.
- **Digital dual VFOs**
With selectable tuning steps of 100 Hz, 5 kHz, and 10 kHz, convenient for each mode of operation.
- **Digital frequency display**
Five, four, or three digits, depending on selected tuning step.
- **Scan of entire band**
Automatic busy stop and free scan.

- **Five memories**

M1-M4...for simplex or ± 600 kHz repeater offset. M5...for nonstandard offset (memorizes transmit and receive frequency independently).

- **SSB/CW search**

Sweeps between 0 and 9.9 kHz around the selected frequency in 100-Hz steps, while the main knob selects in 10-kHz steps. Easy way to find SSB or CW activity.

- **UP/DOWN microphone**

"Beep" sounds with each frequency step. (Supplied with TR-9000.)

- **Effective noise blanker**

Suppresses pulse-type noise on SSB and CW.

- **Improved receiver front-end characteristics**

Low-noise, dual-gate MOSFET and two-stage monolithic crystal filter.

- **RIT control**

Receiver incremental tuning, to tune only the receiver slightly off frequency in the SSB/CW mode. Functions on memory, also.

- **RF gain control**

Threshold-type control, permitting accurate S-meter readings on SSB/CW and FM modes.

- **CW sidetone**

Enables monitoring of keying during CW operation.

- **Automatic AGC selection**

AGC time constant selected automatically with MODE switch (slow for SSB and fast for CW).

- **HI/LOW power switch**

10 watts/1 watt RF output on FM/CW. Always 10 watts on SSB. Improved power module for reliable and stable linear RF output.

- **LED indicators**

VFO A/B, RIT, ON AIR, and BUSY.

- **Rear-panel accessory terminals**

Key, memory back-up voltage, tone input, standby, external speaker, DC supply voltage, and antenna.

- **Compact size**

Only 6-11/16 inches wide by 2-21/32 inches high by 9-7/32 inches deep.

- **Adjustable-angle mobile mount**

With quick-release levers for easy removal.

More information on the TR-9000 is available from all authorized dealers of Trio-Kenwood Communications 1111 West Walnut Street, Compton, California 90220.

 **KENWOOD**
...pacesetter in amateur radio

Matching accessories for fixed-station operation:

- PS-20 power supply
- SP-120 external speaker
- BO-9 System Base...with power switch, SEND/RECEIVE switch for CW operation, backup power supply for memory retention (BC-1 backup power adaptor may also be used for this application), and headphone jack
- MC-46 16-button autopatch (DTMF) UP/DOWN microphone



Specifications and prices are subject to change without notice or obligation.

STAFF

PUBLISHER/EDITOR
Wayne Green W2NSD/1

EXECUTIVE VICE PRESIDENT
Sherry Smythe

ASSISTANT PUBLISHER/EDITOR
Jeff DeTray WB8BTB

ASSOCIATE PUBLISHER/DIRECTOR OF PUBLICATIONS
Edward Ferman WA1UFY

MANAGING EDITOR
John Burnett

ASST. MANAGING EDITOR
Susan Philbrick

EDITORIAL ASSISTANTS
Nancy Noyd
Richard Phenix

REVIEW EDITOR
Paul Grupp KA1LR

CONTRIBUTING EDITORS
Chris Brown KA1D
Tim Daniel N8RK
Alyson Grupp N1BEJ
Larry Kahaner WB2NEL

ADMINISTRATIVE ASSISTANT
Pat Graham

ASSOCIATES

Robert Baker WB2GFE
Bill Gosney KE7C

Sanger Green
Dave Ingram K4TWJ

Joe Kasser G3ZCZ
Dr. Marc Leavey WA3AJR

Dave Mann K2AGZ
Bill Pasternak WA6ITF

Peter Stark K2OAW

PRODUCTION MANAGER/ PUBLICATIONS

Nancy Salmon

ASST. PRODUCTION MANAGER/PUBLICATIONS

Michael Murphy

ADVERTISING GRAPHICS MANAGERS

Robert Drew
Steve Baldwin

Bruce Hedin
Jane Preston

Dennis Christensen

PRODUCTION

Frances Benton
Fiona Davies

Linda Drew
Sandra Dukette

Kenneth Jackson
Dianne Ritson

Patricia Mackowsky/Allen
Theresa Ostebo

Deborah Stone
Judi Wimberly

Donna Wohlfarth

PHOTOGRAPHY

William Heydolph
Terrie Anderson

Paul Babich
Kathy Birkebak

Bryan Hastings
Thomas Villeneuve

TYPESETTING

Sara Bedell
David Hayward

Kelly Smith
Karen Stewart

Michele DesRochers
Steve Jewett

Ann Lord

CORPORATE CONTROLLER

Roy A. Johnson

EXECUTIVE ASSISTANT

Leatrice O'Neil

ACCOUNTING MANAGER

Knud Keller KV4GG/1

CIRCULATION MANAGER

Debra Boudrieau

CIRCULATION

Doris Day
603-924-7296

Pauline Johnstone

BULK SALES MANAGER

Ginnie Boudrieau

ADVERTISING

603-924-7138

Jim Gray W1XU, Mgr.

Nancy Ciampa, Asst. Mgr.

Ross Kenyon KA1GAV

Cornelia Taylor

accept everything without question, deserve to be held in such contempt.

Eventually things begin to change and, fight as they do, with dirty deals such as they handed ex-director Miller, the clique is beginning to lose strength. More and more reform-oriented directors have gotten on the board and are sickened by what they've found at HQ. The reformers want to throw out the scoundrels and get in some new blood.

Well, I say, "better the devil you know than the one you don't." The League is doing well, considering the virtually terminal health of the hobby itself. Most of the amateurs I've talked with have a strong death wish for the hobby. . . "we don't need any more hams. . . the bands are already too crowded" . . . and, "we don't want any technical changes. . . we like CW and sideband." Many feel that only Extra Class amateurs should

have phone privileges. . . as the ARRL HQ proposed in 1963.

A great many amateurs feel that since the politics of amateur radio is complex. . . and after all, this is *only* a hobby. . . it's better to leave everything to the ARRL. Who should know better than HQ what should be done?

The ad in the November QST (page 21) for people interested in the General Manager job which will be open when Baldwin steps down in March was run, apparently, as a sop to the starry-eyed reformers on the board. Little is expected to come of it. Indeed, even though the general membership has no vote in the election of the highest offices. . . General Manager, Editor of QST, and President of the League. . . or in *any* of the other HQ offices. . . the leading contender, Dannals, is said to be making a 50-state campaign tour (*he* said he was making the tour during his recent talks at Peoria and Louisville). As far as anyone

seems to know, this campaign tour is being paid for by the ARRL.

Since there is nothing that you can do now anyway, why worry about all this silly political stuff? The directors who will make your decisions for you are all in place and the old-timers still have everything under control, so it's probably best to forget about the whole thing. After all, as many amateurs say, if we lose amateur radio we can always take up photography.

CLUB 'EM

One of the major problems with ham clubs is that so few hams know how to run them. Furthermore, the whole thing is often a self-defeating system. You see, if there is a turnover of the people running the club. . . as there should be to keep a club healthy. . . the newcomers usually will not be able to benefit from the experience of the chaps who ran it earlier. The re-

Well . . . I Can Dream, Can't I?

by Bandel Linn K4PP



"Your kid sounds so good, I've decided to cast him in my next picture! He'll get \$10,000 a week!"

At Last.

A microthin, synthesized, programmable, sub-audible tone encoder that fits inside the ICOM IC-2AT.

Need we say more?

\$29⁹⁵

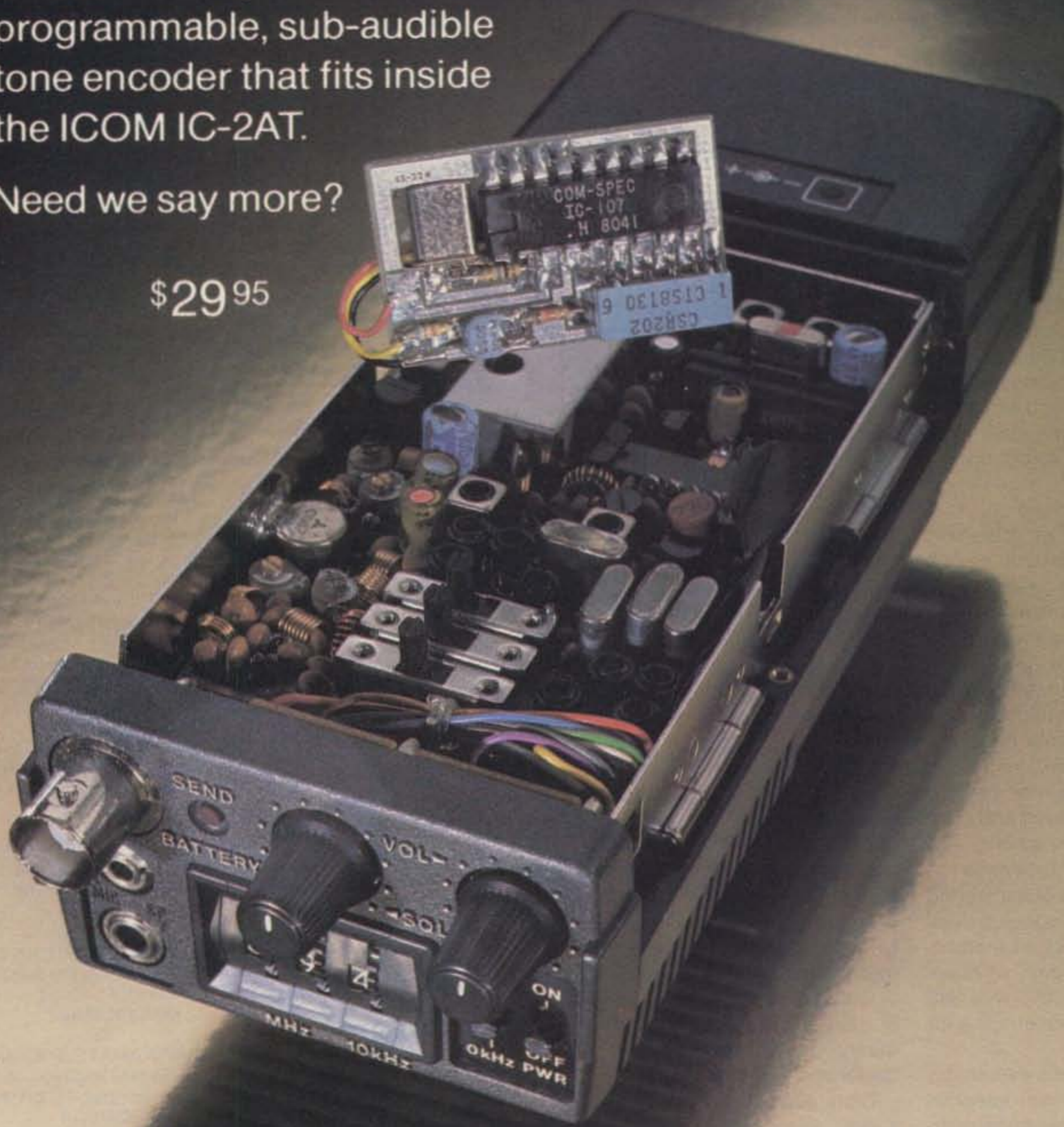

**COMMUNICATIONS
SPECIALISTS**

426 West Taft Avenue, Orange, CA 92667
800/854-0547 California: 714/998-3021

sult is that the same mistakes are made over and over.

If the club is in the clutches of an old-timer clique, as many are, this is a bad situation, too. Old-timers really don't want newcomers in the club and they tend to make the club boring and a put-off for youngsters.

Many years ago I ran a series of articles on how to run a ham club. It was so popular that we put it out as a book. Well, that was quite a few years ago and it is time for some new ideas. I'd like to see some articles by those of you who have made ham clubs work...telling the rest of us how you did it.

The main strength of amateur radio lies in the clubs, so we all have a vested interest in keeping our clubs alive and well.

You know, I wrote several months ago, asking...no, darling...clubs to send in pictures of their groups for publication. Nothing yet. When you get together for Field Day, an outing, a hamfest, an auction...any group activity...take a few minutes and get everyone together for a photograph and send it in. I'd even like to see some interesting ones (in color) on the cover.

Getting back to the clubs...and the rotation of officers. I would suggest that you elect a president for one year only...and at the same time elect a vice president whom you want to be the president next year. Keep the ex-president on the board of directors so you will have continuity. This will help the president pass the word along as to what does and does not work...why the club did such and such two years ago, and so on.

One word of guidance...remember that the club meeting is show business, not club business. Keep as much of the club business in the board of directors as you can and this will make the general meetings a lot more fun.

Be sure you have a welcoming committee which will keep an eye out for any newcomers to your meetings. Make it a point to get acquainted and keep them busy talking about themselves for the first two or three meetings. You won't be able to chase them away with a stick.

Arrange for any members with special interests to communicate their interest to the rest of the group. You may have a red hot DXer who would love to

tell about the rare ones he caught recently...and will bring in the new cards he's gotten. He can also get other members interested in DX and tell them how to go about it.

You'll find chaps interested in SSTV, RTTY, computers, moonbounce, aurora communications, high-speed CW, and so on. Give them their chance to show and tell. I've already mentioned giving the home builders more than their share of the spotlight. Look for any special interest...contests, certificates, traffic handling, whatever...and get 'em up to talk and show.

New gear is of interest, too. Perhaps someone has gotten one of the new Drake keyboards...well, bring it in and show it. That's a complex piece of gear and few hams really understand what it does. We all want to see the newest gear. I always used to lug the newest stuff and I had a tough time getting it back at the end of the meeting.

If you are saddled with a bunch of hoary old-timers who sit by themselves at the back of the meeting room, figure out how to get them up front where they can get in on what is happening. The more you can get fellows together, the more they will enjoy the meeting. I really hate it when I see a club meeting where fellows sit about four seats apart, with a few up front and most toward the rear. This means they are not really into what is going on and are staying away as much as they can from the meeting and each other. Bad news. A speaker will really be put off by this. If you have a guest speaker, do not under any circumstances permit this kind of treatment. He came to speak to a group, not a room full of individuals.

Guest speakers? Easy, usually. Find anyone who is in the industry as a manufacturer or dealer and ask him in to talk.

Club events pull things together. How long has it been since the club set up a demonstration station in a shopping mall? If you do, remember you are selling amateur radio, not just putting things out for people to be confused. Make good graphic signs which explain what is going on. Try to make up some literature which will bridge

Continued on page 148

NOW!

HAL Communications Is Proud To Announce That Our Amateur Radio Products Are Being Stocked At The Following Leading Amateur Dealer Stores:

EASTERN UNITED STATES:

AMATEUR ELECTRONICS SUPPLY
28940 Euclid Ave.
Wickliffe, OH 44092
(216) 585-7388

ELECTRONICS INTERNATIONAL SERVICE CORP.
11305 Elkin Street
Wheaton, MD 20902
(301) 946-1088

MIDWEST UNITED STATES:

AMATEUR ELECTRONICS SUPPLY
4828 W. Fond du Lac Ave.
Milwaukee, WI 53216
(414) 442-4200

DIALTA AMATEUR RADIO SUPPLY
212 - 48th Street
Rapid City, SD 57701
(605) 343-6127

UNIVERSAL AMATEUR RADIO
1280 Aida Drive
Reynoldsburg, OH 43068
(614) 866-4267

HAM RADIO CENTER
8340-42 Olive Blvd.
St. Louis, MO 63132
(314) 993-6060

THE HAM SHACK
808 N. Main St.
Evansville, IN 47711
(812) 422-0231

KRYDER ELEC.
Georgetown N. Shopping Ctr.
2810 Maplecrest Rd.
Ft. Wayne, IN 46815
(219) 484-4946

WESTERN UNITED STATES:

AMATEUR ELECTRONICS SUPPLY
1072 N. Rancho Drive
Las Vegas, NV 89106
(702) 647-3114

CW ELECTRONICS
800 Lincoln Street
Denver, CO 80203
(303) 832-1111

HENRY RADIO, INC.
2050 S. Bundy Dr.
Los Angeles, CA 90025
(213) 820-1234

SOUTHERN UNITED STATES:

ACK RADIO SUPPLY COMPANY
3101 4th Ave. South
Birmingham, AL 35233
(205) 322-0588

AGL ELECTRONICS
13929 N. Central Expwy
Suite 419
Dallas, TX 75243
(214) 699-1081

AMATEUR ELECTRONIC SUPPLY
621 Commonwealth Ave.
Orlando, FL 32803
(305) 894-3238

AMATEUR ELECTRONIC SUPPLY
1898 Drew Street
Clearwater, FL 33515
(813) 461-4267

AMATEUR RADIO CENTER
2805 N.E. 2nd Ave.
Miami, FL 33137
(305) 573-8383

BRITT'S TWO-WAY RADIO
2508 N. Atlanta Rd.
Bellmount Hills
Shopping Center
Smyrna, GA 30080
(404) 432-8006

GISMO COMMUNICATIONS
2305 Cherry Road
Rock Hill, SC 29730
(803) 366-7157

MADISON ELECTRONICS
1508 McKinney Ave.
Houston, TX 77010
(713) 658-0268

N & G DISTRIBUTING CORP.
7201 N.W. 12th Street
Miami, FL 33126
(305) 592-9685

RAY'S AMATEUR RADIO
1590 US Highway 19 South
Clearwater, FL 33156
(813) 535-1416

Call Or Stop-In And See HAL Equipment At Your Favorite Amateur Dealer.

Write today for HAL's latest RTTY catalog.



HAL COMMUNICATIONS CORP.

Box 365
Urbana, Illinois 61801
217-367-7373

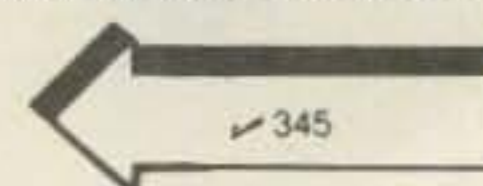



RTTY To Go.

Loud and Clear.

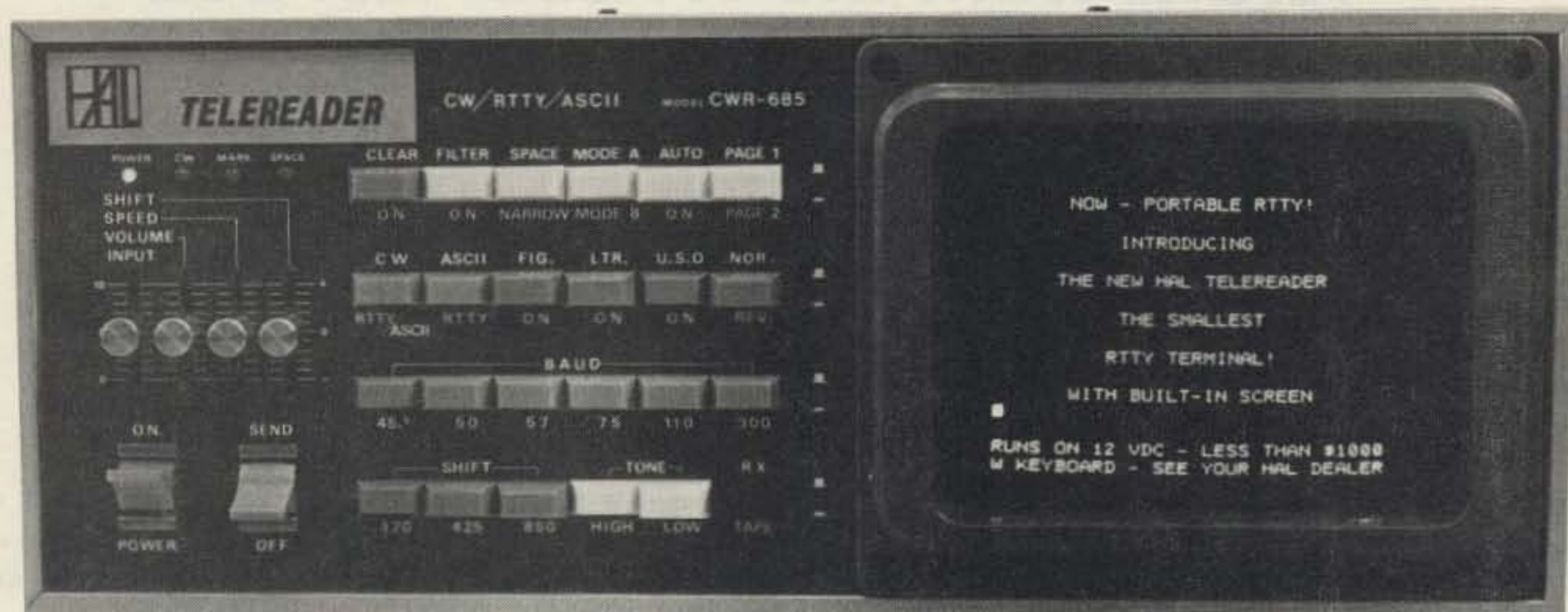

The Portable HAL Telereader CWR-685A.

Now RTTY can hit the road with you, when you take along this portable telereader from HAL.

HAL offers the smallest RTTY terminal you can find. It's easy to pack and go — on long drives, camping trips, boating, anywhere away from home.

Pick up your portable HAL Telereader at your favorite amateur dealer store today — you can order it *to go!*

See HAL RTTY equipment at your favorite amateur dealer store.

Write or call us for more information.

- Baudot, Morse, ASCII
- Built-in RTTY Demodulator
- High or Low RTTY Tones
- Built-in 5" Green CRT
- Four-page Display
- Compact Size (12¾W x 5H x 11½"D)
- With External Keyboard
- Runs on 12 VDC



HAL Communications Corporation
P.O. Box 365
Urbana, Illinois 61801
(217)367-7373

✓345

© HAL 1981

Egad! A Nine-Tube Linear

— results from the W7CSD test bed

The photo bears out the title. But, no, I don't run all nine tubes in the amplifier at the same time. The photo represents the chassis used to test each of the tubes individually. I mounted all the sockets, wired the filaments and screen grids, but the plate and control grids were moved from tube to tube

during the process of experimenting. In the case of grounded-grid, filament wiring also was altered.

What's the purpose of all of this?

There are a lot of reasons for buying an FT-7 or a TS-120V or an Argonaut. They are great for camping or for use where you have to use a battery. But at times you

would like to have a little more power. Obviously, you could buy the TS-120S or the FL-110 linear or maybe build a solid-state linear yourself, complete with low-pass filters. But I have an apple box full of tubes. So, I decided to find out what kind of a tube linear would do the best job.

There are some problems.

Grounded-Cathode

First of all, you can scan the tube data in one of the older ARRL *Handbooks* and find that, seemingly, it is possible to build a kW amplifier that requires very few Watts of drive in the grounded-cathode configuration. You might have to neutralize the amplifier, but that is not a major concern. OK, so you build up this mighty fine structure and you try to get from the solid-state broadband driver to the grid circuit of

your amplifier. If you just link couple, you will find that the impedance match is so bad that nothing comes out of your exciter. You can put 50 Ohms across the link (or in series with the link) and this will make the exciter much happier. You may get a little more out of the amplifier than the 10 Watts from the exciter but not much. I gave it up as a bad idea.

Possibly, you could design some impedance-matching network between a 50-Ohm generator and the grid in a class AB vacuum tube. But there ought to be an easier way.

Grounded-Grid Circuit

Another route seems to be the grounded-grid circuit. As will be seen, this has possibilities with some refinements, but it is very doubtful that with 10 Watts drive you can go to more than a few hundred Watts

Photo by Lois Kiger



The amplifier test chassis! Only one tube is used at a time.

input with a single stage. You easily could go to a kW with a two-stage linear. Actually, the commercial solid-state amplifiers are not getting a power gain much in excess of 10, either. Here, again, with grounded-grid, the input impedance varies from tube to tube and may be a country mile from 50 Ohms.

In the past, many companies have built grounded-grid linears with an untuned input. Hallicrafters, Loudenboomer, and DenTron more recently have done this, just to name a few. It worked very well if you had a 100-Watt tube-type driver. With the advent of 100-Watt broadband solid-state rigs, it doesn't work well at all. This is doubly true if you have a 10-Watt solid-state rig. So, DenTron and possibly others are installing tuned input circuits in their linears and marketing tuned input kits to be installed in existing amplifiers.

If you are going to build your own, two less-than-desirable conditions exist. First of all, you will have to wind a big bifilar-wound ferrite filament choke unless you use an indirectly-heated cathode tube like the 7094. Second, if you are going to get the maximum out, you will have to build a band-changing input tuner or half a dozen switchable, fixed tuned inputs for that many bands.

EXPERIMENTAL RESULTS

Grounded Grid Circuit

Table 1 shows the results

| Tube | Ep | Io | Ip | Eg | PA/P7 |
|--------|------|----|-----|-----|-------|
| 6LQ6 | 900 | 5 | 210 | -10 | 12:1 |
| 7094 | 1500 | 40 | 190 | 0 | 18:1 |
| 813 | 1500 | 10 | 155 | 0 | 14:1 |
| 4-125A | 1500 | 5 | 80 | 0 | 10:1 |
| 4-400A | 1500 | 20 | 135 | 0 | 12:1 |
| 3-400Z | 1500 | 50 | 165 | 0 | 14:1 |
| 811 | 1500 | 35 | 125 | 0 | 12:1 |

Table 2. Grounded-grid amplifier test results. All grids tied together; tuned input.

| Tube | Plate Volts Ep | No Signal | Plate Cur- | Grid Volts Eg | PA/P7* |
|--------|-------------------|------------------------|----------------------------|---------------------|--|
| | | Plate Current Io mA | rent w/excitation Ip | | |
| 6146 | | No | No | | Less than 2:1 (G3 tied to K internally) |
| 829B | 460 | Good | Good | | |
| 6LQ6 | 900 | 5 | 200 | -10 | 9:1 |
| 7094 | 1500 | 40 | 160 | 0 | 12:1 |
| 813 | 1500 | 10 | 60 | 0 | 2:1 |
| 4-125A | 1500 | 5 | 35 | 0 | 1:1 |
| 4-400A | 1500 | 20 | 86 | 0 | 6:1 |
| 3-400Z | 1500 | 50 | 160 | 0 | 12:1 |
| 811 | 1500 | 35 | 65 | 0 | 1:1 |

Table 1. Grounded-grid amplifier test results. All grids tied together; untuned input. *Power output of amplifier compared to power output of FT-7.

of driving seven different tubes with an FT-7, as shown in Fig. 1. The 6146 and the 829B tubes have the suppressor grid internally connected to the cathode and just don't function very well in grounded-grid. However, note the gain of the 6LQ6. If all you are looking for is 100 Watts out, this may be the answer. Most any TV transformer and bridge circuit will give you the makings of a power supply. The circuit is simple and does not require filament chokes. The 7094 is a dandy, but expensive. So is the 3-400Z and would be even better with 3000 volts. At a glance you could conclude the 813, 4-125, and 811 are flat tubes. Not so. They just mismatch 50 Ohms too far. The 4-400A is not so far off and also might look better with 3000 volts.

Table 2 shows data for the same amplifier with a home-brew antenna tuning unit between the FT-7 and the amplifier (Fig. 2). This unit was adjusted to give a 1:1 swr presented to the FT-7. Note that the power gain has skyrocketed in all cases. The 7094 gain has

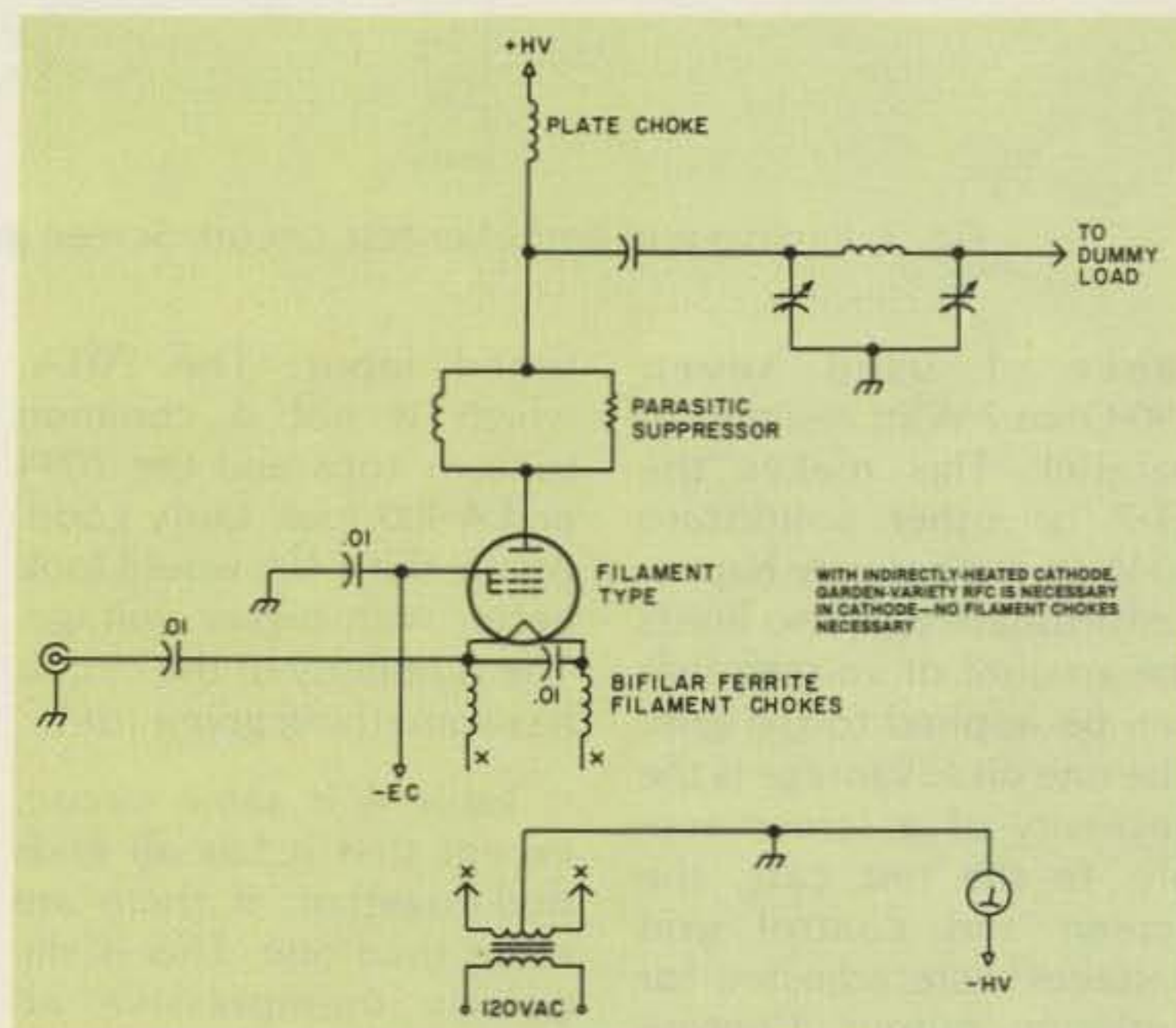

Fig. 1. Grounded-grid amplifier test circuit.

gone to 18:1! The 3-400Z might be nearly this high using 3000 volts. If you have an 811 in the junk box, it now looks like a winner at 12:1. Again, you might go this route with the 6LQ6. But you do have some kind of an input tuned circuit to add. It adds hardware, takes up space, and is another circuit that needs to be manually adjusted.

Passive-Grid Circuit

A third possible approach is the "passive-grid" circuit. I built a big one of

these several years ago, driven with an FT-101.¹ The 1979 ARRL Handbook has such a circuit, as does one of the older Bill Orr Handbooks. The ARRL used an 833, whereas the other one used some kind of a big tetrode. If you have a 100-Watt tube or solid-state exciter, it's a good circuit. With 10 Watts, and using a positive screen voltage, it may be attractive to some. The input impedance is 50 Ohms, almost all resis-

1. CQ, April, 1976, p. 31.

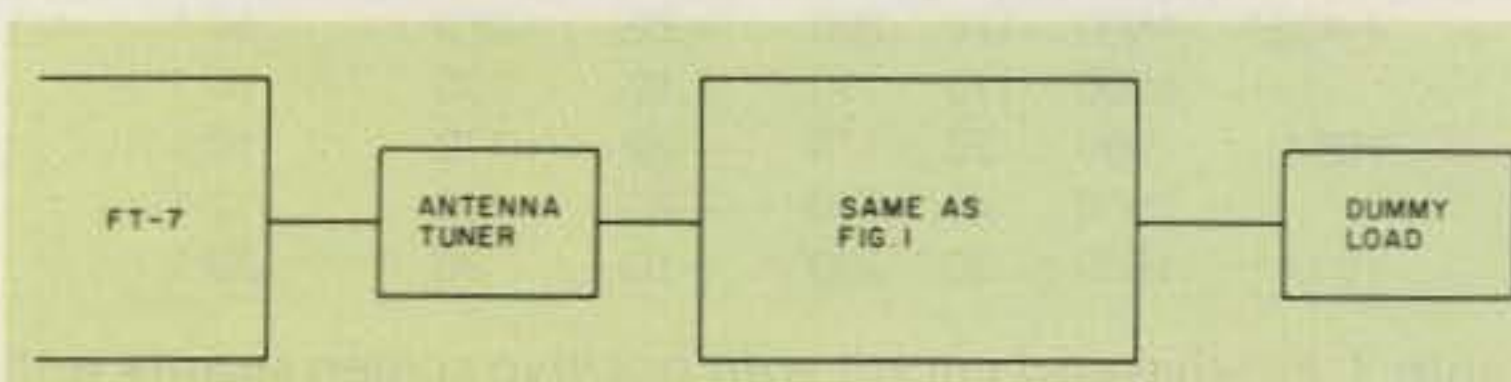

Fig. 2. Block diagram of test circuit of Fig. 1 using tuned input circuit (antenna tuner).

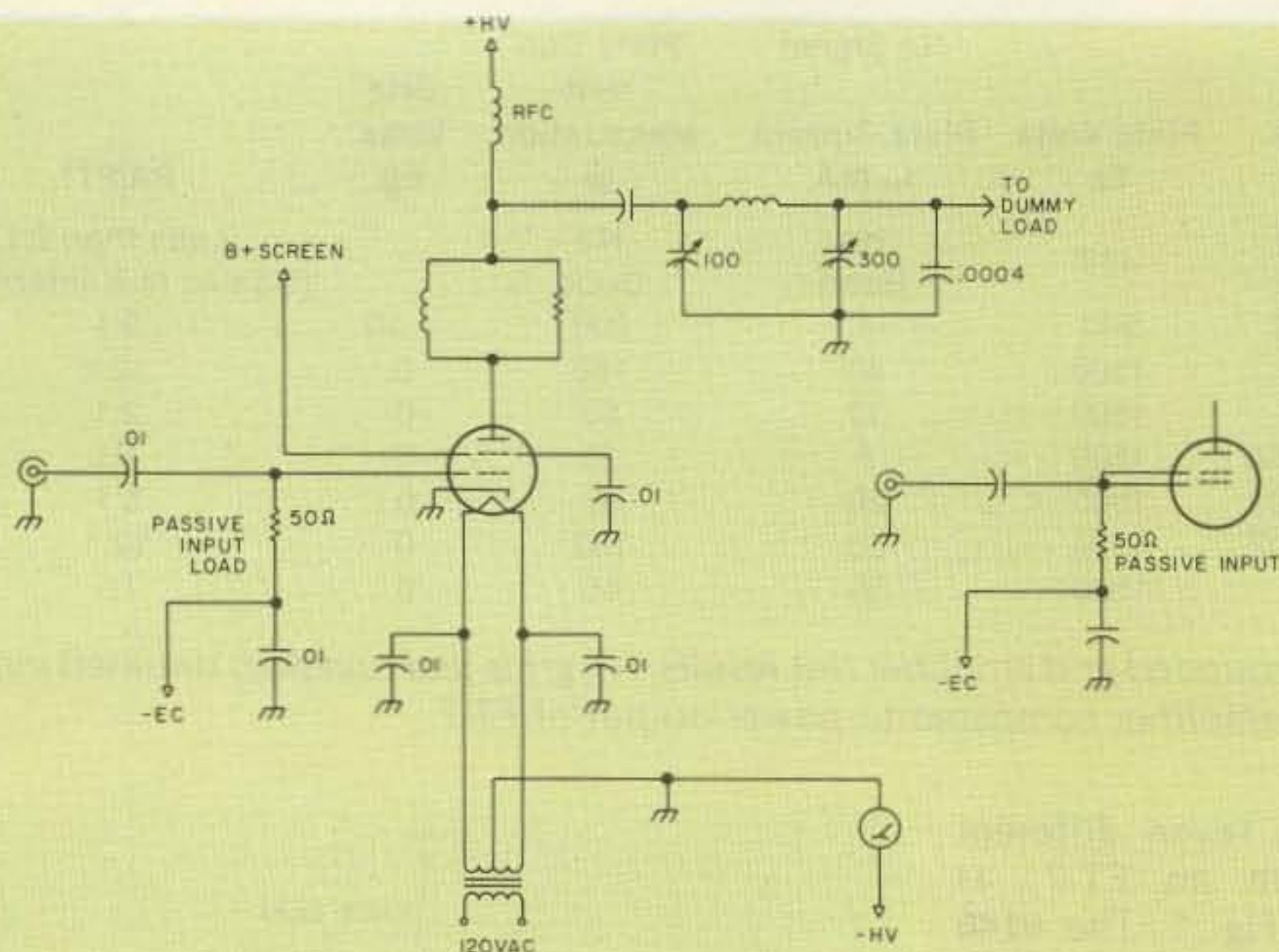

Fig. 3. Passive-grid amplifier test circuit. Screen grid is held positive.

tance. I used seven 390-Ohm 2-Watt resistors in parallel. This makes the FT-7 or other solid-state 10-Watt exciter very happy. Unfortunately, it also limits the amount of voltage that can be applied to the grid. The one disadvantage is the necessity of a screen supply. In the test case, the screen and control grid voltages were adjusted for optimum output. Control-grid voltage was supplied from batteries.

Table 3 shows the results of driving the passive-grid circuit (Fig. 3) and also applying optimum positive potential to the screen. The results compare fairly well with the grounded-grid un-

tuned input. The 701A, which is not a common tube, is tops and the 7094 and 4-400 look fairly good. Again, the 4-400 would look better with higher voltage. The simplicity of the circuit has something going for it.

Table 4 is same circuit, except that it has all grids tied together, if there are more than one. This is singularly unimpressive although the 3-400Z still might look very good at higher voltage. Both of the passive-grid circuits might look much better if you had a 100-Watt driver and, of course, a 100-Watt non-inductive 50-Ohm passive-grid resistor.

OK, fellas, study the data

| Tube | Ep | Io | Ip | Eg | E _{screen} | PA/P7 |
|--------|------|-----|-----|-----|---------------------|-------|
| 829B | 460 | 10 | 200 | -10 | 110 | 5:1 |
| 6146 | 900 | 20 | 100 | -20 | 100 | 5:1 |
| 6146A | 900 | 30 | 110 | -20 | 110 | 6.8:1 |
| 6LQ6 | 460 | 30 | 100 | -20 | 50 | 4:1 |
| | 900 | 30 | 130 | -20 | 50 | 7:1 |
| 813 | 900 | 75 | 100 | -10 | 250 | 2.5:1 |
| | 1500 | 100 | 130 | -20 | 400 | 5:1 |
| 4-125A | 1500 | 75 | 100 | -10 | 200 | 5:1 |
| | 1500 | 75 | 100 | -20 | 270 | 5:1 |
| 4-400A | 1500 | 170 | 200 | -20 | 270 | 10:1 |
| | 1500 | 170 | 190 | -10 | 200 | 10:1 |
| 7094 | 900 | 25 | 170 | -20 | 170 | 10:1 |
| | 1500 | 40 | 200 | -20 | 90 | 12:1 |
| 701A* | 1500 | 30 | 200 | -10 | 70 | 20:1 |

Table 3. Passive-grid circuit with positive screen supply test results. *701A—uncommon surplus tube. Used in identical circuit but another physical setup.

and draw your own conclusions.

Having been a teacher for most of my life, I know this is not the way to end. I see some strange expressions on your faces. You, in the front row, what's your problem?

How did I do the experiment and how valid is the data?

The FT-7 was connected through an antenna change-over relay through the amplifier under test and through an swr meter (which was also calibrated for relative power) to a Heath Antenna®. With the antenna relay not energized, the FT-7 was fed through to the load and the relative power was set to 10%. Then the antenna relay was energized and the amplifier fed to the load. If the meter reads 60%, we have a power ratio of 6:1. On the high output ones, I set the power meter at 100% with the amplifier on and then compared to the FT-7. If it reads 8%, then we have a power ratio of about 12:1.

In each case, the amplifier voltages and loading were adjusted for maximum power out without getting the plate too red. The actual power ratios

may be a little in error, but the differences are so great that the conclusions are evident. An rf ammeter might be used if you choose to use one. Since I^2R equals power, $(I_{amp}/I_{FT-7})^2$ will give you the power ratio.

What was the frequency of the tests?

I originally planned on 80 meters, but the tank circuit wouldn't reach that far, so I used 40 meters.

How about the long grid and plate leads going to some of the remote sockets on the chassis?

Not good at all. But you can get away with it on 40 meters. Nothing even threatened to take off and oscillate. But you better get those leads much shorter if you expect to work on ten.

What will this thing do on a real live antenna rather than a dummy load?

It will do just as well and very likely better. If you have a good antenna with a swr of 1:1, it will behave just like the dummy. If you have an antenna with an swr of 2:1, the FT-7 output to the antenna will be considerably reduced, but the pi-network in the linear will overcome this and will have full output. Instead of a power ratio of 10:1, it might very well go to 12:1 or more.

What's the big difference between an amplifier for a 100-Watt exciter and a 10-Watt exciter?

Another very good question and one that a lot of you may not have thought about. If you have a 10-Watt exciter, you want to get all the power gain you can get. If you get a gain of 20, you still only have 200 Watts out. If you have a 100-Watt exciter, an amplifier with a gain of 6 is pretty good. You now have 600 Watts out and very near the legal limit of 1000 Watts in. A low-mu grounded-grid triode might be ideal. On the other hand, a

In the proud tradition of the S/Line and KWM-2: Collins KWM-380.

What is "tradition"? Fifty years of HF communications experience and a high technology base that makes us an industry leader. Plus added value like the KWM-380 12-month warranty and 24-hour factory "burn-in" followed by individual testing and calibration of each transceiver.

The Collins KWM-380 gives you "tradition" in one box. Microprocessor control provides operation from the front panel or optional remote interface connector. Plug-in read-only-memory I.C. allows the addition

of WARC band changes. Built-in AC/DC power supply lets you operate almost anywhere.

Rate selectable tuning to 10 Hz with frequency memory and split VFO provide excellent operational flexibility.

The Collins KWM-380. A sound investment that offers excellent resale value. See it at your authorized dealer. Collins Telecommunications Products Division, Rockwell International, Cedar Rapids, Iowa 52498. Phone 319/395-5963. Telex 464-435.



Rockwell International

...where science gets down to business



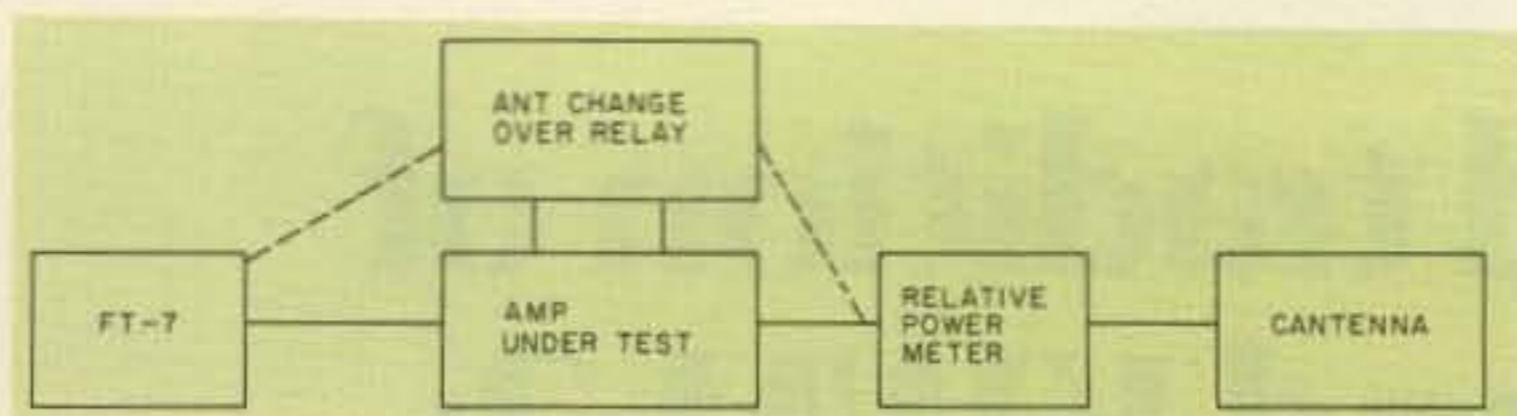

Fig. 4. Passive-grid amplifier test setup for common-grid configuration.

3-400Z (or 500Z) or a 4-400A in a passive-grid circuit would be quite adequate.

Which one did I decide to use?

Well, I built two. Both of them were chosen because I had the tubes. One was the grounded-grid, untuned input 7094 which I succeeded in getting inside a medium-sized cabinet complete with power supply. I can stick the outboard antenna (input) tuner in if I want to. The other uses the old Western Electric 701A in the passive-grid circuit with 70 volts on the screen. I had three of them and two sockets. (If anyone wants a

701A and a socket, make me an offer.) In any case, the decision rests on personal choice, what's in the junk box, and what you would settle for in the way of output.

A Bit of Confession

You would be surprised at the number of Master's and Doctoral dissertations that have been founded on a preconceived conclusion with a bunch of warped data to prove what the author already thought was so. Well, I had a preconceived conclusion that the passive-grid circuit was just great and everybody should build

| Tube | Ep | Io | IL | Ec | PA/P7 |
|--------|------|----|-----|-----|---------------|
| 829B | 460 | 5 | 130 | 0 | 5:1 |
| | 900 | 20 | 175 | 0 | 5.4:1 |
| 6146 | 900 | 40 | 90 | 0 | 5:1 |
| 6146A | 900 | 30 | 100 | 0 | 5.4:1 |
| 6LQ6 | 900 | 10 | 125 | -10 | 6:1 |
| 811 | 1500 | 20 | 50 | 0 | 2:1 |
| 813 | 900 | 0 | 30 | 0 | 1:1 |
| | 1500 | 10 | 50 | 0 | 1.5:1 |
| 4-125A | 1500 | 0 | 30 | 0 | Less than 1:1 |
| 4-400A | 1500 | 25 | 75 | 0 | 3.2:1 |
| 3-400Z | 1500 | 50 | 110 | 0 | 8:1 |
| 7094 | 900 | 20 | 85 | 0 | 5:1 |
| | 1500 | 40 | 110 | 0 | 8:1 |

Table 4. Passive-grid test circuit results after tying all grids together.

one. Before starting on this little data collecting venture, I had already built the 701A. Since it worked so well, it must follow that all passive-grid circuits are fantastic. As you can see, my data disproves this hypothesis. On the other hand, it turns out that I have built a good case for the tuned-input grounded-grid for just about any tube you want to choose. I never did try the

701A, grounded-grid, but I suspect that it would be excellent. By the same token, a 4CX1500A might be good in a passive-grid, but I don't have one.

If you have a strange unknown bottle in your junk collection, cobble up a junker linear and see what it will do. Then build a finished model using whatever circuit works the best.

Have fun! ■

Reader Service for facing page ✓ 70

THE RTTY ANSWER



IRL T.M.

700 TAYLOR RD.
COLUMBUS, OHIO 43230
(614) 864-2464

VISA OR MASTER CHARGE ACCEPTED
IMMEDIATE DELIVERY

THINKING OF RTTY??
APPLE ... TRS ... HEATH ... DEDICATED SYSTEM? SOFTWARE?
INTERFACE? PERFORMANCE? PRICE? We know you have questions ...
check our answers. Call today for information on our terminal units!

Step Up To The Cubic Communications "ASTRO 103"



Dual VFOs Give You Two Radios for the Price of One!

Competitively priced, quality American design and construction by Cubic . . . a leader for 3 decades in defense and commercial electronics

Features:

All band coverage including WWV and the new WARC bands

DUAL VFO's each provide complete band coverage: (You are not limited to a single memorized frequency)

235 Watts input, SSB and CW on all frequencies

IF Passband Tuning not to be confused with ineffective "IF shift"

Utilizes an 8 pole filter which is continuously variable for either high pass or low pass.

CW Crystal Filter (optional), 400Hz 6-pole

Unique Visual Display of Passband

External Receive Antenna Jack allows separate transmit and receive antennas

Tunable Notch Filter when combined with passband tuning, provides the ultimate in removing interference

Full or Semi CW Break-In

Selectable hard/soft keying makes the difference in pile up

Continuously Variable AGC lets you hear the weak signal which would normally be masked by strong adjacent channel interference

Logarithmic Speech Processor

AF, RF and IF Gain Controls to provide an infinite selection of receiver dynamics

4 Function Meter reads "S" units in receive, and selects forward

power (calibrated in watts PEP), reflected power, or ALC level in transmit

Military Quality PC Boards of double sided, plated through glass epoxy material

Modulated Construction with PC boards and assemblies interconnected by plug-in strip line and coaxial connectors. Chassis and cabinet are of rugged steel construction

Call or write for a Free Brochure



CUBIC COMMUNICATIONS

A member of the Cubic Corporation family of companies

305 Airport Road, Oceanside, CA 92054 (714) 757-7525

Complete System 103



PSU-6A
Power Supply/Speaker

ASTRO 103
Transceiver

1500Z-A
1500 Watt Linear
Amplifier

ST-2B
2kW Antenna Tuner

Scott Nelson W7KUF
Box 56, Snowbird Village
Snowbird UT 84092

Drama on Mt. McKinley

— ice, snow, and amateur radio



At 13,000 feet and approaching Windy Corner.

It has been many years since the mountains started influencing my life. As a youngster living in New Hampshire, I remember reading books and looking at photos of far-away peaks bearing no resemblance to the rolling hills of New England. It took years, but in the early seventies I moved to Utah and took up residence in the Wasatch Mountains at Snowbird, one of the country's premier ski areas.

Now, snow-wise and educated in ice and avalanche perils, I sometimes long for the White Mountains of New Hampshire, realizing that a mountain doesn't necessarily have to be over twelve thousand feet and snowcapped to impress me. It was in camp at 14,400' on Mount McKinley, at -25° , when this thought first came to me. We had been climbing for six days before reaching this camp, and now we were into our third day sitting out an endless storm that buffeted our sturdy dome tents on this high ice field, not far from the arctic circle. Above us, Denali, as the mountain was known to the Indians, rose to over twenty thousand feet of ice, granite, and snow.

This was an expedition that had been six months in the planning and had drawn from climbers and skiers associated with Snowbird. Dick Bass, the Texas oilman and owner of the 'Bird, was there with his two sons and two daughters. Bob Bonar, Director of the Ski Patrol, and Liam Fitzgerald, Director of Avalanche Control, were both there, as well as Dr. Gernot Spalleck from the Medical Clinic. The expedition leader was Marty Hoey, Director of the Safety Patrol and an extremely capable climber. Among other notable credentials, she is a member of the China/Everest expedition for 1982.

It was early December, 1980, that plans began to materialize. We each embarked on a conditioning program that included weight lifting and running or bicycling in addition to our normal skiing. New equipment had to be purchased and tested—with safety of prime concern. It was the safety factor that first led me to consider taking ham radio along.

A quick check of the repeater directory confirmed the availability of two meters within range of the mountain. In mid-winter tests in the Wasatch Mountains, both my own Yaesu FT-207R and a friend's Kenwood TR-2400 proved unacceptable because of the whistles and bells, memories, displays, weight, and nicad drain. Quickly, it became apparent that the criteria for acceptance were small size and weight, simple operation, and synthesized frequency control. Both the Tempo S-1 and Icom IC-2AT fit the bill and tested out well. Through the assistance of the folks at Icom, I was soon outfitted with a new hand-held equipped with an alkaline battery pack, and I was ready to go.

The rubber ducky was discarded in favor of a quarter wave, but tests soon showed that it, too, would be marginal. One hike into the mountains with VoCom's five-eighths-wave whip convinced me that there was no other way to go, although at one time I did consider a collapsible three-element beam. Like other complicated solutions, it was discarded in favor of the simple whip. It was to provide the margin of safety we required.

Next on the planning agenda was the Anchorage link station since I wanted to operate on 2 to 20 meters crossband and maintain contact with my family and



Scott Nelson transmitting at 14,400 feet during the storm. (Photo by Bob Bonar)

ham friends in Salt Lake City. Several calls on 14.292 MHz soon brought Ray Morris KL7C into the picture. Being quite familiar with the Wasatch Front, he soon was impressed enough with the expedition to volunteer his services as our much needed link.

Ray, in turn, contacted Roy Davies KL7CUK in Montana Creek, about seventy-five miles from the mountain, who agreed to back us up with simplex coverage. Ray devised a direct-coupled patch while Roy relied on acoustic coupling (as simple as holding the mike to the speaker!). Russ Knodel KL7HC also came aboard as backup, and we were set!

After a shakedown climb on Mt. Rainier (following the same route where eleven climbers tragically lost their lives a month later),

we were off to Anchorage, where, in addition to our sixty-pound packs, we divided over six hundred pounds of group gear that would be towed on sleds behind us. We would be using specially-equipped mountaineering skis on the lower glaciers, thereby eliminating the need to shuttle loads. All one hundred twenty pounds apiece would be carried in one trip until we reached the steeper sections where skis would be traded in for crampons.

The Anchorage-to-Talkeetna leg was on the Alaskan Railroad, a three-hour trip that occasionally yielded a glimpse of the distant mountain. Nearing Talkeetna, we could see ski-equipped planes heading north toward the glaciers where climbers would be dropped off.

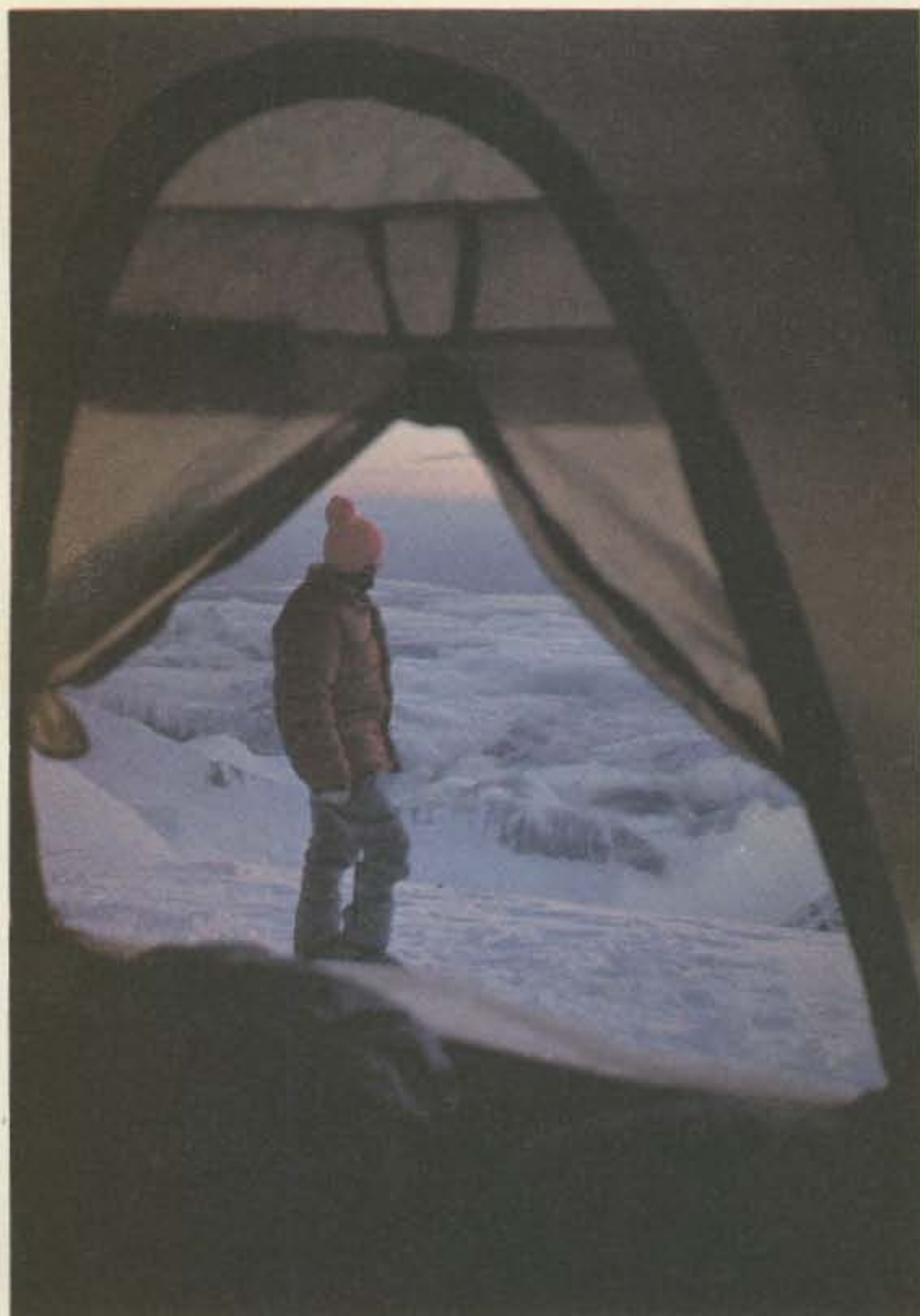

Dr. Gernot Spalleck at 16,000 feet, at 2300 hours.

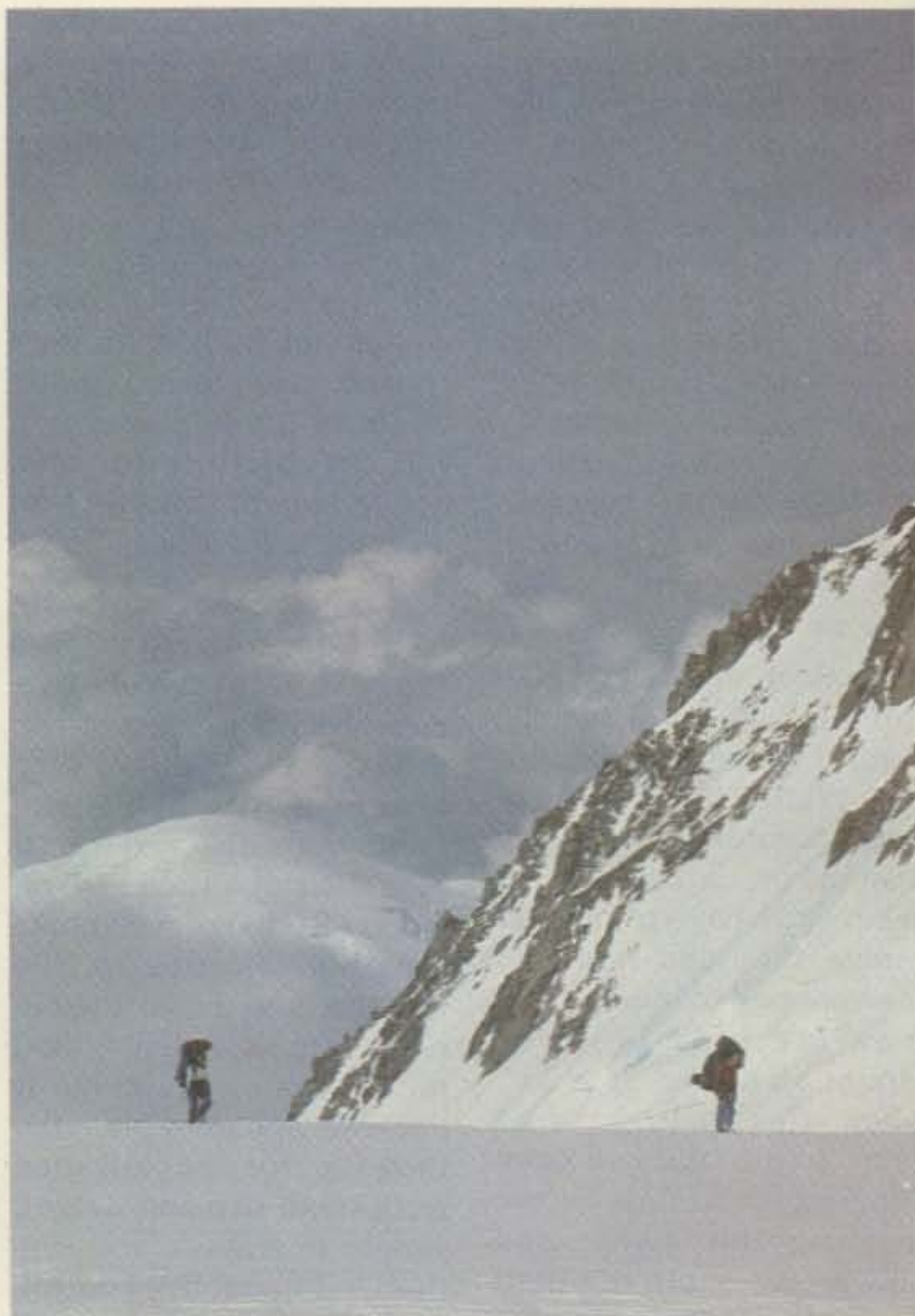

Climbers at 14,500 feet.

Soon it was our turn, and as we stuffed ourselves into the Cessna 185 among packs, sleds, and skis, the drama began. Our pilot, Cliff Hudson, climbed to 8000, and thirty minutes later entered One Shot Pass (no turning back!) and descended to the Northeast Fork of the Kahiltna Glacier (Kahiltna International, to the pilots) where we established base camp at 7000 feet. Here we were in the shadows of fourteen-thousand-foot Mt. Hunter and seventeen-thousand-foot Mt. Foraker. Several other expeditions were preparing to leave, so we decided on an overnight stay before setting out on our own the next morning, after organizing loads for the final time.

I was surprised to find that I could access the 90/30 machine in Anchorage from a spot near the airstrip. A check with KL7CUK

confirmed our arrival, and a schedule was made for a week later when we expected to arrive at 14,400. Although I would try to access the repeater daily, I did not expect to be able to do so until clearing the shadow of the mountain and arriving at 14,400.

The climb from 7000 to 11,000 was a joy. We encountered only one snowstorm, and on several days climbed in shorts with no shirt. The sun was unbearable during the day, and at night the mercury often plummeted fifty or sixty degrees! We climbed anywhere from one thousand to fifteen hundred feet per day depending on the steepness, though generally it was moderate low-angle glacial terrain over a few steeper ice falls. Crevasses were mostly bridged with the winter's snowfall, though occasionally a gap-

ing hole would open up beside the trail.

We roped together from the moment we left the airstrip, a move I was most thankful for on the day I suddenly plunged into a hidden crevasse. Luckily, the rope prevailed, and I didn't sink below the surface. We often joked about our turtle routine, something that occurs as you are trying to right yourself or get up after falling with the heavy pack strapped to your back. Sounds funny, but try it sometime!

After 11,000, the climb got more serious, for facing us was a pitch called "Motorcycle Hill." The sleds were cached with our skis at the base and we began one of several shuttle climbs with loads. The next camp was established at 12,500 just below a pass called "Windy Corner." We were anxious to reach

14,400, for there we planned a few rest days before heading higher. Two loads to 12,500 in one day, and we were off the next day for 14,400. Windy Corner was anything but windy, but medium-angle blue ice proved to be a tricky traverse. With crampons and ice axes, however, we passed with no problems.

In camp that night a day early, I once again tried the repeater and got through. Ray and Roy were standing by as they had all week in case I managed to get into another hot spot. No one was on twenty meters from Salt Lake that evening, so, after a wrap-up of the week's activities, we signed off till the next evening when we would try to run some patches to Utah.

Returning to 12,500 feet the next morning, we loaded the balance of our supplies on our backs and were

off again around Windy Corner, which was still windless. At 1800, I was again able to get into the 90/30 repeater, and for the first time there were Al Wolff KC7O and Mike Mladevosky WA7ARK in Salt Lake City patched through from twenty meters. A few minutes later, Mike had my wife Suzi on the phone, and from twenty-five hundred miles away via two and twenty, I was able to report our progress.

The looks on the faces of the other climbers were of amazement as they heard me talking with Suzi and my son Tyler on what looked to them to be a simple walkie-talkie. Their only experience with radios till then had been with the sometimes-less-than-efficient Motorolas used by the ski patrol.

Following that first conversation, I had daily requests for message-handling from other members of our party, usually consisting of one-way phone calls from Anchorage. The pattern remained the same: the 1800 check-in on 90/30, with WA7ARK and KC7O standing by on twenty meters for either KL7C or KL7CUK.

I tried to limit the on time to fifteen minutes to conserve batteries, but by the time we got through with check-ins, messages, and weather reports, it usually ran more than thirty minutes. I came equipped with four sets of alkalines (24 AA batteries), but the cold weather was eating them up faster than I planned. The procedure was to take the unit out of my pack at 1700 and place it inside my down jacket for warmth. Some evenings this wouldn't be possible, or perhaps was possible for only ten or fifteen minutes. Mike always remarked on those evenings about the deterioration of my signal in both strength and quality. "Forgot to warm up tonight,

didn't you, Scott?" became his standard greeting.

We ran both simplex and repeater patches with equally great results. Al taped all transmissions on cassette, and eventually they will be part of an audio/visual show I am planning on the climb. Suzi found it easier to hop into the car with Tyler and drive to either Mike's or Al's QTH than to rely on a phone patch across town. Undoubtedly, Tyler (2½ years old) enjoyed the excitement of adventure much more while sitting at (or on) Al's or Mike's bench.

If you have never spent three days in your sleeping bag waiting for the weather to clear, you haven't missed much. The evening radio call was the highlight of the day—except when the wind was whipping snow past you at forty miles per hour at -25° F. Five days after arriving at 14,400, it finally cleared and we prepared to climb to 16,000 feet. The previous day it had stopped snowing long enough for us to make a carry to 15,000, but now we were prepared to go up the most difficult section of the mountain.

Suddenly, two French climbers came into camp asking if we had a doctor. A German climber camped near them had come down with pulmonary edema and urgently needed attention. After considerable discussion, Dr. Spalleck predicted that the climber would be in a life-threatening condition if not treated immediately with the proper drugs and, most importantly, taken to a lower altitude.

At 1000 I put out a call again on 90/30, which also is the RACES repeater in Anchorage. Moments later, Roy KL7CUK was on frequency and mobile on his way to Talkeetna where there was both an FAA Flight Service Station and a Park Service Field Station. Arrangements were made for a Bell 206 to leave An-



Dinner in a blizzard.

chorage, 150 miles away, refuel in Talkeetna, pick up a Ranger, and head on to McKinley where the morning's clear skies were rapidly deteriorating. The ceiling was still below us at 11,000 feet, but clouds now were forming in the high basin where we waited with the now-critical climber.

After probing the area for crevasses, a landing area was stomped out and flagged in the new snow. By now we were totally clouded in, and from Roy I learned that the rescue helicopter was approaching the mountain. Four hours had gone by since the first call went out, and now the



Rescue helicopter taking off.



Just past One Shot Pass.



The expedition's banner.

German's life depended on the helicopter getting in.

At the same time we first heard the chopper approaching, we also noticed a bit of blue sky, however, and by the time he arrived, the sky had opened enough for him to land on his first approach. While the downwash from the blades created a white-out with the new snow, the pilot never backed off on the pitch and hovered with the skids just touching the snow as several volunteers loaded the climber into the bird. He was off as quickly as he had arrived, with the clouds closing in as he disappeared from view.

What had begun as a novel experiment in back-country communications had suddenly proved to be an invaluable contribution to saving a man's life. We returned to our camp and again made preparations to join the rest of our group, now more than two-thirds of the way to 16,000 feet.

Because of uncertain weather we dared not wait another day, so at 1600 we broke camp and started up the steepest section of the mountain. I hoped that the cold I had caught a few days before wouldn't affect my climbing, but by 15,000 feet, my breathing told me it had. At 2030 that evening, we dragged into camp to join the others, my lungs

strained to the limit. I had told Roy earlier that I probably would miss that evening's call and had asked him to relay that information to Utah.

The next morning, my high-altitude headache persisted and a new storm was raging. Staying on an exposed ridge at 16,000, we decided to push on to 17,500 where we would be more sheltered from the storm. This was a relatively easy climb, but also the most beautiful in clear weather. Disappointed to miss the photo possibilities, we pushed on through the snow to high camp where my headache still bothered me.

That evening's call was next to impossible, for I had to climb an exposed ridge in order to hit the repeater, and in doing so opened myself up to the full fury of the storm. (Listening now to KC7O's tapes of that and the next evening's conversations, I can understand the alarm felt by those not on the mountain. My voice lacked clarity and enthusiasm, for the altitude was affecting me more than I realized. I remember hearing my little boy's voice and feeling very sad I was not with him and his mother.)

The next morning, the storm continued and we spent the day in our sleeping bags drinking soup and tea and playing cards. Still I

felt no better, and by the second morning knew I would have to go back to 14,400 to re-acclimate myself if I wanted to reach the summit. I left at noon with several other climbers, and we reached our lower camp by late afternoon, where my headache immediately disappeared. I would have to spend at least twenty-four hours there before going back up, but the next morning we awoke to blue skies and knew that the others would be going for the summit. Not having the logistical support for two summit attempts, we all departed for base camp, knowing that the others would join us in a few days.

Disappointed, yes, but, as you quickly learn as a climber, summits are not everything. The climb to 17,500 feet had been the most exhilarating experience of my life and I could not regret a moment of it.

We arrived at base camp at 1945 that evening. With twenty-one hours of daylight and three hours of dusk every midsummer day, Alaskan pilots can fly nearly anytime the weather permits. Within an hour of the time our party was ready, Cliff Hudson was again landing his plane on the strip and we were hurriedly loading our gear and ourselves into his plane. With the weather closing in fast, Cliff elected to take us

all out in one load and come back for the remainder of our gear when the weather cleared.

All the passes were socked in, and our only way out was to follow the Kahiltna for twenty or thirty miles to the toe of the glacier. After nearly three weeks, we saw green again, and a short while later were landing in Talkeetna. Cliff's son met us at the dirt strip with his pickup truck and, as we piled out of the plane, handed us each a cold beer. Sitting on the tailgate still in our climbing boots, goretex, and wool clothes and feeling slightly over-dressed for this warm summer evening, our conversation drifted to our next adventure. What would it be... South America next summer, or maybe Nepal and the Himalaya? I'd have to check the repeater directory on those two. Meanwhile, having finished our beers, we headed into town for a typical American meal: hamburgers and french fries. After three weeks of instant mashed potato mush and eggs, it tasted like a steak dinner.

Cliff was sitting there with us, a cigarette hanging out of the corner of his mouth. Taking a deep breath he said, "There now, how do you like breathing some of this heavy air for a change?"

Heavy air, indeed! ■

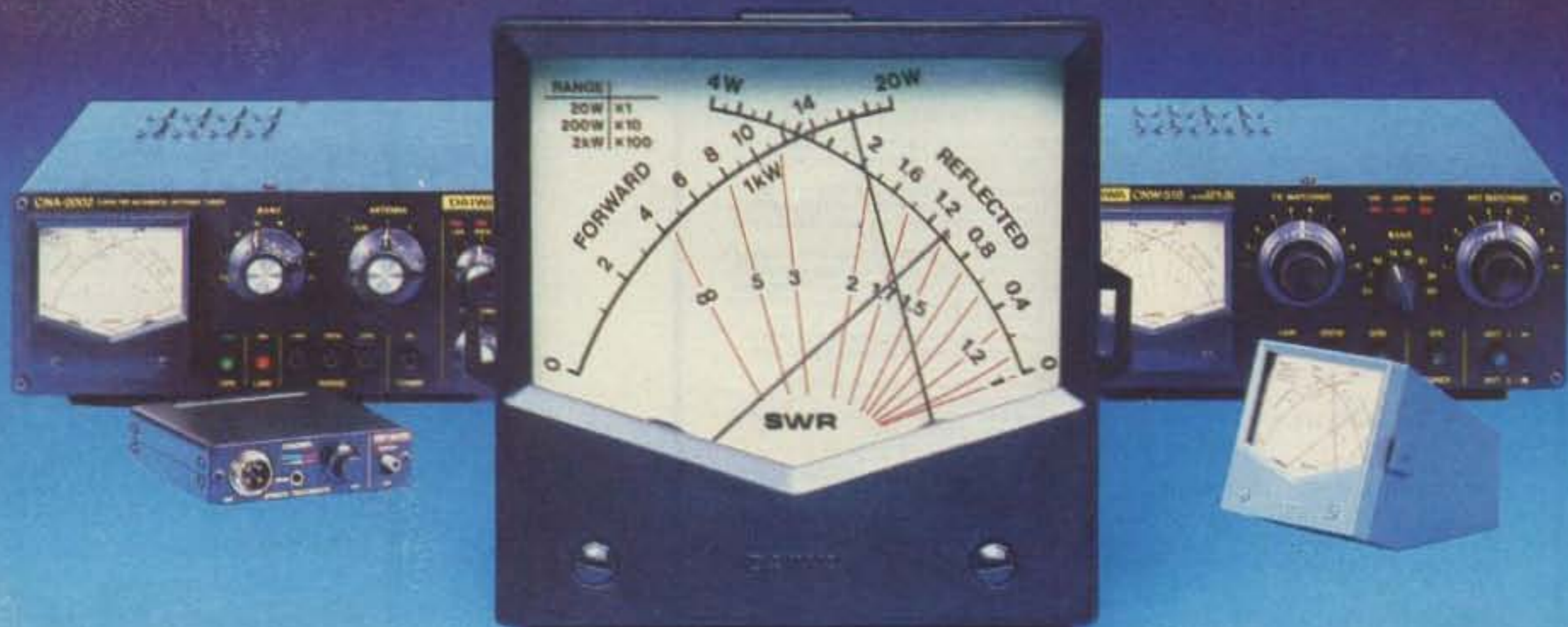

A REVOLUTION IN CONVENIENCE

DAIWA announces an all-new lineup of high-quality amateur radio innovations.

Cross-Needle Meters CN-520 / CN-540 / CN-550

DAIWA cross-needle precision is now available in a compact case. Get forward power, reflected power and SWR readings at a single glance—from a meter that fits anywhere!



CN520 - Frequency: 1.8-60MHz • Power range: Forward 200/2kw, Reflect 40/400 watts • Detection Sensitivity: 40 watts minimum • Accuracy: $\pm 10\%$ at full scale • Dimensions: 72W x 72H x 95D m/m

CN540 - Frequency Range: 50-150MHz • Power Range: Forward 20/200 watts, Reflected 4/40 watts • Detection Sensitivity: 4 watts minimum • Accuracy: $\pm 10\%$ at full scale • Dimensions: same as CN-520

CN550 - Frequency Range: 144-250MHz • Power Range: Forward 20/200 watts, Reflected 4/40 watts • Detection Sensitivity: 4 watts minimum • Accuracy: $\pm 10\%$ at full scale • Dimensions: same as CN-520

Active Audio Filter AF-306

By electronically filtering unwanted signals, the AF-306 gives you clean, distinguishable copy. Featuring its own internal speaker, the AF-306 Active Audio Filter is easy to install, easy to operate.



Input: 2.8v (4v max.) • Output power: 1 watt @ 8 ohms • Distortion: less than .2% • S/N ratio: better than 50dB • Low Cut Filters: 400Hz, 800Hz, 1100Hz • High Cut Filters: 1100Hz, 1600Hz, 2500Hz

Automatic Antenna Tuner CNA-2002

Leading the way in convenience is the Daiwa CNA-2002 2.5 kW (PEP) Automatic Antenna Tuner. Cross-Needle Metering and optimum matching in under 45 seconds make it the perfect compliment to any state-of-the-art amateur station.



Frequency Range: 3.5-30 MHz including WARC bands • Tuning Time: less than 45 seconds • Power Rating: SSB-2.5kw PEP, CW-1kw (50% duty), AM-500 watts, RTTY, SSTV-500 watts (10 minutes) • Output Impedance: 15-250 ohms (unbalanced) Dummy Load: 100 watts 1 minute (installed) • Metering Ranges: Forward power - 20/200/2000 watts, Reflected power - 4/40/200 watts, SWR-1:1-infinity • Power Requirements: 11-16 vdc @ 200 ma

Manual Antenna Tuners CNW-518 / CNW-418

The serious amateur wants to achieve the best antenna match possible. That's why DAIWA offers two manual antenna tuners that maximize power transfer—and offer cross-needle metering as well.



CNW-518 - Frequency Range: 3.5-30MHz including WARC bands • Power rating: 1kw CW (50% duty) • Output Impedance: 10-250 ohms (40-10 meters), 25-100 ohms (80 meters) • Insertion loss: less than 5 dB

CNW-418—Same as above except—Power rating: 200 watts CW

Infrared Cordless Microphone RM-940

DAIWA ingenuity is also evident in the RM-940, an Infrared cordless mobile microphone system. Audio and transmit/receive switching are carried on a safe infrared beam. Experience the freedom of cordless mobile operation. Ask your Daiwa dealer for a demo today!



Microphone: Electret Condenser type • Continuous Operating Time: 5 hours minimum • Charging Time: 8 hours max • Usable Distance: 3.5 feet—microphone to sensor • Power Requirements: Controller—13.8 vdc @ 80 ma, Microphone—2.5 vdc @ 30 ma

Speech Processor RF-670

DAIWA innovative thinking led to the development of the RF-670 Photocoupler Speech Processor. Its unique design gives your signal the boost it needs to cut through bothersome QRM. Get RF-type processing performance with the RF-670's economic photocoupler design.



Clipping Level: 20dB max • Frequency response: 300-3000Hz (-10dB) • Clipping Threshold: less than 2mV at 1kHz • Bandwidth: 2400Hz at 6dB down • Distortion: less than 3% at 1kHz, 20dB clip • Output level: 40mV max • Mike imp.: 600-50k ohms • Power requirement: 13.5v @ 60ma • Dimensions: 90 x 25 x 93 m/m

UHF/VHF Mobile Antennas

Premium quality, high-gain design. Special tilt-over feature for added convenience.

DA500 - 146/440 MHz Dual Band Length 960 m/m

DA100 - 5/8 wave • Length: 1,360 m/m • 146 MHz

DA200 - 7/8 wave • Length: 1,870 m/m • 146 MHz

Gutter Mount

GM500 - Frequency Range: 1.8MHz-500MHz • Power Rating: 1kw • Dimensions: 86W x 54H x 37D m/m

MCM COMMUNICATIONS 858 E. Congress Park Drive
Centerville, Ohio 45459

Exclusive U.S. Agents for these Daiwa products. Dealer inquiry invited.



DAIWA
Amateur Radio Innovations

BEEPER III



BP-3A: case, cable, standard 4-pin connectors. \$39.95 ppd
 BP-3B: same as above, without connectors. \$36.95 ppd
 BP-3C: circuit board only, for custom installations. . . \$29.95 ppd

All models are assembled/tested and carry a 90 day limited warranty. We ship FIRST CLASS/INSURED and we PREPAY shipping in the U.S. Dealer inquiries invited. Ohio residents please add 5% sales tax. Check or money order only.

FAXSCAN INC.

The Professional Touch Comes to Amateur Radio!

- BP-3 produces a gentle (adjustable) high beep to indicate key-down; a low beep to indicate key-up!
- Perfect for low band use, during nets, emergencies, and under noisy conditions!
- Great for VHF, UHF; an essential for any repeater!
- Simple hook-up! BP-3 plugs into your rig's mic connector; your mic plugs into BP-3!
- Designed for instant hook-up to the standard 4-pin mic connector; easily modified with supplied details!
- Works with any radio where PTT line is grounded to XMT. Virtually all modern gear!
- State-of-the-art CMOS circuitry for low power operation. RF proof!
- One 9-volt battery (not included) powers BP-3 for up to one year!
- Small, compact construction: 2-3/8" x 4-3/8" x 1-7/32"
- Available "board only" for custom or repeater use. Commercial quality!

3148 Dorf Drive, ✓85
 Dayton, Ohio 45418

Handful of POWER

Give your low-power 2-meter rig real punch by delivering a potent 25-watt signal with only two watts of drive (also available set up for 200 milliwatts drive). Compact and convenient to mount, VoCom's Model 2C025 is ideal for car, boat or anywhere you've got a 12 VDC source. At only \$84.95 (\$99.95 for 200 mW drive), it's the perfect companion for your Drake, Encomm, Henry, Icom, Kenwood, Motorola, Standard, Wilson, Yaesu or other 2-meter FM portable!



- 2 or 2 watt nominal drive (specify)
- 2 watt model delivers 15-20 watts with only one watt of drive
- 10 MHz bandwidth for CAP or MARS
- Meets all applicable FCC specifications
- 200 mW drive model permits operating Icom IC-2A or Yaesu FT-207R on their battery-saving low-power mode
- Only \$84.95 (\$99.95 for 200 mW drive)

Even More POWER

Give your 2-meter hand-held 50 watts of punch with the Model 2C050, or 100 watts with the Model 2C100 amplifiers. Or use the Model 2C100 with your 25-watt output 2-meter rig, by plugging in the appropriate drive-programming module.

Compact and reliable, all VoCom power amplifiers feature front-panel on-off switching for convenient shut down when they're not needed for short hauls, plus an LED status indicator.

See your dealer or contact VoCom today for a copy of our detailed four-page catalog.

ANTENNAS for 2-meter Hand-Helds

5/8-Wave Gain Antenna

Provides nearly 10-dB gain over a rubber ducky when extended to its full 47", yet telescopes to only 8" for listening or carrying. Works with any BNC equipped radio...

NEW! Short, Compact "UGLY DUCKLING"

Only 4 1/2" short, yet performs like a "full size" ducky. Available for either BNC or threaded mounts.

Available now from your local amateur radio dealer or order direct:

VoCom ✓90
 PRODUCTS CORPORATION 65 East Palatine Road, Suite 111, Prospect Heights, IL 60070
 (312) 459-3680

SAVE \$800 on TEN-TEC Package Deal



546C OMNI-D Series C 9-band Digital Transceiver



243 Remote VFO



255 Power supply/speaker



234/214 Processor/mic.



645 Iambic keyer



444 HERCULES 1.2 kw solid-state Linear

| Package Components | Regular |
|-------------------------------|-----------|
| 546C OMNI-D Series C | \$1289.00 |
| 255 Power supply/speaker | 199.00 |
| 243 Remote VFO | 189.00 |
| 234/214 Processor/microphone | 178.00 |
| 217 500 Hz CW filter | 55.00 |
| 218 1.8 kHz SSB filter | 55.00 |
| 645 Iambic keyer | 85.00 |
| 444 HERCULES linear amplifier | 1575.00 |

Total Regular Price - \$3625.00

Package Price - \$2825.00

You Save - \$800.00

Other accessories *not* included in package:

| | |
|---|---------------|
| 219 250 Hz CW filter (Reg. \$55) | SALE \$ 49.95 |
| 1140 DC circuit breaker | 10.00 |
| 209 300w dry dummy load | 26.00 |
| 227 200w antenna tuner (Reg. \$79) | SALE 72.95 |
| 228 200w tuner w/SWR (Reg. \$95) | SALE 85.95 |
| 299 Synthesized voice frequency readout | 290.00 |

Limited offer, send Check or Money Order now. For prompt shipment, call TOLL FREE 1-800-558-0411 and use MASTERCARD or VISA; COD orders O.K. Prices do not including shipping charges.



AMATEUR ELECTRONIC SUPPLY®

4828 W. Fond du Lac Avenue
 Milwaukee, Wisconsin 53216
 Phone: (414) 442-4200

Wisconsin WATS: 1-800-242-5195
 Nationwide WATS: 1-800-558-0411
 AES Branch Stores in: Clearwater, FL •
 Orlando, FL • Wickliffe, OH • Las Vegas, NV

OMNI-C has what it takes to filter the crowds. To narrow the Amateur Radio world right down to the particular signal you want. The selectivity, sensitivity, dynamic range and operational features you need to cut any crowd down to size. **Tailored i-f response.** OMNI is equipped with the potential for **seven** response curves to handle any listening situation.

Standard filters include an excellent 8-pole 2.4 kHz crystal ladder filter and, in addition, a 150 Hz active audio cw filter with three ranges (450, 300, 150 Hz).

Optional filters include 1.8 kHz 8-pole crystal ladder ssb filter, 500 Hz 8-pole cw filter, and 250 Hz 6-pole cw filter.

Front panel switches put any optional filter in series with the standard filter for up to **16 poles of filtering** for near ultimate skirt selectivity.

Four i-f response curves for ssb and three for cw. That's response tailoring, that's crowd control.

Optimized sensitivity and dynamic range. The OMNI sensitivity range of 0.3 μ V typical (slightly less on 160 & 80M) combines with a 90 dB dynamic range to provide an ideal balance that will handle any situation from copying a weak signal half way 'round the world to keeping the next-door kilowatt from muscling in. And a PIN diode switched 18 dB attenuator is included for extra insurance against overload.

More crowd-handling features—and all standard equipment. **Built-in notch filter.** To drop out unwanted signals or carriers. Tunable from 200 Hz to 3.5 kHz, with a 50 dB notch depth.

3-mode, 2-range offset tuning. To put you where the others aren't and where the elusive DX is. Move just the OMNI receiver, or just the transmitter section, or the entire transceiver, ± 500 Hz or ± 4 kHz. For complete freedom of frequency movement to get away from the crowds.

Built-in noise blanker for those times when your noise-generating neighbor is crowding your receiver. Filtered to handle the big signals easily.

2-speed break-in. When QRM or QRN is heavy, switch to "Slow." Use "Fast" for instant, full break-in for enjoyable rag-chews or stalking DX.

OMNI-C features stand out in any crowd. All solid-state—from the pioneer, Ten-Tec.

Built-in noise blanker for those times when your noise-generating neighbor is crowding your receiver. Filtered to handle the big signals easily.

2-speed break-in. When QRM or QRN is heavy, switch to "Slow." Use "Fast" for instant, full break-in for enjoyable rag-chews or stalking DX.

OMNI-C features stand out in any crowd. All solid-state—from the pioneer, Ten-Tec.

All solid-state—from the pioneer, Ten-Tec.

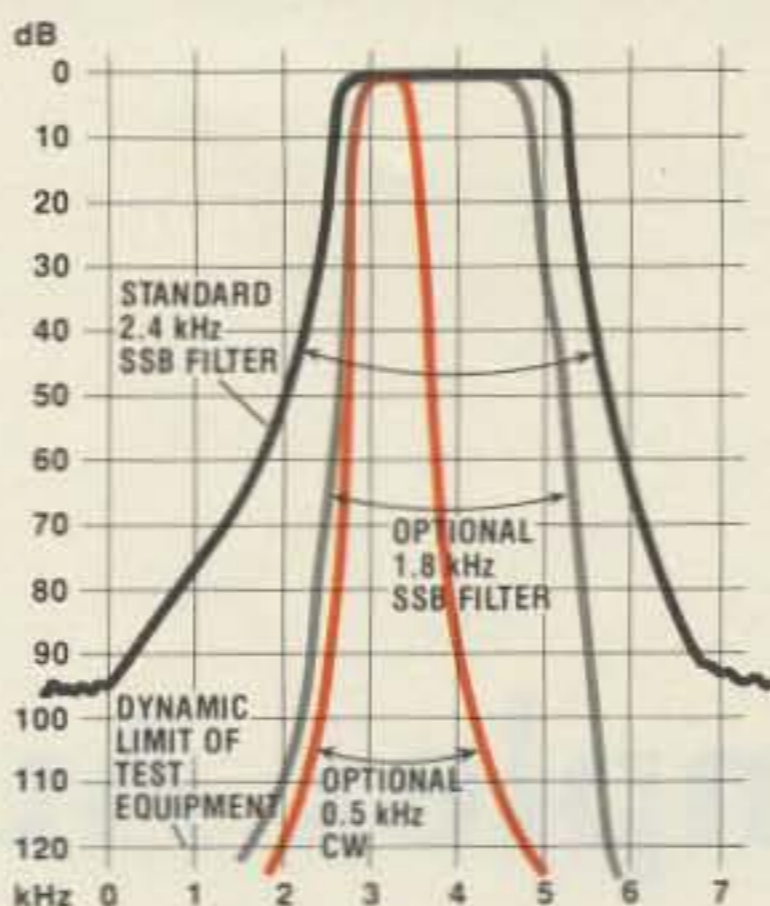

OMNI/SERIES C I-F RESPONSES WITH STANDARD AND OPTIONAL FILTERS.

"Hang" AGC for smoother action. WWV reception on the 10 MHz band. **Digital readout in two colors**, red for the 5 significant places, green for the 6th digit (100 Hz). Instant recognition. **Separate receiving antenna capability.** Switch receiver to a common antenna for transceive or separate receive-only antenna; the system also acts as receiving antenna by-pass with an instant break-in linear amplifier or transverter. **"S"/SWR meter**, electronically switched. **200 watts input, all bands**, with 50-ohm load. 5 year pro-rata warranty. **100% duty cycle** on all bands up to 20 minutes. Full RTTY and SSTV power. **Built-in VOX and PTT** with front panel controls. **Built-in phone patch jacks** for easy interface. **Built-in zero-beat switch** for spotting the exact frequency of a DX station. **Built-in adjustable sidetone volume and pitch.**

Adjustable threshold ALC, optimum power for driving a linear. Provides means of working into a high SWR.

Front panel control of linear or antenna. The rear panel bandswitch terminals control relays or circuits in step with front panel bandswitch.

Automatic sideband selection plus reverse.

Low distortion audio, less than 2%; a Ten-Tec trademark.

Clean signal, exceeding FCC requirements.

High stability over wide temperature and voltage excursions.

Built-in speaker, compression-loaded; in bottom of cabinet.

Plug-in circuit boards for fast easy service.

12-14V dc power for easy mobile use.

The Rig That Filters The Crowd



TEN-TEC OMNI-C

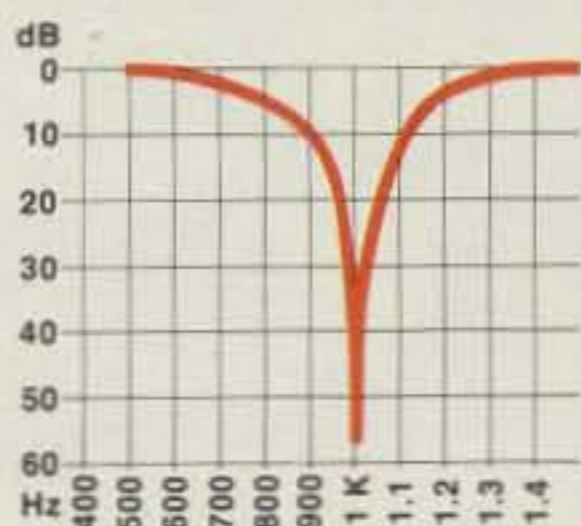

NOTCH FILTER PERFORMANCE ADJUSTED TO 1 kHz POINT.

All 9 hf bands—only crystals are needed for 18 and 24.5 MHz bands.

Broadband design for instant band change without tune-up or danger of damage to the final amplifier. Another Ten-Tec original.

Full complement of accessories:

Model 280 Dual Primary AC Power Supply, \$169; Model 255 Deluxe Power Supply/Speaker Combo, \$199; Model 243 Remote VFO, \$189; Model 215 PC Microphone, \$34.50; Model 214/234 Microphone/Speech processor, \$39/\$139; Model 645 Dual Paddle Keyer, \$85; Model 670 Single Paddle Keyer, \$39; Model 227 Antenna Tuner, \$79; Filters \$55 ea.

Made in the U.S.A.

Model 546 OMNI-C transceiver \$1289

Get out of the crowds with OMNI-C. See your TEN-TEC dealer or write for details.

TEN-TEC, INC.
SEVIERVILLE, TENNESSEE 37862

The Simplex Autopatch

— a telephone interface for everyone's two-meter rig!

Several local hams have been talking about a different kind of VHF autopatch that uses one frequency. This discussion has been going on from time to time over the past few years. We have designed many paper models of such

a machine, with nothing more than a few beers as inspiration. But, in the August, 1978, issue of *73 Magazine*, there was a report of a machine built by John Walker WA6MHF in southern California. Well, needless to say, this sparked the

discussion again, which this time actually led to construction.

For those of you who don't know what a single-frequency autopatch machine is or how one basically works, read on. Since most readers know what a

traditional autopatch repeater is, let's start by explaining that it uses two frequencies (an input and an output), a duplexer (or similar device), and some control circuitry. Once the autopatch repeater is accessed, the transmitter is always transmitting and the receiver is always listening. Thus, two frequencies are used at all times.

Using this method generally requires a duplexer to provide rf isolation between the repeater's transmitter and receiver circuits, in order to use one antenna.

The control circuitry provides the means to access the phone line, limits the length of the call, and terminates the patch.

The simplex method uses a single frequency, does not need a duplexer (unless you are in a very high rf environment), and requires slightly different control circuitry. The receiver is always listening on the simplex channel. When a signal is received and the appropriate tone command is received from the user, both the ON DIGIT and COR LINE enable a circuit to connect

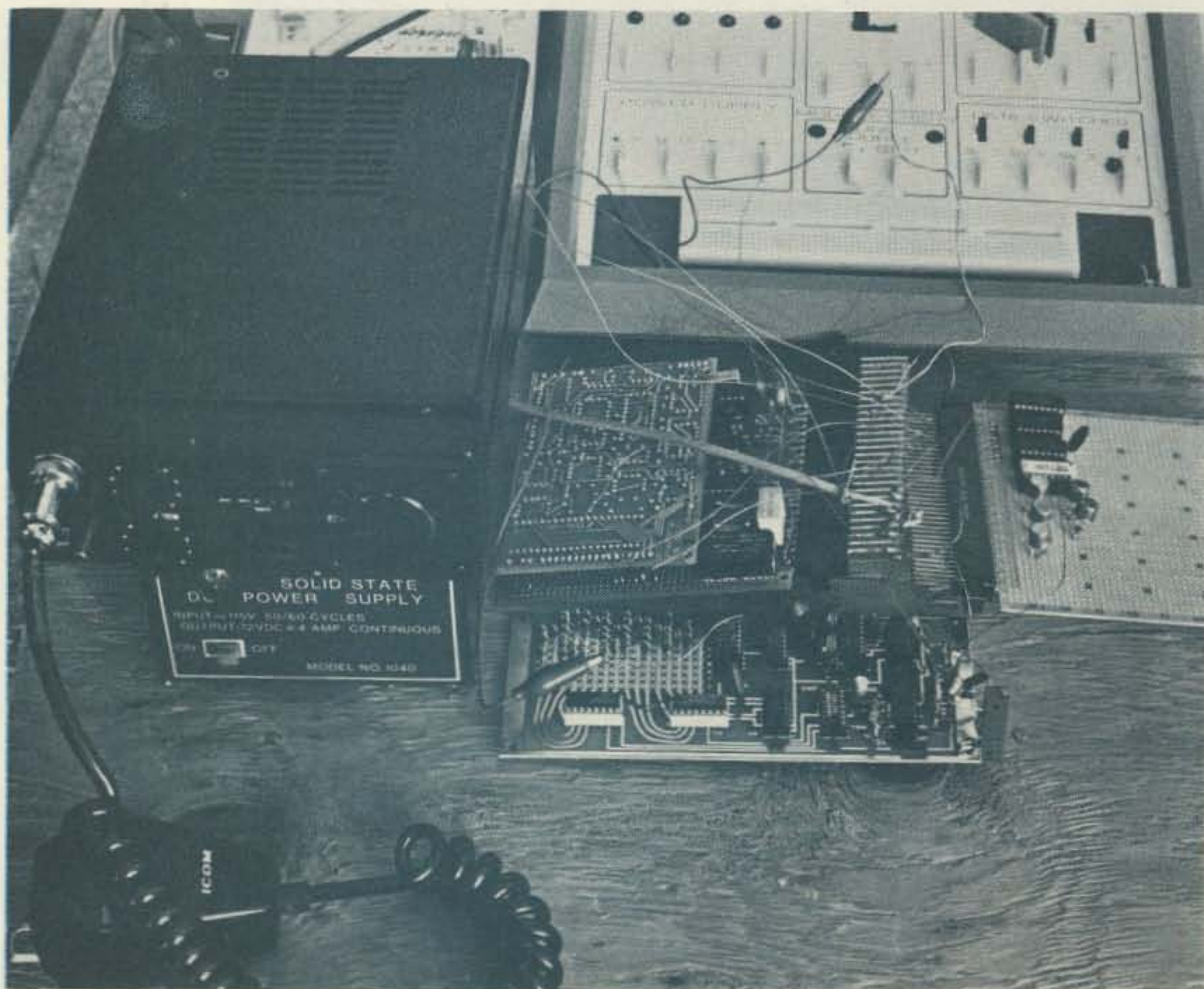

Fig. 1. Complete hardware for simplex autopatch.

the phone line to the receiver and transmitter. At the same time, the transmitter is keyed on for 1.3 seconds and then off (in the receive mode) for about 40 milliseconds. What the user hears is dial tone from the phone line that is interrupted by "clicks" or the receive window. The user then keys his transmitter, and in less than 1.3 seconds (the time until the next receive window), the patch receiver will detect his signal (COR LINE) and inhibit the transmitter. The patch receiver is now locked in, listening to the user. The user then transmits his touch-tone™ signals through the patch receiver to the phone line and on to the central office.

Local patch-control circuitry should check for local calling only and the length of the patch and dump the call if calling criteria are not met. Since this is not the purpose of this article, I will not go any further. When the user releases his transmitter button, the patch receiver responds by enabling the patch transmitter again in the same way as described previously. Thus the user can hear his call being processed (the called party's phone ringing and being answered). The user may talk to his party in a normal push-to-talk mode with the exception of the 1.3-second maximum delay and the "clicking."

Disconnecting the patch is simply a matter of the user keying his transmitter, pausing for the receive window, and signaling the disconnect code. The OFF DIGIT code also disables the patch transmitter from keying and locks the patch receiver in the receive mode.

The disadvantages to this method of autopatching are the "clicks" and the delay in speaking to your called party. The "clicks"

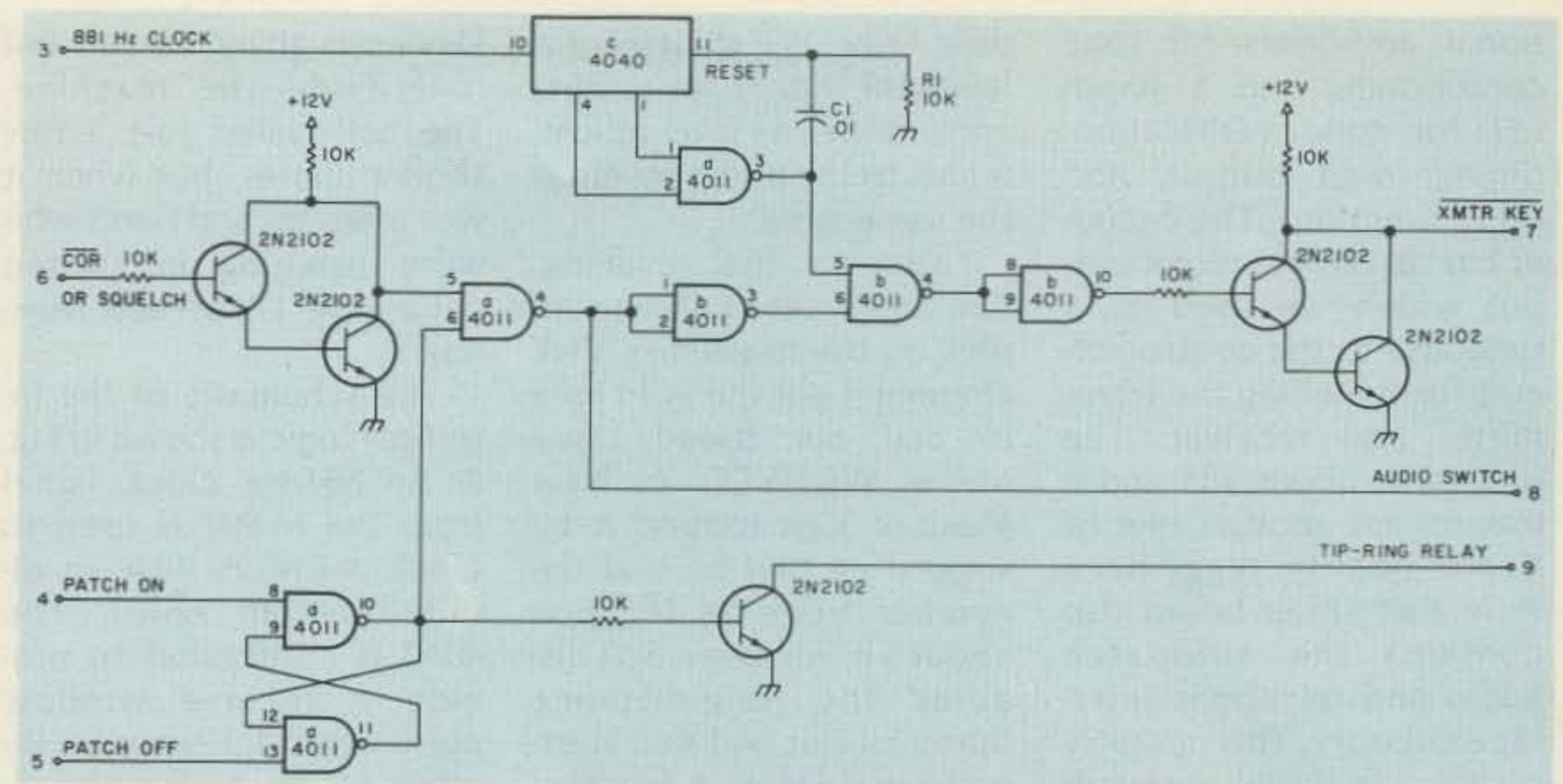

Fig. 2. Interface logic circuit.

are somewhat distracting to some and are quite tolerable by others. I found that with increasing use you can get used to the "clicking," and after experimentation, about 1.3 seconds was about the right speed to sample for a user's signal. Of course, you can set the speed to just about anything you feel is right, within reason. For example, trying to make the "click" shorter by narrowing the receive window less than 40 milliseconds depends on your transmitter-receiver switching time. Obviously, you should use a crystal-controlled receiver (synthesized receivers are much too slow, about 140 milliseconds). Also, the same applies for the transmitter as well. Another point is the method used to switch the antenna from receiver to transmitter. Relays are also much too slow because they add to the total switching transition. Rf detecting (diode switching) in the newer VHF radios works very well.

The advantages are cost, simplicity, portability, and frequency conservation. Since there are no duplexers or similar rf plumbing, you save about \$350 to \$400. You don't need an expensive VHF radio such as a Motorola Micor (which a

good repeater would use and costs over \$1000). I used an Icom IC-22A, which was purchased used for less than \$200. The modifications amounted to tapping the audio, the COR line, and the transmitter key. Later, I removed a 22-microfarad capacitor from the squelch dc amplifier to speed up the switching time. There are other modifications that could be made to improve the switching time, but I decided to study the present design before making any more changes. Since the VHF radio is small and can be run from a battery and there is no rf plumbing, the machine is very portable and has good emergency communications potential.

All you need is a phone line, a quarter-wave whip antenna, and a single channel assignment.

The photograph shows the second breadboard version of the machine. The first version was a real rat's nest. Come to think of it, the second version has just as many wires going in every direction, but it works quite well. Ken Koster WA7RYP is one of the locals who worked on this project with me. Ken was eager to supply some vital circuits as well as his experience to make this machine work. Ken loaned me his Teltone™ M-907 touch-tone decoder from his 450-MHz repeater. The decoder is about 4 inches long and 3 inches wide. It uses opera-

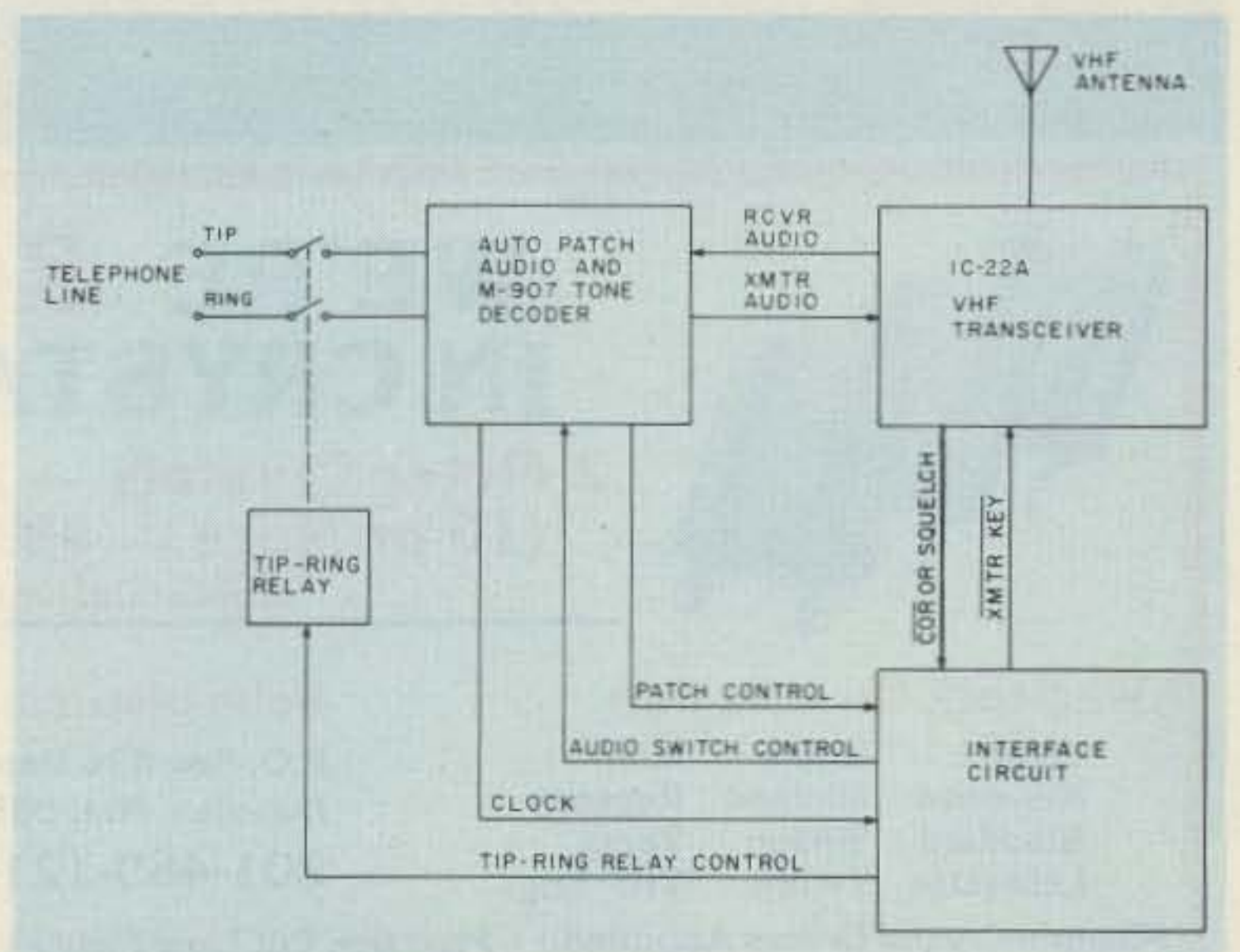

Fig. 3. Block diagram.

tional amplifiers for tone conditioning and a 40-pin LSI for tone verification, timing, digit output, and other functions. The decoder has an 881-Hz clock output which we used as a timebase to the control circuit for switching the transmitter and receiver. The unit costs about \$85 and it mounts on another one of Ken's boards piggy-back style. Ken's main board also contains the autopatch audio and telephone interface circuitry. This circuitry is shown in the photograph in front of the Heathkit Digital Designer which contains the interface and control logic for the IC-22A.

After a few hours of blitz building, we had the second version ready for on-the-air tests. Using a Wilson Mark IV with a tone pad, Ken punched up the access, got the dial tone, punched up the local number, and there she was... the good ol'

time lady. We dialed up a few ham friends for reports and made a few adjustments to the audio levels at the same time.

Later on that evening, Ken and I were talking simplex on the machine's VHF channel. I got this wild idea to call our friend Dave Miller WB5WCG in New Mexico! Ken topped it by suggesting that he dial the number from his location about 5 miles away. So I disabled the long-distance dump circuit and Ken started to dial Dave. A few seconds later, Dave was talking to Ken about our effort. A few short years ago, Dave was a local ham who was participating in our efforts for a single-frequency machine. Actually, he was surprised we finally did it. He knows that we dream a lot and that our fantasies seldom turn into connected silicon chips. During this live on-the-air conversation,

Dave was giving his call and identifying the machine. The call lasted just a few short minutes, but when it was over, several hams who were listening in started calling the DX in New Mexico!

The schematic of the interface logic is shown in Fig. 2. An 881-Hz clock signal from the M-907 is used to clock a CMOS 4040 (a divide-by-4096 chip). The 4040 is configured to provide a receive window pulse every 1.3 seconds. By referring to a data book, you can easily change the sample rate and receive window pulse width. The output of the 4040 is NANDed and used to reset itself (the 4040). The value of R1 and C1 are not very critical. The 4011 latch gates the output of the COR Darlington transistor pair to allow the COR line to control the output of the 4040. The COR LINE and the 4011

latch control the transmitter keying line by using some 4011 NAND gates. A few transistors are used for the receiver COR and key line. The resistor values of these circuits are not very critical either. The transistor Darlington circuits may require some changes for the specific radio they are to interface. Fig. 3 illustrates a block diagram of the machine. The audio circuits interface the radio to the phone line and the tone decoder.

Remember, this machine is not a repeater and cannot be used to contact another ham via a downlink radio path. The machine can only transmit what it hears from the phone line and send to the phone line what the patch receiver hears. I would be interested in hearing from anyone who knows about any similar efforts or any improvements. Please, SASE letters only. ■



CENTRAL NEW YORK'S MOST COMPLETE HAM DEALER



ROBOT 800

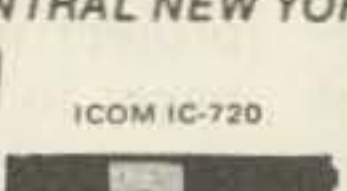

ICOM IC-720



KENWOOD TS830S



DRAKE TR7-DR7



YAESU FT707

Featuring Kenwood, Yaesu, Icom, Drake, Ten-Tec, Swan, Dentron, Alpha, Robot, MFJ, Tempo, Astron, KLM, Hy Grain, Mosley, Larsen, Cushcraft, Hustler, Mini Products, Bird, Mirage, Vibroplex, Bencher, Info-Tech, Universal Towers, Callbook, ARRL, Astatic, Shure, Collins, AEA. *We service everything we sell!*

Write or call for quote. **You Won't Be Disappointed.**
We are just a few minutes off the NYS Thruway (I-90) Exit 32

OUT OF STATE
ORDER TOLL FREE
800-448-9338

ONEIDA COUNTY AIRPORT TERMINAL BUILDING
ORISKANY, NEW YORK 13424
N Y Res Call (315) 736-0184

Warren - K2IXN
Bob - WA2MSH
Al - WA2MSI



WE'RE ROLIN IN CRYSTALS!

**2 Meter Crystals — \$3.95 each
(10 or More — \$3.50 each)**
Quick Delivery

We Stock Crystals For:

| | | |
|-----------|---------|---------|
| Clegg | Drake | Icom |
| Kenwood | Midland | Regency |
| Standard | Wilson | Yaesu |
| Lafayette | Tempo | VHF Eng |

(Custom Crystal Orders Accepted.)

Rolin Distributors

P.O. Box 436 Department 7
Dunellen, N.J. 08812
201-469-1219

Precision Cut Land Mobiles Available

461

AZDEN

**PHASE II
TWIN ANTENNA**

NEW!



- SUPER 80-POUND, 100-MPH GRAY MAGNETIC MOUNT WITH MYLAR BASE
- 5/8 WAVE FOR PHASE II SIGNAL AND *
- 1/4 WAVE FOR CLOSE-IN AND RESTRICTED HEIGHT AREAS
- INSTANT CHANGE-OVER
- SUPERIOR PERFORMANCE
- STAINLESS STEEL SPRING AND WHIP
- CHROME ON BRASS BASE—COMPARE!
- BOTH ANTENNAS ARE FREQUENCY ADJUSTABLE
- COMPLETE WITH 17 FEET OF FOAM COAX AND PL-259 CONNECTOR
- MADE IN U.S.A.

INTRODUCTORY PRICE:
\$29.95

COMPARE!!

TWO ANTENNAS FOR THE PRICE OF ONE!

AMATEUR-WHOLESALE ELECTRONICS
8817 S.W. 129th Terrace, Miami, Florida 33176
Telephone (305) 233-3631 - Telex: 80-3356
HOURS: 9 - 5 Monday thru Friday
• U.S. DISTRIBUTOR • DEALER INQUIRIES INVITED

ORDER NOW TOLL FREE
800-327-3102

New! AZDEN® PCS 3000

BLAZING THE FRONTIER OF

MICROCOMPUTER COMMUNICATIONS



**SUPERIOR
COMMERCIAL GRADE
2-METER FM TRANSCEIVER**

**FREE!
TOUCH-TONE®
PAD KIT INCLUDED**

COMPARE THESE FEATURES WITH ANY UNIT AT ANY PRICE

- **8 MHz FREQUENCY COVERAGE, INCLUDING CAP/MARS BUILT IN:** Receive and transmit 142.000 to 149.995 MHz in selectable steps of 5 or 10 kHz. **COMPARE!**
- **SIZE:** Unbelievable! Only 6 1/4" by 2 1/2" by 9 1/4". **COMPARE!**
- **MICROCOMPUTER CONTROL:** All frequency control is carried out by a microcomputer.
- **MUSICAL TONE ACCOMPANIES KEYBOARD ENTRIES:** When a key is pressed, a brief musical tone indicates positive entry into the microcomputer. **COMPARE!**
- **PUSHBUTTON FREQUENCY CONTROL FROM MICROPHONE OR PANEL:** Frequency is selected by buttons on the front panel or microphone.
- **8 CHANNEL MEMORY:** Each memory channel is reprogrammable and stores the frequency and offset. Memory is backed up by a NICAD battery when power is removed.
- **INSTANT MEMORY 1 RECALL:** By pressing a button on the microphone or front panel, memory channel 1 may be accessed immediately.
- **MEMORY SCAN:** Memory channels may be continuously scanned for quick location of a busy or vacant frequency.
- **PROGRAMMABLE BAND SCAN:** Any section of the band may be scanned in steps of 5 or 10 kHz. Scan limits are easily reprogrammed.
- **DISCRIMINATOR SCAN CONTROL (AZDEN EXCLUSIVE PATENT):** The scanner stops by sensing the channel center, so the unit always lands on the correct frequency. **COMPARE** this with other units that claim to scan in 5-kHz steps!
- **THREE SCAN MODES WITH AUTO RESUME:** "Sampling" mode pauses at busy channels, then resumes. "Busy mode" stops at a busy channel, then resumes shortly after frequency clears. "Vacant" mode stops at a vacant channel and resumes when signal appears. If desired, auto resume may be prevented by pressing one button. **COMPARE!**
- **REMOVABLE HEAD:** The control head may be located as much as 15 feet away from the main unit using the optional connecting cable. **COMPARE!**
- **PL TONE OSCILLATOR BUILT IN:** Frequency is adjustable to access PL repeaters.
- **MICROPHONE VOLUME/FREQ. CONTROL:** Both functions may be adjusted from either the microphone or front panel.
- **NON-STANDARD OFFSETS:** Three accessory offsets can be obtained for CAP/MARS or unusual repeater splits. CAP and Air Force MARS splits are **BUILT IN!** **COMPARE!**
- **25 WATTS OUTPUT:** Also 5 watts low power to conserve batteries in portable use.
- **GREEN FREQUENCY DISPLAY:** Frequency numerals are green LEDs for superior visibility.
- **RECEIVER OFFSET:** A channel lock switch allows monitoring of the repeater input frequency. **COMPARE!**
- **SUPERIOR RECEIVER:** Sensitivity is better than 0.28 uV for 20-dB quieting and 0.19 uV for 12-dB SINAD. The squelch sensitivity is superb, requiring less than 0.1 uV to open. The receiver audio circuits are designed for maximum intelligibility and fidelity. **COMPARE!**
- **ILLUMINATED KEYBOARD:** Keyboard backlighting allows it to be seen at night.
- **TRUE FM, NOT PHASE MODULATION:** Transmitted audio quality is optimized by the same high standard of design and construction as is found in the receiver. The microphone amplifier and compression circuits offer intelligibility second to none.
- **OTHER FEATURES:** Dynamic microphone, built-in speaker, mobile mounting bracket, external remote speaker jack (head and radio) and much, much more. All cords, plugs, fuses, microphone hanger etc. included. Weight: 6 lbs.
- **ACCESSORIES:** CS-ECK 15-foot remote cable. CS-6R 6-amp ac power supply. CS-AS remote speaker. CS-TTK touchtone® microphone kit (wired and tested).

AMATEUR-WHOLESALE ELECTRONICS ORDER NOW TOLL FREE

8817 S.W. 129th Terrace, Miami, Florida 33176
Telephone (305) 233-3631 • Telex: 80-3356
HOURS: 9 - 5 Monday thru Friday



800-327-3102

• U.S. DISTRIBUTOR • DEALER INQUIRIES INVITED

CREDIT CARD HOLDERS MAY USE OUR TOLL FREE ORDERING NUMBER.

The Cheapskate

— a checker for bargain diodes

With a mighty hum and a cloud of smoke, another power supply bites the dust! Sound familiar? If it does and if you roll your own as I do, the diode analyzer discussed here will help save your projects by preventing unworthy di-

odes from creeping into an otherwise good job.

After a few of my bargain diodes turned out not to be bargains, even after checking them on a "diode tester," I decided to build a tester that would check the actual prv and forward volt-

age drop of a diode and to do it with as little cash outlay as possible.

The Cheapskate analyzer will provide you with the information you need when selecting or grading bargain-pack diodes. The culls can be used for noncritical applications, one-way wires, etc. And, the good ones can be graded for performance at whatever voltage or current levels are required by the circuit they are to be used in. It requires *no* external meters or connections other than to the diode under test.

Experience has taught me that test jigs and alligator clip leads with 1000 volts or so on them can be an unhappy combination if one gets careless or is in a hurry. This is the reason for the all-in-one-box design.

This device will allow you to test diodes under actual anticipated operating voltages or currents and to match diodes for HV rectifier strings or other purposes.

This article is not a step-by-step, how-to-make it type for the simple reason of economics. It does not make sense to build an expensive device to test bargain semiconductors. Although once built, I would

recommend testing any diode that you intend to use, even so-called first-quality ones, as it will prevent some nasty surprises.

The tester (Fig. 1) consists of two variable-voltage supplies and their associated metering and switching circuits.

VT1 is a 0-to-130-volt Variac; a 50-Watt rheostat could be used instead. The idea is to vary the input voltage, so whichever means your scrounging or junk box provides will work.

R1, R2, and R* are limiting resistors and limit the voltage out of the prv test section to agree with the meter scale in use. In my case, this meter (M2) was a 50- μ A unit with scales of 100, 15, and 3. So, I set R1, R2, and R* and R4, R5, and R6 for full-scale readings of 1000, 100, and 15 volts at maximum setting of VT1. The meter that you use in your voltmeter circuit will determine the values for these resistors. I would recommend a meter with a 50- or 100- μ A movement as best suited for this application. The meters that you have available will depend on the size of your junk box or what's on sale at the local hamfest.

As high-current dc meters are not cheap—even

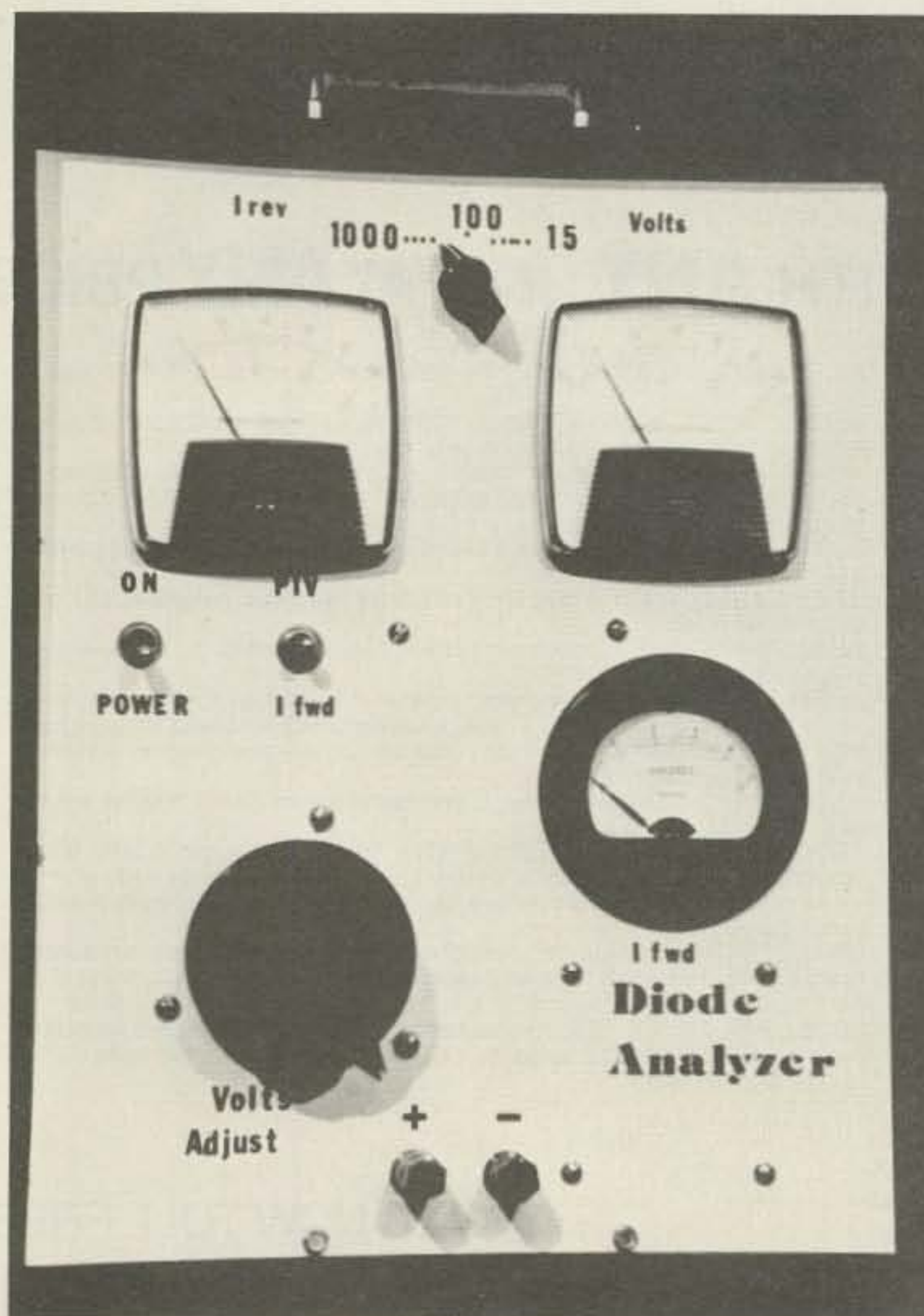

Front panel of the diode analyzer.

TS-130S/V

"Small wonder" ...speech processor, N/W switch, IF shift, digital display

The compact, all solid-state HF SSB/CW mobile or fixed station TS-130 Series transceiver covers 3.5 to 29.7 MHz, including the three new bands.

TS-130 SERIES FEATURES:

- 80-10 meters, including the new 10, 18, and 24-MHz bands. Receives WWV.

- TS-130S runs 200 W PEP/160 W DC input on 80-15 meters and 160 W PEP/140 W DC on 12 and 10 meters. TS-130V runs 25 W PEP/20 W DC input on all bands.
- Built-in speech processor.
- Narrow/wide filter selection on both CW (500 Hz or 270 Hz) and SSB (1.8 kHz) with optional filters.

- Automatic selection of side-band mode (LSB on 40 meters and below, and USB on 30 meters and above). SSB REVERSE switch provided.
- Built-in digital display.
- Built-in RF attenuator.
- IF shift (passband tuning).
- Effective noise blanker.

OPTIONAL ACCESSORIES:

- PS-30 base-station power supply.
- YK-88C (500 Hz) or YK-88CN (270 Hz) CW filter.
- YK-88SN (1.8 kHz) narrow SSB filter.
- AT-130 compact antenna tuner (80-10 meters, including three new bands).
- SP-120 external speaker.

- VFO-120 remote VFO.
- MB-100 mobile mounting bracket.
- PS-20 base-station power supply for TS-130V.



Optional DFC-230 Digital Frequency Controller

Frequency control in 20-Hz steps with UP/DOWN microphone (supplied with DFC-230). Four memories and digital display. (Also operates with TS-120S, TS-530S, and TS-830S.)



PS-30

SP-120

TS-130S

VFO-120



SP-230

TS-830S

VFO-230

AT-230

TS-830S

"Top-notch"... VBT, notch, IF shift, wide dynamic range

The TS-830S has every conceivable operating feature built-in for 160-10 meters (including the three new bands). It combines a high dynamic range with variable bandwidth tuning (VBT), IF shift, and an IF notch filter, as well as very sharp filters in the 455-kHz second IF. Its optional VFO-230 remote digital VFO provides five memories.

TS-830S FEATURES:

- LSB, USB, and CW on 160-10 meters, including the new 10, 18, and 24-MHz bands. Receives WWV.
- Wide receiver dynamic range. Junction FETs in the balanced mixer, MOSFET RF amplifier at low level, and dual resonator for each band.
- Variable bandwidth tuning (VBT). Varies IF filter pass-band width.

- Notch filter (high-Q active circuit in 455-kHz second IF).
- IF shift (passband tuning).
- Built-in digital display (six digits, fluorescent tubes), analog dial, and display hold (DH) switch.
- Noise-blanker threshold level control.
- 6146B final with RF negative feedback. Runs 220 W PEP (SSB)/180 W DC (CW) input on all bands.
- Built-in RF speech processor.
- Narrow/wide filter selection on CW.
- SSB monitor circuit to check transmitted audio quality.
- RIT (receiver incremental tuning) and XIT (transmitter incremental tuning).

OPTIONAL ACCESSORIES:

- SP-230 external speaker with selectable audio filters.
- VFO-230 external digital VFO with 20-Hz steps, five memories, digital display.
- AT-230 antenna tuner/SWR and power meter/antenna switch 160-10 meters, including three new bands.
- YG-455C (500 Hz) or YG-455CN (250 Hz) CW filter for 455 kHz IF.
- YK-88C (500 Hz) or YK-88CN (270 Hz) CW filter for 8.83 MHz IF.
- KB-1 deluxe heavyweight knob.
- (VFOs for TS-830S, TS-530S, TS-130 Series, and TS-120S are compatible with all four series of transceivers.)



KENWOOD

TRIO-KENWOOD COMMUNICATIONS
1111 West Walnut, Compton, California 90220

TS-530S

IF shift, digital display, narrow-wide filter switch

The TS-530S SSB/CW transceiver covers 160-10 meters using the latest, most advanced circuit technology, yet at an affordable price.

TS-530S FEATURES:

- 160-10 meter, LSB, USB, CW, all amateur frequencies, including new 10, 18, and 24 MHz bands. Receives WWV on 10 MHz.

- Built-in digital display (six digits, fluorescent tubes), with analog dial.



MC-50

- IF shift tunes out interfering signals.
- Narrow/wide filter selector switch for CW and/or SSB.
- Built-in speech processor, for increased talk power.
- Wide receiver dynamic range, with greater immunity to overload.
- Two 6146B's in final, allows 220W PEP/180 W DC input on all bands.
- Advanced single-conversion PLL, for better stability, improved spurious characteristics.
- Adjustable noise-blanker, with front panel threshold control.

- RIT/XIT front panel control allows independent fine-tuning of transmit or receive frequencies.

OPTIONAL ACCESSORIES:

- SP-230 external speaker with selectable audio filters.
- VFO-240 remote analog VFO.
- VFO-230 remote digital VFO.
- AT-230 antenna tuner/SWR/power meter.
- MC-50 desk microphone
- KB-1 deluxe VFO knob.
- YK-88C (500 Hz) or YK-88CN (270 Hz) CW filter.
- YK-88SN (1.8 kHz) narrow SSB filter.



SP-230

TS-530S

VFO-240

AT-230



TS-660

"Quad Bander" ...dual VFOs, memory, scan, IF shift, FM, SSB, CW, AM

The TS-660 is a unique, all-mode transceiver designed for operation on 6, 10, 12, and 15 meters.

TS-660 FEATURES:

- FM, SSB (USB), CW and AM operation.
- 10 Hz step digital VFO. The frequency step is determined by mode of operation.

- F. STEP switch allows alternative step size in each mode.
- Dual VFOs built-in.
- 5 channel memory stores frequency and band information.
- Memory scan scans all bands, skips channels not in use.
- UP/DOWN push-button frequency control on microphone.
- UP/DOWN bandswitch.

- Frequency lock function switch.
- IF SHIFT circuit built-in.
- Fluorescent digital display shows Tx/Rx frequencies.
- Squelch circuit for FM, SSB, CW and AM.
- CW semi break-in circuit, with CW side tone.
- 10 W RF output on SSB, CW, FM, 4 W on AM.
- Two antenna terminals provided.

- RIT control. • Noise blanker.

OPTIONAL ACCESSORIES:

- PS-20 power supply.
- SP-120 external speaker.
- MB-100 mobile mounting bracket.
- YK-88C normal CW, (500 Hz) filter or YK-88CN narrow band CW, (270 Hz) filter.
- YK-88A AM (6 kHz) filter.
- VOX-4 speech processor/VOX unit.



KENWOOD

TRIO-KENWOOD COMMUNICATIONS

1111 West Walnut, Compton, California 90220



Digital world clock with two 24-hour displays, quartz time base

The HC-10 digital world clock with dual 24-hour display shows local time and the time in 10 preprogrammed plus two programmable time zones.

R-600

"Now hear this" ... digital display, front speaker, easy tuning

The R-600 is a high performance, general coverage communications receiver covering 150 kHz to 30 MHz in 30 bands, at an affordable price. Use of PLL synthesized circuitry provides high accuracy of frequency with maximum ease of operation.

R-600 FEATURES:

- 150 KHz to 30 MHz continuous coverage, AM, SSB, or CW.
- 30 bands, each 1 MHz wide, for easier tuning.
- Five digit frequency display, with 1 KHz resolution.
- 6 kHz IF filter for AM (wide), and 2.7 kHz filter for SSB, CW and AM (narrow).
- Up-conversion PLL circuit, for improved sensitivity, selectivity, and stability.
- Communications type noise blanker eliminates "pulse-type" noise.
- RF Attenuator allows 20 dB attenuation of strong signals.
- Tone control.
- Front mounted speaker.
- "S" meter, with 1 to 5 SINPO-S scale, plus conventional "S" meter scale.
- Coaxial, and wire antenna

- terminals for low impedance (50 Ω). Wire terminals for high impedance (500 Ω).
- 100, 120, 220, and 240 VAC, 50/60 Hz. Selector switch on rear panel.
- Optional 13.8 VDC operation, using DCK-1 cable kit.
- Other features: carrying handle, headphone jack, and record jack.

OPTIONAL ACCESSORIES:

- DCK-1 DC Cable kit.
- SP-100 External Speaker.

R-1000

"Hear there and everywhere" ... easy tuning, digital display

The R-1000 is an amazingly easy-to-operate, high-performance, communications receiver, covering 200 kHz to 30 MHz in 30 bands. This PLL synthesized receiver features a digital frequency display and analog dial, plus a quartz digital clock and timer.

R-1000 FEATURES:

- Covers 200 kHz to 30 MHz continuously.
- 30 bands, each 1 MHz wide.
- Five-digit frequency display with 1-kHz resolution and analog dial with precise gear dial mechanism.
- Built-in 12-hour quartz digital clock with timer to turn on radio for scheduled listening or control a recorder through remote terminal.
- Step attenuator to prevent overload.
- Three IF filters for optimum AM, SSB, CW. 12-kHz and 6-kHz (adaptable to 6-kHz and 2.7-kHz) for AM wide and narrow, and 2.7-kHz filter for high-quality SSB (USB and LSB) and CW reception.
- Effective noise blanker.
- Terminal for external tape recorder.
- Tone control.
- Built-in 4-inch speaker.
- Dimmer switch to control intensity of S-meter and other panel lights and digital display.

- Wire antenna terminals for 200 kHz to 2 MHz and 2 MHz to 30 MHz. Coax terminal for 2 MHz to 30 MHz.
- Voltage selector for 100, 120, 220, and 240 VAC. Also adaptable to operate on 13.8 VDC with optional DCK-1 kit.

OPTIONAL ACCESSORIES:

- SP-100 matching external speaker.
- HS-6 lightweight, open-air headphone set.
- HS-5 and HS-4 headphones.
- DCK-1 modification kit for 12-VDC operation.



SP-100

R-1000

HS-5

TR-2500

BIG performance, small size, smaller price!

The TR-2500 is a compact 2 meter FM handheld transceiver featuring an LCD readout, 10 channel memory, lithium battery memory back-up, memory scan, programmable automatic band-scan, Hi/Lo power switch and built-in sub-tone encoder.

TR-2500 FEATURES:

- Extremely compact size and light weight 66 (2-5/8) W x 168 (6-5/8) H x 40 (1-5/8) D, mm (inches), 540 g, (1.2 lbs) with Ni-Cd pack.
- LCD digital frequency readout, with memory channel and function indication.
- Ten channel memory, includes "M0" memory for non-standard split frequencies.
- Lithium battery memory back-up, built-in, (estimated 5 year life) saves memory when Ni-Cd pack discharged.
- Memory scan, stops on busy channels, skips channels in which no data is stored.
- UP/DOWN manual scan in 5 KHz steps.
- Repeater reverse operation.

CONVENIENT TOP CONTROLS



- 2.5 W or 300 mW RF output. (HI/LOW power switch.)
- Programmable automatic band scan allows upper and lower frequency limits and scan steps of 5 KHz and larger (5, 10, 15, 20, 30 KHz... etc) to be programmed.
- Built-in tuneable (with variable resistor) sub-tone encoder.
- Built-in 16 key autopatch encoder.
- Slide-lock battery pack.
- Keyboard frequency selection across full range.
- Extended frequency coverage; 143.900 to 148.995 MHz in 5 KHz steps.
- Optional power source, MS-1 mobile or ST-2 AC charger/



power supply allows operation while charging. (Automatic drop-in connections.)

- High impact plastic case.
- Battery status indicator.
- Two lock switches for keyboard and transmit.

STANDARD ACCESSORIES:

- Flexible rubberized antenna with BNC connector.
- 400 mAh heavy-duty Ni-Cd battery pack.
- AC charger.

OPTIONAL ACCESSORIES:

- ST-2 Base station power supply and quick charger (approx. 1 hr.).
- MS-1 13.8 VDC mobile stand/charger/power supply.
- TU-1 Programmable "DIP switch" (CTCSS) encoder.
- SMC-25 Speaker microphone.
- LH-2 Deluxe top grain cowhide leather case.
- PB-25 Extra Ni-Cd battery pack, 400 mAh, heavy-duty.
- BT-1 Battery case for AA manganese or alkaline cells (not Ni-Cd).
- VB-2530 RF power amplifier.
- BH-2 Belt hook.
- WS-1 Wrist strap.
- EP-1 Earphone.

TR-7850

40 W, 15 memories/offset recall, scan, priority, autopatch (DTMF)

Kenwood's remarkable TR-7850 2-meter FM mobile transceiver provides all the features you could desire, including a powerful 40 watts output. A 25 watt version, the TR-7800 is also available.

TR-7850 FEATURES:

- 40 watts output, with selectable high or low power operation.
- 15 multifunction memory channels, easily selectable with a rotary control, M1-M13 memorize frequency and offset (± 600 KHz or simplex).

M14... memorize transmit and receive frequencies independently for non-standard offset. M0... priority channel, with simplex ± 600 KHz or non-standard offset operation.

- Internal battery back-up for memories. Requires four AA Ni-Cd batteries, (not supplied).

- Extended frequency coverage, 143.900-148.995 MHz in 5 or 10 KHz steps.
- Priority alert. Beep alerts operator when signal appears on priority channel.
- Built-in autopatch encoder (DTMF). All 12 plus four additional DTMF signaling tones. (With simultaneous push of REV switch.)
- Autoscan of memories and entire band. Scan resumes automatically.
- Front panel keyboard.
- Compact size.

- UP/DOWN manual scan of entire band and memories, using UP/DOWN microphone (supplied).
- Repeater reverse switch.
- Separate digital displays for frequency and memory channel.
- LED S/RF bar meter.
- Tone switch.

Matching accessories for fixed station operation:

- KPS-12 power supply (for TR-7850)
- KPS-7 power supply (for TR-7800)



SP-40

Compact mobile speaker
Only 2-11/16 W x 2-1/2 H x 2-1/8 D (inches)
Handles 3 watts of audio



KENWOOD

TRIO-KENWOOD COMMUNICATIONS
1111 West Walnut, Compton, California 90220

The TR-7730 is available in two variations: a 16-key autopatch UP/DOWN microphone (MC-46) version, and a basic UP/DOWN microphone version.



TR-7730

**Miniaturized,
5 memories, memory/
band scan**

The TR-7730 is a very compact 25 watt, 2-meter FM mobile transceiver, reasonably priced.

TR-7730 FEATURES:

- Dimensions: 5-3/4 W x 2 H x 7-3/4 D, inches. Weighs 3.3 lbs.

- Extended frequency coverage, 143.900-148.995 MHz, in 5 or 10 KHz steps.
- 25 watts RF output power, with HI/LOW power switch.
- 5 memories for operation in simplex or repeater modes.
- Memory scan, plus automatic band scan.
- UP/DOWN manual scan on microphone (supplied).
- Four digit LED frequency display.
- S/RF bar meter. LED indicators for BUSY, ON-AIR,

- REPEATER offset.
- Tone switch for internal tone encoder (not Kenwood supplied).
- Offset switch, ± 600 kHz. Non-standard offset uses fifth memory.

OPTIONAL ACCESSORIES:

- MC-46 16-key autopatch UP/DOWN microphone.
- SP-40 compact mobile speaker.
- KPS-7 fixed station power supply.



TR-8400

Synthesized 70-cm FM mobile rig

- Covers 440-450 MHz, in 25 KHz steps, with two VFOs.
- Transmit offset switch for ± 5 MHz. Non-standard offset uses fifth memory.
- HI/LOW power switch selects 10 or 1 watt RF output.
- Similar to TR-7730 in other features, including five memories, memory scan, automatic band scan, UP/DOWN manual scan, four digit display, S/RF bar meter, LED indicators, tone switch, and same optional accessories.



- MC-46 16-key autopatch UP/DOWN microphone.

TR-9000

"New 2-meter direction"...compact rig with FM/SSB/CW, scan, five memories

The TR-9000 combines the convenience of FM with long distance SSB and CW. It is extremely compact... perfect for mobile operation. Matching accessories are available for optimum fixed-station operation.

TR-9000 FEATURES:

- FM, USB, LSB, and CW.
- Only 6-11/16 inches wide, 2-21/32 inches high, 9-7/32 inches deep.

- Two digital VFOs, with selectable tuning steps of 100 Hz, 5 kHz, and 10 kHz.
- Digital frequency display. Five, four, or three digits, depending on selected tuning step.
- Covers 143.9000-148.9999 MHz.
- Band scan... automatic busy stop and free scan.
- SSB/CW search of selectable 9.9-kHz bandwidth segments.

- Five memories... four for simplex or ± 600 kHz repeater offsets and the fifth for a non-standard offset (memorizes transmit and receive frequency independently).
- UP/DOWN microphone (standard) for manual band scan.
- Noise blanker for SSB and CW.
- RIT (receiver incremental tuning) for SSB and CW.
- RF gain control.
- CW sidetone.
- Selectable RF power outputs... 10 W (HI)/1 W (LO).
- Mobile mounting bracket with quick-release levers.
- LED indicators... ON AIR, BUSY, and VFO.

OPTIONAL ACCESSORIES:

- PS-20 fixed-station power supply.
- SP-120 fixed-station external speaker.
- BO-9 System Base... with power switch, SEND/RECEIVE switch (for CW), memory-backup power supply, and headphone jack.
- MC-46 16-key autopatch UP/DOWN microphone.



PS-20

TR-9000

BO-9

SP-120



KENWOOD

TRIO-KENWOOD COMMUNICATIONS
1111 West Walnut, Compton, California 90220



TL-922-A

Maximum legal power on 160-15 meters

The TL-922A linear amplifier provides maximum legal power on the 160-15 meter Amateur bands.

TL-922A FEATURES:

- 2000 W PEP (SSB)/1000 W DC (CW, RTTY) input power on 160, 80, 40, 20, and 15 meters, with 80 W drive.
- Excellent IMD characteristics.
- Pair of EIMAC 3-500Z high-

performance transmitting tubes.

- Safety protection.
- Blower with automatic turnoff-delay circuit.
- Variable threshold level type ALC.
- Two meters, one indicating plate current, and the other indicating grid current, relative RF output, and high voltage.



SM-220

High-performance oscilloscope for various monitoring functions

The SM-220 Station Monitor provides a variety of waveform-observing capabilities, and an optional pan display.

SM-220 FEATURES:

- Monitors transmitted SSB and CW waveforms from 1.8 to 150 MHz.
- Monitors signal waveforms in receiver's IF stage.
- Functions as high-sensitivity, wide-frequency-range (up to 10 MHz) oscilloscope.
- Tests linearity of linear amplifiers (provides trapezoid pattern).
- Allows observation of RTTY tuning points (cross pattern).
- Built-in two-tone (1000-Hz and 1575-Hz) generator.
- Expandable to pan-display capability for observing the number and amplitude of stations within a switchable ± 20 kHz/ ± 100 kHz bandwidth.

OPTIONAL ACCESSORIES:

- BS-8 pan-display module for TS-180S, TS-530S, TS-830S, and TS-820 Series.
- BS-5 pan-display module for TS-520 Series.

ACCESSORIES

A wide selection of optional accessories is offered for optimum operating flexibility. In addition to the optional items listed with each piece of equipment described in this catalog, the following accessories are also available:



PC-1 phone patch with hybrid circuit and VU meter for null and audio gain measurements.



MC-60 deluxe dual impedance (50K Ω /500 Ω) desk microphone with 4-pin connector. Also available with UP/DOWN switch, in 6 or 8-pin connector versions.



KB-1 deluxe, heavyweight, aluminum knob for TS-830S, TS-530S, TS-180S, TS-820S, and R-820.



RD-20 50 Ω RF dummy load, (DC-500 MHz) 50 W intermittent, 20 W continuous.

DM-81

Dip meter performs many RF measurements

The DM-81 dip meter is highly accurate and features, in addition to the traditional inductive-coupling technique, capacitive coupling for measuring metal-enclosed coils and toroidal coils.

DM-81 FEATURES:

- Measuring range of 700 kHz-250 MHz in seven bands.
- Built-in storage compartment for all seven coils, capacitive probe, earphone, and ground clip lead.
- All solid-state and built-in battery.
- HC-25U and FT-243 sockets for checking crystals and marker-generator function.
- Amplitude modulation.
- FET for good sensitivity.
- Absorption frequency meter function.
- Earphone for monitoring transmitted signals.
- Capacitance probe for measuring resonant frequencies without removing coil shields, and also for measuring resonant frequencies of toroidal coils.



HS-6 lightweight, open-air headphone set.



MC-46 16-key autopatch UP/DOWN microphone.

OTHER ACCESSORIES:

MC-50 dynamic dual-impedance (50 k Ω /500 Ω) desk microphone.

MC-30S (500 Ω) and **MC-35S** (50 k Ω) dynamic noise-canceling hand microphones.

HS-5 deluxe 8 Ω headphone set.
HS-4 8 Ω headphone set.

NOTE: Prices and specifications of all Trio-Kenwood products are subject to change without prior notice or obligation.



KPS-21 13.8 VDC fixed-station power supply, 21A intermittent, 16A continuous.



KENWOOD

TRIO-KENWOOD COMMUNICATIONS

1111 West Walnut, Compton, California 90220

Look for the Kenwood banner.



Only the best dealers are Authorized Kenwood Dealers. If your dealer displays a Kenwood Authorized Dealer banner and plaque in his store, you will know he can provide you with the service you demand . . . of the same quality as factory service. Authorized Kenwood Dealers employ factory-trained service technicians, maintain an extensive inventory of spare parts, and have direct access to factory service information. When you deal with an Authorized Kenwood Dealer, you deal with an expert on the entire line of Kenwood Amateur Radio equipment.

ALABAMA

Long's Electronics
2808 7th Avenue South
Birmingham, AL 35233
(205) 252-7589

ALASKA

Reliable Electronics
3306 Cope Street
Anchorage, AK 99503
(907) 279-5100

ARIZONA

Power Communications
1640 W. Camelback Road
Phoenix, AZ 85015
(602) 241-9288

CALIFORNIA

Ham Radio Outlet
2620 West La Palma
Anaheim, CA 92801
(714) 761-3033

Ham Radio Outlet
999 Howard Avenue
Burlingame, CA 94010
(415) 342-5757

Ham Radio Outlet*
2811 Telegraph Avenue
Oakland, CA 94609
(415) 451-5757

Ham Radio Outlet
5375 Kearny Villa Road
San Diego, CA 92123
(714) 560-4900

Ham Radio Outlet
6265 Sepulveda Boulevard
Van Nuys, CA 91401
(213) 988-2212

Henry Radio, Inc.
931 North Euclid
Anaheim, CA 92801
(714) 772-9200

Henry Radio, Inc.

2050 S. Bundy Drive
Los Angeles, CA 90025
(213) 820-1234

Webster Radio

2602 East Ashlan
Fresno, CA 93726
(209) 224-5111

COLORADO

CW Electronic Sales Co.
800 Lincoln Street
Denver, CO 80202
(303) 893-5525

FLORIDA

Amateur Electronic Supply
621 Commonwealth
Orlando, FL 32803
(305) 894-3238

Amateur Radio Center
2805 N.E. Second Avenue
Miami, FL 33137
(305) 573-8383

HAWAII

Honolulu Electronics
819 Keeaumoku Street
Honolulu, HI 96814
(808) 949-5564

IDAHO

Ross Distributing Co.
78 South State Street
Preston, ID 83263
(208) 852-0830

ILLINOIS

Erickson Communications
5456 N. Milwaukee Ave.
Chicago, IL 60630
(312) 631-5181

INDIANA

Graham Electronics
133 South Pennsylvania
Indianapolis, IN 46240
(317) 635-5453

Hoosier Electronics

P.O. Box 2001
#9 Meadows Shopping Ctr.
Terre Haute, IN 47802
(812) 238-1456

Kryder Electronics

2810 Maplecrest Road
Georgetown N. Shopping Ctr.
Fort Wayne, IN 46815
(219) 484-4946

IOWA

HI, Incorporated
P.O. Box 864
1601 Avenue "D"
Council Bluffs, IA 51502
(712) 323-0142

KANSAS

Associated Radio Comm.
P.O. Box 4327
8012 Conser
Overland Park, KS 66204
(913) 381-5901

MARYLAND

Electronic Int'l Service
11305 Elkin Street
Wheaton, MD 20902
(301) 946-1088

The Comm Center
9624 Ft. Meade Road
Laurel, MD 20810
(301) 792-0600

MICHIGAN

Radio Supply & Engineer
85 Selden Avenue
Detroit, MI 48201
(313) 831-3175

MINNESOTA

Midwest Amateur Radio Supply, Inc.*
3452 Fremont Avenue South
Minneapolis, MN 55142
(612) 521-5252

MISSOURI

Ham Radio Center
8342 Olive Boulevard
St. Louis, MO 63132
(314) 993-6060

Henry Radio Company
211 North Main Street
Butler, MO 64730
(816) 679-3127

Midcom Electronics
8516 Manchester Road
St. Louis, MO 63144
(314) 961-9990

MONTANA

Conley Radio Supply
318 North 16th Street
Billings, MT 59101
(406) 259-9554

NEBRASKA

Communications Center
1840 "O" Street
Lincoln, NB 68508
(402) 476-7331

NEVADA

Amateur Electronic Supply*
1072 N. Rancho Drive
Las Vegas, NV 89106
(702) 647-3114

NEW HAMPSHIRE

Tufts Radio & Elect. Supply
61 Lowell Road
Hudson, NH 03051
(608) 883-5005

NEW MEXICO

Electronic Module
601 North Turner
Hobbs, NM 88240
(505) 397-3022

NEW YORK

Adirondack Radio Supply
P.O. Box 88
185-191 West Main Street
Amsterdam, NY 12010
(518) 842-8350

Harrison Radio Corporation

20 Smith Street
Farmingdale,
Long Island, NY 11735
(516) 293-7990

Radio World

Oneida County Airport
Terminal Building
Oriskany, NY 13424
(315) 337-0203

OHIO

Amateur Electronic Supply
28940 Euclid Avenue
Wickliffe, OH 44092
(216) 585-7388

Srepco Electronics

314 Leo Street
Dayton, Ohio 45404
(513) 224-0871

Universal Amateur Radio, Inc.

1280 Aida Drive
Reynoldsburg, OH 43068
(614) 866-4267

OKLAHOMA

Derrick Electronics*
P.O. Box 457
714 West Kenosha
Broken Arrow, OK 74012
(918) 251-9923

Kryder Electronics*

5826 Northwest 50th
MacArthur Sq. Shopping Ctr.
Oklahoma City, OK 73122
(405) 789-1951

Radio, Inc.

1000 South Main
Tulsa, OK 74119
(918) 587-9123

OREGON

Portland Radio Supply
1234 S.W. Stark Street
Portland, OR 97205
(503) 228-8647

PENNSYLVANIA

Hamtronics/Treose
4033 Brownsville Road
Treose, PA 19047
(215) 357-1400

J.R.S. Distributors

646 West Market Street
York, PA 17404
(717) 854-8624

SOUTH CAROLINA G.I.S.M.O.

Communications
1039 Latham Street
Rockhill, SC 29730
(803) 366-7157

SOUTH DAKOTA

Burghardt Amateur Center

P.O. Box 73
208 East Kemp Avenue
Watertown, SD 57201
(605) 886-7314

TENNESSEE

Amateur Radio Supply of Nashville

615 S. Gallatin Road
Madison, TN 37115
(615) 868-4956

Memphis Amateur Electronics

1465 Wells Station Road
Memphis, TN 38108
(901) 683-9125

TEXAS

Douglas Electronics
1118 South Staples
Corpus Christi, TX 78404
(512) 883-5103

Electronics Center

2809 Ross Avenue
Dallas, TX 75201
(214) 526-2023

Hardin Electronics

5635 East Rosedale
Fort Worth, TX 76112
(817) 429-9761

Madison Electronics

1508 McKinney Avenue
Houston, TX 77010
(713) 658-0268

Kennedy Associates

2618 Rigsby Avenue
San Antonio, TX 78222
(512) 333-6110

WASHINGTON

ABC Communications

17550 15th Avenue N.E.
Seattle, WA 98155
(206) 364-8300

Amateur Radio Supply Co.

6213 13th Avenue South
Seattle, WA 98108
(206) 767-3222

WISCONSIN

Amateur Electronic Supply
4828 W. Fond Du Lac Ave.
Milwaukee, WI 53216
(414) 442-4200

As of October 1, 1981, all of the above are fully Authorized Trio-Kenwood Communications, dealers.

 **KENWOOD**
TRIO-KENWOOD COMMUNICATIONS
1111 West Walnut, Compton, California 90220

*Interim Dealers

Constant Current from a Voltage Regulator

Ever needed a constant-current supply? Recently, I needed a constant-current source to test some incandescent lamps as radio-frequency broadband noise generators. Rather than design an elaborate circuit, I decided to try using a simple technique by which a constant-voltage regulator can supply a constant current.

If a fixed resistor is placed across the output of a three-terminal voltage regulator, the current drawn from the supply is in-

dependent of the supply voltage. Hence, if the regulator circuit with fixed load is placed in series with any device, the current through the device will be constant and equal to the regulator output voltage divided by the fixed load resistance. The circuit configuration is shown in Fig. 1.

The output current is set by R1. For a 5-volt regulator, the output current is: $I = 5/R1$.

The maximum output current cannot exceed the regulator's output current

rating. Hence, with a standard 7805 or LM309K, R1 should not be smaller than 5 Ohms. The power dissipated by R1 is $25/R1$. The wattage rating of the resistor should be at least twice this value. The voltage drop across the regulator is the supply voltage minus the load voltage and must not be permitted to fall below 7 volts. The supply voltage must therefore be greater than 7 volts plus the load voltage or: $V_s \geq 7 + R_L I_{reg}$.

If the difference between the supply and load volt-

ages drops to less than 7 volts, the current will no longer be constant but will decrease. This can be seen in Fig. 2, where the output current as a function of supply voltage for different load resistances is plotted.

One caution: Do not let the supply voltage exceed the input voltage rating of the regulator chip, which is usually 35 volts. Since I first tried this technique, the circuit also has been used to stabilize the current to a CW laser diode system where I work. ■

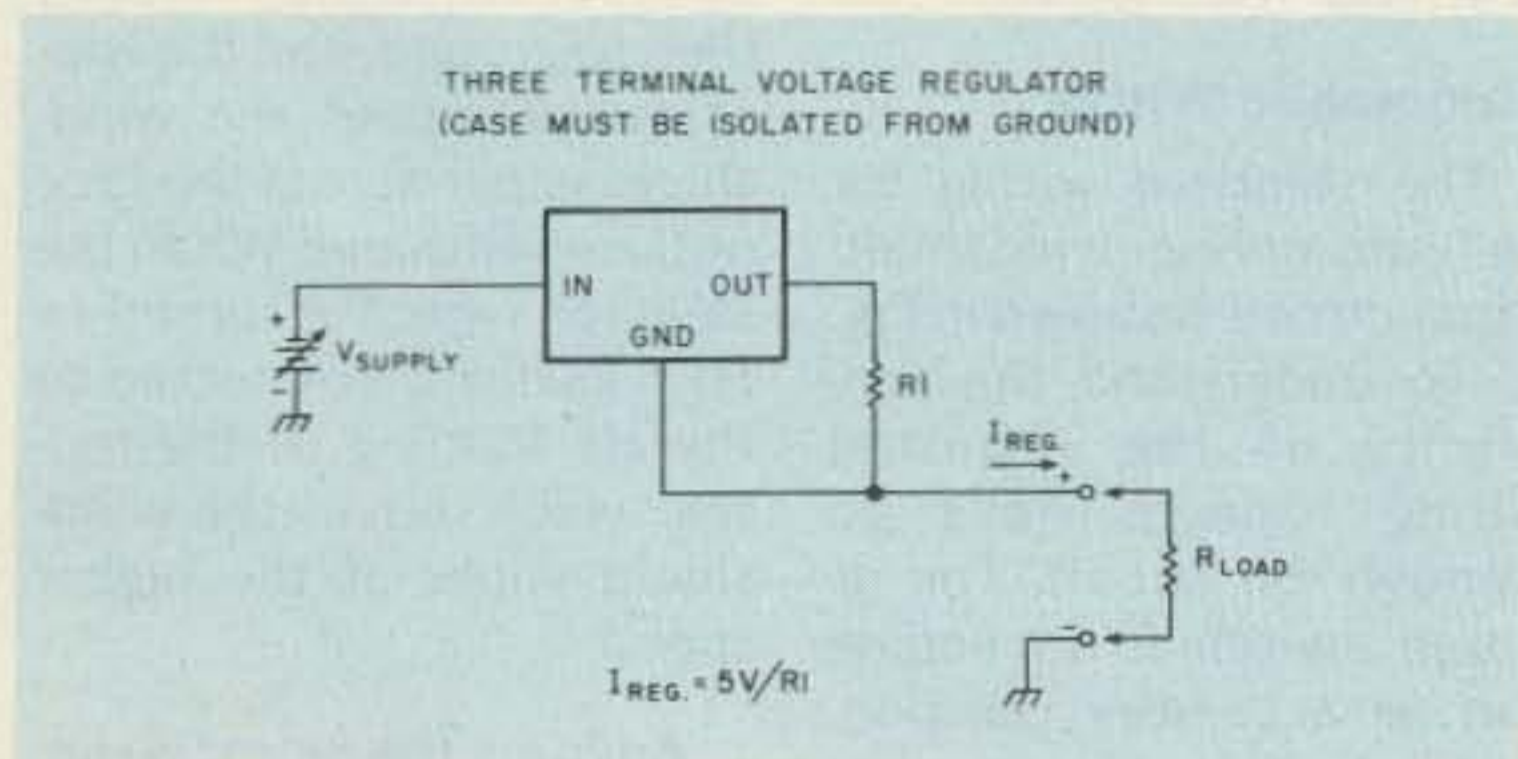

Fig. 1.

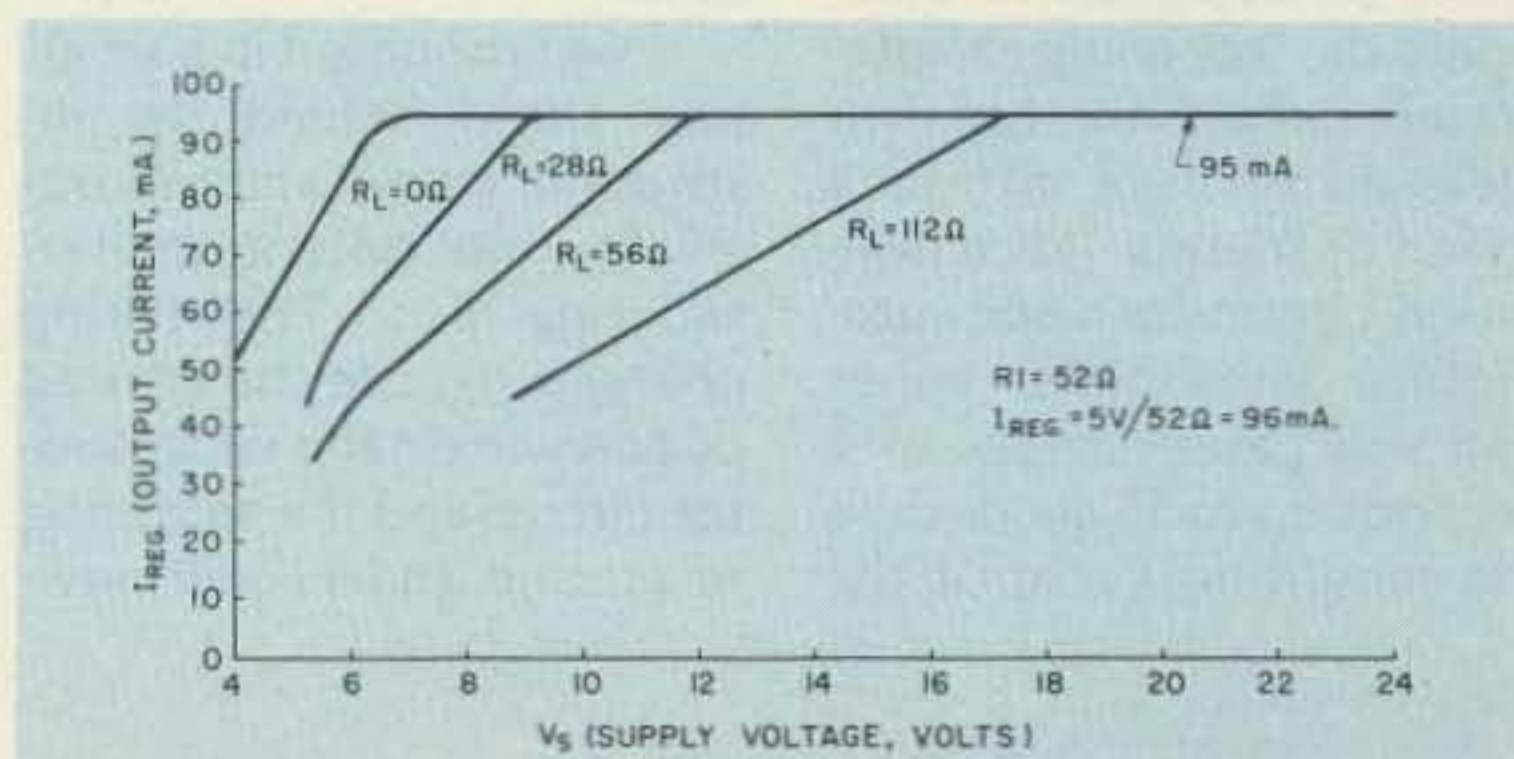

Fig. 2

UNSCRAMBLE

SCANNER ACCESSORIES
 FREE LITERATURE
 501-623-6027

DNE, INC., RT. 7, BX257 ✓43
 HOT SPRINGS, ARK. 71901

POLICE CODE

Two-meter H.T. Amplifier Kit

\$56.95
 PPD. USA

1.5 watts in—20 out
 COR BNC in—SO-239 out
 small size: 1-3/16" x 3" x 4-1/2"
 Class C or AB1

ask about
 our other
 UHF & VHF
 amplifier kits ✓459

QRO ENGINEERING

1398 Edwards Ave.
 Lakewood, OH 44107
 (216) 221-9500

The Hesitator: A Windshield Wiper Control

— a rainy day project

This article is for the amateur who wants to make an inexpensive electronic device, using an integrated circuit, for his own pleasure or as a gift to a friend or friends. It is a hesitation circuit for your automobile windshield wiper and will cause delays of 2 seconds up to 15 seconds in the repetition cycle of the

windshield wiper. It's great for misty or very light rainfalls.

It was mounted in a small box, fitted behind the instrument panel, and mounted by the potentiometer-securing nut. The wiring changes require the cutting of one wire in the wiper motor circuit and the soldering of ground and 12-volt power

leads. I've built three for my friends and one for myself; they work great.

Automobile Wiring

The standard wiring for an automobile windshield wiper circuit is shown in Fig. 1. To understand the simplicity of the required wiring changes, let's go through the circuit. The ignition switch is in engine run or accessory position. To make the wiper motor run, it is necessary to have a complete circuit from 12 volts to the motor and then to ground. Notice that two switches are involved: the wiper selector switch, which permits selecting a low-speed, high-speed, or off position, and a wiper motor switch with parked and run positions.

In the off position of the wiper selector switch and parked position of the wiper motor switch, 12 volts cannot be supplied to the wiper motor.

If the wiper selector

switch is turned to LO, 12 volts is supplied to the LO connection of the motor, then to ground, and the wiper motor moves the windshield wiper across the face of the windshield. When the selector switch is turned to HI, 12 volts is connected to the HI winding of the motor, which moves the windshield wiper at the higher speed.

Anytime the motor is running, it actuates an SPDT switch that alternately moves from ground to 12 volts. The ground position is known as the parked position and the 12-volt position as the run position. The run position takes up approximately 95% of the total time for one cycle of movement of the wiper.

When the wiper selector switch is moved to the OFF position, 12 volts is no longer applied to the motor from the SW1 contacts. If, as is the usual case, the wiper blades are not in the nest-

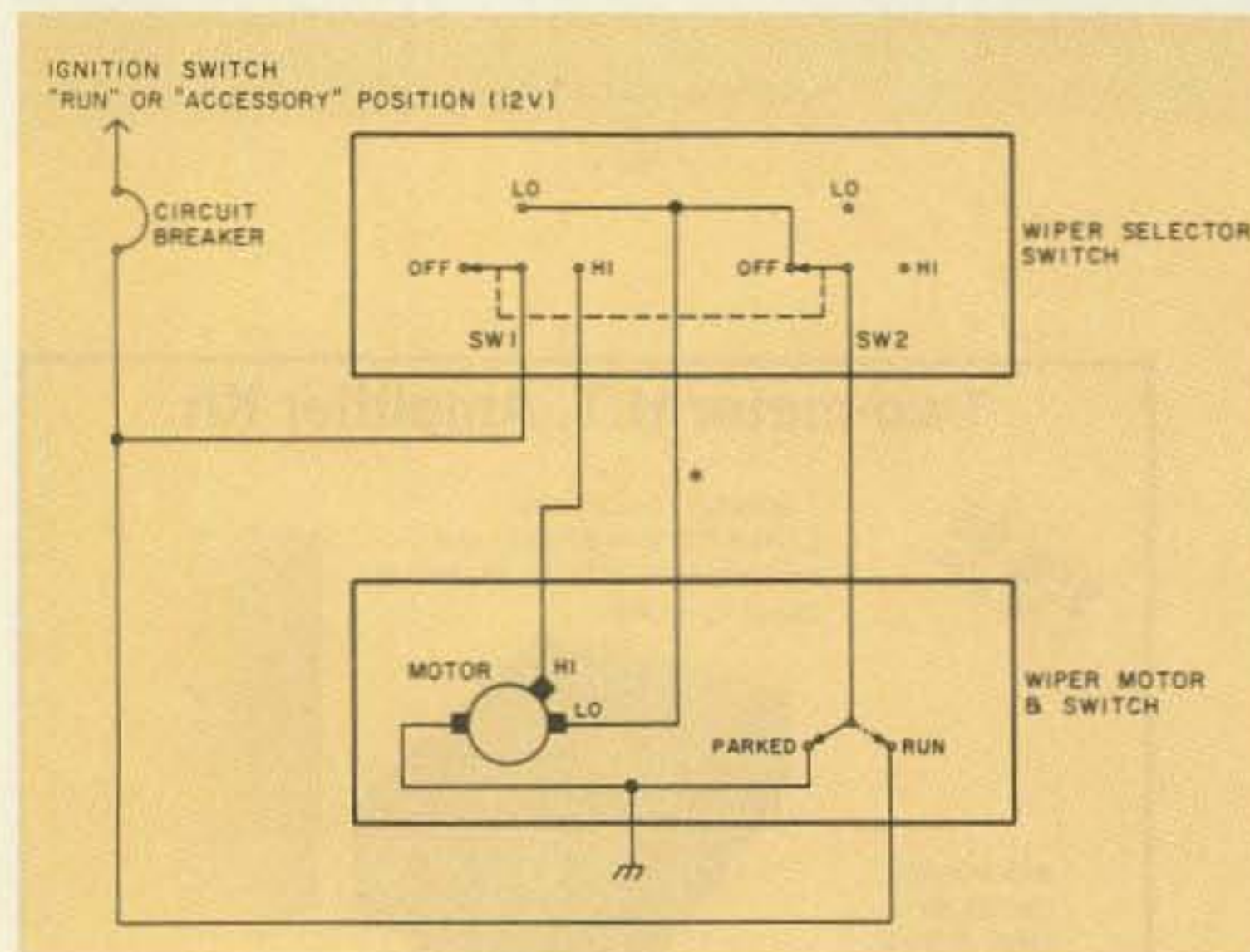

Fig. 1. Automobile wiring circuit of windshield wiper control. The * indicates the point at which the hesitation control unit is installed.

ed position at turn-off time, the wiper motor switch will be in the run position. While in this position, 12 volts will be connected through the switch, through the OFF position SW2 contacts of the wiper selector switch, and to the LO winding of the motor. The motor will continue to run until the motor switch is automatically moved to the parked position. At that time, voltage is no longer applied to the motor, and the wiper blades stop at their nested position.

To put in a hesitation control circuit, it is necessary to break and insert such a control at the point shown in Fig. 1. (See the asterisk.)

Fig. 2 shows the insertion of the control unit, which essentially is an SPDT switch contact operated by a relay, at that point.

In the unenergized condition of the relay, as shown, the contacts look like a straight-through connection, and the wiper selector switch is in control as already explained. (Keep the wiper selector switch in the OFF position.) When we momentarily (1/2 second, or so) switch the control unit contacts to 12 volts manually, the wiper motor will run and move the wiper motor switch to the run position. The wiper blades will make one complete cycle and return to the nested position. Power to complete the cycle is from 12 volts, through the wiper motor switch run position, the OFF position of wiper selector switch SW2, through the unenergized position of the control unit switch, and to the wiper motor. The motor stops when the wiper motor switch goes to the parked position.

All we have to do to make a hesitation controller is to devise a periodic short-term on-condition of its output so as to momen-

tarily connect the LO motor lead to 12 volts to get it into a run/park cycle and to vary the time delay between repeating cycles.

Hesitation Control Unit

The hesitation control unit is designed around the faithful 555 timer. I learned how to use the timer from references 1, 2, 3, and 4. I know that there are a lot more articles on 555 applications, but these were enough.

Fig. 3 shows the schematic of the circuit used with the 555 timer in the astable, or oscillatory, mode. Two diodes in the timing circuit, CR1 and CR2, are used to select the charge and discharge times independent of each other's time constant.

Assume that the timing capacitor, C1, is charging towards 12 volts through CR1 and R1. The timer output (pin 3) will be high, and the length of time it is high is a function of R1 and C1. With the values shown, it is about 1/2 second. When C1 charges to the threshold trip level of the timer, both pin 3 and pin 7 go low. Then timing capacitor C1 will discharge to ground (pin 7) through CR2, R2, and R3. The length of time the timer is off is a function of the values of C1, R2, and R3. R3 is a potentiometer which is varied to control the amount of "hesitation" of the output. In the design shown, it is approximately 2 to 15 seconds. R2 is used to provide a minimum time delay when R3 is at its zero Ohms position.

As soon as the capacitor discharges to the lower trip level of the 555, pin 3 again goes high, completing the cycle. This oscillation continues as long as power is applied to the circuit.

For those who might want to change the above times: charge time =

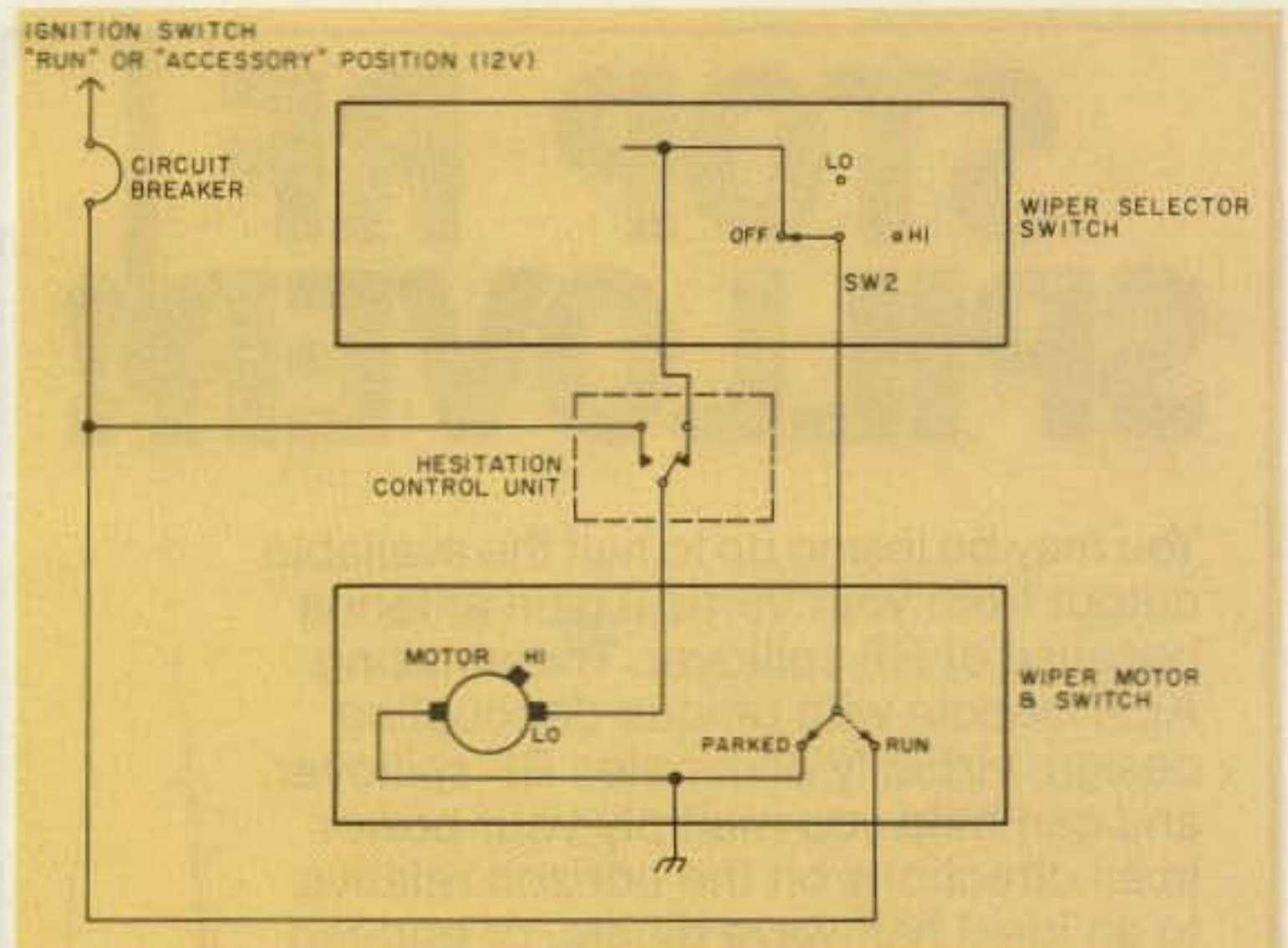

Fig. 2. Windshield wiper control with hesitation control unit added.

$.67C1R1$; discharge time = $.67(R2 + R3)C1$, where C is in farads and R is in Ohms.

Because the relay which pin 3 drives is an inductive load, protective diodes are required to prevent the inductive kick at turn-off from latching or otherwise damaging the output of the timer.

Construction

Construction of the control unit was made as simple and inexpensive as possible. A chassis box 2-3/4" x 2-1/8" x 1-5/8" was used. Prepunched perfboard with holes spaced on a 0.1" x 0.1" grid measuring 1-3/8" x 1-7/8" was used as the mounting board for all components except the relay and its two diodes. The

board was selected to permit an 8-pin IC socket to be used for the 555. The board was mounted on the back of the switch/potentiometer by drilling two holes in the board to clear the switch lugs. Using #16 solid wire to the lugs was sufficient to hold the board securely to the potentiometer/switch combination. Point-to-point wiring was used for the components.

The relay used is of the plastic-cased type. It was mounted to the box by removing its plastic cover and drilling a hole in the top of it to pass a #6 machine screw. The screw must be a flat-head type, with the head on the inside of the plastic cover. Use of a flat-head screw provides suffi-

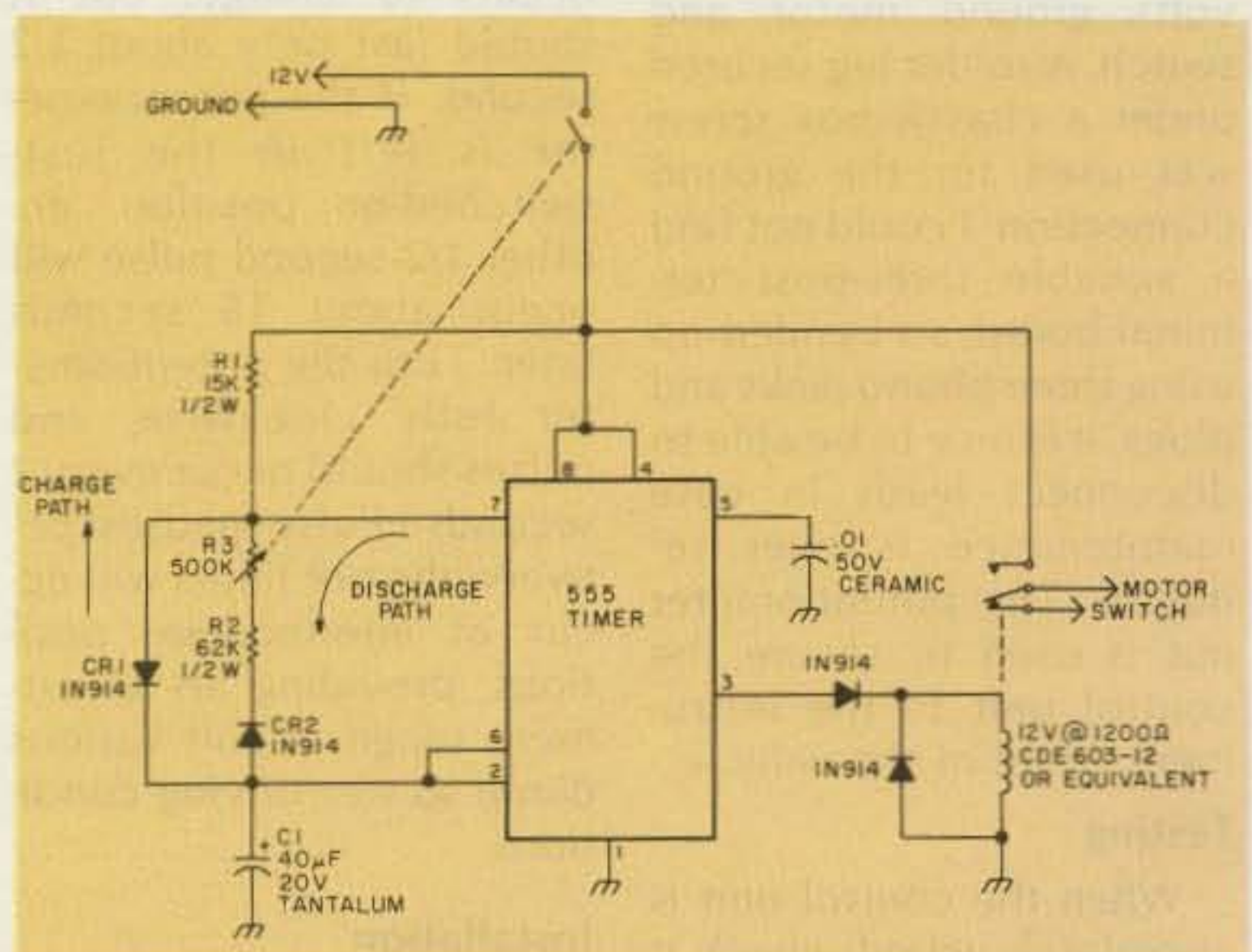

Fig. 3. Windshield wiper hesitation control schematic.

STOP RF SPILLOVER!

You may be losing up to half the available output from your vertical gain antenna because of RF spillover. The amazing AEA Isopole with unique decoupling design, virtually eliminates RF spillover and can help you multiply your power in all directions on the horizon relative to an ideal half-wave dipole, or end-fed non-decoupled "gain" antennas.

**ADVANCED ELECTRONIC
APPLICATIONS, INC.**
P.O. BOX 2160,
LYNNWOOD, WA 98036
CALL 206/775-7373

**AEA Brings you the
Breakthrough!**

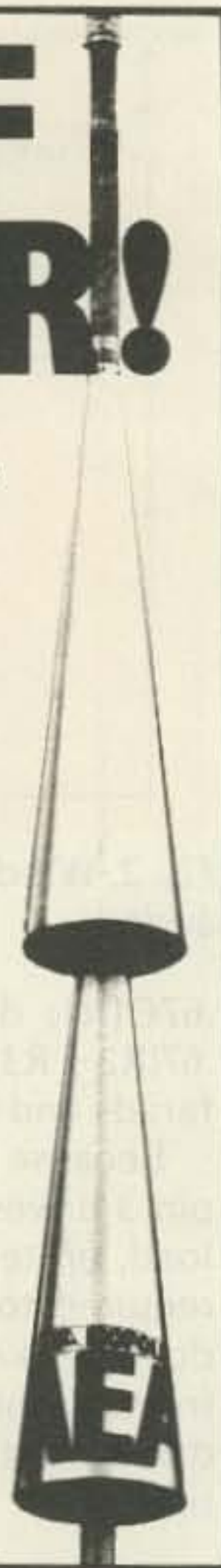

cient clearance between the relay and the screw head. When the cover is reassembled with the relay, the whole thing is mounted on the side of the chassis box with an external nut.

Four connections are required between the control unit and the automobile: 12 volts, ground, motor, and switch. A solder lug secured under a chassis box screw was used for the ground connection. I could not find a suitable three-post terminal board, so I ended up using three phono jacks and plugs; it is nice to be able to disconnect leads in case maintenance is ever required. The potentiometer nut is used to secure the control unit to the instrument panel of the vehicle.

Testing

When the control unit is completely wired, check it with an ohmmeter between the positive power connec-

tion and ground to ensure that there are no shorts. Then connect 12 volts and ground to the proper leads, as well as a voltmeter between ground and the "motor" lead of the unit. Turn on the switch. The voltmeters should indicate an initial 12-volt reading, as C1 begins to charge, but it should last only about 1/2 second. If the potentiometer is left in the just-switched-on position, another 1/2-second pulse will occur about 15 seconds later. Turn the potentiometer fully clockwise, and pulses should occur every 2 seconds. Pulse pauses between the pot limits will occur at intermediate positions, providing an adjustment range to suit various damp to wet driving conditions.

Installation

The wiper motor usually is mounted on the engine

side of the fire wall and on the driver's side of the car. To help locate it, try this: With the car engine off and the ignition switch in the accessory or run position, actuate the wipers. By feeling the running wiper motor, you can verify the fact you found it from the vibration on your hand.

It is necessary to identify two leads on the motor (there are usually four): the low-voltage lead and the 12-volt lead.

Most cars have a connector and plug at the motor; disconnect them. If there is no disconnect, the insulation of the leads will have to be cut to make voltmeter connections. With the ignition switch on and the wiper selector switch off, determine which of the four leads has 12 volts on it. That is the lead to the "run" connection of the wiper motor switch. It is always hot (12 volts) when the ignition is on and will be used to power the control unit.

Next, with the wiper selector switch in the low-speed position, determine which additional lead now has 12 volts on it. This is the lead which must be cut.

Now find a suitable mounting place for the control unit on the instrument panel. A 3/8"-diameter hole (or one to match the shaft of the pot you used) is drilled in the panel and the control unit secured by the nut on the potentiometer.

In addition, a hole through the fire wall must be found to pass the four wires connecting the control unit to the wiper motor. In some cars, a spare blank rubber grommet may be used by drilling a hole through it for the cable. In other cars, a large existing grommet may be drilled to pass the additional wires. If a new hole must be drilled, use a rubber grommet to provide a tight fit around

the wires to prevent engine fumes from getting into the interior of the car.

Determine the wire length needed to go from the control unit to the wiper motor and pass them through the fire wall. Cut the low-speed motor wire and put solderless quick-disconnects on the two separated wires, as well as the two mating wires in the cable. The wire still connected to the motor goes to the "motor" lead of the control unit. The other cut wire is designated as "switch" and goes to that label on the control unit. The ground lead from the control unit is connected (or better, soldered) to a lug placed under a grounded screw on the motor.

The insulation of the hot wire (12 volts) must be removed over a 1/2", or so, length, and the 12-volt lead from the control unit soldered to it. Tape all leads and secure the cable in some manner so that it will not vibrate excessively. Cut off the excess length of the potentiometer shaft and put a nice knob on it. Now you can enjoy driving in a misty or slight rainfall instead of fiddling with the wiper switch. The adjustable wiper rate will keep the windshield clear without needless use of your wipers. You also will have the satisfaction that as an amateur you can make something "practical" to use or to give to your non-technical friends. ■

References

1. "IC Timer Review," H. M. Berlin W3HB, January, 1978, *73 Magazine*.
2. "555 Basics—and More," David Keeler WB4CEO, November, 1978, *73 Magazine*.
3. "Operational Characteristics of the 555 Timer," Bob Marshall WB6FOC, March, 1979, *Ham Radio*.
4. *TTL Cookbook*, Don Lancaster, pp. 171-175.

KDK MAKES 2 METER FM SIMPLE AND EASY!



KDK INTRODUCES A NEW GENERATION OF 2 METER FM RADIOS.

The sparkling 2025A MKII is loaded with new features! East of operation is the design concept at KDK.



SPECIAL!
WINTER SALE! \$299

Includes:
Touch Tone[®] Mike (Ready to Use)
ORDER NOW DIRECT



● Features such as ten channel memory in two banks of five each, a solid 25 watts of power, full MARS and CAP coverage from 143,000 Mhz to 148.995 Mhz, plus built in memory retention for up to one year . . . and much, much more makes this the radio of the year. If you have been waiting to move up to a new model, or have wished for a radio with "everything" . . . KDK has it!

● The ten channel memory is easily addressable and you have two banks of five channels each. You can even use both banks at once for odd splits.

● Standard 600 hz shift up or down. Band scan or memory scan. Memory scan is easy. There is also band scan with upper and lower limits you can choose yourself!

● Built in nicads for the memory retention which has drain in nano-amps, not milli-amps. The internal battery will hold the memory for up to one year! No other radio offers you this feature.

● Fast and easy dialing. Full solid state dialing and you can choose from the front panel either a fast or slow dial rate.

● No relays are used, only solid state switching. This eliminates a trouble spot many radios encounter.

● KDK has also eliminated another trouble spot by completely hand wiring each radio. No internal plugs to become intermittent and no wire wraps either, just good solid wiring.

● KDK gives you one of the hottest receivers you can find. By using UHF (not VHF) dual gate MOS-FETs with electronic auto tuning for the RF amplifier and the first mixer, you have a combination of ultra sensitivity and maximum quietness.

● The audio output stage in the 2025A Mk II uses an integrated circuit which has internal protection against over-voltage and shorted output conditions. Plus it is a high audio output chip – just what you need in a noisy mobile situation.

● The transmitter uses direct VCO varicap modulation for true FM. Your transmitted audio sounds as it should; crisp, clear and natural.

● The power output stage of the 2025A Mk II will not break down even with an infinite VSWR load, and uses heavy duty solid state antenna switching with a four stage low pass filter. All this gives you an exceptionally clean, spur free output.

● KDK has included an adjustable sub audible tone circuit which can also be used for CTCSS or tone burst on transmit. Again, more features!

● Size is 2 7/10" high – 7 1/8" wide – 9 1/2" deep.

● You can switch from 25 watts to 3 watts low power.

● And, of course, the DC cable is included along with the microphone and mobile mounting bracket.

ORDER NOW DIRECT
CALL TOLL FREE
800-251-4141

This number for **ORDERS ONLY!**

Mail Order – COD – Bank Cards

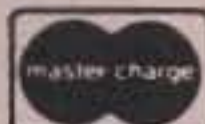
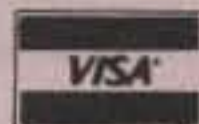

HOURS – 9:00 - 5:00 CST Monday - Saturday
Phone (615) 865-7949
Telex 80-8327

Write for brochure – Dealer inquiries invited!

Warranty information available at your dealer

Company reserves the right to change specifications without notice.

Exclusive US Distributor – Dealers Welcome!

ORDER DIRECT
OR AT YOUR DEALER!

Distributed by:



KDK DISTRIBUTING CO., INC.
617 SOUTH GALLATIN ROAD – MADISON, TN 37115
Phone (615) 865-7949

**The worlds most popular
Satellite TV receiver....**



NOW IN A KIT!

KLM's SKY EYE I SATELLITE RECEIVER brings you a whole new world of fantastic television entertainment... in cable-quality video and sound. It is a two-part system, easy to install and use. The compact **Control Console** is all you need inside your home. The modular **RCVR Unit** mounts at or near the antenna. The superb performance and reliability of the SKY EYE I are proven by the thousands already in use.

The **SKY EYE I KIT** comes in simple easy-to-assemble sections. All microwave circuitry is factory wired and tested. The assembly manual is clearly written, simple and precise. In just a short time you can be enjoying the fabulous world of satellite programming.

SKY EYE I Specifications: Single conversion/ image rejection circuits (easily handle strong and weak signals without instability or distortion) * Built-in DC block for feedline-powered LNA * Full video tuning, 3.7 to 4.2 GHz (for all channels, horizontal and vertical) * Audio tuning 5.5 to 7.5 MHz (gets the subcarrier entertainment, too!) * Separate regulated power supplies for LNA and RCVR * Optional Polarity Control * Control Console to RCVR cabling supplied.

Complete SKY EYE I Receiver Kit: \$695.00

Order toll free: 800-538-2140
(in Calif call 408 779-7363)

ORDER FORM

Sky Eye I Receiver Kit. \$695.00

Total Enclosed \$ _____

(CA residents add sales tax)

Personal Check Cashiers Check/MO

Visa Master Charge (Bank No. _____)

Acct. No. _____

Signature _____ Exp. Date _____

Print Name _____

Address _____

City _____

State _____ Zip _____

Send Me More Information!

KLM ELECTRONICS, INC.
P.O. Box 816, Morgan Hill, CA 95037
Satellite _____
Receivers - Kits - Systems - Components

"Our 11th year of innovations in communications equipment"

**The Luly ANTENNA
and POLARIZER**

- Completely portable Antenna, comes fully assembled (folds like an umbrella and is not a kit).
- The Polarizer is an electronic rotator, which can change polarities with a flick of a switch (no moving parts). Eliminates weight, twisting cables, freeze ups, and down time.

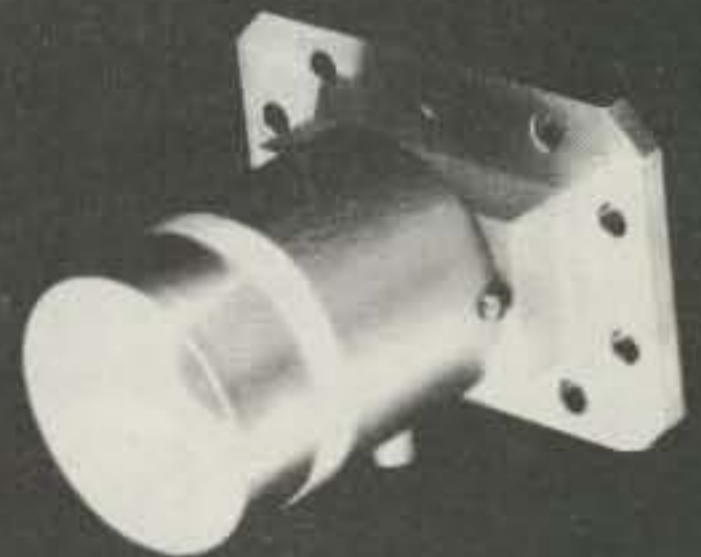

For More Information
Write To:

✓53

LULY TELECOMMUNICATIONS CORP.

P.O. Box 2311, San Bernardino, California 92406

(714) 888-7525

Dealer and Distributor Inquiries Welcome



**Star View
Systems**

H&R COMMUNICATIONS, INC.

Route 3, Box 103G - Pochontas, Arkansas 72455

Introduces the
**MODEL 12K
SYSTEM . . .**

A complete satellite receiving system that you can assemble yourself as a week-end project.

Why spend \$7,000 to \$10,000. Why pay someone else to install it. Do it yourself in a week-end and save.

ONLY \$2,400.00

UPS SHIPPABLE



KIT CONTAINS

- 12' Antenna
- AZ/EL Mount
- 24 Channel Receiver
- 120° LNA
- Feed Horn

- All Miscellaneous Cable and Connectors Needed
- Everything You Need
- No Special Tools Needed
- Complete Antenna Weight Only 125 Pounds

See Your Local Star View Dealer or Call
800-643-0102 or 501-647-2291

Dealer Inquiries Invited

✓86



SATELLITE TELEVISION SYSTEMS

WE WILL NOT BE UNDERSOLD!!

**Complete Systems, Antennas,
Receivers, LNA's & Accessories**

CALL US TODAY!

812-238-1456

**hoosier
electronics**

"Nation's Largest Total Communications Distributor"

P.O. BOX 3300 • TERRE HAUTE, INDIANA 47803

320

TVRO Signal Source

— tuner-based test gear

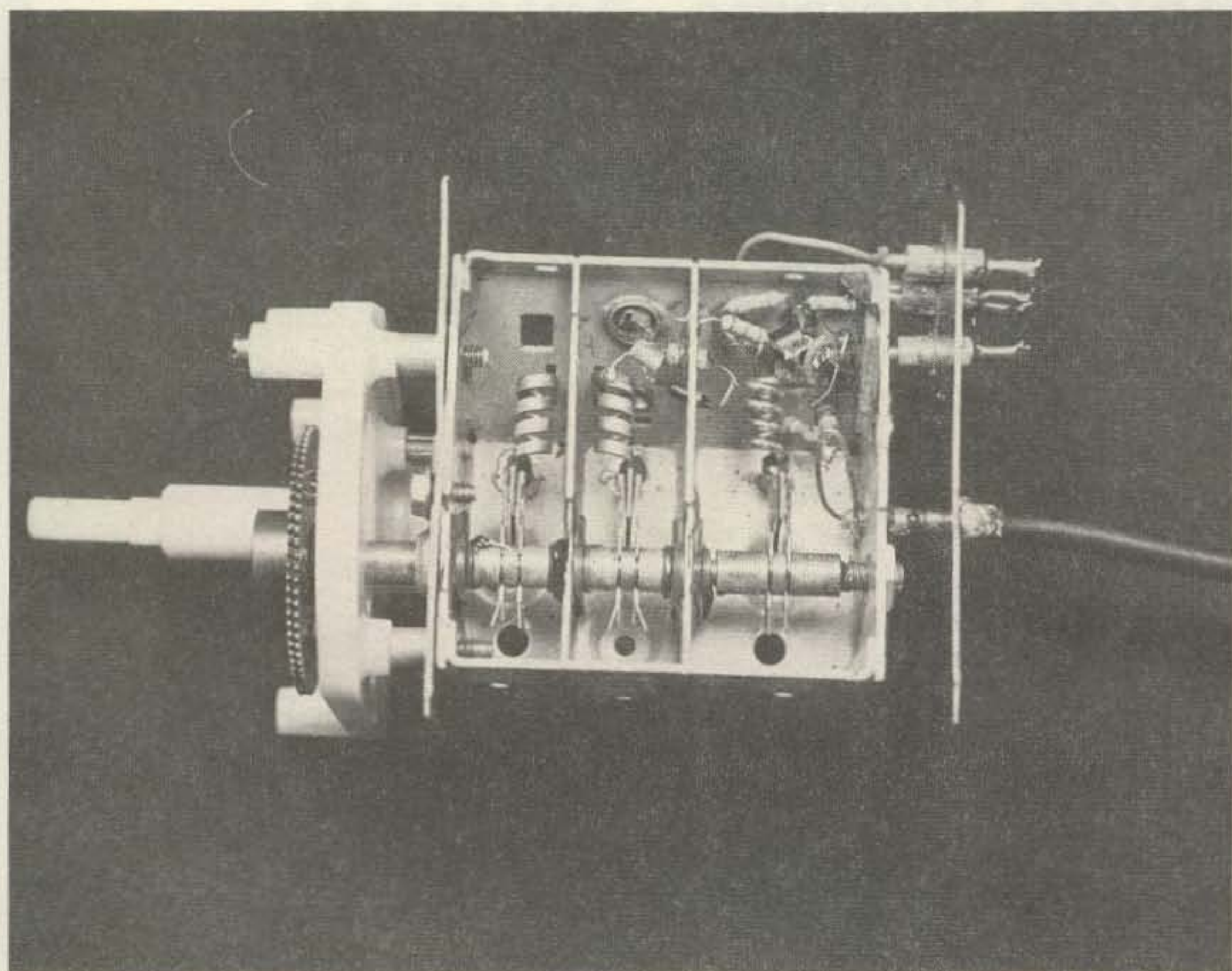

Photo A. Modified oscillator with front and back shields mounted. Bypass capacitors are mounted, and the brass ferrule passes the coax through the shield and the wall of the oscillator. Rf pickup loop can be seen.

In order to do any experimental work at UHF or microwave frequencies for amateur or TVRO projects, certain minimum equipment immediately becomes necessary. The first requirement for this work is to be able to generate known signals at these frequencies, to modulate, and to detect them. The use of microwave equipment from flea markets is not satisfactory because of its limited availability and its cost, and because relatively few units cover the frequency range of interest (500 MHz to 4 GHz).

The solution for the equipment problem turns out to be easy and inexpensive, with almost no debug problems. It consists of a modified UHF TV-tuner oscillator section followed by an harmonic generator. A sensitive detector is necessary for the low-power lev-

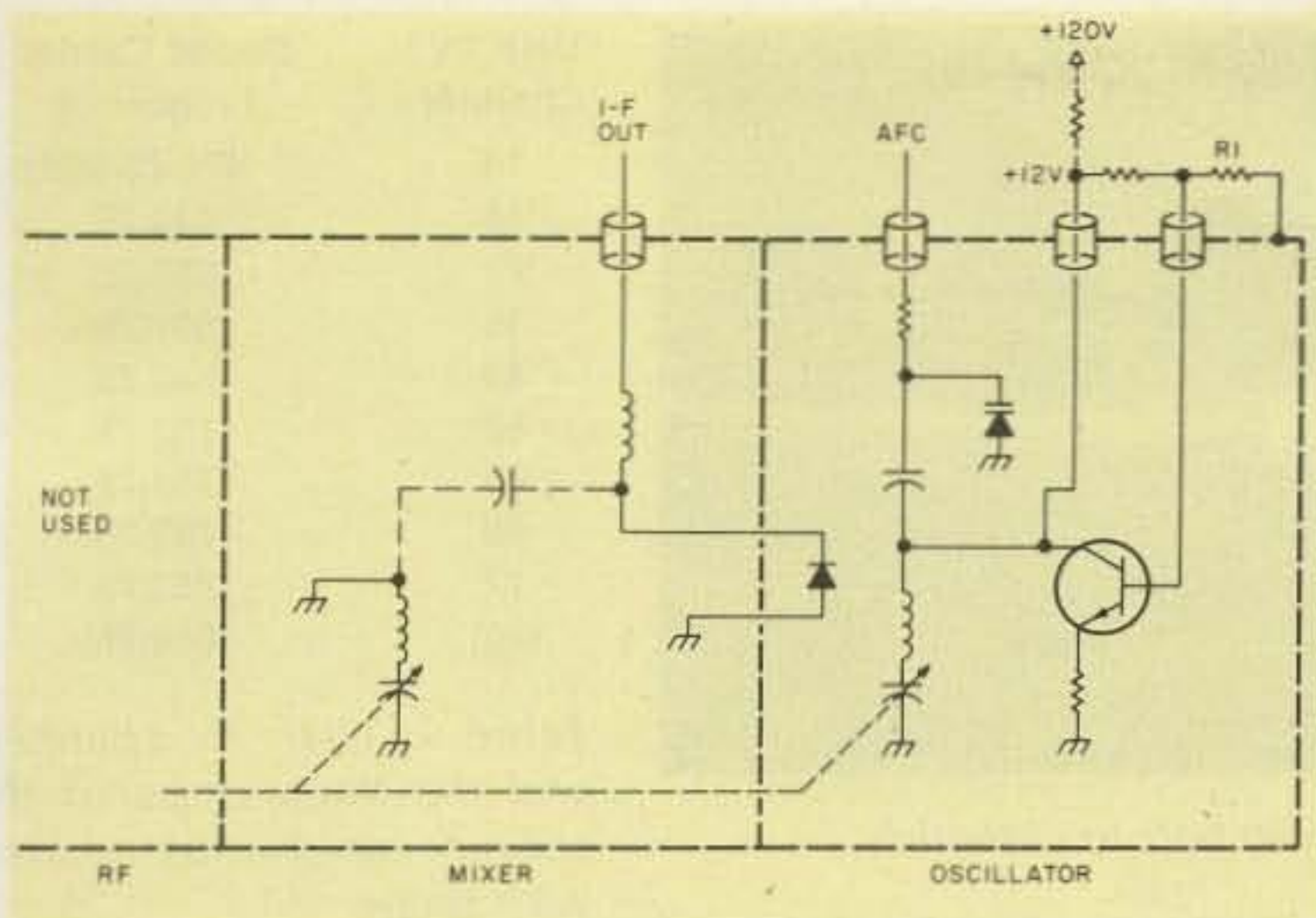

Fig. 1. Typical schematic of oscillator and mixer sections of UHF converters. Power supply is either 12 volts or 120 volts through a dropping resistor. The afc circuit can be used for frequency modulation or fine tuning, and the detector diode is used to monitor relative power output.

els involved, and this is easily found with a simple variable attenuator. The result is a signal source covering 525 MHz to 4.5 GHz with AM and FM modulation and video modulation on the low frequencies (525 to 1300 MHz), low level detection down to one micro-volt, and afc or electronic tuning potential.

The construction requires only hand tools. The four basic units are modular and are reasonable weekend projects once the components have been obtained. Some general UHF techniques are outlined below which may be applied to make similar equipment more efficient.

Power-output monitoring on the fundamental frequency and a simple frequency calibration method also are described below, giving accuracy to about 1% without using a counter.

Generator

The generator consists of a modified oscillator section from a continuous-tuning type UHF TV converter. These are being sold surplus or may be recovered from an old TV set. One of the better units tested was salvaged from a 10-year-old TV set.

These units typically have the oscillator on the high side of the range, 45 MHz above the channel frequency, and cover about 520 to 930 MHz. Fig. 1 shows a typical circuit for the oscillator and mixer portions of the units. The design is simple, with minimum components for unwanted resonances, resulting in stable units. Some of the older units were found to have bimetal temperature-compensating elements. Otherwise, they nearly all have varactor diodes for afc frequency locking as shown in Fig. 1. The types with an afc diode provide easy FM capability and are the ones to use. All of the samples tested had good output which was relatively uniform over the band, dropping 3 dB at the high end. The two-speed vernier-dial mechanisms obviously help tuning.

The diode-mixer circuit coupled into the oscillator is used to check oscillation and output. It does absorb some power and may be cut out if not needed. The first section rf tuning closest to the shaft is disabled to minimize coupling rf out of the enclosure. Verify that the detector diode is all right by checking resistance

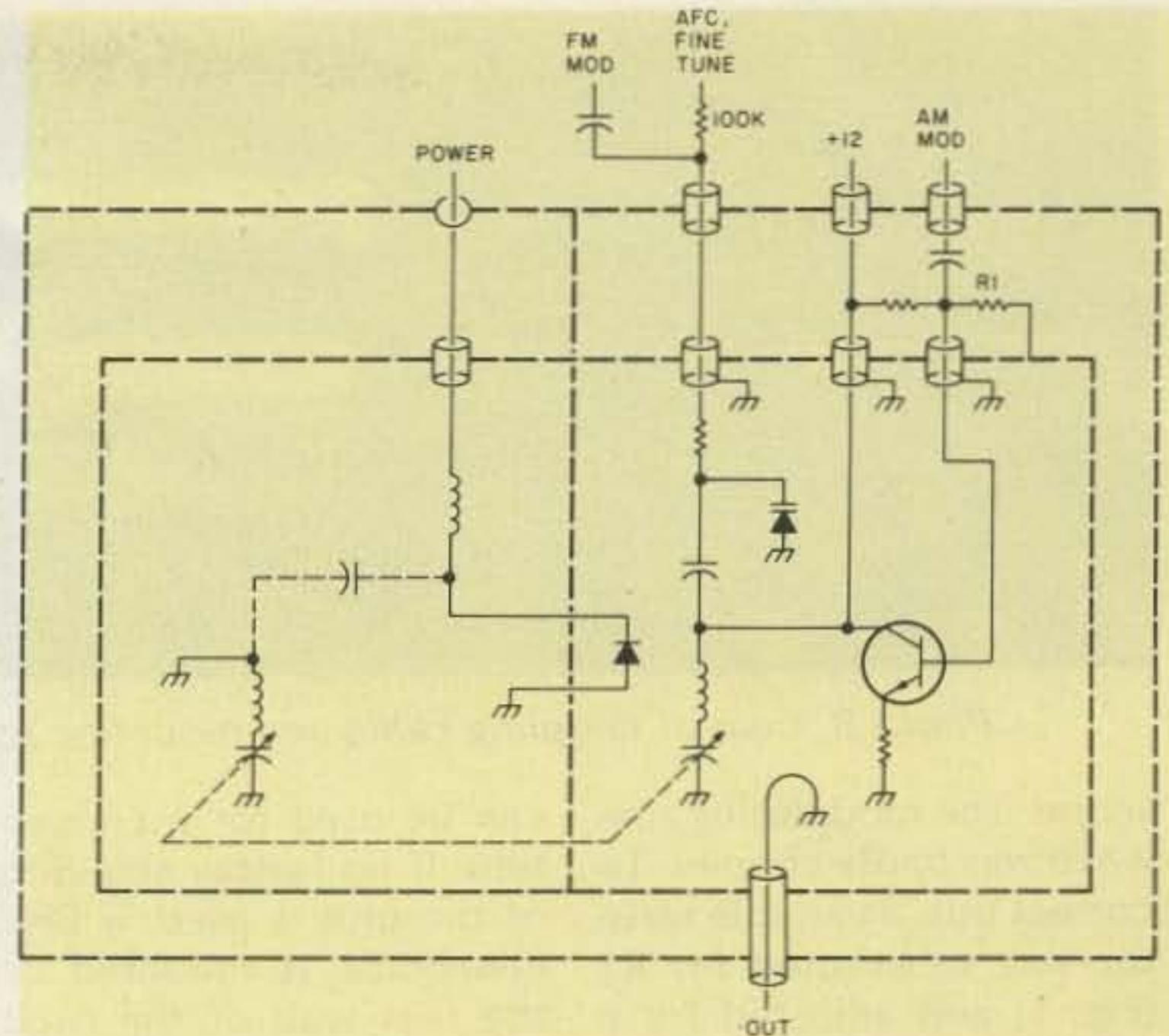

Fig. 2. Modified and shielded converter as used for a signal generator.

at the phono-style connector. Forward resistance should be about 100 Ohms to ground. A 200-microampere-to-one-milliamperemeter will read the output current.

Remove the cover of the tuner and by inspection find the voltage input terminal, the afc terminal, and, if accessible, the base bias terminal. Some units operate as grounded base oscillators, and the base is connected to a feedthrough capacitor with the bias network outside the case.

Power may be supplied in two ways, either through a 12k-to-15k, 2-Watt resistor limiting the current to about 10 mA, or directly from low voltage. The case is negative. A 12-V supply is used, and all units tested have oscillated, but the bias may have to be adjusted for uniform output and good modulation.

Use a series resistor of 2.7k to 3.3k to limit the current for an initial test of the oscillation with a 12-V supply. Current should be about 3 to 4 mA. The mixer-diode connection should show some current with the tuning capacitor fully meshed. A few microamperes indicate oscillation. If

there is no output, increase the supply to 15 or 20 volts maximum for a test. If the detector diode is open, an rf probe can be made with a type 1N914 diode mounted directly on the terminals of a 50-to-100-microampere meter. Carefully probe the oscillator cavity for a reading. When oscillating with the cover removed, the signal should blank a UHF TV set at 10 to 15 feet without an antenna.

After the circuit is oscillating, remove the series-limiting resistor, apply 12 volts, and check for a reasonable and uniform output across the whole tuning range. Diode-mixer current should range from about 30 microamperes at the low-frequency end to perhaps 10 microamperes at the high end of the tuning range. Some oscillators have output as high as 100 microamperes. There should be no dead spots, with good output at the high end.

One oscillator with no high-end output was found to be biased incorrectly. It was discovered by af-modulating the transistor base through a small capacitor and observing the rectified waveform with an oscillo-

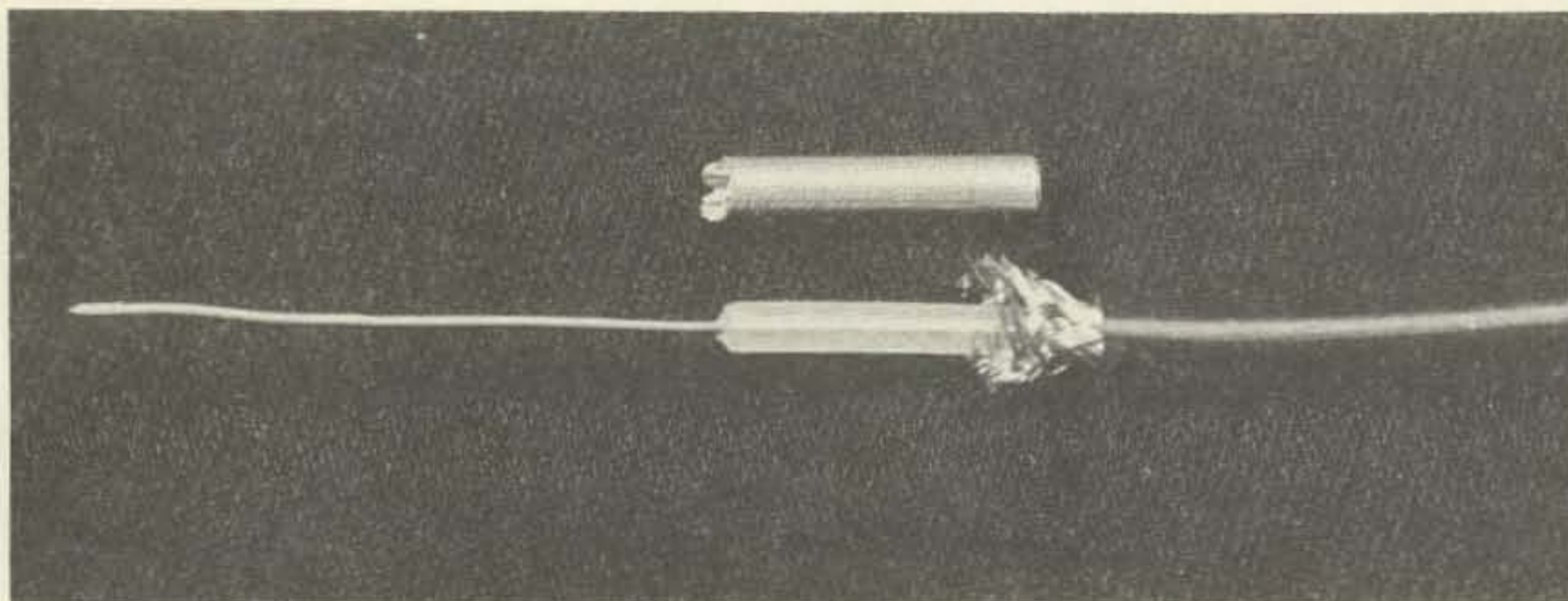

Photo B. Coaxial coupling cable and mounting ferrule before assembly.

scope. The modulating sine wave was badly clipped. To correct this, a variable resistor was substituted for R1 (Fig. 1) and adjusted for a good sine-wave output at low modulation level. A fixed resistor was then substituted for the variable. Linearity improved, and high-end output greatly improved.

Rf-output coupling for the generator is made with a small loop in the oscillator section. Two methods

can be used for a connection. If no further shielding of the unit is used, a BNC connector is mounted on the rear wall of the oscillator cavity as shown in Photo A. Carefully drill a hole in the back plate to accommodate the threaded ferrule of the connector, as shown. A pick-up loop about 1/8 inch by 5/8 inches is positioned parallel to the tuning capacitor and soldered into the BNC connector. This works well. How-

ever, for low-level higher frequency work, adequate shielding is really required.

The rf field from the oscillator is strong, and some of the tuning openings cut in the tuner act as slot antennas at harmonic frequencies, making low-level work impossible. Consequently, a different coaxial method is used to pass through the printed-circuit-board shield.

This rf coupling consists of a ferrule made from brass tubing with an inner diameter equal to the outer diameter of the coaxial cable insulator, as shown in Photo B. An 8-inch length of RG-58/U is trimmed as shown, and the end of the tubing is filed with a notch for easy soldering. The ferrule and coax are mounted as the back shield is assembled.

The shield is made from printed-circuit material which, in the photographs, is 1/32-inch double-sided stock. However, a single-sided material can be used.

| UHF TV Channel | Sound Carrier Frequency |
|----------------|-------------------------|
| 14 | 475.75 MHz |
| 18 | 499.75 |
| 27 | 553.75 |
| 35 | 601.75 |
| 43 | 649.75 |
| 52 | 703.75 |
| 60 | 751.75 |
| 68 | 799.75 |
| 77 | 853.75 |
| (83) | (889.75) |

Table 1. UHF TV channels and the frequencies of the sound carriers associated with them.

The parts are cut approximately as shown in Fig. 3, with the detail dimensions to fit the tuner. The front end is drilled for the tuning shaft and mounting screws, and the rear drilled for the coax ferrule and coaxial bypass capacitors.

Locate the rear-end piece so that the coaxial ferrule is aligned through both the shield and cavity. The ferrule is first soldered into the tuner. Then the rear shield is positioned as shown in Photo A and soldered. The coaxial cable is inserted so that the end of the insulation is just flush with the end of the ferrule. The loop is formed and soldered about 1/8 inch by 5/8 inches as shown. The fanned-out braid is soldered to the outside of the ferrule. This keeps the 50-Ohm impedance and eliminates rf leakage. Replace the tuner covers before shielding.

In order to avoid any unsoldered slots leaking rf, the sides of the shield are soldered on the inside corners (copper facing inward), and the end pieces are located inside the side pieces (copper facing outward) for soldering on the interior surfaces, as shown in Fig. 3. Each of the two side pieces is clamped in a right-angle holder for soldering. An iron with a long tip is invaluable. The larger the box, the easier the soldering will be. The 1/32-inch PC material can be cut with

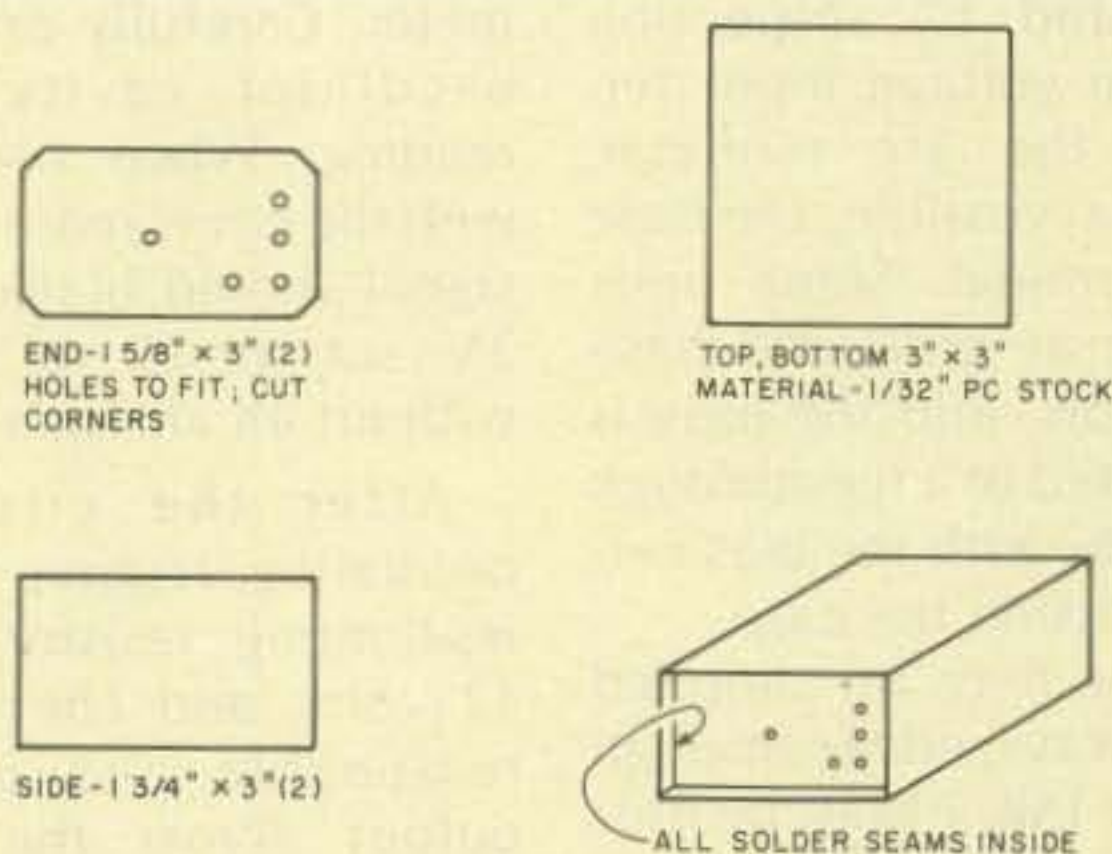

Fig. 3. Shield box dimensions. Actual sizes are determined by the tuner used.

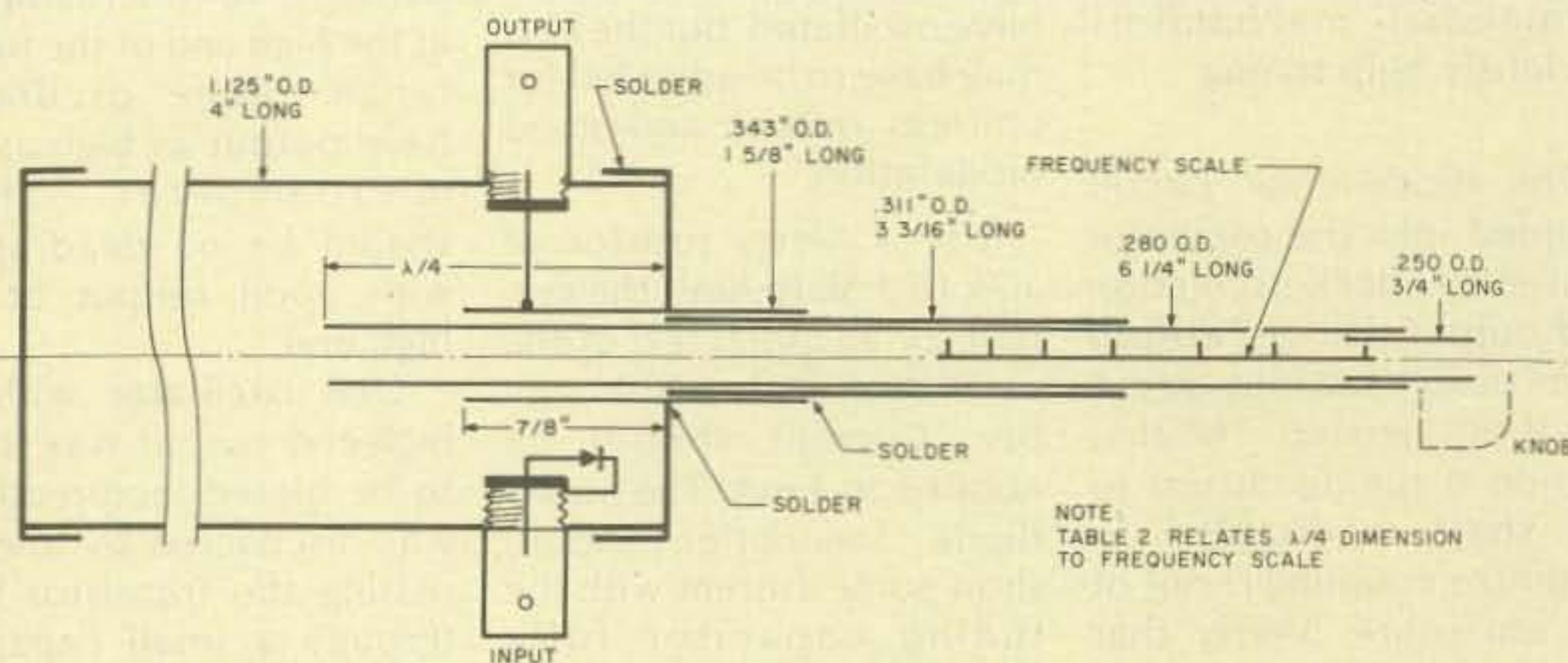

Fig. 4. Cross section of the cavity resonator used for the harmonic generator.

heavy scissors, which makes it easy to fabricate. The usual one-ounce copper PC material is OK because rf cannot penetrate it at these frequencies. When completed, the only hole in the shield should be the shaft opening, with the solder seams continuous.

The oscillator voltage should be limited to 12 volts and should be regulated with a good quality IC-type regulator for stability and low noise, although the current is only about 10 milliamperes. "Mostly AM" modulation is accomplished by capacitively coupling low-level audio or video, limited to about 0.1 to 0.3 volts, into the base of the transistor (Fig. 1). FM modulation is capacitively coupled to the varactor diode, as are the afc or fine-tuning voltages, if desired.

Dial and Calibration

A dial blank cut from clear plastic made a disc 4 inches in diameter. Two circles were scribed on the disk with radii of 1-1/2 inches and 1-3/4 inches to facilitate marking. A clearance hole was made through the disc, and then it was cemented to the hub of a cut-down tuning knob which fits the coarse-tuning shaft. See Photo C. The gearing ratio spreads the tuning over about 340 degrees, which gives a readable dial for the frequency range.

A TV set with detent channel tuning was used for calibration. This will give reasonable accuracy if the input is kept low enough so that the TV set afc doesn't pull the frequency very much to track the oscillator. Remove the TV antenna to keep the input low. A very low-level af signal at 500 to 1000 Hertz is used to FM-modulate the generator (Fig. 1). The TV set is tuned to a local UHF station and the audio tuned in with the fine tuning at the

| Frequency | Quarter wavelength |
|-----------|--------------------|
| 1000 MHz | 7.5 cm |
| 1500 | 5.0 |
| 2000 | 3.75 |
| 2500 | 3.0 |
| 3000 | 2.5 |
| 3500 | 2.14 |
| 4000 | 1.875 |
| 4500 | 1.67 |

Table 2. Quarter-wavelength distances for coaxial cavity center conductor calibration. Refer to Fig. 4.

lowest possible signal strength. The TV set fine tuning is not changed during the calibration procedure. As seen from Table 1, there are TV sound channels on or near each 50 MHz within about 1%, except for channel 83 at the end of the dial.

Mount the dial and cursor temporarily as shown in Photo C. The plastic dial is marked on the reverse side with a non-washable marking pen for neatness. For each 50-MHz dial calibration point, set the TV to the appropriate channel and then tune the oscillator down from the high side for a weak interference pattern (bars) on the screen. Then further carefully adjust the generator tuning until the sound is tuned in. The picture pattern should still be seen, so you will know that you are not tuned to the image frequency—which is 90 MHz lower. Repeat the procedure to check the calibration. The calibration marks should come out in a regularly-spaced pattern. Rub-on numbers can be used for the frequency settings on the dial.

Harmonic Generator

A diode frequency multiplier is used in the harmonic generator to excite a wide tuning-range coaxial reentrant cavity resonator for the frequencies above 900 MHz. For easy fabrication, the center coaxial assembly is made of thin-wall brass tubing, available in hobby

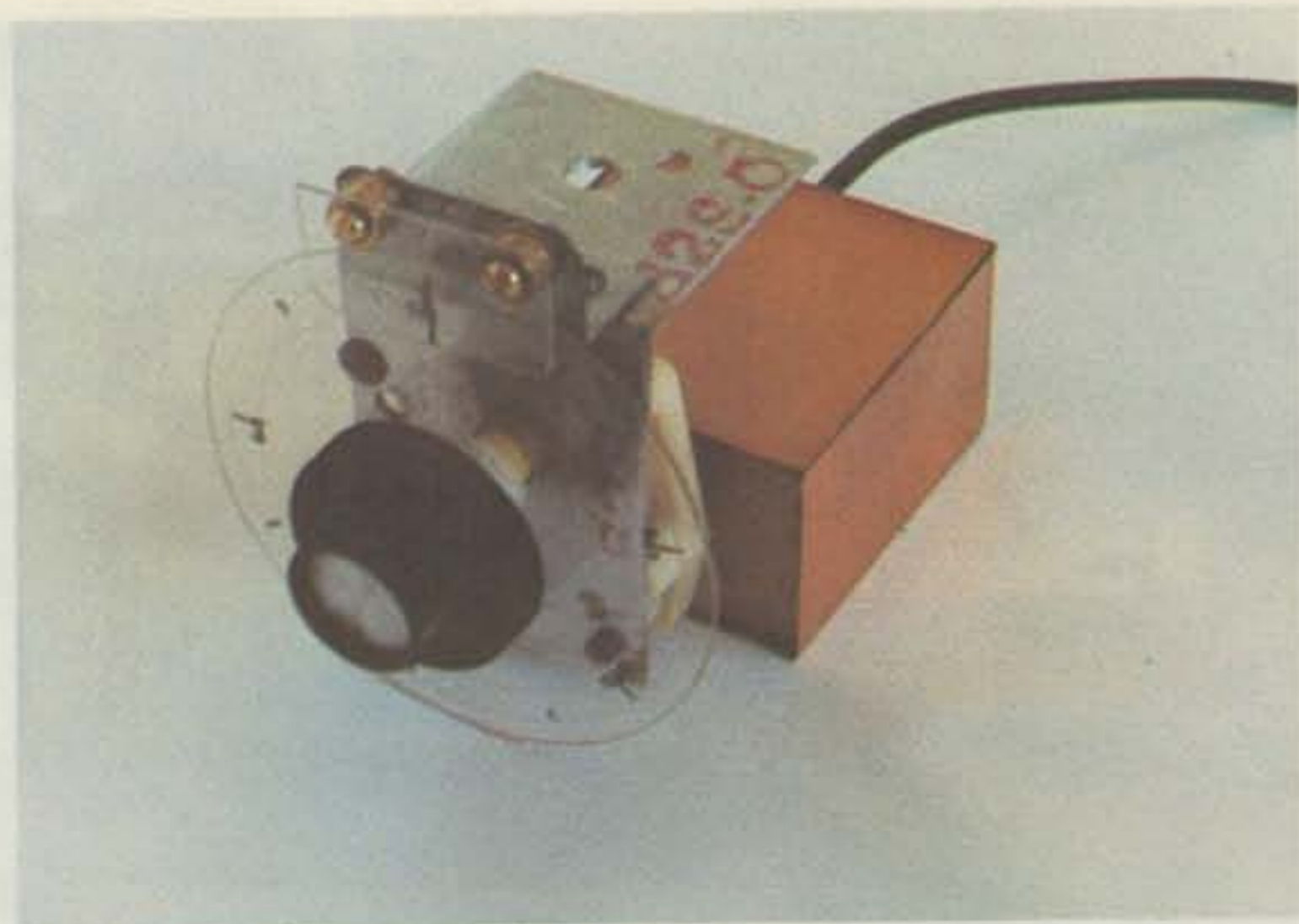

Photo C. Dial assembly with cursor temporarily mounted for calibration.

stores. It comes in successive concentric sliding-fit diameters from 1/16" to 5/8", with a wall thickness of about 0.015".

The outer tubing of the cavity is a brass toilet-overflow tube, 1-1/8" o.d., available in most hardware stores. The ends of the cavity are 1" copper-tubing caps which have an i.d. of 1-1/8". The caps are cut about 3/8" long with a hacksaw. A hole is drilled in the center of one piece for the center conductor of the resonator, as seen in Photo D. The dimensions of the cavity parts are shown in Fig. 4.

As a design aid for maximum efficiency in this type of construction, the following design rules were used.

1) For maximum Q, the ratio of the inner conductor o.d. to the outer conductor i.d. should be about 3.6, representing an impedance of about 77 Ohms.

2) Sliding electrical contacts are hard to make and harder to keep efficient. Therefore, use quarter-wave chokes at joints wherever possible. In chokes, minimize the spacing between the conductors (i.e., for low impedance).

3) The bearing sleeve for

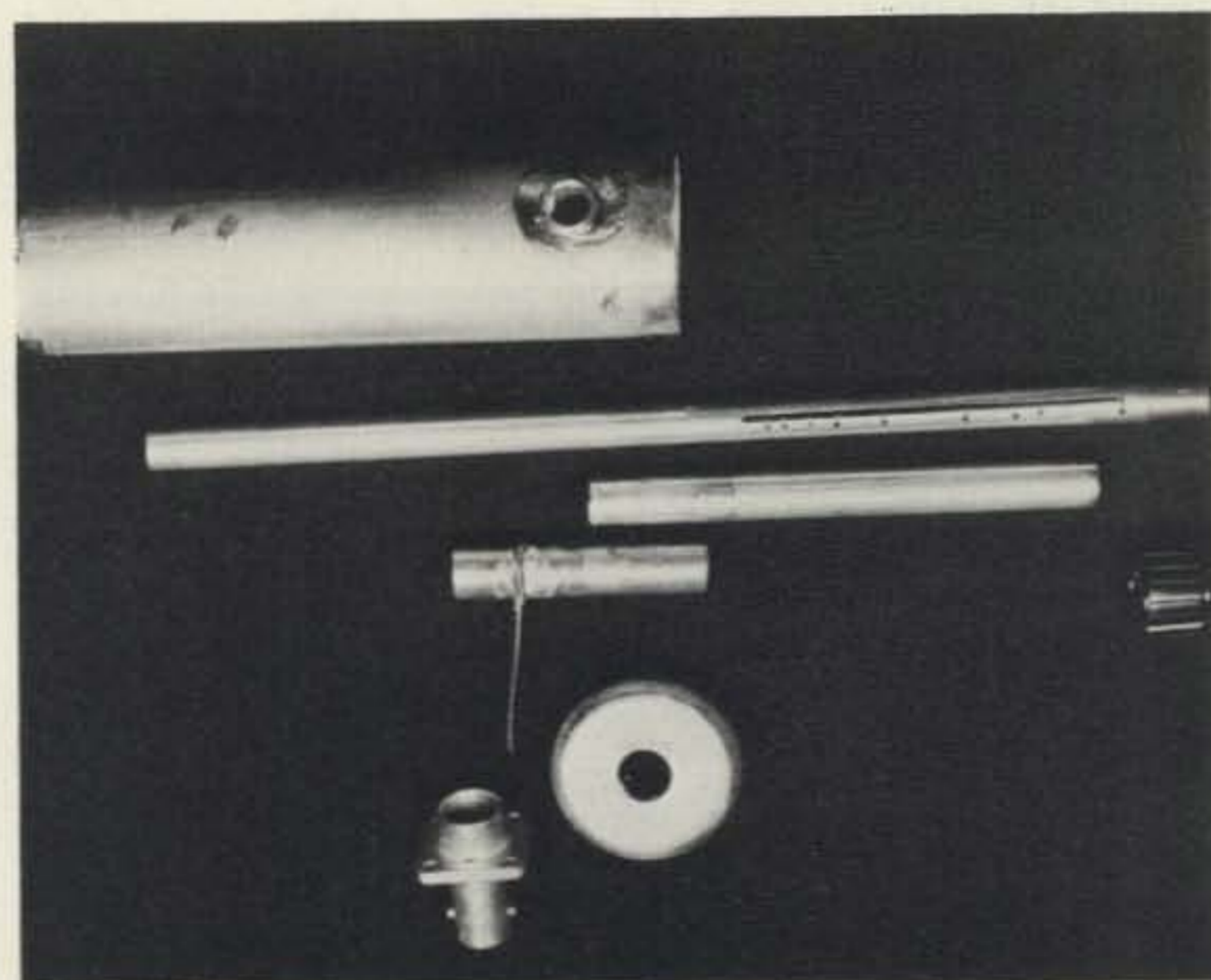

Photo D. Component parts of the harmonic generator prior to assembly. Only one BNC connector and one end cap are shown. The center conductor has been scribed for calibration.

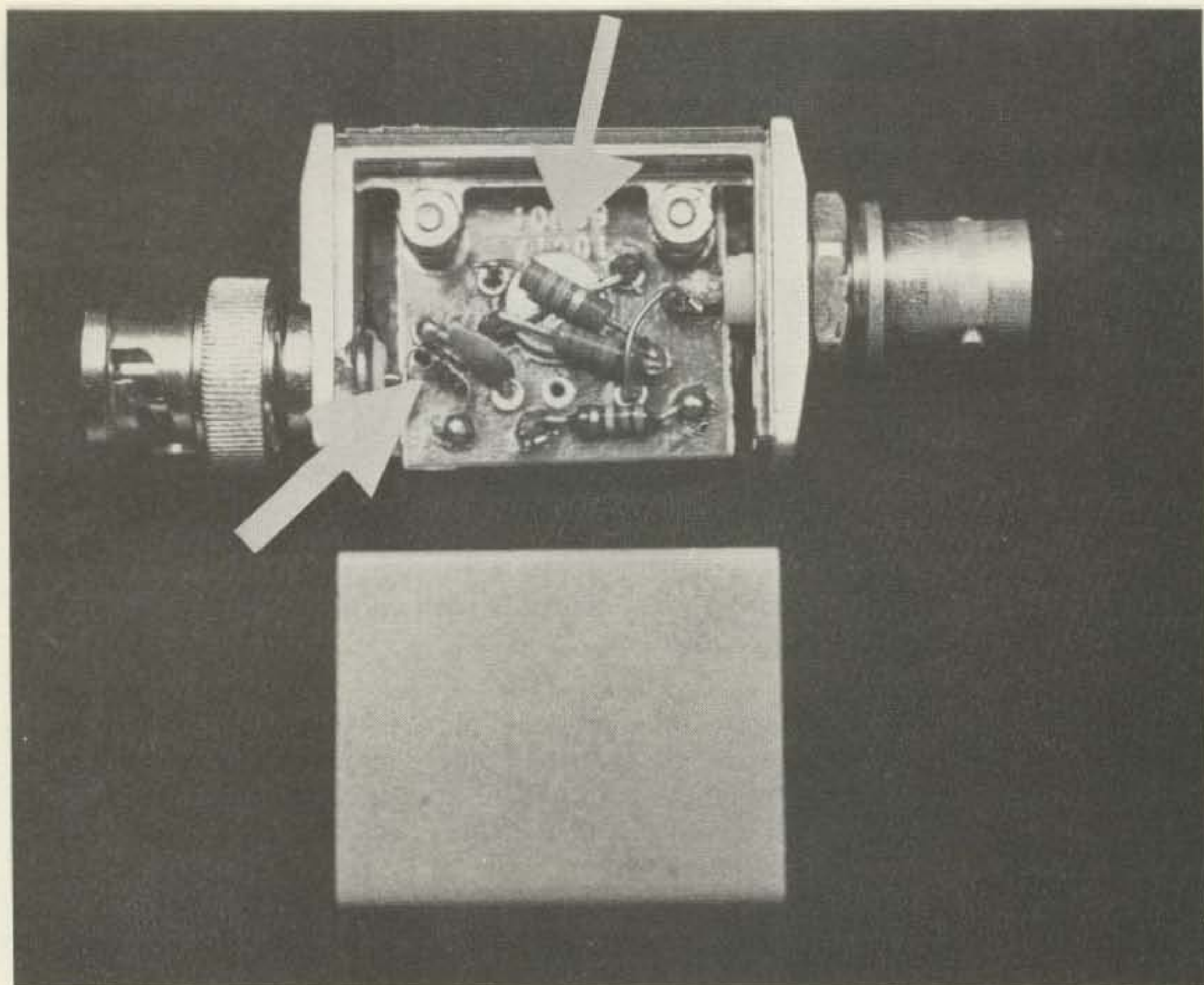

Photo E. Detector assembly. Arrows point to hot carrier diode and to the battery.

the adjustable center coax member is at least one-quarter-wavelength long at the lowest frequency used.

4) Allow about two diameters of the center-coax member clearance to the end cap at the extended (low-frequency) position of the inner conductor. This reduces end effects which would affect the linearity of the tuning scale.

5) The rf feed-coupling loop is close to the short-

circuited end of the cavity, and the ground end is returned to the BNC connector to reduce losses. The loop is actually the harmonic-generating diode. The loop size should be small compared to the wavelength to minimize frequency pulling.

6) If possible, have the interior of the completed coaxial assembly silver plated. A thickness of 0.0001" is adequate and

will not affect the sliding fit.

7) The output is tapped to the center conductor rather than loop coupled. This gives greater output (Photo D).

8) The copper and brass parts should fit well before soldering, and good low-loss soldering helps.

9) Several diode types were tried to get the best harmonic output without idling circuits. The best out-

put came from selecting diodes of the 1N914 type. Idling circuits were not used, to simplify tracking when changing frequency.

The parts of the cavity were cut to size and assembled loosely to position, and file notches were made to locate the assembly positions while soldering. Pre-tin the mating surfaces to help the solder flow. The threaded cable bushings for the BNC connector are first inserted from the inside of the cavity wall, as seen in Photo D. The output connection wire is insulated with a piece of coax center insulator cut to length and inserted before final assembly.

The brass tubing is not hard enough to make contact fingers, but a contact improvement can be made to more sharply define the tuning. In order to do this, slightly compress each end of the coax support bushing by rotating against a flat or in the jaws of long-nose pliers. This cold-working tends to make a tight fit on the sliding center coax conductor. Wear life is limited, but it gives some improvement in output.

Detector

Several types of diodes were compared for best sensitivity, including 1N914, microwave 1N21, and TV-mixer diodes. The

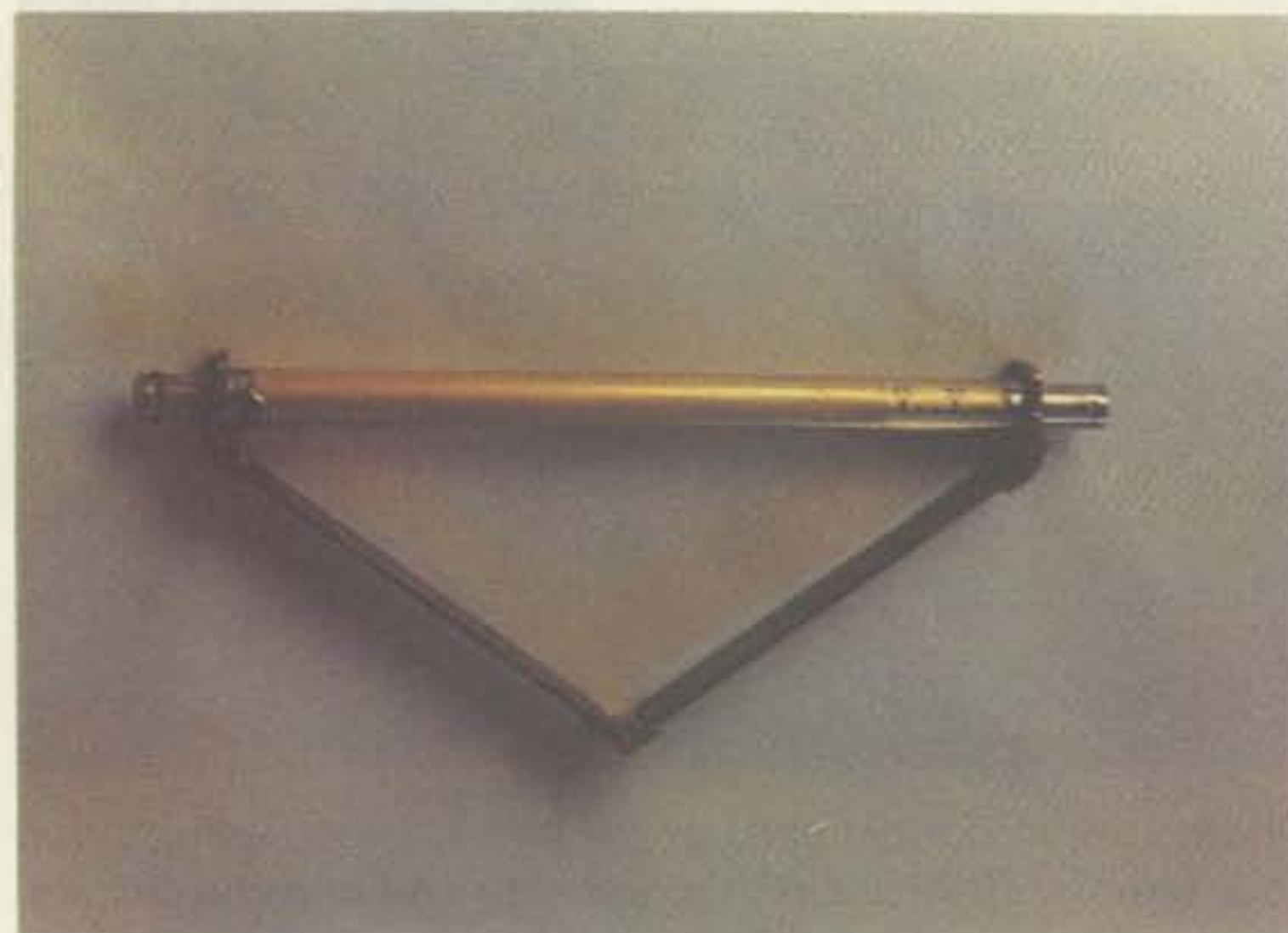

Photo F. Harmonic generator assembled.



Photo G. Attenuator assembled.

best sensitivity was obtained from hot carrier diodes with a small amount of forward dc bias. These diodes developed as much as ten times the rectified af signal of the other types. Both Motorola HEP R0700 and Hewlett Packard 5082-2835 types worked equally well. Since then, Radio Shack has the 5082-2835 type as their part number 276-1124. A forward bias of about 0.25 volts works best, and the maximum forward voltage is 0.340 volts. The output without bias is very poor. Note also that these diodes are very sensitive to damage by electrostatic discharge.

The circuit is shown in Fig. 5. A small mercury watch battery is used in a voltage divider to develop the bias. The current drain is low, and the battery is not switched. The diode must have a dc return connection through the input circuit.

The detector assembly was built into a small mount with BNC connectors salvaged from a scope probe—see Photo E. The battery was mounted within a clearance hole drilled in the PC board, and bridging wires were soldered on either side of the PC board about 90° apart to make contact and to retain the battery. This can be seen in the photo.

The output level of the detector depends on the modulation used. With amplitude modulation on the generator, the rectified signal can be seen on an oscilloscope or detected with an audio amplifier and

speaker. The scope response needs only to be sensitive to the audio frequency used, but it should be high impedance. In this way, 5 to 10 millivolts of modulated signal is easily read at the 4th or 5th harmonic, whereas it is extremely difficult to detect an unmodulated signal above the second harmonic.

In use, the harmonic generator is adjusted for the output frequency desired with AM, and then the desired modulation is used.

Attenuator

The attenuator is a waveguide-beyond-cutoff type.² A coupling loop lying on a diameter of a circular waveguide propagates a wave which the guide cannot support and, therefore, it is attenuated. A similar coupling loop at some distance down the waveguide picks up the energy. If the waveguide diameter is small compared to the wavelength, the relative attenuation is proportional to the separation of the loops. It is relative because of the difficulty in setting a "zero" in the vicinity of the loops. The loops must lie in the same plane and, to avoid reflections, must be terminated in the line-characteristic impedance.

For a circular waveguide, the cutoff wavelength of the lowest mode propagated is 1.71 times the diameter. For 4.2 GHz, this would be a diameter of 12.2 cm (4.8"). Therefore, an attenuator with a diameter of about one centimeter satisfies this condition. The attenuation is 31.9 dB per

diameter² under this condition, provided the coupling loops stay in the same plane and no harmonics are transmitted. The closed harmonic for this size pipe is about 17 GHz.

Because of the end effects, the closest coupling should be about one diameter, which sets the 0-dB point at about 30 dB below the input.

The ratio of tubing diameters should be 2.31 times for 50-Ohm impedance and 3.49 times for 75 Ohms. Using tubing with an i.d. of 0.466", the 50-Ohm center conductor should be 0.188", and, for 75 Ohms, 0.124".

The tubing parts are cut to the dimensions shown in Fig. 6. Cutting is easy if a ring is filed around the tubing and the section snapped off. Small model maker's files are excellent for this. The metal film load resistors have one lead cut off, and the end is scraped so that it can be tinned and then soldered to the center conductor. The larger tubing is then soldered to the BNC fitting flange, and the ground end of the resistor soldered.

The "hot" end of the sliding tubing is expanded slightly to provide some friction-fit to the inner diameter of the barrel, as was done with the coaxial cavity parts. Small brass hinges are used to make a large hinge, preventing relative rotation of the two

ends of the attenuator, as shown in Fig. 6. A relative attenuation scale is marked on the inner barrel, with the zero at about one diameter. The major marks for 30-dB intervals are separated by 0.438" (1.11 cm), and the 10-dB marks by 3.7 mm. The scale was scribed on the brass and the marks inked in.

The hinges can be omitted if the attenuator ends can be kept flat.

Conclusion

An inexpensive low-power generator has been described for the UHF and low microwaves. This generator has capability for beginning the TV and FM signal requirement at these frequencies. The component parts are modular, easy to operate, and may be used in other applications or with other pieces of equipment. The harmonic generator can operate as a wavemeter, and the attenuator will work at lower frequencies. The shielding is effective in limiting stray signal radiation. Some design parameters have been given, which may be applied to other similar equipment for these frequencies. ■

References

1. *Reference Data For Radio Engineers*, 4th edition, ITT Corp., New York, 1956.
2. *Microwave Mixers*, MIT Radiation Laboratory Series, Vol. 16., McGraw-Hill, 1948.

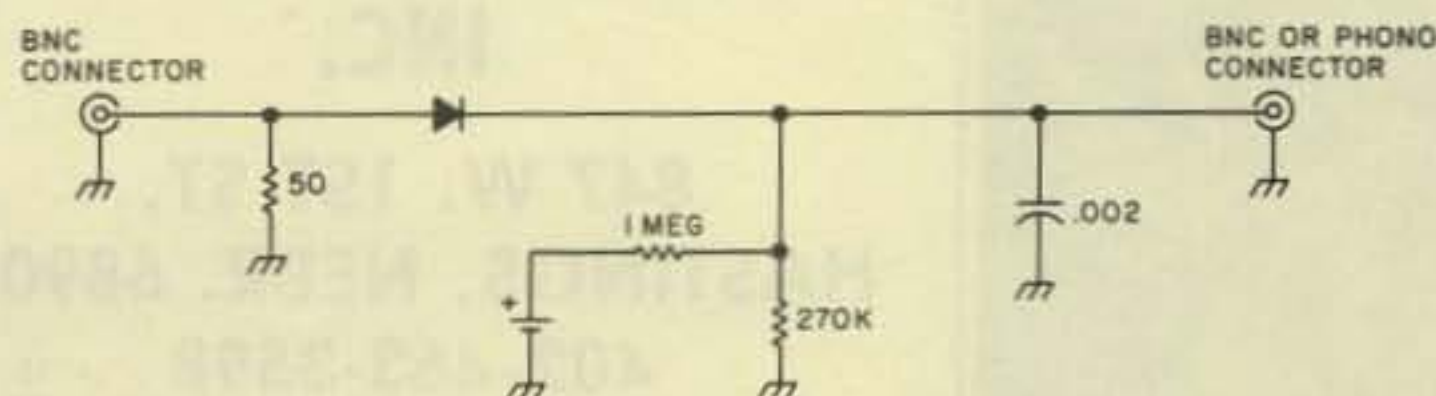

Fig. 5. The detector circuit used to set the frequency of the harmonic generator.

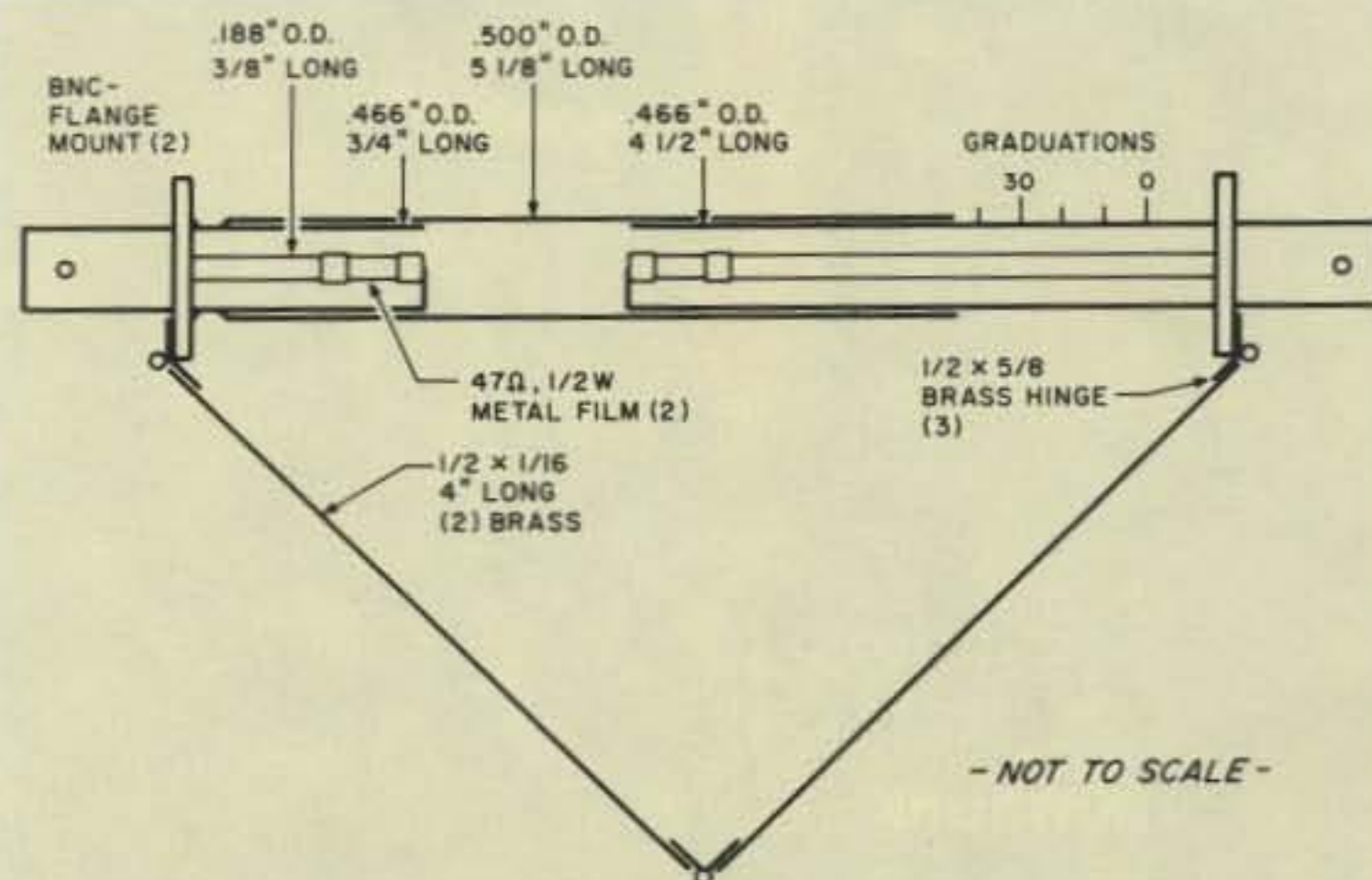
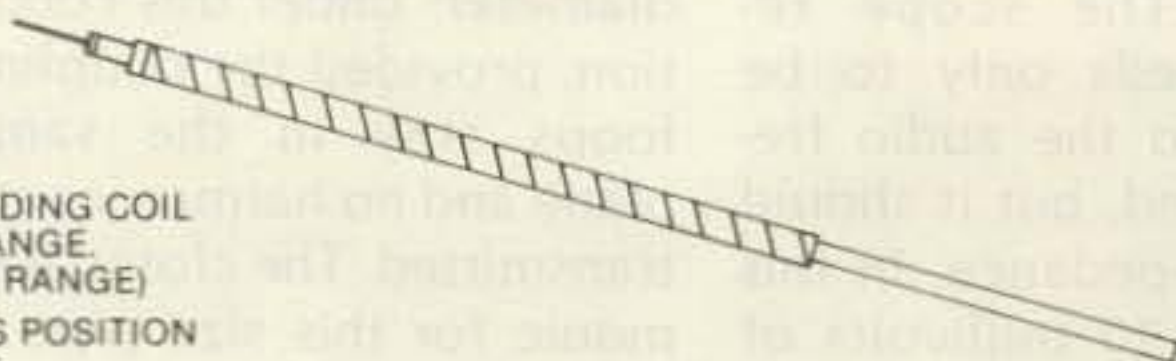

Fig. 6. Attenuator assembly shown in cross section.

ANTECK, INC.

STAINLESS STEEL WHIP—FIBERGLASS LOADING COIL
 — PATENT APPLIED. NO COILS TO CHANGE.
 — LESS THAN 1.5 VSWR (ENTIRE TUNING RANGE)
 TUNE 3.2 TO 30 MHz FROM THE OPERATORS POSITION
 — FAST AND SLOW SCAN RATES



The Model MT-1RT mobile antenna tunes 3.2 to 30 MHz inclusive. 750 watts CW, 1500 watts PEP for hams, military, MARS, CAP, and commercial service. Center loaded for high efficiency. Enables tuning to exact resonance to wanted frequency. Allows full output from solid state finals. No worry about reduced output from shut down circuits. Output is unaffected by moisture and the elements. Tuned by a control box at the operator's position. Mast section contains a double action hydraulic cylinder driven by two miniature hydraulic pumps and 12 volt DC motors for positive control. No creeping during operation or mobile motion. Can be removed up to 500 ft. from antenna.

MT-1RT amateur net \$240.00
 MT-1RTR (retro kit for all MT-1's) \$118.00
 MT-1 amateur net 129.95
 MT-1A (marine) stainless steel \$179.95

9.00 UPS shipping in U.S.
 7.00 UPS in U.S.
 7.00 UPS in U.S.
 7.00 UPS in U.S.



✓356

Route 1, Box 415

ANTECK, INC. Hansen, Idaho 83334 208-423-4100

THE FUTURE OF TELEVISION IS TODAY WITH DOWNLINK.

Why wait until 1985 just to get three channels of satellite reception when Downlink's D-2X receiver can give you sixty channels of brilliantly clear unedited movies, sporting events, world news and special programming from the many satellites over the North American continent... Now The D-2X's modular format and state-of-the-art circuitry allow for sharp, colorful reception of the entire satellite bandwidth (from 3.7-4.2 GHz). So you can get all sixty channels *plus* the new channels that will be available in the future.

Made from the finest microwave components, the Downlink D-2X receiver features dual-conversion design, permitting multiple receiver installations and phase-lock loop processing which brings living color to your TV.

The complete and easy-to-install Downlink System including the D-2X receiver, low-noise amplifier, Skyview I antenna and cable can be yours for \$3,595.00. So live the future of television now... with Downlink.

For the name of the Downlink dealer nearest you call toll-free 800-641-4645, ext. 214. In Missouri, call 800-492-4892.



For more information, contact:
 Downlink, Inc.
 30 Park Street
 Putnam, Connecticut 06260
 (203) 928-7731

ANYBODY CAN SELL TVRO EQUIPMENT

But Only Our Dealers can sell the right equipment for the right price.

Dealer Single Lot

\$1395⁰⁰ FOB Hastings

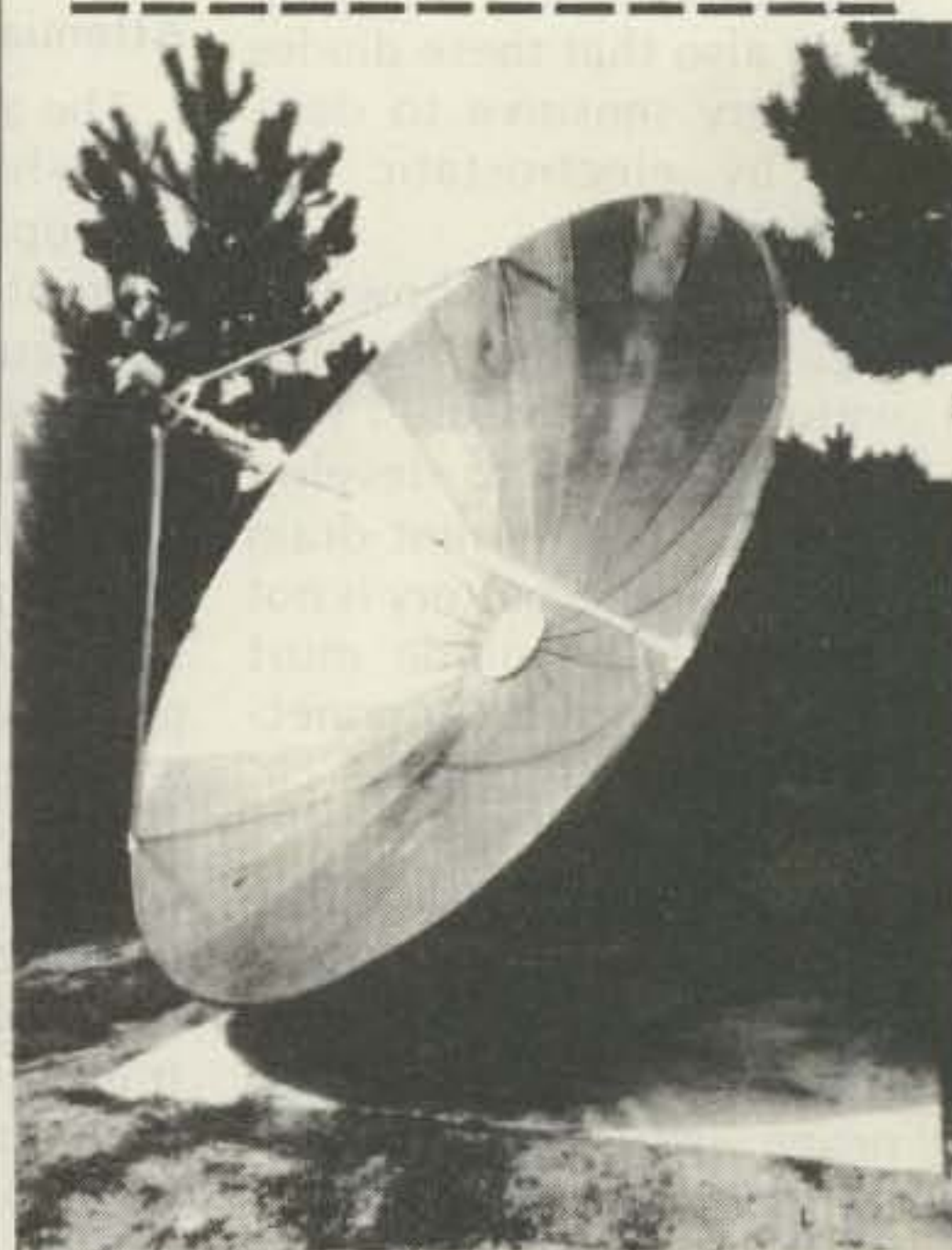

- 12 Ft.
- F/D .375
- Aluminum 24 Section
- Offset Polar mount
- Scaler Horn
- Rotor
- Rotor LNA Mounts
- 41 DB Gain Nominal

COMPLETE SYSTEMS AVAILABLE

**HASTINGS
 ANTENNA
 COMPANY,
 INC.**

847 W. 1ST ST.
 HASTINGS, NEBR. 68901
 402-463-3598 ✓18

FOR THE SERIOUS DEALER ONLY

Alaska Microwave Labs

4335 EAST FIFTH STREET ANCHORAGE
ALASKA 99504 (907) 338-0340 DEPT 73

| | |
|---|---|
| 1/2 WATT 50 ohm Chip Resistors \$1.50 Chip Capacitors 60¢ | GAAS FETS MGF 1400 \$19.00 MGF 1412 \$14.00 MGF 1200 \$14.00 NEW! |
| TRANSISTORS MRF 901 \$3.00 MRF 911 \$4.00 BFR 90 \$3.00 BFR 91 \$3.50 NEC 02157 \$3.25 NEC 02155 \$5.00 NEC 04535 \$10.00 | CAPACITORS 500pf \$0.1 1000pf \$0.1 100pf \$0.1 1000pf \$0.1 |
| IC'S MWA-110 \$8.25 MWA-120 \$8.70 MWA-130 \$9.20 MWA-320 \$10.00 NEC MC 5421 \$13.30 NE 569 PTL \$7.65 NE 542 \$1.75 MC 1358 (A3065) 2.50 | COAX CONNECTORS BNC PLUGS \$1.95 BNC PLUGS \$1.95 SMA PLUGS \$4.10 SMA PLUGS \$8.50 SMA PLUGS \$6.75 SMA PLUGS \$6.75 SMA PLUGS \$6.75 SMA PLUGS \$3.98 Type 'N' \$3.25 Type 'N' \$3.25 Type 'N' \$2.25 |
| FERRITE ISOLATORS \$1.25 NEW! | DUAL GATE MOSFET RCA 40675 \$150 |
| RF CABLE 141" Semi-Rigid \$400 | SILVER PLATING NEW! |
| HOT CARRIER DIODES MFD 101 \$4.50 ND 4131 \$21.00 HN-1 \$2.00 | MIXERS 37-42GHz \$35.00 9-13 GHz \$85.00 |
| PISTON TRIMMERS TRINO (20K OHM) \$2.50 | VTO'S V72-T1 \$98.00 V82-T2 \$98.00 |

OPEN AT 8PM EST CLOSED 8PM PST
ORDERS ARE POSTAGE PAID
COD-VISA-MASTERCARD
IF YOU DO NOT SEE
WHAT YOU WANT ASK
406

The Vanguard

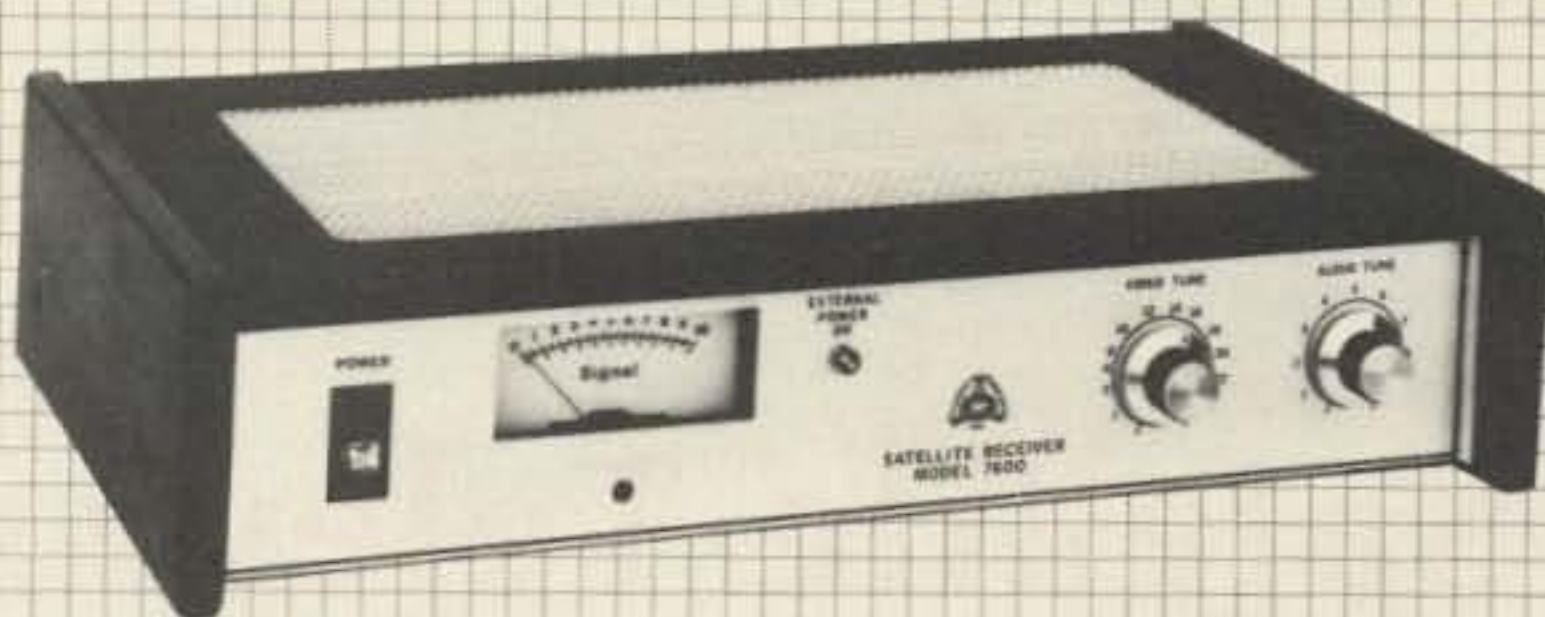

Introducing the Model 7600 Satellite Receiver. New from Gillaspie and Associates. Proof positive of a new generation in satellite receiver technology; the successful integration of the most sought after high performance characteristics and ease of operation capabilities. Attractively packaged. Affordably priced.

See it today and experience the difference performance makes.

- FULL FREQUENCY tunable audio
- Reception 3700 to 4200 MHz
- Built-in video modulator
- Simplified channel tuning
- Improved video sensitivity
- All wood walnut cabinet

The Model 7600 Satellite Receiver System Package comes with its antenna mounted Image Reject Mixer (Down Converter), 100' of RG59-U cable and 100' of Belden DC cable with connectors installed.

Gillaspie & Associates

950 Benicia Ave., Sunnyvale, CA 94086 (408) 730-2500 ✓37

GET THE LAST WORD FIRST!
SEE YOUR GILLASPIE & ASSOCIATES DEALER TODAY!

SATELLITE TV SYSTEMS

"COMPARE OUR QUALITY, PRICES AND SERVICE!"

WE MANUFACTURE:

PARABOLIC DISHES MOTORIZATION SYSTEMS
POLAR MOUNTS LNA HOLDERS
DEMO TRAILERS ALUMINUM HORNS

WE STOCK

W, KL, AV, GZ, ALLIANCE, ATV, CABLE & CONNECTORS, SWITCHES & HARDWARE

CALL, WRITE OR ✓ FOR OUR LATEST BROCHURE AND PRICES.

AUSTIN C. LEWIS LEWIS CONSTRUCTION CO. ✓457
K4GGC P.O. BOX 100
901-784-2191 HUMBOLDT, TN. 38343

"IN BUSINESS AT THIS LOCATION SINCE 1964"

SATURN V

STATE-OF-THE-ART

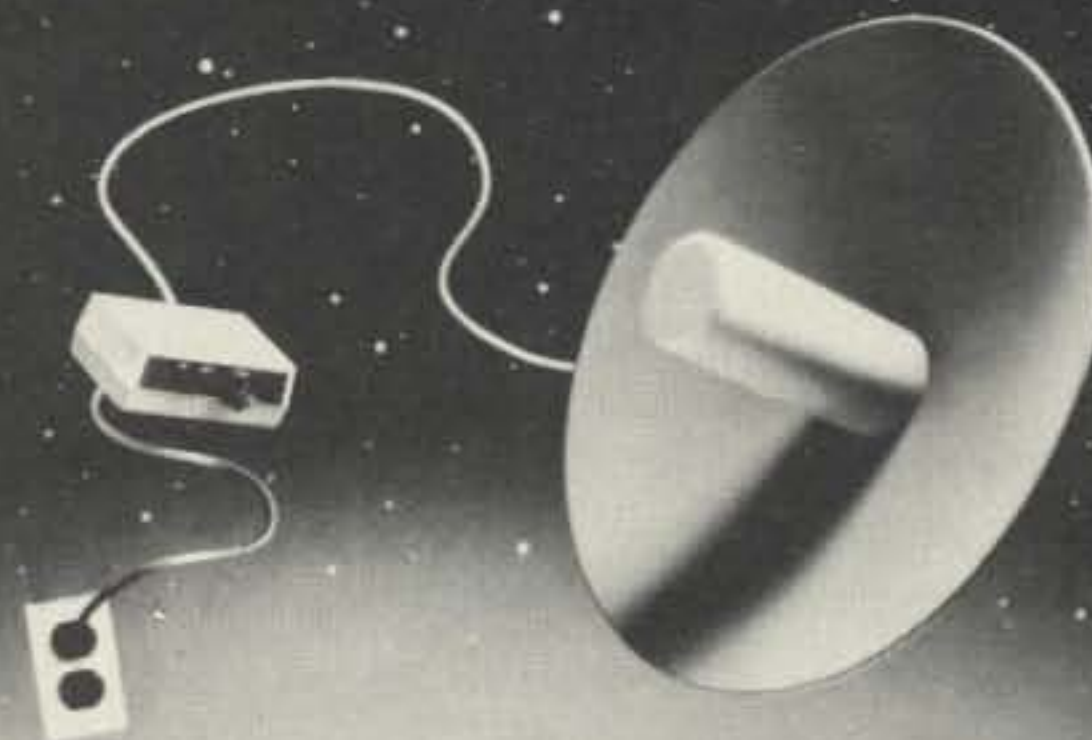

Quantity discount price structures available upon request for dealers. Dealerships, both domestic and foreign available in many areas. For further information, please contact John Michaels, Sales Manager. Telephone hours: Monday thru Thursday, 10-4.

hi-gain

ELECTRONICS

4558 Auburn Blvd., Sacramento, CA 95841
(916) 452-0193

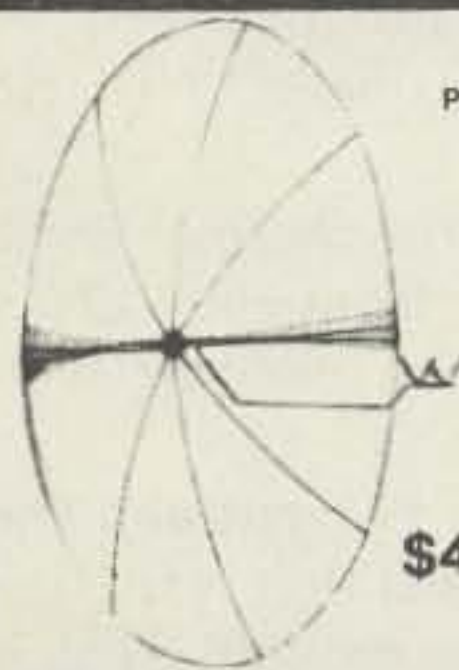

KD-44™
Parabolic Reflector Kit
900MHz - 2.5GHz

25db

A low cost, high quality alternative to snow sleds and yagis. 44" diameter, 2 piece durable lightweight steel const. Includes feedhorn bracket, pre-cut hardware cloth and all hardware needed for assembly. Excellent for weather satellite and 1296 MHz experimenters!

\$49.95

Our kit also comes in a 2ft size with 19db gain - ONLY \$24.50
Send 50¢ for product brochure for information on other kits or use reader service card.

Terms
Check
Money Order
C.O.D.
Bank Cards
S&H COD



TEXAS MICROTRONICS
P.O. BOX 14116
ARLINGTON, TEXAS 76013

817-860-5440



Satellite Television Glossary

— part II

Editor's Note: Reprinted with permission of Reed Publications. This glossary is part of the 86-page *Satellite Television Handbook*, available for \$7.95 (add \$2.00 for 1st class) from Global TV, PO Box 219-H, Maitland FL 32751. Part I of this glossary appeared in the December, 1981, issue of *73 Magazine*.

Margin. A 3-dB increase over the FM threshold, in a TVRO system, of the C/N which will provide an output signal completely free of impulse noise (sparklies). The FCC set this figure when CATV Earth stations were more strictly regulated.

MATV (Master Antenna Television). High-quality UHF and VHF antennas centrally located can provide TV programs for an entire apartment complex, condominium, or townhouse development. These signal distribution systems differ from CATV installations chiefly in size and degree of profit.

MDS (Multipoint Distribution System). This works like a cable system without the cable; a central microwave transmitter at 2 GHz is used to distribute one or two channels of pay TV to subscribers who have roof-mounted dishes and downconverters. The power of the transmitter is so great that the entire receiver is much less expensive than a TVRO. The MDS systems are regional, mostly in the southwest USA.

MHz (Megahertz). The standard abbreviation for millions of cycles per second. Henri Hertz was a famous scientist who pioneered wireless communications.

Microprocessor. A stored-program computer on a chip which can replace ordinary circuit parts and add functions to some manufacturers' receivers.

Microstrip. An improvement of an earlier microwave assembly technique called stripline. Double-sided microwave PC boards have etched upon them transmission lines and inductors. Capacitors and active devices may be soldered on as well.

Mixer. That part of a downconverter which joins together an input signal with that of an LO (local oscillator) to create an output signal which has a frequency that is the numerical difference between the two input frequencies. The program material in the FM carrier is not affected by the mixing process to a lower frequency.

MPAA (Motion Picture Association of America). A Hollywood trade organization which represents the film industry, assigning movie ratings and controlling movie distribution to some extent.

MTBF (Mean Time Between Failures). This is the average elapsed time before samples of a manufacturer's product fail. It is a measure of the reliability of the part.

MTTR (Mean Time To Repair). This is the average down time for a broken part. It measures the ease of repair and is used when considering the possible consequences of the part failing.

Multistage LNA. Three or more transistor amplifier stages are placed end to end (cascaded) so that the gain contribution of each one will add up to approximately 50 dB. In most LNAs the first stage, closest to the antenna feed probe, has the best noise characteristics to minimize the noise propagated along through the remaining stages.

N Connectors. Coaxial cable fittings which interface cables between the LNA and satellite TV receiver. They carry 4-GHz signals at 50 Ohms impedance with low loss.

NAB (National Association of Broadcasters). A trade organization of network affiliate VHF/UHF broadcasters.

NF (Noise Factor). This measures the thermal noise contribution of LNAs and receiver front ends. LNAs typically measure 1.5 dB (120° K) and receivers average 11-15 dB.

NTSC (National Television System Committee). The method of forming a color TV signal that is used in the western hemisphere with few exceptions. NTSC is also the Japanese standard. It has 525 lines per frame and 60 fields per second.

Octave. A measure of frequencies which differ by a factor of two in wavelength.

Orthomode Coupler. A section of waveguide such that two LNAs can be attached at right angles and simultaneously receive both horizontal linear and vertical linear polarized satellite TV programs.

Orthogonal Mode Coupler (or Transducer). See *Orthomode Coupler, above.*

P-P. Peak-to-Peak measurement of a waveform's amplitude as opposed to rms (root mean square), which is otherwise implied.

Packaging. This is the boxing of various circuit parts in a module. Typical ICs are packaged in DIPs (Dual Inline Package) with two rows of pins to fit sockets on the PC board.

PAL (Phase Alternation System). A European color TV system featuring 625 lines per frame and 50 fields per second. Generally this method gives higher resolution TV pictures than the American NTSC (525-line) color system. No PAL is broadcast from American or Canadian satellites but it may be found on INTELSATs.

Parabolic Dish. This antenna shape is commonly used to focus all the microwave energy collected on the dish surface into a single point in front of the dish called the focal point. It can be built from metal sheets, fiberglass, mesh, or wood covered with a metal reflecting surface which is accurate, with respect to a perfect parabola, to within 0.1 inch.

Passive Elements. Electrical components which do not include transistors and cannot amplify the signal. Examples are capacitors, resistors, diodes, inductors, most mixers, and transmission lines.

Path Loss. The loss incurred in a satellite TV signal from the transmitter to the receiver, while in space. Path loss can be measured on either the uplink or downlink path.

Parametric Amplifier. A complex form of LNA which depends upon a high-frequency source (Gunn-effect pump) rather than a dc source to amplify the weak input signal. It works like a MASER. The input signal modulates an electron beam and the pump amplifies it while it travels to the output coupler. These can be cryo-cooled to yield ultra low noise temperatures down to 20° K. Parametric LNAs are much more expensive than GaAsFET LNAs.

PC (Printed Circuit). An easily-made dielectric board on which nearly all the conductors and interconnections are laid out on the surface in thin copper strips and the assembly of the finished products is reduced to soldering on the parts. The wiring step is greatly reduced.

Phase. A relative position of an oscillating signal in full circle coordinates. 0 degrees is just starting, 90 degrees is one-quarter of the way through, 360 degrees is back to the starting point. Two signals are in phase if the phase difference is zero and the peaks and valleys match.

Phased Array. A technique of improving the gain of an antenna system by combining the outputs of several similar VHF/UHF/FM antennas in an array taking care that the output signals from each one are exactly in phase with one another.

PLL (Phase-Locked Loop). One form of FM demodula-

tor which employs a feedback loop to lock a local oscillator to the same frequency and phase as the input signal. The error corrections applied back to the LO are equal to the original program signal that modulated the carrier and are passed through the circuit as the output.

Polar Mount. An antenna mounting and aiming system in which one pivot is positioned one time only and the other pivot (hour axis) is positioned to sweep the satellite arc. Some fine adjustments may be required on the first pivot (declination axis) but this mount is much easier to aim than the azimuth-elevation mount.

Polarization. In order to increase the capacity of TV satellites, transponder frequencies overlap but alternate between vertical linear and horizontal linear polarization. The dish feed and satellite feed polarizations must match or the signal will be lost. Feeds on dishes rotate 90 degrees in many designs or an orthomode coupler allows two LNAs to get both polarizations simultaneously. INTELSAT uses right-hand circular or left-hand circular polarization. Use a hybrid mode feed to receive them.

Port. A physical signal interface. This can be a waveguide flange or connector.

Potted. A form of electronics packaging in which the part is immobilized in plastic.

Power Amplifier. An active device which features a high-level signal output as opposed to an ultra low noise figure. *For comparison see Preamplifier below.*

Power Divider. A passive device similar to a signal distribution splitter but used at 4 GHz to split an LNA's signal for up to 12 separate channels (either all vertical or horizontal). A full-channel CATV or MATV system would require two LNAs and two power dividers to drive 24 separate receivers.

Preamplifier. A class of active devices in which LNAs are included and that feature low noise performance as opposed to high-level signal output. They amplify (strengthen) the signal before it reaches the relatively noisy receiver front end.

Pre-emphasis. A selective amplification of the high frequency end of a satellite TV channel prior to uplink transmission to overcome potential noise problems. Each satellite TV receiver reverses the transformation in its de-emphasis circuits.

Prime Focus Antenna. A parabolic dish antenna in which the LNA is located out in front of the dish at its focal point. This type of feed design is generally the least expensive.

Private Terminal. A TVRO which is not associated with CATV but is for the benefit of a private individual viewer.

Probe. The driven element in a microwave dish antenna system. It is located in the feed and converts rf energy in the waveguide to a signal on a transmission line to the LNA.

Program Control Tones. Telephone-style audio tones preceding and following many satellite TV programs which control automatic program selection equipment used by CATV.

PWM (Pulse Width Modulation). A method used in

USSR TV satellites to encode the audio signal between the video lines of the composite TV picture.

Quieting Curve. A graph of the signal-to-noise ratio (S/N) versus the carrier-to-noise ratio (C/N) for a particular satellite TV receiver. Generally for C/N above 8 dB, $S/N = C/N + 38$. The point on the curve below 8 dB C/N where S/N rapidly falls off is the FM threshold.

Registered TVRO. The FCC accepts registered Earth stations so that it can be protected from possible terrestrial interference. Frequency coordination must be performed as part of the registration procedure.

Regulated Power Supply. A dc power supply which is designed to prevent minor fluctuations in line voltage from propagating into the dc output.

Resolution. A measure of detail reproduction in a TV picture which improves with increasing S/N. It is also a function of the number of scanning lines in a frame. The European color system (PAL, SECAM) has 625 lines and better resolution than the American (NTSC) 525-line system.

RFI (Radio Frequency Interference). Any electrical spurious signals in the i-f range causing static and noise in a receiver. RFI can also be caused by improperly shielded components within a receiver.

RMS (Root Mean Square). A method of measuring the average power or voltage in a sine-wave signal. See *P-P for comparison*.

Rotor Systems. A method of rotating an LNA feed 90 degrees to switch between vertical and horizontal polarizations. Many times an antenna rotor can be used with remote control from indoors.

S/N (Signal-to-Noise Ratio). A TVRO measure of picture quality expressed in dB. Broadcast studios try to put out signals above 50 dB S/N, CATV supplies 45-50 dB S/N, and typical VTRs have an S/N of 45 dB. Watchable pictures go down as far as 40 dB S/N. One or two dB above the C/N FM threshold of a satellite TV receiver will put a TVRO into the 45-dB S/N range for fine pictures.

SATCOM F1. American TV satellite operated by RCA to supply most of cable TV programming on 24 transponders (12 are vertical and the other 12 are horizontally polarized). Also referred to as just F1, it is located at 135 degrees west longitude.

SATCOM F2. American TV satellite operated by RCA to supply assorted video and data programming to Alaska and other points in the USA. Like its sister, F1, it has 24 transponders. It is located at 119 degrees west longitude and can be also referred to as just F2.

Saturated Transponder. A satellite TV transponder which is operating at full power. They do not have agc circuits, so the output transponder power is proportional to the received signal from the Earth. Sometimes the uplink signal is backed off so that the transponder will have a longer useful life. In that case, EIRP levels on the Earth will also be proportionally lower.

Schottky Diodes. High-frequency solid-state rectifiers used to build microwave mixers.

SCPC (Single Channel Per Carrier). One stream of data or programming on a satellite communications carrier as opposed to multiplexing many voice or

data subchannels within a given carrier frequency. Mostly used for voice (telephone), many separate carriers having different frequencies can fit into a 36-MHz-wide satellite transponder.

Scrambling. Techniques to encipher a TV signal to prevent unauthorized reception without a descrambler device. Typically this is done by coding the sync information of the video signal. None of satellite TV for CATV use is scrambled.

SECAM (Sequential With Memory). A French color TV system with 625 lines per frame and 50 fields per second. It is also used in the USSR.

Sensitivity. This performance parameter measures the input signal required to produce an adequate picture from a satellite TV receiver.

Shielding. The design process in which electronic components are protected by sheet metal or other conductors from spurious signals. Coaxial cables are shielded by the outer conductor, which is grounded.

Shrouding. Protective walls or screens around a dish antenna which stops side interference. It is not needed at most Earth-station sites.

Sidelobes. Areas from which noise can leak into a dish antenna from the side. Sidelobe performance is the ability of a given dish to reject these in favor of the satellite signal.

Signal Combiner. This is the reverse of a signal splitter. It allows several TV signals on different channels to be merged onto a single broadband transmission line. Many times this device can be substituted for by a signal splitter connected in the reverse direction.

Signal Distribution System. A network of signal amplifiers, splitters, and cables bringing satellite and off-the-air TV to a number of separate TV sets. Usually all the parts are 75-Ohm devices with baluns to convert to a TV set's 300-Ohm antenna terminals.

Signal Splitter. This is a passive device which enables two or more TV sets to divide a TV signal between them with proper balancing and isolation. It can be supplied in either 75- or 300-Ohm impedances.

Signal Trap. A passive device which filters out a selected channel. This can be used to control the distribution of a premium (pay-TV) channel or to remove a source of interference.

Single Conversion. This technique uses just a single local oscillator and mixer to convert a satellite TV signal from 3.7-4.2 GHz down to the final i-f (usually 70 Hz). Lower parts count and ease of assembly are important advantages over double conversion but care must be taken to prevent noise on the image frequency from leaking into the output.

Sky Noise. Background microwave radiation coming from deep space which can be a noise source for dish antennas. Sky noise provides a lower boundary for the possible noise temperature of any dish antenna and is approximately 16-20° K.

SMA Connectors. Miniature fittings to conduct signals between parts of a downconverter using small circular waveguide.

Snow. Dot-type TV interference associated with weak signals in UHF/VHF TV pictures. See also *Sparklies*.

SNR. See *S/N*.

Solar Interference (Outage). Twice each year, the sun's path will position it behind the TV satellites in a direct line of sight with TVROs. Care must be taken to prevent concentrated heat from cooking the delicate LNA at this time if a prime focus antenna is used in a TVRO.

Space Attenuation. The loss in a TV satellite signal due to the fact that the beam spreads out after leaving the antenna. This is a major factor in path loss.

Sparklies. Weak signal noise which appears as a dot or streak interference in a satellite TV picture. Loss of lock in an FM video demodulator causes this, and in extreme cases tearing or loss of the picture will result.

Spherical Antenna. This is an alternate form of dish antenna, easy for the layman to construct and having a circular cross-section instead of a parabolic one. Another feature is the ability to employ multiple feedhorns in front of the dish to receive signals from up to 10 TV satellites at once within a 40 degree orbital arc. Its design was invented by Oliver Swan.

Spot Beam. An antenna downlink pattern which provides a continent-sized footprint for an INTELSAT satellite. Generally the term describes any narrow satellite beam confined to a specific relatively small area.

SPTS (Satellite Private Terminal Seminar). An industry educational and trade show conducted three times a year in various locations by Robert "Coop" Cooper.

Stability. The ability of a tuning circuit to avoid drift that most often is caused by ambient (surrounding) temperature changes. Lack of stability is the main reason that AFC circuits are used in satellite TV receivers. Crystal control provides the best stability. The term is also used to describe the ability of an amplifier to resist feedback of the output signal around to the input side. Home-built LNAs may become unstable and begin oscillating if leakage is not prevented.

Sweep Generator. A test-equipment device which creates a signal evenly over a range of frequencies. They are used to align frequency-sensitive components such as filters.

Sync Pulse. Sync is an abbreviation for synchronization. Horizontal and vertical oscillators lock on these spikes in a TV set. It is part of the video picture information in the composite TV signal.

Tearing. A form of weak signal interference which causes ragged streaks on the TV picture in vertical lines joining light to dark transitions. If this occurs in a satellite TV picture it is a good indication that the receiver is operating well below FM threshold.

Termination. A connector or passive device at the end of a signal transmission line. This is like an end cap to maintain the impedance of the line.

Terrestrial Microwave. Communications links on the ground using microwaves. One of the allowed ground frequencies is the same as the band allocated to TV satellites, and frequency coordination is needed by commercial TVROs to resolve conflicts.

Test Equipment. Auxiliary electronic signal generating and measuring devices used to tune and troubleshoot electronics equipment, including LNAs and satellite TV receivers. Some of these are: sweep generators, signal generators and markers, frequency counters, volt-ohmmeters, and oscilloscopes.

Test Pattern. This color bar pattern helps satellite TV technicians properly maintain uplink and downlink equipment. It seldom appears on VHF/UHF TV, but on TV satellites it occurs when a transponder is unused.

Threshold Extension. A circuit technique, sometimes located in the loop filter of a phase-locked loop demodulator, which improves the low signal performance of a receiver by lowering the FM threshold by 3 dB C/N.

Tilt Attenuator. A form of signal attenuator which compensates for the fact that high frequency signals lose more strength than low frequencies over a given run of transmission line. One of these is inserted into a signal distribution system just before a trunk-line amplifier.

Translator. A TV repeater which operates on UHF channels 70 to 83 (806-890 MHz). It retransmits ordinary broadcast TV to areas which cannot get direct reception.

Transients. Fluctuations in power supply voltages which can cause noise in a receiver and sometimes, if powerful enough, can damage delicate transistors in the LNA or receiver.

Transponder. Satellite hardware which implements a channel. It consists of a receiver 36 MHz wide in the 6-GHz uplink band and a broadcast transmitter 36 MHz wide on the 5-GHz downlink band. TV satellites have 12 or 24 transponders.

Turnkey. An equipment supplier who installs everything for the end user who only has to "open it with his key." This is the most expensive but most professional installation method.

TVRO (Television Receive-Only). Acronym for a satellite TV receiver (Earth station) consisting of dish antenna, LNA, and one or more receivers.

Tweaking. Tuning by hand to optimize performance of a circuit after assembly. Also called alignment.

Twinlead. A 300-Ohm transmission line to carry TV signals to the set. It is made in the shape of a flat ribbon, having lower losses than coaxial cable (coax) but being less resistant to rf interference.

TWT (Traveling Wave Tube). A high-power microwave amplifier on board TV satellites. Each transponder has one.

UHF (Ultra High Frequency). TV channels 14 through 83 (470-890 MHz), which are 6 MHz wide.

Ultra Low Noise LNA. See *Parametric Amplifiers*.

Uplink. The Earth station which transmits TV programs to the satellite for relay back to the ground. It is also the name for the communications path from the Earth to the satellite.

Vco (Voltage-Controlled Oscillator). A signal-generating component which provides an input to the downconverter and demodulator portions of a

satellite TV receiver. The oscillator's frequency is determined by an applied voltage.

VCR (Video Cassette Recorder). See VTR.

VHF (Very High Frequency). TV channels 2 through 13 in the following bands: channels 2-4 occupy 54 through 72 MHz, channels 5-6 occupy 76 through 88 MHz, and channels 7-13 occupy 174 through 216 MHz.

Video Monitor. A high-quality television screen lacking a tuning circuit which accepts video baseband inputs directly from a TV camera, VTR, or satellite TV receiver with no modulator required. They are not mass-produced and are ironically more expensive than TV sets of the same size.

Vswr (Voltage Standing Wave Ratio). A measure of the efficiency of a signal interface, especially the impedance match of the antenna to the LNA.

VTO (Voltage-Tuned Oscillator). Also called a Vco (see above).

VTR (Video Tape Recorder). A useful adjunct to a satellite TV system.

ITU (International Telecommunications Union). Deals with timely issues such as frequency band allocations worldwide.

Waveguide. A microwave conductor shaped in the form of a rectangular tube to prevent signal loss. Size WR229 is used for 3.7-4.2-GHz satellite TV signals. It can be pressurized to remove ambient moisture and further increase its performance.

West Coast Feed. Satellite TV programming time shifted and broadcast primarily for the benefit of west coast viewers. If one misses a favorite movie on the east coast feed, he can watch it four hours later on the west coast transponder.

WESTAR I. American TV satellite operated by Western Union. It has only 12 transponders and is located at 99 degrees west longitude.

WESTAR II. American TV satellite in the WESTAR series located at 123.5 degrees west longitude. It also has just 12 transponders.

WESTAR III. American 12-transponder TV satellite in the WESTAR series which is located at 91 degrees west longitude.

Wind Loading. The force upon a satellite TV dish and supports caused by air pressure. Generally, a dish should be able to withstand 120 mph (193km/h) and be able to sustain a 40-mph wind without damaging the picture. ■

HAM HELP

I need instruction manuals and schematics for a Singer/Gertsch frequency meter (model FM-6) and a Hickok model 670 oscilloscope. I will promptly reimburse with thanks for loan to copy or copying costs.

Leslie W. Bruce W0OX
335 S. 40th Street
Boulder CO 80303

I am in need of a schematic for a Sideband Engineers model SB-450 transceiver. I will be glad to pay duplicating and mailing costs, or I will duplicate on receipt and send back by mail.

Alex Haynes
2703 Hambleton Rd.
Annapolis MD 21140
(301)-956-2302

I would like to obtain information from other radio amateurs on two-meter repeater locations in New England. I am in the process of compiling a listing of two-meter repeaters in New England showing exact locations (mountaintops, buildings, etc.). Other information such as auto-patch capabilities (access codes not necessary), RACES affiliation also are wanted. Glad to share information with anyone interested.

Ed Soomre N1BFF
1 Alcott Drive
Northboro MA 01532

I need a copy of the scanner circuit that was popular for the HW-202 in 1975. Mine has stopped working.

Gordon Lauder W9PVD
Rt. 2
Webster WI 54893

I am collecting club bulletins from all over the world. Who will send me a copy of his club bulletin? I'll send ours plus postage costs.

Marc Demoor ON1GR
Vredestraat 13
B-9720 De Pinte
Belgium

Satellite TV

FOR THE HOME

Sick of Network TV?

Our receiver lets you get over 75 channels of television directly from earth-orbiting cable TV satellites! HBO, Showtime, super stations, sports and movies worldwide.



We don't just sell information! We Manufacture Hardware!

From offshore oil rigs, data links to hotels and backyard installations, we wrote the book. Constantly updated, our 94 Page

technical information book and catalog gives you all the facts. Inexpensive dishes, feeds, telemetry software, kits and more. Recommended reading by NASA, The Office of Consumer Affairs and quality companies like Rockwell/Collins. Send \$7.95 today!

CALL 309
24-hrs. C.O.D. Hotline
(305) 339-7600



SPACECOAST
RESEARCH CORPORATION
P.O. Box 442-D, Altamonte Spgs, FL 32701

SATELLITE TV
RECEIVER KITS

FACTORY DIRECT

We have complete kits, individual boards, and components. Call or write for further information.

STAR TRAK ✓465
SYSTEMS, INC.

404 Arrawanna St.
Colorado Springs, CO 80909
(303) 475-7050

Robby W0SFR Jera N0AGT Dave W00CDU

LIVE VIA SATELLITE

\$399 COMPLETE RECEIVING SYSTEM

• DISH ANTENNA
MOD #2125
• PREAMPLIFIER
MOD #1201

• RECEIVER
MOD #3602 W05

JUST PUBLISHED: 8 1/2 X 11 BOOK gives a wealth of updated information on • Antennas • Receivers • Low Noise Amplifiers • Sources • Services • Equipment • Manufacturers • Much More.



UNDER \$300
DISH TVRO ANTENNA
FOR ROOF OR PORCH

Our book takes the mystery out of the sophisticated technology of satellite transmission and reception. This volume represents all the essential knowledge made easy to understand, and will show you how easy it is to have a 90 channel reception system so that you can enjoy: first run movies, foreign films, Las Vegas entertainment, live sports, and much more. Everything being telecast in the world could be yours at a twist of a knob!

LIVE VIA SATELLITE, INC.
P.O. Box 2561, Dept. M-1, Delray Beach, FL 33444
Send \$9.95 plus \$2.50 shipping & handling
or call our 24 hr. C.O.D. order line (305) 845-4447

Name _____
Address _____



Stuck with a problem?

Our TE-12P Encoder might be just the solution to pull you out of a sticky situation. Need a different CTCSS tone for each channel in a multi-channel Public Safety System? How about customer access to multiple repeater sites on the same channel? Or use it to generate any of the twelve tones for EMS use. Also, it can be used to access Amateur repeaters or just as a piece of versatile test equipment. Any of the CTCSS tones may be accessed with the TE-12PA, any of the audible frequencies with the TE-12PB. Just set a dip switch, no test equipment is required. As usual, we're a stickler for 1day delivery with a full 1 year warranty.

- Output level flat to within 1.5db over entire range selected.
- Immune to RF.
- Powered by 6-30vdc, unregulated at 8 ma.
- Low impedance, low distortion, adjustable sinewave output, 5v peak-to-peak.
- Instant start-up.

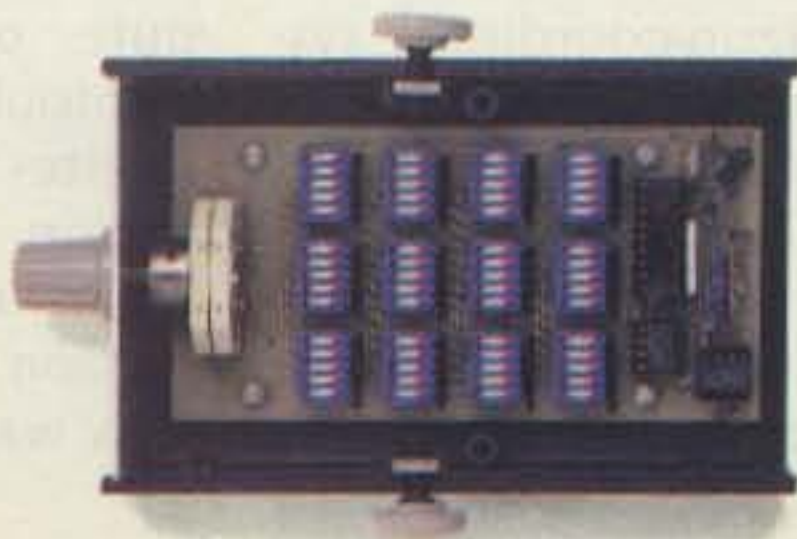

TE-12PA

| | | | | | |
|---------|----------|----------|----------|----------|----------|
| 67.0 XZ | 85.4 YA | 103.5 1A | 127.3 3A | 156.7 5A | 192.8 7A |
| 71.9 XA | 88.5 YB | 107.2 1B | 131.8 3B | 162.2 5B | 203.5 M1 |
| 74.4 WA | 91.5 ZZ | 110.9 2Z | 136.5 4Z | 167.9 6Z | |
| 77.0 XB | 94.8 ZA | 114.8 2A | 141.3 4A | 173.8 6A | |
| 79.7 SP | 97.4 ZB | 118.8 2B | 146.2 4B | 179.9 6B | |
| 82.5 YZ | 100.0 1Z | 123.0 3Z | 151.4 5Z | 186.2 7Z | |

- Frequency accuracy, ± 1 Hz maximum -40°C to $+85^{\circ}\text{C}$
- Frequencies to 250 Hz available on special order.
- Continuous tone

TE-12PB

| TEST-TONES: | TOUCH-TONES: | BURST TONES: |
|-------------|--------------|---------------------|
| 600 | 697 1209 | 1600 1850 2150 2400 |
| 1000 | 770 1336 | 1650 1900 2200 2450 |
| 1500 | 852 1477 | 1700 1950 2250 2500 |
| 2175 | 941 1633 | 1750 2000 2300 2550 |
| 2805 | | 1800 2100 2350 |

- Frequency accuracy, ± 1 Hz maximum -40°C to $+85^{\circ}\text{C}$
- Tone length approximately 300 ms. May be lengthened, shortened or eliminated by changing value of resistor

\$89.95

443

COMMUNICATIONS SPECIALISTS

426 West Taft Avenue, Orange, California 92667
(800) 854-0547/California: (714) 998-3021

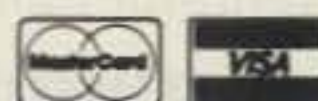

Going Bird Hunting?

— Satellite Central, part III

Stephen Gibson
PO Box 38386
Hollywood CA 90038

Aside from making your equipment work, finding the satellite may be your biggest problem. Typical dish-antenna beamwidths run less than 2 degrees, so you may end up scanning the skies for hours. You can cut the job

down to only a few minutes, however, if you know the location of the satellite relative to your particular location. Here's how to do it.

By now you know that most of the interesting TV satellites are located in geosynchronous orbit above the Earth's equator. The idea of equatorial satellites is not new. In fact, this ideal coverage spot was suggested nearly 37 years ago by

famed science-fiction writer, Arthur C. Clarke, who published an article in *Wireless World* called "Extra-Terrestrial Relays." Fancy that! It's taken some time for the idea to catch on. Bob Cooper W5KHT suggested that we name the belt after Clarke. Good idea.

Can we see Clarke-belt satellites as we did Sputnik? You'd have to really squint because they orbit the Earth nearly 22,300 miles out! To an observer here on Earth, the satellites in Fig. 1 appear to be standing still because they circle the Earth every 24 hours... and in the same direction. This makes tracking a piece of cake. Just point the dish and walk away, hoping a whiff of wind doesn't blow you off boresight!

Getting Our Bearings

To locate a satellite, we must use some frame of reference or coordinate system. While astronomers use the galactic, ecliptic, and equatorial systems, we can take the easy way and use the horizon-coordinate system because the satellites appear to us as static points in the sky. Horizon coordinates are simply azimuth and elevation. Think of elevation as being so many

vertical degrees up from your horizon and think of azimuth as a horizontal twist around to the satellite from a point looking at true north. The vertical tilt and the horizontal twist are seen in Fig. 2. That's all there is to it.

Let's get some idea of what the belt looks like from your location. We also can find a good spot for the dish at the same time. Go outside and look at the southern sky (readers below the equator look north). If you are at a medium latitude, say 30 to 40 degrees north, imagine a giant rainbow arch sweeping across the southern sky from east to west with its highest point about 45 degrees off the horizon (see Fig. 3). Perhaps your imaginary rainbow passes through a tree or rooftop. If so, you'd better find another spot for your dish.

At this point it's a good idea to do some research, and either calculate, compute, or buy a computer printout of satellite coordinates for your specific location. Then go outside again and pinpoint the direction of each satellite you may want to receive before

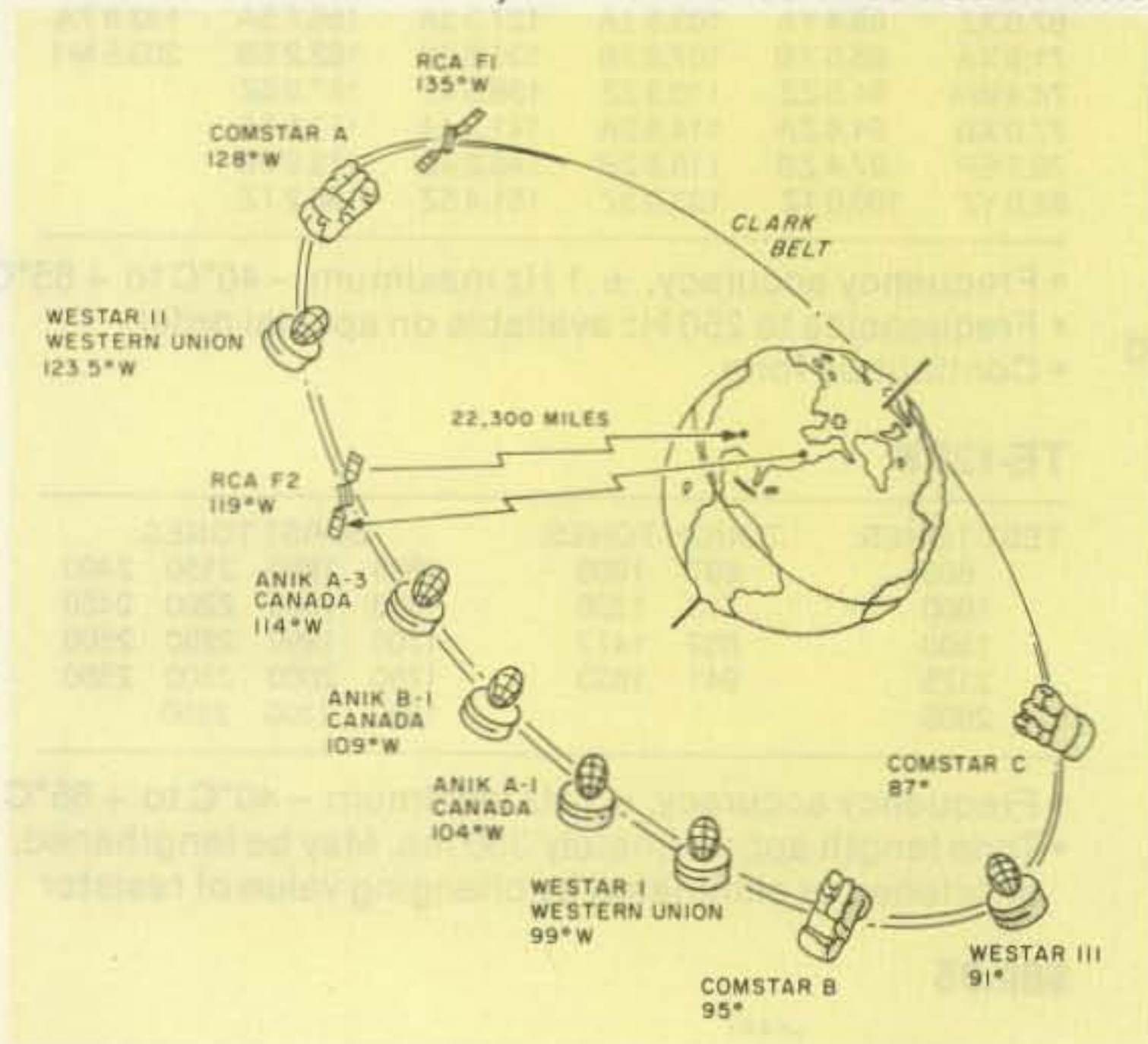

Fig. 1. Geostationary satellites. Clarke-belt satellites circle the globe above the equator at the same rotational speed as the Earth. They appear to us as fixed points in the sky, which simplifies antenna pointing.

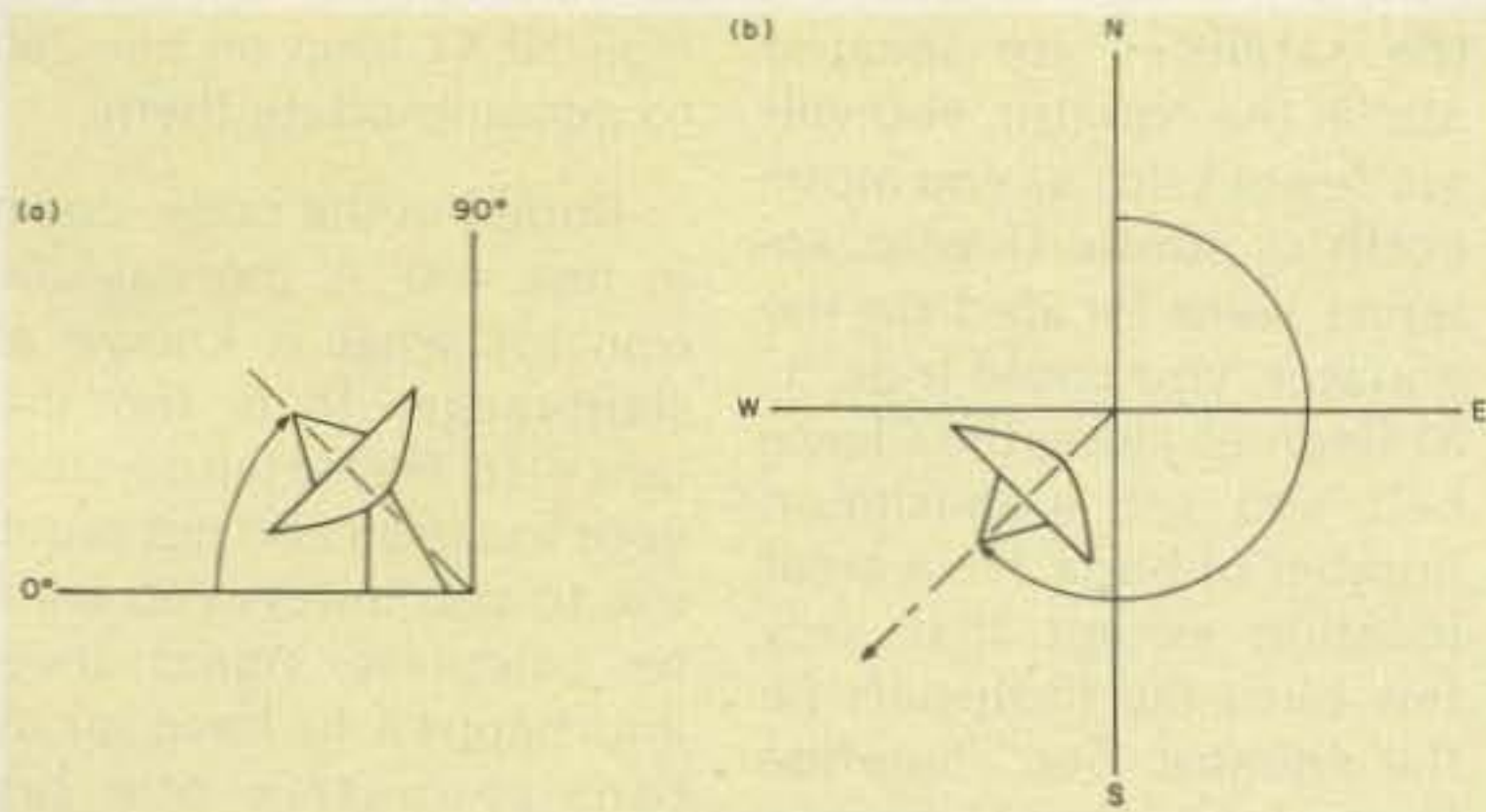

Fig. 2. Az/el coordinates are simple to understand. Elevation is a vertical tilt. Azimuth is a horizontal twist from true north (not magnetic north). (a) Elevation angle is measured from your horizon. (b) Azimuth angle is measured from true north turning clockwise.

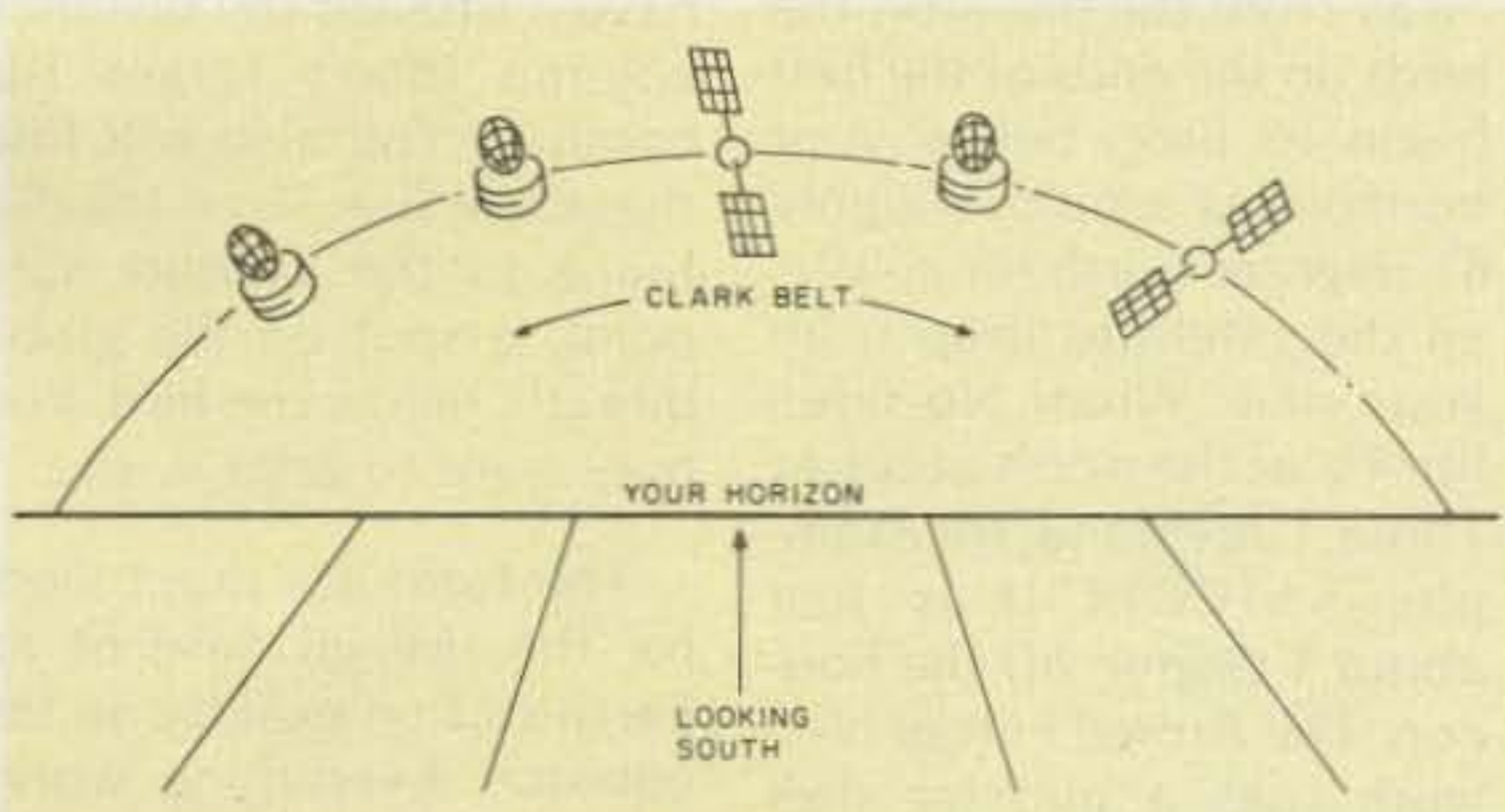

Fig. 3. To an observer at 30 to 40 degrees latitude, the Clarke belt appears as a giant rainbow. At the equator, the Clarke belt appears directly overhead stretching east and west.

you start pouring a concrete antenna base. A friend of mine skipped this step and accidentally erected his dish so that the best TV satellite worth viewing was directly behind a tree!

Even a clear shot doesn't mean you won't have problems, however. I recently moved to a mountaintop where nothing would block my view. Nothing, that is, except heavy interference from Ma Bell who just happens to share this same frequency band (3.7-4.2 GHz)! Ma Bell is a different kind of blockage. I'll cover the illness and the cure for interference in a future "Satellite Central."

Finding All the Info

Scores of articles (and even books) have been published on how to calculate satellite bearings. I've assembled a bibliography

of a select few in the box on this page so that you can go hunting for back issues. Or you can scan the pages of 73 for someone who'll generate a bearing chart for you by computer. If you own a computer or know somebody who'll lend you one, you can use the program listing given here. It's nothing fancy, but it will give you answers with even greater accuracy than you need to point your dish.

It doesn't matter if you opt for graphs or calculators or even a computer to do the work. You still need three pieces of information before you begin: (1) The longitude of the desired satellite, (2) your longitude, and (3) your latitude.

Perhaps you're wondering why we need only the longitude of the satellite? Another look at Fig. 1 will show you that despite their

Go Crazy Doing It Yourself

The following cookbook procedure is a summary of several articles on the subject which I've reduced down to three formulas. Even at that, you may find the process burdensome without a full-function programmable calculator. In the unlikely event that you are reduced to the bare essentials of just a cheapy pocket job or, God forbid, a book of trig tables, here are the exact steps to take:

1) Find out if the satellite is visible from your location and skip this step if you're pretty sure the bird can be seen. Otherwise, calculate the following (watching the signs!):

$$LD = \text{Satellite Longitude} - \text{Your Longitude}$$

Stop here if LD is greater than 81.3 degrees: You can't see it because it's below your horizon.

Then, where LAT = your latitude (use a negative latitude if you are below the equator) and AD = the number of angular degrees you are from the satellite subpoint, do:

$$AD = \cos^{-1}(\cos LD \cos LAT)$$

AD must be less than 81.3 degrees or you should forget it.

2a) Calculate azimuth if you are in the northern hemisphere, where LAT = your latitude:

$$AZ = 180 + \tan^{-1}(\tan LD / \sin LAT)$$

2b) Calculate azimuth if you are in the southern hemisphere by using a negative sign in front of latitude, where LAT = -(your latitude):

$$AZ = \tan^{-1}(\tan LD / \sin LAT)$$

3) Calculate elevation angle:

$$EL = \tan^{-1}(\cos LD \cos LAT - .151 / \sqrt{1 - (\cos LD \cos LAT)^2})$$

You can read more about bird hunting and even dig into the math in the following references:

- "Microcomputers and the Satellite Station," Taggart, 73, February, 1980.
- "Locating Geosynchronous Satellites," Johnston, QST, March, 1978.
- "Calculating Antenna Bearings," Shuch, Ham Radio, May, 1978.
- Satellite Navigator Manual, Gibson, published by STTI.

distance, the latitude of the birds is really zero because they orbit directly above the equator. That's zero degrees latitude. So all we need is longitude. This is measured in degrees running east or west from Greenwich, England. If you look at the program listing, you'll see the west longitude of nearly all Clarke-belt satellites down in the data statements.

Next, you'll need your site coordinates. Like the satellites, your location is measured from the same references, Greenwich, England, and the equator. A good place to look for your coordinates is on a topographical map. You can buy one for your area from a map store or direct from the Department of the Interior. Aeronautical maps

are another good source. Even an atlas will do.

If you can't find a map, call a local radio or TV station and use their coordinates. Perhaps the coordinates of the club repeater will do if it's not too far away. Your local airport tower may be able to give you their coordinates. As a last resort, look in books dealing with astrology! You may find coordinates for your city or one nearby because astrologers also need coordinates to construct their charts.

Hair-Splitting Accuracy

Despite what the purists may say, practical experience has proven that you can be 15 or 30 miles off in coordinates and still find the bird! It's really all a matter of accuracy in

Program listing.

```
10 CLEAR : RESTORE : CLS
20 PRINT "CLARK BELT SATELLITE PROGRAM"
30 PRINT: "(C) 1981 STEPHEN GIBSON
40 "
50 PRINT "EARTH STATION COORDINATES:" : PRINT
60 PRINT "LONGITUDE - INPUT DEGREES, MINUTES, SECONDS"
70 INPUT VD, VM, VS
80 INPUT "IS THAT EAST OR WEST LONGITUDE (E/W) " : VS
90 PRINT: PRINT "LATITUDE - INPUT DEGREES, MINUTES, SECONDS"
100 INPUT HD, HM, HS
110 INPUT "IS THAT NORTH OR SOUTH LATITUDE (N/S) " : HS
120 "
130 CLS
140 PRINT " CLARK BELT SATELLITE ANTENNA BEARINGS"
150 PRINT " "
160 PRINT "SATELLITE", "LONGITUDE", " AZIMUTH", " ELEVATION"
170 PRINT " "
180 "
190 SS="W": WEST LONG FOR ALL SATELLITES!!
200 G = VD+(VM+VS/60)/60 : A = HD+(HM+HS/60)/60
210 IF A=0 THEN A=.001
220 IF VS="W" THEN G=-G
230 IF HS="S" THEN A=-A
240 "
250 " CALCULATIONS
260 FOR J=1 TO 54 : READ SAS , F : F = -F
270 B = G - (F)
280 IF B>180 THEN B = B-360
290 IF B<-180 THEN B=B+360
300 IF B>81.3 THEN D=B-81.3: GOTO 520 : ' ERROR!!
310 Q=(COS(B*.0174533))*(COS(A*.0174533))
320 C=(-ATN(Q/SQR(-Q*Q+1))+1.5708)*57.29578
330 IF C>81.3 THEN D=C-81.3: GOTO 520 : ' ERROR!!
340 "
350 " DO PRINT-OUT
360 C1=C*69.057: 'MILES TOO SUBPOINT (NOT USED)
370 AA=180+(ATN(TAN(B*.0174533)/SIN(A*.0174533)))*57.29578
380 IF A<0 THEN AA=AA-180
390 R=3957: R=22245
400 S=SQR((R*2)+((R+R)*2)-2*R*(R+R)*COS(C*.0174533))
410 EE=((S*2)+(R*2)-((R+R)*2))/((2*R*S)
420 E=(-ATN(EE/SQR(-EE*EE+1))+1.5708)*57.29578-90
430 "
440 PRINT SAS , ABS(F) , AA , E
450 "
460 NEXT
470 "
480 INPUT "WANT ANOTHER Y/N " : AS: IF AS="Y" THEN 10
490 "
500 END
510 "
520 " ERROR FLAG
530 PRINT SAS, " BELOW HORIZON BY " : D : " DEGREES": GOTO 460
540 "
550 DATA "ATS-3", 69, "GOES-1", 75
560 DATA "COMSTAR 3", 87, "WESTAR 3", 91, "COMSTAR 2", 95, "WESTAR 1", 99
570 DATA "ANIK A1", 104, "SMS-1", 105, "ANIK A2", 106.5, "ANIK B", 109, "ANIK A3", 114
580 DATA "CTS-", 116, "SATCOM 2", 119, "WESTAR 2", 123.5, "COMSTAR 1", 128
590 DATA "SATCOM 3R", 132, "SATCOM 1", 135, "SMS-2", 135
600 DATA "ATS-6", 140, "ATS-1", 149, "STATSIONAR 10", 170
610 DATA "INTELSAT IV F4", 181, "MARISAT 2", 183, "INTELSAT IV F8", 186
620 DATA "STATSIONAR 7", 220, "CS-", 225, "ETS-", 230, "BSE-", 250
630 DATA "STATSIONAR T", 261, "EKRRAN 2", 261, "EKRRAN 1", 261, "STATSIONAR 6", 275
640 DATA "PALAPA 1", 277, "STATSIONAR 1", 280, "PALAPA 2", 283, "MARISAT 3", 287
650 DATA "INTELSAT IVA F3", 297, "INTELSAT IV F1", 298.6, "INTELSAT IV F6", 300
660 DATA "INTELSAT IV F5", 300, "STATSIONAR 5", 302, "SYMPHONIE 1", 311
670 DATA "STATSIONAR 9", 315
680 DATA "INTELSAT IV F7", 1, "INTELSAT IV F2", 4, "SYMPHONIE 2", 11.5
690 DATA "STATSIONAR 4", 14, "SIRIC", 15, "MARISAT 1", 15, "INTELSAT IVA F4", 19.5
700 DATA "INTELSAT IVA F1", 24.5, "STATSIONAR 8", 25, "INTELSAT IVA F2", 29.5
710 DATA "INTELSAT IV F3", 34.5
720 END
```

pointing your dish. The typical readouts you might use, such as a carpenter's inclinometer or a compass, may get you within a couple of degrees, anyway. It's like trying to read fractions of mph on your auto speedometer! That's why accuracy in calculations to several places is unnecessary.

We'll attempt to solve this problem later on with a digital or analog readout.

There is a limit to the number of satellites that you can see from your location. The curvature of the Earth blocks your view. The limit of your visibility is about 81 angular degrees in any direction. And, because

the satellites are located above the equator, you will see fewer birds as you move north or south. If your antenna were located on the equator, you could look ± 81 degrees along the Clarke belt and see a maximum number of birds. It's a great location except that very few birds lay footprints on the equator. See "Satellite Central, part I" (73 for November) about footprints. So, you've got to move towards the footprints to receive pictures.

As you move farther away from the equator, the birds on the ends of the belt begin to drop below your horizon. At a point roughly 81 degrees north (or south), all the satellites drop from your view. What? No satellite TV at the north pole? At Thule, Greenland, for example, SATCOM II is just about 1 degree off the horizon. The Armed Forces Network uses a massive dish pointed at the horizon to receive transponder 9.

Signal level is not their only problem. At nearly zero degrees elevation, the dish intercepts terrestrial noise from the Earth which greatly increases their noise floor.

Save Time With a Computer

Perhaps the best way to get satellite bearings is with a computer. It's fast, accurate, and eliminates any drudgery other than merely typing the program into the machine. The listing given with this article is short and devoid of any fancy formatting because I have no idea which machine you'll be using. It's in Microsoft BASIC. Take it from there.

In a nutshell, the program asks for your coordinates and then calculates azimuth and elevation for each satellite in its 54-satellite data base. You can add new birds to the data statements as they are put into orbit. Just be sure to adjust the size of the

FOR/NEXT loop on line 260 to accommodate them.

Buried in the code, down in line 400, is the calculation for what is known as slant-range. It is the distance to the satellite from your location and not much use to you unless you want to calculate signal level and happen to have an intensity-matrix overlay somewhere else. You still may want to include it in the printout. Just print the variable S in line 440. Then add "DISTANCE" onto the end of line 160 so you will have a title for the distance column (don't forget the comma). You also will find that C1 in line 360 is the distance to the satellite subpoint, a spot on the globe directly below the bird. You may want to print it, too.

The formulas don't work for the special case of an Earth station exactly on the equator. Everything works fine if you move the dish a short distance north or south. I've inserted a minor fudge factor of a few seconds of latitude in line 210 just in case you want to test your suspicions and see that a dish at that spot would indeed have an azimuth bearing of 90 degrees or 270 degrees. While fudge factors are not a very good idea, especially in a computer program, it sure beats getting a "division by zero" error message. Besides, the output still will be accurate to within 7.2 seconds of arc! It's hardly worth mentioning when you consider the *real* effort will be erecting that 10-to-20-meter dish on the equator to receive what few signals are actually available!

Other mods worth considering are an error trap so that only visible satellites are printed. You may also want a software counter so that the output doesn't scroll off the screen until the program receives a keyboard command. If you

APARTMENT BLUES?

Get on the air NOW!

with

HANDBOOK OF APARTMENT OPERATION

by Dan Fox, W2IQD.

Everything you need to know about operating from these tough spots. Over 150 fact-filled pages cover every aspect of apartment/condo operation.

MONEYBACK GUARANTEE

only \$12.50 + \$1.50 p&h Check, MC, VISA (card#-date)

to Wessex Publishing Co. Dept. B9

POB 175 N. Chelmsford, MA. 01863

have a printer, it's a simple matter to change all the PRINT statements to LPRINT. Or you could store the answers in another array, then branch to a printer subroutine. TRS-80 Model I users need only POKE the printer device control block with the CRT vectors and

LPRINT thereby, having their cake and eating it with optional branches.

Satellite Central needs your input of comments and ideas—with full credit to be given, of course. Most of the new developments in just the last two years have been from hams like your-

self who have adopted a "Gee whiz, why can't we do it this way?" attitude, and have developed extraordinary designs that "won't work" according to the old guard. Yet simple things like \$75 receivers and cheap window-screen antennas are appearing every-

where. The time is right for you to join in the fun of receiving TV from space.

If you have a question regarding the topics we cover here, feel free to drop me a line (letters only, no calls, please). Sorry, I can answer mail only when it is accompanied by an SASE. ■

Bearcat[®] SCANNERS



LOWEST POSSIBLE PRICES ANYWHERE

(813) 597-1808

| | |
|----------------------------|----------|
| BEARCAT [®] 350 | \$399.95 |
| BEARCAT [®] 300 | \$339.95 |
| BEARCAT [®] 250 | \$269.95 |
| BEARCAT [®] 20/20 | \$279.95 |
| BEARCAT [®] 210XL | \$219.00 |
| BEARCAT [®] 100 | \$289.95 |

ADD \$7.00 PER SCANNER FOR U.P.S. SHIPPING. NO C.O.D. OR CREDIT CARDS ALLOW 30-45 DAYS SHIPPING ON SOME MODELS. WRITE OR CALL FOR SPEC. SHEETS.

EVERGLADES COMMUNICATIONS

2184 J&C BLVD. NAPLES, FLA. 33942

MICROWAVE ANTENNAS ✕

PARABOLIC ANTENNAS FOR SATELLITE RECEPTION, POINT TO POINT, OR MICROWAVE A.T.V., WORK

| | |
|---|-----------|
| 11 FOOT DISH with tripod mount for feed point | \$830.00 |
| POLAR MOUNT for satellite t.v. | \$690.00 |
| MOTORIZED POLAR MOUNT with control unit | \$2294.00 |
| MOTORIZED AZIMUTH - ELEVATION MOUNT | \$2964.00 |
| 6 FOOT DISH | \$350.00 |
| FIXED TOWER MOUNT | \$150.00 |
| TOWER FOR AZ-EL MOUNT | \$420.00 |
| 8 FOOT DISH with same mounts as 6 Foot dish | \$274.00 |
| TRIPOD MOUNT for rooftop mounting of dish | \$170.00 |
| 1/2 INCH DISH mounts to camera tripod | \$60.00 |

ALL REFLECTORS MADE OF METAL IMPREGATED FIBERGLASS, ALL HARDWARE TREATED FOR CORROSION RESISTANCE. FEEDPOINTS FOR MOST FREQUENCIES AVAILABLE ON REQUEST. SHIPPING BY UPS OR MOTOR FREIGHT ALLOW 6 WEEKS FOR DELIVERY. CALL FOR MORE INFO (708) 922-4061, 9 AM to 5PM MOUNTAIN TIME. PRICES SUBJECT TO CHANGE DUE TO MATERIAL COSTS. ✕327

NORDLUND & ASSOCIATES

790 HENDI PLACE, KILBA (L) 400 - 03634 JOHN F. NORDLUND KATHY

Enjoy Satellite TV Now



Better than Cable TV—Over 200 TV and radio services. Why waste money? Learn the whole story and build a video system the family can enjoy. No commercials. FREE movies, sports and Vegas shows—worldwide, crystal clear reception connects to any TV set. Big (8 x 11 in.) book loaded with details, photos, plans, kits—TELLS EVERYTHING! Satisfaction Guaranteed.

Send \$7.95 TODAY! Add \$2.00 for 1st class (air mail) or call our 24 hour C.O.D. rush order line (305) 862-5068. GLOBAL ELECTRONICS, P.O. Box 219-H, Maitland, Florida 32751

HOLIDAY SPECIAL

COMPLETE ASSEMBLED AND TESTED READY TO INSTALL NOT A KIT
AMATEUR TELEVISION MICROWAVE DOWNCONVERTER

50+ dB SYSTEM GAIN
TUNES 2.1 GHz, 2.4 GHz.
PREAMPLIFIER 20+ dB GAIN @ 2.5 dB NF
OUTPUT TUNES TV CHANNELS 2 TO 5
OUTPUT IMPEDANCE 75 OR 300 OHMS
FULL YEAR WARRANTY
PERFORMANCE GUARANTEED OR YOUR MONEY REFUNDED

\$179.95 E.A.

INCLUDING SHIPPING (U.P.S.)
TWO FOR \$345.00 - DEC. 1981 ONLY

VISA AND MASTERCARD ACCEPTED

CALL (804) 489-2156

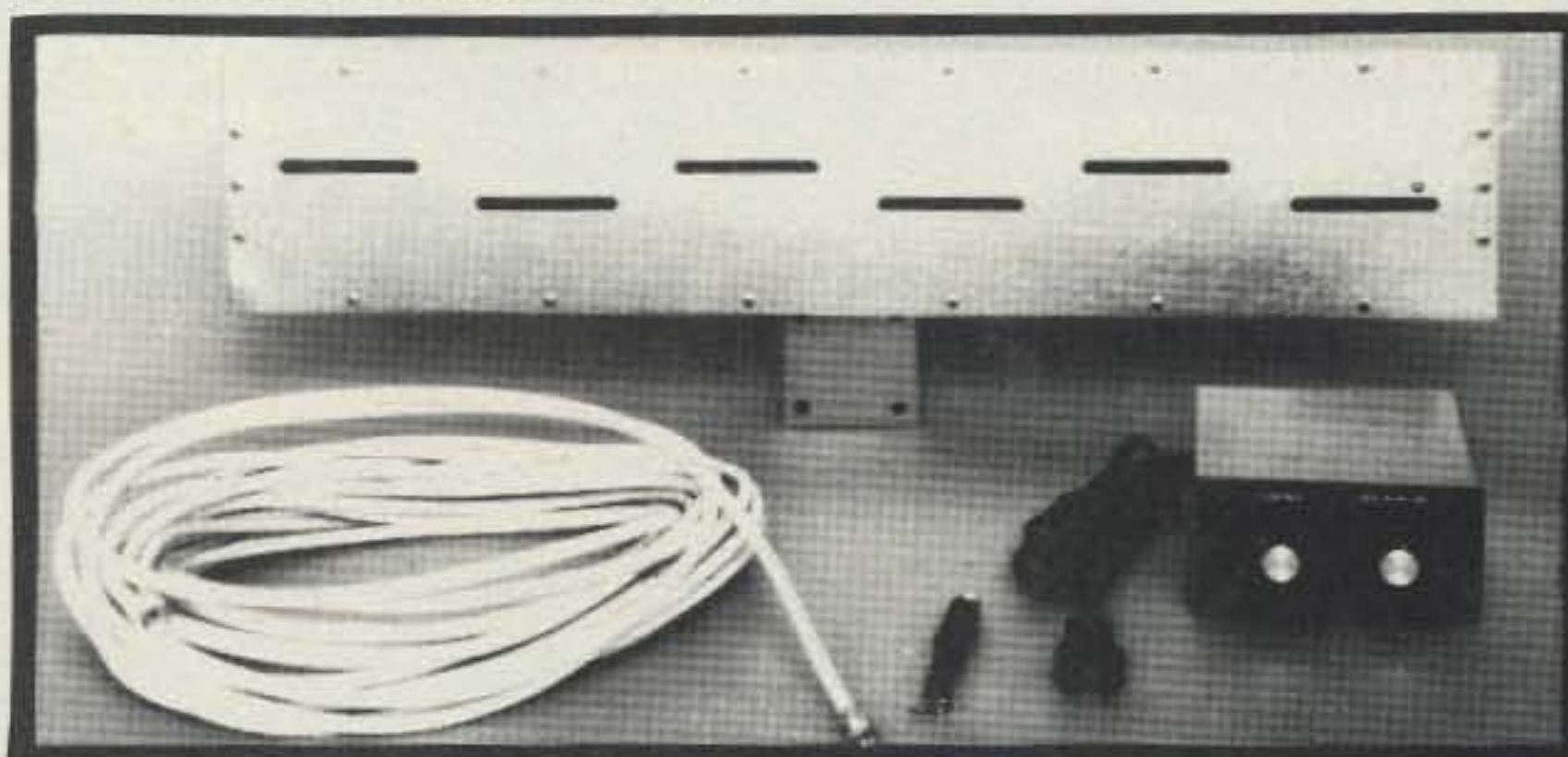

AVAILABLE SEPARATELY - FULLY ASSEMBLED AND TESTED
10+ dB PREAMPLIFIER \$49.95, SLOTTED WAVEGUIDE ANTENNA (15+ dB GAIN) \$29.95, POWER SUPPLY \$34.95

EXTRA • PLESSEY - AVANTEK • EXTRA

WE NOW STOCK PLESSEY 1600 SERIES ICS

AVANTEK GPD SERIES AMPLIFIERS (GPD 401, GPD 402, GPD 403) - 12-14 dB GAIN 5 - 500 MHz. SPECIAL \$25.00 ea.

AVANTEK VTO OSCILLATORS \$130.00 EA. CIRCUIT BOARDS FOR GPD 400 SERIES AMPS \$ 2.00 ea.

VIRGINIA RESIDENTS PLEASE ADD 4% STATE SALES TAX - ADD \$1.00 PER ORDER FOR SHIPPING

See you at the Richmond, VA Hamfest in January
See you at the Vienna, VA Hamfest in February

ELECTRONIC HOBBY INNOVATIONS

✕447

7510 GRANBY STREET SUITE 207 NORFOLK, VIRGINIA 23505 (804) 489-2156

CT2100

HAL Puts MORE Behind The Buttons

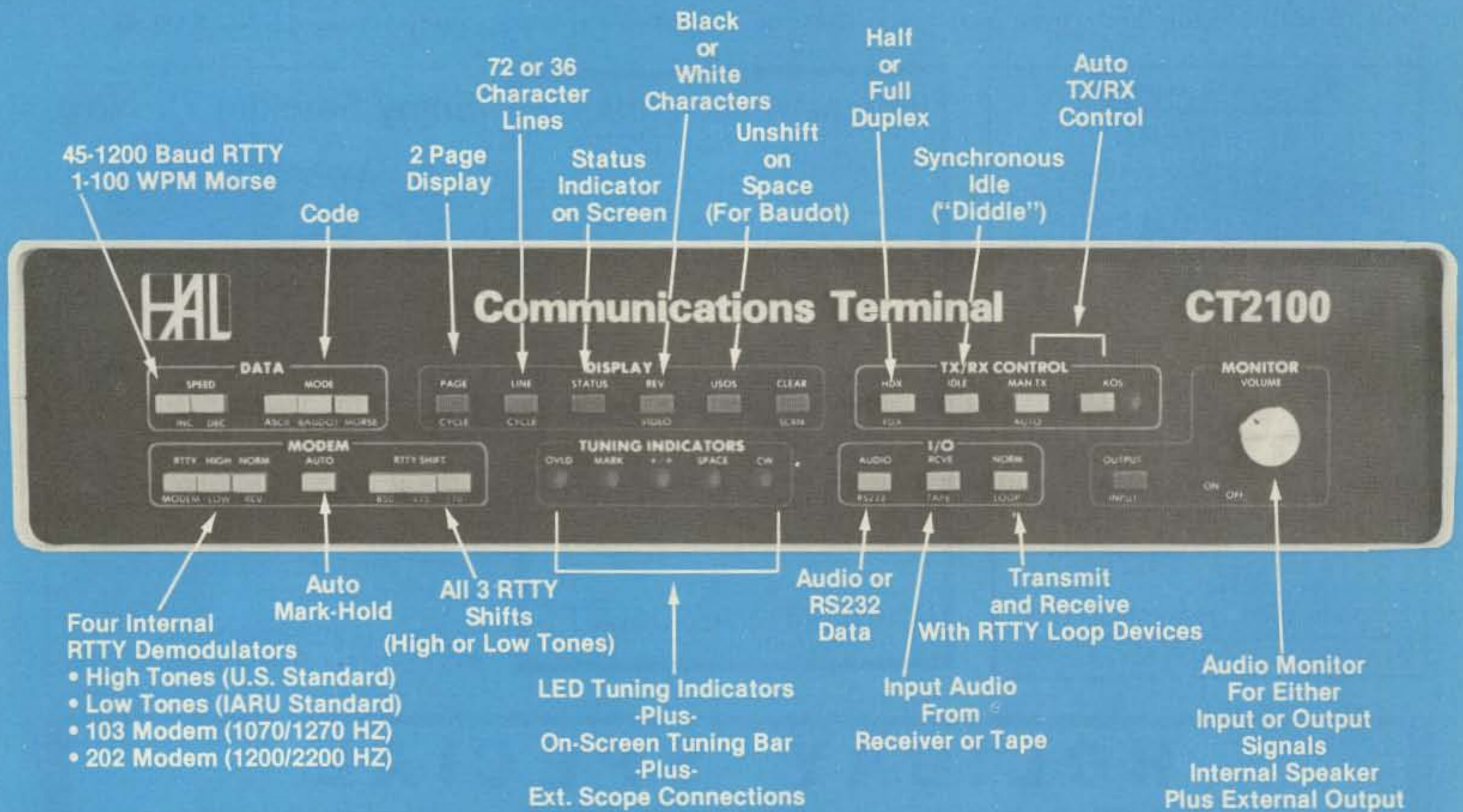

CT2100 System:

- CT2100 Communications Terminal
- KB2100 Keyboard
- Video Monitor
- Printer (300Bd Serial ASCII-MPI-88G)
- RM2100 Rack Adapter
- MSG2100 2000 Character "Brag Tape" ROM

- 24 Line Display
- 2 Pages of 72 Character Lines
- or-
- 4 Pages of 36 Character Lines
- Split Screen (with KB2100)



KB2100



345
 HAL COMMUNICATIONS CORP.
 Box 365
 Urbana, Illinois 61801
 217-367-7373

NOW! HAL Equipment is in stock at leading Amateur Dealers.

When it comes to
**AMATEUR
RADIO QSL's...**



it's the
ONLY BOOK!

US or Foreign Listings

1982
callbooks
NOW READY!

Here they are! The latest editions. World-famous Radio Amateur Callbooks, the most respected and complete listing of radio amateurs. Lists calls, license classes, address information. Loaded with special features such as call changes, prefixes of the world, standard time charts, worldwide QSL bureaus, and more. The U.S. Edition features over 400,000 listings, with over 70,000 changes from last year. The Foreign Edition has over 370,000 listings, over 60,000 changes. Place your order for the new 1982 Radio Amateur Callbooks, available now.

| | Each | Shipping | Total |
|---|---------|----------|---------|
| <input type="checkbox"/> US Callbook | \$18.95 | \$3.05 | \$22.00 |
| <input type="checkbox"/> Foreign Callbook | \$17.95 | \$3.05 | \$21.00 |

Order both books at the same time for \$39.95 including shipping.

Order from your dealer or directly from the publisher. All direct orders add shipping charge. Foreign residents add \$4.55 for shipping. Illinois residents add 5% sales tax.



SPECIAL LIMITED OFFER!
Amateur Radio
Emblem Patch
only \$2.50 postpaid

Pegasus on blue field, red lettering. 3" wide x 3" high. Great on Jackets and caps.

ORDER TODAY!

RADIO AMATEUR
callbook INC.



Dept. B
925 Sherwood Drive
Lake Bluff, IL 60044, USA

61



TEMPO
hand-helds
SAVE
\$\$
on all models!

Synthesized models available for 146, 220 or 440 MHz FM. Comes with telescoping whip antenna, 450 ma/hr nicad battery, wall charger & earphone. Size: 2.5" w x 6.5" h x 1.6" d, 1 lb.
Shown with optional TTP

TEMPO S-5 800 ch., 144-147.995 MHz, 1/5 watts out.
Regular \$279 - **Sale \$249⁹⁵**

TEMPO S-5T as above w/12 button Touch-tone pad.
Regular \$309 - **Sale \$279⁹⁵**

TEMPO S-1 800 ch., 144-147.995 Mhz, 2 watts out.
Regular \$279 - **Sale \$249⁹⁵**

TEMPO S-1T as above w/12-button TTP installed.
Regular \$309 - **Sale \$279⁹⁵**

S-5 & S-1 Accessories:

| | |
|--|---------|
| HM-5 Speaker/microphone..... | \$35.00 |
| S-30 2m FM 30w amplifier (Reg.\$89) SALE | 84.95 |
| S-80 2m FM 80w amplifier (Reg. \$149) SALE | 139.95 |
| TS-HA 2m threaded flexible antenna..... | 8.00 |

TEMPO S2 1000 ch., 220-224.995 Mhz, 2 watts out.
Regular \$289 - **Sale \$259⁹⁵**

TEMPO S-2T as above w/12 button TTP installed.
Regular \$319 - **Sale \$289⁹⁵**

S-2 Accessories:

| | |
|---|---------|
| HM-5 Speaker/microphone..... | \$35.00 |
| S-20 220 MHz FM 20w amp. (Reg. \$89) SALE | 84.95 |
| TS-HA-2 220 MHz threaded flexible antenna.. | 8.00 |

TEMPO S-4 440-449.995 MHz, 25 KHz spacing, 2w.
Regular \$289 - **Sale \$259⁹⁵**

S-4T-12 as above with 12-button TTP installed.
Regular \$319 - **Sale \$289⁹⁵**

S-4T-16 as above with 16-button TTP installed.
Regular \$339 - **Sale \$309⁹⁵**

S-4 Accessories:

| | |
|---|----------|
| HM-6 Speaker/microphone..... | \$ 35.00 |
| S-40 440 MHz 40w amp. (Reg. \$149) SALE | 139.95 |

Accessories for all models:

| | |
|--|---------|
| TS-AD Antenna thread to BNC adaptor..... | \$10.00 |
| TS-CC Carrying case..... | 20.00 |
| TS-CC-TT Carrying case for TTP HT..... | 20.00 |
| TS-MC Cigarette lighter charger..... | 6.00 |
| TS-BP2 Extra 450 ma/hr battery pack..... | 25.00 |

Send Check or Money Order. For prompt shipment, call TOLL FREE 1-800-558-0411 and use MASTER-CARD or VISA; COD orders O.K. Allow \$5⁰⁰ for UPS shipping charges - 48 States.



**AMATEUR
ELECTRONIC SUPPLY®**

4828 W. Fond du Lac Avenue
Milwaukee, Wisconsin 53216
Phone: (414) 442-4200

Wisconsin WATS: 1-800-242-5195
Nationwide WATS: 1-800-558-0411
AES Branch Stores In: Clearwater, FL •
Orlando, FL • Wickliffe, OH • Las Vegas, NV

HUSTLER
HF MOBILES
DELIVER
FIXED STATION
PERFORMANCE

Hustler HF antennas deliver outstanding signal reports — wherever you're mobile!

Design your own HF mobile from a full selection of top-quality; U.S.-made stainless steel ball mounts, quick disconnects, masts, springs, and resonators. You can cover any 6-to-80-meter band. Choose from medium or high power resonators with broadest bandwidth and lowest SWR for optimum performance on any band. Easy band change and garaging with Hustler's fold-over mast, too.



Ask any ham — the best HF mobiles on the road come from: Hustler — still the standard of performance.

HUSTLER

3275 North "B" Avenue
Kissimmee, Florida 32741

An **AMATEUR** Company

TEST YOUR WINGS

Icarus had the right idea. He, and probably every man since the beginning of time, wanted to fly. He had the right idea, but the wrong equipment. With Instant Software's Flight Simulation Series and your TRS-80, you're equipped to fly the World War II reconnaissance missions, perform the feats of a daring mountain bush pilot and experience first hand the tense atmosphere of an air traffic control tower.

Find out what Icarus had to learn the hard way... and master it, with Instant Software's Flight Series.

FLIGHT PATH

O'Hare—A control tower simulation in which you become an Air Traffic Controller. You are responsible for hundreds of human lives, as you guide aircraft through your control sector to a safe landing.

You'll have to deal with different aircraft requirements, wind change warnings and potential mid-air collisions.

Mountain Pilot—Transforms you into a daring bush pilot as you fly badly needed supplies to a remote gold mining camp. You must cross a hazardous mountain range, while struggling with headwinds, tricky navigation and diminishing fuel.

Precision Approach Radar—Combines the skills of pilot and Air Traffic Controller.

The Flight Path package involves you in both sides of flight procedure, from the thrill of flying to the tense drama of air traffic control.

TRS-80 Model I, Level II, 16K RAM; Model III, 16K.

Order No. 0171R-A55 Tape \$9.95 plus \$2.50 shipping.

NIGHT FLIGHT

It's May, 1941, the dreaded Axis battleship, the Bismarck, has broken out of the North Sea and is now somewhere in the North Atlantic. Your mission: make a nighttime photo reconnaissance flight over the Bismarck.

Somewhere out in the cold, gray North Atlantic, the Bismarck tries to elude her pursuers. Your photos are vital. Launch yourself into the night sky with the Night Flight package.

TRS-80 Model I, Level II, 16K; Model III, 16K.

Order No. 0117R-A56 Tape \$9.95 plus \$2.50 shipping.

JET FIGHTER PILOT

The Jet Fighter Pilot package takes you as close to real combat flying as possible... without pulling G's.

In this brilliantly realistic simulation, you become the pilot of a high performance, twin turbo-jet fighter. Total control of the aircraft is yours.

All controls respond the same as they would on a real jet fighter. You'll have to constantly monitor your display and make adjustments to your throttle, flaps, rudder and air spoilers. You decide when to retract flaps, landing gear and release the auxiliary fuel drop-tanks.

After you've flown a few missions with the Jet Fighter package, you'll know you've earned your wings. TRS-80 Model I, Level II, 16K; Model III, 16K.

Order No. 0159R-A53 Tape \$14.95 plus \$2.50 shipping.

AIR FLIGHT SIMULATION

Air Flight Simulation might be more like it! Instrument takeoffs and landings are no picnic—ask any pilot—and this computer simulation is certain to keep you on the edge of your seat.

You begin with a full tank of gas and a flight plan that calls for a simple takeoff and landing—at least until you get the hang of it. Pay close attention to your instrument panel, especially the angle of ascent/bank indicator and air speed indicator—too steep a bank and your air speed will drop like a stone... and so will your plane.

It's about as close to the real thing as you can get this side of a runway. TRS-80 Model I, Level I, Level II, 16K; Model III.

Order No. 0017R-A54 Tape \$9.95 plus \$2.50 shipping.

*TRS-80 is a trademark of Radio Shack, a division of Tandy Corporation

Instant Software™

Peterborough, N.H. 03458 USA

A division of Wayne Green Inc.

TO ORDER:

See your local Instant Software dealer
or call toll-free 1-800-258-5473

orders only

In New Hampshire 1-603-924-7296

Mon.-Fri. 8:00 am—4:30 pm E.S.T.



THIS MANY DEALERS CAN'T BE WRONG.

ALABAMA
THE COMPUTER SHOP, Gadsden
OLENSKY BROS., Mobile

ALASKA
COMPUTER TALK, Anchorage

ARIZONA
CERF, Phoenix
COMPUTER STORE, Phoenix
MESA ELECTRONICS, Mesa
MILLET'S ELECTRONICS, Mesa
PERSONAL COMPUTER PLACE, Mesa
SIMUTEK, Tucson
TOY BOX, Sierra Vista

ARKANSAS
MICRO COMPUTER SYSTEMS, Hot Springs

CALIFORNIA
ADVANCE RADIO (RS DEALER), Grass Valley
ADVANCED COMPUTER PRODUCTS, Santa Ana
ALBANY TYPEWRITER, Albany
ALLTRONICS, San Jose
AMICO ELECTRONIC SUPPLY, Azusa
ASAP COMPUTERS, Signal Hill
BYTE INDUSTRIES, Hayward
BYTE SHOP, Mountain View
CAPITOL COMPUTER SYSTEMS, Sacramento
CHASCO COMPUTERS, El Monte
COAST ELECTRONICS, Morro Bay
COMPUSOUND, Orange
COMPUSUP, Lancaster
COMPUTER MART OF CALIFORNIA, INC.,
Diamond Bar
COMPUTERLAND, San Francisco
COMPUTER PLUS, Sunnyvale
COMPUTER STORE, San Leandro
COMPUTER WORLD, Westminster
DEROSEAR APPLIANCE & REPAIR, Weaverville
DIMENSIONAL SOFTWARE, San Diego
H. W. ELECTRIC, Northridge
EXATRON, Santa Clara
GAME-O-RAMA, Santa Barbara
GOOD FAIRE NATURAL FOODS, Lompoc
HOBBY WORLD ELECTRONICS, Northridge
HUNTINGTON COMPUTING, Corcoran
INLAND ELECTRONICS, Riverside
MALIBU MICROCOMPUTING, Malibu
MARFAM CO., San Jose
MICROCOMPUTING, Corcoran
NET PROFIT COMPUTERS, Torrance
OPAMPTECHNICAL BOOKS, Los Angeles
OPPORTUNITIES FOR LEARNING, Chatsworth
PC COMPUTERS, El Cerrito
Q I COMPUTERS, INC., Lawndale
RAC PRODUCTS, San Jose
RADIO SHACK, El Cajon
RADIO SHACK, Palm Springs
RADIO SHACK, San Diego
RAY SOUND (RS DEALER), Fortuna
SALINAS HOBBY CENTER, Salinas
SHAYER RADIO, San Jose
SILVER SPUR ELECTRONICS, Chino
SOFTWARE PLUS, El Toro

STACEY'S BOOKSTORE, San Francisco
STRAWFLOWER ELECTRONICS (RS DEALER),
Half Moon Bay
THE COMPUTER STORE, Santa Monica
THE FEDERATED GROUP, Commerce
THE SOFTWARE STORE, Huntington Beach
THE SOFTWARE STORE, Los Angeles
WABASH APPLE, El Toro
WENNER BUSINESS SYSTEMS, Los Altos

COLORADO
APPARAT, Denver
FISTEL'S MICRO ELECTRONICS, Denver
POOR RICHARD'S CALCULATORS, Fort Collins

CONNECTICUT
BYTE ME COMPUTER SHOP, New London
COMPUTER LAB, New London
INSTRUCTIONAL SYSTEMS COMPUTERS,
Manchester
TECHNOLOGY SYSTEMS, Bethel
THE COMPUTER STORE, Stamford

DELAWARE
MICRO PRODUCTS, Wilmington

DISTRICT OF COLUMBIA
THE PROGRAM STORE, Washington, D.C.

FLORIDA
ALL SYSTEMS GO, Winter Garden
AMF MICROCOMPUTER CENTER, Tampa
COMPUTER CENTER, West Palm
COMPUTER HAVEN, Melbourne
COMPUTER JUNCTION, Fort Lauderdale
COMPUTER SYSTEM RESOURCES, Gainesville
COMPUTER WORLD, Clearwater
COMPUTERLAND, Jacksonville
COMPUTERLAND, Sarasota
COMPUTERLAND, Tampa
COMPUTERLAND, West Palm Beach
CREATIVE COMPUTING, Orlando
DATA UNLIMITED, Melbourne
H&H HOBBY SALES, Sarasota
HEATHKIT ELECTRONIC CENTER, Hialeah
HIS COMPUTERIZATION, Melbourne
KOBY'S KORNER, Pensacola
MICROCOMP LTD., Miami
MICROCOMPUTER SYSTEMS INC., Tampa
MINI CONCEPTS, Holly Hill
MICRO DATA BASE, Lakeland
RAY'S AMATEUR RADIO, Clearwater
RICK'S TV, Ocala
SOUND IDEAS, Gainesville
SOUTH EAST MICRO DATA, Orlando

GEORGIA
ATLANTA COMPUTER MART, Atlanta
BAILEY'S COMPUTER SHOP, Augusta
DELTA DATA DYNAMICS, Tucker
ENERGY LOGIC, Columbus
FLEMING DRUG CO., Wrens

HAWAII
HONOLULU ELECTRONICS, Honolulu
MILLS ELECTRONICS, Lihua
RADIO SHACK ASSOC. STORE, Honolulu

IDAHO
COX & NELSON, Moscow
DENNIS STONE ENTERPRISES, Fruitland
ELECTRONIC SPECIALTIES, Boise
IDAHO MICROCOMPUTER, Buhl
REAL DATA SYSTEMS, Idaho Falls

ILLINOIS
ALPINE COMPUTER CENTER, Rockford
CHICAGO MAIN NEWSTAND, Evanston
COMPREHENSIVE MICRO SYSTEMS, Chicago
COMPUTER JUNCTION, Elmhurst
COMPUTER STORE, Rockford
COMPUTERLAND, Niles
CREATIVE PROGRAMMING, Charleston
GARCIA & ASSOCIATES, Chicago
ILLINOIS CUSTOM COMPUTERS, Harrisburg
JNI, COMPUTER SYSTEMS, Downers Grove
MIDWEST MICRO COMPUTERS, Lombard
THE PILOT HOUSE, Gladstone
WALLACE COMPUTERS, Peoria

INDIANA
ABC HOBBY, Evansville
D&D ELECTRONICS, Angola
DIGITAL TECHNOLOGY, Lafayette
FALL CREEK ELECTRONICS, Pendleton
GAME HUT, Bloomington
GAME PRESERVE, Indianapolis
PROFESSIONAL MICROCOMPUTER
SOFTWARE, Muncie
SIMONTON LAKE DRUGS, Elkhart
THE BOARDROOM, Indianapolis
THE HAM SHACK, Evansville

IOWA
BEACON ELECTRONICS, Ames
LENWOOD SYSTEMS, Center Point
MEMORY BANK INC., Bettendorf
SERNETT LEISURE CENTER, Carroll

KANSAS
AMATEUR RADIO EQUIPMENT, Wichita
CENTRAL KANSAS COMPUTERS, Harrison
COMMUNICATIONS CENTER, Lincoln
GOSUB INTL, Wichita
HATCH COMPUTER CENTER, Alliance
HIGH TECHNOLOGY, Wichita

KENTUCKY
CBM, INC., Lexington
COMPUTER MAGIC, Louisville
PERRY'S COMPUTER, Bremen

LOUISIANA
ACME BOOK CO., Baton Rouge
COMPUTER SERVICES OF SHREVEPORT,
Shreveport
COMPUTER SHOPPE, Metairie

MAINE
FRYBURG COMPUTER CENTER, Fryeburg
MAINE COMPUTRONICS, Bangor
MAINE MICRO SYSTEMS INC., Auburn
MID MAINE COMPUTER COMPANY, Auburn

MARYLAND
COMM CENTER, Laurel
PROGRAM STORE, Baltimore
SOFTWARE ETC., Frederick
WILLS COMPUTER STORE, Mariow Heights

MASSACHUSETTS
LAND OF ELECTRONICS, Lynn
MARK GORDON COMPUTERS, Cambridge
MIDDLEBORO MUSIC (RS DEALER),
Middleboro
MICROCON, Watertown
OMNITEK SYSTEMS, Tewksbury
SOUND COMPANY, Springfield
STAR COMPUTING, Framingham
THE GAME SHOP, East Acton

MICHIGAN
ALL FOR LEARNING, W. Bloomfield
ALTERNATE SOURCE, Lansing
A.M. ELECTRONICS, Ann Arbor
COMIC KINGDOM, Detroit
COMPUTER CENTER, Garden City
COMPUTER CONNECTION, Farmington Hills
COMPUTER MART, Clawson
COMPUTER MART, Flint
COMPUTERLAND, Kentwood
COMPUTERLAND, Southfield
COMPUTRONICS, Midland
EIGHT BIT CORNER, Muskegon
FERRIS RADIO, Hazel Park
GOLDEN ANVIL, South Haven
HOBBY HOUSE, Battle Creek
LEARNING CENTER LTD., Ann Arbor
MAIN SYSTEMS, INC., Flint
MID-MICHIGAN MEMORY, Dimondale
NEWMAN COMMUNICATIONS, Grand Rapids
NEWMAN COMPUTER EXCHANGE, Ann Arbor
TRI-COUNTY ELECTRONICS & SOUND
CENTER, Fenton
WEATHERWAX DRUGS, Brooklyn
WIZARD'S ARSENAL, East Lansing
YE OLDE TEACHERS SHOPPE, Ypsilanti

MINNESOTA
CODE ROOM, Eden Prairie
LANTOS COMPUTER CORP., Minneapolis

MINNESOTA SOFTWARE, White Bear Lake
RURAL AMERICA ENTERPRISES, Marshall
ZM COMPUTERS, Brooklyn Center

MISSISSIPPI
C.COM, Jackson
DYER'S INC., West Point
SOFTWAREHOUSE, Jackson

MISSOURI
CENTURY NEXT COMPUTERS, Columbia
COMPUTER CENTER, Joplin
COMPUTERS, Florissant
CRC COMPUTERS, Joplin
D'S, Cameron
HOUSE OF COMPUTERS, Joplin
MOORE SOFTWARE, Parkville
SOFTWARE SHACK, Belton

MONTANA
COMPUTER STORE, Billings
THE COMPUTER PLACE, Kalispell

NEBRASKA
APPLETREE SOFTWARE, Battle Creek
COMPUTERS WEST, Omaha
GREAT RACE HOBBY PLACE, Lincoln
HATCH COMPUTER, Alliance
LEZOTTE STUDIO, Ogallala
MICROAGE COMPUTER STORE, Omaha

NEVADA
HURLEY ELECTRONICS, Las Vegas

NEW HAMPSHIRE
BITSNBYTES COMPUTER CENTER, Concord
COMPUFACT, Keene
COVER CRAFT, Amherst
PAUL'S TV, Fremont
PORTSMOUTH COMPUTER CENTER,
Portsmouth
RADIO SHACK ASSOC. STORE, Keene
RADIO SHACK, Claremont
RIDER RADIO (RS DEALER),
Pelaborough
STURDIVANT AND DUNN, Conway

NEW JERSEY
ABE'S TV SALES & SERVICE, Glassboro
ADELMAN'S STATIONERY CO., Union City
BARDAIN BROTHERS, West Trenton
CHANNEL 1 RADIO SHACK, Medford
COMPUTER FORUM, Redbank
COMPUTER MADNESS, Englishtown
COMPUTERMANIA, Piscataway
COMPUTERWORLD OF WESTFIELD, Westfield
CROWLEY'S, Whitehouse Station
DAVE'S ELECTRONICS, INC., Pennsville
ELECTRONIC WORLD, Manasquan
HOBBYMASTERS, Red Bank
J&J ELECTRONIC WORLD, Manasquan
LASHEN ELECTRONICS, INC., Denville
MIDAS DATA SYSTEMS INC., Marlton
RADIO SHACK ASSOC. STORE, Moorestown
RADIOS UNLIMITED, Somersat
SOFTWARE CITY, Pine Brook
SOFTWARE CITY, River Edge

NEW MEXICO
AULTE ELECTRONICS CO., Albuquerque
JAW ENTERPRISES, Clovis
MICROAGE COMPUTER STORE,
Albuquerque
MITCHELL MUSIC, Carlsbad
THOMAS E. CARR JEWELER, Alamogordo
WARGAMES WEST, Albuquerque

NEW YORK
ARISTO CRAFT DISTINCTIVE MINIATURES,
New York
ASD HOME COMPUTER CENTER,
Poughkeepsie
BERLINER COMPUTER CENTER,
New Hyde Park
COMPUTER CORNER, White Plains
COMPUTER RESOURCES, Williamsville
COMPUTER SHOP, Kingston
COMPUTER TREE, Endicott
COMPUTERLAND, Carlisle Place
COMPUTERLAND OF NYC, New York
DIGIBYTE SYSTEMS, New York
MICROCOMPUTER SERVICES, Cohoes
FUTURE VISIONS COMPUTER STORE, Melville
MICROHUT, Brooklyn
MODERN TEK SHOPS, Snyder
MR. COMPUTER, Wappingers Falls
PNR CLEAN AIR ENTERPRISES,
Pittsburgh
PHANTOS RESEARCH, Camillus
PROGRAMS UNLIMITED, Jericho
SOFTRON SYSTEMS, Roseton
WATERLOO HOBBIES, Mineola
WORLD OF COMPUTERS, Port Chester

NORTH CAROLINA
RAYBURN MICRO ELECTRONICS, Sylva
SOUND MILL, Havelock

OHIO
ABACUS II, Toledo
ALTAIR SYSTEMS, INC., Dayton
ASTRO VIDEO ELECTRONICS, INC., Lancaster
CINCINNATI COMPUTER STORE, Cincinnati
COMPUTER STORE, Toledo
COMPUTERLAND, Columbus
COMPUTERLAND, Mayfield Heights
COMPUTERLAND, North Olmsted
COMPUTERLAND, Warren
JERRY'S COMPUTER, Cleveland
JOBAR ENTERPRISES, Middlefield
MICROAGE, Columbus
MICRO COMPUTER CENTER, Centerville
MICRO ELECTRONICS INC., Columbus

MICRO MINI COMPUTER WORLD, Columbus
TWENTY-FIRST CENTURY SHOP, Cincinnati
WANNA PLAY, Cincinnati

OKLAHOMA
COMPUTER STORE, INC., Tulsa
COMPUTER WORLD, Tulsa
WM DAVIS DATA PROFILE MGMT, Moore
RADIO SHACK ASSOC. STORE, Guyton
SOUNDS, ETC., Watonga

OREGON
COMPUTER SPECIALTIES, Salem
COMPUTERLAND OF PORTLAND, Tigard
L&R ELECTRONICS, Grant Pass
PIONEER ELECTRONICS, Sandy

PENNSYLVANIA
ALLIED HOBBIES, Philadelphia
ARTCO ELECTRONICS, Kingston
BELL ELECTRONICS, Edinboro
BELL ELECTRONICS, Grant
COMPUTERLAND, Gettysburg
COMPUTERLAND OF HARRISBURG,
Mechanicsburg
ERIE COMPUTER, Erie
J&E COMMUNICATIONS, Altoona
MAREX ASSOCIATES, Johnstown
PERSONAL COMPUTER CORP., Paoli
PERSONAL SOFTWARE, New Ltd., Malvern
PITTSBURGH COMPUTER STORE, Pittsburgh
STEVEN'S RADIO SHACK DEALER, Phoenixville
RUMPELSTILSKIN TOY SHOP, New Hope
TELEVISION PARTS COMPANY, INC.,
New Brighton

PUERTO RICO
MICRO COMPUTER STORE, Caparra Terrace

RHODE ISLAND
COLONIAL ENTERPRISES (RS DEALER),
Foster

SOUTH CAROLINA
OMNI ELECTRONICS, Charleston

TENNESSEE
ACE MINI SYSTEMS, Clarksville
CHATTANOOGA COMPUTER CENTER,
Chattanooga
COMPUTER WORLD, Nashville
COMPUTERLAB, Memphis
H&H ELECTRONICS, Tullahoma

TEXAS
AUDIO WORKS, Lufkin
CODEDATA INC., Arlington
COMPUTER CONCEPTS, Beaumont
COMPUTER N THINGS, Austin
COMPUTER PROGRAMMING ASSOC., Lubbock
COMPUTER PORT, Arlington
COMPUTER SALES & SERVICE, Fort Worth
COMPUTER SOLUTIONS, San Antonio
COMPUTERLAND OF SW HOUSTON, Houston
COMPUTERS BY O'NEILL, Lake Jackson
COMPUTERS TO GO, Austin
COMPUTEX, Webster
CONSAIR, Ft. Worth
GATEWAY ELECTRONICS, Houston
THE HOBBY CENTER, Abilene
KA ELECTRONICS, Dallas
MAC'S TV, Fairfield
MARYMAC INDUSTRIES (RS DEALER),
Houston
MICRO COMPUTER CONCEPTS, Plano
PAN AMERICAN ELECTRONICS (RS DEALER),
Mission
R.L. COLE'S ELECTRONICS, San Antonio
ROY'S CB & ELECTRONICS, Aransas Pass
BO SOFTWARE, San Antonio
TOTAL COMPUTER STORE, Beaumont
WAGHALTER BOOKS, INC., Houston

UTAH
COMPUTERLAND, Salt Lake City
FOOTHILL MODELERS, Salt Lake City
QUALITY TECHNOLOGY, Salt Lake City

VERMONT
TEMPO CO. (RS DEALER), Brattleboro

VIRGINIA
COMPUTER SOLUTIONS, Leesburg
COMPUTER WORKS, INC., Harrisonburg
FRAME GALLERY, Herndon
HOME COMPUTER CENTER INC.,
Virginia Beach
LITTLE SOLDIER, Alexandria
SYSTEMS MARKETING, Arlington

WASHINGTON
AMERICAN MERCANTILE COMPANY, Seattle
CEJ ELECTRONICS, Richland
COMPUTERLAND, Bellevue
COMPUTERLAND, Federal Way
COMPUTERLAND, Spokane
THE ELECTRONIC SHOP, Olympia
EMPIRE ELECTRONICS, Seattle
EMPIRE ELECTRONICS, Sunnyside
J.B. SALES, Snohomish
LORDS, Port Angeles
PERSONAL COMPUTERS, INC., Spokane
UNIVERSITY VILLAGE MUSIC, Seattle
U.S.S. ENTERPRISE, Kirkland
WESTERN MICROCOMPUTER CENTER,
Bellingham

WEST VIRGINIA
COMPUTER CORNER, Morgantown
COMPUTER STORE, Huntington
OHIO VALLEY ELECTRONIC SYSTEMS,
Wheeling
SOUND & ELECTRONIC SPECIALTIES,
Morgantown

UHF SALES, Evans

WISCONSIN
BYTE SHOP, Greenfield
COMPUTER WORLD, Appleton
COMPUTER WORLD, Green Bay
COMPUTERLAND, Madison
COMPUTERLAND, Milwaukee
COMPUTERLAND, Wausau
COMPUTERLAND OF FOX RIVER VALLEY,
Oshkosh
MAGIC LANTERN COMPUTER, Madison
OMEGA MICROS, Milwaukee
PETTED MICROSYSTEMS, Milwaukee
550 TV SALES, Monroe

WYOMING
COMPUTER CONCEPTS, Cheyenne

AUSTRALIA
CISA MICROCOMPUTING, Sidney
DE FOREST SOFTWARE, Nunawading, Vic

CANADA
Distributor:
MICRON DISTRIBUTING
Toronto, Ont.

ALLIED COMPUTER CENTRE, Thunder Bay
Ontario
ARRON ELECTRONICS, Toronto, Ontario
AULL COMPUTER SYSTEMS, Victoria, B.C.
BITS & BYTES, Dartmouth, N.S.
CENTRAL DISTRIBUTORS LTD., Lachine,
Quebec
COMPUCORNER, Smothers, B.C.
COMPUTART, Ottawa, Ontario
COMPUTER BARN, Sarnia, Ontario
COMPUTER CIRCUIT, London, Ontario
COMPUTER INNOVATIONS, Ottawa, Ontario
COMPUTER SHOP LTD., Calgary, Alberta
COMPUTER WORLD, Vancouver, B.C.
COMPUTERLAND OF BURLINGTON,
Burlington, Ontario
CREATIVE COMPUTERS, Victoria, B.C.
DATATEC COMPUTER SYSTEMS LTD.,
Saskatoon, Sask.
ELECTRONICS 2001, Willowdale, Ontario
GALACTICA COMPUTERS LTD., Edmonton,
Alberta
IRSCO DU QUEBEC, Ste. Foy, Quebec
LYONS LOGIC LTD., London, Ontario
MICROMATION, Toronto, Ontario
MICROSHACK, Saskatoon, Sask.
MICRO SHACK, Regina, Sask.
MSW COMPUTERS, Mississauga, Ontario
NIP & TUCK VARIETY, London, Ontario
OFFICE CENTRE, Kingston, Ontario
SAULT OFFICE MACHINES, Sault St. Marie,
Ontario
STATUS COMPUTER SYSTEMS, St. Catharines,
Ontario
TOTAL COMPUTER SYSTEMS, Ajax, Ontario
WEST WORLD COMPUTERS, Edmonton,
Alberta

ITALY
BITS & BYTES, Milan

FRANCE
JCS Composants, Paris

NETHERLANDS & BELGIUM
Distributor:
SOFTWARE IMPORT BRABANT,
Eindhoven, Neth.

COMPUTER COLLECTIEF, Amsterdam
MICRO COMPUTING, Arnhem
MICRO DYNAMICS, Eindhoven
MUSICPRINT.CHIP, Arkel
OVEL GORNE, Drachten
R.A.L. MICROCOMPUTERS, The Hague

NEW ZEALAND
VISCOUNT ELECTRONICS, Palmerston North

NORWAY
A/S SORLUND, Vedavagen

SWEDEN
SENTEC AB, Jartalla

UNITED KINGDOM
CALISTO COMPUTERS, Birmingham
THE SOFTWARE HOUSE, London

WEST GERMANY
MICROSTUFF, Frankfurt

WHAT DO THEY KNOW THAT YOU DON'T?

Find out. Fill out this coupon (or make a photocopy) and mail it today. You'll receive a dealer pack, filled with details on how you can join the ranks of the successful dealers listed above—with Instant Software.

NAME: _____
 ADDRESS: _____
 CITY: _____ STATE: _____ ZIP: _____

Instant Software Inc. ✓ 445
 Peterborough, N.H. 03458 603-924-7296 DC-17

Micro-Programmed Controllers

— bridging the gap between TTL and microprocessors

There are many times when you need some sort of digital circuit which gets its inputs from somewhere else, makes some simple decisions based on those inputs, and then feeds its outputs to still elsewhere.

A good example is a repeater control circuit. This device gets some inputs—usually digital signals which signal some on/off

condition with either 0 volts or +5 volts—from other parts of the repeater such as a timer, input carrier detector, or touch-tone™ decoder. The control circuitry monitors these inputs, and when certain conditions are satisfied, it sends out control signals to other parts of the repeater such as the transmitter keying relay or an autopatch.

Obviously, such a device is called a controller because it controls things. Although I'm using a repeater control circuit as an example, in reality controllers are much more useful. A controller can be used to control a complex RTTY station, a home heating system, or a burglar alarm.

Controllers used by hams typically take one of three forms. In the simplest

cases, a controller may be built out of relays. In somewhat more complex systems, a controller might be built out of digital logic devices such as the 7400-series TTL integrated circuits which are used in most ham repeaters. And a few repeaters have controllers that use a micro-computer. Obviously, the more complex a controller, the more sophisticated control it can provide. And the computerized repeater systems have some really impressive features.

Relay controllers and controllers built out of just digital logic often are called hard-wired controllers. Their functions are wired into the system. Changing the way the controller works or fixing a bug requires that the wiring be changed.

Computerized controllers, on the other hand, are programmed controllers. Their functions are coded into a computer program which controls the computer. To change what the controller does or to fix a bug, you leave the wiring alone but change the program. This makes modification of the system a snap.

For some simple applications, however, programming a digital microcomputer can be overkill. For these cases, it would be

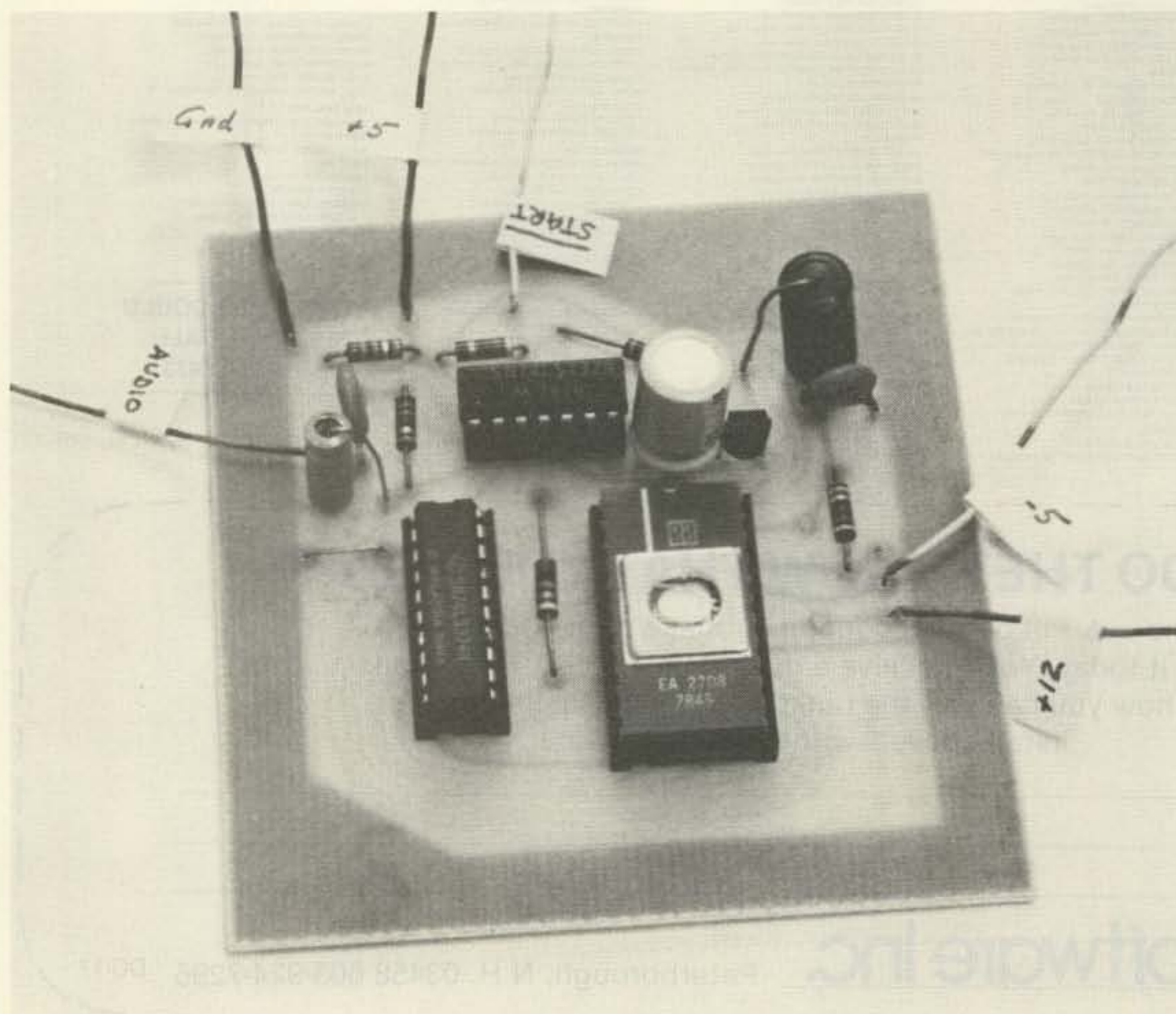

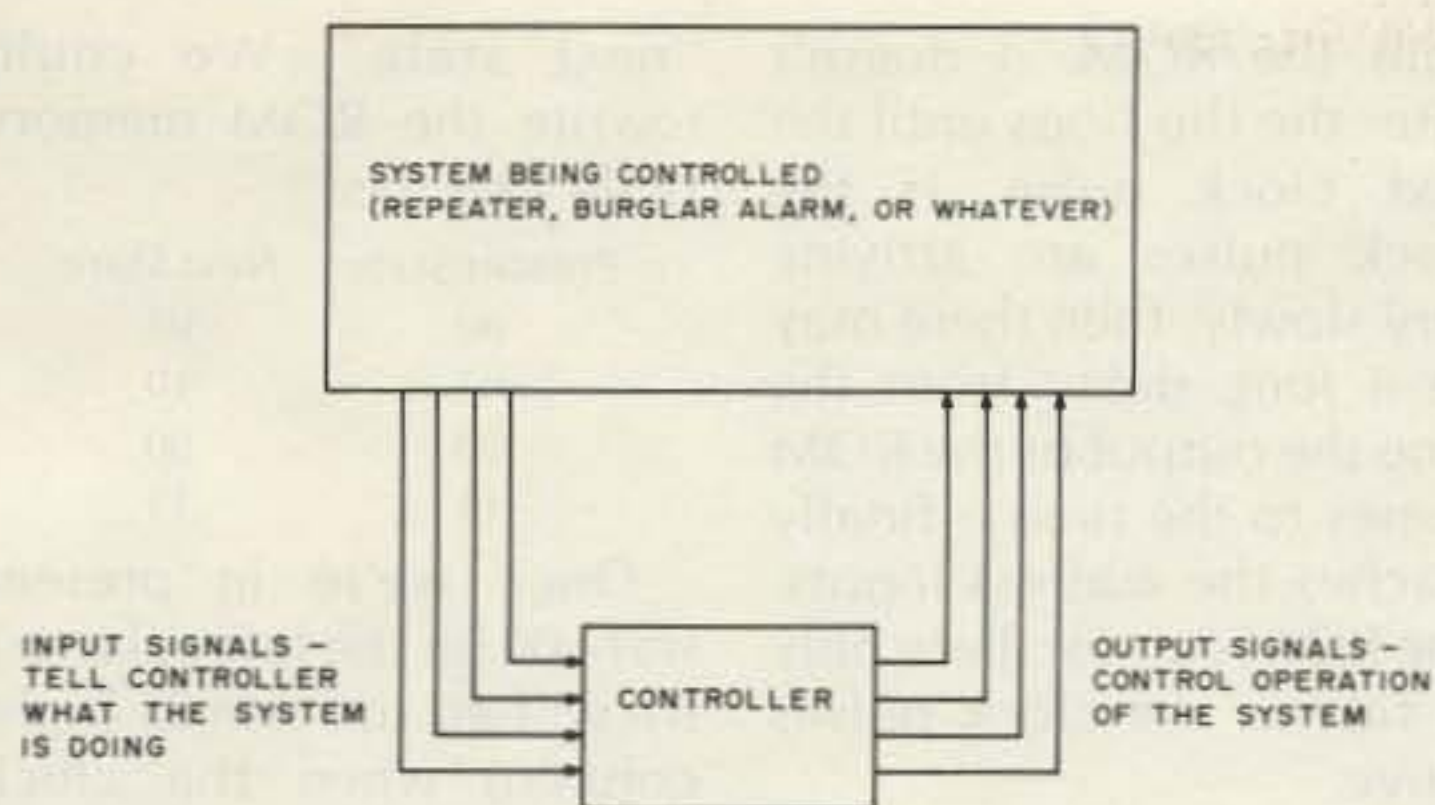

Fig. 1. How a controller fits into a system.

nice to have a simpler device which uses some hard wiring but which can also be programmed to allow simple modifications or improvements as time goes on. Such a device is the micro-programmed controller.

A micro-programmed controller has a program which controls its operation but doesn't have a computer to go with it. Hence, it is much simpler to understand, build, and use. It doesn't have the full power of a computerized controller, but for most simple control jobs, it is good enough.

Micro-programmed controllers are nothing new; in fact, many computers have one inside them for control of their own internal operations. They are seldom used on their own, however, primarily because they are not well known. The purpose of this article is to introduce this very useful and powerful device to hams.

Sequential Controllers

Fig. 1 shows a simple block diagram of how a controller fits into a system. There are inputs from the system to the controller which tell the controller what is going on in the system. In a repeater, for instance, these might come from the carrier-operated relay (COR) or from tone decoders; in a burglar alarm, these might come from door and window switches.

In turn, the controller sends back some output

signals which do things in the system. In a repeater, these might turn on the transmitter or autopatch; in a burglar alarm, they might ring an alarm bell.

Depending upon what the controller does, there are two types of controllers—combinatorial and sequential controllers. Both types have some inputs and provide some outputs. In a combinatorial controller, those outputs depend upon only the present inputs. In a sequential controller, the present outputs depend not just on the present inputs but also on past inputs.

Another way to look at this is as follows: For a particular combination of inputs, a combinatorial controller will always do the same thing, but a sequential controller has memory and will do different things if input signals arrive in a different order.

Consider the example of a burglar-alarm controller. In a combinatorial controller, every time the front door opens, the alarm bell rings. If there is a screen door just outside the main door, then the combinatorial controller will ring the bell when the main door opens even if the screen door is closed. But this would ring the bell when you leave the house.

On the other hand, a sequential controller could be connected to both doors. It could be set up so that if the screen door opens first and then the main door opens, the bell

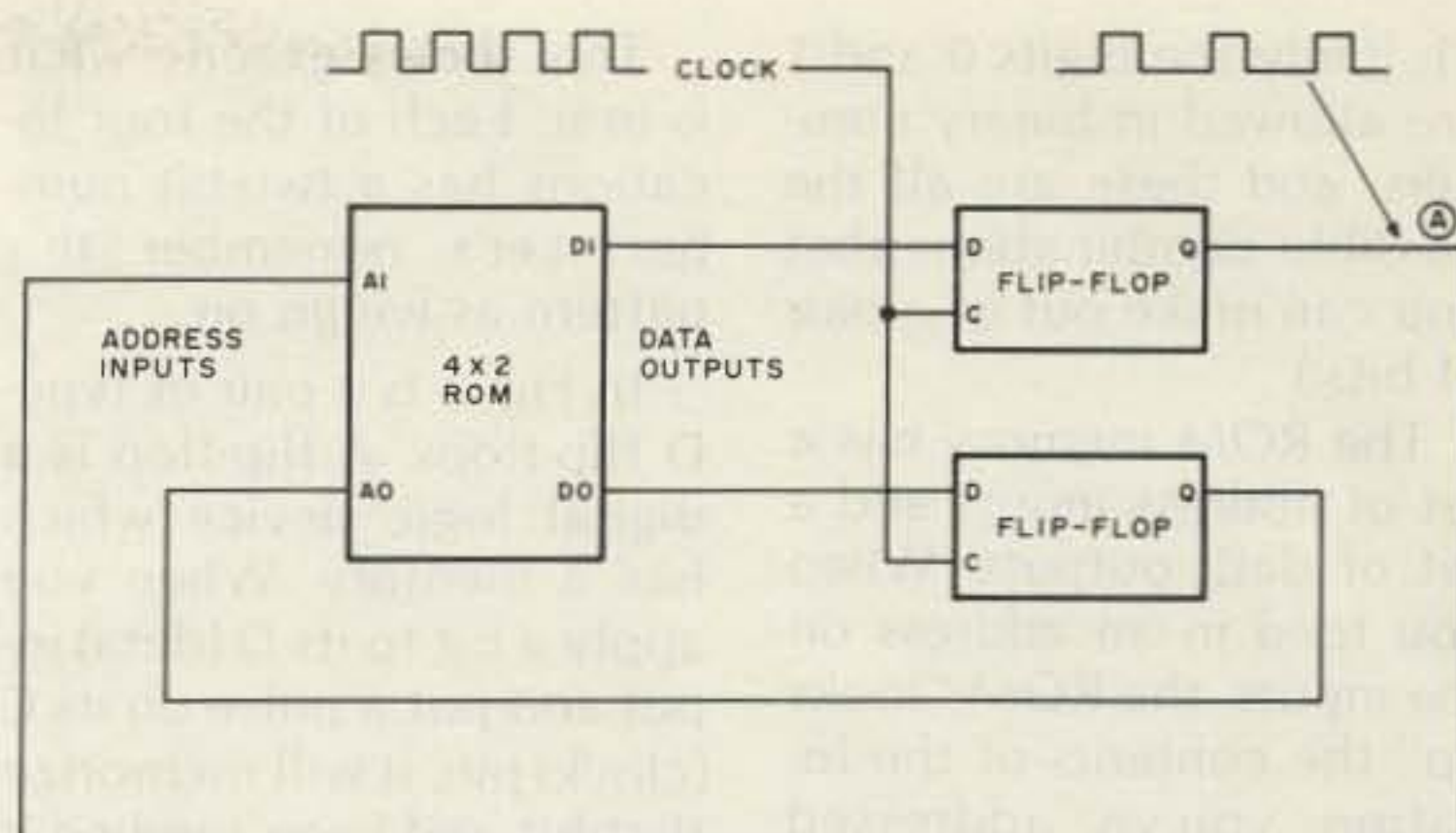

Fig. 2. A very simple micro-programmed sequential circuit.

rings. But if the main door opens before the screen door, then the alarm does not sound. This controller would allow someone to go out but not in. In other words, the sequence of inputs is important.

A sequential controller also can provide a sequence of outputs. It could pulse the alarm bell on and off, or turn it off after ten minutes, or it could alternately pulse a bell and a siren, or toot a song on several horns of different pitch. A combinatorial controller can't do that.

Obviously, a sequential controller is more useful and interesting. It's also more difficult to build. A combinatorial controller can be just a series of relay contacts or simple digital logic which provides an output when some particular combination of inputs is present. A sequential controller, on the other hand, has to have some built-in memory to remember what has happened in the past, and often must have some delay circuits or timers as well. This is why complex ham controllers often have complicated digital logic circuits or microcomputers.

Micro-Programmed Sequential Controllers

A lot of people think that programming a microcomputer is called micro-programming. Not so. Micro-programming means programming on a small scale. In this case, we program a

simple circuit to do some very simple things.

Fig. 2 shows a very simple micro-programmed sequential circuit consisting of a read-only memory (ROM), two type-D flip-flops, and some sort of clock to generate pulses which go to the flip-flops. (This circuit is so simple that it doesn't have any inputs or outputs to the outside world. Hence, this sequential controller can't do anything useful—yet.)

The ROM is a digital memory. It is divided into a number of locations, each of which stores a binary number. In Fig. 2, this is a 4 × 2 ROM, meaning that it has four separate memory locations and each stores two binary digits.

(In case you are not familiar with digital logic, the binary digits (bits) are either 0 or 1. In most common digital circuitry, a 0 is carried along a wire as a voltage of 0 volts, or very close to it, while a 1 is represented by a voltage above 2 volts. Although we tend to think of 0 and 1 as being 0 volts and +5 volts, since these are the supply voltages used in TTL integrated circuits, the most common voltage for a 0 is about 0.2 volts, and the most common voltage for a 1 is between 3 and 4 volts.)

Each of the four locations has an address; this address also is a binary number. In this case, we need two bits to specify an address. The four different addresses are 00, 01, 10, and

11. (Only the digits 0 and 1 are allowed in binary numbers, and these are all the possible combinations that you can make out of a pair of bits.)

The ROM memory has a set of address inputs and a set of data outputs. When you feed in an address on the inputs, the ROM "looks up" the contents of the location you've addressed and feeds the contents of that location out over the data outputs. The 4x2 ROM shown in Fig. 2 has two address input lines (since it needs two bits to specify one of its four addresses) and also happens to have two data output lines, since each location only holds two bits. As such, this is a tiny ROM—so small that nobody makes it. A typical manufactured ROM might have 1024 memory locations with 8 bits in each location.

The ROM gets its data by being programmed. Some ROMs are programmed in the factory when manufactured; other ROMs can be programmed in the field. The particular ROMs hams use most often can not only be programmed in the field, but can also be erased; they are called EPROMs, for Erasable Programmable ROM.

Suppose we programmed the 4x2 ROM as follows:

| Location (Address) | Contents (Data) |
|--------------------|-----------------|
| 00 | 01 |
| 01 | 10 |
| 10 | 00 |
| 11 | 11 |

This shows exactly what is in it. Each of the four locations has a two-bit number. Let's remember this pattern as we go on.

In Fig. 2 is a pair of type-D flip-flops. A flip-flop is a digital logic device which has a memory. When you apply a bit to its D (data) input and put a pulse on its C (clock) pin, it will memorize that bit and keep sending it out the Q output for as long as power is applied or until the next data bit and clock pulse arrive.

In this case, the data arrives from the ROM and is supplied to two flip-flops, one for each bit. The clock signal is a series of pulses generated by some sort of oscillator which arrive at regular intervals. Every time a clock pulse arrives, the two flip-flops memorize the binary data coming out of the ROM and then feed the data back out their Q outputs. This output will then stay there until the next clock pulse arrives, at which time it may change.

Now, we notice that these Q outputs go right back to the address inputs of the ROM—so this is some sort of feedback circuit. If you are at all familiar with feedback, you will remember that feedback does strange things...like make amplifiers oscillate. That's exactly what can happen in this case; it can make the ROM oscillate. But the flip-flops can be thought of as a delay. When an output comes

from the ROM, it doesn't enter the flip-flops until the next clock pulse. If the clock pulses are arriving very slowly, then there may be a long delay from the time the output of the ROM comes to the time it finally reaches the address inputs. The ROM can oscillate only as fast as the clock pulses arrive.

Now let's go back to the pattern we programmed into the ROM earlier, and let's assume that we somehow start with the flip-flops putting out a digital signal of 00. This 00 is sent back to the ROM as an address. Since the ROM has been programmed with a 01 at location 00, it will feed a data output of 01 to the two flip-flops.

At some time later, a clock pulse arrives. All of a sudden, the flip-flops get triggered and memorize the 01 pattern. Now they output 01 back to the ROM's address inputs.

The ROM now gets an address of 01, and so it outputs 10 as data. This goes to the flip-flops, but again nothing happens until a clock pulse arrives. When it does, suddenly the 01 on the flip-flop outputs changes to 10. This goes back to the ROM's address inputs so that the ROM now outputs 00, the number we programmed into location 10. But again, nothing happens until the clock pulse comes. When it finally arrives, the 00 will appear on the flip-flop outputs, and we're right back where we started.

If you leave the circuit sitting there for a long time, it will simply keep cycling back and forth: 00, 01, 10, 00, 01, 10, 00... and so on. It goes through a sequence of addresses. If we call each different address a state, we see that the number going into the ROM is the "present state" while the number coming out will be the

"next state." We could rewrite the ROM memory table like this:

| Present State | Next State |
|---------------|------------|
| 00 | 01 |
| 01 | 10 |
| 10 | 00 |
| 11 | 11 |

Once we're in present state 00 (in the left column), we will go to state 01 (right column) when the clock comes. When we're in state 01 (left column), the next state after a clock comes will be 10 (right column). Finally, from a present state of 10 we'll go right back to 00.

While the circuit is going back and forth like this, we could connect an oscilloscope to point A (see Fig. 2) and would see the waveform shown, since this line is a 0 for two clock pulses and a 1 for one clock pulse. This circuit could, therefore, take a symmetrical clock pulse and produce an output which is unsymmetrical. You can see that, given enough states, we could make this waveform as complex as we'd like. (Later, I'll show you how to build a CW identifier using just three integrated circuits.)

Suppose, though, that somehow we had started off with the flip-flop outputs equal to 11. This table shows us that location 11 has the data 11, so the next state also will be 11. In this case, the circuit will just lock up and stay in the 11 state forever.

So, we have here a circuit which will go through a succession of states following exactly the pattern which is programmed into the ROM. But we have to be careful not to mix up the bits being fed back or the sequence of states will not be the right one. We do this by noting which of the address inputs is the left digit and which is the right. In Fig. 2, we see that the address inputs of the ROM are labeled A1 and A0. When we write

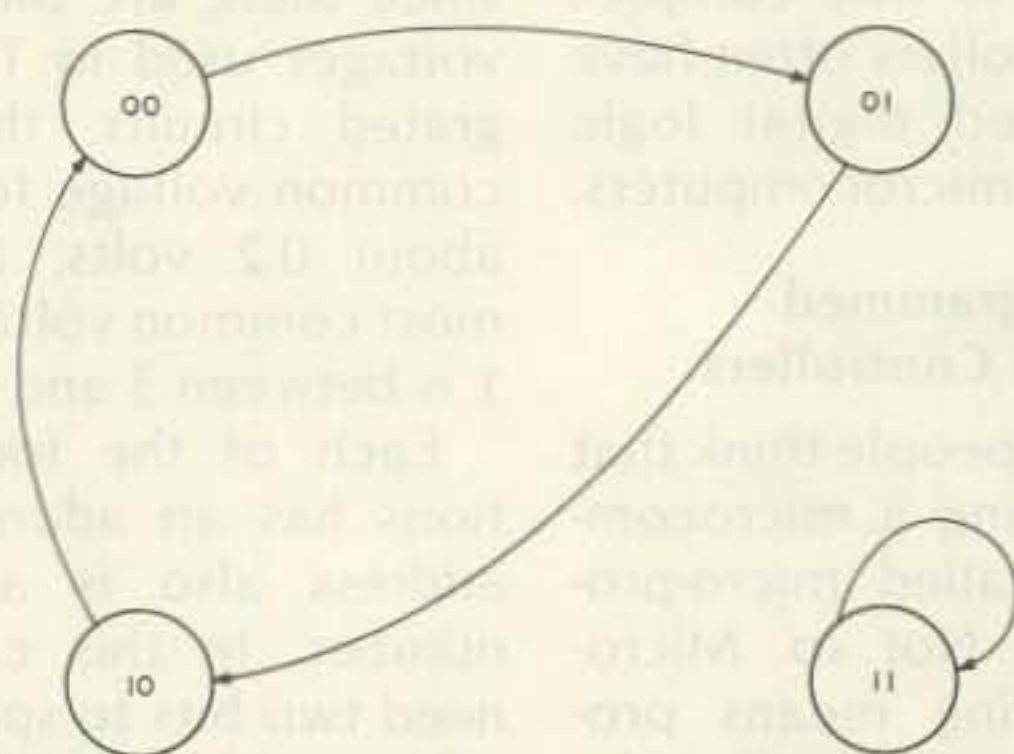

Fig. 3. State map for the circuit in Fig. 2.

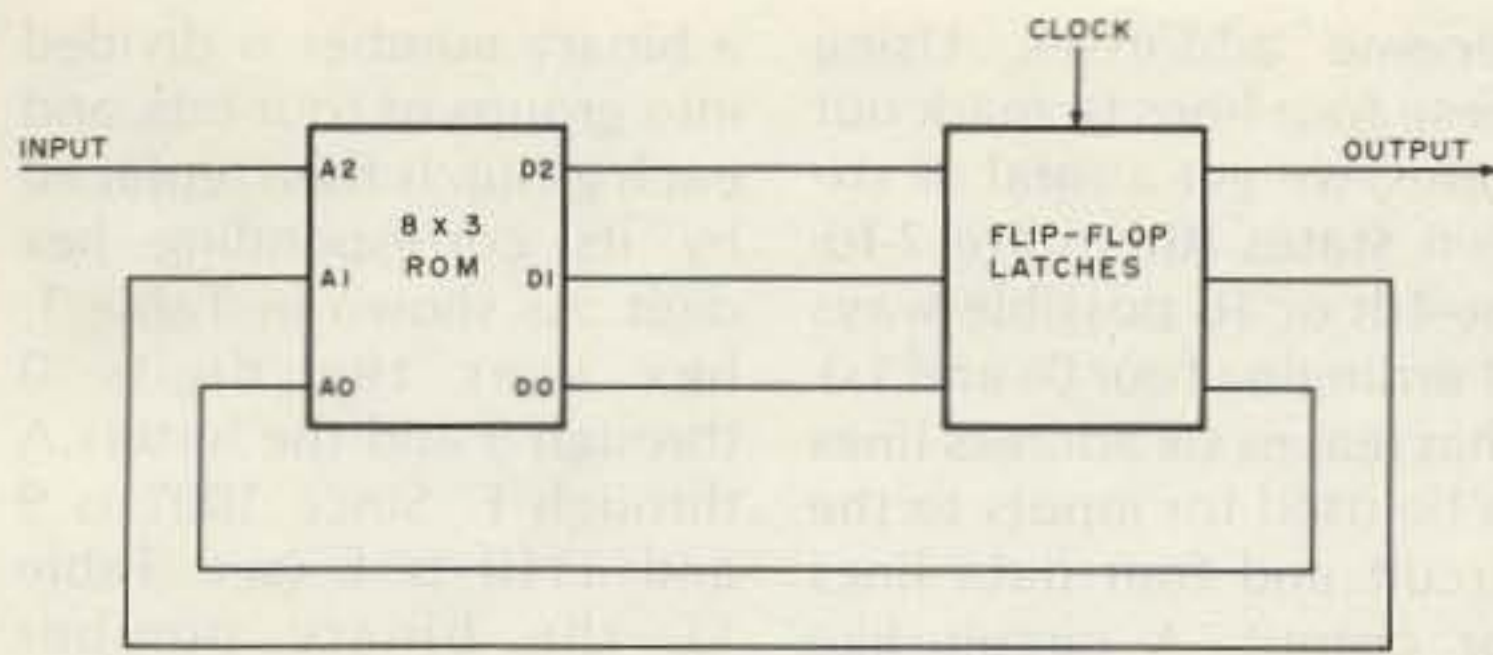

Fig. 4. A more complex controller.

these two bits down on paper, A0 is at the right and the bits are numbered higher as we go left. (For instance, a ROM having ten address inputs would have them numbered from A0 on the right to A9 on the left.) In the same way, D0 is the data bit at the right, and we must make sure that D0 goes around in such a way that it comes back to A0, not to A1.

To make the operation of a circuit like this easier to understand, we use a "state map" or "state diagram," as in Fig. 3. In this map, each state is shown as a circle which is numbered with its state. Like one-way roads on a road map, arrows show how we go from state to state. From state 00 we go to 01, from 01 to 10, from 10 back to 00. But if we're in state 11, then the road leads right back to 11.

Let's look at the more complex circuit in Fig. 4. Since this ROM has three address inputs and three address outputs, it is an 8x3 ROM (there are eight possible ways we can write the three address bits and there are three bits per location). We now need three type-D flip-flops, but rather than showing them individually, we just show them as a big box. Since these flip-flops grab an input and hold it until the next clock pulse, they are usually called latches.

This time we don't feed all the outputs back to the input. We reserve one of the address lines as an input from somewhere else and use one of the latch outputs

for an output to somewhere else. Only two lines are fed back. (The fact that this ROM has the same number of address inputs as data outputs is just coincidental. Most modern ROMs have more address pins than data pins. For instance, the EPROM in Fig. 9 has ten address inputs and only eight data outputs. Sometimes all the outputs go back to the inputs and other times only a few lines go back. It all depends on the application.)

Now, let's assume that this 8x3 ROM is programmed as follows:

| Location (Address) | Contents (Data) |
|--------------------|-----------------|
| 000 | 000 |
| 001 | 000 |
| 010 | 000 |
| 011 | 000 |
| 100 | 001 |
| 101 | 010 |
| 110 | 011 |
| 111 | 111 |

Notice in Fig. 4 that the two bits on the right of each set are being fed back through the latches; let's call these two bits "the state." The remaining address bit will be the input bit, and the remaining data bit will be the output bit. Then we can rewrite the table. The first column will look like this:

| Input | Present State |
|-------|---------------|
| 0 | 00 |
| 0 | 01 |
| 0 | 10 |
| 0 | 11 |
| 1 | 00 |
| 1 | 01 |
| 1 | 10 |
| 1 | 11 |

and the second column will look like this:

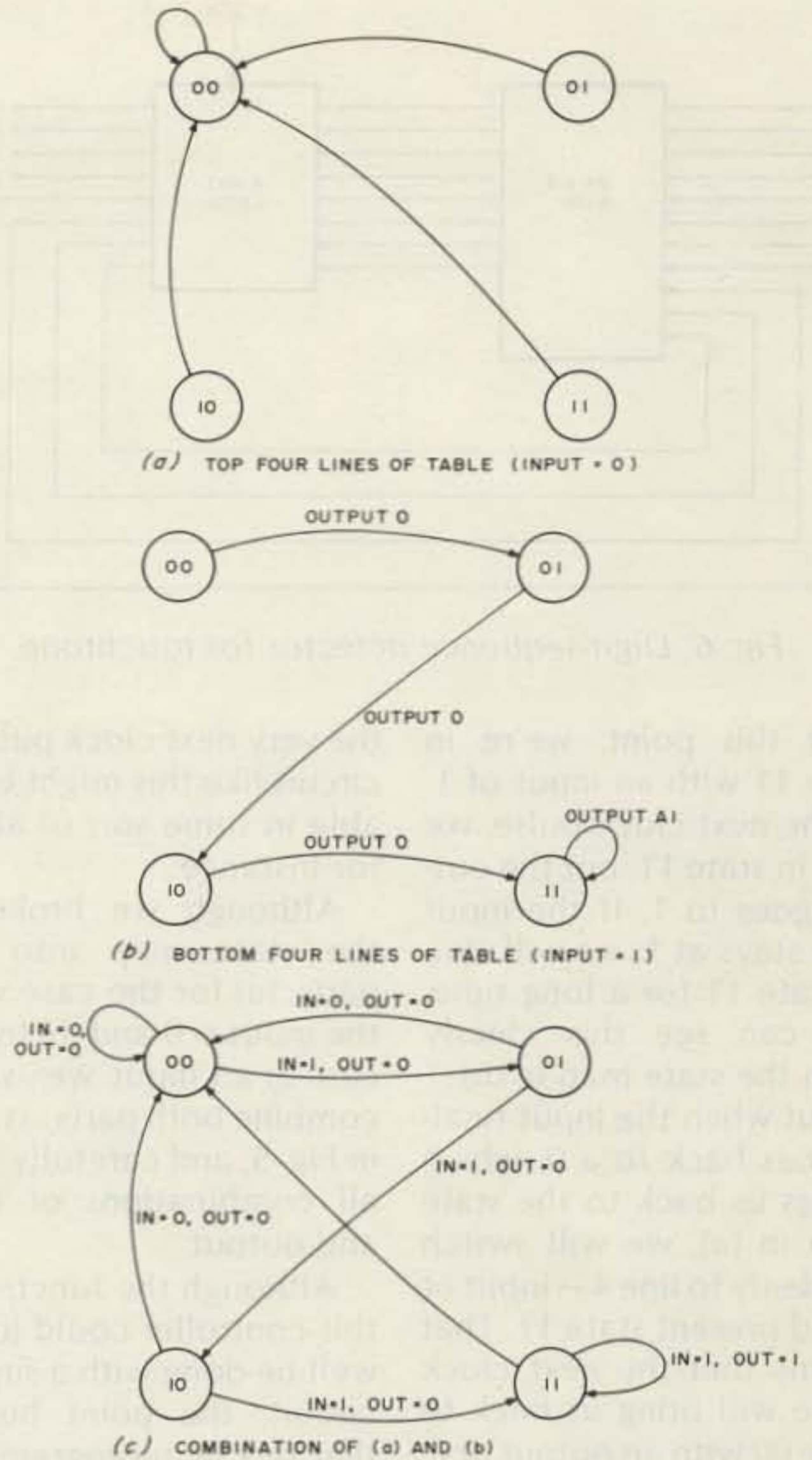

Fig. 5. State map for Fig. 4.

| Output | Next State |
|--------|------------|
| 0 | 00 |
| 0 | 00 |
| 0 | 00 |
| 0 | 00 |
| 0 | 01 |
| 0 | 10 |
| 0 | 11 |
| 1 | 11 |

What does this table tell us? The top four lines of each say this: As long as the input is 0, regardless of what state we're in, the output will be a zero and we will go to state 00 next. This means that when the input is a 0 for a long time, the circuit simply locks up in state 00 and keeps providing a 0 output all the time. The state map for these four lines is shown in (a) in Fig. 5.

Now, suppose that we're in state 0 for a while and suddenly the input changes from 0 to a 1. All of a sudden we're on line 5 of the in-

put table—input 1, present state 00. Then, after the next clock pulse (let's repeat that again—after the next clock pulse), the output will stay at 0 but we will go to state 01 (down to line 6 of the input table).

The state map for the last four lines of the input table is shown in (b) in Fig. 5 and shows how we move from state 00 to state 01 if the input is a 1.

If the input should go back to 0, we'd move back to line 1, and at the next clock pulse, we'll simply shoot back up to state 00 again. But let's assume the input stays at 1 for a while. Then, at the next clock pulse, we'll move to state 10. When we're in state 10 with the input still 1, the next clock pulse moves us to an output of 0 and state 11.

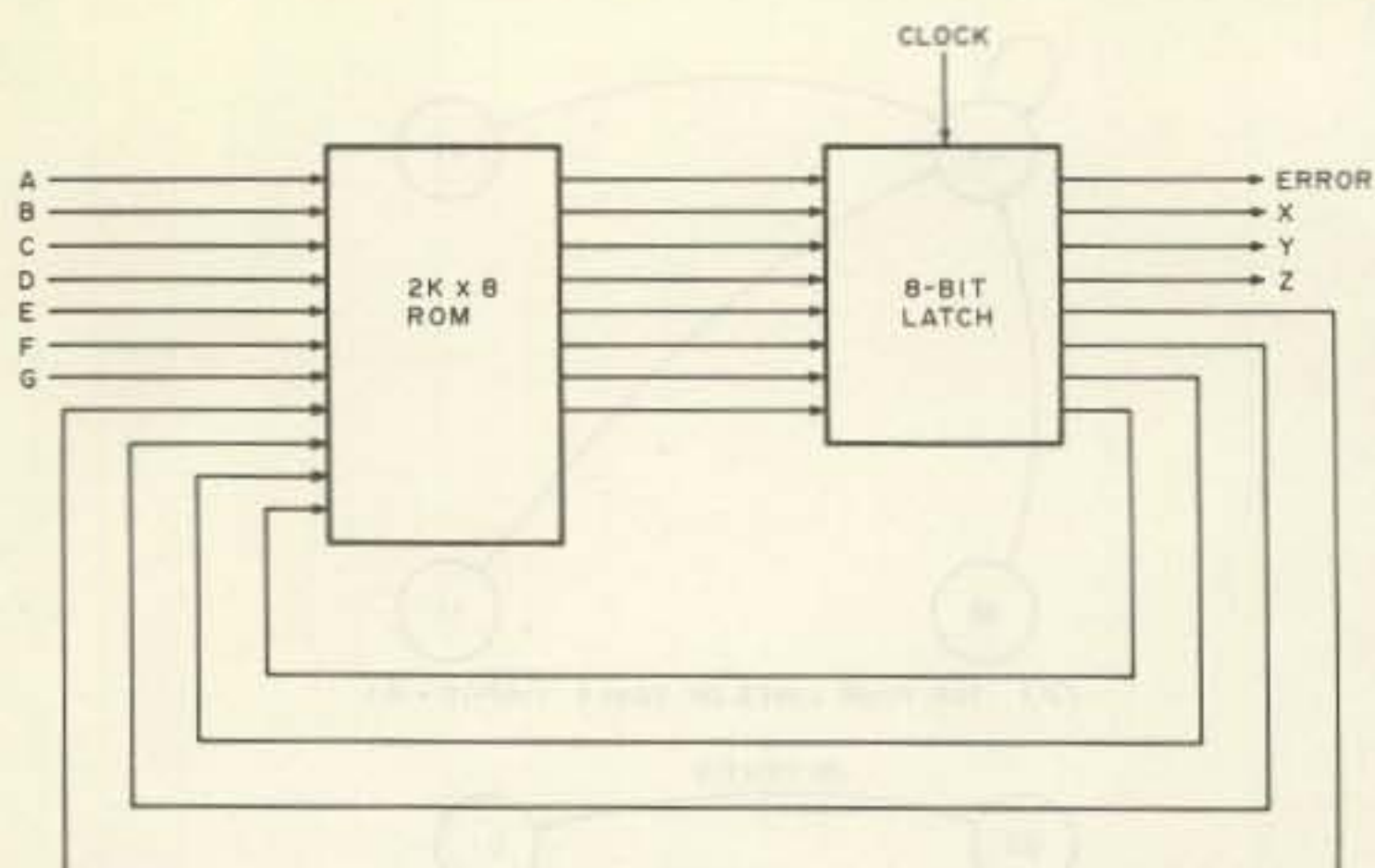

Fig. 6. Digit-sequence detector for touchtone.

At this point, we're in state 11 with an input of 1. At the next clock pulse, we stay in state 11, but the output goes to 1. If the input now stays at 1, we will stay in state 11 for a long time. We can see this clearly from the state map in (b).

But when the input finally goes back to a 0, which brings us back to the state map in (a), we will switch suddenly to line 4—input of 0 and present state 11. That means that the next clock pulse will bring us back to state 00 with an output of 0.

So, this is a delay circuit of sorts. If the input is 0 for a long time, the output stays 0. When the input goes to 1, the output stays at 0 until four clock pulses later, at which point it finally goes to 1, too. But if the input goes to 0, then the output drops back to 0 at

the very next clock pulse. A circuit like this might be usable in some sort of alarm, for instance.

Although we broke up the state map into two parts, (a) for the case when the input is 0 and (b) for the case of a 1 input, we usually combine both parts, as in (c) in Fig. 5, and carefully label all combinations of input and output.

Although the function of this controller could just as well be done with a simpler circuit, the point here is that just by reprogramming the ROM we can get the same circuit to do something completely different. For instance, we could change the last two lines of the table as follows:

| (Column 1) | (Column 2) | (Column 1) | (Column 2) |
|------------|------------|------------|------------|
| 1 | 10 | 1 | 11 |
| 1 | 11 | 0 | 10 |

The circuit here would oscillate between states 11 and 10 and would pulse the output on and off. This could pulse an alarm bell a certain time after a door opened for instance.

Now we see why this is called a micro-programmed sequential controller. It is programmed via very simple (micro) instructions, it operates in a certain sequence, and it can be used to control things.

This idea is a very powerful one. For instance, if we had a ROM with ten address inputs and eight data outputs, we could feed back, say, four data lines to

become addresses. Using these four lines to mark our states, we get a total of sixteen states (there are 2-to-the-4th or 16 possible ways of arranging four 0s and 1s). That leaves six address lines to be used for inputs to the circuit and four data lines for output. A circuit like this could be used as a fairly neat traffic-light controller. The six inputs might go to traffic sensors and a timer, while the four outputs would control a pair of red and green lights. The circuit could then switch the lights in a prearranged sequence, depending on the external timer inputs and the presence of traffic.

Just two more concepts before we look at another practical example.

The number of memory locations depends on the number of address lines, because these determine how many different addresses we can make. With two lines, we could have only four different addresses (00, 01, 10, and 11). With three address lines, we could have eight addresses; with four lines we could have 16 addresses. The equation to use is: Number of locations = 2^n , where n is the number of lines. For instance, the ROM with ten address lines has 1024 memory locations, since $1024 = 2^{10}$.

In electronics, a k means 1000. In digital computer talk, K means 1024, so the above ROM would be called a 1K memory. If you examine Fig. 9 carefully, you will see that that circuit uses a $1K \times 8$ ROM, since there are 10 address lines and 8 data lines.

The other thing to keep in mind is that binary numbers are easy to use if they are small. But talking about big binary numbers like 10011110 gets confusing. Hence, most computer people use a different number system. Either octal or hexadecimal (hex) is used, but hexadecimal is currently more popular. In hex,

a binary number is divided into groups of four bits, and each group is then replaced by its corresponding hex digit. As shown in Table 1, hex uses the digits 0 through 9 and the letters A through F. Since 1001 is 9 and 1110 is E (see Table 1), the binary number 10011110 would be written as 9E in hex.

This is easy to do when the binary number has 4, 8, 12, or 16 bits. But when it has 9 or 10 bits, how do you split them into groups of four? The secret is to add zeros in front of it to stretch it out to a multiple of four bits. For instance, the binary number 110011110 would be stretched out to 000110011110, split up into 0001-1001-1110, and then written as 19E in hex.

A Micro-Programmed Tone Decoder

Many repeater control circuits use touchtone™ signals (a dual-tone signaling system) for repeater control. The actual tones are detected by either tuned-circuit filters or 567 phase-locked loop ICs, and the detected outputs are then used to control repeater functions. Detecting the tones and providing an output for each tone is fairly simple; detecting a sequence of digits (such as dialing the number 1234) and providing an output only when these digits are dialed in the right order is a bit more tricky. A variety of circuits have been used, but a micro-programmed sequential controller can do the job just as well and with less hardware. (Just three ICs, in fact!)

Fig. 6 shows a simplified diagram of the scheme. If we use a $2K \times 8$ ROM (which has 2048 memory locations and, therefore, 11 address-line inputs and 8 data-line outputs), we need an 8-bit latch. Feeding back four data lines from the latch leaves seven input lines and four output lines.

| Decimal Number | Binary Number | Hex Number |
|----------------|---------------|------------|
| 0 | 0000 | 0 |
| 1 | 0001 | 1 |
| 2 | 0010 | 2 |
| 3 | 0011 | 3 |
| 4 | 0100 | 4 |
| 5 | 0101 | 5 |
| 6 | 0110 | 6 |
| 7 | 0111 | 7 |
| 8 | 1000 | 8 |
| 9 | 1001 | 9 |
| 10 | 1010 | A |
| 11 | 1011 | B |
| 12 | 1100 | C |
| 13 | 1101 | D |
| 14 | 1110 | E |
| 15 | 1111 | F |

Table 1. Binary and hex numbers.

MFJ KEYERS

Uses Curtis 8044 IC. Iambic operation, dot-dash memories, weight control, solid state keying. RF proof.



\$79⁹⁵

The MFJ-408 Deluxe Electronic Keyer sends iambic, automatic, semi-automatic, manual. Use squeeze, single lever or straight key.

Speedmeter lets you read speed to 100 WPM.

Socket for external Curtis memory, random code generator, keyboard. Optional cable, \$4.95.

Iambic operation with squeeze key. Dot-dash insertion. **Semi-automatic "bug" operation** provides automatic dots and manual dashes.

Dot-dash memory, self-completing dots and dashes, jam-proof spacing, instant start. **RF proof.**

Solid-state keying: grid block, solid state xmtrs.

Front panel controls: linear speed, weight, tone, volume, function switch. 8 to 50 WPM.

Weight control adjusts dot-dash space ratio; makes your signal distinctive to penetrate ORM.

Tone control. Speaker. Ideal for classroom.

Function switch selects off, on, semi-automatic/manual, tune. Tune keys transmitter for tuning.

Uses 4 C-cells. 2.5 mm jack for power (6-9 VDC). Optional AC adapter MFJ-1305, \$9.95.

Eggshell white, walnut sides. 8x2x6 inches.

MFJ-406, \$69.95, like 408 less speedmeter.



\$49⁹⁵

New MFJ-401 Econo Keyer II gives you a reliable, full feature economy keyer for squeeze, single lever or straight key.

Has sidetone, speaker, volume, speed, internal weight and tone controls. Sends iambic, automatic, semi-automatic, manual. Tune function. Dot-dash memories. 8-50 WPM. "On" LED. Use 9V battery, 6-9 VDC, or 110 VAC with optional AC adapter, MFJ-1305, \$9.95. 4x2x3 1/2".

Reliable solid state keying. Keys virtually all solid state or tube type transmitters.



\$64⁹⁵

MFJ-405 Econo Keyer II. Same as MFJ-401 but has built-in single paddle with adjustable travel. Also jack for external paddle. 4x2x3 1/2".

Optional: Bencher Iambic Paddle, \$42.95; 110VAC adapter, MFJ-1305, \$9.95. **Free catalog.**

Order from MFJ and try it. If not delighted, return within 30 days for refund (less shipping).

One year unconditional guarantee.

Order yours today. Call toll free 800-647-1800. Charge VISA, MC. Or mail check, money order. Add \$4.00 each for shipping and handling.

CALL TOLL FREE ... 800-647-1800

Call 601-323-5869 for technical information, order/repair status. Also call 601-323-5869 outside continental USA and in Mississippi. ✓47

MFJ ENTERPRISES, INCORPORATED

Box 494, Mississippi State, MS 39762

hy-gain

NEW VHF and UHF Mobiles

Hy-Gain's new HyCom series of UHF and VHF mobile antennas have been tested in actual use by amateurs across the U.S. for nearly two years with excellent results. The antennas have weathered the salt spray of the coast, the freezing rain and snow of the northlands, and the blazing sun of the desert southwest. HyCom's materials and workmanship have taken the worst that Mother Nature could dish out, and they still perform as if they were installed yesterday. If you want the finest mobile antenna that you can buy - with proven reliability - try a Hy-Gain HyCom.

HC-144-TLM (for 2-meters)

A 5/8 wave, trunk lip mobile antenna with less than 1.5:1 SWR across the 144-148 MHz band. Maximum power capability is a full 200 watts. Hy-Gain's exclusive screw-in antenna connector eliminates all installation soldering. Includes 18 ft. (5.5m) coax and connector.

HC-144-MAG (for 2-meters)

The same antenna as above except with a powerful 90 lb. (40.8kg) direct pull magnet mount with a neoprene gasket to protect your vehicle's finish.

HC-440-TLM (for 440-450 MHz)

This is a, trunk lip mount antenna featuring two 5/8 wave collinear radiators coupled with a moisture resistant phasing coil. SWR is less than 1.5:1 and maximum power capability is 200 watts. Antenna comes with Hy-Gain's exclusive screw-in antenna connector that eliminates all installation soldering and 18 ft. (5.5m) of coax and connector.

HC-440-MAG (for 440-450 MHz)

The same antenna as above except with a powerful 90 lb. (40.8kg) direct pull magnet mount with neoprene gasket to protect your vehicle's finish.

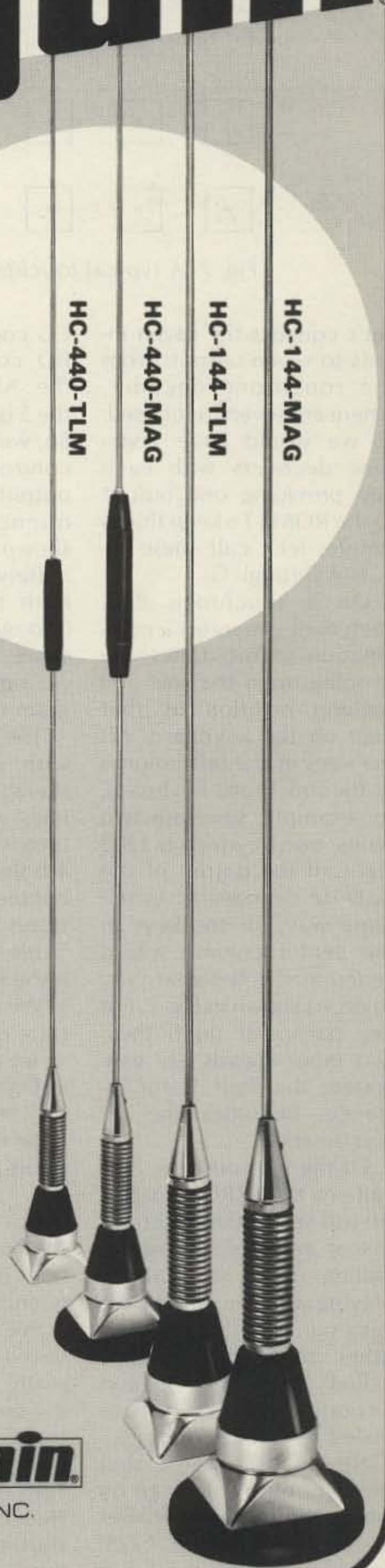

TELEX hy-gain

TELEX COMMUNICATIONS, INC.

✓316

9600 Aldrich Ave. So., Minneapolis, MN 55420 U.S.A.
Europe: 22, rue de la Légion-d'Honneur, 93200 St. Denis, France.

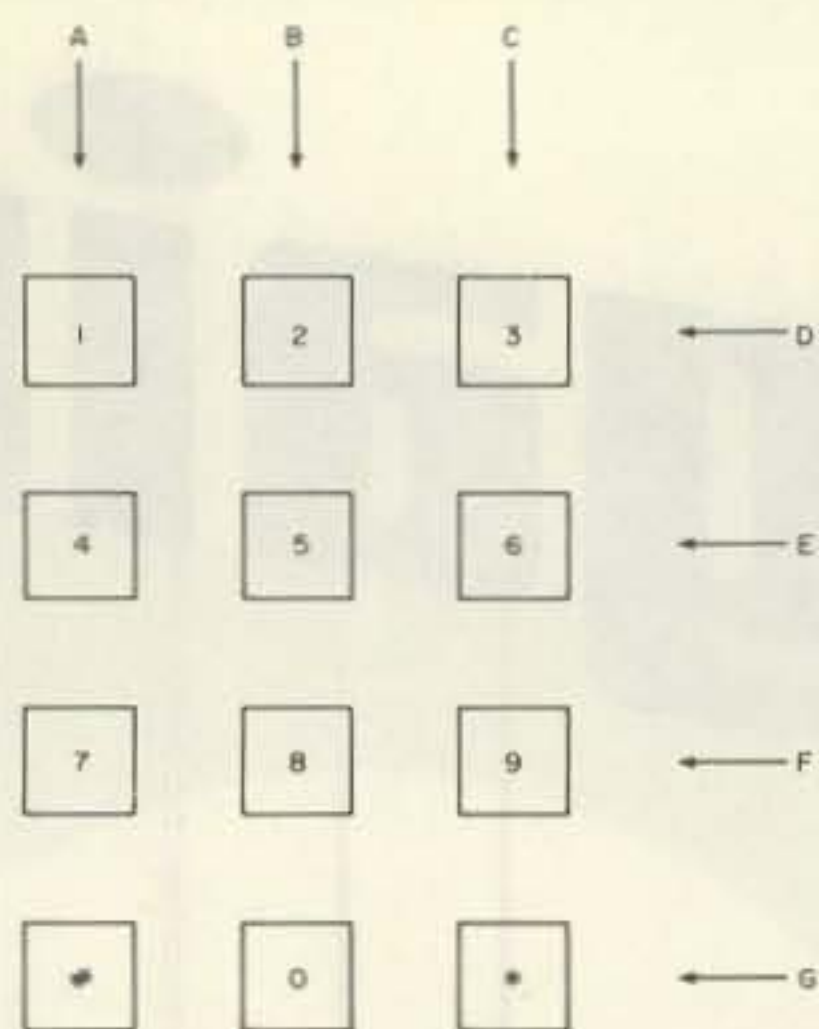

Fig. 7. A typical touchtone dial.

Let's connect the seven inputs to seven outputs from the touchtone decoder. (There are seven tones used, so we would have seven tone decoders with each one providing one output to the ROM.) To keep things simple, let's call these inputs A through G.

On a touchtone dial, each digit generates a combination of two tones, depending upon the row and column position of that digit on the keyboard. All the keys in the left column of the touchtone keyboard, for example, generate two tones, one of which is 1209 Hz. Call the output of the 1209-Hz decoder A. In the same way, all the keys in the center column would generate the B signal, and so on, as shown in Fig. 7. For any particular digit, then, two input signals are generated; the digit 5, for instance, becomes the BE combination.

Of the four outputs, let's call one the ERROR output; we will set up the system so that if an error is made in dialing or if someone is playing with the system, we get a signal on this lead. The other three outputs are called X, Y, and Z and decode three separate dialed sequences of digits.

Now, let's suppose that we want output X to go on whenever the repeater user dials the sequence *275. Fig. 7 shows that the * is a

CG combination, a 2 is the BD combination, the 7 is the AF combination, and the 5 is the BE combination. So, we want our sequential controller to provide an X output when the input sequence detected is as shown in Table 2.

Between digits, however, both tones will disappear (though perhaps not at the same time). Now, how do we figure out how to program the ROM?

The solution is to start with a state map. Since there are four feedback lines, we can have up to sixteen states (since 2 to the 4th power is 16). Let's number them in hexadecimal as states 0 through F (since Table 1 tells us that a hex F is the same as a decimal 15).

With sixteen states, the state map is quite complex, so let's just show five states in Fig. 8. Let's label state 0 the "resting state" and state F the ERROR state. States 1 through 3 are then used for the *275 sequence, while states 4 through E (not shown) would be available for other number sequences.

We'll set up the program so that the controller is normally in the resting state; if it's anywhere else, dialing a * will send it there (that's the purpose of starting the *275 sequence with a *). Hence, state 0 is always the starting point for any number.

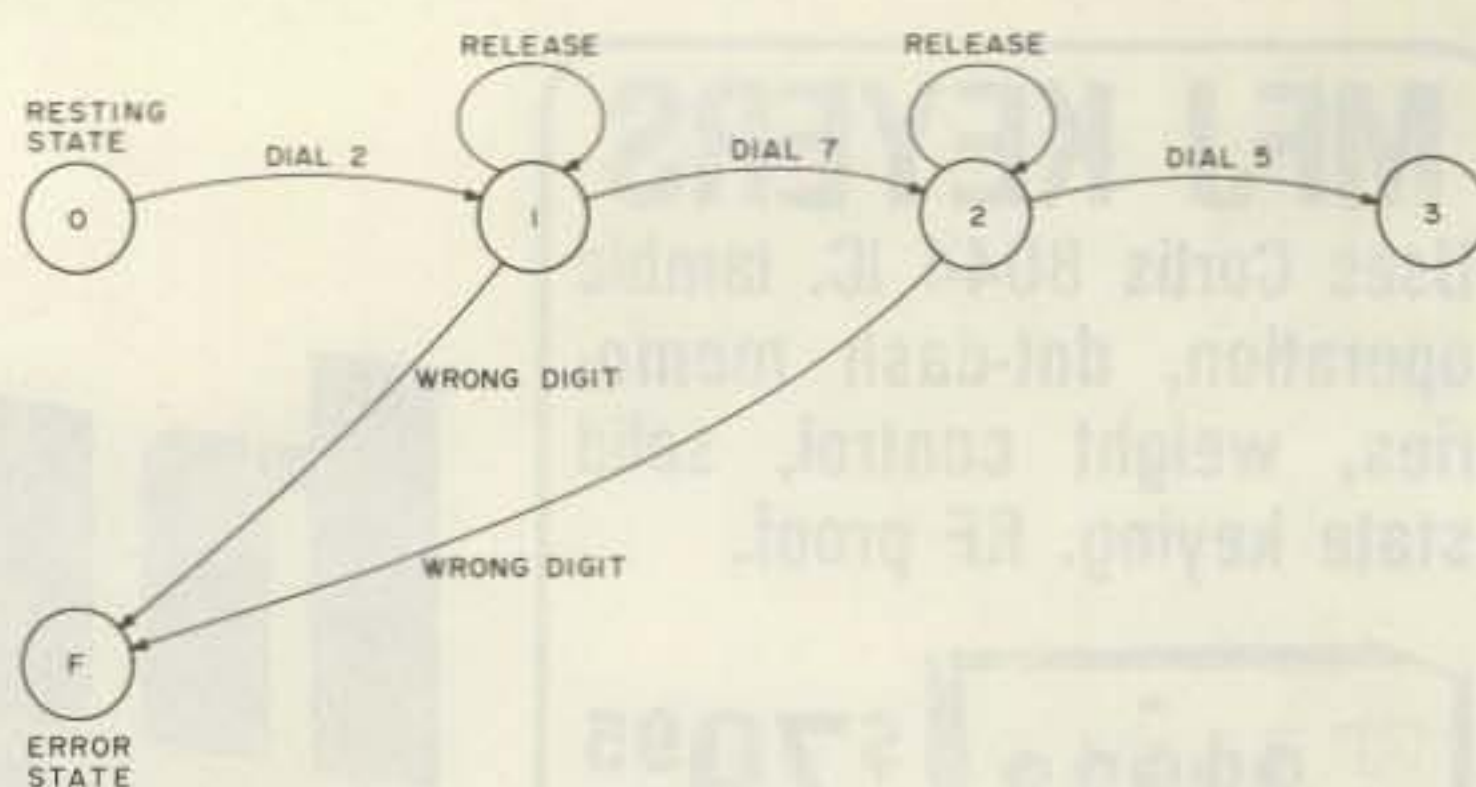

Fig. 8. Partial state map for touchtone-sequence detector.

Once we're in state 0, dialing a 2 takes the controller to state 1, where it stays as long as the 2 is dialed and also when the digit 2 is released. When the 7 is dialed, the controller moves to state 2 and stays there. Finally, when the 5 is dialed, it goes to state 3. If at any time the wrong digit is dialed, the system goes to state F.

Notice that there is a tremendous amount of flexibility here. Depending on exactly how we program the ROM, we can ignore wrong digits while we're in state 0 or go to the ERROR state. We can stay in state 3 after the *275 is dialed until the next * takes us back to state 0, or we can set it up so that the system returns to 0 on the very next clock pulse. Or, we can set up another dialed number sequence to return to state 0.

We can stay in the ERROR state on an error and lock up the whole system, or we can return to 0 on the very next clock pulse. Or, we can stay in state F until a special dialed sequence returns us to state 0; this would allow only control stations to reset the system. The possibilities are immense, with the only limitation being the size of the

ROM. This circuit has fourteen available states (since two are used up for the resting state and the ERROR state); since each digit requires one state, we can handle up to fourteen digits (not counting the * code). We could, therefore, decode a 14-digit number, or two 7-digit numbers, or three 3-digit numbers and one 5-digit number, or any combination we please.

Now, what about the actual ROM program? This is where the job gets slightly tedious (but not at all difficult). Since a 2K x 8 ROM is used, we have to figure out exactly what to put in each and every one of those 2048 locations. We cannot leave any location empty for a very important reason—when power is first turned on, the state of the system is unpredictable. If it should go into some state for which we did not plan, the controller could lock up in that state and never come out of it. Hence, any ROM location we don't specifically need should be programmed with some "escape" data which allows the controller to return to resting state 0.

The basic idea, therefore, is to start with a notebook and set up one line in the notebook for each of the

| A | B | C | D | E | F | G | |
|---|---|---|---|---|---|---|-------------------|
| 0 | 0 | 1 | 0 | 0 | 0 | 1 | (C & G tones = *) |
| 0 | 1 | 0 | 1 | 0 | 0 | 0 | (B & D tones = 2) |
| 1 | 0 | 0 | 0 | 0 | 1 | 0 | (A & F tones = 7) |
| 0 | 1 | 0 | 0 | 1 | 0 | 0 | (B & E tones = 5) |

Table 2.

MFJ SWR/ WATTMETERS

MFJ HF SWR/Wattmeter reads SWR, forward, reflected power from 1.8-30 MHz.



\$49⁹⁵

MFJ-814

New low cost in-line HF SWR/Wattmeter. MFJ-814 lets you monitor SWR, forward, reflected average power in 2 ranges from 1.8 to 30 MHz. Read 200/2000 watts forward, 20/200 watts reflected power. SWR, 1:1-6:1.

Easy push-button switch operation: has power/SWR, high/low range, forward/reflected push-button switches. SWR sensitivity control.

Lighted meter (requires 12V). Rugged aluminum eggshell white, black cabinet. 6 1/4 x 3 1/4 x 4 1/4". SO-239 coax connectors, 2 color meter scale.

MFJ VHF SWR/Wattmeter/ Field Strength Meters

\$29⁹⁵



MFJ-812

New low cost VHF operating aids.

MFJ-812, \$29.95: Read SWR from 14 to 170 MHz to monitor antenna and feedlines.

Read forward and reflected power at 2 meters (144-148 MHz). 2 scales (30 and 300 watts).

Read relative field strength from 1 to 170 MHz. Binding post for field strength antenna.

Easy push-button operation: has forward/reflected and SWR/field strength push-buttons.

Aluminum eggshell white, black cabinet. 4 1/4 x 2 1/4 x 2 3/4". SO-239. 2 color meter scale.

MFJ-810, \$24.95: similar to MFJ-812 less field strength function.

MFJ "Dry" 300 W and 1 KW Dummy Loads.

\$64⁹⁵



MFJ-262

\$26⁹⁵

MFJ-260

Air cooled, non-inductive 50 ohm resistor in perforated metal housing with SO-239 connectors. Full load for 30 seconds, de-rating curves to 5 minutes. MFJ-260 (300 W). SWR: 1.1:1 to 30 MHz, 1.5:1 for 30-160 MHz. 2 1/2 x 2 1/2 x 7". MFJ-262 (1KW). SWR 1.5:1-30 MHz. 3 x 3 x 13".

MFJ-10, 3 foot coax with connectors, \$4.95.

Order from MFJ and try it. If not delighted, return within 30 days for refund (less shipping).

One year unconditional guarantee.

Order yours today. Call toll free 800-647-1800.

Charge VISA, MC. Or mail check, money order. Add \$4.00 each for shipping and handling.

CALL TOLL FREE ... 800-647-1800

Call 601-323-5869 for technical information, order/repair status. Also call 601-323-5869 outside continental USA and in Mississippi. ✓ 47

**MFJ ENTERPRISES,
INCORPORATED**
Box 494, Mississippi State, MS 39762

hy-gain[®]

NEW Extended Double Zepp Antenna Design

The Hy-Gain V2 is 2-meter extended double zepp vertical consisting of two stacked 5/8 waves properly decoupled to allow no RF on the coax feedline. Coax connects to the decoupler inside the antenna for complete weatherproofing. Mechanically the V2 has no equal. It's easy to assemble and all elements are corrosion resistant 6063-T832 aluminum with rustproof hardware. The V2 is a complete antenna that's ready to mount on any mast up to 2" (50.8 mm) in diameter.

Two sets of 1/4 wave radials and a centered feedpoint put the radiation at the horizon, not the sky! The V2 and two competitors were measured for radiation efficiency on a ground-reflection-range, which was designed according to IEEE standard 149-1979, and the results shown below were conclusive.

Hy-Gain V2

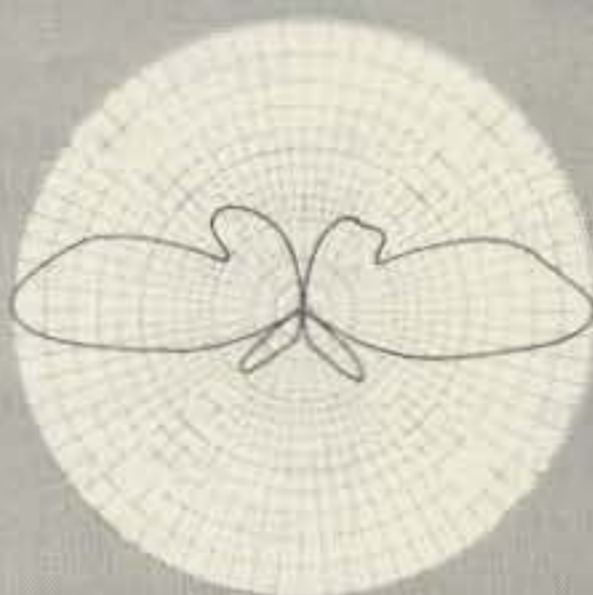

at 146.00 Mcs

Brand C ARX-28

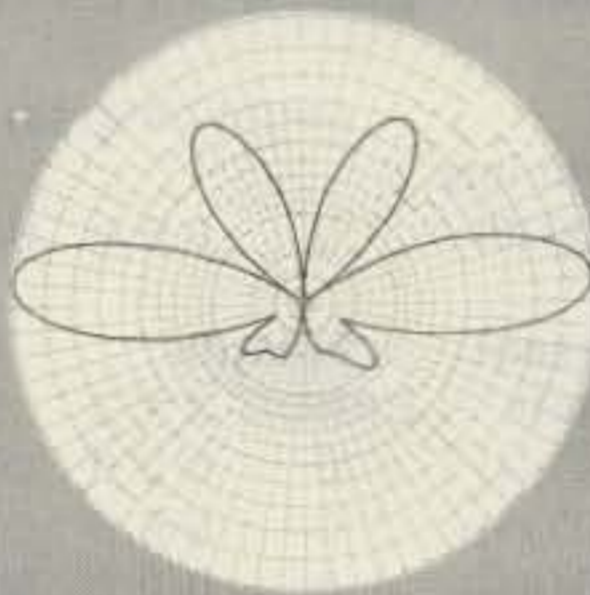

at 146.00 Mcs

Brand A AEA-144

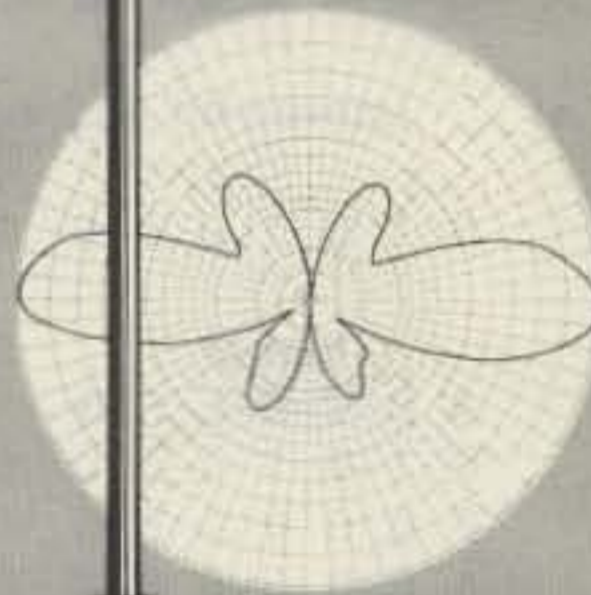

at 146.00 Mcs

Designed to operate from 138 MHz through 174 MHz, the V2 obtains a VSWR of less than 1.5:1 at resonance and has a 2:1 VSWR bandwidth of at least 7 MHz. The antenna's isolation from the support mast is 20 dB minimum.

The new V2 will equal or surpass the electrical performance of any competitive two stacked 5/8 wave antenna, regardless of gains claimed or your money back. Money-back limited to 30 days. If not satisfied, return to place of purchase.

TELEX hy-gain

✓316 TELEX COMMUNICATIONS, INC.
9600 Aldrich Ave. So., Minneapolis, MN 55420 U.S.A.
Europe: 22, rue de la Légion-d'Honneur, 93200 St. Denis, France.

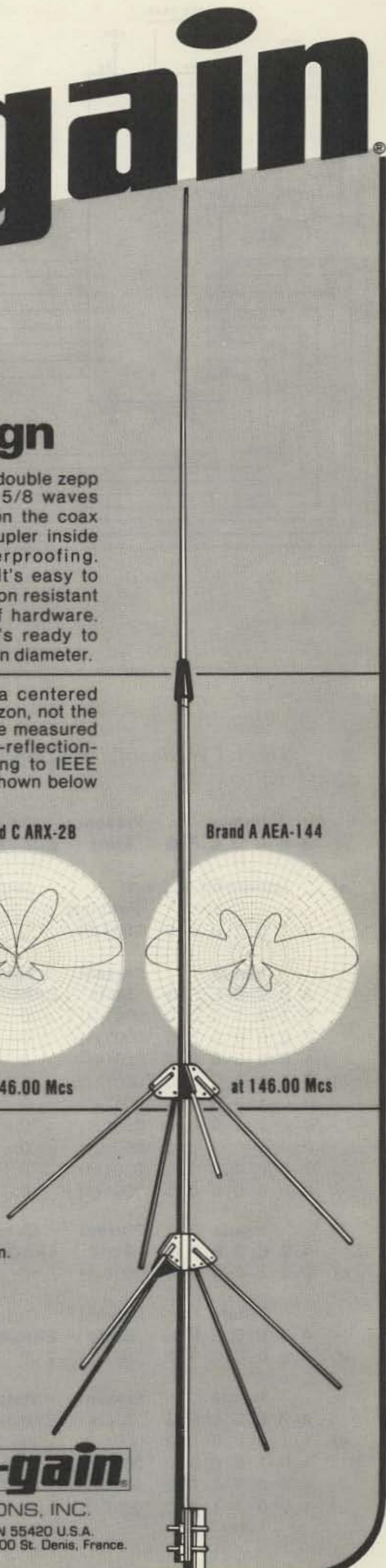

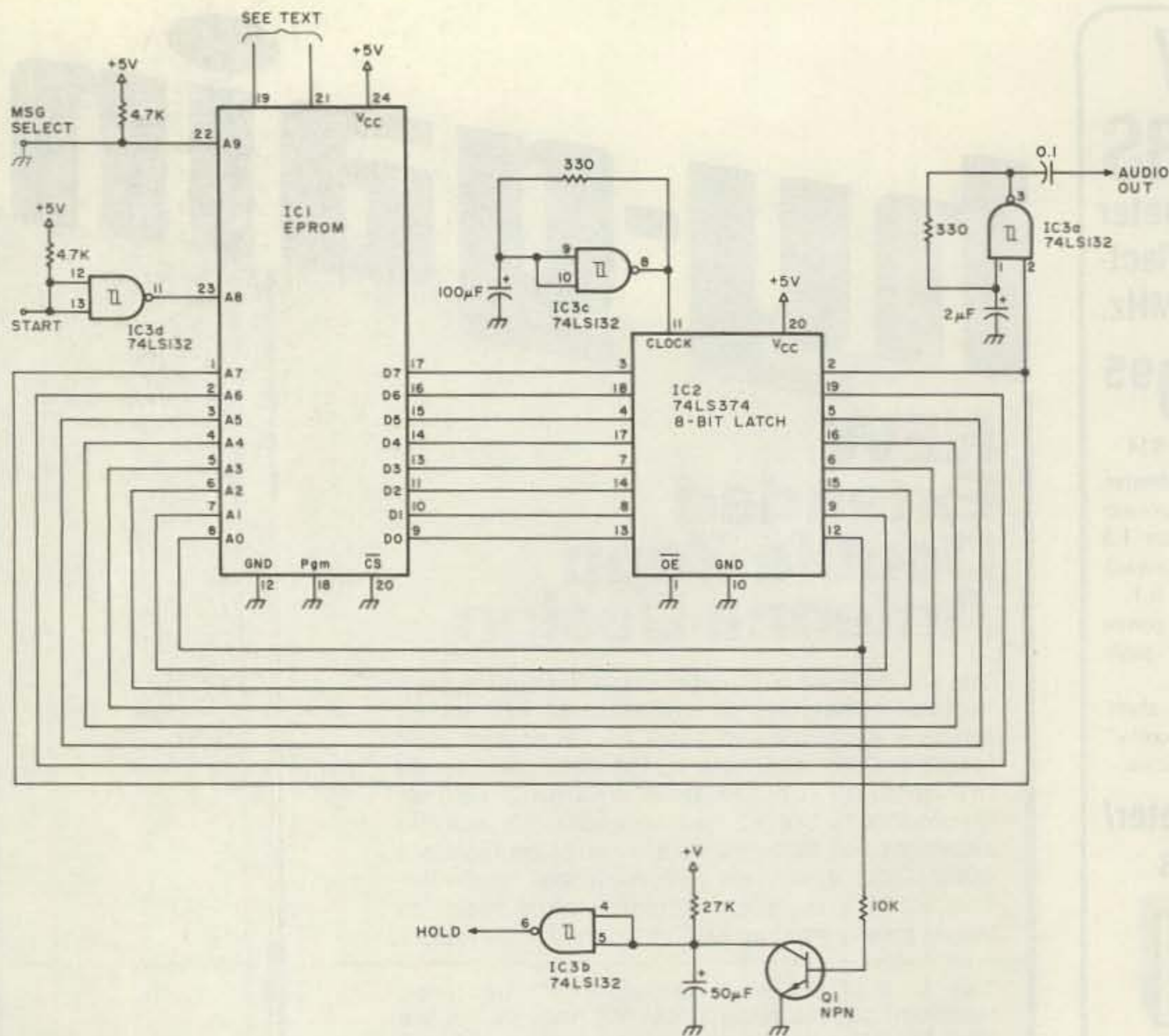

Fig. 9. CW identifier diagram. 74LS132 ground is pin 7; Vcc is pin 14.

| | Inputs | | | | | | | Present State | Outputs | | | Next State | |
|----|----------------------|---|---|---|---|---|---|---------------|------------------|---|---|------------|----------|
| | A | B | C | D | E | F | G | | ERROR | X | Y | Z | |
| a) | (eleven-bit address) | | | | | | | | (eight-bit data) | | | | |
| | First line: | | | | | | | | | | | | |
| | 0 | 1 | 0 | 1 | 0 | 0 | 0 | 0000 (0) | 0 | 0 | 0 | 0 | 0001 (1) |
| | Inputs | | | | | | | Present State | Outputs | | | Next State | |
| | A | B | C | D | E | F | G | | ERROR | X | Y | Z | |
| | 0 | 1 | 0 | 1 | 0 | 0 | 0 | 0001 (1) | 0 | 0 | 0 | 0 | 0001 (1) |
| | 0 | 0 | 0 | 0 | 0 | 0 | 0 | 0001 (1) | 0 | 0 | 0 | 0 | 0001 (1) |
| | 1 | 0 | 0 | 0 | 0 | 0 | 0 | 0001 (1) | 0 | 0 | 0 | 0 | 0001 (1) |
| b) | 0 | 1 | 0 | 0 | 0 | 0 | 0 | 0001 (1) | 0 | 0 | 0 | 0 | 0001 (1) |
| | 0 | 0 | 1 | 0 | 0 | 0 | 0 | 0001 (1) | 0 | 0 | 0 | 0 | 0001 (1) |
| | 0 | 0 | 0 | 1 | 0 | 0 | 0 | 0001 (1) | 0 | 0 | 0 | 0 | 0001 (1) |
| | 0 | 0 | 0 | 0 | 1 | 0 | 0 | 0001 (1) | 0 | 0 | 0 | 0 | 0001 (1) |
| | 0 | 0 | 0 | 0 | 0 | 1 | 0 | 0001 (1) | 0 | 0 | 0 | 0 | 0001 (1) |
| | 0 | 0 | 0 | 0 | 0 | 0 | 1 | 0001 (1) | 0 | 0 | 0 | 0 | 0001 (1) |
| c) | Inputs | | | | | | | Present State | Outputs | | | Next State | |
| | A | B | C | D | E | F | G | | ERROR | X | Y | Z | |
| | 0 | 0 | 1 | 0 | 0 | 0 | 1 | 0001 (1) | 0 | 0 | 0 | 0 | 0000 (0) |
| d) | Inputs | | | | | | | Present State | Outputs | | | Next State | |
| | A | B | C | D | E | F | G | | ERROR | X | Y | Z | |
| | 1 | 0 | 0 | 0 | 0 | 1 | 0 | 0001 (1) | 0 | 0 | 0 | 0 | 0010 (2) |
| e) | Inputs | | | | | | | Present State | Outputs | | | Next State | |
| | A | B | C | D | E | F | G | | ERROR | X | Y | Z | |
| | 1 | 1 | 0 | 0 | 0 | 0 | 0 | 0001 (1) | 1 | 0 | 0 | 0 | 1111 (F) |
| | 1 | 0 | 1 | 0 | 0 | 0 | 0 | 0001 (1) | 1 | 0 | 0 | 0 | 1111 (F) |
| | 1 | 0 | 0 | 1 | 0 | 0 | 0 | 0001 (1) | 1 | 0 | 0 | 0 | 1111 (F) |
| | 1 | 0 | 0 | 0 | 1 | 0 | 0 | 0001 (1) | 1 | 0 | 0 | 0 | 1111 (F) |
| | etc. | | | | | | | | | | | | |

Table 4.

| | |
|-------------|-----------|
| 00000000000 | = hex 000 |
| 00000000001 | = hex 001 |
| 00000000010 | = hex 002 |
| 00000000011 | = hex 003 |
| • | |
| • | |
| • | |
| 11111111111 | = hex 7FF |

Table 3.

want to make the four outputs all 0 and also go to state 1. (The state numbers are shown in binary and the hex state number is in parentheses.)

Once we get to state 1, we want to stay in that state under three possible conditions:

1) as long as the digit 2 is still present;

2) when the digit 2 has disappeared (B and D are both gone); and

3) whenever only one tone is present. This is not shown in the state map, but is due to the fact that when one digit is dialed, the two tones it represents do not come on and off together but may follow each other with a small time delay. Furthermore, some tone decoders may output short pulses if they are triggered by noise or voice signals. Hence, we want to ignore any input which represents just one tone.

These three conditions translate into nine memory locations to be programmed as in Table 4(b). The first line keeps us in state 1 when the BD combination (digit 2) is on; the second line keeps us in state 1 when all tones are absent; the last seven lines keep us there if just one tone is detected.

Next, we want to program in the sequence which returns to state 0 when a * is dialed. This is again just one line as in Table 4(c).

When the digit 7 is dialed, we want to go to state 2—see Table 4(d). Finally, for every other combination of tones, we want to go to the ERROR state F—see Table 4(e).

To give the complete

2048 different addresses, in order. See Table 3.

Next, remember that every unused location should get the data 00000000, which will lead to state 0 (or binary 0000) with all outputs off. This is the escape code which leads back to state 0 if the system ever gets to some unused state. No need to put all those 00000000 codes in yet, but remember them at the end.

Now make yourself a template which will indicate which bit of the address and data is what. The template should look something like the top of Table 4(a). Here we have made a start in filling in the programming table. First, we want to go from state 0 to state 1 when a 2 is dialed, but keeping all outputs off. This is just the one line of Table 4(a).

This entry says that when we are in state 0 and the BD pair of inputs comes in, we

MFJ SHORTWAVE ACCESSORIES

NEW Indoor Tuned Active Antenna. Rivals, can even exceed reception of outside long wire.

Rivals long wires

\$79⁹⁵



MFJ-1020 NEW INDOOR ACTIVE ANTENNA sits on your desk ready to listen to the world. Rivals, can often exceed, reception of outside long wire. Unique Tuned Active Antenna minimizes intermod, provides RF selectivity, reduces noise outside tuned band. Also use as preselector for external antenna. Covers 300 KHz to 30 MHz in five bands. Adjustable telescoping antenna. Controls: Tune, Band Selector, Gain, On-Off/Bypass. LED. FET, bipolar circuitry. Phono jack for external ant. 6x2x6 inches. 9-12 VDC or 9 V battery for portable use. 110 VAC with optional AC adapter, \$9.95.



\$99⁹⁵

MFJ-1040 RECEIVER PRESELECTOR. Improves weak signal reception, rejects out-of-band signals, reduces image response, 1.8 to 54 MHz. Up to 20 db gain. Low noise MOSFET. Gain control. Bandswitch. Can use 2 ant., 2 rcvrs. ON-OFF/Bypass. 20 db attenuator. LED. Coax, phono jacks. 8x2x6 in. Also for XCVRS to 350 watts input. Auto bypass. Delay control. PTT jack. **MFJ-1045, \$69.95.** Same as MFJ-1040, less attenuator, xcvr auto bypass, delay control, PTT. Use 1 ant., 1 rcvr. 5x2x6 in. 9V bat. Both requires 9-18 VDC or 110 VAC with optional AC adapter, \$9.95.

\$89⁹⁵



MOBILE SWL CONVERTERS to hear the short-wave world while you drive. **MFJ-304** (\$69.95) covers 19, 25, 31, 49 meter bands. **MFJ-308** (\$89.95) adds 13, 16, 41, 60 meters. Two dual-gate MOSFETS give excellent sensitivity, selectivity with car receiver. Push button band selector. Tune with car radio. Plugs between antenna and radio. 12 VDC. **304** is 5 1/4 x 1 1/4 x 4". **308** is 6 1/4 x 1 1/4 x 5". **Free catalog.**

MFJ-10, 3 foot coax with connectors, \$4.95.

Order from MFJ and try it. If not delighted, return within 30 days for refund (less shipping). **One year unconditional guarantee.**

Order yours today. Call toll free 800-647-1800. Charge VISA, MC. Or mail check, money order. Add \$4.00 each for shipping and handling.

CALL TOLL FREE ... 800-647-1800

Call 601-323-5869 for technical information, order/repair status. Also call 601-323-5869 outside continental USA and in Mississippi. ✓47

MFJ ENTERPRISES, INCORPORATED
Box 494, Mississippi State, MS 39762



"BRAND NEW"
**CHAMPION MESSAGE
MEMORY KEYS**

Model TE-292

\$125.95

PLUS:

Features:

- State-of-the-Art CMOS Circuitry
- Choice of Message Storage
 - A. Six 50 character messages
 - B. Twelve 25 character messages
 - C. 27 combinations of message C. programming.
- Records at any speed—plays at any speed.
- Memory operating LED
- Use for daily QSO or contests

- Self-completing dots and dashes
- Both dot and dash memory
- Iambic Keying with any squeeze paddle
- 5-50 w.p.m.
- Speed, volume, tone, tune and weight controls
- Sidetone and speaker
- Low current drain CMOS battery operation—portable
- Rear panel Jack for auxiliary power
- Deluxe quarter-inch jacks for keying and output
- Keys grid block and solid rigs
- WIRED AND TESTED FULLY GUARANTEED—LESS BATTERY

\$89.95

Features: Model TE-284

- State-of-the-Art CMOS Circuitry
- Three choices of Message Storage
 - A. Two (50 character each) message storage
 - B. Four (25 character each) message storage
 - C. One 50 character and two 25 character message storage
- Records at any speed—plays at any speed
- Memory operating LED
- Use for daily QSO or contests

PLUS:

- Self-completing dots and dashes
- Both dot and dash memory
- Iambic Keying with any squeeze paddle
- 5-50 w.p.m.
- Speed, volume, tone, tune and weight controls
- Sidetone and speaker
- Low current drain CMOS battery operation—portable
- Deluxe quarter-inch jacks for keying and output
- Keys grid block and solid rigs
- WIRED AND TESTED FULLY GUARANTEED—LESS BATTERY

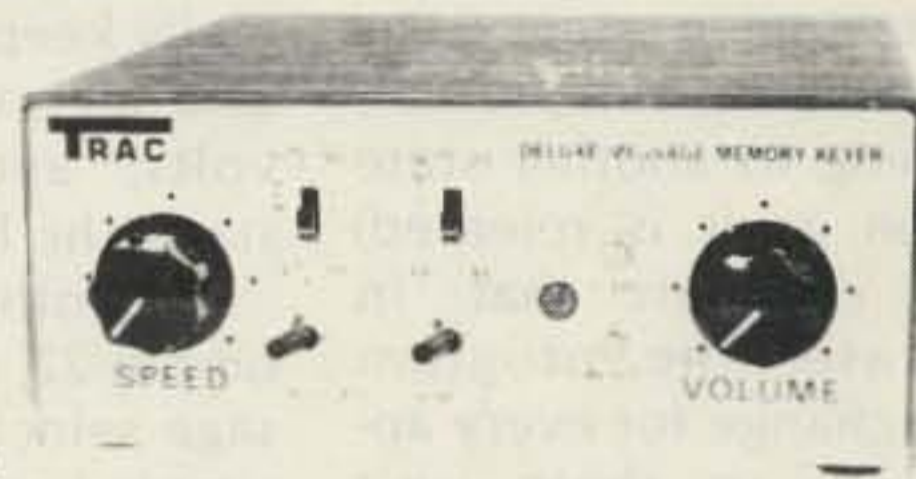

**MESSAGE
MEMORY KEYS**

Model # TE201

\$75.95

Features:

- Advanced CMOS message memory
- Two (50 char. each) message storage
- Repeat function
- Records at any speed—plays back at any speed
- Longer message capacity
Example: send CQ CQ CQ DX de WB2YJM WB2YJM K—then play second message on contact—de WB2YJM QSL NY NY 579 579 Paul Paul K
- Use for daily QSOs or contests

PLUS:

- State-of-the-art CMOS keyer
- Self-completing dots and dashes
- Both dot and dash memory
- Iambic keying with any squeeze paddle
- 5-50 wpm
- Speed, volume, tone, tune and weight controls
- Sidetone and speaker
- Low current drain CMOS battery operation—portable
- Deluxe quarter-inch jacks for keying and output
- Keys grid block and solid state rigs
- WIRED AND TESTED FULLY GUARANTEED—LESS BATTERY

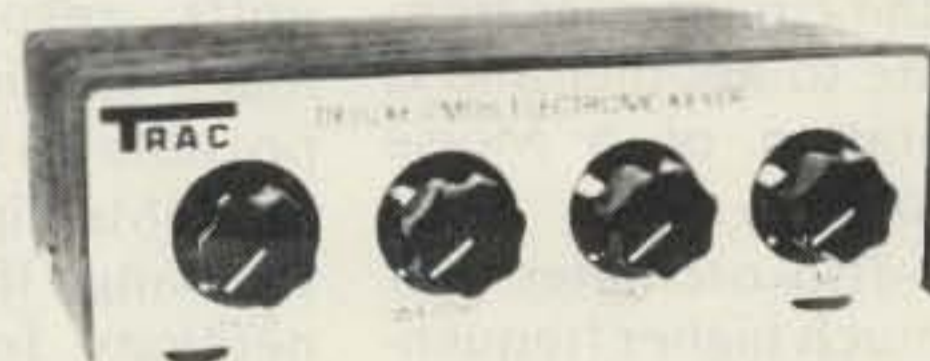

Model # TE144

\$65.95

**Features: Deluxe CMOS
Electronic Keyer**

- State-of-the-art CMOS circuitry
- Self-completing dots and dashes
- Both dot and dash memory
- IAMBIC keying with any squeeze paddle 5-50 wpm

- Speed, weight, tone, volume tune controls & sidetone and speaker
- Semi-automatic "bug" operation & straight keying—rear panel switch
- Low current drain CMOS battery operation—portable
- Deluxe quarter inch jacks for keying and output
- Keys grid block and solid state rigs
- Wired and tested—fully guaranteed—less battery

MODEL TE133—same as TE144 with wgt and tone control internal, less semi-auto keying. \$55.95

MODEL TE122—same as TE133 less wgt, tune, solid state keying \$45.95

AT YOUR DEALER OR SEND CHECK OR MONEY ORDER.

Plus \$2.00 S/H NY Res add tax

TRAC

ELECTRONICS, INC
1106 RAND BLDG.
BUFFALO NY 14203

micro-program for the ROM would take a few pages; besides, the exact program depends on just what options you want to include in the system. For example, the state map in Fig. 7 would ignore multiple digits (*275 would be treated the same as *2275 or *2227777775). In a repeater system where mobile flutter often breaks up one digit into two, this might be preferable, but if this were not acceptable, then breaking up each state into two states (for example, staying in state 1 as long as the 2 is still present, but going to another state as soon as it is released) would eliminate that. In any case, the program would change for every application, so there isn't much need to give one here. But you'd find that it isn't very difficult once you get started.

As to the actual circuit, something similar to Fig. 9 using a 2716 2K x 8 EPROM, a 74LS374 eight-bit latch, and a 74LS132 for buffering and clock would work out just fine. At what frequency should the clock run? The frequency should be fast enough so that a digit is not missed between two clock pulses, but slow enough so that short noise bursts which may produce tiny pulses at the outputs of the tone decoders don't confuse the system. A frequency of perhaps five pulses per second should be about right, but there is nothing critical about this value.

A Micro-Programmed CW Identifier

Here is a practical application of a micro-programmed sequential controller that a lot of hams can use—a CW identifier which has only three integrated circuits.

Fig. 9 shows the complete circuit. It consists of a 1K x 8 EPROM (in this case a 2708, but others can be

used), a 74LS374 8-bit latch which contains eight type-D flip-flops, a 74LS132 quad, a 2-input Schmitt trigger, a transistor, and a handful of resistors and capacitors.

IC1 is the EPROM, hooked up to IC2 in a straightforward micro-programmed sequential controller circuit. There are eight bits brought back as feedback, which leaves two more EPROM address lines as inputs. A8 (pin 23) is buffered through IC3d and acts as the START line. The 4.7k resistor on the input normally keeps the START line at a high voltage near +5 volts, and grounding it starts the IDer.

The other input pin, A9 on pin 22, is used as a message select. In my circuit, I simply keep it grounded all the time as I don't have a second message in the ROM, but if it is allowed to go to a high voltage (with the 4.7k resistor pulling it up), this selects the other half of the ROM and allows a second call to be stored. Each call or short message requires 512 locations (1/2 K) of storage, so the 1K EPROM has room for two messages.

Two sections of the 74LS132 act as oscillators. Up at the top, IC3c oscillates at a frequency of about 20 Hz and, therefore, clocks the latches twenty times per second. This determines the speed at which the circuit goes from one state to another and is the duration of a Morse code dot.

IC3a also oscillates, but at the much higher frequency of about 1000 Hz, and generates the CW-tone output. It is keyed on and off by latched D7 output coming from IC2, pin 2.

In many cases we need a HOLD signal which keys a transmitter whenever the IDer is active. This is done by the circuitry around IC3b. Normally, the capacitor connected to its input charges up to near +5 volts

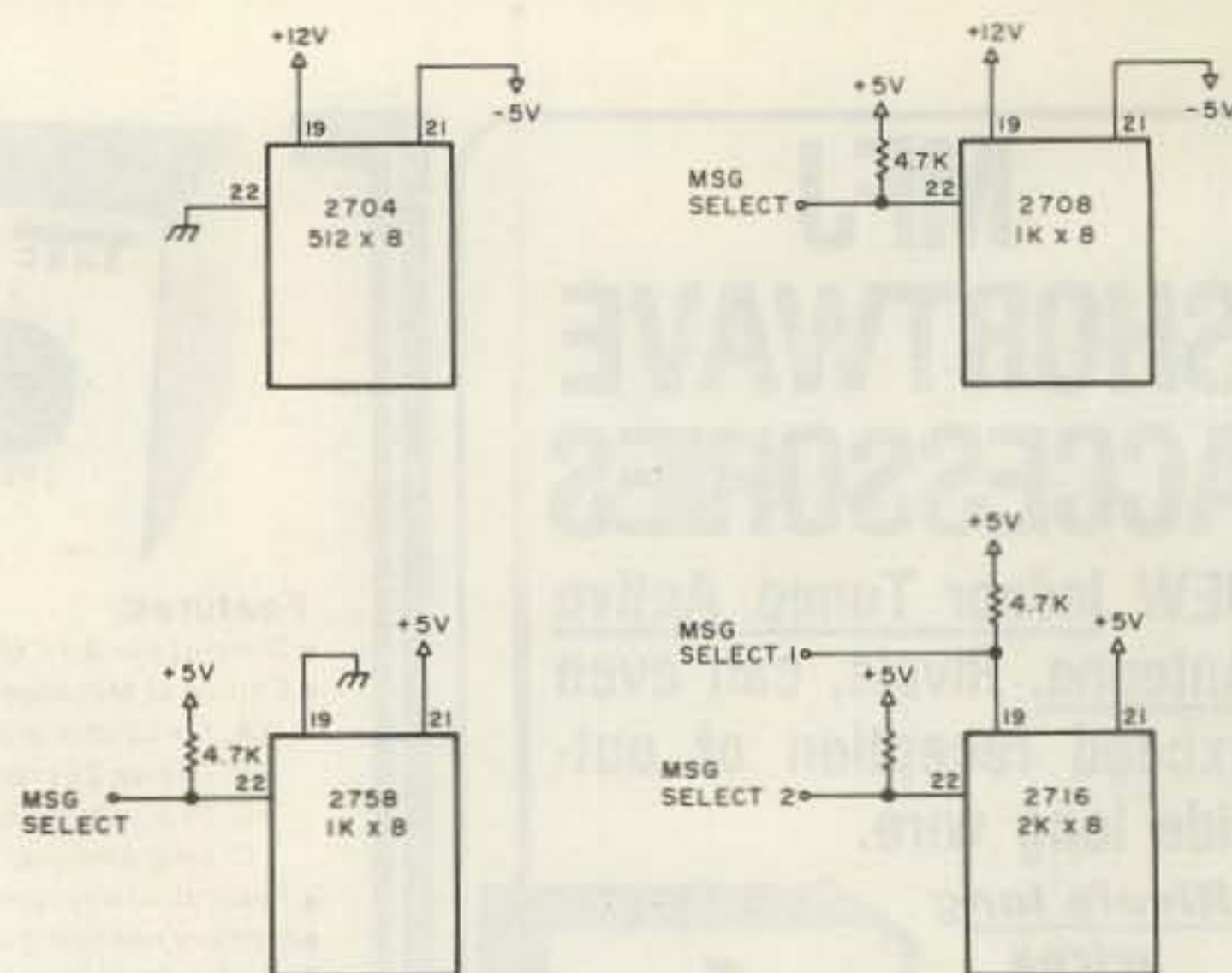

Fig. 10. Four different EPROMs can be used.

through the 27k resistor. This makes the input into IC3b high (1), so its output is a low voltage (0).

Each time the latched data bit D0 goes to a 1, however, the transistor turns on and discharges the capacitor. This makes the HOLD output go high to a 1.

When the IDer is sitting still, D0 is always a 0, and so the HOLD is always low. But as soon as it starts, D0 alternates between 0 and 1, and so the capacitor keeps being discharged all the time. Hence, HOLD goes high and stays there until a half second or so after the IDer stops.

IC1 as shown in Fig. 9 is a 2708 EPROM, available for about \$6. But the 2708 has a disadvantage—it requires three power supplies of +5 volts, -5 volts, and +12 volts, respectively. This makes it hard to use. But it's possible to substitute other EPROMs. Fig. 10 shows how to change the EPROM connections for three other EPROMs; only pins 19, 21, and 22 are affected. Like the 2708, the 2704 also requires three power supplies but has only 512 locations (1/2 K) storage. This EPROM could store only one call, and, so, pin 22 is grounded rather than being used as a message select pin. It is not easy to get since everybody has switched to the 2708 at almost the same price, but

there may be some still lying around.

The 2758 and the 2716 require only a single +5-volt power supply. They are almost identical, except that the 2758 is 1K x 8, while the 2716 is 2K x 8. Quoted prices at this time are about \$10 to \$15 for either. The 2716 has an additional address line (pin 19) which becomes a second message select line. Since this EPROM has 2K locations, it can store four different calls or short messages. They are selected by putting various combinations of ones and zeros on the two select lines; in the rest of this article, we'll just discuss the simplest case where all message select lines are grounded.

Incidentally, when ordering a 2716, do not order the Texas Instruments TMS2716. This IC is also 2K x 8 but requires three supplies like the 2708. TI uses the number TMS2516 for the EPROM with a single supply; everyone else calls it a 2716.

Programming CW into the EPROM

Although I use a computer program to determine the bit pattern to be put into the EPROM, it's important to understand how this is done. Following RTTY terminology, a dot is called a "mark" while the space be-

Two Keys To Perfect Code...



The CODEM: a universal CW interface for your personal computer.

\$124.95

Here is an easy way to get your Morse code software on the air! The CODEM converts received CW audio to RS232 or TTL signal levels and RS232 or TTL signal levels to transmitter keying. The CODEM doubles as a code practice oscillator and CW regenerator. A sharp 800 Hz bandpass filter, AM detector and low pass filter are designed into the CODEM to provide outstanding noise and QRM rejection. Requires a 9 VDC power supply.

CODEM \$124.95
 9 VDC Power Supply 9.95
 Shipping and Handling 5.00

CW89: a sophisticated split screen Morse code transceiver and trainer program for Heath computers.

\$99.95

Transmit and decode CW with your H-8/H-19, H-89 or Z-89. This feature packed program incorporates 4-99 WPM operation, receive autotrack, a 1000 character pre-type buffer, 10 user-definable messages, unique break-in mode, on-screen status, disk I/O and hard copy and a versatile code practice section. A comprehensive manual and prompt card are included with CW89. Requires HDOS, 32K RAM and hardware interface (such as the CODEM).

CW89 postpaid \$99.95
 CW89C H-8/H-89 Interconnect Cable for CODEM 24.95

Save over \$14.00 with complete CW package for H-8/H-89.

Package includes CODEM, Interconnect Cable, Power Supply, CW89 Software, complete documentation and shipping.

CW89P \$249.95

COMMSOFT ✓ 59

665 Maybell Avenue • Palo Alto, CA 94306 • (415) 493-2184

Write for free catalog

California residents add applicable sales tax.

Master Card and VISA accepted

GOTHAM ANTENNAS

(813) 584-8489



SMALL LOT TRAP DIPOLES ✓ 417

| MODEL | BANDS | LGTH | PRICE |
|----------|----------|------|---------|
| TSL 8040 | 80,40 | 78' | \$49.95 |
| TSL 4020 | 40,20,15 | 40' | \$47.95 |

SMALL LOT SHORTENED DIPOLES

| | | | |
|---------|-----------------|------|---------|
| SL-8010 | 80,40,20, 15,10 | 75' | \$59.95 |
| SL-160 | 160 | 130' | \$36.95 |
| SL-80 | 80 | 63' | \$35.95 |
| SL-40 | 40,15 | 33' | \$34.95 |

FULL SIZE PARALLEL DIPOLES

| | | | |
|----------|-----------------|------|---------|
| FPD-8010 | 80,40,20, 15,10 | 130' | \$49.95 |
| FPD-4010 | 40,20,15,10 | 63' | \$44.95 |

NEW! PORTABLE VERTICAL! IDEAL FOR APARTMENTS, CAMPING, TRAILERS!

Folds to 5' Package. No Radials. Required. Fully Assembled. Full Legal Limit. 1:1 VSWR

| MODEL | BANDS | HGHT | PRICE |
|---------|-------|------|---------|
| PV-8010 | 80-10 | 13' | \$59.95 |

PROVEN DESIGN - GOTHAM ALL BAND VERTICALS

| | | | |
|-------|-----------------------|-----|---------|
| V-160 | 160,80,40,20, 15,10,6 | 23' | \$39.95 |
| V-80 | 80,40,20, 15,10,6 | 23' | \$37.95 |
| V-40 | 40,20,15,10,6 | 23' | \$35.95 |

FAMOUS GOTHAM QUADS

U 2 Elements — 3 Bands Complete \$119.95

CHAMPIONSHIP GOTHAM BEAMS
 Full Size Complete from \$79.95

CALL OR SEND LARGE SASE FOR CATALOG. Shipping: Dipoles & Verticals \$2.50 USA; \$7.00 Canada; \$5.00 FPO, APO Beams & Quads Shipped UPS or Freight Collect. Fla. add 4% Sales Tax

P.O. Box 776 • Largo, FL 33540

MFJ RF NOISE BRIDGE

Lets you adjust your antenna quickly for maximum performance. Measure resonant frequency, radiation resistance and reactance. Exclusive range extender and expanded capacitance range gives you much extended measuring range.



• Exclusive range extender • Expanded capacitance range
 • Series Bridge

\$59.95

This MFJ-202 RF Noise Bridge lets you quickly adjust your single or multiband dipole, inverted Vee, beam, vertical, mobile whip or random system for maximum performance.

Tells resonant frequency and whether to shorten or lengthen your antenna for minimum SWR over any portion of a band.

MFJ's exclusive range extender, expanded capacitance range (± 150 pf) gives unparalleled impedance measurements, 1 to 100 MHz. Simple to use. Comprehensive computer proven manual.

Works with any receiver or transceiver. SO-239 connectors. 2 x 3 x 4 inches. 9 volt battery.

Other uses: tune transmatch; adjust tuned circuits; measure inductance, RF impedance of amplifiers, baluns, transformers; electrical length, velocity factor, impedance of coax; synthesize RF impedances with transmatch and dummy load.

Order from MFJ and try it — no obligation. If not delighted, return it within 30 days for a refund (less shipping). This bridge is unconditionally guaranteed for one year.

To order, simply call us toll free 800-647-1800 and charge it on your VISA or MasterCard or mail us a check or money order for \$59.95 plus \$4.00 for shipping and handling for MFJ-202.

Put this MFJ Noise Bridge to work improving your antenna. Order from MFJ or see dealer.

CALL TOLL FREE ... 800-647-1800

Call 601-323-5869 for technical information, order/repair status. Also call 601-323-5869 outside continental USA and in Mississippi. ✓ 47

MFJ ENTERPRISES, INCORPORATED
 Box 494, Mississippi State, MS 39762

| MSG Select A9 | Start Input A8 | Present State A7-A0 | Next State D7-D0 |
|------------------|-------------------|------------------------|---------------------|
| 0 (Gnd) | 0 (Don't) | 00000000 | 00000000 |
| 0 | 1 (Start!) | 00000000 | 00000001 |

(10-bit address) (eight-bit data)

Table 5.

| Location (Address) (Hex—last 2 digits are the present state) | Contents (Data) (Hex—next state) |
|--|-------------------------------------|
| 001 and 101 | 02 |
| 002 and 102 | 03 |
| 003 and 103 | 04 |
| 004 and 104 | 05 |
| 005 and 105 | 06 |
| 006 and 106 | 80 |
| 007 and 107 | 83 |
| 008 and 108 | 84 |
| 009 and 109 | 0A |
| 00A and 10A | 0B |
| 00B and 10B | 0C |
| 00C and 10C | 0D |
| 00D and 10D | 00 |
| . | . |
| . | . |
| 080 and 180 | 81 |
| 081 and 181 | 82 |
| 082 and 182 | 07 |
| 083 and 183 | 08 |
| 084 and 184 | 85 |
| 085 and 185 | 86 |
| 086 and 186 | 09 |

Table 6.

| |
|---------|
| 01 → 02 |
| 02 → 03 |
| 03 → 04 |
| 04 → 05 |
| 05 → 06 |
| 06 → 80 |
| 80 → 81 |
| 81 → 82 |
| 82 → 07 |
| 07 → 83 |
| 83 → 08 |
| 08 → 84 |
| 84 → 85 |
| 85 → 86 |
| 86 → 09 |
| 09 → 0A |
| 0A → 0B |
| 0B → 0C |
| 0C → 0D |
| 0D → 00 |

Table 7.

tween two dots is called a "space." A dash then becomes three marks with no space between them, a letter space is four spaces in a row, and so on. The letter K then becomes mark mark mark space mark space

mark mark mark.

A complete call requires 512 (½K) locations, numbered from 00000000 to 11111111 in binary; in hex they are numbered from 000 to 1FF.

In the EPROM, location 000 is always programmed with a 00 (so that once the sequential controller gets to state 00 it will lock up in state 00 and stay there). Location 100 is always programmed with a 01 (so that the controller will go from that state to state 1). A short table of these locations and data is shown in Table 5.

This shows that if we're in present state 00000000 (or 00 in hex) and the START input (on A8, not way back at the input to inverter IC3d) is a 0, then the next state will be 00 again. But if we're in state 00 and the START is a 1, then the next state will be 00000001 (or 01 in hex). This

is how we handle the problem of getting started.

So these two locations (hex 000 and hex 100) are different in that one stores a 00 while the other stores a 01. As for all the rest of the message memory, ROM locations 101 through 1FF are an exact carbon copy of locations 001 through 0FF. In other words, once we get out of state 00 into any other state, the voltage on the START input doesn't matter any more; regardless of whether the START is still a 1 or whether it has already gone back to a 0, the sequence will be the same.

Now, what's in the rest of the ROM? Let's assume that the call consists of just the letter K (to keep it simple). The ROM contents is then as shown in Table 6. All the rest of the ROM message area is 00. What does all this mean?

First of all, notice in Fig. 9 that the latched D7 bit (which is the data bit on the left when the number is written down on paper) also happens to be the Morse code output bit which goes to the code oscillator, IC3a. When this bit is a 1, we get a tone output; when this bit is 0, we don't get any sound. When is this bit a 1? Whenever we're in any state whose state number starts with a 1; in hex, this means whenever the state number starts with an 8 or any digit greater than 8. So the IDer generates a tone (mark) in states 80, 81, and up, but not in 00, 01, or any state up to 7F.

Table 6 shows exactly which state follows which other state, but we have to pick our way through it to follow the states. It's much easier if we rearrange the lines into the same order that the circuit goes through. Let's do it as shown in Table 7, using an arrow to show how the controller follows the states. For instance, 01 → 02 means that present state 01 will be followed by next state 02.

All the states starting with 0 are at the left and represent spaces (no tone); the states starting with an 8 are at the right and represent marks (tone). Look at the marks on the right: mark mark (space) mark (space) mark mark mark. There's your K!

What we have, then, is six states of space (no tone), three states of mark (the dah that starts the K), one space followed by one mark (the dit), a space, and another three marks (the second dah). At the end, we have a letter space which consists of five more spaces. (The reason for the six spaces at the start is to allow the transmitter some time to come on before the letter is sent.)

In this case, we used a total of 14 space locations (states 00 through 0D) and 7 mark locations (states 80 through 86) for a start delay, one letter, and a letter space at the end. But actually we shouldn't count the six spaces at the beginning since they are a special case, so the letter K used only 8 spaces and 7 marks. With a total message space of 128 spaces (00 through 7F in hex) and 128 marks (80 through FF), this leaves us room for a message of about 15 characters. Enough to spell out something like K2OAW NEW YORK.

Programming the EPROM

Obviously, the hardest part of building this IDer is programming the EPROM; this job involves two parts—first deciding what to put in which location, and then going through the mechanics of doing the actual programming.

Deciding what to put into the EPROM can be done by sitting down with a notebook and making a table something like Table 7. Simply go through, putting down the marks and spaces which correspond to each dit and dah as well as the



SPECTRUM INTERNATIONAL INC.

THE MORSE TALKER

THE PRODUCT THAT SPEAKS FOR ITSELF!!



FEATURES

- ★ Complete self-contained Speaking Morse Tutor
- ★ Latest state of the art microprocessor speed synthesis system
- ★ Suitable for beginners and proficient operators alike
- ★ A "must" for novice classes
- ★ Wide speed range: 2-20 wpm
- ★ High speed option: 12-48 wpm
- ★ Variable group length and single character facility

Spectrum International Inc.

PRICE \$225.00
Shipping \$5.50

P.O. Box 1084 S, Concord, Mass. 01742 USA

SMP 2300 mHz

- LNA-1 \$44.95 2300 2 stage preamp. Use with UCC-1, SMC-1, SMC-2, & other converters.
- UCC-1 \$35.00 Basic downconverter, complete kit. Has RF amp, Mixer, IF amp.
- UCC-2 \$42.00 UCC-1 with HOT-1 transistor.
- SMC-1 \$43.00 Deluxe Introduction to Microwave package. Includes UCC-1, very detailed step by step assembly manual, more parts, the Microwave Antenna Cookbook, Lots of information on performance.
- SMC-2 \$50.00 SMC-1 package with the HOT-1 transistor.
- PER-1 \$11.95 Broadband 2nd IF Amplifier, compensates for long coax runs and poor TV front end noise figure. 2/\$20.00 3/\$29.00
- ANT-1 \$7.95 2300 mHz Microwave Antenna Cookbook. 2nd revision, greatly expanded. Includes coupon worth \$5.00 towards any \$25.00 purchase. The Original.
- ANT-2 \$20.00 Disks and spacers for 32 element, 18db gain antenna.
- HOT-1 \$10.00 NE64535 High performance RF amplifier transistor, specifications. Improves UCC-1 or SMC-1. 2/\$19.00
- TU-8 \$44.95 Deluxe PS kit, includes case, PER-1 will mount inside.
- TU-8A \$54.95 PS with PER-1.
- MOD-2 \$9.00 Fix kit for brand-X converters.

Send SASE for catalog of other kits and parts.

All prices postpaid in US. VISA & MC on orders over \$40. COD add \$3. Va residents add 4% sales tax. Orders (703) 255-2918 Alaska, Hawaii, Virginia only.

new 1-800-368-3028

SMP

Superior Microwave Products, Inc.
P.O. Box 1241
Vienna, VA 22180

✓376

NEW MFJ-312 VHF Converter lets you **HEAR POLICE/FIRE CALLS** and Weather Band on 2 meter rigs. Covers nearly all FCC allocated police/fire VHF-hi freq. (154-158 MHz). Direct freq. readout on synthesized, VFO 144-148 MHz FM rigs.

Now with weather band coverage!



Hear exciting police/fire calls, weather band, maritime costal and more on your 2 meter rig!

Scanning rigs become police/fire scanner. This ingenious MFJ VHF Converter turns your synthesized or VFO 144-148 MHz FM rig into a hot police/fire receiver (154-158 MHz) with direct frequency readout on your rig.

Receive weather plus more on 160-164 MHz. Feedthru allows simultaneous scanning of both 2 meters and police/fire band. No missed calls.

Enjoy all benefits of your rig such as squelch, excellent sensitivity, selectivity, stability, limiting, AM rejection. For handhelds, too.

Two MOSFETS (tuned RF amp, mixer), bipolar crystal oscillator gives excellent performance.

Bypass/off switch allows transmitting. Won't burn out if you transmit (up to 25 watts) with converter on. Low insertion SWR.

Scanning rigs become **police/fire scanner.** Direct freq. readout on synthesized and VFO rigs.

\$59⁹⁵

"On" LED. 9-18 VDC. SO-239. Mtg bkt. 3x4x1". MFJ-311, \$49.95. Like MFJ-312 less WX band. Order from MFJ and try it — no obligation. If not delighted, return it within 30 days for refund (less shipping). One year unconditional guarantee.

Order today. Call toll free 800-647-1800. Charge VISA, MC or mail check, money order for \$59.95 for MFJ-312, \$49.95 for MFJ-311 plus \$4.00 each shipping/handling.

Enjoy exciting police and fire calls, order now.

CALL TOLL FREE ... 800-647-1800

Call 601-323-5869 for technical information, order/repair status. Also call 601-323-5869 outside continental USA and in Mississippi.

MFJ ENTERPRISES, INCORPORATED
Box 494, Mississippi State, MS 39762

✓47

spaces at the beginning, between letters, and at the end.

If a computer of some kind is available, then the program listing given here can be used. This particular program was written in SWTP BASIC for a SWTP 6800 computer, but since it's written in BASIC it should run on other small computers without much modification.

The program has an array called C which contains the dit-dah code for each letter, number, and some characters. When it runs, it asks for the message you'd like to program, converts each character in the message to the Morse code by looking it up in the table, and then figures out the EPROM pattern. It does two things with the resulting data—it POKES it into memory and prints it out. If you have an EPROM programmer on the computer, then the data POKED into memory could be used to program the EPROM directly; if the programmer is separate, then the printed listing would be used.

This particular version POKES the data starting at decimal location 45056 (see line 60 of the program) which happens to be equivalent to the hex address B000 in the computer; this happened to be convenient in my system, but would probably have to be changed for other systems.

The Morse code pattern in array C is stored as two bits for each dot or dash. If the Morse code character has a dit, then the two bits are 01; a dah becomes a 11.

The letters coming from the keyboard are in a code called ASCII. For instance, the code for the letter K is hex 4B. This is equivalent to a decimal 75, so the code for K is stored in the 75th location of C, which is C(75).

Since the code for a K is dah-dit-dah, it is stored as 110111 (or 11 01 11). This

binary number translates to a decimal 55, and so the Morse code for a K is defined in line 350 as C(75) = 55. Each of the other letters, numbers, and symbols is stored in exactly the same way.

Once you know exactly what data must be stored in the ROM, you must actually store it; this is called programming the ROM and requires an EPROM programmer. Such programmers come in two types—manual and programmed. In a manual programmer, each bit pattern for every location is entered by hand via switches and then a button is pushed to program that location. A programmed unit stores the entire code to be "burned" into the EPROM in its own memory first, and then programs the EPROM with that data. Most EPROMs can be programmed with a manual unit, but obviously a programmed unit is much more convenient.

If you run my program on a computer, it may be con-

venient to use a programmer which attaches to the same computer to transfer the bit pattern straight from the read-write memory of the computer to the EPROM. In the case of the SWTP computer, SWTP makes a 2716 programmer

which also will program 2758s; a modification in a *Kilobaud Microcomputing* article (February, 1979, page 82) allows this same unit to program the 2708 or 2704; this explains my choice of EPROMs. Note, however, that there are

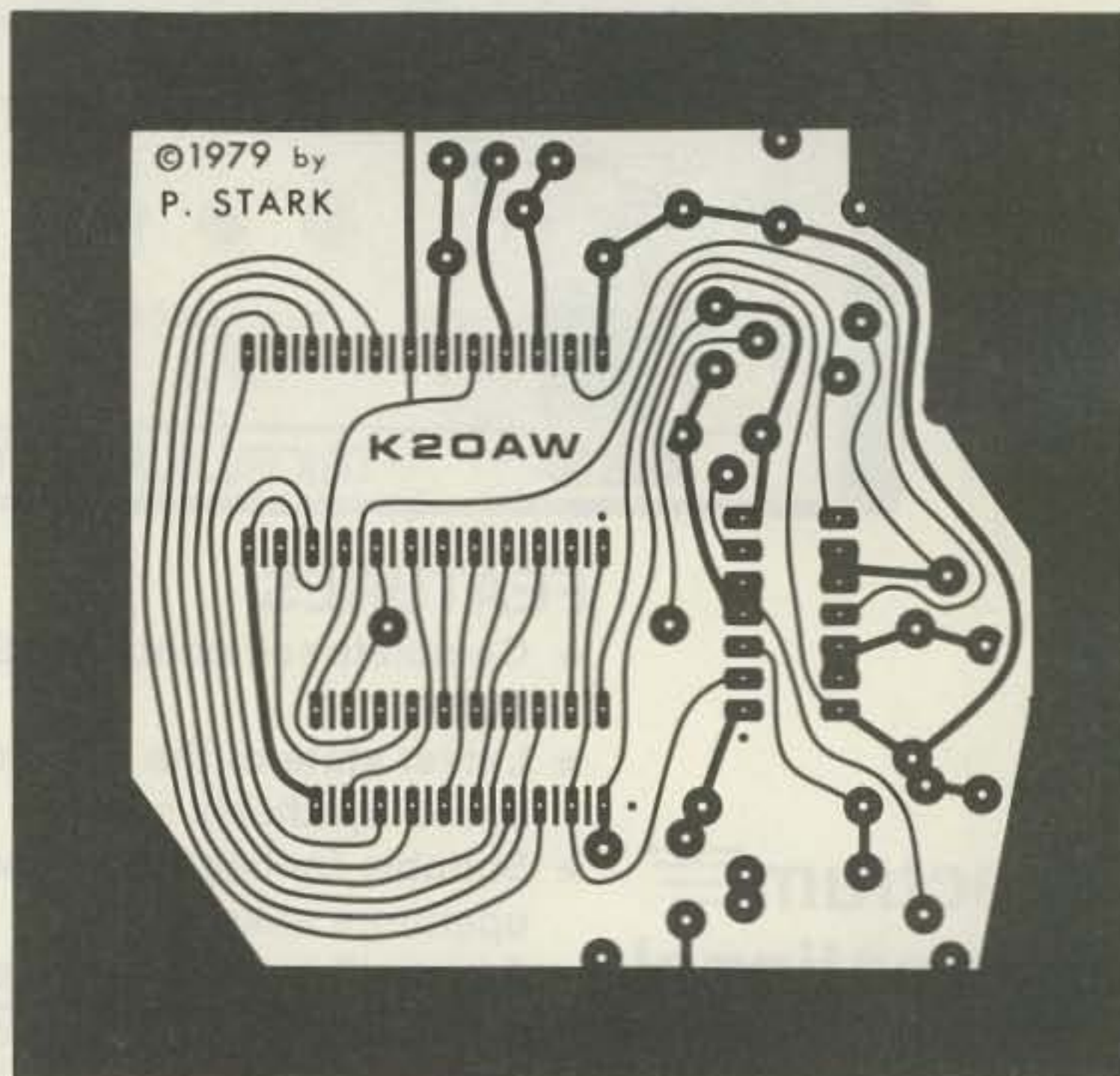

Fig. 11. PC board layout for the CW identifier (copper side of board).

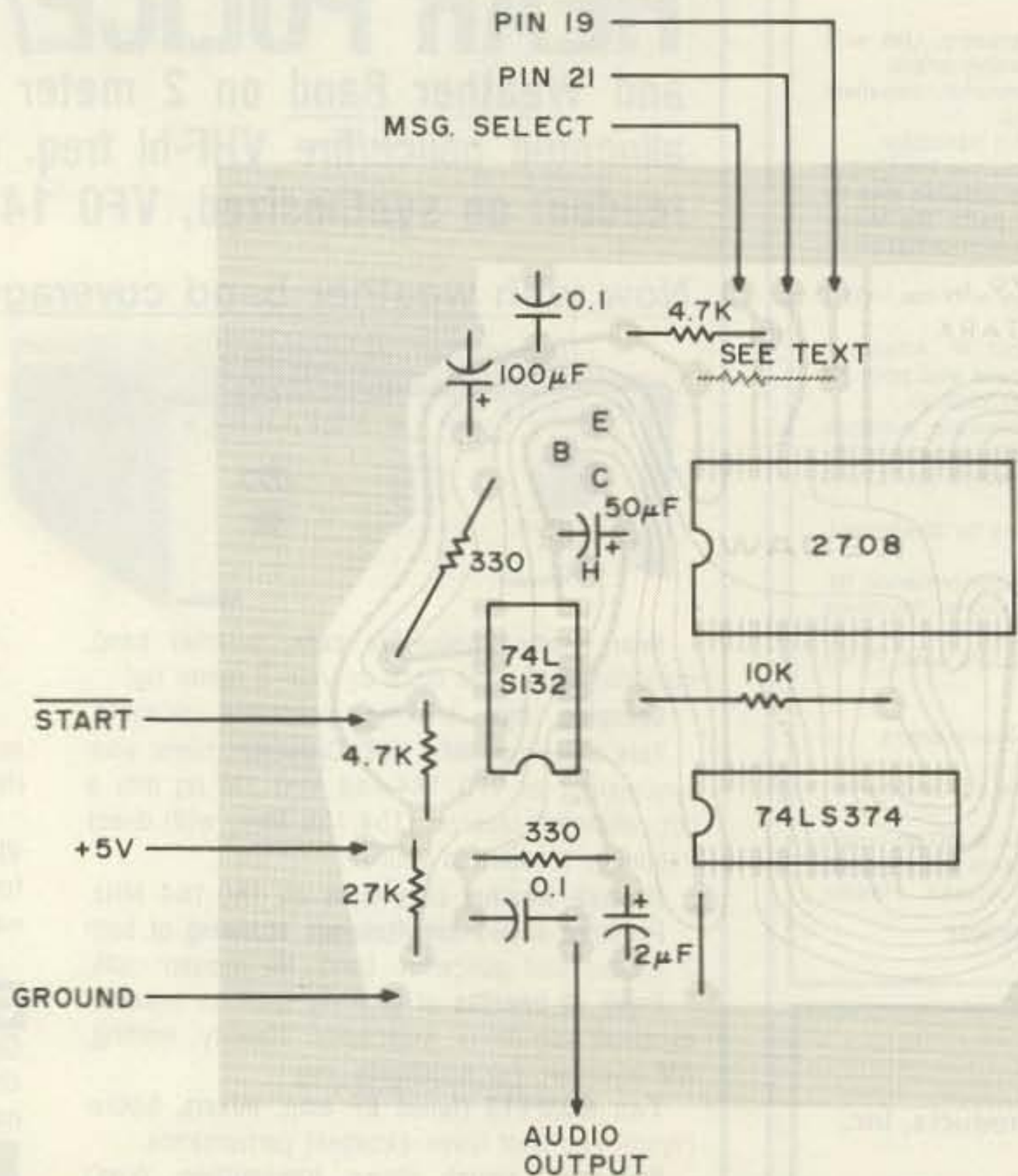

Fig. 12. CW identifier PC board parts placement (component side).

The Sweet Sounding Repeater

MARK 3CR



A Stradivarius is more than a body, neck, and strings. The name alone says it is an instrument of outstanding quality and beautiful sound.

In repeaters the name for optimum performance and clean, natural sound is Mark 3CR. And Mark 3CR also means:

- Receiver sensitivity $< 0.25 \mu\text{V}$.
- Schmitt trigger squelch to capture fading signals
- 13 Morse messages
- Spurious rejection $> 65 \text{ dB}$.
- Autopatch and reverse autopatch
- 15 Function controlled outputs
- Die cast aluminum receiver and transmitter enclosures

For the Finest in

Repeaters • Controllers • Power Amplifiers • Link Transceivers

MICRO CONTROL SPECIALTIES ✓ 49

23 Elm Park, Groveland, MA 01834 (617) 372-3442

PORTA-PEATER™ INSTANT REPEATER

Command and control module makes an instant repeater from any 2 radios with absolutely no modifications to the radios. Interfaces via the external speaker and mic jacks. Perfect for a personal, emergency, or fixed repeater. Write or call for detailed data manual. We accept VISA and M/C. Request catalog.

- 4 individual CW-IDs (1K PROM)
- VOX—COR, COR triggers
- Adj. 0-15 min. ID cycle timer
- Adj. 0-15 min. Time Out timer
- Adj. 0-30 sec. hang timer
- Adj. 20db local mic amp
- True repeater beacon, or manual modes
- 250 volt switching capability
- Complete gain/interface controls
- Complete technical manual
- PCB size 5 1/4" x 5 1/4"
- 22 pin edgcard interface

**Assembled,
Tested,
Burned In,
Programmed
(Inc. \$3. postage)**

\$99.⁰⁰

✓ 302

W-S ENGINEERING
P.O. BOX 58
PINE HILL, N.J. 08021
24 HR. PHONE: 201-852-0269

NEW MFJ-102 SOLID STATE 24 HOUR DIGITAL CLOCK

Switchable to 24 hour GMT or 12 hour format. ID timer. Seconds readout. Bright BLUE .6" digits. Alarm, snooze, lock functions. Power out, alarm on indicators. Assembled.



**Switch to 24 hour GMT
or 12 hour format!
ID timer. Seconds readout.
Bright BLUE .6 inch digits.**

\$32⁹⁵

Now you can switch to either 24 hour GMT time or 12 hour format! Double usefulness.

Switchable "Seconds" readout for accuracy. ID timer. Alerts every 9 minutes after you tap the button. Also use as snooze alarm.

"Observed" timer. Just start clock from zero and note end time of event up to 24 hours.

Alarm. For skeds reminder or wake-up use. Synchronizable with WWV.

Fast/Slow set buttons for easy setting. Big, bright, blue digits (vacuum fluorescent) are 0.6" for easy-on-the-eyes, across-the-room viewing.

Lock function prevents missetting. Operates on 110 VAC, 60 Hz (50 Hz with simple modification). UL approved.

Handsome styling with rugged black plastic case with brushed aluminum top and front.

Sloping front for easy viewing. 6x2x3".

Order from MFJ and try it — no obligation. If not delighted, return it within 30 days for refund (less shipping). One year limited warranty by MFJ.

Order today. Call toll free 800-647-1800. Charge VISA, MC or mail check, money order for \$32.95 plus \$4.00 shipping/handling for MFJ-102.

Put this new improved MFJ digital clock to work in your shack. Order today.

CALL TOLL FREE ... 800-647-1800

Call 601-323-5869 for technical information, order/repair status. Also call 601-323-5869 outside continental USA and in Mississippi. ✓ 47

**MFJ ENTERPRISES,
INCORPORATED**
Box 494, Mississippi State, MS 39762

```

0010 PRINT "PROGRAM TO GET ROM PATTERN FROM GIVEN TEXT STRING"
0020 PRINT "COPYRIGHT (C) 1979 BY PETER A. STARK"
0030 PRINT "ALL RIGHTS RESERVED"
0040 PRINT : PRINT
0050 DIM C(127) :REM CHARACTER CODES
0060 P=45056 :REM ADDRESS 8000 FOR BUFFER LOCATION
0070 Z=2048 :REM EPROM SIZE IS 2K

0080 REM FILL C() ARRAY WITH MORSE CODE

0090 C(32) = 0 :REM SPACE
0100 C(44) = 3935 :REM .
0110 C(45) = 855 :REM -
0120 C(46) = 1911 :REM _
0130 C(47) = 861 :REM /
0140 C(48) = 1023 :REM 0
0150 C(49) = 511 :REM 1
0160 C(50) = 383 :REM 2
0170 C(51) = 351 :REM 3
0180 C(52) = 343 :REM 4
0190 C(53) = 341 :REM 5
0200 C(54) = 853 :REM 6
0210 C(55) = 981 :REM 7
0220 C(56) = 1013 :REM 8
0230 C(57) = 1021 :REM 9
0240 C(63) = 1525 :REM ?
0250 C(65) = 7 :REM A
0260 C(66) = 213 :REM B
0270 C(67) = 221 :REM C
0280 C(68) = 53 :REM D
0290 C(69) = 1 :REM E
0300 C(70) = 93 :REM F
0310 C(71) = 61 :REM G
0320 C(72) = 85 :REM H
0330 C(73) = 5 :REM I
0340 C(74) = 127 :REM J
0350 C(75) = 55 :REM K
0360 C(76) = 117 :REM L
0370 C(77) = 15 :REM M
0380 C(78) = 13 :REM N
0390 C(79) = 63 :REM O
0400 C(80) = 125 :REM P
0410 C(81) = 247 :REM Q
0420 C(82) = 29 :REM R
0430 C(83) = 21 :REM S
0440 C(84) = 3 :REM T
0450 C(85) = 23 :REM U
0460 C(86) = 87 :REM V
0470 C(87) = 31 :REM W
0480 C(88) = 215 :REM X
0490 C(89) = 223 :REM Y
0500 C(90) = 245 :REM Z

0510 REM ERASE THE POKE BUFFER PRIOR TO USE

0520 PRINT "ERASING BUFFER..."
0530 FOR I=0 TO Z-1
0540 POKE (P+I,0)
0550 NEXT I

0560 REM SET UP START-STOP CODES AND INITIAL DELAY

0570 PRINT "POKING DATA INTO BUFFER..."
0580 POKE (P, 0) :REM STOP AT LOCATION 0
0590 POKE (P+256, 1) :REM CONTINUE AT LOCATION 256
0600 FOR I=1 TO 5
0610 POKE (P+I, I+1) :REM LINK 5 MORE SPACES
0620 POKE (P+256+I, I+1)
0630 PRINT I;" = ";I+1
0640 NEXT I
0650 S=6 :REM NEXT SPACE BYTE
0660 M=128 :REM NEXT MARK BYTE
0670 INPUT "ENTER CW MESSAGE", A$
0680 L=LEN(A$) :REM LENGTH OF MESSAGE IN CHARACTERS
0690 FOR I=1 TO L :REM DO FOR EACH CHARACTER
0700 K=ASC(MID$(A$,I,1)) :REM NEXT ASCII CODE
0710 K=C(K) :REM NEXT MORSE CODE

0720 IF K<>0 GO TO 830 :REM SPACE CODE?
0730 REM SPACE CODE REQUIRES A LONG SPACE
0740 FOR J=0 TO 5
0750 POKE (P+S, S+1) :REM POKE 6 SPACES
0760 POKE (P+256+S, S+1)
0770 PRINT S;" = ";S+1
0780 S=S+1
0790 IF S>126 GOTO 1340 :REM ERROR
0800 NEXT J
0810 GOTO 1250 :REM FINISH UP WITH LETTER SPACE

0820 REM NON-SPACE CHARACTER; FIND ITS FIRST MARK
0830 IF K>=16384 GO TO 870
0840 K=K*4 :REM ASSUME 16 BITS, SHIFT LEFT
0850 GOTO 830 :REM TWO BITS UNTIL MARK IS FOUND

0860 REM FOUND NEXT TWO BITS - PUT IN PROPER BYTES
0870 IF K>=49152 GO TO 910 :REM DASH
0880 IF K>=16384 GO TO 1110 :REM DOT
0890 GOTO 1250 :REM WHEN FINISHED, ADD LETTER-SPACE

0900 REM DASH
0910 IF S>125 GO TO 1340 :REM ERROR
0920 IF M>252 GOTO 1340 :REM ERROR
0930 K=K-49152 :REM DELETE DASH
0940 POKE (P+S,M) :REM GO TO 3 MARK STATES
0950 POKE (P+256+S,M)
0960 PRINT S;" = ";M
0970 POKE (P+M,M+1)
0980 POKE (P+256+M,M+1)
0990 PRINT TAB(10);M;" = ";M+1
1000 POKE (P+M+1, M+2)
1010 POKE (P+256+M+1, M+2)
1020 PRINT TAB(10);M+1;" = ";M+2
1030 POKE (P+M+2, S+1)
1040 POKE (P+256+M+2, S+1) :REM RETURN TO SPACE
1050 PRINT TAB(10);M+2;" = ";S+1
1060 S=S+1 :REM UPDATE POINTERS
1070 M=M+3
1080 K=K*4 :REM SHIFT MORSE CODE LEFT 2 BITS
1090 GOTO 870 :REM AND REPEAT

1100 REM DOT
1110 IF S>125 GO TO 1340 :REM ERROR
1120 IF M>254 GO TO 1340 :REM ERROR
1130 K=K-16384 :REM DELETE DOT
1140 POKE (P+S, M) :REM INSERT ONE MARK
1150 POKE (P+256+S, M)
1160 PRINT S;" = ";M
1170 POKE (P+M, S+1) :REM RETURN TO SPACE
1180 POKE (P+256+M, S+1)
1190 PRINT TAB(10);M;" = ";S+1
1200 S=S+1 :REM UPDATE POINTERS
1210 M=M+1
1220 K=K*4 :REM SHIFT MORSE CODE LEFT 2 BITS
1230 GOTO 870 :REM AND REPEAT

1240 REM LETTER SPACE
1250 FOR J=1 TO 4
1260 IF S>125 GO TO 1340 :REM ERROR
1270 POKE (P+S, S+1) :REM POKE A SPACE
1280 POKE (P+256+S, S+1)
1290 PRINT S;" = ";S+1
1300 S=S+1 :REM UPDATE POINTER
1310 NEXT J
1320 NEXT I
1330 END
1340 PRINT "MESSAGE TOO LONG"
1350 STOP

```

Program listing to generate ROM program for the CW identifier.

other ROMs that could be used. For instance, if only a single message is needed, the MM5204Q 512x8 EPROM would fill the bill nicely. If you don't anticipate making changes, then a non-erasable PROM would also work. In a pinch, a pair of 256x8 PROMs could be used, too.

Even if you do not have a programmer, many EPROM suppliers have programming facilities. Occasional

ads from various individuals in the classified columns of computer magazines also offer EPROM programming.

Construction

Building the CW identifier is easy; the circuitry works at a fairly slow speed and no special precautions are needed in building it. Wire-wrapped construction would be fairly easy and very compact, but if you use one of the 2704/2708/

2716/2758 series of EPROMs, then the printed circuit layout of Fig. 11 is for you. (Etched and drilled PC boards are available from Star-Kits, PO Box 209, Mt. Kisco NY 10549, for \$15. Also available is 2708 and 2716 EPROM programming for \$10; you supply the EPROM and the call.)

Fig. 12 is the parts layout for this board. Since this board is usable with any of the four EPROMs shown in Fig. 10, connections to pins

19 and 21 are brought out to pads and require some care on your part.

Though the circuit board layout is designed for the CW identifier, with a few minor trace cuts it could also be used for the touch-tone sequence detector or for many other micro-programmed sequential controllers. So keep this idea in mind next time you need a controller for some project. It's a winner! ■

LARSEN HELPS THE UNDERGROUND.



When you're in a tight spot, dependable communications is crucial. Like repairing a split cable or a broken waterline underground. If you lose touch with the outside world, it's a long climb back to the top.

That's why underground crews use a Larsen Antenna and Magnetic Mount topside, attached to a handheld below. Because Larsen Antennas keep high performance standards, even with the underground.

Külrod® plating, a Larsen exclusive, gives your antenna high conductivity to assure that maximum power goes into communicating—not heat. And the precision tapered stainless steel whip provides flexibility while mini-

mizing radiation pattern distortion, giving you a consistent signal.

Whether your communications take you down under, or just downtown, Larsen Antennas will keep you on top of the situation with dependable performance.

That full measure of performance goes into our product integrity too. With a no nonsense warranty that won't let you down.

For more range with your handheld, or your mobile, you'll find Larsen's performance is tops. Ask your favorite Amateur dealer to demonstrate how you can hear the difference with Larsen Antennas.



Larsen Antennas

IN USA: Larsen Electronics, Inc.

P.O. Box 1799 11611 N.E. 50th Avenue Vancouver, WA 98668 Phone 206-573-2722

IN CANADA: Canadian Larsen Electronics, Ltd.

283 E. 11th Avenue, Unit 101
Vancouver, B.C. V5T 2C4 Phone 604-872-8517

Külrod® is a registered trademark of Larsen Electronics, Inc., U.S.A. and Canadian Larsen Electronics, Ltd., Canada.



SCR 1000/4000

*If You Want The Very Finest Repeater
or Link System Available -
Go With Spectrum*

*Each Unit Virtually Custom Made!
Available With Full Autopatch*

Features

- Low Noise/Wide Dynamic Range Front End for Excellent Sensitivity & IM Rejection.
- 12 Pole IF Filter, & 8 Pole Front End Filter.
- Full Metering, Lighted Status Indicators/Control Push-buttons, Btry. Power Input, AC Pwr. Supply, CW IDer, etc., etc.

SCR1000
& SCR4000
ARE FCC TYPE
ACCEPTED
for Commercial
Services

It takes a full month to make a Spectrum Repeater. Virtually every part and subassembly, right down to the smallest detail, is carefully tested and assembled by hand. There is no mass production involved. All of the assembly and testing is done with great precision by our experienced personnel.

This assures you of the finest quality unit available. One that's been designed, built, tested *and sold* with good 'old fashioned' American ingenuity, care, and attention to detail. This is equipment that's ultra-reliable—and an excellent investment. Equipment that you'll be proud to own years from now. *Call or write our friendly sales people today for the details!*



Shown in Optional Cabinet

**30 or 75W on 2m!
35 or 65W on 220 MHz
40W on 450 MHz**

Available with all of the features you want—Full Autopatch/Reverse Patch/Land-Line Control; **Touch Tone Control** of various repeater functions; "PL"; "Emergency Pwr. I.D."; various Tone & Timer Units, etc. PLUS—the finest Duplexers, Cabinets, Antennas, Cables, etc. Our Repeaters are sold factory direct only, or through Foreign Sales Reps. Get your order in A.S.A.P.!

Commercial Business Radio Dealer Inquiries Invited
180 Day Warranty



SPECTRUM

Export Orders — Contact our International Dept.

1055 W. GERMANTOWN PK., DEPT. S1

new

And Now For Those Who Want
The Finest Quality... But At A Low Price
Introducing The New Low Cost Spectrum
SCR-77 Repeaters - 2M, 220 & 440 MHz!



- Includes:**
- Crystals—high stability .0005%
 - Local Mic
 - Your Call programmed into IDer
 - Provision for Auto-Switchover to Btry. Pwr.
 - Built-in AC Supply; basic Panel Controls, Spkr., LED Indicators

If you're looking for a new Repeater, but you really don't need (or can't afford) all the features and options on our world famous, 'super deluxe' SCR1000/4000, then our new economy line of SCR77 Repeaters is ideal for you!

These new Repeaters maintain the quality of design, components and construction which made Spectrum gear famous. However, all of the "bells & whistles" which you may not need or want have been eliminated—at a large cost savings to you!

The SCR77 is a real "workhorse" basic machine designed for those who want excellent, super-reliable performance year after year—but no frills! ('PL' and a 30Wt. Transmitter are the only "built-in" options available; but Autopatch, Remote Control, and other equipment can be connected via the rear panel jack.)

Of course, if you do want a full featured/super deluxe repeater, with higher power and a full list of available 'built-in' options, then you want our SCR1000 or 4000 "Dream Machine". These units will continue to be available for those who want 'The Ultimate in Repeaters'.

SCR77 Pricing (15Wt.): 2M or 220MHz, \$995.00 Amateur Net. 440MHz, \$1150.00. For no 'plug-in' ID board (Export), deduct \$40.00. Call or write today for a data sheet, or to place your order! Sold Factory Direct or through Export Sales Reps only.

10M FM Repeaters, Remote Bases, RX & TX Boards Now Available!

Join the fun with the growing activity on 10M FM! Extended 'superior' ground-wave contacts; local Repeaters; Remote/Local Bases and Mobile for Nationwide or Foreign DX. All with the ease of 2M FM!

Our Repeaters and Remote Bases are basically made up of 2-SCR1000 Mainframes, complete with a VHF/UHF Link "built-in."



The 10M FM Receiver is "Super Hot" and "Super Sharp." The Transmitter is a 35 Wt. unit with beautiful audio quality.

A Complete Data Package is now available on both complete systems and boards—all commercial quality. Call or write for more information today.

✓68

COMMUNICATIONS CORP.

Inquire about 'surplus' 2M & 220 TX Boards. ½ Price!
Norristown, PA 19401 • (215) 631-1710

Messages from Station Charlie

— when wireless meant life or death

Author's Note: Much is written about transmitters, receivers, antennas, and all the hardware and software of the world of radio. Less is written about the messages made possible by them. This is natural when a W1 writes with pride about his brand-new Superbang 42X and his QSO with a ZL via SSTV on 10.5 GHz using bedsprings for an antenna. We know what *his* message is: "I am using a Superbang 42X with bedsprings for my antenna. . ." • There are times, however, when *messages* are the real point—as in the cases of emergencies and disasters. And certainly it was one of those times at Station Charlie, where messages helped win the big war and kept alive the courage and hopes of men and women in the most desperately lonely of personal wars—those fought by secret agents. • Some names, places, and times have been changed, but this is a true story. • Many thanks, for their help with technical information, to George Fogarty (ex-W2LHC, ex-JA2AD), Stan Willard W9JAS (ex-W9GSE), and Ed Clinton W8STP—formerly Technical Maintenance Officer, Chief Signalmaster, and Signalmaster, respectively, for Station Charlie. • This material has been reviewed for security by the Central Intelligence Agency and the National Security Agency. • Copyright 1981, Richard Phenix: All rights reserved.

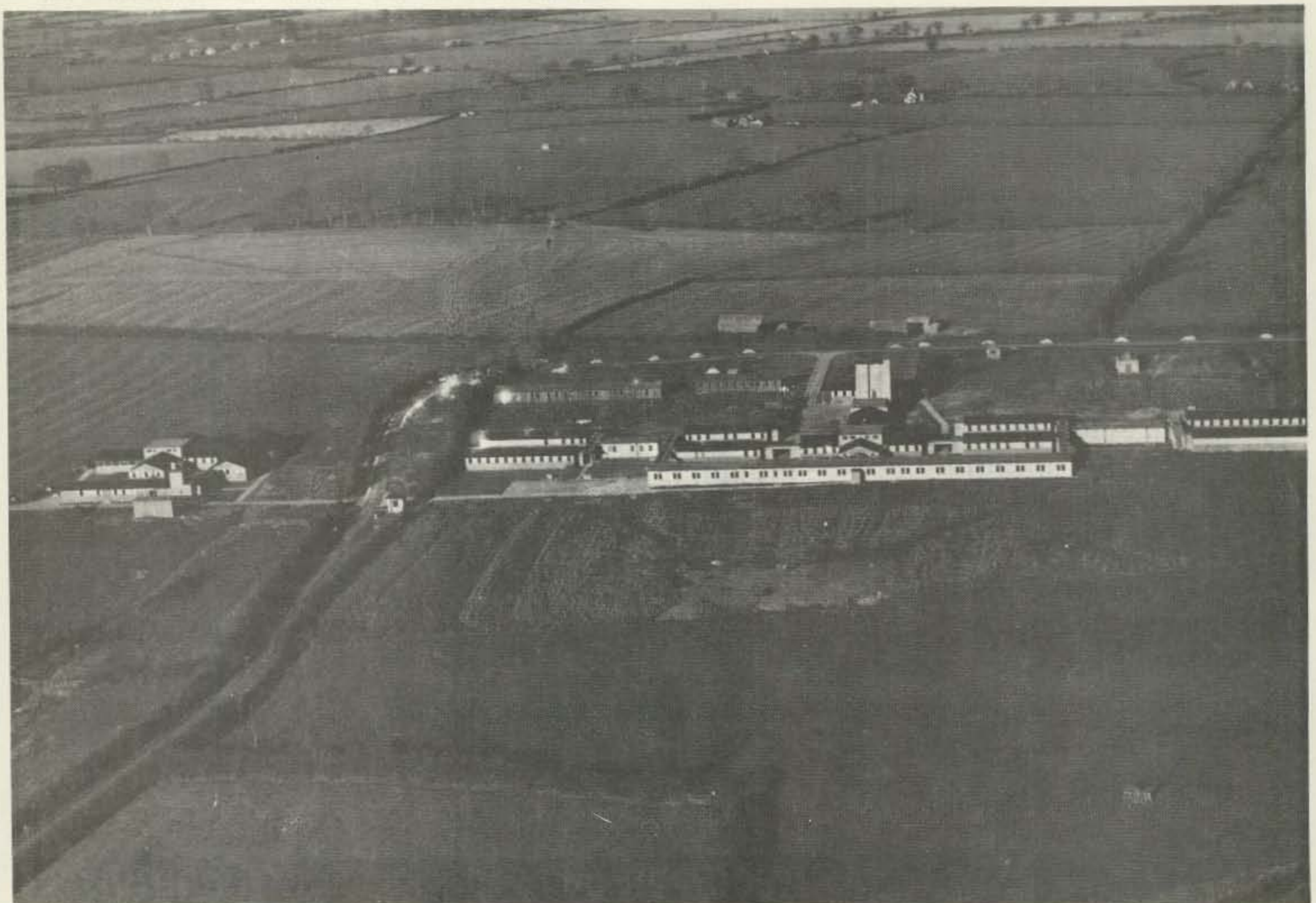

Photo A. Station Charlie, Buckinghamshire, England, 1944.

It is 1944. Station Charlie covers the top of a low, rolling hill in Buckinghamshire, England, not very far from Oxford (Photo A). The station's operations buildings, which make up the "security area," are clustered together at one end of the encampment apart from the rest. Here are housed the communications activities, running 24 hours a day; they are the reason for Station Charlie's existence.

Between them and the "housekeeping area" of mess hall, motor pool, administration buildings, officers' and "other ranks" barracks, runs an old country lane, now closed to public use for the duration by guard posts at Charlie's boundaries, much to the annoyance of the local fox-hunting club. The lane runs from nowhere in particular at one end to the Sow and Pigs pub at the other, in the small village of Poundon. It is possible for perhaps thirty people to be in the pub at the same time—if they watch out for each others' elbows.

But the some fifty men and women working in the operations buildings are too busy to worry about that, and the three hundred or so in the rest of the camp are either sleeping or about to sleep or waiting to go on duty. Station Charlie is an isolated post and, anyway, the job's the thing.

In fields beyond the operations buildings, receiving antennas lift their slender, quadruple-guyed wands 120 feet into the air; a few miles away, lines of equally-tall transmitting antennas march across other fields in the directions of France and the Scandinavian peninsula (Photo B).

One of several stations operated jointly by American and British intelligence agencies, Station Charlie is, in this critical year of World War II, a communications

base for secret agents inside Axis-dominated territories. It is receiving their often-faint Morse signals, deciphering and decoding the messages, and transmitting them by teleprinter to London. It also is encoding and enciphering teleprinted answers or questions from SHAEF (Supreme Headquarters, Allied Expeditionary Force) received over the same secure land lines and is sending them booming out over the English Channel and the North Sea to, it is fervently hoped, alive and receptive ears (see Fig. 1).

The Station At Work

Little was spared to make Station Charlie a reliable link in the communications chains leading from its assigned men and women in the field—close to 100 at times (the "outstations")—to the guarded offices of war planners. There was no James Bond atmosphere at Charlie; we left that to the masterminds behind unmarked and inaccessible doors on London's Baker Street. Our job was to listen for even the faintest whispers of signals, to hear them at once, to copy them without error the first time around, and to allow the vulnerable senders to get the hell off the air quickly; then to translate Morse code groups into clear text in one or another readable language quickly, and fire them off to London quickly; it was to encipher clear texts from London accurately and quickly, to send code groups with copperplate hand fast, but not too fast, and, again, to get the hell off the air. (See Photo C.)

Speed and accuracy. It was our job to provide both. Sitting comfortably on our hilltop, safe and well-fed in the peaceful rolling countryside, speed and accuracy were the priceless contributions we

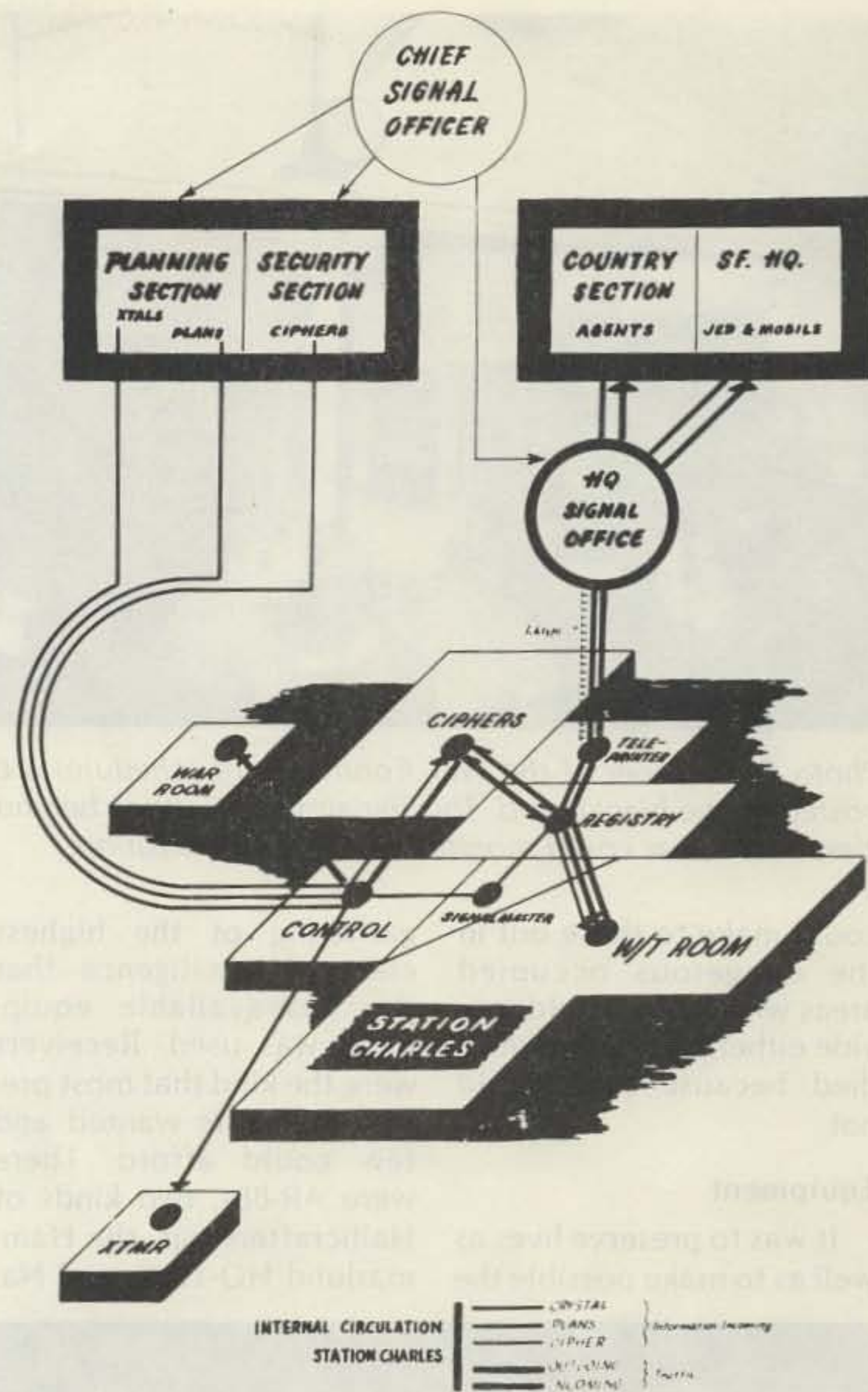

Fig. 1. Operational layout of Station Charlie. British terms are used (W/T—wireless telegraphy, for radio, etc.). "Plans" included calls and schedules (skeds) for transmissions. Agent messages were routed to "country" intelligence offices (Norway, France, etc.) and/or to S.F. (Special Forces) offices during pre- and post-invasion weeks.



Photo B. Transmitting antennas.



Photo C. A corner of the W/T Room. Agent schedules are posted on the blackboard. The Signalmaster's office behind glass at the rear could monitor any operator position.

could make to those out in the dangerous occupied areas who rarely could provide either; they sometimes died because they could not.

Equipment

It was to preserve lives as well as to make possible the

gathering of the highest class of intelligence that the best-available equipment was used. Receivers were the kind that most pre-war amateurs wanted and few could afford. There were AR-88s, two kinds of Hallicrafters rigs, the Hammarlund HQ-120X, and Na-

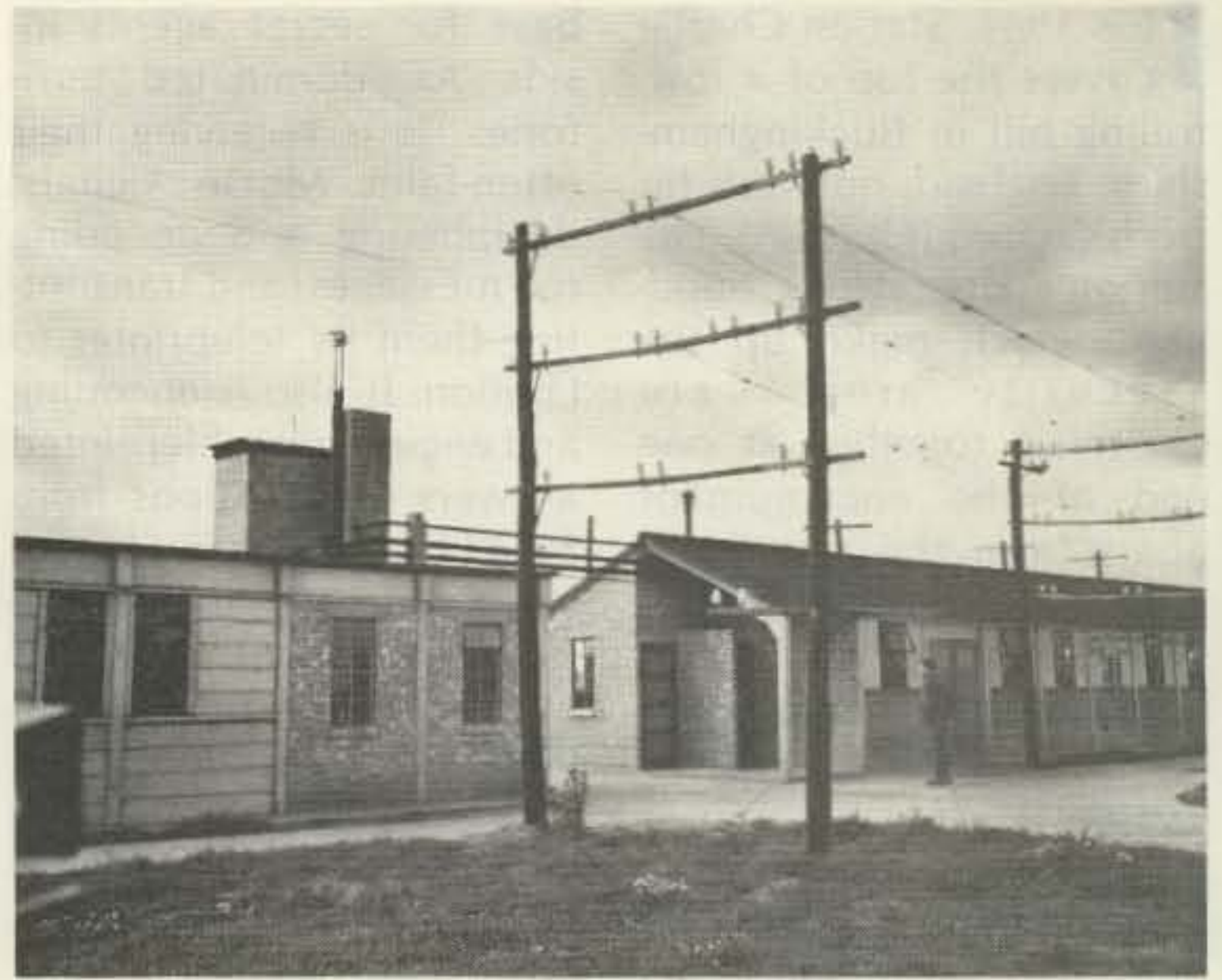

Photo D. Transmitter Building.

tional HRO-5s. Recording equipment was by Creed—beautifully-made British units. (This also was used to “fingerprint” agents for comparison purposes in cases where later it was suspected that the Germans had captured an agent and were using his equipment to try to send us misleading information.)

Good receiving units were essential if transmissions from the field were to be picked up with any reliability. While the equipment of the agents ranged from bulky hand-cranked-generator sets to the then-amazing British fibre-suitcase units, it was mostly the latter Charlie listened for. These measured 12" x 18" x 5" and contained the transmitter, receiver, and power pack with built-in battery charger! The battery was a 6-volt motorcycle type with vibrator high-voltage supply.

Charging was never done while transmitting—that was an invitation to German DF units to join the party! All the Germans had to do—and did, in early days—was to cut power to an area, sector by sector, briefly, until transmissions were interrupted, and then move in fast to encircle the sector pinpointed.

Transmitters, located in separate buildings a few miles away (Photo D) and connected through land lines to the Control Room, included a 400-Watt RCA, 3-to-5-MHz unit, using 807 crystal oscillators and 813s in the output stage (probably ET4036s). Tape-sending equipment was principally McElroy—the pre-war code-speed champion and manufacturers of speed keys—and also Creed and Teletype™.

The RCA transmitter was hellaciously hard on crystals, and one modification made at Charlie was the addition of low-power crystal oscillator doublers ahead of the 807. (Some parts were obtained in typical war-time fashion by fast shuffles—there may still be an American power mower used to cut English grass on the grounds of a now-retired British officer who helped us out.)

A particularly interesting unit was the wideband amplifier (Photo E) of which we had two. Designed and built by the British, each consisted of ten reasonably conventional low-power, crystal-controlled exciter stages, all fed into a wideband rf amplifier; sixteen or twenty 807s in push-pull parallel kept the input and



Photo E. The wideband amplifiers were a technical curiosity at Station Charlie, as described in the text.

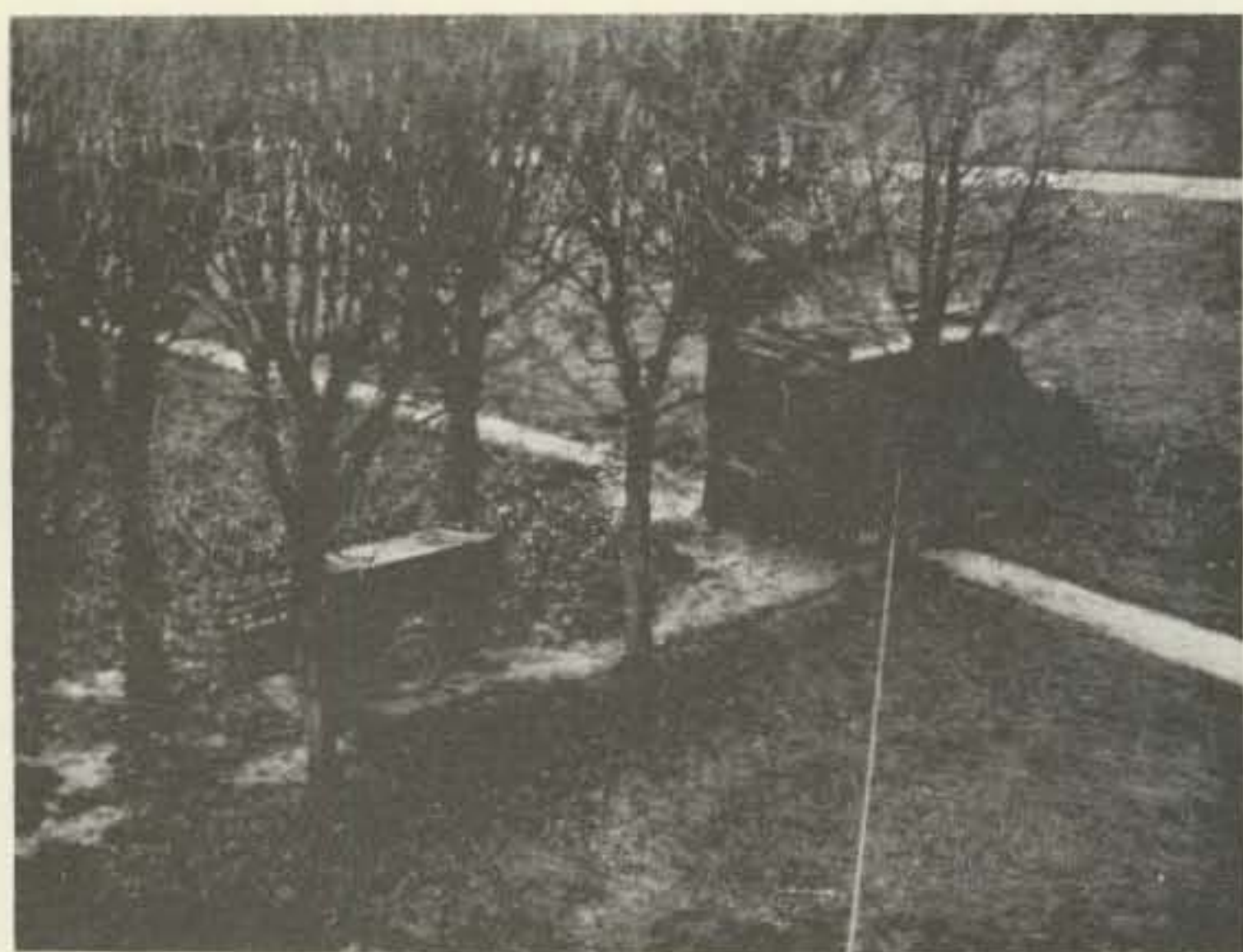

Photo F. One of the mobile units (an SCR-399) at St. Cloud, outside of Paris.

output impedance low. (And the efficiency—about 50 Watts per channel!) Thus, coax could feed the input and the output could go directly into terminated rhombic antennas (about 300 feet on a side) pointed in the right direction. Because of the power gain of the rhombics, the effective power per channel was 350 Watts.

Transmitting antennas were mostly delta-matched doublets on poles 60 to 120 feet in height. Station Charlie crews often took these down and altered them to conform to changes in transmitter operating frequencies and outstation locations!

Receiving antennas were coaxially-fed doublets patched into individual receivers or, via a vacuum-tube isolation amplifier, to groups of receivers.

The Agents

Station Charlie's special task was to work with, first, agents in Scandinavian countries (our "Country Section"—see Fig. 1), second, with the Jedburghs (Jeds), agents parachuted in ahead of invading forces, and, third, with mobile stations which moved with various army units (Photo F). During invasion days and

the weeks following, Jed intelligence was hotlined to the armies, giving them remarkably up-to-date information on what lay immediately ahead. The map in Photo G shows the locations of Jeds geographically and with respect to Allied forces and French resistance groups. (At the time of this photo, the Allies had penetrated well into France, leaving the northwest area clear of Jeds. Those who had been overrun were returned to England—if they had survived—and were readied for other parachute drops.)

Each outstation had its own codes, crystals, transmission "skeds" (see blackboard in Photo C), and secret security checks. The absence of the last in any message was supposed to alert us that the agent had been compromised—that it was the enemy now using the codes and equipment. While both sides had some successes in this sort of counterintelligence, usually the absence of the check was due to forgetfulness or the great pressures under which agents worked in the field, leading them to barebones operations—and to hell with procedures.

Those pressures were sometimes so unbelievably



Photo G. The Cipher Room's small war map of France, with Jed locations indicated by map pins along and beyond fighting fronts. The pin nearest the map's center is close to Chateauroux and probably was for Hamish (see text).

extreme that it seemed almost miraculous when things worked out reasonably according to plan. Parachute drops could miss the right area entirely, suitcase transceivers could bounce shatteringly off rocks (or go "glub" in a lake), the local reception committee might not be there but a German unit just might be, leading to an abandonment of all equipment and (hopefully) a headlong dash to escape. Sometimes it was up to us at Charlie to try to sort out what had happened when the wrong agent came in on a sked or somebody else's code was used in an emergency.

One French agent I met in Paris later in 1944 told me of his months in the Ardennes forest in 1943 and 1944. Regularly on the jump, he said—swimming rivers "while the Boche fired at me" (and once escaping in an empty wine barrel on a friendly farmer's cart)—Citron spoke with dry humor of times when he figured that even his friends were against him: winter clothes parachuted to him in July...one supply drop which consisted of four canisters containing noth-

ing but lampshades...and a day when an urgently-important operational message was due from England and, despite German activity near his hideout, he kept his radio sked and received just one message, saying (roughly): *After due consideration, our staff has concluded that the Maquis group you are with should be named after the French—th Regiment that fought in your area.*

Citron also told of the intensely emotional experience of his first radio contact after jumping into France (he worked a sister station of Charlie's). This backed up what we had been told by the Chief Signal Officer (London) about our own agents—that the first contact with us was universally reported to bring an emotional high unsurpassed by any they experienced thereafter. We all believed this, at Station Charlie, and it gave us additional motivation to do our jobs well, but for me it may not have been until ten years later that the full meaning became clear—when I had occasion to hear from another agent about the magic of that first contact.



You pay LESS at AES... just Call TOLL FREE
1-800-558-0411 - ask for our DISCOUNT DESK



- TS-130S 200w PEP 8-band digital Xcvt \$759.95
- TS-130V 25w PEP 8-band digital Xcvt 599.95
- PS-30 20A power supply for TS-130S 144.95
- PS-20 4.5A power supply for TS-130V 77.95
- DFC-230 Digital frequency controller 289.95
- SP-40 Compact mobile speaker 25.95
- SP-120 External speaker 41.00
- VFO-230 Digital remote VFO 309.95
- VFO-120 Analog remote VFO 164.95
- YK-88C/YK-88CW 500 Hz CW filter 62.95
- YK-88CN 270 Hz CW filter 62.95
- YK-88SN 1.8 KHz SSB filter 62.95
- AT-130 8-band antenna tuner 144.95
- MB-100 Mobile mount 29.95
- MC-30S (lo-Z) or MC-35S (hi-Z) mobile mic 29.95



- TS-530S 9-band digital Xcvt \$799.95
- SP-230 External spkr w/audio filters 71.95
- VFO-230 Digital remote VFO 309.95
- VFO-240 Analog remote VFO 169.95
- YK-88C/YK-88CW 500 Hz CW filter 62.95
- YK-88CN 270 Hz CW filter 62.95
- YK-88SN 1.8 KHz SSB filter 62.95
- AT-230 9-band tuner/SWR, pwr meter 194.95



TL-922A 2kw PEP linear..... (Air Freight) \$ 1229.95

New products available soon:

- R-600 General coverage receiver TBA
- TS-660 6/10/12/15m transceiver TBA
- VOX-4 VOX unit/speech processor TBA
- YK-88A AM I.F. filter TBA
- MC-60 Deluxe microphone (4-pin) 69.95
- MC-60 Deluxe mic. w/UP/DOWN sw. (6-pin) 74.95
- HS-6 Lightweight headphones 20.00
- RD-20 50 ohm dummy load 19.95
- KPS-21 21A (intermit.) DC power supply 124.95



- TS-830S 9-band digital Xcvt \$949.95
- DFC-230 Digital frequency controller 289.95
- SP-230 External spkr w/audio filters 71.95
- VFO-230 Digital remote VFO 309.95
- VFO-240 Analog remote VFO 169.95
- YK-88C/YK-88CW 500 Hz CW filt (1st IF) 62.95
- YK-88CN 270 Hz CW filter (1st IF) 62.95
- YG-455C 500 Hz CW filter (2nd IF) 85.95
- YG-455CN 250 Hz CW filter (2nd IF) 113.00
- AT-230 9-band tuner/SWR, pwr meter 194.95
- SM-220 Monitor scope 359.95
- BS-5 Panadaptor kit for TS-520/S 79.95
- BS-8 Pan kit; TS-530S/830S/820S/180S 79.95



- R-1000 200 KHz-30 MHz digital receiver \$499.95
- SP-100 External speaker 47.95
- DCK-1 cable kit 6.00

IMPORTANT!
The prices shown in this ad are suggested by the Manufacturer.
On most MAJOR items we can save you money with a Big Discount. Call now TOLL FREE and ask for our DISCOUNT DESK.



- TR-7730 Compact 25w 2m FM Xcvt \$329.95
- TR-7730 w/MC-46 TTP microphone 349.95



- TR-7800 25w 2m FM Xcvt \$399.95
- TR-7850 40w 2m FM Xcvt 449.95
- BC-1/TK-1 Memory back-up supply 20.00



- TR-9000 2m SSB/FM/CW Xcvt \$499.95
- PS-20 4.5A power supply 77.95
- BC-1/TK-1 Memory back-up supply 20.00
- BO-9 System base 42.95
- SP-120 External speaker 41.00



- TR-8400 10w synth 450 MHz FM Xcvt \$499.95
- KPS-7 6A ps; TR-7730/7800/8300/8400 83.95
- KPS-12 10A power supply for TR-7850 94.95
- MC-46 Up-dn TTP mic; 7730/8400/9000 49.95



- TR-2500 .3/2.5w 2m FM HT \$329.95
- ST-2 Desk quick chgr/ps 89.95
- SMC-25 Speaker/microphone ... 34.95
- PB-25 Extra 400ma battery 34.95
- LH-2 Leather case 37.95
- MS-1 Mobile stand/chgr/ps 42.95
- BH-2 Belt hook TBA
- BT-1 Alkaline battery case TBA
- EP-1 Earphone TBA
- TU-1 Prog. sub-tone encoder TBA
- WS-1 Wrist strap TBA
- VB-2530 Amplifier TBA

- MC-50 Hi/lo-Z desk microphone \$ 47.95
- MC-30S Lo-Z dynamic mobile mic 29.95
- MC-35S Hi-Z dynamic mobile mic 29.95
- HC-10 Digital world clock 103.95
- HS-4 Headphones 19.95
- HS-5 Deluxe headphones 41.95
- KB-1 Dlx flywheel VFO knob; TS-530S/830S 17.95
- PC-1 Phone patch 62.95
- SP-40 Compact mobile speaker 25.95
- DM-81 Dip meter 103.95

KENWOOD Factory Rebates
(Effective 11-1-81 to 12-31-81)

- TS-130S \$30
 - TS-130S with PS-30 \$50
 - TR-9000 \$35
 - R-1000 \$30
- Double Savings! - Low AES Prices + \$\$ from KENWOOD**

Our Mail Order Experience makes a Big difference - We have over 24 Years!

Call Toll Free: 1-800-558-0411 In Wisconsin (outside Milwaukee Metro area) 1-800-242-5195

AMATEUR ELECTRONIC SUPPLY Inc.

4828 W. Fond du Lac Avenue; Milwaukee, WI 53216 Phone (414) 442-4200

AES BRANCH STORES

WICKLIFFE, Ohio 44092
28940 Euclid Ave
Phone: (216) 585-7388
OH Wats: 1-800-362-0290

ORLANDO, Florida 32803
621 Commonwealth Ave.
Phone: (305) 894-3238
FL Wats: 1-800-432-9424

LAS VEGAS, Nevada 89106
1072 N. Rancho Drive
Phone (702) 647-3114
Outside NV 1-800-634-6227

ASSOCIATE STORE

ERICKSON COMMUNICATIONS
CHICAGO, Illinois 60630
5456 N. Milwaukee Avenue
Phone: (312) 631-5181

| | | | | | | | | | | |
|---|---|---|---|---|---|---|---|---|---|---|
| | A | B | C | D | E | F | G | H | I | J |
| A | a | a | a | a | a | a | a | a | a | a |
| B | b | b | b | b | b | b | b | b | b | b |
| C | c | c | c | c | c | c | c | c | c | c |
| D | d | d | d | d | d | d | d | d | d | d |
| E | e | e | e | e | e | e | e | e | e | e |
| F | f | f | f | f | f | f | f | f | f | f |
| G | g | g | g | g | g | g | g | g | g | g |
| H | h | h | h | h | h | h | h | h | h | h |
| I | i | i | i | i | i | i | i | i | i | i |
| J | j | j | j | j | j | j | j | j | j | j |
| | M | Z | T | J | I | I | V | A | E | D |
| | S | N | Z | F | M | O | Y | H | J | I |
| | G | H | S | E | D | Z | A | B | B | M |
| | H | U | Y | V | Z | I | S | A | F | W |
| | E | X | R | I | A | Y | X | F | D | Y |
| | A | K | H | Z | E | Z | C | M | A | J |
| | Q | M | X | I | K | L | E | D | D | P |
| | K | R | B | E | H | B | C | U | K | Q |
| | L | M | T | G | O | R | G | L | S | F |
| | U | Z | P | N | L | P | R | O | U | X |

etc.

Fig. 2. The one-time pad ciphering table (E over d equals Z, etc.). Agents' copies were printed on handkerchief-size pieces of silk. The plan was to do it in invisible ink, to be developed in the field in plain water in which chemically-treated shoelaces were to be soaked. I suspect this was just one of those dramatic notions never carried out. The table itself was not secret, and a handkerchief made of silk would all by itself have alerted any German.

Swan

"Oh, how many tears I fell that day!" was the way Swan expressed herself to me on that occasion—near the end of the few days I ever knew her as more than just a code name. The radio operator for one of the Nor-

wegian units (all of which were known by bird names), much of her war had been spent in the Stavanger area. For a week after her unit was activated, she had been unable to contact Charlie. Then, in a saeter, much higher up above a small



Photo H. The Perforator Room, in Registry, stored the tape loops with the agents' calls. Perforated tape was state-of-the-art in 1944. We had some of the earliest belt recorders, but they were a total loss at that time.

(a) EBDAD BSCGH CBGAB EBHFA
 (b) DDFJE JBBBB DCEHE GAIFI
 (c) ZUZU IZIZYH YHXXK KZLZL

(a) AAAID GFBEC EHDDI JGBEC
 (b) AFGJG DDBEE FDJCA ACHBC
 (c) MAQUI SINAREANEE DARMŠ

ZUZU—Take meaning (of next code group) up to and including word after fifth hyphen.

IZIZ—Infiltration-completed-into-area-occupied-by-enemy

YHYH—700 and

XKXK—50

ZLZL—Continue spelling for rest of message.

Fig. 3. The received message (line a) written over lines in our copy of the agent's one-time pad (his pad pages were burned as he used them) was deciphered by use of the table in Fig. 2. Line c then was decoded using the table shown in Photo I, excerpts from which are listed here.

fjord than she had been before, tired, discouraged, wet, hungry, and fearful of the German occupation forces—for they surely knew by then that her team was in the vicinity—she tuned in on her assigned frequency at her assigned time and in came the booming signal from Station Charlie: STW STW STW de CAM CAM CAM QRK? QRK? QTC QTC K K repeated over and over as the perforated-tape loop (Photo H) fed through and our W/T operator strained his ears anxiously for the response: CAM de STW QRK...

I like to think that I remember that day, 37 years ago, and maybe I do. I know I told Swan that I did—and meant it—but at Charlie we had many such happy first contacts with agents, whereas for Swan it was, of course, the only one, and tears glistened on her cheeks again as she relived it.

"You were all we had," she said. "My God, that feeling of not being alone after all! We got our courage back... you [Station Charlie] were there, and you never let us down!"

So far as we could know, Station Charlie never let anyone down. There was a set period of time for listening for an agent to keep a

sked, at the end of which the pragmatic assumption was that he was blown—dead or captured—and we could stop sending out our call on a listening watch. Somehow, however, we did not stop unless we had other intelligence that the agent was, indeed, lost. The Charlie W/T operators hated to give up, and it was well understood when some of them used off-shift hours to listen for signals which usually never came.

Hamish

Hamish was one of the Jeds who failed to keep a sked one day. According to the location of his pin on the war map in the Cipher Room (see Photo G), he was operating in a particularly hot area. (This map was backed up by very large-scale maps to help us decipher garbled transmissions which often included critically-important place names. Thus, we could advise London that "German tanks massing at Chatsauvyhf" undoubtedly referred to Chateauroux, not Chateauneuf, which was more than 100 air miles away from the agent's location.)

As with other agents we presumed were lost, Station Charlie kept Hamish "alive" beyond the required period.

I don't remember what it was that made *Hamish* special to me, but he was, and I know that he was particularly in my mind some years later when I met and chatted with a German whose war job had been DFing Allied clandestine transmissions in the Chateauroux area; he told me with pride of some of the successes his unit had enjoyed. But I never mentioned *Hamish*—or Station Charlie—to him.

The Cipher Section

The W/T link was not the only one which broke on occasion. It happened sometimes that a message came in which could not be deciphered. We hated to ask outstations to expose themselves to DFing by repeating transmissions, but when one had come in five by nine that wouldn't break, we could be sure that the trouble was in the ciphering process.

That sort of trouble belonged to my department, the Cipher Section. As the Signalmasters felt about their operators, so I felt about the cipher crew. I couldn't ever say enough in praise for the more than a hundred service men and women who worked the Cipher Room. Most were members of a British women's auxiliary—a famous one dating back to the Boer War. Mostly English or Scots, many had good personal reasons for dedication to the job: husbands, family members, and friends who were out there somewhere or who had already died in combat or in air raids. A few of them had memorized the deciphering table for the one-time-pad cipher system—this consisted of 676 three-letter combinations! (Fig. 2 is of a made-up portion of such a table, showing only 100 of the three-letter combinations.)

Given a priority message hot from the W/T room—

line (a) in Fig. 3—and the correct copy of the one-time pad (page after page of random 5-letter groups) on which the agent had enciphered his message—line (b)—there was usually someone on duty who could write the first over the second and come up with the clear text—line (c)—without looking at the table. (Portions of the clear text sometimes were also in code—as in the Fig. 3 example—and had to be decoded using another table, part of which is shown in Photo I; nobody ever even tried to memorize that one, which yielded thousands of meanings from its four-letter code-group combinations from AAAA through ABAB through ZYZY to ZZZZ!)

We also had specialists who made possible the untangling of messages which came in not only in a language other than English but also via the horribly complicated double-transposition ciphering system used by Scandinavian agents. Based on a memorized key, it had obvious security advantages over code books and tables, but it worked satisfactorily only when, well, only when it worked satisfactorily! Unlike the one-time pad system where each letter was, in effect, independently enciphered by the substitution of another letter, in this system all the letters remained themselves but were by prearrangement twice transposed in their relationships with each other—jumbled about, in other words.

In the worst case, one single misplaced or misnumbered letter in the key could make a stew of an entire message. Fig. 4 shows an example of a message correctly enciphered—(a), (b), and (c)—and also, in (d), (e), and (f), what can happen during deciphering when only seven letters had been

Fig. 4. This shows how an agent enciphered his message number 18 (using, therefore, in a prearranged way, lines 1 and 8 of his memorized poem—see Fig. 5). Note in the second box (b) how sloppy writing of column numbers 5 and 15 could result in misplacing seven letters: (c) is correct; (d) is wrong, resulting in garbled deciphering in (e) and (f) and the thoroughly loused-up result (capital letters). The misplaced letters are boxed here to show how they moved around. This type of error happened to be ho-hum common and gave our experts no problems!

Fig. 5. My own poem (obviously), used only once to check it out. Yes, *dythyrambs* is spelled wrong; but I've always been sorry for people who have so little imagination that they can spell a word only one way (so said Mark Twain).

transposed incorrectly. (Fig. 5 is the poem used as the key in this example. It is one that I wrote for myself in

1943 when I thought I was going into North Africa with a team; I shall never be able to decide whether I am glad

former-a-attached-at-point-given SXXX
 report-attached-at SXXX
 go-train-successfully-attached-and-chose-UP-many SXXX
 go-moving... from-this-area-and-heading YATA
 to-contact-resistance-element-a-in-area YBTA
 -burst-a-needed-urgently-for YCTC
 U
 out-parts-being-manufactured-at-factory TDTD
 around-your-instruction-a-and-will-try YETE
 as-we-receive-further-instructions-will-not YFTF
 key-at-present-to-be-able-to-attack YGTO
 I-further-instruction-a-do-not-attempt YHTH
 successful-but-will-try-again-soon-out YITI
 mt-messages-for-you-and-your-group YJTY
 mly-require-extra-supply-a-food-and-ammunition YLTL
 whether-you-have-managed-to-contact YMTM
 less-to-attempt-another-operation-yet YNTN
 V
 ill-be-fashed-twice-and YOTO
 ele-park-attached... trucks-destroyed-and-many YPTP
 -important-that-you-should-not-attempt YQ7Q
 W
 ill-be-fashed-twice-and YRTR
 -ing-further-orders-before-attempting-fresh YSTS
 I-urgently-ammunition-and-stores-in-readiness-for YTTT
 s-all-concerned-that-they-must-not YUTU
 ing-passed-on-to-active-element-a YVTV
 unable-attempt-operation-due-to-many YWTW
 not-able-to-carry-out-attack-due-to YXTX
 a-out-for-enemy-agent-passing-as YZTZ
 e-supply-out-to-town-of YZTZ
 re-ready-to-begin-attack-on YAAA
 are-not-ready-to-begin-attack-on-target YBUS
 can-carry-out-operation-immediately-if-you YCUC
 cannot-attack-target-yet-due-to-enemy YDUD
 need-fresh-supplies-ammunition-food-soonest-possible YEUU
 were-forced-to-abandon-attack-due-to YFUF
 were-not-in-a-position-to-attempt-any YGUG
 will-try-to-re-establish-contact-and YHUH
 will-not-be-able-to-attempt-operation-yet YIUI
 bar-holding-up-operations-cannot-proceed-until YJUI
 a-before-we-consider-that-it YKUK
 -rod-a-and-true-again-a-are YLUL
 -formed-to-abandon-operation-owing-to-enemy YNUM
 -not-able-to-attack-target-because-of YOUN
 -sely-direction YOUO
 I-ever-you-think-best-but-act YUUF
 I-will-you-be-ready-to-begin-operation YUQU
 I-shall-we-proceed-next-as-we YURU
 a-target-you-propose-attacking-next-becomes YUSU
 a-you-are-waiting-for-them-to YUTU
 a-light-a-will-be-shown-at YUUU
 -will-attempt-to-join-up-with YUYU
 is-area-now-under-our-control-and YUWU
 is-task-will-be-to-embargo-the YUXU
 did-you-not-attempt-to-contact YUYU
 attempt-operation-soon-as-possible-and YUZY
 not-attempt-attack-on-target-until-we-can YVVA
 try-again-soon-as-possible-to-attack YVVB
 try-attack-target-soon-as-possible-if-you-will YVVC
 try-to-re-establish-contact-with-group YVDV
 you-be-able-attack-target-date-given YVEV
 a-must-be-out-between... and YVVF
 all-available-forces-to-attack-enemy YVVD
 good-results-am-proceeding-to-next-agreed YVYH
 draw-immediately-and-proceed-to-area-given YVYI

14 XCXO
 15 XDXD
 16 XEYH
 17 and XFFX
 18 XGGO
 19 and XHXX
 20 XIXI
 21 and XJXX
 22 XKXX
 23 and XLXL
 24 XMXX
 25 and XNXX
 26 XOXX
 27 and XPXP
 28 XQXQ
 29 and XRXR
 30 XSXS
 31 and XTXT
 32 XU XU
 33 and XV XV
 34 XW XW
 35 and XX XX
 36 XY XY
 37 and YZ ZZ
 38 YAAA
 39 and YBYB
 40 YCYC
 41 and YD YD
 42 YE YE
 43 and YF YF
 44 YG YG
 45 and YH YH
 46 YI YI
 47 and YJ YJ
 48 YK YK
 49 and YL YL
 50 YM YM
 51 and YN YN

SYLLABIC TABLE

| | |
|-------|-------|
| ABLE | YOTO |
| ALIV | YPTP |
| ED | YQYQ |
| ENT | YBYB |
| ER | YHYH |
| ERN | YTYT |
| ES | YUYU |
| EST | YVYV |
| FULLY | YWYW |
| IES | YXYX |
| ING | YYY Y |
| INT | YZYZ |
| INTS | ZAAA |
| LY | ZBBB |
| LLY | ZCCC |
| OUR | ZDDD |
| RTY | ZEEE |
| ST | ZFFF |
| TH | ZGGG |
| TY | ZHHH |
| UN | ZIII |

Begin Spelling ZJZJ
 Case Spelling ZKZK
 Continue spelling for rest of this message ZLZL
 Following group is in the plural ZM ZM
 Following group is in singular ZN ZN
 Following group is in past tense ZOZO
 Following group is in present tense ZP ZP

Take meaning up to and following word after:
 the first hyphen ZQZQ
 second ZRZR
 third ZS ZS
 fourth ZT ZT

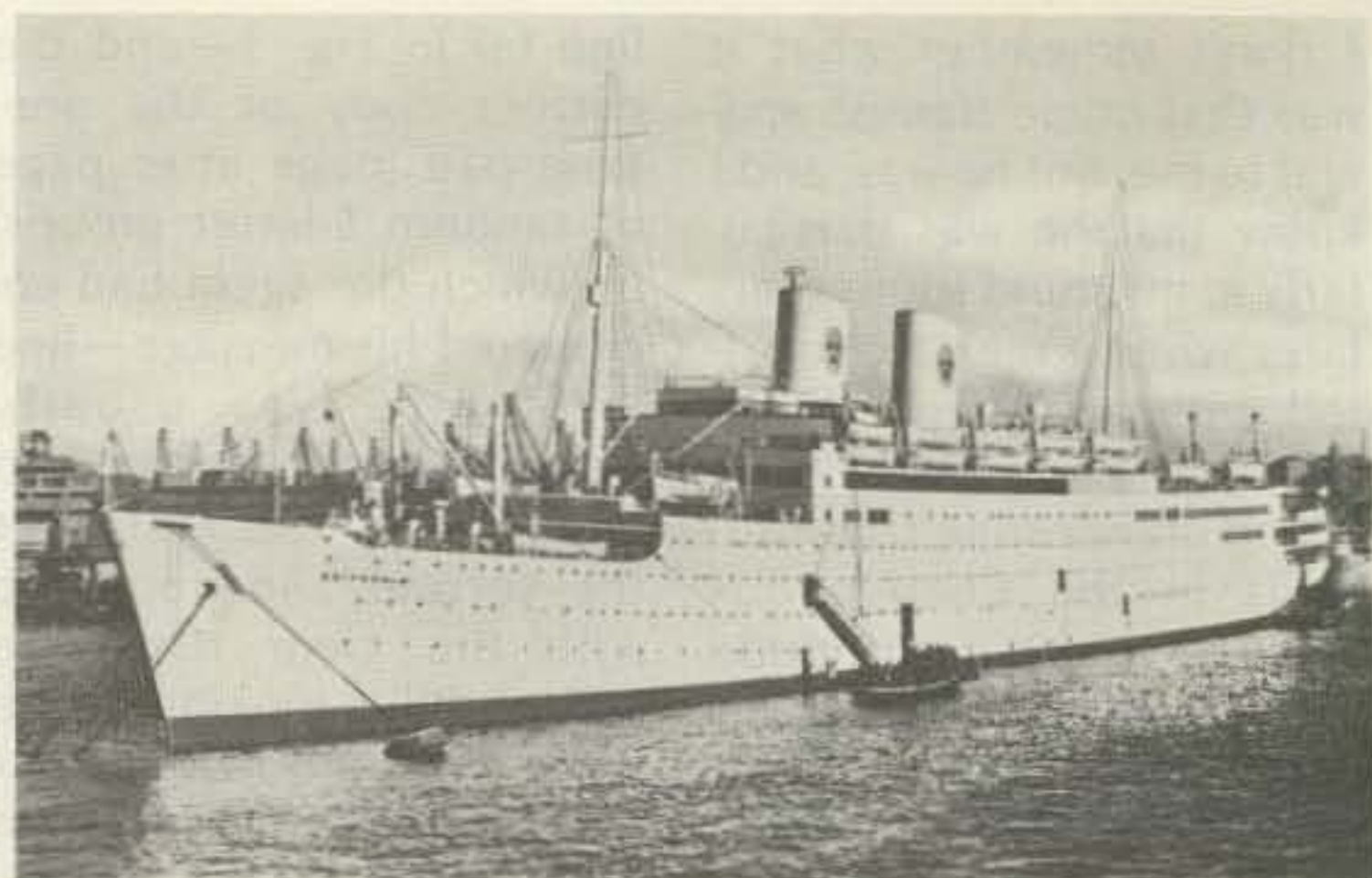

Photo J. The Motor Ship Gripsholm of the Swedish-American Line was famous for her many mercy and diplomatic voyages. She later became the Berlin for the North German Lloyd Line.

Photo I. Part of the code table used by Jeds. This was another refinement that was more accurately thought of as a complication. Designed to shorten messages and, therefore, precious transmission time, agents usually chose to risk longer times on the air in favor of shorter times for the enciphering process.

or sad that that assignment was changed!)
 Visualize, if you can, Swan sitting in a leaky saeter hut with stub of pencil and soggy paper, half-frozen, remembering her own poem—was it *imorgen* or *imorgon*? (one being Norwegian and the other Swedish, for “tomorrow”)—remembering whether it was message 17 or 18 (which determined which lines of the poem to use), constructing her squares, numbering the columns (the first a is 1, the second is 2; the third, 3; no b or c, so d is 4, etc.), writing directions to a safe house for a new agent soon to be parachuted in (GA FEMTE GATE TIL VENSTRE OGDEN SJETTE TIL

HØIRE...), removing the letters vertically from the first square in column-numbered order and writing them horizontally in the second square, removing them again, vertically... and so on, all the time listening for the always-to-be-feared sound of approaching German DFing units. Swan did her work correctly for the most part. I couldn't have! Could you?
 Add to that all transmission problems, QRM, QRN, etc., and it was a wonder that we managed to untangle (without computers) nearly all the “undecipherables.” And that included one which took a score of us weeks to break—and earned us a commendation even though it turned out to

say the war-time equivalent of something like “Having wonderful time, wish you were here.” After all, it *could* have been important!
 It is a temptation to write on and on about the little corner of the war which was Station Charlie and the messages we sent and received, but by now you should have the picture of intensely dedicated W/T operators, cipher personnel, transmitter technicians, controllers, perforators, teleprinter operators, registry clerks, and maintenance technicians, all of us so awfully tenuously linked to the lonely souls to whom our work literally could mean the difference between their eventual return to England—and living—and capture, possible torture, and death.
Ten Years Later
 It is 1954. The M/S *Gripsholm* (Photo J) is plowing her slow and steady way through the Atlantic. Fine on the starboard bow is Dunnet Head at the tip of Scotland, around which is the North Sea—one of the most crowded of graveyards for ships of war. The *Gripsholm* is headed for Gothenburg, Sweden, and then the port of Bremerhaven, Germany.
 It is the dawn watch, and Second Officer Kurt von

Meeteren is on the bridge; Acting QM Ernst Weiss has the wheel (Photo K). Von Meeteren was commander of the German submarine U399 for part of the war, and then of U3021, which, on command at the end of the war, he scuttled in the North Sea. Also on watch is another Quartermaster, a bosun's mate, and two ABs—one on lookout in the foremast and one on fire guard.
 Throughout the ship, men once of the German Navy are on duty, for this is a hand-picked crew: It is the maiden voyage of the *Gripsholm* under charter from the Swedish-American Line by Norddeutscher Lloyd; it is the first passenger ship since WW II to fly the German flag.
 Most of the passengers, however, are Scandinavian, and they had not been told that the only Swede on ship duty would be the Chief Engineer, Eric Toll. It is a difficult experience for many of them—bitterly so, for some—because the war is not that far in the past and no part of it has been forgotten. The German crew is aware of this—it was their war, too, and they were defeated—and members are keeping as low a profile as possible under the circumstances. It is not a happy ship.

TERMINALL

The communications terminal that does it all!



TERMINALL is a hardware and software system which converts your TRS-80* (Model I or Model III) into a state of the art communications terminal. **TERMINALL** is simple to use. **TERMINALL** gives you more for your money. **TERMINALL** works with a general purpose computer and is expandable. **TERMINALL** has it all!

Simplicity

TERMINALL was designed from the outset to be easy to connect to your radio and easy to use. Plug into your receiver headphone jack and copy Morse code or radioteletype (RTTY). Plug into your CW key jack and send Morse code. Attach a microphone connector and send Baudot or ASCII RTTY using audio tones (AFSK). That's all there is to hooking it up.

The software may be loaded into your computer from cassette or disk. Enter your callsign and the time and you will start receiving immediately. No settings or adjustments are necessary to receive Morse code - it's fully automatic - and it works! You may type your message while receiving or transmitting.

You will be on the air, receiving and transmitting any mode in minutes. As we said, **TERMINALL** is simple.

More for your money

■ **TERMINALL** has the RTTY terminal unit - demod and AFSK - built in. This results in a lower total cost because separate terminal units usually cost at least \$225 assembled, and most do not even have a crystal controlled AFSK. **TERMINALL** eliminates not only the higher cost of an external terminal unit, but also eliminates the hassle of interfacing to another piece of equipment.

■ **Outstanding documentation.** Professionally written, 90 page user manual - contains: step-by-step instructions - explicit examples - numerous photographs and illustrations - theory of operation - parts layouts - schematic diagrams - trouble shooting guide.

■ **Built in software backup** - set up the program parameters and messages the way you like to operate - then have the program save a new copy of itself - on either cassette or disk!

■ **Software** supplied on both cassette and auto-run diskette at no additional cost.

■ **Built in separate, multi-stage active filter RTTY and CW demodulators.** No phase lock loops. RTTY demodulator has 170 and 850Hz shift - keyboard selectable - and uses either the panel meter or scope outputs for easy tuning. Copy the weak ones. Copy the noisy ones. Copy the fading ones.

■ **Built in crystal controlled AFSK.** Rock stable for even the most demanding VHF or HF application. A must on many VHF RTTY repeaters.

■ **Built in hardware clock** - one second readout maintains correct time even during cassette I/O. User programmable time/date format.

■ **Built in 110 or 220** volt AC power supply.

■ **Built in parallel printer driver software.** Simply attach a parallel ASCII printer (e.g. the EPSON MX-80) to your printer port to obtain hardcopy in all modes. Note: parallel printers typically cost less than serial ASCII printers.

■ **Fantastic Morse reception;** Six stage active filter demodulator copies the weak ones. Auto adaptive Morse algorithm copies the sloppy ones. Keyboard selectable noise threshold. Received code speed displayed on status line.

■ **Word wrapping.** word mode editing, diddle, ignore carriage returns, user programmable end of line sequence, adjustable carriage width, Transmit delay (fixed, none or auto adaptive) Break mode and more!

■ **The all-in-one TERMINALL design** makes it great for use on HF or VHF -Ham, Commercial, SWL or MARS! SWL's: we will be happy to modify **TERMINALL** for 425Hz reception instead of 850Hz, at no extra cost, if requested with your order. (Some News and weather services use 425Hz).

General Purpose vs Dedicated

TERMINALL has capabilities far surpassing other "dedicated terminal" systems. And yet, since it works on a general purpose computer, the majority of your investment (the TRS-80) is spread out over many different applications - not just Radio communications. And your system is expandable. For example, Disk based mailbox software may be added at any time.

Simplicity of operation. Lower cost. General purpose computer. What are you waiting for? This is the way to go!

Complete with software on cassette and diskette, assembled and tested hardware, and extensive instruction manual. Specify Model I or Model III. Level II 16K required. \$499.



We Discount EPSON Printers.
Call Now!

MACROTRONICS, inc. ®

1125 N. Golden State Blvd.
Turlock, CA 95380

44

To order toll free 1-800-344-7493
In CA and for service (209) 667-2888
or 634-8888

15 Day Money Back Trial Period. One year parts and labor limited warranty. Add \$4 shipping in U.S.A. CA residents add 6% sales tax.

We continue to experience telephone difficulties, please keep trying.

* Recognized trademark of Tandy Corporation.

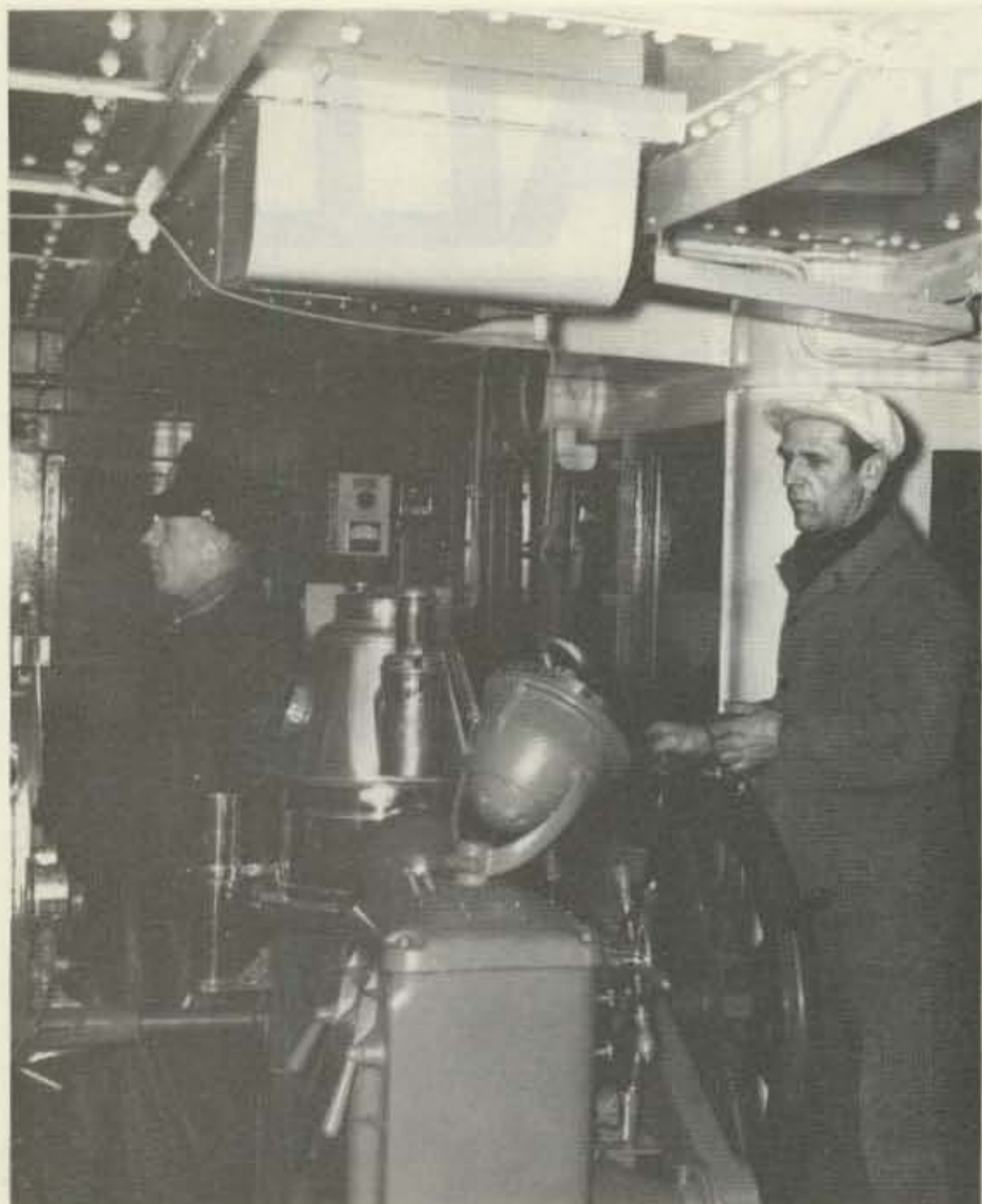

Photo K. On the bridge of the Gripsholm, 2nd Officer Kurt von Meeteren stands the dawn watch, with Acting QM Ernst Weiss at the wheel.



Photo L. Chief Radio Operator Hans Kleiber in the Gripsholm's radio shack.

At this pre-dawn hour, most of the passengers are in their staterooms for the night, forgetting in sleep the German presence that they had been trying to ignore during the day. Some, however, are still up and enjoying each other's company. There is one such group in particular, in one corner of a tourist-class lounge—a Finn, three Swedes, two Norwegians, a Dane, and an American. As a sort of goodnight salute to each other, they are singing their national anthems, one by one. All of them know them all—except for the American. He knows only his and is feeling rather sad about that.

Four Who Were There

One. I was the American and was on my way to Frankfurt, Germany, to be a consultant for a refugee program. By day, I "worked" with the German officers and men, for I had

been given the run of the ship in order to write a story about the *Gripsholm*. (By night, I "played" with my fellow passengers.)

Two. Thus, I had met and interviewed Chief Radio Operator Hans Kleiber (Photo L) who told me of his DFing of Allied agents in France; it was then that I had wondered about *Hamish*. Could Kleiber's unit have been responsible for his disappearance?

Three. Four. And I wondered even more—but *only* to myself (and *never*, before now, to more than a very few)—when, after trying to sing Scandinavian national anthems and joining in on what was supposed to be the last skool of a joyous night, two of my favorite people there, Christi and Dag, turned out to be *Swan* and *Hamish*.

Never before nor since has there been such a moment in my life.

During the hours we had

spent together on board, we had gradually come to know each other, of course, and, as reserves had dropped away, we had talked more and more about the war years and our very personal experiences. I do not remember exactly how the final recognition came about. I never will; it overwhelmed us all too suddenly. We were talking about Norwegian resistance groups, I know, and I think Christi said something like "...when I was with *Swan*..." and I know my jaw dropped. I managed to say some strangled words about Station Charlie... Christi looked at me incredulously... Dag said something like "Oh, my God!"... and then, "I'm *Hamish*...!" and I said, "Oh, my God!"... and the three of us began talking, laughing, and, oh, yes, crying, all at the same time... and Dag ripped off his shirt and

showed us his scarred back where the Gestapo had had him flayed... after he'd been DFed by the Germans... and Christi told us of her very first contact with Station Charlie, and she said, "Oh, how many tears I fell that day...!"

Conclusion

Yes! Sometimes the messages are the most important part of radio communications, amateur or otherwise. And the sounds of such communications can echo down through the years, forever.

I doubt if any of us from Station Charlie can hear Morse code now without remembering, and being grateful for, the small and quiet roles we were privileged to play in those great happenings of WW II, when there were more of the world's people than ever before or since united in a shared belief. ■

MICROLOG
ACT-1

\$995*



We proudly announce our Amateur Communications Terminal, the ACT-1. It's the best value in the Amateur Radio market for your RTTY/CW requirements. Check the combination of features and proven MICROLOG quality. You'll agree, the ACT-1 is a "Tough ACT to follow." Microlog Corp. 4 Professional Dr. Suite 119, Gaithersburg, MD 20760, Tel. 301-948-5307 Telex 908778.

Sales through your local dealer

MICROLOG

51

INNOVATORS IN DIGITAL COMMUNICATION

- SIMPLE DIRECT CONNECTION to your Transceiver.
- COMPLETE SYSTEM, built-in Demodulator & AFSK Modulator with keyboard programmable tone pairs from 500 to 3000 Hz.
- SPLIT-SCREEN operation with keyboard selectable line location
- 1400 character text buffer.
- TEN, 40 CHAR. programmable message memories, plus ID's WRU & SELCALs.
- RANDOM CODE generator & hand key input for practice.
- Baudot 60 to 132 WPM.
- ASCII 110 & 300 baud.
- SYNC-LOCK & NON standard speed ASCII operation from 10 to 200 baud, (slow speed = noise immunity).
- RECORDER INTERFACE for "BRAG-TAPE" or recording off-the-air.
- CODE CONVERTED Printer output in Baudot or ASCII.
- SSTV/GRAPHICS transmit.
- FULL 63 KEY Computer grade keyboard.

*9" monitor \$199.

MIDCOM

CALL NUMBER ONE!

**CARLOAD INVENTORIES • ROCK BOTTOM PRICES
SUPER-FAST SERVICE**

| | | | | | | | |
|------------|---------|-----------|---------|------------|---------------|-------------|-------------|
| LINES: AEA | ALPHA | CUSHCRAFT | DENTRON | KANTRONICS | MINI-PRODUCTS | NYE | TEN TEC |
| AVANTI | BEARCAT | COLLINS | HY GAIN | KLM | MOR GAIN | PALOMAR ENG | UNIVERSAL |
| ASTRON | BIRD | CDE | HUSTLER | KENWOOD | MIRAGE | REGENCY | UNARCO-ROHN |
| ALLIANCE | BENCHER | DRAKE | ICOM | MICROLOG | MFJ | SWAN | VIBROPLEX |

CALL TOLL FREE 1-800-325-3609 IN MISSOURI 314-961-9990
MID-COM ELECTRONICS • 8516 MANCHESTER ROAD • BRENTWOOD, MO 63144



✓ 52

“ELEGANT”

**DESIGNED FOR THE PARTICULAR HAM.
CLUTTERFREE CONSOLES**



PRICES START AT \$203.35
SEND FOR FREE BROCHURE

✓ 89

CLUTTERFREE MODULAR CONSOLES P.O. BOX 5103 TACOMA, WA. 98405 (206) 759 1611



JANUARY SALE

1-800-336-4799

ORDER
TOLL
FREE

ORDER HOURS: 11 am - 8 pm M-F
9 am - 4 pm Saturday

Bonus: 2% Discount for Prepaid Orders
(Cashier's Check or Money Order)

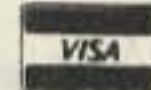

CLOSED TUESDAYS

| TEN-TEC SPECIALS | |
|----------------------|---------|
| 515 Argonaut HF XCVR | 399.95 |
| 525 Argosy HF XCVR | 469.00 |
| 580 Delta HF XCVR | 748.95 |
| 546 Omni-C HF XCVR | 1040.00 |

TEN-TEC Accessories
in stock at discount prices

| MFJ PRODUCTS | |
|-------------------------------------|-------------|
| 989 New 3KW Tuner | 287.75 |
| 962 1.5KW Tuner mtr/switch | 199.95 |
| 961 1.5KW Tuner | 139.95 |
| 9498 300 watt deluxe tuner | 122.00 |
| 941C 300 watt tuner switch/mtr | 78.42 |
| 940 300 watt tuner switch/mtr | 69.70 |
| 484 Grandmaster memory keyer 12 msg | 121.72 |
| 482 4 msg Memory keyer | 87.96 |
| 422 Pacesetter Keyer w/Bencher BY1 | 87.15 |
| 410 Professor Morse keyer | 113.95 |
| 408 Deluxe Keyer with speed mtr | 69.69 |
| 496 Keyboard II | 296.95 |
| 752B Dual turnable filter | 78.42 |
| 102 24-hour clock | 30.95 |
| 260/262 Dry Dummy Loads | 23.50/56.75 |
| 250 2KW PEP Dummy Load | 31.10 |

| ASTRON POWER SUPPLIES (13.8 VDC) | |
|---------------------------------------|--------|
| RS7A 5 amps continuous, 7 amp ICS | 48.60 |
| RS12A 9 amps continuous, 12 amps ICS | 66.35 |
| RS20A 16 amps continuous, 20 amps ICS | 87.20 |
| RS20M same as RS20A + meters | 105.50 |
| RS35A 25 amps continuous, 35 amp ICS | 131.95 |
| RS35M same as RS35A + meters | 151.95 |

| MINIQUAD HQ-1 | |
|---------------------|--------|
| ALLIANCE HD73 Rotor | 91.95 |
| CDE HAM IV ROTOR | 169.95 |

| VoCom Antennas/2m Amps | |
|---------------------------------|--------|
| 5/8 wave 2m hand held Ant | 19.95 |
| 2 watts in, 25 watts out 2m Amp | 69.95 |
| 200 mw in, 25 watts out 2m Amp | 82.95 |
| 2 watts in, 50 watts out 2m Amp | 108.95 |

| MIRAGE AMPS & WATT METERS | |
|---|------|
| MPI HF/MP2 VHF SWR/Watt Meter | CALL |
| B23 2 in, 30 out, All Mode | CALL |
| B108 10 in, 80 out, All Mode, Pre-Amp | CALL |
| B1016 10 in, 160 out, All Mode, Pre Amp | CALL |

| BENCHER PADDLES Black/Chrome | |
|------------------------------|--|
| 35.25/42.95 | |

| BUTTERNUT HF-5V-III 10-80m Vertical | |
|-------------------------------------|--|
| 86.95 | |

SUPER SPECIALS

| | |
|------------------|------|
| AEA Isopole | CALL |
| AEA Keyers | CALL |
| AEA Code Readers | CALL |

| ASTRON POWER SUPPLIES | |
|------------------------------------|--------|
| VS35M 25 amp continuous adjustable | 171.00 |
| VS20M 16 amp continuous adjustable | 124.00 |

| AZDEN PCS 300 Hand-held, 2m | |
|-----------------------------|--|
| CALL | |

| PCS 3000 2m XCVR | |
|------------------|--|
| 284.00 | |

| SENTEC H71200 2m hand-held | |
|----------------------------|--|
| 279.00 | |

| ST 7/T 440-450 hand-held | |
|--------------------------|--|
| 284.00 | |

BIG DISCOUNTS

KENWOOD, ICOM, YAESU, AZDEN, KDK
— Call for our quote —

| HY-GAIN ANTENNAS | |
|--------------------------|--------|
| NEW! TH7DXX Triband Beam | CALL |
| TH3MK3 3-Element Beam | 179.95 |
| TH3JR 3-Element Triband | 138.95 |
| 18AVT/WB 10-80 Vertical | 82.95 |
| 14AVQ/WB 10-40 Vertical | 50.77 |

| CUSHCRAFT ANTENNAS | |
|--------------------------------|--------|
| A4 New Triband Beam 10-15-20m | 205.95 |
| A3 New Triband Beam 10-15-20m | 168.95 |
| AV3 New 10-15-20m Vertical | 41.50 |
| ARX 2B New Ringo Ranger 2m | 34.00 |
| A32-19 2m "Boomer" DX Beam | 75.95 |
| 220B 220 MHz "Boomer" | 68.95 |
| 214B Jr. Boomer 144-146 MHz | 62.10 |
| 214FB Jr. Boomer 144.5-148 MHz | 62.10 |
| A147-11 11-Element 2m | 34.50 |

| TELEX HEADSETS-HEADPHONES | |
|--|-------------|
| C1210/C1320 Headphones | 22.95/32.95 |
| PROCOM 200 Headset/dual Imp. MIC | 77.50 |
| PROCOM 300 lt/wt Headset/dual Imp. mic | 69.95 |

| | |
|-----------------------------|---------|
| CABLE RG8/U Foam 95% Shield | 26¢/ft. |
| 8 wire Rotor 2 #18, 6 #22 | 18¢/ft. |

| KLM ANTENNAS (other antennas in stock) | |
|--|--------|
| KT34A 4-Element Triband Beam | 320.75 |
| KT34XA 6-Element Triband Beam | 469.50 |
| 144-148 13LB 2m 13-Element with balun | 77.95 |
| 144-148 16C 2m 16-Element for oscar | 93.55 |
| 420-450 14 420-450 MHz 14-element beam | 37.54 |
| 420-450 18C 420-450 MHz 18-element oscar | 58.70 |
| 432 16LB 16 elem. 430-434 MHz beam/balun | 60.70 |

| HUSTLER 5BTV 10-80m Vertical | |
|------------------------------|--|
| 92.50 | |

| 4BTV 10-40m Vertical | |
|----------------------|--|
| 73.95 | |

| 3TBA New 10-15-20m Beam | |
|-------------------------|--|
| 161.95 | |

| HF Mobile Resonators | | |
|----------------------|----------|-------|
| | Standard | Super |
| 10 and 15 meter | 7.95 | 12.50 |
| 20 meters | 10.95 | 14.95 |
| 40 meters | 12.50 | 17.30 |
| 75 meters | 13.50 | 27.95 |

| Avanti AP 151.3G 2m on glass ant. | |
|-----------------------------------|--|
| 27.95 | |

ORDER INFORMATION

| | |
|-----------------|--|
| Orders | 1-800-336-4799 |
| Information and | (703) 643-1063 |
| Virginia Orders | |
| Store Hours | M-W-F 12 Noon 8 PM Saturday 9 AM 3 PM |

Mailing Address: 2410 Drexel St.
Woodbridge, VA 22192
Store Location: 14415 Jefferson Davis Hwy.
Woodbridge, VA 22191

— CALL FOR QUOTES —

Send stamp for a flyer. Terms: Prices do not include shipping. VISA and Master Charge accepted. 2% discount for prepaid orders (cashier's check or money order). COD fee \$2.00 per order. Prices subject to change without notice or obligation.

KENWOOD Factory Rebates • (Effective 11-1-81 to 12-31-81)



TS-130S - \$30 REBATE
TS-130S w/PS-30 - \$50



TR-9000 - \$35 REBATE



R-1000 - \$30 REBATE

Double Savings! - Low AES Prices + Rebate from KENWOOD

Rebate offer ends 12-31-81. Don't delay! - call right now TOLL FREE 1-800-558-0411 and get our price. Also, for a limited time we will be quoting lower than normal prices on the TS-530S, TR-7800, TR-7850 & TR-7730.

Call Toll Free: 1-800-558-0411

In Wisconsin (outside Milwaukee Metro Area)
1-800-242-5195

AMATEUR ELECTRONIC SUPPLY Inc.®

4828 W. Fond du Lac Avenue; Milwaukee, WI 53216 - Phone (414) 442-4200

AES BRANCH STORES

WICKLIFFE, Ohio 44092
28940 Euclid Avenue
Phone (216) 585-7388
Ohio Wats 1-800-362-0290
Outside Ohio 1-800-321-3594

ORLANDO Florida 32803
621 Commonwealth Ave.
Phone (305) 894-3238
Fla. Wats 1-800-432-9424
Outside Fla. 1-800-327-1917

LAS VEGAS, Nevada 89106
1072 N. Rancho Drive
Phone (702) 647-3114
Pete WA8PZA & Squeak AD7K
Outside Nev. 1-800-634-6227

ASSOCIATE STORE

ERICKSON COMMUNICATIONS
CHICAGO, Illinois 60630
5456 N. Milwaukee Avenue
Phone (312) 631-5181
Outside ILL. 1-800-621-5802

New AES Branch Store - 1898 Drew Street • CLEARWATER, FLORIDA 33515 • Phone (813) 461-4267

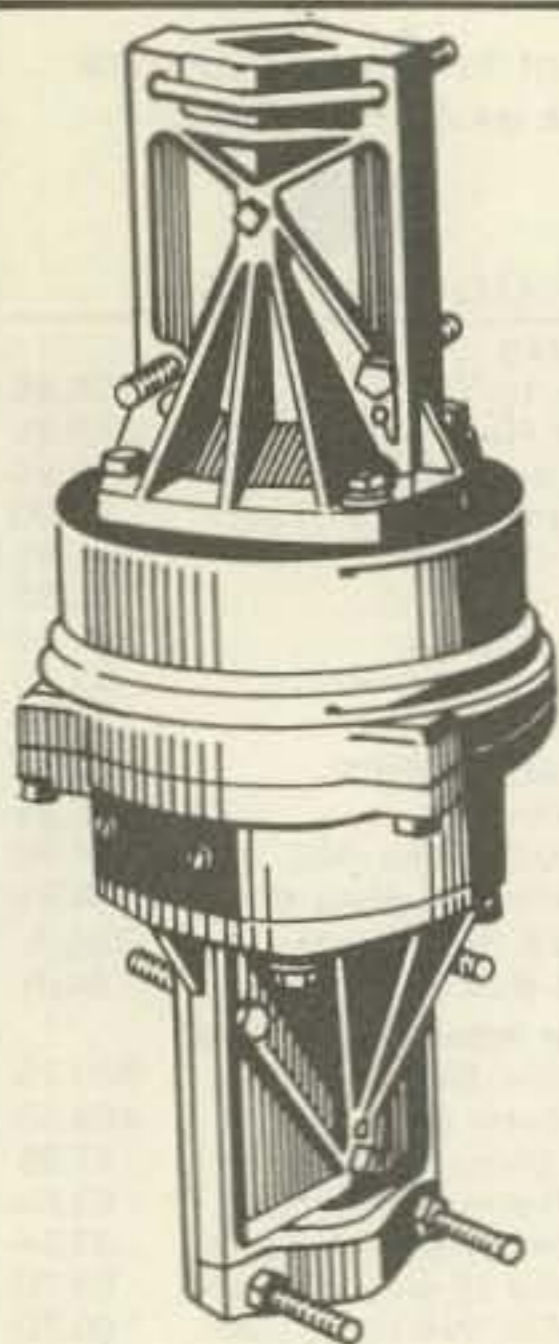

FREE
WITH PURCHASE OF
3-TBA ANTENNA



ALLIANCE HD-73 
HEAVY DUTY ROTOR \$159.95 Value

**3-TBA Tri-Band Beam
10 - 15 - 20 METER
Fixed Station Antenna**

Engineering, performance and Hustler's tradition of outstanding quality is yours in the model 3-TBA tri-band beam for 10, 15, 20 meters.

Improved design featuring reduced element length and unique dual resonance high Q traps reduce wind loading and overall weight, while allowing an exceptionally wide bandwidth.

Specially designed beta match for precision tuning on all three band and static drain off. Oversized boom to element mounting and heavy duty construction throughout assures reliable operation regardless of the weather.

- Lowest SWR at resonance
- Impedance 50 ohms
- Bandwidth at its broadest (650 KHz on 10, 450 KHz on 15, and 200 KHz on 20)
- 8db gain
- 25db front to back ratio
- Maximum power - legal limit
- Longest element - 23-1/2 feet
- Boom Length - 14 feet 8 inches
- Turning radius - 13 feet
- Weight - 40 lbs.

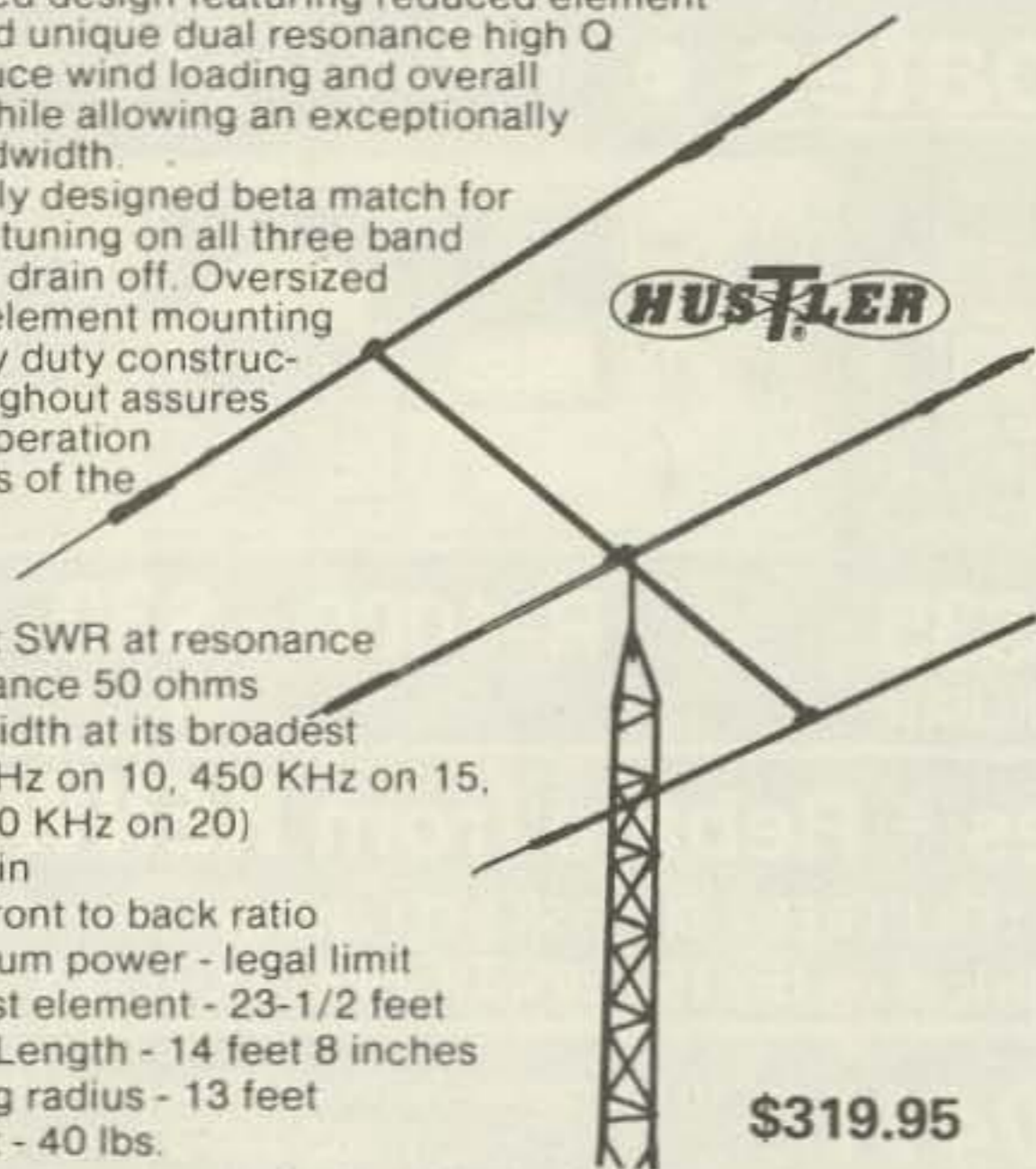

\$319.95

TUFTS
ELECTRONICS

61 LOWELL RD | OPEN DAILY 10-6
HUDSON, NH 03051 | SUNDAY 12-5

SAVE
BOTH FOR ONLY
\$319.95

LIMITED SUPPLY
FREIGHT EXTRA

603-883-5005

✓88

ALL NEW
15 Meter Mobile CW & USB



21.000—21.450 MHz

High 10W (PEP) low 2W (PEP); VFO tuning; noise blanker; fine-tune SB, KHz ± CW off-set; digital frequency counter; 13.8V dc @ 3A, negative ground; L 9.5" x W 9" x H 2.5"; weight (2.3 kg) 5.7 lbs.; mobile mounting bracket.

SERIOUS DEALER LISTS AVAILABLE



✓318

1275 N. GROVE ST.
ANAHEIM, CALIF. 92806 (714) 630-4541

NOTE: Price, specifications subject to change without notice and obligation.

CONTESTING?



**THE NEW LOW COST
AEA CONTEST
KEYER MODEL CK-1
WILL MAKE YOU
MORE COMPETITIVE
THAN EVER!**

\$129.95

SUGGESTED AMATEUR NET

- Automatic Serial Number Generator From 01 to 9999.
- 500 Character Soft Partitioned™ Memory That Can Be Divided Into as Many as 10 Messages.
- Exclusive AEA Memory Editing Capability.
- Two Presettable Speeds With Fast Recall Plus Stepped Variable Speed Selection.
- Iambic Operation From 1 to 99 wpm and Complete Weighting Control.
- Extreme R.F. Immunity, Will Key Any Modern Transceiver, Operates from 12 ± 3 Volts D.C.

SEE YOUR FAVORITE DEALER OR CONTACT

Advanced Electronic Applications, Inc., P.O. Box 2160, Lynnwood, WA 98036. Call 206/775-7373

AEA Brings you the
Breakthrough!

✓2

OVER 70 BRANDS IN STOCK
 LAND-MOBILE RADIO
 Full Service Shop • Spectrum Analysis • Antennas
 New and Used Equipment • CW-SSB-FM, Etc. • Towers
 FCC Study Guides • Code Tapes • Books • Accessories

SPECTRONICS

Specialists in Amateur Radio,
 Short-Wave Listening
 And Contemporary
 Electronic Gear.

HOURS
 MON, TUES, WED.: 9:30-6:00 PM
 THURS, FRI.: 9:30-8:00 PM
 SAT.: 9:30-3:00 PM

BEARCAT • MORGAIN • MANY MORE...

SPECTRONICS INC.
 1009 GARFIELD ST. OAK PARK, IL. 60304
 (312) 848-6777

AMATEUR RADIO
 SHORTWAVE
 SCANNERS

DRAKE
 ICOM
 TEN-TEC
 BIRD
 HYGAIN • ARRIL
 B&W • CODE

CLOSED SUNDAYS, HOLIDAYS

16K Memory 4116-200ns 8/17.50

ALL MERCHANDISE 100% GUARANTEED CALL US FOR VOLUME QUOTES

MA1012A CLOCK MODULE

Complete alarm clock module with special transformer and spec sheets included. Just add switches.
8.99 ea. 3/24

8038 INTERSIL FUNCTION GENERATOR

3.99 ea 5/17.50

.43" Common Cathode LED Display

These are first quality RED displays manufactured by H.P.

#5082-7760 .79ea 100/\$65

95H90 350 MHz ECL PRESCALER CHIP

7.99ea 5/35.95

LINEAR

| | | | |
|--------|------|---------|------|
| LM301V | .34 | LM741V | .29 |
| LM308V | .98 | LM747 | .79 |
| LM309K | 1.49 | LM748V | .59 |
| LM311 | .64 | LM1310 | 2.90 |
| LM317T | 1.95 | MC1330V | 1.89 |
| LM317K | 3.95 | MC1350V | 1.29 |
| LM318 | 1.49 | MC1358 | 1.79 |
| LM323K | 4.95 | LM1414 | 1.59 |
| LM324 | .59 | LM1458V | .69 |
| LM337K | 3.95 | LM1488 | .99 |
| LM339 | .99 | LM1489 | .99 |
| LM377 | 2.29 | LM1800 | 2.99 |
| LM380 | 1.29 | LM1889 | 2.49 |
| LM386V | 1.50 | LM3900 | .59 |
| LM555V | .39 | LM3909V | .98 |
| LM556 | .69 | LM3914 | 3.95 |
| LM565 | .99 | LM3915 | 3.95 |
| LM566V | 1.49 | LM3916 | 3.95 |
| LM567V | 1.29 | 75451V | .39 |
| LM723 | .49 | 75452V | .39 |
| LM733 | .98 | 75453V | .39 |

T=TO-220 V=8 PIN K=TO-3

WE HAVE

7400 SERIES TTL
 74LS00 SERIES TTL
 74S00 SERIES TTL
 4000 SERIES CMOS
 4500 SERIES CMOS
 74C00 SERIES CMOS
 IC SOCKETS
 VOLTAGE REG'S
 MPU'S, EPROMS, MEMORY
 AND MUCH MORE

CALL TOLL FREE
 800-538-5000
 800-662-6233

(CALIF RESIDENTS)

BAY AREA RESIDENTS
 COME VISIT OUR NEW
 RETAIL SHOWROOM

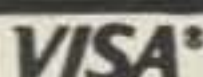

TERMS: For shipping include \$2.00 for UPS Ground, \$3.00 for UPS Blue Label Air. \$10.00 minimum order. Bay Area Residents add 6 1/2% sales tax. Calif. Residents add 6% sales tax. We reserve the right to limit quantities and substitute manufacturer. Prices subject to change without notice. Send SASE for complete list.

New Location

JDR MICRODEVICES, INC.

1224 BASCOM AVE.
 SAN JOSE, CA 95128
 408-247-4852

ETCO

CABLE TV CONVERTERS AND OTHER GOOD STUFF!

SMASHING ALL SALES RECORDS - OUR NEW 30 CHANNEL CABLE TV CONVERTER!

39⁹⁵ \$34.95 ea. / 5
 Converts mid & super band cable channels for viewing on your TV set!
 No. 354AE047

89⁹⁵ \$79.95 ea. / 5 \$74.95 ea. / 10
 HOT NEW IMPORT! REMOTE CONTROL 30 CHANNEL CABLE TV CONVERTER!
 Includes remote TV on/off switch and fine tuning control!
 No. 354VA275

189⁰⁰
 ETCO MKII WIRELESS - THE ULTIMATE CABLE TV CONVERTER!
 Set TV to channel 3 and the tunnel field remote control does it all!
 No. 354ZA008

89⁹⁵ \$79.95 ea. / 5 \$74.95 ea. / 10
 VIDCOR 2000 CONVERTER ELIMINATES PROBLEMS WHEN VIDEOTAPING FROM CABLE TV
 Restores your VCR's capability for programming. Restores remote channel control. Enables videotaping of one cable program while watching another.
 No. 354VA350

19⁹⁵ \$17.50 ea. / 10
 UNUSUAL FACTORY SURPLUS MID-BAND - SUPER-BAND CABLE TV TUNER
 Converts cable channels to a common IF frequency. Expensive! build cable converters, decoders, etc. With schematic. No. 354VA342
 354VA389 - Detailed schematic & spec sheet - \$1.50

4⁹⁵ \$3.95 ea. / 10
 FACTORY SURPLUS UHF TUNERS
 Brand new production surplus. All solid state. Ideal for experimental work building, cable TV converters, etc. No. 354SU099

29⁹⁵ \$27.50 ea. / 5 \$24.95 ea. / 10
 MINIATURE FM WIRELESS MICROPHONE
 Hides in the palm of your hand. Reception on any standard FM radio or receiver.
 No. 354VA482

69⁹⁵ \$49.95 ea. / 5
 QUARTER-MILE WIRELESS MICROPHONE & RECEIVER SYSTEM
 FCC approved crystal controlled wireless mike & receiver. All battery operated. Electric wide range microphone. VU meter.
 No. 354VA093

39⁹⁵ \$34.95 ea. / 5
 FACTORY SURPLUS VHF / UHF "TWIN" VARACTOR TUNERS!
 Admiral No. NC 3143 1 BRAND NEW! Ideal for building or repairing electronically tuned TV "FRONT ENDS". A hard to find item at a sensational price!
 No. 354VC308

4⁹⁵ \$4.49 ea. / 10
 DUMPING! NORELCO ENDLESS LOOP CASSETTES!
 Impossible to find at any price!
 3 minutes - No. 354VA605
 6 minutes - No. 354VA606

144⁸⁸ \$129.95 ea. / 5
 IN STOCK - THE MURA CORDLESS TELEPHONE SYSTEM!
 Answer & originate calls with this sleek, see pocketphone. 400 ft. range! Rechargeable! Last number recall! Paging feature! Use with rotary, touch systems!
 No. 354VA274

9⁹⁵ \$8.95 ea. / 5
 SALE OF QUARTZ BATTERY-OPERATED CLOCK MOVEMENTS!
 Accuracy of 1 min. / year. Up to 4 years operation on 1 alkaline "C" cell. Imported from West Germany. No. 354VA531
 354VA565 - Matching hands - \$2.49/set - \$1.95/set / 5

69⁸⁸ \$59.88 ea. / 5
 20 AMP REGULATED 12VDC POWER SUPPLY!
 13.8 vdc no load, 12.5 vdc full load. Easily handles ham station, marine radio, SSB transmitters up to 400w P.E.P. Brand new, factory sealed. 110 VAC. No. 354VA394
 354VA395 - as shown, 10 amps - \$54.95, \$49.95 ea. / 5

FREE OUR LATEST 98 PAGE FASCINATING CATALOG
 Get packed with unique items, electronic bargains and unusual offers. Write or circle the information card number below.

ETCO ETCO ELECTRONICS NORTH COUNTRY SHOPPING CENTER PLATTSBURGH, N.Y. 12901

Check with order, please. Visa & Mastercard OK. (Sorry, no C.O.D.'s. Add 1% for UPS & Handling (Excess refunded). N.Y. State residents add 7% sales tax. Dealer & Export inquiries invited. Our telephone order desk never closes. Call 1-518-561-8700.

The Great Compromiser

— Henry Clay, eat your heart out

The search for better antennas has been going on ever since Hertz made his original experiments. He, incidentally, came up with findings that many people think were not known until many decades later. In fact, very few new facts relating to antennas have been discovered in the past 75 years; even fewer in

the past 50 years. That doesn't mean, however, that the wheel has not been reinvented countless times!

Of late, there has been a resurgence of interest in a type of antenna often used by military stations during the Hitler War. It was desirable because it avoided losses attendant to the use of Marconi-type antennas. Marconis, unless used in conjunction with excellent ground systems, have an inherent loss that sometimes is unacceptable. This led to research for a system that would avoid such ground losses. The task was further complicated by the fact that military high-frequency communication often was required to operate over a wide range of the HF spectrum.

To reach an acceptable solution of this complicated problem, an old idea was resurrected from the dustbin, dusted off, and slightly modified to meet the exigencies of the situation. It was not an ideal solution. But, then, just what is perfect?

The slightly-compro-

mised solution was a wideband-terminated doublet. Some persons prefer to call it a "squashed rhombic." It has had a number of other nicknames.

The antenna, as shown in the diagram, is a folded, resistance-terminated doublet, one fed with a 600-Ohm balanced transmission line. The terminating resistor may be either a noninductive resistor, suitably protected from the weather, or a 600-Ohm transmission line constructed of high-resistance wire. Alternatively, one could run a normal-loss 600-Ohm line to a convenient location for the terminating resistor. Because of the fact that the resistor must be capable of dissipating 60% of the rf energy supplied to the antenna, its physical size may make it not practical to mount the resistor directly on the doublet.

The length of the doublet is one-third of a wavelength, and the space between wires is one-hundredth of a wavelength. These two dimensions are for the lowest contemplated operating frequency.

A test of an antenna of this type by the US Navy Electronic Laboratory showed a transmission line standing wave ratio of 1.4 to 2.6 over a frequency range of 4 MHz to 22 MHz. Antenna efficiency varied from approximately 20% to 60% over the quoted range. Peaks in radiation efficiency were noted for frequencies at which the antenna was a quarter wavelength and three-quarters wavelength. Below one-quarter wavelength, the radiation efficiency dropped rapidly, but above that point the efficiency dropped more slowly and reached a minimum at a frequency corresponding to one-half wavelength.

Although the efficiency of the wideband doublet is less at any given frequency than that of a conventional half-wave doublet at its resonant frequency, the advantage of wideband operation may outweigh the loss. Translated into dB drop on a receiver's S-meter, the loss is less impressive!

The directional characteristics of the wideband

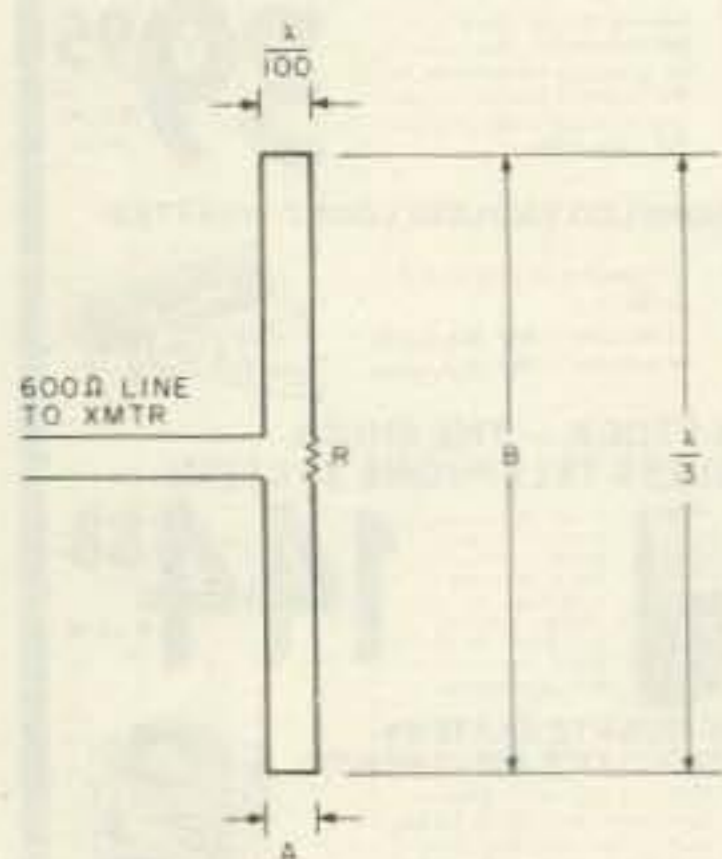

Fig. 1. Wideband doublet antenna (not to scale). Design example: lowest operating frequency—7 MHz; range—7-21 MHz; $A = 42.6$ cm (1.4'); $B = 14.3$ m (46.5'); resistor—600-Ohm noninductive. For transmitter power output of 100 Watts, use at least 60 Watts dissipation.

doublet are similar to those of a conventional doublet. The antenna may be tilted (that is, mounted as a sloper) to have a radiation pattern more nearly nondirectional. A moment's reflection will show you that a transmission line to a sloper would be much easier to install than one to a vertical.

Note that a balanced feedline is required. It's possible, of course, to use coax feed... if you're prepared to design and construct a weatherproof device that'll perform the dual functions of impedance transformation and unbalanced-to-balanced.

The military of both this country and Great Britain made extensive use of this type of antenna, mostly for point-to-point communication circuits.

To sum up, here's what you get: a wideband antenna that'll work moderately

well over a broad frequency spectrum. The vswr on the feedline would not be low enough to make a fixed-tune, solid-state transmitter happy, but would be acceptable by almost all transmitters having a tuned output stage. An impedance-matching device with balun functions would be needed to mate the 600-Ohm line to the input of most transmitters. It would work the new bands as well as those presently allocated (with proper design, of course).

Against these advantages, you must weigh these considerations: a drop in radiation efficiency, the necessity of having a terminating resistor, and a feed-point impedance not compatible to modern transmitters.

You make your choice. ■

Reference

Department of Commerce Circular 513.943, I, June 27, 1949.

50% SAVINGS ON ✓ HF ENGINEERING Products

Reg Price

| | | |
|--------------|---|----------|
| RX220C Kit | 210-240 MHz rcvr w/2 pole 10.7 MHz crystal filter | \$ 74.95 |
| RF28 Kit | 10 mtr RF front end 10.7 MHz out | 3.50 |
| RF50 Kit | 6 mtr RF front end 10.7 MHz out | 3.50 |
| IF 10.7F Kit | 10.7 MHz IF module includes 2 pole crystal filter | 29.50 |
| FM455 Kit | 455 KHz IF stage plus FM detector | 18.00 |
| AS2 Kit | audio and squelch board | 16.00 |
| TX150 Kit | 300 milliwatt, 2 mtr transmitter | 24.95 |
| PA2501H Kit | 2 mtr power amp—kit 1w in—25w out with solid state switching, case, connectors | 69.95 |
| PA4010H Kit | 2 mtr power amp—10w in—40w out—relay switching | 69.95 |
| PA144/15 Kit | 2 mtr power amp—1w in—15w out—less case, connectors and switching | 49.95 |
| PA144/25 Kit | same as PA144/15 kit but 25w | 59.95 |
| PA220/15 Kit | similar to PA144/15 for 220 MHz | 49.95 |
| PS15C Kit | 15 amp—12 volt regulated power supply w/case, w/fold-back current limiting and overvoltage protection | 79.95 |
| PS15C W/T | same as above—wired & tested | 134.95 |
| PS25C Kit | 25 amp—12 volt regulated power supply w/case, w/fold-back current limiting and overvoltage protection | 79.95 |
| O.V.P. | adds over voltage protection to your power supplies, 15 VDC max | 14.95 |
| PS3A Kit | 12 volt—power supply regulator card with fold-back current limiting | 11.95 |
| TRX220 Kit | same as above except for 220 MHz | 259.95 |
| TRX432 Kit | same as above except 10 watt and 432 MHz | 284.95 |
| TRC-1 | transceiver case only | 34.95 |
| TRC-2 | transceiver case and accessories | 34.95 |
| SYN 220 Kit | same as SYN II Kit except 220-225 MHz | 149.95 |
| CD1 Kit | 10 channel receive stal deck w/ diode switching | 89.95 |
| CD2 Kit | 10 channel xmit deck w/switch and trimmers | 19.95 |
| CD3 Kit | UHF version of CD1 deck, needed for 432 multi-channel operation | 19.95 |
| COR2 Kit | carrier operated relay | 24.95 |
| BLC 10/70 | 144 MHz 10W 70W | 149.95 |
| BLC 2/70 | 144 MHz 2W 70W | 174.95 |
| BLC 30/150 | 144 MHz 30W 150W | 249.95 |
| BLD 10/60 | 220 MHz 10W 60W | 159.95 |
| BLE 10/40 | 420 MHz 10W 40W | 259.95 |
| BLE 2/40 | 420 MHz 2W 40W | 189.95 |
| BLE 10/80 | 420 MHz 10W 80W | 289.95 |

ALL ITEMS 1/2 LISTED PRICE. TERMS: Cash, Certified Check, VISA, Master Charge, Prepaid freight, or C.O.D. (frt. & COD Charges Collect). Sales limited to quantities on hand.

ZACKIT/VALLEJO

1815 SONOMA BLVD. VALLEJO, CALIF. 94590

(707) 644-6676

UC

UNIVERSAL COMMUNICATIONS

A Division of Innovative Labs, Inc.

P.O. Box 339

Arlington, Texas 76004-0339

\$749.95

Lots of 1

\$699.95

Lots of 10

NOT A KIT!



Accessories include LNAs (\$595 and up), power supplies for LNAs, feedhorns and antennas.

At last, an inexpensive, state-of-the-art satellite TV receiver

MODEL DL-2000

- Fully tunable audio with AFC
- Channel scan feature standard
- Remote control option available
- Jack for external signal metering
- LED bar readout indicates video quality
- Front panel selection of video polarity
- Built-in RF modulator and video output driver
- High quality construction, attractive packaging
- Local oscillator leakage minimized special mixer design

Accessories include:

- LNAs (\$650 and up)
- Power supplies for LNAs
- Feedhorns and antennas

TERMS: COD, Money Order, Bank Cards (800) 433-5172 ORDERS ONLY

HOURS: 8:30-4:30 CDST; MON-FRI

(817) 265-0391 INFORMATION

Our product may be copied, but the performance is never equalled. P.O. BOX 339, ARLINGTON, TX 76004-0339

UNIVERSAL COMMUNICATIONS

TX 76004-0339

★★★★★ **A STAR IS BORN** ★★★★★

- ★ Ideal for Novices, SWL's and seasoned amateurs
- ★ Built-in code practice oscillator & speaker
- ★ 12 VDC Operation or 120 VAC with adapter provided
- ★ Optional serial/parallel ASCII output port



- ★ Copies Morse, Baudot & ASCII codes
- ★ Two optimized Morse ranges
- ★ Digital & Analog filtering with 16 db AGC
- ★ Automatic speed tracking 3 - 70 WPM

Call or write for brochure or order direct.

CODE★STAR™ Kit CS-K \$169.95
 CODE★STAR Wired CSF \$249.95
 Optional ASCII Output Port Kit CS-1K \$69.95
 Send check or money order. Use your VISA or MasterCard. Add \$5.00 shipping and handling for continental U.S. Wisconsin residents add 4% State Sales Tax.

Microcraft

Corporation ✓50 Telephone: (414) 241-8144
 P. O. Box 513G, Thiensville, Wisconsin 53092

QRZ W1's, W2's and W3's...

LOOKING FOR AEA PRODUCTS IN THE NORTHEAST?

LOOK TO RADIOS UNLIMITED... NEW JERSEY'S FASTEST GROWING HAM STORE!

Get your hands on AEA's great keyers and Isopole antennas at Radios Unlimited. You can reach us easily via the Jersey Turnpike, and when you get here you can TRY BEFORE YOU BUY at our in-store operating position. Yes! Pick out any AEA keyer, (or any other equipment from our

huge stock of ham gear), and try before you buy! We don't mean a little off-the-air diddling with the keyer...we let you PUT IT ON THE AIR AND HAVE A QSO... really check it out under YOUR kind of operating conditions... then decide. We know AEA, and we know you'll select one of these:

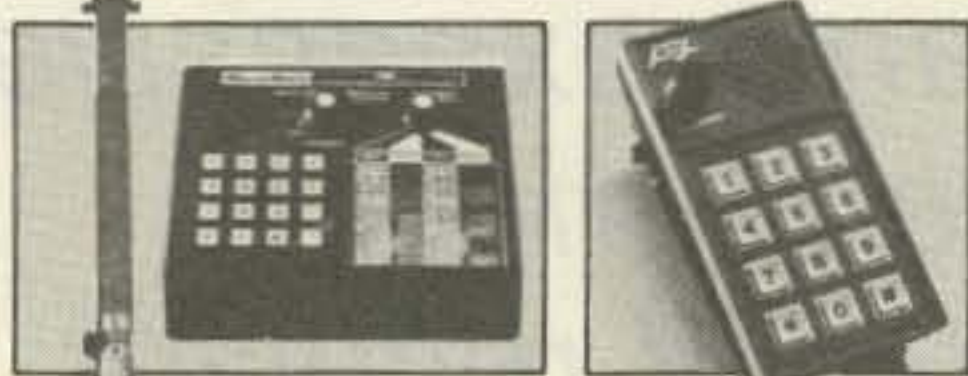

MM-1 MorseMatic™ memory keyer with two micrometers and 37 fantastic features including up to 2000 characters of memory plus virtually every capability of all the other keyers & trainers listed below...
call for super-low price!

CK-1 Contest Keyer with 500 character memory, soft message partitioning, automatic serial number, and much, much more.
call for super-low price!

MK-1 Morse Keyer with selectable dot & dash memory, full weighting, calibrated speed, bug mode and more...
call for super-low price!

KT-1 Keyer Trainer with all the features of the MK-1 above and the MT-1 below...
call for super-low price!

MT-1 Morse Trainer for pulling up that code speed the easy way with automatic speed increase, five letter or random word length and more, more, more...
call for super-low price!

PLUS THE EXCITING ISOPOLES THAT ARE BOOMING OUT THOSE INCREDIBLE VHF SIGNALS WITH MAXIMUM GAIN ATTAINABLE, ZERO DEGREE RADIATION ANGLE AND 1.4:1 SWR ACROSS THE ENTIRE BAND!

| | | |
|--------------------|-------|-----------|
| Isopole 144 | | call for |
| Isopole 220 | | super-low |
| Isopole 144 junior | | price! |
| Isopole 220 junior | | |

Find them all at Radios Unlimited, plus a huge collection of new gear from all major manufacturers...a big selection of used equipment bargains, all you'll ever need in books, accessories, operating aids, coax, connectors and parts plus a modern service department dedicated to keeping you on the air. It's like a perpetual flea market! For directions, call (201) 469-4599.

FIND AEA AT

RADIOS UNLIMITED

1760 EASTON AVENUE, SOMERSET, NJ 08873 • (201) 469-4599

Now, send RTTY with a keyer or CW keyboard!



Micro-RTTY™
 \$299.95 Sugg. price

Kantronics brings you the newest development in RTTY send/receive devices with the **Micro-RTTY™**

Micro-RTTY can instantly convert CW from any keyer or CW keyboard into standard AFSK two-tone RTTY or two-tone CW ID.

Micro-RTTY sends and receives RTTY at 60, 67, 75 and 100 WPM plus ASCII 110 baud. Advanced programming of the internal micro-computer and panel controls provide for transmit/receive, CW ID and automatic or manual carriage return/line feed (CR LF) functions.

Micro-RTTY will receive any shift of RTTY and display the message on ten big, bright florescent displays. An active 100 Hz filter at 2295 Hz and a "tuning eye" make tuning fast and easy. Power is supplied by a 9 Vdc adapter that's included.

All these features, and more, are packed into a small 2½" by 5" by 5¼" enclosure.

See your **Authorized Kantronics Dealer** for a demonstration or write for a FREE brochure.

Kantronics
 (913) 842-7745
 1202 E. 23rd Street
 Lawrence, Kansas 66044

**Ever tried to read computer sales literature?
 Ever tried to talk to a computer salesman?
 Ever tried to make a decision about
 which computer to buy?**

Yes... then you know what frustration is. Help is on its way. Desktop Computing premiered this fall. The first and only computer magazine written in plain English. Preposterous? Not at all. It is possible to explain computers without all the "computerese." That is what Desktop Computing is doing each month. Send the card today for a no-risk subscription that will give you the kind of understandable, useful information on computers you've been waiting for.

Why do you need a plain-English explanation of desktop computers? Because they have just come of age and are saving thousands of businessmen like you an amazing amount of money. They not only save money, do things faster, provide access to more information, allow a smaller staff to do more work, they also allow you to get into services for your customers which were not practical before. You can provide more services at lower cost. To get in on the savings and expanded customer services, you need information. Desktop Computing will bring you that information. Desktop Computing will cut through all the technical hocus-pocus.

In this time of high interest rates, a truly low cost desktop computer system (usually a micro-computer system) is a welcome event. Let Desktop Computing explain what these systems can do for you. The subscription price is \$25 a year

Here's a look at some of the articles \$25.00 will bring you:

- Mailing List Magic
- Surviving the Computer Revolution
- Microcomputers in the Hospital Lab
- Computer Beefs Up Cattle Farm

Wayne Green, the publisher of Desktop Computing (and also of Kilobaud Microcomputing and 80 Microcomputing—both successful computing publications) has gone through both the agony and joy of working with computers. He has lost a quarter of a million on a mainframe big boy computer only to come out on the other side with all the frustration necessary to run a 200 employee publishing firm on several TRS-80's.

Wayne has a reputation for being honest and unafraid. He'll make sure you get the truth. In the meeting introducing the idea of Desktop Computing to his staff Wayne said,

"Our objective is to be the only computing magazine written in plain English."

So that is what you'll be getting—honesty and directness. Desktop Computing will give you all the information you need on computers in plain English.



Call toll-free:
 (800) 258-5473
 or mail the
 coupon below.

Desktop Computing
A WAYNE GREEN PUBLICATION

Relief is here for only \$25.00

YES

Sign me up for Desktop Computing. I will get one year of the only computing magazine written in plain English for \$25.00.

Canadian 1 yr. only/US funds \$27.00 Foreign 1 yr. only/US funds \$35.00.

NAME _____

ADDRESS _____

CITY _____ STATE _____ ZIP _____

SIGNATURE _____ EXPIRE DATE _____

CARD # _____ INTERBANK # _____

Desktop Computing
 80 Pine Street Peterborough, NH 03458

321B6

Wayne Green Books

NEW
ARRIVALS

Annotated BASIC—A New Technique for Neophytes.

BASIC programming was supposed to be simple—a beginner's programming language which was so near to English that it could be easily understood. But, in recent years, BASIC has become much more powerful and therefore much more difficult to read and understand. BASIC simply isn't basic anymore.

Annotated BASIC explains the complexities of modern BASIC. It includes complete TRS-80* Level II BASIC programs that you can use. Each program is annotated to explain in step-by-step fashion the workings of the program. Programs are flowcharted to assist you in following the operational sequence. And—each chapter includes a description of the new concepts which have been introduced.

Annotated BASIC deals with the hows and whys of TRS-80 BASIC programming. How is a program put together? Why is it written that way? By observing the programs and following the annotation, you can develop new techniques to use in your own programs—or modify commercial programs for your specific use.

Annotated BASIC Volume 1 contains Projecting Profits, Surveyor, Things to Do, Tax Shelter, Introduction to Digital Logic, Camelot, The Soundex Code, Deduction, Op Amp, Contractor Cost Estimating. (available November) **BK7384 \$10.95** ISBN 0-88006-028-X

Annotated BASIC Volume 2 contains Rough Lumber List, Trip Mileage, Flight Plan, OSCAR Data, SWR/Antenna Design, Supermaze, Petals Around the Rose, Numeric Analysis, Demons, Air Raid, Geography Test, Plumbing System Design. (available February) **BK7385 \$10.95** ISBN 0-88006-037-9

Order Both Volumes and Save! BK738402 \$18.95

Kilobaud Classroom—

A practical course in digital electronics

by George Young and Peter Stark

Learning electronics theory without practice isn't easy. And it's no fun to build an electronics project that you can't use. *Kilobaud Classroom*, the popular series first published in *Kilobaud Microcomputing*, combines theory with practice. This is a *practical* course in digital electronics. It starts out with very simple electronics projects, and by the end of the course, you'll construct your own working microcomputer!

Authors Young and Stark are experienced teachers, and their approach is simple and direct. Whether you're learning at home or in the classroom, this book provides you with a solid background in electronics—and you'll own a computer that you built yourself!

Kilobaud Classroom contains Getting the Ball Rolling, Gates and Flip-Flops Explained, J.K. Flip-Flops and Clocked Logic, PC Boards and Power Supplies, Hardware Logical Functions, Voltage, Current and Power Supplies, Transistors, Diodes and OP Amps, Pulses and More Pulses, Counters and Registers, Bus Traffic Control, ROM and RAM Memories, I/O Circuitry, Parallel and Serial I/O Ports, Computer I/O III, Computer I/O IV, Computer I/O V, Processor Connections, Finally... The Kilobaud Crescendo, Eproms and Troubleshooting, Expansions and Programming, Machine-Language Programming, Assembly-Language Programming, Connecting to the Outside World.

ISBN 0-88006-027-1 (available December) **BK7386 \$14.95**

The New Weather Satellite Handbook

By Dr. Ralph E. Taggart WB8DQT

Here is the completely updated and revised edition of the best-selling *Weather Satellite Handbook*—containing all the information on the most sophisticated spacecraft now in orbit. Dr. Taggart has written this book to serve both the experienced amateur satellite enthusiast and the newcomer. The book is an introduction to satellite watching that tells you how to construct a complete and highly effective ground station. Not just ideas, but solid hardware designs and all the instructions necessary to operate the equipment are included. An entire chapter is devoted to microcomputers and the Weather Satellite Station. And for the thousands of experimenters who are operating stations, *The New Weather Satellite Handbook* details all the procedures necessary to follow the current spacecraft.

Weather Satellite contains Operational Satellite Systems, Antenna Systems, Weather Satellite Receivers, A Cathode Ray Tube (CRT) Monitor for Satellite Picture Display, A Direct-Printing Facsimile System for Weather Satellite Display, How to Find the Satellite, Test Equipment, Microcomputers and the Weather Satellite Station, Station Operations.

ISBN 0-88006-015-8 available now! **BK7383 \$8.95**



*TRS-80 is a trademark of Radio Shack Division of Tandy Corp.

FOR TOLL-FREE ORDERING CALL 1-800-258-5473
WAYNE GREEN BOOKS • PETERBOROUGH NH 03458

Use the order card or itemize your order on a separate piece of paper and mail to Wayne Green Book Att: Sales • Peterborough NH 03458. Be sure to include check or detailed credit card information. (Visa, Master Charge or American Express accepted.) No C.O.D. orders accepted. All orders add \$1.50 handling. Please allow 4-6 weeks after publication for delivery. Questions regarding your order? Please write to Customer Service at the above address.

AEA

MORSEMATIC MM-1 KEYER

COMPUTERIZED KEYER... GREAT FOR
CONTESTING, DX OR CODE PRACTICE

**CASH
PRICE
\$175.00**

LIST \$199.95

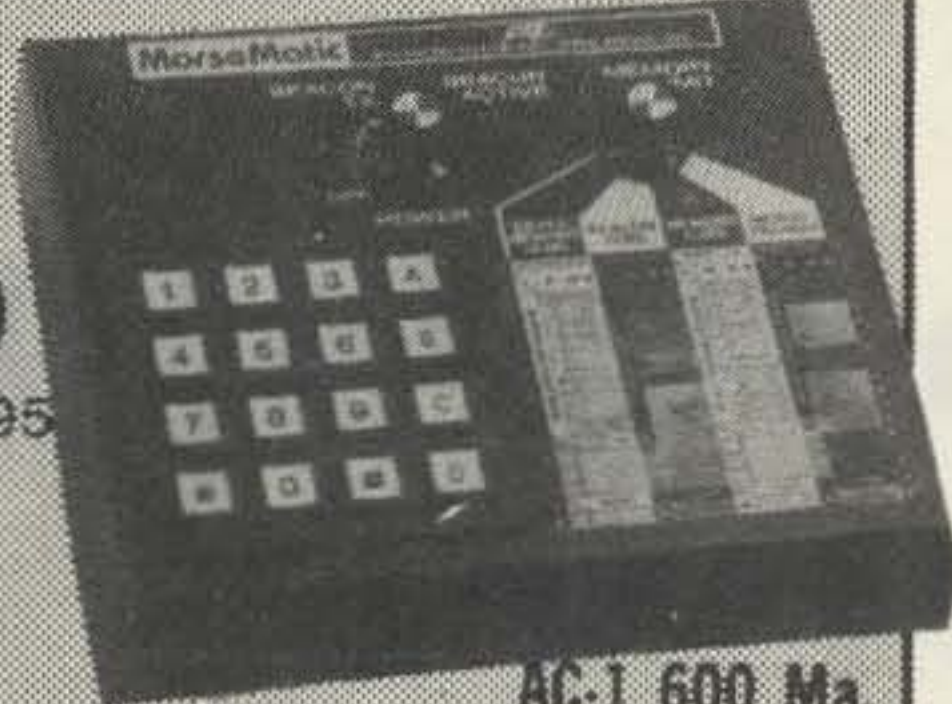

CK-1 CONTEST
KEYER \$129.95

KT-1 KEYER/TRAINER \$129.95

ME-1 MEMORY EXPANSION

BOARD FOR MM-1 KEYER \$59.95

MK-1 STANDARD KEYER \$79.95

MT-1 MORSE TRAINER \$99.95

AC-1 600 Ma.

A.C. SUPPLY

\$14.95

AC-2 350 Ma.

\$9.95

ISOPOLE VHF ANTENNAS

ISOPOLE 144 OR 220 JR. \$29.95

ISOPOLE 144 OR 220 SR. \$39.95

HANDHELD SPECIALS!

| | | |
|---------|---------|----------|
| YAESU | FT-207R | \$259.95 |
| KENWOOD | TR-2400 | \$299.95 |
| ICOM | IC-2AT | \$239.95 |
| TEMPO | S1-T | \$249.95 |
| TEMPO | S-1 | \$229.95 |

*TR-2400 AND FT-207R SPECIAL

—LIMITED OFFER—SUBJECT TO STOCK ON HAND

ALPHA AMPLIFIERS: IN STOCK

| | | |
|-------|------|-----------|
| ALPHA | 374A | \$2155.00 |
| ALPHA | 78 | \$2865.00 |
| ALPHA | 76PA | \$1975.00 |

C.D.E. ROTATORS

HAM IV ROTATOR \$165.00

TAILTWISTER \$235.00

WRITE FOR COMPLETE SPECIFICATIONS ON AEA
KEYERS OR ALPHA AMPLIFIERS

WE STOCK KENWOOD, ICOM AND YAESU

SEND \$1.00 FOR CATALOG AND USED LIST AND
WE WILL ADD YOU TO OUR MAILING LIST.

No Sales Tax in Montana.

**CALL TODAY!
406-259-9554**

**CONLEY RADIO SUPPLY
318 N. 16TH ST.,
BILLINGS, MT 59101**

NICAD BATTERY CHARGERS

RAPID MOBILE CHARGER

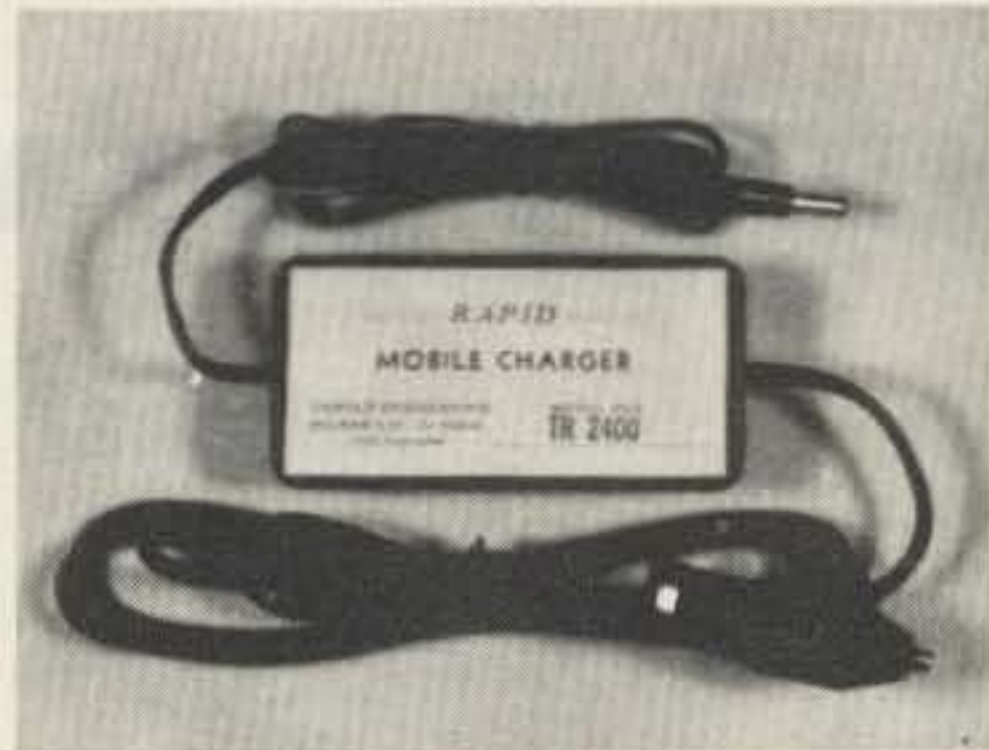

Charge your handheld radio off 12 volt source in 4-6 hours. Will not overcharge your batteries due to automatic shut-off circuitry. Equipped with cigarette lighter plug on the input side and the appropriate charging plug on the output side. *Cord lengths allow for convenient use while charging!* Models available for the Kenwood TR2400, Yaesu 207R, Tempo S1, S2, S4, S5, Santec HT1200, Wilson MKII and MKIV. Other models available also. Please call or write for more info.

\$34.95

RAPID II CHARGER



Our NEW AC version of the Rapid Mobile Charger. Charge your handheld radio in 2-3 hours. Will not overcharge batteries due to the same automatic shut-off circuitry found in our Rapid Mobile Charger. The input is equipped with a UL approved transformer and the output with the appropriate charging plug. *No adjustments necessary!* LED indicator shows current is flowing and all the proper connections have been made. Models available for Kenwood TR2400, Yaesu 207R, Tempo S1, S2, S4, S5, Santec HT1200, Wilson MKII and MKIV.

\$49.95

TERMS: US & Canada add 5% shipping, handling and insurance. All others add 10% (20% Air Mail). COD add \$2.00 COD fee. Ohio residents add 4% sales tax. Visa/Mastercard welcome.

Satisfaction Guaranteed

10 day unconditional guarantee! If you are not satisfied with this product, return it within 10 days in original condition and we will refund your money (less shipping & handling).

Dealers please inquire



DEBCO ELECTRONICS
P. O. BOX 9169 DEPT. C
CINCINNATI, OHIO 45209
Phone: (513) 531-4499

✓330

Touch-Tune with Thumbwheels

— cast away darkness

Ash Nallawalla ZL4LM/VK3CIT
53 Chirnside Avenue
Werribee, Victoria 3030
Australia

It was well before 1977 when my friend, Don ZL4DS, designed a synthesized transceiver using BCD

thumbwheel switches for direct programming/read-out. (That's another story.) A receive-only version, the KR 1000 was built and a prototype, shown in Photo A, was to be sent for evaluation to Arthur Cushen, the famous blind shortwave listener.

In the past, blind radio amateurs and SWLs have relied mainly on crystal markers or sighted spouses and friends to provide frequency readout. In recent years, several commercial aids have been marketed, but they are not always compatible with existing equipment.

I was to take the KR 1000 to the 1978 annual convention of the New Zealand Radio DX League at Tiwai Point, near Invercargill. I was trying to figure out how Arthur could "tune around" without assistance, when the idea struck me!

How about marking the thumbwheel switches in some way so that Arthur would have a starting point? The easiest method

would be to file down or snip off the sharp tip of each thumbwheel switch position corresponding to zero, just enough to make it feel different than the other numbers. (Fig. 1.) A blind person could line up all the zeros and then flick down each switch in turn to arrive at a desired frequency.

Arthur's face lit up when he dialed up his first station (Photo B). "For the first time in many years I have been able to tell the exact frequency of a station without the help of anyone else!" he exclaimed. Later, he wrote about his experience for SWL publications.

In 1978, there were no popular commercial receivers or transceivers (to my knowledge) that used thumbwheel switches, so I did not bother to write this article then. Today, it's a different story. There are several examples around: certain CB-to-10 conversions, Icom IC-2A, AR 240 series (in the US known as Tempo S1/2/5), etc. There must be dozens of non-amateur applications, too.

Even if you are not blind, this simple mod may come in handy if you are caught in the dark or want to demonstrate amateur radio to a blind friend, and perhaps some manufacturer could incorporate the idea as an added feature! ■



Photo A. Direct thumbwheel-switch readout on the prototype KR 1000. (Photo by ZL4LM)



Photo B. Blind SWL Arthur Cushen finding his first station unaided. (Photo by Leo Mizeenbeek)

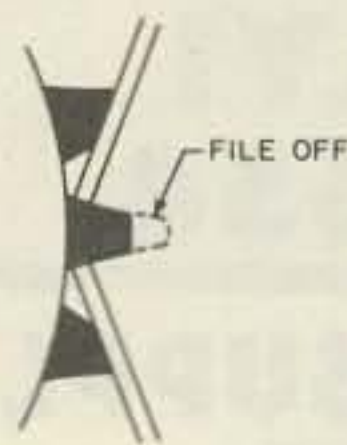

Fig. 1. Modified switch.

2300 MHz MICROWAVE DOWNCONVERTERS

DOWNCONVERTER

Kit.....\$28.50
Assembled.....\$48.50

2300 MHz PREAMP

Kit.....\$25.00

POWER SUPPLY

Assembled.....\$35.00

SATELLITE TV EARTH STATION

- 24 Channel Receiver
- 10' Antenna
- Dexcel 120° LNA

Call for details and price

Also Available: Commercial System with Bogner Antenna\$169.00

2300 MHz ANTENNA



WITH BOX FOR DOWN-CONVERTER
\$27.50

PB RADIO SERVICE

1950 E. PARK ROW • ARLINGTON, TX 76010

404

CALL ORDER DEPT. TOLL FREE
(800) 433-5169

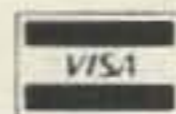

FOR INFORMATION CALL
(817) 460-7071



ICOM

FALL SALE

Now! EEB Is The Only ICOM Authorized Service Center

In The North East

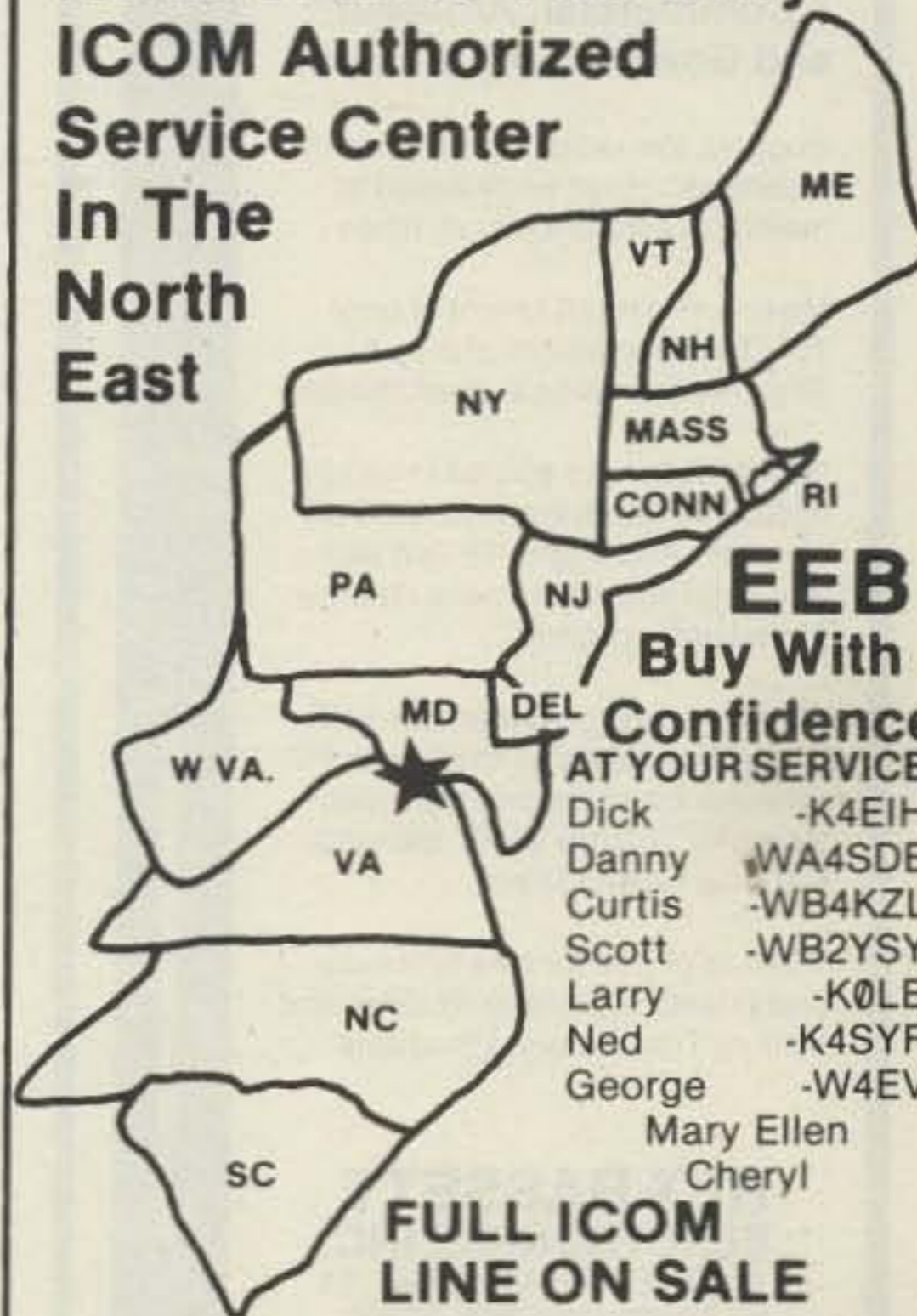

EEB
Buy With

Confidence
AT YOUR SERVICE

- Dick -K4EIH
Danny WA4SDE
Curtis -WB4KZL
Scott -WB2YSY
Larry -K0LB
Ned -K4SYF
George -W4EV
Mary Ellen
Cheryl

FULL ICOM LINE ON SALE

| ICOM | NET | SALE |
|------------|-----------|-----------|
| IC 2AT | \$ 269.50 | \$242.55 |
| IC 3AT/4AT | \$ 299.50 | \$269.55 |
| IC 25A | \$ 349 | \$314.00 |
| IC 730DC | \$ 829 | \$739.00 |
| IC 720ADC | \$1349 | \$1199.00 |
| IC 251A | \$ 749 | \$669.00 |
| IC 290A | \$ 549 | \$489.00 |
| IC 451A | \$ 899 | \$779.00 |

FULL YAESU LINE ON SALE

| | | |
|-------------|-----------|-----------|
| FT 208R | \$ 359.95 | \$323.00 |
| FT 708R | \$ 359.95 | \$323.00 |
| FT 707 | \$ 810 | \$729.00 |
| FT 101MKIII | \$ 925 | \$799.00 |
| FT 290R | \$ 399 | \$359.00 |
| FR 7700 | \$ 549 | \$479.00 |
| FT 902DM | \$1535 | \$1379.00 |

Becoming your #1 Amateur Store.
Visit us on your next trip to Washington, DC.

Call our order desk toll free for quote
(800) 336-8473

prices subject to change

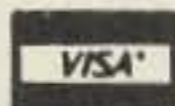

Tue-Sat

10am-4pm EST



Technical information,
VA orders (703) 938-3350

Store opens 10am Tues-Sat
Close 5pm Tues, Wed, Fri,
Close 9pm Thurs, 4pm Sat

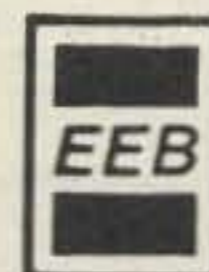

516 Mill Street, N.W.
Vienna, Virginia 22180

**OUR 10th YEAR
SAME LOCATION**

RTTY/CW For the TRS-80*

* A Trademark of the Tandy Corp.

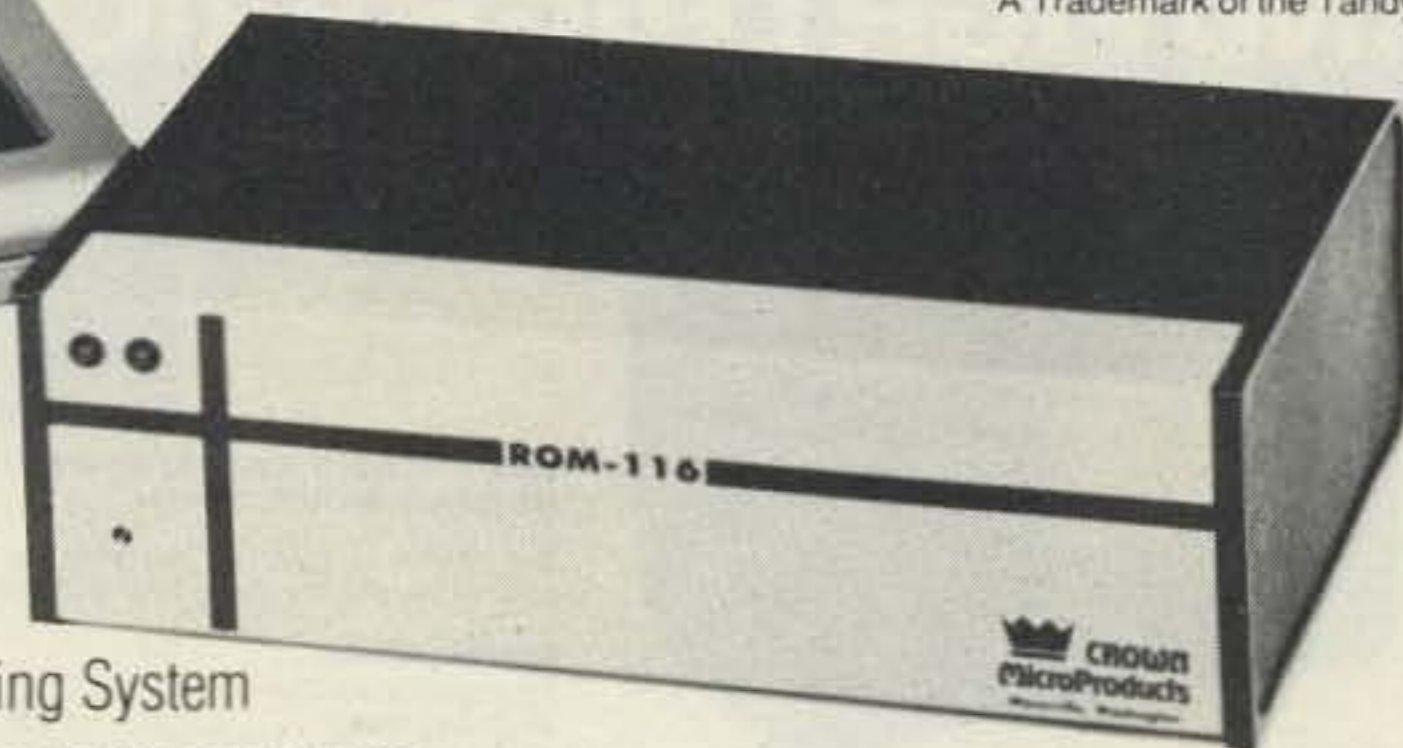

ROM-116

RTTY/CW Operating System

Detailed brochure available on request.

Featuring:

1200 BAUD OPERATION. Not limited to 110 baud because of timing loops. 60, 66, 75 & 100 W.P.M. Plus 110, 150, 300, 600 & 1200 baud operations possible.

FLEXIBILITY OF OPERATION. Instantly change: Baud Rates; Program Mode (ASCII/baudot); Program Status.

SPLIT SCREEN VIDEO. Transmit & receive data displayed separately.

REAL TIME. Automatic CW/ID without user intervention. Automatically updates at end of month or year.



606 State Street, P.O. Box 892-R • Marysville, WA 98270 • (206) 659-4279

Other features include:

- Two Serial Ports
- Fourteen Buffers
- Automatic CW ID
- Transmit Control
- Selective Call Feature
- Error Correction
- Word Wrapping
- Easy To Interface
- 30 Day Unconditional Guarantee
- Hardware requirements: TRS-80 Model 1 or 3 16K External terminal unit.

BASSETT HELIUM MOBILE ANTENNAS

For
Commercial, Amateur,
and Government Services

Rugged, low drag, high efficiency mobile antennas engineered to maintain resonance at all times.

Maximum overall height of only 70". Average weight of only 6 oz. They remain vertical at all speeds.

Helical inductors sealed in helium filled Fiberglass impervious to all weather. Adjustable 17-7ph whips and solid brass hardware chrome plated and polished.

Optimum gain collinears for VHF and UHF. Unity gain models for HF. Amateur band models are inventoried for "off the shelf" delivery. Commercial to specs.

Write or phone for free brochure and prices on Bassett mobiles and Helium Trap Antenna Systems.

**REX BASSETT
ELECTRONICS, INC.**
1633 NE 14th Ave., Bldg. 11
Ft. Lauderdale, Fla. 33305
Tel: 305/561-1400

440

ISOTRON ANTENNAS

THE BEST THINGS
come in little packages...

FOR 80-40-20 METERS

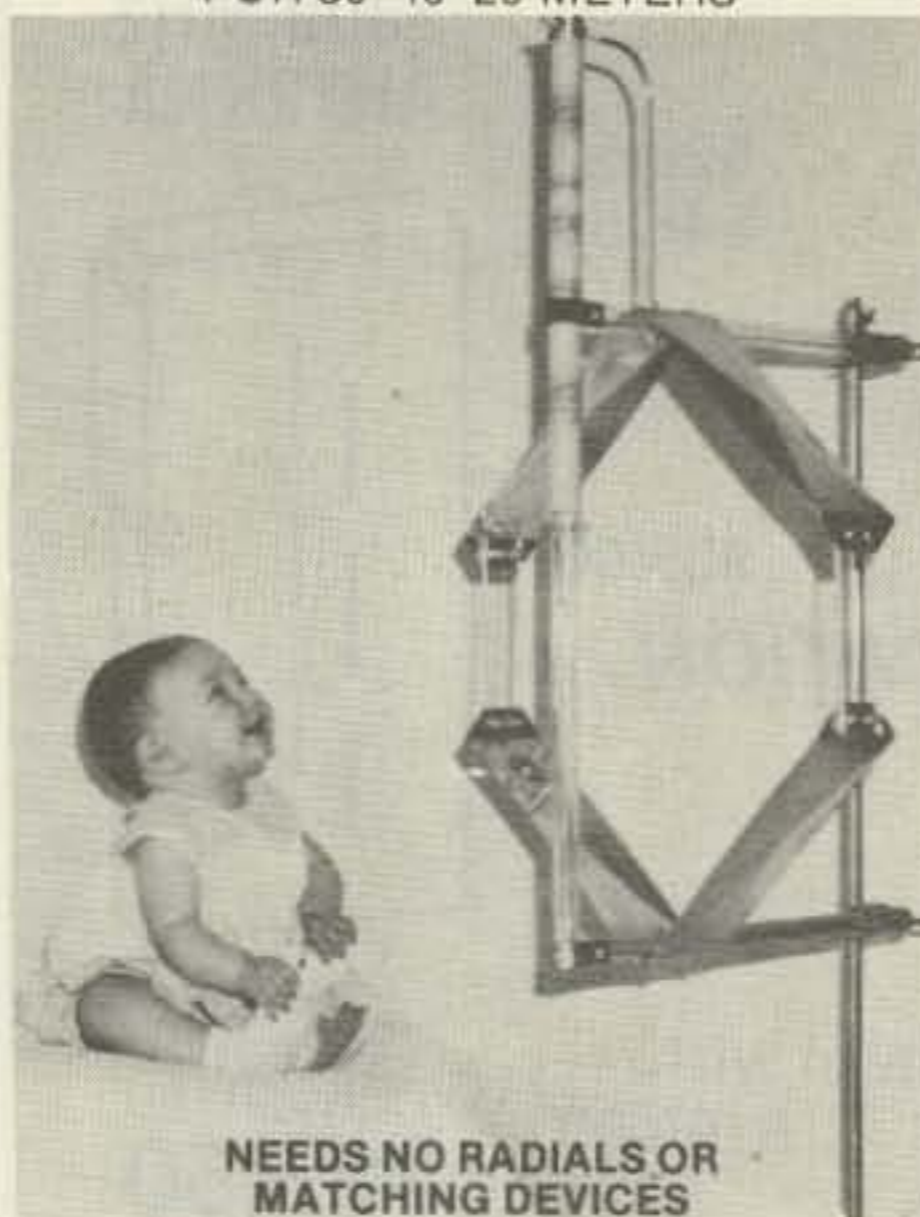

NEEDS NO RADIALS OR
MATCHING DEVICES

ISOTRON 80 54 IN. HIGH ISOTRON 40 31 IN. HIGH ISOTRON 20 17 IN. HIGH

BIG ON PERFORMANCE

SMALL ON SPACE ✓10

BILAL COMPANY

(303) 687-3219

STAR ROUTE

FLOISSANT CO 80816

CABLE TV UHF UP CONVERTER

\$44.95 . . . (Reg. \$59.95)
(shipping \$3.25)

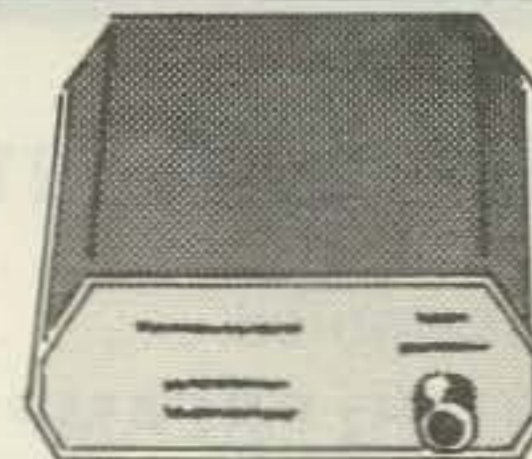

MICROVERTER VUC-36

Converts Mid and Superband Signals to UHF Channels 43 to 83. Allows all sets to tune without costly separate selector boxes. *Rated #1. Accessory kit available for \$2.00, consisting of matching transformer plus 2 jumper cables.

Call or write for Free Catalog

Other 75 ohm Cable Supplies:

| | |
|------------------------------------|-----------|
| 2-way Cable Switch | \$4.95 |
| F59A Connectors | 10/\$2.15 |
| MT6UVFM Back of Set XFMR | \$2.39 |
| 2-way Splitter | \$2.79 |
| 4-way Splitter | \$4.39 |
| F81 "F" Barrel | \$.48 |
| RG-59/U Coax 100% Foil | \$.10/ft |
| Inline Grounding Block | \$1.89 |
| Outdoor Matching XFMR | \$2.25 |
| Indoor Matching XFMR | \$1.25 |
| F61 Chassis Mt. Female | \$.48 |

Parts shipping add 10%, \$1.50 minimum.
COD add \$1.50. Fla. Res. add 4%.

NEMAL ELECTRONICS

5685 SW 80th Street, Miami, FL 33143
Telephone: (305) 661-5534 ✓412

ELECTRIFYING LOW PRICES! BUY DIRECT AND FIGHT HIGH PRICES!

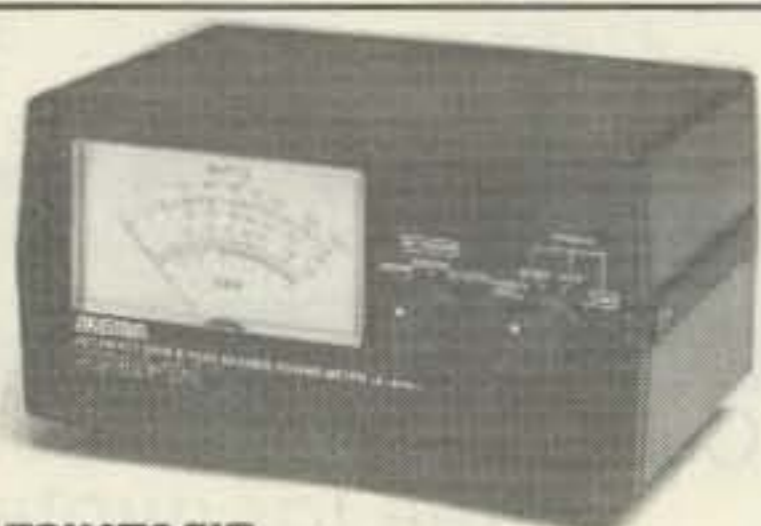

AUTOMATIC SWR & PEAK READING POWER METERS FOR HF/VHF. HF BAND MODEL APM-1H \$85.

Professional peak reading wattmeter with fully automatic VSWR measurement function.

Specifications:
Frequency Coverage 50-150MHz
Power Measuring Mode AVE & PEP 2 modes
RF Power Range 0-200, 1,000, 2,000W, 3 ranges ± 10%
Power Source AC 117V, 60 Hz
Dimensions 8"(W) x 4"(H) x 5 1/2"(D)
Net Weight 3.3 lbs. (1.5 kgs)

VHF BAND APM-1V \$85.

Professional peak reading wattmeter with fully automatic VSWR measurement function.

Specifications:
Frequency Coverage 50-150MHz
Power Measuring Mode AVG & PEP 2 modes
RF Power Range 0-200W, 2 ranges with ± 10%



FLAT RESPONSE SWR & POWER METERS FOR HF/VHF. HF BAND MODEL PM-2H \$50.

Excellent precision through-line SWR/Watt meter specially designed to have flat frequency response.

Specifications:
Frequency Coverage 1.8-60MHz
RF Power Range 0-200, 1,000, 2,000W, 3 ranges ± 10%
Dimensions 8"(W) x 4"(H) x 5 1/2"(D)
Net Weight 2.2 lbs. (1 kg)

VHF BAND PM-2V \$50.

Excellent precision through-line SWR/Watt meter specially designed to have flat frequency response.

Specifications:
Frequency Coverage 50-150MHz
RF Power Range 0-200W, 2 ranges ± 10% accuracy
Dimensions 8"(W) x 4"(H) x 5 1/2"(D)
Net Weight 2.2 lbs. (1 kg)



SWR & POWER METERS FOR HF/VHF. HF BAND MODEL PM-5H \$35.

The PM-5H is especially designed for mobile installation of which directional coupler unit and meter unit are separated.

Specifications:
Frequency Coverage 1.8-30MHz
RF Power Range 0-20, 200W ± 10% accuracy
Power Requirements 12V DC (for meter illumination)
Accessory Included 6ft. long connector cable and velcro for mobile mounting.
Dimensions: 5 1/4"(W) x 2 1/4"(H) x 1 1/2"(D): Meter
3 1/4"(W) x 2 1/2"(H) x 1 1/4"(D): Coupler
Net Weight 0.45 lbs. (200 grams): Meter
0.67 lbs. (300 grams): Coupler

VHF MODEL PM-5V \$35.

Designed to cover VHF band. Illuminated meter is convenient to the use in mobile operation. A complete set to be in display carton.

Specifications:
Frequency Coverage 50-150MHz
RF Power Range 0-20, 200W ± 10% accuracy
Power Requirements 12V DC (for meter illumination)
Accessory Included 6ft. long connector cable and velcro for mobile mounting
Dimensions 5 1/4"(W) x 2 1/4"(H) x 1 1/2"(D): Meter
3 1/4"(W) x 2 1/2"(H) x 1 1/4"(D): Coupler
Net Weight 0.45 lbs. (200 grams): Meter
0.67 lbs. (300 grams): Coupler

Mfg. by AKIGAWA ELECTRONICS CORP. • Exclusive Distributors: MACAW ELECTRONICS, INC. • P.O. Box 66; Carlsbad, CA 92008; Phone: (714) 434-1078; TELEX: 181743 MACAW CSBD

56

Prices do not include shipping and handling and are subject to change without notice.

STILL MORE USABLE ANTENNA FOR YOUR MONEY . . . PLUS 30 Meters!

Butternut's new HF6V automatic bandswitching vertical lets you use the entire 26-foot radiator on 80/75, 40, 30, 20 and 10 meters (full quarter-wave unloaded performance on 15 meters). No lossy traps. Butternut's exclusive Differential Reactance Tuning™ circuitry uses rugged ceramic capacitors and large-diameter self-supporting inductors for radiation efficiency and DX performance unmatched by conventional multiband designs of comparable height.



For complete information concerning the HF6V & other Butternut products see your dealer or write for our free catalog.

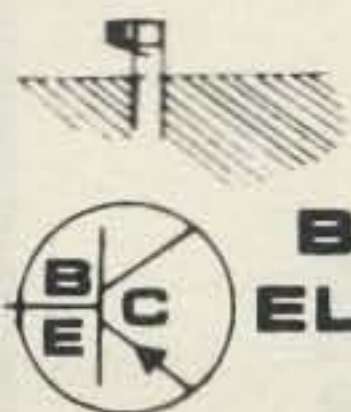

**BUTTERNUT
ELECTRONICS
CO.**

GARY AIRPORT
BOX 356E Rte. 2
SAN MARCOS, TX 78666



**The
HAM SHACK**

808 N. Main
Evansville, IN 47711

GO SOLID STATE WITH TEN-TEC

FANTASTIC PACKAGE DEAL—SAVE \$700

| | LIST | SPECIAL |
|-------------------|--------|---------|
| 546 OMNI-C Xcvr | \$1289 | \$995 |
| 255 Pwr Supp/Spkr | 199 | 149 |
| 444 Hercules Amp | 1575 | 1219 |
| PACKAGE PRICE | \$3063 | 2363 |

Call or write for other Ten-Tec bargain prices

SPECIAL THIS MONTH
HAL CT 2100.....call

| | |
|-------------------------------|--------|
| AEA MBA Reader | \$275 |
| AZDEN PSC 300 2M handheld | call |
| CUBIC ASTRO 103 | \$1175 |
| DAIWA CNA 1001 Autotuner | \$299 |
| ICOM 720A/Pwr Supp/Mik | \$1296 |
| ICOM 730 Xcvr | \$715 |
| ICOM 25A 2m Mobile | \$315 |
| ICOM 2AT/3AT/4AT Handhelds | call |
| KANTRONICS MiniReader package | \$259 |
| MF 496 Keyboard | \$290 |
| MIRAGE B108 2m. Amp | 155 |
| SANTEC Handhelds | call |
| VOCOM 2w in/25w out 2m Amp | 75 |



812-422-0231

MON-FRI 9AM-6PM • SAT 9AM-4PM

Write for our new and used equipment list

UPDATE YOUR 2M RIG

SCANNERS:

IC2AT
KENWOOD TR7400 A, TR7600, IC22S
& TR7625
TEMPO (S-1, S-1A, S-2, S-5)
KDK 2015, KDK 2016A,
YAESU FT227R
MIDLAND 13-510, 13-513
CLEGG FM-28
KIT PRICE \$39.95
(TEMPO & IC2AT
PREASSEMBLED ONLY)
SPECIAL PREASSEMBLED: REG.
\$59.95 SPECIAL NOW \$49.95

AUTO-RESUME SCAN MODULES

YAESU: FT227RA, FT227RB,
FT 207R, CPU2500R
AZDEN: PCS2000, PCS2880,
ICOM: IC255A

FM ADAPTER NOW AVAILABLE

CONVERTS EXISTING HF
TRANSCIVERS TO
10-M FM
Kit \$39.95
Preassembled \$49.95

INCLUDE \$1.50 FOR
POSTAGE AND HANDLING PER ITEM

AED ELECTRONICS

Tel: 514-737-7293

P.O. Box 730, Snowdon Station
Montreal Quebec H3X 3X8 Canada

COAX SWITCHES

from Barker & Williamson, Inc.

Model 593

- **Single Pole 3** Position with grounding of all unused positions
- **Crosstalk** (measured at 30 MHz) is -45db between adjacent outlets and 60 db between alternate outlets

\$19.95



Model 594

- **2 Pole 2 Position**
- **Crosstalk** 45db (measured at 30 MHz)

\$22.00



Specifications for both switches

- **Power** 1 KW-2 KW PEP
- **Impedance** 50-75 ohms
- **VSWR** 1.2:1 up to 150 MHz
- **Dimensions** 1 3/4" high, 5" wide, 3" deep
- **Weight** 1 lb.
- **Mount** Wall or desk

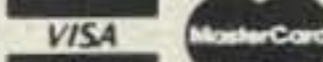

✓ 11 Available at your B&W dealer



Barker & Williamson, Inc.
10 Canal St. Bristol, Pa. 19007
Telephone: (215) 788-5581



FREE!

1982
DISCOUNT
ELECTRONICS
CATALOG

JOIN THE PAK!

Send for our Free catalog and become a member of our exclusive Pak. Our members receive Poly Paks

exciting catalog several times a year. We offer

Penny Sales. Free

Premiums and Low

Low Prices on a wide variety of

Electronic Products such as Computer Peripherals, Integrated Circuits, Speakers, Audio Equipment, Rechargeable Batteries, Solar Products, Semiconductors, and much, much more!

Take advantage of our 25 years as America's foremost Supplier of discount electronics.

RUSH ME YOUR FREE DISCOUNT CATALOG!

NAME: _____

ADDRESS: _____

CITY: _____

STATE: _____ ZIP: _____

CLIP AND MAIL COUPON TODAY TO:

POLY PAKS, INC. ✓ 58

P.O. Box 942, ST1

S. LYNNFIELD, MA 01940

(617) 245-3828

**Over
4.5 Million
Satisfied
Customers**

THERE IS A DIFFERENCE IN QUARTZ CRYSTALS

International's leadership in crystal design and production is synonymous with quality quartz crystals from 70 KHz to 160 MHz. Accurately controlled calibration and a long list of tests are made on the finished crystal prior to shipment.

That is why we guarantee International crystals against defects, material and workmanship for an unlimited time when used in equipment for which they were specifically made.

Orders may be placed by Phone: 405/236-3741. TELEX: 747-147. CABLE: Incrystal · TWX: 910-831-3177 · Mail: International Crystal Mfg. Co., Inc., 10 North Lee, Oklahoma City, Oklahoma 73102.

✓ 36

Write for information.

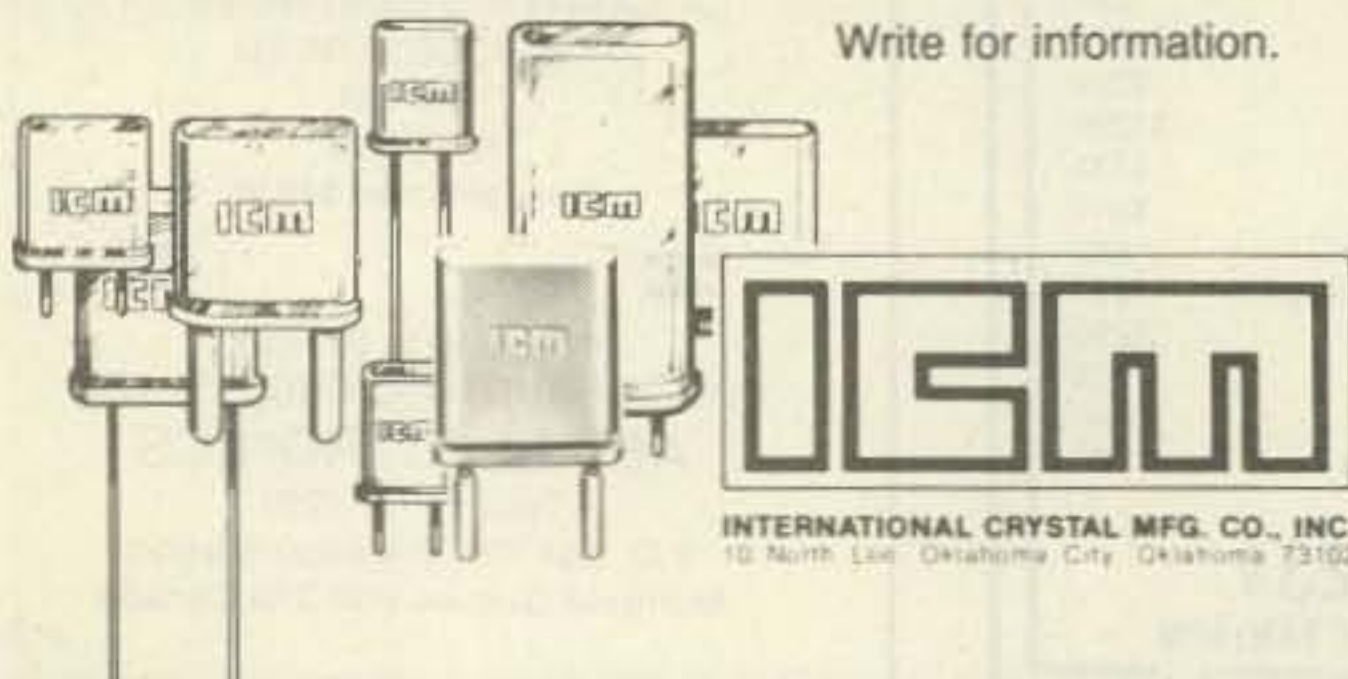

Orbit



ORBIT is the Official Journal for the Radio Amateur Satellite Corporation (AMSAT), P.O. Box 27, Washington, DC 20047. Please write for application.

For a **FREE SAMPLE COPY** please send \$1 to cover First Class Postage and handling to: Orbit, 221 Long Swamp Road, Wolcott, CT 06716.

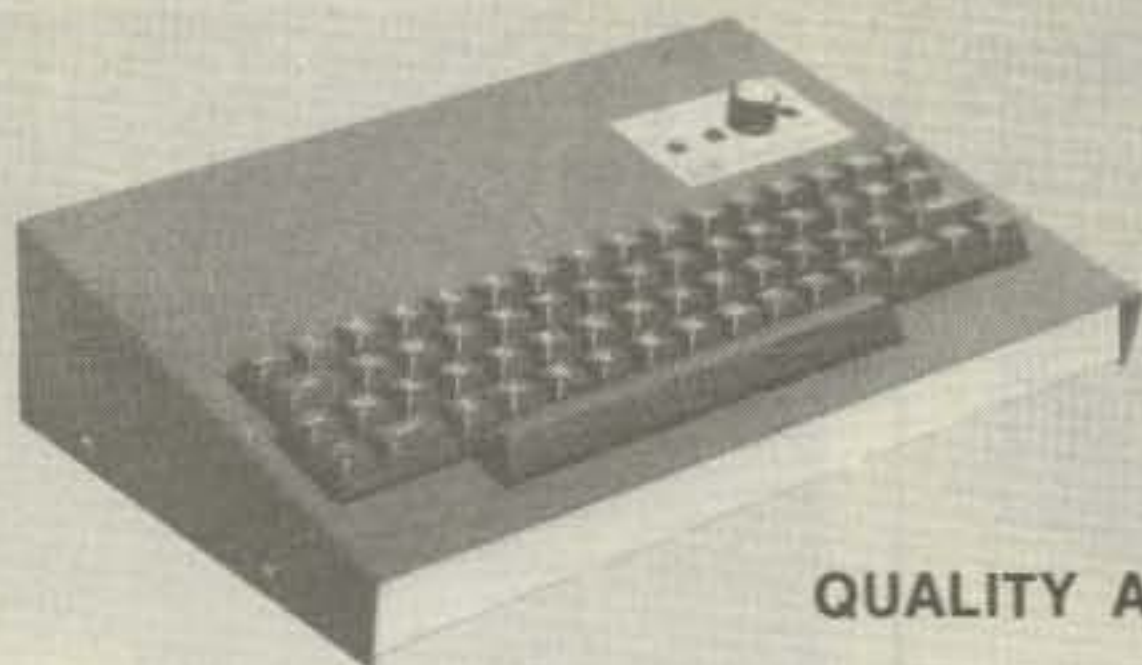

MKB-2000

- Complete set of alphanumeric, punctuation, and special function keys CQ, DE, BK, KN, SK, AR, AS, BT
- 500 character text buffer with BREAK feature
- 10 reprogrammable 40 character message memories
- 1-199 WPM, Weight & Interchar. space, Random Code
- Built-in 110 VAC power supply
- Buffer/Memory fullness indicators
- 1 year warranty on parts and labor
- Attractive anodized brushed aluminum and gray wrinkle finish case, only 13.3 x 9.4 x 3.5 in.
- RTTY/ASCII option includes—"Brag Tape" interface, CW ID, QBF and RY test messages, auto CR/LF and LTR/FIG shift 60,66,75,100,132 WPM Baudot 110,300 baud ASCII
- Other options—Memory expansion, AFSK modulator

MKB-2000 (Morse Only) \$319.00
RTTY/ASCII Option 50.00

MORSE RTTY ASCII

QUALITY AT AN AFFORDABLE PRICE

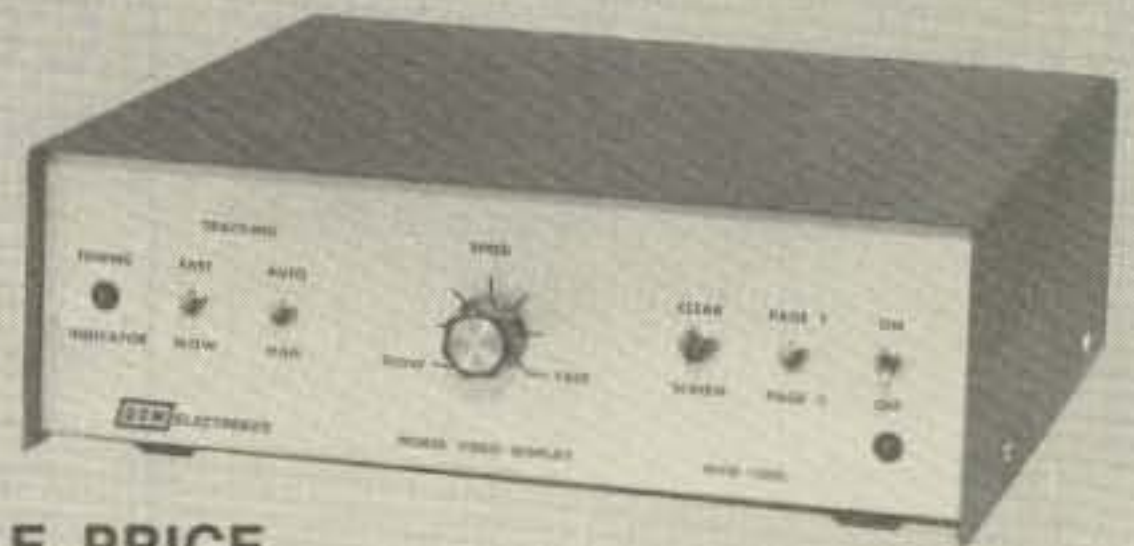

MVD-1000

- Copies Morse Code directly from your receiver
- Automatic speed tracking with self calibration
- 6-60 WPM speed range
- Manual speed tracking to give operator more control
- Active filters and digital sampling for increased noise rejection
- Operates with any TV set, no expensive monitor needed
- Two page display with 16 lines of 32 characters per page
- Attractive anodized brushed aluminum and gray wrinkle finish case, only 3 x 10 x 10 in.
- RTTY/ASCII option includes demodulator

MVD-1000 (Morse Only) \$369.00
RTTY/ASCII Option 89.00

Send For

Free Information

Add \$5.00 per unit for shipping U.S.A.

DGM ELECTRONICS, INC.

787 BRIAR LANE, BELOIT, WISCONSIN 53511 (608) 362-0410



The Standard for Comparison

New **AZDEN® PCS-300** 2-M Handheld FM Transceiver

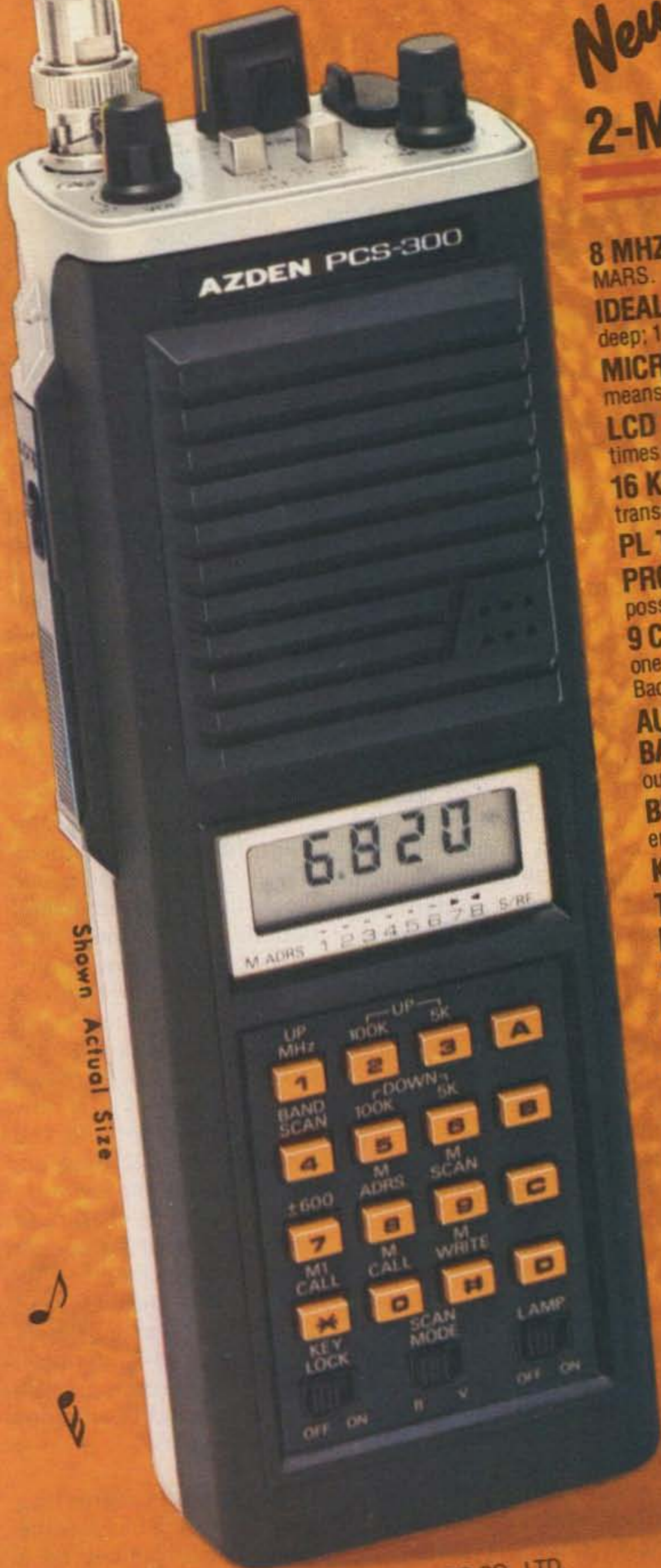

8 MHZ COVERAGE • 142 to 149.995 MHz in 5 kHz steps, including CAP and MARS.

IDEAL SIZE & WEIGHT DISTRIBUTION • 7.3" high by 2.5" wide by 1.8" deep; 1.4 lbs.

MICROCOMPUTER CONTROL • All frequency operations are done by means of a microcomputer keyboard with acquisition tone.

LCD DISPLAY WITH TIMED LAMP • Draws almost no current. Lamp times out automatically after 20 seconds.

16 KEY AUTOPATCH • Keyboard works as a Touchtone® pad while transmitting.

PL TONE SWITCH • Actuates optional subaudible tone module.

PROGRAMMABLE "ODD SPLITS" • Transmit and receive on any possible frequency combination. Reset in seconds.

9 CHANNEL MEMORY WITH SCAN • Eight addressable channels and one externally accessible up/down channel retain frequency and standard offset. Backup drain is a scant 10 microamps!

AUTOMATIC INCLUSIVE OR EXCLUSIVE PROGRAMMABLE BAND SCAN • Limits may be reset in seconds. Scans either inside or outside the limits.

BUSY AND VACANT SCAN MODES • Scan for either an occupied or empty frequency.

KEYBOARD LOCK • Prevents accidental change of frequency or scan status.

TRANSMIT LOCK • Avoids unintentional transmission.

DIGITAL S/Rf AND MEMORY ADDRESS METER • Shows relative signal strength on receive, relative power on transmit. Also shows memory address.

HIGH OR LOW POWER • 3 watts high, 1 watt low. Low power is continuously adjustable from 0.5 to 3 watts.

TRUE FM • Not phase modulation — Unparalleled audio quality.

AUTOMATIC FRONT END TUNING • RF stage is varactor tuned for superior sensitivity and selectivity.

RUGGED COMMERCIAL-GRADE MODULAR CONSTRUCTION
The PCS-300 is built to take years of the toughest operating conditions.

SUPERIOR RECEIVER • Sensitivity is 0.25 μ V for 20 dB quieting, 0.2 μ V for 12 dB SINAD.

BNC ANTENNA CONNECTOR

STANDARD ACCESSORIES • Heavy duty NICAD battery pack (500 mAh), belt clip, hand strap connector, flexible rubber antenna, earphone, ac charging unit, and special stand for table-top operation.

OPTIONAL ACCESSORIES • Deluxe leather case, mobile dc charging cord, external speaker/microphone, and PL tone module.

MANUFACTURER:



JAPAN PIEZO CO., LTD.

No. 12-17, 1-chome, Kami-Renjaku, Mitaka, Tokyo, Japan, Telex: 781-2822452

EXCLUSIVE DISTRIBUTOR: AMATEUR-WHOLESALE ELECTRONICS, INC.

8817 S.W. 129 Terrace, Miami, Florida 33176 Telephone (305) 233-3631 Telex: 80-3356 Toll-free (800) 327-3102

Put Talking Time on Your Repeater

— a Sharp idea

Repeaters everywhere have doodads of every sort, one of which is a time-announcement machine. Historically, these talking clocks were very expensive, bulky, and just plain hard to

use. Recently, Sharp (makers of calculators, watches, refrigerators, microwave ovens, and such) introduced a talking clock. This low-priced device sells for about \$79 and is just ideal

for interfacing to a repeater.

About the Clock

The clock can be found in most discount distribution center catalogs. The model number is CT-660. It is a small electronic clock with a liquid-crystal display (LCD) and a small speaker on the top. The case is plastic with a metal top. All controls are on the bottom in a covered compartment except an auxiliary push-button switch which activates the time announcement. Power is furnished by two AA batteries. A mercury-type battery is preferred and will last about a year during normal use, but the life of the batteries will be shortened by high usage of the voice synthesizer.

hours and minutes as you press the button. After you have the correct time, press the Set button which loads the programmed time into the clock. Failure to press the Set button will result in the time being lost when you return the switch to normal.

The regular time and alarm functions are provided as in any electronic clock, but you have several options. One option is time on the LCD without voice announcement or alarm. A second option is an alarm function that wakes you to a tune; if you fail to rise, it informs you that it is now five minutes later and you are *late*. The last time option is the alarm previously described, plus half-hour and on-the-hour automatic time announcements. Other functions besides time and alarm are talking timers (5 minutes and 30 minutes) for you darkroom people and stopwatch functions for you joggers.

Setting the time is easy. Just flip open the cover on the back, slide the Time/Alarm switch over to the left, to the Time/Set position. Press the Hour button to set the hour. Then set the minutes in a similar manner. Unlike most electronic clocks, holding the button down does not cause the clock to advance. The clock will announce the

The most interesting thing about the clock is the voice. It is produced by a read only memory (ROM) containing the voice pro-

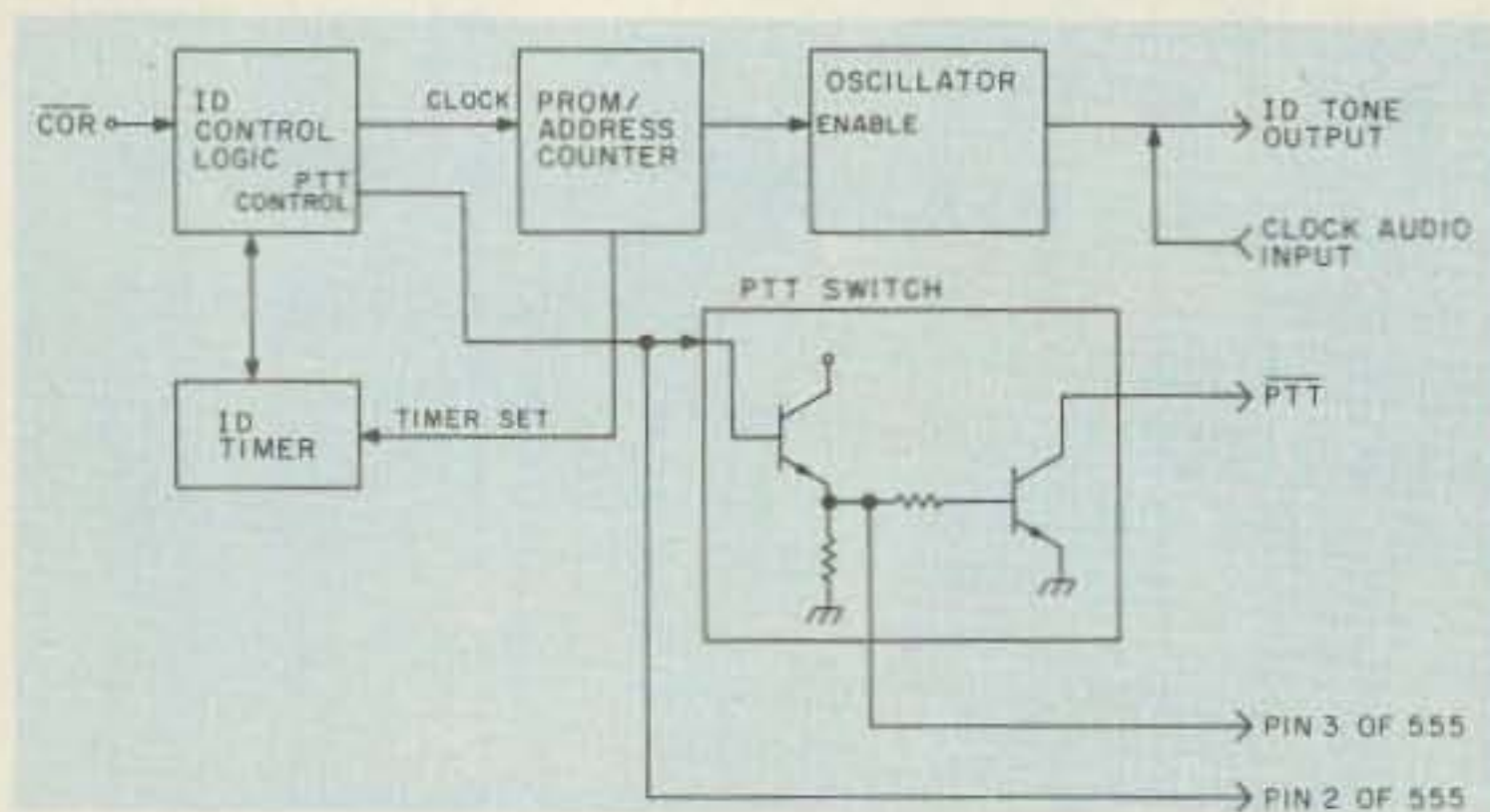

Fig. 1. Talking Time interface.

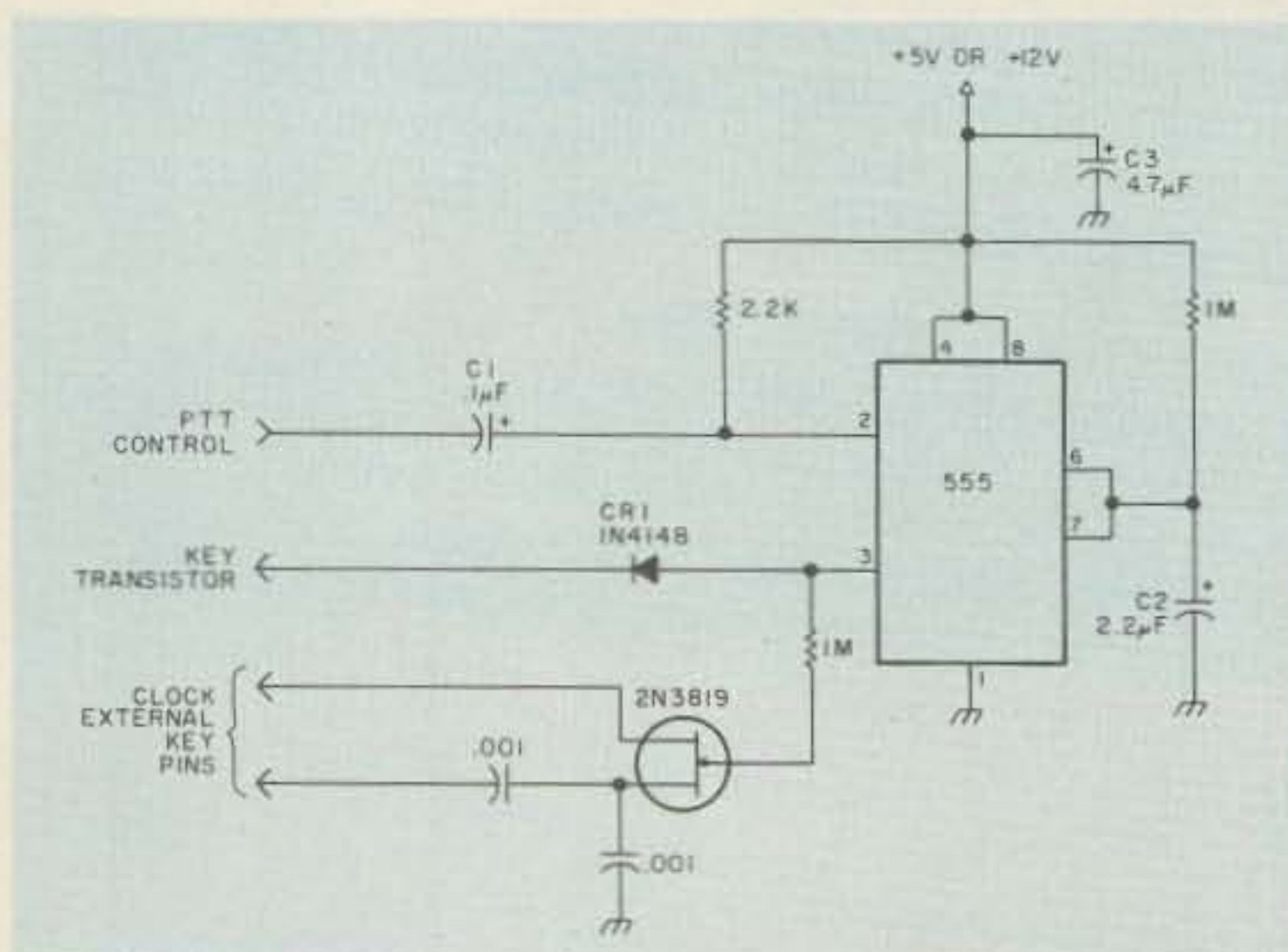

Fig. 2. Clock timer. C1 through C3 are tantalum.

gram, a digital-to-analog (D/A) converter, and clock/CPU LSI chips. The voice is a digital recording of a male voice. The person whose voice Sharp used to make the ROM recording was very articulate in his enunciation of the words. Although the voice sounds vaguely like the voice of a Cylon Centurion from "Battlestar Galactica," it is very easy to understand. To be fair about it, though, it is not as bad as one might imagine. Matter of fact, it is better than most computer voice synthesizers that I have heard, and the whole thing is only about 3/4" high, 2" deep, and 4" wide. It is amazing that it can do so much and be contained in such a small package. It is just the thing to round out your package of bells and whistles on your repeater.

The Connections

Naturally, merely placing the Talking Time atop the repeater cabinet is not all the interfacing required. The problem is to connect the audio from the clock to the repeater and somehow to trigger the voice when you want it to give you the time. On our 146.22/.82 repeater here in Albany (a Motorola Motrac), a couple of us decided that we wanted the time to be announced immediately after the ID.

Fortunately, the clock has very easy hookup points. All that is needed to trigger the voice is a short on the "external key" pins Sharp thoughtfully located on the left side of the case. Audio is brought out by either making a small hole in the case or by soldering wires to the external key pins inside and running all the wires out the hole already in the case. Internal connections consist of: 1) A wire connected to the negative battery terminal; 2) A wire connected to the low side of the speaker; and 3) A

wire connected to each of the external key pins.

The only difficult wire to locate is the low side of the speaker. To locate this connection, position the clock with the volume control on your right; with the top off the clock, locate the two speaker wires. I might note at this point that it is somewhat difficult to remove the top cover of the clock. Remove the three screws in the case—one is visible, one is in the battery compartment, and the other is hiding under the cover, which must be totally removed to gain access.

After the screws are out, push out gently on the inside of the battery compartment while pulling up on the top cover to pop it off the plastic tabs. Now notice that near the rear left of the circuit board is a screw that secures the board. There should be several components sandwiched in there *and* the ground wire from the battery terminal. The low speaker wire is the speaker wire nearest the screw. The high speaker wire has next to it a wire that goes across the board to a spot near the volume control. The clock that I had had an extra hole already in the board at the speaker low point and all I had to do was solder a wire in that hole. That is all there is to the clock connections.

The Interface

To make the clock operate the repeater, a small interface had to be constructed. Wishing the time to be announced after the ID meant that a signal from the ID could start the time sequence. Not wanting to make major changes in the ID unit itself, I decided that the already existing PTT signal could be used as a trigger for the clock. In our ID unit, there is a line which goes high (+5 V dc) and turns on the keying transistor. This transistor, in turn,

Lacue Likes You . . . and you'll like Lacue!

WIRE AND CABLE

| | |
|--|----------|
| RG-213 | 27¢/ft |
| RG-8/U foam, 95% shield | 23.5¢/ft |
| RG-8X foam, 95% shield | 11¢/ft |
| RG-58C/U mil spec | 11¢/ft |
| RG-59 mil spec | 9¢/ft |
| RG-11 | 19¢/ft |
| 450 ohm ladder line 100 ft roll | \$10.25 |
| 8 Conductor Rotor Cable | 15¢/ft |
| 14 Ga. Stranded Copper (50 ft. multiples) | 7¢/ft |
| 12 Ga. Solid Copperweld (50 ft. multiples) | 7¢/ft |
| 14 Ga. Solid Copperweld (50 ft. multiples) | 5¢/ft |
| 8 Ga. Solid Aluminum (50 ft. multiples) | 6¢/ft |

ANTENNA ACCESSORIES

| | |
|-----------------------|----------------------|
| Ceramic Insulators | 45¢ ea. |
| Amphenol PL-259 | 75¢ ea. |
| Van Gorden | Balun \$7.50 |
| | Center Insul. \$4.60 |
| W2AU Balun 4:1 or 1:1 | \$13.25 |
| B&W Traps 40 thru 10 | \$25.65 per pair |
| B&W Traps 80 thru 10 | \$25.65 per pair |

ROTORS

| | |
|-----------------|----------|
| CDE TAILTWISTER | \$228.00 |
| CDE HAM 4 | \$162.95 |
| CDE CD 45 | \$ 89.55 |
| CDE AR 22 | \$ 48.95 |

ALSO AVAILABLE:

Cushcraft, Hy-Gain, Telex, Bencher, Butternut, Regency, Mini Products, Larson, B&W, Hustler, Shure, ARRL, Bird, Callbook, Ameco, Sams Publications, Rohm, Vibroplex, Ham Key, Vocom, Daiwa, and many more.

Prices subject to change without notice.

Hours: Mon.—Sat. 10AM—6PM; Tues. & Fri. 'til 9PM

Telephone: (814) 536-5500

LACUE COMMUNICATIONS ELECTRONICS

102 Village Street
Johnstown, PA 15902

✓ 4

turns on the actual PTT transistor. Refer to Fig. 1. When the line is high, the repeater is keyed.

The simplest way to trigger the voice was to build up a 555 timer which is activated by the line going back low—which only happens after the ID. The 555 timer is set so that it is active for only as long as it takes for the time to be announced. See Fig. 2 for the schematic of the timer circuit.

How It Works

The negative transition of the ID PTT line from high to a low is coupled across C1, producing a negative-going spike. This spike triggers the 555 timer. Pin 3 of the timer goes to a high value. This high is coupled through CR1 to the base of your keying transistor to key your repeater. (The 555 timer can source 200 mA of current, so added drive

should not be necessary.) Also connected to pin 3 through a 1-megohm resistor is an FET switch. The two wires from the external key should be connected as shown. At the same time that the repeater is keyed, the Talking Time is triggered by the FET switch. Audio is injected at the output of the ID unit and the volume control adjusted to control the level of the voice.

Conclusion

Get your club to get a Talking Time and add time to your repeater. It is a neat project that can be done in an afternoon without difficulty. I used a PC board but Vectorboard® could be used as well. A service manual is available from Sharp which is quite detailed in its description of the clock, including timing diagrams and a parts list. Have fun with this project! ■

SOCIAL EVENTS

Listings in this column are provided free of charge on a space-available basis. The following information should be included in every announcement: sponsor, event, date, time, place, city, state, admission charge (if any), features, talk-in frequencies, and the name of whom to contact for further information. Announcements must be received two months prior to the month in which the event takes place.

SOUTH BEND IN JAN 3

A hamfest swap and shop will be held on Sunday, January 3, 1982, at Century Center, downtown on US 33 one way north between the St. Joseph Bank Building and the river, South Bend IN. Tables are \$3.00 each. There is a half acre of carpeted room in the same building as the industrial history museum. Talk-in on .52/.52, .99/.39, .93/.33, .78/.18, .69/.09, and 144.83/145.43. For more information, contact Wayne Werts K9IXU, 1889 Riverside Drive, South Bend IN 46616, or phone (219)-233-5307.

WEST ALLIS WI JAN 9

The West Allis RAC will hold its 10th annual all-indoor Mid-winter Swapfest on Saturday, January 9, 1982, beginning at 8:00 am at the Waukesha County Exposition Center. Advance tickets are \$2.00 and tickets at the door are \$3.00. Reserved 4-foot tables are \$3.00, at the door, \$2.00, and on the balcony, free. Included with the ticket will be a 50¢ coupon toward a sandwich purchase. Prizes will be awarded. For more information, write 1982 Swapfest, PO Box 1072, Milwaukee WI 53201.

RICHMOND VA JAN 10

The Richmond Amateur Telecommunications Society will hold its annual Frostfest on Sunday, January 10, 1982, from 8:00 am to 4:00 pm at the Virginia State Fairgrounds, Richmond VA. Admission is \$3.00 plus a table charge for exhibitors and flea-market displays. Overnight trailer parking with complete

hookups will be available at \$7.00 per night. Various prizes will be given away during the day with three main prizes to be awarded at 3:00 pm. There will be approximately one acre of indoor heated and well-lighted space. Talk-in on 146.34/.94, 146.28/.88, and 146.52. For additional information, call Joe Stern W4LD at (804)-737-0333.

OAK PARK MI JAN 10

The Oak Park Amateur Radio Club, Inc., will hold its annual Swap & Shop on Sunday, January 10, 1982, from 8:00 am to 3:00 pm at the Oak Park High School, at the corner of Oak Park Boulevard and Coolidge Highway, Oak Park MI. Admission is \$2.00 per person. Children 12 and under will be admitted free. Activities will include a league table, a door prize drawing, and a raffle for YLs. There will be free parking available as well as food and refreshments. Talk-in on 146.04/.64 and 146.52. For additional information or reservations, send an SASE to Rob Numerick WB8ZPN, 23737 Couzens, Hazel Park MI 48030, or phone (313)-398-3189.

SOUTHFIELD MI JAN 17

The Southfield High School Amateur Radio Club will hold its annual Swap & Shop on January 17, 1982, from 8:00 am to 3:00 pm at Southfield High School, 24675 Lahser, Southfield MI. Doors will open at 6:00 am for exhibitors. Admission is \$2.00. Reserved 8-foot tables are \$8.00 each and must be paid for in advance. Tables will also be available at the door. There will be lots of parking, food, and door prizes. For more information and/or reservations, write Robert Younker, Southfield High School, 24675 Lahser, Southfield MI 48034, or phone (313)-354-8210.

STUART FL JAN 30

The Martin County Amateur Radio Association will hold its annual Picnicfest Hamfest on

Saturday, January 30, 1982, from 8:00 am to 3:00 pm at Langford Park, Jensen Beach FL. Admission will be free. There will be picnic areas available and a playground for the children. For further details, contact Vern WA4GQY at (305)-334-6220, Don W4OST at (305)-286-0500, or Mike WA4GUH at (305)-334-6000 or (305)-878-7111.

ARLINGTON HEIGHTS IL FEB 7

The Wheaton Community Radio Amateurs will hold their annual hamfest on February 7, 1982, beginning at 8:00 am at the Arlington Park Race Track EXPO Center, Arlington Heights IL. Tickets are \$3.00 at the entrance and \$2.50 in advance. There will be free flea-market tables, expanded floor space, parking, awards, and a large commercial area, including the new computer section. Talk-in on 146.01/.61 and 146.94. For commercial info, call WB9TTE at (312)-766-1684; for general info, call WB9PWM at (312)-629-1427. For tickets, send an SASE to WCRA, PO Box QSL, Wheaton IL 60187.

TRAVERSE CITY MI FEB 13

The Cherryland Amateur Radio Club will hold its ninth annual Swap 'N Shop on Saturday, February 13, 1982, from 8:00 am through 2:30 pm at the Immaculate Conception Middle School gymnasium, 218 Vine Street, Traverse City MI. General admission is \$2.50 and single tables are \$3.00. Talk-in on 146.85 and 146.52. For further information, contact Jerry Cermak K8YVU, Chairman, 3905 Slusher Road, Traverse City MI 49684. An SASE will be appreciated.

MARLBORO MA FEB 14

The Algonquin Amateur Radio Club will hold an electronics flea market on February 14, 1982, at the Marlboro Junior High School cafeteria, Marlboro MA. Sellers will be able to set up from 9:00 am to 10:00 am and doors will be open from 10:00 am until 2:00 pm. Admission is \$1.00. Tables are \$5.00 if a written reservation is made before February 7, 1982, and \$7.50 for any tables remaining after that date. Refreshments will be available. Talk-in on .01/.61 and .52.

For reservations, contact Mac W1BK, 128 Forest Avenue, Hudson MA 01749.

MANSFIELD OH FEB 14

The Mid-Winter Hamfest/Auction will be held on Sunday, February 14, 1982, at the Richland County Fairgrounds, Mansfield OH. Doors will open to the public at 8:00 am. Tickets are \$2.00 in advance and \$3.00 at the door. Tables are \$5.00 in advance and \$6.00 at the door. Half tables are available. Features will include prizes, an auction, and a flea market, all in a large heated building. Talk-in on 146.34/.94. For additional information, advance tickets, and/or tables, send an SASE to Harry Fritchen K8HF, 120 Homewood Road, Mansfield OH 44906, or phone (419)-529-2801.

VERO BEACH FL FEB 20

The Treasure Coast Hamfest will be held on February 20, 1982, at the Vero Beach Community Center, Vero Beach FL. Admission is \$2.00 in advance and \$2.50 at the door. Features will include prizes, drawings, a QCWA luncheon, and tailgating. Talk-in on 146.13/.73, 146.52/.52, 146.04/.64, and 222.34/223.94. For additional information, write PO Box 3088, Beach Station, Vero Beach FL 32960.

ELKIN NC FEB 21

The fifth annual Elkin Winter Hamfest will be held on Sunday, February 21, 1982, at the Elkin National Guard Armory, located one mile from Interstate 77 at exit 85, Elkin NC. Breakfast and lunch will be served at the hamfest by the Foothills ARC of Wilkesboro NC and the Briarpatch ARC of Galax VA. Talk-in on 144.77/145.37, 146.22/146.82, and 146.52. For table reservations, ticket inquiries, or other information, contact Earl Day WB4GQP, 131 Harris Avenue, Elkin NC 28621, or phone (919)-835-3509.

GLASGOW KY FEB 27

The annual Glasgow Swapfest will be held on Saturday, February 27, 1982, beginning at 8:00 am CST at the Glasgow Flea Market Building, 2 miles

Continued on page 133

REVIEW

THE AEA MBA-RO —A SECOND GENERATION MORSE/RTTY READER

RTTY/Morse-code readers are rapidly gaining acceptance in the amateur community, and for a good reason—a reader allows people to sample the activity on RTTY without making the substantial outlay required for a complete system. And while few will admit to it, there are an awful lot of people having an awful lot of fun copying CW with these things! Consequently, AEA's introduction of the MBA-RO reader came as no surprise. AEA has earned a reputation as a major innovator in sophisticated Morse keyers, so it seems logical that they would introduce an equally sophisticated code reader, and in fact they have.

The AEA MBA-RO is a micro-processor-controlled reader designed to display Morse, Baudot, and ASCII codes. While hardly the first such device available to the radio amateur, the MBA-RO incorporates several important improvements over the first generation of readers.

The Features

The MBA-RO is housed in an attractive metal cabinet, measuring 8-3/4" x 5-7/8" x 2". A thirty-two character vacuum fluorescent display allows the operator to see more of a sentence than readers which display only eight or ten characters at a time. This is useful under any conditions, but is particularly helpful when high levels of QRM make for rough copy. It's much easier to make sense out of garbled copy when several words are available for viewing. The bright blue digits make the display readable even under high ambient lighting conditions.

Underneath the display are three knobs. The one on the right is the mode and speed selector. Speeds of 60, 67, 75, and 100 wpm are provided for Baudot RTTY, and ASCII can be displayed at either 110 or 300 baud. Speed in the Morse-code position is tracked automatically, up to 99 wpm. There is a second Morse-code position that caus-

es the speed to be displayed on the far right of the display.

On the left side of the display is the filter selector. While most code readers use only the mark frequency for decoding RTTY, AEA's engineers chose to include filters for both the mark and the space frequencies. This is the method used in virtually all demodulators designed for use with traditional RTTY equipment, and it provides more accurate decoding under high QRM conditions. Prototype samples of the MBA were capable of tuning only one shift, but two shifts are included on production models. Our test unit was equipped to copy 170-Hz and 425-Hz shifts, allowing copy of news services as well as HF ham activity. Those who live where there is RTTY activity on VHF may wish to retune one of the filter positions for an 850-Hz shift. This is a simple procedure requiring an accurately calibrated audio generator. If you don't feel like retuning one of the filters but wish to copy a non-standard shift, you can place the filter in the CW position and decode only the mark frequently. Finally, all filters can be switched out completely.

The control in the very center of the MBA is marked

"Threshold," and above this are two LEDs marked "Tune." The control and LEDs are used to make fine adjustments of the MBA's filters. More on the use of these later.

On the left side of the reader is a row of jacks. There is a 13-V power input (13 V dc \pm 2 V at 500 mA), audio input, audio output, and key input. The audio input can be connected to the speaker output of a receiver, and an external speaker to the output of the MBA. The key jack can be wired in parallel with a keyer, as long as it is wired for positive keying. An external RTTY demodulator can also drive the reader through this jack.

In Use

Getting the MBA-RO on line couldn't be much easier. A small bag of plugs is provided, and a few minutes spent with a soldering iron should produce all the necessary power and audio cables. Making it display off-the-air code can be a bit frustrating until you have a clear understanding of how the Threshold control works. Reading the manual should clear up any problems. I tried CW operation first, which was extremely simple using my IC-701 with its narrow audio filter switched in. The CW filter in the MBA is so sharp (100 Hz!) that I really don't need the Icom's narrow filter—I just use it to make tuning easier. The center of the filters in both the Icom and the MBA are very close

to the same frequency, so peaking a signal in the center of the receiver's passband ensures good copy on the reader. I find it necessary to ride the audio gain control a little more than with other readers I have used; perhaps a tighter agc stage would help here.

The area where most readers show their limitations is in copying poorly sent CW. Most hams' fists are sloppy at best, and it is pretty hard for a small computer to decipher some of the stuff we try to pass off as Morse. The MBA produces copy as good as anything else I have used, and I've tried just about everything! I tuned across one station who was apologizing for his poor sending with a straight key—the MBA copy was perfect. Still, if an operator runs his characters together or uses highly individualized weighting, no machine will provide good copy. The MBA follows changes in speed automatically in the Morse mode. Other systems require you to select a range of speeds or push a reset button when tuning in to another station. The speed did adjust very quickly, although it was occasionally fooled by sloppy sending. The bottom line on the MBA's CW capabilities? If someone is using a keyer and is not running his characters together, the MBA copy will be almost flawless. If someone is pretty good with a straight key, that will be decoded well, too. A surprisingly high level of QRM is



The AEA MBA-RO Morse/RTTY reader.

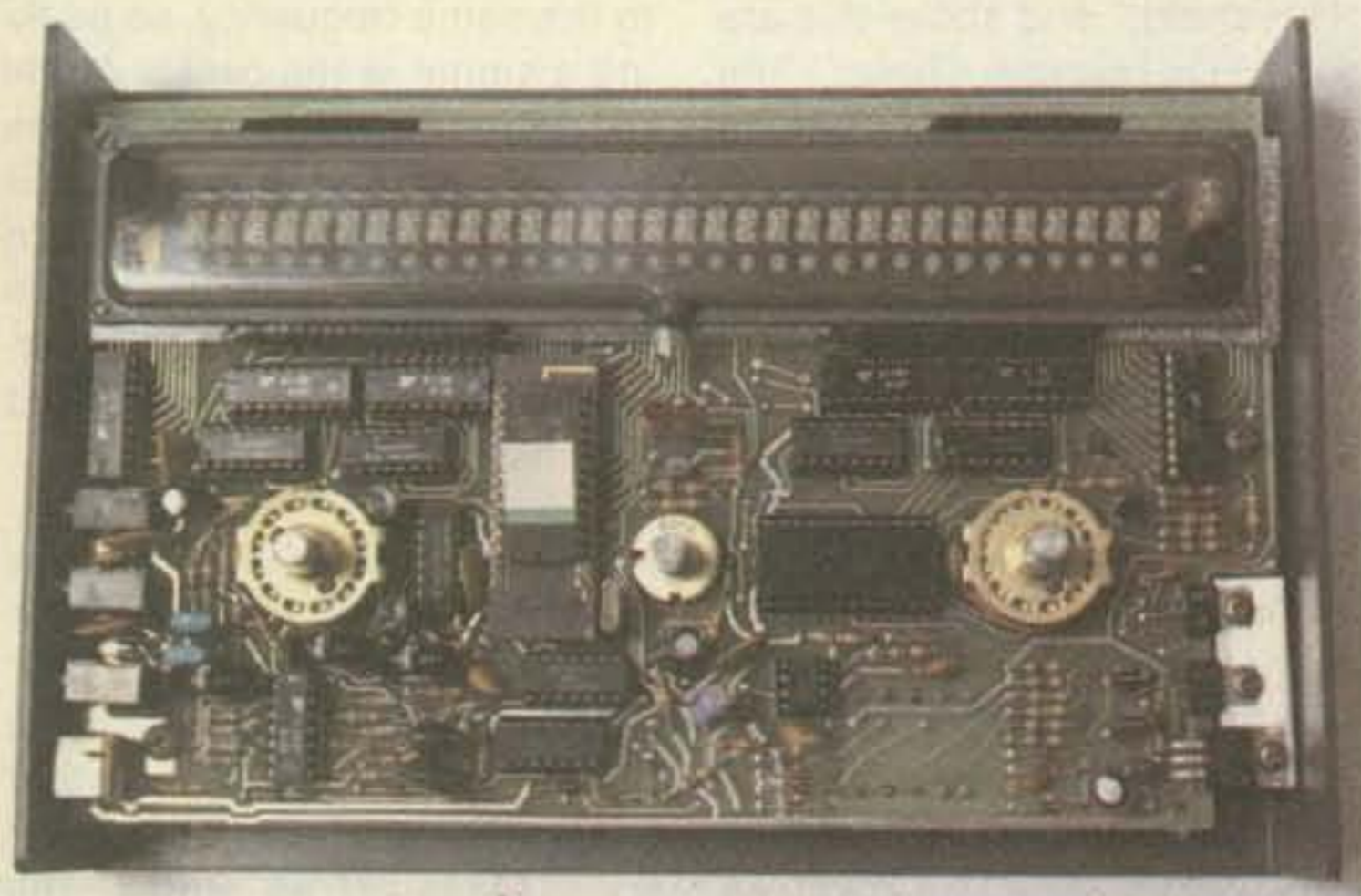

Inside the MBA-RO.

necessary to disrupt copy, due to the narrow internal filters.

RTTY

Performance in the RTTY mode was even more impressive than CW. The MBA copied every bit as well as most of the computer/interface combinations available. It is at a disadvantage at 300-baud ASCII because text flies by so fast you cannot read it! It is doubtful that you'll encounter much 300-baud ASCII, however.

If you have a general-coverage receiver, you may enjoy checking out the news services. AEA thoughtfully includes an order form for a book that lists the time, frequency, shift, and speed of the various services. It's definitely worth getting. If I could just interface the MBA to my MX-80 printer, I would be completely happy. Actually, an up-market MBA with a printer interface should be available by the time you read this review.

The only thing I can really complain about is the necessity of having one's receiver set in the USB position. Since most other RTTY gear is designed to operate on LSB, a switch to invert operation would be handy. This should be relatively simple to add.

Any device that contains a microprocessor emits a certain amount of noise, and the MBA is no exception. Our unit was a very early production model, and there was a just perceptible amount of hash present. AEA now has a very simple modification that reduces even this amount of noise by 40 dB or so. We didn't try the mod, but all units now available probably have the improvement already installed. Let it suffice to say

that even the unimproved version is quiet enough for weak-signal work in both CW and RTTY. With the kind of antennas I've had to use lately, everything seems weak!

Conclusion

The MBA-RO performed exactly as claimed and should make an excellent shack addition for anyone interested in Morse or RTTY. The 32-character display alone gives it a significant advantage over other readers on the market. AEA will shortly be announcing a version of the MBA that incorporates a keyer and allows RTTY to be sent with a paddle—ideal for DXpeditions and maritime mobile stations! For more information, contact AEA, Inc., PO Box 2160, Lynnwood WA 98036. Reader Service number 477.

Paul Grupp KA1LR
73 Magazine Staff

THE YAESU FT-290 —A MULTIMODE MARVEL MADE TO GO ANYWHERE

The Yaesu FT-290 is a unique product, which in itself is unusual in today's copycat world of look-alike transceivers. It is a synthesized multimode (USB, LSB, CW, and FM) two-meter transceiver designed for use under a wide variety of conditions. What makes the FT-290 unique is the level of sophistication packed into such a portable unit. Although it outwardly resembles many multimode two-meter rigs, this one has provision for an eight-nicad C-cell internal battery pack capable of supplying 2 Ah of current!

The Features

Yaesu's engineers have attempted to produce a two-meter



The Yaesu FT-290 multimode 2m transceiver.

rig that will be all things to all hams, and they appear to have succeeded. Hams with mountaintopping aspirations will appreciate the compact size and low current consumption. At 50 mA receive/800 mA transmit, those eight C-cells last forever between charges! There is an internal quarter-wave whip, but also a standard UHF connector to which you can connect a more ambitious antenna. The rig and a compact quad or yagi will be a welcome addition to many a backpacking ham's outfit.

OSCAR fanatics will find plenty to be enthusiastic about as well—the FT-290 operates on both sidebands and allows the operator to change frequency while transmitting.

Operators who only do a little sideband work won't have to give up any features they've come to rely on in FM-only rigs. There are 10 memories protected with a five-year lithium battery backup, choice of stepping rates for the synthesizer, a tone burst generator, provision for an optional internal CTCSS encoder, manual band and

memory scanning from the microphone, and automatic scanning for either open or busy channels. Other useful features include an LCD display, a priority channel scanning circuit, two vfo's, a clarifier, and a very attractive price tag. From an rf standpoint, the 290 keeps up with the pack—FM sensitivity is .25 uV for 12-dB SINAD, and SSB/CW is .5 uV for 20-dB S/N. Selectivity is 2.4 kHz at -6 dB and 4.1 kHz at -60 dB (SSB/CW) and 14 kHz at -6 dB and 25 kHz at -60 dB (FM).

So what's the hitch? Well, the FT-290 only puts out 2.5 Watts of rf. They had to make room for those batteries somehow! For anything but portable work, a separate amplifier is mandatory. Fortunately, Yaesu has a matching 10-Watt linear amplifier available, the FL-2010. The amplifier is directly keyed by the FT-290 with a dc voltage carried on the antenna lead. It's a reasonably compact package and works well. Ten Watts should be adequate for FM operation, but serious SSB operators may want a little more power.

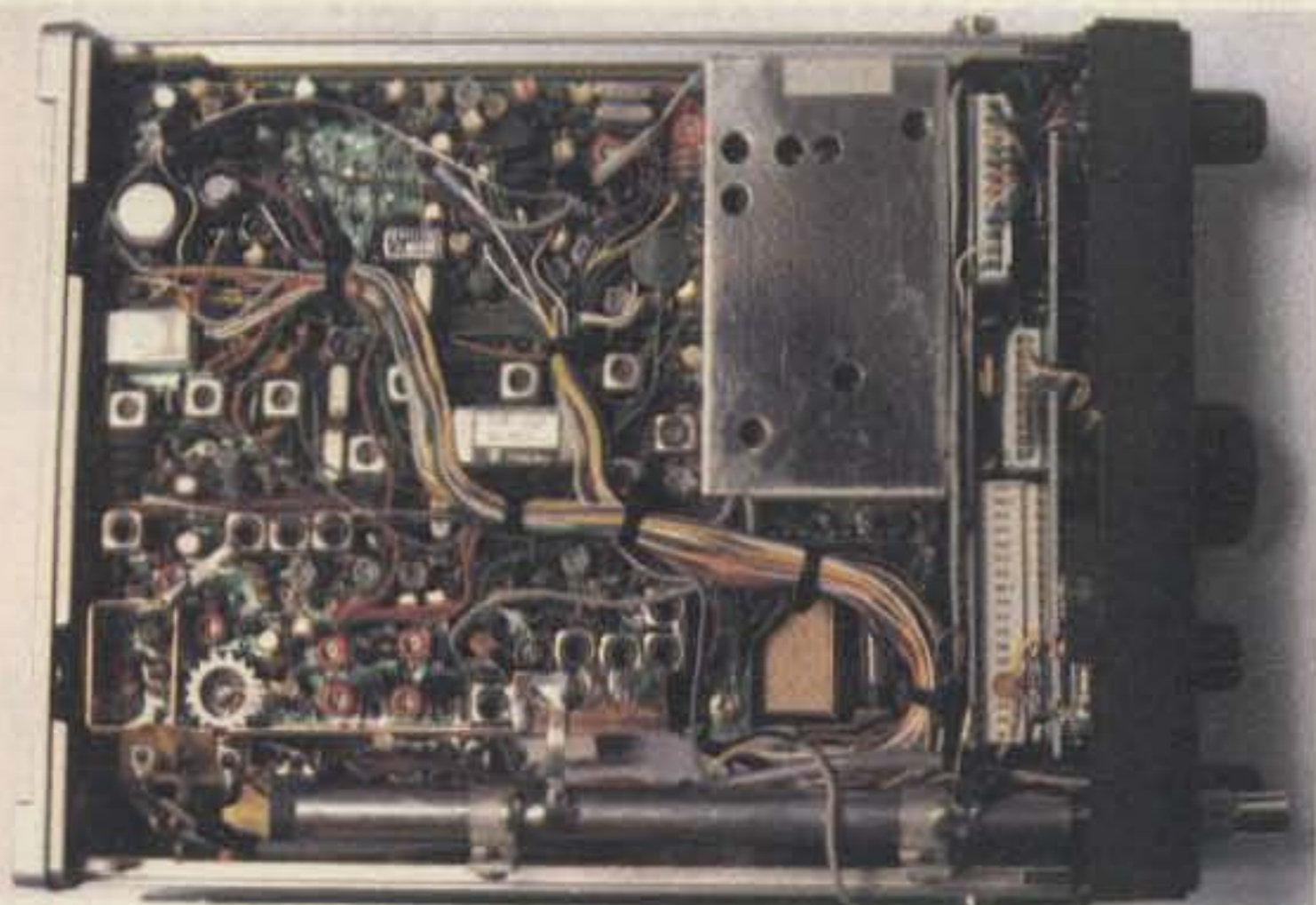

Top view of the FT-290.

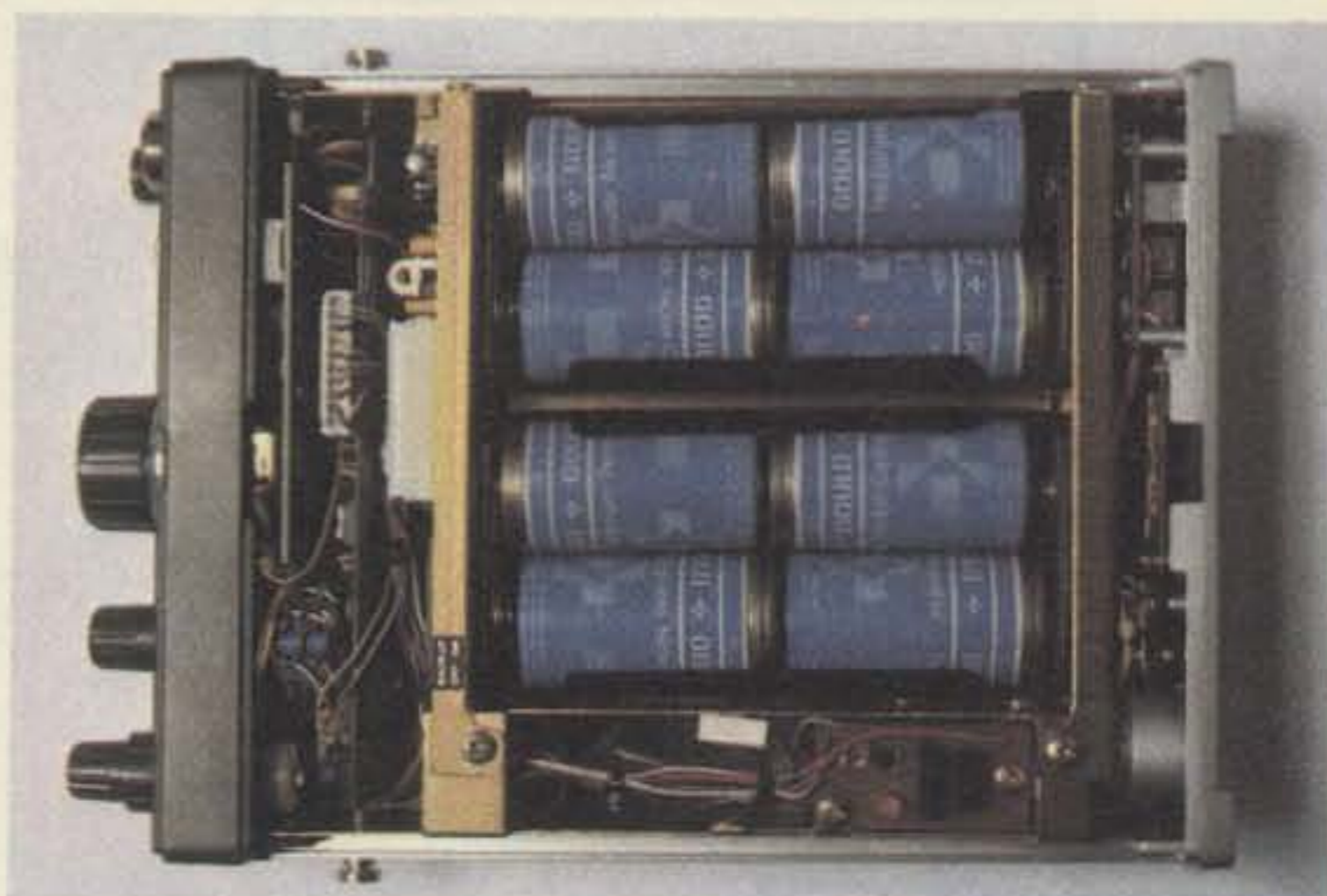

Bottom view of the FT-290.

In Use

The human engineering factors are excellent by any standard. In this respect, the FT-290 is Yaesu's best product yet. For example, the priority channel is not just a single channel—you can choose one of any of the ten memories. Dial up a frequency on the main vfo knob, select one of the memories, and punch the priority switch. A beep will confirm that the switch was activated, and a "P" will appear briefly on the display to let you know that you're in the priority mode. Every few seconds, the priority channel will be checked for activity. If there is activity, the 290 will lock onto that frequency and remain there. Neat! This isn't the only well-thought-out feature. Almost every control and feature appears to have received a great deal of thought. The only inconvenience I encountered was the location of the switch that selects scanning for a busy or open frequency. It's located inside the battery compartment, which means that you had best plan on not changing it too often.

Transmit audio is good in both SSB and FM. I listened on a Kenwood TR-9000 while another staff member transmitted on the 290 and heard no problems. Received audio isn't quite as good as I've come to expect; the frequency response is narrow and the audio has a slightly muffled quality. This is considerably improved with an external speaker.

Conclusions

The FT-290's versatility is a powerful argument in its favor. New Hampshire has no lack of mountains to climb, and once stuffed in its rugged case, this transceiver is a worthy compan-

ion on any outing. The only other rig available that comes close is the Icom portable SSB rig, but it lacks FM capability and the sophisticated features of the 290.

Aside from versatility, the FT-290 gets high marks in performance and human engineering. If this rig is any indication, we can expect to see great things from Yaesu in the not-too-distant future. For more information, contact *Yaesu Electronics Corp.*, 6851 Walthall Way, Paramount CA 90723. Reader Service number 481.

Paul Grupp KA1LR
73 Magazine Staff

THE TELTONE M-929 —UN-TOUCHY TONE DECODING

During the nearly 9 years I have been working with repeater

autopatches and other touch-tone™-operated systems, I have tested and compiled information on a great number of touchtone decoders.

Recently, after spending much time trying to cure the voice falsing problems associated with one type of digital decoder, I ran across an ad for the Teltone M-927 decoder in a trade magazine. They advertised it as the system that "beat Dr. Glitch." Wow, did that catch my eye! The ad had barely come to rest on the top of my desk before I had called the company and ordered one. Normally, I am very skeptical of all-on-one-chip decoders. Because of the rigorous demands of radiotelephone operation, most decoders usually require some adjustments via external circuitry to make them

work properly in a radio system. All-on-one-chip systems often lack the access needed to make these adjustments. Not so with this decoder. In fact, this decoder is so flexible and works so well that I had to let my fellow touch-tone sufferers know about it.

The M-927 decoder is a complete system contained in a single 40-pin dip package. The only external component needed is a 3.58-MHz color burst crystal. The bandsplitter filters and wave-shaping circuitry, major headaches in other systems, are all included on one of the two LSI chips in the M-927 package. Furthermore, since the audio inputs to the differential amplifier are designed to attach directly to the telephone lines, they are internally capacitively coupled and capable of with-

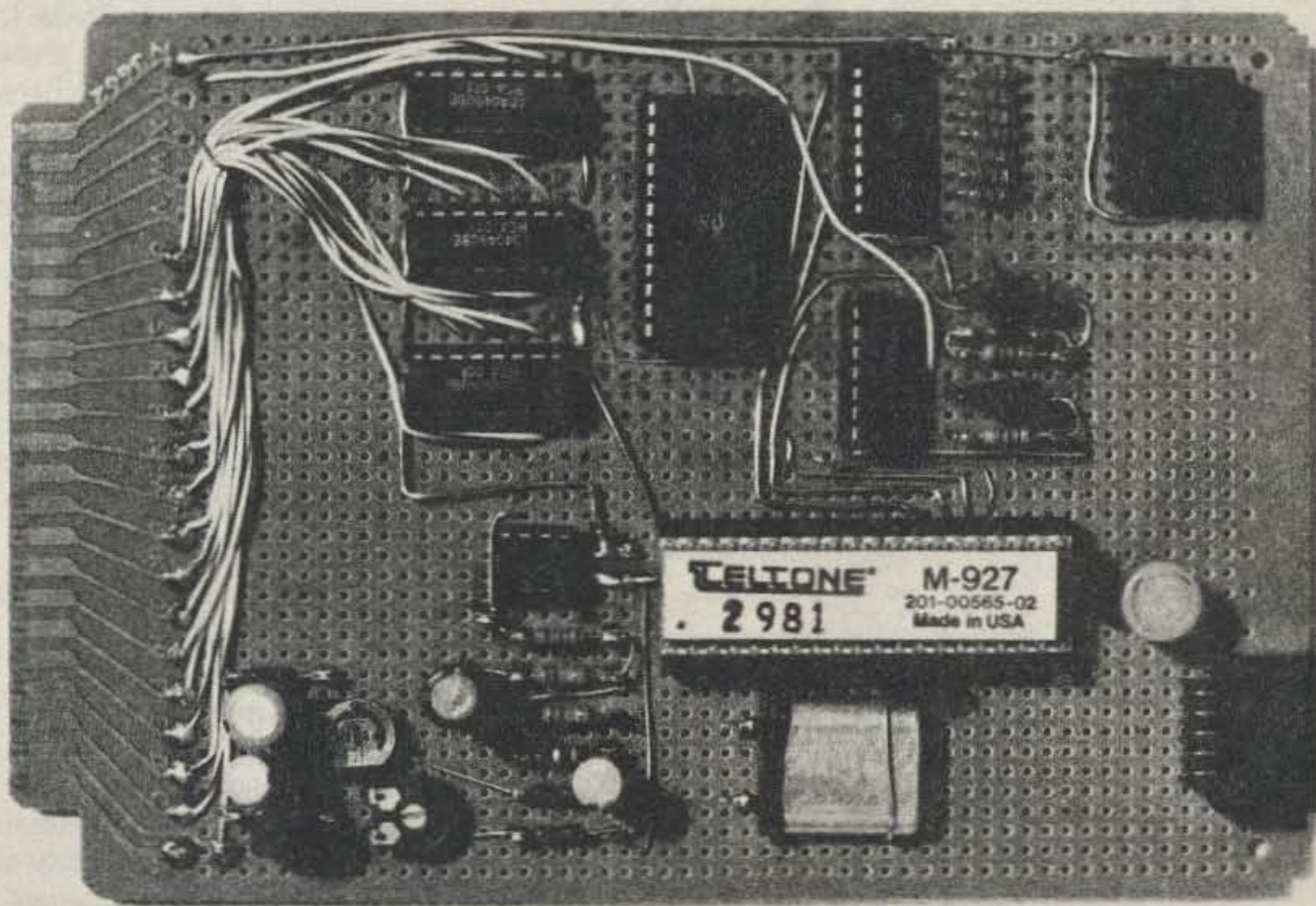

Photo A. The assembled tone decoder board. (Photo by Vic Klein WA4THR)

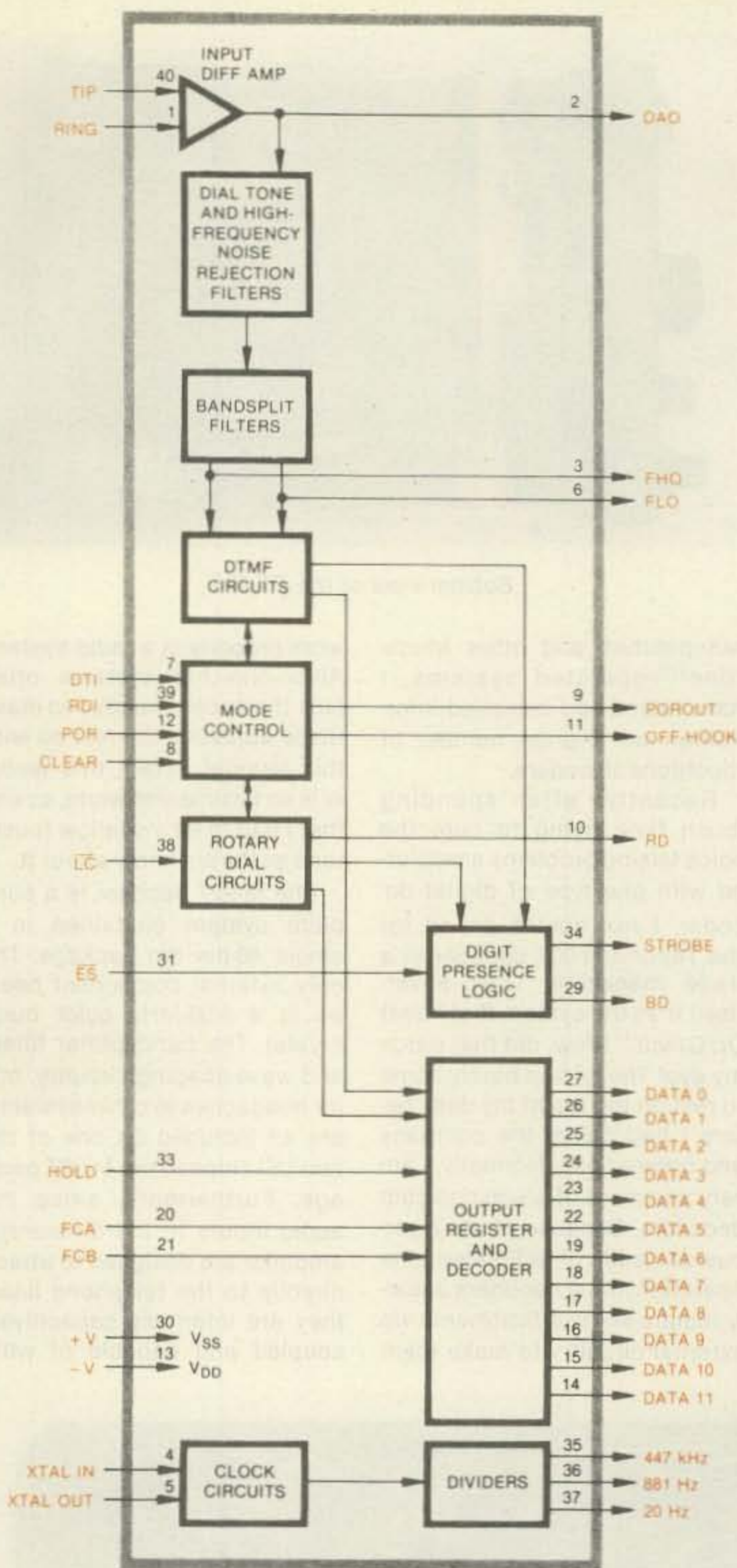

Fig. 1(a). The M-927 block diagram.

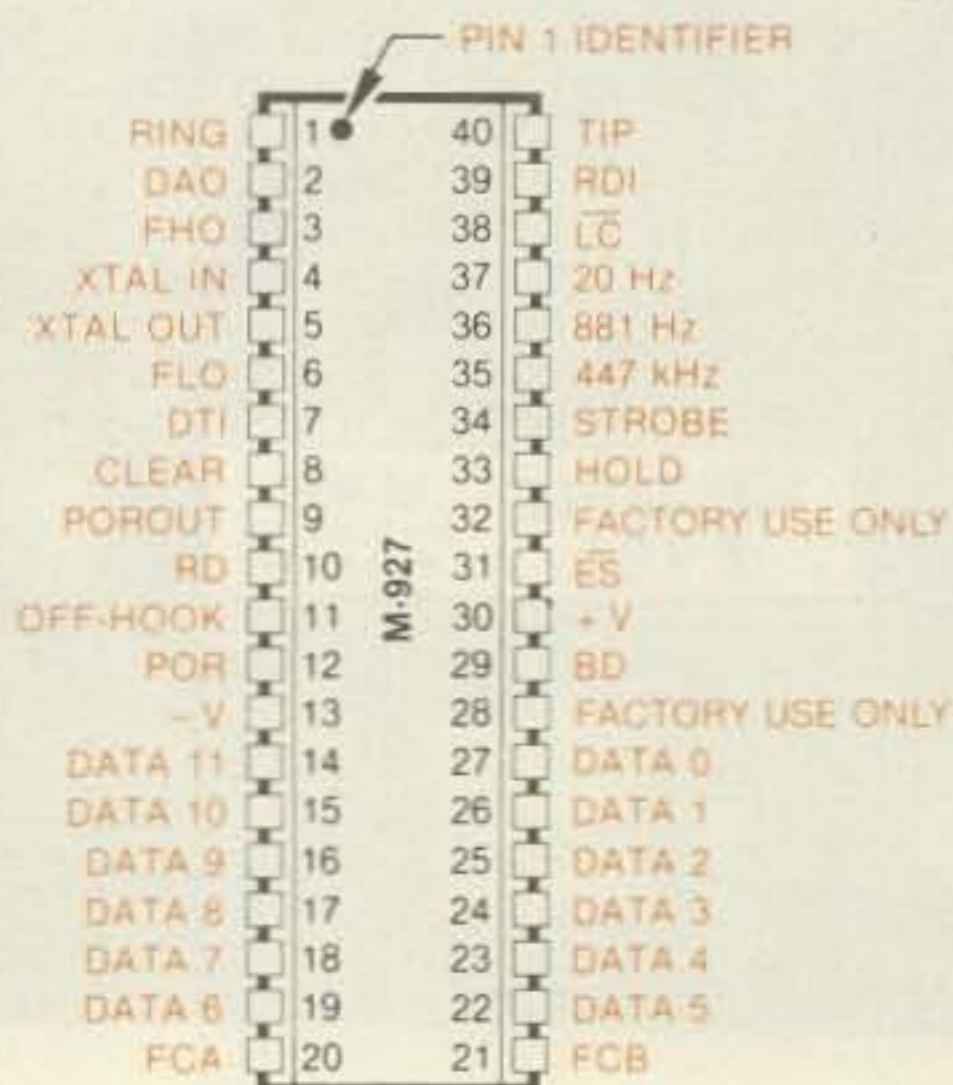

Fig. 1(b). Pinout of the M-927.

| DIGIT | 1 | 2 | 3 | 4 | 5 | 6 | 7 | 8 | 9 | 0 | * | # | A | B | C | D |
|-------|---|---|---|---|---|---|---|---|---|---|---|---|---|---|---|---|
| 0 | 0 | 1 | 1 | 1 | 1 | 1 | 1 | 1 | 1 | 1 | 1 | 1 | 1 | 1 | 1 | 1 |
| 1 | 0 | 1 | 0 | 1 | 1 | 1 | 1 | 1 | 1 | 1 | 1 | 1 | 1 | 1 | 1 | 1 |
| 2 | 1 | 1 | 0 | 1 | 1 | 1 | 1 | 1 | 1 | 1 | 1 | 1 | 1 | 1 | 1 | 1 |
| 3 | 1 | 1 | 1 | 0 | 1 | 1 | 1 | 1 | 1 | 1 | 1 | 1 | 1 | 1 | 1 | 1 |
| 4 | 1 | 1 | 1 | 1 | 0 | 1 | 1 | 1 | 1 | 1 | 1 | 1 | 1 | 1 | 1 | 1 |
| 5 | 1 | 1 | 1 | 1 | 1 | 0 | 1 | 1 | 1 | 1 | 1 | 1 | 1 | 1 | 1 | 1 |
| 6 | 1 | 1 | 1 | 1 | 1 | 1 | 0 | 1 | 1 | 1 | 1 | 1 | 1 | 1 | 1 | 1 |
| 7 | 1 | 1 | 1 | 1 | 1 | 1 | 1 | 0 | 1 | 1 | 1 | 1 | 1 | 1 | 1 | 1 |
| 8 | 1 | 1 | 1 | 1 | 1 | 1 | 1 | 1 | 0 | 1 | 1 | 1 | 1 | 1 | 1 | 1 |
| 9 | 1 | 1 | 1 | 1 | 1 | 1 | 1 | 1 | 1 | 0 | 1 | 1 | 1 | 1 | 1 | 1 |
| 10 | 1 | 1 | 1 | 1 | 1 | 1 | 1 | 1 | 1 | 1 | 0 | 1 | 1 | 1 | 1 | 1 |
| 11 | 1 | 1 | 1 | 1 | 1 | 1 | 1 | 1 | 1 | 1 | 1 | 0 | 1 | 1 | 1 | 1 |

1 OF 12 OUTPUT FORMAT
FCA 0 FCB 0

| DIGIT | 1 | 2 | 3 | 4 | 5 | 6 | 7 | 8 | 9 | 0 | * | # | A | B | C | D |
|-------|---|---|---|---|---|---|---|---|---|---|---|---|---|---|---|---|
| 0 | 1 | 0 | 1 | 0 | 1 | 0 | 1 | 0 | 1 | 0 | 1 | 0 | 1 | 0 | 1 | 0 |
| 1 | 0 | 1 | 1 | 0 | 1 | 1 | 0 | 0 | 1 | 1 | 0 | 0 | 1 | 1 | 0 | 1 |
| 2 | 0 | 0 | 0 | 1 | 1 | 1 | 1 | 0 | 0 | 0 | 0 | 1 | 1 | 1 | 0 | 1 |
| 3 | 0 | 0 | 0 | 0 | 0 | 0 | 0 | 1 | 1 | 1 | 1 | 1 | 1 | 1 | 1 | 1 |
| 4 | 1 | 1 | 1 | 1 | 1 | 1 | 1 | 1 | 1 | 1 | 1 | 1 | 1 | 1 | 1 | 1 |
| 5 | 1 | 1 | 1 | 1 | 1 | 1 | 1 | 1 | 1 | 1 | 1 | 1 | 1 | 1 | 1 | 1 |
| 6 | 1 | 1 | 1 | 1 | 1 | 1 | 1 | 1 | 1 | 1 | 1 | 1 | 1 | 1 | 1 | 1 |
| 7 | 1 | 1 | 1 | 1 | 1 | 1 | 1 | 1 | 1 | 1 | 1 | 1 | 1 | 1 | 1 | 1 |
| 8 | 1 | 1 | 1 | 1 | 1 | 1 | 1 | 1 | 1 | 1 | 1 | 1 | 1 | 1 | 1 | 1 |
| 9 | 1 | 1 | 1 | 1 | 1 | 1 | 1 | 1 | 1 | 1 | 1 | 1 | 1 | 1 | 1 | 1 |
| 10 | 1 | 1 | 1 | 1 | 1 | 1 | 1 | 1 | 1 | 1 | 1 | 1 | 1 | 1 | 1 | 1 |
| 11 | 1 | 1 | 1 | 1 | 1 | 1 | 1 | 1 | 1 | 1 | 1 | 1 | 1 | 1 | 1 | 1 |

BINARY OUTPUT FORMAT
FCA 0 FCB 1

| DIGIT | 1 | 2 | 3 | 4 | 5 | 6 | 7 | 8 | 9 | 0 | * | # | A | B | C | D |
|-------|---|---|---|---|---|---|---|---|---|---|---|---|---|---|---|---|
| 0 | 0 | 1 | 0 | 1 | 0 | 1 | 0 | 1 | 0 | 1 | 0 | 1 | 0 | 1 | 0 | 1 |
| 1 | 0 | 1 | 0 | 1 | 0 | 1 | 0 | 1 | 0 | 1 | 0 | 1 | 0 | 1 | 0 | 1 |
| 2 | 0 | 0 | 0 | 1 | 1 | 1 | 1 | 0 | 0 | 0 | 0 | 1 | 1 | 1 | 1 | 0 |
| 3 | 0 | 0 | 0 | 0 | 0 | 0 | 0 | 1 | 1 | 1 | 1 | 1 | 1 | 1 | 1 | 0 |
| 4 | 0 | 0 | 0 | 1 | 1 | 1 | 1 | 1 | 1 | 1 | 1 | 1 | 1 | 1 | 0 | 1 |
| 5 | 1 | 1 | 1 | 0 | 0 | 1 | 1 | 1 | 1 | 1 | 1 | 1 | 1 | 1 | 0 | 1 |
| 6 | 1 | 1 | 1 | 1 | 1 | 0 | 0 | 0 | 1 | 1 | 1 | 1 | 1 | 1 | 0 | 1 |
| 7 | 1 | 1 | 1 | 1 | 1 | 1 | 1 | 1 | 0 | 0 | 0 | 1 | 1 | 1 | 1 | 0 |
| 8 | 0 | 1 | 1 | 0 | 1 | 0 | 1 | 0 | 1 | 0 | 1 | 1 | 1 | 1 | 1 | 1 |
| 9 | 1 | 0 | 1 | 1 | 0 | 1 | 1 | 0 | 1 | 1 | 1 | 1 | 1 | 1 | 1 | 1 |
| 10 | 1 | 1 | 0 | 1 | 1 | 0 | 1 | 1 | 0 | 1 | 1 | 1 | 1 | 1 | 1 | 1 |
| 11 | 1 | 1 | 1 | 1 | 1 | 1 | 1 | 1 | 1 | 1 | 1 | 1 | 1 | 1 | 0 | 0 |

BINARY AND 2 OF 8 OR 2 OF 7 OUTPUT FORMATS
FCA 1 FCB 0

| DIGIT | 1 | 2 | 3 | 4 | 5 | 6 | 7 | 8 | 9 | 0 | * | # | A | B | C | D |
|-------|---|---|---|---|---|---|---|---|---|---|---|---|---|---|---|---|
| 0 | 1 | 1 | 1 | 1 | 1 | 1 | 1 | 1 | 1 | 1 | 1 | 1 | 1 | 1 | 1 | 1 |
| 1 | 1 | 1 | 1 | 1 | 1 | 1 | 1 | 1 | 1 | 1 | 1 | 1 | 1 | 1 | 1 | 1 |
| 2 | 1 | 1 | 1 | 1 | 1 | 1 | 1 | 1 | 1 | 1 | 1 | 1 | 1 | 1 | 1 | 1 |
| 3 | 1 | 1 | 1 | 1 | 1 | 1 | 1 | 1 | 1 | 1 | 1 | 1 | 1 | 1 | 1 | 1 |
| 4 | 1 | 1 | 1 | 1 | 1 | 1 | 1 | 1 | 1 | 1 | 1 | 1 | 1 | 1 | 1 | 1 |
| 5 | 1 | 1 | 1 | 1 | 1 | 1 | 1 | 1 | 1 | 1 | 1 | 1 | 1 | 1 | 1 | 1 |
| 6 | 1 | 1 | 1 | 1 | 1 | 1 | 1 | 1 | 1 | 1 | 1 | 1 | 1 | 1 | 1 | 1 |
| 7 | 1 | 1 | 1 | 1 | 1 | 1 | 1 | 1 | 1 | 1 | 1 | 1 | 1 | 1 | 1 | 1 |
| 8 | 1 | 1 | 1 | 1 | 1 | 1 | 1 | 1 | 1 | 1 | 1 | 1 | 1 | 1 | 1 | 1 |
| 9 | 1 | 1 | 1 | 1 | 1 | 1 | 1 | 1 | 1 | 1 | 1 | 1 | 1 | 1 | 1 | 1 |
| 10 | 1 | 1 | 1 | 1 | 1 | 1 | 1 | 1 | 1 | 1 | 1 | 1 | 1 | 1 | 1 | 1 |
| 11 | 1 | 1 | 1 | 1 | 1 | 1 | 1 | 1 | 1 | 1 | 1 | 1 | 1 | 1 | 1 | 1 |

BLANK OUTPUT FORMAT
FCA 1 FCB 1

Table 1. Output formats.

standing differential voltages up to 1500 volts. For single input operation, no biasing components are needed. Figs. 1(a) and 1(b) show the decoder block diagram and pinout.

In addition to the touchtone decoding portion of the circuit, Teletone makes provision for dial pulse input as well. The circuit is capable of accepting either touchtones, dial pulses, or both. A couple of enable lines (DT1, RD1) enable the user to selectively inhibit either type of operation.

Data is output from the decoder in one of four selectable formats shown in Table 1. Format 3 is interesting in that when it is selected both binary and 2-of-8 codes are available simultaneously. The blank output format can be used to clear the output latches in applications where momentary output coincident with signal presence is required. In addition to numerical outputs and several testpoints, clock outputs of three different frequencies are available along with a strobe line and a power-on-reset line.

Putting the Decoder to Work

Two weeks after placing the order, I received the decoder. I immediately put it in the circuit shown in Photo A and schematically depicted in Fig. 2. The components before and after the decoder are not absolutely necessary, but I have learned that when lightning strikes it is nice to have buffers between expen-

sive parts and the outside world! The display is convenient for reading the decoder output.

The 741 op amp routes audio from either the main or auxiliary receivers to the decoder audio input in addition to acting as a lightning buffer.

The CD4515 decodes the M-927's binary output into 16 separate outputs which are then inverted and buffered by the CD4049 ICs. The strobe pulse from the M-927 is inverted and delayed by an RC network and a 74C14 Schmitt trigger inverter before being fed to the enable line of the CD4515 decoder. An additional RC network and inverter further delay the strobe pulse before it is output from the tone-decoder board. These delays ensure that both the rising and falling edges of the strobe pulse occur while the data is available at the outputs of the CD4049 inverter/buffers.

Since the M-927's strobe line is connected to the enable line of the CD4515, data is only output from the board while the tone is actually present.

Lastly, the CD4511 display decoder transforms the M-927's binary output to seven-segment form and directly drives a seven-segment common cathode display providing a visual indication of tone-decoder operation.

A lot of decoding on one board, isn't it?

One unrelated aspect of the schematic I'd like to point out is the 15-volt, 1-Watt zener across the power supply inputs. This lit-

the device has saved many expensive ICs in the past by shorting out and burning the power trace right off the board when a voltage regulator went awry or when a lightning bolt hit. It is well worth its insignificant cost.

The Acid Test

Despite the impressive specifications of many touchtone decoders, they often bite the dust when faced with the acid test—amateur repeater operation.

Not this decoder! The M-927 took charge. It stubbornly refused to false decode despite the efforts of our best touchtone imitators. It ignored all manner of squawks and squeals. When it came to touchtones, though, the M-927 really came through. I couldn't hit the buttons on my TT pad fast enough to escape decoding. Even the fastest automatic dialers weren't fast enough to go undecoded!

During the several months that the M-927 has been installed in our system, it has voice falsed, but only twice. Not bad considering the many hours of voice, squelch noise, squawks, and squeals to which it has had to listen!

Rather than leave you with the thought that the M-927 is the perfect touchtone decoder, which it very nearly is, I must point out a few of its shortcomings as well.

The first and worst deficiency noted during several months of repeater operation was the M-927's relatively high signal-to-noise ratio requirement of 25 dB. In repeater terms, this means that the M-927 will not pick a weak signal out of the noise. In practice, we found that if a signal was too noisy for autopatch, it was also too noisy to bring it up. This turned out not to be such a bad shortcoming after all! If you need weak signal capability, Teltone was thinking of you when they created the M-927's big brother, the M-937. It is shown in Photo B. The M-937 has the same features as the M-927 with a signal-to-noise ratio requirement of only 10-15 dB. Although I haven't tested it, Teltone claims that the M-937 will pick signals out of the noise. A side-by-side comparison of specifications of the M-927 and M-937 is shown in Table 2.

A second deficiency, shared by all types of decoders, is temperature range. The M-927

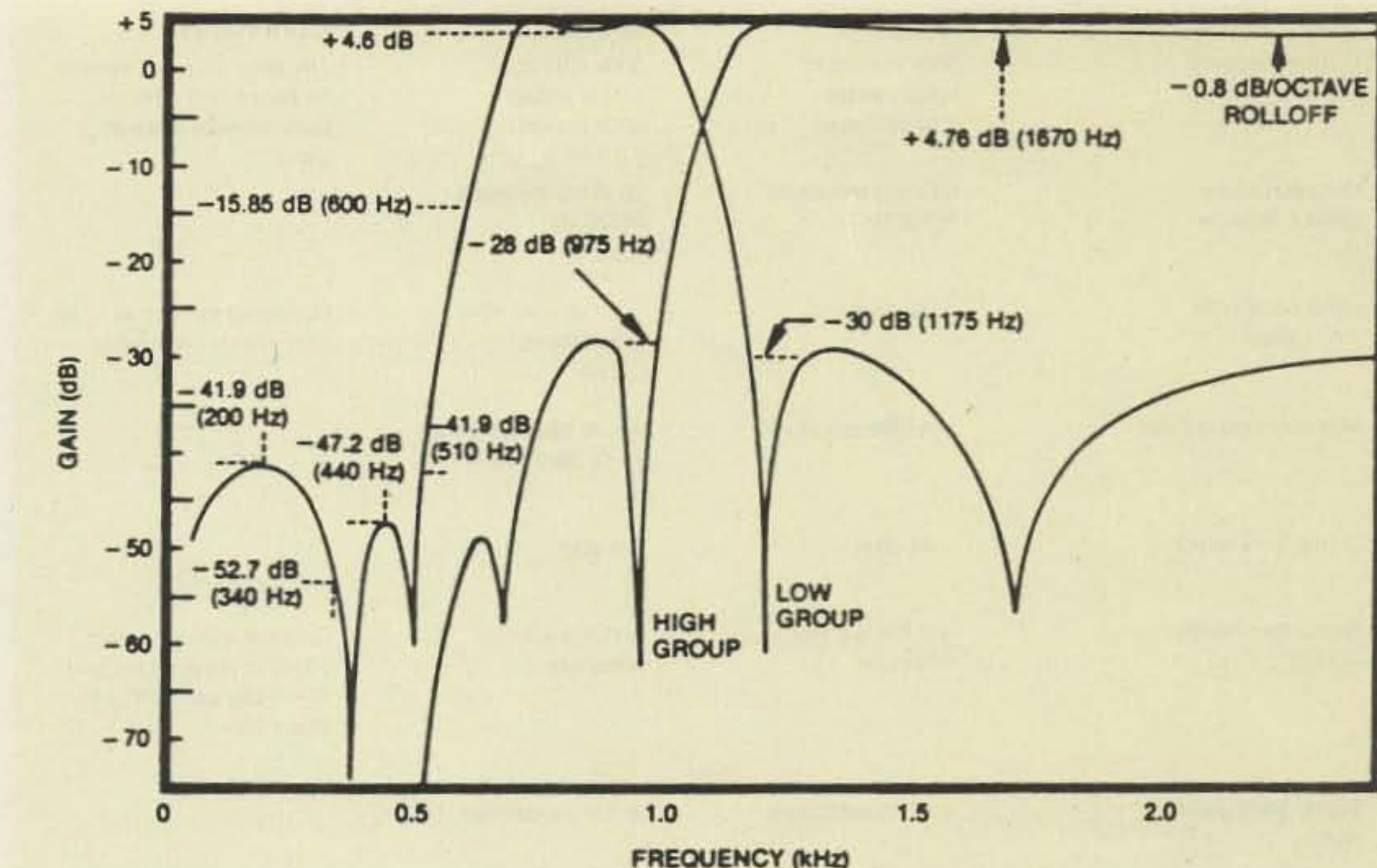

Fig. 2. Bandpass filter characteristics of the M-927.

will operate over the range of 0°C to 70°C. The M-927 can stand the heat of summer, but on cold winter days you'll need to keep it above the freezing mark.

Every weekend our repeater is remotely (via touchtone) switched to standby battery power. During one such weekend I discovered the M-927's third minor flaw—limited

voltage range. Although all of our repeater control circuits are CMOS and are capable of operating down to 3 or 4 volts, the M-927 quits working when its supply voltage goes below about 11 volts. According to the data sheet, the M-927's operating voltage range is 11 to 13.5 volts. Believe it! I nearly had to take the long hike up the moun-

tain to reset the repeater, but luckily after a short period of inactivity the battery recovered to a voltage sufficient to let the M-927 accept my reset command. For battery operation, therefore, I would recommend some type of 12-volt backup supply just for the decode itself.

No other shortcomings were found during three months of

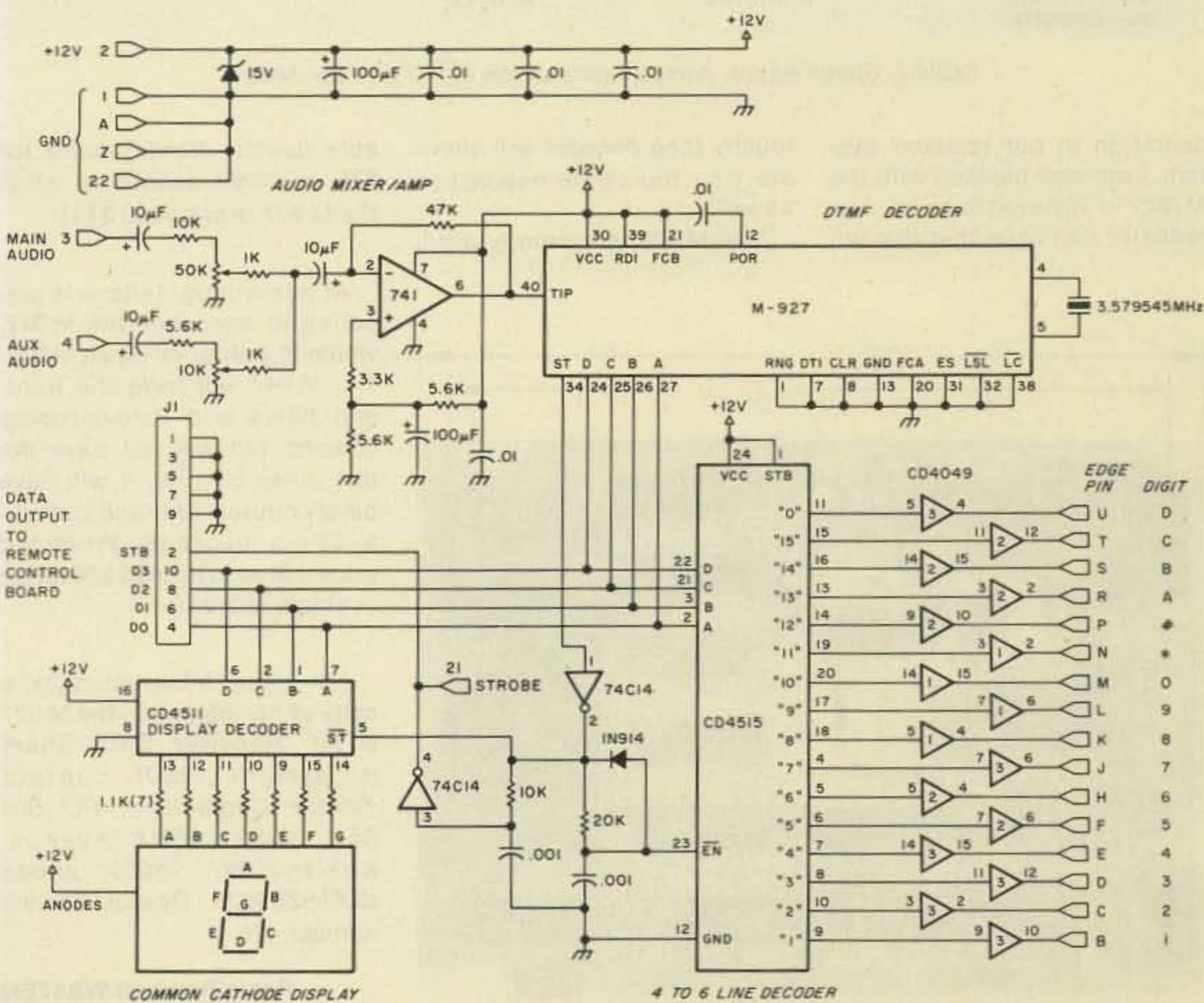

Fig. 3. The tone decoder board schematic.

| Specification | M-927 | M-937 | Comments |
|--|---|--|---|
| Input Impedance f<1 MHz | 500k minimum single ended 1 M minimum | 300k minimum single ended 600k minimum | The Mitel chip set cannot be connected differentially without external parts. |
| Common mode noise tolerance | 60 Vrms minimum f<100 Hz | 60 Vrms minimum f<120 Hz | |
| Input sensitivity ("A" Level) | -30 dBm | -20 to -46 dBm (adjustable) | Measured as high as -28 dBm with a 5-V supply |
| Maximum input level | +6 dBm minimum | A +45 dBm minimum (+10 dBm maximum) | |
| Signal level reject | -40 dBm | A-8 dBm | |
| Signal bandwidth accept | ±(1.5% + 2 Hz) minimum | ±(1.5% + 2 Hz) minimum | Chip set will not detect 100% at band edges and 40 ms ON and OFF, only about 95%. |
| Signal bandwidth reject | ±3.5% maximum | ±3.5% maximum | |
| Twist tolerance (H/IL) | ±8 dB minimum | ±10 dB minimum nominal frequency | Must be at nominal frequencies. |
| Signal recognition time | 25 ms minimum 40 ms maximum | 25 ms minimum 40 ms maximum | Nominal frequencies |
| Pause recognition time | 20 ms minimum 40 ms maximum | 20 ms minimum 40 ms maximum | |
| Signal-to-noise ratio (300-3400 Hz band limited) | 25 dB maximum | 15 dB maximum | 45 ms ON, 45 ms OFF. |
| Speech immunity Mitel CM7291 | 3 hits typical | 1 hit typical | |

Table 2. Specification comparisons of the M-927 and the M-937.

operation in our repeater system. I am well pleased with the M-927's operation in our repeater and hope that this un-

touchy tone decoder will alleviate your touchtone headaches as well.

The M-927 is currently avail-

able directly from Teltone for \$75 in single quantities, while the M-937 is priced at \$131.

At this writing, Teltone is preparing to announce the M-947, which is a stripped down M-927. The M-947 will have the front-end filters and tone-decoding circuits, but will not have the dial pulse circuits. It will have binary outputs only and come in a 22-pin package. Projected price will be in the \$25-\$30 range in single quantities.

For more information or a copy of my reference, the M-927 DTMF Receiver Data Sheet (Copyright 1980), contact Teltone Corporation, PO Box 657, 10801-120th Avenue, Kirkland WA 98033; phone (206)-827-9626. Reader Service number 476.

Robin Rumbolt WA4TEM
1134 Glade Hill Road
Knoxville TN 37919

CHARGE IT! —REPORT ON MODELS FROM DEBCO AND INDIANA QUICK CHARGE

Find something that people want and fill the demand. That is how fortunes are made. The demand for a better way to charge nicad batteries came about shortly after synthesized handie-talkies arrived on the amateur market. Frustrated by the slow charging rate of the simple plug-in adaptors and horrified by the lack of availability and high prices for the official accessory chargers, hams learned to roll their own and before long several enterprising fellows started selling them. I don't know if they have made a fortune yet, but firms like Debc Electronics and Indiana Quick Charge are out to meet the demand.

Testing chargers can be a bit frightening since you are trusting your expensive radio to a power supply designed by someone other than the manufacturer. Most of the synthesized rigs are designed to operate in a tight voltage range. Kenwood's TR-2400, for instance, can be damaged if the input level exceeds 10 volts. Both of the chargers reviewed contained some sort of voltage regulation, but the similarities end there.

Debc's model, the Deb-Ted Rapid Mobile Charger, is designed to act as a go-between between the car cigarette lighter and the rig's battery charger socket. A small plastic box holds a circuit board that features a 723 regulator chip plus one other IC and four transistors. The result is a constant voltage charger that will bring your batteries up to full capacity in about five hours. As the batteries reach capacity, the current level falls off, preventing the harm that may result from overcharging.

Like the Debc unit, Indiana Quick Charge's QC-500 features talk-while-you-charge operation. The QC-500 circuitry is centered around a garden variety LM340 voltage regulator. The design includes two fuses and a hefty filter capacitor. Unlike the Deb-Ted, which is a plug-it-in-and-forget-it device, the Indiana Quick Charge unit gives the operator a switch to select between on and off, and there are three LEDs that indicate the presence of input voltage, a

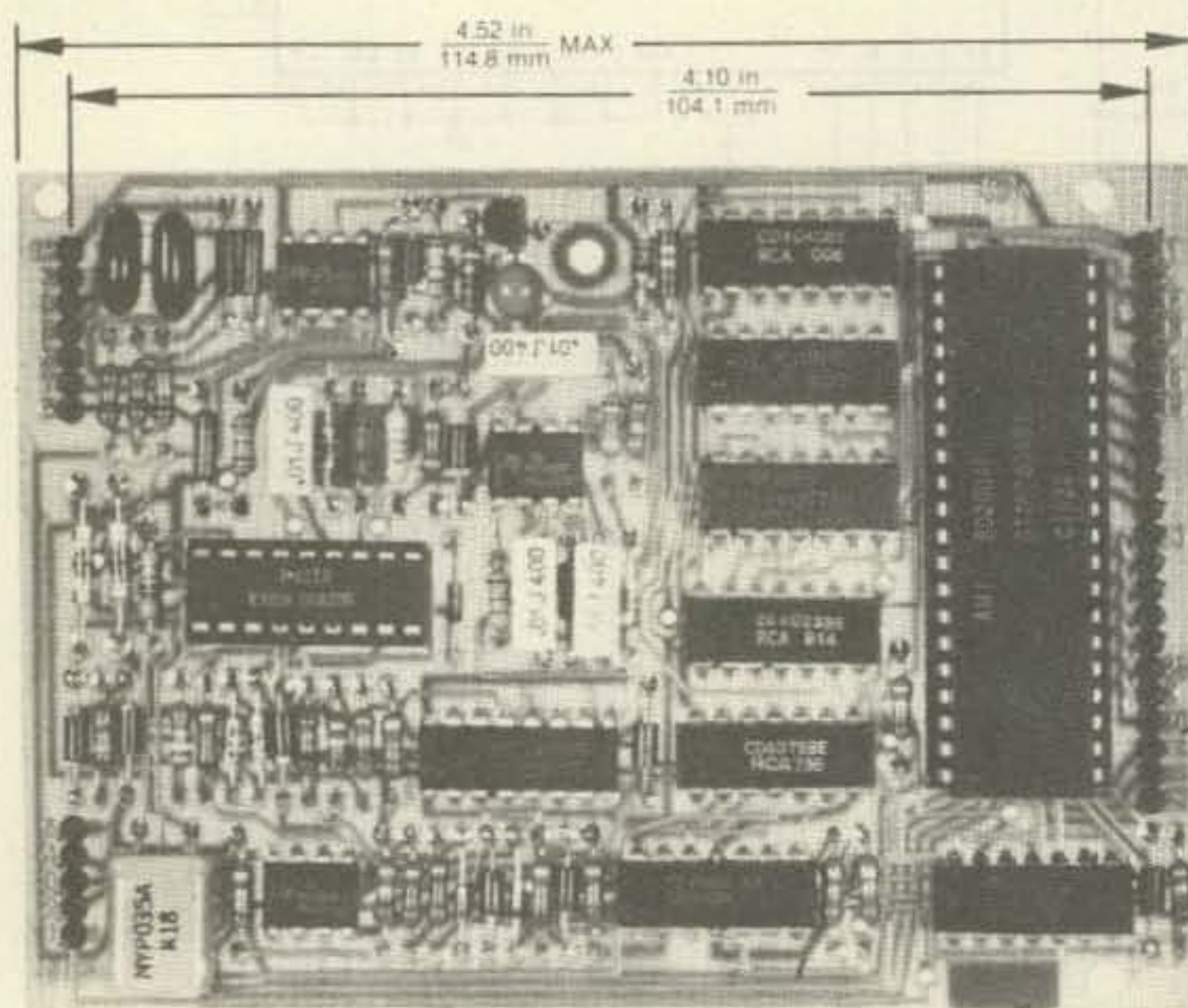
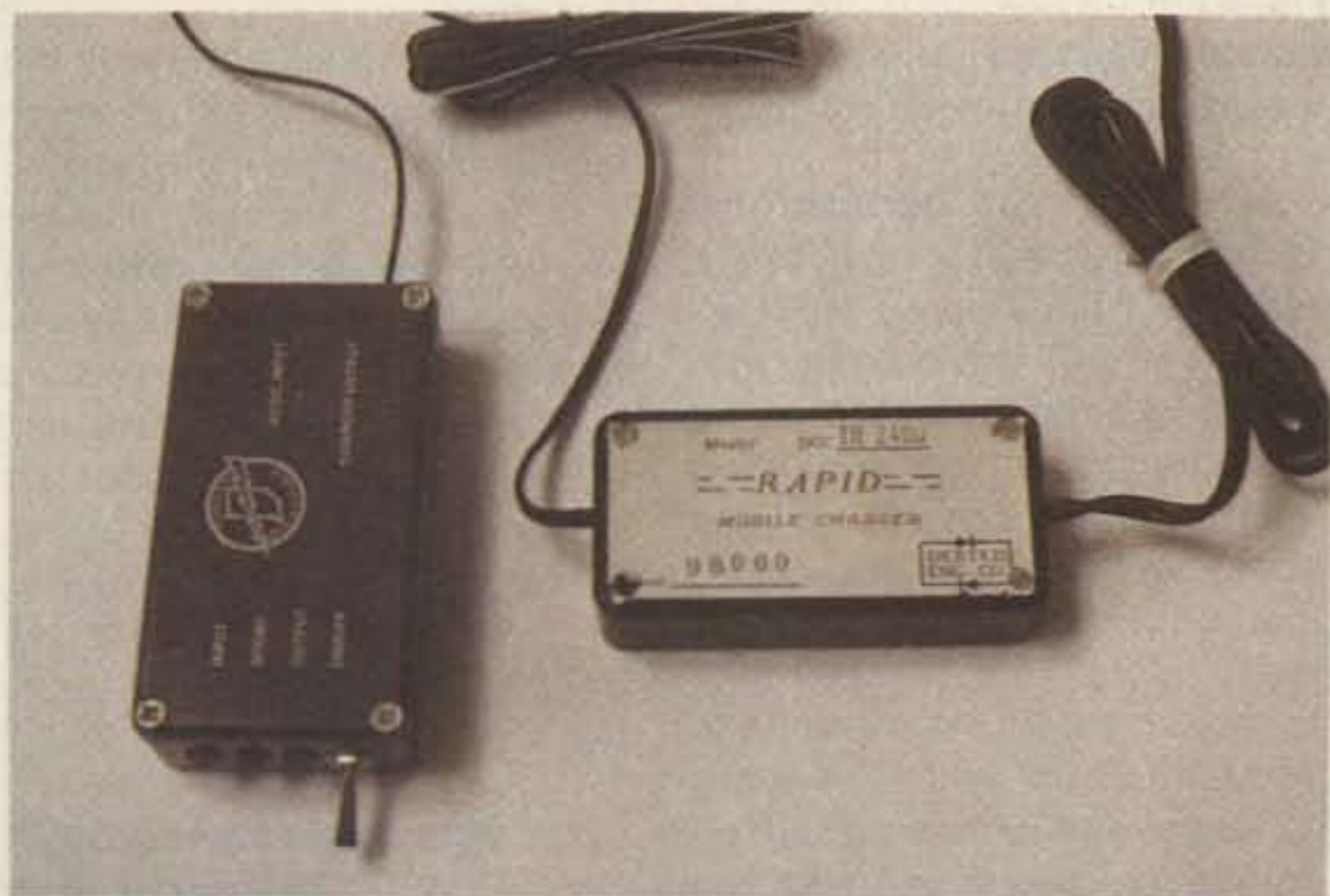

Photo B. The M-937 touchtone decoder.



The Debco Deb-Ted Rapid Mobile Charger and the Indiana Quick Charge QC-500 charger.

short circuit on the output, and the normal output condition. A die-cast aluminum case complements the QC-500's clean, professional layout.

The QC-500 has proven to be a flexible accessory; it can be powered by either a 12-volt lighter or via a wall adaptor transformer. Debco has chosen to offer separate models, one for 12-volt use, the other for 110 V ac. Each company's charger will bring a discharged battery back to life in far less time than the conventional overnight chargers. However, many of the HTs in use today contain batteries that were not specifically intended for these faster energy transfer rates. Luckily, nicads tend to be forgiving and there were no obvious side effects resulting from the use of "quick" or "rapid" chargers.

One problem that plagues an owner of either charger is nonconventional wiring of an automobile's cigarette lighter socket. If you own a late model car and your charger doesn't seem to work, check the polarity of the socket. Normally, the tip is positive and the outer contact goes to ground. Both the Debco and Indiana Quick Charge units have diode protection in case the voltage is reversed. Correcting the problem involves reversing the leads at the socket or inside the charger case since the plugs cannot be disassembled.

Although our tests used a TR-2400, Debco and Indiana Quick Charge chargers are available for most of the other popular synthesized rigs. You can adjust the internal potentiometer if you need a different voltage rating. Don't fall into the

trap of trying to use a line straight from 12 volts to your radio. You'll probably end up with a fried radio and an expensive repair bill.

Both chargers have a lot to offer. I liked the QC-500's classy appearance and flexibility, but I was also impressed by the Deb-Ted's sophisticated circuitry. Perhaps the two firms could get together and produce a super charger.

For more information, contact the manufacturers: *Debco Electronics, PO Box 9169 Dept. C, Cincinnati OH 45209*, Reader Service number 479; *Indiana Quick Charge, 367 West Main St., Danville IN 46122*, Reader Service number 480.

Tim Daniel N8RK
73 Magazine Staff

THE MICROWAVE MODULES MORSE TALKER —AN INFINITELY PATIENT TEACHER

Ah, the great stumbling block: learning the Morse code. Everyone looks for the easy way out, and manufacturers have been quick to provide all sorts of tapes, records, books, and flash cards to help out the would-be ham. With all these devices aimed at teaching the language of dah-di-dah, it takes quite an unusual approach to merit a second glance.

The Morse Talker, manufactured by Microwave Modules and imported by Spectrum International, is unusual enough to be worth not only a second, but even a third glance from both teachers and learners of the code.

The Talker is a small black box with an imposing number of switches and LEDs on its front panel. It generates Morse characters in random order. That's not so unusual, you say. Lots of modern keyers will send random Morse. Ah, but how many of them actually *talk* to you?

The secret of the Morse Talker is a voice synthesizer that tells you, after one, five, or fifty characters have been sent, what those characters were. It's quite impressive to hear this small device send fifty letters and numbers and then, in a voice right out of Star Wars, read them back to you.

You get instant feedback and, more importantly, in the single-letter mode the Morse Talker helps you associate a Morse rhythm with the letter it represents without the need of any visual crutch that will have to be discarded later. The learning process depends totally upon sound, and in theory this should make learning the code an easier task and make speed increases less painful.

Speeds from 2 to 20 words per minute can be selected. At the lower speeds, the code is sent at 12 wpm and spaced out enough to achieve the desired speed. An optional IC can be plugged in to set a speed range of 12 to 48 wpm. The Morse Talker can be programmed to send the entire alphabet and figures, or segments of the alphabet, with each segment adding new letters to the previous one.

The Morse Talker is enclosed in a die-cast box and all components are mounted on two double-sided glass-epoxy circuit boards, one of which contains a microprocessor that generates the code and tells the synthesizer what to say. The code generator program is contained in a 2716 EPROM. The second board contains a Digitalker voice synthesizer with its own microprocessor and memory.

The unit contains a small built-in speaker which provides adequate volume for a small room, or an external speaker or

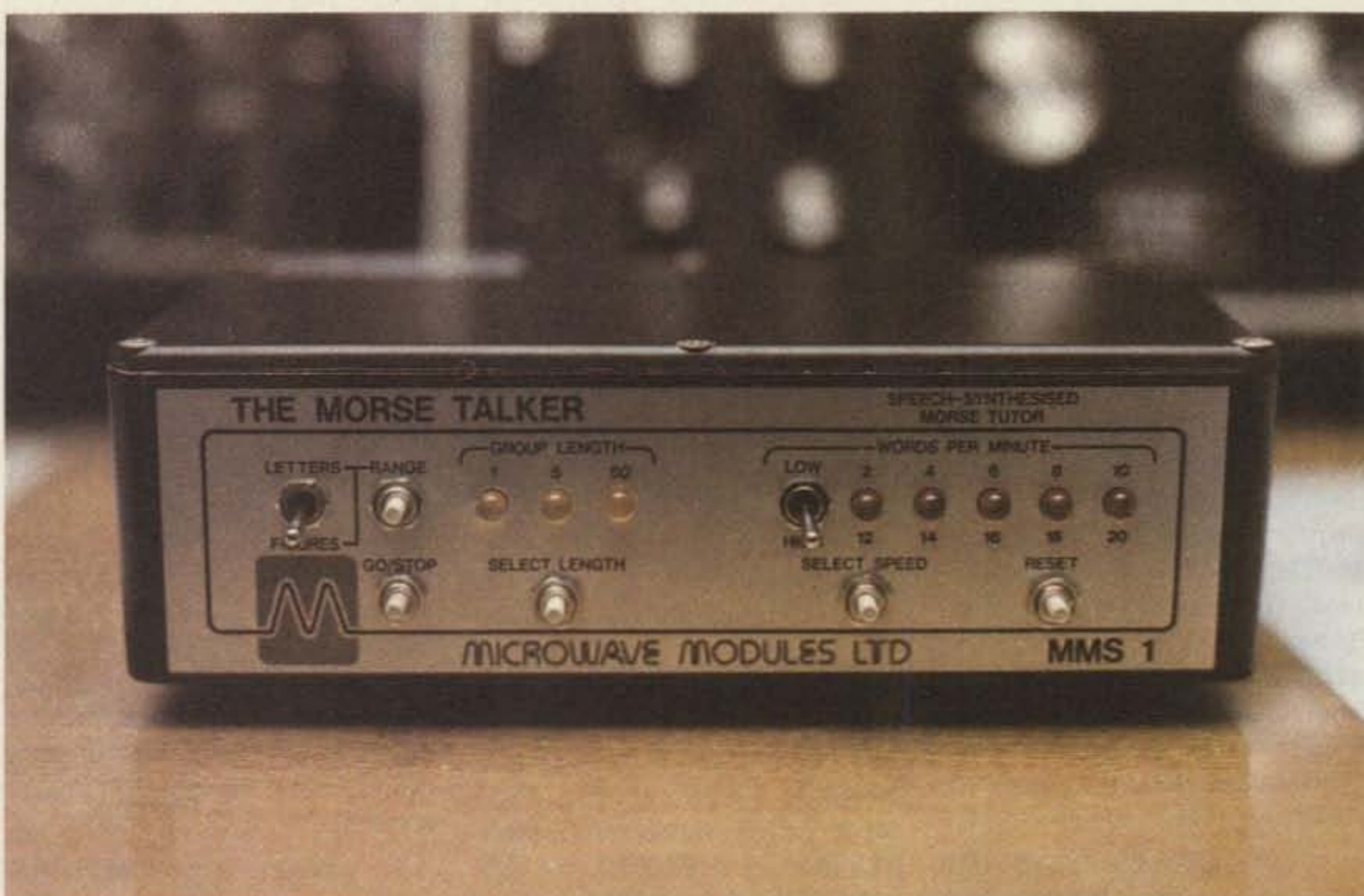

The Microwave Modules Morse Talker.

amplifier can be plugged into a jack on the rear panel. There is also provision for operation as a code practice oscillator by connecting a straight key. A 12-V power supply is required for operation. One failure of the design is the lack of a power on/off switch or accessible volume control (the volume is only adjustable internally).

The only real disadvantage of the Morse Talker is its expense—not too many prospective Novices are going to be able

to rush out and buy one, although the price should be in reach of most clubs sponsoring license courses. Aside from its price, the Morse Talker offers several advantages that make it a very useful training aid.

First, the biggest problem with tapes and records—memorization—is eliminated by the random generation of characters. Second, many users will find using the individual letter mode a very effective way to learn the code. Third, a "test" of 5 or 50 characters sent before

reading back the answers provides a useful measuring stick.

We haven't had the opportunity to give the Morse Talker a real, total-beginner-to-licensed-ham test, but one student who had a chance to use it along with her other code-learning aids (including one each of just about every tape and record made) found it to be the single most useful part of her repertoire. She set up the machine to send individual letters at about 12 wpm and concentrated on connecting the sound with the

letter. A half hour a day with the Morse Talker resulted in learning the characters quite rapidly.

In the end, though, whether you use the Morse Talker or a key and buzzer is not as important as whether or not you are willing to spend some time and effort on learning the code.

For further information, contact *Spectrum International, Inc.*, Box 1084S, Concord MA 01742. Reader Service number 478.

John Ackermann AG9V/1
73 Magazine Staff

FCC

USE OF ADDITIONAL DIGITAL CODES BY AMATEURS PROPOSED (Docket No. 20777 and PR Docket No. 81-699)

In response to a rulemaking petition by the American Radio Relay League (ARRL), the Commission is proposing to amend Part 97 of its rules to permit the use of new and experimental digital processes by amateur radio operators.

Currently, the only digital codes authorized for amateur use are ASCII (American Standard Code for Information Interchange) and the Baudot code. Such limitations may be discouraging the kind of innovation

in the Amateur Radio Service the Commission has explicitly sought to encourage. For example, in 1976 the FCC began a rulemaking in Docket 20777 to deregulate amateur radio by eliminating emission-type restrictions. Because of comments filed in that proceeding, the Commission decided not to relax emission requirements but did authorize amateurs to use the ASCII code.

Because Docket 20777 is dated, the Commission is terminating that proceeding and associating the ARRL's request with a new digital coding proceeding.

The FCC proposes authoriz-

ing the use of any digital code in the transmission of amateur radio communications on frequencies above 50 MHz for domestic communications only. The frequency limitation is intended to protect operations in other countries from possible interference from the transmission of nonstandard codes.

Stations would still be required to identify themselves using conventional voice or telegraphy and would be required to maintain a record of the codes used and provide that record to the Commission on request. At any time, the Commission could restrict or prohibit the use of codes other than ASCII or Baudot by certain stations. These provisions are intended for monitoring and enforcement purposes.

The Commission further proposes to authorize an additional

emission mode for ASCII in certain bands, increase ASCII sending speeds in certain bands, and clarify requirements by replacing the term "baud" with "bits per second."

In a related matter, the Commission denied a rulemaking petition requesting amendment of Part 97 by replacing the table of authorized emission types with a table of authorized bandwidths. This petition is being dismissed because it is inconsistent with the Commission's findings in Docket 20777.

Action by the Commission October 1, 1981, by Fourth Report and Order and Notice of Proposed Rulemaking (FCC 81-458 and 81-459). Commissioners Fowler (Chairman), Quello, Washburn, Fogarty, Jones, Dawson, and Rivera.

For more information contact Steve Lett at (202)-632-7597.

HAM HELP

I would appreciate hearing from anyone who has made any type of modifications to a HAL DS-2000/ST-5000 RTTY system. Mods of special interest are additions of computer-type line printers such as an Epson MX80-FT or the like. I am currently using an old Kleinschmidt 60-wpm machine, but that is no good for the other baud rates and ASCII. I do have a TRS-80 Model III, but would rather use the dedicated HAL system for RTTY. Anybody have any ideas?

Stan Gantz WB5TGL
PO Box 2820
Silver City NM 88062

Help! I need service manuals for the following obsolete FM equipment:

- G.E. "Pre-Prog" mobile, Model 4ES12A3;
- Ac "Spark Plug," Model CVT-1 (WE-15996), a.k.a. Delco Acheiverfone;
- Utica Communications Model "Uticom";
- G.E. "Prog-Line" base station, no model number, housed in a cabinet about the size of a 2-drawer filing cabinet, 25-30 MHz, Tx P.S. numbers 4EP4A1, 4EP4A2; Tx #4ET23A1; Rx P.S. #4EP3A1; RX #4ER24A1.

I also need (dead or alive) a

Motorola # NPN 6013A ac supply, or a # NPN 6011 6-/12-V/ nicad supply. These were used with the old hybrid P-31/33 series of handie-talkies.

Barry Fuerst
218 Flourney St.
Oak Park IL 60304

I am the owner of a Yaesu FT-207-R 2-meter HT. The frequency coverage is from 144 to 148 MHz. I would like to extend this range to cover MARS. I have seen articles on the IC-2A which changed its coverage from 144-148 to 140-149.9955.

This is the type of modification I would like to make to my 207-R. Any information on this mod would be greatly appreciated.

Willard Brown WB3GNN
350 Orchard St.
Old Forge PA 18518

I am looking for other ham radio operators who are owners of Atari computers for the purpose of starting a National Atari Net. This net would meet once a week on a given frequency and would enable us to exchange information and ideas concerning Atari computers.

Sheldon Leemon N8SL
14400 Elm Street
Oak Park MI 48237

I need service information on a WWII piece of equipment made under contract for the US Government. It is an RBM-5, type CAY 46077-A high-frequency receiver made by Westinghouse on contract NX57-38081 in 1942/43. I wrote Westinghouse, but they can't help.

F. Krantz
100 Osage Avenue
Somerdale NJ 08083

RADIO BOOKSHOP

FOR THE NOVICE

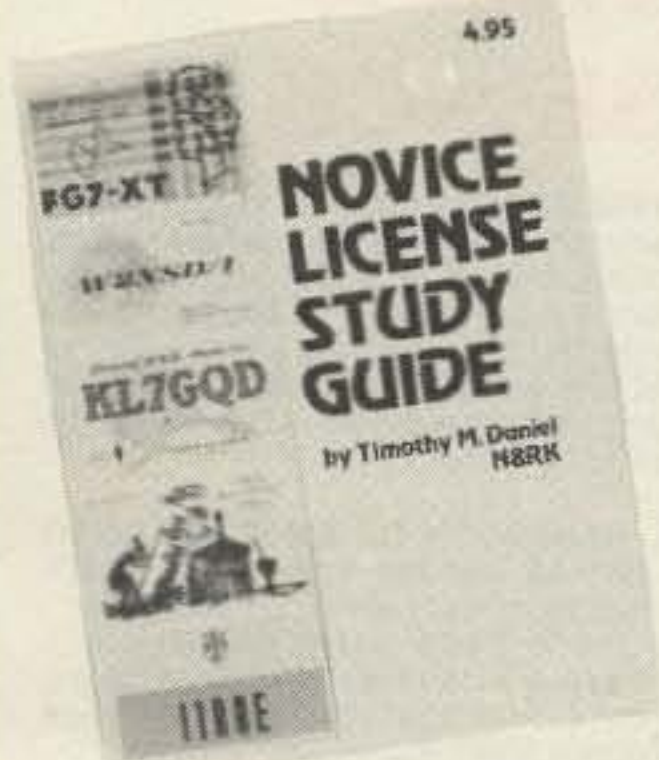

NEW, UPDATED EDITIONS OF OUR FAMOUS NOVICE LICENSE STUDY GUIDE AND NOVICE STUDY TAPES

● **NOVICE STUDY GUIDE**—SG7357—by Timothy M. Daniel N8RK. Here is the most up to date novice guide available. It is complete with information about learning Morse Code, has the latest FCC amateur regulations and the current FCC application forms. This guide is *not* a question/answer memorization course but rather it emphasizes the practical side of getting a ham license and putting a station on the air. It reflects what the FCC expects a Novice to know without page after page of dull theory. The most current information still available at last year's price. \$4.95

● **NOVICE STUDY TAPES**—CT7300—If you are just getting started in ham radio, you'll find these tapes indispensable! This up-to-the-minute revision of the 73 Study Course is the perfect way to learn everything you need to breeze through the Novice written exam. Theory, FCC regulations, and operating skills are all covered, and you'll be amazed at how fast you learn using these tapes!

Once the test is behind you, these tapes will go right on being useful, because they are packed with the latest information on setting up your own ham station, and getting on the air.

Thousands of people have discovered how easy learning from cassette can be—order now and enter the fascinating world of ham radio!—Set of 3—\$15.95.*

Scientists have proven that you learn faster by listening than by reading because you can play a cassette tape over and over in your spare time—even while you're driving! You get more and more info each time you hear it. You can't progress without solid fundamentals. These three hour-long tapes give you all the basics you'll need to pass the Novice exam easily. You'll have an understanding of the basics which will be invaluable to you for the rest of your life! Can you afford to take your Novice exam without first listening to these tapes?

SPECIAL OFFER! Both Novice License Study Guide and Novice Study Tapes \$19.95. Order NP7300.

73 CODE TAPES ANY FOUR TAPES FOR \$15.95! \$4.95 EACH

"GENESIS"

5 WPM—CT7305—This is the beginning tape for people who do not know the code at all. It takes them through the 26 letters, 10 numbers and necessary punctuation, complete with practice every step of the way using the newest blitz teaching techniques. It is almost miraculous! In one hour many people—including kids of ten—are able to master the code. The ease of learning gives confidence to beginners who might otherwise drop out.

"THE STICKLER"

6+ WPM—CT7306—This is the practice tape for the Novice and Technician licenses. It is made up of one solid hour of code, sent at the official FCC standard (no other tape we've heard uses these standards, so many people flunk the code when they are suddenly—under pressure—faced with characters sent at 13 wpm and spaced for 5 wpm). This tape is not memorizable, unlike the zany 5 wpm tape, since the code groups are entirely random characters sent in groups of five.

"BACK BREAKER"

13+ WPM—CT7313—Code groups again, at a brisk 14 per so you will be at ease when you sit down in front of the steely-eyed government inspector and he starts sending you plain language at only 13 per. You need this extra margin to overcome the panic which is universal in the test situations. When you've spent your money and time to take the test, you'll thank heaven you had this back-breaking tape.

"COURAGEOUS"

20+ WPM—CT7320—Code is what gets you when you go for the Extra class license. It is so embarrassing to panic out just because you didn't prepare yourself with this tape. Though this is only one word faster, the code groups are so difficult that you'll almost fall asleep copying the FCC stuff by comparison. Users report that they can't believe how easy 20 per really is with this fantastic one hour tape.

"OUTRAGEOUS"

25+ WPM—CT7325—This is the tape for that small group of overachieving hams who wouldn't be content to simply satisfy the code requirements of the Extra Class license. It's the toughest tape we've got and we keep a permanent file of hams who have mastered it. Let us know when you're up to speed and we'll inscribe your name in 73's CW "Hall of Fame."

— General: License Study Guide —

GENERAL LICENSE STUDY GUIDE—A complete theory course for the prospective General or Technician. This reference explains transistor, amplifier, and general radio theory, while preparing the Novice for the "big" ticket. After getting your ticket, you'll use this guide again and again as an electronics reference source. Not a question/answer guide that becomes dated when the FCC updates the amateur exams. SG7358 \$6.95.

● **ADVANCED CLASS LICENSE STUDY GUIDE**—SG1081—Ready to upgrade your license? To prevent retaking the FCC theory exam, you need the 73 Advanced theory guide. SSB, antenna theory, transmitters, and electronics measuring techniques are covered in detail in this easy-to-follow study guide. Special modes and techniques, such as RTTY, are also treated. An engineering degree is *not* necessary to master the Advanced theory—try this book before visiting the examiner's office! \$6.95.* (Published by TAB Books previous to recent changes in FCC exam material.)

FOR YOUR HAMSHACK

● **QSL CARDS**—73 turns out a fantastic series of QSL cards at about half the cost of having them done elsewhere because they are run as a fill-in between printing books and other items in the 73 Print Shop. 250 Style W—QW0250—for \$8.95*; 500 Style W—QW0500—for \$13.95*; 250 Style X—QX0250—for \$8.95*; 500 Style X—QX0500; 250 Style Y—QY0250—for \$8.95*; 500 Style Y—QY0500—for \$13.95.* Allow 6-12 wks. for delivery.

● **LIBRARY SHELF BOXES**—These sturdy white, corrugated, dirt-resistant boxes each hold a full year of 73, *Kilobaud Microcomputing* or *80 Microcomputing*. With your order, request self-sticking labels for any of the following: 73, *Kilobaud Microcomputing*, *80 Microcomputing*, *CQ*, *QST*, *Ham Radio*, *Personal Computing*, *Radio Electronics*, *Interface Age*, and *Byte*. Order 1—BX1000—for \$2.00*; order 2-7—BX2002—for \$1.50 each*; order 8 or more—BX1002—for \$1.25 each*.

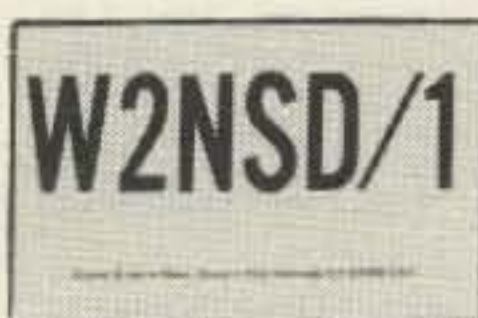

Style Y



Style W



Style X

● Preserve and protect your collection for a lifetime! Order these handsome red binders with gold lettering. \$7.50 for 1, 3 for \$21.75, 6 for \$42.00. (Postpaid within USA, please add \$2.50 per order outside USA.) *Check or money orders only, no phone or C.O.D. orders.* 73 Binders, P.O. Box 5120, Philadelphia, PA 19141.

*NOTE—Above address for Binders only.

—SSTV TAPE—

● **SLOW SCAN TELEVISION TAPE**—CT7350—Prize-winning programs from the 73 SSTV contest. Excellent for Demo! \$5.95.*

BACK ISSUES

● **BACK ISSUES**—Complete your collection; many are prime collectables now, classics in the field! A full collection is an invaluable compendium of radio and electronics knowledge!

ST0000—Single back issue before July 1980. \$3.00
ST0250—Single back issue July 1980 on. \$3.50
ST0500—5 your choice. \$8.75
Add \$1.00 per magazine for shipping.
ST1000—10 your choice. \$14.00
ST2500—25 our choice. \$12.00
ST2501—25 your choice. \$25.00
Add \$7.50 per order for shipping.

● **FREE BACK ISSUE CATALOGS** are yours for the asking. . . specify 73 Magazine, and/or *Kilobaud Microcomputing*, back issue catalog when you send your name and address to us on a postcard.

73 MAGAZINE BINDERS

*Use the order card in this magazine or itemize your order on a separate piece of paper and mail to: 73 Radio Bookshop • Peterborough NH 03458. Be sure to include check or detailed credit card information. No C.O.D. orders accepted. All orders add \$1.50 handling first book, \$1.00 each additional book, \$10.00 per book foreign airmail. Please allow 4-6 weeks for delivery. Questions regarding your order? Please write to Customer Service at the above address. (Prices subject to change on books not published by 73 Magazine.)

FOR TOLL FREE ORDERING CALL 1-800-258-5473

RADIO BOOKSHOP

THE 73 TECHNICAL LIBRARY



● **BEHIND THE DIAL**—BK7307—By Bob Grove. Get more fun out of shortwave listening with this interesting guide to receivers, antennas, frequencies and interference. \$4.95.*

● **THE CHALLENGE OF 160**—BK7309—is the newest book in the 73 technical library, dedicated to 160 meter operating. Si Dunn provides all necessary information to get started on this unique band. The all-important antenna and ground systems are described in detail. The introduction contains interesting photos of Stew Perry's (the King of 160) shack. This reference is a must for new and experienced "Top Band" operators. Price: \$4.95.*

● **SSB... THE MISUNDERSTOOD MODE**—BK7351—by James B. Wilson. Single Sideband Transmission... thousands of us use it every day, yet it remains one of the least understood facets of amateur radio. J. B. Wilson presents several methods of sideband generation, amply illustrated with charts and schematics, which will enable the ambitious reader to construct his own sideband generator. A must for the technically-serious hams. \$5.50.*

● **PROPAGATION WIZARD'S HANDBOOK**—BK7302—by J. H. Nelson. When sunspots riddled the worldwide communications networks of the 1940's, John Henry Nelson looked to the planets for an answer. The result was a theory of propagation forecasting based upon interplanetary alignment that made the author the most reliable forecaster in America today. The book provides an enlightened look at communications past, present, and future, as well as teaching the art of propagation forecasting. \$6.95.*

● **TOOLS & TECHNIQUES FOR ELECTRONICS**—BK7348—by A. A. Wicks is an easy-to-understand book written for the beginning kit builder as well as the experienced hobbyist. It has numerous pictures and descriptions of the safe and correct ways to use basic and specialized tools for electronic projects as well as specialized metal working tools and the chemical aids which are used in repair shops. \$4.95.*

FOR THE CONTESTER

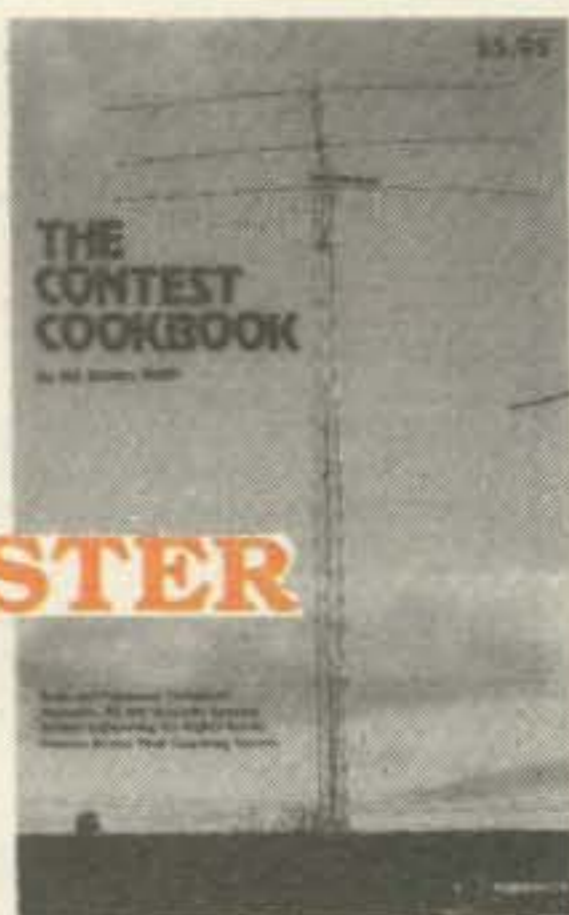

● **THE CONTEST COOKBOOK**—BK7308—reveals the secrets of the contest winners (Domestic, DX and specialty contests), complete with photos and diagrams of equipment used by the top scorers. Find out how to make 150 contacts in one hour. \$5.95.*

NEW!

● **WORLD PRESS SERVICE FREQUENCIES**—BK1202—by Thomas Harrington. Can't wait to hear the evening news, or are you wondering about the news that you aren't hearing? Receive by Radio Teletype (RTTY) all the world news and financial happenings from the world capitals on a 24 hour a day basis. This book gives you the frequencies and times of broadcast of such news services as AP, UPI, Reuters, TASS, VOA and London Press. Also included is an introduction to RTTY with information on equipment, antennas, abbreviations—everything you need to get started in RTTY. \$5.95*

● **THE NEW WEATHER SATELLITE HANDBOOK**—BK7383—by Dr. Ralph E. Taggart WB8DQT. Here is the completely updated and revised edition containing all the information on the most sophisticated and effective spacecraft now in orbit. This book serves both the experienced amateur satellite enthusiast and the newcomer. It is an introduction to satellite watching, providing all the information required to construct a complete and highly effective ground station. Solid hardware designs and all the instructions necessary to operate the equipment are included. For experimenters who are operating stations, the book details all procedures necessary to modify equipment for the new series of spacecraft. Amateur weather satellite activity represents a unique blend of interests encompassing electronics, meteorology and astronautics. Join the privileged few in watching the spectacle of earth as seen from space on your own monitoring equipment. \$8.95.*

● **INTERFERENCE HANDBOOK**—by William R. Nelson, WA6EQG—This timely handbook covers every type of RFI problem and gives you the solutions based on practical experience. Covers interference to TV, radio, hi-fi, telephone, radio amateur, commercial and CB equipment. Power line interference is covered in depth—how to locate it, cure it, work with the public, safety precautions, how to train RFI investigators. Written by an RFI expert with 33 years of experience, this profusely illustrated book is packed with practical easy-to-understand information. BK1230 \$8.95

● **RF AND DIGITAL TEST EQUIPMENT YOU CAN BUILD**—BK1044—Rf burst, function, square wave generators, variable length pulse generators—100 kHz marker, i-f and rf sweep generators, audio osc, af/rf signal injector, 146 MHz synthesizer, digital readouts for counters, several counters, prescaler, microwave meter, etc. 252 pages. \$5.95.*

● **IC OP-AMP COOKBOOK**—BK1028—by Walter G. Jung. Covers not only the basic theory of the IC op amp in great detail, but also includes over 250 practical circuit applications, liberally illustrated. 592 pages, 5½ x 8½, softbound. \$14.95.*

● **OWNER REPAIR OF RADIO EQUIPMENT**—BK7310—by Frank Glass K6RQ. Here's a book that will teach you an approach to troubleshooting without a shack full of test equipment. Written in a narrative, non-mathematical style, it will encourage you to successfully fix your own rig problems 80 to 90% of the time. Even if you don't want to fix, you can learn a lot about how things work and fail. Add to your library and personal expertise. \$7.95.*

HANDBOOKS FOR THE HAMSHACK

● **THE TEN METER FM HANDBOOK**—BK1190—by Bob Hell K9EID. This handbook has been published to help the ten meter enthusiast learn more about the many methods of conversions and tricks that are used to make existing units work better. Join the great "tinkerers" of the world on ten FM and enjoy the fantastic amount of fun in communicating with amateur stations worldwide on ten meter FM. \$4.95.*

● **THE PRACTICAL HANDBOOK OF AMATEUR RADIO FM REPEATERS**—BK1185—by Bill Pasternak WA6ITF (author of 73 Magazine's monthly column "Looking West") This is the book for the VHF/UHF FMer, compiled from material submitted by over a hundred individuals, clubs, organizations and equipment manufacturers. A "must have" for your ham shack shelf. \$12.95.

—The 73— Test Equipment Library



● **VOL. I COMPONENT TESTERS**—LB7359—... how to build transistor testers (8), diode testers (3), IC testers (3), voltmeters and VTVMs (9), ohmmeters (8 different kinds), inductance (3), capacity (9), Q measurement, crystal checking (6), temperature (2), aural meters for the blind (3) and all sorts of miscellaneous data on meters... using them, making them more versatile, making standards. Invaluable book. \$4.95.*

● **VOL. II AUDIO FREQUENCY TESTERS**—LB7360—... jam packed with all kinds of audio frequency test equipment. If you're into SSB, RTTY, SSTV, etc., this book is a must for you... a good book for hi-fi addicts and experimenters, too! \$4.95.*

● **VOL. III RADIO FREQUENCY TESTERS**—LB7361—Radio frequency waves, the common denominator of Amateur Radio. Such items as SWR, antenna impedance, line impedance, rf output and field strength; detailed instructions on testing these items includes sections on signal generators, crystal calibrators, grid dip oscillators, noise generators, dummy loads and much more. \$4.95.*

● **VOL. IV IC TEST EQUIPMENT**—LB7362—Become a troubleshooting wizard! In this fourth volume of the 73 TEST EQUIPMENT LIBRARY are 42 home construction projects for building test equipment to work with your ham station and in servicing digital equipment. Plus a cumulative index for all four volumes for the 73 TEST EQUIPMENT LIBRARY. \$4.95.*

*Use the order card in this magazine or itemize your order on a separate piece of paper and mail to: 73 Radio Bookshop • Peterborough NH 03458. Be sure to include check or detailed credit card information. No C.O.D. orders accepted. All orders add \$1.50 handling first book, \$1.00 each additional book, \$10.00 per book foreign airmail. Please allow 4-6 weeks for delivery. Questions regarding your order? Please write to Customer Service at the above address. (Prices subject to change on books not published by 73 Magazine.)

FOR TOLL FREE ORDERING CALL 1-800-258-5473

RADIO BOOKSHOP

ANTENNA BOOKS

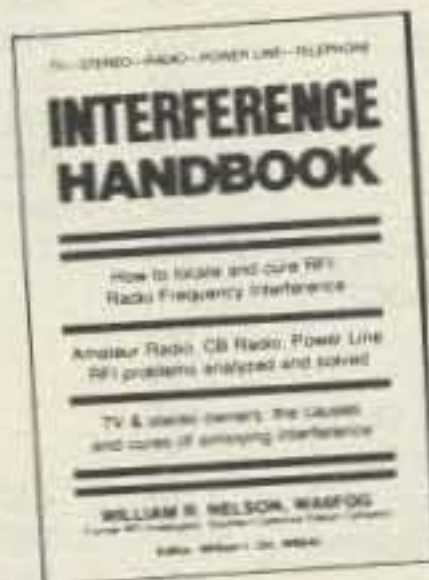

● **VHF ANTENNA HANDBOOK**—BK7368—The NEW VHF Antenna Handbook details the theory, design and construction of hundreds of different VHF and UHF antennas... A practical book written for the average amateur who takes joy in building, not full of complex formulas for the design engineer. Packed with fabulous antenna projects you can build. \$5.95.*

● **PRACTICAL ANTENNAS FOR THE RADIO AMATEUR**—BK1015—A manual describing how to equip a ham station with a suitable antenna. A wide range of antenna topics, systems, and accessories are presented giving the reader some food for thought and practical data for construction. Designed to aid the experienced ham and novice as well. Only \$9.95.*

● **73 DIPOLE AND LONG-WIRE ANTENNAS**—BK1016—by Edward M. Noll W3FQJ. This is the first collection of virtually every type of wire antenna used by amateurs. Includes dimensions, configurations, and detailed construction data for 73 different antenna types. Appendices describe the construction of noise bridges, line tuners, and data on measuring resonant frequency, velocity factor, and swr. \$5.50.*

● **ALL ABOUT CUBICAL QUAD ANTENNAS (2nd edition)**—BK1196—The "Classic" on Quad design, theory, construction, and operation. New 2nd edition contains new feed and matching systems and new data. \$5.95.*

● **BEAM ANTENNA HANDBOOK (New 5th edition)**—BK1197—Yagi beam theory, construction and operation. Information on wire beams, SWR curves and matching systems. A "must" for serious DXers. \$5.95*

● **VHF HANDBOOK FOR RADIO AMATEURS**—BK1198—Contains information on FM theory, operation and equipment, VHF antenna design and construction, satellite-EME, and the newest solid-state circuits. \$6.95*

● **THE RADIO AMATEUR ANTENNA HANDBOOK**—BK1199—All about wire antennas, beams, tuners, baluns, coax, radials, SWR and towers. Clear and complete information. \$6.95*

● **SIMPLE, LOW-COST WIRE ANTENNAS FOR RADIO AMATEURS**—BK1200—All new data and everything you want to know about low-cost, multi-band antennas, inexpensive beams, "invisible" antennas for hams in "tough" locations. \$6.95*

● **HOW TO DEFEND YOURSELF AGAINST RADAR**—BK1201—by Bruce F. Bogner and James R. Bodnar, a lawyer and radar expert. This book gives you the ammunition to challenge the radar "evidence" that usually leads to a speeding conviction. The major part of the book details the inner workings of radar—you'll become more of an expert than most police officers and judges. The remainder of the book outlines how to defend yourself against a speeding ticket—the observations, measures and testimony you must obtain to defend yourself without the help of a lawyer. The price is a lot less than a fine! \$6.95*

COOK BOOKS

● **TTL COOKBOOK**—BK1063—by Donald Lancaster. Explains what TTL is, how it works, and how to use it. Discusses practical applications, such as a digital counter and display system, events counter, electronic stopwatch, digital voltmeter and a digital tachometer. \$9.50.

● **CMOS COOKBOOK**—BK1011—by Don Lancaster. Details the application of CMOS, the low power logic family suitable for most applications presently dominated by TTL. Required reading for every serious digital experimenter! \$10.50.*

● **TVT COOKBOOK**—BK1064—by Don Lancaster. Describes the use of a standard television receiver as a microprocessor CRT terminal. Explains and describes character generation, cursor control and interface information in typical, easy-to-understand Lancaster style. \$9.95.*

SPECIAL OFFER

Chart of UNITED STATES AMATEUR RADIO PRIVILEGES

by class of license, emission type, and frequency from 160 thru 2 meters, including provision for the new 30, 17, and 12 meter bands. This 22 x 28 in. twelve-color chart is the first of its kind to be both informative and decorative. \$3.00 value, only \$1.95 with the purchase of 1 or more books from the Radio Bookshop. (Supplies limited, order now.) CH7300 \$1.95.

THE WELL EQUIPPED HAM SHACK

NEW COMPLETELY UPDATED



● **WORLD REPEATER ATLAS**—BK7315—Completely updated, over 230 pages of repeater listings are indexed by location and frequency. More than 50 maps pinpoint 2000 repeater locations throughout the USA. Foreign listings include Europe, the Middle East, South America, and Africa. \$4.95*

● **THE MAGIC OF HAM RADIO**—BK7312—by Jerrold Swank, W8HXR begins with a brief history of amateur radio and of Jerry's involvement in it. Part 2 details many of ham radio's heroic moments. Hamdom's close ties with the continent of Antarctica are the subject of Part 3. In Part 4 the strange and humorous sides of ham life get their due. And what of the future? Part 5 peers into the crystal ball. \$4.95.*

● **A GUIDE TO HAM RADIO**—BK7321—by Larry Kahaner WB2NEL. What's Amateur Radio all about? You can learn the basics of this fascinating hobby with this excellent beginner's guide. It answers the most frequently asked questions in an easy-going manner, and it shows the best way to go about getting an FCC license. A Guide to Ham Radio is an ideal introduction to a hobby enjoyed by people around the world. \$4.95.*

● **WORLD RADIO TV HANDBOOK 1981, 35TH EDITION**—BK1184—This book is the bible of international broadcasters, providing the only authoritative source of exact information about broadcasting and TV stations world wide. This 1981 edition is completely revised, giving comprehensive coverage of short, medium and long wave, 560 pages of vital aspects of world listening. \$16.50.

MICROCOMPUTER BOOKS FROM 73



● **SOME OF THE BEST FROM KILOBAUD/MICROCOMPUTING**—BK7311—A collection of the best articles that have recently appeared in Kilobaud/ MICROCOMPUTING. Included is material on the TRS-80 and PET systems, CP/M, the 8080/8085/Z80 chips, the ASR-33 terminal. Data base management, word processing, text editors and file structures are covered too. Programming techniques and hardware construction projects for modems, high speed cassette interfaces and TVTs are also included in this large format, 200 plus page edition. \$10.95.*

● **40 COMPUTER GAMES**—BK7381—Forty games in all in nine different categories. Games for large and small systems, and even a section on calculator games. Many versions of BASIC used and a wide variety of systems represented. A must for the serious computer gamesman. \$7.95*

● **THE NEW HOBBY COMPUTERS**—BK7340—This book takes it from where "HOBBY COMPUTERS ARE HERE!" leaves off, with chapters on Large Scale Integration, how to choose a microprocessor chip, an introduction to programming, low cost I/O for a computer, computer arithmetic, checking memory boards...and much, much more! Don't miss this tremendous value! Only \$4.95.*

● **UNDERSTANDING AND PROGRAMMING MICRO-COMPUTERS**—BK7382—A valuable addition to your computing library. This two-part text includes the best articles that have appeared in 73 and Kilobaud Microcomputing magazines on the hardware and software aspects of microcomputing. Well-known authors and well-structured text helps the reader get involved. \$10.95*

● **HOW TO BUILD A MICROCOMPUTER—AND REALLY UNDERSTAND IT**—BK7325—by Sam Creason. The electronics hobbyist who wants to build his own microcomputer system now has a practical "How-To" guidebook. This book is a combination technical manual and programming guide that takes the hobbyist step-by-step through the design, construction, testing and debugging of a complete microcomputer system. Must reading for anyone desiring a true understanding of small computer systems. \$9.95.*

● **HOBBY COMPUTERS ARE HERE!**—BK7322—If you want to come up to speed on how computers work... hardware and software... this is an excellent book. It starts with fundamentals and explains the circuits, and the basics of programming, along with a couple of TVT construction projects, ASCII-Baudot, etc. This book has the highest recommendations as a teaching aid. \$4.95.*

*Use the order card in this magazine or itemize your order on a separate piece of paper and mail to: 73 Radio Bookshop • Peterborough NH 03458. Be sure to include check or detailed credit card information. No C.O.D. orders accepted. All orders add \$1.50 handling first book, \$1.00 each additional book, \$10.00 per book foreign airmail. Please allow 4-6 weeks for delivery. Questions regarding your order? Please write to Customer Service at the above address. (Prices subject to change on books not published by 73 Magazine.)

FOR TOLL FREE ORDERING CALL 1-800-258-5473

List of AdvertisERS

*Please contact these advertisers directly.

To receive full information from our advertisers please complete the following postage-paid card.

| R.S. No. | Page | R.S. No. | Page | R.S. No. | Page | R.S. No. | Page |
|--|--|---|--|---|--------------------------------------|------------------------------------|------|
| 2 | AEA/Advanced Electronic Applications.....42, 102, 166 | * Digital Research Parts.....191 | 354 | Jensen Tools.....169 | 458 | Richcraft Engineering, Ltd.....171 | |
| 477 | AEA/Advanced Electronic Applications.....119 | 43 Don Nobles, Inc.....39 | * KB Microcomputing.....132 | 418 | Rolin Distributors.....28 | | |
| 3 | AED Electronics.....113 | 16 Downlink, Inc.....52 | 81 | KDK Distributing.....43 | 21 | Roux Wire Die, Inc.....168 | |
| 448 | Advanced Communications International.....165 | 425 Doppler Systems.....169 | * KLM Electronics.....44 | 376 | SMP.....81 | | |
| 406 | Alaska Microwave Labs.....53 | * R. L. Drake Company.....153 | * Kantronics.....106, 163 | 65 | S-F Amateur Radio Service.....167 | | |
| 20 | All Electronics.....168 | 453 E.G.E., Inc.....101 | * Kirk Electronics.....164 | 64 | Semiconductors Surplus...186, 187 | | |
| * Amateur Electronic Supply.....24, 65, 93, 101, 167 | * 80 Microcomputing.....132 | * Kenwood.....Cov IV, 7, 32-38, 152 | 4 | 73 Magazine | | | |
| 5 | Amateur-Wholesale Electronics.....29 | * Electronic Equipment Bank.....111 | Electronics.....117 | Books.....108, 127-129, 147 | | | |
| 331 | Amateur-Wholesale Electronics.....115 | 447 | Electronic Hobby Innovations.....63 | Dealers Ad.....162 | | | |
| 461 | Amateur-Wholesale Electronics.....28 | 82 | Electronic Recyclers of MA.....170 | "Moving".....147 | | | |
| 7 | American Crystal Supply.....170 | 400 | Engineering Consulting.....163 | Subscriptions.....131, 170 | | | |
| 356 | Anteck.....52 | * Erickson Communications.....165 | 487 | University Microfilms.....171 | | | |
| * Antenna Bank.....165 | 91 | ETCO Electronics.....103 | 457 | 433 Skytec.....169 | | | |
| * Associated Radio.....139 | * Everglades Communications.....63 | 53 | Live Via Satellite, Inc.....58 | 367 | Slep Electronics.....161 | | |
| 469 | BG Carl Electronics.....169 | 22 | Luly Telecommunications Corp.....44 | 309 | Spacecoast Research Corp.....58 | | |
| 11 | Barker & Williamson.....113 | 85 | MCM Communications.....23 | * Spectronics, Inc.....103, 192 | | | |
| 26 | Bash Educational Services.....160 | 439 | MCM Communications.....153 | 68 | Spectrum Communications.....86, 87 | | |
| 440 | Rex Bassett Electronics, Inc.....112 | 323 | MFJ Enterprises.....73, 75, 77, 79, 81, 83 | 436 | Spectrum International, Inc.....125 | | |
| 10 | Bilal Co.....112 | 37 | MFJ Enterprises.....153 | 478 | Spectrum International, Inc.....125 | | |
| 12 | Bullet Electronics.....188 | * Global Electronics.....63 | 484 | 465 Star Trak Systems, Inc.....58 | | | |
| * Butternut Electronics.....113 | 417 | Gotham Antenna.....79 | 48 | 32 Stellmaker Enterprises.....169 | | | |
| 321 | Certified International.....171 | 9 | HMRll.....171 | 485 | Stellmaker Enterprises.....152 | | |
| 89 | Clutterfree Modular Consoles.....100 | 86 | H & R Communications.....44 | 30 | Strux Corp.....170 | | |
| * Code Quick.....169 | 345 | Hal Communications.....10, 11, 64 | 56 | 69 | Surplus Electronics Corp.....169 | | |
| 41 | Collins Amateur Production/Rockwell International.....15 | 31 | Hal-Tronix.....161 | 316 | Telex Communications, Inc.....73, 75 | | |
| 59 | Commsoft.....79 | * Ham Radio Center/Yaesu.....160 | 49 | 476 | Teltone Corp.....121 | | |
| 28 | Communications Center, NE.....172 | * Ham Radio Outlet.....3 | 51 | * Ten-Tec, Inc.....25 | | | |
| 382 | Communication Concepts, Inc.....138 | 33 | Hamtronics, NY.....189 | 328 | Texas Microtronics.....53 | | |
| 377 | Communications Electronics.....173 | 460 | Handi-Tek.....171 | 449 | The Hamshack.....113 | | |
| 462 | Communications Electronic Specialties.....163 | 18 | Hastings Antenna.....52 | 76 | Trac Electronics.....77 | | |
| 443 | Communications Specialists.....59 | 72 | higain Electronics.....53 | 75 | Trans Com, Inc.....162 | | |
| 15 | Communications Specialists.....9 | 316 | Hy-Gain Div. of Telex Comm.....73, 75 | 88 | Tufts Electronics.....91, 102 | | |
| 444 | Computer Plus.....170 | 320 | Hoosier Electronics.....45 | * Universal Communications.....105, 139 | | | |
| * Conley Radio Supply/AEA.....109 | * Hustler, Inc.....65 | * ICOM.....Cov II | 412 | 422 | Valor.....164 | | |
| * Crown Micro Products.....111, 168 | * IRL.....16 | * Independent Crystal Supply Co.....170 | 327 | * Van Gorden Engineering.....4 | | | |
| 70 | Cubic Communications.....17 | 78 | Indiana Quick Charge.....124 | 311 | Vanguard Labs.....170 | | |
| 330 | Debco Electronics.....109 | 480 | Indiana Quick Charge.....124 | 90 | VoCom Products Co.....24 | | |
| 479 | Debco Electronics.....124 | 6 | Indy Amateur Supply.....171 | 302 | W-S Engineering.....83 | | |
| * Desktop Computing.....107 | 445 | Instant Software Dealers.....67 | 58 | * Wessex Publishing Co.....62 | | | |
| 483 | Desco.....154 | Amateur Radio Programs.....66 | 459 | * Wheaton Community Hamfest.....160 | | | |
| * DGM Electronics, Inc.....114 | 36 | International Crystal.....114 | 60 | 29 | Windward, Inc.....166 | | |
| | 27 | Iscan.....171 | 61 | 83 | Yaesu Electronics Co.....Cov III | | |
| | 409 | JDR Microdevices.....103 | 397 | 481 | Yaesu Electronics Co.....120 | | |
| | 25 | JJT Distributing.....169 | * Radios Unlimited/AEA.....106 | * ZacKIT/VALLEJO.....105 | | | |
| | 38 | Jameco Electronics.....193 | 62 | | | | |

73 MAGAZINE

Books, ETC.

To order, complete the following postage-paid card, or itemize your order including detailed credit card information or check and mail to:
73 Magazine/Mail Order Dept./Peterborough NH 03458.

| Catalog # | Item | Price | Catalog # | Item | Price | Catalog # | Item | Price |
|-----------|--|---------|-----------|---|-------------|-----------|---|---------|
| BK1016 | 73 DIPOLE & LONG WIRE ANTENNAS | \$ 5.50 | BK1028 | IC OP AMP COOKBOOK..... | \$12.95 | | FOR RADIO AMATEURS..... | \$ 6.95 |
| ST0000 | 73 BACK ISSUE..... | \$ 3.00 | BK1230 | INTERFERENCE HANDBOOK..... | \$ 8.95 | BK7311 | SOME OF THE BEST FROM KILOBAUD | \$10.95 |
| ST2500 | 73 BACK ISSUES—25 OUR CHOICE..... | \$12.00 | BK7312 | MAGIC OF HAM RADIO..... | \$ 4.95 | BK7311 | SOME OF THE BEST..... | \$ 7.95 |
| ST0500 | 73 BACK ISSUES—5 YOUR CHOICE..... | \$ 8.75 | BK1033 | MASTER HANDBOOK OF HAM RADIO CIRCUITS..... | \$ 8.95 | BK7351 | SSB THE MISUNDERSTOOD MODE..... | \$ 5.50 |
| ST1000 | 73 BACK ISSUES—10 YOUR CHOICE | | BK7340 | THE NEW HOBBY COMPUTERS..... | \$ 4.95 | CT7350 | SSTV TAPE..... | \$ 9.95 |
| | | \$14.00 | BK7383 | THE NEW WEATHER SATELLITE HANDBOOK..... | \$ 8.95 | SG1081 | STUDY GUIDE—ADV. CLASS..... | \$ 6.95 |
| ST2501 | 73 BACK ISSUES—25 YOUR CHOICE | | CT7300 | NOVICE THEORY TAPES..... | \$15.95 | SG1080 | STUDY GUIDE—EXTRA CLASS..... | \$ 5.95 |
| | | \$25.00 | BK7310 | OWNER REPAIR OF RADIO EQUIPMENT | | SG7357 | STUDY GUIDE—NOVICE CLASS..... | \$ 4.95 |
| BK1196 | ALL ABOUT CUBICAL QUAD ANTENNAS | \$ 5.95 | | | \$ 7.95 | BK1190 | THE TEN METER FM HANDBOOK..... | \$ 4.95 |
| BK1197 | BEAM ANTENNA HANDBOOK..... | \$ 5.95 | BK7305 | POWER SUPPLY HANDBOOK..... | \$ 9.95 | LB7359 | TEST EQUIP LIB V1—COMPONENT TESTERS..... | \$ 4.95 |
| BK7307 | BEHIND THE DIAL..... | \$ 4.95 | BK1015 | PRACTICAL ANTENNAS FOR THE RADIO AMATEUR..... | \$ 9.95 | LB7360 | TEST EQUIP LIB V2—AUDIO TESTERS | |
| BK7309 | CHALLENGE OF 160..... | \$ 4.95 | BK1185 | THE PRACTICAL HANDBOOK OF FM REPEATERS..... | \$ 9.95 | | | \$ 4.95 |
| BK1011 | CMOS COOKBOOK..... | \$10.50 | BK7302 | PROPAGATION WIZARD'S HANDBOOK | | LB7361 | TEST EQUIP LIB V3—RADIO EQUIP..... | \$ 4.95 |
| CT7305 | CODE TAPE—5 WPM..... | \$ 4.95 | | | \$ 6.95 | LB7362 | TEST EQUIP LIB V4—IC TEST EQ..... | \$ 4.95 |
| CT7306 | CODE TAPE—6 + WPM..... | \$ 4.95 | QW0250 | QSL CARDS—STYLE W—250..... | \$ 8.95 | BK7348 | TOOLS & TECHNIQUES..... | \$ 4.95 |
| CT7313 | CODE TAPE—13 + WPM..... | \$ 4.95 | QW0500 | QSL CARDS—STYLE W—500..... | \$13.95 | BK1063 | TTL COOKBOOK..... | \$ 9.50 |
| CT7320 | CODE TAPE—20 + WPM..... | \$ 4.95 | QX0250 | QSL CARDS—STYLE X—250..... | \$ 8.95 | BK1064 | TVT COOKBOOK..... | \$ 9.95 |
| CT7325 | CODE TAPE—25 + WPM..... | \$ 4.95 | QX0500 | QSL CARDS—STYLE X—500..... | \$13.95 | BK7382 | UNDERSTANDING & PROGRAMMING MICROCOMPUTERS..... | \$10.95 |
| CT7394 | CODE TAPES (ANY FOUR ABOVE)..... | \$15.95 | QY0250 | QSL CARDS—STYLE Y—250..... | \$ 8.95 | CH7300 | U.S. AMATEUR RADIO CHART..... | \$1.95 |
| BK7308 | THE CONTEST COOKBOOK..... | \$ 5.95 | QY0500 | QSL CARDS—STYLE Y—500..... | \$13.95 | BK1069 | VERTICAL BEAM & TRIANGLE ANTNS | |
| BK7381 | 40 COMPUTER GAMES..... | \$ 7.95 | BK1199 | THE RADIO AMATEUR ANTENNA HANDBOOK..... | \$ 6.95 | | | \$ 5.50 |
| SG7358 | GENERAL LICENSE STUDY GUIDE..... | \$ 6.95 | BK1044 | RF & DIGITAL TEST EQUIPMENT..... | \$ 5.95 | BK7368 | VHF ANTENNA HANDBOOK..... | \$ 5.95 |
| BK7304 | GIANT BOOK OF AMATEUR RADIO ANTENNAS..... | \$12.95 | BK1059 | RTL COOKBOOK..... | \$ 6.50 | BK1198 | VHF HANDBOOK FOR RADIO AMATEURS | |
| BK7321 | A GUIDE TO HAM RADIO..... | \$ 4.95 | BX1000 | SHELF BOX—1..... | \$ 2.00 | | | \$ 6.95 |
| BK7322 | HOBBY COMPUTERS ARE HERE..... | \$ 4.95 | BX1001 | SHELF BOXES—2-7..... | \$1.50 each | BK7370 | WEATHER SATELLITE HANDBOOK..... | \$ 2.50 |
| BK7325 | HOW TO BUILD A MICROCOMPUTER & REALLY UNDERSTAND IT..... | \$ 9.95 | BX1002 | SHELF BOXES—8 AND UP..... | \$1.25 each | BK1202 | WORLD PRESS SERVICE FREQUENCIES | |
| BK1201 | HOW TO DEFEND YOURSELF AGAINST RADAR..... | \$ 6.95 | BK1200 | SIMPLE, LOW COST WIRE ANTENNAS | | | | \$ 5.95 |

WHAT WILL YOUR NEW RIG BE LIKE?

Read 73 and Find Out

The magic of digital electronics is coming to ham gear . . . and you'll be able to read about these developments in 73. There probably will be more changes in ham equipment in the next few years than ever before in history. You'll see these changes coming in 73, where you'll read about the experiments and pioneering. 73 has more articles than any other ham magazine . . . often more than all the others combined.

When sideband got started, it was moved along by the many pioneering articles in 73. In the 60s it was solid state, with several times as many articles on the subject than in all the other magazines combined. When repeaters and FM got going about ten years ago there were over five times as many articles on the subject published in 73 as in all other ham magazines combined . . . and you can see what changes that brought to hamming. Now we're looking at exciting developments such as narrow band sideband for repeaters . . . which might give us six times as many repeaters in our present bands. We're looking at automatic identification systems which may make it possible for us to read out the call letters of any station tuned in . . . and even the development of self-tuning receivers.

Will stereo double sideband techniques make it possible to have up to 30 times as many stations within a given HF band as is now possible? Hams will be experimenting and reporting on these developments in 73. 73 is an encyclopedia of hamming . . . present and future . . . and just a bit of the past, too.

Without the endless fillers on station activities and club news, 73 is able to publish far more information . . . valuable information . . . on hamming and ham equipment.

You may or may not be a pioneer, but you certainly will want to keep up with what is happening and what the new rigs are going to be like. And, frankly, your support of 73 is needed to keep this type of information coming.

Yes, bill me for 1 year of 73 Magazine at \$25.00

321B6

Name _____

Address _____

City _____ State _____ Zip _____

Canadian \$27/1 year only, US funds. Foreign \$35/1 year only, US funds

Please allow 4 to 6 weeks for delivery

73 Magazine • PO Box 931 • Farmingdale, NY 11737



OSCAR ORBITS

Despite a troubled infancy, amateur radio's newest satellite, UoSAT-OSCAR 9, was alive and well as this issue of 73 went to the printer.

After a perfect launch on October 5, the first signal heard coming from the satellite was a strong carrier with only a small amount of garbled modulation instead of the expected 1200-baud ASCII telemetry. It was five days before the spacecraft was successfully directed into a 300-baud mode, giving the world a chance to obtain and digest information about the satellite's well-being.

Early data indicated that a problem existed with two of the three navigation magnetometers. Experts associated with this with the colder than expected spacecraft temperature. Before any experiments can be conducted, the satellite must be stabilized, an operation that is dependent on knowing the bird's attitude and spin. Without the proper "nav mag" data, a new operational plan must be formulated. It was expected to take four to six weeks to gain full control of the situation.

Satellite enthusiasts report that OSCAR 9's 145.825-MHz beacon can be heard with a rubber-duck-equipped handie-talkie. By using a 5/8-wave or better antenna, it is possible to get a full quieting signal with an ordinary two-meter receiver. The orbital data that was available for OSCAR 9 in early October is:

- Period: 95 minutes, 28.796 seconds
- Longitude increment: 23.86563 degrees west
- Perigee height: 533 km (331.21 mi.)
- Apogee height: 536 km (333.07 mi.)

The orbital listing given below is based on this data. Since OSCAR 9 has a very short track record; the accuracy of the listing may not be as great as it would be with an established satellite.

This article is based on material from the AMSAT SATELLITE

REPORT. For more information on the amateur space program, contact: AMSAT, PO Box 27, Washington DC 20044.

OSCAR 8 ORBITAL INFORMATION FOR JANUARY

| ORBIT # | DATE | TIME (GMT) | EQ. CROSSING (DEGREES WEST) |
|---------|------|------------|-----------------------------|
| 19495 | 1 | 0008:15 | 68.8 |
| 19509 | 2 | 0012:49 | 69.9 |
| 19523 | 3 | 0017:22 | 71.1 |
| 19537 | 4 | 0021:55 | 72.3 |
| 19551 | 5 | 0026:28 | 73.4 |
| 19565 | 6 | 0031:01 | 74.6 |
| 19579 | 7 | 0035:34 | 75.8 |
| 19593 | 8 | 0040:07 | 76.9 |
| 19607 | 9 | 0044:40 | 78.1 |
| 19621 | 10 | 0049:13 | 79.3 |
| 19635 | 11 | 0053:46 | 80.4 |
| 19649 | 12 | 0058:19 | 81.6 |
| 19663 | 13 | 0102:52 | 82.8 |
| 19677 | 14 | 0107:25 | 83.9 |
| 19691 | 15 | 0111:58 | 85.1 |
| 19705 | 16 | 0116:30 | 86.2 |
| 19719 | 17 | 0121:03 | 87.4 |
| 19733 | 18 | 0125:36 | 88.6 |
| 19747 | 19 | 0130:08 | 89.7 |
| 19761 | 20 | 0134:41 | 90.9 |
| 19775 | 21 | 0139:14 | 92.1 |
| 19789 | 22 | 0143:47 | 93.2 |
| 19802 | 23 | 0148:20 | 94.4 |
| 19816 | 24 | 0152:53 | 95.6 |
| 19830 | 25 | 0157:26 | 96.8 |
| 19844 | 26 | 0201:59 | 98.0 |
| 19858 | 27 | 0206:32 | 99.2 |
| 19872 | 28 | 0211:05 | 100.4 |
| 19886 | 29 | 0215:38 | 101.6 |
| 19900 | 30 | 0220:11 | 102.8 |
| 19914 | 31 | 0224:44 | 104.0 |

OSCAR 9 ORBITAL INFORMATION FOR JANUARY

| ORBIT # | DATE | TIME (GMT) | EQ. CROSSING (DEGREES WEST) |
|---------|------|------------|-----------------------------|
| 1307 | 1 | 0049:05 | 146.4 |
| 1322 | 2 | 0039:41 | 144.8 |
| 1337 | 3 | 0030:16 | 143.2 |
| 1352 | 4 | 0020:51 | 141.6 |
| 1367 | 5 | 0011:27 | 140.0 |
| 1382 | 6 | 0002:02 | 138.4 |
| 1398 | 7 | 0128:00 | 136.8 |
| 1413 | 8 | 0118:35 | 135.2 |
| 1428 | 9 | 0109:11 | 133.6 |
| 1443 | 10 | 0059:46 | 132.0 |
| 1458 | 11 | 0050:22 | 130.4 |
| 1473 | 12 | 0040:57 | 128.8 |
| 1488 | 13 | 0031:32 | 127.2 |
| 1503 | 14 | 0022:08 | 125.6 |
| 1518 | 15 | 0012:43 | 124.0 |
| 1533 | 16 | 0003:19 | 122.4 |
| 1549 | 17 | 0129:16 | 120.8 |
| 1564 | 18 | 0119:52 | 119.2 |
| 1579 | 19 | 0110:27 | 117.6 |
| 1594 | 20 | 0101:03 | 116.0 |
| 1609 | 21 | 0051:38 | 114.4 |
| 1624 | 22 | 0042:13 | 112.8 |
| 1639 | 23 | 0032:49 | 111.2 |
| 1654 | 24 | 0023:24 | 109.6 |
| 1669 | 25 | 0014:00 | 108.0 |
| 1684 | 26 | 0004:35 | 106.4 |
| 1700 | 27 | 0138:33 | 104.8 |
| 1715 | 28 | 0128:08 | 103.2 |
| 1730 | 29 | 0117:44 | 101.6 |
| 1745 | 30 | 0107:19 | 100.0 |
| 1760 | 31 | 0056:55 | 98.4 |

OSCAR 8 ORBITAL INFORMATION FOR FEBRUARY

| ORBIT # | DATE | TIME (GMT) | EQ. CROSSING (DEGREES WEST) |
|---------|------|------------|-----------------------------|
| 19928 | 1 | 0045:59 | 79.1 |
| 19942 | 2 | 0050:31 | 80.2 |
| 19956 | 3 | 0055:03 | 81.4 |
| 19970 | 4 | 0059:35 | 82.5 |
| 19984 | 5 | 0104:07 | 83.7 |
| 19998 | 6 | 0108:39 | 84.9 |
| 20012 | 7 | 0113:11 | 86.0 |
| 20026 | 8 | 0117:43 | 87.2 |
| 20040 | 9 | 0122:15 | 88.4 |
| 20054 | 10 | 0126:47 | 89.5 |
| 20068 | 11 | 0131:19 | 90.7 |
| 20082 | 12 | 0135:51 | 91.8 |
| 20096 | 13 | 0140:22 | 93.0 |
| 20109 | 14 | 0144:54 | 94.2 |
| 20123 | 15 | 0149:26 | 95.4 |
| 20137 | 16 | 0153:58 | 96.6 |
| 20151 | 17 | 0158:30 | 97.8 |
| 20165 | 18 | 0203:02 | 99.0 |
| 20179 | 19 | 0207:34 | 100.2 |
| 20193 | 20 | 0212:06 | 101.4 |
| 20207 | 21 | 0216:38 | 102.6 |
| 20221 | 22 | 0221:10 | 103.8 |
| 20235 | 23 | 0225:42 | 105.0 |
| 20249 | 24 | 0230:14 | 106.2 |
| 20263 | 25 | 0234:46 | 107.4 |
| 20277 | 26 | 0239:18 | 108.6 |
| 20291 | 27 | 0243:50 | 109.8 |
| 20305 | 28 | 0248:22 | 111.0 |

OSCAR 9 ORBITAL INFORMATION FOR FEBRUARY

| ORBIT # | DATE | TIME (GMT) | EQ. CROSSING (DEGREES WEST) |
|---------|------|------------|-----------------------------|
| 1775 | 1 | 0043:38 | 145.4 |
| 1790 | 2 | 0034:13 | 143.8 |
| 1805 | 3 | 0024:48 | 142.2 |
| 1820 | 4 | 0015:23 | 140.6 |
| 1835 | 5 | 0005:58 | 139.0 |
| 1851 | 6 | 0131:49 | 137.4 |
| 1866 | 7 | 0122:24 | 135.8 |
| 1881 | 8 | 0113:00 | 134.2 |
| 1896 | 9 | 0103:35 | 132.6 |
| 1911 | 10 | 0054:11 | 131.0 |
| 1926 | 11 | 0044:46 | 129.4 |
| 1941 | 12 | 0035:22 | 127.8 |
| 1956 | 13 | 0025:57 | 126.2 |
| 1971 | 14 | 0016:33 | 124.6 |
| 1986 | 15 | 0007:08 | 123.0 |
| 2002 | 16 | 0133:06 | 121.4 |
| 2017 | 17 | 0123:41 | 119.8 |
| 2032 | 18 | 0114:17 | 118.2 |
| 2047 | 19 | 0104:52 | 116.6 |
| 2062 | 20 | 0055:28 | 115.0 |
| 2077 | 21 | 0046:03 | 113.4 |
| 2092 | 22 | 0036:38 | 111.8 |
| 2107 | 23 | 0027:14 | 110.2 |
| 2122 | 24 | 0017:49 | 108.6 |
| 2137 | 25 | 0008:25 | 107.0 |
| 2153 | 26 | 0134:22 | 105.4 |
| 2168 | 27 | 0124:58 | 103.8 |
| 2183 | 28 | 0115:33 | 102.2 |

CAN 20% BE WRONG?



A recent survey showed that 20% of the 73 subscribers also read Kilobaud MICROCOMPUTING magazine . . . and enjoy it. This is the best way to learn and keep up with the rapidly developing world of microcomputers. There's nothing to be afraid of, you just have to read an interesting magazine and you'll learn. Try a subscription to Kilobaud MICROCOMPUTING and see for yourself.

- New subscription
- Payment enclosed \$ _____
- VISA
- MC
- AE
- Bill me
- Renewal
- 12 issues for \$25.00
- 24 issues for \$38.00
- 36 issues for \$53.00

Card # _____ Interbank # _____
 Signature _____ Exp. date _____
 Name _____
 Address _____
 City _____ State _____ Zip _____

—for even faster ordering service call toll free (800) 258-5473

Canadian: \$27, one year only, U.S. funds. Other foreign: \$35, one year only, U.S. funds. Please allow 6 weeks for delivery. 321B6

MICROCOMPUTING • POB 997 • Farmingdale NY 11737

TRS 80* OWNERS ARISE!



Arise and subscribe to 80 MICROCOMPUTING, the newest and fastest growing microcomputer magazine. This is full of news about programs, accessories and theory on the world's largest selling computer, the TRS-80*—definitely beginner level and includes lots of program listings. Find out what all the fuss is about.

- New subscription
- Payment enclosed \$ _____
- VISA
- MC
- AE
- Bill me
- Renewal
- 12 issues for \$25.00
- 24 issues for \$38.00
- 36 issues for \$53.00

Card # _____
 Interbank # _____ Exp. date _____
 Signature _____
 Name _____
 Address _____
 City _____ State _____ Zip _____

Please allow 6 weeks for delivery
 Canadian: 1 yr. only/\$27 in U.S. Funds
 Foreign: 1 yr. only/\$35 in U.S. Funds

80 microcomputing

• P.O.B. 981 • Farmingdale N.Y. 11737

*TRS-80 is a trademark of Tandy Corporation.

321B6

SOCIAL EVENTS

from page 118

south of Glasgow on Highway 31E. Admission is \$2.00 per person with no extra charge for exhibitors. One free table will be provided per exhibitor with extra tables available at \$3.00 each. There will be a large heated building with plenty of free parking. No meetings or forums will be held—just door prizes, free coffee, and a large flea market. Talk-in on 146.34/.94 or 147.63/.03. For additional information, contact Bernie Schwitzgebel

WA4JZO, 121 Adairland Ct., Glasgow KY 42141.

LIVONIA MI FEB 28

The Livonia Amateur Radio Club will hold its 12th annual LARC Swap 'n Shop on Sunday, February 28, 1982, from 8:00 am to 4:00 pm at Churchill High School, Livonia MI. There will be plenty of tables, door prizes, refreshments, and free parking. Talk-in on 146.52. Reserved table space of 12-foot minimum is available. For further informa-

tion, send an SASE (4 x 9) to Neil Coffin WA8GWL, c/o Livonia Amateur Radio Club, PO Box 2111, Livonia MI 48151.

MIDLAND TX MAR 13-14

The Midland Amateur Radio Club will hold its annual swapfest on Saturday, March 13, 1982, from 8:00 am until 6:00 pm, and on Sunday, March 14, from 8:00 am until 3:00 pm, at the Midland County Exhibit Building east of Midland TX on the north side of Highway 80. Registration is \$5.00 in advance or \$6.00 at the door. An additional \$3.00 will be charged for each table. There will be door prizes. Talk-in on 146.16/146.76 and 146.01/146.61. For more in-

formation, write the Midland Amateur Radio Club, Box 4401, Midland TX 79704.

WINCHESTER IN MAR 14

The Randolph Amateur Radio Association will hold its 3rd annual hamfest on Sunday, March 14, 1982, from 8:00 am to 5:00 pm at the National Guard Armory, Winchester IN. Tickets are \$2.00 in advance and \$3.00 at the door. Table space is \$2.50 and table space with table is \$5.00. Setup times are 6:00 pm to 8:00 pm on Saturday and 6:00 am to 8:00 am on Sunday. For reservations or additional information, contact RARA, PO Box 203, Winchester IN, or phone W9VJX at (317)-584-9361.

HAM HELP

We are happy to provide Ham Help listings free, on a space-available basis. We are not happy when we have to take time away from other duties to decipher cryptic notes scrawled illegibly on dog-eared post cards and odd-sized scraps of paper. Please type or print (neatly!), double spaced, your request on an 8½" x 11" sheet of paper and use upper- and lowercase letters where appropriate. Also, please make a "1" look like a "1," not an "l," which could be an "el" or an "eye," and so on. Hard as it may be to believe, we are not familiar with every piece of equipment manufactured on Earth for the last 50 years! Thanks for your cooperation.

Wanted: work in the electronics field in the Knoxville/Chattanooga area. Experience in digital and rf circuits. I have First Class radiotelephone and Extra class amateur licenses.

Herman F. Schnur
115 Intercept Ave.
North Charleston SC 29405

I need an instruction manual and/or schematic for a model CF capacitor analyzer (Exam-Eter) made by Solar Mfg. Corp., New York. Please write and let me know what you have.

G.V. Mock W4RHD
Rt. 1, Box 60
Fayetteville AR 72701

Wanted: any information on conversion of Cobra 21XLR to 10-meter FM. Uses Uniden PC-199AB board with crystals for 10.24, 10.695, and 36.57 MHz. Has anyone converted this rig? Help!

Al Graff N8CNB
PO Box 332
South Webster OH 45682

I need a schematic and/or manual for an Advance Instruments oscilloscope model OS 15A (sometimes called Xetex). I will copy and return. All your costs gladly paid.

Walter S. Jackson KB3LH
281 Irish Road
Berwyn PA 19312

I have the schematic for my WWII-vintage Hammarlund type CHC 46140 receiver, but no values of components are given. Can anyone supply further data on this radio?

H. Church
309 W. St. Louis St.
Lebanon IL 62254

I need a schematic or a manual on a Central Electronics multi-phase exciter, Model 10B, and Model 458 vfo. I will copy and pay all postage.

Louis Sila WB6FRQ
1085 W. 27th St.
San Bernardino CA 92405

Recently, someone wanted info on war surplus from the '40-'45 era. I had this info and was glad to supply it. My request was to have the postage paid.

I neither got the postage nor a thank-you. You could remind the people requesting such info that a thank-you is appreciated. It will be a cold, frosty day before I comply with another request. Since the last time, I have seen quite a few inserts I could help, but once stung, twice shy.

Leon D. Tallman W1JT/OY1KH
Star Route
South Effingham NH 03882

Am looking for a schematic or assembly manual for a model W5M amplifier. Also same for a model WAP2 preamplifier. These are both Heathkit units. Will copy and return, postage paid. Thank you.

F.N. Lockwood WA6UCP
910 Jack London Drive
Santa Rosa CA 95405

I urgently need a schematic or any service information on the Beltek model W5570 2-meter FM transceiver. The manufacturer in California is out of business. Thank you.

Rev. Ray Vath WB2FYB
PO Box 306
Ridgefield Park NJ 07660

I have a telephone-type (PBX) headset which I would like to hook up to my Kenwood TR-2400. Any info would be appreciated.

Roy Eichelberger KA7GXX
1136 Turquoise Way
Sandy UT 84070

I would like to obtain a manual or schematic for a Gonset Sixty-Three. Also, if anyone needs a Knight Star Roamer manual for his set, he can contact me.

Kevin Neal
Rte. A, Box 221A
Flippin AR 72634

I need a manual and schematic for a General Electric oscilloscope model CRO 5A. Will copy or pay for copy. Also need parts or a used Heathkit IT-11 or IT-28 Capacitor Checker. Thank you.

William P. Pence
800 Old Stage Road
Cave Junction OR 97523

Does anybody know the type of balun and the resistance and wattage of the resistor used in B&W's new folded dipole antenna? Any information concerning the above would be greatly appreciated.

Marvin Rosen N3BQA
20 W. Madison St
Baltimore MD 21201
(301)-685-6308

Needed for parts: a beyond-repair IO-10 Heath scope to complete a partial scope kit.

Rudy Zerdecki WB1CXC
PO Box 321
Indian Orchard MA 01151

I would like a manual and/or schematic for a Tektronic Type 504 oscilloscope. I will pay copying costs.

Dr. H. Castiglione
RD #3, Box 392
Robbinsville NJ 08691

DX



Yuri Blanarovich VE3BMV
Box 292
Don Mills
Ontario M3C 2S2
Canada

One thing that is very obvious and is becoming worse with more activity on the bands is the quality of SSB signals. SSB by its nature is so pure, clean, and lean. Theoretically, two or three stations can operate almost on the same frequency. There is no carrier to interfere as we had on AM. But...then came those \$%& speech compressors in the hands of operators who refuse to try to understand the technical side of things. I think it must be a carry-over from the "ten-four" band where the only thing you had to know was to keep that meter way up there, because that was when you were getting more "pounds" out. Wrong!!!

Speech processing has its value but it has to be understood. When a ham cranks that

devilish instrument all the way up then he starts QRMing his own signal. One can hear the fans running, dogs fighting on the street, and even the stomach rumbling. All this is creating splatter that gives a very bad image of the ham and his station.

It is quite simple to adjust the gain just by observing the plate or rf meter on your transmitter or amplifier. When you press push-to-talk without saying anything, the meter should not move. If you are getting more deflection on the meter when you are not talking than when you are talking, then obviously it is a bit too much. Another situation is bad neutralization, which creates all kinds of spurious signals inside and outside the bands, including terrific TVI. Also watch for a wrong bias adjustment on your PA amplifier or transmitter. That could put your rig into Class C, and there you have another factor contributing to your beautiful signal.

Why all of this? Well, if you listen around you know why. The garbage level on the bands is very high. It doesn't take too many stations to wipe out the band and make it impossible for others to hear that XZ9A who is trying to call you.

The same goes for the DX pile-ups. Gone are the days when you could pick the callsigns out of



Typical Big Gun Contest (and DX) station of K0RF. Cement blocks and boards serve as an operating desk, not for the great looks but for the super-efficient layout of three rigs and all the other gadgets. Outside are three 200-foot towers with assorted high-performance antennas. Chuck K0RF (left) is discussing strategy with George W0UA before an upcoming contest. George is a frequent high scorer in sweepstakes and holds a number of records.



Date 14.10.81 Sheet No. 988

A35.. A35RK 14290 0825 5x8 w G3WBC, Ron asks for QSLs via F.O. Box 46, Waku'Alafo, Tonga. CB6BVO/KH6 14254 0746 5x9 w G3WBC, Walt awaiting transport to Tonga for A35RK opn. Bob W9VBY has finished his work in WY, plans to be on in WB1GDQ/CB6X alt Oct.14, & CB6Z.. /CB6Z during CQ Contest. check 10m 11-1200, 15m 15-1600, 20m fm 0200, 40m later. DA1WA/LX by Wiesbaden ARC during CQ Contest Oct.24-25 with some opn before & after, on all bands 10-10m. QSL via DJ9LO, USA via Steve Hutchins, Box 4773, APO New York, 09109. HL9RH Geert (BTLO) 21320 1156 5x7 wkg ON5RT, QSL via ON5KD. he w/ be QRV 40/80m later. I4..IU... I4G8NU Oct.22-26 by I4G8NM & I4G8VQ in Asinara I. I4G8NU Oct.24-Nov.1 by I4G8N. JX8A Oct.23-26 by JX8NM JW7XB & Co. opn all bands. some CW-opn before/after Contest. K5VT new addr: V.Thompson, Box 32487, Phoenix, Ariz. 85064. QSLs sent to Calif. w/ be OK. KH6XX 3799 0601 5x5 wkg DW3AX, 3798 0612 5x5 & 7007 0525 559 wkg G3HTA, QSL via W3BHK. EV4AA Insk was 76 on Sept.14. during the past 6-yr he has made more than 175,000 QSOs. w/ be QRV Oct.24-25 on all 6-bands fm Rockwall, smallest Texas county. special award for DX-stns wkg Rockwall on 5-bands during Contest period, QSLs not reqd. W5AU Dave GM3KX scheduled to arr 1br Oct.17, hopes to be QRV by Oct.17 for abt 3-wks, using TR1200 on 14175 14202 21345 20545, also CW. GM3TCR may join him later. Z3..ZL.. Z3595 0815 wkg I4EAT. E4(G3HTA) & G4(G3VNL) w/ left the en-route K6 & home. Z36AT Alan 14011 0701 559 w GM3TCR, QSL via G3KZF. Z36CB 14194 1203 5x7 w G3PFS. Z32.. Z32AB Lamar 14023 0620 579 w G3PFS. Z32AF 21000 0146 wkg HP1AC, QSL via J4C8V. Z32AG Fernando 1995 0709 5x6, 14192 0715 5x8 w G3VIE, 28502 1955 5x5 wkg G3OPF & G3VIE. Z32AH Faraday Base, Argentine Is. (AS06) Andrew 14127 2030 5x9 w ON5RT, QSL via GM3TCR. Z32AJ Richard Newstead (G3JNE) w/ be QRV fm Bathurst Base, Adelaide I fm Nov.1, all bands, espes 40-80-160m CW. he also plans opn en-route fm South Georgia on Oct.14-21. Z32.. Z32B W4ABP/W4BT/ZK2ZZ, Gary W3GZK/W4JL/Z32GZ, Richard Z32KZ/W4JL/Z32JK w/ be QRV Oct.19-20 fm SW, Oct.21-28 & CQ Contest fm SW, Oct.29-31 SW, all bands 10-160m espes 1P-opn. QSL via S.Calif. DX Club, Box 509, Menlo Park, Calif. 94025. Z32G 24-hrs opn during both CQ W Contests by Radio Club Nuevo Leon. QSL via XE2AG. Z32H 24-hrs opn Oct.24 to celebrate 16th anniversary of the U.S. QSLs go via W3E2V. Z32.. Z32I 9050N 14030 2116 599 w G3BXX, 14040 2211 579 w G3BXX. 9050N license W3F-opn only.

D02HT 7084 0616 5x7 EG4CH 28604 1619 5x8 V36CT 1504 1740 559 SB3TC 21176 1806 5x9 D6AMM 14175 2042 5x7 M6YK/VP2A 3791 0600 Y32YK 7074 1820 3x4 TXAMD 1511 2053 5x7 HF3FL 3798 0632 5x9 ST9WHV 28500 1041 5x7 ZL1AB 1804/23 fm 0620 SE2ER 7082 2024 5x7 HV35J 28595 1648 5x4 TZA11 21245 Buns 1000 JAZZF 14214 1855 5x5 JILBWT 1871 0850V JA-stns Bm 1900-2100 VE9BL 28037 1046 579 4U1TU 1935 2212 4x5 Florin Van Neevel

QSL A6XWT P81MM ON5CY WA3HUP H44WF VK2HOM TI9FAG TI2FAG ZP2FN WB3GF AR2M K2PL ED8VIE ZARRC HSDAMK G3KZF W3TEH/XRZ K66GX ZL4PO/C ZL4KI O31PV ON6WH P88WG P2CL KG4CH WB1GQ W6CDO/K9H W6CDO 2856P W41HV ON5CX WA3HUP P88GBC WBAH OB6BVO/KH6 DJ9EX YU7EFP/H9M YU7OMI S0WPC W3AUZ

QSLs reqd A71AD H44HP J22CN JW5RM VR1HL/1 VP1FB VP8AJL W6CDO/K9H ZD8RH ZM7JG ZT52Z 945FL

CQ WX DX CONTEST PHONE: 0000 Oct.24 - 2400 Oct.25, CW: 0000 Nov.28 - 2400 Nov.29, all bands 10-160m. exchange RS/RST + ur CQ-Zone No. work each stn once per band. Classes: - MIXED-OPN = all-bands, or single-band (= mark each log separate band entry). - single-opn must show a minimum of 12-hrs opn (12-hrs on that band for a Band Award). - multi-opn = all bands only, single-Tx or multi-Tx (one signal per band), multi-opn stn must show a minimum of 24-hrs opn. multi-yr single-Tx stns may use one other band during the same 10-minute time period, but only to work a new multiplier.

Thanks to Geoff Watts using recent form changes of address and subscription when requested to P.O. Box 142.

the pile because they were clean and understandable. Three bad stations can wipe out half a band and make it difficult for the DX station to hear anyone.

We consider ourselves gentlemen, so let's do it right and be proud of our signals!

BULLETIN OF THE MONTH

This time we look at another weekly DX bulletin from across the pond. It is the continuation of the old and famous Geoff Watts bulletin, still edited by him, published by the RSGB, and called *DX News Sheet*. It is getting close to its 1000th issue. It lists activities and expected operations, has QSL information, and gives upcoming contest rules. The sample shows the arrangement.

DX NEWS

A6XJA, United Arab Emirates, showing up on 15m around 21.200. Operator is Jan-Keur; QSL via PA0LP or direct: PO Box 2730, Abu Dhabi, United Arab Emirates. A6XJC keeps occasional schedules with WB2OHD near 28.688 for short lists around 1500/1530 GMT. Claiming valid license and expects to

be there for some time. QSL via PE0MGM.

A9XDO, Bahrain. Operator Howard showing up on 28.607 at 1545, 14.236 at 0200, 14.020 at 0345. QSL via KA4S. A9XDA, Paul, around 14.182 at 0200; QSL via N4BPP.

A22ZM, Botswana. Mark is now in South Africa; QSL via ZS5CU. A22VL will be on the air for about two years, operated by W9VL, showing up in the major contests and some DXpeditions.

BV2A, Taiwan. Tim is back on the air after the hurricane season. He takes the antennas down himself, rather than let Manager Nature do it. QSL direct.

CE0X, San Felix Island. Wow! Bob Read KF10, ex-WB1GDQ, received his Extra class US license just in time for this historical operation. Both "partners," W0AX and N4CBL, have bowed out of the operation and Bob fired up from CE0X quite quickly. While some were figuring that it would take him a day or so by boat, he managed to get there by air and surprised the world by showing up on 15m for a few QSOs. Later he operated on 20 and 10m also. Apparently, there were only a few hours of



Ever wondered what hit you in the pileup? The answer is in the antennas. This is the VE3BMV Razor Beam, just going up on the top of the 110-foot rotatable pole. It has 4 quad elements (2 driven) and three yagi elements on a 60-foot boom. And there are two of them stacked. They really cut through the pileup and give the edge!

operation his work permitted. The pileups were much worse than Clipperton has experienced. Poor list operators, they did not get the chance. Job well done, considering the restrictions that Bob was faced with. About 700 contacts were made, mostly with US stations. There is some chance he might be invited back and be able to do some more operating. QSL to his SV0BV address: Box 564, Athens, Greece.

FB8WG, Crozet Island. George is operating as much as his schedule is permitting him. He should be there for about 9 months. Usually showing up on the French net on 14.170 or 21.170 at 1800Z. Operating list on weekends around 21.279 from 1200Z. QSL via F2CL. Another one who operates with the help of the list "undertakers." Hoping to get the vfo and operate on his own.

FP0GBG, St. Pierre and Miquelon. Operation by AI W8AH. Also FP0GAP by W8NR,

FP0GAQ by K8CJQ. QSL to their home calls.

HS, Thailand. Thai radio amateurs are back on the air. Apparently they were off because they had to register their rigs. The same old callsigns are still assigned, so there is no change. Dr. George Collins VE3FXT is supposed to be back in HS for some more tests and demonstration of coherent CW, and is hoping to get on from XZ—Burma.

HV, Vatican and Radio Vaticana, is celebrating the 50th anniversary and offering an award for working several amateurs there. Stations in Europe and the USA must work two of the three stations, all others need work only one. The calls are HV3SJ, HV1CH, HV2VO. Starting date was October 1 and it runs until February 1, 1982. Send photocopy of QSL card to Radio Vaticana, Citta del Vaticano, Europe.

T3, Kiribati. The following are separate countries for the DXCC: T30—Western Kiribati



This one is at the "Papa Victor" antenna farm—the W2PV multi-multi station. Stacked Telrex beams on the 110-foot Big Bertha. The configuration reads, from top down: 6 elements on 20, 8 on 15, 10 on 10, 3 on 40, and, again, 10 on 10, 8 on 15 and 6 on 20. That surely gets respect on the band! So, the next time you can't hear the one they are working, don't worry about it (unless you have more elements up there).

(Gilbert or Ocean Island), ex-T3A or VR1; T31—Central Kiribati (British Phoenix Island), ex-T3P, VR1; T32—Eastern Kiribati (Christmas or Line Island), ex-T3L, VR3. Recently active: T32UF around 21025 at 0230; QSL via JA1NVG. T32AB around 21298 at 0300; QSL via N7YL.

V3A, Belize. This is the new prefix and not J9 as previously announced and expected. This should replace the old VP1 prefix in the callsigns. VP2A Antigua is expected soon to become V2A.

XZ, Burma or Karen State? According to JA8BMK and most people, these should be recognized as separate DXCC countries—that is, as XZ9A and XZ5A. There was some activity reported by other stations with XZ2 and XZ1 callsigns operating from Rangoon, Burma.

1A0KM, SMOM or Sovereign Military Order of Malta, was finally accepted by the ARRL as a separate country for DXCC. This

brings the current total back to 319. They were supposed to be in the CQ WW contest but it was a no show. QSL cards are being accepted after January 1, 1982, for all the contacts made with 1A0KM.

3X1Z, Guinea was on again by Jacques W4LZZ on October 11–23. QSL via W4FRU.

5A7BQ, Libya. Operator Abed is active around 28546 at 1700 and claims to be a permanent resident with a valid license. QSL via Box 733, Benghazi, Libya.

5R8, Malagasy Republic, activated by Luigi IV3OSHN/5R8 between September 20–28; QSL via IV3MUC. 5R8AL is active around 28535 at 1730, QSL via WA4VDE.

7O1AB, South Yemen, could be on at any time. J28AZ is the holder of the license and it is supposed to be a matter of picking it up and operating. (We have been hearing about this for six months.)

AWARDS

Bill Gosney KE7C
Micro-80, Inc.
2665 North Busby Road
Oak Harbor WA 98277

W2JIO NAMED AS 1980 ARMSTRONG PIONEER

Bob Gunderson W2JIO has been voted the first recipient of

the annual Armstrong Memorial Award. It was given to him in recognition of his outstanding contributions to amateur radio via his work with and for blind hams. Bob, who was born blind himself, has designed and built many kinds of test instruments with audio outputs as well as

other methods of working with electronics for the sightless. He also founded the Braille Technical Press, and taught electronics for 37 years at the New York School for the Blind, directing many students toward rewarding careers in electronics.

The award was presented at the 1980 ARRL Hudson Division Convention. Bob could not be present, so a tape recording of this event was sent to him along with the plaque.

The award, a sort of "Most Valuable Player" of amateur radio, honors the memory of Major Edwin Armstrong, inventor of frequency modulation and other technical advances which have benefitted amateur radio. It will be given each year to one ham for his or her outstanding service to the amateur community. Some of the nominees for 1981 are Copthorne MacDonald W4ZII, father of SSTV, Don Stoner W6TNS, driving force behind the original OSCAR program, and HRH Hussein, JY1,

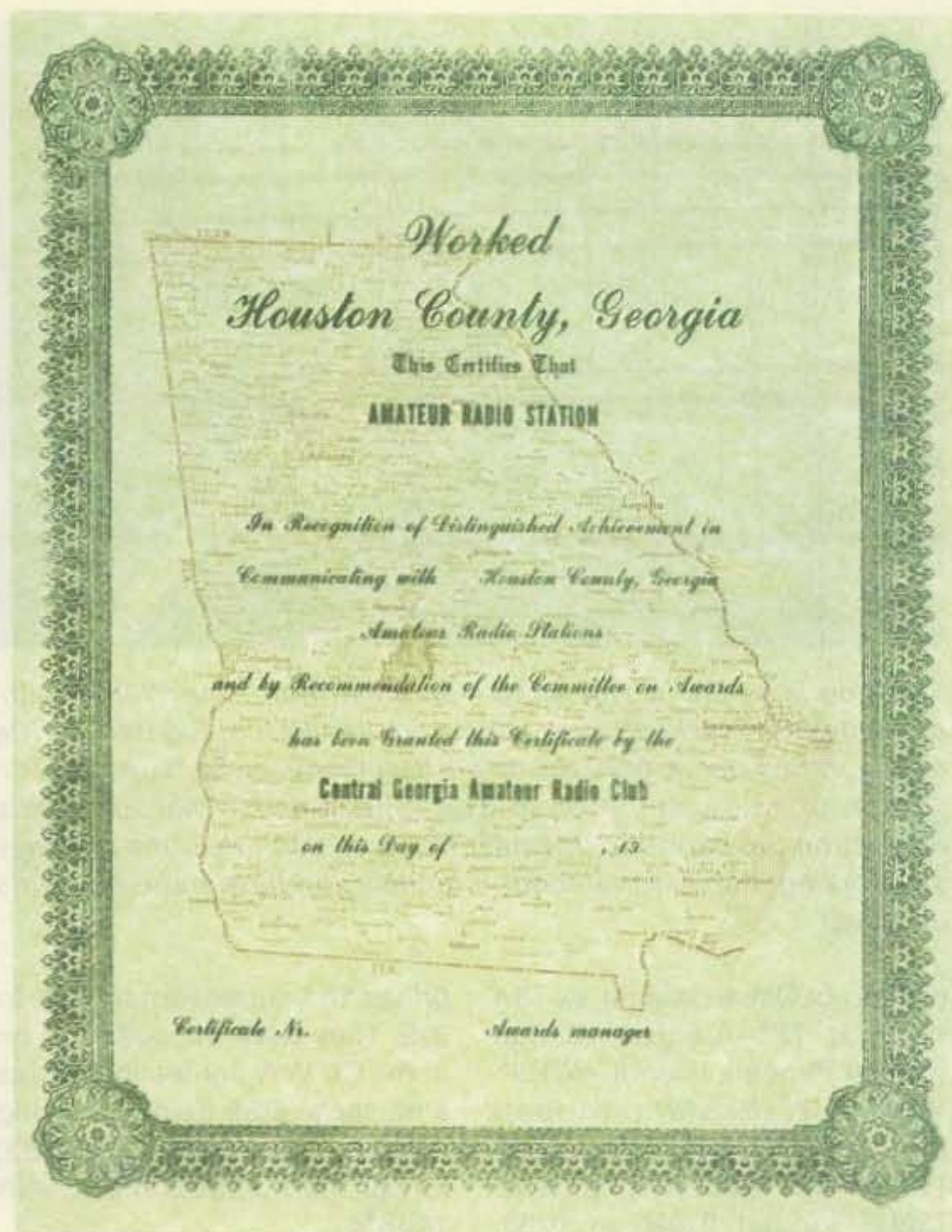

for his help in promoting the concept of amateur radio throughout the Mideast. If you would like to nominate someone, just send a note to Awards Committee, Major Armstrong Memorial Amateur Radio Club, Box 1234, Englewood Cliffs NJ 07632.

SPECIAL EVENTS STATION FOR LEWIS AND CLARK WINTERING SITE

A Special Events station will be sponsored by the Mandan-Bismarck Amateur Radio Club on January 2 and 3, 1982. There will be a distinctive QSL card this year, featuring Sakakawea, the Indian maid who led the expedition to the West Coast.

Time of operation will be 1600-2100 UTC on both days. Frequencies to be used: SSB—14295, 21395, 28595; CW—14065, 21065, 28065; and Novice—21125, 28125. All frequencies plus-minus QRM.

To receive the special commemorative QSL card, send an SASE to the Mandan-Bismarck Amateur Radio Club, PO Box 978, Bismarck ND 58501. (For additional information, you may contact Ed Drewello WB0OFW at the same address, or call (701)-223-0150, Ext. 124.)

THE WORKED HOUSTON COUNTY GEORGIA AWARD

The Central Georgia Amateur Radio Club of Warner Robins, Georgia, is proud to announce the establishment of the Worked Houston County Georgia Award.

The requirements for obtaining this handsome, three-color award are:

- US stations are required to contact five (5) amateur stations in Houston County. Stations in Houston County need ten (10) contacts with other amateur stations in Houston County.
- DX stations are required to contact three (3) amateur stations in Houston County, Georgia.
- All contacts must be made on the 10-through-160-meter amateur bands. Endorsements for single band, single mode, etc., will be honored upon request.
- All contacts must have been made February 14, 1981, or later.
- The fee for this award is \$1.00 plus two (2) first-class stamps for US stations. DX stations please send four (4) IRCs. Send fee and list of claimed contacts (no QSL cards) with complete log information to: Awards Manager, Manuel Matta WD4ENO, 619 American



Boulevard, Warner Robins, GA 31093, USA.

ROYAL ORDER OF HOOTOWLS

The Royal Order of Hootowls became a society in June of 1955 with the "gag" nomination and hand-drawn owl being sent to John Woods W7TMI, after burning the midnight oil with the originator, Lee Singleterry, Sr. W7YJE. Dick W7VIC, Gordy W7UFE, and Tad W7WZK rounded out the charter membership, and the granddaddy of 50-MHz societies was born!

The Order became dormant with the passing of Lee, but in 1977, Don Abell WB5SND located Mrs. Singleterry and was granted permission to reestablish the Order once again. This was completed in 1978 in partnership with Don Verlander WB5VWZ.

The Order is not a net but a society founded to promote friendship and goodwill toward amateurs everywhere, and was developed to enhance and preserve activity on the late Saturday night 6-meter rag-chew.

ROHO membership is open to any licensed amateur who meets the following conditions:

- All contacts must be made on the 6-meter band and must be point-to-point; contacts by relay are not valid.
- Call "CQ Hootowls" on 50.200 at midnight (2400) local time on Saturday night only.
- Establish and maintain two-way contact with a member station for a minimum of one full hour starting at 2400 Saturday night and ending not earlier than 0100 Sunday morning. DX stations may qualify by making contact with an Owl at any time during the above stated period.

● To apply for the affiliation and membership certificate, submit the name, callsign, ROHO number of the member station worked, and the date worked, along with your own name, address, and callsign. There is a one-time membership fee of \$2.00.

Make your check payable to Don Abell, 6821 West Avenue, San Antonio TX 78213.

ROMANTIC ROAD AWARD

The local group (OV) Nordlingen of the German Amateur Radio Club issues this award on the occasion of its Jubilee (25th year) to all licensed radio amateurs and SWLs for contacts with stations along the "Romantic Road," located in Wurzburg, Tauberbischofsheim, Bad Mergentheim, Creglingen, Rothenburg o.d. Tauber, Feuchtwangen, Dinkelsbühl, Nordlingen, Harburg, Donauworth, Augsburg, Landsberg, Schongau, Schwangau, and Fussen.

List of DOKs valid for the award: A 23; B 02, 17, 18, 22; C 20, 21; P 25; T 01, 06, 09, 11, 17, 21; Z 30, 52.

Requirements: Each QSO with stations along the Romantic Road will count 1 point, each CW QSO 2 points, and each RTTY QSO 3 points. Contacts with members of the "OV" Nordlingen, DOK T 09, count double points. European stations need 50 points, and VHF and DX stations need 25 points.

This certificate is also available to SWLs.

The fee: DM5, US\$4, or 10 IRCs. Send to Friedl Schrey, PO Box 1, D-8855 Wemding, W. Germany.

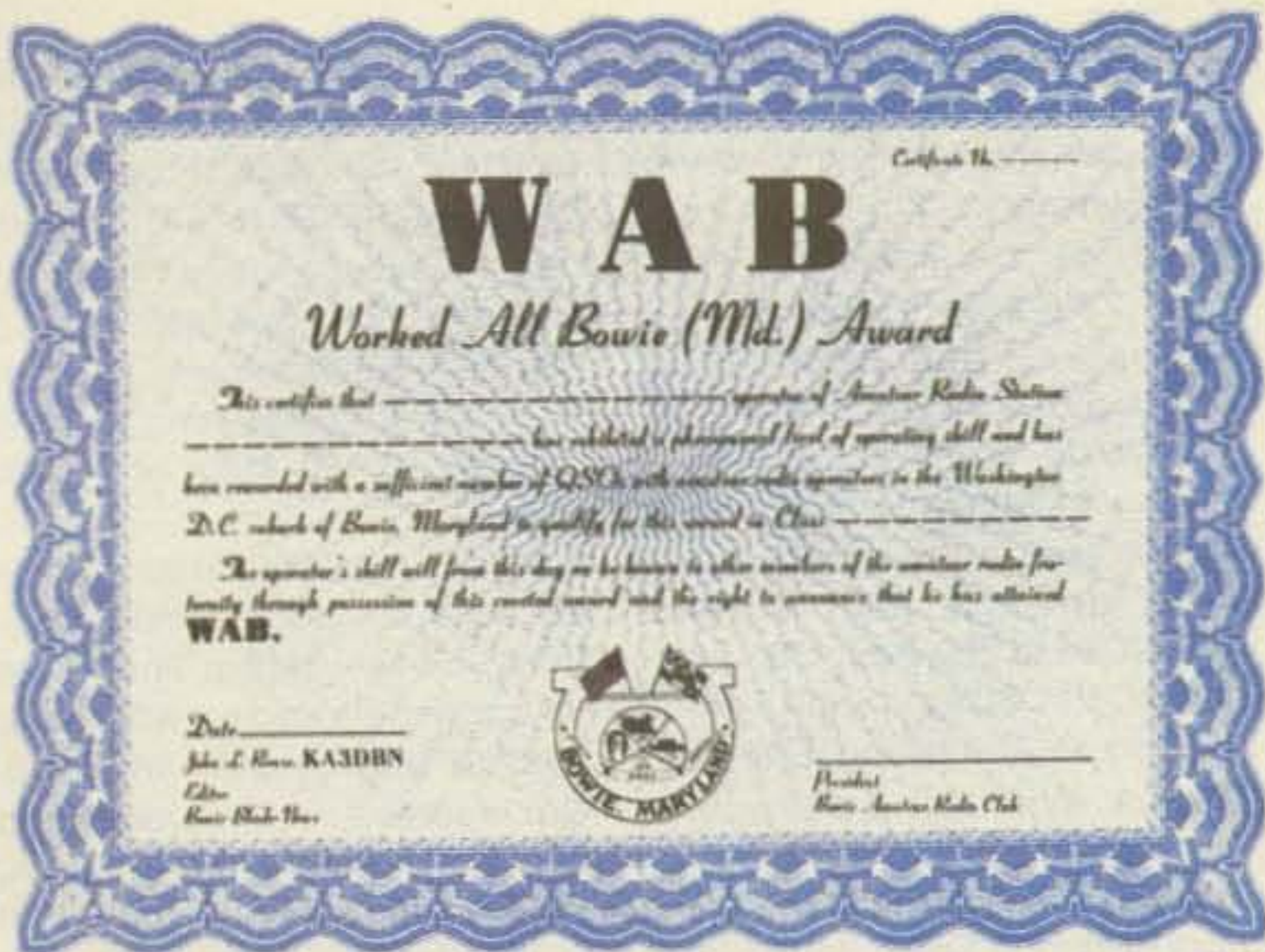

WORKED ALL BOWIE AWARD

The Bowie Maryland Amateur Radio Club is offering the Worked All Bowie Award to amateurs who make contact with stations located in this Washington DC suburb.

The Bowie Award is issued in two classes: Class 1 for contacts with four stations located in the city and Class 2 for two contacts within Bowie. DX stations, to qualify, must work two Bowie amateurs for Class 1 recognition and work one station within Bowie for Class 2.

There is no fee for this award, but applicants are requested to accompany their log extracts with a large (#10) self-addressed stamped envelope. Forward your applications to: John Rouse KA3DBN, PO Drawer M, Bowie MD 20715.

GARRETT ISLAND AWARD

The Bowie, Maryland, ARC is still offering the Garrett Island Award to any amateurs who worked K3PI during the mini-DXpedition to this uninhabited island located near the Chesapeake Bay in Cecil Coun-

ty, Maryland. A second large SASE to John Rouse KA3DBN, PO Drawer M, Bowie MD 20175 will get you the award. By the way, QSL cards are required as proof of contact.

LINCOLN TRAIL AWARD

The Lincoln Trail Amateur Radio Club, Inc., will be holding an in-state DXpedition from Abraham Lincoln's birthplace in Hodgenville, Kentucky. Hodgenville is located in LaRue County.

The expedition will be on February 13 beginning at 0000 UTC. The station call will be NN4H. Planned frequencies are: Phone—15 kHz from bottom of the General phone band; CW—15 kHz from bottom of the General CW band; Novice—15 kHz down from top of band edge. For certificate, send an SASE to Charlie Myers, PO Box 723, Elizabethtown KY 42701.

FREEZE YOUR ARCTIC OFF CERTIFICATE

The Tin Lizzies are at it again! The fourth annual Freeze Your Arctic Off expedition will take place between 1700Z January 23

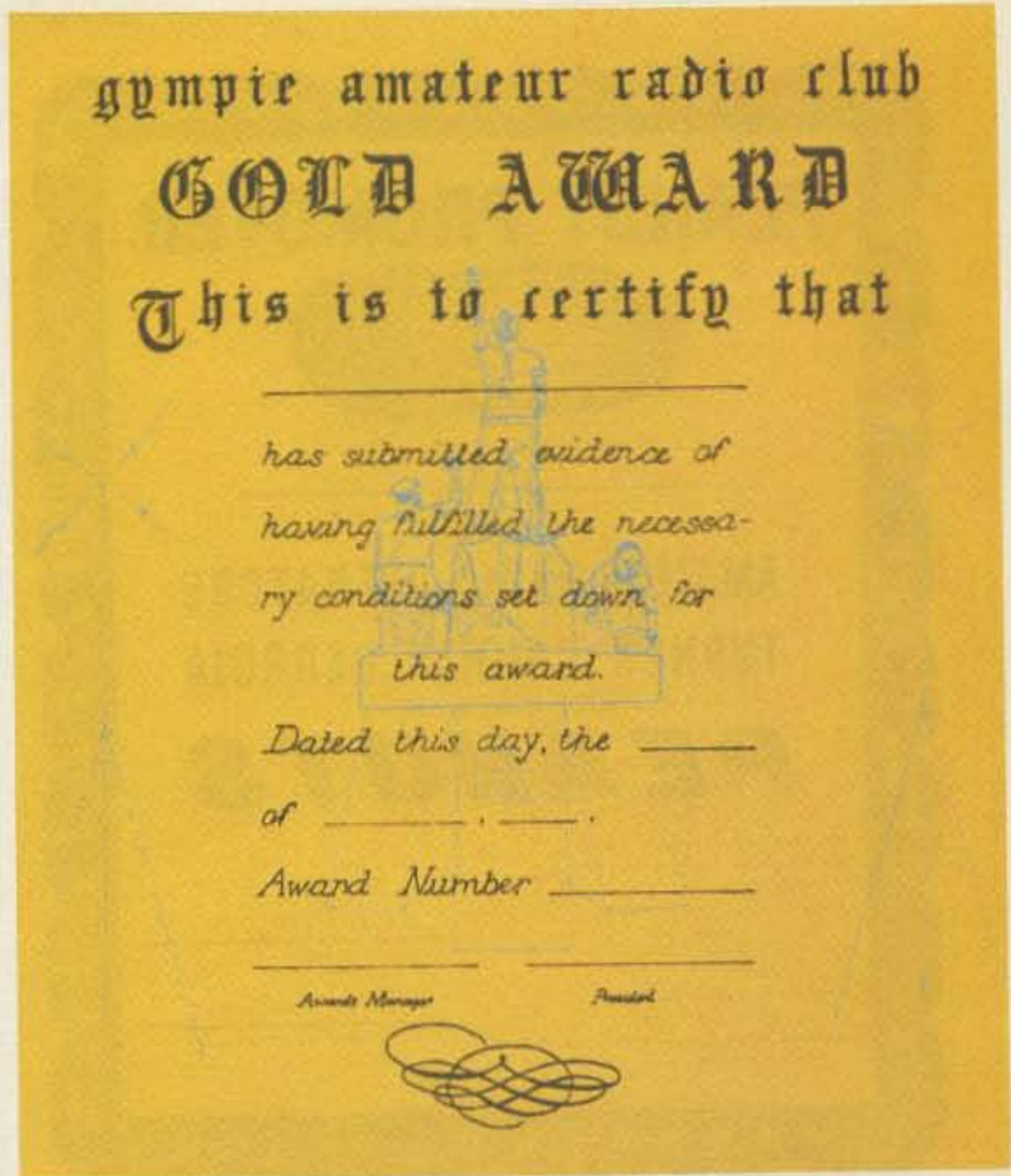

and 1800Z January 24, 1982, using a twenty-mile-wide frozen lake as the ground plane for our phased vertical array. As in the past, a handsome certificate will be sent to all QSLed contacts. No SASE is needed, but please put your contact number on your card.

Look for AD8R/8 on 7.275, 21.380, 146.55, and 146.58 MHz out on the frozen wastes of Lake Saint Clair near the US-Canadian border. QSL to Box 545, Sterling Heights MI 48077-0545.

ROBBINSDALE ARC OPERATION ICEBOX

The Robbinsdale Amateur Radio club (K0LTC) is proud to announce its second Annual Operation Icebox from the frozen surface of Rainy Lake, near International Falls, Minnesota. Operation will begin on February 5, 1982, at 0000 GMT and run till February 6, 1982, at 0000 GMT. The frequencies used will be 10 kHz up from the bottom of the General Phone bands. Novice operation also is planned. There will be two operating stations to cover 80m through 10m. K0LTC is offering an attractive 8½ x 11 commemorative QSL of the event to all who enclose an SASE (business size) with their card. The QSL route is via KB0PM, club president.

GYMPIE AMATEUR RADIO GOLD AWARD

The Gold Award is open to all licensed amateur radio stations and shortwave listeners. Stations must obtain ten (10) points by working Gympie Amateur Radio Club members. Overseas stations need obtain only five (5) points for qualification.

Stations can be worked on any band using any mode. Active modes are: SSB, CW, FM, AM, and RTTY. Contacts on HF count as one (1) point each. Contacts on VHF (52 MHz and up) are worth two (2) points each. A contact with the club station (VK4WIH) counts as two (2) points on any band. Contacts via repeaters are not valid.

Stations can be worked once on each band. QSL cards are not required. Applicants must send a log extract containing all relevant information (date, time, frequency, mode, signal report, callsign). Contacts after October 13, 1980, are valid.

Domestic cost of the award is \$1.00 or three IRCs. Overseas stations: \$2.00 or five (5) IRCs. Address the Awards Manager, Gympie Amateur Radio Club, PO Box 384, Gympie, Qld., 4570, Australia.

PEANUT PROMOTER AWARD

This award is sponsored by the Turner County Chamber of



Canada's largest winter carnival, held annually in February. This year the carnival is being held February 5-14.

We will be operating daily from 2100-2400 Zulu, and on February 7 from 2000-0200Z. This is a free award, and all you need to do is send the log information of QSOs with three (3) Vernon area stations or one contact with the club station (VE7NOR) to PO Box 1706, Vernon BC V1T 8C3. (Vernon area is defined as Armstrong, Enderby, Oyama, Winfield, Lumby, and Vernon.) Frequencies to watch are: 28.575, 21.375, and 14.295 plus or minus QRM, with possible CW and RTTY operation also.

The award is available year-round; all QSOs are valid.

CQ CQ CQ... HIGH SCHOOL AND COLLEGE CLUB STATIONS

The McKinley High School Amateur Radio Station (KH6NF) is trying to make contact with teenagers and young adults around the world. McKinley High is the oldest public high school in the state of Hawaii, being 116 years old this school year. We are located in Honolulu, just minutes away from the famous Diamond Head crater and Waikiki Beach. Our student population is just over 2000, and it rivals the United Nations with our diversity of cultural and national heritages.

The club station has been in operation since 1966, but this year we are making a special effort to contact other club stations and younger members of the amateur radio society. We are inviting everyone to join us on the bands and make this year an outstanding one for youthful hams.

Our hours of operation will be from 1730Z to 1815Z and 0045Z to 0115Z Monday through Friday, and 2000Z to 2130Z Monday, Wednesday, and Friday. At present, we operate on 10 meters, 28.520 MHz \pm QRM. If 10 meters closes up, we will operate 21.420 MHz or 14.320 MHz.

If you are unable to contact us because of poor band conditions, please drop a line to set up a schedule and we will do our best to have a QSO with you. Our address is McKinley High School Amateur Radio Station, 1039 S. King Street, Honolulu HI 96814. Until we meet you on the air... Aloha!

WORKED ALL HAWAII AWARDS

Sponsored by the Big Island Amateur Radio Club, these awards are available to all licensed amateurs. Contacts made after 0000Z January 1, 1982, are valid for the awards.

Any mode on any band is acceptable. No terrestrial repeater contacts will be accepted, and only land-based stations are valid for the awards.

Do not send QSL cards. A list showing the date, time, signal report, mode, callsign, and band, certified by a club or society official, is sufficient.

The fee for any award is US \$3.50; three awards are available: Class A—Wood-carved tiki (certificate only for stations located in the State of Hawaii); Class B—Certificate; and Class C—Certificate.

Class A requirements: Work 100 Hawaiian stations, to include (A) the islands of Hawaii, Maui, Lanai, Molokai, Oahu, and Kauai; (B) the counties of Hawaii, Maui, Kalawao, Honolulu, and Kauai; (C) one of the following islands: Kure, Midway, Necker, Laysan, French Frigate Shoals, Niihau, or Kahoolawe, and (D) 10 or more BIARC members.

Class B requirements: Work 50 Hawaiian stations, to include the islands of Hawaii, Maui, Molokai, Oahu, and Kauai, and 5 or more BIARC members.

Class C requirements: Work 25 Hawaiian stations, to include the islands of Hawaii, Maui, Oahu, and Kauai, and 3 or more BIARC members.

Address all award applications to the Big Island Amateur Radio Club, PO Box 1688, Kamuela HI 96743.

Commerce in conjunction with the Coastal Plains Amateur Radio Club based in Ashburn, Georgia.

To qualify for this award, an applicant must work at least two stations in Turner County, Georgia. Both QSL cards received from these contacts must be sent to the Awards Manager along with an SASE.

Actually, the club has two managers for this award. If your contact was made on six meters, then forward your application to: "Fuz" Tanner WA4NTF, Route 2, Box 351, Ashburn GA 31714. If your contacts were made on any other band, send your application to

Wayne Harrell WD4LYV, Route 1, Box 185, Sycamore GA 31790.

I am not sure if there is a fee for this award—the award rules failed to mention any remittance. To be safe, however, I would enclose a minimum of \$2.00 to cover the club's expenses.

VERNON BC WINTER CARNIVAL CERTIFICATE

We of the North Okanagan Radio Amateur Club (NORAC), along with the Vernon Winter Carnival Society, are sponsoring a certificate this year to celebrate the 22nd Annual Vernon Winter Carnival, western

Take your favorite H.T. out for a drive tonight.

For \$64.95 you get the most efficient, dependable, fully guaranteed 35W 2 meter amp kit for your handy talkie money can buy.

Now you can save your batteries by operating your H.T. on low power and still get out like a mobile rig. The model 335A produces 35 watts out with an input of 3 watts, and 15 watts out with only 1 watt in. Compatible with IC-2AT, TR-2400, Yaesu, Wilson & Tempo! Other 2 meter models are available with outputs of 25W and 75W, in addition to a 100W amplifier kit for 430MHZ.

382
Communication Concepts Inc. 2648 N. Aragon Ave., Dayton, OH 45420
(513) 296-1411

VISA or MASTERCARD for same day shipment.



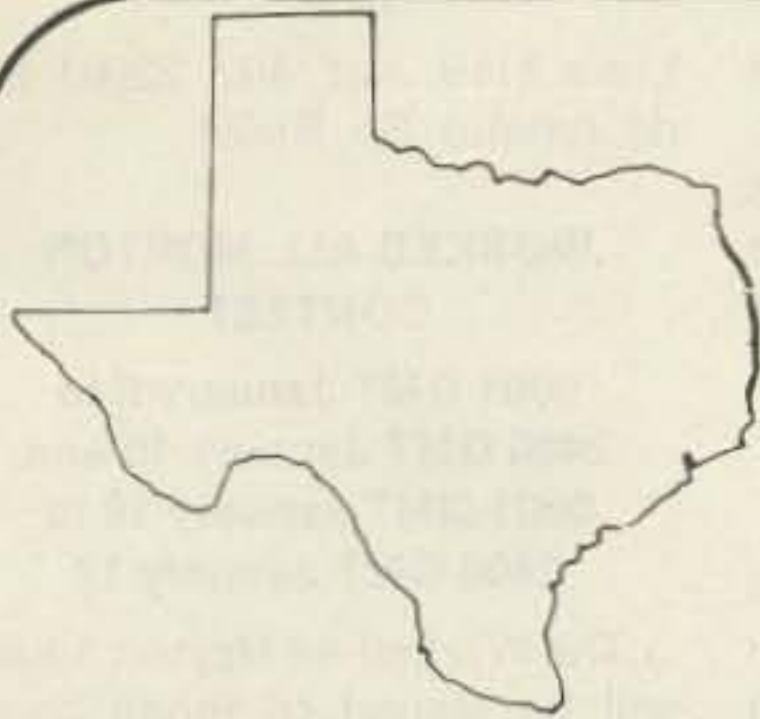

Universal Communications
 A DIVISION OF INNOVATIVE LABS, INC.
 P.O. BOX 339
 ARLINGTON, TEXAS 76004-0339



SUPERVERTER I..... \$99.95

The ultimate in converter technology! Dual-stage selective preamp, mixer, i.f. amplifier and no-drift crystal-controlled oscillator. We recommend this unit for **experienced kit builders**. 12v Stationary Power Supply... \$24.95 for Superverter I.

SELECTIVE PREAMP..... \$44.50

This new unit is not like other wideband preamps. Experienced kit builders can easily add this unit to our existing boards or to other manufacturers' boards to improve overall performance.

2300 MHZ CONVERTER KIT..... \$35.00

Complete with PC board, parts and 10-page instruction book.

VARIABLE POWER SUPPLY..... \$24.95

Complete kit includes all components for working unit, including deluxe box and overlays.

DISK YAGI ANTENNA..... \$25.00

Complete kit with PVC and mounting bracket. Stronger than loop yagi, and equal in gain.

4-FOOT DISH ANTENNA..... \$49.95

Overall 25 dB gain. Partial assembly required. Shipped UPS (ground) only.

DL-2000 SATELLITE RECEIVER..... \$699.95

Fully assembled receiver—this is not a kit.

120° LNA..... \$650.00

COMING NEXT MONTH... OUR OWN
 2300 MHZ TRANSMITTER AND 1691
 WEATHER SATELLITE DOWN CON-
 VERTER (CRYSTAL CONTROLLED
 WITH PREAMP).

TERMS: COD, Money Order, Bank Cards (800) 433-5172 ORDERS ONLY
HOURS: 8:30-4:30 CDST; MON-FRI (817) 265-0391 INFORMATION

Our product may be copied, but the performance is never equalled. P.O. BOX 339, ARLINGTON, TX 76004-0339
UNIVERSAL COMMUNICATIONS

ASSOCIATED RADIO

913-381-5900

8012 CONSER BOX 4327
 OVERLAND PARK, KANSAS 66204

BUY—SELL—TRADE
All Brands New & Reconditioned



We Want to DEAL—Call Us—We'll Do It Your Way.
WE'RE #1



NOTE: SEND \$1.00 FOR OUR CURRENT CATALOG OF NEW AND RECONDITIONED EQUIPMENT.

*** ALSO WE PERIODICALLY PUBLISH A LIST OF UNSERVICED EQUIPMENT AT GREAT SAVINGS. A BONANZA FOR THE EXPERIENCED OPERATOR.**

TO OBTAIN THE NEXT UNSERVICED BARGAIN LIST SEND A SELF ADDRESSED STAMPED ENVELOPE.

EXCHANGE:

QSO number (beginning with 001) and state, province, country, or Texas county.

FREQUENCIES:

Novice—3710, 7110, 21110, 28110; Phone—3940, 7260, 14280, 21370, 28600; CW—3565, 7065, 14065, 21065, 28065.

SCORING:

All non-Texas stations score points as follows: phone contact with fixed station in TX = 1 point; CW contact with fixed station in TX = 2 points; phone contact with mobile station in TX = 5 points; and CW contact with mobile station in TX = 7 points. Multiply by the number of Texas counties worked (254 max.).

All Texas stations score 1 point per contact on phone, 2 points on CW regardless of fixed or mobile. Multiply by the number of states, countries, and Canadian provinces worked.

AWARDS:

Plaques to top scores: US, US-Novice, DX, Canada, Texas fixed, Texas mobile, Texas Novice. Certificates to top score in each state, country, and province. Certificates also to top 10 Texas stations. Special awards as activity dictates.

ENTRIES:

All logs must be received by March 15th. Mail entries to: WTARC, PO Box 9944, Odessa TX 79762-0041.

HB9CDX

SWITZERLAND
SUIZA

HYDROPOWER
CLEAN ENERGY

POTENCIA HIDRAULICA
-ENERGIA LIMPIA



QSL OF THE MONTH: HB9CDX

This colorful card was submitted by Swiss amateur Hans K. Wagner HB9CDX. It's an example of how your card can reflect a personal interest—in this case, hydroelectric power.

If you would like to enter our contest, put your QSL card *in an envelope* and mail it, along with your choice of a book from 73's Radio Bookshop, to 73 Magazine, Pine Street, Peterborough NH 03458, Attention: QSL of the Month. Entries which do not use an envelope (the Postal Service does *occasionally* damage cards) and do not specify a book will not be considered.

**THE GREAT
NORTH DAKOTA QSO BINGE**
0000 to 0800 and 1600 to 2400
GMT January 23, and
0800 to 1600 GMT January 24

Sponsored by the Red River
Radio Amateurs of Fargo, North
Dakota.

EXCHANGE:

RS(T) and state, country, or North Dakota county. Novices, please indicate Novice status.

3540, 7035, 14035, 21035, 28035;
Novice—3725, 7125, 21125,
28125. All frequencies plus or
minus 10.

FREQUENCIES:

Phone—1815, 3905, 7280,
14280, 21380, 28580; CW—1810,

SCORING:

Phone contacts count 10
points, CW count 20, and RTTY

NEWSLETTER CONTEST WINNER



HAMLETTER

Picking a monthly winner for 73's Newsletter Contest is no easy task. There are literally hundreds of entries to sift through. Each month we narrow the field to four or five outstanding publications and then make the tough decision.

Almost without fail, each month's collection of runners-up has included at least one newsletter from a Chicago area club. For some reason unknown to us, the newsletters coming from that part of the country are usually first-rate. Perhaps there is some sort of inter-club rivalry? This month, a nineland publication finally clawed its way to the top, with the winner being *The Hamletter*, published by the Wheaton Community Radio Amateurs.

This suburban Chicago group's newsletter sports a two-

color printing job on the front page and is chock full of black and white photos. But in the end it was a rather small detail that brought victory to *The Hamletter*. Should a copy of this publication fall into the hands of someone who is not a club member, he or she will find plenty of information about the club. A collection of helpful facts can be found every month on the newsletter's masthead. In addition to listing the names and calls of the club officers and newsletter staff, you'll find a mailing address for the club, details about the club meeting time and place, plus a rundown on the club nets and repeaters. This may seem like "obvious" information but for any new or prospective member it can be indispensable.

A newsletter is built from a collection of little details like the masthead. Sometimes you can make subtle changes in your style or layout that will outstrip the improvements of a major reorganization. Establishing a regular format for a publication can give it an identity, but sticking to something because "it's always been that way" may lead to stagnation. Perhaps in 1982 your club can concentrate on the little things; sometimes they make the biggest difference. Keep those newsletters coming!—N8RK.

1st ANNUAL 40- AND 80-METER PHONE CONTEST

SPONSORS:

73 Magazine, Peterborough, New Hampshire 03458

CONTEST PERIODS:

40-Meter Event—0000Z to 2400Z January 9, 1982
80-Meter Event—0000Z to 2400Z January 10, 1982

MISCELLANEOUS RULES:

Work as many stations as possible on 40- and/or 80-meter phone during the specified times of allowable operation. The same station may be worked once on each band. Crossmode contacts will not count. Single-operator stations may operate a total of 16 hours on each band. All multi-operator stations may operate the entire 24-hour period on each band. Off periods must be noted in your logs and on your summary sheet. Off periods are no less than 30 minutes each.

OPERATOR CLASSES:

(A) Single-operator, single transmitter, phone only
(B) Multi-operator, single transmitter, phone only

ENTRY CATEGORIES:

(1) 40-meter band only
(2) 80-meter band only
(3) 40- and 80-meter bands

EXCHANGE:

Stations within the continental US and Canada transmit an RS report and state, province or territory. All other stations, including Alaska and Hawaii, transmit RS report and DX country.

POINTS:

A station may be worked once on each band. US/VE stations earn 1 QSO point per contact with the 48 states and Canada, 2 points for all others. DX stations (including Alaska and Hawaii) earn 1 QSO point per contact within your own coun-

try, 2 points for all others. Contacts made between 1000 and 1400 local time score twice the normal points per contact. Indicate points per contact on your log sheet.

MULTIPLIERS:

1 multiplier point is earned for each US state (48 max.), each Canadian province or territory (12 max.), or each DX country worked on each band.

FINAL SCORE:

Total QSO points times total multiplier points equals claimed score.

CONTEST ENTRIES:

Each contest entry must include a log for each band in your entry category, a dupe sheet for each band, a contest summary, and a multiplier checklist for each band. We recommend that contestants send for a copy of the contest forms. Enclose an SASE to the contest address listed below.

ENTRY DEADLINE:

All entries must be postmarked no later than February 11, 1982.

DISQUALIFICATIONS:

Omission of any required entry form, operating in excess of legal power, manipulating of contest scores or times to achieve a score advantage, or failure to omit duplicate contacts which would reduce the overall score more than 2% are all grounds for immediate disqualification.

AWARDS:

Contest awards will be issued in each entry category in each of the continental US states, Canadian provinces and territories, and each DX country represented. A minimum of 5 hours and 50 QSOs must be worked to be eligible for contest awards.

CONTEST ADDRESS:

Send an SASE to: Whidbey Island DX Club
2665 North Busby Road
Oak Harbor, Washington 98277

count 50. North Dakota stations count an additional 100 point bonus for working five Novices. North Dakota stations multiply score by total of states, provinces, and countries per band and mode. Others multiply by counties worked per band and mode (max. of 53 counties).

ENTRIES AND AWARDS:

Certificates to state and province winners. Plaque to North Dakota winner. Mail logs with usual certification by February 28th to: Bill Snyder W0LHS, Box 2784, Fargo ND 58108-2784.

CQ WORLDWIDE 160-METER CONTEST—CW

Starts: 2200 GMT January 29
Ends: 1600 GMT January 31

EXCHANGE:

RST plus a three-digit contact number starting with 001. US

stations include state and Canadians include province.

SCORING:

US and Canadian stations count 2 points per QSO with other W/VE/VO stations; DX contacts are 10 points each.

DX stations count 2 points per QSO with stations in the same country, 5 points with stations in other countries. QSOs with W/VE/VO stations are 10 points each.

All stations count one multiplier point for each US state, VE province, and DX country. KH6 and KL7 are considered DX. Final score is total QSO points times the sum of multipliers.

AWARDS:

Certificates to the top scorers in each state, VE province, and DX country. Additional awards if the score or returns warrant.

Two plaques are being awarded by the West Gulf ARC, both for single operators—one for the highest scoring US station and the other for Europe. The World Champion in the contest will receive the John Doremus W0AW Memorial Plaque from friends of W0AW. This plaque can be won only once by the same station in a three-year period.

PENALTIES:

Three additional contacts will be deleted from the score for each duplicate, false, or unverifiable contact removed from the log. A second multiplier also will be removed for each one lost by this action.

Violation of the rules and regulations pertaining to amateur radio in the country of the contestant or the rules of the contest, or unsportsmanlike

conduct or taking credit for excessive duplicate contacts or multipliers will be deemed sufficient cause for disqualification. Disqualified stations or operators may be barred from competing in CQ contests for a period of up to three years.

ENTRIES:

Sample log and summary sheets may be obtained from CQ by sending a large SASE with sufficient postage to cover your request. It is not necessary to use the official form; you may use your own. Logs should have 40 contacts per page, show time in GMT, and numbers sent and received; there should be separate columns for QSO points and multipliers. Indicate the multiplier only the first time it is worked.

Mailing deadline for CW entries is February 28th. Logs can

3rd ANNUAL INTERNATIONAL 160-METER PHONE CONTEST

SPONSORS:

73 Magazine, Peterborough, New Hampshire 03458

CONTEST PERIOD:

0000Z January 16, 1982, to 2400Z January 17, 1982

OBJECT:

To work as many stations as possible on 160-meter phone in a maximum of 36 hours of allowable contest time. Multi-operator stations may operate the full 48-hour contest period. Stations may be worked only once!

ENTRY CATEGORIES:

(1) Single operator, single transmitter, phone only (2) Multi-operator, single transmitter, phone only

EXCHANGE:

Stations within the continental US and Canada transmit RS report and state, provinces or territory (i.e., 59 Iowa, 55 Ontario, etc.). All others transmit RS report and DX country.

POINTS:

Five (5) points will be earned for each valid contact with stations in the continental US and Canada. DX contacts outside the continental US and Canada score ten (10) points each. This year for the first time, an additional 5 points *bonus* may be earned for each contact made during the hours of 1000-1400 local time on either day of the contest.

MULTIPLIERS:

1 multiplier point will be earned for each of the 48 continental states, twelve (12) Canadian provinces/territories, and DX countries outside the continental US and Canada worked during the contest.

FINAL SCORE:

Total QSO points times total multiplier points equals claimed score.

CONTEST ENTRIES:

Each contest entry must include logsheets, dupe sheets for 100 contacts or more, a contest summary sheet and a multiplier check sheet. Please note those contacts made between 1000-1400 local time so you'll be sure to get appropriate contest credit.

ENTRY DEADLINE:

All entries must be postmarked *no later than February 18, 1982*.

DX WINDOW:

Stations are expected to observe the DX window from 1.825-1.830 MHz as mutually agreed by top-band operators. Stations in the US and Canada are asked not to transmit in this 5-kHz segment of the band.

DISQUALIFICATION:

If contestant omits any required entry form, operates in excess of the legal power authorized for his/her given area, manipulates operating times to achieve a score advantage, or fails to omit duplicate contacts which may reduce the overall score more than 2%, disqualification may result.

AWARDS:

Contest awards will be issued in each entry category in each of the continental US states, Canadian provinces/territories, and each DX country. A minimum of 5 hours and 50 QSOs must be worked to be eligible for contest awards.

CONTEST ADDRESS:

To obtain information, entry forms, or to submit a contest entry, forward a *self-addressed stamped envelope* to:

160-Meter Phone Contest
Dan Murphy WA2GZB
Post Office Box 195
Andover NJ 07821 USA

be sent directly to the 160 Contest Director, Don McClenon N4IN, 3075 Florida Avenue, Melbourne FL 32901 USA. Alternatively, they can be sent to CQ, 160-Meter Contest, 76 North Broadway, Hicksville NY 11801 USA.

TRIPLE CROWNS OF QRP

This is a new award, instituted in 1982 by the QRP Amateur Radio Club International (QRP ARCI). The triple crowns are three trophies for the leading scores in the three categories of the club's annual spring and fall QSO parties, which are open to members and non-members alike. Special certificates will go to the runners-up as well.

The engraved trophies will be awarded the QRP operators whose combined scores from the spring SSB QSO party and the fall CW competition top

those of other entrants. Trophies will be awarded in these categories: (1) The top US or Canadian QRP station, (2) the leading non-W/VE QRP station, and (3) the front-running Novice or Technician QRP station (based on results of the fall CW contest only).

To be eligible for one of the triple crowns, operators must enter both QSO parties (except Novices and Technicians) because the awards will be based on their combined scores. Winners will be announced in the January, 1983, issue of *QRP Quarterly*, the club publication, which also will publish worldwide results.

The Triple Crowns of QRP will be awarded in addition to the awards issued for individual performances in the fall and spring QSO parties, whose dates will be announced later.

Those contests will continue to cite first and second place overall and top winners from each state, province, and country.

SECOND ANNUAL MICHIGAN QRP CLUB CW CONTEST

Starts: 1500Z January 16
Ends: 1500Z January 17

A CW-only, all bands, 160-to-10-meter QRP contest. Contest is open to all amateurs, and all are eligible for awards. Calling method: CQ CQ CQ QRP DE (your callsign).

EXCHANGE:

RST, QSO number, and power output.

SCORING:

Each station will be competing within its own state (W),

province (VE), or country in one of the three categories: (1) one Watt or less of output power; (2) five Watts or less of output power; and (3) over five Watts of output power.

Each contact is worth one (1) QSO point. Multiply total QSO points (all bands) by the number of states/provinces and countries worked per band for total points. Bonus multiplier—emergency power (100% natural or 100% battery) times 1.5 of total.

AWARDS:

Certificates will be awarded to the highest scoring station in each state (W), province (VE), and country.

ENTRIES:

Log information must include: full log data with a sepa-

rate log for each band, name, address, equipment used, and power output. Logs must be received by the contest manager no later than six (6) weeks after the end of the contest. (W) and (VE) please send an SASE, and all others please send two IRCs if contest results are desired. Send all logs to: Contest Manager, Michigan QRP Club, 281 Crescent Drive, Portland MI 48875.

FIFTH ANNUAL INTERNATIONAL SSTV CONTEST

1500 to 2300 GMT March 13
1500 to 2400 GMT March 14

The contest is sponsored by

73 Magazine, R. Brooks Kendall W1JKF, and Dave Ingram K4TWJ. It is always held on the second full weekend of March. All amateur bands between 3.5 and 29.7 MHz may be used.

EXCHANGE:

Exchange of pictures should include callsign, RST report, and contest number. FCC rules require verbal exchange of callsigns of US stations. Do not include contact number.

SCORING:

One point for each station worked. A station may be worked once on each band for

credit. 1 point for each state or province worked. 5 points for each country worked, but only once for 5 points. 5 points for each continent worked, but only once for 5 points. Total score is the sum of all the credits. Excessive discrepancies in the contest entry may cause disqualification. Entries become the property of the contest committee. The decisions of the contest committee are final.

ENTRIES:

Activity sheets should show station worked, state or province, country, and band (80, 40, 20, 15, 10). Summary sheets should show number of stations

worked, number of states or provinces worked, number of countries worked, number of continents worked, and total score. Contest entries should be postmarked no later than April 30, 1982. Top scorer will be awarded a certificate and a year's subscription to 73 Magazine. Certificates also will be awarded to the top scorer for the most countries worked, and also for the most continents worked.

Send entries to either R. Brooks Kendall W1JKF, 10 Stocker Street, Saugus MA 01906, or David Ingram K4TWJ, Eastwood Village, No. 1201 South, Rt. 11, Box 499, Birmingham AL 35210.

FUN!



John Edwards K12U
78-56 86th Street
Glendale NY 11385

THE YEAR IN REVIEW

Here's for 1981! Now *that* was a year. Remember the great songs we listened to on 2 meters? How about those wonderful movies we watched on our MDS downconverters? I don't know about you, but I feel very nostalgic about that year. It seems, as the old saying goes, like it was only yesterday.

Obviously, ham radio had its usual happenings in 1981. The customary array of scandals, court actions, FCC denials, and net jammers—all in the name of international brotherhood, of course. So, with a flutter in our voice and a crack in our heart, let's relive 1981 all over again. A year of destiny!

ELEMENT 1—CROSSWORD PUZZLE

(Illustration 1)

Across

- 1) 1981 FCC bombshell proposal (2 words)
- 7) What the FCC proposes to call our service
- 8) K2AGZ
- 9) Synonym for frequency hogs
- 11) Popular Soviet DXpedition prefix during 1981
- 14) What the FCC said to expanded 160-meter privileges in 1981
- 16) _____ do you do it?
- 18) 1981: a weak year for many ham dealers to _____ rigs

- 19) A 2-meter rig (abbr.)
- 20) Not CW, not RTTY, not Fax, not SSTV...
- 21) Number of bands covered by a monobander
- 22) Computer _____ chart
- 24) "Knights of Malta": now _____ DXCC
- 25) Nobility or DXCC running total
- 26) Spain
- 27) Interrupted code (abbr.)
- 28) What a contest should be
- 30) Propaganda station (abbr.)
- 32) Ham radio legend

- 33) What you did at your club's picnic last summer
- 34) Proposals for this new spot were firmed up during 1981 (2 words)

- 10) He introduced a bill affecting hams in 1981
- 12) FCC began calling this a "siemens" in 1981
- 13) Amateur space program's anniversary last year
- 15) Electromagnetic range
- 17) Ham radio turns us _____
- 22) New 1981 FCC head honcho, big cheese, numero uno, Mr. Big, top dog
- 23) Austria
- 29) What the ARRL's directors said to raising dues
- 30) FCC rule (abbr.)
- 31) Travel plans of many DXpeditions were complicated by the firing of some of this agency's workers (abbr.)

Down

- 1) FM tone (abbr.)
- 2) Expression of discovery
- 3) Norway
- 4) This and a leg would buy you a new rig during 1981
- 5) What many hams thought 1 across was
- 6) "Fruit" often found on RTTY these days
- 8) Many hams headed here again last spring

ELEMENT 2—MULTIPLE CHOICE

- 1) During 1981, the FCC issued a number of amateur stations special authority to experiment with a new communications mode. This

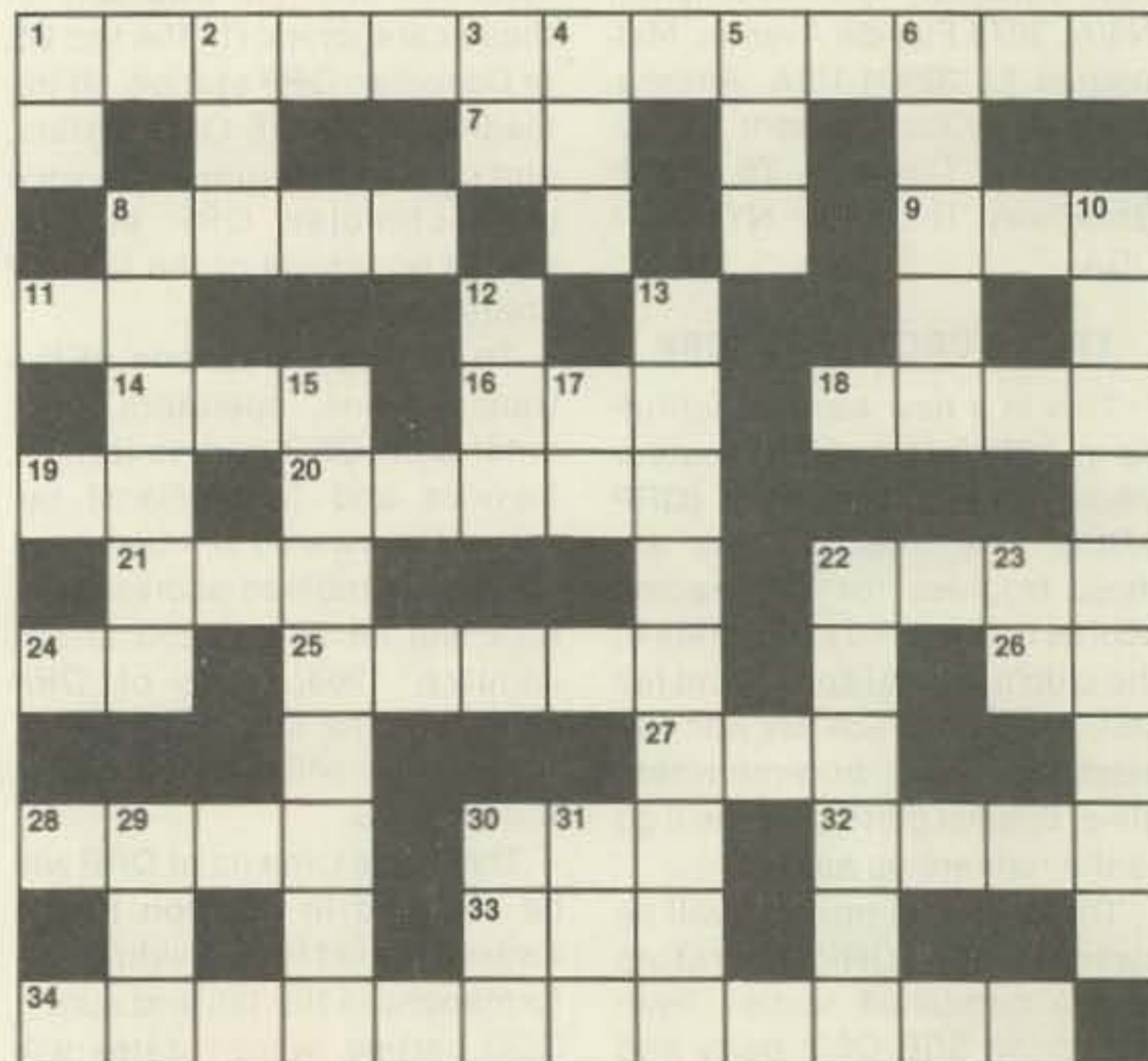

Illustration 1.

technique, which uses 10 to 100 times the bandwidth of conventional modes, is known as:

- 1) Spread Spectrum
- 2) Spread Sideband
- 3) Spread Frequency
- 4) Packet Radio

2) According to the FCC, John W. Munson, Jr., K6EOA, was sentenced to 3 years probation, fined \$500, and ordered to undergo psychotherapy for saying the following over the air:

- 1) "Is this frequency in use?"
- 2) "I would love to shoot me a couple of Feds."
- 3) "Help, help! My boat is sinking!"
- 4) "Five-nine, Cal."

3) It's been a rough year for the ARRL Central Division. First, their director is "fired," next, the recall balloting of his successor gets fouled up. Exactly what problem afflicted the recall election?

- 1) Ballots went to members of the Hudson Division.
- 2) The League forgot to enclose ballots in many of the envelopes they sent out.
- 3) Ballots were mailed with insufficient postage.
- 4) The ballots got lost at the bureau.

4) OSCAR 9, launched on October 6, 1981, was built by hams from what country?

- 1) United States
- 2) Great Britain
- 3) Japan
- 4) West Germany

5) Another ARRL scandal had something to do with QSL cards. What happened?

- 1) A bunch of 6-land hams submitted phony pasteboards for DXCC credit.
- 2) The League lost thousands of WAS QSLs when they were accidentally dumped in a paper shredder.
- 3) The ARRL announced that after July 1, 1981, they would no longer return QSLs submitted for DXCC awards.
- 4) A League vice director was caught sending in forged QSLs for WAC.

ELEMENT 3—MATCHING

Even with a collapsing economy, manufacturers in 1981 brought out the usual array of new ham stuff. Here, match the product to its maker.

Column A

- 1) ST-7/T
- 2) IC-3AT
- 3) FT-ONE
- 4) CT2100
- 5) TR-2500
- 6) 100
- 7) S-4
- 8) MBA Reader
- 9) Micro-RTTY
- 10) μ Matic

Column B

- A) Heathkit
- B) Yaesu
- C) Santec
- D) Tempo
- E) Icom
- F) TriggerTronix
- G) Hal
- H) Bearcat
- I) Kenwood
- J) AEA
- K) Kantronics

ELEMENT 4—TRUE-FALSE

- | | True | False |
|---|-------|-------|
| 1) In 1981, the FCC eased amateur ID rules. | _____ | _____ |
| 2) The FCC began the practice of issuing special event call signs again last year. | _____ | _____ |
| 3) The FCC took action, in 1981, to take away our band at 1215 MHz. | _____ | _____ |
| 4) OSCAR 9 has on-board SSTV capability. | _____ | _____ |
| 5) The first US packet repeater became operational during 1981. | _____ | _____ |
| 6) Last year, many African countries began pushing for the creation of a fourth ITU region. | _____ | _____ |

7) In last year's FUN! poll, 14% of the participants admitted to jamming other stations.

8) Bo Derek became a Novice in 1981.

9) An FCC 1981 working paper proposed, in part, establishment of a code-free VHF ham ticket, amateur privileges on some CB segments, and an expansion of Technician privileges.

10) The technical breakthrough of 1981 was the development of a 3-element, top-performance, tri-band beam that could fit in your pocket.

ELEMENT 5—CRYPTIC PUZZLE

By using a standard substitution code, decipher this message:
 MH PYY MYCQKH CXMC MPPVYCVB KNW XKUUL QH MH
 QHBQWVYC FML FMO CXV VDQJQHMCQKH KP CXV PQWOC-
 YDMOO WMBQKCVDSXKHV DQYVHOV

THE ANSWERS

Element 1:

See Illustration 1A.

Element 2:

1—1 Better save up for that new "spectrum spreader."

2—2 And they took away his ham ticket, too!

3—2 The problems never cease.

4—2 Gee, a G-sat.

5—1 Ever wonder why anybody would even *want* to cheat for a DXCC?

Element 3:

1—C, 2—E, 3—B, 4—G, 5—I, 6—H, 7—D, 8—J, 9—K, 10—A.

Element 4:

1—True. Now IDing is strictly a one-way street.

2—False. Well... I can dream, can't I?

3—True. In accordance with WARC wishes.

4—True. Stand outside and wave as it passes.

5—True. KA6M/6 is San Francisco's "digipeater."

6—True. Four's company...

7—True. Amazing, no?

8—False. The line of Elmer volunteers forms on the right.

9—True. The line to comment also forms on the right.

10—False. And I've also got a bridge in Brooklyn you may be interested in.

Element 5:

Coded as follows:

| | | | | | | | | | | | | | | | | | | | | | |
|---|---|---|---|---|---|---|---|---|---|---|---|---|---|---|---|---|---|---|---|---|---|
| A | B | C | D | E | F | G | H | I | J | K | L | M | N | O | P | Q | R | S | T | U | V |
| M | U | Y | B | V | P | A | X | Q | Z | I | D | J | H | K | S | R | W | O | C | N | E |
| W | X | Y | Z | | | | | | | | | | | | | | | | | | |
| F | T | L | G | | | | | | | | | | | | | | | | | | |

AN FCC ACTION THAT AFFECTED OUR HOBBY IN AN INDIRECT WAY WAS THE ELIMINATION OF THE FIRST-CLASS RADIOTELEPHONE LICENSE

SCORING

Element 1:

Twenty points for the completed puzzle, or 1/2 point for each question correctly answered.

Element 2:

Four points for each correct answer.

Element 3:

Two points per match.

Element 4:

Two points for each correct answer.

Element 5:

Twenty points for the completed puzzle.

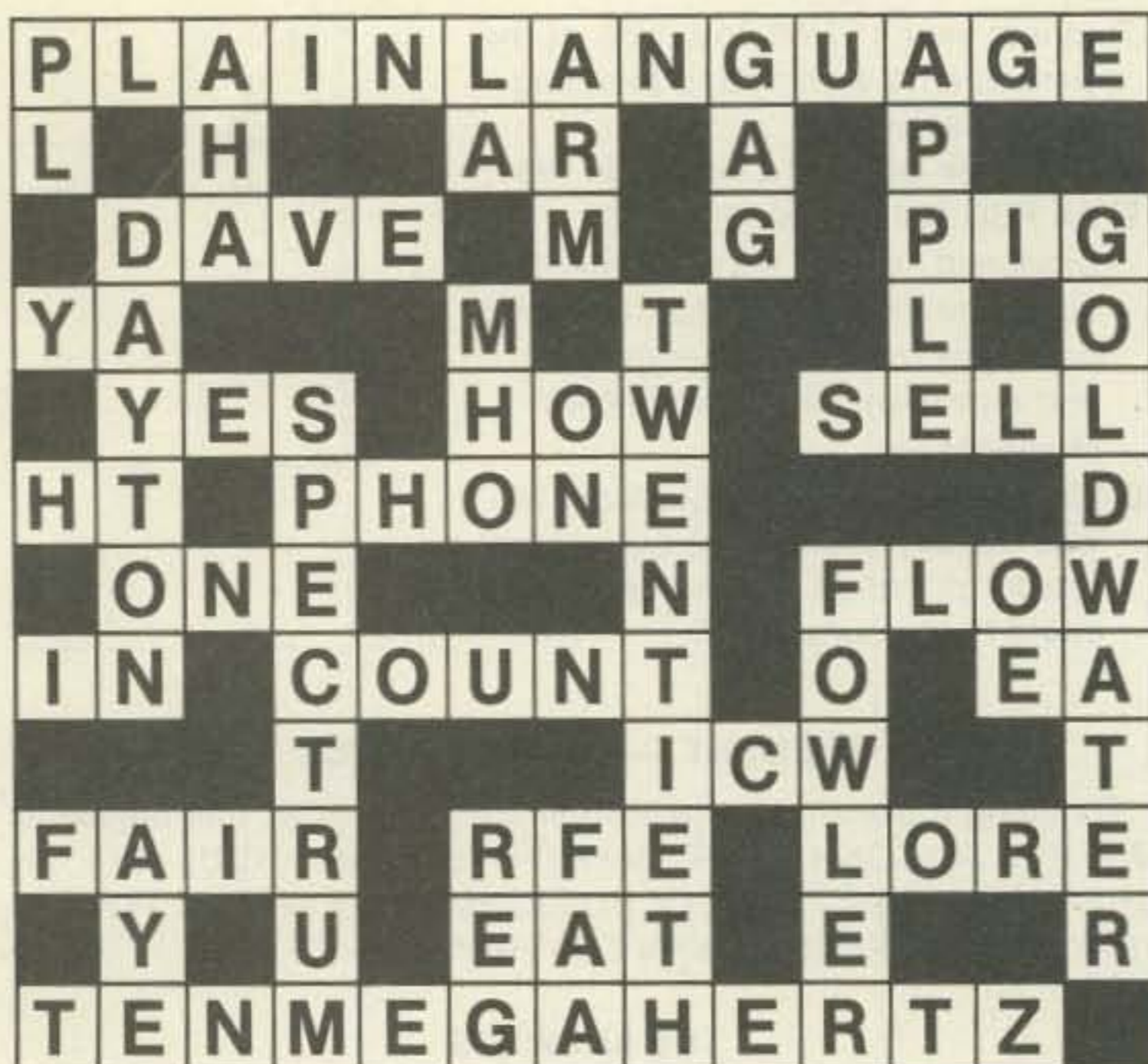

Illustration 1A.

- How well did you remember '81?
- 1-20 points—Comatose during 1981
 - 21-40 points—"It's kinda fuzzy"
 - 41-60 points—"I remember it well"
 - 61-80 points—"Like it was yesterday"
 - 81-100+ points—Perfect recall

READER'S CORNER

Do you have ham-related puzzles you would like to share with FUN's readers? Then send them in for a chance to see your name in print. This month's contribution is by Bob Young W1MXI, of Belmont, Massachusetts.

Five hams set up a schedule with five DX stations. They agreed to use five different frequencies, and it was also agreed that the five hams would work the DX stations in a prearranged sequence. From the following clues, determine each ham's call, the DX station each

is now working, and the DX station to be worked next. (Ed. Note: Names and callsigns do not represent any living amateurs.)

- A) The rotation sequence is the same for each ham.
- B) Bob, who is not W1XT, will work Mongolia next.
- C) W1JO will not work Hong Kong next.
- D) Tom, W1XT, the ham now working Mongolia, and the ham who will next work Taiwan are four of the five hams.
- E) Jack, who previously worked Taiwan, will not next work Hong Kong.
- F) Pat is neither W1WW or W1JO, nor is she now working Hong Kong.
- G) One of the hams is Dan, whose call is W1YS.
- H) Tom is not W1WW.
- I) The ham who will next work Korea is not now working Hong Kong.
- J) W1BX will not be working Hong Kong next.
- K) Jack is not now working Mongolia.

Send in your answers. We'll print the name and call of everyone who solves this puzzle.

| | Bob | Dan | Jack | Pat | Tom | WORKING NOW | | | | | WORKING NEXT | | | | | | | | |
|--------------|-----------|-----|------|-----|-----|-------------|-------|--------|-----------|----------|--------------|-------|--------|-----------|----------|--|--|--|--|
| | | | | | | Japan | Korea | Taiwan | Hong Kong | Mongolia | Japan | Korea | Taiwan | Hong Kong | Mongolia | | | | |
| W1XT | | | | | | | | | | | | | | | | | | | |
| W1JO | | | | | | | | | | | | | | | | | | | |
| W1YS | | | | | | | | | | | | | | | | | | | |
| W1WW | | | | | | | | | | | | | | | | | | | |
| W1BX | | | | | | | | | | | | | | | | | | | |
| WORKING NOW | Japan | | | | | | | | | | | | | | | | | | |
| | Korea | | | | | | | | | | | | | | | | | | |
| | Taiwan | | | | | | | | | | | | | | | | | | |
| | Hong Kong | | | | | | | | | | | | | | | | | | |
| | Mongolia | | | | | | | | | | | | | | | | | | |
| WORKING NEXT | Japan | | | | | | | | | | | | | | | | | | |
| | Korea | | | | | | | | | | | | | | | | | | |
| | Taiwan | | | | | | | | | | | | | | | | | | |
| | Hong Kong | | | | | | | | | | | | | | | | | | |
| | Mongolia | | | | | | | | | | | | | | | | | | |

CORRECTIONS

IC-2 owners who attempt the MARS modification described on page 113 of the October, 1981, issue of 73 may not find a brown jumper on the underside of the MHz thumbwheel switch. Another color of wire may have been used. Avoid any brown jumper that is not located on the switch.

Tim Daniel N8RK
73 Magazine Staff

In building the "Lab-Quality High I Supply" that appeared in your March and April, 1980, issues, I have encountered several problems that, as far as I

know, were never mentioned in your corrections column. The problem is in the current-limiting circuit and its connection to the rest of the supply.

Pin 7 of IC2 will go low when the current falls below the set level, not above it as the article states. Also, when pin 7 goes low it will pull pin 2 low, causing an increase in output instead of a decrease. This results in the pass transistors running wide open when the current falls below the set level and regulation to the set voltage when excessive current is drawn.

I solved the problem by

switching the connections 16 and P on the edge connector and connecting the anode of D3 to pin 3 of IC2 instead of pin 2. A simpler solution that should work is to reverse D3.

The supply works fine now and I have been running my HF rig with it. Thanks for the good construction article. I think 73 is one of the best magazines available for good construction and theory articles for those of us who like to home-brew our equipment.

Jim Skinner AC7C
1032 5th Street
Bremerton WA 98310

Reader Jim Skinner AC7C (this is a call?) has made some good points on the article, "Build This Lab-Quality Hi I Supply," as featured in the March and

April, 1980, issues of 73 Magazine. Of all the projects I have had published in 73, this one has shown the most interest. To date I have received over 44 queries on it, a record. Most all of the letters concerned substitutions of the power transistors with house-numbered devices. A few others concerned the design itself. One reader queried about the overcurrent shut-down circuitry. From what I have been able to discover, this reader (and Jim) have the inputs of the op amp comparator reversed. That will cause the problem he mentioned. Let me close by saying that I am delighted with the interest readers have shown in the project; it surpassed anything I could have imagined back in 1976 when it was designed.

Gary McClellan
La Habra CA

There has never been a better time to subscribe to 73. Ever.

NEW From **73** MAGAZINE

THE MOST UP-TO-DATE REPEATER ATLAS AVAILABLE!

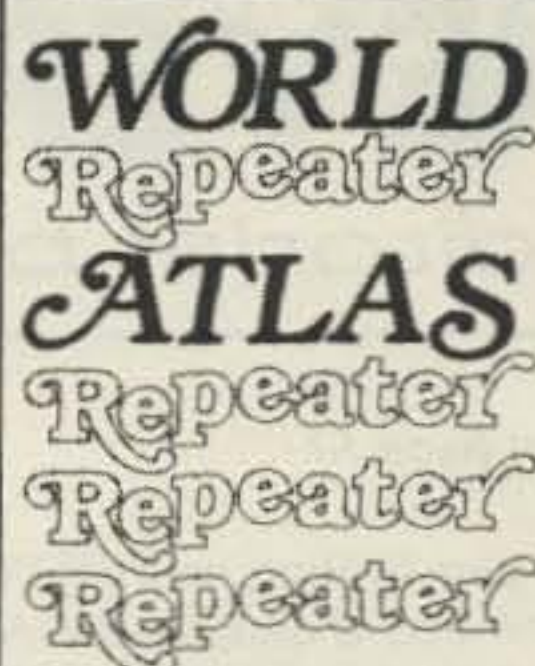

INCLUDES:

- LISTINGS BY STATE AND COUNTRY
- LISTINGS BY FREQUENCY
- MAPS FOR EACH STATE
- 28 MHZ THROUGH 1296 MHZ
- PERFECT FOR MOBILING
- WORLD REPEATER ATLAS—BK7315—Completely updated, over 230 pages of repeater listings are indexed by location and frequency. More than 50 maps pinpoint 2000 repeater locations throughout the USA. Foreign listings include Europe, the Middle East, South America and Africa. \$4.95.

IN STOCK AND READY TO SHIP

*Use the order card in the back of this magazine or itemize your order on a separate piece of paper and mail to: 73 Radio Bookshop • Peterborough NH 03458. Be sure to include check or detailed credit card information.

No C.O.D. orders accepted. Add \$1.50 handling charge for the first book; \$1.00 for each additional book. Questions regarding your order?

Please write to Customer Service at the above address.

Please allow 4-6 weeks for delivery.

FOR TOLL FREE ORDERING CALL 1-800-258-5473

NEW From **73** MAGAZINE

THE 1982 EDITION
**GENERAL LICENSE
STUDY GUIDE**

by Timothy M. Daniel N8RK

This is the complete guide to the General License. Learning rather than memorizing is the secret. This is not a question-and-answer guide that will gather dust when the FCC issues a new test. Instead, this book will be a helpful reference, useful long after a ham upgrades to General. Includes up-to-date FCC rules and an application form.

ORDER yours today and talk to the world.

SG7358 **\$6.95**

The 1982 edition will be ready to ship in February.

*Use the order card in the back of this magazine or itemize your order on a separate piece of paper and mail to: 73 Radio Bookshop • Peterborough NH 03458. Be sure to include check or detailed credit card information. No C.O.D. orders accepted. Add \$1.50 handling charge for the first book; \$1.00 for each additional book. Questions regarding your order? Please write to Customer Service at the above address. Please allow 4-6 weeks for delivery.

**FOR TOLL FREE ORDERING
CALL 1-800-258-5473**

MOVING?

Let us know 8 weeks in advance so that you won't miss a single issue of 73 Magazine.

Attach old label where indicated and print new address in space provided. Also include your mailing label whenever you write concerning your subscription. It helps us serve you promptly. Write to:

73 magazine

Subscription Department
P.O. Box 931
Farmingdale NY 11737

- | | |
|--|---|
| <input type="checkbox"/> Address change only | <input type="checkbox"/> Payment enclosed |
| <input type="checkbox"/> Extend subscription | |
| <input type="checkbox"/> Enter new subscription | <input type="checkbox"/> Bill me later |
| <input type="checkbox"/> 1 year \$25.00 (Canada \$27, Foreign \$35/US funds) | |

If you have no label handy, print OLD address here.

Name _____ Call _____

Address _____

City _____ State _____ Zip _____

print NEW address here:

Name _____ Call _____

Address _____

City _____ State _____ Zip _____

321B6

W2NSD/1 NEVER SAY DIE

editorial by Wayne Green

from page 10

the gap. Setting up a RTTY machine and a couple of CW stations is not going to make it. I've seen so many ham attempts at showing off at malls and fairs, but with nothing to draw in the people. This is show business, too... and you have to get 'em in with something dynamic. A couple of rigs and operators, sitting behind a table, is not show business.

Okay... now you write the articles and tell us how to get things moving.

FRUIT BASKET LEAKS

His Majesty King Hussein (JY1) paid our country a visit recently. After some heavy-duty meetings in Washington, Hussein headed out to Los Angeles. He must not read our Looking West column. At any rate, the L.A. hams got all excited when Hussein called in on the Henry repeater and began working the lists of stations anxious to say hello. Wonder of wonders, particularly for that area, everyone behaved... probably for the first time in several years. The whole group was proud as hell of their ability to cope with royalty and put on a good show.

Frank W6AOA got things set up to do a 20-meter-to-two-meter relay from Jordan that night when His Majesty returned from a dinner engagement. The gang had everything set, waiting for the big moment. Sure enough, a bit late but still game, Hussein arrived back at the hotel and checked into the repeater. At that moment, to the utter dismay of everyone, someone got on and let loose with the four-letter words, reading the king off. That certainly was the time for someone to have a finger on the repeater controls... but no one did and Hussein checked out immediately, remarking that he really didn't need that. Everyone felt absolutely terrible about it and you can be sure that there are going to be some major efforts at com-

paring voice prints of every active station in the area.

On the other hand, considering the way things have been going in L.A., I don't think anyone was really surprised. It has gotten so normal to get on the repeaters and jam them with obscenities that few blink an eye when it happens. Fortunately, that phenomenon is pretty much restricted to Los Angeles. I check in on the repeaters as I travel and I don't hear anything like that anywhere else in the entire world.

Your Majesty, if you happen to read this, I'd like to apologize for all of the good guys... and they are in the great majority.

SYNERGISM

If you're not familiar with the term, it has to do with two or more things which, when mixed together, provide more than the sum of the parts. In the case of radio, we have just such a result when we mix in computers. Only a few people have yet grasped the magnitude of the computer/communications mix which is coming up.

You see, as computer prices come down, a result of the economies provided by microcomputers and mass-production efficiencies, they are going to proliferate. But computers are the key to faster, lower cost, and more accurate communications, so our needs for communications facilities are going to grow along with the growth of computers. This, obviously, provides a challenge for amateurs.

Computers already are sneaking into amateur radio via the many keyboards which are being bought for both CW and RTTY communications. Fellows, you haven't seen *anything* yet. ASCII communications is just barely getting started, having been held back for years by the FCC's insistence that amateurs transmit no signals that all of their monitoring stations could not decipher. The monitoring stations, being about twenty years behind radio technology,

forced amateurs to be the same.

It is going to take a prodigious communications capability to allow everyone in business to communicate with anyone else via computer... instantly. We're going to need efficient high-speed systems and whole new modes of communications. This is where radio amateurs can come in... and will, if I have my way about it.

Being the publisher of a growing number of computer magazines, I have to stay on top of the technical developments as well as the sales and uses of these systems. It may be a bit frightening to old-timer hams to contemplate a new generation of hams who are into 26,000 word-per-minute-digital communications, but that is exactly what is ahead of us... no matter how much we set our heels in to fight it. The day of CW is, at long last, going to fade away. As much fun as CW may be, it is a remnant of the old spark days and inexcusably inefficient. Will we set up some 50-kHz-wide CW bands in the future for old-timers to get on and bat their slow messages out? Probably.

Sure, it's fun to get on CW and make slow contacts with people. But how much is involved other than fun? We are using a very valuable resource, the radio spectrum, and since there isn't enough there for everybody, one of these days we are going to have to bow to the facts of life: You have to pay your way. There is no free lunch... at least not forever. To the extent that amateurs can provide services, we will be able to share in the resources, such as the radio spectrum.

Right now we do provide emergency services. We are living on past glories when it comes to providing trained people for wartime use... we're just too far out of date with our CW and phone communications. We're in the past when it comes to providing new inventions and pioneering them. It's been over ten years since we've come up with anything of serious benefit to the world... such as FM and repeaters. I wouldn't claim a lot of benefit to the world when it comes to international goodwill, either. Perhaps the FCC was right when they proposed getting rid of the list of reasons for amateur radio to exist in their rewrite of our rules.

One way or another, we either

have to bring amateur radio into the 1980s, with old-timers kicking and screaming, or else we are going to have to watch over the demise of our hobby. We really do have to pay our freight.

With the worlds of communications and computers coming together, we have an opportunity to be heroes again. The more we can invent and pioneer high-speed communications systems built around the needs for computer communications, the more valuable we will be. The more that American amateurs can do this, the stronger will be the American technology... and American industry. Don't you really get a little sick of seeing virtually every major step ahead in technology coming from Japan?

Amateurs can again be the elite of our electronics people. The ball will be carried by the youngsters we get into the hobby. The rest of us can cheer them on, help them with experiments, and try not to screw things up any more than is accidental. If you can't carry the flag, at least don't shoot the kid who is carrying it for you.

GREEDY GREEN?

In 1960, due to the low interest in building by amateurs, there were very few construction articles in either *QST* or *CQ*. I started 73 feeling that if I published enough construction projects I could get amateurs into building again. I obviously would have done better with the magazine if I had catered to what the mainstream of amateurs wanted... gossip and new product reviews.

Sideband had just recently been invented by amateurs, so I ran every article I could on sideband... how to build it, how to use it, and so on. Circulation, for a while, slumped as readers wrote in and protested all the sideband information. Sideband, they felt, was a flash in the pan and would soon go away, leaving their age-old AM still king. Eventually, sideband caught on and circulation slowly began to grow again.

It was about this time that I realized that solid state had a big future for amateurs. I published every article I could get amateurs to write about using transistors. Hams began to go solid state. It was a hard uphill climb, with *QST* and *CQ* fighting me every step of the way. In

1968, the technical editor of *QST* lashed out, saying that hams were tube people and that was why *QST* was not publishing transistor articles. Hams would always be tube people... transistors were and always would be inferior to tubes... a flash in the pan.

Despite the ham industry being almost totally dead, having dropped 85% in ham sales as a result of a proposal to the FCC that ham licensing be turned back to the prewar system of just two licenses, I managed to keep 73 going. We were down to a staff of five in those lean days, but still I stuck to pushing amateur radio and experimenting ahead of considerations of larger circulation.

Just as we were beginning to see the light again, I spotted FM and repeaters as the best thing since sliced bread for amateur radio. In 1969, I started going full blast on FM. I ran hundreds of articles on how to build FM rigs and repeaters, published a wide range of books, started a repeater newsletter, gave FM symposiums around the country... all with no help whatsoever from any other ham magazine. The readers responded with their usual enthusiasm... "drop dead with FM, it's a flash in the pan." Circulation dropped off as thousands of angry readers cancelled their subscriptions.

Eventually, FM became popular and things picked up again. The advertisers, ignoring the large number of FM and repeater fans in 73, rushed to advertise their FM equipment in *QST*... as usual.

If I wanted to be the Mork and Mindy of ham magazines, I would flood you with articles on CW, telling you how great it is. Every poll shows that hams do not want to change the CW license exam, no matter how destructive it is. So again I am choosing the way I think we must go and I intend to push amateur radio, kicking and screaming, where it needs to go... both for the future of amateur radio and for the future of our country. The two, I feel, are closely entwined.

There are several factors which I see as significant as far as the future of amateur radio is concerned. One is that we are using what is still a very valuable resource... the radio spectrum. Thus, if we are going to pay our way, we have to provide

benefits to both our country and to the world. Much of the future lies in the microwaves and satellite communications, so if we keep our ham technology twenty years behind there will be no space for us where we need it.

By keeping our amateur population down we are able to make do with communications techniques which are twenty to sixty years old and won't have to come to grips with digital electronics and modern technology. If we start growing, this will force us to invent and pioneer better systems... just as the overcrowded AM bands of 1960 forced the acceptance of sideband... over a lot of old-timer dead bodies.

Unless we take our role as an experimental group seriously, we will eventually be lumped with the CBers into one blah service... one which can at any time be pushed out if something more important comes along. Those of us who are using our ham bands just for fun should realize that we got them because past amateurs provided new inventions, emergency service, international goodwill, and one hell of a bunch of technicians for WWII... when 80% of the licensed amateurs went to war.

We earned the frequencies we are using and now there are many amateurs who feel that for some reason they have a "right" to them. Amateur bands are plain old radio frequencies and will be parcelled out for the best use that can be found for them. If we use them merely for rag chewing and DX pileups, I guarantee you we will lose out in the long run. Many amateurs really don't care whether there are any ham bands in ten years or not. They want to enjoy them... and curse them... now, and what happens later is of no consequence.

The long range survival of amateur radio lies in our providing service which is worthy of the frequencies we are using.

Pushing for the growth of amateur radio is silly from a financial point of view. Fortunately, my computer magazines are doing well and can carry 73 through the storms ahead. Perhaps you can understand why I get a bit exasperated when someone writes in and says I'm pushing for more hams in order to make more money from amateur radio.

WORKING THE PILEUPS

Down through the years of operating from relatively rare DX spots, I've tried every known method of sorting out the pileups. The problem, as I'm sure you recognize, is in getting the call letters of the stations calling... and it can be a rough problem when there are hundreds of stations trying to get through.

If you have a good strong signal you can sort things out much easier than when you are just barely making it through. A good system for working pileups should allow you to cope with weak signals from your station.

Hardly a day goes by that I don't hear some frustrated DX operator trying to cope with the pileups and failing miserably. His weak signals are being covered up by the stations calling him and no one can tell when he is transmitting, which leads the turkey DXers to just keep on calling, in case the chap might be listening. Some of the DXers will get mad at each other and overlap their calling so no one can ever hear the rare station.

Lists are one way around this, but they are slow and annoying to everyone involved. If one were able to find good, sharp list takers, that system might work reasonably well, with one station taking a list perhaps 10 kHz higher and another 10 kHz lower, each passing along about 20 calls at a time. This *can* work, but it isn't a good system in my experience.

It is difficult for the rare station to give the situation a lot of thought when he is facing the pileups. Most of them blunder along, not really knowing what to do. I suggest that it is a kindness, when you run into a situation like this, for an operator with a good solid signal to take a few minutes of the DX station's time and offer some suggestions on speeding up his process.

The best system I've been able to work out... the one which gets me the most contacts per hour... which, after all, is what I'm visiting the rare country for... is one which can be used with even weak signal strengths. It is one which allows me to work not only the louder stations but right on down to the weak mobiles on channel. It does stick to one frequency rather than spreading the callers

all over the band, jamming fifty other contacts.

This system consists of laying down the rules for the callers in no uncertain terms. The rules are simple and must be followed. Any stations which break the rules will be worked, but will not get a card.

1. Stations are to call me for a period of fifteen seconds and then listen.

2. Stations are to call a maximum of three times during the fifteen seconds.

3. Stations are to give the last letter of their call phonetically and nothing else.

4. Operators are to spend their time listening and answer only when requested to.

5. Operators who try to force CW contacts without getting an okay first will not get a card.

6. QSL information will be given every few minutes, so listen, do not request it.

This system allows me to write down the last letter of ten to fifteen different stations during the calling period. I then come back and get the full call of each calling station and exchange signal reports.

When there are too many people calling at one time, I break it up by call area or by country. Sometimes it is handy, where a lot of different countries are calling, to ask for calls according to the number in the call. I've often been surprised when working the States and asking for, say, threes, to have a TF3 or an SM3 call in... even UK3. Of course, there are some foreign stations who refuse to understand English and will call without stopping, ignoring all requests. I sigh, work them, and mark the log for no QSL.

When you're on a DXpedition, you don't want to waste any more time than necessary, so you want your contacts to be made as quickly as possible. Also, when you are one of the pilees in a pileup, you want to waste as little of your time sitting around... or in yelling into the mike... as you can. If you'll encourage DX operators in rare spots to get on the stick and speed up their operations everyone will have more fun. And that's the name of the game. If it isn't fun, we'll stop doing it.

BUNK IN 73

The November DX column in 73 was full of the same old bunk I've been reading for some thirty

years now. Boy, I feel like I'm going through the 1920s and the emotional arguments over spark, with old-timers holding on with "spark forever" slogans.

I see the same old hogwash about CW being able to get through better than phone when signals are weak. The edge used to be a big one when we were using AM. Perhaps the "CW forever" crowd has not noticed that amateurs have invented sideband.

Another old-time rationalization has to do with CW rigs being cheaper than those for sideband. Yeah? The Heath HW-32 put that one away. How many CW-only rigs do you see today? Sure, a CW rig is easier to build, but where are they home-building rigs these days? Don't try to tell me about the poor amateurs in third world countries... they're not on the air because their dictators don't want them on the air, not because equipment is hard to build. Except in the larger countries, it is the wealthier people who are on the air.

Calling all phone ops the equivalent of CBers is baloney... emotional slop.

CW is increasing in use these days because of the digital-electronics systems developed which generate and decipher Morse code. If they would use the equipment with ASCII it would be much more efficient. You need FSK if you are going to combat fading, jamming, noise, and so on.

If we would help people enjoy the use of CW because it is fun

and stop trying to lie about it, we'd have a lot more CW operators... and better ones. The biggest boost we can ever give CW is to stop jamming it down the throats of newcomers and using it as a skill filter to keep people from getting ham licenses. We have a technical hobby and I'd like to see entry to it gained via an honest technical exam... without the cheat books from Bash and the League.

MORE DETECTORS

The only thing that may stand between you and a speeding ticket if you happen to be transmitting in a radar trap is a detector. Many hams have been hit with this, as unfair as it is.

It is worth almost any investment to avoid having a chase car stop you, lights flashing. And if that isn't enough, wait until you face our judicial system. You can read more about the traffic court system in the August issue of *Car and Driver*. The bottom line is that, facts aside, you lose. You will end up paying the fine, your lawyer, and additional insurance premiums. The bottom line makes the cost of the radar detector look cheap.

Our court system is not geared to dispense justice, but rather to collect fines. It is bigger than you are. The best way to win is not to get into the clutches of the law in the first place. They really don't care how innocent you are and it won't cut any mustard with them.

If you are going to be foolish

enough to transmit while you are driving, you'd better figure in another \$250 for a radar detector. That will tell you when to shut up while you pass the police radar units.

You want a superheterodyne type of detector. Do not fall for any of the imaginative technical names which are similar... these do not work as well. None of them work that I have tested, and I've tested a bunch. Any of the superhets will do the job you want... whether it be the Whistler Q-1000, the Radar Intercept, the Gul, the Fox, and so on. Superhet, that's the ticket (or lack of a ticket).

So far in my tests I've found that the Cincinnati Microwave Escort is the best. Sometimes the edge is slight... but the S-meter on it is most helpful in giving me an idea of the closeness of the radar unit... and in discerning the home or business radar security systems which I pick up. The Escort is still \$245 and sells by mail only. It's made by a bunch of hams in Cincinnati.

While the Escort and the superhet Fox can be easily stuck on the dashboard via some Velcro® tape, the Gul detector is a fat oval unit which is a bit more difficult to mount. Works fine. The J. R. Microwave Radar Intercept unit is flat and designed to snap on the sun visor. A mercury switch turns it on when you flip it down. It is almost as sensitive as the Escort. It wires permanently into the car, a drawback if you like to hide your \$250 goodies when you park. If you are sensitive to the police seeing your detector, the Intercept is certainly up out of the way and fairly invisible. I've never had any flack about detectors... even in Connecticut, where I've driven my van with up to seven of them mounted on the visor, dash, and so on.

ARTICLES NEEDED

One of the reasons I bothered to start 73 back in 1960 was that I felt amateurs should read more articles on building things. At that time, the enthusiasm for building had dropped considerably... partly as a result of the drying up of surplus gadgets to work with, but mostly because the two ham magazines of the time, *CQ* and *QST*, were publish-

ing so few construction projects. Indeed, that has continued pretty much unchanged to this day.

Building is fun. Today, with a handful of ICs we can build gadgets which were far beyond us only a couple of years ago. Today we have almost unlimited horizons for home-building of experimental gear. With the communications demands of computers, we need to develop new modes of communications and get them to work.

Those of you who are building and designing new equipment have a responsibility to come away from the workbench now and then and pass along what you've learned. Your enthusiasm will get more hams to building and they, in turn, will get still more hams interested. We're ready at 73 to help you get your material into good professional finished form.

Writing articles is easy. We do have an author's guide, if that will make you feel better. No charge, so the price is right. Mostly you have to remember to double-space your typing, to use a typewriter with upper and lower case (not a TT machine), leave generous margins... and get your details right. Photos are most helpful. Templates, PC-board layouts, and so on are invaluable.

It is most exciting to be a published author. You will hear about it from your friends for a long time. You'll get ego-boosting mail from all around the world. Hams will remember you on the air for a surprising length of time. And your family may show a new respect. You also get paid for the article, a little nicety which will pay for much of the project in most cases. And if you have something which looks like a commercial product, you could end up with a handsome royalty.

Send your articles to The Editor, 73 Magazine, Peterborough NH 03458.

Clubs can help with this by getting members to bring in their new construction projects for a short show-and-tell session at meetings. This will not only encourage the chaps who are building, but it also will get more of the club members thinking in terms of giving it a try.

Building has never in history been easier. A few ICs, some perfboard, and almost anything can happen.

WARC-BAND BEACON

As a result of the 1979 World Administrative Radio Conference (WARC), three new HF bands were allocated to the Amateur Service. It will be some time before these bands are made available to US hams for general use. However, the FCC granted W4MB a license for Experimental Station KK2XJM to operate in the three new bands. Below is the operating schedule of the KK2XJM beacon during the first nine weeks of 1982. For further information, to QSL, or to establish special test schedules, contact R. P. Haviland W4MB, 2100 S. Nova Rd., Box 45, Daytona Beach FL 32019.

| Date | MHz | Power (Watts) |
|-------------|--------|---------------|
| January 7 | 10.140 | 30 |
| January 14 | 24.930 | 3 |
| January 21 | 18.108 | 3 |
| January 28 | 18.108 | 3 |
| February 4 | 24.930 | 3 |
| February 11 | 24.930 | 3 |
| February 18 | 10.140 | 30 |
| February 25 | 18.108 | 30 |
| March 4 | 24.930 | 30 |

TRAVELS WITH WAYNE

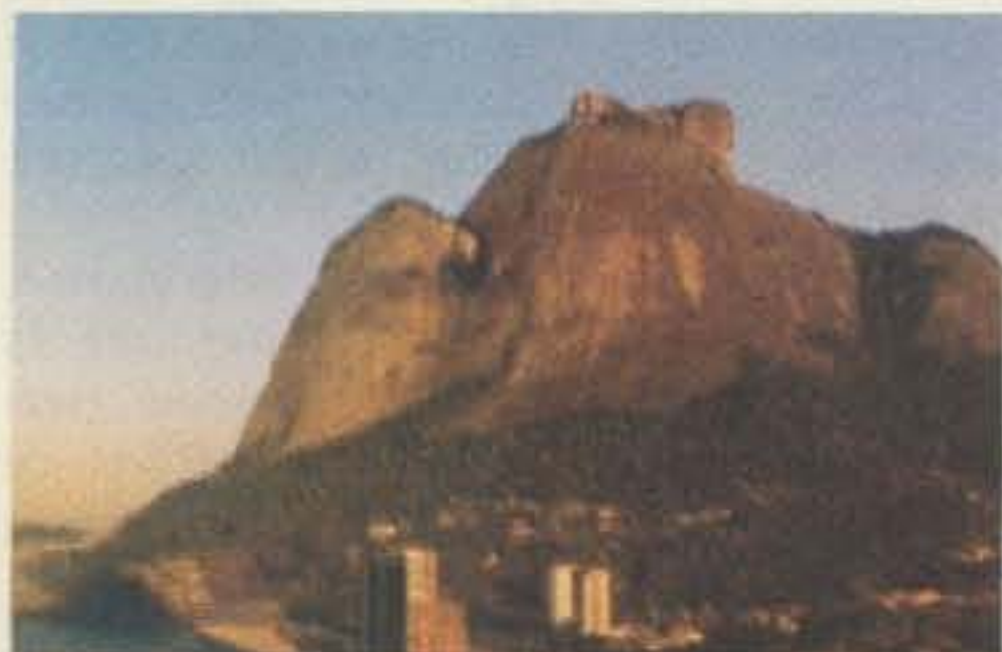

Everyone has heard of the Ipanema beach at Rio de Janeiro. Our hotel was on Sao Conrado, around the corner. Here I arrived, eyes at half mast, after an all-night, red-eye flight from New York. The plan to stop at Brazil had been a sort of last-minute idea to cater to my fetish for visiting as many countries as possible... bringing me up to 99 if you count the UN building in New York... which I do. If it's good enough for the League, it's good enough for me. Not having arranged a ham license for Brazil, I was left with nothing more to do than rest up... and watch the hang gliders jump off the right-hand knob of Pico da Tijuca and then flutter back and forth for hours in the updraft coming from the ocean up the mountain.



Once rested, if a couple of short naps, a business conference, and a big dinner qualify as rest, we were back out to the airport and on our way to Johannesburg. Even in Brazil we felt the controller strike when our plane arrived from the US two hours late, bringing us into Johannesburg well after midnight. Both computer and ham friends were at the airport, despite the hour... and within minutes I was saying hello via one of the local repeaters to hams all around the city. A long plane ride may be comfortable for a deaf amputee, but the rest of us, with little leg room, kids crying, food every couple of hours, people bumping up and down the aisle, movies being shown... and so on... stagger off the plane disoriented and dazed. My first real awareness of Johannesburg was the next morning, early, when Julius ZS6AF came up to present me with a loaner Kenwood TR-2400 and charger. I opened the window curtains and was taken aback by the view. It was like Chicago or Philadelphia, not Africa and mud huts.



I'll bet you've been wondering what happened to all those old VW beetles. I found them, painted yellow, and being used as taxis in Rio. The chap on the left is trying to get his clothes straightened out after leaving the sardine-can ride, complete with baggage. In New York, when you see something like this it means the chap is being mugged.



Doug Goldman 3D6BG hasn't got a whole lot of signal from this rig, but then he is no pileup fan, so this does what he needs. It's sitting there for visiting hams to operate. Of course, it doesn't hurt if you stay at the hotel Doug has built. You won't find better food anywhere... and I can show you at least a half pound put on there as testimony. Fortunately, ham conditions were stinko so I got a chance to talk with Doug, get around the country and take some pictures... and even rest up a bit... for a change. Hamming comes first, of course... then food... then my wife... then rest... just like any other serious ham.



Swaziland looks like this. I'm not sure where they keep all of the African jungles, but I can tell you they don't seem to be in South Africa or Swaziland. Mostly farms in South Africa and idle land elsewhere. That's one of the motel units of Doug's Smoky Mountain Hotel on the left.



Alda Campos, at the right of Sherry, met us at the airport and drove us to our hotel. After we were partially rested she picked us up and took us to see her father's computer store... and plant, making Apple-like computers. I like the eating part of trips. That's her father on the left, Aldenor. It's a big happy family and we did a good job in this meat restaurant... all different kinds of meat. The waiter on the end is hacking off more meat. How do I manage consistently to stay 20 pounds overweight? No problem, I just enjoy meals like this one. Here Sherry and I are doing our best to keep up with endless courses. Computer people can be as nice as hams!



Wayne Green lost in Africa (heh, heh)... I could see the headlines in QST as we struggled to get our rented Cessna started. After an hour of screwing around, it got going... as did we, heading about 300 miles to Swaziland and another country for me. I tried to forget the plane by talking with my HT through the South African repeaters. As we neared Swaziland, I was assured through the Mbabane repeater that my license was in order. I checked the charts and changed from W2NSD/ZS to W2NSD/3D6.



Julius Lieberman ZS6AF, who runs the local ham store and is the importer for South Africa for Kenwood. His station is first rate. So is he.

NEW PRODUCTS

TR-2500 HAND-HELD

Trio-Kenwood Communications has announced the new TR-2500, a compact 2-meter FM hand-held transceiver weighing approximately 1.2 lbs., yet including such features as LCD digital frequency display, 10-channel memory with memory scan, built-in five-year lithium memory backup, manual scan, programmable automatic band scan, built-in tunable sub-tone encoder, built-in 16-key auto-patch encoder, 2.5 Watts rf output, HI/LO power-output switch, and other features. The TR-2500 comes complete with rubberized antenna with BNC connec-

tor, 400 mAh heavy-duty nicad battery pack, and ac charger.

For additional information, contact *Trio-Kenwood Communications, PO Box 7065, Compton CA 90224.*

LEADER LDM-855 DMM

Leader Instruments Corporation, of Hauppauge, New York, now offers a 3½-digit digital multimeter that fills the need for both laboratory and field work. The new LDM-855 offers automatic ranging, semi-automatic zeroing, and a large LCD display for straightforward, hands-free operation. When manual range or function selection controls

have been changed, a momentary audible tone is heard. When used in the resistance mode or for checking continuity, the tone is sounded continuously when short-circuit conditions occur. This enables the operator to make tests without having to constantly look at the meter to see if continuity is present.

Other features include an automatic polarity indicator, ac and dc measurement functions, a LO-OHM mode to provide a lower test voltage, and a low-battery warning incorporated into the liquid crystal display.

Dc voltage range is 0.1 mV to 1000 volts with an accuracy of $\pm 0.5\%$ of reading $\pm 0.2\%$ full scale on the 0.2-to-200-volt range. On the 1000-volt range, accuracy is 10 megohms, overload protection is 1000 V dc and ac peak.

Ac voltage range is 1 mV to 1000 volts. Accuracy for the 2-V range is $\pm 1\%$ reading $\pm 0.4\%$ full scale at 40 to 500 Hz. At 0.5 to 1.0 kHz, accuracy is $\pm 1.5\%$ reading $\pm 0.4\%$ full scale. On the 20- and 200-volt ranges, accuracy is $\pm 1\%$ of reading $\pm 0.25\%$ full scale for 40 to 500 Hz, and $\pm 1\%$ of reading $\pm 0.25\%$ full scale for .5 to 1.0 kHz. On the 1000-volt range, accuracy measures in at $\pm 1.5\%$ of reading $\pm 0.25\%$ full scale at 40 to 500 Hz. Input impedance is 10 megohms and overload protection is 1000 V rms.

Ac and dc current ranges are offered from 10 microamperes to 200 milliamperes. Resistance measurements are offered between 0.1 Ohm to 2000 kilohms. The display is a 3/8-inch, seven-segment liquid crystal with a maximum of 1999 maximum. Reverse polarity is indicated, as is over-range and low battery.

Primary power requirement is two C-cells. The LDM-855 measures 6-1/8 inches wide, 2-1/4 inches high, and 4-7/8 inches deep. The unit weighs 1.1 lbs. It comes complete with instructions manual, a test lead set, and two C-cells.

For additional information, contact *Leader Instruments Corp., 380 Oser Avenue, Hauppauge NY 11788.* Reader Service number 487.

LOW-COST ETCHING SYSTEM

Stellmaker Enterprises has designed a high-quality power etching system that is reasonably priced. The kit includes an air pump, air disperser, base with support for 4½-pint plastic tank with cover, mounting screws, and all necessary instructions.

This compact system will etch PC boards up to 6" x 6", which is the size featured in most magazine articles. The acid agitated by the air pump makes for fast and more even etching.

For more information, write *Stellmaker Enterprises, 250 Pequot Trail, Westerly RI 02891.* Reader Service number 485.

TRIO-KENWOOD R-600 RECEIVER

Trio-Kenwood Communications has just announced a new general-coverage communications receiver, model R-600, covering 150 kHz to 30 MHz in 30 bands. The use of PLL synthesized circuitry results in highly accurate frequency control with maximum tuning ease. The unit features an easy-to-read digital display, AM, SSB, and CW reception, built-in i-f filters, noise blanker, rf attenuator, S-meter,



The Trio-Kenwood Communications TR-2500 hand-held.



The Trio-Kenwood Communications R-600 receiver.

front-mounted speaker, and operation from power sources of 100, 120, 220, and 240 V dc, 50/60 Hz. Operation on 13.8 V dc also is possible, using the optional DCK-1 dc power cable kit.

For further information, contact *Trio-Kenwood Communications*, PO Box 7065, Compton CA 90220; telephone (213)-639-9000.

MFJ-955 VLF/MW/SWL ANTENNA TUNER

The new MFJ-955 VLF/MW/SWL preselecting antenna tuner improves reception of 10-kHz through 30-MHz signals. The MFJ-955 connects between your receiver and antenna. You can peak desired signals while rejecting interference and reduce overload, background noise, cross modulation, and intermodulation. Front-panel switching allows push-button selection of two antennas and two receivers, and a front-tuning knob permits tuning for maximum signal strength. The MFJ-955 measures 5-1/2" x 2" x 3" and is housed in a black and eggshell-white aluminum cabinet.

For more information, contact *MFJ Enterprises, Inc.*, PO Box 494, Mississippi State MS 39762; telephone: (800)-647-1800. Reader Service number 484.

RF-670 SPEECH PROCESSOR

Daiwa has announced a compact audio speech processor that rivals the performance of rf types at an economical price. The photocoupler design delivers a high level of processing with a minimum of distortion. Traditional audio-processor design is handicapped by circuitry time constants that limit the ability of the processor to re-

spond to rapid variations in the level of the input audio signal. The result is distortion and poorer performance. The RF-670's photocoupler/variable-gain amplifier design permits a very rapid response to input levels resulting in clean output. The RF-670 features Velcro® pads for easy mobile or base mounting.

For more information, contact *MCM Communications*, 858 E. Congress Park Drive, Centerville OH 45459. Reader Service number 482.

SURGE SHUNT

The R. L. Drake Company has announced its new model 1549 surge shunt. The surge shunt protects solid-state communications equipment from damage caused by voltage transients entering the antenna system. These transients usually are caused by atmospheric

static discharges or nearby lightning strikes.

The surge shunt can be used with both receivers and transceivers with up to 200 Watts output. Convenient UHF-type coaxial connections are used, permitting use into the UHF range.

For more information, contact the *R. L. Drake Company*, 540 Richard Street, Miamisburg OH 45342; telephone (513)-866-2421.

MICROCRAFT CODE*STAR CODE READER

CODE*STAR is a code reader designed for Novices, SWLs, and veteran amateur radio operators. It should also be very useful to persons learning or trying to improve their Morse code skills.

CODE*STAR's microcomputer monitors the incoming signal and converts it to characters on its large easy-to-read LEDs. CODE*STAR decodes Morse



The MFJ VLF/MW/SWL antenna tuner.



Daiwa's RF-670 speech processor.



Drake's new 1549 surge shunt.

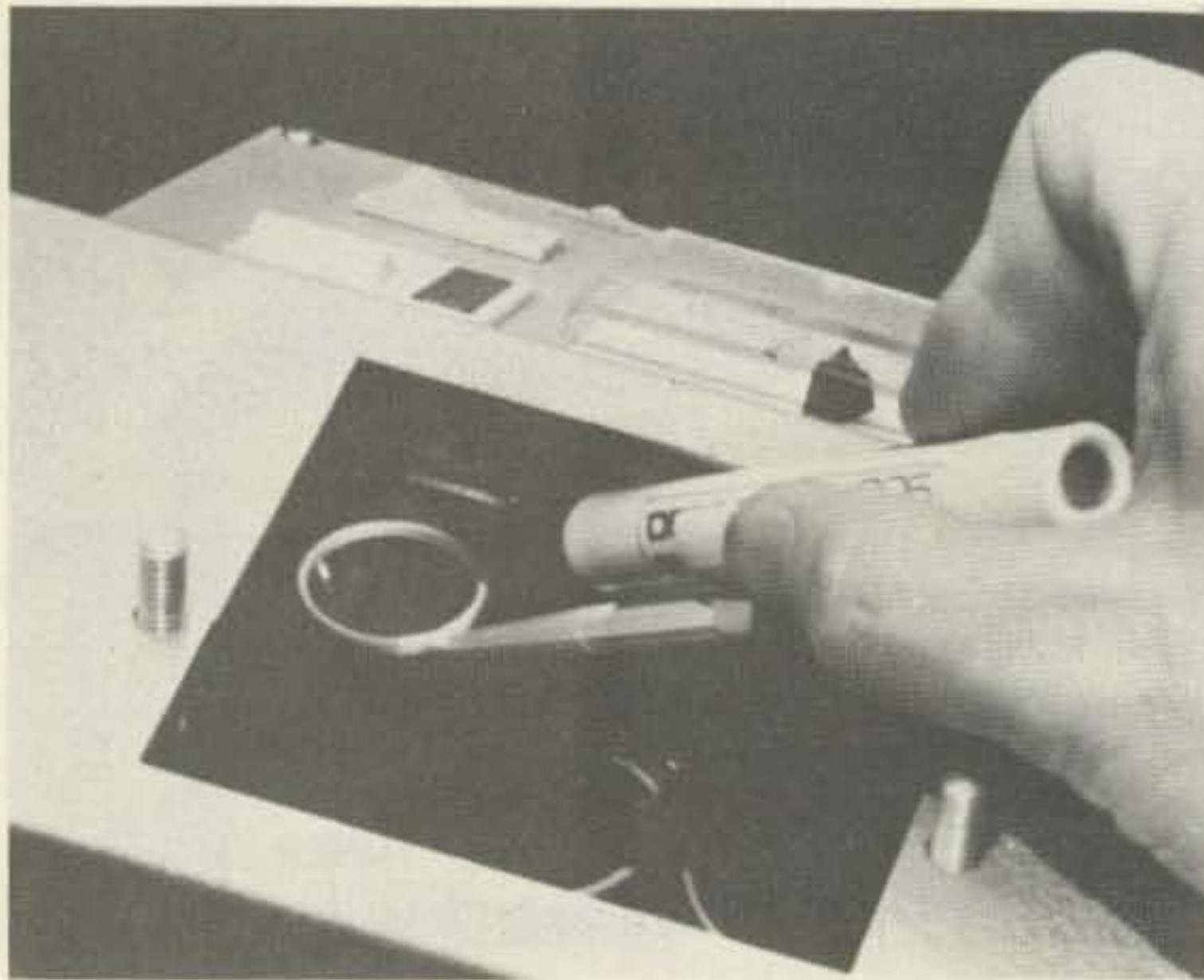

The Desco flashlight/mirror combination.

code, Baudot (RTTY), and ASCII code. There are two specially optimized Morse code ranges with auto-tracking of speed

from 3 to 70 wpm. Special proprietary analog and digital filter methods are employed to substantially reduce errors. An automatic gain control circuit providing up to 16 dB gain helps maintain signals under fading conditions. A built-in code-practice oscillator is handy for code practice and learning the code.

CODE*STAR operates on 12 V dc, which makes it ideal for field or mobile applications. An ac adapter is included if you wish to operate it from 120 V ac. As a special option, you can use CODE*STAR to drive a serial or parallel ASCII printer, TV terminal, or computer. This ASCII output port option is available as a kit that mounts inside CODE*STAR's cabinet on the PC board.

CODE*STAR is available as a complete kit or factory wired and tested.

For more information, contact *Microcraft Corporation*, PO Box 513, Thiensville WI 53092; (414)-241-8144. Reader Service number 486.

FLASHLIGHT/MIRROR COMBINATION

Desco Industries, Inc., has introduced the model 227 flashlight/mirror combination. The plastic dental-type mirror clips to Desco's model 225 disposable pocket flashlight to provide an ideal combination for field or workbench. The unit comes complete and ready to use with two AAA batteries included.

For more information, contact *Desco Industries, Inc.*, 761 Penarth Ave., Walnut CA 91789; telephone (714)-598-2753. Reader Service number 483.

RTTY LOOP

Marc I. Leavey, M.D. WA3AJR
4006 Winlee Road
Randallstown MD 21133

Last month I mentioned a new FSK converter, the FSK-500 from iRL, out in Columbus, Ohio. Let's take a look at this little gem this month.

A few months back, I examined the FSK-500's big brother, the FSK-1000. This box is not really a scaled down 1000, but rather a beneficiary of things learned from the larger unit. The FSK-500 is both a RTTY demodulator and an AFSK (audio frequency shift keying) tone generator. A RTTY modem (modulator/demodulator), if you will.

A look at the receiving, demodulating, end shows quite a performer. Audio input is accepted through a standard phono jack, such jacks being used for all connections but the loop, as a 500-Ohm unbalanced signal. That means that most speaker or "line" outputs will work just fine. The amplitude of this signal may range from 10 mV to 17 volts peak to peak! That's some range, folks. The audio is then passed through a limiter, and selectable bandpass filters are

available to optimize reception for either "narrow," with a bandpass of 75 Hz and low-pass filter rolloff of 28 Hz, or "wide," with a bandpass of 145 Hz and a rolloff of 60 Hz. The narrow filter is normally used for 170-Hz shift RTTY; the wide position is useful for 850-Hz shift, as commonly used on AFSK, and ASCII transmissions.

Three selectable shifts are also provided. Along with the common 850-Hz and 170-Hz shift, a 425-Hz shift is available. This is useful for copying commercial stations and other non-ham signals. By the way, the shift is selectable independently from the bandwidth, so odd combinations can be easily set up.

Internal mark-hold circuitry and autostart are provided, and the level at which a signal begins to be decoded is adjustable by the front panel "threshold" control. The general function is kind of like a RTTY-squelch control, serving to keep the machine quiet when no one is transmitting.

Tuning is aided by both a meter which shows a mid-scale deflection for mark and a full scale deflection for space, and by LEDs which display the mark or space status of the loop.

Outputs from the FSK-500 include an RS-232 compatible output, called "Data Out," which is useful for driving a video terminal or computer. Of course, interfacing to a standard RTTY loop is provided, but, and this is notable, an internal loop supply is *not* provided. That means you have to supply the 60 mA current from another source. This is not too hard, and we will cover that in a little bit.

As if that was not enough, a "Serial In" jack accepts either "dry" contacts, such as a reed relay or isolated keyboard, or RS-232 levels. This allows a computer to key the transmitter and loop. There is also a provision made for connecting a straight key for the mandatory CW identification.

Remember I called this thing a "RTTY modem"? Well, here is the "mod" part. A built-in AFSK generator provides a low impedance, clean, 50-mV audio frequency shift signal. This can either key a VHF transmitter or AFSK, or, when fed to an SSB transmitter as detailed previously, result in a nice, clean FSK signal.

A few more bells and whistles include a transmit/receive remote function and an output able to key the push-to-talk line of most transmitters. Scope outputs are also provided for those of us who like to monitor the RTTY signal on such beasties.

Now, the acid test is not what it looks like on paper or how

pretty the case is, although you can see that for yourself in the photo, but how well it performs on the air. I also like to compare new equipment to older units to see if we have gained anything. So what I did was to find a reasonably clear, but not solid, RTTY signal and sit my wife down in front of the receiver and ask her to tune it in. For comparison, I set up my several-year-old ST-6 and asked her to comment on the two.

Allow me to interject that my wife knows about as much about RTTY as most hams know about cooking blintzes. If she could do it, anyone could!

Well, she could, and despite similar tuning indicators on both demodulators, i.e., two lights and a meter, the FSK-500 appeared easier to tune. Now, I don't know if the filters in the ST-6 are more critical than the FSK-500, but I suspect that that is so. However, when we went looking for signals, there was not one that the ST-6 could copy that the FSK-500 could not do as well on. Very impressive.

All in all, the FSK-500 is a very nice little box. For under \$250, in a box 7.75 inches wide, 3.25 inches high, and 7.375 inches deep (that does not even fill the size of this page!), you can get a demodulator that may well be all you need on RTTY, Murray, or ASCII for a long time. Check out iRL's advertisement here in 73 or drop them a line at 700 Taylor Road, Columbus, Ohio



The FSK-500 from IRL.

43230. Be sure to tell them you read about the FSK-500 here in RTTY Loop.

Oh yes, about that loop supply. One of the only sacrifices apparent in the design of the FSK-500 is the loop supply. Of course, if you are running a computer-based station, you have no need for a current loop. If that

is the case, turn the page and drool over the ads; otherwise, hang in here for a spell. Common teleprinters, such as the Model 15 Teletype®, use a current loop, usually about 150 V dc to 300 V dc, at a constant 60-mA current. It is not hard to design such a supply, and it makes a good construction project for the RTTY-neophyte.

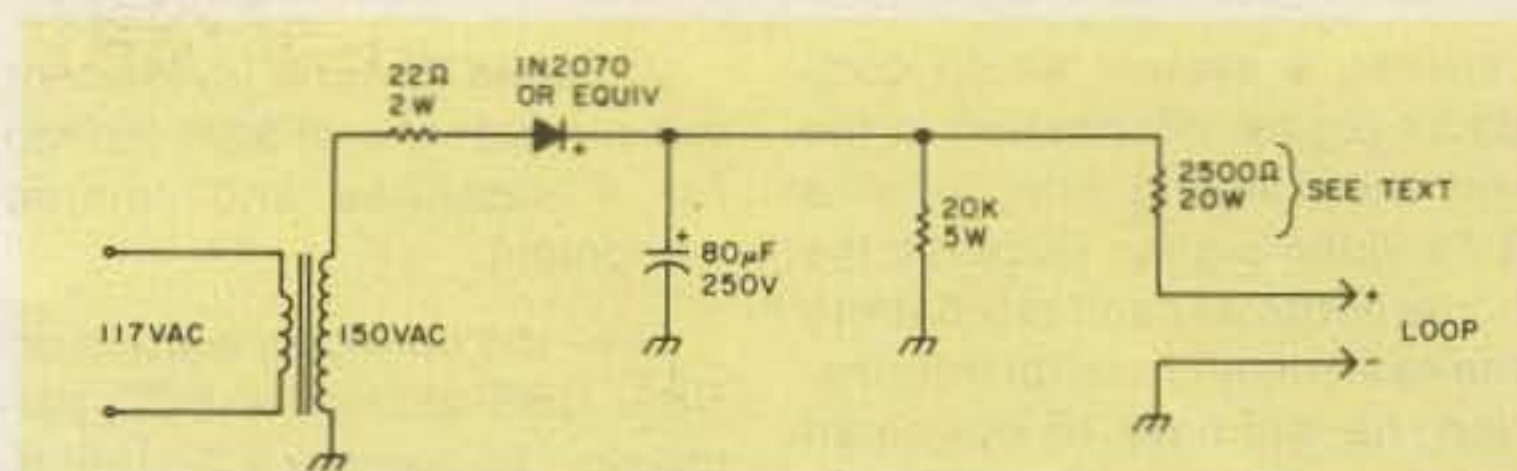

Fig. 1. A local loop supply.

If you have a dc supply (we will worry about where the dc comes from later) providing, let's say, 180 V dc and you hook it up to the selector magnets of your teleprinter, what would happen? After the smoke cleared, you would have a worthless hunk of junk. Why? Remember that the resistance of the selector magnets is in the range of 100 Ohms. If 100 Ohms is placed across a 180-volt source, thinking back to Ohm's Law, it will draw ($I = E/R$) 180/100 equals 1.8 Amps! That would produce about 324 Watts of energy. Think that's enough to fry the coils? I do. In order to limit the current to 60 mA, you have to provide enough resistance in

the circuit. In our example, it would be ($R = E/I$) 180 volts divided by 60 mA (0.06 Amps) equals 3000 Ohms. So a 3000-Ohm resistor at, don't forget this, 180 volts times 60 mA equals a tad more than 10 watts—let's make it a 15-Watt resistor or higher to play safe—is needed.

In practice, you have to account for a variety of resistances; thus an adjustable series resistor is commonly used. A practical circuit is shown in Fig. 1. By the way, *don't* get any bright ideas about eliminating the transformer and just rectifying the ac into loop current. We don't need any hot teleprinter chassis around.

KAHANER REPORT

Larry Kahaner WB2NEL
PO Box 39103
Washington DC 20016

DIRECT BROADCAST SATELLITES: A LONG WAY TO TRAVEL

The fate of Direct Broadcast Satellites is up in the air.

Unlike low-powered satellites similar to SATCOM 1 and 2, which are mainly used to relay TV programming to cable companies owning big dishes, high-powered DBS birds aim their beams directly at smaller-dished consumers. Plans call for viewers to rent or purchase receiving gear and dishes (less than a meter in diameter) and for satellites (more than 200 Watts) to reach homes in as much as one-half of the country at the same time.

Some DBS hopefuls plan subscription TV services—in which case you must buy or rent their decoder—but others suggest that advertiser-supported programming is the way to fly. Still others say that regular video

programming isn't enough to woo the public. They plan high-resolution TV and data banks for home computer hobbyists.

Although the DBS dream has been around for some time, only in the past few months has the FCC tackled the complex policy and technology issue involved in such systems. Last July, they decided to okay DBS on an interim basis pending further discussion. They also agreed to tentatively accept more than half a dozen license applications. However, no DBS applicants expect to begin full operation for another 2 to 5 years.

Some technological hurdles need to be jumped. For instance, DBS uplink frequencies are in the 17-GHz range, and downlink frequencies lie in the 12-GHz band. At those frequencies, engineers worry about attenuation from rain and fog. It seems that the higher the microwave frequency, the less you can sing in the rain.

Interference to fixed services

presents another problem. Some point-to-point microwave services already use those frequencies and what effect DBS will have on their transmission (and what effect they will have on DBS) must still be explored.

However, the biggest "if" in DBS may be economic. Many figures are being bantered about, anywhere from \$200 million to \$800 million for a typical DBS system. If companies charge about \$25 a month for the service (that's the maximum experts suggest viewers would be willing to shell out for any pay TV service), can a DBSer break even? Will consumers pay extra money for only a few additional channels when they already receive 20 or 30 on cable TV? Or would a DBS operator do better with advertising support?

The Space Shuttle might help some aspects of DBS. The most expensive part of hurling a satellite into orbit is the launch. Several DBS applicants noted that once the Shuttle is regularly whizzing back and forth in the coming years, DBS launch cost will be greatly decreased.

COMSAT checked in as the first DBS applicant, asking the Commission for permission almost a year ago to run its service. In a 1,000-page application,

COMSAT'S subsidiary, Satellite Television Corporation, said it plans 3 commercial-free channels. Channel A (Superstar) will feature general entertainment such as films, concerts, and family programming. Channel B (Spectrum) will show children's programs, film classics, and public affairs. Channel C (Viewer's Choice) will offer sports, adult education, and experimental theater.

STC plans to serve the entire US with 4 geostationary satellites—one in each time zone—with spot beams aimed at Hawaii and Alaska. Each bird will carry 3 operational transponders and 3 spares. Liftoff for the first DBS satellite is slated for 1985. It would serve the east coast.

COMSAT and Sears-Roebuck planned to work together on DBS, but Sears pulled out. COMSAT is looking for a new partner but hasn't had much luck.

Another DBS entry comes from a company called Graphic Scanning Corporation. It proposes 2 satellites, each independently programmed. One satellite will target the home computer market with information relayed from the firm's information banks. Data will be sent over the video signal using

teletext, a system which compacts digital information in the vertical blanking interval of a TV's video signal. Because the home hobbyist can't talk back to the satellite and ask for information, he will have to download great quantities of data and then access what he needs and hope it's there.

GSC's other satellite offering appears mundane by comparison. It will transmit the usual TV fare including movies, sports, and concerts.

The company is serious about its application. It owns Graphnet, a computer/networking firm, and lists assets at more than \$83 million.

Video Satellite Systems takes a different approach. It wants to establish an advertiser-supported DBS system with local TV stations and cable companies also receiving, then retransmitting, its programming to viewers. In a sense, it just seems to be another network, like one of the Big Three. VSS will scramble signals destined for these carriers but send unscrambled programming to those areas where consumers constitute the bulk of recipients.

VSS said its total investment will run just shy of \$230 million for 4 satellites and related equipment.

Even the networks want in on DBS. CBS asked for FCC permission to operate a 3-satellite service which would send such goodies as high-resolution TV, a feed to affiliates, pay TV, and teletext. The high-resolution programming would be targeted at affiliates for rebroadcast. That assumes that we all have our hi-res TV sets by then.

Other major companies look for the go-ahead. RCA told the Commission it wants to shoot 4 satellites beyond the wild blue yonder, each carrying 6 transponders, 2 of which will sport high-resolution gear. Service will be aimed at individual homes as well as community antennas. A full system—kind of a starter service—would cost \$400 million. RCA noted that DBS is economically feasible where cable services can't be provided for less than \$500 per home.

The FCC received a total of 13 DBS applications. It accepted those from CBS, DBS Corpora-

tion, Graphic Scanning Corporation, RCA, Hubbard Broadcasting, Video Satellite Systems, and Western Union.

Those applicants that didn't make the FCC's grade include Advance, Inc., National Christian Network, Unitel Corporation, Satellite Development Trust, and Home Broadcast TV Partners. It partially accepted an application from Focus Broadcast Satellite, which doesn't plan its own bird but hopes to use one of the Western Union WESTAR satellites for its interim service.

Most applications weighed several pounds, contained hundreds of diagrams, charts, graphs, pictures, statistics, formulae, tables, and charts. But several consisted of only one or two typewritten pages. These, of course, were rejected by the FCC as "deficient." In other words, the DBS hopeful wasn't serious about his plan or didn't have the funds to back it up—or both. Even longer applications were rejected as deficient. Length isn't everything.

The FCC rejected applications from Home Broadcast TV Partners and Unitel for special

reasons. The drafters were serving time at a federal prison near Terre Haute, Indiana.

Even if all the domestic DBS policy and technical questions are answered, international roadblocks exist. In 1983, the US will join other nations around the Regional Administrative Radio Conference table to discuss frequency allocations for microwave bands.

The FCC proposes that DBS operate in the 17- and 12-GHz range. That's fine for us, but other countries want those frequencies for their own DBS and, in some cases, for other services as well. Because we're dealing with satellites, receiving areas don't stay within neat geographical borders. DBS transmissions from abutting nations will overlap.

By the middle of the decade, about a dozen countries hope to install DBS services: Australia, Canada, China, a Consortium of European nations represented by the European Space Agency, France, Germany, Japan, Luxembourg, Switzerland, United Kingdom, the USSR, and the US.

RARC participants have a lot of talking to do.

LETTERS

ELMER: ALIVE AND WELL

Having read Tom Taorimina's letter in the November, 1981, issue, hoping for the return of Elmer, I have to admit that I agree with Wayne's response. And that ain't all that unusual.

Sure, ham radio has changed. Hell, we all have. To expect the return to the days of 6L6s, homebrew transmitters, and so forth, in this day of transmitters on a chip, is to expect better than the Second Coming.

Those moral changes that Tom said happened in the 60s: let's have them and some more. Maybe we gained a little humanity by getting off our dead ends and out of the back of the bus.

The problem is, some would have us return. Separate but equal drinking fountains. Woman at home, barefoot and pregnant. The man the undis-

puted ruler of the house. Child abuse. No sir, not me, Jim.

Looking back at it that way, it's obvious that Elmer isn't dead. He's alive and well, caring for humanity, like he always did. Only his areas of activity and interest have changed. Now he's into SSTV, satellite communications, cheap and easy microwave. People.

One thing's for sure about old Elmer. He doesn't sit in the sun belt and bitch about how rotten things have become. Elmer's a doer.

And he's got a million-dollar smile.

Nils R. Bull Young WB8IJN
New Carlisle OH

HAM HELP HELPED

We asked for help in your Ham Help section of 73. Man, did we get help! In fact, we are still getting it. Really, all we

asked for was a schematic or a service manual for a DSI frequency counter. Wayne, you could just not believe the response that we received from the ham fraternity when my request was published in your magazine. The response was the most impressive thing that I have ever witnessed in my 29 years of amateur radio. You may talk about the power of the press; 73 Magazine has made a believer out of me.

I want to thank you, and all of the amateur radio fraternity who came to my rescue to help me out. In closing, I want to let you know that if I should ever need a coverage on anything related in our profession, I will most certainly rely on you and your outstanding publications.

Lawrence Neel, Jr. W8PKV
Cincinnati OH

LIP BITING

You can thank or blame your October "Never Say Die" for this letter. That editorial started with a caption which stimulated this reader to give you one old-timer's view of the other side of

the coin. It happens that I have been in ham radio since 1929... have written for *CQ*, *QST*, *Radio Electronics*, *Popular Electronics*, and *Electronics*... have also lectured at hamfests and an IRE convention. Like you, I witnessed and contributed to the growth and popularity of ham radio. Then, due to a new assignment and the pressure of making a living, I dropped out of the fraternity and did not return until after my retirement. Wow!

I missed the multimillion-dollar explosion that was brought about by SSB and the consequent sale of a million or so transceivers and supplementary gear by your advertisers... an era which also resulted in a many-fold increase in the cost of operating a station... an era which also imposed a severe hardship on any prospective newcomer to the hobby. Then along came CB... and that was the straw that broke the camel's back.

So you want to know what is needed to reactivate ham radio? Well... bite your lip and hold on to your temper... what we don't need is a rich man's elongated

issue as specified in your advertisement... then sent me two copies of a subsequent issue rather than the one I expected to get... then kept insisting that I did not pay for my subscription until I got my cancelled check from the bank and gave them the number and date and data.

I started out 1981 by writing an article for 73 entitled "The Jim-Bug." It was promptly accepted. A check followed a few months later. But now is many months later, and I have still not received a proof for review. You must agree that is no way to make friends and encourage more articles. If they have changed their minds, why don't they say so and send the article back to me?

Well, I have now given you over three hours of my time in composing and typing this letter, but I don't want to end it on a negative tone. So I'll put forth some more effort on the subject of promoting the growth of ham radio. To do this, we first have to realize that most of the active hams, who regularly have to fight QRM for enjoyment of their hobby, do not favor additional growth. Second, we have to find ways to get prospective newcomers into the fraternity without mortgaging their homes. This means making available simplified and lower-cost equipment, home-built, kits, or manufactured. Third, we have to provide air space and regulations where such equipment can be used. Fortunately, the air space has already been made available in the new bands... bands which many of us old-timers don't want and can't use. So why not leave it up to the League? Because if we do, we are going to get more of the same SOS.

Jim Owens W5JOF

legea writers on now to build sophisticated and digitalized electronic equipment using lots of integrated circuit devices, which few of us comprehend. Too bad the authors and publishers don't have to stand up in front of an audience for a Q&A session... talk about red faces!

Don't go away now... the pièce de résistance is coming up. Of all the things we surely don't want, your continued writing about your activities in the computer field have to be near the top of the list. Did you ever stop to consider that such writings tend to convince us that your heart and personal interests and ambitions are far removed from our beloved ham radio field?

Now then, if you have indulged me this far, stick around for a few more minutes. I'm about to say something nice. Once in awhile, you publish an article which is down-to-earth and of genuine interest to a sizable percentage of us hams. Let me cite the "Diode Doctor" article which appeared on page 131 in your October issue. Too bad the editors allowed the author to make use of a 9-volt battery which had two positive terminals and no negative terminal. Sure, we inferior hams can figure out the error, but we can also figure on similar errors being in projects that take longer than "about 15 minutes" to build.

By the way, if you are getting the idea that I am an unfriendly correspondent, please refer to your July, 1981, issue, "Fun," page 140, second column, last paragraph. I am one of your staunchest boosters. Nevertheless, I believe you have drifted away from your own publication. Of course, I can only judge by my own experience, but I can't believe your people could possibly single me out for careless treatment. Like the way your Subscription Department loused up my subscription... missed sending me the first

a station" is another tune I've heard often... but not from anyone who was there before. I ask you to recall the cheap and junky Hallicrafters Sky Buddy receiver which sold for \$29.95 in 1938. Today, for about the equivalent inflation-adjusted price of that old crummy receiver, you can buy an allband receiver that will run circles around that old one. Hams have never had it so good as far as equipment prices are concerned.

I did enjoy the "rich man" bit, too. Jim, I started out with nothing and worked hard to build up my business. When I started 73, at times I didn't have enough money to eat but I hung in there and worked 100-hour weeks... and more. My recent trip to Africa cost me little... it was paid for by the people who came to hear me talk in Johannesburg. They paid to hear me because I have taken the time and interest to know my field and be worth listening to when it comes to computers... something I've managed to learn in just the last five years. And Jim, talking with foreign countries is one of the basics of amateur radio, so I've always found hams intensely interested in what is really going on in them... in particular, the rare ones.

Okay, now I'm to the bit about building sophisticated digital electronics. Our recent reader poll gave us an 82% reader vote on our articles being about right, 7% said they were too simple, and 11%, too complex. I don't think we could run the ball any closer to the center of the alley.

With computers and amateur radio coming together on a collision course, I've found that most amateurs want to know all they can about them. I asked for a show of hands at a recent ham club meeting and almost half of those present said they already had a computer. Actually, only about 20% of the active hams have a computer system so far... but that is increasing rapidly.

Jim, with about 90% of our income coming from computers, it would make just plain sense if I gave amateur radio no more than 10% of my time. But I now find myself as the chairman of an FCC subcommittee to get amateur radio into a growth mode, which will take time I could ill afford if plain making money were all that important. You may find many hams who

are spending more time enjoying the benefits of amateur radio, but I wonder how many you'll find who are investing their time as much as I am, and also a few others of NIAC, in the future of our hobby?

Now, on that article. I hope a few readers look it up and explain it to you. There is nothing at all wrong with it. The battery goes between the plus and ground terminals.

The subscription department is far from perfect... but it is one of the best in the country. It is a commercial service and our complaints are a tiny fraction of what we've had in the past. They are also incredibly expensive.

Articles are bought for the purpose of publishing. It can take up to a year or more, if an article is not one of strong time value, before it is published. It'll be along.

Many old-time hams, rather than cope with new narrower band techniques, are pushing to stop ham growth instead. Some may still be around muttering "spark forever" under their breath. Jim, we will develop new modes of communications and we will grow... a lot... or we will die.

May I respectfully also point out that while it is possible to find ham bands which are packed, we also have a bunch of others where there is no crowding. Perhaps, if you could march to a slightly different drummer, you might enjoy interference-free contacts. Much of 10, 6, 2, and upward are quite open. Even 15 is seldom filled up... if ever. So why go the lemming route and insist on adding one more bit of noise to the few jammed-up frequencies?—Wayne.

MONEY GRUBBING?

I find little of interest in 73. My interests are mainly in the technical or project end, and I find that much of this sort of thing is either not present or of no interest. Probably the most important single project these days would have to be low-voltage, high-current power supplies of up to 500 Watts. When was the last time you ran a good article on such as this? Some time ago you used to run useful articles on computer interfaces with ham radio. Then you started some computer mags and, of course, then funneled all these

into the computer publications. But, now, lo and behold, you are a big honcho in the Instant Software market place and appear reluctant to put anything in *80 Micro* that you might be able to flog through Instant Software. Very subtle!

All that aside as a fairly typical money-grubbing ploy, frankly, your attitude to ham radio scares the pants off me. You come out in favour of people being able to buy copies of the examinations, you are against nets, you deplore the fact that anyone wants to remove the certifiably insane from the air, you want to increase the ham population of the States by some 200,000.

Take a look at the two *Callbooks* side by side. There are already more hams in the States than all the rest of the world put together. Your examinations are a joke in many parts of the world. There are probably more lids in the W4/5 district than the whole of the rest of the world. It is almost impossible to do anything organized on the air without having someone deliberately interfere. I suppose you would consider this an infringement of civil rights to restrict these activities! Now you want to get the rest of the "Criminal Band" fraternity on the air. Nice for circulation. Must make you drool!

I clawed my way up to number two on the ARRL Public Service Honor Roll until I quit in disgust when it finally dawned on me that the ARRL did not in fact represent the interests of the amateur but rather the interests of the executives and staff at Newington.

While I sometimes thought your articles on the ARRL were a bit overstated, in general I agreed. Now I am beginning to find some frightening similarities. Would success and fame go to Green's head?

A. E. M. Spence VE7DKY
Vernon BC
Canada

AEM... phooey... and I'll tell you why. There you are carping at someone who is getting things done and moving the world ahead a bit, with your contribution one of having "clawed" your way up to number two on the ARRL Public Service Honor Roll. Well, whoo de doo. Lookie here, I resent your insinuation that I'm money-grubbing. Oh, I'd like to be, but I keep thinking of

more projects and whoosh, away goes the grubbed money.

I did enjoy the bit about Instant Software getting the good 80 programs. If you could hear the beefing I have laid on everyone around here, just trying to get the Instant Software people to even look at a copy of the magazines to see if any of the programs we have published might be worthwhile to distribute, you'd know what I mean. I've tried to get ISI to let the magazines take a look at their losers for possible publication. I think we are making headway there, but only recently. No, you're full of it as far as that one is concerned.

Please let me know where you got the idea I'm against nets. Having called into 'em for years, that's a new charge. Matter of fact, one of the services we're planning for the W2NSD/1 bulletin board is a net listing. And the Bash Cheatos? Well, by refusing to run ads for the Bash "guides," we're passing up perhaps \$15,000 a year in advertising, so what do you want from me? I do think that his "study guides" and the ARRL Q&A Manuals have provided the cheats the easy way to get a license for as long as I can remember. My license study manuals are not that kind... they teach the theory. You're all wet again.

The Callbook? How can you be so off base on everything? They don't list about 90% or more of the Japanese hams... or about 90% of the Russians... and a lot of other foreign hams. If they did, no one would buy the book... it would look like the Manhattan yellow pages... and cost a fortune.

And you're after the CBers too. For your information, sir, about 90% of the US hams licensed in the last ten years started out on CB. Bad operating is not really new... just ask any old-timer. Spence, I was there 50 years ago, so I know what it was like then. I've been active ever since. If you want to know about deliberate interference, just read the editorials in the 1920 and 1930 issues of QST. Nothing has changed... it's just that you have no perspective and you, for some odd reason, think things were better. They weren't. The next thing you'll be beefing about is that people don't build anymore.

Well they do... and more than they did 50 years ago.

Will success go to my head? Probably. I do admit to enjoying it, mostly because as a recognized success I am able to get much more done. My ideas now are able to reach people and, in view of my success, be taken seriously. Would you want to read a book on how to make a million dollars written by someone on welfare?

Power supplies? Lordy, we've published so many power supply articles in 73 that another publisher has taken them and published a book on the subject.

My interest is not to increase the ham population of the United States by 200,000... in which you are consistent in your inaccuracies... it is to lift it to 2,000,000. Why be chintzy?—Wayne.

COMBATTING RADAR

I have recently learned that the State of Wisconsin is in the act of passing a new law outlawing radar detectors. It will be a \$200 fine if you are caught using a radar detector.

Does anyone out there know if the various radar detector companies are willing to go in to try to overturn this law in state court, or at least help someone who wants to? I think it is a crime if they are about to outlaw receiving any type of radio transmission, including radar. If anyone knows how to combat these kinds of laws, or how to go about overturning them, or if they have gone through this kind of thing already, please write Ken Slate W9ITW, 427 Hamburg Street, Ripon WI 54971.

Kenneth H. Slate, W9ITW
Ripon WI

HAM VERSUS CABLE TV

I noticed a letter in your September issue regarding CATV 2-meter interference. I was a CATV technician in charge of quality control at a large north-eastern system for over six years and would like to take this opportunity to discuss this problem.

FCC rules pertaining to radiation from CATV currently state that between 54 and 216 MHz, radiation shall be not more than 20 $\mu\text{V}/\text{m}$ at a distance of three meters. Above and below that frequency range, the level is 15 $\mu\text{V}/\text{m}$ at 30 meters. They further state that should interference to another duly-licensed service occur, radiation must be reduced to the point where no interference occurs regardless of levels involved.

Under the present technology and methodology employed by conscientious CATV systems, it is all but impossible to locate radiation below about 14 $\mu\text{V}/\text{m}$ at three meters. The problem is that the typical 144-MHz rig has a sensitivity of less than 1 μV for 10-dB quieting; near-field radiation is more an inverse linear function than inverse square, so interference is bound to occur in a metropolitan area.

From my experiences, the main trouble spot appears to be 145.25 MHz which is both CATV channel E and a repeater frequency. The following are possible solutions, in no particular order of feasibility.

- 1) Do not assign this frequency to a repeater.
- 2) The cable TV company can offset channel E by plus or minus 10 kHz. These are standard offsets. Probably a greater offset would help.
- 3) The cable company could use a harmonically-related carrier headend.
- 4) The repeater frequency could be offset. Probably 10 to 25 kHz should suffice.
- 5) Hams in areas not present-

ly cabled should keep informed about any CATV activity in their vicinity. Offsetting or using a harmonically-related carrier headend are decisions to be made preferably before activation of a system.

There are many hams in the technical side of CATV who can help and management types are usually pretty open-minded. With the proper attitude, maybe both sides can solve the problem once and for all.

Robert Wanderer WB2MCB
Herzliyya, Israel

Wouldn't it be great if all cable operators shared WB2CMB's open-minded, conscientious attitude? Unfortunately, many CATV companies are reluctant to upset the apple cart, much less spend any money that would result in a reduction of short-term profits.

The idea of a legitimate amateur repeater shifting its frequency to accommodate CATV does not appeal to me. It is just another form of spectrum robbery. Offsetting the cable channel and insisting on a well-shielded system should go a long way towards reducing the problem.

A firm but tactful approach seems to be in order. If the cable operator refuses to cooperate, perhaps some high-power transmissions on or about 145.25 MHz will prompt action.—Tim Daniel N8RK.

TAKE US ALONG

I want to tell you how much I enjoyed Wayne's description of the St. Lucia trip and the fine article by Jeff DeTray, "Contesting from VP5," with more Turks and Caicos adventure. Thanks for taking us along via the article and "Never Say Die." Let's have more satellite and MDS articles.

Wilbur Golson W5CD
Baton Rouge LA

DXPEDITION HELP

DXpeditions International was formed by a small group of DXers who desire to help DXpeditions to the more rare DXCC countries. In order to meet this goal, the DXpedition Fund was established and shall remain on

deposit until a significant contribution can be forwarded to a deserving DXpedition. At the present time, the DXpedition Fund is small, and outside membership and participation is paramount to its success. The DXpedition Fund's assets are on deposit at the Fulton Federal Savings and Loan in Waycross, Georgia. Interest paid on this deposit is returned to the fund. As the fund grows, more assistance will be rendered to DXpeditions which otherwise may not "Make The Trip."

Individuals or clubs may request assistance for their DXpedition by writing to DX Review Committee, DXpeditions International, 999 Wildwood Road, Waycross GA 31501. This request should include the plans and details of the proposed DXpedition. A business-size SASE would also be appreciated. (As you can see, we desire to keep costs down, thus providing more assistance to a DXpedition.)

Before the DX Review Committee can make a final commitment for funds, the DXpedition organizers must meet some

strict criteria. The complete list of criteria will be forwarded to those who request our assistance, but for example, they include the following:

1) The DXpedition must have in hand the licenses or permits required for operation from the proposed DXpedition location.

2) DXpedition members must have the appropriate passports, visas, and other documents required for entrance into the country or locality from which they will operate.

3) DXpedition organizers must furnish a financial statement of DXpedition funds on hand and a complete cost analysis for the DXpedition.

When the DX Review Committee rejects an application for failure to meet requirements, the applicant may reapply at such time the criteria can be met. The amount of assistance will be determined by the assets of The DXpedition Fund, the needs of the DXpedition organizers, and the rareness of the country of proposed operation.

The organizers of DXpeditions International and their families are not eligible to

receive assistance from the DXpedition Fund, but those holding memberships in the organization, either full or limited, shall receive priority consideration when applying for assistance for their DXpeditions.

In order to keep the membership of DXpeditions International informed, a newsletter is printed on a weekly basis. This newsletter is mailed to all members and is devoted to the news and operations of DXpeditions and other DX as may be "On The Bands." Membership categories are:

1) Full Member—Receives the DXpeditions International newsletter and also makes a significant contribution to the DXpedition Fund. (US \$38 fee.)

2) Limited Member—Receives the newsletter but does not make any contribution to the DXpedition Fund. (US \$28 fee.)

3) Friend—Our Friends are not members of DXpeditions International but are individuals who desire to make some contribution to the DXpedition Fund. The size of the contribution varies from Friend to Friend, but the entire amount is deposited into the fund.

DXpeditions International hopes that it can make a marked contribution to the amateur radio fraternity and to DXing. With your help and participation, this goal will be met.

DXpeditions International

JERRY AND DXCC

This is the real K2RA, and unfortunately for me my K2RA call has been bootlegged on the air by some culprit named Jerry since 1978, mostly in contests and on the 20- and 10-meter SSB bands. His location is unknown.

This guy Jerry is using up all of my envelope credits at the North Jersey DX Association QSL Bureau, and that's how I found out about him. I have enough DX cards confirming his contacts made with my K2RA call for me to get DXCC! I have notified the ARRL and the FCC. Jerry can pick up most of his cards with my callsign at this address (except for the ones I sent to the FCC). I will be glad to meet him.

D. M. Rager, Jr. K2RA
Buffalo NY

DOLLAR SAVER/SPACE SAVER WELZ SP-300 SWR & POWER METER 1.8 to 500 MHZ/1 W to 1 KW



Exclusive cross over frequency range
3 Transmitter/3 Antenna Connectors.
One SWR/Power for the serious amateur who operates all bands, HF to 450 MHz

Serious Dealers Listing Available.



1275 N. Grove St.
Anaheim, Cal. 92806
(714) 630-4541

NOTE: Price, Specifications subject to change without notice and obligation.

318

Wheaton Community Radio Amateurs

HAMFEST

Sunday, February 7, 1982

EXPANDED Midwinter Swap 'n Shop

- FREE FLEA MARKET TABLES
- 100 COMMERCIAL BOOTHS
- ALL IN ONE BUILDING
- ACRES OF CLEAR PAVED PARKING
- HOURLY DOOR PRIZES
- RESERVED FLEA MARKET TABLES
- SPECIAL COMPUTER SECTION
- TECH PROGRAMS

Doors open 8 a.m.

ARLINGTON PARK EXPO CENTER

Arlington Park Race Track
Arlington Heights, Illinois
Northwest of Chicago



TICKETS: \$3.00 at the door \$2.50 in advance

Send S.A.S.E. to

Wheaton Community Radio Amateurs
P. O. Box QSL - Wheaton, IL 60187

Talk in on 146.94 Mhz. and 146.01/.61 Mhz.

For reserved Flea Market information call AI WB9PWW 312/629-1427

For Commercial Booth information call WB9TTE 312/766-1684



**FIRST PRIZE
NEW TRANSCEIVER**

Interested In DX?

Dick Bash says you need THE COMPLETE IDIOT'S GUIDE TO DX (by Stu Gregg, NF4Z) if:

- ... you think IRC means International Red Cross
- ... you're still working on your DXCC
- ... you think WAC means a female army person
- ... you're not a BIG GUN (yet)
- ... you think the 'BUREAU' is where you put your socks



The Idiot's Guide pulls no punches and doesn't 'snow' you with nonessentials, but it does unlock some DXers' secrets; for example: How to QSL, What to say, Where to place your antenna, How much power to use, Whose awards can you get, Why and When to use SSB or CW, and much more... things that you need to know, and information that Honor Roll members had to learn the hard way.

Dozens of DXers have been interviewed and their suggestions have been included here. Take a tip from the "Big Guns" and use their secrets and tricks.

THE COMPLETE IDIOT'S GUIDE TO DX is available at dealers nationwide for only \$12.95, but if you can't stand to wait, rush Dick \$15.45 (which will cover First Class postage). If you live in California, please include 84¢ for Sales Tax. Telephone orders accepted 10 AM-6 PM California time.

BASH EDUCATIONAL SERVICES, INC.

P.O. Box 2115
San Leandro, California 94577
(415)352-5420

✓ 26

High Performance - All Mode GENERAL COVERAGE RECEIVER

Yaesu FRG-7700

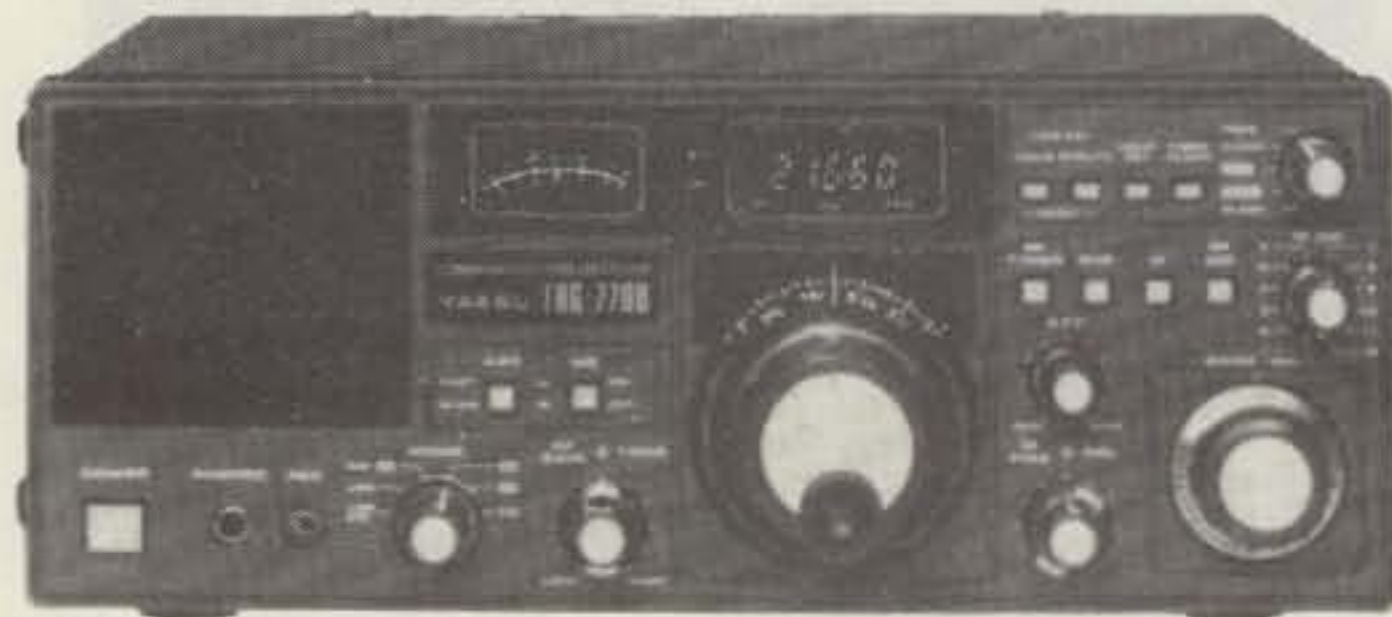

List Price
\$549.00

\$459⁰⁰

(Free shipment UPS
U.S.A. Continental 48 States)

- * 150 KHz. to 29.999 Mhz.
- * SSB, CW, AM and FM
- * Digital Frequency Display
- * Digital Clock/Timer
- * NB, AGC and RF attenuator
- * Wide Med. & Narrow AM Selectivity
- * Optional 12 Memory Frequency Storage & Recall, MU-7700 - \$129.00



Call toll-free
1-800-325-3636

HAM RADIO CENTER
8340-42 Olive Blvd. P.O. Box 28271 St. Louis, MO 63132

Call toll-free
1-800-325-3636

HAM HELP

In order to repair my Hallicrafters receiver, model SX 122, I must find a schematic diagram and my problem is that I can't even find Hallicrafters in the States let alone the schematic.

A tag on the receiver shows it was made in Chicago but the Embassy here has no Chicago address. What to do? Has it gone out of business?

Any help will be greatly appreciated indeed.

Hal R. Cozzens
Managing Director
P.V.S. Enterprises Co., Ltd.
Chongkolnee Bldg., 3rd Floor
56 Suriwong Rd.
Bangkok 5 Thailand

Need manuals for Ballantine Labs model 300E or 300H; also TS-323/AU frequency meter by Hoffman Radio.

Bill O'Meara WB3LPB
807 E. Seminary Ave.
Towson MD 21204

I am looking for information and plans for a touchtone™ decoder. Can you help? Thanks.

W.R. Hudson
PO Box 400814
Dallas TX 75240

I would like to purchase manuals or schematics or copies of them for the following equipment:

1) Alfred—Microwave oscillator, model 621-B. 2) Boonton—(Hewlett-Packard) UHF Q-meter, model 280A. 3) Cimron—Digital multimeter, model 7630. 4) FXR—Power meter, model B-831A. 5) PRD—Receiver, model 915. 6) Polarad—Field intensity meter, model FIM. 7) Polarad—Microwave receiver, model "R" and/or RB-1. 8) Servo Corp. of America—Pulse-sweep generator, model S-880-CS.

Any assistance will be greatly appreciated.

G. Hunt
2529 NW 38 Ct.
Miami FL 33142

MILITARY SIGNAL GENERATORS RECONDITIONED AND LAB CALIBRATED

| | |
|---|----------|
| TS-510/U, RANGE 10 MHZ THRU 420 MHZ AM/CW OR PULSE MODULATION, CALIBRATED ATTENUATOR MILITARY EQUIVALENT TO HP608D..... | \$375.00 |
| TS-403/URM-61, RANGE 1.8 GHZ THRU 4 GHZ AM/PULSE, CALIBRATED ATTENUATOR, MILITARY EQUIVALENT TO HP616A..... | \$345.00 |
| TS-621/URM-52, RANGE 3.8 TO 7 GHZ, AM/PULSE CALIBRATED ATTENUATOR, MILITARY EQUIVALENT TO HP618A..... | \$345.00 |
| HP 606A, RANGE 50 KHZ THRU 450 MHZ AM/CW, CALIBRATED ATTENUATOR..... | 450.00 |
| HP 612A, RANGE 450 MHZ THRU 1230 MHZ AM/PULSE MODULATION, CALIBRATED ATTENUATOR..... | 475.00 |
| HP 614, RANGE 900 THRU 2100 MHZ, AM/PULSE MODULATION, CALIBRATED ATTENUATOR..... | 345.00 |
| URM-25, RANGE 10 KHZ THRU 50 MHZ AM/CW, MODULATION 400HZ AND 1 KHZ, RF OUTPUT 0-2V, PRECISION 50 OHM STOP ATTENUATOR..... | 285.00 |
| URM-26 RANGE 4 MHZ THRU 405 MHZ AM/CW MODULATION, CALIBRATED ATTENUATOR..... | 285.00 |
| TS-497/URR, RANGE 2 MHZ THRU 50 MHZ CALIBRATED ATTENUATOR, AM/CW MODULATION, MILITARY VERSION OF MEASUREMENTS MODEL 80..... | 225.00 |
| TS-418/URM-49, RANGE 400 MHZ THRU 1000 MHZ, AM/CW OR PULSE MODULATION, CALIBRATED ATTENUATOR..... | 225.00 |
| TS-419/URM-64, RANGE 900 THRU 2100 MHZ CW OR PULSE MODULATION, CALIBRATED ATTENUATOR..... | 225.00 |
| SG-13/U, AIRCRAFT VOR/ILS RANGE 108 THRU 135.9 MHZ AND 329.9 TO 335 MHZ, OUTPUT SIGNALS INCLUDE VOR, LOC AND GLIDESLOPE AND 1000CPS, SAME AS COLLINS 479T-2, OPERATES FROM 28VDC AT 3 1/2 AMPS BENCH POWER SUPPLY OR AIRCRAFT BATTERIES. IDEAL FOR AIRCRAFT RADIO REPAIR..... | 295.00 |
| SG-1A/ARN AIRCRAFT RADIO SIG GEN WITH PP-348/ARN 115V/60HZ POWER SUPPLY RANGE 88 THRU 140 MHZ AND 110.1 TO 114.9 MHZ IN 10 KHZ STEPS CALIBRATED OUTPUT 400/1000 HZ, MODULATION INT OR EXT, MILITARY EQUIVALENT TO BOONTON 211A..... | 345.00 |
| MOTOROLA T-1034, FM SIG GEN, RANGE 25-54 MHZ, 130-175 MHZ, 400-470 MHZ AND 890-960 MHZ, VARIABLE OUTPUT FROM 0.1 MV TO 100,000 MV, HAS OUTPUT 1KC DEVIATION METER..... | 475.00 |

FOB OTTO N.C., 30 DAY MONEY BACK GUARANTEE
 WE ACCEPT M/C, VISA OR CHECK, PHONE BILL SLEP (704) 524-7519.



Electronic
 Distributors

Slep Electronics Company

P. O. BOX 100, HWY 441, DEPT. 73
 OTTO, NORTH CAROLINA 28763

✓ 367

NEW PRODUCTS FROM HAL-TRONIX

2304 MHz DOWNCONVERTERS

Frequency Range 2000-2500 MHz

2304 Model 1: Basic three-stage, less case

and connectors.....**\$49.95**

2304 Model 2: Three-stage, includes preamp, with die-cast case and connectors.....**\$59.95**

2304 Model 3: With high-gain preamp, die-cast case and connectors.....**\$69.95**

The above models complete with high-quality drilled PC boards, all electronic components, etc., with 15-page manual.

Note: Any of the above, factory wired, \$50 additional

POWER SUPPLIES FOR THE DOWNCONVERTERS:

Power supply kit # 1, less case and connectors.....**\$19.95**

Power supply kit # 2, includes case & connectors.....**\$24.95**

Power supply—already built, complete.....**\$34.95**

PARTS FOR THE NTSC RF MODULATOR FOR CHANNELS 3, 4, or 5.

This is **not** a complete kit. The hard-to-get parts include the LM-1889, the .08 microhenry tank coil, the 7-14 microhenry adjustable coil, the 10 microhenry RF coil, with schematic (no PC board) as used in Bob Cooper's satellite TV receiver. Real buy at.....**\$5.95**

SHIPPING INFORMATION

ORDERS OVER \$20.00 WILL BE SHIPPED POSTPAID EXCEPT ON ITEMS WHERE ADDITIONAL CHARGES ARE REQUESTED ON ORDERS LESS THAN \$20.00 PLEASE INCLUDE ADDITIONAL \$1.50 FOR HANDLING AND MAILING CHARGES. SEND SASE FOR FREE FLYER

TOUCHTONE DECODER KITS

HAL 567-12: single line in, 12 lines out, complete with 2-sided plated-through G-10 board and all components. Uses seven 567's and three 7402's.....**\$39.95**

HAL 567-16: single line in, 16 lines out, complete with 2-sided plated-through G-10 board and all components; includes 22-pin edge connector. Uses eight 567's and four 7402's. (See construction article in April 1981 Radio & Electronics for complete writeup.).....**\$69.95**

TOUCHTONE ENCODER KITS

HAL ECD-12: 3 x 4 twelve-character encoder utilizing the ICM 7206 Intersil chip. Kit comes complete with both LED and audio-coupled outputs (speaker included). With aluminum anodized case.....**\$29.95**

HAL ECD-16: 4 x 4 sixteen-character encoder utilizing the ICM 7206 Intersil chip. Kit comes complete with LED and audio-coupled outputs (speaker included). With aluminum anodized case.....**\$39.95**



"HAL" HAROLD NOWLAND
WBZXH

✓ 31

HAL-TRONIX

P. O. BOX 1101
 SOUTHGATE, MICH. 48195
 PHONE (313) 285-1782



FAST SCAN

\$399

Have you tried it yet?

TC-1



- *10 Watts Output
- *Standard Frequencies Available
- *Broadcast Standard Subcarrier
- *High-resolution Video
- *Regulated AC Supply Built In
- *Tuneable Downconverter & Preamp

Connect to the antenna terminals of any TV set, add a good 450 MHz antenna, a camera and there you are... Show the shack, home movies, computer games, video tapes, etc.

***HOME BREWERS:**
Ask for our basic
four-module package

OPTIONS:

- *PORTABLE OR MOBILE PROVISION... \$30
- *MONITOR with BNC OUTPUT..... \$30
- *TWO-FREQUENCY EXCITER..... \$30

Call or write for our complete list of specifications, station set-up diagrams, and optional accessories which include antennas, modulators, detectors, test generators, cameras, etc. **WE ARE A FULL-LINE SUPPLIER OF ALL YOUR ATV NEEDS.**

TERMS: VISA or MASTER CARD by telephone or mail, or check or money order by mail. All prices are delivered in USA. Allow three weeks after order for delivery.

P.C. ELECTRONICS 2522 Paxson Lane,
Tom W6ORG Maryann WB6YSS Arcadia, California 91006

SUB-AUDIBLE TONE FOR THE ICOM IC2A/AT

The Trans Com model 401 sub audible tone encoder is designed to be easily installed in the ICOM IC-2A/AT. Simple installation requiring only three connections are all that is needed to operate your IC2A/AT on a tone access repeater.

102 DTMF Repeater Controller

The 102 DTMF Controller is a modular system designed to provide on-off remote-control functions using the standard 12 or 16 digit Touch tone signaling through wire line or radio links. Using modular design up to 16 on-off or momentary control functions can be provided.

FEATURES

- Compatible with PL, CG and most other tone control
- Low current
- Small size 1.0" x .6" x .3"
- Low tone distortion of less than 1% THD
- Tone stability $\pm .2$ hz from -20°C to $+70^{\circ}\text{C}$.
- Can easily be installed in most other radios
- Comes wired and tested
- Two year warranty.



\$29⁹⁵



Features

- Modular design, rack mount
- Plug in DTMF receiver using the latest technology in DTMF decoding—no PII's
- Three types of control cards
 - ON-OFF OPEN COLLECTOR TRANSISTOR
 - ON-OFF LATCHED RELAY OUT-PUT
 - MOMENTARY RELAY OUT-PUT
- Each card can decode a 2, 3, or 4 digit code using any of the 16 digits.
- Easy to install and use
- Two year warranty.

For more information or to order call or write:

Trans Com Inc.

703-13 Annoreno Dr. Addison, Ill., 60101
(312) 543-9055



75



MAKE MONEY... 73 \$SELL MAGAZINE

Selling 73 Magazine, the ham radio magazine that offers quality and quantity, brings the ham into your store. Once through the door you can sell him anything.

Our dealers are telling us that "73" outsells them all... so call today and join the dealers who make money with 73 Magazine.

For information on selling 73 Magazine call 800-258-5473 and speak with Ginnie Boudrieau, our Bulk Sales Manager. Or write to her at:

73 MAGAZINE
80 Pine Street
Peterborough NH 03458



YAESU FT-207R OWNERS

AUTO SCAN MODULE AND BATTERY
SAVER KIT



15 minutes to install; scan restarts when carrier drops off; busy switch controls automatic scan on-off; includes module and instructions.

Model AS-1. \$25.00



**FT-207R BATTERY SAVER KIT
MODEL BS-1 \$14.95**

WRITE FOR CLUB DISCOUNTS

- *No more dead batteries due to memory backup
- *30% less power drain when squelched
- *Simple to install; step-by-step instructions and parts included
- *4 mA memory backup reduced to 500 μ A.
- *45 mA receiver drain reduced to 30 mA.
- *Improved audio fidelity and loudness.

COMMENTS ON THE AS-1:

Enjoy hands-free automatic band scan with your FT-207R. The Model AS-1 provides true scan resume when the carrier drops off. The AS-1 fits in the bottom of the rig with plenty of room left for tone squelch boards. Hundreds of satisfied users say: "The AS-1 is a real winner! Exactly the missing feature needed. I use the auto-scan mode most of the time and get added enjoyment from my rig."

COMMENTS ON THE BS-1:

"I was just about to give my FT-207R away, when I decided to give it one last chance, and I ordered the BS-1 battery saver kit. Well, it made all the difference in the world. I can't believe it is the same rig. I used to carry around an extra battery pack all day, but now my batteries last about twice as long. I no longer have to worry about dead batteries. I used to worry about turning the memory off to conserve power, but with the BS-1 it doesn't matter any more. The audio has improved, and I really like my rig again."

ENGINEERING CONSULTING

P. O. BOX 94355 ✓ 400
RICHMOND, B. C. V6Y2A8, CANADA



INTRODUCING THE CES 500SA SIMPLEX AUTOPATCH

The First Affordable Private Phone Patch

As described in 73 Magazine, 6/81.

Now, for the first time! Every amateur operator can enjoy the unparalleled freedom of a private phone patch in an economical package.

The dramatic new CES 500SA Autopatch is all the equipment you need to patch an FM base station to your home or other telephone line, without expensive repeaters, cavities, or other equipment. Connections with any standard FM base station are rapid and simple.

Bypass the congestion and expense of shared repeaters — break through to greater privacy and convenience with the new CES 500SA Autopatch.

COHERENCE IN
COMMUNICATIONS TECHNOLOGY

CES

COMMUNICATIONS ELECTRONICS
SPECIALTIES, Inc.

P.O. Box 507
Winter Park, Florida 32790
Telephone: (305) 645-0474

Copy RTTY, ASCII and Morse from the palm of your hand.



Have you waited to get into code reading until you found out what this latest fad was about? You can stop waiting, because it's no longer a fad.

Amateurs everywhere are tossing the gigantic clanking monsters of yesteryear that once performed the job of reading radioteletype. They are trading them in for state-of-the-art code-reading devices that are incredibly small, noiseless if desired and infinitely more versatile than their antique predecessors.

Kantronics, the leader in code-reading development, has just introduced the latest and most-advanced breakthrough in the copying of Morse code, radioteletype and ASCII computer language.

The **Kantronics Mini-Reader** reads all three types of code, displays code speed, keeps a 24-hour clock, acts as a radioteletype demodulator and reads all of its decoded information out on a traveling display of 10 easy-to-read characters. It is so compact that it fits in a hand-held, calculator-size enclosure.

At \$289.95, the **Mini-Reader** outperforms anything within another \$400 of its price range.

Call or visit your Authorized Kantronics Dealer now to find out what the latest in technology has done to code-reading.

Kantronics

(913) 842-7745
1202 E. 23rd Street
Lawrence, Kansas 66044

hey look here

call toll free: nights
(800) 231-3057
6-10 PM CDST, M.W.F.
days: 713-658-0268

| | | |
|---------------|----------------|-----------------|
| HYGAIN | TH7DX | List \$499 |
| | Your Cost | \$ 399.00 |
| ICOM | IC 720A/AC | \$1298 |
| | IC 730 | 729 |
| | IC 2AT | 249 |
| | IC 22U | 269 |
| | IC 25A | 309 |
| Santec | HT 1200 | 299 |
| | ST7 440 FM | 299 |
| ETO | Alpha 78 | 2595 |
| | 76A | 1495 |
| | 76PA | 1795 |
| Telrex | TB 5EM | 425 |
| Drake | TR7/DR7 | 1349 |
| | R7/DR7 | 1299 |
| AEA | Morse CK1 | 115.00 |
| YAESU | FT707 | 699 |
| | FRG7700 | 449 |
| | FT101ZD | |
| | Mark 3 Limited | 749 |

Order **KWM 380** Now \$3095.00

Free Filter Included

Rockwell Accessories in Stock

| | | |
|------------------------------|-------|--------|
| Hal CT 2100 | | 699.00 |
| Robot 400A | | 675.00 |
| Janel QSA5 | | 41.95 |
| Bash Books | | 9.95 |
| Amphenol Silver Plate PL-259 | | 1.00 |
| Antique/Rare Tubes | | Call |
| GE 572 B | | 40.00 |
| Timex 24 hour Wallclock | | 24.95 |
| Robot 800A | | 749 |
| Cubic 103 | | 1195 |
| Portable VJ Amplifier | | |
| 2 watts in 33 watts out | | 89.95 |
| Curtis KS Lil' Bugger | | 39.95 |
| Belden 9405 Heavy Duty | | |
| Rotor Cable 2#16, 6#18 | | 45c/ft |
| Belden 8214 RG-8 Foam | | 36c/ft |
| Belden 9258 RG-8X Mini-coax | | 19c/ft |
| Alliance HD73 Rotor | | 109.95 |
| Kenwood Service Manuals | | 12.00 |

(Including Shipping)

Call for **TS830S, TS130S,**

TS-530S plus accessories

MASTERCARD VISA

All prices fob Houston except where indicated. Prices subject to change without notice, all items guaranteed. Some items subject prior sale. Texas residents add 6% tax. Please add sufficient postage, balance collect.

MADISON

Electronics Supply

1508 McKinney
Houston, Texas 77010

VAL-DUCKIE™

Portable Communications Antennas

For amateur and commercial services, the Val-Duckie communication antennas boast 48 different models, from 144 to 512 MHz. Encapsulated in high gloss PVC plastic for weather resistance, all Val-Duckie antennas are 100% factory tuned for minimum VSWR and have a power rating of 35 watts at 50 ohms.



VALOR HT POWER-CHARGER™

Valor's New HT POWER-CHARGER™ allows mobile amateurs to operate and recharge their hand-held radios from the vehicle electrical system.

The HT POWER-CHARGER™ is not just a dropping resistor and diode—but a pair of silicon transistors in a variable current regulator that is self adjusting, depending on the battery charge state.

- Model TR: For Kenwood TR-2400
- Model FT: For Yaesu FT-207R
- Model IC: For Icom IC-2A
- Model TP: For Tempo S1, S2, S4, S5
- Model SA: For Santec HT-1200
- Model WL: For Wilson MI-II, MK-IV

422
valor

185 W. Hamilton St., West Milton, OH 45383
PH: (513) 698-4194, Outside Ohio: 1-800-543-2197, Telex 724-389 ATT.: Valor

KIRK

HIGH STRENGTH FIBERGLASS

AVAILABLE IN A COMPLETE RANGE OF KITS

Special Instruction Manual on Kirk's "Super Quads" \$2.75

- 2 3 4 ELEMENT TRI BAND
10 15 20 METER AMATEUR NET FROM \$256.68
- 2 3 4 ELEMENT DUAL BAND
10 15 OR 10 6 METER AMATEUR NET FROM \$150.42
- 2 ELEMENT 40 METER AMATEUR NET \$523.50
- VHF 4 ELEMENT 2 OR 6 METER
AMATEUR NET FROM \$96.75



SUPER-QUAD KITS

2-3-4
ELEMENTS
OR MORE

WRITE FOR FULL INFORMATION. PRICES DO NOT INCLUDE POSTAGE.
PRICES ARE SUBJECT TO CHANGE.



KIRK ELECTRONICS DIVISION
VIKING INSTRUMENTS, INC.

73 Ferry Rd., Chester, CT 06412 ●Telephone: (203) 526-5324

WORLD TIME WATCH

the first microprocessor watch made especially for hams



24 hr. timer
microprocessor
water resistant
solar assist

New Low Price
—\$59.95

The HAM-1 functions include local time, world time, (G.M.T. too) count-up and count down chronometer, day, month, date, alarm and hourly chime. It's ideal for log-keeping, DX time conversion and 10 minute I.D. timing. The HAM-1 features a high contrast Seiko display and solar cell battery assist. Battery life is better than 4 years. The HAM-1 is water resistant to 20 meters, the case is 100% solid stainless steel and the crystal is scratch resistant mineral glass. The HAM-1 is rugged and durable and has a 1 year warranty.

2 METER AMPLIFIER \$39.95



• 2 Watts In, 10 Watts Out • V.S.W.R. Protected • Can be Used for F.M. & S.S. B. • Led Status Indicators • Low Loss SO-239 Connectors • Current Drain Less Than 2.5A at 13.6 V.D.C. • Massive Heatsink • Built In T/R Switch

TEMPO S-1 UPGRADE KITS \$39.95

Upgrade your early Tempo S-1 to current Production Specifications, kits include: • 450 M.A.H. Battery Pack • New Case Assembly • All New Escutcheons • Spkr./Mic. Jack w/Dust Cap • New Earphone & Jack • P.C.B. and Parts for Easy Installation • Detailed Instruction Manual • For Radios With & Without T.T. Pad.

Other Accessories Available:

Spkr/Mic. Designed for S-1's. . . \$24.95
Heavy Duty Belt Clip. 7.50
Flex Antenna 6.00

To Order Call or Write to:

ADVANCED COMMUNICATIONS
INTERNATIONAL
2411 Lincoln Avenue
Belmont, CA. 94002 U.S.A.
(415) 595-3949

Add \$3.00 per order for shipping & handling. California residents add 6% sales tax. Visa, Master Charge accepted.

EAST COAST #1 GOES NATIONAL THE ANTENNA BANK is East Coast's #1 supplier of ANTENNAS — TOWERS ACCESSORIES

CUSHCRAFT:

| | |
|--|----------|
| A3 New Element Triband Beam..... | \$165.00 |
| A4 New 4 Element Triband Beam..... | \$204.00 |
| AV3 New 3 Band Vertical 10-20m..... | \$ 40.00 |
| AV4 New 4 Band Vertical 10-40m..... | \$ 81.00 |
| AV5 New 5 Band Vertical 10-80m..... | \$ 87.00 |
| RS 20-15-10m Motor Tuned Vertical..... | \$202.00 |
| 32-19 19 Element 2m Boomer DX Beam..... | \$ 74.00 |
| 214B 14 Element 2m Jr. Boomer 144-146..... | \$ 60.00 |
| A147-11 11 Element 2m..... | \$ 33.00 |
| ARX2B 2m "Ringo Ranger" II..... | \$ 33.00 |

—COMPLETE LINE ON SALE—

| | |
|--------------------------------|----------|
| MINI QUAD HQ-16-10-15-20m..... | \$129.00 |
|--------------------------------|----------|

HY-GAIN:

| | |
|--|----------|
| V2 New 2m Vertical..... | \$ 33.50 |
| TH3JR 3 Element Triband Beam..... | \$133.00 |
| TH3MK3 3 Element Triband Beam..... | \$175.00 |
| TH5DX New 5 Element Triband Beam..... | 195.00 |
| TH6DX 6 Element Triband Beam..... | \$235.00 |
| 105BA 5 Element 10m "Long John"..... | \$ 95.00 |
| 155BA 5 Element 15m "Long John"..... | \$145.00 |
| 205BA 5 Element 20m "Long John"..... | \$235.00 |
| 14AVQ 4 Band Vertical 10-40m..... | \$ 48.00 |
| 18AVT 5 Band 10-80m Trap Vertical..... | \$ 78.00 |

—COMPLETE LINE ANTENNAS ONLY ON SALE—

ROTORS & CABLES:

| | |
|--|----------------|
| CDE HAM IV/CD4511..... | \$165.00/94.00 |
| Alliance HD73/U100..... | \$92.00/42.00 |
| RGB/U Foam 95% Shield..... | 24¢/ft. |
| RG213 Mil. Spec..... | 28¢/ft. |
| Mini-8..... | 12¢/ft. |
| 8 Wire Rotor Cable..... | 16¢/ft. |
| Philly Stran Guy Cable in stock—for price & delivery information call (703) 569-1200 | |

#1 ROHN TOWER DISTRIBUTOR SALE:

| | |
|-------------------------------------|----------|
| 20G 10' Tower Section..... | \$ 29.50 |
| 25G 10' Tower Section..... | \$ 39.50 |
| 45G 10' Tower Section..... | \$ 87.50 |
| HDBX 48' Free Standing Tower..... | \$320.00 |
| FR2548 48' 25G Fold-over Tower..... | \$695.00 |

(Freight prepaid on Fold-over Towers. Prices 10% higher west of Rocky Mountains)
We Stock Rohn Accessories—for price & delivery information call (703) 569-1200

HUSTLER SPECIAL COMPLETE LINE:

| | |
|-------------------------------------|---------------|
| 4BTV/5BTU 4 or 5 Band Vertical..... | \$74.00/92.00 |
| MO-1/MO-2 HF Mobile Mast..... | \$ 17.50 |

| | |
|-----------------------------------|-------------------|
| HF MOB. RES. STD. 4kw SUPER 2.0kw | |
| 10 or 15m..... | \$ 8.00 — \$14.00 |
| 20m..... | \$11.00 — \$15.00 |
| 40m..... | \$13.00 — \$18.00 |
| 75m..... | \$14.00 — \$28.00 |
| SF2 2m 5/8 Whip..... | \$ 9.00 |
| HOT "Hustleoff" Mount..... | \$ 14.00 |
| BM-1 Bumper Mount with Ball..... | \$ 13.00 |

| | |
|----------------------------------|----------------------------|
| AVANTI AP151 3G Glass Mount..... | \$ 27.95 |
| W2AU Balun..... | \$17.55 List/Sale \$ 13.35 |
| Traps 10, 15, 20 or 40m..... | \$24.95 List/Sale \$ 18.79 |

VAN GORDON:

| | |
|---------------------------------|---------------------------|
| PD 8010 10-80m Wire Dipole..... | \$ 28.80 |
| PD 4010 10-40m Wire Dipole..... | \$ 25.20 |
| PD 8040 40-80m Wire Dipole..... | \$ 26.40 |
| SD 40 40m Short Dipole..... | \$ 21.60 |
| SD 80 80m Short Dipole..... | \$ 22.80 |
| HiQ Balun..... | \$10.95 List/Sale \$ 7.95 |
| HiQ Center..... | \$ 5.95 List/Sale \$ 4.95 |

ORDERS ONLY (800) 336-8473

ALL OTHER CALLS (703) 569-1200
Shipping cost not included—Prices subject to change
ALLOW 2 WEEKS FOR DELIVERY
No COD—We ship UPS
We reserve the right to limit quantities

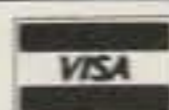

THE ANTENNA BANK
6460 General Green Way
Alexandria, VA 22312



CALL TOLL FREE

For the best deal on

- AEA • Alliance • Ameco • ASP • Belden
- Bencher • Bird • CDE • CES • Collins
- Communications Specialists • Cubic
- Cushcraft • Daiwa • DenTron • Drake
- HAL • Hustler • Hy Gain • Icom • IRL
- KLM • Kantronics • Kenwood
- Larsen • Macrotronics • MFJ
- Mini-Products • Mirage • NPC • Nye
- Panasonic • Palomar Engineers
- Regency • Robot • Shure • Sony
- Standard • Tempo • Ten-Tec
- Transcom • Yaesu

WINTER'S WINNERS

YAESU FT-208R new 2-meter
Hand-Held, regular price
\$359.95 — SALE \$319!

ICOM IC-290A 2-M all modes,
reg. \$549 — Only \$489.95

ICOM IC-730 HF Xcvr, regular
\$829 — Special at \$729

KENWOOD TR-7730, TS-830S
In stock — Call for price

KENWOOD's new TR-2500
Now available — CALL

YAESU FT-207R Hand-Held
Close out — Only \$249.95

COLLINS KWM-380 HF Xcvr
Just a few left at only \$2595

Quantities limited... all prices subject to
change without notice

*We always have an excellent
assortment of fine used equip-
ment in stock... Come in or call*

CALL TOLL FREE

(outside Illinois only)

(800) 621-5802

HOURS: 9:30-5:30 Mon., Tues., Wed. & Fri.
9:30-9:00 Thursday
9:00-3:00 Saturday

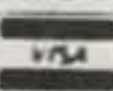

ERICKSON COMMUNICATIONS

Chicago, IL 60630
5456 North Milwaukee Ave.
(312) 631-5181 (within Illinois)

TOWERS

60-FOOT
INSTALLED

**Tower
Power**

Rohn, hot-dipped galvanized truss towers

Installation by experienced crew *anywhere in New England.*

60-foot tower, *INSTALLED*, as low as \$900!

WINDWARD

WINDWARD

**CUSTOM
ENERGY
SYSTEMS**

8 River Drive (Rt. 47)
Hadley, MA 01035

(413) 584-3510

✓29

RADIO DIRECTION FINDING?



AEA
PFDF

MFG. SUGG.
AMATEUR NET
749⁹⁰ INCL.
VHF ANTENNA

TRY THE NEW AEA MODEL PFDF COMPUTERIZED RADIO DIRECTION FINDER

- 1° BEARING RESOLUTION
- SAMPLE AND HOLD
- LONG PERIOD AVERAGING FOR MOBILE
- INTERNAL AUDIO AMPLIFIER AND SPEAKER
- OPERATES FROM 12 V.D.C.

call or write:

AEA
**Brings you the
Breakthrough!**

ADVANCED ELECTRONIC APPLICATIONS, INC.
P.O. Box 2160
Lynnwood, Washington 98036 USA
(206) 775-7373

✓2

✓IT'S PORTABLE - PLUS.
✓IT'S WIDELY COMPATABLE

H. T.
USERS

✓IT'S SELF CONTAINED
✓IT'S EASY TO OPERATE

IT'S M² ENGINEERINGS' NEW HANDI-CON V

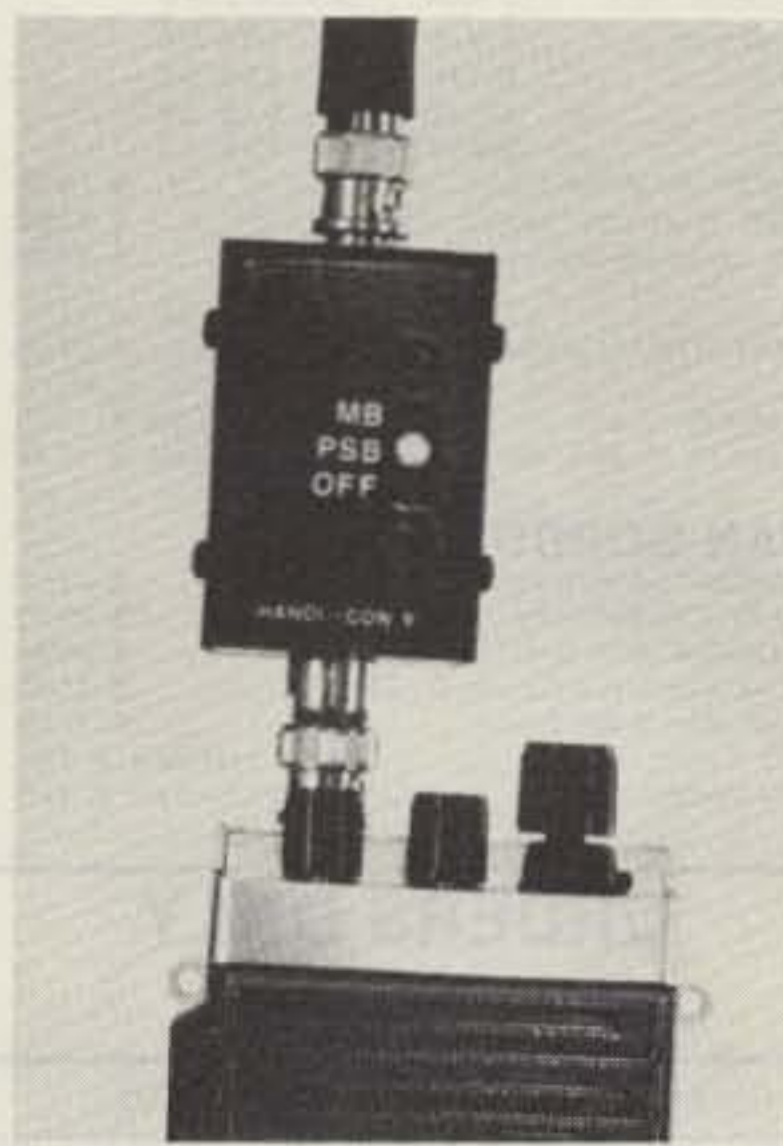

RADIO NOT INCL.

- ANY FULLY SYNTHESIZED 2-METER H.T. CAN NOW BE A COMPLETELY PORTABLE VHF-hi MONITOR
- 2400 CHANNEL CAPABILITY
- DOUBLE BAND COVERAGE.
 - 154 - 158 Mhz fire, police, sheriff, paging & more
 - 159 - 163 Mhz maritime coastal, railroads, N.O.A. weather & more.
- MULTI-BAND & MULTI-CHANNELLED MONITORING WITH SCANNING H.T.'s
- SINGLE 3-POSITION CONTROL
- "OFF" RETURNS TO NORMAL TRANS-CEIVER OPERATION
- LOW LOSS COUPLING TO ANTENNA
- UP TO 6 MOS. OPERATION UNDER AVG. USE WITH A SINGLE AAA CELL
- BI-LATERAL PROTECTION AGAINST ACCIDENTAL TRANSMISSION FOR UP TO 5 WATTS
- size - 2.25 x 1.5 x 1.4 inches
- weight - 4.5 ozs.

• **\$44.95** + \$2.50 pstg. & hndlg.
in Calif. add 6% s.t.x.

contact: M SQUARED ENG.
1446 Lansing ave.
San Jose, Cal. 95118
- or -
Ph. 408-266-9214

Please write for club discounts
on quantity orders

✓77

When it comes to
**AMATEUR
RADIO QSL's...**



it's the
ONLY BOOK!

US or Foreign Listings

1982
callbooks
NOW READY!

Here they are! The latest editions. World-famous Radio Amateur Callbooks, the most respected and complete listing of radio amateurs. Lists calls, license classes, address information. Loaded with special features such as call changes, prefixes of the world, standard time charts, world-wide QSL bureaus, and more. The U.S. Edition features over 400,000 listings, with over 70,000 changes from last year. The Foreign Edition has over 370,000 listings, over 60,000 changes. Place your order for the new 1982 Radio Amateur Callbooks, available now.

| | Each | Shipping | Total |
|---|---------|----------|---------|
| <input type="checkbox"/> US Callbook | \$18.95 | \$3.05 | \$22.00 |
| <input type="checkbox"/> Foreign Callbook | \$17.95 | \$3.05 | \$21.00 |

Order both books at the same time for \$39.95 including shipping.

Order from your dealer or directly from the publisher. All direct orders add shipping charge. Foreign residents add \$4.55 for shipping. Illinois residents add 5% sales tax.



SPECIAL LIMITED OFFER!
Amateur Radio
Emblem Patch
only \$2.50 postpaid

Pegasus on blue field, red lettering. 3" wide x 3" high. Great on Jackets and caps.

ORDER TODAY!

RADIO AMATEUR
callbook INC.

Dept. B
925 Sherwood Drive
Lake Bluff, IL 60044, USA

✓61



**FT-207R
Hand-held
CLOSEOUT
SPECIAL
SAVE \$100**

YAESU FT-207R 2m FM Hand-held. Microprocessor controlled, 800 channels - keyboard entry 144 to 148 MHz. LED display, up/down manual or autoscans, priority channel & memory back-up. ± 600 kHz offsets or any odd splits. 2 1/2 watts or 200 mw output. With Nicad pack, wall charger, flex antenna, earphone & strap. 7 1/4" h x 2 3/4" w x 2 1/4" d, 1 1/4 lbs.

Regular \$339 - Closeout \$239

| Accessories for FT-207R | |
|---|-------------------------|
| NC-1A 15-hr drop-in charger..... | SALE \$44 ⁹⁵ |
| NC-3A 15/4-hr drop-in chgr/AC adapt... SALE | 79 ⁹⁵ |
| FBA-1 Battery sleeve for NC-1A/3A..... | 8 ⁰⁰ |
| NBP-9/FNB-1 Extra NiCad battery pack..... | 23 ⁰⁰ |
| NC-9B Extra 15-hr wall charger..... | 10 ⁰⁰ |
| PA-2 Mobile DC-DC adaptor & charger..... | 39 ⁰⁰ |
| YM-24A Speaker/microphone..... | 32 ⁰⁰ |
| FTS-32E 32 tone CTCSS encoder..... | 40 ⁰⁰ |
| FTS-32ED 32 tone CTCSS enc/dec..... | 75 ⁰⁰ |
| LCC-7 Leather carrying case..... | 35 ⁰⁰ |
| TA-2 19" telescoping whip antenna..... | 9 ⁴⁰ |
| MMB-10 Mobile bracket..... | 15 ⁰⁰ |

Limited Quantity - Order Today!



**AMATEUR
ELECTRONIC SUPPLY®**

4828 W. Fond du Lac Avenue
Milwaukee, Wisconsin 53216
Phone: (414) 442-4200

Wisconsin WATS: 1-800-242-5195
Nationwide WATS: 1-800-558-0411
AES Branch Stores in: Clearwater, FL •
Orlando, FL • Wickliffe, OH • Las Vegas, NV

**FILTER CASCADING
WORKS!**

You can get significantly better performance from your Receiver by improving its IF filtering. The most cost-effective way to do this is to place a superior 8-pole SSB filter essentially in series (or Cascade) with the original unit. The resulting increase in the number of poles of filtering to as many as 16 causes a dramatic increase in selectivity and reduction of adjacent channel QRM. The authors of the following major articles all stress the effectiveness of FOX-TANGO filters in this application and comment on its simplicity: easy soldering; no drilling, no switching, and no panel changes. As a bonus, CW performance is improved as well as SSB, at no extra cost or effort!

Recent Magazine Articles on Filter Cascading
YAESU FT-901/902. See "73", Sept. 1981
HEATH SB104A See "Ham Radio", April 1981
KENWOOD TS820 See "CQ", March 1981

Read the original article or send \$1 to FoxTango for complete details of the one that interests you. To make the modification, order the appropriate cascading kit from below. Each contains the parts specified in the article, the recommended Fox-Tango filter, and complete instructions.

FOX-TANGO Cascading Kits in Stock

| | |
|-------------------------------|------------------|
| YAESU FT-901/902 Series..... | \$60 |
| HEATH SB104A Series..... | \$60 |
| KENWOOD TS820 Series..... | \$65 w/mini amp. |
| *KENWOOD TS520 Series..... | \$65 w/mini amp. |
| *YAESU FT-101 Series (not ZD) | \$65 w/casc bd |

*Proven mods based on articles in preparation

Shipping via Airmail: \$2 US/Canada, \$5 Elsewhere
Florida Residents: Add 4% sales tax

FOX-TANGO stocks the widest variety of custom-made time-tested crystal filters available from any source for Yaesu, Kenwood, Heath, Drake, and Collins rigs. Cascading is only one application for these filters. Others include replacing outdated or inferior original units, filling spots provided for optional filters, or adding extra filters using diode switching boards if the "spots" are filled. However, since the degree of improvement depends upon the quality of the filter used, cheap substitutes are no bargain! FOX-TANGO has never spared expense or effort to make its filters the very BEST and guarantees satisfaction - plus fast, friendly, knowledgeable, personalized service. For information about our complete line, including SSB, CW and AM filters, phone or write for our free brochure. Specify the set you want to improve.

We welcome mail or phone orders and accept payment by VISA, MASTERCARD, M.O., Check, Cash, or C.O.D. (at your expense).

FOX TANGO CORPORATION

Since 1971. By and For Radio Amateurs
Box 15944S, W. Palm Beach, FL 33406
Phone: 1-305-683-9587

✓323



Radio equipment
not included

Also Available....
Floor Space: 51" Wide by 30" Deep
\$192.50

4384 KEYSTONE AVENUE • CULVER CITY, CALIF. 90230 — PHONE (213) 837-4870

... at last ...
your shack organized!

A beautiful piece of furniture — your XYL will love it!

\$16450 S-F RADIO DESK
Deluxe - Ready to Assemble

Designed with angled rear shelf for your viewing comfort and ease of operation.

FINISHES: Walnut or Teak Stain.
Floor Space: 39" Wide by 30" Deep

Additional Information on Request.

Checks, Money Orders, BankAmericard
and Master Charge Accepted.

F.O.B. Culver City. (In Calif. Add 6% Sales Tax.)

DEALER INQUIRIES INVITED

S-f Amateur Radio Services

4384 KEYSTONE AVENUE • CULVER CITY, CALIF. 90230 — PHONE (213) 837-4870

\$9

✓65

☆ **QUALITY parts at** ☆
☆ **DISCOUNT PRICES!** ☆

4PDT RELAY
• 14 pin style
• 3 amp contacts
• 24 volt d.c. or
• 120 volt a.c. coil
• Used but fully tested
\$1.70 EACH
specify coil voltage
LARGE QUANTITIES AVAILABLE
SOCKETS FOR RELAY 50c each

DPDT RELAY
AROMAT 12 VDC
HL2-P-DC 12VDC
compact size
10 amp contacts
P.C. mount
\$3.00 each

TRANSFORMERS
120 volt
primaries

6 VOLTS at 150 mA \$1.25
12 V.C.T. at 500mA \$2.50
16.5 V. at 3 AMPS \$6.50
18 VOLTS at 1 AMP \$4.50
25.2 VCT at 2.8 AMP \$5.50

**COMPUTER
GRADE
CAPACITOR**

3,600 mfd. 40VDC \$1.00
1 3/8" DIA. X 3" HI

6,400 mfd. 60VDC \$2.50
1 3/8" DIA X 4 1/4"

20,000 mfd. 25VDC \$2.00
2" DIA. X 2 1/2" HIGH

22,000 mfd. 25VDC \$2.50
2" DIA X 2 1/2" HIGH

22,000 mfd. 40VDC \$3.00
2" DIA. X 6" HIGH

45,000 mfd. 25 VDC \$3.50
2" DIA. X 4" HIGH

52,000 mfd. 15 VDC \$3.00
2" DIA X 4 1/2" HIGH

72,000 mfd. 15 VDC \$3.50
2" DIA. X 4" HIGH

CLAMPS TO FIT CAPACITORS 50c ea.

**MINI SIZE
BUZZERS**

1 1/2 to 3 volts 75c ea
WITH WIRE LEADS

1 1/2 to 3 volts 75c ea
WITH PIN TERMINALS

3 to 7 volts
WITH PIN TERMINALS
75c each

**16.5 VAC 1 AMP
CLASS 2 XFMR**

**\$3.00
EACH**

**BB 103
VARACTOR DIODE**
4 for \$1.00

**MITSUMI
MODEL UES-A55F
VARACTOR UHF TUNER**

FREQ RANGE
470 - 889 MHz

ANTENNA INPUT
300 OHMS

\$25.00 each
10 for \$220.00

Free! **SEND FOR OUR**
40 PAGE CATALOG Free!

**TYPE N
CONNECTOR**
KINGS UG526 B/U
FITS RG55, RG56,
RG141, RG142, RG223
SOLDER TYPE
\$1.75 EACH
10 for \$16.00

**L.E.D.'s
STANDARD JUMBO
DIFFUSED**

RED 10 FOR \$1.50
GREEN 10 FOR \$2.00
YELLOW 10 FOR \$2.00

**RFI
LINE FILTER**
for line to line
& line to ground
noise suppression
CORCOM # 10K6
Rated: 10 amp
115/250 v 50-400 hz
\$3.75 ea. 10 for \$35.00

FLASHER LED
5 VOLT OPERATION
JUMBO SIZE
2 FOR \$1.70

BI POLAR LED
2 FOR \$1.70

SUB MINI LED
.079" X .098"
20mA at 1.75v
10 FOR \$1.00
200 FOR \$18.00
QUANTITY PRICES AVAILABLE

**SUPER SMALL
PHOTO-FLASH**
170 MFD 330 VOLT

1 1/4" x 7/8"
2 for \$1.50
10 for \$7.00

**CANNON XLR
CONNECTOR**
3 PRONG
CHASSIS MOUNT
CONNECTOR
\$2.00 EACH
10 for \$19.00

**750 MFD 330 V
PHOTO FLASH**

2" HIGH X
1 1/4" DIA.
\$1.25 EACH
10 FOR \$11.00

**RECHARGEABLE
SEALED
LEAD-ACID
BATTERIES**

6 VOLTS 6 AMP/HR
3 1/2 X 2 X 4 1/2 IN.
\$10.00

6 VOLTS 7 1/2 AMP/
4 1/2 X 2 X 4 1/2 IN. HR
\$12.50

***SPECIAL !!*
10 MEG POTS**

4 for \$1.00
10 for \$2.00
100 for \$15.00

2" DIA. 1 1/2 VDC
BUZZER SPECIAL!
50c each
10 for \$4.00
100 for \$35.00

**MRF 901
MICROWAVE
TRANSISTOR**
\$3.00 EA

2" ALLIGATOR CLIPS
7 clips for \$1.00
100 clips for \$12.00
500 clips for \$50.00

ALL ELECTRONICS CORP.

905 S. Vermont Ave. ✓ 20
P.O. BOX 20406
Los Angeles, Calif. 90006
(213) 380-8000

Mon. - Fri. Saturday
9 AM - 5 PM 10 AM - 3 PM

TERMS
• Quantities Limited
• Min. Order \$10.00
• Add \$2.50
Shipping USA
• Calif. Res. Add 6%
• Prompt Shipping

Introducing
NOVAX
MOBILE CONNECTION

✓ 21 YOUR OWN
AUTOPATCH FOR
SIMPLEX OPERATION



**ONLY
\$149.95 KIT**

Wired and Fully Tested
\$199.95

Shipping \$3.50 in U.S.A.
N.Y.S. Residents Add
4% Sales Tax

NOVAX interfaces your standard 2 meter; 220; 450; etc. base station and DTMF telephone, using a high speed scan switching technique so that you can direct dial from your automobile or with the HT from the backyard or poolside—automatically.

- SMALL SIZE—(5" x 6" x 2")
- STATE OF THE ART CIRCUITRY 12-16 V.D.C.
- ADJUSTABLE ACTIVITY TIMER (clears out if mobile is out of range)
- EASY INTERFACING with radio auto & squelch circuit
- SINGLE DIGIT CONTROL (connect and disconnect)
- 3 MIN. CALL DURATION TIMER

TO ORDER—SEND check—money order (MasterCard or Visa accepted) to: R. W. D. Inc., Oriskany, N.Y. 13424 or call 315-736-3087

RTTY/CW
For the TRS-80*

* A Trademark of the Tandy Corp.

ROM-116
RTTY/CW Operating System
Detailed brochure available on request.

Featuring:

1200 BAUD OPERATION. Not limited to 110 baud because of timing loops. 60, 66, 75 & 100 W.P.M. Plus 110, 150, 300, 600 & 1200 baud operations possible.

FLEXIBILITY OF OPERATION. Instantly change: Baud Rates; Program Mode (ASCII/baudot); Program Status.

SPLIT SCREEN VIDEO. Transmit & receive data displayed separately.

REAL TIME. Automatic CW/ID without user intervention. Automatically updates at end of month or year.

Other features include:

- Two Serial Ports
- Fourteen Buffers
- Automatic CW ID
- Transmit Control
- Selective Call Feature
- Error Correction
- Word Wrapping
- Easy To Interface
- 30 Day Unconditional Guarantee
- Hardware requirements: TRS 80 Model 1 or 3 16K External terminal unit



606 State Street, P.O. Box 892-R • Marysville, WA 98270 • (206) 659-4279

S-LINE OWNERS ENHANCE YOUR INVESTMENT

with TUBESTERS™

Plug-in, solid state tube replacements

- S-line performance—solid state!
- Heat dissipation reduced 60%
- Goodbye hard-to-find tubes
- Unlimited equipment life

TUBESTERS cost less than two tubes, and are guaranteed for so long as you own your S-line.

✓433

SKYTEC

Box 535
Talmage, CA 95481

Write or phone for
specs and prices.
(707) 462-6882

BARGAIN PRICED!

AZDEN PCS-3000

STATE-OF-THE-ART 2 METER
MICROCOMPUTER-CONTROLLED
TRANSCEIVER

✓469

299

Calif. res.
add 6%

FREE SHIPPING
ANYWHERE IN U.S.A.

Other AZDEN equip./acc. discounts

B. G. CARL ELECTRONICS

11128 Claire Ave.
Northridge, CA 91326
Call: (213) 363-1216

RF MODULATORS

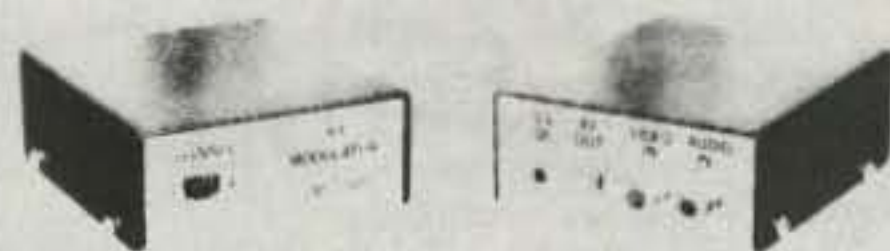

Small Size
3 1/2 x 3 x 1 1/2 Only **49.95**

- CRYSTAL CONTROLLED FOR STABILITY
- IC CIRCUITRY FOR EXCELLENT RELIABILITY
- EXTERNALLY SWITCHED FOR CHANNELS 3 or 4

The VM-1000 RF Modulator is the same type and quality of those found in today's video tape recorders. It has convenient phono jacks for video and audio inputs and has a standard "F" type connector for RF output. Power is supplied by an AC to DC power pack which is included. Call NOW for more information and for quantity discounts.

JJT DISTRIBUTING ✓25

17210 Yukon Ave., Suite #1
Torrance, Calif. 90504

Call COD Orders to: (213) 515-6800

FREE CATALOG



NEW!

CATALOG OF
HARD-TO-FIND
PRECISION TOOLS

✓354

Also contains test equipment
plus wide selection of
tool kits and cases

Jensen's new catalog is jam-packed with more than 2000 quality items. Your single source for hard-to-find precision tools and tool kits used by electronic technicians, scientists, engineers, instrument mechanics, schools, laboratories and government agencies. Send for your free copy today!



JENSEN TOOLS INC.

1230 S PRIEST DR. TEMPE AZ 85281



It's Incredible!

Now You Can Master Code . . .

For your first ham license or upgrade in a matter of days. CODE QUICK is a revolutionary breakthrough discovery which drastically simplifies the learning of Morse Code. Don't torture yourself with an endless maze of dits and dahs. With CODE QUICK each letter magically calls out its own name! Your amazing kit contains 5 power packed cassettes, visual breakthrough cards, and original manual. Write for details or send \$39.95 today to:

WHEELER APPLIED
RESEARCH LAB ✓6
P.O. Box 3261

City of Industry, CA 91744

Ask for CODE QUICK #103
(Calif. add 6% sales tax.)

Even if you have failed before CODE QUICK must work for you or return the kit for total immediate refund!

RECEIVERS

R-1143/WRR-3 - 14-600

Khz AM-CW-FS in five bands;
mechanical digital tuning.
8 1/4 x 17 1/4 x 16 3/4", 80 lbs.
Used, checked: . . . \$295.

Manual, partial repro: \$15.

R-388/URR - 0.5-30.5

Mhz in 30 bands; rackmount. Mil-Collins 51J3;

10 1/2 x 19 x 13", 55 lbs. Used, checked: . . . \$400.

Manual, partial repro: . . . \$10.

HAMMARLUND SP-600JX - 0.54-54 Mhz AM-

CW in seven bands; rackmount. 10 1/2 x 19 x 17", 85 lbs.

Used, checked: \$285 Manual, partial repro: \$10.

R-648/ARR-41 - 190-550 Khz and 2-25 Mhz AM-CW

in 25 bands; mechanical digital tuning. Requires 24 VDC

4 amps; 7 1/2 x 16 x 13 1/4", 35 lbs. Used, checked: \$205.

Manual, partial repro: . . . \$15.

G133 HF RECEIVER - 0.2-30 Mhz SSB-AM-

CW in 30 bands. Set is Collins 51S1 repackaged by

LTV-Temco for mil-airborne use; black front panel, AM

BFO, extra filtering. 6 1/4 x 18 1/4 x 13", 42 lbs. Used,

checked: \$850. Collins 51S1 manual: \$15 with G133

purchase. WRITE FOR CATALOG & SUPPLEMENT.

Prices F.O.B. Lima, O. • VISA, MASTERCARD Accepted.

Allow for Shipping • Send for New FREE CATALOG!

Address Dept. 73 • Phone: 419/227-6573

✓22

FAIR RADIO SALES

1016 E. EUREKA • Box 1105 • LIMA, OHIO • 45802

C.B. SPECIAL

(Repeat of a sell out)

CONVERT THESE TO
10 METER FM

New Hy-Gain 40 channel printed circuit boards assembly (Squelch pot, volume control and channel switch not included). Boards sold as is. Dimension 6" X 6".

1-9 pcs \$7.50 ea.

10-49 pcs \$6.50 ea.

(While quantities last)

REMOTE 40 CHANNEL C.B.

Remotes have a metal frame, speaker, plastic case, and control mic not included. Sold as is. \$14.95 ea

C.B. BARGAIN

C.B. boards missing parts or damaged. Can be used for spare parts. Buy several!! \$3.50 ea

Order information: Please add \$4.00 for S/H via UPS. COD's accepted for orders totaling \$50.00 or more. Florida residents add 4% sales tax. Minimum order \$15.00. Foreign orders US funds only add 20% for S/H. MASTER CARD and VISA accepted.

Surplus Electronics Corp.

7294 N W 54th St.
Miami, Fl 33166
PH# 305-887-8228

✓69

DIRECTION FINDING?



New Technology (patent pending) converts any VHF FM receiver into a modern Doppler Radio Direction Finder. No receiver mods required. See June 1981 issue of 73 for technical description. Kits available from \$245. Write for full details and prices.

DOPPLER SYSTEMS

5540 E. Charter Oak
Scottsdale, Arizona 85254
(602) 998-1151 ✓425

ETCH BOARDS FAST



This Power Etching System will handle PC boards up to 6" x 6". The pump keeps acid agitating for faster, more even etching.

Send \$34.50 plus \$3.50 for postage and handling to:

STELLMAKER ENTERPRISES ✓32

250 PEQUOT TRAIL
WESTERLY, R.I. 02891

QUALITY MICROWAVE SYSTEMS

2100 TO 2600 MHz ANTENNAS
MINIMUM 34 db GAIN OR GREATER

| | |
|--|----------|
| Complete System as pictured (6 month warranty) | \$149.95 |
| Down Converter (Probe Mntd.) assembled & tested | \$59.95 |
| Down Converter (Chassis Mntd.) assembled & tested | \$59.95 |
| Power Supply, assembled & tested | \$49.95 |
| Down Converter PC board, with parts, unassembled & Data | \$39.95 |
| Data Information (Plans) | \$9.95 |

Send cash, check
or money order to:

Phillips-Tech Electronics

Dept. SP-73 ✓421
P.O. Box 33205
Phoenix,
Arizona 85067

For special quantity
pricing, C.O.D.'s,
Mastercharge,
and VISA call:
(602) 274-2885



FINALLY... A SQUARE DEAL ON YOUR ELECTRONIC SCRAP

Many "brokers" pay flat rates on scrap, not
payment on the value of your material. All
material sent to us is individually refined and
assayed for maximum return. Take a look at
some typical yields:

| | |
|------------------|----------------------|
| PC Boards | 50¢ to \$7 per lb. |
| Connectors | 25¢ to \$5 per lb. |
| PC Fingers | \$3 to \$20 per lb. |
| Gold plated pins | \$12 to \$50 per lb. |

For further information, circle our reader service
number or call/write:



ELECTRONIC RECYCLERS OF MASS., INC.

263A S. Main Street, Box 6
Middleton, Mass. 01949
Toll Free (800) 343-8308
In Mass. (617) 777-0455

Copyright 1981, Electronic Recyclers of Mass., Inc.

COAXIAL CABLE SALE

POLYETHYLENE DIELECTRIC

| | |
|--|---------|
| RG213 noncontaminating 95% shield mil spec | 36¢/ft. |
| RG11 75ohms 97% shield mil spec | 25¢/ft. |
| RG214U double silver shield | 95¢/ft. |
| RG174U miniature 50 ohm mil spec | 10¢/ft. |
| RG58U Mil. spec. 95% shield | 11¢/ft. |
| RG58AU Mil. spec. 95% shield, stranded | 13¢/ft. |
| RG223 (RG55AU) double silver shield | 85¢/ft. |

LOW LOSS FOAM DIELECTRIC

| | |
|---|---------|
| RG-8X (mini 8) 95% shield, Blue Jacket | 19¢/ft. |
| RG8U 97% shield white jacket flexible | 30¢/ft. |
| RG8U 80% shield | 19¢/ft. |
| RG58U 80% shield | 08¢/ft. |
| RG58U 95% shield | 10¢/ft. |
| RG59U 75 ohm 100% foil shield (TV type) | 10¢/ft. |

Rotor cable 2-18ga 6-22ga

*Cable—shipping \$3.00 1st 100 ft.
\$2.00 each add'l 100 ft.

CONNECTORS

| | |
|---|------------|
| PL-259 to BNC (UG-255) | \$3.50 ea. |
| PL-259 push-on adapter shell | 10/\$3.89 |
| PL-259 & SO-239 | 10/\$5.89 |
| Double Male Connector | \$1.79 |
| 1 ft. patch cord w/RCA type plugs each end | 3/\$1.00 |
| Reducer UG-175 or 176 | 10/\$1.99 |
| UHF T (M358) | \$2.59 |
| Elbow (M359) | \$1.79 |
| F59A (TV type) | 10/\$2.15 |
| PL-258 (double UHF female barrel) | 98¢ |
| Connectors—shipping 10% add'l, \$1.50 minimum | |

FREE CATALOG

C.O.D. ADD \$1.50—FLA. RES. ADD 4% ✓412

NEMAL ELECTRONICS

5685 S.W. 80th ST., DEPT. RLO, MIAMI, FLORIDA 33143
TELEPHONE (305) 661-5534

WE'VE GONE NATIONAL

Strux Corporation manufactures and
distributes National Radio, Inc. Com-
ponents: Chokes, inductors, coils, and
hardware. We also distribute fixed and
roller inductors, contactors, mil-spec
and designer knobs. For all your elec-
tronic needs, contact Strux Corpora-
tion, 100 East Montauk Highway,
Lindenhurst, New York 11757.

STRUX

✓30

CORPORATION

100 EAST MONTAUK HIGHWAY
LINDENHURST, NEW YORK 11757

SYNTHESIZED SIGNAL GENERATOR

MADE IN
USA



MODEL
SG 100C
\$329.95
plus shipping

• Covers 100 to 179.999 MHz in 1 kHz steps with
thumb-wheel dial • Accuracy .00001% at all fre-
quencies • Internal frequency modulation from 0 to
over 100 kHz at a 1 kHz rate • Spurs and noise at
least 60dB below carrier • RF output adjustable from
5-500mV across 50 ohms • Operates on 12vdc @
½ amp. In stock for immediate shipping. \$329.95
plus shipping. Overnight delivery available at extra
cost. • Range Extender (phase-locked mixer/divid-
er) for above unit. Extends the range from .1 to 580
MHz. Same size as SG-100. Mounts piggyback.
Price: \$299.95.

✓311

VANGUARD LABS

196-23 Jamacia Ave., Hollis, NY 11423
Phone: (212) 468-2720

CB TO TEN METER CONVERSION KITS

KITS for AM—SSB—FM 40 Channel PLL
chassis conversions

DETAILED INSTRUCTIONS for easy in-
stallation with minimum time and equip-
ment

BAND COVERAGE flexibility provides
up to 1 MHz coverage for most PLL
chassis.

PRICES Low cost prices range from
\$8.00 to \$50.00

All kits are in stock including
several different FM kits.

FREE CATALOG Write or call today.

✓78 **INDEPENDENT**

CRYSTAL SUPPLY COMPANY

P.O. Box 183
Sandwich, Ma. 02563-0183
(617) 888-4302

You can pay more —
But you can't get more!

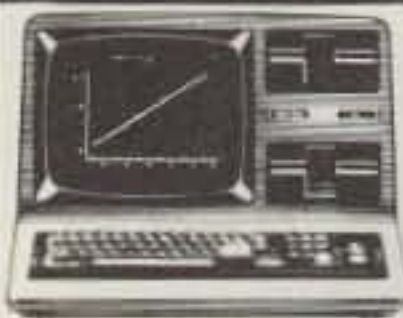

Model III 16K
\$839

Model III 48K
2 disc & RS232C
\$2100

BUY DIRECT. These are just a few of our great
offers which include Printers, Modems, Com-
puters, Peripherals, Disc Drives, Software and
more. call TOLL FREE 1-800-343-8124

We have the lowest possible fully
warranted prices and a full complement
of Radio Shack Software. Write for your
free catalog.

**computer
plus**
245A Great Road
Littleton, MA 01460
617 • 486 • 3193

C.B. TO 10 METER KITS AMERICA'S #1 SOURCE FOR FM — SSB — AM

IN STOCK—Kits for most C.B. Models
New 10-meter FM Discriminator
Board—fits most PLL rigs. Kit—\$40;
Assembled and Tested—\$50.

Factory Conversion—Your Rig or Ours

New and Used—FM & SSB

C.B.s now in stock—From \$90 to \$250

LOW COST—Prices range from \$10.00
to \$50.00.

FREE CATALOG—write or call today.

AMERICAN CRYSTAL SUPPLY COMPANY
P.O. BOX 638
WEST YARMOUTH, MA. 02673
(617) 771-4634 ✓7

Subscription Problem?

73 Magazine does not keep subscrip-
tion records on the premises, there-
fore calling us only adds time and
doesn't solve the problem.

Please send a description of the
problem and your most recent ad-
dress label to:

73 Magazine
Subscription Dept.
PO Box 931
Farmingdale, NY 11737

Thank you and enjoy your subscription.

RED HOT SPECIALS!!

| | |
|-------------------------------------|----------|
| AZDEN PCS 3000, 2 meter | \$285.00 |
| KDK 2025 MK II, 2 meter | 288.00 |
| SANTEC HT 1200, 2 meter handheld | 284.00 |
| JANEL QSA-5, 2 meter preamp | 36.50 |
| NEW BEARCAT 20-20 SCANNER | 278.00 |
| KANTRONICS FIELD DAY II Code rfr. | 360.00 |
| ALL MFJ PRODUCTS 12% off list price | |
| TEN-TEC ARGOSY TRANSCEIVER | 468.00 |
| TEN-TEC DELTA TRANSCEIVER | 738.00 |
| TEN-TEC OMNI C TRANSCEIVER | 1040.00 |
| 1982 CALLBOOKS 10% off list price | |
| KANTRONICS MICRO RTTY SENDER | 255.00 |
| SANTEC ST-7/T 440 MHZ Handheld | 279.00 |
| REGENCY MICRO SCANNER | 199.00 |
| BENCHER BLACK PADDLES | 35.00 |

Price subject to change without notice.
SASE for other RED HOT SPECIALS, new and used.

Ben Franklin Electronics

115 1/2 N Main Hillsboro KS 67063
316-947-2269



✓ 439



CERTIFIED INTERNATIONAL

CHECKING INTO '73' TO SHARE OUR

1982 AMATEUR CALLBOOK SPECIAL

Only \$15.95 U.S. or \$14.95 Foreign —or BOTH for \$29.95

| | | |
|--------------------|----------|---------------|
| allow for shipping | 1 book | 2 books |
| | Zone 2-5 | \$2.00 \$2.50 |
| | Zone 6-8 | \$2.50 \$3.00 |

WE BRING OUR STORE TO YOU AT OVER 50 HAMFESTS PER YEAR.

YOU WILL BE GLAD YOU CHECKED WITH US FOR

CUSHCRAFT AND HUSTLER (full line at 25% off), LARSEN, UNADILLA, BELDEN, COPPERWELD, SIGNALCRAFT, PALOMAR, NYE VIKING, TRIONYK, TRAC, JANEL, BENCHER, VIBROPLEX, AMPHENOL, GOULD AND OTHERS

WE STOCK EVERY KIND OF WIRE THE AMATEUR NEEDS, BY BELDEN, others

CRYSTALS FRESH CUT TO YOUR ORDER FROM \$4.00

QSL'S CUSTOM MADE FOR YOU
CB TO 10 METER CONVERSIONS FROM THE STANDARD SETTER
CERTIFIED COMMUNICATIONS

WE CONVERT OVER 150 MODELS \$45 AND UP, AND SELL NEW 10 METER RIGS WITH DOUBLE WARRANTY FROM \$179.00.

✓ 321

ASK FOR QUOTE, CATALOG, CONVERSION BOOKLET, QSL SAMPLES (INCLUDE 50 cents), OR INFORMATION.



IT'S WORTH YOUR WHILE TO CALL OR WRITE

CERTIFIED INTERNATIONAL

4138 South Ferns Fremont, MI 48412 (516) 924-4561

Automatic TR-2400 Band Scanner

for Kenwood TR-2400 stops and locks on busy, or stops and resumes when carrier drops. Controlled by keyboard, no switches to add. Installs easily inside rig, six simple connections, no modifications. Does not use space provided for PL
Assembled—\$24.95 Kit—\$14.95

TR-9000 Memory Scanner

for Kenwood TR-9000 scans 5 memory channels. Stops on busy and resumes when carrier drops. Uses existing controls. No switches to add. Installs easily inside rig. See product review Sept. issue 73 Magazine.
Assembled—\$39.95

IC-280 Band Scanner—\$29.95

Memory Scanner—\$39.95 both for \$59.90

- * Scanners do not affect normal rig operation.
- * Digital readouts display scanned frequency.
- * All scanners are easy to install using complete and detailed installation instructions.
- * All scanners ASSEMBLED & TESTED (except kit)
- * Satisfaction Guaranteed!

Send check or money order to:

TSCAN

26151 W. Mary Ann Rd., Antioch, IL 60002

include \$1.50 postage & handling
Illinois res. include 5 1/4 % state tax

✓ 27

GO MOBILE WITH YOUR H.T.!

ICOM Available

Guaranteed!

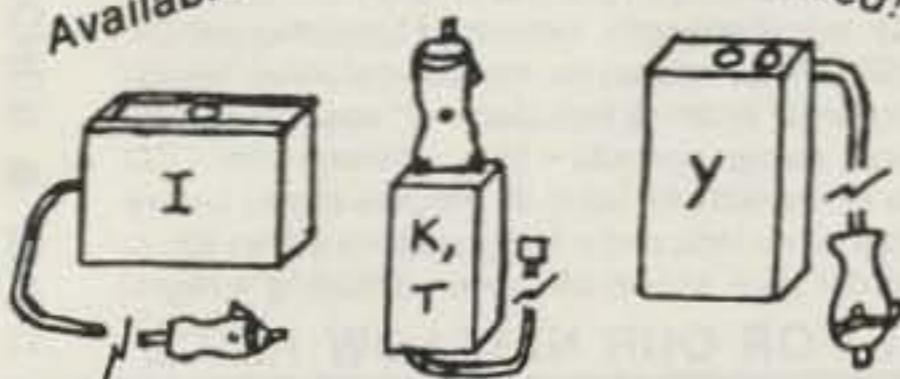

A unique battery eliminator

HANDI-TEK Regulator allows constant hand-held operation from auto DC or base supply with no nicad drain and WITHOUT RADIO MODIFICATION!
Model I—Icom IC-2A/T; K—TR-2400; N—FT-208R

Y—FT-207R, T—Simple mod for Temp
\$24.95 PPD in USA. CA add \$1.50.

✓ 460

HANDI-TEK

P.O. BOX 2205, LA PUENTE, CA 91746

Icom—slides on bottom of radio
Yaesu—fits into battery compartment
Kenwood—powered thru battery plug

THE HMR II

MICROWAVE RECEIVER SYSTEM

24+ dB GAIN • TUNABLE 2.1 TO 2.6 GHz RANGE
6 MONTH WARRANTY • COMPLETE-READY TO INSTALL
PARTS OF HMR II AVAILABLE SEPARATELY

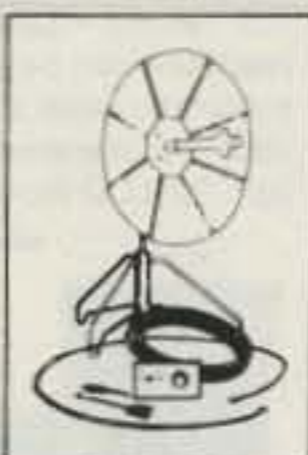

\$179.95 EACH
FOB DENVER
7 lbs.

SEND CHECK, MONEY ORDER OR CERTIFIED FUNDS TO:

HMR
PO BOX 440668 • AURORA,
COLORADO 80044
DEPT. MB

FOR THE LOWEST PRICE ON QUANTITY ORDERS,
CODs, MC OR VISA ORDERS CALL:

✓ 9 (303) 620-9736

FOR THE DO-IT-YOURSELFER
DOWN CONVERTERS POWER SUPPLY

| | | | |
|-----------------------------------|------------------|-------------------------------|------------------|
| ASSEMBLED & TESTED PCB WITH PLANS | 49 ⁰⁰ | ASSEMBLED & TESTED WITH PLANS | 49 ⁰⁰ |
| PCB, PARTS & PLANS | 39 ⁰⁰ | PCB, PARTS, CASE & PLANS | 39 ⁰⁰ |
| PCB & PLANS | 19 ⁰⁰ | PCB & PLANS | 19 ⁰⁰ |
| PLANS | 19 ⁹⁵ | | |

this publication is available in microform



University Microfilms International

300 North Zeeb Road
Dept. P.R.
Ann Arbor, MI 48106
U.S.A.

18 Bedford Row
Dept. P.R.
London, WC1R 4EJ
England

MORSE CODE, BAUDOT and ASCII RTTY FOR THE TRS-80 MODELS I and III

DISASSEMBLED HANDBOOK - VOLUME 4

no RS-232C interface is required

- Chapt. 1: 8 to 800 WPM Morse transmit pgm.
- Chapt. 2: Adding type ahead capabilities
- Chapt. 3: Morse receive decoding program
- Chapt. 4: Merging + 12 prepared messages
- Chapt. 5: Baudot transmit 60-66-75-100 WPM
- Chapt. 6: Baudot receive for above speeds
- Chapt. 7: Merging + 22 prepared messages
- Chapt. 8: ASCII transmit program 110 Baud
- Chapt. 9: ASCII receive decoding program
- Chapt. 10: Merging + 22 prepared messages

\$18 [US] per copy add \$2 shipping
[\$4.50 overseas airmail]

—GERMAN & FRENCH LANGUAGE EDITIONS—

✓ 458 Morse, Baudot & ASCII on disks \$49
[Vol. 4 required for instructions]

RICHCRAFT ENGINEERING LTD.
#1A Wahmeda Industrial Park
Chautauqua, New York 14722

COD orders [US only] [716] 753-2654

TRS-80® DISCOUNT



1-800-841-0860 TOLL FREE

MICRO MANAGEMENT SYSTEMS INC.

DEPT. NO. 13

Downtown Plaza Shopping Center
115C Second Ave. S.W.
Cairo, Georgia 31728
912-377-7120 Ga. Phone No.

✓ 313

Write For Free Catalog

COMMUNICATIONS CENTER

CALL TOLL FREE

1-800-228-4097



**DAIWA CN-720B
SWR
& POWER METER**

The cross-needle meter indicates both forward power and reflected power on one meter and SWR is read directly at the point where the needles intersect. Both power and SWR can be checked instantly without time-consuming sensitivity adjustments — even when using SSB.

*NAV \$218.75

SPECIAL \$149.95



SONY ICF-2001

• FM/AM/SSB/CW/wide spectrum coverage • Dual-conversion superheterodyne circuitry of AM assures high sensitivity and interference rejection • Quartz-crystal, phase-locked-loop frequency synthesis for all bands assures the utmost tuning stability, without a trace of tuning drift • Direct-access, digital tuning keyboard and LCD digital frequency readout for quick, key-touch station selection—maximum accuracy and ease of use • Manual tuning and automatic scanning for effortless signal searching, easy DXing • 6-station presets, plus 2 auxiliary presets, for instant reception of memorized stations on any band—plus LDC memory indication • 5-step LED signal-strength indicator • Local/Normal/DX sensitivity selector for AM • SSB/CW compensator for low-distortion reception • Telescopic antenna, plus external antenna included • 4" speaker for full, rich sound • Slide-bar bass and treble controls • Sleep timer—with LCD readout—can be set in 10-minute increments for up to 90 minutes of play before automatic radio shut-off • Shoulder strap included • Integral stand allows tilt-up desk-top placement • Tape recorder jack allows off-the-air recording • Night-light for LCD illumination

CALL FOR OUR NEW LOW PRICE



JIL SX-200 Programmable Scanner

1. Type: FM & AM
2. Frequency Range: a) 26—57.995 MHz Freq.Space 5kHz; b) 58—88 MHz Freq. Space 12.5 kHz; c) 108—180 MHz Freq. Space 5 kHz; d) 380—514 MHz Freq. Space 12.5 kHz
3. Sensitivity: FM: a) 26—180 MHz 0.4uV S/N 12dB; b) 380—514 MHz 1.0uV S/N 12dB; AM: a) 26—180 MHz 1.0uV S/N 10dB; b) 380—514 MHz 2.0uV S/N 10dB
4. Selectivity: FM: More than 60 dB at 25 kHz; AM: More than 60 dB at 10 kHz
5. Audio Output: 2 Watts
6. External Speaker Impedance: 4—8 ohms
7. Power Supply: 12V DC (included)
8. Antenna Impedance: 50 — 75 ohms. Whip of External Antenna with LO/DX Control (20 dB ATT.)
9. Frequency Stability: 26 — 180 MHz within 300 Hz; 380 — 514 MHz within 1 KHz (at normal temperature)

NAV \$499.95

INTRODUCTORY SPECIAL \$389.95



Low, Low Prices
On Apple Computers & Accessories
"Interface To Your Transceiver
For RTTY Or CW"

**"Our Most Popular Scanner
the JIL SX-100"**



*NAV \$399.00

16 Channels: 30-54 MHz; 140-180 MHz; 410-514 MHz. Digital Clock. Date Display. 110 V. AC or 12-16 V. DC. Seek Rate: Fast 10ch/sec Slow 5ch/sec Bright Green 9 Digit Frequency Display. Ext. Antenna Jack. Ext. Speaker Jack. Large Top Mounting Bracket. Scan Rate: Fast 8ch/sec Slow 4ch/sec Scan Delay Time Variable 0-4 sec.

**UNBELIEVABLY PRICED
AT A LOW \$199.95**

Call for Discount Prices.

Computer

AMDEK
APPLE
ATARI
BASE 2
CENTRONICS
COMMODORE
DC HAYES
HAZELTINE
LEEDEX

MACROTRONICS
MAXELL
MICROSOFT
MOUNTAIN HARDWARE
N.E.C.
NORTHSTAR
PANASONIC
SANYO
SYNCOM

Amateur Radio

AVANTI
BASH BOOKS
BEARCAT
BENCHER
CALL BOOK
CUSHCRAFT
DAIWA
DENTRON

DRAKE
ETO
HUSTLER
HY-GAIN
ICOM
KANTRONICS
KENWOOD

MIRAGE
PANASONIC
SHURE
TEMPO
TELEX
TRAC
YAESU



Call For The Many Unadvertised Specials

PRICES SUBJECT TO CHANGE AND AVAILABILITY

YOUR

WE TRADE

WE EXPORT

28

ELECTRONICS CENTER

1840 "O" Street Lincoln, Nebraska 68508

In Nebraska Call (402) 476-7331

*Nationally Advertised Value



Why use their flexible discs:

Athana, BASF, Control Data, Dysan, IBM, Maxell, Nashua, Scotch, Shugart, Syncom, 3M, Verbatim or Wabash

when you could be using

MEMOREX

for as low as \$1.94 each?

Find the flexible disc you're now using on our cross reference list... then write down the equivalent Memorex part number you should be ordering.

| Product Family | Product Description | Memorex Part Number (2201-1) | CE quant. 100 price per disc (\$) | Athana | BASF | Dysan | IBM | Maxell | Nashua | Scotch 3M | Shugart | Syncom | Verbatim | Wabash | Control Data |
|--|---|------------------------------|-----------------------------------|--------|--------|---------|---------|---------------|--------|------------|---------|-----------|-----------|-----------|--------------|
| Flexible Disc 14 Single-Density Media | IBM Compatible (128 B/S, 26 Sectors) | 3080 | 1.99 | 473071 | 53426 | 800506 | 230580 | FD-128 | FD-1 | 740-0 | S/A-100 | 18000 | FD34-9000 | F111111X | 421907 |
| | IBM Compatible (128 B/S, 26 Sectors) w/ W.F.N. | 3082 | 2.04 | — | — | — | — | — | — | 740-0 | — | — | FD34-9000 | — | — |
| | IBM Compatible (128 B/S, 26 Sectors) w/ W.F.N. & Hub Ring | 3084 | 2.39 | — | — | — | — | — | — | — | — | — | FD34-9000 | — | — |
| | IBM Compatible (128 B/S, 26 Sectors) REVERSIBLE | 1729 | 3.19 | 473072 | 54431 | — | — | — | FD-2 | 740-0-0 | — | 18100 | FD34-9000 | F111111X | — |
| | IBM System 6 Compatible | 3086 | 2.04 | 473077 | 54561 | 800506 | 1889959 | — | — | 740-0-088 | — | 18003 | FD34-9000 | F118111X | — |
| | IBM Compatible (256 B/S, 15 Sectors) | 3108 | 1.99 | 473073 | — | 800504 | 2306445 | — | — | 740-3600 | — | 18006 | FD34-9000 | F112111X | — |
| | IBM Compatible (512 B/S, 8 Sectors) | 3110 | 1.99 | 473074 | — | 800505 | 1889954 | — | — | — | — | 18004 | FD60-9000 | F112111X | — |
| | Shugart Compatible, 32 Hard Sector | 3015 | 1.99 | 470901 | 53802 | 10111 | — | FH1-32 | FD-132 | 740-32 | S/A-101 | 18075 | FD32-9000 | — | 421322 |
| | Wang Compatible, 32 Hard Sector w/Hub Ring | 3087 | 2.49 | — | 54491 | — | — | — | — | 740-30PH | — | — | — | F37A411X | — |
| | CPT 8000 Compatible | 3045 | 2.69 | — | — | — | — | — | — | — | — | 15228 | — | — | — |
| Flexible Disc 14 Double-Density Media | IBM Compatible (128 B/S, 26 Sectors) | 3080 | 2.69 | 474071 | 54568 | 3740/10 | — | FD1-128/M2100 | FD-1D | 741-0 | — | — | FD34-8000 | F131111X | 423007 |
| | Soft Sector (128 B/S, 26 Sectors) REVERSIBLE | 3083 | 3.69 | — | — | — | — | — | — | — | — | — | — | — | — |
| | Shugart Compatible, 32 Hard Sector | 3081 | 2.69 | 470901 | 54596 | 101/10 | — | FH1-32D | — | 741-32 | S/A-103 | 18075 | F332-8000 | F33A411X | 423322 |
| | Wang Compatible, 32 Hard Sector w/Hub Ring | 3088 | 3.09 | — | — | — | — | — | — | — | — | — | — | — | — |
| Flexible Disc 24 Double-Density Media | Soft Sector (128 B/S, 26 Sectors) | 3113 | 3.09 | — | 54438 | 800814 | 1788870 | — | — | S/A-150 | 18183 | FD10-4000 | F121111X | — | |
| | Soft Sector (256 B/S, 15 Sectors) | 3106 | 3.09 | 473477 | 54226 | 800815 | 2736700 | FD2-256D | — | 742-0 | 18154 | FD10-4015 | F122111X | 428612 | |
| Flexible Disc 24 Double-Density Media | Soft Sector (Unformatted) | 3102 | 3.09 | 473485 | — | DY130 | — | FD2-10M | FD-2D | 743-0 | — | 18102 | DD34-4001 | — | 429902 |
| | Soft Sector 1 (128 B/S, 26 Sectors) | 3115 | 3.09 | — | — | — | — | — | — | S/A-150 | — | — | — | — | — |
| | Soft Sector 1 (256 B/S, 26 Sectors) | 3103 | 3.09 | 473471 | 54325 | 800817 | 1788872 | FD2-256D | — | 743-0/266 | — | 18101 | DD34-4029 | F144111X | 429902 |
| | Soft Sector 1 (512 B/S, 15 Sectors) | 3114 | 3.09 | 473472 | 54479 | 800818 | 1689044 | — | — | 743-0/512 | — | 18100 | DD34-4015 | F145111X | 429912 |
| | Soft Sector 1 (1024 B/S, 8 Sectors) | 3104 | 3.09 | 473473 | 54485 | 800819 | 1689045 | — | — | 743-0/1024 | — | 18102 | DD34-4008 | F147111X | 429922 |
| | 32 Hard Sector | 3105 | 3.09 | 470951 | — | 101/20 | — | FH2-32D | — | 743-32 | S/A-151 | 18125 | DD32-4000 | F34A411X | 429922 |
| | Burroughs B-80 Compatible, 32 Hard Sector | 3092 | 3.09 | — | — | — | — | — | — | — | — | — | — | — | — |
| | Soft Sector (1024 B/S, 8 Sectors) w/ Hub Ring | 3116 | 3.49 | — | — | — | — | — | — | — | — | — | — | — | — |
| | Shugart Compatible, 32 Hard Sector | 3181 | 3.39 | — | — | — | — | — | — | — | — | — | — | DD32-4000 | — |
| | Flexible Disc FD Memorex 801 or Equiv. Drive Compatible | FD 91 (New) Jacketed | 30712003 | 2.89 | 470851 | — | FD9V | — | — | FD-185 | 511-0 | — | 18026 | FD85-1000 | F81A111X |
| Mini Flexible Disc 14 5 1/4" Single-Headed Drives Single-Density Media | Soft Sector (Unformatted) | 3401 | 1.94 | 473001 | 54256 | 104/1 | — | MD1 | MD 1 | 744-0 | S/A-104 | 18300 | MD25-01 | M11A211X | 441902 |
| | 10 Hard Sector | 3403 | 1.94 | 473010 | 54257 | 107/1 | — | MD1 | MD 110 | 744-10 | S/A-107 | 18325 | MD25-10 | M11A211X | 441902 |
| | 18 Hard Sector | 3405 | 1.94 | 473018 | 54258 | 105/1 | — | MD1 | MD 118 | 744-18 | S/A-105 | 18326 | MD25-18 | M11A211X | 441902 |
| | Soft Sector (Unformatted) w/Hub Ring | 3431 | 2.14 | — | — | — | — | — | — | — | — | — | MD25-01 | — | — |
| | 10 Hard Sector w/Hub Ring | 3433 | 2.14 | — | — | — | — | — | — | — | — | — | MD25-10 | — | — |
| | 18 Hard Sector w/Hub Ring | 3435 | 2.14 | — | — | — | — | — | — | — | — | — | MD25-18 | — | — |
| Mini Flexible Disc 14 5 1/4" Single-Headed Drives Double-Density Media | Soft Sector (Unformatted) | 3417 | 2.14 | — | 54848 | 104/10 | — | — | — | — | — | — | MD25-01 | — | — |
| | 10 Hard Sector | 3418 | 2.14 | — | 54849 | 107/10 | — | — | — | — | — | — | MD25-10 | — | — |
| | 18 Hard Sector | 3419 | 2.14 | — | 54850 | 105/10 | — | — | — | — | — | — | MD25-18 | — | — |
| | Soft Sector (Unformatted) w/Hub Ring | 3481 | 2.34 | — | — | — | — | — | — | — | — | — | MD25-01 | — | — |
| | 10 Hard Sector w/Hub Ring | 3483 | 2.34 | — | — | — | — | — | — | — | — | — | MD25-10 | — | — |
| | 18 Hard Sector w/Hub Ring | 3485 | 2.34 | — | — | — | — | — | — | — | — | — | MD25-18 | — | — |
| Mini Flexible Disc 24 5 1/4" Double-Headed Drives Double-Density Media | Soft Sector (Unformatted) | 3421 | 2.59 | — | 54824 | 104/20 | — | — | — | S/A-134 | — | — | MD80-01 | — | — |
| | 10 Hard Sector | 3423 | 2.59 | — | 54827 | 107/20 | — | — | — | S/A-157 | — | — | MD80-10 | — | — |
| | 18 Hard Sector | 3425 | 2.59 | — | 54830 | 105/20 | — | — | — | S/A-155 | — | — | MD80-18 | — | — |
| | Soft Sector (Unformatted) w/Hub Ring | 3491 | 2.79 | — | — | — | — | — | — | — | — | — | MD80-01 | — | — |
| | 10 Hard Sector w/Hub Ring | 3493 | 2.79 | — | — | — | — | — | — | — | — | — | MD80-10 | — | — |
| | 18 Hard Sector w/Hub Ring | 3495 | 2.79 | — | — | — | — | — | — | — | — | — | MD80-18 | — | — |

Memorex Flexible Discs...The Ultimate in Memory Excellence

Quality

Memorex means quality products that you can depend on. Quality control at Memorex means starting with the best materials available. Continual surveillance throughout the entire manufacturing process. The benefit of Memorex's years of experience in magnetic media production, resulting, for instance, in proprietary coating formulations. The most sophisticated testing procedures you'll find anywhere in the business.

100 Percent Error Free

Each and every Memorex Flexible Disc is certified to be 100 percent error free. Each track of each flexible disc is tested, individually, to Memorex's stringent standards of excellence. They test signal amplitude, resolution, low-pass modulation, overwrite, missing pulse error and extra pulse error. They are torque-tested, and competitively tested on drives available from almost every major drive manufacturer in the industry including drives that Memorex manufactures. Rigid quality audits are built into every step of the manufacturing process and stringent testing result in a standard of excellence that assures you, our customer, of a quality product designed for increased data reliability and consistent top performance.

Customer-Oriented Packaging

Memorex's commitment to excellence does not stop with a quality product. They are proud of their flexible discs and they package them with pride. Both their packaging and their labeling have been designed with your ease of identification and use in mind. The desk-top box containing ten discs is convenient for filing and storage. Both box labels and jacket labels provide full information on compatibility, density, sectoring, and record length. Envelopes with multi-language care and handling instructions and color-coded removable labels are included. A write-protect feature is available to provide data security.

Full One Year Warranty — Your Assurance of Quality

Memorex Flexible Discs will be replaced by Memorex if they are found to be defective in materials or workmanship within one year of the date of purchase. Other than replacement, Memorex will not be responsible for any damages or losses (including consequential damages) caused by the use of Memorex Flexible Discs.

Quantity Discounts Available

Memorex Flexible Discs are packed 10 discs to a carton and 10 cartons to a case. Please order only in increments of 100 units for quantity 100 pricing. We are also willing to accommodate your smaller orders. Quantities less than 100 units are available in increments of 10 units at a 10% surcharge. Quantity discounts are also available. Order 500 or more discs at the same time and deduct 1%; 1,000 or more saves you 2%; 2,000 or more saves you 3%; 5,000 or more saves you 4%; 10,000 or more saves you 5%; 25,000 or more saves you 6%; 50,000 or more saves you 7% and 100,000 or more discs earns you an 8% discount off our super low quantity 100 price. Almost all Memorex Flexible Discs are immediately available from CE. Our warehouse facilities are equipped to help us get you the quality product you need, when you need it. If you need further assistance to find the flexible disc that's right for you, call the Memorex compatibility hotline. Dial 800-538-8080 and ask for the flexible disc hotline extension 0997. In California dial 800-672-3525 extension 0997.

Buy with Confidence

To get the fastest delivery from CE of your Memorex Flexible Discs, send or phone your order directly to our Computer Products Division. Be sure to calculate your price using the CE prices in this ad. Michigan residents please add 4% sales tax. Written purchase orders are accepted from approved government agencies and most well rated firms at a 10% surcharge for net 10 billing. All sales are subject to availability, acceptance and verification. All sales are final. Prices, terms and specifications are subject to change without notice. Out of stock items will be placed on backorder automatically unless CE is instructed differently. Minimum order \$50.00. International orders are invited with a \$20.00 surcharge for special handling in addition to shipping charges. All shipments are F.O.B. Ann Arbor, Michigan. No COD's please. Non-certified and foreign checks require bank clearance.

Mail orders to: Communications Electronics, Box 1002, Ann Arbor, Michigan 48106 U.S.A. Add \$8.00 per case or partial-case of 100 8-inch discs or \$8.00 per case of 100 5 1/4-inch mini-discs for U.P.S. ground shipping and handling in the continental U.S.A. If you have a Master Card or Visa card, you may call anytime and place a credit card order. Order toll-free in the United States. Call anytime 800-521-4414. If you are outside the U.S. or in Michigan, dial 313-994-4444. Dealer inquiries invited. All order lines at Communications Electronics are staffed 24 hours.

Copyright ©1981 Communications Electronics™



Order Toll-Free!
(800) 521-4414
In Michigan (313) 994-4444

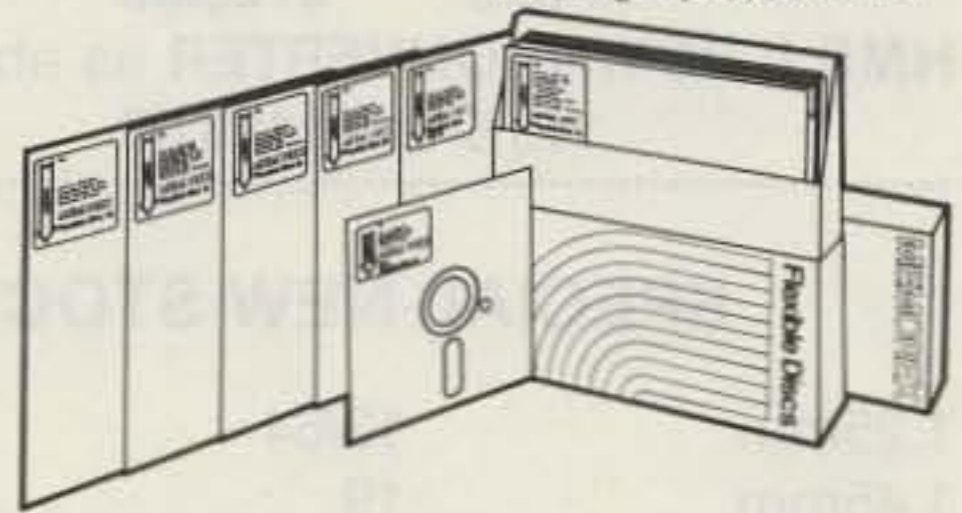

For Data Reliability—Memorex Flexible Discs

COMMUNICATIONS ELECTRONICS™ 376

Computer Products Division

854 Phoenix □ Box 1002 □ Ann Arbor, Michigan 48106 U.S.A.
Call TOLL-FREE (800) 521-4414 or outside U.S.A. (313) 994-4444

Introducing TVRO CIRCUIT BOARDS Satellite Receiver Boards—Now in Stock

DUAL CONVERSION BOARD \$25.00

This board provides conversion from the 3.7-4.2 band first to 900 MHz where gain and bandpass filtering are provided and, second, to 70 MHz. The board contains both local oscillators, one fixed and the other variable, and the second mixer. Construction is greatly simplified by the use of Hybrid IC amplifiers for the gain stages.

SIX 47pF CHIP CAPACITORS
For use with dual conversion board \$6.00

70 MHz IF BOARD \$25.00

This circuit provides about 43dB gain with 50 ohm input and output impedance. It is designed to drive the HOWARD/COLEMAN TVRO Demodulator. The on-board bandpass filter can be tuned for bandwidths between 20 and 35 MHz with a passband ripple of less than 1/2 dB. Hybrid IC's are used for the gain stages.

SEVEN .01 pF CHIP CAPACITORS
For use with the 70 MHz IF board \$7.00

DEMODULATOR BOARD \$40.00

This circuit takes the 70 MHz center frequency satellite TV signals in the 10 to 200 millivolt range, detects them using a phase locked loop, de-emphasizes and filters the result and amplifies the result to produce standard NTSC video. Other outputs include the audio subcarrier, a DC voltage proportional to the strength of the 70 MHz signal, and AFC voltage centered at about 2 volts DC.

SINGLE AUDIO \$15.00

This circuit recovers the audio signals from the 6.8 MHz frequency. The Miller 9051 coils are tuned to pass the 6.8 MHz subcarrier and the Miller 9052 coil tunes for recovery of the audio.

DUAL AUDIO \$25.00

Duplicate of the single audio but also covers the 6.2 range.

DC CONTROL \$15.00

SPECIAL SET OF FIVE BOARDS \$100.00 INCLUDING DUAL AUDIO (2 single audio boards)

1900 to 2500 MHz MICROWAVE DOWNCONVERTER

MICROWAVE RECEIVER This receiver is tunable over a range of 1900 to 2500 MHz approximately, and is intended for amateur use. The local oscillator is voltage controlled, making the I.F. range approximately 54 to 88 MHz for standard TV set channels 2 thru 7.

| | | | | | | | | |
|--|--------|---------|---|---------|----------|---------|---------|--------|
| P.C. BOARD with DATA | 1 to 5 | \$15.00 | 6 to 11 | \$13.00 | 12 to 26 | \$11.00 | 27 - up | \$9.00 |
| P.C. Board with all parts for assembly | | \$49.99 | P.C. Board with all chip caps soldered on . . . | | | \$30.00 | | |
| P.C. Board with all parts for assembly | | | P.C. Board assembled & tested | | | \$69.99 | | |
| plus 2N6603 | | \$69.99 | P.C. Board assembled & tested with 2N6603 | | | \$79.99 | | |

HMR II DOWNCONVERTER with Power Supply, Antenna (Dish) & all Cables for installation. 180 Day Warranty.

| | | | | | |
|--------|----------|---------|----------|---------|----------|
| 1 to 5 | \$150.00 | 6 to 11 | \$140.00 | 12 - up | \$125.00 |
|--------|----------|---------|----------|---------|----------|

YAGI DOWNCONVERTER with Power Supply, Antenna (Yagi) & all Cables for installation. 90 Day Warranty.

| | | | | | |
|--------|----------|---------|----------|---------|----------|
| 1 to 5 | \$150.00 | 6 to 11 | \$140.00 | 12 - up | \$125.00 |
|--------|----------|---------|----------|---------|----------|

YAGI DOWNCONVERTER as above but Kit. (NO CABLES) With Box.

| | | | | | |
|--------|----------|---------|----------|---------|----------|
| 1 to 5 | \$125.00 | 6 to 11 | \$115.00 | 12 - up | \$100.00 |
|--------|----------|---------|----------|---------|----------|

HMR II DOWNCONVERTER as above but Kit. (NO CABLES) With PVC.

| | | | | | |
|--------|----------|---------|----------|---------|----------|
| 1 to 5 | \$125.00 | 6 to 11 | \$115.00 | 12 - up | \$100.00 |
|--------|----------|---------|----------|---------|----------|

SPECIAL NEW STOCK OF CARBIDE DRILL BITS—YOUR CHOICE \$1.99

| | | | | | |
|--------|-------|----|----|----|----|
| 1.25mm | 13/64 | 36 | 47 | 55 | 63 |
| 1.45mm | 19 | 37 | 48 | 56 | 64 |
| 3.2mm | 20 | 38 | 49 | 57 | 65 |
| 3.3mm | 24 | 39 | 50 | 58 | 67 |
| 1/8 | 26 | 40 | 51 | 59 | 68 |
| 3/16 | 29 | 44 | 52 | 60 | 69 |
| 5/32 | 30 | 45 | 53 | 61 | |
| 7/32 | 31 | 46 | 54 | 62 | |

Start taking calls in curious places with the revolutionary, new Cordless *Escort*[®] Phone.

Special Purchase—The *Escort*[®] Cordless Telephone!

We are pleased to announce the Escort Mark III is now available at special pricing. We bought the manufacturer's entire inventory-- and we are passing the savings on to you!

The Escort Mark III was originally designed to retail for \$199.95. Now, we suggest a retail price of \$169.95 to \$189.95. Or, you can move them out at \$149.95. In any event, you'll like the profit margins.

| QUANTITY | DEALER PRICE | GROSS PROFIT AT \$149.95 |
|-------------|--------------|--------------------------|
| 1—2 units | 69.75 each | 53% |
| 3—5 units | 64.50 each | 57% |
| 6—11 units | 62.50 each | 58% |
| 12—23 units | 60.75 each | 59% |

On all orders of 12 or more, we pay the freight! This is your opportunity to stock up for the Christmas buying season. These are ideal gift items, that will really move out!

ESCORT MARK III SPECIFICATIONS

VHF DUPLEXERS

This duplexer was made for RF Harris Mobile Phones and Two Way Radios. These duplexers can be used in any mobile phone or two way radio system, along with having the capabilities to be modified for UHF use. The physical dimensions are 3 3/5" Long, 4 2/5" Wide, and 1 1/10" Deep. The approximate weight is 18 oz./1 lb. 2 oz.. PRICE \$74.99

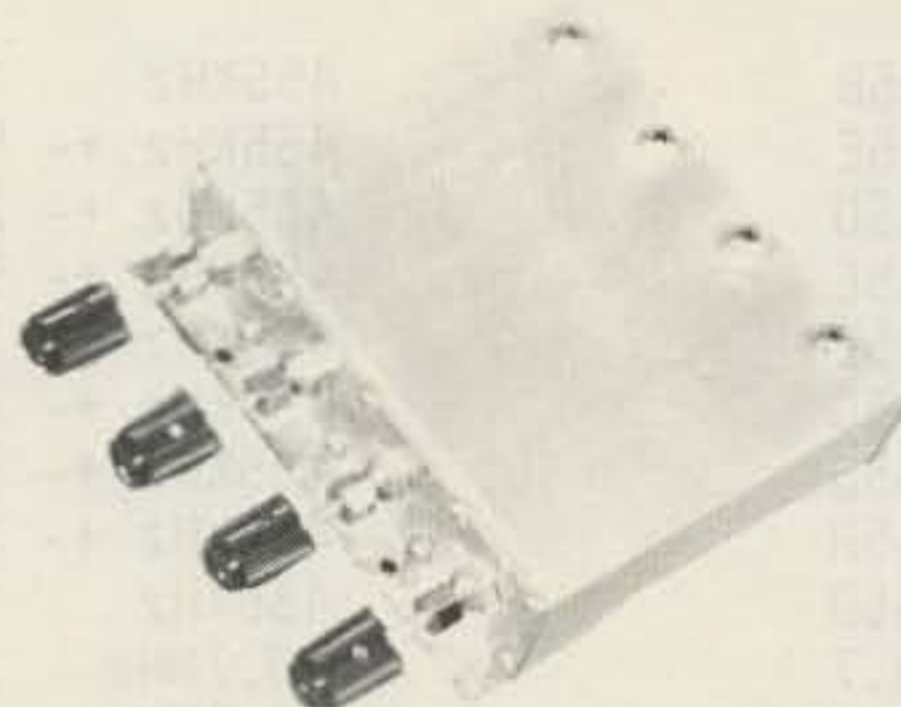

- Operates as a regular telephone on touch-tone or rotary dial systems
- Range up to 300 feet
- Ni-Cad rechargeable batteries included in telephone
- Charger built into base transmitter
- Simple plug-in installation!
- High-performance antenna
- Full duplex, answer and dial out
- Full FCC approval

HOW WE CUT THE CORD.

The new Cordless Phone works on a simple, highly sophisticated principle. A small base station plugs into your regular phone jack, and an electrical wall outlet. The base station then transmits any in- or out-going call to the handheld receiver, anywhere up to 300 feet.

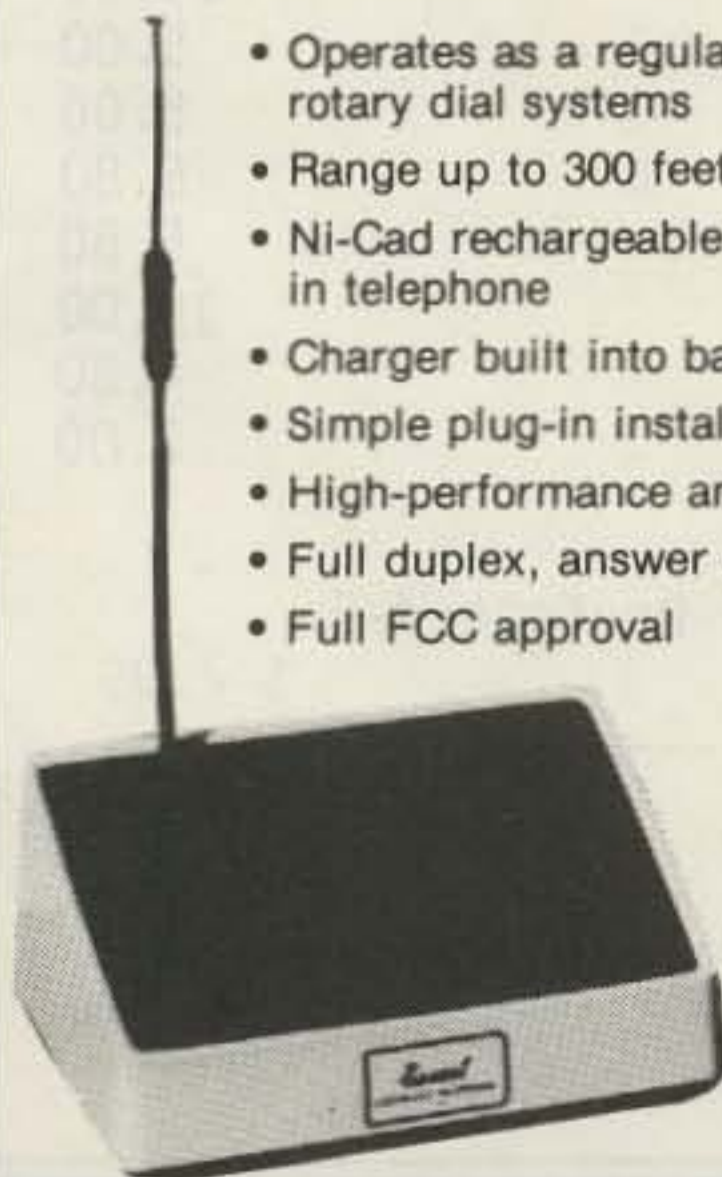

Exactly As Shown

Toll Free Number
800-528-0180
(For orders only)

MHz electronics

"FILTERS"

Collins Mechanical Filter #526-9724-010 Model F455Z32F
455KHz at 3.2KHz Wide.

\$15.00

Atlas Crystal Filters

5.52-2.7/8 5.52MHz/2.7KHz wide 8 pole
5.595-2.7/8/U 5.595MHz/2.7KHz wide 8 pole upper sideband
5.595-.500/4/CW 5.595MHz/.500KHz wide 4 pole CW
5.595-2.7/LSB 5.595MHz/2.7KHz wide 8 pole lower sideband
5.595-2.7/USB 5.595MHz/2.7KHz wide 8 pole upper sideband
5.645-2.7/8 5.645MHz/2.7KHz wide 8 pole
9.0SB/CW 9.0MHz/ 8 pole sideband and CW

Your Choice
\$12.99

Kokusai Electric Co. Mechanical Filter #MF-455-ZL-21H

455KHz at Center Frequency of 453.5Kc Carrier Frequency of 455Kc 2.36Kc Bandwidth

\$15.00

Crystal Filters

| | | | |
|----------|------------|---|-------|
| Nikko | FX-07800C | 7.8MHz | 10.00 |
| TEW | FEC-103-2 | 10.6935 | 10.00 |
| Tyco/CD | 001019880 | 10.7MHz 2 pole 15KHz Bw. Motorola #48D84396K01 Thru #48D84396K05 | 4.00 |
| Motorola | 4884863B01 | 11.7MHz 2 pole 15KHz Bandwidth | 5.00 |
| PTI | 5350C | 12MHz 2 pole 15KHz Bandwidth | 5.00 |
| PTI | 5426C | 21.4MHz 2 pole 15KHz Bandwidth | 5.00 |
| CD | A10300 | 45MHz 2 pole 15KHz Bandwidth (For Motorola Communications equipment) | 5.00 |

Ceramic Filters

| | | | |
|------------|----------------|------------------|---------|
| Murata | BFB455B | 455KHz | \$ 2.40 |
| | CFM455E | 455KHz +- 5.5KHz | 6.65 |
| | CFM455D | 455KHz +- 7KHz | 6.65 |
| | CFR455E | 455KHz +- 5.5KHz | 8.00 |
| | CFU455E | 455KHz +- 1.5KHz | 2.90 |
| | CFU455G | 455KHz +- 1KHz | 2.90 |
| | CFW455D | 455KHz +- 1KHz | 2.90 |
| | CFW455H | 455KHz +- 3KHz | 4.35 |
| | SFB455D | 455KHz | 2.40 |
| | SFE10.7 | 10.7MHz | 2.67 |
| | SFG10.7MA | 10.7MHz | 10.00 |
| Clevite | TO-01A | 455KHz | 5.00 |
| | TO-02A | 455KHz | 5.00 |
| Nippon | LF-B4/CFU455I | 455KHz +- 1KHz | 5.80 |
| | LF-B6/CFU455H | 455KHz +- 1KHz | 5.80 |
| | LF-C18 | 455KHz | 10.00 |
| Token | CF455A/BFU455K | 455KHz +- 2KHz | 4.80 |
| Matsushira | EFC-L455K | 455KHz | 7.00 |

ROTRON MUFFIN FANS Model Mark 4/MU2A1

These fans are new factory boxed 115vac at 14watts 50/60cps. Impedance Protected-F
CFM is 88 at 50cps and 105 at 60cps.

\$ 7.99

SPECTRA PHYSICS INC. Model 088 HeNe Laser Tubes.

Power output 1.6mw. Beam Dia. .75mm. Beam Dir. 2.7mr. 8Kv starting voltage
68K ohm 1watt ballast 1000vdc +-100vdc 3.7ma. TUBES ARE NEW \$59.99

"AMPLIFIERS"

AVANTEK LOW NOISE AMPLIFIERS

| Models | UTC2-102M | AP-20-T | AL-45-0-1 | AK-1000M |
|-----------------|----------------|-----------------|----------------|-----------------|
| Frequency Range | 30 to 200MC | 200 to 400MC | 450 to 800MC | 500 to 1000MC |
| Noise Figure | 1.5dB | 6.5dB | 7dB | 2.5dB |
| Voltage | +15vdc | +24vdc | -6vdc @ +12vdc | +12vdc @ -12vdc |
| Gain | 29dB | 30dB | 30dB | 25dB |
| Power Output | 1dB Gain +7dBm | 1dB Gain +20dBm | 1dB Gain -5dBm | 1dB Gain +8dBm |
| Price | \$49.99 | \$49.99 | \$49.99 | \$69.99 |

Mini Circuits Double Balanced Mixers

Model RAY-3

Very High Level (+23dBm LO) 70KHz to 200MHz LO,RF,DC to 200MHz IF
 Conversion Loss,dB One Octave From Band Edge 6Typ./7.5Max. Total Range 6.5Typ./8Max.
 Isolation,dB Lower Band Edge To One Decade Higher (LO-RF/LO-IF) 55Typ./45Min. Mid. Range (LO-RF/LO-IF) 40Typ./30Min. Upper Band Edge To One Octave Lower (LO-RF/LO-IF) 30Typ./25Min.
 Price \$24.99

Model TSM-3

Standard Level (+7dBm LO) .1MHz to 400MHz LO,RF,DC to 400MHz IF
 Conversion Loss,dB One Octave From Band Edge 5.3Typ./7.5Max. Total Range 6.5Typ./8.5Max.
 Isolation,dB Lower Band Edge To One Decade Higher (LO-RF/LO-IF) 60Typ./50Min. Mid. Range (LO-RF/LO-IF) 50Typ./35Min. Upper Band Edge To One Octave Lower (LO-RF/LO-IF) 35TYP./25Min.
 Price \$11.99

Hewlett Packard Linear Power Microwave RF Transistor HXTR5401/35831E

Collector Base Brakedown Voltage at $I_c=100\mu\text{a}$ 35volts min.
 Collector Emitter Brakedown Voltage at $I_c=500\mu\text{a}$ 30volts min.
 Collector Cutoff Current at $V_{cb}=15\text{v}$ 100 μa max.
 Forward Current Transfer Ratio at $V_{ce}=15\text{v}, I_c=15\text{ma}$ 15min,40typ,125max
 Transducer Power Gain at $V_{ce}=18\text{v}, I_{ce}=60\text{ma}, F=2\text{GHz}$. 3dBmin,4dBtyp
 Maximum Available Gain at $V_{ce}=18\text{v}, I_c=60\text{ma}, F=1\text{GHz}/F=2\text{GHz}$ 14dB typ,8dB typ
 Price \$29.99

Motorola RF Power Amplifier Modules

| Model | MHW612A | MHW613A | MHW710 | MHW720 |
|-----------------|---------------|---------------|---------------|---------------|
| Frequency Range | 146 to 147MHz | 150 to 174MHz | 400 to 512MHz | 400 to 470MHz |
| Voltage | 12.5vdc | 12.5vdc | 12.5vdc | 12.5vdc |
| Output Power | 20watts | 30watts | 13watts | 20watts |
| Minimum Gain | 20dB | 20dB | 19.4dB | 21dB |
| Harmonics | -30dB | -30dB | 40dB | 40dB |
| RF Input Power | 400mw | 500mw | 250mw | 250mw |
| Price | \$57.50 | \$59.80 | \$57.50 | \$69.00 |

Toll Free Number
800-528-0180
 (For orders only)

MHz electronics

"TRANSISTORS"

WATKINS JOHNSON WJ-M62 3.7 to 4.2GHz Communication Band Double Balanced Mixer \$100.00

SSB Conversion Loss 4.9dB Typ. 6dB Max. fR 3.7 to 4.2GHz
 5.5dB Typ. 6.5dB Max. fI DC to 1125MHz fL fR
 fI 880MHz fL fR

SSB Noise Figure fR 3.7 to 4.2GHz
 4.9dB Typ. 6dB Max. fI 30 to 1125MHz fL fR
 5.5dB Typ. 6.5dB Max. fI 880MHz fL fR

Isolation
 fL at R 30dB Min. 40dB Typ. fL 2.8 to 5.35GHz
 fL at I 25dB Min. 30dB Typ. fL 4.5 to 5.35GHz
 20dB Min. 30dB Typ. fL 3.6 to 4.5GHz
 15dB Min. 25dB Typ. fL 2.8 to 3.6GHz

Conversion Compression 1dB Max. fR Level +2dBm

Flatness .2dB Peak to Peak Over any 40MHz Segment of fR=3.7 to 4.2GHz

Third Order Input Intercept +11dBm fR1=4GHz fR2=4.01GHz Both at -5dBm fL=4.5GHz

Group Time Delay .5ns Typ. .75ns Max. fR3.7 to 4.2GHz fL 3480MHz @ +13dBm

VSWR
 L-Port 1.25:1 Typ. 2.0:1 fL 2.8 to 5.35GHz
 R-Port 1.25:1 Typ. 2.0:1 fR 3.7 to 4.2GHz fL fR
 1.4 :1 Typ. 2.0:1 fR 3.7 to 4.2GHz fL fR
 I-Port 1.5 :1 Typ. 2.0:1 fI=100MHz
 1.3 :1 Typ. 2.0:1 fI=500MHz
 1.8 :1 Typ. 2.5:1 fI=1125MHz

SGS/ATES RF Transistors

| Type. | BFQ85 | BFW92 |
|---------------------|---------------------|-----------------|
| Collector Base V | 20v | 25v |
| Collector Emitter V | 15v | 15v |
| Emitter Base V | 3v | 2.5v |
| Collector Current | 40ma | 25ma |
| Power Dissipation | 200mw | 190mw |
| HFE | 40min. 200max. | 20min. 150max. |
| FT | 4GHZ min. 5GHZ max. | 1.6GHZ Typ. |
| Noise Figure | 1GHZ 3dB Max. | 500MHz 4dB Typ. |
| Price | \$1.50 | \$1.50 |

Motorola RF Transistor

| MRF901 | 2N6603 |
|----------------|-----------------|
| 25v | 25v |
| 15v | 15v |
| 3v | 3v |
| 30ma | 30ma |
| 375mw | 400mw |
| 30min. 200max. | 30min. 200max. |
| 4.5GHz typ. | 2GHz min. |
| 1GHZ 2dB Typ. | 2GHz 2.9dB Typ. |
| \$2.00 | \$10.00 |

National Semiconductor Variable Voltage Regulator Sale !!!!!!!!!!!

| LM317K | LM350K | LM723G/L | LM7805/06/08/12/15/18/24 |
|--------------|--------------|---------------|--------------------------|
| 1.2 to 37vdc | 1.2 to 33vdc | 2 to 37vdc | 5, 6, 8,12,15,18,24vdc |
| 1.5Amps | 3Amps | 150ma. | 1Amp |
| TO-3 | TO-3 | TO-100/TO-116 | TO-220/TO-3 |
| \$4.50 | \$5.75 | \$1.00 \$1.25 | \$1.17 \$2.00 |

P & B Solid State Relays Type ECT1DB72

5VDC Turn On 120VAC Contact 7Amps
 20Amps on 10"x10"x.062" Alum.Heatsink with
 Silicon Grease \$5.00

*May Be Other Brand Equivalent

Toll Free Number
800-528-0180
(For orders only)

MHz electronics

"MIXERS"

WATKINS JOHNSON WJ-M6 Double Balanced Mixer

| | | |
|-------------------------|-------------------------|-----------------|
| LO and RF 0.2 to 300MHz | IF DC to 300MHz | \$21.00 |
| Conversion Loss (SSB) | 6.5dB Max. 1 to 50MHz | |
| Noise Figure (SSB) | 8.5dB Max. .2 to 300MHz | WITH DATA SHEET |
| Conversion Compression | same as above | |
| | 8.5dB Max. 50 to 300MHz | |
| | .3dB Typ. | |

NEC (NIPPON ELECTRIC CO. LTD. NE57835/2SC2150 Microwave Transistor

| | | | | |
|---------------|-------------|------------|-------------|--------|
| NF Min F=2GHz | dB 2.4 Typ. | MAG F=2GHz | dB 12 Typ. | \$5.30 |
| F=3GHz | dB 3.4 Typ. | F=3GHz | dB 9 Typ. | |
| F=4GHz | dB 4.3 Typ. | F=4GHz | dB 6.5 Typ. | |

Ft Gain Bandwidth Product at Vce=8v, Ic=10ma. GHz 4 Min. 6 Typ.
 Vcbo 25v Vceo 11v Vebo 3v Ic 50ma. Pt. 250mw

UNELCO RF Power and Linear Amplifier Capacitors

These are the famous capacitors used by all the RF Power and Linear Amplifier manufactures and described in the Motorola RF Data Book.

| | | | | | | | |
|------|--------|------|------|-------|-------|---------------|-----------|
| 10pf | 22pf | 30pf | 40pf | 100pf | 250pf | 1 to 10pcs. | .60¢ each |
| 13pf | 25pf | 32pf | 43pf | 120pf | 820pf | 11 to 50pcs. | .50¢ each |
| 14pf | 27pf | 33pf | 62pf | 180pf | | 51 to 100pcs. | .40¢ each |
| 20pf | 27.5pf | 34pf | 80pf | 200pf | | | |

NIPPON ELECTRIC COMPANY TUNNEL DIODES

| | | | | |
|--------------------------------|-----------|-------------------------|-------------------------|--------|
| | | MODEL 1S2199 | 1S2200 | \$7.50 |
| Peak Pt. Current ma. | Ip | 9min. 10Typ. 11max. | 9min. 10Typ. 11max. | |
| Valley Pt. Current ma. | Iv | 1.2Typ. 1.5max. | 1.2Typ. 1.5max. | |
| Peak Pt. Voltage mv. | Vp | 95Typ. 120max. | 75Typ. 90max. | |
| Projected Peak Pt. Voltage mv. | Vpp Vf=Ip | 480min. 550Typ. 630max. | 440min. 520Typ. 600max. | |
| Series Res. Ohms | rS | 2.5Typ. 4max. | 2Typ. 3max. | |
| Terminal Cap. pf. | Ct | 1.7Typ. 2max. | 5Typ. 8max. | |
| Valley Pt. Voltage mv. | VV | 370Typ. | 350Typ. | |

FAIRCHILD / DUMONT Oscilloscope Probes Model 4290B

Input Impedance 10 meg., Input Capacity 6.5 to 12pf., Division Ration (Volts/Div Factor) 10:1, Cable Length 4Ft., Frequency Range Over 100MHz.

These Probes will work on all Tektronix, Hewlett Packard, and other Oscilloscopes.

PRICE \$45.00

MOTOROLA RF DATA BOOK

List all Motorola RF Transistors / RF Power Amplifiers, Varactor Diodes and much much more.

PRICE \$7.50

Toll Free Number
800-528-0180
(For orders only)

MHz electronics

"SOCKETS AND CHIMNEYS"

EIMAC TUBE SOCKETS AND CHIMNEYS

| | | | | | |
|--------|---------|--------|--------|---------|---------|
| SK110 | Socket | \$ POR | SK626 | Chimney | \$ 7.70 |
| SK406 | Chimney | 35.00 | SK630 | Socket | 45.00 |
| SK416 | Chimney | 22.00 | SK636B | Chimney | 26.40 |
| SK500 | Socket | 330.00 | SK640 | Socket | 27.50 |
| SK506 | Chimney | 47.00 | SK646 | Chimney | 55.00 |
| SK600 | Socket | 39.50 | SK711A | Socket | 192.50 |
| SK602 | Socket | 56.00 | SK740 | Socket | 66.00 |
| SK606 | Chimney | 8.80 | SK770 | Socket | 66.00 |
| SK607 | Socket | 43.00 | SK800A | Socket | 150.00 |
| SK610 | Socket | 44.00 | SK806 | Chimney | 30.80 |
| SK620 | Socket | 45.00 | SK900 | Socket | 253.00 |
| SK620A | Socket | 50.50 | SK906 | Chimney | 44.00 |

JOHNSON TUBE SOCKETS

| | | | | | |
|------------------|--------|----------|--------------------------------------|-------------|-----------|
| 124-115-2/SK620A | Socket | \$ 30.00 | 124-113 | Bypass Cap. | \$ 10.00 |
| 124-116/SK630A | Socket | 40.00 | 122-0275-001 | Socket | 10.00 |
| | | | (For 4-250A, 4-400A, 3-400Z, 3-500Z) | | 2/\$15.00 |

CHIP CAPACITORS

| | | | |
|-------|------|--------|-----------------|
| .8pf | 10pf | 100pf* | 430pf |
| 1pf | 12pf | 110pf | 470pf |
| 1.1pf | 15pf | 120pf | 510pf |
| 1.4pf | 18pf | 130pf | 560pf |
| 1.5pf | 20pf | 150pf | 620pf |
| 1.8pf | 22pf | 160pf | 680pf |
| 2.2pf | 24pf | 180pf | 820pf |
| 2.7pf | 27pf | 200pf | 1000pf/.001uf* |
| 3.3pf | 33pf | 220pf* | 1800pf/.0018uf |
| 3.6pf | 39pf | 240pf | 2700pf/.0027uf |
| 3.9pf | 47pf | 270pf | 10,000pf/.01uf |
| 4.7pf | 51pf | 300pf | 12,000pf/.012uf |
| 5.6pf | 56pf | 330pf | 15,000pf/.015uf |
| 6.8pf | 68pf | 360pf | 18,000pf/.018uf |
| 8.2pf | 82pf | 390pf | |

| | | |
|------------------------|------------------|-------------------------------------|
| PRICES: 1 to 10 - .99¢ | 101 to 1000 .60¢ | * IS A SPECIAL PRICE: 10 for \$7.50 |
| 11 to 50 - .90¢ | 1001 & UP .35¢ | 100 for \$65.00 |
| 51 to 100 - .80¢ | | 1000 for \$350.00 |

WATKINS JOHNSON WJ-V907: Voltage Controlled Microwave Oscillator \$110.00

Frequency range 3.6 to 4.2GHz, Power output, Min. 10dBm typical, 8dBm Guaranteed. Spurious output suppression Harmonic (nf₀), min. 20dB typical, In-Band Non-Harmonic, min. 60dB typical, Residual FM, pk to pk, Max. 5KHz, pushing factor, Max. 8KHz/V, Pulling figure (1.5:1 VSWR), Max. 60MHz, Tuning voltage range +1 to +15volts, Tuning current, Max. -0.1mA, modulation sensitivity range, Max. 120 to 30MHz/V, Input capacitance, Max. 100pf, Oscillator Bias +15 +/-0.05 volts @ 55mA, Max.

Toll Free Number
800-528-0180
(For orders only)

MHz electronics

"TUBES"

| TUBES | PRICE | TUBES | PRICE | TUBES | PRICE |
|-----------------|---------|-----------------|----------|------------|----------|
| 2E26 | \$ 4.69 | 5721 | \$200.00 | 8462 | \$100.00 |
| 2K28 | 100.00 | 5768 | 85.00 | 8505A | 73.50 |
| 3B28 | 5.00 | 5836 | 100.00 | 8533W | 92.00 |
| 3-500Z | 102.00 | 5837 | 100.00 | 8560A | 55.00 |
| 3-1000Z/8164 | 300.00 | 5861/EC55 | 110.00 | 8560AS | 57.00 |
| 3CX1000A/8283 | 200.00 | 5876A | 15.00 | 8608 | 34.00 |
| 3X2500A3 | 200.00 | 5881/6L6 | 5.00 | 8624 | 67.20 |
| 4-65A/8165 | 45.00 | 5894/A | 45.00 | 8637 | 38.00 |
| 4-125A/4D21 | 58.00 | 5894B | 55.00 | 8647 | 123.00 |
| 4-250A/5D22 | 68.00 | 6080 | 10.00 | 8737/5894B | 55.10 |
| 4-400A/8438 | 71.00 | 6083/AX9909 | 89.00 | 8807 | 1000.00 |
| 4-400C/6775 | 80.00 | 6098/6AK6 | 14.00 | 8873 | 260.00 |
| 4-1000A/8166 | 300.00 | 6115/A | 100.00 | 8874 | 260.00 |
| 4CS250R | 69.00 | 6146 | 6.00 | 8875 | 260.00 |
| 4X150A/7034 | 30.00 | 6146A | 6.50 | 8877 | 533.00 |
| 4X150D/7035 | 40.00 | 6146B/8298A | 7.50 | 8908 | 12.00 |
| 4X150G | 50.00 | 6146W | 14.00 | 8916 | 1500.00 |
| 4X250B | 30.00 | 6159 | 11.00 | 8930/X651Z | 45.00 |
| 4CX250B/7203 | 45.00 | 6161 | 70.00 | 8950 | 10.00 |
| 4CX250F/7204 | 45.00 | 6291 | 125.00 | | |
| 4CX250FG/8621 | 55.00 | 6293 | 20.00 | 6BK4C | 5.00 |
| 4CX250K/8245 | 100.00 | 6360 | 4.00 | 6DQ5 | 4.00 |
| 4CX250R/7580W | 69.00 | 6524 | 53.00 | 6FW5 | 5.00 |
| 4CX300A | 99.00 | 6550 | 7.00 | 6GE5 | 5.00 |
| 4CX350A/8321 | 100.00 | 6562/6794A | 25.00 | 6GJ5 | 5.00 |
| 4CX350FJ/8904 | 100.00 | 6693 | 110.00 | 6HS5 | 5.00 |
| 4X500A | 100.00 | 6816 | 58.00 | 6JB5/6HE5 | 5.00 |
| 4CX600J | 300.00 | 6832 | 22.00 | 6JB6A | 5.00 |
| 4CX1000A/8168 | 300.00 | 6883/8032A/8552 | 7.00 | 6JM6 | 5.00 |
| 4CX1500B/8660 | 300.00 | 6884 | 46.00 | 6JN6 | 5.00 |
| 4CX3000A/8169 | 300.00 | 6897 | 110.00 | 6JS6B | 5.00 |
| 4CX5000A/8170 | 400.00 | 6900 | 35.00 | 6JT6A | 5.00 |
| 4CX10000D/8171 | 500.00 | 6907 | 55.00 | 6KD6 | 5.00 |
| 4CX15000A/8281 | 700.00 | 6939 | 15.00 | 6K66/EL505 | 5.50 |
| 4E27/A/5-123A/B | 40.00 | 7094 | 75.00 | 6KM6 | 5.00 |
| 4PR60A | 100.00 | 7117 | 17.00 | 6KN6 | 5.00 |
| 4PR60B/8252 | 175.00 | 7211 | 60.00 | 6LF6 | 6.00 |
| KT88 | 15.00 | 7289/3CX100A5 | 34.00 | 6LQ6 | 6.00 |
| DX362 | 35.00 | 7360 | 11.00 | 6LU8 | 5.00 |
| DX415 | 35.00 | 7377 | 67.00 | 6LX6 | 5.00 |
| 572B/T160L | 44.00 | 7486 | 75.00 | 6ME6 | 5.00 |
| 811 | 10.00 | 7650 | 250.00 | 12JB6A | 6.00 |
| 811A | 13.00 | 7843 | 58.00 | | |
| 812A | 15.00 | 7868 | 4.00 | | |
| 813 | 38.00 | 7984 | 12.00 | | |
| 4624 | 100.00 | 8072 | 55.00 | | |
| 4665 | 350.00 | 8121 | 50.00 | | |
| 5551A | 100.00 | 8122 | 85.00 | | |
| 5563A | 77.00 | 8236 | 30.00 | | |
| 5675 | 15.00 | 8295/PL172 | 300.00 | | |

"WE ARE ALSO LOOKING FOR TUBES NEW/USED ECT."

WE BUY SELL OR TRADE

NOTICE ALL PRICES ARE SUBJECT TO CHANGE WITHOUT NOTICE !!!

Toll Free Number
800-528-0180
(For orders only)

MHz electronics

"MICROWAVE COMPONENTS"

| Company | Part Number | Description | Price |
|-------------------|-------------|---|----------|
| AIL | 70A | Noise Source | \$100.00 |
| AIL | 7010 | Noise Source .2 to 2.6GHz | 100.00 |
| AIL | 07050 | Noise Source | 100.00 |
| AIL | 07051 | Noise Source 7.05 to 10GHz | 150.00 |
| AIL | 07091 | Noise Source 12.4 to 18GHz | 200.00 |
| ARRA | KU520A | Variable Attenuator | 100.00 |
| ARRA | 2416-20 | Variable Attenuator 0-20dB .5 to 1GHz 10W | 50.00 |
| ARRA | 3614-60X | Variable Attenuator 0-60dB 1 to 2GHz 10W | 50.00 |
| ARRA | 4684-20C | Variable Attenuator 0-20dB 3 to 4GHz 10W | 75.00 |
| ARRA | 6684-20F | Variable Attenuator 0-20dB 7 to 11GHz | 75.00 |
| Alfred | 1151 | Sampler Attenuator 1 to 2GHz 0 to 50dB | 200.00 |
| Alfred | 1152 | Sampler Attenuator 2 to 4GHz 0 to 50dB | 200.00 |
| Alfred | 1153 | Sampler Attenuator 4 to 8GHz 0 to 50dB | 200.00 |
| American | 2000-6254 | Adaptor X to SMA 8.2 to 12.4GHz | 75.00 |
| American | 2020-6600 | Directional Coupler .5 to 1GHz 6dB | 75.00 |
| Boonton | 41-4B | Power Detector | 75.00 |
| Coaxial Dynamics | 3023 | Directional Power Detector 60W/rev/15wrev/225-400mc | 50.00 |
| Coaxial Dynamics | 3025 | Directional Power Detector 60W/rev/15wrev/116-150mc | 50.00 |
| FXR/Microlab | CM-A21 | Coupler | 35.00 |
| FXR/Microlab | XP-A39 | Crystal Detector | 35.00 |
| FXR/Microlab | S164A | Variable Attenuator 0-50dB 2.6 to 3.95GHz | 450.00 |
| FXR/Microlab | N414A | Adapter | 35.00 |
| FXR/Microlab | 601A07 | Adapter | 35.00 |
| FXR/Microlab | 6601B | Power Detector | 100.00 |
| General Microwave | N402A-3 | Directional Coupler 2 to 4GHz 20dB | 75.00 |
| General Microwave | N710-20 | 100:1 Divider 1Mc to 250Mc | 35.00 |
| General Microwave | 4276-2 | Adaptor G to H 3.95 to 5.85Gc | 50.00 |
| Hewlett Packard | G281A | Adaptor H to N 7.05 to 10Gc | 35.00 |
| Hewlett Packard | H281A | Adaptor X to N 8.2 to 12.4Gc | 35.00 |
| Hewlett Packard | M4292B | Adaptor 10 to 15Gc | 75.00 |
| Hewlett Packard | M4292A | Adaptor 15 to 22Gc | 75.00 |
| Hewlett Packard | 345B | Noise Source IF 30/60Mc | 200.00 |
| Hewlett Packard | G347A | Noise Source 3.95 to 5.85Gc | 250.00 |
| Hewlett Packard | H347A | Noise Source 7.05 to 10Gc | 250.00 |
| Hewlett Packard | S347A | Noise Source 2.6 to 3.95Gc | 325.00 |
| Hewlett Packard | X347A | Noise Source 8.2 to 12.4Gc | 300.00 |
| Hewlett Packard | 349A | Noise Source 400Mc to 4Gc | 150.00 |
| Hewlett Packard | 355C | Variable Attenuator .5w DC to 1Gc | 50.00 |
| Hewlett Packard | 3600 | Low Pass Filter 4100Mc | 500.00 |
| Hewlett Packard | G382A | Variable Attenuator 0 to 50dB 3.95 to 5.85Gc | 500.00 |
| Hewlett Packard | J382A | Variable Attenuator 0 to 50dB 5.85 to 8.2Gc | 350.00 |
| Hewlett Packard | P382A | Variable Attenuator 0 to 50dB 12.4 to 18Gc | 325.00 |
| Hewlett Packard | X382A | Variable Attenuator 0 to 50dB 8.2 to 12.4Gc | 35.00 |
| Hewlett Packard | 411A-210 | N Tee For 411A | 75.00 |
| Hewlett Packard | H421A | Crystal Detector 7.05 to 10Gc | 85.00 |
| Hewlett Packard | H421A | Crystal Detector 7.05 to 10Gc Matched Pair | 180.00 |
| Hewlett Packard | H424A | Crystal Detector 7.05 to 10Gc Matched Pair | 50.00 |
| Hewlett Packard | 4778 | Thermistor Mount For 430 Series 10Mc to 10Gc | 135.99 |
| Hewlett Packard | G485A | Barretter Mount 3.95 to 5.85Gc | 155.00 |
| Hewlett Packard | J485B | Detector Mount 5.85 to 8.2Gc | 65.00 |
| Hewlett Packard | J486A | Thermistor Mount 5.85 to 8.2Gc | 85.00 |
| Hewlett Packard | H487B | Thermistor Mount 7.05 to 10Gc | 300.00 |
| Hewlett Packard | K487C | Thermistor Mount 18 to 26Gc | 500.00 |
| Hewlett Packard | X487B | Thermistor Mount 12.4 to 18Gc | 400.00 |
| Hewlett Packard | X487A | Thermistor Mount 8.2 to 12.4Gc | 500.00 |
| Hewlett Packard | X487B | Thermistor Mount 8.2 to 12.4Gc | 400.00 |
| Hewlett Packard | G532A | Frequency Meter 3.95 to 5.85Gc | 350.00 |
| Hewlett Packard | H532A | Frequency Meter 7.05 to 10Gc | 600.00 |
| Hewlett Packard | J532A | Frequency Meter 5.3 to 8.2Gc | 200.00 |
| Hewlett Packard | P532A | Frequency Meter 10 to 15Gc | 200.00 |
| Hewlett Packard | X532A | Frequency Meter 8.2 to 12.4Gc | 200.00 |
| Hewlett Packard | 536A | Frequency Meter .94 to 4.2Gc | 350.00 |
| Hewlett Packard | G7520 | Directional Coupler 20dB 3.95 to 5.85Gc | 200.00 |
| Hewlett Packard | X752A | Directional Coupler 3dB 8.2 to 12.4Gc | 200.00 |
| Hewlett Packard | X752C | Directional Coupler 10dB 8.2 to 12.4Gc | 200.00 |
| Hewlett Packard | X752D | Directional Coupler 20dB 8.2 to 12.4Gc | 200.00 |
| Hewlett Packard | 7660 | Dual Directional Coupler .94 to 1.975Gc 20dB | 50.00 |
| Hewlett Packard | 767D | Directional Detector 1.9 to 4.1Gc | 50.00 |
| Hewlett Packard | 787D | Termination 3.95 to 5.85Gc | 75.00 |
| Hewlett Packard | G910B | Moving Load 8.2 to 12.4Gc | 100.00 |
| Hewlett Packard | X914B | Sensor Oscillator | 50.00 |
| Hewlett Packard | 2830A | Microwave Switch 500mc to 12.4Gc SPST | 100.00 |
| Hewlett Packard | 3503 | Bandpass Filter 2 to 4Gc | 200.00 |
| Hewlett Packard | 8431A | Bandpass Filter 8 to 12.4Gc | 200.00 |
| Hewlett Packard | 8436A | RF Detector | 75.00 |
| Hewlett Packard | S471A | Crystal Detector .01 to 18Gc | 100.00 |
| Hewlett Packard | B472A | Pin Modulator 1.8 to 4.5Gc 80dB | 400.00 |
| Hewlett Packard | 8732A | Pin Modulator 3.7 to 8.3Gc 35dB | 350.00 |
| Hewlett Packard | 8733A | Termination 50 ohms | 25.00 |
| Hewlett Packard | 10100B | Preamp. 2 to 1300Mc | 200.00 |
| Hewlett Packard | 10855A | Tracking Generator Shunt | 50.00 |
| Hewlett Packard | 11660A | Limiter | 300.00 |
| Hewlett Packard | 11693A | Pin Absorptive Modulator | 150.00 |
| Hewlett Packard | 13510 | Microwave Switch 100Mc to 18GHz | 200.00 |
| Hewlett Packard | 33001C | Microwave Switch DC to 18Gc SPDT | 100.00 |
| Hewlett Packard | 33102A | Microwave Switch | 75.00 |
| Hewlett Packard | C79-33602A | 0 to 101dB Variable Attenuator DC to 1Gc | 100.00 |
| Hewlett Packard | 59098A | Noise Source | 100.00 |
| Kay | 30-0/4320 | Noise Source 10 to 900Mc | 250.00 |
| Kay | NW781 | Noise Source 10 to 1000Mc | 250.00 |
| Kay | 7921A | Tube Mtg./Attenuator and 2K25 | 250.00 |
| Kay | 7921A1 | X Band Load | 50.00 |
| LEC | 90L426-1 | Directional Coupler 4 to 8Gc 20db (Narda 3044820) | 50.00 |
| MECA | 715-152 | 801162 Variable Attenuator | 75.00 |
| Merrimaac | AU-26A/ | Microwave Switch | 50.00 |
| Microtech | 214972 | Horn Antenna 8.5 to 9.6Gc | 25.00 |
| Military | AT-68/UPM | 6dB Attenuator | 35.00 |
| Military | UG-528/U | Variable Attenuator 0 to 40dB | 100.00 |
| Narda | 708 | Variable Attenuator 2 to 2.5Gc 0 to 17dB min. | 250.00 |
| Narda | 792FM | 2.5 to 12.4Gc 0 to 20dB min. | 250.00 |
| Narda | 2301-20 | Directional Coupler 2 to 4Gc 20dB | 100.00 |
| Narda | 2301-30 | Directional Coupler 2 to 4Gc 30dB | 100.00 |
| Narda | 2366 | Variable Directional Coupler 1.2 to 1.4Gc 7 to 12db | 90.00 |
| Narda | 2863 | 810 Directional Coupler 4 to 8Gc 20db | 100.00 |
| Narda | 2864 | Directional Coupler .95 to 2Gc 10db | 100.00 |
| Narda | 2979 | Directional Coupler .95 to 2Gc 20db | 100.00 |
| Narda | 3002-10 | Directional Coupler 2 to 4Gc 10db | 100.00 |
| Narda | 3002-20 | Directional Coupler 2 to 4Gc 20db | 100.00 |
| Narda | 3003-10 | Directional Coupler 2 to 4Gc 10db | 100.00 |
| Narda | 3003-20 | Directional Coupler 2 to 4Gc 20db | 100.00 |
| Narda | 3004-10 | Directional Coupler 4 to 10Gc 10db | 100.00 |

"TEST EQUIPMENT"

| TEST EQUIPMENT | | |
|-----------------|------------|---|
| Boonton | 202J | AM FM Signal Generator 195 to 270MHz 450.00 |
| Boonton | 202J/207H | AM FM Signal Generator and Univerter 100KHz to 55Mc and 195 to 270Mc 600.00 |
| CMC | 931 | Heterodyne Converter 200 to 1200Mc 200.00 |
| Chushman | MCMS | Monitor 750.00 |
| Alfred | 8000/7051 | Sweep Network Analyzer 100KHz to 40Gc 800.00 |
| Meguro | MSG-2282A | Standard Signal Generator For CB 250.00 |
| Gertsch | FM3 | Frequency Meter 20 to 1000Mc 150.00 |
| Systron Donner | 1037/1291A | Frequency Meter 0 to 50Mc with Plug In to 500Mc 500.00 |
| Singer | SPA3/25A | Spectrum Analyzer 1Kc to 25Mc and a G-6 Companion Sweep Generator 0 to 15Mc and PS-19 Power Supply 1500.00 |
| Measurements | 65B | Standard Signal Generator 75Hz to 35Mc 250.00 |
| Measurements | 140 | Standard Deviation Meter 25 to 1000Mc 200.00 |
| Polarad | MSG-2 | Signal Generator 2150 to 4600Mc 500.00 |
| E.H. | 574 | Microwave Swept Oscillator 8 to 12.4Gc 750.00 |
| Monsanto | 1107 | Time Interval Plug In 50.00 |
| Military | TS-1011/ | UPM84 Spectrum Analyzer 10Mc to 40Gc with 1Each Filter F335/F336/F337/F338/F341/1Each Attenuator CN411/CN410/CN409 and 1Each Adapter UG1239/UG1240/UG1241/UG1242 1800.00 |
| General Radio | 805C | Standard Signal Generator 16Kc to 50Mc 300.00 |
| Hewlett Packard | 230A | Power Amplifier 10 to 500Mc 4.5watts 400.00 |
| Hewlett Packard | 230B | Power Amplifier 10 to 500Mc 4.5watts 800.00 |
| Hewlett Packard | 240A | Sweep Generator 4.5 to 120Mc 400.00 |
| Hewlett Packard | 410C | VTVM to 700MHz 400.00 |
| Hewlett Packard | 4150 | SWR Meter 250.00 |
| Hewlett Packard | 431B | Power Meter 10Mc to 40Gc 150.00 |
| Hewlett Packard | 606A | Signal Generator 50KHz to 65Mc 800.00 |
| Hewlett Packard | 608D | Signal Generator 10 to 420Mc 400.00 |
| Hewlett Packard | 608C | Signal Generator 10 to 480Mc 500.00 |
| Hewlett Packard | 608E | Signal Generator 10 to 480Mc 1500.00 |
| Hewlett Packard | 608F | Signal Generator 10 to 455Mc 1500.00 |
| Hewlett Packard | 612A | Signal Generator 450 to 1230Mc 500.00 |
| Hewlett Packard | 614A | Signal Generator 900 to 2100Mc 500.00 |
| Hewlett Packard | 616A | Signal Generator 1.8 to 4.2Gc 400.00 |
| Hewlett Packard | 616B | Signal Generator 1.8 to 4.2Gc 500.00 |
| Hewlett Packard | 618A | Signal Generator 3.8 to 7.6Gc 400.00 |
| Hewlett Packard | 618B | Signal Generator 3.8 to 7.6Gc 500.00 |
| Hewlett Packard | 620A | Signal Generator 7 to 11Gc 400.00 |
| Hewlett Packard | 623B | Test Set 5925 to 7750Mc 500.00 |
| Hewlett Packard | 626A | Signal Generator 10 to 15Gc 2000.00 |
| Hewlett Packard | 628A | Signal Generator 15 to 21Gc 2500.00 |
| Hewlett Packard | 940A | Frequency Doubler 26.5 to 40Gc 1000.00 |
| Hewlett Packard | 3550A | Portable Test Set 1000.00 |
| Hewlett Packard | 5245L | Frequency Counter 0 to 50Mc 1000.00 |
| Hewlett Packard | 5251A | Plug In For above 20 to 100Mc 100.00 |
| Hewlett Packard | 5252A | Plug In For above 100 to 350Mc 200.00 |
| Hewlett Packard | 5253B | Plug In For above 50 to 500Mc 350.00 |
| Hewlett Packard | 5254B | Plug In For above 200Mc to 3Gc 750.00 |
| Hewlett Packard | 5260A | Frequency Divider to 12.4Gc For above 1000.00 |
| Hewlett Packard | 5262A | Plug In For above Time Interval 100.00 |
| Hewlett Packard | 5327B | DVM and Frequency Meter to 550Mc 1500.00 |
| Hewlett Packard | DY5636 | H Band Generator/Test Set 7.1 to 8.5Gc 1000.00 |
| Tektronix | 491 | Spectrum Analyzer Solid State 10Mc to 40Gc. 7000.00 |
| Micro Tel | MSR903 | Microwave Receiver to 40Gc Digital Readout 9000.00 |
| Tektronix | 190B | Signal Generator 350KHz to 50Mc 150.00 |
| Telonic | 2003 | Sweep/Signal Generator Systems 3305 5 to 1500Mc Autoplex,2/3323 1 to 2000Mc Variable Marker,3340 RF/Output Attenuator 50 ohms,3350 RF Detector,3360A Rate Modulation,3370Display Procoessing. 1000.00 |
| Telonic | 2003 | Sweep/Signal Generator Systems 3303 5 to 500Mc Sweep,3323 1 to 2000Mc Variable Marker,3343 RF/Output 50 ohms,3340 RF Output/Attenuator 50 ohms,3350 RF Detector,3360A Rate Modulation,3370 Display Processing. 750.00 |

| MICROWAVE COMPONENTS | | | |
|---------------------------------|----------------|---|----------|
| Narda | 3004-20 | Directional Coupler 4 to 10Gc 20dB 100.00 | |
| Narda | 3032 | Hybrid .95 to 2Gc 3dB 150.00 | |
| Narda | 3033 | Hybrid 2 to 4Gc 3dB 150.00 | |
| Narda | 3039-20 | Directional Coupler 125 to 250Mc 20dB 150.00 | |
| Narda | 3040-20 | Directional Coupler 240 to 500Mc 20dB 125.00 | |
| Narda | 3043-20 | Directional Coupler 2 to 4Gc 20dB 100.00 | |
| Narda | 3044-20 | Directional Coupler 4 to 8Gc 20dB 100.00 | |
| Narda | 3044B20 | Directional Coupler 3.7 to 8.3Gc 20dB 150.00 | |
| Narda | 3045C30 | Directional Coupler 7 to 12.4Gc 30dB 125.00 | |
| Narda | 4035 | Hybrid 3dB 150.00 | |
| Narda | 22006/ | 3043-20 Directional Coupler 1.7 to 4Gc 20dB 100.00 | |
| Narda | 22007/ | 3043-30 Directional Coupler 1.7 to 4Gc 30dB 100.00 | |
| Narda | 22011/ | 3003-10 Directional Coupler 2 to 4Gc 10dB 100.00 | |
| Narda | 22012/ | 3003-30 Directional Coupler 2 to 4Gc 30dB 100.00 | |
| Narda | 22377 | Adapter X to N 8.2 to 12.4Gc 35.00 | |
| Narda | 22538/ | 4014-10 Directional Coupler 3.85 to 8Gc 10dB 75.00 | |
| Narda | 22539/ | 4015C10 Directional Coupler 7.4 to 12Gc 10dB 85.00 | |
| Narda | 22540A/ | 4013C10 Directional Coupler 2 to 4Gc 10dB 75.00 | |
| Narda | 22574 | Directional Coupler 2 to 4Gc 10dB 100.00 | |
| Narda | 22689 | Directional Coupler 15.8 to 17.3Gc 125.00 | |
| Narda | 22876/ | 4014C6 Directional Coupler 3.85 to 8Gc 6dB 100.00 | |
| Narda | 23105/ | 4015C30 Directional Coupler 7 to 12.4Gc 30dB 100.00 | |
| Norsal | 14064-30 | Directional Coupler 6 to 10Gc 30dB 75.00 | |
| PRD | C101 | Variable Attenuator 5.85 to 8.2Gc 0 to 60dB 350.00 | |
| PRD | U101 | Variable Attenuator 12.4 to 18Gc 0 to 60dB 300.00 | |
| PRD | 205A | Slotted Line with Probe 4 to 10Gc 100.00 | |
| PRD | 585A | Frequency Meter 8.2 to 10Gc 125.00 | |
| PRD | K3414 | 90° Twist 18 to 26.5Gc 50.00 | |
| PRD | 5815 | Wavemeter 7 to 10.6Gc 75.00 | |
| PRD | N6001 | Crystal Switch 50.00 | |
| PRD | X6284 | Thermistor Mount 8.2 to 12.4Gc 125.00 | |
| Quantatron | S100 | Rodstub Tuner 50.00 | |
| RLC | A-2610C | Variable Attenuator 50.00 | |
| Radar Design | D1536 | Directional Coupler 75.00 | |
| Sage | 752-3 | Coupler 25.00 | |
| Sage | 2503 | Mixer 25.00 | |
| Sage | 7753-3 | Directional Coupler 4 to 6Gc 3dB 50.00 | |
| Sperry Microline | 12G1 | Frequency Meter 5.84 to 8.2Gc 200.00 | |
| Stoddart | 90515 | 10dB Attenuator 35.00 | |
| Systron Donner | DBE319A | Tunable Detector 18 to 26.5Gc 200.00 | |
| Tektronix | S1 | Sampling Head Call | |
| Tektronix | S2 | Sampling Head Call | |
| Tektronix | S50 | Pulse Generator Head Call | |
| Tektronix | B170A | 170 ohm Variable Attenuator 50.00 | |
| Telonic | TBP417-34-5CD2 | Bandpass Filter 15.00 | |
| Texscan | 5VF250-500-1AA | Tunable Bandpass Filter 250 to 500Mc 250.00 | |
| Transco | 919C70100 | SPDT Switch 25.00 | |
| Waveline | 601 | Adapter X to TNC 8.2 to 12.4Gc 35.00 | |
| Waveline | 9009-10 | Directional Coupler 4 to 10Gc 10dB 100.00 | |
| Wavetek | 5070 | 0 to 70dB Variable Attenuator 75.00 | |
| Weinschel Eng. | 2692 | +30 to 60dB Vairable Attenuator 50.00 | |
| Microwave Equipment Manufacture | Model | Description | Price |
| PRD | 219/3302/ | 20 to 1000MHz | |
| | 3302L/1106A | Standing Wave Detector and Matched Load | \$250.00 |
| Hewlett Packard | 805A | Slotted Line 500MHz to 4GHz | 200.00 |
| Hewlett Packard | 805C | Slotted Line 500MHz to 4GHz | 400.00 |
| Hewlett Packard | 809B with | 806B Slotted Line 3 to 12GHz/810B Slotted Line 3.95 to 5.85GHz/810B Slotted Line 5.85 to 8.2GHz/X810B Slotted Line 8.2 to 12.4GHz/P810B Slotted Line 12.4 to 18GHz/X281A & H281A Adapter/HX292B Tapered Transition/444A Probe 2.6 to 18GHz/and a 447B Probe/H810B Slotted Line 7.05 to 10.5 | 900.00 |
| Hewlett Packard | 809B with | 806B Slotted Line 3 to 12GHz/H810B Slotted Line 7.05 to 10.5GHz/X810B Slotted Line 8.2 to 12.4GHz/HX292B Tapered Transition H to X/H281A & X281A/with Probe. 444A | 550.00 |

MHz electronics

Toll Free Number
800-528-0180
(For orders only)

(602) 242-8916
2111 W. Camelback
Phoenix, Arizona 85015



FULL LINE ALL PARTS & COMPUTER PRODUCTS

P.O. Box 4430M Santa Clara, CA 95054

Will calls: 2322 Walsh Ave. (408) 988-1640

160

Same day shipment. First line parts only. Factory tested. Guaranteed money back. Quality IC's and other components at factory prices.

INTEGRATED CIRCUITS

Phone orders only (800) 538-8196

Table listing various electronic components including integrated circuits, RAM, MOS-Memory, ROM, IC sockets, wire wrap level, microprocessors, keyboard encoders, and interface kits.



RCA Cosmac 1802 Super Elf Computer \$106.95

The Super Elf is a small single board computer that does many big things. It's an excellent computer for training and for learning programming with its machine language and yet it's easily expanded with additional memory, Full Basic, ASCII Keyboards, video character generation, etc.

for PC cards and a 50 pin connector slot for the Quest Super Expansion Board. Power supply and sockets for all IC's are included plus a detailed 127 pg. instruction manual which now includes over 40 pgs. of software info.

ROM monitor; State and Mode displays; Single step; Optional address displays; Power Supply; Audio Amplifier and Speaker; Fully socketed for all IC's; Full documentation.

Remember, other computers only offer Super Elf features at additional cost or not at all. Compare before you buy. Super Elf Kit \$106.95, High address option \$8.95, Low address option \$9.95.

The Super Elf includes a ROM monitor for program loading, editing and execution with SINGLE STEP for program debugging which is not included in others at the same price.

Questdata, a software publication for 1802 computer users is available by subscription for \$12.00 per 12 issues. Single issues \$1.50. Issues 1-12 bound \$16.50.

An RCA 1861 video graphics chip allows you to connect to your own TV with an inexpensive video modulator to do graphics and games.

Moews Video Graphics \$3.50, Games and Music \$3.00, Chip 8 Interpreter \$5.50, Starship 4K cassette \$14.95.

A 24 key HEX keyboard includes 16 HEX keys plus load, reset, run, wait, input, memory protect, monitor select and single step.

Super Expansion Board with Cassette Interface \$89.95

This is truly an astounding value! This board has been designed to allow you to decide how you want it optioned. The Super Expansion Board comes with 4K of low power RAM fully addressable anywhere in 64K with built-in memory protect and a cassette interface.

gram bugs quickly, then follow with single step. If you have the Super Expansion Board and Super Monitor the monitor is up and running at the push of a button.

A 1K Super ROM Monitor \$19.95 is available as an on board option in 2708 EPROM which has been preprogrammed with a program loader/editor and error checking multi file cassette read/write software.

Other on board options include Parallel Input and Output Ports with full handshake. They allow easy connection of an ASCII keyboard to the input port.

ELECTRONIC SYSTEM KITS

Apple Peripheral Kits SERIAL I/O INTERFACE 0 to 30,000 baud, D.T.R., Input & output from monitor or basic, or use Apple as intelligent terminal.

Z80 Microcomputer

16 bit I/O, 2 MHz clock, 2K RAM, ROM Bread-board space. Excellent for control. Bare Board \$28.50. Full Kit \$99.00. Monitor \$20.00. Power Supply Kit \$35.00. Tiny Basic \$30.00.

Modem Kit \$60.00

State of the art, orig., answer. No tuning necessary. 103 compatible 300 baud. Inexpensive acoustic coupler plans included. Bd. only \$17.00. Article in June Radio Electronics.

60 Hz Crystal Time Base Kit \$4.40

Converts digital clocks from AC line frequency to crystal time base. Outstanding accuracy.

Video Modulator Kit \$9.95

Convert TV set into a high quality monitor w/o affecting usage. Comp. kit w/full instr.

Rockwell AIM 65 Computer

6502 based single board with full ASCII keyboard and 20 column thermal printer. 20 char. alphanumeric display ROM monitor, fully expandable, \$419.00. 4K version \$449.00. 4K Assembler \$35.00. 8K Basic Interpreter \$65.00.

Quest Super Basic V5.0

A new enhanced version of Super Basic now available. Quest was the first company worldwide to ship a full size Basic for 1802 Systems. A complete function Super Basic by Ron Cenker including floating point capability with scientific notation (number range ±.17E⁹⁹), 32 bit integer ±2 billion; multi dim arrays, string arrays; string manipulation; cassette I/O; save and load, basic, data and machine language programs; and over 75 statements, functions and operations.

Type-N-Talk by Votrax

Text to speech synthesizer with unlimited vocabulary, built-in text to speech algorithm, 70 to 100 bits per second speech synthesizer, RS232C interface \$369.00.

1802 16K Dynamic RAM Kit \$149.00

Expandable to 64K. Hidden refresh w/clocks up to 4 MHz w/no wait states. Addl. 16K RAM \$25.00. S-100 4-slot expansion \$ 9.95 Super Monitor V1.1 Source Listing \$15.00

Multi-volt Computer Power Supply

8v 5 amp. ±18v 5 amp. 5v 1.5 amp. -5v 5 amp. 12v 5 amp. -12v option. ±5v, ±12v are regulated. Basic Kit \$35.95. Kit with chassis and all hardware \$51.95. Add \$5.00 shipping. Kit of hardware \$16.00. Woodgrain case \$10.00. \$1.50 shipping.

Super Color S-100 Video Kit \$129.95

Expandable to 256 x 192 high resolution color graphics. 6847 with all display modes computer controlled. Memory mapped. 1K RAM expandable to 6K. S-100 bus 1802, 8080, 8085, Z80, etc. Dealers: Send for excellent pricing/margin program.

Elf II Adapter Kit \$24.95

Plugs into Elf II providing Super Elf 44 and 50 pin plus S-100 bus expansion. (With Super Expansion). High and low address displays, state and mode LED's optional \$18.00.

TERMS: \$5.00 min. order U.S. Funds. Calif. residents add 6% tax. \$10.00 min. VISA and MasterCard accepted. \$1.00 insurance optional. Shipping: Add 5%; orders under \$25.00—10%.

FREE: Send for your copy of our NEW 1981 QUEST CATALOG. Include 88¢ stamp.

ramsey

the first name in Counters!



9 DIGITS 600 MHz \$129⁹⁵ WIRED

PRICES:

| | |
|--------------------------------------|----------|
| CT-90 wired, 1 year warranty | \$129.95 |
| CT-90 Kit, 90 day parts warranty | 109.95 |
| AC-1 AC adapter | 3.95 |
| BP-1 Nicad pack + AC Adapter/Charger | 12.95 |
| OV-1, Micro-power Oven time base | 49.95 |
| External time base input | 14.95 |

The CT-90 is the most versatile, feature packed counter available for less than \$300.00! Advanced design features include; three selectable gate times, nine digits, gate indicator and a unique display hold function which holds the displayed count after the input signal is removed! Also, a 10MHz TCXO time base is used which enables easy zero beat calibration checks against WWV. Optionally; an internal nicad battery pack, external time base input and Micro-power high stability crystal oven time base are available. The CT-90, performance you can count on!

SPECIFICATIONS:

| | |
|--------------|--|
| Range: | 20 Hz to 600 MHz |
| Sensitivity: | Less than 10 MV to 150 MHz Less than 50 MV to 500 MHz |
| Resolution: | 0.1 Hz (10 MHz range) 1.0 Hz (60 MHz range) 10.0 Hz (600 MHz range) |
| Display: | 9 digits 0.4" LED |
| Time base: | Standard-10.000 MHz, 1.0 ppm 20-40°C. Optional Micro-power oven-0.1 ppm 20-40°C |
| Power: | 8-15 VAC @ 250 ma |

7 DIGITS 525 MHz \$99⁹⁵ WIRED



SPECIFICATIONS:

| | |
|--------------|--|
| Range: | 20 Hz to 525 MHz |
| Sensitivity: | Less than 50 MV to 150 MHz Less than 150 MV to 500 MHz |
| Resolution: | 1.0 Hz (5 MHz range) 10.0 Hz (50 MHz range) 100.0 Hz (500 MHz range) |
| Display: | 7 digits 0.4" LED |
| Time base: | 1.0 ppm TCXO 20-40°C |
| Power: | 12 VAC @ 250 ma |

The CT-70 breaks the price barrier on lab quality frequency counters. Deluxe features such as; three frequency ranges - each with pre-amplification, dual selectable gate times, and gate activity indication make measurements a snap. The wide frequency range enables you to accurately measure signals from audio thru UHF with 1.0 ppm accuracy - that's .0001%! The CT-70 is the answer to all your measurement needs, in the field, lab or ham shack.

PRICES:

| | |
|--------------------------------------|---------|
| CT-70 wired, 1 year warranty | \$99.95 |
| CT-70 Kit, 90 day parts warranty | 84.95 |
| AC-1 AC adapter | 3.95 |
| BP-1 Nicad pack + AC adapter/charger | 12.95 |



7 DIGITS 500 MHz \$79⁹⁵ WIRED

PRICES:

| | |
|--|---------|
| MINI-100 wired, 1 year warranty | \$79.95 |
| AC-Z Ac adapter for MINI-100 | 3.95 |
| BP-Z Nicad pack and AC adapter/charger | 12.95 |

Here's a handy, general purpose counter that provides most counter functions at an unbelievable price. The MINI-100 doesn't have the full frequency range or input impedance qualities found in higher price units, but for basic RF signal measurements, it can't be beat! Accurate measurements can be made from 1 MHz all the way up to 500 MHz with excellent sensitivity throughout the range, and the two gate times let you select the resolution desired. Add the nicad pack option and the MINI-100 makes an ideal addition to your tool box for "in-the-field" frequency checks and repairs.

SPECIFICATIONS:

| | |
|--------------|---|
| Range: | 1 MHz to 500 MHz |
| Sensitivity: | Less than 25 MV |
| Resolution: | 100 Hz (slow gate) 1.0 KHz (fast gate) |
| Display: | 7 digits, 0.4" LED |
| Time base: | 2.0 ppm 20-40°C |
| Power: | 5 VDC @ 200 ma |

8 DIGITS 600 MHz \$159⁹⁵ WIRED



SPECIFICATIONS:

| | |
|--------------|---|
| Range: | 20 Hz to 600 MHz |
| Sensitivity: | Less than 25 mv to 150 MHz Less than 150 mv to 600 MHz |
| Resolution: | 1.0 Hz (60 MHz range) 10.0 Hz (600 MHz range) |
| Display: | 8 digits 0.4" LED |
| Time base: | 2.0 ppm 20-40°C |
| Power: | 110 VAC or 12 VDC |

The CT-50 is a versatile lab bench counter that will measure up to 600 MHz with 8 digit precision. And, one of its best features is the Receive Frequency Adapter, which turns the CT-50 into a digital readout for any receiver. The adapter is easily programmed for any receiver and a simple connection to the receiver's VFO is all that is required for use. Adding the receiver adapter in no way limits the operation of the CT-50, the adapter can be conveniently switched on or off. The CT-50, a counter that can work double-duty!

PRICES:

| | |
|---|----------|
| CT-50 wired, 1 year warranty | \$159.95 |
| CT-50 Kit, 90 day parts warranty | 119.95 |
| RA-1, receiver adapter kit | 14.95 |
| RA-1 wired and pre-programmed (send copy of receiver schematic) | 29.95 |



DIGITAL MULTIMETER \$99⁹⁵ WIRED



PRICES:

| | |
|---------------------------------------|---------|
| DM-700 wired, 1 year warranty | \$99.95 |
| DM-700 Kit, 90 day parts warranty | 79.95 |
| AC-1, AC adaptor | 3.95 |
| BP-3, Nicad pack + AC adapter/charger | 19.95 |
| MP-1, Probe kit | 2.95 |

The DM-700 offers professional quality performance at a hobbyist price. Features include; 26 different ranges and 5 functions, all arranged in a convenient, easy to use format. Measurements are displayed on a large 3 1/2 digit, 1/2 inch LED readout with automatic decimal placement, automatic polarity, overrange indication and overload protection up to 1250 volts on all ranges, making it virtually goof-proof! The DM-700 looks great, a handsome, jet black, rugged ABS case with convenient retractable tilt bail makes it an ideal addition to any shop.

SPECIFICATIONS:

| | |
|------------------|----------------------------------|
| DC/AC volts: | 100uV to 1 KV, 5 ranges |
| DC/AC current: | 0.1uA to 2.0 Amps, 5 ranges |
| Resistance: | 0.1 ohms to 20 Megohms, 6 ranges |
| Input impedance: | 10 Megohms, DC/AC volts |
| Accuracy: | 0.1% basic DC volts |
| Power: | 4 'C' cells |

AUDIO SCALER

For high resolution audio measurements, multiplies UP in frequency.

- Great for PL tones
- Multiplies by 10 or 100
- 0.01 Hz resolution!

\$29.95 Kit \$39.95 Wired

ACCESSORIES

| | |
|---|---------|
| Telescopic whip antenna - BNC plug | \$ 7.95 |
| High impedance probe, light loading | 15.95 |
| Low pass probe, for audio measurements | 15.95 |
| Direct probe, general purpose usage | 12.95 |
| Tilt bail, for CT 70, 90, MINI-100 | 3.95 |
| Color burst calibration unit, calibrates counter against color TV signal. | 14.95 |

COUNTER PREAMP

For measuring extremely weak signals from 10 to 1,000 MHz. Small size, powered by plug transformer-included.

- Flat 25 db gain
- BNC Connectors
- Great for sniffing RF with pick-up loop

\$34.95 Kit \$44.95 Wired

ramsey electronic's, inc.
2575 Baird Rd. Penfield, NY 14526

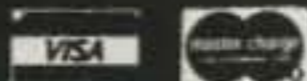

PHONE ORDERS
CALL 716-586-3950

TERMS

Satisfaction guaranteed - examine for 10 days. If not pleased return in original form for refund. Add 5% for shipping insurance to a maximum of \$10. Overseas add 15% COD add \$2. Orders under \$10 add \$1.50 NY residents add 7% tax.

SEMICONDUCTORS SURPLUS

2822 North 32nd Street, #1 • Phoenix, Arizona 85008 • Phone 602-956-9423

MINIMUM ORDER \$10.00 NOT INCLUDING SHIPPING

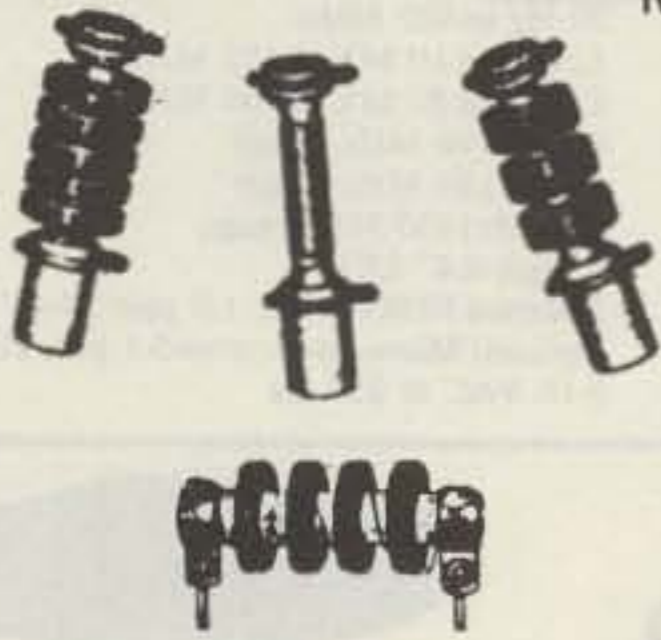

CHOKES AND INDUCTORS

4/1.00

| | |
|--------|--------|
| .3 uH | 82 uH |
| .56 uH | 91 uH |
| 1.8 uH | 180 uH |
| 2 uH | 220 uH |
| 3.1 uH | 270 uH |
| 6.6 uH | 410 uH |
| 52 uH | 450 uH |
| 55 uH | |

2/1.00

| | |
|--------|-------|
| 2.4 mH | 68 mH |
| 22 mH | |

Miller 9055
50-120 uH \$2.50

Summita 20K359
455 kc discrimination
Miller #8806/34H-650 \$2.50



TUBES

| | |
|-----------------|---------|
| 6KD6 | \$ 5.00 |
| 6LQ6/6JE6 | 6.00 |
| 6MJ6/6LQ6/6JE6C | 10.00 |
| 6LF6/6MH6 | 6.60 |
| 12BY7A | 4.00 |
| 2E26 | 4.69 |
| 4X150A | 29.99 |
| 4CX250B | 45.00 |
| 4CX250R | 69.00 |
| 4CX300A | 109.99 |

| | |
|----------------|--------|
| 4CX350A/8321 | 100.00 |
| 4CX350F/J/8904 | 100.00 |
| 4CX1500B/8660 | 300.00 |
| 811A | 20.00 |
| 6360 | 4.69 |
| 6939 | 30.00 |
| 6146 | 7.95 |
| 6146A | 9.00 |
| 6146B/8298 | 9.99 |
| 6146W | 12.95 |
| 6550A | 10.00 |
| 8908 | 14.00 |
| 8950 | 13.00 |
| 4-400A | 145.00 |
| 4-400C | 145.00 |
| 572B/T160L | 44.00 |
| 7289 | 39.99 |
| 3-1000Z | 229.00 |
| 3-500Z | 141.00 |

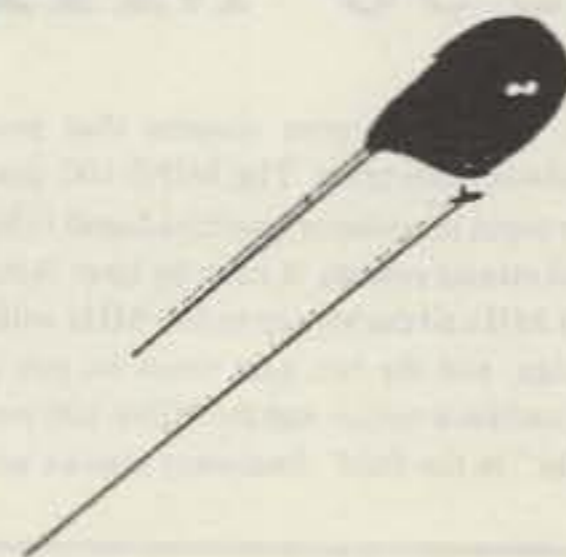

CAPACITORS

DIPPED SILVER MICA CAPACITORS

| | | | |
|-------|-------|--------|-------|
| 5pF | \$.40 | 120pF | \$.25 |
| 10pF | .25 | 150pF | .25 |
| 12pF | .30 | 210pF | .40 |
| 15pF | .30 | 250pF | .40 |
| 20pF | .25 | 330pF | .40 |
| 22pF | .25 | 470pF | .40 |
| 24pF | .25 | 500pF | .40 |
| 33pF | .25 | 560pF | .40 |
| 50pF | .25 | 620pF | .40 |
| 75pF | .25 | 820pF | .50 |
| 82pF | .25 | 6800pF | 1.00 |
| 100pF | .25 | | |

Quantity pricing also.

ASSORTMENTS

Electrolytic Caps.
All types (new).
50 pcs. \$6.99

Capacitors, Resistors & Diodes
Assortment
(All New) (Not Junk)
100 pcs. 4.00
250 pcs. 7.00

500 pcs. 12.00
1000 pcs. 20.00
LED Display
FND 357, 362 red
C. C. 2/1.00
TIL312 LED Display
Red 2/1.29
Assorted Heat Sinks—3 each.
For TO-3, TO-220, TO-66 & TO-5.
12/1.99

Assorted Potentiometers
"All new" not junk. Some with switch,
some with 1/4" shaft.
#S.S. 283 30 for 4.00
#S.S. 284 100 for 10.00
New Miniature Toggle & Rocker
Switch—25 mix. \$6.99

New Assorted Toroid Cores
10 big & small 4.00
TO-3 and TO-66 Used Power Transistors
High voltage switching in CRT's.
30 pcs. Good/Bad? \$ 2.00
100 pcs. 10.00

Hardware Assortment
1 pound mixed screws, standoffs,
washers, feet, insulator 5.00
IC Assortment
50 New IC's. Not Junk.
7400/S/LS Linear, DTL/RTL etc. \$10.00

House numbered AY5-2376
Keyboard encoder chip—88 (keys)
same as DR 2376 6.99 each
5 Way DC Voltage Adapter
Selective voltage: 6, 9, and 12VDC.
Input voltage—115VAC \$9.99

WALL TYPE TRANSFORMERS
115 VAC input
6 VAC @ 10 MA.....2.99
12 V @ 700 MA.....4.99
15 V @ 300 MA.....3.99
115 VAC & 220 VAC input
15 V @ 300 MA.....3.99

DL-1416
4-Digit 16 Segment Alphanumeric
Intelligent Display with Memory,
Recorder, Driver \$14.95 each
Fuse Holders
HKP type for 3AG .89 each
UHF Varactor Tuners—Sony
19.99 each

Teledyne Serendip
Solid State Dip Relay
Part #A641-1 2.49 each

RCA TRANSISTORS
80684
40235
AMPEREX/MOTOROLA
RF TRANSISTOR
BFR91 .75
MRF901 2.00

| RF Transistors | | | | | | | | | |
|----------------|--------|--------------------|-------|--------------------|-------|------------------|---------|-------|-----|
| MRF203 | P.O.R. | BFW92 | 1.00 | 2N5849 | 20.00 | SN7428N | .25 | | |
| MRF216 | 31.00 | MMCM918 | 14.30 | 2N5942 | 40.00 | Z80CPU | 4.99 | | |
| MRF221 | 10.90 | MMCM2222 | 15.65 | 2N5946 | 19.00 | 2708-6 | 1.00 | | |
| MRF226 | 12.65 | MMCM2369 | 15.00 | 2N5862 | 57.50 | 2516/2716 | 2.50 | | |
| MRF227 | 3.45 | MMCM2484 | 15.25 | 2N6080 | 9.20 | 2732-6 | 10.00 | | |
| MRF238 | 12.65 | MMCM3960A | 24.30 | 2N6081 | 10.35 | 2102 | .50 | | |
| MRF240 | 15.50 | MWA110 | 10.00 | 2N6082 | 11.50 | 2114-2 & 3 | 8/16.00 | | |
| MRF245 | 34.00 | MWA120 | 10.00 | 2N6083 | 13.25 | 4104 | 8/16.00 | | |
| MRF247 | 34.00 | MWA130 | 10.00 | 2N6084 | 15.00 | D2116/4116 | 8/18.00 | | |
| MRF262 | 9.20 | MWA210 | 10.00 | 2N6095 | 12.00 | D8257 | 3.00 | | |
| MRF314 | 20.70 | MWA220 | 10.00 | 2N6096 | 15.50 | MC6845 | 10.00 | | |
| MRF406 | 13.80 | MWA230 | 10.00 | 2N6097 | 17.25 | Z80CTC | 4.00 | | |
| MRF412 | 25.30 | MWA310 | 10.00 | 2N6166 | 40.25 | Z80SIO/O or // | 8.00 | | |
| MRF421 | 36.80 | MWA320 | 10.00 | 2N6368 | 28.75 | Z80PIO | 4.00 | | |
| MRF422A | 41.40 | | | A210/MRF517 | 2.00 | 74LS273 | .80 | | |
| MRF422 | 41.40 | Transistors | | BLY38 | 5.00 | 74LS373 | .80 | | |
| MRF428 | 46.00 | 2N2857 | 1.55 | 40280/2N4427 | 1.30 | 74LS374 | .80 | | |
| MRF428A | 46.00 | 2N2857JAN | 2.50 | 40281/2N3920 | 7.00 | 74LS245 | 1.40 | | |
| MRF426 | 15.50 | 2N2949 | 3.60 | 40282/2N3927 | 17.25 | 74LS367 | .40 | | |
| MRF426A | 15.50 | 2N2947 | 15.00 | MMT74 | 1.04 | 74LS14 | .60 | | |
| MRF449 | 12.65 | 2N2950 | 4.60 | IC SALE | | | | 78M05 | .39 |
| MRF449A | 12.65 | 2N3375 | 8.00 | 400CJ | 88 | 78L05 | .30 | | |
| MRF450 | 13.80 | 2N3553 | 1.57 | 2805HC/1405A | 1.00 | 78L15 | .30 | | |
| MRF450A | 13.80 | 2N3818 | 5.00 | 74LS27 | 25 | 78L08 | .30 | | |
| MRF452 | 15.00 | 2N3866 | 1.30 | P3101/82525/74S289 | 1.00 | 79L12 | .49 | | |
| MRF453/GE185 | 17.25 | 2N3866JAN | 2.50 | SCL4013A/BE | .25 | LM317T | 1.99 | | |
| MRF454 | 19.90 | 2N3866JANTX | 4.00 | MC14001BCP | .25 | MC7808T/LM340T-8 | .49 | | |
| MRF454A | 21.83 | 2N3925 | 10.00 | MC14017BCP | .75 | 7805/LM340T-5 | .89 | | |
| MRF455 | 16.00 | 2N3948 | 2.00 | MC14012BCP | .19 | 7812/LM340T-12 | .89 | | |
| MRF455A | 16.00 | 2N3950 | 25.00 | MC14023BCP | .20 | 7815/LM340T-15 | .89 | | |
| MRF458 | 19.90 | 2N3959 | 3.85 | MC14027BCP | .39 | 7824/LM340T-24 | .89 | | |
| MRF472 | 1.00 | 2N3960JANTX | 10.00 | MC14069BCP | .39 | D8202 | 20.00 | | |
| MRF474 | 3.00 | 2N4072 | 1.80 | MC14093BCP | .60 | D8212 | 1.00 | | |
| MRF475 | 2.90 | 2N4427 | 1.30 | MC3420P | 1.00 | D8214 | 2.00 | | |
| MRF476/C1306 | 2.90 | 2N4429 | 7.00 | MCM10152L | 5.00 | 8251 | 3.00 | | |
| MRF477 | 11.50 | 2N4877 | 1.00 | MC7408P | .19 | TMS1000NL | 2.00 | | |
| MRF485 | 3.00 | 2N4959 | 2.30 | 74LS05PC | .20 | MC1306P | .75 | | |
| MRF492 | 23.00 | 2N4976 | 15.00 | AD580 | 1.00 | MC1414L | .29 | | |
| MRF502 | 1.04 | 2N5070 | 18.40 | 8T01B | .60 | LM/SN1458V | .40 | | |
| MRF604 | 2.07 | 2N5071 | 20.70 | CH164A | .25 | LM555V | .30 | | |
| MRF629 | 3.45 | 2N5108 | 4.00 | CG388V | .25 | LM309K/7805CK | 1.00 | | |
| MRF648 | 33.35 | 2N5109 | 1.70 | 74LS20F | .20 | MC6852P | 3.00 | | |
| MRF901 | 2.15 | 2N5179 | 1.00 | 748SN | .39 | RC74LS51N | .15 | | |
| MRF902 | 8.00 | 2N5583 | 4.00 | DS0026CH | 1.00 | SN74LS74N | .20 | | |
| MRF904 | 3.00 | 2N5589 | 8.65 | CD 4013BCN | .30 | PT 1482B | 2.00 | | |
| MRF911 | 3.00 | 2N5590 | 10.35 | CD 4028AE | .49 | EC 1422B | 2.00 | | |
| MRF5176 | 3.00 | 2N5591 | 13.80 | CD 4040 BCN | .80 | LA 4220 Sanyo | 1.00 | | |
| MRF8004 | 2.10 | 2N5635 | 10.35 | CD 4069CN/74C74 | .30 | SN75427N | .30 | | |
| BFR90 | 1.30 | 2N5636 | 12.00 | MM74C74N | .40 | N8T28N/MC6889 | 1.00 | | |
| BFR91 | 1.65 | 2N5637 | 15.50 | CD 4015CN | .75 | D3232/MC3232 | 1.00 | | |
| BFR96 | 2.20 | 2N5641 | 9.20 | DS/DM 8839N | .60 | | | | |
| BFW92A | 1.15 | 2N5643 | 15.50 | DM 75L51N | .75 | | | | |
| | | 2N5645 | 13.80 | TLO-61CP | .30 | | | | |
| | | 2N5842 | 8.00 | | | | | | |

ORDERING INSTRUCTIONS

Check, money order, or credit cards welcome. (Master Charge and VISA only.) No personal checks or certified personal checks for foreign countries accepted. Money order or cashiers check in U.S. funds only. Letters of credit are not acceptable. C.O.D.—\$2.25 + \$2.35 shipping.

Minimum shipping by UPS is \$2.35 + .35 per \$100.00 for insurance. Please allow extra shipping charges for heavy or long items.

All parts returned due to customer error or decision will be subject to a 15% restock charge. If we are out of an item ordered, we will try to replace it with an equal or better part unless you specify not to, or we will back order the item, or refund your money.

PRICES ARE SUBJECT TO CHANGE WITHOUT NOTICE. Prices supersede all previously published. Some items offered are limited to small quantities and are subject to prior sale.

We now have a toll free number, but we ask that it be used for *charge orders only*. If you have any questions, please use our other number. We are open from 8:00 am-5:00 p.m. Monday thru Saturday.

Our toll free number for *charge orders only* is 800-528-3611.

MINIMUM ORDER \$10.00 NOT INCLUDING SHIPPING

SEMICONDUCTORS SURPLUS

2822 North 32nd Street, #1 • Phoenix, Arizona 85008 • Phone 602-956-9423

BULLET ELECTRONICS

P.O. BOX 401244E GARLAND, TX 75040 214/278-3553

★ SUPERSTAR SALE! ★

ALL ITEMS WITH STARS
BUY 3 GET ONE FREE

(No Mixing)
OFFER EXPIRES JAN. 31, 1982 ★

★ Sound Effects Kit \$18.50★

The SE-01 Sound Effects Kit has all you need to build a programmable sound effects machine except a battery and speaker. Only the SE-01 provides you with additional circuitry that includes a Pulse Generator, Mux Oscillator and Comparator to make more complex sounds a snap. Includes T176477, (w/specs) assembly instructions and programming examples. You can easily create Gunshots, Explosions, Steam Trains, Wind & Surf and much more.

Complete Kit \$18.50

With quality PC Board
(Less battery & spkr.)

76477 Chip is Included
Extra chips

\$3.15 ea.

★ ZULU II Clock Kit ★

\$19.95 LESS CASE

- 1/2" LED Readouts
- Quartz XTAL Timebase
- Calendar
- Unique NOX™ Circuit Will Display Readouts On Handclap
- Battery Backup (battery not included)
- High Quality Drilled & Plated PC Boards; Clear Instructions

★ PLASTIC CASE WITH FRONT & REAR PANELS FOR ZULU II \$4.95. ★

New! ★ Doomsday Alarm ★

If you have trouble sleeping and you would like the rest of the neighborhood to share your misery then this little kit will be for you! There is no way to accurately describe the unearthly howls, screams and tones that come out of this kit. Four separate tone oscillators are mixed, cancelled and stepped at a varying rate. 10 Watts of crazy sounds. A great fun kit or a practical burglar alarm. Complete with PC board and all necessary components less speaker. For 6-12 VDC.

9.95 ORDER
KIT DA-02

7 Watt Audio Amp Kit \$5.95

SMALL, SINGLE HYBRID IC AND COMPONENTS FIT ON A 2" x 3" PC BOARD (INCLUDED). RUNS ON 12VDC. GREAT FOR ANY PROJECT THAT NEEDS AN INEXPENSIVE AMP. LESS THAN 3% THD @ 5 WATTS. COMPATIBLE WITH SE-01 SOUND KIT

Overvoltage Protection Kit \$6.95

Protect your expensive equipment from overvoltage conditions. Every computer should have one! Works with any fused DC power source from 10 to 20 volts up to 25 amps.

Stereo AMP/Power Supply Board

Takes low level audio and drives 8 ohm speakers ON-BOARD Rectifiers and Filter supply power for AMP AND TUNER, VOLUME, BALANCE, and TONE SLIDE CONTROLS

PLUG COMPATIBLE with TUNER

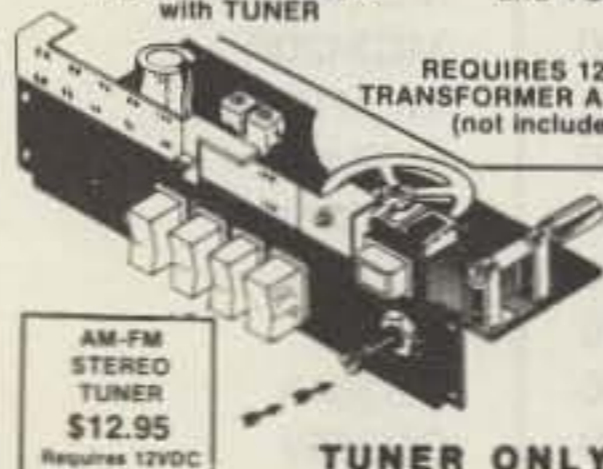

REQUIRES 12VAC TRANSFORMER AT 400 MA (not included) AMP ONLY \$6.95

AM-FM STEREO TUNER \$12.95 (Requires 12VDC)

TUNER ONLY

FEATURES: AM, FM Stereo, Phone Input, Aux Input, AC Cord, 300 Ohm Antenna Input, AM Loopstick Antenna, Standard Turntable Plugs. BUY 3 SETS (Tuner Amp combos) for \$50.00

See Special Fall Prices Below
PRICES GOOD THROUGH JAN. 31, 1982
SHOP EARLY FOR CHRISTMAS!

The Super Music Maker

REVISION 2
\$24.95

(Basic Kit)

Does not include speaker switches or 2708 ROM



Now you can play hundreds of songs using the Bullet Super Music Maker. The unit features a single factory programmed microprocessor IC that comes with 20 pre-programmed short tunes. By adding the additional PROMS (2708's) the system can be expanded to play up to 1000 notes per PROM. Just think... a compact electronic instrument that will play dozens, hundreds or even thousands of selections of music. The kit comes with all electronic components (less the PROM), and a drilled, plated and screened PC Board which measures 4" x 4 1/4". The 7 watt amplifier section is on the same PC board and drives an 8 ohm speaker (not included), from a whisper to ear splitting volume. Since the unit works on 12 VDC or 12 VAC*, vehicle or portable operation is possible. What do you get for \$24.95? Everything but a speaker, transformer, case, switches, and PROM. Additional 2708 albums containing popular tunes are available for \$15.00 each or you can program your own PROMS using information provided with the kit instructions. Lists of available PROM albums are available on request. (Note: Unit plays electronic music one note at a time, it is not possible to play chords or a melody with harmony simultaneously.)

* Envelope control gives decay to notes.

* On board inverter allows single voltage (+12) operation.

OPTIONAL ACCESSORIES

- DIP Switches One 8 pos., One 5 pos. 2.00/Set (Can be directly soldered to PC Bd. to access tunes)
- Rotary Switches Two 5 position 2.50/Set (For remote wiring to PC Bd. to access tunes)
- Attractive Plastic Case 6.50
- Wallplug Transformer 3.00 (For operation on 117VAC house voltage)

Microprocessor Station Clock \$49.95

The ZULU 3TZ is a full blown ROM and MICRO-PROCESSOR unlike other standard clock IC's, it allows exceptional flexibility. Almost a year in design, it is the most advanced station clock on the market.

Adjustable Brightness
.6" - High Intensity
Orange Led Readouts
Seconds Reset/Hold
provides easy
synchronization with
WWV

Quartz Crystal
Timebase and
Battery Backup

QUALITY SOLDER
MASKED & SCREENED
PC BOARDS MAKES
ASSEMBLY A SNAP

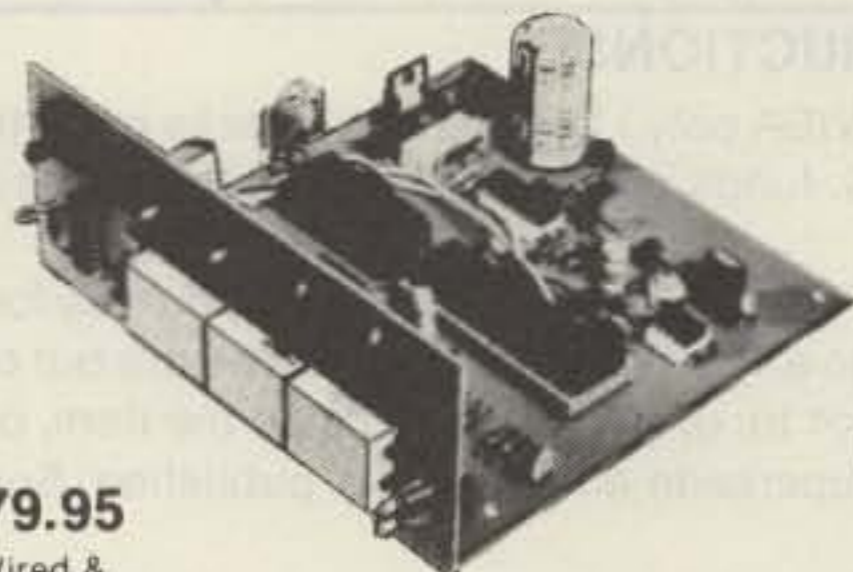

12 Volts
AC or DC

ZONE CHANGE FEATURE

Select one of three
World Time zones,
Local Time (12 Hr.
format) and TWO
24 hr. zones of
your choice.

RFI Protected

ID FEATURE

LED Indicator lights
when activated
flashes at 10 min.
Different audio
tones at
8 and 9 min.

\$49.95

Complete Kit
Including Case &
Wallplug XFMR
for 117VAC
Operation

\$79.95

Wired &
Tested

FALL SPECIALS: GOOD THRU JAN. '82

1. Super Music Maker with case and two 5-position rotary switches \$32.00
2. Super Music with one 2716 2K X 8 PROM filled with over 50 selections of additional music (>1500 notes) \$32.00
3. The Whole Ball of Wax! #2 + case and switches. \$39.95

PS 14 REGULATOR CARD KIT

This is the Regulator Card from our famous 20A Power Supply Kit. Although we ran out of the transformers and heatsinks, many customers have been able to locate their own. The regulator card performs the actual voltage regulation and has adjustable fold back current limiting. Output voltage is stable to 200MV from 0 to 20 Amps and adjustable from 11 to 14 Volts. Designed to drive 2 high current NPN transistors (2N3771 2N5301 or equiv.) The unit assembles quickly. Included are all the on board components including a driver transistor and over-temp shutdown sensor. Designed to screw down to a standard 3" diameter computer grade filter cap. The quality plated PC card is 3-1/2" x 4 3/4".

WITH INSTRUCTIONS

REGULATOR CARD KIT \$14.95

HIGH CURRENT PARTS \$5.00
(2 - 2N3772 & 25A Bridge)

51,000 MFD @ 40V Computer Grade \$3.50

Requires Transformer with 16 - 19 VAC Out @ The Current You Expect To Draw.

- ★ NO C.O.D.'s.
 - ★ SEND CHECK M.O. OR CHARGE CARD NO.
 - ★ PHONE ORDERS ACCEPTED ON VISA AND MASTERCARD ONLY.
 - ★ ADD 5% FOR SHIPPING.
 - ★ TX. RES. ADD 5% STATE SALES TAX.
 - ★ ALL FOREIGN ORDERS ADD 30% FOR SHIPPING CHARGES. U. S. FUNDS ONLY.
- (214) 278-3553

- FM • SSB • CW • ATV • OSCAR
- LINKS • REPEATERS • TRANSMITTERS
- RECEIVERS • PREAMPS • CONVERTERS
- TRANSCEIVERS • POWER SUPPLIES • PA'S

QUALITY VHF/UHF KITS AT AFFORDABLE PRICES

- NEW -

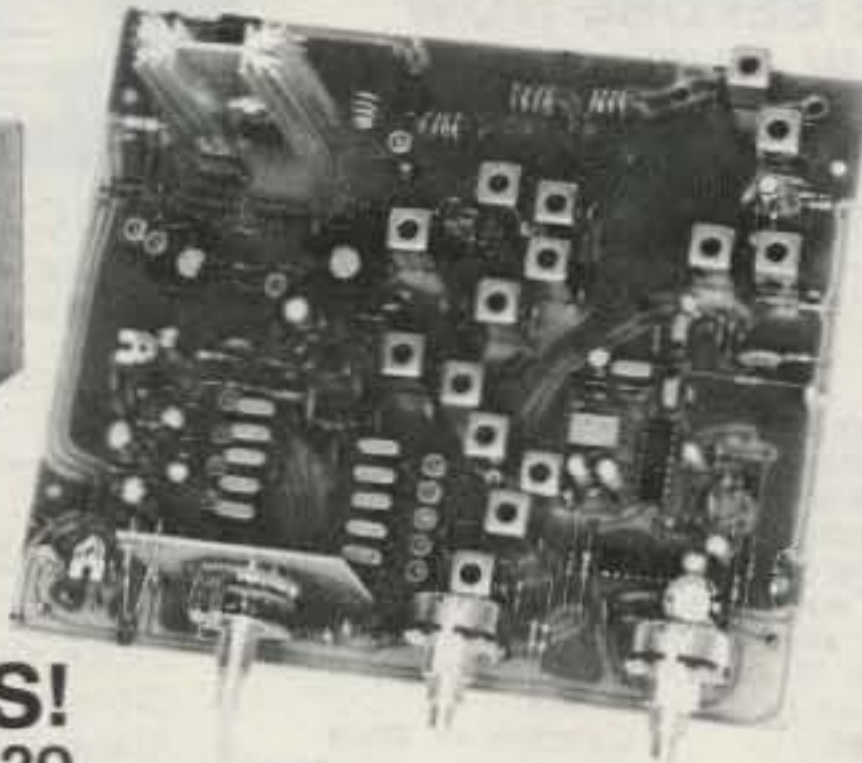

FM-5 PC Board Kit - ONLY \$159.95
complete with controls, heatsink, etc.

**SAVE A BUNDLE ON
VHF FM TRANSCEIVERS!**
10 watts, 5 Channels, for 6M, 2M, or 220

HOLIDAY SPECIAL
Free cabinet kit, complete with speaker, knobs, connectors, hardware. A \$59.95 value, yours free with purchase of kit before Jan. 30th. Hurry! Offer limited.

HIGH QUALITY FM MODULES FOR REPEATERS, LINKS, TELEMETRY, ETC.

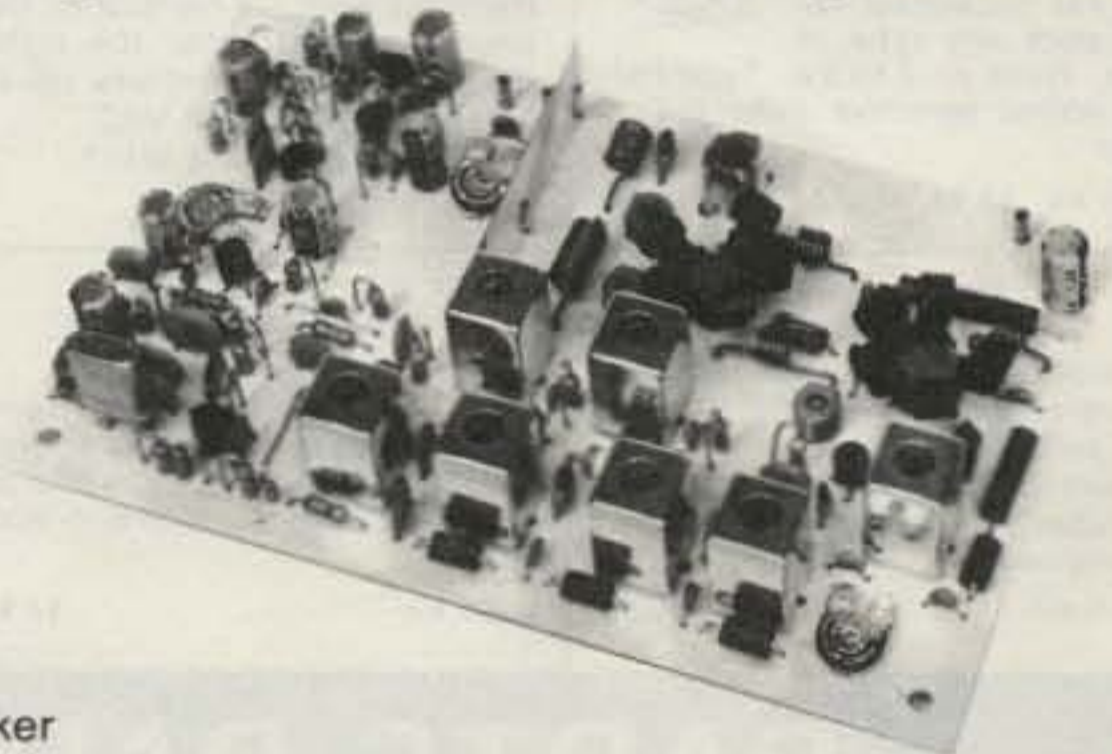
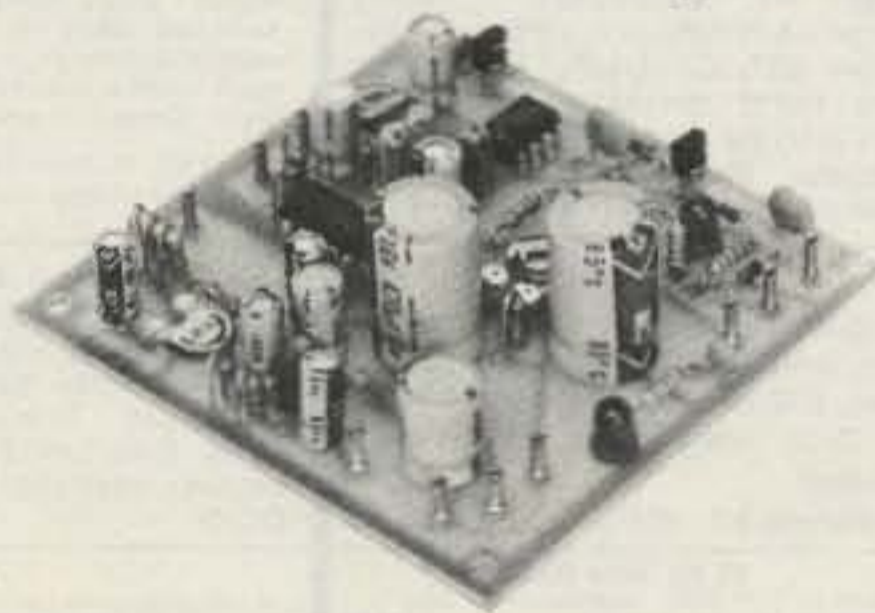
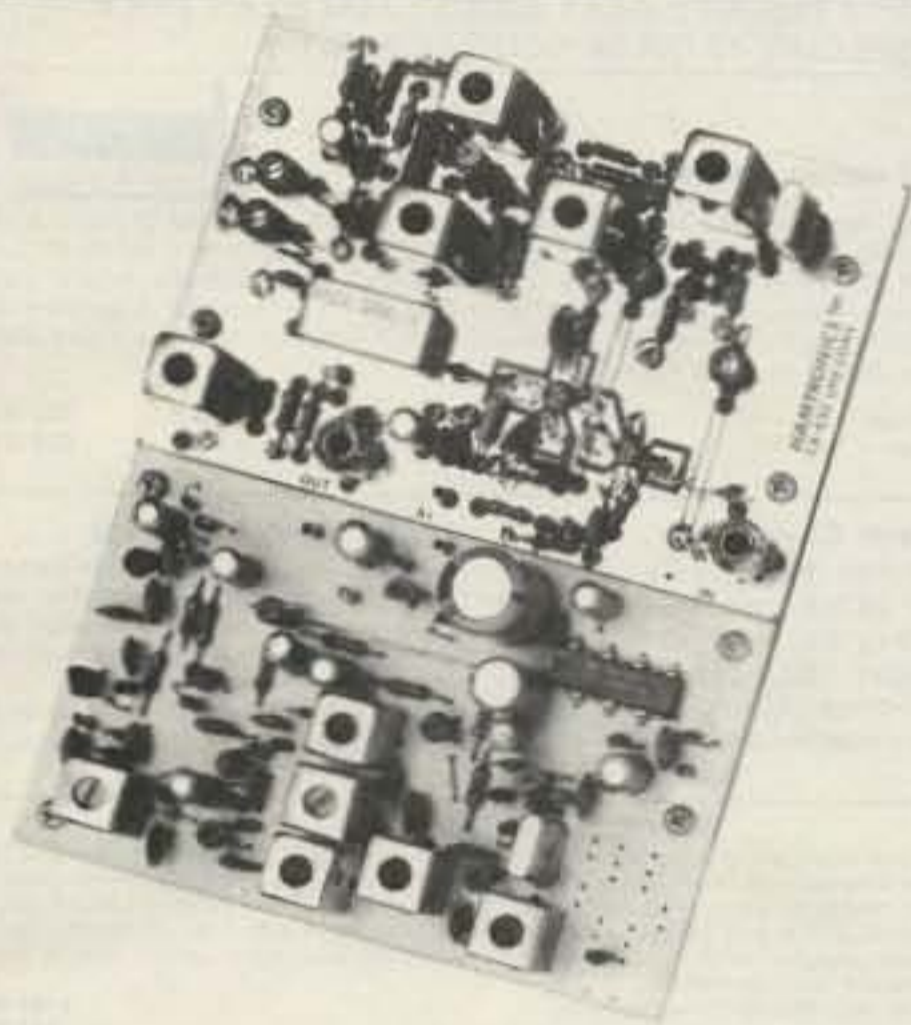

- **R75 VHF FM RECEIVER** for 10M, 6M, 2M, 220, or commercial bands. 4 fantastic selectivity options. Kits from \$84.95 to \$119.95
- **R450 UHF FM RECEIVER** for 380-520 MHz bands. Kits in selectivity options from \$94.95
- **R110 VHF AM RECEIVER** Kit for vhf aircraft band or ham bands. Only \$84.95.

- **COR KITS** With audio mixer and speaker amplifier. Only \$29.95.
- **CWID KITS** 158 bits, field programmable, clean audio. Only \$59.95.
- **A16 RF TIGHT BOX** Deep drawn alum. case with tight cover and no seams. 7 x 8 x 2 inches. Only \$18.00.
- **SCANNER CONVERTERS** Copy 72-76, 135-144, 240-270, 400-420, or 806-894 MHz bands on any scanner. Wired/tested Only \$79.95.

- **T51 VHF FM EXCITER** for 10M, 6M, 2M, 220 MHz or adjacent bands. 2 Watts continuous. Kits only \$54.95.
- **T451 UHF FM EXCITER** for 450 ham band or adjacent. Kits only \$64.95.
- **VHF & UHF LINEAR AMPLIFIERS.** Use on either FM or SSB. Power levels from 10 to 45 Watts to go with exciters & xmtg converters. Kits from \$69.95.



VHF & UHF TRANSMITTING CONVERTERS

For SSB, CW, ATV, FM, etc. Available for 6M, 2M, 220, 440 with many IF input ranges. Converter board kit only at \$79.95 (VHF) or \$99.95 (UHF) or kits complete with PA and cabinet as shown.

VHF & UHF RECEIVING CONVERTERS

20 Models cover every practical rf and if range to listen to SSB, FM, ATV, etc. on 6M, 2M, 220, 440, and 110 aircraft band. Even convert weather down to 2M! Kits from \$39.95 and wired units.

VHF & UHF RECEIVER

PREAMPS. Low noise.

VHF Kits from 27 to 300 MHz. UHF Kits from 300 to 650 MHz. Broadband Kits: 20-650 MHz. Prices start at \$14.95 (VHF) and \$18.95 (UHF). All preamps and converters have noise figure 2dB or less.

- **Call or Write for FREE CATALOG** (Send \$2.00 or 5 IRC's for overseas MAILING)
- **Order by phone or mail • Add \$2 S & H per order** (Electronic answering service evenings & weekends)
- **Use VISA, MASTERCARD, Check, or UPS COD.**

hamtronics, inc.

65-Q MOUL RD. • HILTON NY 14468
Phone: 716-392-9430

Hamtronics® is a registered trademark

We now have available a bunch of goodies too good to bypass. Items are limited so order today

Call Your Phone Order in Today

TERMS: Satisfaction guaranteed or money refunded. C.O.D. add \$2.00. Minimum order \$6.00. Orders under \$10.00 add \$1.50. Add 5% for postage, insurance, handling. Overseas add 15%. N.Y. residents add 7% tax.

**MINI KITS - YOU HAVE SEEN THESE BEFORE NOW
HERE ARE OLD FAVORITE AND NEW ONES TOO.
GREAT FOR THAT AFTERNOON HOBBY.**

FM MINI MIKE

A super high performance FM wireless mike kit! Transmits a stable signal up to 300 yards with exceptional audio quality by means of its built in electret mike. Kit includes case, mike, on-off switch, antenna, battery and super instructions. This is the finest unit available.

FM-3 Kit **\$14.95**
FM-3 Wired and Tested **19.95**

Color Organ

See music come alive! 3 different lights flicker with music. One light each for, high, mid-range and lows. Each individually adjustable and drives up to 300 W. runs on 110 VAC.

Complete kit, ML-1 **\$8.95**

Video Modulator Kit

Converts any TV to video monitor. Super stable, tunable over ch. 4-6. Runs on 5-15V, accepts std. video signal. Best unit on the market! Complete kit, VD-1 **\$7.95**

Led Blinky Kit

A great attention getter which alternately flashes 2 jumbo LEDs. Use for name badges, buttons, warning panel lights, anything! Runs on 3 to 15 volts. Complete kit, BL-1 **\$2.95**

Super Sleuth

A super sensitive amplifier which will pick up a pin drop at 15 feet! Great for monitoring baby's room or as general purpose amplifier. Full 2 W rms output, runs on 6 to 15 volts, uses 8-45 ohm speaker. Complete kit, BN-9 **\$5.95**

CPO-1

Runs on 3-12 Vdc 1 wall out. 1 KHZ good for CPO. Alarm, Audio Oscillator. Complete kit **\$2.95**

CLOCK KITS

Your old favorites are here again. Over 7,000 Sold to Date. Be one of the gang and order yours today!

Try your hand at building the finest looking clock on the market. Its satin finish anodized aluminum case looks great anywhere, while six .4" LED digits provide a highly readable display. This is a complete kit, no extras needed, and it only takes 1-2 hours to assemble. Your choice of case colors: silver, gold, black (specify).
Clock kit, 12/24 hour, DC-5 **\$24.95**
Clock with 10 min. ID timer, 12/24 hour, DC-10 **\$29.95**
Alarm clock, 12 hour only, DC-8 **\$29.95**
12V DC car clock, DC-7 **\$29.95**

For wired and tested clocks add \$10.00 to kit price. SPECIFY 12 OR 24 HOUR FORMAT

FM Wireless Mike Kit

Transmits up to 300' to any FM broadcast radio, uses any type of mike. Runs on 3 to 9V. Type FM-2 has added sensitive mike preamp stage.

FM-1 kit **\$3.95** FM-2 kit **\$4.95**

Whisper Light Kit

An interesting kit, small mike picks up sounds and converts them to light. The louder the sound, the brighter the light. Includes mike, controls up to 300 W, runs on 110 VAC. Complete kit, WL-1 **\$6.95**

Tone Decoder

A complete tone decoder on a single PC board. Features: 400-5000 Hz adjustable range via 20 turn pot, voltage regulation, 567 IC. Useful for touch-tone burst detection, FSK, etc. Can also be used as a stable tone encoder. Runs on 5 to 12 volts. Complete kit, TD-1 **\$5.95**

Car Clock

The UN-KIT, only 5 solder connections

Here's a super looking, rugged and accurate auto clock, which is a snap to build and install. Clock movement is completely assembled — you only solder 3 wires and 2 switches, takes about 15 minutes! Display is bright green with automatic brightness control photocell — assures you of a highly readable display, day or night. Comes in a satin finish anodized aluminum case which can be attached 5 different ways using 2 sided tape. Choice of silver, black or gold case (specify).

DC-3 kit, 12 hour format **\$22.95**
DC-3 wired and tested **\$29.95**

Universal Timer Kit

Provides the basic parts and PC board required to provide a source of precision timing and pulse generation. Uses 555 timer IC and includes a range of parts for most timing needs.

UT-5 Kit **\$5.95**

Mad Blaster Kit

Produces LOUD ear shattering and attention getting siren like sound. Can supply up to 15 watts of obnoxious audio. Runs on 6-15 VDC. Complete kit, MB-1 **\$4.95**

Siren Kit

Produces upward and downward wail characteristic of a police siren. 5 W peak audio output, runs on 3-15 volts, uses 3-45 ohm speaker. Complete kit, SM-3 **\$2.95**

60 Hz Time Base
Runs on 5-15 VDC. Low current (2.5ma) 1 min/month accuracy TB-7 Kit **\$5.50**
TB-7 Assy **\$9.95**

Calendar Alarm Clock

The clock that's got it all: 6-.5" LEDs, 12/24 hour, snooze, 24 hour alarm, 4 year calendar, battery backup, and lots more. The super 7001 chip is used. Size: 5x4x2 inches. Complete kit, less case (not available) **\$34.95**
DC-9 **\$34.95**

Under Dash Car Clock

12/24 hour clock in a beautiful plastic case features 6 jumbo RED LEDs, high accuracy (.001%), easy 3 wire hookup, display blanks with ignition, and super instructions. Optional dimmer automatically adjusts display to ambient light level. DC-11 clock with mtg. bracket **\$27.95 kit**
DM-1 dimmer adapter **\$2.50**
Add \$10.00 Assy. and Test

Video Terminal

A completely self-contained, stand alone video terminal card. Requires only an ASCII keyboard and TV set to become a complete terminal unit. Features are: single 5V supply, 3TAI, controlled sync and baud rates (to 9600), complete computer and keyboard control of cursor, parity error control and display. Accepts and generates serial ASCII plus parallel keyboard input. The 8416 is 64 char by 16 lines with scrolling, upper and lower case (optional) and has RS-232 and 20ma loop interfaces on board. Kits include sockets and complete documentation.
RE 8416 terminal card kit (add \$60.00 for wired unit) **\$189.95**
Lower Case option **\$13.95**
Power Supply **\$14.95**
RF Modulator kit **\$7.95**

PARTS PARADE

IC SPECIALS

LINEAR

| | |
|------|-----------|
| 301 | \$.35 |
| 324 | \$ 1.50 |
| 380 | \$ 1.50 |
| 555 | \$.45 |
| 556 | \$ 1.00 |
| 565 | \$ 1.00 |
| 566 | \$ 1.00 |
| 567 | \$ 1.25 |
| 741 | 10/\$2.00 |
| 1458 | \$.50 |
| 3900 | \$.50 |
| 3914 | \$ 2.95 |
| 8038 | \$ 2.95 |

TTL

| | |
|-------|---------|
| 74S00 | \$.40 |
| 7447 | \$.65 |
| 7475 | \$.50 |
| 7490 | \$.50 |
| 74196 | \$ 1.35 |

SPECIAL

| | |
|----------|----------|
| 11C90 | \$ 15.00 |
| 10116 | \$ 1.25 |
| 7208 | \$ 17.50 |
| 7207A | \$ 5.50 |
| 7216D | \$ 21.00 |
| 7107C | \$ 12.50 |
| 5314 | \$ 2.95 |
| 5375AB/G | \$ 2.95 |
| 7001 | \$ 6.50 |

Resistor Ass't
Assortment of Popular values - 1/4 watt. Cut lead for PC mounting, 1/2" center, 1/8" leads, bag of 300 or more. **\$1.50**

Switches
Mini toggle SPDT **\$1.00**
Red Pushbuttons N.O. **3/\$1.00**

Earphones
3" leads, 8 ohm, good for small tone speakers, alarm clocks, etc. **5 for \$1.00**

Mini 8 ohm Speaker
Approx 2 1/2" diam Round type for radios, mike etc. **3 for \$2.00**

Slug Tuned Coils
Small 3/16" Hex Slugs turned coil, 3 turns. **10 for \$1.00**

Crystals

| | |
|--------------|---------|
| 3.579545 MHZ | \$ 1.50 |
| 10.00000 MHZ | \$ 5.00 |
| 5.248800 MHZ | \$ 5.00 |

AC Adapters
Good for clocks, nicad chargers, all 110 VAC plug one end.
8.5 vdc @ 20 mA **\$1.00**
16. vac @ 160mA **\$2.50**
12. vac @ 250mA **\$3.00**

Solid State Buzzers
small buzzer 450 Hz, 86 dB, sound output on 5-12 vdc at 10-30 mA, TTL compatible. **\$1.50**

AC Outlet
Panel Mount with Leads **4/\$1.00**

CMOS

| | |
|------|--------|
| 4011 | .50 |
| 4013 | .50 |
| 4046 | \$1.85 |
| 4049 | .50 |
| 4059 | \$9.00 |
| 4511 | \$2.00 |
| 4518 | \$1.35 |
| 5639 | \$1.75 |

FERRITE BEADS
With info and specs **15/\$1.00**
6 Hole Balun Beads **5/\$1.00**

CAPACITORS

| TANTALUM | ALUMINUM | DISK CERAMIC |
|---------------------|-----------------------------------|------------------------------|
| Dipped Epoxy | Electrolytic | 01 16V disk 20/\$1.00 |
| 1.5 uF 25V 3/\$1.00 | 1000 uF 16V Radial .50 | 1 16V 15/\$1.00 |
| 1.8 uF 25V 3/\$1.00 | 500 uF 20V Axial .50 | 001 16V 20/\$1.00 |
| .22 uF 25V 3/\$1.00 | 150 uF 16V Axial 5/\$1.00 | 100 pF 20/\$1.00 |
| | 10 uF 15V Radial 10/\$1.00 | 047 16V 20/\$1.00 |

READOUTS

| | |
|------------------------|--------|
| FND 359 4" C.C. | \$1.00 |
| FND 507/510 5" C.A. | 1.00 |
| MAN 72/HP7730 33" C.A. | 1.00 |
| HP 7851 43" C.A. | 2.00 |

Sockets

| | |
|--------|-----------|
| 8 Pin | 10/\$2.00 |
| 14 Pin | 10/\$2.00 |
| 16 Pin | 10/\$2.00 |
| 24 Pin | 4/\$2.00 |
| 28 Pin | 4/\$2.00 |
| 40 Pin | 3/\$2.00 |

DC-DC Converter
+5 vdc input prod. -9 vdc @ 30ma
+9 vdc produces -15 vdc @ 35ma **\$1.25**

25K 20 Turn Trim Pot **\$1.00**
1K 20 Turn Trim Pot **\$.50**

Ceramic IF Filters
Mini ceramic filters 7 kHz B.W. 455 kHz **\$1.50 ea.**

Trimmer Caps
Sprague - 3-40 pf Stable Polypropylene **.50 ea.**

TRANSISTORS

| | |
|--------------------|-----------|
| 2N3904 NPN C-F | 15/\$1.00 |
| 2N3906 PNP C-F | 15/\$1.00 |
| 2N4403 PNP C-F | 15/\$1.00 |
| 2N4410 NPN C-F | 15/\$1.00 |
| 2N4916 FET C-F | 4/\$1.00 |
| 2N5401 PNP C-F | 5/\$1.00 |
| 2N6028 C-F | 4/\$1.00 |
| 2N3771 NPN Silicon | \$1.50 |
| 2N5179 UHF NPN | 3/\$2.00 |
| Power Tab NPN 40W | 3/\$1.00 |
| Power Tab PNP 40W | 3/\$1.00 |
| MPF 102/2N5484 | \$.50 |
| NPN 3904 Type T-R | 50/\$2.50 |
| PNP 3906 Type T-R | 50/\$2.50 |
| 2N3055 | 1.00 |
| 2N2946 UJT | 3/\$2.00 |

Diodes

| | |
|-------------|-----------|
| 5.1 V Zener | 20/\$1.00 |
| 1N914 Type | 50/\$1.00 |
| 1KV 2Amp | 8/\$1.00 |
| 100V 1Amp | 15/\$1.00 |

25 AMP 100V Bridge **\$1.50 each**

Mini-Bridge 50V 1 AMP **2 for \$1.00**

Crystal Microphone
Small 1" diameter 1/4" thick crystal mike cartridge **\$7.75**

Coax Connector
Chassis mount BNC type **\$1.00**

Parts Bag
Asst of chokes, disc caps, tant resistors, transistors, diodes, MICA caps etc. sm. bag (100 pc) **\$1.00** lg. bag (300 pc) **\$2.50**

Leds - your choice, please specify
Mini Red, Jumbo Red, High Intensity Red, Illuminator Red **8/\$1**
Mini Yellow, Jumbo Yellow, Jumbo Green **6/\$1**

Varactors
Motorola MV 2209 30 PF Nominal cap 20-80 PF - Tunable range - **.50 each or 3/\$1.00**

Mini RG-174 Coax **10 ft. for \$1.00**

9 Volt Battery Clips
Nice quality clips **5 for \$1.00**
1/4" Rubber Grommets **10 for \$1.00**

Connectors
6 pin type gold contacts for mA-1003 car clock module price **.75 ea.**

Audio Prescaler

Make high resolution audio measurements, great for musical instrument tuning, PL tones, etc. Multiplies audio UP in frequency, selectable x10 or x100, gives .01 HZ resolution with 1 sec. gate time! High sensitivity of 25 mv, 1 meg input z and built-in filtering gives great performance. Runs on 9V battery, all CMOS.

PS-2 kit **\$29.95**
PS-2 wired **\$39.95**

600 MHz PRESCALER

Extend the range of your counter to 600 MHz. Works with all counters. Less than 150 mv sensitivity. specify -10 or -100

Wired, tested, PS-1B **\$59.95**
Kit, PS-1B **\$44.95**

30 Watt 2 mtr PWR AMP

Simple Class C power amp features 8 times power gain. 1 W in for 8 out, 2 W in for 15 out, 4W in for 30 out. Max output of 35 W, incredible value, complete with all parts, less case and T-R relay.

PA-1, 30 W pwr amp kit **\$22.95**
TR-1, RF sensed T-R relay kit **6.95**

Power Supply Kit

Complete triple regulated power supply provides variable 6 to 18 volts at 200 ma and +5 at 1 Amp. Excellent load regulation, good filtering and small size. Less transformers, requires 6.3 V 1.2 A and 24 VCT

Complete kit, PS-3LT **\$6.95**

RF actuated relay senses RF (1W) and closes DPDT relay.

For RF sensed T-R relay **TR-1 Kit \$6.95**

OP-AMP Special

BI-FET LF 13741 - Direct pin for pin 741 compatible, but 500,000 MEG input z, super low 50 pa input current, low power drain

50 for only **\$9.00** 10 for **\$2.00**

Regulators

| | |
|------|--------|
| 78MG | \$1.25 |
| 79MG | \$1.25 |
| 723 | \$.50 |
| 309K | \$1.15 |
| 7805 | \$1.00 |

Shrink Tubing Nubs
Nice precut pcs of shrink size: 1" x 1/4" shrink to 1/8" Great for splices. **50/\$1.00**

Mini TO-92 Heat Sinks
Thermalloy Brand **5 for \$1.00**
To-220 Heat Sinks **3 for \$1.00**

Opto Isolators - 4N28 type **\$1.00 ea.**
Opto Reflectors - Photo diode + LED **\$1.00 ea.**

Molex Pins
Molex already precut in length of 7. Perfect for 14 pin sockets. **20 strips for \$1.00**

CDS Photocells
Resistance varies with light, 250 ohms to over 3 meg **3 for \$1.00**

DIGITAL RESEARCH: PARTS

"TOP QUALITY PARTS FOR LESS"

M.O.H.O.

It never fails: Someone calls you on the telephone and you need to change phones to get some information. You put the phone down, go to another phone and give them the information, then hang up. Oops! You forgot to hang up the phone you first answered! No more phone calls for you until you discover your mistake!! Or, the phone rings right in the middle of a serious talk with your children, spouse, girl friend, etc. You have to lay the phone down, go to another room to finish your conversation, leaving your caller in silence. Or how many times has one of your not-so-good friends asked you and your spouse to go out Friday night and you are sitting there making all these weird gestures and rolling your eyes, etc. Your spouse does not know whether to pour cold water on you or run screaming into the street. Well **NO MORE.**

Digital Research is proud to announce the **M.O.H.O.**, the first patented, electronic hold control for your home telephone. Return to the same phone or any phone in your home and your party is still there. All the time your party is on hold, they may listen to A.M., F.M., cassette, T.V., or any other device you wish to hook up to **M.O.H.O.** No need to butcher your phone either. Only two wires to connect to your existing phones. One wire to tip and the other wire to ring. For those not too *telephonically* inclined — one to the red wire and one to the green wire. The **M.O.H.O.** resides in an attractive box approximately 6" x 4" x 2", which may be placed anywhere. Now comes the fun part. You have just received **M.O.H.O.** (kit form takes about 1½ hours to complete). There are only two things to do: hook the red and green wire to the telephone and plug **M.O.H.O.** into A.C. outlet. Remember **M.O.H.O.** is completely legal, patented and F.C.C. approved. (We provide you with a Registration Sticker too.)

Assembled and Tested **\$37.50**

Kit **\$29.95** Complete

(For rotary dial add \$1.50 per phone)

POWER SUPPLY TRIPLE OUTPUT

25 Volts @ .18A
5 Volts @ .8A
15 Volts @ 1.25A
Isolated independent outputs
Positive or negative operation
Constant Voltage Regulation
25 Volt line adjustable with 10 turn pot from 23.5 V to 28 Volts. 120 Volt - 60 Hz input Fused - H=3¾" W=5½" D=4"

\$14.95

Precision Hybrid Oscillator Module

Has both 1 MHz and 2 MHz TTL - outputs —Hermetically sealed —Ultra high stability over wide temp. range —originally cost over \$40.00 each — we made a super purchase from a major computer manufacturer — 5 Volt operation - fits standard 24 pin socket - Manufactured by Motorola oscillator division.



MC6871A

3/20⁰⁰

7⁵⁰ w/data

NEO 2137 by NEC

- Microwave R.F. transistor (N.P.N.)
- Micromold Package #37
- Dual Emitter leads
- FT to 4.5 GHz
- VCEO 10V-CC 20 MA. HFE 40-200
- Gain 10V-20MA-1GHZ = 14DB Typical
- Very low noise - High gain 1.5 DB @500 MHZ
- Cleared for high reliability space applications

COMPARE **1⁵⁰**

SCOTCH LOK

Great for connecting a wire to an existing wire without stripping. Absolutely invaluable in hard to reach areas such as under car dash, inside television, etc. Simply put Scotch Lok over existing wire. Insert new wire to be connected. With a standard pair of pliers, compress metal on insulator. No need for tape. Super neat installation. Once you use this, you will never go back to the "old" way.

15/1⁰⁰



UNIVERSAL TIMER KIT

★ Adjustable from 1 sec to 1 hr.

★ Control up to 1 amp "Turn Things On Or Off"

Kit includes all parts necessary to build this exciting kit. Uses: Children's T.V. programs - Darkroom exposures - Amateur 10 min. I.D.er - Egg Timer - Intermittent Windshield Wiper. Absolutely endless uses. Complete kit including power supply, p.c. board DPDT relay, and all parts to make timer operational.

\$8.95

Fixed Inductors

.39 uh - **6/1⁰⁰** 12.5 uh - **8/1⁰⁰**
500 uh - Hash Filter
@ 2 Amps - **4/1⁰⁰**



Molded Choke

13 uh - **8/1⁰⁰** 50 mh - **6/1⁰⁰**
1.2 mh - **8/1⁰⁰**

Variable Inductors

30-40 uh
.9 uh - 1.2 uh
11 uh to 20 uh
.25 uh - .35 uh
.85 uh - .95 uh



4/1⁰⁰

EIAJ #1SS98

NEC #4981-7E
Microwave - Schottky barrier diode
HP-Hot Carrier diodes
5082-2835

99¢ or 6/5⁰⁰

SEE WHAT BILLY BOB HAS TO SAY ON PAGE 18 OF OUR NEW CATALOG!

TERMS:

Add 1 postage, we pay balance. Orders under \$15 add 75¢ handling. No C.O.D. We accept Visa, MasterCard and American Express cards. Tex. Res. add 5% Tax. Foreign orders (Canada 10%) add 20% P & H.

• VISA • MASTERCARD • AMERICAN EXPRESS •

Digital Research: Parts

P.O. Box 401247 • Garland, Texas 75040

(214) 271-2461

SURPLUS VALUES

10 METER BASE STATIONS

Motorola

C51GJB-3100A "Compa stations, 60 watts, PL, 25-30 MHz., good working cond.

\$100.00 ea.
plus shipping

G.E.

V018NR Progress Line 6' uprights, 250 w watts, 25-30 MHz, 110 VAC. Good working cond.

\$250.00 ea.
plus shipping

10 METER TECH SPECIALS

Motorola Motracs, U41HHT-3100. 30 Watts, PL, 25-30 MHz. without accy's.

\$45.00 ea.
plus shipping

Note: Other Mot., GE, RCA units avail. too.

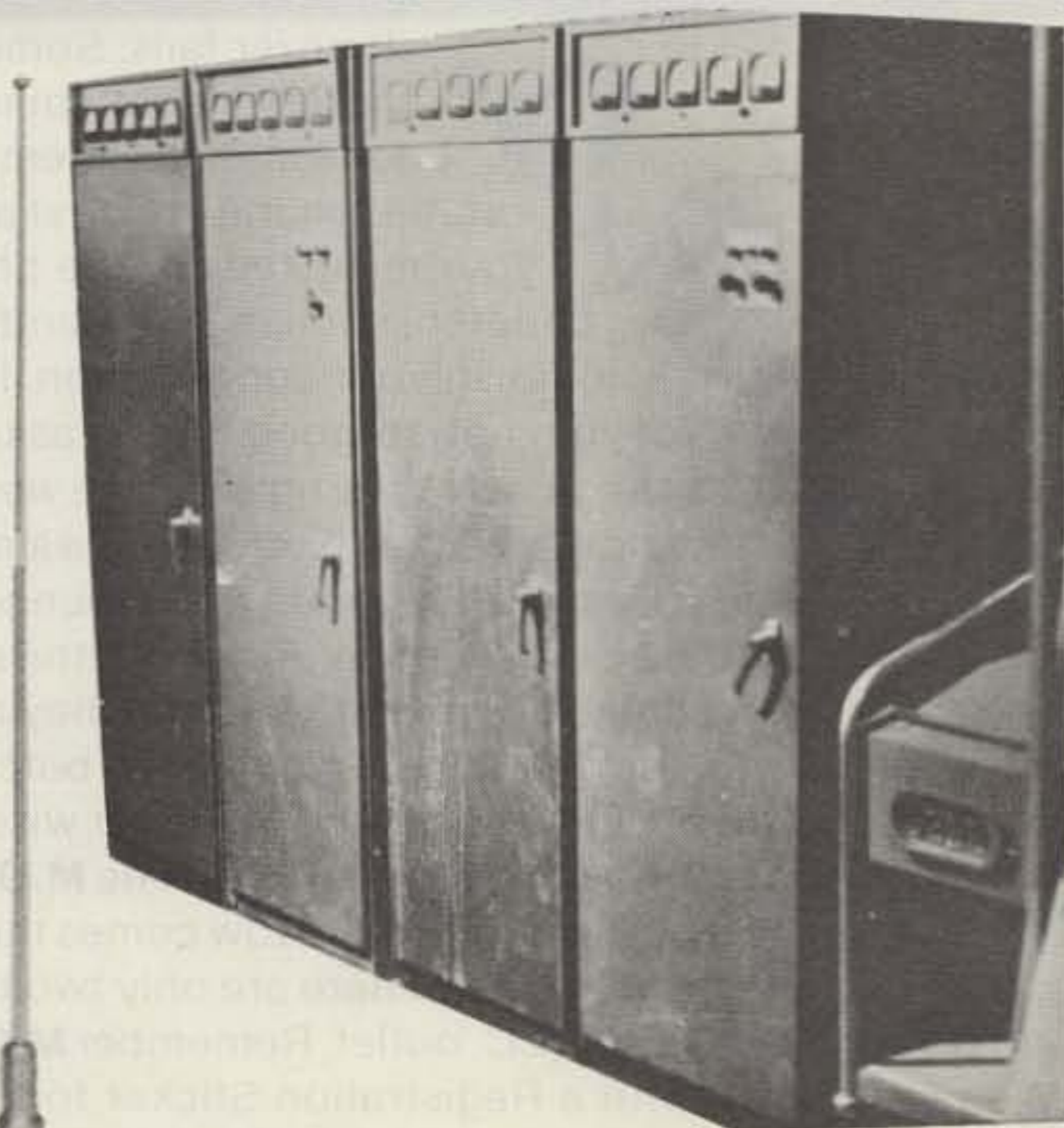

10 METER ANTENNAS

Magnetic or Trunk Mount

Here's a super exclusive from us to you; ASP 732 commercial antennas rated at 200 watts private labelled for the "Batwing". Marked 25-28 MHz., will resonate in 10 Meter range.

only \$19.95 ea.
plus shipping

SOLA DIELECTRIC WATTMETER ELEMENTS

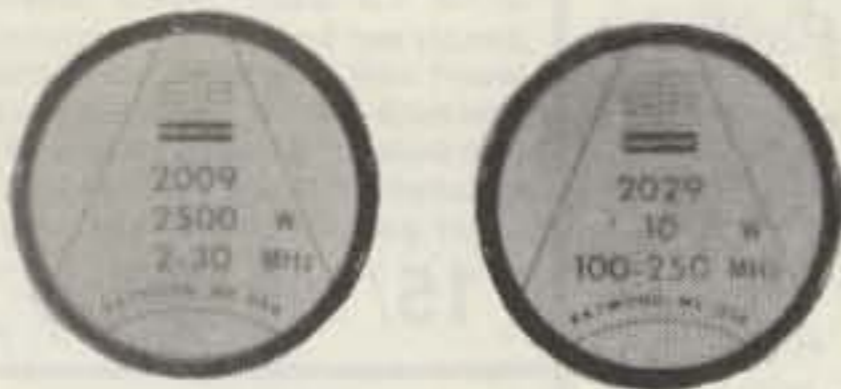

\$30.00
plus shipping

2 TYPES AVAILABLE

| # | power | freq. |
|------|-------|-----------|
| 2009 | 2500W | 2-30 Mhz. |
| 2029 | 10W | 100-250 " |

These are brand new surplus elements at nearly half of catalog price.



OLD NICADS NEVER DIE . . . in most cases at least. We have hundreds of used Motorola Nicads that are unusable because of dead cells, opens strapping, and "poor memory"

Ctn. of 10 for \$10.00
plus shipping



ANTENNA MOUNTS

In case you don't need the whole antenna, here's a super deal too: your choice of mag or trunk mount similar to ASP K220 and K221's.

only \$10.95 ea.
plus shipping

ASSORTED 1/4 WATT RESISTORS

New surplus film carbon type. Values range from 10 ohms to 5 meg. 5% & 10% tolerance. A must for every project builder. Approximately 3000 pcs. per pkg.

\$10.00
plus shipping



MINIMUM ORDER \$10.00

MOTOROLA MANUALS

We've got hundreds of manuals in stock from old tube types to 1980 model gear. Send us your wants.

only \$5.00 ea.
plus shipping



SPECTRONICS, INC.
1009 GARFIELD ST. OAK PARK, IL. 60304

PHONE
(312) 848-6777



7400

| | | | | | |
|---------|------|----------|------|----------|------|
| SN7400N | .20 | SN7472N | .29 | SN74156N | .79 |
| SN7401N | .20 | SN7473N | .35 | SN74157N | .89 |
| SN7402N | .25 | SN7474N | .35 | SN74160N | .89 |
| SN7403N | .25 | SN7475N | .49 | SN74161N | .89 |
| SN7404N | .25 | SN7476N | .35 | SN74162N | .89 |
| SN7405N | .29 | SN7479N | 5.00 | SN74163N | .89 |
| SN7406N | .35 | SN7480N | .50 | SN74164N | .89 |
| SN7407N | .35 | SN7482N | .99 | SN74165N | .89 |
| SN7408N | .29 | SN7483N | .69 | SN74166N | 1.25 |
| SN7409N | .29 | SN7485N | .89 | SN74167N | 2.79 |
| SN7410N | .25 | SN7486N | .35 | SN74170N | 1.95 |
| SN7411N | .29 | SN7489N | 1.75 | SN74172N | 4.95 |
| SN7412N | .35 | SN7490N | .49 | SN74173N | 1.39 |
| SN7413N | .40 | SN7491N | .59 | SN74174N | .99 |
| SN7414N | .69 | SN7492N | .45 | SN74175N | .89 |
| SN7415N | .29 | SN7493N | .45 | SN74176N | .79 |
| SN7417N | .29 | SN7494N | .69 | SN74177N | .79 |
| SN7420N | .25 | SN7495N | .69 | SN74179N | 1.49 |
| SN7421N | .45 | SN7496N | .69 | SN74180N | .79 |
| SN7422N | .29 | SN7497N | 3.90 | SN74181N | 2.25 |
| SN7423N | .29 | SN74100N | 1.49 | SN74182N | .79 |
| SN7425N | .29 | SN74104N | .89 | SN74184N | 2.49 |
| SN7426N | .29 | SN74105N | .89 | SN74185N | 2.49 |
| SN7427N | .25 | SN74107N | .35 | SN74190N | 1.25 |
| SN7428N | .49 | SN74109N | .39 | SN74191N | 1.25 |
| SN7430N | .25 | SN74116N | 1.95 | SN74192N | .89 |
| SN7432N | .29 | SN74121N | .39 | SN74193N | .89 |
| SN7437N | .29 | SN74122N | .55 | SN74194N | .89 |
| SN7438N | .40 | SN74123N | .59 | SN74195N | .69 |
| SN7439N | .25 | SN74125N | .49 | SN74196N | .89 |
| SN7440N | .20 | SN74126N | .49 | SN74197N | .89 |
| SN7441N | .89 | SN74132N | .75 | SN74198N | 1.49 |
| SN7442N | .59 | SN74139N | .75 | SN74199N | 1.49 |
| SN7443N | 1.10 | SN74141N | .99 | SN74221N | 1.25 |
| SN7444N | 1.10 | SN74142N | 3.25 | SN74251N | .99 |
| SN7445N | .89 | SN74143N | 3.49 | SN74276N | 1.95 |
| SN7446N | .79 | SN74144N | 3.49 | SN74279N | .79 |
| SN7447N | .69 | SN74145N | .79 | SN74283N | 1.49 |
| SN7448N | .79 | SN74147N | 1.95 | SN74284N | 3.95 |
| SN7449N | .29 | SN74148N | 1.29 | SN74285N | 3.95 |
| SN7450N | .30 | SN74150N | 1.25 | SN74286N | .89 |
| SN7451N | .30 | SN74151N | .69 | SN74288N | .89 |
| SN7452N | .30 | SN74152N | .69 | SN74289N | .89 |
| SN7453N | .30 | SN74153N | .79 | SN74290N | .89 |
| SN7454N | .30 | SN74154N | 1.25 | SN74291N | 1.49 |
| SN7455A | .25 | SN74155N | .79 | SN74293N | 1.49 |
| SN7460N | .20 | | | | |
| SN7470N | .29 | | | | |

74LS

| | | | | | |
|--------|-----|---------|------|---------|------|
| 74LS00 | .29 | 74LS192 | 1.15 | 74LS273 | 1.95 |
| 74LS01 | .29 | 74LS193 | 1.15 | 74LS279 | .89 |
| 74LS02 | .29 | 74LS194 | 1.15 | 74LS283 | .89 |
| 74LS03 | .29 | 74LS195 | 1.15 | 74LS290 | .99 |
| 74LS04 | .25 | 74LS196 | 1.15 | 74LS293 | .99 |
| 74LS05 | .25 | 74LS197 | 1.19 | 74LS298 | 1.25 |
| 74LS06 | .25 | 74LS198 | 1.19 | 74LS302 | 1.29 |
| 74LS09 | .35 | 74LS199 | 1.49 | 74LS352 | 1.29 |
| 74LS10 | .35 | 74LS200 | 1.49 | 74LS353 | 1.29 |
| 74LS11 | .39 | 74LS201 | 1.49 | 74LS354 | 1.29 |
| 74LS12 | .39 | 74LS202 | 1.49 | 74LS355 | 1.29 |
| 74LS13 | .39 | 74LS203 | 1.49 | 74LS356 | 1.29 |
| 74LS14 | .39 | 74LS204 | 1.49 | 74LS357 | 1.29 |
| 74LS15 | .39 | 74LS205 | 1.49 | 74LS358 | 1.29 |
| 74LS16 | .39 | 74LS206 | 1.49 | 74LS359 | 1.29 |
| 74LS17 | .39 | 74LS207 | 1.49 | 74LS360 | 1.29 |
| 74LS18 | .39 | 74LS208 | 1.49 | 74LS361 | 1.29 |
| 74LS19 | .39 | 74LS209 | 1.49 | 74LS362 | 1.29 |
| 74LS20 | .39 | 74LS210 | 1.49 | 74LS363 | 1.29 |
| 74LS21 | .39 | 74LS211 | 1.49 | 74LS364 | 1.29 |
| 74LS22 | .39 | 74LS212 | 1.49 | 74LS365 | 1.29 |
| 74LS23 | .39 | 74LS213 | 1.49 | 74LS366 | 1.29 |
| 74LS24 | .39 | 74LS214 | 1.49 | 74LS367 | 1.29 |
| 74LS25 | .39 | 74LS215 | 1.49 | 74LS368 | 1.29 |
| 74LS26 | .39 | 74LS216 | 1.49 | 74LS369 | 1.29 |
| 74LS27 | .39 | 74LS217 | 1.49 | 74LS370 | 1.29 |
| 74LS28 | .39 | 74LS218 | 1.49 | 74LS371 | 1.29 |
| 74LS29 | .39 | 74LS219 | 1.49 | 74LS372 | 1.29 |
| 74LS30 | .39 | 74LS220 | 1.49 | 74LS373 | 1.29 |
| 74LS31 | .39 | 74LS221 | 1.49 | 74LS374 | 1.29 |
| 74LS32 | .39 | 74LS222 | 1.49 | 74LS375 | 1.29 |
| 74LS33 | .39 | 74LS223 | 1.49 | 74LS376 | 1.29 |
| 74LS34 | .39 | 74LS224 | 1.49 | 74LS377 | 1.29 |
| 74LS35 | .39 | 74LS225 | 1.49 | 74LS378 | 1.29 |
| 74LS36 | .39 | 74LS226 | 1.49 | 74LS379 | 1.29 |
| 74LS37 | .39 | 74LS227 | 1.49 | 74LS380 | 1.29 |
| 74LS38 | .39 | 74LS228 | 1.49 | 74LS381 | 1.29 |
| 74LS39 | .39 | 74LS229 | 1.49 | 74LS382 | 1.29 |
| 74LS40 | .39 | 74LS230 | 1.49 | 74LS383 | 1.29 |
| 74LS41 | .39 | 74LS231 | 1.49 | 74LS384 | 1.29 |
| 74LS42 | .39 | 74LS232 | 1.49 | 74LS385 | 1.29 |
| 74LS43 | .39 | 74LS233 | 1.49 | 74LS386 | 1.29 |
| 74LS44 | .39 | 74LS234 | 1.49 | 74LS387 | 1.29 |
| 74LS45 | .39 | 74LS235 | 1.49 | 74LS388 | 1.29 |
| 74LS46 | .39 | 74LS236 | 1.49 | 74LS389 | 1.29 |
| 74LS47 | .39 | 74LS237 | 1.49 | 74LS390 | 1.29 |
| 74LS48 | .39 | 74LS238 | 1.49 | 74LS391 | 1.29 |
| 74LS49 | .39 | 74LS239 | 1.49 | 74LS392 | 1.29 |
| 74LS50 | .39 | 74LS240 | 1.49 | 74LS393 | 1.29 |
| 74LS51 | .39 | 74LS241 | 1.49 | 74LS394 | 1.29 |
| 74LS52 | .39 | 74LS242 | 1.49 | 74LS395 | 1.29 |
| 74LS53 | .39 | 74LS243 | 1.49 | 74LS396 | 1.29 |
| 74LS54 | .39 | 74LS244 | 1.49 | 74LS397 | 1.29 |
| 74LS55 | .39 | 74LS245 | 1.49 | 74LS398 | 1.29 |
| 74LS56 | .39 | 74LS246 | 1.49 | 74LS399 | 1.29 |
| 74LS57 | .39 | 74LS247 | 1.49 | 74LS400 | 1.29 |
| 74LS58 | .39 | 74LS248 | 1.49 | | |
| 74LS59 | .39 | 74LS249 | 1.49 | | |

74S

| | | | | | |
|-------|-----|--------|------|--------|-------|
| 74S00 | .45 | 74S243 | 3.25 | 74S373 | 3.49 |
| 74S02 | .45 | 74S244 | 3.25 | 74S374 | 3.49 |
| 74S03 | .45 | 74S251 | 1.45 | 74S387 | 2.95 |
| 74S04 | .55 | 74S252 | 1.45 | 74S471 | 10.95 |
| 74S05 | .55 | 74S253 | 1.45 | 74S472 | 10.95 |
| 74S08 | .50 | 74S257 | 1.35 | 74S473 | 10.95 |
| 74S09 | .50 | 74S258 | 1.35 | 74S474 | 12.95 |
| 74S10 | .45 | 74S259 | 1.35 | 74S475 | 12.95 |
| 74S11 | .45 | 74S260 | .79 | 74S476 | 12.95 |
| 74S12 | .45 | 74S261 | 2.95 | 74S477 | 5.95 |
| 74S13 | .45 | 74S262 | 2.95 | 74S478 | 5.95 |
| 74S14 | .45 | 74S263 | 2.95 | 74S479 | 5.95 |
| 74S15 | .45 | 74S264 | 2.95 | 74S480 | 5.95 |
| 74S16 | .45 | 74S265 | 2.95 | 74S481 | 5.95 |
| 74S17 | .45 | 74S266 | 2.95 | 74S482 | 5.95 |
| 74S18 | .45 | 74S267 | 2.95 | 74S483 | 5.95 |
| 74S19 | .45 | 74S268 | 2.95 | 74S484 | 5.95 |
| 74S20 | .45 | 74S269 | 2.95 | 74S485 | 5.95 |
| 74S21 | .45 | 74S270 | 2.95 | 74S486 | 5.95 |
| 74S22 | .45 | 74S271 | 2.95 | 74S487 | 5.95 |
| 74S23 | .45 | 74S272 | 2.95 | 74S488 | 5.95 |
| 74S24 | .45 | 74S273 | 2.95 | 74S489 | 5.95 |
| 74S25 | .45 | 74S274 | 2.95 | 74S490 | 5.95 |
| 74S26 | .45 | 74S275 | 2.95 | 74S491 | 5.95 |
| 74S27 | .45 | 74S276 | 2.95 | | |
| 74S28 | .45 | 74S277 | 2.95 | | |
| 74S29 | .45 | 74S278 | 2.95 | | |
| 74S30 | .45 | 74S279 | 2.95 | | |
| 74S31 | .45 | 74S280 | 2.95 | | |
| 74S32 | .45 | 74S281 | 2.95 | | |
| 74S33 | .45 | 74S282 | 2.95 | | |
| 74S34 | .45 | 74S283 | 2.95 | | |
| 74S35 | .45 | 74S284 | 2.95 | | |
| 74S36 | .45 | 74S285 | 2.95 | | |
| 74S37 | .45 | 74S286 | 2.95 | | |
| 74S38 | .45 | 74S287 | 2.95 | | |
| 74S39 | .45 | 74S288 | 2.95 | | |
| 74S40 | .45 | 74S289 | 2.95 | | |
| 74S41 | .45 | 74S290 | 2.95 | | |
| 74S42 | .45 | 74S291 | 2.95 | | |
| 74S43 | .45 | 74S292 | 2.95 | | |
| 74S44 | .45 | 74S293 | 2.95 | | |
| 74S45 | .45 | 74S294 | 2.95 | | |
| 74S46 | .45 | 74S295 | 2.95 | | |
| 74S47 | .45 | 74S296 | 2.95 | | |
| 74S48 | .45 | 74S297 | 2.95 | | |
| 74S49 | .45 | 74S298 | 2.95 | | |
| 74S50 | .45 | 74S299 | 2.95 | | |

CA-LINEAR

| | | | |
|---------|------|---------|------|
| CA3010H | .99 | CA3089N | 3.75 |
| CA3013H | 2.15 | CA3096N | 3.95 |
| CA3023H | 3.25 | CA3130H | 1.39 |
| CA3035H | 2.49 | CA3140H | 1.25 |
| CA3039H | 1.35 | CA3150H | 1.25 |
| CA3046N | 1.30 | CA3401N | .59 |
| CA3059N | 1.25 | CA3600N | 3.50 |

CD-CMOS

| | | | |
|--------|------|---------|-------|
| CD4000 | .39 | CD4098 | 2.49 |
| CD4001 | .39 | CD4506 | .75 |
| CD4002 | .39 | CD4507 | .99 |
| CD4005 | 1.19 | CD4508 | 3.95 |
| CD4007 | .25 | CD4510 | 1.39 |
| CD4009 | .49 | CD4511 | 1.29 |
| CD4010 | .49 | CD4512 | 1.49 |
| CD4011 | .39 | CD4514 | 3.95 |
| CD4012 | .25 | CD4515 | 2.95 |
| CD4013 | .49 | CD4516 | 1.49 |
| CD4014 | 1.39 | CD4518 | 1.79 |
| CD4015 | 1.19 | CD4519 | .89 |
| CD4016 | .59 | CD4520 | 1.29 |
| CD4017 | 1.19 | CD4526 | 1.79 |
| CD4018 | .99 | CD4528 | 1.79 |
| CD4019 | .49 | CD4529 | 1.95 |
| CD4020 | 1.19 | CD4543 | 2.79 |
| CD4021 | 1.29 | CD4562 | 11.95 |
| CD4022 | 1.19 | CD4566 | 2.79 |
| CD4023 | .29 | CD4583 | 2.49 |
| CD4024 | .79 | CD4584 | .75 |
| CD4025 | .23 | CD4723 | 1.95 |
| CD4026 | 2.95 | CD4724 | 1.95 |
| CD4027 | .69 | MC14409 | 17.95 |
| CD4028 | .89 | MC14410 | 18.95 |
| CD4029 | 1.49 | MC14411 | 15.95 |
| CD4030 | .49 | MC14412 | 15.95 |
| CD4034 | 3.49 | MC14419 | 7.95 |
| CD4035 | .99 | MC14433 | 15.95 |
| CD4040 | 1.49 | MC14538 | 2.49 |
| | | MC14541 | 1.95 |

Phone Tunes

As Seen on "Good Morning America" Replaces the Telephone Ringer Bell with a Selection of 30 Familiar Tunes



Each Unit will play any of the following tunes:

- Rule Britannia
- O Canada
- Colonel Bogey
- Westminster Chimes
- Mexican Hat Dance
- Twinkle, Twinkle Little Star
- Deutschlandlied
- God Save the Queen
- Close Encounters
- Happy Birthday
- Wedding March
- Jingle Bells
- Auld Lang Syne
- Soldiers Chorus
- Sailor's Hornpipe
- Charge!
- Greensleeves
- Lorelei
- Eyes of Texas
- Star Spangled Banner
- Oranges and Lemons
- Wilhelmus
- Mozart Sonata
- Pomp & Circumstance
- William Tell Overture
- Bach Toccata in D Minor
- Shave and a Haircut
- Blue Danube Waltz
- Beethoven's 5th
- La Marseillaise

Replaces monotonous telephone ringer bell. Easily connects to any standard telephone. Can be used alongside regular phone or replace a remote ringer elsewhere in building or outside. FCC approved. Can be used on any telephone system - worldwide. Use a different tune to identify extension phones. Microprocessor controlled. Adjustable volume control and variable tune speed control. Operates on two 9-volt batteries or AC Adapter (not included).

PT030 Phone Tunes \$49.95
AD30 AC Adapter \$8.95

DISCRETE LEDs

| | | | |
|---------------------|------|---------------------|------|
| XC556R .200" red | 5/51 | MV50 .085" red | 6/51 |
| XC556G .200" green | 4/51 | XC209R .125" red | 5/51 |
| XC556Y .200" yellow | 4/51 | XC209G .125" green | 4/51 |
| XC556C .200" clear | 4/51 | XC209Y .125" yellow | 4/51 |
| XC22R .200" red | 5/51 | XC526R .185" red | 5/51 |
| XC22G .200" green | 4/51 | XC526G .185" green | 4/51 |
| XC22Y .200" yellow | 4/51 | XC526Y .185" yellow | 4/51 |
| MV10B .170" red | 4/51 | XC526C .185" clear | 4/51 |

Diffused Bi-Color LED
 Part No. 1-99 100+
 XC5491 .79 .69

XC5M RED LED METAL MFG. HDW. 24 LEADS.
 RL-2 . \$3.99 ea. or 3/\$1.00

DISPLAY LEDs

| | | | | | | | |
|---------------------|---------------------|-----------------------|--------------------------|------|----------|----|-------|
| C.A. - Common Anode | D.D. - Double Digit | C.C. - Common Cathode | RHD - Right Hand Decimal | | | | |
| Type | Polarity | Ht | Price | Type | Polarity | Ht | Price |
| MAN 1 | C.A.-red | .2 | | | | | |

DEALER DIRECTORY

Phoenix AZ

The Southwest's most progressive communications company stocking Kenwood, Icom, Yaesu, MFJ, B&W, Astron, Larsen, Cushcraft, Hy-Gain, Bearcat, and more. Would like to serve you! Power Communications Corp., 1640 West Camelback Rd., Phoenix AZ 85015, 241-Watt.

Culver City CA

Jun's Electronics, 3919 Sepulveda Blvd., Culver City CA 90230, 390-8003. Trades 463-1886 San Diego. Call us for a low quote.

Fontana CA

Complete lines ICOM, DenTron, Ten-Tec, Mirage, Cubic, Lunar, over 4000 electronic products for hobbyist, technician, experimenter. Also CB radio, landmobile. Fontana Electronics, 8628 Sierra Ave., Fontana CA 92335, 822-7710.

San Diego CA

We buy and sell Surplus Army Navy Electronics, also Terminated Material. What do you want to sell? Write for catalogue. Electronic-town, Inc., 440-7th Avenue, PO Box 2046, San Diego CA 92112, 232-9379.

San Jose CA SAN FRANCISCO BAY AREA

Homebrewers' haven; tons of new and used Ham/Computer gear and components. Serving Hams since 1958. We specialize in ICOM, KLM, Mirage, Comptronix. We ship worldwide. Tele-Com Electronics, 15460 Union Avenue, San Jose CA 95124, 377-4479.

San Jose CA

Bay area's newest Amateur Radio store. New & used Amateur Radio sales & service. We feature Kenwood, ICOM, Azden, Yaesu, Ten-Tec, Santec & many more. Shaver Radio, Inc., 1378 So. Bascom Ave., San Jose CA 95128, 998-1103.

Denver CO

Experimenter's paradise! Electronic and mechanical components for computer people, audio people, hams, robot builders, experimenters. Open six days a week. Gateway Electronics Corp., 2830 W. 44th Ave., Denver CO 80211, 458-5444.

Miami FL

Amateur Radio Center, Inc. "Everything for the Amateur" Since 1960, 2805 N.E. 2nd Avenue, Miami FL 33137, 573-8383, TWX 522035.

Smyrna GA

For your Kenwood, Yaesu, ICOM, Drake and other amateur needs, come to see us. Britt's Two-Way Radio, 2506 N. Atlanta Rd., Smyrna GA 30080, 432-8006.

Preston ID

Ross WB7BYZ, has the Largest Stock of Amateur Gear in the Intermountain West and the Best Prices. Call me for all your ham needs. Ross Distributing, 78 So. State, Preston ID 83263, 852-0830.

Terre Haute IN

Your ham headquarters located in the heart of the midwest. Hoosier Electronics, Inc., #9 Meadows Center, P.O. Box 3300, Terre Haute IN 47803, 238-1456.

Littleton MA

The ham store of N.E. you can rely on. Kenwood, ICOM, Wilson, Yaesu, DenTron, KLM amps, B&W switches & wattmeters, Whistler radar detectors, Bearcat, Regency, antennas by Larsen, Wilson, Hustler, GAM. TEL-COM Inc. Communications & Electronics, 675 Great Rd., Rt. 119, Littleton MA 01460, 496-3040.

Hudson NH

New England's Distributor and Authorized Service Center for all Major Amateur Lines. Tufts Radio Electronics, Inc., 61 Lowell Road, Hudson NH 03051, 863-5005.

Ann Arbor MI

See us for products like Ten-Tec, R. L. Drake, DenTron and many more. Open Monday through Saturday, 0830 to 1730. WB8VGR, WB8UXO, WD8OKN and W8RP behind the counter. Purchase Radio Supply, 327 E. Hoover Ave., Ann Arbor MI 48104, 668-8696.

Charlotte NC

Santec, Hy-Gain, Cubic Comm., Antenna Specialists, Wilson, W2AU/W2VS, B&W, Pathcom, Nye Viking, Electra, MFJ, Bash, CQ, Arrl., Ameco, Callbook Service, Sales New & Refurbished. Home-Tronics, 1217 Plaza, Charlotte NC 28205, 334-7974.

Somerset NJ

New Jersey's only factory-authorized ICOM and YAESU distributor. Large inventory of new and used specials. Most major brands in stock. Complete service and facilities. Radios Unlimited, 1760 Easton Avenue, P.O. Box 347, Somerset NJ 08873, 469-4599.

Amsterdam NY UPSTATE NEW YORK

Kenwood, ICOM, Drake, plus many other lines. Amateur Dealer for over 35 years. Adiron-dack Radio Supply, Inc., 185 West Main Street, Amsterdam NY 12010, 842-8350.

Central NY

Amateur radio hardwood displays made to your specifications—callsigns, plaques, awards or special orders. High quality, fast service, low prices. A.&M. Woodcraft, 313 N. Madison St., P.O. Box 243, Rome NY 13440, 337-5642.

Syracuse-Rome-Utica NY

Featuring: Kenwood, Yaesu, ICOM, Drake, Ten-Tec, Swan, DenTron, Alpha, Robot, MFJ, Tempo, Astron, KLM, Hy Gain, Mosley, Larsen, Cushcraft, Hustler, Mini Products. You won't be disappointed with equipment/service. Radio World, Oneida County Airport-Terminal Building, Oriskany NY 13424, 337-0203.

Columbus OH

The biggest and best Ham Store in the midwest featuring quality Kenwood products with working displays. We sell only the best. Authorized Kenwood Service. Universal Amateur Radio Inc., 1280 Aida Dr., Reynoldsburg (Columbus) OH 43068, 866-4267.

Scranton PA

ICOM, Bird, Cushcraft, Beckman, Fluke, Larsen, Hustler, Antenna Specialists, Astron, Avanti, Belden, W2AU/W2VS, CDE, AEA, Vibroplex, Ham-Key, CES, Amphenol, Sony, Fanon/Courier, B&W, Ameco, Shure. LaRue Electronics, 1112 Grandview St., Scranton PA 18509, 343-2124.

Houston TX

Experimenter's paradise! Electronic and mechanical components for computer people, audio people, hams, robot builders, experimenters. Open six days a week. Gateway Electronics Inc., 8932 Clarkcrest, Houston TX 77063, 978-6575.

San Antonio TX

Complete 2 way service shop. Call Dee. W5FSP. Selling Antenna Specialists, Avanti, Azden, Bird, Hy-gain, Standard, Vibroplex, Midland, Henry, Cushcraft, Dielectric, Hustler, ICOM, MFJ, Nye, Shure, Cubic, Tempo, Ten-Tec and others. Appliance & Equipment Co., Inc., 2317 Vance Jackson Road, San Antonio TX 78213, 734-7793.

Vienna VA

The Washington metropolitan area's leading supplier of the latest in Amateur Radio and Test Equipment. On your next trip to the Nation's Capital, stop by and see us. Electronic Equipment Bank, Inc., 516 Mill St. N.E., Vienna VA 22180, 938-3350.

Casper WY

Serving Wyoming Hams with lots of good stuff like Callbook, antenna parts, specials and bargains. Willy and Larry Dean invite you to drop in anytime. Radio Activity, 531 W. Collins Dr., Casper WY 82601, 237-5248.

DEALERS

Your company name and message can contain up to 25 words for as little as \$150 yearly (prepaid), or \$15 per month (prepaid quarterly). No mention of mail-order business or area code permitted. Directory text, and payment must reach us 60 days in advance of publication. For example, advertising for the March '82 issue must be in our hands by January 1st. Mail to 73 Magazine, Peterborough NH 03458. ATTN: Nancy Ciampa.

PROPAGATION

J. H. Nelson
4 Plymouth Dr.
Whiting NJ 08759

EASTERN UNITED STATES TO:

| | GMT: | 00 | 02 | 04 | 06 | 08 | 10 | 12 | 14 | 16 | 18 | 20 | 22 |
|--------------|------|----|----|----|----|----|----|-----|-----|-----|-----|-----|-----|
| ALASKA | 21 | 7 | 7 | 7 | 7 | 7 | 7 | 7 | 7A | 14 | 21 | 21A | |
| ARGENTINA | 14 | 7A | 7 | 7 | 7 | 7 | 7 | 7A | 14 | 21A | 21A | 21A | 21 |
| AUSTRALIA | 21A | 7A | 7B | 7B | 7B | 7B | 7B | 7B | 14 | 14A | 21 | 21 | 21A |
| CANAL ZONE | 14 | 7A | 7 | 7 | 7 | 7 | 7 | 7A | 14 | 21A | 21A | 21A | 21 |
| ENGLAND | 7 | 7 | 7 | 7 | 7 | 7 | 7 | 14 | 21A | 21A | 14A | 14 | 7A |
| HAWAII | 21A | 7A | 7B | 7 | 7 | 7 | 7 | 7 | 7B | 14 | 21 | 21A | 21A |
| INDIA | 7 | 7 | 7B | 7B | 7B | 7B | 7B | 14 | 14A | 14 | 7B | 7B | 7B |
| JAPAN | 14A | 7A | 7B | 7B | 7B | 7 | 7 | 7 | 7B | 7B | 7B | 7B | 14 |
| MEXICO | 14 | 7A | 7 | 7 | 7 | 7 | 7 | 7 | 14 | 21A | 21A | 21A | 14A |
| PHILIPPINES | 21 | 7A | 7B | 7B | 7B | 7B | 7B | 7 | 7 | 7 | 7 | 7B | 14 |
| PUERTO RICO | 14 | 7 | 7 | 7 | 7 | 7 | 7 | 14 | 14A | 21A | 21A | 21 | 14 |
| SOUTH AFRICA | 14 | 7 | 7 | 7B | 7B | 14 | 14 | 21A | 21A | 21A | 21 | 14A | |
| U. S. S. R. | 7 | 7 | 7 | 7 | 7 | 7 | 7B | 14 | 21A | 14A | 7B | 7B | 7 |
| WEST COAST | 21 | 7A | 7 | 7 | 7 | 7 | 7 | 7 | 14 | 21 | 21A | 21A | 21A |

CENTRAL UNITED STATES TO:

| | | | | | | | | | | | | | |
|--------------|-----|----|----|----|----|----|----|----|-----|-----|-----|-----|-----|
| ALASKA | 21 | 7 | 7 | 7 | 7 | 7 | 7 | 7 | 14 | 14 | 21 | 21A | |
| ARGENTINA | 21 | 14 | 7 | 7 | 7 | 7 | 7 | 7A | 14 | 21 | 21A | 21A | 21A |
| AUSTRALIA | 21A | 14 | 7A | 7B | 7B | 7B | 7B | 7B | 14A | 21 | 21 | 21A | |
| CANAL ZONE | 21 | 7A | 7 | 7 | 7 | 7 | 7 | 14 | 21 | 21A | 21A | 21A | 21 |
| ENGLAND | 7B | 7 | 7 | 7 | 7 | 7 | 7 | 7B | 21 | 21A | 14A | 14 | 7B |
| HAWAII | 21A | 14 | 7 | 7 | 7 | 7 | 7 | 7 | 7 | 14 | 21A | 21A | |
| INDIA | 7B | 7A | 7B | 7B | 7B | 7B | 7B | 7B | 14 | 7B | 7B | 7B | |
| JAPAN | 21A | 14 | 7B | 7B | 7 | 7 | 7 | 7 | 7 | 7B | 7B | 7B | 14 |
| MEXICO | 14 | 14 | 7 | 7 | 7 | 7 | 7 | 7 | 14 | 14 | 21A | 21A | 21 |
| PHILIPPINES | 21A | 7A | 7B | 7B | 7B | 7B | 7B | 7 | 7 | 7 | 7 | 7B | 14 |
| PUERTO RICO | 21 | 7A | 7 | 7 | 7 | 7 | 7 | 14 | 14A | 21A | 21A | 21A | 14A |
| SOUTH AFRICA | 14 | 7A | 7 | 7B | 7B | 7B | 7B | 14 | 14 | 21A | 21A | 21 | 14A |
| U. S. S. R. | 7 | 7 | 7 | 7 | 7 | 7 | 7B | 7B | 14 | 14A | 7B | 7B | 7B |

WESTERN UNITED STATES TO:

| | | | | | | | | | | | | | |
|--------------|-----|----|----|----|----|----|----|----|-----|-----|-----|-----|-----|
| ALASKA | 21A | 14 | 7 | 7 | 7 | 7 | 7 | 7 | 7 | 14 | 21 | 21A | |
| ARGENTINA | 21 | 14 | 7A | 7 | 7 | 7 | 7B | 14 | 14A | 21 | 21A | 21A | |
| AUSTRALIA | 21A | 21 | 14 | 7 | 7B | 7B | 7B | 7B | 14 | 21 | 21 | 21A | |
| CANAL ZONE | 21 | 14 | 7A | 7 | 7 | 7 | 7 | 14 | 21 | 21A | 21A | 21A | |
| ENGLAND | 7B | 7 | 7 | 7 | 7 | 7 | 7B | 7A | 21 | 14A | 14B | 7B | |
| HAWAII | 21A | 14 | 14 | 7 | 7 | 7 | 7 | 7 | 14 | 21 | 21A | 21A | |
| INDIA | 14B | 14 | 7B | 7B | 7B | 7B | 7B | 7B | 7A | 7B | 7B | 7B | |
| JAPAN | 21A | 14 | 14 | 7B | 7 | 7 | 7 | 7 | 7 | 7B | 14 | 21 | |
| MEXICO | 21 | 14 | 7 | 7 | 7 | 7 | 7 | 14 | 14 | 21A | 21A | 21A | |
| PHILIPPINES | 21A | 14 | 7A | 7B | 7B | 7B | 7B | 7 | 7 | 7 | 7B | 14A | |
| PUERTO RICO | 21 | 14 | 7 | 7 | 7 | 7 | 7 | 14 | 21 | 21A | 21A | 21A | |
| SOUTH AFRICA | 14A | 14 | 7 | 7B | 7B | 7B | 7B | 14 | 14 | 21A | 21A | 21 | 14A |
| U. S. S. R. | 7B | 7 | 7 | 7 | 7 | 7 | 7B | 7B | 14A | 7B | 7B | 7B | |
| EAST COAST | 21 | 7A | 7 | 7 | 7 | 7 | 7 | 14 | 21 | 21A | 21A | 21A | |

First letter = day waves Second = night waves
A = Next higher frequency may also be useful
B = Difficult circuit this period F = Fair G = Good
P = Poor * = Chance of solar flares; # = of aurora

January

| SUN | MON | TUE | WED | THU | FRI | SAT |
|-----|------|------|------|------|-----|-----|
| | | | | | 1 | 2 |
| | | | | | G/G | G/F |
| 3 | 4 | 5 | 6 | 7 | 8 | 9 |
| G/F | G/G | G/G | G/F | G/G | G/G | G/G |
| 10 | 11 | 12 | 13 | 14 | 15 | 16 |
| G/G | G/G | G/F* | F/F* | F/F | F/F | G/F |
| 17 | 18 | 19 | 20 | 21 | 22 | 23 |
| G/F | G/F* | G/F* | F/F* | F/P* | F/P | G/F |
| 24 | 25 | 26 | 27 | 28 | 29 | 30 |
| G/G | G/G | G/G | G/G | G/F | G/F | G/G |
| 31 | | | | | | |

THE EVOLUTION OF A CHAMPION!

FT-101ZD Mk III



The FT-101ZD Mk III is the latest chapter in the success story of the FT-101 line. Armed with new audio filtering for even better selectivity, the FT-101ZD now includes provision for an optional FM or AM unit. Compare features and you'll see why active operators everywhere are upgrading to Yaesu!

Variable IF Bandwidth

Using two 8-pole filters in the IF, Yaesu's pioneering variable bandwidth system provides continuous control over the width of the IF passband — from 2.4 kHz down to 300 Hz — without the shortcomings of single-filter IF shift schemes. No need to buy separate filters for 1.8 kHz, 1.5 kHz, etc.

Improved Receiver Selectivity

New on the FT-101ZD Mk III is a high-performance audio peak/notch filter. Use the peak filter for single-signal CW reception, or choose the notch filter for nulling out annoying carriers or interfering CW signals. In the CW mode, you can choose between the 2.4 kHz SSB filter and an optional CW filter (600 or 350 Hz) from the mode switch.

Diode Ring Front End

The FT-101ZD now sports a high-level diode ring mixer in the front end. This type of mixer, well known for its strong signal performance, is your assurance of maximum protection from intermod problems on today's crowded bands.

WARC Bands Factory Installed

The FT-101ZD Mk III comes equipped with factory installation of the new 10, 18, and 24 MHz bands recently assigned to the Amateur Service at WARC. In the meantime, use the 10 MHz band for monitoring of WWV!

RF Speech Processor

Not an additional-cost option, the FT-101ZD RF speech processor provides a significant increase in average SSB power output, for added punch in those heavy DX pile-ups. The optimum processor level is easily set via a front panel control.

Worldwide Power Capability

Every FT-101ZD comes equipped with a multi-tap power transformer, which can be easily modified from the stock 117 VAC to 100/110/200/220/234 VAC in minutes. A DC-DC converter is available as an option for mobile or battery operation.

Convenience Features

Designed fundamentally as a high-performance SSB and CW transceiver, the FT-101ZD includes built-in VOX, CW sidetone, semi-break-in T/R control on CW, slow-fast-off AGC selection, level controls for the noise blanker and speech processor, and offset tuning for both transmit and receive. The Mk III optional FM unit may be used for 10 meter FM operation, or choose the optional AM unit for WWV reception or VHF AM work through a transverter (AM and FM units may not both be installed in a single transceiver).

Full Line of Accessories

See your Yaesu dealer for a demonstration of the top performance accessories for the FT-101ZD, such as the FV-101Z External VFO, SP-901P Speaker/Patch, YR-901 CW/RTTY Reader, FC-902 Antenna Tuner, and the FTV-901R VHF/UHF Transverter. Watch for the upcoming FV-101DM Digital Memory VFO, with keyboard frequency entry and scanning in 10 Hz steps!

Nationwide Service Network

During the warranty period, the Authorized Yaesu Dealer from whom you purchased your equipment provides prompt attention to your warranty needs. For long-term servicing after the warranty period, Yaesu is proud to maintain two fully-equipped service centers, one in Cincinnati for our Eastern customers and one in the Los Angeles area for those on the West Coast.

Note: A limited quantity of the earlier FT-101ZD (with AM as standard feature) is still available. See your Yaesu dealer. FT-101ZD Mk III designates transceivers bearing serial #240001 and up, with APF/Notch filter built in and AM/FM units optional.

681

Price And Specifications Subject To
Change Without Notice Or Obligation

YAESU ⁸³ 
The radio.

YAESU ELECTRONICS CORP., 6851 Walthall Way, Paramount, CA 90723 ● (213) 633-4007
YAESU Eastern Service Ctr., 9812 Princeton-Glendale Rd., Cincinnati, OH 45246 ● (513) 874-3100

Dyna-"mite."



Photo shown is TR-7730 in 16-key autopatch UP/DOWN microphone version.

Miniaturized, 5 memories, memory/band scan

TR-7730

The TR-7730 is an incredibly compact, reasonably priced, 25-watt, 2-meter FM mobile transceiver with five memories, memory scan, automatic band scan, and other convenient operating features. The TR-7730 is available in two variations: a 16-key autopatch UP/DOWN microphone (MC-46) version, and a basic UP/DOWN microphone version.

TR-7730 FEATURES:

- **Smallest ever Kenwood mobile**
Measures only 5-3/4 inches wide, 2 inches high, and 7-3/4 inches deep, and weighs only 3.3 pounds. Mounts even in the smallest subcompact car, and is an ideal combination with the equally compact TR-8400 synthesized 70-cm FM mobile transceiver.
- **25 watts RF output power**
HI/LOW power switch selects 25-W or 5-W output.
- **Five memories**
May be operated in simplex mode or repeater mode with the transmit frequency offset ± 600 kHz. The fifth memory stores both receive and transmit frequency independently, to allow operation on repeaters with nonstandard splits. Memory backup terminal on rear panel.
- **Memory scan**
Automatically locks on busy memory channel and resumes when signal disappears or when SCAN switch is pushed. Scan HOLD or microphone PTT switch cancels scan.
- **Automatic band scan**
Scans entire band in 5-kHz or 10-kHz steps and locks on busy channel. Scan resumes when signal disappears or when SCAN switch is pushed. Scan HOLD or microphone PTT switch cancels scan.
- **Extended frequency coverage**
Covers 143.900-148.995 MHz in switchable 5-kHz or 10-kHz steps.
- **UP/DOWN frequency control from microphone**
Manual UP/DOWN scan of entire band in

5 kHz or 10 kHz steps is possible when using either autopatch or basic UP/DOWN microphone versions.

- **Offset switch**
Allows VFO and four of five memory frequencies to be offset ± 600 kHz for repeater access or simplex.
- **Four-digit LED frequency display**
Indicates receive and transmit frequency.
- **S/R/F bar meter and LED indicators**
Bar meter of multicolor LEDs shows S/R/F levels. Other LEDs indicate BUSY, ON AIR, and REPEATER offset.
- **Tone switch**

Optional accessories:

- **MC-46** 16-key autopatch UP/DOWN microphone
- **SP-40** compact mobile speaker
- **KPS-7** fixed-station power supply

More information on the TR-7730 and TR-8400 is available from all authorized dealers of Trio-Kenwood Communications 1111 West Walnut Street Compton, California 90220

Synthesized 70-cm FM mobile rig

TR-8400

- **Synthesized coverage of 440-450 MHz**
Covers upper 10 MHz of 70-cm band in 25-kHz steps, with two VFOs.
- **Offset switch**
For ± 5 MHz transmit offset on both VFOs and four of five memories, as well as simplex operation. Fifth memory allows any other offset by memorizing receive and transmit frequencies independently.
- **DTMF autopatch terminal**
On rear panel, for connecting DTMF (dual-tone multifrequency) touch pad (for accessing autopatches) or other tone-signaling device.
- **HI/LOW RF output power switch**
Selects 10 watts or 1 watt output.
- **Virtually same size as TR-7730**
Perfect companion for TR-7730 in a compact mobile arrangement.
- **Other features similar to TR-7730**
Five memories, memory scan, automatic band scan (in 25-kHz steps), UP/DOWN manual scan, four-digit LED receive frequency display (also shows transmit frequency in memory 5), S/R/F bar meter and LED indicators, tone switch, and same optional accessories.

KENWOOD
...pacesetter in amateur radio



Specifications and prices are subject to change without notice or obligation.