

# Amateur Radio's Technical Journal

 A Wayne Green Publication

# 73

**Great Projects  
You Can Build!**

**Push-button  
Tuning  
for the 701**  
Page 14

**Set-and-Forget  
Rotator Control**  
Page 22

**Fanatic's  
Antenna Tuner**  
Page 42

**Monster  
Power Supply**  
Page 56

**State-of-the-Art  
Audio Filter**  
Page 32

**Cheapo Keyer**  
Page 104

**Plus 8 More!**

## A Perfect "10"

Timer, counter, logic probe—10 functions in all. That's the Multi-Board One, and you can build it. WA2BHB

## Remote-Control Your IC-701

Simpler than commercial controllers, this home-brew unit nevertheless features push-button band changing and frequency selection, scanning, and expanded coverage. N2GW

## Automatic Beam Aimer

Here's the scoop on adding set-and-forget convenience to your rotator control. Works with most common control boxes. K9AZG

## Life-Support System for HTs

At home or in the car, this do-it-yourself charger and accessory box could be the best friend your handie-talkie ever had. WB6BHI

## What?

### Another Audio Filter Project?

Yup. And even the most modern receivers benefit from this QRM-crusher. W4MLE

### A Tuner for Antenna Fanatics

Anyone experimenting with antennas needs a darned good tuner. Construct this one and save your finals. Staff

## Digital Basics

This is no time to be a digital illiterate. Part III reveals the secrets of multivibrators, shift registers, and other notorious devices. K4IPV

## The Money-Maker Power Supply

Need 12 volts for your transceiver? Save half the cost of a commercial unit by assembling this 25-Amp monster. WA6TTY

## TVRO Q & A: Part III

LNAs are expensive, but rolling your own is a losing proposition. WB0POP

## The Sound of Silence

Beep!! Your TS-180 is off the air, Charlie. HB9BLU

## Build the Re-Fuser

It's a self-replacing fuse. Why blow one when you can blow two? K5CN

## No Smoking in the Ham Shack

Overvoltage kills solid-state finals. Protect yours for \$1.00. N7JJ

## Tempo MARSer

Get the S-1 off those crowded ham channels. Expand your coverage above and below the amateur band. WB6IQN

## CW and the Apple II

The simplicity of BASIC plus the speed of machine language equals a near-perfect Morse keyboard. N5MR

## Everyman's Audio Amplifier

Make this one-chip amp a permanent part of your test bench. It's an easy project for beginning experimenters. W3KBM



701 Remote Control—14

## Award-Winning Program

Certificate hunters, cut your paperwork down to size. Let your Pet track your quest for excellence. WB2GFE

## Speed Demon

How fast was that? Find out with this wpm display for Heath's 1410 keyer. K4ZHM

## Keyer on a Shoestring

Hams are cheap and so is this keyer. Big spenders will build the deluxe, two-chip version. WB5PPV

## I Got My Ticket! Now What?

A look at what Elmer forgot to tell you. N1II

## Never Say Die—6

Circuits—109,112

Fun!—110

Ham Help—111,146

Social Events—113

Contests—114

Letters—115

RTTY Loop—116

DX—118

Awards—122

Satellites—124

Reader Service—130

New Products—134

Review—139

Dealer Directory—162

Propagation—162





# The Dynamic Duo

ICOM's 2 Meter and 440 MHz FM



IC-2AT

IC-25A

IC-45A

IC-4AT

25 watt/5 memories/2 scanning systems in a 2"H x 5½"W x 7"D package is what has made the easy-to-use IC-25A the most popular 2 meter FM mobile transceiver ever. Now ICOM presents the second half of its mobile duo...IC-45A. The IC-45A covers 440-449.995 MHz. Both transceivers are supplied with touchtone® microphones standard.

**Dual VFO's.** Dual VFO's give an extra stored frequency for scanning (memory scan scans 5 memories plus 2 VFO's) and each VFO has a different tuning rate for easy QSY.

	VFO A	VFO B
IC-25A	5 KHz	15 KHz
IC-45A	5 KHz	25 KHz

**5 Memories.** Instant access to most used frequencies. VFO A information is transferred to the selected memory by pushing the write (IC-25A) or W/CK (IC-45A) button.



IC-BU1

**Priority Channel.**

Any memory channel may be monitored for activity on a sample basis, every 5 seconds, without disruption of a QSO conducted on a VFO frequency.

**LED Bar Meter.** Shows strength of received signal as well as relative transmitter output from the fully protected final RF amplifier. APC (automatic power control) is used to detect SWR and adjust the power output to a safe level.

**Simplex/Duplex Operation.** Standard 600 KHz offset initializes into radio at turn on. Offset may be changed by pressing the priority button while in VFO operation. Rotating the main tuning knob will now change the offset up or down and the offset will be displayed on the frequency readout.

**Adjustable Power Levels.**

	Hi Pwr	Lo Pwr
IC-25A	25 W	1 W
IC-45A	10 W	1 W

Pulling the squelch knob out places the unit into low power. Both the high and low power may be independently set to accommodate your simplex/repeater requirements or amplifier input characteristics.

**Nor/Rev Capability.** Use of this button on the IC-25A or the W/CK button on the IC-45A, in the duplex mode, allows one touch monitoring of the repeater input frequency. If simplex operation is possible you will know instantly.

**Scanning.** Pushing the S/S button initiates the scan circuitry. With the mode switch in a memory position the unit will scan all 5 memories plus the 2 VFO frequencies.

With the mode switch in a VFO position, the unit will scan the entire band or the portion of the band defined by memories 1 and 2. Full band scan or program band scan is selected from the front panel in the IC-25A, internally on the IC-45A.

Both units have internally switched scanning choices of adjustable delay period after a

carrier is received then resume scan, or resume on carrier drop.



**The Most Compact FM Mobiles on the Market.** Fits in the smallest of places. Stacking, matching Mobile Mounts for complete mobile communications for your car.

**Memory Backup.** When the optional IC-BU1 backup power unit is installed on the back of the IC-25A or IC-45A, memory will be maintained while transferring the unit from power source to power source. If the unit is not removed from power, it will maintain memory even when turned off with or without the IC-BU1.

 **ICOM**  
The World System



# 5-STORE BUYING POWER in action!

NEVER BEFORE...  
NEVER AGAIN!



**IC-730**



**SALE!**

REGULAR \$829

**\$649<sup>95</sup>**

LIMITED TIME ONLY...  
LIMITED QUANTITY  
ACT!



CALL NOW FOR  
SPECIAL PRICES



TS-930S

**NEW**



TR-2500



TR-7950

2 METERS, 45 WATTS,  
21 CHANNEL MEMORY



TS-830S

**KLM/Tri Ex**

**KT-34A**

4 ELEMENT TRIBANDER

REGULAR \$389.95

**SALE! \$309**

**KT-34XA**

6 ELEMENT TRIBANDER

REGULAR \$569.95

**SALE! \$459**

CALL FOR OTHER KLM PRICES.

TRI EX W51 TOWER  
w/KLM KT-34A **\$1099**

TRI EX W51 TOWER  
w/KLM KT-34XA **\$1239**

TRI EX W51, 51' TOWER  
REGULAR \$999.95 **\$829<sup>95</sup>**

PRICES ARE FOB CALIF. EXCEPT FOR CERTAIN  
COMBINATIONS. PLEASE INQUIRE.

**ETD ALPHA**

ALL ALPHA  
AMPLIFIERS IN STOCK  
FOR FAST DELIVERY

CALL FOR SPECIAL PRICES



EXAMPLE  
**76PA**

REGULAR \$2395

**SALE! \$1799**

**MIRAGE** AMPLIFIERS



AVAILABLE  
AT LOW  
PRICES

2 METER AMPLIFIER

**B-3016**

30W in, 160W out.

REG. \$239.95

**SALE!**  
**\$199<sup>95</sup>**

**B-1016**

10W in, 160W out.

REG. \$279.95

**SALE!**  
**\$249<sup>95</sup>**



**YAESU**

HANDHELDS



2 METER  
FT-208R



70CM  
FT-708R

**SALE!**  
**\$289<sup>95</sup>**

**FREE SHIPMENT** (U.P.S. Brown)  
CONTINENTAL U.S.A.  
EXCEPT FOR SOME ALPHA, TRI EX and KLM ITEMS.

**FREE PHONE 800 854-6046**

9:30AM to 5:30PM PACIFIC TIME.

OVER-THE-COUNTER, 10AM to 5:30PM.

MONDAY THROUGH SATURDAY

CALIFORNIA CUSTOMERS PLEASE PHONE OR VISIT LISTED STORES.

**ANAHEIM, CA 92801**

2620 W. La Palma,  
(714) 761-3033 (213) 860-2040  
Between Disneyland & Knott's Berry Farm

**BURLINGAME, CA 94010**

999 Howard Ave., (415) 342-5757  
5 miles south on 101 from S.F. Airport.

**OAKLAND, CA 94609**

2811 Telegraph Ave., (415) 451-5757  
Hwy 24 Downtown. Left 27th off-ramp.

**SAN DIEGO, CA 92123**

5375 Kearny Villa Road (714) 560-4900  
Hwy 163 & Clairemont Mesa Blvd.

**VAN NUYS, CA 91401**

6265 Sepulveda Blvd., (213) 988-2212  
San Diego Fwy at Victory Blvd.

AEA • ALLIANCE • ALPHA • AMECO • AMPHENOL • ARRL • ASTRON  
• AVANTI • BENCHER • BERK-TEK • BIRD • B&W • CALLBOOK • CDE  
• COLLINS • CUBIC • CURTIS • CUSHCRAFT • DAIWA • DATONG

• DENTRON • DRAKE • DX ENGINEERING • EIMAC • HUSTLER  
• HY-GAIN • ICOM • J.W.MILLER • KENWOOD • KLM • LARSEN  
• LUNAR • METZ • MFJ • MICRO • LOG • MINI • PRODUCTS

• MIRAGE • NYE • PALOMAR • ROBOT • ROHN • SHURE • SWAN  
• TELEX • TELREX • TEMPO • TEN-TEC • TRISTAO  
• YAESU and many more!

Prices, specifications, descriptions subject to change without notice. Calif. residents please add sales tax.

SERVING HAMS  
BETTER.  
North...south...east...west.

Bob Ferrero, W6RJ/K6AHV,  
Jim Rafferty, N6RJ  
other well known hams  
give you courteous,  
personalized  
service.



**HAM  
RADIO  
OUTLET**

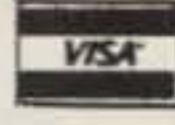



# INFO

## Manuscripts

Contributions in the form of manuscripts with drawings and/or photographs are welcome and will be considered for possible publication. We can assume no responsibility for loss or damage to any material. Please enclose a stamped, self-addressed envelope with each submission. Payment for the use of any unsolicited material will be made upon acceptance. All contributions should be directed to the 73 editorial offices. "How to Write for 73" guidelines are available upon request.

## Editorial Offices:

Pine Street  
Peterborough NH 03458  
Phone: 603-924-9471

## Advertising Offices:

Elm Street  
Peterborough NH 03458  
Phone: 603-924-7138

## Circulation Offices:

Elm Street  
Peterborough NH 03458  
Phone: 603-924-9471

## Subscription Rates

In the United States and Possessions:  
One Year (12 issues) \$25.00  
Two Years (24 issues) \$38.00  
Three Years (36 issues) \$53.00

## Elsewhere:

Canada and Mexico—\$27.97/1 year only, U.S. funds. Foreign surface mail—\$44.97/1 year only, U.S. funds drawn on U.S. bank. Foreign air mail—please inquire.

## To subscribe, renew or change an address:

Write to 73, Subscription Department, PO Box 931, Farmingdale NY 11737. For renewals and changes of address, include the address label from your most recent issue of 73. For gift subscriptions, include your name and address as well as those of gift recipients.

## Subscription problem or question:

Write to 73, Subscription Department, PO Box 931, Farmingdale NY 11737. Please include an address label.

73: *Amateur Radio's Technical Journal* (ISSN 0098-9010) is published monthly by 73, Inc., a subsidiary of Wayne Green, Inc., 80 Pine Street, Peterborough NH 03458. Second class postage paid at Peterborough NH 03458 and at additional mailing offices. Entire contents copyright © 1982, Wayne Green, Inc. All rights reserved. No part of this publication may be reprinted or otherwise reproduced without written permission from the publisher. Microfilm Edition—University Microfilm, Ann Arbor MI 48106. Postmaster: Send address changes to 73, Subscription Services, PO Box 931, Farmingdale NY 11737.

## R-X Noise Bridge



- Learn the truth about your antenna.
- Find its resonant frequency.
- Adjust it to your operating frequency quickly and easily.

If there is one place in your station where you cannot risk uncertain results it is in your antenna.

The Palomar Engineers R-X Noise Bridge tells you if your antenna is resonant or not and, if it is not, whether it is too long or too short. All this in one measurement reading. And it works just as well with ham-band-only receivers as with general coverage equipment because it gives perfect null readings even when the antenna is not resonant. It gives resistance and reactance readings on dipoles, inverted Vees, quads, beams, multiband trap dipoles and verticals. No station is complete without this up-to-date instrument.

Why work in the dark? Your SWR meter or your resistance noise bridge tells only half the story. Get the instrument that really works, the Palomar Engineers R-X Noise Bridge. Use it to check your antennas from 1 to 100 MHz. And use it in your shack to adjust resonant frequencies of both series and parallel tuned circuits. Works better than a dip meter and costs a lot less. Send for our free brochure.



The price is \$59.95 in the U.S. and Canada. Add \$3.00 Shipping/Handling. California residents add sales tax.

Fully guaranteed by the originator of the R-X Noise Bridge.

**ORDER YOURS NOW!**

# Palomar Engineers

Box 455, Escondido, CA. 92025

Phone: [714] 747-3343

# Westland Electronics

## Microprocessor & Interface

1771	24.50	6845	12.95	DAC-0800	3.99
1791	34.95	6850	4.49	INS8250	14.90
21102	1.49	8085A	8.95	MM58167	12.75
2112	1.65	8212	2.75	TMS9900	29.95
2516	4.75	8214	3.95	TR1602B	2.49
2532	7.95	8216	2.75	SC-01	55.00
2651	12.95	8224	3.29	Z80A-CPU	7.95
4044L-2	2.49	8226	2.79	Z8OACTC	7.49
6502	8.99	8228	4.49	Z8OADart	19.95
6800	6.99	8251	6.95	Z8OAPIO	7.49
6802	11.95	8255	6.49	Z8OASIO	17.95
6809	19.95	AY5-1013A	4.95	Z8603	74.95
6821	4.95	AY5-2376	12.39	Z8671	29.95

## 1 Amp TO-220 Voltage Regulators

PART #	1-24	25-99	100-499
7805 (LM340T-5)	.85	.75	.65
7812 (LM340T-12)	.85	.75	.65
7815 (LM340T-15)	.85	.75	.65
7818 (LM340T-18)	.85	.75	.65

## Linear Integrated Circuits

8038	3.95	LM393	.97	MC3302	.90
LF351	.75	LM733	.99	MC1458	.59
LF353	1.29	LM741-8	.35	MC1514	1.39
LF357	1.39	LM741-14	.35	NE555	.45
LM301	.45	LM747	.77	NE556	.98
LM307	.49	LM748	.49	NE565	1.25
LM311	.95	LM1310	1.69	NE5534	1.99
LM318	1.75	LM1458	.69	NE5538	2.25
LM324	.90	LM1800	2.49	SSM2010	7.50
LM339	.79	LM1818	3.49	SSM2020	7.50
LM358	.90	LM1889	2.99	SSM2030	7.50
LM377	2.49	LM2900	.69	SSM2040	7.50
LM380N-14	1.25	LM3900	.89	SSM2044	5.75
LM381	1.80	LM3905	1.49	SSM2055	6.50
LM383	3.29	LM3914	3.79	XR2206	5.19
LM384	1.95	LM3915	3.79	XR4136	.99
LM386	.99	LM3916	3.79	XR4741	1.95
LM387	1.49	LM4500	3.29	XR558	1.99

## 5% Carbon Film Resistors

We stock all 5% standard values between 1 Ohm and 1 Meg Ohm.

¼ Watt	
Package of 5	.20
Package of 100 (one value)	1.50
Package of 1000 (one value)	9.75
½ Watt	
Package of 5	.25
Package of 100 (one value)	1.75
Package of 1000 (one value)	15.00

Sampler box consisting of 5 each of all 169 standard 5% values between 1 Ohm and 10 Meg Ohm (845 pieces total).

¼ Watt Sampler Box	25.00
½ Watt Sampler Box	28.00

We Also Stock ¼ Watt Resistors

## 1% ¼ Watt Metal Film Resistors

We now stock all 481 Standard EIA values between 10 Ohms and 1 Meg Ohm.

Package of 5	.45
Package of 100 (one value)	5.50
Box of 1000 (one value)	28.00

Send for our full line catalog of IC's, Resistors, Capacitors, Diodes, Regulators, Crystals, Trim Pots, Switches, Sockets, Connectors, RF Chokes, and more.

Minimum Order \$10.00

Shipping	
10-24.99	3.00 Above 50.00 ... FREE
25-49.99	1.50 C.O.D. ... Add 1.50

## WESTLAND ELECTRONICS

37387 Ford Rd. • Westland, MI 48185

Order Line - 1-800-521-0664

In Michigan - 313-728-0650 ✓ 154



The ultimate team...the new

# Drake "Twins"



The **TR7A** and **R7A**  
offer performance and versatility  
for those who demand the ultimate!

## TR7A Transceiver

- **CONTINUOUS FREQUENCY COVERAGE** — 1.5 to 30 MHz full receive coverage. The optional AUX7 provides 0 to 1.5 MHz receive plus transmit coverage of 1.8 to 30 MHz, for future Amateur bands, MARS, Embassy, Government or Commercial frequencies (proper authorization required).
- **Full Passband Tuning (PBT)** enhances use of high rejection 8-pole crystal filters.
- New!** Both 2.3 kHz ssb and 500 Hz cw crystal filters, and 9 kHz a-m selectivity are standard, plus provisions for two additional filters. These 8-pole crystal filters in conjunction with careful mechanical/electrical design result in realizable ultimate rejection in excess of 100 dB.
- New!** The very effective NB7 Noise Blanker is now standard.
- New!** Built in lightning protection avoids damage to solid-state components from lightning induced transients.
- New!** Mic audio available on rear panel to facilitate phone patch connection.
- **State-of-the-art design** combining solid-state PA, up-conversion, high-level double balanced 1st mixer and frequency synthesis provided a no tune-up, broadband, high dynamic range transceiver.

## R7A Receiver

- **CONTINUOUS NO COMPROMISE** 0 to 30 MHz frequency coverage.
- **Full passband tuning (PBT).**
- New!** NB7A Noise Blanker supplied as standard.
- **State-of-the-Art features** of the TR7A, plus added flexibility with a low noise 10 dB rf amplifier.
- New!** Standard ultimate selectivity choices include the supplied 2.3 kHz ssb and 500 Hz cw crystal filters, and 9 kHz a-m selectivity. Capability for three accessory crystal filters plus the two supplied, including 300 Hz, 1.8 kHz, 4 kHz, and 6 kHz. The 4 kHz filter, when used with the R7A's Synchro-Phase a-m detector, provides a-m reception with greater frequency response within a narrower bandwidth than conventional a-m detection, and sideband selection to minimize interference potential.
- **Front panel pushbutton control** of rf preamp, a-m/ssb detector, speaker ON/OFF switch, i-f notch filter, reference-derived calibrator signal, three agc release times (plus AGC OFF), integral 150 MHz frequency counter/digital readout for external use, and Receiver Incremental Tuning (RIT).

## The "Twins" System

- **FREQUENCY FLEXIBILITY.** The TR7A/R7A combination offers the operator, particularly the DX'er or Contester, frequency control agility not available in any other system. The "Twins" offer the only system capable of no-compromise DSR (Dual Simultaneous Receive). Most transceivers allow some external receiver control, but the "Twins" provide instant transfer of transmit frequency control to the R7A VFO. The operator can listen to either or both receiver's audio, and instantly determine his transmitting frequency by

appropriate use of the TR7A's RCT control (Receiver Controlled Transmit). DSR is implemented by mixing the two audio signals in the R7A

- **ALTERNATE ANTENNA CAPABILITY.** The R7A's Antenna Power Splitter enhances the DSR feature by allowing the use of an additional antenna (ALTERNATE) besides the MAIN antenna connected to the TR7A (the transmitting antenna). All possible splits between the two antennas and the two system receivers are possible.

Specifications, availability and prices subject to change without notice or obligation.

See your Drake dealer or write  
for additional information.



**COMING SOON: New RV75 Synthesized VFO**  
Compatible with TR5 and 7-Line Xcvrs/Rcvrs

- Frequency Synthesized for crystal-controlled stability
- VRTO (Variable Rate Tuning Oscillator\*) adjusts tuning rate as function of tuning speed.
- Resolution to 10 Hz
- Three programmable fixed frequencies for MARS, etc.
- Split or Transceive operation with main transceiver PTO or RV75



# W2NSD/1 NEVER SAY DIE

editorial by Wayne Green



## WHERE'S THE SOLDER?

For years, the pride of my workbench was my 300-Watt soldering iron. I looked for it the other day, thinking I might frame it as a historic remnant of a long lost past, and couldn't find it. Well, I don't need that old 300-Watter anymore anyway. These days, a simple pencil iron is enough to do irreparable damage. Some of these damned chips we use today would probably self-destruct if just allowed in the room with the 300-Watt iron. But the fact is that though the tools have changed, we're getting into an

era of a high interest in building electronic gadgets.

The recent emphasis on relatively simple building projects in 73 has brought in quite a bit of congratulatory mail. It's appreciated. You know, when I started 73, back in 1960, one of the basic reasons I felt that the magazine was needed was to encourage hams to build more. As the editor, I'd had one hell of a battle with the publisher of CQ over this. He wanted monthly columns, which were a lot cheaper to publish. I'd built the magazine up from a real loser to a big winner with construction... and found myself fired. So I started 73 and got right at it with construction projects.

Just to make sure that you know right off when you look at the table of contents on the cover, we'll put a soldering-iron logo by each project. Mind you, these are not going to be all-band transceivers which could take you a year to build. I'll still



leave those for *Ham Radio*, if they stay afloat.

While it may go without saying that I'm hoping you will write up any construction projects you develop, let me make sure that there is no misunderstanding here. If you design something which might be of interest to the rest of 73 readers, I hope you'll write it up. Type the article double-spaced, leave generous margins, get a friend with a good camera to take art-gallery-class photos of your gem... and let's have it.

Sure, it's fun to operate. But I've never gotten so wrapped up in operating that I missed a meal. Now building... many is the time I've started working on a project and found myself looking at the rising sun, having missed dinner, midnight snack, and all those usual buffering pick-me-ups in between. Hell, building something is more fun than coffee ice cream.

And yes, you can go fairly far afield. Sure, we're mostly interested in amateur radio, but that won't stop us from publishing interesting projects which are involved with other aspects of life such as photography, computers, and so on. You'll get my attention the fastest with gadgets which tie computers and amateur radio together. I know as well as you that we have the tools to make incredible changes in communications over the next few years. It's getting time for us to grab those tools and carve out some pioneer territory with high-speed Morse, RTTY, or ASCII... or whatever pleases you.

We have the parts to make incredibly sophisticated repeaters... yet I've seen little to

amaze me so far. Let's get cracking... and writing. I'll publish... and pay.

## CIRCUITS CIRCUITS CIRCUITS

Some years ago I began reprinting little circuits out of foreign electronics magazines which I thought might interest the more dedicated experimenter. They were presented with very little backup information... just enough for the experienced builder to put the project together and get it working. We're running that section again and would like to have you send in little circuits for almost anything. You don't have to put together a whole article—just the circuit, the parts values, and a hint of what it will do. Perhaps you've found a circuit from some other (non-ham) magazine which readers might find of value... or from a book. We'll scan the foreign magazines and see what we can find for you. You don't have to draft the circuits. Just sketch them clearly, showing all parts values. If there are any special parts, show what they are and where they can be obtained. The address is Circuits, Editorial Offices, 73 Magazine, Peterborough NH 03458. By the way, don't forget to include your choice of book from the Radio Bookshop, which we'll send you when your circuit is published.

For that matter, authors of articles on construction projects should remember that 73 is read in over 200 countries and that in most of them parts are darned hard to come by. Thus, if there is any way to do it, try to use commonly available parts... or at least suggest such as replacements if you've used a 1963 transistor in your unit. A builder in Chile will not be happy if you merely specify a Radio Shack part number... give a bit more in details since his Radio Shack may not carry the full line.

One of the main reasons why 73 is so treasured by DX hams is that it runs more construction projects than any other ham magazine in English in the world. We can't come close to the Japanese ham magazine, but then they have about three times as many active hams there as we do, so that's natural. If I could get someone to translate the Japanese construction projects, I could put out a couple

## TECHNICAL EDITOR WANTED

The search is on! We're looking for a knowledgeable ham to become Technical Editor of 73 Magazine. If you enjoy our small-construction-project format and can tell a good circuit from a bummer, then you're a prime candidate.

Duties of the Tech Editor include checking the technical accuracy of articles, working with authors to get the best new manuscripts, making sure 73 publishes timely reviews of the latest ham gear, climbing the tower to repair the 20-meter beam, installing Wayne's new mobile rigs, etc. There is plenty of opportunity for fun, too, working contests from W2NSD, learning about microcomputers, mountaintopping from the drive-up peak just down the road.

Furthermore, Peterborough just happens to be located in one of the most beautiful areas of the country. The quality of life is superb. Sound interesting? If you are a non-smoker, we'd like to hear from you. Resumes should be sent to Jeff DeTray, Wayne Green, Inc., Peterborough NH 03458.





## R-600

**"Now hear this" ...digital display, easy tuning**

The R-600 is an affordably priced, high performance general coverage communications receiver covering 150 kHz to 30 MHz in 30 bands. Use of PLL synthesized circuitry provides maximum ease of operation.

### R-600 FEATURES:

- 150 kHz to 30 MHz continuous coverage, AM, SSB, or CW.
- 30 bands, each 1 MHz wide, for easier tuning.
- Five digit frequency display, with 1 kHz resolution.
- 6 kHz IF filter for AM (wide), and 2.7 kHz filter for SSB, CW and AM (narrow).
- Up-conversion PLL circuit, for improved sensitivity, selectivity, and stability.

- Communications type noise blanker eliminates "pulse-type" noise.
- RF Attenuator allows 20 dB attenuation of strong signals.
- Tone control.
- Front mounted speaker.
- "S" meter, with 1 to 5 SINPO "S" scale, plus standard scale.
- Coaxial and wire antenna terminals.
- 100, 120, 220, and 240 VAC, 50/60 Hz. Selector switch on rear panel.
- Optional 13.8 VDC operation, using DCK-1 cable kit.
- Other features include carrying handle, headphone jack, and record jack.

### Optional accessories for R-600 and R-1000:

- DCK-1 DC Cable kit.
- SP-100 External Speaker.
- HS-6, HS-5, HS-4 Headphones.
- HC-10 Digital World Clock.



## R-1000

**High performance, easy tuning, digital display**

The R-1000 high performance communications receiver covers 200 kHz to 30 MHz in 30 bands. An up-conversion PLL synthesized circuit provides improved sensitivity, selectivity, and stability.

### R-1000 FEATURES:

- Covers 200 kHz to 30 MHz.
- 30 bands, each 1 MHz wide.
- Five-digit frequency display with 1-kHz resolution and analog dial with precise gear dial mechanism.
- Built-in 12-hour quartz digital clock/timer.
- RF step attenuator.
- Three IF filters for optimum AM, SSB, CW.
- Effective noise blanker.
- Tone control.
- Built-in 4-inch speaker.
- Dimmer switch.
- Wire and coax antenna terminals.
- Voltage selector for 100, 120, 220, and 240 VAC. Operates on 13.8 VDC with optional DCK-1 kit.



## TS-530S

**"Cents-ational" ...IF shift, digital display, narrow-wide filter switch**

The TS-530S SSB/CW transceiver covers 160-10 meters using the latest, most advanced circuit technology, yet at an affordable price.

### TS-530S FEATURES:

- 160-10 meters, LSB, USB, CW, all amateur frequencies, including new 10, 18, and 24 MHz bands. Receives WWV on 10 MHz.
- Built-in digital display (six digits, fluorescent tubes), with analog dial.

- IF shift tunes out interfering signals.
- Narrow/wide filter selector switch for CW and/or SSB.
- Built-in speech processor, for increased talk power.
- Wide receiver dynamic range, with greater immunity to overload.
- Two 6146B's in final, allows 220W PEP/180 W DC input on all bands.
- Advanced single-conversion PLL, for better stability, improved spurious characteristics.
- Adjustable noise-blanker, with front panel threshold control.

- RIT/XIT front panel control allows independent fine-tuning of receive or transmit frequencies.

### Optional accessories:

- SP-230 external speaker with selectable audio filters.
- VFO-240 remote analog VFO.
- VFO-230 remote digital VFO.
- AT-230 antenna tuner/SWR/power meter.
- MC-50 desk microphone
- KB-1 deluxe VFO knob.
- YK-88C (500 Hz) or YK-88CN (270 Hz) CW filter.
- YK-88SN (1.8 kHz) narrow SSB filter.



## TS-660

**The TS-660 "QUAD BANDER" covers 6, 10, 12, 15 meters.**

- FM, SSB (USB), CW, and AM
- Dual digital VFO's
- Digital display
- IF shift built-in
- 5 memories with memory scan
- UP/DOWN microphone
- All-mode squelch
- Noise blanker
- CW semi break-in/sidetone
- 10' W on SSB, CW, FM; 4 W on AM.

### Optional accessories:

- PS-20 power supply
- VOX-4 speech processor/VOX
- SP-120 External speaker
- MB-100 Mobile mount
- YK-88C, YK-88CN CW filters
- YK-88A AM filter.



# KENWOOD

TRIO-KENWOOD COMMUNICATIONS

1111 West Walnut, Compton, California 90220



# STAFF

**PUBLISHER/EDITOR**  
Wayne Green W2NSD/1

**EXECUTIVE VICE PRESIDENT**  
Sherry Smythe

**ASSISTANT PUBLISHER/EDITOR**  
Jeff DeTray WB8BH

**MANAGING EDITOR**  
John Burnett

**ASST. MANAGING EDITOR**  
Susan Philbrick

**EDITORIAL ASSISTANTS**  
Nancy Noyd  
Richard Phenix  
Steve Jewett

**TECHNICAL EDITOR**  
Charles E. Martin AB4Y

**ASSISTANT TO THE PRESIDENT**  
Matthew Smith KA1IEI

**ASSOCIATES**  
Robert Baker WB2GFE  
John Edwards KI2U  
Bill Gosney KE7C  
Sanger Green  
Chod Harris VP2ML  
Dr. Marc Leavey WA3AJR  
J. H. Nelson  
Bill Pasternak WA6ITF  
Peter Stark K2OAW

**PRODUCTION MANAGER/PUBLICATIONS**  
Nancy Salmon

**ASST. PRODUCTION MANAGER/PUBLICATIONS**  
Michael Murphy

**ADVERTISING GRAPHICS MANAGERS**  
Steve Baldwin  
Fiona Davies  
Bruce Hedin  
Jane Preston

**PRODUCTION**  
Frances Benton  
Linda Drew  
Denzel Dyer  
Phil Geraci  
Louis Marini  
Scott Philbrick  
Dianne K. Ritson  
Anne Rocchio  
Mary Seaver  
Deborah Stone  
Theresa Verville  
Judi Wimberly  
David Wozmak

**PHOTOGRAPHY**  
Sandra Dukette  
Laurie Jennison  
Irene Vail  
Robert M. Villeneuve  
Thomas Villeneuve

**TYPESETTING**  
Sara Bedell  
Melody Bedell  
Marie Barker  
Michele DesRochers  
Jennifer Fay  
Lynn Haines  
Linda Locke  
Debbie Nutting  
Ellen Schwartz  
Karen Stewart

**GENERAL MANAGER**  
Debra Wetherbee

**CONTROLLER**  
Roger J. Murphy

**ACCOUNTING MANAGER**  
Knud Keller KV4GG/1

**CIRCULATION MANAGER**  
Patricia Ferrante  
603-924-9471

**BULK SALES MANAGER**  
Ginnie Boudrieau  
1-(800)-343-0728

**ADVERTISING**  
603-924-7138

Jim Gray W1XU, Mgr.  
Nancy Ciampa, Asst. Mgr.  
Ross Kenyon KA1GAV  
Cornelia Taylor

hundred pages a month of things for you to build.

I've mentioned before that if you have a DX friend you can help him a lot by giving him a subscription to 73. The magazine gets positively worn out in most countries. A few years ago, when the dollar was weak, they had no problem getting the magazine, but today it's almost prohibitive in many countries. Of course, behind the Iron Curtain they are not permitted to send money for magazine subscriptions, so they have to depend entirely on the friendship of fellow hams who are more fortunate in where they live.

## CQ FAILS CODE TEST!

One of our readers in New Mexico sent in an envelope he received from our friends at CQ. On the cover is a bunch of Morse code. The reader translated the code for us, chuckling

*Continued on page 140*



## QSL OF THE MONTH: AG5X

This month's winning QSL is from Bob Jackson AG5X of Webster TX. Bob has a stunningly simple ultra-modern QSL design. The call-sign is presented visually around the upper left-hand perimeter of the card. The call-sign is displayed in modern type in the lower right-hand space balancing the image and contributing to the overall pleasing effect of the card.

To enter 73 Magazine's QSL of the Month Contest send your QSL in an envelope to: Editorial Offices, 73 Magazine, Peterborough NH 03458. Specify a book from 73's Radio Bookshop (located elsewhere in this magazine). Entries which are not in an envelope or do not select a book will not be considered.

## Well... I Can Dream, Can't I?

by Bandel Linn K4PP

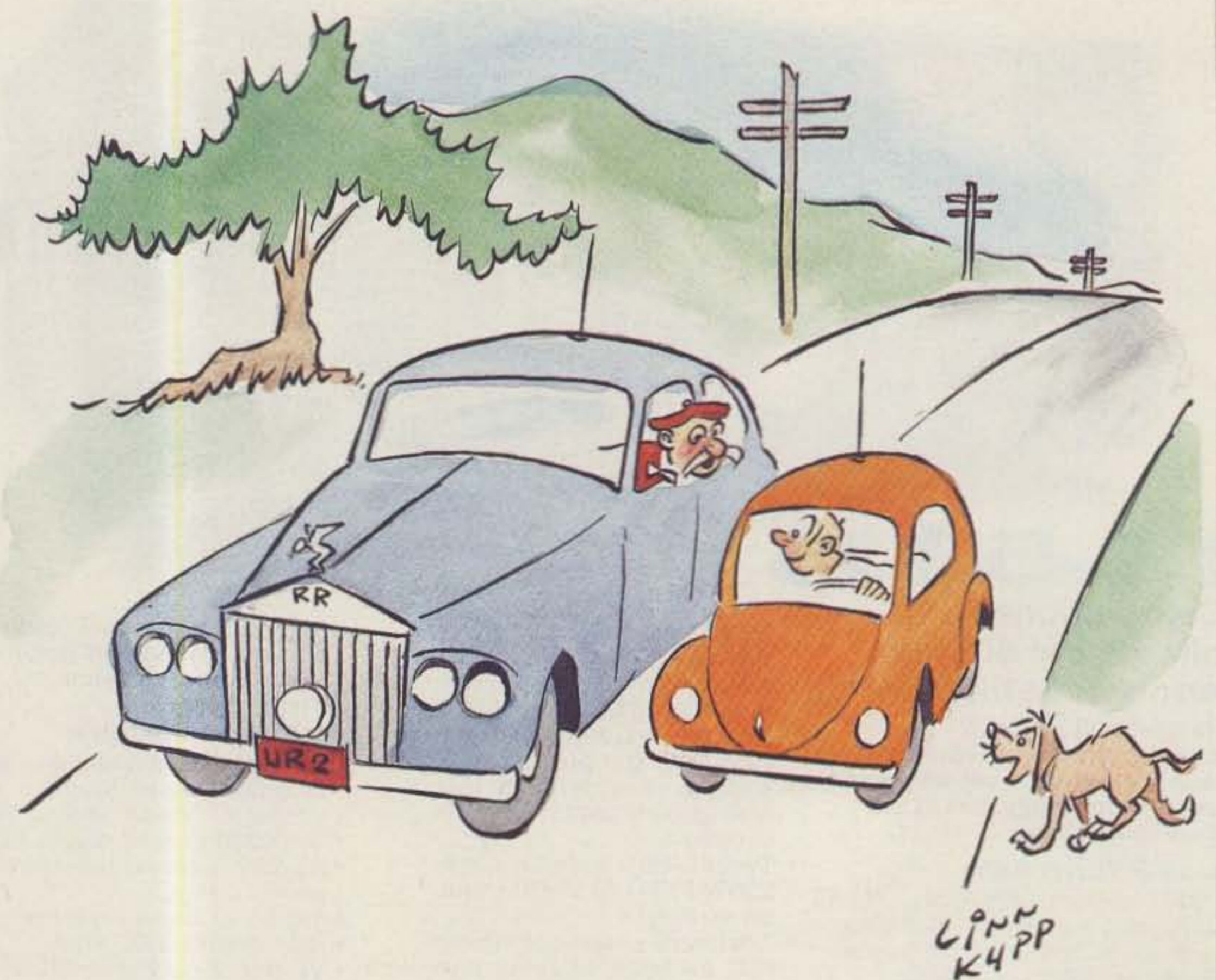

"I'm the guy you were talking to on 2 meters! Please follow me to our yacht landing for dinner!"



# ICOM HF

## Three Choices—Three Great Radios

### IC-720A

Listen to signals from around the world with a 100 KHz — 30 MHz receiver. Talk with a 160 — 10 meter transceiver — ready to go WARC 79 bands, dual VFO's — split operation. ICOM's DFM (Direct Feed Mixer), passband



tuning, speech compressor, 100 watts, SSB, CW, AM, RTTY (FSK), computer compatible tuning, 12 volt operation, all features standard except CW & AM narrow filters. ICOM system\* accessories are available for a complete station.

### IC-740

Versatility plus! ICOM's newest addition to HF offers features most asked for by ham operators. 160 — 10 meters, variable noise blanker and AGC with off position, IF shift and passband tuning, automatic SSB mode



selection, notch filter, switchable CW filter, 8 memories, SWR meter, XIT, speech compressor, 100 watts and 12 volt operation. Options are FM, automatic keyer, internal AC power supply and 5 IF filters. ICOM system\* compatible.

### IC-730

Go portable/mobile with ICOM's small HF. ICOM system\* compatible. 100dB dynamic range, +19.5dBm intercept point receiver utilizing ICOM's DFM, SSB, CW, AM, dual VFO's — split operation, one memory per band, CW/SSB filter



options, 100 watts, 12 volt operation.

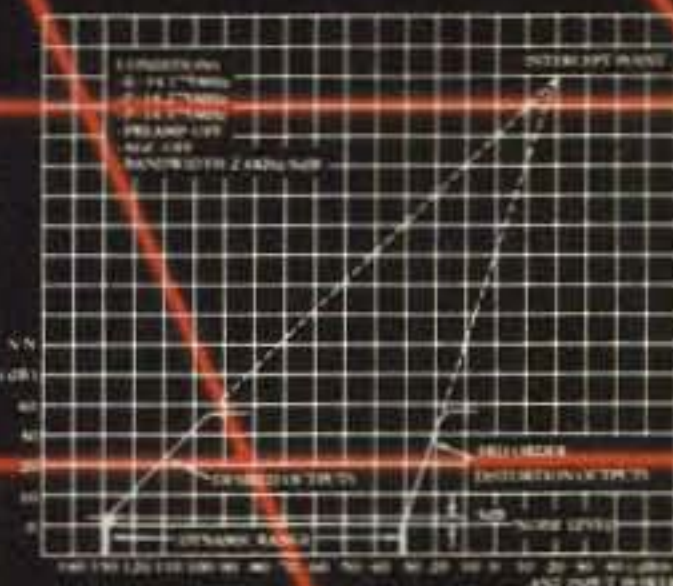

**\*ICOM system.** The same accessories work with all three HF transceivers — IC-2K1 autobandswitching broadbanded linear amplifier, AT-500 or AT-100 autobandswitching autotuning antenna tuners, IC-PS15 power supply, BC-10A memory backup, IC-SP3 external speaker, IC-HP1 headphones, IC-AH1 autobandswitching mobile antenna, IC-MB5 mobile mount and IC-SM5 desk microphone (condenser type).



# ICOM

## The World System



## A Perfect "10"

*Timer, counter, logic probe—10 functions in all. That's the Multi-Board One, and you can build it.*

**Ed. Note:** WA2BHB's article was one of the honorable mention winners in our Home-Brew Contest. Mike will be receiving a \$50 bonus in addition to his normal article payment.

The Multi-Board One (MB-1) started out as a circuit to give a courtesy beep indicating time-out reset on my repeater. A quick prototype showed that with a few extra components, the circuit could be a handy gadget to have in the shack, too. Being a home-brew nut,

I'm always needing an extra gated signal source, another trigger, an oscillator, or just one more logic level indicator, etc. I always seem to be one short of whatever it is I need to prototype a new design. Well, the MB-1 was the answer to my problems. It satisfied the two basic re-

quirements to be an addition to my bench: It was cheap, and it did more than one thing (10 in fact!).

The MB-1 as designed is all on one  $1\frac{3}{4}'' \times 2\frac{1}{2}''$  printed circuit board and can perform the following functions:

- Variable signal generator up to 500 kHz
- Adjustable positive gated astable oscillator
- Adjustable negative gated astable oscillator
- Adjustable positive gated monostable
- Adjustable negative gated monostable
- Adjustable timer with normally off output
- Adjustable timer with normally on output
- TTL/CMOS logic probe, with audible and LED output indicators
- Pulse stretcher
- Repeater beeper

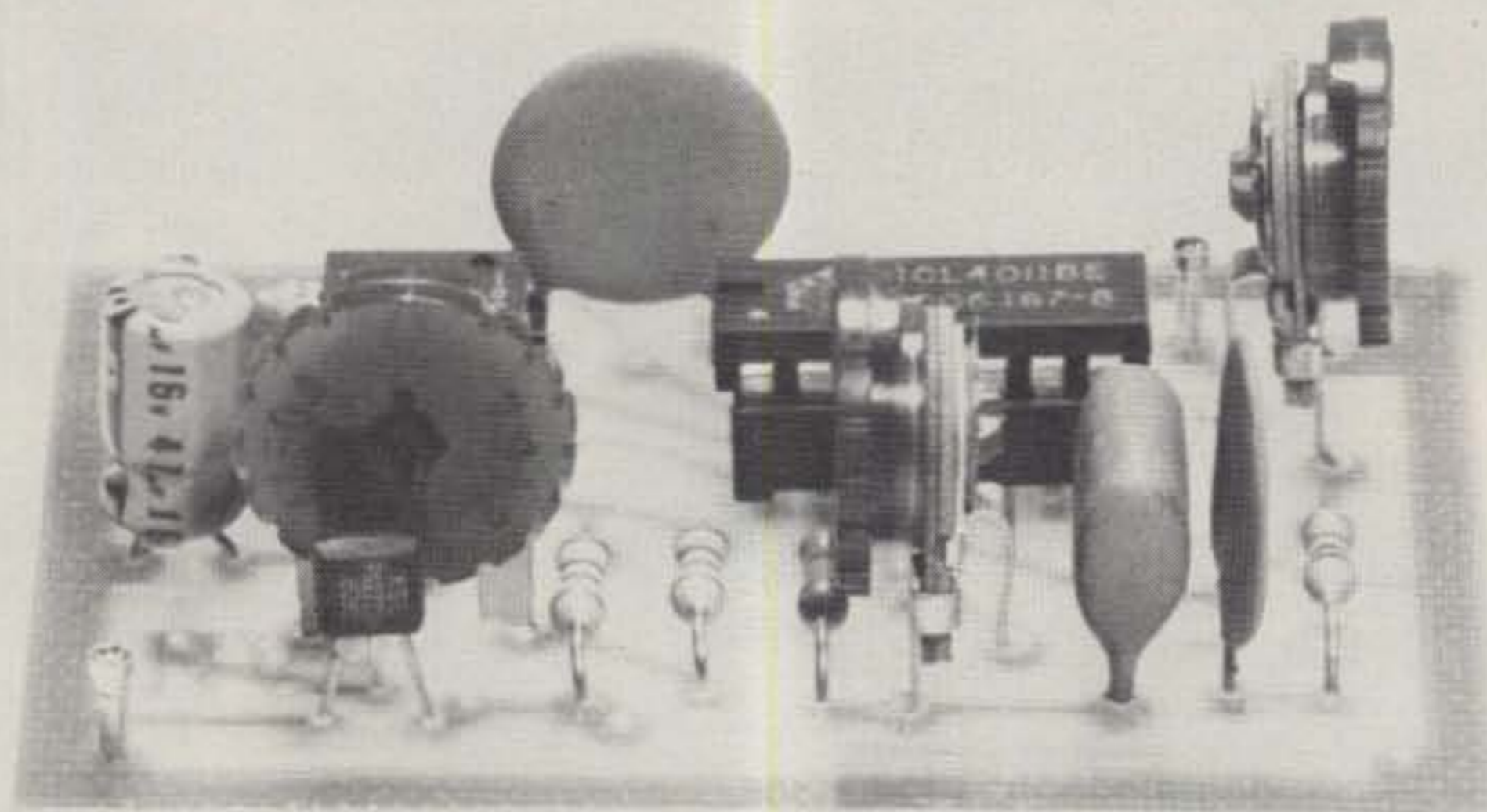

An assembled MB-1. A complete kit of all parts and a G10 reflow soldered printed circuit board is available for \$12 postpaid from W-S Engineering Corp., PO Box 58, Pine Hill NJ 08021; telephone (201)-852-0269.

Fig. 1 shows the schematic. It is simple and easy to build. The photo shows a completed unit. Fig. 2 shows the connection/jumper assignments needed to create any of the various MB-1 functions. See Fig. 3 for component layout with jumper hole assignments labeled with letters.

All adjustments for oscillator frequency, pulse length, and output level are on the printed circuit board. You may want to replace the board-mounted trim pots



with multiturn panel-mounted units and the timing capacitor can be mounted with additional capacitors on a rotary wafer switch so you can have several ranges available. The variations are endless and, for a few dollars, you can create a lot of useful test gear for the shack.

### Theory of Operation

The Multi-Board One uses a basic RC oscillator with an enable signal being provided by a 555 timer setup in various trigger modes. One half of a 4011 quad NAND gate is set up with a positive enable input at pin 1 driven by the output of the 555

timer. The output of pin 3 of the 555 timer is normally low, so the 4011 oscillator is off. When pin 3 goes high, the oscillator turns on. Pin 2 of the 555 is the trigger input. When a negative-going pulse causes the voltage at

this point to drop to below one-third of  $V_{CC}$ , the output of the 555 (pin 3) goes high and the 4011 oscillator turns on. If pin 2 of the 555 is held low (grounded), the oscillator acts as a generator.

The pulse length potenti-

ometer controls the duration of the high output of the 555 (pin 3, point F). Anything 10k Ohms or greater can be used. The larger the value of this potentiometer and the larger the value of  $C_1$ , the longer the "on" dura-

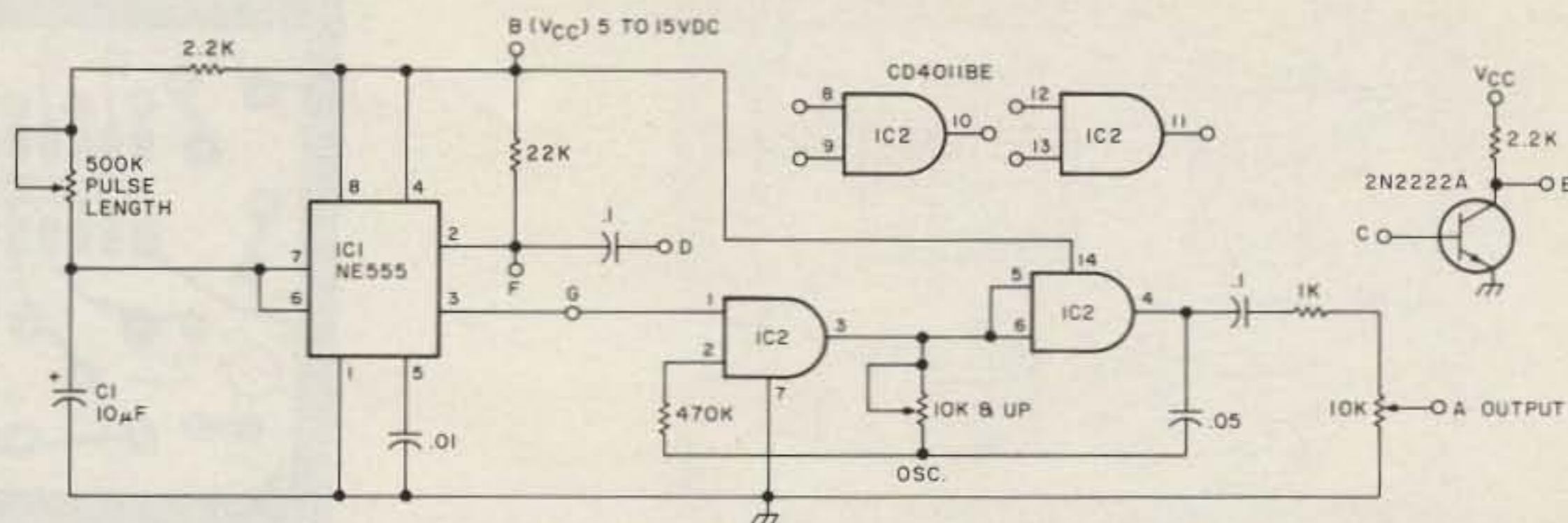

Fig. 1. MB-1 schematic.

Function	Input	Output	Interconnections
1. Signal Generator	1. None	1. Point A Ac signal, will drive 8-Ohms & up	1. Point F jumpered to ground
2. Beeper and Positive Gated Astable	2. Point C through 22k resistor	2. Point A Pulse of ac	2. Jumper point E to F
3. Beeper and Negative Gated Astable	3. Point D with a negative-going pulse	3. Point A Pulse of ac	3. None
4. Positive Trigger Monostable	4. Same as #2	4. Point G Dc pulse	4. Same as #2
5. Negative Trigger Monostable	5. Same as #3	5. Same as #4	5. None
6. Audible CMOS Logic Probe (See Note #1)	6. Tie points 8 & 9 together. Put a 100k resistor from 8 & 9 to ground. Points 8 & 9 are now the Input.	6. Point A Ac signal to speaker	6. Point 10 to F Connect point B to power source of CMOS circuit being checked.
7. CMOS Logic Probe with LED output	7. Same as #6	7. Same as #6 for audio. For LED, positive LED leg to point G, other leg through 1k to ground	7. Same as #6
8. CMOS Logic Probe with Pulse Stretcher (See Note #2)	8. Same as #6	8. Same as #6 or #7 as desired	8. Same as #6
9. Reverse Logic for #6,7,8	9. Same as #6	9. Same as #6 or #7	9. Point 10 to points 12 & 13. Point 11 to F.

Note #1: Set duration potentiometer to minimum so there is no delay.  
 Note #2: Set duration potentiometer to position of desired "pulse stretch" length.  
 All instructions assume ground and power connections are correct.

Fig. 2. Hookup connection function chart.



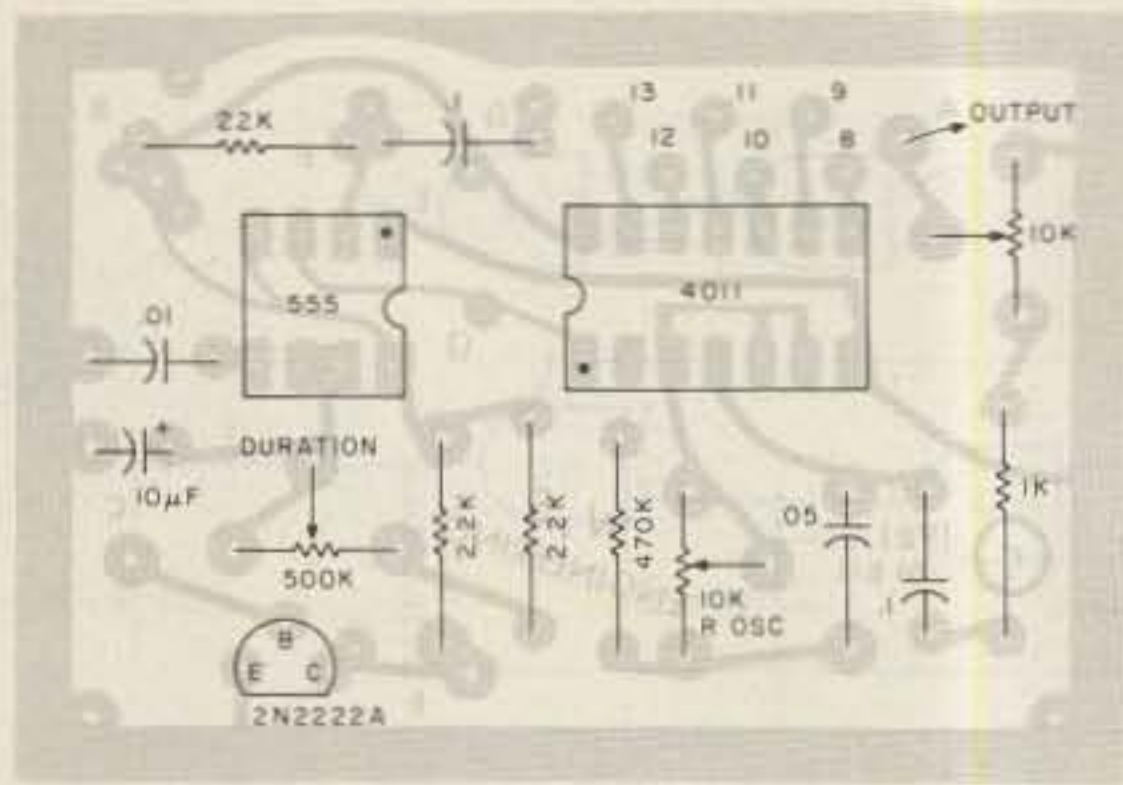

Fig. 3. MB-1 PCB layout, component side.

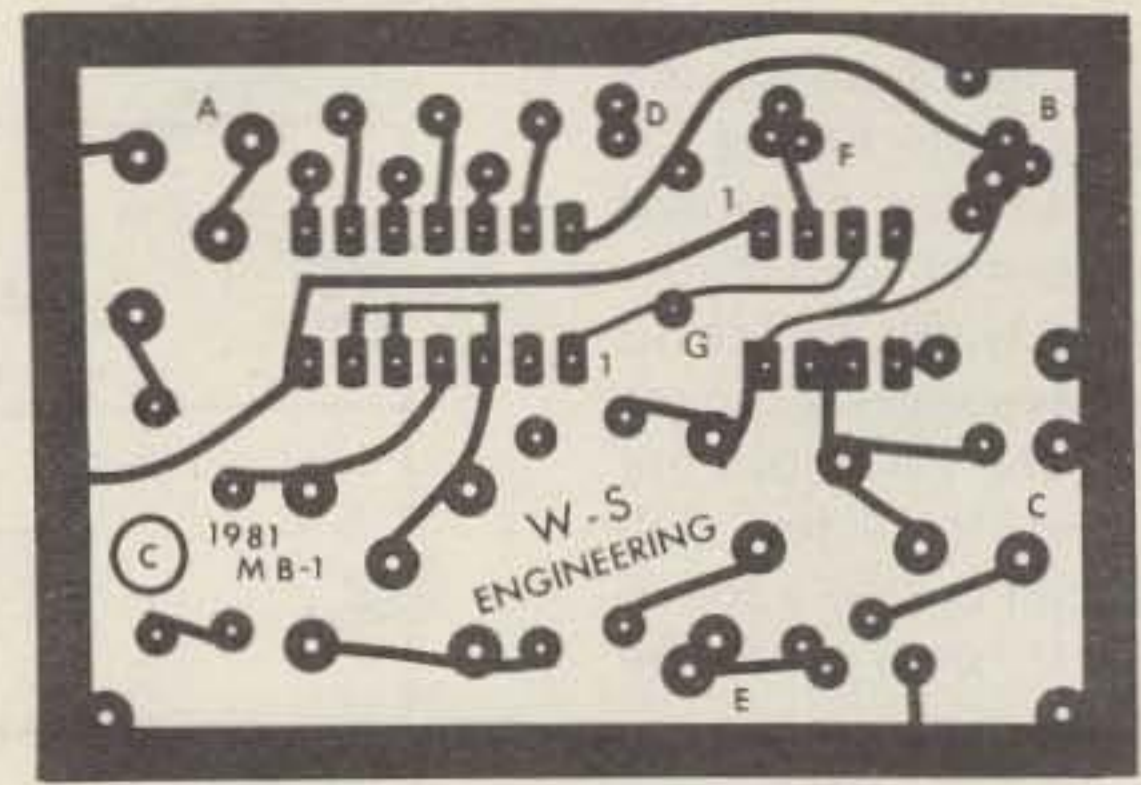

Fig. 4. MB-1 PCB layout, foil view.

tion. Timing can be set from milliseconds to hours. Note that C1 must be a high-grade, very-low-leakage electrolytic capacitor. Cheap or surplus capacitors have far too much leakage, and the circuit will not work with them.

The frequency of oscillation is controlled by the potentiometer labeled OSC. This potentiometer can be from several Ohms to megohms. The higher the value, the lower the frequency of oscillation. The output frequency is determined by the .05-uF capacitor and R-OSC. You can get this circuit to work up into the megahertz

range, but above 500 kHz, stability becomes a problem for such a simple circuit.

A buffered input is available by using the 2N2222A. It also acts as an inverter.

The output level from the circuit for the astable and oscillator modes is controlled by the 10k-Ohm output potentiometer. As designed, the circuit will drive an 8-Ohm or greater speaker. In a reasonably quiet room, you can hear the audio output quite well.

### Construction

Building of the circuit is very easy if you use the printed circuit board ap-

proach. Fig. 3 shows the pictorial layout of the PCB. Fig. 4 is a foil view of the actual printed circuit layout. Parts are not critical, but if you use cheap parts, the circuit performance is significantly degraded. Since this circuit is so small, it pays to use first-class prime parts.

### Checkout and Setup

The fastest way to verify that your MB-1 works is to configure it as a generator. Hook up the board as per Fig. 2, function 1. Fig. 5 shows sample physical configurations, so you can make sure you have everything correct. Set R-OSC at mid-range and R-OUTPUT for maximum audio. After you apply Vcc, you will hear a tone from the speaker. If no output, vary the R-OSC and R-OUTPUT settings. If you still don't hear anything, start checking for bad ICs, incorrect wiring, solder shorts, etc.

### Applications for the MB-1

I have found the MB-1 to be the most useful and cheapest little circuit I've designed. I have one in two different testers acting as

simulated microphones. Another is used as a CMOS spare logic probe. I particularly like the audible feature so I can hook it to one part of a circuit and not have to look at it to know what is going on. And yet another is being used as a basic 455-kHz signal generator for rough applications. And last but not least, one is the original "beeper" for my PortaPeater repeater.

You will probably think of more applications for this circuit after you have made a few. Figs. 2 and 5 should get you up and running. After you have put a few of these modules to work, you'll probably wonder how you got along without them!

I'm more than happy to answer any questions or provide any application assistance you may need. However, please provide an SASE. This greatly speeds up the answer process and keeps me from destroying the household budget.

W-S Engineering has a complete kit of all parts including a PCB for \$12.00 postpaid in the U.S.A. (W-S Engineering, PO Box 58, Pine Hill NJ 08021). ■

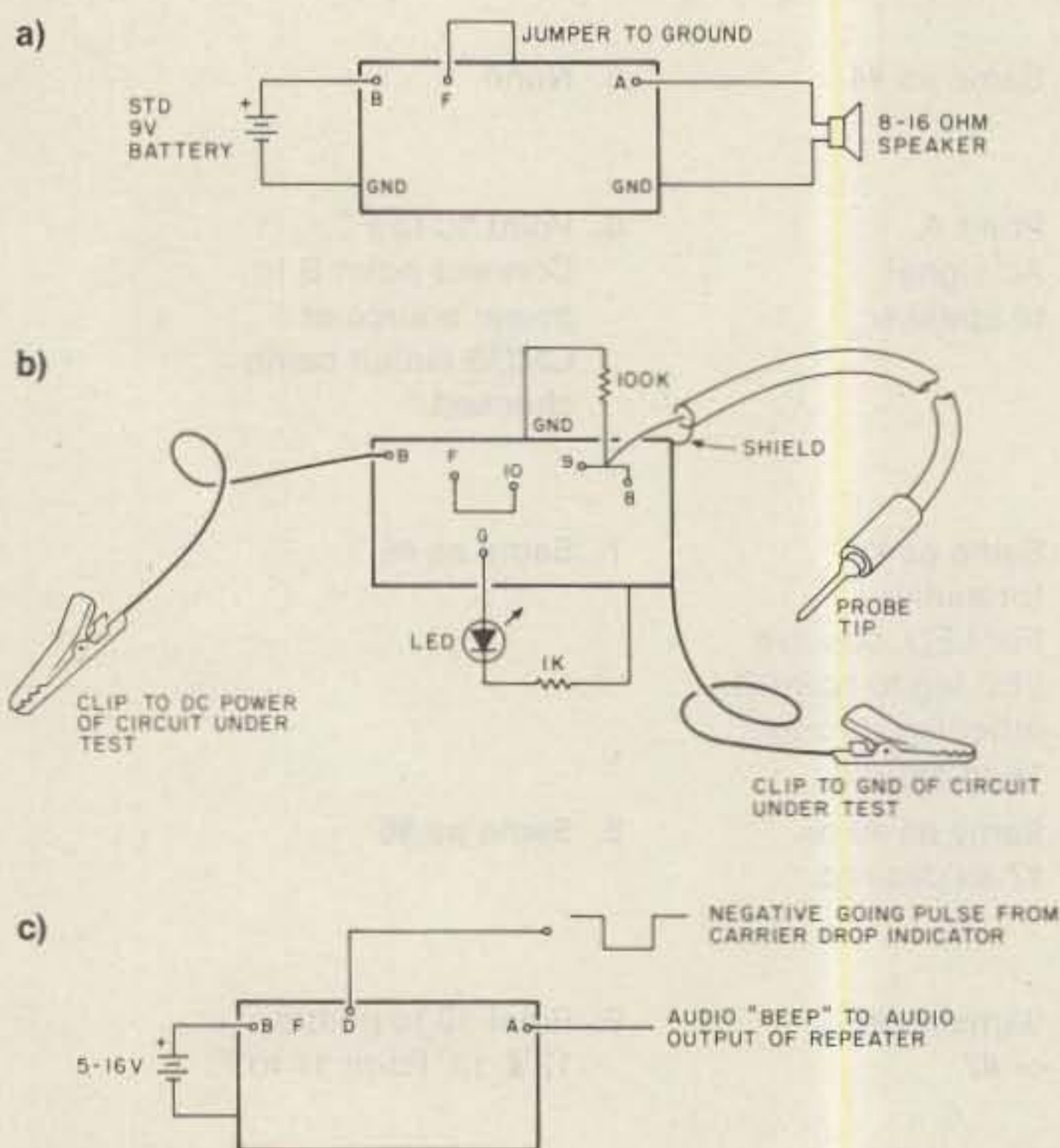

Fig. 5. Sample applications. (a) Hookup for audio signal generator (function #1). (b) CMOS logic probe with LED indicator (function #7). (c) Repeater beeper (indicates timeout reset) with negative pulse trigger (function #3).

### Parts List

Bare PCB	8-pin DIP socket
NE555 IC	2N2222A transistor
CD4011BE IC	47-uF, 16 V dc capacitor
10k trimpot (Panasonic Q0A14)	22k, 1/4-W resistor
2 500k trimpots (Panasonic Q0A56)	2 2.2k, 1/4-W resistors
.01-uF bypass capacitor, 50 V dc	470k, 1/4-W resistor
.10-uF capacitor, 50 V dc (2)	1k resistor
.047 metallized polyester capacitor	100k, 1/4-W resistor
16-pin DIP socket	T1 3/4 Red LED



# hy-gain®

## MONOBANDERS MAXIMUS

**MAX. MECHANICAL INTEGRITY,  
ELECTRICAL PERFORMANCE,  
SPACE SAVINGS AND SELECTION**

MODEL NO.	AVERAGE GAIN		NO OF ELEMENTS	LONGEST ELEMENT		BOOM LENGTH		TURNING RADIUS		BANDS	SHIPPING WEIGHT	
	db	db		ft.	m	ft.	m	ft.	m		Meters	lbs.
402BAS	4.9	25	2	45.9	16.1	25	7.6	40	47	21.3		
204BAS	10	25	4	36.5	26	22.5	6.7	20	55	25		
205BAS	11.6	35	5	36.5	34	25	7.6	20	77	35		
155BAS	12	25	5	24.5	26	17.5	5.3	15	42	19		
105BAS	12	35	5	18.5	24	15	4.6	10	29	13		

3-Element Monobanders also available.  
Optional BN-86 balun recommended for above antennas.

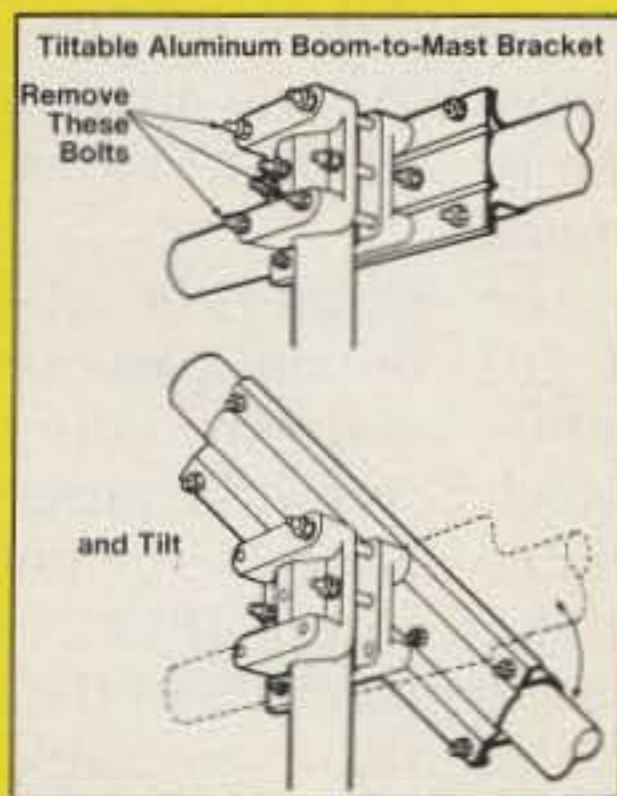
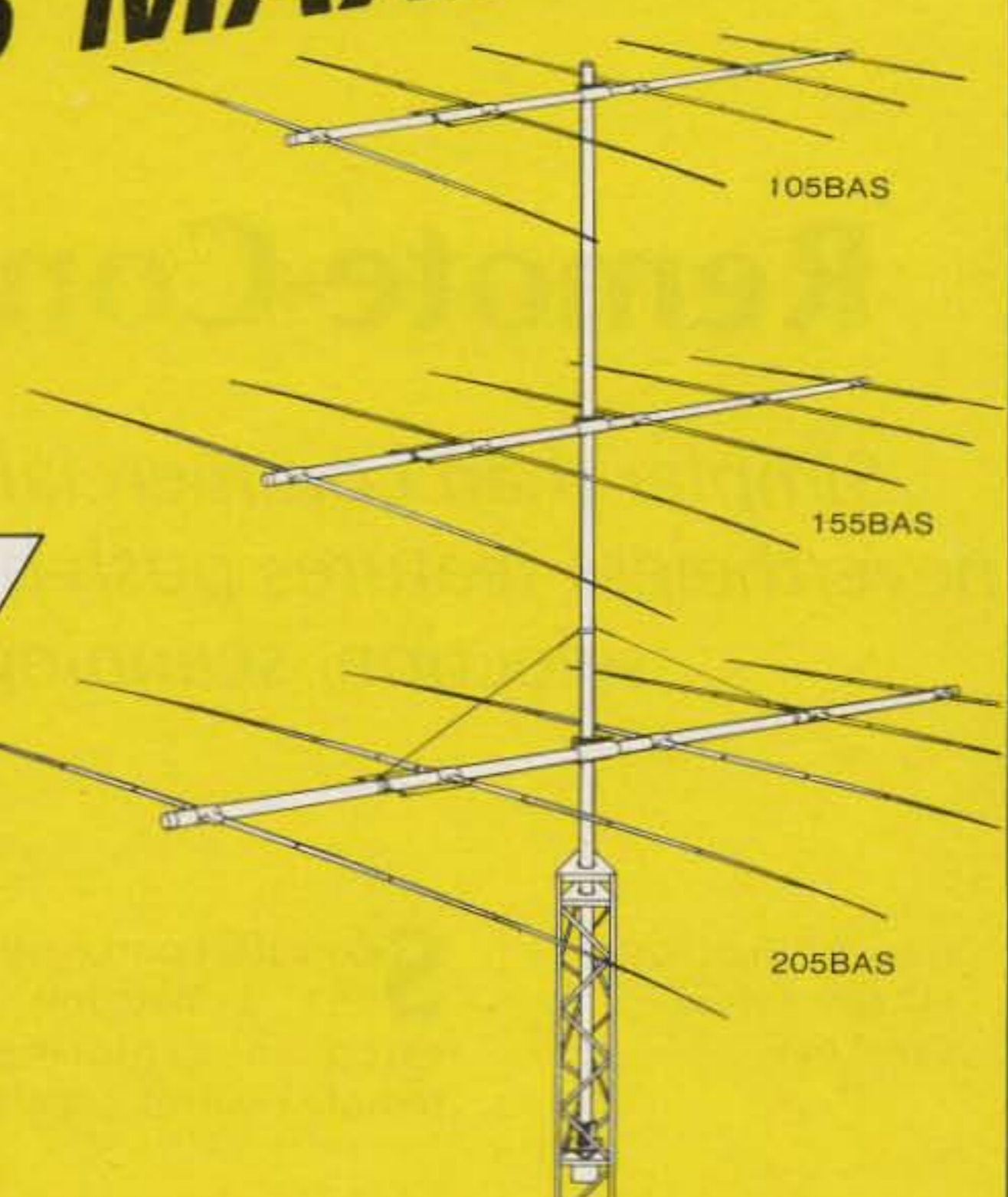

**MECHANICALLY** Hy-Gain monoband antennas employ the best materials available and are fabricated with accurate tooling for an integral balance so all parts work together. For example, our element-to-mast brackets are the best in the industry and our tilttable mast-to-boom clamps are unique. Stainless steel hardware is chemically passivated to eliminate rust. All tubing and parts are deburred and finished so you don't have to re-manufacture the antenna before installation. It all adds up to antennas with maximum mechanical integrity that withstand 80 mph (129 km/h) windloads and radial ice.

**ELECTRICAL** performance is not based on theoretical calculations alone but is tuned and tested for optimum results on our government approved test range. Hy-Gain's factory tuned 52 ohm Beta Match is exclusive and assures positive dc ground for lightning protection and reduced precipitation static. Though sometimes unconventional, our meticulous element spacing assures maximum F/B ratio and uncompromising power gain. VSWR at resonance is less than 1.5:1. All Hy-Gain monobanders handle maximum legal power with a 4:1 safety margin. In short, electrical performance is at maximum by design and requires no re-tuning.

**SPACE** problems are virtually eliminated. Even our largest monoband antennas fit most residential lots. And thanks to Hy-Gain's careful materials selection and superb mechanical engineering, the weight and windload of antennas is at an absolute minimum to permit stacking on conventional heavy duty towers and rotators. This gives you maximum DX performance even with limited space.

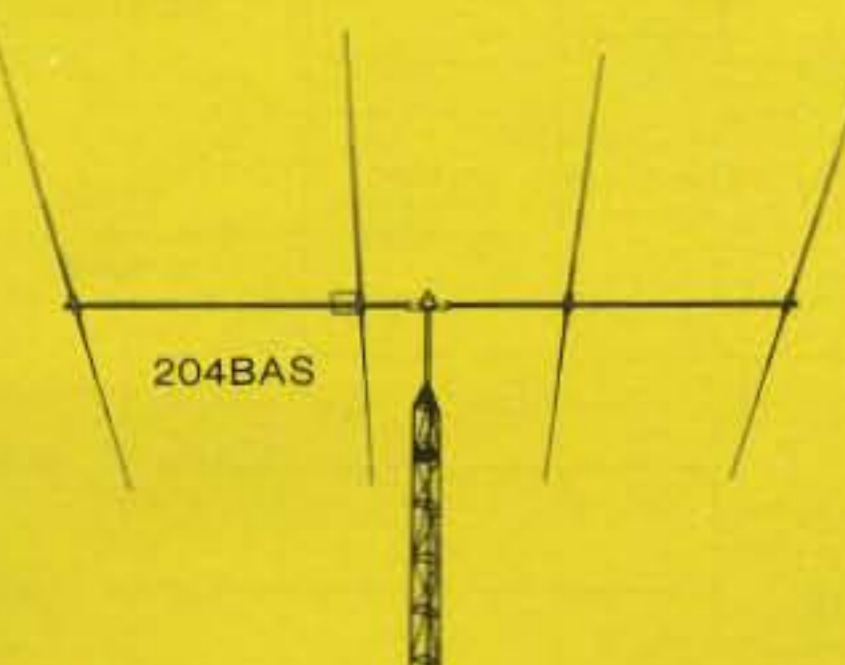

### MONOBAND BEAMS

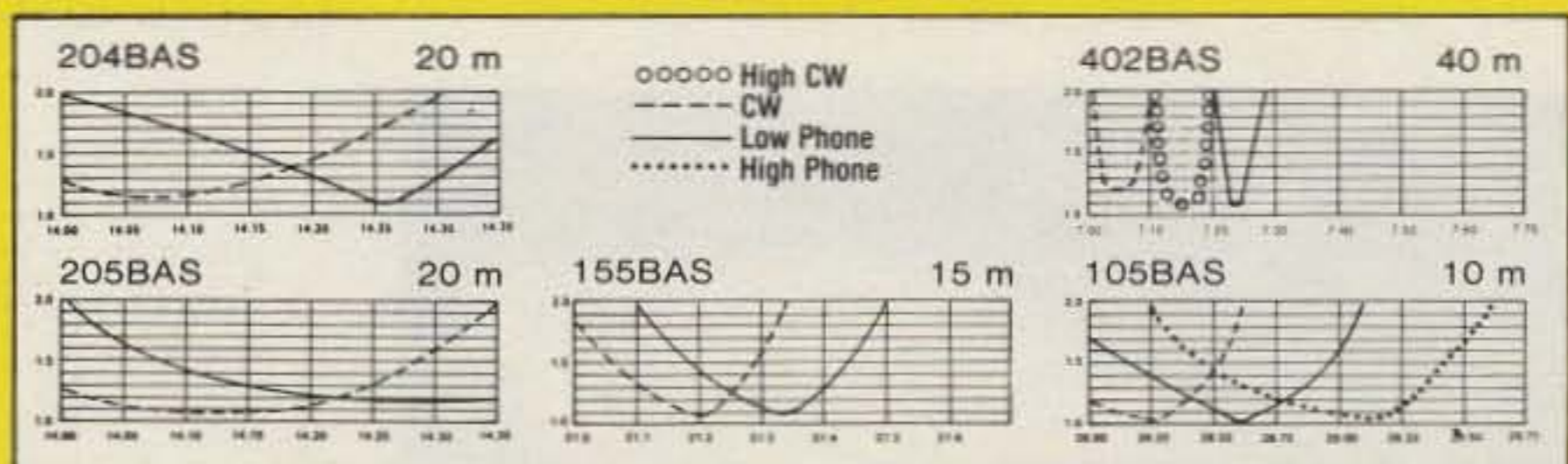

Hy-Gain Monobander Antennas Maximus  
at Better Amateur Dealers

**TELEX** *hy-gain*

TELEX COMMUNICATIONS, INC.

9600 Aldrich Ave. So., Minneapolis, MN 55420 U.S.A.  
Europe: Le Bonaparte-Office 711, Centre Affaires Paris-Nord, 93153 Le Blanc-Mesnil, France.



# Remote-Control Your IC-701

*Simpler than commercial controllers, this home-brew unit nevertheless features push-button band changing and frequency selection, scanning, and expanded coverage.*

Glenn Williman N2GW  
612 Auth Avenue  
Ocean NJ 07712

Soon after purchasing my IC-701, I became interested in exploring the remote-control capabilities

of the radio. I was not willing to spend the money for the manufacturer's unit, but I also did not need many of the built-in features obviously intended for use with their companion 2-meter set, the IC-211. Some cautious experimenting with the accessory connector on the rear panel led to the design of this relatively simple control unit which can perform all the operations I feel are necessary for operation on the HF bands. Basically, this unit can perform the following functions:

- push-button control of bandswitching
- frequency selection
- manual frequency scanning (fast or slow)

- extension of frequency range of standard IC-701

## Theory of Operation

In order to understand the operation of the remote-control unit, the requirements for controlling the IC-701 must first be examined.

The synthesizer in the IC-701 contains two presettable up-down counters which control the programmable divider in the phase-locked loop (PLL), one counter for each of the two vfo positions selectable on the front panel. The frequency data is encoded and read in serially, and in the normal mode of operation the data contains four characters, i.e., after the serial

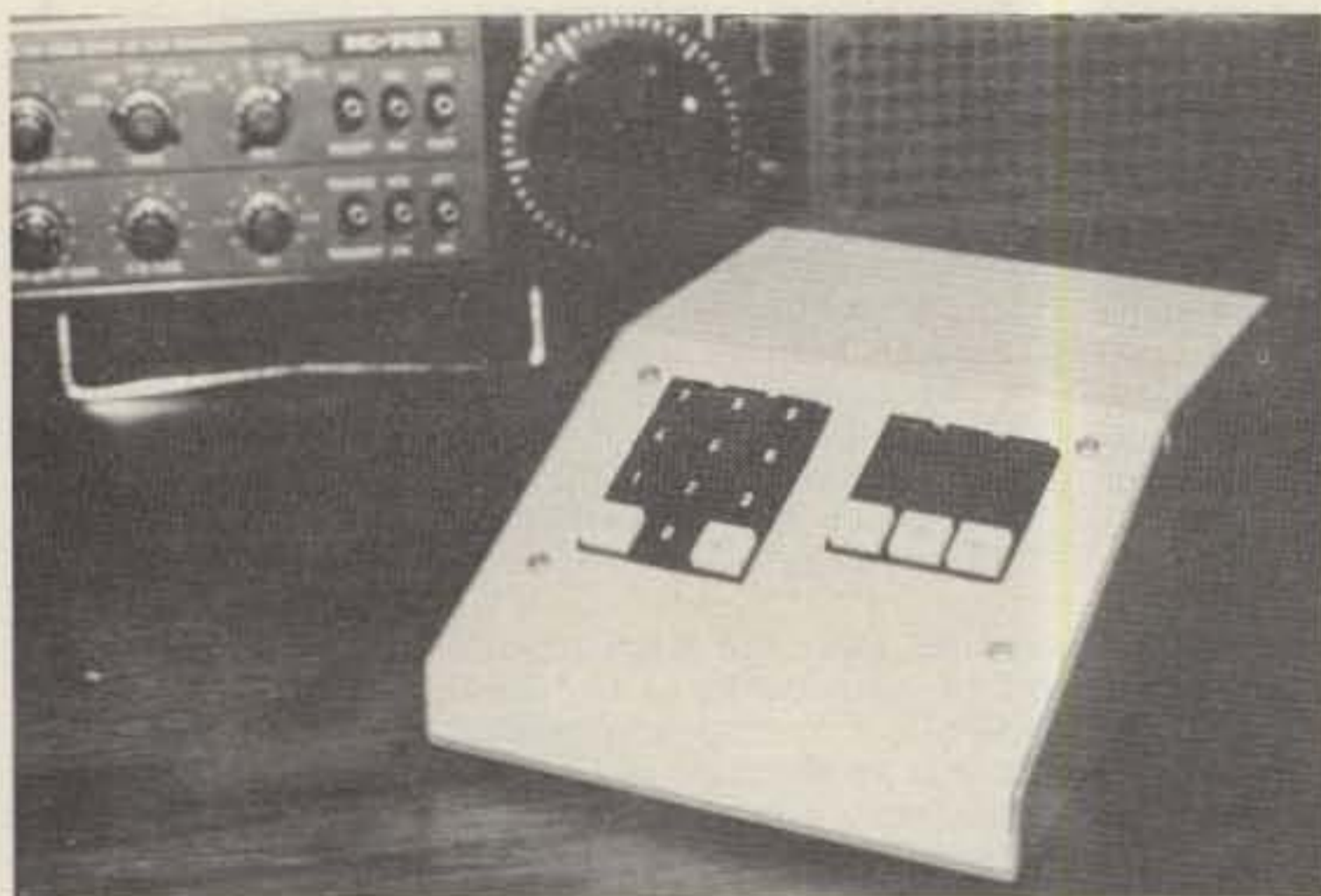

Front view.

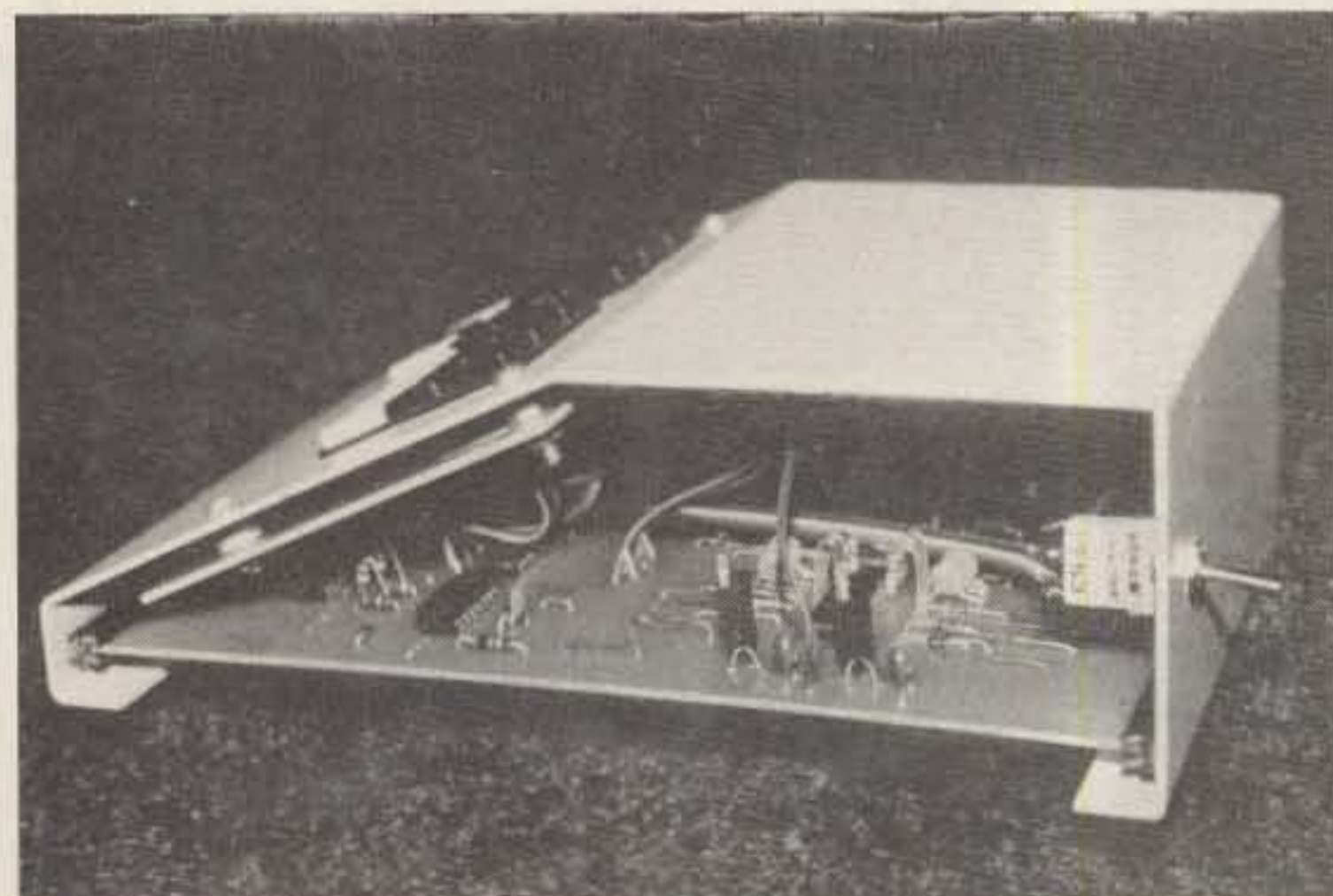

Side view.

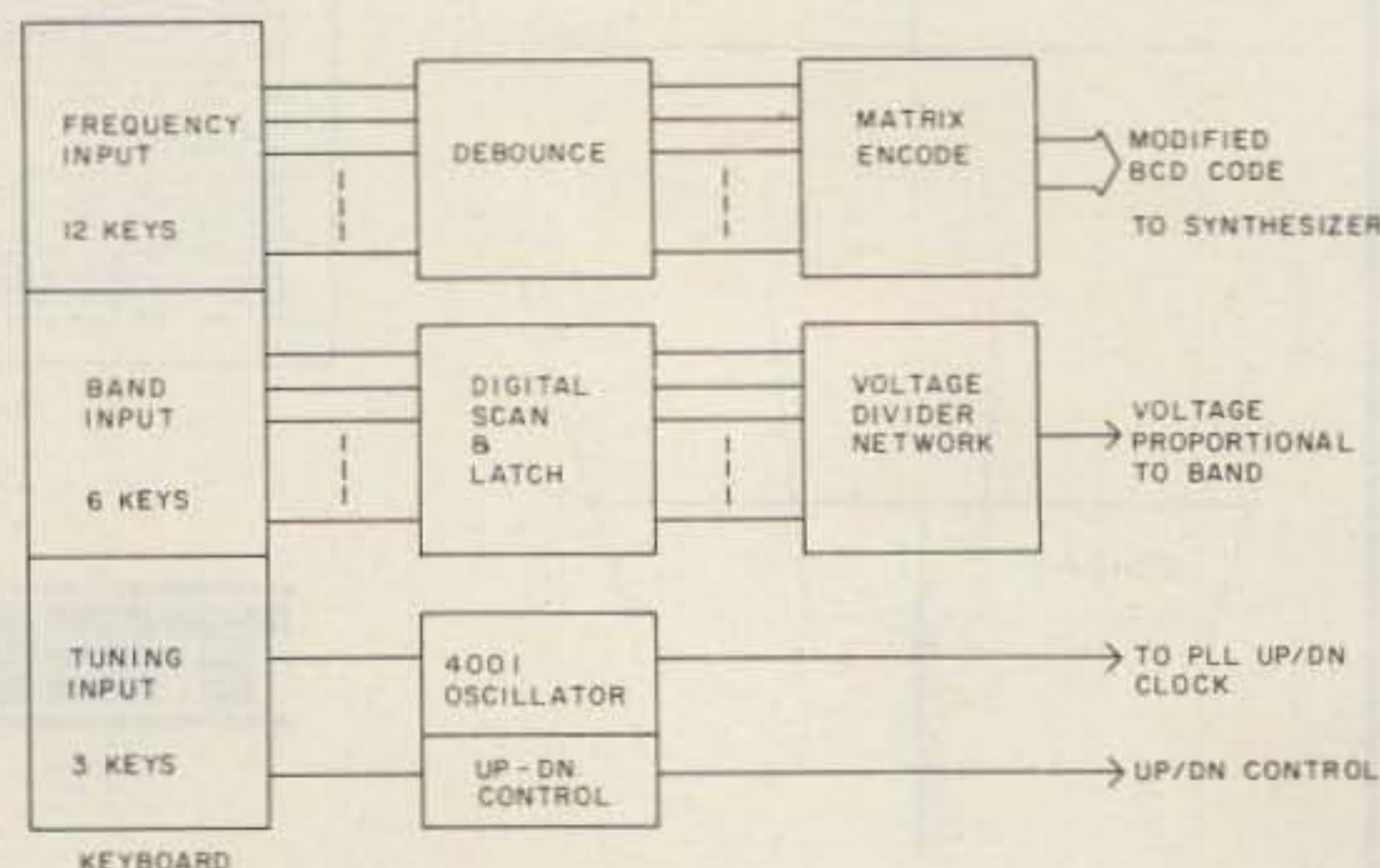

Fig. 1. Block diagram.



# THE RTTY ANSWER



## Now...300 Baud & Super-RATT

for either iRL terminal unit

- All circuits on small module inside TU
- No changes to our outstanding filters
- Just add one switch and the module
- Factory installed or you can do it

the most powerful RTTY program  
for your Apple computer

- 65 pages of excellent documentation
- Features galore
- Available with or without custom cable

## and still the finest in RTTY

the FSK-1000 Terminal Unit

- Unparalleled selectivity achieved with sophisticated true limiterless design
- Ultra sharp active filters
- Tuneable shift (80-1000 Hz.)
- Selectable bandwidths (100/55 Hz.)
- Three mode autostart
- Positive dynamic range indicator
- Extruded aluminum enclosure
- Adjustable "mark hold"
- Keyboard activated transmit
- Optional AFSK keyer
- Internal loop supply, RS232, & TTL

the FSK-500 Terminal Unit

- Superior selectivity
- Selectable bandwidths
- All standard shifts
- 3 shift AFSK keyer included
- Narrow shift I.D. included
- Preselector included for QRM suppression
- Economically priced
- Fully wired and tested
- Compact size
- RS232 or TTL
- Optional loop supply

from iRL 700 Taylor Road Columbus, Ohio 43230 (614) 864-2464  
 Visa or Master Card accepted. Immediate delivery.

If you write RTTY computer programs, call us. We are looking for new ideas in software.



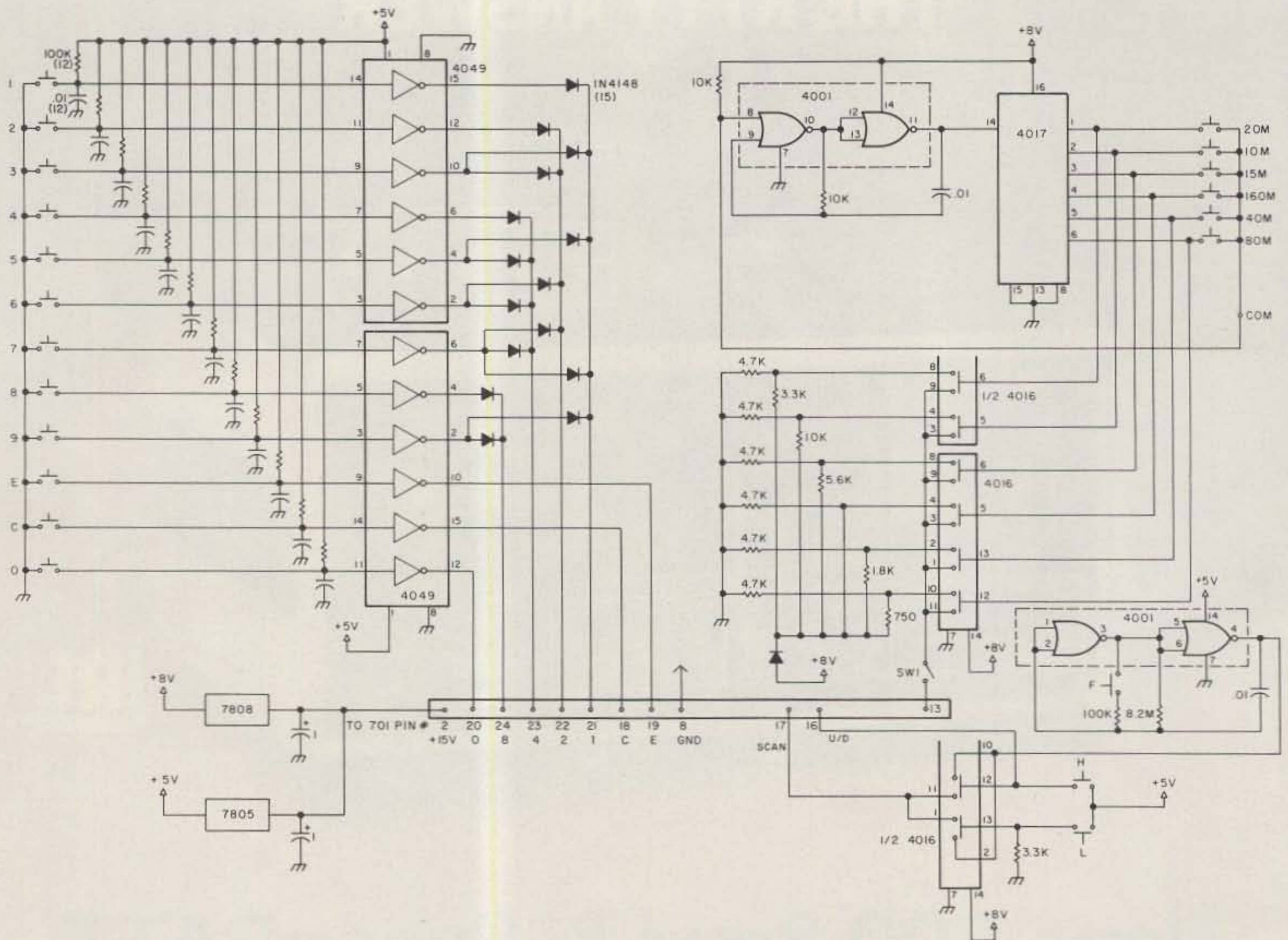

Fig. 2. Remote-control circuit.

data of the first four characters is entered, any succeeding data is ignored until the counters are again cleared.

Automatic bandswitching is accomplished by a stepping relay which is driven by a differential comparator. A front-panel switch selectable tap on a voltage-divider chain is compared to a similar voltage-divider chain switched by the stepping relay. When the two voltages are approximately equal, the relay is de-energized.

Therefore, two types of signals are required: a series of pulses to program the frequency of the synthesizer and an analog voltage proportional to the desired band. Fortunately, access to these signals (and many others) is provided at the accessory plug on the rear

panel of the IC-701. The frequency programming inputs are always active and are terminated internally either by resistors to ground or within the PLL LSI unit. The analog voltage input for bandswitching becomes active only when the bandswitch on the front panel of the IC-701 is placed in the external position.

### Circuit Description

Knowing the types of signals required and the further requirements which I imposed of using simple push-buttons and CMOS circuitry, the circuit shown in Fig. 2 evolved. A block diagram is shown in Fig. 1.

The frequency information is keyed in by twelve SPST push-button switches which are effectively debounced and encoded with a diode matrix.

As the switch is closed, in Fig. 3, the inverter is pulled to ground and any bounce is damped by the effect of the RC network. When the switch is opened, any bounce is again damped since as long as any of the damped or filtered bounce transients do not exceed  $V_{CC}/2$ , the switch is effectively debounced at the output of the inverter. For this circuit, 100k and .01 uF provided the necessary time constant for the switches used.

The debounced switches for 0 through 9 are then encoded into a BCD code. The exception is the 0 key. A separate line is used for the 0 character, rather than representing it as the absence of all other lines. This is presumably required since the PLL unit loads

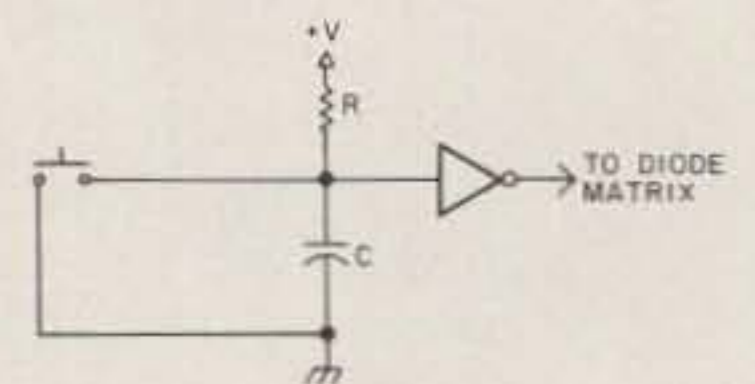

Fig. 3.

data serially one "digit" at a time with each keystroke. The C and E keys are control signals. The C key clears the counters, and the bottom edge of the selected frequency band will be displayed. The E key resets the counters and must always be used prior to entering digit information.

In order to achieve push-button control of the bandswitching, a digital scan and latch circuit is used. A 4001 RC oscillator running at about 4 kHz clocks a counter with decoded outputs (in this case a 4017,



# CT2100

## HAL Puts MORE Behind The Buttons

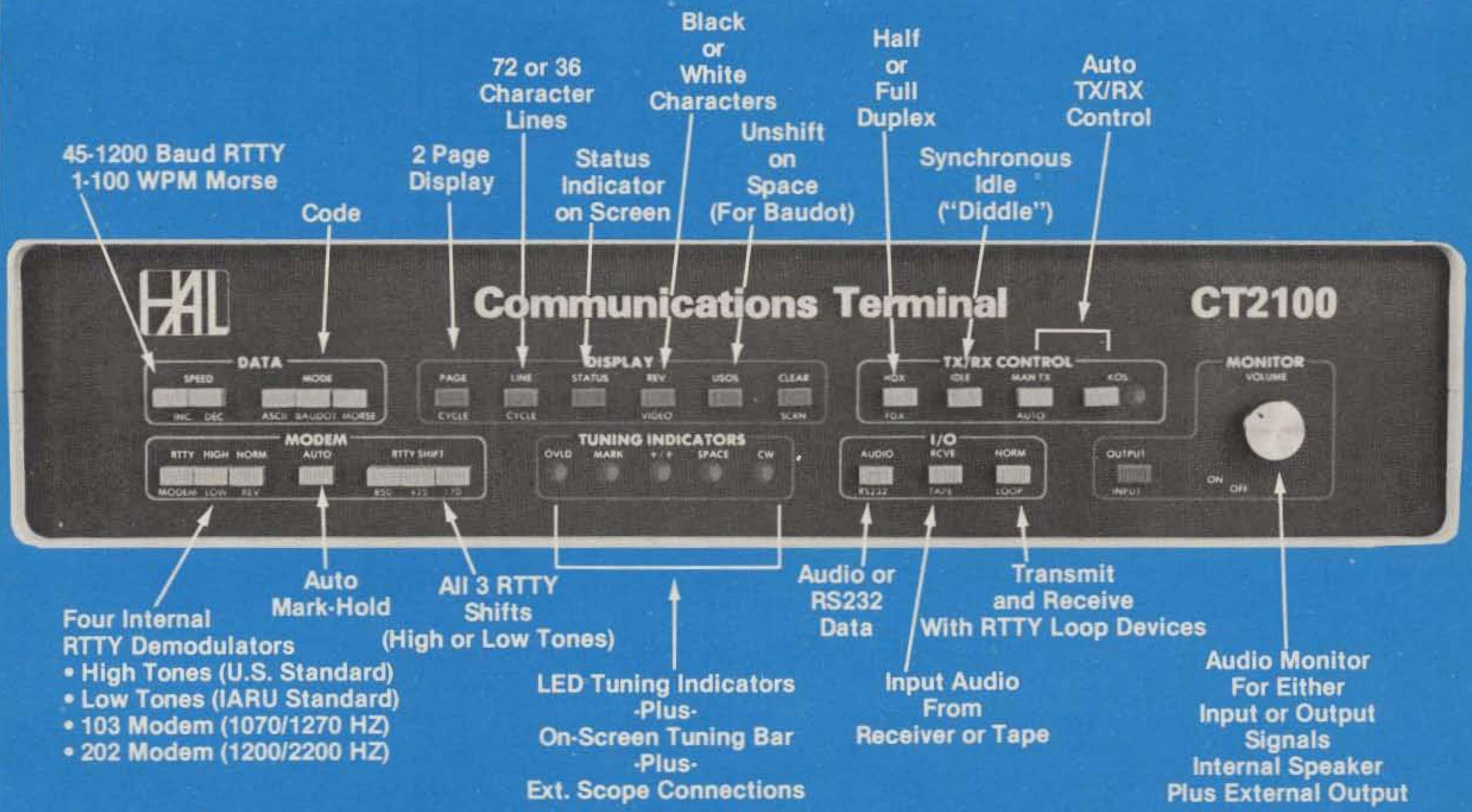

### CT2100 System:

- CT2100 Communications Terminal
- KB2100 Keyboard
- Video Monitor
- Printer (300Bd Serial ASCII-MPI-88G)
- RM2100 Rack Adapter
- MSG2100 2000 Character "Brag Tape" ROM

- 24 Line Display
- 2 Pages of 72 Character Lines
- or-
- 4 Pages of 36 Character Lines
- Split Screen (with KB2100)



✓ 345  
**HAL COMMUNICATIONS CORP.**  
 Box 365  
 Urbana, Illinois 61801  
 217-367-7373



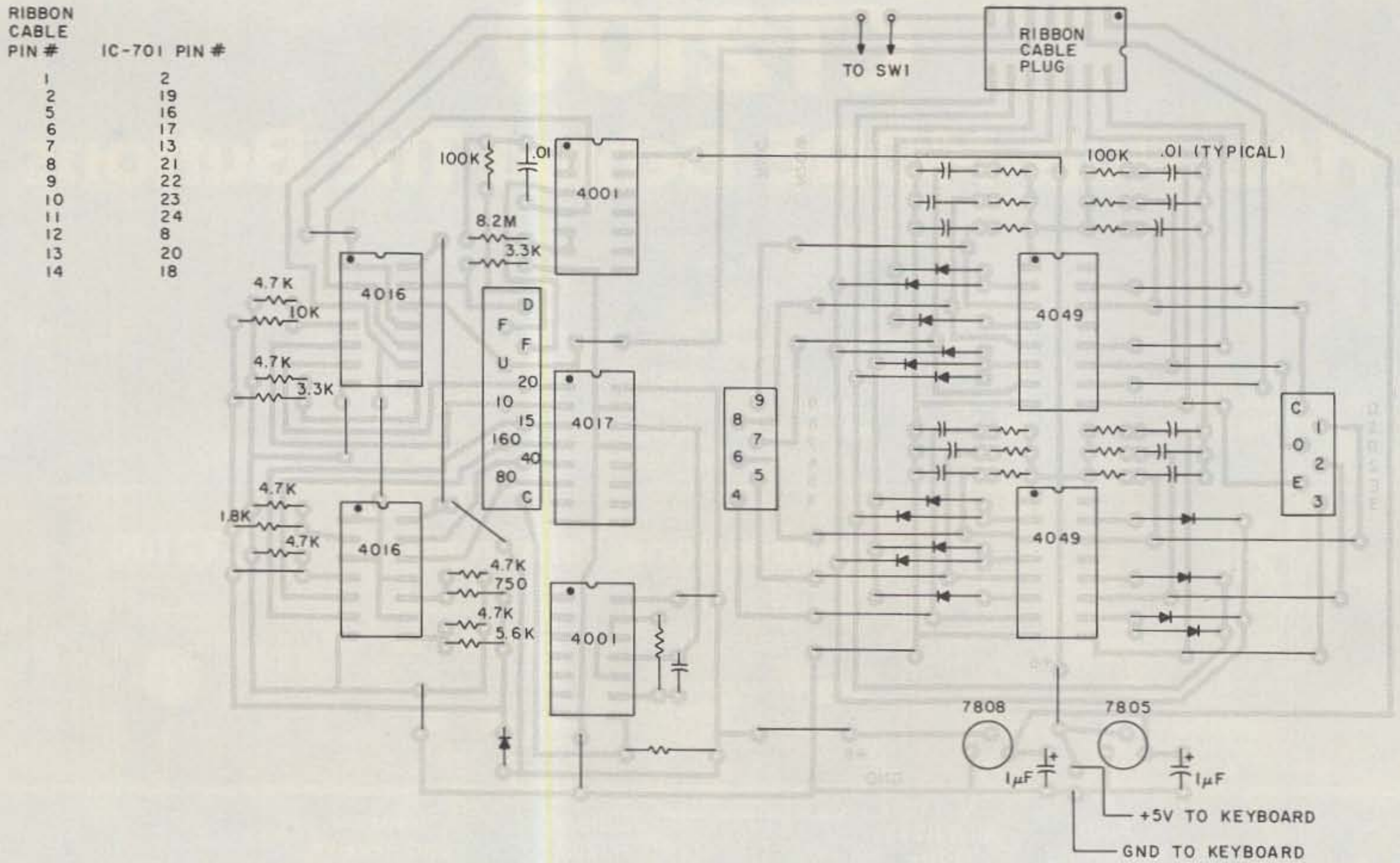

Fig. 4(a). Control circuitry component layout.

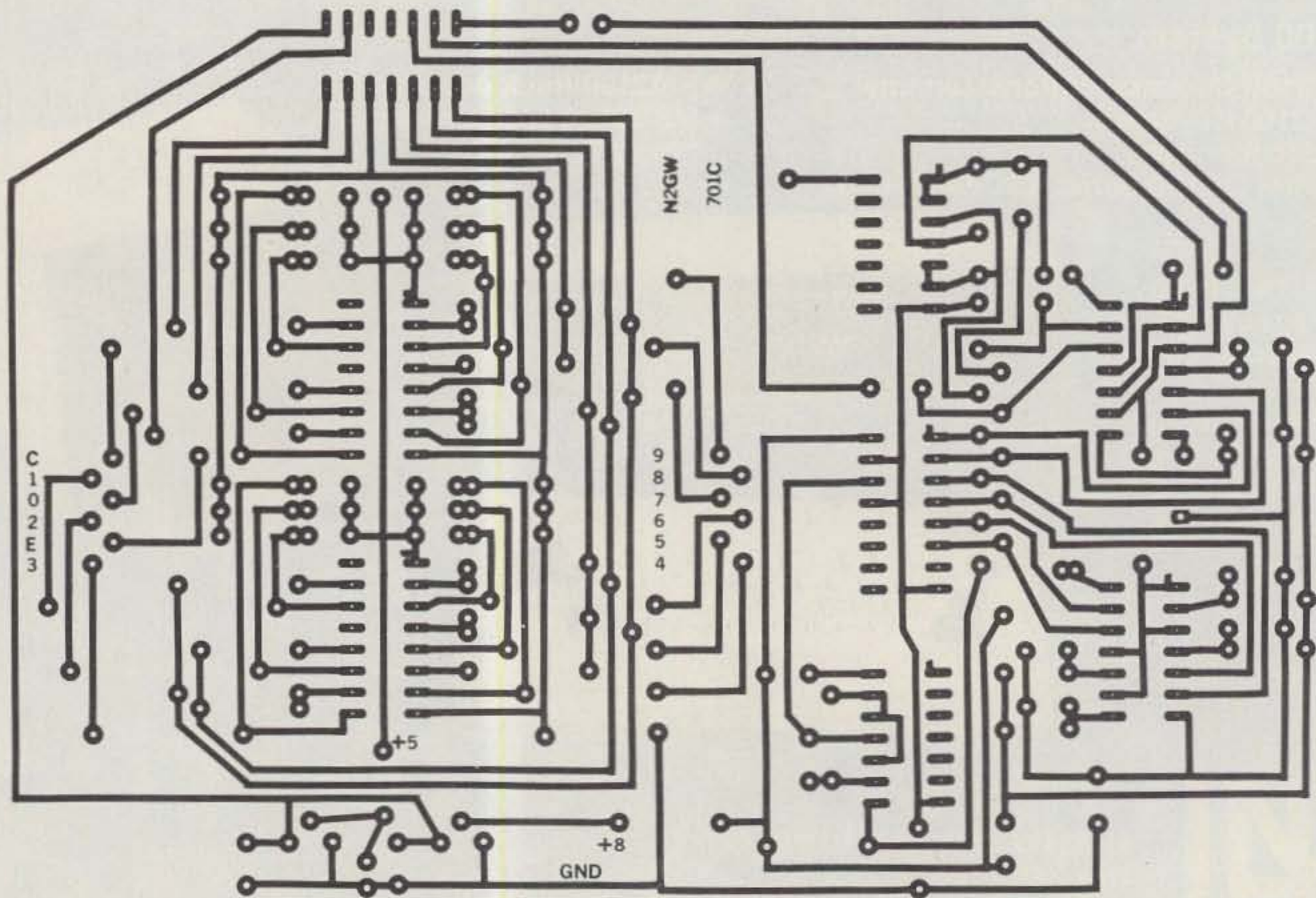

Fig. 4(b). Control circuitry PC board.



since they were available). Assume the counter is stopped in state #1, and the clock is inhibited by the 10k pull-up resistor. Depressing any of the other five keys corresponding to states 2 through 6 pulls down pin 8 of the 4001, since outputs 2 through 6 are low, and enables the clock. The counter cycles until the high decoded output corresponds to the depressed key. Then the clock and counter are again stopped. Essentially what happens is that the selected output line of the counter is latched high by whichever key is momentarily pressed. This selected line also controls one of six bilateral switches (4016s). The input side of the bilateral switch is connected to a voltage divider whose voltage corresponds to a particular band, and the outputs are all common and fed to the band select input of the 701.

Another 4001 RC oscillator serves as the scan clock input to the 701 in order to clock the divider in the PLL unit which tunes the synthesizer up or down in frequency. There are two inputs for this on the 701. Clocking one line will increment or decrement the synthesizer depending on an up or down signal on the other line. The RC oscillator is run at both a fast (500-Hz) and slow (10-Hz) rate so that fast and slow tuning can be accomplished. The H key tunes the 701 higher in frequency; the L key tunes lower in frequency, and the F key increases the tuning rate to a fast scan and must be depressed with an H or L key for fast tuning.

Power for the remote control is obtained from the 15-V-dc pin on the 701 accessory plug and is then regulated down to +8 V and +5 V for the different portions of the circuit. The up-down counters (fast and slow) and the frequency preset logic are all standard

CMOS in the 701 and run at +5 V dc. The bandswitching voltage dividers in the 701 are fed with regulated +8 V dc, so this must be duplicated in the remote-control unit.

#### Construction

Two printed circuit boards were designed for this project, although a small IC breadboard will work nicely. One is for the keyboard (3" x 4.5") and one is for the control circuitry (6.75" x 4.5"). These are shown in Figs. 4(b) and 5(b). The push-button

switches mount directly on the printed circuit board. Parts placement is shown in Figs. 4(a) and 5(a). The boards mount in an LMB type MDC 752 modular console. Ribbon cable (12-conductor) is used to connect the remote control to the accessory plug for the IC-701.

#### Operation

The layout of the keyboard with the bandswitching and tuning keys on the right side and frequency selection keys on the left side lends itself to

easy operation. Typical usage of the remote control goes like this:

1. Change band using one of six band select keys.
2. Enter particular frequency, e.g., 21.320.0, by using the 12 frequency select keys (sequence keyed in this example would be E3200).
3. Tune up or down (fast or slow) using the 3 frequency scanning keys (below band select keys).

Changing from one band to another and moving from one end of the band to the other can be done con-

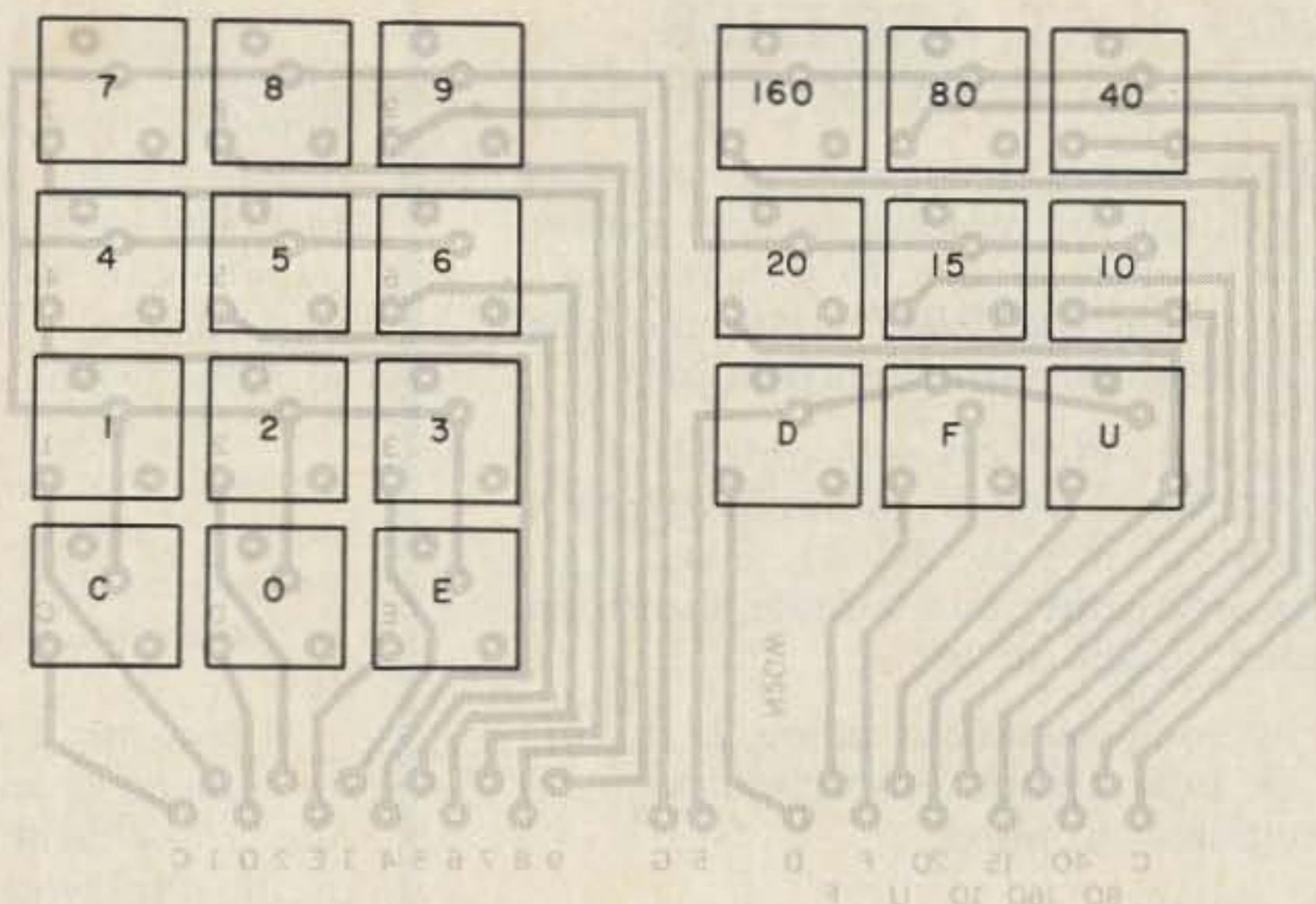

Fig. 5(a). Keyboard component layout.

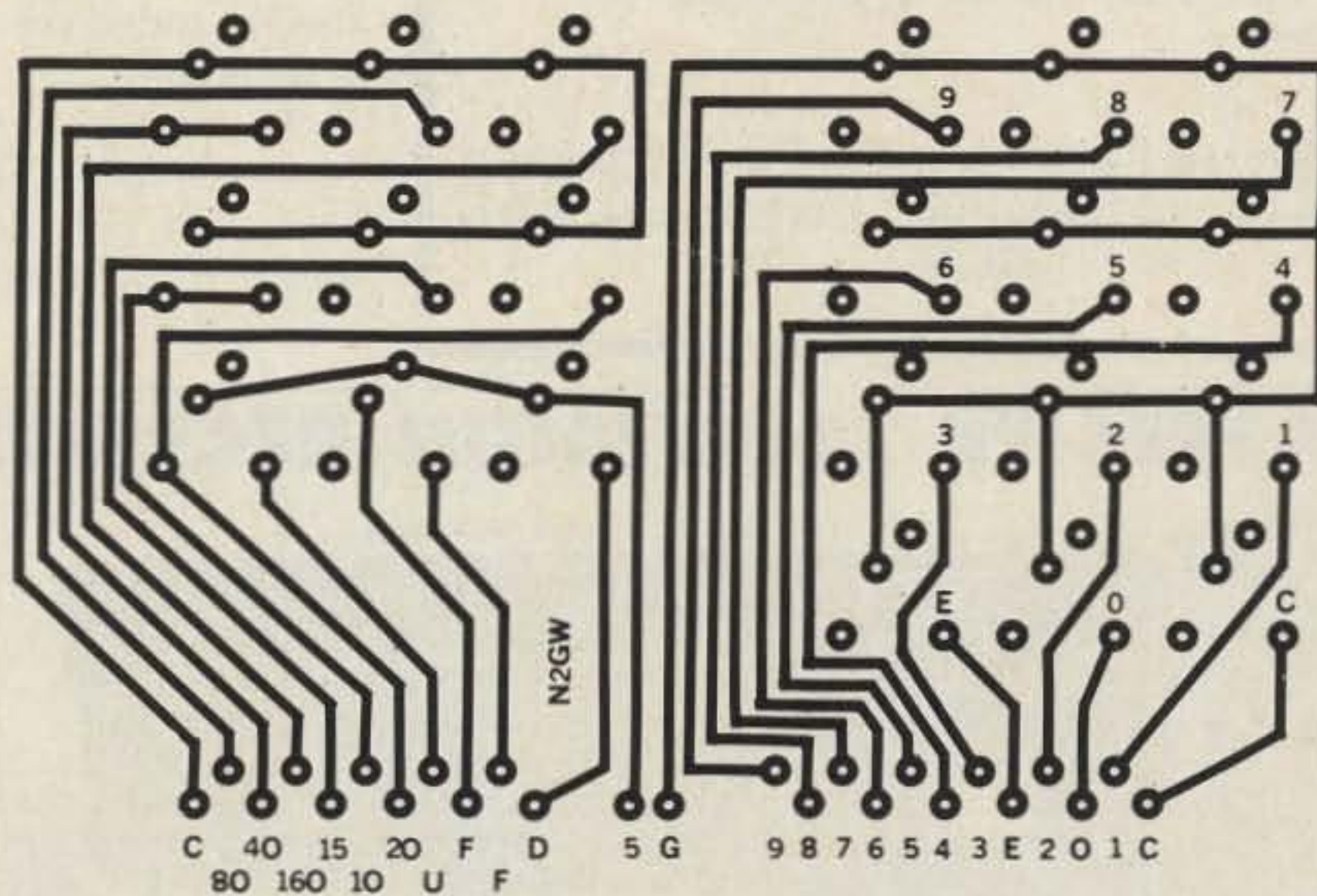

Fig. 5(b). Keyboard PC board.



## NOT JUST ANOTHER REGULATED POWER SUPPLY!

The **FASTRAK**® model 2001 voltage regulator module is ideal for making reliable power supplies in a jiffy. Use it to power your mobile rig, other **FASTRAK**® series modules or as a general purpose bench supply.

- ▶ Component selection sets output voltage (3.3 to 400 V dc) and current capability (5 mA to 100 A). Over voltage protection and remote shutdown included. Uses no ic's.
- ▶ One evening assembly using 2 × 3.6 inch pc board and comprehensive instructions supplied.
- ▶ Price: \$10.80

Price includes: glass-epoxy, etched, plated, drilled pc board; instruction manual; postage in U.S.A. (Ohio residents add 5% sales tax).

Send \$1.00 for illustrated **FASTRAK**® product catalog and refund coupon.



**PROHAM ELECTRONICS INCORPORATED**  
34620 LAKELAND BLVD EASTLAKE OH 44094  
(216) 951-2110

siderably faster than by manual tuning, and with no transmitter tuning, the capability for instant QSY becomes more realizable.

There are several interesting operating tricks which can also be accomplished with the remote control.

1. The RIT, once turned on, will not be defeated when tuning with the remote control, as it will with the manual tuning control.

2. Pressing "E" and "1" simultaneously and releasing the "E" first will add 1 MHz to the displayed frequency; however, the display will only change on 20 meters and the display will indicate 15.xxx.x.

The following is a list of the expanded coverage that is available:

160m—1.000.0 to 2.999.9;  
80m—3.000.0 to 4.999.9,  
MHz will not display "4";  
40m—7.000.0 to 7.999.9;

20m—14.000.0 to 15.999.9;  
15m—21.000.0 to 22.999.9,  
MHz will not display "22";  
10m—no expanded coverage.

There are obviously other features that could be built into the remote control. Memory would be a "nice-to-have" addition and really not that hard to do although the sequential (serial) data input requirement does complicate things somewhat. I don't miss additional memory, over the two in the 701, but then again I didn't miss the remote control until I began using it. The ability to instantly move to different frequencies around the band is the most useful one for me and it has become an operating convenience I wouldn't be without.

Keys for the keyboard and circuit boards are available. Please enclose an SASE for details. ■

## SATELLITE TELEVISION RECEIVER

# KITS



*Rainbow makes a top-of-the-line Receiver affordable*

The Electronic Rainbow Receiver consists of a receiver with an external down-converter that mounts at the antenna, feeds the voltage to the LNA through the coax cable. The 4GHz signal is down converted to 70 MHz and is fed through the RG59/U coax to the receiver.

Rainbow Kits are supplied with simple step by step instructions. All the circuits that you need expensive test equipment to do are pre wired and tested. All printed circuit boards have the outline of each part printed on them.

### RECEIVER FEATURES

Built in RF modulator • Detent Tuning-3.7 to 4.2 GHz • Variable Audio-5.5 to 7.5 MHz • Invert Video • Channel Scan • Voltage monitoring • Meter output • Remote Tuning

### SPECIFICATIONS:

Single Conversion Image Rejection Downconverter • Threshold 8 db CNR • IF Bandwidth 24MHz • Output IV Audio and Video • IF Frequency 70MHz • Video Bandwidth 4.5MHz • Size 3½"Hx8½"Dx11¼"W

### Complete Satellite TV Receiver

#### KIT #1 — Contains:

- Mainboard • Tuning Board • Down-converter Board • Modulator Board
- All parts needed to complete receiver
- Down Converter built in case.
- Cabinet, attractive black brushed anodized metal with silk screened front and back for a professional look
- 70 MHz Filter is pre-wired and tested.
- Complete instruction Manual. **\$395.00**

#### KIT #2 — Board Kit Contains:

- Main Board • Tuning Board • Down-converter board • Modulator Board
- Parts List, assembly and alignment manual
- 4GHz local oscillator and 70MHz filter is pre-wired and tested. **\$129.00**

Instruction manual. Contains printed circuit board layouts, parts placement, and alignment instructions. **\$25.00**

*Ask about guaranteed to play*

We will accept telephone orders for Visa & Mastercard  
No C.O.D. Orders  
TO ORDER CALL 317-291-7262  
800-428-3500  
Complete kit weighs 10 lbs. Please add sufficient postage  
6254 LaPas Trail  
Indianapolis, Indiana 46268

**ELECTRONIC RAINBOW**  146



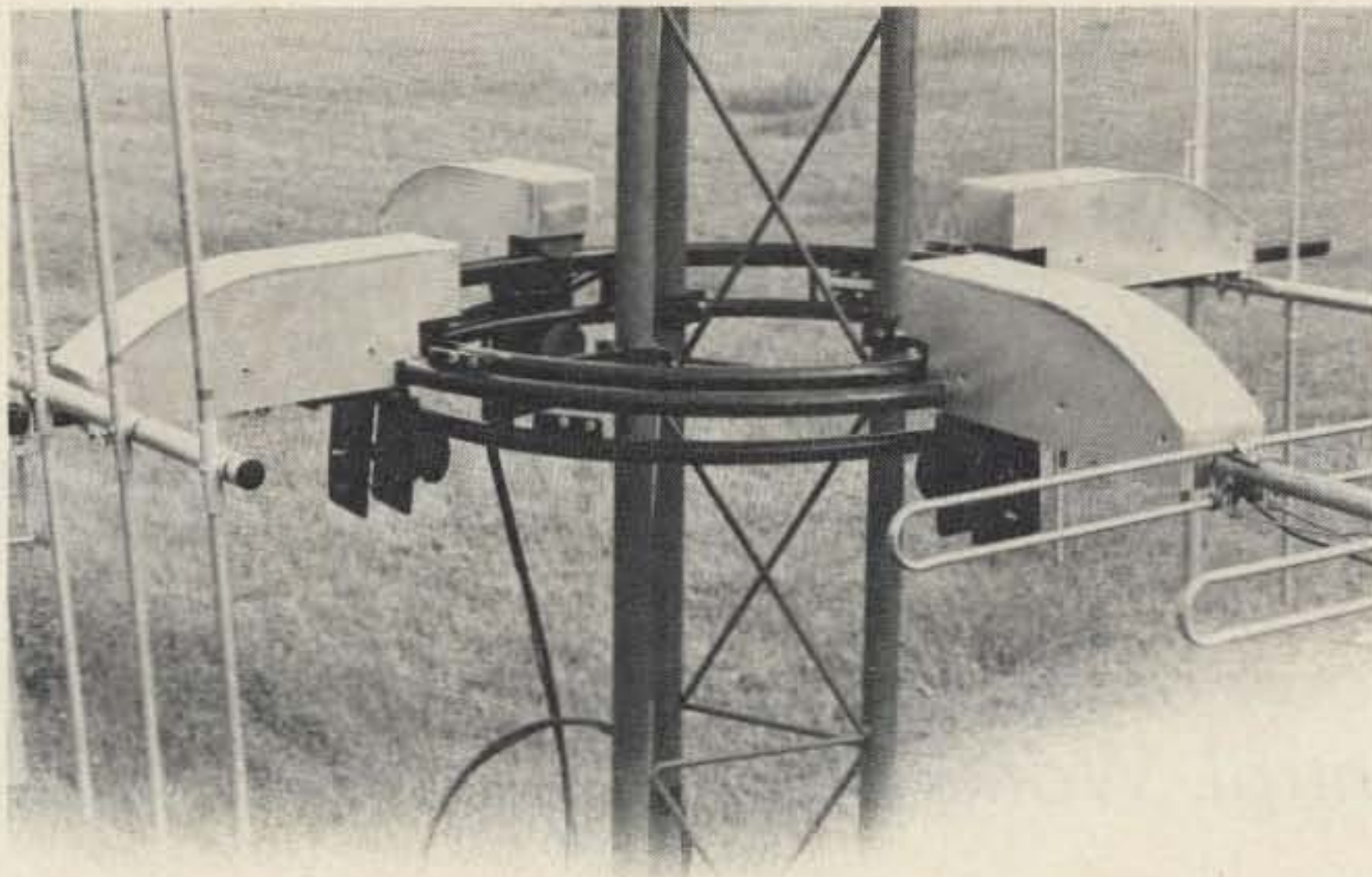

**NEW!**  
**POLAR RESEARCH'S**

**Multi-Directional, Motor Driven Antenna Mounting  
Systems For Discriminating Radio Operators!**

The  
**Li'l Slipper**  
(ANTENNAS NOT INCLUDED)

Never before has an antenna mounting system been available to radio operators with the advantages and features of Polar Research's Li'l Slipper. The tremendous versatility and widespread applications of the Li'l Slipper system eliminate any cumbersome, awkward, inefficient and inaccessible antenna configurations due to the old normal single mast, vertical antenna stacking. Greatly reducing tower interference to the radiation pattern of the antenna, the Li'l Slipper's design effectively distributes wind-load evenly on the tower's structure while maintaining all antennas in a true perpendicular position, tangent at any point to the rotor's arc.

Exclusive Li'l Slipper features include a high torque geared drive motor; all electric, end-of-rotation circuitry; acceptance of masts up to 2" O.D. on all four housings; and limitless applications with VHF, Split-Boom, H.F. Beams, Quads, TV/FM antennas, and even UHF Dishes and Corner Reflectors.



**INTRODUCTORY PRICE - \$399.95 PLUS SHIPPING**

(Visa and Mastercard Accepted)

**Call Toll Free 1-800-328-2041**

U.S. AND FOREIGN PATENTS PENDING

176

**Polar Research, Inc.**

**P.O. Box 781**

**Thief River Falls, MN 56701; Phone (218) 681-7413**

DEALER INQUIRIES INVITED



# Automatic Beam Aimer

*Here's the scoop on adding set-and-forget convenience to your rotator control. Works with most common control boxes.*

Guy Slaughter K9AZG  
753 W. Elizabeth Drive  
Crown Point IN 46307

I have a smart knob in my shack. It looks like any other dumb old pointer knob sticking out of a black box, but it's really quite clever. Turn it to a given beam heading, and it makes the Cushcraft tribander atop the tower outside my house rotate to that same direction and stop there, all by itself.

I built its prototype originally for my sightless friend, W9PBS, who until then had a problem knowing which way his four-element monobander was aimed. The voltmeter needle on his Ham IV rotator control that usually reads out the direction his beam is pointing is worthless to him, of course. It was while mulling over the problem of converting that analog needle's silent message into something more useful that I came up with the idea for the smart knob. And I liked it so well while debugging it and burning it in on my own operating table that I had to build one for myself.

That's because my own DC-45 rotator control, identical with the Ham IV's and the control for the CDE's big antenna whirler, the Tailtwister, requires holding down both a brake release and a direction button while the beam is swinging from one compass point to another. This can take as much as half a minute for a 180-degree direction change. The smart knob, on the other hand, requires only a quick twirl to the desired beam heading and it does the rest itself, bringing the antenna around to the target while I tweak my transceiver tuning to peak that rare call up out of the mud and prepare to enter it in my log.

If you have a CDE rotator, I think you'd enjoy a smart knob, too. Mine's been in use for many months now without ever rebelling at its task. So has the one in daily use by W9PBS, who actually switches it between two separate Ham IVs, driving 15- and 20-meter monobanders mounted on separate towers.

The knob itself is fastened to the shaft of a 25k pot extending from a black box which, along with all the other parts and pieces inside except those scrounged from my junk collection, was bought at my neighborhood Radio Shack, for a total of less than \$50. The heart of the gadgetry inside the box is that pot and a 12-volt-dc power supply capable of providing 150 mA or so (see Fig. 1). The supply feeds two sections of an LM339 quad comparator chip, three 2N3904 transistors, and three 12-volt relays with DPDT contacts rated at three Amps. (See Radio Shack numbers in the Parts List.) But before we get into their functions, let's discuss the CDE rotator control system.

It is a conventional low-voltage ac capacitor-start motor whose direction of rotation depends on which half of its winding pair is energized. Though the light-duty CD-45, the medium-duty Ham IV, and the heavy-duty Tailtwister rotators have different braking systems and varying num-

bers of ball bearings in their innards, they are similar electrically and their control boxes are identical. Each contains the motor-feed transformer, the start capacitor, three push-and-hold button switches for brake release and directional control, and the direction-indicating circuitry. That circuitry consists of a power supply which provides 13 volts dc, a voltmeter to read it, and a calibration pot.

Inside the motor housing there is a variable resistor shunted across the floating-ground, 13-volt supply (and connected to it by rotor cable terminal posts 3 and 4 on the back panel of the control box). The movable arm of that remote resistor, mechanically linked to the motor rotor, is chassis-ground, cabled to terminal post 1 on the control unit.

The resistor is tied into the direction-indicating voltmeter circuit so that the meter reads full scale—13 volts—when the rotor is fully clockwise, zero volts at full counterclockwise, and 6½ volts at the halfway



point. The voltmeter face is calibrated accordingly, north at half scale, south at full clockwise and full counterclockwise, with the other points of the compass in between.

And that's where the smart knob comes in. If we connect the outside terminals of its 25k pot across binding posts 3 and 7 on the rear apron of the control box (shunting the rotor-feed wires already there), the pot will be in parallel with the 13-volt, direction-indicator supply, and the pot's center terminal will show a voltage to ground proportional to the difference in relative settings of the pot and the rotor-mounted resistor.

With the rotor turned due north so that 6½ volts appears on the voltmeter, turning the smart knob's pot to half rotation—map north as indicated by the pointer knob, straight up—will bring to zero the voltage between its center terminal and chassis ground. Now rotate the pot clockwise, and that zero voltage will climb toward plus 6½, depending upon the degree of rotation. Turn it counterclockwise, and the voltage will fall back to zero at the midsetting, then begin a negative climb to -6½ when it's at full counterclockwise.

That's the secret of the smart knob's intelligence. All we need to do now is harness this intelligence to control the rotor motor and braking circuit so that our beam points wherever the knob tells it to.

Fig. 1 shows how the center terminal of the 25k linear-taper pot feeds two sections of the comparator chip so that one senses positive voltages, the other negative. Because each turns on a switching transistor whose collector current flows through relay coils, one or the other relay is pulled in whenever there is a difference in rotation an-

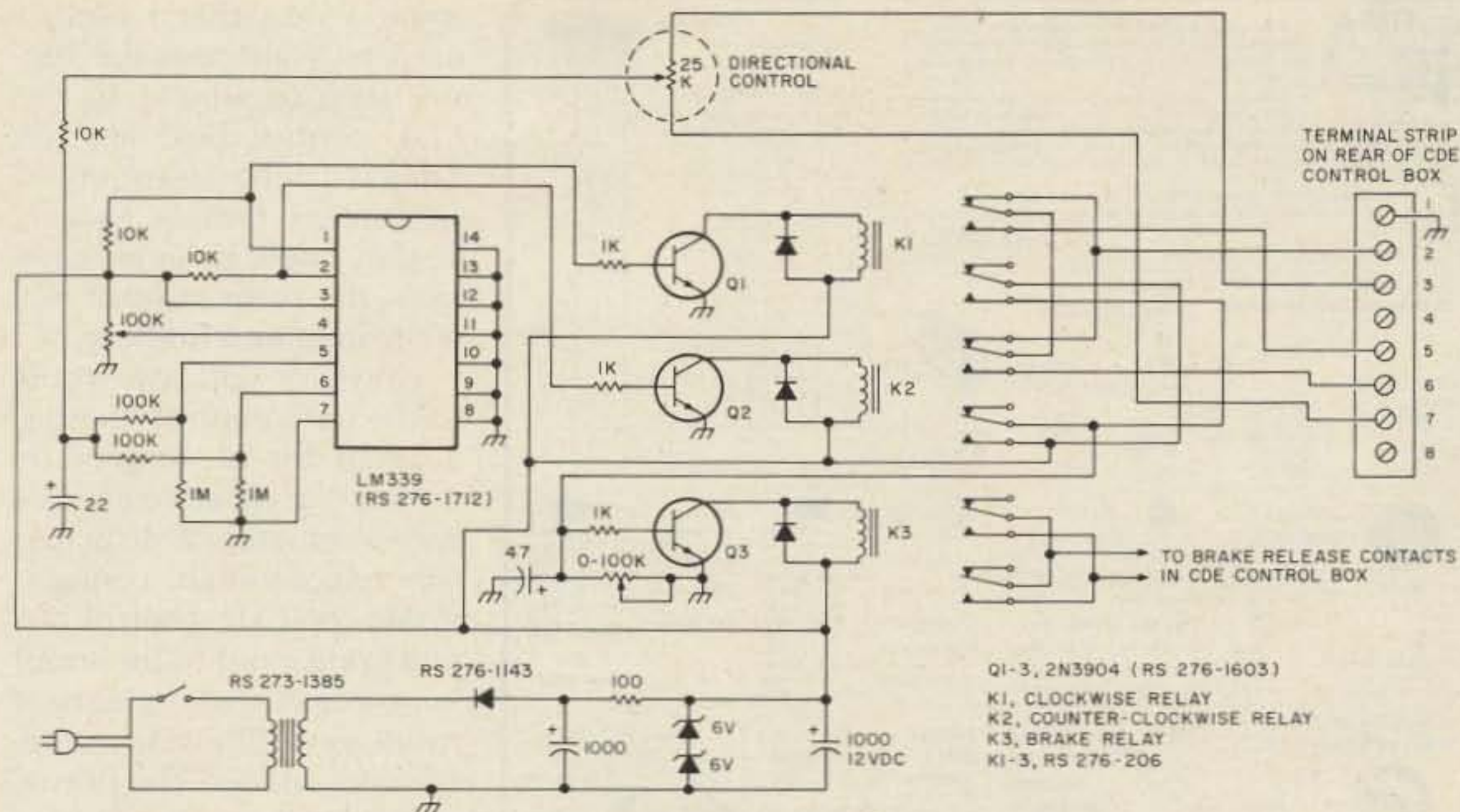

Fig. 1. Rotator control schematic.

gle between the smart knob and the beam rotor.

The relay contacts parallel the push-button switches of the rotor control box, thus energizing the brake and rotor motor, which swings the antenna to the direction called for by the smart knob; then the contacts open to hold it there. They are so interconnected that even a component failure or human error cannot trigger simultaneous clockwise and counterclockwise rotation. And there is a time-delay circuit in the brake-release relay's switching-transistor circuitry ensuring that the rotor—and the heavy load it carries—coasts to a stop before the brake is reapplied, thus averting the tower-twisting, rotor-ruining torque that the inertia of a suddenly-braked antenna can exert.

The component values shown provide a variable braking delay of about two to five seconds, adequate for my tribander and the heavier four-element monobanders used by W9PBS.

There is one small limitation. Because the voltage signalling the counterclockwise comparator to turn on its switching transistor falls to zero when antenna rota-

tion approaches full counterclockwise south, and because even a smart knob requires a small fraction of a volt to sense, counterclockwise rotation will stop about 5 degrees from due south. But that's no big deal. Most beams have 60-degree lobes; you still can nudge the antenna the rest of the way with the manual push-buttons, or

you can tell the smart knob to go full south clockwise where it has lots of voltage to sense. And it will.

There are no particular construction hints to pass along. Everything is dc and, therefore, lead lengths and dress are not a problem. I used perfboard and wired point-to-point because I'm not into printed-circuit fabrication. On one of the

#### Parts List

- 1 cabinet (270-453)
- 1 transformer, 12 V, 300 mA (273-1385)
- 3 relays, 12 V, DPDT (276-206)
- 1 on-off switch (275-612)
- 1 package (2) zener diodes, 6 V (276-571)
- 1 25k pot, linear taper (271-1715)
- 2 100k minipots (271-220)
- 1 package (15) 2N3904 transistors (276-1603)
- 1 quad comparator LM339 (276-1712)
- 1 14-pin dip socket (276-1999)
- 2 1,000-µF electrolytics (272-957)
- 1 47-µF electrolytic (272-1027)
- 1 22-µF electrolytic (272-1026)
- 1 3-Amp rectifier diode (276-1143)
- 1 PC board, 4½" x 6" (276-1394)
- 1 package push-in terminals (270-1394)
- 1 package (50) diodes (276-1620)
- 3 10k, ¼-Watt fixed resistors
- 2 100k, ¼-Watt fixed resistors
- 2 1 meg, ¼-Watt fixed resistors
- 4 1k, ¼-Watt fixed resistors
- 1 length, (two, three feet) eight-conductor cable\*
- 1 knob, pointer, junk-box type

\*If you've got a rotator, you must have some cable somewhere, probably hanging in the garage. My Radio Shack doesn't stock it. The other parts will add up to around \$45, if you buy them all new. Happy knobbing.



**TUSA** A WHOLE NEW WORLD OF TV VIEWING WITH TUSA'S NEW MODEL CVU-48, 40 CHANNEL CABLE TV CONVERTER. Receive all the EXTRA CABLE TV "MIDBAND" & SUPERBAND CHANNELS on your UHF DIAL. Eliminates the need for renting or leasing. This stable and reliable system converts extra cable TV channels so they can be received on the UHF tuner of your TV set. Provides the extra midband and superband channels now distributed by most cable companies. Channels 2 to 13 can also be seen directly on the VHF portion of your tuner.

**A MUST FOR VIDEO-TAPING FROM CABLE TV!**  
The system allows you to program both pay (pay TV decoder required) and standard cable channels for taping on any VCR — while you are watching a different channel on your TV.  
Now \$28<sup>95</sup> ea. PLUS POSTAGE

**WINEGARD 75 OHM UHF YAGI ANTENNAS**  
12 db GAIN CHANNELS 44 - 52 \$8<sup>95</sup> ea. 6 OR MORE \$6<sup>35</sup> ea. OPTIONAL Winegard UHF Antenna Preamp 18db Gain \$39<sup>95</sup> ea.

**BRAND NEW UHF VARACTOR TUNERS**  
Sanyo 45 MHz Output \$24<sup>95</sup> ea. Mitsumi 45 MHz Output \$24<sup>95</sup> ea.

**POPULAR IC's**  
TOP QUALITY NO SECONDS

TYPE	DESCRIPTION	1-8	10-UP
LM 380N	2 watt Audio Power Amp	\$1.49	\$1.29
LM 386N	Low Voltage Audio Amp	1.99	1.29
NE 561	Phase Locked Loop	12.95	11.95
NE 564N	Digital Phase Locked Loop	3.50	3.15
LM 565N	Phase Locked Loop	1.49	1.29
LM 723N	Video Amp	1.89	1.44
MC 1330	Video Detector	2.49	1.99
MC 1349	Video IF Amp	2.99	1.85
MC 1350	Video IF Amp	1.75	1.55
MC 1362	Video IF Amp AGC	2.69	2.09
MC 1376P	RF Modulator	3.99	2.87
MC 1458	Dual Comp. Op Amp	.69	.79
MC 1496A	Balanced Mod/Demodulator	1.79	1.59
LM 1800	PLL Stereo Decoder	4.49	3.95
LM 1809	Video Modulator	2.95	2.49
<b>LINEAR VOLTAGE REGULATORS</b>			
LM 7805	5 Volt Positive Volt. Reg.	1.39	1.25
LM 7808	8 Volt Positive Volt. Reg.	1.39	1.25
LM 7812	12 Volt Positive Volt. Reg.	1.39	1.25
LM 7815	15 Volt Positive Volt. Reg.	1.39	1.25
LM 7818	18 Volt Positive Volt. Reg.	1.39	1.25
LM 7824	24 Volt Positive Volt. Reg.	1.39	1.25

**POPULAR MICROWAVE PARTS**  
MRF-901 \$2.75 9-UP 2.19  
MRF-911 3.46 9-UP 3.12  
MDD-101 .98  
CHIP CAPS - .001 mfd .50 25-UP .30  
2N6603 formerly MRF 902 11.36

**MV-2109** 33pf Taming Blade 1-9 \$1.20 ea. 10-UP .99 ea.

**5% MICA CAPS 5%**  
10pf 42c ea. 500pf .99c ea.  
43pf 36c ea. 1200pf .89c ea.  
110pf 36c ea. 3000pf 1.39 ea.

**Radial Lead Caps** 10 mfd @ 50V 1-11 \$2.25 ea. 12 or more .16 ea.  
1 mfd @ 50V 1-11 .25 ea. 12 or more .16 ea.  
470 mfd @ 35V 1-11 .39 ea. 12 or more .49 ea.  
1000 mfd @ 35V 1-11 .89 ea. 12 or more .69 ea.  
2200 mfd @ 35V 1-11 1.29 ea. 12 or more 1.09 ea.  
2250 mfd @ 30V 1-11 1.69 ea. 12 or more 1.39 ea.

**Axial Lead Caps** 1000 mfd @ 50V 1-11 \$3.99 ea. 12 or more .79 ea.  
2200 mfd @ 35V 1-11 1.39 ea. 12 or more 1.19 ea.  
2250 mfd @ 35V 1-11 1.59 ea. 12 or more 1.39 ea.  
3300 mfd @ 35V 1-11 1.99 ea. 12 or more 1.79 ea.

Call us for CERAMIC DISCS

**PRINTED CIRCUIT THUMB-WHEEL POTENTIOMETERS**  
1-12 \$ .99  
13-99 \$ .35  
100-999 \$ .29  
1/4 watt, 10k ohm, thumb or screwdriver adjustable. Mount vertically on PC boards or terminal strips.

**TUSA MAX-2 LOW LOSS MATCHING TRANSFORMERS**  
Indoor 75-300 \$1.29  
10-UP .98  
Outdoor 75-300 1.69  
10-UP 1.49

**PROJECT BOXES** Woodgrain  
This box is 11 1/4" W x 4 1/2" H x 6 1/2" D with a removable aluminum U-shaped chassis 11" W x 3 1/2" H x 6" D inside.  
4 or more \$12.50 ea. \$10.95 ea.

**UHF - VHF - FM SPLITTER** 40-900 MHz  
TUSA MAX-3  
Low Loss 3.5-4 db, Low VSWR, Waterproof Housing \$2.49 ea.

**SURPLUS AUDIO & VIDEO RF MODULATORS**  
Hook up sheet included. Now \$5.49 ea.

**DELUXE A-B SWITCH**  
For CATV - MATV - VCR  
75 ohm - 90 db isolation. While They Last \$6.95 ea.

**SURPLUS PENNSYLVANIA VHF VARACTOR TUNERS**  
45 MHz output. Channels 2 through 13 as well as the mid-band channels. Schematic included. WHILE THEY LAST! \$13.95 ea.

**POPULAR MISCELLANEOUS PARTS**  
10K Volume Control with DPDT switch \$ 1.49  
10-UP 1.19  
8x10 Speaker Cabinet with speaker 10.95  
2 or more 8.95  
Toroids - T30-12 .46  
20-UP .25  
Toroids - T37-2 .38  
20-UP .25

**800-854-4655** TOLL FREE ORDER LINE OUTSIDE CALIFORNIA  
**714-635-5090** INFORMATION AND CALIFORNIA ORDER LINE  
MAIL ORDERS WELCOME - PLEASE INCLUDE POSTAGE - SHIPPED SAME DAY RECEIVED - NO MINIMUM ORDER

**R.F. ELECTRONICS**  
1056 N. STATE COLLEGE BLVD., DEPT. G  
ANAHEIM, CALIFORNIA 92806  
AD PRICES GOOD THRU OCTOBER 15

OPEN TUES - FRI 10-6  
SAT 10-5  
CLOSED SUN & MON

smart knobs that I built, I used an eight-terminal barrier strip to wire it to the CDE control box, and on others I chassis-mounted six-contact female sockets so they could be unplugged from the rotor control box for testing and fiddling.

However you wire yours to the CDE control, there is a small bit of surgery required: You need to shunt a two-conductor cable across the brake-switch contacts inside the CDE control box and bring it out to the smart knob box. There is plenty of room to work inside the rotor control, and the plastic cabinet can be flexed enough to pass the cable between it and the chassis if you don't want to drill it for a connector socket.

If you use a plug and socket for this, be sure the brake contacts are connected to the female half of the connector, because the brake wires are hot with 120 V ac.

With the smart knob built and connected to the CDE control box, disconnect the brake-energizing cable so that the antenna won't be swinging back and forth as you adjust the pick-up-dropout points of the switching transistors by tweaking the 100k minipot feeding pin 4 of the comparator chip. Once you have that minipot properly set so that the device neither hunts for a null nor fails to respond to a 3-to-5-degree rotation of the smart knob, you can loosen the pointer-knob set screw on the 25k pot shaft to line it up at due north when the antenna is pointing due north.

Having thus compensated for any discrepancy between zero voltage at the pot's wiping contact and its precise half-resistance setting, you will find calibration is remarkably accurate at all points of the compass. ■

# ege, inc.

453  
Call for Quotes  
Dealer Inquiries Invited

# NOVEMBER VALUES

Information and Virginia Orders: (703) 643-1063  
13646 Jefferson Davis Highway, Woodbridge, Virginia 22191  
Store Hours: M-W-F 12 noon-8 p.m.; T-Th-S 10 a.m.-4 p.m.

- TEN-TEC SPECIALS**  
515 Argonaut HF XCVR. 399.95  
525 Argosy HF XCVR. 499.95  
546 Omni-C HF XCVR. 1069.00  
Complete Line of Filters and Accessories in Stock  
— CALL FOR QUOTE —
- ICOM TRANSCEIVERS AND ACCESSORIES**  
HF-720, 730, 740 CALL  
VHF/UHF-2A/2AT, 3AT, 4AT, 25A CALL
- MIRAGE VHF/UHF AMPLIFIERS/METERS** CALL
- VOCOM ANTENNAS/2m AMPLIFIERS**  
5/8 wave 2m Hand-held Antenna 14.95  
2 watts in, 25 watts out 2m Amplifier 69.95  
200 mW in, 25 watts out 2m Amplifier 82.95  
2 watts in, 50 watts out 2m Amplifier 105.95  
Power Packet for ICOM 2A/2AT 179.95
- ASTRON POWER SUPPLIES (13.8 VDC)**  
RS-7A 5 amps continuous, 7 amp ICS 48.60  
RS-12A 9 amps continuous, 12 amps ICS 68.35  
RS-20A 16 amps continuous, 20 amps ICS 87.20  
RS-20M same as RS-20A + meters 105.50  
RS-35A 25 amps continuous, 35 amps ICS 131.95  
RS-35M same as RS-35A + meters 151.95  
VS-35M 25 amp continuous, adjust volt & amp 171.00  
VS-20M 16 amp continuous, adjust volt & amp 124.00
- MFJ PRODUCTS** (Call for other MFJ items)  
989 New 3-kW Antenna Tuner 287.75  
982 1.5-kW Tuner switch/meter 189.95  
949B 300-watt Deluxe Tuner 122.00  
941C 300-watt Tuner switch/meter 79.95  
940 300-watt Tuner switch/meter 69.70  
496 Keyboard II 289.95  
752B Dual Tunable SSB/CW Filter 79.95
- BENCHER PADDLES** Black/Chrome 34.95/42.95
- AEA KEYERS, READERS, ANTENNAS** CALL  
MM-2, CK-2, KT-2, MBA/RO, MBA/RC, Isopoles

- SUPER SPECIALS**
- ROTORS**  
ALLIANCE HD73 91.95  
CDE Ham IV 195.95
- AZDEN** PCS 300 Hand-held 283.95  
NEW! PCS 4000 2m XCVR 283.95
- SANTEC**  
144up 2m Hand-held 285.00  
440up 440-450 MHz Hand-held CALL
- TOKYO HIGH-POWER**  
HL32V 2m Amplifier, 2 in, 30 out 71.95  
HL20U 440-450 MHz Amplifier, 2 in, 20 out 98.00  
HL160V 2m Amplifier, 2/10 in, 160 out 299.95  
HF Tuners CALL
- KDK FM 2030 25-watt FM XCVR** 278.95
- MICROLOG Act-1 RTTY/MORSE SYSTEM** CALL

- BIG DISCOUNTS**  
KENWOOD, ICOM, YAESU  
AMERITRON HF AMPLIFIERS  
— Call for quotes —
- DAIWA/MCM/J.W. MILLER**  
CN-520/CN-540 SWR/Watt Meters 59.95/69.95  
CNW 418/CNW-518 Ant Tuners 169.95/279.95  
CNA-2002 Auto 25-kW Ant Tuner 399.95
- CABLE BY SAXTON**  
RG213 Mil Spec 26c/ft  
RG8/U Foam 95% Shield 24c/ft  
8-wire Rotor 2 #18, 6 #22 16c/ft  
Mini-8 12c/ft
- TELEX HEADSETS/HEADPHONES**  
C1210/C1320 Headphones 28.95/40.95  
PRO COM 200 Headset/Dual Imp Mic 81.95  
PRO COM 300 It/wt Headset/Dual Imp Mic 73.95

- ANTENNAS**  
AVANTI AP 151.3G 2m On-glass Antenna 28.95  
LARSEN LM-150 5/8 Mag Mount 36.00  
MOSLEY HF ANTENNAS CALL  
MINIQUAD HQ-1 129.95  
SUPER STICK II 5/8 2m Antenna 15.95  
BUTTERNUT HF6V 10-80m Vertical 109.95
- HY-GAIN ANTENNAS** CALL FOR QUOTES  
Most antennas now with stainless hardware  
HY-GAIN ANTENNA/TOWER PACKAGES CALL
- CUSHCRAFT** (Other antennas in stock)  
A4 New Triband Beam 10-15-20m 224.95  
A3 New Triband Beam 10-15-20m 172.95  
AV3 New 10-15-20m Vertical 44.50  
ARX-2B New Ringo Ranger 2m 34.50  
A32-19 2m "Boomer" DX Beam 81.95  
220B 220 MHz "Boomer" 74.95  
214B "Jr. Boomer" 144-146 MHz, SSB 68.20  
214FB "Jr. Boomer" 144.5-148 MHz, FM 68.20  
A147-11 11-element 2m 37.95
- KLM ANTENNAS** (Other antennas in stock)  
KT34A 4-element Triband Beam 309.95  
KT34XA 6-element Triband Beam 459.95  
144-148-13LB 2m 13-element with Balun 77.95  
144-148-16C 2m 16-element for Oscar 93.55  
420-450-14 420-450 MHz 14-element Beam 37.54  
420-450-18C 420-450 MHz 18-element for Oscar 58.70  
432-16LB 16-element 430-434 MHz Beam/Balun 60.70
- HUSTLER**  
5-BTV 10-80m Vertical 99.95  
4-BTV 10-40m Vertical 78.98  
3-TBA New 10-15-20m Beam 188.95
- HF MOBILE RESONATORS** Standard Super  
10 and 15 meter 8.00 13.50  
20 meters 11.00 15.95  
40 meters 13.00 18.50  
75 meters 14.00 28.95

## ORDER TOLL FREE 1-800-336-4799

Order Hours: M-F 11 a.m. to 7 p.m.; Saturday 10 a.m. to 4 p.m.  
Bonus: 2% Discount for Prepaid Mail Orders (Cashiers Check or Money Order)

Send stamp for a flyer. Terms: Prices do not include shipping. VISA and Master Charge accepted. 2% discount for prepaid orders (cashier's check or money order). COD fee \$2.00 per order. Prices subject to change without notice or obligation. No personal checks accepted. Returns subject to 10% restocking fee.



## SWD-1 VIDEO CONVERTER

FOR CABLE TV



The SWD-1 Video Converter is utilized on cable TV systems to remove the KHz's signal from a distorted video (channel 3 in/out) and also pass thru the normal undistorted/detected audio signal. Rocker switch selects operating mode to remove KHz's distortion from the video or pass all other channels normally. Simple to assemble—less than 30 minutes. Pre-tuned. Input/output Channel 3. Impedance 75 ohms, 117VAC.

SWD-1 Video Converter Kit ..... \$69.95

## VTR ACCESSORIES

### SIMPLE SIMON VIDEO STABILIZER



Simple Simon Video Stabilizer, Model VS-125, eliminates the vertical roll and jitter from "copy guard" video tapes when playing through large screen projectors or on another VTR. Simple to use, just adjust the lock control for a stable picture. Once the control is set, the tape will play all the way through without further adjustments. Includes 12V power supply.

VS-125 Video Stabilizer, wired ..... \$54.95

### SIMPLE SIMON VIDEO SWITCHING BOX



#### The Affordable Video Control Center

Excellent in isolation and no loss routing system. Simple Simons VSB-300 Video Switching Box enables you to bring a variety of video components together for easy viewing/dubbing. Also you gain the ability to record one channel while viewing another. Unit includes two F-type quick connector ended cables.

VSB-300 Video Switching Box, wired ..... \$19.95

## UHF ANTENNAS and ACCESSORIES

### MDS-AMATEUR-ETV 32 ELEMENT YAGI ANTENNA

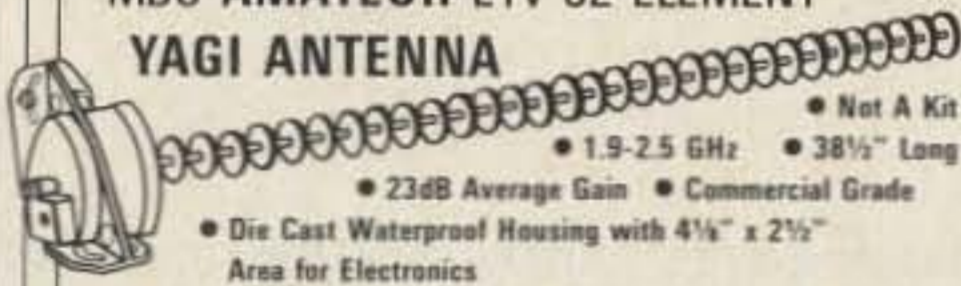

• Not A Kit • 1.9-2.5 GHz • 38 1/2" Long  
• 23dB Average Gain • Commercial Grade  
• Die Cast Waterproof Housing with 4 1/4" x 2 1/2" Area for Electronics  
• Includes P.C. Probe, F-61 Connector and Mounting Hardware

MAE-2 32 Element YAGI Antenna ..... \$23.95

### Kato Sons' Down Converter Kit ★ 1.9 - 2.5GHz ★

Designed for Simple Simon by former Japanese CO Amateur Magazine's UHF Editor/Engineer. Unit utilizes new ingenious Printed Circuit Probe for maximum gain. Circuit board fits inside MAE-2 antenna housing. Requires 1 hour assembly. IC and capacitors pre-soldered.

Model KSDC-KIT 1.9 - 2.5GHz Down Converter Kit ..... \$34.95

### Kato Sons' Regulated Variable DC Power Supply

For use with KSDC-KIT 1.9 - 2.5GHz Down Converter. Completely assembled with Attractive Cabinet, TV/Converter Mode Switch, Frequency Control and LED Indicator.

Model KSPS-1A Assembled Power Supply ..... \$23.95

**SPECIAL INTRODUCTORY SAVINGS**

ORDER ALL THREE ITEMS

MAE-2, KSDC-KIT and KSPS-1A for Only. **\$74.95**

Regular price if ordered separately \$82.85  
— CO-AX CABLES ARE NOT INCLUDED —

### ZYZZX VHF-UHF Wideband Antenna Amplifier



#### Revolutionary New HYBRID IC Broadband Amplifiers

50 MHz - 900 MHz  
Model ALL-1 12dB Gain  
Model ALL-2 35dB Gain

These units are not available anywhere else in the world. Each unit will serve many purposes and is available in Kit or Assembled form. Ideal for outdoor or indoor use. I/O impedance is 75 ohms. Amplifiers include separate co-ax feed power supply. Easily assembled in 25 minutes. No coils, capacitors to tune or adjust.

ALL-1 Complete kit w/ power supply \$24.95 ALL-1 Wired/ Tested w/ power supply \$34.95  
ALL-2 Complete kit w/ power supply \$4.95 ALL-2 Wired/ Tested w/ power supply \$4.95

### Our New STVA 14.5dB GAIN, 14 ELEMENT CORNER REFLECTOR YAGI ANTENNA



STVA-3 Yagi Antenna, 14.5dB Gain, Selectable 75 or 300 ohm Channel 60-80. \$19.95

STVA-4 Yagi Antenna, 14.5dB Gain, Selectable 75 or 300 ohm Channel 44-52. \$19.95

RG-59/U 75 ohm Low Loss Coax Cable \$ .12/ft. F-59 Coax Connector \$ .39 ea.  
MT-1 Special UHF 75-300 ohm Matching Transformer \$1.45 ea.

# Switch to Bambi!™

## Electronically

Bambi Electronic Video Switch ... makes switching of your VCR/VTR, Pay TV Decoders, Cable TV, Video Discs, Video Games, Closed Circuit TV, Antennae and Microcomputer as easy as pushing buttons.

The Bambi Electronic Video Switch is an electronic switching network which can accept up to six different sources of video signals and provide the flexibility of directing the inputs to any or all of the three outputs.

Now you can eliminate ... the drudgery of disconnecting and reconnecting your video equipment each time you use it ... the tangled mess of cables which are impossible to trace out ... not being able to use more than one function at a time.

Bambi lets you enjoy using your video equipment the way it should be ... electronically and on line at the push of a button.

Model BEVS-1 Wired

**\$129.95**



Bambi's front panel was designed with the user in mind. Computer styled construction, with soft-touch keyboard (rated for over 10 million operations), arranged in matrix form allows easy input/output selection without referring to charts. Functions selected through the keyboard are immediately displayed on the 18 LED status indicators.



Check the quality of Bambi against that of much higher priced competition. All solid state electronic switching provides low attenuation (3dB), wide frequency response (40-890 MHz), and excellent isolation between signal sources (each I/O section individually shielded for 65dB min. isolation).

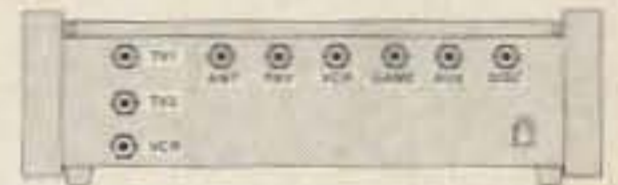

#### Bambi's Specifications:

- Input/Output Impedance 75 ohm
- Signal Loss 3dB ±1dB
- Noise 4dB ±1dB
- Input Return Loss 12dB min.
- Isolation 65dB min.
- Power Req. 117VAC 60 Hz, 2W
- Dimensions 10 1/4" W x 6 1/2" D x 3 1/4" H
- Weight 4 1/2 lbs

## 7+11 SWD PARTS KITS

### MITSUMI VARACTOR UHF TUNER

Model UES-A56F

**\$24.95**

Freq. Range UHF470 - 889MHz  
Antenna Input 75 ohms  
Channels 14-83 Output Channel 3

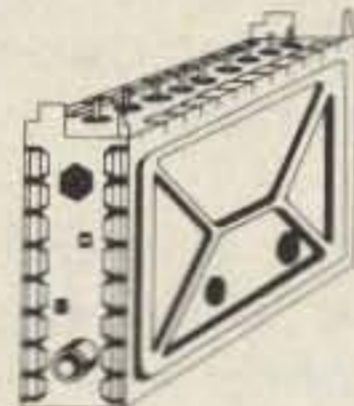

KIT NO	PART NO	DESCRIPTION	PRICE
1	VT1-SW	Varactor UHF Tuner, Model UES-A56F	\$24.95
2	CB1-SW	Printed Circuit Board, Pre-Drilled	18.95
3	TP7-SW	P.C.B. Potentiometers, 1-20K, 1-1K, and 5-10K ohms, 7-pieces	5.95
4	FR35-SW	Resistor Kit, 1/4 Watt, 5% Carbon Film, 32-pieces	4.95
5	PT1-SW	Power Transformer, PRI-117VAC, SEC-24VAC, 250ma	6.95
6	PP2-SW	Panel Mount Potentiometers and Knobs, 1-1KBT and 1-5KAT w/Switch	5.95
7	SS14-SW	IC's 7-pcs, Diodes 4-pcs, Regulators 2-pcs Heat Sink 1-piece	29.95
8	CE9-SW	Electrolytic Capacitor Kit, 9-pieces	5.95
9	CC33-SW	Ceramic Disk Capacitor Kit, 50 W.V., 33-pieces	7.95
10	CT-SW	Variable Ceramic Trimmer Capacitor Kit, 5-65pfd, 6-pieces	5.95
11	L4-SW	Coil Kit, 18mhs 2-pieces, .22µhs 1-piece (prewound inductors) and 1 T37-12 Ferrite Torroid Core with 3 ft. of #26 wire	5.00
12	ICS-SW	I.C. Sockets, Tin inlay, 8-pin 5-pieces and 14-pin 2-pieces	1.95
13	SR-SW	Speaker, 4x8" Oval and Prepunched Wood Enclosure	14.95
14	MISC-SW	Misc. Parts Kit Includes Hardware (6/32, 8/32 Nuts, & Bolts), Hookup Wire, Ant. Terms, DPDT Ant. Switch, Fuse, Fuseholder, etc.	9.95
When Ordering All Items, (1 thru 14), Total Price			139.95

## 7+11 PWD PARTS KITS

### INTRODUCING OUR 7+11 PWD PARTS KITS



KIT No	PART NO	DESCRIPTION	PRICE
1	1VT1-PWD	Varactor UHF Tuner, Model UES-A56F	\$24.95
2	2CB1-PWD	Printed Circuit Board, Pre-drilled	18.95
3	3TP11-PWD	PCB Potentiometers 4-20K, 1-5K, 2-10K, 2-5K, 1-1K, and 1-50k (11 pieces)	8.95
4	4FR-31-PWD	Resistor Kit, 1/4W, 5% 29-pcs, 1/2 W 2-pcs	4.95
5	5PT1-PWD	Power Transformer, PRI-117VAC, SEC-24VAC at 500ma	9.95
6	6PP2-PWD	Panel Mount Potentiometers and Knobs, 1-1KBT and 1-5KAT with switch	5.95
7	7SS17-PWD	IC's 7-pcs, Diodes 4-pcs, Regulators 2-pcs Transistors 2-pcs, Heat Sinks 2-pcs	29.95
8	8CE14-PWD	Electrolytic Capacitor Kit, 14-pieces	6.95
9	9CC20-PWD	Ceramic Disk Capacitor Kit, 50 WV, 20-pcs	7.95
10	10CT5-PWD	Variable Ceramic Trimmer Capacitor, 5-65pfd, 5-pieces	4.95
11	11LS-PWD	Coil Kit, 18mhs 3-pcs, .22µhs 1-piece (prewound inductors) and 2 T37-12 Ferrite Toroid cores with 6 ft. #26 wire	6.00
12	12ICS-PWD	IC Sockets, Tin inlay, 8 pin 4-pcs, 14 pin 1-pc and 16 pin 2-pcs	2.95
13	13SR-PWD	Enclosure with PM Speaker and Pre-drilled Backpanel for mounting PCB and Ant. Terms	14.95
14	14MISC-PWD	Misc. Parts Kit, Includes Hardware, (6/32, 8/32 Nuts & Bolts), Hookup Wire, Solder, Ant. Terms DPDT Ant. Switch, Fuse, Fuseholder, etc.	9.95
15	15MC16-PWD	Mylar Capacitors, 14-pcs and Silver Mica Capacitors 2-pieces	7.95
When Ordering All Items, (1-15), Total Price			159.95

## SIMPLE SIMON ELECTRONIC KITS,™ Inc.

3871 S. Valley View, Suite 12, Dept. 7, Las Vegas, NV 89103

NEED 6 OR MORE OF AN ITEM? WRITE FOR QUANTITY DISCOUNTS

In Nevada Call: 702-871-2892

Outside Nevada Call: 1-800-782-3716

Available by Mail Order Only  
Send Check\* or Money Order. Minimum Order: \$16.95. Add 10% Shipping and Handling on orders under \$40.00. For orders over \$40.00, add 5%. Minimum Shipping and Handling \$2.00. Cat. \$1.00 — VISA and Mastercard Acceptable — \*Check orders will be held 30 days before shipping.



## Life-Support System for HTs

*At home or in the car, this do-it-yourself charger and accessory box could be the best friend your handie-talkie ever had.*

**F**or the first couple of weeks after you buy your 2-meter handie-talkie "brick" (Tempo, Icom, Yaesu, etc.), it is sort of fun to plug and unplug the unregulated charger so that the nicad battery pack stays at full charge. After that, though, the newness wears off and it is just a pain in the lower backside to try to guess at how long you ought to leave the juice on before you boil the cells dry. Not only that, but you

are never really sure whether you have given the battery pack full charge or whether you are consistently undercharging the nicad pack, a notorious cause of nicad deterioration.

In addition, it would be sort of nice to be able to operate mobile with your brick and use the same mobile speaker and microphone that you use for all your other mobile equipment plus the mobile's bat-

tery-generator charging system. The brick box described here will solve these problems and perform the following functions:

- 1) Regulates the voltage and limits the current from the factory-supplied wall charger so that the nicad batteries in the brick may be left on charge for as long as you like without overcharging.
- 2) Allows the car (or boat, or

snowmobile, or aircraft) battery-charging system also to charge the brick batteries with a regulated, current-limited circuit.

- 3) Permits you to plug in a mobile microphone and provides an amplifier-matching circuit between microphone and brick that is adjustable for exactly the right amount of deviation.
- 4) Allows the speaker amplifier in the brick to drive an



*The completed brick box.*

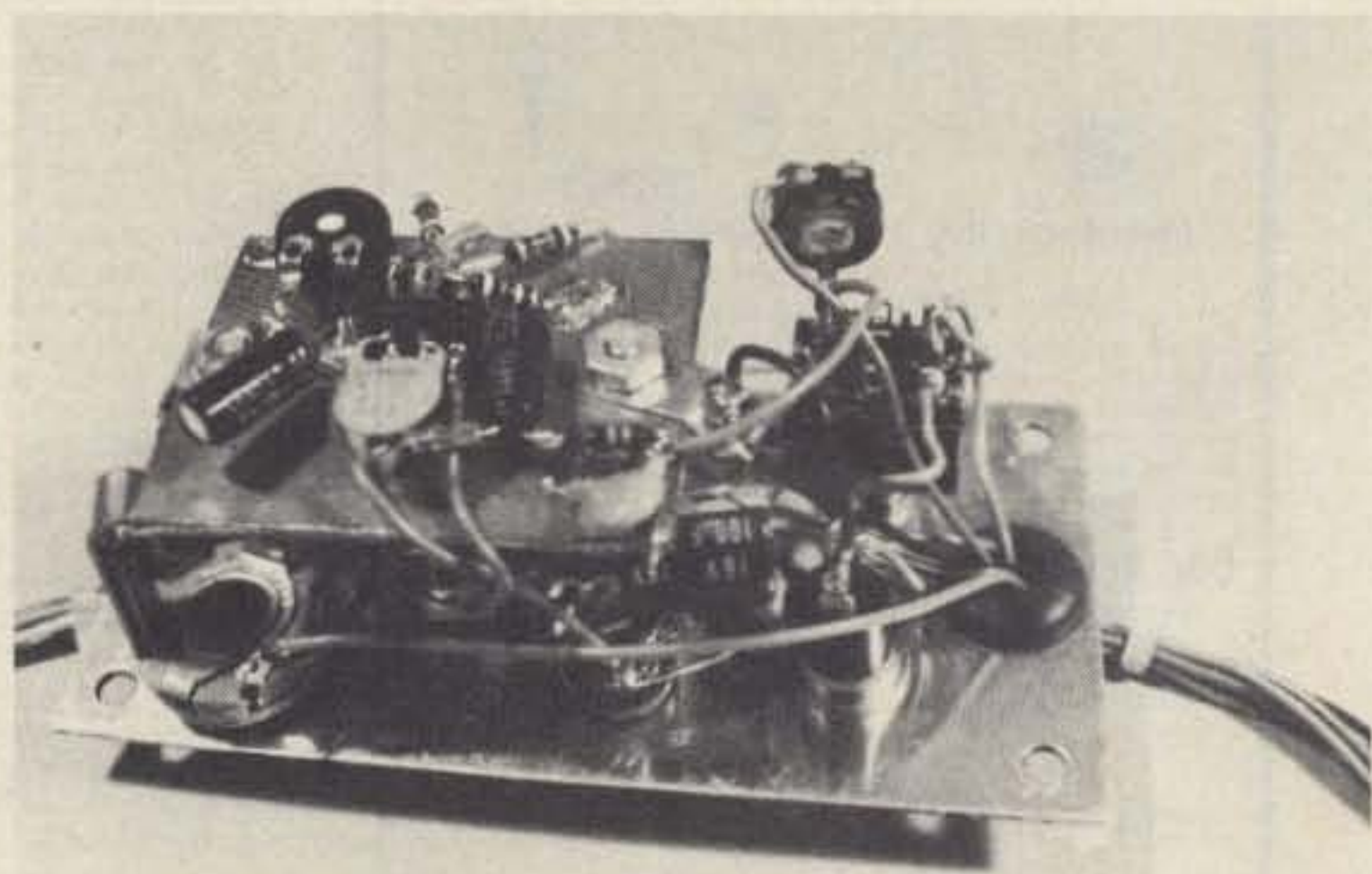

*Inside view of the brick box showing unique "cobweb" construction.*



external mobile speaker (with an option to install a speaker-driver-amplifier for higher power output) or a set of high- or low-impedance headphones.

5) Permits you to plug in to an already-existing mobile installation such as a private aircraft audio panel or a VHF-FM boat system and use the microphone/speaker/headphone setup in the mobile craft.

6) All these goodies cost less than \$10 (plus an extra \$5 for the high-power speaker amp).

Here are the ground rules for using this article: Most of the parts are available from any well-stocked ham store or "hobby-shop" electronics place. You may freely substitute for any of the parts. None of the parts values is really critical—a variation of  $\pm 20\%$  should never really be noticed. Also, this article was written using the Tempo S1, and interfacing with standard commercial FM microphones and aircraft microphone-headsets (carbon or amplified dynamic). Other rigs and other microphones may require modifications of the mike amplifier circuit as shown later.

### Regulator

The power supply regulator must perform two functions. First, on a deeply-discharged nicad battery pack, the regulator must limit the charging current below approximately 200 mA. Limiting the charging current in this manner prevents the cells from outgassing and drying out the electrolyte. Second, the charger must limit the end-charge voltage to the cells to approximately 1.37 volts for each cell, at which point the cells may be allowed to trickle-charge at this voltage indefinitely.

The current limiting may be done by either of two methods. First, if the wall charger itself is one of the

"12-V, 50-mA" variety, no external limiting will be necessary. The wall charger itself provides the necessary current protection by its design. However, a fully-discharged 450-mAh battery will require over 9 hours to fully recharge, so you may wish to consider the alternative fast-charge circuit described a little later.

For those using a current-limited wall-pack charger, the circuit shown in Fig. 1 will regulate the final trickle charge voltage to 1.37 volts per cell, or an output of 11.6 volts into the Tempo S1 CHG jack. (1.37  $\times$  8 cells + 0.7 volts, to compensate for one silicon diode inside the S1 in series with the charger line.) The basic circuit uses a 7805 (or 78M05 or 78L05) regulator, with a 1k variable resistor used to set the exact output voltage. To set the output voltage accurately, connect a 470-Ohm resistor across the 11.6-volt regulated output and adjust R1 (the 1k variable) for exactly 11.6 volts on an accurate voltmeter across the 470-Ohm resistor. The value of C1 (1000  $\mu$ F) is not critical at all, providing that there is less than 150 mV ripple on the output with the 470-Ohm resistor attached. Up to a point, adding more capacitance to this point increases the charge rate (milliamperes)

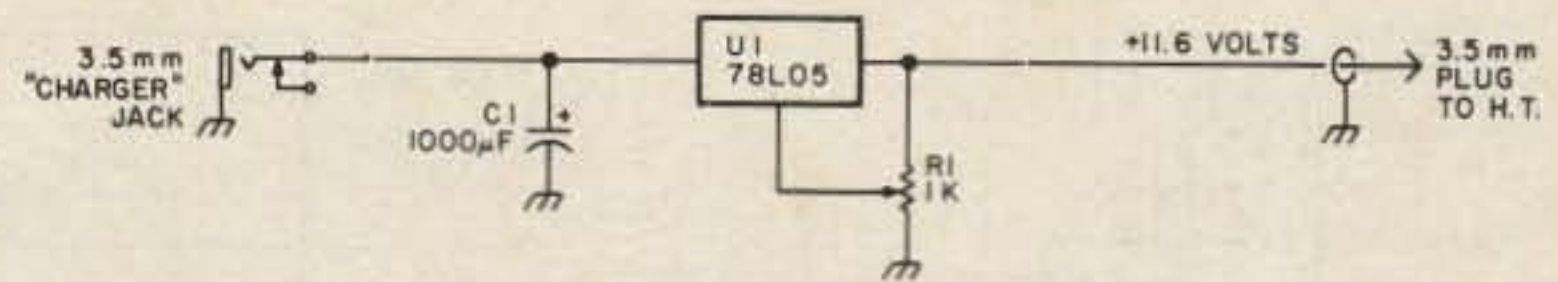

Fig. 1. The basic brick-box charger-regulator.

of the wall charger. I found 1000  $\mu$ F to be the optimum value; do not go below 0.1  $\mu$ F or the regulator will become unstable.

### High-Power Regulator

In the event you can get your hands on a wall power pack with more output or for those who are going to use the almost unlimited current available from an automotive (or boat, or aircraft, etc.) supply to recharge the brick batteries, some method of current limiting must be employed to ensure that the nicad battery pack does not overheat due to excess charging current. Incidentally, for those of you looking for a very inexpensive high-current 12-volt wall-pack-style charger, look in the auto-supply stores or the automotive department of the larger discount houses for a "cold-weather battery maintenance charger." These little rascals look just like a low-power calculator wall pack, with one end terminated in a cigar lighter plug, but the fact of the matter is that they put out 12 volts at a whopping 300 mA. Don't forget the 1000- $\mu$ F filter capacitor, though,

because these high-power wall packs have a pretty raw, rectified ac waveform.

The trick to use to keep the maximum available current below 200 mA is to use a 78L05 for the regulator called out above. The 78X05 is actually a whole family of regulators where X defines the normal maximum current available. If X = L (78L05), normal current maximum is 100 mA; if X = M (78M05), normal current maximum is 500 mA; and if X = nothing (7805), the current available is 1 Amp.

Now, the internal current-limiting circuit in these ICs sets the current-limit point to about 150% of the maximum normal current, so if you use a 78L05 as your voltage regulator IC, the maximum current that your nicad pack can draw is approximately 150 mA, well within the maximum charge capacity of your brick's nicad pack.

Since I had planned to use the brick box in aeronautical mobile use in addition to use with a high-power wall-pack charger, not only did I use the 78L05 as my regulator, but I also supplied both a 3.5-mm jack on the brick box to plug-in the

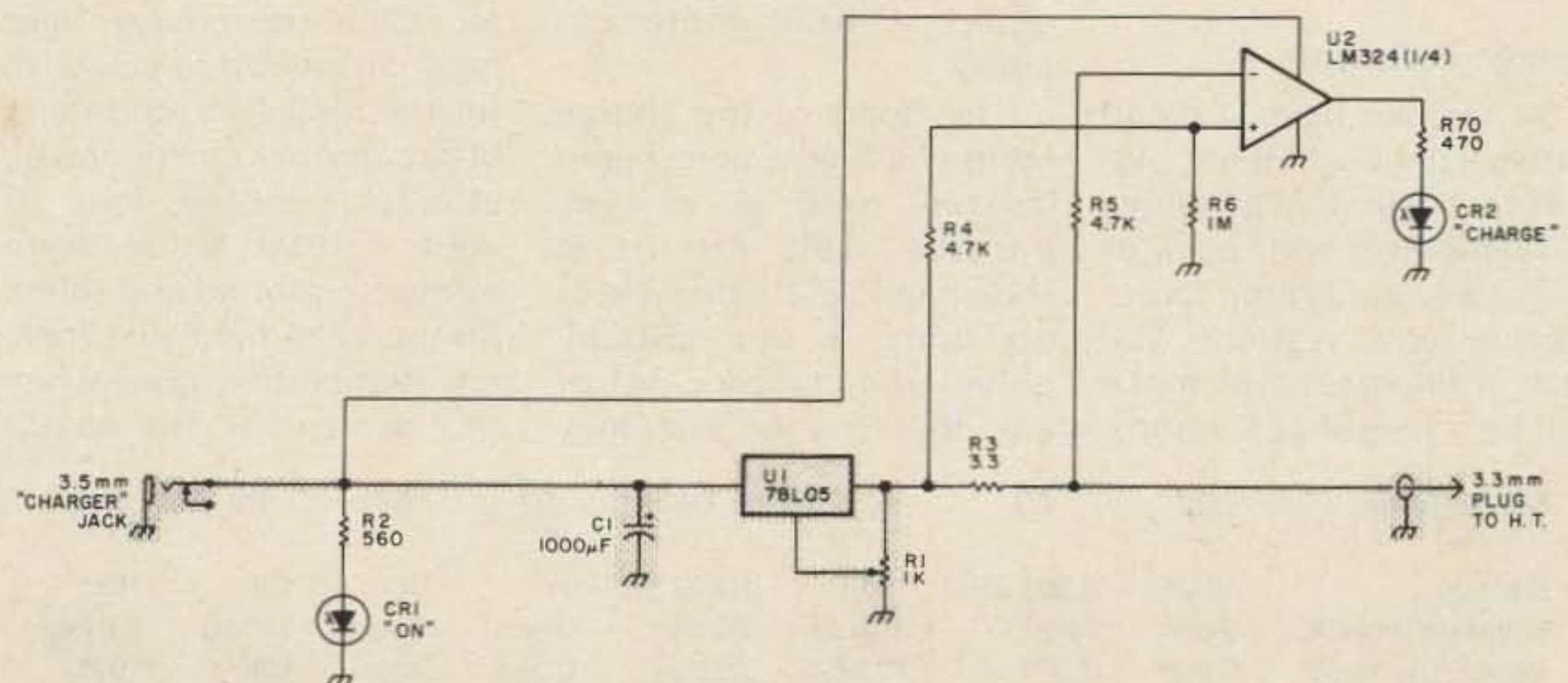

Fig. 2. Adding charge-indicator circuitry.



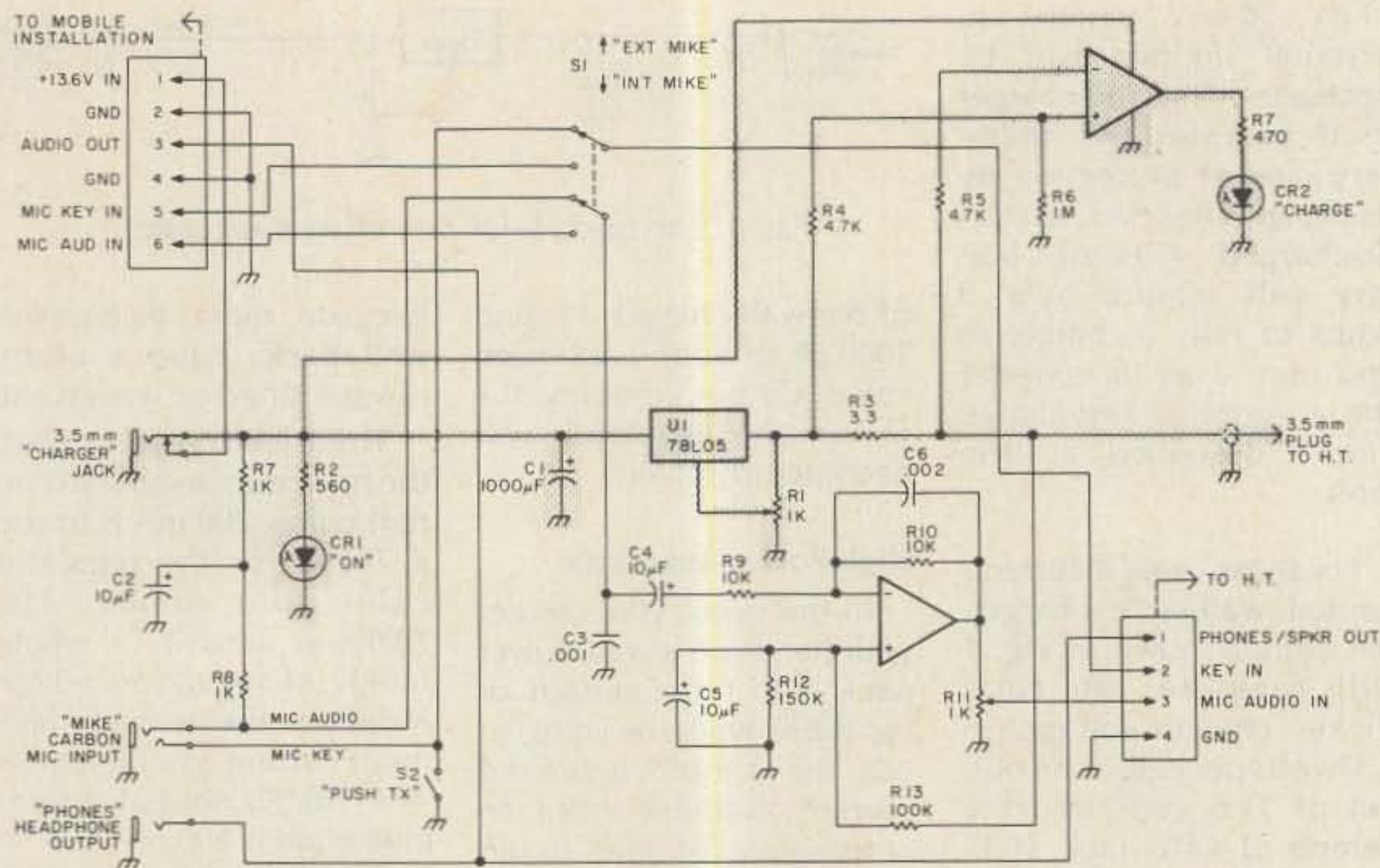

Fig. 3. The deluxe mobile-base brick-box schematic.

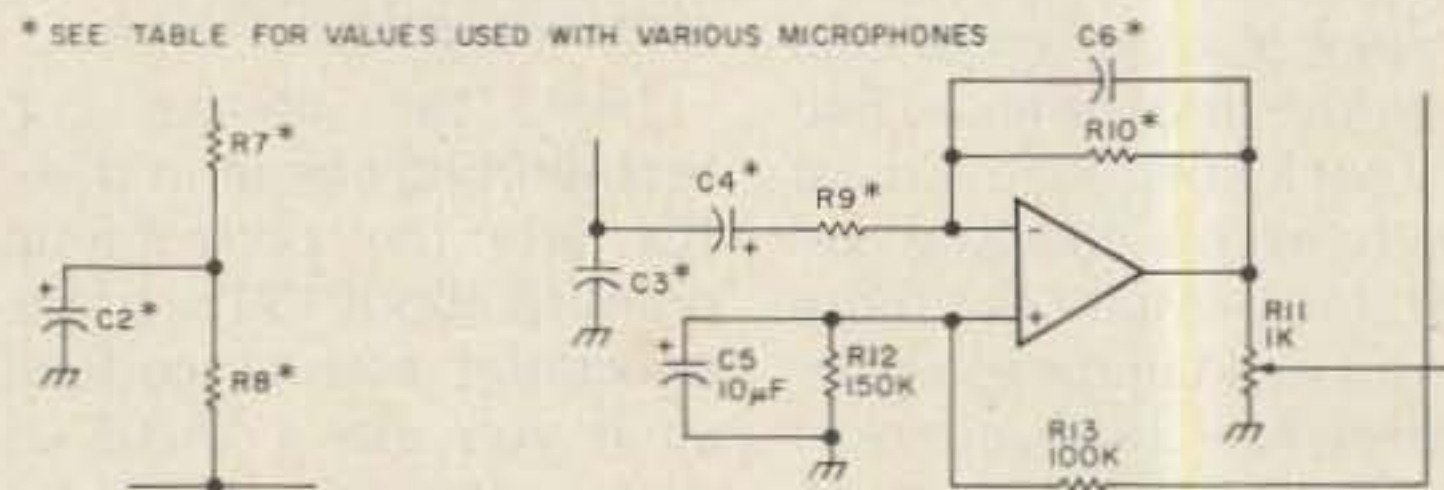

Fig. 4. Parts changes for various microphone types. See Table 1 for values.

wall pack charger and a cable connection to a molex®-type connector for attachment to the aircraft electrical system. As we shall see, using a 6-pin molex connector allows me to use the mobile microphone and speaker/phones, as well as the aircraft battery-charging system.

### Charge Indicators

So far, we have a nicad battery pack charging system that will accept a low- or high-power wall pack or a battery-generator automotive-type system. The first refinement to make will be a pair of LED lamps.

One of the lamps will tell us when power is being supplied into the charger and the second lamp will tell us when the end-of-charge cycle of the nicad pack has occurred. The first lamp is easy: an LED and a resistor (R2) will tell us if our wall pack or auto system is plugged in. The second (end-of-charge) lamp requires a little more circuitry.

The heart of the charge lamp is a high-gain op amp (LM324) used as a comparator. This circuit is shown in Fig. 2. The type of op amp is not critical, either. The common 741 or any other *true* op amp may

be substituted. The so-called Norton (LM3900/MC3401) op amps may be used, but you are on your own for the circuit modifications which are necessary.

The 3.3-Ohm resistor (R3) introduces a negligible voltage loss to the charging circuit, yet drops more than enough millivolts for the op amp to work with. The presumption is that when the charge current drops below 20 mA, the nicad pack is fully charged. At this current, the 3.3-Ohm resistor drops about 70 mV. The op amp senses this voltage drop and when the voltage drops below 70 mV, the charge light extinguishes. R6 (1 Meg) sets the current level at which the charge light turns on and off; if you wish for the light to turn on and off at another current level, attach a resistive load of your chosen value from output to ground and select R6 until the light just flickers. Remember, now, when this lamp is *lit*, the nicads

are *charging* and when it is *dark*, the nicads are either *disconnected* or *fully charged*.

### Microphone Amplifier

The second refinement is a matching circuit shown in Fig. 3 which will take the output of a standard mobile microphone (carbon or amplified dynamic) and massage it to fit the input requirements of the brick. (Note: for those of you using straight low-z or high-z dynamic, ceramic, or crystal microphones, see Fig. 4. The various values for Fig. 4 are shown in Table 1.) Since the requirements of the brick are a microphone voltage of some 200 millivolts peak-to-peak and the output of the carbon/dynamic microphone biased with 10 mA (by R7/R8) is about 500 millivolts p-p, the op amp circuit shown will provide an output somewhat in excess of requirements and can be adjusted to the proper deviation level with R11. The rationale here was not so much that we *had* to have an op amp to drop a 500-mV level to 200 mV, which could well have been done with a simple resistive network, but we had one leftover op amp from the IC used in the charge-light circuit, and the op amp is necessary for the alternate mike circuits shown in Fig. 4.

Once again, since this brick box was intended for use as both a base-station patch box and a mobile interface unit, a microphone jack was installed on the brick-box chassis, plus a pair of wires to the molex connector for attachment to the aircraft microphone and PTT switch. A switch was included on the brick box so that either internal microphone (the brick-box jack) or external microphone (through the molex plug to the mobile mike setup) could be selected. This was done so that the

are *charging* and when it is *dark*, the nicads are either *disconnected* or *fully charged*.

Microphone	C2	C3	C4	C6	R7	R8	R9	R10
Carbon	10 $\mu$ F	0.001 $\mu$ F	10 $\mu$ F	0.002 $\mu$ F	1k	1k	10k	10k
Crystal/Ceramic	Open	10 pF	.005 $\mu$ F	20 pF	Open	Open	1 meg	1 meg
Low-Z Dynamic	Open	0.001 $\mu$ F	10 $\mu$ F	220 pF	Open	Open	10k	100k

Table 1. Values for various microphone types.



pilot of the aircraft (WB6BHI) or the back-seat passenger (WD6EWI) could access the 2-meter rig separately and independently.

The remainder of the elementary brick box is quite simple. The speaker output of the transceiver is run to both the headphone jack in the brick box and a wire to the mox plug for external mobile speaker.

### Speaker Amplifier

Although this concludes the construction of the elementary brick box, several comments from my fellow hams led to the first major modification of the box. Since my major application of the box was for airborne use and I was feeding the puny 1/2-Watt speaker signal out of the brick into a 10-Watt airborne cabin speaker amp, I never noticed how poor the speaker audio really was. A few tests convinced me that a

speaker amp of some sort was in order. Since the most common high-power chip in general use and availability today is the LM383, I chose to use this fine device. Although the design is very straightforward, I recommend that you heat-sink this device to the biggest piece of metal you can find. In fact, if I were going to include this circuit in my own brick box, I would undoubtedly use the metal chassis cover for the heat sink. The tried and proven circuit of the speaker amp is shown in Fig. 5.

### Conclusion

The brick box has been in operation for almost a year now with no serious problems. My S1's batteries have always given me the expected service when charged by the box and mobile service has been beyond any hopes I ever had. (You get up to ten thousand

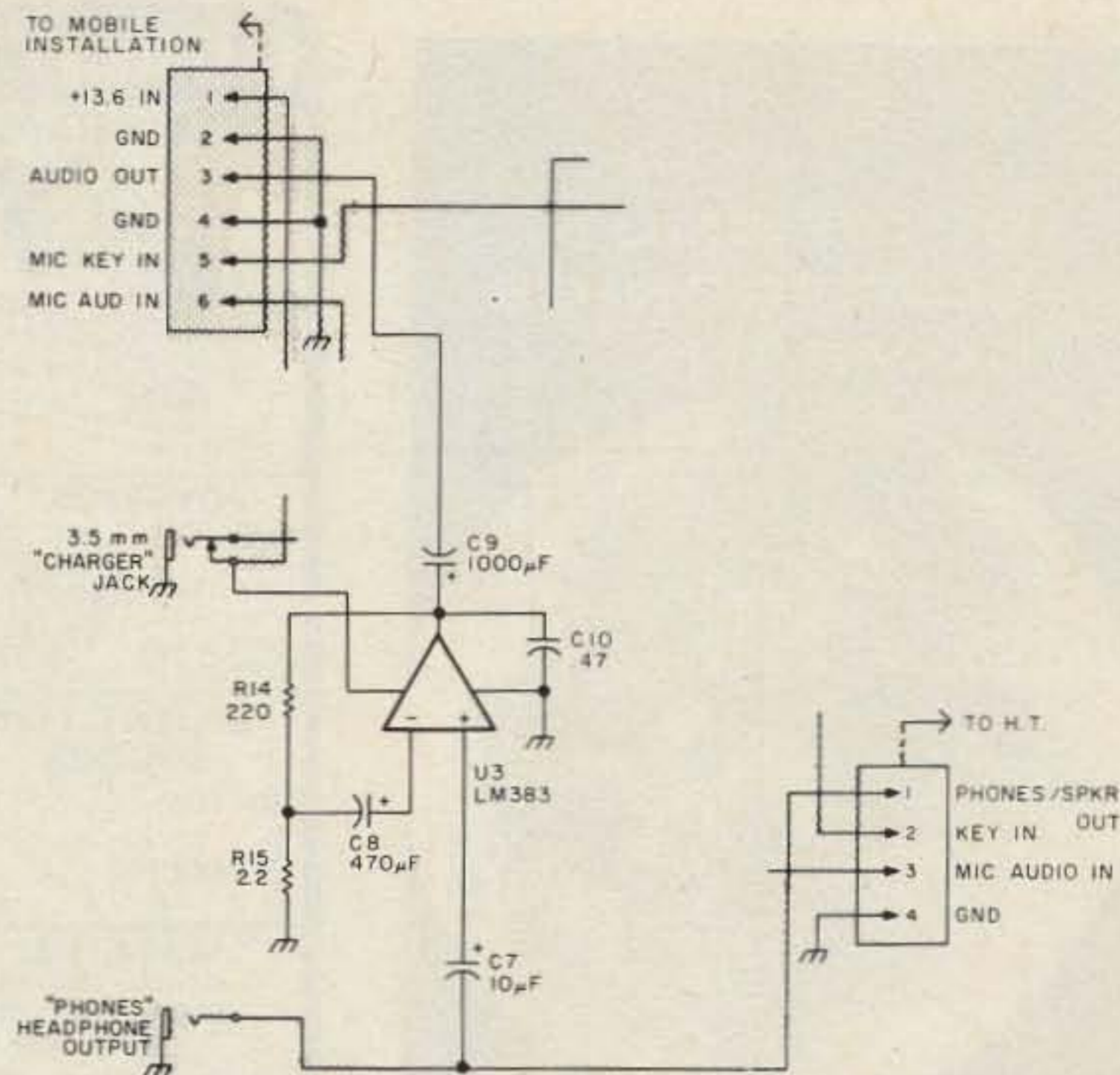

Fig. 5. Adding a high-power speaker amplifier.

feet and call CQ on .52 simplex!) My thanks to WD6EWI for his comments and criticism and N6AUB for his patient on-the-air testing. My additional thanks to the hundreds of

hams between Grass Valley, California, and Oshkosh, Wisconsin, who gave us hints and suggestions for improvement during our recent aeronautical mobile cross-country. ■

We accept VISA, MC, C.O.D., CHECK or M.O.

## FIRST QUALITY COMPONENTS - NOT MAIL ORDER "SECONDS"

Min. order \$10.00 - add 5% Shpg and \$1.00 Ins

### ARIES ZERO INSERTION FORCE SOCKETS -

cam actuated, true zero insertion - tin plated solder tail pins - capable of being plugged into dip sockets, including wire wrap

Stock No.	No. Pins	1-24	25	50
11055	24	\$ 4.35	\$3.90	\$3.60
11056	28	4.50	4.05	3.75
11057	40	5.95	5.35	4.95
11058	64	10.50	9.45	8.70

### RESISTOR ASSORTMENT - 82508 - 700 pcs. (1 each below assortment) \$22.50

Stock No. 82501 10 ea. of 10-12-15-18-22-27-33-39-47-56 OHM \$3.95 each for any assortment  
 Stock No. 83502 10 ea. of 68-82-100-120-150-180-220-270-330-390 OHM  
 Stock No. 82503 10 ea. of 470-560-680-820-1K-1.2K-1.5K-1.8K-2.2K-2.7 OHM  
 Stock No. 82504 10 ea. of 3.3K-3.9K-4.7K-5.6K-6.8K-8.2K-10K-12K-15K-18K OHM  
 Stock No. 82505 10 ea. of 22K-27K-33K-39K-47K-56K-68K-82K-100K-120K OHM  
 Stock No. 82506 10 ea. of 150K-180K-220K-270K-330K-390K-470K-560K-680K-820K OHM  
 Stock No. 82507 10 ea. of 1M-1.2M-1.5M-1.8M-2.2M-2.7M-3.3M-3.9M-4.7M-5.6M OHM

### WILD ROVER 60/40 ROSIN CORE SOLDER

Stock No.	Dia.	Length (feet)	Weight (oz.)	Price
50075	062	9	1.5	\$3.28
50076	062	25	4	4.36
50077	062	50	8	6.02
50078	032	33	1.5	4.08
50079	032	88.5	4	5.16
50080	032	175	8	6.82

### TI WIRE WRAP SOCKETS

Tin plated phosphor bronze contact - 3 wrap

Stock No.	No. Pins	1-24	25	100
11301	8	\$ .45	\$ .40	\$ .36
11302	14	.66	.59	.54
11303	16	.72	.64	.58
11304	18	.82	.73	.66
11305	20	1.11	.99	.90
11306	22	1.26	1.12	1.02
11307	24	1.41	1.25	1.14
11308	28	1.71	1.52	1.38
11309	40	2.31	2.05	1.86

### TI LOW PROFILE SOCKETS

Tin plated phosphor bronze con. 1cl pins with gas tight seal

Stock No.	No. Pins	1-24	25	100
11201	8	\$ .15	\$ .13	\$ .12
11202	14	.18	.15	.14
11203	16	.21	.18	.16
11204	18	.24	.21	.19
11205	20	.27	.24	.21
11206	22	.30	.26	.23
11207	24	.33	.30	.25
11208	28	.38	.34	.29
11209	40	.53	.45	.40

### ELPAC POWER SUPPLIES - DC/DC CONVERTERS

SINTEC Stock No.	ELPAC Part No.	Input Voltage (VDC)	Output Voltage (VDC)	Output Current (mA)	Dimensions (HxWxD) in Inches	Price
13825	CB3801	3.0-7.0	12±0.6	0-25	48x51x3.05	7.95
13826	CB3811	3.0-7.0	12±0.6	0-25	48x51x3.05	7.95
13827	CB3802	3.0-7.0	15±0.7	0-20	48x51x3.05	7.95
13828	CB3812	3.0-7.0	15±0.7	0-20	48x51x3.05	7.95
13829	CB3804	3.0-7.0	20±0.7	0-10	48x51x3.05	7.95
13830	CB3814	3.0-7.0	20±0.7	0-10	48x51x3.05	7.95
13831	CL3801	4.0-7.0	12±0.6	125	85x121x2.77	59.95
13832	CL3811	4.0-7.0	12±0.6	125	85x121x2.77	59.95
13833	CL3802	4.0-7.0	15±0.7	100	85x121x2.77	59.95
13834	CL3812	4.0-7.0	15±0.7	100	85x121x2.77	59.95
13835	CL3804	4.0-7.0	20±0.7	50	85x121x2.77	59.95
13836	CL3814	4.0-7.0	20±0.7	50	85x121x2.77	59.95

### ELPAC POWER SUPPLIES - SOLV SERIES FULLY REGULATED

SINTEC Stock No.	ELPAC Part No.	Output Voltage	Output Current Rating	Dimensions (HxWxD) in Inches	OVP	Price
13802	SOLV15-5	5	3.0A	4-7/16x4x2	Fixed included	\$39.95
13803	SOLV15-12	12	1.5A	4-7/16x4x2	Fixed included	39.95
13804	SOLV15-15	15	1.2A	4-7/16x4x2	Fixed included	39.95
13806	SOLV15-24	24	0.75A	4-7/16x4x2	Fixed included	39.95
13808	SOLV30-5	5	6.0A	5-5/8x4-7/8x3-1/16	OVP-6	59.95
13809	SOLV30-12	12	4.0A	5-5/8x4-7/8x3-1/16	OVP-4	59.95
13810	SOLV30-15	15	3.3A	5-5/8x4-7/8x3-1/16	OVP-4	59.95
13812	SOLV30-24	24	2.0A	5-5/8x4-7/8x3-1/16	OVP-4	59.95

### OK MACHINE AND TOOL

**IC INSERTION/EXTRACTION KIT**  
Includes DIP IC extractors and inserters to accommodate all ICs from 14 to 40 pins. Tools that engage conductive surfaces are CMOS safe and include grounding lugs. Stock No. 13309 \$37.74

**SOCKET WRAP ID**  
DIP socket-sized plastic panels with numbered holes in pin locations. Slip onto socket before wire wrapping to identify pins. Also write on them for location, IC part number, function, etc. Simplifies initial wire wrapping, troubleshooting and repair. \$1.82 per pack of 10

**IC EXTRACTOR**  
One-piece, spring steel construction. Will extract all LSI, MSI and SSL devices with 8 to 24 pins. Stock No. 13313 \$2.10

### Special of the Month!

**MEMORY SALE!**  
4116-3 200NS 16K Dynamic Ram \$2.10 ea. 8/\$15.52 Stock No. 47650  
2114-L-3 300NS 4K Static Ram \$2.45 ea. 8/\$17.84 Stock No. 47640  
2716 450NS 16K Eprom \$3.90 ea. Any Quantity! Stock No. 47632

### MODUTEC

**Miniclamp AC Volt-Ammeter** allows singling one conductor out of many without disarrangement. Stock No. AC Amperes Price  
13730 0-25A \$39.50  
13731 0-50A 39.50  
13732 0-100A 39.50

**ACCESSORY LINE SPLITTER** allows fast readings of AC power consumption of plug in equipment without separation of leads. Stock No. 13727 \$9.95

**POCKET SIZED BATTERY TESTER** for all types of small batteries from 1.35v to 4.5v. Stock No. 13733 \$13.95

**VOLT-I-CATOR** automotive diagnostic meter plugs into lighter socket and indicates battery condition and charging rates. Stock No. 13736 \$15.95

**AC VOLTAGE TESTER** plugs into any 110v service receptacle to check time voltage over 50-150 VAC. Stock No. 13735 \$14.95

**VOM-MULTITESTER** versatile Volt-Ohm-Milliammeter in small package. Stock No. 13729 \$13.95

**SINTEC CO.** Drawer Q Milford NJ 08848-9990



**TOLL 800-526-5960**  
**FREE** in NJ (201) 996-4093

Send for Free Catalog - over 1100 parts.



# BUTTERNUT ELECTRONICS COMPANY

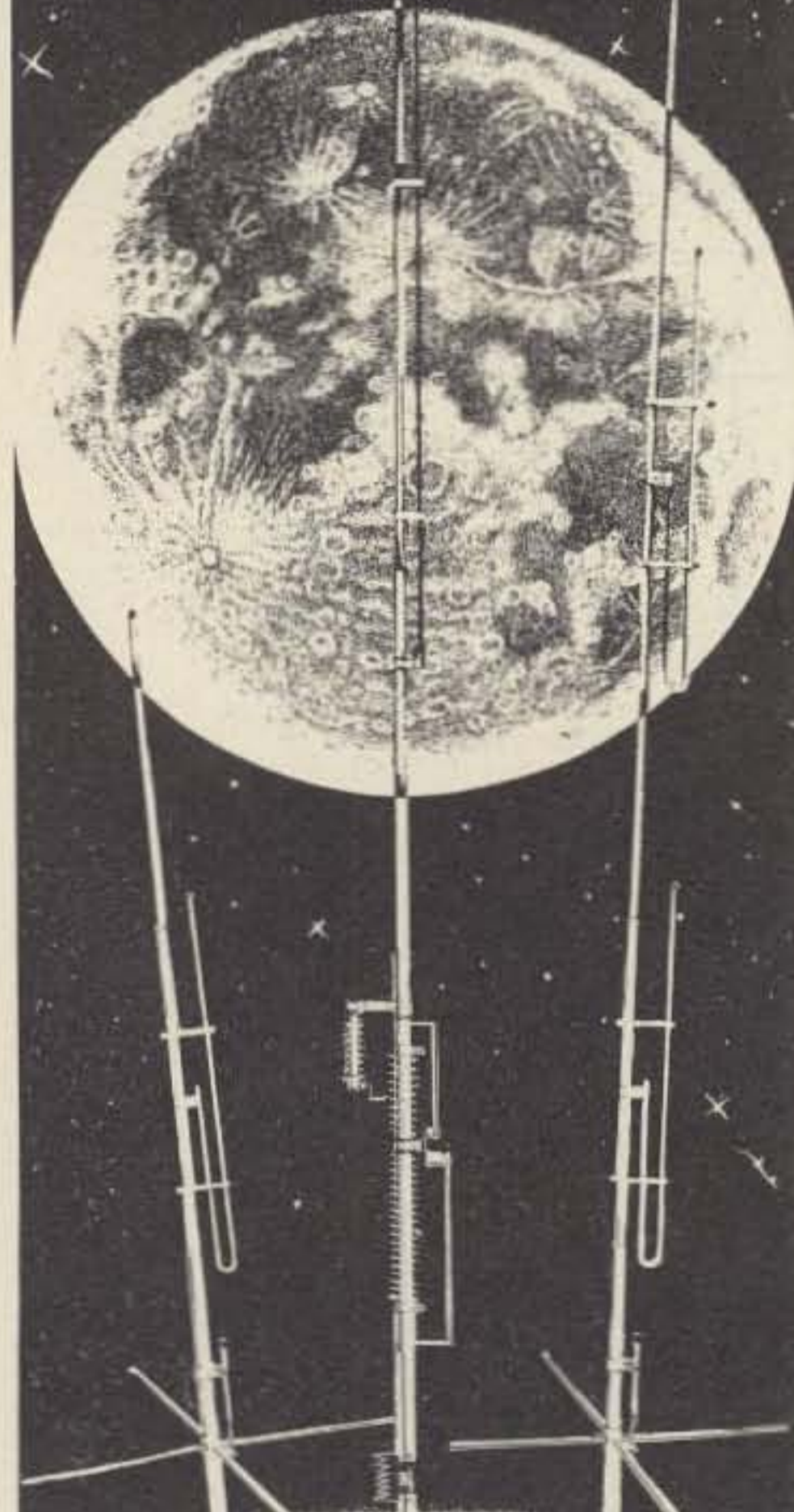

## THE WINNERS

**Model HF6V** - Completely automatic bandswitching 80 through 10 plus 30 meters. Outperforms all 4- and 5-band "trap" verticals of comparable size. Thousands in use worldwide since December '81! 160 meter option available now; retrofit kits for remaining WARC bands coming soon. Height: 26 ft/7.8 meters; guying not required in most installations.

**Model 2MCV Trombone** - omnidirectional collinear gain vertical for 2 meters having the same gain as "double-A" types, but the patented "trombone" phasing section allows the radiator to remain unbroken by insulators for maximum strength in high winds. No coils "plumber's delight" construction and adjustable gamma match for complete D.C. grounding and lowest possible SWR. Height: 9 ft/2.98 meters

**Model 2MCV-5 "Super-Trombone"** - Same advanced features as the basic 2MCV but a full wavelength taller with additional "Trombone" phasing section for additional gain. Height: 15 ft/4.8 meters

All BUTTERNUT ANTENNAS use stainless steel hardware and are guaranteed for a full year. For further information on these and other BUTTERNUT products write for our FREE CATALOG!

### BUTTERNUT ELECTRONICS

GARY AIRPORT BOX 356 E. RTE 2  
SAN MARCOS, TEXAS 78666

## QUALITY parts at DISCOUNT PRICES

### 4 CHANNEL 8 TRACK HOME UNIT



BRAND NEW UNITS... ASSEMBLY INCLUDES; TAPE HEAD, MOTOR BELT, 110VAC MOTOR, PRE-AMP, LIGHTS, SWITCHES, SOLENOID AND OTHER USEFUL PARTS... AN EXCEPTIONAL BUY!  
\$7.25 PER ASSEMBLY

### MINI BSR

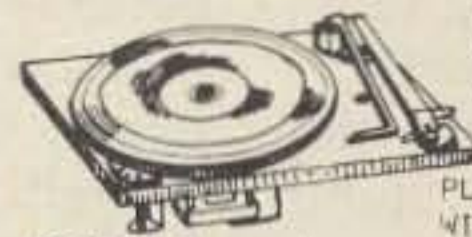

\$17.50 each

### AUTOMATIC RECORD CHANGER

B.S.R. MODEL C136R/C/3  
PLAYS 33/45/78 RECORDS  
MINI SIZE: 8 1/4" X 12"  
INCLUDES DUST COVER AND PLASTIC CASE (NOT PICTURED) WITH FRONT CUT OUT TO FIT STEREO UNIT (NOT INCLUDED).

### JOYSTICK

PRECISION DEVICE... CONTAINS 4 50K CENTER TAPPED ALPS POTS. \$4.75 ea



### BLACK PLASTIC CASE

PAC-TEC SERIES C



BLACK PLASTIC ENCLOSURE ADJUSTABLE HEIGHT FROM 1.63" TO 2.93"; WIDTH 6.85"; DEPTH 8". BUILT-IN STAND OFFS FOR P.C. BOARDS..FRONT AND BACK PANELS NOT INCLUDED.. \$5.25 PER CASE

### VARIABLE DIODES

BB-103 3 FOR \$1.00  
100 FOR \$30.00  
MV2205 3 FOR \$1.00  
100 FOR \$30.00

### MITSUMI MODEL UES-A55 VARIABLE UHF TUNER

FREQ RANGE 470 - 889 MHz  
ANTENNA INPUT 300 OHMS  
\$25.00 each  
10 for \$220.00

### MINI SIZE BUZZERS

1 1/2 to 3 volts 75¢ ea WITH WIRE LEADS  
1 1/2 to 3 volts 75¢ ea WITH PIN TERMINALS  
3 to 7 volts WITH PIN TERMINALS 75¢ each

### PHOTO FLASH CAPACITORS

170 MFD 330 VOLT  
1 1/2" X 7/8"  
2 FOR \$1.50  
10 FOR \$7.00  
600 MFD 360 VOLT  
3 3/4" HIGH X 1" DIA.  
\$1.00 EA. 10 FOR \$9.00  
750 MFD 330 VOLT  
2" HIGH X 1 3/4"  
\$1.25 EACH 10 FOR \$11.00  
SLIDE POTS  
500K linear taper  
2 7/8" LG. -  
1 3/4" TRAVEL 75¢ EACH

### COMPUTER GRADE CAPACITOR

1700 mfd. 150VDC \$2.00  
2 1/2" DIA X 4 3/4" HIGH  
3,600 mfd. 40VDC \$1.00  
1 3/8" DIA. X 3" HI  
6,400 mfd. 60VDC \$2.50  
1 3/8" DIA X 4 1/4"  
12,000 mfd. 40 VDC \$3.00  
2" DIA X 4 1/4" HIGH  
18,000 mfd. 75 VDC \$4.00  
2 1/2" DIA X 4 1/2" HIGH  
22,000 mfd. 15 VDC 2" DIA X 2 1/2" HIGH \$2.00  
22,000 mfd. 40VDC 2" DIA. X 6" HIGH \$3.00  
24,000 mfd. 30 VDC 1 5/8" DIA X 4" HI \$3.50  
31,000 mfd. 15 VDC 1 5/8" DIA X 4" HI \$2.50  
72,000 mfd. 15VDC 2" DIA. X 4" HIGH \$3.50  
COMPUTER GRADE CAPACITOR SPECIAL  
180,000 mfd. at 6V 2 1/2" DIA X 4 1/2" HIGH \$1.50  
CLAMPS TO FIT CAPACITORS 50¢ ea

### TRANSFORMERS

120 volt primaries  
5.6 VOLTS at 750 MA \$3.00  
6 VOLTS at 150 mA \$1.25  
12 V.C.T. at 500 mA \$2.50  
16.5 V. at 3 AMPS \$6.50  
18 VOLTS at 350 MA \$2.00  
18 VOLTS at 1 AMP \$4.50  
18 V.C.T. at 2 AMP \$5.50  
24 VOLTS at 250 ma \$2.50  
28 VCT at 3.6 AMP \$6.50  
35 V.C.T. at 1 AMP \$3.50  
42 V.C.T. at 1.2 AMP \$4.50  
65 V.C.T. at 2 AMP \$5.50

### L.E.D.'s STANDARD JUMBO DIFFUSED

RED 10 FOR \$1.50  
GREEN 10 FOR \$2.00  
YELLOW 10 FOR \$2.00  
FLASHER LED 5 VOLT OPERATION RED JUMBO SIZE 2 FOR \$1.70  
BI POLAR LED 2 FOR \$1.70  
SUB MINI LED RED .079" X .098" 10 FOR 20mA at 1.75v \$1.00  
200 FOR \$18.00

### LED HOLDERS

TWO PIECE HOLDER FOR JUMBO LED 10 FOR 65¢ 200 FOR \$10.00  
BLACK LIGHT (ULTRAVIOLET) G.E. # F6T5BL \$2.50 each

## FREE! SEND FOR OUR NEW 40 PAGE CATALOG FREE!

### KEYBOARD w/ case

16 KEY KEYBOARD MATRIX ENCODED  
TERMINATES TO FLEXIBLE CABLE WITH CONTACTS ON .100 CENTERS. EDGE CONNECTOR INCLUDED... \$4.50 PER KEYBOARD, CASE, AND CONNECTOR.

### EDGE CONNECTOR

ALL ARE .156" SPACING  
15/30 GOLD SOLDER EYELET \$2.00 EACH  
18/36 GOLD SOLDER EYELET \$2.00 EACH  
22/44 GOLD SOLDER TAIL (P.C. STYLE) \$2.50 EA 10 FOR \$22.50  
22/44 TIN SOLDER TAIL (P.C. STYLE) \$1.35 EA 10 FOR \$12.50  
42/84 GOLD SOLDER EYELET \$4.00 EACH

### CANNON XLRA-3-13 CONNECTOR

3 PRONG CHASSIS MOUNT CONNECTOR \$2.00 EACH 10 for \$19.00

### 4PDT RELAY

14 pin style  
3 amp contacts  
24 volt d.c. or 120 volt a.c. coil  
Used but fully tested  
\$1.70 EACH specify coil voltage  
LARGE QUANTITIES AVAILABLE SOCKETS FOR RELAY 50¢ each

### 6 VDC RELAY

MINIATURE D.P.D.T. 3 AMP CONTACTS FUJITSU # FBR3210005 \$1.75 EA 10 / 16.00

### 2 CHANNEL LIGHT ORGAN

EASILY HOOKS INTO STEREO SPEAKERS AND ALLOWS 110 VAC LIGHTS TO DANCE WITH MUSIC. TWO SEPARATE 110 VAC OUTPUTS FOR HIGH AND LOW FREQUENCY AUDIO SIGNALS. USE TWO ORGANS FOR STEREO... \$6.50 PER UNIT.  
COLOR LIGHT STRING AVAILABLE \$1.75 EA

### L-PAD

STANDARD 8 OHM 50 DB L-PAD... \$1.50 EACH

### MICROWAVE TRANSISTORS

75 ohm CO-AX 12 FOOT R.C.A. PLUGS BOTH ENDS. USED FOR VIDEO GAMES, ETC \$1.25 EA

### EQUIPMENT SLIDES

CHASSIS-TRAK MODEL C3005 3 SECTION. LENGTH 22" CLOSED. HOLDS TO 85 LBS, EXTENDS 23" \$5.00 PER PAIR SOME HARDWARE INCLUDED

### 4 WATT STEREO AMP

ASSEMBLY INCLUDES VOLUME, BALANCE AND TONE CONTROLS, CERAMIC PHONE INPUT, LINE INPUT AND 8 OHM OUTPUT FOR SPEAKER OR HEADPHONES. OPERATES ON 12 VAC @ 500MA. OUR ABOVE 12 VOLT TRANSFORMER IS IDEAL FOR THIS APPLICATION. \$4.50 EACH

### 13 VDC RELAY

CONTACT: S.P.N.C. 10 AMP @ 120 VAC ENERGIZE COIL TO OPEN CONTACT... \$1.00 EACH  
SPECIAL PRICE \$1.00 EACH

### MINI-PUSH BUTTON

S.P.S.T. MOMENTARY NORMALLY OPEN 1/4" BUSHING 35¢ EACH 10 FOR \$3.25 100 FOR \$30.00 SPECIFY COLOR: RED, BLACK, WHITE, GREEN, YELLOW.

### KEY SWITCH

S.P.S.T. 4 AMPS @ 125 VAC KEY REMOVES BOTH POSITIONS \$3.50 EA

### LIGHTED PUSH BUTTON

RED LIGHTED 120 VAC 10 AMP. S.P.S.T. "POWER" PRINTED ON FACE. MOUNTS IN 7/8" SQUARE HOLE.. \$1.50 EA 10/ \$13.50

### 6volt 9amp/hr RECHARGEABLE

ELPOWER # EP690 SOLID GEL CELL 5 1/2" X 4 1/4" X 2 3/4"..... \$15.00 EACH

### CRYSTALS

CASE STYLE HC33/U 2 MHz: 3579,545 KC \$3.50 EACH 51.50 EACH

### 8' LINE CORD

SUT M/E 18 - 3 ROUND GRAY \$2.00 EACH 10 FOR \$18.50

### 0-10 MINUTE TIMER

ADJ. TIMING MOTOR FROM 0 - 10 MIN; RATED 10 AMPS. 125 VAC MOUNTS ON 1" CENTERS... \$4.75 EACH

### 2" ALLIGATOR CLIPS

7 clips for \$1.00 100 clips for \$12.00 500 clips for \$50.00

## ALL ELECTRONICS CORP

905 S. Vermont Ave. P.O. BOX 20406 Los Angeles, Calif. 90006

Quantities Limited  
Min Order \$10.00  
Add \$2.50 Shipping USA

Call. Res. Add 6%  
Prompt Shipping  
NO C.O.D.!

TOLL FREE ORDER NUMBER 800-826-5432 AK-HI-CA (213)380-8000



# COMPUTERIZED MORSE KEYERS

AEA, the first company to introduce microcomputerized products to the Amateur Radio market, is proud to announce the second generation of computerized electronic keyers. Each keyer is pre-programmed, no computer language is required of the operator. The easy to use keypads eliminate up to 75 switches or potentiometers, thereby greatly simplifying the operation of such sophisticated keying systems. We invite you to compare the features of our keyers (shown below) to ANY others.

IMPORTANT KEYS AND/OR TRAINER FEATURES	AEA MM-2	AEA KT-2	AEA CK-2
Speed Range (WPM)	2-99	1-99	1-99
Memory Capacity (Total Characters)	500	N/A	500
Message Partitioning	Soft	N/A	Soft
Automatic Contest Serial Number	Yes	N/A	Yes
Selectable Dot and Dash Memory	Yes	Yes	Yes
Independent Dot & Dash (Full) Weighting	Yes	Yes	Yes
Calibrated Speed, 1 WPM Resolution	Yes	Yes	Yes
Calibrated Beacon Mode	Yes	N/A	No
Repeat Message Mode	Yes	N/A	Yes
Front Panel Variable Monitor Frequency	Yes	Yes	Yes
Message Resume After Paddle Interrupt	Yes	N/A	Yes
Semi-Automatic (Bug) Mode	Yes	Yes	Yes
Real-Time Memory Loading Mode	Yes	N/A	Yes
Automatic Word Space Memory Load	Yes	N/A	Yes
Instant Start From Memory	Yes	N/A	Yes
Message Editing	Yes	N/A	Yes
Automatic Stepped Variable Speed	No	No	Yes
2 Presettable Speeds, Instant Recall	No	No	Yes
Automatic Trainer Speed Increase	Yes	Yes	N/A
Five Letter or Random Word Length	Yes	Yes	N/A
Test Mode With Answers	Yes	Yes	N/A
Random Practice Mode	Yes	Yes	N/A
Standard Letters, Numbers, Punctuation	Yes	Yes	N/A
All Morse Characters	Yes	Yes	N/A

For more information write AEA, or better yet see your favorite dealer for a demonstration.

Software ©copyright by AEA.

PRICES AND SPECIFICATIONS SUBJECT TO CHANGE WITHOUT NOTICE OR OBLIGATION.

**ADVANCED ELECTRONIC APPLICATIONS, INC.**

P.O. Box C-2160,  
Lynnwood, WA 98036  
(206) 775-7373  
Telex: 152571 AEA INTL

## MM-2



MorseMatic™

## KT-2



Keyer Trainer

## CK-2



Contest Keyer

**AEA**  
Brings you the  
breakthrough!

## HI-Q BALUN

- For dipoles, yagis, inverted vees & doublets
- Replaces center insulator
- Puts power in antenna
- Broadbanded 3-40 MHz
- Small, lightweight and weatherproof
- 1:1 Impedance ratio
- For full legal power and more
- Helps eliminate TVI
- With SO 239 connector



only \$12.95

## HI-Q ANTENNA CENTER INSULATOR



Small, rugged, lightweight weatherproof  
Replaces center insulator  
Handles full legal power and more

\$6.95 With SO 239 connector

## HI-Q ANTENNA END INSULATORS



Rugged, lightweight, injection molded of top quality material, with high dielectric qualities and excellent weatherability. End insulators are constructed in a spiral unending fashion to permit winding of loading coils or partial winding for tuned traps.

- May be used for:
- Guy wire strain insulators
  - End or center insulators for antennas
  - Construction of antenna loading coils or multiband traps

\$4.95

## DIPOLES

MODEL	BANDS	LENGTH	PRICE WITH HI-Q BALUN	WITH HI-Q CENTER INSULATOR
<b>Dipoles</b>				
D-80	80,75	130	\$31.95	\$27.95
D-40	40,15	66	28.95	24.95
D-20	20	33	27.95	23.95
D-15	15	22	26.95	22.95
D-10	10	16	25.95	21.95
<b>Shortened dipoles</b>				
SD-80	80,75	90	35.95	31.95
SD-40	40	45	32.95	28.95
<b>Paralleled dipoles</b>				
PD-8010	80,40,20,10,15	130	43.95	39.95
PD-4010	40,20,10,15	66	37.95	33.95
PD-8040	80,40,15	130	39.95	35.95
PD-4020	40,20,15	66	33.95	29.95
<b>Dipole shorteners - only, same as included in SD models</b>				
S-80	80,75			\$11.95 pr
S-40	40			\$10.95 pr

All antennas are complete with a HI-Q Balun or HI-Q Antenna Center insulator, No. 14 antenna wire, ceramic insulators, 100 nylon antenna support rope (SD models only 50) rated for full legal power. Antennas may be used as an inverted V and may also be used by MARS or SWLs.

**Antenna accessories**—available with antenna orders  
Nylon guy rope 450# test 100 feet \$4.49  
Ceramic (Dogbone Type) antenna insulators \$1.50 pr  
SO-239 coax connectors .55

All prices are postpaid USA 48  
Available at your favorite dealer or order direct from

**Van Gorden Engineering**  
Dealer Inquiries Invited

BOX 21305 B, SOUTH EUCLID, OHIO 44121



# What?! Another Audio Filter Project?

*Yup. And even the most modern receivers benefit from this QRM-crusher.*

I got my hands on one of those toy transceivers a few months ago—the kind with a flea-power transmitter and a direct-conversion receiver—and for a while, I had a ball with it.

But slowly, some drawbacks began to manifest themselves—not so much in the rig, but inside my head, where ringing noises refused to go away. The receiver is quite sensitive and has a tremendous dynamic range but it has no agc (automatic gain control), so when you're tuning for weak DX signals and come across a Texas rock crusher... Well, I generally don't cherish corona flickering between my ears.

It slowly dawned on me that even my main station

receiver, though it has a good agc system for CW, exhibits some other rather nasty habits which it shares with the little plaything receiver. And eventually, I began to think about doing something about it.

Unfortunately, most modern ham-band receivers—even the very good ones—do very little after extracting audio from the product detector, except to amplify it and cram it into a speaker or a headphone output. Many things can be done to audio to make communications a lot better, especially on CW.

The audio unit to be described is my second major effort in that direction. The previous unit, built about 1960, used vacuum tubes and weighed enough to

keep my house and shack from blowing away in Hurricane Donna. That unit, described in a long article in *QST*,<sup>1</sup> offered peak clipping, audio selectivity, and volume compression, none of which was available in the receivers of that day—or in most 1981 models. There is one big difference. Modern receivers usually (but not always) have agc systems which work well with SSB and CW.

My new audio processor would have to be all solid state, like the rest of my equipment, and it would have to offer the same features as the original, with suitable improvements.

If you work contests or DX pileups on CW, you know that a 400-Hz pass-band sounds like you're listening to all outdoors, especially if you have experienced the good selectivity of the 100-Hz-and-under variety.

But selectivity has its trade-offs. Any sort of noise impulse is stretched. Key clicks, which sound like a small-arms fight in some Middle Eastern desert, become a rolling artillery barrage when they're stretched through a sharp filter. So, even with a good receiver agc, you still need to do something about the noise pulses before you introduce selectivity.

And, for those receivers without agc or only a poor agc, audio compression works wonders. Before good agc was developed for SSB and CW, a CW operator had to tune his receiver with one hand on the dial and the other on the rf gain control. Even with that kind of receiver (or with a modern direct-conversion job with no agc), one-handed tuning becomes possible when you use audio compression.

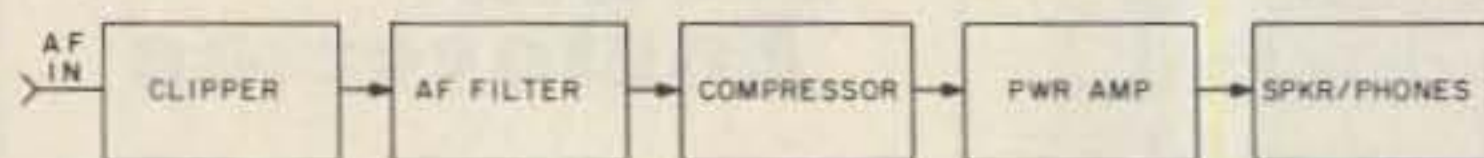

Fig. 1. Audio processor block diagram.



So, I decided my fancy solid-state processor must begin with a peak clipper, followed by a good stage of selectivity, followed by compression, and then (finally) by enough power to drive a loudspeaker and phones. It must be connected to the receiver only by a patch cord from the headphone or speaker output to the processor input, so that no modifications need be made to the receiver (see Fig. 1).

### Clipping

Clipping and compression are terms which are often misunderstood. Clipping, for our purposes, is the process of whacking off any audio signal which exceeds some preset amplitude. The waveform is grossly distorted and lots of harmonics are generated in the process.

The clipping circuit chosen for this application is the familiar full-wave, series peak clipper (Fig. 2). It works like this:

Audio from the receiver is fed through a capacitor to a pair of small silicon diodes (1N914s or similar) in series, anodes connected together. A positive voltage is applied to the anodes, so that current flows through both diodes to ground through load resistors.

As long as those diodes conduct, they look like pieces of wire to the audio signal coming in from the receiver. But the moment a positive audio peak voltage becomes greater than the forward bias, the diode ceases to conduct, and the signal can't get any bigger in that direction. The negative half cycle, though, goes through because it only forward biases the diode even more.

But the other half cycle then collides with the second diode, with reversed polarity, and the other audio peak is clipped off. A good sine wave applied to

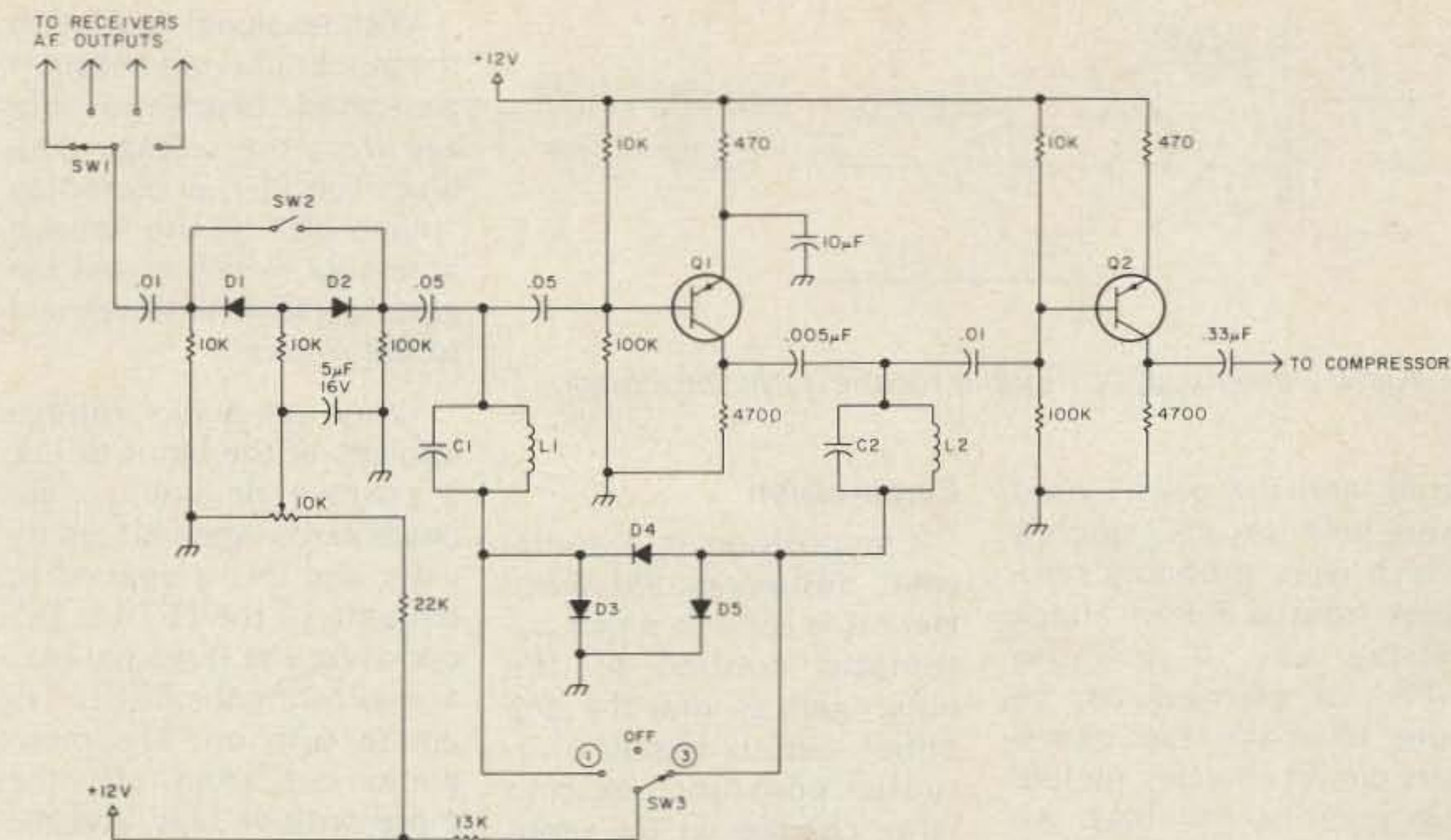

Fig. 2. Clipper-selectivity section of processor. Q1 and Q2 are PNP audio transistors such as the 2N3906. L1 and L2 are 88-mH telephone toroids. See text for C1 and C2.

the clipper comes out looking much like a square wave. Noise pulses, of course, also are clipped. How deeply the signal is clipped depends on how much bias voltage is applied to the diodes by the 10k pot. The voltage can be made so high that no clipping occurs, or so low that no signal gets through at all. The clipper can also be defeated by closing SW2 which shunts the audio around the diodes completely.

In use, the clipping threshold is set at some in-

termediate point which the operator finds to be comfortable. The setting will be affected, of course, by the audio gain control on the receiver.

### Selectivity

The output of the clipper is fed to the selective circuit through a capacitor which blocks dc. Any of a variety of selective circuits could be used here, including the popular bridged-T active audio filters using IC op amps. I chose to use parallel-resonant 88-mH telephone toroids because I

can change the resonant frequency simply by changing the values of the parallel capacitors. To change a bridged-T involves three capacitors in each pole of the filter. (See Fig. 2.)

The output of the clipper is applied across one 88-mH toroid tuned to 700 Hz with capacitors totaling 0.57 µF. Another blocking capacitor isolates the toroid from the dc on the base of Q1. The transistor amplifier restores the considerable insertion loss caused by the clipper and the toroid filter. Any handy transistor can be

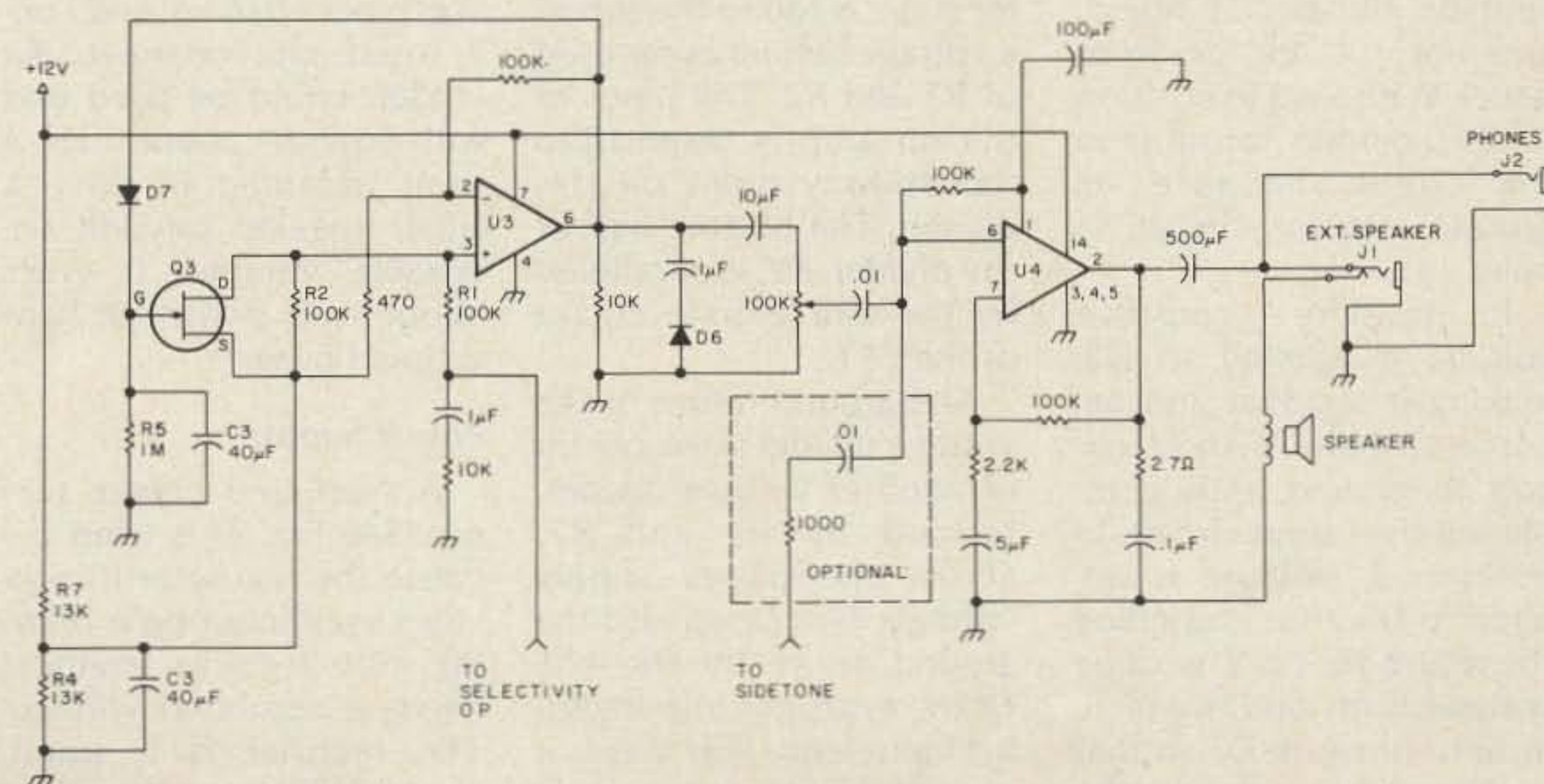

Fig. 3. Audio compression and power. Q3 is a 2N3819 FET or any similar audio FET. U3 is a TL081 FET op amp. U4 is an EC5700, ULN2277, or FE IC27. D1-D7 are 1N914s or similar.



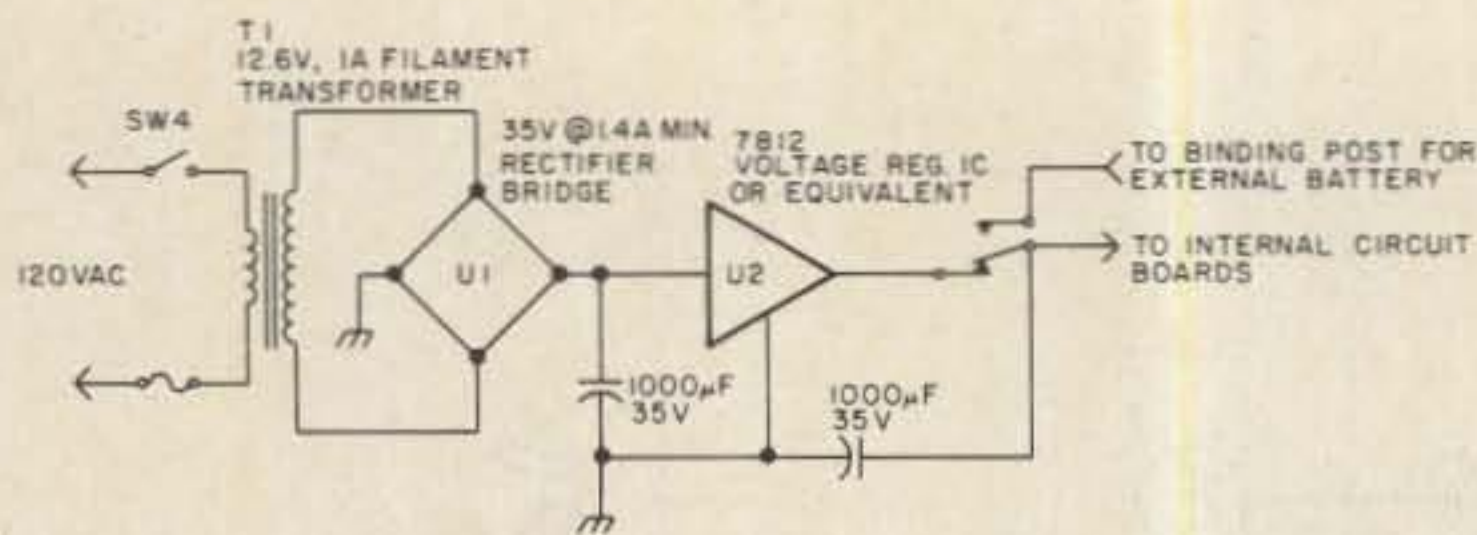

Fig. 4. Power supply suitable for the audio processor.

used, and the ones I used were junk box PNP silicons which were probably refugees from a Radio Shack red-tag sale. If you use NPNs or germaniums, be sure to make the necessary circuit changes, including polarity and bias. Almost any inexpensive audio transistor in a suitable amplifier circuit will do the job.

The output of Q1, taken from the collector, is coupled to the second toroid, tuned to the same frequency as the first, and again the insertion loss is restored by Q2. Actually, it is somewhat more than restored, and the output is ample to drive the next stage.

In operation, you can elect to use both toroids, for maximum selectivity, only one toroid for intermediate sharpness, or neither one, leaving you with only the selectivity of the receiver itself. Switching is done by means of diodes, so that signal leads can be kept on the circuit board, and not run to the front panel. With SW3 in position 2 (Off), neither toroid is in the circuit because its ground return circuit is open.

In position 1, positive voltage is applied to D3, making it conduct and become virtually a short circuit to ground, thus completing the toroid circuit. In position 3, voltage is applied to D5, thus grounding the return for L2. The same voltage turns on D4 which, in turn, turns on D3 so that both toroids are now in the circuit, for maximum selectivity

### Compression

Compression is a somewhat misunderstood term. Here it is used to mean automatic control of the audio gain so that the amplifier output remains virtually constant, despite large changes in the input level. The process does *not* distort the waveform of the signal. (See Fig. 3.)

In the circuit I chose,<sup>2</sup> the compression amplifier (U3) is a TL081 FET op amp, inexpensive and readily available. The output of the filter is fed to the non-inverting input of op amp U3, and its output is fed to the input of an audio power amplifier chip, U4.

The output of U3 is also fed to a voltage doubler formed by D6 and D7. This generates a positive dc voltage which is proportional to the audio output voltage of U3, and this dc voltage is fed to the gate of FET Q3.

The FET acts simply as a variable resistor. Note that audio coming out of the filter stage is fed to the top of a voltage divider composed of R1 and R2. The input of the op amp is taken from the midway point on this divider. The bottom half of the divider, R2, is paralleled by the source-drain circuit of the FET.

The ground return of the voltage divider is the center of another voltage divider, formed by R4 and R7, across the power supply voltage. This tap is also the ground return for the 470-Ohm resistor in the inverting input lead. This makes it possible to use only a single power supply for U3, rather than two.

With no signal applied to the input of U3, no output is generated, hence no voltage from the voltage doubler. The FET is biased to "pinch off" by the voltage across R2, which makes the gate negative with respect to the source.

When an audio voltage appears at the input of U3, a positive dc voltage appears across the voltage divider and this is applied to the gate of the FET via D7, opposing the negative bias and allowing the FET to begin to turn on. The more audio out from U3, the more positive bias, and the more the FET turns on, making its resistance lower and lower. The effect is the same as moving the input to U3 further toward the ground end of a volume control; it applies less audio voltage to the input, thus cutting back on the output. The result is excellent volume compression in which the output remains almost constant despite great changes in input level.

Some of the output audio is picked off by the volume control and fed to the audio amplifier IC, U4.

### Audio Amplifier

A considerable variety of audio amplifier ICs is available. I used a ULN2277 for U4, which provides two Watts per channel, and I only used one channel. An LM386 could be used and will provide about half a Watt of audio to drive a small speaker beyond endurable volume. It costs about one dollar at ham supply houses.<sup>3</sup>

### Power Supply

A regulated power supply (See Fig. 4) is used because the regulator IC provides excellent ripple filtering, not because anything needs a regulated voltage. The rectifier is a small, cheap bridge or it can be made up from discrete diodes rated at one Amp or

more at 35 volts or more. The regulator chip will deliver one Amp, maximum, regulated, and that's probably three times the actual demand of the system. The output amplifier chip probably can be run directly from the unregulated output of the power supply, provided this does not introduce noticeable hum in the output.

### Construction

Construction is straightforward and non-critical. I built the power supply into a corner of a small aluminum cabinet box, using a small piece of perfboard to mount the components. The board was mounted to the chassis with the small metal mounting lugs obtained by drilling them off old-style tie-point strips. This type of mounting is extremely convenient because it permits standing the boards on edge and provides for easy removal for service or modification.

The IC circuits were built on universal circuit boards.<sup>4</sup> One board was sawed in half, and the compressor and clipper built on one half, the output amplifier on the other.

The toroids were mounted on a piece of perfboard with dabs of five-minute epoxy, leads anchored to tie-points, and then the perfboard was bolted to the edge of another type of universal circuit board on which each cluster of four holes is connected together by a foil pad. This is useful for mounting the transistors and other components by their leads.

Each board was stood on edge and bolted to the chassis with brackets. But these should *not* be used for circuit grounds. Grounding each board directly to the chassis will probably result in ground loops which produce hum, noise,



# WHY COMPRO- MISE

Others claim more gain for their antennas than the IsoPole™ antennas, but none can beat the IsoPole for HONEST on-the-horizon omni-directional gain unless you are willing to spend at least THREE TIMES AS MUCH!!! The IsoPole is easiest of ALL competitive models to assemble, has a weather protected, factory-tuned matching network, (no more aggravating SWR variations with weather changes), uses all stainless steel hardware, and is designed to withstand severe icing and wind conditions. The IsoPole antenna is UPS shippable without the standard 10 foot 1 1/4 inch TV mast. You can buy the mast from your local ham dealer, hardware store, or Radio Shack™ store for less than the shipping costs of a single mast. When good strong, low cost 10 foot sections of mast are so easily available, why compromise by using several shorter pieces that have to be joined together?

For more details, please write for our latest catalog or visit your favorite dealer.

Prices and Specifications subject to change without notice or obligation.

**ADVANCED ELECTRONIC APPLICATIONS, INC.**  
P.O. Box C-2160,  
Lynnwood, WA 98036  
(206) 775-7373  
Telex: 152571 AEA INTL

2  
**AEA** Brings you the Breakthrough!

## SATELLITE TV KIT



THE POPULAR SAT-TEC RECEIVER IN KIT-FORM!

Featured in a Radio Electronics magazine cover story (May 82), the reliable R2B Sat-tec TV receiver is now operating in thousands of locations. The R2B is easy to build; pre-etched, plated boards with screened component layout assures accurate component placement and the critical IF section and local oscillator are pre-assembled and aligned! All parts are included for the R2B; attractive case, power supply, descriptive operating manual as well as complete assembly instructions. Features of the receiver include; dual conversion design for best image rejection, fully tunable audio to recover 'hidden' subcarriers, divide by two PLL demodulator for excellent threshold performance, tight tracking AFC to assure drift free reception, and of course, full 24 channel tunable coverage.

Build your satellite TV system around the R2B, close to ten thousand others already have and now it's available in kit form at a new low price. Order yours today.

A complete Satellite TV System requires a dish antenna, LNA (low noise amplifier), Receiver and Modulator.  
R2B Receiver Kit **\$395.00**  
R2B Receiver, Wired and Tested **\$595.00**  
120° K Avantek LNA **\$495.00**  
RM3 RF Modulator **\$49.95**  
Prices include domestic UPS shipping and insurance.

RAMSEY ELECTRONICS INC.  
2575 BAIRD RD.  
PENFIELD, NY 14526  
716-586-3950

VISA  
master charge  
ORDER TOLL-FREE  
1-800-828-6288

## GIANT HEAVY DUTY TRUCK TARPAULINS

12x16	\$23	26x40	\$89
16x20	\$32	26x55	\$115
20x20	\$36	30x60	\$145
18x24	\$38	50x100	\$390
18x32	\$50	60x120	\$547
20x30	\$50	50x150	\$562

Before Midnight December 19

Viking Ind. will send any of the above truck size tarpaulins to any reader of this publication who reads and responds to this test before midnight December 19. Each tarpaulin Lot (#Z-18, PVC) is constructed of high density fabric (with virgin grade ingredient, supplied by Gulf Oil Co., Dow Chemical Co., and Union Oil Co.) with nylon reinforced rope hems, double lock stitched hems, electronically welded seams, 100% water proof, #4 (1/2" dia.) metal grommets set on 3 ft. centers with reinforced triangular corner patches and are recommended for all heavy duty use, and all bulk or pallet riding materials, and will be accompanied with a LIFETIME guarantee that it must perform 100% or it will be replaced free. Add \$7 handling & crating for each tarp ordered, Viking Ind. pays all shipping. Additional cost for color preference. Should you wish to return your tarpaulins you may do so for a full refund. Any letter postmarked later than December 19 will be returned. LIMIT: Fifty (50) tarps per address, no exceptions. Send appropriate sum together with your name & address to: Tarp Test Dept. #485K, Viking Ind., 6314 Santa Monica Blvd., L.A., CA 90038, or for fastest service from any part of the country call collect, before midnight 7 days a week (213) 462-1914 (Ask Exchange Operator for) TARP TEST #485K, have credit card ready.

**NEW!**  
Hi-Power



## TRANSI-TRAP Lightning & Static "T" Protectors

**Don't hook-up  
your coax without one!**

Protects sensitive solid state components in your equipment from high-surge voltages produced by nearby lightning strikes, high wind, and static build-up. Even distant storm fronts are known to cause damaging surges without warning or time for grounding.

The replaceable Arc-Plug™ cartridge, which can fire thousands of times, utilizes a special ceramic gas-filled tube with precisely tailored firing speed and level, safely by-passing surges to ground. Standard air-gap devices are ineffective due to their erratic performance.

Transi-Trap Protectors are the first devices in the industry designed with "isolated ground." This keeps damaging arc-energy off the chassis and routes it directly to ground.

Available at your Dealer or add \$2.00 direct in U.S. • Ohio residents add Sales Tax.



AlphaDelta Transi-Trap Protection Systems are designed to reduce the hazards of lightning-induced surges. These devices, however, will not prevent fire or damage caused by a direct stroke to antenna or other structure.

## ALPHA DELTA COMMUNICATIONS

P.O. Box 571, Centerville, Ohio 45459 • (513) 435-4772





oscillation, and all sorts of nasties.

Instead, use a common ground on each circuit board insulated from the mounting feet, and connect the circuit ground with a wire directly to the negative voltage tie-point on the power supply board.

### Operation

After the project passes its "smoke test," you're ready to learn to use it. Hook it up to your receiver and hook up the output to a loudspeaker.

Set the volume control about one-fourth open, put the selectivity switch in the Off position, and turn the clipper on. Feed a steady signal into the amplifier. The tone from a 100-kHz calibrator will work fine. Adjust the clipping threshold, noticing that at the clockwise extreme of the pot, you get no signal output at all. At the counter-clockwise position you get no clipping and at points in between clipping is apparent because of the change of audio quality of the clipped signal.

Flip in one filter section and notice that the clipped signal suddenly sounds clean again. The harmonics have been filtered out. The second toroid section won't seem to have much effect in this test—but it will in actual operation.

Now find a place on the receiver dial which is fairly clear of signals, turn off clipping and selectivity, and set the receiver volume control until you can just hear the crackle of background noise in the speaker, or to where you can hear a weak CW signal. Leave the volume control set, and tune across the band slowly, stopping to listen to each signal you come to.

Loud signals are no louder than weak ones, but you will notice that the background noise disappears while a strong signal is pres-

ent. This is because the compression has reduced the overall gain.

Now tune away from the strong signal to a no-signal spot and listen. Notice that after a few seconds, background noise slowly becomes audible, as the compressor increases gain again. It has a fast-attack, slow-decay time constant.

Decay time is set by R5 and C3 in the gate circuit of the FET. Resistor and capacitor values are chosen to give a delay of several seconds so that the amplifier won't "pump" on a strong CW signal. Instead, it reduces gain in proportion to the average strength of the signal and keeps the gain reduced during the brief key-up periods between letters and words and even during brief pauses.

If recovery time were very short, band noise, weak QRM signals slightly off frequency, and other disturbances would appear in the background instantly whenever the desired station released his key—very tiring and disturbing to the receiving operator. Try it if you like, by temporarily replacing C3 with, say, a 0.47- $\mu$ F capacitor.

### Changes to Play With

The overall design of this unit is quite flexible and, since it is built in modules, with each section on its own circuit board, it is quite easy to experiment.

Various degrees of selectivity can be achieved, for example, by shunting the toroids with resistors, to broaden them, or by adding a third toroid for extreme selectivity. Various kinds of active audio filters can be substituted for the toroids. Skirt selectivity of the toroid filters can be improved by insertion of two 1N914s reverse-connected in parallel between the first toroid and the coupling capacitor to the base of Q1 (see Fig.

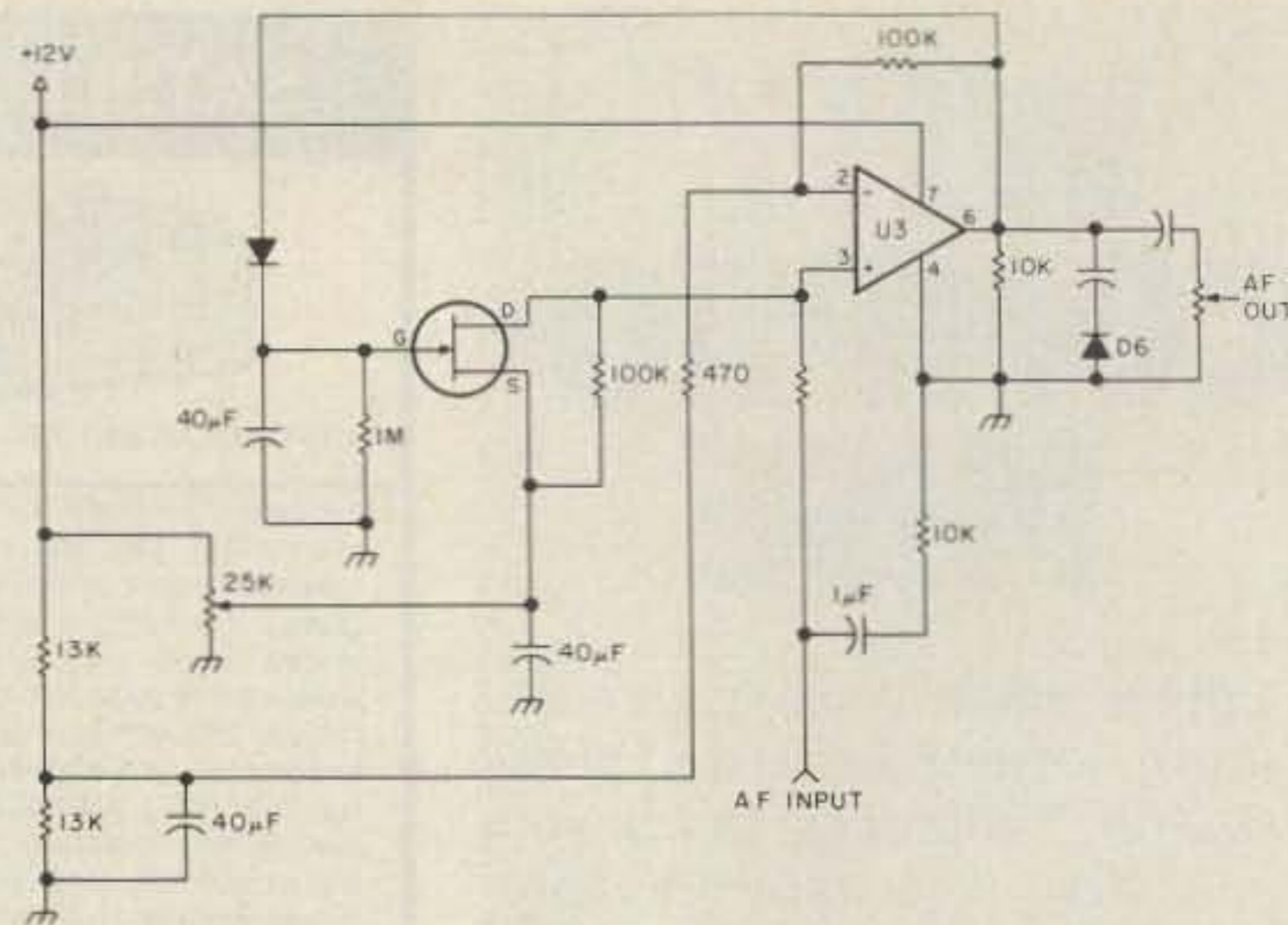

Fig. 5. Compression control modifications.

1). These are silicon diodes which will not conduct at all until forward voltage across the junction exceeds about 0.7 volts. Therefore, the base of Q1 won't "see" any output from the toroid until the voltage rises above 0.7 volts, thus effectively rejecting low-level QRM on the skirts of the filter.

The compression threshold can be manipulated over a wide range, if desired, since compression does not begin on weak signals until they reach a certain minimum voltage. That's because the FET is pinched off and some of the bias must be overcome before the FET drain begins to conduct at all.

However, if the drain is removed from the R3-C4 tap (leaving the other components attached), and connected to the wiper of a pot, this delay of the attack can be changed at will (see

Fig. 5). One end of the pot is connected to +12 V dc and the other end is grounded. When the wiper is grounded, the FET turns fully on, reducing the op-amp output sharply.

When the wiper is moved toward the top of the pot, the source becomes more and more positive. Hence, the gate becomes more and more negative with respect to the source, and more and more compression bias is required from the op amp to turn on the FET. It is possible to set the pot to provide compression on any signal, no matter how weak, or to prevent compression of any but the very strongest signals.

An S-meter can be built which will show the relative strength of received signals by measuring the compression bias (see Fig. 6). A simple FET voltmeter reads the bias generated by the op-amp output.

The unit can be muted for full break-in (QSK) CW operation if desired by us-

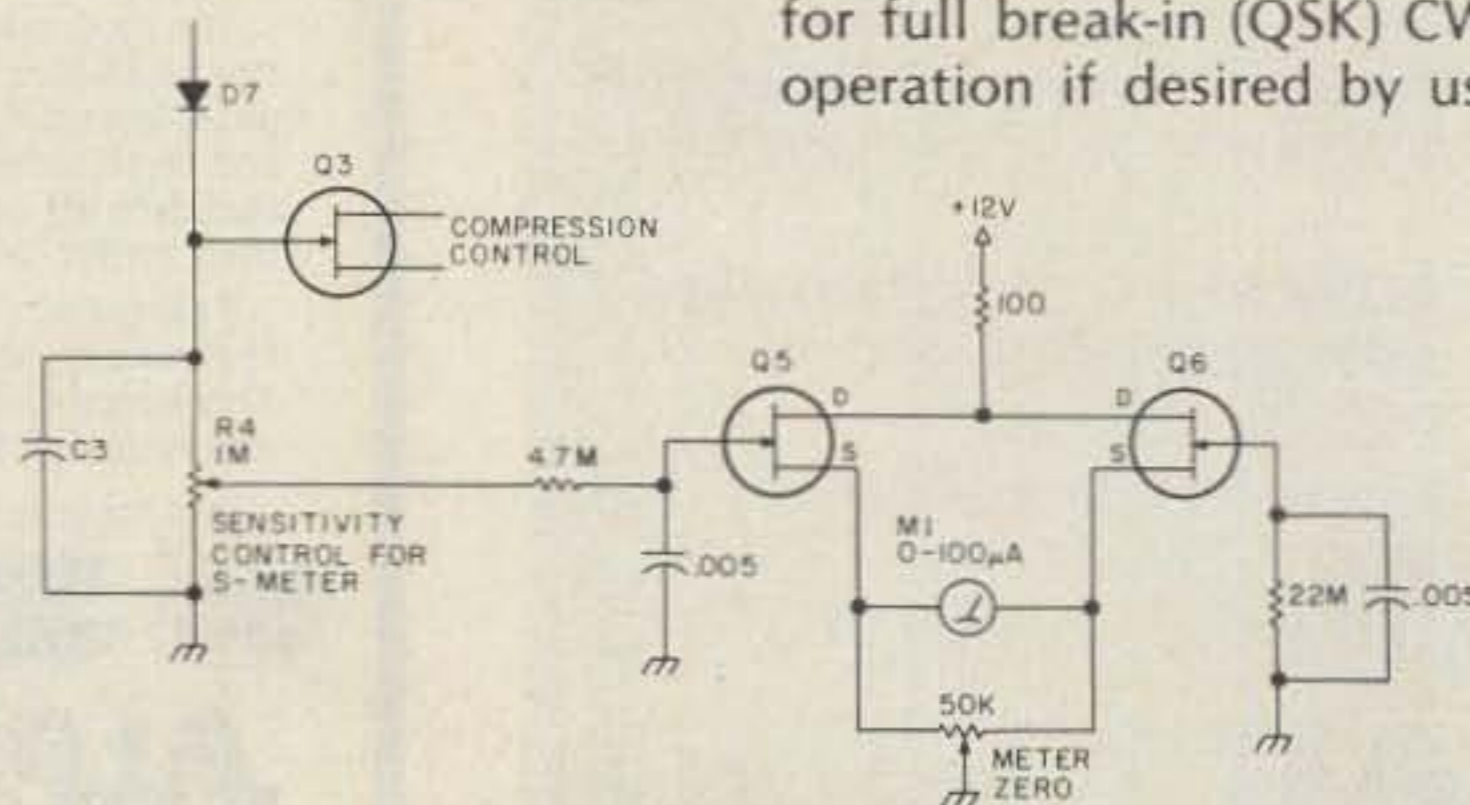
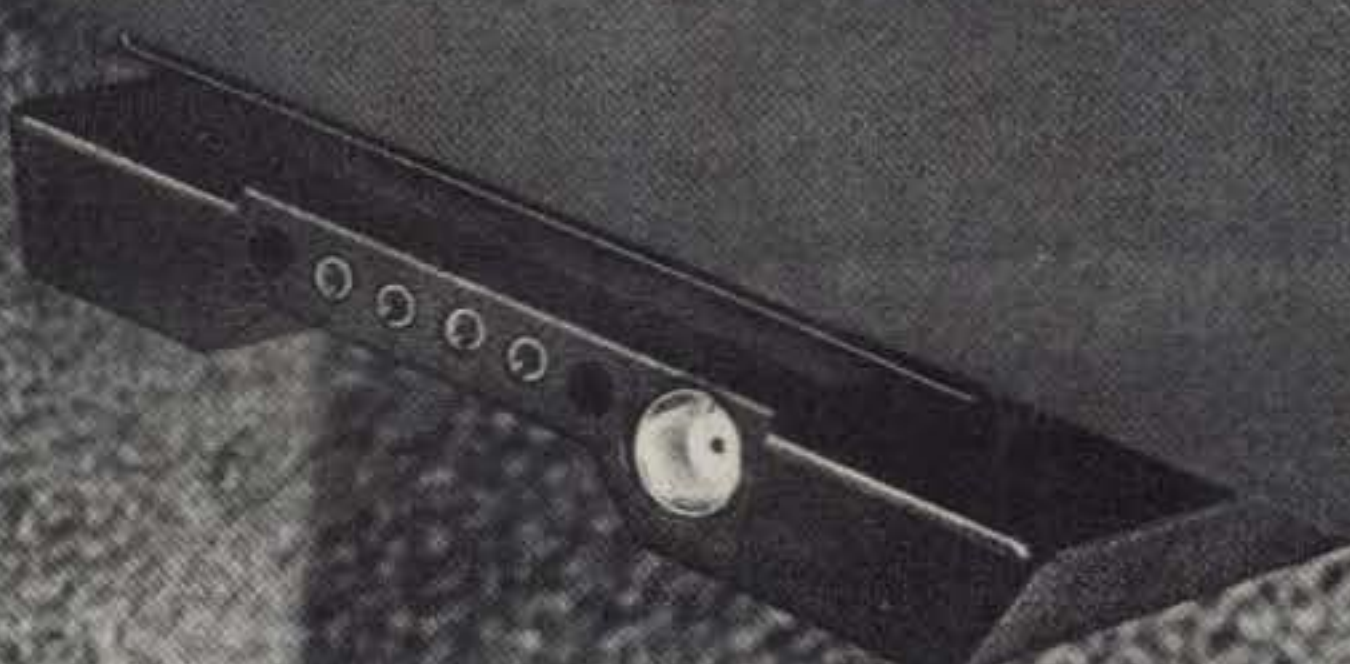

Fig. 6. Optional S-meter circuit.





# A second ago an expensive radio was connected here.

Now it's on its way to another car. Or perhaps a boat. Or maybe it's tucked safely away.

Because this amateur invested in a Larsen QUIK-Change Radio Mount System. It lets him move his radio from one vehicle to another instantly — with no manual connections. So now he can use one radio in several vehicles or several radios in one vehicle.

The beveled, high impact plastic slides self-align and self-lubricate for smooth, non-binding engagement time after time. When the radio is removed, the small vehicle base blends unnoticed into the interior, with no unsightly connections or exposed wires. And when

the radio is left in the vehicle, the optional key lock keeps it safe and secure.

The QUIK-Change works with all radio makes at only a fraction of the price of a radio. So you can afford to have one for each vehicle and radio you own.

The next time you visit your amateur dealer, ask for a QUIK-Change demonstration. It only takes a second. And it'll save you a lot of minutes changing radios.

**QUIK-Change™**  
**RADIO MOUNT SYSTEM**  
by Larsen Electronics, Inc.

322



Write for information.

**IN USA: Larsen Electronics, Inc. Box 7**  
11611 N.E. 50th Avenue P.O. Box 1799  
Vancouver, WA 98668 Phone: 206-573-2722

**IN CANADA: Canadian Larsen Electronics, Ltd.**  
283 E. 11th Avenue, Unit 101  
Vancouver, B.C. V5T 2C4 Phone 604-872-8517



# SATURN V

## STATE-OF-THE-ART



The Saturn V is a deep fringe microwave receiver for homeowners that are outside of the service area of local pay TV stations (i.e., HBO, Showtime). It is normally used within line of sight of a transmitting tower in a 50 mile range and is simply attached to your TV antenna mast. This unit is completely ready to install including all cable and mounting hardware. It is designed to be installed by the homeowner.

We accept MasterCharge & Visa.

Microwave and Satellite Systems



4558 Auburn Blvd., Suite 208  
Sacramento, California 95841

(916) 454-2190

1-3	\$165.00
4-11	\$120.00
12-49	\$105.00
50-99	\$ 95.00
100-149	\$ 85.00
150-up	\$ 80.00

ing a transistor switch to clamp the clipper diodes when the key is down. The keying signal for the transistor can be a logic low or high picked off from a solid-state electronic keyer, such as the Accu Keyer, or by the relays of other keyers. See Fig. 7.

When the muting transistor is off, which it always is when the key is up, it has no effect on the operation of the diode clipper, but SW2 must be open for muting to function properly.

When the key is down, the transistor turns on to saturation. This offers a low-resistance path to ground for the dc bias on the diodes, effectively grounding both the diodes and the audio signals passing through them. Because of its lower junction voltage drop, a germanium transistor will work better here than silicon. Even so, muting is not absolute and some signal from the receiver gets through at low level. The circuit does not

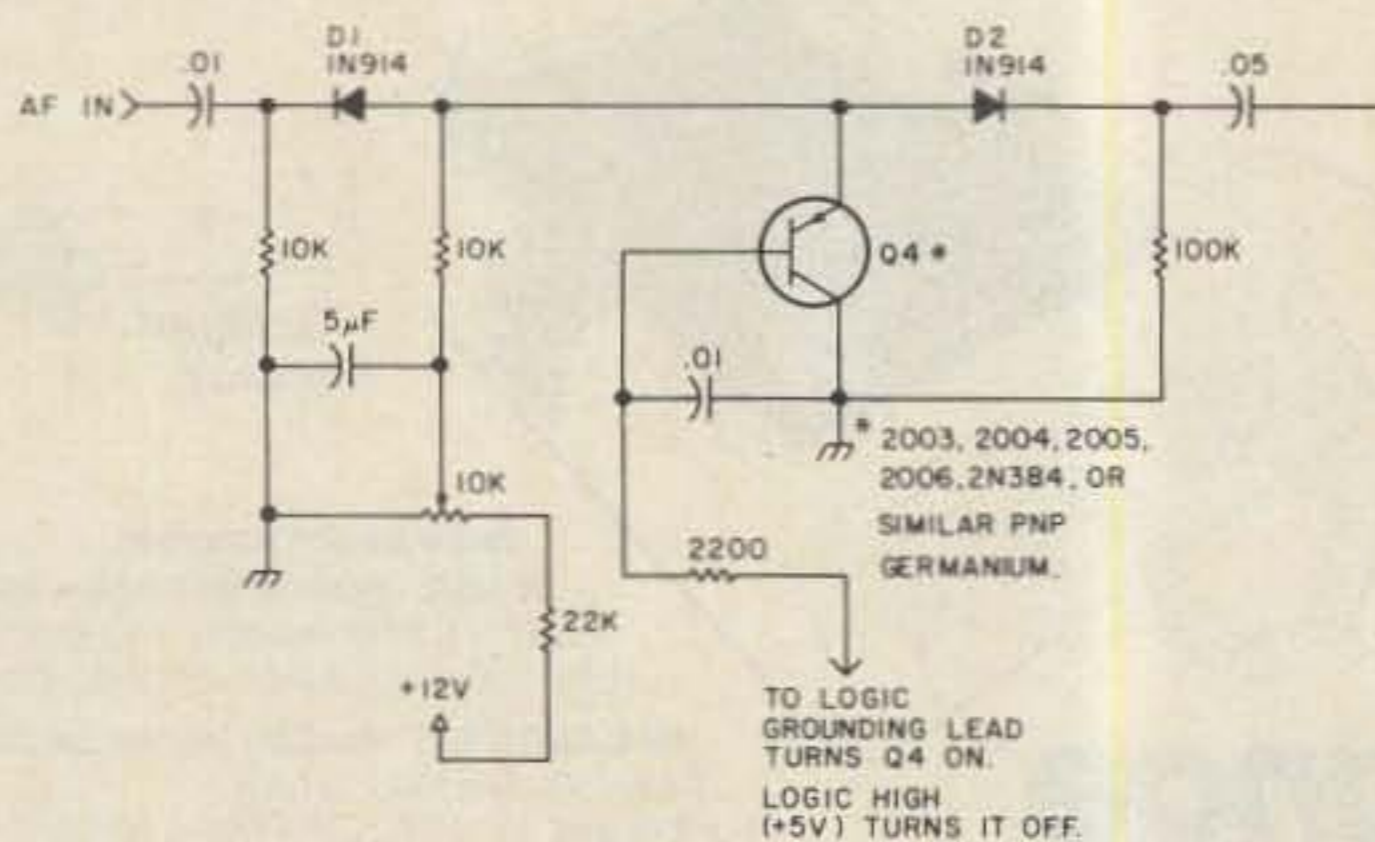

Fig. 7. Muting circuit added to peak clipper.

affect operation of the rest of the audio processor.

Sidetone can be injected into the amplifier when the key is down, making it appear in the same speaker which carries the incoming signals (see Fig. 3). Since the sidetone is injected after the clipping, compression, and selectivity, it is not affected by processor operation and can be set for any convenient pitch or volume.

Several inputs can be provided for the processor, selecting them by switch from the front panel. This makes it possible to use the processor on just about any receiver in the shack.

Auxiliary outputs often come in handy, too, for driving phone patches and similar uses. I provided mine with three front-panel headphone jacks—one of each of the popular sizes of plugs—so that any handy headphones can be plugged in without a hassle.

I built in a little two-inch speaker for convenience in testing and portable operation, but a phone jack is provided for an external speaker. Plugging in the external speaker mutes the internal one. Both speakers can be muted by a front-panel switch, if desired.

A back-panel switch can be added to allow operating the unit from an automobile battery for Field Day or emergency situations. The SPDT switch is connected with the pole to the internal +12-volt lines of the circuit boards. One contact is connected to the output of the 12-volt regulator chip. The other contact is hooked to a back-panel binding post which goes to the external battery. A second binding post should be provided to permit connection to the battery negative.

A 1000-µF 35-volt capacitor is connected from the pole of the switch to ground. It helps with the filtering of the regulator out-

put and, when used on a car battery, it helps to subdue ignition and voltage regulator noises and alternator whine.

### Troubleshooting

Troubleshooting the processor is as simple as troubleshooting can be. Nothing is critical as to value or adjustment, except that the tuned filter circuits must be on exactly the same frequency. Failure to operate properly will almost always prove to be traceable to a wiring error or a faulty diode, transistor, or IC chip, a solder bridge on a circuit board, or failure to solder a connection. ■

### References

1. George Thurston W4MLE, "A Versatile Receiver Audio System," *QST*, May, 1962.
2. C. W. Andreasen N6WA, "The Amazing Audio Elixir," 73, September, 1979. Note that the diagram in this article has an error. The lead from CR2 to the gate of the FET is *not* connected to the voltage divider or to the source of the FET. What is shown as a connection dot should be a non-connecting cross-over.
3. Suitable audio amplifier chips available from Radio Shack and other suppliers include: LM1877N-9, dual-channel, two Watts per channel, (catalog number 276-702); LM386, one-channel, 400-mW output (276-1731); LM383/TDA2002, one-channel 8-Watts (276-703); BA521, one-channel 5.8 Watts (276-704).
4. The IC board is available from several suppliers, such as Global Specialties Co., 70 Fulton Terrace, Box 1942, New Haven CT 06509, or 351 California St., San Francisco CA 94104, or from Radio Shack, catalog number 576-170, for about \$3.00 each. This board is perforated for IC chips and has lands which permit connecting up to four components to each IC pin.

The second type of universal board has a quad land pattern, that is, each cluster of four holes in a square is connected by foil. It is excellent for mounting transistors and other components by their leads. Sold by Calctro (G.C. Electronics), catalog number J4-609, for less than \$2.00 each.



# DRAKE COMMUNICATIONS TERMINALS



## Microprocessor Controlled

**DRAKE**  
**Theta 9000E**

The ultimate in communications versatility, the **Drake Theta 9000E** provides complete transceive capability of CW (Morse Code), RTTY (Baudot), and ASCII. A full computer RS232 interface, cassette tape storage port, selective calling feature with answer-back, light pen graphics, printer interface and word processing software are all standard.

Seven large 256 character memories are backed up with battery power so there is no need to reload information with each use. Memories may also be partitioned providing up to 29 separate storage locations. A type-ahead buffer of 3120 characters makes it easy to compose your response while still receiving. Operator controlled scrolling permits review of up to 10,720 previously received characters. Line length is selectable at 40 or 80 characters, your choice, and all mode and speed indicators are displayed on the screen for instant status recognition. The 9000E has 3 tone groups and 3 shifts which are all keyboard selected.



You won't buy any other communications terminal once you have studied all the advanced operating convenience built into the **Drake Theta 9000E**. It's complete.



**DRAKE**  
**Theta 550**

The **Drake Theta 550** is a compact receive-only communications terminal and is designed to demodulate and display the three most popular over-the-air modes of data communications: CW (Morse Code), RTTY (Baudot), and ASCII. Any standard TV monitor can be used.

A full-featured microprocessor controlled unit, the **Drake Theta 550** has selective calling, battery backed-up memory, audio monitor, and informative L.E.D. tuning indicators. There is also interfacing to permit the addition of a dot matrix printer for "hard" copy and a keyer paddle input to permit CW transmission with full iambic operation.

CW automatically tracks over a speed range of 5 to 50 words per minute and RTTY modes offer nine selectable standard speeds of transmission. 12 volts DC is required.

This unit is ideal for shortwave listeners and hams who have been missing the increasing volume of data communications over the air.



## LA7 Line Amplifier

Line output, input levels as low as 15 mV rms (47 kilohm) will result in an output of 1 mW nominal into a 600 ohm balanced line. Output level adjustable by internal pre-set level control. Interfaces low level audio to RTTY terminal unit or phone line that requires a 600 ohm balanced/unbalanced input. One 36" phono to phono cable supplied.

**R. L. DRAKE COMPANY**



**DRAKE**

540 Richard St., Miamisburg, Ohio 45342. USA  
Phone: (513) 866-2421 • Telex: 288-017





**"BRAND NEW"**  
**CHAMPION MESSAGE  
 MEMORY KEYER**  
 Model TE-292  
**\$125.95**

**Features:**

- State-of-the-Art CMOS Circuitry
- Choice of Message Storage
  - A. Six 50 character messages
  - B. Twelve 25 character messages
  - C. 27 combinations of message C. programming.
- Records at any speed—plays at any speed
- Memory operating LED
- Use for daily QSO or contests

**PLUS:**

- Self-completing dots and dashes
- Both dot and dash memory
- Iambic Keying with any squeeze paddle
- 5-50 w.p.m.
- Speed, volume, tone, tune and weight controls
- Sidetone and speaker
- Low current drain CMOS battery operation—portable
- Rear panel Jack for auxiliary power
- Deluxe quarter-inch jacks for keying and output
- Keys grid block and solid rigs
- WIRED AND TESTED FULLY GUARANTEED—LESS BATTERY

**\$89.95**



**Features: Model TE-284**

- State-of-the-Art CMOS Circuitry
- Three choices of Message Storage
  - A. Two (50 character each) message storage
  - B. Four (25 character each) message storage
  - C. One 50 character and two 25 character message storage
- Records at any speed—plays at any speed
- Memory operating LED
- Use for daily QSO or contests

**PLUS:**

- Self-completing dots and dashes
- Both dot and dash memory
- Iambic Keying with any squeeze paddle
- 5-50 w.p.m.
- Speed, volume, tone, tune and weight controls
- Sidetone and speaker
- Low current drain CMOS battery operation—portable
- Deluxe quarter-inch jacks for keying and output
- Keys grid block and solid rigs
- WIRED AND TESTED FULLY GUARANTEED—LESS BATTERY



**MESSAGE  
 MEMORY KEYER**

**Features:**

- Advanced CMOS message memory
- Two (50 char each) message storage
- Repeat function
- Records at any speed—plays back at any speed
- Longer message capacity  
 Example send CQ CQ CQ DX de WB2YJM WB2YJM K—then play second message on contact—de WB2YJM QSL NY NY 579 579 Paul Paul K
- Use for daily QSOs or contests

**Model # TE201**

**\$75.95**

**PLUS:**

- State of the art CMOS keyer
- Self completing dots and dashes
- Both dot and dash memory
- Iambic keying with any squeeze paddle
- 5-50 wpm
- Speed, volume, tone, tune and weight controls
- Sidetone and speaker
- Low current drain CMOS battery operation—portable
- Deluxe quarter inch jacks for keying and output
- Keys grid block and solid state rigs
- WIRED AND TESTED FULLY GUARANTEED—LESS BATTERY



**Model # TE144**  
**\$65.95**

**Features: Deluxe CMOS  
 Electronic Keyer**

- State-of-the-art CMOS circuitry
- Self completing dots and dashes
- Both dot and dash memory
- IAMBIC keying with any squeeze paddle 5-50 wpm
- Speed, weight, tone, volume tune controls & sidetone and speaker
- Semi-automatic "bug" operation & straight keying—rear panel switch
- Low current drain CMOS battery operation—portable
- Deluxe quarter inch jacks for keying and output
- Keys grid block and solid state rigs
- Wired and tested—fully guaranteed—less battery

MODEL TE133—same as TE144 with wgt and tone control internal, less semi-auto keying. **\$55.95**

MODEL TE122—same as TE133 less wgt, tune, solid state keying. **\$45.95**

AT YOUR DEALER OR SEND CHECK OR MONEY ORDER.

Plus \$2.00 S/H NY Res add tax

**TRAC**

**ELECTRONICS, INC**  
**1106 RAND BLDG.**  
**BUFFALO NY 14203**



**The  
 HAM SHACK**

808 N. Main • Evansville, IN 47711

<b>AEA</b>	
MBA-RO Reader	\$269.00
MBA-RC Rcv/Code Conv. Xmt	395.00
MM-2 MorseMatic Ultimate Keyer	135.00
CK-2 Contest Memory Keyer	99.00
KT-2 Keyer/Trainer	89.00
Isopole 144/220 MHz	35.00
<b>ALLIANCE</b>	
HD73 (10.7 sq. ft.) Rotator	\$99.00
U-100 Small Rotator	45.00
<b>ASTRON</b>	
RS7A 5-7 Amp Power Supply	\$49.00
RS12A 9-12 Amp	69.00
RS20A 16-20 Amp	89.00
RS20M 16-20 Amp w/meter	109.00
RS35A 25-35 Amp	135.00
RS35M 25-35 Amp w/meter	149.00
<b>AZDEN PCS 4000/300</b>	call
Most accessories in stock	call
<b>B&amp;W</b> Folded Dipole 80-10 meter	\$135.00
<b>BASH</b>	
Study Guides/Tapes	\$9.95
<b>BENCHER</b>	
BY-1 Paddle	\$36.00
BY-2 Chrome Paddle	45.00
<b>BUTTERNUT HF6V</b>	\$119.00
<b>CALLBOOK US/DX</b>	\$19.95/18.95
<b>CUSHCRAFT</b>	
A3 Tribander 3 EL	\$179.00
A4 Tribander 4 EL	229.00
214B 14 EL 2 Mtr Boomer	69.00
32-19 Super Boomer	83.00
ARX-2B Ringo Ranger II	36.00
<b>DAIWA</b>	
CN 520 1.8-60 MHz Small Mtr.	\$63.00
CN 620B 1.8-150 MHz Mtr	110.00
<b>DRAKE</b>	
TR7A Xcvr	\$1439.00
R7A Receiver	1399.00
TR5 Xcvr	695.00
<b>ENCOMM (SANTEC)</b>	
ST-144/uP	\$285.00
ST-440/uP	call
<b>HAL</b>	
CT2100 Terminal	\$695.00
RS2100 Scope	295.00
CWR 685A TeleReader	870.00
<b>HY-GAIN</b>	
TH7DX 7 EL Tribander	call
TH3 MK3S 3 EL Tribander	call
V2 2 Mtr Vertical "Excellent"	call
HAM IV Rotator 15 sq. ft.	call
Tailtwister Rotator 20 sq. ft.	call
Crank-up Towers	call
<b>ICOM</b>	
720A Magnificent Xcvr!	\$1140.00
740 Xcvr Wow!	call
730 Excellent Rig! Low Price	call
251A 2 Mtr All Mode	575.00
290H 2 Mtr All Mode	call
25A 2 Mtr Very Small Mobile	call
2 AT/3 AT/4 AT HT's	235.00
IC R70 Fantastic Receiver!	call
<b>KLM</b>	
KT34A 4 EL Tribander	\$309.00
KT34XA 6 EL Tribander "Beautiful Ant."	465.00
<b>KANTRONICS</b>	
Interface	\$165.00
Mini-Terminal Rcv/Code Conv. Xmt	249.00
Mini-Reader Pkg.	225.00
<b>LARSEN</b>	
NLA 150MM 2 Mtr Mag.	\$39.00
2 meter 2-20, 4-40 MHz	call
<b>MFJ</b>	
496 Keyboard	\$289.00
941C Tuner	81.00
VHF Converter for 2 Mtr HT's	36.00
<b>MIRAGE</b>	
B108	\$155.00
B1016	239.00
B3016	205.00
<b>ROHN Towers</b>	call
<b>SHURE</b>	
444D Very Nice Mic!	\$50.00
<b>TEN-TEC</b>	
Corsair new Xcvr	call
525 Argosy	call
<b>TOKYO HY-POWER</b>	
HL32V 25W Amp	\$79.00
HL82V 80W Amp	149.00
HL160V 160W Amp	285.00
VOCOM Amplifiers/Ants.	call

This is a partial listing. Please call for accessories and other products not listed. Prices & availability subject to change.

✓ 449

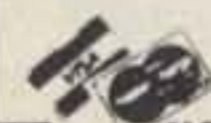

**812-422-0231**

MON-FRI 9AM-6PM • SAT 9AM-3PM

Send SASE for our new & used equipment list.



Ducks are getting smaller!  
and...

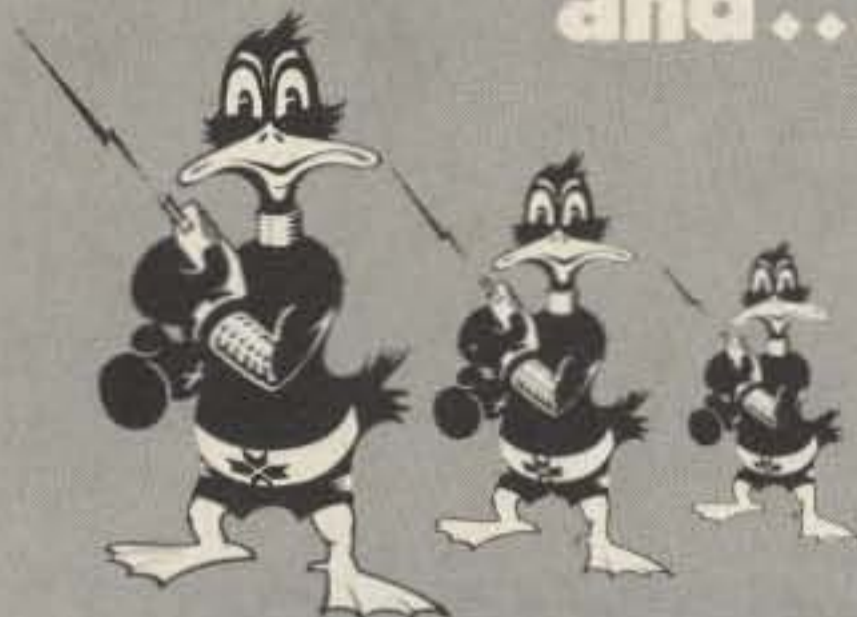

better!



Actual Size

Because you and the leading radio manufacturers want the best-performing, the best looking antenna; Centurion has grown to be the Duck leader. We've developed many smaller antennas to make the hand-held radio perform better, and now the newest duck...the Tuf Duck "mini". It's shorter (about 3") yet it's a full 1/4 wave radiator on VHF.

**CENTURION**  
**TUF DUCK**  
**ANTENNAS**

**CENTURION**  
Phone 402/467-4491  
Telex 48-4377 CENTURION LCN  
P.O. Box 82846 Lincoln, NE 68501 2846

102

**RTTY - 50**  
Basic Terminal Unit

- 60 mA Loop Keying
  - PLL Demod w/2 pole filter
  - AFSK Generator
- \$79<sup>00</sup>**

Call or write for FREE catalog with over 65 P.C. Boards & Kits.

**RTTY - 100**  
Expanded Version of the Popular RTTY - 50

- AFSK
  - 850/170
  - TTL & RS232
  - 60 mA Loop
  - Loop Supply
  - Auto Start
  - 4 Pole Filters
  - AGC (80db)
- \$189<sup>00</sup>**

**COMMUNICATIONS DESIGN INC.**

1105 Lehr St. — West Memphis, Arkansas 72301  
(501) 735-4568

**NEMAL ELECTRONICS**  
**COAXIAL CABLE SALE**



- RG8U 20 ft. PL-259 ea. end \$4.95
- RG214U dbl silver shield, 50 ohm \$1.35/ft.
- 100 ft. RG8U with PL-259 on each end \$19.95
- BELDEN Coax in 100 ft. rolls
- RG58U #9201 \$11.95
- Grounding strap, heavy duty tubular braid
- 3/16 in. tinned copper 10c/ft.
- 3/8 in. tinned copper 30c/ft.

- POLYETHYLENE DIELECTRIC**
- RG213 noncontaminating 95% shield mil spec 36c/ft.
  - RG174U mil spec, 96% shield 10c/ft.
  - RG11U 96% shield, 75-ohm mil spec 25c/ft.
  - RG8U 96% shield, mil spec \$27.95/100 ft. or 31c/ft.
  - RG6A/U double shield, 75-ohm 25c/ft.
  - RG58AU stranded mil spec 12c/ft.
  - RG58 mil spec, 96% shield 11c/ft.
- LOW LOSS FOAM DIELECTRIC**
- RG8X 95% shield (black, white or gray) \$14.95/100 ft.
  - RG8U 80% shield 17c/ft.
  - RG58U 80% shield 18c/ft.
  - RG58U 95% shield 07c/ft.
  - RG59U 100% foil shield, TV type 10c/ft.
  - RG8U 97% shield 11 ga. (equiv. Belden 8214) 31c/ft.
  - Rotor Cable 8-con. 2-18 ga. 6-22 ga. 19c/ft.

- CONNECTORS MADE IN USA**
- Amphenol PL-259 79c
  - PL-259 push on adapter shell 10/\$3.89
  - PL-259 & SO 239 10/\$5.89
  - Double Male Connector \$1.79
  - PL-258 Double Female Connector 98c
  - 1 ft. patch cord w/RCA type plugs each end 3/\$1.00
  - Reducer UG-175 or 176 10/\$1.99
  - UG-255 (PL-259 to BNC) \$3.50
  - Elbow (M359) \$1.79
  - F59A (TV type) 10/\$2.15
  - UG 21D/U Amphenol Type N Male for RG8 \$3.00
  - BNC UG88C/U, male \$1.25
  - 3/16 inch Mike Plug for Collins etc \$1.25
  - UG273 BNC to PL-259 \$3.00

FREE CATALOG  
COD add \$1.50—FLA. Res. add 5% Sales Tax

Connectors—shipping 10% add'l, 2.50 minimum

Cable—shipping \$3.00 1st 100 ft. \$2.00 each add'l 100 ft.

1327 NE 119th Street, Dept. RLO, No. Miami, FL 33161 Call (305) 893-3927

**ALL BAND TRAP VERTICAL ANTENNAS!**

FULL 1/4th WAVE - All Bands! Automatic Selection with proven Hi-Q Traps. 3 Models-ALL self supporting Ground or roof mount. HEAVY Double wall seamless Aluminum lower section - HI STRENGTH FIBER-GLASS TUBING OVER-ALL. NO WOBBLY, LUMPY TRAPS - NO UNSIGHTLY CLAMPS needed Same size all the way up 1 1/4" - Traps hidden inside. You can use it in a 1 ft. sq. Backyard! Neighbors will never know this is a Hi-Power ALL Direction DX Antenna FOR APARTMENTS, ROW HOUSES, MOBILE HOMES - CONDOS etc. where minimum space and neat appearance is MANDATORY! Instant "Drive In" ground mount (included). Use with or without radials (included) (All angle roof mount - Extra) COMPLETELY PRE-TUNED - NO ADJUSTMENTS NEEDED EVER! NO TUNER NEEDED Over All Bands (except 80 meter - 400 KC) SWR 1-1 to 2-1 at Band edges, Stnd. SO239 connector - 50 ohm for any length. RG58U - RG8U feedline. Matches ALL MAKES TRANSCIEVERS. 2000 Watt PEP. Input power. Shipped - PRE-PAID IN USA. Assembles in 10 min. using only screwdriver. WEATHERPROOF!

- No.-AVT80-10 — 5 Band — 29"11" — \$179.95
- No.- AVT40-10 — 4 Band — 19"3" — \$129.95
- No.- AVT20-10 — 3 Band — 11"6" — \$99.95

SEND FULL PRICE FOR PP DEL IN USA (Canada is \$5.00 extra for postage, clerical, Customs etc.) or order using VISA, MASTER CARD or AMERICAN EXPRESS. Give Number and Ex. date. Ph 1-308-236-5333 9AM-6PM weekdays. We ship in 2-3 days. Prices will increase, so order NOW AND SAVE. All Antennas Guaranteed for 1 year - 10 day money back trial, if returned in new condition. Free Inf.



WESTERN ELECTRONICS 80  
Dept. A7-11 Kearney Nebr. 68847

**CONTACT-80 . . .**

An ultra sophisticated yet simple to operate RTTY System for the demanding operator at an affordable price.

**Features:**

- Disk I/O; SAVE, LOAD, KILL & DIR . . .
- TRI-SPLIT screen, user defined . . .
- 10 CANNED MESSAGES
- DYNAMIC BUFFER ALLOCATION . . .
- Live HARDCOPY for parallel printers . . .
- Keyboard CONTROL OF STATION . . .
- AUTO-ID; RTTY, CW (selectable ON/OFF) . . .
- CLOCKED OUTPUT rate . . .
- All BAUDOT speeds plus ASCII (110) . . .
- NAME, DATE, TIME from computer . . .
- On screen BIT PATTERN SCOPE . . .

Requires TRS-80, MOD-III with your CALL SIGN plus TU with 60ma loop.

- DISK I/O; VERSION . . . \$279.00
- CASSETTE I/O; VERSION . . . \$229.00

Post Paid

**CommTek**

4493 Orleans Dr., Dunwoody, GA 30338  
(404) 946-9314



# A Tuner for Antenna Fanatics

*Anyone experimenting with antennas needs a darned good tuner. Construct this one and save your finals.*

Various antenna tuner networks for the HF bands have come and gone over the years, but two forms have evolved as time-proven favorites—the Pi

and T networks. The basis for the durability of these networks is a combination of electrical as well as constructional reasons.

The Pi network will not match an extreme range of impedances, but it is relatively easy to construct and adjust in operation. Its main disadvantage is that it requires considerable amounts of capacitance on the lower frequency bands when working into low-impedance loads. Usually, padding capacitors are required across the variable capacitors on the lower frequency bands when a high-power tuner is being constructed since 1,000- or 2,000-pF variable capacitors rated at 2 to 3 kilovolts are not exactly common items.

On the other hand, the T network does not require extreme amounts of capacitance even on the low-frequency bands when matching into the same or even greater range of load impedances than a Pi network

will accommodate. The T network is, however, slightly more tedious to adjust and also to construct since the variable capacitors used must have both their stator and rotor sections above ground. The popular "Transmatch," by the way, is a basic variation of the T network.

But, why not have the best of both networks in a single multiband tuner? This article describes a switchable, multi-network tuner which is designed to optimize the matching possibilities available using commonly-available L/C components of moderate electrical and physical dimensions and, of course, of moderate cost. The tuner can be tailored to handle PEP output powers from 500 to 1000 Watts. The physical dimensions are quite moderate for the power-handling capabilities involved and one easily can add such features as selectable antenna switching and swr monitoring.

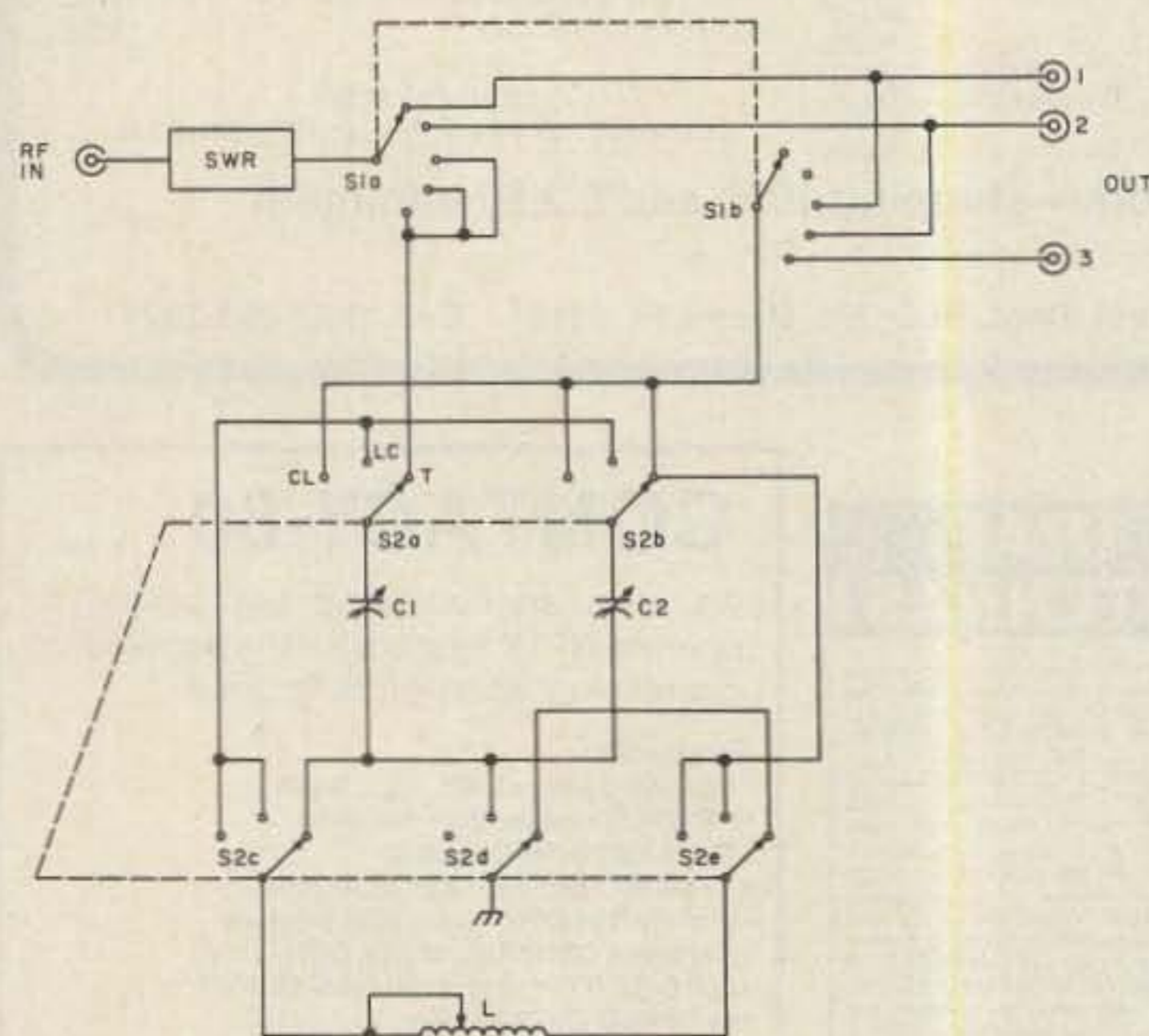

Fig. 1. Tuner circuitry. The S2 switch arrangement may appear complex, but wiring is not complicated nor are long lead lengths introduced, since most of the wiring is between switch lugs. Normally, a two-wafer switch would have to be used, although single-wafer surplus switches having a 5P3T action can be found. C1 and 2—at least 250 pF each, rated at 1.5 kV for 300 Watts, 2 kV for 500 Watts, and 4 kV for 1 kW; L—18 to 28 $\mu$ H, #10 or 12 wire; S1 and 2—Centralab PA-2000 series or similar.



The schematic of the tuner is shown in Fig. 1. As shown, it incorporates selectable LC-, CL-, or T-network tuning, input switching direct to any of three loads (one of which can be a dummy load), switching using the tuner network to any one of two selectable antenna loads, and complete, internal swr measurement circuitry. Of course, one can scale up or down the possibilities shown in the schematic in any way desired in order to construct just the basic tuner, expand the antenna switching possibilities, etc.

The reason for having selectable LC- or CL-network tuning (a reversible L network) instead of a simple Pi-network option is to further increase the mileage obtainable out of the components used. Since two variable capacitors have to be used in the design of the tuner, the option is available to use them in a conventional Pi-network manner as tunable input/output capacitors or to parallel them and use them as combined output or input capacitors. The latter will provide a greater range of impedance-matching possibilities at the expense of only a bit more component switching complexity, and so it was used.

If one uses a conventional input/output tuned Pi network with extremely wide-range variable capacitors, it usually will be found that any load that can be matched using both variable input/output capacitors can also be matched using only *either* a variable input or output capacitors and a suitable value of inductance. However, the capacitance range of a single variable capacitor required will usually be less than the combined capacitance of separate input/output variable capacitors in a Pi network.

The practical construction details of the tuner are not difficult to follow or perform if you approach them on a step-by-step basis. The 500-Watt output-rated version of the tuner is housed in an attractive two-tone blue/gray Radio Shack enclosure (#270-269) measuring 7-7/8" x 3-1/2" x 5-7/8". This aluminum housing is easy to work and you can construct the tuner using basic hand tools.

After you have initially sized-up the placement of components within the enclosure, drill or punch out the necessary mounting holes on the rear panel for the coax connectors, on the bottom of the enclosure for inductor and capacitor mounting, and on the front panel for control shafts, switches, meter, etc. Generally, the following sequence of mounting and wiring and components will make the tuner go together easily:

- 1) Mount the front-panel network changeover switch and the rear-panel coax connectors.
- 2) Mount the two variable capacitors. These capacitors have to be "above" ground. There are numerous ways to achieve a suitable mounting. The simplest is probably through the use of plastic #6 mounting screws/nuts with 1/4" spacers to keep the capacitor rotors above ground. If such material is not readily available, a 1/4"-thick piece of Plexiglas™ or bakelite can be used to raise the capacitors above the enclosure bottom using metal hardware.
- 3) Wire up the network changeover switch to the capacitors with leads extended to where the inductor and antenna selector switch will be mounted.
- 4) Mount the variable inductor and the swr measurement circuitry (if used).
- 5) Mount the antenna selector switch to the back panel

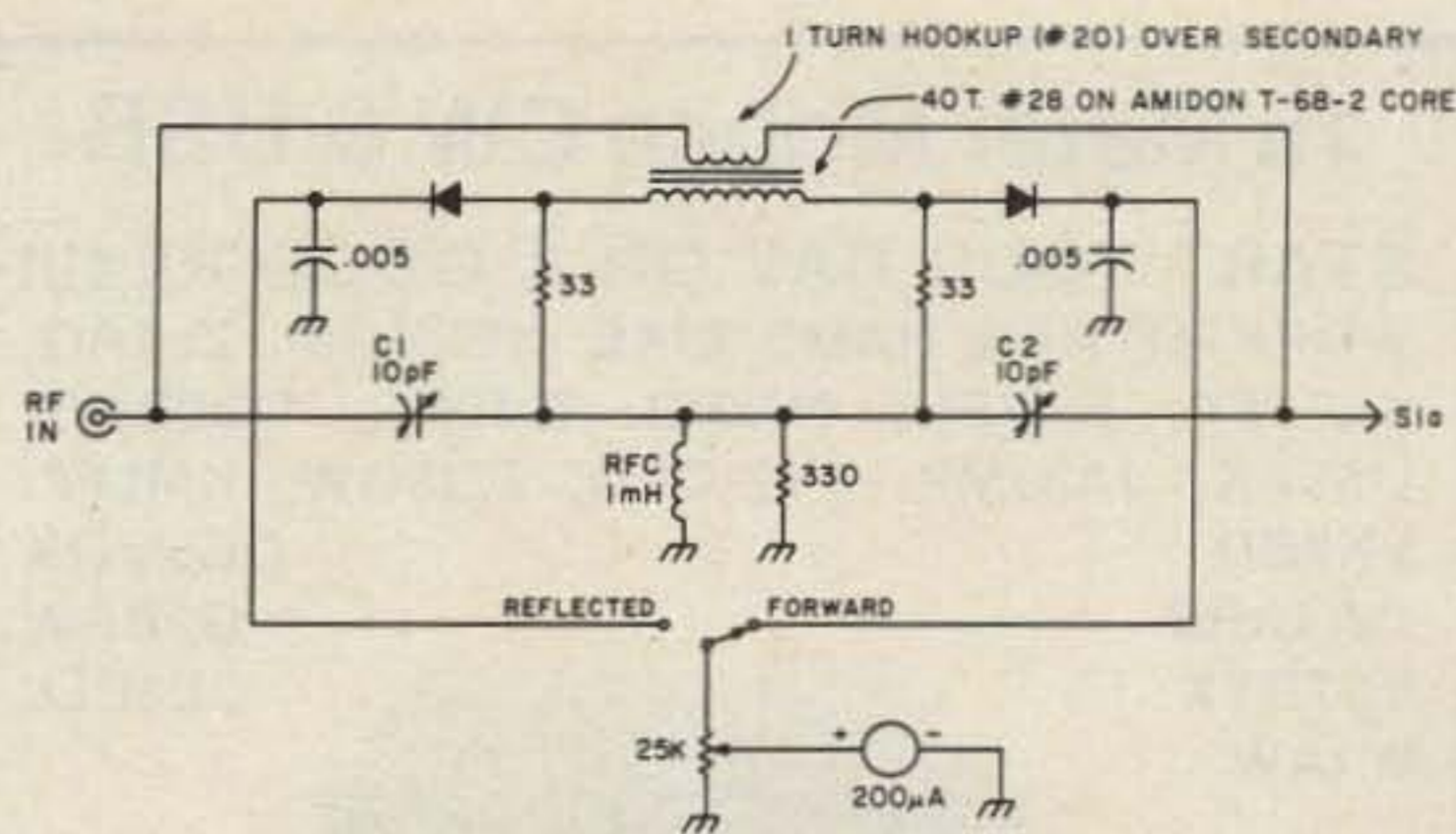

Fig. 2. The swr circuitry is simple but sensitive and needs no shielding inside the tuner enclosure. With a 50-Ohm carbon resistor on the S1 side and the meter switch to reflected, adjust C1 for minimum meter reading. Do the same with C2 when the resistor is connected to the rf in side and rf is fed into the S1a side of the circuit.

(using 1/2" to 3/4" standoff hardware) and wire it up.

- 6) Mount the insulated shaft couplings on the variable capacitors, extension shaft to the antenna selector switch, etc.

Of course, you can vary the location of the components in a variety of ways, but you should more or less plan out the construction of the tuner in the manner illustrated above. It really takes less time to complete than is involved in even assembling a commercial kit which often has rather laborious point-to-point wiring instructions.

Another swr bridge circuit was constructed using a toroid-core transformer and it worked very well. The circuitry of the bridge is shown in Fig. 2. The components are mounted on a small piece of perforated board stock; there is no need to etch a board for the few components involved and they can be wired together directly.

The board is mounted inside the rear panel of the tuner directly by the input coaxial connector. No shielding is required since the toroid is largely self-shielding. The sensitivity allows for measurements with 10 to 20 Watts of transmitter output power even on the low-frequency

bands. The only thing that you must do, however, is to balance out the stray capacitances in the circuitry as noted in the caption for Fig. 2. The procedure is simple but it cannot be neglected if proper readings are to be obtained on 10 and 15 meters.

The meter used happened to be a surplus CB one that had an swr scale, but any inexpensive meter with a 200-mA or more sensitive movement will suffice. There is no real need to calibrate the meter since it normally is used only to adjust the tuner for a minimum reading in the reflected switch position once the meter has been adjusted for a full-scale reading in the forward switch position.

A minor point, by the way, about the meter switch used: It is spring-loaded, so it must be pushed down to read forward and will snap back to its reflected position (labeled SWR). This small refinement makes it rather easy to adjust the tuner since the way the switch and meter adjustment control are placed on the front panel the index finger on one hand can be used to depress the switch while the thumb and middle finger are used to adjust the control. The other hand is free



## 15 Meter Mobile CW & USB

**START YOUR DAY ON A GOOD KEY!!!**  
**WORK OTHER HAMS LIKE: XE2BGM, ZL1PQ,**  
**KL7JFV, EA7EU, NN3SI, DJ8RR, DL0BBC,**  
**US6AK, JA3JMP, PY2-CPQ, FO8GW, KM6FF,**  
**VK2BD** **OE8MOK**  
**OA4ARB** **G3BRW**  
**VE7DYX** **CE1BLL**  
**W1AW**



High 10W (PEP) low 2W (PEP); VFO tuning; noise blanker; fine-tuned SB, KHz  $\pm$  CW off-set; digital frequency counter; 13.8V dc @ 3A, negative ground; L 9.5" x W 9" x H 2.5"; weight (2.3 kg) 5.7 lbs.; mobile mounting bracket.



BY: **PANASONIC®**  
 JUST SLIGHTLY AHEAD  
 OF OUR TIME

SOON — NEW  
 10-160 METERS

AMATEUR DIVISION OF MATSUSHITA ELECTRIC  
 DLR. INFO. & ORDER, CALL  
 1275 N. GROVE ST.  
 ANAHEIM, CALIF, 92806 (714) 630-4541

NOTE: Price, specifications subject to change without notice and obligation.

to adjust the tuning controls.

Speaking of controls, there is no turns indicator on the rotary inductor. Regular turns counters take up a lot of enclosure space and are not all that necessary unless you insist on extremely fast control presetting. In reality, if you note the setting of all the other controls for the band/antenna being used, it is a simple matter to rotate the inductor for approximate minimum swr and then finish up the tuning by going back and forth between the inductor and capacitor tuning controls.

It's no secret that it generally only makes sense to home-brew a tuner if one can find the components necessary at reasonable prices. If you built a 500-Watt version of this tuner using all new, off-the-shelf parts, the parts cost could easily run around

\$120. On the other hand, using surplus or new surplus parts, the cost could be as low as \$25. Simply hunt around for the parts needed at the right prices. Fair Radio Sales (1016 E. Eureka, Box 1105, Lima OH 45802), for instance, which frequently advertises in 73, often has very good buys on transmitting-type variable capacitors and inductors.

The tuner has been labeled as a "Universal Coupling Unit." That euphuistic name was only the result of having a limited selection of words available in a rub-on lettering set. No tuner will, of course, couple to absolutely all loads. The tuner described will couple a 50-Ohm output transmitter to just about any reasonable antenna load; the same as can be done by commercially available tuners which use the same type of circuitry and component dimensions. ■



# ICOM

FOR THE PROFESSIONAL AMATEUR



## SPECIAL LIMITED OFFER

SSB-CW MODE PORTABLE RADIOS

IC-502-A 6 METER  
 LIST 239.00 N&G PRICE 185.00  
 IC-202-S 2 METER  
 LIST 279.00 N&G PRICE 215.00

# N&G

DISTRIBUTING  
 7201 N.W. 12 ST.  
 MIAMI, FLA. 33126  
 (305) 592-9685  
 (305) 763-8170  
 WATTS 800-327-3364



IC 730 H.F.  
 LIST \$829.00



IC-720A H.F.  
 LIST \$1349.00



IC-25-A  
 LIST \$349.00



IC-451A U.H.F.  
 LIST \$899.00



IC-2AT IC-3AT IC-4AT  
 Accessories Stocked



AZDEN ★ NEW! ★ AZDEN ★ NEW! ★ AZDEN ★ NEW! ★ AZDEN

THE GIANT **AZDEN**® COMPANY  
**REVOLUTIONIZES THE STATE OF THE ART**  
**AWE AND AZDEN**. INTRODUCE THE BRILLIANT NEW **PCS-2800**  
**MICROCOMPUTER CONTROLLED**  
**SUPERIOR COMMERCIAL GRADE**  
**10 METER**  
**FM TRANSCEIVER**

**SPECIAL**

**\$229.<sup>00</sup>**

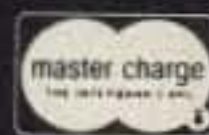

**COMPARE THESE FEATURES**  
**WITH ANY UNIT AT ANY PRICE**

- **FREQUENCY RANGE:** Receive and transmit: 28.000 to 29.995 MHz, 10KHz steps with built-in - 100 KHz repeater offset.
- **ALL SOLID STATE-CMOS PL DIGITAL SYNTHESIZED.**
- **SIZE: UNBELIEVABLE! ONLY 6 3/4" x 2 3/8" x 9 3/4". COMPARE!**
- **MICROCOMPUTER CONTROLLED:** All scanning and frequency-control functions are performed by microcomputer.
- **DETACHABLE HEAD:** The control head may be separated from the radio for use in limited spaces and for security purposes.
- **SIX-CHANNEL MEMORY:** Each memory is re-programmable. Memory is retained even when the unit is turned off.
- **MEMORY SCAN:** The six channels may be scanned in either the "busy" or "vacant" modes for quick, easy location of an occupied or unoccupied frequency. **AUTO RESUME. COMPARE!**
- **FULL-BAND SCAN:** All channels may be scanned in either "busy" or "vacant" mode. This is especially useful for locating repeater frequencies in an unfamiliar area. **AUTO RESUME. COMPARE!**
- **INSTANT MEMORY-1 RECALL:** By pressing a button on the microphone or front panel, memory channel 1 may be recalled for immediate use.
- **MIC-CONTROLLED VOLUME AND SQUELCH:** Volume and squelch can be adjusted from the microphone for convenience in mobile operation.
- **DIRECT FREQUENCY READOUT:** LED display shows operating frequency, NOT channel number. **COMPARE!**
- **TEN (10) WATTS OUTPUT:** Also 1 watt low power for shorter

- distance communications. LED readout displays power selection when transmitting.
- **DIGITAL S/RF METER:** LEDs indicate signal strength and power output. No more mechanical meter movements to fall apart!
- **LARGE 1/2-INCH LED DISPLAY:** Easy-to-read frequency display minimizes "eyes-off-the-road" time.
- **PUSHBUTTON FREQUENCY CONTROL FROM MIC OR FRONT PANEL:** Any frequency may be selected by pressing a microphone or front-panel switch.
- **SUPERIOR RECEIVER SENSITIVITY:** 0.28 uV for 20-dB quieting. The squelch sensitivity is superb, requiring less than 0.1 uV to open. The receiver audio circuits are designed and built to exacting specifications, resulting in unsurpassed received-signal intelligibility.
- **TRUE FM, NOT PHASE MODULATION:** Transmitted audio quality is optimized by the same high standard of design and construction as is found in the receiver. The microphone amplifier and compression circuits offer intelligibility second to none.
- **OTHER FEATURES:** Dynamic Microphone, built in speaker, mobile mounting bracket, external remote speaker jack (head and radio) and much, much more. All cords, plugs, fuses, microphone hanger, etc. included. Weight 6 lbs.
- **ACCESSORIES:** 15' REMOTE CABLE....\$29.95. FMPS-4R A/C POWER SUPPLY....\$39.95. TOUCHTONE MIC. KIT....\$39.95. EXTERNAL SPEAKER....\$18.00.

**AMATEUR-WHOLESALE ELECTRONICS** ORDER NOW TOLL FREE

8817 S.W. 129th Terrace, Miami, Florida 33176  
Telephone (305) 233-3631 • Telex: 80-3356

U.S. DISTRIBUTOR DEALER  
INQUIRIES INVITED

**1-800-327-3102**

CREDIT CARD HOLDERS MAY USE OUR TOLL FREE ORDERING NUMBER.



# Digital Basics

*This is no time to be a digital illiterate. Part III reveals the secrets of multivibrators, shift registers, and other notorious devices.*

Joseph J. Carr K4IPV  
5440 South 8th Road  
Arlington VA 22204

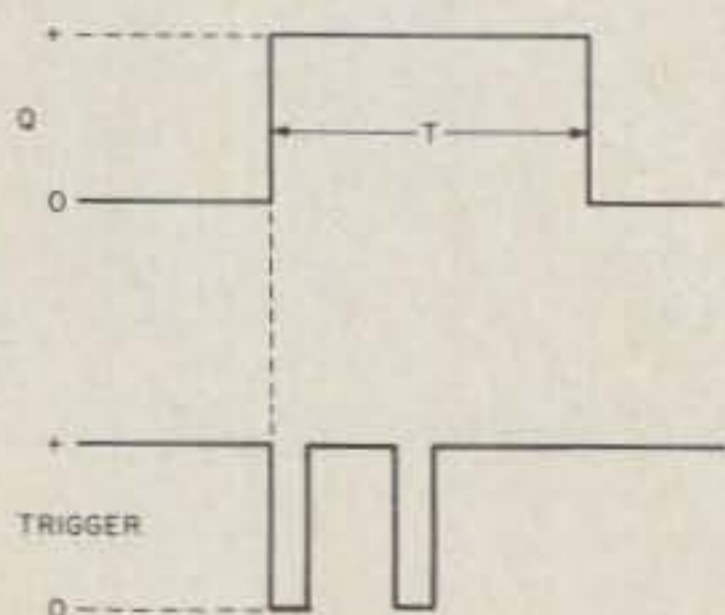

Fig. 1(a). One-shot multivibrator. Trigger pulse causes output to go HIGH for period  $T$ . The second pulse has no effect.

The first two parts of this three-part series led you step by step into the digital electronics swimming pool. We now can wade in past the ankle-deep water of the kiddies' pool and venture into knee-deep water. Thus far, we have discussed the

various digital IC logic families, assorted types of gates, and a variety of flip-flops. We now will turn to the subjects of multivibrators and counters.

## Multivibrators

A multivibrator is basically a pulse-producing circuit. There are three basic forms of multivibrator: *monostable*, *bistable*, and *astable*. It takes little imagination to detect that these designations refer to the *stable output states* that are possible for each type of circuit.

The monostable multivibrator has but *one stable state* (usually the state in which  $Q = \text{LOW}$ ... but not always). Triggering the monostable multivibrator

causes the  $Q$  to go HIGH for a time, but since this is not a stable state,  $Q$  will drop LOW again when a pre-determined time period has elapsed. Monostable multivibrators are also called *one-shot* circuits and also (erroneously, albeit graphically) *pulse-stretcher* circuits. The latter label is a misnomer because the circuit does not actually stretch a pulse but generates a *new* pulse that has a longer period.

The bistable multivibrator has two stable states. It can remain in either state (i.e.,  $Q = \text{LOW}$  or  $Q = \text{HIGH}$ ) indefinitely. The RS flip-flop is an example of a bistable multivibrator.

The astable multivibrator has *no* stable states. It is in-

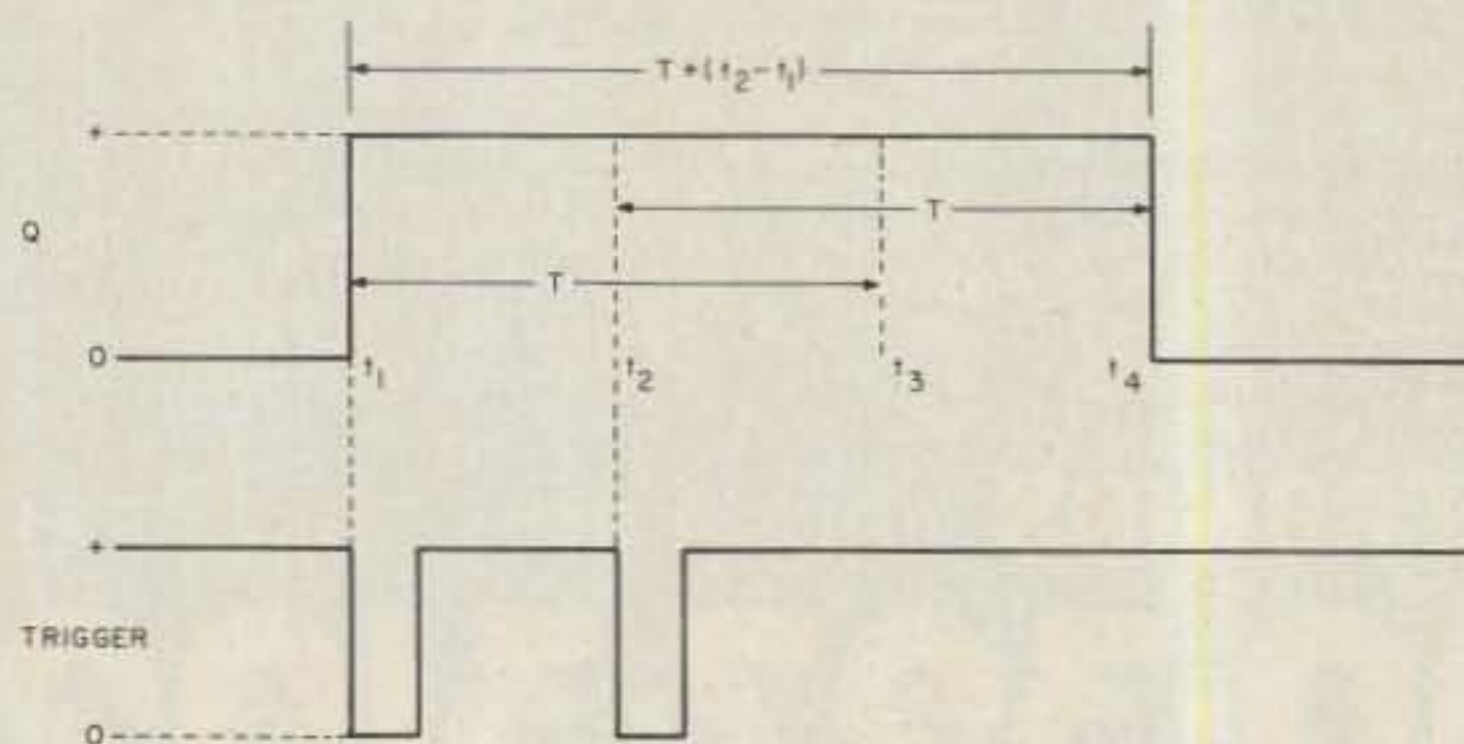

Fig. 1(b). A retriggerable monostable multivibrator can be retriggered while the output is still HIGH. Note that the total duration of the HIGH state is not  $2T$ .



capable of remaining in either Q LOW or Q HIGH states. The Q output of the astable multivibrator will flip back and forth between the HIGH and LOW states, producing a square-wave pulse-train output signal. For this reason, the astable circuit is usually used to produce the clock pulses found in digital circuits.

There are several ways to produce each of these types of multivibrator. Space prevents us from considering all of them. We will examine a few circuits built from discrete gates and the integrated circuits. Some IC devices, like the 555 timer, will operate in either the monostable or astable mode.

When we speak of bistable multivibrators, we actually are talking about the RS flip-flop. Recall from the earlier sections of this article that the RS FF can remain happily in either the Q=LOW or the Q=HIGH states indefinitely.

Most monostable multivibrators will not respond to further input trigger pulses until the period of the output pulse has "timed out," i.e., the output has returned to its stable state. Monostables that will not respond to further trigger commands until the output duration has expired are *nonretriggerable* monostables.

Some one-shot circuits, however, are *retriggerable*, meaning that they will respond to further input trigger commands while the one-shot is in the unstable state (i.e., before it has timed out). Consider Fig. 1 to see how this works. Fig. 1(a) shows the operation of the regular nonretriggerable one-shot multivibrator. The first trigger pulse causes the output to go HIGH and it remains HIGH for period T. A second trigger pulse has no effect on the one-shot because it occurs before T expires.

Now consider Fig. 1(b). This is a timing diagram for the retriggerable monostable multivibrator. The output goes HIGH when the first pulse arrives. But before T expires, a second trigger pulse is received. This second pulse causes the one-shot to retrigger, so the output will remain HIGH for an additional period T. Note that the total duration of the HIGH state is not 2T, but T plus the portion of the first period that expired prior to the second trigger, or  $T + (T_2 - T_1)$ .

An example of a monostable multivibrator built from a CMOS type-D flip-flop is shown in Fig. 2. Recall the rules for the type-D FF: (1) Since D is HIGH, a HIGH will be transferred to the Q output when the CLK line goes HIGH, and (2) when the clear line goes HIGH, the Q output is forced LOW. The operation of the one-shot circuit in Fig. 2, then, is as follows:

- When the circuit is at rest, Q is LOW and any charge on capacitor C1 is drained off through diode D1.
- When a trigger pulse is received by the CLK input, Q goes HIGH. When Q is HIGH, capacitor C1 will charge through resistor R1.
- When C1 has charged to a potential of approximately 2 volts, the clear input thinks it is HIGH, so the FF will force Q LOW.
- The period that Q was HIGH, i.e., the period of the

one-shot, is determined by the time constant of R1C1 and the potentials of the Q output and the point at which the clear input thinks that it is HIGH instead of LOW.

The circuit in Fig. 2(a) uses a diode (D1) across the timing resistor (R1) to discharge C1 during the period when Q is LOW. This diode is not strictly necessary but serves to speed up the circuit considerably. Without D1, the charge on capacitor C1 would bleed off through R1. But this would require another R1C1 time constant (or so) before the voltage across C1 would discharge enough to permit retriggering of the one-shot. The purpose of D1 is to discharge C1 rapidly so that retriggering can occur almost immediately after Q drops LOW—see the waveform in Fig. 2(b).

The use of D1 creates a little problem, however.

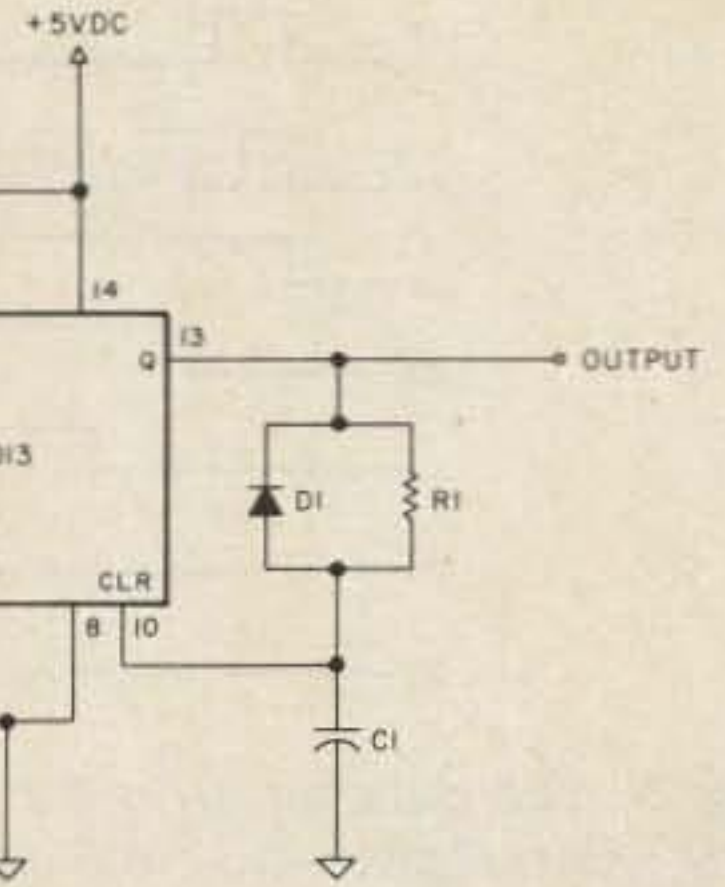

Fig. 2(a). A CMOS flip-flop is the basis for this monostable multivibrator. R1 and C1 determine the length of the pulse. D1 allows the flip-flop to be retriggered immediately after clearing.

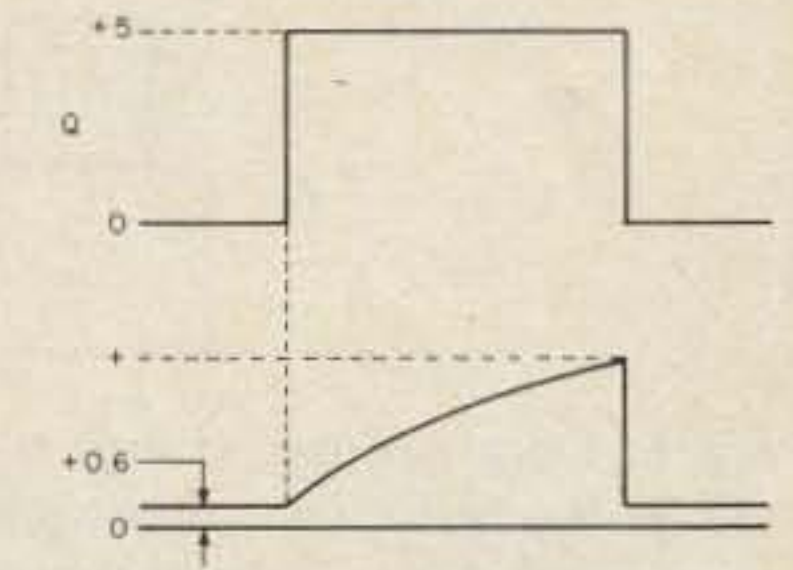

Fig. 2(b). The potential across C1 never drops below 0.6 volts because of the presence of D1.

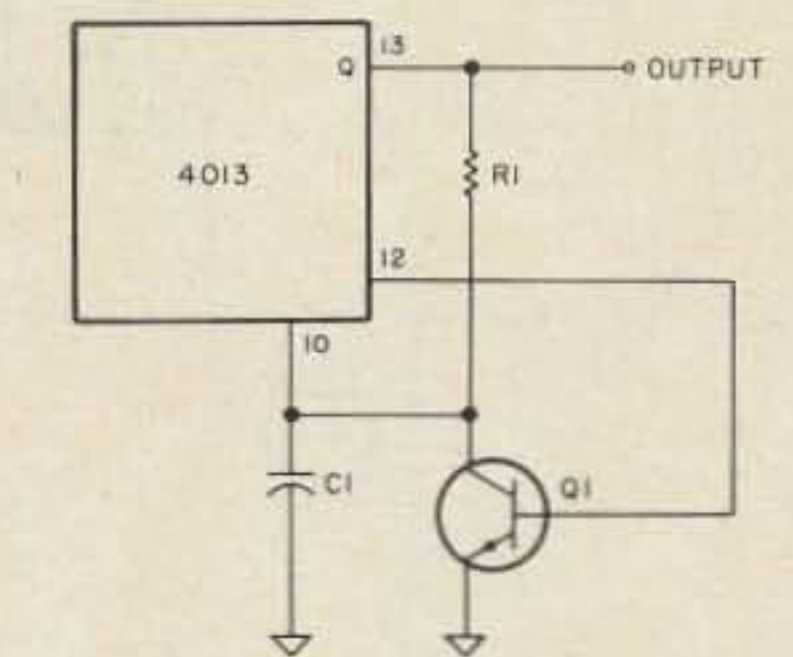

Fig. 3. Monostable multivibrator. The diode in Fig. 2(a) is eliminated by using Q1 to discharge C1.

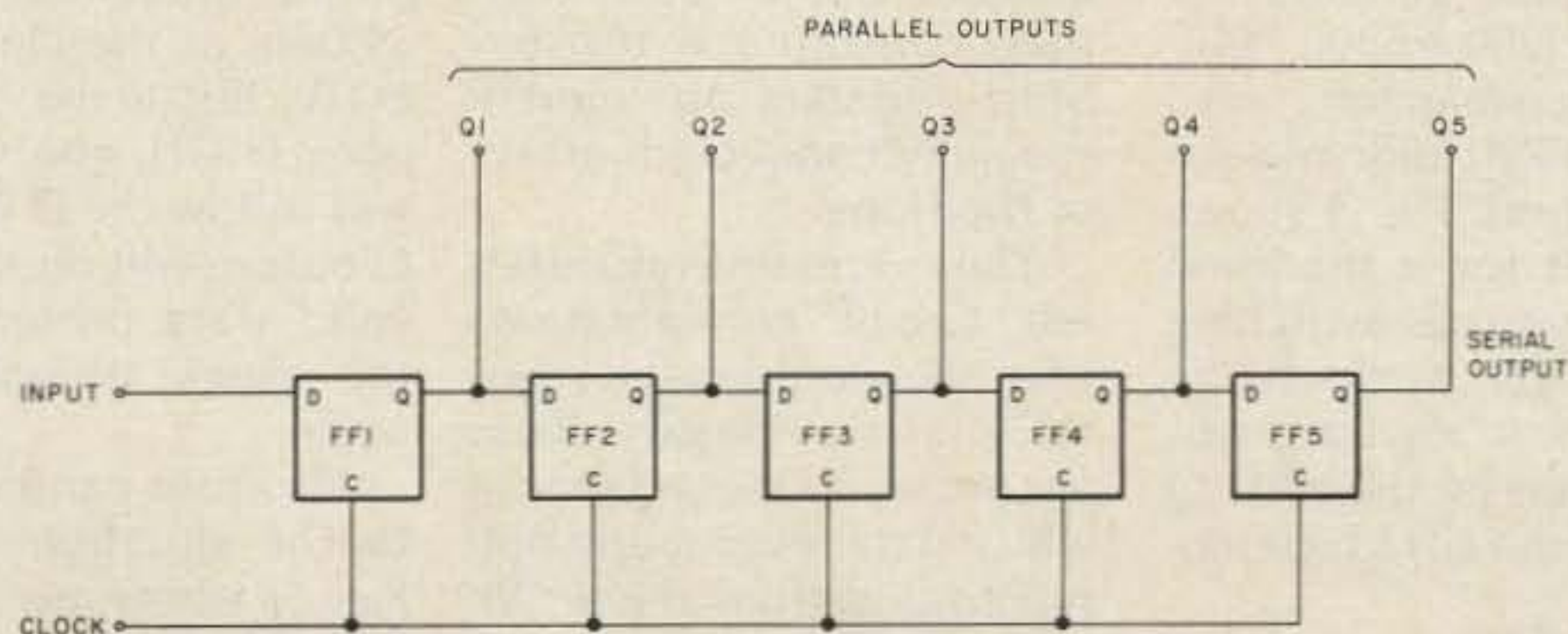

Fig. 4. Flip-flops can be combined in series to form a register which can store several bits of data. This version has serial input and either serial (SISO) output or parallel (SIPO) output.



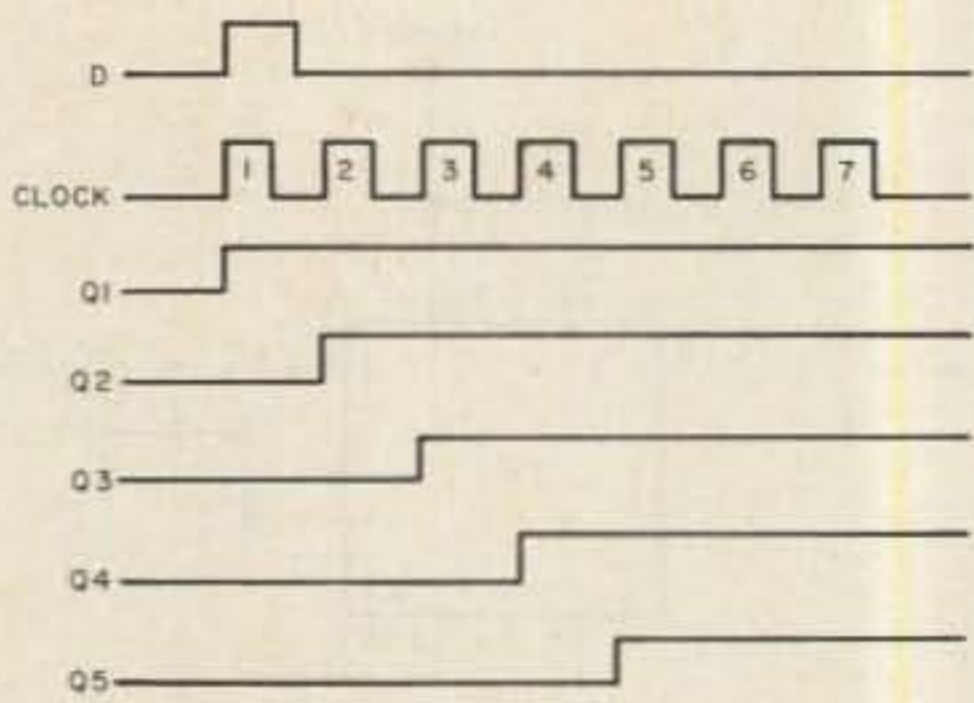

Fig. 5. The data bit (0) is transmitted through a five-stage SISO shift register by clocking the register five times.

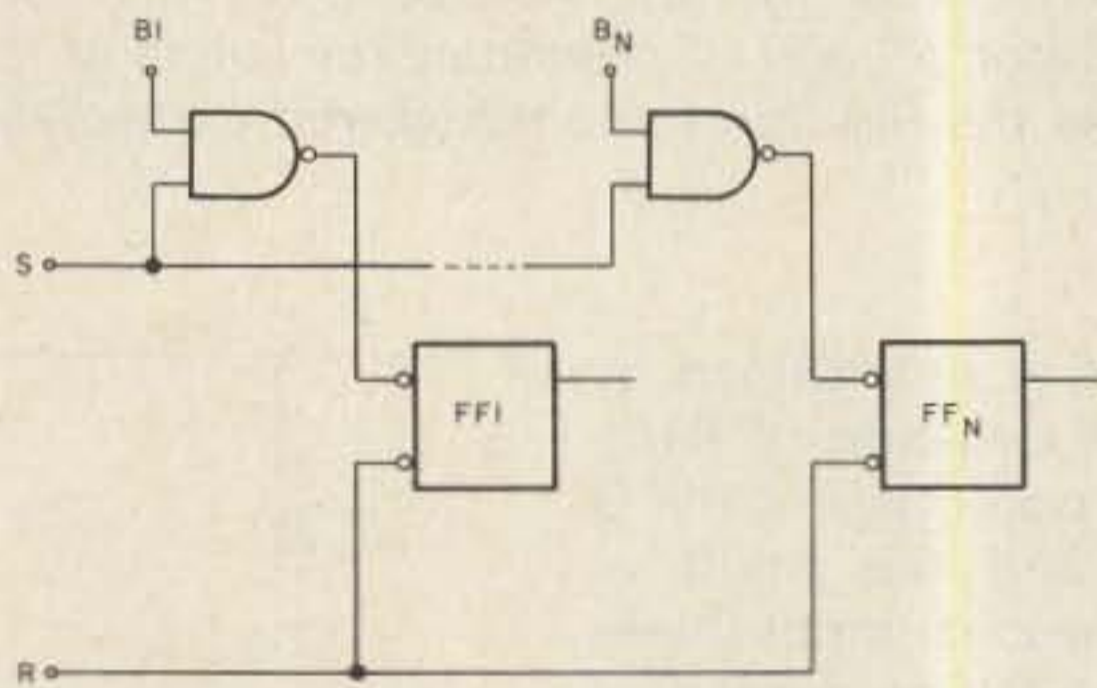

Fig. 6. Data is entered into this parallel-entry shift register via  $B_1$ - $B_N$ . Before entry, the register is reset via  $R$ . The data is then loaded by bringing the set line ( $S$ ) HIGH.

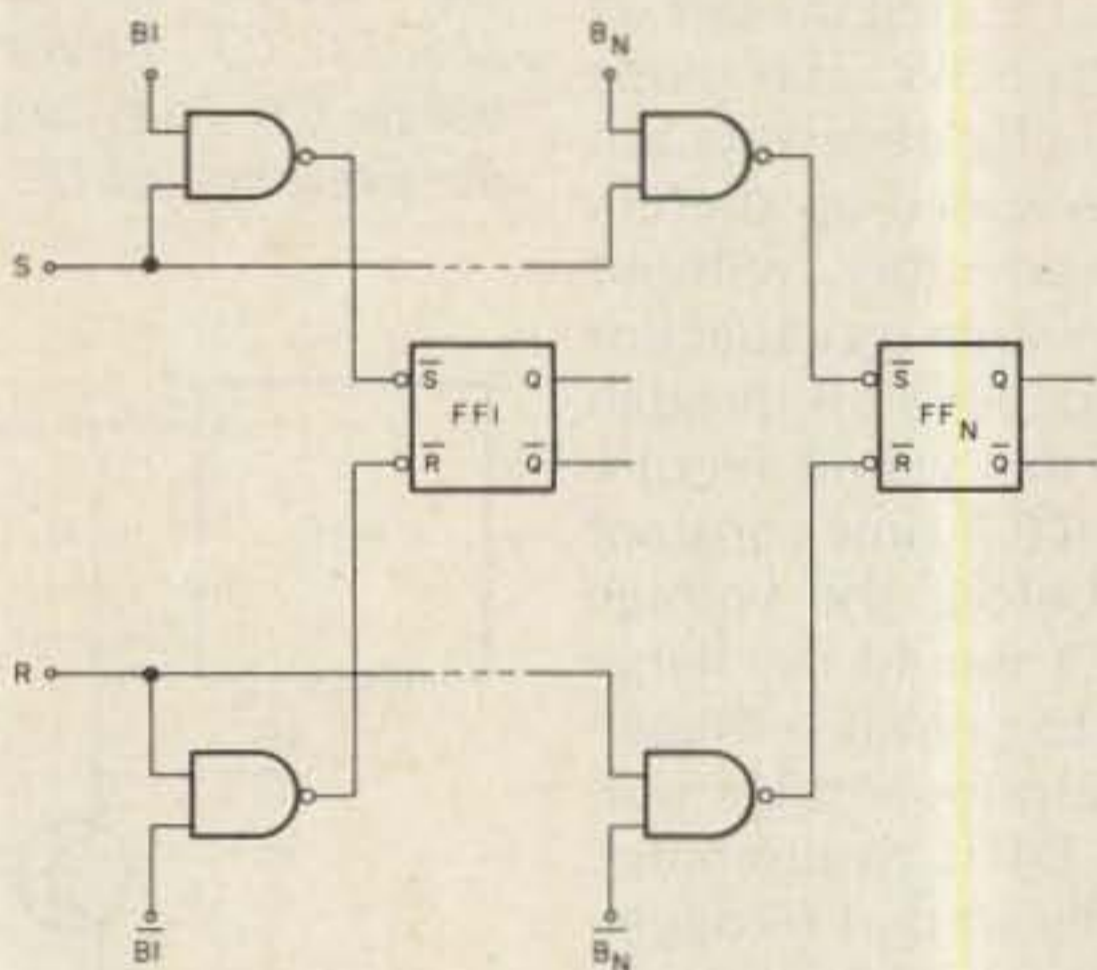

Fig. 7. The jam parallel-input shift register eliminates the need to clear the registers.

The charge potential across  $C_1$  cannot drop lower than the function potential of the diode (200 to 300 millivolts in germanium types and 600 to 700 millivolts for silicon types). Fig. 3 shows the circuit for a modified version that uses switching transistor  $Q_1$  to discharge  $C_1$ . The base of transistor  $Q_1$  is driven by the NOT-Q output of the 4013 flip-flop.

### Shift Registers

A flip-flop is able to store a single bit of digital data.

When two or more flip-flops are organized to store multiple bits of data, then they constitute a register. Most registers are merely specially-connected arrays of flip-flops.

There are several different circuit configurations that one would call a register, and we classify them according to the manner in which data is input and output to and from them. We have, for example, serial-in-serial-out (SISO), serial-in-parallel-out (SIPO), parallel-

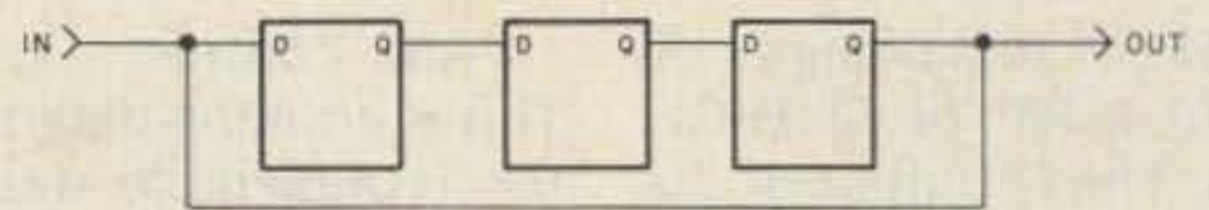

Fig. 8. A recirculating shift register automatically couples the output data back to the input. This is something like a dog chasing its tail.

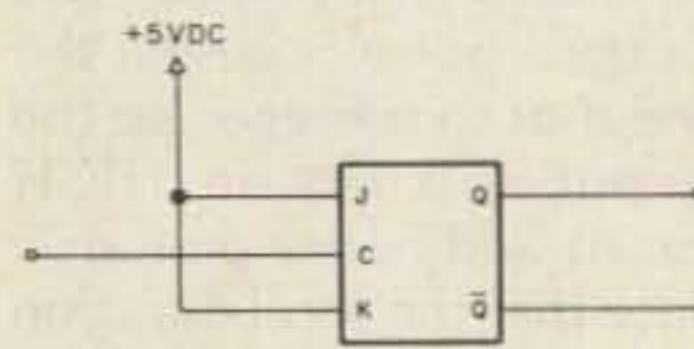

Fig. 9(a). The core of most frequency counters is the J-K flip-flop configuration. In this case, the J and K inputs are both tied HIGH.

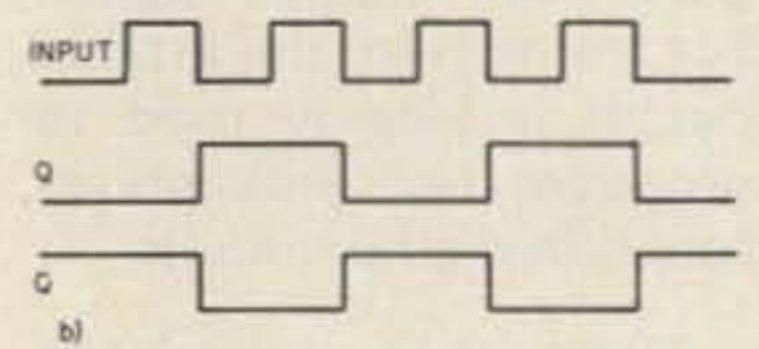

Fig. 9(b). A single J-K flip-flop is a divide-by-two counter.

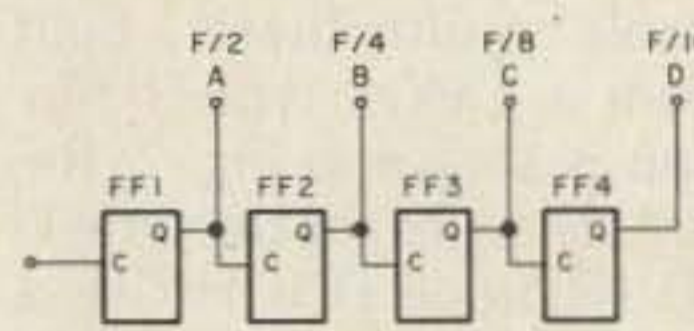

Fig. 10(a). By cascading several J-K flip-flops, the division ratio increases by powers of two.

in-parallel-out (PIPO), and parallel-in-serial-out (PISO).

Fig. 4 represents both SISO and SIPO shift registers. The only significant difference is that the parallel output lines, used on the SIPO register, would be absent on the SISO register.

The SIPO shift register consists of a cascade chain of type-D flip-flops that have their clock lines connected together. Recall the rules for type-D flip-flops: Data can be transferred from the D input to the Q output only when the clock input is HIGH. The input can change at will and the output will remain the same as long as the clock line is LOW. But if the clock line goes HIGH, the Q output will follow the D input. The Q output will retain the last valid data present before the clock dropped LOW again.

This rule can be applied to the situation shown in Fig. 5, where we show the transmission of a single bit of data from left to right through a SISO shift regis-

ter. At the occurrence of the first clock pulse, the input line is HIGH. This point is the D input of FF1, so a HIGH, which is applied to the D input of the second flip-flop (FF2), remains after the clock pulse disappears.

When the second clock pulse arrives, FF2 sees a HIGH on its D input and FF1 sees a LOW on its D input. This situation causes a LOW at Q1 and a HIGH at Q2.

The third clock pulse sees a LOW condition on the D inputs of FF1 and FF2 and a HIGH at the input of FF3. The third clock pulse, then, causes Q1 and Q2 to be LOW and Q3 to be HIGH.

Note that the SISO input remains LOW after the initial HIGH during clock pulse number 1. This means that the single HIGH condition will be propagated through the entire SISO shift register, one stage at a time. The HIGH bit will shift one flip-flop to the right each time a clock pulse arrives.

If the data at the input had changed, then the bit pattern at that input would be propagated through the shift register.

The shift register in Fig. 4 is a five-bit, or five-stage, register (any bit length could be selected). On the sixth clock pulse, therefore, the HIGH is propagated out of the register, so all flip-flops are now LOW.





# ICOM

# - Check the Big Savings at AES!

## SAVE \$\$ - HF Equipment



IC-720A 9-band Xcvr (Reg. \$1349) .. **SALE \$1149.00**  
 FL-32 500Hz CW filter ..... 59.50  
 FL-34 5.2 KHz AM filter..... 49.50



IC-730 8-band Xcvr (Reg. \$829)..... **SALE \$649.95**  
 FL-30 SSB filter (passband tuning) ..... 59.50  
 EX-195 Marker unit ..... 39.00  
 EX-202 LDA interface; 730/2KL/AH-1..... 27.50  
 EX-203 150 Hz CW audio filter..... 39.00  
 EX-205 Transverter switching unit ..... 29.00



IC-740 9-band Xcvr (Reg. \$1099)..... **SALE \$979.95**  
 EX-238 Internal power supply..... TBA  
 EX-241 Marker unit..... TBA  
 EX-242 FM unit..... TBA  
 EX-243 Electronic keyer unit..... TBA  
 EX-54 9 MHz 500 Hz filter ..... TBA  
 EX-52 455 KHz 500 Hz CW filter..... TBA  
 EX-53 455 KHz 250 Hz CW filter..... TBA

### Accessories common to IC-720/730/740

PS-15 Power supply (Reg. \$149)..... **SALE \$134.95**  
 CF-1 Cooling fan for PS-15 ..... 45.00  
 EX-144 Adaptor for CF-1 on PS-15..... 6.50  
 PS-20 20A power supply (Reg. \$229) .. **SALE 199.95**  
 CF-1 Cooling fan for PS-20..... 45.00  
 Adaptor cable; PS-20 to 720/730/740 ..... 10.00  
 FL-44 SSB filter; 730/740 (Reg. \$159) **SALE 144.95**  
 FL-45 500 Hz CW filter; 730/740 ..... 59.50  
 SM-5 Electret desk microphone ..... 39.00  
 HM-10 Scanning mobile mic; 730/740 ..... 39.50  
 SP-3 Base station speaker ..... 49.50  
 MB-5 Mobile mount; 720A/730..... 19.50  
 Phone patch; specify radio (Reg. \$139) **SALE 129.95**  
 AH-1 Mobile ant./tuner (Reg. \$289) .... **SALE 259.95**  
 AT-100 100w auto. tuner (Reg. \$349) .. **SALE 314.95**  
 AT-500 500w auto. tuner (Reg. \$449) .. **SALE 399.95**  
 IC-2KL Solid-state linear (Reg. \$1795) **SALE \$1395.00**  
 IC-R70 Gen. cov. receiver (Reg. \$795) **SALE \$699.95**

## SAVE \$\$ - VHF/UHF



IC-251A 2m All-mode Xcvr. 144.8-148.1999 MHz. 10w, digital, memories, scan, 2 VFOs 13.8vdc/117vac. 4 1/2" h x 9 1/4" w x 10 1/2" d, 11 lbs (Reg. \$749) ... **SALE \$599.95**  
 IC-451A UHF All Mode Transceiver for OSCAR mode B or J & simplex. Models for 430-440 or 440-450 MHz. Similar to IC-251A (Regular \$899)..... **SALE \$769.95**  
 IC-AG1 UHF Preamp. (Reg. \$89)..... **SALE 79.95**  
 IC-551D 6m SSB/CW/FM\* transceiver, 50-53.999 MHz. 80 watts. (Reg. \$699)..... **SALE \$599.95**  
 EX-106\* FM adaptor (Reg. \$125)..... **SALE 112.95**  
 PS-20 AC power supply (Reg. \$229) ... **SALE 199.95**  
 CF-1 Cooling fan; PS-20 ..... 45.00



IC-290A 2m All Mode mobile xcvr. 143.8-148.199 MHz, 1/10w, 5 memories, 2 VFOs, T/T mic. 6 1/2" w x 2 1/2" h x 8 5/8" d. (Reg. \$549) ..... **Closeout \$399.95**  
 IC-290H 25w 2m All Mode (Reg. \$549) **SALE 489.95**  
 IC-490A UHF All Mode mobile xcvr. 430-439.995 MHz, 10w, memories, two VFOs, scanning microphone. 2 1/2" h x 6 5/8" w x 8 5/8" d (Reg. \$649) .... **SALE \$579.95**  
 IC-560 6m SSB/FM/CW mobile xcvr. 10w, digital, memories, scan, two VFOs 13.8vdc/3.5A. 2 1/2" h x 7 1/4" w x 9" d, 6 lbs. Mic. & mt. (Reg. \$489) ... **SALE \$439.95**

IC-25A Compact 2m FM mobile xcvr. 25w, 5 memories, scan, priority, 2 VFOs, T/T microphone. 2" h x 5 1/2" w x 7" d, 3 1/4 lbs. (Reg. \$349) ..... **SALE \$309.95**  
 IC-45A 440-450 mobile xcvr ..... TBA  
 IC-22U 2m mobile. 1/10w, thumbwheel freq. select. 6 1/2" w x 2 1/2" h x 8 1/2" d. (Reg. \$299)..... **SALE \$249.95**  
 EX-199 Remote frequency selector..... 35.00

### VHF/UHF Portables:

IC-202S 2m SSB Transceiver. 3w PEP output. Uses "C" cells, optional Nicad pack/charger or AC supply/spkr. With mic., ant. & strap (Reg. \$279)..... **SALE \$249.95**  
 IC-20L 2m, 10w ampl. (Reg. \$98).... **SALE 89.95**  
 IC-402 432 MHz portable SSB Transceiver. Features same as IC-202S above (Reg. \$389).... **SALE 349.95**  
 IC-30L 10w, 432 amp. (Reg. \$105).... **SALE 94.95**  
 BC-15 Nicads & AC chgr for 202S/402..... 57.50  
 BC-20 Nicads & DC-DC chgr for 202S/402..... 57.50  
 IC-505 6m SSB port. (Reg. \$449)..... **SALE 399.95**  
 FM module ..... 49.95  
 Internal nicad battery pack ..... 79.50  
 AC charger..... 12.50  
 SP4 Remote speaker for portables..... 24.95



## SAVE \$30

IC-2AT Synthesized 2m FM Hand-held with T/T pad. 800 ch. in 5 KHz steps. 144-147.995, selected by thumb wheels & +5 KHz upshift switch; ± 600 KHz offsets. 15 or 1.5w output with supplied nicad pack. Optional packs for larger capacity or higher power. Supplied with 250 ma. nicad pack (BP-3), wall charger, flex antenna, belt clip, strap, earphone and plugs. 6.6" h x 2.6" w x 1.4" d, 1 lb.

Hand-held Transceivers	Regular	SALE
IC-2AT HT w/TTP, nicad & chgr ....	\$269.50	\$239.50
IC-2A 2m HT w/nicad & wall chgr ....	239.50	214.50
IC-3AT 220 HT/TTP, nicad & chgr ....	299.95	239.95
IC-3A 220 HT/nicad & charger.....	269.00	229.95
IC-4AT 440 HT/TTP, nicad & chgr ....	299.00	239.95
IC-4A 440 HT/nicad & charger.....	269.00	229.95
Hand-held accessories	Regular	SALE
BC-25U Extra wall charger.....		\$12.50
BC-30 Drop-in charger for BP-2, 3 & 5 .....		69.00
BP-2* 450 ma, 7.2v nicad pk, 1w output.....		39.50
BP-3 Extra 250 ma nicad pk, 1.5w output.....		29.50
BP-4 Alkaline battery case.....		12.50
BP-5* 450 ma, 10.8v nicad pk, 2.3w output.....		49.50
*BC-30 required to charge BP-2 & BP-5		
CP-1 Cig lighter plug & cord; BP-3 .....		9.50
DC-1 DC operation module.....		17.50
FA-2 Flexible antenna for 2A, 2AT (BNC).....		10.00
HM-9 Speaker/microphone.....		34.50
LC-2A Leather case w/o TTP cut-out.....		34.95
LC-2AT Leather case w/TTP cut-out.....		34.95
ML-1 2m mobile linear (Reg \$89) .....	<b>SALE</b>	79.95
3A-TTN 16-button TTP front; 2A/3A/4A.....		39.50
Commspec SS-32M 32-tone encoder.....		29.95
IC-M12 12ch. Marine Hand-held.....	<b>Special</b>	\$229.95

Other ICOM accessories:

24PP 24-pin accessory plug.....	\$ 4.00
BC-10A Mem. back-up; 25A/720A/730/740.....	9.50
BU-1 Memory back-up; 25A/490A.....	38.75
EX-2 Relay box w/marker; 720A/730.....	34.00
HM-3 Deluxe mobile mic, specify radio.....	17.50
HM-5 Noise canx mobile mic, 4 pin .....	34.50
HM-7 Amplified mobile mic, 8-pin .....	29.00
HM-8 Touch-tone mic, 8-pin.....	49.50
HM-10 Scanning microphone .....	39.50
HP-1 Headphones.....	34.50
SM-5 8-pin electret desk mic.....	39.00

All Sale Prices subject to change without notice.



## AES STORE HOURS

Mon. thru Fri. 9-5:30; Sat. 9-3

## E-X-P-A-N-D-E-D WATS HOURS

Milwaukee WATS line answered until 8 pm Mon. thru Thurs.

Please use WATS line for Placing Orders. For other information, etc. please use Regular line.

# Order Toll Free: 1-800-558-0411

In Wisconsin (outside Milwaukee Metro Area) 1-800-242-5195

# AMATEUR ELECTRONIC SUPPLY<sup>®</sup> Inc.

4828 W. Fond du Lac Avenue; Milwaukee, WI 53216 - Phone (414) 442-4200

## AES BRANCH STORES

**WICKLIFFE, Ohio 44092**  
 28940 Euclid Avenue  
 Phone (216) 585-7388  
 Ohio WATS 1-800-362-0290

**ORLANDO, Fla. 32803**  
 621 Commonwealth Ave.  
 Phone (305) 894-3238  
 Fla. WATS 1-800-432-9424

**CLEARWATER, Fla. 33515**  
 1898 Drew Street  
 Phone (813) 461-4267  
 No In-State WATS

**LAS VEGAS, Nev. 89106**  
 1072 N. Rancho Drive  
 Phone (702) 647-3114  
 No In-State WATS

**CHICAGO, Illinois 60630**  
 ERICKSON COMMUNICATIONS  
 5456 N. Milwaukee Avenue  
 Phone (312) 631-5181

Outside Ohio 1-800-321-3594

Outside Florida 1-800-327-1917

No Nationwide WATS

Outside Nevada 1-800-634-6227

Outside Illinois 1-800-621-5802



The SISO shift register can be made into a SIPO device by adding parallel output lines at Q1, Q2, Q3, Q4, and Q5.

One use for the SIPO register is serial-to-parallel binary-code conversion. For economic reasons, digital data usually is transmitted as a serial stream of bits, i.e., the bits of the digital word are sent over a communications link. But most computers and other digital instruments use a parallel form of data entry. Parallel data transfer is more expensive but is considerably faster than serial transmission. If, for example, we have an eight-bit system, we would need an eight-stage SIPO shift register to convert the serial code to parallel form. The code is entered into the SIPO register one bit at a time so that after eight clock pulses the first bit will appear at Q8 and the last bit at Q1.

Parallel-entry shift registers are faster to load than serial-input shift registers. This is because a single bit can be changed, if needed. In the serial type, to change a single bit of data requires us to ripple through the entire contents.

There are two basic forms of parallel data entry: *parallel* and *jam*. In parallel entry, shown in the partial schematic of Fig. 6, the register must first be cleared (i.e., all bits set to zero) by bringing the *reset* line momentarily LOW. The data that is applied to inputs B1 through B<sub>n</sub> can be loaded into the register by momentarily bringing the *set* line HIGH.

The *jam* entry circuit shown in the partial schematic of Fig. 7, is also able to load data from bits B1 through B<sub>n</sub>. While *jam* entry may not look superior at first glance, it is, because IC shift registers using this technique have internal inverter stages at the complement inputs. These have their inputs connected to

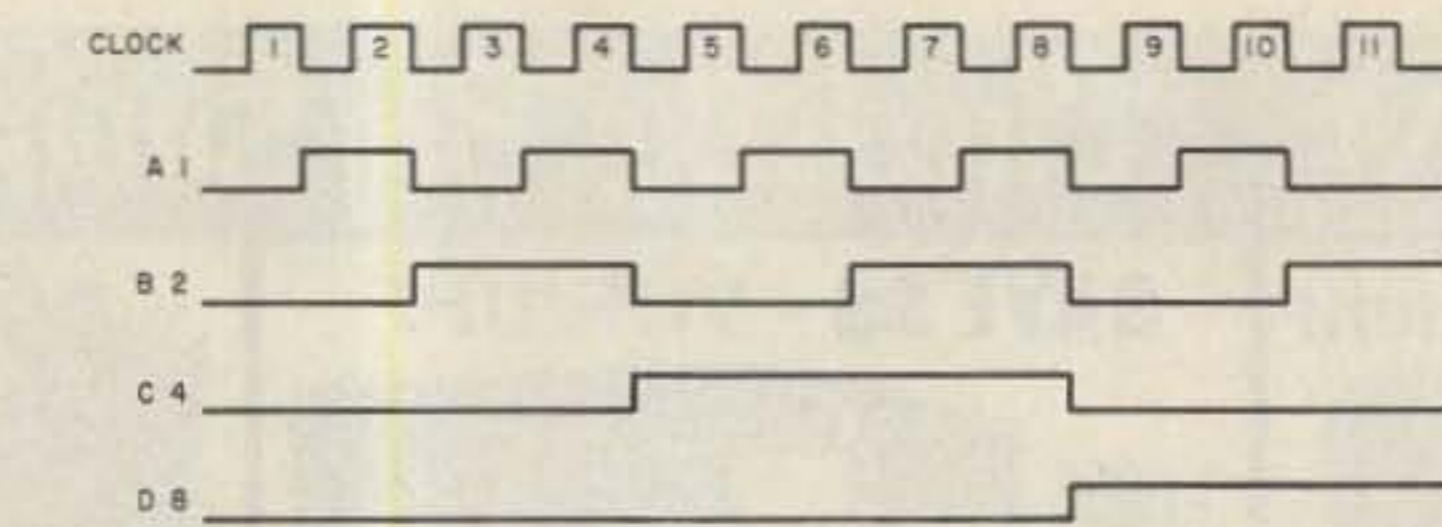

Fig. 10(b). A modulo-16 ripple counter has four outputs.

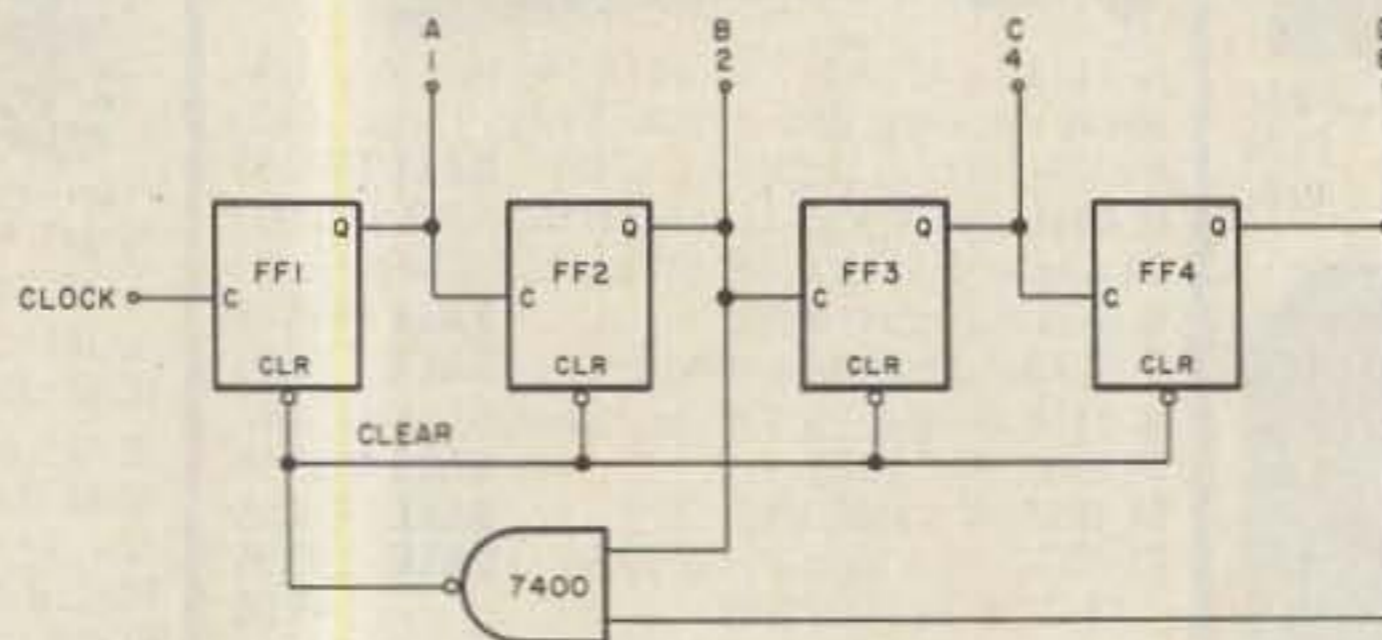

Fig. 11(a). A counter can have something other than a divide-by-two ratio when the flip-flops are forced to reset. The 7400 turns a divide-by-sixteen counter into a divide-by-ten circuit.

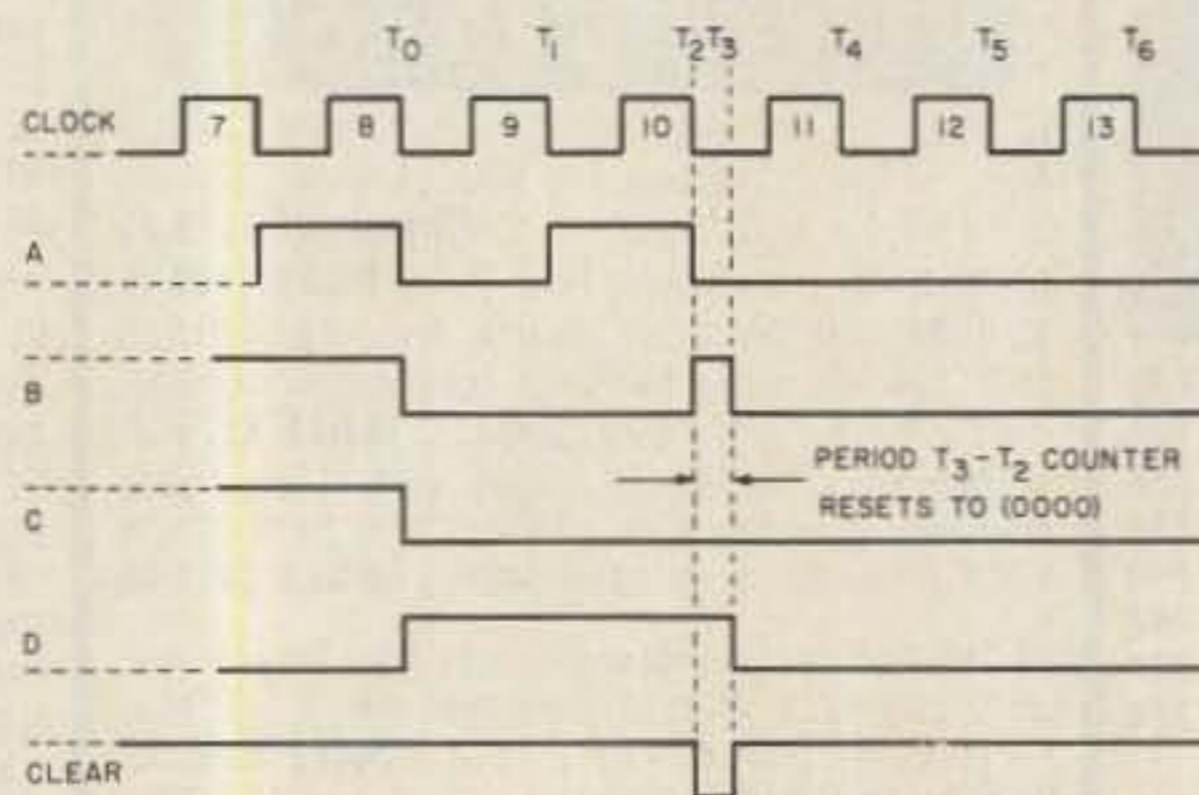

Fig. 11(b). After ten pulses, the counter resets. The result is a decimal-based counter.

the non-complemented inputs, eliminating the need to clear the register before loading.

A recirculating shift register is shown in Fig. 8. Since the output of a serial shift register allows the outside world to see only one bit at a time, we must empty the entire contents of the shift register in order to read these contents. But that would ordinarily destroy the data, because the input would be HIGH or LOW during the entire operation. A single-read operation, then, would fill up the register with all ones or zeros. The recirculating shift register connects the output (serial output) back to the in-

put, so that a read operation would automatically rewrite the data back into the shift register.

### Digital Counters

A *digital counter* is a device or circuit that operates as a *frequency divider*. The most basic digital counter is the J-K flip-flop connected with the J and K inputs tied HIGH (i.e., placed in the clocked mode). This makes the output produce one output pulse for every two input pulses. It is, then, a binary or divide-by-two counter.

Those fancy digital frequency/period counters are nothing more than digital divide-by-10 counters con-

nected so that the binary-coded output is converted to a decimal display.

There are two basic classes of digital counter circuits, serial and parallel. The serial counters are called ripple counters because a change in the input must ripple through all stages of the counter to its proper point. Parallel counters also are called synchronous counters.

In a ripple counter, the data is transferred serially, which means that the output of one stage becomes the input of the next stage.

The basic element in most counters is the J-K flip-flop. See Fig. 9(a). Note in the figure that the J and K inputs are permanently tied HIGH, so they will remain active.

A timing diagram for this divide-by-two circuit is shown in Fig. 9(b), and it shows the action of the circuit. J-K FF outputs change state on negative-going transitions of the clock pulse. In Fig. 9(b), the first negative-going transition causes the Q output to go HIGH. Q will remain HIGH until the input sees another negative-going clock pulse. At that time, the output will drop LOW. The action required to make a complete output requires two clock pulses, so this J-K flip-flop is dividing the input frequency by two.

We can make a binary ripple counter by cascading two or more stages, as shown in Fig. 10(a). This particular circuit uses four J-K FFs in cascade. Any number, however, could be used.

The major problem with this type of counter is that only those division ratios that are powers of two can be accommodated. In the four-stage circuit shown, the possible division ratios are 2, 4, 8, and 16.

Frequency division is one major use for a counter circuit. In some electronic instruments, for example, we may want to prescale a fre-



# MFJ ANTENNA TUNERS <sup>16</sup> MODELS

## MFJ-941C 300 Watt Versa Tuner II

Has SWR/Wattmeter, Antenna Switch, Balun. Matches everything 1.8-30 MHz: dipoles, vees, random wires, verticals, mobile whips, beams, balanced lines, coax lines.



Ham Radio's most popular antenna tuner. Improved, too.

**\$89<sup>95</sup>**  
(+ \$4)

Fastest selling MFJ tuner . . . because it has the most wanted features at the best price.

Matches everything from 1.8-30MHz: dipoles, inverted vees, random wires, verticals, mobile whips, beams, balanced and coax lines.

Run up to 300 watts RF power output.

SWR and dual range wattmeter (300 & 30 watts full scale, forward/reflected power). Sensitive meter measures SWR to 5 watts.

Flexible antenna switch selects 2 coax lines, direct or through tuner, random wire/balanced line, or tuner bypass for dummy load.

12 position efficient airwound inductor for lower losses, more watts out.

Built-in 4:1 balun for balanced lines. 1000V capacitor spacing.

Works with all solid state or tube rigs.

Easy to use, anywhere. Measures 8x2x6", has

SO-239 connectors, 5-way binding posts, finished in eggshell white with walnut-grained sides.

4 Other 300W Models: MFJ-940B, \$79.95 (+ \$4), like 941C less balun. MFJ-945, \$79.95 (+ \$4), like 941C less antenna switch. MFJ-944, \$79.95 (+ \$4), like 945, less SWR/Wattmeter. MFJ-943, \$69.95 (+ \$4), like 944, less antenna switch. Optional mobile bracket for 941C, 940B, 945, 944, \$3.00.

### MFJ-900 VERSA TUNER



MFJ-900

**\$49<sup>95</sup>**  
(+ \$4)

Matches coax, random wires 1.8-30 MHz.

Handles up to 200 watts output; efficient airwound inductor gives more watts out. 5x2x6".

Use any transceiver, solid-state or tube.

Operate all bands with one antenna.

2 OTHER 200W MODELS:

MFJ-901, \$59.95 (+ \$4), like 900 but includes 4:1 balun for use with balanced lines.

MFJ-16010, \$39.95 (+ \$4), for random wires only. Great for apartment, motel, camping, operation. Tunes 1.8-30 MHz.

### MFJ-949B VERSA TUNER II



MFJ-949B

**\$139<sup>95</sup>**  
(+ \$4)

MFJ's best 300 watt Versa Tuner II.

Matches everything from 1.8-30 MHz, coax, randoms, balanced lines, up to 300W output, solid-state or tubes.

Tunes out SWR on dipoles, vees, long wires, verticals, whips, beams, quads.

Built-in 4:1 balun. 300W, 50-ohm dummy load. SWR meter and 2-range wattmeter (300W & 30W).

6 position antenna switch on front panel, 12 position air-wound inductor; coax connectors, binding posts, black and beige case 10x3x7".

### MFJ-962 VERSA TUNER III



MFJ-962

**\$229<sup>95</sup>**  
(+ \$10)

Run up to 1.5 KW PEP, match any feed line from 1.8-30 MHz.

Built-in SWR/Wattmeter has 2000 and 200 watt ranges, forward and reflected.

6 position antenna switch handles 2 coax lines (direct or through tuner), wire and balanced lines.

4:1 balun. 250 pf 6KV cap. 12 pos. inductor. Ceramic switches. Black cabinet, panel.

ANOTHER 1.5 KW MODEL: MFJ-961, \$189.95 (+ \$10), similar but less SWR/Wattmeter.

MFJ-10, 3 foot coax with connectors, \$4.95.

### MFJ-984 VERSA TUNER IV

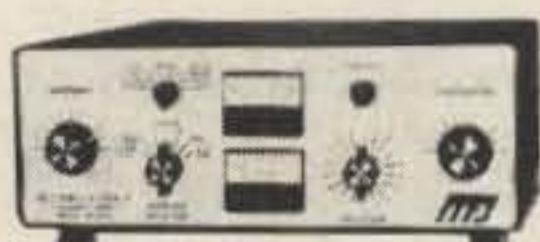

MFJ-984

**\$329<sup>95</sup>**  
(+ \$10)

Up to 3 KW PEP and it matches any feedline, 1.8-30 MHz, coax, balanced or random.

10 amp RF ammeter assures max. power at min. SWR. SWR/Wattmeter, for./ref., 2000/200W.

18 position dual inductor, ceramic switch.

7 pos. ant. switch. 250 pf 6KV cap. 5x14x14".

300 watt dummy load. 4:1 ferrite balun.

3 MORE 3 KW MODELS: MFJ-981, \$239.95 (+ \$10), like 984 less ant. switch, ammeter.

MFJ-982, \$239.95 (+ \$10), like 984 less ammeter, SWR/Wattmeter. MFJ-980, \$209.95 (+ \$10), like 982 less ant. switch.

### MFJ-989 VERSA TUNER V



MFJ-989

**\$329<sup>95</sup>**  
(+ \$10)

New smaller size matches new smaller rigs — only 10-3/4Wx4-1/2Hx14-7/8D".

3 KW PEP. 250 pf-6KV caps. Matches coax, balanced lines, random wires 1.8-30 MHz.

Roller inductor, 3-digit turns counter plus spinner knob for precise inductance control to get that SWR down.

Built-in 300 watt, 50 ohm dummy load.

Built-in 4:1 ferrite balun.

Built-in lighted 2% meter reads SWR plus forward/reflected power. 2 ranges (200 & 2000W).

6 position ant. switch. Al. cabinet. Tilt bail.

To order or for your nearest dealer

CALL TOLL FREE **800-647-1800**  

For tech. info., order or repair status, or calls outside continental U.S. and inside Miss., call 601-323-5869.

All MFJ products unconditionally guaranteed for one year (except as noted).

Products ordered from MFJ are returnable within 30 days for full refund (less shipping).

Add shipping & handling charges in amounts shown in parentheses.

Write for FREE catalog, over 80 products

**MFJ ENTERPRISES, INCORPORATED**

Box 494, Mississippi State, MS 39762



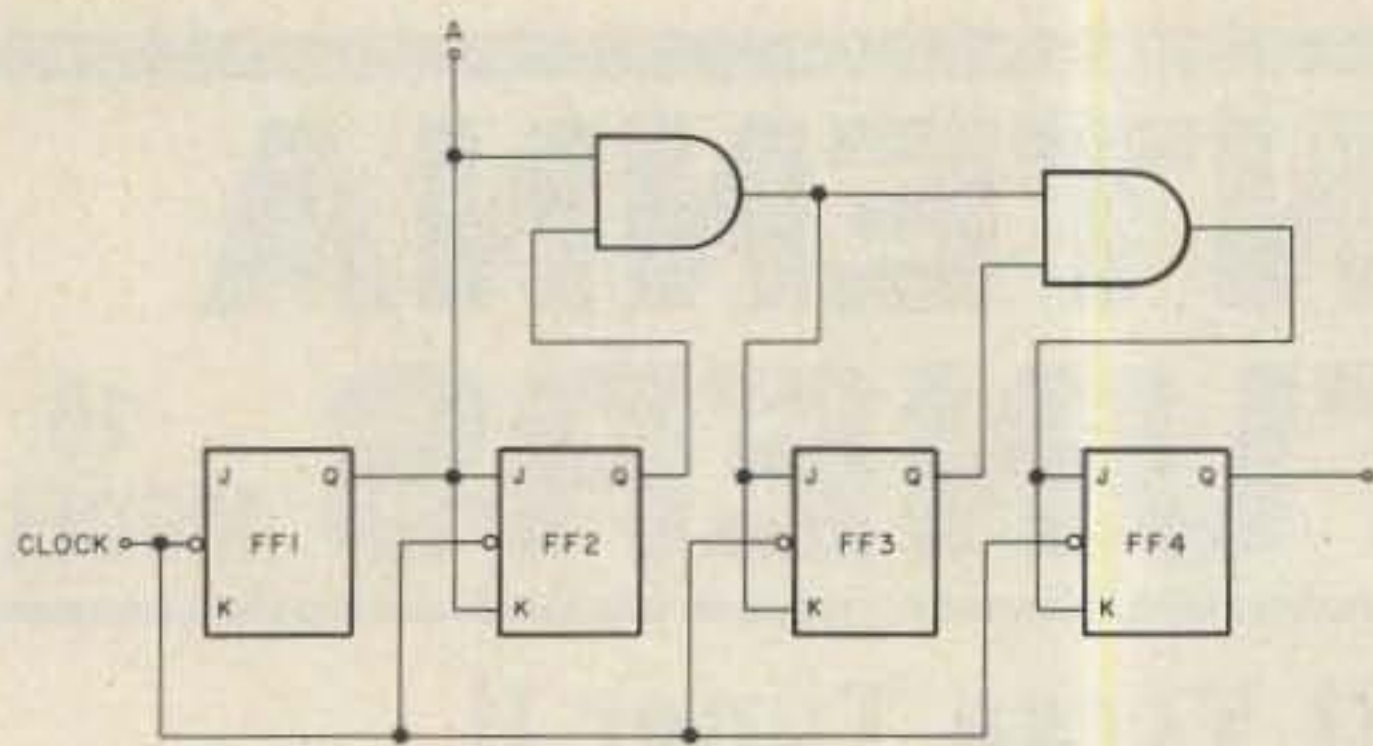

Fig. 12. By feeding the clock inputs in parallel, a synchronous counter becomes much faster than the ripple version.

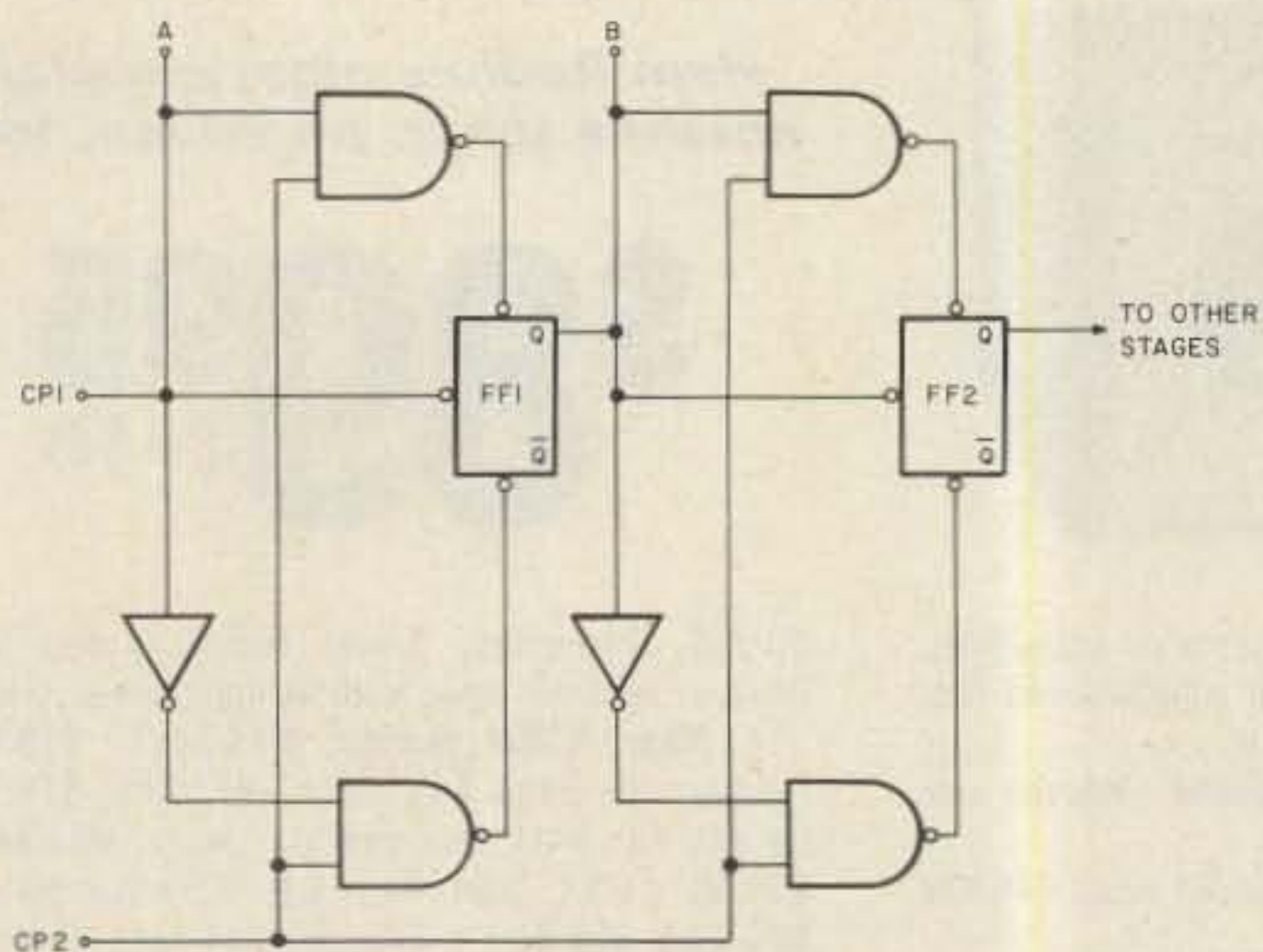

Fig. 13. A preset counter can be made by using a jam input. When CP2 is raised HIGH, a preset bit pattern is entered.

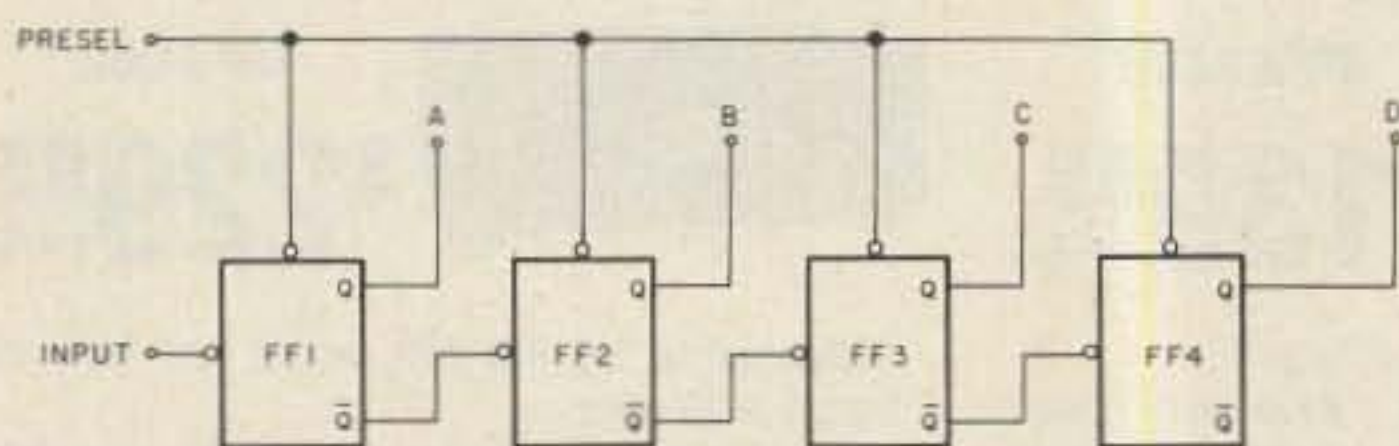

Fig. 14(a). A counter can count down by toggling each flip-flop with the preceding stage's Q output.

quency, i.e., divide it from some other frequency to a lower frequency that can be handled by a digital counter or other digital instrument.

But this is only one application for the counter circuit. One of the most common applications, alluded to in the last paragraph, is to *count*, i.e., tell us the total number of pulses that passed. Consider again the circuit of Fig. 10(a) and the timing diagram of Fig. 10(b). Outputs A, B, C, and D are coded in binary, with A being the least significant bit and D the most significant.

These are weighted in a 1-2-4-8 code system to represent decimal digits 0 to 9 or hexadecimal digits 0 to 15. These are the normal weights of the binary number system.

Consider the timing diagram of Fig. 10(b). Note that all B output changes occur following the arrival of a pulse. After pulse number one has passed, the  $Q_A$  line is HIGH and all others are LOW. This means that the binary word on the output lines is  $0001_2$  (i.e.,  $1_{10}$ ); one pulse has passed.

Following pulse number 2 we would expect  $0010_2$

(i.e.,  $2_{10}$ ) because two pulses have passed. Note that  $Q_B$  is HIGH and all others are LOW. The digital word is, indeed,  $0010_2$ .

The counter in Fig. 10(a) is called a *modulo-16*, or *base-16*, counter, or a *hexadecimal* counter (all meaning the same thing). The output of a *hexadecimal* counter can be decoded to drive a display device that indicates 0 through 9 (i.e., decimal) or 0 through F (hexadecimal). In most applications where a real, live, human is to read the display, a *decimal* readout is provided.

**Decimal Counters.** A decimal counter operates in the *base-10*, or *decimal*, number system. The most significant bit of a decimal counter produces one output pulse for every ten input pulses. Decimal counters are also sometimes called *decade* counters. The decimal counter forms the basis for digital event, period, and frequency counters. Thus, the hexadecimal counter in Fig. 10 is not suitable for decimal counting unless it is modified for base-10 operation.

Fig. 11 shows a TTL hex counter modified by adding a single TTL NAND gate. Recall that a TTL J-K FF uses inverted inputs for the clear and set functions. As long as the clear input remains HIGH, the flip-flop will function normally, but when the clear input is momentarily brought LOW, then the Q output of the FF goes LOW.

The decade counter in Fig. 11(a) is connected so that all four clear inputs are tied together to form a common clear line. This line is connected to the output of a TTL NAND gate (i.e., one section of a 7400 device). Recall the rules of operation for the TTL NAND gate: If either input goes LOW, then the output goes HIGH, but if both inputs are HIGH, then the output goes LOW.

The idea behind the circuit of Fig. 11 is to clear the counter to 0000 following the tenth input pulse. Let's examine the timing diagram in Fig. 11(b) to see if the circuit does the correct thing. Up until the 10th pulse, this diagram is the same as for the base-16 counter discussed previously.

The output of the NAND gate will keep the clear line HIGH for all counts through 10. The inputs of this gate are connected to the B and D lines. The D line stays LOW, forcing clear HIGH up until the 8th input pulse has passed. At that time— $T_0$  in Fig. 11(b)—D will go HIGH and bit B drops LOW, so the clear line remains HIGH for the 9th pulse.

The clear line will remain HIGH until the end of the 10th pulse. At that point ( $T_2$ ) both B and D are HIGH, so the NAND gate output drops LOW, clearing all four flip-flops (i.e., forcing them to the state where all four Q outputs are LOW). The counter is therefore reset to 0000.

The reset counter produces a 0000 code, so the B and D outputs are now LOW, forcing the clear line HIGH again. The entire reset cycle occurs during period  $T_1-T_2$ . This period has been expanded greatly for graphic illustration purposes in the figure, but actually takes only nanoseconds or microseconds.

The 11th pulse will increment the counter one time, so the output will be  $0001_2$ . The count sequence, in decimal, then, is 0-1-2-3-4-5-6-7-8-9-0-1... etc. The output code is a ten-digit version of four-bit binary (hexadecimal) and is called *binary-coded decimal*, or BCD.

**Synchronous Counters.** Ripple counters suffer from one major problem: *slow speed*. The counter elements are wired in cascade, so an input pulse must ripple through the entire chain before it affects the output.



# TERMINALL



apple\* + TRS-80\*

## APPLE REVIEW WINDOW

```

0: (FOX TEST) 1: (RY TEST) 2: (COMSG)
3: ( ) 4: ( ) 5: ( )
6: (BRAG) 7: (CONTEST) 8: ( )
9: ( ) : ( ) : (CR / LF)
/ (TIME) ( ) (COUNT)

RCV (NORM) ASCII 110 DYL - A DIDS
170 K - 072 WM ICL 1237.46
THIS IS THE REVIEW WINDOW
IT ALLOWS LOOKING BACK AT HISTORICAL
DATA WHICH HAS SCROLLED OFF THE
SCREEN (SEVEN LINES)

THIS IS THE SHORT DIALOG WINDOW RCV
(NINE LINES)
    
```

**TERMINALL** is a hardware and software system that converts your personal computer into a state of the art communications terminal. Terminall features simple connections to your computer and radio plus sophisticated and reliable software.

### Simplicity

**TERMINALL** was designed from the outset to be easy to connect to your radio and easy to use. Plug into your receiver headphone jack and copy Morse Code or radioteletype (RTTY). Plug into your CW key jack and send Morse Code. Attach a microphone connector and send Baudot or ASCII RTTY using audio tones (AFSK). That's all there is to hooking it up.

The software is loaded into your computer from disk or cassette. Enter your callsign and the time and you will start receiving immediately. No settings or adjustments are necessary to receive Morse Code, it's fully automatic -and it works! You may type your message while receiving or transmitting.

You will be on the air, receiving and transmitting in any mode, in minutes. As we said, **TERMINALL** is simple.

### More for your money.

■ **TERMINALL** has the RTTY terminal unit - demod and AFSK - built in. This results in a lower total cost.

■ **Fantastic Morse reception.** Six stage active filter demodulator copies the weak ones. Auto adaptive Morse algorithm copies the sloppy ones. Received code speed displayed on status line.

■ **Outstanding documentation.** Professionally written, 90 page user manual contains step-by-step instructions.

■ **Built in, separate, multi-stage, active filter RTTY and CW demodulators.** No phase lock loops. RTTY demodulator has 170 and either 425 or 850 Hz shift-

keyboard selectable - and uses either the panel meter or scope outputs for easy tuning. Copy the weak ones. Copy the noisy ones. Copy the fading ones.

■ **Built in crystal controlled AFSK.** Rock stable for even the most demanding VHF or HF applications. A must on many VHF RTTY repeaters.

■ **Built in 110 or 220 volt AC power supply.**

■ **Built in parallel printer driver software.** Simply attach a parallel ASCII printer (e.g. the EPSON MX-80) to your printer port to obtain hardcopy in all modes.

■ **Multi level displays** - allows examining and editing of historical text.

■ **Word wrapping,** word mode editing, diddle, ignore carriage returns, user programmable end of line sequence, adjustable carriage width, multiple user-defined WRU, transmit delay (fixed, none

## TRS-80 NORMAL DISPLAY

```

Line 1
Line 2 (Four line edit window
Line 3 to create text.)
Line 4

RCV (oldest received data)
XMT (transmitted data)
RCV (received data)
XMT (most recent transmitted data)
RCV (most recent received data)
    
```

or auto adaptive), break mode and more!

■ **The all-in-one TERMINALL design** makes it great for use on HF or VHF, Ham, Commercial, SWL or MARS! SWL's: **TERMINALL** may be jumpered for either 425 or 850 Hz reception to copy news and weather services.



15 Day Money Back Trial Period on Factory Direct Orders

### System Requirements

**TERMINALL T1** Communications terminal for the TRS-80 Model I. Requires a Model I TRS-80, 16K RAM and Level II BASIC. Includes software on cassette and disk, assembled and tested hardware and an extensive instruction manual. \$499.

**TERMINALL T3** Communications terminal for the TRS-80 Model III. Requires a Model III TRS-80, 16K RAM and Model III BASIC. Includes software on cassette and disk, assembled and tested hardware and an extensive instruction manual. \$499.

**TERMINALL T2** Communications terminal for the APPLE II. Requires an APPLE II or APPLE II Plus with 48K RAM and disk. Software is provided on disk in DOS 3.2 format; Use MUFFIN utility to convert to DOS 3.3 format. Includes software on disk, assembled and tested hardware and an extensive instruction manual. \$499.

Add \$4.00 shipping U.P.S. reg. delivery - CA residents add 6% sales tax.

**TO ORDER (209) 634-8888 or 667-2888**

We are experiencing telephone difficulties.

Please keep trying.



**MACROTRONICS, inc.®**

1125 N. Golden State Blvd. DEPT. GST  
Turlock, California 95380

\*TRS-80 is a Registered Trademark of Tandy Corp.  
Apple is a Registered Trademark of Apple Computer Inc.  
1 yr. parts & labor limited warranty.

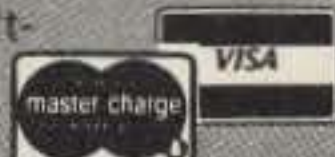

**NEW!**  
**DISK STORAGE & RETRIEVAL**  
Standard on Disk Versions

**The communications terminal that does it all!**



Introducing our Latest Model — NOVAX II  
SIMPLEX / DUPLEX  
AUTOPATCH

NOVAX I

NOVAX II

**NOW TWO MODELS TO SERVE YOU BETTER**  
YOUR OWN PRIVATE AUTOPATCH

**NOVAX**  
MOBILE CONNECTION

NOVAX interfaces your standard 2 meter, 220; 450; etc. Base station and telephone, using a high speed scan switching technique so that you can direct dial from your automobile or with your HT from the backyard or poolside — Automatically ... Easy installation transceivers, featuring solid state switching, offer best results ... Available interfaced with an ICOM 22U.

FEATURES	NOVAX I	NOVAX II
• 3 min. Call duration timer	YES	YES
• Up to 45 sec. activity timer	YES	YES
• Single digit Access Control	YES	NO
• DTMF (Touch Tone)* phone connection	YES	YES
• 4 digit Access Control	NO	YES
• Toll Restrict	NO	YES
• LED Digital Display	NO	YES
• Vinyl covered alum. case size	5" x 6" x 2"	10" x 8" x 1 1/2"
• Directly Interfaces with Repeater	NO	YES
• Rotary Dial System (incl. Last digit dial)	NO	YES—"Option"—\$49.95
• Ring Back (reverse autopatch) "Option"	YES—\$39.95; Kit \$29.95	YES—Wired—\$39.95
• Price	Kit: \$169.95/wired \$219.95	Wired only \$279.95
N.Y.S. Res. add appro. Sales Tax	SHIPPING ADD \$3.50 In U.S.A.	

To order, send check, money order to:  
MASTER CHARGE AND VISA ACCEPTED

CURRENT DEVELOPMENT CORPORATION  
(formerly R.W.D. Inc.)

Box 162 - Tudman Rd.  
Westmoreland, N.Y. 13490  
or Phone 315-829-2785 ✓ 21

\* Trademark ITT

A synchronous counter feeds the clock input to all flip-flops in parallel, and this results in a much faster operation.

Fig. 12 shows a partial schematic for a synchronous binary counter. We accomplish synchronous operation by using four flip-flops, with clock inputs tied together, and a pair of AND gates.

One AND gate is connected so that both Q1 and Q2 are HIGH before FF3 is active. Similarly, Q2 and Q3 must be HIGH before FF4 is made active. On a clock pulse, any of the four flip-flops scheduled to change will do so simultaneously. Synchronous counters attain faster speeds, although ripple counters seem to predominate in most applications.

**Preset Counters.** A preset counter increments from a preset point other than 0000. For example, suppose we wanted to count from

$5_{10}$  (0101<sub>2</sub>). We could preset the counter to 0101 and then increment from there.

Fig. 13 shows a common method for achieving preset conditions for the jam input. Only two stages are shown here, but adding two additional stages will make it a four-bit counter. Of course, any number of stages may be connected in cascade to form an  $n$  bit preset counter.

In Fig. 13, the preset count is applied to points A and B, and both bits will be entered simultaneously when clock line CP2 is brought HIGH. Line CP2 is sometimes called the enter or jam terminal. Once the preset bit pattern is entered, the counter will increment from this with every transition of clock line CP1.

**Down Counters.** A down counter decrements, instead of incrementing, the count for each excursion of the input pulse. If the reset

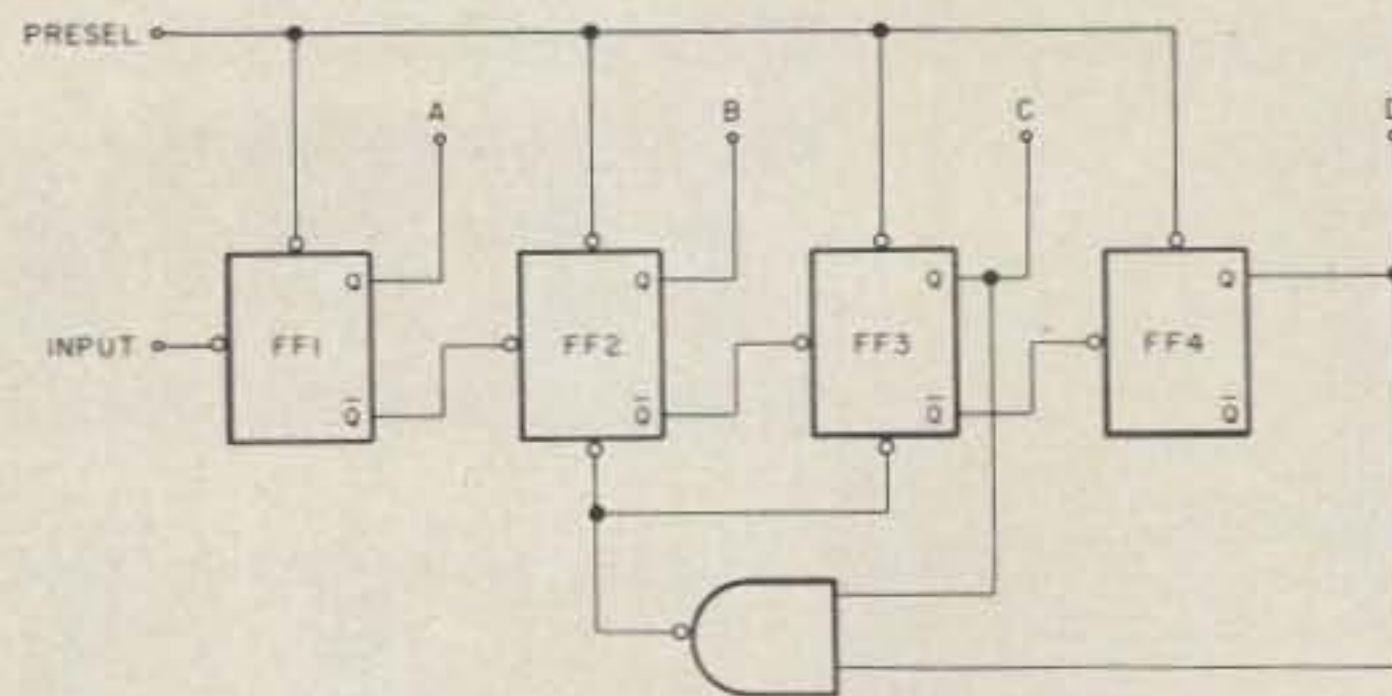

Fig. 14(b). This decade counter counts down, starting at the binary state 1001.

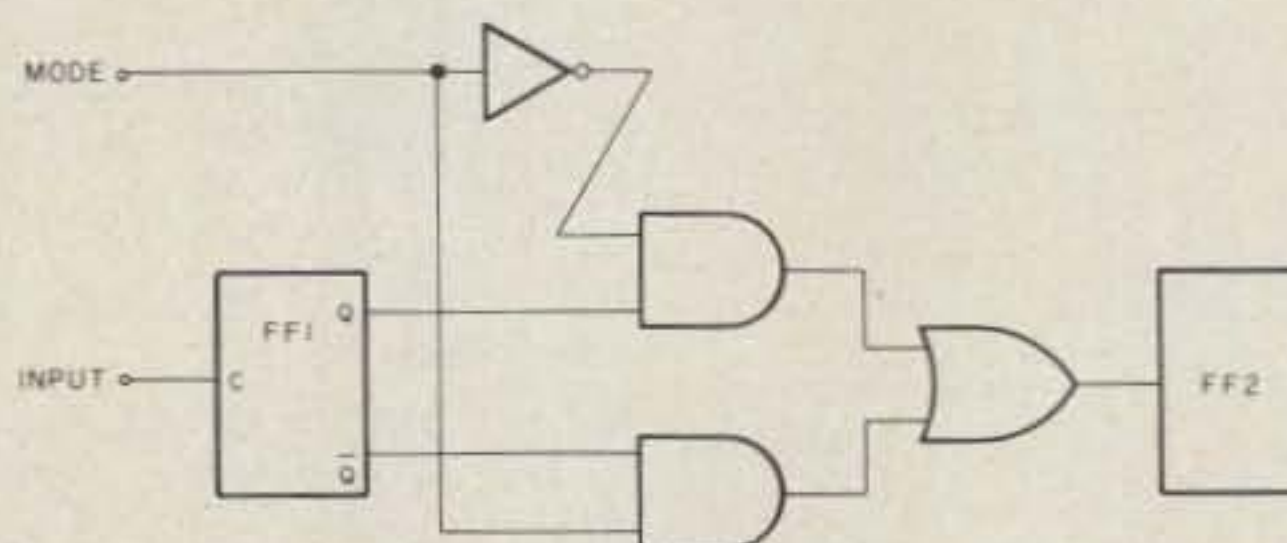

Fig. 15. A counter can offer the choice of up and down modes by adding logic.

condition is 0000, then the next count would be 0000 - 1, or 1111 (it would have been 0001 in an up counter).

We use basically the same circuit as before but toggle each FF from the NOT-Q rather than Q of the preceding FF. An example of a four-bit binary down counter is shown in Fig. 14. Note that the outputs are taken from the Q outputs of the FFs but that toggling is from the NOT-Q.

The preset inputs of the flip-flops are connected together to provide a means to preset the counter to its initial (i.e., 1111) state. This counter is also called a subtraction counter because each input pulse causes the output to decrement by one bit.

A decade version of this circuit is shown in Fig. 14(b). As in the case of the regular decade counter, a NAND gate is added to the circuit to reset the counter following the 10th count. We detect the states where outputs C and D are HIGH, and then clear the two middle FFs. This action forces the output to 1001<sub>2</sub> (i.e., 9<sub>10</sub>). The counter then decre-

ments from 1001 in the decimal sequence 9-8-7-6-5-4-3-2-1-0-9... etc.

**Up/Down counters.** Some counters will operate in both up and down modes, depending upon the logic level applied to a mode input. Fig. 15 shows a representative circuit in which the first two stages of a cascade counter are modified by the addition of several gates. If the mode input is HIGH, then the circuit is an up counter, but if the mode input is LOW, then the circuit operates as a down counter.

### Conclusion

This three-part series has offered you the basics of digital electronics. With this information, you should be able to conduct a large number of experiments, build most of the simple-to-moderate-difficulty digital projects published in this (and other) magazines, and even design a few circuits. From here, let me recommend that you begin to study microprocessors and microcomputers. From the radio amateur's point of view, interfacing is very important. ■



# step up to the best...

Without doubt LR-1 is the repeater value leader! Compare its outstanding performance with any repeater -- then look at its price. LR-1 features include individual die-cast shielding of receiver and transmitter plus a separately shielded 6-stage receiver prefilter for peak performance in harsh RF environments • Front panel metering of all vital functions • CW identifier • Symmetric hard limiting for clean natural audio • Low power MOS control logic • Even the cabinet is included -- just plug in and go! The price? Only \$1095 (US amateur club net).

**LINKING?** The LR-1 is also available with control circuitry for Link Transceiver operation. Now link repeater sites with the flexible control capability you've always wanted.

**HIGH POWER?** Our PA-75 power amplifier is the champion! Ruggedly built to give years of dependable operation in continuous duty repeater service.



Mark 3C repeaters and controllers have no equal in performance. Both units feature auto patch, reverse autopatch, autodial, 13 Morse messages and a total of 39 functions. Both feature microprocessor control and both have been proven in the field from icy Alaska to tropical Brazil. A Mark 3C supercontroller can make any repeater a super performer. The Mark 3CR repeater is in a class by itself. It combines superbly designed RF circuitry in one handsome package. It is without doubt the world's most advanced repeater!

CALL OR WRITE FOR FULL DETAILS

## MICRO CONTROL SPECIALTIES

23 Elm Park • Groveland, Massachusetts 01834 • Telephone (617) 372-3442



# The Money-Maker Power Supply

*Need 12 volts for your transceiver? Save half the cost of a commercial unit by assembling this 25-Amp monster.*

Since the advent of solid-state transceivers, there has been the need for a simple high-current 12-volt power supply. The power supply described in this article will produce 13.8 volts at up to 25 Amps continu-

ous duty. All the parts should be readily available.

First of all, you will need to determine how much current your transceiver draws, and at what voltage. Look up the current drain during transmit in your

owner's manual. For a 100-Watt radio, this may be about 20 Amps. Most transceivers, whether they be small two-meter radios or large multiband 100-Watt HF ones, will have a voltage rating of 13.8 volts. This seems to be an industry standard. Thus, if you were to build a 12-volt supply, you probably would not achieve the full rated power output.

Once the voltage and maximum current are determined, you may choose a transformer. If it is not possible to find one of the proper ratings locally, then try requesting catalogs from the following three companies. They all seem to have a large stock of transformers at good prices.

- Delta Electronics  
PO Box 2  
Amesbury MA 01913  
(617)-388-4705
- Fair Radio Sales Co.  
PO Box 1105  
Lima OH 45802  
(419)-227-6573
- Meshna  
PO Box 62  
Lynn MA 01904  
(617)-595-2275

A minimum of 13.3 volts rms must be supplied to the filter for a regulated output of 13.8 volts. This is equal to the desired output voltage plus five volts divided by 1.414. The current rating, of course, must be greater than or equal to the desired output current. In my case, the required current was 22 Amps at 13.8 volts. Thus, the transformer should have a current rating of at least 22 Amps and the secondary rms voltage should be at least 13.3 volts  $(13.8 + 5)/1.414$ . I chose, from the Meshna catalog, a 15-volt, 15-Amp autotransformer. The stock number was T-658 and the price was eight dollars. I bought two of them to put in parallel for a total of 30 Amps. Meshna provides instructions to convert these autotransformers to regular transformers. This just involves rewiring of the attached terminal board.

While you are looking through the catalogs, keep an eye out for some high-current rectifiers, large heat sinks for both the rectifiers and the pass transistors, and some "computer-

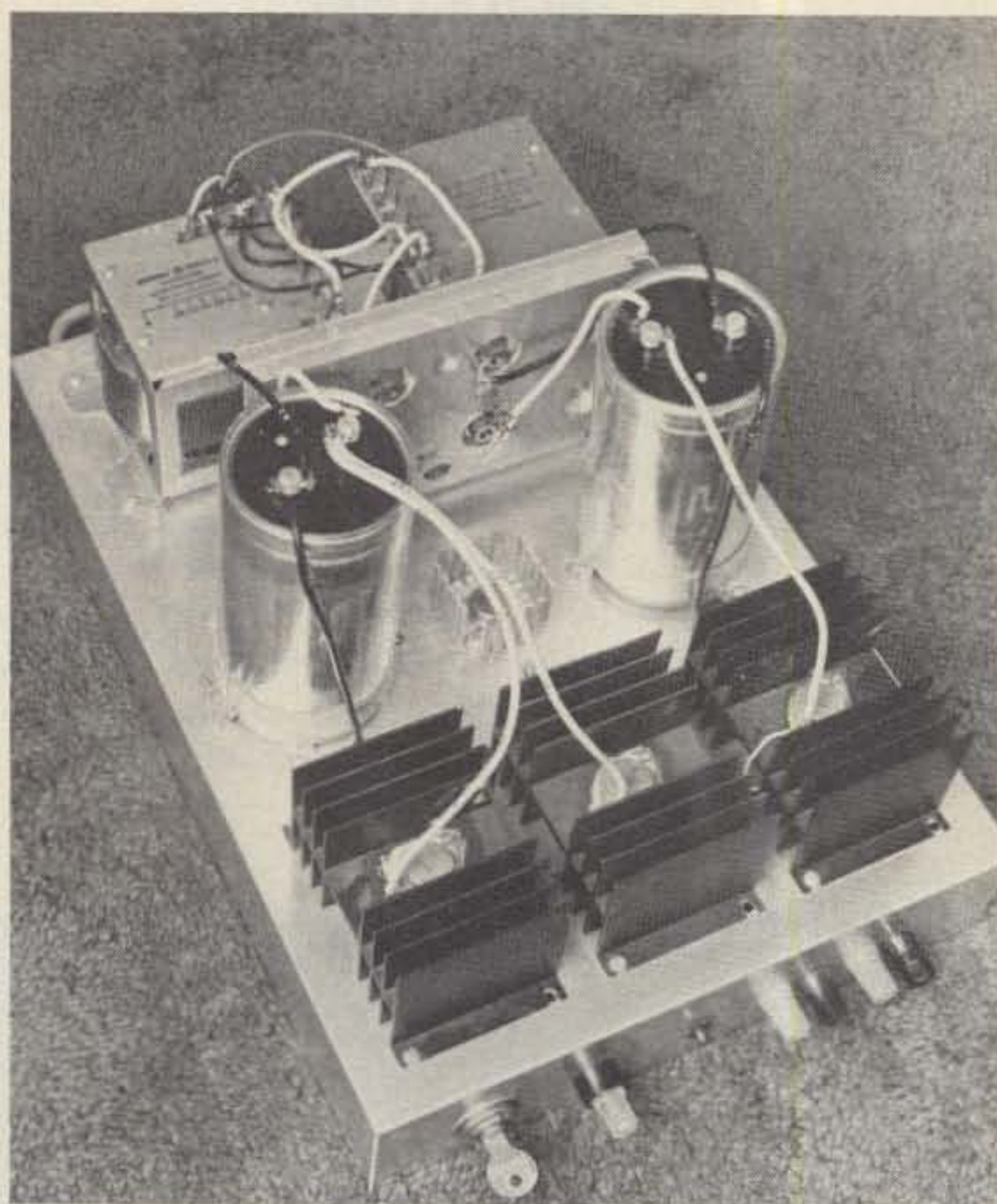

*The completed 13.8-volt, 25-Amp supply includes overvoltage protection.*



grade" capacitors. See the parts list for the values. Also, please note that in most cases, the values in this power supply are not very critical. As long as they are close, they should work. Most of the smaller parts are available at Radio Shack. In these cases, the part numbers are shown as RS numbers.

### Circuit Description

The circuit is a full-wave bridge rectifier with a linear regulator. See Fig. 1. The voltage regulator consists of an LM317 which provides base drive for the pass transistors. The LM317 is an adjustable three-terminal voltage regulator that when supplied with 27 volts on its input can provide an adjustable 1.2-to-25 volts at 1.5 Amps. In this case, we will be inputting 15 volts times 1.414 or 21.2 volts (peak) from the rectifier/filter combination. The regulator output voltage must be 13.8 volts plus the base-emitter drop of the pass transistors. This will be 13.8 volts + 0.7 volts, or 14.5 volts.

Three pass transistors are used and they share the output current equally. There are several options for over-voltage protection and these will be discussed towards the end.

### Circuit Blocks

Each section in the block diagram will now be described. When doing the actual construction, build one block at a time and test it as you go. This will save debugging time and may prevent burned out parts. Build them in this order:

- 1) Power transformer, rectifiers, filter capacitors, and 117-V ac input circuit.
- 2) Voltage-regulator circuit (LM317).
- 3) Pass-transistor circuit.
- 4) Output-protection circuit.

Note that the power supply can be used without any

protection circuit, but you must be very careful of short circuits. It is possible to lose the supply and the radio with one mistake!

### Transformer Circuit

The transformer circuit consists of the line cord, fuse, pilot lamp, transformer, rectifiers, and filter capacitor. See Fig. 2. Get yourself a heavy-duty line cord for this power supply as you may be drawing 3 to 4 Amps on the transformer primary. A three-wire cord is preferred and the green or ground wire should be connected to the power supply chassis.

Use a 5- to 10-Amp fuse for the primary circuit and a small neon lamp with built-in series resistor for the pilot lamp. I used a key lock for the On-Off switch to prevent "unauthorized" use.

First, mount and wire the transformer(s) and line cord to the chassis. Connect the switch, pilot lamp, and fuse to the primary circuit. Then mount the rectifiers to the rectifier heat sink and mount the assembly near the secondary side of the transformer. Use at least number 12 or, better, number 10 house wiring to wire all the secondary circuits, rectifiers, and pass transistors. The rectifiers must have mica insulators so they won't short out through the heat sink. Also, a layer of silicone thermal grease should be applied between the rectifiers and the heat sink. Extra grease should be wiped off after the rectifiers are bolted down. The rectifiers will have a voltage drop of about one volt at 25 Amps, so the power they must dissipate will be: 1 volt times 25 Amps at a 50% duty cycle = 12.5 Watts each. Make sure the heat sink is a large one.

Next, mount the filter capacitor(s). Use heavy gauge wire for the capacitor(s), too. Now, recheck all wiring

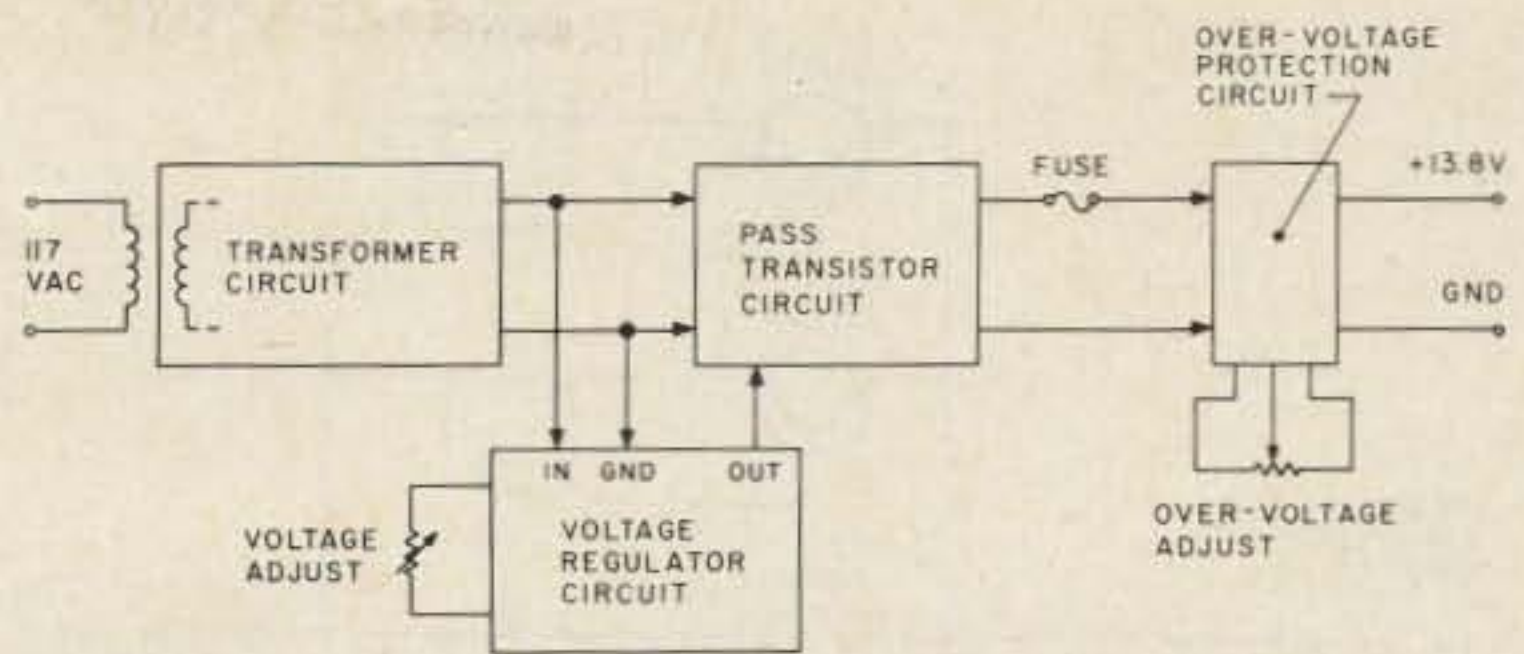

Fig. 1. Block diagram of the complete power supply. Each section is discussed separately. There are three options for the overvoltage protection circuit.

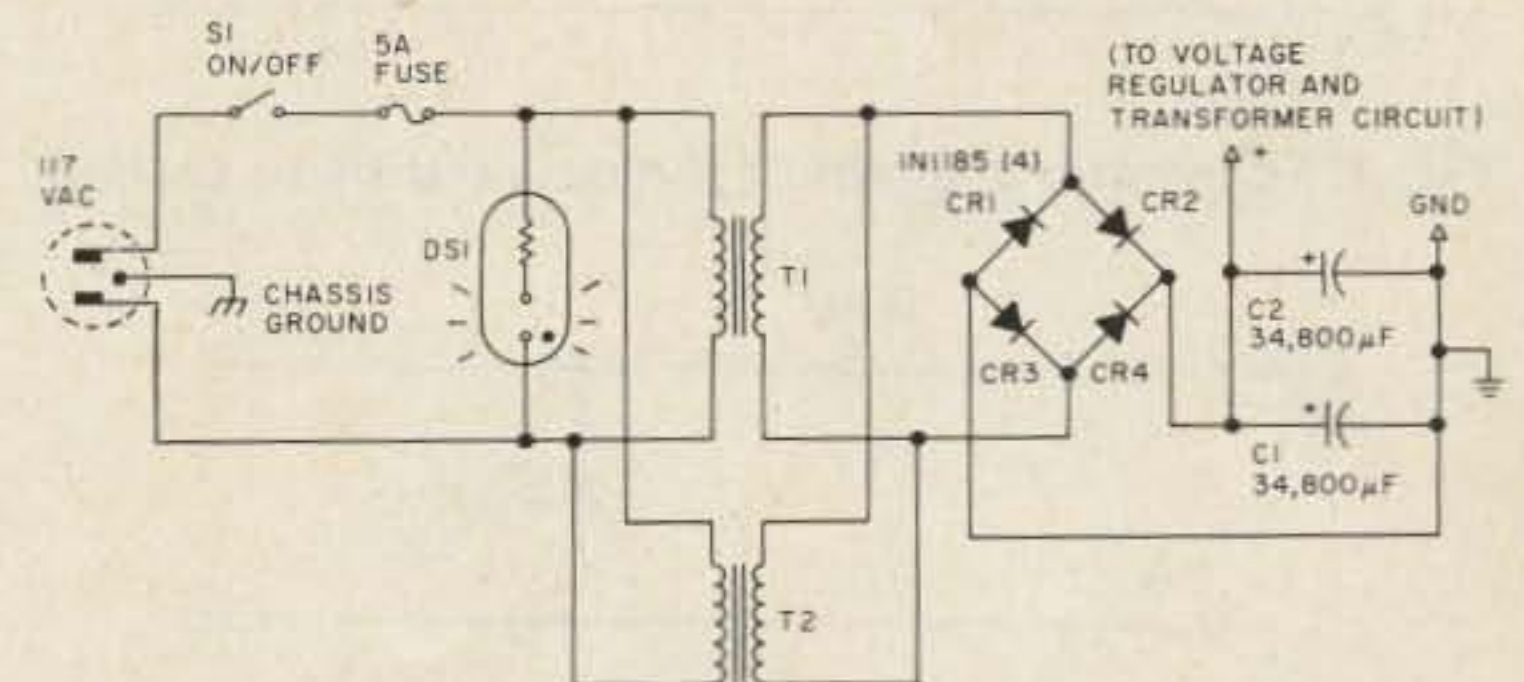

Fig. 2. Schematic diagram of the transformer section. The transformers are rated 15 volts at 15 Amps.

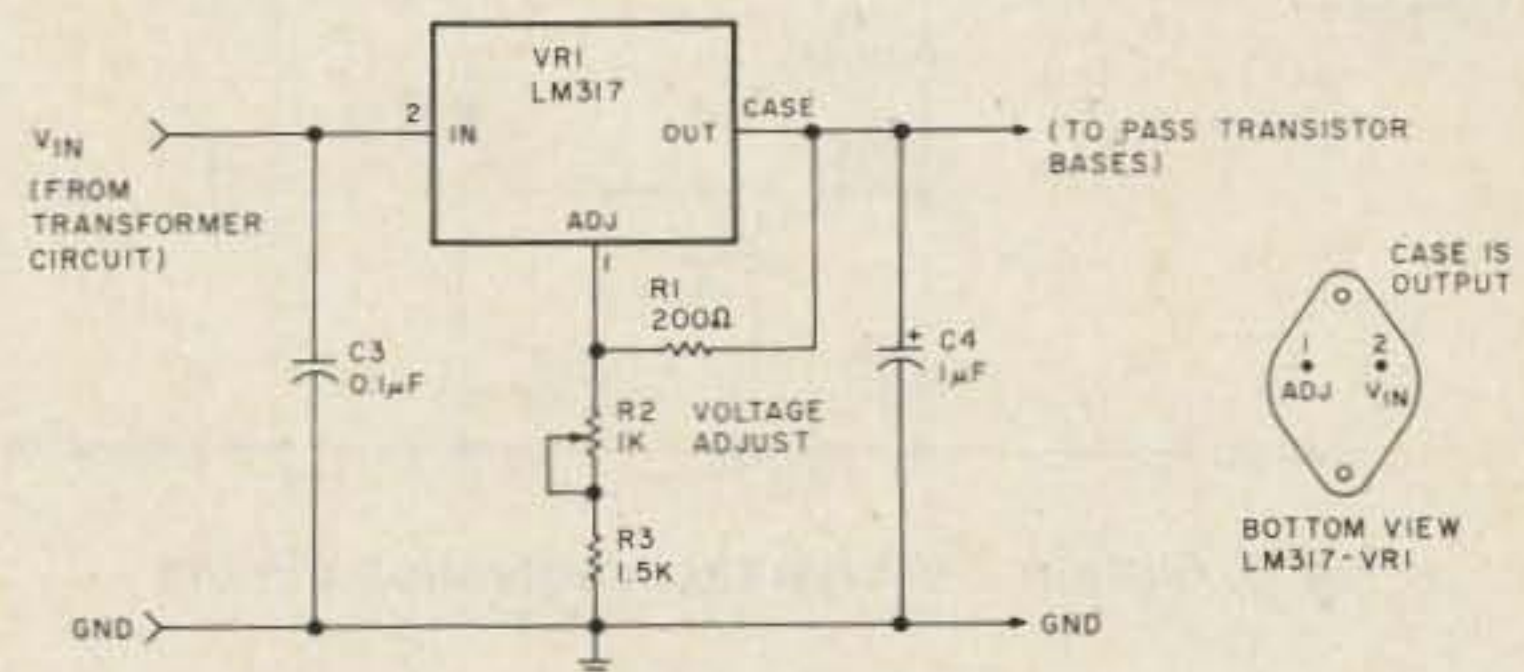

Fig. 3. Schematic diagram of the voltage regulator. R1 can be 200 to 250 Ohms. All resistors are rated at 1/2 Watt. C3 is a ceramic and C4 is electrolytic. Both should be mounted as close to VR1 as possible.

against the schematic. Make sure that the switch is off and plug the line cord into the wall socket. Be careful of any primary transformer connections as there will be 117 V ac there. Connect a voltmeter set on the 50-volt scale to the filter capacitor terminals and turn the power on. You should measure an unloaded voltage of about 15 volts times 1.414 = 21.2 volts dc. Record your voltage reading, as we will be using it for some power calculations later. Make sure the On-Off switch works and that the pilot light works

with the switch. Note that since there is nothing connected to the filter capacitor terminals to bleed off the voltage stored there, it might be wise to connect a 1000-Ohm, 1/2-Watt resistor across the terminals before continuing. Turn the power off and use your voltmeter to verify that the voltage is near zero.

### Voltage Regulator Circuit

Now start construction of the voltage-regulator circuit. See Fig. 3. Mount the LM317 regulator to the chassis using a small TO-3 heat sink. Use some silicone



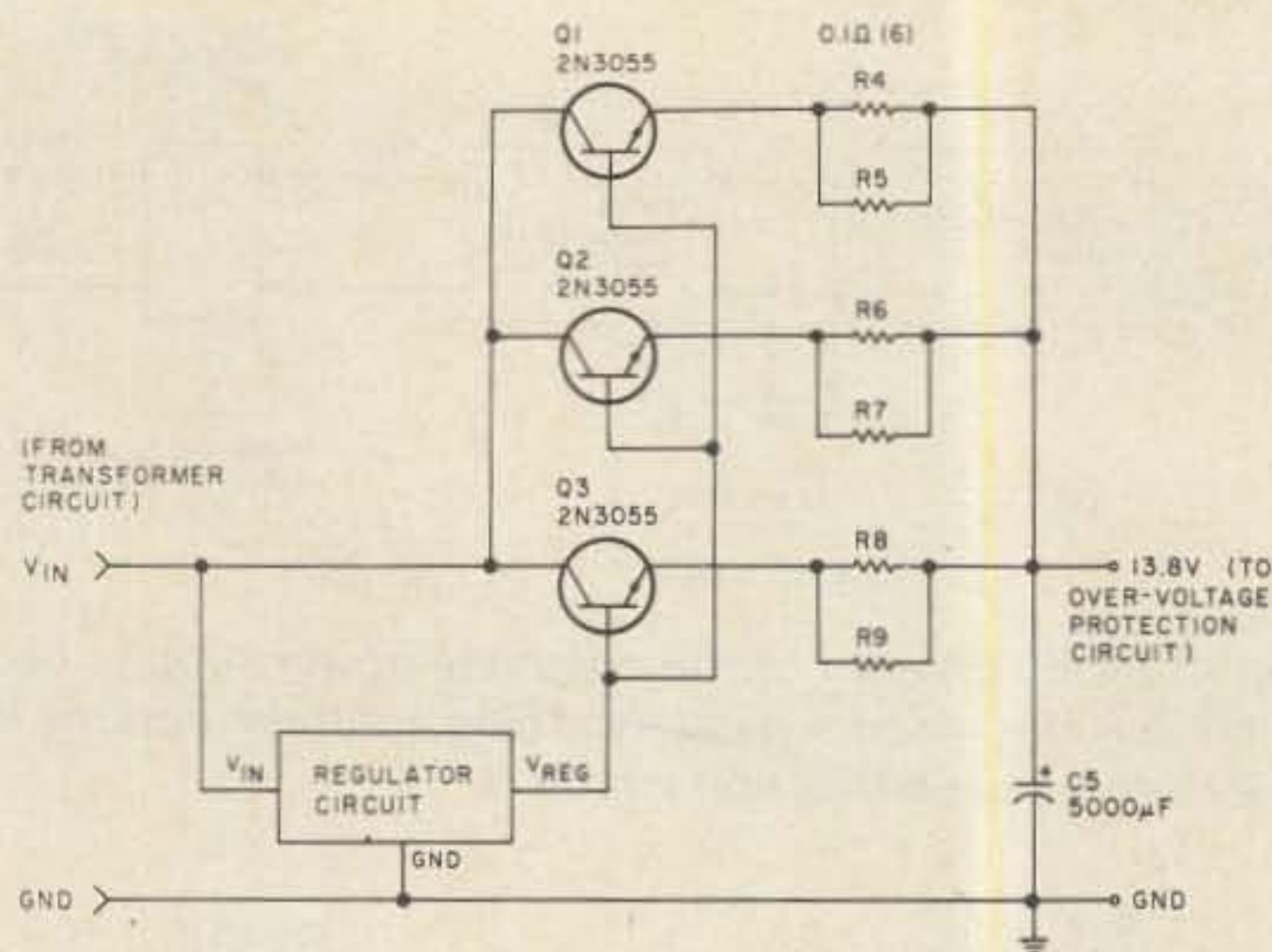

Fig. 4. Schematic diagram of the pass transistor section.

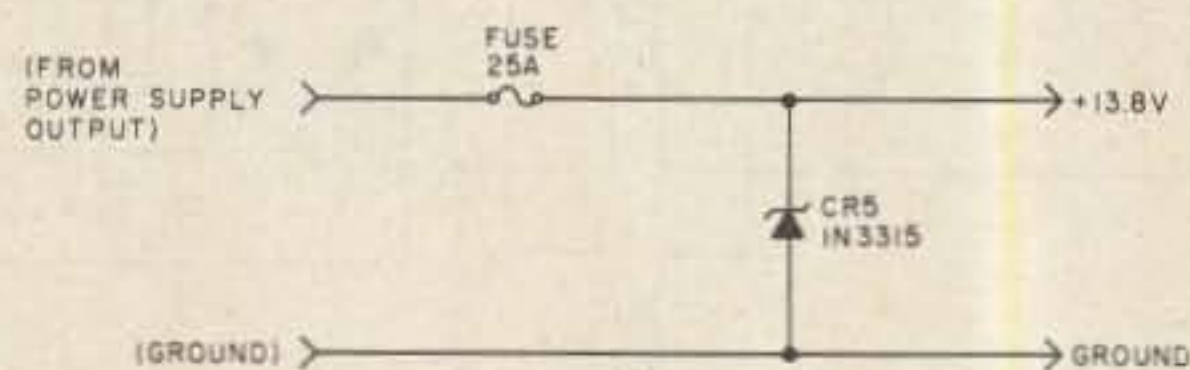

Fig. 5. Option 1 overvoltage protection circuit.

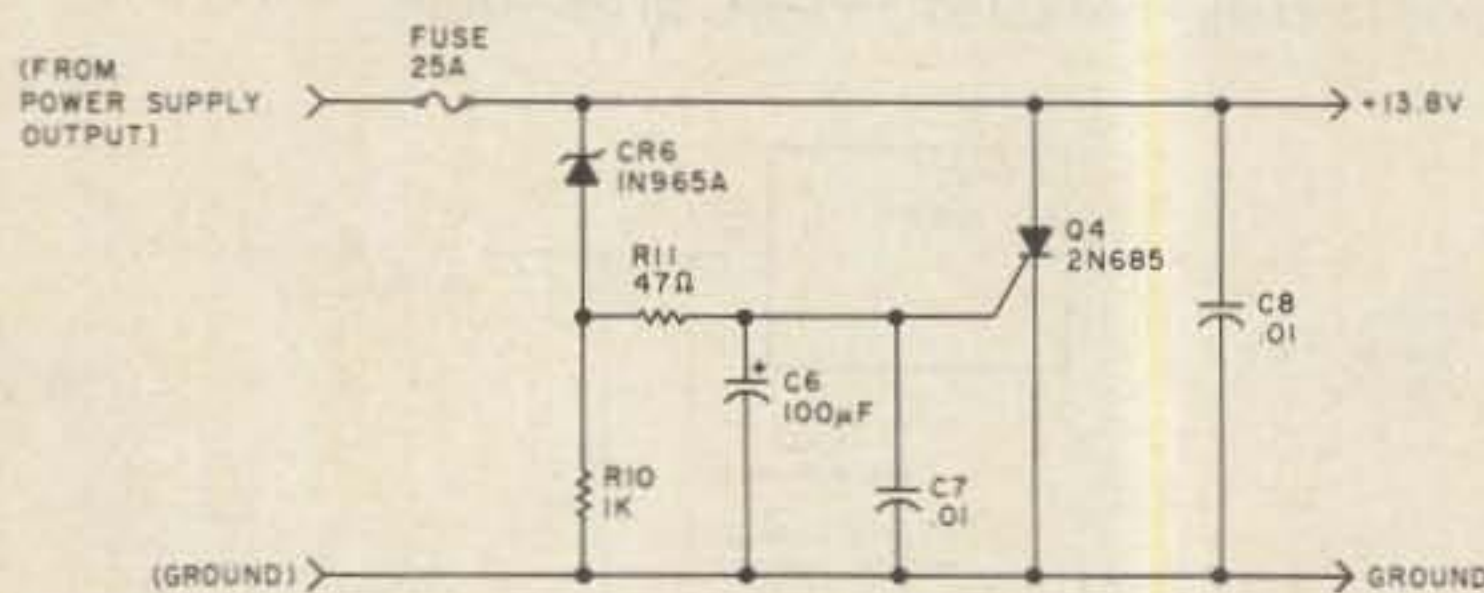

Fig. 6. Option 2 overvoltage protection circuit.

grease and be sure to use a mica insulator because the regulated output voltage is connected to the case. To determine the power dissipation of this regulator, take the unloaded voltage reading you took earlier and subtract 14.5 volts. Then multiply by 1.5 Amps. In my case, the power dissipated was: (21.2 volts minus 14.5 volts) times 1.5 Amps = 10 Watts. The heat sink must be large enough to dissipate this power.

Mount the voltage control pot on the top or the front of the chassis. Finish wiring the regulator circuit using point-to-point methods. Here, you can use smaller gauge wire since the highest current will only be 1.5 Amps. Now connect the regulator input to the

positive terminal of the filter capacitor. Make sure that the negative terminal of the filter capacitor is grounded to the chassis.

Temporarily connect a 10- to 50-Ohm, 10-Watt resistor across the voltage regulator output to act as a load. Connect a voltmeter across this load resistor and set the voltage control to the midway point. Turn on the power and verify that you are getting about 11 to 17 volts as the voltage-control pot is adjusted. If the output does not vary with the control, double-check the wiring to the LM317.

#### Pass Transistor Circuit

If everything is OK so far, the next step is to mount the pass transistors. See Fig. 4. Use large TO-3 heat sinks

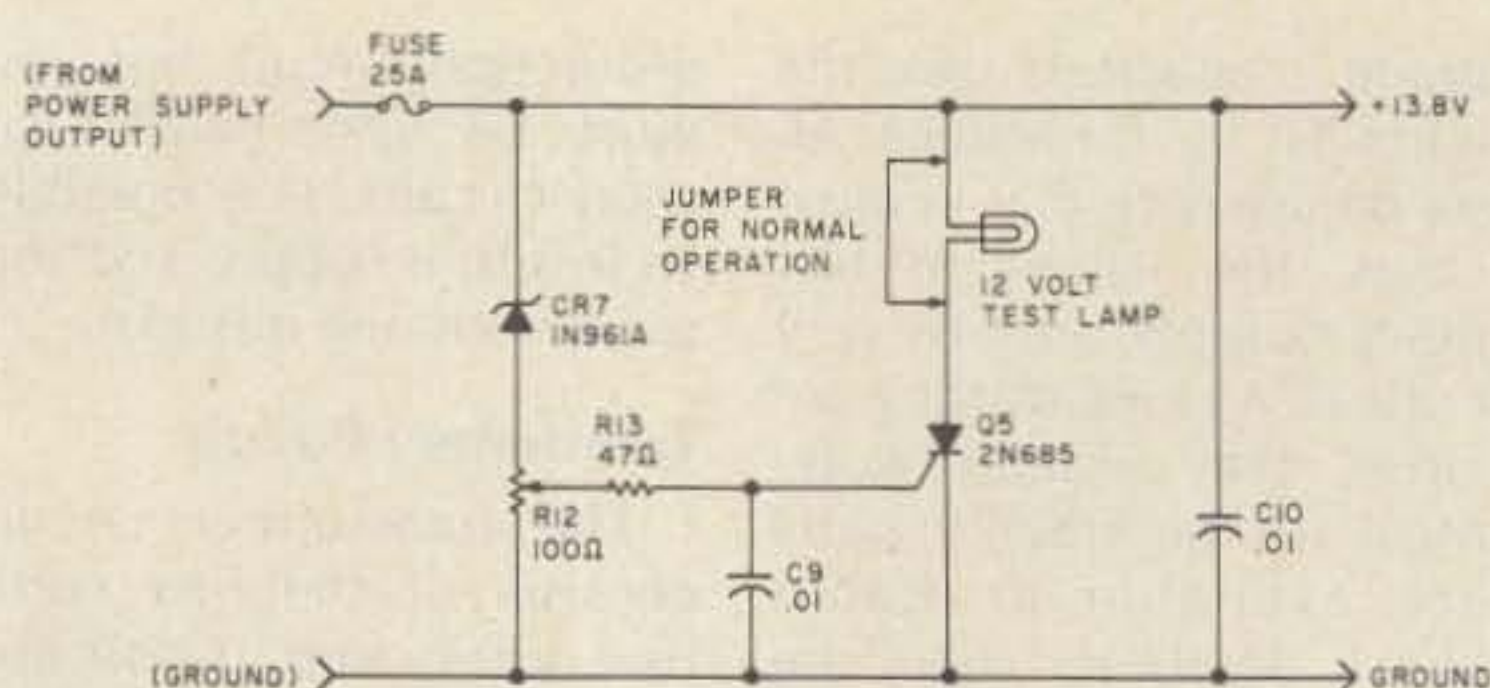

Fig. 7. Option 3 overvoltage protection circuit. This version has an adjustable voltage-limit point.

and mount the transistors using mica insulators and silicone grease. Be sure to drill holes in the chassis for the wires to the transistors. Use rubber grommets.

To determine the maximum power dissipation of the pass transistors, you will need the unloaded voltage you measured across the filter capacitor. Take this voltage and subtract 13.8 volts. Then multiply this by one third of the total output current. In my case, the power dissipated in each transistor was (21.2 volts minus 13.8 volts) times (22 Amps/3) = 54.3 Watts. Make sure that the heat sinks are large enough to dissipate this much heat. I found that a finned heat sink of about 3" times 4" times 2" was alright.

After the transistors are mounted to the chassis, connect all the bases together and run a wire from there to the voltage-regulator output. Small gauge wire is OK. Connect two 0.1-Ohm, 5-Watt resistors in parallel and solder one end of this to one of the emitters. Connect the other four resistors likewise. Finish the rest of the pass-transistor sections using 10- or 12-gauge wire for the emitter and collector terminals, the connections to the filter capacitors, and to the output terminals of the power supply.

Verify all wiring completed so far and then connect a 1- or 2-Ohm, 200-Watt resistor across the power supply output (you'll

probably have to combine several resistors to get one of these). Connect a voltmeter across this load resistor. Turn the voltage control to minimum. Stand back and turn the power on! If all goes well, you should see a voltage of about 10 volts. If you are using a load resistor of 1 Ohm, then it is drawing 10 volts/1 Ohm = 10 Amps. Try adjusting the voltage control and record the minimum and maximum voltages. These limits should bracket the required 13.8 volts. Make sure that the maximum power supply voltage will not exceed the trip-point of the overvoltage protection circuit. Otherwise, it will trip and you will lose a fuse. If you choose not to install a protection circuit, you may lose a radio!

#### Output-Protection Circuit

It is surprising how many commercial power supplies, including those of various ham manufacturers, do not incorporate some form of overvoltage circuit. The following are three options that will work. All use some method of sensing an overvoltage condition and then clamping or "shorting" the power supply output, thus blowing a high-current fuse.

The first and simplest option is to use a zener diode directly across the output. See Fig. 5. Choose a zener voltage of about two volts over the normal power supply voltage. The current rating should be greater than that of the power supply so



MICROLOG  
**ACT-1**

**\$995\***



## MEMORY BACK-UP AND HIGH SPEED PRINTER OUTPUT\*

### Never Lose Your Memory Again!

All "Here-is" memories, ID's and all keyboard input parameters are retained for 2 weeks by the internal Ni-Cad battery & charging circuit. Load up the memories, carry the ACT-1 out to your field-day site and be ready to go as if you never turned it off! Also included in this option package is the high speed code converted RS-232 serial printer output.

The best gets better at MICROLOG Corp.  
18713 Mooney Dr., Gaithersburg, MD 20879  
Tel. 301-258-8400      TELEX 908153.

**MICROLOG**

INNOVATORS IN DIGITAL COMMUNICATION

- SIMPLE DIRECT CONNECTION to your Transceiver.
- COMPLETE SYSTEM, built-in Demodulator & AFSK Modulator with keyboard programmable tone pairs from 500 to 3000 Hz.
- SPLIT-SCREEN operation with keyboard selectable line location
- 1400 character text buffer.
- TEN, 40 CHAR. programmable message memories (doubles with BATT. BACKUP), plus ID's WRU & SELCALs.
- RANDOM CODE generator & hand key input for practice.
- Baudot 60 to 132 WPM.
- ASCII 110 & 300 baud.
- SYNC-LOC MODE for improved ASCII operation.
- RECORDER INTERFACE for "BRAG-TAPE" or recording off-the-air.
- CODE CONVERTED printer output in Baudot or ASCII.
- SSTV/GRAPHICS transmit.
- FULL 63 KEY Computer grade keyboard.

\*9" monitor \$199. Battery Backup & RS232 print \$125.



the fuse, rather than the zener, will blow. The current rating of the fuse should be between the power supply output current and the zener current rating. For example, for this power supply, choose a 25-Amp fuse and a 16- or 17-volt, 50-Watt zener.

The disadvantage of this circuit is that it is not adjustable and there still may be a chance that the zener will blow first before the fuse. This will still protect your radio, because when zeners fail, they usually stay shorted and this will reduce the overvoltage to near zero.

The second option is also not adjustable. It is an SCR (silicon-controlled rectifier) crowbar circuit. This circuit was published by Tom Lawrence WB4QLW in *73 Magazine*, August, 1977. This is the one I used for my power supply because it is fairly simple and the parts are readily available. See Fig. 6.

Here is how it works: As the power supply output starts to increase from normal and reaches the zener voltage, the zener will start to conduct current. This current will produce a voltage drop across the 1000-Ohm resistor and trigger the gate of the SCR. When the SCR becomes triggered, it will latch on and short the power-supply output, thus blowing the fuse. It is really not necessary to heat-sink the SCR since the shorted condition will last only as long as it takes for the fuse to open. Make sure that the maximum adjustable output voltage is less than the zener voltage rating.

The third and last option is similar to the previous except that the crowbar voltage is adjustable. See Fig. 7. This circuit was published by Joel Eschmann K9MLD in *73 Magazine*, August, 1979.

The operation is the same, except the trip-point can be adjusted from the

Parts List					
Item	Qty.	Item	Buy at	Approximate Cost	
C1, C2	2	34,800 $\mu$ F, 50 V ea., or equiv.	Meshna	\$ 5.00	
C3	1	0.1 $\mu$ F	RS272-0135	\$ .39	
C4	1	1 $\mu$ F	RS272-1055	\$ .89	
C5	1	4700 $\mu$ F, 25 V	RS272-1022	\$ 3.59	
CR1-4	4	1N1185, 150 V, 35 Amp	Meshna	\$ 4.50	
DS1	1	Neon lamp w/series resistor	RS272-0706	\$ 2.19	
Q1-Q3	3	2N3055 or equivalent	RS276-2020	\$ 5.97	
R1	1	200 to 240 Ohms, 2 W	RS271-0135	\$ .89	
R2	1	1000-Ohm potentiometer	Meshna	\$ 1.00	
R3	1	1.5k, 1/2 W	RS271-0025	\$ .19	
R4-R9	6	0.1-Ohm, 3 W, or equivalent	Meshna	\$ 1.00	
S1	1	SPST switch, 5 A contacts	RS275-0603	\$ 1.49	
T1, T2	2	15 V, 15 A transformer or equivalent	Meshna	\$16.00	
<b>Option 1 Parts</b>					
CR5	1	16 V or 17 V, 50 W zener (1N3315)			
<b>Option 2 Parts</b>					
C6	1	100 $\mu$ F, 35 V	RS272-1016	\$ 0.79	
C7, C8	2	0.01 $\mu$ F	RS272-0131	\$ 0.29	
CR6	1	15 V, 400 mW zener (1N965A)			
Q4	1	50-100 V, 16 A SCR (2N685, 2N1844, 2N4441)			
R10	1	1000 Ohms, 1/2 W	RS271-0023	\$ 0.19	
R11	1	47 Ohms, 1/2 W	RS271-0009	\$ 0.19	
<b>Option 3 Parts</b>					
C9, C10	2	0.01 $\mu$ F	RS272-0131	\$ 0.29	
CR7	1	10 V, 400 mW zener (1N061A)			
Q5	1	50-100 V, 16 A SCR (2N685, 2N1844, 2N4441)			
R12	1	100-Ohm potentiometer			
R13	1	47 Ohms, 1/2 W	RS271-0009	\$ 0.19	

zener voltage rating upwards. To test this circuit, break the connection between the anode of the SCR and the positive output line. Insert a 12-volt lamp in series as shown. Adjust the voltage control for maximum voltage and adjust the overvoltage control to maximum (wiper all the way toward the ground end).

Turn on the power supply. The test lamp should be off. Start turning the overvoltage control until the lamp just turns on. Now turn the control about 1/8 to 1/4 turn back in the other direction. This will add a small buffer zone. The lamp should still be on. Now turn the power supply off and then on again. The lamp should stay off. If the lamp is still on, try the adjustment again.

Try turning the voltage-

adjust control from maximum to minimum and then back to maximum. The lamp should remain off. If so, all is well. Note that to turn off the lamp it is necessary to reset the SCR by momentarily turning off the power supply. When the crowbar is adjusted correctly, remove the lamp and reconnect the anode of the SCR back to the positive output. Now, when the overvoltage reaches the trip-point, the SCR will turn on and blow the fuse.

### Conclusion

This completes the construction of the basic power supply. If you wish, you may add a voltmeter and an ammeter. You also may wish to make and install a cover to dress up the chassis.

The voltage adjust and overvoltage-protection ad-

just controls may be placed anywhere out of the way. If you plan to use this supply in a dedicated application, the controls, once set, may be left alone.

If you will be using the supply at various voltage levels, I would suggest option 1 or 2 for your protection circuit. That way, there will be less chance to misadjust the overvoltage control and, consequently, less chance of blown fuses.

So, enjoy your new power supply and, at the same time, observe normal precautions while using its high-current capabilities. Also, if you have a well-stocked junk supply, just think how much you will have saved over a commercial supply! If you have any questions, please send an SASE for a reply. Have fun! ■



**SALE SALE SALE**

**GOING-  
OUT-OF-  
BUSINESS  
SALE**

**Last Day—  
Dec 31<sup>ST</sup>  
1982  
CALL US!**

**If we have what  
you want in stock  
we will beat ANY-  
ONE'S price and  
ship it FREE!**

**No charge cards...  
cash or  
cashier's check  
only**

**Ben Franklin  
Electronics  
115½ N. Main  
Hillsboro KS 67063  
316-947-2269**

439

# HT-Power!

Limited Offer...

## SUPER STICK II

2 METER 5/8 WAVE TELESCOPIC ANTENNA

### PLUS

## A DUCK FOR UNDER A BUCK

# \$19<sup>99</sup> + 1¢

FOR THE DUCK

	PRICE	GAIN *	BASE CONNECTOR **	FULLY COLLAPSED
SUPER STICK II	\$19. <sup>95</sup>	6-9 DB	BNC-Tempo 5/15-32 TNC-F—50239	Collapsed is a matched 1/4 Wave Antenna
BRAND C	\$26. <sup>95</sup>	6-9 DB	BNC ONLY	NA Will not transmit in collapsed position
BRAND V	\$24. <sup>95</sup>	5-8 DB	BNC ONLY	NA Will not transmit in collapsed position

\* Measured Field Strength Over Rubber Duck

\*\* Specify Base Type BNC, Tempo, Ect.

RD2S  
Stubby

The Tuned Antenna Company brings you the Super Stick II for those long hauls with your H.T., plus our 5/8 Wave Antenna may be operated collapsed with the same operating characteristic of a Rubber Duck Antenna. The Super Stick II is available with Tempo S-1, BNC-TNC-F-PL-259 Bases at a price that is several bucks under other 5/8 Wave Antennas, making the Super Stick II the best buy around. See your local dealer for stock. Settle for nothing less than a Super Stick II.

Terms: C.O.D., check or money order. Please add \$2.00 for first antenna and \$1.00 for each additional antenna to cover shipping and handling. California residents add 6% sales tax.

FOR DEALER LOCATION  
OR TO ORDER CALL:  
(714) 268-0720

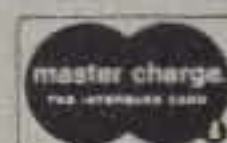

**THE TUNED ANTENNA  
CO.**

9520 Chesapeake Dr. #606  
San Diego, California 92123

57



HOW CAN I INTERCEPT SMUGGLERS? SECRET SATELLITES? RESCUE MISSIONS? SIGNALS FROM SPACE?

WHAT IS THE TRUTH ABOUT ANTENNAS? TUNERS? PREAMPLIFIERS?

HOW CAN I CHOOSE THE BEST RECEIVER? ANTENNA?

WHAT ARE THE LAWS REGARDING LISTENING IN?

UNCOVER LISTENING EXCITEMENT YOU NEVER THOUGHT POSSIBLE!

For your **FREE COPY** of **MONITORING TIMES**--

**CALL NOW!** Toll-free 1-800/438-8155

(cont. US except NC).

Others dial 1-704/837-2216

or write to

Grove Enterprises, Dept. D, 140 Dog Branch Road  
Brasstown, NC 28902 ✓352

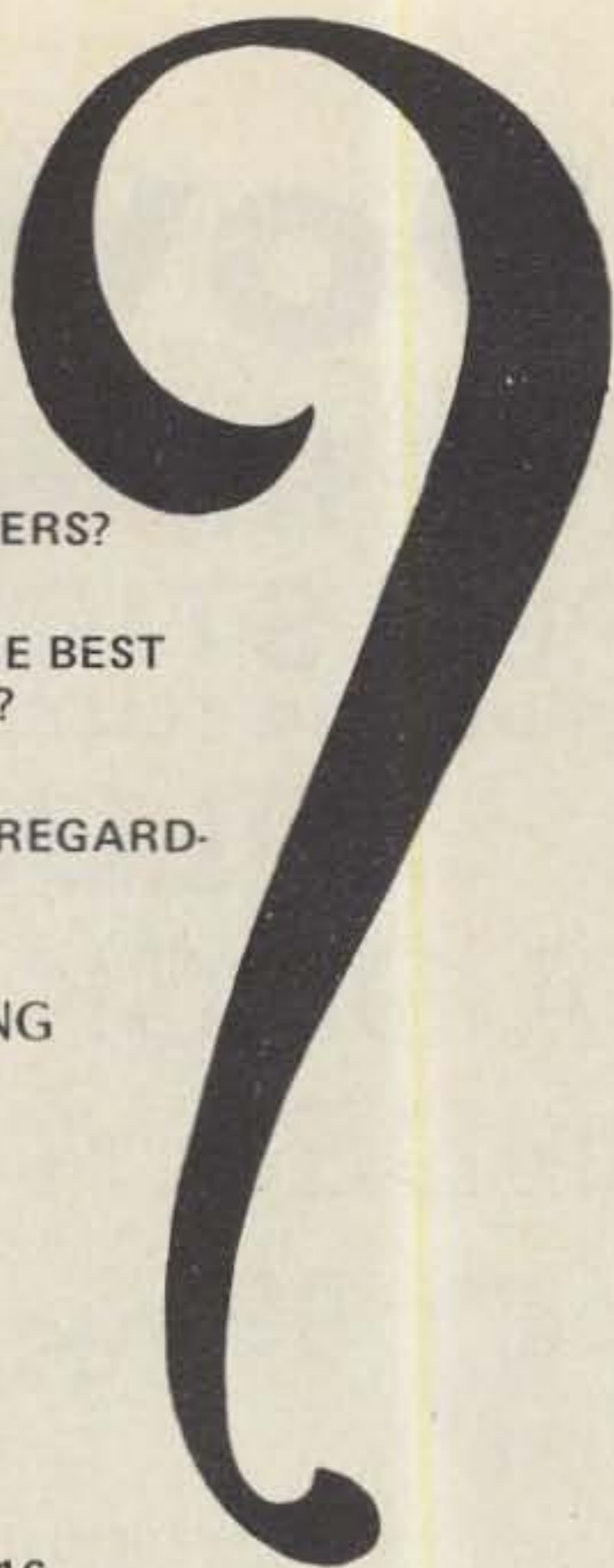

## 1900 - 2500 MHZ KITS

**DOWN CONVERTER KIT**  
\$19.95



- 1 P.C. BOARD PRE-DRILLED AND SOLDER FLOWED
- 3 MRF901 TRANS.
- 2 HP DIODES
- 6 CHIP CAPS "LARGE"
- 8 RESISTORS
- 4 PREPARED COILS, FACTORY WOUND
- 1 10 MFD CAP.

**SUPPLY CABINETS**  
ALUMINUM CABINETS PREPARED TO FIT  
POWER SUPPLY KIT.....\$9.95

**MANUFACTURED CABLE SETS**

- 10FT. PLUS 3FT.....\$19.95
- 75FT. PLUS 3FT.....\$15.95
- 50FT. PLUS 3FT.....\$12.95

**ANTENNA KIT**  
\$19.95



- 33 WASHERS
- 32 SPACERS
- 1 3 FOOT ROD
- 2 NUTS
- 1 8" PVC PIPE
- 2 4" END CAPS
- 1 MOUNTING BAR
- 1 "F" CONNECTOR
- 1 NUT AND BOLT

**DISCOUNTS**

- 2 TO 4.....10%
  - 5 TO 9.....15%
  - 10 TO 24.....20%
  - 25 TO 49.....25%
  - 50 TO 99.....30%
  - 100 TO 999.....35%
  - 1000 UP.....40%
- DIFFERENT KITS CAN NOT BE ADDED FOR QUANTITY DISCOUNTS.

**POWER SUPPLY KIT**  
\$19.95



- 1 P.C. BOARD
- 1 POWER TRANSF.
- 1 317L ADJUSTABLE REGULATOR
- 1 FINE TUNING POT. WITH SWITCH
- 1 COARSE TUNING POT.
- 2 KNOBS
- 3 "F" CONNECTORS
- 4 POWER DIODES
- 1 RF CHOKE
- 3 RESISTORS
- 3 DISK CAPS.
- 1 1000 MFD CAP.
- 1 DPDT MINI TOGGLE SWITCH
- 1 LED WITH HOLDER

### MAIL ORDERS

ADD \$5.00 FOR SHIPPING AND HANDLING. TRIONYX IND. INC.  
INDIANA RESIDENTS ADD 4% SALES TAX. 6219 COFFMAN RD.



American Express  
Cards  
Welcome



INDIANAPOLIS, IND.  
46268 ✓104  
(317) 291-7280  
(317) 291-2995

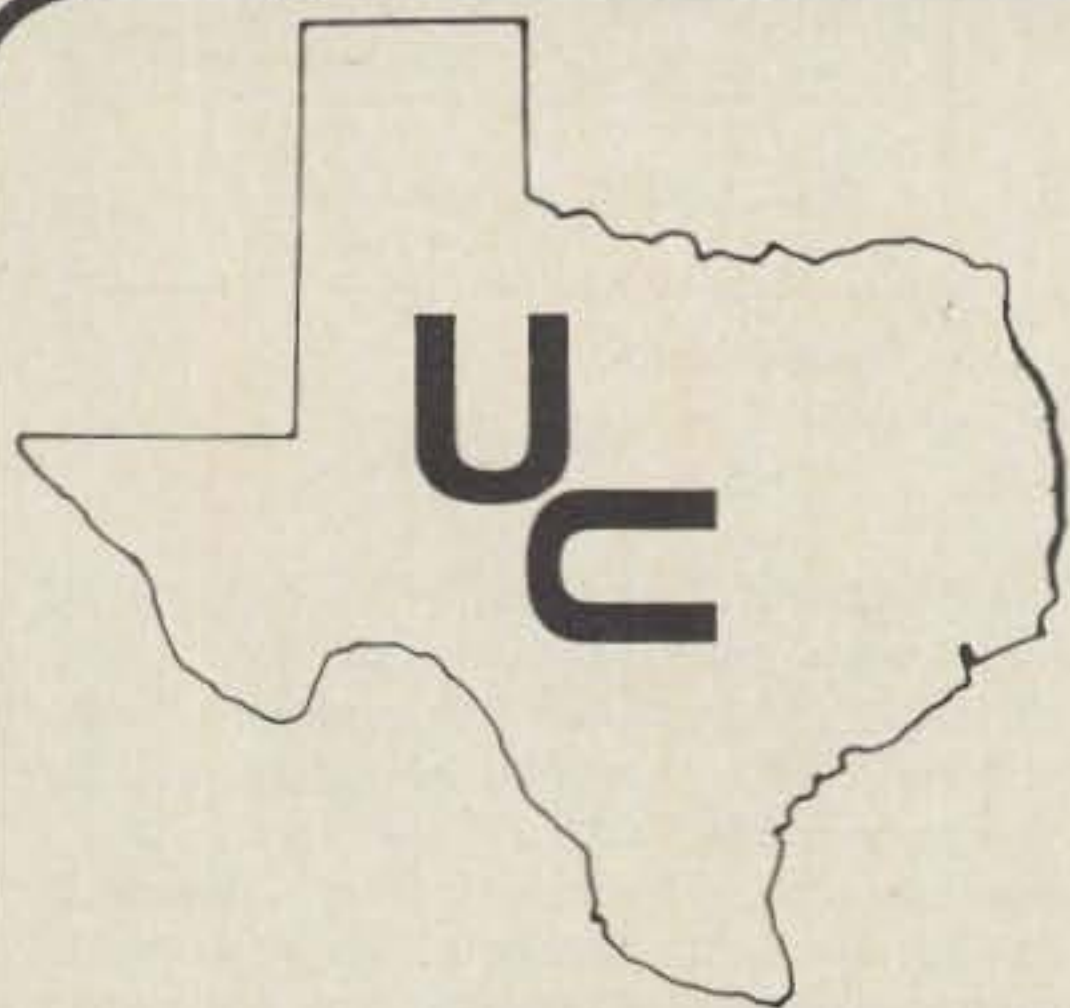

**UNIVERSAL COMMUNICATIONS**  
P.O. BOX 339  
ARLINGTON, TEXAS 76004-0339  
(817) 860-1641

A DIVISION OF  
INNOVATIVE LABS, INC.

### KITS

- DOWN CONVERTER.....\$19.95
- VARIABLE P/S.....\$19.95
- CIGAR ANTENNA.....\$19.95

### KIT SPECIAL

- (ORDER ALL THREE & SAVE).....\$49.95
- HIGH-GAIN TRANSISTOR.....\$6.95
- DRIFT MODIFICATION.....\$1.25
- KD 44 DISH ANTENNA.....\$47.95

### ASSEMBLED

- ASSEMBLED DOWN CONVERTER.....\$39.95
- ASSEMBLED POWER SUPPLY.....\$29.95
- CIGAR ANTENNA.....\$19.95

### ULTIMATE SPECIAL

- (ALL THREE ABOVE PRODUCTS).....\$79.95
- SUPERVERTER I—CRYSTAL NOT INCL.  
(ASSEMBLED ONLY).....\$109.95
- SELECTIVE PREAMP.....\$26.95

OUR PRODUCT MAY BE COPIED... BUT THE PERFORMANCE IS NEVER EQUALLED

MC—VISA WELCOME

8:30-5:30 MON-FRI



## AVANTEK GPD SERIES AMPLIFIERS GPD 401,402,403 12 - 14 DB GAIN

5 - 500 MHZ      POWER 15 VDC      TOS MOUNTING  
IDEAL FOR COUNTER AND TV PREAMPLIFIERS  
COMPLETE WITH CIRCUIT BOARD FOR MOUNTING  
**\$25.00 EA., SET OF THREE \$65.00**

## AMATEUR MICROWAVE DOWNCONVERTER

COMPLETE ASSEMBLED READY TO INSTALL NOT A KIT

**SPECIAL \$179.95**

INCLUDING SHIPPING (U.S.)

VISA AND MASTERCARD ACCEPTED

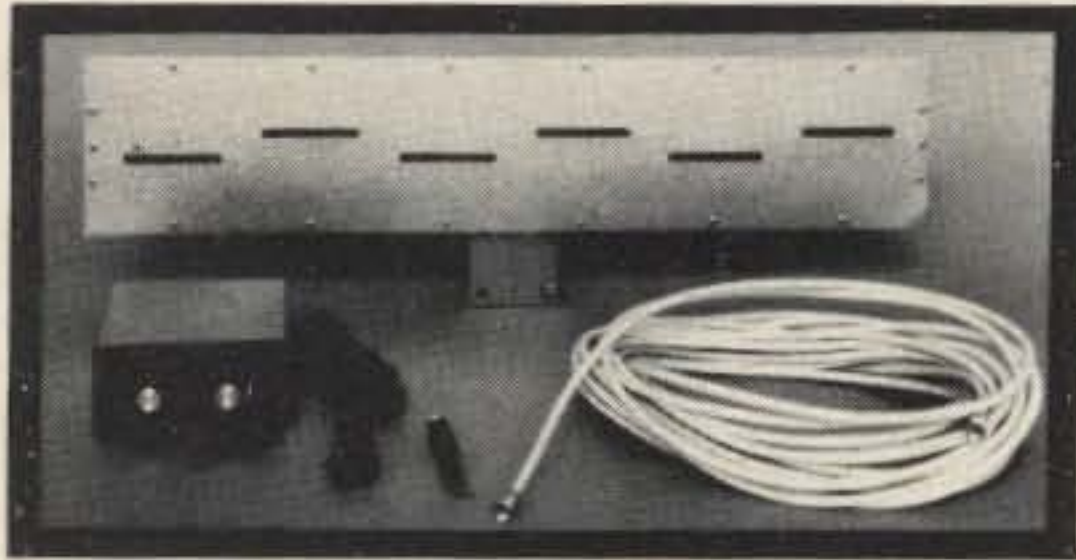

50+ dB SYSTEM GAIN  
TUNES 2.1 GHz. to 2.4 GHz.  
PREAMPLIFIER 20+ dB GAIN 12.5 dB NF  
OUTPUT TUNES TV CHANNELS 2 TO 6

OUTPUT IMPEDANCE 75 OR 300 OHMS  
FULL YEAR WARRANTY  
PERFORMANCE GUARANTEED OR  
YOUR MONEY REFUNDED

CALL (804) 489-2156

ELECTRONIC HOBBY INNOVATIONS

7510 GRANBY STREET SUITE 207 NORFOLK, VIRGINIA 23505

## FREQUENCY COUNTERS to 1.3 GHZ

By OPTOELECTRONICS inc Ft. Lauderdale, Florida

**MODEL K-7000-AC** 10 Hz to 550 MHz counter. 50 Ohm & 1 Megohm inputs via BNC type connectors on rear panel. This model is available in optional kit form.

-K-7000-AC	counter assembled 115 VAC 12VDC	\$150.00
-K-7000-ACK	counter kit form	120.00
-N-CAD-705	internal N-Cad battery pack	25.00

**MODEL 7010-S** 10 Hz to 500 MHz counter. 50 Ohm & 1 megohm inputs via BNC type connectors on rear panel. Precision OCXO or optional 0.1 PPM ovenized (OCXO) time base. Both have 10 turn calibration adjustment accessible from rear panel. Excellent UHF sensitivity with new amplifier circuitry. Optional extended frequency range to 1 GHz.

-7010-S	500 MHz counter 115VAC 12VDC	\$199.00
-ER-1000	1 GHz extended frequency range	95.00
-OCXO-70	Ovenized 0.1 PPM time base Ovc	65.00
-N-Cad-76	Internal N-Cad Battery Pack	25.00

**MODEL LFM-1110** Low frequency multiplier. A frequency counter accessory enabling tone frequencies to be counted faster and more accurately. Has low pass filter for off-the-air tone-squish measurements. BNC input/output.

**MODEL 8010-S** Deluxe 10 Hz to 500 MHz counter. External 10 MHz clock input/output on rear panel. Display "HOLD" function, display "TEST" function. Optional 1 GHz extended range. Excellent sensitivity. Optional ultra precision ovenized oscillator with 0.05 PPM stability to 45° C.

-8010-S	500 MHz counter 115VAC 12VDC	\$295.00
-ER-1000	1 GHz extended frequency range	95.00
-OCXO-80	0.05 PPM oven time base	105.00
-N-CAD-86	Internal N-Cad battery pack	60.00

**MODEL 8013-S** 10 Hz to 1.3 GHz frequency counter. Has all features of model 8010-S plus standard range to 1.3 GHz. Typical sensitivity of 1.3 GHz - 50 mV (-13 dBm).

-8013-S	1.3 GHz counter 115VAC 12VDC	\$495.00
-OCXO-80	0.05 PPM oven time base	105.00
-N-CAD-86	Internal N-Cad battery pack	60.00

-LFM-1110	Low frequency multiplier 115VAC 12VDC	\$125.00
-N-CAD-1110	Internal N-Cad battery pack	25.00
-BNC-PC	3 ft. 50 Ohm BNC patch cable	8.95

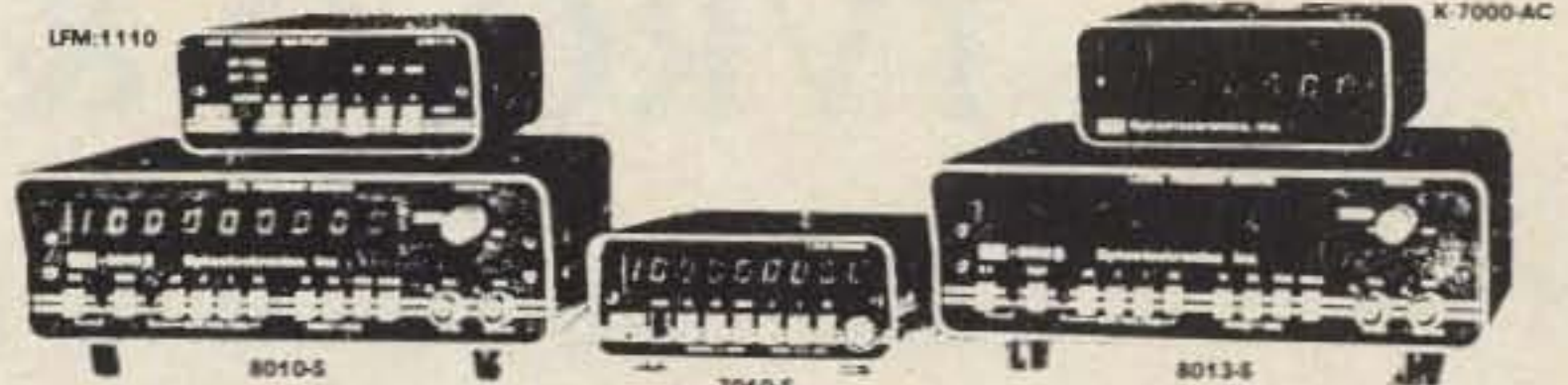

• ALL ALUMINUM CASES WITH MACHINE SCREWS  
• 100% PARTS & LABOR GUARANTEE FOR ONE YEAR  
• 115 VAC (60 HZ) OPERATION  
• CERTIFIED NIST TRACEABLE CALIBRATION

MODEL	RANGE (FROM TO Hz)	TUNE RATE		AVERAGE SENSITIVITY		GATE TIME(S)	MAX RESOLUTION			SENSITIVITY CONSOLE	EXT. CLOCK INPUT OUTPUT	METER
		TRIG	STABILITY DESIGN	BELOW 500 MHz	ABOVE 500 MHz		12 MHz	30 MHz	MAX FREQ			
K-7000-AC	100 MHz	1.0/0.5	± 1 PPM 5% (50)	24 DBM	10 uV	1.0	10 Hz	10 Hz	100 Hz	Yes	Yes	Yes
7010-S	500 MHz	1.0/0.5	± 1 PPM 10% (10)	27 DBM	20 uV	1.0	1 Hz	1 Hz	10 Hz	Yes	Yes	Yes
8010-S	500 MHz	1.0/0.5	± 0.05 PPM 10% (10)	27 DBM	20 uV	1.0	1 Hz	1 Hz	10 Hz	Yes	Yes	Yes
8013-S	1.3 GHz	1.0/0.5	± 0.05 PPM 10% (10)	27 DBM	20 uV	1.0	1 Hz	1 Hz	10 Hz	Yes	Yes	Yes

NOW IN STOCK

447

# \*\*\*\*\* 2300 MHz VARIABLE DOWNCONVERTER \*\*\*\*\*

## ANTENNA KIT

**\$16.95**

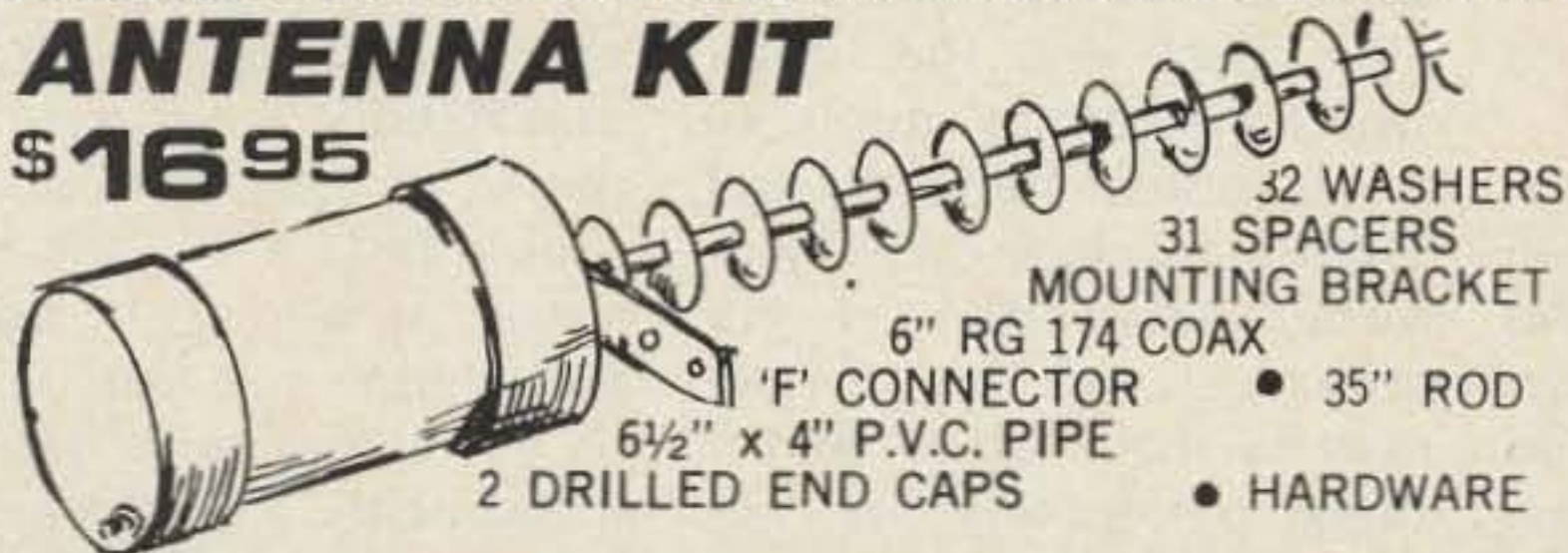

32 WASHERS  
31 SPACERS  
MOUNTING BRACKET  
6" RG 174 COAX  
"F" CONNECTOR  
6 1/2" x 4" P.V.C. PIPE  
2 DRILLED END CAPS  
• 35" ROD  
• HARDWARE

## POWER SUPPLY KIT

**\$16.95**

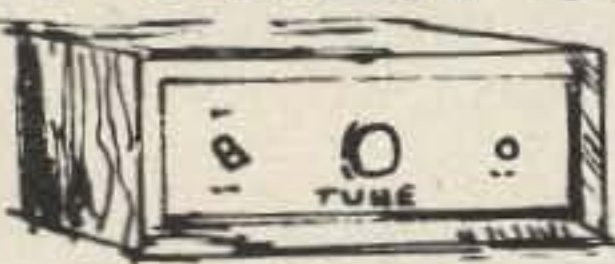

POWER TRANSFORMER  
COURSE TUNE POT.  
FINE TUNE POT.  
3 "F" CONNECTORS  
RESISTORS & CAPS  
LED WITH HOLDER  
TERMINAL STRIP  
P.C. BOARD  
RF CHOKE  
KNOB  
WIRE  
2 SWITCHES  
4 DIODES  
LM 317 REG.

**WOOD GRAIN CABINET WITH SILK SCREENED front and back \$10.95 Extra**

**BUILT POWER SUPPLY.....\$34.95**

Complete  
Down Converter  
System  
INCLUDES  
ANTENNA KIT  
POWER SUPPLY KIT  
CONVERTER KIT  
**SPECIAL \$49.95**

**QUANTITY DISCOUNTS**  
Any Price in Adv.

10 pcs.	12% off
25 pcs.	18% off
50 pcs.	25% off
100 pcs.	30% off
1000 pcs.	35% off

No Mixing for  
Quantity Discount

## PARTS

Converter P.C. Board  
Plated through holes  
for stability.....\$4.95  
Power Supply  
P.C. Board .....2.95  
MRF 901 .....2.00  
NEO2135 .....4.95  
2835 Diodes ..... .95  
.001 Chip  
Caps. .... 10/3.95  
Choke Set of 4.....1.95  
LM 317 Regulator 1.25  
"F" Connectors  
Chassis ..... .50  
Wall Transformer  
12 VAC 700 MA....4.95  
"U" Bolt .....95  
BALUN  
75 to 300 ohm.....1.95  
BALUN  
for rabbit ears...2.95  
\*RG 59/U COAX  
WITH CONNECTORS  
FACTORY MADE  
100 Ft. .... \$17.50  
50 Ft. .... 9.50  
25 Ft. .... 5.75  
3 Ft. .... 2.50

## CONVERTER KIT

**\$16.95**

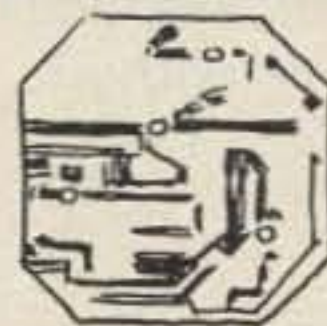

P.C. BOARD PRE-DRILLED  
SOLDER PLATED WITH  
PLATED THROUGH HOLES  
FOR A MORE STABLE PICTURE.

NEW!!  
... 2137 HOT TRANS...  
3 MRF 901 TRANSISTOR  
2 HP 2835 Diodes  
6 .001 Chip Caps.  
9 Resistors  
4 Prewound chokes  
1 Electrolytic Cap.  
1 Pre Made Probe

★ WIRED P.C. BOARD TESTED,  
READY TO CONNECT TO  
CAN WITH PROBE & CABLE  
CONNECTOR ATTACHED.  
**\$24.95**

We will tune converter board for \$12.50  
trouble shoot  
add .....7.50  
trouble shoot  
power supply..\$12.50  
plus any parts needed.

We will accept telephone orders for Visa & Mastercard  
No C.O.D. Orders  
TO ORDER CALL **317-291-7262**  
**800-428-3500**  
Complete kit weighs 10 lbs. Please add sufficient postage  
**6254 LaPas Trail**  
**Indianapolis, Indiana 46268**

# ELECTRONIC RAINBOW

146



# TVRO Q & A: Part III

*LNAs are expensive, but rolling your own is a losing proposition.*

Ken Rae WB0POP  
737 South Clarkson  
Denver CO 80906

## **W**hat is the purpose of an LNA?

The purpose of an LNA is to amplify the signal collected by the feedhorn (approximately 4 microvolts) to a usable level without adding any appreciable noise.

## *Are all 120-degree LNAs the same?*

No, they are not. Some manufacturers meet the specifications by just a bare margin, and other manufacturers give you a 100-degree LNA yet call it a 120-degree LNA because it's sort of a stepping stone; you buy either a 100 or 120. There are some indications that manufacturers will include a 105-degree LNA as a step in progression of degrees Kelvin.

## *Is the LNA's bandwidth important?*

A few years back it was said that the bandwidth of many LNAs was too wide for TVRO application. Since then most of the

manufacturers have installed bandpass filtering to narrow down the amount of outside noise that could come in. We don't want the whole world walking through the LNA. We would like to amplify the TVRO frequencies exclusively.

## *Should I buy or build an LNA?*

I recommend that you buy your first LNA. I've seen only 10% of the people who try to construct an LNA actually succeed and build something that is worth having. The disasters are horrible, so if you build an LNA, do it after you have bought one. Buy one, put your system up, get it running, and then go back and construct a low-noise amplifier for your own use and education. Then you can sell your commercial LNA for the same price you paid for it.

## *How hard is it to build an LNA?*

An analogy would be if you went down and got plate-glass sheets and tried to grind your own zoom lens for a 35mm camera. You can just imagine the precision required to do this and to add optical coating that you

would have to put on for color pictures. Well, you're trying about the same thing when building an LNA.

## *What is the most misunderstood thing about building an LNA?*

That it is much like HF work or the old tube work clear back into the fifties, where you could simply insert a tube or transistor and turn the machine on to see it run. GaAsFETs have a very critical LC reactive component to their nature, and if these parameters are not met the transistor will not perform. Meeting these parameters is difficult and takes a lot of time and meticulous work. There are people who claim that they can throw transistors into a stripline design and learn the recipe for creating a low-noise amplifier. In some cases this does work. But as a general rule, the misconception is that you can put it together, turn it on, and it will run for you. I have never seen this first try, first serve situation.

## *Why are LNAs so expensive?*

Profit is one reason, but in past years they've been extremely expensive because

20% of the LNA cost is materials and the rest is labor, much of which is because a design engineer or a microwave engineer has to sit and tune the LNA for proper specifications. This is extremely expensive at the rate of pay for engineers. The common laborer on a construction test bed is not able to bring a low-noise amplifier to specifications by simply plugging in the transistor, soldering it down, and shipping it out. It has to be tuned with precise instruments. The prices are dropping now, however, and they have come down almost two-thirds in the last 3 years.

## *Will the open-end LNA work with no feedhorn?*

Yes, it will. You can take the common commercial LNA with the open mouth and omit the feedhorn; this works exceptionally well for a .3 to a .4 dish. Now, if you go much larger than a .45 or .5 dish, where they're flatter, then you'll want some sort of a funneling device on the front of your horn such as a square-flanged horn or a funnel to create a more directional beam from the focal point to the dish.



# Boman, A WORLD AHEAD OF THE COMPETITION

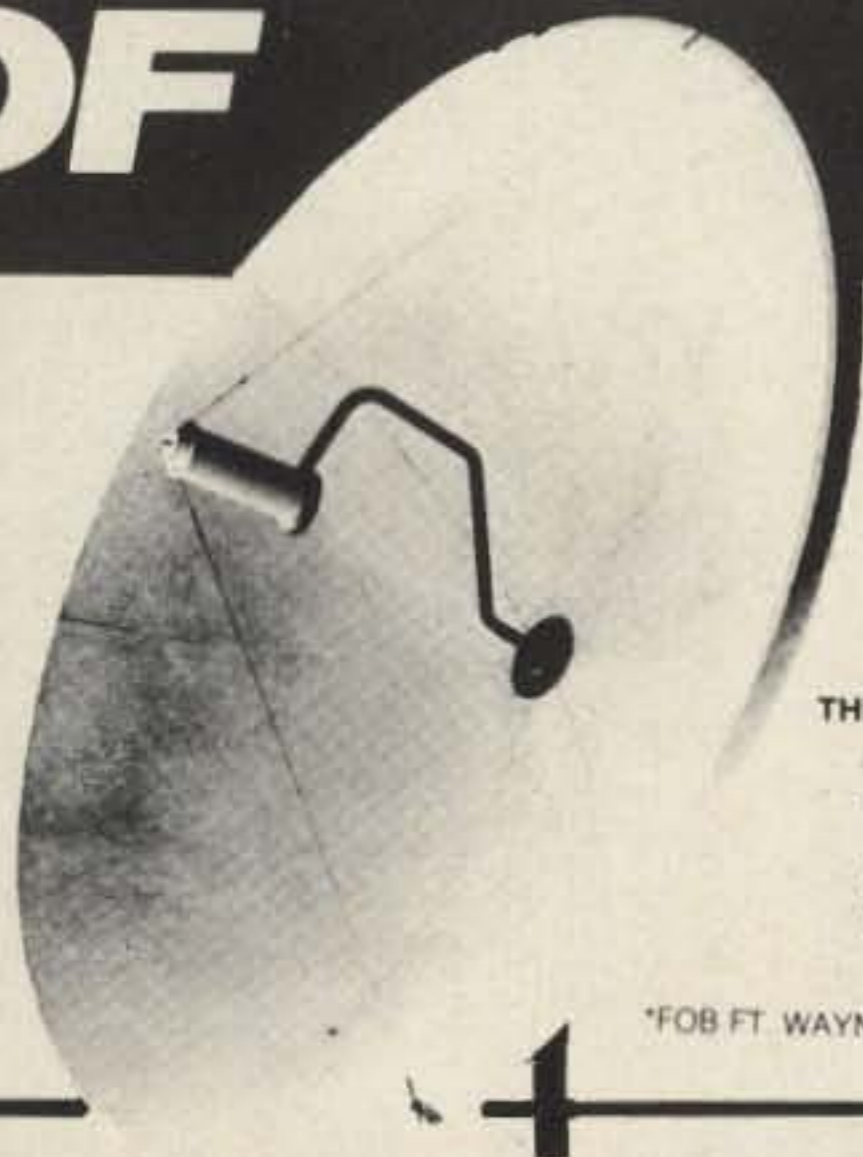

THERMO COMPRESSION MOLDED

**SUPER DISH**

**\$499<sup>50</sup>** DISTR. PRICE

\*FOB FT. WAYNE, IN

The BOMAN SA-3000 is a THERMO-COMPRESSION MOLDED Satellite Antenna . . . NO MORE GRIEF! FEATURES: • 3.0 meter diameter • 8 interlocking fiberglass sections for quick, precise assembly • Unique design allows for superior stress resistance to withstand extreme environmental changes

**NO MORE GRIEF!**



The Boman SR-800B Satellite Receiver

uses advanced technology to provide high quality reception at a very affordable price.

Features:

24 Channel Capability • 6 Audio Channels  
Fine Tuning Control • AFC • Illuminated Signal Strength Meter • Attractive Design Fits & Decor.



Receiver **\$249.50**  
Down Converter **149.50**  
**\$399.00**

**DEALER PRICE 3 PCS OR MORE**

MODEL SR 800  
24 Channels  
Detent Tuning  
Stereo Capability  
6 Audio Channels  
AFC  
Signal Strength Meter  
Fine Tuning  
Uses RG-59 Cable  
Off-On Button  
Stereo Indicator Lamp  
Built in Modulator



**\$399<sup>50</sup>** DISTR. PRICE

ORDER WITH:  
A - 100° Low Noise Converter (LNC)  
B - 110° Low Noise Converter (LNC)  
C - Down Converter



QTY.	OPEN ACCT	Pay w Order
10 UNITS (1 cs.)	\$443 <sup>89</sup>	\$399 <sup>50</sup>
30 UNITS (3 cs.)	\$421 <sup>67</sup>	\$379 <sup>50</sup>
60 UNITS (6 cs.)	\$388 <sup>33</sup>	\$349 <sup>50</sup>
600 UNITS	\$366 <sup>11</sup>	\$329 <sup>50</sup>
1000 UNITS	\$332 <sup>77</sup>	\$299 <sup>50</sup>

MODEL LNA-915  
LOW NOISE AMPLIFIER  
**110° K OR BETTER**

All BOMAN MICROWAVE AMPLIFIERS are 100% tested and marked for each guaranteed test parameter before they are released. All measurements are taken with equipment calibrated and maintained in accordance with military standard MIL-C-45662.

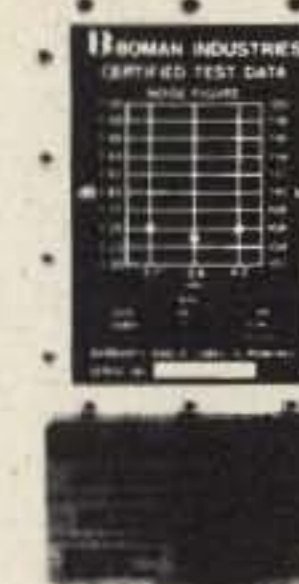

100 PCS \$24.95  
500 PCS \$19.95  
1000 PCS \$12.95

EPOXY Painted Cast Aluminum Feed Horn  
**\$37<sup>50</sup>** DISTR. PRICE

The BOMAN MODEL MWF-65

feed flange mates with standard commercial LNA 229 flanges. The feed's circular guide impedance is matched to the standard 229 wave guide. Average VSWR measured over the 3.7 to 4.2 band is better than 1.2/1. This means that the ULTRA-SPEC Microwave Feed contributes virtually nothing to system noise. Includes necessary mounting hardware.



POLAR-MATIC Feed with Control

**\$99<sup>50</sup>** DISTR. PRICE

The BOMAN MODEL EFH-75

changes polarization electrically without use of a rotor. The Probe, located inside the circular waveguide, changes polarity mode instantaneously thus improving system performance and consumer acceptance. Epoxy painted cast aluminum with all hardware. Step-up your systems with the Boman Electronic Feed Horn Model EFH-75.



**COMPLETE SYSTEMS AS LOW AS \$1797<sup>50</sup>** DISTR. PRICE



BOMAN INDUSTRIES  
SATELLITE PRODUCTS DIVISION  
9300 HALL RD., DOWNEY, CA 90241

TOLL FREE INSIDE CA: (800) 352-2553 OUTSIDE CA: (800) 421-2533



ENTER requested information in the spaces indicated below. A FREE BOMAN Satellite T-Shirt (SAT-SHIRT) will be promptly mailed to you along with our latest catalog.

Name \_\_\_\_\_  
Address \_\_\_\_\_  
City \_\_\_\_\_ Company \_\_\_\_\_  
State \_\_\_\_\_  
Zip \_\_\_\_\_



*Is a 60-dB LNA better than a 30-dB LNA?*

No, I wouldn't say so, not in natural use if the mixer is within the vicinity of the low-noise amplifier. If you're going to put your mixer inside the house and run 60-80 feet of coax or heliax to the mixer, then you need some extra dBs from your LNA and gain to pump the signal down the coax, but in effect they're equal in quality. A lot of people will think a 60-dB gain is better than a 30-dB gain. As far as the noise level goes, that is established by the first transistor amplifier of the GaAsFET LNA, and therefore stages added behind it do not improve the noise figure. They improve the ability of the low-noise amplifier to push the rf further down the coax without getting back down to an unworkable level at the other end of the coax.

*My LNA works all right at night, but is very noisy during the day; why is that?*

It sounds like you have a heat problem inside the LNA where the chip capacitor is separating and/or closing due to the heat and expansion of the circuitry. Normally the day and night transition is not noticeable on a TV screen unless you're a very particular person and see more sparklies during the day than you do at night. But if this is the case, it's usually due to the temperature of the LNA, and its circuitry is failing during the day. The other type of interference that comes during the day is unassociated with temperature, light, or conditions of the sunspot cycles. The satellite noise figure is due to its position relative to the sun on its receiving antennas and whether it's charging its batteries or not. And all these parameters influence noise during the day.

One of the biggest clues to terrestrial interference is the fact that it's usually

more predominant during the day than at night due to the fact that telephone traffic is a lot heavier during the day. The deviation is higher due to the volume of FM traffic that is coming out of the terrestrial interfering signal and deviates further into the video portion of the band of the particular channel that you're watching. Therefore, you'll notice the interference is heavier during the day than it is at night. If around 9 or 11 o'clock at night, when telephone volume drops off, the TV gets more and more clear, then you can suspect that you have terrestrial microwave interference, and I would go look for it with a spectrum analyzer at that point.

*What is a dc block and is it really needed?*

Yes, most of the commercial LNA manufacturers require that the dc power for the LNA be fed through the coax from the center conductor—this being a plus 15 to a plus 28 volts in some applications. In order to put the dc onto the coax going up to the LNA and at the same time have the rf from the LNA coming down that coax, you must divorce the two from each other at the mixer. A dc block is simply a capacitor, usually in the neighborhood of 1000 pF, inserted into the signal path allowing the rf to go through but keeping the dc on the LNA side of the stripline. An rf choke in the neighborhood of 5.6 or 10 millihenries is used to divorce the rf from the dc bias line that comes from the house. This enables you to have just one cable going to the LNA.

*Do holes in the waveguide hurt anything?*

It depends on how large the holes are. If they're no larger than one-eighth to one-quarter inch, they don't have very much effect if there are only one or two in the waveguide. I have quite a few holes in the home-

built waveguides that I've used and I can see no difference whether I leave them open or cover them.

*Do waveguide flanges have to be airtight?*

The only reason that you would need an airtight or sealtight flange between waveguide joints is to make sure that you don't interfere with another system. If you have a high-power oscillator feeding down one of these waveguides or if you were receiving side interference from terrestrial microwave or something of this nature, then airtight flanges are needed. At the low level of signal that we are talking about, the normal, compressed, bolted-together waveguides are extremely efficient. The amount of enhancement gained by goldplating, sealing, soldering, and shimming the flanges is nearly useless. Moisture seepage or air seepage might be another consideration if you're having condensation problems inside your waveguide, but most waveguides are open. My waveguide is open and has been for three years.

*How much gain is necessary for a "perfect" picture?*

For a perfect picture, something in the neighborhood of 30-36 dB is usually needed. The LNA output must be sufficiently strong to drive the mixer stage. The mixer diodes, if not driven properly, will add appreciable noise to the system. This dictates about 33-dB minimum.

*Why do some people use round horns and others use square horns?*

A long time ago it was understood that you get an easier impedance match and less loss with a square horn. I'm not sure whether that is true, but square horns do have one distinguishing factor: The pick-up probe and the impedance matching tend to be consistent in

single-mode operation. Hence the square waveguide is heavily used in military and commercial applications.

Circular waveguides collect an equal amount of E and H fields, these being perpendicular to each other. That is, when the wave enters the dish, the E and H fields are perpendicular. The E field is the electrostatic field and the H field is the magnetic field; therefore, in getting the maximum power transfer, you must have an equal amount of these two properties.

The circular waveguide more readily matches the configuration of the circular parabolic dish, the spherical dish, and also the wavefront you are trying to receive. The circular waveguide is therefore more receptive to the incoming wave than the square waveguide. In summation, the circular waveguide outdoes the square waveguide by approximately 1 to 1.5 dB. However, the transition that you use may cause a loss of .5 to 1 dB, so you may not gain anything by going from circular to square, depending on how well your transition works.

*Why use a horn instead of a dipole?*

The dipole by itself does not have the gain. What you are trying to do is focus the waves onto the probe in the rear of the waveguide. This gathering of the waves is extremely valuable when you're working with small signal levels of TVRO.

*What is a scalar horn?*

A scalar horn is simply an rf choke that keeps the signal from going over the outside of the waveguide or feedhorn and traveling back out toward the satellite. It also represents a sort of yagi antenna; a scalar horn's ribs re-radiate the wave toward the center of the waveguide, acting as an electrical funnel that catches and shoves the wave into the mouth of



NO POSTAGE  
NECESSARY  
IF MAILED  
IN THE  
UNITED STATES



**BUSINESS REPLY CARD**

FIRST CLASS PERMIT NO. 73 PETERBOROUGH NH 03458

POSTAGE WILL BE PAID BY ADDRESSEE

**73 Magazine**

**Box 931**

**Farmingdale, NY 11737**





**YES! I'd like to give 73 Magazine for  
the holidays. (12 issues—\$19.97).**



Check enclosed  
 MC  
 VISA  
 AE  
 Bill me

Card# \_\_\_\_\_  
Signature \_\_\_\_\_  
Name \_\_\_\_\_  
Address \_\_\_\_\_  
City \_\_\_\_\_ State \_\_\_\_\_ Zip \_\_\_\_\_  
Exp. date \_\_\_\_\_  
Interbank # \_\_\_\_\_

**Please enter a one year gift subscription to:**

Name \_\_\_\_\_  
Address \_\_\_\_\_  
City \_\_\_\_\_ State \_\_\_\_\_ Zip \_\_\_\_\_

All Gift Subscriptions Begin with Jan. 1983 Issue.  
73 Magazine • Box 931 • Farmingdale, NY 11737  
Canada & Mexico \$22.97, 1 year only. U.S. Funds  
Foreign \$39.97, 1 year only. U.S. Funds Drawn on U.S. Bank



# Star View CRAIG Systems™

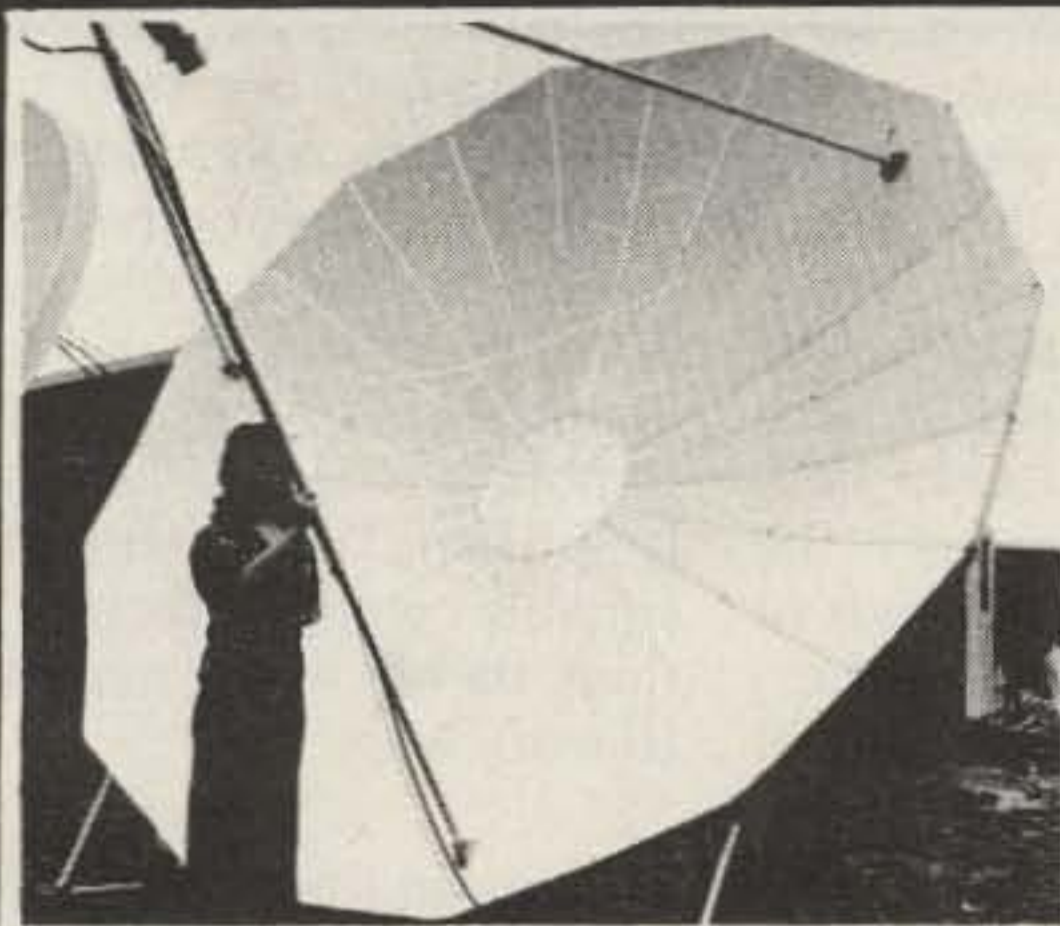

- STAR VIEW MODEL 12K**
- Complete System
  - Easy to Install
  - Reasonably Priced
  - UPS Shippable  
Weight 125 Pounds
  - More than 100 Channels Accessible

**THE STAR VIEW 12K SYSTEM KIT CONTAINS:**

- 12 Foot Antenna
- Azimuth Elevation Mount
- 24 Channel Receiver
- 120° Low Noise Amplifier
- Feed Horn
- Cables & Connectors
- No Modular Included  
(May be ordered separately for \$79.95)

**\$2595.00**

Available through your local Craig Star View dealer • Call or write for information • Dealership inquiries welcome • Price subject to change without notice.

**H&R COMMUNICATIONS, INC.** Subsidiary of Craig Corp.  
Route 3, Box 103G Pocahontas, Arkansas 72455 Call 800-643-0102 or 501-647-2291

## Alaska Microwave Labs

4335 E. 5TH STREET ANCHORAGE, ALASKA 99504  
(907) 338-0340 DEPT 73

CHIP CAPACITORS	
1.2, 2.2, 3.3, 4.7, 6.8, 10, 18, 22, 27, 47, 100, 120, 180, 220, 270, 330, 390, 470, 560, 680, 820, 1K, 1.2K, 1.8K, 3.9K, 8.2K, 10K, 100K	\$ .60
GaAs FETS	
MGF1400 NF 2.0DB @ 4GHZ MAG 15DB	\$19.00
MGF1412 NF 0.8DB @ 4GHZ MAG 18DB	\$85.00
MCF1200 NF 1.0DB @ 1GHZ, NF 2.2DB & MAG 14DB @ 4GHZ	\$14.00
COAX CONNECTORS	
BNC CHASSIS MOUNT SQUARE FLANGE	\$1.95
BNC PLUG FOR RG-58	\$1.95
SMA CHASSIS MOUNT SQUARE FLANGE	\$6.10
SMA CHASSIS MOUNT PLUG SQ FLANGE	\$8.50
SMA CHASSIS MOUNT STRIP-LINE TAB	\$6.75
SMA PLUG FOR RG-58	\$6.75
SMA PLUG FOR RG-174	\$6.75
SMA PLUG FOR 141 SEMI RIGID	\$3.98
TYPE N CHASSIS MOUNT SQUARE FLANGE	\$3.75
TYPE N PLUG FOR RG-9/RG-8	\$3.75
TYPE N DOUBLE MALE	\$7.25
TYPE N FOR 141 SEMI-RIGID	\$15.00
TYPE N CHASSIS MOUNT PLUG SQUARE FLANGE	\$14.00
SILVER PLATING KIT	
Will plate Copper, Brass, Bronze, Nickel, Tin, Pewter, Gold, and most white metal alloys	\$36.00
VTO	
V72T-1 2.7GHZ TO 3.2GHZ MIN POWER OUT 10 MW	\$98.00
TUNING VOLTAGE 0 TO 20V Vcc +15 VDC @ 60 MA	\$98.00
V82T-1 SAME AS V72T-1 BUT FREQ. 3.6GHZ TO 4.2GHZ	\$98.00
TEFLON CIRCUIT BOARD DBL SIDED 1 OZ	
APPROX. 3.25" x 5.0" x .010	\$5.50
APPROX. 3.25" x 5.0" x .0312	\$6.50
APPROX. 3.25" x 5.0" x .0625	\$10.50
FEED-THRU CAPACITORS	
1000 PF SOLDER TYPE	\$ .50
470 PF SOLDER TYPE	\$ .50
LEADLESS CERAMIC CAPACITORS	
1000 PF	\$ .25
NO WARRANTY ON SEMICONDUCTORS ✓ 406	
OPEN AT 8 PM EST CLOSED 8PM PST ORDERS ARE POSTAGE PAID COD - VISA - MASTERCARD	

## FILTER CASCADING

The most cost-effective way to improve the selectivity of any receiver - old or new - is to improve its IF filtering. A Fox-Tango Cascading Kit puts a high-quality steep-sided 8-pole filter in series with your present filter(s), both SSB and CW. The result is narrower Bandwidth and better Shape Factor, both of which dramatically reduce adjacent channel QRM - a necessity in today's crowded bands.

- CONSIDER THESE KIT FEATURES**
- Easy installation - 30 minute average.
  - No drilling, switching, alignment.
  - 16 poles of filtering yield:
    - Filter Shape Factor as high as 1.19.
    - Ultimate Rejection better than 100dB.
    - Works wonders on SSB; improves CW.
  - Compensates for Filter insertion loss.
  - Complete instructions, clear diagrams.
  - No RX audio impairment, TX unaffected.
  - Includes Filter and all needed parts.
  - Fits all models of Series - any letter.
  - All Filters 8-pole - Guaranteed One Year.

**SPECIFY KIT WANTED WHEN ORDERING**

YAESU FT101 \$75; FT101ZD \$70; FT107 \$75; FT901/2 \$65; FR101 \$55 (filter only). KENWOOD TS520/R599 \$70; TS820 \$70; TS830/RB20 \$150 (Two Filters). HEATH SB104A \$60.

Shipping \$3 (Air \$5). FL Sales Tax 5%

In addition to the above, FOX-TANGO stocks a wide line of \$55 SSB, CW, and AM 8-pole filters for Yaesu, Kenwood, Drake R4C and 7-line, and Heathkit. Also, special filters made to order. Send specs for quote.



**GO FOX-TANGO - TO BE SURE!**  
Order by Mail or Telephone.  
AUTHORIZED EUROPEAN AGENTS  
Scandinavia: MICROTEC (Norway)  
Other: INGOIMPEX (West Germany)

**FOX TANGO CORPORATION**  
Box 15944S, W. Palm Beach, FL 33406  
Phone: (305) 683-9587 ✓ 323

# SATMAR BRINGS SATELLITE TV DOWN TO EARTH

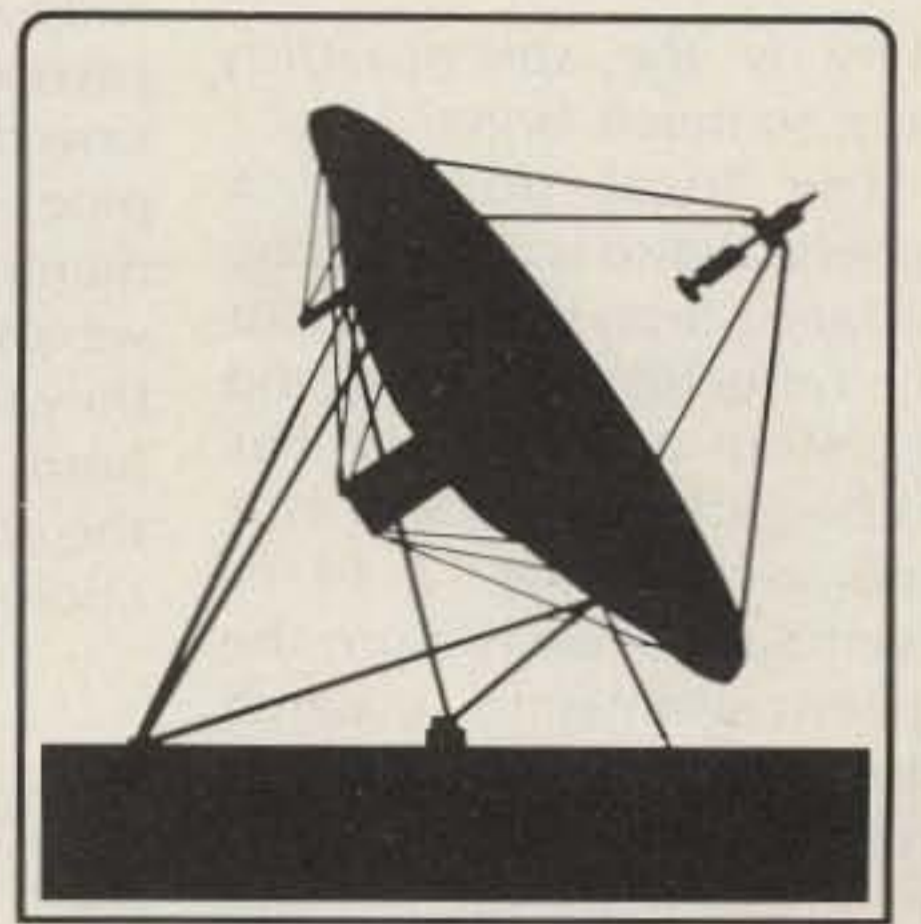

Satellite TV can indeed be your window to the world. With one of our systems you will have the ability to receive over 50 channels of movies, sports, educational, news, financial and religious programming.

Our TVRO systems are configured from a wide selection of components for your own particular viewing interests and geographical location and are specifically designed to allow you to do the installation yourself.

**Example A**  
Configured for  
**Denver, Colorado**

- Micro Scan 11 ft, 4 piece fiber-glass parabolic antenna with polar mount and electric remote LNA rotor.
- Dexcel 120° K LNA
- Lowrance "System 7" receiver with built-in modulator and stereo audio processing.
- Circular scalar feed horn
- 100 ft. cable assembly

**COMPLETE SYSTEM\***  
**\$2640.00**

## SATMAR SATELLITE TV

2230 E. Indian School Rd.  
Phoenix, Arizona 85016

**(602) 954-6008**

\*F.O.B. Phoenix, Arizona ✓ 168

See List of Advertisers on page 130



the waveguide. The scalar horn applies most readily to a deep dish—low focal-distance-to-diameter ratio (F/D). The horn must "look" at a wider angle. The funnel-shaped horns are more directional and are used with a flat dish.

*Why is the spherical-dish horn so much larger?*

The focal point of a spherical dish is quite a long distance from the surface of the reflecting spherical and therefore a larger area has to be gathered in. It is as if you are traveling 12, 14, or even 32 feet away from the spherical antenna to catch the microwave signal. You're sort of like a catcher in a baseball game; you want to use a large glove to catch that little ball. The further away you are, the more directional you want your view of the antenna. Therefore, the broader the horn is, the narrower the beam is. So you want to catch this nar-

row beam, making the horn appear much larger in physical size. The diameter of the mouth is much broader than for a parabolic dish.

*What horn do you use on a .3-F/D dish?*

On a .3 you would use a wide-angle horn such as a sawed-off waveguide, a sawed-off piece of 2-inch pipe, or a rectangular commercial 229 waveguide. The waves spread very rapidly as they leave the mouth of the horn. This leads us to use the scalar horn as the best choice.

*Is a gold- or silver-plated horn better than a copper one?*

Gold or silver is better, but for all the cost of having the gold plating or the silver plating done, you will probably increase the signal only a tenth of a dB. So it's cost prohibitive to do this type of thing.

*Are there any surplus horns?*

"Surplus" is not really the word because you can go to any plumbing shop and find a 2-inch diameter circular piece of downspout copper tubing—and that is your "surplus" waveguide. There are square and rectangular waveguides. An abundance of them are being thrown out every month by AT&T into scrap yards where they're sold for scrap copper. (They knock off the brass fittings on the ends of the flanges for brass scrap.) There are probably tons of this lying around all over the United States.

*How thick should the walls of the horn be?*

Thick enough to withstand abuse such as from dropping it or from wild weather. In mounting it, you might bang into it, so you don't want it to distort readily with normal handling. Something like 24-gauge or 28-gauge copper is the thin-

nest you should use to make it rigid.

*Can you use PC material for the horn?*

I don't like to use PC board material because you solder to only one side at a time, leaving only thin copper to hold the corners together. Bracing it on the outside takes extra work such as putting brackets around it to hold it together. Generally speaking it will work reasonably well, although I think there's easier material to work with.

*Where can I buy a horn?*

That, I wouldn't know. Most horns can be built readily out of sheet copper drawn out on the kitchen table, cut with a pair of tin snips, folded, and soldered together, just as you would fold up cardboard to make a box for Christmas wrapping. Most of the amateur enthusiasts construct their own horns. ■



## SATELLITE TELEVISION SYSTEMS

**WE WILL NOT BE UNDERSOLD!!**

Complete Systems, Antennas,  
Receivers, LNA's & Accessories

CALL US TODAY! ✓320

**812-238-1456**

**hoosier electronics**

"Nation's Largest Total Communications Distributor"  
P.O. BOX 3300 • TERRE HAUTE, INDIANA 47803

### SATELLITE TV SYSTEMS

"COMPARE OUR QUALITY, PRICES AND SERVICE!"

**WE MANUFACTURE:**

PARABOLIC DISHES  
POLAR MOUNTS  
DEMO TRAILERS  
CUSTOM PARTS

MOTORIZATION SYSTEMS  
LNA HOLDERS  
ALUMINUM HORNS

**WE STOCK:**

WASHBURN  
KLM  
AVANTEK  
GARDINER

GILLASPIE  
DRAKE  
LOWRANCE

ALLIANCE  
ATV  
CABLE & CONNECTORS  
SWITCHES & HARDWARE

CALL, WRITE OR ✓ FOR OUR LATEST BROCHURE AND PRICES.

AUSTIN C. LEWIS  
K4GGC  
901-784-2191

LEWIS CONSTRUCTION CO.  
P.O. BOX 100  
HUMBOLDT, TN. 38341

"IN BUSINESS AT THIS LOCATION SINCE 1964" ✓452

### 2 GHz Microwave Receiving Systems

The new **Micro-System** features a machined 18" parabolic reflector for maximum efficiency, a linear feed-point downconverter with ceramic high performance RF preamplifier transistor, a variable 12 to 18 volt regulated power supply and 50' of 75Ω coaxial downlead, including a 3' jumper and matching transformer. The **Micro-System** includes a full 6 month warranty.

**Micro-System (MS-021)** .....\$159<sup>95</sup>  
**Micro-System (MS-578)** .....\$169<sup>95</sup>  
**Micro-System (MS-645)** .....\$179<sup>95</sup>

Shipping & Handling: USA...\$4<sup>00</sup> AK, HI & PR...\$10<sup>00</sup>

#### Data Service Company

✓346 3110 Evelyn Street  
Roseville, MN • 55113





## QUALITY MICROWAVE TV SYSTEMS

### 1.9 to 2.5 GHz Antennas

Complete System (Rod Style as pictured)	\$124.95
Complete System (Reflector Style as pictured)	\$149.95
Down Converter, Assembled & Tested	\$64.95
Power Supply (12 to 18v)	\$49.95

Also Dish Style Antennas In Stock.

**Galaxy Electronics** ✓178  
6007 N. 61st Ave.  
Glendale, Az.  
85301  
(602) 247-1151

COD's  
Quantity Pricing



90 DAY WARRANTY  
PARTS & LABOR



sample issue  
only \$2.50  
PPD

OUR 16TH YEAR!

## AMATEUR TELEVISION MAGAZINE

 ✓115

"FOR THE SPECIALIZED COMMUNICATION RADIO AMATEUR"

	Surface U.S./Canada Mexico	Surface All Foreign	Airmail Central S. America	Airmail All Other Foreign
1/2 year	\$ 10.00	\$ 13.00	\$ 20.00	\$ 23.00
1 year	\$ 20.00	\$ 26.00	\$ 40.00	\$ 46.00
2 year	\$ 38.00	\$ 50.00	\$ 78.00	\$ 90.00
3 year	\$ 56.00	\$ 74.00	\$116.00	\$134.00

ATV-SSTV-FAX-RTTY-Satellites-EME  
Microwave and Computers.

Published 12 times per year by Mike Stone WB9QCD  
P.O. Box H, Lowden, Iowa 52255 0408

## RELIABLE MICROWAVE TV ANTENNAS

### 2.1 to 2.6 GHz Frequency Range

34db System Gain (or Greater)

Complete System (as pictured)	\$149.95
Down Converter Probe Style (Assembled and Tested)	\$ 64.95
Power Supply (12V to 16V DC+) (Assembled and Tested)	\$ 59.95



### PETERSON ELECTRONICS

4558 Auburn Blvd.  
Sacramento, CA 95841  
(916) 486-9071

✓182

C.O.D.'s  
SPECIAL QUANTITY  
PRICING  
Dealers Wanted



1 YEAR WARRANTY  
PARTS & LABOR

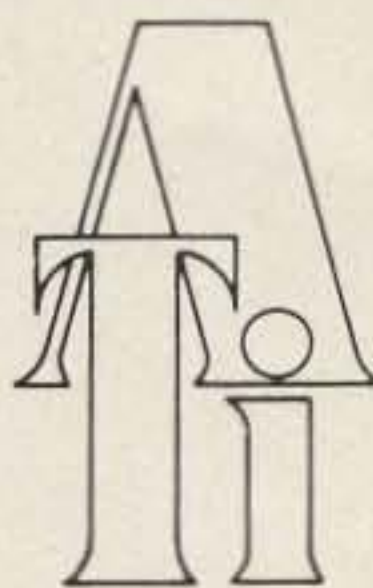

2300

MHz

**NEW  
LOW  
PRICE**

## READY TO INSTALL... 89.95

CONVERTER KIT.....	29.95
NEC NEO2137 TRANSISTOR.... 3 for....	7.95
CONVERTER KIT ASSEMBLED.....	38.95
POWER SUPPLY ASSEMBLED.....	19.95
CIGAR ANTENNA.....	19.95
HOUSING, MTG BRKT, 50 COAX.....	19.95

TERMS: CHECK, VISA, MASTER CARD

## IN STOCK - READY TO SHIP

2012 15th Av. • Ft. Worth, Tx. 76102

817-332-2994

✓175



**EM-3**

## INTRODUCING SMP'S DOWNCONVERTER KIT!!

**NEW**

2300 MHz MICROWAVE DOWNCONVERTER  
KIT. Includes high quality PC board, NE02137 &  
NE02136 transistors, thermal drift stabilizer,  
silver solder, .141 hardline, matched diodes,  
F-connectors, molded coils, instructions.

**29.95**

EM-4 The EM-3 with NE64535 high performance RF  
transistor; Adds 3db gain to EM-3 and reduces noise figure.  
37.95.

## DO IT RIGHT THE FIRST TIME WITH SUPERIOR QUALITY — WITHOUT HIDDEN COSTS

THOSE 19.95  
"DEALS" DON'T  
HAVE IT ALL —  
**WE DO!**

- Detailed Instructions
- Post-Paid Delivery
- Thermal Drift Stabilizer
- F-Connectors
- Hardline Antenna Probe

- High Gain RF Stage
- Matched Diodes
- Molded Coils
- Silver Solder
- Toll-Free Number

Sale!

Sale!

Send SASE for Catalogue

Sale!



DA-3 62.95  
EM-3 & RFA-1



TU-8 Power  
Supply 34.95

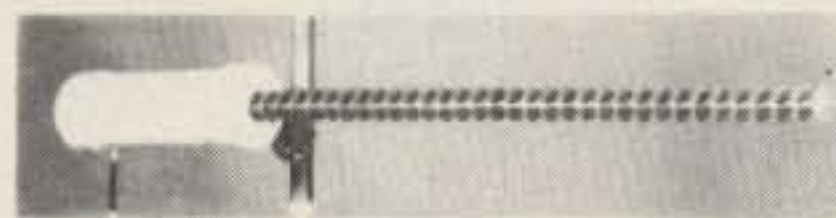

ANT-4 Antenna 30.00  
with Adjustable Bracket



RFA-1 34.95  
Preamplifier

# SMP

Superior Microwave Products, Inc.  
P.O. Box 1241  
Vienna, VA 22180

Orders Only: 1-800-368-3028  
Info., VA & D.C.: 1-703-255-2918  
Discounts Over \$100  
All Orders Postpaid & Shipped in 48 Hours

*We Don't Compromise On Quality*



✓376



# The Sound of Silence

*Beep!! Your TS-180 is off the air, Charlie.*

Tony Ruepp HB9BLU  
Ifangstr. 73  
CH-8153 Ruemlang  
Switzerland

The TS-180 contains a very effective swr protection circuit. If ever the swr exceeds a given limit, this circuit immediately cuts off your transmission and lights the LED. This state is held until you (or the VOX) release the transmit button.

When transmitting CW, I very seldom watch the rig. I rather "see" the letters and words passing by while staring at a hole in the air. Several times I did not realize my transmission had been

cut off, but I learned it immediately when I returned to receive and heard my partner in another QSO wondering where I might have gone. My 40m and 80m antennas swing in the wind and often exceed the swr limit for a moment.

The following very simple modification guarantees gaining your immediate attention whenever the protection circuit has fired. It simply steals the sidetone and even recycles the protection circuit if you're operating in the VOX mode. It's an easy job to do (takes about 15 minutes and costs less than a dollar) if you follow the instructions carefully:

Prepare a diode (1N4148 or equivalent) and a piece of insulated wire (length about 50 cm). Strip one end and pre-tin it.

1) Remove the eight screws which secure the top cover.

2) Lift the cover slightly and unplug the speaker.

3) Remove the cover entirely.

4) Locate the protection-circuit LED above the digital frequency display. This LED is mounted on the LED unit. The leftmost pin on it is labeled PRL and a blue wire is soldered to it.

5) Make sure no other wires are touching that pin, then solder the prepared wire to it.

6) Bend the wire 1.5 cm

behind the pin to the left. Bend it to the rear again after another 3 cm and follow the edge of the PLL assembly to the rear of the rig.

7) Bend it to the right again and cut it 2 cm from the CW key jack.

8) Strip ¼ cm and tin it.

9) Now carefully place the wire in its proper position and tape it close to its end to the chassis.

10) The CW key jack has 5 soldering lugs. Locate the one with the brown wire. (This wire leads to the STS pins of the i-f assembly.)

11) Solder the anode of the diode to the lug with the brown wire and the cathode (ring) to the added wire.

This completes the modification. ■

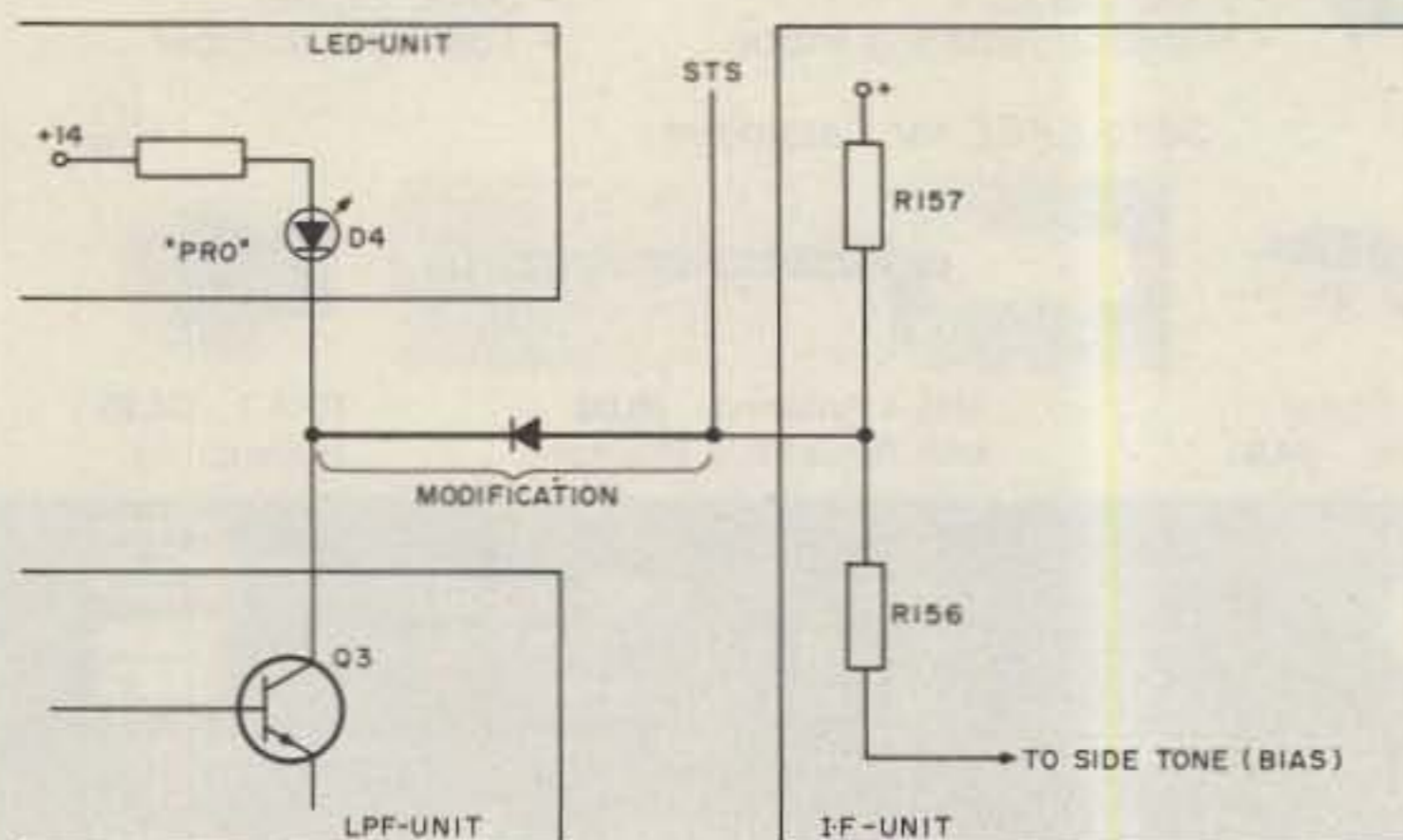

Fig. 1.

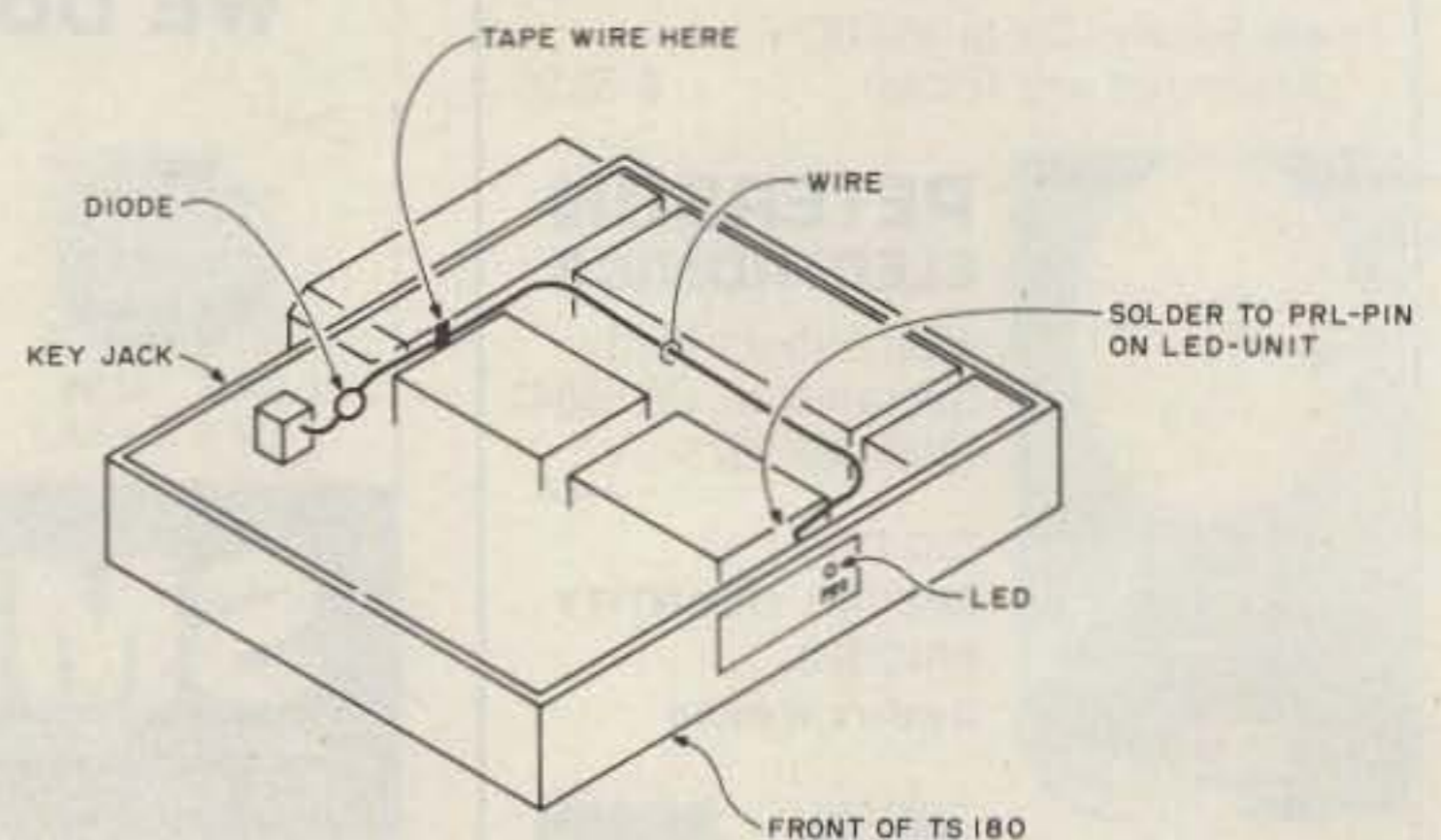

Fig. 2.



# At Last.

A microthin, synthesized, programmable, sub-audible tone encoder that fits inside the ICOM IC-2AT.

Need we say more?

\$29.95

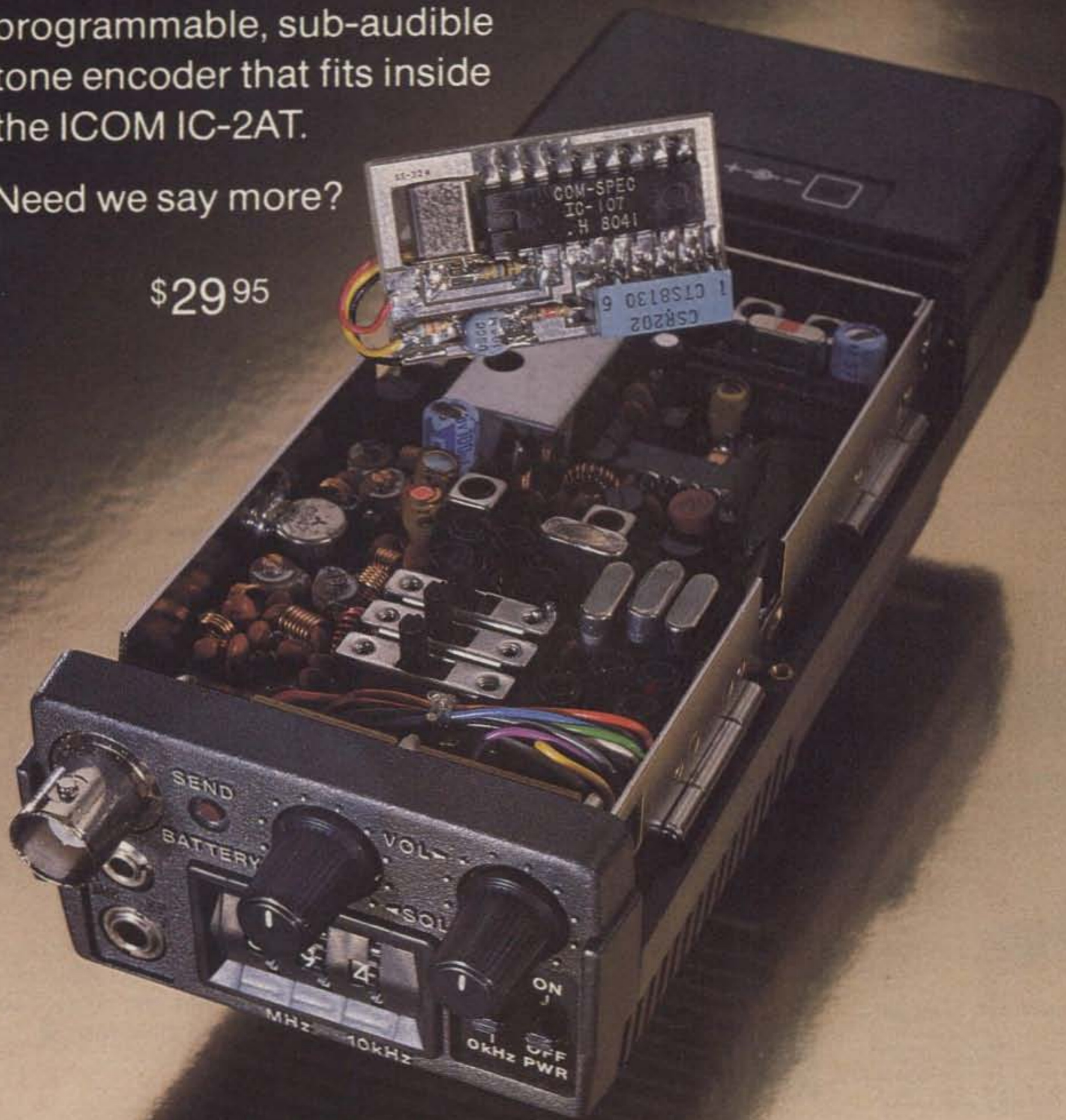

**COMMUNICATIONS  
SPECIALISTS**

426 West Taft Avenue, Orange, CA 92667  
800/854-0547 California: 714/998-3021



# Build the Re-Fuser

*It's a self-replacing fuse.  
Why blow one when you can blow two?*

A. W. Edwards K5CN  
456 Glenmore  
Corpus Christi TX 78412

I am sure that many technicians have made a trip to a remote, unattended electronic installation to restore some piece of equipment to service only to find that the problem

was an open fuse. When the fuse was replaced, everything was normal; no other defect was apparent.

This article describes a circuit which will detect the open-fuse condition, give the load and/or supply time to recover, replace the open fuse with a good one, and announce the fact that the reserve fuse is now in service.

places F2 in the main load line. If the load now is capable of proper operation, F2 will hold, restoring the equipment to service. The TD heater is again short-circuited, so it resets.

SCR2 may be used to activate a small oscillator, e.g., a Sonalert™ or other type. This modulator can be made to signal, via an rf carrier, that the main fuse has failed and that the system is in the backup condition.

The modulating system may be a periodic beep or a continuous tone. The Sonalert device can give local aural notice, as well as providing electrical modulation.

A relay arrangement might also be employed, with the relay coil across the main fuse. ■

Fig. 1 shows the general circuit for a dc-powered unit. So long as the regular fuse, F1, is good, the heater element of the time-delay device is shorted out by it. Should F1 open, the heater appears in series with the load. After a delay period for the thermal device to operate, the TD switch contacts close and power is applied to the gates of SCRs 1 and 2. SCR1 conducts and

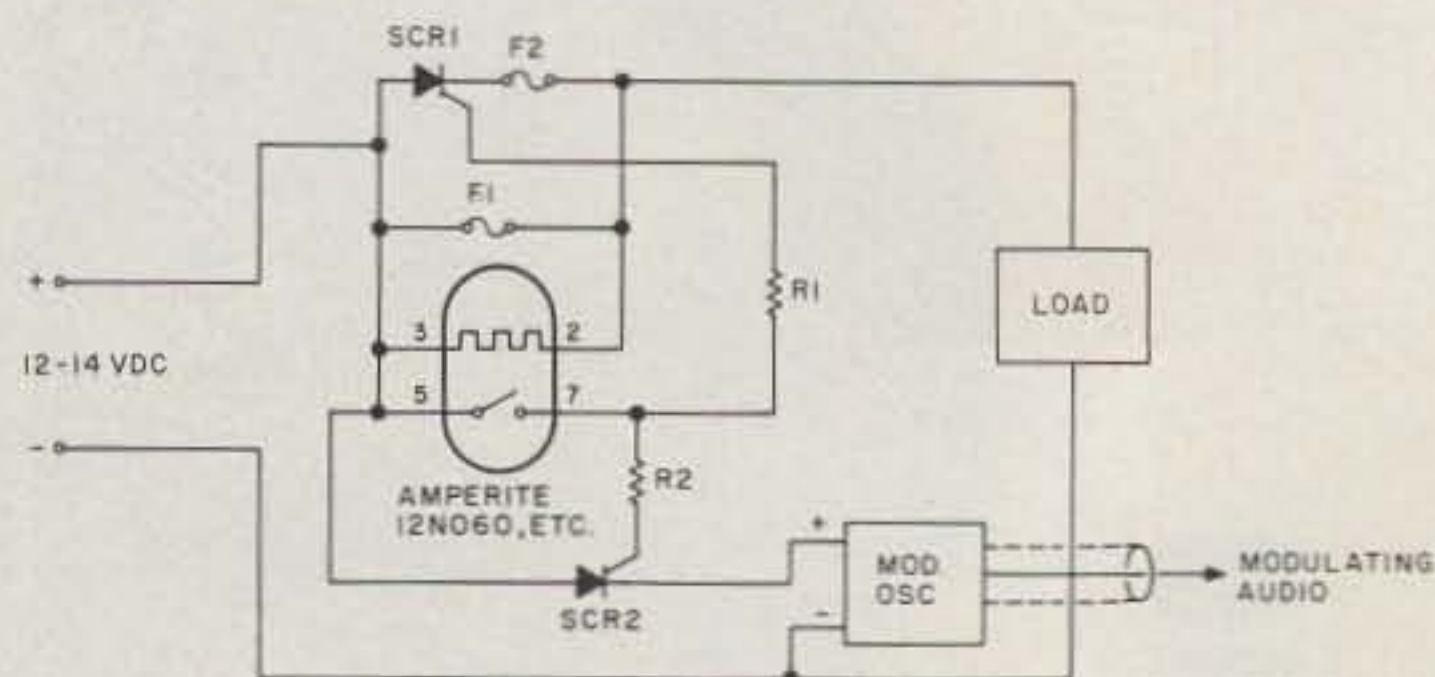

Fig. 1. Dc-operated circuitry.



## FAST SCAN

\*\$249

A modular approach... for your own custom-designed ATV system... Here's how



**PA5 10 WATT ATV POWER MODULE \$89 ppd**  
The PA5 will put out 10 watts RMS power on the sync tips when driven with 80 mw by the TXA5 exciter. 50 ohms in and out, plus bandwidth for the whole band with good linearity for color and sound. Requires 13.8 vdc regulated @ 3 amps.

**TXA5-4 ATV EXCITER/MODULATOR \$89 ppd**  
This wired and tested module is designed to drive the Motorola MHW-710 module in the PA5 10 watt linear amp. The crystal in the 100 mHz region keeps harmonics out of two meters for talk back. The video modulator is full 8 mHz for computer graphics and color. Requires 13.8 vdc reg @ 70 ma. Tuned with xtal on 439.25, 434.0, or 426.25 mHz. Provision for sync expanding. Two frequencies available.



**FMA5 AUDIO SUBCARRIER GENERATOR \$29 ppd**  
Puts audio on with your camera video just as broadcast TV does at 4.5 mHz. Puts out up to 1 v p-p to drive the TXA5 or VM-2, 3, or 4 modulators. Requires low Z mic (150 to 600 ohms), and +12 to 18 vdc @ 25 ma. Works with any xmtr with 5 mHz video bandwidth.



**TVC-2 ATV DOWNCONVERTER... \$55 ppd**  
Stripline MRF901 (1.7 db NF) preamp and double balanced mixer module digs out the weak ones but resists intermods and overload. Connects between uhf antenna and TV set tuned to channel 2 or 3. Varicap tunes 420 to 450 mHz. Requires +12 to 18 vdc @ 20 ma. Super sensitive TVC-2L with NE64535 preamp (.9db NF) stage... \$69 ppd.

**\*TXA5, PA5, FMA5 and TVC Basic Module Pkg.**

Call or write for our complete list of specifications, station set-up diagrams, and optional accessories which include antennas, modulators, detectors, test generators, cameras, etc. **WE ARE A FULL-LINE SUPPLIER OF ALL YOUR ATV NEEDS.**

TERMS: VISA or MASTER CARD by telephone or mail, or check or money order by mail. All prices are delivered in USA. Allow three weeks after order for delivery.  
(213) 447-4565 Charge card orders only

P.C. ELECTRONICS
2522 Paxson Lane,  
Arcadia, California 91006

Tom W6ORG Maryann WB6YSS



# You've got to get a Santec to get it right!



Compare Santec to anything you like, and you'll see — you've got to get a Santec to get: ■ memory channels which store standard repeater offsets for instant recall ■ less than 10 ma drain in receive to conserve power while you're monitoring ■ extremely wide power options of 0.1 W, 1.0 W or even 3.5 W for varying conditions ■ an accurate 24 hour clock for instant reference ■ and a full two year extended service plan which no one else will match.

When you get a Santec, you also get: ■ the widest frequency range of any handheld ■ odd offsets other than  $\pm 600$  kHz ■ variable step sizes in bandscan ■ a 500 ma battery with charger ■ a full six digit back-lighted LCD display for full frequency readout plus the memory channel number ■ the easiest keyboard entry of any handheld ■ eight modes of scan, search, manual control and open scan ■ the ability to change batteries without losing memory data ■ easily programmable bandscan ■ a frequency lock switch on the keyboard ■ an automatic low battery indicator ■ and much more.

FEATURE	SANTEC ST-144	YAESU FT-208	KENWOOD TR-2500
Size (mm)	68 x 170 x 47	61 x 168 x 49	66 x 168 x 40
Weight with Batt.	600 gm	720 gm	540 gm
Readout	LCD (full 6 digits)	LCD (4 digits)	LCD (4 digits)
Memory Channels	10	10	10
Memory of Offsets	YES	NO	NO
Memory Backup	YES, Capacitance	Yes, Lithium Batt.	Yes, Lithium Batt.
Search Mode	YES	NO	NO
Step Size	5-100 kHz	5 or 10 kHz only	5-30 kHz
Battery	Quick Change Pack 500 ma-hr, 9.6 V	Quick Change Pack 450 ma-hr, 10.8 V	Slide-on Pack 400 ma-hr, 8.4 V
Frequency Coverage	142-148.995 Tx (149.995 optional) 142-149.995 Rx	143.5-148.495 Tx/Rx	143.9-148.995 Tx/Rx
Power (max)	3.5 W High 1.0 W Med. 0.1 W Low	2.5 W High  0.2 W Low	2.5 W High
Priority	YES (in Mem/Scan)	Yes (Priority Ch.)	NO
Clock	YES	NO	NO
Computer Current Saver	YES (<10 ma)	NO (20 ma)	NO (27 ma)
Display	6 Digits + Mem. #	4 Digits + Mem. #	4 Digits

**New! Affordable Price! See your Authorized Santec Dealer for details.**

Competitors' specifications were obtained from published specifications sheets, and they are subject to change without notification to Santec or Encomm, Inc.

Shown with optional SM-3 speaker microphone.



Accessories for SANTEC Handheld Radios  
clockwise from upper left:  
Leather Case (ST-LC)  
Base Charger & Power Supply (ST-5BC)  
Remote Speaker (MS-50S)  
Mobile Charger (ST-MC)  
Speaker Microphone (SM-3)

The ST-144  $\mu$ P is approved under FCC Part 15.



© 1982, Encomm, Inc.  
2000 Avenue G, Suite 800, Plano, Texas 75074  
Phone (214) 423-0024 • TLX 79-4783 ENCOMM DAL  
Repairs, Parts & Service Available 

Export orders invited.

All stated specifications are subject to change without notice or obligation.

Encomm, Inc. 2000 Avenue G Suite 800 Plano TX 75074

Please send me more information about:  
 The ST-144/ $\mu$ P  
 Authorized SANTEC Dealers

NAME \_\_\_\_\_ CALL \_\_\_\_\_  
 ADDRESS \_\_\_\_\_  
 CITY \_\_\_\_\_ STATE \_\_\_\_\_ ZIP \_\_\_\_\_

**YOU MAY SEND A DUPLICATE OF THIS FORM.**





# No Smoking in the Ham Shack

*Overvoltage kills solid-state finals. Protect yours for \$1.00.*

John J. Lapham, Jr. N7JJ  
4718 18th NE  
Seattle WA 98105

This two- or three-component addition to a power supply will give the experimenter a visual indication of an over-voltage

condition and do it for much less than the cost of a meter (see Fig. 1). All that is required is a low-power zener diode, an LED, and (possibly) a low-wattage resistor.

For example, in Fig. 1, the unregulated voltage is 18 volts. Since a voltage-regu-

lator failure could occur if there were a collector-emitter short, there conceivably could be 18 volts at the power supply output. Suppose the load can't safely operate at that potential for very long. By choosing the right zener, the experimenter can have an inexpensive visual indication of this condition. The mathematics are simple!

Remember Ohm's Law?  $E = IR$ . For this example, a zener is chosen which will reduce the 18 volts by the 1.5 to 1.7 volts which are used to turn on the LED:  $V_{zener} = 18 - 1.7 = 16.3$  volts. In a normal output voltage condition, the zener will not conduct and the LED will not turn on, but if the output rises to the breakdown value plus the LED conduction value, the LED will light. But suppose you don't have (in this case)

a 16-volt zener. Maybe you only have a 13-volt zener. What then?

Well,  $18\text{ V} - (13\text{ V} + 1.7\text{ V}) = 3.3\text{ V}$ . What is going to drop that 3.3 volts? Remember that resistor? Now you can use it. The resistance must equal that 3.3 volts divided by the current through the conducting LED, in this case .02 Amperes. Using Ohm's Law we get:  $R = E/I$ , or  $R = 3.3\text{ volts}/.02\text{ Amps} = 165\text{ Ohms}$ . This value of resistance is then placed in series with the LED and zener to drop the excess voltage (see Fig. 2).

If the voltage is required to be monitored exactly, then a meter is the better choice. But if an absolute over-voltage value is the only concern, then this circuit could be utilized for around \$1.00. It could be a bargain. ■

**NEW**

**RADIO ACTIVITY**  
**925 South Ninth**  
**Lander**  
**Wyoming 82520**

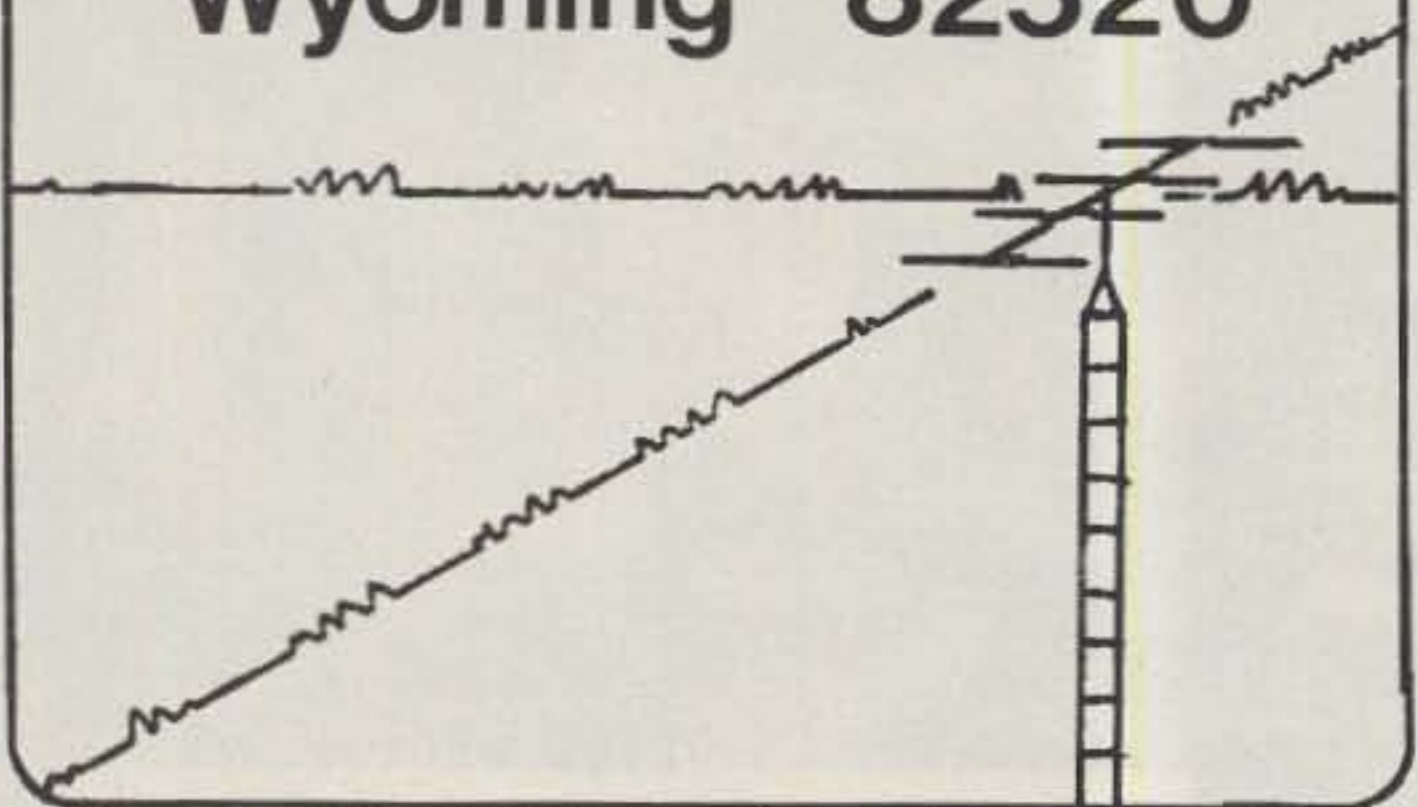

**LOCATION**

✓315

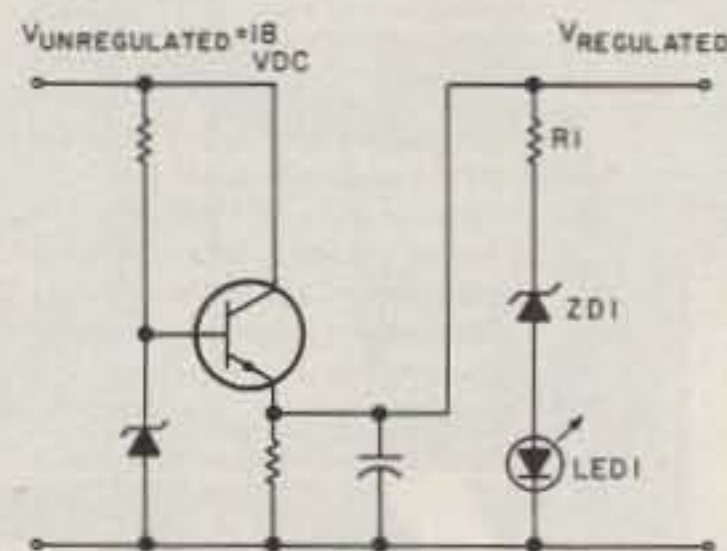

Fig. 1. R1, ZD1, and LED1 comprise the monitor circuit.

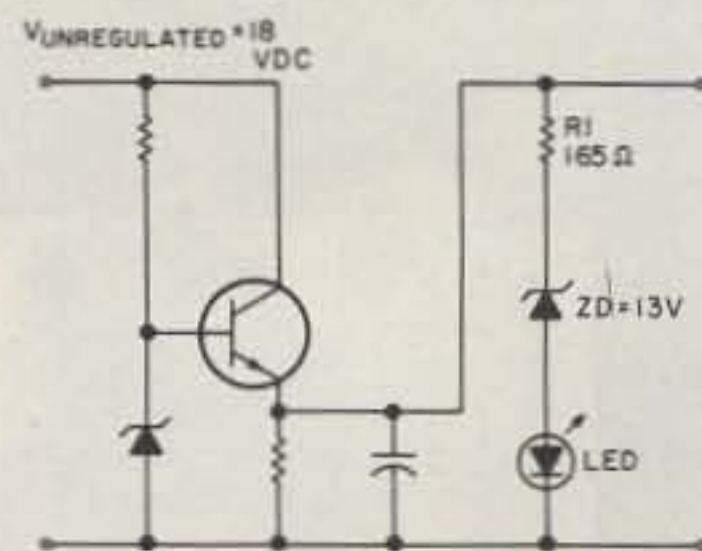

Fig. 2. The correct value for R1.



## PORTAPEATER™

\$179.00 assembled  
unit

### M100 A

\$99.00 assembled  
board

## INSTANT REPEATER ANY BAND ANY MODE

\* 4 Channel PROM  
CW I Der

\* VOX or COR  
operation

\* 250 volt  
switching  
capability

\* An Instant  
Repeater



\* Works with any  
type radios

\* Complete Timer  
Functions

\* Built In Test  
Functions

\* 20 Page  
Technical Manual

(Fully tested, programmed, assembled) ✓302

W-S ENGINEERING P.O. BOX 58, PINE HILL, N.J. 08021  
(201-852-0269)

Don't Be Left Out in the Cold  
with the Russian Woodpecker

## GET A MOSCOW MUFFLER™

Another first from AEA. The Woodpecker Blanker, WB-1 really works. This unit effectively blanks the pulsing interference of the Russian Woodpecker. Two versions are available, the WB-1 for use with communication receivers and WB-1C for use with all popular transceivers.



This extremely useful accessory is designed for direct insertion between your receiver (or transceiver) and the antenna. It is both MORE EFFECTIVE than I.F. type blankers and requires NO MODIFICATIONS to your receiver! The unit operates from a 13 VDC  $\pm$  2 VDC power source at less than 575 mA. (AEA AC wall unit AC-1 will operate the blanker.)

The blanker works well on both CW and SSB modes that are being interfered with by a woodpecker. Controls on the front panel include; four push button switches, a synchronize control and a width control. The WB-1 also features a low-noise untuned broadbanded 6 db gain pre-amp which can be selected with or without the blanker enabled. The WB-1C uses the same circuitry but includes a carrier operated relay (COR). This provides protection to the receiver section during transmissions from the attached transceiver.

For more details, write for our latest catalog or visit your favorite dealer.

Prices and Specifications subject to change without notice or obligation.

**ADVANCED ELECTRONIC  
APPLICATIONS, INC.** ✓2

P.O. Box C-2160,  
Lynnwood, WA 98036  
(206) 775-7373

Telex: 152571 AEA INTL

**AEA** Brings you the  
Breakthrough!

## RTTY SCOPE

**NEW!**



### At Last! An RTTY Tuning Scope!

And who else but HAL would bring you such a practical solution to the RTTY tuning problem. If all you have is flashing lights, you know how difficult it can be to match your transmit frequency with that of a received RTTY signal. The RS2100 RTTY Scope ends these problems with an accurate display of the received signal (both signal amplitude and phase). The RS2100 is a matching companion for the CT2100 Communications Terminal and may be used with most HAL and other manufacturers' RTTY equipment. An internal loop supply is included.

- X-Y tuning scope indication
- 1" diameter green phosphor CRT
- Front panel focus, intensity, and position controls
- Internal 200 VDC, 60 ma loop supply
- Two loop keying circuits (high voltage or optical isolator)
- 3-1/2" x 8-1/4" x 10-3/16", 9 lbs net, 12 lbs shipping 120/240 VAC, 50/60 Hz power
- Scope indicator works with CT2100, DS2050, DS2000, CWR685, CWR6850, CWR670, CWR6700, ST5000, ST-6K, ST-5K, and more
- Loop supply works with CT2100, DS2050, DS2000, CWR685, and CWR6850

Write or call for more details. See the RS2100 at your favorite HAL dealer.



**HAL COMMUNICATIONS CORP.**

BOX 365 ✓345  
URBANA, ILLINOIS 61801 217-367-7373



# Tempo MARSer

*Get the S-1 off those crowded ham channels. Expand your coverage above and below the amateur band.*



Fig. 1. The Tempo S-1 transceiver.

Edison Fong WB6IQN  
Signetics Corporation  
811 E. Arques Avenue  
Sunnyvale CA 94087

The Tempo S-1, introduced about two years ago, remains as one of the most popular VHF synthesized transceivers. This is because of its compact size, durability, reliability, and performance. This article will show that with some simple modifications, the radio's bandwidth can be extended to 140-155 MHz, thus covering MARS, mobile telephone, fire, police, etc. Although some degradation of performance occurs on the band extremes, no measurable degradation was observed within the amateur band. The few components and items needed are listed in the box.

The techniques presented here can be applied to similar transceivers such as the Icom IC-2A, but are much more complex with microprocessor-control radios

such as the Kenwood TR-2400 and Santec HT-1200. Although the unit is capable of transmitting in the commercial band after the modifications, only authorized persons should do so. In addition, the modifications are not FCC-approved.

## S-1 Background

The block diagram of the S-1 is shown in Fig. 2. The master oscillator is in a phase-locked-loop configuration so that only a single base crystal (6.82666 MHz) is used for the reference oscillator. This oscillator is fed through a programmable divider chip (NIS-103). Initially, this divider spans  $N=800-1600$ , giving the S-1 144-148-MHz capabilities. For example, the following divisions give the divider outputs and operating frequencies shown:



Division	Output (MHz)	Frequency (MHz)
N=800	1.33	144
N=1000	1.66	145
N=1200	2.00	146
N=1400	2.33	147
N=1600	2.66	148

NIS-103 does not directly divide the reference oscillator because NIS-105 contains other circuitry. The output signal is then mixed with the 43.1-MHz crystal oscillator. If the output of these two signals is summed and is fed through the vco consisting of the 2SK61 and then tripled via the 2SC1764, the output of the vco becomes 134.30 MHz. The vco generates the sum signal directly producing a clean signal as opposed to tapping the signal off the mixer

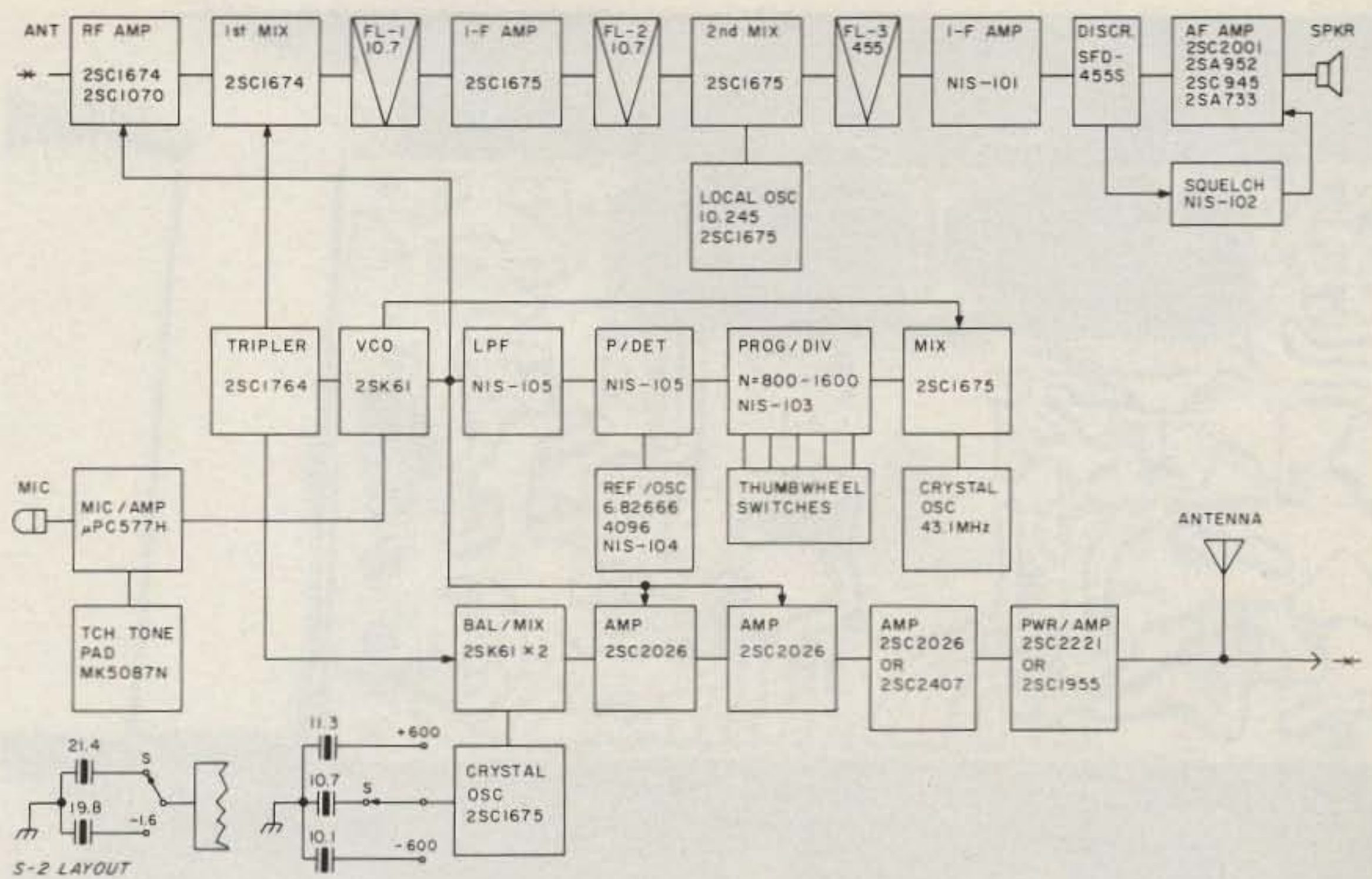

Fig. 2. Block diagram of the S-1.

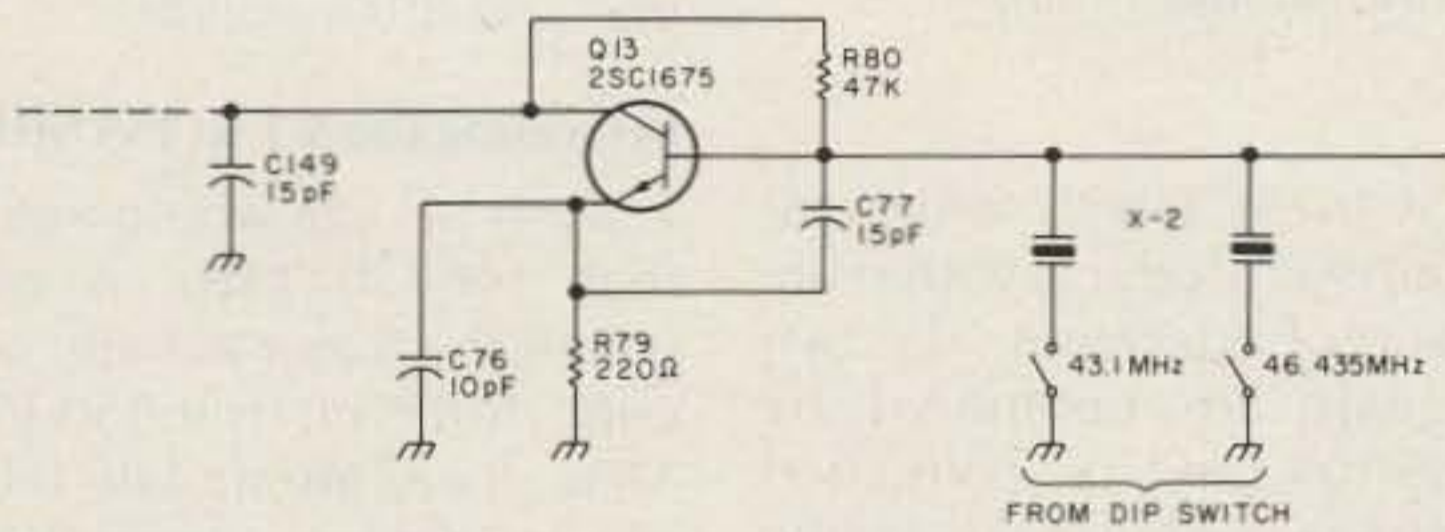

Fig. 3. Wiring configuration showing the switching of the two crystals.

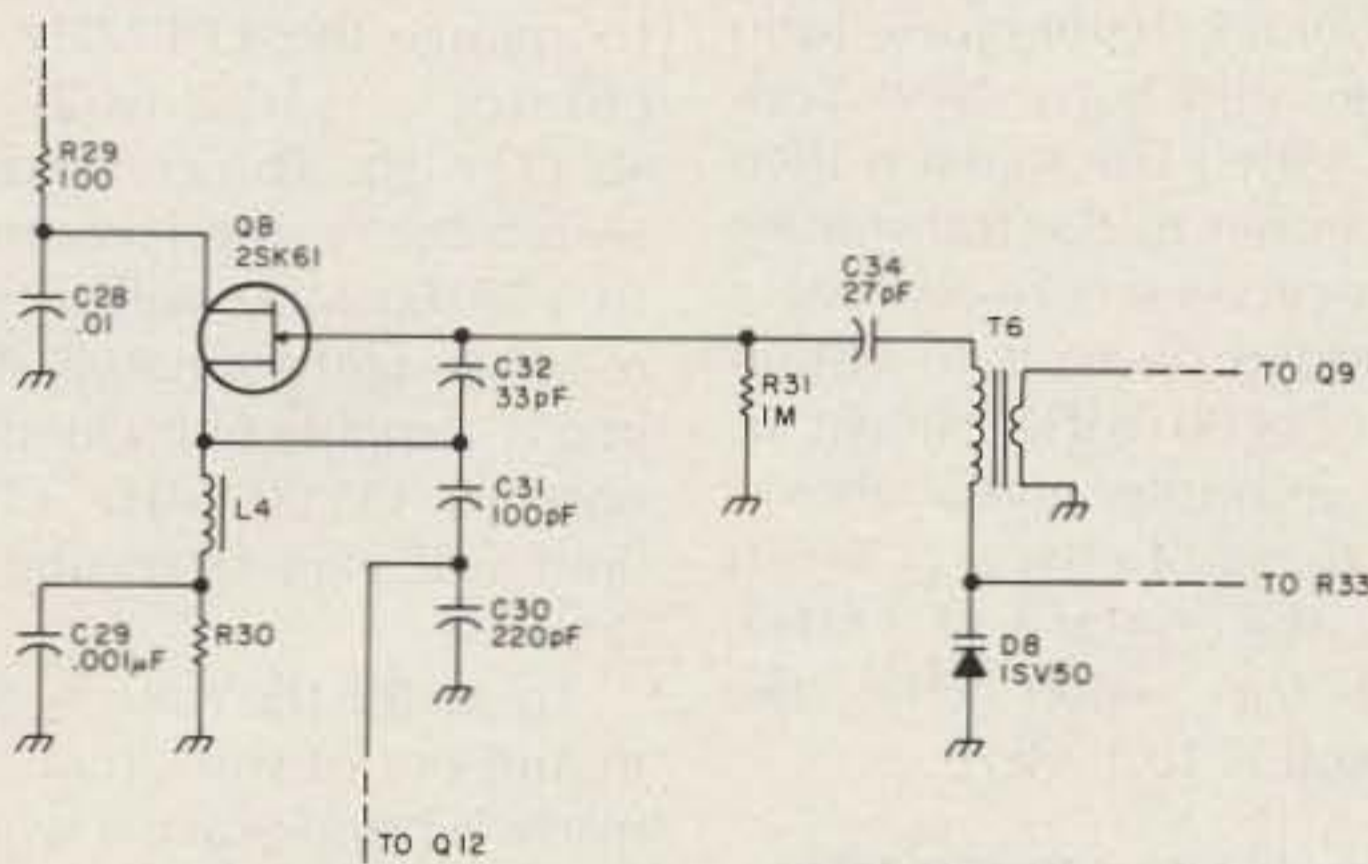

Fig. 4. Schematic of the vco. The only point at which the varactor diode can be connected is between C31 and C30 since the dc voltage will not disturb the circuit.

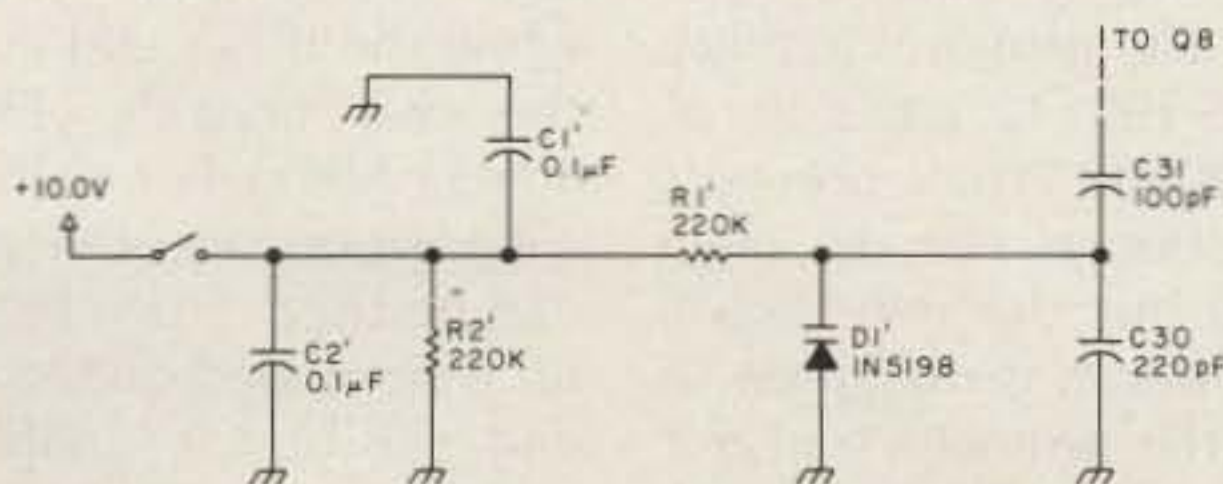

Fig. 5. Hookup of the varactor diode and how it is switched in and out of the circuit.



Fig. 6. Mounting of the varactor diode, C1', and R1' on the receiver board.



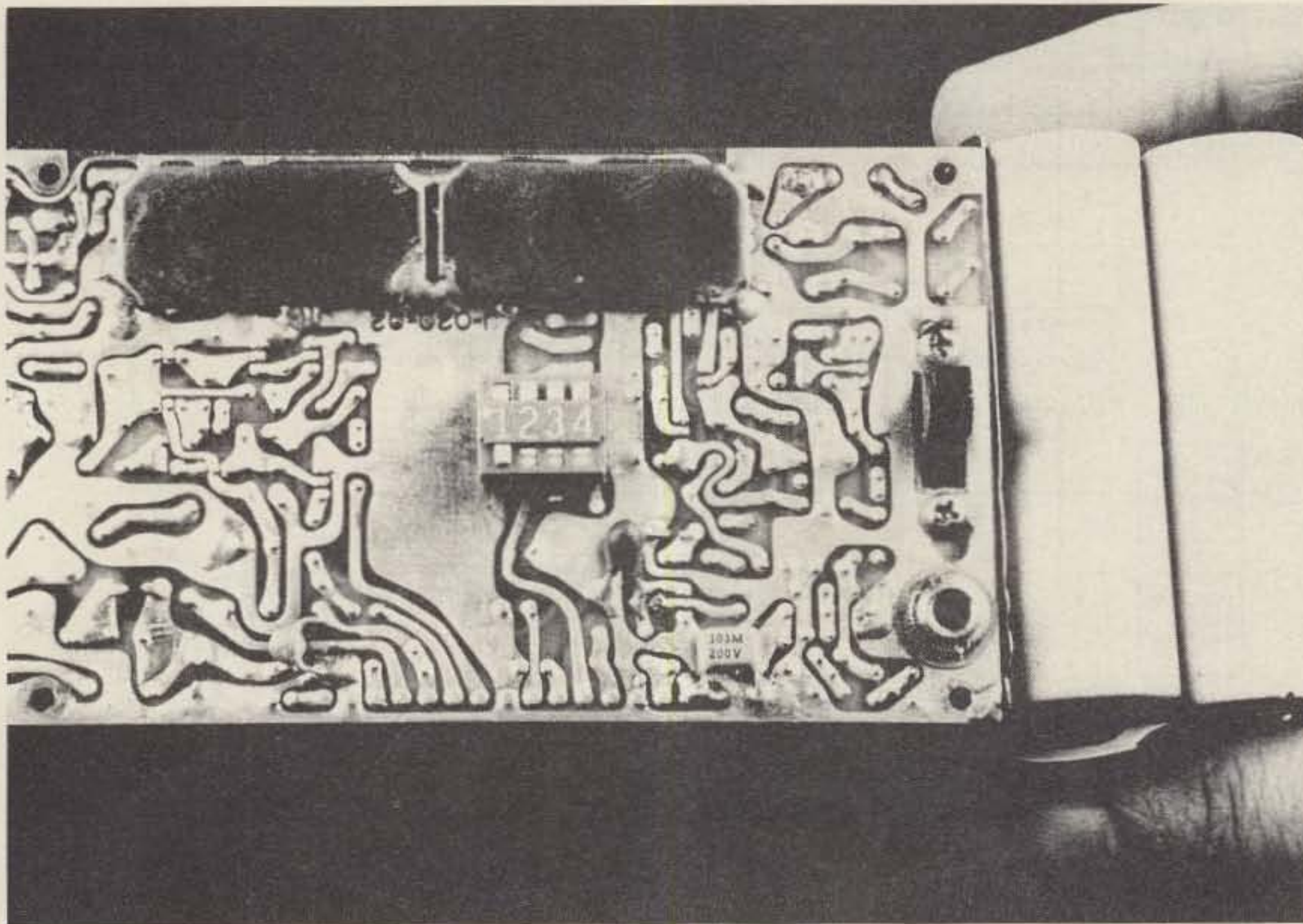

Fig. 7. Four-position switch mounted on the back of the transmitter board.

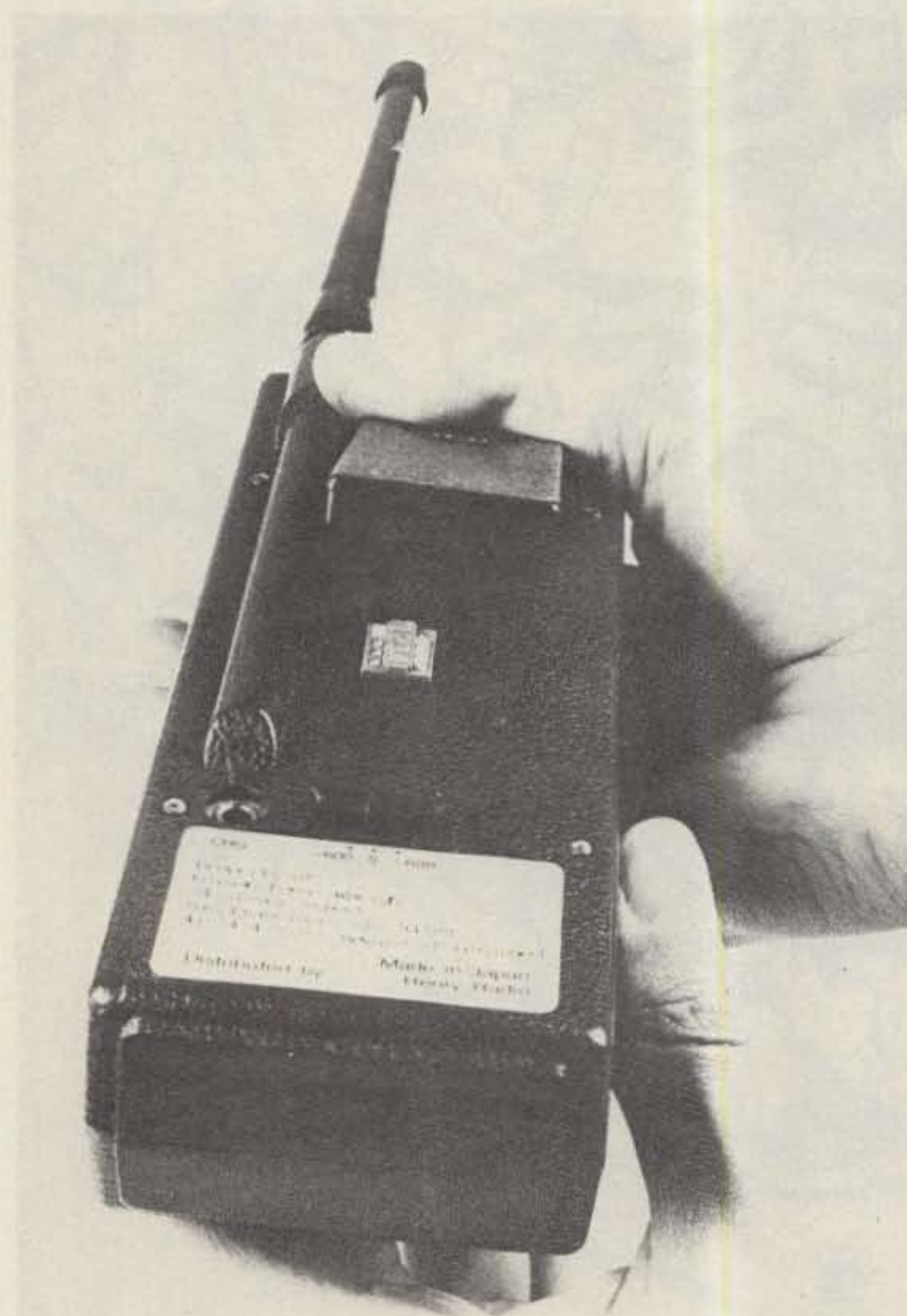

Fig. 8. The back of the transceiver showing the placement of the DIP switch.

section of the thumbwheel switches. With the unit removed from the housing, the three-section switch separates easily. On the switch furthest to the left, there are two rubber stoppers. Remove these and repack the switch. Coverage is now available from 140-150 MHz. Because of the varactor-tuned circuits in the transmitter and receiver, degradation in performance is minimal. With a dummy load into a Bird wattmeter, transmit power is still 1.5 Watts, and sensitivity is below 1  $\mu$ V at the new band edges. No degradation was measurable within the amateur band.

Generally speaking, there is limited activity below 144 MHz, but from 148-150 MHz there is military, MARS, paging, and other action.

#### Extending the S-1 to 155 MHz

Most people would agree that 148-150 MHz is not where the major activity occurs. However, from 150-155 MHz, there are mobile telephone, paging, fire, police, ambulance, and other activities. A practical method of alternating the frequency is to change the 43.1-MHz oscillator crystal (X-2) to 46.433 MHz. This crystal will switch the synthesizer range to 150-160 MHz with direct readout. Unfortunately, the vco is capable of locking up only to 155.00 MHz. (This limit will vary from unit to unit.)

To switch the two crystals in and out of the circuit, remove X-2 and place it where the private line (PL) circuitry normally would go. Using RG-178 B/U (or RG-174, which is bulkier), connect one end to the receiver while the other end goes to the two crystals (43.1 or 46.433 MHz). For switching, a 4-position SPST DIP switch can be used. Since the crystal is grounded on the other end, it is best to disable the crystal by ungrounding it. Fig. 3 shows the wiring configuration. With the new

(2SC1675), which will have spurious products within the band of operation. The two signals are compared by NIS-105 and a correction voltage is sent back to the vco. (More on phase-locked-loop techniques can be obtained from Floyd Gardner's *Phaselock Techniques*, John Wiley and Sons, New York NY, 1966.) The signal is then fed either to the transmitter or receiver where 10.7 MHz is added on to it to obtain the 144.00 MHz shown in the example given above. For transmit offsets of +600 kHz, the crystal is 11.3 MHz, and for -600 kHz, the crystal is 10.1 MHz.

#### Extension to 140-150 MHz

The S-1 can easily be extended for operation from 140-150 MHz with minimum effort and no extra components. The programmability of NIS-103 is capable of  $N=0-2000$ . What prevents this action is not the electronics but the mechanics. Henry Radio is obligated to allow the radio to transmit only in the amateur band. This is done by placing rubber stoppers on the MHz



# DRAKE TR5 Transceiver

1942-1982  
Celebrating our 40th  
Anniversary in business  
**SPECIAL ANNIVERSARY PRICE**  
\$799.95 Amateur Net



## A NEW DIMENSION IN PERFORMANCE

- U.S. Made • Competitive Price • All Solid State • 12V DC • SWR Protected •
- Broadband • No Tune Up • Full Break-in CW • 150 Watts PEP, SSB or CW Input •
- High Dynamic Range • Excellent Sensitivity/Selectivity • Digital Readout •
- 160-10 Meters Plus WARC Bands and MARS Coverage\* •

Front panel switching allows independent MODE and optional crystal filter selection.

A passive double balanced mixer is employed in the receiver front end. This stage is preceded by a low noise high dynamic range bipolar rf amplifier to provide good, strong signal performance and weak signal sensitivity.

Accurate digital readout of operating carrier frequency is displayed to 100 Hz.

A rugged, solid-state PA provides continuous duty in SSB and CW modes. A cooling fan (FA7) is available for more demanding duty cycles, such as SSTV or RTTY. The PA also features very low harmonic and spurious output.

VOX GAIN, VOX DELAY, VOX disable, QSK, selectable AGC time constants, RIT and noise blanker selection are front panel controlled for ease of operation.

The TR5 is designed with modular construction techniques for easy accessibility and service.

### GENERAL

**Frequency Coverage:** 1.8-2.0\*, 3.5-4.0, 7.0-7.5, 10.0-10.5, 14.0-14.5, 18.0-18.5\*, 21.0-21.5, 24.5-25.0\*, 28.0-28.5\*, 28.5-29.0, 29.0-29.7\* MHz. (\*With accessory range crystal).

**Modes of Operation:** Usb, Lsb, Cw.

**Frequency Stability:** Less than 1 kHz drift first hour. Less than 150 Hz per hour drift after first hour. Less than 100 Hz change for a  $\pm 10\%$  line voltage change.

**Readout Accuracy:**  $\pm 10$  ppm  $\pm 100$  Hz.

**Power Requirements:** 13.6 V-dc regulated, 2 A. 12 to 16 V-dc unregulated, 0.8 V rms maximum ripple, 15 A.

#### Dimensions:

**Depth:** 12.5 in. (31.75 cm), excluding knobs and connectors.

**Width:** 13.6 in. (34.6 cm).

**Height:** 4.6 in. (11.7 cm) excluding feet.

**Weight:** 14 lb. (6.35 kg)

### TRANSMITTER

**Power Input (Nominal):** 150 Watts, PEP or Cw.

**Load Impedance:** 50 ohms.

**Spurious and Harmonic Output:** Greater than 40 dB down.

**Intermodulation Distortion:** Greater than 30 dB below PEP.

**Carrier Suppression:** Greater than 50 dB.

**Undesired Sideband Suppression:** Greater than 60 dB at 1 kHz.

#### Duty Cycle:

Ssb, Cw: 100%.

Lock Key (w/o FA7 Fan): 30%, 5 minutes maximum transmit.

Lock Key (w/FA7 Fan): 100%.

**Microphone Input:** High Impedance.

**Cw Keying:** Instantaneous full break-in, adjustable delay.

### RECEIVER

**Sensitivity:** Less than 0.5  $\mu$ V for 10 dB S+N/N except less than 1.0  $\mu$ V, 1.8-2.0 MHz.

**Selectivity:** 2.3 kHz minimum at -6 dB. 4.1 kHz maximum at -60 dB (1.8:1 shape factor).

**Ultimate Selectivity:** Greater than -95 dB.

**Agc:** Less than 5 dB output variation for 100 dB input signal change, referenced to agc threshold.

**Intermodulation:** (20 kHz or greater spacing) *Intercept Point:* Greater than 0 dBm. *Two-Tone Dynamic Range:* Greater than 85 dB.

**I-f Frequency:** 5.645 MHz.

**I-f Rejection:** 50 dB, minimum.

**Image Rejection:** 60 dB, minimum below 14 MHz. 50 dB, minimum above 14 MHz.

**Audio Output:** 2 watts, minimum @ less than 10% THD (4 ohm load).

**Spurious Response:** Greater than 60 dB down.

### ACCESSORIES AVAILABLE

Model 7021 SL300 CW Filter  
Model 7022 SL500 CW Filter  
Model 7027 SL1000 RTTY Filter  
Model 7023 SL1800 RTTY Filter

Model 7026 SL4000 AM Filter  
Model 7024 SL6000 AM Filter  
Model 1570 PS75 AC Power Supply  
Model 1545 RV75 Synthesized Remote VFO

Model 1531 MS7 Speaker  
Model 1507 CW75 Keyer  
Model 1558 NB5 Noise Blanker  
Model 7077 Microphone

**R. L. DRAKE COMPANY**



540 Richard St., Miamisburg, Ohio 45342. USA  
Phone: (513) 866-2421 • Telex: 288-017



# AT LAST!

This service will be available nationally. Lab tested & time proven modifications professionally installed in your amateur Handy-Talkie 2M, 220, 440, MH2 transceiver by Henry Radios warranty technicians (KNOWN AS "A&W PRODUCTIONS")



## HAVE ALL PL TONES AVAILABLE AT YOUR FINGER TIPS

Outboard the dip switch! Have it neatly inlaid into the back cover of your Handy-Talkie making all 32 PL Tones Selectable at a moment's notice.

**\$25** Got your own PL? Send it to us with your Handy-Talkie unit and we do the professional installation for you.

**\$55** We will install a new PL and inlay the dip switch into the back cover of your Handy-Talkie ready to operate.

Send us your Handy-Talkie unit and a check or money order plus \$3.50 for shipping and handling payable to **A&W PRODUCTIONS, INC.**

For **TEMPO** units the dip switch is inlaid into the Push-to-Talk bar. The **TEMPO S-15** will have the dip switch inlaid into the back cover.

**\$45** We will install a **NEW BATTERY BEATER** in your **TEMPO S-1, S-2, S-4, S-5** READY to operate. Your New Battery Beater will use the same jack as the charger with no new holes and regulation circuits built into unit. Comes with Cigar Lighter Adapter with internal fuse.

**CONTACT A&W PRODUCTIONS FOR SPECIAL MODIFICATIONS YOU MAY WANT TO HAVE DONE. WE SPECIALIZE IN THE TEMPO HANDY-TALKIES.**

WE ARE AN OFFICIAL "TEMPO" REPAIR STATION

**ALL WORK GUARANTEED FOR 30 DAYS. SEND YOUR HANDY-TALKIE AND A CHECK OR MONEY ORDER TO:**

**A&W PRODUCTIONS**  
3305 Pico Blvd., Santa Monica  
California 90405 (213) 828-9310

164

crystal switched in, it was found that locking of the vco extended only to 152 MHz. The range can be extended to 155 MHz by tuning T6, but the lower portion of the 2-meter band would not lock. This is an uncompromising situation, especially with the new repeater subband and fire and law enforcement between 153 and 155 MHz.

Is it possible to have the best of both worlds? Yes.

This is the reason for the 4-position DIP switch rather than a two-position one. In order to extend the lock range of the vco, a varactor diode was incorporated.

Some general rules must be clarified before proceeding to any physical modifications. First, removing any components is out of the question. This is because the S-1 uses flow-through solder. The risk of damaging other compo-

nents is high. Second, the varactor diode must be connected to a point where the dc voltage is isolated since the diode must be controlled by a dc voltage. The schematic for the vco is shown in Fig. 4. The node between C30 and C31 is the only point at which a varactor diode could be placed.

The 1N5148 varactor diode was chosen because of its range, 47 pF (no voltage) and 14.7 pF (minimum value), with about 10-volts reversed bias across it. A 220k (1/8-Watt) resistor was tied to Vcc to reverse-bias the diode. An additional resistor must be used to discharge the diode when the voltage is removed. Bypass capacitor C1' was placed next to R1' to prevent rf interference, and C2' was installed next to R2'. The final configuration appears as shown in Fig. 5.

In the 150-155-MHz area, the switch is closed, which reduces the capacitance on the varactor diode. In the 140-150-MHz region, the switch is opened. The two additional resistors should be 1/8-Watt to conserve space, but there is room for 1/4-Watt resistors. C1', D1', and R1' are placed at the bottom printed circuit board under the shield plate in parallel with C30, as shown in Fig. 6. This method is preferable to minimize lead inductance. R2' and C2' were mounted next to S3 since its lead inductance is not important. It is recommended that a frequency counter and rf generator be available so that T6 can be optimized for maximum bandwidth.

The uncommitted switch on the 4-position DIP switch can be used for subaudible tone or tone burst if desired. Mounting of the DIP switch is done on back of the transmit board, as shown in Fig. 7. A square hole is made on the back of the S-1 to access the switch, as shown in Fig. 8. Be sure to define the position of the hole carefully so

that the position of the hole will match the position of the switch.

## Useful Hints

Because the S-1 is so compact, rf tends to feed back into the critical sections of the transceiver. It was found that bypass capacitors (0.1 uF) installed in the supply leads in both the receiver and transmitter boards improved the PLL stability. As a general rule, do not solder the crystal case to ground. This can break the vacuum seal on most crystals and shift its frequency, and at times it may stop oscillating altogether. However, clamping the crystal to ground is permissible and is recommended. Also, placing a sheet of aluminum foil around the battery and then grounding it eliminates rf feedback into the touch-tone™ pad.

## Results

The original specifications of the S-1 are unchanged. In the low extreme (140 MHz) sensitivity is still below 1 uV, while at 155 MHz it was observed to be 1.5 uV, more than adequate for most applications. The vco lost lock at 156 MHz but was extremely stable below 155 MHz. By tuning T6, the upper or lower frequency extremes can be extended but the overall bandwidth is about 15 MHz. On transmit, at least 1.5 Watts was available at all frequencies. (Remember: A dummy load must be used when testing on unauthorized frequencies.) While switching from 140-150 MHz to 150-155 MHz, the unit must be turned off while the crystal is switched and then turned on again. This is because once the vco locks to a certain frequency, it is difficult to break lock and relock again when there is a 3-MHz difference between the two oscillator crystals.

The author would like to thank Glen Toth of Signetics for the photographs. ■

## Items Needed

- 1—Crystal (same as for the AR-22C—X-3, 46.433 MHz)
- 1—4-position DIP switch
- 6"—RG-178 B/U coax or equivalent (RG-174 can be used but it is bulky)
- 1—Varactor diode, 1N5148
- 2—1/8-Watt, 220k resistors
- 2—0.1-uF bypass capacitors

The Tempo S-1 service manual can be obtained from Henry Radio, 2050 S. Bundy Drive, Los Angeles CA 90025, for \$7.50

The crystal may be obtained from Ace Communications, Inc., 2832-D Walnut Avenue, Tustin CA 92680, for \$2.00



“We have intolerable spring generated RF noise in our mobile rig”



“Our antennas are lasting less than six months on these high vibration vehicles”



## Revolutionary DURA-FLEX™ shock mount solves both problems.



- **DURA-FLEX™ neoprene elastomer**—first significant advance in antenna shock absorption technology in 25 years.
- **Completely eliminates RF noise** in radio systems generated by metal-to-metal contact with conventional steel springs.
- **Drastically reduces whip vibration** which can damage or break steel spring equipped antennas on high-vibration vehicles or in off-road environments.
- **Solid brass adaptors** molded into neoprene...braid totally isolated through center cavity.
- **Thoroughly field tested** in extreme environments of heat, cold, humidity, and abrasion.
- **Five models available** for 2 meters, 220 MHz and UHF operations, rooftop, trunk lip and magnetic mounts.



**Installation problems?**  
Try our unique Avanti capacitive-coupled on-glass mobile antenna. Mounts on glass—no damage to vehicle.



**Don't advertise your mobile rig!**  
Try our disguise antennas for both 6 and 2 meters... any vehicle!

**the antenna specialists co.**

the antenna specialists co.  
a member of **The Allen Group Inc.**  
12435 Euclid Ave., Cleveland, OH 44106  
Canada: A. C. Simmonds & Sons, Ltd.



© "Stripes of Quality"

**we design solutions.**



# More Transceiver

Contest or rare DX — the world is waiting to hear from the new breed of HF operators who'll have the power of a microcomputer at their instant command. Introduction of the Heath SS-9000 signals a new era in Amateur Radio communications. An era full of exciting promise. Challenge. And opportunity...



Anticipating the future, the Hams at Heath have created a remarkably advanced HF transceiver based on microprocessor logic. And with it, they open an entire universe of innovation and potential to the serious, active ham.

## MORE WORLD HORIZONS

In the SS-9000, Heath met a major design goal: *provide the highest-tech, most versatile transceiver possible.* Our objective? Nothing less than setting the pace for transceiver performance in the next decade. And transforming the whole state-of-the-art in amateur telecommunications.

As a microprocessor-controlled, nine band (including WARC) Transceiver, the SS-9000 pioneers the revolution in com-

puter-enhanced hamshacks — with advanced design applications yet to be imagined. At your command under direct, modem, RS-232 terminal or computer control, it could break all known records for station performance.

## MORE TOTAL TALK POWER

Even without a command terminal, Heath's SS-9000 will be the best transceiver your club or QTH ever aired. The superbly sensitive front end is mated to a transmitter providing 1W QRP or 100W PEP output on SSB/CW/RTTY. At any level, dedicated operators who appreciate the finest and expect great results will discover it to be a hot CQ and DX magnet.

The SS-9000 features push-button up or down band scan and

RIT with a rotary tuning dial that utilizes an optical encoder (plus quartz PLL-synthesized BFO, HFO and a VFO linked to separate readouts). This gives you digitally-precise tuning with  $\pm 100$  Hz resolution in 16 selectable scan rates. Our dual fluorescent display is not just an advance in panel design... it's a quantum leap forward in T/R/Tr flexibility! Now you can write, recall and shift a total of 27 separate frequencies (3 per band) around the dual display and work simplex operation on one or two frequencies, split operation on different T & R frequencies or cross-mode on either or both displayed frequencies. The unseen frequency stored in memory remains available for instant exchange and

## There's more for the Ham at Heath®

### Heathkit®

Heath  
Company



# than ever before.



display, offering you speed and advantage that was undreamed of until now.

## MORE MICRO CONTROL

Harness the SS-9000 to a video terminal, ASCII teletype or home computer. You'll have an unbeatable team to travel the airwaves. Using built-in ROM (Read-Only Memory) commands, the Terminal Interface within each SS-9000 acts as a control/monitor with battery backup to handle a wide variety of tasks the user may define. This unique feature lets you write-in and display (or change) the operating and memory frequencies for each band, set T/R/Tr activity on each readout, toggle between and alternate either one freely with the memory frequency.

Keyboard command also allows you to set and switch the band, mode, pass-band shift, baud and scan rates, plus switch to one of five band-matched antennas. One on-board F8 CPU raises switching efficiency to the highest limit.

## MORE FOR YOUR MONEY

Try one for the most exceptional capability ever offered. More QSO action than you thought possible. And all for a lot less than you'd expect to pay. Test-prove the SS-9000. See how it's perfectly matched to the PS-9000 AC Power Supply that has an in-cabinet speaker and two digital 12 or 24-hour clocks. Both units benefit from thermal and over-current protection with high VSWR cutback. Ahead of their time, the SS-9000 and PS-9000 are not kits. They come to you fully assembled, calibrated and aligned, with a one year limited warranty.

## MORE IN STORE FOR YOU

Your local Heathkit Electronic Center\* is eager to demonstrate the SS/PS-9000 Team — our first 'intelligent' rigs. Ready for the future of Amateur Radio, they're here, today! Get a hands-on tryout at your nearby Heath Ham Headquarters.

## MORE IN CATALOG, TOO

For complete details and specs, get a copy of your FREE Heathkit catalog. Write: Heath Company, Dept. 011-954, Benton Harbor, MI 49022.

303



\*Units of Veritechnology Electronics Corporation in the U.S., a subsidiary of Zenith Radio Corporation.

In keeping with Heath's ongoing policy of product improvement, specifications are subject to change without notice or obligation.

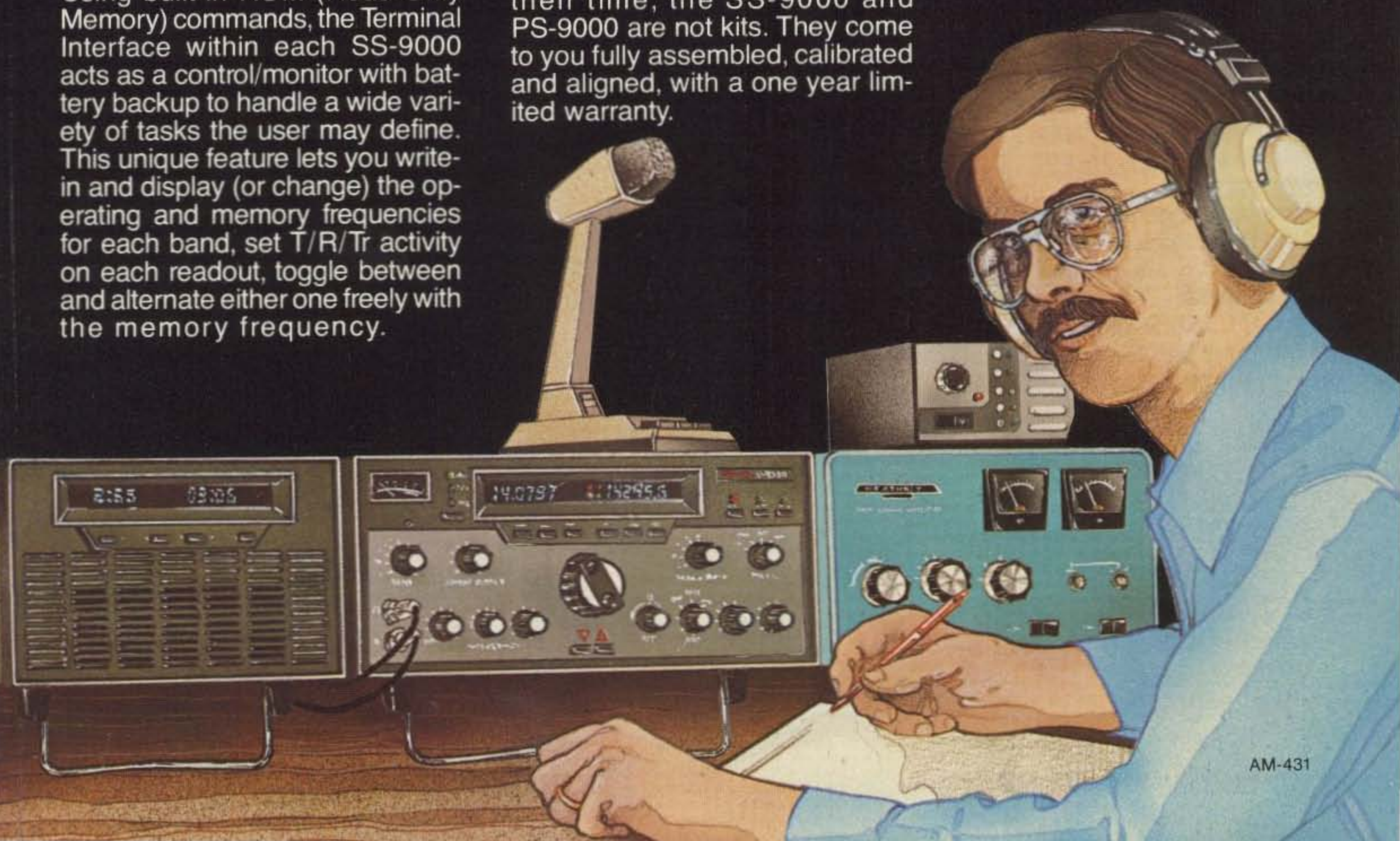



# CW and the Apple II

*The simplicity of BASIC plus the speed of machine language equals a near-perfect Morse keyboard.*

There are many good programs floating around for the Apple II microcomputer which will let one touch-type Morse code. However, CW isn't nearly as effective coming out of the Apple's itty-bitty speaker as it is coming out of your antenna. This article describes a very simple (and cheap!) interface for the Apple which should key most rigs.

The key to this interface is the neat little game I/O connector that Apple has so thoughtfully included with your computer. This connector is an ordinary 16-pin DIP socket with the layout shown in Fig. 1.<sup>1</sup>

Although there are 16 pins on this connector, only three of them are needed for this interface. These are: pin 1 for +5 volts, pin 8 for ground, and pin 15 as the keying output.

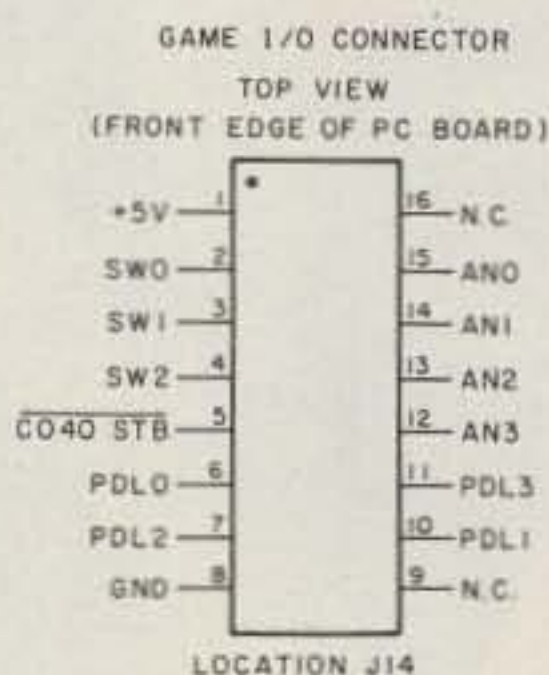

Fig. 1.

I next took an ordinary 16-pin solder-tail DIP IC socket (16¢ at James Electronics) and soldered wires to pins 1, 8, and 15 on it. I use this socket as a male plug, and plug it into the game paddle I/O socket whenever I get in the mood for CW.

Pin 15 is designated output AN0 by Apple, and is

driven by chip F14, a 74LS259. The Apple manual suggests buffering this output, and Fig. 2 shows the buffering circuit I used to key my Ten-Tec Triton IV transceiver.

U1 is a single AND gate from a 74C08 CMOS quad AND gate (49¢ at Radio Shack). Q1 is a 2N2222 NPN

utility transistor (10¢ at Radio Shack).

There are other combinations of parts that work which may even be cheaper than this circuit. However, these are the first ones I ran across in my junk box, and, as the old proverb says, "If it works, don't fix it."

One word of caution: If you use a quad CMOS chip, as I did, be sure to ground the inputs to the unused gates—otherwise the chip may malfunction. Thus, for the 74C08, you should ground pins 4, 5, 9, 10, 12, and 13.

My Triton IV is an all-solid-state rig employing low keying voltages that a 2N2222 can handle with ease. If your rig uses grid-block keying, a slightly different circuit should be used—see Fig. 3.

Q2 can be substituted, but should have a  $V_{ce}$  greater than the keying voltage employed in your rig. The 2N5401 and the 2N4888 can handle up to about 300 volts.

For a cathode-keyed rig, the circuit in Fig. 4 can be used.

Q5 is a 2N4123, and Q6 is a high-voltage, high-current silicon NPN power transistor such as the Delco DTS-801, -802, or -804.

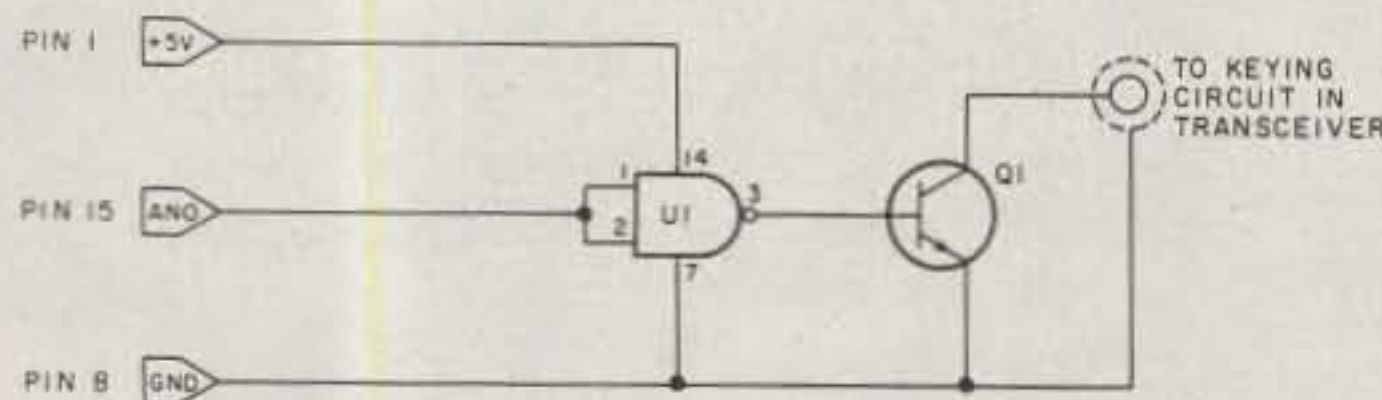

Fig. 2.

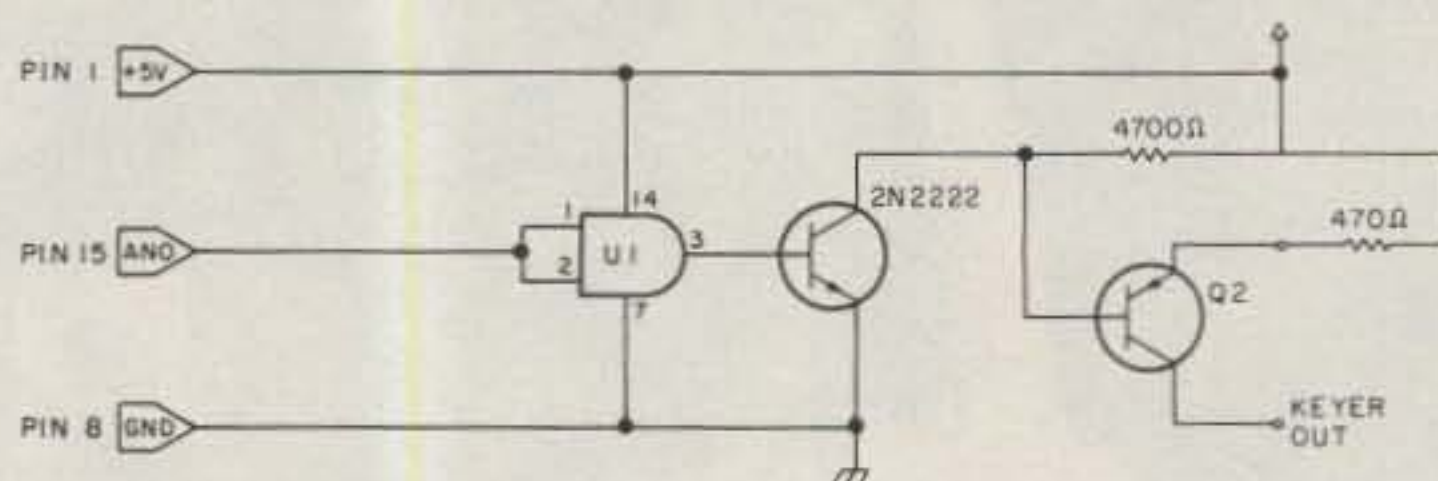

Fig. 3.

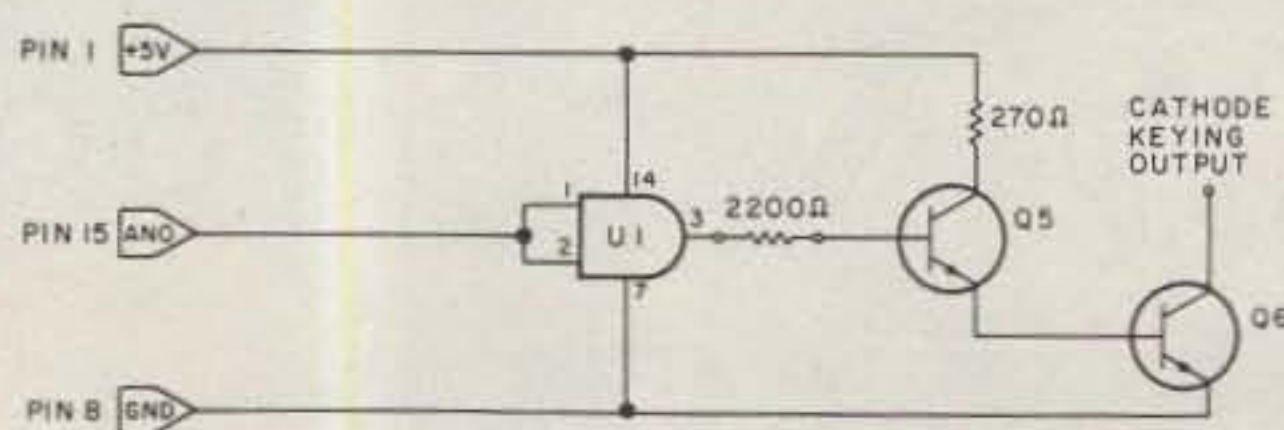

Fig. 4.



# DUAL DRIVE TRIBANDERS

- 20, 15 and 10 meters • Wideband. Low SWR. No tuner needed
- Exclusive phased dual drive gives higher gain • Exclusive coaxial capacitors have lower losses, higher Q • Transmitter power is radiated not lost in the traps • Full power low loss balun. Gives improved beam pattern

TET Antenna Systems presents three full size trap multiband beams to meet every amateur need. 5 element, 4 element, and 3 element models all with the exclusive TET dual phased drive. This famous drive system originated with HB9CV and was perfected by JA3MP. When you buy TET dual drive you know you have the best. It has more gain - just like adding another parasitic element. And wide bandwidth so you can use your solid-state transceiver on both phone and CW without a tuner.

Only the highest quality materials are used throughout. All aluminum tubing is 6061-T6 alloy. Stainless steel fasteners are provided for all electrical connections. Tubing is cut and predrilled to precision tolerances for easy one afternoon assembly. Light weight and low wind area designs permit use of simpler support structures.

All models feature full 3 Kw PEP power handling, VSWR typical 1.5 or less across all of 20, 15 and, on 10 meters, from 28.0 to 29.2 MHz. Drive impedance is 50 ohms and maximum element length 27'. They accommodate masts from 1 1/2 to 2" diameter, withstand winds to 100 mph and are furnished complete with a low loss balun that easily withstands full rated power. For gain and front-to-back ratio specifications write or call the factory.

	HB35T	HB43SP	HB33SP
Boom Length:	24' 7"	19' 8"	13' 2"
Turn Radius:	18' 10"	16' 9"	15'
Wind Area Ft <sup>2</sup> :	7.9	6.6	4.7
Wind load lbs. @ 80 mph:	160	132	102
Boom Dia.:	2"	2"	1-5/8"
Weight, lbs.:	50	38	27
Price:	\$329.95	\$239.95	\$174.75
	+ shipping	+ shipping	+ shipping

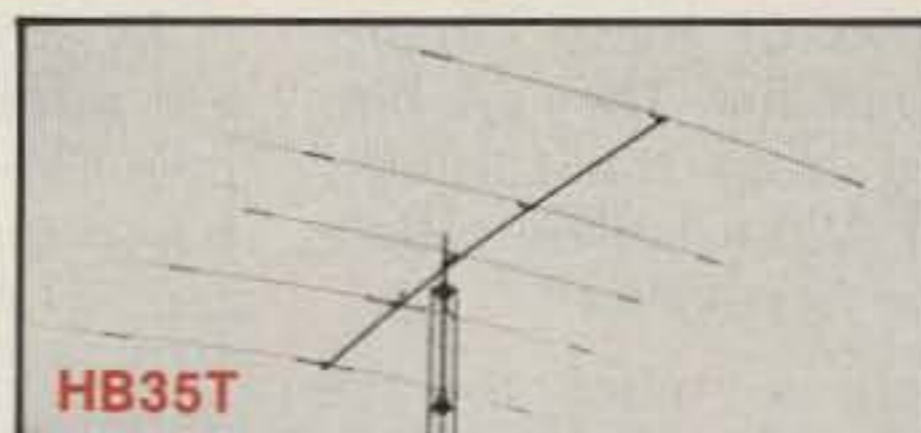

HB35T

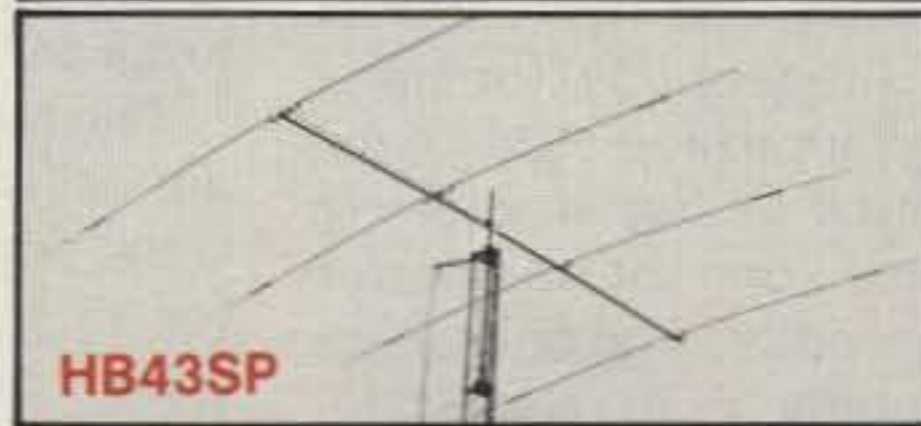

HB43SP

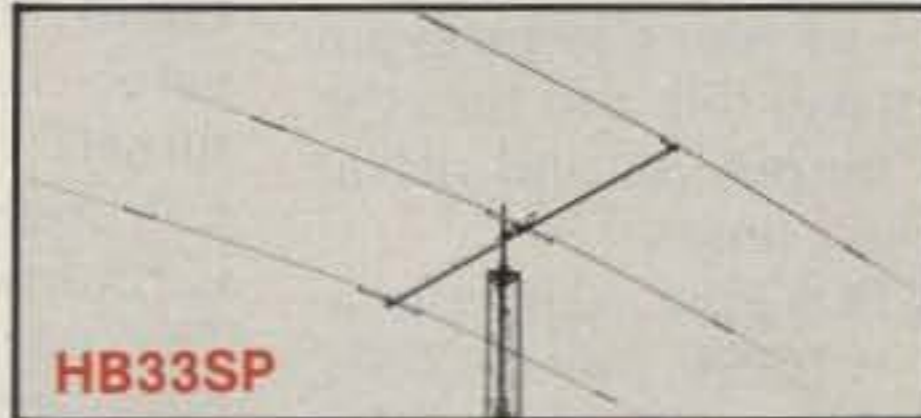

HB33SP

Send for free catalog describing these dual drive beams, our VHF Swiss quads, roof-mount towers, elevation rotators and more. Don't wait any longer to start working rare DX. Order your dual-drive beam today!

BY MAIL:  
TET Antenna Systems  
1924-E W. Mission Road  
Escondido, CA 92025



BY PHONE: 714-743-7025 ✓ 170

## TET ANTENNA SYSTEMS

# GET COMPETITIVE...GET DATONG!

World's finest accessories for the serious operator

### FL-2 MULTI-MODE AUDIO FILTER

Installs in speaker line. Provides independently adjustable Lo-Pass and Hi-Pass cutoff frequencies between 200-3500 Hz in CW mode. Shape factor apx. 1.4:1 on a 5:50 db scale. Peak/notch mode provides up to 45 db action.



\$209.95

### ASP - RF SPEECH PROCESSOR

Installs in MIC line. RF clipping with speech shaping from 0 to 30 db in 6 db steps. Frequency response 400-3400 Hz ± 3 db. Total harmonic distortion at 1 KHz, at 30 db clip level - 1/2%. Accepts Hi or Lo impedance MICs.



\$179.95

### RFA - BROADBAND PREAMPLIFIER

Strengthens signal reception of any transceiver/receiver between 5 and 200 MHz. 9 db gain + low noise and 3rd order intercept of + 20 dbm. RF switched. Requires 12 dc @ 40 ma.

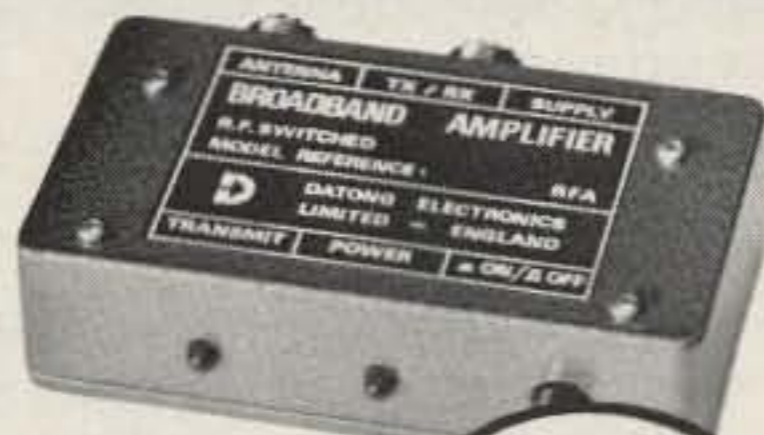

\$74.95

### "G4MH MINIBEAM ANTENNA"

High performance, miniature antenna has 6' turning radius. Built from quality materials for durability in the worst weather. 11' element/5' boom. Weighs 14 lbs. Operating frequencies: 20m, 15m, 10m. Kit - \$139.95.



\$169.95

- ALL DATONG PRODUCTS CARRY A 90 DAY WARRANTY
- VISA-MASTERCARD WELCOME



**AR** Technical Products Corp. ✓329

877 S. Adams Road  
P.O. Box 62  
Birmingham, MI 48012  
Phone (313) 644-5698



The connoisseur of keying circuits may find the latter two of these circuits very familiar. They are borrowed from Jim Garrett's (WB4VVF) excellent article on the Accukeyer.<sup>2</sup>

Well, so much for the hardware end—the rest is free! (I spent 75¢ for parts for my interface. Add an extra buck or two if your rig requires one of the latter two circuits.) The only thing remaining is to add statements to your CW program which will tell it to turn the AN0 output on and off at the right times.

By POKEing a 0 into location -16296 (hex \$C058), AN0 is set to zero volts. Conversely, by POKEing a 0 into memory location -16295 (hex \$C059), AN0 is switched to +5 volts.

CW programs can vary greatly, but probably all of them, whether written in BASIC, assembly language, or machine language, will have one subroutine to send a dit and another subroutine to send a dah. If your program is in BASIC, then the statement POKE -16296, 0 should be added to your program as the first statement in both the dit-forming and dah-forming subroutines. Likewise, add the statement POKE -16295, 0 as the last statement in each subroutine. Also, it is a good idea to add the statement POKE -16296, 0 as one of the first statements in your program, so that output AN0 will be initialized to zero volts each time the program is run.

If your dit- and dah-forming subroutines are in assembly or machine language, the following commands will work. Insert the command:

```
AD 59 C0      LDA $C059
immediately before the command which starts the code element sounding. Likewise, insert:
AD 58 C0      LDA $C058
immediately after the com-
```

mand, which stops sounding the code element.

As a final example, here are a few details from my own CW program, which is based on "The Morse Master," 73 Magazine, January, 1979, p. 114. A BASIC listing of the pertinent parts of my program is shown in Fig. 5.

The Morse code is held in an array A\$(P), where 3s stand for dahs and 1s stand for dits. As each letter is typed on the Apple keyboard, the corresponding value in the array is returned. For example, when C is pressed, the value 3131 is returned from the array. The subroutine at 1000 then peels off the digits one by one from the left. If a 3 is present, the dah subroutine at 1300 is selected. If a 1 is present, the dit subroutine at 1200 is selected.

My dit and dah subroutines are almost identical. They each call the same machine-language subroutine at memory location 16002. This subroutine is listed in machine and assembly form in Fig. 6. In hex, 16002 is written as \$3E82.

This machine-language program is almost identical to the tone-generator program shown on pages 43-45 of the Apple Reference Manual. Each time before it is called, two values must be POKEd into memory. The first is variable PP, which determines the frequency of the output tone through the speaker. This can be any number between 0 and 255 (I prefer 96) and this number is POKEd into memory location 16000 (hex \$3E80). The second number required by the subroutine tells it how long the code element should be sent. In the dit subroutine, this is variable X, and, in the dah subroutine, I used variable T. This second number is POKEd into memory location 16001 (\$3E81 hex). (I use X=10 and T=40 for a code speed of about 30 wpm.)

```
6 GOSUB 32000
7 POKE - 16296,0
10 HIMEM: 15999
199 REM—MORSETYPER MAIN PROGRAM
200 GET K$
220 P = ASC(K$)
225 REM—PRINTS LETTER TO BE SENT ON SCREEN
230 PRINT CHR$(P);
240 GOSUB 1000
250 REM—ADDS SPACE AFTER EACH LETTER
260 FOR Q = 1 TO SP ; NEXT Q
300 GO TO 200

999 REM—MORSE SENDING SUBROUTINE
1000 L = LEN( A$(P) )
1005 FOR I = 1 TO L
1010 R$ = MID$( A$(P) , I , 1)
1015 IF R$ = "1" THEN GOSUB 1200
1020 IF R$ = "3" THEN GOSUB 1300
1025 NEXT I
1030 RETURN
1199 REM—DIT SUBROUTINE
1200 POKE 16000, PP: POKE 16001,X : CALL 16002
1201 FOR L = 1 TO X : NEXT L
1202 RETURN
1299 REM—DAH SUBROUTINE
1300 POKE 16000,PP : POKE 16001, T : CALL 16002
1301 FOR L = 1 TO X : NEXT L
1302 RETURN
```

Fig. 5. BASIC listing.

Notice that the first statement in the assembly-language program is LDA \$C059, which sets the game I/O output AN0 to 5 volts. When the code element has all been sent, the program branches to \$3E99 where the command LDA \$C058 is given, which resets AN0 to zero volts before returning to the main BASIC program.

```
3E82 AD 59 C0 LDA $C059
3E85 AD 30 C0 LDA $C030
3E88 88 DEY
3E89 D0 05 BNE $3E90
3E8B CE 81 3E DEC $3E81
3E8E F0 09 BEQ $3E99
3E90 CA DEX
3E91 D0 F5 BNE $3E88
3E93 AE 80 3E LDX $3E80
3E96 4C 85 3E JMP $3E85
3E99 AD 58 C0 LDA $C058
3E9C 60 RTS
```

Fig. 6.

Fig. 7 shows a BASIC listing which will POKE the machine-language subroutine in Fig. 6 into memory at location 16002 (hex \$3E82). One of the first statements in my main BASIC program calls this subroutine before any other action is taken by the program.

Well, that's it in a nutshell. If anyone has any problems, send me an SASE and I'll try to help. ■

#### References

1. *Apple II Reference Manual*, January, 1978, p. 25.
2. *The Radio Amateur's Handbook*, ARRL, 1977, p. 364-5.

```
32000 POKE 16002,173: POKE 16003,89 : POKE 16004,192
32005 POKE 16005,173: POKE 16006,48 : POKE 16007,192
32010 POKE 16008,136: POKE 16009,208: POKE 16010,5
32015 POKE 16011,206: POKE 16012,129: POKE 16013,62
32020 POKE 16014,240: POKE 16015,9 : POKE 16016,202
32025 POKE 16017,208: POKE 16018,245: POKE 16019,174
32030 POKE 16020,128: POKE 16021,62 : POKE 16022,76
32035 POKE 16023,133: POKE 16024,62 : POKE 16025,173
32040 POKE 16026,88 : POKE 16027,192: POKE 16028,96
32050 RETURN
```

Fig. 7. BASIC subroutine for POKEing machine-language subroutine into memory at location 16002 (hex \$3E82).



# CES INTRODUCES THE NEW 510SA "SMART PATCH"

## The State of the Art Simplex Interconnect

Communications Electronics Specialties introduces the CES 510SA "Smart" Simplex Autopatch, with many important new features never available before:

- Three digit control codes with user programming.
- A sophisticated toll restrict provides positive long distance lock out.
- Time-out and COR activity timers with warning beeps and digital programming.
- Rotary or DTMF dialing.
- Phone line in-use detector prevents interrupting a call in progress, and sends unique CW sequence.
- Phone ring detection logic enables unique CW sequence.
- Digital programming of the sample rate and width, and noise gate sensitivity control, for easy interfacing with most radios.

Simple and direct connections to radio.

**Options available:**

- Smart CW identifier with unique CW messages for each patch function.
- FCC type accepted phone line coupler.
- Special tone squelch kit to operate patch through repeaters.



The 510SA — the newest advance in interconnect technology, from the innovators at: Communications Electronics Specialties, Inc.  
 Post Office Box 507 • Winter Park, Florida 32790  
 (305) 645-0474 • Toll-free (for orders only): (800) 327-9956

462

## ASSOCIATED RADIO

913-381-5900

8012 CONSER BOX 4327  
 OVERLAND PARK, KANSAS 66204

# BUY—SELL—TRADE

All Brands New & Reconditioned



YOU WANT A DEAL — WE WANT TO DEAL  
 CALL NOW!!!

# SAVE—SAVE—SAVE



NOTE: SEND \$1.00 FOR OUR CURRENT CATALOG OF NEW AND RECONDITIONED EQUIPMENT  
 SEND \$1.00 FOR OUR WHOLESALE LIST OF UNSERVICED & OVERSTOCK ITEMS.  
 SEND \$2.00 FOR BOTH. THEY WILL BE MAILED SEPARATELY.



# Super Loaded "Or" Basic Repeater / Link Systems - Spectrum's

**new**

**Got Both!**

VHF/UHF  
LINK/CONTROL  
RCVR.

COMMERCIAL VHF/UHF  
TRANSCEIVERS



**NEW SCR77**

SCR1000/4000 & XCVRS. F.C.C.  
TYPE ACCEPTED FOR SERVICES

Shown in  
Optional Cabinet

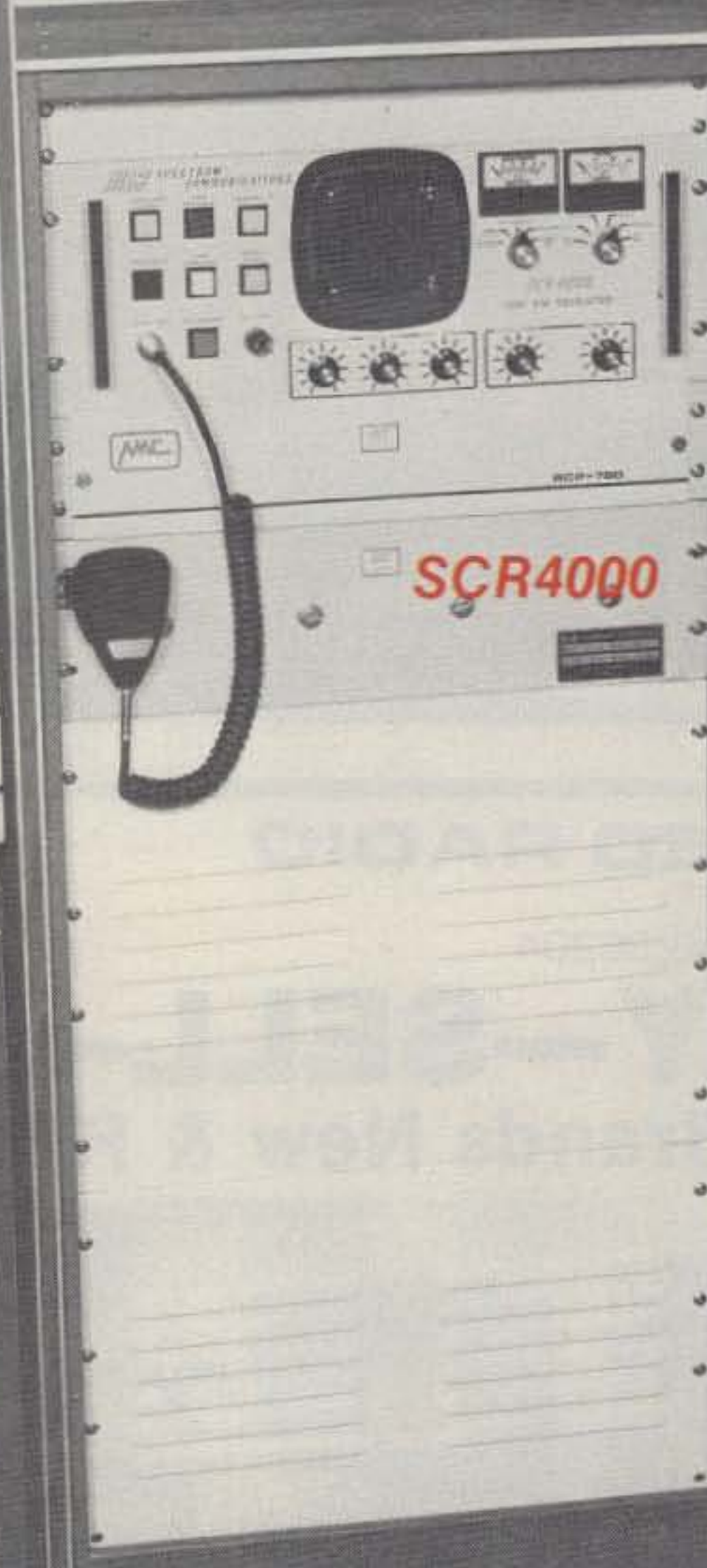

Spectrum now makes 2 lines of Repeaters—the world famous Super Deluxe' SCR1000/4000, and our new Low Cost line of SCR77 Repeaters/Link Transceivers.

The New SCR77 10-30 Wt. Repeaters maintain the quality of design, components and construction which have made Spectrum gear famous *throughout the world* for years, however, all of the "bells & whistles" which you may not need or want have been eliminated—at a large cost savings to you! The SCR77 is a real "workhorse" basic machine designed for those who want excellent, super-reliable performance year after year—but no frills! ('PL', 12 Pole IF Filter, Front End Preselector, and a 30 Wt. Transmitter are the only 'built-in' options available; but Autopatch, Remote Control, and other equipment can be connected via the rear panel jack.)

Of course, if you do want a full featured/Super Deluxe Repeater, with higher power (30-75 Wts.), and a full list of 'built-in' options, then you want our SCR1000 or 4000—'The Ultimate in Repeaters'. Available with: Full Autopatch/Reverse Patch/Land-Line Control; Touch Tone Control of various repeater functions; 'PL'; "Emergency Pwr. ID"; various Tone & Timer Units, etc. Rack mount Link Rcvrs & Xmtrs also available.

Call or write today for data sheets & prices! Sold Factory Direct or through Export Sales Reps only. Get your order in A.S.A.P.!

NOW LOCATED IN OUR NEW LARGER PLANT!

THANKS FOR YOUR 8+ YEARS OF SUPPORT!



**SPECTRUM**  
Export Orders Welcomed

1055 W. GERMANTOWN PK., DEPT S11



## 10M FM Repeaters, Remote Bases, ■

Join the fun with the growing activity on 10M FM! Extended 'superior' groundwave contacts; local Repeaters; Remote/Local Bases and Mobile for Nationwide or Foreign DX. All with the ease of 2M FM! **Or, tie a 10M Remote Base into your existing VHF/UHF Repeater!**

Our Repeaters and Remote Bases are basically made up of 2-SCR-



## ■ RX & TX Boards Now Available!

1000 Mainframes, complete with a VHF/UHF Link "built-in." The 10M FM Receiver is "Super Hot" and "Super Sharp." The transmitter is a 35 Wt. unit with beautiful audio quality.

A Complete Data Package is now available on both complete systems and boards — all commercial quality. Call or write for more information today.

## SPEC COMM REPEATER BOARDS & SUB-ASSEMBLIES

These are Professional "Commercial Grade" Units—Designed for Extreme Environments (-30 to +60° C).

All equipment assembled & tested. For 2M, 220 MHz & 450 MHz!

### SCR200 & SCR 450 BOARD

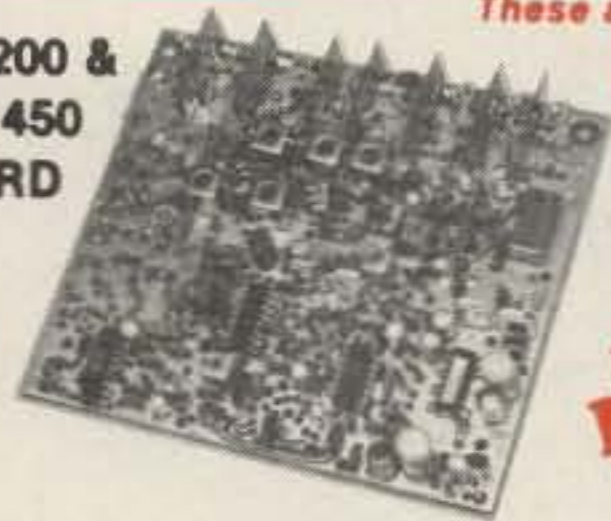

10M ALSO AVAILABLE

**new**

#### SCR200 VHF Receiver Board

- **Totally New Advanced Design!**
- 8 Pole Front End Filt. + wide dynamic range—reduces overload, spurious Resp. & IMs!
- Sens. 0.3 uV/12dB SINAD typ.
- Sel. -6dB @ ± 6.5 KHz. -130dB @ ± 30KHz. (8 Pole Crystal + 4 Pole Ceramic Filtrs.)
- 'S Meter,' Discriminator & Deviation Mtr. Outputs!
- Exc. audio quality! Fast squelch! w/0.0005% Crystal. ("Super Sharp" IF Filt. also avail.)

#### SCR200 Receiver Assembly

- SCR200 mounted in shielded housing
- Completely asmbld & tested, w/F.T. caps, SO239 conn.
- As used in the SCR1000. Ready to drop into your system! *High Recommended!*

#### SCR450 UHF Receiver Bd. or Assy.

- Similar to SCR200, except 420-470MHz



#### SCAP Autopatch Board

- Provides all basic autopatch functions
- Secure 3 Digit Access; 1 Aux On-Off function, Audio AGC; Built-in timers; etc. Beautiful Audio!
- 0/1 inhibit bd. also available
- Write/call for details and a data sheet

#### RPCM Board

- Used w/SCAP board to provide "Reverse Patch" and Land-Line Control of Repeater
- Includes land line answering circuitry

#### ID250 CW ID & Audio Mixer Board

- Adjustable ID tone, speed, level, timing cycle
- 4 Input AF Mixer & Local Mic amp
- COR input & xmtr. hold circuits
- CMOS logic, PROM memory—250 bits/channel
- Up to 4 different ID channels!
- Many other features. Factory Programmed



FL-6

#### FL-6 Rcvr. Front-End Preselector

- 6 Hi Q Resonators with Lo-Noise Transistor Amp (2M or 220 MHz).
- Provides tremendous rejection of "out-of-band" signals w/out the usual loss! Can often be used instead of large expensive cavity filters
- Extremely helpful at sites with many nearby VHF transmitters to "filter-out" these "out-of-band" signals

#### CTC100 Rptr. COR Timer/Control Bd.

- Complete solid state control for rptr. COR, "Hang" Timer, "Time-Out" Timer, TX Shutdown/Reset, etc.
- Includes Inputs & Outputs for panel controls & lamps

#### Repeater Tone & Control Bds.—For SCR1000/4000 & CTC100/ID250 only

##### TRA-1 "Courtesy Tone Beeper" Board

- Puts out a tone beep apx. 1 sec. after RX sig. drops—thus allowing time for breakers
- Resets T.O. Timer after "beep"

##### TMR-1 "Kerchunker Killer" or "Time Out Warning Tone" Bd.

- For One of above 2 functions
- "Kerchunker Killer" provides adj. delay (0-10 sec.) for initial rptr. access. Auto-Reset at end of QSO.
- T.O. Warning Tone provides alerting "warble tone" apx. 10 sec. before "time out."

**new**

#### PSM-1 Repeater Power Supply Mod Kit

- For SCR-1000 or SCR-4000
- Replaces Darlingtion Pass Tr.—for improved reliability
- Includes new overvoltage "Crowbar" shut-down circuit.
- Complete kit, w/assembled PC board. \$19.50 + \$3.50 shipping/handling.

#### PRM200 Power Supply Filter Cap/Regulator/Metering Board

- As used in the SCR1000 as main part of 13.8VDC/8A Pwr. Sply.
- Includes 14,000 uF Filter Cap, Reg. IC and Driver Trans., V/I Meter shunts and cal pots.
- Requires Xfmr., Br. Rect., Pass Tr./Heat Sink, (Optional Meter), for complete supply.



#### SCT410 XMTR. ASSY.

##### SCT110 VHF Xmtr/Exciter Board

- 7 or 10 Wts. Output 100% Duty Cycle!
- Infinite VSWR proof.
- True FM for exc. audio quality.
- Designed specifically for continuous rptr service. Very low in "white noise."
- Spurious -70 dB. Harmonics -60 dB.
- With .0005% xtal.
- BA-10 30 Wt. Amp board & Heat Sink, 3 sec. L.P. Filter & rel. pwr. sensor. BA75 75 Wt. unit also available.

##### SCT110 Transmitter Assembly

- SCT110 mounted in shielded housing.
- Same as used on SCR1000.
- Completely asmbld. w/F.T. caps, SO239 conn.
- 10, 30, or 75 Wt. unit.

##### SCT410 UHF Transmitter Bd. or Assy.

- Similar to SCT110, 10 Wts. nom.
- Avail. w/ or w/o OS-18 Super High Stability Crystal Osc/Oven.
- BA-40 40W. UHF AMP. BD. & HEAT SINK.

##### PCB-1 Xmtr. Power Control Board

- For SCT110 or SCT410 Exciters
- Varies B+ to control Pwr. Out
- Switchable Hi, Low, or Med. Pwr. out, locally or remotely. Adj. levels.

#### TTC100 Touchtone

##### Control Board



Interface to any Radio or AF system!

- 3 digit ON, 3 digit OFF control of a single repeater function, or (optional) 2 functions (2 digits ON/OFF each).
- Can be used to pull in a relay, trigger logic, etc.
- Typically used for Rptr., ON/OFF, HI/LO Pwr PL ON/OFF, Patch Inhibit/Reset, etc.
- Stable anti-falsing design 5s limit on access
- For add'l function(s), add a "Partial TTC" board

# COMMUNICATIONS CORP.

INQUIRE ABOUT 'SURPLUS' RX & TX BOARDS. REDUCED PRICE!

Norristown, PA 19401 • (215) 631-1710

Call, or ✓ 68  
Send for  
Data Sheets!



# Everyman's Audio Amplifier

Make this one-chip amp a permanent part of your test bench.  
 It's an easy project for beginning experimenters.

**M**otivation seems to be a combination of need, circumstance, and availability. These all came

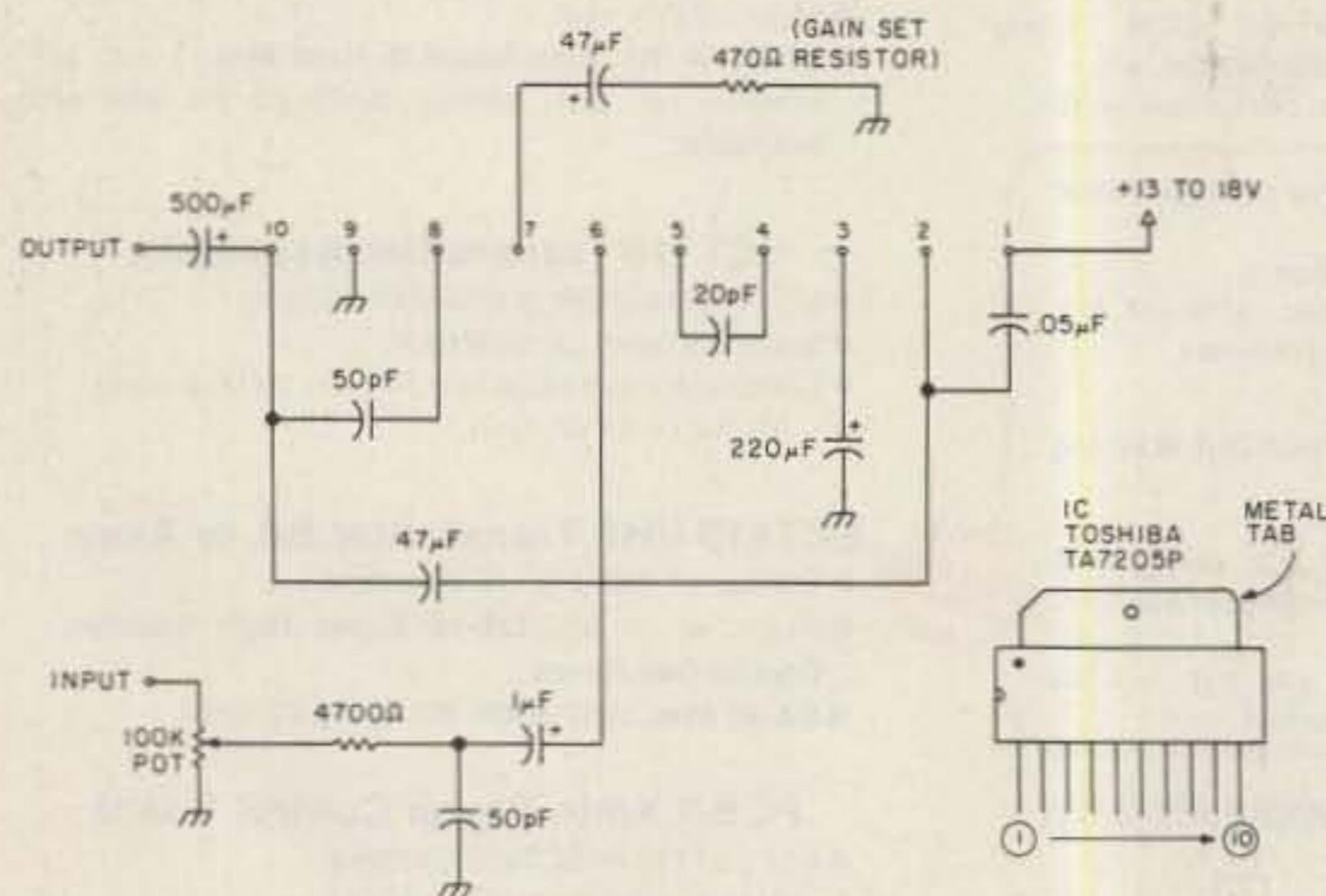

Fig. 1. Schematic of the general-purpose, one-IC audio amplifier.

together when my audio signal tracer died its final time, died when I needed to check a mike that someone said "doesn't sound like it used to."

I have long ago learned not to ignore good advice in small packages that come over the local repeater. The availability was provided by an IC, a Toshiba TA7205P that had been purchased from Digital Research, a good source of supply that I first met through 73. The charm it held for me is that its pins will fit into one side of a standard 20-pin DIP socket.

The diagram of the fin-

ished product is shown in Fig. 1. The external parts count is low and non-exotic. The supply voltage range is wide enough to make it go from any small supply that you have around the bench, and it works "carside" quite well, running off a cable that goes into the cigarette lighter. The series RC network connected to pin 7 is the gain set.

As shown, there is ample gain to get a fair amount of noise out of the average mike. The volume control allows the handling of a good range of input levels, making it handy for many bench chores. ■

**COMPARE the HAZER™ with foldover + telescoping towers**

- Antenna systems mount on Hazer-Hazer follows parallel to outside of tower - Raise to tower top or lower completely to ground level.
- Safety - speed - convenience
- Ease to install and use
- Price
- For Rohn 20 & 25 tower  
Complete with winch 100 ft. of cable hardware and instructions.

HAZER II Heavy duty aluminum \$279.95 plus \$17.00 shipping  
 HAZER III Standard duty aluminum \$199.95 plus \$13.00 shipping  
 HAZER IV Heavy duty gal. steel \$249.95 plus \$28.00 shipping

MARTIN ENGINEERING P.O. BOX 253 BOONVILLE, MO 65233

134 **816-882-2734**

**LIMITED SPECIAL \$555.00**

**HAMEG** Oscilloscopes  
 20 MHz DUAL TRACE  
 to meet every need

WITH PROBES: ×1 & ×10

- ONE YEAR FULL WARRANTY
- SOLID STATE
- ASSEMBLED & CALIBRATED

**NEW RECTANGULAR CRT**

MODEL HM-203 **(603)434-5371**

DEALER INQUIRIES INVITED

133

RFD-5 DERRY, N.H. 03038 WARNER HILL





## Stuck with a problem?

Our TE-12P Encoder might be just the solution to pull you out of a sticky situation. Need a different CTCSS tone for each channel in a multi-channel Public Safety System? How about customer access to multiple repeater sites on the same channel? Or use it to generate any of the twelve tones for EMS use. Also, it can be used to access Amateur repeaters or just as a piece of versatile test equipment. Any of the CTCSS tones may be accessed with the TE-12PA, any of the audible frequencies with the TE-12PB. Just set a dip switch, no test equipment is required. As usual, we're a stickler for 1day delivery with a full 1 year warranty.

- Output level flat to within 1.5db over entire range selected.
- Immune to RF.
- Powered by 6-30vdc, unregulated at 8 ma.
- Low impedance, low distortion, adjustable sinewave output, 5v peak-to-peak.
- Instant start-up.

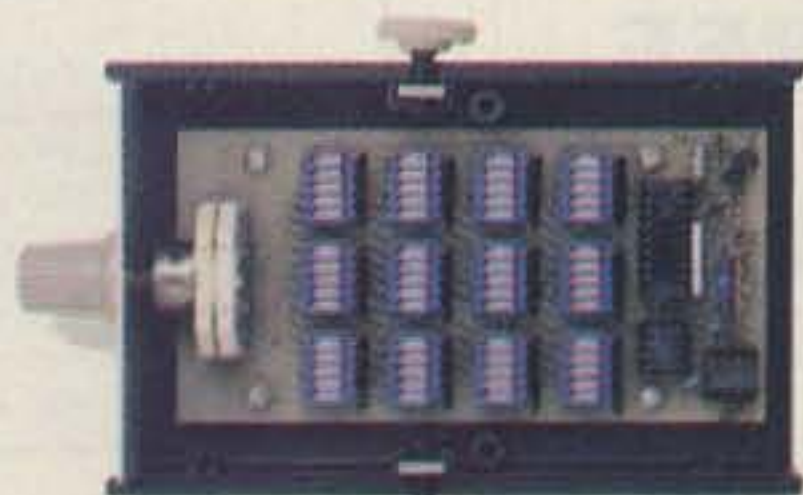

### TE-12PA

67.0 XZ	85.4 YA	103.5 1A	127.3 3A	156.7 5A	192.8 7A
71.9 XA	88.5 YB	107.2 1B	131.8 3B	162.2 5B	203.5 M1
74.4 WA	91.5 ZZ	110.9 2Z	136.5 4Z	167.9 6Z	
77.0 XB	94.8 ZA	114.8 2A	141.3 4A	173.8 6A	
79.7 SP	97.4 ZB	118.8 2B	146.2 4B	179.9 6B	
82.5 YZ	100.0 1Z	123.0 3Z	151.4 5Z	186.2 7Z	

- Frequency accuracy,  $\pm 1$  Hz maximum  $-40^{\circ}\text{C}$  to  $+85^{\circ}\text{C}$
- Frequencies to 250 Hz available on special order.
- Continuous tone

### TE-12PB

TEST-TONES:	TOUCH-TONES:	BURST TONES:
600	697 1209	1600 1850 2150 2400
1000	770 1336	1650 1900 2200 2450
1500	852 1477	1700 1950 2250 2500
2175	941 1633	1750 2000 2300 2550
2805		1800 2100 2350

- Frequency accuracy,  $\pm 1$  Hz maximum  $-40^{\circ}\text{C}$  to  $+85^{\circ}\text{C}$
- Tone length approximately 300 ms. May be lengthened, shortened or eliminated by changing value of resistor

**\$89.95**

✓ 15

**COMMUNICATIONS SPECIALISTS**

426 West Taft Avenue, Orange, California 92667  
(800) 854-0547/California: (714) 998-3021

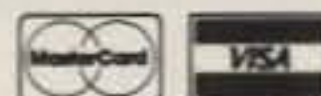



**2 for 1**  
Performance  
from  
**MIRAGE**

Dual-purpose power amplifiers for HT and XCVR!



- 1-10 Watts Input
- All-mode operation
- 5 year warranty

model:  
**B1016 (2 meters)**

1W In = 35W Out  
2W In = 90W Out  
10W In = 160W Out  
with RX preamp!

\$279.95

**C106 (220 MHz)**

1W In = 15W Out  
2W In = 30W Out  
10W In = 60W Out  
with RX preamp!

\$199.95

**D1010 (430-450 MHz)**

1W In = 20W Out  
2W In = 45W Out  
10W In = 100W Out

\$319.95

There's more, and  
WATT/SWR Meters, too!  
See your nearest Dealer

**MIRAGE**  
**MIRAGE**  
**MIRAGE**  
COMMUNICATIONS EQUIPMENT, INC.  
P.O. Box 1393  
Gilroy, CA 95020  
(408) 847-1857  
**made in U.S.A.**

## THE AUTEK "QRM ELIMINATOR"



Model QF-1A  
For SSB & CW  
\$69.00 (+ \$4)

115 VAC supply built-in. Filter by-passed when off.

Auxiliary Notch rejects 80 to 11,000 Hz! Covers signals other notches can't touch.

Four main filter modes for any QRM situation.

Continuously variable main selectivity (to an incredible 20 Hz!)

Continuously variable main frequency. (250 to 2500 Hz!)

AUTEK pioneered the ACTIVE AUDIO FILTER back in 1972. Today, we're still the engineering leader. Our new QF-1A is the latest example. It's INFINITELY VARIABLE. You vary selectivity 100:1 and frequency over the entire usable audio range. This lets you reject whistles with dual notches (to 70 dB), or reject SSB hiss and splatter with a fully adjustable lowpass plus aux. notch. Imagine what the NARROWEST CW FILTER MADE will do to QRM! HP rejects low frequencies. Skirts exceed 80 dB. 1 watt speaker amp.

Built-in 115 VAC supply. 6 1/2 x 5 x 2 1/2. Two-tone grey styling. Even latest rigs include only a fraction of the QF-1A selectivity. Yet it hooks up in minutes to ANY rig—Yaesu, Kenwood, Drake, Swan, Atlas, Tempo, Heath, Collins, Ten-Tec, etc. Just plug it into your phone jack and connect spkr. or phones to the output. Join the thousands of owners who now hear stations they couldn't copy without a QF-1A! It really works!

## WORLDS RECORD KEYS. OVER 4000 DX QSO'S IN 2 DAYS!



\$100.50 (+ \$4)

Model MK-1 Keyer \$104.50

Probably the most popular "professional" contest keyer in use, yet most owners are casual CW operators or novices. After a few minutes, you'll see how memory revolutionizes your CW operation! Just start sending and record your CQ, name, QTH, etc. in seconds. 1024 bits stores about 100 characters (letters, numbers). Playback at any speed. Dot/dash memories, triggered clock, repeat, combine, 5 to 50+ WPM, built-in monitor and 115 VAC supply. Works with any paddle. Sit back and relax while your MK-1 calls CQ and handles standard exchanges!

Optional memory expander (ME-1) expands any MK-1 to 400 characters. ME-1 factory installed \$35. Owner installed, only \$21 (+ \$4). Add more memory now or later!

*Autek Research*

BOX 302 DEPT. S

ODESSA, FLORIDA 33556 • (813) 920-4349

## NO LONG DELAYS. WE SHIP 95% OF ORDERS FROM STOCK

We sell only factory direct. No dealer markup in our price. Order with check, M.O., VISA, MC. Add \$4 postage and handling in 48 states. (\$7 for UPS air). Add \$7 to Canada, HI., AK. Add \$22 elsewhere (shipped air). Add 5% tax in Fla.



Organize your shack with a  
**CLUTTERFREE MODULAR  
CONSOLE \$203.35**

- Large, 42" H x 57" W x 29" D
- Strong groove-construction
- Mar-resistant wood grain finish
- Options, drawers & face plate
- For ham or home computer
- Visa and Master Charge

**CLUTTERFREE  
MODULAR  
CONSOLES**

P.O. Box 5103 Tacoma, WA 98405  
(206) 272-8321 ✓ 89

## GOTHAM ANTENNAS (305) 294-2033



SMALL LOT TRAP DIPOLES			
MODEL	BANDS	LGTH	PRICE
TSL 8040	80.40	78'	\$49.95
TSL 4020	40.20.15	40'	\$47.95

SMALL LOT SHORTENED DIPOLES			
MODEL	BANDS	LGTH	PRICE
SL-8010	80.40.20.	75'	\$59.95
	15.10		
SL-160	160	130'	\$38.95
SL-80	80	63'	\$37.95
SL-40	40.15	33'	\$36.95

FULL SIZE PARALLEL DIPOLES			
MODEL	BANDS	LGTH	PRICE
FPD-8010	80.40.20.	130'	\$49.95
	15.10		
FPD-4010	40.20.15.10	63'	\$44.95

NEW! PORTABLE VERTICAL! IDEAL FOR APARTMENTS, CAMPING, TRAILERS!

Folds to 5' Package. No Radials. Required. Fully Assembled Full Legal Limit. 1:1 VSWR

MODEL	BANDS	HGHT	PRICE
PV-8010	80.10	13'	\$59.95

PROVEN DESIGN GOTHAM ALL BAND

VERTICALS			
MODEL	BANDS	HGHT	PRICE
V-160	160.80.40.20.	23'	\$44.95
	15.10.6		
V-80	80.40.20.	23'	\$42.95
	15.10.6		
V-40	40.20.15.10.6	23'	\$40.95

FAMOUS GOTHAM QUADS

2 Elements—3 Bands Complete \$149.95  
CHAMPIONSHIP GOTHAM BEAMS

Full Size Complete from \$99.95

DEALER INQUIRIES INVITED

CALL OR SEND LARGE SASE FOR CATALOG. Shipping: Dipoles & Verticals \$2.50 USA. \$7.00 Canada. \$5.00 FPO, APO Beams & Quads Shipped UPS or Freight Collect Fla. Add 5% Sales Tax ✓ 417

1415 First St. • Key West, FL 33040



# RTTY/CW For the TRS-80\*

\* A Trademark of the Tandy Corp.

## ROM-116

Now includes:

- TEXT EDITING
- RTTY PICTURES
- SAVE TEXT TO DISK *Detailed brochure available on request.*

## Featuring:

**1200 BAUD OPERATION.** Not limited to 110 baud because of timing loops. 60, 66, 75 & 100 W.P.M. Plus 110, 150, 300, 600 & 1200 baud operations possible.

**FLEXIBILITY OF OPERATION.** Instantly change: Baud Rates; Program Mode (ASCII/Baudot); Program Status.

**SPLIT SCREEN VIDEO.** Transmit & receive data displayed separately.

**REAL TIME.** Automatic CW/ID without user intervention. Automatically updates at end of month or year.

Other features include:

- Two Serial Ports
- Fourteen Buffers
- Automatic CW/ID
- Transmit Control
- Selective Call Feature
- Error Correction & Editing
- Word Wrapping
- Easy to Interface
- 30 Day Unconditional Guarantee
- Hardware Requirements: TRS-80 Model I or III 16K EXTERNAL TERMINAL UNIT REQUIRED



606 State Street, P.O. Box 892-R • Marysville, WA 98270 • (206) 659-4279

# PERFECT ANTENNA?

FOR  
10-15-20 METERS

VERTICAL

OMNI-GAIN

HALFWAVE  
END FED

NO RADIALS

NO REFLECTED  
POWER

BROADBAND

FIXED OR  
PORTABLE

REMOTE TUNING

2 KW PEP

UPS SHIPPABLE

# R3

R3 may be the perfect antenna for condominiums, apartments, small lots or any limited space situation. It is a great antenna for hams who are concerned about neat appearance and maximum performance.

R3's self supporting radiator is only 21ft-6.4m high x 1ft .304m wide at the base. Assembly is quick and easy for portable, marine, field day, DX-peditions, or fixed installations. It is complete with remote tuner.

AVAILABLE THROUGH  
DEALERS WORLDWIDE



**cushcraft**  
CORPORATION

THE ANTENNA COMPANY  
P.O. Box 4680  
Manchester, NH 03108 USA  
TELEX 953050



SEND FOR THIS  
FREE CATALOG NOW



SAVE MONEY  
HIGH QUALITY  
FAST DELIVERY

We are utilizing the latest equipment and technology to maintain our quality at reasonable prices.

**JAN  
CRYSTALS**

- General Communication
- Industry
- Marine VHF
- Scanners
- Amateur Bands
- CB Standard
- CB Special
- Microprocessor

Call or Write

**JAN CRYSTALS**

P.O. Box 06017  
Ft. Myers, Fl. 33906-6017  
All Phones (813) 936-2397

DAIWA COMMUNICATIONS ESSENTIALS

## Automatic Antenna Tuner



### Automatic Antenna Tuner Model CNA-1001

Frequency Range: 3.5—30MHz (Including WARC Bands)

Power Rating: 500 Watts PEP

Internal Dummy Load: 50 Watts/1 Minute

Impedance Matching: 15-250 Ohms to 50 Ohms Resistive

Input Power Required for Automatic Tune: 1, 5 or 10 Watts (Set by rear panel switch)

Tune-up Time: 45 Seconds Max.

Power Requirement: 13.8 VDC/.2 Amp

Write for complete specifications



**J.W. Miller Division  
BELL INDUSTRIES**

19070 Reyes Ave. ■ P.O. Box 5825  
Compton, California 90224

(213) 537-5200 ■ TWX 910-346-6740



# Award-Winning Program

*Certificate hunters, cut your paperwork down to size. Let your Pet track your quest for excellence.*

Here's a simple program for the Pet that was designed to keep track of what states have been worked on what bands for 5BWAS. For each state, the program records the call-sign of the station worked on each band (80, 40, 20, 15, and 10 meters). You can display the entries, just the totals for one particular band, or the totals for all bands

combined (mixed). The data is stored in a data file on cassette tape and takes about two minutes to load, save, or verify. The program also provides a way of changing or deleting any entry, if required.

The program was written to be flexible enough that it could be used for other awards records such as Worked All Zones (WAZ) or

Worked All Continents (WAC). To change the program for another award, simply modify the values in lines 180-200 as required:

- AWS** = The 3-letter award name (WAS, WAZ, WAC, etc.)
- NE** = The number of entries for the award—must be 50 or less due to the current Pet display limitations. (WAS = 50, WAZ = 40, WAC = 6, etc.)
- IES** = Entry input question used

- in line 770:  
For WAZ you could use:  
IES = "ZONE (01-40)".
- For WAC you could use:  
IES = "CONTINENT (NA, SA, EU, AF, AS, OC)".
- KS** = The string of entry names each 2 characters long:  
For WAZ you would use:  
190 KS = "010203.....20",  
200 KS = KS + "212223.....40".
- For WAC you would use:  
190 KS = "NASAEUAFASOC"  
200 (deleted—not used!)

## Program listing.

```

100 REM ***** 5BWAS-RECORDS *****
110 REM
120 REM BY - ROBERT W. BAKER, WB2GFE
130 REM      15 WINDSOR DRIVE
140 REM      ATCO, NEW JERSEY 08004
150 REM
160 REM *****
170
180 AWS="WAS" : NE=50 : IES="STATE (2-LETTER ABBREV)"
190 KS="ALAKAZARACAOCTDEFLGAHIIDILINIAXSKYLAMEMDMAMIMNMSMONTNENV"
200 KS=KS+"NHJNHNHNDHOKORPARISCSDTHTUTVTVAWAWVWY"
210
220 POKE 59468,12 : DIM D$(NE),T(6) : NH=INT(NE/2) : E$="....."
230
240 REM DISPLAY MENU
250
260 PRINT "J":SPC(10);"AW#:" - AWARD RECORDS"
270 GOSUB 1410 : CLOSE 1 : PRINT " 0 = DONE"
280 PRINT " 1 = LOAD DATA FROM TAPE"
290 PRINT " 2 = SAVE DATA ON TAPE"
300 PRINT " 3 = VERIFY DATA ON TAPE"
310 PRINT " 4 = INITIALIZE DATA"
320 PRINT " 5 = ENTER DATA (ADD,CHANGE,DELETE)"
330 PRINT " 6 = DISPLAY DATA"
340 PRINT " 7 = DISPLAY TOTALS" : GOSUB 1410
350 PRINT "ENTER COMMAND # "
360 GET R# : IF R#="" THEN 360
370 IF R#="0" THEN PRINT R# : END
380 N=VAL(R#) : IF N<1 OR N>7 THEN 360
390 PRINT R#
400 IF IL=0 THEN ON N GOTO 460,540,610,700,760,990,1260
410 ON N GOTO 460,420,420,700
420 PRINT "INITIALIZE OR LOAD DATA FIRST!" : GOTO 350
430
440 REM LOAD DATA FROM TAPE
450
460 PRINT "INSERT ".AWS." INPUT TAPE"
470 OPEN 1,1,0,AWS+".DATA" : PRINT "READING DATA!"
480 FOR N=1 TO NE : INPUT#1,D$(N) : IF ST=0 THEN NEXT
490 IF ST=64 AND N=NE THEN PRINT "*** DATA LOADED ***" : IL=1 : GOTO 270
500 GOTO 660
510
520 REM SAVE DATA ON TAPE
530
540 PRINT "INSERT ".AWS." OUTPUT TAPE"
550 OPEN 1,1,0,AWS+".DATA" : PRINT "WRITING DATA!"
560 FOR N=1 TO NE : PRINT#1,D$(N) : NEXT
570 PRINT "*** DATA SAVED ***" : GOTO 270
580
590 REM VERIFY DATA ON TAPE WITH MEM
600
610 PRINT "INSERT ".AWS." TAPE TO VERIFY"
620 OPEN 1,1,0,AWS+".DATA" : PRINT "VERIFYING DATA!"
630 FOR N=1 TO NE : INPUT#1,C# : IF ST=0 AND C#=D$(N) THEN NEXT
640 IF ST=64 AND N=NE THEN PRINT "*** TAPE DATA VERIFIED ***" : GOTO 270
650 IF C#<>D$(N) THEN PRINT "DATA MIS-MATCH!" : GOTO 270
660 PRINT "TAPE READ ERROR!" : ST = "ST" : GOTO 270
670
680 REM INITIALIZE ALL ENTRIES
690
700 PRINT "CLEARING ALL ENTRIES!"
710 FOR N=1 TO NE : D$(N)=E$+E$+E$+E$+E$ : NEXT
720 PRINT "*** DATA INITIALIZED ***" : IL=1 : GOTO 270
730

```

```

740 REM ADD, CHANGE, DELETE ENTRIES
750
760 PRINT "J"
770 PRINT "AW#:" IES$ : INPUT R# : IF R#="" THEN 260
780 N=0 : FOR Z=1 TO (2*NE)-1 STEP 2 : N=N+1
790 IF R#<>MID$(KS,Z,2) THEN NEXT : GOTO 770
800 INPUT "BAND (80,40,20,15,10) " : R# : IF R#="" THEN 770
810 I=-1 : IF R#="80" THEN I=0
820 IF R#="40" THEN I=10
830 IF R#="20" THEN I=20
840 IF R#="15" THEN I=30
850 IF R#="10" THEN I=40
860 IF I<0 THEN 800
870 PRINT "CURRENT ENTRY = " : MID$(D$(N),I+1,10)
880 INPUT "CALL (D=DELETE) " : C# : IF C#="" THEN 770
890 IF LEN(C#)>10 THEN 880
900 IF C#="D" THEN C#=E$
910 C#=LEFT$(C#+E$,10) : B#=C#+RIGHT$(D$(N),40)
920 IF I<1 THEN 950
930 B#=LEFT$(D$(N),I)+C#
940 IF I<40 THEN B#=B#+RIGHT$(D$(N),40-I)
950 D$(N)=B# : GOTO 770
960
970 REM DISPLAY DATA BY BAND/MIXED
980
990 INPUT "BAND (80,40,20,15,10,M=MIXED) " : B#
1000 I=0 : IF B#="80" THEN I=1
1010 IF B#="40" THEN I=11
1020 IF B#="20" THEN I=21
1030 IF B#="15" THEN I=31
1040 IF B#="10" THEN I=41
1050 IF (I=0) AND (B#<>"M") THEN 990
1060 PRINT "AW#:" AWS : PRINT "RECORDS:" : PRINT "-----"
1070 PRINT "BAND:" B#
1080 IF I=0 THEN PRINT "MIXED"
1090 IF I>0 THEN PRINT B#;" MTRS"
1100 PRINT "-----"
1110 FOR N=1 TO 25 : IF N>NH THEN PRINT TAB(9);"I" : GOTO 1150
1120 IF I=0 THEN 1190
1130 PRINT TAB(9);"I " : MID$(KS,2*N-1,2) : " " : MID$(D$(N),I,10)
1140 PRINT " " : MID$(KS,(2*N)+NE-1,2) : " " : MID$(D$(N+NH),I,10)
1150 IF N<25 THEN PRINT
1160 NEXT N
1170 PRINT "DEPRESS ANY KEY TO CONTINUE"
1180 PRINT "ANY KEY" : PRINT " TOM" : PRINT "CONTINUE" : GOTO 1390
1190 FOR X=1 TO 41 STEP 10 : C#=MID$(D$(N),X,10) : IF C#=E$ THEN NEXT
1200 PRINT TAB(9);"I " : MID$(KS,2*N-1,2) : " " : C#
1210 FOR X=1 TO 41 STEP 10 : C#=MID$(D$(N+NH),X,10) : IF C#=E$ THEN NEXT
1220 PRINT " " : MID$(KS,(2*N)+NE-1,2) : " " : C# : GOTO 1150
1230
1240 REM ADD BAND TOTALS
1250
1260 PRINT "ADDING BAND TOTALS!"
1270 FOR X=1 TO 6 : T(X)=0 : NEXT X
1280 FOR N=1 TO NE : T(0)=0 : FOR I=1 TO 5
1290 IF MID$(D$(N),10*I-9,10)<>E$ THEN T(0)=1 : T(I)=T(I)+1
1300 NEXT I : T(6)=T(6)+T(0) : NEXT N
1310 PRINT "AW#:" AWS : PRINT "TOTALS " : PRINT "-----"
1320 PRINT SPC(11);"80 METERS:" : T(1)
1330 PRINT SPC(11);"40 METERS:" : T(2)
1340 PRINT SPC(11);"20 METERS:" : T(3)
1350 PRINT SPC(11);"15 METERS:" : T(4)
1360 PRINT SPC(11);"10 METERS:" : T(5)
1370 PRINT SPC(9);"MIXED BANDS:" : T(6) : PRINT : GOSUB 1410
1380 PRINT "DEPRESS ANY KEY TO CONTINUE!"
1390 GET R# : IF R#="" THEN 1390
1400 GOTO 260
1410 PRINT "M" : RETURN

```



**New!**  
**AZDEN® PCS-4000**

*Small - yet so Sophisticated...  
 so Advanced - there is  
 No Comparison!*

SHOWN ACTUAL SIZE

**FEATURES SO  
 UNIQUE AND  
 OF SUCH  
 SUPERIOR  
 COMMERCIAL-  
 GRADE  
 QUALITY,  
 THAT...**



**IT CARRIES A  YEAR LIMITED WARRANTY!**

- **8 MHZ COVERAGE, CAP/MARS BUILT IN:** 142.000-149.995 MHz in selectable steps of 5 or 10 kHz. **COMPARE!**
- **TINY SIZE:** Only 2" H x 5.5" W x 6.8" D! **COMPARE!**
- **MICROCOMPUTER CONTROL:** At the forefront of technology!
- **UP TO 8 NON-STANDARD SPLITS:** Ultimate versatility for CAP/MARS. **COMPARE!**
- **16-CHANNEL MEMORY IN TWO 8-CHANNEL BANKS:** Retains frequency and standard offset.
- **DUAL MEMORY SCAN:** Scan memory banks either separately or together. **COMPARE!**
- **TWO RANGES OF PROGRAMMABLE BAND SCANNING:** Limits are quickly reset. Scan the two segments either separately or together. **COMPARE!**
- **FREE AND VACANT SCAN MODES:** Free scanning stops 5 seconds on a busy channel. Vacant scanning stops on unoccupied frequencies.
- **DISCRIMINATOR SCAN CENTERING (AZDEN EXCLUSIVE PATENT):** Always stops on frequency.
- **TWO PRIORITY MEMORIES:** Either may be instantly recalled at any time. **COMPARE!**
- **NICAD MEMORY BACKUP:** Never lose the programmed channels!
- **FREQUENCY REVERSE:** The touch of a single button inverts the transmit and receive frequencies, no matter what the offset.
- **ILLUMINATED KEYBOARD WITH ACQUISITION TONE:** Unparalleled ease of operation.
- **BRIGHT GREEN LED FREQUENCY DISPLAY:** Easily visible, even in direct sunlight.
- **DIGITAL S/R F METER:** Shows incoming signal strength and relative output.
- **BUSY-CHANNEL AND TRANSMIT INDICATORS:** Bright LEDs show when a channel is busy and when you are transmitting.
- **FULL 16-KEY TOUCHTONE® PAD:** Keyboard functions as autopatch when transmitting.
- **PL TONE:** Optional PL tone unit allows access to PL repeaters. Deviation and tone frequency are fully adjustable.
- **TRUE FM:** Not phase modulation. Unsurpassed intelligibility and fidelity.
- **25 WATTS OUTPUT:** Also 5 watts low power for short-range communication and battery conservation. (Transmitter power is fully adjustable)
- **SUPERIOR RECEIVER:** Sensitivity is 0.2 uV for 20-dB quieting. Audio circuits are designed to rigorous specifications for exceptional performance, second to none. **COMPARE!**
- **REMOTE-CONTROL MICROPHONE:** Memory A-1 call, up/down manual scan, and memory address functions may be performed without touching the front panel! **COMPARE!**
- **OTHER FEATURES:** Dynamic microphone, built-in speaker, mobile mounting bracket, remote speaker jack, and all cords, plugs, fuses and hardware are included.
- **ACCESSORIES:** CS-6R 6-amp ac power supply, CS-AS remote speaker, and Communications Specialists SS-32 PL tone module.
- **ONE-YEAR LIMITED WARRANTY!**

EXCLUSIVE DISTRIBUTOR:

**AMATEUR-WHOLESALE ELECTRONICS**

8817 S.W. 129th Terrace, Miami, Florida 33176 Telephone (305) 233-3631 Telex: 80-3356

TOLL FREE... 800-327-3102

MANUFACTURER:

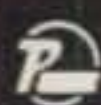
 **AZDEN**

**JAPAN PIEZO CO., LTD.**

1-12-17 Kamirenjaku, Mitaka, Tokyo, 181 Japan.

Telex: 781-2822452





Once these three lines have been changed, the rest of the program should not have to be modified.

The remainder of the program is very straightforward. Line 220 ensures that the Pet is in the upper-case/graphics mode and defines the data (D\$) and totals (T) arrays along with the blank entry value (E\$). Lines 260-340 display the program "menu" which allows the user to select the desired program function from those available. Lines 350-380 get the number of the desired function and check that a valid selection was made. Lines 400-420 then branch to the routine to perform the selected function, but the data must first be initialized or loaded from tape before any other function can be performed. This ensures that the data matrix (D\$) has been set correctly before attempting to use any values contained within it. Each of the avail-

able functions is then performed by one of the routines in the remainder of the program.

The first time you use the program, initialize the data to clear all entries. Then enter each callsign for the appropriate QSO on each band for each state. You make the entries by first specifying the state to be entered. If you hit "RETURN" without making an entry, the program will return to the menu selection. If the state is not found (incorrect 2-letter code), you will be asked again for the band (80, 40, 20, 15, or 10 meters). If "RETURN" is entered without any data, you will be asked for the state again. If an incorrect band is entered, you will be asked for the band again.

When a correct state and band have been entered, the current entry for that state and band will be displayed. If you enter

"RETURN" without any data, the current entry will be unchanged and you will be asked for the next state. If you enter a "D" followed by "RETURN", the current entry will be deleted (set back to periods). Any other data entered followed by "RETURN" is assumed to be the callsign to be entered for that state on that band. If the callsign is longer than 10 characters, you will have to reenter the callsign. All callsigns entered will have periods appended to make them 10 characters long before they are stored. The five callsigns for each state are stored together as one 50-character string to save memory space.

When all entries have been made, display the data on each band and check if correct. If required, go back and make any corrections. You also can display the totals and check for the correct number of

states on each band. Before stopping the program, make sure that you save the data on tape. It's also a good idea to take the extra time to verify the data file, to make sure it was correctly saved. You might even want to save more than one copy on tape while you have everything in memory. Now you simply load the old data file the next time you want to add, correct, or examine anything. If you make any changes, don't forget to save the new data on tape. For those who want to go even further with their award records, you could keep separate data files for each mode (SSB, CW, RTTY, SSTV, etc.).

To answer the question before it's asked, for anyone too lazy to type in the program, I'll be happy to supply copies on tape for \$2.00 each. However, please send all requests directly to me and not through the magazine. ■

### CUSHCRAFT

A3 3 Element Triband Beam	\$172.50
A4 4 Element Triband Beam	\$224.50
A743 7 & 10 MHz Add On for A3	\$61.20
A744 7 & 10 MHz Add On for A4	\$61.20
AV3 3 Band Vertical 10-20m	\$44.20
AV4 4 Band Vertical 10-40m	\$81.50
AV5 5 Band Vertical 10-80m	\$88.50
R3 14.21.28 MHz Ringo	\$224.50
32-19 Boomer 19 Element 2m	\$81.50
214B Jr. Boomer 14 Element 2m	\$68.00
A147-11 2m 11 Element Antenna	\$37.50
A147-4 2M 4 Element Antenna	\$23.75
ARX-2B 134-164 MHz Ringo Ranger II	\$34.00
A144-10T 145 MHz 10 Element	\$44.20
A432-20T 432 MHz 20 Element	\$44.20
A14T-MB Twist Mounting Boom & Bracket	\$23.75

Full Line Available on Sale Call.

### ROHN

20G 10 ft. Stacking Section	\$32.00
25G 10 ft. Stacking Section	\$39.50
45G 10 ft. Stacking Section	\$87.50
25AG 2.3 or 4 Top Section	\$52.50
HDBX 48 48 ft. Free Standing Tower	\$320.00
HBX56 56 ft. Free Standing Tower	\$340.00
FK2548 48 ft. 25G Foldover Tower	\$725.00*
TB3 Thrust Bearing	\$48.00
SB25G Short Base for 25G	\$16.50
BPH25G Hinged Base Plate	\$59.75
AS25G Accessory Shelf	\$9.50
HB25AG 14" House Bracket	\$14.50
BPC25G Cement Base Plate	\$32.00
BAS25G Short top section w/lacc shelf	\$36.00
M200 16 gauge, 10 ft. 2" O.D. Mast	\$19.50
M200H 1/8" wall, 10 ft. 2" O.D. Mast	\$36.00

Freight prepaid on Fold-over towers. Prices 10% higher west of Rocky Mts



### MINI-PRODUCTS

HQ-1 Mini-Quad 6/10/15/20m Antenna	\$129.95
B-24 2 Element HF Mini-Beam 6/10/15/20m	\$99.00
RK-3 3rd Element Add-on for B-24. Improves 10-20m	\$67.00
C-4 Mini-Vertical 6/10/15/20m	\$59.00



## The Antenna Bank

### HUSTLER

4BTV 40-10 Mtr. Vertical	\$79.00	
5BTV 80-10 Mtr. Vertical	\$100.00	
M01/M02 HF Mobile Mast	\$18.00	
HF Mobile Resonators. Std. 400W .SUPER 2KW		
10 or 15m	\$9.00	\$13.00
20m	\$11.00	\$16.00
40m	\$13.00	\$18.00
75 or 80m	\$14.00	\$29.00
BM-1 Bumper mt. with S.S. Strap	\$13.00	
SSM-2 Commercial S.S. Ball	\$14.00	
SF-2 5/8 Wave, 2 Meter Antenna	\$9.00	
HOT Hustloff Mt. with Swivel ball	\$14.00	
G6-144B 2M Colinear, fixed Station, 6db	\$68.00	
G7-144 2M Colinear, fixed Station, 7db	\$99.00	

Full Line Available on Sale Call

### VAN GORDON ON SALE AT SPECIAL PRICES

 **ORDERS ONLY**   
**800-336-8473**

- Shipping charges not included
- Prices subject to change without notice
- Limited quantities
- No COD's

**(703) 569-1200**

6460H General Green Way  
Alexandria, VA 22312

### HY-GAIN

TH3JRS Jr. Thunderbird, 750W PEP	\$156.00
HQ-2S Hy-Quad, 2 Element	\$262.00
TH5DXS Thunderbird, 5 Element	\$309.00
TH3MK3S Thunderbird, 3 Element	\$215.00
TH2MK3S Thunderbird, 2 Element	\$134.00
TH7DX Thunderbird, 7 Element	\$376.00
392S TH6DXX Conversion Kit to TH7DX	\$135.00
105BAS 5 Element 10m "Long John"	\$114.00
155BAS 5 Element 15m "Long John"	\$175.00
205BAS 5 Element 20m "Long John"	\$292.00
14AVQ/WBS 10-40m Vertical	\$51.00
18AVT/WBS 10-80m Vertical	\$87.50
V-2S Colinear Gain Vertical 138-174 MHz	\$37.50
BN-86 Ferrite Balun, 10-80 meters	\$16.00
HDR-300 Deluxe Rotor, Digital Readout	\$427.00

### ★ SUPER HY-GAIN PACKAGE ★

HG52SS 52' Self Sup. Crank-Up	
TH7DX Thunderbird, 7 Element	
HM IV Rotor	
COA (3) Coax Arms	
HG-10 Mast Mast 10	

SALE \$1584.50 Free Freight

HG50MT2 50 ft. side sup. Crank-up tower	
TH3MK3S 3 Element Thunderbird	
CD-45 Rotor	
COA 3 Coax-Arms	
HG-5 Mast	

SALE \$1158.00 Free Freight

NO SUBSTITUTIONS PLEASE

Philly Stran Guy Cable in stock

### ROTORS & CABLES

CDE HAM IV Rotor	\$195.00
CDE T2X Rotor	\$244.00
CDE 45 Rotor	\$102.75
Alliance HD-73 Rotor	\$92.00
Alliance U100 Rotor	\$42.00
RG-8/U Foam Coax 95% Shield	24c/ft.
RG-213 Coax, Mil. Spec	28c/ft.
Mini-8 Coax 95% Shield	12c/ft.
Rotor Wire 8 Conductor	16c/ft.
4 Conductor	7.5c/ft.



# N & G DISTRIBUTING Corporation

7201 N.W. 12th Street  
Miami, Florida 33162



Nos especializamos en exportacion a sur America. Los mejores precios, servicio, calidad, y garantia. 2 minutos del Aeropuerto.  
Para más información llame gratis.  
1-800-327-3364

... We're the U.S.A.'s  
Exclusive Distributor  
of **F9 FT TONNA**  
**VHF / UHF**  
**ANTENNES**  
from REIMS, FRANCE

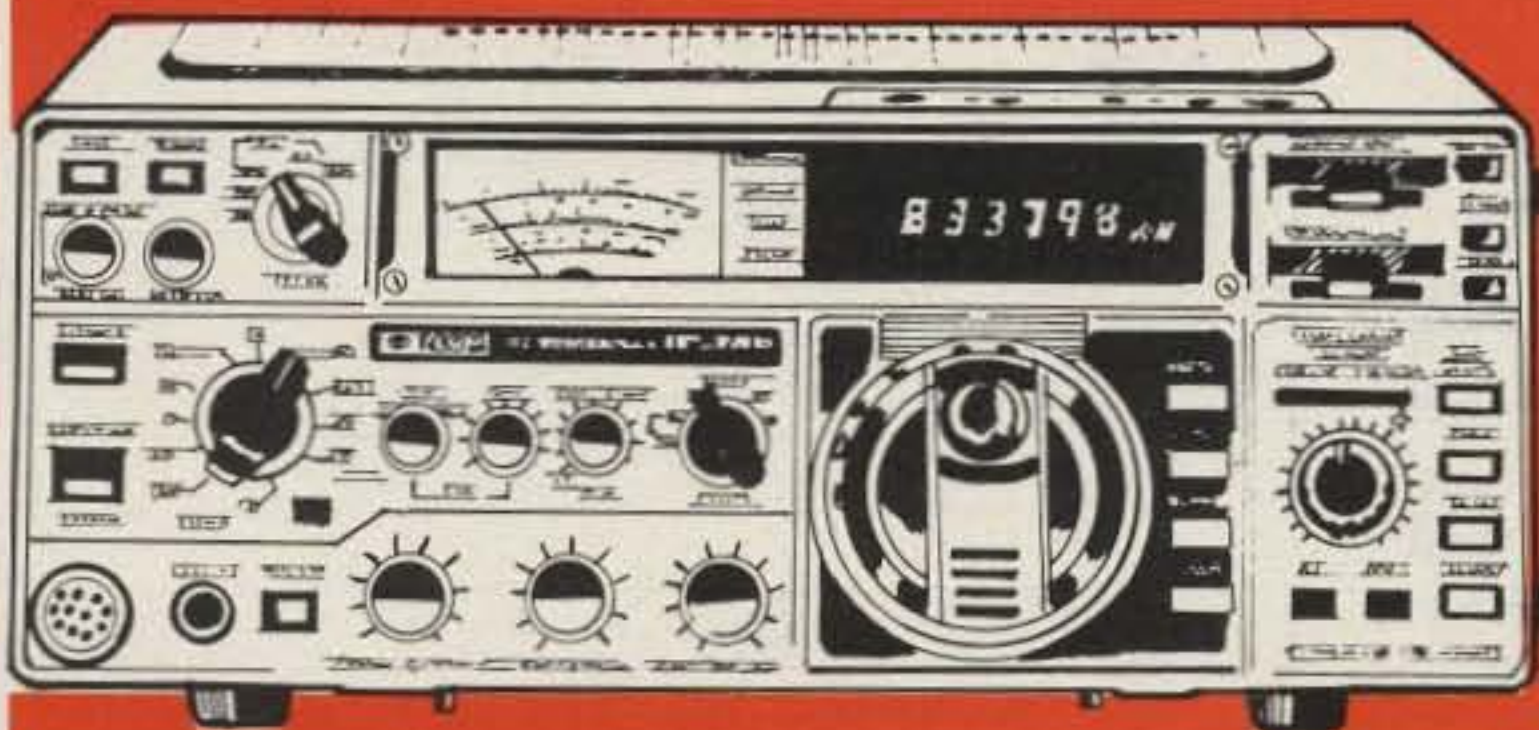

**IC-740 Extensive Versatility for the Serious Operator.** The most advanced solidstate HF base station on the amateur market. Features of the IC-740 receiver include variable width and continuously adjustable noise blanker, continuous, adjustable speed AGC, adjustable IF shift and variable passband tuning. The IC-740 allows maximum transmit flexibility with front panel adjustment of VOX gain and VOX delay along with ICOM's unique synthesized three speed tuning.

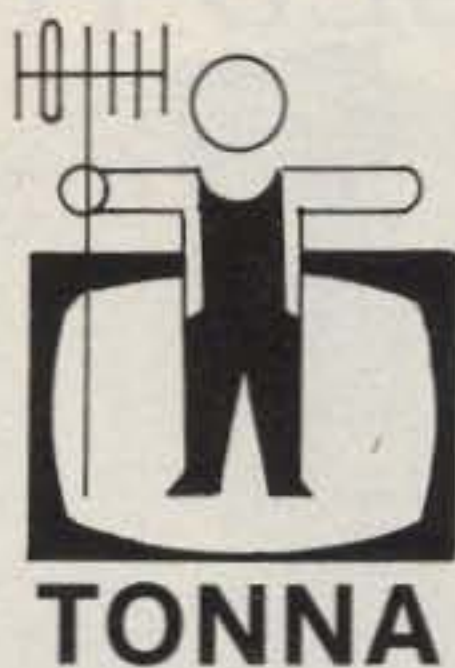
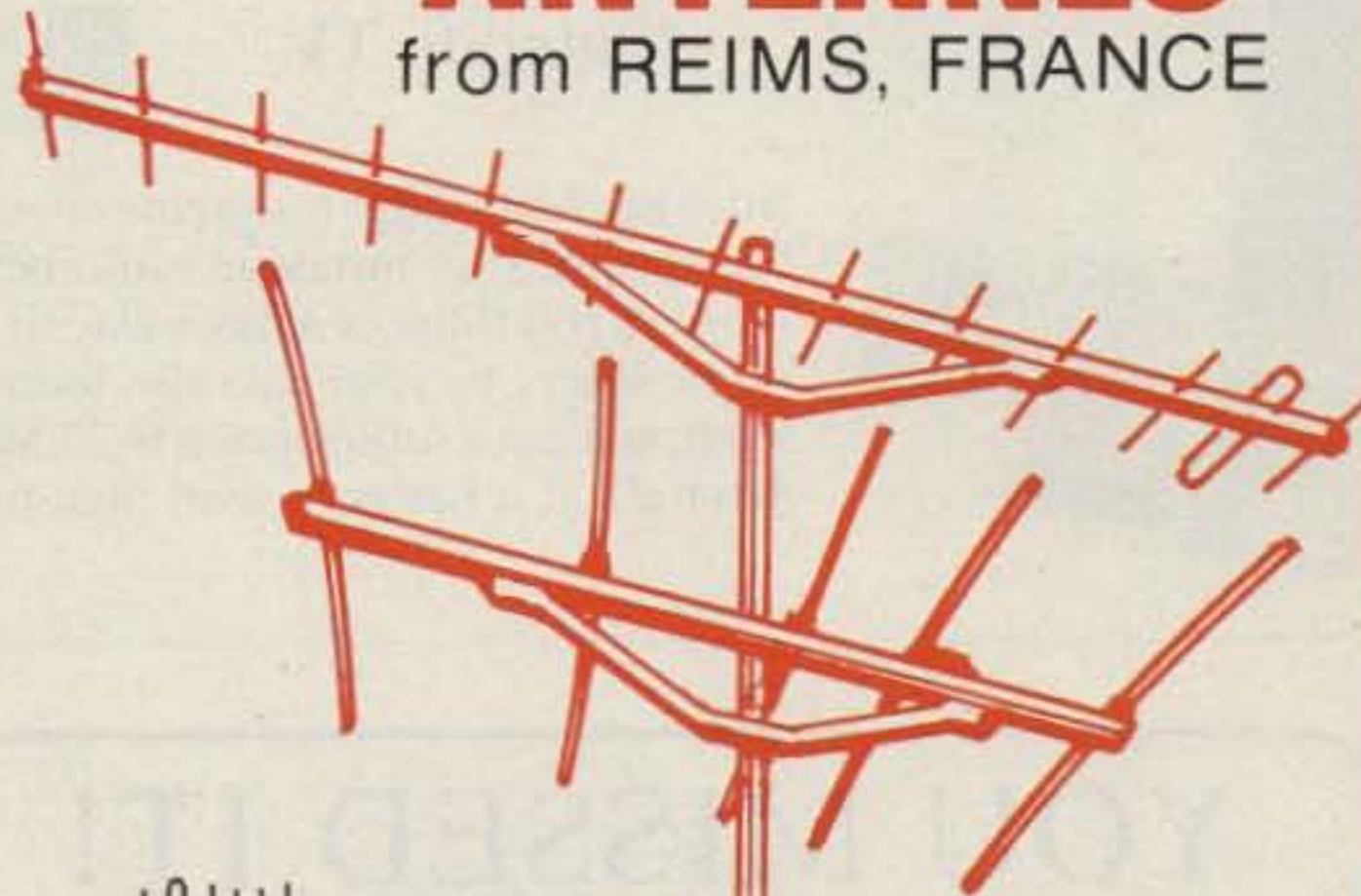

- **20421**  
21 Ele. - 432/  
435 MHz  
18 dB
- **20116**  
16 Ele. - 144/  
146 MHz  
16.5 dB
- **4X23 Ele.**  
1296 MHz  
G:23.5 dB iso

Ask About  
Our  
**DEALER**  
Program.

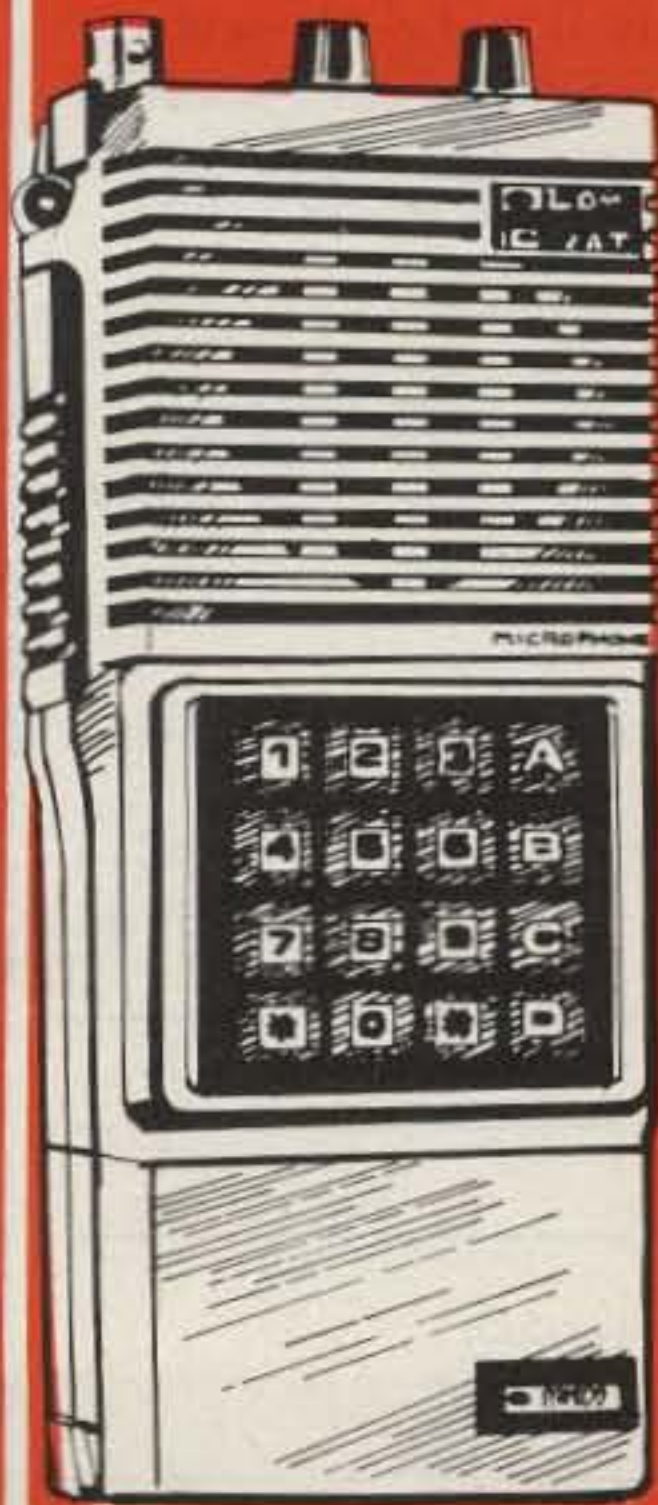

**IC-2AT**  
ICOM's popular 2 meter, 800 channel, compact, handheld transceiver with Touchtone® built-in. Comes standard with BP3 (250 mAh) battery, wall charger, belt clip, flexible antenna. A wide variety of batteries and accessories available.

Call N & G  
for Price Quote

Call N & G  
for Price Quote

Call Toll Free on our National Wats Line **1-800-327-3364** (Dade) 1-305-592-9685 (Broward) 1-305-763-8170



SAY

with a subscription to  
73 MAGAZINE

73 is a virtual encyclopedia for radio amateurs, covering everything from Amplifiers to Zepps, including

- \* Digital communications
- \* Hardware construction
- \* Pioneering articles
- \* Satellite TV



No other ham radio magazine covers the entire spectrum of amateur radio better than 73. Can you think of a nicer way to say Happy Holidays to your favorite ham than by sending them a subscription to 73 Magazine? After all, it is better to send than to receive.

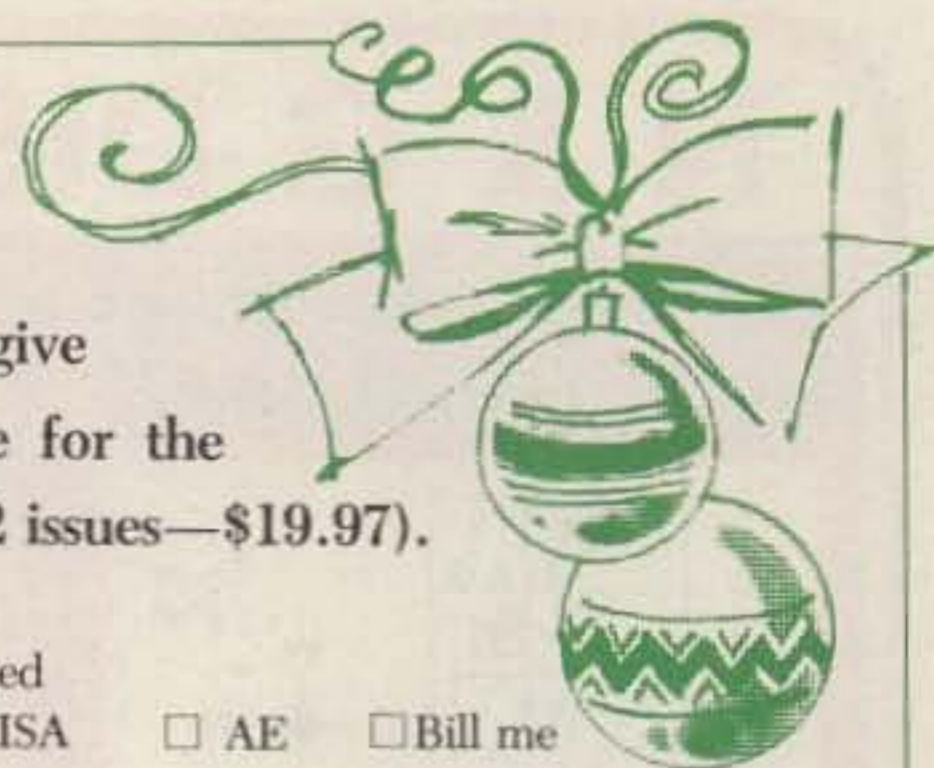
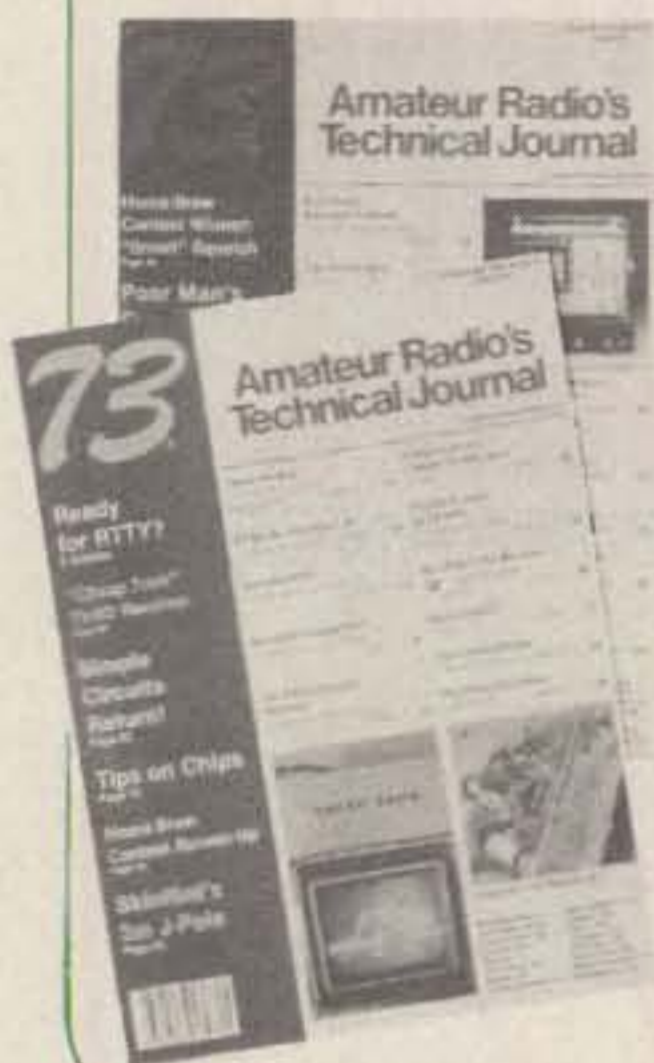

YES!

I'd like to give  
73 Magazine for the  
holidays. (12 issues—\$19.97).

- Check enclosed  
 MC    VISA    AE    Bill me

Card# \_\_\_\_\_  
 Exp. date \_\_\_\_\_  
 Signature \_\_\_\_\_  
 Interbank # \_\_\_\_\_  
 Name \_\_\_\_\_  
 Address \_\_\_\_\_  
 City \_\_\_\_\_  
 State \_\_\_\_\_ Zip \_\_\_\_\_

Please enter a one year gift subscription to:

Name \_\_\_\_\_  
 Address \_\_\_\_\_  
 City \_\_\_\_\_  
 State \_\_\_\_\_ Zip \_\_\_\_\_

Canada & Mexico \$22.97, 1 year only, U.S. Funds  
 Foreign \$39.97, 1 year only, U.S. Funds Drawn on U.S. Bank  
 All Gift Subscriptions Begin With Jan. 1983 Issue.  
 73 Magazine • Box 931 • Farmingdale, NY 11737

62NR6

YOU MISSED IT!



But you still need that issue of 73 Magazine.  
 Well, it's not too late to get it.  
 Send for your free Back Issue Catalog.  
 A complete listing, including editorial highlights.  
 You still need it.  
 And we've still got it.

YES, I want my free Back Issue Catalog for 73 Magazine.

Name \_\_\_\_\_  
 Address \_\_\_\_\_  
 City \_\_\_\_\_ State \_\_\_\_\_ Zip \_\_\_\_\_

73 Magazine, Mail Order, 80 Pine St., Peterborough, NH 03458

MOVING?

Let us know 8 weeks in advance so that you won't miss a single issue of 73 Magazine.  
 Attach old label where indicated and print new address in space provided. Also include your mailing label whenever you write concerning your subscription. It helps us serve you promptly. Write to:

**73 magazine**

Subscription Department  
 P.O. Box 931  
 Farmingdale NY 11737

- Extend my subscription one additional year for only \$19.97  
 Payment enclosed    Bill me

Canadian and Mexican \$22.97 US funds, Foreign surface \$39.97 US funds, drawn on US banks.

If you have no label handy, print OLD address here.

32NR6M

AFFIX LABEL

Name \_\_\_\_\_ Call \_\_\_\_\_  
 Address \_\_\_\_\_  
 City \_\_\_\_\_ State \_\_\_\_\_ Zip \_\_\_\_\_

print NEW address here:

Name \_\_\_\_\_ Call \_\_\_\_\_  
 Address \_\_\_\_\_  
 City \_\_\_\_\_ State \_\_\_\_\_ Zip \_\_\_\_\_



From **73** = MAGAZINE  
**THE MOST UP-TO-DATE REPEATER ATLAS AVAILABLE!**

**WORLD Repeater ATLAS Repeater Repeater Repeater**

**INCLUDES:**

- LISTINGS BY STATE AND COUNTRY
- LISTINGS BY FREQUENCY
- MAPS FOR EACH STATE
- 28 MHZ THROUGH 1296 MHZ
- PERFECT FOR MOBILING
- WORLD REPEATER ATLAS—BK7315—Completely updated, over 230 pages of repeater listings are indexed by location and frequency. More than 50 maps pinpoint 2000 repeater locations throughout the USA. Foreign listings include Europe, the Middle East, South America and Africa. \$4.95.

**IN STOCK AND READY TO SHIP**

\*Use the order card on the Reader Service page of this magazine or itemize your order on a separate piece of paper and mail to: 73 Radio Bookshop • Peterborough NH 03458. Be sure to include check or detailed credit card information. No C.O.D. orders accepted. Add \$1.50 handling charge for the first book; \$1.00 for each additional book. Questions regarding your order? Please write to Customer Service at the above address. Please allow 4-6 weeks for delivery.

**FOR TOLL FREE ORDERING CALL 1-800-258-5473**

# CALL LETTER HATS

ONLY \$5

Hats Are One-Size-Fits All w/ Nylon Mesh Back

101 Elm St Suite 4  
Peterborough, NH 03458

LINE 1  Morsekey   My Own Logo

LINE 2

LINE 3

Or

CIRCLE ONE  
Green Blue Red Gold





Introduced and the talk of the Dayton Hamfest these Attractive and Durable Call Letter Hats are just the thing for Hamfests, Field Day, contests and Club Activities. Messages are printed by computer and can be up to 6 lines of 18 small letters, 3 lines of 9 large letters or any combination. The Morse Key or your logo takes one large line. Discounts for Club orders and Free logo with orders for 12 and up. Once your logo is on file with us it is free with any quantity, and remember every hat can have a different call or message.

# CALL LETTER T SHIRTS

T-Shirts are Highest Quality 50/50 Cotton Polyester



COLOR  
White/Blue Trim White/Red Trim  
Light Blue Tan

SIZE  
Adult Sm Med Lrge X-Lrge  
Child 2-4 6-8 10-12 14-16

\$8.00

LINE 1  Morsekey   My Own Logo (Provide B & W Copy)

LINE 2

LINE 3

LINE 4

LINE 5



Our comfortable and durable T-Shirts are the finest quality available. Make up your own message, DXCC, WAS, WAC, Hams do it with higher frequency, DX Hound, DX-Peditions, Please QSL and any other message. Up to six lines of 10 large letters each or up to 12 lines of 20 small letters each. Discounts for Club orders and FREE logo with orders for 12 or more. FAST MAIL ORDER !!

CALL LETTER HATS 101 Elm St. Suite 4, Peterborough, NH 03458

Name \_\_\_\_\_

Address \_\_\_\_\_

City \_\_\_\_\_ State \_\_\_\_\_ Zip \_\_\_\_\_

Card  Money Order  Charge Card

Exp Date \_\_\_\_\_

Signature \_\_\_\_\_

ORDER BLANK  Add \$2 To Total For Shipping Charges



**FRANCIS ENTERPRISES INCORPORATED**  
 P. O. Box 906  
 Poplar Bluff, Mo.  
 314-989-3248

We Build Quality Into Our Products

WE ARE LOCATED 11 MI. SO. ON 87 HWY

**MANUFACTURERS | DISTRIBUTORS**  
 GRAIN BINS - INDUSTRIAL - ELECTRICAL - IRRIGATION EQUIP.

# Satellite Television

Whether you need 1 system or 100 we have the highest quality antenna to meet your utmost expectations and quality standards, at easy to live with prices.

Send:  
 \$7.95 for  
 Introduction to  
 Satellite manual.

Pictured is our 11 ft Dish with our easy setting one man installation trailer.



151

**Write or call us for more information.**



# FREE! Brand New Catalog With Over 150 Programs

Best  
Software  
Under The  
Sun

Instant Software's new catalog is free and it offers 150 of the finest programs you can find. At reasonable prices...and a variety you've never seen before in one catalog. And they're all contained in the new 16 page 1983 Instant Software catalog. You'll find:

**ASSEM/ZSIM**—2 great utilities in one super package. Assembly language programmers, this package solves all your programming problems from ASSEM to ZSIM.

**Super Utility Plus**—the most powerful program of its kind. A must for every serious TRS-80\* disk installation.

**Geography Explorer Series**—the exciting, attention-holding series that teaches your children essential geographical facts.

**Phaser Blast**—phaser-armed robots, enemy Hovertanks...prepare for a journey into the war of the future.

**Space Shuttle**—experience the ultimate flight as you pilot America's

Columbia through launch, orbit, re-entry and landing.

Plus dozens of other practical, mind-boggling or spine-tingling programs.

And now you can get the new 1983 Instant Software Catalog absolutely free. You don't even have to pay for the phone call. Just dial toll free:

**1-800-258-5473**

and ask for your free copy of Instant Software's 1983 Catalog. It could be the smartest call you'll make all year.

**Instant Software. The best software under the sun.**



## Instant Software™

(a subsidiary of Wayne Green Inc.)

Route 101 & Elm St.

Peterborough, NH 03458

\*TRS-80 is a registered trademark of the Radio Shack division of Tandy Corp.

Yes, I want a free catalog!  
Please send my free copy to:

Name \_\_\_\_\_

Address \_\_\_\_\_

City \_\_\_\_\_ State \_\_\_\_\_ Zip \_\_\_\_\_

I have a \_\_\_\_\_ computer

**Instant Software™**

Peterborough, N.H. 03458 USA A subsidiary of Wayne Green Inc.

The best software under the sun.



# Orbit



**ORBIT** is the Official Journal for the Radio Amateur Satellite Corporation (AMSAT), P.O. Box 27, Washington, DC 20047. Please write for application.

For a **FREE SAMPLE COPY** please send \$1 to cover First Class Postage and handling to: Orbit, 221 Long Swamp Road, Wolcott, CT 06716.

## NEW FAST CHARGE For Your Battery Packs

RECHARGE YOUR HAND HELD RADIO BATTERY PACKS TO FULL CAPACITY IN AS LITTLE AS 45 min. EXAMPLE—Fully Charge ICOM BP3 in 30-45 Minutes.

SEPERATE FUSES PROVIDED INTERNALLY FOR A.C. AND D.C. OPERATION. —BUILT IN REVERSE POLARITY PROTECTION.

ONE UNIT DOES IT ALL Charge, ICOM, YAESU, KENWOOD, TEMPO, SANTEC and Others Automatically in Your Home, Car, Boat, R.V. or Airplane with Built-in Heavy Duty Power Supply or 12 to 24 V. External D.C. Supply Such as Cigar Lighter in Your Car.

All Solid State Precision Components Used Throughout. In A Unique Circuit Allows Fast Charging Without Any Perceptible Heating Of Cells. Charger Measures Remaining Charge In Cells Constantly And Turns Off Automatically When Battery Is Fully Charged. Battery Can Be Left Connected Indefinitely.

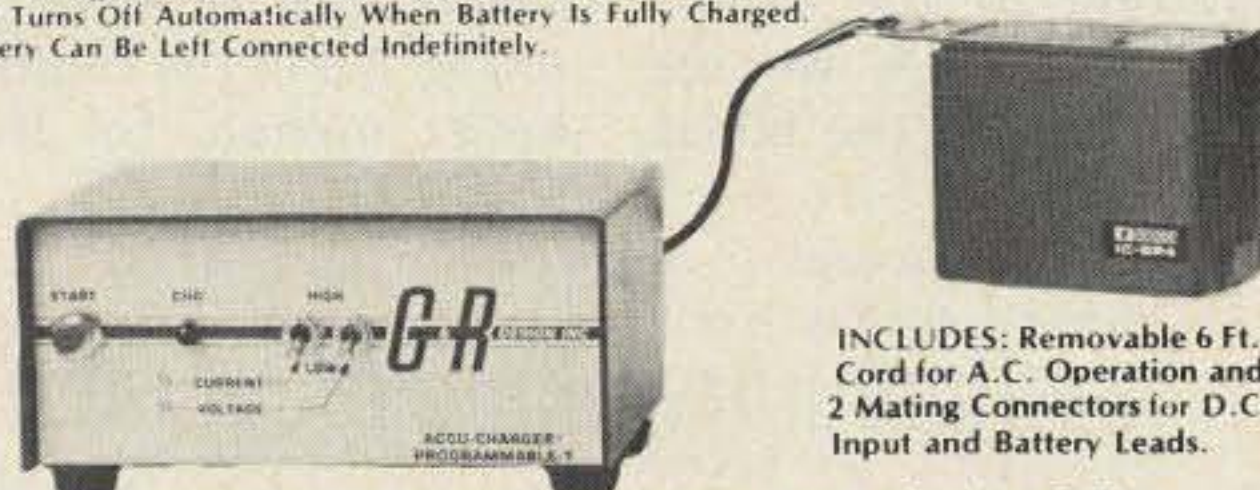

INCLUDES: Removable 6 Ft. Cord for A.C. Operation and 2 Mating Connectors for D.C. Input and Battery Leads.

FEATURES: High Quality, Custom Designed Heavy Gauge Aluminum Cabinet.

FULL 1 YR. WARRANTY ON PARTS AND WORKMANSHIP

ACCESSORY CONNECTOR TO FIT ICOM BATTERY PACKS, BP-2, BP3, BP4, BP5, \$3  
PRE-PAID ORDERS INCLUDE \$3 SHIPPING & HANDLING  
PHONE ORDERS—CALL [209] 586-7059

**\$79.00**

CALIF. RESIDENTS INCLUDE 6% TAX

MAIL PRE-PAID ORDERS TO:

**GR** DESIGN INC

P.O. BOX 4463 SONORA, CALIF. 95370

DEALER INQUIRIES INVITED

✓149

## COMMUNICATIONS DIVISION

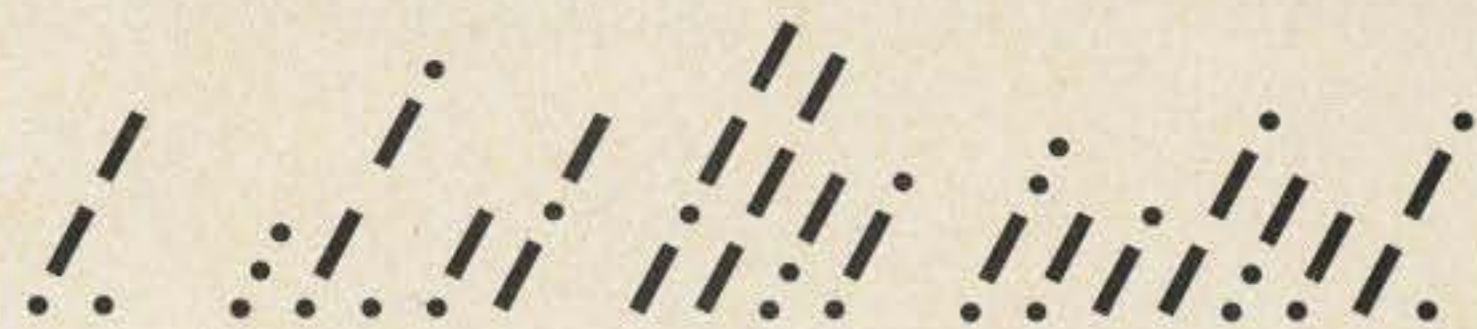

# (We Speak Your Language.)

Backed by over 54 years of experience, Harvey continues to offer the broadest selection and finest service available for the amateur radio community. This experience has taught us that the ham needs special treatment and that is why Harvey has established a special division dedicated to the needs of the U.S. and foreign ham alike.

One thing is for certain. A ham will never get the run around from Harvey. If we don't have something in stock, we say so and will order it for you—or—tell you where to get it. However, we are sincerely dedicated to the ham community and, as a result, our

expansive inventory means that, more than likely, we will have what you are looking for in stock.



Yaesu FT-One

ICOM IC-720A

AEA  
Alliance  
Antenna Specialists  
ARRL  
Astatic  
Bearcat  
Bencher  
B&W  
C.P.E.S.  
Centurion  
C.D.E.  
Cushcraft  
Daiwa  
Digimax  
R.L. Drake  
Gotham Antennas  
Grundig  
H.M. Electronics  
Icom  
Kantronics

K.D.K.  
Larsen  
McKay Dymek  
M.F.J.  
Midland  
J.W. Miller  
Mirage  
Wm. M. Nye  
Regency

Santec  
System One  
Telex Hygain  
Tempo  
The Tuned Antenna  
Trilectic  
VoCom  
W.S. Engineering  
Yaesu

CALL TOLL FREE:

**1-800-223-2642**

Ask for Dou "Joe" Chin—KB2MU

# HARVEY

25 W. 45th St., N.Y., N.Y. 10036 (212) 921-5920



# Speed Demon

*How fast was that? Find out with this wpm display for Heath's 1410 keyer.*

Jerry Wayne Campbell K4ZHM  
Rte. 4, Box 126 Barkley  
Nicholasville KY 40356

First, let's look at what we need to calculate the words-per-minute speed of the keyer. The *ARRL Handbook* gives the following formula for calculating code speed:

$$\text{words/min} = \text{dots/min} / 25 = 2.4 \times \text{dots/sec}$$

From the Heath 1410 keyer manual, we see that for each dot generated (space included), the clock in the keyer generates two pulses. The clock pulse rate is twice the dot rate. If we measure the clock pulses

instead of the dots, the formula becomes:

$$\text{words/min} = 1.2 \text{ clock pulses/sec}$$

Multiplying the clock pulses/sec by 1.2 is the same as measuring the clock pulses for 1.2 seconds. 1.2 seconds is 72 cycles at the 60-Hz power-line frequency; therefore, if we count the clock pulses for 72 cycles of the line frequency, we are effectively multiplying our keyer clock pulses/sec by 1.2. Thus, by counting the clock pulses from the keyer for 1.2 seconds, we can read the code speed directly on the seven-segment displays.

Referring to the timing diagram in Fig. 1, we see that by dividing the 60-Hz

line frequency as shown (first by 6, then again by 6, then by 2, then finally by 2; see Fig. 2) we obtain a 1.2-second gating pulse. We now have the means to time the keyer clock pulses for 1.2 seconds and the count will update each 1.2 seconds. The reset pulse clears the counters 0.6 seconds prior to the counting interval. Send dots and/or dashes for over 2.4 seconds, and the readout will display for 0.6 seconds the speed at which the keyer is set.

Power, the 60-Hz line frequency, and, of course, the keyer clock pulses are all taken from the keyer. Refer to Fig. 3 and the Heath 1410 keyer manual for the fol-

In the following, I will describe a digital display I added to my Heath 1410 keyer to display the wpm setting of the keyer. The same principle can be applied to other keyers.

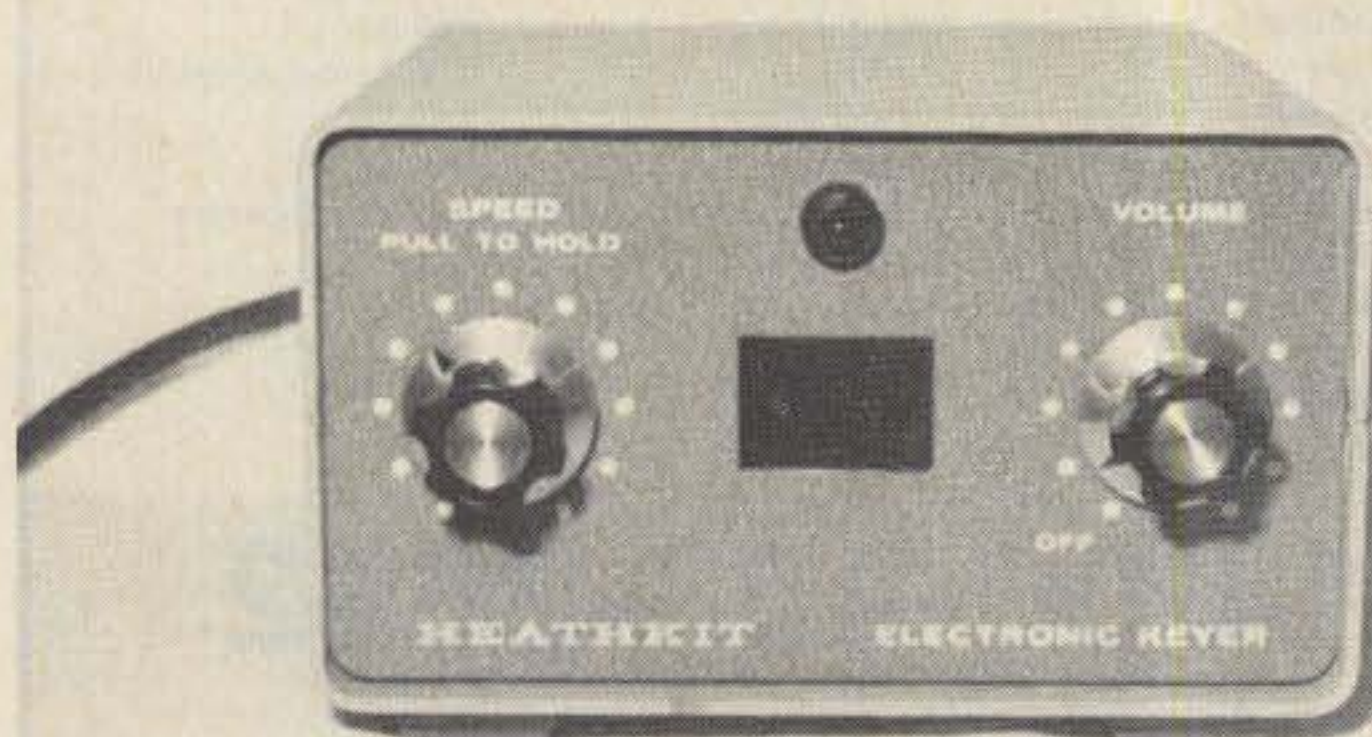

The assembled keyer with the counter modification.

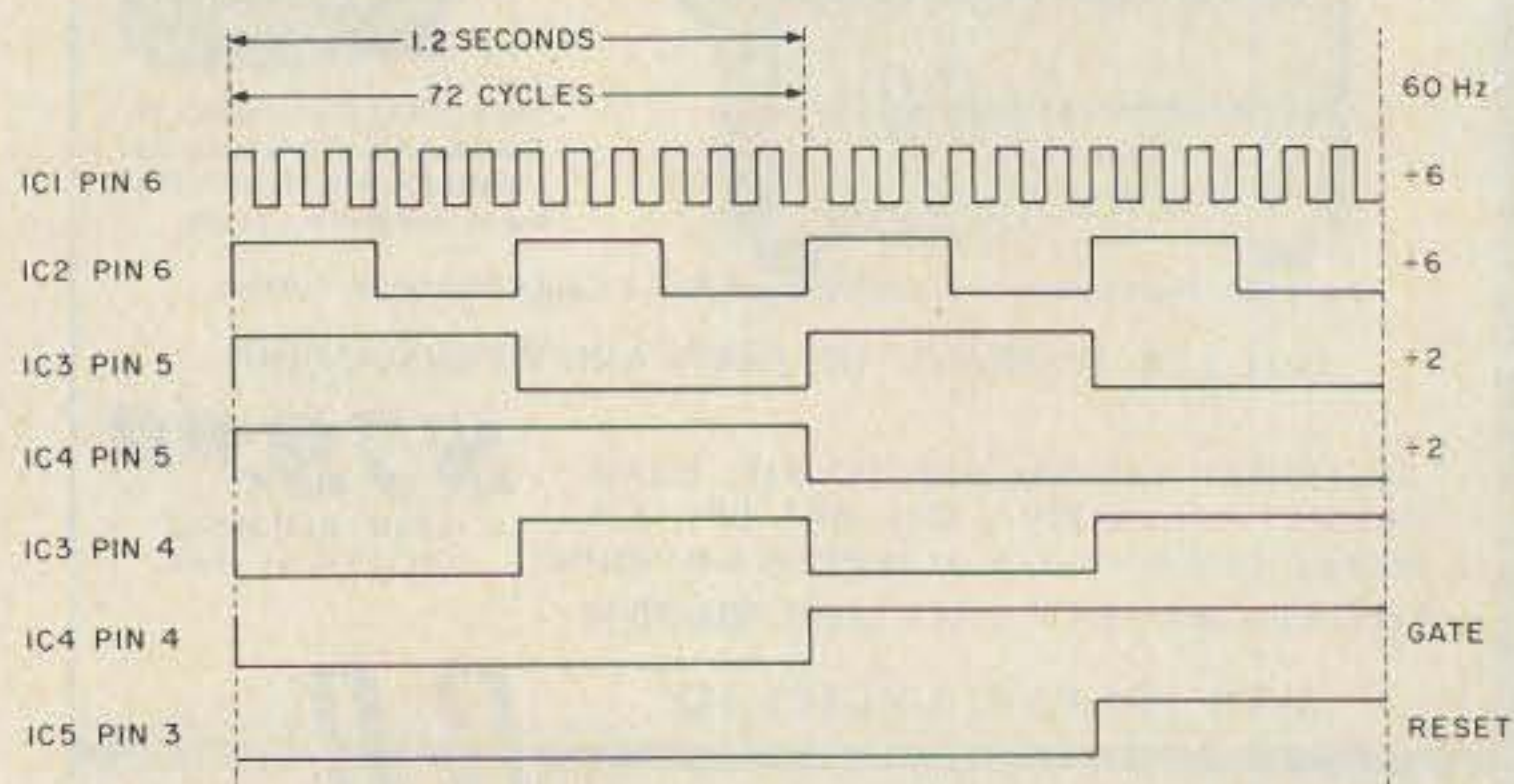
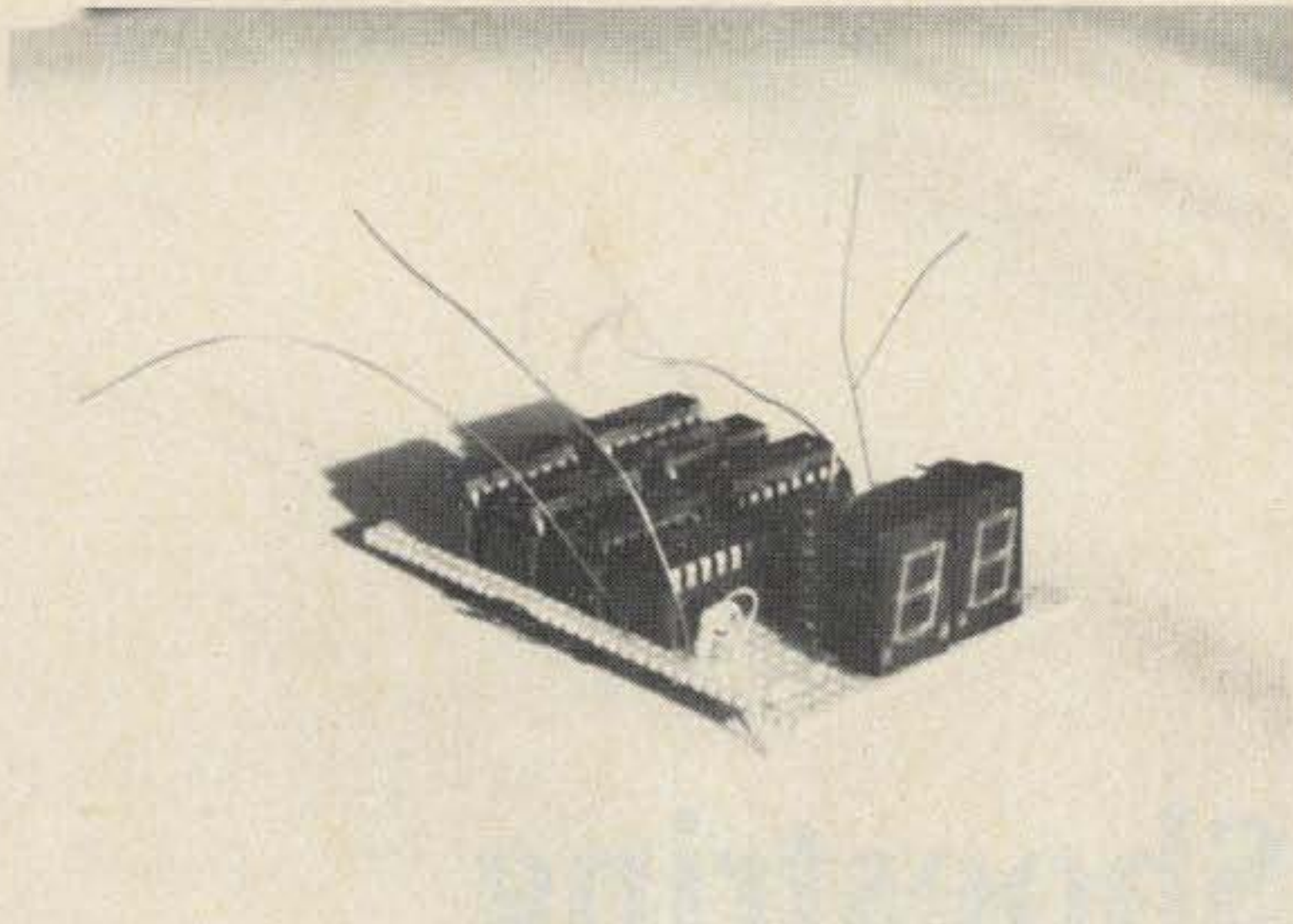
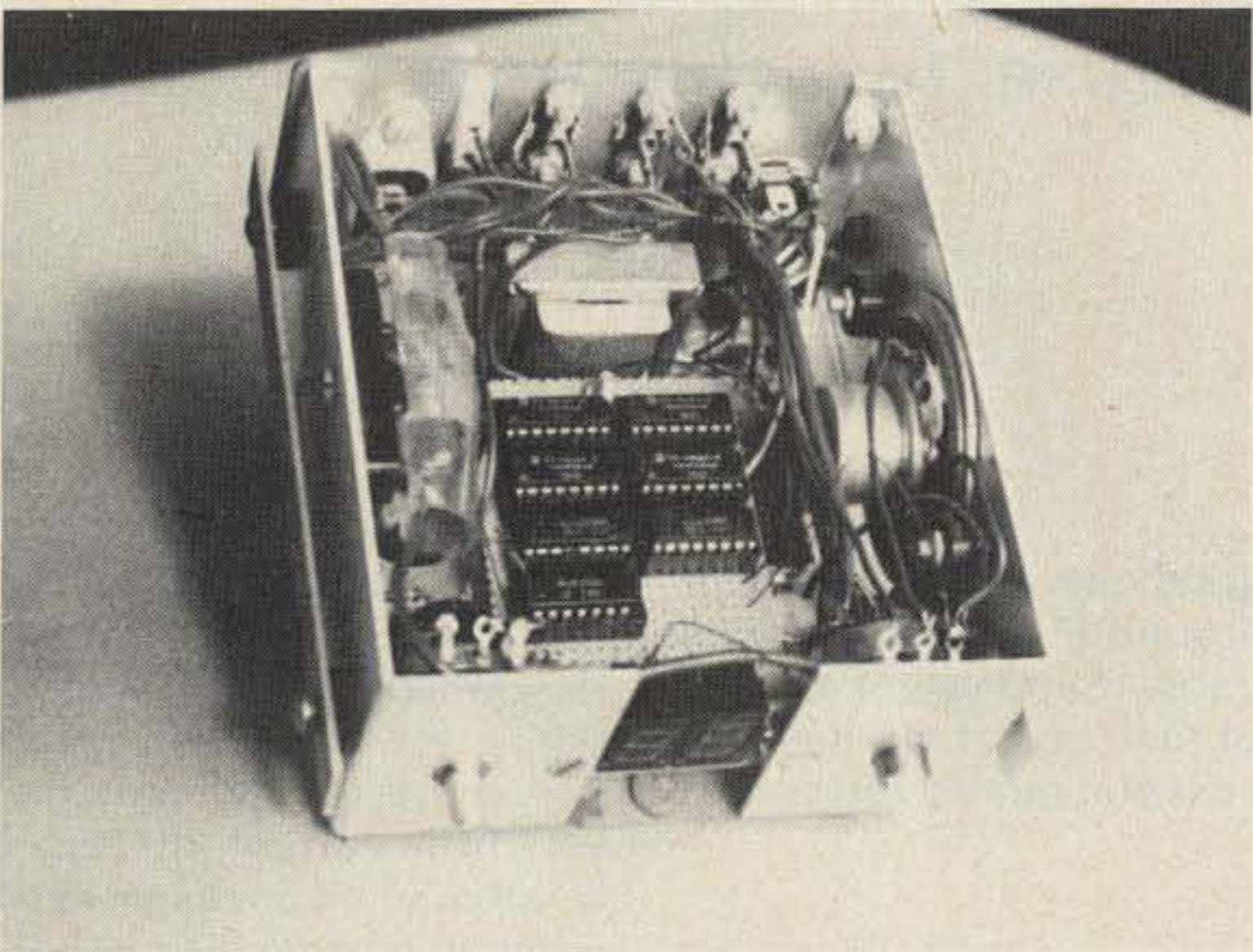

Fig. 1. Timing pulses appearing at various points in the circuit.





The completed counter board before mounting in the keyer.



The counter board is mounted using right-angle brackets and the mounting holes for the removed paddles.

lowing connections. The keyer clock pulse is obtained from point D on the keyer speed control. The 60-Hz signal is obtained from either side of the secondary of the power transformer and ground. The resistor values shown, R1 and R2, are for the Heath keyer. A convenient source for the 5 V dc is the speaker lead that is connected to the 5 V dc supply.

I replaced the neon on-off indicator lamp with an

LED. I then connected the inputs of the remaining 1/4 IC5 to pin 12 of IC3 in the keyer, and the output to the LED; see Fig. 2. The LED lights up on the mark portion of the code character.

When sending code, the display of the speed will

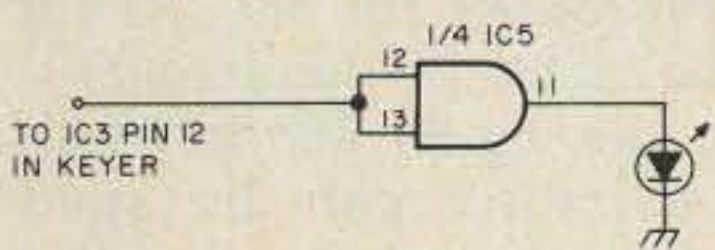

Fig. 2. LED mark indicator for keyer output.

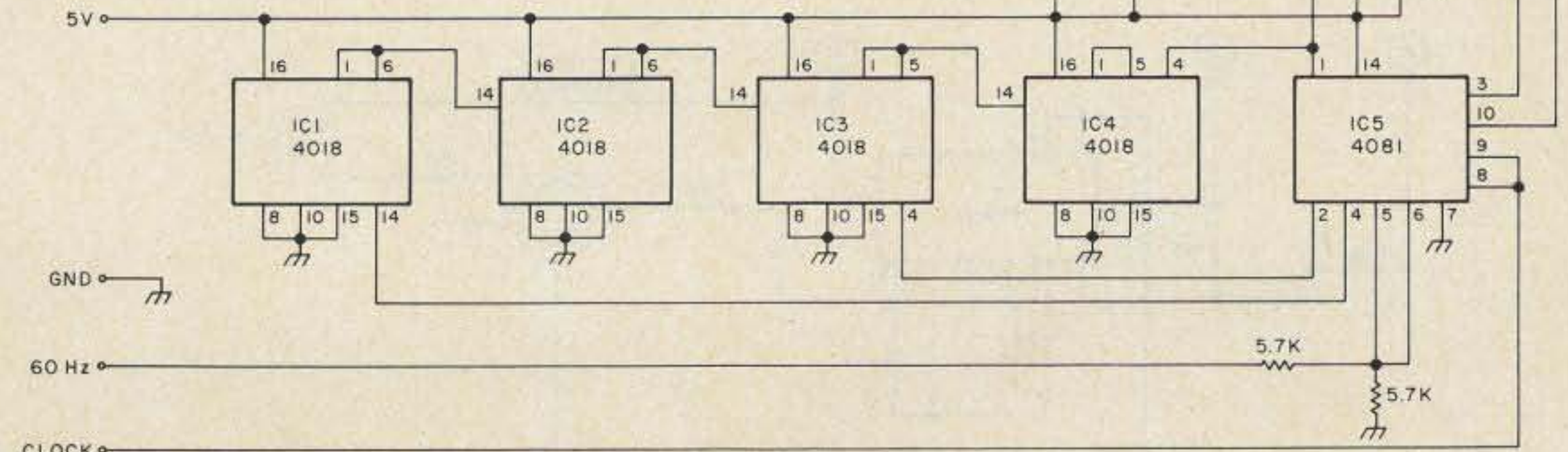

Fig. 3. Code-speed reader for the Heath 1410 keyer.

## Ceco Now Has Video



### Cameras, Monitors, Connectors, Video Tape and Lenses

8mm F1.3      16mm F1.6  
25mm      50mm  
22-88mm Zoom

CALL CECO'S VIDEO DEPT.  
FOR OUR LOW, LOW PRICES  
Dealer Inquiries Invited

(212) 646-6300      (800) 221-0860  
TELEX: 235135



COMMUNICATIONS, Inc.  
2115 AVENUE X,  
BROOKLYN, N.Y. 11235

vary. You are seeing the average speed at which you were sending in that 1.2-second interval.

There are several methods of housing the display. I use a Bencher paddle with my keyer, so I

removed the keyer paddles from the keyer and took out the center post. I then mounted a red lens over the opening. The display and circuitry are then mounted behind the lens using the mountings for the removed paddle assembly. ■



# Keyer on a Shoestring

*Hams are cheap and so is this keyer.  
Big spenders will build the deluxe, two-chip version.*

Joel R. Donaldson WB5PPV  
17 Fenwick Drive  
Laredo TX 78041

**M**ost great keyers aren't very cheap, and most cheap keyers aren't particularly great. However, here's a fair-to-

good one you can build for around \$10.00 using all new parts. If you've got any sort of junk box at all, it should cost you quite a bit less. It's

not iambic or self-completing, it lacks contest memories, weight control, and a few other bells and whistles, but it is simple, draws very little current, fits nicely into a small package, and is capable of sending good, clean CW. A keying transistor and floating ground make it usable with just about every modern rig, and a sidetone circuit can be added easily if your rig lacks one. In short, it makes a good first keyer or a nice second circuit for the vacation or QRP set.

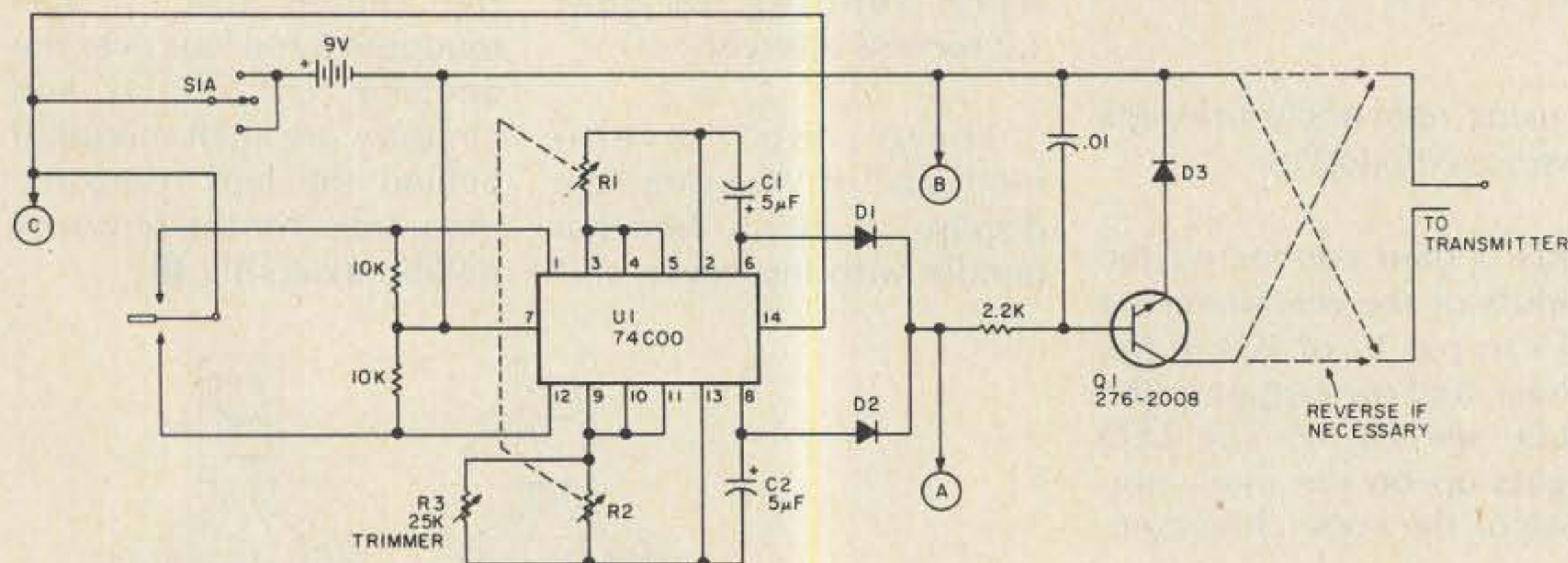

Fig. 1. One-chip keyer circuit. The entire circuit must be isolated from the enclosure. R1, R2—30k or 50k "stereo" linear taper dual pot. D1, D2, D3—any silicon diode. Q1 shown is a Radio Shack part number.

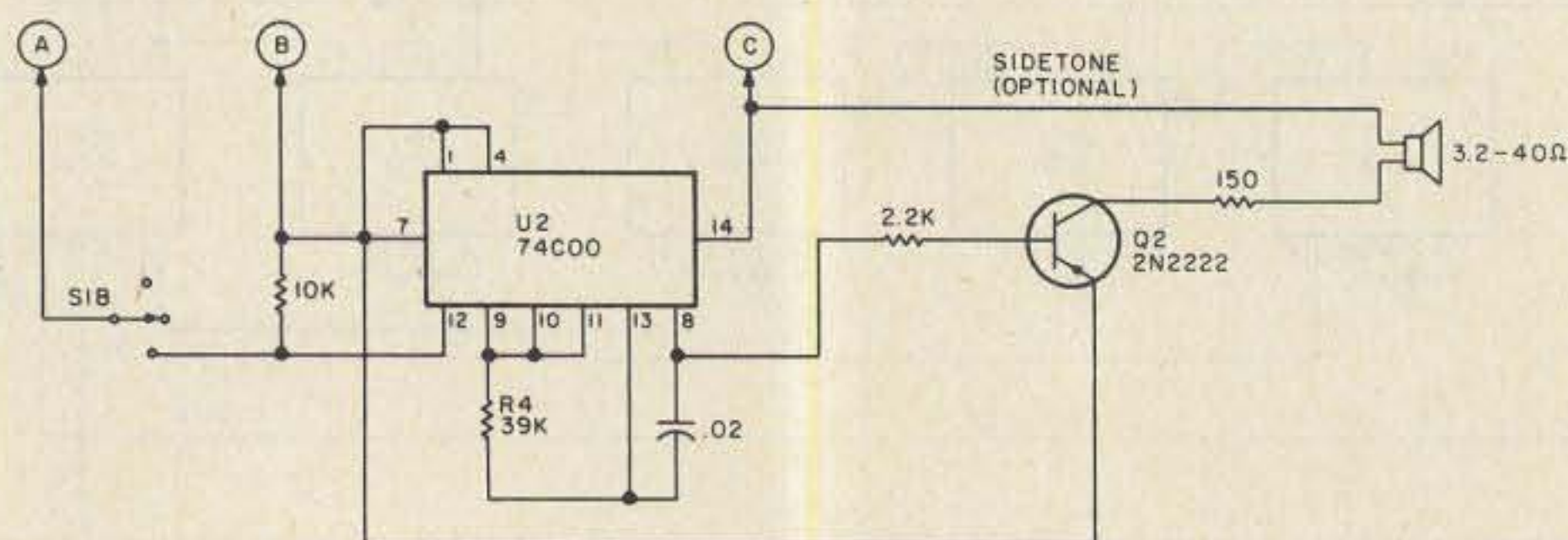

Fig. 2. Optional sidetone circuit connects to the keyer at points A, B, and C.



fixed percentage faster than the other, thereby providing a definite dash-to-dot ratio. The output of both oscillators is connected to the sidetone (if used) and to Q1, the keying transistor, through D1 and D2, which prevent one oscillator from interfering with the other. Q1 conducts whenever either oscillator is in the "on" state, thus keying the transmitter in step with the oscillators.

The sidetone circuit (Fig. 2) also consists of a 74C00 connected as an oscillator, but with R and C values changed so as to produce an audio-frequency tone. The output of this oscillator is switched by Q2, which provides enough drive to power a small speaker. The pitch of the sidetone may be changed by using a slightly different value for R4. The sidetone circuit connects to the keyer at points A, B, and C.

I mentioned earlier that this circuit has a floating ground. As shown on the schematic, no connections are to be made to the keyer cabinet. This eliminates expensive and hard-to-find reed relays, lowers power consumption, and sidesteps the need to modify the keyer whenever a different transmitter is used. Also, it is suggested that you stick to a battery to power your keyer unless you are certain that your power supply is isolated from ground. When connecting the keyer for the first time, it may be necessary to reverse the two keyer output leads to prevent the transmitter from being keyed all the time (wrong polarity to Q1). After the correct way has been found, a connector can be soldered on.

Adjustment consists of merely trimming R3 until the dits are about one-third as long as the dahs. Once this has been done, it will probably never have to be

done again, since this ratio stays about the same over a fairly wide range of keying speeds and battery voltages. However, if it is anticipated that several operators of widely varying proficiencies will be using the same keyer, it might be better to make R3 a front-mounted control or at least provide a hole in the cabinet for quick screwdriver adjustments.

It seems kind of pointless to blow a considerable amount of money on a keyer paddle when the actual circuitry costs so little, so I would like to suggest a rather unoriginal but appropriately frugal alternative. It consists of a short piece of steel packing strap or hacksaw blade sandwiched between two telephone switch or relay contacts. The packing strap or blade is scraped clean of all paint in the contact area, and a piece of paddle-shaped Plexiglas™ which protrudes through the front of the cabinet is bolted to one end. When the paddle is moved in either direction, the strap touches one of the contacts. The strap need not make a perfect connection for the keyer to operate, since the CMOS oscillators will operate even with several thousand Ohms of contact crud. The strips of phenolic that insulated the switch or relay before modification are used in the same application; they make sure that neither the strap nor the contacts make an electrical connection with the cabinet. Fig. 3 shows one possible arrangement for the entire keyer, including the paddle.

Rf shielding for this circuit is not too critical; the prototype worked fine with no case at the 100-Watt level. I used a 1- by 1½-inch piece of perfboard for the keyer circuit, and the sidetone was added as an afterthought on another small piece of board. A center-off

# NOT-A-KEYER



## The FIST FIGHTER™

Using a straight key or "bug?" Then send your code with the Fist Fighter, and make it sound perfect. "Swing" and ragged edges are filtered out and your dots and dashes are always timed, 1:3. No new hand motions or special key needed, so you'll send code like a pro in no time. Great for novice or old-timer.

Price: From \$59.95

Contact Blacksburg Group for more information.

**Blacksburg Group**

Box 242

Blacksburg, Virginia 24060

703/951-9030

118

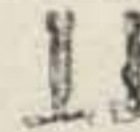

switch was used to control both the keyer power and sidetone, as the HW-101 already has a sidetone built in.

With the cost of amateur radio equipment what it is today, CW just has to offer one of the best potentials for having a lot of fun without spending a lot of money.

Vintage CW rigs abound on the used market, and a good QRP rig can be purchased new without going too far into debt. Costing about as much as a cheap microphone, this circuit reflects the same spirit of fun on a shoestring. Use and enjoy. ■

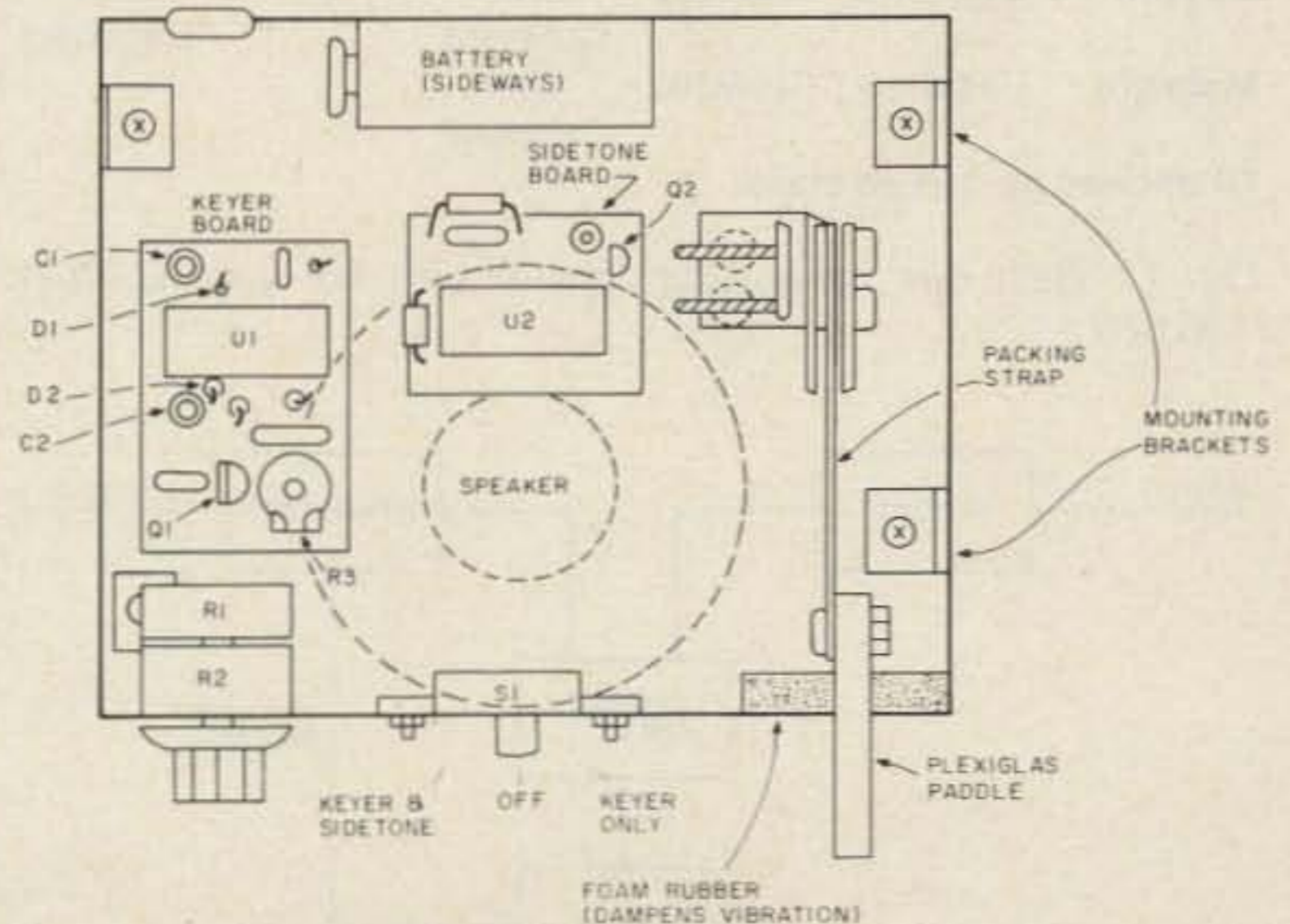

Fig. 3. Typical arrangement of circuit boards, controls, and paddle.



# I Got My Ticket! Now What?

*A look at what Elmer forgot to tell you.*

**F**or many recently licensed hams, trying to operate a new ham station is just as difficult as learning the code or studying for

the written exams. Anyone who has ever been involved in a licensing class knows people who have gotten licenses and set up stations,

but never quite made any contacts on the air. New hams have many questions about operating. The following are some of the more common ones.

minutes and don't hear anyone calling, you can try a CQ, but pick a quiet frequency and limit your CQ.

Local Time	80	40	Band 20*	15	10
6:00 am					
9:00 am			DX		
Noon			DX	DX	
3:00 pm	Local		DX	DX	DX or Local
6:00 pm	Local/ Ragchew	Local/ Ragchew	DX	DX	DX or Local
9:00 pm	Crowded	Crowded	DX/ Crowded	DX	Local/ Ragchew
Midnight	Ragchew	Crowded	DX/ Crowded		

\*If allowed by license class

Fig. 1. "Best bet" operating frequencies for a newcomer (1981-82).

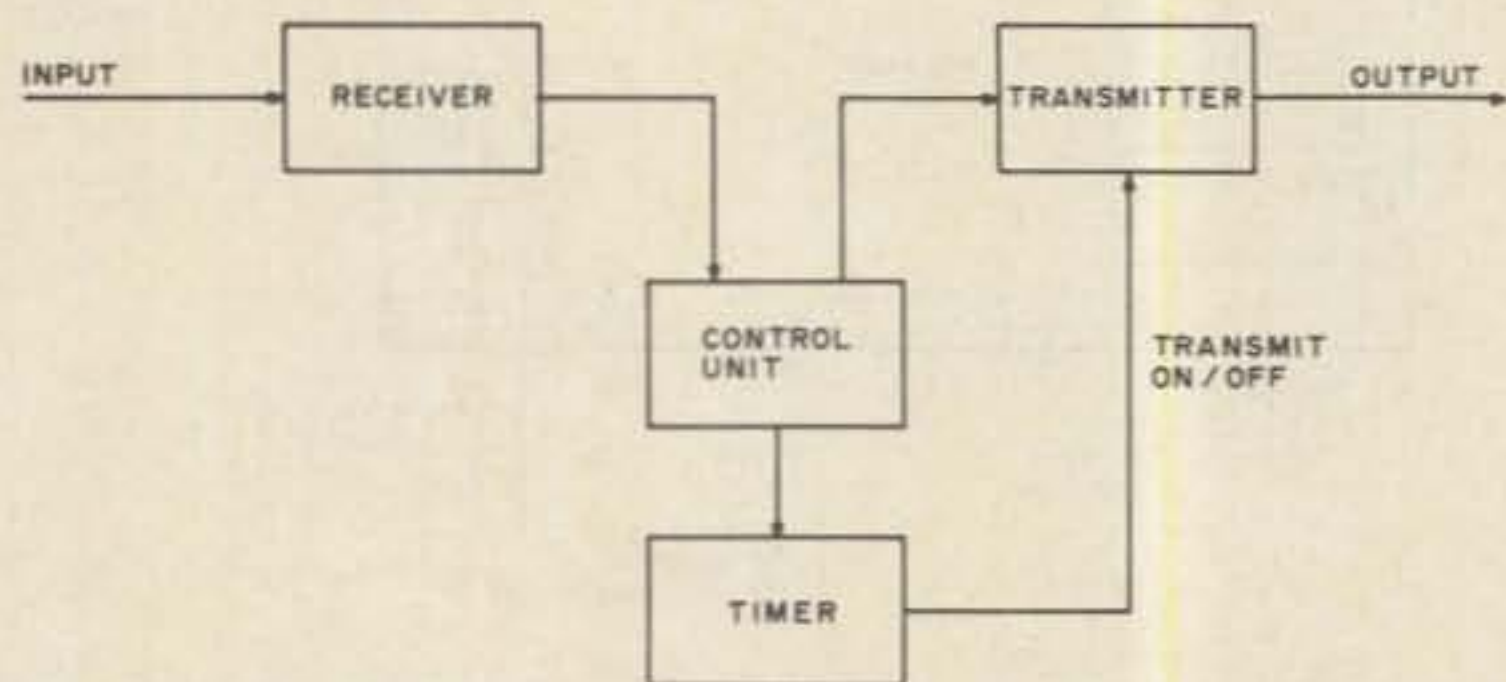

Fig. 2. Typical repeater.

*I have had my station set up for a month and have managed to make just one contact. How come?*

Let's assume your rig is working. The problem could be where and when you are trying to operate. For example, on a Friday or Saturday night, 80 and 40 meters (Novice band) are jammed and just about everyone has a problem. If you try 10 meters and the band is closed, you still won't work anybody. The trick is to pick a band and a time when there are a number of stations on, but the QRM is not overwhelming. Try 40 meters in the late afternoon, 15 in the early evening, or 10 on a Sunday afternoon (see Fig. 1).

*Should I call CQ or just listen?*

Use common sense. If you tune around for a few

*Why limit it? I thought the traditional 3x3 or even a 3x4 was a good idea.*

Look at it from the listener's point of view. If I hear you calling CQ for a long period of time and get tired of listening to you call, I won't want to reply to you. If you are that boring with a CQ, think how boring you would be in a QSO. With today's equipment, just call "CQ CQ CQ de WA1WTB WA1WTB," repeat once, and then K. If there is no answer, you can always try again.

*You said to pick a quiet frequency. How can I tell if no one is using it?*

Assuming you don't hear anything, just send QRL or IE. On voice, say "Is this frequency in use?" If there is no reply, you are perfectly correct to assume you can transmit without bothering anyone.



Am I better off operating CW or SSB to start with?

I am not sure what you mean by "better off." Assuming license class is not a consideration (you have more than a Novice license), try operating both and see what you like. Sideband initially takes less effort to operate but the frequencies are more crowded during prime operating hours. You usually can do better with DX on CW without fighting everyone's kilowatt.

What if I want to join a QSO that is already under way?

Let's be very blunt about it. In some cases, you won't be welcome. Hams are a cross section of people, no more and no less. However, on CW, a simple "BK" is enough to be invited in. On SSB, "May I join you? This is WA1WTB" or any English language equivalent is acceptable. Be careful of using "Break."

What is the problem with "Break?"

It used to be the normal and accepted way to break in but recently, especially on repeaters, "Break" or "Break Break" is used to indicate an emergency situation when you want to transmit in a hurry.

Is repeater operation different from other types of QSOs?

Yes. Almost every area or repeater is slightly different. It is a good idea to listen for a while before you get on a new repeater. Almost all are equipped with a timer which will cut you off if you talk for more than 1, 2, or 3 minutes, depending on the setting.

What controls the timer? I really don't want to get cut off in mid-sentence.

Some timers reset as soon as the repeater's receiver no longer receives a carrier. Others reset as soon as the repeater's transmitter shuts off. Some repeaters

FREQUENCY	TRANSMITTER			TUNER/MATCHBOX		
	Preselect or Driver	Plate	Load	Input Cap	L	Output Cap
3700						
3750						
3800						
7000						
7050						
7100						
7150						
7200						
21000						
21100						
21200						

Fig. 3. Sample tuning chart.

transmit a beep tone when the timer has been reset (see Fig. 2).

Why limit the time for transmitting?

The primary reason is to force a pause between transmissions, and to do so often enough to allow anyone who wants to join the QSO time enough to transmit his call. In addition, it allows mobile stations to get into the repeater without having to wait any longer than a minute or two.

Do mobile stations have a priority?

Usually yes—both on repeaters and elsewhere. First, they are limited by their motion as to how long they will stay in range. Second, they are more likely to have seen an emergency situation or to need directions or other aid. Good procedure again follows common sense—let a mobile in quickly to find out if he has a problem.

I hear a lot about "kerchunking" repeaters. What is the story here?

Kerchunking is a very common practice of pressing your mike button to see if your transmitted signal is strong enough to bring up a repeater. Since it is a transmission without identification, it is technically illegal but it is also generally a worthless test. Quite often you can be on the fringe area of a repeater and be

able to bring the repeater up but be too noisy to copy.

Is there a better way?

Sure. Key your mike and identify by saying, "This is WB1AJG—is anyone around?" If you don't make the repeater, nothing is lost. If you do make the repeater and no one answers, it doesn't make any difference since you won't have anyone to talk to!

When I identify myself on a repeater, should I use phonetics?

With a little experience you will know the answer to that question for your own call. If it contains an F, S, or other easily confused letter, you can use phonetics, but it is not usually done unless the station you are talking to does not repeat your call correctly. The same holds true for signal reports—they are not usually given

unless asked for or you wish to indicate a problem.

Which signal reports are usually given on repeaters? Q5 S9 does not seem appropriate.

Since the signal strength you are receiving is due to the repeater and not due to the station you are talking to, the best you can do is tell if you are copying OK ("full quieting") or noisy. Some hams will say "50% quieting" which indicates they are copying half noise and half signal, but this non-technical use of "quieting" is a wild guess at best.

What about reports on other bands or when you are not using a repeater?

I suggest telling the truth. On CW, if you had a transmitter problem and your tone was not T9 or perfect, wouldn't you want the other guy to tell you? The

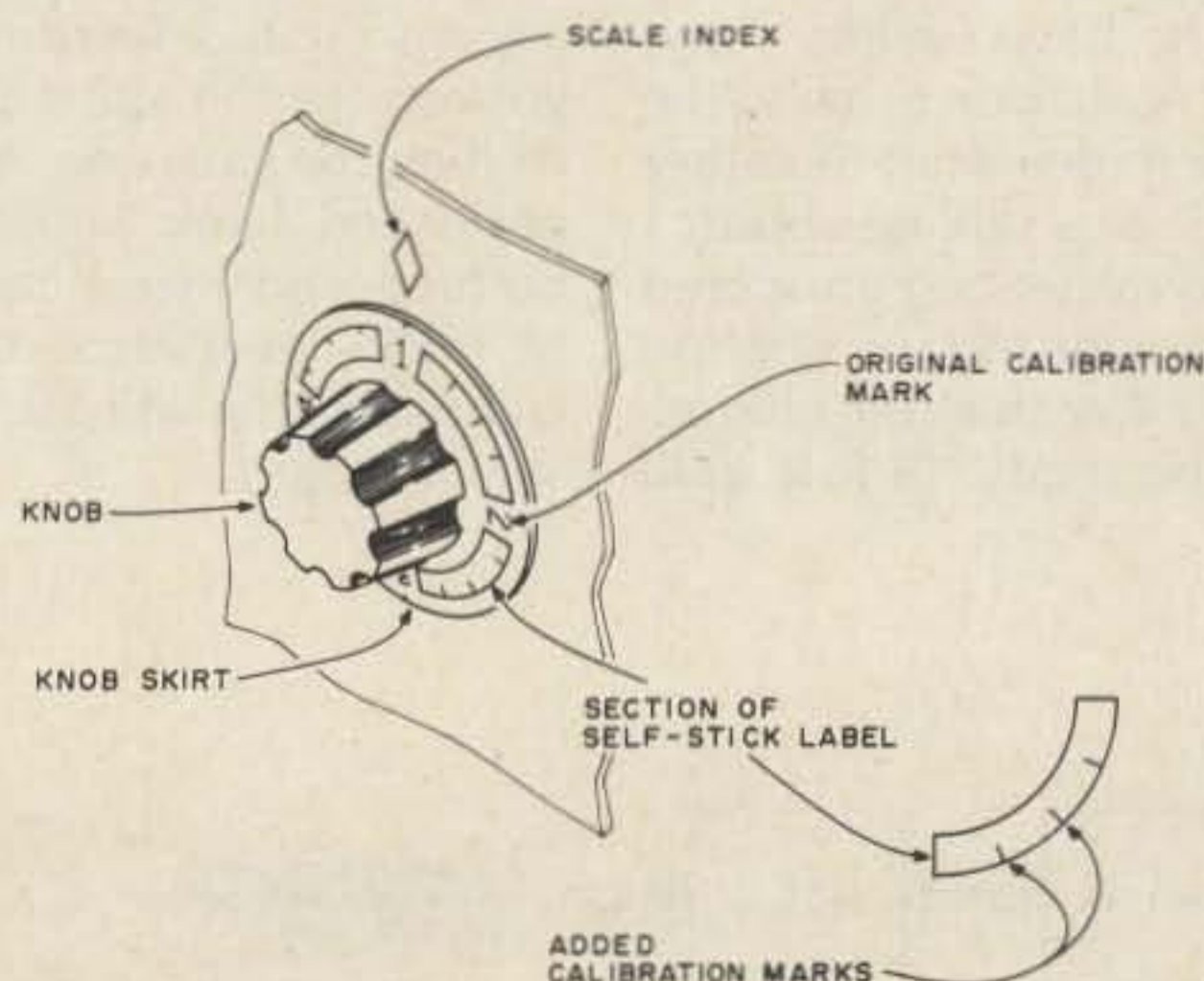

Fig. 4. Adding calibration marks to a skirt-type knob.



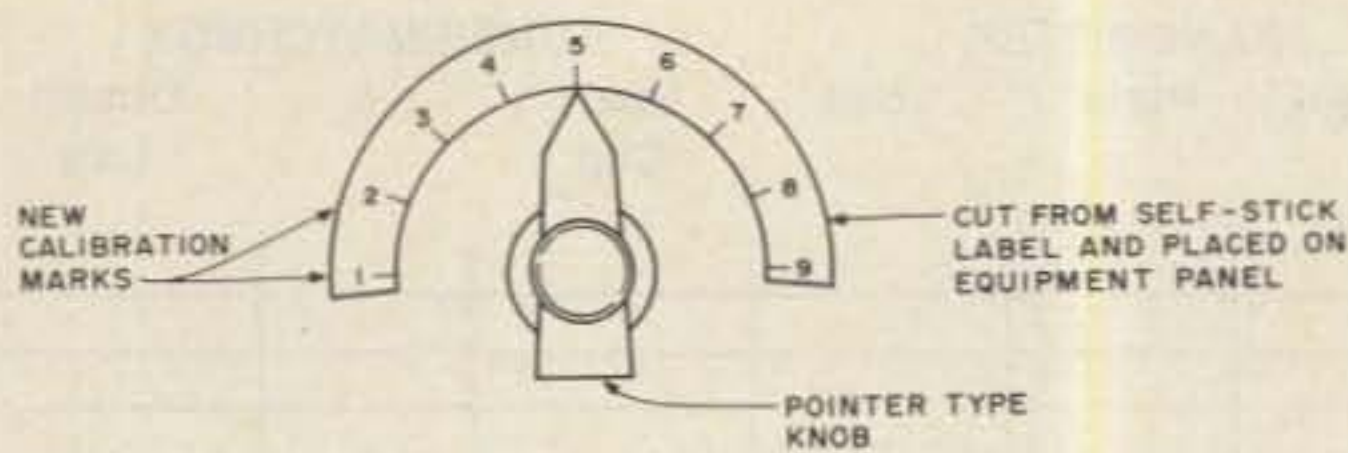

Fig. 5. Adding calibration marks to a pointer-type knob.

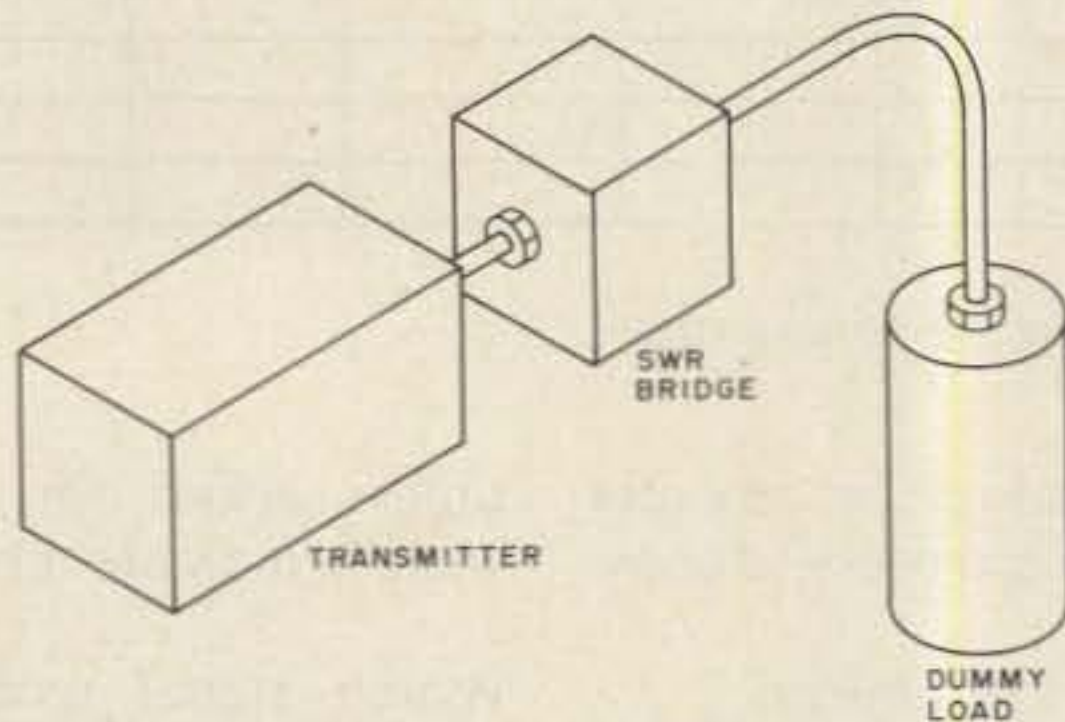

Fig. 6. Step 1: Tune up the rig into a dummy load.

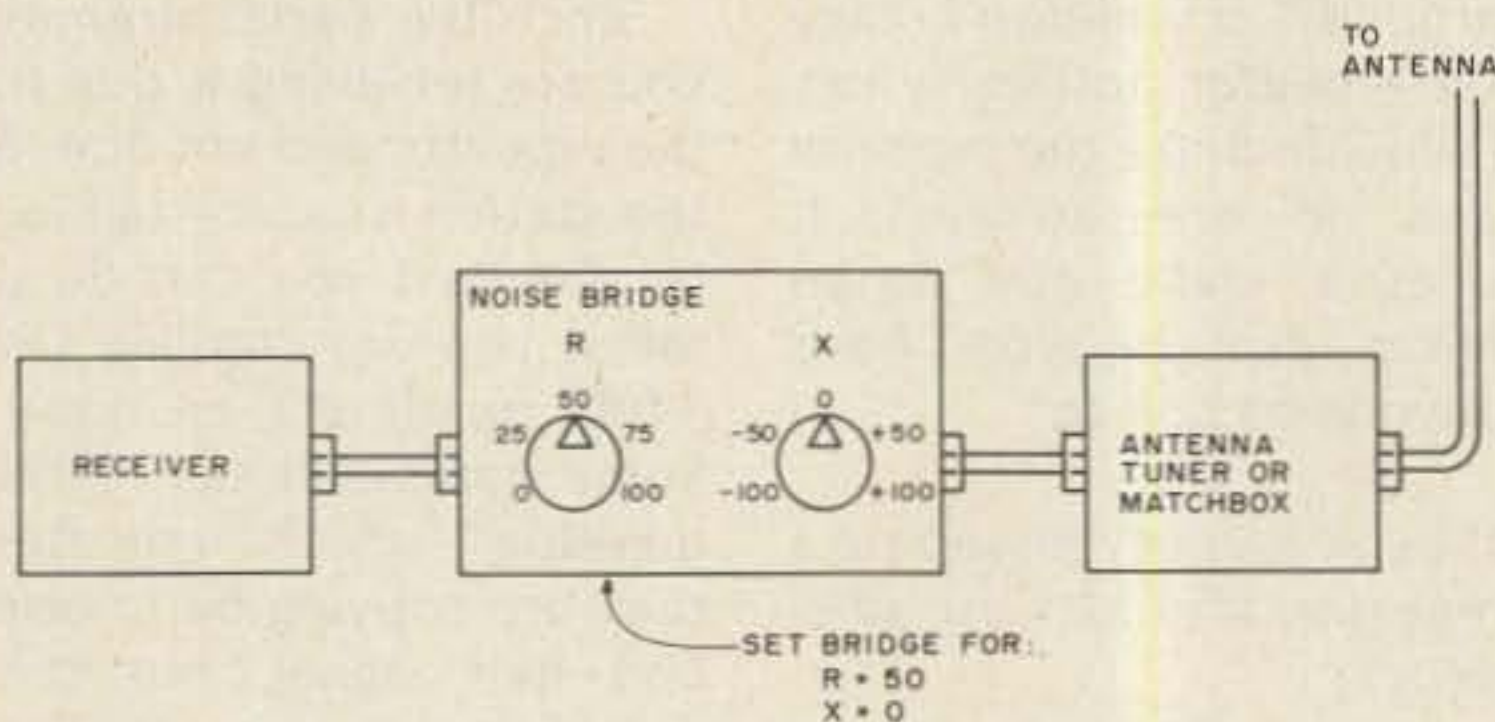

Fig. 7. Step 2: Adjust tuner to provide a 50-Ohm load.

same holds for asking the other ham to QRS or slow down.

*Frankly, I was hesitant to ask. Won't a request to QRS brand me as a beginner?*

Possibly, but we were all beginners once. Besides, what is the sense of sending "R" (I have solid copy) when you don't have the foggiest idea what the other station was talking about? I would rather be considered a ham who just is not too fast on CW than the character who sends: "R R R solid

copy here OM please repeat your name, QTH, and my report." Besides, there are real ways to be branded a beginner.

*For example?*

Break into an emergency net when you cannot contribute anything. Keep making unsolicited, helpful suggestions to the station controlling the situation. An experienced ham would say nothing and listen carefully. If the net control station wants help, he will ask for it specifically.

*Any other common things to avoid?*

Sure. If you want to sound silly in the middle of a QSO, give out with an extended "H-E-L-L-O-O-O-O" to check your plate current or output power. Think how you must sound on the other end. If you feel absolutely compelled to make a check in mid-QSO, simply say to the other guy, "excuse me," put your rig in tune, and make a quick check. However, putting out a carrier for an extended period of time is a great way to be unpopular and cause unnecessary QRM. Besides, it's pretty rough on your finals.

*I guess I don't understand. If I have to tune my rig and match it to the antenna, I have to transmit a carrier.*

Yes, but you don't have to transmit it for very long. There are at least two ways to handle this problem. The first is to make up a tuning chart for your rig (and antenna tuner if you use one). Record the dial readings as you tune up every 50 or 100 kHz. Now, when you change frequency from one end of the band to the other, just set your knobs to the chart and you will only have to tweak them slightly to tune up, which can be done in 2 or 3 seconds (see Fig. 3).

*Some of the knobs on my rig have calibration marks every quarter of a revolution. Is this good enough to allow me to preset them?*

Probably not, but you can ink-in additional lines on the knob or use sections of self-stick labels. Place a small piece of self-stick la-

bel on the knob skirt (Fig. 4) or on the panel (Fig. 5) with the additional calibration marks inked in. Plain white paper fastened with rubber cement is also durable and easily removed later. If you draw lines on the paper or labels, you can protect them with artist's fixative or varnish.

*What is the second way of tuning up without transmitting a carrier for an extended period?*

Actually you can tune up without transmitting a carrier at all. It takes three pieces of equipment: your swr bridge, a dummy load, and a noise bridge. First, connect your rig (Fig. 6) through the swr bridge to a dummy load, and at the frequency you want to operate, tune up your rig into the dummy load. Then, connect the noise bridge as shown in Fig. 7 and set the resistance control on the noise bridge to 50 Ohms and the reactance control to zero Ohms. Next, tune your antenna tuner or matchbox for a minimum noise as heard in your receiver. If you have a transceiver, be very careful not to transmit with the noise bridge in the line or it will go up in a very rapid puff of smoke.

Now, remove the noise bridge and reconnect the transmitter through the swr meter to the antenna tuner, and you are ready to operate. What you have done is tuned your transmitter to its design condition of maximum power out into a 50-Ohm load, and you have made the antenna tuner and antenna look like a 50-Ohm load. Connect the two (Fig. 8) and you are ready to transmit, with maximum power out. You can also use this technique to make up a tuning chart so that you have to go through the procedure only once for each 50- or 100-kHz band segment you like to operate in. ■

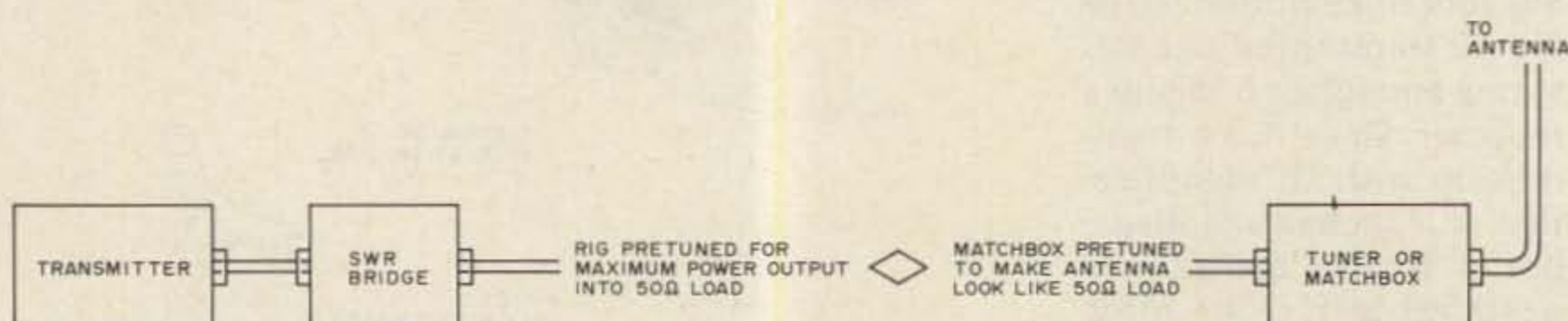

Fig. 8. Tuned up—without ever transmitting through the antenna.



# CIRCUITS

Do you have a technique, modification, or easy-to-duplicate circuit that your fellow readers might be interested in? If so, send us a concise description of it (under two pages, double-spaced) and include a clear diagram or schematic if needed.

In exchange for these technical gems, 73 offers you the choice of a book from the Radio Bookshop, to be sent upon publication. Submit your idea (and book choice) to: Circuits, Editorial Offices, 73 Magazine, Peterborough NH 03458. Submissions not selected for publication will be returned if an SASE is enclosed.

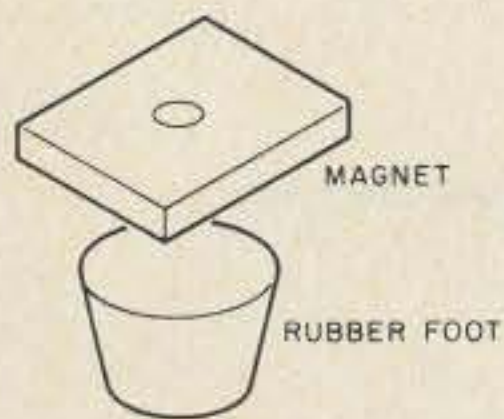

**REMOVABLE MAGNETIC FEET:** Gear such as Drake's TR-22C is fine for mobile or portable use but often lacks refinements like rubber feet that make it suitable for use in the shack. My solution to this deficiency was to epoxy several small magnets to some rubber feet and then stick them to the bottom of the radio. When the rig goes portable, just remove the feet. If you don't have any magnets handy, you can remove some from the magnetic cabinet latches sold in hardware stores.—Thomas Hart AD1B, Westwood MA.

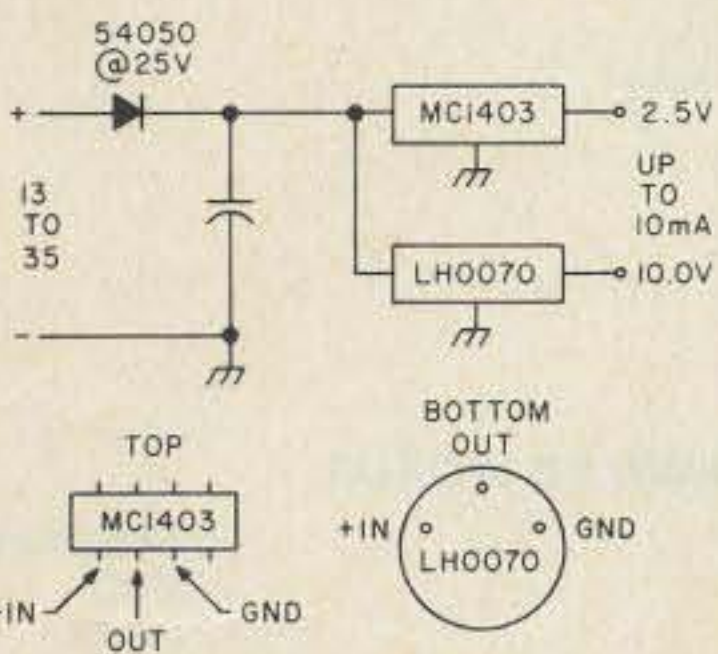

**SIMPLE VOLTAGE STANDARD:** This circuit gives you a voltage standard to check your VOM or electronic voltmeter. The MC1403 will deliver 2.5 volts while the output of the LH0070 is 10 volts. Both sources are accurate to one percent or better. You can get other voltages by using different members of the MC140X and LH007X precision regulator series. The diode can be anything rated over 40 mA and 60 volts piv.—J. T. Miller N6BM, Yucaipa CA.

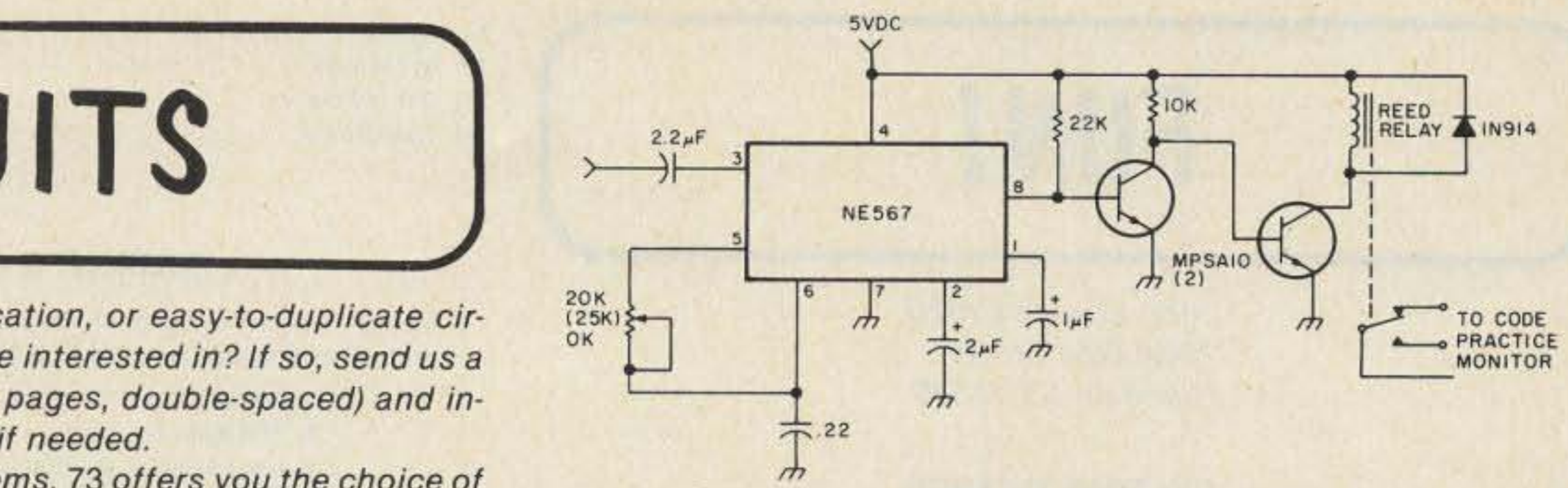

**CW FILTER:** This filter features a 40-Hz bandwidth and no ringing. To use it, tune your receiver so that the code-practice oscillator duplicates the signal you want to copy.—Ronald Folkert, Benton Harbor MI.

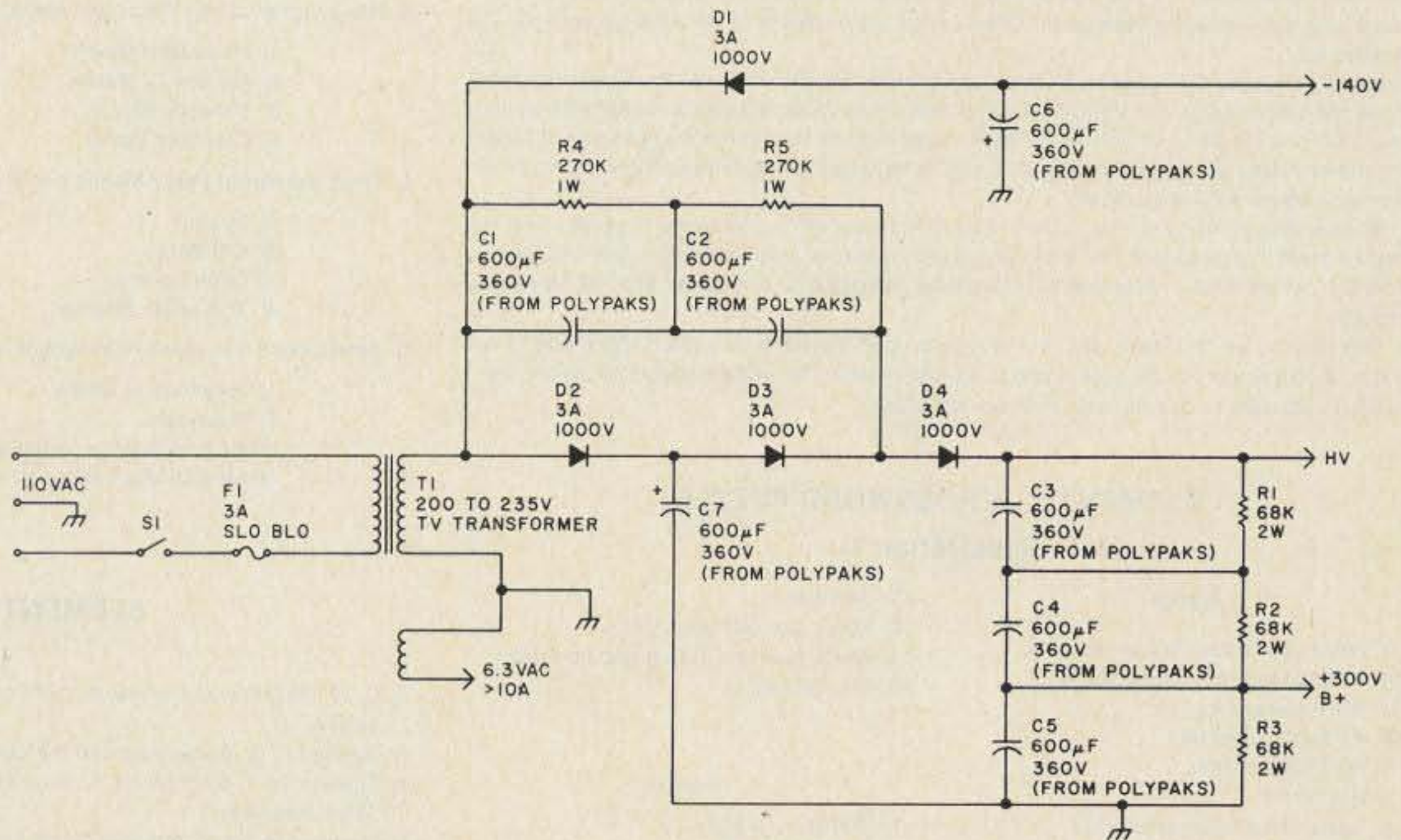

**SUBSTITUTE TRANSFORMER FOR HEATH GEAR:** The power transformer found in many newer TV sets can be used with a voltage-doubler circuit to provide up to 450 volts dc, as well as bias and filament voltages. I used this approach to replace the transformer in a Heathkit HX-10; it also should be suitable for the SB and HW series of Heath radios. (Note: Your rig's wiring may need to be modified if it has 12-V filaments.)—Terry Martin, Carrollton GA.

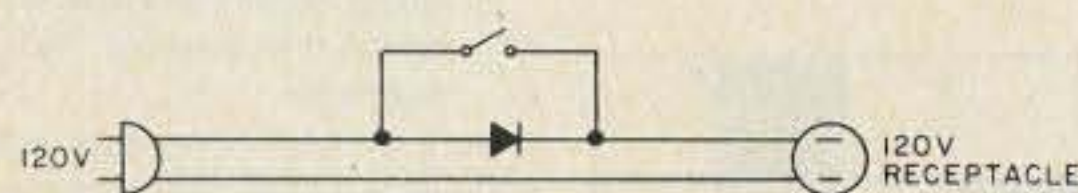

**HEAT CONTROL FOR A SOLDERING IRON:** This handy circuit allows you to reduce the temperature of a soldering iron. Just place a diode in series with one side of the ac line. You can easily switch the control in and out by shorting the diode. The polarity of the diode doesn't matter. I used a 1N2070 diode rated at 400 volts, 0.75 Amperes. Any similar diode will do.—H. H. Hunter W8TYX, Columbus OH.

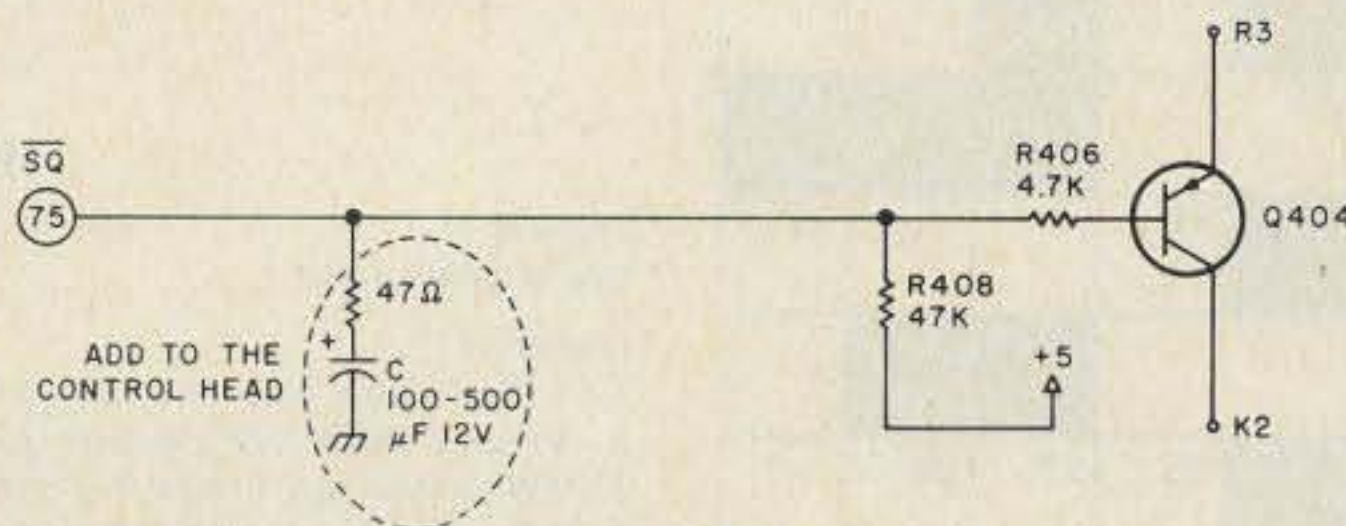

**SCAN DELAY FOR THE AZDEN 2000:** By adding a capacitor and resistor to the Azden 2000's control-head circuitry, you can have a delay before the receiver resumes scanning. There is approximately one second of delay for each 100 uF of capacitance added.—Hiam Sandel KB2IV, Flanders NJ.

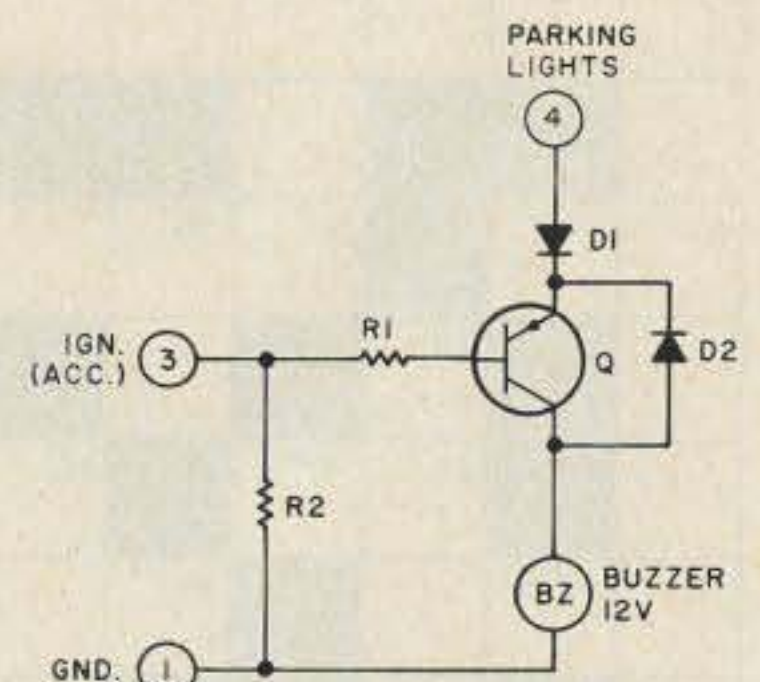

**HEADLIGHT REMINDER:** If your headlights or parking lights are on, there will be 12 volts on terminal 4. If the ignition is off, terminal 3 will be at ground. When these two conditions are met, the transistor is turned on and the buzzer sounds. KA5CRI/9 suggests that this circuit can be built into a surplus seat-belt buzzer.—Steve Stout KA5CRI/9, Palatine IL.



# FUN!

John Edwards KI2U  
78-56 86th Street  
Glendale NY 11385

## CW REMEMBERED

Like it or not, we are witnessing the twilight of the CW era. After more than a century as a mainstay of electrical and electronic communication, CW is on the way out.

I make this statement purely as a rational observation. Nobody (including Wayne) has forced me to this conclusion. Just look at the facts. Thanks to microelectronics, radiotelephone transceivers need be no larger in size than CW-only rigs. Computer generated digital communication has now reached a point where it is inexpensive and portable. It's also faster and more reliable than code. CW—except as a means of personal enjoyment—is washed up.

Apparently, the FCC agrees with this point of view. Shortly you'll see the Commission remove the CW requirement from the Tech license. After that, it's just a matter of time (the year 2000 sounds good) before the feds eliminate all code requirements. In an age of 1s and 0s, dits and dahs don't make sense. Just as CW replaced spark, computerized communication techniques will replace CW.

By now your getting the feeling that I hate CW. Not at all. I've pounded the brass with the best of them. It's just that I, like most true radio amateurs, look forward to new challenges. And CW, while fondly remembered, should be relegated to the dusty attic of ham-radio history.

This month, we look back at CW and reflect upon the contributions it has made to our hobby. And if any of you have anything to say about what I've written about CW, remember: I passed a 20-wpm code test. Can you say the same?

## ELEMENT 1—CROSSWORD PUZZLE

(Illustration 1)

- |   |  |
|---|--|
| <p><b>Across</b></p> <p>1) What the "wave" in question is</p> <p>6) As opposed to amateur (abbr.)</p> <p>8) QRN silencer (abbr.)</p> <p>9) Hams can't be this</p> <p>11) FCC rule section</p> <p>13) Not down</p> <p>14) Telegrapher's slang for shift</p> <p>16) Slash</p> <p>17) 3.14</p> <p>18) CW term of affection</p> <p>19) CW chuckle</p> <p>20) Learning code is this</p> <p>22) Ham organization</p> <p>24) ARRL's Stan</p> | <p>25) Jammer</p> <p>26) Some say CW does this</p> <p>29) ARRL brasspounding position (abbr.)</p> <p>30) No code ops?</p> <p style="text-align: center;"><b>Down</b></p> <p>1) Points on a key</p> <p>2) Pressing a key</p> <p>3) Weak signal place to noise</p> <p>4) Early code mode</p> <p>5) CW subband location</p> <p>7) US President's initials</p> <p>10) End of message (abbr.)</p> <p>12) A bug is semi-</p> |
|---|--|

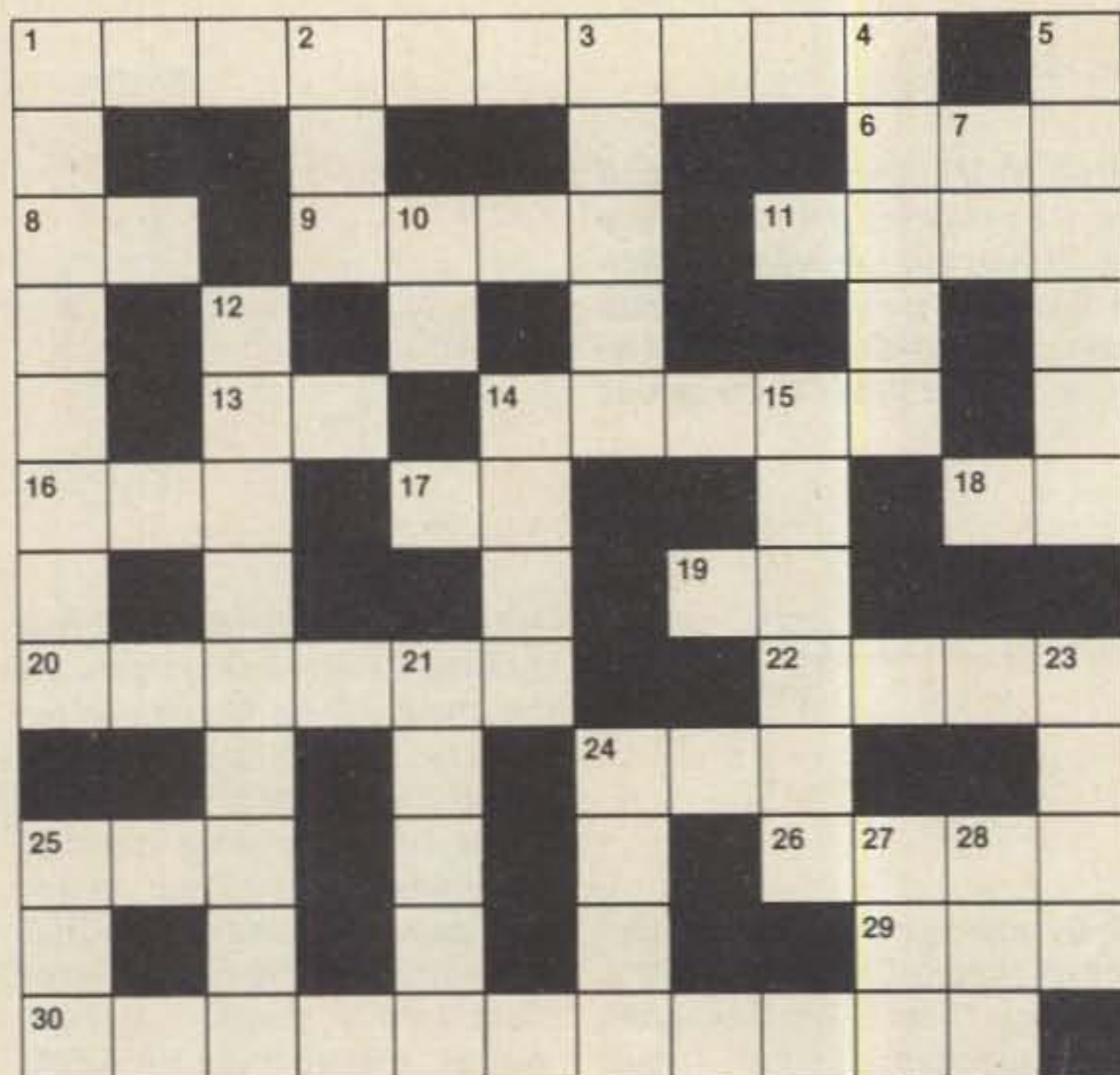

Illustration 1.

- |                         |                                  |
|-------------------------|----------------------------------|
| 14) Weary while sending | 24) Sometime key plating         |
| 15) CW noises           | 25) On-air organization          |
| 21) Old 160 bother      | 27) Negative charge              |
| 23) Vibroplexes         | 28) Traffic organization (abbr.) |

## ELEMENT 2—MULTIPLE CHOICE

- Samuel F. B. Morse, father of telegraphy, was a man of many talents. At the time he invented the telegraph, what was his profession?
  - Professor of art at New York University
  - Electrical engineer
  - Lab assistant to Thomas Edison
  - Professor of theology at Yale
- What were the first words transmitted via code?
  - Testing one, two, three.
  - Hello, Watson. Can you hear me?
  - Greetings from the President.
  - What had God wrought!
- The inventor of the Vibroplex semiautomatic key was:
  - Hugo Gernsback
  - Horace G. Martin
  - Thomas Edison
  - Clarence Tuska
- What did Hiram Percy Maxim name his favorite spark transmitter?
  - Sparky
  - Old Betsy
  - Little Darling
  - The ARRL Special
- What device was used on telegraph lines to create an audible sound at the receiving end?
  - Heterodyne beater
  - Sounder
  - Beat-frequency oscillator
  - Mechanical audio oscillator

## ELEMENT 3—TRUE-FALSE

- |   | True  | False |
|---|-------|-------|
| 1) C. W. McCall was the inventor of "continuous waves."   | _____ | _____ |
| 2) Samuel F. B. Morse invented the continental code.  | _____ | _____ |
| 3) The initials F. B. in Morse's name stood for "Fine Business."                                      | _____ | _____ |
| 4) It's legal to send continental code on US ham frequencies.   | _____ | _____ |
| 5) The FCC officially banned spark transmissions in 1954.   | _____ | _____ |
| 6) Our end of message signal—AR—is nothing but the American Morse letters FN meaning "Finish."        | _____ | _____ |
| 7) The "Glass Arm" is the top award presented by the Society of Wireless Pioneers.                    | _____ | _____ |
| 8) Barry Goldwater K7UGA is the ham who introduced the League's "Tune in the World" CW practice tape. | _____ | _____ |
| 9) The first memory keyer used six relays.  | _____ | _____ |
| 10) At one time, the Extra-class ticket required proficiency at 25 wpm.                               | _____ | _____ |

## ELEMENT 4—SCRAMBLED WORDS

- |         |           |          |
|---------|-----------|----------|
| GUB     | BONK      | YEKDROAB |
| CCNOTTA | GRINSP    | KGILC    |
| YREKE   | SIFT      | DESEP    |
|         | IGHTEWING |          |

## THE ANSWERS

- Element 1:**  
See Illustration 1A.
- Element 2:**  
1—1 They always said that learning the code was an art.  
2—4 Funny, Morse didn't include God as a co-inventor in his patent.  
3—2 What! you didn't know this one?  
4—2 The League still has it in its museum.  
5—2 Click. Click-click. Click.
- Element 3:**  
1—False. He wrote that crummy CB "Convoy" song.  
2—False. American.  
3—False. Finley Breese.  
4—True. Why not? It's the one the FCC tests us on.







# CIRCUITS

Do you have a technique, modification, or easy-to-duplicate circuit that your fellow readers might be interested in? If so, send us a concise description of it (under two pages, double-spaced) and include a clear diagram or schematic if needed.

In exchange for these technical gems, 73 offers you the choice of a book from the Radio Bookshop, to be sent upon publication. Submit your idea (and book choice) to: Circuits, Editorial Offices, 73 Magazine, Peterborough NH 03458. Submissions not selected for publication will be returned if an SASE is enclosed.

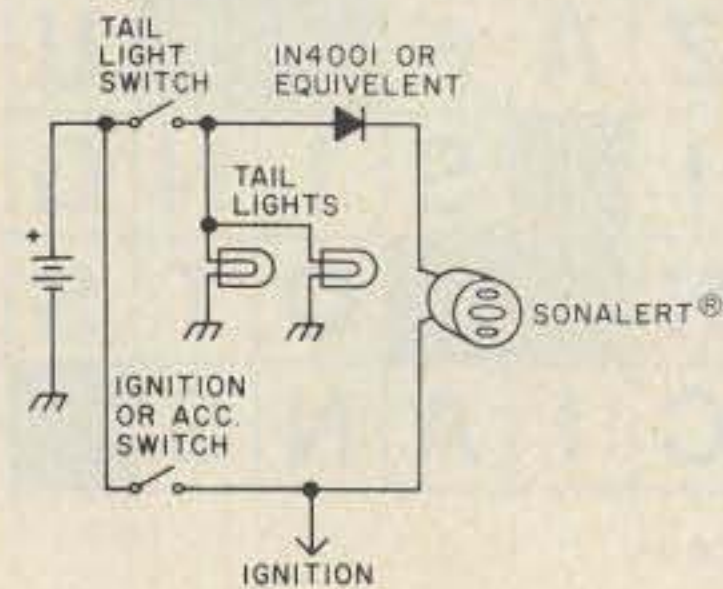

SIMPLIFIED HEADLIGHT RE-

**MINDER ALARM:** The circuit uses just two components, one silicon diode and one Sonalert™ (4-28 V dc). Both of these items can be purchased surplus. The diode is a prevention device, protecting the signaling device and ensuring that the ignition switch is isolated from the circuit.—Richard S. Shepard AI5H, San Antonio TX.

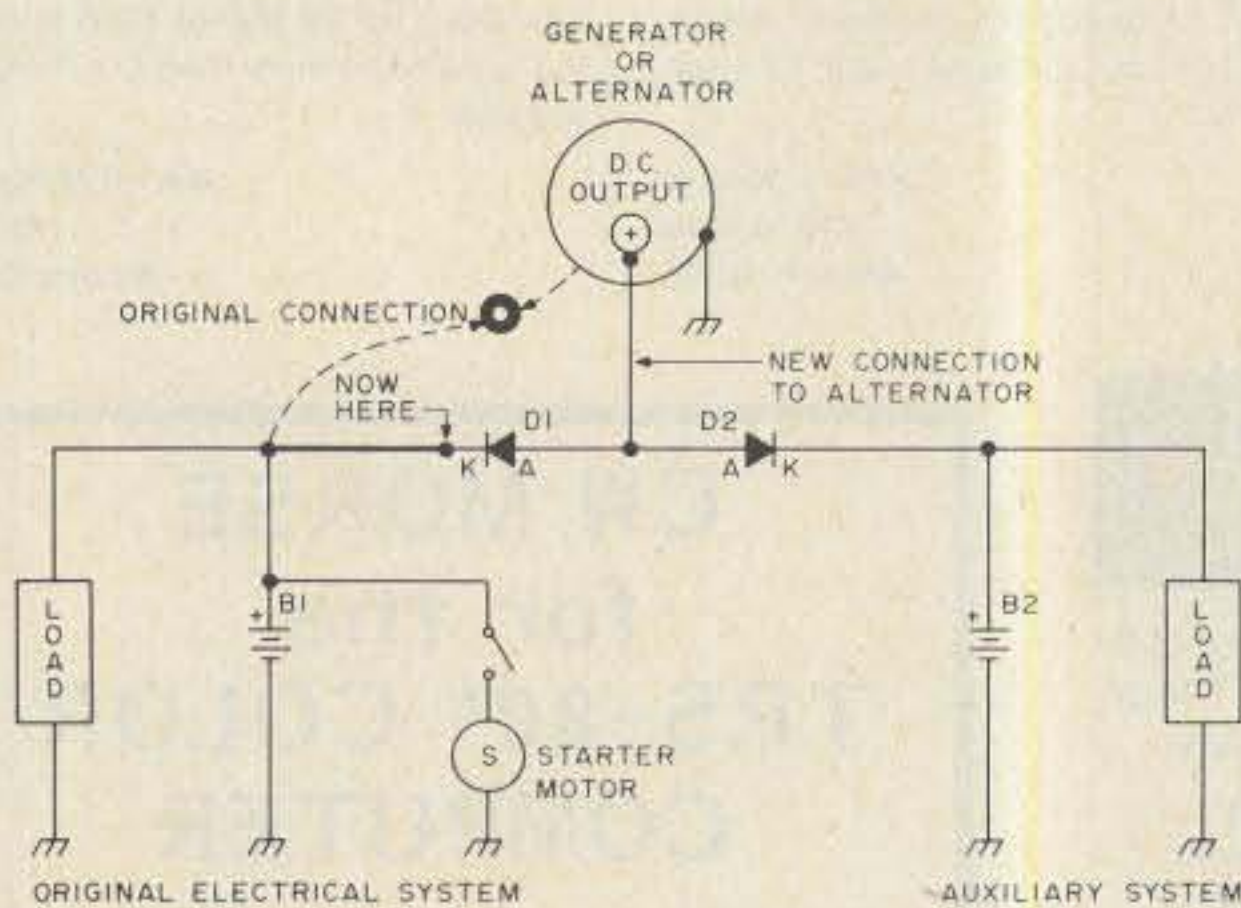

**DC AUXILIARY SYSTEM WITH ISOLATION:** Presented here is a simple auxiliary battery system. Battery B2 is isolated from the primary battery by diode D2, and D1 is protected as well. Both diodes should be at least 40 Amperes forward current, and 50 to 100 piv. A heavy wire from the junction of the two anodes connects to the charging device terminal. Do not rewire so that D1 is between the battery and the starter motor.—A. W. Edwards K5CN, McAllen TX.

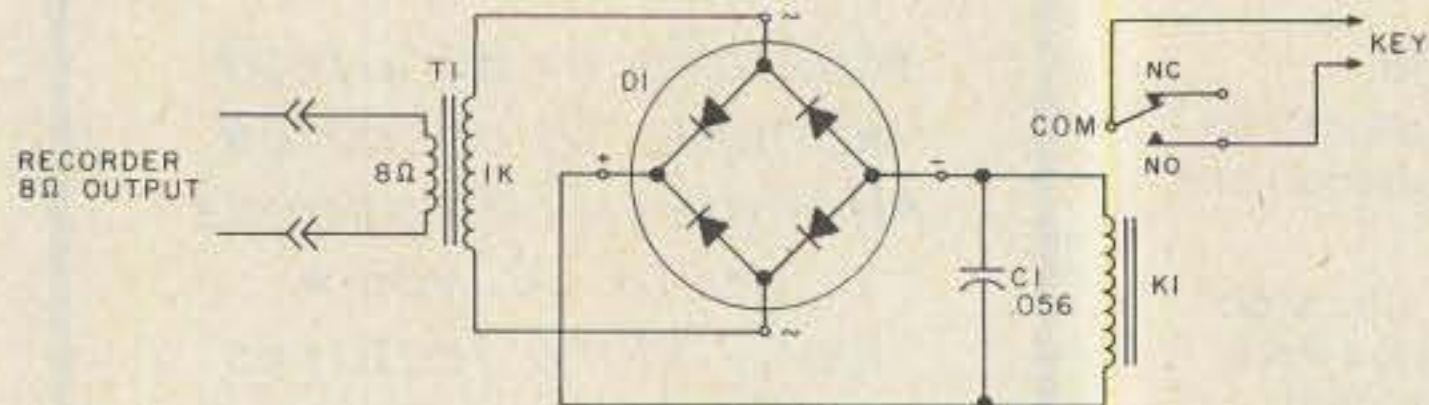

**AUTOMATIC CQ CALLER:** Record and send CQ or CQ DX—or any message—cheaply and easily. Begin by recording your message on a cassette tape. This recording will be used to drive the circuit. Mount the full-wave bridge astride the relay (K1). Solder the + and common leads to the coil leads. T1 is Superglued to K1. The assembly can be mounted inside a transceiver or outboard in a box. Wire the relay output to the keyjack. Install a jack to receive the audio output from the cassette. Endless-loop cassettes are available from Radio Shack. Five-minute cassettes are available from Pyramid Data Systems, 6 Terrace Ave., New Egypt NJ 08533.—Dave Nesbitt WD4AAW, Decatur GA.

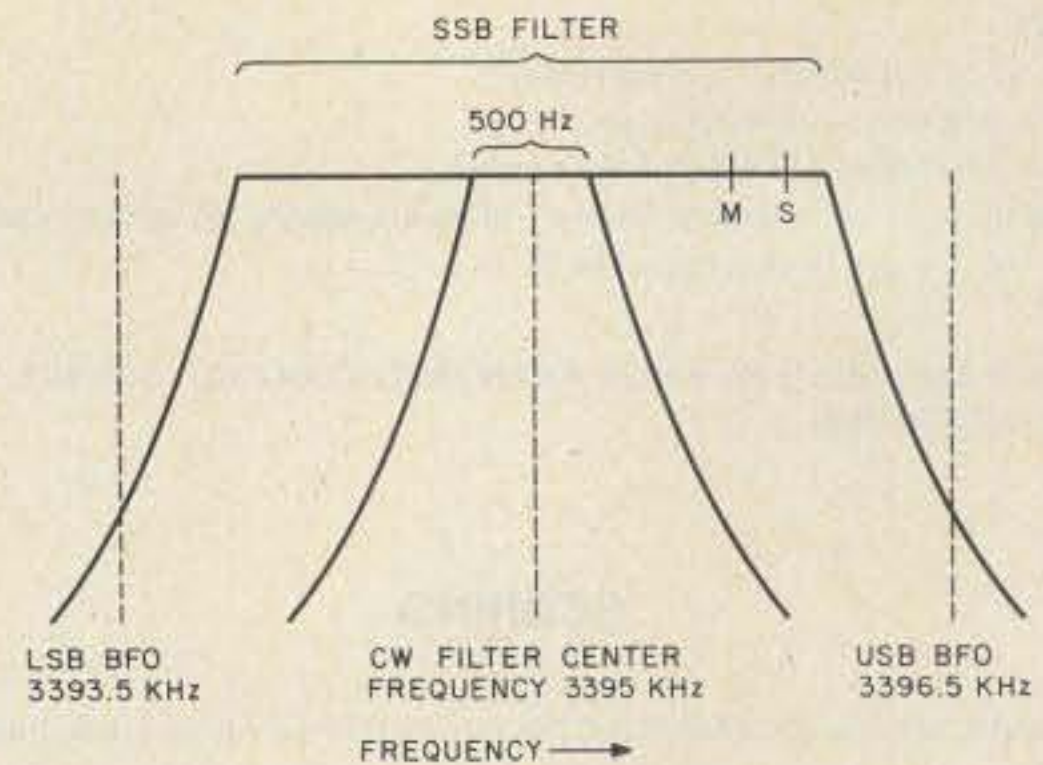

Fig. 1.

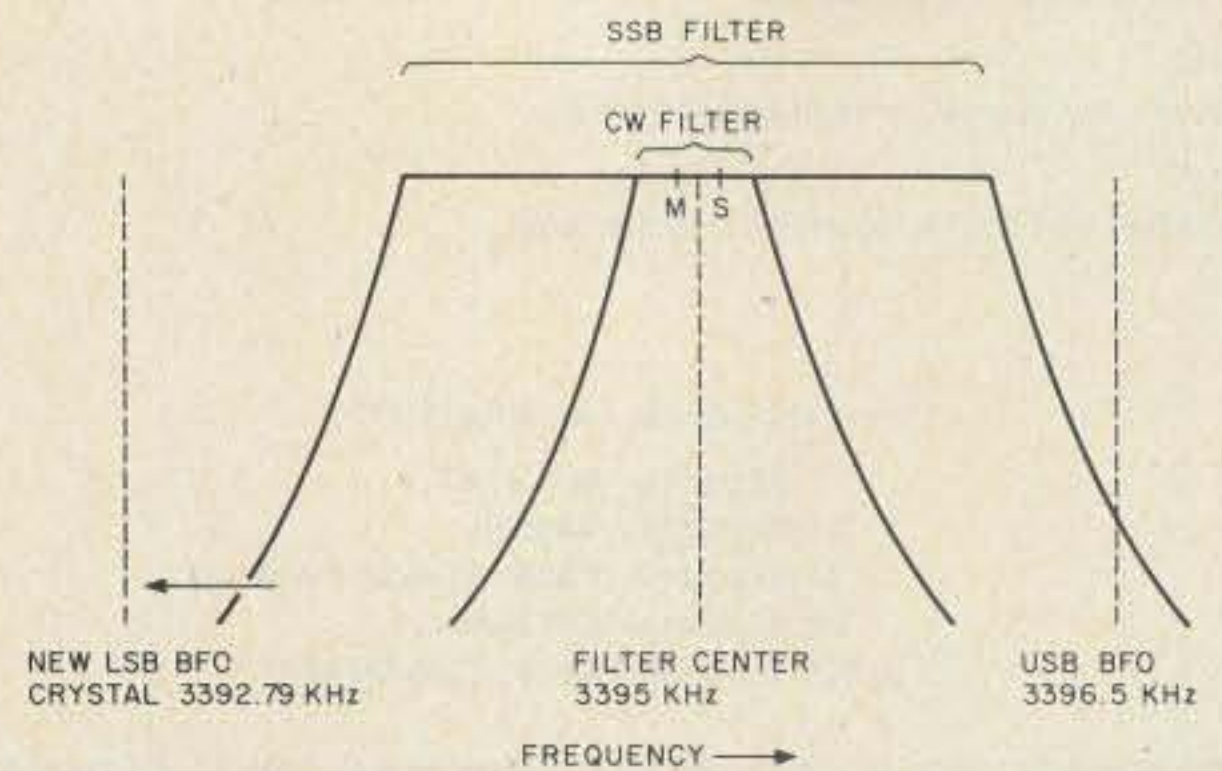

Fig. 2.

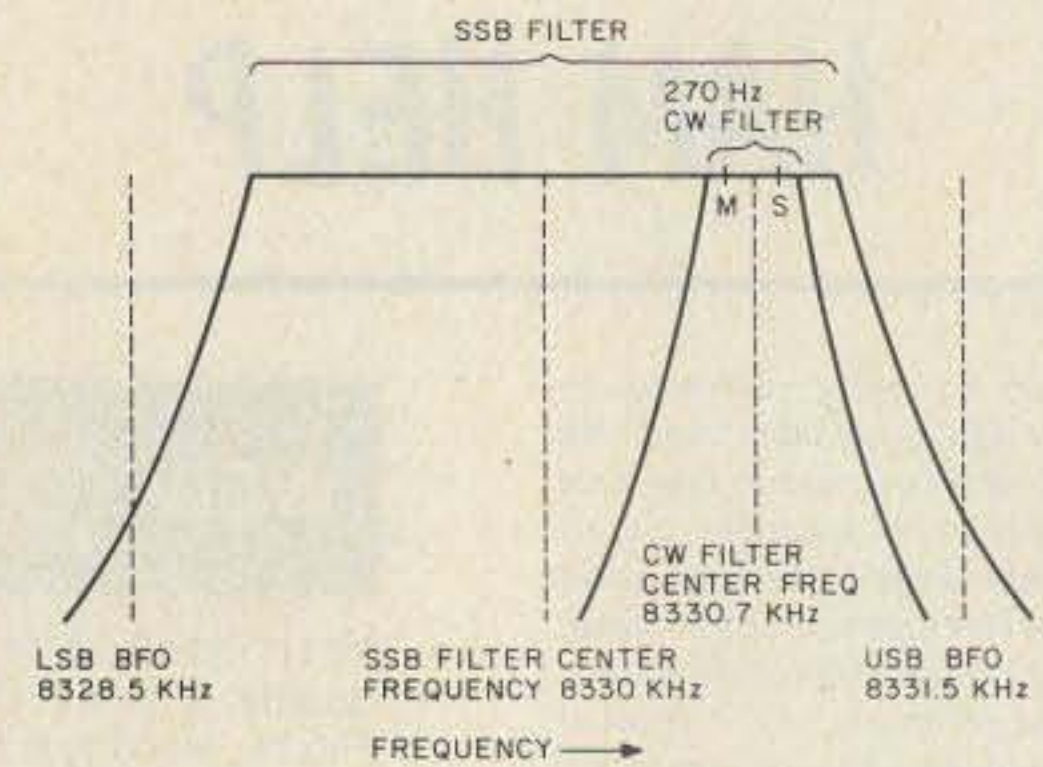
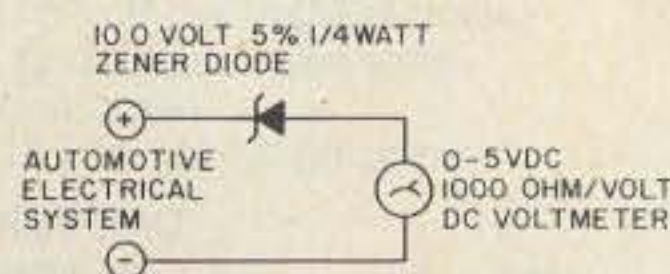

Fig. 3.

**MODIFICATION TO THE KENWOOD TS-520S FOR AFSK:** Fig. 1 shows the passband of the Kenwood TS-520S. By installing a crystal with a frequency of 3392790 Hz, the RTTY tones of 2125/2295 Hz will be right in the middle of the filters' respective passbands. See Fig. 2.

Fig. 3 shows the i-f filters. When installing the 270-Hz filter, follow the directions given in the manual except for the following: 1) install the filter in the SSB narrow position; and 2) jumper lead "A" to the "SSN" position and jumper lead "B" to the "SSB" position.

To set the filter, turn the switch to "CAL" and tune for a 2210-Hz tone (a scope is helpful, or else tune to a null on your RTTY tuning meter).—Richard Kulaga KA9EDX, Fond du Lac WI.



**AN INEXPENSIVE EXPANDED-SCALE VOLTMETER:** Use an unsealed 0-5-V-dc 1000-Ohm-per-volt meter movement. Solder a 10.0-volt, 5%, 1/4-Watt zener diode to the positive meter terminal (this is located under the

case). Use as short as possible a lead for good mechanical stability, observing zener polarity. Change the numbering on the meter face to 10-15 V dc. Use either a razor-pointed marking pen or dry-transfer numbers. Reassemble the meter and test it before installing it in your car. To ensure greatest accuracy, pre-check the zener and make certain that it is as close as possible to 10.0 volts.—Alan Christian WA6YOB, San Jose CA.



# SOCIAL EVENTS

Listings in this column are provided free of charge on a space-available basis. The following information should be included in every announcement: sponsor, event, date, time, place, city, state, admission charge (if any), features, talk-in frequencies, and the name of whom to contact for further information. Announcements must be received at 73 Magazine by the first of the month, two months prior to the month in which the event takes place. Mail to Editorial Offices, 73 Magazine, Pine Street, Peterborough NH 03458.

## DEARBORN MI NOV 4

Encon Corporation, in cooperation with Solarex Corporation, will provide a free photovoltaic (electricity from the sun) seminar at 7:30 pm on November 4 at the Dearborn Hyatt Regency, Dearborn MI. A talk on the history, production, and applications of solar cells will inform and educate all those who attend. For reservations, contact Encon Corporation, 27584 School Craft Rd., Livonia MI 48150; (313)-261-4130.

## SOUTH GREENSBURG PA NOV 6

The Foothills Amateur Radio Club will hold its annual Swap and Shop on Saturday, November 6, 1982, at St. Bruno Church, South Greensburg PA. Tickets are \$2.00 each or 3 for \$5.00. There will be an indoor flea market and food. Talk-in on 146.07/67 and .52/.52. For more details, contact Mario Carrerra W3TTN, or write FARC, PO Box 236, Greensburg PA 15601.

## SELLERSVILLE PA NOV 7

The R. F. Hill ARC will hold its 6th annual hamfest on November 7, 1982, in the Sellersville National Guard Armory, Sellersville PA. Doors will open at 7:00 am for sellers and 8:00 am for buyers. There will be refreshments and heat. Talk-in on .28/.88 and .52. For further information, contact R. F. Hill ARC, Box 29, Colmar PA 18915.

## CONCORD NC NOV 7

The Cabarrus Amateur Radio Society, Inc., will hold its annual hamfest on November 7, 1982, from 9:00 am to 5:00 pm, at the Concord Boys Club, Spring Street, Concord NC. Admission tickets are \$2.50 in advance, \$3.00 at the door. Flea-market tables are \$4.00; table space is \$2.50. There will be bingo for the ladies, speakers, and forums. Hot food, beverages, and free parking will be available. Talk-in on 146.655. For advance tickets, flea-market tables, or space, send a check to CARS, PO Box 1290, Concord NC 28025.

## NORTH HAVEN CT NOV 7

The Southcentral Connecticut Amateur Radio Association's (SCARA's) third annual electronics flea market will be held on Sunday, November 7, 1982, indoors at the North Haven Recreation Center on Linsley Street in North Haven CT. Regular admission is \$1.25; children under 12 with an adult will be admitted free. Sellers' spaces are \$6.00. The best spaces will be assigned first. A limited number of free tables will be

provided to the first reservations received. When those tables are gone, space will be available for selling from the floor or from your own table. Food will be available. Sellers may set up at 8:00 am, and walk-ins will be admitted from 9:00 until 3:00. For reservations, send check or money order payable to "SCARA" to Ed Goldberg WA1ZZO, 433 Ellsworth Avenue, New Haven CT 06511. Include an SASE for confirmation.

## BANGKOK THAILAND NOV 12-14

The Radio Amateur Society of Thailand (RAST) will hold the 12th annual South East Asia Network Convention (SEANET 82) on Friday, Saturday, and Sunday, November 12-14, 1982, at the Imperial Hotel, Bangkok, Thailand. There will be lectures, discussions, and commercial exhibits. For more details, contact RAST Secretary, PO Box 2008, Bangkok, Thailand.

## NEWMARKET ONT CANADA NOV 13

The York Region ARC will hold its annual flea market on Saturday, November 13, 1982, from 0800 to 1400 EST, at the Newmarket Community Centre, Newmarket, Ontario. Doors will open at 0630 for exhibitors. General admission is \$2.00 (children will be admitted free of charge if accompanied by an adult). Refreshments will be available. Exhibitors' tables are \$2.00 each. Talk-in on 142.52 (VE3YRA) and 147.225/.825 (VE3YRC).

## FORT WAYNE IN NOV 14

The Allen County Amateur Radio Technical Society, Inc. (AC-ARTS), will hold the 10th annual Fort Wayne Hamfest on November 14, 1982, at the Allen County Memorial Coliseum, Fort Wayne IN. Admission is \$2.50 in advance and \$3.00 at the door; children under age 11 will be admitted free. Regular tables are \$6.00 and premium tables are \$20.00. The Coliseum charges a \$1.00 parking fee. Doors will open to the general public at 8:00 am and for vendor setups at 5:00 am. For further ticket or table information, write Becky Skinner KA9GWE, 9720 Pinto Lane, Fort Wayne IN 46804.

## BILLERICA MA NOV 20

The Honeywell 1200 Radio Club and the Waltham Amateur Radio Association will hold their annual amateur radio and electronics auction on Saturday, November 20, 1982, at the Honeywell Plant, 300 Concord Road, Billerica MA (exit 27 off route 3). Doors will open at 10:00 am and admission and parking are free. There will be a snack bar and a bargain parts store. Talk-in on 147.72/12 and 146.04/64. For more information, contact Doug Purdy N1BUB, 3 Visco Road, Burlington MA 01803.

## CANTON OH NOV 21

The Massillon Amateur Radio Club (W8NP) will present Auctionfest '82 on November 21, 1982, at the Nazir Grotto Hall, 6th and Dueber Avenue SW, Canton OH. Advance tickets are \$2.50; at the door, \$3.00. Doors will open at 7:00 am for setups and 8:00 am for others. The auction will start at 11:00 am. Talk-in on 146.52. For advance tickets or tables, contact Steve Nevel WD8MIJ, 1864 Massachusetts Avenue SE, Massillon OH 44646.

## GREENSBORO NC NOV 27-28

The Greensboro Amateur Radio Club will hold the second annual Greensboro Hamfest on November 27-28, 1982, at the National Guard Armory, Greensboro NC. The hours will be 9:00 am to 5:00 pm on November 27th and 9:00 am to 3:00 pm on November 28th. Pre-registration before November 12, 1982, is \$3.00 and registration at the door is \$4.00. There will be tables and tailgating available. Talk-in on 145.25, .19/.79, and .52. For pre-registration (please include an SASE) or more

details, contact Russ Brandt KE4KL, 1301 Dayton Street, Greensboro NC 27407.

## STONY BROOK LI NY NOV 28

The Radio Central Amateur Radio Club will hold its fourth annual Ham-Central, 1982 edition, on Sunday, November 28, 1982, in the main social hall of Temple Isaiah, 1404 Stony Brook Road, Stony Brook LI NY (about 50 miles east of New York City). Doors will open at 7:30 am for sellers and dealers and at 8:30 for the general public. Admission is \$2.00 and XYLs and children under 12 will be admitted free. Nine-foot tables are \$5.00 each and half tables are \$3.00. Features will include an updated antenna lecture by Art (W2LH) and Madeline (W2EEO) Greenberg, home-cooked hot food, and drinks. Talk-in on 144.550/145.150 (WA2UEC) and 146.52. For additional information, maps, and advance reservations, contact Scotty Policastro KA2EQW, 80 7th Street, Bohemia NY 11716, (516)-589-2557, or Bob Yarmus K2RGZ, 3 Haven Court, Lake Grove NY 11755, (516)-981-2709.

## HAZEL PARK MI DEC 5

The 17th annual Hazel Park Amateur Radio Club Swap and Shop will be held Sunday, Dec. 5, at Hazel Park High School, Hazel Park MI. Hazel Park High School is located on Hughes Street at 9 1/2 Mile Rd., 1 mile east of I-75. Tickets are \$1.50 in advance or \$2.00 at the door. Tables are \$1.00 per foot. Doors open at 8:00 am. Plenty of food and parking will be available. Talk-in on 146.52. For tickets, table reservations, and information, send an SASE to Hazel Park Amateur Radio Club, PO Box 368, Hazel Park MI 48030 or telephone (313)-398-3189.

### ATTENTION: ICOM & KENWOOD OWNERS!!

IF YOU ARE NOT RECEIVING OUR MONTHLY NEWSLETTERS, YOU ARE NOT TUNED INTO A WEALTH OF INFORMATION!!!



Subscription Cost for 10-ICOM or Kenwood Newsletters: USA \$9.00 Annual (Bulk Rate); \$12.00 First Class, Canada & Mexico \$10.00 - elsewhere (Air Mail) \$12.00 SPECIAL PRICE FOR BOTH NEWSLETTERS (20 issues) \$2.00 OFF INDIVIDUAL PRICES. We honor Master Charge and VISA. Telephone orders accepted. \*We are an information exchange for ICOM and Trio/Kenwood Users\*. Please send a S.A.S.E. for our informational brochure and list of ICOM & Kenwood Kits. Send to:

**USERS INTERNATIONAL RADIO CLUB**  
364 Kilpatrick Ave., Port St. Lucie, FL 33452  
USA - Phone 305/878-7296

## DON'T TIME OUT... TIME IN Introducing Toggle Time

Model TI-10 time alert for repeater operators to avoid timing out repeater. (PATENTED)  
\*Sensitive enough for HT's \*Automatic; Senses RF carrier-no connection to rig \*Battery powered \*Resets on carrier drop-out \*Adjustable timing period \*Size 5 1/4 x 3 5/16 x 1 3/4  
\*Weight 8 oz./226.8 Grams  
Piercing, 6.5 KHz alert tone  
Model TI-10 assembled..\$69  
Model TI-10k, kit form..\$52  
Printed Circuit Board and Documentation.....\$15.00



Toggle Time is a 10 minute timer that would be utilized by a ham to keep within FCC 10 min. ID rules. It is actuated by a toggle switch which serves two purposes:

Dealer \* Begins timing period when power is applied. \*  
Inquiries \* When Toggle Time times out it lets you know with a loud tone. Price \$14.95  
Invited Shipping & Handling add \$2 Send check, money order or COD \*battery included

140 \* When ordering, please specify model \* 3 1/4 x 2 1/8 x 1 1/8

**COMSTAR RESEARCH** P.O. BOX 771 Madison Heights, MI 48071



# CONTESTS

Robert Baker WB2GFE  
15 Windsor Dr.  
Atco NJ 08004

## ALARA CONTEST

**Starts: 0001 GMT November 13**  
**Ends: 2359 GMT November 13**

Sponsored by the Australian Ladies' Amateur Radio Association, the contest is open to all licensed operators and SWLs throughout the world. YLs work everyone, OMs work YLs only. All bands may be used, phone and CW combined. Each station may be worked twice on each band—once on phone and once on CW. All contacts must be made in accordance with operator and station license regulations. No net or list operations, no crossmode, and no repeater contacts may be claimed.

### EXCHANGE:

ALARA members send RS(T), serial number starting with 001, and ALARA number and name. Others (YL nonmembers or OMs) send RS(T), serial number starting with 001, and name.

### FREQUENCIES:

Phone—3570-3590, 7100-7120, 14280-14300, 14180-14200, 21350-21370, 21180-21200, 28480-28520.

CW—3525-3535, 7010-7020, 14050-14060, 21125-21135, 28100-28110.

### SCORING:

On phone—10 points for ALARA club stations contacted (VK2DYL or VK3DYF), 5 points for ALARA members, 3 points for YL non-members, 1 point for OMs.

On CW—double all point values shown for phone.

For SWLs—5 points for ALARA members logged and 3 points for YL nonmembers logged.

### AWARDS:

Certificates will be awarded to the top scoring ALARA member in each country and VK call area; top scoring YL nonmember, OM, and SWL on each continent; and the top scoring VK Novice.

### ENTRIES:

Send a single log containing date/time

in GMT, band, mode, callsign worked, report and serial number sent/received, name of operator of station worked, and points claimed. Logs must be signed and should show full name, callsign, and address of operator along with final score claimed. Logs must be legible, either typed or printed, no carbon copies please. No logs will be returned and the decision of the contest manager will be final. Logs must be received by the contest manager by Dec. 31st. Address entries to: Mrs. Margaret Loft VK3DML, 28 Lawrence St., Castlemaine, Victoria, Australia 3450.

## EUROPEAN DX CONTEST—RTTY

**Starts: 0000 GMT November 13**  
**Ends: 2400 GMT November 14**

Sponsored by the Deutscher Amateur Radio Club (DARC). Only 36 hours of operation out of the 48-hour period are permitted for single-operator stations. The 12 hours of nonoperation may be taken in not more than three periods at any time during the contest. Operating classes include: single operator/allband and multi-operator/single transmitter. Multi-operator/single transmitter stations are only allowed to change band one time within a 15-minute period, except for making a new multiplier. Use all amateur bands from 3.5 through 28 MHz. A contest QSO can be established between all continents and also one's own continent. However, QSOs as well as QTC traffic with one's own country are *not allowed!* Each station can be worked only once per band.

### EXCHANGE:

Exchange the usual six-digit number consisting of RST and progressive QSO number starting with 001.

### SCORING:

Each QSO counts 1 point. Each QTC (given or received) counts 1 point. Multipliers will be counted according to the European and ARRL countries list. The multiplier on 3.5 MHz may be multiplied by 4, on 7 MHz by 3, and on 14 through 28 MHz by 2. However, contacts within the same continent only count as a multiplier of one per band (including 80 and 40 meters). The final score is the total QSO points plus QTC

points multiplied by the sum total multipliers.

### QTC TRAFFIC:

Additional point credit can be realized by making use of the QTC traffic feature. A QTC is a report of a confirmed QSO that has taken place earlier in the contest and later sent back to another station—the general idea being that after a number of stations have been worked, a list of these stations can be reported back during a QSO with another station. An additional 1 point credit can be claimed for each station reported.

A QTC contains the time, call, and QSO number of the station being reported, i.e., 1300/DA1AA/134. This means that at 1300 GMT you worked DA1AA and received number 134. A QSO can be reported only once and not back to the originating station. A maximum of 10 QTCs to a station is permitted. You may work the same station several times to complete this quota but only the original contact has QSO point value. Keep a uniform list of QTCs sent. QTC 3/7 indicates that this is the 3rd series of QTCs sent and that 7 QSOs are reported.

### AWARDS:

Certificates to the highest scorer in each classification in each country, reasonable score provided. Continental leaders will be honored with plaques. Certificates will also be given stations with at least half the score of the continental leader or with at least 250,000 points. The minimum requirements for a certificate or a trophy are 100 QSOs or 10,000 points.

### ENTRIES:

Violation of the rules, unsportsmanlike conduct, or taking credit for excessive duplicate contacts will be deemed sufficient cause for disqualification. The decisions of the contest committee are final. It is suggested to use the log sheets of the DARC or equivalent. Send a large SASE to get the wanted number of logs and summary sheets (40 QSOs or QTCs per sheet). SWLs apply the rules accordingly. Entries should be sent no later than December 15th to: DARC DX Awards, PO Box 1328, D-895 Kaufbeuren, West Germany.

### EUROPEAN COUNTRY LIST:

C31, CT1, CT2, DL, DM, EA, EA6, EI, F, FC, G, GC Guer, GC Jer, GD, GI, GM, GM Shetland, GW, HA, HB9, HB0, HV, I, IS, IT, JW Bear, JW, JX, LA, LX, LZ, M1, OE, OH, OH0, OJ0, OK, ON, OY, OZ, PA, SM, S, SV, SV Crete, SV Rhodes, SV Athos, TA1, UA1346, UA2, UB5, UC2, UN1, UO5, UP2,

UQ2, UR2, UA Franz Josef Land, YO, YU, ZA, AB2, 3A, 4U1, 9H1.

## DELAWARE QSO PARTY

**Starts: 1700 GMT November 13**  
**Ends: 2300 GMT November 14**

Sponsored by the Delaware ARC. Stations may be worked once per band and mode for QSO and multiplier credits.

### EXCHANGE:

QSO number, RS(T), and Delaware county, ARRL section, or country.

### FREQUENCIES:

CW—1805, 3560, 7060, 14060, 21060, 28160.

SSB—1815, 3975, 7275, 14325, 21425, 28650.

Novice—3710, 7120, 21120, 28120.

### SCORING:

Delaware stations score 1 point per QSO. Multiply total by the number of ARRL sections and DX countries worked.

Others score 5 points per Delaware station worked. Multiply total by the number of Delaware counties worked on each band and each mode (maximum of 36 multipliers possible). The three Delaware counties are: Kent, New Castle, and Sussex.

### ENTRIES & AWARDS:

Appropriate awards will be given to the top scorers. In addition, a certificate to all stations working all three Delaware counties. If you work all three counties and want the WDEL Award, send two 20-cent stamps and an address label. Mail logs by December 17th to: Charlie Sculley AE3H, 103 E. Van Buren Avenue, New Castle DE 19720. Send an SASE for a copy of the results.

## SANDUSKY RADIO EXPERIMENTAL LEAGUE QSO PARTY

**Starts: 1800 GMT November 13**  
**Ends: 1800 GMT November 14**

The 50th Anniversary of the Sandusky (Ohio) Radio Experimental League, Inc., will be observed and celebrated with a QSO party while members of the club operate on five amateur bands using the club call, W8LBZ. Frequencies will be: 28150 and 7125 for Novices; 3740, 7040, 14040, 21040, and 28040 on CW; 3910, 7265, 14280, 21360, and 28600 on phone. All frequencies plus/minus 10 kHz.

# YELLOW THUNDER SMOKE SIGNALS

## NEWSLETTER CONTEST WINNER

This month's winner is *Smoke Signals*, published by the Yellow Thunder Amateur Radio Club of Baraboo WI. The layout is superb and the articles are written in a humorous, low-key style. The newsletter is full of excellent news items from around the nation and overseas, making it appear more like a nationally-based newsletter. Also, a schedule of all the traffic nets in Wisconsin is included. The paper is full of interesting items, such as fox-hunt rules and updates on the members' activities. The editor, Jim Romelfanger K9ZZ, has done an outstanding job.

To enter your club's newsletter in our contest, send a copy to: Editorial Offices, 73 Magazine, Peterborough NH 03458.

# CALENDAR

Nov 6-7  
Nov 13  
Nov 13-14  
Nov 13-14  
Nov 13-15  
Nov 13-15  
Nov 20-21  
Nov 20-21  
Dec 4-5  
Dec 11-12  
Dec 19  
Jan 8  
Jan 9  
Jan 15-16  
Jan 15-16

ARRL Sweepstakes—CW  
Australian Ladies' ARA Contest  
European DX Contest—RTTY  
W8LBZ QSO Party  
North Carolina QSO Party  
CQ-WE Contest  
ARRL Sweepstakes—Phone  
Trinidad and Tobago QSO Party  
ARRL 160-Meter Contest  
ARRL 10-Meter Contest  
CARF Canada Contest  
73 Magazine 40-Meter Worldwide SSB Championship  
73 Magazine 80-Meter Worldwide SSB Championship  
73 Magazine 160-Meter Worldwide SSB Championship  
Hunting Lions in the Air Contest



All amateurs worldwide are invited to participate. A special QSL card/certificate will be sent to all who send their QSL card to the QSL Manager, W8LBZ, 2909 West Perkins Avenue, Sandusky OH 44870.

### CQ-WE CONTEST

**Starts: 1400 GMT November 13**  
**Ends: 0500 GMT November 15**

Sponsored by the Bell System Amateur Radio Fraternity, the contest is open to present and retired employees of Bell, Western Electric, AT&T, and subsidiaries of AT&T. Contact local interworks coordinator for logs and complete rules, or write Steve Wheatley WN8GUE, Bell Laboratories, 2525 Shadeland Avenue, PO Box 1008, Indianapolis IN 46206. Telephone: (317)-352-2442 at work or (317)-545-4029 at home.

### NORTH CAROLINA QSO PARTY

**1700 GMT November 13 to**  
**0200 GMT November 14**  
**1200 GMT November 14 to**  
**0100 GMT November 15**

This year's party is sponsored again by the Alamance ARC (K4EG). The same station can be worked on each band. Cross-band and repeater contacts are not permitted.

#### EXCHANGE:

RS(T) and NC county or ARRL section.

#### FREQUENCIES:

SSB—3980, 7280, 14280, 21380, 28580.  
CW—60 kHz up from lower band edge.

Novice/Tech—20 kHz up from lower band edge.

#### SCORING:

NC stations count one point per QSO and multiply total by sum of ARRL sections.

Others count 2 points per NC contact and multiply total by number of NC counties worked (100 max.). Add a bonus of 25 points for working the club station, K4EG.

#### AWARDS:

The top scorer in and out of state will receive the 1983 *Callbook* of his/her choice. Certificates to top scorers in each ARRL section.

#### ENTRIES:

Send logs and summary sheets showing essential details to: F. R. Ashley WB4M, 2731 Blanche Dr., Burlington NC 27215. Include large SASE for results. Mailing deadline is December 13th.

### TRINIDAD AND TOBAGO QSO PARTY

**Starts: 0000 GMT November 20**  
**Ends: 2359 GMT November 21**

The 9Y4 QSO party has been organized by the Trinidad and Tobago Amateur Radio Society, Inc., to commemorate 20 years of independence, 5 years as a republic, and 50 years of amateur radio. Use all bands from 10 through 160 meters on SSB, CW, or via satellites.

#### EXCHANGE:

The usual 5- and 6-figure serial number signal report plus a progressive 3-digit number starting with 001.

# RESULTS

## 1982 SPRING BARTG RTTY CONTEST RESULTS

Single-Operator Section			
No.	Call sign	Points	Total QSOs
1.	W3EKT	668196	373
2.	EABRU	518560	343
3.	W3FV	504648	276
4.	G3HJC	462870	221
5.	I2OLW	462384	336
6.	I1TXD	430560	272
7.	SM6ASD	405958	261
8.	W4CQI	400044	242
9.	I2WEG	384948	252
10.	WB3CCZ	376516	218
Multi-Operator Section			
1.	G3ZRS	513540	270
2.	LZ1KDP	505310	321
3.	OH2AA	431600	314
4.	G3UUP	299936	216
5.	I4JXE	282906	193
Shortwave Listener Section			
No.	Name/Call	Points	QSOs
1.	OK-1-12880 (Czech SWL)	282534	187
2.	Y2-10521/0 (DM SWL)	130052	98
3.	Y2-6346/K (DM SWL)	95256	76
4.	NL4483 (PAO/SWL)	91276	121
5.	J. Matthews (USA)	63680	60

#### AWARDS:

A certificate will be awarded to any station working 5 or more 9Y4 or 9Y50 stations.

#### ENTRIES:

Logs must show date/time in GMT, sta-

tion worked, and number sent/received. It is requested that a remittance of \$2.00 or IRC equivalent be included with your log if you are eligible for an award. Entries must be postmarked no later than December 21st and addressed to: TTARS, PO Box 1167, Port of Spain, Trinidad, WI.

# LETTERS

## FEEDBACK

I know you like feedback, so here comes a long-postponed letter.

I still believe your magazine is the best all-around ham publication, but the cost is starting to concern me. You needn't defend it again. I'm fully aware that costs are continually rising. However, the saddle-staple binding of the July, 1982, edition definitely upset me. Is there an article shortage? Or are costs that high?

Speaking of articles, I had a few good ideas for short articles, but I fooled around and someone beat me to the punch—three times. Keep encouraging us to write. Even short articles are always interesting and often useful.

I particularly enjoy those about ham radio history and electronic history in general. I really loved that series your dad wrote a few years ago. Is it available in book form? By the way, how is the old gentleman?

In defense of your feelings about the code test, the July issue proves you have nothing against CW. I found the articles presented a fresh approach to some old gadgets, my favorite part of ham radio.

Incidentally, I preferred the table of contents cover when looking up old articles

but I have enjoyed most of the photo covers also. My favorite was probably the chess board made up of vacuum tubes back around 1967. I once suggested a cover picture of sculpture made from the junk box. You did that a few years ago, too. I'm now working on a chess game from solid-state devices.

Another positive comment. No other magazine I have ever seen prints such an excellent mix of letters—pro and con—no matter what the subject.

Finally, I was very excited about the Braille DX Service ("Letters," July) but no address was given. I would like to pass this info to some sight-impaired friends. Could you please publish it?

**Tom Grabowski K3SPY**  
Baltimore MD

*Thanks, Tom. I don't think I get to a hamfest at which someone doesn't push me to get the Ancient Aviator articles by my father into book form. Our book division is working on this, although I'd like to get Dad to write more about some of the dirty work which went on during the time he was starting the first transatlantic airline. He's doing well at 86, spending half of his time in northern New Hampshire and half in New York. He really should write more. The saddle stitching is a little less expen-*

*sive than the perfect-binding style, but the main reason for changing was our re-emphasis on construction articles. The saddle-stitched magazine lies flat on the workbench for reading or building, while the perfect bound style flops itself shut all the time. I've been pushing the fun of building gadgets for over 30 years now and I don't intend to stop. CW? The only thing I have against it is its being mandatory. I am convinced that if we made it a matter of ham pride, we would have more CW than ever. Many hams are obstinate people like me... as long as I am forced to do something they can go to hell. Call it Yankee perverseness, if you like.*

*The address you're looking for is BDXS, 8347 W. 6th Ave., Lakewood CO 80215; (303)-233-4335.—Wayne.*

## INNER PROCESSES

It is enjoyable to read such a practical and informative article as "Electric Health via Negative Ions" by Michael Windolph (July, '82). I especially liked the sensible statement, "Know what you are doing and be careful!"

I wanted to bring up a side point that might be of interest to your readers. To a large extent, we have become so accustomed to harmful environments that we have lost touch with our original, instinctive intelligence. It can be regained by patient, hard, and dedicated work, but it does take time.

To fully regain our instinctive intelligence to know when something is wrong, we must not only adjust our physical en-

vironment but also place our inner life in order. I find best-selling author Vernon Howard's books very helpful in this respect. Mr. Howard tells us that we have played a wrong note for so long that we have forgotten what the right note should sound like.

Using negative ions to enrich our air is 100% practical. To combine such simple and helpful projects on the practical level with intense observation of our inner processes would lead to better understanding of both worlds.

Keep up the good work. I look forward to every issue.

**Tommy Russell**  
Boulder City NV

## GEARVAKI

I can't tell you what a pleasant surprise and thrill it was to read that *The GEARVAKI Bulletin* had been selected Newsletter of the Month for August. It's gratifying to know that our "peculiar brand of madness" is appreciated by you folks out there in the real world of amateur radio publishing.

The *Bulletin*, of course, is a labor of love (we sure as hell don't make any money at it). It had its beginnings back in the distant past when my co-conspirators and I decided that too many hams, ham organizations, and ham publications tended to take themselves much too seriously. We started to poke fun at them—and ourselves—through the *Bulletin*.

We recognize that there is a serious side to amateur radio, but *The GEARVAKI*



*Bulletin* gives people a chance to take a "time out." With limited funds and distribution, we'll continue our periodic wackiness as long as possible. Your recognition has given us a chance to increase our readership some, and perhaps momentarily lighten the lives of our brother and sister hams. It helps us, too. Editing the paper is real therapy!

Anyway, on behalf of Dr. Felix R. One-hundredton, Dr. Elwood P. Lishnus, Dr. Avruell U. Harnishe, Ti-Grace Gaboon, Lelah Lilah Lowlou, and the rest of the GEAR-VAKI ruling mob, thanks from the bottoms of our warped little hearts.

Joe Ventolo, Jr. K8DMZ  
Editor  
The GEARVAKI Bulletin  
Enon OH

## SACRIFICES

Re Mr. Richardson's letter in the August 73 about rude tendencies in ham equipment salespeople:

I was formerly employed with one of the largest ham equipment dealers in the US, and I'd have to say that what he says is true to a certain extent. But give the guy behind the counter a break—there are a few legitimate reasons.

First, the salesguy is making a big sacrifice for the sake of his job; he has probably given up being an active ham. You can't talk, think, and eat ham radio all day and go on the air after work! No way. You get burned out sooner or later. Secondly, it was my experience that the amount of immature, rude nerds is disproportionately high in the ranks of hams as compared to the general population. Woe to the salesman who sold a guy an HT that breaks after a week!

I've had a guy threaten to kill me for refusing to return his money on a defective transceiver! If you take a radio in for service many times, you'll get incessant calls about its status until it's fixed, as if it'll get fixed faster while the serviceman is busy on the phone. So many hams go berserk when they don't have their daily radio fix, you wouldn't believe it!

You see guys come in, clamp a pair of headphones on and space out for hours listening to the Yamaguchi on display—without spending a dime. How many businesses would put up with that? If you politely tell them to leave, they get mad as heck. Hey, what can you otherwise do?

Finally, I ended up getting pretty darned disgusted with the technical ignorance of many hams of late. We had to wire dozens of mike plugs, even for Extra-class hams. As a salesman, you were expected to constantly give advice on how to hang antennas, read an SWR bridge, or zero-beat a CW signal. That's fine to a certain extent, but

so many wouldn't take the time to pick up an antenna manual to find out, even to maybe learn something. Why? If you are so damn lazy you memorized the Bash books to get your license, you're not about to read the ARRL antenna book to learn how to cut a dipole (which you should have known how to do in the first place). No, keep taking the easy way out and ask the radio shop guy.

So, after all this and more, a sincere guy or a beginning ham might come into a radio shop and just might get a little short-shrifted. Sorry, guys.

### Name and address submitted

P.S. Please withhold my name from print. I might decide to go back into the ham business after all. (Where's my valium?)

*By golly, you're not trying to tell us that you think that knowing the code isn't all that's needed? All these nerds who have been driving you crazy have passed the code test, so what are you beefing about? They may have an Extra-class license and be able to copy code at twenty per, but they can't wire a mike plug, eh? Well, that's what most hams want us to have, my friend, so stop beefing. Until I see some Bash books in shreds at ham stores I will continue to believe that most hams don't want anyone to know any theory... or how to build even the simplest of stuff... or to know one end of an antenna from the other. Your customer stories are the same as I'm hearing from all of the ham dealers. I've been pushing for a change from depending on the damned code to a real technical test, not a Bashed one... with no noticeable success.—Wayne.*

## KEEP THE CODE

In response to your comments about having a no-code license, I was under the impression that amateur radio was developed "to provide a voluntary, non-commercial service that provides for emergency communications, the advancement of the state of radio art, and a trained pool of operators, technicians, and electronics experts (97.1.)"

Well, it seems to me that if we are to follow this rule we should go out of our way as licensed hams to help people become trained operators of CW. As you well know, CW can be heard when voice communications cannot be understood. Because of this, CW can be utilized much more efficiently during emergency situations.

I teach at the Virginia School for the Deaf and Blind in Staunton, Virginia. Two 14-year-old girls, both visually impaired, passed both parts of the Novice requirements this year and received their call letters (KB4AHA and KB4AGZ). For those who feel that the CW portion of the Novice

exam is too hard, especially those who claim to be skilled enough to pass the technical portion of the Extra-class exam, I would like to have them talk to these two girls and the other 400-plus-thousand licensed hams across the United States.

In closing, if the no-code license is approved, the only people who will benefit are the 2-meter-rig manufacturers and those who don't really care enough about ham radio to take the time to learn one of the most important and useful aspects of amateur radio... CW.

William F. Bowman KA4UFI  
Staunton VA

*Well, Bill, what you say was true thirty years ago... maybe even twenty years ago. But you're so out of date with current technology that I don't know where to start. Apparently you are unaware of RTTY, which has been around for well over 30 years on the ham bands. You seem not to know about recent developments such as integrated circuits, digital electronics, and so on. Yes, in the days of spark, everything you've written was true. Alas, we still have a surprising number of hams who are living isolated in the old spark days.—Wayne.*

## PRICED OUT

These days, most countries, particularly Canada, have serious money problems, but even in our poor economic condition we haven't been reduced to the point where we have an official 1/2-cent coin.

I know the true value of our penny may not even be worth half of its face value, but it seemed very funny to me to see on the cover of your August, 1982, issue #263 that the price of the magazine was printed as \$2.49 1/2.

Either the proofreader missed it, or you have decided to print an error deliberately to see how many people really read it "from cover to cover."

*ALSO TIME ISSUE!*  
R. Ian McAuley VE3MYO  
Alexandria, Ontario

We have an opening for a new proofreader... any takers?—Wayne.

## LAID OUT

Your new cover layout for the August issue of 73 Magazine is great. Plus, I was glad to see that the articles were more in line with the 73 of a couple years ago. I was beginning to have my doubts about 73, as the articles seemed to be getting away from ham radio somewhat. Having been a subscriber to 73 in excess of ten years, I hope the August

issue is an indication of better ham radio articles to come.

Now, if you could just come out with a blockbuster RTTY issue like you did a couple of years back!

Vince Staffo WB2FYZ  
Ilion NY

*The September issue was packed with RTTY goodies, and let me make it perfectly clear (to coin a phrase) that I think that the future of hamming is tied in with digital communications... and that's RTTY. I want to publish articles on higher and higher-speed digital communications, on error-correcting code systems, on automatic relaying, and so on. If enough of us chip in (pun), perhaps we can set up some international relay system which will be of immense value in emergencies. We might even think about an organization which could be called the International Radio Relay League! The mind boggles. Anyway, glad you enjoyed the issue, and yes, we'll be having a lot more interesting construction projects.—Wayne.*

## NO THANKS

Just a short note to state that I have, over a period of 4 or 5 or 6 months, helped upwards of 50 hams and others through your "Ham Help" column (particularly on older receivers, transmitters, etc.).

Sad to say, only about 8 have even bothered to reply and thank me, or at least tell me to "get lost."

Kind of makes you wonder.

Roy H. Wilkinson  
Bloomington MN

P.S. I have a much better "batting average" with the readers of Popular Electronics' "Operation Assist" column. Also, I miss your "want ads" column!

*Roy, the place for your ham ads is in a ham ad paper, not a magazine. It takes about three months to print a ham ad in a magazine and by that time the stuff is usually sold. The ham ad papers get the ads out there in a couple weeks and do a nice job of it. I really hate to take bread out of the mouth of small entrepreneurs by competing with them in 73, so I urge all readers to use the specialty publications and keep them healthy. I wish that QST would do that, too. You'll note that we don't try to compete with CQ magazine and their specialized coverage of contests. Sure, there are only a couple thousand hams who are seriously interested in contests, but those who are should read and support the publication dedicated to them... which is CQ. I don't know what to say about the ungrateful cretins who get help and then say nothing.—Wayne.*

# RTTY LOOP

Marc I. Leavey, M.D. WA3AJR  
4006 Winlee Road  
Randallstown MD 21133

One of the questions raised a few months back regarding the design of a radioteletype receive program was how to make such a receiver immune to garbage or noisy signals. This month I'll take a look at

one technique which can be used to overcome such a problem: multiple sampling.

Recall that each data pulse in a 60-wpm Murray character, of which there are five, lasts for 21 ms. Mechanical teleprinters do not use the entire pulse, but rather a small sample of it. Where this sample window is positioned depends upon the adjustment of the range selector. That is, only a small slice of each

data pulse is read in order to determine whether that pulse is a mark or a space. Fig. 1 shows how this window overlaps the longer data pulse. Since mechanical printers time the "intra-pulse" interval from the position of the window on the data pulse, advancing the window toward the beginning of the pulse will enable the next pulse to be read that much sooner and can allow speeds slightly greater than 60 wpm to be read. It is by using this technique that so-called "66-speed" machines can be copied on an otherwise unmodified Model 15.

In an analogous fashion, simple RTTY receive programs such as those described here in the past sample each data pulse only once and use that information to recon-

struct the Murray character. With the routines presented a few years ago, for example, a momentary sample from the middle of each pulse was obtained. A delay of 20 ms between samples kept the windows positioned near the middle of each data pulse.

The difficulty with such a scheme is that noise or fading can distort individual pulses within a character, thus changing the interpretation. A simple solution is to look at each pulse not just once, but several times, and base the decision of what to call that pulse on the sum of those samplings. Regular samples can be taken at, say, two-ms intervals to produce a time scheme such as shown in Fig. 2.

Having sampled each pulse many times and presuming we have stored that infor-



## WORLD TIME WATCH

the first microprocessor watch  
made especially for hams



24 hr. timer  
microprocessor  
water resistant  
solar assist

New Low Price  
-\$59.95

The HAM-1 functions include local time, world time, (G.M.T. too) count-up and count down chronometer, day, month, date, alarm and hourly chime. It's ideal for log-keeping, DX time conversion and 10 minute I.D. timing. The HAM-1 features a high contrast Seiko display and solar cell battery assist. Battery life is better than 4 years. The HAM-1 is water resistant to 20 meters, the case is 100% solid stainless steel and the crystal is scratch resistant mineral glass. The HAM-1 is rugged and durable and has a 1 year warranty.

**2 METER AMPLIFIER**  
\$39.95



- 2 Watts In, 10 Watts Out • V.S.W.R. Protected • Can be Used for F.M. & S.S. B.
- Led Status Indicators • Low Loss SO-239 Connectors • Current Drain Less Than 2.5A at 13.6 V.D.C. • Massive Heatsink • Built In T/R Switch

**TEMPO S-1 UPGRADE KITS**  
\$39.95

Upgrade your early Tempo S-1 to current Production Specifications, kits include: • 450 M.A.H. Battery Pack • New Case Assembly • All New Escutcheons • Spkr./Mic. Jack w/Dust Cap • New Earphone & Jack • P.C.B. and Parts for Easy Installation • Detailed Instruction Manual • For Radios With & Without T.T. Pad.

Other Accessories Available:

Spkr/Mic. Designed for S-1's. . . \$24.95  
Heavy Duty Belt Clip. . . . . 7.50  
Flex Antenna . . . . . 6.00

To Order Call or Write to:

**ADVANCED COMMUNICATIONS  
INTERNATIONAL**  
2411 Lincoln Avenue  
Belmont, CA. 94002 U.S.A.  
(415) 595-3949

Add \$3.00 per order for shipping & handling. California residents add 6% sales tax. Visa, Master Charge accepted.

## NEW MFJ-102 SOLID STATE 24 HOUR DIGITAL CLOCK

Switchable to 24 hour GMT or 12 hour format. ID timer. Seconds readout. Bright **BLUE** .6" digits. Alarm, snooze, lock functions. Power out, alarm on indicators. Assembled.



Switch to 24 hour GMT  
or 12 hour format!  
ID timer. Seconds readout.  
Bright **BLUE** .6 inch digits.

**\$32.95**

Now you can switch to either 24 hour GMT time or 12 hour format! Double usefulness.

Switchable "Seconds" readout for accuracy. ID timer. Alerts every 9 minutes after you tap the button. Also use as snooze alarm.

"Observed" timer. Just start clock from zero and note end time of event up to 24 hours.

Alarm. For skeds reminder or wake-up use. Synchronizable with WWV.

Fast/Slow set buttons for easy setting.

Big, bright, blue digits (vacuum fluorescent) are 0.6" for easy-on-the-eyes, across-the-room viewing.

Lock function prevents missetting.

Operates on 110 VAC, 60 Hz (50 Hz with simple modification). UL approved.

Handsome styling with rugged black plastic case with brushed aluminum top and front.

Sloping front for easy viewing. 6x2x3".

Order from MFJ and try it — no obligation. If not delighted, return it within 30 days for refund (less shipping). One year limited warranty by MFJ.

Order today. Call toll free 800-647-1800. Charge VISA, MC or mail check, money order for \$32.95 plus \$4.00 shipping/handling for MFJ-102.

Put this new improved MFJ digital clock to work in your shack. Order today.

**CALL TOLL FREE . . . 800-647-1800**

Call 601-323-5869 for technical information, order/repair status. Also call 601-323-5869 outside continental USA and in Mississippi.

**MFJ ENTERPRISES, INCORPORATED**  
Box 494, Mississippi State, MS 39762

## International Crystals & Kits **FOR THE EXPERIMENTER**

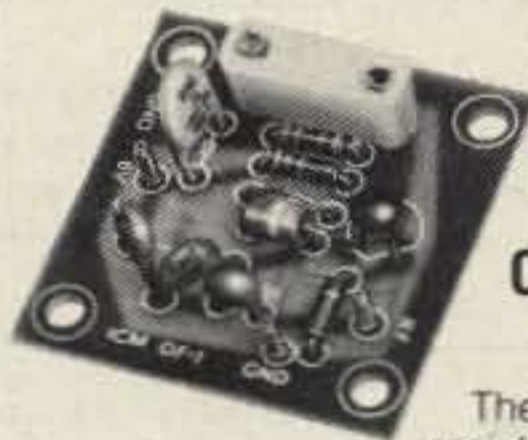

**\$5.96**  
ea.

**OF-1 OSCILLATOR**

The OF-1 oscillator is a resistor/capacitor circuit providing oscillation over a range of frequencies by inserting the desired crystal, 2 to 22 MHz, OF-1 LO, Cat. No. 035108. 18 to 60 MHz, OF-1 HI, Cat. No. 035109. Specify when ordering.

**MX-1 Transistor RF Mixer**  
3 to 20 MHz, Cat. No. 035105  
20 to 170 MHz, Cat. No. 035106 . . . . . **\$7.02 ea.**

**SAX-1 Transistor RF Amp.**  
3 to 20 MHz, Cat. No. 035102  
20 to 170 MHz, Cat. No. 035103 . . . . . **\$7.02 ea.**

**BAX-1 Broadband Amp**  
20 Hz to 150 MHz, Cat. No. 035107 . . . . . **\$7.34 ea.**



**\$6.88**  
ea.

.02% Calibration  
Tolerance

**EXPERIMENTER  
CRYSTALS**  
(HC 6/U Holder)

**Cat. No. Specifications**  
031300 3 to 20 MHz — For use in OF-1L OSC Specify when ordering  
031310 20 to 60 MHz — For use in OF-1H OSC Specify when ordering

CONDITIONS OF SALE: Sold on a cash basis. Shipping and postage inside U.S. will be prepaid by International. ORDERING INSTRUCTIONS: Order by catalog number. Enclose check or money order with your order. FOREIGN ORDERS: Prices quoted for U.S. orders only. Orders for shipment to other countries will be quoted on request. Prices subject to change. Minimum foreign order \$25.00.

WRITE FOR BROCHURE



**International Crystal Mfg. Co., Inc.**  
10 North Lee, Oklahoma City, Oklahoma 73102



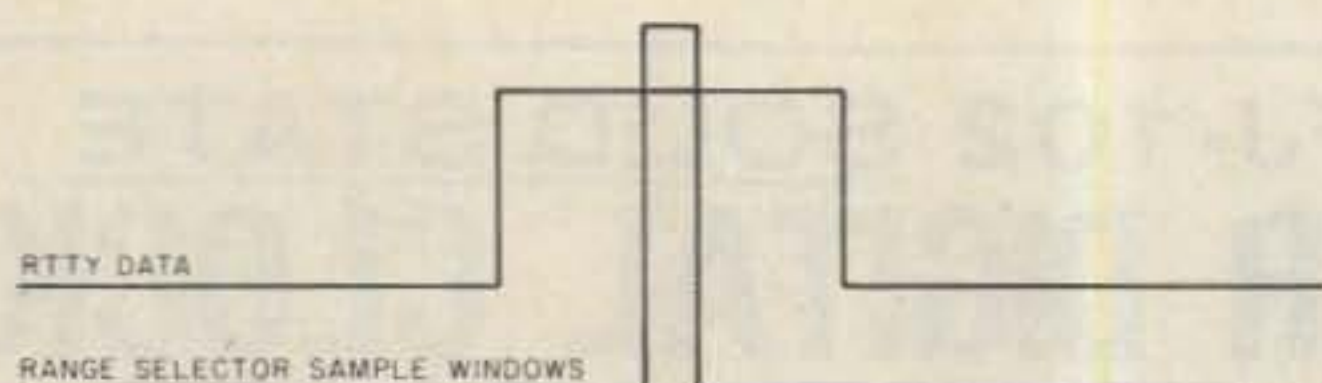

Fig. 1. The sample window.

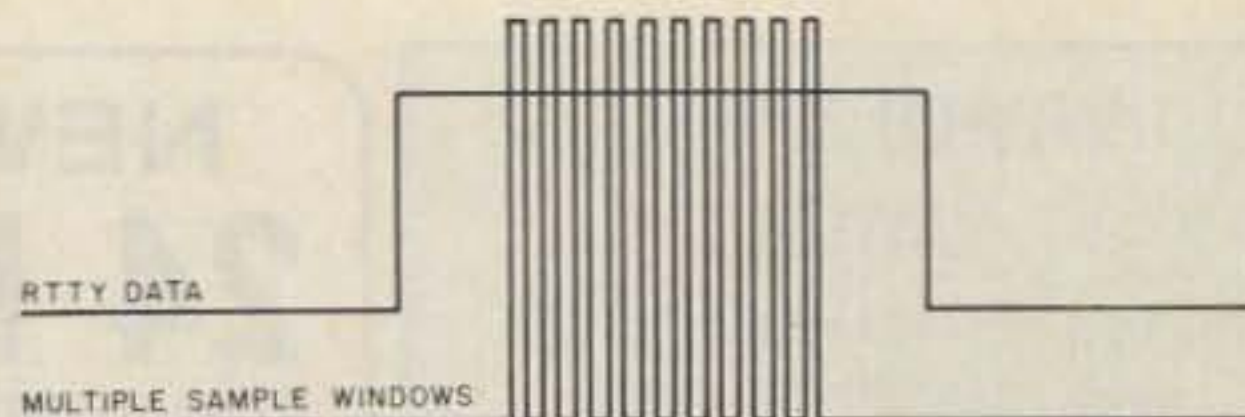

Fig. 2. Computer's multiple samples.

mation in some usable format, we must now decide what to do with that knowledge. Unless the circuit being monitored is an absolutely clear channel, it is doubtful that all ten (in this example) samples will be identical. In the case of pure noise, one might expect an average of half mark and half space, so a threshold would seem appropriate to adjudicate when to call a given pulse "mark," when "space," and when to throw it out. For want of a better suggestion, let's settle on seven or more samples one way or the other to label a state. Reading less than seven pulses of either mark or space will render the individual bit trash.

So you have a trash pulse, now what? It would seem that there are at least two ways to deal with that. Either you arbitrarily assign it as a mark or space and take your chances with the character, or you decide the entire character is lost and just loop out the time. The latter appeals to me the most; after all—garbage is garbage, no? In order to implement that, all you would need to do is keep track of how many bits you have read and delay whatever is left to get to the next stop bit.

I don't know how confusing that all is when you read it; it was not all that clear in the writing. I think that Fig. 3, a flowchart of what I am talking about, will help clear things up, though. The character reception routine is entered with a bit counter set at five, the number of pulses in a Murray character. After detection of a start pulse, additional counters for mark and space are set up and cleared. A loop is entered to sample each pulse ten times and register the state of the pulse sampled in the appropriate counter. After ten samples have been taken, the counters are examined to determine the probable identity of the pulse and record that in the correct position. Assuming all has gone well thus far, the sampling process is repeated for each of the five data bits, and the Murray character transmitted is recovered.

However, what if a bit is in error? What I have directed here is to trash the entire character. We do that by branching to a routine which waits out the remaining bits'

time and then exits with a null for the received character. One presumes that the translation scheme used will ignore such a character.

This type of scheme is useful for eliminating erroneous characters where the error is generated between transmission and reception. For those errors generated on

the operator side of the keyboard, you are on your own!

Turning to the mailbag, I have a note here from Leo F. McAuliffe, Jr., of Ashland, Massachusetts, who is a shortwave listener interested in copying RTTY. Leo is looking for a device which will display received RTTY on a TV screen, without having to invest a lot of money. Well, Leo, as you may have appreciated in the pages of ads here in 73, there is not a lot on the market to do what you ask. Those units that are commercially available cost several hundreds of dollars, which you indicate is out of your range. I might suggest two possible alternatives. One would be to scout the hamfests in your area for an older, used, video RTTY unit, such as an old Microlog receiver. These were made some years back and should be turning up for reasonable prices on the flea-market circuit. Another idea is to put together a small unit yourself, using a dedicated computer, costing under \$100, and an ASCII video display. Such displays may be old terminals or receive display boards, none of which should cost too much. For some time and elbow grease, you may be quite happy with what you will come up with. If there is sufficient interest, I would be willing to work out the design of such a unit. Let me know with, as they used to say on the tube, your cards and letters.

Among the new arrivals here at WA3AJR is another computer, an Atari 400. I bought it for the kids, but you know who is at the keyboard more and more. I am impressed by the programmability of this unit and hope that we will be able to use it on ham radio. I will keep my eyes open for applications, and I hope you do, too. I look forward to sharing with you whatever we all can discover in future columns.

Next month, some more investigations into the design of the ideal RTTY terminal program, as well as a look at what some of you are saying. Winter is a great time to work in the shack, even though these new transistorized/Cized rigs don't put out the heat of a pair of 807s. Let's see what kind of things we can do in next month's RTTY Loop.

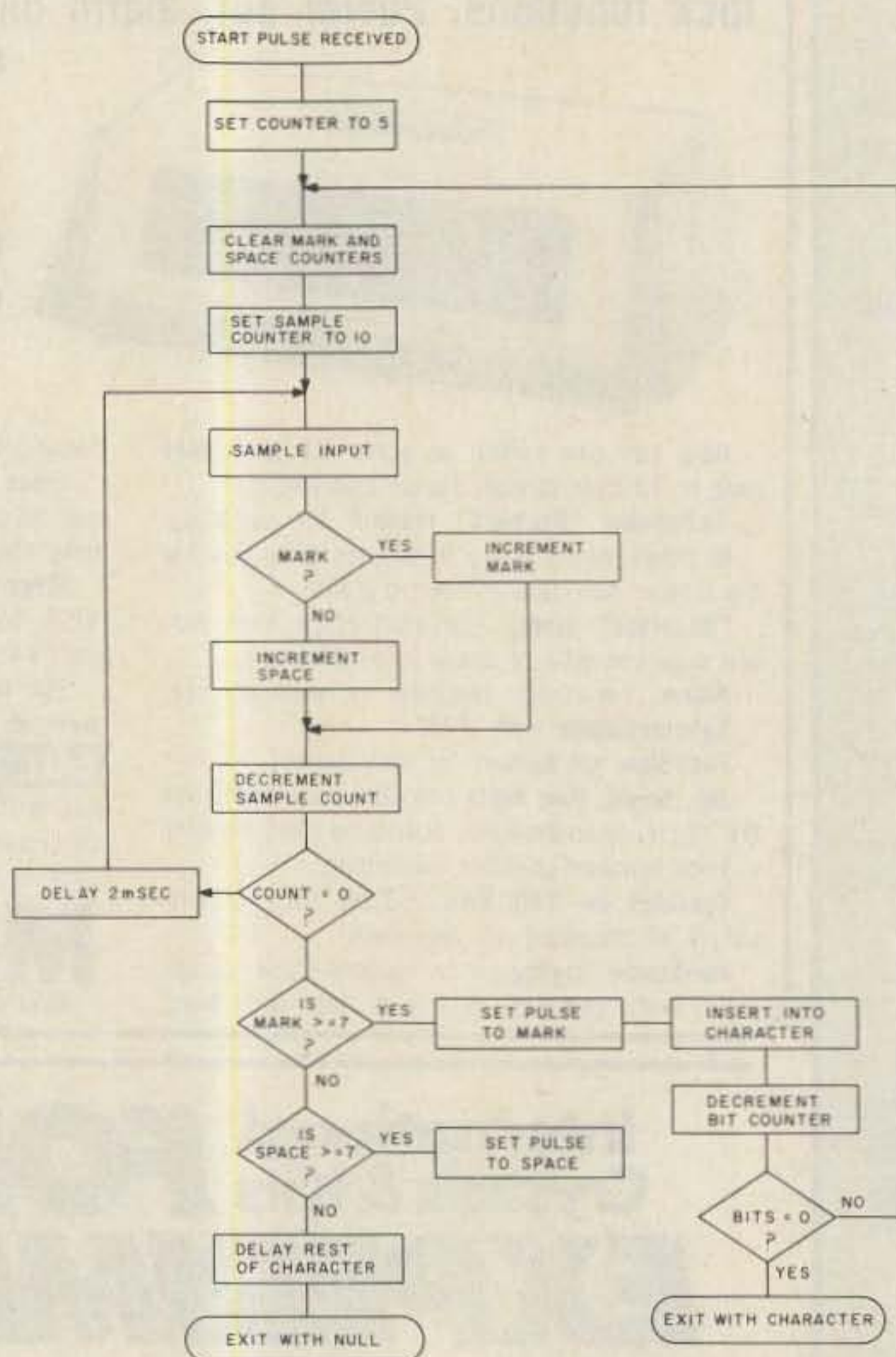

Fig. 3. Multiple sample flowchart.

# DX

Chod Harris VP2ML  
Box 4881  
Santa Rosa CA 95402

## THE TOP TEN

What are the Top Ten? No, not the best selling rock-and-roll records, but the most sought-after countries in the DX world. Every year *The DX Bulletin* surveys the top DXers in this country and other countries to determine which countries are most needed. *The DX Bulletin* concentrates on those DXers with more than 250 countries worked and is the most prestigious of all the bulletins. Its Top 73 list is the most

complete and well-respected of any such list in the world. Some amateur radio manufacturers determine who will receive DX-pedition rigs on the basis of this survey. *The DX Bulletin* recently granted permission for this column to reproduce the 1982 list of the most needed countries. Here is the list, with comments on future amateur radio activity. (For further information on *The DX Bulletin*, write 306 Vernon Avenue, Vernon, Connecticut 06066.)

1. **China BY.** China tops everyone's most wanted list, with almost no legal amateur radio since the early 1950s. But that is changing (see this column, July). More BY stations are coming on the air, and BY

will move down the most wanted list in future years. Not rapidly, but it will slowly move down until everyone has worked BY.

2. **VK/Heard.** This tiny rock near Antarctica will host one or two major DXpeditions in 1983. Watch Heard drop completely off the most wanted list next year.

3. **VU/Laccadives.** The only island worth landing on in this archipelago is the base of considerable pirate activity. No, not radio pirates, but real life pirates who don't leave live victims. No one in his right mind goes anywhere near the Laccadives.

4. **Albania ZA.** It's the political climate that keeps amateur radio out of Albania. As one of the poorest of the Eastern European countries and one close to the Soviets, Albania has taken a dim view of ham radio for years. There are signs of a softening of this attitude, however, and rumors continue to fly of a DXpedition to Albania any day now. Don't hold your breath, but don't hesitate to work any ZA you might hear.

5. **Cambodia XU.** Political turmoil and

civil war preclude ham radio from Cambodia. Official permission is unlikely in the near future; we'll just have to wait until things calm down.

6. **South Yemen 7O.** A similar case to Albania. South Yemen is in the Soviet camp, and they don't endorse amateur radio.

7. **Bouvet 3Y.** Another tiny island near Antarctica. Bouvet sees occasional tourist and scientific traffic. Permission from Norway can be obtained, and Bouvet might well be a target of a DXpedition soon, but probably not this winter.

8. **Andamans VU.** At least one amateur is listed as having a license for the Andamans, but activity has been non-existent. The Indian rules prevent outside amateurs from getting licenses, and the locals don't seem to show enough interest in activating one of the rarest of all DXCC countries.

9. **Burma XZ.** The official Burmese government says "No" to any amateur radio, and the ARRL refuses to accept the operations from the "rebel" north half of the



## "BEEPER III"



**"THE PROFESSIONAL TOUCH COMES TO AMATEUR RADIO!"**

"BP-3 automatically provides a gentle high frequency beep at the beginning of each transmission and a low beep at the end. Virtually eliminates "talk-over"! Operates for up to one year on a single 9-V battery (not supplied). Can be directly interfaced to any transceiver which is keyed by grounding the PTT line (the PTT line voltage must be positive, not greater than 24 VDC, nor the current greater than 100 ma.) Works with virtually all modern gear. You've heard it, now you can have it!"

### "ADD THE BEEP!"

- BP-3A Complete with case, cable, Standard 4-pin connectors . . . **39.95 pp**
  - BP-3B As above except without connectors. Add your own . . . **36.95 pp**
  - BP-3C Circuit-board version for custom installation . . . **29.95 pp**
- All units assembled/tested. OH residents add 6% Sales Tax!

**FAXSCAN INC.** ✓85  
3148 Dorf Drive • Dayton, Ohio 45418 TM

# DISPLAY YOUR STUFF

With the AEA MBA-RO Reader Automatic display of transmitted and received Morse and RTTY coded signals has come of age. It is proving to be most worthwhile for improving one's own transmitted "fist" and for allowing SWL's or visitors the opportunity to experience the thrill of Amateur Radio coded transmission.



While no machine can yet match the ability of a skilled CW operator in copying poor fists or signals buried in the noise, the MBA-RO by AEA excels even when compared against units costing much more. The large 32 character display allows much easier reading than shorter displays, especially at higher speeds such as 60 WPM or 100 WPM RTTY. The MBA-RO also features dual filters for RTTY decoding of either 170 Hz or 425 Hz (easily changed to 850 Hz) shift transmissions.

For more details, write for our latest catalog or visit your favorite dealer.

Prices and Specifications subject to change without notice or obligation. Software © copyright by AEA.

**ADVANCED ELECTRONIC APPLICATIONS, INC.** ✓2  
P.O. Box C-2160,  
Lynnwood, WA 98036  
(206) 775-7373  
Telex: 152571 AEA INTL

**AEA** Brings you the Breakthrough!

# Hear Police/Fire Weather

on 2 Meter Handhelds with this MFJ VHF Converter.



Scanning Handhelds become Police/Fire Scanners

MFJ-313  
**\$39.95**

New MFJ VHF converter turns your synthesized scanning 2 meter handheld into a hot Police/Fire/Weather band scanner.

144-148 MHz handhelds receive Police/Fire on 154-158 MHz with direct frequency readout. Hear NOAA weather, maritime coastal plus more on 160-164 MHz.

Mounts between handheld and rubber ducky. Feedthru allows simultaneous scanning of both 2 meters and Police/Fire bands. No missed calls.

Highpass input filter and 2.5 GHz transistor gives excellent uniform sensitivity over both bands. Crystal controlled.

Bypass/OFF switch allows transmitting. Won't burn out if you transmit (up to 5 watts) with converter on. Low insertion SWR. Uses AAA battery. 2 1/4 x 1 1/2 x 1 1/2 in. BNC connectors.

Enjoy scanning, memory, digital readout, etc. as provided by your handheld on Police/Fire band.

### 220 MHz Converter for 2 M Handheld

MFJ-314 **\$59.95** MFJ-314, like MFJ-313 but lets you receive 221-225 MHz on your 2 meter handheld.

### Police/Fire/Weather Band Converter for 2 Meter Mobile Rigs.

MFJ-312 **\$59.95**

MFJ-312, like MFJ-313 but for mobile 2 meter rigs. Transmit up to 40 watts thru converter without damage. SO-239 connectors. Mobile mounting brackets. Rugged. "ON" LED. Use 12 VDC or AAA battery. 3x4x1 in.

Order from MFJ and try it-no obligation. If not delighted, return it within 30 days for refund (less shipping). One year unconditional guarantee.

Order today. Call toll free 800-647-1800. Charge VISA, MC or mail check, money order for amount indicated plus \$4.00 each shipping. Hear police/fire/weather. Order now. ✓47

**CALL TOLL FREE ... 800-647-1800**

Call 601-323-5869 in Miss. outside continental USA, tech/order/repair info. Telex 53-4590.

**MFJ ENTERPRISES, INCORPORATED**  
Box 494, Mississippi State, MS 39762

## MOR-GAIN

1/2-size (75M only 66')

Multi-Band (5, 4, 3 bands)  
80/75M thru 10M

Broadbanded - no traps used

Prices start at \$82.50

## MOR-GAIN

**THE MOR-GAIN HD DIPOLES** are the most advanced, highest performance multi-band HF dipole antennas available. Patented design provides length one-half of conventional dipoles. 50 ohm feed on all bands, no tuner or balun required. Can be installed as inverted VEE. Thousands in use worldwide. 22 models available including two models engineered for optimum performance for the novice bands. The Mor-Gain HD dipoles N/T series are the only commercial antennas specifically designed to meet the operational requirements of the novice license. Our 1-year warranty is backed by nearly 20 years of HD dipole production experience.

For detailed 10-page brochure, write or phone directly to **MOR-GAIN**, P.O. Box 329T, Leavenworth, Ks. 66048, Tel. (913) 682-3142.

## MOR-GAIN





A gaggle of FO8s. Did you work 3 FO8 stations on two different bands during their Tiurai celebration July 14-22? If so, you qualify for a special award, but you must request the award before the end of the year. 15 active FO8s made more than 5000 QSOs during the celebration. (FO8GM photo courtesy of WB6GFJ.)

country. This political mess shows no signs of being straightened out in the foreseeable future.

10. *San Felix CE0X*. Getting a license is trivial (I have one), but getting onto the island is impossible. The entire island is a military base (like Aves in the Caribbean) and "gringos" are not welcome. Even the Chileans have been unable to convince the military higher-ups that they mean no harm in their planned DXpedition. A recent "operation" from San Felix turned into a fiasco when the Chileans claimed the operator was nowhere near the island at the time. This could break at any time, but I rate it doubtful.

The main difference in this list from a similar one twenty years ago is in the reasons for lack of activity from a country. Twenty years ago the reasons were physical inaccessibility and lack of transportation and accommodations in the country. It's hard to mount a DXpedition when you have to pack your gear, generators, and fuel in on camels. The transportation picture has changed for the better, and no spot on this earth is out of reach of a determined amateur.

But the political realities have changed for the worse. Certain cheats and frauds in the last 20 years and increasing sensitivity to feelings in developing countries have led to a more formal approach to the documentation needed for a DXpedition to "count" for DXCC. The conservative attitude of the ARRL DXCC staff means an amateur cannot simply operate from a country; he must be welcomed by that country and operate with their full cooperation. This is simply impossible in many countries. Many emerging countries are reluctant to put *anything* down in writing, although they are eager to give verbal permission to operate.

Another reason for the reluctance of countries to permit even visiting amateurs to operate is the fear of spying, internal revolt, or outside takeover, all of which require radio communications. Unsophisticated customs officials cannot differentiate between spy gear and a TS-830. (On second thought, are there any real differences?) So it is simpler always to say "No" than to see if it is possible to say "Yes." We probably won't see this attitude change quickly. Only patient demonstrations and years of support, documentation, and assistance will win jittery governments over to the value of amateur radio, as we see happening in China.

What does this mean for the DXer? If you want to get on the Honor Roll (having worked almost all the DXCC countries), you must have patience. It may be many years before we see significant radio operations from many of the Top Ten.

If you do hear one of these highly desired countries on the air and are fortunate enough to work it, the battle is only half over. Now you have to get a QSL card to prove you worked him.

## QSLs AND QSLING

There is more to DXing than working the DX station; getting the confirmation of the contact can be every bit as challenging as breaking through the pileup. But a few hints and suggestions can substantially improve your QSL percentage and get some of those coveted pasteboards "on the wall."

In this first part of this series on QSLing we will consider the card itself: the selection, design, and printing of your own QSL card. In future columns we will advise how to fill out the card, how to get the card to the appropriate place, and QSL bureaus.

### Your Personal QSL Card

There are no rules requiring that acknowledgement of a DX contact must be in the form of a postcard-sized paper. QSL means acknowledgement of a contact, not a special card. But *everyone* who seeks those acknowledgements uses the universally accepted QSL card. In more than 100,000 requests for my QSLs, I have *never* received a request without such a card. Only a tiny handful have been other than postcard-sized. So while there are no formal requirements for the dimensions of the QSL, I recommend sticking to the standard format.

### Choosing Your Card

Given the transient nature of most DX QSOs, the DX station has little opportunity to get to know you. If the QSLing is handled by a QSL manager, the person filling out your return card will know even less about you. So your QSL card reflects your personality and amateur radio interests even more than your DX contact.

When the time comes to choose your QSL card, you first have to decide on a custom card or an off-the-shelf commercial card. There are dozens of commercial QSL card printers. Most offer a set of samples and designs for a nominal fee. Once

upon a time the QSL printers would obtain the FCC list of new licensees and send you a set of samples and order forms before you even received your license! You were so pleased to learn your callsign that you immediately ordered 1000 of their fanciest cards. 950 of these are probably still gathering dust in your basement.

The advantages of commercial QSL printers are many. They produce a good looking card at relatively small expense. The card is easily recognizable as a QSL and it is printed on stock heavy enough to go through the mail as a postcard. Prices range upward from a few cents a card. You can select from a bewildering variety of cards, including multi-colored cards, two-sided cards, and more. Ordering your commercial QSLs is trivial: You pick your design, fill in the blanks on the form, and send in your money. You will get your cards back in a few weeks—longer if you use one of the smaller printers.

But for DXing, standard QSL designs have one major disadvantage: They are all the same. No, not identical, but an active DX station who receives thousands of QSLs each year will have seen dozens or hundreds of similar cards. Your card will be one of the pack; it won't stand out. Some hams try to make their cards stand out by using bright orange QSLs that glow in the dark. I still see spots before my eyes from opening an envelope with one of these Day-Glo orange QSLs. But I have received bunches of these, too. Certain QSL designs are so popular that I have received hundreds of cards identical except for the callsign. Needless to say, I am not intrigued to receive yet another one of the same design.

This doesn't mean that standard design QSLs end up in the circular file. It just means that they get answered just like any other QSL, no faster or slower. The call and the individual operator will not be remembered any length of time.

The cards (and operators) who do stick in the mind after the QSL is answered are those personal cards, cards which say something about the ham and his station.

If you do decide on a commercially-produced, standard QSL card, there are a few things to keep in mind when making your selection. First, avoid commercially-produced two-sided cards. These are the cards with the personal information on one side (callsign, name, and address) and a standard QSL form on the reverse. Why avoid these? The DX station must first find your QSO in his log. This means comparing the time of the QSO on the back of the card and the callsign on the front with his pages and pages of log. Sometimes the card must be flipped several times before the QSO is located in the log. Then, in order to fill out the return card, the DX operator must first record the QSO information and then turn the card over to get the callsign. Big deal, you say. How difficult is it to turn the card over? Flipping one or two or ten or a hundred cards is no big deal. But when you deal with thousands and thousands of cards, the QSLer soon learns to dread the sight of another two-sided card.

Two-sided cards also lead to possible errors on your return QSL. In the process of flipping the card, the DX station might forget the call, or transpose two letters, etc. The result might be a QSL card which will be rejected by the DXCC checkers.

This does not mean that all two-sided QSL cards are useless for DX purposes. There is nothing wrong with a card which has the call and name on one side and the QSO information on the reverse, *as long as the callsign also appears on the reverse*. Then the DX station (or QSL manager) doesn't have to flip the card; the call-

sign is right there on the reverse with the QSO information. But few commercially-available two-sided cards offer this option. It requires custom printing of *both* sides of the card, greatly increasing the costs, and eliminating many of the economies of scale of QSL printing. So if you intend to do a lot of DXing, stick with single-sided QSL cards.

Another thing to check when you purchase commercial cards is the glossy finish. Many of these very handsome and attractive finishes will not absorb ink from felt tip pens. The ink puddles up and smudges off. Hard pencils may make a very light trace on some coated cards. Test your sample cards with your usual writing utensil. Does the pen make a clear, clean impression which doesn't smear? Not all shiny cards have this problem; you have to check the sample.

Another possible problem with commercial QSLs is the use of strange typefaces. Some amateurs choose an exotic typeface for their callsign and address, one that is different, on the hope that it will make their standard card more distinctive. Don't! These weird typefaces are often difficult to read. Typefaces that look like script or brush strokes are especially difficult to read. What difference does it make, you ask? If your callsign is difficult to read, the DX station might get it wrong. Then he might not find it in the log, or he might fill out your QSL to someone else's call! For the same reason avoid those ubiquitous silver-on-black QSLs. They are very difficult to read!

### Custom QSLs

I personally prefer custom-designed QSLs, both to send and to receive. I feel the QSL card is an extension of your amateur radio personality, and it should say something about you and your amateur career. Custom-designed QSLs need not be elaborate or expensive, and the initial effort quickly pays off in improved returns.

What should go onto your personal QSL? Make sure you have the basic information: your callsign, name, and address including county. You will also need blanks for the QSO information. If you work one mode or band predominantly, you might want to customize the QSO information. For example, a 20-meter enthusiast might have "Freq. 14 \_\_\_\_\_ MHz." Be sure to say that this card is a confirmation of the QSO described; many commercial cards omit this vital line.

I have used both the box format and a sentence format for the QSO information, and I definitely recommend the former. The sentence format (i.e., "This confirms our 2X \_\_\_\_\_ QSO on \_\_\_\_\_ on \_\_\_\_\_ MHz at \_\_\_\_\_ UTC, with your signals \_\_\_\_\_ RST.") is cumbersome and very prone to error. The box format is clean and easy to fill in and read. Amateurs seem to be able to make the simplest task complicated and so produce a bewildering number of combinations of these QSO information boxes. For consistency and to assist the person filling out the return card, I suggest the following format: Callsign, Date, UTC, MHz (not band), 2X(mode), RST. If you are designing your own card from scratch, be sure to leave enough space in each of the boxes for the required information. In other words, the boxes for the callsign and date should be substantially larger than those for the other information. Better yet, take a blank QSL with well-designed boxes and steal the format.

Another important item to include on your custom QSL is a request for the DX station's card. You would be amazed at the number of QSLs I have received without such a request. Since I receive and



**\*QUALITY  
\*PRICE  
\*PERFORMANCE**

**SATELLITE**

**Tunable Audio Demodulator** — Tunes from 5.4 to 8.2 MHz. Switchable 5 KHz. LP filter for Canadian birds. Varactor tuning diodes included. Use two for MTV.

**Bare Board (M81-020B)** . . . . . \$24.95  
**Two Boards (M81-021B)** . . . . . \$39.95

**Canadian Audio Descrambler** — Takes the normal audio output from your receiver and decodes the 'chirping' sub-carriers heard on Anik A/B.

**Kit (R81-010K)** . . . . . \$59.95  
**Assembled & Tested (R81-010T)** . . \$94.95

**NEW! Canadian Audio Filter** — A very sharp low-pass filter designed to remove the 'chirping' from the Canadian audio.

**Kit (R82-020K)** . . . . . \$19.95  
**Assembled & Tested (R82-020T)** . . \$29.95

**Developed for high performance  
in weak signal areas:**

**Discrete 70 MHz PLL** — Replaces NE 564 video demodulator without the need for an ECL divider (70 MHz I.F.). Guaranteed tracking to 85 MHz. Wide bandwidth. Lower C/N, reduced 'tearing'. May be remotely tuned.

**Kit (M82-010K)** . . . . . \$124.95  
**Assembled & Tested (M82-010T)** . . \$159.95

All prices include complete and comprehensive documentation, U.S. postage & handling. For overseas postage & handling, add \$2.00.

P.O. Box 1656  
Kodiak, Alaska 99615  
(907) 486-5118  
(907) 486-6215



**DigiCom Engineering, Inc.**



**4511 RTTY Interface  
for TRS-80\* Color  
Computer Owners**

- Simply plug into Program Pak\* slot.
- No software to load, it is in ROM.
- Split screen features word wrap and continuously displays status.
- Selective calling stores incoming messages on cassette tape.
- Baudot and ASCII modes.
- Standard EIA signals to your T.U.
- Complete documentation supplied.

**4511 RTTY Interface**  
✓171 **\$169.95**

RIDGE  
SYSTEMS  
CO., INC.

Tested & assembled; 90 day warranty; we pay shipping. Mass. residents add 5% sales tax.

\*A trademark of Tandy Corp.  
P.O. Box 772, Acton, MA 01720 (617) 264-4251

**MFJ DUMMY  
LOADS**

**Tune up fast into 50  
ohm resistive load.  
Extend life of finals.**



Includes  
high quality  
transformer  
oil.

**\$34<sup>95</sup>**

**New MFJ-250 VERSALOAD** Kilowatt Dummy Load lets you tune up fast. Extends life of transmitter finals. Reduces on-the-air QRM.

Run 1 KW CW or 2 KW PEP for 10 minutes, 1/2 KW CW or 1 KW PEP for 20 minutes. Continuous duty with 200 watts CW or 400 watts PEP. Complete with derating curve.

Quality 50 ohm non-inductive resistor. Oil cooled. Includes high quality, industrial grade transformer oil (contains no PCB).

Low VSWR to 400 MHz: Under 1.2:1, 0-30 MHz. 1.5:1, 30-300 MHz. 2:1, 300-400 MHz.

Ideal for testing HF and VHF transmitters. SO-239 coax connector. Vented for safety. Removable vent cap. Has carrying handle. 7-1/2 in. high, 6-5/8 in. diameter.

**MFJ "Dry" 300 W and  
1 KW Dummy Loads.**

**\$64<sup>95</sup>** MFJ-262 **\$26<sup>95</sup>** MFJ-260

Air cooled, non-inductive 50 ohm resistor in perforated metal housing with SO-239 connectors. Full load for 30 seconds, derating curves to 5 minutes. MFJ-260 (300 W). SWR: 1.1:1 to 30 MHz, 1.5:1 for 30-160 MHz. 2 1/2 x 2 1/2 x 7 in. MFJ-262 (1 KW). SWR 1.5:1 for 30 MHz. 3 x 3 x 13 inches.

**MFJ HF SWR/Wattmeter**

**\$29<sup>95</sup>**  
MFJ-816



**New MFJ-816 low cost HF SWR/Wattmeter** for 1.8 to 30 MHz range. Torodial current pickup gives uniform sensitivity over entire HF frequency. Read SWR, forward and reflected power in 2 ranges (30 and 300 watts) on two color scale. SO-239 coax connectors. 4-1/2 x 2-3/8 x 2-7/8 in.

Order from MFJ and try it. If not delighted, return it within 30 days for refund (less shipping).

One year unconditional guarantee. Order today. Call TOLL FREE 800-647-1800. Charge VISA, MC. Or mail check, money order. Write for free catalog.

**CALL TOLL FREE ... 800-647-1800**

601-323-5869 in MS, outside continental USA.

**MFJ ENTERPRISES, INCORPORATED**  
Box 494, Mississippi State, MS 39762

**\*\*\*\*\* A STAR IS BORN \*\*\*\*\***

- ★ Ideal for Novices, SWL's and seasoned amateurs
- ★ Built-in code practice oscillator & speaker
- ★ 12 VDC Operation or 120 VAC with adapter provided
- ★ Optional serial/parallel ASCII output port



- ★ Copies Morse, Baudot & ASCII codes
- ★ Two optimized Morse ranges
- ★ Digital & Analog filtering with 16 db AGC
- ★ Automatic speed tracking 3 - 70 WPM

A code reader so advanced it costs you less! Call or write for brochure or order direct.  
CODE★STARTMKit . . . . . CS-K \$169.95  
CODE★STAR Wired . . . . . CSF \$229.95  
Optional ASCII Output Port Kit . . . . . CS-1K \$ 59.95  
Optional ASCII Output Port Kit Wired (Specify 110 or 300 Baud and 20mA or TTL level) . . . . . CSIF \$ 79.95  
Send check or money order. Use your VISA or MasterCard. Add \$5.00 shipping and handling for continental U.S. Wisconsin residents add 4% State Sales Tax.

*Microcraft*

Corporation Telephone: (414) 241-8144  
P. O. Box 513G, Thiensville, Wisconsin 53092

**SONY SHORTWAVE VALUES!**

**ICF-4800**  
**6-BAND POCKET WORLD RECEIVER**  
• 6-band pocket world receiver—SW 1-5, plus MW  
• Extremely compact and lightweight—palm sized!  
• SW band spread dial—easy tuning • Tuning indicator

**\$89<sup>95</sup>**  
plus \$3.00 shipping (Cont'l U.S.)

**31-BAND ICF-6800W PORTABLE WORLD RECEIVER**  
ONLY plus \$8.00 shipping (Cont'l USA)  
**\$699.95 LIST \$549<sup>95</sup>**

**ICF-2001 INSTANT ACCESS DIGITAL SHORTWAVE SCANNER**  
ONLY plus \$5.00 shipping (Cont'l USA)  
**\$349.95 LIST \$279<sup>95</sup>**

**5-BAND ICF-6500W PORTABLE SW RECEIVER**  
ONLY plus \$5.00 shipping (Cont'l U.S.)  
**\$199.95 LIST \$179<sup>95</sup>**

**SPECTRONICS, INC.**  
1009 GARFIELD ST. OAK PARK, IL. 60304

**(312) 848-6777**





send thousands of cards each year. I do not answer cards that don't have a specific request for my card; I assume the card is an answer to a card I sent. By the way, avoid those cute QSLs with the QSO information hidden on a drawing of a rig, etc. Anything that makes the QSO information hard to find or decipher will slow up your return card.

So much for the nuts and bolts of QSL card design. What about the overall look? What personal information will customize your QSL? A photograph of yourself at your operating position with QSLs and awards in the background says more about you than any amount of text. A

good photograph shows your equipment, station layout, your most prized awards, and (very important) adds a face to your call. My favorite QSLs to receive are definitely photographic QSLs, because they say so much about the operator without listing hundreds of awards no one has ever heard of.

The major drawback to a photographic QSL is the considerable initial expense. But if you can find a friend who will take a good black-and-white photograph, you can save a good part of the cost. There is usually at least one good photographer in every radio club.

What about listing your equipment and

antennas on the QSL? Every time I have done this, I have changed the gear as soon as the cards come back from the printer. If you trade your equipment regularly and try new antennas every season, you should leave the listing of gear off the card. If you are satisfied with your Collins gear and Big Bertha, by all means list the equipment; the DX station is always interested in knowing what produced that strong signal.

Once your card is designed, there remains the choice of how to print it. Some of the QSL printers will produce a custom card from your sketch, but expect to pay for their services. I prefer the quick-print approach, as I usually print many

thousands of cards at a time, and the quick-print shops will produce a card for less than a penny apiece. I provide camera-ready copy and the printer prints four cards on each sheet of paper and cuts them into QSL-sized cards. (Postal Service requirements insist on a certain minimum size for postcards; check this before you have the cards trimmed. Also make sure your card will fit into a standard small envelope without folding.)

Whatever format or type of QSL card you select, you still have to fill it out properly, get it to the correct individual, and get his card back. We'll discuss these other steps on QSLing in future months.

# AWARDS

## GLADESPEDITION

The Fort Myers Amateur Radio Club will be conducting a "Gladespedition" to Glades County, Florida. Operations will begin on November 13, 1982. W4LX will be operating in the General bands, both CW and SSB. Some Novice contacts will also be made. If you need Glades County, be sure to look for them. QSL to: David Fox KA8CXQ, PO Box 051131, Tice FL 33905. SASE please.

## 45th PARALLEL

The Tri-County Wireless group will mini-DX from Gaylord, Michigan, on the 45th parallel (halfway between the equator and the north pole) from 1400Z November 13 through 0600 November 14. Phone only at 3.925, 7.250, 14.300, 21.375, and 28.550. Certificate for QSL and SASE to N8COY.

## ABC-TV

The ABC-TV Washington Engineering Group, celebrating the first year of operation from the network's new Washington news bureau, will be on the air Saturday, November 13, from 1400Z to 2200Z, on SSB frequencies (plus or minus 5 kHz): 7.245 and 14.285 and on CW for Novice and Technician contacts on 7.125 (listening at 45 minutes past each hour). KB7ZZ/3 will also be on 145.190 FM (W3DOS/R) throughout the operation period. Special events QSLs via business-size SASE to: Steve Malis KA4ORL, 2520 Heathcliff Lane, Reston VA 20091.

## JERSEY DEVIL STATION

The West Jersey Radio Amateurs (WJRA) will mount a second operation from the South Jersey Pine Barrens, the haunt of the feared Jersey Devil. Beginning and ending at midnight, the courageous WJRA group will attempt again this year to operate the entire 24 hours of Halloween, October 31st. A unique, handsome certificate engraved with a countenance of the Jersey Devil will be sent to all stations worked who send an SASE to WJRA, PO Box 62, Burlington NJ 08016. Frequencies to be used are 15 kHz from the bottom of each General phone band, 80 through 2 meters, and 146.55 FM. Novice operation will also be 15 kHz up.

The Jersey Devil was born in 1735, a 13th child, in the Pine Barrens of Burlington County at a place called Leeds Point. Not long after its birth, on a foggy and dreary night so usual in the Pine Barrens, the child assumed a serpent-like body,

cloven hoofs, the head of a horse, wings of a bat, and the forked tail of a dragon. With loud raucous cries, it flew up the chimney and into the heart of the Pine-lands. Appearances and sightings occur even today. On Halloween, the WJRA will maintain a radio vigil, trying once again to capture a glimpse of the Devil. Will they see him? Give them a call—W2JUG—and get a first-hand report.

## 73 MAGAZINE AWARDS PROGRAM WORK THE WORLD

97 WD6DFN	126 WB7UCU
98 KN4F	127 KA3FUU
99 WA2WRD	128 WD4JEQ
100 N8BDI	129 W7GLU
101 WB9NOV	130 VK2PY
102 KA3DBN	131 VK3DXY
103 K9GHP	132 KB2WH
104 W0YBV	133 I1WXY
105 KA7GIN	134 K3WUR
106 W8HTM	135 KA1RC
107 N6ATS	136 PY2CAR
108 KC5TK	137 I1EEW
109 K3STM	138 K0LST
110 9G1RT	139 HI3LRB
111 WA2LYF	140 ZL1SZ
112 ZS6ABA	141 ZS6XS
113 VK2HD	142 ZS6XK
114 VE3LVN	143 PY2FK
115 VE1ACK	144 JF1CPH
116 PY2BTR	145 W1SIX
117 VE3JPJ	146 PA0TP
118 HC2RG	147 JJ1KTI
119 WA9IVU	148 W3BHM
120 VK2NHV	149 JA5MG
121 KH6KU	150 JF1SEK
122 N5CSW	151 KA0MMD
123 WN5MBS	152 8P6OV
124 AK1H	153 KC8AU
125 VK3BMA	

## NORTH AMERICAN AWARD

213 N5CSW	230 VE7DRI
214 KH6KU	231 I1EEW
215 K9RNR	232 W3BHM
216 VE1YX	233 PY2CAR
217 WN5MBS	234 KA2IAL
218 VK3BMA	235 KA1RC
219 WB7UCU	236 KA0MMD
220 4Z4VG	237 WD5IBM
221 PY1BVY	238 WB2VTD
222 OE1-111080	239 N4CXX
223 W7GLU	240 N7CZH
224 I1WXY	241 N5AUB
225 VK3DXY	242 KA2JJK
226 4W-16260	243 HI3AMF
227 VK2PY	244 PY2FK
228 OE2ABM	245 K2YOF
229 K0LST	246 PY2RHL

247 K9LJP	258 JF1CPH
248 HI3LRB	259 JJ1KTI
249 W9CC	260 VE6CNV
250 ZL1SZ	261 I5HOR
251 KA9CEJ	262 PY2RAN
252 ZS6XS	263 KA5FLE
253 ZS6XK	264 PY1DWM
254 PA0TP	265 JF1SEK
255 PA0IEM	266 JA5MG
256 W9CC	267 KC8AU
257 PY1EWN	268 N6GBM

## SOUTH AMERICAN AWARD

186 N5CSW	211 PY2FK
187 KH6KU	212 K9LJP
188 K9RNR	213 HI3LRB
189 WN5MBS	214 WD0AQC
190 DA1AS	215 ZL1SZ
191 VK3BMA	216 KA9CEJ
192 WB7UCU	217 ZS6XS
193 4Z4VG	218 ZS6XK
194 PY1BVY	221 W9CC
195 WA9AHZ	222 KA0MMD
196 W7GLU	223 JF1CPH
197 W8UMP	224 W1SIX
198 VK2PY	225 PY2IEM
199 VK3DXY	226 PA0TP
200 I1WXY	227 JJ1KTI
201 N5AUB	228 ZL2LQ
202 N7CZH	229 KA2JJK
203 N4CXX	230 8P6OV
204 A11Y	231 JF1SEK
205 KA1RC	232 JA5MG
206 PY2CAR	233 KC8AU
207 W3BHM	234 N5ACU
208 I1EEW	235 VE6CNV
209 K0LST	236 N6GBM
210 HI3AMF	

## ASIAN AWARD

142 N5CSW	163 PY2FK
143 KH6KU	164 N4AKO
144 W7GLU	165 HI3LRB
145 WD4JEQ	166 ZL1SZ
146 WB7UCU	167 ZS6XS
147 VK3BMA	168 ZS6XK
148 DA1AS	169 PA0TP
149 AK1H	170 JF1CPH
150 W1SIX	171 JR7ICN
151 WN5MBS	172 PY2IEM
152 I1WXY	173 JJ1KTI
153 KB2WH	174 JA5PWW
154 8P6OV	175 OZ5EDR
155 VK3DXY	176 W3BHM
156 HZ-16260	177 JH3OHO
157 4W-16260	178 HI3AMF
158 VK2PY	179 JA3UCO
159 PY2CAR	180 KA0MMD
160 KA1RC	181 JF1SEK
161 I1EEW	182 JA5MG
162 K0LST	183 KC8AU

## AFRICAN AWARD

160 N5CSW	168 W7GLU
161 KH6KU	169 JA5PWW
162 K9RNR	170 VK2PY
163 WN5MBS	171 HZ-16260
164 DA1AS	172 4W-16260
165 VK3MBA	173 VK3DXY
166 WB7UCU	174 I1WXY
167 4Z4VG	175 K0LST

176 I1EEW	192 WA1UDH
177 W3BHM	193 KA2JJK
178 AL7O	194 JR3LVI
179 PY2CAR	195 JF1CPH
180 PY1DWM	196 KA0MMD
181 N4CXX	197 PA0TP
182 TU2HJ	198 JJ1KTI
183 KA1RC	199 PY1BVY
184 JH7OFH	200 HI3AMF
185 PY2FK	201 PY2RAN
186 HI3LRB	202 JH3OHO
187 ZL1SZ	203 JF1SEK
188 W8UMP	204 JA5MG
189 ZS6XS	205 KC8AU
190 ZS6XK	206 N5AUB
191 PY2IEM	207 4X4OQ

## EUROPEAN AWARD

251 WD8MAI	282 N7CZH
252 W7GLU	283 N5AUB
253 OE3SWL-DWZ	284 TU2HJ
254 OE1-111080	285 HI3AMF
255 DF5VO	286 PY2FK
256 WB7UCU	287 KA5BQM
257 VK3BMA	288 K2YOF
258 WN5BMS	289 JA9AXS/1
259 VE1YX	290 PY2SZK
260 K9RNR	291 K9LJP
261 KH6KU	292 HI3LRB
262 N5CSW	293 WD0AQC
263 KH6F	294 ZS1SZ
264 I1WXY	295 ZL2LQ
265 VK3DXY	296 KA9CEJ
266 KA7CPZ	297 ZS6XS
267 HZ-16260	298 ZS6XK
268 4W-16260	299 PA0TP
269 VK2PY	300 PY2IEM
270 OE2ABM	301 WA2FYW
271 K0LST	302 JR7ICN
272 VE7DRI	303 JF1CPH
(14 MHz)	304 WP4ATF
273 VE7DRI	305 JJ1KTI
(21 MHz)	306 VE6CNV
274 I1EEW	307 JA5PWW
275 W3BHM	308 JH3OHO
276 PY2CAR	309 JY9CW
277 KA2IAL	310 JF1SEK
278 KA1RC	311 JA5MG
279 KA0MMD	312 N6GBM
280 WB2VTD	313 KC8AU
281 N4CXX	

## OCEANIA AWARD

145 N5CSW	163 PY2CAR
146 KH6KU	164 I1EEW
147 WN5MBS	165 K0LST
148 JA9AXS/1	166 JG1QLT
149 VK3MBA	167 PY2FK
150 WB7UCU	168 OZ-DR-1239
151 KA3FUU	169 N4AKO
152 W7GLU	170 HI3LRB
153 K3WUR	171 ZL1SZ
154 VK2PY	172 ZS6XS
155 VK3DXY	173 ZS6XK
156 KB2WH	174 JF1CPH
157 I1WXY	175 JR3LVI
158 N7CZH	176 JR7ICN
159 N4CXX	177 PA0TP
160 W1SIX	178 JA5PWW
161 K3WUR	179 JJ1KTI
162 KA1RC	180 W3BHM



## DIRECTION FINDING?

- ★ Doppler Direction Finding
- ★ No Receiver Mods
- ★ Mobile or Fixed
- ★ Kits or Assembled Units
- ★ 135-165 MHz Standard Range



- ★ Circular LED Display
- ★ Optional Digital Display
- ★ Optional Serial Interface
- ★ 12 VDC Operation
- ★ 90 Day Warranty

**New Technology** (patent pending) converts any VHF FM receiver into an advanced Doppler Direction Finder. Simply Plug into receiver's antenna and external speaker jacks. Use any four omnidirectional antennas. Low noise, high sensitivity for weak signal detection. Kits from \$270. Assembled units and antennas also available. Call or write for full details and prices.

**DOPPLER SYSTEMS,** 5540 E. Charter Oak, (602) 998-1151  
Scottsdale, AZ 85254

DAIWA COMMUNICATIONS ESSENTIALS

## SWR & Pwr Meters



### Model CN-630

Frequency Range: 140-450 MHz  
SWR Detection Sensitivity: 5 Watts min.  
Power: 2 Ranges (Forward, 20/200 Watts)  
(Reflected, 4/40 Watts)  
Dimensions: 180 x 85 x 120 mm;  
7.12 x 3.37 x 4.75 in.

### Model CN-620B (New 2 Kw Scale)

Frequency Range: 1.8-150 MHz  
SWR Detection Sensitivity: 5 Watts min.  
Power: 3 Ranges (Forward, 20/200/2000 Watts)  
(Reflected, 4/40/400 Watts)  
Dimensions: 165 x 75 x 97 mm; 6.5 x 3 x 4 in.

### Model CN-720B (New 2 Kw Scale)

Frequency Range: 1.8-150 MHz  
SWR Detection Sensitivity: 5 Watts min.  
Power: 3 Ranges (Forward, 20/200/2000 Watts)  
(Reflected, 4/40/400 Watts)  
Dimensions: 180 x 120 x 130 mm; 7 x 4.75 x 5 in.

Write for complete specifications.



**J.W. Miller Division**  
**BELL INDUSTRIES**

19070 Reyes Ave. ■ P.O. Box 5825  
Compton, California 90224

(213) 537-5200 ■ TWX 910-346-6740

## Radio World

CENTRAL NEW YORK'S MOST COMPLETE HAM DEALER



Featuring Kenwood, Yaesu, Icom, Drake, Ten-Tec, Swan, Dentron, Alpha, Robot, MFJ, Tempo, Astron, KLM, Hy Grain, Mosley, Larsen, Cushcraft, Hustler, Mini Products, Bird, Mirage, Vibroplex, Bencher, Info-Tech, Universal Towers, Callbook, ARRL, Astatic, Shure, Collins, AEA. We service everything we sell!

Write or call for quote. **You Won't Be Disappointed.**

We are just a few minutes off the NYS Thruway (I-90) Exit 32

OUT OF STATE  
ORDER TOLL FREE  
800-448-9338

ONEIDA COUNTY AIRPORT TERMINAL BUILDING  
ORISKANY, NEW YORK 13424

N Y Res Call (315) 736-0184

Warren - K2IXN  
Bob - WA2MSH  
Al - WA2MSI



## SPECTRUM INTERNATIONAL INC.

### THE MORSE TALKER

THE PRODUCT THAT SPEAKS FOR ITSELF!!



### FEATURES

- ★ Complete self-contained Speaking Morse Tutor
- ★ Latest state of the art microprocessor speed synthesis system
- ★ Suitable for beginners and proficient operators alike
- ★ A "must" for novice classes
- ★ Wide speed range: 2-20 wpm
- ★ High speed option: 12-48 wpm
- ★ Variable group length and single character facility

PRICE MMS 1 \$225 Shipping \$5.50  
MMS 2 \$295

**Spectrum International**

**Inc. P.O. Box 1084 S, Concord, Mass. 01742 USA**



**OCEANIA (Cont.)**

181 VE6CNV	186 JA5MG
182 JH3OHO	187 KC8AU
183 JA3UCO	188 N5AUB
184 KA0MMD	189 N6GBM
185 JF1SEK	

**73 DX COUNTRY CLUB AWARD (SSB)**

75 WD6DFN	96 NR4S
76 8P6OV	97 VK3BMA
77 KN4F	98 WD4JEQ
(1979)	99 KC4YY
78 KN4F	100 N5CSW
(1980)	101 4W-16260
79 WA9IVU	102 VK2PY
80 W7HAZ	103 N2CFN
81 K9IML	104 W1SIX
82 AG7P	105 N4CXX
83 KA1UA	106 ZS6XS
84 N6ATS	107 VE3JPJ
85 KE7C	108 I2ODZ
86 KA3FUU	109 I5HOR
87 VK2HD	110 KA1RR
(1979)	111 WB3HTK
88 VK2HD	112 KI2G
(1980)	113 DE0DXM
89 VK2HD	(1979)
(1981)	114 DE0DXM
90 9G1RT	(1980)
91 SV1GJ	115 DE0DXM
92 WA8KMK	(1981)
93 VK2NHV	116 KA6D
94 CT2CQ	117 DJ9ZB
95 HC2RG	

**73 DX COUNTRY CLUB (CW) AWARD**

13 VE1ACK	18 4X4FU
14 KC3W	19 PY2FK
15 K0LST	20 PY2BTR
16 OE2ABM	21 DF5UT
17 K6FO	

**73 DX COUNTRY CLUB (MIXED) AWARD**

22 WB5LBR	24 NL7J
23 WD6EEQ	25 KA0MMD

**DX CAPITALS OF THE WORLD AWARD**

18 N6ATS	24 VK2PY
19 VK2HD	25 WB3BVL
20 ZS6ABA	26 WB2TOJ
21 SV1GJ	27 PY2FK
22 VE1ACK	28 VE6CNV
23 4Z4VG	

**10-METER DX DECADE AWARD**

1 WB4WRE/M	7 WD5JRG
2 AC3Q	8 WA4ZLZ
3 W5TJQ	9 WB8LSV
4 WD0AVG	10 WB9WFZ
5 DA2AL	11 W8AKS/6
6 WB4TZA	12 KA3FUU

**SPECIALTY COMMUNICATIONS AWARD CLASS A: WORKED ALL STATES**

1 WA6VGS
2 KE7C

**SPECIALTY COMMUNICATIONS AWARD CLASS A-1: DX COUNTRIES**

9 K3WUR	16 N5CSW
(RTTY)	(RTTY)
10 WB2VTD	17 HB9MQM
(RTTY)	(OSCAR 7/8)
11 PY3CJS	18 OE4HQ
(RTTY)	(RTTY)
12 KE7C	19 VE2QO
(RTTY)	(RTTY)
13 AL7O	20 VE2QO
(RTTY)	(OSCAR 7/8)
14 PY1EWN	21 ON4CM
(RTTY)	(RTTY)
15 OE1PBA	(RTTY)

**Q-5 AWARD OF EXCELLENCE**

61 N7CPE	67 KA5KKZ
62 N8BDI	68 KA9ENM
63 KA7EI	69 PY2UGS
64 W8UPD	70 KA3FUR
65 KA2IDJ	71 KA6JQB
66 WB9KUV	72 KA7CPZ

73 KA1DJB	92 KB8WJ
74 KA3GSN	93 KA0JTT
75 WB9HPR	94 KA5KOS
76 W4PCK	95 VK2VVA
77 KA4LSJ	96 KA4WBR
(28 MHz)	97 KA8MVV
78 KA4LSJ	98 KA1HJK
(21 MHz)	99 KA9JJK
79 KA3FUU	100 KA2IAL
80 N1BDB	101 WL7AHD
81 KP4FCK	102 PY2SZK
82 KA2MIM	103 KA0MMD
83 W1DWA	104 KA1HFN
84 KA2JMJ	105 KA9CEG
85 KA7JNP	106 KA9CEJ
86 WA2AKX	107 KA9LYH
87 KP4ERH	108 N8CYS
88 KA8CUS	109 WB9UIA
89 KA4VNS	110 NS4J
90 N8CJF	111 VE6CNV
91 WD0EPV	112 KA2LHO

**CENTURY CITIES AWARD**

23 KC9CA	31 8P6OV
24 N8CJF	32 KA0MMD
25 KE7C	33 WA6NIE
26 AK0G	34 VE3JPJ
27 WB7VBQ	35 KA9BJX
28 KA8MVV	36 KA1HJK
29 KA3FUU	37 NP4DZ
30 OE8MOK	38 VE6CNV

**DISTRICT ENDURANCE AWARD**

8 XE1TIS	12 SV1GJ
(49 min.)	(42 min.)
9 K0WNY	13 OK2QX
(52 min.)	(56 min.)
10 KE7C	14 KA0MMD
(14 min.)	(39 min.)
11 KA3FUU	(50 min.)

**WORKED ALL USA AWARD (80 METERS)**

7 WA0RVK	9 W4PCK
8 N4QH	10 WB2ZEL

**WORKED ALL USA AWARD (40 METERS)**

4 WD0BOS	6 N4QH
5 N5AHZ	7 KA1DNB

**WORKED ALL USA AWARD (20 METERS)**

11 KA9JOL	14 WA0CEL
12 KE7C	15 KA4OOU
13 KC4YY	16 KA9LYH

**WORKED ALL USA AWARD (15 METERS)**

5 KA4IFF	7 N4QH
6 WB9UKS	8 WB7VQB

**WORKED ALL USA AWARD (10 METERS)**

5 VK7NBT	7 N4QH
6 VE1BWP	8 N5CSW

**WORKED ALL USA AWARD (6 METERS)**

8 N5DDB	10 K4GOK
9 N9CEX	11 W4CKD

**WORKED ALL USA AWARD (MIXED BAND)**

54 N7CPE	68 KA0JTT
55 KA3GSN	69 KA2MIM
56 KA3FUU	70 KA8MVV
57 KA4VNS	71 N3CHN
58 AG7P	72 N3AKQ
59 N8CJF	73 KA1HJK
60 KA5EEZ	74 KA0MMD
61 KA7JNP	75 WB9UIA
62 WA9IVU	(1980)
63 8P6OV	76 WB9UIA
64 KA7CPZ	(1981)
65 AK0G	77 WB9UIA
66 VE3JPJ	(1982)
67 HC2RG	78 VE6CNV

# SATELLITES

Net Name	Day	Time	Freq. (MHz)
East Coast	Wed	2100 Eastern	3.850
Mid-America	Wed	2100 Central	3.850
West Coast	Wed	2000 Pacific	3.850
New York City	Wed	2200 Eastern	144.400
Goddard Center	Wed	2100 Eastern	146.835
Los Angeles	Wed	2000 Pacific	145.805
UK	Sun	1000 UTC	3.780
International	Sun	1800 UTC	21.280
International	Sun	1900 UTC	14.282
European	Sat	1000 UTC	14.280
Espanol	Sun	1900 UTC	14.180
Asia/Pacific	Sun	1100 UTC	14.305
South Pacific	Sat	2200 UTC	28.878
South Africa	Sun	0900 UTC	14.280
SEASAT	Sun	1300 UTC	7.280
Australian	Sun	1000 UTC	3.680
New Zealand	Wed	0800 UTC	3.850

Table 1. AMSAT nets provide up-to-the-minute news about amateur satellite developments.

**AMSAT NETS**

Keeping up with the latest developments in the amateur space program is as easy as tuning your ham rig to one of the AMSAT nets. During these sessions, you'll hear information ranging from the latest Phase III news to tips on when and where to work the rare satellite DX. Technical discussions abound, and you can usually pick up the latest tracking data. Table 1 is a list of these informative gatherings.

**PHASE IIIB PROGRESS**

Summer was a time of further testing and refinement for the Phase IIIB satellite, now tentatively scheduled for January, 1983,

**Amateur Satellite Reference Orbits**

Date	OSCAR 8		RS-5		RS-6		RS-7		RS-8		Date	
----	UTC	EQX	UTC	EQX	UTC	EQX	UTC	EQX	UTC	EQX	----	
Nov	1	0013	79	0008	296	0157	326	0101	311	0133	317	1
	2	0017	80	0002	296	0141	324	0051	310	0131	318	2
	3	0022	81	0157	326	0126	322	0042	309	0128	319	3
	4	0026	82	0151	327	0110	319	0032	308	0125	320	4
	5	0030	84	0146	327	0055	317	0022	307	0122	320	5
	6	0035	85	0141	327	0040	315	0013	306	0119	321	6
	7	0039	86	0135	327	0024	312	0003	305	0116	322	7
	8	0043	87	0130	327	0009	310	0153	334	0114	323	8
	9	0048	88	0125	327	0152	337	0143	333	0111	324	9
	10	0052	89	0119	328	0137	335	0133	332	0108	324	10
	11	0057	91	0114	328	0121	333	0124	332	0105	325	11
	12	0101	92	0109	328	0106	330	0114	331	0102	326	12
	13	0105	93	0103	328	0050	328	0104	330	0059	327	13
	14	0110	94	0058	328	0035	326	0055	329	0057	328	14
	15	0114	95	0053	329	0020	323	0045	328	0054	329	15
	16	0119	96	0047	329	0004	321	0035	327	0051	329	16
	17	0123	98	0042	329	0148	349	0026	326	0048	330	17
	18	0127	99	0037	329	0132	346	0016	325	0045	331	18
	19	0132	100	0031	329	0117	344	0006	324	0043	332	19
	20	0136	101	0026	329	0101	342	0156	354	0040	333	20
	21	0141	102	0020	330	0046	339	0146	353	0037	333	21
	22	0002	78	0015	330	0031	337	0137	352	0034	334	22
	23	0006	79	0010	330	0015	335	0127	351	0031	335	23
	24	0011	80	0004	330	0000	332	0117	350	0028	336	24
	25	0015	81	0159	0	0143	360	0108	349	0026	337	25
	26	0019	82	0153	1	0128	357	0058	348	0023	338	26
	27	0024	83	0148	1	0112	355	0048	347	0020	338	27
	28	0028	84	0143	1	0057	353	0039	346	0017	339	28
	29	0033	86	0137	1	0041	350	0029	346	0014	340	29
	30	0037	87	0132	1	0026	348	0020	345	0011	341	30
Dec	1	0041	88	0127	2	0011	346	0010	344	0009	342	1
	2	0046	89	0121	2	0154	13	0000	343	0006	342	2
	3	0050	90	0116	2	0139	11	0150	12	0003	343	3
	4	0055	91	0111	2	0123	9	0140	11	0000	344	4
	5	0059	93	0105	2	0108	6	0130	10	0157	15	5
	6	0103	94	0100	2	0052	4	0121	9	0154	16	6
	7	0108	95	0055	3	0037	2	0111	8	0151	17	7
	8	0112	96	0049	3	0022	359	0102	7	0149	17	8
	9	0117	97	0044	3	0006	357	0052	7	0146	18	9
	10	0121	98	0038	3	0149	24	0042	6	0143	19	10
	11	0125	100	0033	3	0134	22	0033	5	0140	20	11
	12	0130	101	0028	4	0119	20	0023	4	0137	21	12
	13	0134	102	0022	4	0103	17	0013	3	0134	21	13
	14	0139	103	0017	4	0048	15	0004	2	0132	22	14
	15	0000	78	0012	4	0032	13	0153	31	0129	23	15



launch. According to the *AMSAT Satellite Report*, malfunctions which occurred in both communications transponders during a midsummer thermal/vacuum test were quickly corrected by the AMSAT DL crew in Germany.

If all goes as planned, Phase IIIB will fly aboard the seventh launch (L7) of the European Space Agency (ESA) Ariane missile. The January launch date depends to a large extent on the success-

ful launches of L5 and L6. The former was scheduled for early September and the latter for late November.

ESA's Ariane is now a head-on competitor with the Space Shuttle as a commercial satellite launcher. By means of low prices, advertisements in satellite industry magazines, and other marketing tools, ESA has built a backlog of more than 20 spacecraft awaiting a boost into orbit.

## NEW — REVOLUTIONARY MULTI—MODE & CRYPTO—DECODER NOW FOR THE FIRST TIME—PRINT THOSE UNPRINTABLE SIGNALS

- BIT INVERSION • TOR—SITOR • NON STANDARD SHIFT • WEATHER FORMAT
- PLUS ALL SPEEDS AND SHIFTS OF BAUDOT, ASCII, AND CW—AMTOR WHEN APPROVED.



### FEATURES:

ASCII	110, 150, 300, 600, and 1200 BAUD rates.
BAUDOT	60, 66, 75, 100, and 132 WPM
MORSE	CW—AUTO—RANGE Up to 60 WPM
TOR—SITOR	Both ARQ and FEC modes with full receive only function on these codes. AMTOR when approved.
BIT INVERSION	5 level security BIT inversion for BAUDOT decoding from key pad. Decodes any combination of BIT inversion being used for security.
3 SEL CALLS	Factory programmed - for amateur or RTTY listening Displays actual SEL CALL on screen.
2 VIDEO FONTS	Weather box and standard ASCII font

SPEED READOUT	ASCII & BAUDOT - Automatic search gives speed of transmission.
VIDEO OUTPUTS	Composite video 1.5. V P - P negative sync, four formats.
PRINTER DRIVER	Isolated Loop MIL -188 or RS -232 and optional parallel ASCII. All with handshaking available.
LOOP SUPPLY	60 MA/20/ MA auto adjusting loop supply available as option.
OTHER FEATURES	Front panel indicators, rear panel jacks, status line, multiple scroll inhibit, and un-shift on space.

M 600 \$799.95 SHIPPING \$4.00

UNIVERSAL ELECTRONICS INC. DEPT. G-10

1280 AIDA DR., REYNOLDSBURG, OHIO 43068 614-866-4267

## ANTENNAS FOR HF, VHF, UHF

### Two Meter

**"The Big John"\*** 13 Element Quad 22' Boom 16.5dBd gain F/B 30 dB Mast Size Up to 2" Bandwidth 144-145 MHz \$89.95

**"The Little John"\*\*\*** 11 Element Quad 18' Boom 15.5 dBd gain F/B 30db Mast Size 2" Bandwidth 144-145 MHz \$69.95

**"PTG Special"\*\*\*** 9 Element Quad 13' Boom 14.8 DBd F/B 30 dB Bandwidth 144-146 MHz \$69.95

Featuring The Wondermatch Driven Element

### Six Meter

**"6-PTG-4"** 4 Element Yagi 13' Boom 12 dBi Mast Size 2" Longest Element 115" 50-51 MHz \$79.95

You've Heard About Us On The Air, So Call Collect Between 8AM-10PM Or Write For Details

\* Measured at JWL Laboratories

\*\* First Place Winner at Baton Rouge Gain Measuring Contest (7/31/82).

\*\*\* Second Place Winner at Baton Rouge Gain Measuring Contest (7/31/82).

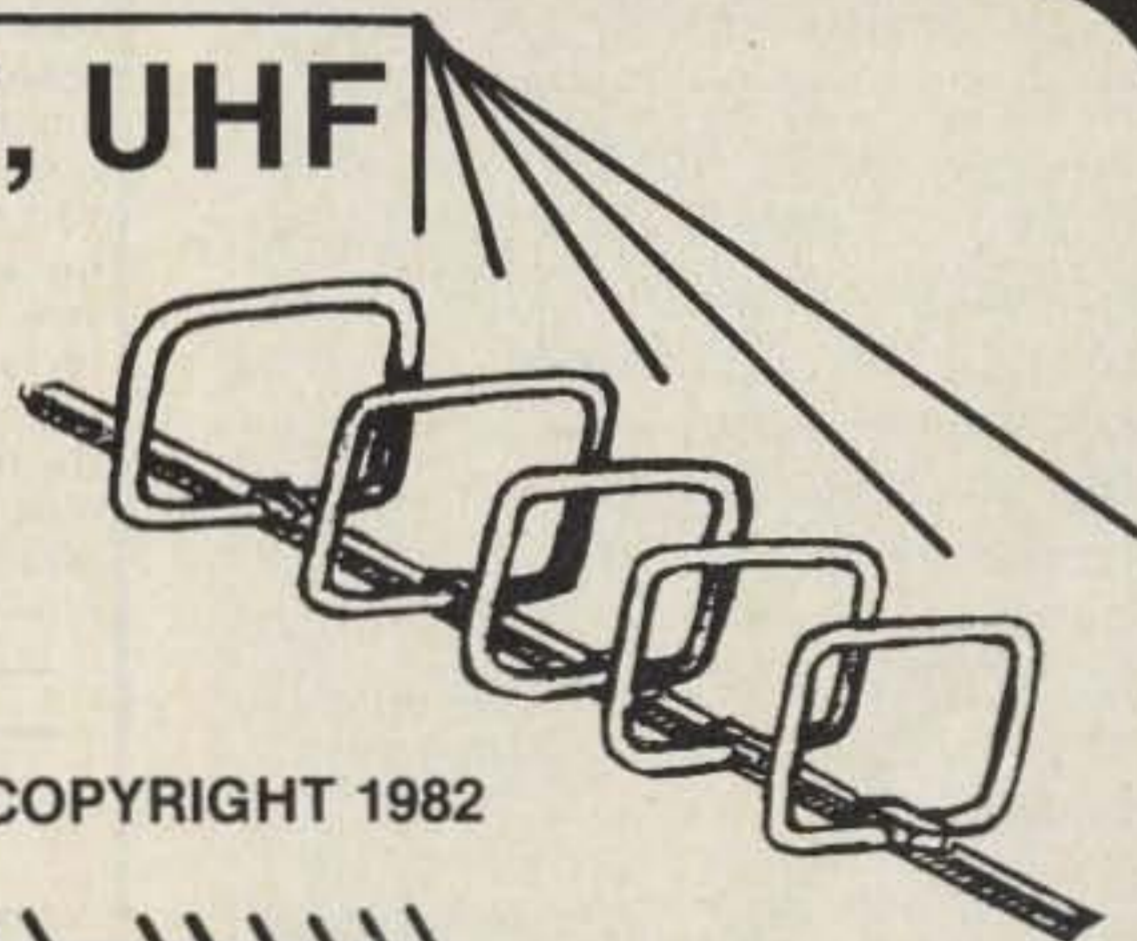

COPYRIGHT 1982

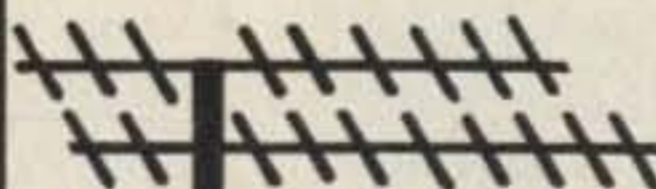

(713) 464-7720 Dick-WB5JWL  
Gordy-KD5NQ

**JWL ELECTRONICS**  
9138 Western Drive  
Houston, TX 77080



# FLEXI- BILITY



AEA once again breaks new ground in the code communications field with the new model MBA-RC reader/code converter. The MBA-RC decodes Morse, Baudot or ASCII signals off the air and displays them on a large 32 character alphanumeric vacuum fluorescent display. In addition, it will output Morse code for keying your transmitter. It will also generate RTTY (Baudot or ASCII AFSK two tone output. (170 or 850 Hz shifts.) Any of the acceptable input codes can be converted to any of the specified output codes (any speed to any speed). If you have any of the common Baudot RTTY terminals as an example, you can now send and receive Morse and ASCII with your keyboard and printer. You can even generate ASCII or BAUDOT RTTY using your Morse hand key or memory keyer.

Get the details. Write for our free product catalogue or better yet, see your favorite dealer.

Prices and Specifications subject to change without notice or obligation.  
Software ©copyright by AEA.

**ADVANCED ELECTRONIC  
APPLICATIONS, INC.**

P.O. Box C-2160,  
Lynnwood, WA 98036  
(206) 775-7373

Telex: 152571 AEA INTL

**AEA** Brings you the  
Breakthrough!

## 1983 CALLBOOKS

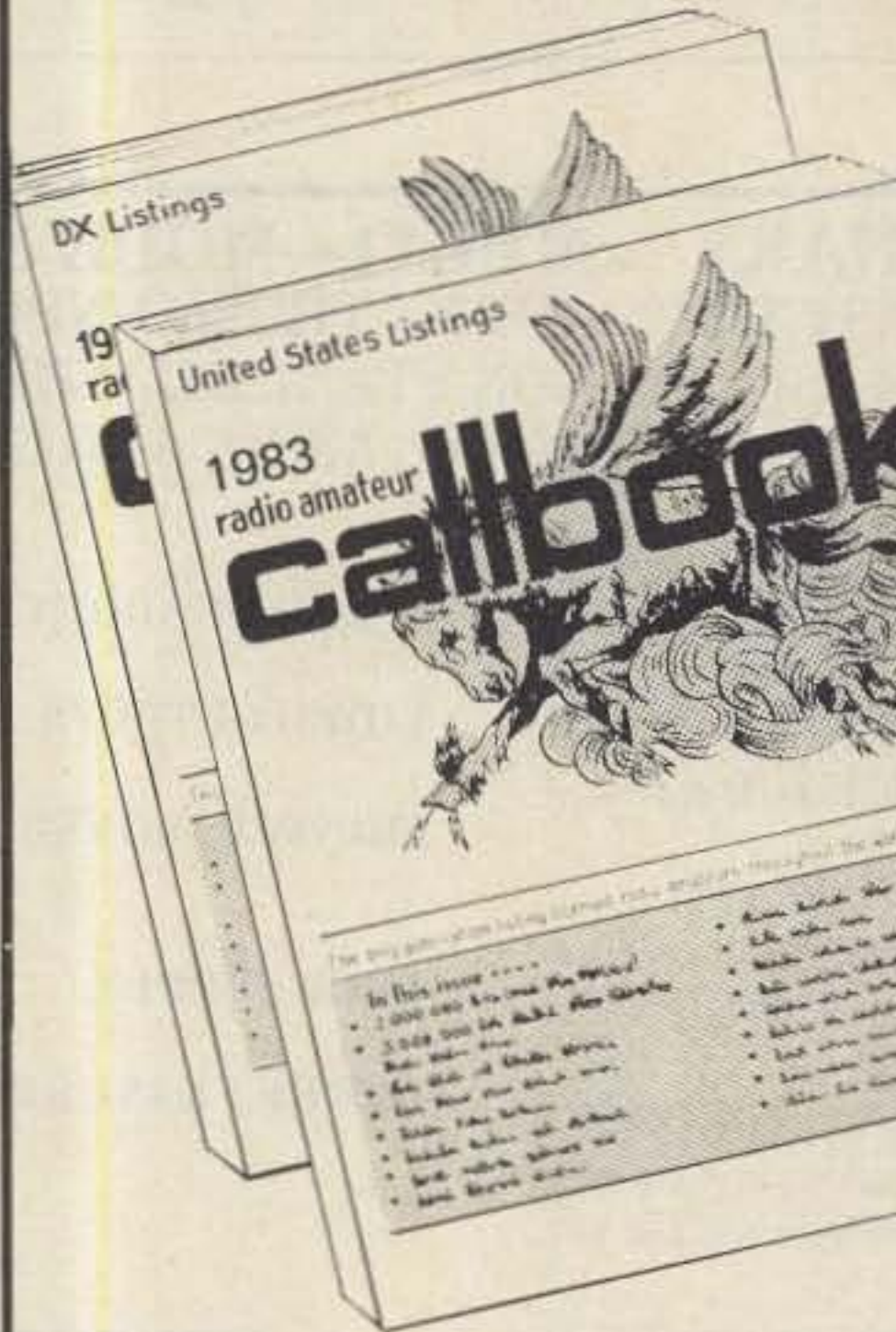

**Order today!  
NEW 1983  
RADIO AMATEUR CALLBOOKS  
READY DECEMBER 1ST!**

The latest editions of the world-famous Radio Amateur Callbook will be available soon. The U.S. edition features over 400,000 listings, with over 75,000 changes from last year. The Foreign edition has over 370,000 listings, over 50,000 changes. Each book lists calls and the address information you need to send QSL's. Special features include call changes, census of amateur licenses, world-wide QSL bureaus, prefixes of the world, international postal rates, and much more. The new 1983 Callbooks will be published December 1, 1982. Order your copies now.

	Each	Shipping	Total
<input type="checkbox"/> US Callbook	\$19.95	\$3.05	\$23.00
<input type="checkbox"/> Foreign Callbook	\$18.95	\$3.05	\$22.00

Order both books at the same time for \$41.95 including shipping.

Order from your dealer or directly from the publisher. All direct orders add shipping charge. Foreign residents add \$4.55 for shipping. Illinois residents add 5% sales tax.



**SPECIAL OFFER!**

Amateur Radio  
Emblem Patch  
only \$2.50 postpaid

Pegasus on blue field, red lettering. 3" wide x 3" high. Great on Jackets and caps.

RADIO AMATEUR  
**callbook** INC.



Dept. B  
925 Sherwood Drive  
Lake Bluff, IL 60044, USA

Announcing

## NEW AUTOPATCH

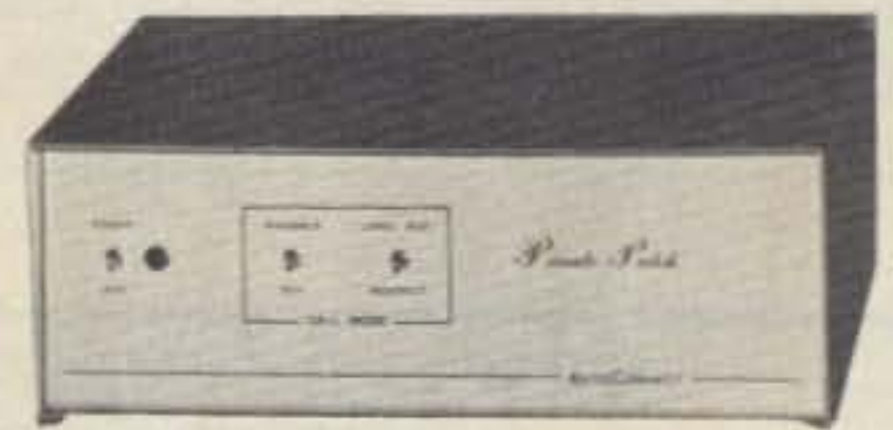

### PRIVATE PATCH

Introducing **Private Patch**. A giant step forward in non-sampling Autopatch/Interconnect technology, capability and standard features. Our revolutionary new techniques of audio and digital signal processing offer several advantages over conventional sampling/scanning type Autopatches: 1. The annoyance of continuous squelch tails is *totally* eliminated. Makes conversation much more natural and enjoyable. 2. In addition to superb simplex capability, operation through repeaters is made possible. 3. The only connections made to your base transceiver are to microphone and speaker jacks. **NO INTERNAL CONNECTIONS OR MODIFICATIONS NECESSARY!** Use **Private Patch** simplex for local operation, through a repeater for extended range. CW ID makes your Autopatch legal, and alerts you to incoming calls when ringback is turned on. Channel monitor logic precludes ringback transmission if channel is in prior use. Eliminates accidental interference. Five digit owner programmable access code and operator/long distance inhibit switch assure security and protect your phone bill. Positive control is assured by **Private Patch** logic functions. A fully digital timing approach eliminates all Timing adjustments. Three/six minute timer shuts down **Private Patch** if you drive out of range. Resettable with reset code for additional talk time as required. Self contained AC supply. Modular phone jack and modular phone cord provided. All electronics contained on one high quality glass circuit card. **Private Patch** contains 42 integrated circuits and 16 transistors. Send for additional information. Compare our features. (State callsign when ordering.)

**Special Factory Direct  
Introductory Price**

**1 YEAR WARRANTY**



**\$489**



Postage Paid

**PHONE: (213) 540-1053**

**AUTOCONNECT**

P.O. BOX 4155  
TORRANCE, CA 90510

DEALERSHIPS INVITED



# RADIO BOOKSHOP

## FOR THE NOVICE

New, updated editions  
of our famous novice  
license study guide and novice study tapes.

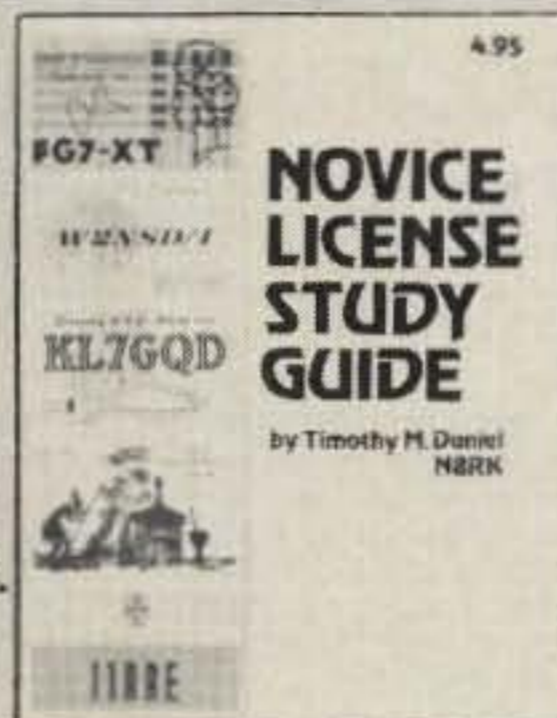

73

## Code Tapes

any four tapes for  
\$15.95! \$4.95 each

### "GENESIS"

**5 WPM**—CT7305—This is the beginning tape for people who do not know the code at all. It takes them through the 26 letters, 10 numbers and necessary punctuation, complete with practice every step of the way using the newest blitz teaching techniques. It is almost miraculous! In one hour many people—including kids of ten—are able to master the code. The ease of learning gives confidence to beginners who might otherwise drop out.

### "THE STICKLER"

**6+ WPM**—CT7306—This is the practice tape for the Novice and Technician licenses. It is made up of one solid hour of code, sent at the official FCC standard (no other tape we've heard uses these standards, so many people flunk the code when they are suddenly—under pressure—faced with characters sent at 13 wpm and spaced for 5 wpm). This tape is not memorizable, unlike the zany 5 wpm tape, since the code groups are entirely random characters sent in groups of five.

### "BACK BREAKER"

**13+ WPM**—CT7313—Code groups again, at a brisk 14 per so you will be at ease when you sit down in front of the steely-eyed government inspector and he starts sending you plain language at only 13 per. You need this extra margin to overcome the panic which is universal in the test situations. When you've spent your money and time to take the test, you'll thank heaven you had this back-breaking tape.

### "COURAGEOUS"

**20+ WPM**—CT7320—Code is what gets you when you go for the Extra class license. It is so embarrassing to panic out just because you didn't prepare yourself with this tape. Though this is only one word faster, the code groups are so difficult that you'll almost fall asleep copying the FCC stuff by comparison. Users report that they can't believe how easy 20 per really is with this fantastic one hour tape.

### "OUTRAGEOUS"

**25+ WPM**—CT7325—This is the tape for that small group of overachieving hams who wouldn't be content to simply satisfy the code requirements of the Extra Class license. It's the toughest tape we've got and we keep a permanent file of hams who have mastered it. Let us know when you're up to speed and we'll inscribe your name in 73's CW "Hall of Fame."

• **NOVICE LICENSE STUDY GUIDE**—by Timothy M. Daniel N8RK. Here is the most up to date novice guide available. It is complete with information about learning Morse Code, has the latest FCC amateur regulations and the current FCC application forms. This guide is *not* a question/answer memorization course but rather it emphasizes the practical side of getting a ham license and putting a station on the air. It reflects what the FCC expects a Novice to know without page after page of dull theory. The most current information still available at last year's price. SG7357 \$4.95.\*

• **NOVICE STUDY TAPES**—If you are just getting started in ham radio, you'll find these tapes indispensable! This up-to-the-minute revision of the 73 Study Course is the perfect way to learn everything you need to breeze through the Novice written exam. Theory, FCC regulations, and operating skills are all covered, and you'll be amazed at how fast you learn using these tapes!

Once the test is behind you, these tapes will go right on being useful, because they are packed with the latest information on setting up your own ham station, and getting on the air.

Thousands of people have discovered how easy learning from cassette can be—order now and enter the fascinating world of ham radio! CT7300 Set of 3—\$15.95.\*

Scientists have proven that you learn faster by listening than by reading because you can play a cassette tape over and over in your spare time—even while you're driving! You get more and more info each time you hear it. You can't progress without solid fundamentals. These three hour-long tapes give you all the basics you'll need to pass the Novice exam easily. You'll have an understanding of the basics which will be invaluable to you for the rest of your life! Can you afford to take your Novice exam without first listening to these tapes?

Special Offer! Both Novice License Study Guide  
and Novice Study Tapes \$19.95 Order NP7300.

## GENERAL LICENSE STUDY GUIDE

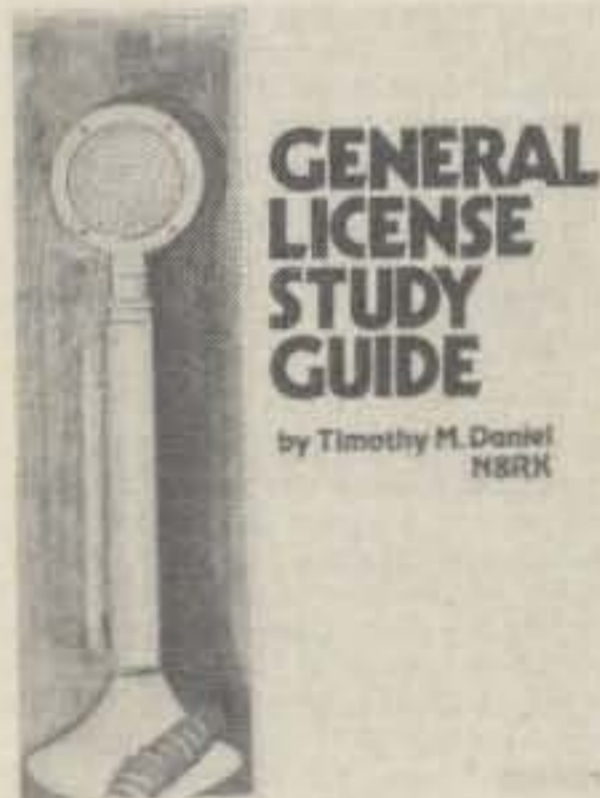

**GENERAL LICENSE STUDY GUIDE**—By Timothy M. Daniel N8RK This is the complete guide to the General License. Learning rather than memorizing is the secret. This is not a question-and-answer guide that will gather dust when the FCC issues a new test. Instead, this book will be a helpful reference, useful long after a ham upgrades to General. Includes up-to-date FCC rules and an application form. Order yours today and talk to the world. SG7358 \$6.95

Style W

Style Y

Style X



• **QSL CARDS**—73 turns out a fantastic series of QSL cards at about half the cost of having them done elsewhere because they are run as a fill-in between printing books and other items in the 73 Print Shop. 250 Style W—QW0250—for \$8.95\*; 500 Style W—QW0500—for \$13.95\*; 250 Style X—QX0250—for \$8.95\*; 500 Style X—QX0500; 250 Style Y—QY0250—for \$8.95\*; 500 Style Y—QY0500—for \$13.95.\* Allow 6-12 wks. for delivery.

• **LIBRARY SHELF BOXES**—These sturdy white, corrugated, dirt-resistant boxes each hold a full year of 73, *Kilobaud Microcomputing* or *80 Microcomputing*. With your order, request self-sticking labels for any of the following: 73, *Kilobaud Microcomputing*, *80 Microcomputing*, *CQ*, *QST*, *Ham Radio*, *Personal Computing*, *Radio Electronics*, *Interface Age*, and *Byte*. Order 1—BX1000—for \$2.00\*; order 2-7—BX2002—for \$1.50 each\*; order 8 or more—BX1002—for \$1.25 each\*.

• Preserve and protect your collection for a lifetime! Order these handsome red binders with gold lettering. \$7.50 for 1, 3 for \$21.75, 6 for \$42.00. (Postpaid within USA, please add \$2.50 per order outside USA.) Check or money orders only, no phone or C.O.D. orders. 73 Binders, P.O. Box 5120, Philadelphia, PA 19141.

\*NOTE—Above address for Binders only.

## For Your Ham Shack 73 Magazine Binders

• **BACK ISSUES**—Complete your collection, many are prime collectables now, classics in the field! A full collection is an invaluable compendium of radio and electronics knowledge!

73300	73 BACK ISSUE—BEFORE JULY 1980	\$ 3.00
73350	73 BACK ISSUE JULY 1980 THRU OCT. 1981	\$ 3.50
73350P	73 BACK ISSUE NOV. 1981 TO PRESENT	\$ 3.50
73005	73 BACK ISSUE—5 YOUR CHOICE	\$10.75
73010	73 BACK ISSUE—10 YOUR CHOICE	\$16.00
73025	73 BACK ISSUE—25 YOUR CHOICE	\$27.00
73125	73 BACK ISSUE—25 OUR CHOICE	\$14.00

Shipping: Please add \$1.00 per magazine. Orders of ten magazines or twenty-five magazines add \$7.50 per order.

\*Use the order card in this magazine or itemize your order on a separate piece of paper and mail to: 73 Radio Bookshop • Peterborough NH 03458. Be sure to include check or detailed credit card information. No C.O.D. orders accepted. \$1.50 for the first book, \$1.00 each additional book for U.S. delivery and foreign surface. For foreign airmail \$10.00 per book. Please allow 4-6 weeks for delivery. Questions regarding your order? Please write to Customer Service at the above address. (Prices subject to change on books not published by 73 Magazine.)

FOR TOLL FREE ORDERING CALL 1-800-258-5473



# RADIO BOOKSHOP

## HAND BOOKS FOR THE HAMSHACK

**THE COMPLETE SHORTWAVE LISTENER'S HANDBOOK**, 2nd EDITION by Hank Bennett and Harry L. Helms. This comprehensive volume contains loads of new information from all over the world on the latest developments in SWL technology clubs, associations, practices and stations. A thorough guide to stations of the world by general continental area and frequency is included. BK1241 \$9.95

**THE TEN METER FM HANDBOOK**—by Bob Hell K9EID. This handbook has been published to help the ten meter enthusiast learn more about the many methods of conversions and tricks that are used to make existing units work better. Join the great "tinkerers" of the world on ten FM and enjoy the fantastic amount of fun in communicating with amateur stations worldwide on ten meter FM. BK1190 \$4.95.\*

**THE PRACTICAL HANDBOOK OF AMATEUR RADIO FM REPEATERS**—by Bill Pasternak WA6ITF (author of 73 Magazine's monthly column "Looking West") This is the book for the VHF/UHF FMer, compiled from material submitted by over a hundred individuals, clubs, organizations and equipment manufacturers. A "must have" for your ham shack shelf. BK1185 \$12.95.\*

## THE 73 TEST EQUIPMENT LIBRARY

**VOL. II AUDIO FREQUENCY TESTERS**—Jam-packed with all kinds of audio frequency test equipment. If you're into SSB, RTTY, SSTV, etc., this book is a must for you... a good book for hi-fi addicts and experimenters, too! LB7360 \$1.95.\*

**VOL. III RADIO FREQUENCY TESTERS**—Radio frequency waves, the common denominator of amateur radio. Such items as SWR, antenna impedance, line impedance, RF output, and field strength; detailed instructions on testing these items includes sections on signal generators, crystal calibrators, grid dip oscillators, noise generators, dummy loads, and much more. LB7361 \$1.95.\*

**VOL. IV IC TEST EQUIPMENT**—Become a troubleshooting wizard! Here are 42 home construction projects for building test equipment to work with your ham station and in servicing digital equipment. Plus a cumulative index for all four volumes for the 73 TEST EQUIPMENT LIBRARY. LB7362 \$1.95.\*

ALL THREE OF THE ABOVE ONLY \$4.95 ORDER LB7365

**RF AND DIGITAL TEST EQUIPMENT YOU CAN BUILD**—BK1044—Rf burst, function, square wave generators, variable length pulse generators—100 kHz marker, i-f and rf sweep generators, audio osc, af/rf signal injector, 146 MHz synthesizer, digital readouts for counters, several counters, prescaler, microwave meter, etc. 252 pages. BK1044 \$5.95.\*

## FOR THE CONTESTER

**THE CONTEST COOKBOOK**—This book reveals the secrets of that elite group of operators who top the list when the contest results are published. It contains detailed suggestions for the first-time contestee as well as tips for the advanced operator. Domestic, DX, and specialty contests are all discussed, complete with photographs and diagrams showing the equipment and operating aids used by the top scorers. For the serious contestee. BK7308 \$5.95.

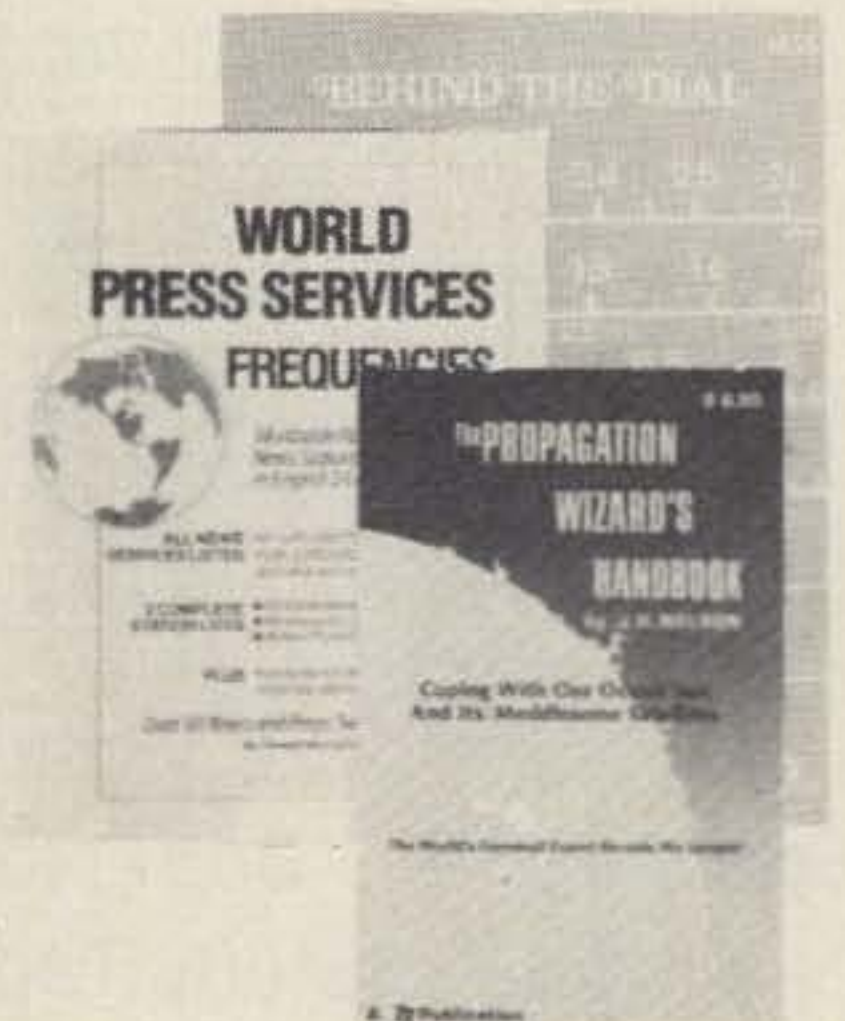

**TOOLS & TECHNIQUES FOR ELECTRONICS**—by A. A. Wicks. This is an easy-to-understand book written for the beginning kit-builder as well as the experienced hobbyist. It has numerous pictures and descriptions of the safe and correct ways to use basic and specialized tools for electronic projects, as well as specialized metal-working tools and the chemical aids which are used in repair shops. BK7348 \$4.95.\*

**BEHIND THE DIAL**—This book explains, in detail, what's going on on all the frequencies, from shortwave up to microwave. It gives the reader a good idea of what he can find and where to find it, including some of the secret stations such as the C.I.A. and the F.B.I. Everything is covered short of microwave monitoring. Anyone interested in purchasing a shortwave receiver should have a copy of this book. surveillance, station layout consideration, antenna systems, interface, and the electromagnetic spectrum, are included. BK7307 \$4.95

**THE NEW WEATHER SATELLITE HANDBOOK**—by Dr. Ralph E. Taggart WB8DQT. Here is the completely updated and revised edition containing all the information on the most sophisticated and effective spacecraft now in orbit. This book serves both the experienced amateur satellite enthusiast and the newcomer. It is an introduction to satellite watching, providing all the information required to construct a complete and highly effective ground station. Solid hardware designs and all the instructions necessary to operate the equipment are included. For experimenters who are operating stations, the book details all procedures necessary to modify equipment for the new series of spacecraft. Amateur weather satellite activity represents a unique blend of interests encompassing electronics, meteorology and astronautics. Join the privileged few in watching the spectacle of earth as seen from space on your own monitoring equipment. BK7383 \$8.95.\*

## THE 73 TECHNICAL LIBRARY



**THE CHALLENGE OF 160**—The growth of amateur radio today is encouraging the use of 160 meters. All the information necessary to get started on this unique band, the all-important antenna and ground systems are described in detail. Also, how to get on, top-band operating tips, top-band transmitters, propagation, weather receiving equipment, and more are covered in full. The introduction contains interesting photos of Stew Perry's (the King of 160) shack. This reference is useful to new and experienced top-band operators. BK7309 \$4.95

**INTERFERENCE HANDBOOK**—by William R. Nelson, WA6EQG—This timely handbook covers every type of RFI problem and gives you the solutions based on practical experience. Covers interference to TV, radio, hi-fi, telephone, radio amateur, commercial and CB equipment. Power line interference is covered in depth—how to locate it, cure it, work with the public, safety precautions, how to train RFI investigators. Written by an RFI expert with 33 years of experience, this profusely illustrated book is packed with practical easy-to-understand information. BK1230 \$8.95.\*

**OWNER REPAIR OF RADIO EQUIPMENT**—by Frank Glass K6RQ. Here's a book that will teach you an approach to troubleshooting without a shack full of test equipment. Written in a narrative, non-mathematical style, it will encourage you to successfully fix your own rig problems 80 to 90% of the time. Even if you don't want to fix, you can learn a lot about how things work and fail. Add to your library and personal expertise. BK7310 \$7.95.\*

## NEW

**EVERYTHING YOU ALWAYS WANTED TO KNOW ABOUT AMATEUR TELEVISION**, (but were afraid to ask)—By Mike Stone WB0QCD. This book is a complete guide to setting up your own amateur radio television station. It contains—A history, what equipment you need, video theory, cameras, recorders, lighting, special effects, sound ATV DXing, mobile FSTV, ATV repeaters, ATV groups, building projects, test equipment, dealer directory, a cumulative index of over 1000 articles on amateur TV and much more. This is the new, 1982 edition. From the publishers of *Amateur Television Magazine*. \$9.95 BK1244

**WORLD PRESS SERVICE FREQUENCIES**—by Thomas Harrington Can't wait to hear the evening news, or are you wondering about the news that you aren't hearing? Receive by Radio Teletype (RTTY) all the world news and financial happenings from the world capitals on a 24 hour a day basis. This book gives you the frequencies and times of broadcast of such news services as AP, UPI, Reuters, TASS, VOA and London Press. Also included is an introduction to RTTY with information on equipment, antennas, abbreviations—everything you need to get started in RTTY. BK1202 \$7.95\*

**SSB... THE MISUNDERSTOOD MODE**—by James B. Wilson. Single Sideband Transmission... thousands of us use it every day, yet it remains one of the least understood facets of amateur radio. J. B. Wilson presents several methods of sideband generation, amply illustrated with charts and schematics, which will enable the ambitious reader to construct his own sideband generator. A must for the technically-serious ham. BK7351 \$5.50.\*

**PROPAGATION WIZARD'S HANDBOOK**—by J. H. Nelson. When sunspots riddled the worldwide communications networks of the 1940s, John Henry Nelson looked to the planets for an answer. The result was a theory of propagation forecasting based upon interplanetary alignment that made the author the most reliable forecaster in America today. The book provides an enlightened look at communications past, present, and future, as well as teaching the art of propagation forecasting. BK7302 \$6.95.\*

**IC OP-AMP COOKBOOK**—by Walter G. Jung. Covers not only the basic theory of the IC op amp in great detail, but also includes over 250 practical circuit applications, liberally illustrated. 592 pages, 5 1/2 x 8 1/2, softbound. BK1028 \$14.95.\*

\*Use the order card in this magazine or itemize your order on a separate piece of paper and mail to: 73 Radio Bookshop • Peterborough NH 03458. Be sure to include check or detailed credit card information. No C.O.D. orders accepted. \$1.50 for the first book, \$1.00 each additional book for U.S. delivery and foreign surface. For foreign airmail \$10.00 per book. Please allow 4-6 weeks for delivery. Questions regarding your order? Please write to Customer Service at the above address. (Prices subject to change on books not published by 73 Magazine.)

FOR TOLL FREE ORDERING CALL 1-800-258-5473



# RADIO BOOKSHOP

## ANTENNA BOOKS

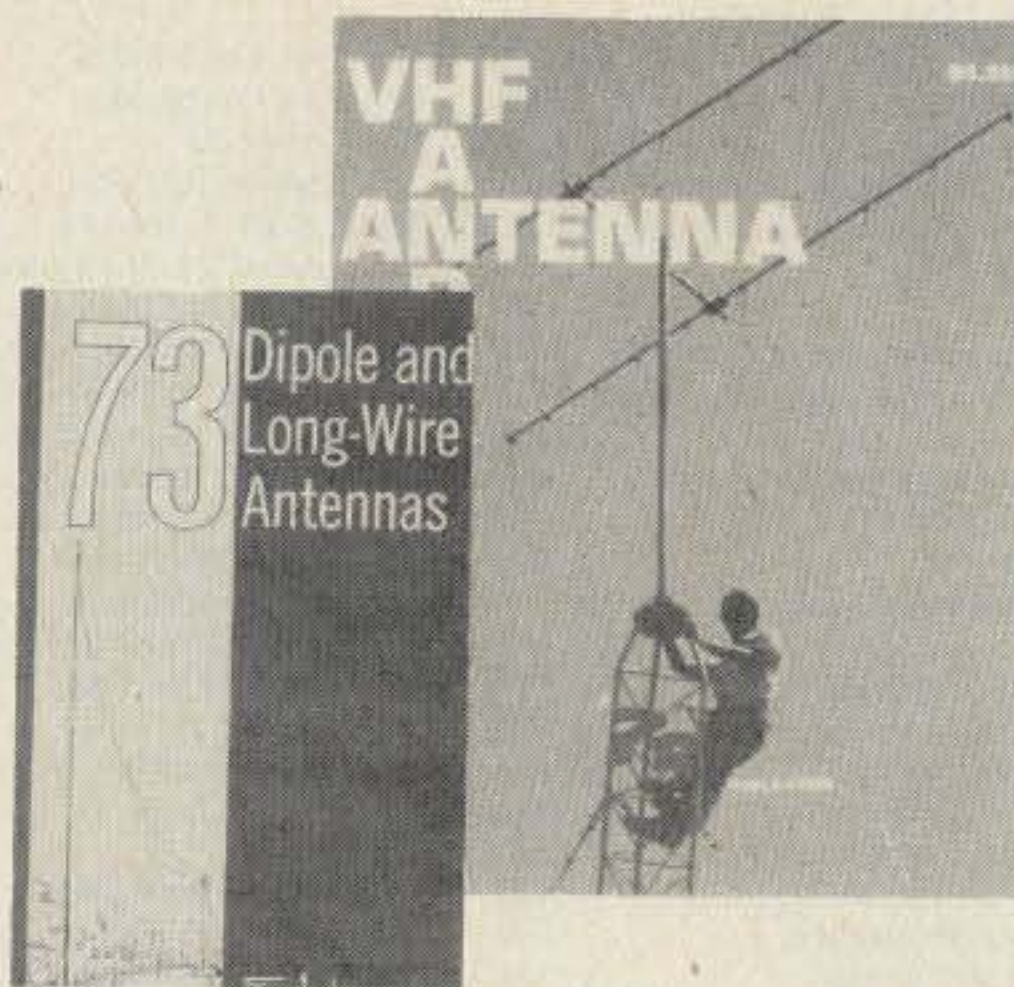
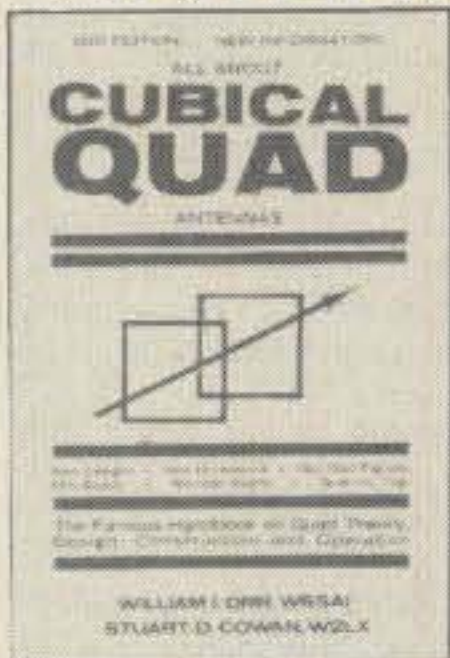

**VHF ANTENNA HANDBOOK**—The new *VHF Antenna Handbook* details the theory, design, and construction of hundreds of different VHF and UHF antennas... a practical book written for the average amateur who takes joy in building, not full of complex formulas for the design engineer. Packed with fabulous antenna projects you can build. BK7368 \$5.95.\*

● **BEAM ANTENNA HANDBOOK (New 5th edition)**—BK1197—Yagi beam theory, construction and operation. Information on wire beams, SWR curves and matching systems. A "must" for serious DXers. \$5.95\*

● **VHF HANDBOOK FOR RADIO AMATEURS**—BK1198—Contains information on FM theory, operation and equipment, VHF antenna design and construction, satellite-EME, and the newest solid-state circuits. \$6.95\*

● **THE RADIO AMATEUR ANTENNA HANDBOOK**—BK1199—All about wire antennas, beams, tuners, baluns, coax, radials, SWR and towers. Clear and complete information. \$6.95\*

● **SIMPLE, LOW-COST WIRE ANTENNAS FOR RADIO AMATEURS**—BK1200—All new data and everything you want to know about low-cost, multi-band antennas, inexpensive beams, "invisible" antennas for hams in "tough" locations. \$6.95\*

**73 DIPOLE AND LONG-WIRE ANTENNAS**—by Edward M. Noll W3FQJ. This is the first collection of virtually every type of wire antenna used by amateurs. Includes dimensions, configurations, and detailed construction data for 73 different antenna types. Appendices describe the construction of noise bridges, line tuners, and data on measuring resonant frequency, velocity factor, and swr. BK1016 \$5.50.\*

● **ALL ABOUT CUBICAL QUAD ANTENNAS (2nd edition)**—BK1196—The "Classic" on Quad design, theory, construction, and operation. New 2nd edition contains new feed and matching systems and new data. \$5.95.\*

● **HOW TO DEFEND YOURSELF AGAINST RADAR**—BK1201—by Bruce F. Bogner and James R. Bodnar, a lawyer and radar expert. This book gives you the ammunition to challenge the radar "evidence" that usually leads to a speeding conviction. The major part of the book details the inner workings of radar—you'll become more of an expert than most police officers and judges. The remainder of the book outlines how to defend yourself against a speeding ticket—the observations, measures and testimony you must obtain to defend yourself without the help of a lawyer. The price is a lot less than a fine! \$6.95\*

## MICROCOMPUTER BOOKS

**ANNOTATED BASIC—A NEW TECHNIQUE FOR NEOPHYTES. VOL 1 & 2**—*Annotated BASIC* explains the complexities of modern BASIC. It includes complete TRS-80\* Level II BASIC programs that you can use. Each program is annotated to explain in step-by-step fashion the workings of the program. Programs are flowcharted to assist you in following the operational sequence. And—each chapter includes a description of the new concepts which have been introduced. Volume 1 BK7384 \$10.95 Volume 2 BK7385 \$10.95

**HOBBY COMPUTERS ARE HERE!!** If you want to come up to speed on how computers work—hardware and software—this is an excellent book. It starts with fundamentals and explains the circuits and the basics of programming, along with a couple of TVT construction projects, ASCII, Baudot, etc. This book has the highest recommendations as a teaching aid. \$2.47. BK7322

**KILOBAUD KLASROOM**—By George Young and Peter Stark. Learning electronics theory without practice isn't easy. And it's no fun to build an electronics project that you can't use. *Kilobaud Klassroom* the popular series first published in *Kilobaud Microcomputing*, combines theory with practice. This is a *practical* course in digital electronics. It starts out with very simple electronics projects, and by the end of the course you'll construct your own working microcomputer! BK7386 \$14.95

● **40 COMPUTER GAMES**—BK7381—Forty games in all in nine different categories. Games for large and small systems, and even a section on calculator games. Many versions of BASIC used and a wide variety of systems represented. A must for the serious computer gamer. \$7.95\*

● **UNDERSTANDING AND PROGRAMMING MICROCOMPUTERS**—BK7382—A valuable addition to your computing library. This two-part text includes the best articles that have appeared in 73 and *Kilobaud Microcomputing* magazines on the hardware and software aspects of microcomputing. Well-known authors and well-structured text helps the reader get involved. \$10.95\*

**TEXTEDIT—A Complete Word Processing System in kit form**—by Irwin Rappaport. *TEXTEDIT* is an inexpensive word processor that you can adapt to suit your needs, from writing form letters to large texts. It is written in modules, so you can load and use only those portions that you need. Included are modules that perform right justification, ASCII upper/lowercase conversion, one-key phrase entering, complete editorial functions, and much more! *TEXTEDIT* is written in TRS-80\* Disk BASIC, and the modules are documented in the author's admirably clear tutorial writing style. Not only does Irwin Rappaport explain how to use *TEXTEDIT*; he also explains programming techniques implemented in the system. *TEXTEDIT* is an inexpensive word processor that helps you learn about BASIC programming. It is written for TRS-80 Models I and III with TRS-DOS 2.2/2.3 and 32K. \*TRS-80 and TRSDOS are trademarks of the Radio Shack Division of Tandy Corporation. BK7387 \$9.97

● **SOME OF THE BEST FROM KILOBAUD/MICROCOMPUTING**—BK7311—A collection of the best articles that have recently appeared in *Kilobaud/MICROCOMPUTING*. Included is material on the TRS-80 and PET systems, CP/M, the 8080/8085/Z80 chips, the ASR-33 terminal. Data base management, word processing, text editors and file structures are covered too. Programming techniques and hardware construction projects for modems, high speed cassette interfaces and TVTs are also included in this large format, 200 plus page edition. \$10.95.\*

**THE NEW HOBBY COMPUTERS**—This book takes up from where "HOBBY COMPUTERS ARE HERE!" leaves off, with chapters on Large-Scale Integration, how to choose a microprocessor chip, an introduction to programming, low-cost I/O for a computer, computer arithmetic, checking memory boards...and much, much more! Don't miss this tremendous value! Only \$2.47. BK7340

## COOK BOOKS

**TTL COOKBOOK**—by Don Lancaster. Explains what TTL is, how it works, and how to use it. Discusses practical applications, such as a digital counter and display system, events counter, electronic stopwatch, digital voltmeter and a digital tachometer. BK1063 \$9.50.\*

**CMOS COOKBOOK**—by Don Lancaster. Details the application of CMOS, the low power logic family suitable for most applications presently dominated by TTL. Required reading for every serious digital experimenter! BK1011 \$10.50.\*

**TVT COOKBOOK**—by Don Lancaster. Describes the use of a standard television receiver as a microprocessor CRT terminal. Explains and describes character generation, cursor control and interface information in typical, easy-to-understand Lancaster style. BK1064 \$9.95.\*

## THE WELL EQUIPPED HAM SHACK

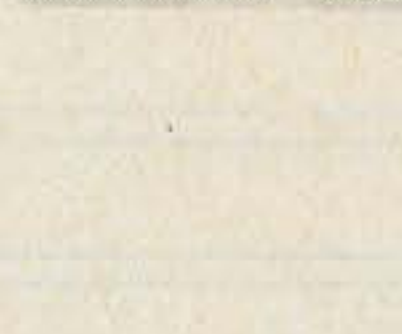
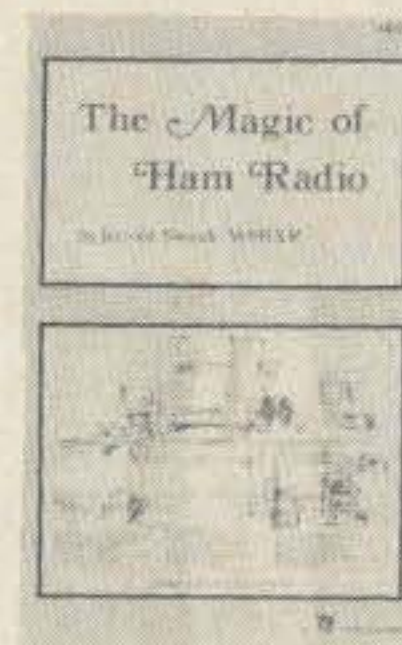

**WORLD Repeater ATLAS**  
Repeater  
Repeater  
Repeater  
Repeater

**WORLD REPEATER ATLAS**—Completely updated, over 230 pages of repeater listings are indexed by location and frequency. More than 50 maps pinpoint 2000 repeater locations throughout the USA. Foreign listings include Europe, the Middle East, South America, and Africa. \$4.95\* BK7315

**THE MAGIC OF HAM RADIO**—by Jerrold Swank W8HXR. Under various call signs, W8HXR has been heard on the ham bands since 1919. He has watched amateur radio grow from the days of Model A spark coils to an era of microprocessors and satellite communications. Jerry has responded to calls for help from earthquake-stricken Managua and tornado-ravaged Xenia. Antarctica, one of man's loneliest outposts, has been a bit less lonely, thanks to Jerry's tireless phonepatching efforts. Drawing on his own colorful experiences and those of many other hams, Jerry has compiled this word-picture of ham radio during the past six decades. BK7312 \$4.95

**A GUIDE TO HAM RADIO**—by Larry Kahaner WB2NEL. What's Amateur Radio all about? You can learn the basics of this fascinating hobby with this excellent beginner's guide. It answers the most frequently asked questions in an easy-going manner, and it shows the best way to go about getting an FCC license. A Guide to Ham Radio is an ideal introduction to a hobby enjoyed by people around the world. \$4.95.\* BK7321

**WORLD RADIO TV HANDBOOK 1982, 25TH EDITION**—This book is the bible of international broadcasters, providing the only authoritative source of exact information about broadcasting and TV stations world wide. This 1981 edition is completely revised, giving comprehensive coverage of short, medium and long wave, 560 pages of vital aspects of world listening. \$16.50. BK1184

\*Use the order card in this magazine or itemize your order on a separate piece of paper and mail to: 73 Radio Bookshop • Peterborough NH 03458. Be sure to include check or detailed credit card information. No C.O.D. orders accepted. \$1.50 for the first book, \$1.00 each additional book for U.S. delivery and foreign surface. For foreign airmail \$10.00 per book. Please allow 4-6 weeks for delivery. Questions regarding your order? Please write to Customer Service at the above address. (Prices subject to change on books not published by 73 Magazine.)

FOR TOLL FREE ORDERING CALL 1-800-258-5473



# List of AdvertisERS

\*Please contact these advertisers directly.

To receive full information from our advertisers please complete the postage-paid card.

R.S. No.	Page	R.S. No.	Page	R.S. No.	Page	R.S. No.	Page	
2	AEA/Advanced Electronic Applications . . . . . 31, 35, 75, 119, 126	* Crown Micro Products . . . . . 93	308	J. W. Miller/Div. Bell Industries . . . . . 93, 123	65	S-F Amateur Radio Services . . . . . 137		
115	A5ATV Magazine . . . . . 69	21	Current Development Corp. . . . . 54		168	Satmar Satellite TV Systems . . . . . 67		
164	A&W Productions . . . . . 80	106	Cushcraft Corp. . . . . 93, 135	*	500	73 Books . . . . . 98, 99, 127-130, 141, 144		
448	Advanced Communications International . . . . . 117	346	Data Service Co. . . . . 68	*		Moving . . . . . 98		
124	Advanced Computer Controls . . . . . 133	485	DenTron Radio Co., Inc. . . . . 134	*		Subscriptions . . . . . 98, 131, 144		
*	Alaska Microwave Labs . . . . . 67	* Digi Com Engineering, Inc. . . . . 121	425	Doppler Systems . . . . . 123	*	University Microfilms . . . . . 144		
20	All Electronics Corp. . . . . 30	* DX Signal Co. . . . . 144	452	Lewis Construction Co. . . . . 68	148	Shaver Electronics . . . . . 142		
*	Alpha Delta Communications . . . . . 35	453	EGE, Inc. . . . . 24	484	Lunar Electronics . . . . . 134	*	Simple Simon Electronics Kits . . . . . 25	
486	Alpha Delta Communications . . . . . 136	447	Electronic Hobby Innovations . . . . . 63	77	M-Squared Engineering, Inc. . . . . 145	112	Sintec Co. . . . . 29	
*	Amateur Electronic Supply . . . . . 49	146	Electronic Rainbow Industries, Inc. . . . . 20, 63	44	Macrotronics, Inc. . . . . 53	367	Slep Electronics . . . . . 146	
5	Amateur-Wholesale Electronics . . . . . 45, 95	* Electrovalue Industrial, Inc. . . . . 145	45	Madison Electronics . . . . . 137	45	SMP . . . . . 69		
63	Antenna Specialists . . . . . 81	24	Encomm, Inc. . . . . 73	134	Martin Engineering . . . . . 90	162	Space Electronics . . . . . 142	
329	AR Technical Products Corp. . . . . 85	479	Encon . . . . . 136	47	MFJ Enterprises . . . . . 51, 117, 119, 121	*	Spectronics, Inc. . . . . 121, 160	
*	Associated Radio . . . . . 87	400	Engineering Consulting Service . . . . . 142	483	MFJ Enterprises . . . . . 138	68	Spectrum Communications . . . . . 88, 89	
186	Atomtronics . . . . . 111	22	Fair Radio Sales . . . . . 145	48	MHz Electronics . . . . . 148-157	436	Spectrum International, Inc. . . . . 123	
*	Autek Research . . . . . 92	85	Faxscan, Inc. . . . . 119	49	Micro Control Specialties . . . . . 55	173	Spider Antenna . . . . . 133	
130	Auto Connect . . . . . 126	323	Fox-Tango Corp. . . . . 67, 111	50	Microcraft Corp. . . . . 121	69	Surplus Electronics . . . . . 142	
175	Automated Technology, Inc. . . . . 69	477	Fox-Tango Corp. . . . . 138	51	Microlog . . . . . 59	183	Tayco Communications . . . . . 142	
11	Barker & Williamson, Inc. . . . . 133	151	Francis Enterprises, Inc. . . . . 99	*	Mirage Communications . . . . . 92	316	Telex Communications . . . . . 13	
439	Ben Franklin Electronics . . . . . 61, 144	149	G & R Design, Inc. . . . . 101	*	Mor-Gain . . . . . 119	170	TET Antenna Systems . . . . . 85	
*	Bilal Co. . . . . 145	178	Galaxy Electronics . . . . . 69	480	Mortly . . . . . 136	*	The Antenna Bank . . . . . 96	
*	Birch Hill Sales . . . . . 144	143	GLB Electronics . . . . . 143	123	N & G Distributing . . . . . 44, 97	118	The Blackburg Group . . . . . 105	
153	Bit "O" Byte . . . . . 143	417	Gotham Antenna . . . . . 92	318	National Comm. Group Co. . . . . 44	449	The Ham Shack . . . . . 40	
157	Boman Industries . . . . . 65	132	Grand Systems . . . . . 142	412	Nemal Electronics . . . . . 41	57	The Tuned Antenna . . . . . 61	
12	Bullet Electronics . . . . . 146	352	Grove Enterprises, Inc. . . . . 62	*	Orbit Magazine . . . . . 101	76	Trac Electronics . . . . . 40	
*	Butternut Electronics Corp. . . . . 30	86	H & R Communications . . . . . 67	*	P. C. Electronics . . . . . 72	104	Trionyx Industries . . . . . 62	
187	Call Letter Hats . . . . . 99	31	Hal-Tronix . . . . . 132	*	Palomar Engineers . . . . . 4	*	Universal Communications . . . . . 62	
92	Ceco Communications, Inc. . . . . 103	345	Hal Communications . . . . . 17, 75	488	Pegasus Electronics . . . . . 136	155	Universal Distributors . . . . . 146	
102	Centurion International . . . . . 41	*	Ham Radio Outlet . . . . . 3	182	Peterson Electronics . . . . . 69	*	Universal Electronics . . . . . 125	
482	Channel Master, Div. of Avnet, Inc. . . . . 138	33	Hamtronics, NY . . . . . 159	404	P. B. Radio Service . . . . . 133	179	Users International Radio Club . . . . . 113	
89	Clutterfree Modular Consoles . . . . . 92	129	Harvey . . . . . 101	300	Pipo Communications . . . . . 145	*	V-J Products, Inc. . . . . 137	
487	Com-Rad Industries . . . . . 139	303	Heath Co. . . . . 82, 83	176	Polar Research, Inc. . . . . 21	422	Valor Enterprises . . . . . 135	
150	Commtek . . . . . 41, 145	320	Hoosier Electronics . . . . . 68	*	Proham Electronics . . . . . 20	*	Van Gorden Engineering . . . . . 31	
382	Communications Concepts, Inc. . . . . 135	*	ICOM . . . . . 9, Cov. II	315	Radio Activity . . . . . 74	311	Vanguard Labs . . . . . 145	
462	Communications Electronics Specialties, Inc. . . . . 87	78	Independent Crystal Supply . . . . . 142	61	Radio Amateur Callbook, Inc. . . . . 126	*	Viking Ind. . . . . 35	
*	Communications Design . . . . . 41	445	Instant Software . . . . . 100, 132	397	Radio World . . . . . 123	478	VoCom Products . . . . . 138	
15	Communications Specialists . . . . . 71, 91	36	International Crystal Mfg. Co. . . . . 117	62	Ramsey Electronics . . . . . 147, 161	302	W-S Engineering . . . . . 75, 143	
140	Comstar Research . . . . . 113	*	IRL . . . . . 15	185	Ramsey Electronics . . . . . 35	481	W-S Engineering . . . . . 134	
152	CQ Products . . . . . 135	38	Jameco Electronics . . . . . 158	147	Randall Sherman . . . . . 144	80	Western Radio Electronics . . . . . 41	
		39	Jan Crystals . . . . . 93	156	RF Electronics . . . . . 24	154	Westland Electronics . . . . . 4	
		354	Jensen Tools, Inc. . . . . 144	171	Ridge Systems Co., Inc. . . . . 121	83	Yaesu Electronics Corp. . . . . Cov. III	
		72	JDL Industries . . . . . 38	133	Rivendell Associates . . . . . 90	476	Yaesu Electronics Corp. . . . . 134	
				*	R. L. Drake . . . . . 5, 39, 79	336	Z Associates . . . . . 142	
				*	RQ Service Center . . . . . 144			

## 73 MAGAZINE

### Books, ETC.

To order, complete the postage-paid card, or itemize your order including detailed credit card information or check and mail to:  
73 Magazine/Mail Order Dept./Peterborough NH 03458.

Catalog#	Item	Price	Catalog#	Item	Price	Catalog#	Item	Price	Catalog#	Item	Price
BK1018	73 DIPOLE & LONG WIRE ANTENNAS	\$ 5.50	CT7306	CODE TAPE—6+ WPM	\$ 4.95	BK7305	POWER SUPPLY HANDBOOK	\$ 9.95	CT7350	SSTV TAPE	\$ 5.95
73300	73 BACK ISSUE—BEFORE JULY 1980	\$ 3.00	CT7313	CODE TAPE—13+ WPM	\$ 4.95	BK1015	PRACTICAL ANTENNAS FOR THE RADIO AMATEUR	\$ 9.95	SG1081	STUDY GUIDE—ADV. CLASS	\$ 6.95
73350	73 BACK ISSUE JULY 1980 THRU OCT. 1981	\$ 3.50	CT7320	CODE TAPE—20+ WPM	\$ 4.95	BK1185	THE PRACTICAL HANDBOOK OF FM REPEATERS	\$ 9.95	SG1080	STUDY GUIDE—EXTRA CLASS	\$ 5.95
73350P	73 BACK ISSUE NOV. 1981 TO PRESENT	\$ 3.50	CT7325	CODE TAPE—25+ WPM	\$ 4.95	BK7302	PROPAGATION WIZARD'S HANDBOOK	\$ 6.95	SG7357	STUDY GUIDE—NOVICE CLASS	\$ 4.95
73005	73 BACK ISSUE—5 YOUR CHOICE	\$ 10.75	CT7394	CODE TAPES (ANY FOUR ABOVE)	\$ 15.95	QW0250	QSL CARDS—STYLE W—250	\$ 8.95	BK1190	THE TEN METER FM HANDBOOK	\$ 4.95
	Add \$1.00 per magazine for shipping		BK7308	THE CONTEST COOKBOOK	\$ 5.95	QW0500	QSL CARDS—STYLE W—500	\$ 13.95	LB7359	TEST EQUIP LIB V1—COMPONENT TESTERS	\$ 4.95
73010	73 BACK ISSUE—10 YOUR CHOICE	\$ 16.00	BK7381	40 COMPUTER GAMES	\$ 7.95	QX0250	QSL CARDS—STYLE X—250	\$ 8.95	LB7360	TEST EQUIP LIB V2—AUDIO TESTERS	\$ 4.95
73025	73 BACK ISSUE—25 YOUR CHOICE	\$ 27.00	SG7358	GENERAL LICENSE STUDY GUIDE	\$ 6.95	QX0500	QSL CARDS—STYLE X—500	\$ 13.95	LB7361	TEST EQUIP LIB V3—RADIO EQUIP	\$ 4.95
73125	73 BACK ISSUE—25 OUR CHOICE	\$ 14.00	BK7304	GIANT BOOK OF AMATEUR RADIO ANTENNAS	\$ 12.95	QY0250	QSL CARDS—STYLE Y—250	\$ 8.95	LB7362	TEST EQUIP LIB V4—IC TEST EQ.	\$ 4.95
	Add \$7.50 per order for shipping		BK7321	A GUIDE TO HAM RADIO	\$ 4.95	QY0500	QSL CARDS—STYLE Y—500	\$ 13.95	BK7348	TOOLS & TECHNIQUES	\$ 4.95
BK1196	ALL ABOUT CUBICAL QUAD ANTENNAS	\$ 5.95	BK7322	HOBBY COMPUTERS ARE HERE	\$ 4.95	BK1199	THE RADIO AMATEUR ANTENNA HANDBOOK	\$ 6.95	BK1063	TTL COOKBOOK	\$ 9.50
BK1197	BEAM ANTENNA HANDBOOK	\$ 5.95	BK7325	HOW TO BUILD A MICROCOMPUTER & REALLY UNDERSTAND IT	\$ 9.95	BK1044	RF & DIGITAL TEST EQUIPMENT	\$ 5.95	BK1064	TVT COOKBOOK	\$ 9.95
BK7307	BEHIND THE DIAL	\$ 4.95	BK1201	HOW TO DEFEND YOURSELF AGAINST RADAR	\$ 6.95	BK1059	RTL COOKBOOK	\$ 6.50	BK7382	UNDERSTANDING & PROGRAMMING MICROCOMPUTERS	\$ 10.95
BK7309	CHALLENGE OF 160	\$ 4.95	BK1028	IC OP AMP COOKBOOK	\$ 12.95	BX1000	SHELF BOX—1	\$ 2.00	CH7300	U.S. AMATEUR RADIO CHART	\$ 1.95
BK1011	CMOS COOKBOOK	\$ 10.50	BK1230	INTERFERENCE HANDBOOK	\$ 8.95	BX1001	SHELF BOXES—2-7	\$ 1.50 each	BK1069	VERTICAL BEAM & TRIANGLE ANTNS	\$ 5.50
CT7305	CODE TAPE—5 WPM	\$ 4.95	BK7312	MAGIC OF HAM RADIO	\$ 4.95	BX1002	SHELF BOXES—8 AND UP	\$ 1.25 each	BK7368	VHF ANTENNA HANDBOOK	\$ 5.95
			BK1033	MASTER HANDBOOK OF HAM RADIO CIRCUITS	\$ 8.95	BK1200	SIMPLE, LOW COST WIRE ANTENNAS FOR RADIO AMATEURS	\$ 6.95	BK1198	VHF HANDBOOK FOR RADIO AMATEURS	\$ 6.95
			BK7340	THE NEW HOBBY COMPUTERS	\$ 4.95	BK7311	SOME OF THE BEST FROM KILOBAUD	\$ 10.95	BK7370	WEATHER SATELLITE HANDBOOK	\$ 2.50
			BK7383	THE NEW WEATHER SATELLITE HANDBOOK	\$ 8.95	BK7351	SSB THE MISUNDERSTOOD MODE	\$ 5.50	BK1202	WORLD PRESS SERVICE FREQUENCIES	\$ 5.95
			CT7300	NOVICE THEORY TAPES	\$ 15.95				BK1184	WORLD RADIO TV HANDBOOK	\$ 16.50
			BK7310	OWNER REPAIR OF RADIO EQUIPMENT	\$ 7.95				BK7315	WORLD REPEATER ATLAS	\$ 4.95



# Better by the dozen.

- 1. NEVER SAY DIE**—If you want controversy, Wayne Green W2NSD/1 will give it to you. His popular column ranges from travelogue to tirade and is guaranteed to entertain, inspire and enlighten you.
- 2. DX**—This globe-trotting column keeps you informed about the news of the DX world from Kingman Reef to Bahrain.
- 3. CONTESTS**—You get all the news on the contest world from Robert Baker WB2GFE. He'll give you information on upcoming events and results from recent contests.
- 4. FUN**—Just for fun, John Edwards KI2U provides you with wacky puzzles, quizzes, and games that test your ham mettle.
- 5. FCC**—If you're looking to the future, these outtakes from the Federal Register chronicle changes in policy and regulations that relate to amateur radio.
- 6. RTTY LOOP**—To keep you abreast of radioteletype developments, Marc Leavey WA3AJR explains the new RTTY equipment, the increasing role of computers in RTTY, and other matters of interest to digital communications fans.
- 7. REVIEWS**—Before you buy, save yourself some money... check 73's in-depth evaluation of the latest gear.
- 8. HAM HELP**—As a service to you, 73 prints your questions in our magazine. This helps you to obtain hard-to-get parts, schematics, and owner's manuals.
- 9. SATELLITES**—From Phase III to TVRO, 73 Magazine covers the news of the satellite world like no other radio amateur magazine.
- 10. NEW PRODUCTS**—This brief look at the latest ham equipment on the market keeps you on top of new developments in amateur radio.
- 11. AWARDS**—To find out what certificates are available where, read Bill Gosney KE7C's coverage of all the ham radio awards.
- 12. CONSTRUCTION**—The builder's magazine... that's 73. You get the best projects from the best authors every month.

Send me a dozen issues of  
**73** MAGAZINE  
for the dozen reasons listed!

Check enclosed for 1 year for only \$19.97

Bill:  MC  VISA  AMEX  ME

Card# \_\_\_\_\_ Interbank# \_\_\_\_\_

Exp. date \_\_\_\_\_ Sig. \_\_\_\_\_

Name \_\_\_\_\_

Address \_\_\_\_\_

City \_\_\_\_\_ State \_\_\_\_\_ Zip \_\_\_\_\_

Canada & Mexico \$22.97 1 year U.S. funds.

Foreign surface \$39.97 1 year U.S. funds drawn on US bank only

Foreign airmail—please inquire.

32NR6

73 Magazine • PO Box 931 • Farmingdale, NY • 11737

Please allow 6-8 weeks for delivery

## 73 MAGAZINE FOR RADIO AMATEURS

Subscription Department  
P.O. Box 931  
Farmingdale, NY 11737

**1-800-258-5473**

For orders only please.

Foreign air mail, please inquire.





# NEW PRODUCTS FROM HAL-TRONIX

## 2304 MHz DOWNCONVERTERS

Frequency Range 2000-2500 MHz

2304 Model 1: Basic three-stage, less case

and connectors.....\$49.95

2304 Model 2: Three-stage, includes preamp, with die-cast case and connectors.....\$59.95

2304 Model 3: With high-gain preamp, die-cast case and connectors.....\$69.95

The above models complete with high-quality drilled PC boards, all electronic components, etc., with 15-page manual.

Note: Any of the above, factory wired, \$50 additional

### POWER SUPPLIES FOR THE DOWNCONVERTERS:

Power supply kit # 1, less case and connectors.....\$19.95

Power supply kit #2, includes case & connectors.....\$24.95

Power supply—already built, complete.....\$34.95

### PARTS FOR THE NTSC RF MODULATOR FOR CHANNELS 3, 4, or 5.

This is **not** a complete kit. The hard-to-get parts include the LM-1889, the .08 microhenry tank coil, the 7-14 microhenry adjustable coil, the 10 microhenry RF coil, with schematic (no PC board) as used in Bob Cooper's satellite TV receiver. Real buy at.....\$5.95

### SHIPPING INFORMATION

ORDERS OVER \$20.00 WILL BE SHIPPED POSTPAID EXCEPT ON ITEMS WHERE ADDITIONAL CHARGES ARE REQUESTED ON ORDERS LESS THAN \$20.00 PLEASE INCLUDE ADDITIONAL \$1.50 FOR HANDLING AND MAILING CHARGES SEND SASE FOR FREE FLYER

## TOUCHTONE DECODER KITS

**HAL 567-12:** single line in, 12 lines out, complete with 2-sided plated-through G-10 board and all components. Uses seven 567's and three 7402's.....\$39.95

**HAL 567-16:** single line in, 16 lines out, complete with 2-sided plated-through G-10 board and all components; includes 22-pin edge connector. Uses eight 567's and four 7402's. (See construction article in April 1981 Radio & Electronics for complete writeup.).....\$69.95

## TOUCHTONE ENCODER KITS

**HAL ECD-12:** 3x4 twelve-character encoder utilizing the ICM 7206 Intersil chip. Kit comes complete with both LED and audio-coupled outputs (speaker included). With aluminum anodized case.....\$29.95

**HAL ECD-16:** 4x4 sixteen-character encoder utilizing the ICM 7206 Intersil chip. Kit comes complete with LED and audio-coupled outputs (speaker included). With aluminum anodized case.....\$39.95



**"HAL" HAROLD NOWLAND**  
**W8ZXH**

✓31 **HAL-TRONIX**

P. O. BOX 1101  
SOUTHGATE, MICH. 48195  
PHONE (313) 285-1782



**Beat The Price Increase!**  
Instant Software's prices are going up.

Instant Software's prices are going up. Stop waiting for the right time to buy! Stock up now on all the programs you want, and SAVE. Shop early and save \$\$\$\$\$\$ on your Christmas shopping also.

Remember, this is the last chance to buy Instant Software's products at the old 1982 prices. Effective November 15, 1982\* Instant Software will be raising its prices on most of its products. Order today so that you too can beat the Instant Software price increase. Just call toll free:

**1-800-258-5473**

\*Old prices will not be accepted after this date.

**Instant Software™**

(a subsidiary of Wayne Green Inc.)

Route 101 & Elm St. Peterborough, NH 03458  
603/924-9471





BARKER & WILLIAMSON'S  
**PORTABLE ANTENNA**

MODEL 370-10



Designed for APARTMENTS — MOTELS — VACATIONS  
 Quick Simple Installation. Operates on 2, 6, 10, 15, 20 and 40 meters. All coils supplied. Only 22-1/2 inches long. Weighs less than 2 lbs. Supplied with 10 ft. RG 58 coax and counter poise. Whip extends to 57 inches. Handles up to 300 watts. VSWR—1.1:1 when tuned  
 Write for more details and other B&W products



BARKER & WILLIAMSON, INC.  
 10 CANAL STREET  
 BRISTOL, PA. 19007  
 215-788-5581

✓11



**The New Standard in High Performance Repeater Control...**

- FRIENDLY, POWERFUL, EASY TO USE - Human engineered to be your "assistant" at the repeater, with capability second to none.
- REMOTELY CONFIGURABLE - Change command codes, messages, tone characteristics, timing, and more, remotely! Reliable storage in E<sup>2</sup>PROM.
- Room to grow: BUILT IN! - Features intelligent remote control and meter readback. Interfaces to synthesized remote bases and links. Planned software upgrade path.
- SUPPORT - We invented the "Computer Controlled Talking Repeater," so we know how to provide the applications assistance, and long term support so crucial to a computer based product.
- BRING YOUR REPEATER SYSTEM INTO THE 80'S - Starting at less than \$1200!

**The RC-850 Repeater Controller!**

Call or write for detailed specifications.

Manual and demonstration cassette tapes available separately.



10816 Northridge Square  
 Cupertino, CA 95014  
 (408) 253-8085

✓124

**The Spider™ Antenna**

The modern multi-band mobile antenna—switch to 10, 15, 20 or 40 meters without stopping to change resonators.

**Features of the Spider™ Antenna**

- The Spider™ Antenna is less than six feet high and the longest resonator projects out from the mast 24 inches. This gives a slim profile, low height and light weight, offering little wind resistance and eliminating the need for a spring mount.
- Each resonator is tuned to the desired portion of the band by a tuning sleeve which slides over the outside of the resonator.
- SWR is approximately 1:1 at the selected resonant frequency.
- Base impedance approximately 50 ohms, requiring no matching network.
- Ideal for use on vans, campers, motor homes, travel trailers; also in mobile home parks, apartment houses and condominiums.
- Spider™ Antennas are not made on a production line; they are virtually custom built.

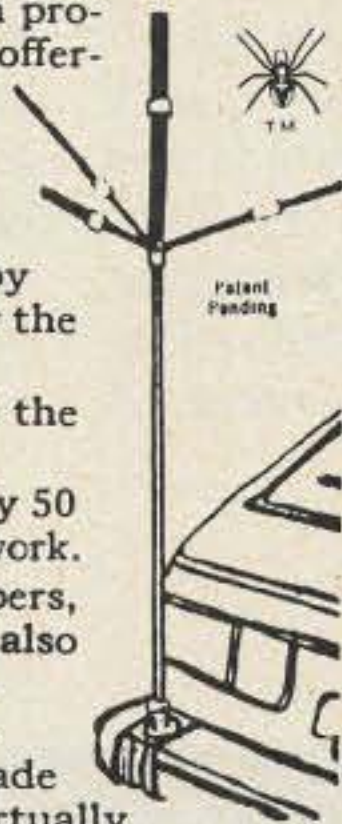

**The Spider™ Maritimer™** is the ultimate antenna for marine use. Constructed of non-magnetic stainless steel and nickel-chrome plated bronze, and using the regular Spider™ resonators and tuning sleeves.

**The Spider™ Adapter** converts any mono-band antenna with a half inch mast into a modern four-band antenna at a modest price.

For further information, prices write or call

**MULTI-BAND ANTENNAS**  
 7131 OWENSMOUTH AVENUE, SUITE 463C  
 CANOGA PARK, CALIF. 91303  
 TELEPHONE: (213) 341-5460 ✓173

**SATELLITE TELEVISION SYSTEMS**



PB RADIO SERVICE  
 1950 East Park Row  
 Arlington, TX 76010

✓404

- \* PRODELIN 10' ANTENNA  
 8 peice for easy shipping/Injection molded for precision
- \* CHAPARRAL POLAROTOR  
 Changes polarity in less than half a second/Feed & LNA never moves
- \* DEXCEL RECIEVER  
 Great looks/Great performance/2 YEAR WARRANTY/  
 Dentent tuning/ Built in modulator
- \* DEXCEL 120° L.N.C.  
 Eliminates need for old fashioned LNA/2 YEAR WARRANTY/Best LNC made

- \*ALSO AVAILABLE  
 1900 to 2500 MHz Microwave Downconverters  
 Kit.....\$28.50  
 Assembled.....\$48.50  
 SLOTTED ARRAY ANTENNA.....\$21.95  
 COMMERCIAL M.D.S. SYSTEM.....\$169.95

CALL ORDER DEPT. TOLL FREE:  
 (800) 433-5169

INFORMATION CALL:  
 (817) 460-7071

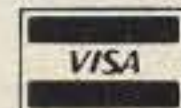

\*ALSO AVAILABLE  
 UHF T.V.DECODER,  
 F-V 3 BOARDS,  
 PARTS & INFORMATION



# NEW PRODUCTS

## GaAsFET VHF/UHF AMPLIFIERS

Lunar has announced a line of narrowband tuned receiving preamplifiers for the VHF and UHF communities. Typical specifications exceed those of previously-available receiving preamplifiers by up to ten times in performance. Exhibiting very high gain at VHF (typically 22-24 dB), moderate gain at UHF (typ. 16 dB), and a very low noise figure (typ. 0.3-0.4 dB on VHF and 0.5-0.6 dB on UHF land-mobile frequencies), these units are also well-suited to high-rf environments, exhibiting 1-dB compression power levels of +10 dBm or more.

The good gain, coupled with the very low noise figure, effectively reduces a typical repeater receiver sensitivity to that of ambient limitations. 6-10-dB improvements in receiver performance have been consistently reported by users in a typical repeater installation between the duplexer and receiver input.

Units are built to the customer's specified frequency, but do exhibit a typical bandwidth of 5% CF with little degradation in performance. Dc input is well-filtered and regulated, which allows accepting any dc voltage between 12 and 28 V (drain approx. 35 mA). VHF connector options include BNC, SMA, N in and out; UHF connector options are SMA, N in and out, with SMA in BNC out the standard option. SMA to RG-58 connectors are in-

cluded as options for UHF units. Frequencies are available from as low as 15 MHz to as high as the 800-MHz land-mobile bands.

For further information, contact *Lunar Electronics, 2775 Kurtz Street, Suite 11, San Diego CA 92110*. Reader Service number 484.

## NEW FROM W-S ENGINEERING

W-S Engineering, manufacturers of the Porta-Peater, have announced the introduction of new related products that will be of interest to both Porta-Peater owners and other amateurs alike.

In addition to the Porta-Peater M-100, which will interface with any two transceivers or receiver and transmitter pairs to create a full-function repeater, W-S Engineering now offers its new Porta-Link PL-250 and MB-1 Multi-Board building block.

The Porta-Link PL-250 is a single-board simplex link and portable repeater that may be interfaced with two transceivers, or two receiver-transmitter pairs, to form a complete repeater system for applications that do not require a CW-ID system. Owners of the Porta-Peater can add the Porta-Link board and have a complete duplex link, remote base, and dual repeater. The PL-250 has on-board controls for timeout duration, hang time, audio balance, local mike gain, and local speaker amplifier gain. Connections to the PL-250

are done via a 22-pin, 0.156-inch edge connector.

The MB-1 Multi-Board building block is a "universal" circuit that can provide up to ten different functions. Configured by the user, the MB-1 can be a variable audio-frequency signal generator, variable radio-frequency signal generator, audible CMOS logic probe, LED output logic probe, repeater beeper, gated monostable, gated astable, pulse stretcher, adjustable timer, individual positive and negative edge triggers, and more.

The MB-1 is completely self-contained and operates on any dc voltage between 5 and 15 volts. Output level, pulse length, and frequency are fully adjustable with on-board controls. The MB-1 comes complete with an assembly and applications manual, and all parts, sockets, PC board, and accessories are furnished.

For further information about these products, contact *W-S Engineering, PO Box 58, Pine Hill NJ 08021*. Reader Service number 481.

## YAESU FT-102

Yaesu Electronics Corporation has announced the availability of its new FT-102 line of HF equipment.

The FT-102 transceiver utilizes an all-new transmitter section featuring three 6146B final tubes for extremely low distortion. In addition to VOX and an rf clipping-type speech processor, the FT-102 transmit audio may be adjusted for optimum response to the operator's voice.

The FT-102 receiver uses husky JFET components in the front end for wide dynamic range. A number of filter options are available, with wide/narrow filter selection independent of

the mode switch. Audio peak filtering for CW, audio shaping for all modes, and an i-f notch filter provide outstanding intelligence recovery. The noise blanker is highly effective against the "woodpecker" and pulse noises.

Equipped for SSB and CW operation, the FT-102 option list includes an AM/FM module for activating those modes. Other accessories for the FT-102 are the FV-102DM synthesized vfo, the SP-102 speaker with audio filter, the SP-102P speaker/patch, and the FC-102 1.2-kW antenna tuner with optional remote antenna selector.

For further information, contact *Yaesu Electronics Corp., PO Box 49, Paramount CA 90723*. Reader Service number 476.

## DENTRON'S NEW 5-BAND TRANSCEIVER

DenTron Radio Company has begun production on a new 200-Watt, CW, SSB solid-state transceiver named the Horizon One, which covers 80-15 meters and any 500-kHz segment of 10 meters. Its sensitivity is .35  $\mu$ V for 10-dB signal-to-noise ratio, with selectivity of 2.4 kHz at 6-dB points and G-60-dB factor of 1.7:1. Performing with the latest MOSFET and ballasted emitter semiconductors, the Horizon One also has a pinpoint digital frequency readout using LSI technology.

Input power is 200 W PEP with an output of 100 W PEP nominal and 80 W PEP on 10 meters. Power requirements are 12.6-14.5 V dc regulated at 2.0 Amps maximum and 12.6-14.0 V dc regulated or unregulated at 18 Amps peak. The Horizon One has a built-in VOX, noise blanker, and hand mike as standard

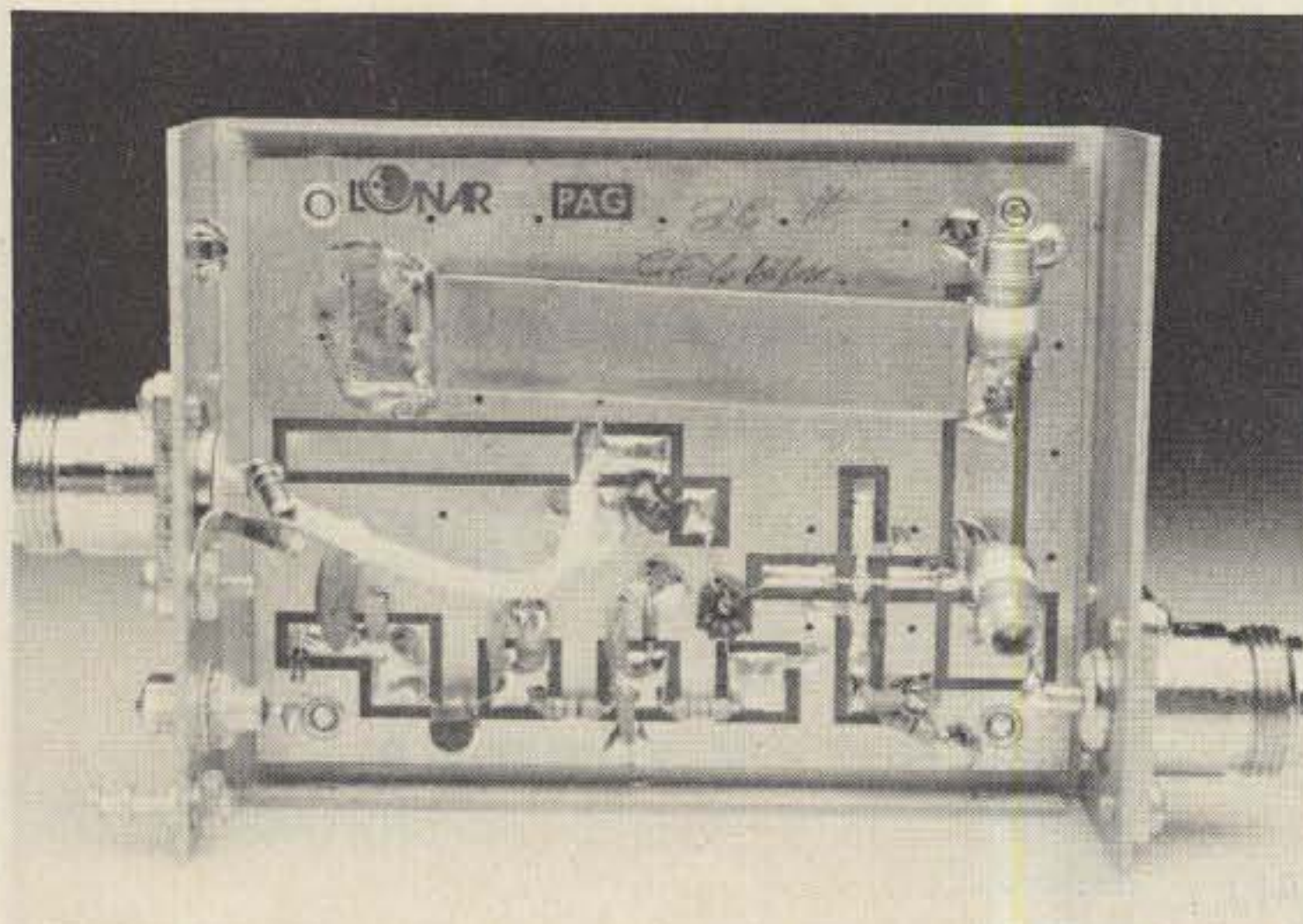

Lunar's GaAsFET VHF/UHF amplifier.



Yaesu's FT-102.



**ALL YOUR GEAR AT YOUR FINGERTIPS IN A CONVENIENT CONSOLE DESK**

Requires only 60" corner space  
Formica desk top and shelves  
Shelf height adjustable  
Solid maple legs  
\$495.00 check or M.O.  
Shipped freight collect  
Allow 30-45 days delivery  
Send for detailed brochure

**CQ PRODUCTS**

8280 Janes Ave.  
Suite 137-1700  
Woodridge, IL. 60517



(Chair and equipment not included)  
Weight of table is 250 lbs.

**Take your favorite H.T. out for a drive tonight.**

VISA or MASTERCARD for same day shipment.

For \$69.95 you get the most efficient, dependable, fully guaranteed 35W 2 meter amp kit for your handy talkie money can buy.

Now you can save your batteries by operating your H.T. on low power and still get out like a mobile rig. The model 335A produces 35 watts out with an input of 3 watts, and 15 watts out with only 1 watt in. Compatible with IC-2AT, TR-2400, Yaesu, Wilson & Tempo! Other 2 meter models are available with outputs of 25W and 75W, in addition to a 100W amplifier kit for 430MHZ.



**Communication Concepts Inc.**

382  
2648 N. Aragon Ave., Dayton, OH 45420  
(513) 296-1411

**pro-am™**

**Mobile HF Antennas**

The Pro-Am HF mobile series are heavy-duty, slim line construction, designed for the HF Amateur Bands, 75M, 40M, 20M, 15M, and 10M.

Heavy-gauge copper wire wound on 3/8" fiberglass, with nickel-chrome brass fittings and 17-7 taper ground S.S. whips assure dependable mobile operation. The 4' S.S. whip is field tunable for lowest VSWR and double locked with S.S. set screws. The antenna features 3/8-24 ferrule to fit standard mobile mounts. Power-rated at 500 watts P.E.P. for top mobile performance. Approx. 8' length.

MODEL	BAND
PHF75	75 Meters
PHF40	40 Meters
PHF20	20 Meters
PHF15	15 Meters
PHF10	10 Meters

Write or call today for complete details.

**valor Enterprises, Inc.**

185 W. Hamilton St., West Milton, OH 45383  
PH: (513) 698-4194, Outside Ohio: 1-800-543-2197  
Telex: 724-389 ATT: Valor

**BASE RINGO RANGER II**

7dB GAIN  
HIGHEST GAIN  
2 METER OMNI  
OUTPERFORMS  
CONE AND  
DOUBLE ZEPP  
WORK MORE STATIONS  
ELIMINATE NOISE  
LIGHTNING PROTECTED  
ACCESS MORE REPEATERS  
ASSEMBLE EASILY  
INSTALL QUICKLY  
A COMPLETE ANTENNA  
ALL PARTS INCLUDED  
600,000 HAPPY USERS  
BECOME ONE TODAY  
ARX-2B 134-164MHz  
ARX-220B 220-225MHz  
ARX-450B 435-450MHz

**TERRIFIC 2 METER RANGERS**

**MOBILE RANGERS**

MORE RANGE  
3 dB GAIN  
5/8" STAINLESS WHIP  
GRIP TIGHT 90LB  
MAGNET  
CHROME PLATED BASE  
NEAT APPEARANCE  
THUMB LOCK ADJUSTMENT  
NO WHIP CUTTING  
LOW PRICE  
MAGNETIC MOUNTS  
AMS-147 146-148 MHz  
AMS-220 220-225 MHz  
TRUNK LIP MOUNTS  
ATS-147 146-148 MHz  
ATS-220 220-225 MHz

**MOBILE**

**BUY FROM YOUR DEALER**



**THE ANTENNA COMPANY**

48 Perimeter Road, P.O. Box 4680  
Manchester, NH 03108  
Telex - 953050





DenTron's Horizon One.

equipment. Optional accessories include an ac power supply, matching antenna tuner, linear amplifier, and mobile mount.

For further information, contact Tim Neill, Technical Sales Representative, DenTron Radio Company, Inc., 1605 Commerce Drive, Stow OH 44224; (216)-688-4973. Reader Service number 485.

#### DIVERSITY RECEPTION FOR REPEATERS

Pegasus Electronics has announced a new diversity receiving system for repeaters. Now you can turn any repeater into a "super repeater" by adding a VS-2 voting system and an rf link. The VS-2 compares the audio quality of any 2 receivers (they need not be matched) and connects the one that hears you best to the repeater for retransmission. Since the VS-2 is always listening to both receivers, it can continuously update as you go from a peak on one to a null on the other. The result: You have a repeater which sounds like it has no "dead" spots and your users are always readable as long as they are solid into any *one* of your receivers.

The VS-2 was designed to work with anything. It has all its own level controls and ensures a constant output to your repeater. It was designed to be installed by anyone who knows how to read a scope. The VS-2 is supplied on a single circuit board (5 1/8" x 5 1/4") and contains two squelch circuits (COS). It is fully compatible with 12-volt logic, 5-volt logic, and inverted logic by cutting the desired jumpers (or you can use your own logic

and bypass that portion of the VS-2). The VS-2 is not a kit—it comes fully assembled and tested and is warranted for one full year.

For further information, contact Pegasus Electronics, Inc., 88 New Dorp Plaza, Staten Island NY 10306. Reader Service number 488.

#### PHOTOVOLTAIC SYSTEMS

Encon Corporation, authorized distributors of Solarex photovoltaic products, has a publication entitled *The Complete Photovoltaic Systems Catalog* which can answer many of your questions about solar energy conversion and distribution. The catalog covers an introduction to photovoltaic systems, photovoltaic cells and panels, renewable energy batteries, charge controllers and metering devices, ac power inverters, how to select a workable system for your needs, basic 12-volt systems, large-dc/small-ac systems, components and accessories you will need, solar demonstrators, educational materials, marine and recreational panels, and much more.

If you have an interest in direct conversion of sunlight to power, you will enjoy this catalog and overview of the entire subject. A price guide as well as an applications questionnaire form are included so that you can obtain expert advice and assistance for potential applications that you may have in mind. Encon will assist you with your questions and needs in solar applications.

For further information, contact Encon Corporation, 27584 Schoolcraft, Livonia MI 48150. Reader Service number 479.

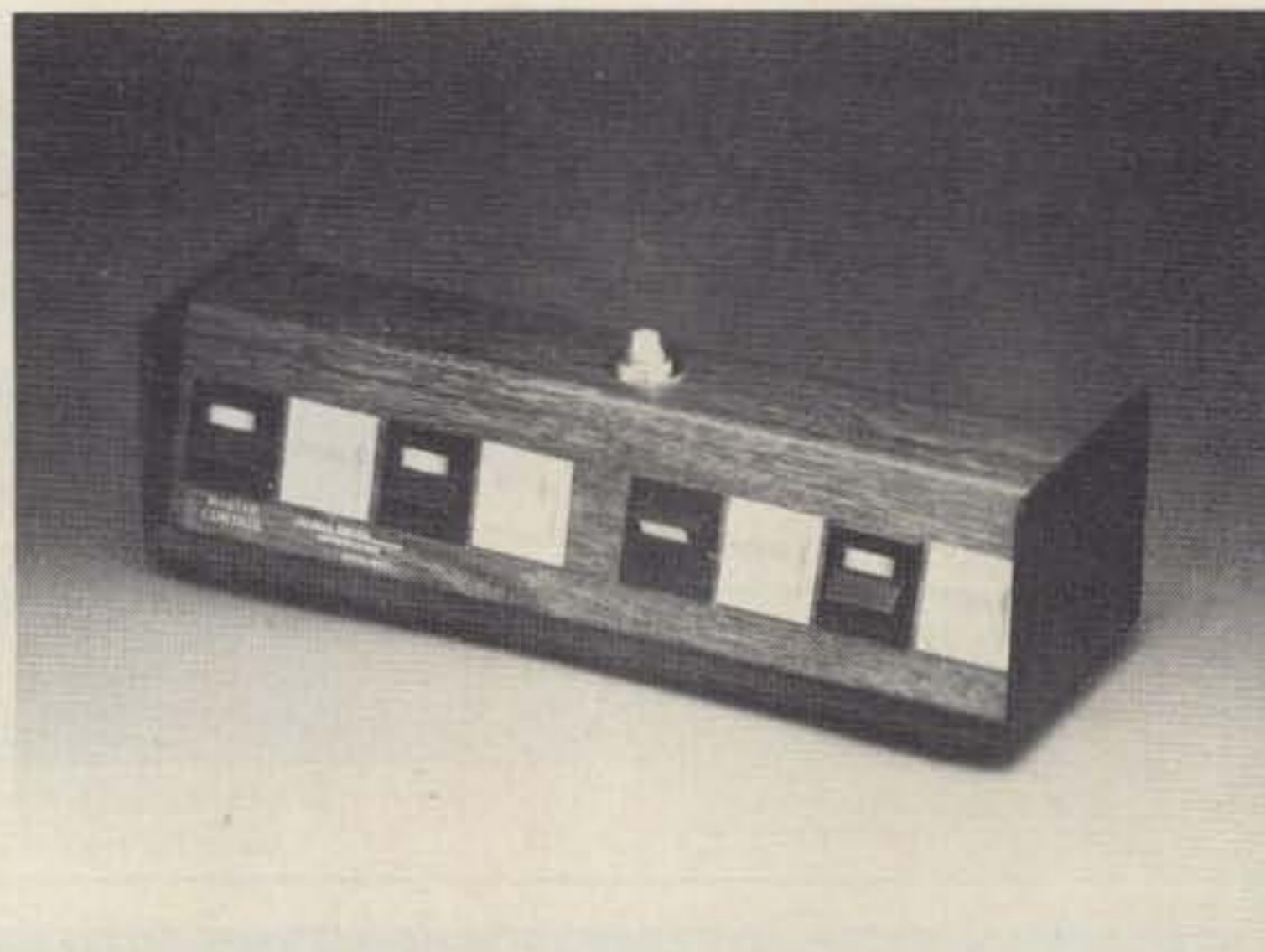

Alpha Delta's Master Control Console.

#### MASTER CONTROL CONSOLE

Alpha Delta Communications has just announced its new Master Ac Control Console which combines power-surge protection and centralized "on/off" control of several components. The MACC unit plugs into a single outlet and provides eight plug-in "U" ground outlets: one "hot" outlet for continuously-powered appliances such as a clock, for example, and seven outlets for individually-controllable components.

The front panel has rocker switches for the individually-controllable components, plus a master control "on/off" rocker which allows the entire system to be turned on or off at once. All rockers are lighted when "on."

The surge-protection feature is perhaps the most important feature of Alpha Delta's MACC unit. The delicate circuitry of modern solid-state electronic equipment is particularly vulnerable to damage from power surges and spikes which can be caused by natural or man-made sources such as lightning strikes, electric motors, transformers, wind-blown snow, clouds, fluorescent lamps, power outages, and the like. The MACC is tested to IEEE pulse standards and is rated at 15 A, 125 V ac, 60 Hz, 1875 Watts continuous-duty total for the console.

Priced at \$79.95 (US), the MACC is available from Alpha Delta dealers or, for \$4 more to cover postage and handling, direct from the factory. Alpha Delta will quote on overseas postage and on the "European Model" MACC-E available with VDE-approved socket for 240 V ac.

For further information, contact Alpha Delta Communications, PO Box 571, Centerville OH 45459. Reader Service number 486.

#### MORTTY SOFTWARE FOR COMMUNICATIONS

MORTTY is a general-purpose communications program adaptable to almost any set of conventions in current use. It includes ASCII and Baudot capabilities at a wide range of baud rates. There are 18 parameters for adaptation to particular conventions such as full screen, split screen, full or half duplex, and many more. There are 15 disk operations, including disk file send, receive, direct binary to hex upload, hex to binary download, automatic message capture with file sequencing, and automatic answering of messages from a disk file.

The equipment required to make use of the program is an H89 or Z89 microcomputer with 32K of memory and an H88-3 serial interface. MORTTY reprograms the serial interface for baud rate, etc., according to the communications mode selected, and does the translation between ASCII and Baudot when a Baudot mode is in use. In place of the H89 or Z89 with H88-3, you may use an H8 with H19 terminal and H8-4 serial interface with H17 disk system.

The software required is HDOS v. 2.0, which is the current Heath disk operating system. Heath claims that programs should be upward-compatible with new HDOS releases, but we cannot guarantee that this will always be true.

The price of the MORTTY pro-



... at last - everything at your

**fingertips !!!**



**\$184<sup>50</sup>**

Radio Equipment  
NOT Included  
F.O.B. Culver City  
(CA Residents add 6% sales tax)

Bring ORGANIZATION & CONVENIENCE to your HAM Station! Eliminate clutter and provide lots of space for everything you need - Tuners, VFO, CW Keyers, Filters, Telephone, Log Book, Etc...

- ANGLED REAR SHELF
- ALL PARTS FITTED
- STURDY CONSTRUCTION
- WALNUT or PECAN FINISH

Floor space: 39" w by 30" d.  
Also: 51" w by 30" d - \$199.50

Dealers Inquiries Invited

**A Finely Crafted Piece of Furniture  
With a REAL Purpose ...**

Call : (213) 837-4870 or Write for Information

**S-F Amateur Radio Services**

4384 Keystone Ave., Culver City, CA 90230

**look here**

**1-713-658-0268**

ICOM IC740	969.00
IC701 (New)	800.00
IC490A	569.00
IC730	699.00
IC25A	309.00
IC3AT/IC4AT	269.00 ea.
YAESU FT230R	299.00
FT1	2395.00
FT10ZD/3	749.00
FT707	649.00
FT208R/FT708R	289.00 ea.
FRG7700	449.00
DRAKE TR5	699.00
TR7A	1450.00
R7A	1400.00
Cubic 103	1095.00
Bird	Stock
Kenwood R600	299.00
TR7730/TTM	299.00
Tote 'n Talk Cordless	
Base/Telephone	149.00
NEW Signal/One Milspec	Soon
Permitron Wireless Burglar Alarm	
3 Remotes	199.00
W6TOG Kits	Stock
Demo TS530S	600.00

Alpha 78AF	
(Hi Serial No.)	2795.00
Kantronics Interface	169.00
Minireader	249.00
Santec HT1200	
+ Batt/cord	269.00
Belden 99258, RG8X	19¢/ft.
8214, RG8 foam	36¢/ft.
8267, RG213	43¢/ft.
8448, Rotor	27¢/ft.
9405, HD Rotor	45¢/ft.
AEA MBARO	269.00
MM2	125.00
CK2	89.00
Robot 800A	749.00
400	675.00
Butternut HF6V	125.00
Saxton 450 OHM	
Openwire Line	20¢/ft.

MENTION YOU SAW IT IN THIS AD

MASTERCARD VISA

All prices fob Houston except where indicated. Prices subject to change without notice, all items guaranteed. Some items subject prior sale. Texas residents add 6% tax. Please add sufficient postage, balance collect.

**MADISON**  
Electronics Supply  
1508 McKinney  
Houston, Texas 77010



**2 METER 90 WATT OUTPUT  
AMPLIFIER WITH 18 DB GAIN PREAMP**

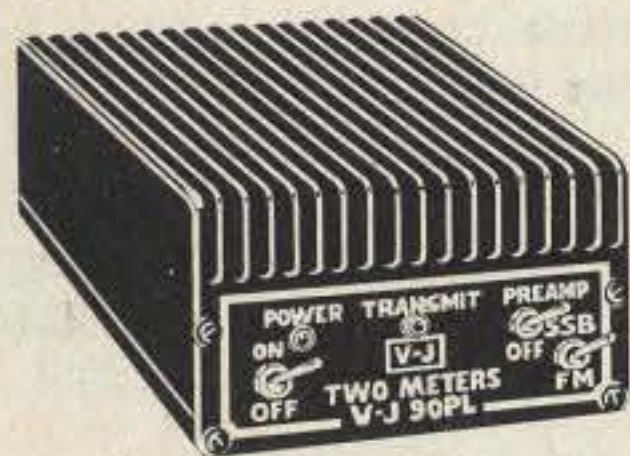

Model 90PL  
FOR ONLY  
FACTORY DIRECT

**\$139.95\***  
PLUS SHIPPING

- FREQUENCY range 144 - 148 MHz
- OPERATION FM or SSB (completely linear) Class AB1
- RF DRIVE 1 to 30 watts
- KEYING RF activated with high quality relays
- SSB operation built in delay
- POWER REQUIREMENTS typical 10 watts drive, 13 amps at 13.8 VDC
- IDLE current 20 mills
- MOBILE or FIXED operation
- PREAMP 18DB gain minimum
- NOISE FIGURE less than 1.5 DB
- PREAMP KEYING independent — separately RF activated relays
- CONSTRUCTION wrap around aluminum heat sink 2 pieces 360 degrees cooling
- SIZE 7"(w) x 6"(d) x 3"(h) — WEIGHT 3 lbs. 9 ozs.
- IMMEDIATE SHIPMENT

**SPECIAL OFFER**

**Matching Power Supply**

**\$99.95\***  
PLUS SHIPPING

15 AMP SUPPLY wt. 13 lbs. size 8"(w) x 5"(h) x 6"(d)  
IMMEDIATE SHIPMENT  
ALL PARTS AND LABOR WARRANTED ONE FULL YEAR

VJ90PL Amplifier \$139.95 plus \$3.00 shipping  
VJ15 POWER Supply \$99.95 plus \$7.00 shipping  
\*Prices USA only

POWER MEASUREMENT  
AT 13.8VDC

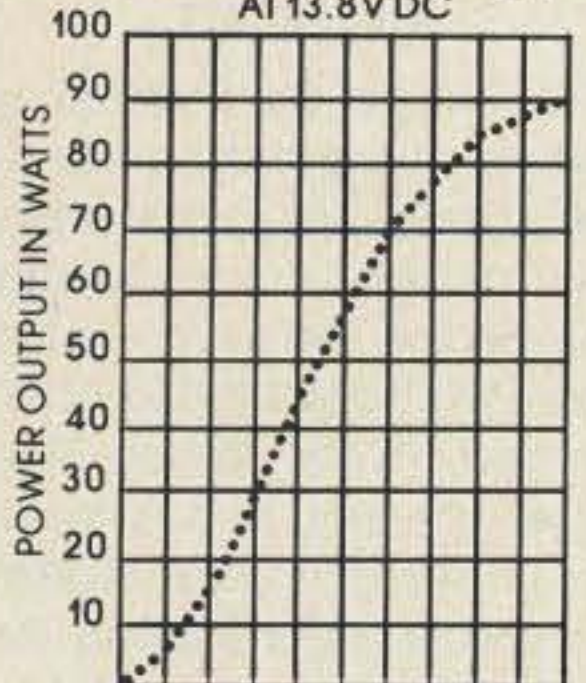

POWER CHART

VISA, MASTER CHARGE, M.O. or C.O.D. • PHONE (713) 477-0134

**V-J PRODUCTS, INC.** 505 East Shaw, Pasadena, Texas 77506

SERVING THE ELECTRONICS INDUSTRY SINCE 1965





MFJ's VHF converter.



Channel Master's model 6128 satellite receiver.

gram is \$100.00 ppd in the USA. Ohio purchasers should add 6% sales tax. Foreign prices will depend on the additional expenses of mailing. This price buys a printed copy of a thorough user's guide of about 60 pages and a 5 1/4" hard-sector disk with the absolute binary MORTTY program.

For further information, write "MORTTY program" or "Phillip L. Emerson" at 3707 Blanche, Cleveland Heights OH 44118. Reader Service number 480.

#### MFJ-313 POLICE/FIRE/WEATHER BAND CONVERTER FOR 2-METER HAND-HELDS

MFJ has introduced its new compact VHF police/fire/weather band converter for 2-meter hand-helds.

It turns your synthesized 144-148-MHz hand-held into a police/fire receiver (154-158 MHz) and gives you direct frequency readout on your hand-held. A programmable scanning hand-held becomes a sensitive programmable police/fire scanner.

You can also receive weather, maritime coastal, and more on the 160-164-MHz band. Feed-through allows simultaneous

scanning of both 2 meters and the 160-164-MHz band.

A high-pass input filter and a 2.5-GHz transistor give very high uniform sensitivity over both the 154-158-MHz and 160-164-MHz bands. Each band is crystal-controlled for excellent stability.

A Bypass/Off position allows transmitting through the converter. It is protected against burnout if you transmit (up to 5 Watts) with the converter on. Short direct-signal paths give low insertion swr.

This compact converter measures only 2 1/4 x 1 1/2 x 1 1/2 inches and weighs 4 ounces. A single AAA battery (not included) gives you months of operation. The cabinet is black and is made of rugged, lightweight aluminum for years of hard use. BNC connectors mount the converter directly between your handie-talkie and antenna without cables.

For further information, contact MFJ Enterprises, Inc., PO Box 494, Mississippi State MS 39762. Reader Service number 483.

#### NEW FROM VOCOM

VoCom Products Corporation has announced two new prod-

ucts for the amateur 220-MHz band: a "two Watts in, twenty Watts out" power amplifier with a suggested list price of \$84.95 and a "Power Pocket" for the Icom IC-3AT hand-held transceiver with a suggested list price of \$229.95.

With the Power Pocket, the 220-MHz operator now has the same advantage that he had on two meters: the convenience of a hand-held and the punch of a mobile rig. Styled essentially the same as the two-meter version, the 220-MHz Power Pocket offers a large speaker, an audio amplifier, an rf power amplifier, and a battery charger that meets the current requirements of the radio. For example, you can use the amplified hand-held in your car on the way to work, hold your own in any QSO, and arrive with a battery that is still charged... as good or better than it was when you started!

For further information, contact VoCom Products Corporation, 65 East Palatine Road, Prospect Heights IL 60070. Reader Service number 478.

#### EARTH-STATION RECEIVER

Channel Master has just introduced a new Earth-station receiver, the model 6128, offering a wide range of features and advanced electronics. The receiver is a 24-channel synthesized unit employing a single downconverter installed at the dish and a receiver unit located in the home.

For simplified tuning, the full 24-channel number format is displayed on the receiver's LED digital channel display. Channels are power-selected by Up/Down push-buttons and fine tuning is provided with the assistance of the Center/Fine Tune meter.

Two Priority Audio buttons select audio channels (6.8 and 6.2 MHz), while additional audio channels may be selected manually.

A signal-strength meter shows the relative strength of received signals. The Channel Scan button is depressed to cycle the receiver through the complete horizontal channel range in about one second, as an aid to aiming the antenna.

Automatic polarity switching allows one-button selection of any channel without additional polarity adjustments, and a built-in modulator eliminates the need for a separate modulator. The model 6128 is capable of receiving normal or inverted video signals. An optional model 6192 remote control unit offers the added convenience of remote channel selection and fine tuning.

For further information, contact Channel Master, Division of Avnet, Inc., Ellenville NY 12428. Reader Service number 482.

#### NEW TS-830, TS-930, R-820 FILTER KIT

Fox Tango Corporation has announced the availability of a special high-quality matched-filter kit designed to significantly improve the selectivity of the popular Kenwood R-820, TS-830, and new TS-930 series. These rigs all use similar dual-conversion i-f systems with 8830-kHz first and 455-kHz second intermediate frequencies. I-f bandwidth filtering at both frequencies is used to provide VBT (variable bandwidth tuning). However, in the TS-830S model, the 2.7-kHz bandwidth of both original filters (resulting in a net bandwidth of 2.4 kHz with VBT off), the combined filter shape



factors (1.34 with VBT off), and a combined ultimate rejection of about 80 dB leave much to be desired.

Under the same conditions, the Fox Tango filters (both 8-pole discrete crystal units instead of the original monolithic

and ceramic types) each have a bandwidth of 2.1 kHz (net bandwidth of 1.99 kHz), a combined shape factor of 1.19 (the lower, the better), and an ultimate rejection greater than 110 dB (the higher, the better). The effects are even more pronounced when

VBT is used to narrow the operating i-f bandwidth to reduce QRM.

The matched-pair filter kit, complete with detailed instructions, two 2.1-kHz Fox Tango filters (guaranteed for one year), and all needed cables and parts,

is being offered at an introductory price of \$150 plus \$3 for shipping (\$5 for air).

For further information, contact *Fox Tango Corporation*, PO Box 15944, W. Palm Beach FL 33406; (305)-683-9587. Reader Service number 477.

## REVIEW

### COM-RAD INDUSTRIES CR1720A

#### "MOBILE EAR" ANTENNAS

Jim Waldron of Com-Rad has been interested in space-saving antennas for a long time, and he has built and tested dozens of them with the idea that a better antenna can be built and is much needed. Jim's idea of a "better" antenna is one that is small, compared with a full-size antenna for the band selected; one that is rugged and has a low profile; one that is easy to tune; and one that is duck soup for mobile operation, yet may be used in portable or fixed operation as well.

At first glance, the Mobile Ears look something like a cross between a giant coil and a short dipole, and that is almost exactly what they are. The large-diameter helix is resonated to frequency by the capacitance-to-ground of the adjustable "resonator"—a capacity hat which is basically two telescoping whip antennas mounted above the coil and parallel with the roof of the automobile. The helix radiates vertically-polarized rf energy in the radial, rather than axial, mode... similar to that from a conventional vertical antenna.

The CR1720A comes from the factory with a large magnetic mount that will defy almost any attempt to remove it accidentally from the roof of your car once it has been placed in position. The shunt feed has been factory-preset to provide the proper 50-Ohm feedpoint impedance, and a UHF chassis-type rf connector (SO-238) is located on the center support pillar just above the mounting base. Although it is normally used with the magnetic mount supplied by Com-Rad, the Mobile Ear can be used with any mount that is connected directly to ground, such as groundplane radials or the like.

The reason for this is that the coaxial cable is connected to the antenna rather than to the mounting base; for proper operation, the base of the antenna should be grounded. For example, you might wish to replace the magmount with a permanent base for the home station, and this can be done by using the 3/8-24 bolt at the bottom of the antenna—the one that the magmount screws into.

The CR1720A comes completely assembled, except for attachment of the telescoping whips to the top of the support pillar. This is easily and quickly done by sliding the setscrew ends of each whip over the 5/16-inch stubs at the top of the support pillar and tightening the setscrews.

After you have mounted the antenna in the desired location on your car roof, connect an swr bridge in the line between the antenna and your transceiver or transmitter by means of a short length of coaxial cable, placing it as close as practical to the antenna itself (within two or three feet). Set the telescoping whips to approximately 50 inches each, and set your transmitter to the desired operating frequency. Apply a small amount of power and look at the swr. Small incremental adjustments of

whip length by sliding the ends in or out (*out*—or longer—to lower the frequency and *in*—or shorter—to raise the frequency) will quickly provide a 1:1 vswr. Observe the lowest possible swr that you can get with your particular vehicle. If it isn't less than about 1.5:1, you can move the clamp ring of the shunt feed in tiny increments to achieve a perfect match. In the case of the test antenna, this wasn't necessary, as a perfect 1:1 match was obtained immediately.

I checked the bandwidth after achieving a perfect match and found that the frequency could be moved 65 kHz in either direction from the resonant frequency without exceeding 2:1 vswr. This means that with most rigs you can operate over your favorite phone or CW segment of the 20-meter band without any re-tuning at all. Of course, if you are a perfectionist, you can achieve exact matching at any frequency within the band... no sweat.

In the case of the test antenna, the inner sections of the whips were fully extended and the outer sections only partly extended. This gives the largest possible diameter at all times. I resonated the antenna at 14.025 MHz and found each whip length to be exactly 53¼ inches, measured from the surface of the support pillar. On the phone portion of twenty meters, I found that 14.3 MHz required a whip length of only 48½ inches.

This is likely to vary slightly from car to car because of the different sizes of roof area, etc. A station wagon, for example, will have more groundplane area than a tiny subcompact, but both will work!

No doubt you are anxious to hear about results, and I won't disappoint you. The twenty-meter Mobile Ear really works. After tuning the antenna to resonance and firing up the 73 FT-707 transceiver (with my 1980 Olds Omega parked in my driveway), I found myself in the middle of the WAE contest on Sunday afternoon, August 15th. I answered many calls and received replies from each one. All were 599. Now, I'll admit that this is often the case in a contest, to make things easier for the report giver, but I got an answer to the first call every time! Not only that, but when I called CQ I got answers, too. In the space of only a few minutes I had worked UT5, UQ2, DL7, OZ1, OH5, UK5, G4, N9, K0, and W4 lands! (Naturally, the US stations don't count, but I wanted to try the antenna.) To date, I've not done much with phone, as I am predominantly a CW operator. However, a few contacts up around 14.300 have been made with good results—G3, for example... and others.

I noticed that the noise pickup of the antenna is surprisingly low compared with other verticals I've tried. One possible explanation could be that the com-

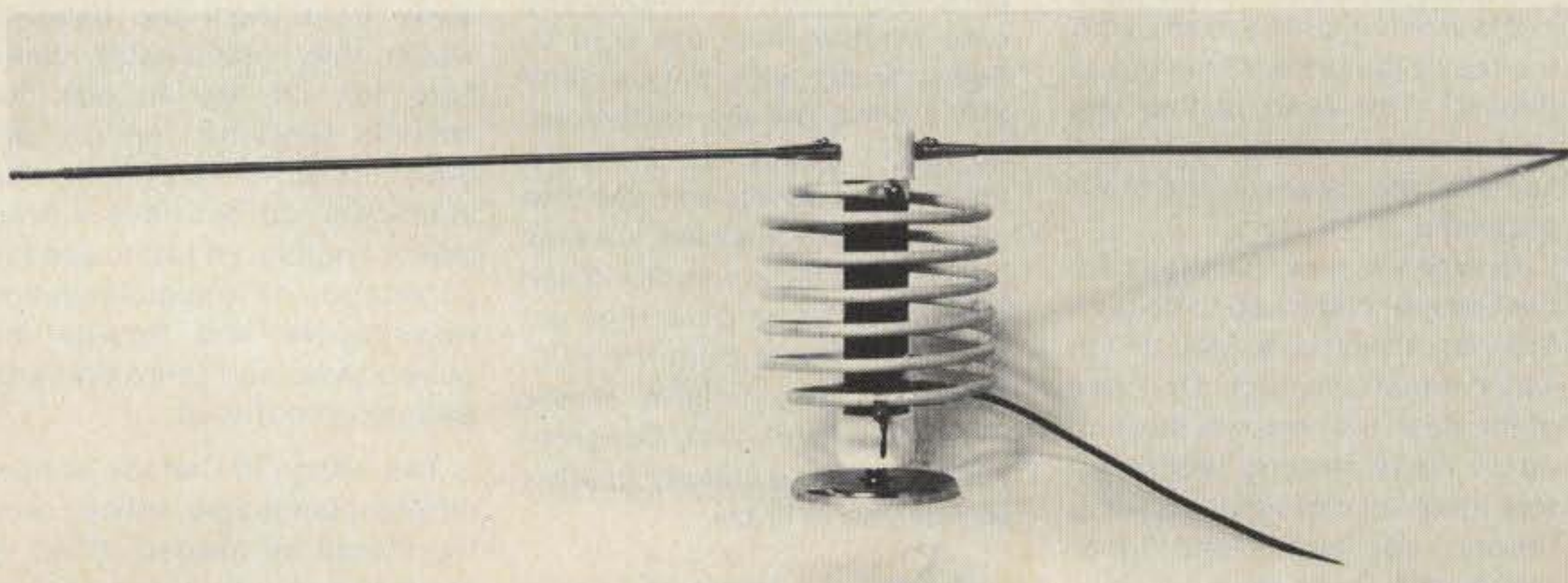

Com-Rad's Mobile Ear antenna.



ponents are horizontally-configured and thus less subject to man-made or natural QRN.

I should mention that the CR1720A is beautifully made—the helix is heavy-duty aluminum tubing and the whips are stainless steel. The supporting pillar appears to be heavy-wall PVC and the magmount is chrome-plated steel. Everything considered, the CR1720A is a very fine portable/mobile/fixed antenna, one that the 73 staff

really liked. You ought to know that the antenna doesn't need to be removed to put my car in the garage, so yours shouldn't need to be removed either, unless you want to. In public parking facilities, just slide in the whips, remove the coax, take the Mobile Ear off the roof and stow it in the trunk. It takes about 20 seconds . . . and, best of all, it can be re-mounted and ready to go in about the same time. In my case, I ran the whips fore and aft

parallel to the car's centerline so that they wouldn't be sticking out into the side. If you live in an apartment or condo where outside antennas are forbidden, you might find one of the Mobile Ears to your liking.

By the way, the "17" part of 1720 means that this antenna will also work on the 18-MHz (17-meter) band whenever that becomes available to amateurs in the United States. The

CR1720A is one of three Mobile Ears which cover 12/15 meters, 17/20 meters, and 30/40 meters: versatile, indeed. The CR1720A lists for \$55 plus \$4 shipping, direct from the manufacturer.

For further information, contact *Com-Rad Industries, 1635 West River Parkway, Grand Island NY 14072*. Reader Service number 487.

**Jim Gray W1XU**  
**73 Magazine Staff**

---

# W2NSD/1 NEVER SAY DIE

*editorial by Wayne Green*

---

*from page 8*

a lot, I suspect. It read: C/Q/ THE/FASTEIET/GROWING/ AMATEUR/RADIO/MAGAZINE/ That's operculiform sending . . . and does not surprise us.

## BUNCH GETS BASHED!

The recent Bash debacle in Baltimore should put an end to the fantasy that Bash is doing anyone any good except Bash. I also hope it will shut up a lot of the hams who are moaning about the code and ignoring the fact that Bash has totally done away with any need for technical competence. . . or at least had until the Baltimore epic.

As usual, Bash collected his most generous fees and set about helping a large group of hopefuls to memorize the answers to the FCC exams. He drilled them thoroughly, as always. But this time the FCC had made some very minor changes in the wording of the exam, with the result that 89% of his group flunked. The word is that the changes were small, such as in some of the values in the math problems.

One of the new questions for the General class had to do with the yagi antenna, asking which way it radiated energy. Only *one* of the Bash trainees got this one right! We're dealing with massive ignorance of amateur radio theory, not superficial ignorance, with these memorization sessions and the Bash books.

You know, I've been writing about this problem for quite a long time now and I've had almost zero response from readers. I have yet to hear of one single case where an amateur or a club has protested to a ham dealer carrying the Bash books. Not one case of an irate ham tearing up the books. No protests to CQ for carrying the ads for these pernicious books. No, it is obvious that no one really gives a damn whether a newcomer to amateur radio has even the slightest technical knowledge or even the ability to pass a fair test. So why all the fuss about Morse code? Am I talking to a bunch of hypocrites?

The Bash books and the Bash high-priced blitz weekend course are designed for one thing: to help people cheat at the FCC exams and bypass the entry requirements. As long as you don't care if people cheat to get a ham ticket, why should you care whether they are sold by Sears along with a two-meter HT? I don't see any difference, do you? If you really, sincerely, believe that people who cheat to get their ham licenses are suddenly going to be wonderful and productive hams once they get the magic paper from the FCC, then you also believe in the tooth fairy and that Congress will balance the budget. In other words, you're crazy.

Frankly, I'd rather see Sears making all that money instead

of Bash; at least we would have more than a tiny dribble of new hams. Bash, despite his heroic efforts, has only been able to bring in a few thousand new hams for us. True, he's probably responsible for much of the few we've had. But if we are going to go along with the Bash system, which you have wholeheartedly accepted, let's go all the way and get some mass merchandisers into the act.

You've seen this thing happening and you haven't done a damned thing about it. Why should I have any respect for you? The hypocrisy over the code just makes this all the more irrational. And don't try to tell me that this is all news to you. Baloney.

## NO SECOND LANGUAGES

There has been a liberally-fueled effort to cope with the inrush of Hispanics by allowing them to continue to use Spanish in school rather than force them to learn English. Fortunately, there is now a gathering movement against this policy. We showed that the "melting pot" system worked in America and then we tried to ignore it.

The more we keep newcomers to the United States able to make do without learning English, the more we are taking away from them the benefits which they presumably came here for. I'd like to see our schools teaching foreign languages, but not catering to students who do not have a solid use of English. I'd like to see the publication of foreign-language newspapers and foreign-language radio and television programs discouraged.

The lesson in Canada of how different languages split a country should be heeded. When a group in a country holds on tight to its language and culture, it is

a disruptive force. Americans living in other countries tend to stick together and avoid learning the language as much as possible. This hurts both them and the country in which they are living.

The Indians (Asian) have long had a problem with this. In every country where there are a significant number of Indians, they are clannish and generate resentment with the other people. We don't have many Indians in the US, so we are not aware of them, but we do see the Chinese, who have the same problem. For many years we sort of accepted that the Chinese for some reason don't know English and run either laundries or restaurants.

Both the Indians and the Chinese are very hard-working people and, I suspect, if either group had made an effort to integrate into their new countries, they would have virtually taken over. Of course, Americans used to be hard-working people. . . and a few still are. . . but for the most part I see few remnants of this heritage. Perhaps we are most fortunate that the Chinese in America are so clannish and thus are kept from enjoying and benefitting from our educational opportunities.

We still live in a world where hard work pays off. This is one of the reasons we have so few wealthy people. Given equal opportunity, I suspect that the US would be as proportionately populated with wealthy Chinese as it is wealthy Jews. In Taiwan, Hong Kong, and Singapore, we see how well the Chinese can do when they are not held down by Communism. Perhaps we are fortunate, in a way, that the political systems in China have been so destructive. I'm sure that the Chinese could, if working in a free country, run circles around us.



# Wayne Green Books

NEW  
ARRIVALS

## TEXTEDIT

a complete  
word processing  
system in kit  
form.

by  
Irwin Rappaport

A WAYNE GREEN  
PUBLICATION

## TEXTEDIT—A Complete Word Processing System in kit form

by Irwin Rappaport

TEXTEDIT is an inexpensive word processor that you can adapt to suit your needs, from writing form letters to large texts. It is written in modules, so you can load and use only those portions that you need. Included are modules that perform:

- right justification
- ASCII upper/lowercase conversion
- one-key phrase entering
- complete editorial functions
- and much more!

TEXTEDIT is written in TRS-80\* Disk BASIC, and the modules are documented in the author's admirably clear tutorial writing style. Not only does Irwin Rappaport explain how to use TEXTEDIT; he also explains programming techniques implemented in the system.

TEXTEDIT is an inexpensive word processor that helps you learn about BASIC programming. It is written for TRS-80 Models I and III with TRSDOS 2.2/2.3 and 32K.

**BK7387 \$9.97 Disk Available DS7387 \$19.97**

0-88006-050-6

## Annotated BASIC—A New Technique for Neophytes.

BASIC programming was supposed to be simple—a beginner's programming language which was so near to English that it could be easily understood. But, in recent years, BASIC has become much more powerful and therefore much more difficult to read and understand. BASIC simply isn't basic anymore.

*Annotated BASIC* explains the complexities of modern BASIC. It includes complete TRS-80\* Level II BASIC programs that you can use. Each program is annotated to explain in step-by-step fashion the workings of the program. Programs are flowcharted to assist you in following the operational sequence. And—each chapter includes a description of the new concepts which have been introduced.

*Annotated BASIC* deals with the hows and whys of TRS-80 BASIC programming. How is a program put together? Why is it written that way? By observing the programs and following the annotation, you can develop new techniques to use in your own programs—or modify commercial programs for your specific use.

*Annotated BASIC Volume 1* contains Projecting Profits, Surveyor, Things to Do, Tax Shelter, Introduction to Digital Logic, Camelot, The Soundex Code, Deduction, Op Amp, Contractor Cost Estimating.

**BK7384 \$10.95** ISBN 0-88006-028-X

**AVAILABLE NOW!**

*Annotated BASIC Volume 2* contains Rough Lumber List, Trip Mileage, Flight Plan, OSCAR Data, SWR/Antenna Design, Supermaze, Petals Around the Rose, Numeric Analysis, Demons, Air Raid, Geography Test, Plumbing System Design.

**BK7385 \$10.95** ISBN 0-88006-037-9

Order Both Volumes and Save! **BK738402 \$18.95**

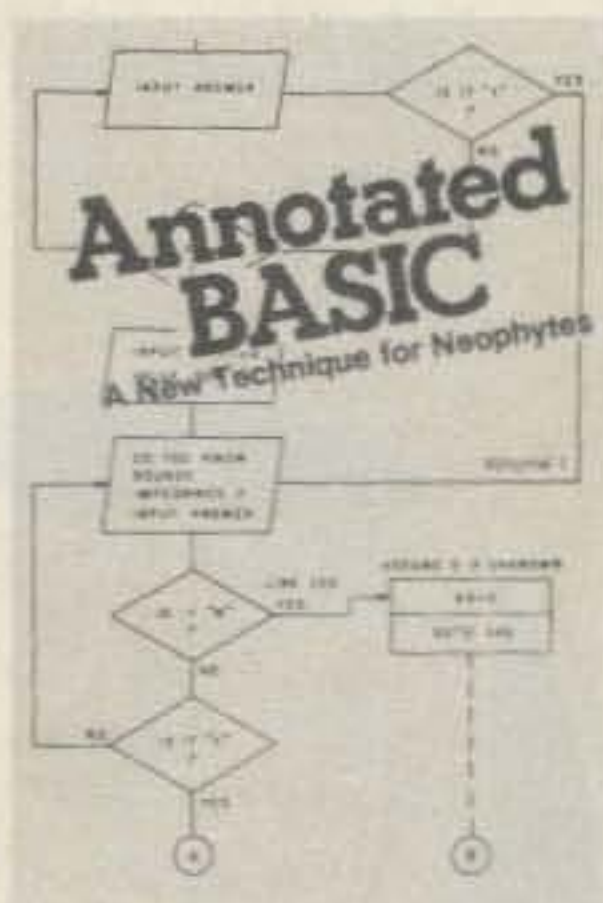

## KILOBAUD KLASROOM

Learn Digital  
Electronics While  
Building Your Own  
Computer!

By George Young  
and Peter Stark

## KILOBAUD KLASROOM—

A practical course in digital electronics

By George Young and Peter Stark

Learning electronics theory without practice isn't easy. And it's no fun to build an electronics project that you can't use. *Kilobaud Klassroom* the popular series first published in *Kilobaud Microcomputing*, combines theory with practice. This is a *practical* course in digital electronics. It starts out with very simple electronics projects, and by the end of the course you'll construct your own working microcomputer!

Authors Young and Stark are experienced teachers, and their approach is simple and direct. Whether you're learning at home or in the classroom, this book provides you with a solid background in electronics—and you'll own a computer that you built yourself!

*Kilobaud Klassroom* contains Getting the Ball Rolling, Gates and Flip-Flops Explained, J.K. Flip-Flops and Clocked Logic, PC Boards and Power Supplies, Hardware Logical Functions, Voltage, Current and Power Supplies, Transistors, Diodes and OP Amps, Pulses and More Pulses, Counters and Registers, Bus Traffic Control, ROM and RAM Memories, I/O Circuitry, Parallel and Serial I/O Ports, Computer I/O III, Computer I/O IV, Computer I/O V, Processor Connections, Finally... The Kilobaud Crescendo, Eproms and Troubleshooting, Expansions and Programming, Machine-Language Programming, Assembly-Language Programming, Connecting to the Outside World.

ISBN: 0-88006-027-1 **AVAILABLE NOW! BK7386 \$14.95**

## THE NEW WEATHER SATELLITE HANDBOOK—

By Dr. Ralph E. Taggart WB8DQT—

Here is the completely updated and revised edition of the best-selling *Weather Satellite Handbook*—containing all the information on the most sophisticated spacecraft now in orbit. Dr. Taggart has written this book to serve both the experienced amateur satellite enthusiast and the newcomer. This book is an introduction to satellite watching, that tells you how to construct a complete and highly effective ground station. Not just ideas, but solid hardware designs and all the instructions necessary to operate the equipment are included. An entire chapter is devoted to microcomputers and the Weather Satellite Station, and for the thousands of experimenters who are operating stations, *The New Weather Satellite Handbook* details all the procedures necessary to follow the current spacecraft.

*Weather Satellite* contains Operational Satellite Systems, Antenna Systems, Weather Satellite Receivers, A Cathode Ray Tube (CRT) Monitor for Satellite Picture Display, A Direct-Printing Facsimile System for Weather Satellite Display, How to Find the Satellite, Test Equipment, Microcomputers and the Weather Satellite Station, Station Operations.

ISBN 0-88006-015-8 available now! **BK7383 \$8.95**



\*TRS-80 and TRSDOS are trademarks of the Radio Shack Division of Tandy Corporation.

FOR TOLL-FREE ORDERING CALL 1-800-258-5473  
WAYNE GREEN BOOKS • PETERBOROUGH NH 03458

Use the order card or itemize your order on a separate piece of paper and mail to Wayne Green Books Att: Sales • Peterborough NH 03458. Be sure to include check or detailed credit card information. (Visa, Master Charge or American Express accepted.) No C.O.D. orders accepted. All orders add \$1.50 for the first book, postage and handling; \$1.00 each additional book; \$10.00 per book foreign air mail. Please allow 4-6 weeks after publication for delivery. Questions regarding your order? Please write to Customer Service at the above address.



FROM TAYCO...  
MAGNAVOX FV 25 - 26 CHANNEL  
**CABLE TV CONVERTER**  
and REMOTE CONTROL

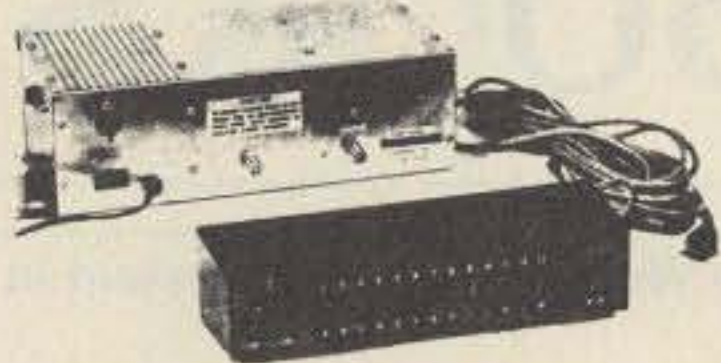

Get The Most From Cable TV  
**VHF-MIDBAND-SUPERBAND**

- Select any channel with easy pushbutton tuning from up to 25' away
- Perfect for the bedroom TV
- Saves wear on TV tuner - avoid costly repairs
- Ideal for the handicapped
- Easy 5 minute installation
- Receives those EXTRA channels your TV can't get
- Works with any TV
- 90 Day Guarantee

2-way Splitter 2.19  
"F" Fittings .23ea - 10/1.80  
Belden RG/59 .11/ft.  
24 Hour Order Line (607) 962-7313  
NYS Add Tax  
Buy 2 - We Pay Shipping  
C.O.D.'s - \$1.50 extra

only \$59.95  
Mail Order SPECIAL  
**\$49.95**  
+4.25 Shipping Handling

Order Direct From  
**TAYCO COMMUNICATIONS**  
R3 - 146A Narrows Ck. Rd. - Corning N.Y. 14830  
- DEALERS WANTED - ✓ 183

**SUPER LOW PRICES!**

- AZDEN PCS-4000 2-METER \$299.00
  - AZDEN PCS-300 2-METER HT \$285.00
  - SANTEC 144UP 2-METER HT \$289.00
  - SANTEC 440UP HANDHELD \$319.00
  - KENWOOD 2500 HANDHELD \$299.00
  - YAESU FT-208R 2-METER HT \$309.00
  - YAESU FT-708R 440 HT \$329.00
  - TEMPO S-15 2-METER HT \$249.00
  - TEMPO S-2 220 HT \$249.00
  - ALL KENWOOD & ICOM HF RIGS 12% OFF.
  - ALL LARSEN 2-METER ANTENNAS 15% OFF.
  - ALL YAESU & TEN-TEC HF RIGS 15% OFF.
  - ALL HYGAIN & HUSTLER ANT. 30% off.
  - ALL MFJ PRODUCTS 15% OFF LIST.
- RADIOS, ANTENNAS & ACCESSORIES ARE IN NEW, FACTORY SEALED CARTONS. FULL MANUFACTURERS WARRANTY. PRICES CASH & SHIPPING. CREDIT CARDS ADD 3%.

**SHAVER RADIO, INC.**  
1378 S. Bascom Ave. San Jose, Calif. 95128  
408-998-1103 ✓ 148

**YAESU FT-207R OWNERS**  
AUTO SCAN MODULE AND BATTERY SAVER KIT



15 minutes to install; scan restarts when carrier drops off; busy switch controls automatic scan on-off; includes module and instructions.

**Model AS-1. \$25.00**

**new**

**FT-207R BATTERY SAVER KIT MODEL BS-1 \$14.95**

- \*No more dead batteries due to memory back-up
- \*30% less power drain when squelched
- \*Simple to install; step-by-step instructions and parts included
- \*4 mA memory backup reduced to 500 uA.
- \*45 mA receiver drain reduced to 30 mA.
- \*Improved audio fidelity and loudness

**ENGINEERING CONSULTING**

P.O. Box 3966 ✓ 400  
ANAHEIM, CALIFORNIA 92803

**DX TXT 1.0**

A Great Circle Calculator plus Log in an Apple® Computer. Information on 467 specific worldwide locations (318 + 50 states + ...). Enter your coordinates and DX TXT will calculate the short path beam heading and distance from your QTH. Any location callable by Prefix, location name, or record number. Data bank includes geographic descriptor, specific location, IRC, and Zone.

Requires an Apple® Computer with one Disk II and DOS 3.3. Printer function optional.

\$39.95 plus \$2 - S&H (Ark. residents add 4%)  
Demo Disk available Dealer Inquiries Invited

**LANNES JOHNSON**

100 Plaza Street West Helena, AR 72390  
1-501-572-7511  
TRS-80 VERSION AVAILABLE SOON

**THE LITTLE GIANT BRAKE**



**BEND & FORM .060 ALUM. & STEEL!**

**EASY TO USE!** CLEAN SMOOTH BENDS TO 90°  
**BUILD CUSTOM CABINETS YOU'LL BE PROUD OF! COMMERCIAL QUALITY at 1/10 THE COST!!**

**GUARANTEED!** clamps not incl.  
NO COD OR CREDIT CARDS. ALL ORDERS IN US FUNDS. ALL FOREIGN ORDERS ADD \$5.50 SHIPPING IN ADDITION TO P&H.  
**\$22.95 + 2.50**

**Z ASSOCIATES**  
P O BOX 757  
3050 NE 55 TH AVE.  
SILVER SPRINGS, FLA. 32688

**P&H**

✓ 336

**WANTED FOR CASH**

Your Military Surplus Electronic Material: Airforce, Navy or Army Equipment, Modules, Tubes, or Parts. It costs nothing to get our highest offer.

**Call Collect NOW 201-440-8787**

35 Ruta Court  
South Hackensack, N.J. 07606  
**SPACE ELECTRONICS Co.**  
Our 22nd Year

✓ 162

**DIGITAL DISPLAY**

30 DAY FREE TRIAL



**YAESU HEATH DRAKE COLLINS KENWOOD**

NEW YAESU DIGITAL DISPLAYS CONVERTED FOR YAESU KENWOOD HEATH COLLINS AND DRAKE TRANCEIVERS RECEIVERS AND TRANSMITTERS. 5 ACTIVE RED LED DIGITS READ DOWN TO 10 HZ. REAR PANEL 10 HZ DIGIT DEFEAT SWITCH. FROM COLD MAX. 100 HZ. DRIFT IN 24 HRS. 1 3/8" HIGH, 4 1/2" WIDE & 6 1/2" DEEP. STEEL CASE IS BLACK. LOWER FRONT PANEL IS BRUSHED ALUMINUM. UNITS FOR MODEL NUMBERS UNDERLINED WORK WITHOUT ANY INSTALLATION BY PLUGGING INTO EXISTING JACKS ON THE RADIOS. MODELS WITH AN \* ASTERISK HAVE A POWER SUPPLY/TRANSFORMER AND OFF SWITCH. ALL POSTAGE PAID.

IF YOUR EXTERNAL VFO JACK IS USED FOR A VFO, REC. OR TRANSMITTER; FOR A MALE/FEMALE PLUG/JACK ADD \$5.00

FT101 SERIES FT301 TS520S(8E) PLUG INTO REAR JACK FOR VFO SIGNAL AND POWER. NO INSTALLATION REQUIRED. \$110.00

TS520 TS820 TS900 TS600 R599 T599 FR101 FL101 FRG7

FT7(a&b) HW104 ----- ALL PARTS & INFO. -- \$115.00

\*75S SERIES \*KWM SERIES \*32S SERIES \*R-4 SERIES FRDX RECEIVERS

\*FT100 \*FT400 & 401 \*FT560 & 570 \*HW100-101 \*SB100-102

\*SB300-303 \*HR1680 ----- ALL PARTS & INFO. -- \$125.00

YC221 FOR FT221(8R) W/D SERIAL. FT221 TS700. 7 D16. --- \$75.00

SEND U.S. CASHIERS CHECK OR M.O., 30 DAY MONEY BACK. YOU PAY RETURN POSTAGE. WRITE WITH MOD. & SERIAL NO. FOR INFORMATION. WRITE IF YOUR RADIO IS NOT LISTED--WILL MAKE ONE YR WARRANTY.

**GRAND SYSTEMS**

P.O. BOX 2171 20352 40A AVE.  
BLAINE WASH. ✓ 132 LANGLEY B.C.  
U.S.A. 98230 (604) 530 4551 CANADA V3A2Y8

**C.B. SPECIAL**

(Repeat of a sell out)

**CONVERT THESE TO 10 METER FM**

New Hy-Gain 40 channel printed circuit boards assembly (Squelch pot, volume control and channel switch not included) Boards sold as is. Dimension 6" X6"

1-9 pcs \$7.50 ea.  
10-49 pcs \$6.50 ea.

(While quantities last)

**REMOTE 40 CHANNEL C.B.**

Remotes have a metal frame Speaker, plastic case, and control mic not included Sold as is. \$14.95 ea

**C.B. BARGAIN**

C.B. boards missing parts or damaged Can be used for spare parts. Buy several!! \$3.50 ea

Order information: Please add \$4.00 for S/H via UPS. COD's accepted for orders totaling \$50.00 or more. Florida residents add 4% sales tax. Minimum order \$15.00 Foreign orders US funds only add 20% for S/H. MASTER CARD and VISA accepted.

**Surplus Electronics Corp.**

7294 NW 54th St. ✓ 69  
Miami FL 33166  
P.H.# 305-887-8228

**CB TO TEN METER CONVERSION KITS**

**10 METER FM**—Limiter discriminator board with specific instructions to fit over 80 different AM & SSB chassis

**SSB-AM KITS**—Now in stock kits for most CB models—23 or 40 channels

**NEW & USED**—FM—SSB—AM converted C.B.'s in stock

**ANEXTER MARK ANTENNAS**

—You saw them at Dayton. Now in stock the HW-3 three band helewip that covers 10—15—20 meters with no traps

**FREE CATALOG**—Write or call today

**INDEPENDENT**

**CRYSTAL SUPPLY COMPANY**

141 Rt. 6A, Box 183  
Sandwich, Ma. 02563-0183  
(617) 888-4302 ✓ 78



## » » BIT "O" BYTE « «

All Prices Include Shipping and Tax in the U.S.A. ALL DISK are WARRANTED against material defects for 90 days from date of purchase.

- 5 1/4 inch Diskettes (soft sectored), Center Reinforcing Ring, Jacket and plastic box-stand. = \$27 for box of 10 to 20. 20 to 100 is \$25 per box.
- SYMTEC HIGH RES LIGHT PEN—With software = \$185.00
- 16K RAM CARD for the APPLE II or II + BARE BOARD = 30.00
- PADDLE-ADAPPLE only = \$27.50
- MAGIC KEYBOARD only = \$86.00
- MICROBUFFER II For most printers 32K = \$250.00
- Epson Parallel 16K = \$135.00
- Epson Serial 8K = \$135.00
- ECHO II Speech Synthesizer with Software on 3.3 disk and Speaker = \$170.00
- THUNDERCLOCK PLUS with software = \$125.00
- BSR X-10 INTERFACE OPTION = \$45.00
- DOS-DATER DISK = \$20.00
- PASCAL SOFTWARE DISK = \$20.00
- RAMDISK-320 = \$1225.00
- Advertised in SoftTalk.
- I will carry other items in the future. If you don't see what you need let me know. Coming soon VISA charging and computer ordering.

Most products carry a 90 day warranty.

The prices may change without notice.

Please send ORDERS with payment and inquiries to:

✓153 BIT "O" BYTE  
P.O. Box 60972  
Sunnyvale, CA 94088

## GLB HIGH PERFORMANCE PRESELECTORS

MODEL P50 to P500



- 50 - 500 MHz
- Ultimate rejection over 80 dB
- Five large helical resonators
- Low noise
- High overload resistance
- Typical rejection figures:
  - ± 600 kHz at 144 MHz: -30 dB
  - ± 1.6 MHz at 220 MHz: -40 dB
  - ± 5 MHz at 450 MHz: -45 dB
- The solution to interference, intermod and desens problems on repeaters
- 12V DC operation
- Dimensions only 1.6 x 2.6 x 4.75 excluding connectors
- Custom tuned to your frequency
- Low cost — only \$69.95
- Allow \$2.00 for shipping and handling

We have a complete line of transmitter and receiver strips and synthesizers for Amateur and commercial use. Write or call for our free catalog.

We welcome MasterCard or VISA

## GLB ELECTRONICS

1952 Clinton St., Buffalo, N. Y. 14206  
1-(716) 824-7936, 9 to 4 ✓143

## PORTAPEATER™

\$179.00 assembled unit

### M100 A INSTANT REPEATER ANY BAND ANY MODE

\$99.00 assembled board

\* 4Channel PROM CW I Der

\* VOX or COR operation

\* 250 volt switching capability

\* An Instant Repeater



\* Works with any type radios

\* Complete Timer Functions

\* Built In Test Functions

\* 20 Page Technical Manual

(Fully tested, programmed, assembled) ✓302

W-S ENGINEERING P.O. BOX 58, PINE HILL, N.J. 08021  
(201-852-0269)

## Put Your Computer "On-The-Air"

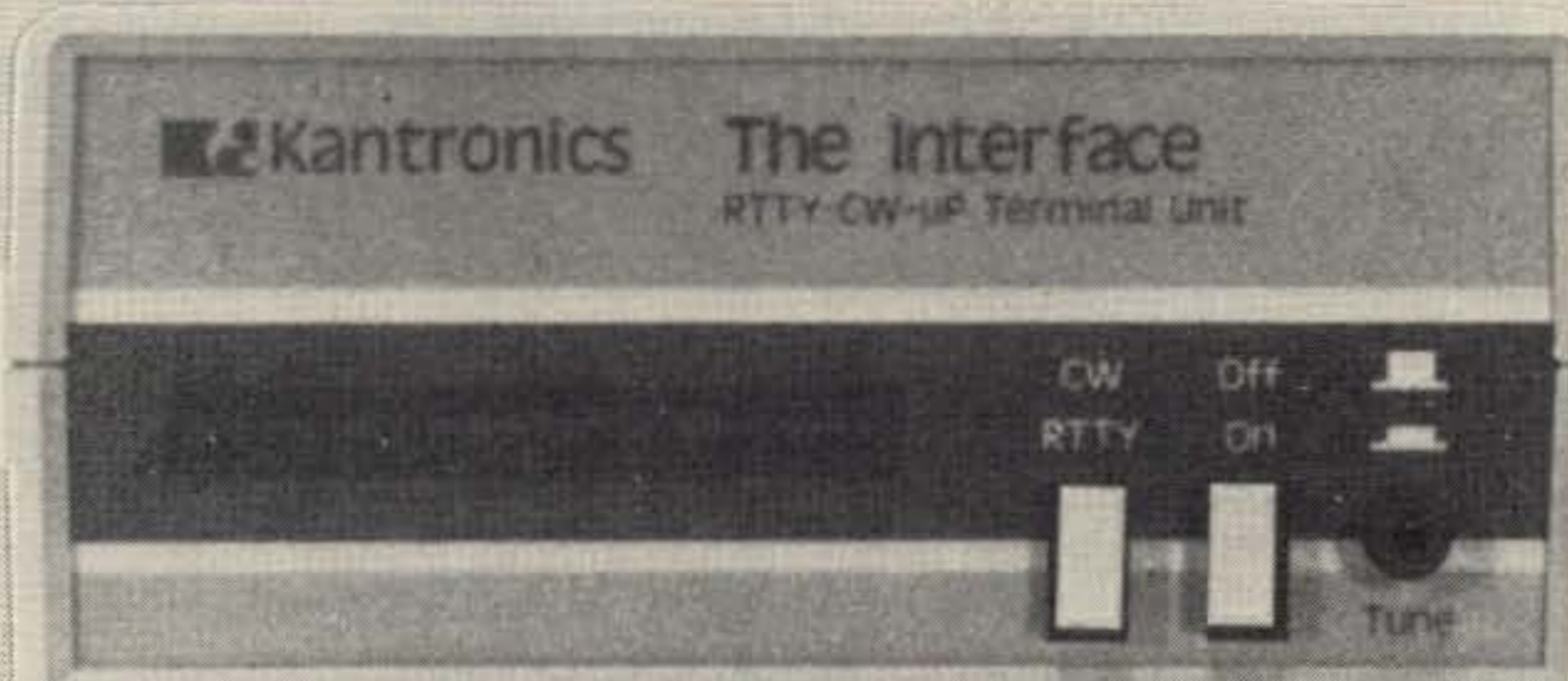

## The Interface™

Sugg. Price \$189.95

Your personal computer becomes a complete CW/RTTY/ASCII send and receive terminal with The Interface linking it to your transceiver.

If you own an Apple II or Apple II Plus, Atari 400 or 800, TRS-80 Color Computer, or VIC-20, The Interface will put your computer "On-The-Air".

Software for each system features split screen display, buffered keyboard, status display, and message ports. Attach any Centronics compatible printer for hard copy. Software is available, on diskette for the Apple and program boards for the others, at an additional cost.

Apple diskette	Atari board	VIC-20 board	TRS-80C board
\$29.95	\$49.95	\$49.95	\$59.95

See The Interface at your authorized Kantronics dealer, or contact:

## Kantronics

(913) 842-7745 1202 E. 23rd Lawrence, Kansas 66044



## RIG TROUBLES GOT YOU DOWN?

- YOU COULD SHIP YOUR RIG TO THE FACTORY FOR REPAIR.
- YOU COULD SHIP IT TO RQ SERVICE CENTER FOR REPAIR.
- BUT YOU STAND A GOOD CHANCE OF FIXING IT YOURSELF WITH HELP FROM YOUR OWN COPY OF "OWNER REPAIR OF RADIO EQUIPMENT"
- THIS BOOK WILL BE SHIPPED POSTPAID FROM K6RQ FOR \$8.95

**RQ SERVICE CENTER**  
14910 LG Blvd.  
Los Gatos, CA 95030



## SHOP BY MAIL

### BOOKS

Dick Bash:  
ARRL  
73 Books  
Callbook Co.  
and many more . . . . .

### MAPS

ARRL  
A.R. Callbook Co.

### CODE TAPES

Kantronics  
ARRL

### SPECIALTIES

QSL Cards  
Log Books,  
Coax-Seal, 5' or 50' rolls  
Covercraft Dust Covers

### MAGAZINES

(single copies)  
Byte  
Popular Computing  
QST  
Ham Radio  
73  
80 Microcomputer  
Desk Top Computing

### BIRCH HILL SALES

P.O. Box 234 - Peterborough, NH 03458

(603) 924-7959

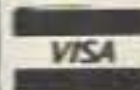

Catalog \$1<sup>00</sup>



## Subscription Problem?

73 Magazine does not keep subscription records on the premises, therefore calling us only adds time and doesn't solve the problem.

Please send a description of the problem and your most recent address label to:

73 Magazine  
Subscription Dept.  
PO Box 931  
Farmingdale, NY 11737

Thank you and enjoy your subscription.

### DX-Notes

- \*2000+ DXCC Band/Mode Countries!
  - \*SEVEN wide Worked/Confirmed Columns!
  - \*Log the entire DX Callsign!
  - \*YOU Designate the Modes and Bands!
- PLUS \*Buro! \*3rd Party! \*Reciprocal Licensing!  
\*Space to enter YOUR World Atlas page #  
\*IARU Continent! \*ITU Zone! \*CQ Zone!  
\*Unique "Rareness" Rating!  
\*Latitude! \*Longitude!

### PLUS Info computed for YOUR QTH:

- \*Time Zone Difference! \*Propagation Factor!
- \*Distance in Kilometers! \*Distance in Miles!
- \*EXACT Beam Headings - Including DX to You!

### PLUS Complete Prefix and Name Guides!

- 1200+ Prefixes are cross-referenced!
- 400+ Countries are indexed alphabetically!

DX-Notes do the work - YOU do the DX-ing!

SEND Call, Name, Address, Time Zone, QTH Info  
(Latitude & Longitude OR Direction & Distance  
From a nearby town To Your QTH) and \$12.50PPd

TO: OR: Call HAWAII!  
Randall Sherman KH6MD (808) 877-7371 (18-022)  
PO Box 158 " 879-4080 (04-172)  
Kahului, Maui, Hawaii 96732 VISA MC ✓ 147



## NEW DX ANTENNAS

### QUALITY - ECONOMY

WE MANUFACTURE:  
MONOBAND YAGI BEAMS  
TRI BAND YAGI BEAMS  
CENTER INSULATORS - BALUNS  
DUMMY LOADS - AND MORE!

All DX products are fully guaranteed.  
Send large S.A.S.E. for free catalog.  
Dealer inquiries are welcome.

## DX Signal Co.

P.O. BOX 37, Lacon, IL 61540  
Phone (309) 246-2087

## this publication is available in microform



### University Microfilms International

300 North Zeeb Road  
Dept. P.R.  
Ann Arbor, MI 48106  
U.S.A.

18 Bedford Row  
Dept. P.R.  
London, WC1R 4EJ  
England

## SALE SALE SALE GOING-OUT-OF- BUSINESS SALE

Last Day-Dec 31<sup>ST</sup>  
1982

CALL US!

If we have what you want in stock  
we will beat ANY

ship it FREE!

No charge cards . . .  
cash or cashier's check

**Ben Franklin Electronics**  
115 1/2 N. Main Hillsboro KS 67063  
316-947-2269 ✓ 439

## FREE CATALOG



**NEW!**  
CATALOG OF  
HARD-TO-FIND  
PRECISION TOOLS

✓ 354

Also contains test equipment  
plus wide selection of  
tool kits and cases

Jensen's new catalog is jam-packed with  
more than 2000 quality items. Your single  
source for hard-to-find precision tools and  
tool kits used by electronic technicians,  
scientists, engineers, instrument mechanics,  
schools, laboratories and government  
agencies. Send for your free copy today!



**JENSEN TOOLS INC.**  
7815 S 46TH STREET PHOENIX AZ 85040

## PRESERVE 73 MAGAZINE BINDERS & FILE CASES

Keep your issues of 73 Magazine together, handy  
and protected in handsome and durable library files  
or binders. Both styles bound in red leatherette with  
the magazine logo stamped in gold.

Files: Each file holds 12 issues, spines visible  
for easy reference. \$9.50 each, 3 for \$27.00,  
6 for \$30.00

Binders: Each binder holds 12 issues and opens  
flat for easy reading. \$7.50 each, 3 for \$21.75,  
6 for \$42.00

(Postage paid in USA. Foreign orders include \$2.50  
per item)

Please state years: 1977 to 1983

Send check or money order to:

JESSE JONES BOX CORP.

P.O. Box 5120

Philadelphia, PA 19141

Allow 4 to 6 weeks for delivery



# ISOTRON ANTENNAS

THE BEST THINGS  
come in little packages...

FOR 80-40-20 METERS

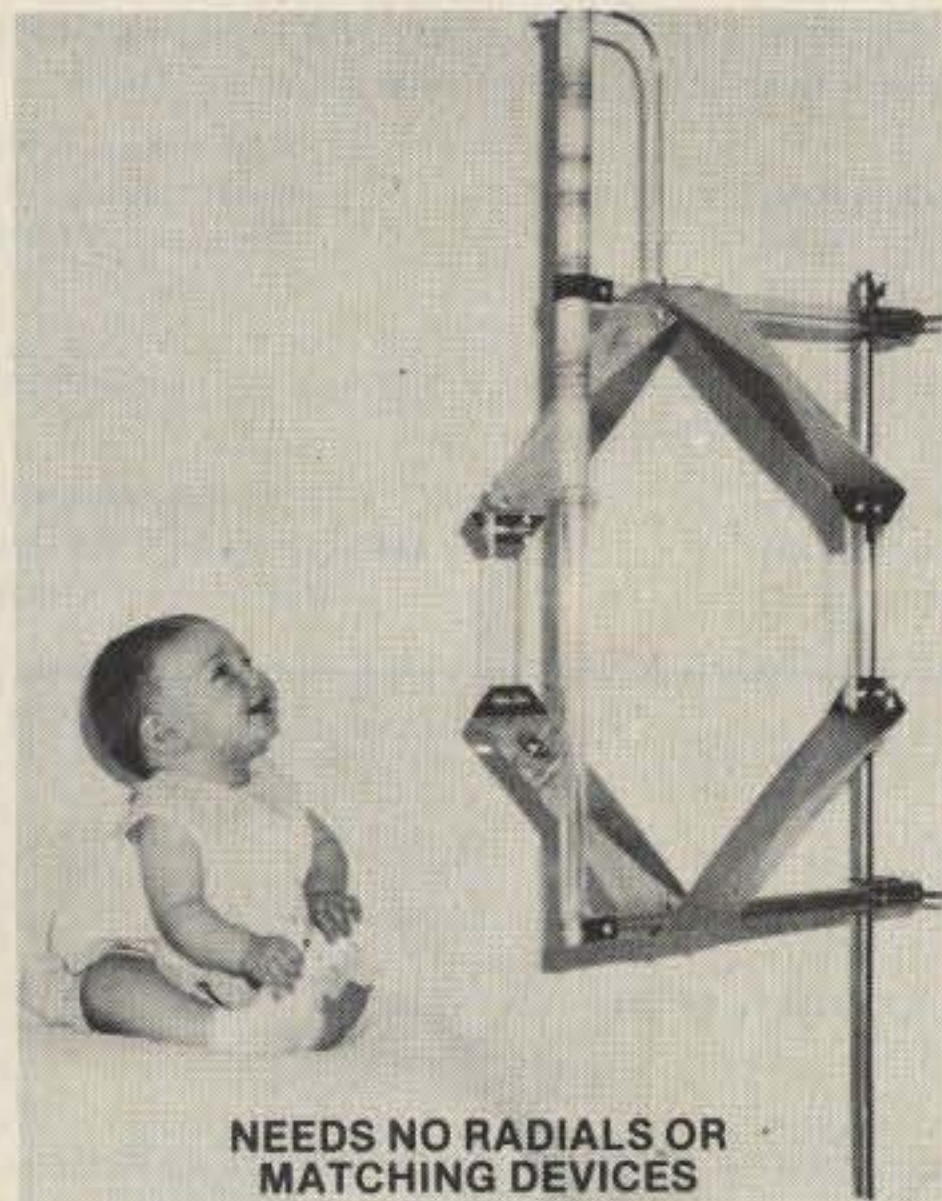

NEEDS NO RADIALS OR  
MATCHING DEVICES

ISOTRON 80 54 IN. HIGH    ISOTRON 40 31 IN. HIGH    ISOTRON 20 17 IN. HIGH

**BIG ON PERFORMANCE**

**SMALL ON SPACE**

**BILAL COMPANY**

(303) 687-3219

STAR ROUTE

FLORISSANT CO 80816

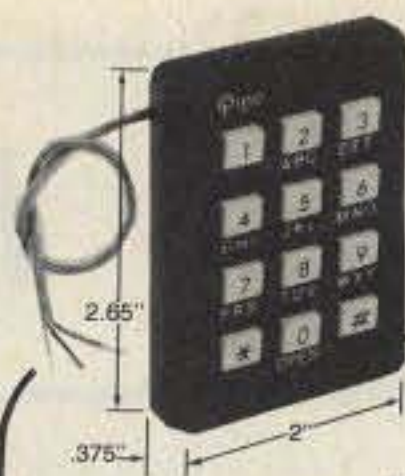

## THE PROFESSIONAL, TOUCH TONE ENCODER

An ultra high quality encoder for professional application. Absolute reliability and function makes the difference. There's a Pipo encoder for every system and application. Totally serviceable, easy to operate and install. Call or write for free catalog and information! (213) 852-1515 or P.O. Box 3435, Hollywood, CA 90028.

PATENTED

\* AT&T

**Pipo Communications®**

Emphasis is on Quality & Reliability ✓ 300

## SYNTHESIZED SIGNAL GENERATOR



MADE IN  
USA

MODEL  
SG1000  
\$349.95  
plus shipping

- Covers 100 to 185 MHz in 1 kHz steps with thumb-wheel dial
- Accuracy 1 part per 10 million at all frequencies
- Internal FM adjustable from 0 to 100 kHz at a 1 kHz rate
- Spurs and noise at least 60 dB below carrier
- RF output adjustable from 5-500 mV at 50 ohms
- Operates on 12 Vdc @ 1/2 Amp
- Available for immediate delivery
- \$349.95 plus shipping
- Add-on Accessories available to extend freq. range; add infinite resolution, voice and sub-audible tones, AM, precision 120 dB calibrated attenuator
- Call for details • Dealers wanted worldwide.

**VANGUARD LABS** ✓311  
196-23 Jamaica Ave., Hollis, NY 11423  
Phone: (212) 468-2720

## CONTACT-80...

An ultra sophisticated yet simple to operate RTTY System for the demanding operator at an affordable price.

### Features:

- Disk I/O; SAVE, LOAD, KILL & DIR...
- TRI-SPLIT screen, user defined...
- 10 CANNED MESSAGES
- DYNAMIC BUFFER ALLOCATION...
- Live HARDCOPY for parallel printers...
- Keyboard CONTROL of STATION...
- AUTO-ID; RTTY, CW (selectable ON/OFF)...
- CLOCKED OUTPUT rate...
- All BAUDOT speeds plus ASCII (110)...
- NAME, DATE, TIME from computer...
- On screen BIT PATTERN SCOPE...

Requires TRS-80, MOD-III with your CALL SIGN plus TU with 60ma loop.

DISK I/O; VERSION..... \$279.00

CASSETTE I/O; VERSION..... \$229.00

Post Paid

## CommTek

✓150

4493 Orleans Dr., Dunwoody, GA 30338  
(404) 946-9314

## PACKET RADIO TREASURE TROVE

MODEM  
BOARD  
SINGLE  
BOARD  
COMPUTER

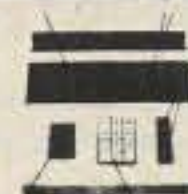

POWER  
SUPPLY  
AND  
MORE!

### SURPLUS FINANCIAL TERMINAL CONTAINING:

- 202 TYPE MODEM BOARD: 0-1800 baud. separate 600 ohm audio xfms, TTL digital I/O, 5 x 5.5"
- 8080A CPU BOARD: With sockets for 4ea 2708s. Also in sockets, 8251 Programmable Communications Interface (USART), 8253 Triple Programmable Interval Timer, 8228 System Controller/3-state Bus Driver, 256 bytes RAM, 29 other support ICs, xtal, clock IC, 7.5 x 10"
- ENCLOSED POWER SUPPLY: With pwr cord & switch. +5V @ 2.5A, +12V @ 350ma, -5V @ 250ma, plus 2 unregulated voltages for display, 3 x 4 x 8"
- DOCUMENTATION PACKAGE: Includes schematics & Technically Oriented User Manual.
- MISC.: 20 Key Decimal & Function Keyboard, 16 Digit Fluorescent Display, Mag Stripe Credit Card Reader, Speaker and MORE

Units are removed from service and in good working condition. High quality modern construction throughout. Each is given a full off-line test before shipment. Large quantity in stock. You'd have to buy a lot of turkeys before finding another gem like this.

PRICE, SURFACE UPS INCLUDED ..... \$55  
DOCUMENTATION PACKAGE ..... \$5

ELECTROVALUE INDUSTRIAL INC.  
P.O. BOX 157-W  
MORRIS PLAINS, NJ 07950  
Formerly Electravalue Industrial

Phone orders and  
questions welcome  
201/267-1117

## M<sup>2</sup> ENGINEERING'S VHF H.T. CONVERTERS

- DOUBLE BAND HC-V, HC-U2
- SINGLE BAND HC-V220
- BI-LATERAL PROTECTION AGAINST ACCIDENTAL TRANSMISSION FOR UP TO 5 WATTS

• STANDARD BNC CONNECTORS

• HC-V  
154 - 158  
159 - 163

• HC-U2  
460 - 464  
480 - 484

• HC-V220  
221 - 225

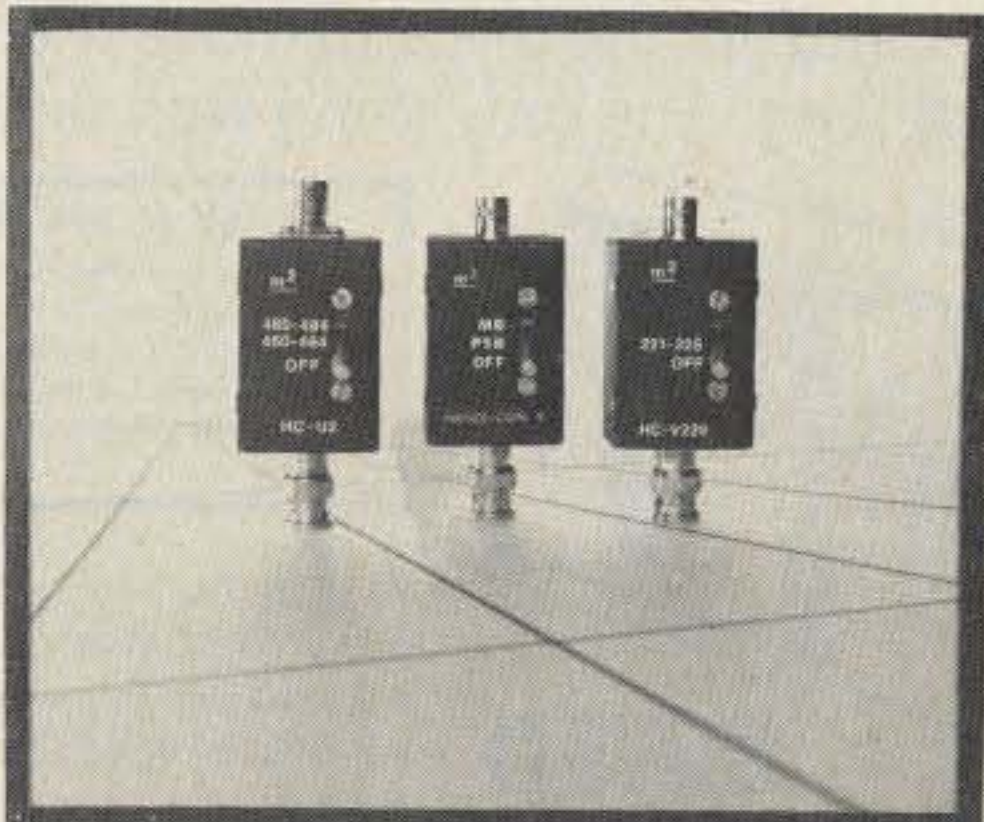

HC-U2  
\$59.95

HC-V  
\$47.45

HC-V220  
\$54.95

• USES SINGLE AAA CELL

• LOW LOSS COUPLING TO ANTENNA

• "OFF" RETURNS TO NORMAL TRANSCEIVER OPERATION

• SIZE: approx. 2 x 1.5 x 1.5

• WEIGHT: 3.9 ozs.

✓77  
**M-SQUARED ENGINEERING, INC.**  
1446 LANSING AVE.  
SAN JOSE, CA. 95118  
CALL SANDY 408-266-9214

DEALERS  
WELCOME

Shipping included

Calif. residents add  
6.5% sales tax

## PLATE TRANSFORMERS

ALL REMOVED FROM EQUIPMENT WITH 115 VAC 50-60 Hz PRIMARIES:

#TF1UX02YY/129 - 2250 VCT 565 ma (1785 WV) secondary: 115/230 V primary. 6 1/4 x 5 1/4 x 4 3/4", 32 lbs. sh. \$34.95

#SS-HW201P - 2000VCT 500ma (1500 WV, 700 ma intermittent); 7x5 1/2 x 5", 32 lbs. sh. \$30.00

#229621/610 - 5760VCT 321ma or 4800 VCT 475 ma (7150 WV); 115/230V primary, 9 1/4 x 10 3/4 x 8 1/4", 115 lbs. sh. \$65.00

53.3 uf 3500 VDC CAPACITOR - 10 1/2 x 4 1/2 x 3 3/4", 11 lbs. sh. CSI #4W3081; NEW. \$27.50

TUBES - used-chk.: 811A: \$9. 813: \$16. 3B28: \$6.50  
4 3/4" sq. ROTRON MUFFIN or similar fans, 14 W; used-checked \$8.95

CHOKE #3C557N/610 - 11 Hy 500 ma 55 ohms; 10 KV test. 9x7x6", 42 lbs. sh. \$12.50

#SS-P243 - 900 VCT 250 ma; 4 1/4 x 4 1/4 x 3 3/4", 16 lbs. ~~\$9.95~~ \$7.95

1500 WVDC CAPACITORS - removed from equip.: 8 mf, 5 1/4 x 3 3/4 x 2 1/2": \$4. 10 mf, 5 1/2 x 3 3/4 x 3": \$5.

Prices F.O.B. Lima, O. • VISA, MASTERCARD Accepted. Allow for Shipping • Write for FREE CATALOG Address Dept. 73 • Phone: 419/227-6573

**FAIR RADIO SALES** ✓22  
1016 E. EUREKA • Box 1105 • LIMA, OHIO • 45802



## SLEP ELECTRONICS

GIVES TOP TRADE ON YOUR USED . . .  
ATLAS COLLINS DRAKE ICOM

KENWOOD TENTEC . . . .

AND ON YOUR USED TEKTRONIX AND  
HEWLETT-PACKARD TEST EQUIPMENT  
ON YOUR USED AVIONIC EQUIPMENT  
AND ON YOUR USED MILITARY AVIONIC  
AND GROUND ELECTRONIC EQUIPMENT

WE OFFER NEW FACTORY—BOXED  
LATEST MODELS OF . . . .

COLLINS CUBIC/SWAN DENTRON  
DRAKE ICOM KENWOOD TENTEC  
PLUS ALL MAJOR ANTENNA LINES

TELL US WHAT YOU WANT  
AND WHAT YOU HAVE TO TRADE . . .  
WE'LL DO THE REST.

Write or phone Bill Slep (704) 524-7519



Electronic  
Distributors

**Slep Electronics Company**

P. O. BOX 100, HWY 441, DEPT. 73  
OTTO, NORTH CAROLINA 28763

✓367

## HAM HELP

I need a Blonder-Tongue Prism-matic  
PM-2 rotor to complete my OSCAR-8  
transceiver system (or the address of this  
company).

Mark S. Kiziuk N2DMI  
2623 E. 11th St.  
Brooklyn NY 11235

I would like to purchase an original  
manual for a Tektronix 3S76.

Eiichi Takarada  
1423 Vassar Rd.  
Rockford IL 61103

I need a schematic and any other avail-  
able information on the Triplet model 3440  
oscilloscope. I will gladly pay costs.

Walt Wilson W0LE  
4905 Lakeridge Rd.  
Denver CO 80219

I need information on a digital frequen-  
cy readout for my Heath HW-101  
transceiver.

D. C. Pugh WA6HYB  
4660-125 North River Road  
Oceanside CA 92056

### REGENCY SCANNERS

### BEARCAT SCANNERS

T720 Air . . . . .	169.00	D810 . . . . .	270.00	BC350 . . . . .	369.00
D 100 . . . . .	159.00	M 100 . . . . .	205.00	BC300 . . . . .	339.00
D 300 . . . . .	209.00	M 400 . . . . .	245.00	BC200 . . . . .	CALL

All Bundy low profile IC Sockets just 1¢ per pin  
Example: 8 pin—8¢; 40 pin—40¢  
Ham IV Rotor—\$165.00  
Columbia 8 Con (2#18/6#22)—17¢/ft.  
Columbia RG 59v 100 foil shield TV type—7¢/ft.  
Berk Tek Grey 96% RG 8X—14¢/ft.  
US made PL 259—10/\$5.50  
Call for Quantity Quotes



Universal Dist.  
RAYMOND RICHARD  
RT. 1, BOX 25E  
CLERMONT, FL 32711

UG 176 Reducer—10/\$1.99  
SO 239—10/\$5.89  
3 amp fuse—20/\$1.50  
Sanyo 3V Lithium—\$5.95  
Gould 1.2v 500 mAh AA Nicad  
10/\$14.50 100/\$125.00  
1000/\$1100.00  
GSC Reg. Power Supply  
35 Amp Rack Mt. List \$227.00  
SALE \$149.00

(904) 394-2511  
(313) 278-8217

✓155

\* **B E C** \* **Bullet Electronics Corp.** P.O. Box 401244E Garland, TX. 75040 (214) 278-3553

✓12

## THE PRESIDENT SAYS: "HOGWASH!!"

After taking one look at the TRIPUT POWER SUPPLY our engineer declared that the units were worth several hundred dollars each. He pointed out the engineering, high quality construction and state-of-the-art integrated design in support of his position. The President of **BEC** more pragmatically pointed out the already full warehouse and the two trailer truck loads of power supplies waiting in the parking lot, and set the price to move them **QUICKLY!** We have a large quantity, but the supply won't last long. The only thing we ask is *please* read the ordering rules.

QUALITY DOUBLE SIDED GLASS BOARD



**REGULATOR ASSEMBLY**  
(part of unit)

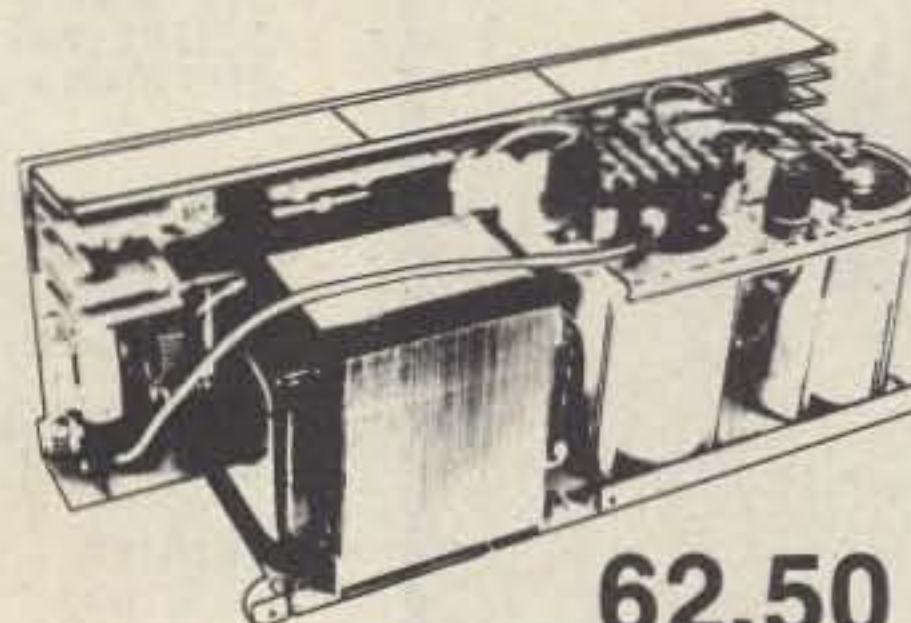

**COMPLETE UNIT**  
(as you receive it)

**62.50**

Plus Freight  
21 lbs.

ORDERS SHIPPED WITHIN CONTINENTAL U.S. ONLY! 6 x 5¼ x 12  
**ORDERING RULES**

1. Mail check or MO for \$62.50 + \$5.00 for shipping or phone (214) 278-3553 to charge VISA/MC or COD order. (UPS COD only, add \$2.50 COD fee)
2. Texas residents include 5% sales tax.
3. Orders for this unit will be shipped within **48 HOURS** or we pay the freight! (weekends or holidays excluded)
4. **ONE TIME OFFER! LIMIT TWO (2) SUPPLIES PER CUSTOMER.**

### 13.6V @ 20A MODIFICATION

By changing a few parts on the board the Triput Power Supply will do 11 - 14V (adjustable) at up to 20A. Perfect for that 2 meter linear amp! We send step by step instructions and necessary parts. **Modification per instructions will not void the 30 day warranty.**

- +12V @ 7A; +5V @ 10A; -12V @ 5A
- UNIT IS COMPLETELY ASSEMBLED!
- Fused primary and DC sections
- HUGE SHIELDED TRANSFORMER
- 2% Load & Line Regulation
- Low Ripple (<100mv)
- Short Circuit Protection
- Overvoltage Protection on all three outputs
- 25A Bridge Rectifier
- Over 60,000 mfd of filters
- High Efficiency **Switching Regulator** reduces heatsink area
- Schematics and service guide included
- Thermal Shutdown
- Statis LED's (3)



# ramsey the first name in Counters!



## 9 DIGITS 600 MHz \$129<sup>95</sup> WIRED

**PRICES:**

CT-90 wired, 1 year warranty	\$129.95
CT-90 Kit, 90 day parts warranty	
AC-1 AC adapter	109.95
BP-1 Nicad pack + AC Adapter/Charger	3.95
OV-1, Micro-power Oven time base	12.95
External time base input	49.95
	14.95

The CT-90 is the most versatile, feature packed counter available for less than \$300.00! Advanced design features include: three selectable gate times, nine digits, gate indicator and a unique display hold function which holds the displayed count after the input signal is removed. Also, a 10MHz TCXO time base is used which enables easy zero beat calibration checks against WWV. Optionally, an internal nicad battery pack, external time base input and Micro-power high stability crystal oven time base are available. The CT-90, performance you can count on!

**SPECIFICATIONS:**

Range:	20 Hz to 600 MHz
Sensitivity:	Less than 10 MV to 150 MHz Less than 50 MV to 500 MHz
Resolution:	0.1 Hz (10 MHz range) 1.0 Hz (60 MHz range) 10.0 Hz (600 MHz range)
Display:	9 digits 0.4" LED
Time base:	Standard-10,000 MHz, 1.0 ppm 20-40°C. Optional Micro-power oven-0.1 ppm 20-40°C
Power:	8-15 VAC @ 250 ma

## 7 DIGITS 525 MHz \$99<sup>95</sup> WIRED



**SPECIFICATIONS:**

Range:	20 Hz to 525 MHz
Sensitivity:	Less than 50 MV to 150 MHz Less than 150 MV to 500 MHz
Resolution:	1.0 Hz (5 MHz range) 10.0 Hz (50 MHz range) 100.0 Hz (500 MHz range)
Display:	7 digits 0.4" LED
Time base:	1.0 ppm TCXO 20-40°C
Power:	12 VAC @ 250 ma

The CT-70 breaks the price barrier on lab quality frequency counters. Deluxe features such as; three frequency ranges - each with pre-amplification, dual selectable gate times, and gate activity indication make measurements a snap. The wide frequency range enables you to accurately measure signals from audio thru UHF with 1.0 ppm accuracy - that's .0001%! The CT-70 is the answer to all your measurement needs, in the field, lab or ham shack.

**PRICES:**

CT-70 wired, 1 year warranty	\$99.95
CT-70 Kit, 90 day parts warranty	84.95
AC-1 AC adapter	3.95
BP-1 Nicad pack + AC adapter/charger	12.95

## 7 DIGITS 500 MHz \$79<sup>95</sup> WIRED



**PRICES:**

MINI-100 wired, 1 year warranty	\$79.95
AC-Z Ac adapter for MINI-100	3.95
BP-Z Nicad pack and AC adapter/charger	12.95

Here's a handy, general purpose counter that provides most counter functions at an unbelievable price. The MINI-100 doesn't have the full frequency range or input impedance qualities found in higher price units, but for basic RF signal measurements, it can't be beat! Accurate measurements can be made from 1 MHz all the way up to 500 MHz with excellent sensitivity throughout the range, and the two gate times let you select the resolution desired. Add the nicad pack option and the MINI-100 makes an ideal addition to your tool box for "in-the-field" frequency checks and repairs.

**SPECIFICATIONS:**

Range:	1 MHz to 500 MHz
Sensitivity:	Less than 25 MV
Resolution:	100 Hz (slow gate) 1.0 KHz (fast gate)
Display:	7 digits, 0.4" LED
Time base:	2.0 ppm 20-40°C
Power:	5 VDC @ 200 ma

## 8 DIGITS 600 MHz \$159<sup>95</sup> WIRED



**SPECIFICATIONS:**

Range:	20 Hz to 600 MHz
Sensitivity:	Less than 25 mv to 150 MHz Less than 150 mv to 600 MHz
Resolution:	1.0 Hz (60 MHz range) 10.0 Hz (600 MHz range)
Display:	8 digits 0.4" LED
Time base:	2.0 ppm 20-40°C
Power:	110 VAC or 12 VDC

The CT-50 is a versatile lab bench counter that will measure up to 600 MHz with 8 digit precision. And, one of its best features is the Receive Frequency Adapter, which turns the CT-50 into a digital readout for any receiver. The adapter is easily programmed for any receiver and a simple connection to the receiver's VFO is all that is required for use. Adding the receiver adapter in no way limits the operation of the CT-50, the adapter can be conveniently switched on or off. The CT-50, a counter that can work double-duty!

**PRICES:**

CT-50 wired, 1 year warranty	\$159.95
CT-50 Kit, 90 day parts warranty	119.95
RA-1, receiver adapter kit	14.95
RA-1 wired and pre-programmed (send copy of receiver schematic)	29.95

## DIGITAL MULTIMETER \$99<sup>95</sup> WIRED



**PRICES:**

DM-700 wired, 1 year warranty	\$99.95
DM-700 Kit, 90 day parts warranty	79.95
AC-1, AC adaptor	3.95
BP-3, Nicad pack + AC adapter/charger	19.95
MP-1, Probe kit	2.95

The DM-700 offers professional quality performance at a hobbyist price. Features include: 26 different ranges and 5 functions, all arranged in a convenient, easy to use format. Measurements are displayed on a large 3 1/2 digit, 1/2 inch LED readout with automatic decimal placement, automatic polarity, overrange indication and overload protection up to 1250 volts on all ranges, making it virtually goof-proof! The DM-700 looks great, a handsome, jet black, rugged ABS case with convenient retractable tilt bail makes it an ideal addition to any shop.

**SPECIFICATIONS:**

DC/AC volts:	100uV to 1 KV, 5 ranges
DC/AC current:	0.1 uA to 2.0 Amps, 5 ranges
Resistance:	0.1 ohms to 20 Megohms, 6 ranges
Input impedance:	10 Megohms, DC/AC volts
Accuracy:	0.1% basic DC volts
Power:	4 'C' cells

### AUDIO SCALER

For high resolution audio measurements, multiplies UP in frequency.

- Great for PL tones
- Multiplies by 10 or 100
- 0.01 Hz resolution!

\$29.95 Kit \$39.95 Wired

### ACCESSORIES

Telescopic whip antenna - BNC plug	\$ 7.95
High impedance probe, light loading	15.95
Low pass probe, for audio measurements	15.95
Direct probe, general purpose usage	12.95
Tilt bail, for CT 70, 90, MINI-100	3.95
Color burst calibration unit, calibrates counter against color TV signal	14.95

### COUNTER PREAMP

For measuring extremely weak signals from 10 to 1,000 MHz. Small size, powered by plug transformer-included.

- Flat 25 db gain
- BNC Connectors
- Great for sniffing RF with pick-up loop

\$34.95 Kit \$44.95 Wired

ramsey electronic's, inc. 2575 Baird Rd. Penfield, NY 14526

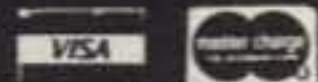

PHONE ORDERS CALL 716-586-3950

**TERMS**

Satisfaction guaranteed - examine for 10 days, if not pleased, return in original form for refund. Add 5% for shipping insurance to a maximum of \$10. Overseas add 15%. COD add \$2. Orders under \$10 add \$1.50. NY residents add 7% tax.



FACIT 4555 SERIAL PAGE PRINTER

The Facit 4555 alphanumerical serial printer is complete. Equipped with RS232C Interface, printing mechanism, control electronics, drive electronics, power supply and character generator. The adaptation electronics can be modified in four versions: Bit-parallel data transfer, CCITT (EIA, RS232C) for bit-serial data transfer and the current loop (TTY) interface also for bit serial data transfer. The Facit 4555 prints on ordinary paper and is adjustable for different paper widths and formats, 9.5" paper width with 66 lines per page or DIN A4 with 70 lines per page.

SPECIFICATIONS

Print speed	up to 60ch.s.	Char. spacing	2.54mm/1/10" 80ch/line
Printing mode	Incremental.		1.55mm/0.06" 132ch/line
Max. # of ch/line	80 alt. 132.	Char. Code	ECMA-6 7-bit coded char. set
Matrix	7 X 5 dot matrix.	Char. Set	63 Char. various national versions.
Char. Size Height	2.7mm/1/8"	Feed mechanism	Sprocket feed.
Char. Size Width	1.3mm/0.05" 132ch/line		
	2.1mm/0.083" 80ch/line		

THESE UNITS WERE PULLED OUT OF SERVICE IN GOOD WORKING CONDITION. WE CHECK EACH UNIT ON A RADIO SHACK TRS-80 COLOR COMPUTER.



PRINTER ONLY \$129.99

Printer with linecord, box of paper, inter-connect cable for TRS-80 COLOR COMPUTER.

\$149.99

GENEVA CALCULATOR WATCH

This attractive watch has the following modes:  
 Normal Time Setting,  
 Calendar Setting,  
 Daily Alarm Time Setting,  
 Weekly Alarm Time Setting,  
 Chronograph,  
 Calculator.



Featured in Black Plastic \$24.99 or Featured in Stainless Steel \$29.99

SILICON DIODES

MR751	100vdc	6Amps	10/\$5.00	100/\$38.00
MR510	1000vdc	3Amps	10/\$3.75	100/\$24.00
HEP170	1000vdc	2Amps	20/\$2.00	100/\$15.00
1N3209	100vdc	15Amps	\$2.00	10/ \$15.00
BYX21/200	200vdc	25Amps	\$2.00	10/ \$15.00
1N2138A	600vdc	60Amps	\$5.00	10/ \$40.00
DS85-04C	400vdc	80Amps	\$10.00	10/ \$80.00
1N3269	600vdc	160Amps	\$15.00	10/\$120.00
275241	300vdc	250Amps	\$20.00	10/\$175.00
7-5754	300vdc	400Amps	\$30.00	10/\$250.00
RCD-15	15KVDC	20ma.	\$3.00	10/ \$20.00
SMFR20K	20KVDC	20ma.	\$4.00	10/ \$30.00
1N4148	signal		30/\$1.00	100/ \$3.00

FEED THRU SOLDER RF CAPACTORS

470pf +-20%
5/\$1.00 or 100/\$15.00 or 1000/\$100.00
1000pf/.001uf +-10%
4/\$1.00 or 100/\$20.00 or 1000/\$150.00

E PROMS

2708 1024x1	\$2.00 each
2716 2048x8	\$4.00 each
27L32/25L32	\$10.00 each

FAIRCHILD 4116 16K DYNAMIC RAMS 200ns. Part # 16K75

25 For \$25.00 or 100 For \$90.00 or 1000 For \$750.00

HEWLETT PACKARD MICROWAVE DIODES

1N5711	(5082-2800)	Schottky Barrier Diodes	\$1.00 or 10 for \$ 8.50
1N5712	(5082-2810)	" " "	\$1.50 or 10 for \$10.00
1N6263	(HSCH-1001)	" " "	\$ .75 or 10 for \$ 5.00
5082-2835		" " "	\$1.50 or 10 for \$10.00
5082-2805	Quad Matched	" " "	per set \$5.00 or 10 for \$40.00

**Toll Free Number  
 800-528-0180  
 (For orders only)**

**MHz electronics**

PRICES SUBJECT TO CHANGE WITHOUT NOTICE



RECALL PHONE MEMORY TELEPHONE WITH 24 NUMBER AUTO DIALER

The Recall Phone Telephone employs the latest state of art communications technology. It is a combination telephone and automatic dialer that uses premium-quality, solid-state circuitry to assure high-reliability performance in personal or business applications. \$49.99



ARON ALPHA RAPID BONDING GLUE

Super Glue #CE-486 high strength rapid bonding adhesive. Alpha Cyanoacrylate. Set-Time 20 to 40 sec., 0.7fl.oz. (20gm.) \$2.00



THOUCH TONE PAD

This pad contains all the electronics to produce standard touch-tone tones. New with data.

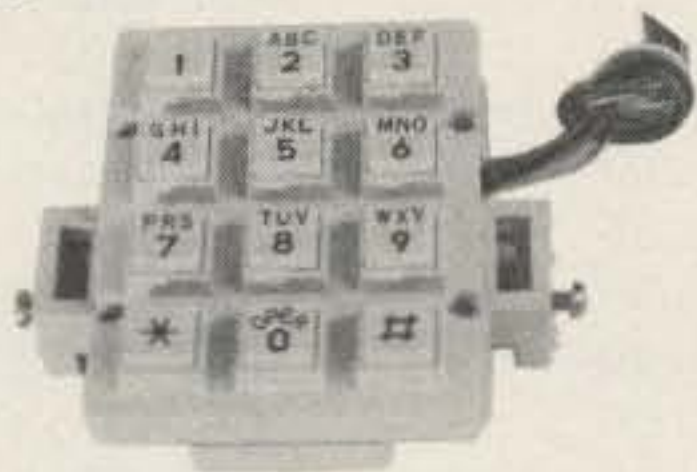

\$9.99 or 10/\$89.99

MITSUMI UHF/VHF VARACTOR TUNER MODEL UVE1A

Perfect for those unscrambler projects. New with data.



\$19.99 or 10/\$149.99

INTEGRATED CIRCUITS

		1 to 10	11up
MC1372P	Color TV Video Modulator Circuit.	\$ 4.42	\$2.95
MC1358P	IF Amp., Limiter, FM Detector, Audio Driver, Electronic Attenuator.	5.00	4.00
MC1350P	IF Amplifier	1.50	1.25
MC1330A1P	Low Level Video Detector	1.50	1.15
MC1310P	FM Stereo Demodulator	4.29	3.30
MC1496P	Balanced Modulator/Demodulator	1.50	1.25
LM565N	Phase Locked Loop	2.50	2.00
LM380N14	2Watt Audio Power Amplifier	1.56	1.25
LM1889N	TV Video Modulator	5.00	4.00
NE564N	Phase Locked Loop	10.00	8.00
NE561N	Phase Locked Loop	10.00	8.00

FERRANTI ELECTRONICS AM RADIO RECEIVER MODEL ZN414 INTERGRATED CIRCUIT.

Features:

1.2 to 1.6 volt operating range., Less than 0.5ma current consumption. 150KHz to 3MHz Frequency range., Easy to assemble, no alignment necessary. Effective and variable AGC action., Will drive an earphone direct. Excellent audio quality., Typical power gain of 72dB., TO-18 package. With data. \$2.99 or 10 For \$24.99

NI CAD RECHARGEABLE BATTERIES

- AA Battery Pack of 6 These are Factory New. \$5.00
- SUB C Pack of 10 2.5Amp/Hr. \$10.00
- Gates Rechargeable Battery Packs
- 12vdc at 2.5Amp/Hr. \$11.99
- 12vdc at 5Amp/Hr. \$15.99



VHF DUPLEXERS

This duplexer was made for RF Harris Mobile Phones. These duplexers can be used in any mobile phone system, along with having the capabilities to be modified for UHF use. Dimensions are 3 3/5" Lx 4 2/5" Wx 1 1/10" D. App. weight is 18oz./11b.2oz.



PRICE \$74.99

**Toll Free Number  
800-528-0180  
(For orders only)**

PRICES SUBJECT TO CHANGE WITHOUT NOTICE

**MHz electronics**



# RF TRANSISTORS, MICROWAVE DIODES

PART	PRICE	PART	PRICE	PART	PRICE
1S2199	\$ 7.50	2N6083	\$ 13.25	CA2612 (TRW)	\$ 25.00
1S2200	7.50	2N6084	15.00	CA2674 (TRW)	25.00
2N1561	25.00	2N6094 /M9622	11.00	CA2881-1 (TRW)	25.00
2N1562	25.00	2N6095 /M9623	12.00	CA4101 (TRW)	25.00
2N2857	1.55	2N6096 /M9624	15.50	CA4201 (TRW)	25.00
2N2857JAN	2.55	2N6097	17.25	CA4600 (TRW)	25.00
2N2876	11.00	2N6136	21.85	CD1889	20.00
2N2947	18.35	2N6166	40.25	CD2545	20.00
2N2948	15.50	2N6201	50.00	CMD514AB	20.00
2N2949	3.90	2N6459	18.00	D4959	10.00
2N2950	4.60	2N6603	12.00	D4987M	20.00
2N3375	8.00	2N6680	80.00	D5147D	10.00
2N3553	1.57	2SC756A	7.50	D5506	10.00
2N3632	13.80	2SC781	2.80	D5827AM	20.00
2N3818	5.00	2SC1018	1.00	DMD6022	30.00
2N3866	1.30	2SC1042	12.00	DMS-2A-250	40.00
2N3924	3.35	2SC1070	2.50	HEP76	4.95
2N3927	17.75	2SC1239	2.50	HEPS3002	11.30
2N3950	25.00	2SC1251	12.00	HEPS3003	30.00
2N4072	1.80	2SC1306	2.90	HEPS3005	10.00
2N4127	21.00	2SC1307	5.50	HEPS3006	19.90
2N4427	1.30	2SC1760	1.50	HEPS3007	25.00
2N4428	1.85	2SC1970	2.50	HEPS3010	11.34
2N4957	3.45	2SC2166	5.50	HTEF2204 H.P.	112.00
2N4958	2.90	8B1087 (M.A.)	25.00	5082-0112 H.P.	14.20
2N4959	2.30	A50-12	20.00	5082-0253 H.P.	105.00
2N5090	13.90	A283B	5.00	5082-0320 H.P.	58.00
2N5108	4.00	ALD4200N (AVANTEK)	395.00	5082-0386 H.P.	POR
2N5109	1.70	AM123	97.35	5082-0401 H.P.	POR
2N5160	3.45	AM688	100.00	5082-0438 H.P.	POR
2N5177	21.62	BB105B	.52	5082-1028 H.P.	POR
2N5179	1.00	BD4/4JFBD4 (G.E.)	10.00	5082-2711 H.P.	23.15
2N5583	4.00	BFQ85	1.50	5082-3080 H.P.	2.00
2N5589	8.65	BFR90	1.30	5082-3188 H.P.	1.00
2N5590	10.35	BFR91	1.65	5082-6459 H.P.	POR
2N5591	13.80	BFW92	1.50	5082-8323 H.P.	POR
2N5635	10.95	BFX89	1.00	35826E H.P.	POR
2N5637	15.50	BFY90	1.00	35831E H.P.	29.99
2N5641	9.20	BGY54	25.00	35853E H.P.	71.50
2N5642	10.95	BGY55	25.00	35854E H.P.	75.00
2N5643	15.50	BGY74	25.00	HPA0241 H.P.	75.60
2N5645	13.80	BGY75	25.00	HXTR3101 H.P.	7.00
2N5646	20.70	BL161	10.00	HXTR3102 H.P.	8.75
2N5691	18.00	BLX67	11.00	HXTR6101/2N6617 H.P.	55.00
2N5764	27.00	BLY568CF	25.00	HXTR6104 H.P.	68.00
2N5836	5.45	BLY87	13.00	HXTR6105 H.P.	31.00
2N5842	8.00	BLY88	14.00	HXTR6106 H.P.	33.00
2N5849	20.00	BLY89	15.00	QSCH1995 H.P.	POR
2N5913	3.25	BLY90	20.00	JO2000 TRW	10.00
2N5922	10.00	BLY351	10.00	JO2001 TRW	25.00
2N5923	25.00	C4005	20.00	JO4045 TRW	25.00
2N5941	23.00	CA402 (TRW)	25.00	K3A	10.00
2N5942	40.00	CA405 (TRW)	25.00	MA450A	10.00
2N5944	9.20	CA612B (TRW)	25.00	MA41487	POR
2N5945	11.50	CA2100 (TRW)	25.00	MA41765	POR
2N5946	19.00	CA2113 (TRW)	25.00	MA43589	POR
2N6080	9.20	CA2200 (TRW)	25.00	MA43636	POR
2N6081	10.35	CA2213 (TRW)	25.00	MA47044	POR
2N6082	11.50	CA2418 (TRW)	25.00	MA47651	25.50

**Toll Free Number**  
**800-528-0180**  
**(For orders only)**

PRICES SUBJECT TO CHANGE WITHOUT NOTICE

**MHz electronics**



# GaAs, TUNNEL DIODES, ETC.

PART	PRICE	PART	PRICE	PART	PRICE
MA47100	\$ 3.05	MRF503	\$ 6.00	PT4186B	\$ POR
MA47202	30.80	MRF504	7.00	PT4209	POR
MA47771	POR	MRF509	5.00	PT4209C	POR
MA47852	POR	MRF511	8.65	PT4566	POR
MA49558	POR	MRF605	20.00	PT4570	POR
MB4021	POR	MRF629	3.47	PT4571	POR
MBD101	1.00	MRF644	23.00	PT4571A	POR
MDO513	POR	MRF816	15.00	PT4577	POR
MHW1171	42.50	MRF823	20.00	PT4590	POR
MHW1182	48.60	MRF901	3.00	PT4612	POR
MHW4171	49.35	MRF8004	2.10	PT4628	POR
MHW4172	51.90	MS261F	POR	PT4640	POR
MHW4342	68.75	MT4150 Fair.	POR	PT4642	POR
MLP102	25.00	MT5126 Fair.	POR	PT5632	POR
MM1500	32.32	MT5481 Fair.	POR	PT5749	POR
MM1550	POR	MT5482 Fair.	POR	PT6612	POR
MM1552	50.00	MT5483 Fair.	POR	PT6626	POR
MM1553	50.00	MT5596 Fair.	POR	PT6709	POR
MM1614	10.00	MT5764 Fair.	POR	PT6720	POR
MM2608	5.00	MT8762 Fair.	POR	PT8510	POR
MM3375A	11.50	MV109	.77	PT8524	POR
MM4429	10.00	MV1401	8.75	PT8609	POR
MM8000	1.15	MV1624	1.42	PT8633	POR
MM8006	2.30	MV1805	15.00	PT8639	POR
MO277L	POR	MV1808	10.00	PT8659	POR
MO283L	POR	MV1817B	10.00	PT8679	POR
MO3757	POR	MV1863B	10.00	PT8708	POR
MP102	POR	MV1864A	10.00	PT8709	POR
MPN3202	10.00	MV1864B	10.00	PT8727	POR
MPN3401	.52	MV1864D	10.00	PT8731	POR
MPN3412	1.00	MV1868D	10.00	PT8742	POR
MPSU31	1.01	MV2101	.90	PT8787	POR
MRA2023-1.5 TRW	42.50	MV2111	.90	PT9790	41.70
MRF212/208	16.10	MV2115	1.55	PT31962	POR
MRF223	13.25	MV2201	.53	PT31963	POR
MRF224	15.50	MV2203	.53	PT31983	POR
MRF237	3.15	MV2209	2.00	PTX6680	POR
MRF238	12.65	MV2215	2.00	RAY-3	24.99
MRF243	25.00	MWA110	7.45	40081	POR
MRF245	34.50	MWA120	7.80	40281	POR
MRF247	34.50	MWA130	8.25	40282	POR
MRF304	43.45	MWA210	7.80	40290	POR
MRF315	23.00	MWA220	8.25	RF110	25.00
MRF420	20.00	MWA230	8.65	SCA3522	POR
MRF421	36.80	MWA310	8.25	SCA3523	POR
MRF422	41.40	MWA320	8.65	SD1065	POR
MRF427	16.10	MWA330	9.50	SS43	POR
MRF428	46.00	NEC57835	5.30	TP1014	POR
MRF450/A	13.80	ON382	5.00	TP1028	POR
MRF453/A	17.25	PPT515-20-3	POR	TRW-3	POR
MRF454/A	19.90	PRT8637	POR	UTO504 Avantek	70.00
MRF455/A	16.00	PSCQ2-160	POR	UTO511 Avantek	75.00
MRF458	19.90	PT3190	POR	V15	4.00
MRF463	25.00	PT3194	POR	V33B	4.00
MRF472	1.00	PT3195	POR	V100B	4.00
MRF475	2.90	PT3537	POR	VAB801EC	25.00
MRF477	11.50	PT4166E	POR	VAB804EC	25.00
MRF502	1.04	PT4176D	POR	VAS21AN20	25.00

**Toll Free Number  
800-528-0180  
(For orders only)**

**MHz electronics**

PRICES SUBJECT TO CHANGE WITHOUT NOTICE



COAXIAL RELAY SWITCHES SPDT

Electronic Specialty Co./Raven Electronics FSN 5985-556-9683 \$49.00  
 Part # 25N28 Part # SU-01  
 26Vdc Type N Connector, DC to 1 GHz.

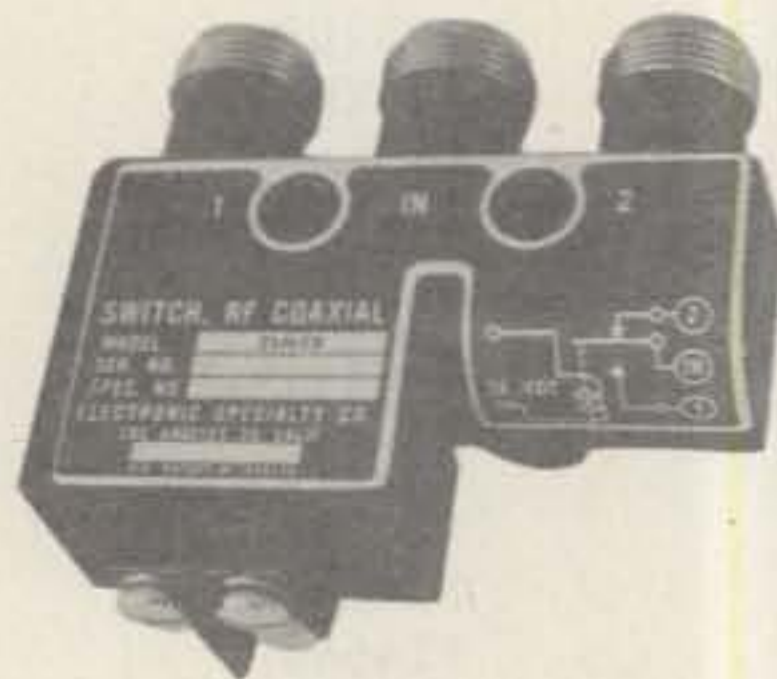

Amphenol  
 Part # 316-10102-8  
 115Vac Type BNC DC to 3 GHz.

FXR  
 Part # 300-11182  
 120Vac Type BNC DC to 4 GHz.  
 FSN 5985-543-1225

FXR  
 Part # 300-11173  
 120Vac Type BNC Same  
 FSN 5985-543-1850

\$29.99

\$39.99

\$39.99

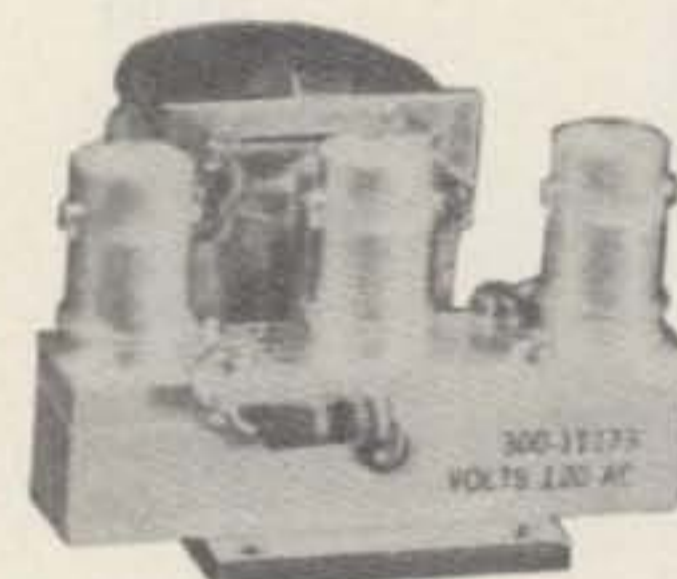
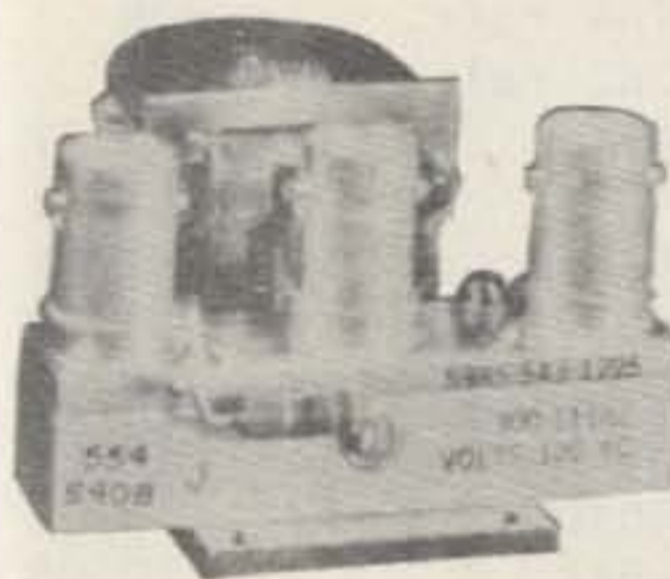
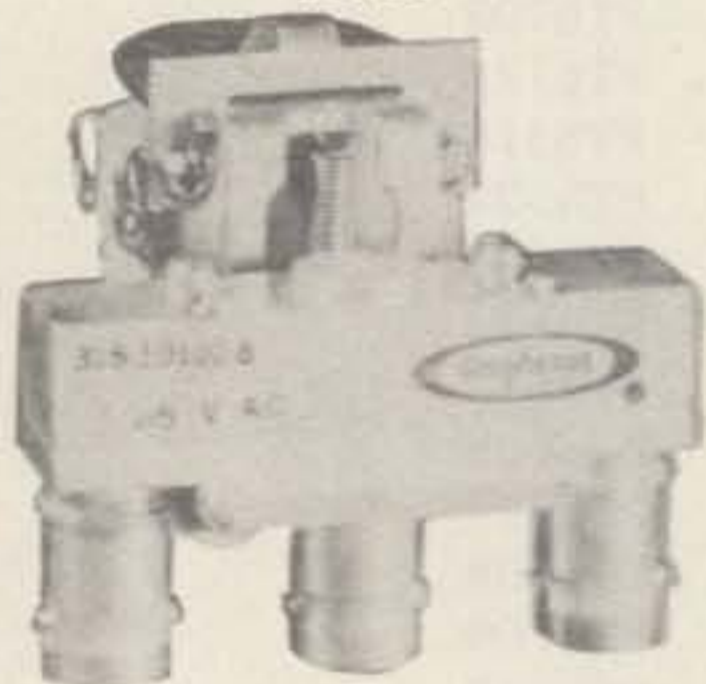

BNC To Banana Plug Coax Cable RG-58 36 inch or BNC to N Coax Cable RG-58 36 inch.

\$7.99 or 2 For \$13.99 or 10 For \$50.00

\$8.99 or 2 For \$15.99 or 10 For \$60.00



SOLID STATE RELAYS

P&B Model ECT1DB72  
 PRICE EACH \$5.00

5vdc turn on

120vac contact at 7amps or 20amps on a 10"x 10"x .124 aluminum. Heatsink with silicon grease.

Digisig, Inc. Model ECS-215  
 PRICE EACH \$7.50

5vdc turn on

240vac contact 14amps or 40amps on a 10"x 10"x .124 aluminum. Heatsink with silicon grease.

Grigsby/Barton Model GB7400  
 PRICE EACH \$7.50

5vdc turn on

240vac contact at 15amps or 40amps on a 10"x 10"x .124 aluminum. Heatsink with silicon grease.

NOTE: \*\*\* Items may be substituted with other brands or equivalent model numbers. \*\*\*

**MHz** electronics

Toll Free Number  
 800-528-0180  
 (For orders only)

PRICES SUBJECT TO CHANGE WITHOUT NOTICE



# "MIXERS"

## WATKINS JOHNSON WJ-M6 Double Balanced Mixer

LO and RF 0.2 to 300MHz	IF DC to 300MHz	\$21.00
Conversion Loss (SSB)	6.5dB Max. 1 to 50MHz	
Noise Figure (SSB)	8.5dB Max. .2 to 300MHz	WITH DATA SHEET
Conversion Compression	same as above	
	8.5dB Max. 50 to 300MHz	
	.3dB Typ.	

## NEC (NIPPON ELECTRIC CO. LTD. NE57835/2SC2150 Microwave Transistor

NF Min F=2GHz	dB 2.4 Typ.	MAG F=2GHz	dB 12 Typ.	\$5.30
F=3GHz	dB 3.4 Typ.	F=3GHz	dB 9 Typ.	
F=4GHz	dB 4.3 Typ.	F=4GHz	dB 6.5 Typ.	

Ft Gain Bandwidth Product at Vce=8v, Ic=10ma. GHz 4 Min. 6 Typ.  
 Vcbo 25v Vceo 11v Vebo 3v Ic 50ma. Pt. 250mw

## UNELCO RF Power and Linear Amplifier Capacitors

These are the famous capacitors used by all the RF Power and Linear Amplifier manufacturers, and described in the RF Data Book.

5pf	10pf	18pf	30pf	43pf	100pf	200pf	1 to 10pcs.	\$1.00 ea
5.1pf	12pf	22pf	32pf	51pf	110pf	220pf	11 to 50pcs.	\$ .90 ea
6.8pf	13pf	25pf	33pf	60pf	120pf	470pf	51 up	pcs. \$ .80 ea
7pf	14pf	27pf	34pf	80pf	130pf	500pf		
8.2pf	15pf	27.5pf	40pf	82pf	140pf	1000pf		

## NIPPON ELECTRIC COMPANY TUNNEL DIODES

		MODEL 1S2199	1S2200	\$7.50
Peak Pt. Current ma.	Ip	9min. 10Typ. 11max.	9min. 10Typ. 11max.	
Valley Pt. Current ma.	Iv	1.2Typ. 1.5max.	1.2Typ. 1.5max.	
Peak Pt. Voltage mv.	Vp	95Typ. 120max.	75Typ. 90max.	
Projected Peak Pt. Voltage mv.	Vpp Vf=Ip	480min. 550Typ. 630max.	440min. 520Typ. 600max.	
Series Res. Ohms	rS	2.5Typ. 4max.	2Typ. 3max.	
Terminal Cap. pf.	Ct	1.7Typ. 2max.	5Typ. 8max.	
Valley Pt. Voltage mv.	VV	370Typ.	350Typ.	

## FAIRCHILD / DUMONT Oscilloscope Probes Model 4290B

Input Impedance 10 meg., Input Capacity 6.5 to 12pf., Division Ration (Volts/Div Factor) 10:1, Cable Length 4Ft. , Frequency Range Over 100MHz.  
 These Probes will work on all Tektronix, Hewlett Packard, and other Oscilloscopes.

PRICE \$45.00

## MOTOROLA RF DATA BOOK

List all Motorola RF Transistors / RF Power Amplifiers, Varactor Diodes and much much more.

PRICE \$7.50

**Toll Free Number**  
**800-528-0180**  
**(For orders only)**

**MHz electronics**

PRICES SUBJECT TO CHANGE WITHOUT NOTICE



# "SOCKETS AND CHIMNEYS"

## EIMAC TUBE SOCKETS AND CHIMNEYS

SK110	Socket	SPOR
SK300A	Socket For 4CX5000A,R,J, 4CX10,000D, 4CX15,000A,J	\$520.00
SK400	Socket For 4-125A,250A,400A,400C,4PR125A,400A,4-500A,5-500A	260.00
SK406	Chimney For 4-250A,400A,400C,4PR400A	74.00
SK416	Chimney For 3-400Z	36.00
SK500	Socket For 4-1000A/4PR1000A/B	390.00
SK600	Socket For 4CX250B,BC,FG,R,4CX350A,F,FJ	51.00
SK602	Socket For 4CX250B,BC,FG,R,4CX350A,F,FJ	73.00
SK606	Chimney For 4CX250B,BC,FG,R,4CX350A,F,FJ	11.00
SK607	Socket For 4CX600J,JA	60.00
SK610	Socket For 4CX600J,JA	60.00
SK620	Socket For 4CX600J,JA	66.00
SK626	Chimney For 4CX600J,JA	10.00
SK630	Socket For 4CX600J,JA	66.00
SK636B	Chimney For 4CX600J,JA	34.00
SK640	Socket For 4CX600J,JA	36.00
SK646	Chimney For 4CX600J,JA	71.00
SK700	Socket For 4CX300A,Y,4CX125C,F	225.00
SK711A	Socket For 4CX300A,Y,4CX125C,F	225.00
SK740	Socket For 4CX300A,Y,4CX125C,F	86.00
SK770	Socket For 4CX300A,Y,4CX125C,F	86.00
SK800A	Socket For 4CX1000A,4CX1500B	225.00
SK806	Chimney For 4CX1000A,4CX1500B	40.00
SK810	Socket For 4CX1000A,4CX1500B	225.00
SK900	Socket For 4X500A	300.00
SK906	Chimney For 4X500A	57.00
SK1420	Socket For 5CX3000A	650.00
SK1490	Socket For 4CV8000A	585.00

## JOHNSON TUBE SOCKETS AND CHIMNEYS

124-111/SK606	Chimney For 4CX250B,BC,FG,R, 4CX350A,F,FJ	\$ 10.00
122-0275-001	Socket For 3-500Z, 4-125A, 250A, 400A, 4-500A, 5-500A	(pair)15.00
124-0113-00	Capacitor Ring	15.00
124-116/SK630A	Socket For 4CX250B,BC,FG,R, /4CX350A,F,FJ	55.00
124-115-2/SK620A	Socket For 4CX250B,BC,FG,R, /4CX350A,F,FJ	55.00
	813 Tube Socket	20.00

## CHIP CAPACITORS

.8pf	10pf	100pf*	430pf
1pf	12pf	110pf	470pf
1.1pf	15pf	120pf	510pf
1.4pf	18pf	130pf	560pf
1.5pf	20pf	150pf	620pf
1.8pf	22pf	160pf	680pf
2.2pf	24pf	180pf	820pf
2.7pf	27pf	200pf	1000pf/.001uf*
3.3pf	33pf	220pf*	1800pf/.0018uf
3.6pf	39pf	240pf	2700pf/.0027uf
3.9pf	47pf	270pf	10,000pf/.01uf
4.7pf	51pf	300pf	12,000pf/.012uf
5.6pf	56pf	330pf	15,000pf/.015uf
6.8pf	68pf	360pf	18,000pf/.018uf
8.2pf	82pf	390pf	

PRICES: 1 to 10 - .99¢ 101 to 1000 .60¢ \* IS A SPECIAL PRICE: 10 for \$7.50  
 11 to 50 - .90¢ 1001 & UP .35¢ 100 for \$65.00  
 51 to 100 - .80¢ 1000 for \$350.00

## TUBE CAPS (Plate)

HR1, 4	\$11.00
HR2,3, 6 & 7	13.00
HR5, 8	14.00
HR9	17.00
HR10	20.00

## WATKINS JOHNSON WJ-V907: Voltage Controlled Microwave Oscillator \$110.00

Frequency range 3.6 to 4.2GHz, Power output, Min. 10dBm typical, 8dBm Guaranteed.  
 Spurious output suppression Harmonic (nf<sub>0</sub>), min. 20dB typical, In-Band Non-Harmonic, min. 60dB typical, Residual FM, pk to pk, Max. 5KHz, pushing factor, Max. 8KHz/V, Pulling figure (1.5:1 VSWR), Max. 60MHz, Tuning voltage range +1 to +15volts, Tuning current, Max. -0.1mA, modulation sensitivity range, Max. 120 to 30MHz/V, Input capacitance, Max. 100pf, Oscillator Bias +15 +/-0.05 volts @ 55mA, Max.

**Toll Free Number**  
**800-528-0180**  
**(For orders only)**

# MHz electronics

PRICES SUBJECT TO CHANGE WITHOUT NOTICE



# TUBES

<u>TYPE</u>	<u>PRICE</u>	<u>TYPE</u>	<u>PRICE</u>	<u>TYPE</u>	<u>PRICE</u>
2E26	\$ 5.69	KT88	\$ 20.00	6562/6974A	\$ 50.00
2K28	100.00	DX362	50.00	6832	22.00
2X1000A	300.00	DX415	50.00	6883/8032A/8552	7.00
3B22	19.75	572B/T160L	49.00	6897	110.00
3B28/866A	7.50	592/3-200A3	144.00	6907A	75.00
3-500Z	102.00	807	7.50	6939	15.00
3-1000Z	400.00	811	10.00	7094	125.00
3CX1000A/8283	428.00	811A	15.00	7117	17.00
3CX1500A7/887	533.00	812A	35.00	7211	60.00
3X2500A3	200.00	813	50.00	7289/3CX100A5	34.00
3CX3000A7	490.00	829B	38.00	7360	11.00
4-65A/8165	45.00	832A	28.00	7377	67.00
4-125A/4D21	58.00	4624	310.00	7408	4.00
4-250A/5D22	75.00	4662	80.00	7650	250.00
4-400A/8432	90.00	4665	585.00	7695	8.00
4-400C/6775	95.00	5675/A	25.00	7843	58.00
4-1000A/8166	300.00	5721	200.00	7854	83.00
4B32	22.00	5768	85.00	7868	5.00
4E27A/5-125B	155.00	5836	100.00	7894	12.00
4CS250R	146.00	5837	100.00	8072	65.00
4X150A/7034	30.00	5861/EC55	110.00	8117A	130.00
4X150D/7035	40.00	5876A	25.00	8121	60.00
4X150G/8172	100.00	5881/6L6W	6.00	8122	100.00
4X250B	30.00	5893	45.00	8236	30.00
4CX250B/7203	45.00	5894/A	50.00	8295/PL172	506.00
4CX250F/G/8621	55.00	5894/B	60.00	8462	100.00
4CX250K/8245	100.00	5946	258.00	8505A	73.50
4CX250R/7580W	69.00	6080	10.00	8533W	92.00
4CX300A/8167	140.00	6083/AX9909	89.00	8560/A	65.00
4CX350A/8321	83.00	6098/6AK6	14.00	8560AS	90.00
4CX350F/J/8904	95.00	6115/A	110.00	8608	34.00
4X500A	282.00	6146	7.00	8637	38.00
4CX600J/8809	607.00	6146A	7.50	8643	100.00
4CW800F	625.00	6146B/8298A	8.50	8647	123.00
4CX1000A/8168	340.00	6146W	14.00	8737/5894B	60.00
4CX1500B/8660	397.00	6156	66.00	8873	260.00
4CX5000A/8170	932.00	6159	15.00	8874	260.00
4CX10000D/8171	990.00	6161	233.00	8875	260.00
4CX15000A/8281	1260.00	6291	125.00	8877	533.00
4PR60A	100.00	6293	12.00	8908	12.00
4PR60B/8252	175.00	6360	5.00	8930/651Z	71.00
4PR400A/8188	192.00	6524	53.00	8950	12.00
5CX1500A	569.00	6550	10.00		
6BK4C	6.00	6JM6	6.00	6LQ6 (Sylvania)	7.50
6DQ5	5.00	6JN6	6.00	6LU8	6.00
6FW5	6.00	6JS6B	6.00	6LX6	6.00
6GE5	6.00	6KG6/EL505	6.00	6ME6	6.00
6GJ5	6.00	6KM6	6.00	12BY7A	4.00
6HS5	6.00	6KN6	6.00	12JB6A	6.00
6JB5/6HE5	6.00	6LF6	6.00	6KD6	6.00
6JB6A	6.00	6LQ6 (GE)	6.00	6JT6A	6.00
				6KD6	6.00

NOTICE ALL PRICES ARE SUBJECT TO CHANGE WITHOUT NOTICE !!  
TUBES MAY EITHER BE NEW OR SURPLUS CONDITION !!

**Toll Free Number**  
**800-528-0180**  
**(For orders only)**

**MHz electronics**

PRICES SUBJECT TO CHANGE WITHOUT NOTICE



# "TVRO BOARD LIST"

**70 MHZ IF BOARD:** This circuit provides about 43dB gain with 50 ohm input and output impedance. It is designed to drive the Demodulator. The on-board bypass filter can be tuned to bandwidths between 20 and 35 MHz with a passband ripple of less than 1/2 dB. Hybrid IC's are used for the gain stages.

**SINGLE AUDIO BOARD:** This circuit recovers the audio signals from the 6.8 MHz frequency. The Miller 9051 coils are tuned to pass the 6.8MHz subcarrier and the 9052 coil tunes for recovery of the audio.

**DUAL AUDIO BOARD:** Duplicate of the single audio but also covers the 6.2 range.

**DC CONTROL BOARD:** No description.

DUAL AUDIO BOARD	PRICE EACH
Printed Circuit Board	\$ 25.00
2 3pf sm	1.00
2 12pf sm	1.00
2 50pf sm	1.00
2 68pf sm	1.00
4 91pf sm	1.00
5 .001mfd	.35
6 .01mfd	.35
2 .047mfd	.35
1 .47mfd 25vdc	.35
2 1mfd 10vdc	.59
4 4.7mfd 35vdc	.59
1 470mfd 25vdc	1.29
2 220K 1/4w	.15
2 150K 1/4w	.15
2 6.8K 1/4w	.15
2 3.3K 1/4w	.15
2 2.2K 1/4w	.15
4 1K 1/4w	.15
2 10 ohm 1/4w	.15
2 50K pots	1.00
1 5K pot	1.00
2 CA3065	2.16
1 LM380	1.56
1 7812 Voltage Reg.	1.17
5 2N2222	.50
4 Miller 9051	5.99
2 Miller 9052	5.99
<b>TOTAL KIT PRICE</b>	<b>97.62</b>

DC CONTROL BOARD	PRICE EACH
Printed Circuit Board	15.00
2 470mfd 25vdc	1.29
2 4.7mfd 25vdc	.59
1 1meg 1/4w	.15

3 10K 1/4w	.15
1 3.3K 1/4w	.15
3 2.2K 1/4w	.15
1 1K 1/4w	.15
2 5K 10 turn trimpot	1.00
4 10K 10 turn trimpot	1.00
1 10K 10 turn with dial	10.00
1 7815 Voltage Reg.	1.17
1 LM324	2.50
1 5 pole rotary switch	2.50
1 SPDT switch	1.00
1 DPDT swich	1.00
1 0-1ma meter	5.00
1 18 to 24vdc at 1 amp power supply	24.99
<b>TOTAL KIT PRICE</b>	<b>74.27</b>

DEMODULATOR BOARD	PRICE EACH
Printed Circuit Board	\$ 40.00
1 1mfd 35vdc	.59
13 .01mfd 50vdc disc	.35
1 470mfd 25vdc	1.29
2 100mfd 16vdc	.69
2 22mfd 35vdc	.59
3 4.7mfd 35vdc	.59
1 4300pf sm	2.00
1 330pf sm	1.00
1 100pf sm	1.00
1 91pf sm	1.00
2 3pf sm	1.00
1 2 to 8pf ceramic trimmer	1.00
1 100uh choke	1.50
1 4.7uh choke	1.50
1 2.7uh choke	1.50

4 100K 1/4w	.15
1 51 ohm 1/4w	.15
1 27K 1/4w	.15
5 10K 1/4w	.15
1 8.2K 1/4w	.15
2 4.7K 1/4w	.15
1 2.2K 1/4w	.15
1 1.2K 1/4w	.15
3 1K 1/4w	.15
3 560 ohm 1/4w	.15
1 470 ohm 1/4w	.15
1 390 ohm 1/4w	.15
1 300 ohm 1/4w	.15
1 270 ohm 1/4w	.15
1 150 ohm 1/4w	.15
1 41 ohm 1/4w	.15
1 10K pot	1.00
1 NE592/LM733N	2.50
1 NE564	5.00
1 MWA120 (Motorola)	7.80
1 7812 Voltage Reg.	1.17
1 7815 Voltage Reg.	1.17
3 2N2222	.50
2 1N34/38	.50
1 HP5082-2800	2.20
1 5 to 7 volt Zenner	1.00
<b>TOTAL KIT PRICE</b>	<b>92.25</b>

COMPLETE KIT WITH DUAL AUDIO \$923.23  
COMPLETE KIT WITH SINGLE AUDIO 880.77

LESS 10% ON ALL COMPLETE KIT ORDERS

BOARDS AND PARTS MAY BE PURCHASED SEPERATELY AT THE PRICES LISTED ABOVE.

ALL PRICES ARE SUBJECT TO CHANGE WITHOUT NOTICE!!!!!!!!!!!!!!!!!!!!!!!!!!!!!!!!!!!!

## TVRO BOARD DESCRIPTION AND PARTS LIST

**DUAL CONVERSION BOARD:** This board provides conversion from the 3.7-4.2 band first to 900 MHz where gain and bandpass filtering are provided and, second, to 70 MHz. The board contains both local oscillators, one fixed and the other variable, and the second mixer. Construction is greatly simplified by the use of Hybrid IC amplifiers for the gain stages.

**DEMODULATOR BOARD:** This circuit takes the 70 MHz center frequency satellite TV signal in the 10 to 200 millivolt range, detects them using a phase lock loop, de-emphasizes and filters the result to produce standard NTSC video. Other outputs include the audio subcarrier, a DC voltage proportional to the strength of the 70 MHz signal, and AFC voltage centered at about 2 volts DC.

DUAL CONVERSION BOARD	PRICE EACH
Printed Circuit Board	\$ 25.00
6 47pf chip caps	1.00
2 4.7mfd 35vdc	.59
2 .01mfd 50vdc disc cap	.35
4 1.5 to 8pf piston trimmer cap	5.99
2 470 ohm 1/4w	.15
2 MWA320 (Motorola)	8.65
1 7815 Voltage Reg.	1.17
1 VTO8090	150.00
1 VTO8240	156.25
2 1N4005	.39
1 DBM500/1100 (Varil)	125.00
1 MLP102 (Engleman)	25.00
8 SMA Male Connector	5.00
<b>TOTAL KIT PRICE</b>	<b>572.64</b>

70 MHZ IF BOARD	PRICE EACH
Printed Circuit Board	25.00

3 MWA120	7.80
7 .01mfd 50vdc	.35
2 4.7mfd 35vdc	.59
1 10pf sm	1.00
5 22pf sm	1.00
1 18pf sm	1.00
1 33pf sm	1.00
2 330 ohm 1/4w	.15
5 J.W. Miller 4500-4	4.99
1 7815 Voltage Reg.	1.17
<b>TOTAL KIT PRICE</b>	<b>86.45</b>

SINGLE AUDIO BOARD	PRICE EACH
Printed Circuit Board	\$ 15.00
1 3pf sm	1.00
1 12pf sm	1.00
1 50pf sm	1.00
1 68pf sm	1.00
2 91pf sm	1.00
3 .001mfd	.35
3 .01mfd	.35

1 .047mfd	.35
1 .47mfd	.35
1 1mfd 10vdc	.59
3 4.7mfd 35vdc	.59
1 470mfd 25vdc	1.29
1 220K 1/4w	.15
1 150K 1/4w	.15
1 6.8K 1/4w	.15
1 3.3K 1/4w	.15
1 2.2K 1/4w	.15
3 1K 1/4w	.15
1 10 ohm 1/4w	.15
1 50K pot	1.00
1 5K pot	1.00
1 CA3065/MC1358P	2.16
1 LM380	1.56
1 7812 Voltage Reg.	1.17
3 2N2222	.50
2 Miller 9051	5.99
1 Miller 9052	5.99
<b>TOTAL KIT PRICE</b>	<b>55.16</b>

**Toll Free Number**  
**800-528-0180**  
**(For orders only) PRICES SUBJECT TO CHANGE WITHOUT NOTICE**

**MHz electronics**



# "CHIPS"

FAIRCHILD VHF AND UHF PRESCALER CHIPS	PRICE
95H90DC 350MC Prescaler divide by 10/11	\$ 8.50
95H91DC 350MC Prescaler divide by 5/6	8.50
11C90DC 650MC Prescaler divide by 10/11	15.50
11C91DC 650MC Prescaler divide by 5/6	15.50
11C06DC UHF Prescaler 750MC D Type Flip Flop	12.30
11C05DC 1GHz Counter Divide by 4 (Regular price \$75.00)	50.00
11C01FC High Speed Dual 5/4 Input NO/NOR Gate	15.40
82S90 Presettable High Speed Decade/Binary Counter used with the 11C90/91 or the 95H90/91 Prescaler can divide by 100. (Signetics)	5.00
11C24DC This chip is the same as a Motorola MC4024/4324 Dual TTL Voltage Control Multivibrator.	3.37
11C44DC This chip is the same as a Motorola MC4044/4344 Phase Frequency Detector.	3.37

**GENERAL ELECTRIC CO. GUNN DIODE MODEL Y-2167**  
 Freq. Gap (GHZ) 12 to 18, Output (Min.) 100mW, Duty (%) CW, Typ. Bias (Vdc) 8.0, Type. Oper. (MAdc) 550, Max. Thres. (mAdc) 1000, Max. Bias (Vdc) 10.0. **\$39.99**

**VARIAN GALLIUM ARSENIDE GUNN DIODES MODEL VSX-9201S5**  
 Freq. Coverage 8 to 12.4GHz, Output (Min.) 100mW, Bias Voltage (Max.) 14vdc, Bias current (mAdc) Operating 550 Typ. 750 Max., Threshold 850 Tup. 1000 Max. **\$39.99**

**VARI-L Co. Inc. MODEL SS-43 AM MODULATOR**  
 Freq. Range 60 to 150MC, Insertion Loss 13dB Nominal, Signal Port Imp. 50ohms Nominal, Signal Port RF Power +10dBm Max., Modulation Port BW DC to 1KHZ, Modulation Port Bias 1ma. Nominal. **\$24.99**

AVANTEK CASCADABLE MODULAR AMPLIFIERS	Model UTO-504	UTO-511
Frequency Range	5 to 500 MHz	5 to 500 MHz
Gain	6dB	15dB
Noise Figure	11dB	2.3dB to 3dB
Power Output	+17dB	-2dB to -3dB
Gain Flatness	1dB	1dB
Input Power Vdc	+24	+15
mA	100	10
PRICE	\$70.00	PRICE \$75.00

HEWLETT PACKARD MIXERS MODELS	10514A	10514B
Frequency Range	2MHz to 500MC	2MHz to 500MC
Input/Output Frequency L & R	200KHz to 500MC	200KHz to 500MC
	X DC to 500MC	DC to 500MC
Mixer Conversion Loss (A)	7dB	7dB
(B)	9dB	9dB
Noise Performance (SSB) (A)	7dB	7dB
(B)	9dB	9dB
PRICE	\$49.99	PRICE \$39.99

## FREQUENCY SOURCES, INC MODEL MS-74X MICROWAVE SIGNAL SOURCE

MS-74X: Mechanically Tunable Frequency Range (MHz) 10630 to 11230 (10.63 to 11.23GHz) Minimum Output Power (mW) 10, Overall Multiplier Ratio 108, Internal Crystal Oscillator Frequency Range (MHz) 98.4 to 104.0, Maximum Input Current (mA) 400.

The signal source are designed for applications where high stability and low noise are of prime concern. these sources utilize fundamental transistor oscillators with high Q coaxial cavities, followed by broadband stable step recovery diode multipliers. This design allows single screw mechanical adjustment of frequency over standard communications bands. Broadband sampling circuits are used to phase lock the oscillator to a high stability reference which may be either an internal self-contained crystal oscillator, external primary standard or VHF synthesizer. This unique technique allows for optimization of both FM noise and long term stability. List Price is \$1158.00 (THESE ARE NEW) **Our Price—\$289.**

## HEWLETT PACKARD 1N5712 MICROWAVE DIODE

This diode will replace the MBD101, 1N5711, 5082-2800, 5082-2835 ect. This will work like a champ in all those Down Converter projects. **\$1.50 or 10/\$10.00**

## MOTOROLA MHW1172R LOW DISTORTION WIDEBAND AMPLIFIER MODULE.

Frequency Range: 40 to 300 MHz., Power Gain at 50MHz 16.6min. to 17.4max., Gain Flatness ±0.1 Typ. ±0.2 Max. dB., DC Supply Voltage -28vdc, RF Voltage Input +70dBmV **PRICE \$29.99**

## GENERAL ELECTRIC AA NICADS

Model #41B905HD11-G1  
 Pack of 6 for \$5.00 or 60 Cells, 10 Packs for \$45.00  
 These may be broken down to individual cells.

### ORDERING INSTRUCTIONS

**DEFECTIVE MATERIAL:** All claims for defective material must be made within sixty (60) days after receipt of parcel. All claims must include the defective material (for testing purposes), our invoice number, and the date of purchase. All returns must be packed properly or it will void all warranties.

**DELIVERY:** Orders are normally shipped within 48 hours after receipt of customer's order. If a part has to be backordered the customer is notified. Our normal shipping method is via First Class Mail or UPS depending on size and weight of the package. On test equipment it is by Air only, FOB shipping point.

**FOREIGN ORDERS:** All foreign orders must be prepaid with cashier's check or money order made out in U.S. Funds. We are sorry but C.O.D. is not available to foreign countries and Letters of Credit are not an acceptable form of payment either. Further information is available on request.

**HOURS:** Monday thru Saturday: 8:30 a.m. to 5:00 p.m.

**INSURANCE:** Please include 25¢ for each additional \$100.00 over \$100.00, United Parcel only.

**ORDER FORMS:** New order forms are included with each order for your convenience. Additional forms are available on request.

**POSTAGE:** Minimum shipping and handling in the US, Canada, and Mexico is \$2.50 all other countries is \$5.00. On foreign orders include 20% shipping and handling.

**PREPAID ORDERS:** Order must be accompanied by a check.

**PRICES:** Prices are subject to change without notice.

**RESTOCK CHARGE:** If parts are returned to MHZ Electronics due to customer error, customer will be held responsible for all extra fees, will be charged a 15% restocking fee, with the remainder in credit only. All returns must have approval.

**SALES TAX:** Arizona must add 5% sales tax, unless a signed Arizona resale tax card is currently on file with MHZ Electronics. All orders placed by persons outside of Arizona, but delivered to persons in Arizona are subject to the 5% sales tax.

**SHORTAGE OR DAMAGE:** All claims for shortages or damages must be made within 5 days after receipt of parcel. Claims must include our invoice number and the date of purchase. Customers which do not notify us within this time period will be held responsible for the entire order as we will consider the order complete.

OUR 800 NUMBER IS STRICTLY FOR ORDERS ONLY  
 NO INFORMATION WILL BE GIVEN 1-800-528-0180

**TERMS: DOMESTIC:** Prepaid, C.O.D. or Credit Card

**FOREIGN:** Prepaid only, U.S. Funds—money order or cashier's check only.

**C.O.D.:** Acceptable by telephone or mail. Payment from customer will be by cash, money order or cashier's check. We are sorry but we cannot accept personal checks for C.O.D.'s.

**CONFIRMING ORDERS:** We would prefer that confirming orders not be sent after a telephone order has been placed. If company policy necessitates a confirming order, please mark "CONFIRMING" boldly on the order. If problems or duplicate shipments occur due to an order which is not properly marked, customers will be held responsible for any charges incurred, plus a 15% restock charge on returned parts.

**CREDIT CARDS: WE ACCEPT MASTERCARD VISA AND AMERICAN EXPRESS.**

**DATA SHEETS:** When we have data sheets in stock on devices we do supply them with the order.



(602) 242-3037  
 (602) 242-8916

2111 W. CAMELBACK ROAD  
 PHOENIX, ARIZONA 85015

Toll Free Number  
 800-528-0180  
 (For orders only)

48



7400

\*\*Number of Pins of each I.C. for easy Socket purchase

Table listing various 7400 series integrated circuits with columns for Part No., Pins, Price, and Function.

Table listing various 74LS series integrated circuits with columns for Part No., Pins, Price, and Function.

Table listing various 74S/PROMS series integrated circuits with columns for Part No., Pins, Price, and Function.

Table listing various CA—LINEAR series integrated circuits with columns for Part No., Pins, Price, and Function.

Table listing various CD—CMOS series integrated circuits with columns for Part No., Pins, Price, and Function.

MICROPROCESSOR COMPONENTS

Table listing MICROPROCESSOR CHIPS with columns for Part No., Pins, Price, and Function.

Table listing Z80, Z80A, Z80B, Z8000 SERIES microprocessors with columns for Part No., Pins, Price, and Function.

Table listing 6800/68000 SERIES microprocessors with columns for Part No., Pins, Price, and Function.

Table listing 8080A SERIES microprocessors with columns for Part No., Pins, Price, and Function.

Table listing MICROPROCESSOR MANUALS & DATA BOOKS with columns for Part No., Price, and Description.

Table listing DYNAMIC RAMS with columns for Part No., Pins, Price, and Function.

Table listing STATIC RAMS with columns for Part No., Pins, Price, and Function.

Table listing EPROMS with columns for Part No., Pins, Price, and Function.

Table listing PROMS with columns for Part No., Pins, Price, and Function.

Table listing DATA ACQUISITION components with columns for Part No., Price, and Description.

Evaluation Kits

INTERMIL

Table listing various Evaluation Kits with columns for Part No., Pins, Function, and Price.

Table listing 74C—C/MOS components with columns for Part No., Pins, Price, and Function.

Table listing 74HC High Speed CMOS components with columns for Part No., Pins, Price, and Function.

Table listing Programmable Array Logic (PALs) components with columns for Part No., Pins, Price, and Function.

CONNECTORS

Table listing DB25 — D Subminiature connectors with columns for Part No., Description, Price.

Table listing Solder Eyelet/Wire Wrap Edge Card connectors with columns for Part No., Cnts, Sp, Description, Price.

Table listing RF Coaxial Connectors with columns for Part No., Description, Price.

LINEAR

Table listing various Linear components with columns for Part No., Price, and Description.

CAPACITOR CORNER

Table listing 50 VOLT CERAMIC DISC CAPACITORS and MINI. ALUMINUM ELECTROLYTIC CAPACITORS with columns for Value, Price, and Description.

IC SOCKETS

Table listing IC SOCKETS with columns for Part No., Price, and Description.



- FM • SSB • CW • ATV • OSCAR
- LINKS • REPEATERS • TRANSMITTERS
- RECEIVERS • PREAMPS • CONVERTERS
- TRANSCEIVERS • POWER SUPPLIES • PA'S

# QUALITY VHF/UHF KITS AT AFFORDABLE PRICES

**- NEW -**

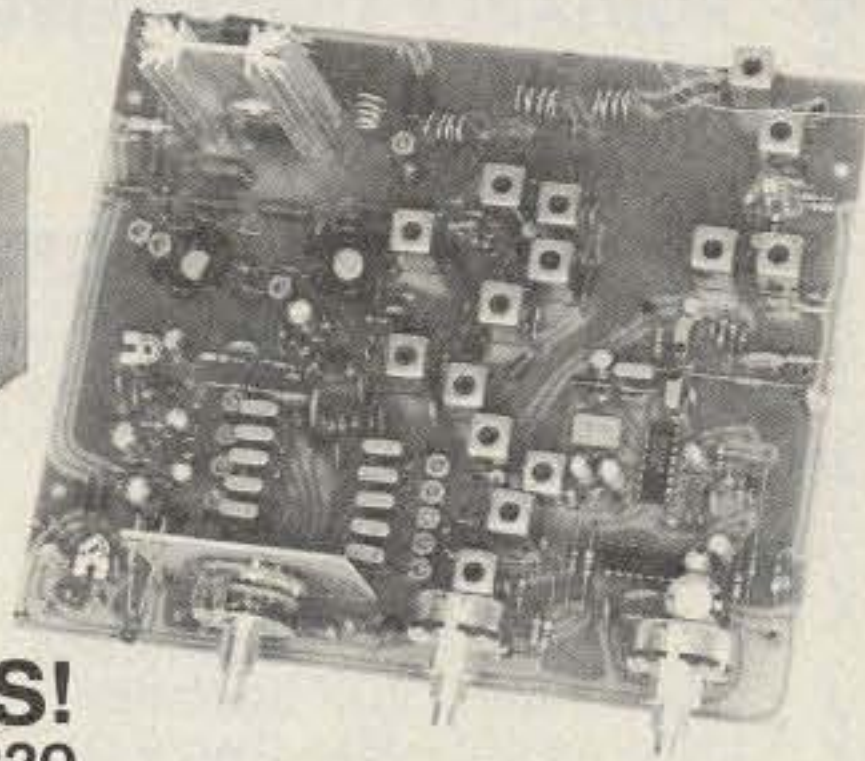

FM-5 PC Board Kit - **ONLY \$159.95**  
complete with controls, heatsink, etc.

**SAVE A BUNDLE ON  
VHF FM TRANSCEIVERS!**  
10 watts, 5 Channels, for 6M, 2M, or 220

★  
**SPECIAL  
OFFER**  
Free cabinet kit, complete  
with speaker, knobs, connectors,  
hardware. A \$59.95 value,  
yours free with purchase  
of kit. Hurry!  
Offer limited.  
★

## HIGH QUALITY FM MODULES FOR REPEATERS, LINKS, TELEMETRY, ETC.

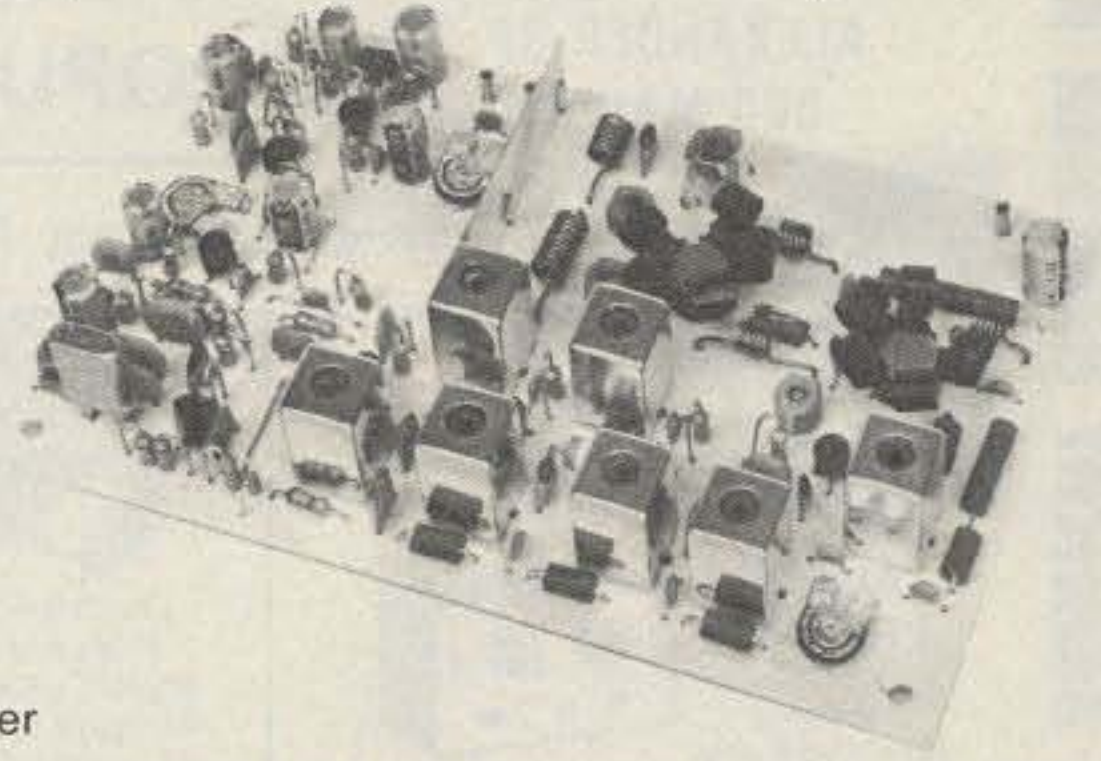
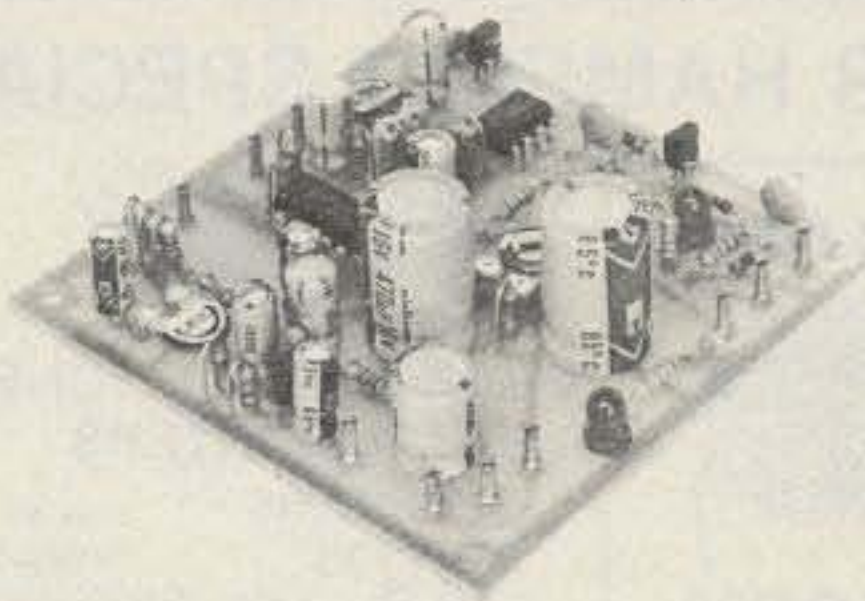
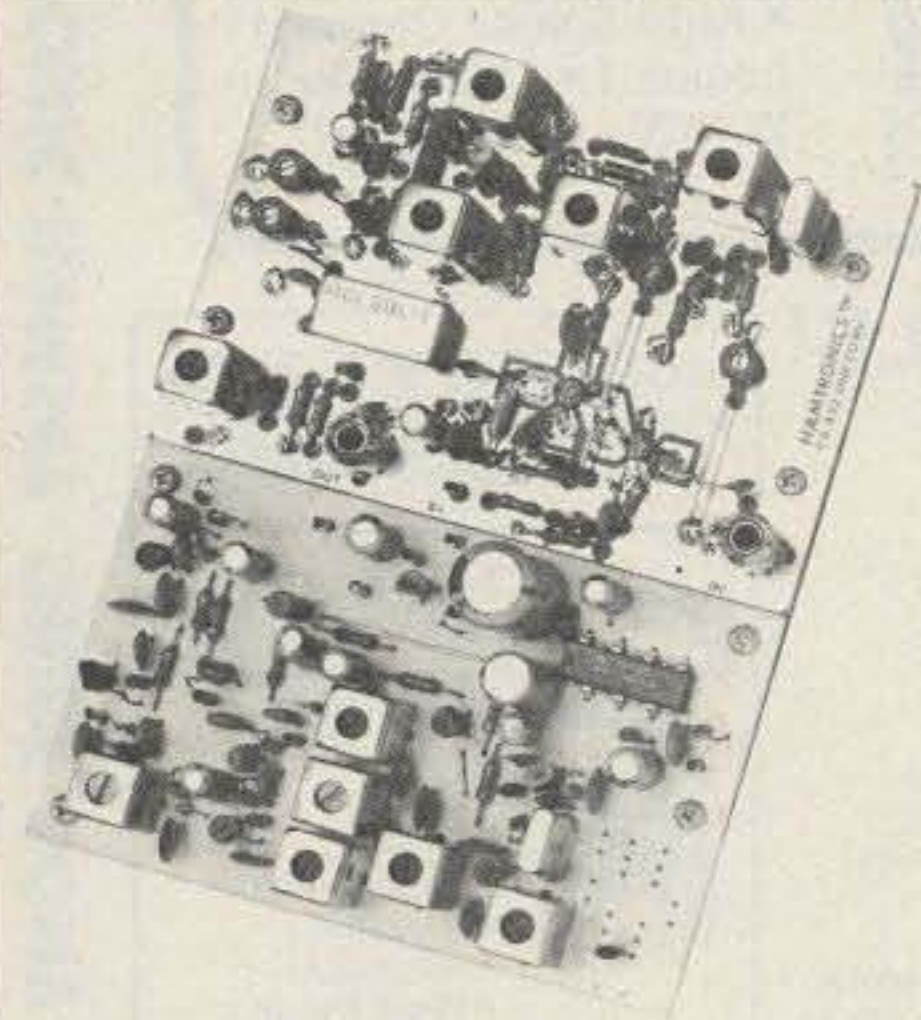

- **R76 VHF FM RECEIVER** for 10M, 6M, 2M, 220, or commercial bands. Fantastic selectivity options. Kits from \$84.95 to \$109.95
- **R450 UHF FM RECEIVER** for 380-520 MHz bands. Kits in selectivity options from \$94.95
- **R110 VHF AM RECEIVER** Kit for vhf aircraft band or ham bands. Only \$84.95.

- **COR KITS** With audio mixer and speaker amplifier. Only \$29.95.
- **CWID KITS** 158 bits, field programmable, clean audio. Only \$59.95.
- **A16 RF TIGHT BOX** Deep drawn alum. case with tight cover and no seams. 7 x 8 x 2 inches. Only \$18.00.
- **SCANNER CONVERTERS** Copy 72-76, 135-144, 240-270, 400-420, or 806-894 MHz bands on any scanner. Wired/tested Only \$79.95.

- **T51 VHF FM EXCITER** for 10M, 6M, 2M, 220 MHz or adjacent bands. 2 Watts continuous. Kits only \$54.95.
- **T451 UHF FM EXCITER** 2 to 3 Watts on 450 ham band or adjacent. Kits only \$64.95.
- **VHF & UHF LINEAR AMPLIFIERS.** Use on either FM or SSB. Power levels from 10 to 45 Watts to go with exciters & xmtg converters. Kits from \$69.95.

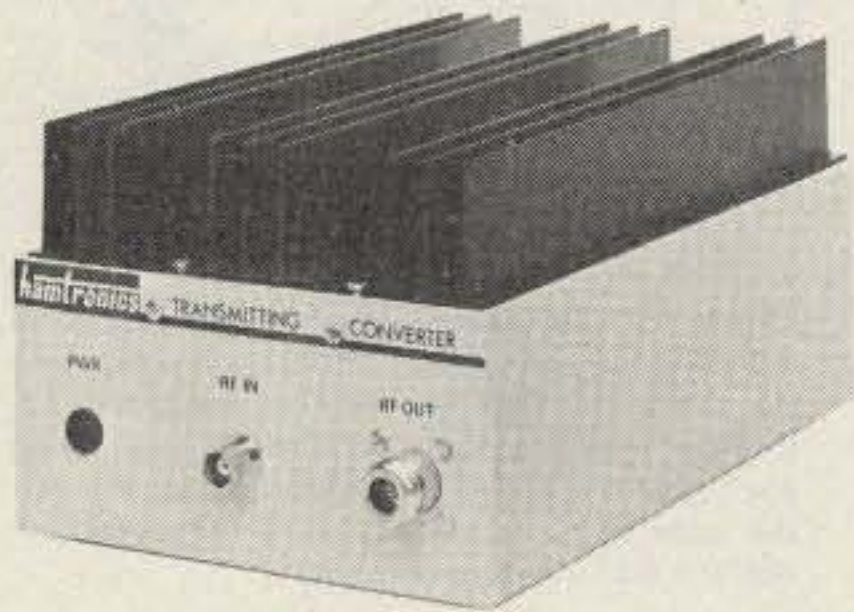

### VHF & UHF TRANSMITTING CONVERTERS

For SSB, CW, ATV, FM, etc. Available for 6M, 2M, 220, 440 with many IF input ranges. Converter board kit only at \$79.95 (VHF) or \$99.95 (UHF) or kits complete with PA and cabinet as shown.



### VHF & UHF RECEIVING CONVERTERS

20 Models cover every practical rf and if range to listen to SSB, FM, ATV, etc. on 6M, 2M, 220, 440, and 110 aircraft band. Even convert weather down to 2M! Kits from \$39.95 and wired units.



### VHF & UHF RECEIVER

**PREAMPS.** Low noise.

VHF Kits from 27 to 300 MHz. UHF Kits from 300 to 650 MHz. Broadband Kits: 20-650 MHz. Prices start at \$14.95 (VHF) and \$18.95 (UHF). All preamps and converters have noise figure 2dB or less.

- **Call or Write for FREE CATALOG** (Send \$1.00 or 4 IRC's for overseas MAILING)
- **Order by phone or mail** • Add \$2 S & H per order (Electronic answering service evenings & weekends)
- Use VISA, MASTERCARD, Check, or UPS COD.

**hamtronics, inc.**

65-R MOUL RD. • HILTON NY 14468

Phone: 716-392-9430

Hamtronics® is a registered trademark



**HOLIDAY GIFT VALUES FROM SPECTRONICS!**



**6-BAND POCKET WORLD RECEIVER**

- 6-band pocket world receiver—SW 1-5, plus MW
- Extremely compact and lightweight—palm sized!
- SW band spread dial—easy tuning • Tuning indicator

**\$89<sup>95</sup>**  
plus \$3.00 shipping (Cont'l U.S.)



**FREE WRNO T-SHIRT** with purchase of ICF-4800 Above. From WRNO — World's first commercial (3 Million Watts!) SW Radio station. Offer good thru December 31st, 1982. SPECIFY SIZE (S,M,L, and XL)

**"easy-talk'r" VOX PORTABLE TRANSCEIVER**



- Up to 1/2 mile FM Transmitting
- "Hands free" VOX operation
- Light weight—less than 9 Oz.

Valuable aid for Amateur use in antenna installation, tuning/pruning, field day, etc., plus hundreds of applications in home business, sports and recreation. Uses 9 volt battery (not supplied.)

**\$49<sup>95</sup>** ea.  
plus \$3.00 shipping

**BEARCAT BC-100 HAND-HELD PROGRAMMABLE SCANNER**

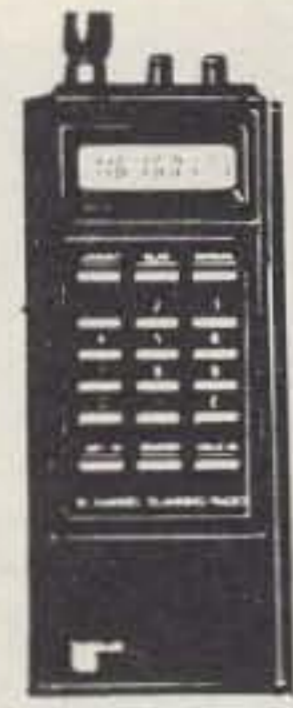

Reg. **\$349<sup>95</sup>**

**SALE \$299<sup>95</sup>**  
plus \$3.00 shipping

- 8 Band, 16 Channel
- Auto Scan • Channel Lockout • "Now Take it With You Anywhere!"

**ALEXANDER BP 4-W 500 MAH NICAD**



**\$24<sup>95</sup>** plus \$2.00 shipping  
Fits Wilson Mark II, and Mark IV plus Yaesu FT-207. 500 MAH, 11.7 V. Nickel-Cadmium.



**AMECO PREAMPS** add \$3.00 shipping (Cont'l USA only)

Model PLF-2.....	\$52.95
Model PLF-2E (240V).....	\$57.95
Model PT-2.....	\$79.95
Model PT-2E (240V).....	\$84.95

**POPULAR HAMFEST SPECIALS!**

**VoCom POWER POCKET**



plus \$8.00 shipping (Cont'l USA)  
**\$199<sup>95</sup>**  
Accepts any version of the IC-2A, applies its output to a wide-band rf amplifier, and delivers 25 watts to your mobile antenna. Mobile talk-out power!



**SUB-AUDIBLE TONE HEADQUARTERS**

**ENCODERS** plus \$2.00 shipping  
**\$29<sup>95</sup>** EACH (Cont'l USA only)

We stock **Communications Specialists** SS-32 and SS-32M encoders for most any mobile or hand-held applications including the very popular Icom Handhelds.



**NEW! IC3AT (220 MHz) IC4AT (440 MHz)**



- ICOM IC2A, IC2AT**
- Compact
  - Quality Construction
  - Versatile
  - Affordable
  - Wide Range of Accessories Available

CALL FOR PRICE & AVAILABILITY

**FIXED, PORTABLE And MOBILE ANTENNA VALUE FAVORITES!**

**MORGAIN MULTI-BAND ANTENNAS**



80-40HD/A 80/40 Mtr bands (69).....	99.00
75-40HD/A 75/40 Mtr bands (66).....	94.50
75-10HD/A 75/40/20/15/10 Mtr (66).....	126.95
80-10HD/A 80/40/20/15/10 Mtr (69).....	132.00

Add \$5.00 for shipping (Cont'l U.S.A.)

**B&W PORTABLE APARTMENT ANTENNA**



**\$39<sup>50</sup>**  
plus \$2.00 shipping

Quick, easy mounting. Tunes 2, 6, 10, 15, 20 and 40 meter Amateur bands, plus SW BC bands in some ranges. 360 watts SSB/CW. 22 1/2" whip extends to 57". 14" mount. Includes 5 base-loading coils. Weighs less than 2 lbs.

**AVANTI THRU-GLASS ANTENNA**



**\$32<sup>95</sup>** plus \$3.00 shipping

The Avanti On-Glass is the first two-way communications antenna that mounts on glass and transmits and receives through the glass. Extremely low VSWR is achieved by adjusting special tuning slug on matching network inside the vehicle. Can be easily removed for car washes without special tools.



**FAMOUS "EAVESDROPPER" SW RECEIVING ANTENNA**  
**\$59<sup>95</sup>** plus \$3.00 shipping (Cont'l U.S.)

**TO ORDER:**

CALL OR WRITE. MASTER CARD, VISA, MONEY ORDERS, PERSONAL CHECKS TAKE 3 WEEKS TO CLEAR, ACCEPTED. INTERNATIONAL ORDERS WELCOME, PLEASE REQUEST PRO FORMA INVOICE. ILLINOIS RESIDENTS ADD 6% SALES TAX.

**HOURS:**

MON. THRU WED. 9:30-6:00, THURS-FRI. 9:30-8:00, SAT. 9:30-3:00

**STOP BY AND VISIT WHEN IN THE CHICAGOLAND AREA!!**



**SPECTRONICS, INC.**  
1009 GARFIELD ST. OAK PARK, IL. 60304

PHONE  
**(312) 848-6777**







We now have available a bunch of goodies too good to bypass. Items are limited so order today

**Call Your Phone Order in Today**  
TERMS: Satisfaction guaranteed or money refunded. C.O.D. add \$2.00. Minimum order \$6.00. Orders under \$10.00 add \$1.50. Add 5% for postage, insurance, handling. Overseas add 15%. N.Y. residents add 7% tax.

**MINI KITS - YOU HAVE SEEN THESE BEFORE NOW  
HERE ARE OLD FAVORITE AND NEW ONES TOO.  
GREAT FOR THAT AFTERNOON HOBBY.**

<p><b>FM MINI MIKE</b></p>  <p>A super high performance FM wireless mike kit! Transmits a stable signal up to 300 yards with exceptional audio quality by means of its built in electret mike. Kit includes case, mike, on-off switch, antenna, battery and super instructions. This is the finest unit available.</p> <p>FM-3 Kit <b>\$14.95</b> FM-3 Wired and Tested <b>19.95</b></p>	<p><b>Color Organ</b></p> <p>See music come alive! 3 different lights flicker with music. One light each for, high, mid-range and lows. Each individually adjustable and drives up to 300 W. runs on 110 VAC.</p> <p>Complete kit, ML-1 <b>\$8.95</b></p>	<p><b>Video Modulator Kit</b></p> <p>Converts any TV to video monitor. Super stable, tunable over ch. 4-6. Runs on 5-15V, accepts std. video signal. Best unit on the market! Complete kit, VD-1 <b>\$7.95</b></p>	<p><b>Led Blinky Kit</b></p> <p>A great attention getter which alternately flashes 2 jumbo LEDs. Use for name badges, buttons, warning panel lights, anything! Runs on 3 to 15 volts. Complete kit, BL-1 <b>\$2.95</b></p> <p><b>Super Sleuth</b></p> <p>A super sensitive amplifier which will pick up a pin drop at 15 feet! Great for monitoring baby's room or as general purpose amplifier. Full 2 W rms output, runs on 6 to 15 volts, uses 8-45 ohm speaker. Complete kit, BN-9 <b>\$5.95</b></p>
<p><b>FM Wireless Mike Kit</b></p>  <p>Transmits up to 300' to any FM broadcast radio, uses any type of mike. Runs on 3 to 9V. Type FM-2 has added sensitive mike preamp stage.</p> <p>FM-1 kit <b>\$3.95</b> FM-2 kit <b>\$4.95</b></p>	<p><b>Whisper Light Kit</b></p> <p>An interesting kit, small mike picks up sounds and converts them to light. The louder the sound, the brighter the light. Includes mike, controls up to 300 W, runs on 110 VAC. Complete kit, WL-1 <b>\$6.95</b></p>	<p><b>Tone Decoder</b></p>  <p>A complete tone decoder on a single PC board. Features: 400-5000 Hz adjustable range via 20 turn pot, voltage regulation, 567 IC. Useful for touch-tone burst detection, FSK, etc. Can also be used as a stable tone encoder. Runs on 5 to 12 volts. Complete kit, TD-1 <b>\$5.95</b></p>	<p><b>Car Clock</b></p> <p>The UN-KIT, only 5 solder connections</p> <p>Here's a super looking, rugged and accurate auto clock, which is a snap to build and install. Clock movement is completely assembled - you only solder 3 wires and 2 switches, takes about 15 minutes! Display is bright green with automatic brightness control photocell - assures you of a highly readable display, day or night. Comes in a satin finish anodized aluminum case which can be attached 5 different ways using 2 sided tape. Choice of silver, black or gold case (specify)</p> <p>DC-3 kit 12 hour format <b>\$22.95</b> DC-3 wired and tested <b>\$29.95</b></p>
<p><b>Universal Timer Kit</b></p> <p>Provides the basic parts and PC board required to provide a source of precision timing and pulse generation. Uses 555 timer IC and includes a range of parts for most timing needs.</p> <p>UT-5 Kit <b>\$5.95</b></p>	<p><b>Mad Blaster Kit</b></p> <p>Produces LOUD ear shattering and attention getting siren like sound. Can supply up to 15 watts of obnoxious audio. Runs on 6-15 VDC</p> <p>MB-1 Kit <b>\$4.95</b></p>	<p><b>Siren Kit</b></p> <p>Produces upward and downward wail characteristic of a police siren. 5 W peak audio output, runs on 3-15 volts, uses 3-45 ohm speaker. Complete kit, SM-3 <b>\$2.95</b></p> <p><b>60 Hz Time Base</b></p> <p>Runs on 5-15 VDC. Low current (2.5mA) 1 min/month accuracy TB-7 Kit <b>\$5.50</b> TB-7 Assy <b>\$9.95</b></p>	<p><b>Calendar Alarm Clock</b></p> <p>The clock that's got it all: 6-5" LEDs, 12/24 hour, snooze, 24 hour alarm, 4 year calendar, battery backup, and lots more. The super 7001 chip is used. Size: 5x4x2 inches. Complete kit, less case (not available) DC-9 <b>\$34.95</b></p> <p><b>Under Dash Car Clock</b></p> <p>12/24 hour clock in a beautiful plastic case features 6 jumbo RED LEDs, high accuracy (001%), easy 3 wire hookup, display blanks with ignition and super instructions. Optional dimmer automatically adjusts display to ambient light level. DC-11 clock with mtg. bracket <b>\$27.95 kit</b> DM-1 dimmer adapter <b>\$2.50</b> Add \$10.00 Assy. and Test</p>

## PARTS PARADE

<p><b>IC SPECIALS</b></p> <p><b>LINEAR</b></p>  <p>301 <b>\$ .35</b> 324 <b>\$1.50</b> 380 <b>\$1.50</b> 555 <b>\$ .45</b> 556 <b>\$1.00</b> 565 <b>\$1.00</b> 566 <b>\$1.00</b> 567 <b>\$1.25</b> 741 <b>10/\$2.00</b> 1458 <b>\$ .50</b> 3900 <b>\$ .50</b> 3914 <b>\$2.95</b> 8038 <b>\$2.95</b></p> <p><b>CMOS</b></p>  <p>4011 <b>\$.50</b> 4013 <b>\$.50</b> 4046 <b>\$1.85</b> 4049 <b>\$.50</b> 4059 <b>\$9.00</b> 4511 <b>\$2.00</b> 4518 <b>\$1.35</b> 5639 <b>\$1.75</b></p>	<p><b>TTL</b></p> <p>74S00 <b>\$ .40</b> 7447 <b>\$ .65</b> 7475 <b>\$ .50</b> 7490 <b>\$ .50</b> 74196 <b>\$1.35</b></p> <p><b>SPECIAL</b></p> <p>11C90 <b>\$15.00</b> 10116 <b>\$ 1.25</b> 7208 <b>\$17.50</b> 7207A <b>\$ 5.50</b> 7216D <b>\$21.00</b> 7107C <b>\$12.50</b> 5314 <b>\$ 2.95</b> 5375AB/G <b>\$ 2.95</b> 7001 <b>\$ 6.50</b></p>	<p><b>Resistor Ass't</b></p> <p>Assortment of Popular values - 1/4 watt. Cut lead for PC mounting, 1/2" center, 1/8" leads, bag of 300 or more. <b>\$1.50</b></p> <p><b>Switches</b></p> <p>Mini toggle SPDT <b>\$1.00</b> Red Pushbuttons N.O. <b>3/\$1.00</b></p> <p><b>Earphones</b></p> <p>3" leads, 8 ohm, good for small tone speakers, alarm clocks, etc. <b>5 for \$1.00</b></p> <p><b>Mini 8 ohm Speaker</b></p> <p>Approx. 2 1/2" diam Round type for radios, mike etc. <b>3 for \$2.00</b></p> <p><b>Solid State Buzzers</b></p> <p>small buzzer 450 Hz, 86 dB sound output on 5-12 vdc at 10-30 mA, TTL compatible. <b>\$1.50</b></p>	<p><b>Crystals</b></p> <p>3.579545 MHZ <b>\$1.50</b> 10.00000 MHZ <b>\$5.00</b> 5.248800 MHZ <b>\$5.00</b></p> <p><b>AC Adapters</b></p> <p>Good for clocks, nicad chargers, all 110 VAC plug one end</p> <p>8.5 vdc @ 20 mA <b>\$1.00</b> 16. vac @ 160mA <b>\$2.50</b> 12. vac @ 250mA <b>\$3.00</b></p> <p><b>AC Outlet</b></p> <p>Panel Mount with Leads <b>4/\$1.00</b></p>	<p><b>600 MHz PRESCALER</b></p>  <p>Extend the range of your counter to 600 MHz. Works with all counters. Less than 150 mv sensitivity, specify -10 or -100</p> <p>Wired, tested, PS-1B <b>\$59.95</b> Kit, PS-1B <b>\$44.95</b></p>																		
<p><b>READOUTS</b></p> <p>FND 359 4" C.C. <b>\$1.00</b> FND 507/510 5" C.A. <b>1.00</b> MAN 72/HP7730 33" C.A. <b>1.00</b> HP 7851 43" C.A. <b>2.00</b></p>	<p><b>DC-DC Converter</b></p> <p>+5 vdc input prod. -9 vdc @ 30ma +9 vdc produces -15 vdc @ 35ma <b>\$1.25</b></p> <p>25K 20 Turn Trim Pot <b>\$1.00</b> 1K 20 Turn Trim Pot <b>\$ .50</b></p>	<p><b>Slugs Tuned Coils</b></p> <p>Small 3/16" Hex Slugs turned coil, 3 turns. <b>10 for \$1.00</b></p> <p><b>CAPACITORS</b></p> <table border="1"> <tr> <th>TANTALUM</th> <th>ALUMINUM</th> <th>DISK CERAMIC</th> </tr> <tr> <td>Dipped Epoxy</td> <td>Electrolytic</td> <td>01 16V disk <b>20/\$1.00</b></td> </tr> <tr> <td>1.5 uF 25V <b>3/\$1.00</b></td> <td>1000 uF 16V Radial <b>\$ .50</b></td> <td>1 16V <b>15/\$1.00</b></td> </tr> <tr> <td>1.8 uF 25V <b>3/\$1.00</b></td> <td>500 uF 20V Axial <b>\$ .50</b></td> <td>001 16V <b>20/\$1.00</b></td> </tr> <tr> <td>.22 uF 25V <b>3/\$1.00</b></td> <td>150 uF 16V Axial <b>5/\$1.00</b></td> <td>100 pF <b>20/\$1.00</b></td> </tr> <tr> <td></td> <td>10 uF 15V Radial <b>10/\$1.00</b></td> <td>047 16V <b>20/\$1.00</b></td> </tr> </table>	TANTALUM	ALUMINUM	DISK CERAMIC	Dipped Epoxy	Electrolytic	01 16V disk <b>20/\$1.00</b>	1.5 uF 25V <b>3/\$1.00</b>	1000 uF 16V Radial <b>\$ .50</b>	1 16V <b>15/\$1.00</b>	1.8 uF 25V <b>3/\$1.00</b>	500 uF 20V Axial <b>\$ .50</b>	001 16V <b>20/\$1.00</b>	.22 uF 25V <b>3/\$1.00</b>	150 uF 16V Axial <b>5/\$1.00</b>	100 pF <b>20/\$1.00</b>		10 uF 15V Radial <b>10/\$1.00</b>	047 16V <b>20/\$1.00</b>	<p><b>30 Watt 2 mtr PWR AMP</b></p> <p>Simple Class C power amp features 8 times power gain, 1 W in for 8 out, 2 W in for 15 out, 4W in for 30 out. Max output of 35 W, incredible value, complete with all parts, less case and T-R relay.</p> <p>PA-1, 30 W pwr amp kit <b>\$22.95</b> TR-1, RF sensed T-R relay kit <b>6.95</b></p> <p>MRF-238 transistor as used in PA-1 8-10db gain 150 mhz <b>\$11.95</b></p> <p><b>RF actuated relay senses RF (1W) and closes DPDT relay. For RF sensed T-R relay TR-1 Kit <b>\$6.95</b></b></p>	<p><b>Power Supply Kit</b></p> <p>Complete triple regulated power supply provides variable 6 to 18 volts at 200 ma and +5 at 1 Amp. Excellent load regulation, good filtering and small size. Less transformers, requires 6.3 V 1A and 24 VCT. Complete kit, PS-3LT <b>\$6.95</b></p>
TANTALUM	ALUMINUM	DISK CERAMIC																				
Dipped Epoxy	Electrolytic	01 16V disk <b>20/\$1.00</b>																				
1.5 uF 25V <b>3/\$1.00</b>	1000 uF 16V Radial <b>\$ .50</b>	1 16V <b>15/\$1.00</b>																				
1.8 uF 25V <b>3/\$1.00</b>	500 uF 20V Axial <b>\$ .50</b>	001 16V <b>20/\$1.00</b>																				
.22 uF 25V <b>3/\$1.00</b>	150 uF 16V Axial <b>5/\$1.00</b>	100 pF <b>20/\$1.00</b>																				
	10 uF 15V Radial <b>10/\$1.00</b>	047 16V <b>20/\$1.00</b>																				
<p><b>TRANSISTORS</b></p> <p>2N3904 NPN C-F <b>15/\$1.00</b> 2N3906 PNP C-F <b>15/\$1.00</b> 2N4403 PNP C-F <b>15/\$1.00</b> 2N4410 NPN C-F <b>15/\$1.00</b> 2N4916 FET C-F <b>4/\$1.00</b> 2N5401 PNP C-F <b>5/\$1.00</b> 2N5402 C-F <b>4/\$1.00</b> 2N3771 NPN Silicon <b>\$1.50</b> 2N5179 UHF NPN <b>3/\$2.00</b> Power Tab NPN 40W <b>3/\$1.00</b> Power Tab PNP 40W <b>3/\$1.00</b> MPF 102/2N5484 <b>\$.50</b> NPN 3904 Type T-R <b>50/\$2.50</b> PNP 3906 Type T-R <b>50/\$2.50</b> 2N3055 <b>\$.80</b> 2N2646 UJT <b>3/\$2.00</b></p>	<p><b>Crystal Microphone</b></p> <p>Small 1" diameter 1/4" thick crystal mike cartridge <b>\$.75</b></p> <p><b>Coax Connector</b></p> <p>Chassis mount <b>\$1.00</b> BNC type <b>\$1.00</b></p> <p><b>9 Volt Battery Clips</b></p> <p>Nice quality clips <b>5 for \$1.00</b> 1/4" Rubber Grommets <b>10 for \$1.00</b></p> <p><b>Parts Bag</b></p> <p>Ass't of chokes, disc caps, tant resistors, transistors, diodes, MICA caps etc sm. bag (100 pc) <b>\$1.00</b> lg. bag (300 pc) <b>\$2.50</b></p> <p><b>Connectors</b></p> <p>6 pin type gold contacts for mA-1003 car clock module. <b>.75 ea.</b></p> <p><b>Leds - your choice, please specify</b></p> <p>Mini Red, Jumbo Red, High Intensity Red, Illuminator Red <b>8/\$1</b> Mini Yellow, Jumbo Yellow, Jumbo Green <b>6/\$1</b></p> <p><b>Varactors</b></p> <p>Motorola MV 2209 30 PF Nominal cap 20-80 PF - Tunable range - <b>.50 each or 3/\$1.00</b></p>	<p><b>Crystal Microphone</b></p> <p>Small 1" diameter 1/4" thick crystal mike cartridge <b>\$.75</b></p> <p><b>Mini RG-174 Coax</b></p> <p>10 ft. for <b>\$1.00</b></p>	<p><b>OP-AMP Special</b></p> <p>BI-FET LF 13741 - Direct pin for pin 741 compatible, but 500,000 MEG input z, super low 50 pa input current, low power drain.</p> <p>50 for only <b>\$9.00</b> 10 for <b>\$2.00</b></p> <p>78MG <b>\$1.25</b> 7812 <b>\$1.00</b> 79MG <b>\$1.25</b> 7815 <b>\$1.00</b> 723 <b>\$.50</b> 7905 <b>\$1.25</b> 309K <b>\$1.15</b> 7912 <b>\$1.25</b> 7805 <b>\$1.00</b> 7915 <b>\$1.25</b></p> <p><b>Shrink Tubing Nubs</b></p> <p>Nice precut pcs of shrink size: 1" x 1/4" shrink to 1/8" Great for splices. <b>50/\$1.00</b></p> <p><b>Mini TO-92 Heat Sinks</b></p> <p>Thermalloy Brand <b>5 for \$1.00</b> To-220 Heat Sinks <b>3 for \$1.00</b></p> <p><b>Opto Isolators - 4N28 type</b> <b>\$.50 ea.</b> <b>Opto Reflectors - Photo diode + LED</b> <b>\$1.00 ea.</b></p>	<p><b>Molex Pins</b></p> <p>Molex already precut in length of 7 Perfect for 14 pin sockets <b>20 strips for \$1.00</b></p> <p><b>CDS Photocells</b></p> <p>Resistance varies with light, 250 ohms to over 3 meg <b>3 for \$1.00</b></p>																		



# DEALER DIRECTORY

## Culver City CA

Jun's Electronics, 3919 Sepulveda Blvd., Culver City CA 90230, 390-8003. Trades 463-1886 San Diego. 827-5732 (Reno NV).

## Fontana CA

Complete lines ICOM, DenTron, Ten-Tec, Mirage, Cubic, Lamar, over 4000 electronic products for hobbyist, technician, experimenter. Also CB radio, landmobile. Fontana Electronics, 8628 Sierra Ave., Fontana CA 92335. 822-7710.

## San Diego CA

We buy and sell Surplus Army Navy Electronics, also Terminated Material. What do you want to sell? Write for catalogue. Electronictown, Inc., 440-7th Avenue, PO Box 2048, San Diego CA 92112, 232-9379.

## New Castle DE

Factory Authorized Dealer! Yaesu, ICOM, Ten-Tec, KDK, Azden, AEA, Kantronics, Santee. Full Line of Accessories. No Sales Tax in Delaware. One mile off I-95. Delaware Amateur Supply, 71 Meadow Road, New Castle DE 19720, 328-7728.

## San Jose CA

Bay area's newest Amateur Radio store. New & used Amateur Radio sales & service. We feature Kenwood, ICOM, Azden, Yaesu, Ten-Tec, Santee & many more. Shaver Radio, Inc., 1378 So. Bascom Ave., San Jose CA 95128. 998-1103.

## Smyrna GA

For your Kenwood, Yaesu, ICOM, Drake and other amateur needs, come to see us. Britt's Two-Way Radio, 2506 N. Atlanta Rd., Smyrna GA 30080, 432-8006.

## Preston ID

Ross WB7BYZ has the Largest Stock of Amateur Gear in the Intermountain West and the Best Prices. Call me for all your ham needs. Ross Distributing, 78 So. State, Preston ID 83263, 852-0830.

## Terre Haute IN

Your ham headquarters located in the heart of the midwest. Hoosier Electronics, Inc., #9 Meadows Center, P.O. Box 3300, Terre Haute IN 478003, 238-1456.

## Baltimore MD

Always buying lab grade test equipment HP, Tek, Gr. L&N, Etc. Also buy microwave coaxial & waveguide HP, Ixr, waveline, etc. Prefer "K", "P", "R" but will consider larger wgt too. Cadisco 514 Ensor St., Balto, MD 21202, 685-1893.

## Littleton MA

The Reliable Ham Store Serving N.E. Full line of ICOM & Kenwood, Yaesu HTs, Drake, Daiwa, B&W accessories. Curtis & Trac keys. Larsen, Hustler, Telex/Hy-Gain products. Mirage amps., Astron P.S., Alpha Delta protectors, ARRL & Kantronics instruction aids. Whistler radar detectors. Full line of coax fittings. TEL-COM Electronic Communications 675 Great Rd. (Rt. 119), Littleton MA 01460, 486-3400/3040.

## Ann Arbor MI

See us for products like Ten-Tec, R. L. Drake, DenTron and many more. Open Monday through Saturday, 0830 to 1730. WBSVGR, WBSUXO, WDSOKN and WSRP behind the counter. Purchase Radio Supply, 327 E. Hoover Ave., Ann Arbor MI 48104, 668-8696.

## Hudson NH

New England's Distributor and Authorized Service Center for all Major Amateur Lines. Tufts Radio Electronics, Inc., 61 Lowell Road, Hudson NH 03051, 883-5005.

## Somerset NJ

New Jersey's only factory-authorized ICOM and Yaesu distributor. Large inventory of new and used specials. Most major brands in stock. Complete service and facilities. Radios Unlimited, 1760 Easton Avenue, P.O. Box 347, Somerset NJ 08873, 469-4599.

## Buffalo NY WESTERN NEW YORK

Niagara Frontier's only full stocking Amateur dealer. Also Shortwave, CB, Scanners, Marine, Commercial. Operating displays featuring Kenwood and others. Towers, Antennas, Sales and Service. DX Communications, 3214 Transit Road, West Seneca NY, 668-8873.

## Amsterdam NY UPSTATE NEW YORK

Kenwood, ICOM, Drake, plus many other lines, Amateur Dealer for over 35 years. Adirondack Radio Supply, Inc., 185 West Main Street, Amsterdam NY 12010, 842-8350.

## Syracuse-Rome-Utica NY

Featuring: Kenwood, Yaesu, ICOM, Drake, Ten-Tec, Swan, DenTron, Alpha, Robot, MFJ, Tempo, Astron, KLM, Hy-Gain, Mosley, Larsen, Cushcraft, Hustler, Mini Products. You won't be disappointed with equipment/service. Radio World, Oneida County Airport-Terminal Building, Oriskany NY 13424, 736-0184.

## Columbus OH

The biggest and best Ham Store in the midwest featuring quality Kenwood products with working displays. We sell only the best. Authorized Kenwood Service. Universal Amateur Radio Inc., 1280 Aida Dr., Reynoldsburg (Columbus) OH 43068, 866-4267.

## Bend OR

Satellite TV. Known brands. Call today for more information and inquire about our dealer program. WESPERCOM, P.O. Box 7226, Bend OR 97708, 389-0996.

## Philadelphia PA/ Camden NJ

Waveguide & Coaxial Microwave Components & Equipment. Laboratory Grade Test Instruments, Power Supplies, Buy, Sell & Trade all popular makes—HP, GR, FXR, ESL, Sorensen, Singer, etc. Lectronic Research Labs, 1423 Ferry Ave., Camden NJ 08104, 541-4200.

## Scranton PA

ICOM, Bird, Cushcraft, Beckman, Fluke, Larsen, Hustler, Antenna Specialists, Astron, Avanti, Belden, W2AU/W2VS, CDE, AEA, Vibroplex, Ham-Key, CES, Amphenol, Sony, Fanon/Courier, B&W, Ameco, Shure. LaRue Electronics, 1112 Grandview St., Scranton PA 18509, 343-2124.

## San Antonio TX

Amateur, Commercial 2-way. Selling Antenna Specialists, Avanti, Azden, Bird, Hy-Gain, Standard, Vibroplex, Midland, Henry, Cushcraft, Dielectric, Hustler, ICOM, MFJ, Nye, Shure, Cubic, Tempo, Ten-Tec and others. Appliance & Equipment Co., Inc. 2317 Vance Jackson Road, San Antonio TX 78213, 734-7793.

## DEALERS

Your company name and message can contain up to 25 words for as little as \$150 yearly (prepaid), or \$15 per month (prepaid quarterly). No mention of mail-order business or area code permitted. Directory text and payment must reach us 60 days in advance of publication. For example, advertising for the Jan. '83 issue must be in our hands by Nov. 1st. Mail to 73 Magazine, Peterborough NH 03458. ATTN: Nancy Ciampa.

# PROPAGATION

J. H. Nelson  
4 Plymouth Dr.  
Whiting NJ 08759

## EASTERN UNITED STATES TO:

	GMT:	00	02	04	06	08	10	12	14	16	18	20	22
ALASKA	14	7A	7	7	7	7	3A	7	7A	14A	21A	21	
ARGENTINA	14	14	7	7	7	7A	14A	21A	21A	21A	21A	21	
AUSTRALIA	21	14	7B	7B	7B	7B	7B	14B	14	14	21A	21A	
CANAL ZONE	14A	14	7	7	7	7	14A	21A	21A	21A	21A	21	
ENGLAND	7	7	7	3A	7	7	14	21A	21A	14	14	7	
HAWAII	21	14	7B	7	7	7	7	7B	14	21A	21A	21A	
INDIA	7B	7B	7B	7B	7B	7B	14	21	14	7B	7B	7B	
JAPAN	14	7B	7B	7B	7B	7	3A	14B	14B	14	14	21	
MEXICO	21	14	7	7	7	7	7A	21	21A	21A	21	21	
PHILIPPINES	14	14	7B	7B	7B	7B	3A	14B	14	14	14	14A	
PUERTO RICO	14	7	7	7	7	7	14	21	21A	21A	21	14A	
SOUTH AFRICA	14	7	7	7B	7B	14	21A	21A	21A	21A	21A	14A	
U. S. S. R.	7	7	7	7	7	7B	14	21A	21	7B	7B	7	
WEST COAST	21A	14	7	7	7	7	7	14	21A	21A	21A	21A	

## CENTRAL UNITED STATES TO:

ALASKA	14	14	7	7	7	7	3A	7	7A	14A	21A	21
ARGENTINA	14	14	7	7	7	7	14	21A	21A	21A	21A	21
AUSTRALIA	21A	14	7B	7B	7B	7B	7B	7B	14	14	21A	21A
CANAL ZONE	21	14	7	7	7	7	14	21A	21A	21A	21A	21A
ENGLAND	7	7	7	3A	7	7	7A	21	21A	14	14	7
HAWAII	21A	14A	14B	7	7	7	7	7	14	21A	21A	21A
INDIA	7B	14B	7B	7B	7B	7B	7B	14	14	7B	7B	7B
JAPAN	21	14	7B	7B	7B	7	3A	3A	14B	14	14	21A
MEXICO	14	14	7	7	7	7	7	14	21A	21A	21	21
PHILIPPINES	21A	14	7B	7B	7B	7B	3A	7	14	14	14	21A
PUERTO RICO	14A	7	7	7	7	7	14	21	21A	21A	21A	21
SOUTH AFRICA	14	7	7	7B	7B	14	21A	21A	21A	21A	21A	14A
U. S. S. R.	7	7	7	7	7	7B	7B	21	14	7B	7B	7

## WESTERN UNITED STATES TO:

ALASKA	21	14	7	7	7	7	3A	3A	7	14	21	21A
ARGENTINA	21	14	7A	7	7	7	7B	21	21A	21A	21A	21
AUSTRALIA	21A	21A	14	14B	7B	7B	7B	7B	14	14	21A	21A
CANAL ZONE	21	14	7	7	7	7	7	21	21A	21A	21A	21A
ENGLAND	7B	7	7	3A	7	7	3A	14	21	14	14	7B
HAWAII	21A	21	14	14	7	7	7	7	14	21A	21A	21A
INDIA	7B	21	14B	7B	7B	7B	7B	7B	14	7B	7B	7B
JAPAN	21A	21	14B	7B	7	7	3A	3A	14B	14	14	21A
MEXICO	21	14	7	7	7	7	7	14	21A	21A	21	21
PHILIPPINES	21A	21	14B	7B	7B	7B	7	7	14	14	14	21A
PUERTO RICO	21	7	7	7	7	7	7	14A	21A	21A	21A	21A
SOUTH AFRICA	14	7	7	7B	7B	7B	7B	14	21A	21A	21A	14A
U. S. S. R.	7B	7	7	7	7	7B	7B	14	14	7B	7B	7B
EAST COAST	21A	14	7	7	7	7	7	14	21A	21A	21A	21A

A = Next higher frequency may also be useful.

B = Difficult circuit this period.

First letter = night waves. Second = day waves.

G = Good, F = Fair, P = Poor. \* = Chance of solar flares.

# = Chance of aurora.

NOTE THAT NIGHT WAVE LETTER NOW COMES FIRST.

NOVEMBER						
SUN	MON	TUE	WED	THU	FRI	SAT
	1	2	3	4	5	6
	F/F	FIG	FIG	P/F	FIG	G/G
7	8	9	10	11	12	13
G/G	G/G*	P/F*	FIG	G/G	G/G	F/F
14	15	16	17	18	19	20
F/F	G/G	G/G	FIG	F/F	P/F	FIG
21	22	23	24	25	26	27
G/G	G/G	G/G	G/G	G/G*	FIG*	P/F*
28	29	30				
P/F	P/F	FIG				



# New Yaesu FT-102 Series Transceiver of Champions!



The long-awaited new generation of Yaesu HF technology has arrived! New research in improved receiver filtering and spectral purity is brought to bear in the competition-bred FT-102, the HF transceiver designed for active Amateurs on today's intensely active bands!

#### Unique Cascaded Filter System

The FT-102 utilizes an advanced 8.2 MHz and 455 kHz IF system, capable of accepting as many as three filters in cascade. Optional filters of 2.9 kHz, 1.8 kHz, 600 Hz, and 300 Hz may be combined with the two stock 2.9 kHz filters for operating flexibility you've never seen in an HF transceiver before now!

#### New Receiver Front End

Utilizing husky junction field-effect transistors in a 24 volt, high-current design, the FT-102 front end features a low-distortion RF preamplifier that may be bypassed via a front panel switch when not needed.

#### Notch and Audio Peak Filter

A highly effective 455 kHz IF Notch Filter provides superb rejection of heterodynes, carriers, and other annoying interference appearing within the IF passband. On CW, the Audio Peak Filter may be switched in during extremely tight copy conditions for post-detection signal enhancement.

#### Variable IF Bandwidth with IF Shift

The FT-102's double conversion receiver features Yaesu's time-proven Variable Bandwidth System, which utilizes the cascaded IF filters to provide intermediate bandwidths such as 2.1 kHz, 1.5 kHz, or 800 Hz simply by twisting a dial. The Variable Bandwidth System is used in conjunction with the IF Shift control, which allows the operator to center the IF passband frequency response without changing the incoming signal pitch.

#### Wide/Narrow Filter Selection

Depending on the exact combination of optional filters you choose, a variety of wide/narrow operating modes may be selected. For example, you may set up 2.1 kHz in SSB/WIDE, 1.8 kHz in SSB/NARROW, then select 1.8 kHz for CW/WIDE, and 600 Hz or 300 Hz for CW/NARROW. Or use the Variable Bandwidth System to set your SSB bandwidth, and use 600 Hz for CW/WIDE and 300 Hz for CW/NARROW! No other manufacturer gives you so much flexibility in selecting filter responses!

#### Variable Pulse Width Noise Blanker

To combat ignition noise, the "Woodpecker," and power line noise are modern-day enemies of effective Amateur operation. The FT-102 Noise Blanker offers improved blanking action on today's man-made noise sources (though no blanker can eliminate all forms of band noise) for more solid copy under adverse conditions.

#### Low Distortion Audio/IF Stage Design

Low distortion, wide dynamic range, stability, and AGC problems have been largely eliminated thanks to improved technology. Yaesu's engineers have put particular attention on maximizing intelligence recovery in the receiver. While elementary frequency cascading schemes often degrade performance, the FT-102's unique blend of crystal and ceramic IF filters plus audio tone control provides very low phase distortion, reduced passband ripple, and hence increased recovery of information.

#### Heavy Duty Three-Tube Final Amplifier

The FT-102 final amplifier uses three 6146B tubes for more consistent power output and improved reliability. Using up to 10 dB of RF negative feedback, the FT-102 transmitter third-order distortion products are typically 40 dB down, giving you a studio quality output signal.

#### Dual Metering System

Adopted from the new FT-ONE transceiver, the Dual Metering System provides simultaneous display of ALC voltage on one meter along with metering of plate voltage, cathode current, relative power output, or clipping level on the other. This system greatly simplifies proper adjustment of the transmitter.

#### Microphone Amplifier Tone Control

Recognizing the differences in voice characteristics of Amateur operators, Yaesu's engineers have incorporated an ingenious microphone amplifier tone control circuit, which allows you to tailor the treble and bass response of the FT-102 transmitter for best fidelity on your speech pattern.

#### RF Speech Processor

The built-in RF Speech Processor uses true RF clipping, for improved talk power under difficult conditions. The clipping type speech processor provides cleaner, more effective "punch" for your signal than simpler circuits used in other transmitters.

#### VOX with Front Panel Controls

The FT-102 standard package includes VOX for hands-free operation. Both the VOX Gain and VOX Delay controls are located on the front panel, for maximum operator convenience.

#### IF Monitor Circuit

For easy adjustment of the RF Speech Processor or for recording both sides of a conversation, an IF monitor circuit is provided in the transmitter section. When the optional AM/FM unit is installed, the IF monitor may be used for proper setting of the FM deviation and AM mic gain.

#### WARC Bands Factory Installed

The FT-102 is factory equipped for operation on all present and proposed Amateur bands, so you won't have to worry about retrofitting capability on your transceiver. An extra AUX band position is available on the bandswitch for special applications.

#### Full Line Of Accessories

For maximum operating flexibility, see your Authorized Dealer for details of the complete line of FT-102 accessories. Coming soon are the FV-102DM Synthesized VFO, SP-102 Speaker/Audio Filter, a full line of optional filters and microphones, and the AM/FM Unit.

Price And Specifications Subject To  
Change Without Notice Or Obligation

# YAESU

## The radio.



83

YAESU ELECTRONICS CORP., 6851 Walthall Way, Paramount, CA 90723 • (213) 633-4007  
YAESU Eastern Service Ctr., 9812 Princeton-Glendale Rd., Cincinnati, OH 45246 • (513) 874-3100



# Top-Notch.



## VBT, notch, IF shift, wide dynamic range

### TS-830S

Now most Amateurs can afford a high-performance SSB/CW transceiver with every conceivable operating feature built in for 160 through 10 meters (including the three new bands). The TS-830S combines a high dynamic range with variable bandwidth tuning (VBT), IF shift, and an IF notch filter, as well as very sharp filters in the 455-kHz second IF. Its optional VFO-230 remote digital VFO provides five memories.

#### TS-830S FEATURES:

##### • 160-10 meters, including three new bands

Covers all Amateur bands from 1.8 to 29.7 MHz (LSB, USB, and CW), including the new 10, 18, and 24-MHz bands. Receives WWV on 10 MHz.

##### • Wide receiver dynamic range

Junction FETs (with optimum IMD characteristics and low noise figure) in the balanced mixer, a MOSFET RF amplifier operating at low level for improved dynamic range (high amplification level not needed because of low noise in mixer), dual resonator for each band, and advanced overall receiver design result in excellent dynamic range.

#### Matching accessories for fixed-station operation:

- SP-230 external speaker with selectable audio filters
- VFO-230 external digital VFO with 20-Hz steps, five memories, digital display
- AT-230 antenna tuner/SWR and power meter
- MC-50 desk microphone
- HC-10 digital world clock
- YG-455C (500-Hz) and YG-455CN (250-Hz) CW filters for 455-kHz IF
- YK-88C (500-Hz) and YK-88CN (270-Hz) CW filters for 8.83-MHz IF
- HS-5 and HS-4 headphones
- MC-30S and MC-35S noise-cancelling hand microphones

#### Other accessories not shown:

- TL-922A linear amplifier
- SM-220 Station Monitor
- PC-1 phone patch

##### • Variable bandwidth tuning (VBT)

Continuously varies the IF filter passband width to reduce interference. VBT and IF shift can be controlled independently for optimum interference rejection in any condition.

##### • IF notch filter

Tunable high-Q active circuit in 455-kHz second IF, for sharp, deep notch characteristics.

##### • IF shift

Shifts IF passband toward higher or lower frequencies (away from interfering signals) while tuned receiver frequency remains unchanged.

##### • 6146B final with RF NFB

Two 6146B's in the final amplifier provide 220 W PEP (SSB)/180 W DC (CW) input on all bands. RF negative feedback provides optimum IMD characteristics for high-quality transmission.

##### • Built-in digital display

Six-digit large fluorescent tube display, backed up by an analog dial. Reads actual receive and transmit frequency on all modes and all bands. Display Hold (DH) switch.

##### • Adjustable noise-blanker level

Built-in noise blanker eliminates pulse-type (such as ignition) noise. Front-panel threshold level control.

##### • Various IF filter options

Either a 500-Hz (YK-88C) or 270-Hz (YK-88CN) CW filter may be installed in the 8.83-MHz first IF, and a very sharp 500-Hz (YG-455C) or 250-Hz (YG-455CN) CW filter is available for the 455-kHz second IF.

##### • More flexibility with optional digital VFO

VFO-230 operates in 20-Hz steps and includes five memories. Also allows split-frequency operation. Built-in digital display. Covers about 100 kHz above and below each 500-kHz band.

##### • Built-in RF speech processor

For added audio punch and increased talk power in DX pileups.

##### • RIT/XIT

Receiver incremental tuning (RIT) shifts only the receiver frequency, to tune in stations slightly off frequency. Transmitter incremental tuning (XIT) shifts only the transmitter frequency.

##### • SSB monitor circuit

Monitors IF stage while transmitting, to determine audio quality and effect of speech processor.

More information on the TS-830S is available from all authorized dealers of Trio-Kenwood Communications, 1111 West Walnut Street, Compton, California 90220.

 **KENWOOD**  
...pacesetter in amateur radio



Specifications and prices are subject to change without notice or obligation.