

Amateur Radio's Technical Journal

A Wayne Green Publication

73

**10 New
Construction
Articles!**

**PC Boards
for Pennies**
Page 30

**Attack at
Amboy Cay**
Page 20

**World's
Simplest
COR**
Page 24

**Save Your
Slow Scans**
Page 38

VIC 20 Code
Page 14

CQ de Sealand
Page 84

Construct This

Customized Power Supply

Whether you want 5 Amps or 30, this supply can give it to you. But you only pay for what you need. W9ODK 8

VisiCode: The VIC 20 Way to Extra Class

First you get random practice groups. Then you get the answers. W7LTH, KA7AQA 14

Running Scared at Spratly

Only steel nerves and luck stood between the 1979 DXpedition and disaster. KB7NW 20

The COR of a Reliable Repeater

Carrier-operated relays are the most-used circuits in any repeater. Use this simple design to get maintenance-free operation. WA7SPR 24

Precision Speed Control for the Billboard Keyer

Get more for your money by adding this circuit to last month's project. KD7S 26

PC Boards for Penny-Pinchers

Get picture-perfect circuit boards without buying a darkroom. W2HCQ 30

Faultless SSTV Picture Preservation

The dynamic duo of computer and printer helps save those perfect moments. Just add this program. KF9X 38

Save Your Signal with Forward Error-Correction

In a hostile signal environment, you need all the help you can get. W9JD/2 44

A Colorado-Style Battery Monitor

Texas has its barbecue and Chicago its pizza. Colorado's claim to fame is this near-perfect device. Wilson 48

The Totally-Modified 2000

Take Azden's popular 2-meter rig and add all the extras you ever wanted. W1GV/4 50

Send Your TR-7800 to Obedience School

This Kenwood rig has some interesting habits—such as a slow scan rate. Can you retrain it in one easy session? KE6VK 54

Do You Know Where Your Signal Goes?

It doesn't just sneak off your antenna and hide. Find out where your lobes are and what they look like with this simple procedure. N4UH 56

Cheap Scanning for the IC-701

Here's a device that's stingy in cost but generous in benefits. AG9D 64

To Go Where No Ham Has Gone Before—Sealand!

An enterprising team of DXers takes to the high seas to work S1, the smallest country in the world. DF2AO 84

1001 Uses for the 9400

Experiment with this cheap chip. It's the IC you've always wanted, with applications you've never dreamed of. W3KBM 88

Propagation Explosion on 220

This theoretical inquiry into the properties of 220 MHz yielded some unexpected results. Find out when and why your signal will be at its best. W9MKE 90

18 kV with No Transformer

You need high voltage, but surplus transformers can't turn the trick. Try this solid-state solution. WA4WDL 94



VIC 20 Code—14

Never Say Die—6	Fun!—107
73 International—68	Reader Service—114
Social Events—96	New Products—116
Ham	Review—118
Help—98, 99, 123	Letters—122
Corrections—99, 124	Awards—124
Circuits—100	Satellites—128
DX—104	Dealer Directory—146
Contests—106	Propagation—146



ICOM IC-751

The New Standard of Comparison

NEW
Competition
Grade
Transceiver!



ICOM is proud to announce the most advanced amateur transceiver in communications history. Based on ICOM's proven high technology and wide dynamic range HF receiver designs, the IC-751 is a competition grade ham receiver, a 100KHz to 30 MHz continuous tuning general coverage receiver, and a full featured all mode solid state ham band transmitter, that covers all the new WARC bands. And with the optional internal AC power supply, it becomes one compact, portable/field day package.

Receiver. Utilizing an ICOM developed J-FET DBM, the IC-751 has a 105dB dynamic range. The 70.4515MHz first IF virtually eliminates spurious responses, and a high gain 9.0115MHz second IF, with ICOM's PBT

selectivity. A deep IF notch filter, adjustable AGC and noise blanker (can be adjusted to eliminate the woodpecker), audio tone control, plus RIT with separate readout provides easy-to-adjust, clear reception even in the presence of strong QRM or high noise levels. A low noise receiver preamp provides exceptional reception sensitivity as required.

Transmitter. The transmitter features high reliability 2SC2097 transistors in a low IMD (-32dB @ 100W), full 100% duty cycle (internal cooling fan standard), 12 volt DC design. Quiet relay selection of transmitter LPF's, transmit audio tone control, monitor circuit (to monitor your own CW or SSB signal), XIT, and a high performance speech processor enhance the IC-751 transmitter's operation. For the CW operator, semi break-in or full QSK is provided for smooth, fast break-in keying.

Dual VFO. Dual VFO's controlled by a large tuning knob provide easy access to split frequencies used in DX operation. Normal tuning rate is in 10Hz increments and increasing the speed of rotation of the main tuning knob shifts the tuning to 100Hz increments automatically. Pushing the tuning speed button gives 1KHz tuning. Digital outputs are available for computer control of the transceiver frequency and functions, and for a synthesized voice frequency readout.

32 Memories. Thirty two tunable memories are provided to store mode, VFO, and frequency, and the CPU is backed by an internal lithium memory backup battery to maintain the memories for up to seven years. Scanning of frequencies, memories and bands are possible from the unit, or from the HM 12 scanning microphone. In the Mode-S mode, only those memories with

a particular mode are scanned; others are bypassed. Data may be transferred between VFO's, from VFO to memories, or from memories to VFO.

Standard Features. All of the above features plus FM unit, high shape factor FL44A, 455 KHz SSB filter, full function metering, SSB and FM squelch, convenient large controls, FM option, a large selection of plug-in filters, and a new high visibility multi-color fluorescent display that shows frequency in white, and other functions in white or red, make the IC-751 your best choice for a superior grade HF base transceiver.

Options. External frequency controller, external PS-15 power supply, internal power supply, high stability reference crystal (less than 100Hz, -10°C to +60°C), HM12 hand mic, desk mic, filter options: SSB: FL30
CWN: FL52A, FL53A
AM: FL33

 **ICOM**
The World System

ICOM America, Inc., 2112-116th Ave NE, Bellevue, WA 98004 (206)454-8155 / 3331 Towerwood Drive, Suite 307, Dallas, TX 75234 (214)620-2780
All stated specifications are approximate and subject to change without notice or obligation. All ICOM radios significantly exceed FCC regulations limiting spurious emissions

751683

5-STORE BUYING POWER *in action!*

Unlike some retailers, when Ham Radio Outlet guarantees satisfaction there'll be no question. **YOU CAN COUNT ON IT!**

KENWOOD SPECIALS!!



TS-930S w/Antenna Tuner Plus 3 Free Bonus Items

- 1)-SP-930 SPKR.
- 2)-MC-60A MIC.
- 3)-YK-88C-1 FILTER.

Reg. \$2029 Value

\$1799

A \$230.00 SAVING

Free Shipment UPS (Brown).



TR-2500/
TR-3500
SAVE!

SUBSTANTIAL SAVINGS

TS-430S

Check our low prices and don't forget Free Shipment UPS (Brown).



ALL ETO ALPHA SPECIAL SALE PRICES



Example: 76PA
\$1699.95

NEW! MIL-SPEC 1030



General coverage: 10kHz-30MHz.
Power output: 150W PEP.
Built-in. AC/DC, speaker, RF clipping, Pre-IF adjustable noise blanker. Synthesized passband tuning. IF notch filter. Seven digit readout. Much more.

Ask for details.



IC-740 w/FREE EX-238 Power Supply Plus

\$50
FACTORY REBATE
LIMITED TIME ONLY

CHECK LOW, LOW PRICE



KT-34A
SALE \$299
KT-34XA
SALE \$459

PRICES ARE FOB CALIF. EXCEPT FOR CERTAIN COMBINATIONS. PLEASE INQUIRE



W-51
SALE \$799
W-36
CALL FOR PRICE
LM-470D
CALL FOR PRICE



B-3016 REG. \$239.95 SALE \$199.95
B-108 REG. \$179.95 SALE \$159.95
B-1016 REG. \$279.95 SALE \$249.95
B-23S REG. \$89.95 SALE \$79.95

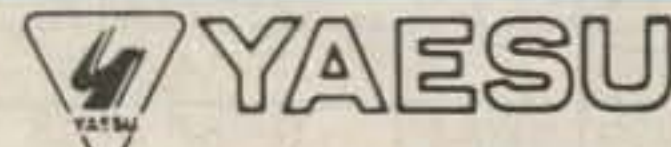

FT-208R



FT-708R



NEW!
FT-980

SERVING HAMS BETTER.
North... south... east... west.

Bob Ferrero, W6RJ
Jim Rafferty, N6RJ
other well known hams give you courteous, personalized service.



FREE SHIPMENT (U.P.S. Brown) CONTINENTAL U.S.A.

ON MOST ITEMS THAT CAN BE SHIPPED UPS BROWN. THERE ARE SOME EXCEPTIONS IN ALPHA, TRI-EX AND KLM

FREE PHONE **800 854-6046**

9:30AM to 5:30PM PACIFIC TIME.

OVER-THE-COUNTER, 10AM to 5:30PM.

MONDAY THROUGH SATURDAY

CALIFORNIA CUSTOMERS PLEASE PHONE OR VISIT LISTED STORES.

ANAHEIM, CA 92801
2620 W. La Palma,
(714) 761-3033 (213) 860-2040
Between Disneyland & Knott's Berry Farm

BURLINGAME, CA 94010
999 Howard Ave., (415) 342-5757
5 miles south on 101 from S.F. Airport.

OAKLAND, CA 94609
2811 Telegraph Ave., (415) 451-5757
Hwy 24 Downtown. Left 27th off-ramp.

SAN DIEGO, CA 92123
5375 Kearny Villa Road (619) 560-4900
Hwy 163 & Clairemont Mesa Blvd.

VAN NUYS, CA 91401
6265 Sepulveda Blvd., (213) 988-2212
San Diego Fwy at Victory Blvd.

AEA • ALLIANCE • ALPHA • AMECO • AMPHENOL • ARRL • ASTRON
AVANTI • BELDON • BENCHER • BERK-TEC • BIRD • B & W
BUTTERNUT • CALLBOOK • CDE • COLLINS • CURTIS • CUSHCRAFT

DAIWA • DRAKE • DX EDGE • DX ENGINEERING • EIMAC
HUSTLER • HY-GAIN • ICOM • J. W. MILLER • KENWOOD • KLM
LARSEN • LUNAR • METZ • MFJ • MICRO-LOG • MINI-PRODUCTS

MIRAGE • NYE • PALOMAR • ROBOT • ROHN • SHURE
SIGNAL ONE • TEMPO • TEN-TEC • TRISTAO • VOOCOM • YAESU
and many more!

Prices, specifications, descriptions subject to change without notice. Calif. residents please add sales tax

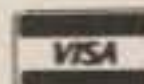

Toroid Cores



- All the popular sizes and mixes.
- Fast Service. Same day shipment via first class mail or air.

IRON POWDER TOROIDS:

CORE SIZE	MIX 2 5-30 MHz u = 10	MIX 6 10-90 MHz u = 8.5	MIX 12 60-200 MHz u = 4	SIZE OD [in.]	PRICE USA \$
T-200	120			2.00	4.25
T-106	135			1.06	1.75
T-80	55	45		.80	1.05
T-68	57	47	21	.68	.95
T-50	51	40	18	.50	.70
T-37	42	30	15	.37	.60
T-25	34	27	12	.25	.45

RF FERRITE TOROIDS:

CORE SIZE	MIX Q1 u = 125 .1-70 MHz	MIX Q2 u = 40 10-150 MHz	MIX H u = 850 to 10 MHz	SIZE OD [in.]	PRICE USA \$
F-240	1300			2.40	9.00
F-114	1500			1.14	2.50
F-87	900	300		.87	1.25
F-50	750	250	5000	.50	.80
F-37	550	200	4000	.37	.60
F-23	250	100	1500	.23	.50

Chart shows uH per 100 turns

Ferrite Beads slip over 18 ga. wire

FB-1 for 50-200 MHz . . . \$2/dozen

FB-2 for 50 MHz & below . . . \$2/dozen

Jumbo Beads slip over #12 wire

FB-3 for 50 MHz & below . . . \$3/dozen

EXPERIMENTER'S KITS

Iron Powder Toroids \$10.00

Includes:

1 ea. T25-12, T37-2, T80-2, T106-2.

2 ea. T25-6, T37-6, T50-2, T50-6.

3 ea. T68-2.

RF Ferrite Toroids \$10.00

Includes:

1 ea. F50-Q2, F114-Q1.

2 ea. F23-Q1, F23-Q2, F37-Q1.

F37-Q2, F50-Q1, F87-Q1.

TO ORDER: Specify both core size and mix for toroids. Packing and shipping \$1.50 per order USA and Canada. Californians add 6% sales tax.



Minimum Credit Card Order: \$5.00

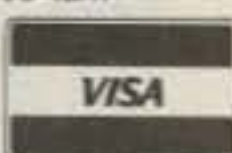

Fast service. Free brochure and winding chart on request.

Palomar Engineers

Box 455, Escondido, CA 92025
Phone: (619) 747-3343

MAXIMIZER

NEW

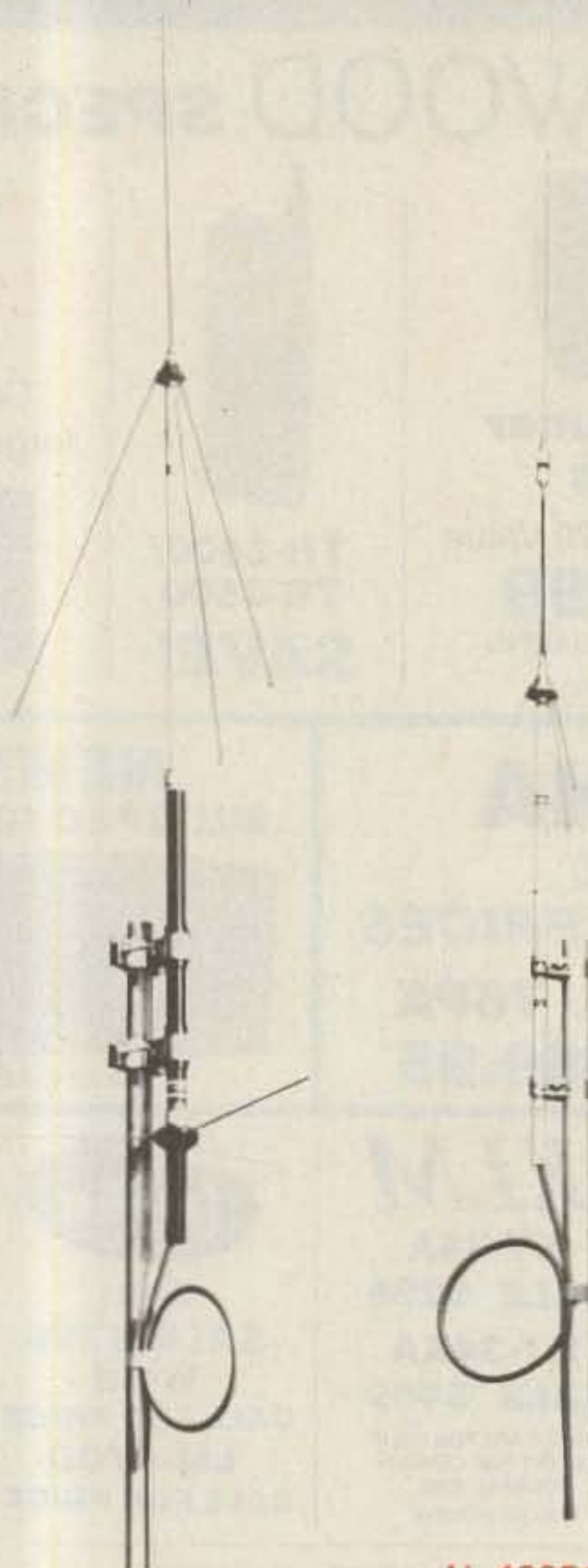

AL-144GF

AL-432F II

AL-460F II

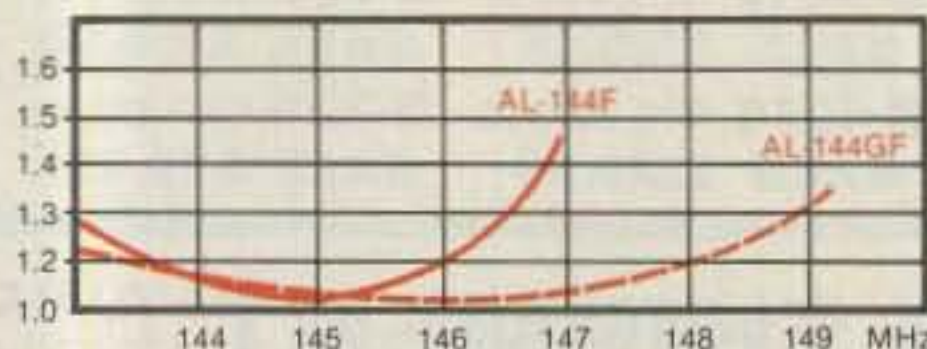

AL-144GF - 1/2λ + 1/4λ collinear for 2 meters. Supplied with ground plane radial kit to deliver superior performance and full band coverage.

AL-432FL - 5/8λ + 5/8λ collinear base station antenna for 430-440 MHz. Built-in ground plane. Excellent gain. Ideal for reaching fringe areas.

KLM

Electronics Inc.

See your KLM Dealer or write for our complete catalog. P.O. Box 816, Morgan Hill, California 94035

INFO

Manuscripts

Contributions in the form of manuscripts with drawings and/or photographs are welcome and will be considered for possible publication. We can assume no responsibility for loss or damage to any material. Please enclose a stamped, self-addressed envelope with each submission. Payment for the use of any unsolicited material will be made upon acceptance. All contributions should be directed to the 73 editorial offices. "How to Write for 73" guidelines are available upon request.

Editorial Offices:

Pine Street
Peterborough NH 03458
Phone: 603-924-9471

Advertising Offices:

Elm Street
Peterborough NH 03458
Phone: 603-924-7138

Circulation Offices:

Elm Street
Peterborough NH 03458
Phone: 603-924-9471

Subscription Rates

In the United States and Possessions:

One Year (12 issues) \$25.00

Two Years (24 issues) \$38.00

Three Years (36 issues) \$53.00

Elsewhere:

Canada and Mexico—\$27.97/1 year only, U.S. funds. Foreign surface mail—\$44.97/1 year only, U.S. funds drawn on U.S. bank. Foreign air mail—please inquire.

To subscribe, renew or change an address:

Write to 73, Subscription Department, PO Box 931, Farmingdale NY 11737. For renewals and changes of address, include the address label from your most recent issue of 73. For gift subscriptions, include your name and address as well as those of gift recipients.

Subscription problem or question:

Write to 73, Subscription Department, PO Box 931, Farmingdale NY 11737. Please include an address label.

73: *Amateur Radio's Technical Journal* (ISSN 0745-080X) is published monthly by Wayne Green, Inc., 80 Pine Street, Peterborough NH 03458. Second class postage paid at Peterborough NH 03458 and at additional mailing offices. Entire contents copyright © 1983, Wayne Green, Inc. All rights reserved. No part of this publication may be reprinted or otherwise reproduced without written permission from the publisher. Microfilm Edition—University Microfilm, Ann Arbor MI 48106. Postmaster: Send address changes to 73, Subscription Services, PO Box 931, Farmingdale NY 11737.

WE WANT YOU!

TO CALL **TOLL FREE**



1-800-325-3636

FOR A TRADE-IN QUOTE

**We Trade
on New or Used Equipment**

(Check for prices on available used equipment)

HAM RADIO CENTER

8340-42 Olive Blvd. • P.O. Box 28271 • St. Louis, MO 63132



In Missouri Call 1-314-993-6060



W2NSD/1 NEVER SAY DIE

editorial by Wayne Green



STILL ANOTHER FCC REVOLUTION

The FCC is still pursuing deregulation with a passion and, for the most part, I'm in tune with this. I think amateur radio would be much more able to provide the services it is supposed to if we had far fewer limitations. Well, they just may be in the works, according to some information sent in by watchful K1NEB.

Docket 83-114, "A Re-Examination of Technical Regulation," has the intention of eliminating burdensome technical regulations for all Services, and that obviously includes Amateur. If you think about this for a bit, you'll see that this could be the weight lifted off our shoulders that we have been needing for years.

Within the purview of this docket, we could find the limitations on RTTY speeds, frequency shift, and so on eliminated. We've never needed these. We've been perfectly able to test out our own technical parameters and set our own standards without the help of the FCC, with their usual limitations which have been brought forward from years ago.

If we can get rid of these bothersome remnants of the past, we can experiment with more efficient data communications and error-correcting codes without always having to fight for Special Temporary Authority releases. The pressures of the marketplace will encourage the development of standards, but the freedom from oppressive regulations will allow us to try different ideas and keep finding better ways of communicating.

We're going into a digital world—digital messages, digi-

tal pictures, digital voice, digital music. If we don't keep up with all of this, we are going to find ourselves redundant. Will we still find pileups of analog voice DXers trying to get through to DXpeditions in twenty years? Or will we be sending bursts of digitalized voice at high speeds which will be received by a holographic-coherence detector and queued up for response?

The Honor Roll contingent may want to fight it to the death, but all those jokes about automatic DXCC rigs are getting believable. As soon as someone comes up with a good automatic-identifying system for rigs, we are well along that road. Once it's possible to have your rig work and confirm 300 countries in a day all by itself, we may be waking to a time when amateurs

in rare countries will actually be able to have interesting contacts instead of being hounded off the air every time they show up.

The dropping of technical restrictions could help the development of facsimile and slow-scan television, allow more realistic power limitations for some repeaters, allow FM stations to add more services (such as teletext, communications, and calling), and might let amateurs experiment with wider band systems which transmit shorter times to make up for the use of frequencies. After all, our limitation is a combination of frequencies and time and it is getting time to think about this.

You know, just as the video

Continued on page 102



W3PIG

4942 LINDA DR
PITTSBURGH, PA.
15236

RADIO _____ QSO OF _____

ON _____ MC _____ AT _____ GMT

UR SIGS RST _____ PSE QSL TNX

73 DE CHUCK ENGLERT

QSL OF THE MONTH

To most hams, a callsign is as important as a name. Countless hours have been spent devising memorable phonetics for calls or selecting the absolute best phonetics for a specific purpose—those with the most audio punch for ramming through the DX pileups or those with the shortest number of syllables for rapid contest calls. But there are hams among us who have the good fortune of a callsign instantly recognizable. Such is the case with this month's QSL of the Month winner, Chuck Englert W3PIG. Although the suffix to Chuck's call is none too complimentary, he has turned it into an interesting and memorable QSL card. With this familiar face looking out at you from the wall of the shack, you might forget the QSO, but you will never forget the call.

To enter 73's QSL of the Month contest, put your card in an envelope with your choice of a book from 73's Radio Bookshop and send it to 73, 80 Pine Street, Peterborough NH 03458, Attn: QSL of the Month. Entries not mailed in an envelope or which do not specify a book will not be accepted.

STAFF

PUBLISHER/EDITOR
Wayne Green W2NSD/1

EXECUTIVE VICE PRESIDENT
Sherry Smythe-Green

ASSISTANT PUBLISHER/EDITOR
Jeff DeTray WB8BTH

MANAGING EDITOR
John Burnett

ASST. MANAGING EDITOR
Susan Philbrick

EDITORIAL ASSISTANTS
Nancy Noyd
Richard Phenix
Steve Jewett

TECHNICAL EDITOR
Avery L. Jenkins WB8JLG

**ASSISTANT
TO THE PRESIDENT**
Matthew Smith KA1IEI

ASSOCIATES
Robert Baker WB2GFE
John Edwards K1ZU
Bill Gosney KE7C
Sanger Green
Chod Harris VP2ML
Dr. Marc Leavey WA3AJR
J. H. Nelson
Bill Pasternak WA6ITF
Peter Stark K2OAW

PRODUCTION MANAGER
Nancy Salmon

**ASST. PRODUCTION
MANAGER**
Michael Murphy

**ADVERTISING GRAPHICS
MANAGER**
Scott W. Philbrick

DESIGN DIRECTOR
Christine Destremes

PRODUCTION

Linda Drew
Denzel Dyer
Michael Ford
Marjorie Gillies
Phil Geraci
Donna Hartwell
Taylor Morris
Kimberly Nadeau
Paula Ramsey
Anne Rocchio
Kenneth Sutcliffe
Theresa Verville
Robert M. Villeneuve
David Wozmak
Karen Wozmak

PHOTOGRAPHY

Thomas Villeneuve
Sandra Dukette
Laurie Jennison
Sturdy Thomas
Irene Vail

TYPESETTING

Sara Bedell
Darlene Bailey
Laurel Beckmann
Prem Krishna Gongaju
Lynn Haines
Nancy Massal
Debbie Nutting
Lindy Palmisano
Heidi Thomas

GENERAL MANAGER/VICE PRESIDENT
Debra Wetherbee

CONTROLLER/VICE PRESIDENT
Roger J. Murphy

ACCOUNTING MANAGER
Knud Keller KV4GG/1

CIRCULATION MANAGER
Patricia Ferrante
603-924-9471

BULK SALES MANAGER
Ginnie Boudrieau
1-(800)-343-0728

ADVERTISING

603-924-7138
Jim Gray W1XU, Mgr.
Nancy Ciampa, Asst. Mgr.
Ross Kenyon KA1GAV
Cornelia Taylor, Office Coordinator



TS-930S

"DX-traordinary" ... superior dynamic range, auto. antenna tuner, QSK, dual NB, 2 VFO's, general coverage receiver.

A superlative, high-performance, all solid-state HF transceiver, that covers all Amateur HF bands, and incorporates a 150 kHz to 30 MHz general coverage receiver having an excellent dynamic range.

TS-930S FEATURES:

- 160-10 Meters, with 150 kHz-30 MHz general coverage receiver. Covers all Amateur frequencies, plus WARC, on SSB, CW, FSK, and AM. UP conversion digital PLL circuit.
- Excellent receiver dynamic range. Typical two-tone dynamic range, 100 dB (20 meters, 50-kHz spacing, 500 Hz CW bandwidth).
- All solid-state 28 volt operated final amplifier. Lowest IM distortion. Power input 250 W on

SSB/CW/FSK, 80 W on AM. SWR/Power meter.

- Available with AT-930 automatic antenna tuner built-in, or as an option. Covers 80-10 meters, including WARC bands.
- CW full break-in. CMOS logic IC, plus reed relay. Switchable to semi break-in.
- Dual digital VFO's, 10-Hz steps, includes band information.
- Eight memory channels. Stores frequency and band data. Internal battery memory back-up, est. 1 yr. life. (Battery not Kenwood supplied.)
- Dual mode noise blanker. NB-1, with threshold control, for "pulse" noise. NB-2 for "woodpecker."

- SSB IF slope tuning, allows independent adjustment of the low and/or high frequency slopes of the IF passband.
- CW VBT and pitch control. VBT tunes out interfering signals. CW pitch control shifts IF pass-band and beat frequency. "Narrow-Wide" filter switch.
- Tuneable, peak-type audio filter for CW.
- AC power supply built-in.
- Fluorescent tube digital display (100 Hz resolution, modifiable to 10 Hz) with digitalized sub-scale, in 20-kHz steps.
- RF speech processor.
- One year limited warranty.

- SSB monitor circuit.

Optional Accessories:

- AT-930 Auto. antenna tuner.
- SP-930 External speaker with selectable audio filters.
- YG-455C-1 (500 Hz) or YG-455CN-1 (250 Hz) plug-in CW filters for 455 kHz IF.
- YK-88C-1 (500 Hz) CW plug-in filter for 8.83 MHz IF.
- YK-88A-1 (6 kHz) AM plug-in filter for 8.83 MHz IF.
- SO-1 commercial grade TCXO.
- MC-60A deluxe desk microphone, 8-pin, with pre-amplifier, UP/DOWN switches.

NEW



TS-430S

"Digital DX-terity" ... General coverage, Superior dynamic range, 2 VFO's, 8 memories, Scan, Notch, COMPACT!

Combines compact styling with state-of-the-art circuit design and performance.

TS-430S FEATURES:

- 160-10 meters, with 150 kHz-30 MHz general coverage receiver. Covers all Amateur frequencies, plus WARC. UP-conversion digital PLL circuit.
- USB, LSB, CW, AM, and FM (optional) all mode.
- Compact lightweight design. Only 10-5/8 (270) W x 3-3/4 (96) H x 10-7/8 (275) D, inches (mm); only 14.3 lbs. (6.5 kg.).
- Superior receiver dynamic range with Dyna-Mix high sensitivity direct mixing system.

- 10-Hz step dual digital VFO's. Operate independently, include band and mode information. Dial torque adjustable. Step switch for 10-Hz or 100-Hz steps. A-B switch shifts "B" VFO to "A" VFO frequency and mode, or vice versa. VFO LOCK switch. RIT for VFO or memory. UP/DOWN manual scan with optional UP/DOWN microphone.
- Eight memories store frequency, mode, and band data. 8th memory stores RX/TX frequencies independently.
- Lithium battery memory back-up. (Est. 5 yr. life.)
- Memory Scan.
- Programmable automatic band scan width.
- IF shift circuit for minimum QRM.
- Tuneable notch filter, built-in.
- Narrow-wide filter selection on SSB, CW, AM (filter optional).
- Speech processor, built-in.
- All solid state. Input rated 250 W PEP on SSB, 200 W DC on CW, 120 W on FM (optional), 60 W on AM. Operates on 12 VDC or on 120 VAC, or 220/240 VAC with optional PS-430 AC power supply.
- Fluorescent tube digital display indicates frequency to 100 Hz (10 Hz modifiable).
- All-mode squelch circuit, built-in.
- Built-in noise blanker.
- RF attenuator (20 dB).
- VOX circuit, plus semi break-in with side-tone.

Optional accessories.

- PS-430 compact AC power supply.
- PS-30 or KPS-21 AC supplies.
- SP-430 external speaker.
- MB-430 mobile mounting bracket.
- AT-130 compact antenna tuner, 80-10 m, incl. WARC.
- AT-230 base antenna tuner, 160-10 m, incl. WARC.
- FM-430 FM unit.
- YK-88C (500 Hz) or YK-88CN (270 Hz) CW filters.
- YK-88SN (1.8 kHz) narrow SSB filter.
- YK-88A (6 kHz) AM filter.
- MC-42S UP/DOWN hand microphone.
- MC-60A deluxe desk microphone, UP/DOWN switch.

KENWOOD

TRIO-KENWOOD COMMUNICATIONS
1111 West Walnut, Compton, California 90220

Construct This Customized Power Supply

Whether you want 5 Amps or 30, this supply can give it to you. But you only pay for what you need.

With more and more equipment on the market requiring a separate source of 12 V dc, almost every ham shack needs a power supply capable of operating such equipment on 115 V ac. Even if your 12-volt transceiver is normally mobile, you might want to bring

it into the house for testing or as a substitute for the base station. Many HF transceivers operate at a high power level requiring 20 to 30 Amps on transmit while QRP rigs and VHF transceivers require 5 to 10 Amps or less. This article describes a general power supply design

which can be expanded in 5-Amp steps from 5 to 30 Amps. That way you do not need to build a larger unit than your requirements dictate.

This power supply is unique in both its simplicity and its immunity to damage from overloads. The heart of the circuit is an LM340T-15 integrated circuit, a fixed 15-V regulator with short-circuit and high temperature protection. It provides excellent regulation and is virtually immune to overload and short-circuit damage. The output of this regulator IC is fed to a Darlington-connected emitter-follower which increases the rated 1.5-Amp output of the IC to as high as 30 Amps. A single driver transistor, Q1, is used with from one to six output transistors, Q2-Q7, connected in parallel depending on

the output current required. One 2N3055 power transistor is used for each 5 Amps of output. The 0.15-Ohm resistor in the emitter of each transistor performs a dual function. It serves as a current-sense resistor providing a voltage output proportional to the current through its transistor and provides for equal sharing of current among the parallel-connected transistors.

The LM340 is so well-protected from overload that it can operate into a short circuit all day. If the chip temperature becomes too high, the internal thermal protection will simply shut it down until the heat sink cools off. The external current-amplifying transistors need some protection, though, since their power dissipation could far exceed their ratings in the case of a short

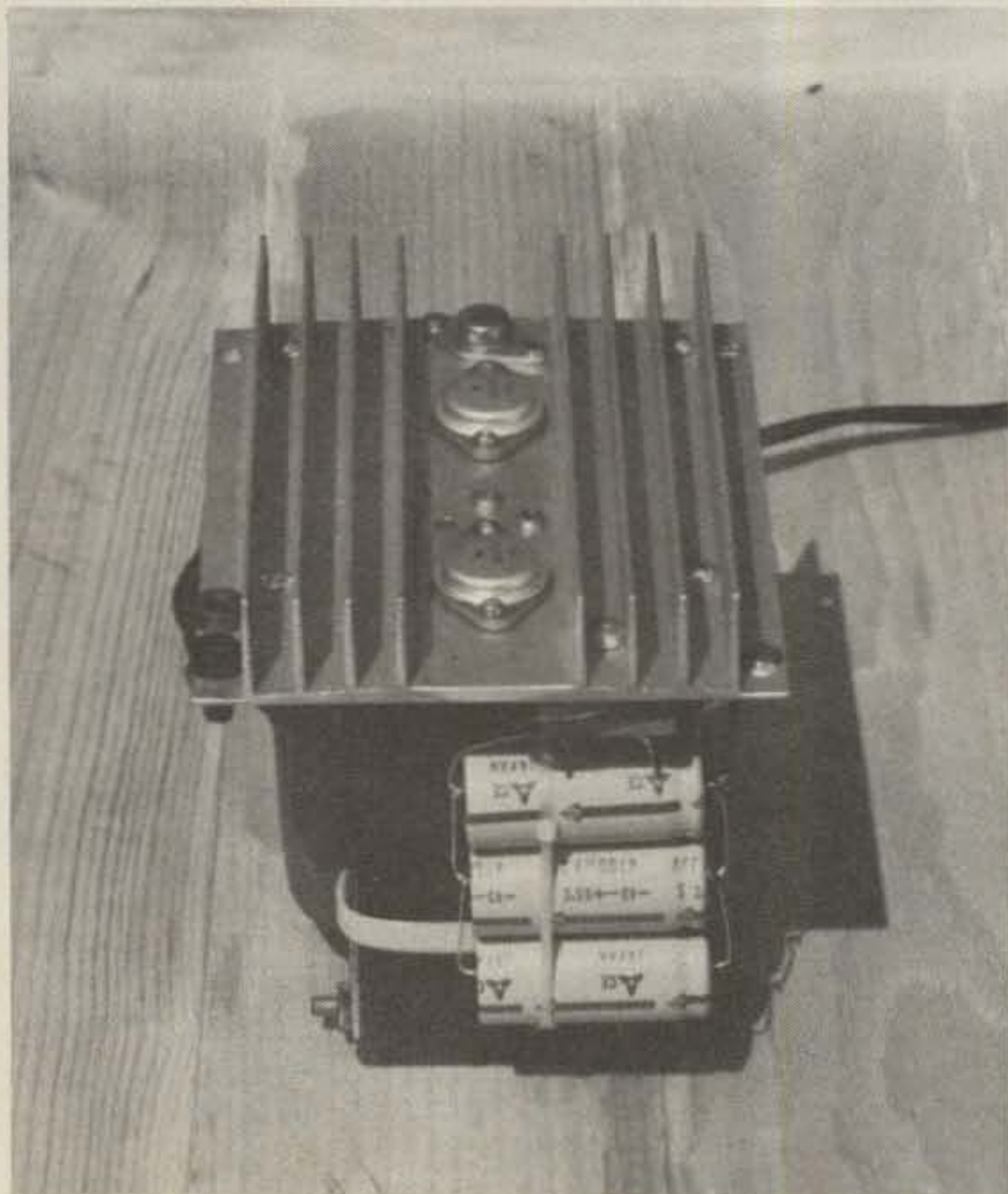

The completed 10-Amp unit.

Supply Capacity	C1	F1	T1
5 Amps	7,500 uF, 25 V	2A SB*	Triad F-242u
10 Amps	15,000 uF, 25 V	4A SB	Triad F-243u
15 Amps	22,000 uF, 25 V	6A SB	Triad F-244u
20 Amps	30,000 uF, 25 V	8A SB	Triad F-244u
25 Amps	40,000 uF, 25 V	10A SB	Triad F-245u
30 Amps	50,000 uF, 25 V	12A SB	Triad F-245u**

*Slow-blow fuse.

**CW & SSB service only.

Table 1.

circuit or sustained overload. To accomplish this protection, the voltage across one of the emitter resistors is fed to the gate of SCR1. A current of 5 Amps develops 0.75 V across the 0.15-Ohm resistor, which is sufficient to trigger the SCR. As soon as SCR1 has fired, the pass stage of the regulator is shut down completely and the output of the LM340 is connected directly to the load. The IC regulator then supplies its short-circuit current (about 1.5 Amps) to the load through the SCR. This current holds the SCR on until the power supply is shut off and allowed to reset itself automatically. The function is essentially that of an electronic circuit breaker.

Another advantage of using the LM340 is thermal protection. If the IC is mounted on the heat sink near the output transistors, the internal temperature-sensing circuitry will detect the sink temperature and shut the whole supply down if it becomes excessive.

The output of the supply is equal to the output of the IC regulator (15 V) minus the base-emitter drops of the driver and pass transistors and the voltage across the emitter resistor. Since this voltage varies with current, the output voltage will change from 14 V at no load

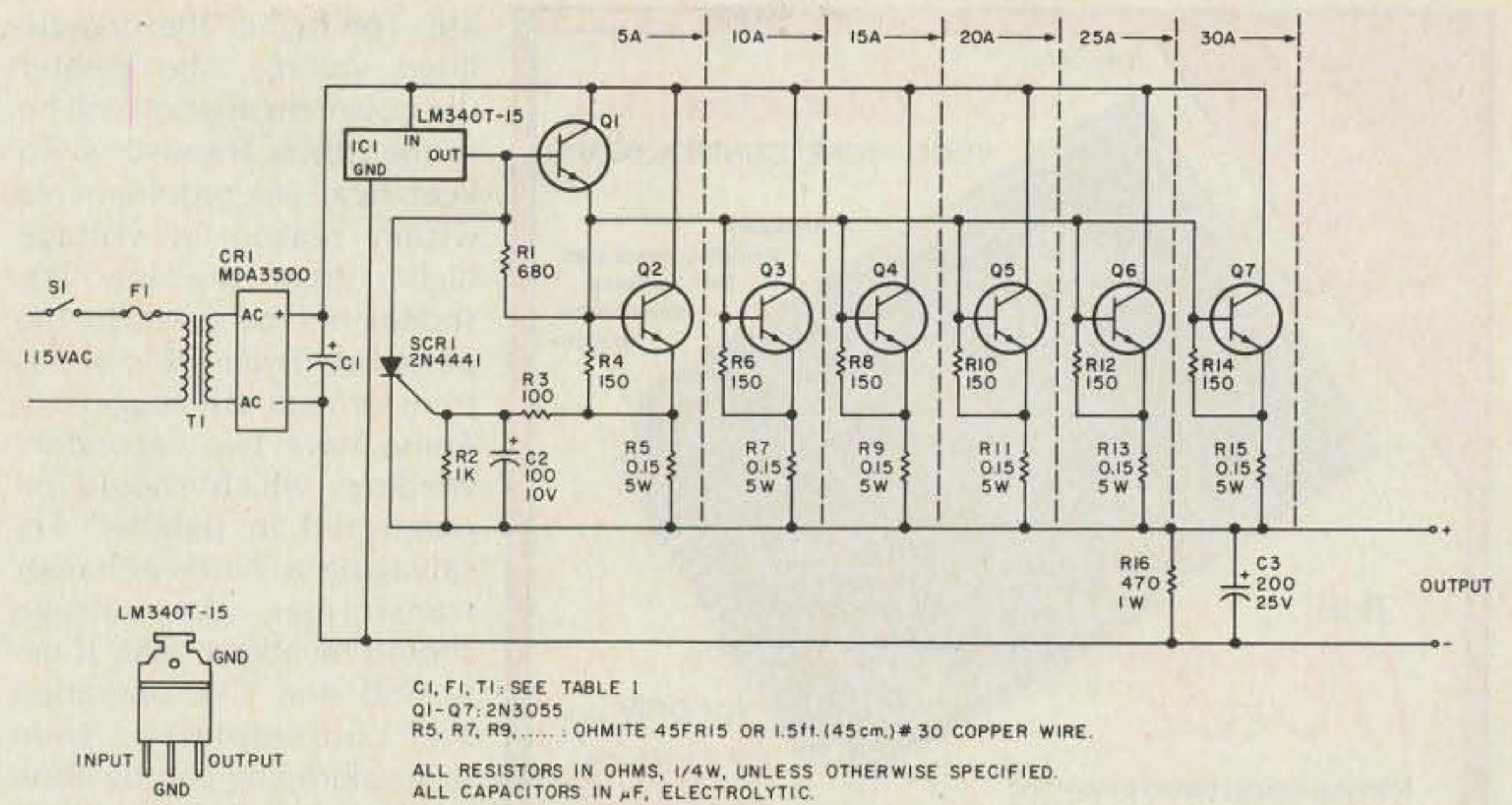

Fig. 1. 13-V-dc power supply schematic.

to about 13 V at full load. This is much tighter regulation than an automotive electrical system where variations of 11 to 16 V are possible. All amateur equipment which requires a nominal 12 V is designed to operate over this range with 13 to 14 V being optimum. Line regulation is essentially perfect with no variation in output seen for varying ac line voltages.

Construction can be as simple or elaborate as the builder desires. The photos show that the whole circuit can easily be built right on the heat sink. In the author's 10-Amp version, the heat sink was mounted on the transformer with 3/16" bolts,

creating a compact and sturdy open-frame design. The 115-V-ac connections were heavily insulated with plastic rubber for safety. If your supply can be tucked away out of sight, this is an ideal (cheap) construction method. If appearance is important, the supply could be built into an attractive box, into the speaker cabinet in the station, etc. The heat

sink(s) must be mounted external to an enclosed cabinet so that adequate cooling can take place.

Table 1 lists suggested components for various power levels of the supply. The transformer, T1, must be chosen to supply about 18 to 20 V to the filter capacitor, C1, at the full load. The LM340T-15 requires a minimum of 17 V to oper-

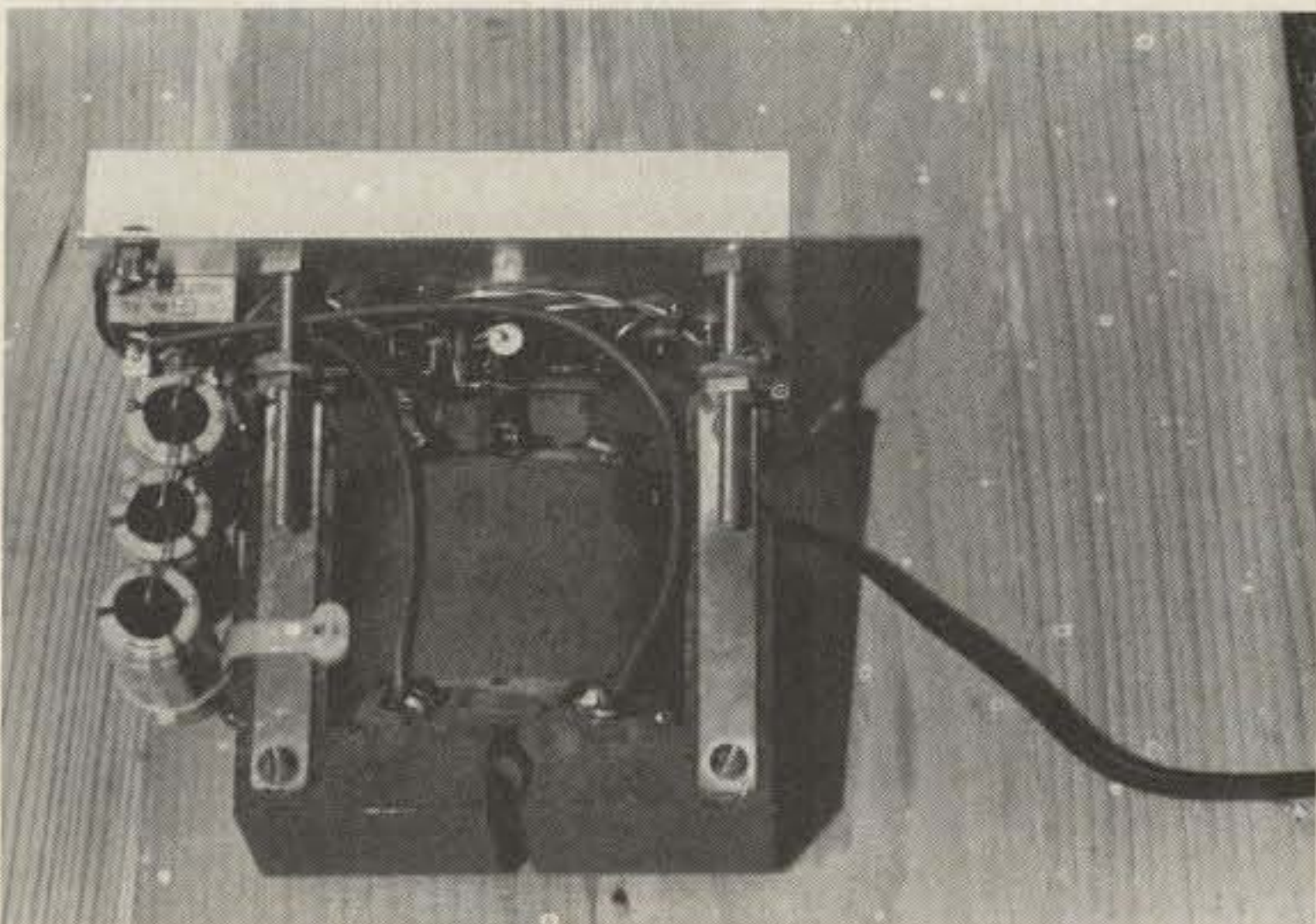

The heat sink can simply be bolted to the transformer to make a compact open-frame supply.

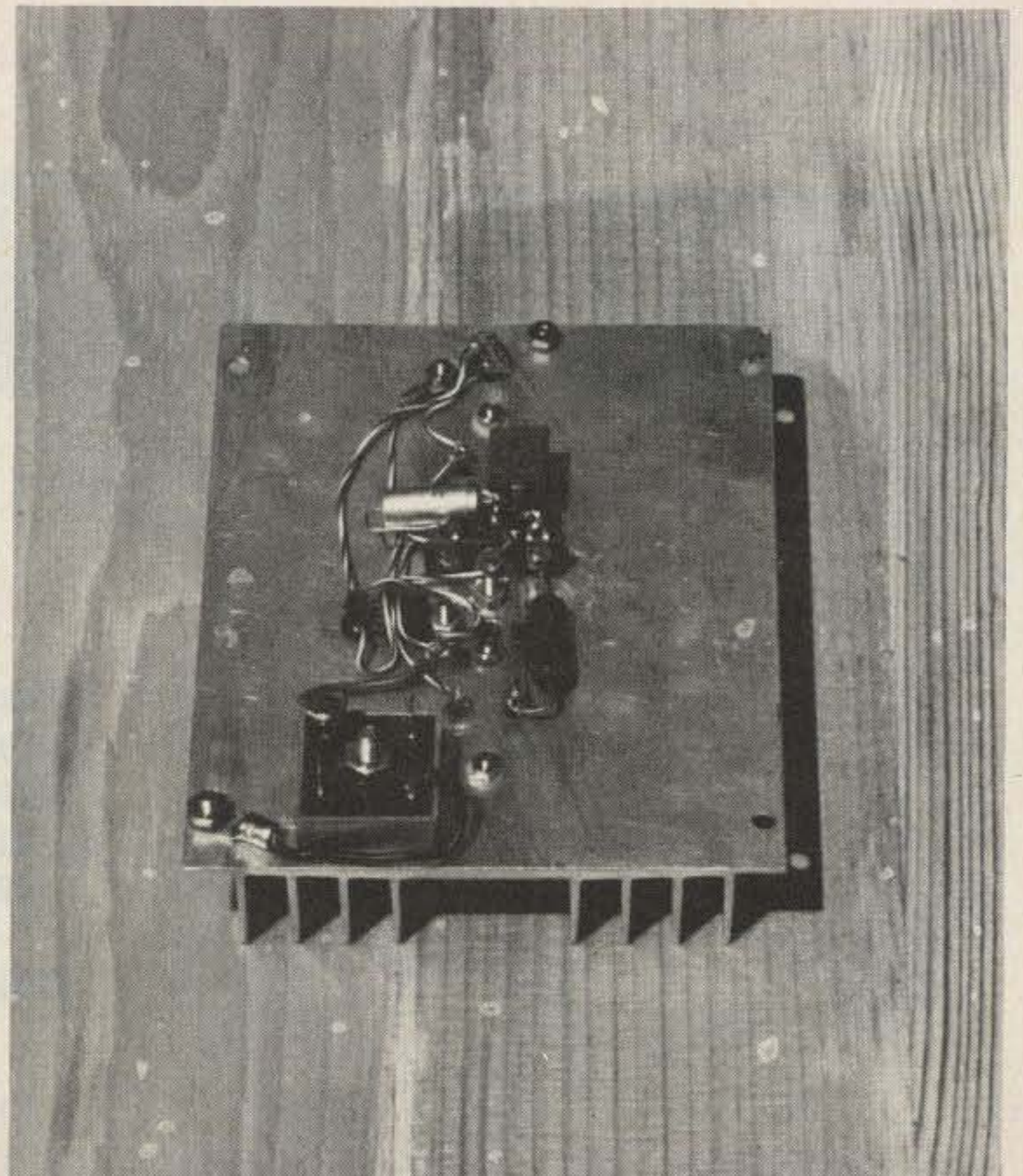

All of the circuitry fits neatly on the heat sink.

NEW

The only **INTELLIGENT**
TOUCH-TONE* CONTROL BOARD



- Repeaters
- Remote receiver sites
- Remote bases
- Home control
- Security

THE
ITC-32

for only ...
\$389

Microcomputer based power and flexibility with state-of-the-art Mitel tone decoding.

- 28 remotely commandable outputs
- 4 remotely sensed inputs
- Control and monitor over the air or over the telephone**
- Morse code or tone encoded response messages
- Alarm generation
- PLUS Repeater COR/ID/Timer function!

ACC advanced computer controls

Call or write for detailed specs on the ITC-32 Intelligent Touch-Tone Control Board.

10816 Northridge Square, Cupertino, CA 95014

(408) 749-8330

* Touch-Tone is a registered trademark of AT&T

** Optional Telephone Interface Board available

Price and specifications subject to change without notice or obligation.

✓67

ate. The higher the unregulated voltage, the greater the power dissipation will be in the power transistors. To keep heat-sink requirements within reason, a voltage higher than the low 20s should not be used. In the parts list, Triad F-240 series transformers are suggested. These have two secondary windings which should be connected in parallel. Try salvaging a battery-charger transformer; the voltage should be about right. If only SSB and CW operation are contemplated, then some skimping can be done on the transformer and heat sink. However, continuous operation such as FM, RTTY, or SSTV requires a transformer whose amperage rating equals the full output of the supply, and heat-sinking of 2° C/Watt per transistor or better. One Wakefield 401 or equivalent for each transistor should be adequate. Be sure to mount the

fins vertically and in a location where free air circulation is provided. Fan cooling will greatly reduce the heat-sink size required. The fan should be controlled by a thermostatic switch (70° C would be a good temperature rating) mounted near the hottest part of the sink.

Many power supplies are available to operate 12-V-dc ham rigs, many of which are very expensive. With the exception of the transformer, all the components specified in this circuit are quite economical. A little scrounging and ingenuity will result in a power supply of exceptional performance and reliability for a very low cost. ■

All parts, including a 30-Amp transformer, are available from All Electronics Corp., PO Box 20406, Los Angeles CA 90006. Send for a catalog.

MISSOURI RADIO CENTER 1-800-821-7323

KENWOOD TS-430S



- All Bands
- General Coverage
- 200 Watts
- Dual VFO's
- 8 Memories

ICOM IC-740



- 1.8 to 30 MHz
- Super Receiver
- 200 Watts
- Selectable IF/PBT Tuning

YAESU -NEW FT-77

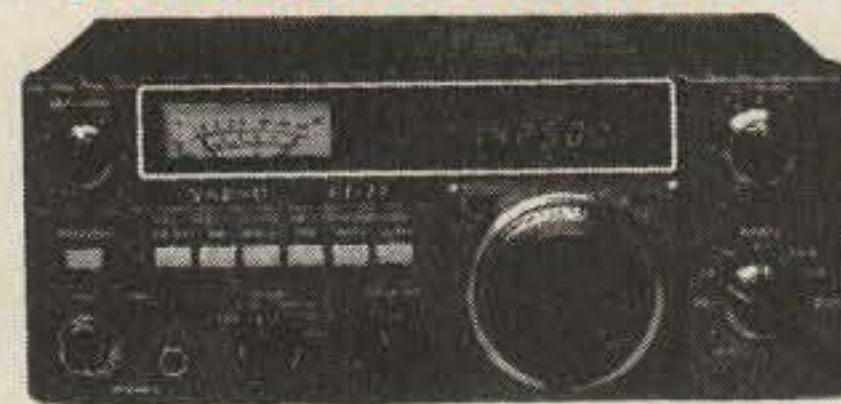

- Extremely Compact
- 200 Watts
- 3.5 to 30 MHz
- inexpensive

ANTENNA SALE

CUSHCRAFT

A-3	\$175
A-4	\$226
R-3	\$226
AV-5	\$ 90
214-FB	\$ 69
32-19	\$ 82
40-2CD	\$260

HYGAIN TOWERS

HG37SS	\$ 649
HG52SS	\$ 919
HG54HD	\$1429
HG70HD	\$2339
HG50MTS	\$ 749
LARSEN	CALL

BUTTERNUT

HF6V	\$109
KLM	
KT34A	\$299
KT34XA	\$449
144-148LBA	\$ 69
AEA	
ISOPOLE 144 + 220	\$39.95

HYGAIN

TH7DXS	\$378
TH5MK2S	\$318
EXPLORER 14	\$275
TH3JRS	\$158
TH2MKS	\$138
18AVT/WS	\$ 94
18HTS	\$335
V2S	\$ 37

CALL "TOLL FREE" FOR ALL ANTENNAS & ACCESSORIES

CALL FOR HYGAIN TOWER PACKAGES.

2900 N.W. VIVION RD. / KANSAS CITY, MISSOURI 64150 / 816-741-8118

✓258

ANNOUNCING PRIVATE PATCH II

TONE TO PULSE SIMPLEX INTERCONNECT

AT LAST...Professional quality interconnect at an *affordable* price! Imagine the convenience of having your own private, commercial quality mobile telephone in your car. And without the hassles of shared systems. Put your base FM transceiver to work while on the road. Our *ultra state of the art* digitally processed audio scheme (Patent pending) *totally* eliminates the continuous train of squelch tails which has kept you away from sampling interconnects. Our nonsampling approach has additional benefits: 1. Interface to your transceiver is the MOST SIMPLE EVER. Connects only to microphone and speaker jacks! NO INTERNAL CONNECTIONS OR MODIFICATIONS REQUIRED! 15 minutes typical installation time. 2. Works with ANY FM transceiver. (T/R speed is not critical.) 3. Operates through any repeater or simplex without use of tone equipment. Imagine having TOTAL access to your own home phone from 100 miles away! Our *busy channel ringback inhibit logic* prevents "accidental" interference to a QSO in progress when a phone call is received. This feature will keep you out of hot water with co-channel users! Discover for yourself what high quality simplex interconnect sounds like. Call us, and listen to actual "on the air" tapes of this incomparable interconnect product.

STANDARD FEATURES

- Compatible with either rotary or tone exchanges
- 16 Digit buffer memory — dial as fast as you want
- 3201 tone decoder chip
- High quality glass circuit board
- CW identification

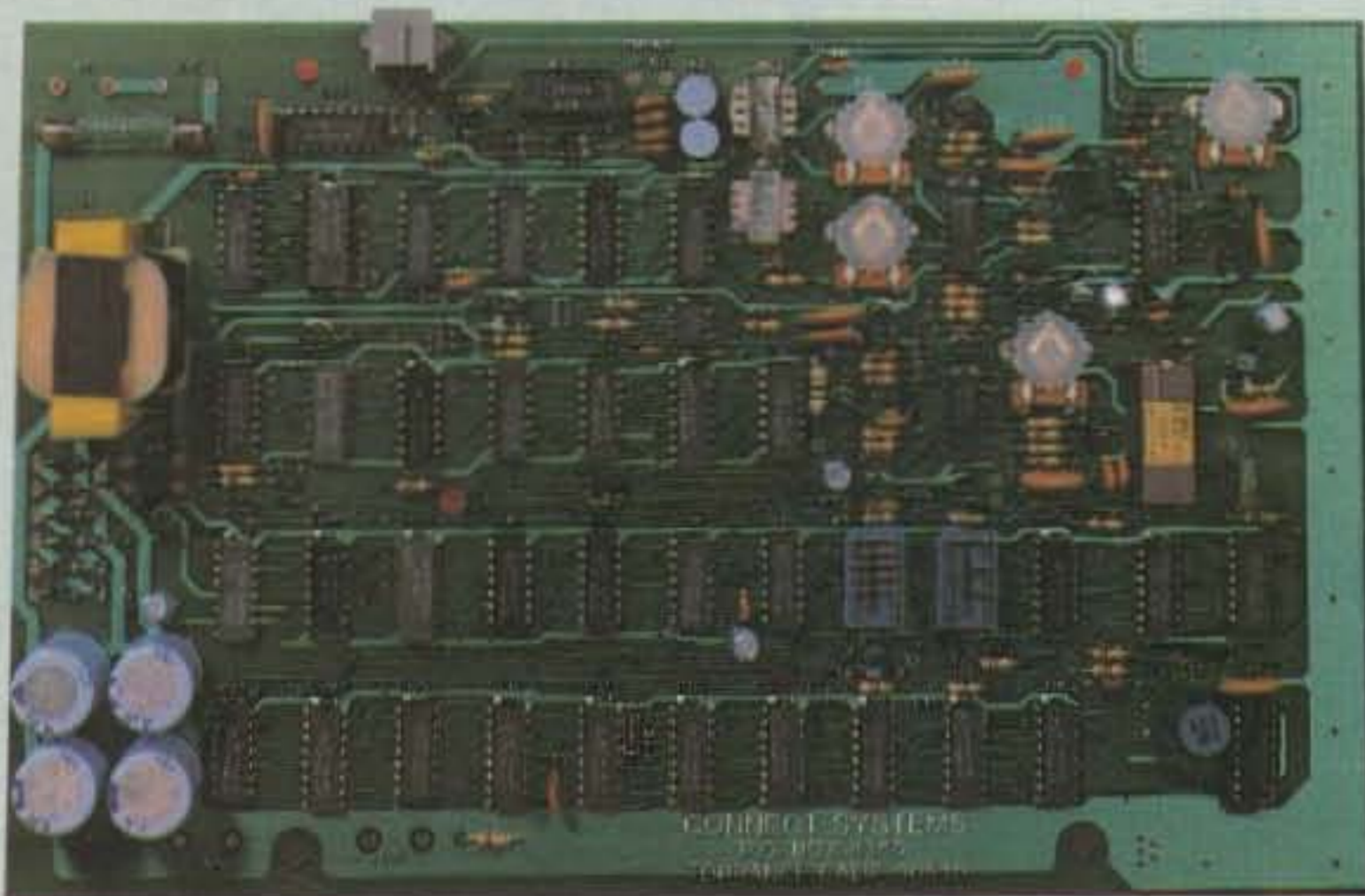

**QUALITY AND ENGINEERING...
THAT YOU CAN DEPEND ON!!**



- Five digit user programmable sequential access code — 60,000 code combinations
- Sophisticated toll restrict — restricts any quantity of leading digits
- Both accessing and dialing are compatible with speed dialing equipment
- Operates superb through repeaters — no special tone equipment required
- Three/six minute "time out" timer is resettable from mobile four CW ID warnings during last minute
- Ringback (reverse patch) pages you once with CW ID — answer when convenient with your access code
- Busy channel ringback inhibit logic — prevents accidental interference to QSO in progress
- Most easily interfaced autopatch on the market
- Positive control logic
- Fully digital timing — there are *no* timing adjustments! assures quick easy set-up
- Touch tone™ digits and strobe pulse available on DIP socket
- Modular phone jack and cord
- Self contained 115 VAC supply (230 VAC 50/60 cycle export model available)

PRIVATE PATCH II \$475

NOW REDUCED

PRIVATE PATCH I \$399

HAS MOST OPERATIONAL FEATURES OF PRIVATE PATCH II — BUT IS FOR USE ONLY ON DTMF EXCHANGES

AND OF COURSE:

**ONE YEAR WARRANTY
14 DAY RETURN PRIVILEGE
UNMATCHED CUSTOMER SERVICE**

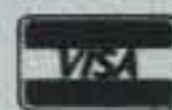

SEND OR CALL FOR BROCHURES
INQUIRE ABOUT COMMERCIAL MODELS
DEALERSHIPS INVITED

Connect Systems

P.O. BOX 4155
TORRANCE, CA 90510
PHONE (213) 540-1053

MAXIMIZERS

NEW

new SIX BAND VERTICAL ANTENNA

Model AV-25
NO TRAP VERTICAL
for 80, 40, 30, 20, 15, 10
meters.

\$99.50

UPS SHIPPING
& HANDLING
ADD \$11



- Only 25 ft. high.
- Three parallel vertical elements.
- Rugged steel tubing.
- Direct feed with 52 ohm coax, low SWR.
- Broad band.
- Capacity loaded, top and sides.
- Only one coil, high in 80 M element.
- Also available for commercial frequencies.



4 1/2" DIA.
SPACERS

AR-25 Radial
System for AV-25
antenna. Four
multiwire radials
that are resonant
on each of the six
bands. \$19.50

PATENT PENDING



ALL OUR PRODUCTS MADE IN USA

BARKER & WILLIAMSON

Quality Communication Products Since 1932

At your Distributor write or call

10 Canal Street, Bristol PA 19007

(215) 788-5581

11

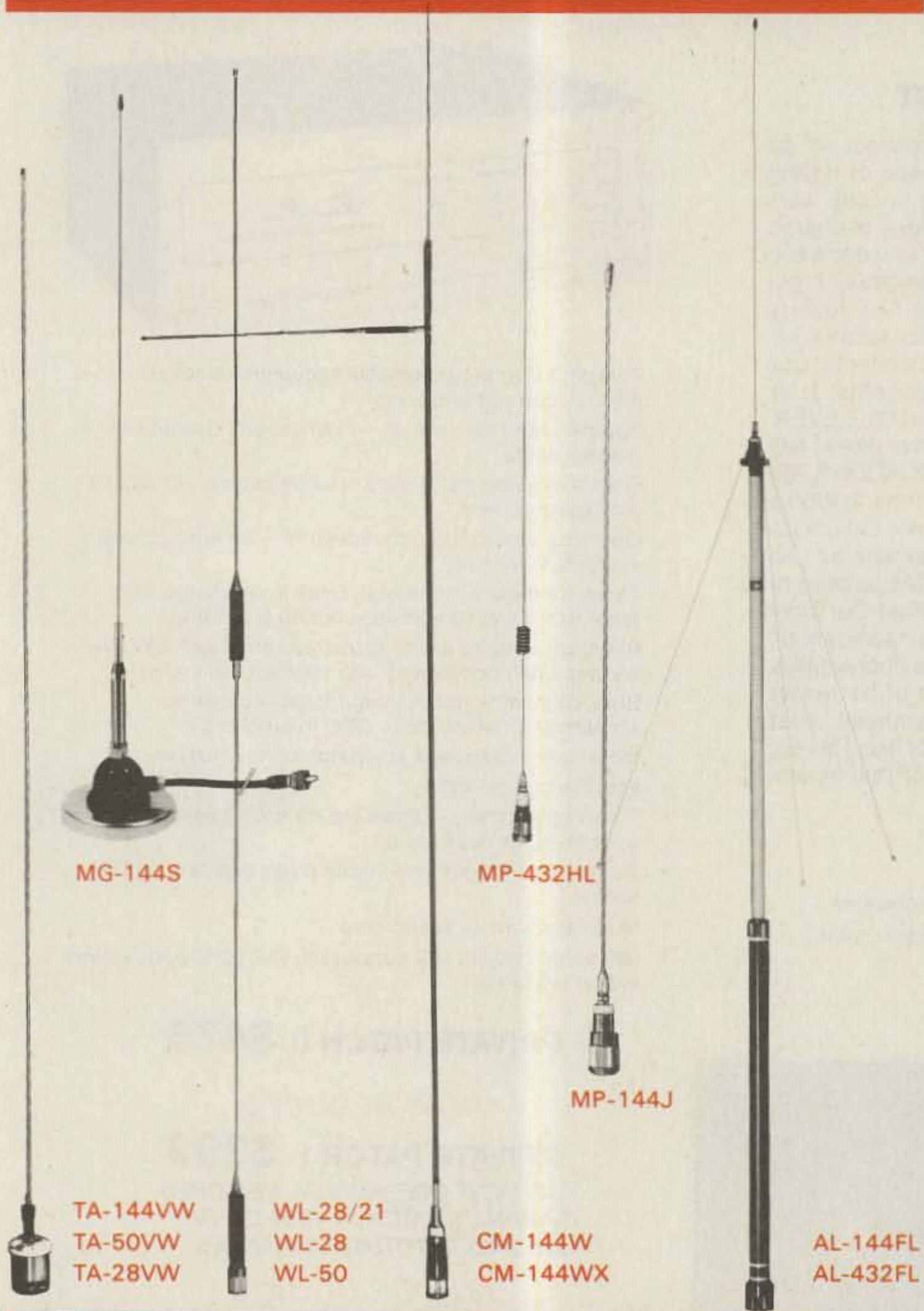

MG-144S

MP-432HL

MP-144J

TA-144VW
TA-50VW
TA-28VW

WL-28/21
WL-28
WL-50

CM-144W
CM-144WX

AL-144FL
AL-432FL

Get the most out of going mobile with KLM's hot new **MAXIMIZER** base/mobile and handi antenna series. Single and multiband models from 21 to 440 MHz deliver **MAXIMUM** coverage and performance without frills or compromise.

MAXIMIZER mobile sampler: TA-series: 1/2λ whips for 144, 220, and 440 MHz voltage protection.

MG-144S: 1/4λ monopole with powerful magnet mount.

WL-series: center loaded whips for 28/21, 28 and 50 MHz

MP-432HL: 5/8λ + 3/8λ whip for 432 MHz

CM-series: multiband whips for 15/10/6/2 meters or 10/6/2 meters.

AL-series: high gain 1/4λ for mobile/handi applications.

There's more! See your KLM dealer or write for a catalog.

KLM Electronics, Inc. P.O. Box 816,
Morgan Hill, CA 95037 (408) 779-7363

KLM

Electronics Inc.

Entirely professional level!

You'll find the difference the more you use it.

ULTIMATE QUALITY, NRD-515



Receiver, NRD-515

SPECIFICATIONS

Receiving frequency range: 100kHz to 30MHz continuous (30 bands)
 Receiving modes: USB/LSB/CW/RTTY/AM
 Receiving system: Up conversion type
 Double superheterodyne
 First IF: 70.455MHz
 CW/SSB AM
 0.5µV 2µV
 2µV 6µV
 Sensitivity (S/N 10dB):
 1.6 to 30MHz
 100 to 1600kHz
 Selectivity: 6kHz/2.4kHz/0.6kHz/0.3kHz
 (*Option)
 Stability: Within 50Hz/one hour
 Power requirements: AC 100/117/220/240V, 50/60Hz, 50VA
 Dimensions and Weight: 340mm(W)×140mm(H)×300mm(D); Approx. 7.5kg
 Preset memory (Option): 24ch.
 Frequency stability: Less than 50Hz per hour after warming up.
 Image rejection ratio: 70dB or more
 IF rejection ratio: 70dB or more
 Input impedance: 50 to 75 ohms, unbalanced
 AF outputs:
 Speaker output: 1W or more (4 ohms)
 Record/line output: 1mW or more (600 ohms)

Highest grade all-wave receiver

NRD-515

Best for 59

Transmitter, NSD-515



SPECIFICATIONS

Rated output power: 100W NSD-515 (50W 28MHz band)
 Frequency range: 1.8MHz-2.0MHz/3.5MHz-4.0MHz/
 7.0MHz-7.3MHz/14.0MHz-14.35MHz/
 21.0MHz-21.45MHz/28.0MHz-29.0MHz/
 29.0MHz-29.7MHz/Optional new bands
 approved by WARC '79
 10.1MHz-10.15MHz/18.068MHz-
 18.168MHz/24.89MHz-24.99MHz/
 Mode of emission: A3J (USB/LSB) A1 (CW) F1 (RTTY)

• For more information please contact to;



Japan Radio Co., Ltd.

MAIN OFFICE: 5th and 6th Floors, Akasaka Twin Tower (Main), 17-22, Akasaka 2-chome, Minato-ku, Tokyo 107, JAPAN
 Phone: (03) 584-2411 Telex: 242-5420 JRCTOK J
U.S.A. BRANCH OFFICE: T. Hayashi, 120 East 56th Street, New York, New York 10022
 Phone: 212-355-1180 Telex: 230-645636 JAPANRADIO NYK

AUSTRALIA: N.S.W.—EMONA ELECTRONICS PTY LTD. Phone: 398-6378
 Victoria—VICOM IMPORTS PTY LTD. Phone: (03) 62 6931
FINLAND: Kotka—VISI RADIO OY Telex: 53260 VISI SF
FRANCE: Paris—SOCIETE G.E.S. (GENERAL ELECTRONIC SERVICES) Phone: (1) 345 35 92
CANADA: Vancouver—GLENWOOD TRADING CO., LTD. Phone: 604 984 0404
GERMANY: Hannover—RICHTER & CO. Phone: (0511) 352 1111
ITALY: Milanese—TECHNOVENT, ITALIA, SRL Phone: 02 32 83 089

SWITZERLAND: SEICOM AG Phone: 064 515566
U.K.: Derbyshire—LOWE ELECTRONICS, LTD. Phone: 0629-2430

VisiCode: The VIC 20 Way to Extra Class

First you get random practice groups. Then you get the answers.

Photos by KA7AQA

Well, it finally happened. After a concentrated, purposeful effort for several years to ignore computers, I succumbed as I knew I eventually would. To justify the expenditure, I decided to get a computer that could be used for games and have both sound and color so as to interest my 8-year-old son, Tom. And, of course, it had to be relatively inexpensive. I chose the Commodore VIC 20.

In recent months, this computer has become very popular, especially among the local hams. I decided it would be fun to incorporate some ham uses for the VIC 20, and as a first attempt, recalling having read an article in 73 about a Morse-code learning program for the Commodore Pet, I thought a similar program would be appropriate. Looking back through my library of 73s, I retrieved the article, "The Code Pet," by Alden Lansdowne AA0G, December, 1981.

Using Alden's program as a guide, I began converting (in computerese, "transporting") the Pet code program into a format that the VIC 20 would like. I can tell you that there is no better way of learning how your computer works than to get into programming, and transporting a program is perhaps a little less traumatic than starting from scratch.

After many hours of hair-pulling and mumbling unkind words, I finally got a usable program going. I still had some timing problems with the code speed, and I enlisted the aid of Hoa Nguyen KA7AQA, who is one of our local VIC 20 experts. He quickly solved the problem. The finished program is one that will make it easy for anyone with a VIC 20 not only to learn Morse

code, but also to be able to increase code speed up to 20 wpm.

The program features a choice of code speeds of 5 to 20 wpm and also a choice of having the characters displayed directly after being sent (good for learning at the slower speeds) or keeping the screen blank until 41 groups of random characters have been sent—then automatically displaying them so that you can check your accuracy. You also can stop the program for an immediate display by pressing the S key.

Code groups traditionally have consisted of five characters, but due to the VIC 20 displaying 22 characters per line, I decided that three groups of six would avoid split groups on the screen. I stopped at 41 groups to avoid scrolling.

The listing should be self-explanatory to an experienced programmer. However, here are a few remarks as to what is taking place within the program that may be of help to a beginner.

Lines 260-270 contain the formula for selecting the code speed.

- P controls the character speed.
- K controls the space between characters.
- P and K together control the pause between character groups.

MORSE CODE PRACTICE

```
100 REM VIC 20 CODE PRACTICE PROGRAM W7LTH KA7AQA
110 PRINT "MORSE CODE PRACTICE"
120 PRINT "*****"
130 PRINT "I WILL SEND MORSE CODE"
140 PRINT "AT RANDOM IN GROUPS OF"
150 PRINT "SIX CHARACTERS AT THE"
160 PRINT "SPEED YOU DESIRE."
170 PRINT "AFTER 41 GROUPS OF SIX A COPY"
180 PRINT "OF THE TEXT WILL"
190 PRINT "APPEAR. IF YOU WISH TO STOP"
200 PRINT "BEFORE I'M FINISHED, TYPE 'S'."
210 PRINT "WHAT SPEED WOULD YOU LIKE ME TO SEND?"
220 INPUT "M (5 TO 20 WPM)"; P
230 IF P<5 OR P>20 THEN 220
240 V=P
250 IF P>12 THEN K=1:GOTO 270
260 K=ABS(INT(P*42+153-8807/P))-P+13
270 P=ABS(INT(P*(-2.333)+96-1387/P))
280 PRINT "DO YOU WANT VIDEO AND AUDIO?"
290 INPUT " (Y/N)"; Q#
300 IF Q#="Y" THEN 320
310 POKE 36879,107
320 PRINT "CHECK YOUR ACCURACY"
330 POKE 36878,10:REM VOLUME
340 A=INT(RND(1)*47)+44
350 IF (A=64) OR (A=57 AND A=63) THEN 340
360 FOR I=44 TO A
370 READ A#
380 NEXT
390 FOR I=1 TO LEN(A#)
400 D#=MID$(A#,I,1)
410 IF D#="L" THEN L=3*P:REM DAH LENGTH
420 IF D#="S" THEN L=P:REM DIT LENGTH
430 POKE 36876,232:REM FITCH
440 FOR J=1 TO L:NEXT J
450 POKE 36876,0
460 FOR J=1 TO P:NEXT J:REM PAUSE BETWEEN DITS AND DAHS
470 NEXT I
480 REM END OF LETTER
490 PRINT CHR$(A)
500 RESTORE
510 GET E#:IF E#="S" THEN 620
520 C=C+1
530 IF C=6 THEN C=0:GOTO 560:REM CHECK 6 CHAR. GROUP
540 FOR J=1 TO K:NEXT J:REM SPACE BETWEEN CHARACTERS
550 GOTO 340
560 FOR I=1 TO P*6+2*K:NEXT I:REM SPACE BETWEEN GROUPS
570 G=0+1:H=H+1
580 IF G=3 THEN G=0:GOTO 610
590 IF H=41 THEN 620
600 PRINT " "
610 GOTO 340
620 REM END
630 POKE 36879,17
640 POKE 36878,0
650 PRINT "YOU HAVE COPIED "H" GROUPS OF SIX LETTERS AT "V"W.P.M."
660 PRINT CHR$(31)
670 PRINT "*****"
680 END
690 DATA LLSSLL,LSSSL,LSLSL,LSSLS
700 DATA LLLLL,LLLLL,SSLLL,SSSLL,SSSSL,SSSSS,LSSSS,LLSSS,LLLLS,LLLLS
710 DATA B,B,B,B,B,SSLLSS,B
720 DATA SL,LSSS,LSLS,LSS,S,SSLS,LLS,SSSS,SS,LLLL,LSL,SLSS,LL,LS,LLL,SLLS,LLSL
730 DATA SLS,SSS,L,SSL,SSSL,SLL,LSSL,LSLL,LLSS
READY.
```

EXPLANATION
 □ = CLEAR SCREEN
 ▣ = CURSOR DOWN
 ■ = HOME

Program listing.

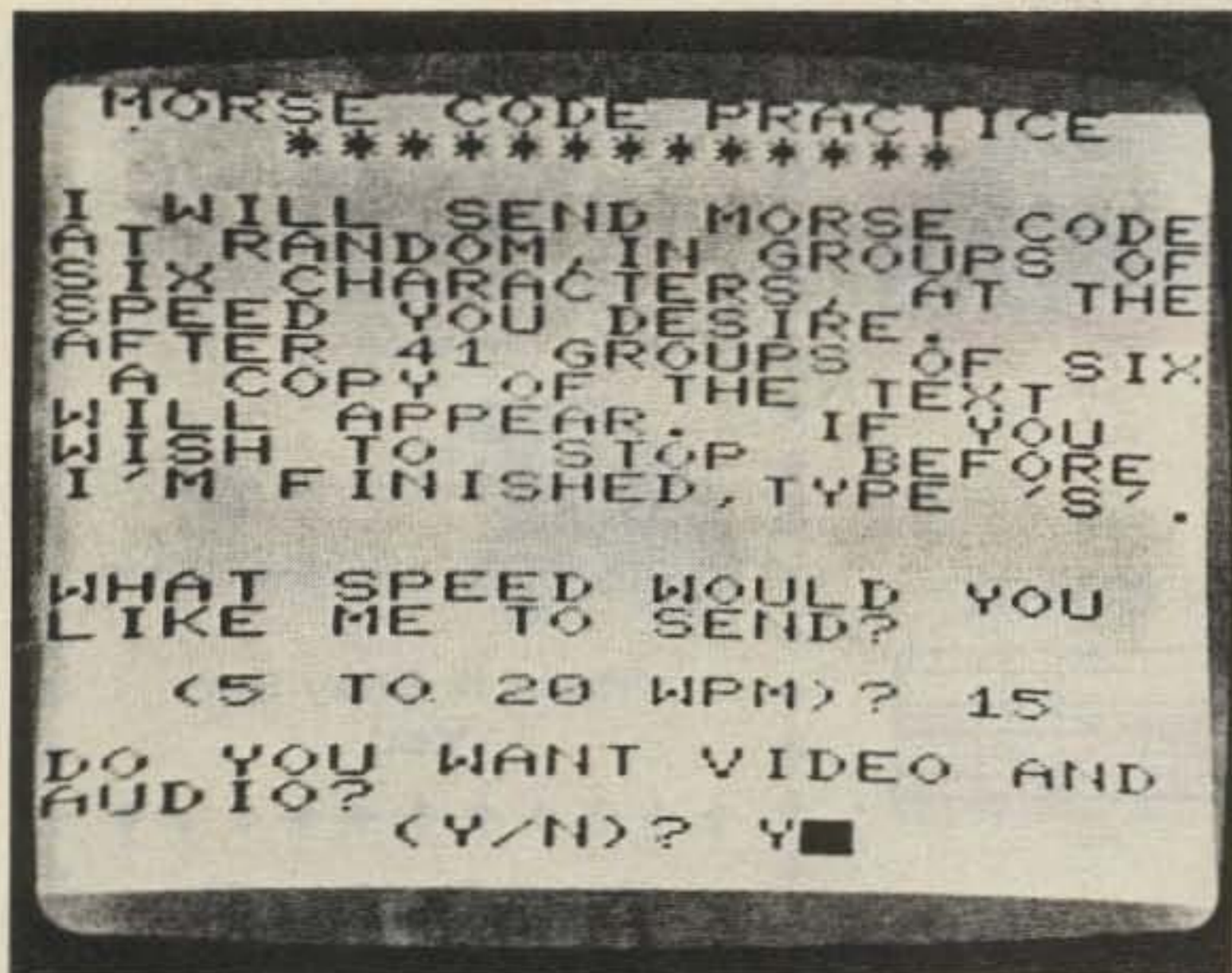

Photo A. Screen display after loading program and selecting code speed and audio plus video.

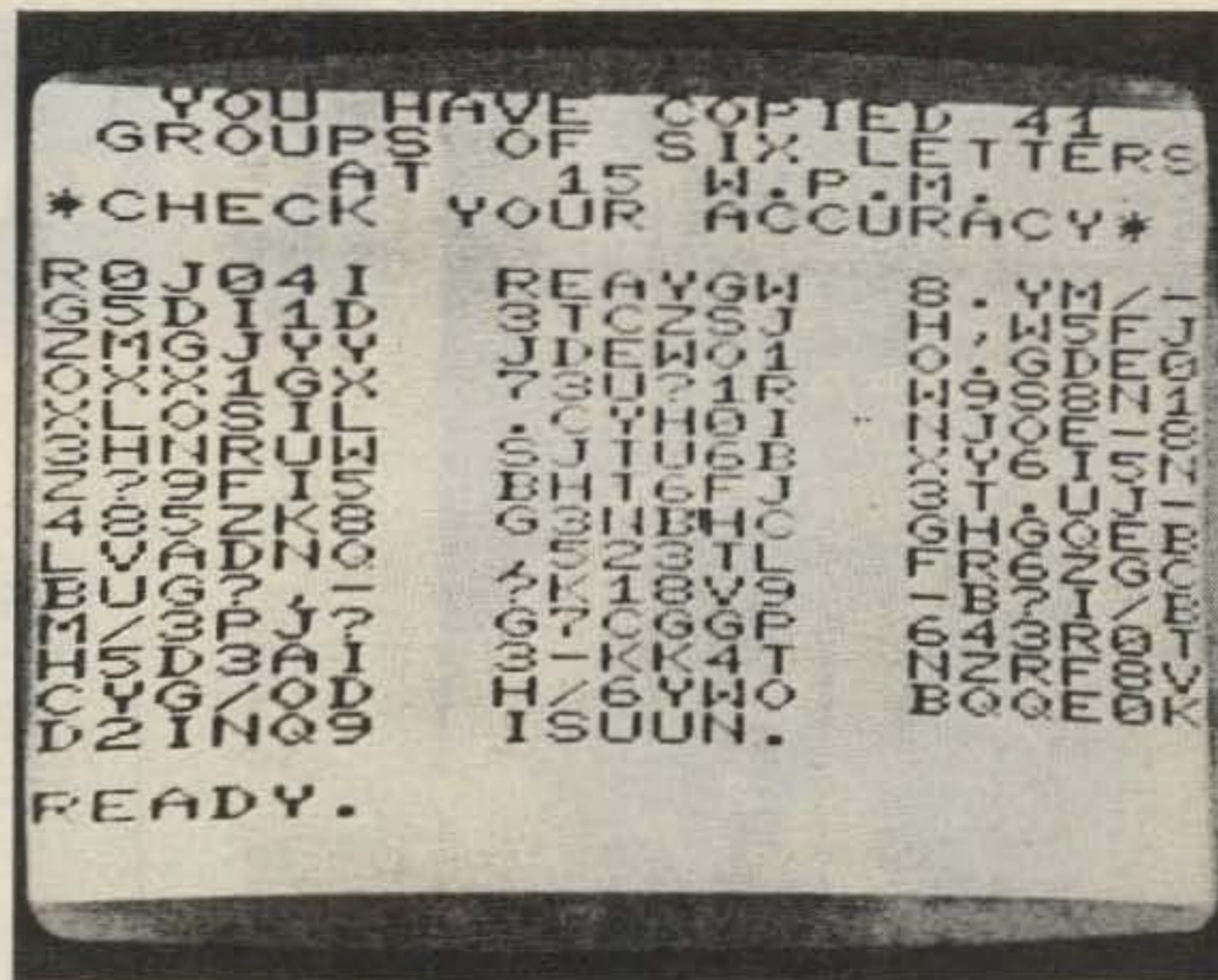

Photo B. Screen display after 41 groups of characters are shown (full screen).

It was found that a formula involving 1/P gives more accurate code speed than the linear equation AAQG used.

- Line 340 generates a character.
- Line 350 selects only the

ASCII characters of the alphabet, numbers 0 to 9, plus certain punctuation marks.

● Line 490 puts the character on the screen. If you wish to see each character before the code is sent, change this line number to 355.

This has been a very inter-

esting learning experience and I know you will enjoy using the program. It should be very useful in radio clubs for group code practice as well as individual use.

Feel free to customize it in any way you like. I am convinced that computers

are compatible with ham radio and are here to stay.

For any of you who would like a taped copy of this program, send me a blank cassette tape along with \$3.00 for postage and handling, and I will make you a copy. ■

\$15 DTMF DECODER \$15

The LJM2RK decoder kit converts your receiver into a special receiver or control. When a user-selected time-tone combination is received, the output provides a relay control for activating speakers or other devices.

INPUT: Audio from transceiver, scanner, etc.
OUTPUT: SPST (N.O.) relay.

FEATURES: Single or dual tones adjustable over the 16 digit Touch Tone range • Adjustable response time • Relay output • Manual or auto reset • Single tone ON latching with different single tone reset OFF • Operates on 12VDC • Interfacing of multiple boards for multi-digit sequential activation and reset.

APPLICATIONS: Call-up system • Repeater or commercial controls • Etc. limited only to your imagination •

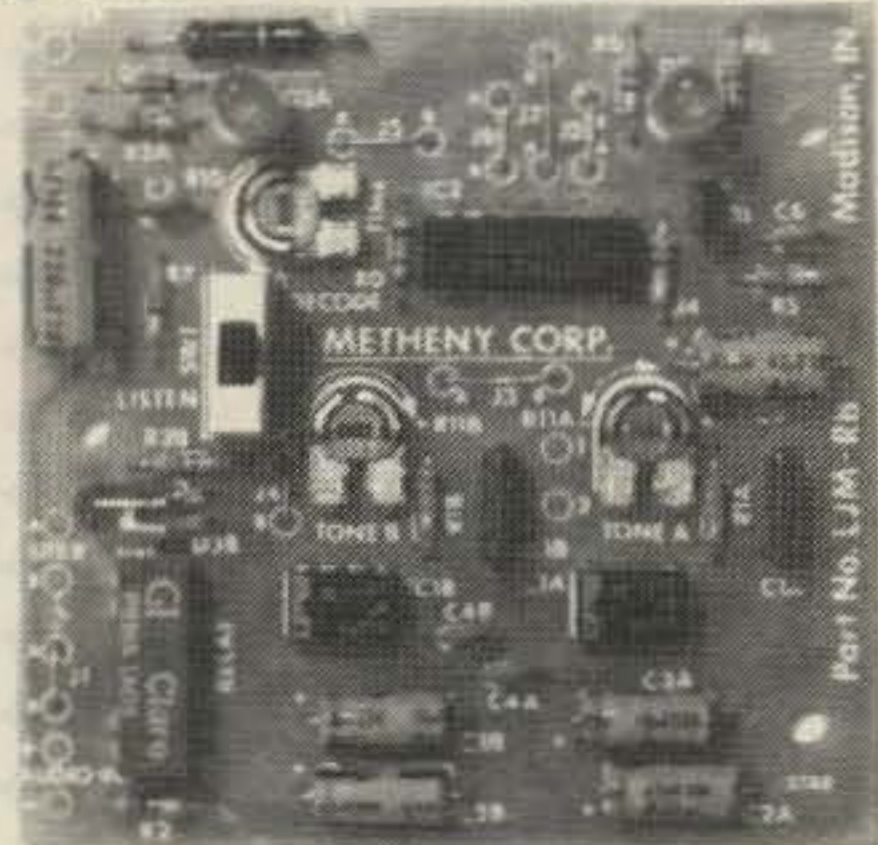

Actual Size 3"x3" - Shown Assembled

LJM2RK decoder kit includes all component, relay, and P.C. Board. . . \$15 plus \$1.50 shipping.

LJM2RC enclosure kit includes molded case, speaker, input cable. . . \$5 plus \$1.50 shipping.

For information and to order write:

THE METHENY CORPORATION
204 Sunrise Drive, Madison, IN 47250

The only thing we can't disguise is the professional quality of **as** amateur antennas.

Amateur Radio spoken here!

FREE decal just for fun!

Name _____
Address _____
City _____ State _____ Zip _____

the antenna specialists co.
a member of The Allen Group Inc.
12435 Euclid Avenue, Cleveland, Ohio 44106
Export: 55 N. Main St., Freeport N.Y. 11520
Canada: A. C. Simmonds & Sons, Ltd. ✓63

**BUTTERNUT
ELECTRONICS
COMPANY**

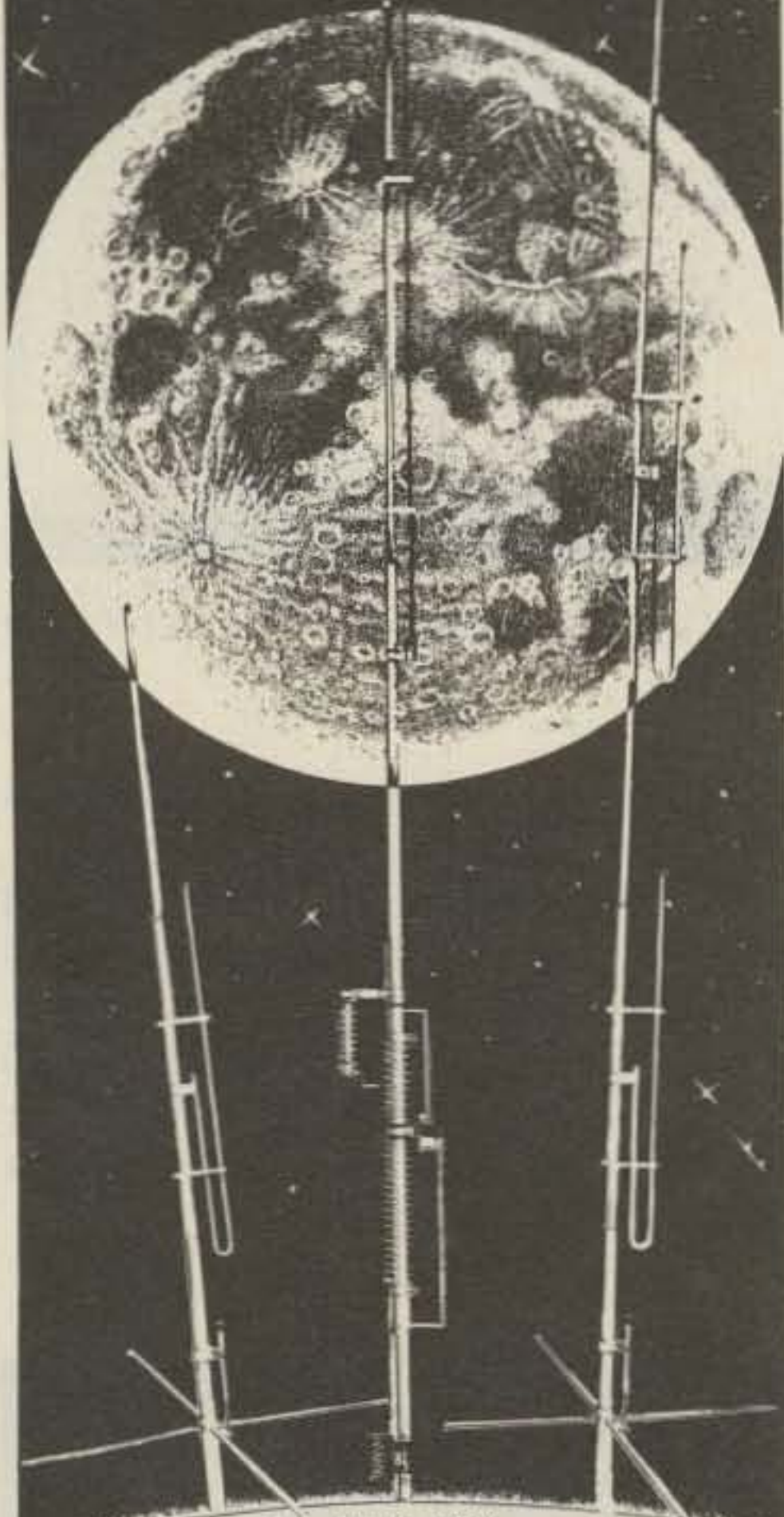

Model 2MCV "Trombone"
Model HF6V
Model 2MCV-5 "Super Trombone"

**THE
WINNERS**

Model HF6V—Completely automatic bandswitching 80 through 10 plus 30 meters. Outperforms all 4- and 5-band "trap" verticals of comparable size. Thousands in use worldwide since December '81! 160 meter option available now; retrofit kits for remaining WARC bands coming soon. Height: 26 ft/7.8 meters; guying not required in most installations.

Model 2MCV "Trombone"—omnidirectional collinear gain vertical for 2 meters having the same gain as "double- λ " types, but the patented "trombone" phasing section allows the radiator to remain unbroken by insulators for maximum strength in high winds. No coils "plumber's delight" construction and adjustable gamma match for complete D.C. grounding and lowest possible SWR. Height: 9.8 ft/2.98 meters

Model 2MCV-5 "Super-Trombone"—Same advanced features as the basic 2MCV but a full wavelength taller with additional "Trombone" phasing section for additional gain. Height: 15.75 ft/4.8 meters

All BUTTERNUT ANTENNAS use stainless steel hardware and are guaranteed for a full year. For further information on these and other BUTTERNUT products write for our FREE CATALOG!

**BUTTERNUT
ELECTRONICS**
405 E. Market St. Lockhart, TX 78644

MAXIMIZER

NEW

VSWR CHART

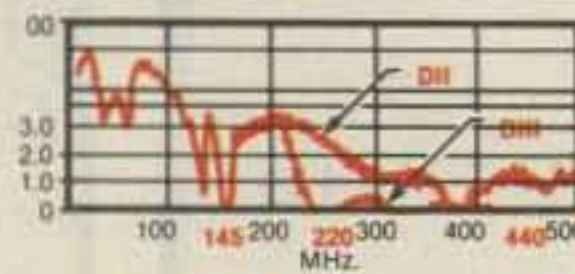

IMPEDANCE

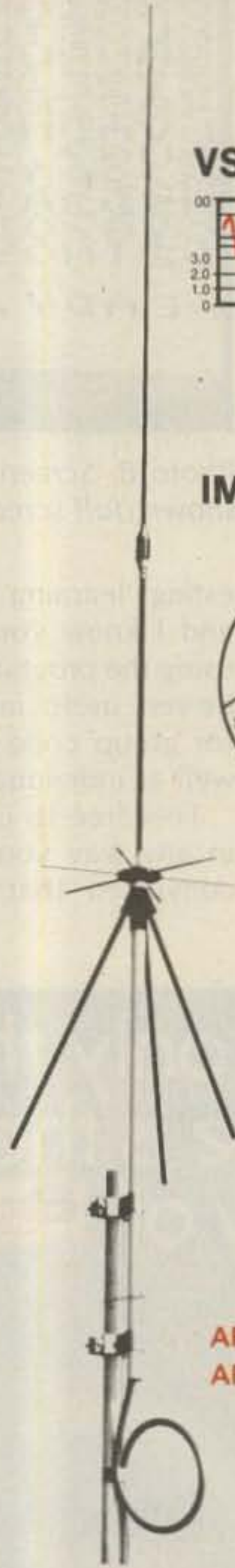
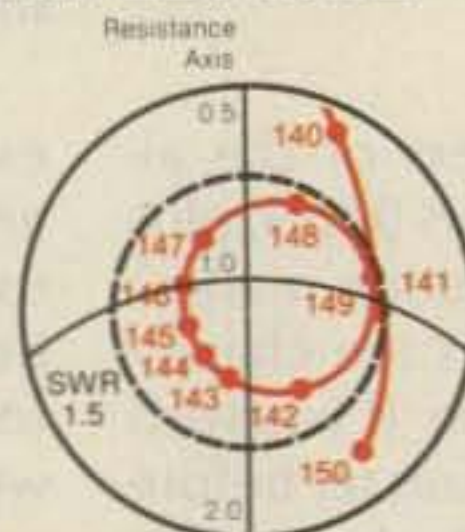

AP-144DII
AP-144DIII

AP-144DII - this $5/8\lambda + 5/8\lambda$ collinear base station vertical for 2 meters delivers significant gain over a groundplane. Built-in lightning/static arrestor. Rugged construction suitable for marine applications, too.

APP-1434DIII - UHF disc radials extend gain performance to 430-440 MHz.



Electronics Inc.

See your KLM Dealer or write for our complete catalog. P.O. Box 816, Morgan Hill, California 94035

**Have You Ever Used
Satellites?
Let the Pathfinder
Series
FROM**



**Computer
Applications**

**Make It Easy For
You**

Pathfinder II

**A Satellite Tracking Package
For The Apple II Plus™**



Has a world AND a US map and can print BOTH on your Epson MX™ printer. Tracks in real time w/o a clock. SYSTEM REQUIREMENTS: Apple II Plus, 48K RAM, DOS 3.3.

THESE EASY TO USE AND UNDERSTAND PACKAGES ENABLE YOU TO:
(1) Track circular orbit satellites in real time on a world map. (2) Print all tables. (3) Rapidly predict specific or all orbits between dates you select. (4) Rapidly compute orbital characteristics. (5) Maintain a disk resident data base of satellite reference data.

Pathfinder II is provided on a DOS 3.3 disk and Pathfinder III is on a TRSDOS 1.3 disk. Both have a comprehensive users manual.

Pathfinder III

**A Satellite Tracking Package
For The TRS 80 Mod III™**



Pathfinder III can track TWO satellites simultaneously!! SYSTEM REQUIREMENTS: TRS 80 MOD III, 48K RAM, TRSDOS 1.3.

Each package is only **\$49.95**

Please add \$2.00 for handling (in California add \$3.00 for sales tax).

Send Check or Money Order To:

COMPUTER APPLICATIONS

629 Arbor Ave., Ventura, CA 93003

or Call (805) 644-9327

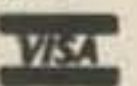

new!

JPC/AZDEN®

4000 SERIES FM TRANSCEIVERS

10 METERS & DOWN



PCS-4000
2-m FM Transceiver

COMMERCIAL-GRADE
QUALITY AT AMATEUR PRICES

EXCLUSIVE 1 YEAR LIMITED WARRANTY! COMPARE!

THE 4000 SERIES



PCS-4300 70-cm FM Transceiver



PCS-4500 6-m FM Transceiver



PCS-4800 10-m FM Transceiver

COMING SOON
PCS-4200 1 1/4-m FM Transceiver



PCS-300
2m Handheld
FM Transceiver
142-149.995 MHz

- **WIDE FREQUENCY COVERAGE:** PCS-4000 covers 142.000-149.995 MHz in selectable steps of 5 or 10 kHz. PCS-4200 covers 220.000-224.995 MHz in selectable steps of 5 or 20 kHz. PCS-4300 covers 440.000-449.995 MHz in selectable steps of 5 or 25 kHz. PCS-4500 covers 50.000-53.995 MHz in selectable steps of 5 or 10 kHz. PCS-4800 covers 28.000-29.990 MHz in selectable steps of 10 or 20 kHz.
- **CAP/MARS BUILT IN:** PCS-4000 includes coverage of CAP and MARS frequencies.
- **TINY SIZE:** Only 2"H x 5.5"W x 6.8"D. COMPARE!
- **MICROCOMPUTER CONTROL:** At the forefront of technology!
- **UP TO 8 NONSTANDARD SPLITS:** Ultimate versatility. COMPARE!
- **16-CHANNEL MEMORY IN TWO 8-CHANNEL BANKS:** Retains frequency and standard simplex or plus/minus offsets. Standard offsets are 600 kHz for PCS-4000, 1.6 MHz for PCS-4200, 5 MHz for PCS-4300, 1 MHz for PCS-4500, and 100 kHz for PCS-4800.
- **DUAL MEMORY SCAN:** Scan memory banks either separately or together. COMPARE!
- **TWO RANGES OF PROGRAMMABLE BAND SCANNING:** Limits are quickly reset. Scan the two segments either separately or together. COMPARE!
- **FREE AND VACANT SCAN MODES:** Free scanning stops 5 seconds on a busy channel; auto-resume can be overridden if desired. Vacant scanning stops on unoccupied frequencies.
- **DISCRIMINATOR SCAN CENTERING (AZDEN EXCLUSIVE PATENT):** Always stops on frequency.
- **TWO PRIORITY MEMORIES:** Either may be instantly recalled at any time. COMPARE!
- **NICAD MEMORY BACKUP:** Never lose the programmed channels!
- **FREQUENCY REVERSE:** The touch of a single button inverts the transmit and receive frequencies, no matter what the offset.
- **ILLUMINATED KEYBOARD WITH ACQUISITION TONE:** Unparalleled ease of operation.
- **BRIGHT GREEN LED FREQUENCY DISPLAY:** Easily visible, even in direct sunlight.
- **DIGITAL S/R F METER:** Shows incoming signal strength and relative power output.
- **BUSY-CHANNEL AND TRANSMIT INDICATORS:** Bright LEDs show when a channel is busy and when you are transmitting.
- **FULL 16-KEY TOUCHTONE® PAD:** Keyboard functions as autopatch when transmitting (except in PCS-4800).
- **PL TONE:** Optional PL tone unit allows access to private-line repeaters. Deviation and tone frequency are fully adjustable.
- **TRUE FM:** Not phase modulation. Unsurpassed intelligibility and audio fidelity.
- **HIGH/LOW POWER OUTPUT:** 25 or 5 watts selectable in PCS-4000; 10 or 1 watt selectable in PCS-4200, PCS-4300, PCS-4500, and PCS-4800. Transmitter power is fully adjustable.
- **SUPERIOR RECEIVER:** Sensitivity is 0.2 uV or better for 20-dB quieting. Circuits are designed and manufactured to rigorous specifications for exceptional performance, second to none. COMPARE!
- **REMOTE-CONTROL MICROPHONE:** Memory A-1 call, up/down manual scan, and memory address functions may be performed without touching the front panel! COMPARE!
- **OTHER FEATURES:** Dynamic microphone, rugged built-in speaker, mobile mounting bracket, remote speaker jack, and all cords, plugs, fuses, and hardware are included.
- **ACCESSORIES:** CS-7R 7-amp ac power supply, CS-4.5R 4.5-amp ac power supply, CS-AS remote speaker, and Communications Specialists SS-32 PL tone module.
- **ONE YEAR LIMITED WARRANTY!**

EXCLUSIVE DISTRIBUTOR

DEALER INQUIRIES INVITED

AMATEUR-WHOLESALE ELECTRONICS

TOLL FREE... 800-327-3102

8817 S.W. 129th Terrace, Miami, Florida 33176

Telephone (305) 233-3631

Telex: 80-3356

MANUFACTURER



JPC/AZDEN

JAPAN PIEZO CO., LTD.

1-12-17 Kamirenjaku, Mitaka, Tokyo, 181 Japan.

Telex: 781-2822452

CES INTRODUCES THE NEW 510SA "SMART PATCH"

The State of the Art Simplex Interconnect

Communications Electronics Specialties introduces the CES 510SA "Smart" Simplex Autopatch, with many important new features never available before:

- Three digit control codes with user programming.
- A sophisticated toll restrict provides positive long distance lock out.
- Time-out and COR activity timers with warning beeps and digital programming.
- Rotary or DTMF dialing.
- Phone line in-use detector prevents interrupting a call in progress, and sends unique CW sequence.
- Phone ring detection logic enables unique CW sequence.
- Digital programming of the sample rate and width, and noise gate sensitivity control, for easy interfacing with most radios.

Simple and direct connections to radio.

Options available:

- Smart CW identifier with unique CW messages for each patch function.
- FCC type accepted phone line coupler.
- Special tone squelch kit to operate patch through repeaters.



CES

The 510SA — the newest advance in interconnect technology, from the innovators at:
Communications Electronics Specialties, Inc.
 Post Office Box 507 • Winter Park, Florida 32790
 (305) 645-0474 • Toll-free (for orders only): (800) 327-9956 ✓462

OUR ISOLATORS FOR YOUR PROTECTION

Prevents:

disk drive woes, printer interaction, memory loss and damage due to lightning or AC power line disturbances.



Commercial Grade Isolators

ISO-1 3 Isolated Sockets \$76.95
 ISO-2 2 Isolated Socket Banks, 6 Sockets 76.95

Industrial Grade Isolators

ISO-3 3 Double Isolated Sockets 115.95
 ISO-11 2 Double Isolated Banks, 6 Sockets 115.95

Laboratory Grade Isolators

ISO-17 4 Quad Isolated Sockets 200.95
 ISO-18 2 Quad Isolated Banks, 6 Sockets 169.95

Circuit Breaker, any model (Add-CB) Add 10.00

Remote Switch, any model (Add-RS) Add 18.00

ESP Electronic Specialists, Inc.
 171 South Main Street, Box 389, Natick, Massachusetts 01760

Toll Free Order Desk 1-800-225-4876
 MasterCard, VISA, American Express

✓18

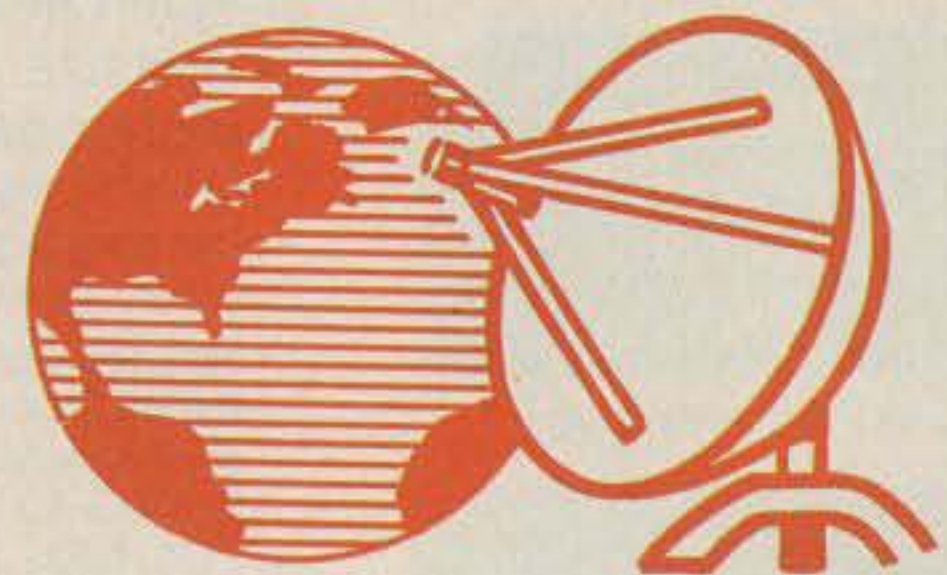

SATELLITE TELEVISION SYSTEMS

WE WILL NOT BE UNDERSOLD!!

Complete Systems, Antennas, Receivers, LNA's & Accessories

CALL US TODAY! ✓320

812-238-1456

hoosier electronics

"Nation's Largest Total Communications Distributor"

P.O. BOX 3300 • TERRE HAUTE, INDIANA 47803

IT'S A CODE TEACHER. IT'S A KEYSER. IT'S HERE AT LAST!

Finally, the affordable alternative to those high priced code teachers and keyers . . . and the cassettes that never seem to work.

If you're a *Ham* to be, want to up-grade, or just need a good keyer, then the **Morse Code Teacher®** is for you.

Based on the CPP1 single chip micro-computer, this powerful little board will get your code speed where you want it, *fast!*



MORSE® **CODE TEACHER**

Fun to Build
Perfect for Code Classes
Great Club Project
A Must for "Novices
and Technicians"

Watch for upcoming articles and reviews in *Radio Electronics'* special projects #7, *Ham Radio*, "73" and *CQ*.

- Easy to use
- Contains 15 programmed tables
- Adjustable speed from 2wpm to over 40wpm
- Doubles as electronic keyer (iambic type)
- No more searching for a particular practice group
- No more stopping and rewinding
- Based on 8 bit micro-computer (CPP1)

Complete Kit — Morse Code Teacher® \$49⁹⁵
Complete Kit — Morse Code Teacher®
with board, wired and tested \$59⁹⁵

To order your **Morse Code Teacher®** send us your name, address, and check or money order to
Greenbrier Marketing International, Inc.,
509 So. 48th St., Suite 105, Tempe, AZ 85281

ATTENTION! Dealers and Club Directors.
Call toll free for quantity pricing information —
1-800-621-9740

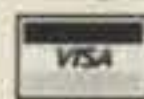

VISA® and MASTERCARD® orders accepted.

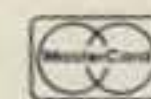

GREENBRIER

Greenbrier Marketing International, Inc.

509 So. 48th St., Suite 105, Tempe, AZ 85281
Telex 6835022 GMITP—602/966-0511

See List of Advertisers on page 114

Running Scared at Spratly

Only steel nerves and luck stood between the 1979 DXpedition and disaster.

Ed. Note: In late April, a yacht carrying four German hams on a DXpedition to the Spratly Island area was fired on by Vietnamese forces. Deithelm Mueller DJ4EI and Gero Band DJ3NG perished following that attack, which occurred about 350 miles south of Vietnam in an area claimed by both Vietnam and China. The rest of the party was later rescued by a freighter.

The following is from the log of the sailing yacht *Banyandah*, South China Sea, Saturday, March 31, 1979.

0600:

Dawn is breaking on this, our third day at sea since departing Brunei, North Borneo. On the far western horizon, an expanding band of

changing pastels is rising. The sea and sky are becoming distinct.

The sky brightens further, highlighting the pearl-grey clouds with crowns of liquid gold, and a charge of excitement runs through all on board. Silhouetted against this display of nature's beauty, my six passengers are

scanning the horizon for the first hint of our mysterious destination. Their chatter sounds like a flock of birds greeting a new and lovely day.

Ahead, somewhere, lies Amboyna Cay of the Spratly Islands. According to the pilot book, we should find only a 50-yard circle of sand surrounded by a bit of fringing reef. But recent hostile

military activity in this area may have changed all of that.

0700:

According to my calculations, we should be very close. I shall climb to the masthead lookout for a look around.

0715:

A tiny irregularity breaks the otherwise barren horizon, and pointing to it I yell



Map of the South China Sea area, with the Spratly Islands circled.

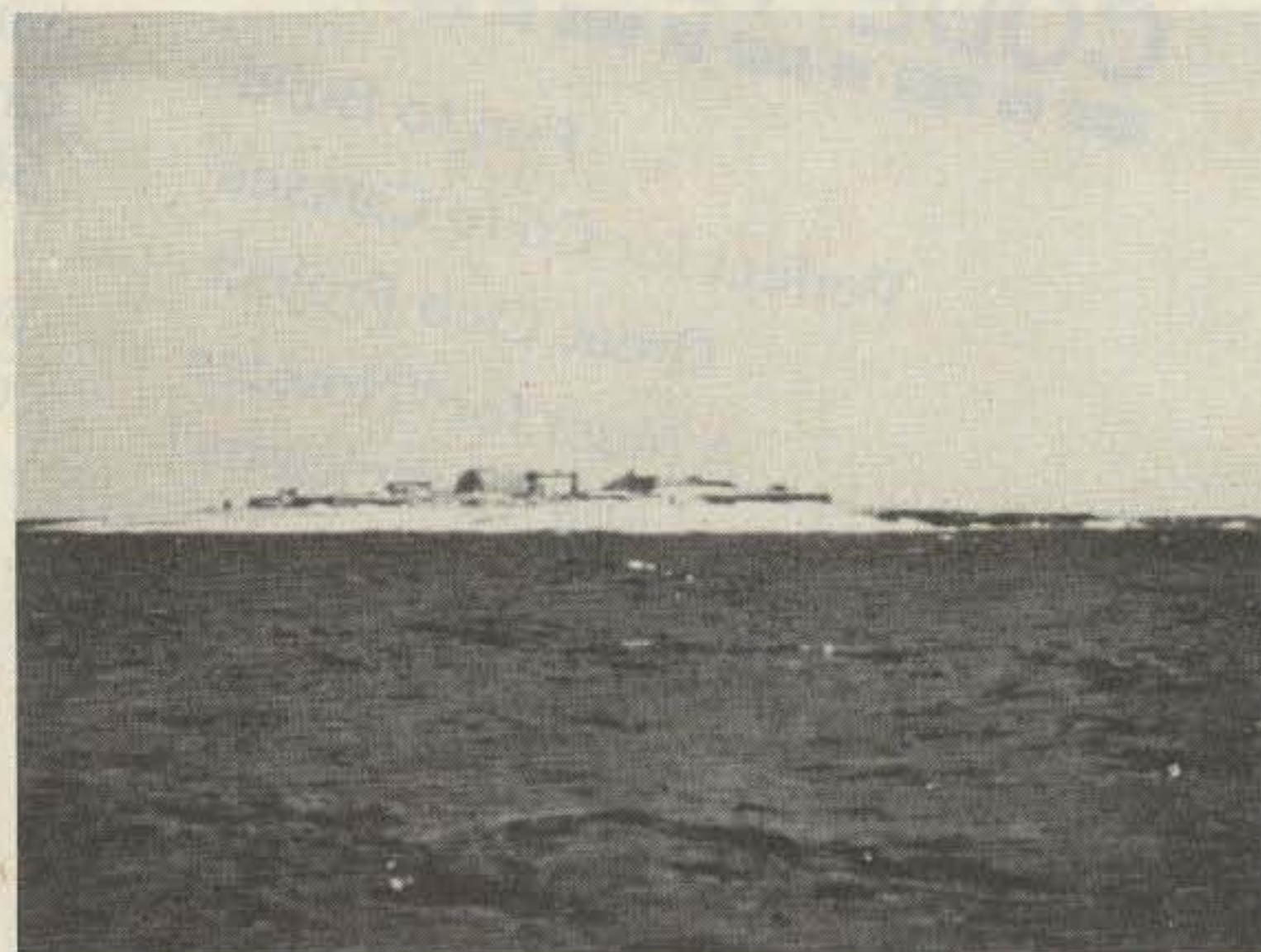

Amboyna Cay, showing the military camp.



Victory! Wharftside Brunei, after 151DX



The sailing yacht Banyandah.

down, "Land, ho!" A cheer rises up from the deck, and happy, excited faces turn to follow the direction of my outstretched arm.

Since nothing can be seen from deck level, a barrage of questions assaults me as I climb down the 50-foot mast. "How big is it?" "Is it sand?" "Any trees?" "Did you see any buildings?"

"Hold on, you guys. It was just a tiny blip. In a half-hour it will pop up out of the ocean as if by magic."

0745: Through binoculars, a crescent of yellowish sand is just visible, rising out of the sea as we ride up the swell, disappearing as we slide down. Everybody wants a look through the glasses, but Harry Mead VK2BJL, the team leader, gets the first chance.

"Jack, is that a rock I see on the right-hand side?" We rise up on a large swell and I see what could be a rock, a wreck, or almost anything. It's just too small to make out.

0800: It's not a rock or a wreck. It now looks like a huge tent—like a circus tent, only tan in color. Other objects, possi-

bly structures, are situated about it. I'm beginning to get worried. Who could be on our island? The guys are getting edgy also; Stew K4SMX keeps talking about a letter he has which explains that we are a scientific expedition studying radio propagation. He keeps saying that the letter is written in both Russian and Vietnamese. That sounds as if he knows something I do not.

0810: People are visible on the island. Three distinct groups are equally distributed around that tiny mound of sand, with a smaller group at the top. The "top" is only eight feet above sea level.

0815: The smaller, centralized group has begun signaling us with semaphore flags. Everyone turns to me, and John KV4KV asks the obvious: "What are they saying?"

"Look, I haven't a clue. But I think I'll anchor the boat just offshore and row in for a friendly chat. After all, we don't even know who they are. Besides, they can only tell us to go away, right?"

My wife doesn't look so sure, but the rest of the group nod or mumble comments like, "We've come

this far; we ought to give it a go."

After everyone agrees, Stew beams his gracious southern hospitality smile and says, "I'll even go in with you."

Trouble

0915: We're running scared, powering away from Amboyna Cay just as fast as our eighty-horsepower engine will push us. And we're searching the horizon in every direction for any intruder, deathly frightened that we might sight one.

What happened back there was insane. I mean, we're just ordinary folk—peaceful family men—out on an adventure. We meant them no harm, and there was definitely no reason for them to try to kill us.

I guess things really began to happen once we came within a mile of the island. From that distance, we could see that the cay

was about half the size of a football field and that at the center were several buildings of clapboard and corrugated iron, as well as two radio towers. We also could see that the perimeter was reinforced with a wall of sandbags and that on this wall was a sign which read in large white letters, "BAOTHEP."

I began my final approach with one operator at the radio, scanning the bands, listening for a possible contact with the island. The other operators were on deck, clustered close together by the center cockpit. Judith was at the controls, and I was at the bow, searching for a clear patch in which to anchor.

I remember that it had become deathly quiet—I heard only the distant sounds of a light wind upon the sea and the sound of my heart beating in my ears as it pumped adrenaline through my body. Then, as I

reached out for the anchor-release mechanism, an abrupt order rang out, and groups of green-clad men began to scatter.

Explosions cut the air—boom... boom... boom. The physical impact of the concussions slammed into my body, and I was involuntarily flung to the deck, my mind already beginning to record every intimate detail of those hour-long seconds.

I saw four puffs of grey-white smoke hanging in mid-air above the cay. I heard a shrill whistle and felt heat on my cheek. I saw the five operators throw themselves headlong into the cockpit, heedless of any injury. As I looked along the deck, I saw the two drums of gasoline nakedly lashed to the rail. For an instant, my mind's eye imagined a huge blossoming orange-red ball of death erupting from them. Then I screamed, "Move it! Move it! Full power!"

Getting myself up on all fours, I saw Judith at the helm, kicking bodies away from the controls. And then, with her eyes sunk deep in their sockets and her teeth exposed in a grin of animal fear, I watched her slam the boat into gear and push the throttle to full power.

For what seemed like hours, we waited, rigid and unmoving, our every nerve straining, searching for the slightest warning of a new attack. But none came. We were lucky.

Success At Last

1S1DX, Spratly Islands 1979, is now history. Directly after the attack, we returned to Brunei. Three expedition members thought it too dangerous to continue; secretly, so did I. But Harry, Stew, and Bill K1MM wanted to try again. A new island was chosen, one which US government officials assured us was "safe." That assurance reinstated

my confidence, and I accepted the charter. Later, those assurances proved nothing more than hog-wash.

We docked at Maura port in the early morning hours of the 3rd. We reprovisioned that day and departed that night. Two and a half days later, on a morning very similar to the one at Amboyna, we made landfall. Immediately, two unmarked ships closed in on us from opposite directions. One steamed directly across our bow, only 200 yards off. It appeared to be a phantom ship—no flag, no markings, and no crew visible. When it had passed, we altered our course, put on the power, and prayed.

Again, we were lucky. But all of us thought we had just about used up our quota of luck. We were tired and fed up with feeling scared all the time. We decided to head for home.

I set a course for a reef which was charted as completely submerged, but which was near our rhumb line and worth investigating. We arrived the next morning, a glassy smooth day with absolutely no swell or wind.

As we circled the reef, I watched from the masthead, shaking my head in disbelief as we rounded the weather end. Our luck was still holding, for right on the edge a cluster of coral rocks had been dashed up by some long-ago storm and a baby sand island was forming. It was no larger than my deck area, but it was above water at all tides.

This tiny scrap of sand, surrounded by miles of open ocean and hostile forces, became 1S1DX, the last active amateur radio station in the Spratly Islands. ■

MICROWAVE TV ANTENNA SYSTEMS

Freq. 2.1 to 2.6 GHz • 34 db Gain +



TWO YEAR WARRANTY
PARTS & LABOR

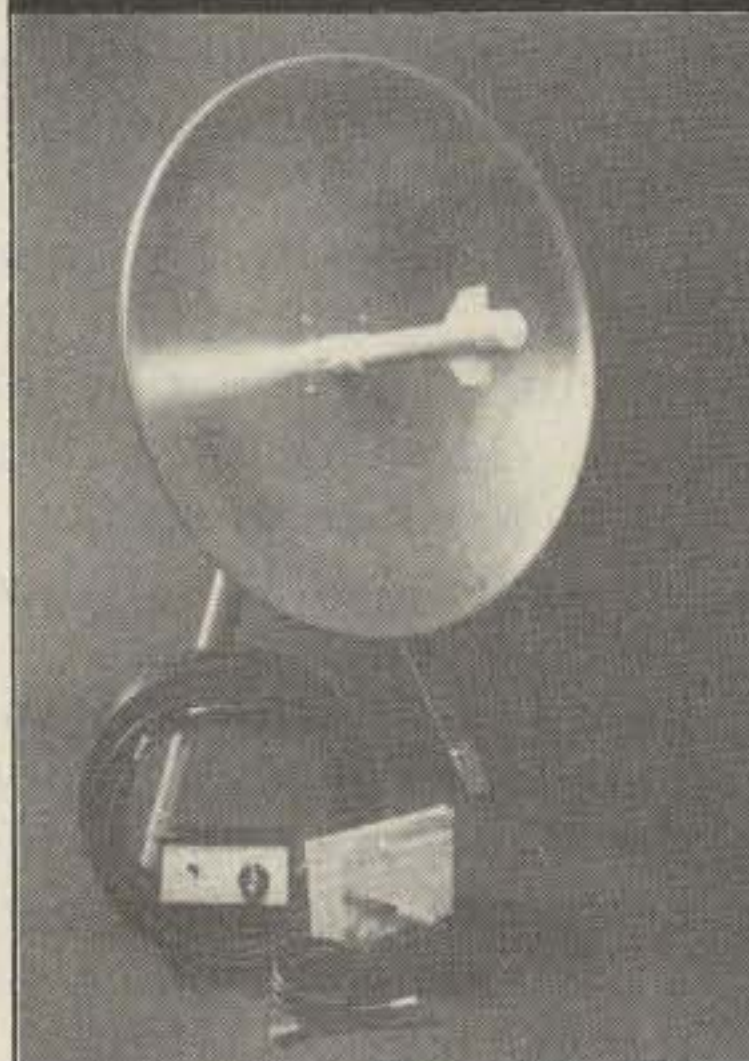

COMPLETE SYSTEMS

(as Pictured)

Commercial 40"

Rod Style \$ 89.95

Parabolic 20"

Dish Style \$ 79.95

COMPONENTS

Down Converters

(both types) \$ 34.95

Power Supplies

(12V to 16V) \$ 24.95

Data Info (Plans) \$ 9.95

CALL OR WRITE FOR
KITS, PARTS, INDIVIDUAL
COMPONENTS

We Repair All Types Down
Converters & Power Supplies

**Phillips-Tech
Electronics**

P.O. Box 34772 ✓246
Phoenix, AZ 85067
(602) 265-8255

Special Quantity Pricing
Dealers Wanted

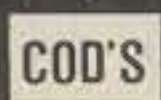

KCS

ELECTRONICS CORPORATION

SEMICONDUCTOR PARTS & PRODUCTS

FACTORY PRIME DEVICES INCLUDE:

- Capacitors
all types & styles
- Chokes & Coils
- Connectors
- Digital & Linear IC's
- Hardware & Accessories
- IC Sockets
- Memory
- Microwave Semiconductors
- Resistors
fixed & variable
- Transformers
- Transistors & MORE!

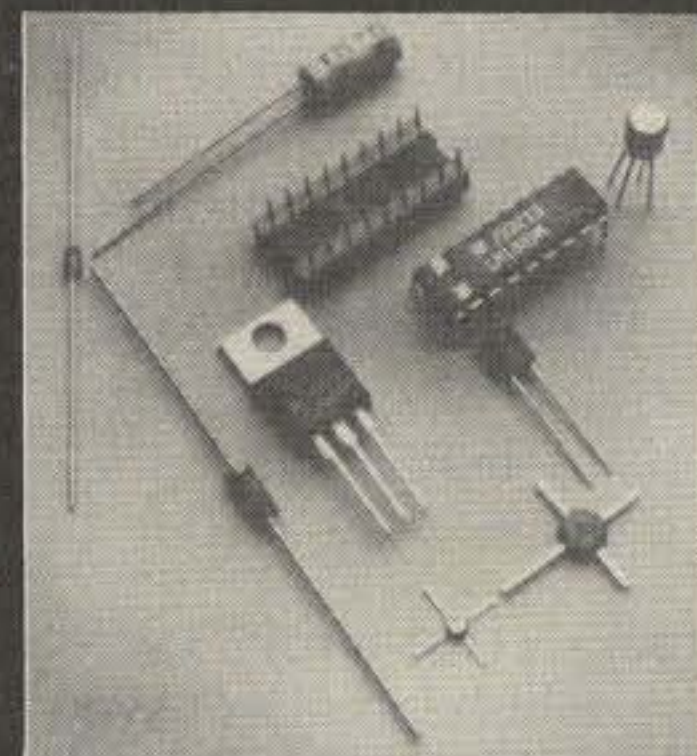

MANUFACTURERS SUCH AS: Motorola, National, NEC,
J.W. Miller, Texas Instruments and more!

WE STOCK & SUPPLY DEVICES FOR: OEM's,
Distributors, Hobbyists, Magazine Projects, Engineers,
Schools, Technicians & You!

Call or Write for Quantity Pricing
and FREE Catalog.

P.O. Box 33205
Phoenix, AZ 85067 **(602) 274-2885**

✓230

LSI comes to AMATEUR RADIO

Digital Microsystems™ Chips Now Available

REPEATER CONTROL

- Complete repeater control incorporating ID, tail and timeout timers, audio generator, local control and PL enable • Perfect as main controller or as backup for your present system • Master enable input for non-override local control • Switchable PL input for access security • ID on start-up can be selected • Non volatile ID memory • Selectable timeout length • Automatically powers up and runs; ideal for remote applications • Selectable ID transmission rate • Adjustable tail timer length • Force ID input for manual trigger of ID sequence • Latched COR for ID holdoff and timing control • Two separate Morse outputs for interfacing to audio and/or logic. One is direct audio, the other can be used as a keying line • Crystal controlled timers • Any number of selectable messages can be transmitted using MCMG chip • Test input for automatic transmission of CW test message following ID

Digital Microsystems™ SCRC Chip \$89.95

DTMF DIGITAL CONTROL

- Provides digital input and output capability under the control of a DTMF decoder • Perfect for repeater, remote base, and other homebrew control applications • 21 separate i/o pins which can be set high or low by a four digit custom sequence. Each bit may be checked by entering a digit code. The chip will respond with a Morse code 1 or 0 depending upon the logic state • Direct interface with the Mostek 5102 DTMF decoder chip • Anti-jamming mode automatically activates to prevent tampering • Five second timer for proper control sequencing and grouping • May be purchased in two different versions — version "A" for 12 digit decoding, "B" for 16 digit decoding • Each chip is different — the codes for each chip are randomly selected by computer, but custom codes are available at extra cost

Digital Microsystems™ DCC Chip \$34.95

LOOK AT WHAT ONE CHIP CAN DO!

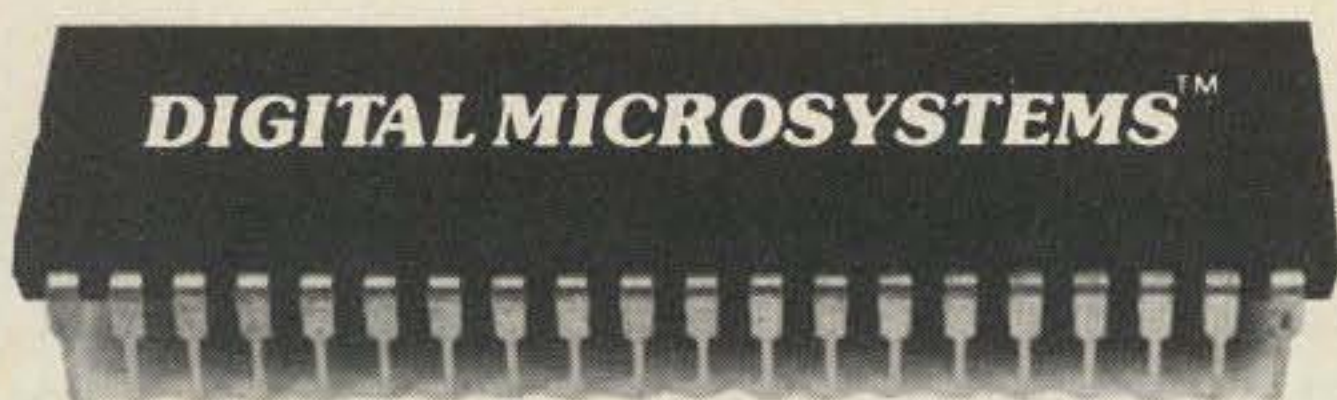

ASCII to MORSE CODE CONVERTER

- Turns any ASCII terminal or computer into a Morse code keyboard • When used with a computer, reduces system overhead and allows system time for disk access • When used with Morse to ASCII chip, any ASCII terminal or computer is transformed into a Morse code system • 1 to 90 words per minute transmission rate keyboard selectable. 1-30 wpm in 1 wpm increments, 32-90 wpm in 2 wpm increments • Master enable output for compatibility with Morse to ASCII converter chip • Two separate Morse outputs for easy interface to your transmitter; one high one low • Logically perfect Morse code generation • 110 and 300 baud • Automatic line feed insertion selectable by user • Selectable automatic echo back of ASCII characters • Internal 32 byte type-ahead buffer • Supports Modem control type handshaking with UARTS • Compatible with personal computer RTTY software packages • **PARALLEL ASCII TO MORSE CODE CONVERTER** • Similar to SATOM chip but for parallel strobed ASCII keyboards • 16 letter buffer for ID • Automatic test and CQ message generation

Digital Microsystems™ SATOM Chip \$34.95
Digital Microsystems™ PATOM Chip \$24.95

MORSE CODE to ASCII CONVERTER

- Advanced adaptive algorithm converts most hand sent and machine sent Morse code to ASCII • 110 and 300 baud • Automatic line feed insertion selectable by user • Automatic carriage return insertion selectable by user • Selectable number of characters per line before insertion of carriage return or line feed (if selected) • Master enable input for compatibility with ASCII to Morse converter chip (SATOM) • Two separate ASCII outputs for easy interface to RS232 or RS422 drivers • Designed to work with any ASCII compatible terminal or computer • Internal inverter may be selected to invert incoming Morse waveform before decoding

Digital Microsystems™ MTOA Chip \$39.95

MORSE CODE MESSAGE GENERATOR

- Up to 6 separate user definable messages • Completely non-volatile memory • Will not forget your messages when power is shut off • Supports manual, continuous automatic, and timed automatic modes • User selectable transmission rate • Individual messages, or groups of messages may be transmitted • Can be wired as a beacon controller, automatically repeating any selected messages • Can be wired as a repeater/remote base ID controller: a. Automatic repeat of any selected message(s) at selectable intervals; b. Latched COR input for trigger of ID mode; c. ID holdoff mode selectable for repeater ID mode • Two separate Morse outputs available — direct audio or digital logic • Two message in-progress signals available — one high, the other low • Crystal controlled 1, 5, 6, 7, 8, 9, and 10 minute timers, useful for repeater ID mode • Perfect companion to your RTTY, ATV, or SSTV station

Digital Microsystems™ MCMG Chip \$49.95

GENERAL SPECIFICATIONS

- All circuitry contained on a single chip • Crystal controlled for accuracy • Requires 5 volts DC • TTL/CMOS compatible I/O pins • Chips designed with the experimenter/homebrew specialist in mind • Manual for each chip available for \$5 postpaid • Deductible with order

ORDERING INFORMATION

- All prices include shipping. Massachusetts residents please add 5% sales tax. Check or Money Order for payment. Prices and specifications subject to change without notice or obligation.

ACCESSORIES CRYSTALS

one required per chip \$5.00 ea.

DIGITAL MICROSYSTEMS, Inc.
607 SUDBURY STREET
MARLBORO, MA 01752

✓17

The COR of a Reliable Repeater

Carrier-operated relays are the most-used circuits in any repeater. Use this simple design to get maintenance-free operation.

Frank Kalmus WA7SPR
RF Power Labs, Inc.
21820—87th S.E.
Maltby Industrial Village
Woodinville WA 98072

There are a great number of repeaters on the air at the present time, and nearly all of them require the use of a reliable Carrier Operated Relay (COR).

The COR is the gadget that switches on the repeat-

er transmitter when the receiver detects an incoming signal. It is automatic and uses a relay to switch around some of the circuitry in your repeater, making possible remote control of the repeater without station operator attendance.

An average repeater will trigger about 25,000 to 100,000 times per year. This requires a COR with very reliable components to ensure

continuous operation over many years. This particular relay, COR-1, is very simple in construction and throughout its design uses quality parts readily available at reasonable prices.

The COR-1 is constructed on a standard plug-in PC card. Messing around with ICs and timers on top of a remote mountain can be a frustrating experience, and it was to make replacement

easy (should it ever be necessary) that I designed the COR-1 on a plug-in card, as well as the matching access-code and tone-decoder boards. The following circuit has been on the air in my 220-MHz repeater for over five years now and has never given me any problems.

Description

The COR is a control module designed for repeater use. In the presence of a carrier, the repeater receiver will activate the COR causing the relay to energize and triggering a 3-minute timer. After this time has elapsed, if the received carrier has been continuously present, the COR circuit will open the relay and the repeater will "time out" until the signal breaks for at least 200 ms. A delay that can be set from .1 to 4 seconds will hold the relay in operation whenever the carrier shuts down ("squellch-tail timer").

The ID input does the following: (a) switches the relay on when activated, (b) allows for normal COR input

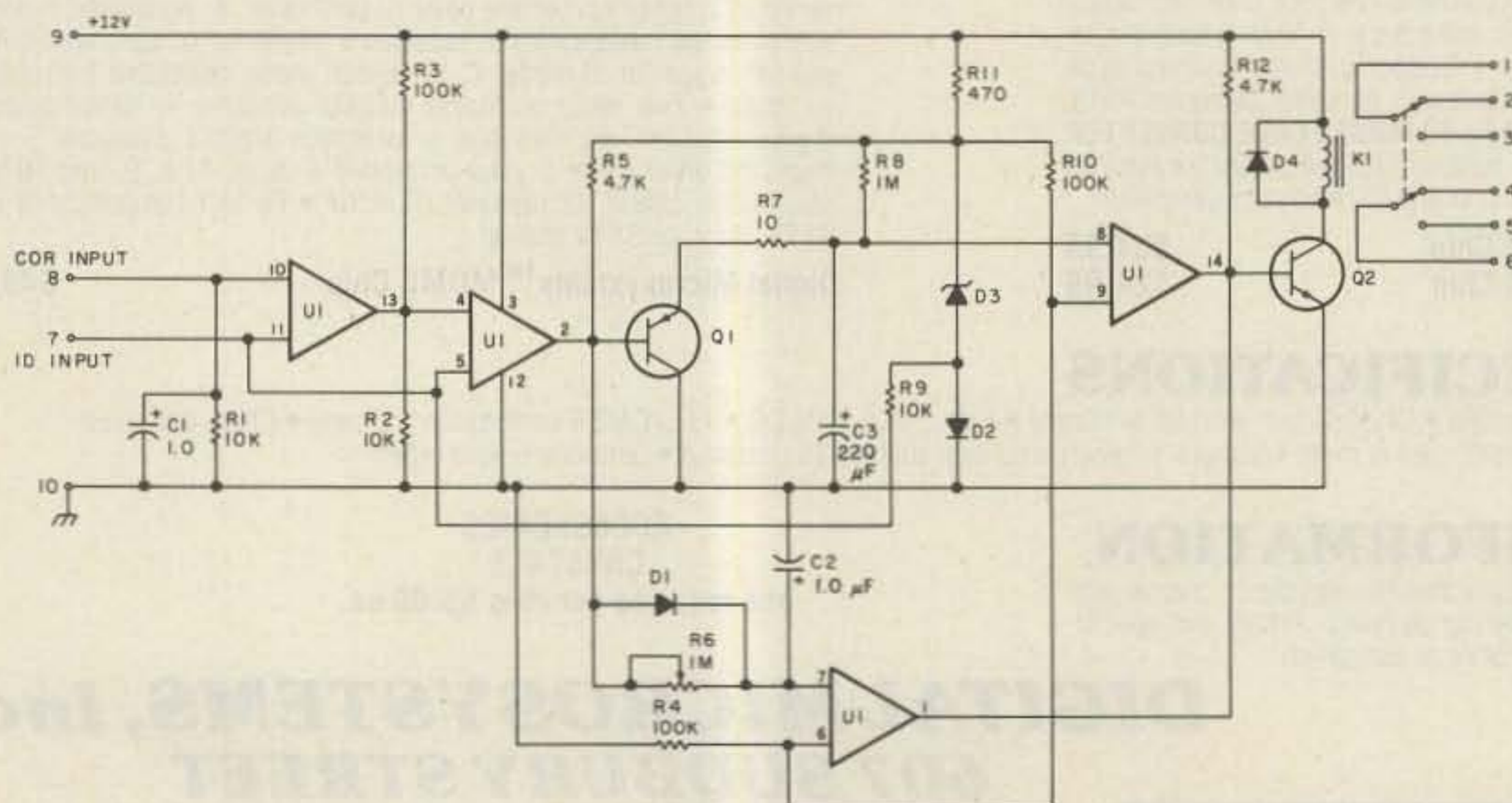

Fig. 1. Schematic of the COR-1.

operation when opened, and (c) disables the circuit when shorted to ground.

Theory of Operation

With the ID input open, a positive voltage greater than .8 volts applied to the COR input will change the status of the comparator's outputs 2 and 13. Transistor Q1 opens and C3 starts charging through R8 for the 3-minute timing. Comparator output pin 1 will drive Q2 and the relay. Each time the COR input goes below .6 volts Q1 will turn on, discharging C3 and resetting the 3-minute timer; also, C2 will discharge through R6, holding the relay in operation.

The ID input has been designed to be driven by any voltage above 1.2 volts, and when in the standby position should be left open. An internal bias circuit (D2, R3) fixes the potential at pins 5 and 11 close to .75 volts. An open collector PNP transistor is the appropriate way to attack the ID input. Any logic or analog input will do if an isolating diode is inserted in series (cathode to ID input). If shorted to ground, the ID input will disable the circuit.

For proper circuit operation, the inputs should not be driven above the power supply level; they can withstand up to 30 volts without any damage. Negative voltages at the inputs must be avoided if greater than 300 mV below ground level.

R1 and C1 are assigned to establish the input impedance and filter squelch pulses coming from the repeater. Their values can be adapted to other requirements. The circuit will operate from 9 to 16 volts.

Testing

Apply 12 volts to the COR. With all inputs open the output relay will be off. Using a jumper, put 12 volts in the COR input. The relay will operate immediately. By taking the 12 volts out,

the relay will hold for a few moments before it goes off (set this time by rotating R6).

To check the main timer, hold a 10k-Ohm resistor in parallel with R8 while activating the COR input with 12 volts. After a few seconds the relay will kick off. That means the timing circuit is operating normally.

Ground the ID input with a jumper. The relay will not operate whatever the COR input condition is. Remove the ground and apply 12 volts to the ID input. The relay will operate and the circuit will perform just as with the COR input.

I am sure that with one possible exception, the relay, you can find most parts for this project in your junk box. It should take only a few minutes to put the COR together once you

have the PC board finished. A direct-contact PC print of the 1:1 positive takes only a few minutes to make. Good luck!

If you have any problems with the construction or

parts availability, you can buy the entire COR-1 board, fully tested and assembled, from me for \$23.00 postpaid. Please address me at 7016 NE 138th, Kirkland WA 98033. ■

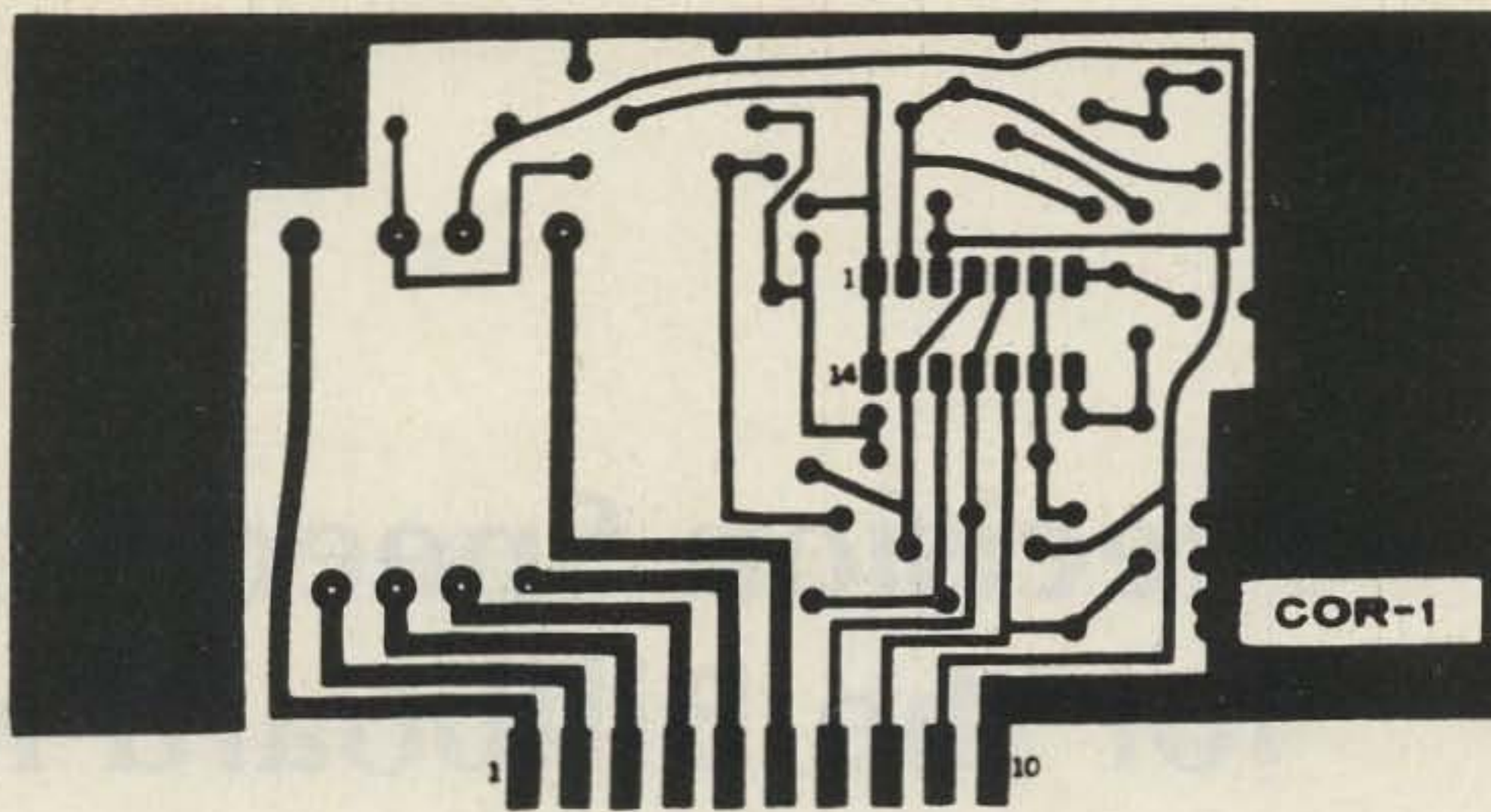

Fig. 2. PC board.

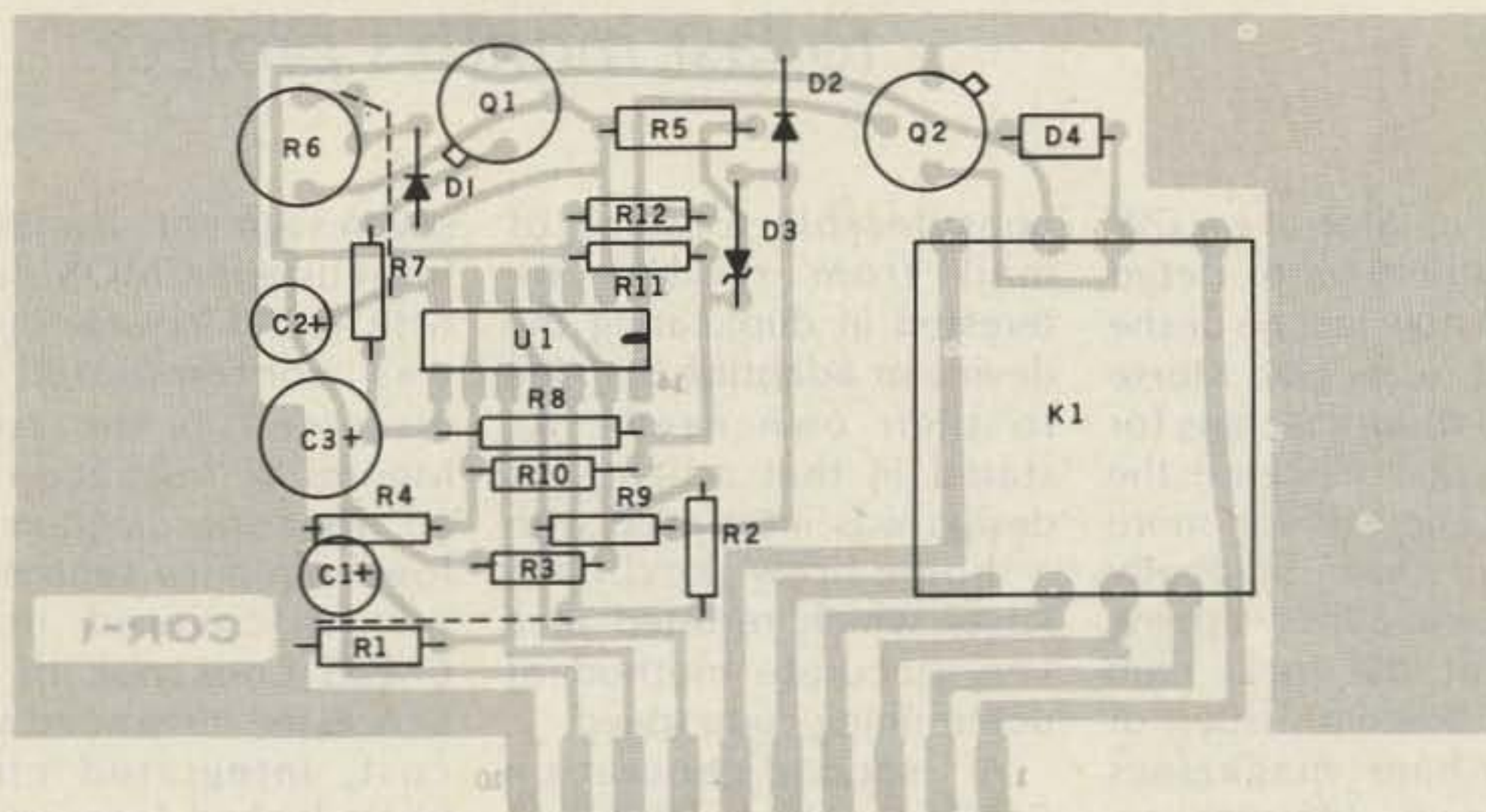

Fig. 3. Parts placement.

Parts List

R7	Resistor, 1/4 W, 5% carbon, 10 Ohms
R11	Resistor, 1/4 W, 5% carbon, 470 Ohms
R5, R12	Resistor, 1/4 W, 5% carbon, 4.7k Ohms
R1, R9, R2	Resistor, 1/4 W, 5% carbon, 10k Ohms
R4, R10, R3	Resistor, 1/4 W, 5% carbon, 100k Ohms
R8	Resistor, 1/4 W, 5% carbon, 1 megohm
R6	Potentiometer, 1 megohm
C1, C2	Capacitor, electrolytic, 1 uF, 35 V
C3	Capacitor, electrolytic, 220 uF, 16 V
D1, D2	Diode, switching (1N914)
D3	Diode, zener, 5.1 V, 400 mW, 5%
D4	Diode, rectifier, 1 Amp, 100 V (1N4002)
Q1	Transistor, 2N2905A or 2N4402
Q2	Transistor, 2N2270 or 2N4400
U1	Integrated circuit (LM339N)
K1	Relay, 12 V (NC2D-JP-DC12V)
	Printed circuit board

Precision Speed Control for the Billboard Keyer

Get more for your money by adding this circuit to last month's project.

Sooner or later, every CW operator tries to determine just how fast he or she can send or receive Morse code. For those reaching for a higher class of license, the need to know is far more significant than somebody trying to win a lie-swapping contest at the local club meeting. Recent issues of various ham magazines have shown different approaches to solving the problem in a state-of-the-art manner.^{1,2,3} My contribution in this direction (reference 1) generated a

considerable amount of mail from readers interested in duplicating the device or adapting the idea to their own needs. As stated in that article, the design was interfaced with a home-brew keyboard keyer which resulted in a very accurate method of determining code speed.

A second-generation CMOS keyboard keyer I designed⁴ did not lend itself well to an LED readout circuit due to the heavy current demands of TTL integrated circuits and the

seven-segment displays. A low-current CMOS design with liquid crystal display was contemplated but discarded as too costly. Months of frustration ended when the diagram of a low-frequency synthesizer was discovered in the *CMOS Cookbook* by Don Lancaster. It featured a low-cost, integrated circuit phase-locked loop and appeared promising. A prototype was quickly constructed and proved to be ideal in this application.

That which follows is a

description of the basic theory, construction, and operation of such a synthesizer and its application to my latest keyboard keyer.

What's Involved

Code speed in an electronic keyboard keyer such as the "Billboard" can be determined from the following formula: clock speed (Hz) × 2.4 = speed (wpm). Solving for a code speed of one wpm gives us the figure of 0.41666 Hz. This frequency is the basis for all frequencies generated in the synthesized clock.

The actual theory of phase-locked loops and frequency synthesizers using these devices is well beyond the scope of this article. Numerous papers on the subject have been published and the reader is encouraged to consult one of these if he or she feels the need for additional background. An excellent source of information on a very basic level is, again, the *CMOS Cookbook*. In fact, the majority of the circuitry presented here came directly from that book.

The function of the PLL circuitry in the synthesized clock is to multiply the reference frequency by any number between one and

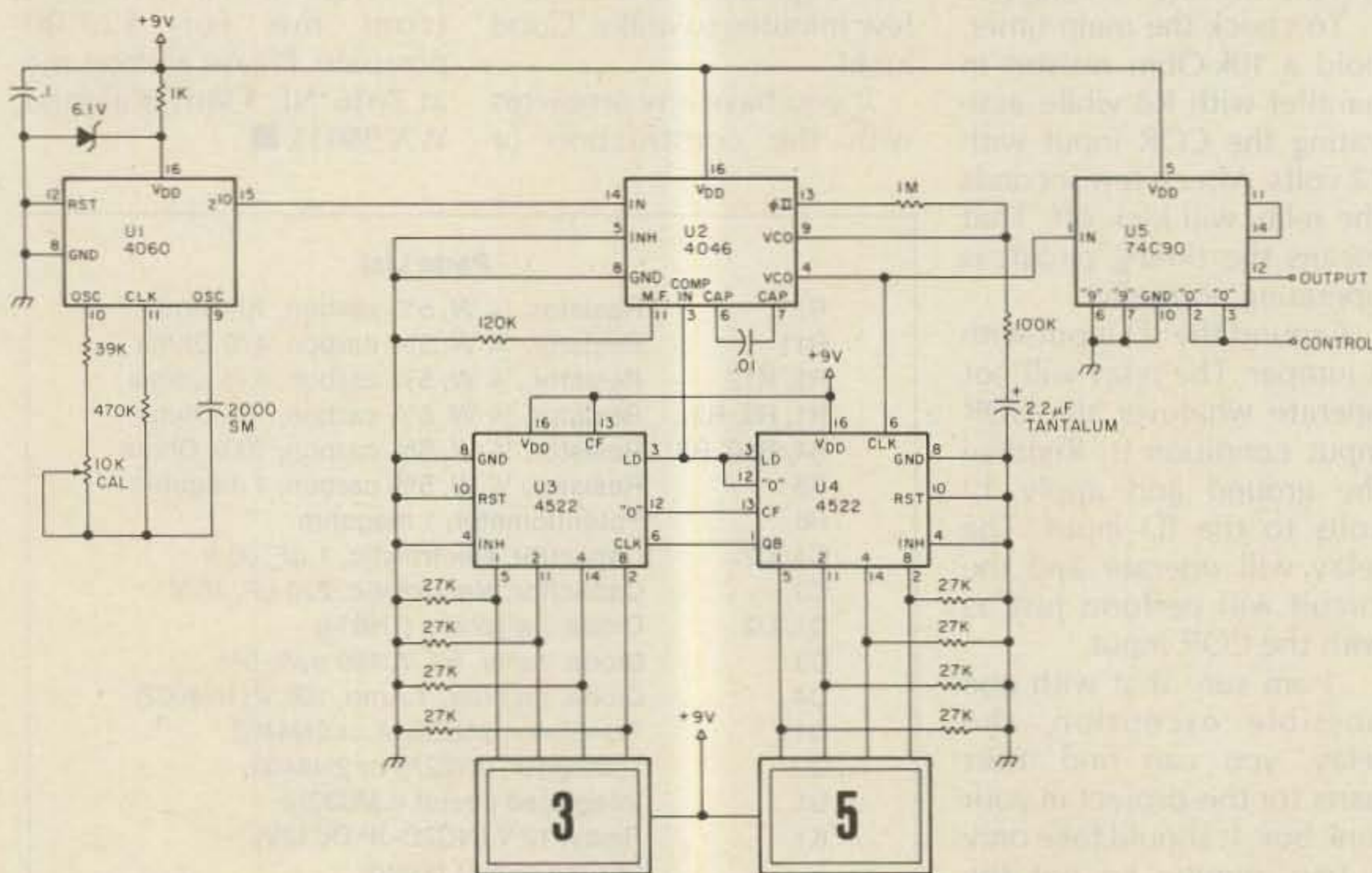

Fig. 1. Schematic diagram of the synthesized clock for the Billboard keyboard keyer.

ninty-nine as dialed up by the thumbwheel switches. The end result is the proper frequency necessary to generate any code speed from one to ninty-nine wpm.

A brief look at the schematic clearly indicates the simplicity of the circuit. Integrated circuit U1 is a unique and very versatile chip. It consists of a fourteen-stage binary ripple counter in addition to a pair of uncommitted gates. This IC and its associated components form the timebase which generates the reference frequency. The resistors and silver mica capacitor connected to pins 9, 10, and 11 along with the two previously mentioned gates form a digital relaxation oscillator. The 10k-Ohm potentiometer is a miniature ten-turn device and is used to adjust the oscillator frequency to exactly 4,266.6 Hz. The oscillator frequency is fed internally to the counter stages of U1 and is available at pin fifteen divided by 1,024. The resultant frequency is a 4.1666 Hz square wave which is fed to the input of the phase-locked loop chip, U2. Sharp-eyed readers will note that the decimal point has been moved one place to the right, thus corresponding to a clock speed necessary to produce code at ten words per minute. This is the actual timebase used, but a later stage will divide the output by ten for reasons which will be explained shortly.

A 6.1-volt zener diode and 1,000-Ohm resistor provide the necessary voltage regulation for the timebase oscillator to ensure both long- and short-term frequency stability. Likewise, a silver mica capacitor is specified in the timing circuit.

Integrated circuits U2, U3, and U4 perform the function of multiplying the reference frequency by the

numbers indicated on the thumbwheel switches. Thus, if these switches are set to 35 as shown on the schematic, the output frequency from the voltage controlled oscillator (pin 4 of U2) will be $4.1666 \text{ Hz} \times 35 = 145.831 \text{ Hz}$. Referring back to the formula for determining code speed, we find that $145.831 \times 2.4 = 350 \text{ wpm}$. A little fast for most of us, perhaps, but remember, we are going to divide this by ten shortly, which gets us back to 35 wpm.

If all this seems a bit confusing, the reader is invited to plug in the numbers which correspond to other code speeds to gain familiarity with the arithmetic involved. Work the formulas backwards a time or two and everything will fall into place.

This brings us to integrated circuit U5, a CMOS version of the ever-popular 7490 decade counter. The chip actually consists of a divide-by-five and a divide-by-two counter which, when cascaded, gives us the desired divide-by-ten function. It may appear unusual that the reference frequency was purposely chosen to be ten times the desired output and then divided later. It all comes clear, however, when one considers the needs of the actual keyer.

The original clock circuit in the Billboard is keyed. That is, it is only running during character generation. This is typical of most keyers and keyboards. For reasons beyond the scope of this paper, the synthesized clock must run continuously. It would, of course, be a simple matter to gate the output of the synthesizer on and off, but this would lead to intolerable and unpredictable time delays between a key-pressed command and actual character generation. By presetting U5 to zero (bringing pins two and three

high) and holding it there, the output (pin twelve) is inhibited even though a string of clock pulses is present at the input. However, when the zero-reset line is brought low, the output is no longer inhibited and a string of perfectly symmetrical square waves at one-tenth the input frequency is presented to the keyboard circuitry. The delay between a key-pressed command and character generation is now insignificant, even at low speeds. At speeds in excess of ten words per minute, it is virtually identical to the keyed clock.

Only two connections need be made to the actual keyboard circuitry itself. Pin twelve of the 74C90 is connected in place of pin four (Q2A on the keyboard schematic) and pins two and three, the control lines, are connected to pin eight of Q3A, the CD4013 dual-D flip-flop.

Power for the synthesizer is taken from the same supply used to activate the keyboard. Current drain is in the vicinity of one to two milliamperes.

Construction

Once again, perfboard and point-to-point wiring were used to construct the unit. Miniature flea clips provide a convenient means of neatly terminating the wires which go off the board.

After the circuit was operating properly and calibrated, I coated both sides of the board with clear acrylic spray to prevent movement of the wires and provide a degree of protection from dirt and moisture. The synthesizer board was mounted with aluminum spacers and 6-32 hardware.

Calibration

Setting the timebase oscillator to precisely 4,266.6 Hz is most easily accomplished with the aid of a frequency counter. Initial-

ly, I attempted to measure the oscillator frequency directly at pin nine of U1. I found that the introduction of the frequency counter and probe to this sensitive part of the circuit caused the frequency to be pulled considerably. Instead, the thumbwheel switches were set to ninety-six wpm and the ten-turn calibration potentiometer was adjusted to show a frequency of exactly 400 Hz at pin one of the 74C90. If the builder does not have access to a counter, some other method of adjustment will have to be devised. Perhaps comparison of the synthesized signal to an accurately calibrated audio oscillator could do the job.

The long-term stability of the timebase and resultant accuracy of the synthesizer is nothing short of amazing. A calibration check was made six months after the initial adjustment and no change was necessary. Frequent on-the-air comparisons with others using sophisticated, microprocessor-controlled keyboards with programmable speed controls confirm the accuracy of this system.

Considering the minimal investment in both parts and labor involved, there is no longer a valid reason to have to guess at your code speed. Although no specific information is available, this design should be easily adaptable to other keyboards and regular keyers. I would be interested in hearing from others who have built this device and will respond to those who include an SASE. ■

References

1. Jones, "A Digital Speed Readout For The Electronic Keyer," *QST*, July, 1978.
2. Wageman, "Accu-Keyer Speed Readout," *Ham Radio*, September, 1979.
3. Batie, "QRQ, QRS—By The Numbers," 73, June, 1980.
4. Jones, "The Billboard Keyboard Keyer," 73, July, 1983.

The Interface

Software Available for Six Computers

The versatility of the personal computer gives you a whole new world with the Kantronics Interface™ and Hamsoft™ or Hamtext™. The Interface™ connects to any of six popular computers with Hamsoft™ or Hamtext™ giving you the ability to send and receive CW/RTTY/ASCII. An active filter and ten segment LED bargraph make tuning fast and easy. All programs, except Apple, are on program boards that plug directly into the computer.

Hamtext™, our new program, is available for the VIC-20 and Commodore 64, with all the features of Hamsoft™ plus the ability to save received information to disc or tape, variable buffer sizes, VIC printer compatibility, and much more. Our combination of hardware and software gives you the system you want, with computer versatility, at a reasonable price.

Hamsoft™ Features

Split Screen Display
1026 Character Type Ahead Buffer
10 Message Ports-255 Characters each
Status Display
CW-ID from Keyboard
Centronics Type Printer Compatibility
CW send/receive 5-99 WPM
RTTY send/receive 60, 67, 75, 100 WPM
ASCII send/receive 110, 300 Baud

Hamsoft™ Prices

Apple Diskette	\$29.00
Atari Board	\$49.95
VIC-20 Board	\$49.95
TRS-80C Board	\$59.95
TI-99 Board	\$99.95

Hamtext™ Prices

VIC-20 Board	\$99.95
Commodore 64 Board	\$99.95

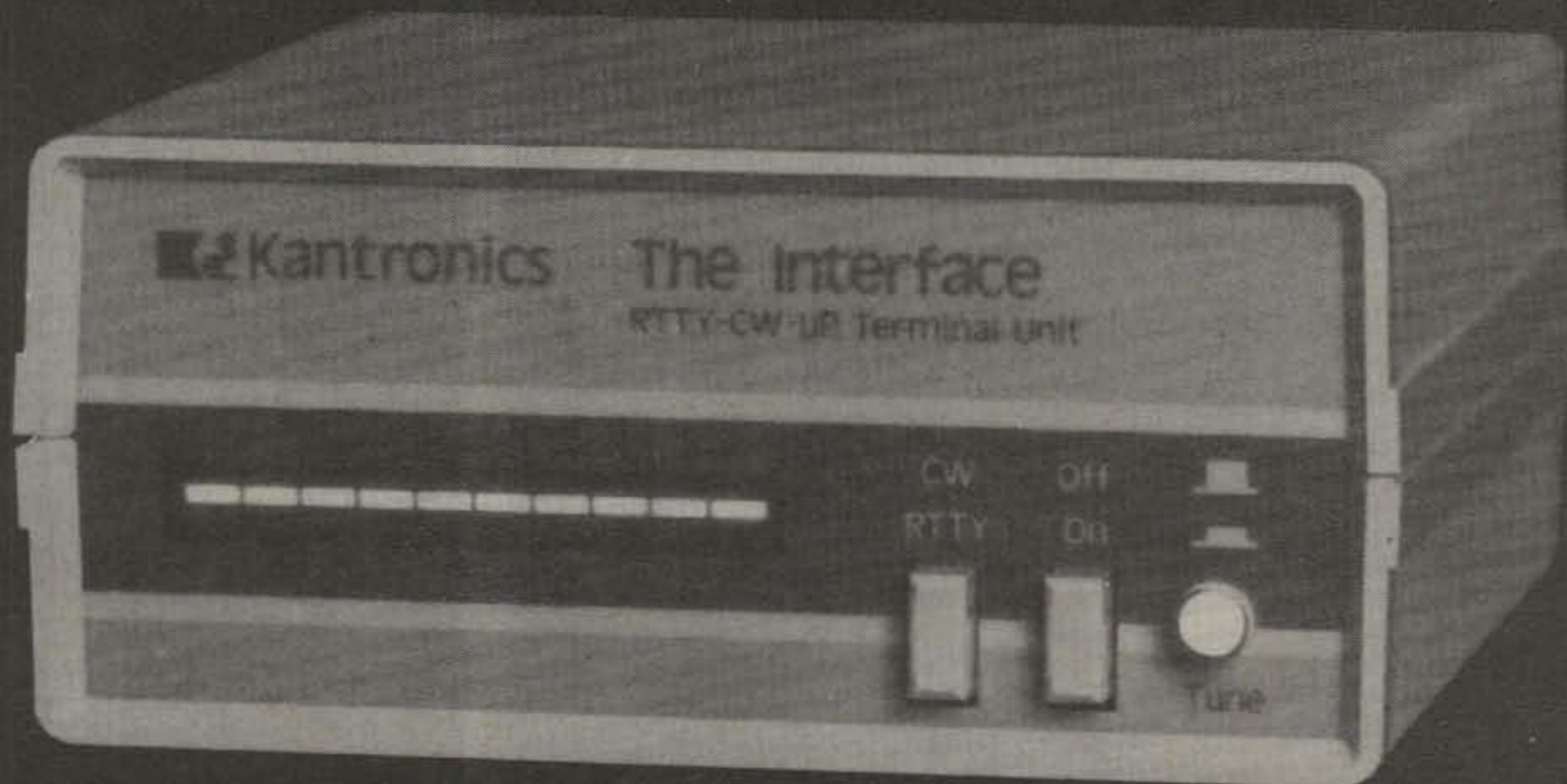

Suggested Retail \$169.95

For more information contact your local Kantronics Dealer or:
Kantronics 1202 E. 23rd Street Lawrence, KS 66044

Proven Success

Our best salesmen don't even work for Kantronics

Dear Sirs:

I am writing first of all to say how much I enjoy my Kantronics Interface and the software that I bought for my VIC-20 micro-computer. For a very reasonable price I have had a whole new world of amateur radio--not to mention some commercial transmissions I have been able to copy--opened to me.

P.S.
Am #tickled pink"with this setup and having a ball. Thanks for a nice product !

Dear Phil:

I recently purchased a VIC 20 computer and your companies "Interface" and software for RTTY and CW and I must say it does a magnificent job. I have worked over twenty countries on RTTY on 15 and 20 meters in one month. The copy on CW is unbelievably excellent.. adding a new dimension to amateur radio for me. "you done good,"as we say here in Tennessee.

I must tell you, I have the equipment in operation and it works super good! I think it is an outstanding piece of electronics.

Your directions f
TW state the

Gentlemen:

It's nice to find someone like you that responds to user suggestions - keep up the good work.

The Interface is available with software for six popular computers. Hamsoft is our original program for the Apple II, II+, or IIe; Atari 400 or 800; Radio Shack Color Computer, VIC-20, or Texas Instruments TI-99/4A. Hamtext, our advanced program, works with the Apple II, II+, or IIe; VIC-20, or Commodore 64.

The Interface and Hamsoft or Hamtext combination has put computerized communications at a reasonable price. Contact your local Kantronics dealer or write us for more information.

 **Kantronics**

(913) 842-7745
1202 E. 23rd Street
Lawrence, Kansas 66044

PC Boards for Penny-Pinchers

Get picture-perfect circuit boards without buying a darkroom.

Some years ago, I rediscovered a technique for making printed circuit boards which was prevalent in the fledgling years of the industry. Called silk-screen printing, it is a very acceptable method of transferring a resist pattern to a clad board, is very inexpensive initially, will be successful even for a beginner, and, once mastered, will find many applications in the ham shack.

Briefly, the technique involves the pressing of ink through an open-weave fabric which has had portions of the weave rendered impervious to ink. It's as simple as it sounds!

Getting Started

As with anything, there is a modest cash outlay. However, this is tempered by the fact that at least 50% of your initial cost is non-recuring.

Even the total cost, amortized over several projects, is much less than any other method.

Materials are readily available from local suppliers in almost any community and can be obtained in one Saturday morning.

From past experience, a 12" x 12" (inside opening) frame should be adequate to handle 90% of the boards you will want to make. We'll use that as a construction example. Of course, you can make larger frames by following these general instructions later.

Procuring the Materials

You may be able to find a lot of the materials for this project by scrounging around the house. Remember, nothing is very critical; your own wood, hinges, screws, and whatever prob-

ably will work. Assuming you find nothing at all, be prepared to spend about \$25.00. Your first stop should be a lumber yard. Here is what you'll need from this source:

- 5 feet of 1" x 1" clear pine trim lumber. Almost anything will work here; the 1" x 1" is nominal anyway.
- 1 piece of 1/2"-thick "good one side" exterior-grade plywood about 18" x 24".
- 4 #6 x 2" flathead wood screws.
- 4 small flat angles and screws.
- 2 small butt hinges, no wider than the pine trim lumber you bought.
- 1 small bottle of white glue.
- 1 small can of white shellac.
- 1 quart of benzene.
- 1 package of cheesecloth, preferably real cotton.

● 1 1/2" or 3/4" paint brush, throw-away type.

Now find any halfway good arts and crafts or artists' supply store. You'll need to purchase the following articles:

- 1/2 yard (about 18" x 36") of screen-printing silk. This is sufficient to make two 12" x 12" screens. The clerk may ask you what "mummy" silk you require. Explain that you'll be printing on metal. Ask for a fine or medium weave.
- 18" x 36" (a half sheet) of water-soluble printing film. You may have to buy a whole sheet—no problem if you store the balance carefully rolled in a cool dry place. Heat and moisture degrade the film in time.
- 1 squeegee, at least as long as the narrowest dimension of the pattern you wish to transfer. The author's squeegee is 7" long

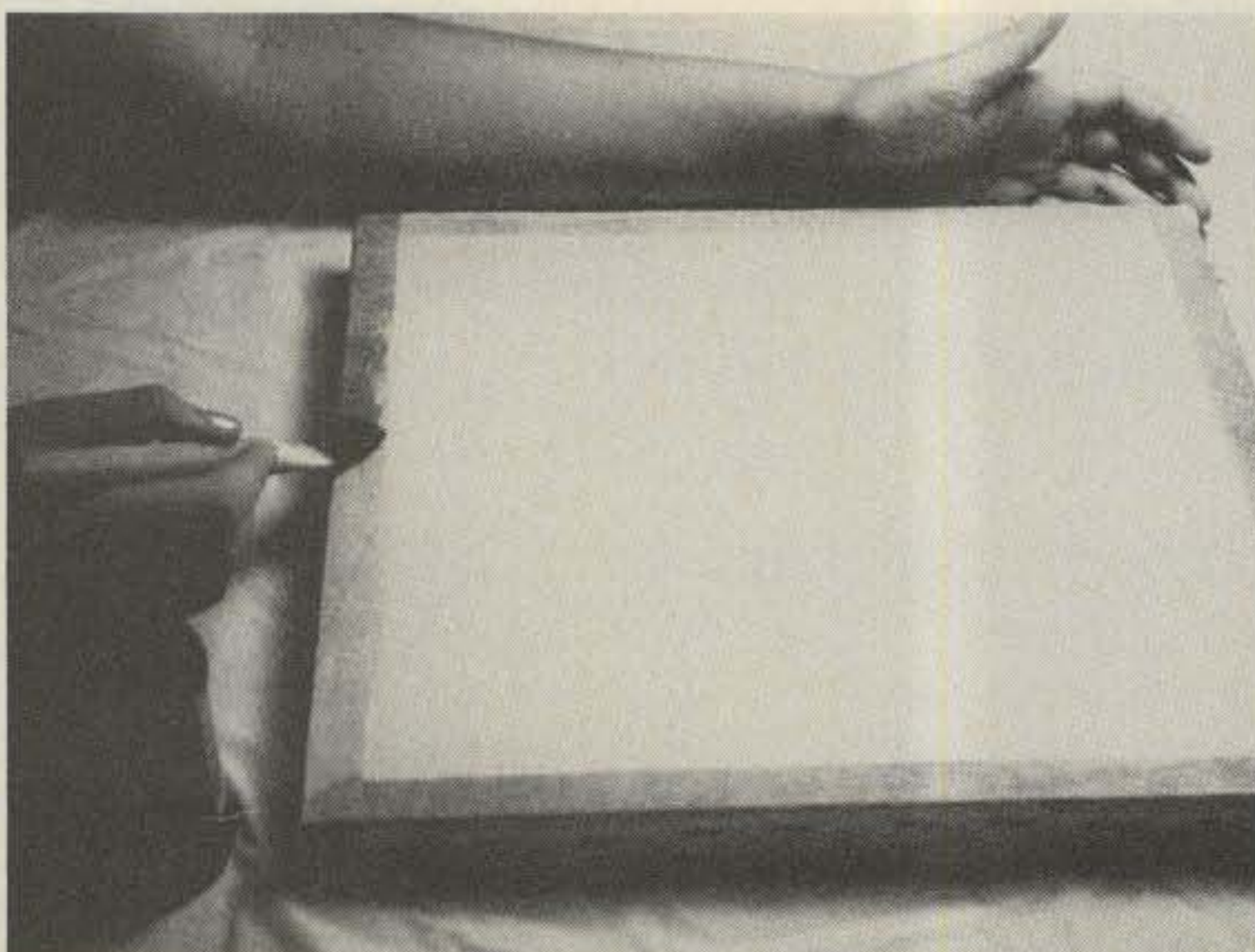

Photo A. Shellacking the screen to the frame.

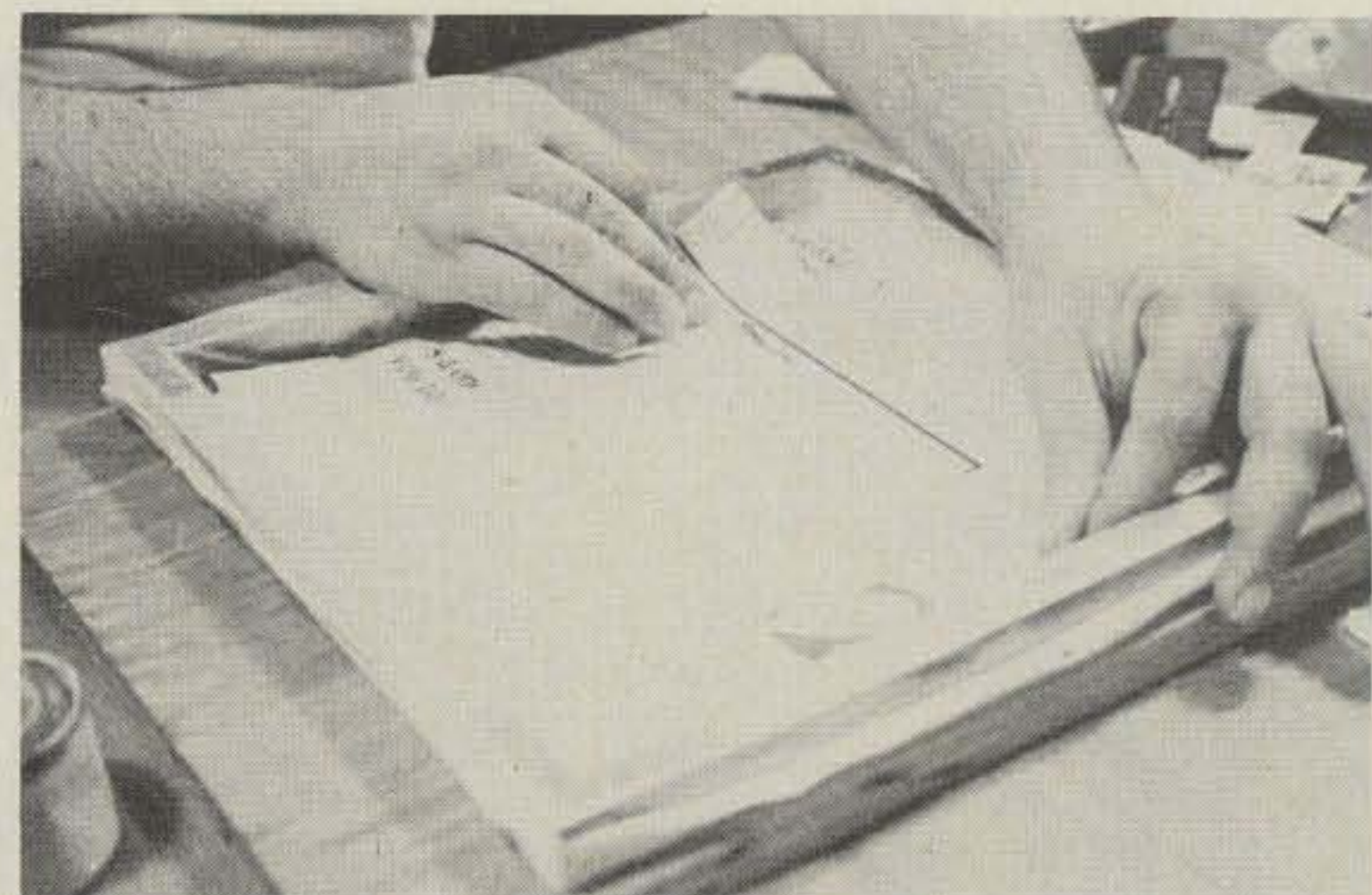

Photo B. Newspaper/tape technique to block out open screen areas.

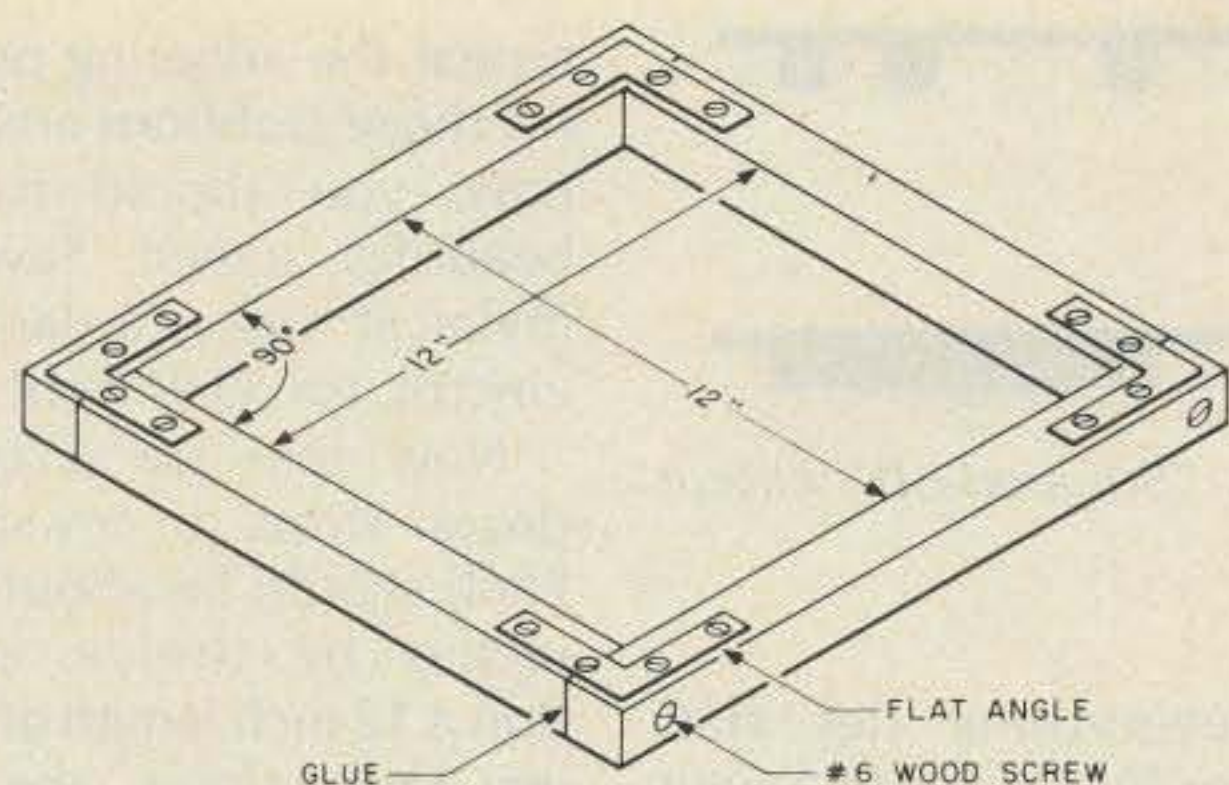

Fig. 1. Frame construction detail.

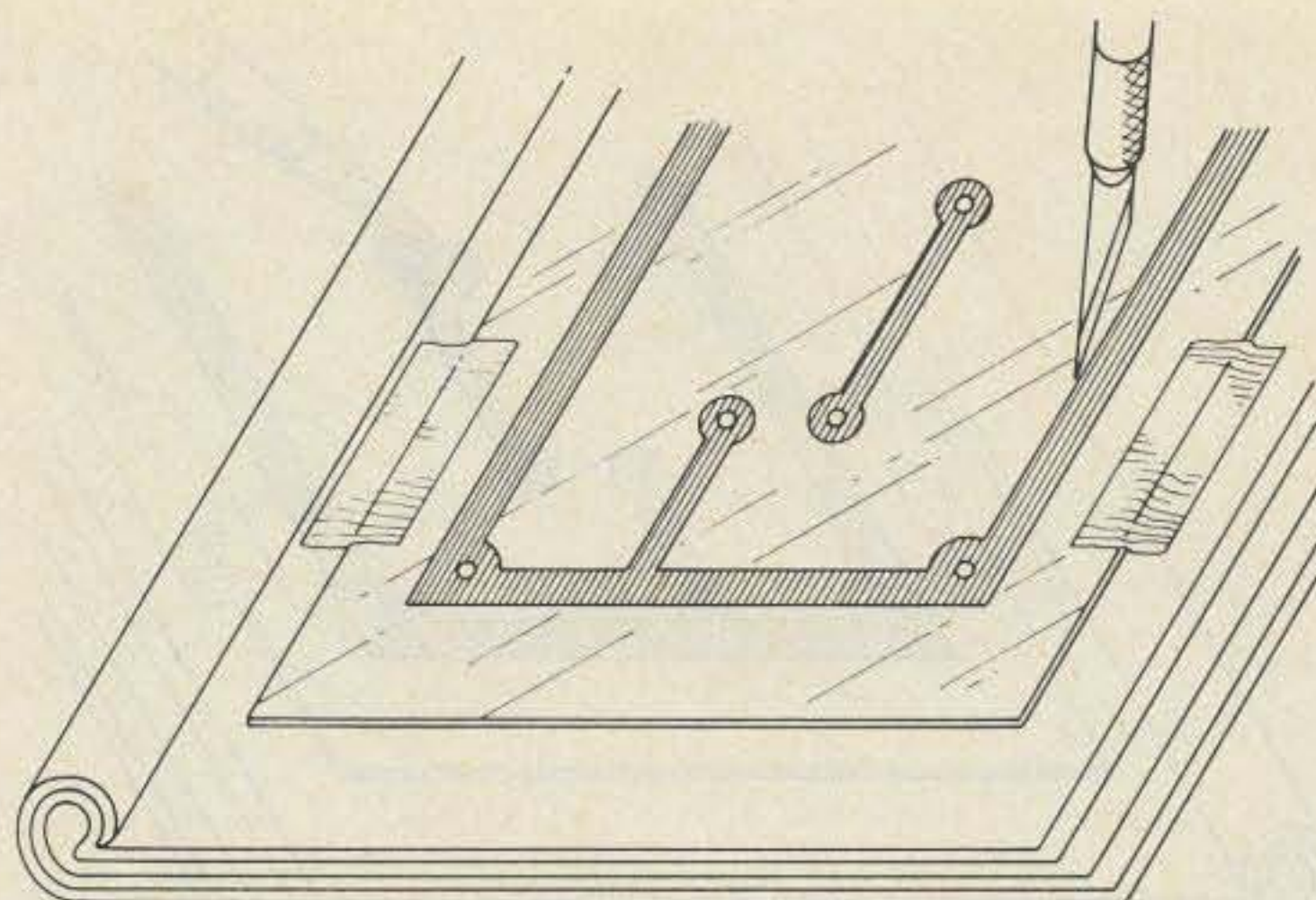

Fig. 2. Cutting out the circuit outline.

and suffices for 90% of the work done.

- 1 small can of screen-printing ink, any color that contrasts well with copper, suitable for printing on metal.

- 1 roll of 1"-wide drafting tape.

- 1 X-acto® knife and a package of #11 blades.

Make your last stop your neighborhood grocery. Purchase a bottle of *white* vinegar, a bottle of rubbing (isopropyl) alcohol, and a can of non-chlorinated scouring powder. You now own all the supplies you'll need to screen-print circuit patterns on copperclad.

Making the Frame

Sand the good surface and edges of the plywood to remove any slivers and give them a light coat of shellac. Clean your brush with a bit of the isopropyl alcohol.

Cut two pieces of wood 12" long, taking care to leave the ends as square as possible. If you have access to a miter box, it will simplify the task considerably. The squarer you build the frame, the more intricate the work you will be able to do with it.

Cut two pieces of wood 12" + twice the thickness of the wood you are using, again as square as possible.

Glue and screw the four pieces together as shown in Fig. 1. Pre-drilling the screw holes will help here. Try to make the joints as flush as possible. Wipe off excess glue with a damp sponge. Holding the frame square

(against a square, how else?), assemble the four corner angles to it.

You should now have a neat, square frame measuring 12" x 12" *inside*. Check the joints on the underside. They should be smooth. Any minor "step" should be sanded off. Shellac the frame with a thin even coat, and set aside to dry. Don't forget to clean the brush.

Preparing the Film

While you're waiting for the frame to dry, you can begin preparing the film from the artwork. Use drafting tape to secure your artwork to your work surface.

Cut a piece of film about 4" larger than the finished board size. Identify the emulsion side by gently scraping away at a tiny corner of the film with the X-acto knife. The green stuff that peels away is the emulsion. Tape the film, emulsion side up, over the artwork, centering it carefully.

Pay attention! This is the first area where you can seriously foul up and render your subsequent steps difficult and frustrating if not futile. You must now cut around the outline of the circuit pattern on the artwork (see Fig. 2). With the lightest touch possible, cut through the emulsion without creasing or badly scoring the mylar™ backing sheet. A little experimenting helps here. You'll soon develop a touch light enough to prevent scoring or creasing. Use a sharp blade and change often—usually at the first

signs of snagging. If you crease or score the backing sheet, the film will curl up like a potato chip and render the subsequent steps very difficult or impossible.

Slip your X-acto blade carefully between the emulsion and backing sheet and lift off that emulsion representing the copper you want to stay behind (see Fig. 3). If you haven't quite cut through the emulsion, go back, cut loose the stubborn section, and continue peeling.

A couple of hints at this juncture: Use a thickness of wax paper under your palm to keep from sticking to the emulsion and transferring skin oils which will make the next steps harder. Use drafting tools such as straight edges, French curves, and circle and shape templates to guide the knife blade. This results in very neat work and allows you to hold some pretty amazing dimensional tolerances.

Another point: Unless you're making 1296-MHz striplines which require ultimate precision and strict adherence to the architecture, you can "square off" circuit pads and such in order to make life easier for yourself (see Fig. 4).

When you complete your film cutting, you should have a "negative" of your desired pattern. Untape it and turn it over. Rub your fingers lightly over the backing. You shouldn't be able to

"read the pattern in braille." Don't score the backing sheet! Set the film aside between two sheets of wax paper and place it under a heavy book. This step is unnecessary if you are ready to adhere the film immediately.

Pick up the frame. It should be dry by now. A quick swipe with steel wool all over will smooth down the shellac and make the frame easier to clean later. Cut a piece of screen fabric four inches larger than the outside dimensions of the frame. Our design example requires a piece of fabric 18" x 18". See Fig. 5. Center the frame on the screen fabric. Fold a 1" hem on one edge as shown. Staple the hem against the side as shown. A stapler gun is nice for this. Keep your work neat. Repeat the same procedure on the *opposite* edge, pulling the fabric as taut as you can, anchoring the frame without damaging it.

Repeat the process on the other two edges, again pulling it taut on the last edge. You can do anything you want to tuck in the corners, as long as you don't turn them under the frame to create a lump on the screen side. The underside of the frame should be smooth.

If you're satisfied that the fabric is evenly and relatively taut on the bottom, you can now shrink the fabric. Gently, using running hot water, a generous sprinkling

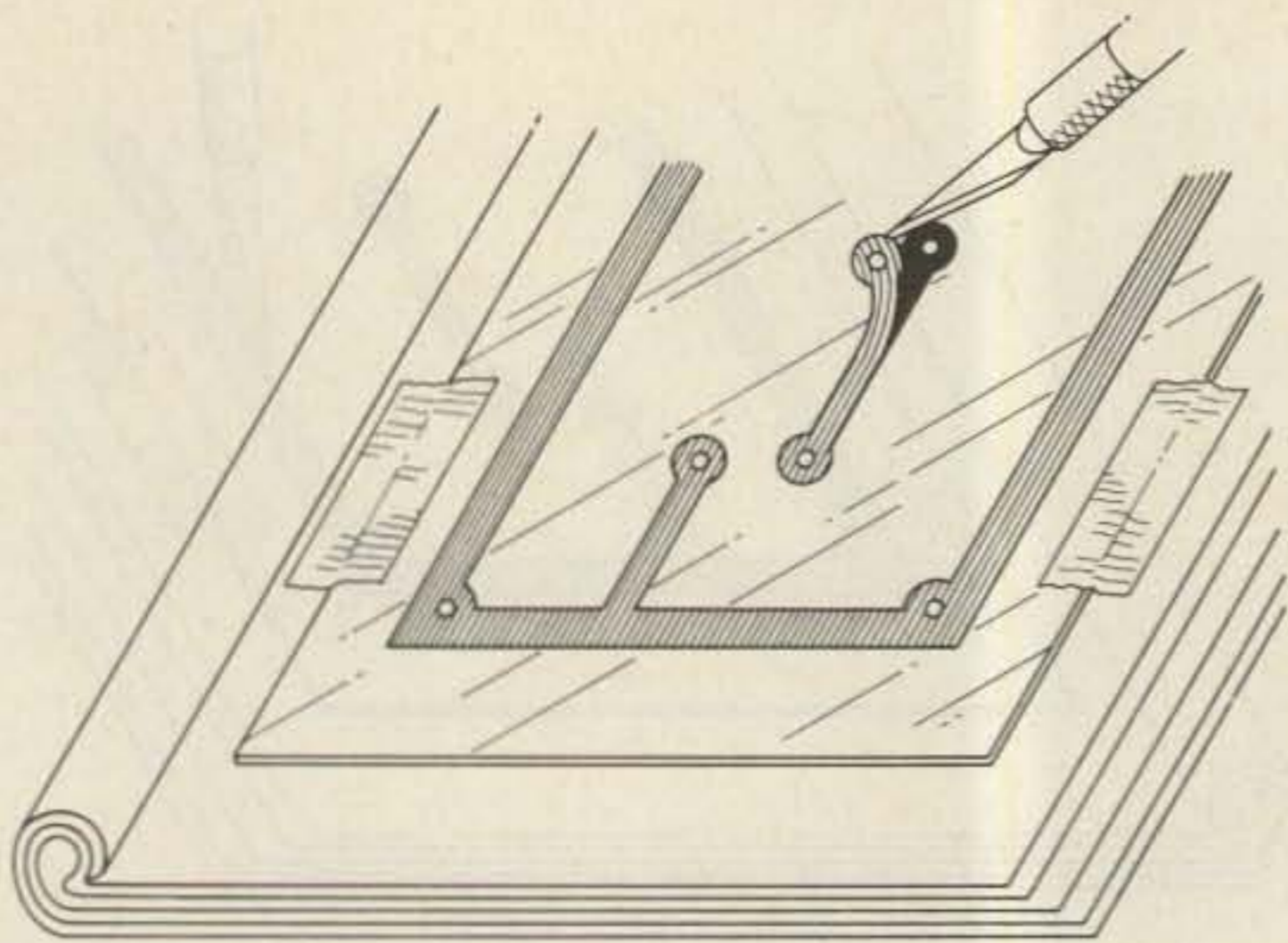

Fig. 3. Extracting the desired pattern.

of scouring powder, and your fingertips, scour the front and back of the fabric all over. Two or three scourings should do it. Rinse thoroughly with hot water. Inspect your work by holding it up to the light. Make sure that the weave is open and no areas are blocked by unremoved sizing or scouring powder. Once all traces of sizing and scouring powder have been removed, set the screen on edge to dry, turning it on a new edge frequently. Hot sunlight helps immensely to speed the process.

Meanwhile, procure four small pieces of copperclad board of the thickness you plan to use for your circuit board. Another hint: Cut your board with a pair of heavy tin shears, the kind sheet metal men call "bulldogs." It's much neater and easier than most home methods presently advocated.

Now examine your screen, making sure it's dry and quite taut. Thumping the screen with your finger should produce a satisfying "tunk" sound. As you can see, testing procedures are highly sophisticated. Once you are sure the screen and frame are absolutely dry, lay the screen bottom up on your bench. Carefully shellac the fabric which is in contact with the bottom of the frame (see Photo A). Do not shellac any other areas. Take extreme care not to

dribble any shellac onto the screen except where it touches the wood. If you dribble shellac onto any other part of the screen, you will ruin it.

Place the now dry sheet of plywood, shellacked side up, on your table. Give the surface a quick swipe with fine steel wool. Center the screen frame, screen side down, on your piece of plywood. Slip a piece of the copperclad you prepared under each corner of the frame. Clamp the frame to the plywood taking care not to distort it (see Fig. 6). Neatly screw the two hinges to one side of the frame and to the plywood as shown.

You've just built a homebrewer's tool that will last you several years and, once you've been exposed to it, you'll wonder how you ever home-brewed without it.

You're already now to adhere the film to the silk. This is the second most vulnerable area, so extreme care must be taken. Swing your frame open and remove the copperclad shims. Place newspaper (enough sheets to equal or just exceed the thickness of the circuit-board stock you plan to use) onto the platen (plywood sheet). Make sure the frame closes flat without forcing it. Place your prepared film, emulsion side up, on the newspaper stack, centering it in the frame opening. Close the frame, ensuring

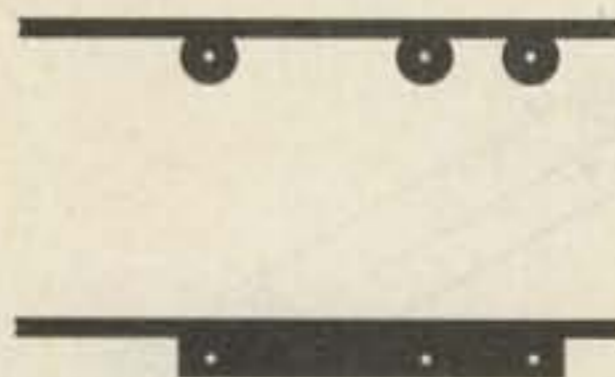

Fig. 4. "Squared-off" circuit pad.

that everything lies flat, more or less in contact with the silk. See why you weren't supposed to crease the film?

Make a mixture of two parts white vinegar and one part isopropyl alcohol. About a cupful will do the job. Make two four-inch square pads using several thicknesses of cheesecloth and open the frame. Soak one cheesecloth pad in the mixture and sponge the screen thoroughly in its raised position using the vinegar/alcohol mixture. Wring out all excess moisture from the cheesecloth pad and close the frame over the film. Briskly rub the screen over the film surface with the dampened cheesecloth pad until the film underneath is thoroughly damp. Immediately use the dry cloth pad to blot up the moisture over the film. Use some pressure here. Don't rub—blot. This forces the threads of the weave into the softened emulsion. Areas that don't seem to be cooperating can be adhered by carefully reapplying the damp cloth and dry cloth in sequence. Take care not to over-soften and drag emulsion into "open" areas. Err on the side of caution until you get the hang of it.

Assuming your adhering job passes muster (uniform screen showing through the weave in all areas contacting the emulsion), let it sit for a while to harden. Open your frame. Starting at one corner, the one you scratched away to identify the emulsion side, gently peel off the mylar backing, watching all the while for areas that didn't quite stick to the screen. Go back and

repeat the adhering process for those stubborn areas. By now, you should have a beautiful screen. Save the mylar; it makes a dandy dielectric for VHF work.

Now tear up a couple dozen strips of newspaper. Each should be about three inches by twelve inches. Run a 12-inch length of drafting tape along one long edge of a newspaper piece, overlapping the tape $\frac{1}{2}$ " over the paper. Starting $\frac{1}{2}$ " inside the film border, tape it down as shown in Photo B. Repeat for an adjacent edge. Continue around in a circle (square?).

When you have done four sides, continue around again, overlapping the tape over the previous tape strip until you have climbed up the inside of the frame and the entire inside of the frame is covered with what looks like solid tape. Why not use straight tape and forget the newspaper bit? You want as little as possible of the tape adhesive in contact with the screen. One, you want to prevent stressing the screen unduly when you remove the blackout when changing artwork; and two, you don't want to glob up any open screen with damn near insoluble hard-tape adhesive.

Whatever newspaper and tape is sticking up out of the frame you can trim flush with the top. Run a strip of tape around the inside of the frame and fold it over onto the top edge of the frame.

Cut a piece of circuit board as square as possible about a half inch larger than the finished board size you want. Run a file over the edges at a forty-five degree bevel to break off any sharp foil "zingers" that stick up. A barely perceptible piece of copper sticking up will slice up your screen or, worse yet, your thumb. Center the piece of copper under your screen image, leaving equal margins all around. Open the frame

TECHNOLOGICAL BREAKTHROUGH!



NEW

AMERICA'S SECOND GENERATION MICROWAVE RECEIVER

SATURN-15 XHP

JDL Leads Again

The **Saturn-15 XHP**, an engineering breakthrough from JDL laboratories, has new State-of-the-Art technology never before incorporated in amateur band general microwave receivers. This technology increases reception from distances never before achieved. By designing totally **new circuitry**, and using **new ultra-sensitive components**, coupled with a precision tuned 30 inch receiving dish, a system gain of 68 decibels makes the Saturn-15 XHP the leader in microwave receivers. In field tests, the Saturn-15 XHP received clear, crisp pictures, where other units tested were snowy. During these tests the Saturn-15 XHP's highly sensitive downconverter probe was able to receive a color picture without a dish. No other unit tested could pass this test.

Free Movies for You

That's right! **Free** movies, sports, and special events, 24 hours a day and all commercial free. The Saturn-15 XHP super deep fringe microwave receiver can be used by homeowners outside the service area of local **over-the-air** pay TV stations (ex. HBO, Showtime). Yes, if the local pay TV station installs microwave receivers on homeowners TV mast, you too can receive those unscrambled signals free by installing the Saturn-15 XHP on your TV mast in minutes. A signal can be received up to 100 miles, depending on the height and power of the local transmitter, and the installed height of the Saturn-15 XHP. If you have waited to own a microwave receiver, or own a low power unit, call and order your Saturn-15 XHP and own the most powerful receiver available today. Free TV—yours for a call. Note: General microwave receivers cannot be used for receiving scrambled signals. Nor can they pick up from cable TV or their relay towers.

A Total Unit

The Saturn-15 XHP comes complete with a 30 inch precision tuned receiving dish, advance design downconverter, power tuner, 60 feet

coaxial cable, necessary adapters, mounting hardware, and installation instructions. A six month parts and service warranty covers the Saturn-15 XHP.

Information for your Area

By calling our **information number** (916) 454-2190 and talking to one of our trained technicians, we can help determine if the Saturn-15 XHP will work for you.

A Very Special Introductory Offer!!!!

As JDL Industries has and continues to provide the very best in products and customer service, we want everyone to be able to enjoy our new system, Saturn-15 XHP. The regular price for the Saturn-15 XHP is \$285.00. Order C.O.D., pay only \$260.00 and save \$25.00. Trade in your old unit, from any manufacturer or home built, working or not, with your order, pay only \$235.00—save \$50.00. Or if you own our original Saturn-5 and wish to upgrade to the Saturn-15 XHP, return your unit and pay only \$210.00—a savings of \$75.00. We also accept Visa and Mastercharge at the regular price, \$285.00. Sorry—no personal checks. Shipping (\$9.50) and 6% sales tax for Calif. residents not included. Trade-in units become the property of JDL Industries and **cannot** be returned under any circumstances.

Call our toll free number for placing **orders only**. **Information is not available at this number.** 1-1-800-824-7927

U.P.S.—C.O.D./Volume prices on request — (916) 454-2190

Microwave Systems

JDL 
INDUSTRIES, INC.

4558 Auburn Blvd., Suite 208, Sacramento, CA 95841

Saturn-15 XHP must be returned within 14 days of delivery for refund if not satisfied, and is subject to a 25% restocking charge.

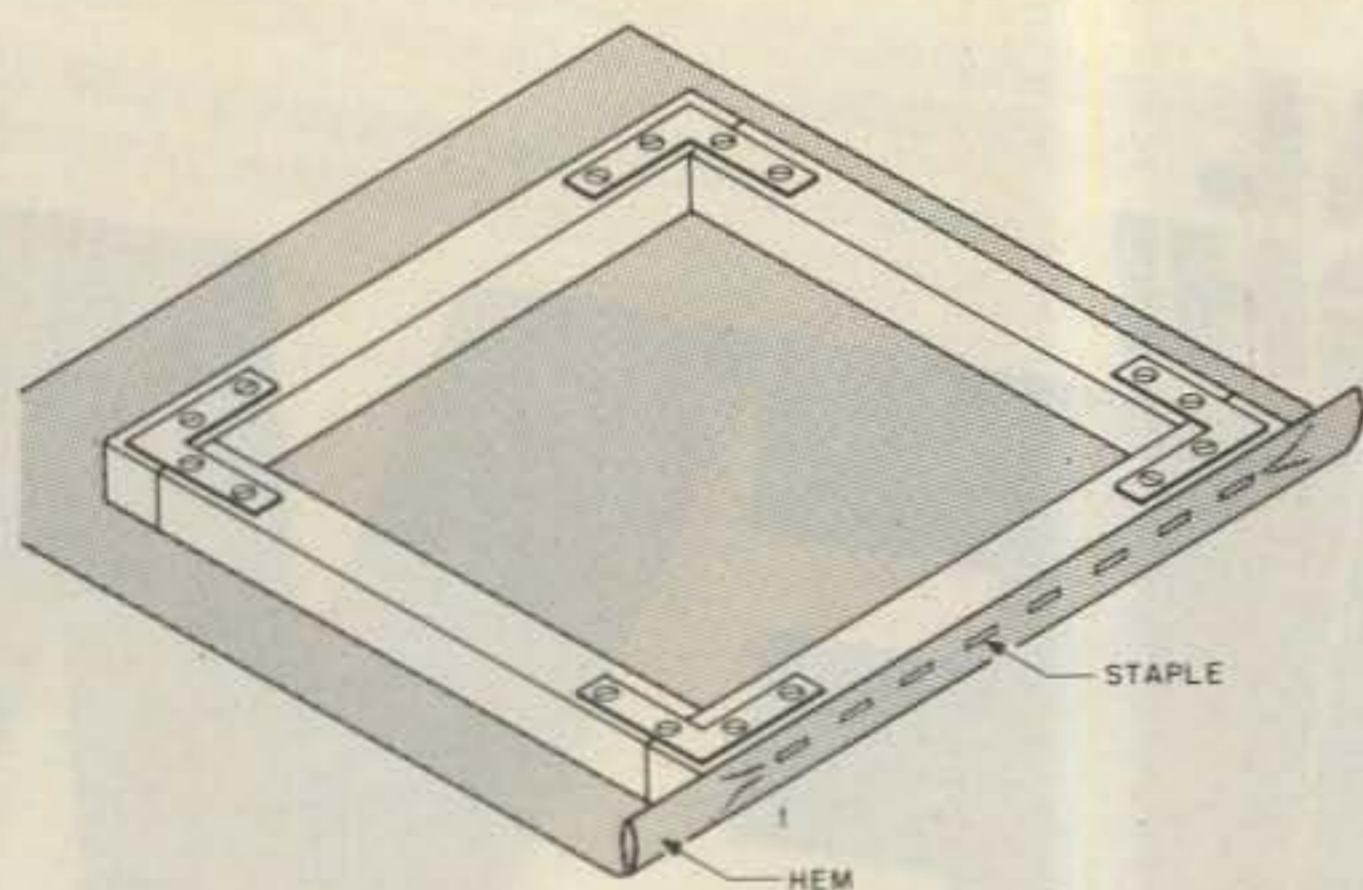

Fig. 5. Attaching the fabric to the outside edge of the frame.

without disturbing the copperclad. Take the four pieces of copperclad you used as spacers and securely tape one along each edge of the board to form a nest into which you can drop succeeding boards. Check to see that you didn't disturb anything and that your image still falls within the confines of the board. Remove the board and scour it shiny with the cleanser. Rinse in hot water and let it dry.

Open your ink can. The ink should be about the consistency of canned pudding. Stir it well with a tongue depressor or dull butter knife. Place the dry board in the nest. Close the frame over the board. Place about a 3/8" to 1/2" bead of ink on the screen along a short edge of the board about a half inch away from the border. Pick up your squeegee and with one slow, deliberate, firm stroke, drag the ink across the artwork past the opposite border. Put down the squeegee, open the frame, and gaze down on your perfect, ready-to-etch board. Carefully set your masterpiece aside to dry. Then make a few more boards, sell them to your friends, and charge plenty. Recoup your investment.

Thoroughly clean your screen and tools with benzene immediately after use. Use this stuff outside if you can; it's highly flammable. Make sure every trace of ink is removed from the clear areas of the screen if you plan to reuse it for this or

any other project. Hold the screen up to the light; any blocked areas will show up soon enough. Etch your boards according to the etchant manufacturer's instructions. Clean the ink off the board with benzene or steel wool after you are done etching.

Want to print a different pattern? Simply peel off the newspaper blocking and dissolve away the old film with hot running water. Scour as before, adhere your new film, and repeat all other pertinent parts of the process. Several boards on the same screen? Why not? Simply block out the ones you don't want to print using tape and newspaper.

Is the underside of the screen gobbled up with ink or are you getting a fuzzy image during a longish printing run? Simply clean both sides of the screen thoroughly with benzene. Bad image on a board? Just wash the ink off with benzene and put the board back into rotation. Club projects? Ideal. While you're at it, why not print up some really neat club T-shirts or some really professional signs for the next flea market. QSLs? A cinch in any color, including rainbow.

Now what about those boards that are literally a can of worms and could not be cut by hand even if your life depended on it? These are still most economically done by the silk-screen process. Most large cities have companies which specialize

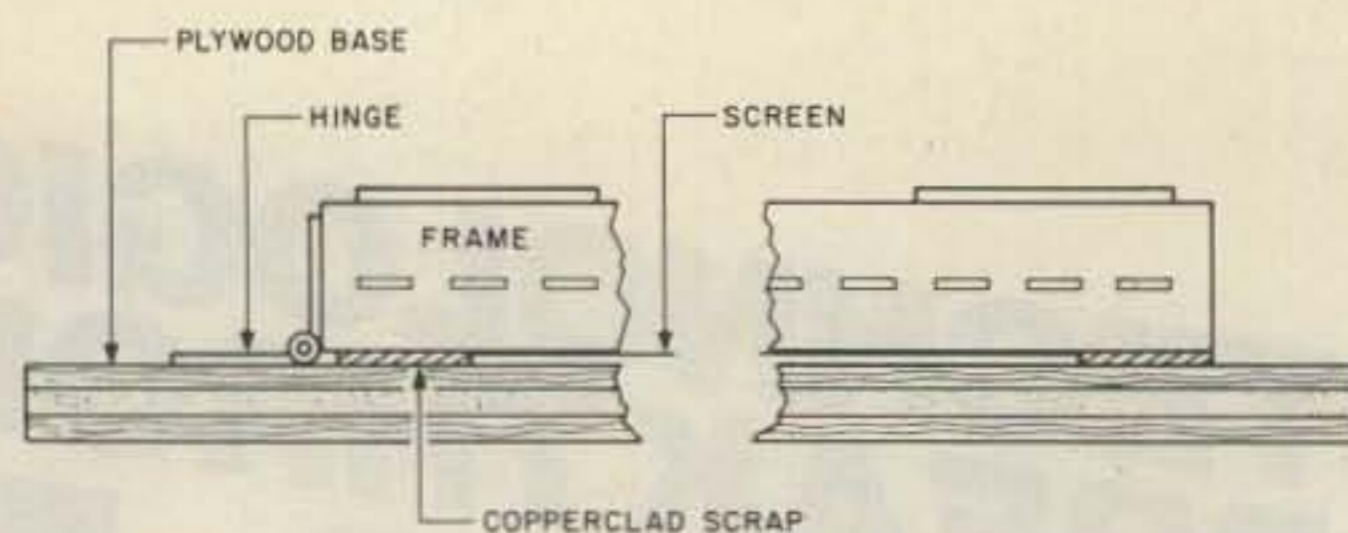

Fig. 6. Attachment of the frame to the plywood support.

in preparing printing screens photographically (see reference at end). Simply send them your artwork and frame and in a week or ten days they will return your absolutely flawless screen for less than the price of a full-size photographic transparency.

Double-sided boards? No problem. All double-sided boards have registration marks. Print your first side as described making sure to include the registration marks. Clear out your screen and adhere to the reverse side. Using a common pin, prick through the centers of the reverse side registration marks into the plywood platen. Drive two small brads into the plywood at the pinpricks so that just the heads protrude a little less than the thickness of the circuit board. On the now dry boards on which you just printed the first side, drill through the registration marks with a drill just large enough to clear the heads of the brads. Drop the boards over the brads, printed side down, print the other side, and etch the board.

What else can you do with this little marvel? How about front panels? Make up some scale artwork using Presstype or LeRoy lettering and ink. Have a photographic screen made, either positive or negative—your choice, just advise the screenmaker. Use your imagination. Using copperclad and a negative screen,

etch away the lettering. Brightly polish the remaining copper and backlight the panel. The lettering will show up in a subdued green glow. Stunning! Using the positive and double-sided laminate, you will have copper letters and a green insulated panel. If you don't etch the backside, you'll have electrical integrity to boot.

Aluminum panel? Absolutely! Make your layout, screen print it on, and leave the ink on. Etch your panel with lye first as described in the *Radio Amateur's Handbook* or obtain a piece of brightly polished aluminum, screen print it, then etch the aluminum as above. Wash the ink off with benzene after etching and stare at the most strikingly beautiful panel you ever saw—polished raised letters on a satin background.

Once you develop skill with this technique, it will take you less time to produce things with this method than it did to read this article. You will soon be using this method in ways that would amaze even the author. For those of you who might feel that this technique is complex, I teach this technique routinely to Brownies and Cub Scouts who seem to have absolutely no problem making really cute stuff with screen printing.

Finally, I stand ready to answer any and all queries in exchange for an SASE. ■

For photographic preparation of silk screens, contact:
William R. Blount and Sons, Inc.
100 Dexter Street
Pawtucket RI 02860

DRAKE • Free Power Supply • Special!

For a Limited time Only! - Purchase either a **DRAKE TR-5** or **TR-7A** at the Low **AES®** Sale Price and receive a matching Power Supply - **FREE!!!**



TR-7A 160-10m Xcvr/1.5-30 Mhz Rcvr
Regular \$1699 - **Sale \$1449**
with - **FREE PS-7** Power Supply

TR-7 Accessories	Regular	SALE
PS-7 25A continuous power supply	\$299.00	269 ⁹⁵
PS-75 15A power supply	199.00	179 ⁹⁵
MS-7 Speaker	49.00	
RV-7 Remote VFO	195.00	174 ⁹⁵
RV-75 Synthesized remote VFO	299.95	269 ⁹⁵
FA-7 Fan for TR-7A or PS-7	34.95	
SL-300 300 Hz CW filter	59.95	54 ⁹⁵
SL-1000 1 KHz RTTY filter	59.95	54 ⁹⁵
SL-1800 1.8 KHz SSB/RTTY filter	59.95	54 ⁹⁵
SL-4000 4 KHz AM filter	59.95	54 ⁹⁵
SL-6000 6 KHz AM filter	59.95	54 ⁹⁵
MMK-7 Mobile mounting kit	79.00	69 ⁹⁵
7073 Hand microphone w/plug	29.95	
7077 Desk microphone w/plug	49.00	44 ⁹⁵
AUX-7 Range prog. board, 1 RRM-7	45.00	
RRM-7 Range rec. module	8.50	
WARC-7 WARC kit (3 RTM-7s)	24.95	
RTM-7 Range trans. module	8.50	
*Special order, requires proof of license		
7037 Extender card service kit	50.00	
7804 TR-7/TR-7A service manual	35.00	



R-7A 0-30 MHz digital Receiver
Regular \$1649 - **Special \$1199**

R-7A Accessories	Regular	SALE
MS-7 Speaker	\$ 49.00	
RV-75 Synthesized remote VFO	299.95	269 ⁹⁵
1544 R-7A to RV-75 adaptor	29.50	
SL-300 300 Hz CW filter	59.95	54 ⁹⁵
SL-1000 1 KHz RTTY filter	59.95	54 ⁹⁵
SL-1800 1.8 KHz SSB/RTTY filter	59.95	54 ⁹⁵
SL-4000 4 KHz AM filter	59.95	54 ⁹⁵
SL-6000 6 KHz AM filter	59.95	54 ⁹⁵
1548 R-7A to TR-7A cable interface	29.50	
7037 Extender card service kit	50.00	
7805 R-7A service manual	35.00	

R-7A - Quantity Limited at Special Price!



TR-5 9-band Digital Solid State Xcvr
Regular \$799⁹⁵ - **Sale \$679⁹⁵**
with - **FREE PS-75** Power Supply

TR-5 Accessories:	Regular	SALE
PS-75 15A power supply	\$199.00	179 ⁹⁵
PS-7 25A power supply	299.00	269 ⁹⁵
MS-7 Speaker	49.00	
RV-75 Synthesized remote VFO	299.95	269 ⁹⁵
FA-7 Fan for TR-5 or PS-7	34.95	
NB-5 Noise blanker	90.00	82 ⁹⁵
SL-300 300 Hz CW filter	59.95	54 ⁹⁵
SL-500 500 Hz CW filter	59.95	54 ⁹⁵
SL-1000 1 KHz RTTY filter	59.95	54 ⁹⁵
SL-1800 1.8 KHz SSB/RTTY filter	59.95	54 ⁹⁵
SL-4000 4 KHz AM filter	59.95	54 ⁹⁵
SL-6000 6 KHz AM filter	59.95	54 ⁹⁵
MMK-7 Mobile mounting kit	79.00	69 ⁹⁵
7073 Hand microphone	29.95	
7077 Desk microphone w/plug	49.00	44 ⁹⁵
Accessory range crystals	10.00	

Linear amplifiers
L-7 2kw PEP linear w/3-500Z tubes 1400.00 1129
L-75 1.2kw PEP linear w/3-500Z tube 854.95 699⁹⁵

Terminals
Theta 9000E Communications terminal \$995.00 869⁹⁵
550 Rec. only communications terminal 499.95 439⁹⁵
7030 12" green screen monitor 159.95 129⁹⁵

Tuners/Antenna
MN-75 200w 160-10m ant. tuner 259.00 229⁹⁵
MN-2700 1kw 160-10m ant tuner 349.00 309⁹⁵
B-1000 4:1 balun; MN-75/MN-2700 29.95
AK-75 Multiband dipole antenna 39.95
AA-75 Antenna insulator kit 3.49

Misc. Accessories:
CW-75 Electronic keyer \$79.95 72⁹⁵
DL-300 300w dry dummy load 26.95
DL-1000 1kw dry dummy load 59.95 54⁹⁵
FA-7 Fan for DL-1000 34.95
P-75 Phone patch 79.95 72⁹⁵
HS-75 Headset 19.95
RP-700 Receiver front end protector 90.00
SP-75 Speech processor 159.00 142⁹⁵
LA-7 8-600 ohm line amplifier 49.95
1549 200w antenna surge shunt 24.95

Filters
LF-2 2-outlet AC line filter 39.95 34⁹⁵
LF-6 6-outlet AC line filter 69.95 59⁹⁵
TV-3300-LP 1kw 80-10m low-pass 33.95
TV-300-HP 300 ohm high-pass filter 14.95
TV-75-HP 75 ohm high-pass filter 17.95

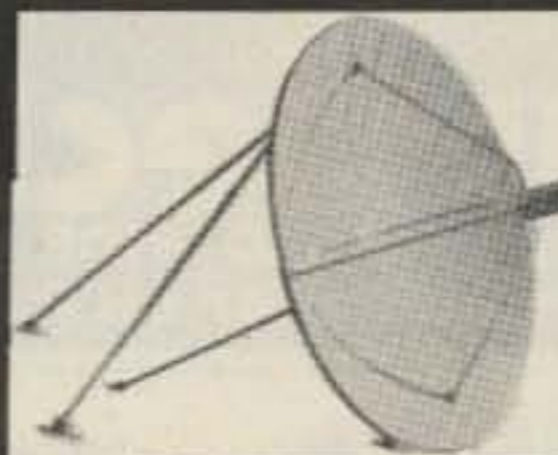

DRAKE Satellite Television

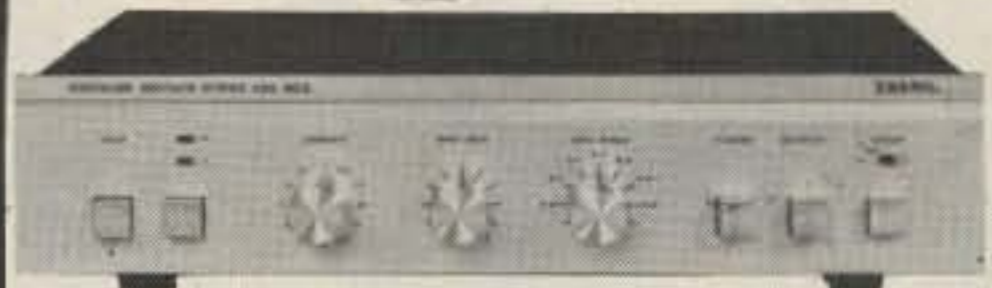

UPS O.K.! Regular SALE
ESS-2250 Earth station* 2250.00 1795
*A complete Earth Station System consisting of the ESR-224 receiver with built-in RF modulator, down converter, 120° LNA, 10 foot aluminum dish antenna, polar mount, polarotor & 150' cable.



ESR-24 Receiver w/down converter... \$895.00 689⁹⁵
SA-24 Stereo adaptor 349.95 269⁹⁵
Modulator for channel 3 or 4 79.95 59⁹⁵
SPH-24 Splash proof housing 30.00 24⁹⁵
TM-24 Remote tuning meter 49.00 39⁹⁵
RT-24 Remote control w/30' cable 59.95 49⁹⁵
Fixed channel adaptor 50.00
Internal mounting kit 15.00
LNA-120 120° LNA 498.00 299⁹⁵

DRAKE Theta 7000E/TR-930 Combination Closeout



DRAKE Theta 7000E Communications Terminal. Complete, automatic send/receive of Morse code CW, Baudot & ASCII code (RTTY) **Regular \$1095***
DRAKE TR-930 9" Video monitor **Regular 185***

Regular Combination Price - **\$1280***
Combination Closeout Price - **\$699⁹⁵**
*DRAKE'S Suggested List Price 7000E (only) - \$589⁹⁵

AES STORE HOURS

Mon. thru Fri. 9-5:30; Sat. 9-3

E-X-P-A-N-D-E-D WATS HOURS

Milwaukee WATS line 1-800-558-0411 answered evenings until 8:00 pm, Monday thru Thursday.

Please use WATS line for Placing Orders.
For other information; etc. please use Regular line.

Order Toll Free: 1-800-558-0411

In Wisconsin (outside Milwaukee Metro Area)
1-800-242-5195

AMATEUR ELECTRONIC SUPPLY [®] Inc.

4828 W. Fond du Lac Avenue; Milwaukee, WI 53216 - Phone (414) 442-4200

AES BRANCH STORES

WICKLIFFE, Ohio 44092
28940 Euclid Avenue
Phone (216) 585-7388
Ohio WATS 1-800-362-0290
Outside Ohio 1-800-321-3594

ORLANDO, Fla. 32803
621 Commonwealth Ave.
Phone (305) 894-3238
Fla. WATS 1-800-432-9424
Outside Florida 1-800-327-1917

CLEARWATER, Fla. 33575
1898 Drew Street
Phone (813) 461-4267
No In-State WATS
No Nationwide WATS

LAS VEGAS, Nev. 89106
1072 N. Rancho Drive
Phone (702) 647-3114
No In-State WATS
Outside Nevada 1-800-634-6227

Associate Store

CHICAGO, Illinois 60630
ERICKSON COMMUNICATIONS
5456 N. Milwaukee Avenue
Phone (312) 631-5181

15 min. from O'Hare!

WE SHIP WORLDWIDE

Barry Electronics Corp.

WORLD WIDE AMATEUR RADIO SINCE 1950

Your one source for all Radio Equipment!

For The Best Buys In Town
Call: 212-925-7000

✓305

KITTY SAYS: WE ARE NOW OPEN 7 DAYS A WEEK.
Saturday & Sunday 10 to 5 PM

Monday-Friday 9 to 6:30 PM

Come to Barry's for the best buys in town. For
Orders Only Please Call: 1-800-221-2683.



"We're raising a racket with
our Super Summer Prices."



ICOM

IC-R70, IC-720A, IC-730, IC-740, IC-25A/H, IC-35A
IC-45A, IC-251A, IC-2KL, IC-471A, IC-290H, IC-751



YAESU

FT-ONE, FT-980, FT-102, FT-77, FT-707, FT-230R
FT-726R, FT-480R, FT-720RU, FT-290R, FRG-7700, FT-625RD



YAESU
FT-208R
FT-708R

ICOM
IC2AT
IC3AT
IC4AT

Land-Mobile H/T
Wilson Mini-Com II
Yaesu FTC-2203, FT-4703
Icom IC-M12 (Marine)
Tempo M-1

DRAKE TR-5, TR-7A, R-7A, L-7, L-15, Earth
Satellite Receiver ESR-24, THETA 9000E & 500,
EARTH SATELLITE STATION ESS-2250



**ROCKWELL/COLLINS
KWM-380**

VoCom/Mirage
Tokyo Hy-Power
Amplifiers &
5/8λ HT Gain
Antennas IN STOCK

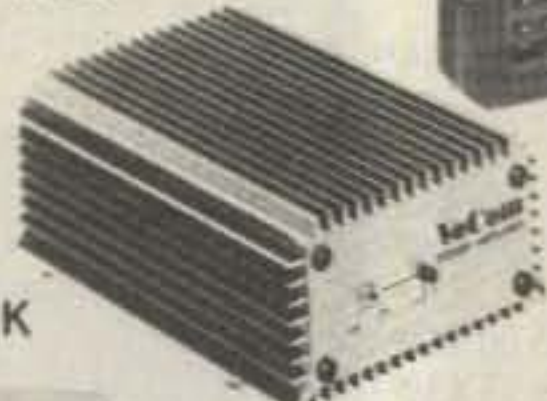

SMART PATCH

CES-Simplex Autopatch 510-SA Will Patch FM
Transceiver To Your Telephone. Great For
Telephone Calls From Mobile To Base. Simple
To Use - \$319.95.

**SANTEC
ST-220/UP
ST-144/UP
ST-440/UP**



NEW IMPROVED

**MURCH Model
UT2000B**

**MFJ Models
900, 940B, 941C & 982.**



**SPECTRUM
COMMUNICATIONS REPEATERS
SCR-1000, 4000 & 77
Commercial & Amateur In Stock**

**DENTRON AMPLIFIERS
GLA-1000C**

**KANTRONICS
Field Day 2, Mini-Reader,
Interface, Software &
Code Tapes**

AEA CP-1 Computer Patch

**Complete Butternut Antenna
Inventory In Stock!**

**Communications Specialists
Encoders In Stock!**

Smallest Wireless
Telephone Available
600 ft. range w/encoder \$135.00

**BENCHER PADDLES &
Vibroplex Keys In Stock!!**

**New TEN-TEC
Corsair In Stock**

**DIGITAL
FREQUENCY
COUNTER**

Trionyx-
Model TR-1000
0-600 MHz
Digimax Model
D-510 50 Hz-1GHz



Tri-Ex Towers
Hy-Gain Towers
& Antennas,
and Rotors
will be shipped direct
to you FREE of shipping cost.

AEA 144 MHz
AEA 440 MHz
ANTENNAS



**EIMAC
3-500Z
572B, 6JS6C
12BY7A &
4-400A**

**BIRD
Wattmeters &
Elements
In Stock**



MAIL ALL ORDERS TO BARRY ELECTRONICS CORP., 512 BROADWAY, NEW YORK CITY, NY 10012.

**New York City's LARGEST STOCKING HAM DEALER
COMPLETE REPAIR LAB ON PREMISES**

"Aqui Se Habla Espanol"

BARRY INTERNATIONAL TELEX 12-7670
TOP TRADES GIVEN ON USED EQUIPMENT
STORE HOURS: Monday-Friday 9 to 6:30 PM
(\$1.50 parking across the street)
Saturday & Sunday 10 to 4 PM (Free Parking)
AUTHORIZED DIST. MCKAY DYMEK FOR
SHORTWAVE ANTENNAS & RECEIVERS.

**NEEDED:
SERVICE
DEPARTMENT
TECHNICIANS!!**

We Stock: AEA, ARRL, Alpha, Ameco, Antenna Specialists, Astatic, Astron, B & K, B & W, Bash, Bencher, Bird, Butternut, CDE, CES, Collins, Communications Spec. Connectors, Covercraft, Cubic (Swan), Cushcraft, Daiwa, Dentron, Digimax, Drake, ETO (Alpha), Eimac, Encomm, Henry, Hustler (Newtronics), Hy-Gain, Icom, KLM, Kantronics, Larsen, MCM (Daiwa), MFJ, J.W. Miller, Mini-Products, Mirage, Newtronics, Nye Viking, Palomar, RF Products, Radio Amateur Callbook, Robot, Rockwell Collins, Saxton, Shure, Swan, Telex, Tempo, Ten-Tec, Tokyo Hi Power, Trionyx TUBES, W2AU, Waber, Wilson, Yaesu Ham and Commercial Radios, Vocom, Vibroplex, Curtis, Tri-Ex, Wacom Duplexers, Repeaters, Phelps Dodge, Fanon Intercoms, Scanners, Crystals.

**WE NOW STOCK COMMERCIAL COMMUNICATIONS SYSTEMS
DEALER INQUIRIES INVITED. PHONE IN YOUR ORDER & BE REIMBURSED.**

COMMERCIAL RADIOS stocked & serviced on premises.

Amateur Radio & Computer Courses Given On Our Premises, Call

Export Orders Shipped Immediately. TELEX 12-7670

IRT/LEX-"Spring St. Station"
Subways: BMT-"Prince St. Station"
IND-"F" Train-Bwy. Station"
Bus: Broadway #6 to Spring St.

Ampersand electronics



Oscilloscope Probe Kit

This passive probe incorporates a three-position slide switch in the head and has a cable length of 1.5 meters.

Bandwidth: D.C. to 100 MHz.

TO ORDER: Mail Order Only, check or money order. Add 6% sales tax on California orders. Add \$1.20 per probe shipping & handling. Other models available starting at \$27.00.

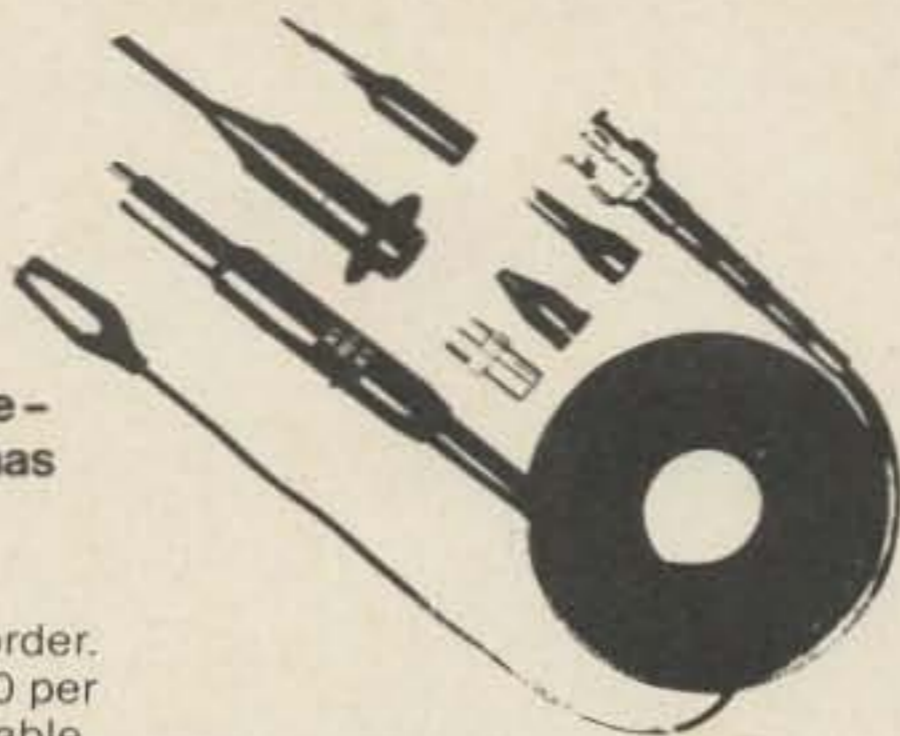

Model SP100.... \$39.95

6065 Mission Gorge Rd. #66 • San Diego, CA 92120

NO MORE MISSED CALLS OR ANNOYING CHATTER.

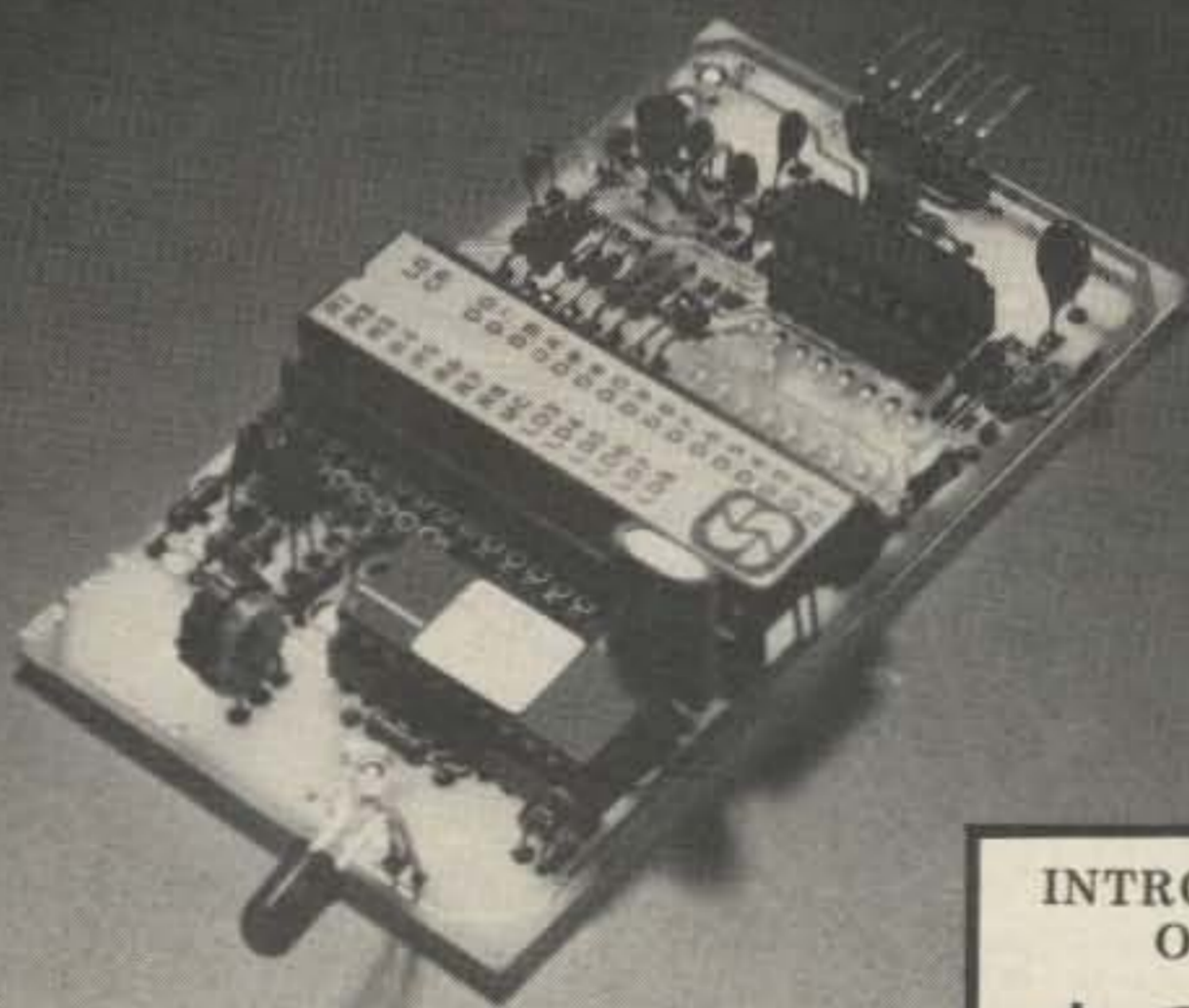

INTRODUCTORY OFFER!

\$89.

shipping & handling charges included

Speedcall's new DTMF commercial-grade kit lets you take control!

Now it's possible for individuals and repeater groups to have a personal (or emergency) commercial-quality DTMF system, at very low cost. Speedcall's new 312K decoder kit easily assembles into a compact, high-performance unit. Features include a virtually unfalsable "Wrong Digit Lockout" circuit which permits only correct signals to be accepted as valid. And the 312K decodes all sixteen digits, permitting expanded flexibility and special control applications.

Commercial versions of the 312K are used to perform selective calling of mobile fleet operations, on-off control of remote facilities (such as power, valves, pumps, etc.), and to receive the status of single functions (repeater site failure or intrusion, equipment vandalism, power failure, valve or compressor function change, etc.) Speedcall Corporation manufactures a complete line of DTMF signaling and control systems. For more information write or call Speedcall at 415/783-5611.

Output: Single open collector output, 200mA.
Input Signal Range: 20mV to 6V (flat input).
Code Capacity: 3 to 8 digit address plus select any of the 16 touch-tone digits as desired.
Battery Voltage: 13.8VDC Nom. (9 to 16VDC) @ 30mA nominal on standby.
Assembled Dim: 3/4" H x 2-1/8" W x 3-3/4" L
With Enclosure: 1" H x 2-1/2" W x 4-5/8" L



Kit with Enclosure, Reset Push Button and Buzzer ... \$104.

To order, send check or money order to:



2020 National Avenue • Hayward, California 94545
 415-783-5611

(California Residents add 6% Sales Tax)

HI-Q BALUN

- For dipoles, yagis, inverted vees & doublets
- Replaces center insulator
- Puts power in antenna
- Broadbanded 3-40 MHz
- Small, lightweight and weatherproof
- 1:1 Impedance ratio
- For full legal power and more
- Helps eliminate TVI
- With SO 239 connector



only \$13.95

HI-Q ANTENNA CENTER INSULATOR



Small, rugged, lightweight weatherproof. Replaces center insulator. Handles full legal power and more. With SO 239 connector

\$6.95

HI-Q ANTENNA END INSULATORS



Rugged, lightweight, injection molded of top quality material, with high dielectric qualities and excellent weatherability. End insulators are constructed in a spiral unending fashion to permit winding of loading coils or partial winding for tuned traps.

May be used for

- Guy wire strain insulators
- End or center insulators for antennas
- Construction of antenna loading coils or multiband traps

\$4.95

DIPOLES

MODEL	BANDS	LENGTH	PRICE WITH HI-Q BALUN	WITH HI-Q CENTER INSULATOR
Dipoles				
D-80	80,75	130	\$31.95	\$27.95
D-40	40,15	66	28.95	24.95
D-20	20	33	27.95	23.95
D-15	15	22	26.95	22.95
D-10	10	16	25.95	21.95
Shortened dipoles				
SD-80	80,75	90	35.95	31.95
SD-40	40	45	32.95	28.95
Parallel dipoles				
PD-8010	80,40,20,10,15	130	43.95	39.95
PD-4010	40,20,10,15	66	37.95	33.95
PD-8040	80,40,15	130	39.95	35.95
PD-4020	40,20,15	66	33.95	29.95
Dipole shorteners - only, same as included in SD models				
S-80	80,75			\$11.95 pr
S-40	40			\$10.95 pr

All antennas are complete with a HI-Q Balun or HI-Q Antenna Center insulator, No. 14 antenna wire, ceramic insulators, 100 nylon antenna support rope (SD models only 50) rated for full legal power. Antennas may be used as an inverted V and may also be used by MARS or SWLs.

Antenna accessories—available with antenna orders
 Nylon guy rope 450# test 100 feet \$4.49
 Ceramic (Dogbone Type) antenna insulators \$1.50 pr
 SO-239 coax connectors .55

All prices are postpaid USA 48
 Available at your favorite dealer or order direct from

Dealer Inquiries Invited
Van Gorden Engineering

BOX 21305 B, SOUTH EUCLID, OHIO 44121

Faultless SSTV Picture Preservation

The dynamic duo of computer and printer helps save those perfect moments. Just add this program.

David A. Gauger KF9X
3900 Bluebird Lane
Rolling Meadows IL 60008

Let's face it, ham radio is terrific—and even more so if you team it up with any of several allied fields in

electronics. I'm not at all surprised by the large percentage of hams who also own personal computing

equipment. If you're like me, you've dabbled in several allied fields including personal computing and

Program listing.

```

0000 ;>>>>  HARDCOPY PRINT OF SLOW SCAN VIDEO  <<<<<<<
0002 ;      WRITTEN FOR KIM-1 WITH PRINTER
0004 ;
0006 ;      BY - DAVID A. GAUGER
0008 ;
0020 START      .BA $2F00
0024 PAGE       .DE $0000
0028 LETTERS    .DE $3000
002B PBDD       .DE $1703
0030 PBD        .DE $1702
0032 PAD        .DE $1700
0034 TIME1      .DE $1704
0038 TIME2      .DE $1705
003B TIMEOUT    .DE $1707
0040 CRLF        .DE $1E2F
0042 PRINTCHAR  .DE $1EAO
0044 LINECOUNT .DE $0003
0100 ;CLEAR ABOUT 12K OF MEMORY FOR STORAGE OF PIXEL INFO
0110 ;STORE ADDRESS OF FIRST PAGE IN $00,$01
2F00 A900      0120 CLEARMEMRY LDA #00
2F02 BD0000    0130      STA #00
2F05 A931      0140      LDA #31
2F07 BD0100    0150      STA #01
2F0A A0FF      0160      LDY #FF
2F0C A900      0170      LDA #00
2F0E CB        0180 INC.Y      INY
2F0F 9100      0190      STA (PAGE),Y
2F11 C0FF      0200      CPY #FF
2F13 D0FB      0210      BNE INC.Y
2F15 EE0100    0220      INC #01
2F18 A960      0230      LDA #60
2F1A CD0100    0240      CMP #01
2F1D D0EF      0250      BNE INC.Y
                0260 ;SETUP ADDRESS IN $00,$01
2F1F A900      0270 SETADDR  LDA #00
2F21 BD0000    0280      STA #00
2F24 A931      0290      LDA #31
2F28 BD0100    0300      STA #01
2F2B A0FF      0310      LDY #FF
                0320 ;SETUP PB2 AS OUTPUT TO STROBE A-D CONVERTER
2F2B A904      0330 SETPORT  LDA #04
2F2D BD0317    0340      STA PBDD
2F30 CB        0350 GETPIXEL INY
2F31 A9FB      0360      LDA #FB
2F33 D00217    0370      AND PBD.
2F36 BD0217    0380      STA PBD.
                0390 ;USE TIMER TO WAIT FOR A-D TO FINISH CONVERSION
2F39 A910      0400      LDA #10
2F3B BD0417    0410      STA TIME1
2F3E AD0717    0420 WAIT     LDA TIMEOUT
2F41 F0FB      0430      BEG WAIT
                0440 ;GET DATA FROM A-D AND STORE IT AWAY
2F43 AD0017    0450      LDA PAD.
2F46 9100      0460      STA (PAGE),Y
                0470 ;NOW BRING STROBE PIN OF A-D HIGH AGAIN
2F48 A904      0480      LDA #04
2F4A D00217    0490      ORA PBD.
2F4D BD0217    0500      STA PBD.
0510 ;SINCE WE WANT ABOUT 125 PIXELS PER HOR. SWEEP
                0520 ;WE MUST DELAY ABOUT 530 MICROSECONDS , WE USE
0530 ;THE TIMER AGAIN FOR THIS.
2F10 AB42      0540      LDA #42
2F12 BD0517    0550      STA TIME2
2F15 AD0717    0560 WAITAGAIN LDA TIMEOUT
2F18 F0FB      0570      BEG WAITAGAIN
2F1A C0FF      0580      CPY #FF
2F1C D0D2      0590      BNE GETPIXEL
2F1E EE0100    0600 ;INCREMENT STORAGE THROUGH SUCCEEDING PAGES
                INC #01
2F21 A960      0620      LDA #60
2F23 CD0100    0630      CMP #01
2F26 D0CB      0640      BNE GETPIXEL
0650 ;WE HAVE FINISHED GETTING DATA FROM CAMERA
0660 ;
0670 ;NOW PRINT THE PICTURE
2F68 202F1E    0680 BEGINPIX  JSR CRLF
2F6B 202F1E    0690      JSR CRLF
0700 ;SETUP $00,$01 ONCE AGAIN TO DEFINE STARTING PG. OF
0710 ;BRIGHTNESS LEVEL RETRIEVAL
2F6E A900      0720      LDA #00
2F70 BD0000    0730      STA #00
2F73 A931      0740      LDA #31
2F75 BD0100    0750      STA #01
2F78 A000      0760      LDY #00
0770 ;WAIT FOR A SYNC PULSE BEFORE STARTING TO PRINT
2F7A 20AE2F    0780 WAIT4SYNC JSR PIXEL ;GET A NBR
2F7D C93C      0790      CMP #3C
2F7F B0F9      0800      BCS WAIT4SYNC ;GREATER THAN 3C TOO HIGH
0810 ;WE FOUND SYNC PULSE - NOW WAIT FOR IT TO FINISH
2F81 20AE2F    0820 SYNCPUSE  JSR PIXEL
2F84 C93C      0830      CMP #3C
2F86 90F9      0840      BCC SYNCPUSE
2F88 BC0200    0850      STY #02
2F8B 202F1E    0860      JSR CRLF
2F8E AC0200    0870      LDY #02
2F91 A974      0880      LDA #74
2F93 BD0300    0890      STA LINECOUNT
0900 ;
0910 ;WE RECALL THE STORED NUMBERS AND USE THEM AS AN OFFSET
0920 ;TO FIND WHICH ASCII VALUE TO PRINT - AS DEFINED IN THE
0930 ;LOOK-UP TABLE.
2F96 20AE2F    0940 PRINTONE  JSR PIXEL
2F99 AA        0950      TAX
2F9A BD0030    0960      LDA LETTERS,X
2F9D BC0200    0970      STY #02
2FA0 20A01E    0980      JSR PRINTCHAR
2FA3 AC0200    0990      LDY #02
                1000 ;LINECOUNT COUNTS NBR OF CHARACTERS PRINTED IN EACH LINE
2FAB CE0300    1010      DEC LINECOUNT
2FAD D0EB      1020      BNE PRINTONE
                1030 ;MUST BE DONE WITH THIS LINE
1040 ;GO WAIT FOR NEXT SYNC PULSE
2FAB 4C7A2F    1050      JMP WAIT4SYNC
2FAE CB        1060 PIXEL     INY
2FAF C000      1070      CPY #00
2FB1 D00A      1080      BNE LOADPIXEL
2FB3 EE0100    1090      INC #01
2FB5 A960      1100      LDA #60
2FB8 CD0100    1110      CMP #01
2FBB F003      1120      BEG STOP
2FBD 9100      1130 LOADPIXEL LDA (PAGE),Y
2FBF 60        1140      RTS

```

SSTV. What follows is a simple means of obtaining hard-copy pictures from your SSTV camera, using a KIM-1 single-board micro-computer. The method should be adaptable to other micros using the 6502 microprocessor.

If you're still with me, I presume you have an SSTV camera and a computer with printer. The only other item needed is an 8-bit A/D (analog to digital) converter. You'll have to make a single tap into your camera to obtain the picture information. Incidentally, there is no reason why one could not obtain that signal from the SSTV monitor circuitry so that hard-copy pictures could be printed out from signals received over the air.

Hardware

First, let's talk printers. The typical garden-variety 80-column printer may not give you what you consider

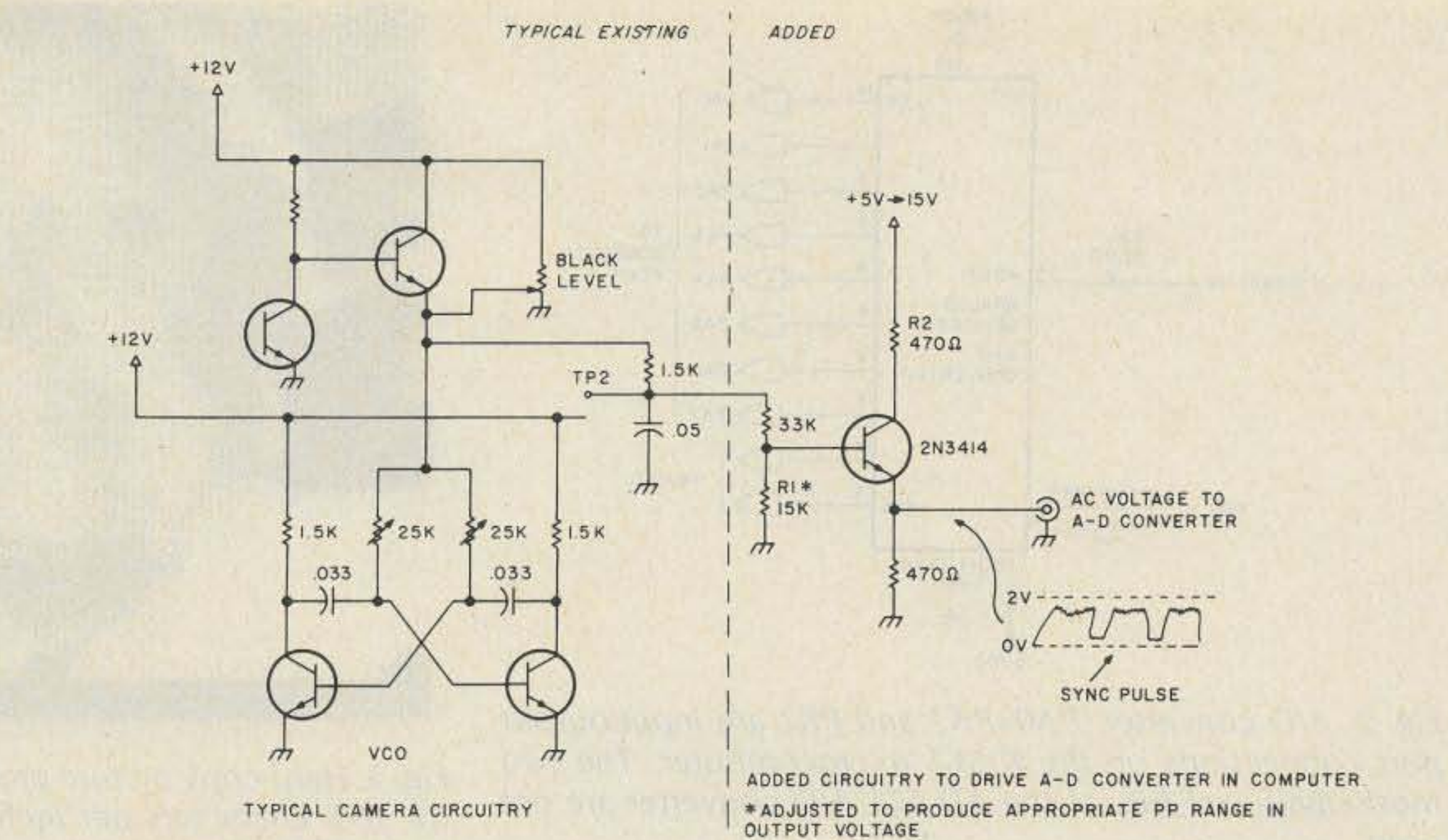

Fig. 1. Emitter-follower circuit used to drive A/D converter from SSTV camera. Alternate values for R1 and R2 are discussed in the text.

an adequate picture unless you can decrease the horizontal and vertical pitch. Pictures printed on a standard LA-36, for example, are not very impressive. I own an LA-34 which has programmable pitch. This is

what gives the density and contrast necessary for a picture which is at least adequate. I've seen commercial setups in which the printer double-prints each line, overstriking each character to enhance its density.

In the case of the LA-34 and other programmable printers, picture density and contrast can be enhanced by decreasing the horizontal and vertical pitch as much as is possible—in my case, 16.5 characters per

```

1150 ;SETUP FOR TAKING NEXT PICTURE
1160 ;BY LOADING PROPER ADDRESS IN $FA $FB
1170 ;AND JUMPING TO MONITOR.
2FC0 A900 1180 STOP LDA #00
2FC2 BDFA00 1190 STA $FA
2FC5 A92F 1200 LDA #2F
2FC7 BDFB00 1210 STA $FB
2FCA 4C4F1C 1220 JMP $1C4F
1230 ;THIS IS THE LOOKUP TABLE WHICH DEFINES
1240 ;WHICH ASCII CHARACTER IS TO BE PRINTED
1250 ;FOR ANY GIVEN BRIGHTNESS LEVEL.
1260 CHARTABLE .BA $3000
1270 .MC $6000
1280 .BY 20 20 20 20 20 20 20 20
3000 202020 1280
3003 202020
3006 2020
3008 202020 1290 .BY 20 20 20 20 20 20 20 20
300B 202020
300E 2020
3010 202020 1300 .BY 20 20 20 20 20 20 20 20
3013 202020
3016 2020
3018 202020 1310 .BY 20 20 20 20 20 20 20 20
301B 202020
301E 2020
3020 202020 1320 .BY 20 20 20 20 20 20 20 20
3023 202020
3026 2020
3028 202020 1330 .BY 20 20 20 20 20 20 20 20
302B 202020
302E 2020
3030 202020 1340 .BY 20 20 20 20 20 20 20 20
3033 202020
3036 2020
3038 202020 1350 .BY 20 20 20 20 20 20 20 20
303B 202020
303E 2020
3040 204040 1360 .BY 20 40 40 40 40 40 40 40
3043 404040
3046 4040
3048 404040 1370 .BY 40 40 40 40 40 40 40 40
304B 404040
304E 4040
3050 404040 1380 .BY 40 40 40 40 40 40 40 40
3053 404040
3056 4040
3058 404040 1390 .BY 40 40 40 40 40 40 40 40
305B 404040
305E 4040
3060 404040 1400 .BY 40 40 40 40 40 40 40 40
3063 404040
3066 4040
3068 404040 1410 .BY 40 40 40 40 40 40 40 40
306B 404040
306E 4040
3070 4E4E4E 1420 .BY 4E 4E 4E 4E 4E 53 53 53
3073 4E4E53
3076 5353
3078 53536E 1430 .BY 53 53 6E 6E 6E 6E 6E 6F
307B 6E6E6E
307E 6E6F
3080 6F6F6F 1440 .BY 6F 6F 6F 6F 79 79 79 79
3083 6F7979
3086 7979

```

```

308B 793B3B 1450 .BY 79 3B 3B 3B 3B 3B 2E 2E
308B 3B3B3B
308E 2E2E
3090 2E2E2E 1460 .BY 2E 2E 2E 27 27 27 27 27
3093 272727
3096 2727
3098 606060 1470 .BY 60 60 60 60 60 20 20 20
309B 606020
309E 2020
30A0 202020 1480 .BY 20 20 20 20 20 20 20 20
30A3 202020
30A6 2020
30A8 202020 1490 .BY 20 20 20 20 20 20 20 20
30AB 202020
30AE 2020
30B0 202020 1500 .BY 20 20 20 20 20 20 20 20
30B3 202020
30B6 2020
30B8 202020 1510 .BY 20 20 20 20 20 20 20 20
30BB 202020
30BE 2020
30C0 202020 1520 .BY 20 20 20 20 20 20 20 20
30C3 202020
30C6 2020
30CB 202020 1530 .BY 20 20 20 20 20 20 20 20
30CE 202020
30D0 202020 1540 .BY 20 20 20 20 20 20 20 20
30D3 202020
30D6 2020
30DB 202020 1550 .BY 20 20 20 20 20 20 20 20
30DE 202020
30E0 202020 1560 .BY 20 20 20 20 20 20 20 20
30E3 202020
30E6 2020
30EB 202020 1570 .BY 20 20 20 20 20 20 20 20
30EE 202020
30F0 202020 1580 .BY 20 20 20 20 20 20 20 20
30F3 202020
30F6 2020
30FB 202020 1590 .BY 20 20 20 20 20 20 20 20
30FE 202020
1600 END. .EN

```

```

LABEL FILE: [ / = EXTERNAL ]

START=2F00 /PAGE=0000 /LETTERS=3000
/PBDD=1703 /PBD.=1702 /PAD.=1700
/TIME1=1704 /TIME2=1705 /TIMEOUT=1707
/CRLF=1E2F /PRINTCHAR=1EA0 /LINECOUNT=0003
CLEARMEMORY=2F00 INC.Y=2F0E SETADDR=2F1F
SETPORT=2F2B GETPIXEL=2F30 WAIT=2F3E
WAITAGAIN=2F55 BEGINPIX=2F6B WAIT4SYNC=2F7A
SYNCPULSE=2F81 PRINTONE=2F96 PIXEL=2FAE
LOADPIXEL=2FBD STOP=2FC0 CHARTABLE=3000
END.=3100
//
0000
>

```

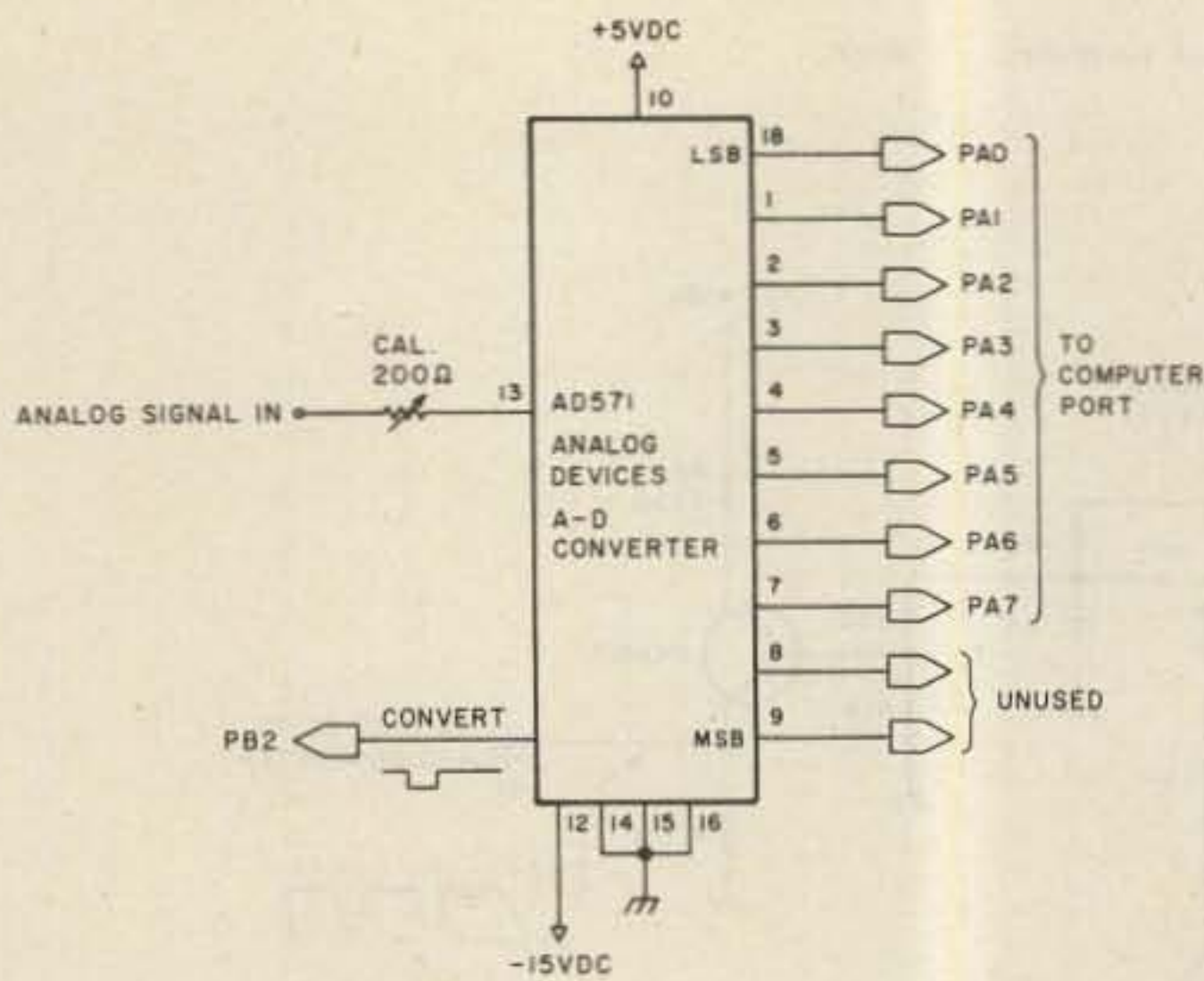

Fig. 2. A/D converter. PA0-PA7 and PB2 are input/output port connections on the KIM-1 microcomputer. The two most significant bits of the AD 571 A/D converter are not used.

inch horizontally and 12 lines per inch vertically.

The idea is quite simple. Somewhere in your camera there is likely to be a dc voltage which varies with brightness. In my case, I use an old Dage CCTV camera with a Hal Devices converter. There is a very convenient dc voltage which drives the vco (voltage controlled oscillator) in the Hal converter which I tapped for this purpose. As shown in Fig. 1, I used an emitter follower to provide for minimum loading of the converter and stiff drive. This voltage rises and falls in proportion to the brightness level as the camera circuitry sweeps the vidicon horizontally across the picture, and, indeed, even reflects the horizontal 5-millisecond sync pulses which trigger each new line. All we need to do is convert this voltage to a digital value by the use of an 8-bit A/D converter and store this information in memory.

I used the circuit of Fig. 2 to perform the conversion task. It contains a 10-bit A/D converter, but I used only the least significant 8 bits. This limits the voltage conversion range to 2.55 volts. Thus, the emitter-follower circuitry I use tailors the video signal so that it spans

slightly less than 2.00 volts. There is no reason why a different voltage range could not be accommodated by slight modifications to the circuitry shown in Fig. 1. If you have an 8-bit converter available, you probably have a resolution of about 40 mV. You would want to change my emitter-follower circuit (Fig. 1) to provide a greater voltage swing fed to the A/D converter so as to preserve gray-scale resolution. Try increasing R1 and eliminating R12 and increasing B+ to 10-15 volts.

The AD571 converter which I use is relatively expensive but easy to use. The eight LSB outputs are con-



Fig. 3. Hard-copy picture produced by dot-matrix printer set for 16.5 characters per inch horizontally and 12 lines per inch vertically.

nected to PA0-PA7, and the blank-and-convert pin is connected to PB2. The outputs on port A are tri-stated until PB2 is driven low, commanding the converter to do its thing. After 25 microseconds have elapsed, the data on Port A represents the analog input in digital form. The sequence is then (1) pull PB2 low, (2) wait for valid data, (3) read and store data on Port A, and (4) push PB2 high again.

Software

The software (see Listing 1) occupies less than one page (256 bytes) of KIM-1 memory plus one additional page for the character

lookup table. The routines are straightforward and documented in the listing. The program consists of four sections: (1) clear memory, (2) acquire data and store in memory, and (3) recall data and print character from... (4) the lookup table. I used pages \$31-\$5F to store data, but any 12K block can be used by making the appropriate changes in the software.

Since an SSTV picture is approximately 125 lines from top to bottom, it's logical to store about that same number of values across each line since little improvement in resolution can be had by increasing beyond 125. The KIM-1 on-board timer is used to space the video samplings by about 530 microseconds. Simple math reveals that 125 samplings of 530 microseconds each is a time duration of about 66,000 microseconds. At a horizontal sweep frequency of 15 Hz, each sweep takes about 66,000 microseconds, so our delay is about right.

The software simply samples the dc output of the camera each 530 microseconds until all 12K of memory is filled. It then proceeds to reset the pointers and read the values out sequentially.

```

1230 ;THIS IS THE LOOKUP TABLE WHICH DEFINES
1240 ;WHICH ASCII CHARACTER IS TO BE PRINTED
1250 ;FOR ANY GIVEN BRIGHTNESS LEVEL.
1260 CHARTABLE .BA $3000
1280 .BY 20 20 20 20 20 20 20 20
1290 .BY 20 20 20 20 20 20 20 20
1300 .BY 20 20 20 20 20 20 20 20
1310 .BY 20 20 20 20 20 20 20 20
1320 .BY 20 20 20 20 20 20 20 20
1330 .BY 20 20 20 20 20 20 20 20
1340 .BY 20 20 20 20 20 20 20 20
1350 .BY 20 20 20 20 20 20 20 20
1360 .BY 20 40 40 40 40 40 40 40
1370 .BY 40 40 40 40 40 40 40 40
1380 .BY 40 40 40 40 40 40 40 40
1390 .BY 40 40 40 40 40 40 40 40
1400 .BY 40 40 40 40 40 40 40 40
1410 .BY 40 40 40 40 40 40 40 40
1420 .BY 4E 4E 4E 4E 4E 4E 53 53
1430 .BY 53 53 6E 6E 6E 6E 6E 6E
1440 .BY 6F 6F 6F 6F 79 79 79 79
1450 .BY 79 3B 3B 3B 3B 3B 2E 2E
1460 .BY 2E 2E 2E 27 27 27 27 27
1470 .BY 60 60 60 60 60 20 20 20
1480 .BY 20 20 20 20 20 20 20 20
1490 .BY 20 20 20 20 20 20 20 20
1500 .BY 20 20 20 20 20 20 20 20
1510 .BY 20 20 20 20 20 20 20 20
1520 .BY 20 20 20 20 20 20 20 20
1530 .BY 20 20 20 20 20 20 20 20
1540 .BY 20 20 20 20 20 20 20 20
1550 .BY 20 20 20 20 20 20 20 20
1560 .BY 20 20 20 20 20 20 20 20
1570 .BY 20 20 20 20 20 20 20 20
1580 .BY 20 20 20 20 20 20 20 20
1590 .BY 20 20 20 20 20 20 20 20
1600 END. .EN

```

Lookup table.

Don't Get Stuck With Low Resolution & Only One Memory

This Is The Unit That Can Be Upgraded

Interface Systems

LINDALE, TX



COLOR CONVERSION FOR ROBOT 400*

Interface System's new 12 memory conversion offers picture perfect high resolution color. This new system is the 3064-C Series. Its twelve 64K RAMs, video input multiplexing and timing circuits provide excellent results in both receiving and transmitting. Four modes of operation are available at the operator's fingertips. Its compatibility with existing on-the-air transmissions is outstanding. It provides more memory storage capability than any other unit currently available to SSTVers.

Modes of Operation

1. 8.5 sec. frame sequential
2. 17 sec. high resolution frame sequential
3. 128 line sequential (25.5 sec.) single frame transmission
4. 256 line sequential (51 sec.) single frame transmission

Storage Capability

1. 12 B/W pictures (128 x 128) world standard format now in use
2. 6 high resolution B/W pictures (128 x 256)
3. 4 full color pictures (128 x 128) 4,096 hues of color
4. 2 high resolution full color pictures (128 x 256) 4,096 hues of color

Total Capability

1. Used with B/W camera and RGB filters
2. Instantly snatch color pictures using color camera
3. Instantly snatch a commercial or public color television picture
4. Single snatch capability from a VCR composite or RF outputs
5. Interface any computer (B/W or color) using the I/O port
6. Displays, transmits and receives 4 x 3 or 1 x 1 aspect ratio in any mode. 4 x 3 aspect ratio is full screen.
7. Compatible with systems now in use worldwide
8. Overlays graphics (snatch & receive modes) over any picture in memory

Any future modifications will be sent to you free of charge providing order is received on or before September 30, 1983.

BASIC SYSTEM NECESSARY TO GET ON COLOR

You may purchase either High Resolution or Standard Resolution, which you may later upgrade.

Standard Resolution

3000-C Conversion. This system contains twelve 16K memory chips. This board is completely assembled, aligned and tested. Kit includes all installation parts and instructions. Kit \$485

High Resolution

3064-C Conversion. This is the 3000-C system upgraded for high resolution. It contains twelve 64K memory chips. Kit includes all installation parts and instructions. Kit \$560

Television Interface

ISTV-3. This system is installed in your television set. It provides interfacing to the first video amp and the red, green and blue guns of the television set. It also provides red, green and blue video outputs from the TV set providing correct color separation. This modification makes an ideal monitor for both standard and high resolution color video. Kit \$134

Additional Modification Available

- | | |
|---|-------|
| 1. Single frame (line sequential) and color bar generator | \$ 65 |
| 2. Full screen (4 x 3 aspect ratio) | \$134 |
| 3. First sync modification and graphic overlay | N/C |
| 4. CIM 4000. This is a computer interface module for any computer with an I/O port. Video is transferred from the memories of the ROBOT 400* to the memories of the computer. All types of image processing and graphic overlays are possible (software not included) | \$120 |

The following TV sets can be used with this system:

Gold Star 13", model #CR407
K-Mart 13", model #KMC 1311G
And Others

All modifications can be installed by **Interface Systems**. For further information or to place an order, call (214) 882-9908.

INTERFACE SYSTEMS

Route 4, Box 634K, Lindale, TX 75771

**WE REVOLUTIONIZED
COLOR SLOW SCAN TV**

*Robot 400 is trademark of Robot Research, Inc.

ALL HF BANDS!



The SLINKY DIPOLE[®] Antenna

A broadband, low SWR dipole that really works in apartments, small yards, attics, anywhere a small antenna is a must. Indoors or out, you can work ANY HF BAND, including 10 MHz. No gimmicks or add-ons. Imagine 80M in as little as 24 ft.! Complete kit and instructions, plus 50 ft. of coax. Easy to set up and adjust. More information available - just call or write.

Blacksburg Group
Box 242 Suite 500
Blacksburg, Virginia 24060
703/951-9030

\$67.95 postpaid (in U.S.A.)
Money Back Guarantee
Virginia residents
add 4% sales tax



Operation

Once the hardware is connected and the program loaded, start the sequence at \$2F00, but wait until the camera vertical sweep is at the top. In my case, I address \$2F00 and watch the SSTV monitor, punching GO on the KIM-1 keypad as the vertical sweep begins a fresh sweep. After about 8 seconds have elapsed, the printer will print CR/LF several times and then begin printing line after line of the picture. At the conclusion, the computer reloads the starting address of the program and jumps to the KIM monitor.

My first few attempts at printing pictures immediately revealed that the aspect ratio was way off—that is, the picture was not square or even close. Happily enough, the error was almost exactly 2:1; the picture was twice as long as it should have been for its

width. The solution was simple: print every other line. The program watches for a sync pulse (sync pulses in my camera deliver a voltage less than \$3C), so it was simple to wait for a string of values less than \$3C and then begin printing. In order to print every other line, one merely prints past the next sync pulse by loading a value in LINECOUNT which ensures this. The software waits for the "next" sync pulse before beginning to print again. This seems to work well. Incidentally, this threshold value will probably differ with each hardware setup, so be prepared to modify the value found in addresses \$2F7E and \$2F85 to be just a few counts larger than the digital value returned by your A/D converter for camera sync pulses.

Which character do we print? Early in the game I used my BASIC interpreter to print every ASCII charac-

ter in 8 lines across the page. This printout was viewed from a distance and my subjective judgment selected the following characters, starting with the least dense and growing toward the most dense: \$20 (space), \$60 ('), \$27 (,), \$2E (.), \$3B (;), \$79 (y), \$6F (o), \$6E (n), \$53 (S), \$4E (N), and \$40 (@).

These characters are placed across page \$30 of memory. The hashing technique is used whereby the video value retrieved is used as the address in page \$30. If, for instance, the A/D converter returned the value of \$50, then the program looks at \$3050 and prints the ASCII character stored at that address. The spacing and placement of the characters was done by experimentation and can be adjusted easily by the user to meet individual camera characteristics. Since my camera gives minimum voltage for black and sync and higher values for bright and white, the values in the table are arranged this way, with the (@) stored in the lower addresses and the (.) stored in the higher addresses. If a camera gives the reverse, namely, a lower voltage for a brighter level, reverse the order of the stored values in page \$30.

It is unlikely that my placement of values in the lookup table will suffice for your camera, so let me suggest the following: Manually load the table with my suggested values, starting at \$3000, loading 25 each of the ASCII characters until you reach the top of the page at \$30FF.

Focus the camera on a photo having a nice range of grays and including full white and full black. Start the program at \$2F00 and then look at the values stored in the 12K of RAM. Note the minimum and maximum values found. These represent the sync-through-white range of your

camera. If sync is returned by your converter as, say, \$20, and full white is returned as \$61, then you know that all values converted will fall within this range. Your lookup table values will be evenly spread from \$3020 to \$3061, and addresses above and below this range may be loaded with \$00 since, theoretically, they will never be used. Note that you may adjust the placement or dispersion of values across the range to account for individual camera characteristics. If, for instance, you want more contrast, then load fewer of the numbers for the center of the gray scale, namely, fewer \$79s and \$6Fs, making up for this decrease by increasing the occurrence of numbers near the ends of the range.

As with any such picture, it must be viewed from a distance to disallow the eye from reading the individual characters and enhancing the overall picture. The lighting of the subject is a very important consideration, and users should experiment. In general, use a hair light directly above the subject and light the face more from one side than the other. Avoid direct frontal lighting as this flat lighting tends to hide the features. Fig. 3 shows a typical printout.

I've had more fun than I anticipated, producing a hard-copy picture of a visitor and giving it to him to take home. People seem to deem this a reasonable justification for having a computer, and if you're anything like me you need every justification you can get to cover your expenditures of time and money.

I've just begun to experiment with this technique and no doubt many improvements will be made to what I've started here. I'd be most interested in hearing from others who have found ways to improve it. ■

ALL ITEMS ARE
GUARANTEED OR SALES
PRICE REFUNDED.
PRICES F.O.B.
HOUSTON
PRICES SUBJECT TO
CHANGE WITHOUT
NOTICE.
ITEMS SUBJECT TO
PRIOR SALE.

MADISON Electronics Supply

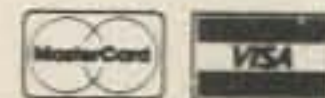

Houston COM-VENTION '83
The 1983 ARRL
National
Oct. 7-9, 1983
Astro Village Hotel

- KDK 2030 25W 2M FM**
Super reliable! \$259.00
- BOOKS, BOOKS, BOOKS -**
Bash, Radio Pub., TAB,
Callbooks, Gilfer, RTTY, SAMS,
Rider, ARRL, AMECO - Our
shelves are full!
- CUSHCRAFT R3/A4** 229.00
- MFJ 1224 Interface** 79.95
- JSC 450 Ohm ladderline** . .20/ft.
RG8x Silver14/ft.
- KANTRONICS Software** 10% off
- AEA CP1** 199.95
- JERSEY SPECIALTY**
- RG21329/ft.
- ALLIANCE HD73** 99.95
- ICOM 25H**
- 45W, 2M FM 349.00
- YAESU FT77** 539.00
- FV101DM (limited) 150.00
- SP101 (limited) 20.00
- FT208RA Call
- ALPHA DELTA &
SHERWOOD** 10% off list
- ANTECO 5/8 2M**
Mag Mnt Ant-Complete .. 25.00
- SOLAR POWER**
Corp. Modules Call
- MFJ 496 Keyboard** 269.00
- HAL CT2200** 829.00
- MPT3100** 2449.00
- 12' screen 189.00

See you at the
ARRL Delta Division Con.
at the Civic Center
August 13 & 14

- BENCHER Single lever**
paddles New Item
- Black 39.95
- Chrome 49.95
- TOKYO HYPower**
- HL160V 3-10
in/160-180 out 299.00
- HC2000 Tuner 299.00
- FOXTANGO Filters** 10% off. Call
- KANTRONICS Interface** .. 139.95
- PRO-AM Mobile**
whips 75M to 10M .. 20.00 ea.
- SIGNAL ONE One**
Mil Spec (good trades) 4995.00
- HAL MPT3100/**
- Message unit 2449.00
- ST5000 219.00
- ST6000 649.00
- ETO Alpha 77DX** 3775.00
- 77SX Export Call
- WELZ Meters** 10% off
- DRAKE TR7A/RV75** ... 1700.00
- ICOM IC 751 and IC271**.... Call

We will open and inspect
all equipment at your
request. Accessories
purchased will be installed
and tested without charge.

IF IT'S
NOT LISTED,
CALL ME!!

ROBOT

- 1200C SSTV \$1139.00
- 450C 789.00
- 800C/800CH 789.00
- 400C Conversion Kit 469.00
- 800C Conversion Kit 155.00

Big LCD Clock

GMT/Local twin display, black frame with
large, easy-to-read display (.6" high)
Batteries included. \$29.95 + \$1.50 shipping



HAM TAGS

\$12.95 + \$1.50 shipping



NYE MB-V Deluxe Tuner

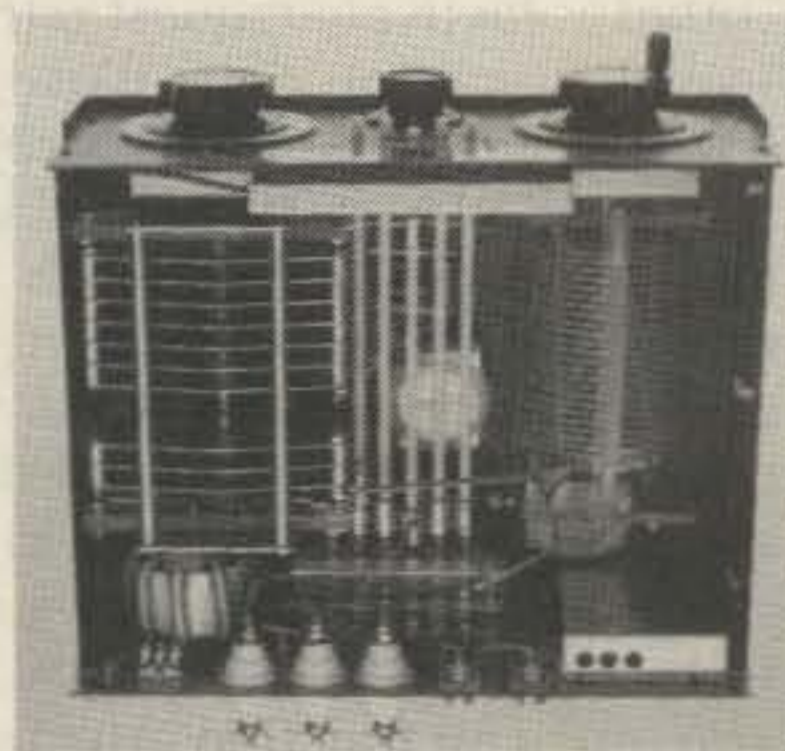

List \$485.00 **Madison \$435.00**

COMPUTERS + RADIO = RTTY/MORSE

- #1 **AEA CP1, Kantronics Interface,**
VIC 20 Hamsoft and computer with
cables to fit your VIC 20 radio
\$325.00
- #2 Above package with **HAMTEXT**
\$375.00
- #3 **MFJ 1224, Kantronics Hamsoft,**
VIC 20 and the cables for your
radio. \$225.00

DON'S CORNER: We will do warranty work, no
matter where it was bought. That might not be
real bright, but it's friendly, and where would we
be without friends. Speaking of which . . . Do
you get any calls or remarks about TVI/RFI?
We have several good books on the subject
from ARRL, Orr. First, DON'T PANIC!!

Ground systems are the most frequent
culprit. Be sure you're not running parallel to
the tx line. No? Check for inductance coupling
with fences, rain gutters, etc. Go step by step.
Need help? Call our regular number for advice.
YOU ARE NOT UNIQUE, and we might help.

New HAL MPT 3100 ASR



The MPT3100 software may be added to any
DS3100 ASR with MSO3100 hardware package.
There are three new operating modes:

STORE: Up to 32,000 characters. All rec'd text is
stored. Each message has seq. number ID. Time-
Date data automatically.

EDIT: Edit any or all in storage. ID's altered to
fit tx sequence. Custom code insertion (i.e. ID).
Subdivide files.

RELAY: All changes and edits can be stored. TX
can have quick-break feature for direct ASR TX.
Non-destructive.

PLUS A LOT MORE . . . Call us!

1508 McKINNEY
HOUSTON, TEXAS 77010

*CALL FOR QUOTES
713-658-0268

We stock what we advertise, and much more.
TOLL FREE - ORDERS ONLY
1-800-231-3057

Save Your Signal with Forward Error-Correction

In a hostile signal environment, you need all the help you can get.

There have been several short articles on packet radio over the past few years, but this article will present some different ideas on using computers to obtain error-free transmission of digital data over poor-quality radio channels (see "Computers and HF," 73 Magazine, January, 1981). The current efforts in setting up packet networks share several things in common. They all use rather large blocks (about 260 bytes), and they all use error-detecting codes with no forward error-correction capability. Since these systems are being set up to make use of the specialized integrated circuits that are being produced for the commercial market, this result is to be expected—the commercial market uses the telephone system for its long-haul communications, and these types of packets will probably work very well on a phone line or on a radio channel that acts like a phone line.

A good quality VHF radio channel, or a VHF repeater channel, behaves very much

like a telephone channel when it comes to bandwidth, level stability, and noise bursts, so it is reasonable to expect these packet systems to work fairly well in these cases. Considerable effort has gone into commercial research on this topic, so it is probably smart to follow their recommendations—when our radio channels act like phone lines.

On the other hand, a normal HF radio channel does not act very much like a telephone channel. On a typical day one can expect noise bursts every few seconds, deep fading, and lots of interference from other signals. In short, the channel is much more "hostile" than a repeater channel, and many more transmission errors can be expected per unit time. This means that for a packet system to work, it will be forced to transmit only very short packets in order to get some passed error-free between noise bursts and interference. In this mode, the framing and control bits added to the data in a packet become a very significant overhead

and greatly reduce system throughput.

Another problem with the packet approach as it stands is that only one packet at a time is sent to the receiving station, and the sending station must wait for an acknowledgement of correct receipt before sending the next packet. On a very long HF path, or especially on a satellite path, that requirement can add significant delays to the process. Under these circumstances it would be desirable to send several blocks of data in one transmission, and then allow the receiving station to selectively request retransmission of only those blocks that it received garbled.

I have been working on a different approach to the problem of sending digital data over poor-quality radio channels for the past year. It uses shorter blocks and a code which allows forward error-correction so that it can function effectively under the most severe conditions. I expect it to work much better than packets over HF and satellite paths.

Approach

This scheme has been set up primarily for the single-station-to-single-station mode of operation, as opposed to the multi-user, shared channel operation of a packet repeater. All coding and decoding is done in

software, and standard asynchronous RTTY modulators and demodulators are used. The coding and block format would work just as well, however, if synchronous modulators and demodulators were used.

The system transmits 8-bit bytes as its data, allowing either computer machine code or ASCII text to be accommodated. The communications channel is assumed to be very noisy and prone to interference and fading (a typical HF channel under bad conditions). Since errors are assumed to occur very often, a system of forward error-correction is used.

As opposed to the cyclic redundancy check (CRC) used in packet schemes, where a packet must be retransmitted when one or more errors are detected in a block, a forward error-correction scheme uses several additional check symbols transmitted along with the data to allow it to detect and correct (up to a point) transmission errors within the data. Only when more errors occur than the code is capable of correcting must a block be retransmitted.

To allow the sending station to transmit several blocks before pausing to listen for acknowledgements, an "address" field is included in each block. This

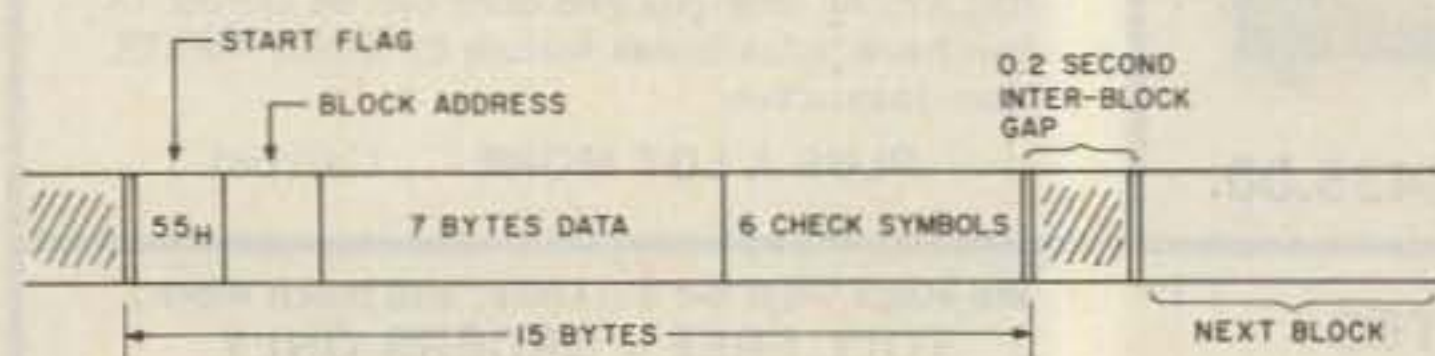

Fig. 1. Encoded block format.

```

U 146 MHzj!0aY[
U Channel! ]2=! ]
U CascadeI<&p<;
U Impulse,yvd%P
U Signalshg4='<
U Samples3u3f5+
U Mixers ~[&0}a
U 1.2.3.4j()r+H
U DistortV$0K6a
U Phase I?y.r:<
U Pattern)-4L05
U Deviate>Xi. q
U Pulses aER9H'
U Initial01k,(r
U ClippedfTM^h]
U ConnectihA.tl
U Cutoff :V_0$w
U 120 dB ,*QJYZ

```

```

146 MHz
Channel
Cascade
Impulse
Signals
Samples
Mixers
1.2.3.4
Distort
Phase I
Pattern
Deviate
Pulses
Initial
Clipped
Connect
Cutoff
120 dB

```

```

aY[U #hannel! ]2
] ?U#Ca3cadeI<&p
5ImpulseLzvd%PU
Miwn' lshg49'-?U
Samples3u3f5+?U
Mixars!~[&0}aU
g7()r+HU Distor
V$0K6aU Phase I
e9p:<U Pattern)
QL05U Deviate>X
qU Pulses aER9H
tia101k,(rU Cli
edfTM^hJU Conne
tihA.tlU Cutoff
V_0$wU 120 dB ,
QJYZ?U 146 MHzj
AaY[?U Channel!
] ?U CascadeI<.p

```

```

Channel
Cascade
Impulse
iwn' lsh
Samples
Mixers
Distor/
Phase I
Pattern
Deviate
Pulses
Initial
Con~ued
Cedoff*
120 dB
146 MHz
Channel
Cascade

```

Fig. 2. Output under ideal conditions.

Fig. 3. Output under severely degraded conditions.

8-bit number is uniquely assigned by the transmitting station to each block to identify it. The receiving station then acknowledges receipt of a block by sending its address. Those blocks that are not acknowledged (their addresses are not received back at the transmitting station) are then retransmitted. This feature allows up to about 256 blocks to be transmitted in a single transmission before pausing to listen for acknowledgements from the receiving station. This way, the long transmission delays of a satellite channel will not be nearly as costly in throughput.

After some analysis and experimentation, a twice-interleaved Reed-Solomon code of length 15 was chosen to encode each block of data. This code takes 9 bytes of data, computes 6 unique check symbols, and transmits them together as a block of 15 bytes. As shown in Fig. 1, each block begins with a start flag (55H), a block address byte, and 7 data bytes. The final 6 bytes of the block are the check symbols used by the decoding soft-

ware for error-detection and -correction. The use of 6 check symbols allows the correction of up to 3 errors anywhere within the 15 bytes of the block, and detection of a garbled block when more than 3 errors occur. To give the decoding software ample time to correct a garbled block, a 0.2-second steady mark is transmitted between blocks.

Block transmission times (including the 0.2-second inter-block gap) are about 1.7 seconds at 110 bps, 0.7 seconds at 300 bps, and 0.32 seconds at 1200 bps. If the transmitting station chose to transmit a full 256 blocks before its pause to listen for acknowledgements, the maximum time per transmission would be about 7 minutes at 110 bps, 3 minutes at 300 bps, and 1-1/2 minutes at 1200 bps. These are all convenient transmission lengths to avoid abusing transmit/receive relays in the transmitters.

By using comparatively short blocks and incorporating forward error-correction, this system has the ability to function effectively under conditions much worse than those which can be toler-

ated by a normal packet system. Since 3 out of every 15 characters in a block can be garbled and still allow the block to be corrected to full accuracy, no blocks need to be retransmitted if the channel error rate is always 20% or less. In contrast, the packet system will require a retransmission whenever even a single error is experienced in a block. The net effect is that many fewer block retransmissions will be required for this scheme under poor conditions.

In exchange for this added capability, one must realize that even under the best conditions, only 7 out of every 15 characters are real data, and one now also needs additional coding and decoding software to use the system.

Example Decode

A program was developed to test the encoding and decoding functions, and sample output from this program is shown in Figs. 2 and 3. The test program takes a prepared list of 6 and 7 character words or easily recognizable sequences, encodes these using the proper for-

mat, and sends them to the local transmitter as an FSK signal. The transmitter is operated with its oscillator only, and the local receiver is tuned to demodulate the test signal. This signal is then recorded on tape and represents a noise-free example of a sequence of properly-encoded data blocks.

To test the decoder function, the tape is replayed, but the recorder output is mixed in with noise from the same receiver tuned to an unused area of an HF band. The noise level from the receiver is then adjusted until the demodulator is producing garbled output much of the time. The test program prints out the raw received data block, and also the data after it has been processed by the decoder. Often the decoder can be observed to have successfully corrected a badly garbled block.

Fig. 2 is an example of program output under ideal, no-noise conditions. The left column is the raw received 15-character data block, including the start flag (it prints as a "U"), the address field (prints as a blank), the 7 data characters, and the 6

check symbols. The check symbols look like random garbage, but rest assured that they have meaning to the decoder! The right column is the character sequence that is output from the decoder. In this no-noise case, every block is correctly decoded, of course, and, indeed, even the raw data is error-free.

The output shown in Fig. 3, however, is after the noise level has been increased enough to cause all blocks to sustain several errors. (At this noise level there were also several blocks where more than the allowable number of errors occurred and, as expected, the decoder was not able to correct the data in these cases.) By comparing the raw data block, with errors, to the decoder output and to the known correct block in Fig. 2, one can see that the decoder is often able to correct the blocks. (Not shown

in this listing, but extremely important, is the decoder flag that indicates when it has detected a bad block that it could not correct. Each of the blocks that were not successfully decoded would have had this flag set.)

Fig. 3 also illustrates that the decoder can not only correct several errors in a block, but also it can often correct a block when the start flag was so corrupted by noise that the received data is not in the proper position within the block.

Networks

This system is optimized for station-to-station links and HF channels, while packet systems are optimized for VHF repeater and multi-user channels. This does not mean, however, that the two cannot be mutually beneficial. For local networks, using high-quality repeater channels, the pack-

et scheme alone would be used. But for those HF or satellite links where data is being passed between isolated packet networks, packets could be transferred by breaking them up into the smaller blocks required for the forward error-correcting scheme and sending them to the receiving station as a series of these smaller blocks. At the receiving station (a "gateway" into the receiving network), the blocks would be properly assembled to restore the packet, and the packet would be introduced into the local network like any other. Unless one is blessed with a very good HF channel, this approach will probably be more successful than attempting to transmit the packet, intact, over the HF or satellite link.

Conclusions

A complete software system incorporating this

error-correction scheme has been completed for amateur digital communications and has been in use (on the air) for almost a year by the time this is printed. While it is still undergoing changes and enhancements, it is already a very viable system and provides greatly improved communications over standard RTTY.

The existing software is written for Digital Group Z-80 computers and requires a minimum of 26K memory. It requires only conventional RTTY interface hardware and is available from the author.

Further refinements are planned for the system, including incorporation of a hardware interface board to simplify the software and allow higher speed operation (up to 9600 bps) while making it easier for people operating other computer systems to use the system. ■

YOU'LL NEVER GET A BETTER DEAL

HUSTLER ANTENNAS

SF2 - "Buck Buster" 5/8" Wave
2 Meter Antenna w/3/8 x 24"
Threaded Base -
3dB gain **\$8⁹⁵**

**HOT - EASY ON/OFF
TRUNK MOUNT**
with 3/8 x 24" Swivel Ball
for CG144 & SF-2

\$14⁹⁵

CG144 **\$23⁹⁵**
5.2dB gain
Collinear
w/3/8 x 24"
Threaded Base

G6144 - 6dB
Base
Antenna **\$68⁵⁰**

G7144 - 7dB
Commercial
Grade Base
Antenna **\$98⁰⁰**

And many other Hustler Antennas & Mounts

BBL144	25 ⁹⁵	MRK-1	13 ⁷⁵
BBLT144	35 ⁰⁰	SFM	24 ²⁵
BBLT440	24 ⁷⁵	THF	13 ⁹⁵
HLM	13 ⁹⁵	UHT-1	8 ⁹⁵

**CECO STOCKS THE ENTIRE HUSTLER
VHF/UHF & COMMERCIAL LINE
DEALER INQUIRIES INVITED**

CeCo

COMMUNICATIONS, INC.

2115 AVENUE X
BROOKLYN, N.Y. 11235
(212) 646-6300
(800) 221-0860
TELEX: 235125



**We're changing
what repeaters
can do ... for YOU!**

Whether you're a repeater owner, control op, or user, the RC-850 controller offers you capabilities you've only dreamed of. Like natural sounding speech synthesis ... easy, remote Touch-Tone programming ... talking meter readback ... synthesized remote base operation ... and an autopatch with features you have to hear to believe.

Most important of all, upgrade through software, prevents obsolescence. Which lets us bring you new features, like our scheduler, for automatic changeover of repeater status by time and day of week ... And our mailbox, for leaving messages for your friends. Plus much, much more!

**The
RC-850 Repeater
Controller—The
New Standard in
High Performance!**

Ask anyone that owns an RC-850 controller. Or ask us for our demo tape, so you can hear for yourself.

acc advanced
computer
controls

Call or write for detailed specifications
on the RC-850 Repeater Controller.

10816 Northridge Square • Cupertino, CA 95014 • (408) 749-8330

812-422-0231



The HAM SHACK

✓ 449

808 N. Main
Evansville, IN 47711



ICOM-2AT



ENCOMM/SANTEC
ST-144/uP



YAESU-FT77



TEN-TEC CORSAIR

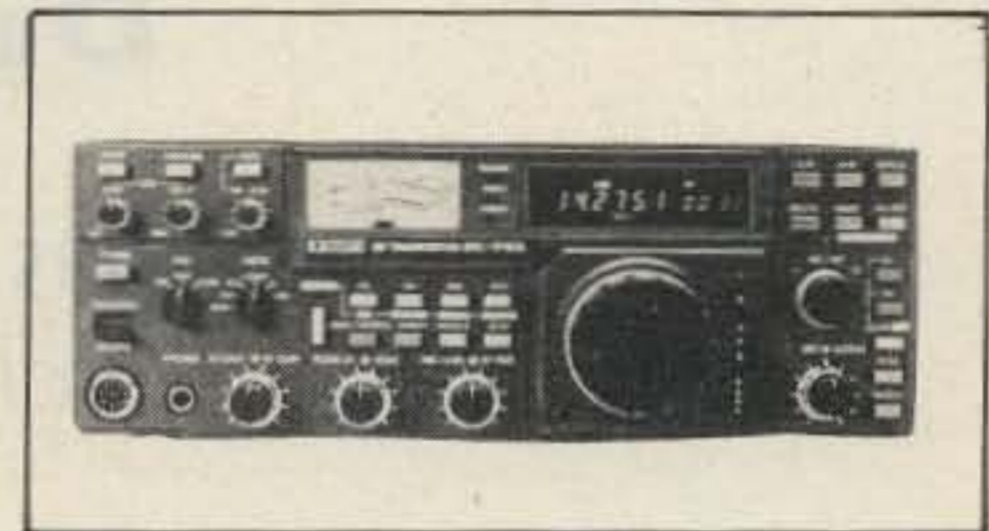

ICOM-751

- AEA**
CP-1 New Computer Interface call
CK-2 Contest Memory Keyer \$139.00
144 Isopole Antenna 40.00
- ALLIANCE**
HD73 (10.7 sq ft) Rotator \$99.00
U-110 Small Rotator 49.00
- ASTRON**
RS7A 5-7 Amp Power Supply \$49.00
RS12A 9-12 Amp Power Supply 69.00
RS20A 16-20 Amp Power Supply 89.00
RS20M 16-20 Amp w/meter 109.00
RS35A 25-35 Amp 135.00
RS35M 25-35 Amp w/meter 149.00
RS50A 37-50 Amp 199.00
RS50M 37-50 Amp w/meter 225.00
VS-20M Variable w/meter 125.00
VS-35M Variable w/meter 175.00
VS-50M Variable w/meter 249.00
RS-12S w/speaker 74.00
RS-20S w/speaker 104.00
- B&W**
Folded Dipole 80-10 Meter, Only 90' Long,
No Tuner Necessary \$135.00
- BASH**
Books and Tapes \$9.95
- BENCHER**
BY-1 Paddle/BY-2 Chrome \$36.00/45.00

- BUTTERNUT**
HF6V 80-10 Meter Vertical \$119.00
ZA-1A Balun 16.50
- CUSHCRAFT**
A3 Tribander 3 EL \$179.00
A4 Tribander 4EL 229.00
R3 Motor Tuned Vertical 229.00
214B Boomer 14EL 2M 69.00
214FB Boomer 14EL FM 69.00
228FB Power Pack 28EL 2M FM 189.00
32-19 Super Boomer 19 EL 2M 83.00
220B Boomer 17 EL 220 MHz 75.00
ARX-2B Ringo Ranger II 2M 39.00
Rotatable Dipoles call
- DAIWA**
CN-520 1.8-60 MHz SWR/Pwr Mtr \$63.00
CN-620B 1.8-150 MHz SWR/Pwr Mtr 110.00
CN-630 140-450 MHz SWR/Pwr Mtr 129.00
CS-201 2-position switch 22.00
- DRAKE**
TR7A Xcvr w/PS7 \$1,435.00
R7A Receiver 1,225.00
TR5 Xcvr w/PS75 675.00
- ENCOMM (SANTEC)**
ST-144/uP, 220/uP, 440/uP
The Handhelds Offering the Most Features
Call for Your Discount Price
- HAL**
DS3100/MPT/ST6000 \$2,825.00
CT2200/KB2200 945.00
- HY-GAIN**
TH7 DXS 7EL Tribander \$375.00
TH5 MK2S 5EL Tribander 319.00
402BAS 2EL 40 Meter Beam 199.00
66BS 6EL 6 Meter Beam 109.00
18HTS 80-10 Meter Beam 339.00
V2S 2 Meter Vertical 39.00
5/8 Wave 2M Mag Mt. 20.00
CD45 8.5 sq ft Rotator 105.00
Ham IV 15 sq ft Rotator 195.00
T2X 20 sq ft Rotator 249.00
HDR300 25 sq ft Rotator 435.00
Free Shipping on all crank-up towers
- ICOM**
We Have All the Great ICOM Transceivers in Stock
Call About the New Ones Now Available
IC-2AT Now Only \$215.00
3AT/4AT Handhelds 235.00
25A new display & mic 305.00
290H 2M All Mode 479.00
45A 440 MHz 349.00
R70 Superb Receiver 629.00

- KLM**
KT34A 4EL Triband Beam \$299.00
KT34XA 6EL Triband Beam 459.00
144-148-13LBA 2M Long Boomer 79.00
143-150-14C 2M Satellite Ant. 79.00
420-470-18C Satellite Ant. 59.00
Maximizer Antennas Call
- KANTRONICS**
The Fantastic Interface for CW, RTTY, ASCII
Software Available for VIC20, VIC64, APPLE,
ATARI, TR80C, TI99
Call for a Package Price
- LARSEN**
NLA-150-MM 5/8 Wave 2M Mag Mt. \$39.00
- MFJ**
989 3KW Roller Inductor Tuner \$289.00
941C Tuner/Meter/Ant. Switch/Balun 81.00
940B Tuner/Meter/Ant. Switch 72.00
900 Tuner 45.00
401 Econokeyer 45.00
422 Keyer/BENCHER Paddle combo 89.00
722 Filter w/notch 63.00
812 VHF Meter 29.00
816 HF Meter 29.00
1040 Deluxe Preselector 89.00
103 New 24hr Clock 33.00
313 VHF Conv for HT 36.00
- MIRAGE**
B108 10/80 Preamp \$155.00
B1016 10/160 Preamp 245.00
B3016 30/160 Preamp 199.00
D1010N 10/160 440 MHz 275.00
MP1/MP2 Watt Meters 100.00
- ROHN**
25G \$42.00
- SHURE**
444D Desk Mic/414A Hand Mic \$50.00/36.00
- TEN-TEC**
New 2M Handheld \$285.00
Argosy II Digital 535.00
2KW Tuner Kit 185.00
The Fantastic Corsair Call
- TOKYO HY-POWER**
HL30V 2/30W Amp \$63.00
HL160V 3 or 10/160W Preamp 295.00
HC2000 2KW Tuner 295.00
HL82V 10/80W Preamp 145.00
HL20U 2/20W UHF Amp 99.00
HL45U 10/45W Preamp 175.00
HL90U 10/80W Preamp 299.00
- YAESU**
FT77 Call for Prices

Prices and Availability Subject to Change

Send SASE for our new & used equipment list.
MON-FRI 9AM-6PM • SAT 9AM-3PM

A Colorado-Style Battery Monitor

Texas has its barbecue and Chicago its pizza. Colorado's claim to fame is this near-perfect device.

Lynwood H. Wilson
Jamestown Star Rt.
Boulder CO 80302

A battery monitor should tell you when your battery is in trouble, but it shouldn't make trouble for your battery. The ideal device (all the books start with the ideal device, don't they?) draws no current

when the voltage is good and draws as little as possible to warn you when the voltage is low. This circuit approaches the ideal, drawing less than 30 μ A in normal operation and about 3 mA when flashing the LED.

A big factor in the low power consumption of this circuit is the 3909 flasher

chip. An LED can be a heavy load for a small battery, but a flashing LED draws less power and more attention. The 3909 is designed to be an LED flasher, to operate on voltages as low as 1.5, and to draw minimum current. It is also usable as an oscillator, an amplifier, and who knows what else (it's one of those!). So check the National Semiconductor *Linear Applications* and enjoy yourself, but this time (surprise) we are using it as the designer seems to have intended.

holding the Darlington (Q2 and Q3) off. When the battery gets tired, the voltage to the base of Q1 falls too low to hold it on. The current through R4 is thus available to turn on the Darlington. Pin 4 of the IC is pulled down to ground, and the LED (any LED) begins to flash. The value of R5 should be large enough that pin 2 does not go more than 7 V above pin 4 with the input voltage you are using. R5 controls flash rate and current drain.

The circuit is straightforward, and values are not critical. I used 2N3904 transistors throughout, but I suspect any low leakage silicon NPNs would work. The capacitor sees a voltage reversal of 1.5 V each cycle and probably should be rated for it, but I used an ordinary electrolytic and it's been working fine for some time.

Voltage from the divider, R1 and R2, normally holds Q1 on, which sinks the current through R4 to ground,

My monitor keeps watch on a 9-V battery and seems to work quite well at 12 V, but for higher voltages, R1, R4, and R5 can be increased in value. R2 sets the limit voltage, and it is a bit tricky to adjust. It is much easier if you use an adjustable power supply rather than a voltage divider to get the source voltage, since the difference in current from on to off can change the output of a voltage divider enough to make you think you'll never get it right. Never mind how I know. ■

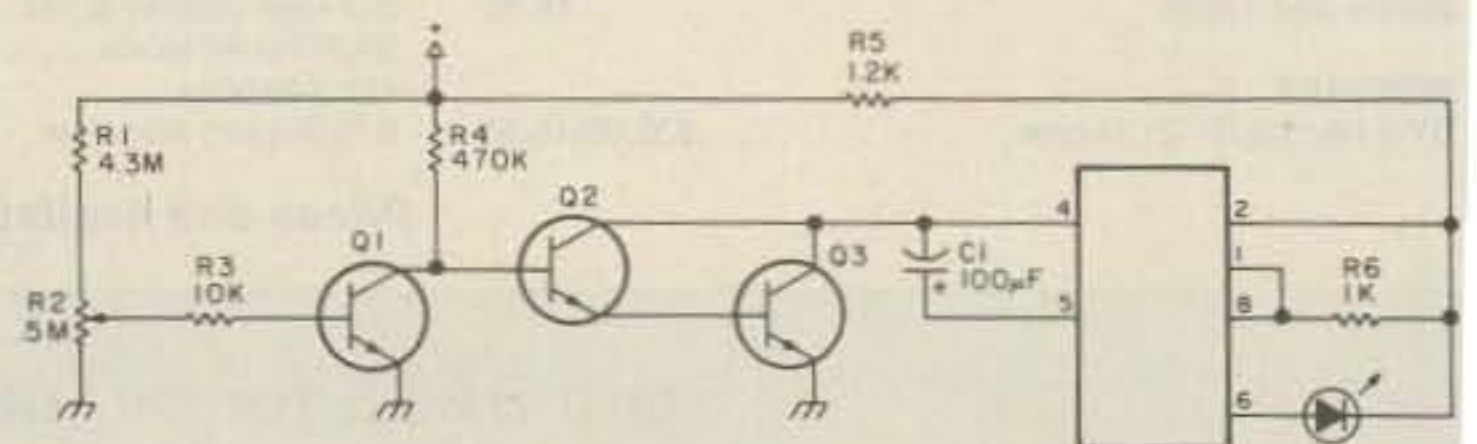
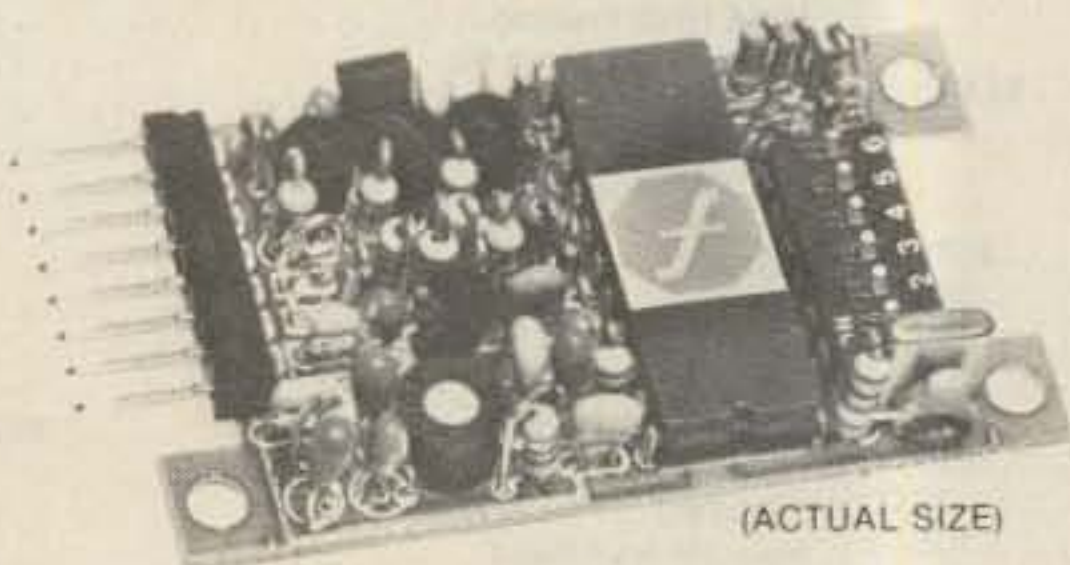

Fig. 1. Battery monitor.

PROGRAMMABLE CTCSS ENCODER/DECODER



- All 37 EIA Tones
 - Quartz Accurate
 - Universal
- \$54.⁹⁵**

IMMEDIATE DELIVERY AVAILABLE FROM NEW YORK AND CALIFORNIA DISTRIBUTION CENTERS

For more information call TOLL-FREE
(800) 828-6884
NY: (800) 462-7242
CANADA: (416) 884-3180



FERRITRONICS
MOBILE DATA SYSTEMS

1319 PINE AVE.
NIAGARA FALLS NY 14301

218

step up to the best...

Without doubt LR-1 is the repeater value leader! Compare its outstanding performance with any repeater -- then look at its price. LR-1 features include individual die-cast shielding of receiver and transmitter plus a separately shielded 6-stage receiver prefilter for peak performance in harsh RF environments • Front panel metering of all vital functions • CW identifier • Symmetric hard limiting for clean natural audio • Low power MOS control logic • Even the cabinet is included -- just plug in and go!

LINKING? The LR-1 is also available with control circuitry for Link Transceiver operation. Now link repeater sites with the flexible control capability you've always wanted.

HIGH POWER? Our PA-75 power amplifier is the champion! Ruggedly built to give years of dependable operation in continuous duty repeater service.



Mark 3C repeaters and controllers have no equal in performance. Both units feature auto patch, reverse autopatch, autodial, 13 Morse messages and a total of 39 functions. Both feature microprocessor control and both have been proven in the field from icy Alaska to tropical Brazil. A Mark 3C supercontroller can make any repeater a super performer. The Mark 3CR repeater is in a class by itself. It combines superbly designed RF circuitry in one handsome package. It is without doubt the world's most advanced repeater!

CALL OR WRITE FOR FULL DETAILS

MICRO CONTROL SPECIALTIES

23 Elm Park • Groveland, Massachusetts 01834 • Telephone (617) 372-3442

The Totally-Modified 2000

Take Azden's popular 2-meter rig
and add all the extras you ever wanted.

The PCS-2000, Azden's first radio on the US amateur market, is an extremely popular 2-meter FM rig. There have been numerous modifications for this transceiver—adaptations for various specialized situations—and this article is a compilation of them. Amateur-Wholesale Electronics receives a lot of inquiries about PCS-2000 mods. Here they are.

The modifications described here include PL™-tone installation information, a full-band-scan mod (in case you want to scan across 144-148 MHz in one sweep instead of in separate 1-MHz sweeps), a nicad memory backup mod, and CAP/MARS mods. Other modifications have been done; the Up, Down, and M1 Call buttons on the microphone, for example, may be rewired to perform other functions. Here, we will give details only for the aforementioned four modifications of the PCS-2000, since they are by far the most common and most asked-for.

PL-Tone Installation

The PCS-2000 needs an external tone oscillator for PL use. Any PL-tone generator may be used. Tone injection is done on the PLL board, which is on the top of the rear section, toward

the front. (The board number is 50-30160.)

Look near the center of this board and locate the space for R159—it is vacant. Install a resistor of 22k to 47k Ohms in this space. Near R159, there are two holes with white circles around them. One of these holes is next to R124 and R127—this is ground. The other hole is for PL-tone injection.

Full Band Scanning

The PCS-2000 microcomputer is programmed to autoscan in steps of 10 kHz, within one of these four ranges: 144-145, 145-146, 146-147, or 147-148 MHz. Depending on the MHz digit at the time scanning is begun, the PCS-2000 will remain inside one of these ranges. This is convenient, since it allows the receiver to cross a given frequency four times as often as would

be the case if the scan range were a full 4 MHz. Thus it is less likely that a short transmission will be missed entirely. This narrow-scan feature also reduces the number of unwanted channels that are scanned.

However, sometimes it is desirable to scan the entire 2-meter band, perhaps because the local repeaters are on widely separated frequencies, or because you may not know where they are (on an extended trip). This can be done manually by hitting the MHz Up key just as the microcomputer gets to the top of its 1-MHz scan range. (It takes good timing!) But we can easily get a couple of ICs to do this for us. The circuit is given in Fig. 1.

This circuit is connected to IC401, IC402, and associated circuitry on the control board, which is located on top of the control-head sec-

tion of the PCS-2000. External connections should, of course, be made to the underside of the board; the board is easily removed for this purpose. Ground connections should be made to the common bus on the board. This entire circuit can be built on a piece of perf-board about 1 inch square. The best place for the completed circuit is right behind the Offset/Scan switch PC board. Proper insulation measures should be taken to avoid short circuits between circuit boards.

When this modification has been installed, the Auto-scan key will cause the PCS-2000 to scan across the range 144.000-147.990 MHz in increments of 10 kHz. If the 5k Up button is activated, the range becomes 144.005-147.995 MHz, again in steps of 10 kHz.

Nicad Memory Backup

Failure of any of the three little silver-oxide memory backup cells can give the illusion of a rig in need of drastic repair service. The most common symptom is activation of the memory-scan function after a transmission; there also may be false or strange readings on the frequency display. Removing the memory backup cells will eliminate these horrible manifestations, but of course you have to re-

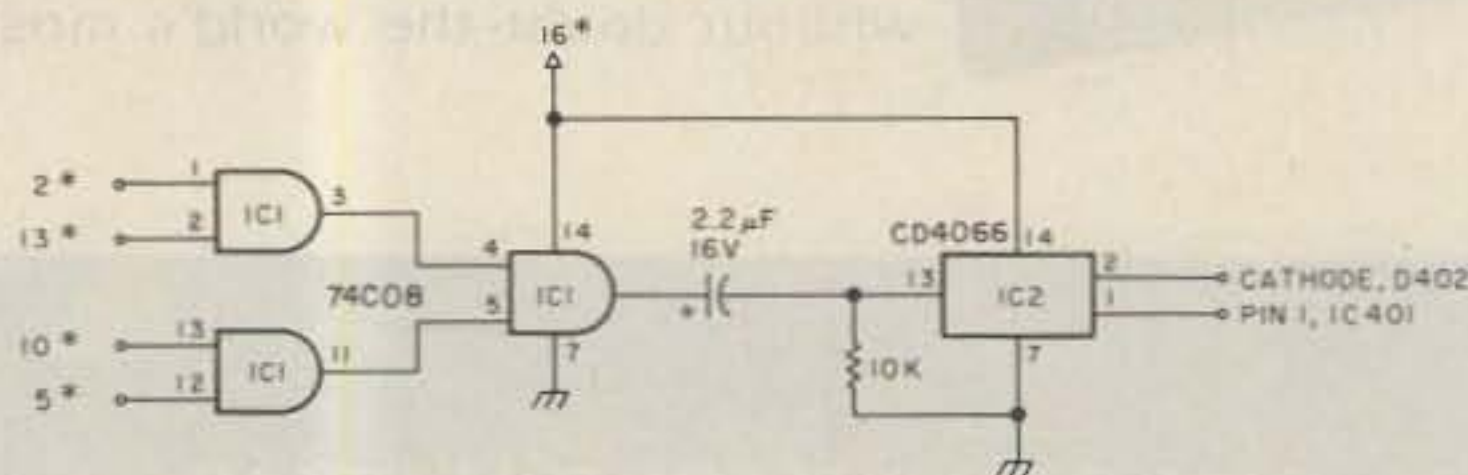

Fig. 1. Full-band-scan modification for the PCS-2000. The circuit is wired to the control board, which is the circuit board on top of the control head. External connections marked with an asterisk (*) are pin numbers for IC402. IC1—74C08; IC2—CD4066.

place the cells if you want the memories retained while the radio is off. The silver-oxide cells (type 76) can be found in most camera shops; however, there's an easier way to replace them — easier in the long run, because you shouldn't have to tamper with them again for several years.

A special nicad battery is available from Amateur-Wholesale Electronics. It is used in the PCS-3000 unit, but will fit into the PCS-2000 without much trouble. It is moderately priced (less than three new silver-oxide cells). You'll also need a 1000-Ohm resistor, available at Radio Shack stores for a few cents.

To perform this mod, remove the three silver-oxide cells from their holder and solder the leads of the nicad battery to the terminals of the silver-oxide cell holder. (Be sure to observe the proper polarity. Remember Murphy's Law—the chances of getting the polarity correct if you guess are *considerably* less than 50-50.) It is best to solder on the underside of the board.

Locate D408, adjacent to the cell holder. Solder the 1000-Ohm resistor across D408 on the underside of the board. This causes the nicad to be trickle-charged while the radio is on, at the rate of about 1.5 mA. It is recommended that the nicad from the PCS-3000 be used, since it is just the right size, physically and electrically, for this application. If another nicad is used, it should have a capacity of at least 50 mAh.

CAP/MARS Mods

Some confusion exists concerning the modifications for extended frequency coverage for the PCS-2000. There are two different modifications; which one you need depends on whether the transmitting and receiving frequencies are both on one side of the 2-meter band, or whether

they are on opposite sides of the band. For Air Force and Navy MARS, both frequencies are generally on the same side of the band (for example, RX 143.460, TX 142.155). For CAP and Army MARS, the frequencies usually straddle the band (for example, RX 148.150, TX 143.900). This is shown in Fig. 2.

The PCS-2000 can be modified to reach frequencies as low as 142.000 MHz and as high as 149.995 MHz. (At the extremes of this range, there is some reduction in receiver sensitivity and transmitter output power.) When pin 13 of the TC9122 programmable divider is pulled low, the actual operating frequency goes either up or down by exactly 4.000 MHz, although the display reading does not change. If the display shows a frequency between 144.000 and 145.995 MHz, the new frequency is 4.000 MHz *above* the indication on the display; if the display shows 146.000 to 147.995, the actual frequency is 4.000 MHz *below* this indication.

Same-Side Splits: Air Force and Navy MARS

Cut the gray wire from pin 4 of connector L on the receiver board and solder it to pin 13 of the TC9122. Connect the three diodes as shown in Fig. 3 and run a wire from the anodes of D2 and D3 to the point marked "UL" on the control board (the top board in the control head). Cut the foil on the Offset/Scan switch PC board as shown.

Once these changes have been made, the radio will still work normally when the Offset/Scan switch is set to F, B, or V on the right-hand side, but on the left-hand side, pin 13 of the TC9122 is low, and the frequencies differ by 4.000 MHz from the display as previously described.

Position V on the left side

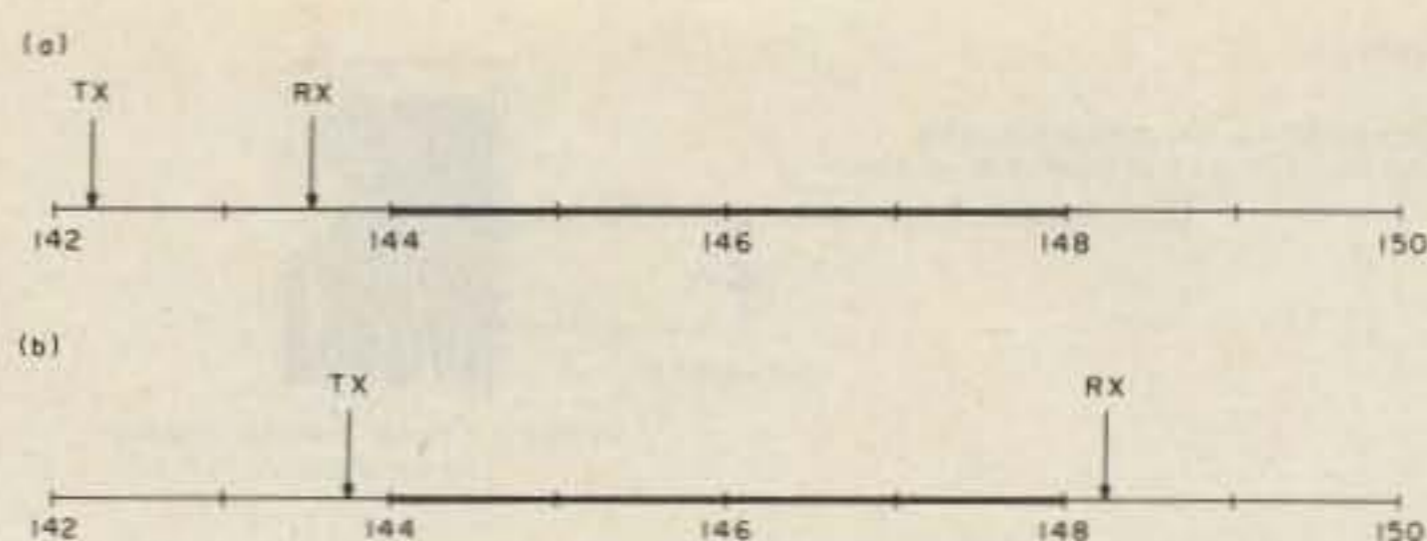

Fig. 2. Examples of same-side splits (a) and straddle splits (b). The amateur band is shown by the heavy line. When modifying the PCS-2000 for CAP/MARS operation via repeaters, same-side splits and straddle splits require somewhat different circuits, as discussed in the text.

of the Offset/Scan switch will provide simplex operation. Positions B and F allow repeater operation when the proper offset crystal has been installed. (The display will not follow crystal-controlled offsets.) To obtain the proper offset, the original 17.9-MHz crystal, which gives an offset of +1.000 MHz, must be replaced. This crystal is located on the transmitter board, the larger board on the underside of the rear unit.

To determine the frequency for the new crystal, first determine the value of the offset, and whether it is positive (TX frequency higher than RX) or negative (TX lower than RX). Use the formulas: offset freq = TX freq - RX freq; crystal freq (MHz) = 16.900 + offset (MHz). For example, suppose you want to receive on 143.460 and transmit on 142.155. This is an offset of -1.305 MHz: offset freq = 142.155 MHz - 143.460 MHz = -1.305 MHz. Therefore, the crystal frequency must be: crystal freq = 16.900 MHz - 1.305 MHz = 15.595 MHz.

If the transmitting frequency is very far from the edge of the 2-meter band, the transmitter output power may be reduced. This is normal, since the circuit is tuned for the range of 144 to 148 MHz. Some transmitter retuning will increase the output at out-of-band frequencies. With the radio upside down and the front panel toward you, locate T107 and T108, just to the left of

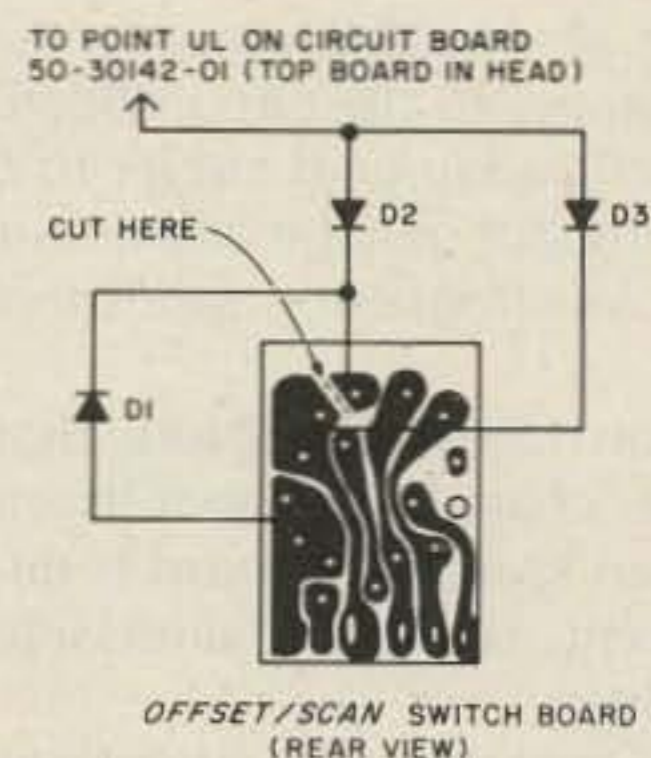

Fig. 3. Modification to the circuit board behind the Offset/Scan switch for same-side CAP/MARS repeater operation. Care should be exercised to be sure that the circuit-board foil is cut in the right place (it's easy to do it wrong) and that the cut is clean.

the 16.900-MHz crystal. These transformers may be adjusted with a small screwdriver to obtain somewhat more output. You can use the digital S/rf meter on the front panel of the PCS-2000, but it is better to use a wattmeter.

When retuning the transmitter in this manner, be careful to note the original positions of the transformer cores, in case you want to return the unit to normal. Also, do not over-adjust the transformers, since this will seriously degrade the power output in the amateur band.

If the offset required is more than 3.000 MHz either way, a different modification is needed.

Straddle Splits: CAP and Army MARS

To get larger splits, perform the modifications

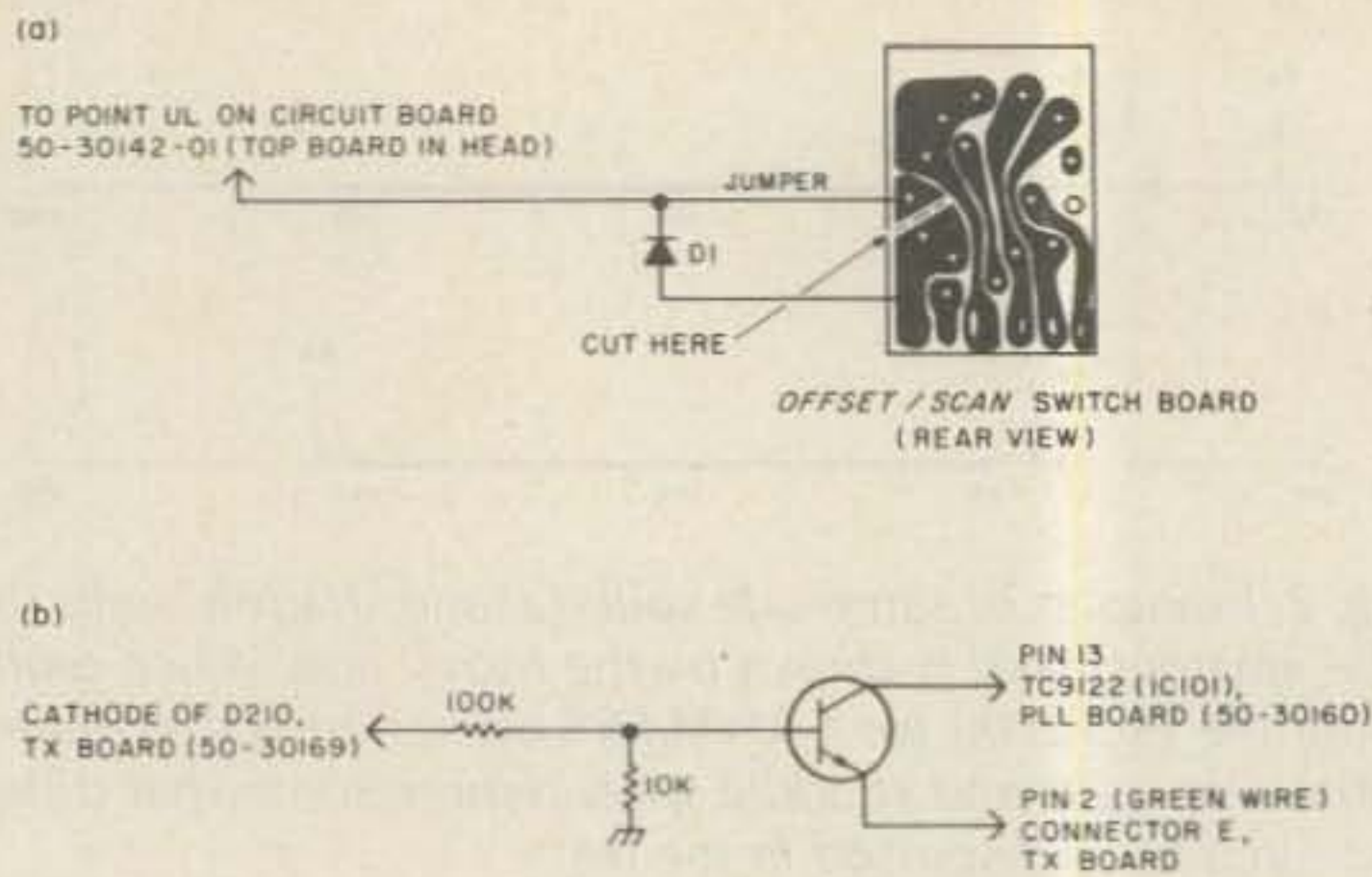

Fig. 4. Modifications for CAP/MARS straddle splits. At (a), changes to the circuit board behind the Offset/Scan switch; at (b), additional circuit to be installed. (The NPN switching transistor may be any common transistor suitable for digital or low-frequency applications.)

shown in Fig. 4. (Note that the change to the Offset/Scan switch PC board is different than for same-side splits.)

Once these modifications are done, the PCS-2000 will function normally when the Offset/Scan switch is in either B or V on the right-hand side. When the switch is in

the F position on the right, CAP/MARS simplex is provided, on frequencies either up or down 4.000 MHz from the display frequency (as previously described).

Positions B, V, and F on the left-hand side of the Offset/Scan switch will provide CAP and MARS repeater operation with straddle splits,

once the 17.9-MHz crystal has been replaced by one having the proper frequency.

To determine the new crystal frequency, use the following formulas: offset freq = TX freq - RX freq; crystal freq = 20.900 + offset (MHz), if offset is negative; crystal freq = 12.900 + offset (MHz), if offset is positive. For example, suppose you want to receive on 148.150 and transmit on 143.900. This is an offset of -4.250 MHz: offset freq = 143.900 MHz - 148.150 MHz = -4.250 MHz. Since this is a negative offset value, crystal freq = 20.900 MHz - 4.250 MHz = 16.650 MHz.

To operate on these frequencies, set the display to 144.150 with the Offset/Scan switch to the left of center. Then your receiving frequency is 148.150 MHz, and the correct offset (-4.250 MHz) will occur during transmission periods.

The arithmetic here is a

little bit confusing, but following these instructions carefully should yield the desired results.

The NPN transistor and the resistors shown in Fig. 4 may be obtained at Radio Shack or any local parts supplier. The crystal should be parallel-resonant, 32-pF, with HC-25/U holder; they may be obtained from any crystal manufacturer. Frequency should be specified to within about 3 kHz, preferably to the nearest 1 kHz.

Conclusion

It is hoped that this information will enable owners of the PCS-2000 to derive more operating convenience from their rigs. Of course, there are many other possible modifications. These four, however, are frequently asked for.

I would like to thank Mark Thomas at Amateur-Wholesale Electronics for his assistance in compiling this information. ■

2300 MHz

<p>BUILT CONVERTER ANTENNA POWER SUPPLY</p> <p style="font-size: 2em; font-weight: bold;">NOW 77.90</p>	<p>KIT PC BOARD ALL PARTS DOWN CONVERTER</p> <p style="font-size: 2em; font-weight: bold;">9.95</p>
--	--

<p>DISK YAGI ANTENNA \$12.95</p> <p>COMPLETE KIT WITH PVC AND MOUNTING BRACKET</p>	<p>POWER SUPPLY \$15.95</p> <p>VARIABLE 4 TO 15 VOLTS</p>
<p>ALUMINUM CABINET \$6.95</p> <p>ANODIZED BLACK WITH BRUSHED FINISH ALL HOLES ARE PRE-PUNCHED</p>	<p>BUILT CONV BOARD \$22.50</p> <p>BUILT P/S & CABINET \$34.95</p> <p>COMPLETE SYSTEM BUILT \$77.90</p>

TRIONYX INC ADD \$5.00 FOR SHIPPING & HANDLING

6219 COFFMAN RD 104 INDIANAPOLIS, INDIANA 46268 NO COD

317 291 7280 PHONE OR MAIL ORDER

WORK THE U.H.F. BANDS

Add a transverter or converter to your existing 10m, 6m or 2m equipments. Choose from the largest selection of modules available for DX, OSCAR, EME, ATV.

<p>TRANSVERTERS</p> <p>POWER AMPLIFIERS</p> <p>all models include RF VOX & Low Noise RX Pre-Ampl. (no pre-amp in MML432-100)</p> <table style="width: 100%; border-collapse: collapse;"> <tr> <td style="width: 20%;">2 Meters:</td> <td style="width: 20%;">100W output</td> <td style="width: 20%;">MML144-100-LS</td> <td style="width: 20%;">1W or 3W in</td> <td style="width: 20%; text-align: right;">\$254.95</td> </tr> <tr> <td></td> <td>100W output</td> <td>MML144-100-S</td> <td>10W input</td> <td style="text-align: right;">\$264.95</td> </tr> <tr> <td></td> <td>50W output</td> <td>MML144-50-S</td> <td>10W input</td> <td style="text-align: right;">\$214.95</td> </tr> <tr> <td></td> <td>30W output</td> <td>MML144-30-LS</td> <td>1W or 3W in</td> <td style="text-align: right;">\$109.95</td> </tr> <tr> <td></td> <td>25W output</td> <td>MML144-25</td> <td>3W input</td> <td style="text-align: right;">\$114.95</td> </tr> <tr> <td>432 MHz:</td> <td>100W output</td> <td>MML432-100</td> <td>10W input</td> <td style="text-align: right;">\$399.95</td> </tr> <tr> <td></td> <td>50W output</td> <td>MML432-50</td> <td>10W input</td> <td style="text-align: right;">\$239.95</td> </tr> <tr> <td></td> <td>30W output</td> <td>MML432-30-L</td> <td>1W or 3W in</td> <td style="text-align: right;">\$199.95</td> </tr> <tr> <td>1268-1296 MHz:</td> <td></td> <td></td> <td></td> <td style="text-align: right;">Coming soon. Watch for details.</td> </tr> </table>	2 Meters:	100W output	MML144-100-LS	1W or 3W in	\$254.95		100W output	MML144-100-S	10W input	\$264.95		50W output	MML144-50-S	10W input	\$214.95		30W output	MML144-30-LS	1W or 3W in	\$109.95		25W output	MML144-25	3W input	\$114.95	432 MHz:	100W output	MML432-100	10W input	\$399.95		50W output	MML432-50	10W input	\$239.95		30W output	MML432-30-L	1W or 3W in	\$199.95	1268-1296 MHz:				Coming soon. Watch for details.	<table style="width: 100%;"> <tr> <td style="width: 50%;">MMT 50-144</td> <td style="width: 50%; text-align: right;">\$189.95</td> </tr> <tr> <td>MMT 144-28</td> <td style="text-align: right;">\$179.95</td> </tr> <tr> <td>MMT 432-28 (S)</td> <td style="text-align: right;">\$269.95</td> </tr> <tr> <td>MMT 439-ATV</td> <td style="text-align: right;">\$349.95</td> </tr> <tr> <td>MMT 1296-144</td> <td style="text-align: right;">\$339.95</td> </tr> </table> <p>OTHER MODELS AVAILABLE write for details</p>	MMT 50-144	\$189.95	MMT 144-28	\$179.95	MMT 432-28 (S)	\$269.95	MMT 439-ATV	\$349.95	MMT 1296-144	\$339.95
2 Meters:	100W output	MML144-100-LS	1W or 3W in	\$254.95																																																				
	100W output	MML144-100-S	10W input	\$264.95																																																				
	50W output	MML144-50-S	10W input	\$214.95																																																				
	30W output	MML144-30-LS	1W or 3W in	\$109.95																																																				
	25W output	MML144-25	3W input	\$114.95																																																				
432 MHz:	100W output	MML432-100	10W input	\$399.95																																																				
	50W output	MML432-50	10W input	\$239.95																																																				
	30W output	MML432-30-L	1W or 3W in	\$199.95																																																				
1268-1296 MHz:				Coming soon. Watch for details.																																																				
MMT 50-144	\$189.95																																																							
MMT 144-28	\$179.95																																																							
MMT 432-28 (S)	\$269.95																																																							
MMT 439-ATV	\$349.95																																																							
MMT 1296-144	\$339.95																																																							

ANTENNAS (incl. 50 ohm balun)

2 Meter J-Beams: 12.3 dBd gain	
8 over 8 Horizon'l pol D8-2M	\$63.40
8 by 8 Vertical pol D8-2M-vert	\$76.95
1250-1300 MHz Loop-Yagi 1296-LY	\$44.95
70 cm/MBM 48	\$75.75
70 cm/MBM 88	\$105.50

70/MBM 48

Send 36¢ stamps for full details of all our VHF/UHF items.

Pre-selector filters	Pre-amplifiers	Antennas
Low-pass filters	Transverters	Crystal Filters
Varactor triplers	Converters	

si

Spectrum International, Inc.
Post Office Box 1084S
Concord, Mass. 01742 USA 436

MICROLOG AIR-1

SPECIFICATIONS

INPUTS: Receiver audio, in & out phono jacks for easy speaker connections. Hand key input allows code practice that reads your sending and drives the transmitter keying outputs.

OUTPUTS TO TRANSCEIVER: Positive and negative switching for CW & FSK keying, solid state or tube type transmitters, AFSK tones at microphone compatible levels, T/R(PTT) transmitter control.

PRINTER OUTPUT: Uses standard VIC printer for "Hard-Copy" of both receive and transmit data regardless of on-the-air mode. Also has hi voltage transistor switch on board for driving current-loop type printers.

DISC & TAPE INTERFACE: Uses standard VIC DISC & DATASET for recording off the air and making long "brag tapes." Another handy feature is the ability to save and re-load your "here-is" memories easily. Since this function is also compatible with your VIC disc drive, it's especially nice for quick start-up.

VARIABLE MEMORY UTILIZATION: A unique Microlog feature allows you to select the size of your text buffer and 8 "HERE-IS" messages from the available computer RAM. It automatically takes into account any memory expansion cartridges you've added. The unexpanded VIC has about 3000 characters for you to allocate. You could for example choose eight 300 character messages and a 600 character text buffer. If you don't tell it otherwise, the system will default to eight 100 character "HERE-IS" memories and a 2200 character text buffer. The expanded VIC will have different default memory sizes, depending on the amount of added memory. The programmable "HERE-IS" memories can be loaded or inserted into the text buffer for transmission at any time.

TEXT BUFFER: Allows you to type ahead while receiving. Text entered into the buffer is visible above the split-screen line for correction before sending.

AUTO-START: Inhibits the display of non-RTTY data.

TUNING INDICATORS: On screen visual tuning aid and audio (pitch) reference tone for RTTY and CW. (Audio is heard thru your tv or monitor's sound channel, just like any other VIC generated audio.)

W R U (Who Are You?): Automatically responds with your call sign when a user programmable sequence up to 15 characters is received.

SEL-CALS: Two 15 character user programmable sequences. Receipt of selcal #1 enables the printer, disc or tape. Receipt of #2 disables these outputs for unattended message store (mailbox).

FULL SPEED OPERATION: Transmit and receive Morse — 5 to 199 WPM, Baudot — 60, 66, 75, 100, 132 WPM, ASCII — 100 & 300 baud.

MORSE SPEED TRACKING: Automatic and speed lock modes, keyboard selectable.

VIDEO DISPLAY: Color keyed display makes optimum use of the computer's color capability. Uses standard VIC format of 23 lines of 22 characters.

SPLIT-SCREEN: Displays text buffer input above and receive/real-time transmit text below the split line.

TOP LINE DISPLAY: Constant display of Time, Mode, Speed/Code in use, and status indicators.

TEST MESSAGES: Quick brown fox and RYRY's in Baudot, U*U* in ASCII, and VVV in Morse.

SPECIAL SYNC-LOCK MODE: Allows improved ASCII operation and "Paced Output" in Baudot RTTY.

T/R(PTT): Fully automatic control of your XMTR via the Push-to Talk line in both RTTY and Morse.

UN-SHIFT on SPACE: Automatically shifts back to "LETTERS" upon receipt or transmission of a Baudot space. Keyboard command on/off.

SYNC: Transmits "Blank Fill" in RTTY and BT in Morse when the text buffer is empty and unit is in transmit. Keyboard command on/off.

OUTPUT MODES: CHAR — outputs each character as typed. WORD — outputs full word when spacebar is typed. LINE — outputs full line when carriage return is typed. BUFFER — outputs full buffer, on command.

REAL-TIME CLOCK: Uses the VIC's internal clock for constant on screen display of time which can be inserted into text buffer on keyboard command.

WORD WRAP AROUND: Prevents splitting words at the end of a line. Works in receive as well as transmit.

MORSE TONE DETECTOR: Single tone, 800 Hz center frequency, with effective bandwidth of 300 Hz. Pitch reference regenerated audio tone for easy tuning.

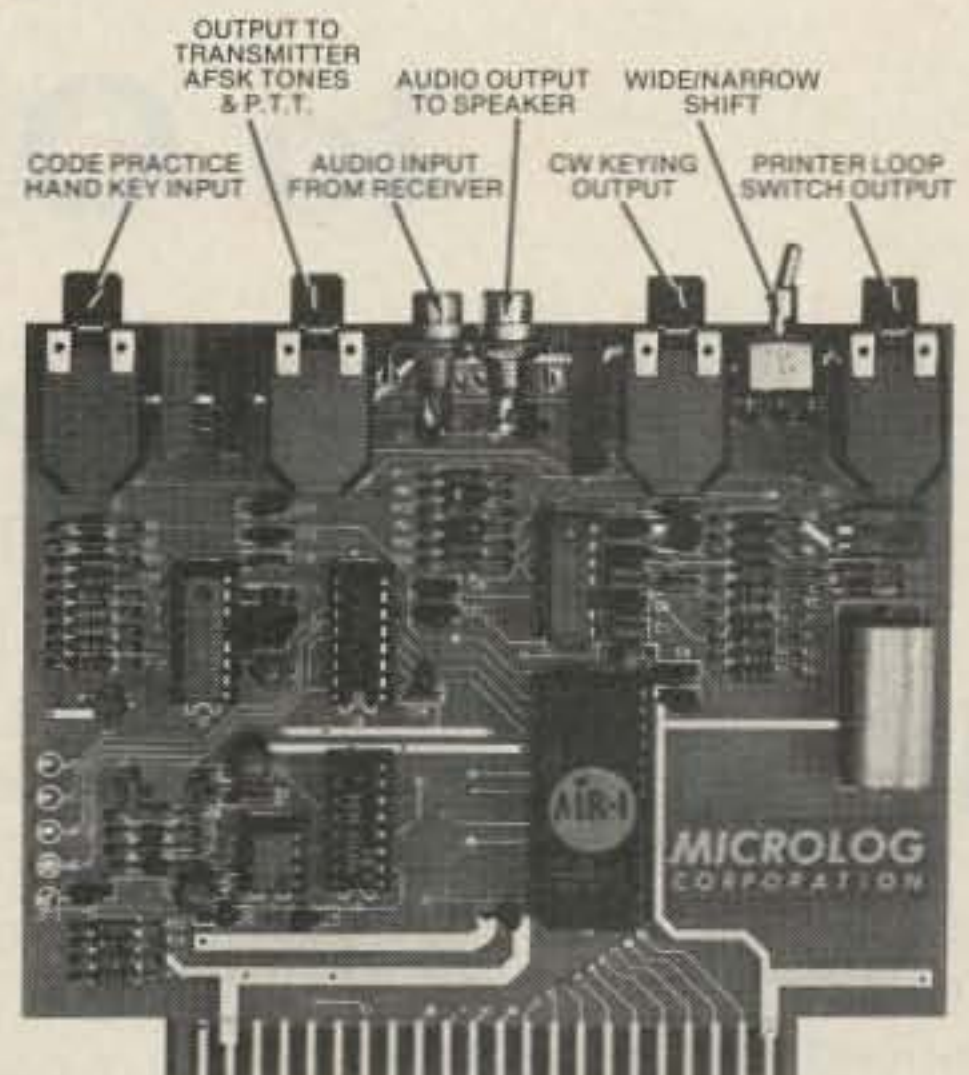

RTTY DEMODULATOR: True dual tone computer enhanced demodulator circuit on standard 2125/2295 Hz tone pair compatible with HF RTTY and VHF FM operation. Switch selected wide and narrow shift.

CODE PRACTICE: Random five character code group generator sends at any speed you set via the keyboard. Hand key input for sending practice and manual morse transmission.

CW ID & NORMAL ID: Two independent 16 character memories for either 2 calls or one normal and one with auto-CW ID for RTTY.

MECHANICAL: Printed circuit board is G-10 epoxy, double sided with plated thru holes. Board is solder masked and silk-screened with parts locations for easy troubleshooting. Size is 5 3/4" wide by 4 1/2" deep by 3/4" high. Fits directly into VIC expansion port and is compatible with popular expander boards in use.

NO EXTERNAL POWER REQUIRED: Unit is completely powered by host computer, eliminating the need for outboard power supply. (Entire system; VIC, Microlog AIR-1, & video monitor can easily run from 12 VDC power for remote or emergency battery operation.)

CONNECTIONS: All inputs/outputs are convenient 1/4" 3 circuit phone or RCA phono types. Mating plugs are all provided.

Note: VIC, VIC-20 and DATASET are trademarks of Commodore Electronics, Ltd.

MICROLOG
INNOVATORS IN DIGITAL COMMUNICATION

Send Your TR-7800 to Obedience School

This Kenwood rig has some interesting habits — such as a slow scan rate. Can you retrain it in one easy session?

I was quite happy with my Kenwood TR-7800 transceiver until the day I happened to compare it with a Bearcat 210 scanner. I first noticed that the Bearcat 210 was scanning much more rapidly than the TR-7800. Since the TR-7800 scanning is completely controlled by the microprocessor, the only way to increase the scan speed is to make the microprocessor run faster.

The microprocessor clock rate can be adjusted by L1 on the control board. It is normally set for a frequency of 346 kHz. By removing the slug completely, I was able to get the clock frequency above 600 kHz. And sure enough, the scan speed had also nearly doubled, with no

noticeable compromise in performance.

Another Bearcat 210 feature stops the scanning once a signal is detected and then automatically resumes scanning after the signal drops out. In contrast, the TR-7800 only stops for a short time when it finds a signal. Then the scan is restarted even though the signal remains. This was interesting, to say the least.

Since scanning can be manually started or stopped from the switches on the front panel, it is possible to electronically actuate these switches to change the scan characteristics. A circuit to do this is shown in Fig. 1. It consists of three one-shot pulse generators and two

FET switches. Assume the squelch line (SS) goes high indicating the presence of a signal. This causes one-shot U2-B to turn on switch U3-B and close the path between E0 and B3 for about 100 milliseconds, turning the scanning off. When SS returns to a low level, U1 generates a two-second delay pulse which then triggers one-shot U2-A and closes switch U3-A between E3 and B0 and restarts the scanning. The re-scan delay may be adjusted by changing the value of C1 or making R2 adjustable.

Since the tone switch was

not being used for anything, I removed and taped the two wires going to it and then connected the switch to the scan-control circuit. When the switch is off, all the standard scan features are still functional.

The components will fit easily on a 1.2" × 1.8" circuit board and can be tucked into an open area behind the tone switch. Fig. 2 indicates where the lines may be attached and the color coding of the TR-7800 wiring. I found that a lead clipped from a ¼-Watt resistor could be pushed in-

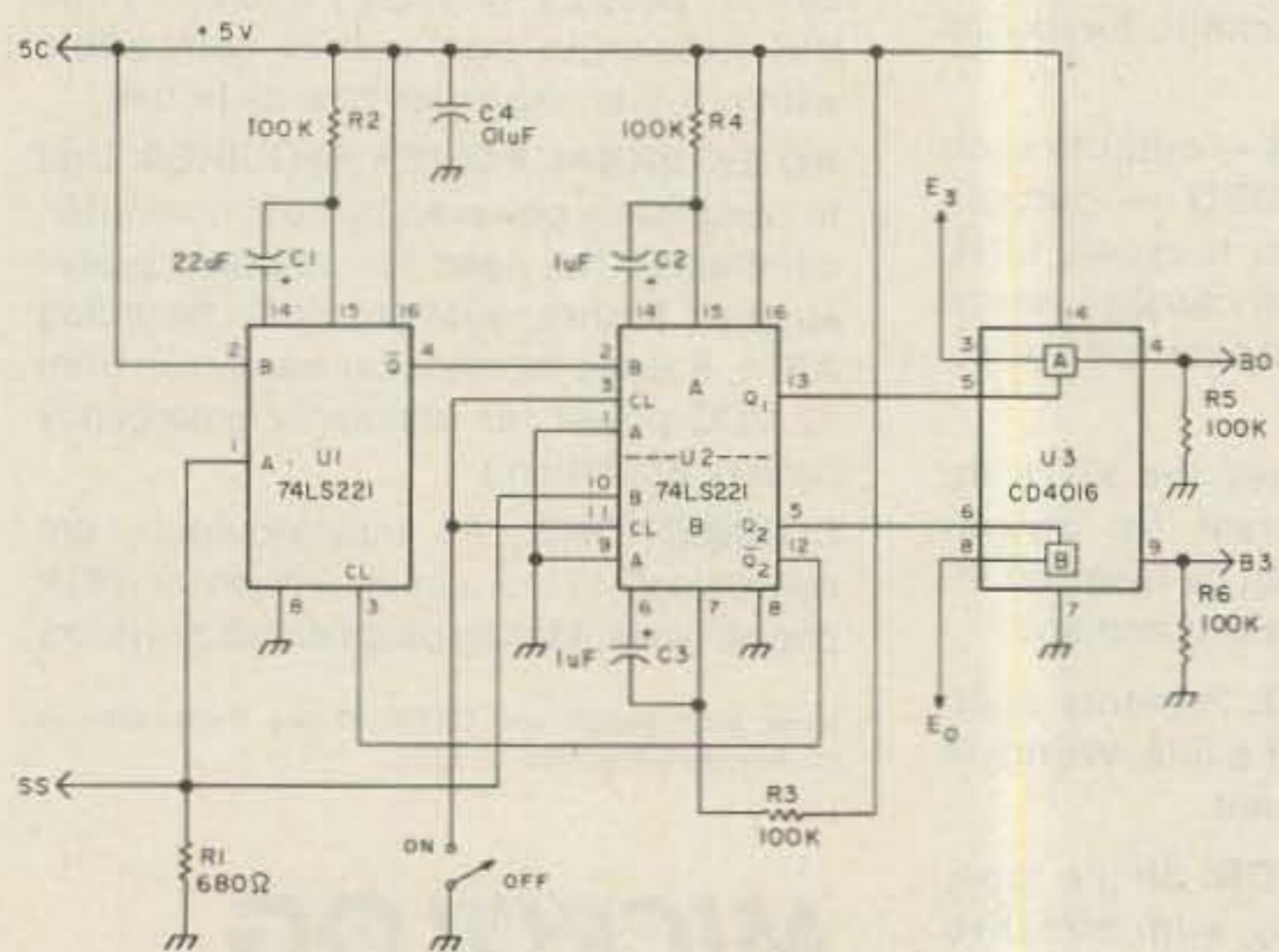

Fig. 1. Scan-control circuit.

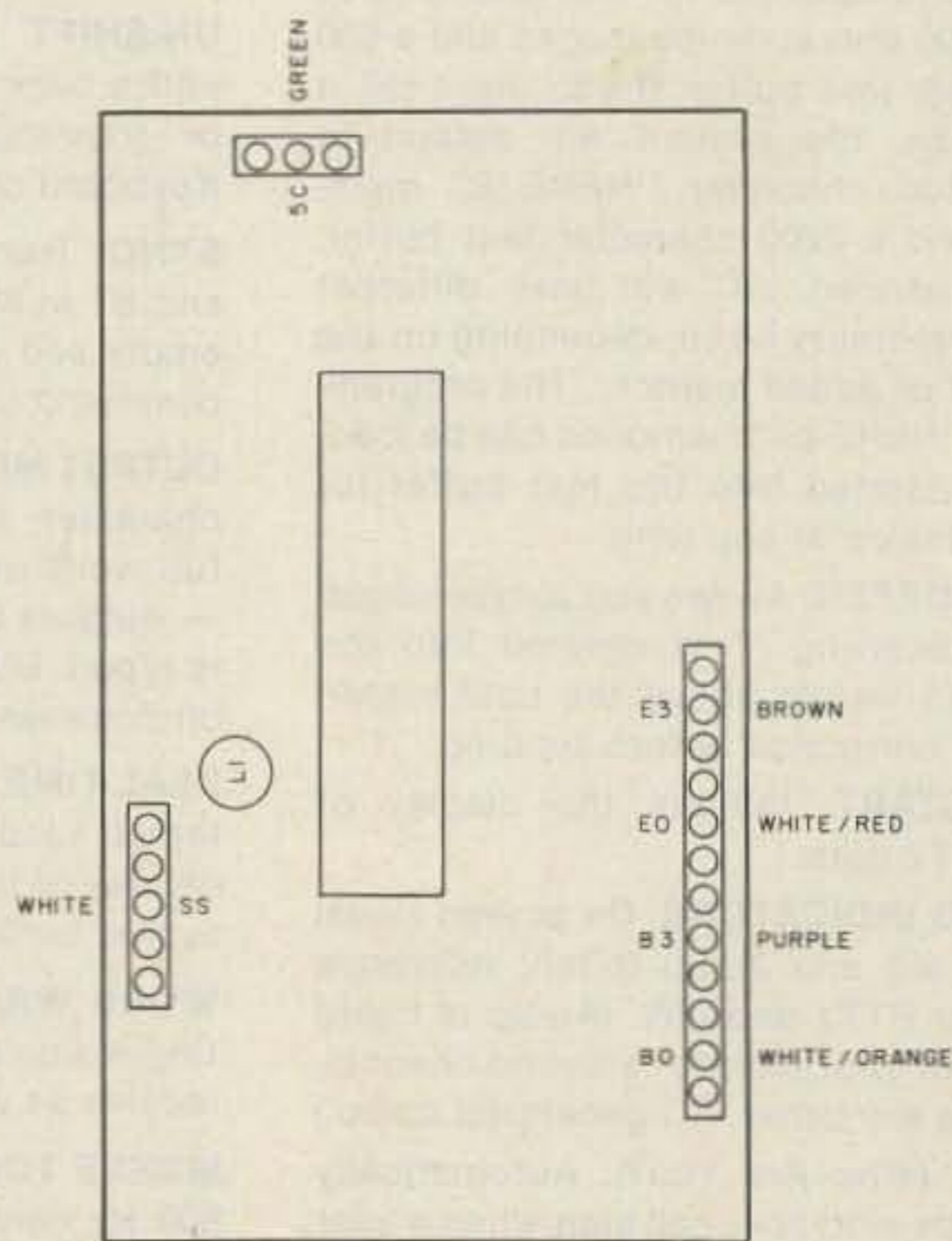

Fig. 2. Control board layout.

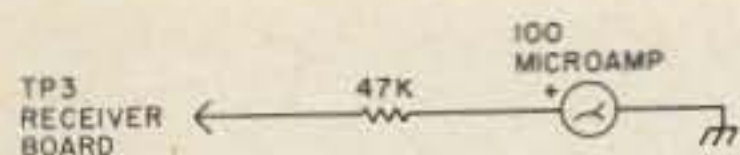

Fig. 3. S-meter circuit.

to the gap between the connector shell and the pin. This provides an easy way to tap into a signal line without cutting into the wiring.

An additional problem is that the five-LED S-meter does not give enough resolution for applications such as hidden transmitter hunting

or antenna tuning. Fig. 3 shows a simple meter circuit which connects to TP3 on the receiver board. A calibration of the meter reading vs. input signal is given in Fig. 4. Signals greater than 100 microvolts cause no further increase in meter reading.

These modifications have made my TR-7800 more convenient and fun to use. These same changes should also work on the new TR-7850. ■

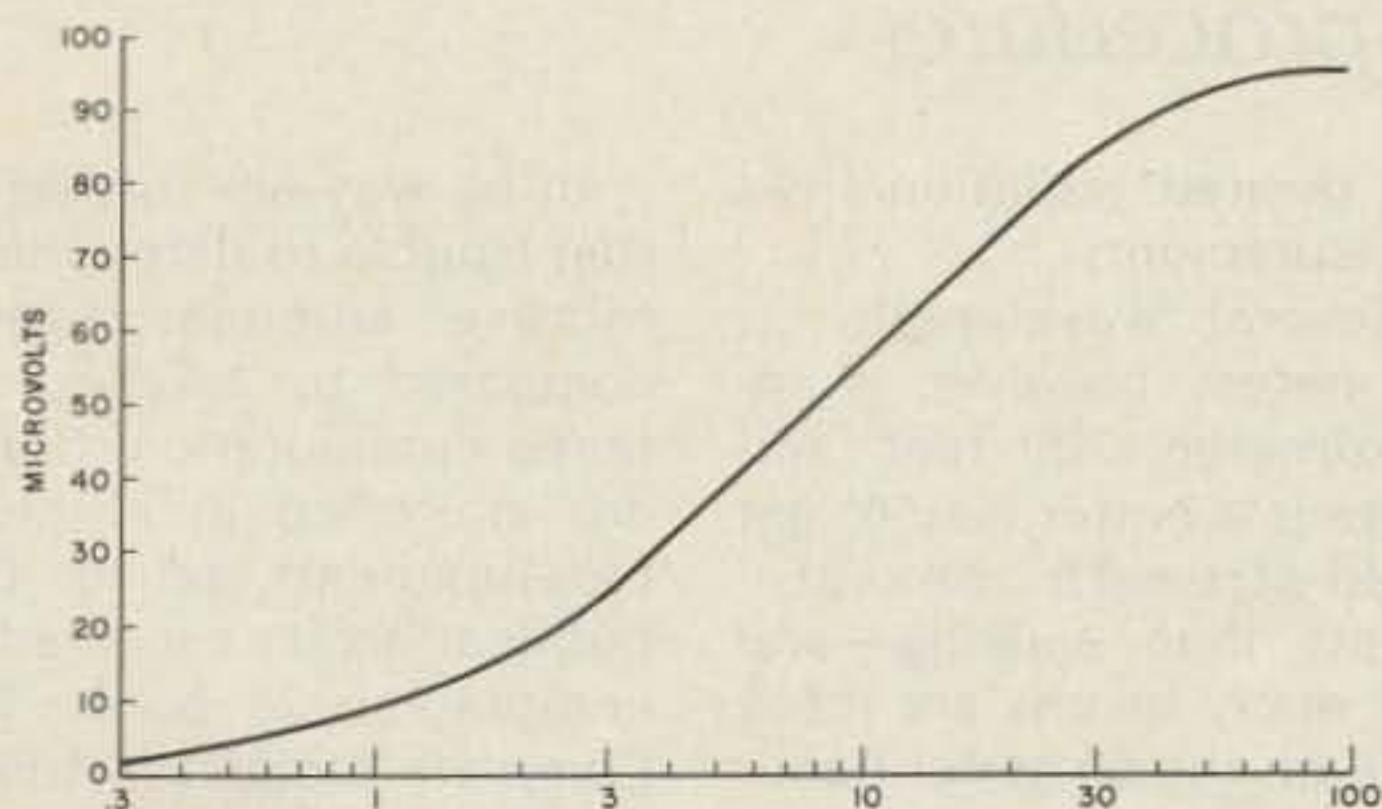

Fig. 4. S-meter reading vs. microvolts.

Orbit



ORBIT is the Official Journal for the Radio Amateur Satellite Corporation (AMSAT), P.O. Box 27, Washington, DC 20047. Please write for application.

For a **FREE SAMPLE COPY** please send \$1 to cover First Class Postage and handling to: Orbit, 221 Long Swamp Road, Wolcott, CT 06716.

Hy-Gain Antennas

TH7DXS 7 element triband beam	\$ 376.00
TH5MK2S 5 element triband beam	309.00
TH3MK3S 3 element triband beam	215.00
TH3JrS 750W PEP 3 el tribander	156.00
TH2MK3S 2 element triband beam	134.00
TH6 to TH7DXS conversion Kit	135.00
205BAS 20m 5 element "Long John"	292.00
155BAS 15m 5 element "Long John"	175.00
105BAS 10m 5 element "Long John"	114.00
18AVT/WBS 80-10m trap vertical	87.50
14AVQ/WBS 40-10m trap vertical	51.00
V2S 2m colinear gain vertical	37.50
BN-86S Beam mount 1:1 balun	17.00

Full line available at big savings!

Hy-Gain Crank-up Towers

HG-33MT2 Side supported	\$ 744.00
HG-35MT2 Side supported	546.00
HG-50MT2 Side supported	754.00
HG-37SS Self-supporting	642.00
HG-52SS Self-supporting	923.00
HG-54HD Self-supporting	1500.00
HG-70HD Self-supporting	2351.00

Crankups freight prepaid in continental US

Hustler

5BTV 80-10m vertical	\$ 100.00
4BTV 40-10m vertical	79.00
G7-144 2m colinear vertical	99.00
G6-144B 2m colinear vertical	68.00
MO-1,2 HF mobile masts	18.50
RK-10 10m resonator	9.00
RK-15 15m resonator	9.00
RK-20 20m resonator	12.00
RK-40 40m resonator	13.75
RK-75 75m resonator	14.75
RK-80 80m resonator	14.75
BH-1 Bumper mount	13.00
SSH-2 S.S. ball mount	14.00
HOT "Hustloff" mount	14.00
SF-2 2m 5/8 mobile whip	9.00

Entire line at super savings!

THE ANTENNA BANK

6460H General Green Way
Alexandria, Virginia 22312
703-569-1200

All prices subject to change without notice

Rohn Towers

20G 10 ft section	\$ 29.50
20AG() top section	32.75
25G 10 ft section	41.00
25AG() top section	53.50
45G 10 ft section	93.75
45AG() top section	104.75
BX48 6 sq ft max	204.00
HBX48 10 sq ft max	253.00
HDBX48 18 sq ft max	316.00
FK2548 48 ft foldover	794.00
FK4544 44 ft foldover	1117.00

Daiwa/Miller

CS-201 2 way coax switch	\$ 20.00
CS-401 4 way coax switch	62.00
CN-520 HF SWR/Power meter	59.00
CN-540 VHF SWR/Power meter	69.00
CN-550 UHF SWR/Power meter	76.00
CN-620B HF/VHF SWR/Power meter	107.00
CN-720B HF/VHF SWR/Power meter	150.00
CNW-418 auto tuner/meter	148.00
CNW-518 auto tuner/meter	285.00

Mini-Products

HQ-1 "Mini-Quad" 6,10,15,20m	\$ 129.95
B-24 "Mini-Beam" 6,10,15,20m	99.00
RK-3 3rd element for B-24	67.00

ORDERS ONLY: 800-336-8473

ALL others call: (703) 569-1200

No COD - We ship UPS

Allow two weeks for delivery

Shipping cost not included

We reserve the right to limit quantities

We gladly except VISA and MASTERCARD

Cushcraft Antennas

A4 4 element triband beam	\$ 224.50
A3 3 element triband beam	172.50
R3 Gain triband vertical	224.50
AV5 80-10m trap vertical	88.50
AV4 40-10m trap vertical	81.50
AV3 20-10m trap vertical	44.20
32-19 19 element 2m "Boomer"	81.50
214B 14 element 2m "Jr Boomer"	68.00
214FB 14 element FM "Jr Boomer"	68.00
A147-11 11 element 2m beam	37.50
A144-10T 10 element 2m twist beam	44.20

Full line available at great savings!

Rotors

HDR-300 Digital readout 25 sq ft	\$ 427.00
T2X "Tailtwister" 20 sq ft	244.00
HAM-1V 15/7.5 sq ft	195.00
CD-45 8.5/5 sq ft	102.75
AR-22XL 3/1.5 sq ft	49.95
HD-73 Dual speed 10.7 sq ft	89.00
U-100 Approx. 3 sq ft	42.00
8 cond rotor cable	.16/ft
6 cond rotor cable	.15/ft
4 cond rotor cable	.075/ft

MFJ Enterprises

MFJ-900 200 Watt Versa Tuner	\$ 41.95
MFJ-941C 300 watt Versa Tuner II	77.55
MFJ-949B 300 watt Versa Tuner II	117.55
MFJ-962 1500 watt Versa Tuner III	193.15

Other MFJ products at similar savings!

Coax and Wire

RG-213/u Milspec 95% shield	.28/ft
RG-8/u "Superflex" foam	.24/ft
Mini-8 foam	.12/ft
RG-58/u "Superflex" foam	.12/ft
#14 stranded copper 50,75,100, or 150 ft	.05/ft
#14 copperweld 50 ft multiples	.075/ft

Do You Know Where Your Signal Goes?

*It doesn't just sneak off your antenna and hide.
Find out where your lobes are and what they look like
with this simple procedure.*

We hams will put up a new antenna for DX and then spend hours on the air trying to see how well it works. If it's a success, we're happy. If not, we may take it down and try something else. How many of us really know whether the directivity of our new sloper or single-loop quad is doing what we think it should? How many of us keep some record of an installation to compare one antenna's performance with another's?

Antenna pattern mea-

surements of a rotary beam are easy to do. Set up a field-strength meter at your own or a friend's station, rotate the antenna, take measurements, and plot the results.

If it's a fixed antenna at the higher frequencies, 14 MHz and up, pattern measurements may be taken by walking around the antenna keeping several wavelengths from it. If measurements are taken too close to the antenna, the static field and the induction field will cause major errors in

the desired radiation field measurements.

Several wavelengths at 80 meters, however, is approximately 700 feet, and there is a better way to get field-strength measurements than walking—and not many beams are rotatable on the 80-meter band.

Relative Antenna Patterns

The measurements to be discussed are of a relative nature and are not rigorous field-strength measurements. This statement is made early in the article so that qualified radio engineers will not be misled as to its technical thoroughness of field-strength measurements.

The IRE "Standards of Radio Wave Propagation—Measuring Methods, 1942"¹ states two basic methods of measuring radio-field intensities. These are mentioned to indicate what a technical field-strength measurement would be.

One method consists of measuring the voltage produced in a standard antenna by the field to be measured and computing the radio-field intensity from the measured voltage and the dimensions and form of the standard antenna. The other consists of comparing voltages produced in an antenna by the field to be measured and by a standard field.

In no way am I going to that trouble to determine a relative antenna pattern compared to another antenna configuration. If you are interested in absolute measurements, get the IRE publication; it's excellent. A comprehensive book, *The Complete Broadcast Antenna Handbook*,² has a chapter on carrying out field-strength measurements. Closer at hand, your own library probably, is W2YE's *Ham Radio* article³ on the subject, or W2IMU's in *QST*.⁴

Read some of the above for background information. What will be discussed herein is a practical, unscientific method of determining a radiation pattern around your antenna. It is a repeatable measurement, and the technique can be used to compare other configurations of the same antenna or different ones. Nothing new is claimed for this method, but it has been a long time since such a detailed article on the subject has been published.

Let me (1) describe what was done, (2) discuss the results, and (3) conclude with the effectiveness of this method.

Tools Required for Measurements

The necessary tools to develop a 360° pattern of



Fig. 1. Survey map showing antenna location and points where measurements were taken.

your antenna's radiation are: (1) a map of the route around the area encompassing your antenna; (2) a receiver with a signal-strength meter tunable to the frequency at which measurements are to be made, and operable in an automobile; (3) a short vertical antenna which can be mounted on the roof of an automobile; (4) a power source isolated from the automobile power system (desirable, but not mandatory), and (5) an automobile or other means of carrying the equipment.

Survey Map

A map must be used which has sufficient detail to show the roads and/or streets in your area. The Geological Survey charts⁵ are excellent for this study. Lay out a route on the map which will circle the antenna site staying at least ¼ mile from the antenna for the 80-meter band and no more than 7 miles maximum. Wherever possible, stay within two miles, as the signal strength drops off fast as the distance from the antenna increases. Then lay out points on the map equally spaced around the area to be driven. Draw a line on the map from the antenna to the first point, and record 0 degrees and the distance from the antenna to that point. For every other point, with a protractor, determine its angle from the 0° point and measure distance from the antenna to that point. From the map scale, the distance should be in feet or meters. Twenty-six locations were used in the study for this article; see Fig. 1. A table (Table 1) was drawn up to indicate location number, a description of the location, and its distance and bearing from the antenna, as well as data to be recorded.

Receiver

The receiver may be anything that has a signal-

Location No.	Location Description	Distance from Ant. (Feet)	Bearing from North (Degrees)	dB above 1 uV	Microvolts	Corrected microvolt (x 10,000)
0	Farm road & Rary Road	1200	0	38	80	9.6
1	Tonn Farm House	1450	24	41	120	17.4
2	Driveway, abandoned farm	2250	57	30	32	7.2
3	Chenault Rd., .1 mile south of Rary Rd.	2250	70	32	40	9.0
Etc.						

Table 1. Tabulation of measurement data.

strength meter, can work from a portable power supply, and is tunable to the antenna operating frequency. I could have used my TS-520 transceiver, but I used my HRO-500 receiver instead. It operates from 12 volts dc, is very stable, has a signal-strength meter calibrated in S-units up to S9, and a dB scale up to 40 dB. In addition, it has a dB scale calibrated in dB above 1 microvolt; 0 dB is the same as S1.

The dB scale has an advantage over the S-unit scale as it can be used more easily to determine microvolts, whose numbers are nonlinear as they increase relative to the dB scale. Each S-unit represents a certain number of dBs above some reference level, usually 1 microvolt. If you know how many dBs per S-unit for your particular receiver, you can calculate microvolts. If you use S-units for pattern plotting, you lose a certain amount of plotting sensitivity.

For example, using the S-meter gives nine points on the meter which are linearly spaced. Changing to dBs and thence to microvolts gives you a range from 1 microvolt to 100 microvolts for S1 to S9. Going from S8 to S9 is one division, but is equivalent to going from 56 to 100 microvolts. The plotted pattern is more sensitive to a microvolt scale than an S-unit scale. All patterns plotted herein are in

S-Reading	dB above 1 Microvolt	Microvolts
0	- 5	.56
1	0	1.0
2	5	1.7
3	10	3.4
4	15	5.6
5	20	10.0
6	25	18.0
7	30	32.0
8	35	57.0
9	40	100.0

Table 2. Comparison of S-readings, dBs, and microvolts.

microvolts vs. bearing angle.

Another example of S-units, dBs, and microvolts is shown in Table 2.

Receiving Antenna

A vertical antenna mounted in the center of the automobile's roof is desirable. I used my 2-meter 5/8-wave vertical, which has a magnetic mount, until I found it had an intermittent in it. I then switched to a ¼-wave two-meter antenna mounted on the car roof-gutter which seemed to work just as well. The antenna was mounted on the side of the car facing the antenna under test. As the car went around the circle, it always presented the same configuration to the test antenna. It is thus believed that any directional characteristic of the automobile antenna system is a constant.

Isolated Power Source

Early measurements of the antenna under test were made with the receiver plugged into the cigarette lighter receptacle of the car. Because auto ignition

noise produced an S1 to S2 signal, the ignition was turned off for each reading. As was my practice, the 0° first reading was repeated as the last reading. It was found that the reading read higher than when it was first read.

The complete run is 6.7 miles and takes about 30 minutes to complete. It is believed that the car battery voltage was lower at the beginning of the run and that the charging of the battery during the run produced a higher voltage at the end of the run. Perhaps this changed the sensitivity of the receiver; no other explanation was determined.

After connecting the receiver to its own 12-volt battery, it was found that ignition interference was eliminated and readings could be taken with the engine running. That saved wear on the starter in the car.

Another advantage of having the receiver continuously operating is the ability to maneuver the car to a proper stop point. It may be necessary to move forward or back up while watching

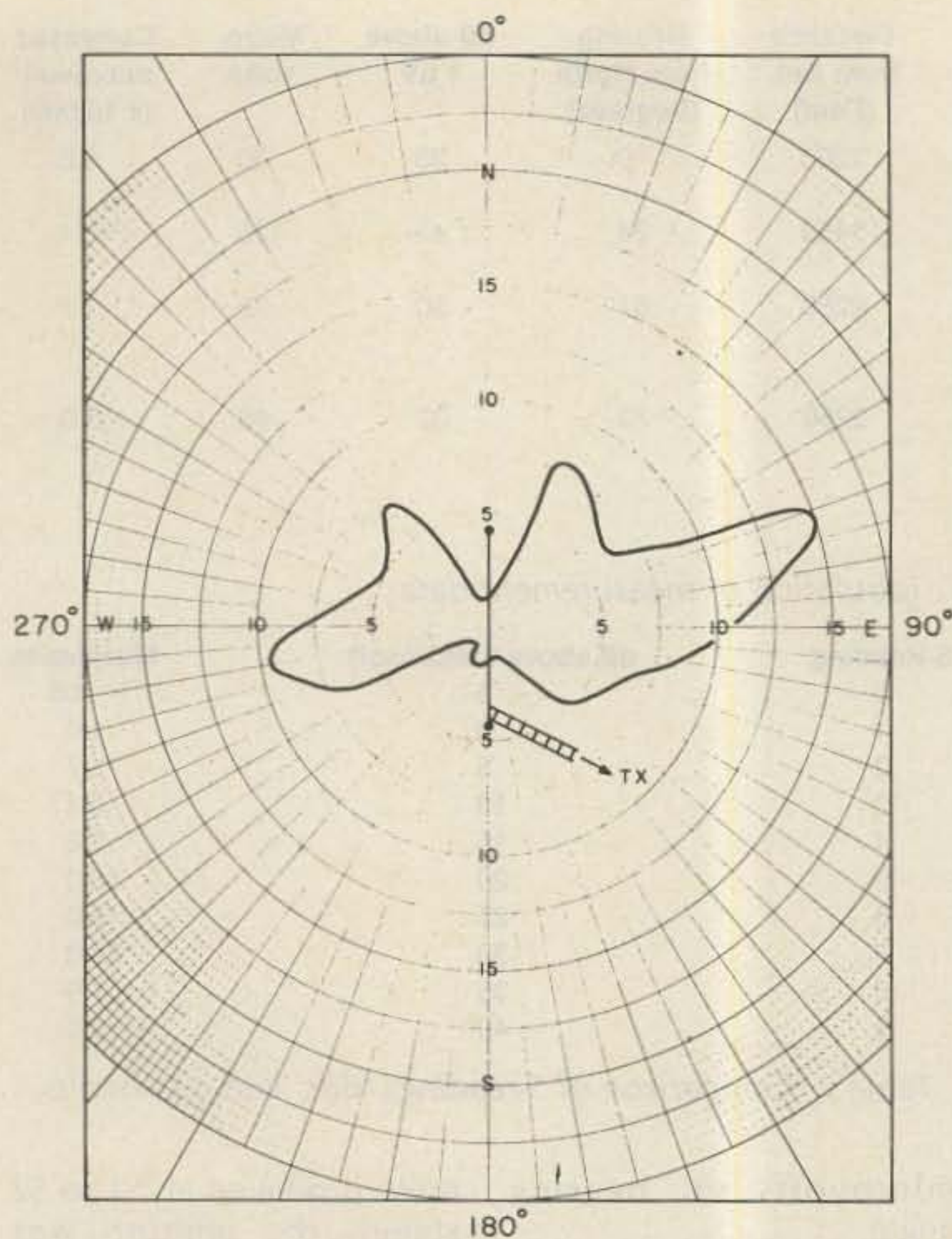

Fig. 2. Actual field pattern of an 80-meter full-wave Zepp antenna fed as shown, radiating over undulating land.

the signal-strength meter to prevent stopping at a point influenced by local wires. There will be a pronounced drop in signal strength if you stop beneath an overhead wire, for example. Even a utility-pole guy wire may cause amplitude interference to the test signal. Stop in an area where signal strength remains constant.

Solo or with Partner?

Do you run the test by yourself or with another ham? It would be desirable to have a friend at the transmitter operating site who would turn the transmitter on and off at your request. You could communicate using the transceiver in the car or by using a 2-meter setup.

Living in the country and being retired, I did it by myself. Fortunately, the 80-meter band between 9 am and 3 pm during the work week is lightly populated because of propagation conditions and normal

work hours. I could put the transmitter on 3.8 MHz and run my test with no one knowing it. In crowded areas, a helper may be necessary.

The Transmitter

The transmitter used for the test was a Heathkit SB-100. It was desired to keep the signal output at a modest level since the transmitter would be on continuously for 30 minutes at a time. For ease of setting power input and monitoring it, 100-mA plate current was used. After adjusting the antenna tuner for minimum swr between the SB-100 and tuner, when used, plate current was adjusted by varying the grid drive. It was noted while on dummy load that initially the plate current would drop to about 95 mA after a few minutes operation. Grid drive would then be increased to give 100 mA and the plate current would remain there. The transmitter

would then be switched back to the antenna to be tested and measurements made in the automobile.

Zepp Antenna Measurements

The first antenna to be studied was a full-wave Zepp antenna 240 feet long which runs on a north-south line. It is about 60 feet high at the northern end and about 50 feet high at its southern end. That antenna is used for communications on 80 meters and 40 meters. It is fed by a 600-Ohm open-wire line at the southern end. Theoretical field patterns state that so feeding it would produce four major lobes, a skewed cloverleaf with respect to the wire. The two northern lobes would be stronger than the two southern lobes. The desire for stronger lobes into the northeast was the reason for feeding the southern end.

The theoretical pattern is based on level ground beneath the antenna and a perfectly conducting one. The actual ground, especially to the east, is far from level; the ground drops from 800 feet to 750 feet and rises again to 800 feet in a horizontal distance of 1000 feet.

It had been possible to get S9 signals at close range with a vertical antenna used in preliminary tests with the SB-100 running at 75 Watts input. However, it was necessary to use about 600 Watts input with the Zepp to get comparable signals; a linear was added to the SB-100 output. Such is the difference between a horizontally-polarized and a vertically-polarized antenna with the receiving setup used.

Fig. 2 shows the results on the full-wave Zepp. It has four major lobes with the supposedly southern lobe horribly skewed.

Ground-Wave Attenuation

The data used to plot Fig. 2 was not the raw data ob-

tained from the signal-strength meter. Using such data would provide a grossly distorted picture of the field pattern. Some sort of a signal attenuation factor must be considered, especially at the greater distances.

Reference 6 has an excellent chapter on ground-wave propagation. It points out that energy is abstracted from the surface wave to supply losses in the ground. So the attenuation of this wave is directly affected by ground conductivity and the Earth's dielectric constant.

The information in reference 6 is detailed enough to permit you to calculate the attenuation vs. distance relation. If you know your local ground conductivity and dielectric constant, you can be reasonably accurate on the attenuation factor.

Another approach is to recognize the additional error accrued by ignoring the above and saying, "Attenuation varies inversely as the distance."

Example: The signal strength at 1000 feet is 4.5 microvolts. What is the signal strength if no attenuation existed?

Solution: $S_c = S_a D$, where S_c = corrected signal strength (microvolts), S_a = actual signal strength (microvolts), D = distance (feet or meters); therefore, $S_c = 4.5 \times 1000 = 4500$ microvolts.

This was the method used to facilitate changing the raw data to plotting data. The rationalization to do this was that relative differences between configurations were desired, not absolute differences.

W2LL Antenna Measurements—Tower 1

In 1961, Gene Black, now W2LL, hit upon an odd antenna system for 80 meters which he had been using on and off and suggesting to friends. In 1972, he talked me into trying it. After getting my 100 countries on 80

Buy Hi-Res Monitors Direct!

\$109.95

plus \$4.75 shipping

Model TM-12PC-GX 12" P31 GRAPHICS

- * 1200 line resolution
- * 18.9 MHz band width

Compatible with: IBM-P.C. / APPLE II & III / VIC-20
 COMMODORE 64 / ROBOT-800 KEYBOARD
 TRS-80* / Z-81* / ZX-80 / Any Composite Video Computer

RGB Color Monitors available @ \$299.95 / \$9.50 shipping.

*Slight modification inst. enclosed.



VISA, MasterCard & American Express accepted. No C.O.D.

Call Toll Free 1-800-258-6370
 18 Bridge Street, Salem, NH 03079

DIRECTION FINDING?



- ★ No Receiver Mods
- ★ High Sensitivity
- ★ 135-165 MHz Standard Range
- ★ Mobile, Base or Remote Use
- ★ Bright LED Display
- ★ Optional Digital Readout
- ★ Optional Serial Interface
- ★ Kits or Assembled Units
- ★ 12VDC Operation
- ★ 90 Day Warranty

New Technology (patent pending) converts any VHF FM receiver into an advanced Doppler Direction Finder. Simply plug into receiver's antenna and external speaker jacks. Use any four omnidirectional antennas. Low noise, high gain for weak signal detection. Use serial AFSK option for remote display or tape recording data. Kits from \$270. Assembled units and antennas also available. Call or write for full details and prices.

DOPPLER SYSTEMS
 5540 E. Charter Oak
 Scottsdale, AZ 85254
 (602) 998-1151

A DESIGN EVOLUTION



- Linear (all mode) RF power amp with automatic T/R switching (adjustable delay)
- Receive preamp option, featuring GaAs FETS (lowest noise figure, better IMD). Device NF typically .5 dB.
- Thermal shutdown protection incorporated
- Remote control available
- Rugged components and construction provide for superior product quality and performance
- Affordably priced offering the best performance per dollar
- Designed to ICAS ratings, meets FCC part 90 regulations
- 1 year transistors warranty
- Add \$5 for shipping and handling (Cont. U.S.). Calif. residents add applicable sales tax.
- Specifications/price subject to change

MODEL 1	FREQUENCY 2	OUTPUT POWER	INPUT POWER	SUGG. PRICE LESS TAX
	(MHz)	(W)	(W)	\$
1410 1410G	144	160	10	225 265
1412 1412G	144	160	30	199 239
2210 2210G	220	130	10	225 265
2212 2212G	220	130	30	199 239
4410 4410G	440	100	10	225 265
4412 4412G	440	100	30	199 239

1. Models with G suffix have GaAs FET preamps. Non-G suffix units have no preamp.
2. Covers full amateur band.

★SEND FOR FURTHER INFORMATION★

TE SYSTEMS

TE SYSTEMS ✓32
 P.O. Box 25845
 Los Angeles, CA 90025
 (213) 478-0591

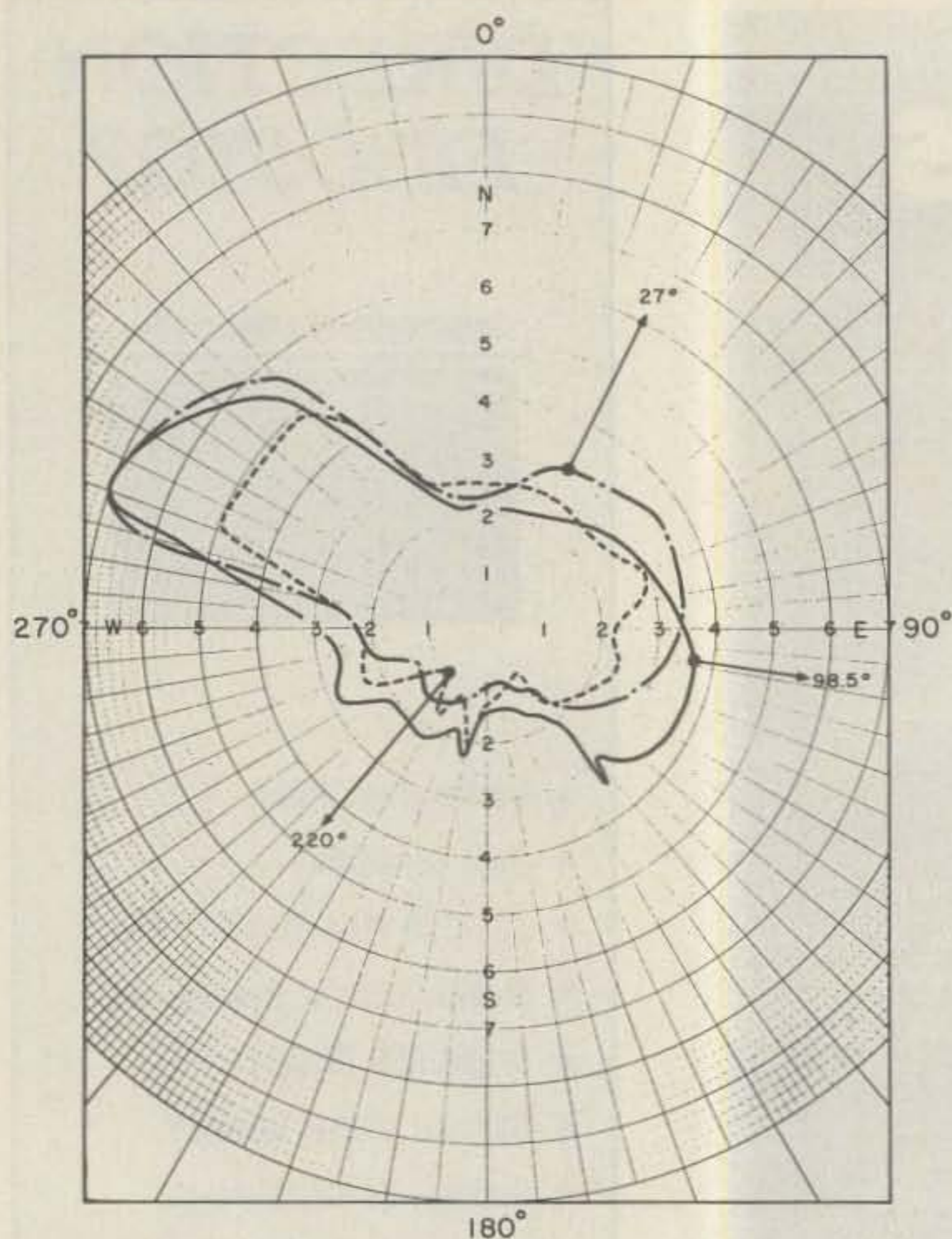

Fig. 3. Radiation pattern of W2LL antenna on number 1 tower which has multiple guy wires.

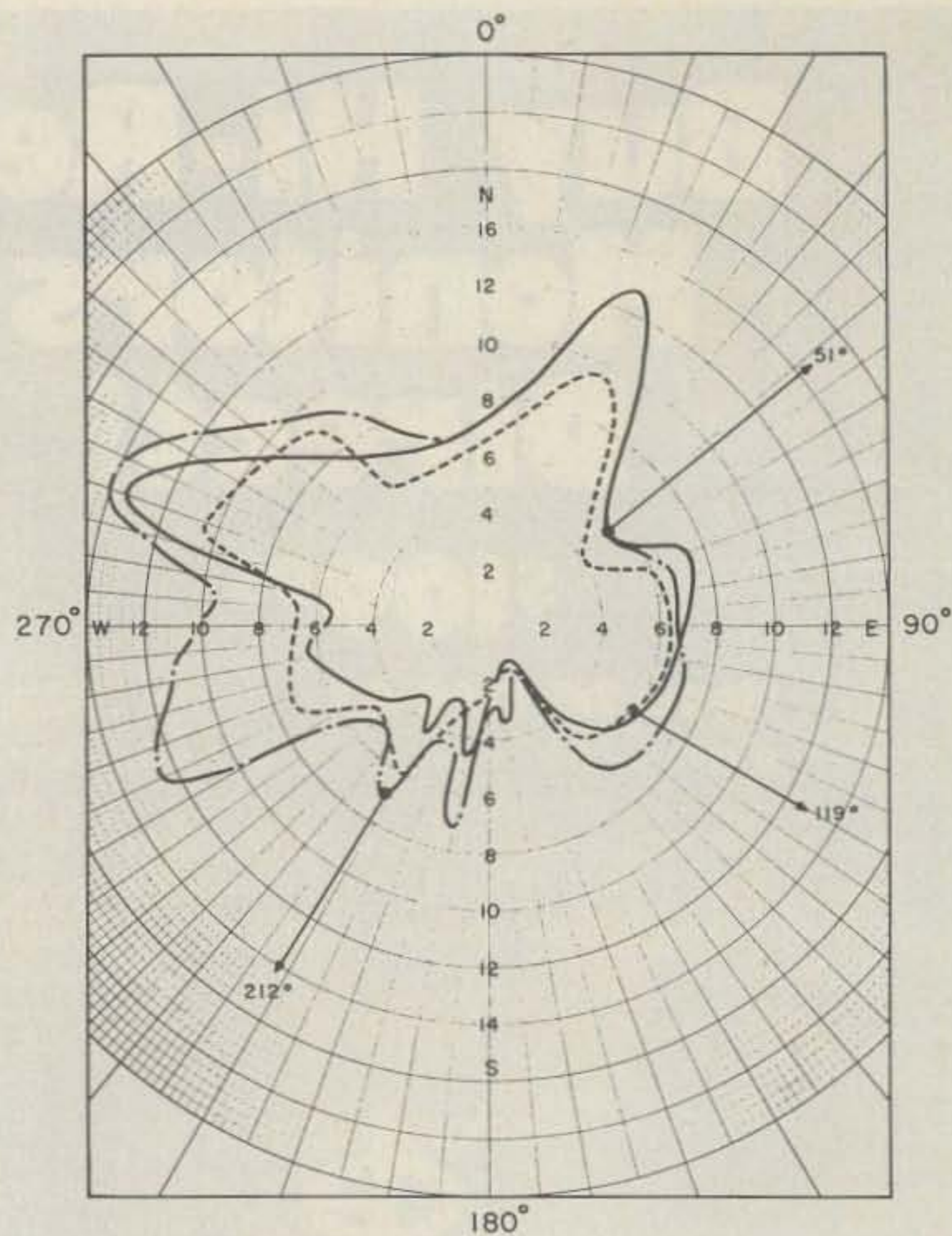

Fig. 4. Radiation pattern of W2LL antenna on number 2 tower which is free-standing.

meters as W2MB in NJ with it, it has been my favorite for that band. The antenna uses your high frequency tower and beam with an 80-meter quarter-wave horizontal or sloping wire. That wire is excited from the center wire of a coax line with the shield connected to the tower. It has currently become popularized by others and is called a quarter-wave sloper. Since that title imparts no real description of this antenna, and since I've always known it as "the W2LL antenna," I will so refer to it that way herein.

Incidentally, the secret for those who have weird loading problems and "it does not work" is to isolate the coax transmission line from the antenna system by use of a balun. One lead of the balun output goes to the quarter-wave wire, and the other is grounded to the tower. It will always work that way!

One characteristic of the W2LL antenna is an apparent directivity in line with the horizontal wire for systems that are electrically greater than a quarter wave. W2LL has noted, when using the system on 160 meters where it looks less than a quarter wave with his tower, that directivity is opposite to the direction the horizontal wire is pointed.

Since a new W2LL antenna was being put in at my new North Carolina residence, I wanted to see how the 80-meter directivity followed the changing of the direction that the horizontal wire was pointing. Also, would I be better by having two or more horizontal wires connected simultaneous?y? Hence these measurements.

The tower used is 50 feet high and has a steel pole extended above the tower to place the TH6DXX tribander beam at 60 feet above

ground. The tower is guyed by three lines from the 30-foot level which are spaced 120° apart. Two guy wires approach the ground at 45° and connect directly to anchor pipes which are driven into the ground. The third guy wire runs horizontally for about 50 feet to a pulley, and then down to a winch used to permit fold-over and erection of the tower. That guy is insulated from ground by the tree. The whole system is excited from the balun output which connects to the tower and quarter-wave horizontal wire at the 50-foot level.

Pattern runs were made with the horizontal wire pointed in three directions from north: 27°, 98.5°, and 220°. There was no suitable tie point to have a direction in the fourth quadrant.

After massaging the raw data with the attenuation factor, it was plotted and is shown in Fig. 3.

The plots of all three curves on one sheet indicate that there is really not much effort in positioning the horizontal wire in different directions. That result is in contradiction to my previous experience. The only explanation that occurs to me is that the profusion of guy wires has already established a radiation pattern and the effect of the single wire is negligible. With that tower, a quarter-wave wire in any direction is satisfactory.

W2LL Antenna Measurements—Tower 2

Fortunately, I have a second tower, which is free-standing, no guy wires, and has a TH6DXX tribander at the 50-foot level. Runs were made on that antenna with the horizontal wire at 51°, 119°, and 212°. A plot of the radiation runs on the second tower are shown in Fig. 4.

A change in directivity

Hi Pro Repeaters ELCO

MAGGIORE ELECTRONIC LAB.

Manufacturers of Quality Communications Equipment

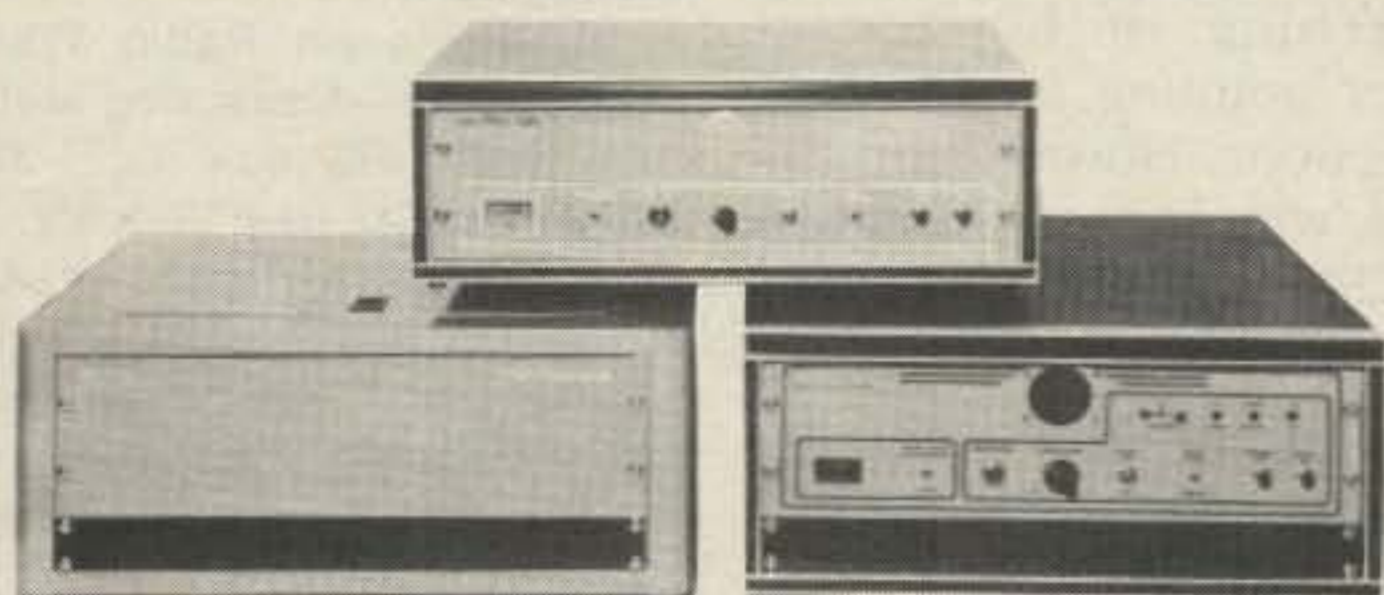

- Repeaters
- Links
- Remote Base
- Low Band VHF UHF
- Receivers
- Transmitters
- Antennas
- Standard and Computerized Controllers
- Standard and Computerized Auto Patches
- Duplexers

MAGGIORE ELECTRONIC LAB. ✓ 46
590 Snyder Ave.. Phone (215) 436-6051
West Chester, PA 19380 Telex 499 0741 MELCO

WRITE OR CALL FOR OUR COMPLETE CATALOG

TERMINALL

RADIO MODEM

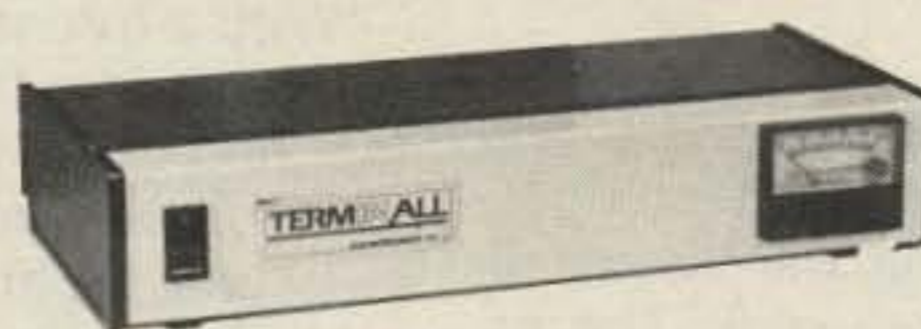

apple TRS-80 ATARI

SEND & RECEIVE CW & RTTY

TERMINALL is a hardware and software system which converts your Personal Computer into a state of the art communications terminal.

- TERMINALL is easy to use. Plug into your receiver headphone jack and copy Morse code or radioteletype. Plug into your CW key jack and send Morse code. Attach a Microphone connector and send Baudot or ASCII RTTY using audio tones (AFSK). That's all there is to hooking it up.
- Fantastic Morse reception. No adjustments are necessary to receive Morse code. It's fully automatic! Six stage active filter demodulator and auto adaptive Morse algorithm copies the weak and sloppy ones.
- Separate RTTY and CW demodulators. Built in crystal controlled AFSK. CW and PTT keying, 60 mil loop interconnect, RS 232 IN and OUT, hand key input and side tone output.
- Built in parallel printer driver software allows hardcopy in all modes.
- Hardware clock maintains accurate time.

- Multiple user defined WRU functions. You select initiate sequence, terminate sequence, what to transmit back and whether to save on tape or disk.
- Word wrapping, word mode editing, diddle, ignore carriage returns, user programmable end of line sequence, adjustable carriage width, transmit delay (fixed, none or auto adaptive), excellent documentation, break mode and much more.
- TERMINALL has capabilities far surpassing dedicated terminal systems. And since it works on a general purpose computer, the majority of your investment (your computer) is spread out over many different applications. You get more for your money.
- Complete with software on cassette and diskette, assembled and tested hardware, and extensive instruction manual. Call or write for specifications on TERMINALL for TRS-80 Model I or Model III, Apple II or ATARI 400/800 COMPUTERS. \$499.
- 15 day money back trial period. One year parts and labor limited warranty on factory direct orders.

To Order

(209) 667-2888



MACROTRONICS, inc.

1125 N. Golden State Blvd
Turlock, CA 95380

COD

* Apple is a Registered Trademark of Apple Inc.
TRS-80 is a Registered Trademark of Tandy Corp.
Atari is a Registered Trademark of Atari Inc.
Shipping U.P.S. Reg. Del. \$4.00 CA residents add 6% sales tax.

PACKET RADIO

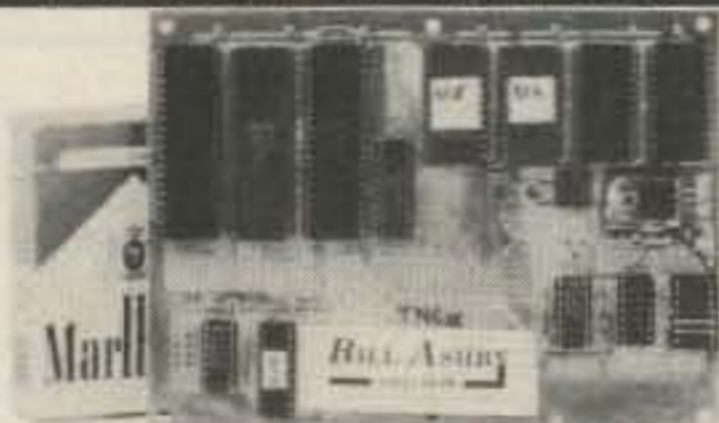

ASCII—USA/AX.25 HDLC CONVERTER

USA/AX.25 is AMRAD/ARRL approved digital format STANDARD used on amateur packet radio networks

PAC/NET board only \$80.00
Assembled/Tested. No ICs. 90day warranty

Package of all ICs except 2-2716 EPROMs \$80.00

PAC/NET SYSTEM

PAC/NET SYSTEM \$240.00

System Tested 4.5 x 6" board complete with all ICs and programmed EPROMs personalized for each purchaser. Requires only single 8-10 volt 1/2 amp power. 1 year guarantee of hardware/software/AX.25 standard RS232 serial ASCII at any user baud rate. RS232 HDLC for 202 modem used for AFSK or direct to RF equipment for FSK.

Custom Systems Custom Programming

BILL ASHBY
AND SON

K2TKN—KA2OEG 201-658-3087
BOX 332 PLUCKEMIN N.J. 07978

SEMICONDUCTORS:

MRF-208 - 12.00	MHW-252 - 50.00
MRF-240 - 15.50	MHW-710-1 - 61.00
MRF-247 - 34.80	MPSH-81 - .50
MRF-309 - 27.60	MV2205 - .58
MRF-422 - 41.40	78L08CP - .50
MRF-454 - 20.00	2N4401 - .75
MRF-901 - 1.75	2N5190 - 1.50
SBL-1 Double-Balance Mixer - 6.50	

P.C. BOARDS FOR MOTOROLA BULLETINS

EB-18A - 12.00	AN-762 - 14.00
EB-27A - 14.00	AN-791 - 10.00
EB-63 - 14.00	EB-67 - 14.00
KEMET CHIP CAPACITORS: 56 pf, 82 pf, 100 pf, 390 pf, 470 pf; -.50 ea	
680 pf, 1000 pf; -.55 ea	
5600 pf, 6800 pf, .1 uf; -1.00 ea	
.33 uf; -1.90 ea .68 uf; -3.90 ea	

CAMBION RF CHOKES: .15 uh, .22 uh, .33 uh, 4.7 uh, 10 uh - 1.20 ea
BROADBAND TRANSFORMERS PER MOTOROLA BULLETINS: AN-762, EB-27A, EB-63
UNDERWOOD/SEMCO METAL-CLAD MICA CAPACITORS: 5pf, 10pf, 15pf, 25pf, 30pf, 40pf, 56pf, 60pf, 68pf, 80pf, 91pf, 100pf, 200pf, 250pf, 390pf, 470pf, 1000pf

We also carry a line of VHF, UHF amplifiers and ATV equipment.

Call or write for our free catalog.



Communication Concepts Inc.



2648 North Aragon Ave • Dayton, Ohio 45420 • (513) 296-1411 ✓ 14

THE WORLD FAMOUS

FREE

ETCO

CATALOG OF
ELECTRONICS

- VIDEO
- TELEPHONE
- CABLE TV
- PARTS
- AUDIO
- ELECTRONICS
- and much, much more!

1000's OF FASCINATING
FACTORY CLEAROUTS.
SURPLUS SPECIALS AND
BARGAIN OFFERS NOT FOUND
IN STORES OR CATALOGS
ANYWHERE!



ETCO ELECTRONICS ✓ 248
DEPT. 590

Mailing List Control Center
Box 840
Champlain, N.Y. 12919

NOW
112
PAGES

I Enclose _____ (cash OK);
Please rush postpaid

- \$1 for 1 year subscription to the world famous ETCO catalog.
- \$3 Canadian & Foreign 1 year subscription to the ETCO catalog.
- 304 page handbook "BUILD YOUR OWN EARTH STATION". (TA025) \$10.00
- 360 pages MASTER HANDBOOK OF TELEPHONES. (TA001) \$11.00
- FREE - sample copy of the bargain packed ETCO catalog. (USA only)

Name _____

Address _____

City _____

State _____ Zip _____

definitely can be noted although a skewing effect can be seen; the lobes are not in direct line with the quarter-wave wire direction.

Finally, three horizontal wires were connected together using the above directions for each. The effect was to compress the maximum excursions of the individual patterns. The results using the horizontal wire pointing in the 212° direction give the best overall results and was the final selection. There is nothing to be gained by switching from one wire to another to give controlled directivity; the 212° position is the best in all directions.

One thing not expected was the lack of distinct directivity along the 119° direction. I have no explanation except to point out that the first tower was used as the support for the 119° horizontal wire direction.

Also, the distance between the two towers is 130 feet! There unquestionably is an interaction between the two towers.

With a free-standing tower, erected far from interfering bodies, a definite advantage may be derived by switching separate horizontal wires for controlled directivity. You must determine that yourself experimentally. I would be very interested in hearing from someone with that situation.

Conclusions

OK, what have I accomplished by doing all this? Let me list what can be concluded for my setup.

- (1) I had a lot of fun learning about my antennas.
- (2) The Zepp is putting a major lobe into the northeast.
- (3) Unusual terrain causes drastic pattern changes to the Zepp pattern.
- (4) The 60-foot number 1

tower has a non-programmable radiation pattern. Isolation of the guys from the tower with insulators would probably alleviate that characteristic. It is still a pileup buster as is!

(5) The 50-foot number 2 tower is programmable by switching in horizontal wires pointing in different directions. However, in my case, why bother? A wire in the 212° direction is best of all.

(6) There appears to be definite cross-talk between the two towers.

(7) Tying in two or more horizontal wires will tend to make the pattern omnidirectional, but at the expense of stronger lobes.

These tests have shown me graphically the difference between classical radiation patterns and what I am actually getting. Variations in the terrain surrounding the antenna and the interference of large metal structures are two

things which have disrupted ideal conditions. Now I know what is happening and don't have that nagging doubt in my mind, "Where is the signal going?" Do you know where yours is going? ■

Bibliography

- ¹"Standards on Radio Wave Propagation—Measuring Methods, 1942," IRE (now IEEE), 330 West 42nd St., New York NY.
- ²*The Complete Broadcast Antenna Handbook*, "Design, Installation, Operation and Maintenance," John E. Cunningham, TAB Books, Blue Ridge Summit PA 17214.
- ³"Measuring Signal Strength," C. F. Maylott W2YE, *Ham Radio*, August, 1980, page 20.
- ⁴"Antenna Performance Measurements," Dick Turrin W1IMU, *QST*, November, 1974, page 35.
- ⁵"Long Transmission Lines for Optimum Antenna Location," Henry G. Elwell, Jr. N4UH, *Ham Radio*, October, 1980, page 14.
- ⁶*Electromagnetic Waves and Radiating Systems*, Edward C. Jordan, Chapter 16, "Ground Wave Propagation," Prentiss-Hall, New York NY.

Introducing The SRT-3000 RTTY Communications Send-Receive Terminal

SRT-3000
List
\$995.00
Introductory
Price
\$795.00



- Built-in demodulator & AFSK modulator for 170,425,850 Hz shifts, high and low tone pairs • 60,66,75,100,132 WPM Baudot, 110,300 Baud ASCII, 5-99 WPM Morse • 1000 character text buffer with BREAK feature • Ten 80 character message memories with battery backup • Selectable display formats, 24 lines x 72 characters (2 pages), 24 lines x 36 characters (4 pages), 16 lines x 36 characters (6 pages) • Split screen operation • On screen status line displays a tuning bar, mode, speed, shift, tone pair, normal/reverse, USOS, WRU, SELCAL, buffer mode and buffer count • Cassette interface for long "Brag Tapes" or unattended message storage • Baudot and ASCII printer outputs • Built-in audio monitor • Built-in 110 VAC power supply • Other features—PTT control, WRU, SELCAL, sync idle, CW ID, USOS, auto-start, full or half duplex, scope outputs, weight control, intercharacter spacing, reverse video, RS-232, word wrap around • Compact size only 13.3 x 10.3 x 4 inches • Made in USA.

Send For
Free Information

DGM ELECTRONICS, INC.

787 Briar Lane, Beloit, Wis. 53511
(608) 362-0410

HAL-TRONIX

HAL 2304 MHz DOWN CONVERTERS (FREQ. RANGE 2000/2500 MHz)
2304 MODEL #1 KIT BASIC UNIT W/PREAMP LESS HOUSING & FITTINGS ... \$19.95
2304 MODEL #2 KIT (with preamp) ... \$29.95
2304 MODEL #3 KIT (with High Gain preamp) ... \$39.95
MODELS 2 & 3 WITH COAX FITTINGS IN & OUT AND WITH WEATHER-PROOFED DIE CAST HOUSINGS
BASIC POWER SUPPLY ... \$19.95
POWER SUPPLY KIT FOR ABOVE WITH CASE ... \$24.95
ANTENNAS & OTHER ACCESSORIES AVAILABLE. SEND FOR MORE INFO.

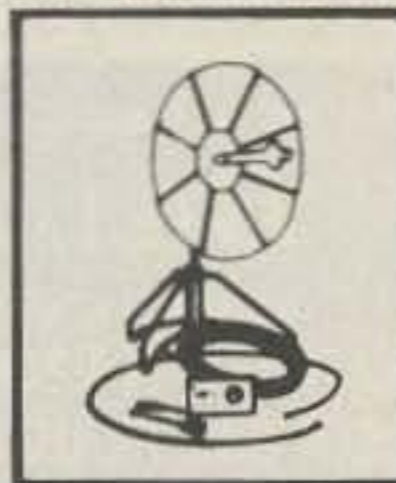

2100-2500 MHZ

*HMR-II COMPLETE UNIT
COMPLETE SYSTEM AS SHOWN. NOT A KIT. INCLUDES A PC BOARD, POWER SUPPLY, CABLES & CONNECTORS—PRE-ASSEMBLED AND TESTED 24dB GAIN OR GREATER.
1 UNIT ... \$149.95
2 UNITS ... \$139.95 ea.
3 OR MORE UNITS ... \$129.95 ea.

*HAM MICROWAVE RECEIVER

PRE-SCALER KITS

HAL 300 PRE (Pre-drilled G-10 board and all components) ... \$14.95
HAL 300 A/PRE (Same as above but with preamp) ... \$24.95
HAL 800 PRE (Pre-drilled G-10 board and all components) ... \$29.95
HAL 800 A/PRE (same as above but with preamp) ... \$39.95

PRE-AMPLIFIER

HAL-PA-19 WIDE BAND PRE-AMPLIFIER, 2-200 MHz BANDWIDTH (-3dB POINTS), 19dB GAIN FULLY ASSEMBLED AND TESTED \$8.95
HAL-PA-1.4 WIDE BAND PRE-AMPLIFIER, 10 MHz TO 1.4 GHz, 12dB GAIN FULLY ASSEMBLED \$12.95
HAL-PA-2.1 GHz 2 STAGE PRE-AMPLIFIER, DESIGNED FOR 2304 DOWN CONVERTER, MADE TO PIGGIE-BACK ON THE 2304 BOARD. OFFERS 20 dB GAIN. ALSO HAS AN IMAGE REJECTION FILTER. \$34.95

SHIPPING INFORMATION: ORDERS OVER \$25 WILL BE SHIPPED POST-PAID EXCEPT ON ITEMS WHERE ADDITIONAL CHARGES ARE REQUESTED. ON ORDERS LESS THAN \$25, PLEASE INCLUDE ADDITIONAL \$2.50 FOR HANDLING AND MAILING CHARGES. SEND 20¢ STAMP FOR FREE FLYER.

HAL-TRONIX INC.

P.O. BOX 1101
SOUTHGATE, MICH. 48195
PHONE (313) 285-1782 ✓31



"HAL" HAROLD C. NOWLAND
WBZXH

ASSOCIATED RADIO

913-381-5900

8012 CONSER BOX 4327
OVERLAND PARK, KANSAS 66204

BUY-SELL-TRADE

All Brands New & Reconditioned



**YOU WANT A DEAL — WE WANT TO DEAL
CALL NOW!!!**



SAVE-SAVE-SAVE



**NOTE: SEND \$1.00 FOR OUR CURRENT CATALOG OF NEW AND RECONDITIONED EQUIPMENT
SEND \$1.00 FOR OUR WHOLESALE LIST OF UNSERVICED & OVERSTOCK ITEMS.
SEND \$2.00 FOR BOTH. THEY WILL BE MAILED SEPARATELY.**

HOW CAN I INTERCEPT
SMUGGLERS? SECRET
SATELLITES? RESCUE
MISSIONS? SIGNALS
FROM SPACE?

WHAT IS THE TRUTH
ABOUT ANTENNAS?
TUNERS? PREAMPLIFIERS?

HOW CAN I CHOOSE THE BEST
RECEIVER? ANTENNA?

WHAT ARE THE LAWS REGARD-
ING LISTENING IN?

UNCOVER LISTENING
EXCITEMENT YOU
NEVER THOUGHT
POSSIBLE!

For your **FREE COPY** of
MONITORING TIMES--

CALL NOW! Toll-free
1-800/438-8155

(cont. US except NC).

Others dial 1-704/837-2216

or write to

Grove Enterprises, Dept. D , 140 Dog Branch Road
Brasstown, NC 28902

✓ 352

HIGH PERFORMANCE PRESELECTOR-PREAMP

The solution to most interference, intermod, and desense
problems in **AMATEUR** and **COMMERCIAL** systems.



- 40 to 1000 Mhz - tuned to your frequency
- 5 large helical resonators
- Low noise - High overload resistance
- 8 dB gain - ultimate rejection > 80 dB
- 10 to 15 volts DC operation
- Size - 1.6 x 2.6 x 4.75" exc. connectors
- **FANTASTIC REJECTION!**

Typical rejection:
±600 Khz@144 Mhz: -28dB
±1.6 Mhz@220 Mhz: -40dB
±5 Mhz@450 Mhz: -50dB

Price - **\$79.95** bipolar w/RCA jacks.
Connector options: BNC \$5, UHF \$6,
N \$10

SUPER HOT! GaAs Fet option \$20

AUTOMATIC IDENTIFIERS

ID-1

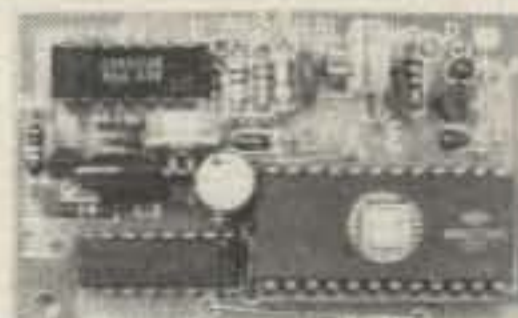

ID-2



- For transceivers and repeaters - **AMATEUR** and **COMMERCIAL**
- Automatic operation - adjustable speed and amplitude
- Small size - easy installation - 7 to 15 volts DC
- 8 selectable, reprogrammable messages - each up to 2 min. long
- Wired, tested, and programmed with your message(s)
- Model ID-1 - \$39.95 Model ID-2 w/2 to 10 minute timer - \$59.95

We offer a complete line of transmitter and receiver strips
and synthesizers for amateur and commercial use.

Request our free catalog. Allow \$2 for UPS shipping - Mastercard and VISA welcome

GLB ELECTRONICS

1952 Clinton St. Buffalo, NY 14206
716-824-7936, 9 to 4

✓ 143

Cheap Scanning for the IC-701

Here's a device that's stingy in cost but generous in benefits.

James R. Harden AG9D
129 Harborwoods Circle
Clearwater FL 33519

You don't have to be stingy, as I am, to build The Scotchman. If you own a radio that will work with Icom's RM-2 but you can't justify the cost, this may be for you. In my own case, I

didn't need all the features of the RM-2. All I really wanted was a machine to scan my IC-701 around the frequency where a scheduled contact would be. As the project evolved, I

learned that for another couple of bucks, and with the addition of a manual switch, the machine will start any place I choose and scan up or down until stopped.

Many projects tell you to hold down the cost by going to your junk box. If yours has what you need, fine. Mine never does. Al-

most everything I used was new from Radio Shack. You can include all the options, use a prettier box, go top dollar all the way, and still get by for less than \$35 plus tax.

How It Works

An inspection of the book that comes with the 701, 245, or 211 will show that a pulse applied to pin 17 of the accessory socket will step the frequency one unit either way. The direction it steps is determined by voltage or no voltage (microprocessor logic high or low) on pin 16. Pins 16 and 17 are referenced to ground on pin 8. The book warns: "Care should be taken not to apply voltages other than -0.5 V to $+5.0\text{ V}$ to terminals between no. 14 and no. 24, as they are connected to the CMOS IC." It's written in Japanese-style English, but the message comes through loud and clear! Keep the voltage low!

I want to thank Robert Johnson W9TKR for sending pinout information on the Icom 245 and 211.

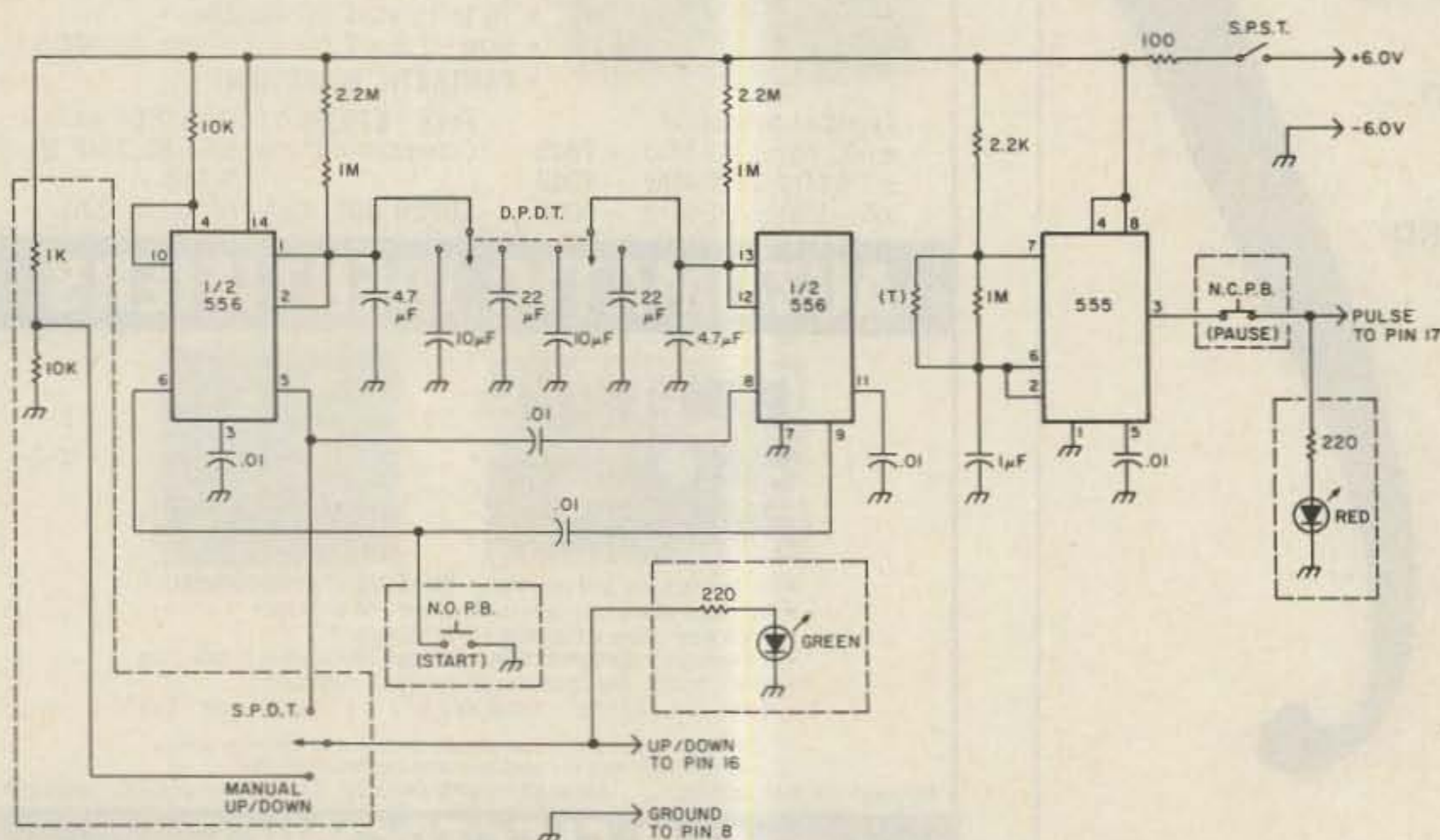

Fig. 1. Schematic diagram. Components inside dotted lines are optional features. If optional components are omitted the unit will work, but with less control.

These units do use pins 16 and 17 for frequency control. Other Icoms may bring connection to the CMOS IC out to a different place.

The simplest pulse generator I know is a 555 IC working in the astable mode. With two external resistors and two capacitors, a 555 will generate regularly-spaced pulses as long as voltage is applied. L. B. Cebik W4RNL wrote a very good explanation of how the 555 series of ICs work in the September, 1980, *QST*.

The values of resistance and capacitance I used with the 555 give pulses at approximately 1 Hz. I put a tailoring resistor in parallel with the one-megohm resistor between pins 6 and 7. You may find a single resistor that will give the right pulse rate, or you could use a potentiometer. By tailoring, I got a pulse rate of about 1.2 Hz. This is fast enough to cover the band in a reasonable time. It's still slow enough for a few clear words to come through as the radio scans across each

station. I can recognize a voice or identify a callsign.

The up/down function is controlled automatically by a 556 IC. The 556 is two 555s in one case. The two timers are operated in the monostable mode and connected so that each starts the other. If equal values of resistance and capacitance are used in each timer, the on and off times at pin 5 will be close to equal. I wanted to be able to vary

sweep time by changing resistance, but I couldn't make it work. Selecting capacitance with the double-pole, double-throw, center-off switch gives the three different sweep times.

Optional Features

The first two options give additional control. A normally closed push-button in the pulse line works as a pause control. I use it when I want to hear a bit more of

a station or when the scan goes too far in one direction. A normally open push-button between pin 6 of the 556 and ground gives a positive start and control of beginning sweep direction.

A third option is the manual up/down control. It is a two-resistor voltage divider and a single-pole, double-throw, center-off switch. Voltage from the divider is connected to one switch terminal for a logic high.

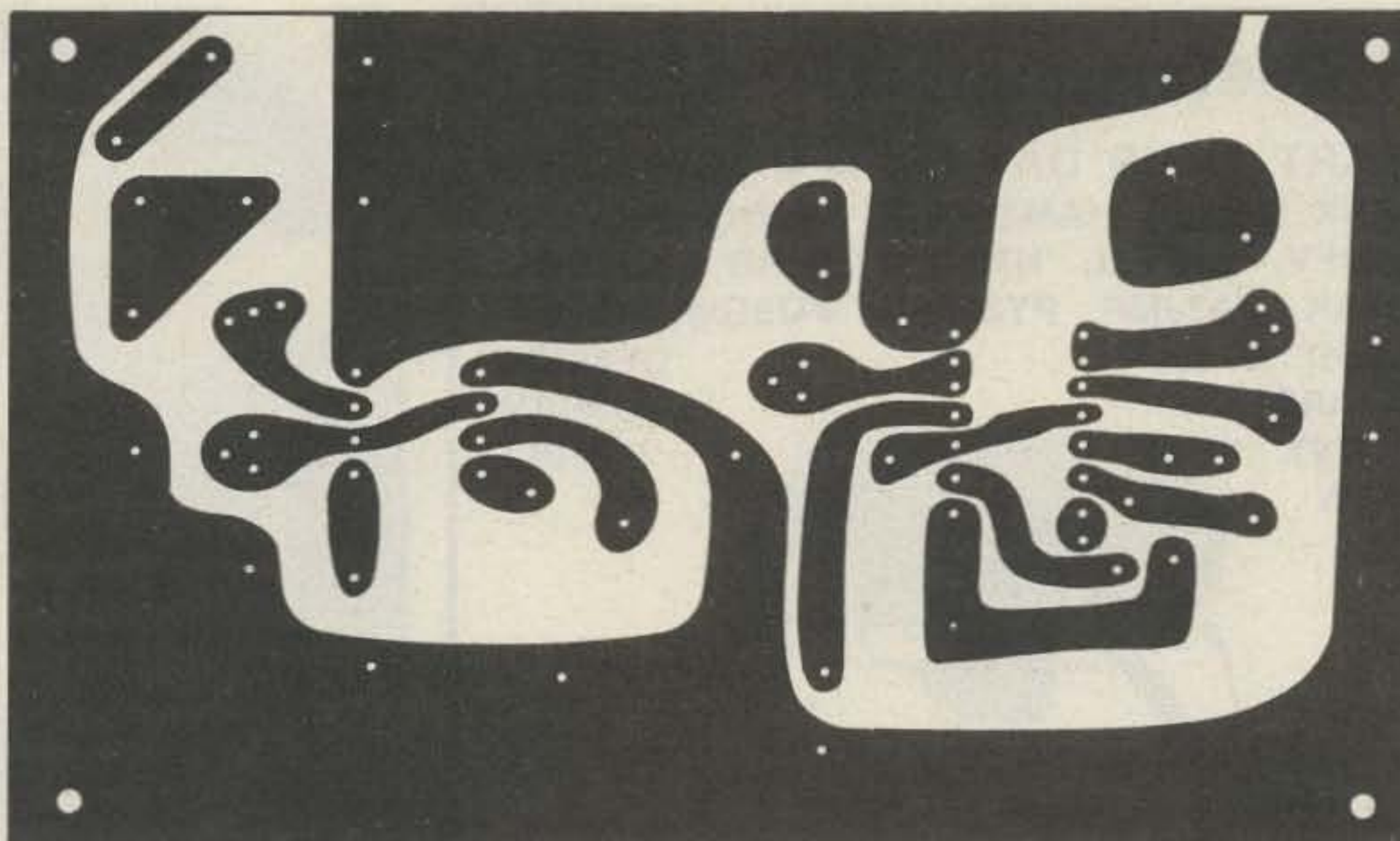

Fig. 2. Printed circuit board (foil side).

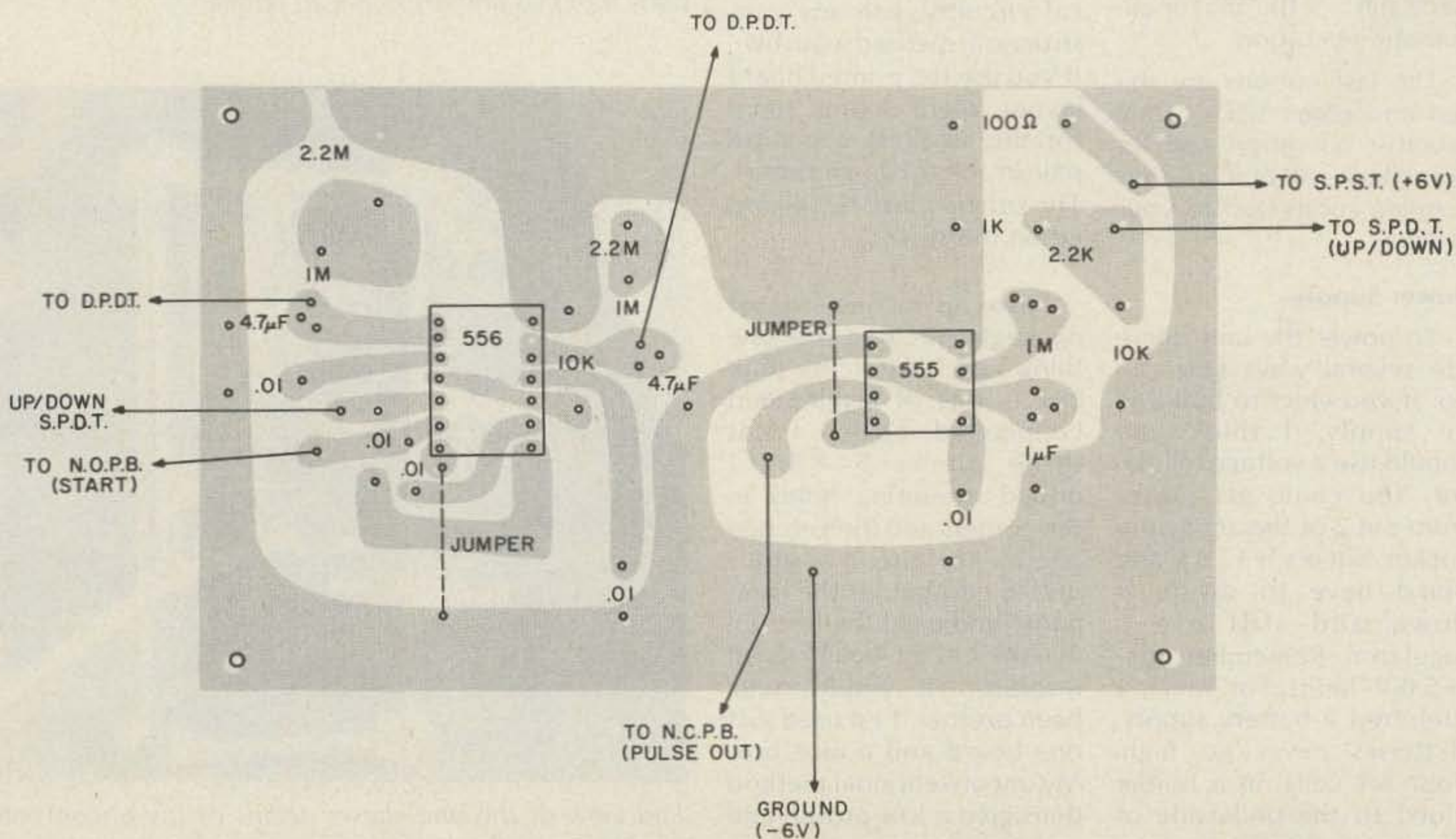

Fig. 3. Printed circuit board (component side).

15 Meter Mobile CW & USB

START YOUR DAY ON A GOOD KEY!!!
WORK OTHER HAMS LIKE: XE2BGM, ZL1PQ,
KL7JFV, EA7EU, NN3SI, DJ8RR, DL0BBC,
US6AK, JA3JMP, PY2-CPQ, FO8GW, KM6FF,
VK2BD
OA4ARB
VE7DYX
W1AW

OE8MOK
G3BRW
CE1BLL



High 10W (PEP) low 2W (PEP); VFO tuning; noise blanker; fine-tuned SB, KHz \pm CW off-set; digital frequency counter; 13.8V dc @ 3A, negative ground; L 9.5" x W 9" x H 2.5"; weight (2.3 kg) 5.7 lbs.; mobile mounting bracket.



JUST SLIGHTLY AHEAD

NOW ONLY
\$279.00

DLR. INFO. & ORDER, CALL
 1275 N. GROVE ST.
 ANAHEIM, CALIF, 92806 (714) 630-4541

NOTE: Price, specifications subject to change without notice and obligation.

✓318

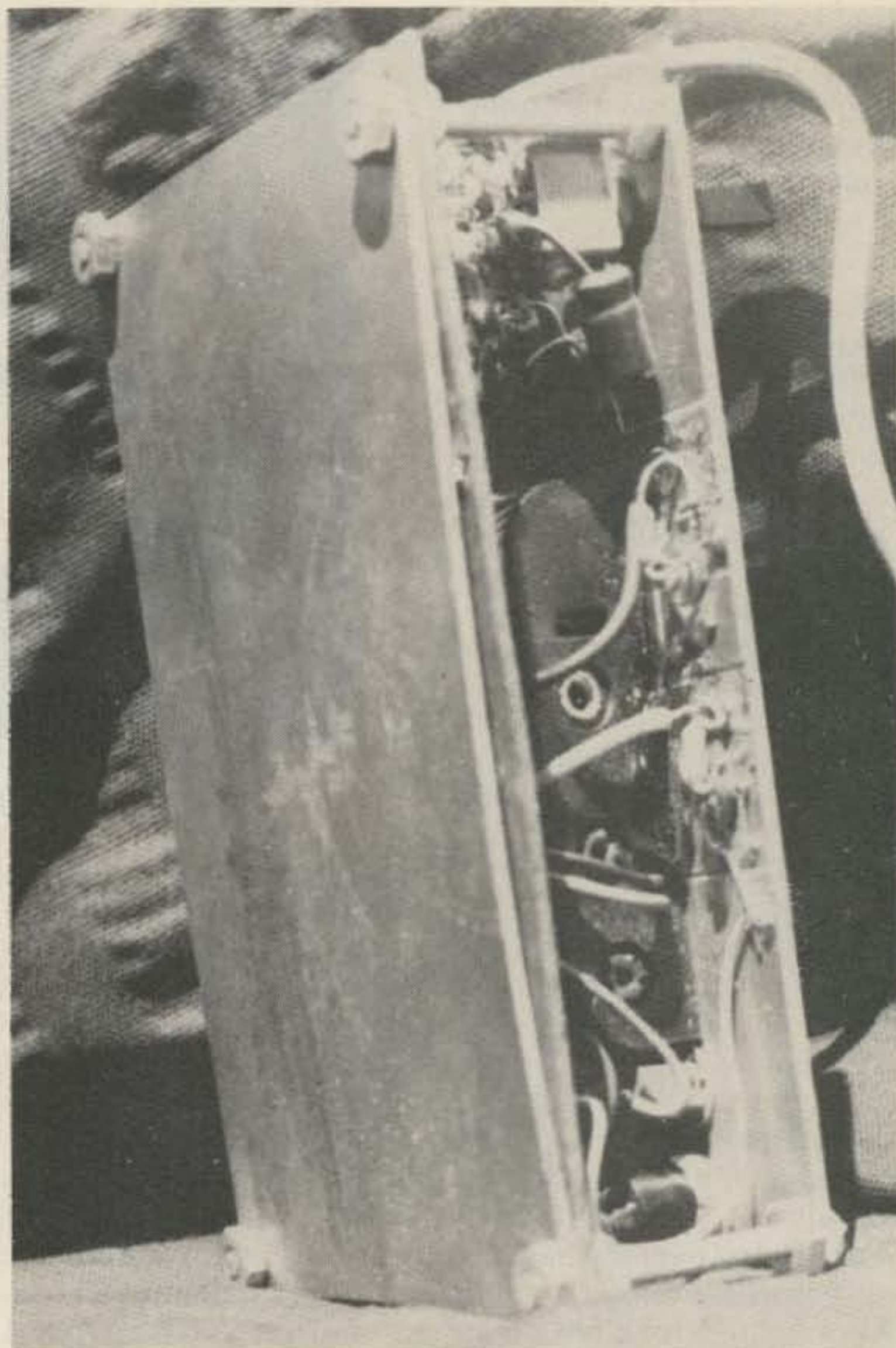

Side view shows battery case cemented to underside of front panel. Places where I cut foil with a file to make connector pads for LEDs and resistors can be seen.

Center off gives logic low. The other terminal connects pin 5 of the 556 for automatic operation.

The last options are the red and green LEDs. They monitor operation and let you check the unit without it being connected to your radio.

Power Supply

To power the unit, there are several ways you can go. If you elect to build an ac supply, I think you should use a voltage regulator. You could get power from pin 2 of the accessory socket, but it's +13.5 V and you'd have to divide it down and still use a regulator. Remember that +5.0-V limit! For mine, I preferred a battery supply. Batteries never go high. Four AA cells, in a holder glued to the underside of the front panel, do very well.

Construction

Since there isn't any critical circuitry, use any construction method you like. If you use the printed board layout, there is only room for the smallest capacitor pair in the up/down timers. The others must be mounted on the switch.

I used an unconventional packaging method. The one thing I do have in my junk box is lots of single-sided copperclad board. I cut three pieces 3" x 5". I drilled mounting holes in the corners and then etched one for the circuit board. I drilled another for the front panel and used the last under the circuit board as an insulator. It would have been prettier if I'd used just one board and a nice box. My unconventional method does give a low profile and it saved a couple of dollars. I'm stingy, remember? ■

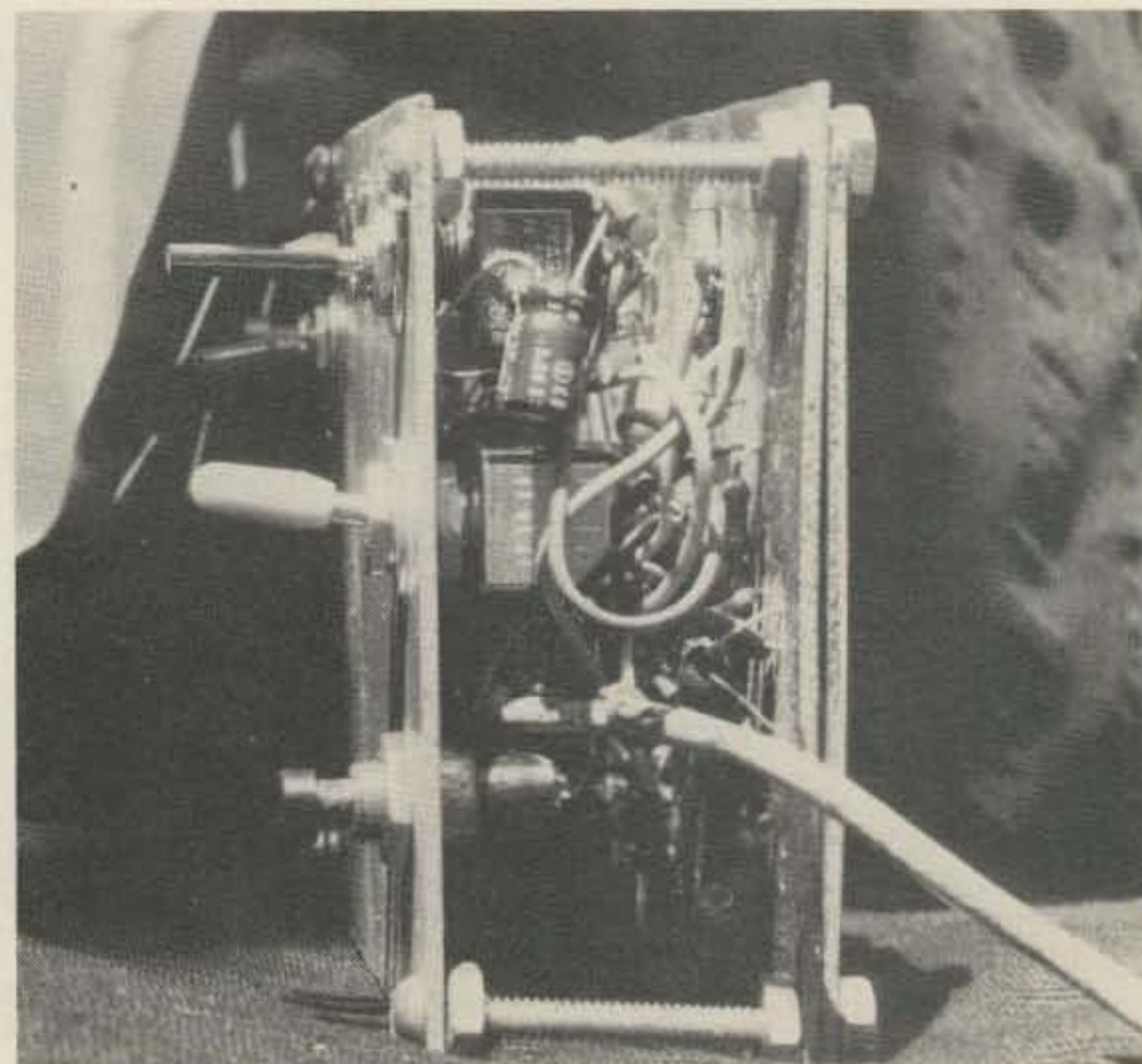

End view of the unit shows details of my unconventional packaging method. The timing capacitor mounted on the switch is visible.



Stuck with a problem?

Our TE-12P Encoder might be just the solution to pull you out of a sticky situation. Need a different CTCSS tone for each channel in a multi-channel Public Safety System? How about customer access to multiple repeater sites on the same channel? Or use it to generate any of the twelve tones for EMS use. Also, it can be used to access Amateur repeaters or just as a piece of versatile test equipment. Any of the CTCSS tones may be accessed with the TE-12PA, any of the audible frequencies with the TE-12PB. Just set a dip switch, no test equipment is required. As usual, we're a stickler for 1day delivery with a full 1 year warranty.

- Output level flat to within 1.5db over entire range selected.
- Immune to RF.
- Powered by 6-30vdc, unregulated at 8 ma.
- Low impedance, low distortion, adjustable sinewave output, 5v peak-to-peak.
- Instant start-up.

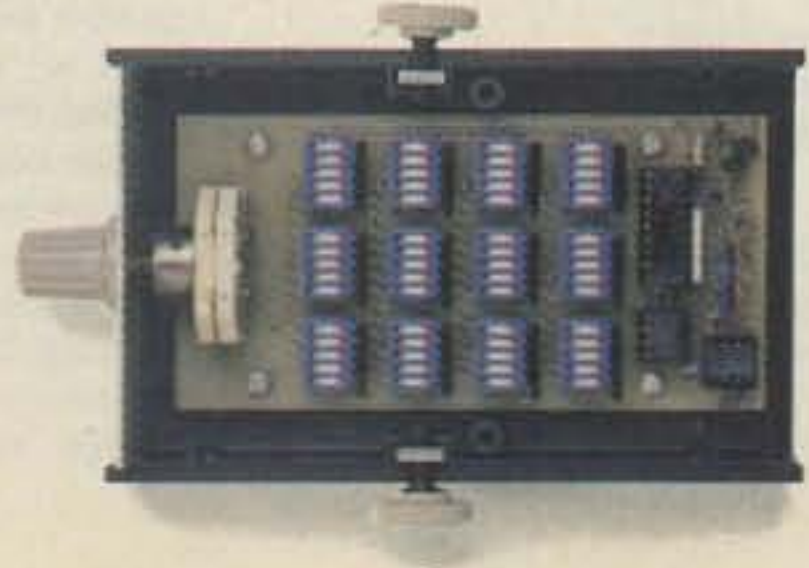

TE-12PA

67.0 XZ	85.4 YA	103.5 1A	127.3 3A	156.7 5A	192.8 7A
71.9 XA	88.5 YB	107.2 1B	131.8 3B	162.2 5B	203.5 M1
74.4 WA	91.5 ZZ	110.9 2Z	136.5 4Z	167.9 6Z	
77.0 XB	94.8 ZA	114.8 2A	141.3 4A	173.8 6A	
79.7 SP	97.4 ZB	118.8 2B	146.2 4B	179.9 6B	
82.5 YZ	100.0 1Z	123.0 3Z	151.4 5Z	186.2 7Z	

- Frequency accuracy, $\pm .1$ Hz maximum -40°C to $+85^{\circ}\text{C}$
- Frequencies to 250 Hz available on special order.
- Continuous tone

TE-12PB

TEST-TONES:	TOUCH-TONES:	BURST TONES:
600	697 1209	1600 1850 2150 2400
1000	770 1336	1650 1900 2200 2450
1500	852 1477	1700 1950 2250 2500
2175	941 1633	1750 2000 2300 2550
2805		1800 2100 2350

- Frequency accuracy, ± 1 Hz maximum -40°C to $+85^{\circ}\text{C}$
- Tone length approximately 300 ms. May be lengthened, shortened or eliminated by changing value of resistor

\$89.95

COMMUNICATIONS SPECIALISTS

426 West Taft Avenue, Orange, California 92667
 (800) 854-0547/California: (714) 998-3021

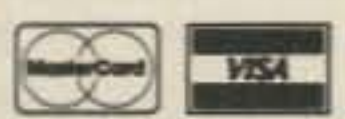

73 INTERNATIONAL

Each month, 73 brings you amateur radio news from around the world. In this collection of reports from our foreign correspondents, we present the latest news in DX, contests, and events, as well as keep you abreast of the technical achievements of hams in other countries.

If you would like to contribute to your country's column, write to your country's correspondent or to 73: Amateur Radio's Technical Journal, Pine Street, Peterborough NH 03458, USA, Attn: Avery L. Jenkins WB8JLG.



BRAZIL

Gerson Rissin PY1APS
PO Box 12178, Copacabana
20000 Rio de Janeiro, RJ
Brazil

VHF-DX ACTIVITY

Lauro PY3BZM is located in the city of Sao Sebastiao do Cai in Rio Grande do Sul State, South Brazil. He is listening almost every day on 144.3 MHz SSB or FM from 2300 to 0200 UTC, trying for QSOs with Central and North America. Lauro uses a Yaesu FTV-901 transverter with a Brazilian Mac VS 100 linear amplifier excited by an FT-902 DM transceiver. The antenna is a 15-element yagi polarized on 45 degrees.

Lauro has already worked FM7CS, J88AR, J73CS, and J73PD and received all of their QSL cards, except from J73CS. Remy FM7CS used only 3 Watts and a 2 x 9 element beam. Robert J88AR also used low power, 10 Watts, and a 2 x 12 element antenna.

The distances Lauro worked are: J73PD, Roseau, Dominica Island—5108 km; FM7CS, Fort de France, Martinica—5015 km, and J88AR, Kingstown, St. Vincent Windward Islands—4862 km.

For skeds, please contact Lauro Muller PY3BZM, Rua Tiradentes 978, 95760 Sao Sebastiao do Cai, RS, Brazil.

CW GROUP

On October 7, 1982, a few of the CW operators in the city of Santo Andre, an important industrial city in the State of Sao Paulo, established the CW Group of Santo Andre (CWSA). First elected president: Marcos Andre PY2NBI, vice-president: Clovis Crauchi PY2ORW, members of the directory: Alfredo PY2WUK, Ikeda PY2NG, Clovis PY2IBE, Luiz PY2FK, and Oity PY2TNX. They will sponsor the CWSA Award, rules for which we will publish soon.

GCWA AWARD

Sponsored by the Araras Group of CW, the GCWA Award is available to all licensed amateurs for confirmed contacts with 15 different PY2 stations and 3 GCWA members.

Contacts must have been made after

January 19, 1981, on any amateur band. Only two-way CW mode. Send to the address below, GCR log of stations worked (call, date, time, band, mode, and report), your personal QSL, copy of the GCWA member's QSL, and 15 IRCs for mailing expenses. There are no special endorsements for the GCWA Award. SWL: Same rules. Apply to GCWA Award, PO Box 15, 13600 Araras, SP, Brazil.

GCWA 60 AWARD

Available to the amateur or SWL who has obtained the GCWA Award and has contacted 60 PY2 stations and 3 other GCWA members. Send GCR log of stations worked (call, date, time, band, mode, and report), your personal QSL, copy of the GCWA member's QSL, and 15 IRCs for mailing expenses to the same address as above.

There are no special endorsements for the GCWA 60 Award. GCWA members: PY1BGJ, PY1BVY, PY1CC, PY1DFF, PY1EWN, PY2AAU, PY2CMS, PY2DCP, PY2DHP, PY2DV, PY2GMN, PY2GQT, PY2IBD, PY2IBN, PY2JN, PY2Vfy, PY2XIO, PY2WR, PY2RFC, PY2OIN, PY2IER, PY2ORF, PY2OIL, PY4CAX, PY5CL, PY5FI, PPSWUO.



CANADA

Gary Honeywell VE3ARS
PO Box 2610, Station D
Ottawa, Ontario
Canada K1P 5W7

Just over two years ago, Canadian amateurs had the opportunity of advising the Canadian Department of Communications in Ottawa on the matter of TRC24. TRC24 is the designation for a circular put out by the DOC which details the requirements for the amateur license. Examinations for the amateur license are based on TRC24. The Canadian Amateur Radio Federation (CARF), with the assistance of other organizations, undertook to represent amateurs in these discussions.

Under the direction of W. J. (Bill) Wilson VE3NR, former Director General of the Telecommunications Regulatory Branch, the Federation studied the old requirements and came up with a proposal that seemed to fulfill the needs of the DOC and would ease the burden on prospective amateurs. This proposal was the result of many discussions with DOC officials and comments received from amateurs across the country as part of the CARF National Symposiums.

The outlook for amateur radio was very positive. Favorable comments on the amateur effort were received by the Federation from DOC officials, and letters of appreciation were received from many Canadian amateur instructors who had followed the events as they were reported in TCA (The Canadian Amateur magazine). Our optimism was short-lived.

Several weeks ago, the new draft of TRC24 was unveiled by DOC. With shock and dismay, amateurs learned that despite all the effort that was put into the amateur proposal and despite the enthu-

siasm by DOC officials that greeted the effort, not one item of an amateur proposal was used. Needless to say, the Federation pursued the matter with the men in charge, but at this writing, no one as yet knows what happened.

From conversations with Bill Wilson and A. P. (Art) Stark VE3ZS, the two men most responsible for the amateur submission, and after having examined all the correspondence between DOC and the Federation on the matter, I discovered one interesting thing: Almost all of the DOC personnel who had participated in the discussions with CARF had been either transferred or retired before TRC24 was formulated. It almost seems as though the amateurs were forgotten in the rush to leave. It might be noted that TRC24 was circulated just prior to the government's fiscal end-of-year, and this leads me to conclude that someone was anxious to use up a budget before the money was lost and took any old copy of TRC24 that they could find or make up for printing. Prior to this, DOC had informed a CARF official that there were few funds in the budget to do this.

Recently, CARF took this matter up with the new Director General who indicated that he was unaware of the problem but would look into it. As he only recently attained his position in DOC, it was not expected that he would appreciate the efforts that amateurs put into the submissions. However, CARF officials were pleasantly surprised to find that he was indeed interested in determining what had transpired and why the efforts of both amateurs and government officials had resulted in such a debacle. We are confident that a solution will be found.

In the May issue of 73, mention was made of the question of Canadian amateur participation in examinations. The response to this question was far from favorable. The majority of letters I received (as editor of TCA) indicated that the exams were best left to the DOC. Some amateurs suggested that since the quality of the code sending was so poor as to result in only a 50% pass rate, amateurs should be permitted to participate in the code portion alone. Comments are still coming in.

Speaking of TCA, some of you may not know that Canada has its own amateur radio magazine. The Canadian Amateur celebrated its tenth anniversary in January of this year with a special issue devoted to the history of the magazine. Sponsored by CARF, TCA caters to the Canadian amateur with stories and news items that have a Canadian flair. It is not in competition with magazines like 73 as it is obtained only through membership in CARF. Information about CARF can be obtained by writing to The Canadian Amateur Radio Federation, PO Box 356, Kingston, Ontario, Canada K7L 4W2, or by calling (613) 544-6161.



FRANCE

Claude Guee F1DGY
11 Rue Emile Labiche
28100 Dreux, France

REGULATION

In 1983, the French administration (PTT) began using a new amateur examination. Nevertheless, the license characteristics are unchanged: F1—(codeless) radiotelephony for frequencies above 144 MHz, and

F6—radiotelephony and radiotelegraphy for all frequencies allowed (F8, 9, 2, 3, 5 are the former F6).

Instead of taking the examination at home or at a radio club, the candidate has to go to one of the nine centers (except for handicapped or 65-year-old persons). Two or three sessions are scheduled for this year. The exam consists of the following parts:

Radiotelephony. (A) procedure, regulations—10 questions; (B) technical—30 questions. The score in (A) must be at least 15/30 points, in (B) at least 36/90 points, and in (A + B), 60/120 points.

No answer gives 0 points, a right answer scores 3 points, and a wrong answer scores -1 point.

This type of examination (audio-visual) is also used for driving licenses.

Radiotelegraphy. 10 words/minute—26 letters, 10 numbers, 8 signs, and 40 Q-signals. The examination is done in three parts: 30 groups (5 letters, numbers, signs), 30 words in text, and a test on Q-signals.

According to the administration, 50% of the candidates succeed.

ARIANE STORY

According to the official commission of investigation created after the last failure (September 10th, 1982), a lubrication defect in the gear of the turbo-pump feeding the cryogenic motor was responsible for the plummet into the Atlantic.



GIBRALTAR

Jimmy Bruzon ZB2BL
2712 Flat Bastion Road
Gibraltar

AMATEUR RADIO IN GIBRALTAR

I am sure many of you have, at one time or another, worked Gibraltar. However, on numerous occasions I have come across some amateurs on the HF bands who have returned my call with "It's the first time I've worked a ZB2 after 25 years of hamming."

Gibraltar, with a population of about 30,000 inhabitants, all living within an area of two and a quarter square miles, has only a handful of active amateurs. At present, the most active stations are ZB2EO, ZB2GR, ZB2HM, ZB2HO, ZB2J, and ZB2HC. They are active on the HF bands most evenings, but there are a number of others like myself who don't show up so frequently. In future columns I will be including more information on the operating habits of all the ZB2s, as I am sure it will be welcome, especially by those of you who have not as yet worked The Rock.

Licensing requirements in Gibraltar are similar to those of the United Kingdom with some minor modifications, the most upsetting one being the non-existence of a Class-B license. This means that to obtain an amateur radio license one has to pass the City and Guild's Radio Amateurs Examination and the CW test before applying. We do, however, enjoy the privilege of being able to operate on the 50-MHz and 70-MHz amateur bands.

As far as reciprocal licensing is concerned, this is quite simple; any amateur whose country has reciprocal licensing arrangements with the UK can apply for a reciprocal license in Gibraltar. The call-sign issued usually consists of the home call/ZB2. This form of license, known as a temporary license, is issued free of charge. Applications for amateur radio

High-tech. Low-price.



HW-5400: a price performance triumph! A microprocessor enhanced, synthesized HF SSB transceiver...NOW ONLY **\$649⁹⁵**

SIMPLY SPECTACULAR

Don't let the low price fool you... HW-5400 *outperforms* comparable transceivers on 80-10 meters. This masterpiece of kit engineering is solid state, broadbanded and synthesized for rock solid stability and accuracy. It operates on USB, LSB and CW with automatic sideband selection, full break-in (QSK) and 16 memories. The power amplifier transistors from Motorola are VSWR protected. Plus *superior receiver quality* with super sensitivity and dynamic range.

HIGH-TECH CONVENIENCE

Seven mode and function symbols give you total transceiver status at a glance. Patent-pending dual-speed tuning squeezes out new QSO's at 50 Hz steps...or flies through bands in 1 kHz steps. *Split Memory Access* lets you review or change transmit frequency while in receive, without missing a word. And the Frequency Entry Keypad option instantly synthesizes QSY to any point in the band. Matched with Split Memory Access, this option will give you contest-winning DX control.

Treat yourself to the pride of building and operating the HW-5400 and HWA-5400-1 Power Supply/Speaker. It's the perfect transceiver system that leads the way in price...and performance.



FREE CATALOG!

Get full details and specs in the latest Heathkit catalog. Write today: Heath Company, Dept. 011-084, Benton Harbor, MI 49022. Or visit your local Heathkit Electronic Center.*

There's more for the Ham at Heath

See our complete line including the SS-9000 computer controllable transceiver, QRP transceiver, coax switcher, amplifier and antenna tuners.

Order toll free MasterCard and Visa 800-253-0570.



Heathkit®

Heath
Company

licenses should be made to The Wireless Officer, Post Office, 104 Main Street, Gibraltar.

Quite often we hear from amateurs wanting to come over and do some operating from Gib. There are a number of hotels quite willing to allow you to hoist up antennas on the roof, and I will be providing more detailed information in the future. However, bear in mind that The Rock is a very efficient rf screen, so if the idea is to be able to work west into the US, a hotel on the west side of The Rock must be chosen, and the same rules apply when you want to work toward the east.

Omnidirectional coverage is very difficult to achieve unless one is willing to sit and operate from the top of The Rock, and that is one thing I would not recommend. Previous experience has proved that it is far easier to create a pileup whilst operating from either the eastern or western sides of Gibraltar than doing it from the top. Apparently the fact that The Rock is a very poor conductor seems to be the cause of the very poor results which have been experienced on various occasions when operating from its top. However, the fact that ground-plane antennas have also been tried seems to dispel this assumption.

In the not too distant future, a group of ZB2s will be setting up a station on the top. The exact date has yet to be decided, but I will be giving you information on the event well in advance so that those stations who have not yet worked Gibraltar get the chance to do so, and certificate hunters will get the chance to obtain the ZB2BU Award.

The ZB2BU Award and the ZB2 Award are issued by the Gibraltar Amateur Radio Society, and both awards are available to hams and SWLs. To obtain the ZB2BU Award, all that is required is a log copy proving that ZB2BU has been worked on three different bands. The processing fee is three dollars. The ZB2 Award requirement is proof (log copy) of having worked five different ZB2 stations on any band(s), and the processing fee for this award also is three dollars. Applications should be mailed to The Awards Manager, GARS, PO Box 292, Gibraltar.

Well, that's about all from me for this month. When I write about the operating habits of ZB2s, I will start with Gordon Black ZB2J, who is the oldest licensed resident amateur on The Rock.

73 for now es CU next month.



GREAT BRITAIN

Jeff Maynard G4EJA
10 Churchfields
Widnes WA8 9RP
Cheshire, England

THE UK SCENE

Just about every household in the United Kingdom is now within range of 625-line UHF television transmissions (for the four main networks). Nevertheless, the old Band 1 405-line VHF transmissions continue although notice has been given that these will be phased out over the next few years.

The continued use of frequencies in Band 1 for television has been the main reason for the lack of any 50-MHz (6-meter) allocation in the UK. (It should be noted that 50 MHz is not an ITU-allocated amateur band in IARU Region 1.)

The imminent demise of 405-line VHF TV transmissions has not escaped the

RSGB (Radio Society of Great Britain) which has been pressing the Home Office (the regulatory authority) for an allocation. The RSGB has been keen to point out that 50 MHz is an important region of the radio spectrum where there is much work to be done in relation to propagation.

The first breakthrough came when the Home Office licensed a beacon in the 6-meter band although operation was initially confined to hours outside those of television broadcasting. This has recently been changed to 24-hour operation. The beacon, callsign GB3SIX, is located on the Isle of Anglesey in North Wales and transmits 100 W ERP on 50.020 MHz. GB3SIX beams westward (290°) towards the US, and recent reception reports have included one from Hartford, Connecticut.

The early part of 1983 saw a much more important breakthrough for UK 6-meter operation when the Home Office agreed to issue forty special research licenses for 50 MHz. Anticipating a great deal of interest, the RSGB invited applications for these licenses and, of some 200 initial enquirers, a few over 100 completed application forms. The lucky 40 were chosen by the Home Office to give a good geographic spread. All UK prefixes are represented in the forty and all holders have Class-A licenses which provide for the CW working. Transmissions may take place only outside television broadcasting hours (which are approximately 0600-0900 and 1200-2400 local time).

During television broadcasting hours or to make a 6-meter contact with another UK ham still requires a crossband (28-MHz/50-MHz) QSO.

Needless to say, our Oriental colleagues have not been slow to spot another chance to increase their UK profits. At the time of writing, the RSGB magazine, *Radio Communication*, contains advertisements for a 6-meter option on the FT-726 and for a self-contained 6-meter rig, the FT-690R. This latter is not described in detail but presumably is a close relative of the multimode 2m and 70-cm rigs, the FT-290 and the FT-790, respectively.

The chance of any home-grown commercial rigs for 6m (or any other, for that matter) are so close to zero as to make no difference. Jaybeam has at least produced a 2-element 6m antenna for vertical or horizontal mounting. Some other 6m enthusiasts have already turned their minds to antennas. Discussions have taken place between G4BPY AND G4GLT on the feasibility of stacking yagis and even of producing a 6 over 6.

Although quite restricted at the moment, the 6m licenses represent a major step forward for UK amateurs, and the RSGB is to be congratulated for its efforts in securing the concession. It is to be hoped that the band will be made available for wider use within a very short time.



GREECE

Manos Darkadakis SV1IW
Box 3751
Athens, Greece

At the beginning of this column, I would like to thank the editors of 73 for their idea of bringing news from amateurs all over the world to the readers of the magazine.

First of all, let's make a short flashback to Greek amateur radio history, which started out in 1958. There was some radio activity before then, but not on a constant

basis. A few Greek people and some British were operating from 1933 up to 1948, except during World War II, of course.

In 1958, there was some recognition from the Greek government of the amateur service, and the Radio Amateur Association of Greece was born. After that, people interested in getting an amateur radio operator license were taking examinations at RAAG headquarters; if they passed (not so easy as it sounds), they were rewarded with a conditional license. I use the term "conditional" because at that time there was no law covering the amateur radio service and the government could recall the license at any time and for any reason.

Because of this situation, Greece had only about 200 licensed radio operators up to 1967.

In 1967, with the dictatorship in power, this licensing procedure stopped. A law was made for radio amateurs in 1972 but did not become effective until 1974, just after the end of dictatorship in Greece. From then on, the way was wide open to everybody.

Examinations established by the Ministry of Post and Telecommunications take place twice per year on a regular basis. Today, the Greek amateur population consists of 500 amateurs, and anybody can consider this a big difference. A lot of things have changed from the time that a few pioneers started back in 1933.

Finally, RAAG's latest goal was to obtain the privilege of mobile operation, which was not permitted until 1980. It took about 5 years for the law to be changed so that radio operators could use their gear from cars, boats, etc.

In my next column, we will talk about the Greek amateur community itself and its organization.



GUAM

James T. Pogue KH2AR
68 Banyan Circle
FPO San Francisco 96630

THE VIEW FROM GUAM

Guam's hams and would-be hams have cause to celebrate! Amateur as well as commercial radio exams will once again be offered here on a regular and continuing basis. No exams have been given on Guam since June, 1982.

Prior to this time, the Guam Civil Service Commission had done all radio license testing on behalf of the FCC, mailing completed exams, code tests, and all other information back to the Honolulu District Office for scoring. Turnaround time for this procedure was quite good, and everyone seemed pleased.

In early 1982, however, the Commission announced that due to budgetary cutbacks they would no longer be able to offer radio examinations here on Guam. Anyone who wished to obtain an amateur license of the Technician class or higher, or any of the commercial licenses, would have to travel to Honolulu for testing.

When this announcement was made, several island hams approached Rear Admiral Bruce DeMars, Commander Naval Forces Marianas, and requested that he look into the possibility of having the Navy administer exams for the FCC at no charge. The approval for this arrangement finally came through in early April, 1983. Marianas Amateur Radio Club (MARC) President Dave Chartier W1YRM an-

nounced that exams will most likely be given on a quarterly basis as before, but will now be administered by representatives from the Naval Communications Area Master Station (NAVCAMS) here on Guam.

MARC has a supply of FCC form 610 applications for amateur licenses as well as form 756 applications for commercial radiotelephone and radiotelegraph licenses. Forms may be obtained by writing to Marianas Amateur Radio Club, PO Box 445, Agana GU 96910, and enclosing either a self-addressed stamped envelope or self-addressed envelope with sufficient IRCs to cover return postage.

When the applicant completes the appropriate form, he should send it to the FCC, PO Box 50023, Honolulu HI 96850. The FCC then will inform the applicant when and where the test will be given here on Guam. Advance notice of at least one month will be given prior to scheduling of test dates.

After the tests are scored in Honolulu, applicants will be notified by mail as to whether they passed or failed. Applicants who pass will have their paperwork forwarded to FCC headquarters for issuance of the appropriate license.

All of us who are either anxious to upgrade or get our first license owe a note of thanks to the Navy and those amateurs who worked to get approval of this system.



ISRAEL

Ron Gang 4Z4MK
Kibbutz Urim
Negev Mobile Post Office
85530 Israel

In June, I briefly outlined the Israeli amateur scene and licensing structure. In this month's column, I'd like to sketch out how a typical amateur here goes about getting on the air and in this way give you some of the flavor of ham life in our country.

Our typical amateur started out while still in high school, finding out about the hobby either from friends or a notice advertising an amateur radio course. The course is either at a high school, community center, or local radio club. (Community centers in Israel offer a wide variety of activities ranging from arts and crafts and folk dancing to computers, and some of them also have a club station with a ham on staff part-time to supervise it.)

4X4HQ, for instance, the Tel Aviv Youth Center's club, has turned out scores of licensed amateurs over the past years. While learning the code and theory, the newcomer can get a taste of what's on the bands by operating the club station, under watchful supervision, of course.

Well, he or she has finally passed the Novice test and is now faced with the task of assembling a station on a meager high-school student's budget. Thankfully, there is no shortage of surplus equipment available (one of the very few advantages of living in a country with a high defense budget). Some of this gear finds its way to junk dealers where ham scouts snooping around are quick to let out the word on the two-meter grapevine. Other items are sometimes donated directly to the Israel Amateur Radio Club. Such was the case last year with forty-four excellent circa 1960 Siemens tube-type general-coverage communications receivers retired from government service. Interested IARC

MFJ RTTY / ASCII / CW COMPUTER INTERFACE

Lets you send and receive computerized RTTY/ASCII/CW. Copies all shifts and all speeds. Copies on both mark and space. Sharp 8 Pole active filter for 170 Hz shift and CW. Plugs between your rig and VIC-20, Apple, TRS-80C, Atari, TI-99, Commodore 64 or most other personal computers. Uses Kantronics software and most other RTTY/CW software.

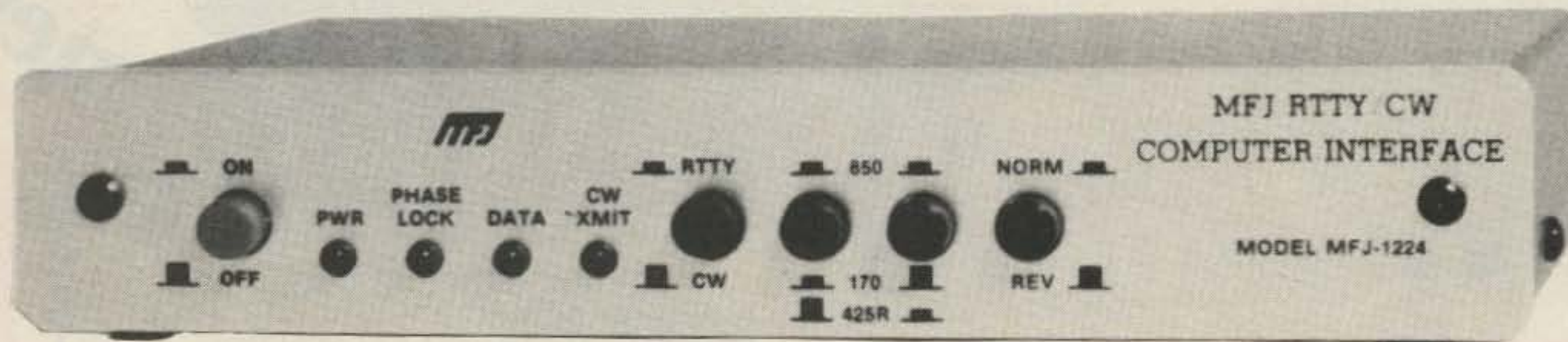

- Copies on both mark and space tones.
- Plugs between rig and VIC-20, Apple, TRS-80C, Atari, TI-99, Commodore 64 and most other personal computers.
- Uses Kantronics software and most other RTTY/CW software.

\$ 99⁹⁵
MFJ-1224

This new MFJ-1224 RTTY/ASCII/CW Computer Interface lets you use your personal computer as a computerized full featured RTTY/ASCII/CW station for sending and receiving.

It plugs between your rig and your VIC-20, Apple, TRS-80C, Atari, TI-99, Commodore 64, and most other personal computers.

It uses the Kantronics software which features split screen display, 1024 character type ahead buffer, 10 message ports (255 characters each), status display, CW-ID from keyboard, Centronic type printer compatibility, CW send/receive 5-99 WPM, RTTY send/receive 60, 67, 75, 100 WPM, ASCII send/receive 110, 300 baud plus more.

You can also use most other RTTY/CW software with nearly any personal computer.

A 2 LED tuning indicator system makes tuning fast, easy and positive. You can distinguish between RTTY/CW without even hearing it.

Once tuned in, the interface allows you to copy any shift (170, 425, 850 Hz and all shifts between and beyond) and any speed (5 to 100 WPM on RTTY/CW and up to 300 baud on ASCII).

Copies on both mark and space, not mark only or space only. If either the mark or space is lost the MFJ-1224 maintains copy on the remaining tone. This greatly improves copy under adverse conditions.

A sharp 8 pole active filter for 170 Hz shift and CW allows good copy under crowded, fading and weak signal conditions. Uses FET input op-amps.

An automatic noise limiter helps suppress static

crashes for better copy.

A Normal/Reverse switch eliminates retuning while stepping thru various RTTY speeds and shifts.

The demodulator will even maintain copy on a slightly drifting signal.

A +250 VDC loop output is available to drive your RTTY machine. Has convenient speaker output jack.

Phase continuous AFSK transmitter tones are generated by a clean, stable Exar 2206 function generator. Standard space tones of 2125 Hz and mark tones of 2295 and 2975 Hz are generated. A set of microphone lines is provided for AFSK out, AFSK ground, PTT out and PTT ground.

FSK keying is provided for transceivers with FSK.

High voltage grid block and direct outputs are provided for CW keying of your transmitter. A CW transmit LED provides visual indication of CW transmission. There is also an external hand key or electronic keyer input jack.

In addition to the Kantronics compatible socket, an exclusive general purpose socket allows interfacing to nearly any personal computer with most appropriate software. The following TTL compatible lines are available: RTTY demod out, CW demod out, CW-ID input, +5 VDC, ground. All signal lines are buffered and can be inverted using an internal DIP switch.

For example, you can use Galfo software with Apple computers, or RAK software with VIC-20's. Some computers with some software may require some external components.

DC voltages are IC regulated to provide stable

AFSK tones and RTTY/ASCII/CW reception.

Aluminum cabinet. Brushed aluminum front panel. 8x1 1/4x6 inches. Uses 12-15 VDC or 110 VAC with optional adapter, MFJ-1312, \$9.95.

RTTY/ASCII/CW Receive Only SWL Computer Interface



\$ 69⁹⁵
MFJ-1225

Use your personal computer to receive commercial, military and amateur RTTY/ASCII/CW traffic.

The MFJ-1225 automatically copies all shifts (850, 425, 170 Hz shift and all others) and all speeds.

It plugs between your receiver and VIC-20, Apple, TRS-80C, Atari, TI-99, Commodore 64 and most other personal computers.

It uses Kantronics software which features CW receive 5-99 WPM, RTTY receive 60, 67, 75, 100 WPM, and ASCII receive 110, 300 baud, plus more.

An automatic noise limiter helps suppress static crashes for better copy, while a simple 2 LED tuning indicator system makes tuning fast, easy and positive.

In addition to the Kantronics compatible socket, a general purpose socket provides RTTY out, RTTY inverted out, CW out, CW inverted out, ground and +5VDC for interfacing to nearly any personal computer with most appropriate software.

Audio in, speaker out jacks. 4 1/2 x 1 1/4 x 4 1/4 in. 12-15 VDC or 110 VAC with adapter, MFJ-1312, \$9.95.

ORDER ANY PRODUCT FROM MFJ AND TRY IT-NO OBLIGATION. IF NOT DELIGHTED, RETURN WITHIN 30 DAYS FOR PROMPT REFUND (LESS SHIPPING).

- One year unconditional guarantee • Made in USA.
- Add \$4.00 each shipping/handling • Call or write for free catalog, over 100 products.

MFJ

MFJ ENTERPRISES, INC.
Box 494, Mississippi State, MS 39762

TO ORDER OR FOR YOUR NEAREST DEALER, CALL TOLL-FREE

800-647-1800. Call
601-323-5869 in Mississippi and outside continental U.S.A. Telex 53-4590.



SPECTRUM - UHF POWER

*Boost your repeater
or Base Stn.'s Coverage
with the new SCA 100*

100-W. Amp.

SCP30

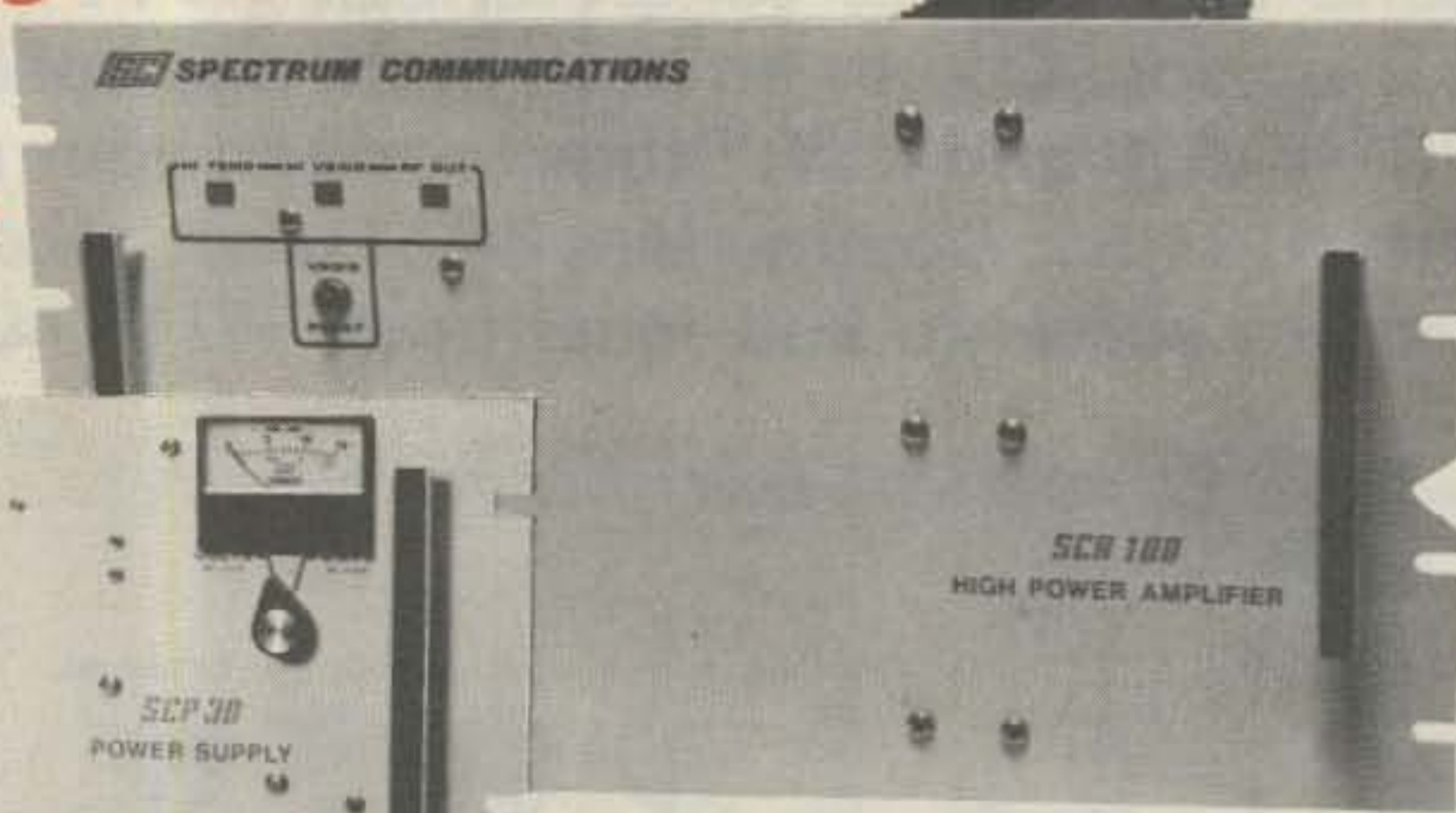

SCA100

new

6 Mo.
Warranty

**The first Amp really designed
"from the ground up" for
True 100% Duty Cycle!**

SCA100 SPECIFICATIONS

Power Output: 100 Watts
RF Input Power for full output: 40W, (SCA100); or
10W, (SCA100-10)
Duty Cycle: 100% Continuous
Frequency Range: 406-512 MHz
Voltage/Current: 13.6VDC nom. 15A typ. (SCA100)
Size: 10½" H x 19" W Panel. 9" Deep.

The SCA100 100 Watt 440 MHz Power Amp & its companion power supply were specifically designed for absolutely 100% Continuous Repeater or Base Station Duty—i.e., "key-down" for hours, or even months at a time. It is definitely not just another "mobile amp" bolted to a rack panel! Both units use the finest quality high power components available, along with very heavy duty mechanical construction.

A massive "deep fin" heat sink is used along with a high efficiency forced air cooling system. This is far more effective than normal convection cooling. Even after hours of key-down operation, the heat sink is only slightly warm! This ensures years of trouble-free operation, even in high ambient temperature areas. Excellent cooling is the key to success for any high power amp, and an area where competitive units are sadly lacking!

MANY UNIQUE FEATURES

- **Automatic High VSWR Protection**—amp goes to "Bypass" mode for VSWR>3:1, and automatically "Resets" up to 4 times before latching off. Prevents needless trips to the repeater site for momentary faults.
- **Automatic Overtemperature Protection**—amp switches to Bypass mode in the unlikely case that it begins to overheat. Autoreset when cool.
- **Automatic Amp Bypass if power supply should fall**—permits "straight through" exciter operation on battery backup power.
- **Reverse DC Voltage Protection**
- **LED Status Indicators** for RF Output, VSWR and Overtemp Shutdown. Front panel VSWR Reset button.



Behind the panel heat sink permits use in secure cabinet with locking front door—without loss of cooling effectiveness.

- **RF Bypass Relay** doubles as RF triggered T/R relay for transceiver use.
- **Unusually Tight RF Shielding**—eliminates very common "stray RF" problems.
- **Linear Mode Option**—for SSB or AM.

SCP30 HIGH CURRENT 30A POWER SUPPLY

The SCP30 is the companion supply for the SCA100 Amp., but it may be used for any application requiring an extremely heavy duty 25-30A cont. duty supply.

AC Input: 115/230VAC nom. (100-130V on 115V tap.)
DC Output: 13.8V nom.
Max Output Current: 25A (100% Cont.); 30A (Int.)
Regulation NL to FL: 0.8V typ.
Ripple: 100-150mVpp typ.
Metering: Output Voltage & Current
19" Rack Mount. 7" H. 25 lbs.

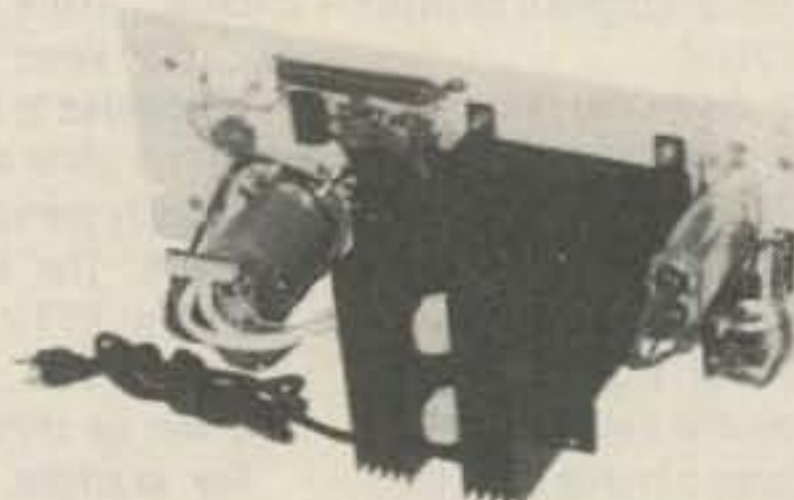

- **Massive Ferro-resonant Transformer** combined with a unique low dissipation regulator provides excellent regulation and ripple rejection without the usual high heat dissipation series regulator.
- **Over-Current Protection Circuit**

Call or write for details



68

SPECTRUM COMMUNICATIONS

1055 W. Germantown Pk, S8 • Norristown, PA 19401 • (215) 631-1710 • Telex: 846-211

members mailed postcards to the club, a draw was held, and for a nominal donation to the club's treasury, the winners became the owners of these beautiful boat anchors.

Now, the first transmitter is almost always home-brew, crystal-controlled, built from scrounged parts, reminiscent of what American Novices were putting together in the fifties and sixties. The schematic diagram must be on file with the Communications Ministry, as all transmitters must be authorized and registered. In Israel, it is a criminal offense to be in possession of unlicensed transmitting equipment.

And what is the scope of our Novice's on-the-air activity? After putting up some kind of simple antenna, our new ham begins his DXing on 15-meter CW and works the local gang on 40 meters on Saturdays, our Sabbath. But few Novices are satisfied with these limitations after the novelty has worn off, and with the radio club's help they go for the Grade-B license for the use of all bands and modes.

By this stage, few amateurs will still be working with home-brew gear. I must point out that customs duties on ham gear in Israel are quite reasonable, so that Japanese transceivers sell here for slightly under US list prices. And this is in a country with 100-to-200-percent duty on automobiles, electrical appliances, and television receivers. So it's not rare to hear fellows with the latest Kenwood rigs who don't own their own car. But then, we must keep our priorities straight!

There's a lot of used gear for sale ranging from older tube-type transceivers to fairly recent solid-state rigs, again with prices comparable to those stateside. At present, there's only one outfit dealing in new ham gear, but they seem to be doing a rip-roaring business.

The Grade-B licensee will no doubt also get on the very popular two-meter band, using the five national repeaters with a wide variety of equipment—but more about that in a future column when we'll delve into the VHF scene here.

I hope that you don't get the idea that all beginning hams here are youngsters, but a great many indeed are. Recently, the Holon-Bat Yam (a southern suburb of Tel Aviv) Club started a course especially for adults who found it emotionally difficult to be studying with a group of kids. However, I know of adults who studied along with younger enthusiasts without any hang-ups.

Just recently, a correspondence course for the Novice-class ticket was put out by the "Open University," a government-aided post-secondary institution, and they are reported to have a Grade-B course in the works. Hopefully, their books will soon be available over the counter, and at long last, literature in the Hebrew language will be available for aspiring radio hams.

An interesting statistic is that in the last five years, over 250 new licenses have been issued, this being roughly one-quarter of the total Israeli amateur population. There can be no mistake about it—ham radio is definitely on the upswing here!

AWARDS FROM ISRAEL

The Israel Amateur Radio Club has two certificates available. The first is the veteran $4 \times 4 = 16$ Award and is valid for all contacts with Israeli stations since 1948. You need a total of sixteen contacts on at least four different bands in any mode.

The second certificate is the new Israeli Award. This is valid only for contacts

made after January 1, 1982. Twenty-five points are required—contacts on frequencies lower than 10 MHz are worth two points and on other bands are worth one point, while VHF and UHF contacts are worth ten points.

For either of these two awards, send one dollar or four IRCs plus a fully detailed log of the contacts certified by another licensed amateur to: Awards Manager, Israel Amateur Radio Club, POB 4099, Tel Aviv, 61040, Israel.

The Jerusalem amateurs have just recently made available the Jerusalem Award. You need five contacts with Jerusalem stations dating from January 1, 1983, on any bands or modes, crossmode acceptable. Here QSLs are necessary, and along with them send ten IRCs to the award custodian: Dr. Milt Gordon 4X6AA, POB 4079, Jerusalem, Israel.

All the above awards also are available to shortwave listeners under the same conditions as to hams.

Well, that wraps it up for this month. I'll be happy to relate any areas of the Israeli amateur scene that may interest you in this column, so don't hesitate to drop me a line. Till next month, 73 and shalom.



ITALY

Dr. Giancarlo "Chas" Martelli I0XXR
18, Via Beviliani
00162 Roma, Italy

Italian amateurs are not yet permitted to use the new WARC bands, including 160 meters. The WARC Acts were ratified with a presidential law dated July 27, 1981, and it stated that the WARC 79 Acts should become effective in Italy on February 1, 1983.

Despite that, and in open contrast, the Ministero delle Poste, with its own edict, issued the new Italian band plan which does not consider the new WARC bands, including the 160-meter band, and does not mention the UHF bands above 24 GHz.

The band plan, which was issued without previous consultation with the Associazione Radioamatori Italiani (ARI), is filled with errors and discrepancies with respect to the WARC allocations confirmed on the other side by an official law of the republic. One of the funniest topics is the statement that in case of natural disasters, the Ministero delle Poste reserves use of the 144-146-MHz band for "its own international relief communications."

This gives only a pale idea of the situation of the Italian administrative bureaucracy, completely out of tune with the real necessities of an advanced society. It misunderstands the specialized and technical problems in any field due to the lack of capable and specialized personnel and due to the chronic laziness of the office workers.

I think that the ARI is presently making some progress toward overcoming the situation, but there are not many hopes for a fast resolution to the problem.

Diploma Anno Santo (Holy Year Award)

This award will be issued by the ARI, Sezione di Roma, PO Box 361, 00100 Roma, Italy. It will celebrate the Extraordinary Jubilee, 1983. The requirements are, for Europe: 15 QSOs, any band, any mode, with stations in Rome, or 10 QSOs with Rome stations and one QSO with a station in Vatican City; for other continents,

10 QSOs, or 7 and 1, respectively. The same stations can be worked only once per band.

The award period: March 25, 1983, to April 30, 1984. Send logs certified by officials of your association (or two other amateurs) with your application and US \$8.00 or 20 IRCs.

The award is 18 x 13 inches, beautifully printed in six colors on deluxe paper, and represents engraved copper artwork of the St. Peter Basilica. The same artwork is used on the special QSL which will be used mostly by the radio amateurs of Rome in the course of the Holy Year.

The St. Peter engraving and the layout of the award is by an artist in Rome who is also a radio amateur—I0EBR.

New Italian Prefix

The Italian Ministero delle Poste e Telecomunicazioni has recently started to assign IK to the prefix of all new licensees. The callsign combinations re-started with AAA for all IK-prefix licenses.

The IW prefix is for special licenses with permission to operate to 28 MHz. These are no-code licenses. Different prefixes are assigned to the residents in the so-called "special statute regions." These regions have their own parliament which institutes minor laws with regard to particular local administrative and economic problems. Sardinia has an IS0 prefix and Sicily has an IT9. Other special statute regions and their prefixes include: Valle d'Aosta—IX1, Trentino Alto Adige—IN3, and Friuli Venezia Giulia—IV3.

Other prefixes are assigned to the Italian islands:

Ligure Archipelagus—IA1
Tuscan Archipelagus—IA5
Ponziane Islands—IB0
Napoli Islands—IC8
Eolie Archipelagus—ID9
Ustica Island—IE9
Egadi Archipelagus—IF9
Pelagie Archipelagus—IF9 (Zone 33)
Pantelleria Island—IH9 (Zone 33)
Cheradi Islands—IJ7
Tremiti Islands—IL7
Minor Sardinian Islands—IM0



KOREA

J. Michael Wengert HL9KT/KH2AC
CPO Box 2961
Seoul, Korea

The Korean Amateur Radio League President, Mr. Min-sup Lee, is now on the air with his newly acquired callsign, HL1AOT. Mr. Lee is the first Korean National Assemblyman to hold an amateur radio license and to operate on ham bands. Unlike US Senator Barry Goldwater or the Japanese Dietman who also are legislator/hams, Mr. Lee became a radio amateur after being elected to public office. In fact, Mr. Lee was elected KARL president even before he was licensed. He holds the Radiotelephone Class license and is expected to operate SSB in the 3.5-, 7-, 21-, and 28-MHz bands as well as 144-MHz FM. He operates Korean-made equipment. A welcome to HL1AOT to ham radio and to his second year as president of the Korean Amateur Radio League.

SIARA

A new organization is being formed, or rather, an old organization is being reactivated, in Korea. It is the Seoul Interna-

tional Amateur Radio Association. SIARA was formed originally in 1978 as a way for hams of various nationalities to get together socially. Later, a club of HL9 operators (US military/civilians) was formed and more or less took the place of SIARA. Now, in 1983, SIARA is being reorganized with the sole purpose of promoting reciprocal operating agreements between Korea and nations of the rest of the world. Our sister organization, TIARA, in Tokyo, proved to be very effective in such a capacity in Japan. Now that the US military authorities have decreed that all HL9 operation will take place only from US military installations, and considering that about 90% of all American hams in Korea live off post, it would seem that such an organization would be useful in getting direct operating permission from the Korean government instead of the US signal authorities. If you are a ham of any nationality residing in Korea or planning to live here, contact SIARA, CPO Box 2961, Seoul, Korea, or telephone 720-6188 and ask for Mike.

A net, composed mostly of members of TIARA (Tokyo International Amateur Radio Association), AARCK (American Amateur Radio Club of Korea), FEARL (Far East Amateur Radio League), and SIARA meets every Sunday. The time for The Far East Net is 0100Z, and frequency is 14.285 MHz. Everybody is welcome, the language is English, and the *Westlink News* tape is aired at 0130Z.

Items of operating news are requested from all HL stations as well as station or club photographs. Send all information to me. That's all for this month. 73 from the Land of the Morning Calm.



JAPAN

R. E. Waite W9PQN
Tomigaya Grand—301, 2-19-5 Tomigaya
Shibuya-Ku
Tokyo 151, Japan

NO RECIPROCAL LICENSING IN JAPAN YET! WHAT HAPPENED?

Japan has not signed a reciprocal agreement with a single country. Not even one. This, in spite of the fact that Japan has the largest number of ham operators in the world: over 500,000 and increasing every month. Furthermore, Japanese firms manufacture most of the amateur radio

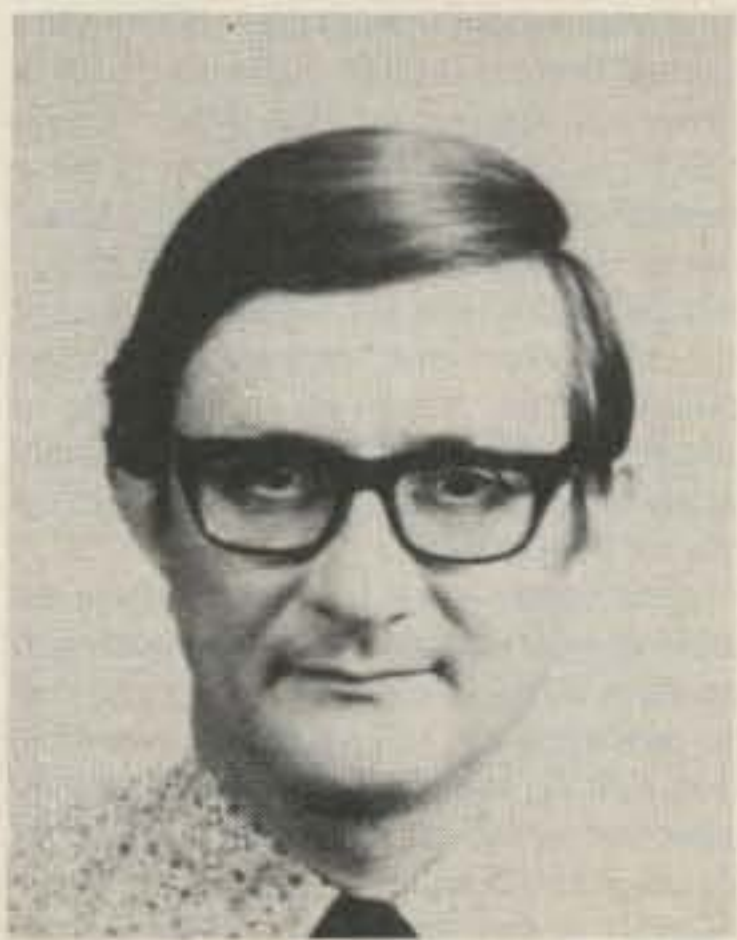

Roy Waite W9PQN.

equipment sold around the world, and by now probably everyone is aware of the superpower status that Japan has attained in the fields of computers, televisions, cameras, radios, audio equipment, etc.

Japanese tourists are most of those travelling in Asia, including Australia, replacing Americans in that latter category. Japanese industry produced more automobiles than did the US last year, and Nippon Steel replaced the United States Steel Corporation as the world's largest producer of steel. (Most Japanese, however, live in small, crowded "rabbit hutches" and do not yet enjoy the "good life," but this is a separate matter.)

But when it comes to a relatively and apparently simple matter like amateur radio reciprocal operating, the score is zero. What happened?

Until 1981, Japanese radio law stipulated that only Japanese nationals could operate ham radio in Japan:

Article 5.

A license for a radio station shall not be granted to a person in any of the following categories:

Paragraph 1.

(1) A person who is not a Japanese national...

On May 15th, 1981, the Japanese upper house of the government passed a new law and added the following paragraph to the existing radio laws of Japan:

Paragraph 2.

The provisions contained in the preceding paragraph shall not apply to the following radio stations:

An Amateur Radio station (a radio station established by an individual for the purpose of conducting radio communications for his personal interest) which is established by an individual who holds citizenship of a country that permits Japanese nationals to establish the same kind of radio station in that country.

So there you have it! Pretty simple, isn't it? There is the legal status for reciprocal operating. It's on the books. It's the law! So all we do now is fire up the rig and go on the air, right? Wrong! Agreements have to be signed with governments of other countries first. Well, all right. Let's sign the agreements. Japanese officials have stated privately that their goal is to sign an agreement with America first. The other countries can wait. Well, all right again. I happen to be an American. I feel sorry for the citizens of other countries, but if Japan wants to sign with America first, I'll go along with that. Why don't we sign? Here it is getting towards the end of 1983 and so far we have nothing. Well, not exactly nothing. Read on.

The Japanese government sent letters to the governments of twelve "prominent" countries around the world, including the United States, outlining the terms of a reciprocal agreement that Japan would like to enter into. Some responses were thereafter received—some good, some not so good. The US response, mercifully, indicated that the US would not accept the Japanese terms. Why do I say "mercifully"? Well, first of all we will have to understand the regulations that presently apply to Japanese applicants to get on the air here in Japan.

After passing the Japanese license examination, if a Japanese person wishes to operate with more than 10 Watts, he has to pay a fee the equivalent of over \$100 and wait six months for a government inspection which can be rather strict. Of course, if he is satisfied to stay within the 10-Watt power limitation, he simply applies for that through the JARL, pays his

fee, and after permission is granted, he may go on the air without going through the trauma of an inspection. But only 10 Watts.

It is these terms plus some additional red tape that the Japanese government wishes to pass on to the Americans and other foreigners who wish to operate in Japan. This seems to ignore the short-term visitor to Japan. How will he get on the air? Obviously he won't have time to wait for the inspectors to come, so he will have to operate with only 10 Watts. And don't forget the \$100-plus fee he has to pay for only a few days of operating.

Another condition the Japanese government wishes to impose on the foreign ham is a requirement that the applicant obtain written permission from the landlord or hotel manager (or whomever) to operate ham radio on the premises. Furthermore, prior application to the government will not be permitted. Application has to be made by the applicant after he arrives in Japan. We are told that an American visitor would be allowed to operate a station owned by a Japanese friend. But what if you don't happen to have a Japanese friend?

Is this reciprocity? Of course not. And it is for that reason that the US has wisely decided to negotiate the matter. But, my friends, the word "negotiate" to a bureaucrat turns on all kinds of happy thoughts, for this is the stuff that justifies their existence. Negotiations take days, months, even years, as we all know. But negotiate we must if we are going to get anywhere.

Another side problem is that 88% of Japan's amateurs are no-code phone-class Novices. How will they fit into the US scheme? The US is considering letting them use the bands above 50 MHz. In Japan, these same Novice no-coders are allowed everything except the 20-meter band, but they are limited to 10 Watts.

Incidentally, the no-code-class hams in Japan are the reason that, for the most part, Japanese amateur radio is more or less an extension of the citizens band, including its numerous abuses, bad manners, overcrowding, and general lack of knowledge of what amateur radio is all about. (Are you listening, America?) But that, too, is another story.

Japan has a long history of xenophobia and it is not surprising that it has taken so long to come this far. Non-Japanese are barred from many activities in Japan. For instance, an American lawyer is strictly forbidden to practice law in Japan, even if he can speak, read, and write Japanese fluently and could pass the bar examination if he were permitted to take it. Conversely, a Japanese lawyer may take the bar examination in any one of the States and freely practice law in the US. Many are doing so.

Discrimination is not illegal in Japan and is freely practiced. It is not unusual, for example, to see an advertisement in the vernacular press promoting a certain product or inviting readers to participate in some sort of promotional contest, with the notation at the bottom of the advertisement, "Japanese nationals only."

In the area of trade, Japanese are often considered to be unpatriotic if they purchase foreign-made goods here. Tobacco dealers (controlled by the government) are not allowed to promote US cigarettes and, in fact, only 30% of the cigarette shops throughout Japan are allowed to sell American cigarettes. (The question of whether smoking is good for you or not is a separate matter. The Japanese government has not yet determined that smoking is hazardous to your health, and cigarette

packages carry only a mild warning: "Don't smoke too much.")

The government puts an extremely high tariff on beef and oranges imported from the US, which results in US beef selling at \$25 and \$30 per pound and oranges at \$2 each. These measures are designed to protect the Japanese farmers. In fact, the Japanese have never allowed any product to be imported that would damage Japanese industry or agriculture in any way. An American car costs two times here what it would cost in the US due to taxes and charges added by government regulations. Japan, on the other hand, freely sells automobiles, cameras, computers, television sets, and, of course, ham rigs and whatever else in the US.

Now back to ham radio. A Japanese ham may take the US test and receive a license and callsign of his very own. In Japan, even if you take and pass the Japanese ham exam (many Americans and other non-Japanese have done so), you will be given an operator's permit but not a callsign. You will have to operate a Japanese club station—but not without first reporting the fact to the government.

Some of the preceding does not seem pertinent to ham radio, but I think it is useful to look at reality instead of viewing Japan through cherry-blossom-colored glasses. So many Americans visit Japan for a few days and seem to come away convinced that everything is fine in Japan, the "great economic miracle." Few would care to live in crowded hovels and pay super-high prices for goods which are kept artificially high by government regulations.

So, with this background information in mind, where Americans are not allowed to participate in society, where all American (all non-Japanese) residents are fingerprinted when they take up residence here (and re-fingerprinted every five years) and required to carry a foreign registration card at all times, and where foreign goods are not welcome, it should not come as a surprise that the Japanese government is reluctant to license foreign hams. There is a tendency for the government of Japan to try to control its residents, and this tendency is even more evident in the case of non-Japanese residents. We often refer to Japan as the country of "over-control."

This is not meant to be an indictment of Japanese people in general. I am sure you will find the Japanese people very friendly and especially helpful and polite to Americans. You can even see the pain in their faces when they explain to you that, "This is Japan, you know. Only we Japanese can get an amateur radio callsign in this country. Sorry."

The JARL, under the able leadership of Shozo Hara JA1AN, has done a lot in attempting to solve the problem and continues to work closely with the Ministry of Posts and Telecommunications. It's possible that a solution will be forthcoming soon. We wish them a lot of luck.



LIBERIA

Brother "Don" Donard, Steffes, C.S.C.
EL2AL/WB8HFY
Brothers of Holy Cross
St. Patrick High School
PO Box 1005
Monrovia, Republic of Liberia

The Liberia Radio Amateur Association is making an all-out effort to help the Gan-

ta Leprosy Control Center which finds itself practically in a state of emergency.

The two-room, mud-walled houses in which the patients live are termite- and rat-infested. The lepers have no feeling in their extremities, and the patients awake in the morning to find that their fingers and feet have been chewed on by the rats. The situation is bad, and Sister Dr. Chambers has made an appeal for help.

H. Walcott Benjamin, president of the Liberia Radio Amateur Association, and S. Richelieu Watkins, assistant minister of Post and Telecommunications of Liberia, have decided to organize the amateurs and put on a worldwide special-event program. The object of this program is to acquaint the outside world with the plight of these unfortunate patients in the hope that help will come. Mr. Watkins has forbidden amateurs in Liberia to request donations, but it is hoped that donations will come.

Mr. Benjamin has set up a special QSL manager, Bob SM4CWY, who will handle all the mailing for the project. His address is Box 134, S-67101, Arvika, Sweden.

The association designed a special QSL card with pictures of the leper colony on it. The special event began in May and will continue to December 31, 1983. Any amateur who contacts one of our Liberian amateur stations and sends a QSL card to our manager with a self-addressed envelope and postage coupons will receive the special QSL card. There is a special award if an amateur submits satisfactory evidence of having worked six Liberian counties on any band, with at least two contacts on CW.

Amateurs in Liberia work under severe handicaps. Their numbers are small (less than a hundred) and in some of the counties there may be no operators at all, or just one or two. There is a Liberian Net which meets every day and everyone makes a special effort to check in twice a week. Because of schedule conflicts, it is difficult for all amateurs to check in at the time scheduled for the net.

In spite of these difficulties, Liberian amateurs have distinguished themselves several times by their handling of real emergency situations. It is almost routine for amateurs in outlying areas where there are no doctors or medical facilities to accept medical advice, over the air, from a doctor in the city who very likely is an amateur himself.

If the amateurs in Liberia succeed in substantially helping the Ganta lepers, they will chalk up another victory in their efforts to help their fellow man.



NEW ZEALAND

D. J. (Des) Chapman ZL2VR
459 Kennedy Road
Napier, New Zealand

In a previous column, I explained the national structure of NZART and this month I shall move on down the line to the branch level of the organization.

There are 80 branches of NZART throughout the country, each branch an autonomous body, affiliated with the national association. Branches have their own finances, club rooms, and assets in the way of amateur radio equipment, test gear, repeater stations, etc. They make their own policies and domestic decisions in most instances, without any reference to the national body. The only decisions

**The BEST is still
"made in U.S.A."**



MIRAGE

**American made RF Amplifiers and Watt / SWR Meters
of exceptional value and performance.**

• 5 year warranty • prompt U.S. service and assistance

RF AMPLIFIERS

2 METERS-ALL MODE

B23 2W in=30W out \$89.95
(useable in: 100 mW-5W)

B108 10W in=80W out \$179.95
(1W=15W, 2W=30W) RX preamp

B1016 10W in=160W out \$279.95
(1W=35W, 2W=90W) RX preamp

B3016 30W in=160W out \$239.95
(useable in: 15-45W) RX preamp
(10W=100W)

220 MHz ALL MODE

C106 10W in=60W out \$199.95
(1W=15W, 2W=30W) RX preamp

C1012 10W in=120W out \$289.95
(2W=45W, 5W=90W) RX preamp

C22 2W in=20W out \$89.95
(useable in: 200mW-5W)

RC-1 AMPLIFIER

REMOTE CONTROL \$24.95
Duplicates all switches, 18' cable

WATT / SWR METERS

• peak or average reading

• direct SWR reading

MP-1 (HF) 1.8-30 MHz

MP-2 (VHF) 50-200 MHz

\$119.95

430-450 MHz ALL MODE

D24 2W in=40W out \$199.95
(1W=25W)

D1010 10W in=100W out
(1W=25W, 2W=50W) \$319.95

Available at local dealers throughout the world.

MIRAGE
COMMUNICATIONS/EQUIPMENT, INC.

P.O. Box 1393, Gilroy, CA 95020 (408) 847-1857

requiring ratification from the national association are those which might conflict with that association's constitution and rules.

The main objectives of the branches are "to further the objects of the NZART, to establish and operate amateur transmitting stations, etc., to foster local interest in amateur radio and associated electronics, and to assist with Civil Defense and emergency communications."

Branches are controlled by a president and a committee elected at the Annual General Meeting each year. Branch activities include the following: participation in the annual National Field Day station operation, the annual Amateur Radio Emergency Corps (AREC) Network Field Day, meeting every month for the purpose of conducting club business, providing technical or nontechnical discussions or lectures, and organizing other activities for the members' interest.

Looking through the "Branch Directory" published in the *NZART Annual Call Book* indicates that most branches have a regular club net, all have a branch call-sign, most meet regularly each month, organize or run classes of instruction for prospective radio amateurs and encourage qualified amateurs to advance their respective licenses by further qualifying at CW, and operate a section of the AREC in their areas, and about half of the branches operate and maintain VHF repeaters. A few branches in the larger cities also operate a UHF repeater.

Some branches organize group projects from time to time, and these project kits are made available to branch members at a small cash profit to the branch to assist club finances. In some instances, the project kits are also made available to all NZART members through the national magazine, *Break-In*, or by direct advertising methods to the various branches throughout the country.

Some recent project kits include power supplies, 12-V fixed and variable, RTTY accessories, VHF converters, preamplifiers, instrument cases, small transceivers, and numerous pieces of small ancillary equipment for use in or around the amateur radio station.

Amongst the NZART contests and awards, there is one for working different branches; overseas stations are required to work 35 different branches, and there is a special endorsement if the award is worked within a 12-month period. (The cost is 60 cents NZ, and if you want further information, contact me at the QTH above.) Some individual branches have branch awards, including Auckland, Upper Hutt, Kapiti, Mamawatu, Gisborne, Christchurch, Western Suburbs, Hutt Valley, and Wanganui.

Bits 'n' Pieces

The results of the National Field Day Contest held in February have just come to hand. ZL1RK of the Western Suburbs Branch station was 1st overall, ZL1VK of the Papakura Branch station was 2nd overall, and ZL2ABJ of the Napier Branch station was 3rd overall. Napier ZL2ABJ (Branch 25, NZART), as well as making 3rd place overall, was 1st place in the ZL2 area (see the photo). Because of various problems, there are winners for each of the four ZL districts at each Field Day as well as overall winners for the whole country. ZL1RK also won the ZL1 area contest; the winners of the ZL3 and 4 areas were not available at the time of writing.

New ZL Awards

As part of the NZART activities for World Communications Year, 1983, a Five-Band Worked all Pacific Award will be



The Napier Branch 25 Group, winners of the ZL2 section of the 1983 National Field Day Contest.

made available. The requirements are to work 30 eligible countries in the Pacific (e.g., those Oceania countries eligible for WAC as Oceania) on each of 5 different bands, making a total of 150 contacts. QSLs are not required. Send a list of log extracts to the NZART Awards Manager, 152 Lytton Road, Gisborne, New Zealand, with NZ\$9.00 for airmail postage and the award, which is on a handsome, suitably-inscribed wooden shield with an NZART badge mounted on it.

Another new ZL award available this year is the IARU Region III Operating Award. This award is made available to publicize Region III. It is for all licensed amateurs and SWLs. Contacts made after April 5, 1982, are eligible, but certificates will date from January 1, 1983, as part of WCY. QSL cards are not required. Send a certified list of eligible contacts from your log book; the cost is NZ\$1.00 surface mail or NZ\$2.00 by airmail. The basic award requires 7 countries, the Silver Star endorsement requires 12 countries, and the Gold Star endorsement requires 17 countries. Awards may be endorsed for any mode or band. Eligible countries: Japan, Australia, New Zealand, Korea, Philippines, Hong Kong, New Guinea, Thailand, Singapore, India, Sri Lanka, Tonga, Western Samoa, Solomon Islands, Indonesia, Malaysia, and Fiji. Send your applications to the NZART Awards Manager, 152 Lytton Road, Gisborne, New Zealand.

NZART has a new president, Don Mackay ZL3RW, who has been on the air since 1952 when he started off with an ARC-5 war-surplus transmitter. Don is involved with the electronics industry in Christchurch and has served in many positions in ham radio, both at branch and national levels. He also had a period as editor of *Break-In* from 1970 to 1976. Don is returning to the administrative ranks of NZART after a spell from these duties, and when time permits he is active from 160 through 432 MHz and with mobile activities 80 to 10 and 2 meters.

Our retiring president, Jumbo (Arthur Godfrey ZL1HV) has served the amateur fraternity of New Zealand well. Arthur travelled extensively during his presidency, visiting most branches and attending branch meetings throughout the country. His actions were appreciated by amateurs everywhere, especially those in the smaller centers without any direct representation on the National Council. We all wish him well and hope that the time gained will be put to good use on the ham bands.

Another old-timer making a return to the national scene as a councillor is "Jock" White ZL2GX. Jock is better known to overseas amateurs as the NZART Awards Manager, a position he has held for over 35 years. He has been associated with NZART for some 50 years now and is a life member of the national association and his local branch at Gisborne. He has retired now, so he must have some spare time available to help administer our national organization.



NORWAY

Bjorn-Hugo Ark LA5YJ
Postboks 39, Manglerud
Enebakkveien 208
Oslo 6, Norway

I would like to begin this presentation of ham radio in Norway with the sad news of a great loss to DXing in Norway. Our top DXer, Arne-Sten Grettland LA1KI, left us last autumn only 40 years old. The whole DX fraternity is still stunned with grief. All the great times we had together are still clearly remembered. As president and one of the founders of the LA-DX Group and a member of the board of NRRL and many other associations, he will be remembered for his willingness and eagerness to do everything for everybody. We often wondered: How does he manage time to work DX? A great friend to everyone, may he rest in peace.

LA1KI started what I am here writing about: He joined the whole country in one DX association, an association which now has 76 members and is still growing. 76 members does not sound like a lot, but remember there are only 4000 amateurs in Norway and to be a member you must show proof of having at least 100 countries confirmed. Most have more than 200. Those 76 members together with the Trondheim DX Association are the top DXers and contesters in Norway. You probably have heard them in the pileups.

In the Oslo area, there is a DX frequency on 2 meters, 145.375 MHz FM. You will always find somebody listening on that frequency if you happen to visit Norway. (I will write about reciprocal licensing below.)

The LA-DX Group meets every Sunday at 0900 Norwegian time, on 3750 kHz, to exchange news and information about the happenings on the HF bands. Quite often during wintertime, DX stations check in, and we are very pleased indeed.

Actually, some of the comments made after a DXpedition has taken place could give some of the guys on that expedition something to remember till next time. Of course, Europeans are not the easiest lot to handle in a pileup, but the right guy on the frequency can do wonders with the mob. The opposite, which unfortunately happens too often, makes you wonder: Why on earth did I choose DXing as a hobby and not rag chewing? You really just want to give it all up. But, stubborn as only a DXer can be, you stick it out, wait for the moment when the QRM gives in a little, work the station, and go QRT, still wondering why you don't sell the gear.

I will in the future take up this matter and offer some comments about the DXpedition's way of handling the traffic and try to illuminate what really is going on on the frequency. I think quite a few hams not interested in DXing would like to have that explained—why people behave as if they haven't the slightest idea about normal human behavior. Sometimes I really wonder myself.

It's not very easy to start a column! I'm not sure what should be in it, so I'll just have to take a chance and hope somebody will be reading it. I have already mentioned reciprocal licensing, and I can assure you that a license in Norway is not very difficult to obtain. You won't have to wait for an answer too long, either, if you fill the requirements and do as I suggest below.

Norway has reciprocal licensing agreements with the following countries, as per April: Canada, Denmark, England, Finland, France, Iceland, Luxembourg, Spain, Switzerland, Sweden, USA, Germany, Austria, and Holland.

The procedure to be followed by a foreign amateur to obtain temporary permission to operate an amateur radio station in Norway is as follows: The person in question shall prove, by a copy of his license, for example, that he has been registered in his country as a radio amateur.

An application should be made on a special application form, B1.570.3.80, obtainable from the Norwegian Telecommunications Administration. The address is listed below. Do remember an SASE and sufficient IRC postage to cover the way you want the form to be forwarded to you.

The application should be carefully filled out and sent to the proper licensing administration in the applicant's native country. The administration concerned is requested to give, under "Comments on the Applicant," its opinion on the applicant. The form should then be forwarded to The Norwegian Telecommunications Administration, Radio Inspection Office, PO Box 6701 St. Olavs Plass, Oslo 1, Norway.

A certificate of good conduct, issued by the applicant's local police authority, must be enclosed.

The application should be sent in time to arrive at the headquarters of the Norwegian Telecommunications Administration at least one month before the permission will be required.

A foreign amateur staying permanently will be issued an LA0 callsign, valid for one year at a time. If the stay is less than one year, temporary permission will be issued for three months at a time. The callsign used will be the same as used in the amateur's native country, followed by

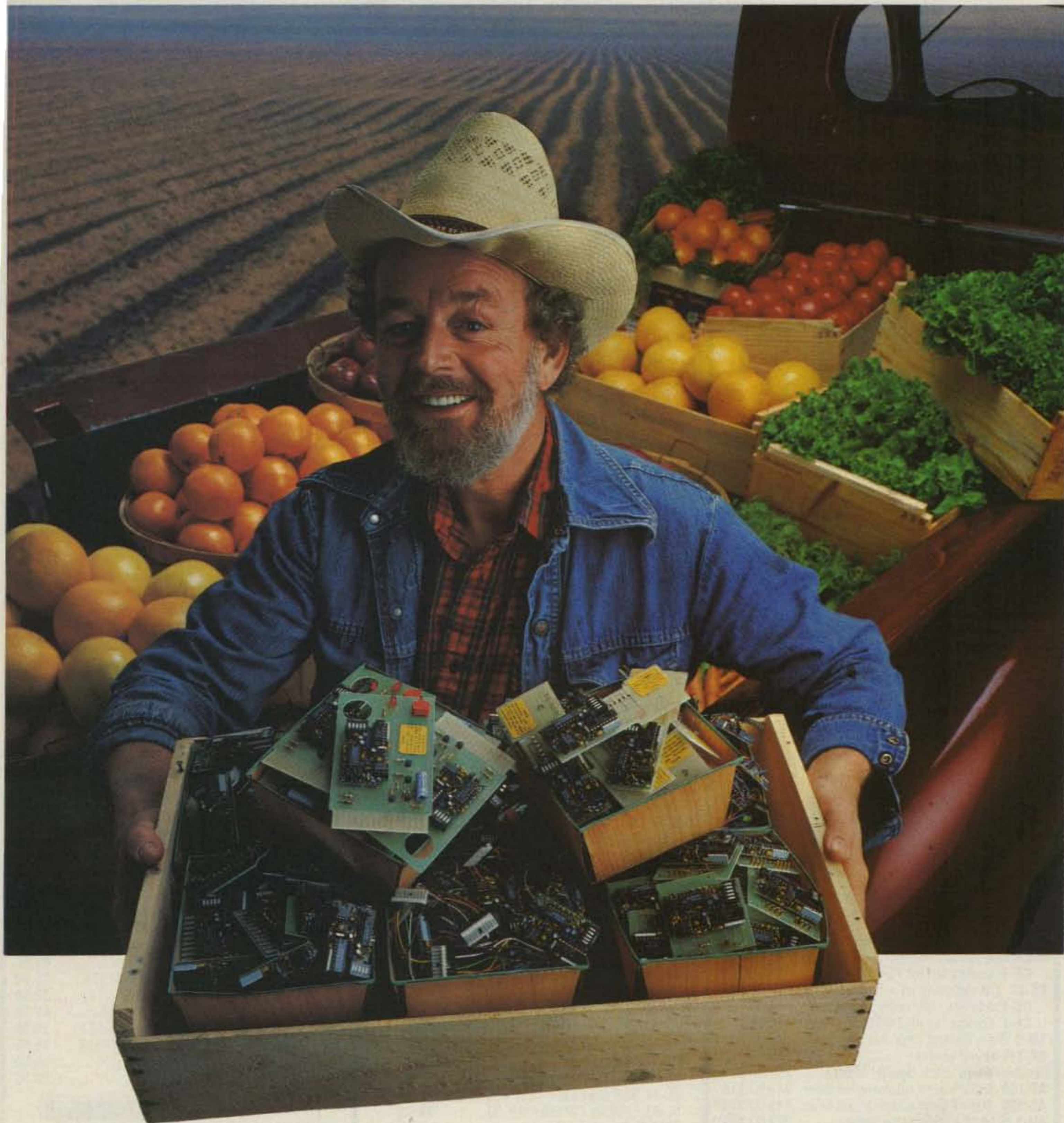

Plug-In Bumper Crop

From the fertile grounds of Communications Specialists comes our fresh harvest of direct CTCSS plug-ins to spade through valuable installation time and cultivate profits. They're available for most popular mobiles, portables, and repeater panels, and all incorporate our industry standard, field programmable TS-32.

Just call our sales or engineering departments toll free from anywhere in the USA (including California) and reap what we've sown.

 **COMMUNICATIONS
SPECIALISTS** ✓15

426 West Taft Avenue, Orange, CA 92667
714/998-3021 Entire USA 800/854-0547





ICOM

- Check the Savings at AES®!



HF Transceivers: Regular SALE
IC-740* 9-band 200w PEP Xcvr..... \$1099.00 949⁹⁵
 *plus **FREE PS-740** Internal power supply & **\$50 Factory Rebate** until 7-31-83

- | | | |
|---|-----------|-------------------|
| PS-740 Internal power supply..... | \$159.00 | 149 ⁹⁵ |
| EX-241 Marker unit..... | 20.00 | |
| EX-242 FM unit..... | 39.00 | |
| EX-243 Electronic keyer unit..... | 50.00 | |
| FL-44 SSB filter (2nd IF)..... | 159.00 | 129 ⁹⁵ |
| FL-45 500 Hz CW filter (1st IF)..... | 59.50 | |
| FL-54 270 Hz CW filter (1st IF)..... | 47.50 | |
| FL-52 500 Hz CW filter (2nd IF)..... | 96.50 | 89 ⁹⁵ |
| FL-53 250 Hz CW filter (2nd IF)..... | 96.50 | 89 ⁹⁵ |
| MB-12 Mobile mount..... | 19.50 | |
| HM-10 Mobile scan microphone..... | 39.50 | |
| IC-730 8-band 200w PEP Xcvr w/mic... | \$829.00 | 649 ⁹⁵ |
| FL-30 SSB filter (passband tuning)... | 59.50 | |
| FL-44 SSB filter (2nd IF)..... | 159.00 | 129 ⁹⁵ |
| FL-45 500 Hz CW filter..... | 59.50 | |
| EX-195 Marker unit..... | 39.00 | |
| EX-202 LDA interface; 730/2KL/AH-1 | 27.50 | |
| EX-203 150 Hz CW audio filter..... | 39.00 | |
| EX-205 Transverter switching unit... | 29.00 | |
| HM-10 Mobile scan microphone..... | 39.50 | |
| MB-5 Mobile mount..... | 19.50 | |
| IC-720A 9-band Xcvr/.1-30 MHz Rcvr | \$1349.00 | 899 ⁹⁵ |
| FL-32 500 Hz CW filter..... | 59.50 | |
| FL-34 5.2 KHz AM filter..... | 49.50 | |
| MB-5 Mobile mount..... | 19.50 | |
| IC-7072 transceiver interface, R-70... | 112.50 | |

- New Model!** Regular SALE
IC-751 9-band xcvr/.1-30 MHz Rcvr... TBA
 Internal power supply..... TBA
 FL-52A 500 Hz CW filter..... TBA
 FL-53A 250 Hz CW filter..... TBA
 FL-33 AM filter..... TBA
 HM-12 Hand microphone..... TBA
 SM-6 Desk microphone..... TBA
 External frequency controller..... TBA
 High stability reference crystal..... TBA

- Accessories: 720/730/740** Regular SALE
PS-15 External 20A power supply..... \$149.00 134⁹⁵
 EX-144 Adaptor; CF-1/PS-15..... 6.50
 CF-1 Cooling fan for PS-15..... 45.00
PS-20 20A switching ps w/speaker..... 229.00 199⁹⁵
 CC-1 Adaptor; HF radio to PS-20..... 10.00
 CF-1 Cooling fan for PS-20..... 45.00
SM-5 8-pin electret desk mic..... 39.00
SP-3 External speaker..... 49.50
 Speaker/phone patch (specify radio)..... 139.00 129⁹⁵
AT-100 100w 8-band automatic ant tuner 349.00 314⁹⁵
AT-500 500w 9-band automatic ant tuner 449.00 399⁹⁵
AH-1 5-band mobile ant w/tuner..... 289.00 259⁹⁵

- HF Linear Amplifier** Regular SALE
IC-2KL 160-15m/WARC solid state linear 1795.00 1299



VHF/UHF Multi-modes: Regular SALE
IC-251A 2m FM/SSB/CW Xcvr/AC ps... \$749.00 569⁹⁵
\$50 Factory Rebate until 7-31-83

- | | | |
|-----------------------------------|----------|-------------------|
| IC-551D 80w 6m Xcvr..... | \$699.00 | 599 ⁹⁵ |
| PS-20 20A switching ps/spkr..... | 229.00 | 199 ⁹⁵ |
| CF-1 Cooling fan for PS-20..... | 45.00 | |
| EX-106 FM adaptor..... | 125.00 | 112 ⁹⁵ |
| IC-451A 430-440 SSB/FM/CW Xcvr/ps | 899.00 | 769 ⁹⁵ |
| IC-451A/High 440-450 MHz Xcvr/ps | 899.00 | 769 ⁹⁵ |
| AG-1 15 db preamp, IC-451A/45A... | 89.00 | 79 ⁹⁵ |

- VHF/UHF FM:** Regular SALE
IC-25A 2m, 25w, up-dn-ttp mic, grn leds \$359.00 319⁹⁵
IC-25H as above, but 45 watts..... 389.00 349⁹⁵
IC-25A '82 model; 25w, ttp mic, red leds 349.00 289⁹⁵
IC-45A 440 FM xcvr, 10w, TTP mic..... 399.00 359⁹⁵
IC-22U 10w 2m FM non-digital Xcvr.... \$299.00 249⁹⁵
EX-199 Remote frequency selector... 35.00

- VHF/UHF Multi-modes:** Regular SALE
IC-290A 2m FM/SSB, TTP mic..... \$549.00 389⁹⁵
IC-290H 25w 2m SSB/FM Xcvr, TTP mic 549.00 489⁹⁵
IC-560 10w 6m SSB/FM/CW Xcvr..... 489.00 439⁹⁵
IC-490A 10w 430-440 SSB/FM/CW Xcvr 649.00 579⁹⁵

- VHF/UHF Portables:** Regular SALE
IC-202S 2m port. SSB Xcvr, 3w PEP \$279.00 249⁹⁵
IC-505 3/10w 6m port. SSB/CW Xcvr 449.00 399⁹⁵
BP-10 Internal nicad battery pack... 79.50
BC-15 AC charger..... 12.50
EX-248 FM unit..... 49.50
LC-10 Leather case..... 34.95

- IC-3PS** Power supply..... 95.00 89⁹⁵
IC-20L 2m amp, 10w PEP or FM..... 98.00 89⁹⁵
IC-30L 432 amp, 10w PEP/FM..... 105.00 94⁹⁵
New models! Regular SALE
IC-120 1.2 GHz FM mobile..... TBA
RP-1210 1.2 GHz, 10w repeater..... TBA
IC-271A 2m, 25w multimode..... TBA
IC-471A 430-450 MHz, 10w base..... TBA
RP-3010 440 MHz repeater..... TBA



- Shortwave receiver** Regular SALE
R-70 100KHz-30MHz digital receiver... \$749.00 649⁹⁵
EX-257 FM unit..... 38.00
IC-7072 Transceive interface, 720A 112.50
FL-44 SSB filter (2nd IF)..... 159.00 129⁹⁵
FL-63 250 Hz CW filter (1st IF)..... 48.50
SP-3 External speaker..... 49.50
EX-299 (CK-70) 12V option..... 9.95
MB-12 Mobile mount..... 19.50



ICOM Handhelds

The Transceivers. The IC-2A features full coverage of the 2 meter ham band. The IC-3A covers 220 to 224.99 Mhz, and the IC-4A, 440 to 449.995 Mhz. Each comes with BP-3 rechargeable battery, AC wall charger, flex antenna, earphone, wrist strap, and belt clip. Accessories are interchangeable. Slide on, removable battery pack allows quick change and may be charged while removed from transceiver.

- 2 meters:** Regular SALE
IC-2A .15/1.5w 2m HT/batt/wall cgr \$ 239.50 214⁹⁵
IC-2AT .15/1.5w 2m HT/batt/cgr/TTP... 269.50 219⁹⁵
220 MHz:
IC-3A 220 HT/batt/wall cgr..... 269.95 229⁹⁵
IC-3AT .15/1.5w 220 HT/batt/cgr/TTP 299.95 239⁹⁵
440 MHz:
IC-4A .15/1.5w 440 HT/batt/wall cgr... 269.95 229⁹⁵
IC-4AT .15/1.5w 440 HT/batt/cgr/TTP 299.95 239⁹⁵

- Hand-held Accessories:** Regular
BC-25U Extra 15-hour wall charger..... \$10.00
BC-30 1/15-hour drop-in charger for BP-2/3/5 69.00
BP-2* 450 ma, 7.2v 1w ext. time battery..... 39.50
BP-3 Extra std. 250ma 8.4v 1.5w battery..... 29.50
BP-4 Alkaline battery case..... 12.50
BP-5* 450 ma, 10.8v 2.3w hi-power battery... 49.50
 *BC-30 required to charge BP-2 & BP-5
FA-2 Extra 2m flexible antenna..... 10.00
CA-2 Telescoping 3/4-wave 2m antenna..... 10.00
CA-5 3/4-wave telescoping 2m antenna..... 18.95
CA-3 Extra 220 flexible antenna..... 9.12
CA-4 Extra 440 flexible antenna..... 9.12
CP-1 Cigarette lighter receptacle chgr for BP-3... 9.50
DC-1 DC operation module..... 17.50
HM-9 Speaker/microphone..... 34.50
LC-2A Leather case without TTP cutout..... 34.95
LC-2AT Leather case with TTP cutout..... 34.95
ML-1 2m 2.3/10w HT amp. (Reg. \$89).. SALE 79.95
ML-25 2m 20w HT amp. (Reg. \$199⁹⁵) SALE 179.95
IC-M12 12 ch Marine hand-held.. SPECIAL \$199.95

- Misc. accessories:** Regular
24-PP 24-pin accessory plug..... \$ 4.00
BC-10A Memory back-up; 551/720/730/740.. 8.50
BC-20 Nicads & DC-DC charger for portables... 57.50
BU-1 Memory back-up; 25A/290A/490A..... 38.50
EX-2 Relay box w/marker; 720A/730/701..... 34.00
HM-3 Deluxe mobile mic, specify radio 17.50
HM-5 Noise canx mobile microphone, 4 pin.... 34.50
HM-7 Amplified mobile microphone, 8 pin..... 29.00
HM-8 Touch-tone mic; 255A/260A, 8 pin..... 49.50
HM-10 Scan mic.; 255A/260A/290A/25A..... 39.50
HM-11 Scan mic.; 490/25A/290A..... 39.50
HM-14 Scanning/TTP mic; IC-25A/45A..... 49.50
SM-2 4-pin electret desk microphone; 551D.... 39.00
SM-5 8-pin electret desk mic.; 251A/451A..... 39.00
Mobile mount, specify radio..... 19.50
GC-4 World clock..... 99.95



Order Toll Free: 1-800-558-0411

In Wisconsin (outside Milwaukee Metro Area)
1-800-242-5195

AMATEUR ELECTRONIC SUPPLY® Inc.

4828 W. Fond du Lac Avenue; Milwaukee, WI 53216 - Phone (414) 442-4200

AES BRANCH STORES

WICKLIFFE, Ohio 44092
 28940 Euclid Avenue
 Phone (216) 585-7388
 Ohio WATS 1-800-362-0290
 Outside Ohio 1-800-321-3594

ORLANDO, Fla. 32803
 621 Commonwealth Ave.
 Phone (305) 894-3238
 Fla. WATS 1-800-432-9424
 Outside Florida 1-800-327-1917

CLEARWATER, Fla. 33575
 1898 Drew Street
 Phone (813) 461-4267
 No In-State WATS
 No Nationwide WATS

LAS VEGAS, Nev. 89106
 1072 N. Rancho Drive
 Phone (702) 647-3114
 No In-State WATS
 Outside Nevada 1-800-634-6227

Associate Store

CHICAGO, Illinois 60630
 ERICKSON COMMUNICATIONS
 5456 N. Milwaukee Avenue
 Phone (312) 631-5181

15 min. from O'Hare!

In both cases, a fee of Norwegian kroner 90 must accompany the application. Operations taking place in the Norwegian Arctic or Antarctic are subject to special conditions. Application must be made separately for such operations. The license issued to the applicant in his native country must correspond to a Norwegian Class-A (General) or Class-B (voice) license. In the latter case, the prefix will be LB0 or the suffix will be /LB. I hope you will enjoy operation from Norway and make some good friends there. I wish you good luck and welcome!



PAPUA NEW GUINEA

Regi Freymadi P29NSF
 P.O. Box 165
 Rabaul, Papua New Guinea

Once again, greetings from P29-land to all amateurs around the world. The New Guinea Islands received a lot of "shakes" during March; one earthquake registering 5.5 on the Richter scale lasted four minutes and was followed by dozens of aftershocks. Fortunately, no loss of life and not too much damage were suffered and I'm very happy to report that there was no damage to rig or antennas. That would have been a real disaster!

Bob P29NBF, in Goroka had a visit from the electronics king of Australia, Dick Smith VK2DIK, who was touring Papua New Guinea with his wife. Goroka was on the itinerary with an overnight stop from 14 March to the 25th. Dick got together with Bob P29NBF and Margaret P29NUN, and he did manage a number of contacts from Bob's shack. We knew we would hear from Dick again soon as he resumed his "around-the-world helicopter flight" in May, setting out for Indonesia and west from there.

The Annual General Meeting of the Papua New Guinea Amateur Radio Society was held in Port Moresby on March 25 and a new committee was elected. Amateurs from other provinces had been invited to come up on the 80-meter net for voting, but apparently no votes were received over the air. Bob P29BS was elected president, but has since resigned for health reasons. Peter P29NUK is the secretary and Pat P29NPN is the treasurer.

Trevor P29ZTD is the committee member representing VHF activity. The QSL Bureau remains with Rae P29NYL, who has handled it so efficiently in the past. Col P29NAB is the awards manager, and net controllers for the 80m net are Gordon P29NGG, Brian P29BP, and Peter P29NUK/ZUK. Also discussed at the meeting was the fact that a monthly column now appears in 73 giving news of the P29 ham scene. Everyone was interested and agreed that it was a good thing to get P29 on the map. With P29BS having resigned the presidency, an extraordinary General Meeting will have to be held. It is hoped that Bob can be persuaded to change his mind. He is a ham of long standing and vast experience and is admirably suited to the task.

Over the Easter weekend we had two amateurs staying with us: Shirley P29SM and her OM, Phil P29PM. Phil has just been allocated a full call; he was P29NPM previously. Shirley and Phil are from the Summer Institute of Linguistics at Ukarumpa. They are spending two months in the East New Britain province and will be erecting buildings in a village a few



The late Arne-Sten LA1KI and Hugo LA5YJ involved in some heavy contesting at LA1KI's. Photo by Jorgen LA5UF, the third participant.

kilometers from our QTH. The buildings will be used for literary classes in the local language. We had fun with three operators in the shack at times and it was a case of musical microphones rather than musical chairs! We were able to oblige a number of VK stations and a VS6 with contacts for the Bird of Paradise Award. Phil and Shirley spent 12 months in the United States some years back, and while there, Shirley attended a ham cram course which enabled her to obtain her full call.

The Western Province of Papua New Guinea should be fairly well represented on the amateur bands soon, with operations going ahead at the OK Tedi Mine in the Star Mountains. The mine will eventually be producing gold, silver, and copper and is still in the stages of construction. John P29NJS is already on location and operating there. Another operator was due at OK Tedi during the second week of April. He is VK3BSO, Stan from Melbourne, and we hope to hear him soon with a P29 callsign. Signals should be good from such a lofty QTH.

Now a bit of history from the area which might be of interest. Prior to World War I and beginning in the late 1880s, the northeastern part of New Guinea and the New Guinea Islands were German possessions. A powerful radio station was in operation at Bitapaka, approximately 45 kilometers from Rabaul. The radio tower was between 80 and 100 feet high, balanced on a glass ball. From there, radio contact was maintained with Berlin via relay stations.

At the outbreak of World War I, when the German transmissions were monitored, it appeared that they were in regular contact with a German warship (the *Scharnhorst*?) in the New Guinea waters. This led to a considerable force being sent by the Australian government for the invasion, to be ready for anything, as it were. The Australian soldiers landed at Kabakaul and proceeded to march towards Bitapaka, about 10 kilometers away. On the way, they ran into a ragged band of German planters and native police, hastily armed with any weapons they could lay their hands on. Shots were fired and a number of men killed, mainly Germans. The radio contacts with the formidable warship had been a sham to deceive the enemy! There was no warship nearby. The capitulation was quick and relatively painless.

There is a final chapter to this particular story: About 50 years later, my OM removed the guy anchors of the radio tower at the site. By then a TB hospital was there, being run by Catholic nuns (a lot of them German), and they wanted to be rid

of the three huge cement anchors for the guy wires. RSJs 1 foot in size had been cemented in to give support to the tower. That was the last evidence of the setup.

More news from here next month. See you then.



WEST GERMANY

Mitchell B. Wolfson DJ0QN
 Carl-Von-Linde-Str. 35
 D-8044 Lohhof
 Federal Republic of Germany

Here are some aspects of operating VHF/UHF in Germany. This should assist any of you planning a trip here in the future and give non-visitors an insight into the primary differences between operating in Germany and the United States and Canada.

The most obvious difference between the VHF and UHF bands is the pure lack of "wide open spaces" found on the 2-meter and 70-cm bands, plus the total lack of a 6-meter or 220-MHz band. Our allocation on 2 meters is from 144 to 146 and on 70 cm from 430 to 440 MHz. That's it. Oh, we also have a number of frequencies available and in use on 1240 and above, but now I will concern myself with the two primary bands of 2 meters and 70 cm.

Another major difference is the lack of private repeaters and autopatch repeaters (verboten!). This certainly makes operating repeaters in Germany a different experience than operating in the USA or Canada, but not necessarily a less enjoyable one.

A different attitude prevails in Germany, aside from any difference in mentality. This is due to many factors, such as the limited number of repeater pairs available, the concentrated population centers, and the Class-C (code-free) license. One interesting aspect of operating here is the number of random QSOs going on, exchanging QTH, name, DOK (DARC chapter), etc. This is done on a large scale just to collect QSL cards! Yep, just like on the HF bands in the States, but on a larger scale, QSLs are exchanged for VHF/UHF repeater contacts.

A major reason for this is the DLD Awards program held by the DARC. These awards are given for confirming various DOKs. QSLing in Germany is actually relatively cheap since DARC members can send and receive any number of cards

through their local chapter which, in turn, sends the cards through the DARC QSL card computer in Baunatal. In other words, no postage costs! This is a boon to the visitor to Germany, as he or she can, without hesitation, call CQ on a German repeater, perhaps make a nice QSO, and receive a QSL card in a few months to boot. Just don't forget to get some QSLs printed yourself!

Depending on your location, there will always be at least one repeater on each band within working distance. Operating patterns will be like any other industrialized country, so don't get frustrated if you can't make a QSO at 2:00 pm on a Tuesday afternoon. Some repeaters are incredibly busy, such as the "Zugspitze Relay" located here in southern Bavaria. Due to this repeater's tremendous coverage of southern Germany, Austria, and Switzerland, it is really difficult to get a word in edgewise, even late in the evening.

This is, of course, assuming that it isn't being jammed when you want to use it. (Even the disciplined Germans have their share of turkeys!) If you run into this type of situation, you can either go to another repeater or switch to a simplex frequency. The main calling frequency in Germany is 145.500. In addition, most of the DOKs will have a club simplex frequency. For example, my club, DOK C-26, uses the frequency of 145.325. Give it a try when you're in the northern part of Munich!

Many of you have heard about the required 1750-Hz tone burst required in Germany. This is correct, but it is definitely not required for a casual visitor to Germany's population centers. After a repeater has been brought up by tone burst, it will remain on as a straight carrier-operated repeater for a number of seconds. This should allow you sufficient time to gain access. In the worst case, you can always whistle up a repeater. It is cer-

2-METER AND 70-CM STANDARD REPEATER BAND PLAN IN GERMANY

Channel	Input	Output
R0	145.000	145.600
R1	145.025	145.625
R2	145.050	145.650
R3	145.075	145.675
R4	145.100	145.700
R5	145.125	145.725
R6	145.150	145.750
R7	145.175	145.775
R8	145.200	145.800
R9	145.225	145.825

Simplex frequencies are every 25 kHz from 145.250 to 145.575; calling frequency is 145.500. SSB/CW is located on the bottom of the 144-MHz band (very active). There are also a number of linear transponders on oddball pairs.

R70	431.050	438.650
R71	431.075	438.675
R72	431.100	438.700
R73	431.125	438.725
R74	431.150	438.750
R75	431.175	438.775
R76	431.200	438.800
R77	431.225	438.825
R78	431.250	438.850
R79	431.275	438.875
R80	431.300	438.900
R81	431.325	438.925
R82	431.350	438.950
R83	431.375	438.975
R84	431.400	439.000
R85	431.425	439.025
R86	431.450	439.050
R87	431.475	439.075

tainly not worth a large investment in time or money to acquire a 175-Hz generator before arriving here, but it can help under specific circumstances (rural areas, 70 cm, etc.). By the way, Austrian repeaters do not require tone burst.

Last but not least, don't forget that although you may get the impression that most German hams speak excellent English, this is not necessarily true, especially on VHF/UHF. Many of the people you meet may be Class-C licensees with no HF operating experience. Please speak slowly and clearly and have patience with your QSO partner. Enjoy your visit; you may make many permanent friends during your stay!



SWEDEN

Rainer Martinsson SM2DMU
Sikea 3178
S-915 00 Robertsfors, Sweden

I have covered the regulations concerning amateur radio in Sweden, so this month I will give you the details for obtaining a reciprocal license if you are planning your holidays in Sweden. The follow-

ing is an extract from a memorandum published by the Swedish Telecommunication Authorities.

1. General Rules.

The following rule must be conformed to by any foreign national wishing to obtain a permit to hold and utilize an amateur radio transmitter in Sweden.

On condition that there is no risk of the transmitter or the permit being misused, and provided that its use will not contravene the interest of the community, a permit will be granted to:

Any foreign radio amateur, during a temporary stay in Sweden, who has passed an acceptable test made by the authorities

concerned in his native country and concerning whom satisfactory information has been obtained and who, on special enquiry, has been considered fit to hold such a permit in Sweden.

Any foreign radio amateur who has obtained a permit to hold and utilize an amateur radio transmitter in Sweden has to follow the direction stated in the Swedish Regulations concerning the Amateur Radio Service mentioned above.

2. Application Procedure.

Any foreign radio amateur applying for temporary permit shall submit his application early enough to reach the Swedish Telecommunications Authorities no later than one month before the permit is required. The application, which may be written in Swedish, Danish, Norwegian, English, French, or German, shall normally be furnished with a pronouncement made by the licensing authorities in the applicant's native country. The application may, however, be sent direct to the Telecommunications Administration in doing which either a copy of the license valid in the applicant's native country provided that it was issued not more than six months ago, or a certificate issued by the licensing authorities in the applicant's native country, proving his holding of a valid license, must be enclosed. Such a certificate must not be older than six months. The application shall also be accompanied by a certificate of good conduct (impunity) issued by the police authorities in the applicant's native country. In certain countries, however, such a certificate cannot be obtained. A certificate issued by the applicant's amateur radio organization must be enclosed instead.

When applying for a temporary permit, the following documents *must* be sent in:

1. The application form.
2. A certificate issued by the police authorities (in certain cases the applicant's amateur radio organization as above).
3. A copy of the valid license or a pronouncement delivered by the licensing authorities in the applicant's native country (as above).

3. Fees.

80 Swedish kronor for a maximum of three months during a period of twelve months (one year). The time may at most be divided into four different periods. The fee shall be paid on the receipt of the invoice.

The application should be addressed to Swedish Telecommunications Radio Department, Licensing Section, S-123 86 Farsta, Sweden.

4. Callsigns.

To any foreign radio amateur obtaining a temporary permit there will be assigned a callsign, consisting of his ordinary callsign immediately followed by /SM and a digit stating the district within which the radio transmitter is to be used temporarily. For traffic exchanged from a mobile or portable radio transmitter, the letters M (MM for vessel) or P, respectively, preceded by an oblique stroke, may be added to the callsign.

5. Classes of Certificates.

A license for a foreign radio amateur will be issued and valid for the Swedish class of certificate corresponding to the class of certificate assigned to the licensee in his native country.

With this, I end the extract from memorandum no. Rft 1940. Anyone who wishes to obtain further information can write to the above address or call (08)-713-2162. Swedish Telecommunications will be happy to answer your questions and assist you in your application.

Best Picture at the Best Price - From \$495.00
VIDEOSCAN 1000 - HIGH RESOLUTION SSTV

Once you see our picture, you won't settle for anything less!



New generation amateur-standard scan converter sends and receives sharp pictures with up to 16 times better resolution than earlier units. Compatible with existing SSTV plus high resolution modes. Three scan rates, optional call sign and much more. Easy to use. Amateur, phone line TV, surveillance, teleconferencing, etc. Free "How To Get Started In SSTV".
Kit: VS-K \$495.00 Wired: VS-F \$695.00 Shipping: \$8.00

CODE STAR - PRICED FROM \$149.95
More Features Per Dollar Than Anything Else!

Copies code from your receiver! Improves your code speed too!



Ideal for novices, SWLs and seasoned amateurs. Built-in code-practice oscillator and speaker. Copies Morse, RTTY and ASCII. Large LEDs. Easy to connect and operate. Automatic speed tracking. Excellent digital/analog filtering. 12VDC or 120VAC with AC adapter provided. Compact. 2lbs. Connect computer (like VIC-20)/printer with optional ASCII output port.
Kit: CS-K \$149.95 Wired: CS-F \$199.95 Shipping: \$5.00
ASCII Port Kit: CS-1K \$49.95 Wired: CS-1F \$69.95

MORSE-A-KEYER -- CW Keyboard Kit: MAK-K \$159.95 Wired: MAK-F \$199.95 Shipping: \$5.00

Call or write for FREE brochures, Factory Direct - WE'RE AS NEAR AS YOUR PHONE!

Microcraft Corporation Telephone: (414) 241-8144
P. O. Box 513G, Thiensville, Wisconsin 53092 ✓50



NEW! EASY, FUN KIT!
New 2 kW tuner kit from TEN-TEC ends constant retuning, guarantees best match, and saves \$80! Model 4229 Only \$199

Here's the best antenna tuner in amateur radio!
The best quality components, best design, and the best value.
• Reversible "L" circuit guarantees best possible match and widest bandwidth—you may need to tune only once to cover the higher bands and only two or three times on lower bands. • Finest quality parts—ceramic insulators—ceramic inductor form—heavy duty ceramic switch with silver contacts—silver plated roller inductor—• Built-in SWR bridge shows ratios from 1:1 to 5:1 • Built-in 2 kW dual-range watt meter shows power levels from 10 to 2000 watts • Handles 2 kW PEP, 1 kW CW • Frequency range 1.8—30 MHz continuous coverage • Built-in balun—matches variety of antennas, balanced or unbalanced, to 50 ohm unbalanced outputs • Built-in bypass switch • 4-position antenna selector • Coax connectors plus post terminals • Lighted linear dial scale for easy tuning • Black finished aluminum cabinet with stainless steel bail (5½" h x 12¾" w x 13¼" d) • Also available assembled as Model 229 in slightly different styling at \$279.

See your TEN-TEC dealer or write for details:
TEN-TEC, Inc., Highway 411 East, Sevierville, TN 37862.



MAXIMIZE YOUR POTENTIAL WITH 73!

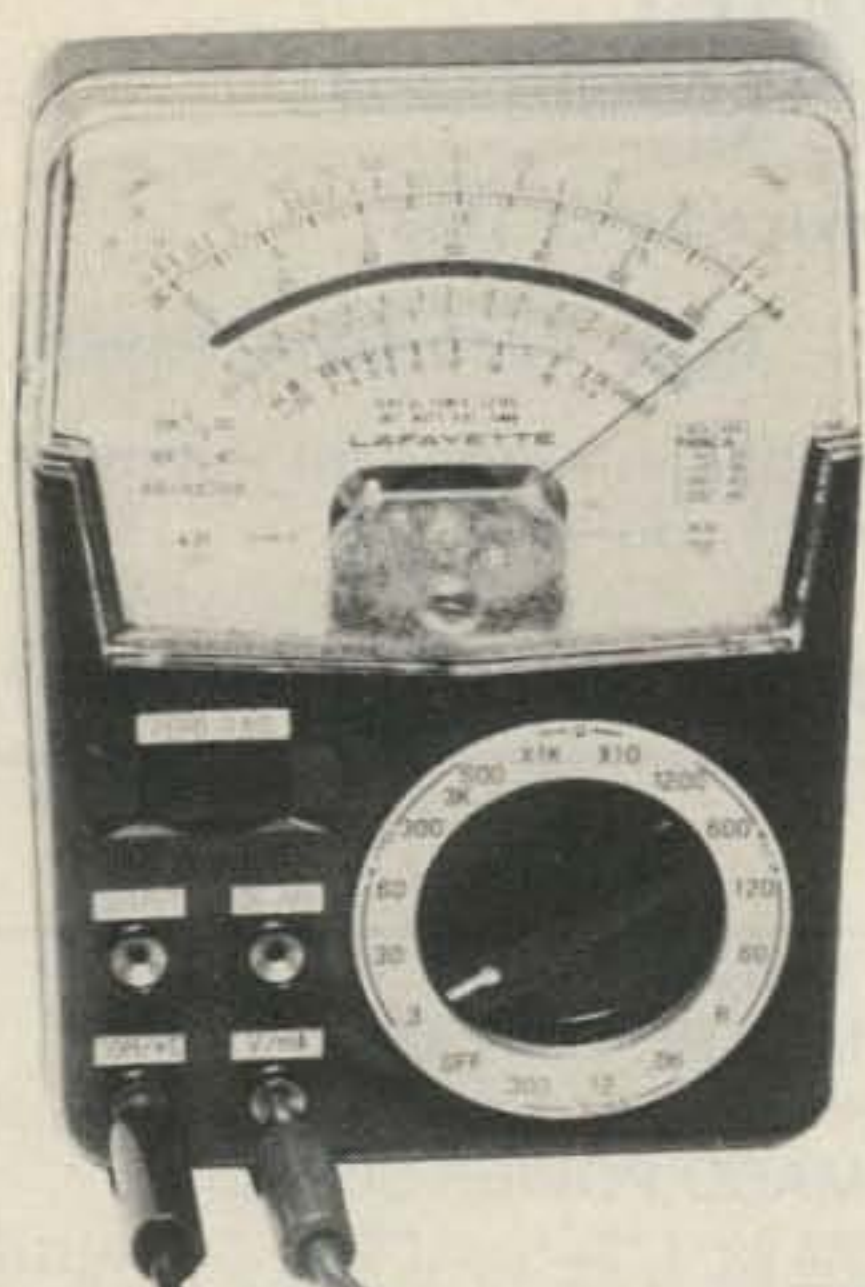

73: Amateur Radio's Technical Journal gives you more easy-to-build construction projects and circuit designs than any other magazine of its kind. Informative articles by the dozens, on all phases of amateur radio, written by hams for hams.

73 always keeps you one step ahead with...

Scores of useful building projects you'll enjoy by the hour.

In-depth equipment reviews, guaranteed to save you time, trouble and money.

73 International—delivers all the facts you need about licensing laws, club news, contests, and awards all around the globe.

DXing—valuable tips for newcomers, the personalities behind the callsigns, what's happening on the DXpedition scene, and much, much more!

New Ham Bands—timely reports on the new WARC bands, how to modify your rig to use them, what to do about antennas.

Satellite TV—keep up with the technology and all the latest developments in satellite communications.

PLUS

RTTY—with over 30,000 hams owning microcomputers, RTTY is developing a whole new life. 73 gives you more articles on RTTY than all the other magazines combined.

Ham Help—puts you in touch with other readers to get hard-to-find parts, schematics, and owner's manuals.

Contests—rules and results keep you informed about ham radio's competitive side.

Subscribe to 73 today! We'll keep you involved, informed, and completely entertained. To order, simply send in the attached order form, the coupon, or call toll free 1-800-258-5473. And if you include payment or charge card information you'll get a 13th issue FREE!



Yes, I want to subscribe to 73: Amateur Radio's Technical Journal. I understand that with payment enclosed or credit card order I will receive a free issue making a total of 13 issues for \$19.97

Check enclosed/MO MC VISA AE Bill me

Card# _____ Exp. Date _____

Signature _____

Name _____

Address _____

City _____ State _____ Zip _____

Canada & Mexico \$22.97/1 yr only US funds

Foreign surface \$39.97/1 yr only US funds drawn on US bank

Foreign airmail please inquire

Please allow 6-8 weeks for delivery

338F6

73: Amateur Radio's Technical Journal • PO Box 931 • Farmingdale, NY 11737

PERFECT ? ANTENNA?

FOR
10-15-20 METERS

VERTICAL
OMNI-GAIN
HALFWAVE
END FED
NO RADIALS
NO REFLECTED
POWER
BROADBAND
FIXED OR
PORTABLE
REMOTE TUNING
2 KW PEP
UPS SHIPPABLE

R3

R3 may be the perfect antenna for condominiums, apartments, small lots or any limited space situation. It is a great antenna for hams who are concerned about neat appearance and maximum performance.

R3's self supporting radiator is only 21ft-6.4m high x 1ft .304m wide at the base. Assembly is quick and easy for portable, marine, field day, DX-peditions, or fixed installations. It is complete with remote tuner.

AVAILABLE THROUGH
DEALERS WORLDWIDE



THE ANTENNA COMPANY
P.O. Box 4680
Manchester, NH 03108 USA
TELEX 953050

106

IRON POWDER and FERRITE PRODUCTS

AMIDON

Associates 334

Fast, Reliable Service Since 1963

Small Orders Welcome

Free 'Tech-Data' Flyer

Toroidal Cores, Shielding Beads, Shielded Coil Forms
Ferrite Rods, Pot Cores, Baluns, Etc.

12033 OTSEGO STREET, NORTH HOLLYWOOD, CALIFORNIA 91607

3% CASH DISCOUNT--CASHIERS CHECK OR M/O

AZDEN

PCS-300 2 METER HANDHELD.....269.95
PCS-4000 25 WATT MICRO-COMPUTER.....269.95

BUTTERNUT ANTENNAS

ZMCV-5 2 METER 5/2 WAVE COLLINEAR.....31.00
2 MCV 2 METER COLLINEAR.....30.75
HF6V 10-80 PLUS 30 METER VERTICAL.....110.00
HF6VX SAME AS ABOVE/SMALLER PACKAGE.....127.00
TBR-160 HD 160 METER ADD DN KIT.....45.00

CUSHCRAFT

A3 10-15 & 20 MHZ 3 ELEMENT BEAM.....176.95
A4 10-15 & 20 MHZ 4 ELEMENT BEAM.....228.50
A3SK/A4SK S/S HARDWARE FOR A3&A4'S.....41.50
A32-19 144-146 MHZ 19 ELEMENTS.....83.00
AV-4 10-15-20-40 M 1/4 WAVE VERTICAL.....83.00
AV-5 10-15-20-40-80 M 1/4 WAVE VERTICAL.....90.78
10-3CD 28 MHZ 3 ELEMENT SKY WALKER BEAM.....76.50
10-4CD 28 MHZ 4 ELEMENT SKY WALKER BEAM.....90.00
15-3CD 21 MHZ 3 ELEMENT SKY WALKER BEAM.....97.00
15-4CD 21 MHZ 4 ELEMENT SKY WALKER BEAM.....104.50
20-3CD 14 MHZ 3 ELEMENT SKY WALKER BEAM.....174.50
20-4CD 14 MHZ 4 ELEMENT SKY WALKER BEAM.....242.50
AMS-147 146-148 MHZ MOBILE MAG MOUNT.....27.95
ATS-147 146-148 MHZ MOBILE TRUNK MOUNT.....27.95
A147-11 146-148 MHZ 11 ELEMENT BEAM.....38.00
A147-20T 144&147 MHZ 20 ELEMENT BEAM.....63.00
ARX-2B 134-164 MHZ RONGO RANGER.....34.95
A144-11 144 MHZ 11 ELEMENT BEAM.....38.00
A144-10T 145 MHZ 10 ELEMENT TWIST.....44.98
A144-20T 145 MHZ 20 ELEMENT TWIST.....69.50
214B 144-146 MHZ 14 ELEMENT BOOMER.....69.50
214FB 14 ELEMENT BOOMER.....69.50
617-6B 6 METER 6 ELEMENT BOOMER.....180.00
MANY OTHER ANTENNAS IN STOCK AT SAVINGS

DAIWA/MILLER

DS-201 2 POSITION COAX SWITCH.....21.00
CS-401 4 POSITION COAX SWITCH.....62.95
CN-520 1.8-60 MHZ SWR/POWER METER.....69.75
CN-540 50-148 MHZ SWR/POWER METER.....77.25
CN-620-B 1.8-150 MHZ SWR/POWER METER.....108.00
CN-603 140-450 MHZ SWR/POWER METER.....129.80
CN-720-B 1.8-150 MHZ SWR/POWER METER.....155.00
CN1001A AUTOMATIC ANTENNA TUNER.....311.00

ROTORS & CABLES

HD-73 ALLIANCE W/METER USES 6C CABLE.....99.00
RG213 (RGG MIL-SPEC) CABLE PER 100 FT.....28.00
U100 ALLIANCE W/AUTOMATIC DIAL SET.....45.25
HDR-300 HYGAIN DELUXE DIGITAL.....430.59
AR22XL TELEX AUTOMATIC BELL ROTOR.....60.00
CD451L TELEX METERED ROTOR.....103.00
HAM IV TELEX METERED W/WEDGE BRAKE.....199.75
T2X SUPER DUTY METERED & WEDGE BRAKE.....248.69
B CONDUCTOR ROTOR CABLE PER 100 FT.....17.00
B CONDUCTOR ROTOR CABLE ALL 8 GAGE PER FT.....33
100 FT RGG SUPERFLEX W/PL259 INSTALLED.....29.80
MINIATURE RGG (RGGX) PER 100 FT.....16.00
RG11 75 OHM CABLE PER FOOT.....25

HY-GAIN

TH7DXS 7 ELEMENT TRIBAND BEAM.....359.00
TH3MK3 3 ELEMENT TRIBAND BEAM.....218.85
TH3JRS 3 ELEMENT TRIBAND BEAM.....154.50
HQ-2 10-15-20M HY-QUAD BEAM.....259.00
TH7 KIT FOR TH6DXX UPDATE.....137.00
V2-S 2M VERTICAL COLINEAR BASEW/SS H/W.....38.50

KDK 2 METER RADIOS

FM2030 2 METER SYNTHESIZED RADIO.....269.95

MINI-PRODUCTS

HQ-1 MINIATURE 4 BAND QUAD.....132.00

MACO POWER SUPPLIES

2006 S/L 8 AMP 1/L 6 AMP C/L 4 AMP.....48.00
2010 S/L 12 AMP 1/L 10 AMP C/L 6 AMP.....61.50
2020 S/L 24 AMP 1/L 20 AMP C/L 12 AMP.....73.80
2030 S/L 36 AMP 1/L 30 AMP C/L 18 AMP.....115.65

MFJ PRODUCTS

MFJ-102 12/24 HOUR CLOCK.....30.69
MFJ-202 RF NOISE BRIDGE.....52.00
MFJ-262 1 KW DRY DUMMY LOAD.....57.25
MFJ-308 8 BAND SW CONVERTER.....87.40
MFJ-311 154-158MHZ CONV. FOR 2 M SYN.....43.80
MFJ-481 MEMORY KEYS 50 CHARACTER MESS.....75.00
MFJ-494 SUPER KEYBOARD 50 CHARACTERS.....245.50
MFJ-496 SUPER KEYBOARD 256 CHARACTERS.....297.00
MFJ-722 SUPER CW/SSB FILTER/OPTIMIZER.....61.00
MFJ-825/B30 SWR/PEK WATTMETER W/B30.....104.00
MFJ-941C ANT TUNER/SWR METER 1:4 BAL.....79.00
MFJ-989 3KW TUNER LOADED.....289.00
MFJ-16010 RANDOM WIRE TUNER.....34.90

MIRAGE AMPLIFIERS

B-23 144-148 2 IN 30 OUT.....78.50
B-10B 144-148 10 IN 80 OUT.....157.00
B-1016 144-148 10 IN 160 OUT.....244.00
B-3016 144-148 30 IN 160 OUT.....203.25
D-1010N 430-450 10 IN 100 OUT.....286.95
D-1010U 430-450 10 IN 100 OUT.....286.95
MP-1 WATTMETER H/F.....100.00

TEMPO RADIOS & AMPS

S-1 2 MTR. SYN. 143-147 MHZ.....240.00
S1-T 2 MTR. SYN. W/TT PAD.....250.00
S-15 2 MTR. 5 WATT H/H 140-150 MHZ.....265.00
S-15BEXP 2 MTR. 5 WATT H/H 150-160 MHZ.....307.00
S-15T SAME AS S-15 WITH TT PAD.....293.50
S-15TBEXP SAME AS S-15B WITH TT PAD.....322.50
ACH-15 AC QUICK CHARGER FOR S-15'S.....54.00
CC-15 LEATHER CASE FOR S15'S.....25.00
BP-15 SPARE BATTERY PACK FOR S-15'S.....30.50
HM-15 SPEAKER/MICROPHONE.....36.50
S-30 30 WATT POWER AMP FOR WALKIES.....84.00
S-80 80 WATT POWER AMP FOR WALKIES.....148.79

TEN-TEC

560 CORSAIR 1.8-30 MHZ NEW TEN-TEC.....1035.00
MA114 ATT SSB/CW 10-80M ANALOG.....458.00
545 200 WATT SSB/CW 10-80M ANALOG.....738.00
580 DELTA 200 WATT SSB/CW 10-160M DIG.....765.00
444 HERCULES 1 KW AMP W/POWER SUPPLY.....1659.00

VOCOM PRODUCTS

2C025-2W 2 IN 25 OUT 2 METER AMPLIFIER.....69.98
2C050-2W 2 IN 50 OUT 2 METER AMPLIFIER.....101.30
2C100-2/25 W IN 80 TO 100 WATTS OUT.....170.00

WILSON BY MACO

SY-33 3 ELEMENT 10, 15, 20 METERS.....207.87
SY-36 6 ELEMENT 10, 15, 20 METERS.....285.36
33-6MK ADD ON 40 METERS TO TRIBANDS.....88.50
GR-1 GROUND KIT FOR WV-1A.....27.00
WV-1A 4 BAND TRAP VERTICAL 10-40 METERS.....88.50

CALL FOR QUOTES ON
OTHER RELATED PRODUCTS
FOB ORIGIN



Amateur
Equipment,
Accessories
& Antennas.
Export Anywhere.

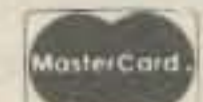

2317 Vance Jackson Rd.
San Antonio TX 78213

(512) 733-0334

COD Available

(Toll free number 800-531-5405)

Hours: 8:30 a.m. to 5:00 p.m. Monday thru Friday
9:00 a.m. to 2:00 p.m. Saturday - CST
Prices Subject to Change without notice.

NICAD MEMORY ERASE — WHAT??

- Complete automatic operation
- Erases + Charges + Checks
- Rapid charges in 35 min. (typically)
- Automatically repairs shorted cells
- No dangerous heat build up
- Front panel selects up to 3 different packs
- Unlimited battery combinations with program modules (user programable)
- LED status indicators
- Supplied with universal EZ hook wire leads



The GMS 401 is a complete automatic NICAD conditioner and rapid charger. Never before has this been offered anywhere at any price and it's so good it's being patented. NICAD memory characteristics must be dealt with otherwise your battery pack is not delivering all it could. The GMS 401 will automatically erase and rapid charge any type NICAD pack from 1 to 10 cells.

Specify Voltage of Battery Pack(s) with order. One program module included — optional modules \$2.25 each.

\$89.00 plus \$4.00 Shipping
(PA Residents add 6% sales tax)

Now Available—A commercial version of the GMS 401. Designed to charge up to and including the commercial 15 volt Nicad packs. \$139.00 plus same shipping and module cost as the GMS 401.

CONTROL PRODUCTS UNLIMITED, INC.
P.O. Box 10, Downingtown, PA 19335
215-383-6395 ✓25

Take your favorite H.T. out for a drive tonight.

VISA or MASTERCARD for same day shipment.

For \$69.95 you get the most efficient, dependable, fully guaranteed 35W 2 meter amp kit for your handy talkie money can buy.

Now you can save your batteries by operating your H.T. on low power and still get out like a mobile rig. The model 335A produces 35 watts out with an input of 3 watts, and 15 watts out with only 1 watt in. Compatible with IC-2AT, TR-2400, Yaesu, Wilson & Tempo! Other 2 meter models are available with outputs of 25W and 75W, in addition to a 100W amplifier kit for 430MHZ. ✓382



Communication Concepts Inc.

2648 N. Aragon Ave., Dayton, OH 45420
(513) 296-1411

"BEEPER III"



"THE PROFESSIONAL TOUCH COMES TO AMATEUR RADIO!"

"BP-3 automatically provides a gentle high frequency beep at the beginning of each transmission and a low beep at the end. Virtually eliminates "talk-over"! Operates for up to one year on a single 9-V battery (not supplied). Can be directly interfaced to any transceiver which is keyed by grounding the PTT line (the PTT line voltage must be positive, not greater than 24 VDC, nor the current greater than 100 ma.) Works with virtually all modern gear. You've heard it; now you can have it!"

"ADD THE BEEP!"

- BP-3A Complete with case, cable, Standard 4-pin connectors. . . . **\$9.98 pp**
 - BP-3B As above except without connectors. Add your own. . . . **\$6.98 pp**
 - BP-3C Circuit-board version for custom installation. . . . **\$9.98 pp**
- All units assembled/tested. OH residents add 6% Sales Tax"

FAXSCAN INC. ✓85
3148 Dorf Drive • Dayton, Ohio 45418

1983-1984
AMATEUR RADIO

CALL DIRECTORY

THE BARGAIN AT **\$14.95** Plus Shipping

A no frills directory of over 415,000 U.S. Radio Amateurs. 8½x11, easy to read format. Completely updated.

Also available for the first time ever—
(Alphabetically arranged—Sold separately)
Geographical Index
by State, City and Street No. and Call
Name Index
by Name and Call

- Ordering Information:
- Directory—\$14.95
 - Geographical Index—\$25.00
 - Name Index—\$25.00
- Add \$3.00 Shipping to all orders.

Dealer / Club inquiries welcome
Send your order—enclosing check or money order in U.S. dollars to:
Buckmaster Publishing ✓255
70 Florida Hill Road
Ridgefield, CT 06877 U.S.A.

TRS-80® MODEL III DISK SOFTWARE

— TRSDOS® COMPATIBLE —

PROGRAM	DISK-PAK I	REGULAR
Super-Log	\$ 19.95
Custom Beam Heading	\$ 26.95
Compu-Log	\$ 16.95
Antenna Anatomy	\$ 14.95
Super Duper	\$ 9.95
Micro-Clock	\$ 9.95
Micro-DX	\$ 9.95
IRC Management	\$ 9.95

ONLY \$49.95 **\$118.60**
VALUE

— ADD \$3.00 Shipping/Handling —

PROGRAM	DISK-PAK II	REGULAR
Novice Theory Review	\$ 19.95
General Theory Review	\$ 19.95
Advanced Theory Review	\$ 19.95
Extra Theory Review	\$ 19.95
Morse Code Trainer	\$ 16.95

ONLY \$29.95 **\$96.75**
VALUE

OFFER BY MAIL ORDER ONLY
Write For Detailed Brochure

MICRO-80 INC.

2665 SOUTH BUSBY ROAD ✓27
OAK HARBOR, WA 98277

TS430S FILTER DEAL

For superior performance at lower cost, use top-rated 8-pole Fox Tango crystal filters to fill the optional spots in your rig. For example, our 1800 Hz FT2808 equivalent of the YK88SN has a 60/6dB shape factor of 1.7 compared with 2.0, a price of \$55 vs \$63, and squarer shoulders at the top with steeper skirts all the way down to more than -80dB.

For more pleasant audio use our 2100 Hz for SSB and/or our 6000 Hz for AM. For CW, our 400 Hz unit is better than the YK88C, while our 250 Hz is sharper than the YK88CN. The more you buy, the more you save!

BIGGER IS BETTER!

Fox Tango filters are better because of their discrete crystal (not monolithic) construction. This makes them slightly larger than YK filters so they are patched into the circuit with short lengths of coax. Installation is easy — no drilling or circuit changes. Order with confidence.

INTRODUCTORY PRICES — Complete Kit

- Any ONE filter **\$55**
- Any TWO filters **\$100 (Save \$10)**
- Any THREE filters **\$145 (Save \$20)**

Includes all needed cables, parts, detailed instructions. Specify the type(s) desired.

- AM — FT2811 (6000 Hz Bandwidth)
 - CW — FT2801 (250 Hz); FT2802 (400 Hz)
 - SSB — FT2808 (1800 Hz); FT2809 (2100 Hz)
- Shipping \$3 per order. (\$5 air) FL Sales Tax 5%

ONE YEAR WARRANTY
GO FOX-TANGO—TO BE SURE!
Order by Mail or Telephone.
AUTHORIZED EUROPEAN AGENTS
Scandinavia MICROTEC Makedien 26
3200, Sandefjord, NORWAY
Other INGOIMPEX, Postfach 24 49
D-8070, Ingolstadt, W. GERMANY

FOX TANGO CORPORATION
Box 15944 H, W. Palm Beach, FL 33416
(305) 683-9587 ✓8

Bernhard Lurssen DF2AO
Fergersbergstrasse 11
D-2863 Ritterhude
F. R. of Germany

To Go Where No Ham Has Gone Before — Sealand!

*An enterprising team of DXers takes to the high seas
to work S1, the smallest country in the world.*

Let's activate a new country, we thought. Let's just go there and set up our station, we thought. It obviously was a simple thing to do.

But yet here I am, cowering in a soapbox, swinging 40 feet above the stormy North Sea, firmly clinging to the support wires. Then at last! The waves down

below me have disappeared and given way to firm ground to step upon. My eyes have stopped looking anxiously through the holes in the bottom of the soapbox lift and turned to catch a glimpse of the smallest state in the world: Sealand.

It had all started more than a year ago. Along with

a couple of friends, who later formed the team, I began to think about DXpeditions to the more remote spots of the globe. But the problem was: It's all been done! Then, all of a sudden, one of us came up with the idea. There was an artificial island called Sealand in the North Sea outside British territorial waters which was

declared independent years ago. The proposal to go there was enthusiastically met by all the amateurs present. So at once we sent a letter to Sealand describing in general the amateur radio service and in particular our idea of a DXpedition to activate the island for the first time.

In the meantime, we gathered information about Sealand from newspaper articles and books. The following picture emerged from our studies: During World War II, the United Kingdom built several offshore platforms firmly grounded at the bottom of the sea for air defense purposes. One of them, the one in question, then being called "Roughs Tower," was put up in 1940 about seven miles east of Harwich. Its exact position at 51° 53' North, 1° 28' East puts it outside British territorial waters.

The artificial island was maintained for a few years after the war, and upon leaving, the British did not dismantle it. In early 1967, a group of people including Roy Bates and his family went out to the island and took possession of it. On the 2nd of September, 1967, it was proclaimed the independent "Principality of Sealand," and Roy Bates

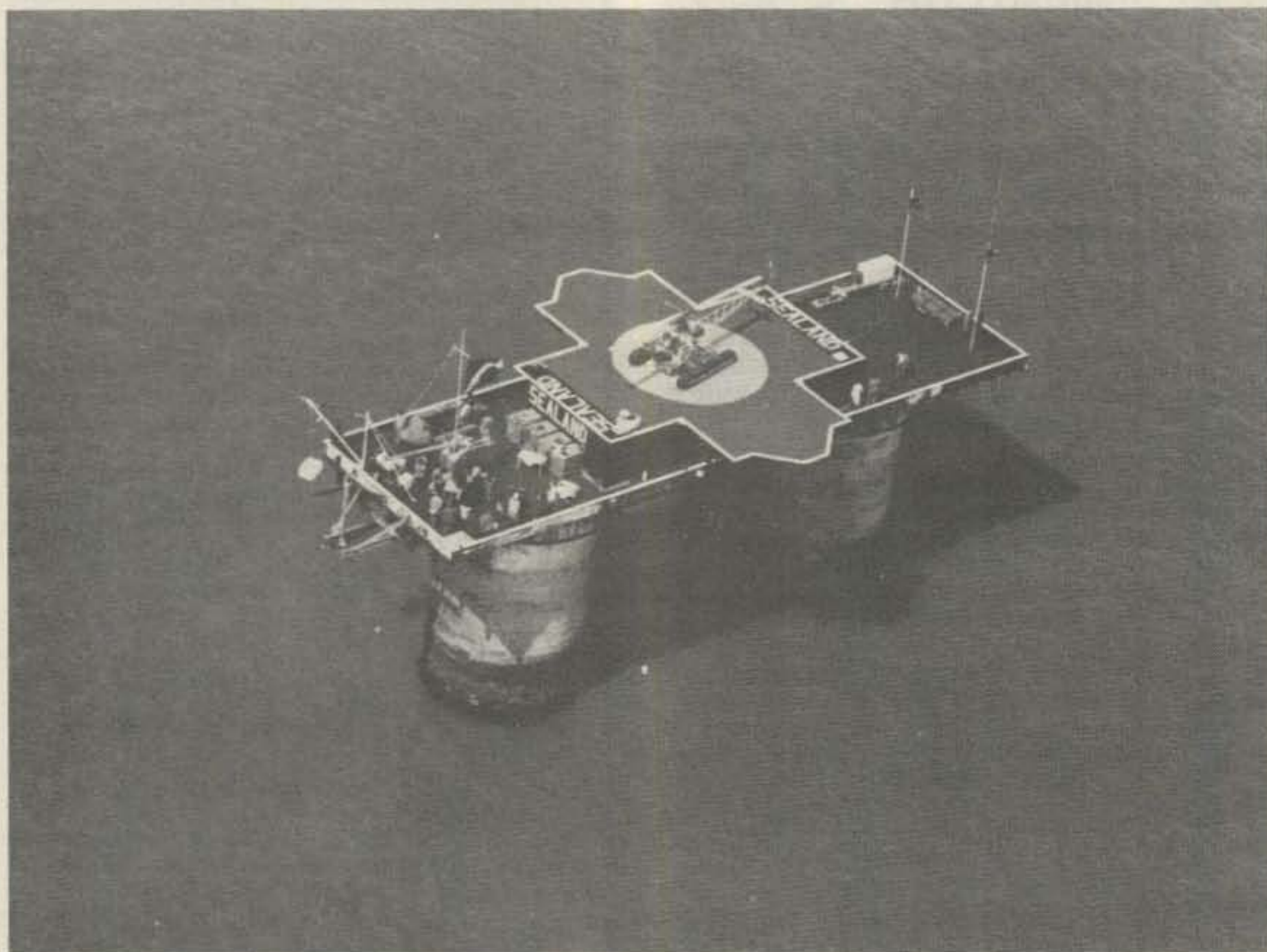

Sealand on a calm day. (Photo by Southend Air Photography, Ltd., courtesy of Jeff Maynard G4EJA.)

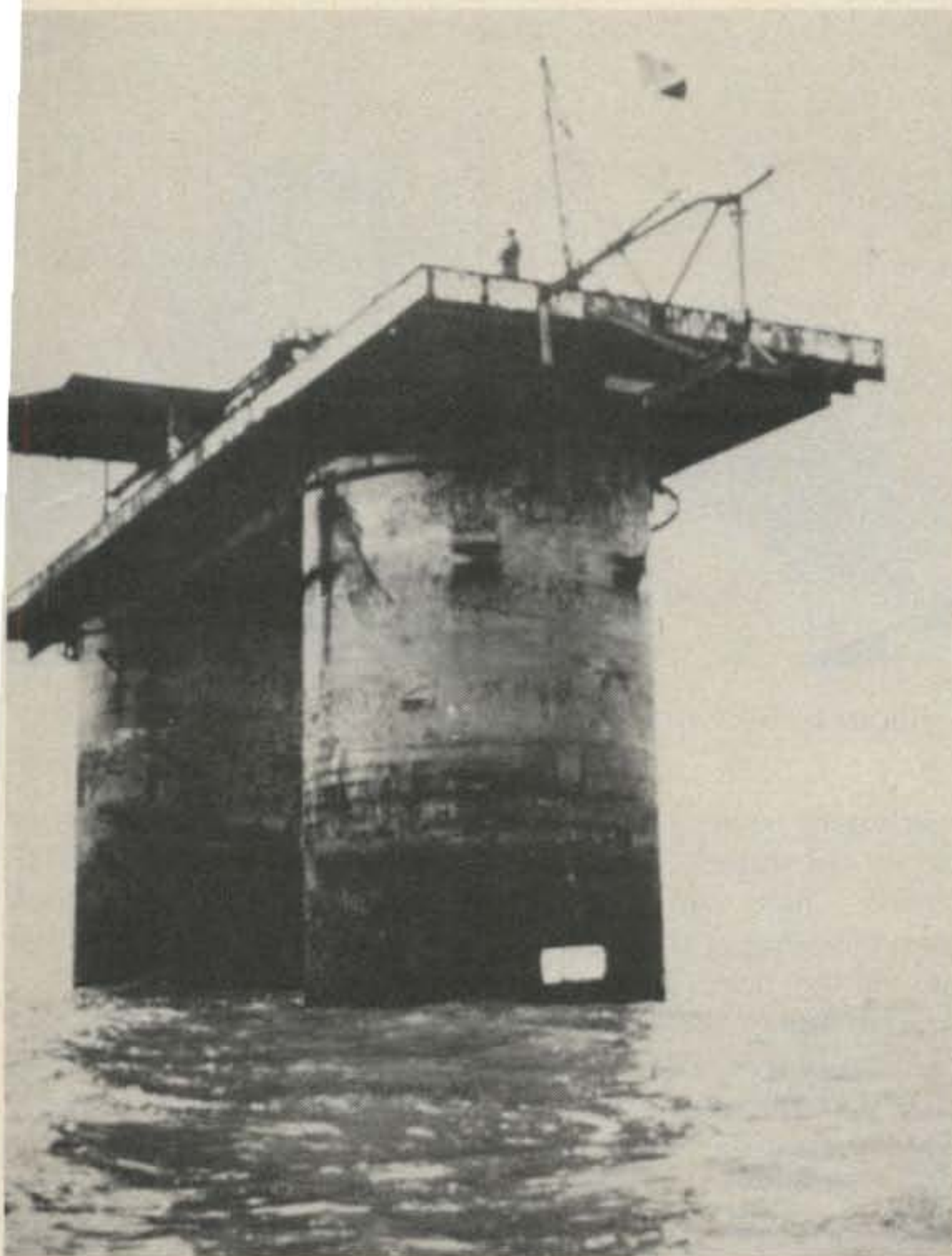

Photo A. Soapbox lift swinging above the waves.

and his wife Joan became Prince and Princess of Sealand. The usual attributes of statehood, like a coat of arms, constitution, citizenship, passports, coins, stamps, and a national flag subsequently were adopted.

Following a few quarrels with the local authorities, Prince Roy was summoned to appear at a number of British courts, but in each case it was ruled that Sealand was outside the United Kingdom and therefore not within its jurisdiction.

The only "nationwide" crisis which shook the small state occurred in 1978 when the previously-dismissed foreign minister successfully launched a coup d'état. But his interregnum did not last long. After only six days, the principality struck back. A rapid-deployment force of four people returned by helicopter and retook possession of the platform.

A public session of the Sealand Court of Justice

sentenced the leader of the coup to seven weeks of detainment. After that, he finally was allowed to leave the country. Since then, the history of Sealand has continued a lot smoother.

After getting to know this stormy history, we did not really expect a positive answer. But to our great surprise, we were invited by Prince Roy himself to come and to celebrate the 15th anniversary of Sealand's independence. Immediately, we began working out the details of the DXpedition. The team consisted of four members: Butz DL6PE, Geri DK8KW, Dick DC5BT, and Ben DF2AO. Lots of equipment, coax strings, orange juice, food, and other bits and pieces had to be obtained and coordinated properly until we had taken care of everything we thought useful.

Finally, on the 31st of August, 1982, we packed our bags and left Cologne

STATEMENTS ISSUED BY THE PRINCIPALITY OF SEALAND

During the 39/45 war, Great Britain established an artificial island on the High Seas. This island was equipped with radar and heavy armaments and occupied by some two hundred servicemen. The task of the island and its inhabitants was to guard the approaches to the Thames Estuary where large and vulnerable convoys of shipping were assembled. Some time after the cessation of hostilities, the island was derelicted and abandoned by the British Government.

In the winter of 1966, a British family took possession and commenced the task of equipping and restoring the island. On the 2nd September 1967, they hoisted their own flag and declared the existence of a new State—the Principality of Sealand. Their rights and claims of Sovereignty over the island and its territorial waters have been ratified time after time over the intervening years by National Courts and leading international jurists.

European States have—during disputes involving Sealand—stated that they have no rights or authority in Sealand and the major European States have repeatedly given de facto recognition to the existence and the Sovereignty of Sealand.

Over the years since the declaration of Statehood by Sealand, the family lived a free frontier lifestyle. They made and enforced the laws of Sealand. They faced and drove off armed attackers and on one occasion a member of the family was actually kidnapped by armed men and forcibly taken to a foreign country against his will.

Sealand came under threats from hostile naval units from other States; in the early days of independence, there were the most determined attempts made to isolate and starve out the island. The elements and the sea had to be fought constantly with a relentless determination. It was a very busy, active, and adventurous life for the family and their fellow Sealanders and they all thrived on it.

Sealand issues her own coins and postage stamps and runs a postal service between Sealand and Britain, the British postal services collect mail for Sealand's collection and delivery to and from the island.

It is now planned to extend Sealand by reclaiming land from the sea and by building leisure and industrial complexes. There will be a modern freeport for the transshipment of cargo from larger to smaller vessels for the better distribution of freight throughout Scandinavia and Northern Europe. With the potentials and the planned developments of Sealand, it is unquestionably the greatest commercial adventure of this century.

Perhaps there is still something of the old buccaneering spirit about Sealand, but it must be made quite clear that Sealand is a realistic and very modern fact. This spirit will ensure that the Sealand story will continue and that Sealand will go on to emphasize the freedom and determination of the individual and to bring back the excitement and dash of the old merchant adventurers. Sealand is unique. There is nothing anywhere in the world like Sealand and the development of the Sealand potential will also be unique.

Bureaucracy will be at an absolute minimum and free enterprise and bright ideas will always be actively encouraged and rewarded without the State taking the larger share of earnings or penalizing in any way the true spirit of adventure and hard work that it is our aim to engender. The only taxes payable on Sealand will be those decided by businessmen controlling the Sealand State Corporation in order to raise money necessary to run the island.

with two cars to reach Oostend in Belgium later that night. There we boarded a ferry. After having managed to take a nap on board, we

reached Dover very early in the morning. Our voyage continued round the mouth of the river Thames until we reached Southend-on-Sea

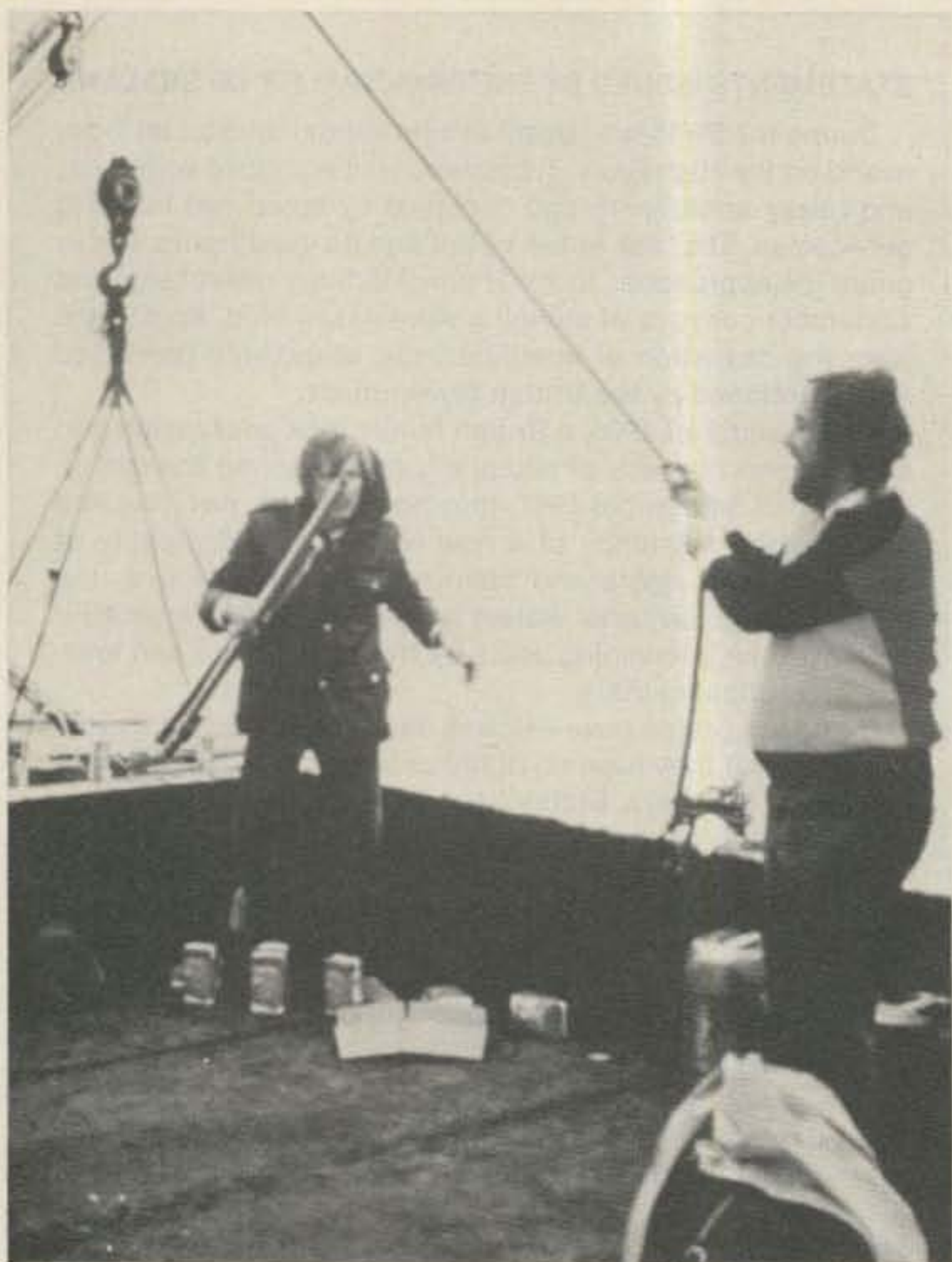

Photo B. Antennas and orange juice being unloaded by Dick (left) and Geri.

where Prince Roy received us in his private apartment. After a short audience which included the issue of our personal licenses with the S1 calls, we headed for Felixstowe where our boat to Sealand awaited us. It was not a very large one, but it did rather nicely on all three trips necessary to get everything across.

The most exciting stage of our trip, however, was the last one. In Photo A, you can see the aforementioned soapbox lift almost touching the waves. After the overwhelming moments described in the first paragraph above, the great instant had arrived. (It was a small step for a ham...)

The soapbox lift had to



Photo D. The 2m station operated by Ben.



Photo C. Butz operating the CW station inside the tower.

work hard to get all the luggage "upstairs." Photo B shows Dick working and Geri assisting at the unloading of the box. One of the orange juice packages was torn to pieces, but, luckily, that was the only casualty. The reception committee was formed by Prince Michael of Sealand, son and successor-to-be of Prince Roy, who gave us more than just a helping hand during the erection of masts and antennas.

After we went through the necessary passport formalities, the HF stations, consisting of two IC-720As, a five-band GPA, and a window, were put up immediately inside one of the concrete towers at about sea level. The first station finally

was on the air on the 1st of September at 1956 UTC. Soon afterwards, Butz took up telegraphy at the other station (see Photo C).

You can imagine that very mixed reactions were instantly flooding in from our QSO partners around the world. The majority expressed their pleasure that at last Sealand was on the air; others did not believe a word, but obviously did not want to miss us. There even were two or three "imitators," but they soon gave up.

In the same tower as our shack we also were assigned a living room. (Each tower includes seven stories of circular rooms, and on top of the platform there are another eight rooms.)

On the next day, the anni-



Photo E. Dick (left) and Geri enjoying a sunny day out in the "countryside."



Position: 51° 53' North 01° 28' East
QTH-locator: AL 0 8c

Sealand

- S 1 AB
- S 1 AD
- S 1 AH
- S 1 AS

Fig. 1. DXpedition QSL card.

versary day, we put up the 2-meter station, a TS-700S, a 60-Watt linear, and a 10-element yagi beam. Photo D shows Ben working 2m DX in the 2m shack on top of the platform. In general, not-too-regular shifts added up to an almost continuous operation on HF and VHF.

During our time off we had quite a few interesting conversations with the three natives present, so a lot of additional information about Sealand was supplied to us. Sometimes, when the weather was nice, we could even take a sun bath—see Photo E.

All in all, we were given the impression that we were

very welcome on Sealand. Therefore, the five days really passed in a jiffy, and soon the 6th of September, our day of departure, had arrived. The crossing to England was a lot rougher than it had been on our way to the island, but again nothing suffered any damage. Again we crossed the channel at night, and then returned to Cologne.

After our return we sat together and summarized our DXpedition. About 3600 contacts were established with more than 80 countries on all continents. One thousand QSOs were made on 2m, almost exclusively by Dick. We had great fun, and

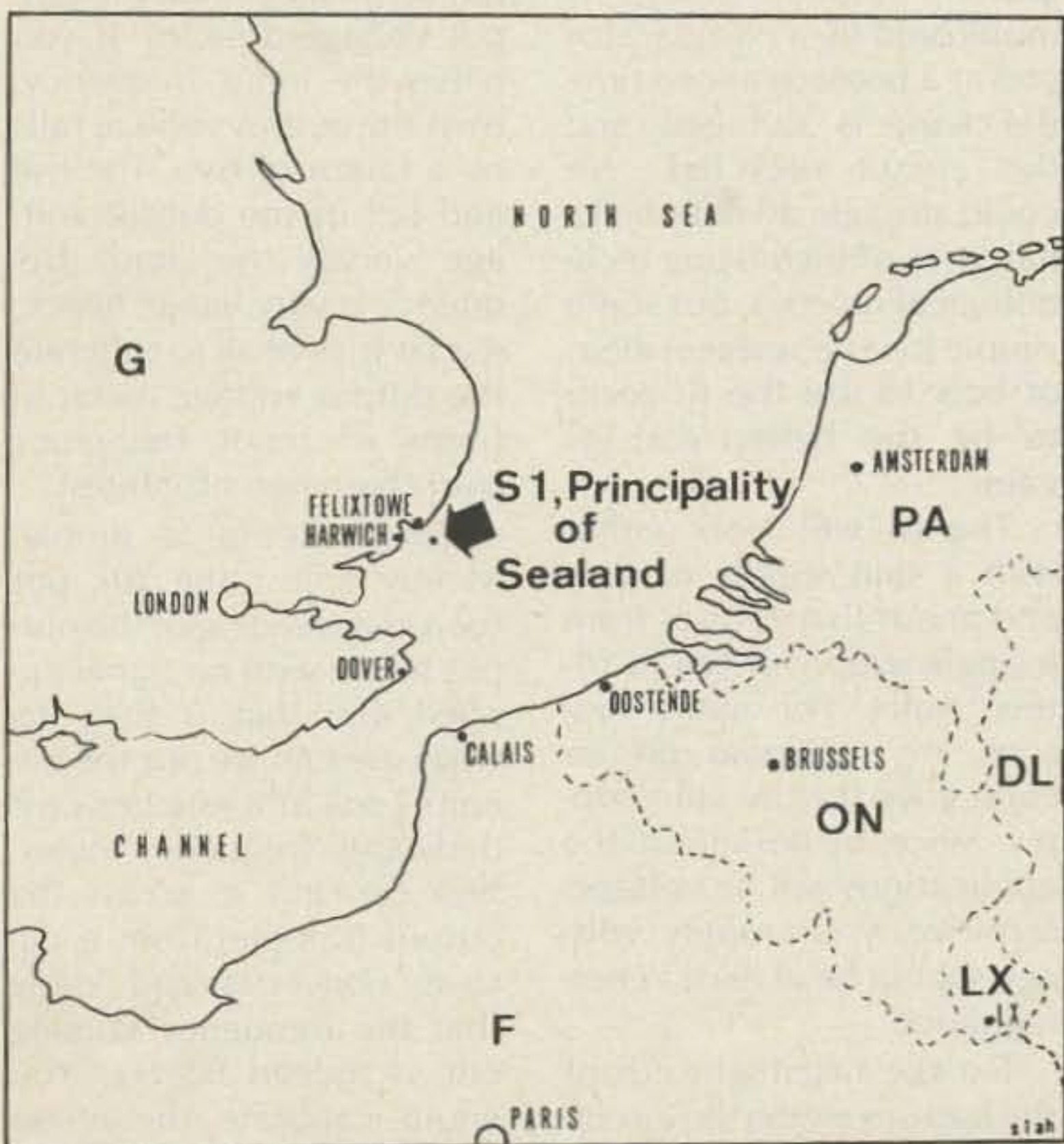

Fig. 2. Map of southern North Sea area.



CALL LETTER

HATS — T SHIRTS

101 & Elm Street, Suite 4 Peterborough, NH 03458

HATS

Only \$6

HAT COLORS
Royal Blue Navy Blue
Red Gold Green

Hats Are One Size Fits All - Nylon Mesh Back

LINE 1 CIRCLE ONE OF THE DESIGNS ABOVE

LINE 2

OR

LINE 3

OR

LINE 4

OR

NOTE: Hats Maximum 8 Large or 16 Small Letters Per Line



T SHIRTS

Only \$8

SHIRT SIZES

Adult: Sm Med Large X-Large
Child: 2-4 6-8 10-12 14-16

SHIRT COLORS

Lgt Blue Lgt Green Tan
Wht/Red Trim Wht/Blue Trim

Attractive and Durable, just the thing for field days, contests, conventions or any other activity. Ideal personalized gifts for special occasions and they carry your own personal message. Imprints are permanent and guaranteed not to fade, peel or shrink. Order 12 or more and we will reproduce your own business or club logo FREE. Remember, every item can have a Different name or message in addition to your logo. Imprints are generated by computer for total flexibility and FAST service.

CALL LETTER HATS 101 & Elm Street, Suite 4 Peterborough, NH 03458 ✓187

Name _____ Phone _____

Address _____

City _____ State _____ Zip _____

Ck Money Order Charge Card # _____

Signature To Validate Order _____ Exp. Date _____

ORDER BLANK

Add \$2 To Total For Shipping Charges

we erased the last white spot on the radio amateur's world map. So now this, too, has been done. But we'll return to Sealand in a few weeks, possibly before you

read this. Anyway, please listen for us on the usual DX frequencies in SSB and 22 kHz from the band edges in CW. Hpe cuagn. Ben DF2AO. ■

Constitution of the Principality of Sealand

1. Every person has the right to liberty and justice.
2. Every person has the right to exercise his own beliefs provided only that such beliefs do not infringe upon the beliefs and well-being of others.
3. The freedom of the individual can be restricted only by the due process of law.
4. All individuals are equal before the law and no one may suffer prejudice for any reason.
5. The legal system is based on the British Common Law and the British Law of Contract with certain exceptions.
6. Any ordinances passed in Sealand by the Senate properly constituted will exclude and take precedence over such Laws.
7. The National language of Sealand is English and all official documents must be in that language.
8. All companies registered in Sealand are subject to the same laws as individuals.
9. Every person shall have the right either to join or refrain from joining a Sealand Trade Union but no person will be permitted to attempt to coerce any other person so to join and no trade union other than a Sealand Trade Union will be recognized on the island.

Sealand, PO Box 3, Felixstowe, Suffolk, England

1001 Uses for the 9400

Experiment with this cheap chip. It's the IC you've always wanted, with applications you've never dreamed of.

Allen S. Joffe W3KBM
1005 Twining Road
Dresher PA 19025

The 9400 is now available, off the shelf, from Radio Shack. Part #276-1790 priced at \$3.49 will allow you to take a flying leap into the world of IC ex-

perimentation. The 9400 is a 14-pin DIP that may be used in one of two modes. It will convert an applied voltage to a frequency or will, with some slight circuit rearrangement, convert an applied frequency to a dc voltage.

Briefly described, the chip is a marriage of bipolar and CMOS technologies

which utilizes the principle of charge balancing. This is a fancy buzzword for the process which takes an input voltage and converts it to a current which is then operated on by an "on chip" integrator. The integrator capacitor charge is monitored by a comparator and at a predetermined time the charge is "dumped" and the circuit recycled. We could struggle all over hell's half acre of high-flying technological niceties, but some simple (on the surface) ideas of how to use the IC seem to be the better part of valor.

The IC will work either with a split supply of plus and minus five volts or from a single supply of ten to fifteen volts. For many reasons, my personal preference goes for the split supply. Since, by definition, the applications will be voltage-sensitive, your supply voltage should be at least zener-regulated.

For the first flight out of the barn, examine the circuit of Fig. 1. This shows the use of the 9400 as a dc-to-10-

kHz frequency-to-voltage converter. In basic English, if you put a one-kHz tone (waveshape is unimportant) into the circuit, the meter at the output would show a voltage of some 360 millivolts. If you double the input frequency, then the output voltage doubles. If you halve the input frequency, then the output voltage falls by a factor of two. The rise and fall of the output voltage versus the input frequency is very linear; hence, it is no trick at all to calibrate the output voltage meter in terms of input frequency over the range of interest.

Circuit setup is simple. Merely adjust the 20k pot for a zero reading of the output meter with no signal applied and that is that. To what use can we put the circuit? Look at it as a low-cost dedicated frequency meter. You can put it across the output (sample) from a dc-to-ac converter and know that the frequency coming out is indeed 60 Hz. You could calibrate the meter for mark and space frequencies of your RTTY setup. In

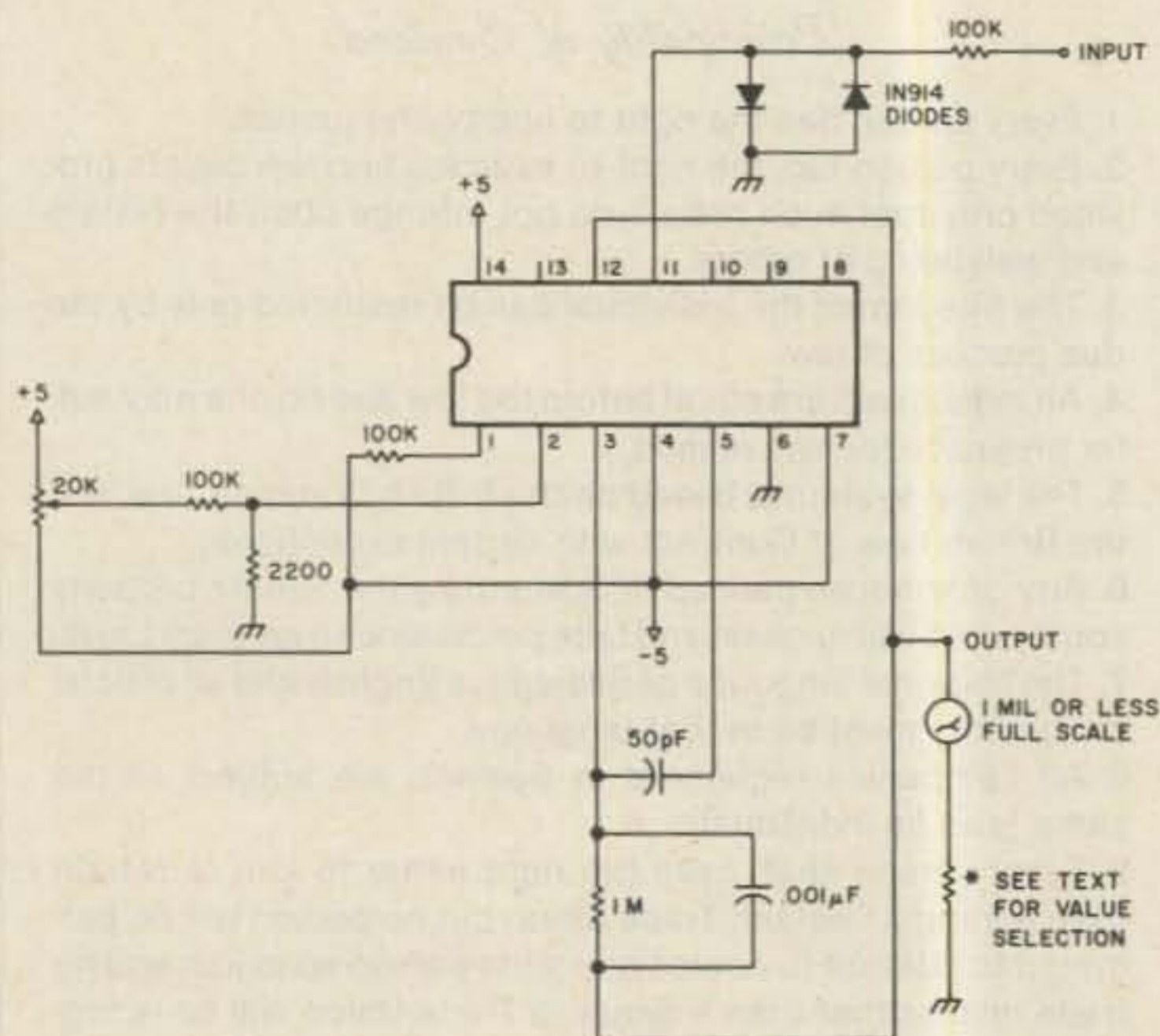

Fig. 1. The 9400 used as a dc-to-10-kHz frequency-to-voltage converter. Note: Pins 8, 9, 10, and 13 not used.

any situation where you want to keep tabs on an audio frequency up to 10 kHz, this simple handful of parts will give you a way.

By now you may get the idea that this is a versatile item, and you are right. For the gentlemen who know that CW is still a viable part of the ham art, try this on for size. The circuit of Fig. 1 makes an interesting variety of CW filter. Due to the use of a comparator as part of the chip's innards, a comparator with a threshold of some 200 millivolts, some good things are available. Feed the voice coil output of your receiver to the input of what is now our "CW purifier." Place an audio amplifier right across the output. Tune in a CW signal and advance the gain control of the receiver until you hear picture-pure code in the speaker. Almost all of the background garbage vanishes, be it Russian BCI on forty meters or the guy up the road a few kHz. The CW note is quite pleasing to the ear, the waveshape being a sawtooth ramp of the same frequency as the beat note applied to the input. Weak off-frequency stations and sideband splatter just vanish.

There is one fly in the ointment after all... Murphy lives! If the signal fades so that the audio level is not high enough to trip the threshold of the comparator, you get nothing out but beautiful silence. This may mean a bit of twiddling with the audio gain control of the receiver, but the results overall are quite impressive.

Let's review a bit of the bidding before looking at the 9400 in its other mode. The two diodes across the input are safety valves to prevent any exuberant voltage in excess of the IC safety zone from sending it to IC heaven. The circuit as configured has a limit of 10 kHz, above which the input voltage versus output voltage is

no longer linear. To use the device as an analog frequency meter, merely wire up what you see. If you want to use the device strictly as a CW filter, then replace the meter circuitry with a 47k resistor from the output pin to ground. Couple out of the resistor with a .005- μ F capacitor which will de-thunk the output which might otherwise be generated by the Morse flowing through it. Remember to at least zener-regulate the supply which will have a current demand of ten mils or less.

Leaving it to your originality to come up with other uses of the 9400, let us examine Fig. 2, the circuit that becomes a voltage-to-frequency device. Simply put, any voltage (ac or dc) that is put into the circuit produces a frequency at the output. Within the linear range of the circuit (10 Hz to 10 kHz), this output frequency is in direct proportion to the applied voltage. To pick some random numbers: If one volt in gave a 5-kHz tone at the output, then 2 volts in would give 10 kHz at the output. As there are two output pins shown, we have to watch which one we use as they differ in one respect. For a given voltage input, the output frequency at pin 8 will be twice the frequency as at pin 10, as there is a divide-by-two built into the 9400, the output of which appears at pin 10.

While most of the uses for this configuration get a bit abstruse, the simplest idea is to connect the input to +5 volts through a variable resistor network and vary the input voltage. Listen to the output and you will hear the frequency vary with the applied voltage. My 9400 produces one kHz with an applied voltage of 1.3 volts and just a shade over 2 kHz with double the applied voltage. This frequency was measured at pin 8. Measured at pin 10 (due to the divided frequency avail-

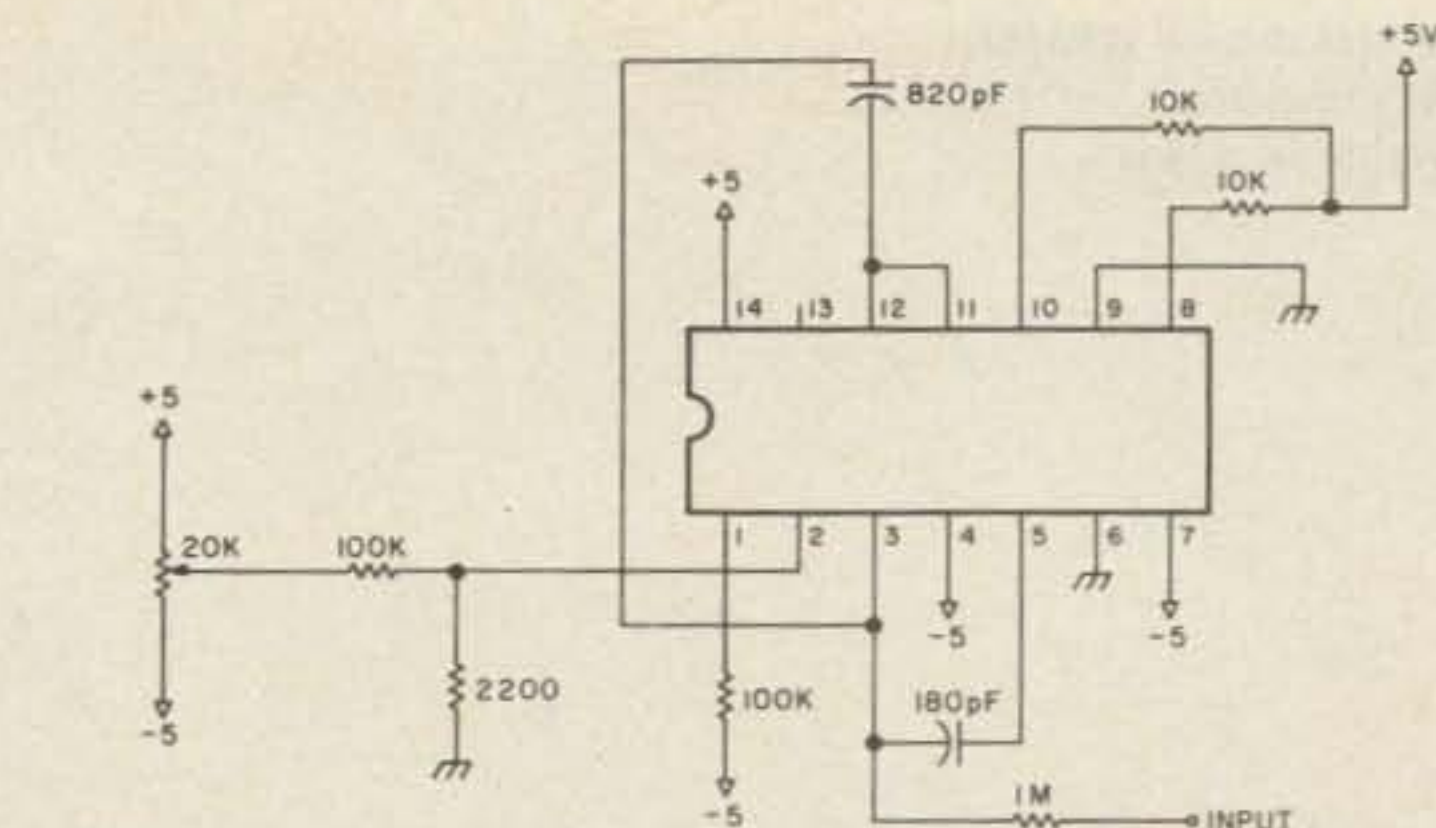

Fig. 2. The 9400 used as a 10-Hz-to-10-kHz voltage-to-frequency converter.

able), these frequencies would be half those appearing at pin 8. You can see the sensitivity of the frequency change by appreciating that one millivolt changed the frequency by one Hz.

A non-related (hamwise) application readily becomes apparent if you shut off the power supply to the unit when it is set up as an oscillator. As the filter capacitors drain down, the frequency falls in a fine siren-like fashion. If you have a function generator capable of producing triangles, ramps, pulses, and square waves, it is possible to get all sorts of weird and/or pleasing noises upon application of these waveforms to the 9400. Everything from motorboats to phasers and sirens is readily achieved.

Getting down to the nitty-gritty, the voltage-to-frequency mode does not seem to lend itself to simple implementation for the ham. For openers, contrast the simple setup of the frequency-to-voltage mode (which consisted of turning a pot until an output meter read zero) with the following setup for the voltage-to-frequency mode: Set the input voltage to 10 millivolts and trim the zero adjust pot to obtain an output frequency of 10 Hz. Set the input voltage to 10.00 volts and trim either the input resistor or the 180-pF capacitor until the output frequency is 10 kHz.

Now let us consider some of the applications that ap-

pear. We could construct a simple audio voltmeter that would tell us that one voltage is higher or lower than another, which might have some possible use. We could use it as a bridge balance indicator. We could use it in any situation where a sensor changes ohmic value, causing a change in output voltage to produce a change in frequency which might be measured by a standard frequency meter or a 9400 connected as an F/V converter using an analog meter. Such an application might utilize a thermistor for remote temperature sensing. Without belaboring the situation unduly, unless you get interested in some form of ham-connected digital transmission or something that requires some sort of FSK that naught else will provide, the F/V mode of the 9400 will be of greater value than the V/F mode under discussion.

Keep in mind that the dual uses of the chip will often be complementary so that the V/F and the F/V modes used together will produce a desired end result. The modest investment in the 9400 and some time learning what it can do are well worth the money and time. Ham radio has and is going through various technological phases. Keep up with them to a degree and many unexplored facets of the world's greatest hobby will become your yellow brick road to happiness. ■

Propagation Explosion on 220

This theoretical inquiry into the properties of 220 MHz yielded some unexpected results. Find out when and why your signal will be at its best.

Not long ago, I was talking to a ham friend of mine who is locally considered as quite learned in the ways of the black magic world above 2 meters. When I raised the subject of 220 MHz and the appalling lack of local activity on that band, he gave me a somewhat irritated look and dismissed the issue by saying, "Who'd want to use those frequencies? You can't get out of your backyard with them, anyway."

Wasn't that what they said at one time about everything below 200 meters? A rather strange attitude, I thought, for a man who is supposed to be savvy about that part of the radio spectrum. The more I thought, the more curious I became about the 220-MHz band. Surely, this good ham and electronics professional who daily uses the many amateur and commercial frequencies above 148 MHz couldn't be discounting their usefulness for communications! Or was my friend trying to say that some mysterious radio anomaly existed just around the 220-MHz band

which rendered only it useless? (My rather overactive imagination quickly conjured up a sort of propagational black hole which sucked up all energy from transmitters in that region.) Obviously, none of this was true. Yet, the myth of 220 as a band that offers little to amateurs seems to persist among a lot of us in the fraternity. I wanted to know why.

Could the myth be based, partly, at least, on some propagational features of 220 that are alien to the understanding and experiences of most lower-frequency operators? In earlier years, it was generally true that almost all VHF work was done at essentially local distances (i.e., up to about 30 miles). Even today, particularly in densely populated areas, this range is still probably typical of the average amateur communication path. Therefore, I reasoned that if any unusual propagational behavior degraded signal strength at 220 on paths of this length, especially during the earliest days of experimentation on this fre-

quency, it might be part of the explanation of why this much-neglected band got its less-than-good reputation then, and why the band maintains its reputation with amateurs like my friend even to this day. I needed to study this possibility, and I needed an adventuresome, experimentally-inclined partner to help me. Jim K9MLK, who was located about 10 miles from my station, gamely agreed to help.

How's the Weather on 220?

Though far from being a scientific type, the next requirement I would have to fulfill would be carrying out my investigation in as scientific a manner as possible. Therefore, a working hypothesis was in order. I began with a piece of information that even relative newcomers to VHF have known for years: Weather changes in the lower atmosphere can affect propagation at these frequencies. But what, *specifically*, about the weather would change 220-MHz propagation? What about the effects of solar activity? Though generally discounted as a fac-

tor, could it be ruled out entirely here? And could I discount the effects of the Earth's magnetic field? I arbitrarily set a hypothesis which would include most common elements of the weather and of solar and geomagnetic activity. I decided that K9MLK's 220-MHz signal strength, as received at my location, would probably vary with changes in air temperature, humidity, the level of the cloud ceiling over the transmission path, barometric pressure, geomagnetic fluctuations as measured by the "A" index, and solar flux numbers. The latter two types of data would be provided on each appropriate test day by the National Bureau of Standards station, WWV, and the National Oceanic and Atmospheric Administration (NOAA). Humidity and temperature measurements could be taken at my station location, but cloud-ceiling data and barometric-pressure readings, because of the lack of accurate home instruments, would have to be obtained from the flight service at the local airport.

Setting Up the Test

The remaining things which required a decision before beginning our tests were choosing transmission mode, antenna, polarization, power level, station equipment, and, lastly, a method of measurement for the received signal which would be accurate and yet would be easy to use. Two criteria would have to be satisfied in making these decisions. First, our station equipment would have to operate in some mode which could provide some constant-carrier signal for meaningful comparison. This constraint almost automatically dictated that we use CW, AM, or FM. Second, in the interest of scientific control, what was true with one station had to be true with the other, that is, power levels, antennas, antenna height, model(s) of equipment, type of feedline, method of measuring the received signal, and the like had to be duplicated on both ends of the transmission path as nearly as possible. We also would have to duplicate the time of day each time the experiment was run so we could minimize any effects other unknown but *time*-related variables might have on our signal-strength measurements.

Picking station gear was relatively easy and consequently came first. Two AM transceivers became available almost immediately, so AM became the mode of choice because of convenience. The transmitter sections were low powered and thus offered an unexpected opportunity. Since each of us would be putting only about 1/2 Watt into our feedlines, we felt that, at a distance of 10 miles, we should be able to detect even relatively small signal changes which might be the result of propagational shifts. It was our belief that

higher power levels might have masked this phenomenon over such a short path. As for polarization and antenna decisions, horizontal was chosen since it has traditionally been used in most weak-signal work. Both stations, then, were outfitted with horizontally-mounted, homemade 5-element quagi beam antennas, and both were fed with RG-8/U foam coaxial cable. Lastly, in an attempt to abide by the rule of duplication, both antennas were to be mounted as close as possible to a height of 40 feet. That would, it was hoped, minimize individual station differences based on antenna height gain or feedline length.

The final decision to be made concerned choosing a method for measuring and comparing the levels of received signal. Neither of us felt particularly comfortable working in any measurement scale that was nonlinear, so a very simple yet reliable alternative had to be devised. Because both receivers employed circuits with excellent agc characteristics, we simply decided to measure the differences in associated voltage at a no-signal and a signal-present condition. Since the voltage figures used for final data analysis are *difference* numbers, any internal voltage variations or any transient external receiver conditions such as an increase in line noise which might increase the total voltage reading during the experiment are essentially minimized as a data bias. To further minimize bias caused by variations within each of our stations, we both measured signal voltages in this manner and then these readings were averaged to produce the day's final data. Voltage readings were taken at both ends of the experiment with each station transmitting a constant-amplitude 1000-

Hz audio tone to the other for a period of 60 seconds.

Data was collected in this manner over the period of November 1, 1979, to March 25, 1980. This period was purposely chosen since it represented the best of several possible experimental conditions. First, we felt we would best be able to test the influence of warm and cold air inversions which are so common in this part of the midwest in the fall. Second, we would experience a wider range of temperature and humidity extremes during this time than probably any other. And lastly, this particular time period was predicted to be near the maximum for solar activity in the current solar cycle. So, if the sun had any influence on propagation at this frequency, we felt that it probably would be most evident at this time.

The Expected and the Not-So-Explainable

The results of the experiment are portrayed in Figs. 1 through 5. Each of these

graphs shows a correlation line between received signal and data from one of the five meteorological or geo-solar variables mentioned in the starting hypothesis. For those of you who are mathematically inclined, these correlation lines were derived by using standard regression methods.

Results range from the expected to the almost unexplainable. Fig. 1, for example, shows the relationship between signal strength and the percentage of air humidity. A statistically significant negative relationship between the two is strongly suggested here. The findings indicate that as humidity levels declined in the atmosphere over the transmission path, signal strengths increased in response. According to Thornburg in the March, 1978, *QST*, while this phenomenon is known to occur with signals transmitted in the gigahertz range, it is not typically associated with propagation at frequencies this low. Yet the effect at

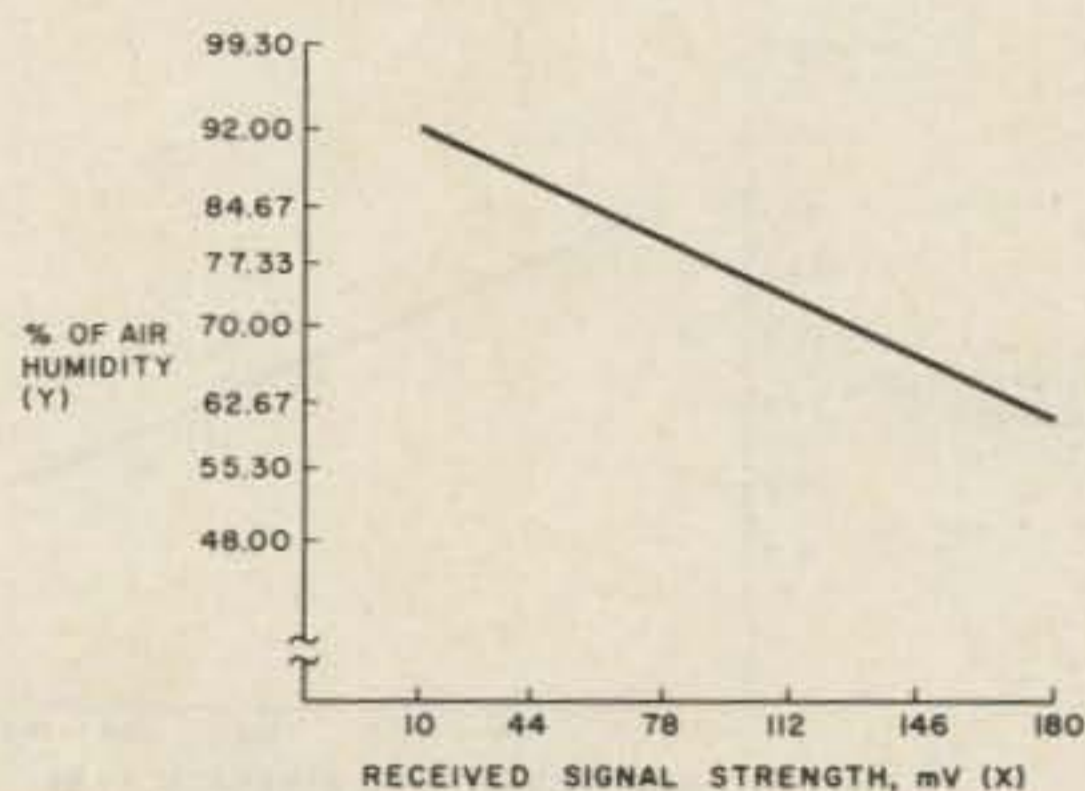

Fig. 1. Relationship between humidity and signal strength.

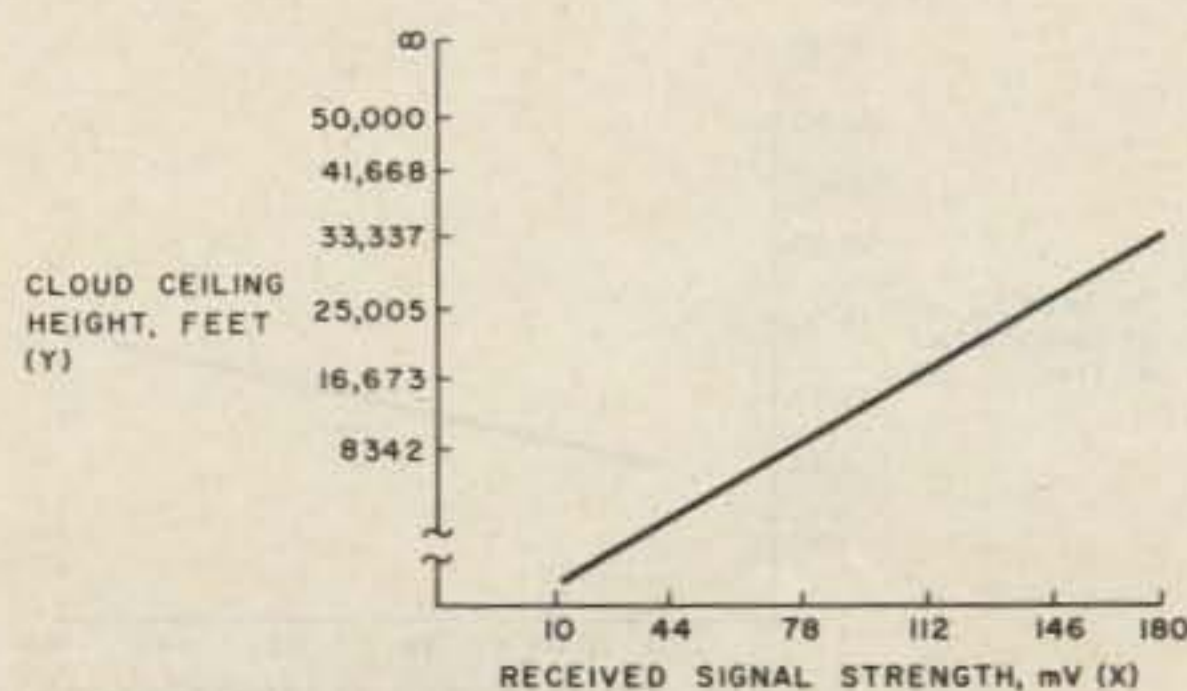

Fig. 2. Cloud ceiling height vs. signal strength.

220 appears to exist. (It was interesting to note that during our test, during periods of high moisture, such as rainy or snowy days, signal strengths which typically ran at S9 or better under more clear conditions, would plummet into the noise level.)

Fig. 2, on the other hand, shows the relationship between signal strength and cloud-ceiling height in feet. Some intuitive feeling suggested prior to this experiment that at this frequency and above, a low cloud ceiling might act almost as a pipeline or duct. In other

words, it might concentrate the signal and its strength. Also, the possibility occurred to me that if a cloud layer did duct the signal, this phenomenon might exist if and only if the cloud layer were at some critical height above ground. That is, signal reinforcement might take place only with the cloud layer present *above* or *below* some special height. The data portrayed in Fig. 2 suggests the opposite is more likely. A mild correlation was found between signal strength and ceiling height and this correlation was statistically significant. Yet

the relationship was positive. So, here the data was suggesting that as the cloud ceiling rose, signal strength also slowly rose. This finding doesn't give much support to the belief that a low cloud ceiling will increase signal strength. Nor did the data analysis support the notion of a particular critical ceiling height above any certain level.

It is difficult to know how important this apparent relationship is. One possible explanation for the correlation between signal strength and cloud height might be found in the fact that periods of high humidity are most frequently associated with wet and stormy conditions, and these conditions are normally accompanied by lower cloud ceilings. Thus, the correlation between cloud height and signal strength may, in fact, be only an indirect reflection of the relationship between high humidity and low signal strength as was discussed earlier.

Fig. 3 represents a phenomenon that is somewhat harder to explain. Here a weak positive correlation was found to exist between signal strength and barometric pressure. In short, the data indicates that as barometric pressure rose (an event typical of the coming of clear dry weather), signal strength generally tended to increase as well. This finding should not come as any surprise to veteran weak-signal operators on 6 and 2 meters who know that the changeover between low- and high-pressure weather systems can produce some pretty nice DX contacts at times. What will be surprising to the mathematically inclined reader is the fact that the relationship on 220 MHz was not found to be statistically significant. At least mathematically, the apparent changes in signal levels could not clearly be

explained by changes in barometric pressure.

Again, a *possible* explanation exists. As was just mentioned, it is well established and commonly known that weather-front boundaries involving differences between low- and high-pressure air masses do enhance signals over *long* paths, but this experiment was conducted over a relatively short transmission path. It was probably true that over our 10-mile path no sizable differences in barometric pressure existed during our tests, and thus no sharp reflecting air-mass boundaries were available to provide us with significant enhancement of our signals. Certainly, more testing of this idea should take place before the short-path effect of barometric pressure changes on signal propagation is ruled as unimportant.

The next relationship, signal strength and air temperature, is much clearer. Fig. 4 shows a strong negative correlation line between the two, thus suggesting that as temperature over the transmission path lowers, signal strengths tend to increase. This correlation was found to be statistically significant, thus giving some weight to the contention held by many old-time VHF operators that signals were often stronger on a cold, clear day.

Geo-Solar Activity and Its Effect

The effects of the sun interacting with the Earth's magnetic field were, at least by the criteria we used, predictably disappointing. Fig. 5 shows the data comparing the NOAA "A" index with signal strength on 220 MHz. For those not familiar with this measurement, the "A" index is a linear scale which is designed to show variations in the magnetic field of the

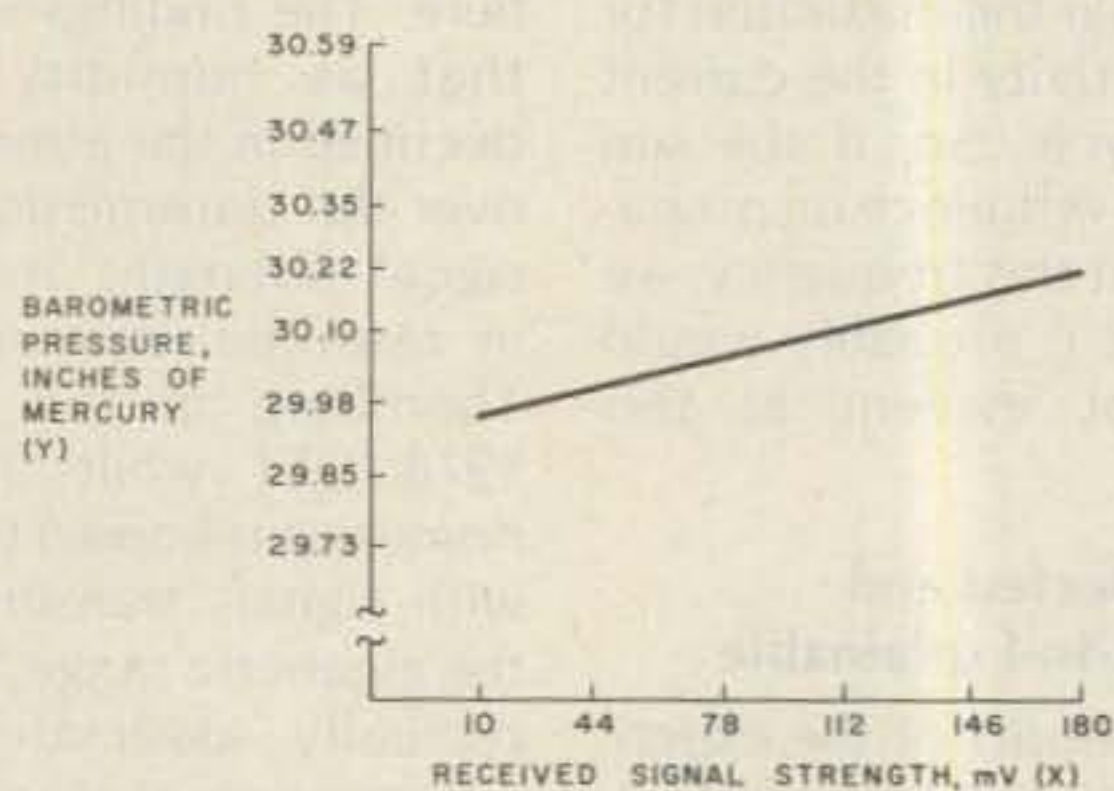

Fig. 3. Barometric pressure vs. signal strength.

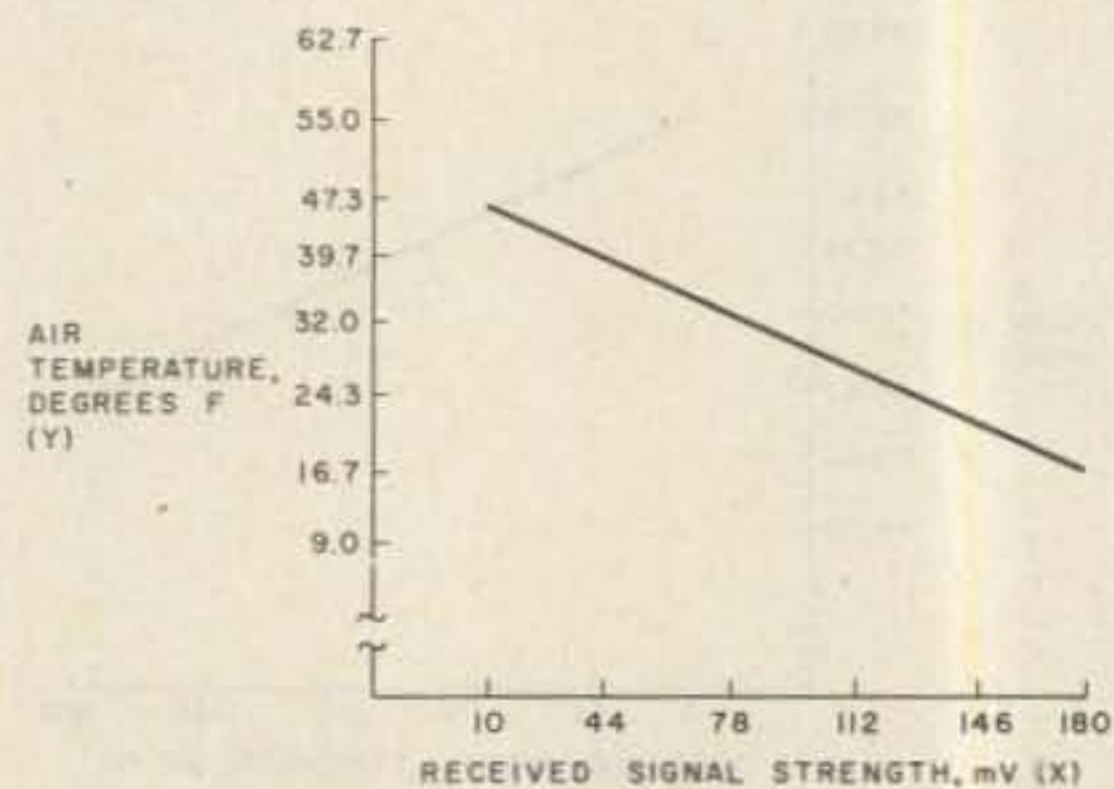

Fig. 4. Air temperature vs. signal strength.

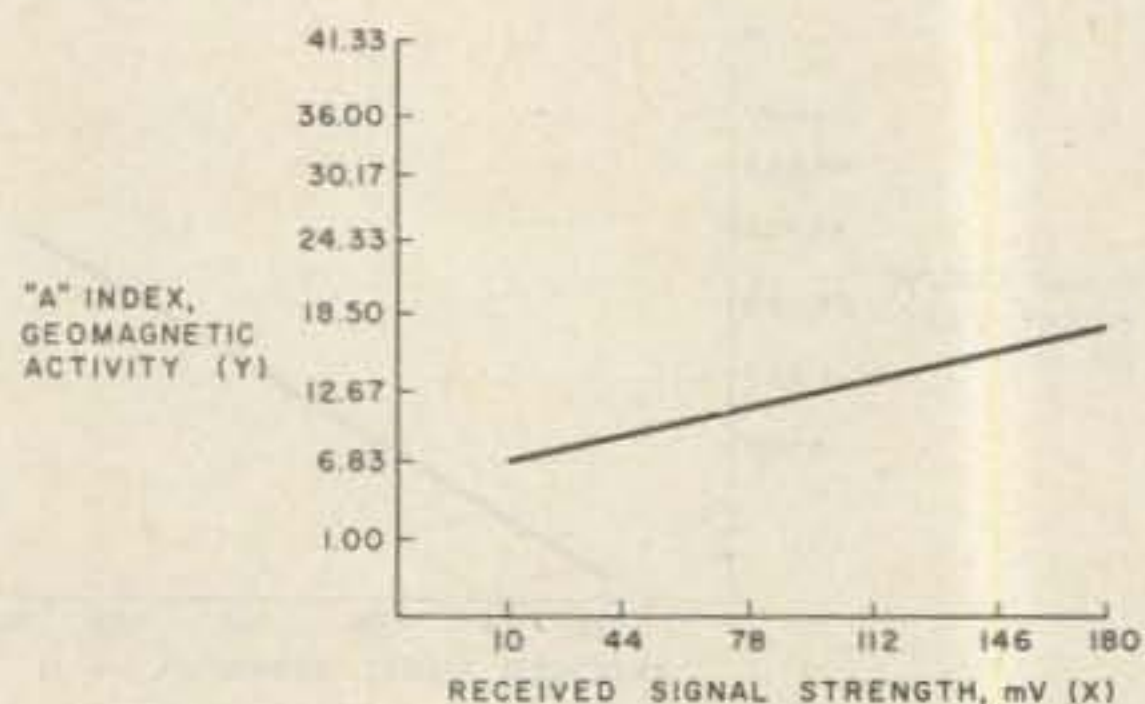

Fig. 5. "A" index (geomagnetic activity) vs. signal strength.

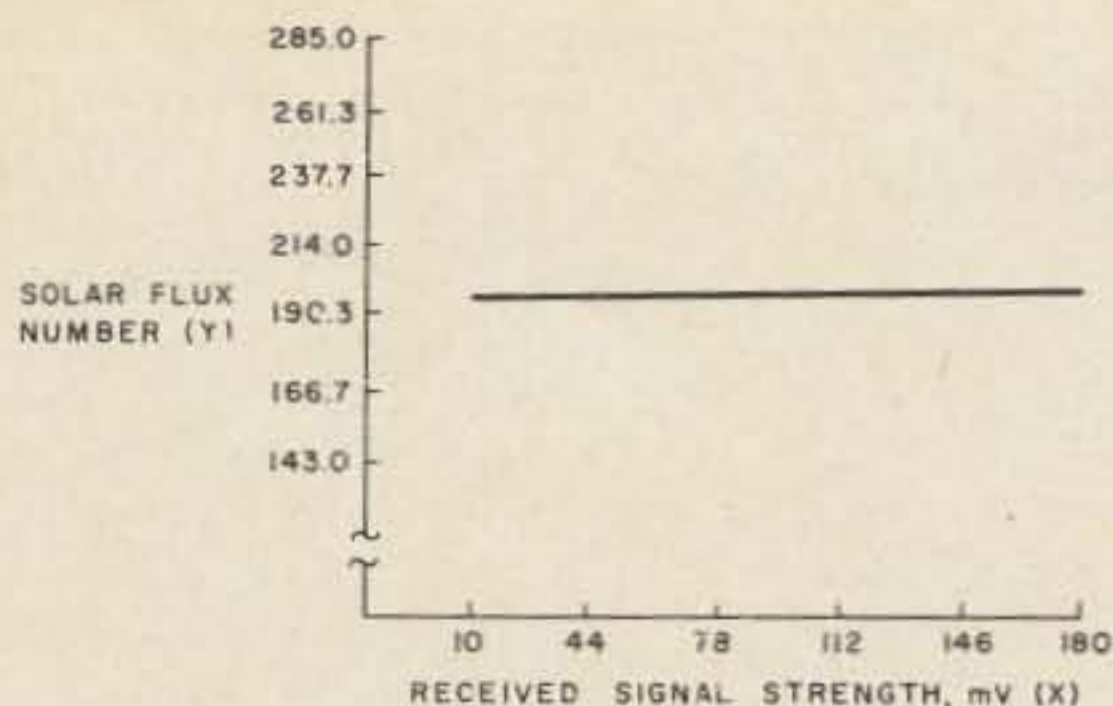

Fig. 6. Solar flux number vs. signal strength.

Earth. This data is collected daily and transmitted hourly by WWV. Although a very weak positive correlation was shown to exist here, this correlation was not found to be statistically significant. In fact, the correlation is so weak as to indicate that the relationship between the two possibly might be caused by strictly random events. Again, it should be remembered that the lack of a significant relationship here for short-path propagation does not in any way prove that geomagnetic variations are insignificant in shaping 220-MHz propagation over longer paths.

The interaction of solar activity and signal strength, as in the prior comparison, also was minimal. Here, as indicated in Fig. 6, though, the lack of any statistically-significant correlation between what are essentially sunspot count numbers and 220-MHz signals was even more evident. Again, any positive correlation of the data was so small as to be explainable in terms of random events or accidents. Thus, a reasonable conclusion to be drawn from this last comparison might be that regardless of changes in the sunspot number, signal levels over short paths on 220 will probably not be improved or hurt significantly as a result.

What Does This All Mean?

The original intent of our experiment and this article was to shed some light on the behavior of 220 MHz. It

was felt that if this band were better understood, even in just the area of signal propagation, other amateurs might be more encouraged to explore the band for the first time.

What we found can be summarized in very plain words as a fascinating propagational picture. 220-MHz propagation is not as mundane and as simple as it might seem to the uninitiated. Nor is it so formidable or so unpredictable that the average ham could not understand and even take advantage of it. What does appear to the band user is a colorful propagational world which is probably not quite like what most of us experience on 2 meters and below. Here, over relatively short distances you can expect your signal strength to vary with air temperature, humidity, cloud conditions over the signal path, and possibly to some extent, even barometric pressure. Expect high temperature, high humidity, the presence of precipitation, and the presence of low cloud ceilings to degrade signal levels. On the other hand, our experiment predicts that you can expect relatively cloud-free, cool, low-humidity days (days typically characterized by high barometric-pressure readings) to produce much better signal reports. However, other than providing pleasant conditions in which to work, the sun and its associated sunspot activity cannot be counted upon to

BITTEN BY THE ATV BUG?

Let P.C. put you on the air and SAVE!

Complete System price \$249.00 SAVE \$13.00







TXA5-4 Exciter/Modulator \$89.00 ppd.
Wired and tested module designed to drive PA5 10 watt linear amplifier. The 100 MHz crystal design keeps harmonics out of two meters for talk back. Video modulator is a full 8 MHz for computer graphics and color. Requires 13.8 VDC reg. @ 70 ma. 80 mw output power. Tuned with crystal on 439.25, 434 or 426.25 MHz. Dual frequency model available \$115.00 ppd.

PA5 10 Watt ATV Power Amplifier . \$89.00 ppd.
The PA5 will put out 10 watts RMS power on sync tips when driven with 80 mw by the TXA5 exciter. 50 ohms in and out plus bandwidth for the whole band with good linearity for color and sound. Requires 13.8 VDC reg. @ 3 amps.

FMA5 Audio Subcarrier Generator . \$29.00 ppd.
Puts audio on your camera video just as broadcast does at 4.5 MHz. Puts out 1 V p-p to drive TXA5. Requires low Z mike, 150 to 600 Ω and 12 to 18 VDC @ 25 ma. Works with any transmitter with 5 MHz video bandwidth.

TVC-2 ATV Downconverter \$55.00
Stripline MRF 901 preamp and double balanced mixer digs out the weak ones and resists intermod and overload. Connects between UHF antenna and TV set. Output channels 2 or 3. Varicap tuner 420 to 450 MHz. Requires 12 to 18 VDC @ 20 ma.
Supersensitive TVC 2L with NE64535 preamp (.9 db N.F.) \$69.00 ppd.

Call or write for our complete catalog of specifications, station setup diagrams, and optional accessories which include: antennas, modulators, test generators, cameras and much, much more. See Ch. 14 1983 ARRL Handbook.

TERMS: VISA or MASTERCARD by telephone or mail, or check or money order by mail. All prices are delivered in USA. Allow three weeks after order for delivery.
(213) 447-4565 Charge card orders only

P.C. ELECTRONICS

Tom W6ORG Maryann WB6YSS 2522 Paxson Lane, Arcadia, California 91006

either increase or decrease 220 signals over a short path. This lack of effect also appears true for changes in the Earth's magnetic field, as well.

One additional word about the methodology employed here and about the interpretation of our findings is in order before concluding. We realize that more scientific and perhaps more precise results might have been achieved had this experiment been performed with professional equipment and personnel involved. It was, however, performed under conditions which are consistent with the Amateur Radio Service. Consequently, the reader is reminded that the conclusions drawn here are only meant to suggest the indication of possible relationships. That is all that the mathematical tools used in the analysis of the data may claim anyway. Certainly, more complete and con-

trolled research should be conducted in these areas and other members of the hobby are heartily encouraged to do so.

The author wishes to extend his sincere thanks to Jim Genisio K9MLK, without whose help this research might have been impossible, to Sr. Rosemary Schmalz, PhD, Mathematics Department, St. Mary of the Woods College, for her assistance in computer analysis of the data, and also to the National Oceanic and Atmospheric Administration, Boulder, Colorado, for their help by providing solar data and general information. ■

References

The Radio Amateur's Handbook, Fifty-Third Edition, American Radio Relay League, 1976, Chapter 19.

Thornburg, Bob, "Microwave Mobile Propagation," *QST*, March, 1978.

18 kV with No Transformer

You need high voltage, but surplus transformers can't turn the trick. Try this solid-state solution.

One drawback of the proliferation of solid-state components has been the disappearance of high-voltage power supplies and components, particularly high-voltage transformers. This became clear about two years ago when I needed a negative 600-volt supply to test a surplus reflex klystron. The current requirements were less than one hundred microamperes. After realizing the junk box no longer contained such traditional items as a 250-0-250-volt television power transformer, I had to come up with a different solution—voltage multipliers.

A times-four multiplier supplied the needed negative 600 volts directly from the 117-volt line. Later, a

small transformer with a 115-volt secondary was used to isolate the supply from the ac mains for safety.

Since then, I have made several high-voltage, low-current supplies ranging from 18 kilovolts to 600 volts for applications including infrared image converters, a two-inch oscilloscope, and a simple Geiger counter.

C1's voltage is added to the input and charges C2 through D2.

Because some of the charge on C1 is transferred to C2, reducing the voltage on C1, several complete cycles are required to charge C2 to two times peak input voltage E . But, for clarity, let's assume that C2 is fully charged to $2E$.

During the third half cycle, the voltage across C1 bucks the input and the voltage across C2 charges C3 through D3 to $2E$. Now, during the fourth half cycle, the sum of input voltage E plus the voltage across C1, E , plus the voltage across C3, $2E$, charges C4 through D4 to a total voltage of $4E$.

A basic times-four multiplier schematic is shown in Fig. 1. As the input voltage alternates between plus E and minus E , it is easy to see how the circuit multiplies the voltage. During the first half cycle, C1 is charged through D1 to plus E volts. During the next half cycle,

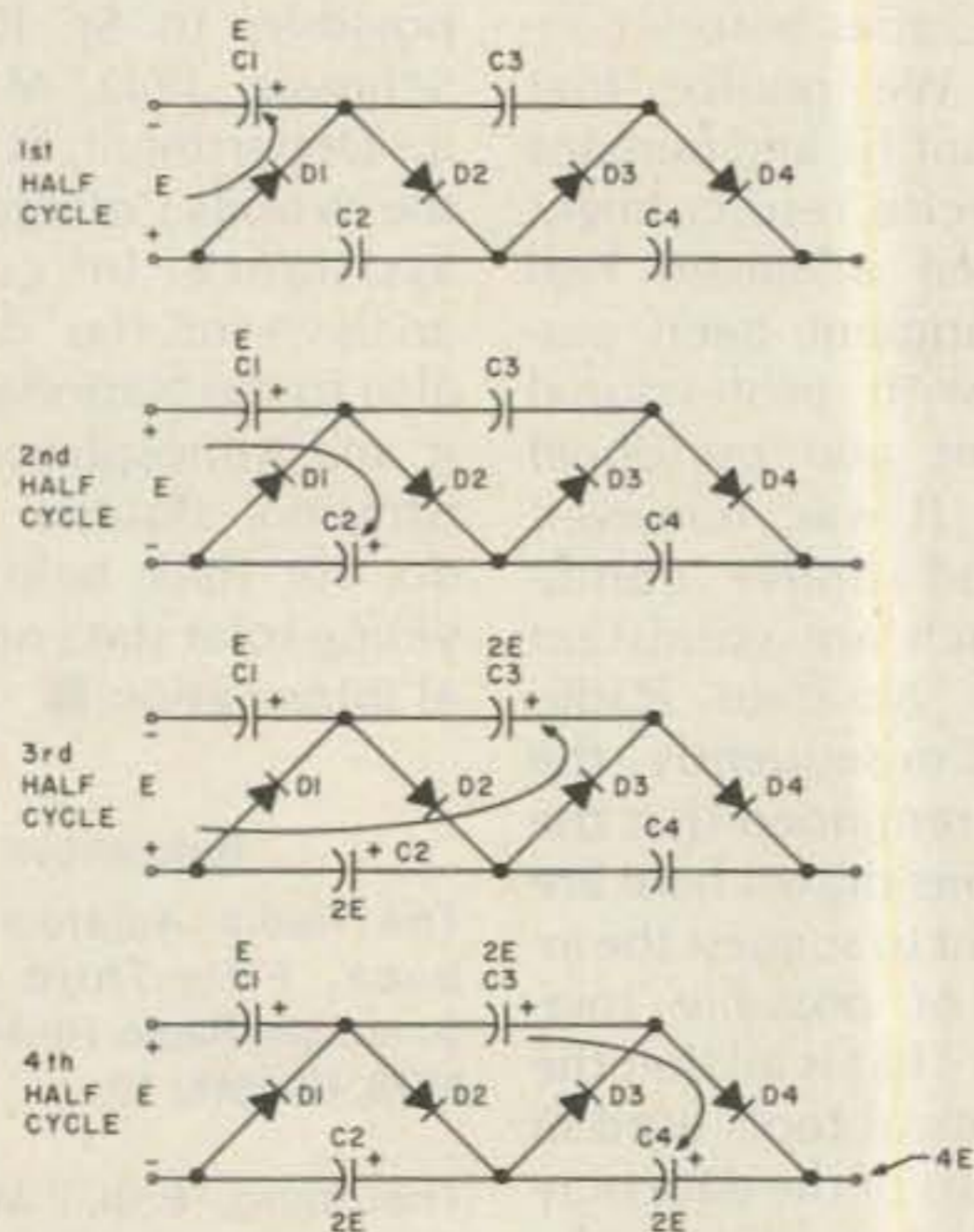

Fig. 1. Operation of a times-four voltage multiplier.

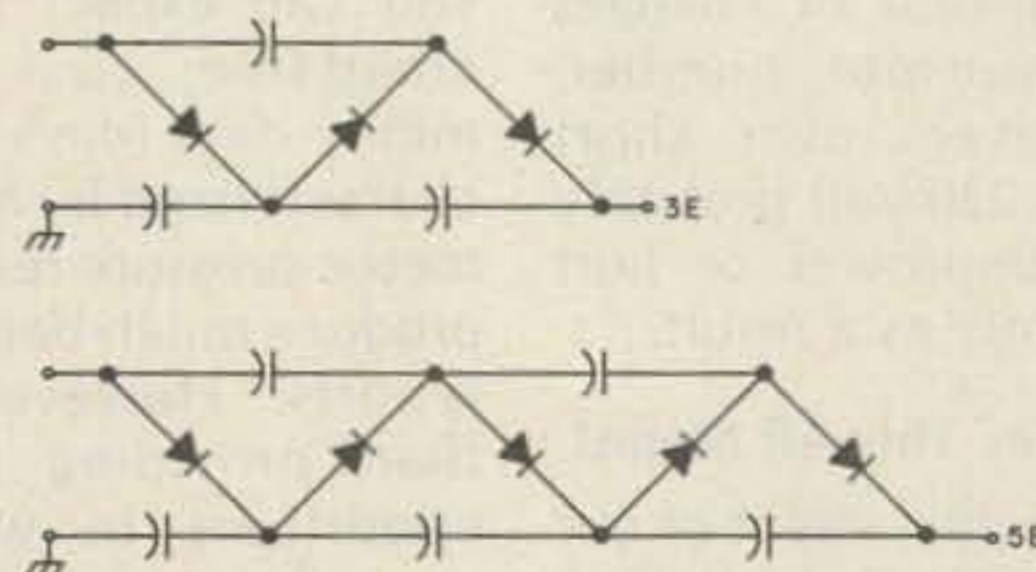

Fig. 2. Schematic of times-three and times-five voltage multiplier.

However, the voltage across C2 bucks the charging voltage and therefore C4 is charged to 2E. The output voltage is the sum of the voltage across C2 and C4, or 2E plus 2E, or simply 4E.

By adding pairs of diodes and capacitors, outputs of 6E, 8E, or higher can be obtained. The breakdown voltage of the individual diodes and capacitors should be greater than twice the peak input voltage.

This is fine for multiplication by even numbers, but what about multiplication by odd numbers to get 3E, 5E, or odd multiples of the peak input voltage? Examining Fig. 1, the sum of the voltages across C1 plus C3 is 3E, but there is also an ac voltage of E volts peak present. By switching the input ac and ground connections, the ac voltage will be on the other capacitor chain and odd dc multiples of the input are obtainable. See Fig. 2. The circuits shown in Figs. 1 and 2 are for positive output voltages. To get negative output voltages, all that needs to be done is to reverse the polarity of each diode (and each capacitor if electrolytics are used).

As an example, I needed an 800-to-1000-volt supply for a Geiger-Mueller tube for a demonstration of radioactivity. I had a 115-volt secondary, 15-milliampere transformer available. Using a times-six multiplier

would yield $(115)(1.4)(6) = 966$ volts.

A multiplier was built with six 1N4006 diodes and six .0075- μ F disc ceramic capacitors. The no-load output was measured to be 920 volts. Out of curiosity, I measured the output voltage as a function of the load resistance. The results are plotted in Fig. 3. Actually, Fig. 3 shows two curves, one using .0075- μ F capacitors and one using 0.1- μ F capacitors. Obviously, the output regulation is much better with the larger capacitors. However, the light loading of the Geiger-Mueller tube permitted me to retain the smaller .0075- μ F capacitors.

Another way of improving the output regulation would be to increase the input frequency, which is what I did for an 18-kilovolt supply I built for a 6032A infrared image converter tube. This supply, shown in Fig. 4, consists of two separate supplies driven by a single source. One supply is a twenty-two-times multiplier for the 18-kV anode. The other supply is a times-four multiplier for the focus electrode. Both supplies are driven from a 600-volt, 2-kHz solid-state inverter salvaged from a damaged aircraft transponder. All of the capacitors are .002- μ F/2-kV disc ceramics and each diode symbol represents two 1N4006 diodes in series.

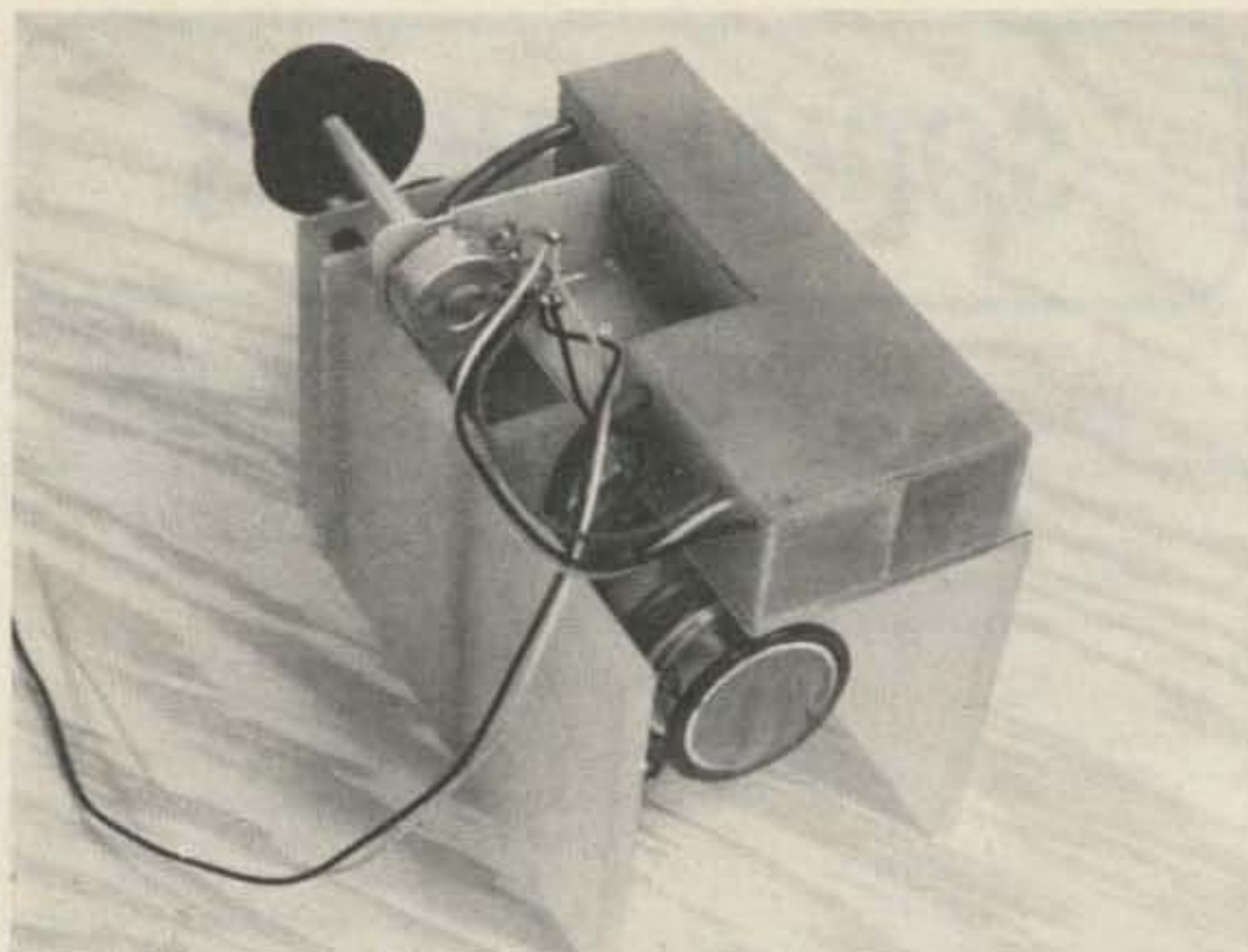

Completed 18-kV and focus supply for an infrared viewer.

Originally, the focus voltage was derived from a resistive voltage divider across the anode supply. Without this additional load, the output voltage would increase smoothly with the input, but would drop very slowly when the input was reduced. With the resistor present, the focus potential varies smoothly.

The photograph shows the completed supply. The two multiplier chains were potted to reduce losses from corona. Those who might be interested in exact design and analysis of these types of power supplies should read the excellent article by Dr. E. H. Borneman in *Electronic Design*, 7, March 29, 1978, pp. 72-74. ■

A 116-megohm load was used as a bleeder and load for the output of the focus

supply because the current drain by the focus electrode was negligible.

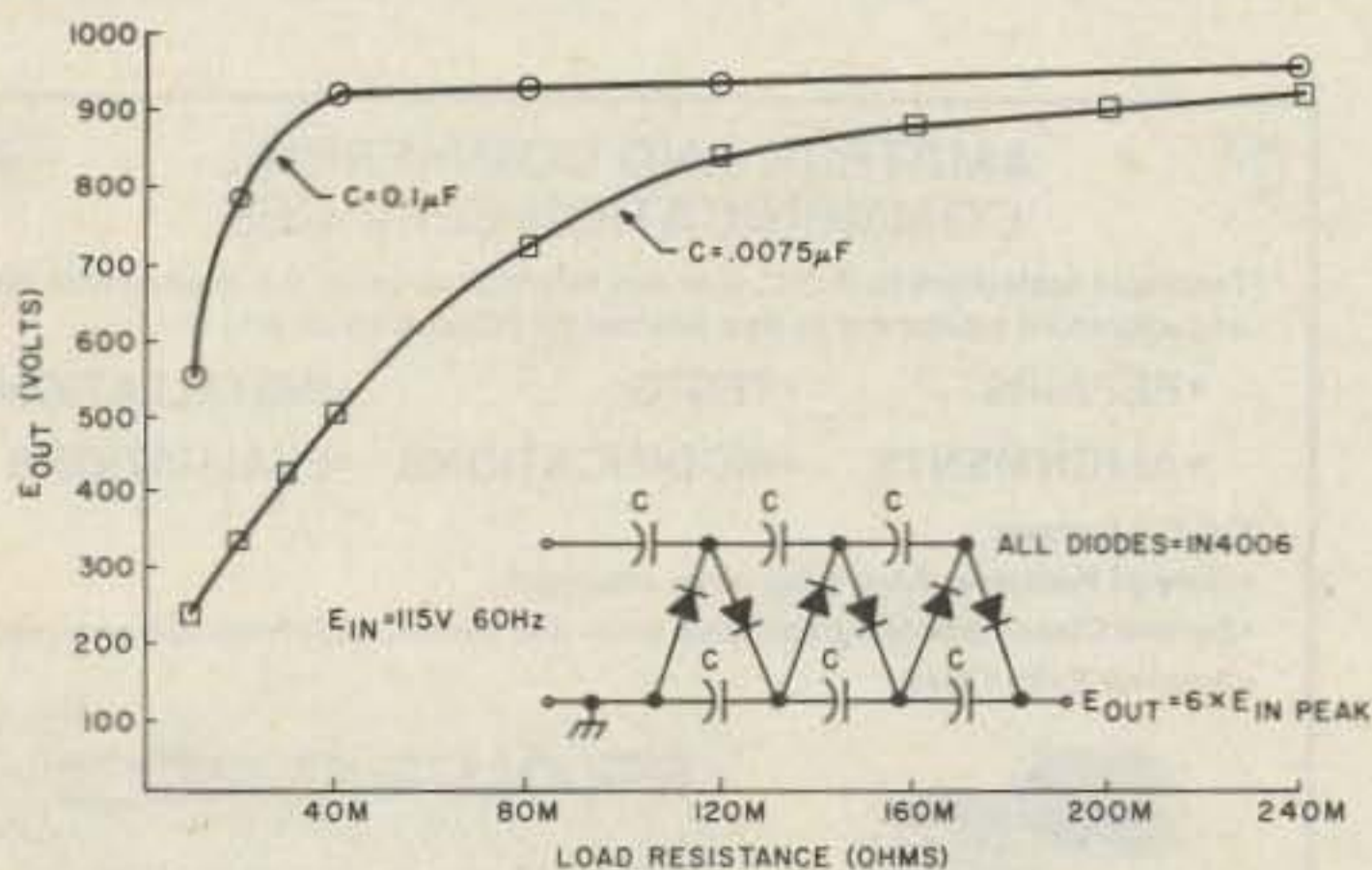

Fig. 3. Output characteristics of Geiger-Mueller high-voltage supply.

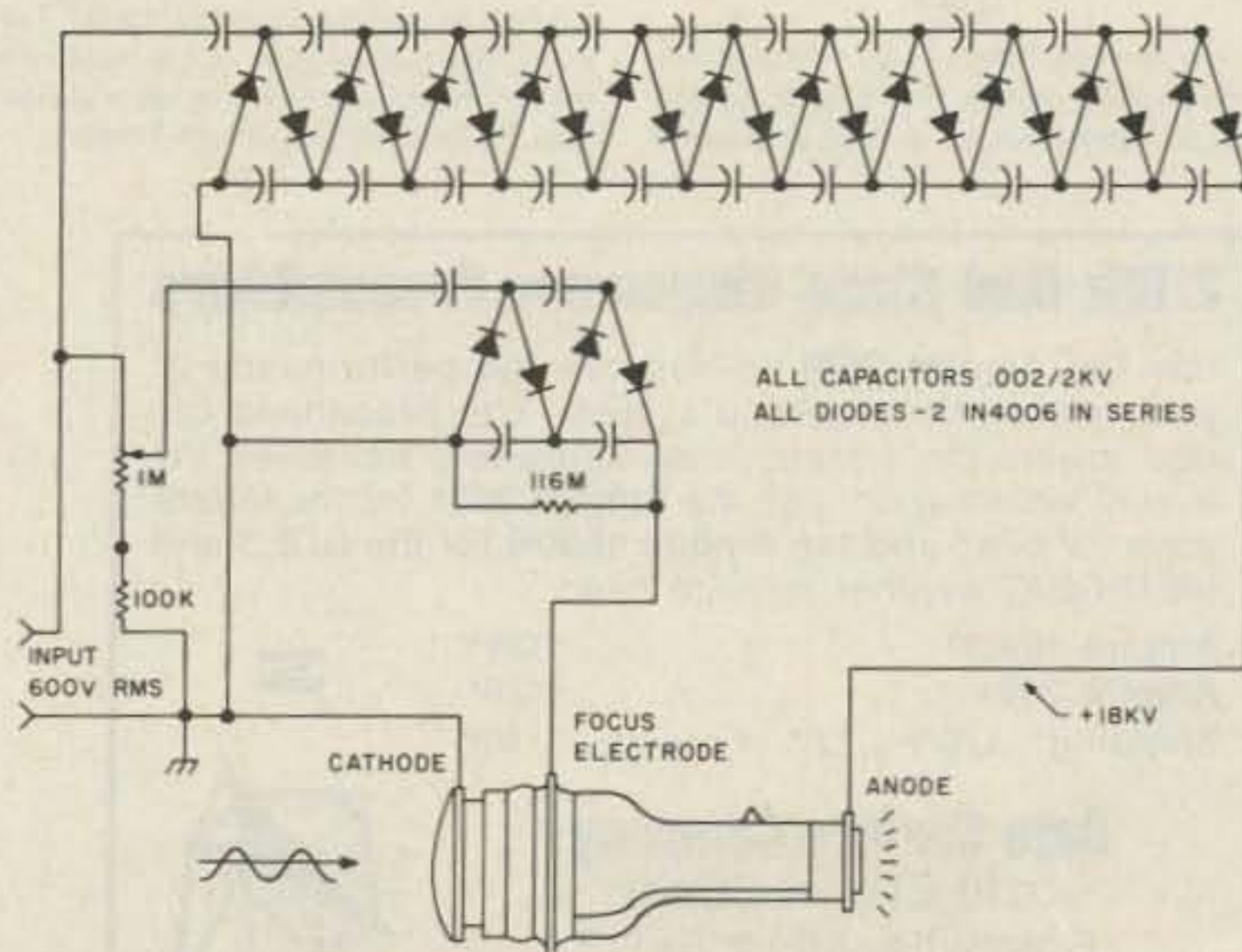

Fig. 4. 18-kV supply for image converter tube.

SOCIAL EVENTS

Listings in this column are provided free of charge on a space-available basis. The following information should be included in every announcement: sponsor, event, date, time, place, city, state, admission charge (if any), features, talk-in frequencies, and the name of whom to contact for further information. Announcements must be received by 73 Magazine by the first of the month, two months prior to the month in which the event takes place. Mail to Editorial Offices, 73 Magazine, Pine St., Peterborough NH 03458.

CHARLESTON SC JUL 23-24

The Charleston Hamfest will be held on July 23-24, 1983, at the Omar Shrine Temple, Charleston SC. Talk-in on 146.16/76. For more information, call (803)-747-2324.

JACKSON WY AUG 5-7

The 1983 ARRL Rocky Mountain Division Convention, in conjunction with the 51st WIMU Hamfest, will be held on August 5-7, 1983, at the Virginian Motel, Jackson WY. Talk-in on 146.22/82 and .3923 kHz. For reservations, call the Virginian at (307)-733-2792. For more information, phone R. L. "Pete" Stull WB7AMP at (307)-382-9032 or Dave Gregory N7COA at (307)-875-5324.

MOBERLY MO AUG 7

The NEMO ARC of Kirksville MO and the Tri-County ARC of Moberly MO will hold the 5th annual North Missouri Hamfest on Sunday, August 7, 1983, at the Moberly Municipal Auditorium, Moberly MO. The auditorium has 12,000 square feet of air-conditioned space for the inside flea market and there will be a limited number of tables available free. Tickets are \$1.50 in advance or \$2.50 at the door. Doors will open for the flea market and distributors beginning at 8:00 am and for the hamfest, from 9:00 am until 3:00 pm. There will be forums, films, sandwiches, and drinks, as well as donuts and coffee for the early birds. Talk-in on 147.69/09. For more information and/or tickets, contact Sam Fischer KA0ILO, PO Box 341, Moberly MO 65270.

ANGOLA IN AUG 7

The Steuben County Radio Amateurs will hold their 25th annual FM Picnic and Hamfest on Sunday, August 7, 1983, at Crooked

Lake, Angola IN. Admission is \$2.50. Features will include picnic-style BBQ chicken, inside tables for exhibitors and vendors, a large electronics flea market, and overnight camping (fee charged by county park). Talk-in on 146.52 and 147.81/21.

PITTSBURGH PA AUG 7

The 46th annual South Hill Brass-pounders and Modulators Hamfest will be held on August 7, 1983, from 9:00 am to 4:00 pm, at the South Campus of the Community College of Allegheny County, Pittsburgh PA. Tickets are \$3.00 each or 2 for \$5.00. Features will include computer, OSCAR, and ATV demonstrations, as well as a flea market. Talk-in on 146.13/73 and 146.52 simplex. For further information, contact Andrew L. Plato, 1433 Schaeffler Drive, W. Homestead PA 15120.

AUSTIN TX AUG 12-14

The Austin Amateur Radio Club and the Austin Repeater Organization will sponsor Austin Summerfest '83 on August 12-14, 1983, at the Austin Marriott Hotel, Interstate 35 at Highway 290. Admission is \$5.00 in advance and \$6.00 at the door. Swapfest tables are available on a first-come, first-served basis, but each seller may also reserve one table in advance for \$1.00. Summerfest '83 will combine the Texas VHF-FM Society Convention with forums, meetings, an indoor swapfest, dealer exhibits, and many outside activities for the family at Austin's annual Aqua Festival. Talk-in on 146.34/94. For more information, write Austin Summerfest '83, PO Box 13473, Austin TX 78711.

DUNKIRK NY AUG 13

The Lake Erie International Hamfest Association will hold its fifth annual Lake Erie International Hamfest on Saturday, August 13, 1983, beginning at 8:00 am, at the Chautauqua County Fairgrounds, Dunkirk NY. Admission is \$2.50 in advance and \$3.00 at the gate. Each flea-market space is \$1.00 plus admission. There will be indoor dealer exhibits as well as a large flea market. Talk-in on 146.25/85 and 146.52. For more information, write Lake Erie International Hamfest, PO Box 455, Dunkirk NY 14048.

POMONA CA AUG 13

The Tri-County Amateur Radio Association will sponsor the TCARA 13th Annual Hamfest and Picnic on Saturday, August 13, 1983, from 8:00 am to 2:00 pm, at the Los Angeles County Fairgrounds in Pomona CA. Tables will be available for ham/computer exhibits and displays. There will be sandwiches and soft drinks available. For more information, contact Tony Skvarek W6ELZ, 1514 W. Mission #14, Pomona CA 91766.

BURLINGTON VT AUG 13-14

The Burlington Amateur Radio Club will hold its annual International Hamfest and Flea Market on August 13-14, 1983, at the Old Lantern Campgrounds, Charlotte VT. For both days, tickets are \$4.00, outdoor flea-market spaces are \$2.00, and indoor spaces are \$5.00. Food and drink will be available. Talk-in on .34/94, .01/61, and .52 simplex. For further information, contact Frank W1CTM, Burlington Amateur Radio Club, PO Box 312, Burlington VT 05402.

TACOMA WA AUG 13-14

The Radio Club of Tacoma Hamfair will be held on Saturday and Sunday, August 13-14, 1983, at Olson Auditorium, Pacific Lutheran University, Tacoma WA. Events will include seminars, contests, a flea market, commercial exhibits, a dinner, and a loggers' breakfast. A 31" x 6' flea-market table is \$10.00 for both days if reservation is postmarked before August 1st and \$15.00 if reserved after August 1st. Dormitory and trailer spaces will be available. Talk-in on 147.28 and 224.52. For more information, contact Grace Teitzel AD7S, 701 So. 120th, Tacoma WA 98444, or phone (206)-564-8347.

HAMDEN CT AUG 14

The seventh annual WELI/Hamden Radio Club Flea Market will be held on Sunday, August 14, 1983, from 9:00 am to 4:00 pm, rain or shine, at Radio Towers Park, Banham Street, Hamden CT. General admission is \$1.00 and vendor space is \$5.00. For further information, contact Darrow Loucks WA1ZWA, 199 Wayland Street, Hamden CT 06518, or call (203)-288-3765 after 6:00 pm.

GEORGETOWN KY AUG 14

The Bluegrass Amateur Radio Society will hold the Central Kentucky ARRL Hamfest on Sunday, August 14, 1983, from 8:00

am to 5:00 pm, at Scott County High School, Longlick Road and US Route 25 Georgetown KY (off I-75/64). Tickets are \$3.50 in advance and \$4.00 at the gate. There is no charge for outside flea-market space. Features will include technical forums, awards, and exhibits in a/c facilities. For more information or tickets, write Edward B. Bono WA4ONE, PO Box 4411, Lexington KY 40504.

MONTGOMERYVILLE PA AUG 14

The Mid-Atlantic Amateur Radio Club will hold its annual hamfest on Sunday, August 14, 1983, from 9:00 am to 4:00 pm, rain or shine, at the Route 309 Drive-In Theater, 1/4 mile north of Route 63, Montgomeryville PA (6 miles north of the Fort Washington interchange of the Pennsylvania Turnpike). Admission is \$2.50 with \$1.00 additional for each tailgate space (tailgate setup begins at 8:00 am). There will be refreshments and ample parking. Talk-in on 147.66/06 (WB3JOE/R) or 146.52 simplex. For further information, write the club at PO Box 352, Villanova PA 19085.

WILLOW SPRINGS IL AUG 14

The Hamfesters Radio Club, Inc., will hold their 49th annual hamfest and picnic on Sunday, August 14, 1983, at Santa Fe Park, 91st and Wolf Road, Willow Springs IL (southwest of Chicago). Tickets are \$2.00 in advance and \$3.00 at the gate. Featured will be the famous swappers' row. There will be exhibits for OMs and XYLs. For advance tickets, send a check or money order and an SASE to Hamfesters, PO Box 42792 Chicago IL 60642.

RENO NV AUG 19-21

The Wide Area Data Group will host the 1983 ARRL Pacific Division Convention on August 19-21, 1983, at the Tennis Pavilion at the MGM Grand Hotel, Reno NV. The convention hall will open at 6:00 pm on Friday, August 19, and close at 3:00 pm on Sunday, August 21. Tickets for convention facilities only are \$7.50 in advance and \$10.00 at the door; tickets for all facilities including the banquet and after-dinner sessions, are \$35.00 in advance and \$37.50 at the door. There will be an indoor Swap Meet (with tables available at \$5.00 each), forums, commercial and club exhibits, a banquet with Roy Neal K6DUE as the featured after-dinner speaker, an RV park with all hookups, special room rates, and many nearby attractions. Talk-in on 147.63/03, 147.90/30, and 222.86/224.46. For reservations for special room rates at the MGM Grand, call (800)-648-5080. For further information, contact Royce P. Bell

2 GHz Dual Stage Microwave Preamplifiers

Use the **Ampire 2001** to improve the performance of your microwave receiving system. The broadband design lowers the system noise figure and increases the overall system gain. Use the **Ampire 2001** for the microwave TV band and the **Ampire 1690N** for the GOES and METEOSAT weather satellite band.

Ampire 1690N\$139⁹⁵
Ampire 2001\$129⁹⁵
Shipping: USA...\$2⁰⁰ Foreign...\$10⁰⁰

Data Service Company
3110 Evelyn Street
Roseville, MN • 55113
612-636-9469 ✓346



AMATEUR AND COMMERCIAL COMMUNICATION SERVICES

**Technical assistance by F.C.C. licensed technicians using the finest repair, test, and alignment equipment to give you results you can count on.

- REPAIRS
- TESTS
- INSTALLATIONS
- ALIGNMENTS
- MODIFICATIONS
- EVALUATIONS

**F.C.C. Licenses;

- General Radiotelephone (ship radar endorsed)
- Second Class Radiotelegraph (ship radar and aircraft radiotelegraph endorsed)
- Amateur Extra Class



PARSEC
COMMUNICATIONS

(517) 627-2650 (8 am to 6 pm)

(517) 627-2879 (6 pm to 10 pm) (est)

12325 Madonna Dr, Lansing, MI 48917

Geff N8CE ✓4

KD7DI, Public Relations Director, Wide Area Data Group, Inc., PO Box 3132, Sparks NV 89432-3132.

**OAKLAND NJ
AUG 20**

The Ramapo Mountain ARC (WA2SNA) will hold its 7th annual flea market on August 20, 1983, at the Oakland American Legion Hall, 65 Oak Street, Oakland NJ (20 miles from the GW Bridge). Admission is \$1.00 and non-ham family members will be admitted free. Indoor tables are \$6.50 and tailgating is \$3.00. Talk-in on 147.49/146.49 and .52. For more information, contact Tom Risseeuw N2AAZ, 63 Page Drive, Oakland NJ 07436, or phone (201)-337-3389 after 6:00 pm.

**BLOSSBURG PA
AUG 20**

The Tioga County ARC will hold its 7th annual Amateur Radio Hamfest on Saturday, August 20, 1983, from 0800 to 1600, at Island Park, Blossburg PA, just off Route 15. There will be a flea market and food will be available. Talk-in on 146.19/.79 and 146.52. For more information, write Tioga County ARC, PO Box 56, Mansfield PA 16933, or contact John T. Winkler WB3GPY, RD #2, Box 269, Wellsboro PA 16901, on .19/.79.

**MARYSVILLE OH
AUG 20-21**

The Marysville OH Hamfest will be held on Saturday and Sunday, August 20-21, 1983, rain or shine, at the fairground in Marysville OH. Admission is \$3.00 each and children under 12 will be admitted free. There will be a large flea-market area and each 10-foot space is \$2.00. Features will include inside commercial exhibits, food and free overnight camping on the grounds, and a square dance and entertainment on Saturday night. For more information, contact Union Co. ARC, 13613 US 36, Marysville OH 43040, or phone (513)-344-0468.

**HUNTSVILLE AL
AUG 20-21**

The Huntsville Hamfest will be held on Saturday and Sunday, August 20-21, 1983, at the Von Braun Civic Center, Huntsville AL. There is no admission charge. There will be exhibits, forums, an air-conditioned indoor flea market, and non-ham activities. Tours of the Alabama Space and Rocket Center will be available for the family. Flea-market tables are \$4 per day and should be reserved prior to the hamfest. A limited number of camping sites with hookups are available at the VBCC on a first-come, first-served basis. Talk-in on 3.965 and .34/.94. For more information, write Huntsville Hamfest, 2804 S. Memorial Parkway, Huntsville AL 35801.

**LAFAYETTE IN
AUG 21**

The Tippecanoe Amateur Radio Association will hold its 12th annual hamfest on Sunday, August 21, 1983, beginning at 7:00 am, at the Tippecanoe County Fairgrounds, Teal Road and 18th Street, Lafayette IN. Tickets are \$3.00. Features will include a large flea market, dealers, and refreshments. Talk-in on .13/.73 or .52. For advance tickets and additional information, write Lafayette Hamfest, Route 1, Box 63, West Point IN 47992.

**RIVER GROVE IL
AUG 21**

The Chicago Area Computer Hobbyist Exchange and the Chicago Amateur Radio Club will hold a joint swapfest on August 21, 1983, from 10:00 am to 4:00 pm, at Triton College, Fifth Avenue (just north of North Avenue), River Grove IL (8600W and 2000N). For more information, call CARC at (312)-545-3622.

**ST. CHARLES IL
AUG 21**

The Fox River Radio League will hold a hamfest on Sunday, August 21, 1983, at the Kane County Fairgrounds, St. Charles IL. Located midway between Elgin and Aurora in the Fox River Valley, the hamfest can be reached from either the northwest or east-west tollways via the state route 31 exits. Advance tickets are \$2.00; at the gate, \$3.00. Overnight camper and motor-home parking (available by prior arrangement) is \$3.00. All commercial exhibits, contests, and demonstrations will be indoors. There will be indoor and outdoor flea markets. Talk-in on 146.94 simplex or 147.21/81 (Aurora). For camping, commercial exhibits, and flea-market reservations, contact George R. Isely WD9GIG, 736 Fellows Street, St. Charles IL 60174. For tickets, send a check and a business-size SASE to Gerald Frieders W9ZGP, 1501 Mollitor Road, Aurora IL 60505.

**WILMINGTON DE
AUG 21**

The eighth annual New Delmarva Hamfest will be held on Sunday, August 21, 1983, at Gloryland Park, 5 miles south of Wilmington DE. Admission is \$2.25 in advance, \$2.75 at the gate. Tailgating is \$3.50; bring your own table. There will be limited space under the pavilion on a first-come, first-served basis. Food and drinks will be available. Talk-in on .52 and .13/.73. For more information and a map, send an SASE to Stephen J. Momot K3HBP, 14 Balsam Road, Wilmington DE 19804. For advance tickets, make checks payable to Delmarva Hamfest, Inc.

**TRUMANSBURG NY
AUG 27**

The annual Finger Lakes Hamfest will

be held on August 27, 1983, from 8:00 am to 5:00 pm, at the Trumansburg Fairgrounds, Rt. 96, 12 miles NW of Ithaca NY. Admission is \$2.00 at the gate. There will be a flea market, commercial exhibitors, a boat anchor auction, refreshments, and a craft show for the ladies. Talk-in on .37/.97 and .52. For further details, write Dave W2CFP, 866 Ridge Road, Lansing NY 14882.

**PORTLAND OR
AUG 27-28**

The Hoodview Amateur Radio Club will hold its first hamfest on August 27-28, 1983, at Mount Hood Community College, Gresham OR. Hours will be 9:00 am to 6:00 pm on Saturday and 9:00 am to 3:00 pm on Sunday. Admission is \$2.00 and children under 12 will be admitted free. Swap tables will be \$2.50 and \$5.00. Food will be available and children's activities will be provided. Talk-in on 147.88/.28 repeater and 146.52 simplex. For more information, please send an SASE to Hamfair '83, PO Box 20264, Portland OR 97220.

**MONTGOMERY AL
AUG 27-28**

The Central Alabama Amateur Radio Association will hold its 6th annual hamfest on Saturday and Sunday, August 27-28, 1983, at the Huntington College Delchamps Student Center, Montgomery AL. The hours will be from 0800 to 1700 on Saturday and to 1500 on Sunday; setups will be at 0600 on Saturday. Admission and parking are free. Features will include a flea market, a DX forum, a RTTY demonstration, and on Saturday night, a dutch-treat buffet with Peter Weatherall G3MLO of Canterbury, England, as guest of honor. Talk-in on 146.04/.64, 146.31/.91, 147.78/.18, or 146.25/.85. For further information or market reservations, write Hamfest Committee, 2141 Edinburgh Drive, Montgomery AL 36116, or phone Phil at (205)-272-7980 after 1700 CDST (2200 UTC).

**SEWELL NJ
AUG 28**

The Gloucester County ARC will sponsor the fifth annual GCARC Ham/Comp Fest Electronics Show and Flea Market on Sunday, August 28, 1983, from 8:00 am to 3:00 pm, at the Gloucester County College, Tanyard Road, Sewell NJ. Tickets are \$2.00 in advance and \$2.50 at the door. Parking spaces for tailgaters and dealers are \$3.00 each. Doors will open for setups at 7:00 am and indoor and outdoor spaces will be available. (If the weather is bad, the hamfest will be held entirely indoors.) Features will include speakers, seminars, contests, and FCC exams. Talk-in on 146.52, 147.78/.18, and 223.96/224.36. For more informa-

tion, contact GCARC Hamfest Committee, PO Box 370, Pitman NJ 08071, or phone (609)-456-0500 or (609)-338-4841 days, or (609)-629-2064 evenings.

**HERSHEY PA
AUG 28**

The Central Pennsylvania Repeater Association, Inc., will hold its 10th annual Hamfest/Computerfest on August 28, 1983, adjacent to Hersheypark, Hershey PA. Registration is \$3.00 and wives and children will be admitted free. There will be a special reduced admission to Hersheypark for families of registrants. At the indoor dealer and flea-market area, 10-foot spaces are \$8.00 each, 8-foot tables are \$4.00 each, and single electric sockets are \$1.00 each. An outdoor tailgate area and food and refreshments also will be available. Talk-in on 145.47, 146.76, and 146.52 MHz. For further information or advance registration, write Timothy R. Fanus WB3DNA, Hamfest reservations, 6140 Chambers Hill Road, Harrisburg PA 17111, or phone (717)-564-0897 between 12:00 noon and 8:00 pm.

**WENTZVILLE MO
AUG 28**

The St. Charles Amateur Radio Club, Inc., will hold its 8th annual hamfest on August 28, 1983, at the Wentzville MO Community Club. Tickets are \$1.00 each or 4 for \$3.00 in advance and \$1.50 each or 4 for \$5.00 at the door. Admission per car is \$1.00. Features will include a large open-air flea market, dealers, distributors, contests, and food. For tickets, motel or camping information, or dealer reservations, write SCARC Hamfest '83, PO Box 1429, St. Charles MO 63301.

**DALTON MA
AUG 28**

The Northern Berkshire Amateur Radio Club will hold a flea market on August 28, 1983, at the Veterans of Foreign Wars, West Housatonic Street, Dalton MA. Admission is \$1.00 and XYLs and children will be admitted free. Tailgating is free and tables are free on a first-come basis. Refreshments will be sold by the Dalton VFW.

**ARGOS IN
AUG 28**

The Marshall County ARC will hold their 8th annual hamfest on August 28, 1983, from 8:00 am to 2:00 pm, at the Marshall County 4-H Fairgrounds, State Road 10, Argos IN. Tickets are \$2.00 in advance and \$3.00 at the door. There will be more space this year and computers, as well as ham gear, will be on display. Table rental is \$4.00 and dealers may set up at 6:00 am. Food, hot and cold drinks, and activities for the ladies (including arts and crafts)

MULTI-BAND SLOPERS
160, 80, and 40 meters

Outstanding DX performance of slopers is well known. Now you can enjoy 2 or 3 band BIG-SIGNAL reports! Automatic bandswitching • Very low SWR • Coax feed • 2kw power • Compact • Ground or tower feed • Hang from any support 25 ft. high or higher • Easy to install • Very low profile • Complete instructions • Immediate shipment - Check ok

3 BAND SLOPER - 160, 80, & 40 Meters - 60 ft. long	\$ 43.00	frt.ppd
2 BAND SLOPER - 80 & 40 Meters - 41 ft. long	\$ 30.00	frt.ppd
3-BAND NO TRAP DIPOLE, 160, 80, & 40M - 113ft. long	\$ 66.00	frt.ppd
2-BAND NO TRAP DIPOLE, 80, & 40M - 84ft. long	\$ 49.00	frt.ppd

FOR ADDN'L INFO on these and other unique antennas: send SASE

W9INN ANTENNAS
BOX 393-S MT. PROSPECT, IL 60056

BUY FACTORY DIRECT & SAVE!!! DEALERS & DISTRIBUTORS

THE ONE STOP SOURCE FOR:
* COAXIAL CABLE—RG-8/U, 213, 214 ETC.
* MULTI CONDUCTOR CABLE—SHIELDED & UN-SHIELDED
* ROTOR CABLE—4, 5 & 8 CONDUCTOR ETC.

* CONNECTORS—TYPE N, UHF, BNC, ADAPTERS ETC.

WRITE FOR COMPLETE CATALOG OR CALL COLLECT FOR THE MOST COMPETITIVE PRICES.

 **cz labs**

P.O. Box 95-55 Railroad Ave.
Garnerville, New York 10923

(914) 947-1554-1555

will be available. For more information, write Marshall County ARC, Box 151, Plymouth IN 46563, or call Bob Nellans KB9DE at (219)-892-5224.

**LEBANON TN
AUG 28**

The Short Mountain Repeater Club will hold the Lebanon Hamfest on Sunday, August 28, 1983, at Cedars of Lebanon State Park, US Highway 231, Lebanon TN. There will be outdoor facilities only and exhibitors must bring their own tables. Food and drink will be available. Talk-in on 146.31/146.91. For further information, contact Morris Duke W4WXQ, 210 Disspayne Drive, Donelson TN 37214.

**FLINT MI
AUG 28**

The Genesee County Radio Club, the Bay Area Amateur Radio Club, the Lapeer County Amateur Radio and Repeater Club, the Saginaw Valley Amateur Radio Association, and the Shiawassee Amateur Radio Association will hold the seventh annual Five County Swap-n-Shop on Sunday, August 28, 1983, from 8:00 am to 3:00 pm, at Bentley High School, 1150 Belsay Road, Flint MI. Tickets are \$2.00 per person in advance and \$3.00 at the door. Children under 12 will be admitted free. Features will include a computer forum, trunk sales, free parking, and a food concession. Dealers may set up beginning at 5:00 am. Talk-in on 146.52 and 147.87/27. For table reservations, contact Bill Cromwell K8BH, 1204 Overland Drive, Lennon MI 48449, or phone (517)-288-5046.

**LARAMIE WY
SEP 9-10**

The fourth annual High Plains Ham Roundup will be held on September 9-10, 1983, at Yellow Pine and Pole Creek Campgrounds, Medicine Bow National Forest, 10 miles east of Laramie, Interstate Highway 80, Lincoln Monument turnoff. The campgrounds have been reserved for hams and their families. Bring your own food and drink and stay as long as you wish. Roast beef will be furnished for the potluck supper on Saturday evening. There will be a bluegrass band, a barbershop quartet, and a sing-along. Talk-in on 146.25/85, 146.22/82, or 146.52

simplex. For further information, contact Mick Marchitelli, PO Box 731, Laramie WY 82070.

**HAMBURG NY
SEP 9-10**

Ham O Rama '83 will be held on Friday and Saturday, September 9-10, 1983, at the Erie County Fairgrounds (Buffalo Raceway), Hamburg NY, just south of Buffalo NY. The hours on Friday are 6:00 pm to 9:00 pm and on Saturday, 7:00 am to 5:00 pm. General admission is \$3.50 in advance and \$4.00 at the gate. The inside flea market is \$10.00 and the outside flea market is \$3.00. Features will include new equipment, video, and computer displays, technical and non-technical programs, an auction, and a radio test bench. Talk-in on .31/.91 (W2EUP). For more information, contact N. Oldfield WA2ZSJ, 126 Greenway Boulevard, Cheektowaga NY 14225.

**JOHNSON CITY TN
SEP 10**

The Bristol, Kingsport, and Johnson City Amateur Radio Clubs will hold the 3rd annual Tri-Cities Hamfest on Saturday, September 10, 1983, at the Gray Fairgrounds, Gray TN, midway between the three cities and just off I-81. General admission is \$2.00 in advance and \$3.00 at the gate; flea market, \$5.00. Everything will be indoors and computer enthusiasts are welcome. For tickets or more information, write Tri-Cities Hamfest, PO Box 3682 CRS, Johnson City TN 37601.

**MOBILE AL
SEP 10-11**

The Mobile Amateur Radio Club will sponsor the Hospitality Hamfest on September 10-11, 1983, beginning at 9:00 am, at Al's Party Palace, 2671 Dauphin Island Parkway (1 mile off I-10). Admission is free. There will be XYL and YL activities, swap tables, adequate parking, reasonable overnight rates, and good food. Talk-in on 146.22/82. For more information, write Jim Wilder N4GUC, (205)-343-7365.

**WINDSOR ME
SEP 10-11**

The Augusta Emergency Amateur Radio Unit will hold the 1983 ARRL-sanctioned State of Maine Hamfest on Sep-

tember 10-11, 1983, at the Windsor Fairgrounds. The gate donation is still \$1.00 and camping is \$2.50 per night. Features will include a flea market, programs for all, speakers, commercial distributors, light meals, and the traditional Saturday bean and casserole supper. Talk-in on the 146.22/82 repeater or on 146.52. For further information, contact N1AZH, RFD #2, Box 3678, Greene ME 04236, or phone (207)-946-7557.

**MONETT MO
SEP 11**

The Ozarks Amateur Radio Society will hold the 2nd annual Ozarks Amateur Radio Club Congress & Swapfest on Sunday, September 11, 1983, beginning at 11:00 am, at the Monett City Park, junction of highways US 60 and MO 37, Monett MO (about 40 miles southwest of Springfield MO). There is no admission charge and no charge for swappers and tailgate traders (all space available on a first-come, first-

served basis). The picnic and social hour begin at 1:00 pm. Bring a single covered dish to the country-style picnic and share in the buffet. Clubs are urged to attend as a group with an intent to form an alliance to expand the event in future years. Talk-in on 146.37/97, 146.52, and 7.250. For more information, contact OARS, Box 327, Aurora MO 65605.

**BOULDER CO
SEP 25**

The Boulder Amateur Radio Club will hold its fall swapfest, Barcfest, on September 25, 1983, from 9:00 am to 3:00 pm at the National Guard Armory, 4750 N Broadway, Boulder CO. Admission is \$3.00 per individual or per family. There will be an indoor and outdoor flea market, a snack bar, and free parking. Talk-in on 146.10/70 and 146.52 simplex. For more information, phone Tim Groat KR0U at (303)-466-3733, or write 1000 East 10th Avenue, Broomfield CO 80020.

HAM HELP

I need service manuals for the HQ-129X and Lavoie LA-261 oscilloscopes, I will pay for copies.

John Poplawski WB2GFR
9 E. 15th St.
Bayonne NJ 07002

Wanted: tuning slug or L105 coil assembly for a Collins R388. I am also looking for coil-winding information for the 20- and 40-meter plug-in coils on a pre-WWII Meissner signal shifter.

Walt Hill NM6L
Rt. 2, Box 323 Aliso Circle
Bishop CA 93514

I am looking for the schematic and manual for the Collins 75-A3 receiver. I will pay a reasonable price for the original or copies, plus all postage costs.

Donald D. Kupferschmidt WB9YYA
3004 N. 70th St.
Milwaukee WI 53210

Does anyone have the manuals or schematics for a Gonset G-76 6-80-meter transceiver and a Signal Corps BC-659 transceiver? I will pay a reasonable price for copies.

Gene Smith KA6ZAH
PO Box 2403
Oroville CA 95965

I need the addresses for Jerold Antenna Corp., Galvin Antenna Corp., and Grundig Radio Corp. I also need manuals for the Eico 944, the Eico 625, the Jerold 704B TV SWR meter, the US army ME6 multimeter, the US army TS-155E/UP, the B & K TV analyst 1076, and the Grundig 3165U. I have an Eico 950B manual if anyone needs it.

Kevin Nea
Rt. A Box 221A
Flippin AR 72634

I am looking for modifications for the Davco DR-30 receiver. I would also like to purchase any Davco receivers, speakers, or power supplies in any condition.

Michael Crestohl VE2FW
PO Box 642
Victoria Station
Montreal, Quebec
Canada H3Z 2Y7

I need schematics for the following: KIN TEL model 301 voltage standard; RT-66 transceiver; BC-983-A VHF/UHF radio modulator; BC-638-A frequency meter with type 5004 monitor crystal; Nems-Clarke noise-factor measurement unit, type NTS-200; and Hickok VTVM, Navy Model OBG-1.

John C. White WB6BLV
560 North Indiana
Porterville CA 93257

I am trying to find any kind of information, including the manual, schematic, or even old ads, for the Hallicrafters FPM-200 transceiver. It is a solid-state rig made around 1959-60.

Hans Zimmermann HB9AQS
PO Box 50
CH-3780 Gstaad
Switzerland

PRESERVE

73 WITH



BINDERS & FILE CASES.

Keep your issues of 73 Magazine handy and protected in handsome and durable library file boxes or binders. Both styles are bound in red leatherette with the magazine logo stamped in gold.

File boxes: each file box holds 12 issues, with spines visible for easy reference.

\$5.95 each, 3 for \$17.00, 6 for \$30.00

Binders: each binder holds 12 issues and opens flat for easy reading.

\$7.50 each, 3 for \$21.75, 6 for \$42.00

(USA postage paid. Foreign orders must include \$2.50 per item.)

Please state years desired (1977 to 1984).

Send check or money order to:

Jesse Jones Box Corp., P.O. Box 5120, Philadelphia, PA 19141; please allow 6 to 8 weeks for delivery. Sorry, no C.O.D. or phone orders.

**this publication
is available in
microform**



University Microfilms International

300 North Zeeb Road
Dept. P.R.
Ann Arbor, MI 48106
U.S.A.

18 Bedford Row
Dept. P.R.
London, WC1R 4EJ
England

HAM HELP

We are happy to provide Ham Help listings free, on a space-available basis. We are not happy when we have to take time from other duties to decipher cryptic notes scrawled illegibly on dog-eared post cards and odd-sized scraps of paper. Please type or print your request (neatly!), double spaced, on an 8 1/2" x 11" sheet of paper and use upper- and lowercase letters where appropriate. Also, please make a "1" look like a "1," not an "l," which could be an "el" or an "eye," and so on. Hard as it may be to believe, we are not familiar with every piece of equipment manufactured on Earth for the last 50 years! Thanks for your cooperation.

A small group of Limassol amateurs is trying to organize a club station and attract young people to the hobby, but our own means are not sufficient to do so. We are making an appeal to amateurs worldwide for help, either in equipment or funds.

Aris Kaponides 5B4JE
Secretary, Limassol CARS Group
PO Box 1723
Limassol
Cyprus

I have an Osborne 1 computer and I would like to get on RTTY. Could anyone help me find software for it?

Orbra W. Bliss W9GEK/HC1BW
Box 3000
Opalocka FL 33055

I have an Eico model 324 rf signal generator kit. I would be very grateful if someone sent me the assembly manual, schematic diagram, parts list, or any other information about it.

Darshan V. Bhatia
6-3-345/3, Rd. No. 1
Banjara Hills
Hyderabad-500034
India

Telephone buffs: Could you assist me with schematics and data for GTE's telephone intercom, which uses an Orbit Industries PC board? The board is a DA-2. I am repairing the unit for a needy elderly couple.

J. F. Johnston W6ESK
14210 Douglas Lane
Saratoga CA 95070

I am writing this as a reply to the many hams who answered my ham help letter requesting diode ratings. I was very pleasantly surprised at the amount of replies I received. Thanks, fellows, for the wonderful turnout of mail and phone calls.

G. Kitts KA3IMO
38 Queenlily Road
Levittown PA 19057

I have a Sears model 412 3880 0700 (which was made by Yaesu a few years ago). I would like any modification infor-

mation to put it on 145-148 MHz. I am also looking for the external channel selector for it, model 3881. And if anyone can tell me about using the VIC-20 on SSTV, or video reception of satellite photos, please get in touch.

Ken Walker KA4WBR
Route 3, Box 97
Rocky Mount NC 27801

I'm looking for operation and maintenance manuals for the following military-surplus signal generators: TS-418/URM-49 (400 MHz to 1000 MHz) and TS-510A/USM-44A (10 MHz to 420 MHz). I will copy and return the manuals or pay a reasonable amount for your copying expenses.

Bruce A. Rahn WB9ANQ
410 Coronado Trail
Enon OH 45323

I need information on the PLL of the Icom 22. My unit drifts out of lock and returns, apparently from a thermal intermittent. I am also seeking any information

on redesigning the 22 for band expansions. Finally, does anyone have an EPROM substitute for the diode board?

I will gladly pay for copying or mailing costs.

Robert Palmer
Unit 705-So
520 Palm Springs Blvd.
Indian Harbour Beach FL 32937

I have a Pickering Radio Company model KB-1 CW keyboard, serial number 182. It works well except it makes a J when I press the 0 key. I do not have a schematic of the unit. Can someone help me?

John A. Barolet KJ3E
108 Elliott Court
California MD 20619

I need a schematic, power plug, and any information on a KLM 10-160BL 2-meter amplifier.

Tom Norris KA4RKT
Rt. #1 Box 412
Auburn KY 42206

CORRECTIONS

"Unleash the TS-900," which appeared on page 10 of the February, 1983 issue, should have been titled "Unleash the TS-9000"; in addition, Q8 in Fig. 4 was drawn with the collector and emitter leads reversed.

Avery L. Jenkins WB8JLG
73 Staff

On page 87 of the July issue, in "Down-Under Depth Sounder," the construction notes said that pins 8 and 16 of IC4 and IC5 should be soldered to the board last. Actually, these supply pins should be soldered first.

Avery L. Jenkins WB8JLG
73 Staff

TET ANTENNA SYSTEMS

SUPER HB9CV BEAMS THE BEST!

Only TET Gives You VSWR Of 1.5:1 Or Less Over The Entire Band. Phone or CW - The TET Covers It All Without A "Tuner". Rugged Construction - No Nonsense - No "Hose Clamps" - Yet Lightweight And Low Windload. TET's Dual-Drive Phasing System Offers More Gain... It's Like Adding An Extra Element! On The Air Performance? Ask a TET Owner. They Are Our BEST Salesmen!

NEW! 40 METER MONOBAND

HB40NL2

2EL - "TRAPLESS"
16'6" BOOM - 52 LB.
44' EL. - 6.5 dB GAIN
\$254.95

HB40NL3

3EL - "TRAPLESS"
33' BOOM - 81 LB.
44' EL. - 8 dB GAIN
\$379.95

HB9CV SUPER TRIBAND

HB33SP

3EL - 27 LB
13'2" BOOM
\$189.95

HB43SP

4EL - 38 LB
19'8" BOOM
\$249.95

HB35T

5EL - 50 LB
24'7" BOOM
\$349.95

Rotors - Thrust Bearings - Swiss Quads VHF UHF Discons - HF Verticals - Etc!

CASH - CHECK - M.O. - VISA - MASTERCARD
PLEASE INCLUDE UPS SHIPPING
TO ORDER, OR FOR COMPLETE CATALOG
CALL OR WRITE:

SULTRONICS

(513)376-2700

15 Sexton Dr., Xenia, Ohio 45385

The Spider™ Antenna

The modern multi-band mobile antenna —switch to 10, 15, 20 or 40 meters without stopping to change resonators.

Features of the Spider™ Antenna

- The Spider™ Antenna is less than six feet high and the longest resonator projects out from the mast 24 inches. This gives a slim profile, low height and light weight, offering little wind resistance and eliminating the need for a spring mount.
- Each resonator is tuned to the desired portion of the band by a tuning sleeve which slides over the outside of the resonator.
- SWR is approximately 1:1 at the selected resonant frequency.
- Base impedance approximately 50 ohms, requiring no matching network.
- Ideal for use on vans, campers, motor homes, travel trailers; also in mobile home parks, apartment houses and condominiums.

The Spider™ Adapter converts any mono-band antenna with a half-inch mast into a modern four-band antenna.

The Spider™ Maritimer™ is the ultimate for marine use. Made of non-magnetic stainless steel and nickel-chrome plated bronze, using regular Spider™ resonators and tuning sleeves.

Accessories — Bumper, ball, angle and stud mounts. Quick disconnects. RG-58A/U coaxial cable and connectors. Ground radial systems. Copper foil and copper braid ground straps.

For further information, prices write or call

MULTI-BAND ANTENNAS

7131 OWENSMOUTH AVENUE, SUITE 463C
CANOGA PARK, CALIF. 91303
TELEPHONE: (213) 341-5460

HOT ROD ANTENNA

Achieve 1 or 2 db gain over ANY 1/2 wave two meter telescopic antenna. The AEA model HR-1 Hot Rod™ antenna was designed by Dr. D.K. Reynolds (designer of the IsoPole) to deliver maximum performance for any hand-held transceiver with a BNC fitting.

The factory-tuned HR-1 is 20% shorter, lighter and places far less stress on your hand-held connector and case. It will easily handle over 25 watts of power, making it an excellent emergency base or mobile antenna. In the collapsed position, the Hot Rod antenna will perform like a helical quarter wave.

The Hot Rod antennas can be expected to make the same improvement to hand-held communications that the IsoPole brand antennas have made to base station operations. Why pay more when the best costs less?

Prices and Specifications subject to change without notice or obligation.

ADVANCED ELECTRONIC APPLICATIONS, INC.

P.O. Box C-2160,
Lynnwood, WA 98036
(206) 775-7373

Telex: 152571 AEA INTL

AEA Brings you the Breakthrough!

CIRCUITS

Do you have a technique, modification, or easy-to-duplicate circuit that your fellow readers might be interested in? If so, send us a concise description of it (under two pages, double-spaced) and include a clear diagram or schematic if needed.

In exchange for these technical gems, 73 offers you the choice of a book from the Radio Bookshop, to be sent upon publication. Submit your idea (and book choice) to: Circuits, Editorial Offices, 73 Magazine, Peterborough NH 03458. Submissions not selected for publication will be returned if an SASE is enclosed.

WARPING ZENER VOLTAGES TO AN EXACT VALUE: Most people think of a zener diode as being a fixed reference voltage, perhaps containing some tolerance around the nominal voltage, but fixed nonetheless. In fact, a zener's voltage is rather dependent upon the current flowing through it. By varying the zener current, the reference voltage can usually be varied by about 10 percent. For example, a nominal 12-V, 1-W zener diode (1N4742) can be set to any voltage between about 11.5 and 12.5 V. Thus, by using a combination of zener and potentiometer, a very precise reference voltage can be obtained. However, this is a relatively high impedance source and loading will change the zener voltage.—Craig Crichton K7UKW, The Dalles OR.

VARIABLE SIDETONE FOR THE HW-101: This circuit adds a separate volume control for the 101's CW sidetone. Remove C311 and use the mounting holes to connect the additional components to the board. The value of the capacitors is not critical; any combination between .002 and .005 uF should work.—Vernon Henry, Manchester NH.

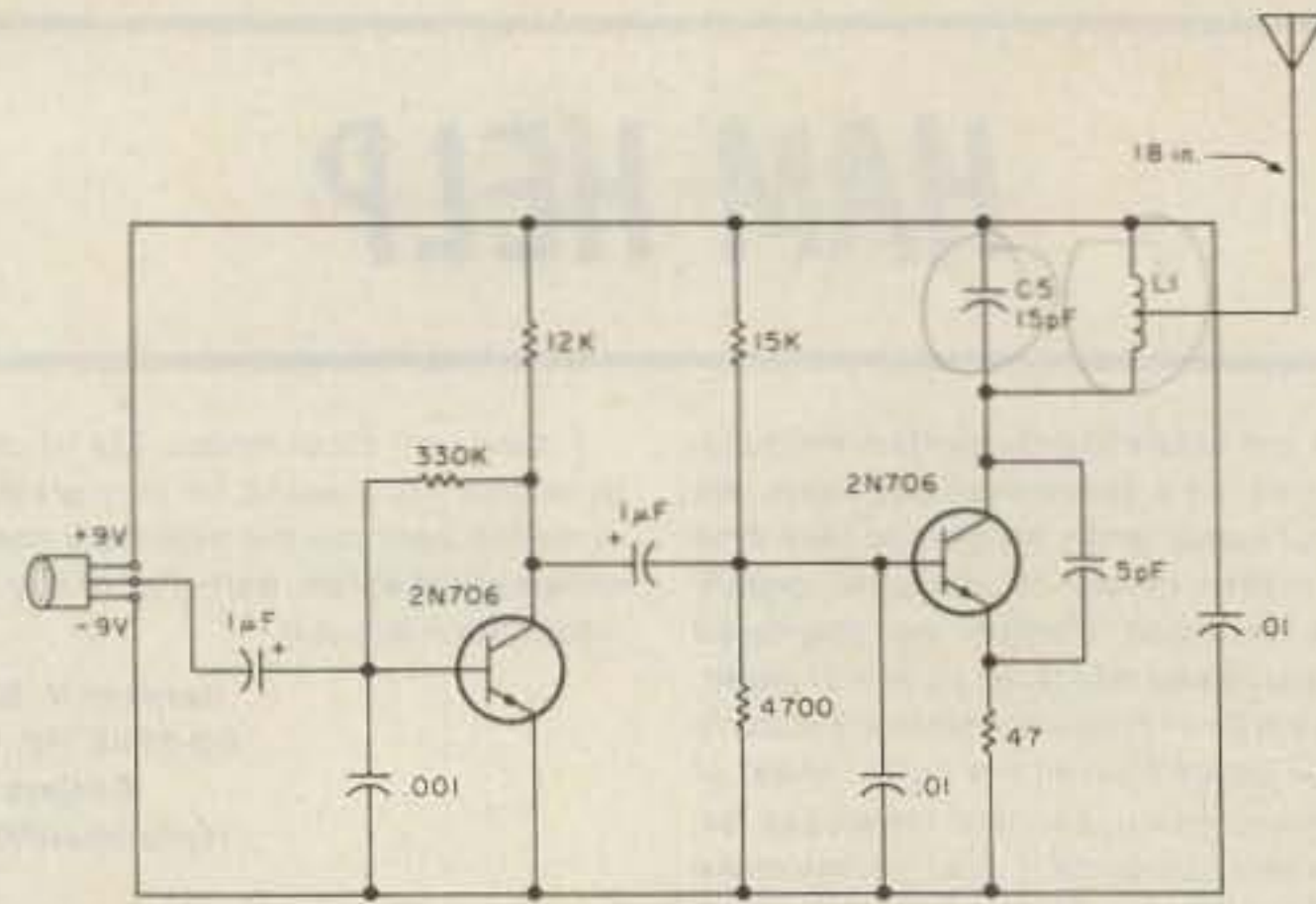

SIMPLE FM TRANSMITTER: This transmitter can be tuned to the FM broadcast band, 2 meters, or other VHF bands by changing C5 and L1. The values given for C5 and L1 will place the frequency somewhere in the FM broadcast band. L1 is 4 turns of #20 enameled wire airwound, 1/4 inch in diameter, 5mm long, and center-tapped. The microphone is an electret type and the antenna is 18 inches of any type of wire. Keep all leads as short as possible to minimize stray capacitance. The range of the transmitter is several hundred yards.—James Kretschmar N4HCJ, Huntsville AL.

MEMORY POWER SUPPLY FOR THE ICOM IC-720A: The IC-720A memory for both vfo's can be powered by the Radio Shack

9-V-dc Battery Eliminator (cat. no. 270-1552). To interface the supply to the rig, cut off the snap connector of the Battery Eliminator and replace it with a phono plug with the positive lead going to the center conductor of the plug.—Charles Hall N4ESJ, Sterling VA.

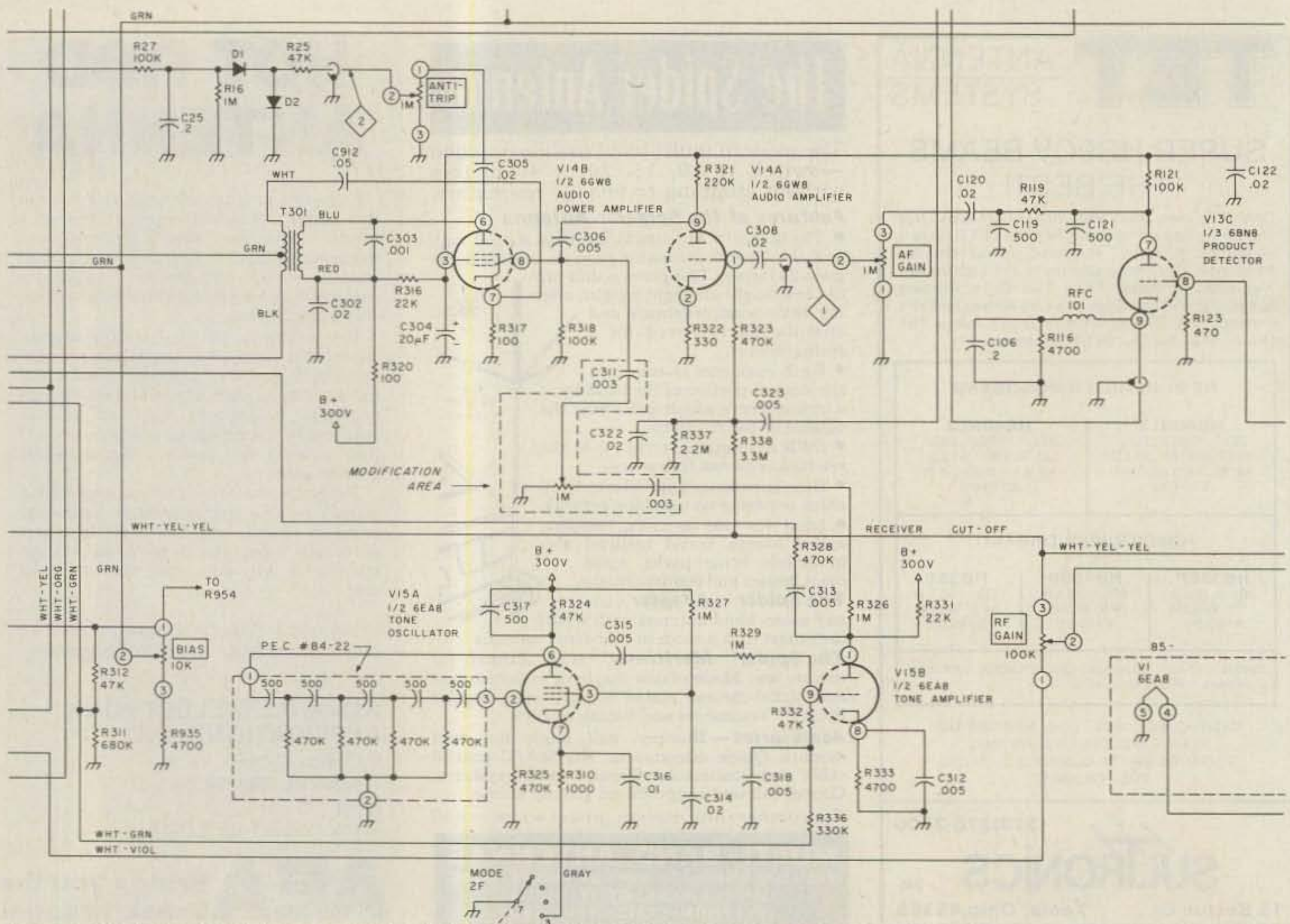

Radio World

CENTRAL NEW YORK'S MOST COMPLETE HAM DEALER



Featuring Kenwood, Yaesu, Icom, Drake, Ten-Tec, Swan, Dentron, Alpha, Robot, MFJ, Tempo, Astron, KLM, Hy Grain, Mosley, Larsen, Cushcraft, Hustler, Mini Products, Bird, Mirage, Vibroplex, Bencher, Info-Tech, Universal Towers, Callbook, ARRL, Astatic, Shure, Collins, AEA. We service everything we sell!

Write or call for quote. You Won't Be Disappointed.

We are just a few minutes off the NYS Thruway (I-90) Exit 32

OUT OF STATE
ORDER TOLL FREE
800-448-9338

ONEIDA COUNTY AIRPORT TERMINAL BUILDING
ORISKANY, NEW YORK 13424

Warren - K2IXN
Bob - WA2MSH
Al - WA2MSI

... at last ... your shack organized!

A beautiful piece of furniture - your XYL will love it!

\$184.50 S-F RADIO DESK

Deluxe - Ready to Assemble

Designed with angled rear shelf for your viewing comfort and ease of operation.

FINISHES: Walnut or Teak Stain.

Floor Space: 39" Wide by 30" Deep

Additional Information on Request.

Checks, Money Orders, BankAmericard and Master Charge Accepted.

F.O.B. Culver City. (In Calif. Add 6% Sales Tax.)

DEALER INQUIRIES INVITED

S-f Amateur Radio Service



Radio equipment not included

Also Available
Floor Space: 51" Wide by 30" Deep

\$199.50

4384 KEYSTONE AVENUE • CULVER CITY, CALIF. 90230 — PHONE (213) 837-4870

RF TRANSISTORS

FRESH STOCK - NOT SURPLUS

2-30 MHz					
P/N	Net	Match/Pr	P/N	Net	Match/Pr
MRF412	\$18.00	\$39.00	MRF455	\$13.50	\$30.00
MRF421	27.00	58.00	MRF455A	13.50	30.00
MRF450	12.50	28.00	MRF458	18.00	40.00
MRF450A	12.50	28.00	MRF492	20.00	43.00
MRF453	15.00	33.00	SRF2072	15.00	33.00
MRF435A	15.00	33.00	SRF2769	15.00	33.00
MRF454	16.50	36.00	CD2545	18.50	40.00
MRF454A	16.50	36.00	CD3424	19.00	41.00

High Gain Matched Pairs & Quads Available

P/N	Net	P/N	Net
MRF406	\$14.50	MRF475	\$ 5.00
MRF422	39.50	MRF476	3.50
MRF433	14.50	MRF477	13.00
MRF435	42.00	SD1407	37.00
MRF449	14.50	SD1487	28.00
MRF449A	14.50	S10-12	14.50

VHF & UHF TRANSISTORS

Type	Mount	Rating	MHz	Net/ea.
MRF238	(s)	30W	145-175	\$13.00
MRF240	(s)	40W	145-175	15.00
MRF245	(F)	80W	130-175	27.00
MRF247	(F)	80W	130-175	27.00
MRF492	(F)	70W	27-50	20.00
SD1416	(F)	80W	130-175	29.50
SD1477	(F)	125W	130-175	37.00
SD1441	(F)	150W	130-175	83.50
2N6081	(s)	15W	130-175	7.75
2N6082	(s)	25W	130-175	9.75
2N6083	(s)	30W	130-175	9.75
2N6084	(s)	40W	130-175	12.00
2SC1955	—	1W	130-175	15.00
2SC2289	—	5W	130-175	20.00
MRF641	(F)	15W	430-470	18.00
MRF644	(F)	25W	430-470	21.50
MRF646	(F)	45W	430-470	24.50
MRF648	(F)	60W	430-470	33.50

Technical Assistance and cross-reference information on CD, PT, RF, SRF & SD PIN's. Call our Engineering Dept. (619) 744-0728

WE SHIP SAME DAY C.O.D. or VISA/M.C. Minimum Order \$20.00 Add \$3.50 Shipping RF Parts Catalog Avail. OEM & Quantity Discounts ORDERS ONLY: 800-854-1927



WESTCOM

1320 Grand Ave. San Marcos
California 92069 (619) 744-0728

MEASURE MORE WITH YOUR DMM

\$14.50

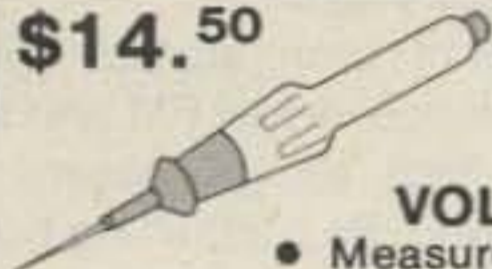

MODEL P1 X10 HIGH VOLTAGE PROBE

- Measures up to 10,000 volts
- 90 Megohms in probe works with 10 Megohm meters to divide voltage by ten.
- 1% accuracy
- Safe operation with insulating probe of high impact plastic

\$12.50

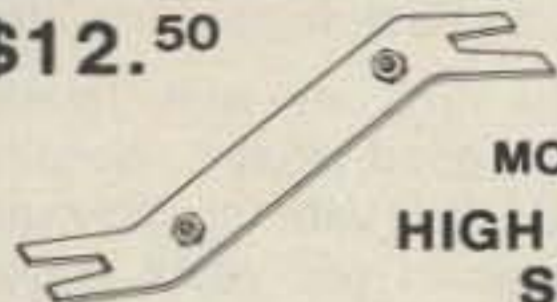

MODEL M2 HIGH CURRENT SHUNT

- Measures to 400 amps intermittently, 50 amps continuously.
- Manganin alloy for stable 1% accuracy
- Measures AC and DC currents
- Direct reading .001 ohm shunt, each millivolt read by DMM is one ampere
- Meter probes plug into jacks in the shunt
- Shunt attaches to binding posts and to car battery terminals

ORDER FROM

SCIENTIFIC INSTRUMENTS

3379A Papermill Road
Huntingdon Valley, PA 19006

ADD \$2 FOR SHIPPING AND HANDLING

Homebrew Headquarters

PROJECT PACKS*

DIRECT from ENGLAND

2 Meter Converter R & EW 10/81
Low noise 144-146 to 28-30 MHz
MOSFET Converter \$37.50

2 Meter Pre-Amp. R & EW 4/82
Gain 22 db, BW 6 MHz, NF > 1.5 db,
Z_i/Z_o 50 Ω \$6.50

2 Meter GaAs Pre-Amp. (Mast Head Mount w R/T relay) R & EW 10/82
Gain 17 db, BW 6 MHz, NF > 1.0 db
Z_i/Z_o 50Ω \$123.50

UHF (70 CM) Converter R & EW 11/81
Low noise 432-434 to 28-30 MHz
MOSFET Converter \$38.50

UHF (70 CM) Pre-Amp. R & EW 3/82
Gain 13 db, BW 20 MHz, NF > 2 db,
Z_i/Z_o 50 Ω \$9.50

23 CM Converter R & EW 3/82
Low Noise 1240-1325 MHz to 2 or 10
Meter Converter \$43.50

Air Band Receiver R & EW 9-10/82
108-136 MHz, 720 Channel Synthesized
VHF AM Receiver \$162.00

FET Dip Oscillator Rad Com 11/81
1.6 - 215 MHz (includes tone dip feature) \$52.50

*US Distributor for RADIO & ELECTRONIC WORLD

Catalog 50 cents

RADIOKIT

Box 411S, Greenville, NH 03048
(603) 878-1033

AMATEUR MICROWAVE TV ANTENNA'S

1.9 to 2.5 GHz Frequency Range
50 db System Gain

Complete System (Rod Style as pictured, 25 db Gain)

PS-3 \$69.95

Complete System (Dish Style as pictured, 50 db Gain)

PS-5 \$109.95

All systems come complete with Accessory package of

- Control Box
- 60' Coax Cable
- Mounting Hardware
- Matching Transformer
- Instructions
- 90 Day Warranty

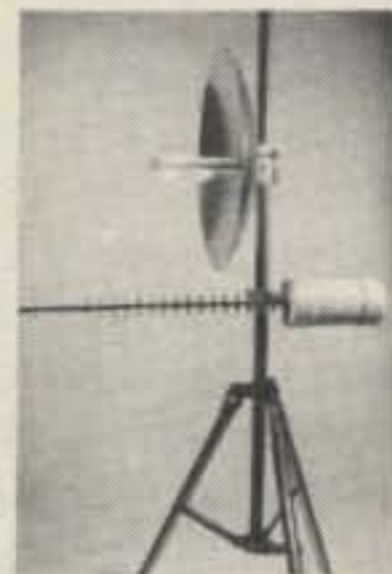

S.E.I. Inc.

912 West Touhy Avenue
Park Ridge, Illinois, 60068

Out of State Call 1-800-323-1327

In State Call 312-564-0104

C.O.D.'s Accepted • Special Quantity Pricing
Dealers Wanted



W2NSD/1 NEVER SAY DIE

editorial by Wayne Green

from page 6

recorder is opening up the unwanted television transmitting hours to prime-time watching via delayed viewing, we amateurs might start thinking in terms of sending messages to friends rather than actually talking with them. Our soon-to-come satellite will work this way. We'll send a message to it which will be stored and then, as the satellite circles over Bangkok, say, it can be dumped upon demand.

The cost and bother of writing letters is a limiting factor, but if we could keep in touch every day or so with a hundred friends via amateur radio messages, messages which would be delivered error-free and without fail, I wonder how we would look at our hobby. The DXpedition in Burma could be reached via messages which would be queued up for them, each then answered and confirmed.

Or perhaps you're willing to fight to death to keep amateur radio the way it is today... virtually unchanged in the last 50 years. I've enjoyed what we've had, but I'm looking for change... for faster, surer communications. I'd love to swap messages with old friends... Eddie W2OCL, Frankie W2OCM, good old Walt W2LBF, Frank W6AOA, Reg W6ITH... old ham friends from places where I've lived, such as Sarasota, Hampton, Brooklyn, Troy, Dallas, Cleveland... hams from countries I've visited all around the world. It's a real bear finding Paul 9M8PW on the bands in the few minutes a week I have available, yet I'd like to keep in touch without the dollar or so postage and three weeks for airmail to Borneo.

We'll see what comes of the latest FCC effort toward deregulation. I'm certainly behind them 100% on this one.

POTENTIAL GROWTH

Should my modest concept of having a ham club in every school in the country come about (and I think it can be

swung), there is going to be some demand from this program for assistance from existing ham clubs... a need for information to help faculty advisors cope and a need for beginner-type study courses.

For starters, I'd like to devote at least a page of 73 each month to a message of inspiration for potential club members, something which might be posted on the bulletin boards of schools along with meeting notices. You can help with this. You can help a lot, actually. Sure, I can write little messages telling about the fun I've had in amateur radio, but I'm just one of over a million hams around the world, so every possible experience I've had has been eclipsed a hundred or thousand times over... if you'll think about it and write.

I'd like to have some of your stories telling us why you enjoy amateur radio. I'd like to hear about some of the things which have been exciting to you about the hobby. I'd like to hear how it may have helped you in some way. I know that ham radio saved my life once and the lives of a whole bunch of my friends. There are stories in every ham... and some of them are very exciting. Let's get them told and see if we can use the enthusiasm that you and I have built up for this wonderful hobby to spark interest in yet another generation of hams. We need them.

There are fascinating stories of DXpeditions, of moonbounce operations, of contest operations, of getting medicine to some remote spot of the world to save a life, of rescue at sea... and all of these can be translated into what are almost typical personal experiences as examples of what amateur radio has to offer the newcomer.

Sure, I can write about those bitter cold nights on top of the local mountain, Mt. Monadnock, trying to establish contact with WA1KPS with an experimental 10.5-GHz transceiver. I had to have it pointed in exactly the right direction and be tuned to

exactly the right frequency at the right time to make it go. I stood there in the cold framework of a fire tower with the wind whipping me into numbness, holding onto the transceiver so the wind wouldn't whip it off into the night and aiming its little horn antenna hopefully in the right direction, a flashlight cradled by my head against my neck to light up the dials. I'm not sure why such misery is fun, but it sure is.

I remember the night when I was on my first DXpedition. We were sailing toward Navassa Island from the Bahamas and were in the grips of a fierce storm. It was pitch black and the ship was rolling almost beyond recovery every now and then. I'd been on watch all night because no one had dared to try to get up to the bridge in the storm. The captain was there, convinced that the black mass looming ahead was just another inky cloud, while I was sure it must be land. Just moments before we would have crashed on a reef offshore of the island, I spotted a small light, convincing the captain that perhaps it was not a cloud.

Then there's the time two other hams on a trip with me came within minutes of being killed by the Shifta tribesmen of Somalia when we were driving in the great Rift Valley in the Kenya desert. But was that any more exciting than sitting in Puerto Rico and hearing ham signals bouncing off the moon on 1200 MHz from all around the world... and working them?

Your stories don't have to be dramatic; we just want to know what it is about amateur radio that makes it such an important part of your life. My own life is riddled with it. So, probably, is yours. What gets you? Is it traffic handling? Contests? Certificates? Outdoing others with over-the-air filth? Jamming repeaters? DXing? Eyeball nets? Hamfests? Dig down in your memories and give me the material to fire the imaginations of a million kids... two million. And please double-space it, okay?

JOBS AND CAREERS

Back in 1960, one of the kindest people to me that year was the publisher of CQ who fired me. I was at a loss for a few months, looking around for what to do next. I tried an ad agency and hated it. The idea for

a new ham magazine devoted to building small construction projects was eating at me, but it takes a bundle of money to start a magazine and I had no big bundle.

Efforts at firing the enthusiasm of a couple of hams with money came to naught. So, despite my involvement with putting on a Hudson Amateur Radio Council convention in New York, getting Mensa started, being involved deeply with car rallies as president of the Porsche Club, and so on, I decided what the hell and got 73 Magazine going. The work started in May and the first issue came out in October. Fortunately, it was in the black and the long haul toward success was started. I'd sold off everything I could to get things going... my boat, plane, horse, one of my Porsches—anything which would bring in some money.

Just as the magazine was really getting going (in 1963), the "Incentive Licensing" debacle hit and within a couple of years 80% of the ham dealers in the country were out of business, taking away both the counter sales of the magazine and a lot of advertising. Then virtually every major manufacturer went either out of business or into something else. We got down to about five people to survive those hard years.

It wasn't until around 1970 and my discovery of FM and repeaters that things began to turn around. By publishing hundreds of articles, organizing FM symposiums, putting out a dozen or so books on FM and repeaters (even a special *Repeater Bulletin*), I began to build up interest in this activity. QST, CQ, and Ham Radio either fought me or were indifferent to FM, so I got no help from them.

By 1975, we were finally in fairly good shape, despite a hard battle with the IRS over expenses of ten years previous. This was when we started *Byte*... only to have it disappear in the middle of the night after a few months of getting an incredible start. Bent, but not stopped, as they say, we worked hard to pay off the mountain of bills left by *Byte* when the magazine left, taking its fat bank account with it. As soon as we could, we started *Kilobaud Microcomputing*, which took off fine. That was in January, 1977. In 1978, we started our Instant

Software division with one technician working out of the potato cellar. That grew to where we had to get a whole building for it...our Elm Street building.

By 1980, we'd seen the growth of the TRS-80 and figured that we'd try something new: a system-specific magazine (*80 Micro*). It was a first and started off with 132 pages. By the end of the first year, it was up over 400 pages!

By late 1981, we were able to get *Desktop Computing*, a magazine in plain English for the businessman, going. And then a year later, *inCider*, our Apple magazine, was up and running, following the same successful path of *80 Micro*.

All this meant more people, more buildings, and a development of our management team. Almost everyone coming into Wayne Green Inc. started out from the bottom, learning from those already here and then working on up into management.

Now the growth is picking up. This month we started *Hot CoCo* for the Radio Shack Color Computer, and we have a growing number of new publications in the planning stages. We're even thinking of getting into a new-magazine-a-month mode by next year!

There are plans for developing a college, a combination high tech and business college. We're working toward a possible television station. We're going to be expanding our book department substantially... and so on. All this means, of course, that we're going to be needing a lot more people to help with the growth.

At present, we have about 250 people. In a year, I think we'll be running about double this... and double again within another year. This means that we have an awful lot of good hot career spots open for people interested in working in magazine publishing, education, graphic arts, data processing, writing, editing, technician work, programming, sales, marketing, sales force managing, circulation, writing up new products, and so on. No, we don't have a lot of spots for top management. We're both lean on management and primarily interested in developing managers from our own ranks so they will know what we're doing and how it all fits together. Oh, we'll be

needing some experienced people to help get completely new projects going.

While most of our development will be in New Hampshire, we are going to test out an idea in Boston and see if it flies. If so, we may be looking for teams in every major city around the country to work on similar projects. And if the pilot project college is a success, can there be college franchises?

One of the best things about our success has been the fun involved. The people working here have been having a fantastic time. Ideas are constantly springing up for new divisions of the business...new publications...promotions.

So, if you're looking for a career, what we're doing up here in New Hampshire may be what you're looking for. You can't find a better place in the country to live and work. No, we still don't hire smokers, so our air is crystal clean. Even if you've quit smoking recently, please don't call, okay? We want people who are not addicted to drugs... even tobacco. We have beauty in our mountains, the lowest taxes in the country, surprisingly low-cost housing, and a quality of life that California only wishes it could provide.

Readers with small high-tech firms should start thinking in terms of an eventual move to New Hampshire. I'm aiming at starting a high-tech industrial complex which will have a good low-cost pool of high-tech youngsters available to work at product design, production, programming, sales, and so on. You'll have a chance, once we get going, to get the cream of the country's brains, helping them to train for life and getting their enthusiasm at bargain rates.

Keep thinking about this. I'll have more news as we move ahead.

WWII FINAL BATTLE WON!

A card from Joe Vegh W5VSV of Corpus Christi put things into an interesting perspective. He says, "Dear Wayne: Sorry about your undying love affair with the Nipponese! I'll straighten screws, glue on decals, touch up paint, and complain like hell to the manufacturer, but I will not knowingly buy Nipponese products unless there is no other choice *and* I need the products. It is a sorry thought indeed that

our government purchases products from a nation which caused us so much pain! The final battle of WWII is now in progress!"

Amen! Yessir, I got to thinking about Joe's position on this and as a veteran of WWII, I can see where he's coming from. Those Nipponese worked hard and long to try to kill me during the war, and they did manage to polish off about 20% of my shipmates in American submarines. When I look back at the trouble the Japanese caused (and the Germans and the Italians), why, it makes my blood boil.

And just a generation earlier, those Germans, along with the Austrians, Hungarians, and so on, were out there killing my parents' friends. These are things that we probably should not forget when we are shopping and thinking in terms of a Porsche car or even a German meal. But that isn't the end of it by any means, because when I look back in my genealogy books, I find that a surprising number of my ancestors were being fought by the British in the revolution. I wish I'd thought of that when I was shopping for a Jaguar car a couple years ago. Those English scoundrels killed tens of thousands of pioneer Americans.

And what about the rebs in the Civil War? You can bet that the next time I see a southern fried chicken franchise I am going to turn and head the other way. Just think of the thousands upon thousands of Yankee youngsters that were slaughtered by the rebels!

And how many of you have forgotten the Alamo? Should we casually forget the brutal killing of our patriots in San Antonio...and not all that long ago, either? I'll bet that if Joe thinks about it, he'll be right out there on the Rio Grande with a machine gun wiping out the wetbacks who are infiltrating our country and taking away the low-paying jobs from our inner city illiterates.

Perhaps we should think more in terms of blacklisting businesses who consort with our known enemies. We're already doing this to some extent with firms who are doing business in South Africa, and they haven't even fought a war against us yet! The Arabs have blacklisted firms doing business with Israel, such as Coca Cola; you get Pepsi in most Arab

countries. Well, I want you to remember the next time you see a McDonald's that they have branches in Germany, Italy, Japan, Britain, and so on. The same goes for the southern fried chicken chain.

The brutal fact is, if you look at it, that about the only major country in the world we haven't had a war with is Russia. That's something to think about when you are looking to see where your real friends are, isn't it? You know, thinking about that, the fuss over the huge American military budget (which is mostly to threaten Russia), and the growing groups against nuclear weapons, perhaps we could make everyone happy with one simple change. I know this is a daring thought, but it seems to be the direction that the nuclear opponents and disarmament groups are headed—what if we just turned America over to Russia?

With the US and the USSR together, we could take over every other country in the world in a couple of years, setting up a real world government. Then, without the need for military spending by *any* country and an end to coups in the erstwhile Third-World countries, we could all work toward getting enough food to feed everyone.

We hear a lot about Hitler killing twelve million people during the war, but we don't hear so much about the even greater number that Stalin wiped out to consolidate his power. With such ruthless control from Moscow, we might see countries like India cut back in population to a more controllable number. The Russians have managed to get used to communist rule and the slave labor camps that go with it, so we probably could, too. I'm sure that many people would prefer that problem to a nuclear war...right? Heck, we have people ready to die to fight nuclear power plants!

Without the need to support a monster military-industrial complex, I'll bet we could most of us go back to farming, cultivating a small plot of land and taking it easy. We wouldn't have to work so hard to support the government bureaucrats...which is taking over one third of our work these days, as I recall. We could get rid of our computers, most of our telephones, throw out the television, and go back to

the simple life of a hundred years ago.

Isn't it interesting what creative thoughts a new point of view can generate?

SCI-FUN

With the awakening interest in science, there may be an opportunity for all you ex-science teachers who have gone on to greater earnings in industry to reap some benefits. Just because you are making a lot better living in the electronics industry doesn't mean that you can't still teach...and make more than ever.

My utopian view of the ideal teaching system encompasses the concept of learning being fun. It has to do with people learning under their own steam instead of the system I grew up under: slavery. Yep, I'm looking forward to the emancipation of kids. I *had* to go to school every day. It was the law. There was no free will about it.

Now that there seems to be a sprinkling of parents who are becoming aware that educators have been going with the flow, making more and more of our government-run educational system plain vanilla, perhaps it is time for an alternate approach, at least as far as science education is concerned. I have the concept for a series of books which would make science

fun...not only for kids, but for anyone interested in taking a few hours away from Monday Night Football, M*A*S*H reruns, and other prime-time garbage which lines our way from the crib to the coffin.

If you think you're a good enough writer to put together a book which will cover some particular aspect of science and do it in both an entertaining and informative way, start outlining what you have in mind, write a first chapter, and let's see if we might be in business.

THE AGONY OF DEFEET

In amongst all of the usual bad news (which must sure be popular since there is so much of it) was a news flash of particular interest to me. It had to do with a recent medical breakthrough to the effect that flat feet are now being considered as normal.

When I was young, having flat feet was on a par with the heart-break of psoriasis. I had 'em. I mean that my footprint in the locker room coming out of the shower was square. I had no detectable arch at all. Well, I suppose the flat feet went well with my knock knees.

Those damned arch-support shoes may be okay for people with weak arches, but they are terrible for people with perfectly good, though flat, arches. The

foot experts did everything they could to get my flat bones to arch, adding a good deal of extra pain to my already painful teen years.

When I was twenty, the government decided that there really was not going to be any way to bring the great war to a successful conclusion without my full cooperation. They reasoned with me about this with draft notices, but I escaped death in the trenches by joining the Navy. Well, with flat feet I figured I probably could swim better than I could walk.

Already being a ham at the time, I opted for their radio technician training, which turned out to be incredibly good, truly an anomaly for the government. After nine months of this training, it was time to go into the fleet. Since I'd have the best chance to be my own boss on either a submarine or a destroyer, the extra pay and the special food you get on submarines swung it that way. I volunteered.

They have a tough physical for the submarine service. I was sent down to be checked out. I sat there with all the others, memorizing the eye chart. But when it came my turn, they said "too fat; next."

Not to be dumped out of submarines that easily, I pressed them. How much overweight

was I really? They grudgingly looked it up and said I was eight pounds overweight. This was Friday, so I asked if I came back Monday eight pounds lighter I'd pass. Sure.

Early Saturday morning, I was out on the grinder running. I then went over the damned obstacle course four times. Then I changed into my liberty clothes and headed for San Francisco, where I walked miles, ending up at a steam bath. I steamed for hours, the sweat pouring off.

By Monday morning, I was almost totally exhausted. I'd had nothing to eat since Friday and hardly anything to drink. I dragged myself into the sick bay examination room and presented myself for weigh-in. Sure enough, I was ten pounds lighter! The doctor was not terribly impressed. He took another look at me and said, "You're disqualified for submarine duty because you have flat feet."

I was furious as well as incredibly tired as I staggered back to the school. When I got there, they asked me if I'd passed the submarine physical. I said sure, and that was that. As the depth charges dropped around us off the coast of Japan, I looked at my medical records where it was clearly stamped in red: **DISQUALIFIED FOR SUBMARINE DUTY.**

DX

Chod Harris VP2ML
Box 4881
Santa Rosa CA 95402



The Cheynes II, a former whaling tender, carried the Heard Island DX Association 15-member team to and from Heard Island.

THE HEARD ISLAND STORY

This year, DXers have enjoyed not one but two successful DXpeditions to tiny, frozen Heard Island in the southern Indian Ocean. The "Heard Island Expedition" won the race to Heard (see this column, January, 1983) with VK6FS first in the VK0CW logbook on January 22. Jim Smith's "Heard Island DX Association" group arrived soon thereafter, and for a few days, DXers worldwide had a choice of Heard Island stations to call. Despite poor band conditions, by the time bad weather forced the two groups off Heard, DXers had made about 45,000 QSOs with the DXpeditioners.

A few months later, the primary operators of both Heard Island DXpeditions met at the International DX Convention in Visalia, California, and at the Dayton Hamvention in Ohio in April.

Al Fischer K8CW Heard Island Expedition

On the last day of December, 1982, the Heard Island Expedition departed Perth in western Australia for Heard. For two and a half weeks the expedition yacht, the *Anaconda II*, battled the winds and seas of the notorious southern Indian Ocean before making landfall at Kerguelen Island, about 300 miles north of Heard. The winds blew out 25 sails during the passage, and the DXpedition generators got a good workout supplying electricity to the sewing machines repairing ripped sails. Any expedition member venturing out on deck

kept a safety line firmly attached to the boat, as the rough seas made falling overboard an ever-present concern.

The *Anaconda II* reached the comparative calm of Atlas Cove on Heard Island on January 21, but the amateur radio operators learned that the old radio towers hadn't survived the last winter. The DXpeditioners appropriated one of the best-preserved of the numerous shacks abandoned 30 years ago. The tribander and vertical went up, the Icom transceivers were connected up to the amp supply linears, and VK0CW went on the air.

At first, Al couldn't raise a pileup from Heard. Simultaneous pileups on Chad, China, and others made DXers overlook the comparatively weak signal out of the Indian Ocean. Al finally got the contacts rolling, however, and, with the help of Dave VK3DHF, made more than 30,000 contacts in the next month.

The Icoms survived the harsh environment faultlessly, and even the tribander outlasted all but the strongest winds. Unfortunately, propagation on the higher bands was poor. 20 and 40 meters provided most of the contacts, and a beacon on 6 meters went unanswered the entire trip. Al found California DXers hardest to work, since the radio path to California passed directly over Europe, and he couldn't get European DXers to stand by during the short propagation window to W6.

The stay on the island was not without its hazards. A constant wind blew fine vol-

canic sand into everything: sleeping bags, food, clothing. It was so cold that Al left the amp supply linears on all the time, for warmth, even though Australian regulations prohibit the use of linears on CW. The DXpeditioners also provided communications for the mountaineering group tackling Heard's volcanic peak, Big Ben. This short-range communication task forced the amateurs off the DX bands during some of their best propagation, as the generators had to be turned off. Perhaps worst of all, the amateurs had only 2 cases of beer to last 6 weeks!

Between stints at the radio, the DXpeditioners assisted some of the scientists on the expedition with their research. Since the largest plant life of the island is no bigger than a cabbage, scientific interest centered on an abundant bird population and the colonies of elephant seals. So when Al wasn't handing out Heard Island contacts, he was chasing (and tackling!) penguins for blood samples!

VK0CW lost the triband beam in a hurricane, but it was a tribute to the advance planning that the expedition had so little trouble. The tribander was equipped with newly-machined parts, since regular hardware would have had little chance against Heard's hostile climate. The expeditioners even spent a night in a deep freeze in Australia, testing their tents and sleeping bags against the anticipated harsh weather.

Jim Smith VK9NS— The Heard Island DX Association

Meanwhile, Jim Smith's group was having transportation problems. Their chartered ship, the *Cheyne II*, had to put back into port twice, putting the group behind schedule. By the time the 15 members of the Heard Island DX Association DXpedition landed on Heard, the Heard Island Expedition had been on the air for more than a week. And this was just the start of Jim's troubles.

The first group grabbed the best of a sorry lot of abandoned shacks at the Atlas Cove landing site. Jim Smith's group had to set up shop as far away as possible, to avoid mutual interference, but the remaining shacks were uninsulated and doorless. The hard ground made driving guy stakes almost impossible, and their Minooka Special didn't even last the first night. The 3-element monobanders for 10 and 15 were useless, with the low maximum usable frequencies. Intermod problems between the two DXpedition stations, less than a half-mile apart, kept the two groups from operating 20 meters at the same time. At times, Heard Island transmitters sat idle, with no one calling!

Weather conditions went from bad to worse on Heard. The barometer plummeted as a hurricane lashed across the island. The Heard Island Expedition, whose mountaineering team had reached the top of Big Ben, packed up their gear and boarded their ship for the sail back to Australia. The high winds and waves forced the *Cheyne II* to fire up its boilers, to avoid being dragged onto the rocks. But the *Cheyne II* was critically short on fuel from its long, upwind trip to Heard. So once the engines were started, the Heard Island DX Association group was forced to curtail operation, leaving Heard after only 14,000 contacts. But the storm did further damage. *Cheyne II*'s motor launch, used to ferry personnel and equipment between ship and shore, sank in the heavy seas. The Heard Island DX Association mountaineering team, thwarted in their attempt to climb Big Ben by, of all things, too warm weather (4-5 degrees Celsius—about 40° F.), was trapped on the other end of Heard, with no way to get

to the *Cheyne II*. The *Anaconda II* loaned their inflated Zodiac tender to rescue the stranded climbers.

Even the return trip was not the easy downwind sail predicted. The *Cheyne II* was so low on fuel by this time that they "sailed" most of the way back to Australia. "Drifted" might be a more accurate description of the process, as sheets and tarps were fashioned into makeshift sails for the mastless vessel. A mid-ocean rendezvous and refueling helped the *Cheyne II* limp home from its odyssey.

Between them, the two DXpeditions did an excellent job of satisfying the DX demand for Heard, even though the poor propagation kept the total number of contacts low and frustrated those DXers looking for 5-band contacts. And the 6-meter beacon went unheard the entire trip. On the plus side, Kirsti Smith, Jim's wife, was the first YL operator on Heard, under her own VK0NL callsign. Jim's group also made the first RTTY and satellite contacts from Heard Island.

But even as Jim returned to Norfolk Island with his wife, and Al Fischer was reunited with his new bride, the Heard Island 1983 saga continued.

Rumors and accusations filled the airways and DX bulletins and carried over to the personal presentations at the conventions. Did the amateur community "buy" seats on the Heard Island Expedition for too much money? Was the *Cheyne II* really properly fueled and equipped for the voyage? It is unfortunate that such bitter aftereffects should mar two fine DXpeditions.

The final chapter of the Heard Island DXpeditions has not yet been written. Both groups invested a great deal of money to bring Heard Island onto the amateur bands, and both hope to recoup some of those funds now.

QSLs: If you were one of the lucky ones who worked Heard, you should have your QSL card by now. If not, try another card to N2DT for North American contacts with VK0CW and VK0HI, or via Box 90 Norfolk Island, South Pacific 2899, for VK0JS and VK0NL contacts. Jim Smith got his QSL cards out quickly and included a pitch for membership in the Heard Island DX Association Club.

Finances: Whether you worked Heard or not, you have to admire the courage and dedication of the operators of both groups. "Frozen Fingers" Al Fischer interrupted his honeymoon to leave for Heard, and he endured weeks at sea, terrible weather, and hostile penguins to help you work Heard. He figures his personal costs for the trip at over \$10,000.

Meanwhile, Jim Smith is selling philatelic covers from the Heard trip to help cover the more than \$23,000 he advanced the HIDXA for the trip, and to help pay for the next DXpedition by this active amateur.

If you haven't made a contribution, no matter how small, to one or more of the sponsoring groups, by all means do so now. Your membership in one of the three DX organizations involved in the Heard DXpeditions will encourage other operations of this type.

In a few months the promised slide, movie, and videotape presentations should be out, and DXers around the world will be able to share in some of the excitement of a major DXpedition. And it seems unlikely that there will ever again be two different stations simultaneously active from Heard Island.

(For an insider's view of the HIDXA DXpedition to Heard Island, see "The True Story Behind Heard Island," 73, July, 1983, page 20.—Ed.)

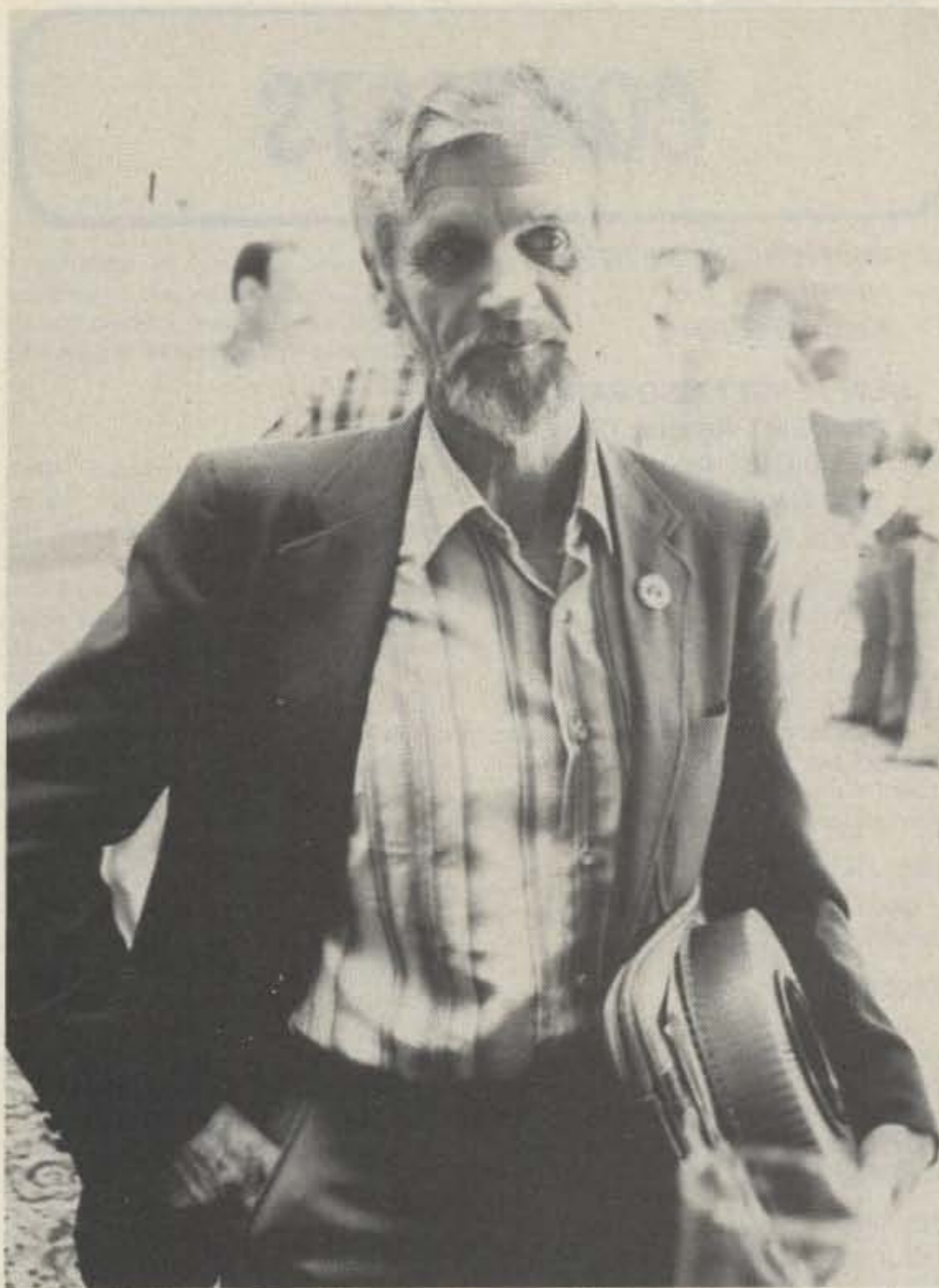

Jim Smith VK9NS, organizer and chief operator of the VK0JS Heard Island DX Association DXpedition, spoke at the International DX Convention in Visalia CA.

PILEUP BUSTING—BY THE EXPERTS

At the International DX Convention in Visalia, California, in April, program chairman Jay O'Brien W6GO moderated a panel of top DXpeditioners on the topic of busting pileups. Members of the panel have made hundreds of thousands of contacts over many years of DXpeditioning. Here are their suggestions of ways to get through the calling horde:

Eric Sjolund SM0AGD: "How do I break pileups? I gave that up ten years ago; it's so much easier to be on the other end of the pileups! Seriously, first listen to the pileup: where is the DX station listening? Don't stay on the same frequency; keep moving around. If the pileup is especially heavy, move to the edge of the crowd. Send your complete callsign once, then listen, don't send just the suffix, as that takes too much time. On SSB, use proper phonetics, not crazy, cute, or geographic phonetics. When I work split I'll suddenly change my listening frequency and announce it once. If you're listening, you can catch me quickly."

Al Fischer K8CW: "Listen first, to determine the DX station's listening frequency. I use wide splits to eliminate calls from transceiver-equipped stations. I usually work the loudest station first, a plus for DXers with large antenna farms. Finally, when the DX station asks for the station with the 'N,' stations without an 'N' in their call had better stop sending. I maintained a blacklist of poor operators on the cover of the logbook; they won't get QSLs!"

Jim Neiger N6TJ: "Listen to the pattern of the operator: who does he come back to? Avoid sending just your suffix; having to go back to confirm the rest of the callsign is too slow. Don't get into a shouting match with a rival; neither of you will work the DX station. If you can do it on CW, you can do it on phone; CW is where it's at!"

Fred Laun K3ZO: "On CW, tune down from the top of the pileup. Find the last station worked, and move a little lower for your call. On SSB, count to 3 after the DX station says 'QRZ,' to give the pileup a chance to thin out a little. If you are transmitting more than 10 seconds at a time, you're doing something wrong. Don't say 'QRP'; send your call. If the DX station can hear your 'QRP,' he can hear your callsign."

Jim Smith VK9NS: "Don't send just your suffix. I write logs left to right, and you don't want to go into the log backwards. I listen for the weaker signals as well as the strong ones, but don't spread the pileup out too much. As I use push-to-talk, I hear the tailenders. Familiar calls are easier to recognize, so being active on the DX bands helps break pileups."

Iris Colvin W6QL: "Listen to the DX station, especially instructions such as listening frequency; working by call areas, etc. If you're not getting through, try something different."

CONTESTS

Robert Baker WB2GFE
15 Windsor Dr.
Atco NJ 08004

NEW JERSEY QSO PARTY

2000 GMT August 13 to
0700 GMT August 14
1300 GMT August 14 to
0200 GMT August 15

The Englewood ARA invites all amateurs worldwide to participate in the 24th annual NJ QSO Party. Phone and CW are considered the same contest. A station may be contacted once on each band. Phone and CW are considered separate "bands" but CW contacts may not be made in phone band segments. NJ stations may work other NJ stations.

EXCHANGE:

QSO number, RS(T), and ARRL section, country, or NJ county.

FREQUENCIES:

1810, 3535, 3900, 7035, 7135, 7235, 14035, 14280, 21100, 21355, 28100, 28610, 50-50.5, and 144-146. Suggest phone activity on the even hours; 15 meters on the odd hours (1500 to 2100 GMT); 160 meters at 0500 GMT.

SCORING:

Out-of-state stations multiply the number of complete contacts with NJ stations by the number of NJ counties worked (21 maximum). NJ stations count 1 point per W/K/VE/VO QSO and 3 points per DX QSO. Multiply total QSO points by the number of ARRL sections (including NNJ and SNJ—maximum, 74). KP4, KH6, KL7, etc., count as 3-point DX contacts and as section multipliers.

AWARDS:

Certificates will be awarded to the first-place station in each NJ county, ARRL

section, and country. In addition, a second-place certificate will be awarded when 4 or more logs are received. Novice and Technician certificates will also be awarded.

ENTRIES:

Logs must show date/time in GMT, band, and emission. Logs must be received not later than September 10th. The first contact for each claimed multiplier must be indicated and numbered and a checklist of contacts and multipliers should be included. Multi-operator stations should be noted and calls of participating operators listed. Logs and comments should be sent to: Englewood Amateur Radio Assoc., Inc., Post Office Box 528, Englewood NJ 07631.

A #10 SASE should be included for results. Stations planning active participation in NJ are requested to advise the EARA by August 1st of their intentions so that they can plan for full coverage from all counties. Portable and mobile operation is encouraged.

NEW MEXICO QSO PARTY

Starts: 1800 GMT August 20
Ends: 2100 GMT August 21

Sponsored by the Albuquerque DX Association. Work stations once per band and mode. Repeat QSOs are allowable for credit only if the NM station changes counties. NM stations operating on county lines count as a single QSO, but multiplier credit is allowed the non-NM station for both counties. Use all amateur bands except 30 meters. Repeater QSOs are not allowed. Entry categories include both single and multi-operator, regardless of whether operating fixed, portable, or mobile.

EXCHANGE:

Phone—1835, 3985, 7230, 14280, 21370,



S.M.A.R.T.
SOUTHWEST MICHIGAN AMATEUR RADIO TEAM

NEWSLETTER OF THE MONTH

Reminiscent of Clark Kent dashing into a telephone booth and returning as Superman, this month's winning newsletter recently received quite a face-lift. The makeover began when the club changed its name from the Oshtemo Amateur Radio Club, a rather plebeian title, to the Southwest Michigan Amateur Radio Team—or SMART, for short. To the name change, add a club member who also happens to be a graphics artist and you get a handsome logo such as the one adorning the SMART newsletter masthead.

Newsletter editor Clint Williams KB8SY said the name change was prompted by the club's acquisition, through an anonymous donor, of an ACC repeater controller. Not many clubs are that lucky, and SMART has made the most of their good fortune.

The newsletter offers the latest information on upcoming events, board meetings, and RACES. In addition, the Letters to the Editor column is often filled with controversial subjects and provides a forum for all of the club's 160 members to speak their piece. Some of the reports in the SMART newsletter have been on the Skywarn Net, the technical committee's efforts to make the most use of the new repeater controller, the Slow-Speed CW Net, and, last but not least, on members who have recently upgraded.

Congratulations to the SMART team not only for having an active club, but also for having the foresight to provide an equally active newsletter to back it up.

To enter your club's newsletter in 73's Newsletter of the Month Contest, send a copy to 73, Pine Street, Peterborough NH 03458.

28570, and 147.51. CW—1805 and 60 kHz up from low end. Novice—25 kHz up from low end.

SCORING:

Count 2 points for each phone QSO and 3 points for each CW QSO. NM stations multiply total QSO points by total number of NM counties, states, provinces, and DX countries worked. All others multiply total QSO points by the total number of NM counties worked (33 maximum).

AWARDS:

Piaques will be presented to the top-scoring NM stations, the highest-scoring non-NM station in each entry category, and the highest-scoring NM club with 3 or more members submitting scores. Certificates will be awarded to the top scorers from each NM county, state, province, and DX country in each entry category. A special certificate will be awarded the highest-scoring NM mobile or portable station.

ENTRIES:

Entries must be postmarked no later than October 1st and addressed to: Ed Graham N5HH, 12449 Regent NE, Albuquerque NM 87112. All entries must include a summary sheet, and entries with over 200 QSOs must include dupe sheets. Include a large SASE for results.

SARTG WORLDWIDE RTTY CONTEST

Contest Periods:
0000 to 0800 GMT August 20
1600 to 2400 GMT August 20
0800 to 1600 GMT August 21

This is the 12th annual contest sponsored by the Scandinavian Amateur Radio Teletype Group (SARTG). Operating classes include a) single operator, b) multi-operator, single transmitter, and c) SWL.

Please note that the logs from multi-operator stations must contain the names and call signs of all operators involved. The same station may be worked once on each band for QSO and multiplier credits. Only two-way RTTY QSOs will count.

EXCHANGE:

RST and QSO number.

SCORING:

QSOs with your own country count 5 points. Other countries on the same continent count 10 points. Other continents count 15 points. In USA, Canada, and Australia, each call district will be considered as a separate country. Use the DXCC list and the above-mentioned call areas for multipliers. Note that contacts with a station which would count as a multiplier must be found in at least 5 logs or a contest log must be received from the multiplier station in order to be valid. Final score is the sum of QSO points times the sum of the multipliers. SWLs use the same rules for scoring, but based on stations and messages copied.

AWARDS:

Top stations in each class, country, W/K, VE/VO, and VK call district.

ENTRIES:

Logs must be received by October 10th and should contain band, date/time in GMT, call sign, exchanges sent and received, points, multipliers, and final score. Use a separate sheet for each band and enclose a summary sheet showing the scoring, classification, call sign, name, and address. Multi-operator stations should include the names and call signs of all operators involved. Comments will be very much appreciated by the contest committee. Send logs to: SARTG Contest and Award Manager, C. J. Jensen OZ2CJ, PO Box 717, 8600 Silkeborg, Denmark.

CALENDAR

Aug 6-7	ARRL UHF Contest
Aug 13-15	New Jersey QSO Party
Aug 19-21	A5 Magazine UHF FSTV DX Contest
Aug 20-21	SARTG Worldwide RTTY Contest
Aug 20-21	New Mexico QSO Party
Aug 27-28	Occupation Contest
Sep 3	DARC Corona 10-Meter RTTY Contest
Sep 9-11	Connecticut Oyster Festival
Sep 10-11	ARRL VHF QSO Party
Sep 10-11	Cray Valley Radio Society SWL Contest
Sep 17-19	Washington State QSO Party
Oct 1-3	Oregon QSO Party
Oct 8-9	ARRL QSO Party—CW
Oct 9-10	ARRL QSO Party—Phone
Oct 15-16	ARRL Simulated Emergency Test
Oct 22-23	Pennsylvania QSO Party
Oct 22-23	MF Runde SW Activity Weekend
Oct 22-23	CLARA Ac-Dc Contest
Oct 22-23	ORP ARCI Fall QSO Party
Nov 5-6	ARRL Sweepstakes—CW
Nov 6	DARC Corona 10-Meter RTTY Contest
Nov 19-20	ARRL Sweepstakes—Phone
Dec 3-4	ARRL 160-Meter Contest
Dec 10-11	ARRL 10-Meter Contest
Feb 4-5	South Carolina QSO Party
Feb 18-19	America Radio Club International DX Contest

RESULTS

1982 AMERICA RADIO CLUB INTERNATIONAL DX CONTEST

1.	Angel Romero WD4CPS	4450 points
2.	Elpidio Padilla WD4GZI	3475 points
3.	Tony Pineda WD4MXF	2700 points
4.	Juan B. Huarte KA4BBR	2600 points
5.	Guillermo Cabrera WD4FHM	2525 points
6.	Roberto Suarez KI4S	2150 points
7.	Orestes Falcon WD4HZR	2125 points
8.	Lily Suarez N4DJI	2100 points
9.	Idelfonso Martinez WD4EMB	2025 points
10.	Milton Romero WD4ELB	2000 points

OCCUPATION CONTEST

Starts: 1800 GMT August 27

Ends: 2400 GMT August 28

The Radio Association of Erie PA is sponsoring their third annual contest. The contest is open to all amateur radio operators. The rules have been changed this year so that individual occupations will be of greater importance. This change should make this year's contest less confusing and more enjoyable.

EXCHANGE:

RS(T); occupation; and state, province, or country.

FREQUENCIES:

CW—40 kHz from the bottom of the

ham bands. Phone—1820, 3920, 7250, 14300, 21400, and 28600.

SCORING:

Score 3 points for each new occupation worked, one point for all similar occupations worked, and 2 points for all retirees worked. There are no multipliers.

AWARDS:

A plaque will be given to the top-scoring station. Certificates for the top stations in each state, province, and country.

ENTRIES:

Mailing deadline for logs is October 1st. They should be sent to: Chris Robson KB3A, 6950 Kreider Rd., Fairview PA 16415.

RESULTS

1983 NEW HAMPSHIRE QSO PARTY

State	Call	QSO x 5	Multipliers	Score
AL	WB4VEK	10	1	10
AR	WB5RYB	110	5	550
AZ	AK7J	45	4	180
CA	N6CPQ	25	2	50
NFL	K4DDB	180	5	900
SFL	N4FBY	55	6	330
ID	WB7EUI	15	2	30
IL	W9QWM	10	1	10
IN	W9XD	5	1	5
IA	K0HQE	45	6	270
KS	N0CLY	75	4	300
LA	W5WG	205	7	1435
EMA	K1BA	130	9	1170
MD	WA3EOP	60	6	360
MS	W5UCY	75	5	375
NNJ	W2CJJ	105	7	735
NM	KB5DQ	45	4	180
ENY	N2BFG	190	9	1710
WNY	KC7QE	30	3	90
OK	N5AFV	70	4	280
PA	KA3DSW	120	7	840
SD	KC0ZU	80	5	400
TN	KD4PP	40	3	120
NTX	WA5DTK	70	2	140
STX	W5PWG	185	6	1110
VT	K1HKI	120	7	840
VA	N4GTU	50	7	350
WA	KN7L	35	5	175
ONT	VE3KK	35	4	140

FUN!

John Edwards KI2U
78-56 86th Street
Glendale NY 11385

RADIOS WE HAVE KNOWN

Do you remember the first rig you ever owned? Of course you do. To a ham, that first ransceiver, transmitter, or receiver is like a first love—a memory to be nurtured and cherished forever. I'll never forget my first rig. Unlike most old-timers, my initial radio was a VHF job—the venerable Heathkit® Sixer. I can still remember gently cradling the package in my arms as I rode the subway home from the old Heathkit store on New York's West 45th Street. Tossing homework and other chores aside, I constructed my first rig during a single weekend orgy of soldering and wiring. I still bear a one-inch scar on the spot where I tried to solder a diode to my left arm. Ah, memories.

The only unpleasant experience I ever had with that radio came at the moment I unveiled it to my "Elmer." He laughed. Never having heard of VHF construction techniques, had oscillator caps and resistors dangling on two-inch leads and enough cold solder joints to make a Heath technician cry. Still, with some help, I eventually got my Sixer running and made quite a few DX contacts during the terrific sunspot summers of 1968 and 1969.

I have no idea whatever happened to that wonderful old rig. It was lost while moving during the spring of 1972. Today, I use a Kenwood TS-520 and a transverter on six. You know, I miss the roar of that old super-regenerative receiver.

ELEMENT 1—CROSSWORD PUZZLE

(Illustration 1)

Across

- 1) Commercial-made boat anchor
- 7) Crystal oven entrance
- 8) Ham antenna maker killed by CB boom
- 11) Interference type (abbr.)
- 12) Fellow ham (abbr.)
- 16) Dry
- 17) Kit brand formerly sold by Allied
- 19) Another kit maker
- 21) Book publisher or bill
- 24) Cornell-
- 26) KP4-land city: San-

- 27) Operator (abbr.)
- 30) 0-land state (abbr.)
- 31) Nationwide electronics chain (2 words)

Down

- 1) Last great kit seller
- 2) Month before Field Day
- 3) Former tube maker
- 4) 0-land state (abbr.)
- 5) Canada's radio authority (abbr.)
- 6) Prototype surfaces

- 8) Telegraphic laugh
- 9) Northern Ireland prefix
- 10) Negative reply
- 13) Two connectors that join
- 14) 8-U, 59-U
- 15) Telegraphic thank you
- 18) Stand by
- 20) Telegraphic query
- 22) Rig type
- 23) Grid-meter
- 25) Take one rig and another
- 26) Slang for tube
- 28) Canada prefix
- 29) Current type (abbr.)

ELEMENT 2—MULTIPLE CHOICE

1) Sonar Radio, the former famous maker of VHF ham transceivers, currently manufactures:

- 1) HF rigs
- 2) CBs
- 3) antennas
- 4) computer peripherals

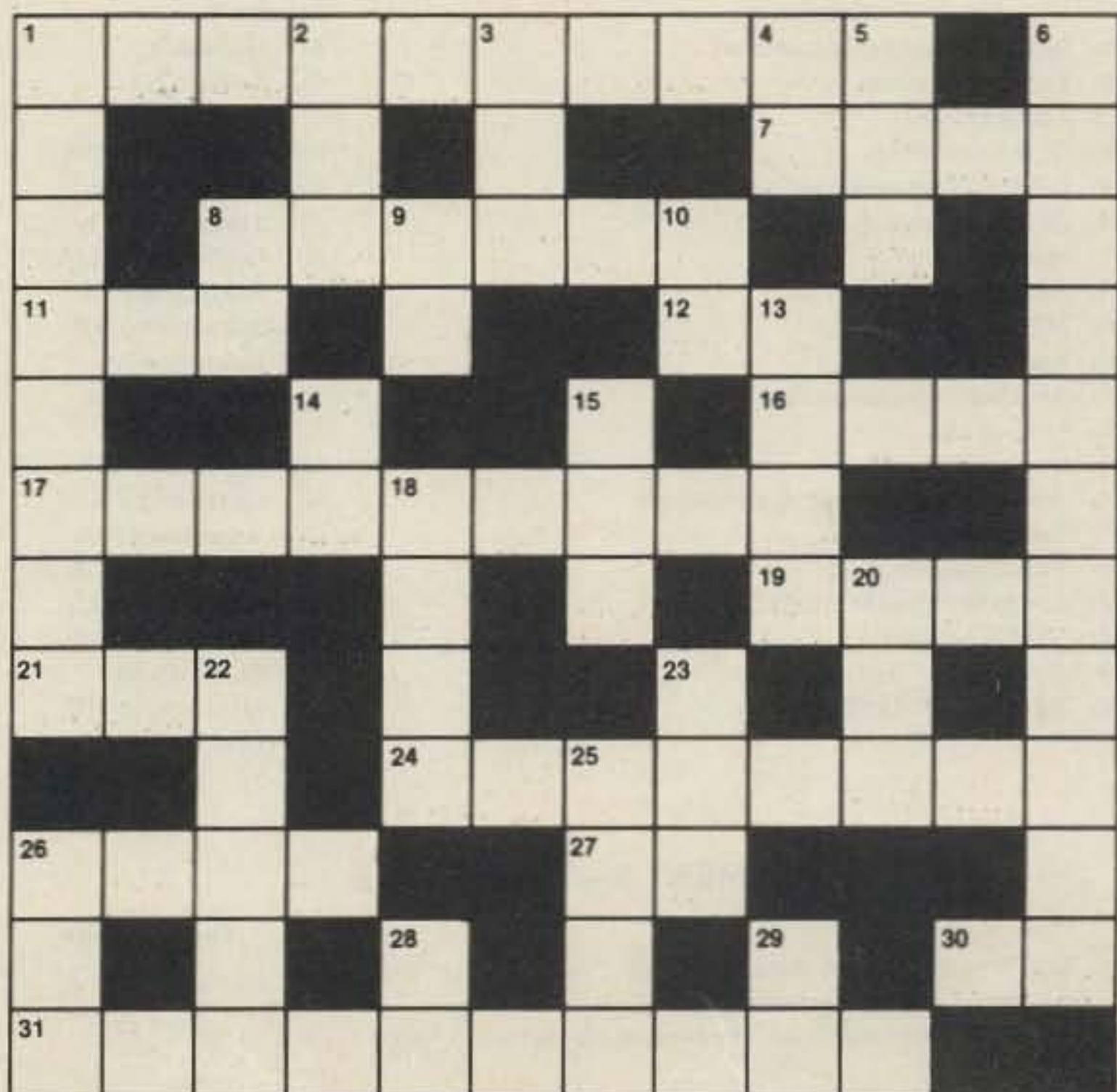

Illustration 1.

- 2) The first popular 2-meter transceiver was the:
- 1) Galaxy Hightopper
 - 2) Clegg Odin
 - 3) Gonset Communicator
 - 4) Kenwood TS-520
- 3) An "audion" was:
- 1) a type of amplifier
 - 2) a tube
 - 3) an old-fashioned oscillator
 - 4) a musical instrument
- 4) Which of the following was NOT a Hallicrafters rig:
- 1) SX-111
 - 2) HT-17
 - 3) HT-220
 - 4) Super-Skyrider
- 5) E. F. Johnson's HF transmitter kit was known as the:
- 1) Viking
 - 2) Signal Slicer
 - 3) Comet
 - 4) Q5er

ELEMENT 3—MATCHING I

Match the former ham manufacturers and distributors in Column A with their QTHs in Column B.

Column A	Column B
1) Sideband Engineers	A) Oceanside CA
2) Sonar Radio	B) Brooklyn NY
3) LTV-University	C) Burbank-Anaheim CA
4) Squires-Sanders	D) Chicago IL
5) Regency	E) Jamaica-Syosset NY
6) Galaxy	F) Millington-Watchung NY
7) Terminal Radio	G) Buchanan MI
8) Burstein-Applebee	H) Indianapolis IN
9) Lafayette Radio	I) Jersey Shore PA
10) Amperex	J) San Francisco CA
11) Greenlee Tool	K) Hicksville NY
12) Gonset	L) Harrison NJ
13) Hallicrafters	M) Council Bluffs IA
14) RME-ElectroVoice	N) Kansas City MO
15) Alltronics-Howard	O) Mars Hill NC
16) Uncle Dave's Radio Shack (Fort Orange Radio)	P) Albany NY
17) Atlas Radio	Q) Oklahoma City OK
18) Hammarlund	R) Boston MA
19) E. F. Johnson	S) Waseca MN
20) RCA Electron Tubes	T) Rockford IL
	U) New York NY

ELEMENT 4—MATCHING II

Match the current ham manufacturers and distributors in Column A with their QTHs in Column B.

Column A	Column B
1) Spectrum Communications	A) Urbana IL
2) Larsen Antennas	B) Buffalo NY
3) Macrotronics	C) Miami FL
4) GLB Electronics	D) Miamisburg OH
5) Communications Specialists	E) San Diego CA
6) Antenna Specialists	F) Turlock CA
7) Hustler	G) Cedar Rapids IA
8) HAL Communications	H) Norristown PA
9) MFJ Enterprises	I) Steademp NY
10) Kantronics	J) Lawrence KS
11) Amateur-Wholesale Electronics	K) Kissimmee FL
12) R. L. Drake	L) Bristol PA
13) Cushcraft	M) Lynnwood WA
14) Advanced Electronic Applications	N) Lancaster PA
15) Collins Radio	O) Vancouver WA
16) Robot Research	P) Morgan Hill CA
17) Clegg Communications	Q) Cleveland OH
18) KLM Electronics	R) Manchester NH
19) Ham Radio Center	S) St. Louis MO
20) Barker & Williamson	T) Mississippi MS
	U) Orange CA

ELEMENT 5—TRUE-FALSE

	True	False
1) The famous Drake 2-meter portable—the TR-22C—was actually made by Kenwood.	___	___
2) A famous semi-automatic keyer was known as the Blitz Bug.	___	___
3) Arthur A. Collins W9CXX was the founder of Henry Radio.	___	___

- 4) During its entire history, International Crystal has manufactured only one type of product—crystals. ___
- 5) The first transmitter offered by Heath was the Mohican. ___

THE ANSWERS

Element 1:

See Illustration 1A.

Element 2:

- 1—4 1975: Ham makers turn to CB. 1983: Ham makers turn to computers. 1990: Automobile makers turn to ham radio?
- 2—3 The year was 1952 and the mode was AM. Could the first jammer be far behind?
- 3—2 Lee DeForest's revolution in electronics; the audion was the first triode.
- 4—3 The HT-220 is Motorola's popular VHF hand-held transceiver.
- 5—1 More than one Novice's first rig.

Element 3:

- 1—J, 2—B, 3—Q, 4—F, 5—H, 6—M, 7—U, 8—N, 9—E, 10—K, 11—T, 12—C, 13—D, 14—G, 15—R, 16—P, 17—A, 18—O, 19—S, 20—L.

Element 4:

- 1—H, 2—O, 3—F, 4—B, 5—U, 6—Q, 7—K, 8—A, 9—T, 10—J, 11—C, 12—D, 13—R, 14—M, 15—G, 16—E, 17—N, 18—P, 19—S, 20—L.

Element 5:

- 1—True It was almost identical to Kenwood's own TR-2200, except that the Kenwood model had additional channels.
- 1—False Vibroplex's bug was called the "Lightning Bug." The "Blitz Bug" is Cushcraft's lightning arrestor.
- 3—False How about Arthur Radio? Collins Radio.
- 4—False The company has, from time to time, made and sold receivers, oscillators and other products.
- 5—False The AT-1 in 1953.

SCORING

Element 1:

Twenty points for the completed puzzle, or one-half point for each question correctly answered.

Element 2:

Four points for each correct answer.

Element 3:

One point for each correct match.

Element 4:

One point for each correct match.

Element 5:

Four points for each correct answer.

Have the mists of nostalgia dimmed your memory?

- 1-20 points—First rig was a CB.
 21-40 points—Can't remember your first rig.
 41-60 points—Your first rig was your only rig.
 61-80 points—Still own every rig you ever used.
 81-100 points—First rig was a Collins.

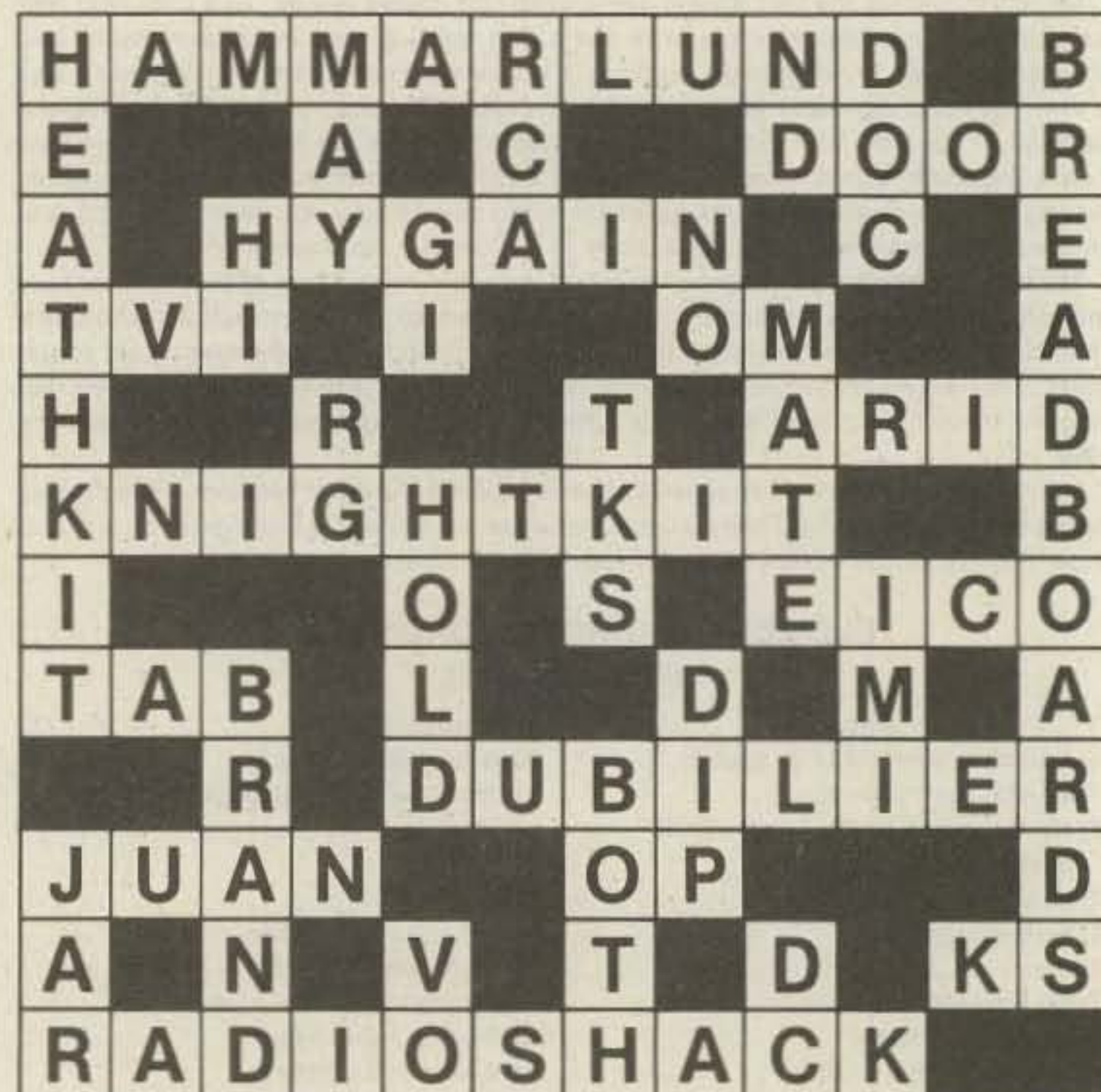

Illustration 1A.

hy-gain®

- ANTENNA
- TOWER
- ROTOR

SAVE \$500

★ ★ Package Deal ★ ★

Ends July 31st, 1983. Hurry! - Order from AES today. The complete package will be shipped to you PREPAID with NO SHIPPING CHARGES within the continental 48 States.

Hy-Gain EX-14 Explorer 14 20-15-10 meter beam. New driven element design, covers full band under 2:1. Maximum legal power; 14' x 1 1/2" boom; 7.5ft² wind area; stainless hardware; 1:1 balun; 43 lbs.

Hy-Gain HG52SS 52' Self-Supporting Crank-Up Tower. Rated 9 ft² @ 50 mph. Galvanized steel, includes hand-cranked winch; retracts to 21'. With base, rotator plate, 10' mast and (3) coax support arms.

Hy-Gain CD-45-II Medium duty rotor for arrays up to 8.5 ft², in-tower mounted. Bell design, 98 ball bearings and disc brake system. Independent brake release & CW/CCW rotation switches. Meter readout accurate to ± 1°. Requires 8-conductor cable.

Package components:	Regular
EX-14 antenna w/BN-86 balun . . .	\$ 399.95
HG52SS crank-up tower	1095.00
HG10 10' mast	68.50
HGCOA coax arms (3), \$13 ea	39.00
CD-45-II rotator	164.95

Total Regular Value - \$1767.40
PACKAGE PRICE - \$1267⁴⁰
 (YOU SAVE \$500.00 + SHIPPING)

or

You choose a Package! . . . Purchase any other Hy-Gain Tower/HF Beam/Rotor Combination, add any other Hy-Gain or TELEX items and receive an additional 10% Discount from our already Low Sale Prices on the entire package, plus get FREE Shipping. Does not include Hy-Gain log-periodics or R-3501 rotor. Ends 7/31/83 - Order Now!

KLM KT-34A

4-element trapless
20-15-10 meter
beam

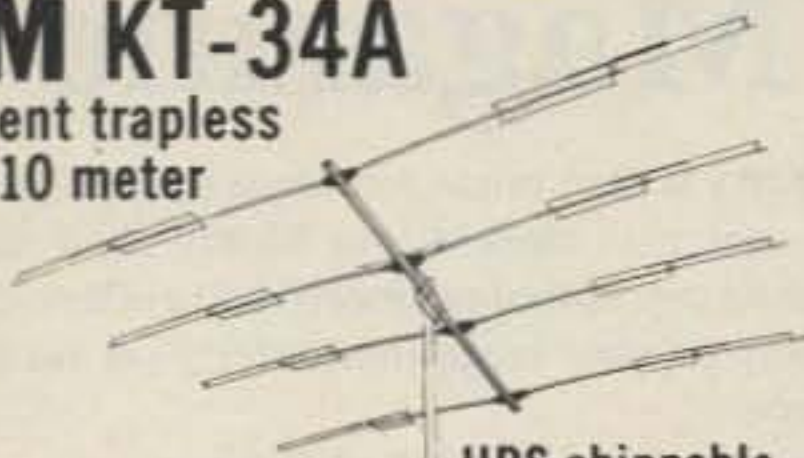

UPS shippable

Quantity Limited
at Special Price

Regular \$389⁹⁵
Special \$299⁹⁵

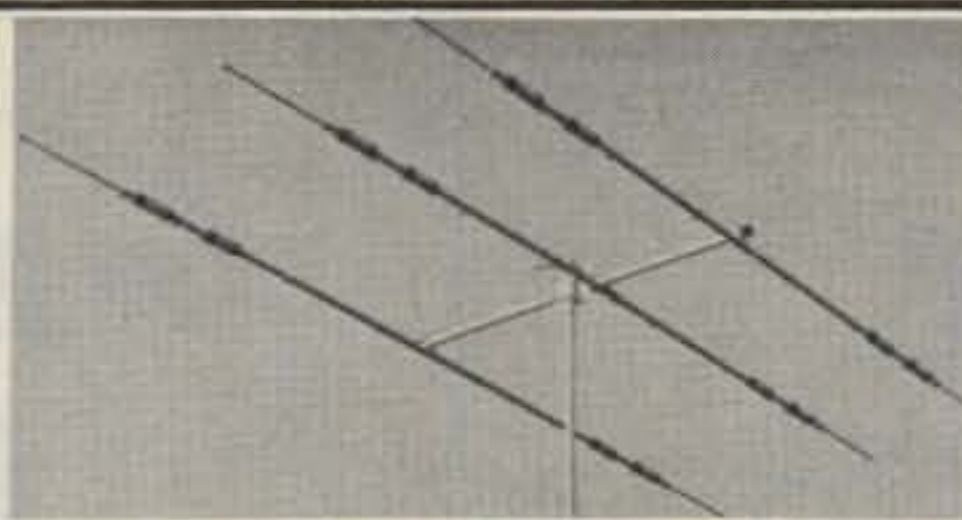

CUSHCRAFT Multiband Beams

Model	Regular	SALE
A-3 20/15/10m, 3-el, 14' boom	\$249.95	179 ⁹⁵
A-743 40 or 10 MHz add-on kit	89.95	69 ⁹⁵
A-3SK Stainless steel hardware kit	49.95	39 ⁹⁵
A-4 20/15/10m, 4-el, 18' boom	329.95	229 ⁹⁵
A-744 40 or 10m add-on kit	89.95	69 ⁹⁵
A-4SK Stainless steel hardware kit	54.95	44 ⁹⁵

Mini-Products HQ-1 4-band HYBRID QUAD Antenna

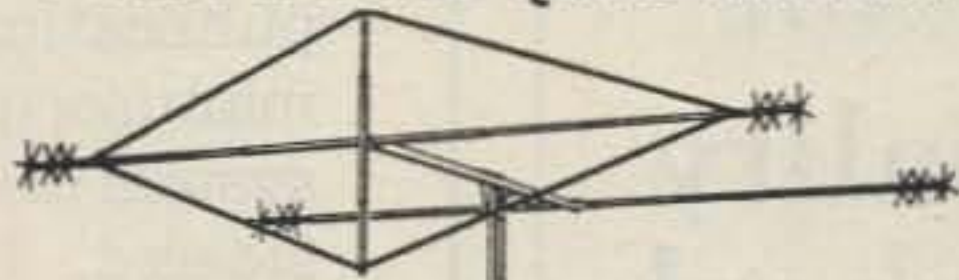

A compact, gain antenna that providing maximum efficiency in the smallest practical size. Uses a unique loaded quad reflector and overcoupling principle that results in a wide bandwidth and good forward gain. Bands - 6, 10, 15 & 20 meters; Power - 1200W PEP; Element length - 11'; Boom - 4 1/2'; Wt. - 15 lbs. Install & turn w/TV hardware. (Reg. \$159.50) . . . **Sale \$139⁹⁵**

BUTTERNUT Vertical

Model	Regular	SALE
HF-6V 80/40/30/20/15/10m vertical	\$169.50	119 ⁹⁵
TBR-160HD High power 160m adapt.	55.50	49 ⁹⁵
RMK-II Roof mount kit w/radials	47.00	42 ⁹⁵
STR-II Radial kit, only	33.50	29 ⁹⁵



ALLIANCE
 Dual-Speed
 Rotor
\$99⁹⁵

Model HD-73

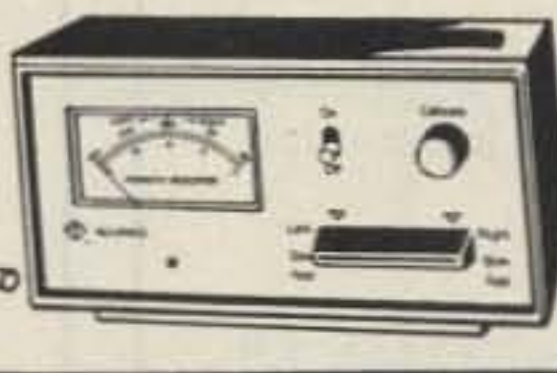

BELDEN 8214 RG-8 (foam-type) coaxial cable
 100' bulk roll - **\$36⁹⁵**; other lengths, 42¢/ft.
BELDEN 8448 8-conductor rotor cable
 100' bulk roll - **\$29⁹⁵**; other lengths, 33¢/ft.
BELDEN 9405 8-conductor, hvy-duty rotor cable
 100' bulk roll - **\$39⁹⁵**; other lengths, 44¢/ft



CLOSEOUT

KENWOOD TS-120S, 130S, 530S, 830S Owners!
 DFC-230 Digital Frequency Controller. 20 Hz step Digital VFO w/4 Memories/Scan. Control Xcvr frequency from UP/DOWN mic. (supplied) or FAST STEP switch. Scan speed selectable in single, slow, or fast continuous 20 Hz steps from mic. Transfer freq. from VFO-memory or memory-VFO; split-freq. with Xcvr VFO on Transmit, DFC-230 on Receive. (Reg. \$289⁹⁵) . . . **Closeout \$169⁹⁵**

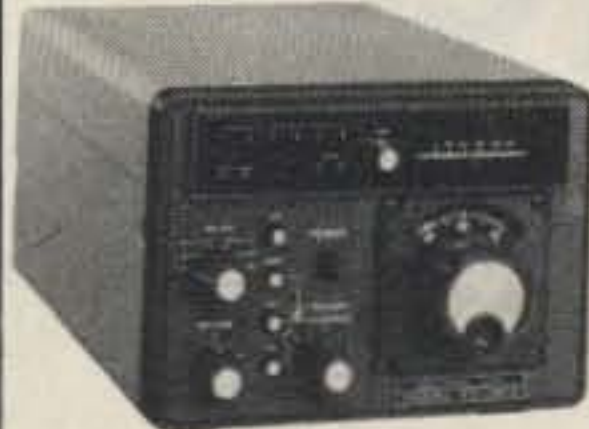

YAESU FV-101Z

External VFO for the FT-101Z/ZD, FT-901/902 series transceivers.

Regular \$175
Closeout \$129⁹⁵



SP-901P

Speaker/Hybrid phone patch combination for FT-901/902/101ZD.

Regular \$76
Closeout \$59⁹⁵

AEA HTM MICROPHONE

Electret type w/volume control and plug wired for ICOM HT's.

Closeout - \$9⁹⁵



MAXON MX-49S 49 MHz FM, 2-way radio with boom mic headset/whip ant. Clips to belt/pocket; Manual or "hands-free" VOX operation. Great for tower work! 100mW; up to 1/2 mile range. 4 1/2" h x 2 1/2" w x 1" d, 9 oz. Uses (1) 9v battery. **\$49⁹⁵** each; **\$44⁹⁵** each, in pairs.



Order Toll Free: 1-800-558-0411

In Wisconsin (outside Milwaukee Metro Area)
 1-800-242-5195

AMATEUR ELECTRONIC SUPPLY[®] Inc.

4828 W. Fond du Lac Avenue; Milwaukee, WI 53216 - Phone (414) 442-4200

AES BRANCH STORES

Associate Store

WICKLIFFE, Ohio 44092
 28940 Euclid Avenue
 Phone (216) 585-7388
 Ohio WATS 1-800-362-0290

ORLANDO, Fla. 32803
 621 Commonwealth Ave.
 Phone (305) 894-3238
 Fla. WATS 1-800-432-9424

CLEARWATER, Fla. 33575
 1898 Drew Street
 Phone (813) 461-4267
 No In-State WATS

LAS VEGAS, Nev. 89106
 1072 N. Rancho Drive
 Phone (702) 647-3114
 No In-State WATS

CHICAGO, Illinois 60630
 ERICKSON COMMUNICATIONS
 5456 N. Milwaukee Avenue
 Phone (312) 631-5181

Outside Ohio 1-800-321-3594

Outside Florida 1-800-327-1917

No Nationwide WATS

Outside Nevada 1-800-634-6227

Outside Illinois 1-800-621-5802

THE SELECTRIC™ INTERFACE

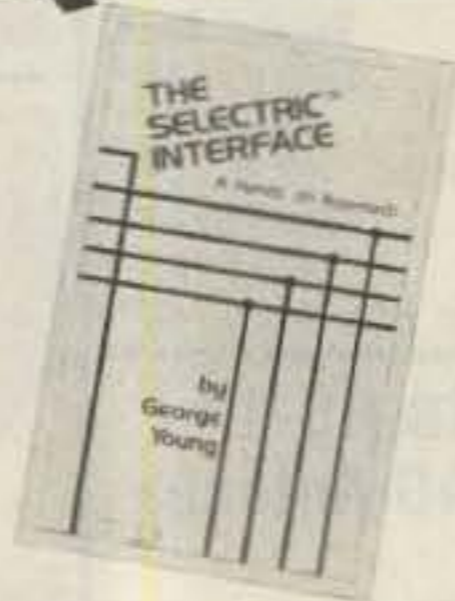

Daisy wheel quality without daisy wheel expense.

You need the quality print that a daisy wheel printer provides but the thought of buying one makes your wallet wilt. *The Selectric™ Interface*, a step-by-step guide to interfacing an IBM Selectric I/O Writer to your microcomputer, will give you that quality at a fraction of the price. George Young, co-author of *Microcomputing* magazine's popular "Kilobaud Classroom" series, offers a low-cost alternative to buying a daisy wheel printer.

The Selectric™ Interface includes:

- step-by-step instructions
- tips on purchasing a used Selectric™
- information on various Selectric™ models, including the 2740, 2980, and Dura 1041
- driver software for Z80, 8080, and 6502 chips
- tips on interfacing techniques

With *The Selectric Interface* and some background in electronics, you can have a high-quality, low-cost, letter-quality printer. Petals not included.

Credit card orders call TOLL-FREE 1-800-258-5473. Or mail your order with payment plus \$1.50 shipping and handling to: Wayne Green Inc. Attn: Retail Book Sales, Peterborough, NH 03458.

Dealer inquiries invited.

ISBN 0-88006-051-4

128 pages

\$12.97

Yes, I want **Selectric Interface** (BK7388). Enclosed is \$12.97 per copy plus \$1.50 for shipping and handling.

MASTER

VISA

AMEX

Card # _____ Expires _____

Signature _____

Name _____

Address _____

City _____

State and Zip _____ 338B6S

All orders shipped UPS if complete street address is given.

**“AUTHOR
AUTHOR!”**

The call for authors is out!

Wayne Green Books announces a September 1, 1983 deadline for submitting manuscript proposals for the upcoming publication list. Ideas for book-length manuscripts about any microcomputer system or area of electronics will be considered. In addition to payment and royalties, we offer our distribution channels and the marketing support your book deserves.

Send proposals or requests for a copy of our **Writer's Guide** to:

Editor, **Wayne Green Books**

Peterborough, NH 03458.

Or call **toll-free 1-800-343-0728**.



**MAKE IT
EASY TO SAVE
your copies of**



73 Magazine

Your magazine library is your prime reference source—keep it handy and keep it neat with these strong library shelf boxes. They are made of white corrugated cardboard and are dust resistant. Use them to keep *all* your magazines orderly yet available for constant reference.

Self-sticking labels are available for the following:

80 Micro	73 Magazine	Radio Electronics
Microcomputing	QST	Personal Computing
inCider	CQ	HOT CoCo
Desktop Computing	Ham Radio	Interface Age

One box (BX1000) is \$2.00, 2-7 boxes (BX1001) are \$1.50 each, and 8 or more boxes (BX1002) are \$1.25 each. Be sure to specify which labels we should send.

Call **TOLL-FREE** for credit card orders:

1-800-258-5473

73 Magazine

Attn: Book Sales, Peterborough, NH 03458

SHIPPING AND HANDLING CHARGES \$2.00 per order, up to and including a quantity of eight. 25¢ for each additional box ordered.

RADIO BOOKSHOP

FOR THE NOVICE

New, updated editions
of our famous novice
license study guide and novice study tapes.

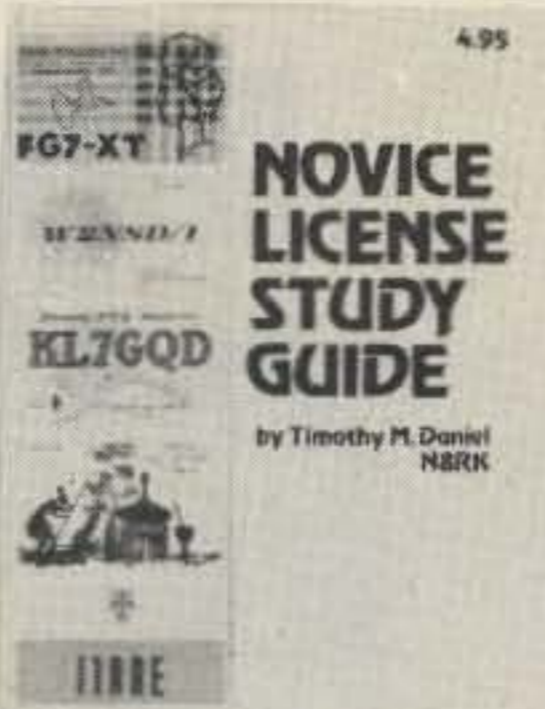

● **NOVICE LICENSE STUDY GUIDE**—by Timothy M. Daniel N8RK. Here is the most up to date novice guide available. It is complete with information about learning Morse Code, has the latest FCC amateur regulations and the current FCC application forms. This guide is not a question/answer memorization course but rather it emphasizes the practical side of getting a ham license and putting a station on the air. It reflects what the FCC expects a Novice to know without page after page of dull theory. The most current information still available at last year's price. SG7357 \$4.95.*

● **NOVICE STUDY TAPES**—If you are just getting started in ham radio, you'll find these tapes indispensable! This up-to-the-minute revision of the 73 Study Course is the perfect way to learn everything you need to breeze through the Novice written exam. Theory, FCC regulations, and operating skills are all covered, and you'll be amazed at how fast you learn using these tapes!

Once the test is behind you, these tapes will go right on being useful, because they are packed with the latest information on setting up your own ham station, and getting on the air.

Thousands of people have discovered how easy learning from cassette can be—order now and enter the fascinating world of ham radio! CT7300 Set of 3—\$15.95.*

Scientists have proven that you learn faster by listening than by reading because you can play a cassette tape over and over in your spare time—even while you're driving! You get more and more info each time you hear it. You can't progress without solid fundamentals. These three hour-long tapes give you all the basics you'll need to pass the Novice exam easily. You'll have an understanding of the basics which will be invaluable to you for the rest of your life! Can you afford to take your Novice exam without first listening to these tapes?

Special Offer! Both Novice License Study Guide and Novice Study Tapes \$19.95 Order NP7300.

GENERAL LICENSE STUDY GUIDE



GENERAL LICENSE STUDY GUIDE—By Timothy M. Daniel N8RK This is the complete guide to the General License. Learning rather than memorizing is the secret. This is not a question-and-answer guide that will gather dust when the FCC issues a new test. Instead, this book will be a helpful reference, useful long after a ham upgrades to General. Includes up-to-date FCC rules and an application form. Order yours today and talk to the world. SG7358 \$6.95



Style W



Style Y



Style X

● **QSL CARDS**—73 turns out a fantastic series of QSL cards at about half the cost of having them done elsewhere because they are run as a fill-in between printing books and other items in the 73 Print Shop. 250 Style W—QW0250—for \$8.95*; 500 Style W—QW0500—for \$13.95*; 250 Style X—QX0250—for \$8.95*; 500 Style X—QX0500; 250 Style Y—QY0250—for \$8.95*; 500 Style Y—QY0500—for \$13.95.* Allow 6-12 wks. for delivery.

LIBRARY SHELF BOXES—These sturdy white corrugated, dirt boxes each hold a full year of 73, *Microcomputing* or 80 *Micro Desktop Computing*, *inCider*. With your order, request self-sticking labels for any of the following: 73, *Microcomputing*, 80 *Micro*, *CQ*, *QST*, *Ham Radio Personal Computing*, *Radio Electronics*, *Interface Age*, and *Byte*. Order 1—BX1000—for \$2.00*; order 2-7—BX2002—for \$1.50 each*; order 8 or more—BX1002—for \$1.25 each*.

● Preserve and protect your collection for a lifetime! Order these handsome red binders with gold lettering. \$7.50 for 1, 3 for \$21.75, 6 for \$42.00. (Postpaid within USA, please add \$2.50 per order outside USA.) Check or money orders only, no phone or C.O.D. orders. 73 Binders, P.O. Box 5120, Philadelphia, PA 19141.

*NOTE—Above address for Binders only.

For Your Ham Shack 73 Magazine Binders

73
Code Tapes
any four tapes for
\$15.95! \$4.95 each

"GENESIS"

5 WPM—CT7305—This is the beginning tape for people who do not know the code at all. It takes them through the 26 letters, 10 numbers and necessary punctuation, complete with practice every step of the way using the newest blitz teaching techniques. It is almost miraculous! In one hour many people—including kids of ten—are able to master the code. The ease of learning gives confidence to beginners who might otherwise drop out.

"THE STICKLER"

6+ WPM—CT7306—This is the practice tape for the Novice and Technician licenses. It is made up of one solid hour of code, sent at the official FCC standard (no other tape we've heard uses these standards, so many people flunk the code when they are suddenly—under pressure—faced with characters sent at 13 wpm and spaced for 5 wpm). This tape is not memorizable, unlike the zany 5 wpm tape, since the code groups are entirely random characters sent in groups of five.

"BACK BREAKER"

13+ WPM—CT7313—Code groups again, at a brisk 14 per so you will be at ease when you sit down in front of the steely-eyed government inspector and he starts sending you plain language at only 13 per. You need this extra margin to overcome the panic which is universal in the test situations. When you've spent your money and time to take the test, you'll thank heaven you had this back-breaking tape.

"COURAGEOUS"

20+ WPM—CT7320—Code is what gets you when you go for the Extra class license. It is so embarrassing to panic out just because you didn't prepare yourself with this tape. Though this is only one word faster, the code groups are so difficult that you'll almost fall asleep copying the FCC stuff by comparison. Users report that they can't believe how easy 20 per really is with this fantastic one hour tape.

"OUTRAGEOUS"

25+ WPM—CT7325—This is the tape for that small group of overachieving hams who wouldn't be content to simply satisfy the code requirements of the Extra Class license. It's the toughest tape we've got and we keep a permanent file of hams who have mastered it. Let us know when you're up to speed and we'll inscribe your name in 73's CW "Hall of Fame."

BACK ISSUES—Complete your collection; many are prime collectables now, classics in the field! A full collection is an invaluable compendium of radio and electronics knowledge!

73300	73 BACK ISSUE—BEFORE JULY 1980	\$ 3.00
73350	73 BACK ISSUE JULY 1980 THRU OCT. 1981	\$ 3.50
73350P	73 BACK ISSUE NOV. 1981 TO PRESENT	\$ 3.50
73005	73 BACK ISSUE—5 YOUR CHOICE	\$10.75
73010	73 BACK ISSUE—10 YOUR CHOICE	\$16.00
73025	73 BACK ISSUE—25 YOUR CHOICE	\$27.00
73125	73 BACK ISSUE—25 OUR CHOICE	\$14.00

Shipping: Please add \$1.00 per magazine. Orders of ten magazines or twenty-five magazines add \$7.50 per order.

*Use the order card in this magazine or itemize your order on a separate piece of paper and mail to: 73 Radio Bookshop • Peterborough NH 03458. Be sure to include check or detailed credit card information. No C.O.D. orders accepted. \$1.50 for the first book, \$1.00 each additional book for U.S. delivery and foreign surface. For foreign airmail \$10.00 per book. Please allow 4-6 weeks for delivery. Questions regarding your order? Please write to Customer Service at the above address. (Prices subject to change on books not published by 73 Magazine.)

FOR TOLL FREE ORDERING CALL 1-800-258-5473

RADIO BOOKSHOP

ANTENNA BOOKS



VHF ANTENNA HANDBOOK—The new *VHF Antenna Handbook* details the theory, design, and construction of hundreds of different VHF and UHF antennas... a practical book written for the average amateur who takes joy in building, not full of complex formulas for the design engineer. Packed with fabulous antenna projects you can build. BK7368 \$5.95.*

ALL ABOUT CUBICAL QUAD ANTENNAS (2nd edition)—The "Classic" on Quad design, theory, construction, and operation. New 2nd edition contains new feed and matching systems and new data. BK1196 \$6.95.

THE RADIO AMATEUR ANTENNA HANDBOOK—All about wire antennas, beams, tuners, baluns, coax, radials, SWR and towers. Clear and complete information. BK1199 \$7.95

SIMPLE, LOW-COST WIRE ANTENNAS FOR RADIO AMATEURS—All new data and everything you want to know about low-cost, multi-band antennas, inexpensive beams, "invisible" antennas for hams in "tough" locations. BK1200 \$7.95

HOW TO DEFEND YOURSELF AGAINST RADAR—by Bruce F. Bogner and James R. Bodnar, a lawyer and radar expert. This book gives you the ammunition to challenge the radar "evidence" that usually leads to a speeding conviction. The major part of the book details the inner workings of radar—you'll become more of an expert than most police officers and judges. The remainder of the book outlines how to defend yourself against a speeding ticket—the observations, measures and testimony you must obtain to defend yourself without the help of a lawyer. The price is a lot less than a fine! BK1201 \$6.95.*

73 DIPOLE AND LONG-WIRE ANTENNAS—by Edward M. Noll W3FQJ. This is the first collection of virtually every type of wire antenna used by amateurs. Includes dimensions, configurations, and detailed construction data for 73 different antenna types. Appendices describe the construction of noise bridges, line tuners, and data on measuring resonant frequency, velocity factor, and swr. BK1016 \$5.50.*

BEAM ANTENNA HANDBOOK (New 5th edition)—by William I. Orr & Stuart D. Cowan. Yagi beam theory, construction and operation. Information on wire beams, SWR curves and matching systems. A "must" for serious DXers. BK1197 \$7.95.

COOK BOOKS

TTL COOKBOOK—by Don Lancaster. Explains what TTL is, how it works, and how to use it. Discusses practical applications, such as a digital counter and display system, events counter, electronic stopwatch, digital voltmeter and a digital tachometer. BK1063 \$9.50.*

CMOS COOKBOOK—by Don Lancaster. Details the application of CMOS, the low power logic family suitable for most applications presently dominated by TTL. Required reading for every serious digital experimenter! BK1011 \$10.50.*

TVT COOKBOOK—by Don Lancaster. Describes the use of a standard television receiver as a microprocessor CRT terminal. Explains and describes character generation, cursor control and interface information in typical, easy-to-understand Lancaster style. BK1064 \$9.95.*

IC OP-AMP COOKBOOK—by Walter G. Jung. Covers not only the basic theory of the IC op amp in great detail, but also includes over 250 practical circuit applications, liberally illustrated. 592 pages, 5 1/2 x 8 1/2, softbound. BK1028 \$14.95.*

THE WELL EQUIPPED HAM SHACK



MICROCOMPUTER BOOKS

THE SELECTRIC INTERFACE—by George Young. You need the quality print that a daisy wheel printer provides but the thought of buying one makes your wallet wilt. **SELECTRIC™ INTERFACE**, a step-by-step guide to interfacing an IBM Selectric I/O Writer to your microcomputer, will give you that quality at a fraction of the price. George Young, co-author of *Kilobaud Microcomputing* magazine's popular "Kilobaud Classroom" series, offers a low-cost alternative to buying a daisy wheel printer. **SELECTRIC INTERFACE** includes: step-by-step instructions, tips on purchasing a used Selectric, information on various Selectric models, including the 2740, 2980, and Dura 1041, driver software for Z80, 8080, and 6502 chips, tips on interfacing techniques. With **SELECTRIC INTERFACE** and some background in electronics, you can have a high-quality, low-cost, letter-quality printer. Petals not included. BK7388 \$12.97

40 COMPUTER GAMES FROM KILOBAUD MICROCOMPUTING—Forty games in nine different categories. Games for large and small systems, and a section on calculator games. Many versions of BASIC used and a wide variety of systems represented. A must for the serious computer gamesman. BK7381 \$7.95*

KILOBAUD CLASSROOM—By George Young and Peter Stark. Learning electronics theory without practice isn't easy. And it's no fun to build an electronics project that you can't use. *Kilobaud Classroom* the popular series first published in *Kilobaud Microcomputing*, combines theory with practice. This is a *practical course* in digital electronics. It starts out with very simple electronics projects, and by the end of the course you'll construct your own working microcomputer! BK7386 \$14.95

TEXTEDIT—A Complete Word Processing System in kit form—by Irwin Rappaport. **TEXTEDIT** is an inexpensive word processor that you can adapt to suit your needs, from writing form letters to large texts. It is written in modules, so you can load and use only those portions that you need. Included are modules that perform right justification, ASCII upper/lowercase conversion, one-key phrase entering, complete editorial functions, and much more! **TEXTEDIT** is written in TRS-80* Disk BASIC, and the modules are documented in the author's admirably clear tutorial writing style. Not only does Irwin Rappaport explain how to use **TEXTEDIT**; he also explains programming techniques implemented in the system. **TEXTEDIT** is an inexpensive word processor that helps you learn about BASIC programming. It is written for TRS-80 Models I and III with TRS-DOS 2.2/2.3 and 32K. *TRS-80 and TRSDOS are trademarks of the Radio Shack Division of Tandy Corporation. BK7387 \$9.97

COMPUTER CARNIVAL—by Richard Ramella. Your child can become a crackerjack computerist with the sixty TRS-80 Level II programs in **COMPUTER CARNIVAL**. This large-type, spiral bound book for beginners is a veritable funhouse of games, graphics, quizzes and puzzles. Written by *80 Micro* columnist Richard Ramella, the programs are challenging enough to ensure continued learning, yet short enough to provide your child with the immediate delight and reward of mastering basic computing skills. And for even greater enjoyment, get the **CARNIVAL COMPANION**, a 30-minute cassette containing all the programs in the book. Eliminates tiresome typing and lets your child spend more time enjoying the programs. BK7389 \$16.97 CC7389 Book and Cassette \$24.97

WORLD REPEATER ATLAS—Completely updated, over 230 pages of repeater listings are indexed by location and frequency. More than 50 maps pinpoint 2000 repeater locations throughout the USA. Foreign listings include Europe, the Middle East, South America, and Africa. BK7315 \$2.00

THE MAGIC OF HAM RADIO—by Jerrold Swank WBHXR. Under various call signs, WBHXR has been heard on the ham bands since 1919. He has watched amateur radio grow from the days of Model A spark coils to an era of microprocessors and satellite communications. Jerry has responded to calls for help from earthquake-stricken Managua and tornado-ravaged Xenia. Antarctica, one of man's loneliest outposts, has been a bit less lonely, thanks to Jerry's tireless phonepatching efforts. Drawing on his own colorful experiences and those of many other hams, Jerry has compiled this word-picture of ham radio during the past six decades. BK7312 \$4.95

A GUIDE TO HAM RADIO—by Larry Kahaner WB2NEL. What's Amateur Radio all about? You can learn the basics of this fascinating hobby with this excellent beginner's guide. It answers the most frequently asked questions in an easy-going manner, and it shows the best way to go about getting an FCC license. *A Guide to Ham Radio* is an ideal introduction to a hobby enjoyed by people around the world. BK7321 \$4.95.*

WORLD RADIO TV HANDBOOK 1983, 26TH EDITION—This book is the bible of international broadcasters, providing the only authoritative source of exact information about broadcasting and TV stations world wide. This 1983 edition is completely revised, giving comprehensive coverage of short, medium and long wave, 560 pages of vital aspects of world listening. BK1184 \$16.50

*Use the order card in this magazine or itemize your order on a separate piece of paper and mail to: 73 Radio Bookshop • Peterborough NH 03458. Be sure to include check or detailed credit card information. No C.O.D. orders accepted. \$1.50 for the first book, \$1.00 each additional book for U.S. delivery and foreign surface. For foreign airmail \$10.00 per book. Please allow 4-6 weeks for delivery. Questions regarding your order? Please write to Customer Service at the above address. (Prices subject to change on books not published by 73 Magazine.)

FOR TOLL FREE ORDERING CALL 1-800-258-5473

RADIO BOOKSHOP

HAND BOOKS FOR NEW! THE HAMSHACK

AMATEUR RADIO CALL DIRECTORY, 1982-1983 Edition. Compiled by: Jack A. Speer N1BIC and Ashok K. Anand. Here it is, and at a price you can afford! A directory of over 410,000 radio amateurs in the United States (as licensed by the U.S. Gov't). Completely updated for 1983. Easy to handle 8 1/2 x 11 format. BK1254 \$14.95

THE TEN METER FM HANDBOOK—by Bob Heil K9EID. This handbook has been published to help the ten meter enthusiast learn more about the many methods of conversions and tricks that are used to make existing units work better. Join the great "tinkerers" of the world on ten FM and enjoy the fantastic amount of fun in communicating with amateur stations worldwide on ten meter FM. BK1190 \$4.95.*

THE COMPLETE SHORTWAVE LISTENER'S HANDBOOK, 2nd EDITION by Hank Bennett and Harry L. Helms. This comprehensive volume contains loads of new information from all over the world on the latest developments in SWL technology clubs, associations, practices and stations. A thorough guide to stations of the world by general continental area and frequency is included. BK1241 \$9.95

THE PRACTICAL HANDBOOK OF AMATEUR RADIO FM REPEATERS—by Bill Pasternak WA6ITF (author of 73 Magazine's monthly column "Looking West") This is the book for the VHF/UHF FMer, compiled from material submitted by over a hundred individuals, clubs, organizations and equipment manufacturers. A "must have" for your ham shack shelf. BK1185 \$12.95.*

THE 73 TEST EQUIPMENT LIBRARY

VOL. II AUDIO FREQUENCY TESTERS—Jam-packed with all kinds of audio frequency test equipment. If you're into SSB, RTTY, SSTV, etc., this book is a must for you... a good book for hi-fi addicts and experimenters, too! LB7360 \$1.95.*

VOL. III RADIO FREQUENCY TESTERS—Radio frequency waves, the common denominator of amateur radio. Such items as SWR, antenna impedance, line impedance, RF output, and field strength; detailed instructions on testing these items includes sections on signal generators, crystal calibrators, grid dip oscillators, noise generators, dummy loads, and much more. LB7361 \$1.95.*

VOL. IV IC TEST EQUIPMENT—Become a troubleshooting wizard! Here are 42 home construction projects for building test equipment to work with your ham station and in servicing digital equipment. Plus a cumulative index for all four volumes for the 73 TEST EQUIPMENT LIBRARY. LB7362 \$1.95.*

ALL THREE OF THE ABOVE ONLY \$4.95 ORDER LB7365

RF AND DIGITAL TEST EQUIPMENT YOU CAN BUILD—BK1044—Rf burst, function, square wave generators, variable length pulse generators—100 kHz marker, i-f and rf sweep generators, audio osc, at/rf signal injector, 146 MHz synthesizer, digital readouts for counters, several counters, prescaler, microwave meter, etc. 252 pages. BK1044 \$5.95.*

FOR THE CONTESTER

THE CONTEST COOKBOOK—This book reveals the secrets of that elite group of operators who top the list when the contest results are published. It contains detailed suggestions for the first-time contestee as well as tips for the advanced operator. Domestic, DX, and specialty contests are all discussed, complete with photographs and diagrams showing the equipment and operating aids used by the top scorers. For the serious contestee. BK7308 \$5.95.

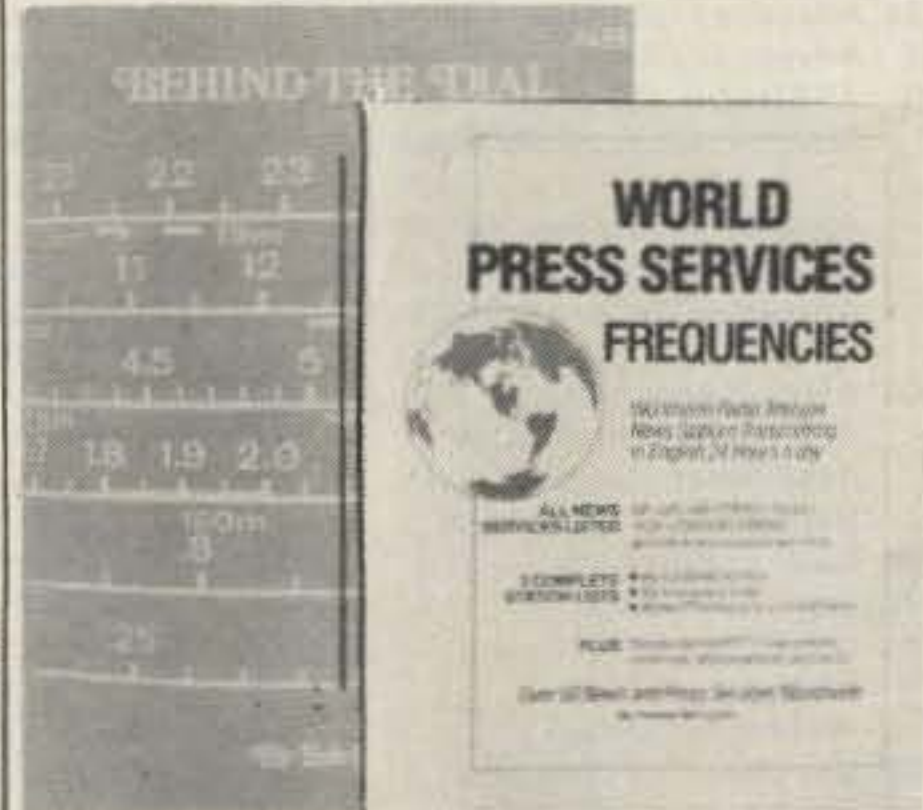

2 NEW RTTY BOOKS

WORLD WIDE RADIO TELETYPE STATIONS IN FREQUENCY ORDER—8th EDITION Compiled by Universal Electronics, Inc. Contains 2198 frequencies of stations that have been logged in 1982. Frequency, call sign, name of station, ITU country symbol, times of reception and details are included. All types of RTTY stations are listed including schedules of 82 press and news agencies operating on 637 frequencies. Includes 77 meteorological stations on 279 frequencies. Covers all RTTY stations from 3 MHz to 30 MHz, air, metro, government, military, diplomatic, covers all services. This is the most accurate RTTY list there is and a must for the serious RTTY enthusiast. BK1270 \$10.95.

WORLDWIDE RADIO TELETYPE CALL SIGN LIST OF UTILITY STATIONS—8th EDITION Compiled by Universal Electronics, Inc. Contains more than 4000 call signs in alphanumeric order. All types of stations are listed. 183 utility station mnemonics and name abbreviations. Plus abbreviations for regional states in Australia, Canada, USA and USSR. All ITU Symbols designating countries or geographical areas. Table of allocation of international call sign series. Revised radio regulations on identification of stations, including formation or call signs. All services listed. BK1271 \$4.95

70 YEARS OF RADIO TUBES AND VALVES—by John Stokes "Great, the best book on the history of radio tubes that I've ever seen!" raved 73's technical editor. Written by an expert who has been involved in radio since '29, this book will be of special interest to "old-timers" and will provide those younger hams with a unique sense of the history of their hobby. BK1272 \$21.95

EVERYTHING YOU ALWAYS WANTED TO KNOW ABOUT AMATEUR TELEVISION, (but were afraid to ask)—By Mike Stone WB0QCD. This book is a complete guide to setting up your own amateur radio television station. It contains—A history, what equipment you need, video theory, cameras, recorders, lighting, special effects, sound ATV DXing, mobile FSTV, ATV repeaters, ATV groups, building projects, test equipment, dealer directory, a cumulative index of over 1000 articles on amateur TV and much more. **This is the new, 1982 edition.** From the publishers of *Amateur Television Magazine*. BK1244 \$9.95

WORLD PRESS SERVICE FREQUENCIES—by Thomas Harrington Can't wait to hear the evening news, or are you wondering about the news that you aren't hearing? Receive by Radio Teletype (RTTY) all the world news and financial happenings from the world capitols on a 24 hour a day basis. This book gives you the frequencies and times of broadcast of such news services as AP, UPI, Reuters, TASS, VOA and London Press. Also included is an introduction to RTTY with information on equipment, antennas, abbreviations—everything you need to get started in RTTY. BK1202 \$7.95*

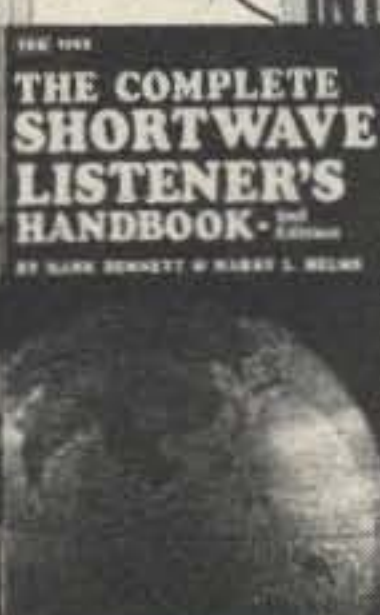

THE 73 TECHNICAL LIBRARY

PROPAGATION WIZARD'S HANDBOOK—by J. H. Nelson. When sunspots riddled the worldwide communications networks of the 1940s, John Henry Nelson looked to the planets for an answer. The result was a theory of propagation forecasting based upon interplanetary alignment that made the author the most reliable forecaster in America today. The book provides an enlightened look at communications past, present, and future, as well as teaching the art of propagation forecasting. BK7302 \$6.95.*

SSB... THE MISUNDERSTOOD MODE—by James B. Wilson. Single Sideband Transmission... thousands of us use it every day, yet it remains one of the least understood facets of amateur radio. J. B. Wilson presents several methods of sideband generation, amply illustrated with charts and schematics, which will enable the ambitious reader to construct his own sideband generator. A must for the technically-serious ham. BK7351 \$5.50.*

INTERFERENCE HANDBOOK—by William R. Nelson, WA6EQG—This timely handbook covers every type of RFI problem and gives you the solutions based on practical experience. Covers interference to TV, radio, hi-fi, telephone, radio amateur, commercial and CB equipment. Power line interference is covered in depth—how to locate it, cure it, work with the public, safety precautions, how to train RFI investigators. Written by an RFI expert with 33 years of experience, this profusely illustrated book is packed with practical easy-to-understand information. BK1230 \$11.95.

OWNER REPAIR OF RADIO EQUIPMENT—by Frank Glass K6RQ. Here's a book that will teach you an approach to troubleshooting without a shack full of test equipment. Written in a narrative, non-mathematical style, it will encourage you to successfully fix your own rig problems 80 to 90% of the time. Even if you don't want to fix, you can learn a lot about how things work and fail. Add to your library and personal expertise. BK7310 \$7.95.*

TOOLS & TECHNIQUES FOR ELECTRONICS—by A. A. Wicks is an easy-to-understand book written for the beginning kit-builder as well as the experienced hobbyist. It has numerous pictures and descriptions of the safe and correct ways to use basic and specialized tools for electronic projects, as well as specialized metal-working tools and the chemical aids which are used in repair shops. BK7348 \$4.95.*

BEHIND THE DIAL—This book explains, in detail, what's going on on all the frequencies, from shortwave up to microwave. It gives the reader a good idea of what he can find and where to find it, including some of the secret stations such as the C.I.A. and the F.B.I. Everything is covered short of microwave monitoring. Anyone interested in purchasing a shortwave receiver should have a copy of this book. surveillance, station layout consideration, antenna systems, interface, and the electromagnetic spectrum, are included. BK7307 \$4.95

THE NEW WEATHER SATELLITE HANDBOOK—by Dr. Ralph E. Taggart WB8DQT. Here is the completely updated and revised edition containing all the information on the most sophisticated and effective spacecraft now in orbit. This book serves both the experienced amateur satellite enthusiast and the newcomer. It is an introduction to satellite watching, providing all the information required to construct a complete and highly effective ground station. Solid hardware designs and all the instructions necessary to operate the equipment are included. For experimenters who are operating stations, the book details all procedures necessary to modify equipment for the new series of spacecraft. Amateur weather satellite activity represents a unique blend of interests encompassing electronics, meteorology and astronautics. Join the privileged few in watching the spectacle of earth as seen from space on your own monitoring equipment. BK7383 \$8.95.*

*Use the order card in this magazine or itemize your order on a separate piece of paper and mail to: 73 Radio Bookshop • Peterborough NH 03458. Be sure to include check or detailed credit card information. No C.O.D. orders accepted. \$1.50 for the first book, \$1.00 each additional book for U.S. delivery and foreign surface. For foreign airmail \$10.00 per book. Please allow 4-6 weeks for delivery. Questions regarding your order? Please write to Customer Service at the above address. (Prices subject to change on books not published by 73 Magazine.)

FOR TOLL FREE ORDERING CALL 1-800-258-5473

ADVERTISERS

*Please contact these advertisers directly.
To receive full information from our advertisers please complete the postage-paid card.

R. S. No.	Page	R. S. No.	Page	R. S. No.	Page	R. S. No.	Page	
2	AEA/Advanced Electronic Applications	99	462	Communications Electronics Specialties, Inc.	18	*	Ham Radio Center	5
40	AEA/Advanced Electronic Applications	119	15	Communications Specialists	67, 77	*	Ham Radio Outlet	3
482	AEA/Advanced Electronic Applications	118	222	Computer Applications	16	33	Hamtronics, NY	142, 143
6	AC5D Computer Programs	129	*	Computer Trader	130	303	Heath Co.	69
448	Advanced Communications International	119	*	Connect Systems	11	320	Hoosier Electronics	18
124	Advanced Computer Controls	46	481	Continental Satellite Systems	116	*	ICOM	Cov. II, 120
67	Advanced Computer Controls	10	25	Control Products Unlimited	83	78	Independent Crystal Supply	130
20	All Electronics	117	*	Cotec	130	28	Interface Systems	41
*	Amateur Communications, Etc.	82	*	Crown Micro Products	117	480	International Crystal	116
*	Amateur Electronic Supply	35, 78, 109	106	Cushcraft Corp.	82	*	Japan Radio	13
5	Amateur-Wholesale Electronics	17	12	C. Z. Labs, Inc.	97	*	JDL Industries	33
334	Amidon Associates	82	*	Data Ed	59	354	Jensen Tools	130
*	Ampersand Electronics	37	346	Data Service Company	96	*	Kantronics	28, 29
*	Associated Radio	63	256	Davilyn Corp.	130	230	KCS Electronics Corp.	22
11	Barker & Williamson, Inc.	12	*	DGM Electronics, Inc.	62, 118	*	Kenwood	7, Cov. IV
305	Barry Electronics	36	17	Digital Microsystems	23	*	KLM Electronics	4, 12, 16
476	Base 2 Systems	116	425	Doppler Systems	59	*	Lee-Art, Inc.	129
26	Bee Computers	129	219	E-Tek	130	*	Macrotronics, Inc.	61
*	Bill Ashby & Son	61	18	Electronic Specialists, Inc.	18	45	Madison Electronics	43
*	Blacksburg Group	42	29	Esoteric Engineering	130	46	Maggiore Electronics	61
226	Buckmaster Publishing	83	248	Etco Electronics	61	9	MFJ Enterprises	71
255	Buckmaster Publishing	125	85	Faxscan, Inc.	83	233	MFJ Enterprises	117
*	Butternut Electronics Corp.	16	218	Ferritronics	48	234	MFJ Enterprises	119
187	Call Letter Hats	87	8	Fox-Tango Corp.	83	260	MFJ Enterprises	121
7	Ceco Communications, Inc.	46	323	Fox-Tango Corp.	119	478	MFJ Enterprises	116
13	Coin International, Inc.	130	178	Galaxy Electronics	129	48	MHZ Electronics	132-141
14	Communications Concepts, Inc.	61	*	Gilco International, Inc.	128	27	Micro-80, Inc.	83
382	Communications Concepts, Inc.	83	229	Gizmo Electronics	125	49	Micro Control Specialties	49
485	Communications Concepts, Inc.	116	143	GLB Electronics	63	50	Microcraft	80
			16	Greenbrier Marketing International, Inc.	19	51	Microlog Corporation	53
			352	Grove Enterprises	63	479	Microlog Corporation	116
			31	Hal-Tronix	62	*	Mirage Communications	75
			483	Hallward Products	120	258	Missouri Radio Center	10
						318	National Comm. Group Co.	66
						249	National Photo Finishers	129
						412	Nemal Electronics	125
						137	Nuts & Volts	130
						*	Orbit Magazine	55
						*	P. C. Electronics	93
						*	Palomar Engineers	4
						4	Parsec Communications	96
						182	Peterson Electronics	125, 129
						246	Phillips-Tech Electronics Corp.	22
						477	Poly Phaser Corp.	116
						484	QZX Newsletter	120
						61	Radio Amateur Callbook, Inc.	121
						397	Radio World	101
						454	Radiokit	101
						62	Ramsey Electronics	131, 145
						133	Rivendell Associates	125
						150	Royal	125
						65	S-F Amateur Radio Services	101
						261	SEI, Inc.	101
						253	Scientific Instruments	101
						500	73 Books	110-115, 127
							Dealer Ad	127
							Moving	127
							Subscription	81, 98, 125
							University Microfilms	98
						*	Spectronics	144
						68	Spectrum Communications	72
						436	Spectrum International, Inc.	52
						3	Speedcall Corp.	37
						173	Spider Antenna	99
						*	Ten-Tec	80, 116
						32	TE Systems	59
						245	TET/Sultronics	99
						*	The Antenna Bank	55
						63	The Antenna Specialists	15
						449	The Ham Shack	47
						205	The Metheny Corp.	15
						104	Trionyx	52
						189	Universal Software	129
						*	V-J Products, Inc.	121
						*	Van Gorden Engineering	37



BOOKS, ETC.

To order, complete the postage-paid card, or itemize your order including detailed credit card information or check and mail to: 73 Magazine/Mail Order Dept./Peterborough NH 03458.

Catalog#	Item	Price	Catalog#	Item	Price	Catalog#	Item	Price	Catalog#	Item	Price
73300	73 BACK ISSUE - BEFORE JULY 1980	\$ 3.00	BK7309	CHALLENGE OF 160	\$ 4.95	BK7310	OWNER REPAIR OF RADIO EQUIPMENT	\$ 7.95	SG7358	STUDY GUIDE - GENERAL CLASS	\$ 6.95
73350	73 BACK ISSUE - JULY 1980 THRU OCT 1981	\$ 3.50	BK1011	CMOS COOKBOOK	\$10.50	BK1185	THE PRACTICAL HANDBOOK OF FM REPEATERS	\$12.95	BK1190	THE TEN METER FM HANDBOOK	\$ 4.95
73350P	73 BACK ISSUE - NOV 1981 TO PRESENT	\$ 3.50	CT7305	CODE TAPE - 5 WPM	\$ 4.95	BK7302	PROPAGATION WIZARD'S HANDBOOK	\$ 6.95	LB7360	TEST EQUIP LIB V2 - AUDIO TESTERS	\$ 4.95
73005	73 BACK ISSUE - 5 YOUR CHOICE	\$10.75	CT7306	CODE TAPE - 6+ WPM	\$ 4.95	QW0250	QSL CARDS - STYLE W - 250	\$ 8.95	LB7361	TEST EQUIP LIB V3 - RADIO EQUIP	\$ 4.95
	Add \$1.00 per magazine for shipping		CT7313	CODE TAPE - 13+ WPM	\$ 4.95	QX0250	QSL CARDS - STYLE X - 250	\$ 8.95	LB7362	TEST EQUIP LIB V4 - IC TEST EQ	\$ 4.95
73010	73 BACK ISSUE - 10 YOUR CHOICE	\$16.00	CT7320	CODE TAPE - 20+ WPM	\$ 4.95	QY0250	QSL CARDS - STYLE Y - 250	\$ 8.95	BK7387	TEXTEDIT - WORD PROCESSING KIT	\$9.97
73025	73 BACK ISSUE - 25 YOUR CHOICE	\$27.00	CT7325	CODE TAPE - 25+ WPM	\$ 4.95	QY0500	QSL CARDS - STYLE Y - 500	\$13.95	D57387	TEXTEDIT - DISK	\$19.97
73125	73 BACK ISSUE - 25 OUR CHOICE	\$14.00	CT7394	CODE TAPES (ANY FOUR ABOVE)	\$15.95	BK1199	THE RADIO AMATEUR ANTENNA HANDBOOK	\$ 6.95	BK7348	TOOLS & TECHNIQUES	\$ 4.95
	Add \$7.50 per order for shipping		BK1241	THE COMPLETE SHORTWAVE LISTENER'S HANDBOOK	\$ 9.95	BK1044	RF & DIGITAL TEST EQUIPMENT	\$ 5.95	BK1063	TTL COOKBOOK	\$ 9.50
BK1196	ALL ABOUT CUBICAL QUAD ANTENNAS	\$ 5.95	BK7308	THE CONTEST COOKBOOK	\$ 5.95	BK1016	73 DIPOLE & LONG WIRE ANTENNAS	\$ 5.50	BK1064	TVI COOKBOOK	\$ 9.95
BK7384	ANNOTATED BASIC VOL 1	\$20.95	BK7381	40 COMPUTER GAMES	\$ 7.95	BK1000	SHELF BOX - 1	\$ 2.00	BK7382	UNDERSTANDING & PROGRAMMING MICROCOMPUTERS	\$10.95
BK7385	ANNOTATED BASIC VOL 2	\$10.95	BK1244	EVERYTHING YOU ALWAYS WANTED TO KNOW ABOUT AMATEUR TV	\$ 9.95	BK1001	SHELF BOXES - 2-7	\$1.50 each	BK7368	VHF ANTENNA HANDBOOK	\$ 5.95
BK1197	BEAM ANTENNA HANDBOOK	\$ 5.95	BK7321	A GUIDE TO HAM RADIO	\$ 4.95	BK1002	SHELF BOXES - 8 AND UP	\$1.25 each	BK1198	VHF HANDBOOK FOR RADIO AMATEURS	\$ 6.95
BK7307	BEHIND THE DIAL	\$ 4.95	BK7322	HOBBY COMPUTERS ARE HERE	\$ 2.47	BK1200	SIMPLE LOW COST WIRE ANTENNAS FOR RADIO AMATEURS	\$ 6.95	BK1184	WORLD RADIO TV HANDBOOK	\$16.50
			BK1201	HOW TO DEFEND YOURSELF AGAINST RADAR	\$ 6.95	BK7311	SOME OF THE BEST FROM KILOBAUD	\$10.95	BK7315	WORLD REPEATER ATLAS	\$ 2.00
			BK1028	IC OP AMP COOKBOOK	\$14.95	BK7351	SSB THE MISUNDERSTOOD MODE	\$ 5.50			
			BK1230	INTERFERENCE HANDBOOK	\$ 8.95	SG7357	STUDY GUIDE - NOVICE CLASS	\$ 4.95			
			BK7386	KILOBAUD CLASSROOM	\$14.95						
			BK7312	MAGIC OF HAM RADIO	\$ 4.95						
			BK7340	THE NEW HOBBY COMPUTERS	\$ 2.47						
			BK7383	THE NEW WEATHER SATELLITE HANDBOOK	\$ 8.95						
			CT7300	NOVICE THEORY TAPES	\$15.95						

SHIPPING AND HANDLING CHARGES: \$1.50 for the first book, \$1 for each additional book for US delivery and foreign surface, \$10 per book for foreign airmail.

WAYNE GREEN BOOKS

KILOBAUD KLASROOM

by George Young and Peter Stark

Makes learning electronics fun and easy. First published as a series in *Kilobaud Microcomputing*, the book combines the learning of essential theory with practical, hands-on experience. The course begins with basic electronic projects and culminates in the construction of your own programmable microcomputer. The direct instructional methods of authors Young & Stark make KILOBAUD KLASROOM a simple way for you to acquire a solid background in digital electronics.

BK7386 (419 pages).....\$14.95



THE SELECTRIC INTERFACE by George Young

You need the quality print that a daisy wheel printer provides but the thought of buying one makes your wallet wilt. The SELECTRIC™ INTERFACE, a step-by-step guide to interfacing an IBM Selectric I/O Writer to your microcomputer, will give you that quality at a fraction of the price. George Young, co-author of *Kilobaud Microcomputing* magazine's popular "Kilobaud Classroom" series, offers a low-cost alternative to buying a daisy wheel printer. The SELECTRIC INTERFACE includes: step-by-step instructions, tips on purchasing a used Selectric, information on various Selectric models, including the 2740, 2980, and Dura 1041, driver software for Z80, 8080, and 6502 chips, tips on interfacing techniques. With The SELECTRIC INTERFACE and some background in electronics, you can have a high-quality, low-cost, letter-quality printer. Petals not included.

BK7388 (125 pages).....\$12.97

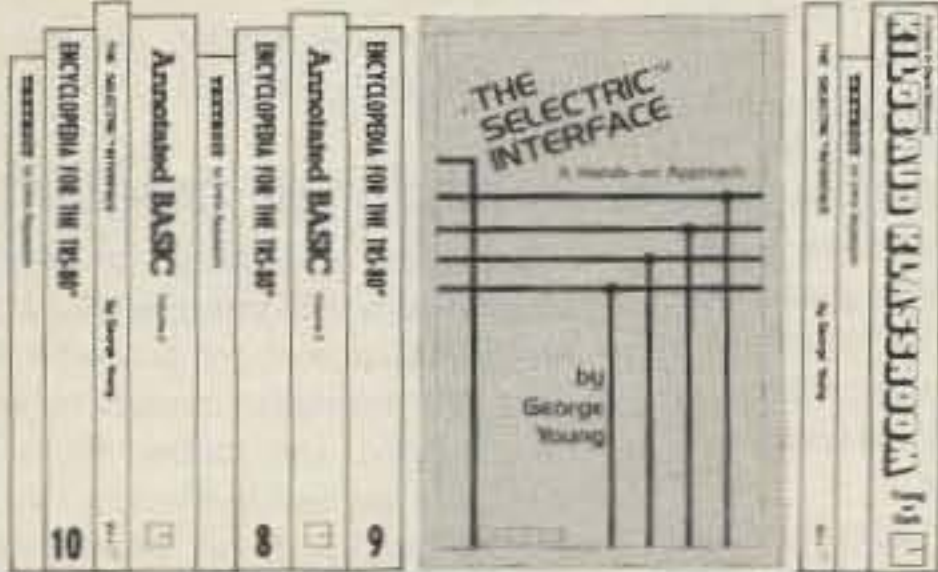

GENERAL LICENSE STUDY GUIDE

By Timothy M. Daniel N8RK

This is the complete guide to the General License. Learning rather than memorizing is the secret. This is not a question-and-answer guide that will gather dust when the FCC issues a new test. Instead, this book will be a helpful reference, useful long after a ham upgrades to General. Includes up-to-date FCC rules and an application form. Order yours today and talk to the world.

SG7358 (87 pages).....\$6.95

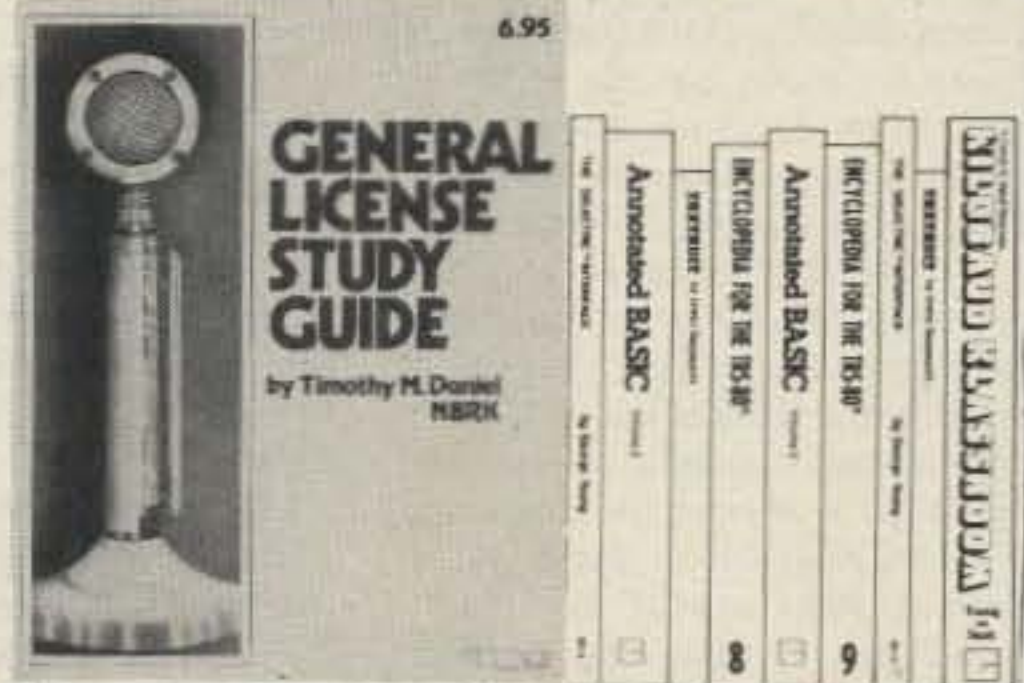

NOVICE LICENSE STUDY GUIDE

By Timothy M. Daniel N8RK

Here is the most up-to-date novice guide available. It is complete with information about learning Morse code, has the latest FCC amateur regulations and the current FCC application forms. This guide is *not* a question/answer memorization course but rather it emphasizes the practical side of getting a ham license and putting a station on the air. It reflects what the FCC expects a Novice to know without page after page of dull theory. The most current information still available at last year's price.

SG7357 (98 pages).....\$4.95

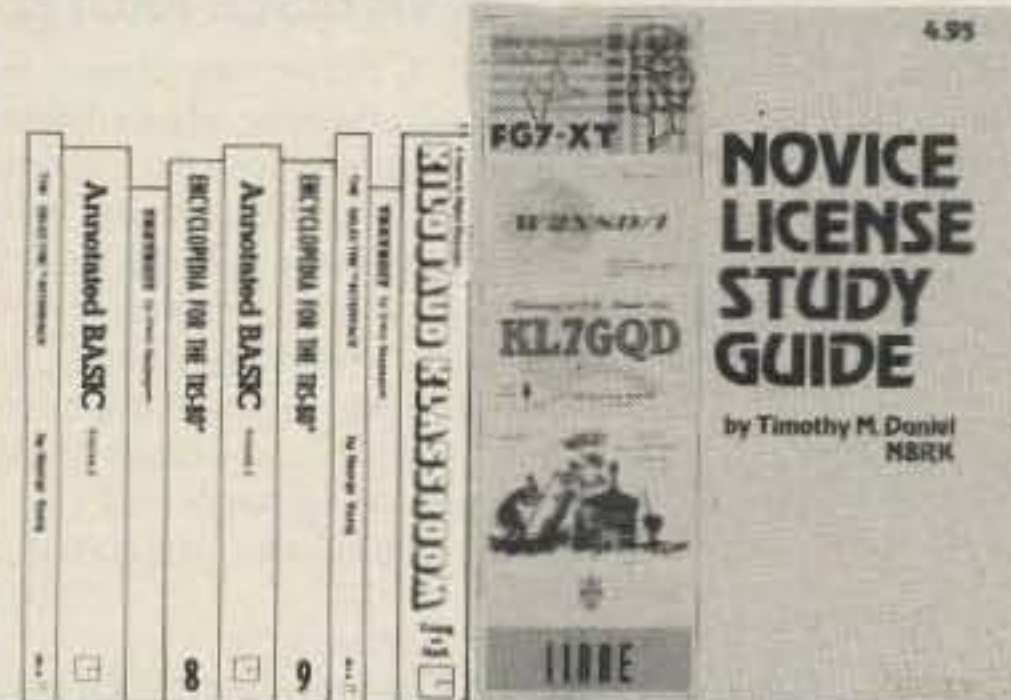

THE NEW WEATHER SATELLITE HANDBOOK by Dr. Ralph E. Taggart WB8DQT

Here is the completely updated and revised edition of the best-selling *Weather Satellite Handbook*—containing all the information on the most sophisticated and effective spacecraft now in orbit. Dr. Taggart has written this book to serve both the experienced amateur satellite enthusiast and the newcomer. The book is an introduction to satellite watching, providing all the information required to construct a complete and highly effective ground station. Not just ideas, but solid hardware designs and all the instruction necessary to operate the equipment are included. For the thousands of experimenters who are operating stations, the book details all procedures necessary to modify their equipment for the new series of spacecraft. Amateur weather satellite activity represents a unique blend of interests encompassing electronics, meteorology and astronautics. Join the privileged few in watching the spectacle of earth as seen from space on your own monitoring equipment.

BK7383 (132 pages).....\$8.95



FOR TOLL-FREE ORDERING CALL 1-800-258-5473
WAYNE GREEN BOOKS•PETERBOROUGH NH 03458

Itemize your order on a separate piece of paper and mail to Wayne Green Books, Attn: Sales, Peterborough, NH 03458. Be sure to include check or detailed credit card information. (Visa, MC or AMEX accepted.) No C.O.D. orders accepted. All orders add \$1.50 for the first book, postage and handling; \$1.00 each additional book; \$10.00 per book foreign air mail. Please allow 4-6 weeks after publication for delivery. Questions regarding your order? Please write to Customer Service at the above address.

NEW PRODUCTS

NEW CRYSTAL CATALOG AND CROSSOVER LIST

A new 32-page crossover list and custom crystal catalog is now available from International Crystal Mfg. Co., Inc.

A comprehensive crossover listing of the most popular types of commercial two-way equipment is featured. This listing provides the user with the ICM crystal catalog number referenced to the manufacturer's equipment number.

A complete listing of ICM custom crystals featuring charts to establish ICM catalog numbers along with available holder dimensions is included.

To obtain your copy, write to *International Crystal Mfg. Co., Inc., Dept. G, PO Box 26330, Oklahoma City OK 73126*. Reader Service number 480.

BASE 2 SYSTEMS' "MUF PLOT"

Base 2 Systems has released software which for the first time enables shortwave listeners and amateur radio operators to predict band openings at the start of each day instead of relying on one- to three-month-old estimates from periodicals. The program also computes the great-circle bearing and distance to a target area.

Dubbed "Mufplot" because it plots Maximum Usable Frequency, the program is versatile and easy to use. After being customized to the latitude and longitude of the purchaser, it computes the best frequencies for a 24-hour period to any country or US state, or to any of eight world regions. Plots of MUF to ships at sea, DXpeditions, or other special loca-

tions are obtained by entering the appropriate latitude and longitude instead of a radio prefix. Graphs can be in either the user's local time or UTC.

Computation of MUF is accomplished by inputting daily solar flux data from reports of WWV or others into the program's analog of an ionospheric emulation developed through US naval research.

Output to either video display or printer consists of a graph of MUF and text. Mufplot is available now for the Commodore VIC-20 with 16K expansion and the Commodore 64, and a Radio Shack Color Computer version will soon be available.

For more information, contact *Base 2 Systems, 2534 Nebraska St., Saginaw MI 48601; (517)-777-5613*. Reader Service number 476.

EASY-TO-SHIP SATELLITE DISH

A 16-foot satellite antenna aptly named "Silver Max" is the latest offering of Continental Satellite Systems of Clackamas, Oregon.

The Silver Max was developed and manufactured to solve the problems of those who require maximum power of a large dish but are in locations like Hawaii, Alaska, Puerto Rico, Colombia, or the Bahamas, where normal shipment of big antennas is difficult or impossible. The Silver Max can be shipped by UPS or air freight.

The 16-foot model joins Continental's 12-foot "Silver Feather," the 10-foot "Silver Star," and the 8-foot "Silver Edition." For more information, contact *Conti-*

ental Satellite Systems, PO Box 648, Oregon City OR 97045; (503)-656-2774 or (800)-331-2774. Reader Service number 481.

AMATEUR TV RECEIVING CONVERTER

Communications Concepts has announced its new ATV-2 amateur television receiving converter. The ATV-2 has two super-sensitive rf preamplifier stages using the low-noise MRF-901 (1.7 dB NF) transistors. The ATV-2 tunes from 420-450 MHz and downconverts to channels 2, 3, or 4 on your standard TV set. The circuit uses durable microstrip design for stability and simplicity. The combination of a dual-rf stage, the microstrip design, and the hot-carrier diode double-balanced mixer reduces UHF TV intermod problems. The local oscillator is varactor-controlled for ease of tuning. An additional feature not found on other ATV downconverters is the incorporation of a post-amplifier stage (6 dB minimum gain) following the double-balanced mixer. This post-amplifier stage is used to overcome the conversion loss of the mixer. It also delivers a signal level that is acceptable to the TV set to overcome the TV set's sensitivity threshold. The addition of the post-amplifier circuitry is most noticeable on very weak signal reception.

For more information, contact *Communications Concepts, Inc., 2648 North Aragon Ave., Dayton OH 45420; (513)-296-1411*. Reader Service number 485.

MICROLOG'S SINGLE-BOARD TU

Microlog has announced the AIR-1, a single-board terminal unit and operating program that needs no external power supply or extras to put your VIC-20 computer on CW and RTTY. The AIR-1 features the Microlog CW-decoding algorithms and computer-enhanced RTTY detection. Plug-in jacks make connection to your radio simple and the on-screen tuning indicator and an audio reference tone make it easy to use. A Microlog feature allows you to select the size of your text buffer and 8 "HERE IS" messages from the available computer RAM. It automatically takes into account any memory-expansion cartridges you have added. Baudot, ASCII, and Morse speeds are fully adjustable and WRU and selcal routines are included.

The AIR-1 fits directly into the VIC expansion port and is compatible with popular expander boards.

For more information, contact *Microlog Corporation, 18713 Mooney Drive, Gaithersburg MD 20879; (301)-258-8400*. Reader Service number 479.

TEN-TEC 2M HAND-HELD

Ten-Tec has announced a new 2-meter hand-held transceiver designed in collaboration with Motorola. The model 2591 HT is a fully-synthesized rig using a keypad for frequency and function control. The transmitter puts out 2.5 W or 300 mW with a maximum current drain of less than 700 mA. The HT will step up or down in 5-, 10-, 15-, 25-, or 30-kHz steps, and there is room for 10 stored frequencies and repeater offsets. The scanning feature allows for a programmable band scan or a memory scan, with special lockout provisions for unwanted frequencies. Standard accessories for the 2591 include a rubber-ducky antenna and a wall charger.

For more information, contact *Ten-Tec, Inc., Sevierville TN 37862*.

MFJ'S VHF CONVERTER

Triple the usefulness of your 2-meter handie-talkie with this new MFJ-313 police, fire, and weather-band converter. The compact VHF converter mounts between your handie-talkie and rubber ducky antenna and turns any synthesized rig into a public-service band receiver. The converter also will give you direct frequency readout and allow simultaneous scanning of both 2 meters and police bands. A high-pass input filter and a 1.0-GHz transistor give you very high uniform sensitivity over both the 154-158-MHz and 160-164-MHz ranges. Each band is crystal-controlled for excellent stability. An automatic bypass allows transmitting through the converter without burnout.

For more information, contact *MFJ Enterprises, 921 Louisville Rd., Starkville MS 39759; (800)-647-1800*. Reader Service number 478.

POLYPHASER PROTECTION

With X PolyPhaser's new rotor-cable lightning protector, you can obtain proper protection for your shack's rotor control box. The 8-conductor model IS-RCT is designed to have a fast response time with 50-nanosecond, three-element crowbar gas tubes. You can mount it on a ground pipe or tower leg, and the case is made with UV stabilized plastic and stainless-steel grounding hardware.

For additional information, contact

TO: SOUTHERN AFRICA
FROM: MICHIGAN

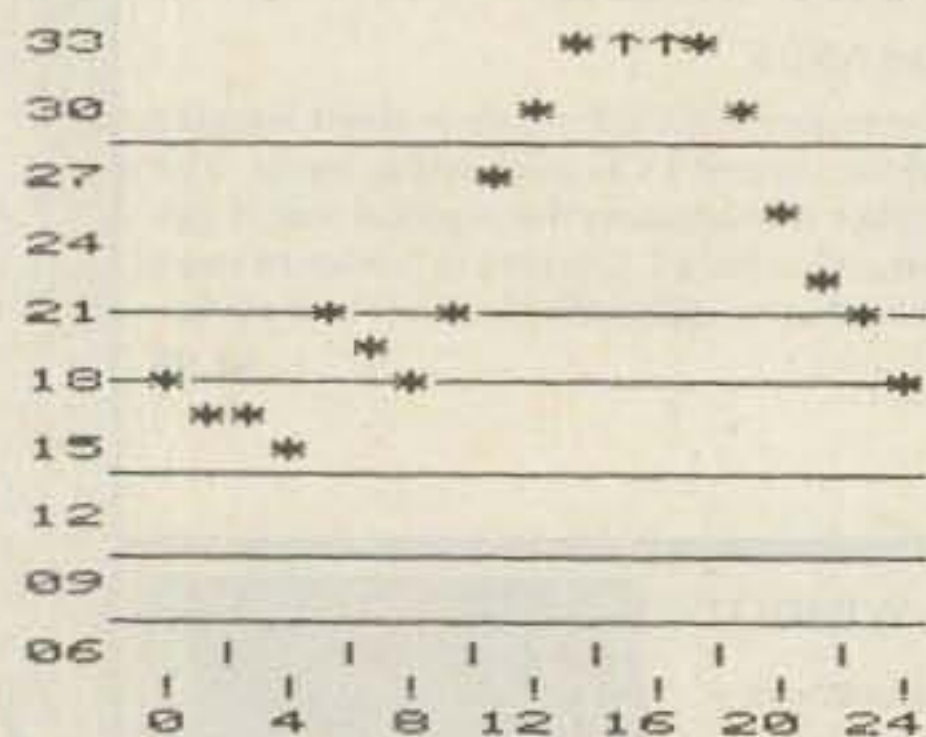

TO: 255 (DX)
8855 MILES
98 DEG
DATE: APRIL 23
TIME: UTC
SUNSPOT # 57

TO: WESTERN EUROPE
FROM: MICHIGAN

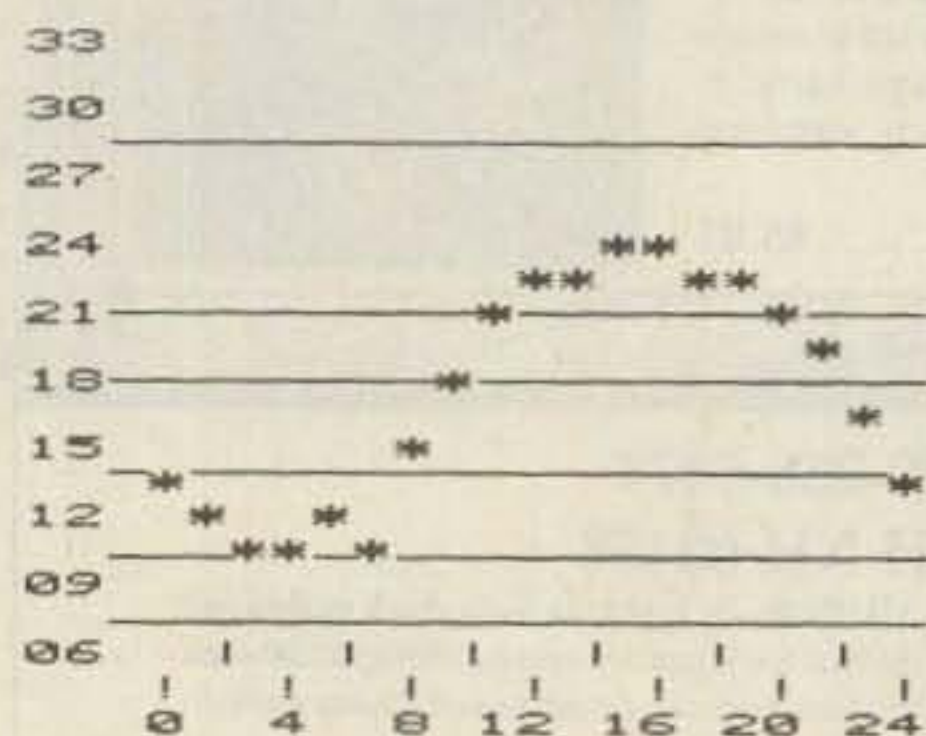

TO: F (DX)
3959 MILES
51 DEG
DATE: APRIL 23
TIME: UTC
SUNSPOT # 57

Sample Mufplot printout.

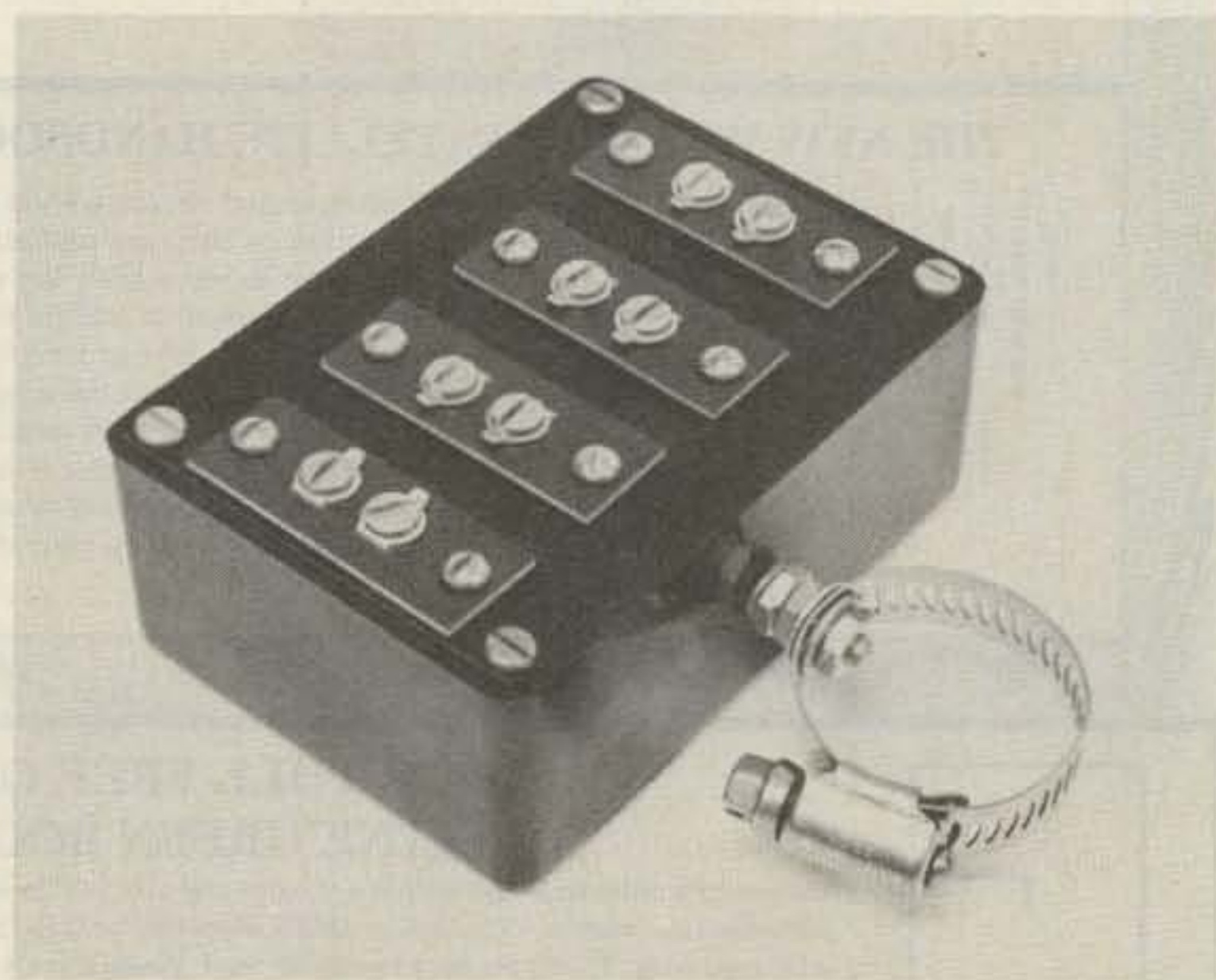

The PolyPhaser rotor-cable lightning protector.

RTTY/CW For the TRS-80*

* A Trademark of the Tandy Corp.



ROM-116

Now includes:

- TEXT EDITING
 - RTTY PICTURES
 - SAVE TEXT TO DISK
- Detailed brochure available on request.*

Featuring:

1200 BAUD OPERATION. Not limited to 110 baud because of timing loops. 60, 66, 75 & 100 W.P.M. Plus 110, 150, 300, 600 & 1200 baud operations possible.

FLEXIBILITY OF OPERATION. Instantly change: Baud Rates; Program Mode (ASCII/Baudot); Program Status.

SPLIT SCREEN VIDEO. Transmit & receive data displayed separately.

REAL TIME. Automatic CW/ID without user intervention. Automatically updates at end of month or year.



606 State Street, P.O. Box 982-R • Marysville, WA 98270 • (206) 659-4279

Other features include:

- Two Serial Ports
- Fourteen Buffers
- Automatic CW/ID
- Transmit Control
- Selective Call Feature
- Error Correction & Editing
- Word Wrapping
- Easy to Interface
- 30 Day Unconditional Guarantee
- Hardware Requirements: TRS-80 Model I or III 16K EXTERNAL TERMINAL UNIT REQUIRED

MFJ 24 HOUR CLOCKS

Your choice: dual 24 hour LCD display, or 24/12 hour with ID timer, or 12 inch quartz analog.

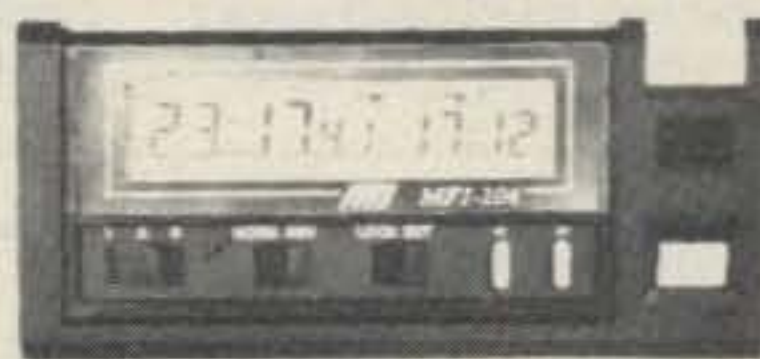

\$39.95 DUAL 24 HOUR LCD
MFJ-104

Two independent 24 hour LCD displays! Read both GMT and local times at a glance.

Six digit main display has seconds readout. Four digit auxiliary. Switch reverses main/aux.

Alarm plays 4 selectable melodies. Alarm "ON" indicator. Snooze button.

Quartz timing. Synchronizable to WWV. Flip-top cover serves as stand.

Night light. Forward/reverse, fast/slow set buttons. Lock function prevents mis-setting. Display main time only, main/auxiliary or main/alarm time. Includes battery. 4x2x1/2 inches.



24/12 HOUR, ID TIMER **\$32.95**
MFJ-102

Switchable 24 hour GMT or 12 hour format. ID timer sounds every 9 minutes after reset. Switchable seconds readout.

Observed timer. Just start clock from zero and note time of event up to 24 hours.

Bright blue 0.6" vacuum fluorescent digits. Alarm with snooze function. Synchronizable with WWV. Fast/slow set buttons. Lock function prevents mis-setting. Power out, alarm "ON" indicators. 110 VAC, 60 Hz (50 Hz with simple modification). UL approved.

Black, brushed aluminum top/front. 6x2x3".

24 HOUR QUARTZ
MFJ-105

\$49.95

True 24 hour quartz wall clock has huge 12 inch diameter face. Gives excellent visibility across computer/radio room.

Fifteen seconds per month accuracy. Single "AA" battery provides over one year operation, immunity from power line failure and eliminates power cord.

Sweep second hand. Brown hi-impact case. Glass front. 24 hour military time format.

Order from MFJ and try it. If not delighted, return within 30 days for refund (less shipping).

One year unconditional guarantee.

Order yours today. Call toll free 800-647-1800. Charge VISA, MC. Or mail check, money order. Add \$4.00 each for shipping and handling.

CALL TOLL FREE 800-647-1800

Call 601-323-5869 in Miss., outside continental USA, tech/repair info. Telex 53-4590 MFJ STKV

MFJ ENTERPRISES, INCORPORATED

Box 494, Mississippi State, MS 39762

WACOM DUPLXERS

Our Exclusive Bandpass-Reject Duplexers
With Our Patented

B_pB_r CIRCUIT[®] FILTERS

... provides superior performance, especially at close frequency separation.

Models available for all commercial and ham bands within the frequency range of 40 to 960 MHz.

TELEPHONE
817/848-4435

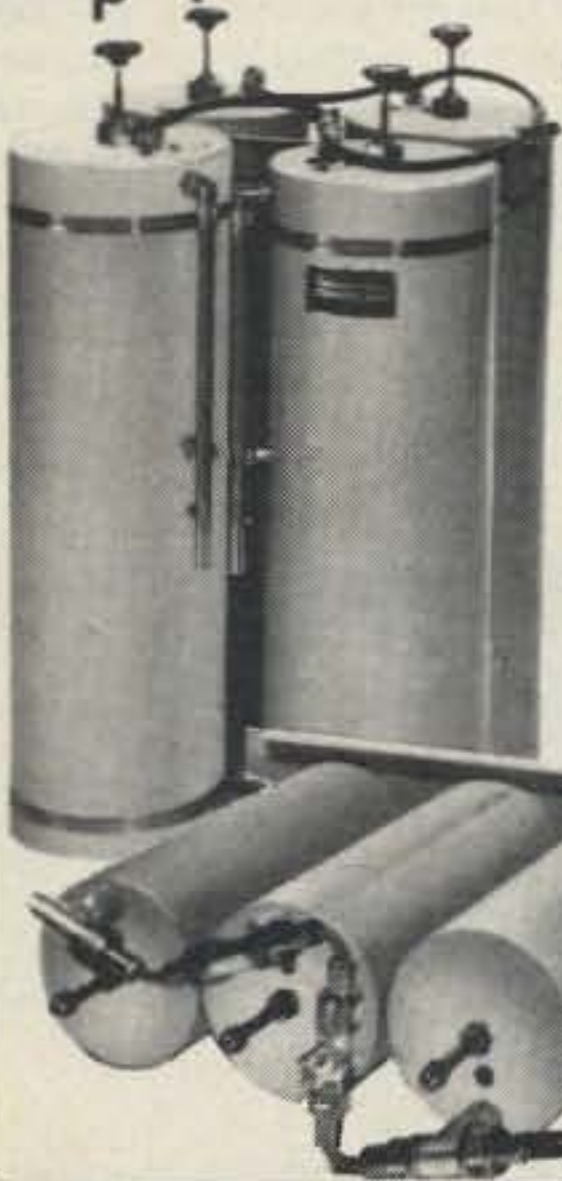

**WACOM
PRODUCTS, INC.**

P.O. BOX 7127 • WACO, TEXAS 76710 • 817/848-4435

TOLL FREE ORDERS • 1-800-826-5432

AK, HI, CA OR INFORMATION • (213) 380-8000

5 KEY ASSEMBLY

\$1.00 EACH
CONTAINS 5 SINGLE-POLE NORMALLY OPEN SWITCHES. MEASURES 3 3/4" LONG

6 KEY ASSEMBLY

\$1.25 EACH
CONTAINS 6 SINGLE-POLE NORMALLY OPEN SWITCHES. MEASURES 4 1/4" LONG

120V INDICATOR

75¢ EACH
NEON INDICATOR. RATED 120 V 1/3 W. MOUNTS IN 5/16" HOLE. RED LENS.
10 FOR \$7.00
100 FOR \$65.00

MINIATURE 6 VDC RELAY

\$1.50 EACH
10 FOR \$13.50
SUPER SMALL SPDT RELAY. GOLD COBALT CONTACTS.
RATED 1 AMP AT 30 VDC. HIGHLY SENSITIVE, TTL DIRECT DRIVE POSSIBLE. OPERATES FROM 4.3 TO 6 V. COIL RES. 220 OHM.
1 3/16" x 13/32" x 7/16"
AROMAT # RSD-6V

13 VDC RELAY

\$1.00 EACH
CONTACT: S.P.N.C. 10 AMP @ 120 VAC. ENERGIZE COIL TO OPEN CONTACT...
COIL: 13 VDC 650 OHMS
SPECIAL PRICE \$1.00 EACH

SEND FOR FREE 40 PAGE CATALOG!

MINIATURE TOGGLE SWITCHES

AVAILABLE IN EITHER P.C. OR SOLDER LUG PLEASE SPECIFY TERMINAL STYLE DESIRED
ALL ARE RATED 5 AMPS @ 125 VAC

SPDT

\$1.00 EACH
10 FOR \$9.00
100 FOR \$80.00

DPDT

\$2.00 EACH
10 FOR \$18.00
100 FOR \$175.00

SPDT CENTER OFF

\$1.00 EACH
10 FOR \$9.00
100 FOR \$80.00

CALL FOR LARGER QUANTITY QUOTES

ALL ELECTRONICS CORP.

905 S. VERMONT • P.O. BOX 20406 • LOS ANGELES, CA 90006

- QUANTITIES LIMITED
- FOREIGN ORDERS INCLUDE SUFFICIENT SHIPPING
- USA 32.50 SHIPPING NO C.O.D.
- CALIF. RES. ADD 6%

20



PolyPhaser Corporation, 1500 West Wind Blvd., Kissimmee FL 32741. Reader Service number 477.

AEA'S AMT-1 AMTOR TERMINAL UNIT

Advanced Electronic Applications, Inc., has released the AMT-1 AMTOR terminal unit which offers full AMTOR error-correcting data communications plus RTTY, ASCII, and CW modes as well. The AMT-1 will operate with most HF receivers, home computers, or data terminals, and both the mode and configuration may be controlled either from the terminal keyboard or by computer program. This terminal

unit offers both ARQ and FEC AMTOR modes, RTTY from 1 to 100 baud, CW transmission from 1 to 99 wpm, and ASCII communications to 110,300 baud. An RS-232 interface is used to connect the terminal unit to a computer, and the modem offers an active 4-pole receive bandpass filter feeding into an audio discriminator. The frequency shift is 170 Hz using standard tone pairs. The AMT-1 will operate from any external power supply providing 12 V dc regulated at .85 A.

For more information, contact *Advanced Electronic Applications, Inc., PO Box C-2160, Lynnwood WA 98036; (206)-775-7373. Reader Service number 482.*



AEA's AMT-1 AMTOR terminal unit.

REVIEW

WHAT I THINK ABOUT DGM'S SRT-3000

Having spotted the box on page 116 of the May issue ("What Do You Think?"), I feel inspired to submit the following account of my experiences with one of the products advertised in 73, shown on page 51 of the same issue.

My initial contact with DGM Electronics, Inc., located in Beloit WI, was when I wrote to inquire about the SRT-3000, a "high-performance RTTY communications send-receive terminal," to quote the company's advertisement. Brochures arrived in a few days, and although some were Xerox copies of type-written originals, the information was pertinent and well-presented. (The fact that some material was Xeroxed posed no problem; rather, it told me that this was a new organization doing its best to get started on a small budget.)

My second inquiry brought a personal letter from Dennis G. Makovec WA9CIY, along with a copy of the instruction manual for the SRT-3000. I assume Dennis's initials form the company logo. The manual proved to be superbly-assembled and well-planned, including 28 pages of explicit instructions purely on the operational capabilities of the terminal.

An order was placed with DGM for an SRT-3000 and a video monitor around March 1, and UPS delivered two well-packaged cartons about two weeks later. The keyboard and monitor were connected to my two-meter transceiver with a minimum of trouble. Both a discussion and a block diagram are provided in the manual for the various connections and options. Yes, RCA phone jacks are used, but they are of high quality and a positive "feel" is obtained when plugging in the cables. The unit has been used daily, and no connection problems have been encountered.

When turning on the power, a status line appears on the monitor, displaying the mode, amount of frequency shift, transmit buffer status, speed, and a real-time clock that can be set by keying in the correct time followed by whatever one chooses, such as the date. Then, whenever the appropriate command code is issued, the unit will transmit the time and other information as was entered previously. A very handy feature for logging during QSOs, assuming one still maintains a log! Other information presented by the status line includes a tuning bar along with various receive options.

Since anyone can read the various features in the ad, I'll elaborate a bit on some of the aspects that are not mentioned specifically, but which are examples of how well-planned this device was. For instance, selcal (selective calling) is a feature which prevents the unit from displaying on its screen and/or on an associated printer unless a certain sequence of characters is received first. This sequence is most often the callsign, or at least the suffix of the station call. The ending sequence is usually NNNN, which is programmed into the SRT-3000 (although it can be reprogrammed by the user). What this means is that the screen remains blank and a printer (if used) remains quiet unless someone sends your station call. Then the screen and printer become active, displaying all incoming characters until NNNN is received. (See "The New Communications: VHF Mailboxes," by AF2M, page 48, May, for details.)

A great idea, right? If no printer is used, selcal can save messages to you rather than having them scroll off the screen, while in cases where a printer is used, appreciable amounts of paper are saved. But the DGM SRT-3000 also has W-R-U ("who are you"), which has its own activation code, that in turn triggers a response from the terminal that turns on the transmitter and sends a canned message. The idea here is that others can verify that you are, in fact, monitoring. My concern was that the selcal code (again typically the station callsign) and the W-R-U code (usually the station's call plus ZW or something similar) would pose a problem: If someone sent the station call, the terminal would accept the incoming call if it happened to be in the selcal mode but would reject the incoming call if left in the W-R-U mode, since the W-R-U requires the additional characters. In other words, how should one leave the unit? In selcal and get all calls but not provide a response? Or in W-R-U and get only those calls that included the ZW tacked onto the end of the station callsign, but provide confirmation?

Well, the people at DGM thought of that: what it amounts to is that the terminal is both in selcal and W-R-U when in the W-R-U mode, which of course means that it will dutifully record incoming messages addressed to the station callsign only and/or record messages and respond to those which contain the extra characters. What more could you want?

As a matter of fact, a "break" feature would be nice, and the SRT-3000 has one. Imagine yourself having just loaded its thousand-character transmit buffer with a response message to the chap you're in QSO with, when all of a sudden he asks a question that deserves an immediate response. What to do? Ignore his question until you have run the contents of the buffer, or clear the buffer, answer the question, and then start all over again? No problem with this terminal: Simply hit "control-break," "transmit," and answer the question. Then hit "escape," and the buffer, safe and sound, will also be transmitted.

A word about modes: The SRT-3000 transmits and receives Morse, Baudot, and ASCII at a variety of speeds. It generates both high and low tones, including "modem" tones for those wishing to use the many bulletin boards available on telephone circuits.

Mode, speed, and tone changes are only a couple of keystrokes away, which is a joy for an old teletype[®] hack like me. I am accustomed to opening up a printer, unbolting the typing unit from its base, lifting it off, and exchanging a pair of gears, followed by reassembly and a thorough hand-washing to remove ink and grease each and every time a speed change was desired. Now I change speeds electronically, in the length of time it takes to type three or four characters. To go from Baudot at 60 wpm to ASCII at 110 baud, I hold "control" and type A110 and then release "control." Other speed and mode changes are equally simple: M for Morse, B for Baudot, etc.

Anyone who (a) is learning Morse code or (b) is teaching others will find the random code generator a joy. With a cassette tape recorder attached to the SRT-3000 cassette port, and a printer, the terminal

generated beautiful Morse in five-character random groups, either letters only, or letters, figures, and the four required punctuation marks (period, comma, slant bar, question mark). The cassette machine gets the Morse characters, of course, and the printer types the groups in perfect columns. What a great way to produce practice material! And speeds are in 1-wpm increments, as determined by the operator, from 1 to 99 wpm. You want clear text in Morse? Type it into the transmit buffer (1000 characters maximum), turn on the cassette machine and printer, turn off the transmitter unless you want it to go over the air, and proceed. Perfect copy is the result. I taught a licensing course for several years at the local community college, and how simple it would have been to generate practice cassettes for my students had I owned an SRT-3000! Mr. Green is probably glad I didn't, because my recommendation was that students purchase the 73 code practice tapes, hi.

Something else you should know: the SRT-3000 has a printer port that can be programmed by keystrokes to any of the standard speeds in either ASCII or Baudot. The port will stay in that mode regardless of the incoming and outgoing language being used. For example, I am using a teletype model 35 which is an ASCII printer running at 110 baud. I have the printer port set for that mode, and no matter what I'm using to communicate over the air, the model 35 gets it all. You read it right: I can be using Morse, Baudot, or ASCII over the air, and the SRT-3000 translates it all to ASCII at 110 baud and sends it to the printer. So don't give that model 15 or 28 away quite yet; it's just as easy to program the printer part of them. Why am I using a model 35? Because it gives me the extra ASCII characters and



The DGM Electronics SRT-3000.

WORLD TIME WATCHES

the newest and best watches for hams from ACI



5 modes plus hourly chime

dual time shows GMT & local time

12/24 hour time

5 year lithium battery

ACI's new HAM-II's functions include local time, a second time zone for GMT, count-up and count down stopwatches, alarm, hourly chime, and high brightness backlight. The special tri-function display shows a two-alpha day of the week, digital day-month, and six digit time in the main display. The second time zone display shows mode (T2), four digit local time and six digit GMT (or any other time zone). It's ideal for contests and logkeeping. The HAM-II, like its predecessor the HAM-I, is built rugged to last with a scratch resistant mineral glass crystal. The HAM-II case is polycarbonate, water resistant to 2.4 ATM, and the polyurethane band remains flexible even at very low temperatures.



4 modes plus hourly chime

independent analog/digital

12/24 hour time

ACI's HAM-III breaks the ana-digi price barrier with a rugged and functional, yet handsome watch for hams. It combines independently functioning analog and digital timepieces, both with quartz crystal accuracy. While the analog section is on local time, the digital section can display your choice of month-date-day, six digit time (ideal for GMT) with a 12/24 hour option, alarm time, or six digit chronograph. The HAM-III is built rugged with a scratch resistant crystal, die cast case, stainless steel band, and German time movement. The HAM-III is water resistant to 2.4 atm. It's available with a white face and stainless band, or goldtone face and stainless/goldtone band.

SPECIAL OFFER

buy a HAM-II and a HAM-III and get a 10% discount off the HAM-III

HAM-II \$22.95 HAM-III \$49.95
HAM-III/stainless-gold \$59.95
add \$3.00 per order for shipping and handling. CA. residents add 6 1/2% sales tax. VISA, M/C accepted.

To order, call or write:

Advanced Communications Int'l
2411 Lincoln Avenue
Belmont, CA. 94002
448 (415) 595-3949

NEW TS830S for \$150?

Yes indeed! Just add a Matched Pair of top-quality 2.1KHz BW (bandwidth) Fox Tango Filters. Here are a few quotes from users:

"... Makes a new rig out of my old TS830S!..."
"...VBT now works the way I dreamed it should..."
"...Spectacular improvement in SSB selectivity..."
"...Completely eliminates my need for a CW filter..."
"...Simple installation - excellent instructions..."

The Fox Tango filters are notably superior to both original 2.7KHz BW units but especially the modest ceramic 2nd IF; our substitutes are 8-pole discrete-crystal construction. The comparative FT vs Kenwood results? VBT OFF — RX BW: 2.0 vs 2.4; Shape Factor: 1.19 vs 1.34; 80dB BW: 2.48 vs 3.41; Ultimate Rejection: 110dB vs 80. VBT SET FOR CW at 300Hz BW — SF 2.9 vs 3.33; Insertion Loss: 1dB vs 10dB.

AND NOW A NEW TS 930S!

Tests prove that the same filters improve the '930 even more than our '830. Don't buy CW filters—not even ours. You probably won't need them!

INTRODUCTORY PRICE: (Complete Kit)...\$150
Includes Matched Pair of Fox Tango Filters, all needed cables, parts, detailed instructions. Specify kit desired: FTK-830 or FTK-930.
Shipping \$3 (Air \$5). FL Sales Tax 5%



ONE YEAR WARRANTY
GO FOX-TANGO - TO BE SURE!
Order by Mail or Telephone.

AUTHORIZED EUROPEAN AGENTS
Scandinavia MICROTEC (Norway)
Other: INGOIMPEX (West Germany)

FOX TANGO CORPORATION

Box 15944S, W. Palm Beach, FL 33406
Phone: (305) 683-9587 ✓323

ENJOY COMFORTABLE LISTENING



PSK-1 POWER SPEAKER

Now you can enjoy plenty of transceiver audio without having to turn your hand-held volume control up so far it goes into distortion. The PSK-1 features a powerful 2 1/2 watt (output) 20 db audio amplifier that will interface with virtually any communication receiver speaker output jack. Experience the luxury of distortion-free room filling audio from your hand-held transceiver even in a noisy mobile environment.

The PSK-1 is housed in an attractive case that would also decorate any base station. Power can be obtained from any 12 VDC source capable of 500 mA.

Prices and Specifications subject to change without notice or obligation.

ADVANCED ELECTRONIC APPLICATIONS, INC.

P.O. Box C-2160,
Lynnwood, WA 98036
(206) 775-7373 ✓40
Telex: 152571 AEA INTL

AEA Brings you the Breakthrough!

Hear Police/Fire Weather

on 2 Meter Handhelds with this MFJ VHF Converter.



Scanning Handhelds become Police/Fire Scanners

MFJ-313
\$39.95

New MFJ VHF converter turns your synthesized scanning 2 meter handheld into a hot Police/Fire/Weather band scanner.

144-148 MHz handhelds receive Police/Fire on 154-158 MHz with direct frequency readout. Hear NOAA weather, maritime coastal plus more on 160-164 MHz.

Mounts between handheld and rubber ducky. Feedthru allows simultaneous scanning of both 2 meters and Police/Fire bands. No missed calls.

Highpass input filter and 2.5 GHz transistor gives excellent uniform sensitivity over both bands. Crystal controlled.

Bypass/OFF switch allows transmitting. Won't burn out if you transmit (up to 5 watts) with converter on. Low insertion SWR. Uses AAA battery. 2 1/4 x 1 1/2 x 1 1/2 in. BNC connectors.

Enjoy scanning, memory, digital readout, etc. as provided by your handheld on Police/Fire band.

220 MHz Converter for 2 M Handheld

MFJ-314 MFJ-314, like MFJ-313 but lets you receive 221-225 MHz on your 2 meter handheld.
\$59.95

Police/Fire/Weather Band Converter for 2 Meter Mobile Rigs.

MFJ VHF BAND EXPANDER
160-164 MHz ON
154-158 MHz OFF-BYP MFJ-312
\$59.95

MFJ-312, like MFJ-313 but for mobile 2 meter rigs. Transmit up to 40 watts thru converter without damage. SO-239 connectors. Mobile mounting brackets. Rugged. "ON" LED. Use 12 VDC or AAA battery. 3x4x1 in.

Order from MFJ and try it—no obligation. If not delighted, return it within 30 days for refund (less shipping). One year unconditional guarantee.

Order today. Call toll free 800-647-1800. Charge VISA, MC or mail check, money order for amount indicated plus \$4.00 each shipping. Hear police/fire/weather. Order now. ✓234

CALL TOLL FREE ... 800-647-1800

Call 601-323-5869 in Miss. outside continental USA, tech/order/repair info. Telex 53-4590.

MFJ ENTERPRISES, INCORPORATED
Box 494, Mississippi State, MS 39762

higher speed than the Baudot machines cannot accommodate. But a Baudot printer would still serve as well, except at higher speeds.

If I had to find fault with the SRT-3000, it would be this: DGM does not presently provide an annunciator to serve as the signal bell. The terminal will transmit the "bell" code just fine, but it ignores it when received. Perhaps something can be added. A gentle "peep" upon receipt of a bell code would be nice, and maybe it could even be toggled on and off. But considering all aspects, I think the SRT-3000 is superb. The price is \$1144 including a video monitor. 73 and happy RTTYing.

For additional information, contact DGM Electronics, Inc., 787 Briar Lane, Beloit WI 53511.

Stanley Coutant AA6SC
Sierre Madre CA

QZX

A newsletter? How do you review a newsletter for 73? It doesn't beep, light up, plug in, or charge your batteries.

But QZX, the newsletter for hams who own Sinclair/Timex computers, does transmit. It transmits a lot of very good information, and we thought the best way to bring it to our readers' attention would be through a close look at what it does provide.

First, let's start out with the products it serves—the ZX-80, Micro Ace, ZX-81, and TS-1000. With an average \$50 price tag, these are among the best computer buys a ham can make. A low-end computer is one of the best ways to get on RTTY or packet radio, costing less than many a model 33 in the flea market. A small extra investment in time to write software and build an interface with your rig is all you need—and that's time you would spend cleaning grease off the gears of an old Teletype® machine.

Ham applications for computers differ from many others in that they do not require large amounts of memory, rapid storage-medium access, or complex mathematical calculations. What they do require is easy access to I/O ports and simplicity of real-time programming. The Sinclair, with its TTL interfacing, meets the first requirement, and the plethora of Z-80 assembly-language manuals makes learning the Timex/Sinclair computers' native language that much easier.

In addition to communications uses, you can develop the extras—like an electronic logbook, dupe sheets, or even a rotor controller. These models, with very accessible innards, seem to be designed with the hardware hacker in mind.

The Need For Support

Unless you are a super-fast designer with an endless stream of creative ideas and lots of time on your hands, you need assistance in developing uses for your computer. Computer dealers are notorious for knowing little about ham/computer interfacing, and the staff in the department stores which offer you the best prices on Sinclair/Timex computers know even less about computers in general, much less amateur radio.

This is where QZX comes in. As a system-specific publication, everything in the magazine pertains to your computer. As an amateur-radio publication, it offers the additional advantage of focusing on a specific area of computer use.

Published by Alex F. Burr K5XY and edited by Ambrose Barry W4GHV/5, each month's QZX is literally jammed with programs and circuits. For example, the April issue contained programs to compute antenna headings, manage net rosters,

and calculate propagation, as well as a RTTY send/receive program. Circuits included a simple terminal unit and an interface for the Sinclair computers.

In addition to the program, a brief synopsis of each is provided. Explanations of algorithms and special instructions are included as well. And the listings are reproduced directly from the author's printout, eliminating the possibility of typing errors.

Another regular feature of QZX covers reviews. The publishers are up front about their policy; in one recent issue, they said "if you have objections to us doing reviews of products advertised in QZX, let us know. We intend to present objective comments on them. If an item advertised in QZX is obtained for review and found to be less than 'OK' in our opinion, we will simply decline to print that review. A rather polite way of avoiding a 'cut throat.' Those not advertised but reviewed will receive our honest opinions and will be printed."

A useful column in the newsletter is "Bits & Bytes," a compendium of useful tips similar to 73's "Circuits" feature. Subjects ranging from power-supply problems to photographing program listings from your video monitor are all addressed here. And if you miss a juicy topic, information on it may be recovered via the QZX Net, an almost nightly gathering of the Timex/Sinclair faithful, the schedule for which appears in the newsletter.

The newsletter is printed on plain paper and graphics are limited to schematics. All of this adds up to savings in production costs—savings which are passed on to subscribers. At \$12 for a one-year subscription, QZX is much cheaper than a slick magazine, and in terms of applicable material, you probably get a lot more for your money.

From programs to reviews and advertising, QZX is a perfect solution to one of the great problems of owning a computer—what to do with it. As amateurs, we have the unique ability to generate new ideas and practical uses for almost any piece of electronic equipment. But newsletters such as QZX are necessary for us to share all of that knowledge.

For more information, contact QZX Newsletter, 2025 O'Donnell, Las Cruces NM 88001. Reader Service number 484.

Avery L. Jenkins WB8JLG
73 Staff

RADIO ELECTRONICS BUYERS GUIDE

Almost every ham, whether or not a confirmed builder or modifier of radio equip-

ment, someday will need a part or component to fill an exact requirement. Maybe it will be something as rare as a tube socket or as common as a lamp bulb or fuse holder. The home-brewer, of course, will need IC sockets, circuit boards, capacitors, resistors, displays, inductors, transformers... and all the rest.

Now put yourself in either pair of shoes: Where would you look for the exact part you need? Sure, you're gonna say 73, right? Well, okay; I'll go along with you to a point... but suppose you have dozens of parts and items that you need. Doesn't that mean that you'll have to look through maybe dozens of ads, searching for all the things on the parts list? Right; see what I mean?

Enter the *Radio Electronics Buyers Guide*, a stupendous compendium of electronics goodies listed by type of component in alphabetical order. This beaut of a book lists it all... and not only one source but dozens of sources. Here, let's take a look at how it works. Suppose you need a 9900-series microprocessor—an IC. You look up IC and then the series... ahhh, here it is on page 46. The listing gives two sources: Active Electronics and Jameco Electronics. Active stocks a variety of 19. Now, you turn to page 88 and find Active Electronics. Their address and telephone number, as well as information about catalog cost and minimum order, is listed for your convenience. Same thing for Jameco Electronics on page 90.

Let's take a different component and try it again. What about a mechanical digital counter for a project that you have been working on? Yep, there it is on page 23, sold by BCD Radio Parts. What about a marine-band crystal for the VHF frequencies? There it is on page 24. Rolin Distributors has 'em. And so it goes, for hundreds of items.

Even if you don't build but have a friend who does, get this neat little book for him or her. It makes a wonderful present and will really be appreciated. If you're the kind of ham who has a library of needed info, get the book. Hallward Products, publisher of the *Guide*, has required that a supplier be willing to sell in small quantities to individuals by mail order. Each one has been contacted by the publisher and has agreed to the terms. The information in the *Guide* is contained in a computer and therefore can be edited and added to as the market changes.

The 1983 *Radio Electronics Buyers Guide* is available from Hallward Products, 32 Sunset Court, St. Louis MO 63121. Reader Service number 483.

Jim Gray W1XU
73 Staff



ICOM's IC-490A.

ICOM'S IC-490A 430-MHZ TRANSCEIVER

Even newly-licensed hams quickly gain an appreciation for the amazing number of knobs, readouts, microprocessors, Watts, and features being crammed into smaller and smaller radios these days.

As a long-time resident of the UHF bands, I was happy to learn of ICOM's latest multi-mode radio for the 420-450-MHz band, the IC-490A, and to get an opportunity to try one out. Actually, calling the "490A" a multi-mode rig may be a bit misleading. The rig covers the 430-440-MHz portion of the band only, and in the US and Canada this does not include the portion used for FM according to the current band plan. However, if you're interested in OSCAR satellite work in the 435-MHz range or weak-signal work at 432 MHz, you'll find this rig packed with useful features.

Designed primarily for mobile use, the radio was also found to be quite acceptable for home use as well when powered from an optional 12-V-dc supply. A battery back-up option is available to maintain memory channels when the rig is removed from its power source.

When I first sat down to operate the radio, my initial impression was that there weren't nearly enough controls to operate all the features which the radio offered according to the manual. A well-thought-out control system, however, places non-routine adjustments such as scanning-speed timing, stop timing and full or programmed segment scanning internally. These adjustments are often a matter of personal preference; once these decisions are made, further adjustment is usually not necessary. In addition, many front-panel controls have multiple uses.

Frequency Control Features

The IC-490A's frequency control is typical of many ICOM radios. A detent-type main tuning control is used for either of two vfo's. Designated "A" and "B", each vfo is selected by a push-button switch. Vfo "A" can be used to dial up frequencies for subsequent storing in one of four memory positions. Those interested in both weak-signal work and OSCAR work as described earlier will find it useful to leave one vfo set for each range.

QSYing anywhere within the 10 MHz provided was actually faster than with many 144-MHz rigs I've operated. There is a "1 MHz up" button which increases the currently-selected frequency in 1-MHz steps up to 439 and then restarts at 430. In addition, four tuning spreads are provided (although it's not obvious without studying the manual). In the SSB or CW modes, each tuning step is 100 Hz. There are two FM mode positions called FM1 and FM2. Position FM1 provides tuning steps of 25 kHz, while FM2 steps the frequency 5 kHz per tuning-knob click. These are the normal tuning speeds for each mode. In addition, a "1 kHz" button overrides the tuning speed of any mode in favor of a 1-kHz-per-click rate. This scheme is a little tricky to get used to and, even after a couple of months, I still have to think about it a bit more than I'd like. It does get you around the band quickly with a minimum of extra controls, though the mode switch also permits changing the repeater offset frequency to virtually any frequency desired. Upon powering up, the radio normally comes on with a 5-MHz offset. Again, this radio does not cover the US or Canadian repeater band.

Scanning

Two types of scanning are provided: scanning of memory channels or scan-

When it comes to

QSL's...



it's the
ONLY BOOK!

US or Foreign Listings

1983
callbooks

Here they are! The latest editions of the world-famous Radio Amateur Callbook are available now. The U.S. edition features over 400,000 listings, with over 75,000 changes from last year. The Foreign edition has over 370,000 listings, over 50,000 changes. Each book lists calls and the address information you need to send QSL's. Special features include call changes, census of amateur licenses, world-wide QSL bureaus, prefixes of the world, international postal rates, and much more. Place your order for the new 1983 Radio Amateur Callbooks, available now.

	Each	Shipping	Total
<input type="checkbox"/> US Callbook	\$19.95	\$3.05	\$23.00
<input type="checkbox"/> Foreign Callbook	\$18.95	\$3.05	\$22.00

Order both books at the same time for \$41.95 including shipping.

Order from your dealer or directly from the publisher. All direct orders add shipping charge. Foreign residents add \$4.55 for shipping. Illinois residents add 5% sales tax.



SPECIAL OFFER!

**Amateur Radio
Emblem Patch
only \$2.50 postpaid**

Pegasus on blue field, red lettering. 3" wide x 3" high. Great on Jackets and caps.

ORDER TODAY!

✓61

RADIO AMATEUR
callbook INC.

Dept. B
.....
925 Sherwood Drive
Lake Bluff, IL 60044, USA



2 METER 90 WATT OUTPUT AMPLIFIER WITH 18 DB GAIN PREAMP

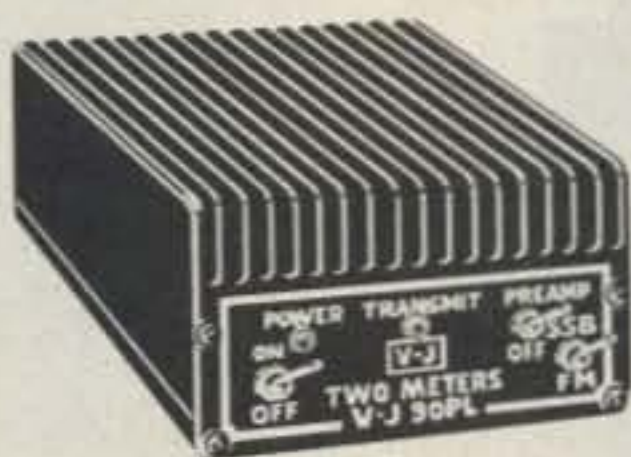

Model 90PL
FOR ONLY
FACTORY DIRECT

\$139.95*
PLUS SHIPPING

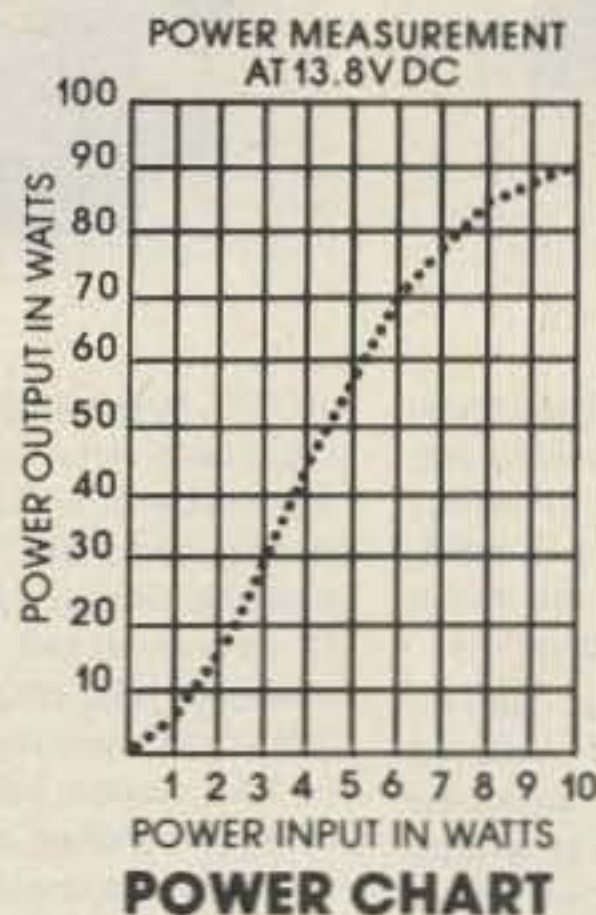

- FREQUENCY range 144 - 148 MHz
- OPERATION FM or SSB (completely linear) Class AB1
- RF DRIVE 1 to 30 watts
- KEYING RF activated with high quality relays
- SSB operation built in delay
- POWER REQUIREMENTS typical 10 watts drive, 13 amps at 13.8 VDC
- IDLE current 20 mills
- MOBILE or FIXED operation
- PREAMP 18DB gain minimum
- NOISE FIGURE less than 1.5 DB
- PREAMP KEYING independent — separately RF activated relays
- CONSTRUCTION wrap around aluminum heat sink 2 pieces 360 degrees cooling
- SIZE 7"(w) x 6"(d) x 3"(h) — WEIGHT 3 lbs. 9 ozs.
- IMMEDIATE SHIPMENT

SPECIAL OFFER

Matching Power Supply

\$99.95*
PLUS SHIPPING

15 AMP SUPPLY wt. 13 lbs. size 8"(w) x 5"(h) x 6"(d)
IMMEDIATE SHIPMENT
ALL PARTS AND LABOR WARRANTED ONE FULL YEAR

VJ90PL Amplifier \$139.95 plus \$3.00 shipping
VJ15 POWER Supply \$99.95 plus \$7.00 shipping
*Prices USA only

VISA, MASTER CHARGE, M.O. or C.O.D. • PHONE (713) 477-0134

V-J PRODUCTS, INC. 505 East Shaw, Pasadena, Texas 77506

SERVING THE ELECTRONICS INDUSTRY SINCE 1965

MFJ NOISE BRIDGE

Adjust antenna for maximum performance. Measure resonant frequency, radiation resistance, reactance. Individually calibrated resistance scale, expanded capacitance range, built-in range extender gives accurate extended measuring range.



- Individually calibrated resistance range
- Built-in range extender
- Expanded capacitance range

\$59.95

NEW FEATURES: Individually hand calibrated resistance scale, expanded capacitance range (± 150 pf), built-in range extender gives accurate measurements and much extended measuring range, 1-100 MHz, Simple to use. Comprehensive computer proven manual.

This New MFJ-202B Noise Bridge lets you quickly adjust your single or multiband dipole, inverted vee, beam, vertical, mobile whip or random system for maximum performance.

Tells resonant frequency and whether to shorten or lengthen your antenna for minimum SWR over any portion of a band.

Works with any receiver or transceiver. SO-239 connectors. 5x2x4 inches. Use 9 volt battery.

Other uses: tune transmatch; adjust tuned circuits; measure inductance, RF impedance of amplifiers, baluns, transformers; electrical length, velocity factor, impedance of coax; synthesize RF

impedances with transmatch and dummy load.

Order from MFJ and try it-no obligation. If not delighted, return it within 30 days for a refund (less shipping). This bridge is unconditionally guaranteed for one year.

To order, simply call us TOLL FREE 800-647-1800 and charge it to your VISA or Master Charge account or mail us a check or money order for \$59.95 plus \$4.00 shipping and handling for MFJ-202B. Order today.

Put this MFJ Noise Bridge to work improving your antenna. Order from MFJ or see your dealer.

CALL TOLL FREE ... 800-647-1800

Call 601-323-5869 in MS, outside continental USA or for tech./order/repair info. Telex 53-4590 STKV.

MFJ ENTERPRISES, INCORPORATED
Box 494, Mississippi State, MS 39762

✓260

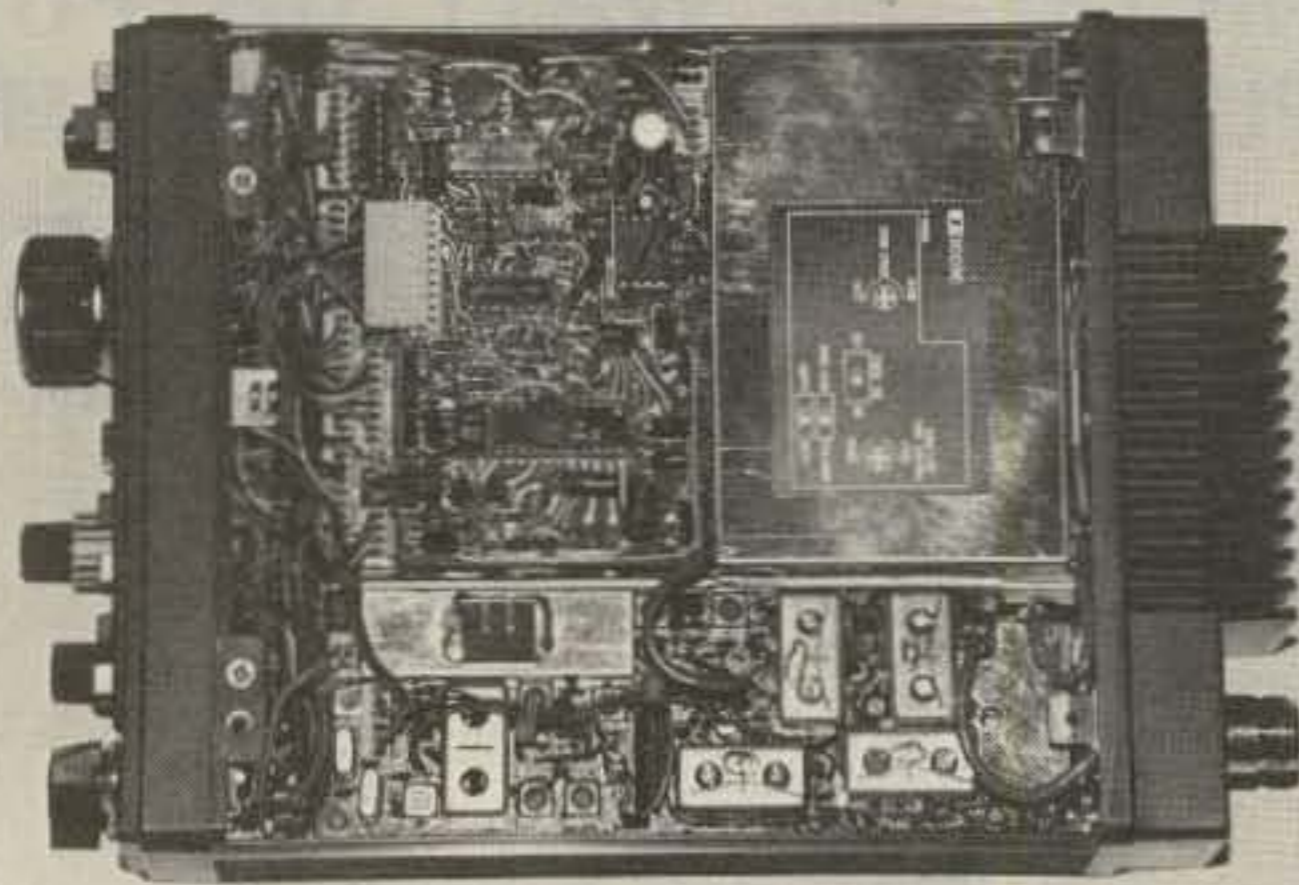

Top view of the IC-490A.

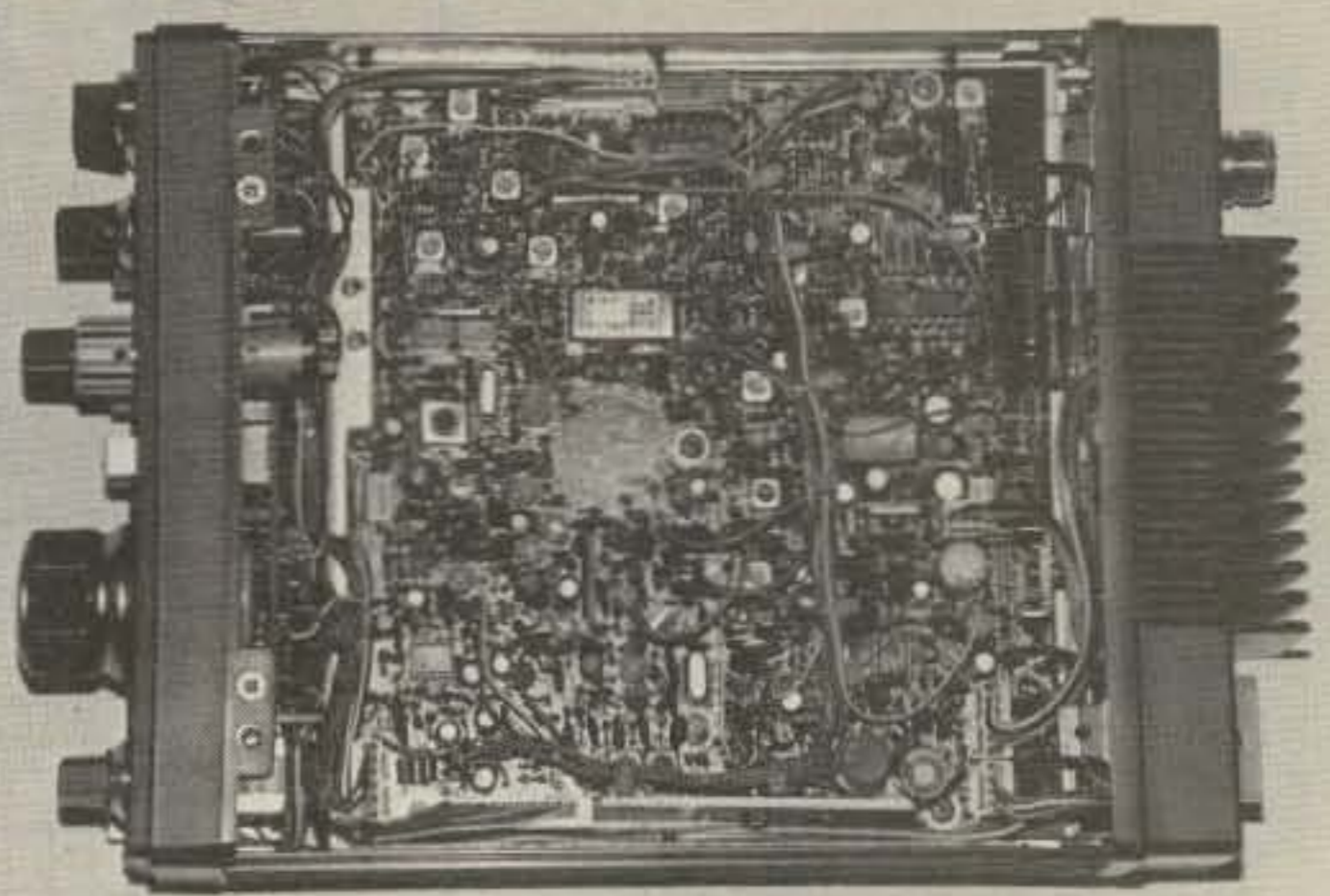

Bottom view of the IC-490A.

ning of band segments up to the entire band. Band segments are determined by the frequencies stored in memories 1 and 2. Memory 1 would be the lowest frequency of the segment and memory 2 would be the highest.

The IC-490A also includes a priority channel feature to let you keep track of a favorite frequency or calling frequency while operating on another frequency. The priority frequency can be any memory channel. The microprocessor selects the priority channel for an automatic quick look every 5 seconds. It does not lock onto this channel even if in use and it will not switch the priority channel if you're in the transmit mode. In addition to all the vfo's, memories, and priority channels, there is a "calling channel" feature. Pushing a single button selects a programmed channel and overrides whatever memory or vfo had been in use. This channel is not scanned and, frankly, I haven't found a good use for it. But it's there for those who do.

Other features include a noise blanker which is quite effective in eliminating ignition and other pulse noises, and an agc (automatic gain control) to reduce fading (especially mobile "picket fencing," which is particularly rapid at these frequencies). An RIT (receiver incremental tuning) feature shifts the received frequency ± 800 Hz to follow drifting signals or change the other station's CW note to one which is more pleasing.

I was glad to see that ICOM used an "N"-type connector (UG-21/U) for the rf output. This type of connector is designed for use on UHF to keep losses at a minimum, but all too often manufacturers forget these details.

Frequency is displayed on a nice read-

out which is sufficient for precision down to 100 Hz (on FM, 4 digits provided precision to 1 kHz). For example, a frequency of 432.1985 is displayed as 2.198.5. Numerals are 3/8" high and are much brighter than the traditional red variety.

Light-emitting diodes are also used for a "light-bar"-type display of received signal strength and relative transmitter output. I must admit that I was a little prejudiced against such devices. "How can a readout of 7 or 8 diodes approach the precision of a meter?" Well, it doesn't, but with a little practice, a flickering diode can be interpreted pretty closely. And for conveying information at a glance, light bars to me are more useful. I became convinced of this when an intermittent ground on my mobile antenna would increase the vswr and decrease my power output. Since the problem was intermittent, I might have blamed my varying signal strength on normal propagation, not noticing the slight movement of the meter needle. However, the blinking diode on the light bar was immediately obvious and the antenna problem was quickly located and corrected.

Circuit Description

The IC-490A uses a 39.38-MHz phase-locked-loop local oscillator for both transmit and receive. A rotary encoder driven by the main tuning knob controls a microprocessor which in turn determines the frequency of a voltage-controlled oscillator (vco). In the SSB/CW modes, the receiver is dual conversion with i-f's of 39.38 MHz and 10.75 MHz. In FM, an additional i-f of 455-kHz is used for triple conversion.

When transmitting in SSB, a carrier frequency of 10.7485 MHz for USB and

10.7515 MHz for LSB is fed to a balanced modulator. After filtering of the appropriate sideband, an SSB signal of 10.75 MHz is obtained. For CW operation, the USB carrier is shifted +800 Hz. This was found to be convenient when frequent mode changes take place between USB and CW. If you are in the CW mode and tune in an SSB station, you don't have to return when you change mode.

In FM, a separate crystal oscillator produces a 10.75-MHz signal which is modulated separately. A 28.68-MHz second local oscillator and an approximately 390-MHz first oscillator controlled by the microprocessor and vco puts you in the band. Rf power output is 10 Watts.

The manual is 45 pages in length, of which 13 pages are devoted to the circuit-description portion. For those wishing to get into the "nitty-gritty" of how the 490A does its thing, this section is certainly clear and concise (with liberal use of block diagrams, charts, and schematics). The largest section is the 14-page "operation" part which is, in my view, required reading. Only a page or two is needed to get you on the air, but to fully explore the intricacies and capabilities of this radio, time should be spent with this section and several pages devoted to control functions.

The manual was very complete, with extra information on satellite operations, drawings illustrating mobile installation, and two foldout inserts. One is a schematic diagram large enough such that every component can be seen clearly. The second insert is a large board layout which shows each circuit board full size, with several colors indicating all circuit paths on double-sided boards.

Likes and Dislikes

Only a few things bothered me about the radio. First, there is no rf gain control, although I must admit that it was several weeks after I began using the radio before I missed it. I have yet to find any multi-mode rig which includes provisions for a narrow CW filter even as an option. The agc recovery time was a little slow even in the fast position. The radio's front end tends to get "crunched" a bit by strong locals and the agc can pump somewhat and mask weak signals.

On the positive side, this is really a "fun" radio to use, especially after I gained some proficiency in making my way about the band using the memory channels and other features to their fullest. I used the radio during the Spring Sprint Contest and I attribute several contacts and sections to the radio's ability to quickly switch between a number of frequencies and keep tabs on the band.

Even at home, I found myself increasingly using the 490A instead of the "big rig." CW operation was very pleasant, with a nice sounding CW sidetone. Excellent on-the-air reports were received on both CW and SSB. Receiver sensitivity was very good.

In summary, I found the IC-490A an excellent radio as a primary station or as a secondary station for those who have already gone the "transverter route." So be careful—the IC-490A may become your primary station.

For further information, contact ICOM America, Inc., 2112-116th Ave. NE, Bellevue WA 98004; (206)-454-8155. The retail price is approximately \$650.00.

Dave Mackey K1KA
Amherst NH

LETTERS

FUN FRACAS

I'm writing in reference to the Fun! poll results that were published in your May, 1983, issue. My complaint is about John Edwards' comments on questions 31 and 32. On question 32 he agrees with the majority opinion by saying "Free speech lives!", thus saying that politically-oriented nets are OK. But on question 31,

he wants to deny the right of free speech to those who like to talk about ideas of a religious nature. He does this by saying "amen" to the majority who said no to religiously-oriented nets.

This is a very hypocritical viewpoint. If Mr. Edwards or anyone else doesn't like to listen to religious viewpoints or discussions about the Bible, they can employ their own form of censorship, tune to another frequency, or turn off their radio.

Well, Wayne, that's my viewpoint on the subject. Except for this one minor point, you have a great magazine. Please keep up the good work.

Mark Regan
Reynoldsburg OH

TERRIFIC TEN-TEC

Ten-Tec treats me very well. They make quality gear. Dick Frey and company are quick to keep it running. They care about their customers and are always more than fair. I have had two, and my next one will be a Ten-Tec also.

Bob Solon WD8LKI
Toledo OH

SCAPEGOATS

It appears that every time someone loses touch with reality, they blame the steel and auto workers for the economic plight of their industries. The workers' wages are always compared to those of the Japanese, and the conclusion is made that the Americans are getting paid too much.

How about comparing the US executives to their Japanese counterparts? They get 4 or 5 times as much, not just 10 or 15 percent. Another thing is taxes; 35 to 45 percent of our wages go to pay some kind of tax. If these taxes were eliminated, we could live on the same pay and benefits as the Japanese. By the way, I wonder what

magazine editors are paid in Japan. Maybe by their standards, you're overpaid, too!

H. W. Lueck WB9IRH
Western Springs IL

AMERICAN TRAGEDY

I would like to know if you could give me some information. I bought a Swan 700 CX and 117 XC power supply about seven years ago. I really liked it and always had good reports with it. Several months ago, I went out and forgot to ground my antenna and it was hit by lightning.

Well, I could not get any of the electronics service places to repair it. They all told me that they don't service Swan any more. Finally, I got a couple of hams to look at it and they told me it was damaged too badly to fix. I sent the power supply all the way out to New Mexico and had it repaired. Now I am stuck with a power supply and no transceiver.

I was laid off at Piper Aircraft in Vero Beach FL just about a year ago. So I cannot afford a new set or a second-hand rig or cash. All of the amateur electronics stores only have Master Charge, Visa, or American Express cards.

I would like to know if you know of any amateur stores that do their own financing anymore. At least maybe my wife could get financing so that I could buy something.

I have had my license since 1964, and I sure miss being on the air.

If you read this and have the time for any information, I would like to say thank you very much.

Jim Player WB4WED
Box 247
Malabar FL 32950

BATTLE SCARS

I was listening on 20 recently to a couple of hams discussing their radio clubs. One was putting his talents on display with an outstanding choice of words poken with excellent diction. He was describing not only the interesting meetings but also the public-service involvement. He told of their emergency communications equipment and training, the gigantic field day, and their participation in parades and other public-service events. When I thought of the efforts of our local club, they looked pale in comparison, and ours is a "working" club.

Then the excellent speaker turned it over to the other ham—to his opponent. I would say. I don't know how sensitive the first guy's ego was, but the second ham was out to smash it. Now, the second ham has no slouch at expressing himself either, but the extremely bassy voice and the "We have all that plus..." etc., sounded to me like the old put-down. Both had beautiful signals. Too bad it had to be tension, instead of relaxation and fun.

When I was growing up, I was known to have quite a temper. I'd get so mad I couldn't see straight. My big brother liked to tease me because he said I looked cute when angry, and when I was angry I could ever land a punch on him, only an occasional shin kick. Instead of letting off steam, afterwards I always felt guilty and shamed. There was just no winning. It took a lot of living and several changes of environment before I learned that you can catch more flies with honey than with vinegar.

Battles on the air do happen. They're fun to monitor. Did you ever participate in

one? One time I was working a phone patch from overseas. We did the usual frequency check, asking "Is this frequency busy?" No answer, so we began the patch. "Hey, the frequency up 1 kc is busy, can't you guys move someplace else?" So move we did. The same thing happened once more. Then we found a frequency that sounded pretty good so we again started the patch. This time it was much worse. We had landed on someone's private frequency. The screaming went on during and after the patch and pretty well ruined our efforts, but his unkindest cut was, "How did you manage to get a license?" Somehow, I managed not to answer that one.

Once, after tuning the bands for a half hour looking for a CQ, and another half hour of calling CQ without result, I decided to call in on this good old boy net. One member asked another "Did you hear that weak signal in there?"

"Yeah, Barney, let's let him in. Go ahead breaker."

"Hi, Fellas, thanks for letting me in. This is W9HD, W9 Hot Dog. The name is Paul. You're all coming in good here in Bloomfield, Indiana, today."

"Stan, do you know W9 Hot Dog?"

"Nope, I sure don't. Edna says she wants me to put a new bedroom on the back side of the house..." Well, they did let me in, but that was as far as it went.

Just a few days ago, I was again working an overseas phone patch. We landed just a kc away from the "Brown Sugar Net," and I was asked by Pete K6EDV to move. I promptly asked him to please wait, adding that this was to be a short call. Believe it or not, Pete got his net to stand by for a few minutes while ND4JPK and I handled a beautiful interference-free patch. Afterwards, Pete said, "Being nice to people, isn't that what ham radio is all about?"

Paul L. Schmidt W9HD
Bloomfield IN

IMPRISONED

As you know, more and more hams are finding themselves "confined" to apartments, townhouses, and condos. As such, we are severely limited to the amount of wire we can string up.

I know there must be a lot of innovative designs being used for indoor/invisible antennas. But most articles (of what few there are) represent only a few various designs.

How about a general request by you to the ham community to submit designs for said antennas? It would be most appreciated.

I love your magazine; its worth to the ham world is heartily appreciated.

A. Reid Maertz KD5SI
Houston Tx

CALL FOR PAPERS

Papers are invited for the 1983 VHF Conference sponsored by the Electrical Engineering Department of Western Michigan University in Kalamazoo. The principal emphasis will be placed on engineering developments applied to radio communication, design, and construction on the frequencies of 30 to 1200 MHz.

One of the basic purposes of this conference is to provide a maximum opportunity to present findings by those experimenting, designing, constructing, testing, and inquiring into problems and methods applicable to VHF radio. Practic-

ing engineers who are radio amateurs find this conference made for them.

This is an opportunity for beginning or mature researchers to report their findings to their peers. We especially encourage the inexperienced inquirers to obtain some experience by presenting a paper at our VHF Conference.

Authors wishing to present papers should send a synopsis or abstract (typically one or two pages with diagrams) describing the paper to Dr. Cassius Hesselberth W8FLH, Chairman, Department of Electrical Engineering, Western Michigan University, Kalamazoo MI 49008. Foreign authors are requested to have a US contact.

The deadline for submission of synopses is August 15, 1983. Speakers will be notified of acceptance by August 20, 1983. A reproducible copy for the printed proceedings should be mailed to the chairman one month prior to the day of the conference.

C. A. Hesselberth W8FLH
Kalamazoo MI

WEEKDAY WARRIOR

OK, Wayne, I've unloaded on Newington and now you're next. You're just as bad as the ARRL when it comes to major contests. Why do all of you think that everyone works Monday through Friday and is off on the weekend? What about the shift worker, whose weekends off are few and far between? What about the ones who work six days and are off only one? Or the preacher who may be available on Saturday but not on Sunday? Some of us like to contest, too, Wayne, and you're not being fair to all of your subscribers. Your format could remain the same—just add a category for those of us who are available for only limited operation (say a 6-, 8-, or 10-hour limit). That way, we can shoot for some top honors also, in our own category. Why should we participate and submit an entry when we know ahead of time we can't be competitive with those who were available all weekend. I managed to work six hours of the ARRL 10-meter contest even though I was working that weekend. In six hours, I had 203 contacts (not great) with 98 multipliers (damn good). However, I did not submit an entry because there was no way that score could compete with the full weekend operator. It probably would have been a decent score in a limited-operation category.

Why should we play, Wayne, if we can't play to win? Give us weekend workers a category in the big contests also. I would even consider being a contest committee volunteer if I thought you were being fair to everyone.

Butch Lutz N5ACU
Silsbee TX

RIGHT ON, FCC

I am glad to see that the FCC has decided to make the no-code license a reality. It's something that has been needed for a while. Maybe now we will see some real growth in amateur radio.

There have always been two main reasons given for not having a code-free license. One is that the code requirement keeps the loonies off the amateur band. This just isn't so. Here in the Houston area, just listen to a few of the 2-meter repeaters. There is foul language, arguments, and jamming. You can hear the same type of thing on 40-, 75-, and 80-meter phone, nationwide. The second reason is that "I had to learn the code, so do they." This is really a silly reason to have a code requirement. This reason is for the self-centered person who only thinks of what he had to do to get a license.

I believe that having the Technician license as the entry to amateur radio is also good. If a person should get interested in learning the code, he can and thus upgrade himself. But if he is happy with phone only and using the VHF and UHF bands, then he can stay where he is. I believe this will work well for everyone and hope that the FCC will not be swayed from carrying out this program.

Michael Friedel
Deer Park TX

SPIKE WARNING

Something happened to me last summer that cost me a lot of time and effort. Perhaps some others may benefit from my experience.

I was at my well-lit workbench working on a converter circuit for the VHF region: a xtal oscillator and a frequency-double/tripler chain to get up that high. I was using my frequency counter to keep track of what each stage was doing, but I kept getting wild readings on the counter. I suspected self-oscillation and did all the standard cures: etched new boards using shorter runs, more attention to shielding, decoupling, etc. Still, erratic readings on the counter. Sometimes I would despair and put the thing aside for a while.

Then one day I had occasion to turn off my workbench light while the oscillator and counter were going, and the counter settled down to a nice, steady count, right where it should have. The culprit causing me to spend so many hours on such a simple circuit was the noisy fluorescent fixture above my workbench. It was radiating a bunch of "spikes" into the counter, which was faithfully counting them along with my oscillator frequencies!

Jim White
Sacramento CA

HAM HELP

I need the manuals or schematics for the Canadian RCA Wireless Field Set #19, Mark II and Mark III. I will pay a reasonable fee for copies or originals.

Charles Di Cecca KA1GON
909 Hancock St.
Quincy MA 02170

To complete my collection of 73 magazines, I need the first issue—October, 1960. If anyone knows where I could locate this issue, please let me know.

Lyle Johnson WA7GXD
5971 S. Aldorn Dr.
Tucson AZ 85706

AWARDS

Bill Gosney KE7C
Micro-80, Inc.
2665 North Busby Road
Oak Harbor WA 98277

DARC DX AWARDS

Representing the Deutscher Amateur Radio Club (DARC), Eberhard Warnecke DJ8OT informed us about the three major awards made available to DXers by this well-known German group.

All DARC awards are based on the European Countries List. To qualify, all contacts must be made from the same country. QSL cards must be submitted with each application. All cards must be in their original form and an appropriate postage fee must be included to ensure the safe return of your cards.

The service charge is 2 US dollars per award, 1 US dollar per endorsement. \$2.00 US is sufficient for the postage and handling of your QSLs.

European Countries List: C31, CT1, CT2, DL, DM, EA, EA6, EI, F, FC, G, GC (Guernsey), GC (Jersey), GD, GI, GM, GM (Shetland), GW, HA, HB9, HB0, HV, I, IS, IT, JW (Bear), JW, JX, LA, LX, LZ, M1, OE, OH, OH0, OJ0, OK, ON, OY, OZ, PA, SM, SP, SV, SV (Crete), SV (Rhodes), SV (Athos), TA, TF, UA1346, UA Franz Josef Land, UA2, UB5, UC2, UN, UO5, UP2, UQ2, UR2, YO, YU, ZA, ZB2, 3A, 4U1, 9H1.

Europa Diploma

To qualify for the Europa Award, applicants must provide evidence of having contacted European countries and ob-

taining at least 100 QSO points by utilizing the following points system: Confirmed contacts made during the current and two preceding years count 1 point. Older contacts are devaluated by a quarter point per year (i.e., .75, .50, .25). The sum of all confirmed European countries on different bands in a calendar year is multiplied by the respective multiplier points earned from making individual contacts. Contacts over 5 years prior do not qualify. See the example in Table 1.

Worked All Europe Award

WAE certificates are awarded to amateurs in three operator classes: Class WAE III—40 different countries in Europe and 100 minimum points; Class WAE II—50 different countries in Europe and 150 points earned; Class WAE I—55 different European countries and 175 points earned.

To score points, each European country counts one point on each of the six (1.8 through 28 MHz) bands. Only four bands per country, however, may be utilized for point scores. If the same station is worked on all five of the six bands, five points per country is earned. Two additional points are earned for making contacts on one of the VHF-UHF bands. Stations outside Europe may claim 2 points per European contact on 1.8 and 3.5 MHz.

The WAE series of awards is made available for either All Telegraphy or All Telephony.

EU-DX-D

This award has been claimed annually

	1977	1976	1975	1974	1973	1972	1971
Confirmed QSOs	32	48	52	44	38	36	71
Multiplier	1.0	1.0	1.0	.75	.50	.25	.00
Annual Score	32	48	52	33	19	9	0
Total Score	32	48	52	33	19	9	0 = 193

(Date of the sample application was December 31, 1977.)

Table 1.

since 1964. It is issued for mixed operation, all CW, and all phone. For the mixed class, at least 30% of the contacts must be made in a different mode.

The basic idea of the award is for applicants to work all the required contacts within a single calendar year. A minimum of 50 points must be earned each year. 20 points must be made with European countries, while the other 30 points may be non-European.

All amateur bands may be used; however, a country may be contacted only once in the effort to achieve the requirements of this award.

The countries qualifying the applicant for this award appear in the European Countries List shown above. Stickers are available for each additional block of 4 European plus 6 non-European countries within the same year, ending December 31st.

The EU-DX-D may be claimed anew every year. Each year's score may be added to achieve EU-DX-D 500 and EU-DX-D 1000. A seal of merit depicts the 500 award; a special awards trophy is awarded to anyone who accumulates 1000 points.

All applications, QSLs, and awards fees should be sent to: Eberhard Warnecke DJ8OT Postfach 101244, 5620 Velbert 1, Federal Republic of Germany.

Representing the Diploma interests Group of Germany (DIG), DJ8OT also provided me with very detailed information about the awards program being sponsored by this very unique group of radio amateurs.

Worked DX Stations Award

The WDXS Award issued by DIG is available to amateurs with no band or mode restrictions. To qualify, all contacts must be made after January 1, 1964.

This award is issued in 4 classes of operating achievement:

Class 4: DX stations must work 200 European stations, 10 of which must be on 40 and/or 80 meters. European stations must work 200 other European stations, 20 of which must be on 40 and/or 80 meters.

Class 3: DX stations must work 500 European stations, 25 of which must be on 40 and/or 80 meters. European stations must work 500 other Europeans, 50 of which must be on 40 and/or 80 meters.

Class 2: DX stations must work 1,000 European stations, 50 of which must be on the 40 and/or 80 meter band. European stations must work 1,000 other Europeans, 50 of which must be on the 40 and/or 80 meter band.

Class 1: DX stations must work 2,000 European stations, 100 of which must be on the 40 and/or 80 meter band. The requirement is the same for Europeans.

No QSL cards are required. General certification rules apply. Should all your contacts be on CW, DIG will provide a special "CW Award" sticker for this accomplish-

ment. Fee for the WDXS Award is US \$5.00 or 10 IRCs.

European Prefixes Award

The EU-PX-A is issued by DIG for contacts of 100 different European prefixes on or after January 1, 1969. There are no band or mode restrictions. Endorsement stickers are awarded for 150, 200, 250, and 300 prefixes claimed.

Should all your contacts be on CW, the sponsor has made a special "CW Award" sticker available to recognize this achievement.

GCR apply and award fee is US \$5.00 or 10 IRCs.

The One Million Award

The 1,000,000 Award is issued by DIG to those amateurs who can accumulate one million points by adding together the postal codes of each German station contacted. The same postal code may be claimed only once.

In making application for this award, your list of contacts would look something like that shown in Table 2.

As you will note, the list of contacts is made in order of the postal code numbers in the right-hand column. Some postal codes may appear on your QSL or in the *Callbook* as one-, two-, or three-digit numbers. In these instances, add zeros to make four-digit codes (i.e., a postal code may appear as 41; add zeros to make it 4100).

GCR apply and the award fee is the same as with other DIG awards—\$5.00 or 10 IRCs.

Worked DIG Members Award

The W-DIG-M Award is issued to those amateurs who submit proof of working DIG members on any band or mode with no restrictions as to date.

Three classes of this award are issued:

Class 3: DX stations work 15 DIG members; European stations work 50 DIG members.

Class 2: DX stations work 30 DIG members; European stations work 75 DIG members.

Class 1: DX stations work 50 DIG members; European stations work 100 DIG members.

A "CW Only" sticker is available for making all contacts on CW. GCR apply and the award fee is \$5.00 US or 10 IRCs.

International Airport Award

The IAPA will be issued for contacts with amateur radio stations in 50 different cities which have international airports. All 6 continents must be worked and the applicant may claim only one contact from his or her own country. All contacts must be made after January 1, 1973, and there are no band or mode restrictions.

Fee for this diploma is US \$5.00 or 10 IRCs.

Call	Date	Band	QTH	Postal Code
DL7IG	18/8/69	80	Berlin	1000
DL7TZ	12/11/68	20	Hamburg	2000
DL9KP	11/10/69	40	Duisburg	4100
DJ8OT	27/11/69	80	Velbert	5620
DL2JB	13/1/68	40	Laudenbach	6941
DL9XN	15/6/67	15	Bobligen	7030
Total at least				1,000,000

Table 2.

CORRECTIONS

Several countries were inadvertently omitted from 73's Work the World DX listing on page 120 of the June issue. Contacts with the following countries are also valid QSOs for WTW:

S8	Transkei	3B9	Rodriguez Island
S9	Sao Tome and Principe	3C	Equatorial Guinea
ST	Sudan	3D6	Swaziland
ST0	South Sudan	3V	Tunisia
SU	Egypt	3X	Republic of Guinea
TJ	Cameroon	3Y	Bouvet Island
TL	Central African Empire	5A	Libya
TN	Congo	5H	Tanzania
TR	Gabon	5N	Nigeria
TT	Chad	5R	Malagasy Republic
TU	Ivory Coast	5T	Mauritania
TY	Banin	5U	Niger
TZ	Mali	5V	Togo
VK0	Heard Island	5X	Uganda
VQ9	Aldabra Island	5Z	Kenya
VQ9	Chagos (Diego Garcia)	6O	Somalia
VQ9	Descroches	6W	Senegal
VQ9	Farquhar	7P	Lesotho
XT	Upper Volta	7Q	Malawi
ZD7	St. Helena	7X	Algeria
ZD8	Ascension Island	8Q, VS9	Maldiv Islands
ZD9	Gough Island and Tristan da Cunha	9G	Ghana
		9J	Zambia
ZE	Rhodesia	9L	Sierra Leone
ZS1, 2, 4, 6	South Africa	9Q	Republic of Zaire
ZS2	Prince Edward Island	9U	Burundi
ZS2	Marion Island	9X	Rwanda
ZS3	Southwest Africa (Namibia)		
3B6, 7	Agalega and St. Brandon		
3B8	Mauritius		

Avery L. Jenkins WB8JLG
73 Staff

SYNTHESIZED SIGNAL GENERATOR



MODEL
SG1000
\$349.95
plus shipping

MADE IN
USA

- Covers 100 to 185 MHz in 1 kHz steps with thumb-wheel dial
- Accuracy 1 part per 10 million at all frequencies
- Internal FM adjustable from 0 to 100 kHz at a 1 kHz rate
- Spurs and noise at least 60 dB below carrier
- RF output adjustable from 5-500 mV at 50 ohms
- Operates on 12 Vdc @ 1/2 Amp
- Available for immediate delivery
- \$349.95 plus shipping
- Add-on Accessories available to extend freq. range, add infinite resolution, voice and sub-audible tones, AM, precision 120 dB calibrated attenuator
- Call for details • Dealers wanted worldwide.

VANGUARD LABS ✓311
196-23 Jamaica Ave., Hollis, NY 11423
Phone: (212) 468-2720

Custom Mailing Lists on Labels!

Amateur Radio Operator NAMES

Custom lists compiled to your specifications

- Geographic by ZIP and/or State
- By License Issue or Expiration Date
- On Labels of Your Choice

Total List: 415,000 Price: \$25/Thousand
Call 203: 438-3433 for more information

Buckmaster Publishing ✓255

70 Florida Hill Rd., Ridgefield, CT 06877

NEMAL ELECTRONICS

COAXIAL CABLE SALE



- RG8U-20 ft., PL-259 ea. end.....\$4.95
- RG214U dbl silver shield, 50 ohm.....\$1.55/ft.
- 100 ft. RG8U with PL-259 on each end \$19.95
- BELDEN Coax in 100 ft. rolls
- RG58U #9201.....\$11.95
- Grounding strap, heavy duty tubular braid
- 3/16 in. tinned copper.....10c/ft.
- 3/8 in. tinned copper.....30c/ft.

CONNECTORS MADE IN USA

- Amphenol PL-259.....79c
- PL-259 Teflon/Silver.....\$1.59
- PL-259 push-on adapter shell.....10/\$3.89
- PL-259 & SO-239.....10/\$5.89
- Double Male Connector.....\$1.79
- PL-258 Double Female Connector.....98c
- 1 ft. patch cord w/RCA type plugs each end.....3/\$1.00
- Reducer UG-175 or 176.....10/\$1.99
- UG-255 (PL-259 to BNC).....\$3.50
- Elbow (M359).....\$1.79
- F59A (TV type).....10/\$2.15
- UG 21D/U Amphenol Type N Male for RG8.....\$3.00
- BNC UG88C/U, male.....\$1.25
- 3/16 inch Mike Plug for Collins etc.....\$1.25
- UG273 BNC to PL-259.....\$3.00

FREE CATALOG

COD add \$2.00—FLA. Res. add 5% Sales Tax

Orders under \$30.00 add \$2.00

Connectors—shipping 10% add'l, \$3.00 minimum ✓412

Cable—shipping \$3.00 1st 100 ft. \$2.50 each add'l 100 ft.

1327 NE 119th Street, Dept. 73, No. Miami, FL 33161 Call (305) 893-3924

MICROWAVE

ATV TRANSMITTER 2.3 TO 2.45 GHZ

4.5 SUB-CARRIER GENERATOR

VIDEO MODULATOR

PHASE III OSCAR

GIZMO ELECTRONICS

Box 164 Radley, KS 66768 ✓229

(316) 724-6505

Free Shipping in U.S.

Kansas residents 3% sales tax

HAMEG OSCILLOSCOPE



- 20 MHz Dual Trace
- Built-in Component Tester
- X-Y Operation (1:1 Ratio)
- 2 x 20 MHz, Max. 2 mV/cm
- Timebase 40 ns - 0.2 s/cm
- Trigger Bandwidth 30 Mhz

✓133

RFD-5

Rivendell Assoc.

DERRY, N.H. 03038

WARNER HILL

(603) 434-5371

Subscription Problem?

73 does not keep subscription records on the premises, therefore calling us only adds time and doesn't solve the problem.

Please send a description of the problem and your most recent address label to:

73 Amateur Radio's
Technical Journal

Subscription Dept.
PO Box 931
Farmingdale, NY 11737

Thank you and enjoy your subscription.

RELIABLE MICROWAVE TV ANTENNAS

2.1 to 2.6 GHz Frequency Range

34db System Gain (or Greater)

Complete System (as pictured)
Down Converter Probe Style
(Assembled and Tested)
Power Supply (12V to 16V DC+)
(Assembled and Tested)



1 YEAR WARRANTY
PARTS & LABOR

PETERSON ELECTRONICS

4558 Auburn Blvd.
Sacramento, CA 95841
(916) 486-9071 ✓182

C.O.D.'s
SPECIAL QUANTITY
PRICING
Dealers Wanted



CONTACT-80...



RTTY your TRS-80 with CONTACT 80 MARK II for 1983!

TRS-80, MOD III INTERFACE (included with system) gives keyboard STATION CONTROL and connects with the TTY TU of your choice.
(No other equipment needed for CW operation)

Cassette & Disk Features:

- BAUDOT, ASCII & MORSE...
- CW RX speed AUTOSYNC & unique FIST-FIXER...
- TRI-SPLIT screen (user sets HIS way)...
- "Unlimited" STORED MSG. sizes...
- Automatic DYNAMIC BUFFER ALLOCATION...
- Live HARDCOPY plus other Line-printing...
- AUTO-ID, TIME/DATED transmissions...
- On screen "OSCILSCOPE", CLOCK, COUNTERS...
- Unique EDITOR, CLOCKED-KEYING, NAME-LINE...
- AUTO-DIDDLE, K/B ROLLOVER, REPEATING KEYS...
- Fast CASSETTE I/O and many other features...

Additional Disk Features:

- Two-way message SELCALL A "PERSONAL MSO"...
- AUTO-MONitor frequency activity to disk...
- SAVE, LOAD, KILL & DIR plus other I/O...

INTRODUCTORY SPECIAL

- DISK VERSION.....\$199.00
- CASSETTE VERSION.....\$179.00
- CASSETTE, later upgrade to DISK.....\$20.00

Guaranteed-Include Amateur CALLSIGN-POST PAID

ROYAL
407 Conkle Road ✓150
Hampton, GA 30228 Telephone: (404) 946-9314



Two Modes Award

This award requires the applicant to work 50 different countries on CW, including Germany and all six continents, and again the same 50 countries on phone. All contacts must be made on or after January 1, 1962, to qualify.

GCR apply and award fee is US \$5.00 or 10 IRCs.

Worked German Large Cities

The WGLC Award is available in three classes. There are no restrictions as to modes. There are no band endorsements. All contacts must be made by using more than one band. Each city may be claimed only once regardless of band. All contacts must be made on or after January 1, 1962.

Class 3: DX stations work 10; Europeans must work 20 cities.

Class 2: DX stations work 20; Europeans must work 40 cities.

Class 1: DX stations work 30; Europeans must work 60 cities.

Should all your contacts be made on CW, DIG has prepared a special "CW Only" sticker made available upon your initial application.

German Large Cities are: Aachen, Augsburg, Berlin, Bielefeld, Bochum, Bonn, Bottrop, Braunschweig, Bremen, Bremerhaven, Darmstadt, Dortmund, Dusseldorf, Duisburg, Erlangen, Essen, Frankfurt/Main, Freiburg, Furth, Gelsenkirchen, Gottingen, Hagen, Hamburg, Hannover, Heidelberg, Heilbronn, Herne, Kaiserslautern, Karlsruhe, Kassel, Kiel, Koblenz, Koln, Krefeld, Leverkusen, Lubeck, Ludwigshafen, Mainz, Mannheim, Monchengladbach, Mulheim/Ruhr, Munchen, Munster, Neuss, Nurnberg, Oberhausen, Offenbach/Main, Oldenburg, Osnabruck, Recklinghausen, Regensburg, Remscheid, Rheydt, Saarbrucken, Salzgitter, Solingen, Stuttgart, Trier, Ulm, Wanne-Eickel, Wiesbaden, Wilhelmshaven, Witten, Wolfsburg, Wurzburg, Wuppertal.

GCR apply and award fee is the usual US \$5.00 or 10 IRCs.

As you can see, both DARC and DIG have very extensive award programs made available for you and me. Should you wish to inquire or for that matter submit application for one or more of the awards shown in this column thus far, may I suggest that you write our good friend DJ8OT directly: Eberhard Warnecke DJ8OT, Postfach 101244, 5620 Velbert 1, Federal Republic of Germany.

There remain two additional awards being sponsored by DIG; however, I wish to caution you not to apply for them through DJ8OT. The following awards have separate award custodians.

Action 40 Award

This diploma can be applied for only by licensed amateurs having proven contacts with at least 100 different amateur stations within one calendar month after November 1, 1977, on the 40-meter amateur band only.

All modes are accepted. Contest QSOs and crossband QSOs do not count. Split-frequency QSOs do count, however.

Your application must show the call-sign worked, the name and QTH of the operator, mode, and date and time GMT. GCR apply and award fee is US \$5.00 or 10 IRCs. Mail your application and fee to: Klaus Kleine DJ1ZP, Fasanenweg 22, D-4714 Selm-Bork, Federal Republic of Germany.

DIG Diploma 77

This diploma requires the applicant to work at least 77 DIG members from at least 7 different countries, but only 7 x 7 (49) DIG members out of one's own coun-

try, after January 1, 1977. The award is made for phone only, and mixed modes or bands are accepted. Fee is US \$5.00 or 10 IRCs. For further explanation of this award or for submitting application, write to: Henry Bielinski DC6JG, Werfstr. 245, D-2300 Kiel 14, Federal Republic of Germany.

HUNTINGTON COUNTY 4-H FAIR

The Huntington County Amateur Radio Society will operate a special-event station at the Huntington County 4-H Fair on August 1st through August 3rd. The station will be operating from 2100 GMT to 0300 GMT each day using the call KC9GS. The operating frequencies will be 3900-3930, 7230-7260, 14280-14310, 21350-21380, and 28600-28630. QSL information will be given when contacts are made.

OYSTER CREEK NUCLEAR GENERATING STATION

The Jersey Shore Amateur Radio Society will operate KF2T at the Oyster Creek (NJ) Nuclear Generating Station between 1800Z, Saturday, August 6, and 1800Z, Sunday, August 7. Phone operations will be near 3930, 7230, 14260, 21260, and 28560 kHz. CW/Novice will be 30 kHz from lower band edges; VHF on 146.58. RTTY may be used on 3640, 7085, and 14085. QSLs to JSARS, 619 17th Avenue, South Belmar NJ 07719. Enclose an SASE for a commemorative QSL.

LONGEST PORCH IN THE WORLD

The Tri-County Wireless Group will operate N8COY on Aug 13, 1500-2300Z, from the famous Grand Hotel's "Longest Porch in the World," in Mackinac Island, Michigan. SSB frequencies: 7.280, 14.280, 21.380, 28.580, and FM 147.480. QSL and regular SASE to N8COY for a special QSL. DXers via Bureau.

MOUNTAIN STATE AWARD

The Logan County ARC will hold its third annual "Mountain State Award" expedition from 1600 UTC, August 20, until 0400 UTC, August 21, 1983. The call sign will be KC8NR. Operations will take place on a West Virginia mountaintop in Logan County, which is located in the heart of southern West Virginia's billion-dollar coal fields.

Phone operating frequencies will be approximately 25 kHz from the low end of the General phone bands as propagation allows. Novice band frequencies of 3725 and 7125 should be checked each hour.

A handsome 8" x 10" certificate will be awarded to all contacts submitting a QSL and a legal-size SASE to Basil Napier WD8KWC, RFD 1 Box 198, Chapmanville WV 25508.

CAMP GOOD DAYS AND SPECIAL TIMES

Ed Holdsworth N2EH, president of the Rochester (NY) Amateur Radio Association (RARA), has announced that the club will operate an amateur radio station on the site of Camp Good Days and Special Times, located at Camp Onanda on Canandaigua Lake, New York. The dates of operation will be Saturday, August 27, and Sunday, August 28, between approximately 11 am and 5 pm. The frequencies and bands are as follows: 80 meters, phone, between 3.900 MHz and 3.925 MHz, and CW, between 3.525 MHz and 3.550 MHz; 40 meters, phone, between 7.230 and 7.250, and CW, between 7.025 and

7.050; 15 meters, phone, between 21.350 and 21.375, and CW, between 21.025 and 21.075. In addition, 2 meters FM will be operated locally.

Camp Good Days and Special Times is a special camp for children who have cancer. It was established in 1980 by Gary Mervis of Rochester, the father of Teddi Mervis, a 9-year-old girl who had incurable brain cancer. Teddi passed away last year but Gary has kept the camp going and it has grown each year.

RARA members will operate the radio station, using their club call sign, K2JD. For a special certificate, confirmation of contact and an SASE should be sent to RARA, PO Box 1388, Rochester NY 14603. Camp Good Days and Special Times is a registered not-for-profit organization in New York State.

CLEMMONS UNITED METHODIST CHURCH

Throughout the month of September, WB4TAL will operate as a special-event station from within the Clemmons United Methodist Church, in Clemmons, North Carolina. The occasion is the celebration of the 200th anniversary of the church. Operation will be in the general portion of the HF phone bands and on 2 meters FM. CW will be available upon request. For a commemorative QSL card send an SASE to WB4TAL, PO Box 366, Clemmons NC 27012.

ELMER AWARD

Named in honor of all the "Elmers" who, since Marconi, have given of their time and talents to help others become amateur radio operators, the Northern New Jersey Chapter of QCWA has established its Elmer Award. The award will recognize as "Elmer-of-the-Year" the radio amateur in northern New Jersey who has done the most to pass on the knowledge that he or she has gained over the years to the next generation of amateur radio operators. The award will consist of two appropriately engraved plaques. The first will carry the name of each year's winner and rotate annually; the second will carry the name of the current year's winner and may be kept permanently. The winner will be selected by a panel of five judges, three of whom shall be members of the Northern New Jersey Chapter of QCWA; two will be prominent local amateurs. Presentation of the award will be made to the 1983 winner at the chapter's annual meeting, the evening of Friday, November 18, at the Burns Country Inn, Clifton NJ.

Rules

1. Nominations for the award may be made by any licensed amateur radio operator in northern New Jersey.

2. Nominees must be licensed amateur radio operators who reside in northern New Jersey.

3. Each nomination shall be accompanied by a statement (of 500 words or less) detailing the reasons the nominee is deemed worthy of the award.

4. All nominations must be received on or before September 1, 1983, by the chairman of the chapter's Elmer Award Committee.

Please direct all communications to: Gordon S. Gregory N2IN, 8 Winding Way, Denville NJ 07834; (201)-627-4426.

MISS AMERICA PAGEANT

The Southern Counties Amateur Radio Association plans to have a special-event station during the Miss America Pageant from September 13-17, 1983. Last year,

they made 1,800 contacts in 49 states and 5 foreign countries with 800 confirmed. Due to more advance planning, they hope to surpass those figures this year.

NORTHWEST CORNER OF THE WORLD

The Wisconsin Valley Radio Association, of Wausau (Marathon County), Wisconsin, is pleased to announce the following special-event station: the second annual "If The World Is Round, Then How Come It Has Corners?"

Marathon County, Wisconsin, is located in north central Wisconsin. Besides being the largest county in Wisconsin (somewhat larger than the state of Rhode Island), it also contains the intersection of the 45° north parallel and the 90° west meridian. This point occurs near the city of Wausau, Wisconsin. This places Wausau exactly halfway between the North Pole and the Equator, and halfway between the Zero Meridian at Greenwich, England, and the International Dateline. It is the "Northwest Corner of the World."

The other three 45°/90° "corners" are located as follows: in the Pacific Ocean west of Chile, in the Indian Ocean southwest of Australia, and in a remote northern area of the Chinese province of Sinkiang, near the Mongolian border.

The Wisconsin Valley Radio Association will operate on the exact site of the 45° N/90° W intersection on September 18, 1983, using the club station call sign, W9SM. Operation will be from 7:00 am to 7:00 pm CDT. Frequency of operation will be dependent upon band conditions but will be 25 kHz up from the bottom of the General phone portion of whatever band is being used.

Send an SASE for a QSL card. Send an SASE and \$1.00 for a certificate to: Wisconsin Valley Radio Association, Inc., Box 363, Wausau WI 54401.

UNIONTOWN PA

The Uniontown Amateur Radio Club W3PIE of Uniontown, Pennsylvania, will be operating a special-event station on September 24, 1983, to celebrate Fayette County's 200th anniversary. Operations will be conducted from 1300Z to 2100Z, on or about the frequencies of 7.235, 14.285, and 21.360 on SSB; also 146.52 simplex between 2300Z and 0100Z for local contacts. An 8 x 10 certificate will be issued for contacts made during these times. Please send a large SASE and QSL to W3PIE, c/o John T. Cermak WB3DOD, PC Box 433, Republic PA 15475.

ANNO SANTO AWARD

The Anno Santo Award (Holy Year Award) is sponsored by the Rome section of the Associazione Radioamatori Italiani. The award is printed on deluxe paper and is about 19 x 13 inches (47 x 33 cm). It represents an engraving of St. Peter's Basilica. The same artwork is printed on the special QSL that will be used by most of the hams of Rome during the Holy Year.

WHITE TAIL DEER AWARD

The Mid-Michigan Amateur Radio Club has announced the first of a series of awards featuring the wildlife of Michigan. The certificate is available to all licensed amateurs and shortwave listeners. The White Tail Deer Award requires contact with two Mid-Michigan Amateur Radio Club stations, or contacts with one MMARC station and three White Tail Deer Award certificate holders. For Novice applicants, the requirements are one contact with an MMARC station or one con-

Dealers SELL

Selling 73 will make money for you. Consider the facts:
Fact #1: Selling 73 increases store traffic—our dealers tell us that 73 is the hottest-selling amateur radio magazine on the newsstands.

Fact #2: There is a direct correlation between store traffic and sales—increase the number of people coming through your door and you'll increase sales.

Fact #3: Fact #1 + Fact #2 = INCREASED SALES, which means more money for you. And that's a fact. For information on selling 73, call 800-343-0728 and speak with Ginnie Boudrieau, our bulk sales manager. Or write to her at 73, Route 101 & Elm St., Peterborough, NH 03458.

73 Amateur Radio's
 Technical Journal

80 Pine Street Peterborough, NH 03458
 800-343-0728

MOVING?

Let us know 8 weeks in advance so that you won't miss a single issue of **73**.

Attach old label where indicated and print new address in space provided. Also include your mailing label whenever you write concerning your subscription. It helps us serve you promptly. Write to:

73 Amateur Radio's Technical Journal Subscription Department
 P.O. Box 931
 Farmingdale NY 11737

- Extend my subscription one additional year for only \$19.97
 Payment enclosed Bill me

Canada and Mexico \$22.97, US funds, Foreign Surface \$39.97;
 US funds, drawn on US banks, Foreign Airmail, please inquire.

If you have no label handy, print OLD address here.

AFFIX LABEL

Name _____

Address _____

City _____ State _____ Zip _____

print NEW address here:

Name _____

Address _____

City _____ State _____ Zip _____

MAKE SAVING MONEY A WAY OF LIFE

With **LIVING ON A SHOESTRING: A Scrounge Manual for the Hobbyist**. Almost anything you find can be put to good use if you follow the techniques of a master scrounger. George Ewing W8WTE shows you how to:

- Find electronic parts
- Scrounge by the rules
- Scrounge a vehicle
- Locate tools and other surplus
- Read up on scrounging
- Scrounge a place to live

Cartoons and case histories of scroungers add a humorous touch. With **LIVING ON A SHOESTRING**, you can't always get something for nothing, but you can certainly get it for less. \$7.97 Softcover, 7x9, 128 pp. approx., ISBN 0-88006-059-X

Call TOLL FREE 1-800-258-5473 for credit card orders. Or mail your order with payment or complete credit card information. Include \$1.50 for shipping and handling. Send to:

Wayne Green Inc.
 Attn: Book Sales
 Peterborough, NH 03458

A Wayne Green Publication

Dealer Inquiries Invited

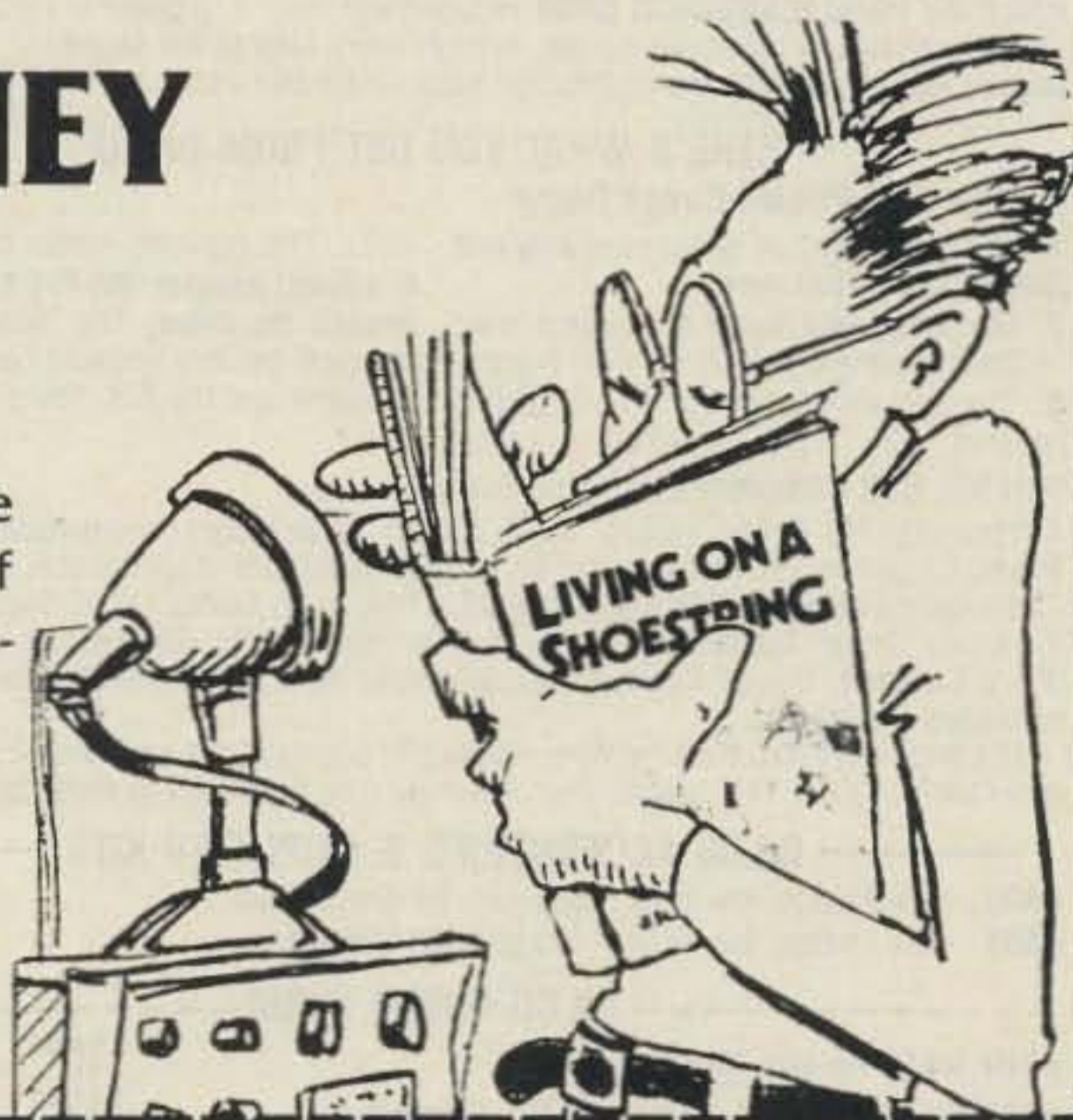

YES, I want to scrounge!

338B6

Send me _____ copies of **LIVING ON A SHOESTRING**. Enclosed is \$7.97 (BK7393) per copy plus \$1.50 shipping and handling.

MASTERCARD bank # _____ VISA AMEX
 Card # _____ Expires _____

Signature _____

Name _____

Address _____

City _____ State and Zip _____

MORE GAIN Than a Varactor UHF Tuner

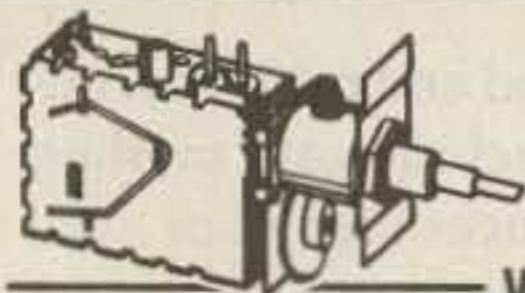

\$15⁰⁰ SATISFACTION GUARANTEED
Frequency Range 470-899 MHz Channels
14-83. Output Channel 3. Ch 2 or 4 Avail.
PART #B20 **\$15⁰⁰**
WHAT'S IN IT?

To make a regular UHF tuner into a **GILCO HIGH GAIN TUNER**, each and every one of the following steps is painstakingly taken by a certified technician:

1. The first thing GILCO does is change the standard diode to a **hot carrier diode**.
2. The tuner's output is then measured on our JERROLD field strength meter and compared to a computer derived chart from which we determine the correct value coil to add across the IF output for **maximum pre-peaked gain**.
3. The tuner is then fed a standard 10db 300 ohm antenna input and while monitoring the output on our HEWLETT PACKARD spectrum analyzer, the tuner is tuned to the desired channel and its oscillator is offset for the desired output frequency as follows:
Channel 2: 58 Mhz, Channel 3: 63 Mhz, Channel 4: 68 Hhz

We call this step peaking because the tuner's output looks like a peak on our spectrum analyzer and the highest point of that peak is actually adjusted for the desired output.

4. The last step is one more measurement on the field strength meter which is again compared to our performance chart to calculate the correct value of the second coil which is added to the tuner's internal connections.

This procedure was developed by GILCO and it is our computer derived performance charts that make our tuner better, that's because **almost every tuner gets a different value coil** before it's peaked and again a different value coil after it's peaked. The combinations are endless and **the way we determine the values is our secret...**

GILCO PARTS KIT & PRINTED CIRCUIT BOARD

- Use with GILCO High Gain Tuner
- Requires NO Modification to Your Television
- Individually Packaged and Labeled Parts Save Guesswork
- The only tools required for assembly are: screwdriver, soldering iron, voltmeter. No drilling is required to the P/C board.
- This kit was designed to take advantage of the GILCO high gain tuner which means its circuitry is **simpler and more efficient** than those circuits that require inferior varactor tuners.

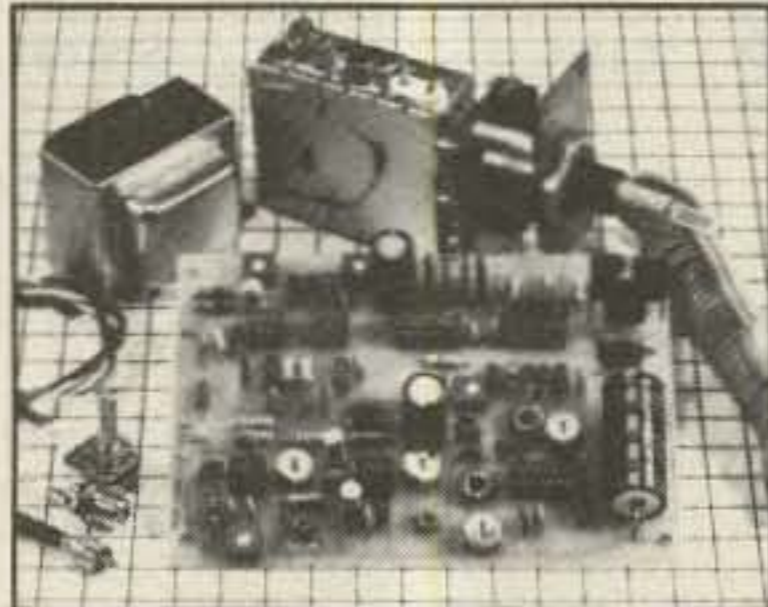

Pre-drilled, pre-screened, plated through the holes P/C board. All hardware, connectors, 22 page illustrated instruction manual, & Gilco Hy-Gain tuner. Kit assembles in just 4 hours.

FREE 22 Page Instruction Book included with each P/C Board or Parts Kit. This instruction book will guide the builder through every step of the assembly. **Nearly every page is illustrated.** With this Instruction Book, estimated assembly time is 4 hours.

HERE'S WHAT YOU GET FROM GILCO

- Part No. B21 Printed Circuit Board** **\$17⁰⁰**
1. This Printed Circuit Board uses **only one jumper, others use nine.**
 2. **The component layout is screen printed** on the component side of the P/C board.
 3. The solder side of the P/C board is covered with high temperature solder resist. This prevents solder bridges.
 4. **Newest Addition: the P/C board is plated through the holes.** This allows for easier and more positive soldered contact between the parts and the P/C board.

Part No. B22 Complete Electronic Parts Kit **\$80⁰⁰**

All resistors (30), Potentiometers (1-5K, 3-10K), Panel Mount Potentiometer (10K), Electrolytic Capacitors (6), Ceramic and Mylar Disc Capacitors (35), Variable Capacitors (4), All Integrated Circuits (7), Voltage Regulator, Heat Sink, Diodes (4), IC Sockets (4-8 pin, 3-14 pin), Power Transformer (24V, 1A), Coil Kit with No. 26 wire (4), Speaker (4", 3oz.), Standoffs, Coaxial Cable, All Miscellaneous Hardware, Etc. All parts are individually packaged and labeled.

All components including the Wire, Hardware, Coaxial Cable and Heat Sinks are included in the parts kit. This means your assembly time from start to finish is just 4 hours.

GILCO ACCESSORIES & AMPLIFIER KITS

- #A02 New 2 stage, low noise, 28db gain RF amplifier kit **Kit \$18⁰⁰**
- #A03 New 1 stage, low noise, 14db gain RF amplifier **Kit \$10⁵⁰**

GILCO ORDER FORM

#B20 GILCO Hy-Gain Modified Tuner	\$15 ⁰⁰
#B21 GILCO Predrilled, Screen Printed, Circuit Board	\$17 ⁰⁰
#B22 GILCO Parts Kit (Less P/C Board)	\$80 ⁰⁰
#B20, B21, B22 Complete P/C Board and Parts Kit (all three)	\$110 ⁰⁰
#A02 Two stage, 28 db gain, Amplifier Kit	\$18 ⁵⁰
#A03 One stage, 14db gain, Amplifier Kit	\$10 ⁵⁰
Name _____	Total _____
Address _____	Tax _____
City _____ State _____ Zip _____	Ship _____
Total _____	

Mail Order Only. Send check or money order to:
GILCO INTERNATIONAL, INC.
P.O. Box 8817, Coral Gables, Florida 33124

CALL (305) 823-5891 for COD orders **PLEASE WRITE FOR OUR FREE CATALOG**
SHIPPING: Orders under \$50 add 10%, Orders over \$50 add 5%, FL residents +5% Tax

tact with a White Tail Deer Award certificate holder. For shortwave listeners, the requirements are one MMARC station heard or one White Tail Deer Award certificate holder. A detailed list showing name, call, and QTH of the station or stations worked or heard should be accompanied by one dollar US to cover postage and printing costs. Payment may be made by cash, check, money order, IRCs, or USA postage cards, and photocopies of QSLs will be accepted. Contacts may be made over any period of time, so dig back through your logs. Also, note any special endorsements that you want on your award. Repeater contacts cannot be used, but satellite contacts can. Send applications and information to: Gary Lorenz WD8JFF, Awards Manager, MMARC, 3210 N. County Line Rd., Farwell MI 48622.

Twiss WA2RFX, who represents the Overlook Mountain ARC in Lake Katrine New York. In his letter, Harold enclose details of a very nice award being offered through his club.

This award requires applicants to contact other amateurs residing in the New York county of Ulster.

To qualify, DX stations must contact two amateurs in Ulster County, while amateurs in the continental US must make three contacts. There are no band mode limitations, and there are no date restrictions.

To apply, submit a list of contacts giving the usual logbook data in addition to the award fee of 50 cents or 4 IRCs to Harold Twiss WA2RFX, Country Lane Lake Katrine NY 12449.

NEW AWARD FROM PARS

The Poway Amateur Radio Society (PARS) has announced that a handsome new certificate, known as the "Distinguished PARS Communicator," is now available. The certificate has been issued to promote amateur radio contacts between PARS members and the amateur community at large. To qualify for the PARS certificate, operators must contact 5 PARS members (25 for San Diego County residents) and then submit their list of contacts in log form with an SASE to: Operations—PARS, PO Box 996, Poway CA 92064.

WORKED A SHEBOYGAN AWARD

With activity on 10 meters at an all-time high, now is your opportunity to earn the very attractive WAS (Worked A Sheboygan) Award.

All that is required is that a contact be made with any station in Sheboygan County, Wisconsin, on the 10-meter band.

To apply, merely send your logbook information to the Awards Manager, Sheboygan County ARC, Inc., Farnsworth J High School, Sheboygan WI 53081. As a gesture, should you find that earning the award is impossible, why not drop the J High School a letter and arrange for a schedule with one of their amateurs. Their club station is K9ERO.

ULSTER COUNTY AWARD

I received a very complimentary letter about our Awards column from Harold

SATELLITES

Amateur Satellite Reference Orbits

Date	OSCAR 8		RS-5		RS-6		RS-7		RS-8		Date
	UTC	EQX	UTC	EQX	UTC	EQX	UTC	EQX	UTC	EQX	
Aug 1	0113	104	0142	17	0107	14	0048	6	0038	368	1
2	0117	105	0136	17	0052	11	0038	5	0035	1	2
3	0121	106	0131	17	0036	9	0028	4	0032	1	3
4	0126	107	0126	17	0021	7	0019	3	0029	2	4
5	0130	108	0120	18	0006	4	0009	2	0027	3	5
6	0134	109	0115	18	0149	32	0000	1	0024	4	6
7	0139	110	0110	18	0134	29	0149	30	0021	5	7
8	0000	86	0104	18	0118	27	0139	29	0018	6	8
9	0004	87	0059	18	0103	25	0130	28	0015	6	9
10	0009	88	0053	19	0047	22	0120	28	0012	7	10
11	0013	89	0048	19	0032	20	0110	27	0010	8	11
12	0017	90	0043	19	0017	18	0101	26	0007	9	12
13	0022	91	0037	19	0001	16	0051	25	0004	10	13
14	0026	92	0032	19	0144	43	0041	24	0001	10	14
15	0030	94	0027	19	0129	41	0032	23	0150	41	15
16	0035	95	0021	20	0114	38	0022	22	0155	42	16
17	0039	96	0016	20	0058	36	0013	21	0152	43	17
18	0043	97	0011	20	0043	34	0003	20	0149	44	18
19	0048	98	0005	20	0028	31	0152	49	0147	45	19
20	0052	99	0000	20	0012	29	0143	49	0144	45	20
21	0056	100	0154	51	0155	57	0133	48	0141	46	21
22	0101	101	0149	51	0140	54	0123	47	0138	47	22
23	0105	103	0143	51	0125	52	0114	46	0135	48	23
24	0109	104	0138	51	0109	50	0104	45	0132	49	24
25	0114	105	0133	51	0054	47	0054	44	0130	49	25
26	0118	106	0127	52	0038	45	0045	43	0127	50	26
27	0122	107	0122	52	0023	43	0035	42	0124	51	27
28	0127	108	0117	52	0008	40	0026	41	0121	52	28
29	0131	109	0111	52	0151	68	0016	41	0118	53	29
30	0135	110	0106	52	0136	65	0006	40	0115	54	30
31	0140	112	0101	52	0120	63	0156	69	0112	54	31
Sep 1	0001	87	0055	53	0105	61	0146	68	0110	55	1
2	0005	88	0050	53	0049	58	0136	67	0107	56	2
3	0010	89	0045	53	0034	56	0127	66	0104	57	3
4	0014	90	0039	53	0019	54	0117	65	0101	58	4
5	0018	91	0034	53	0003	51	0107	64	0058	58	5
6	0023	92	0029	54	0146	79	0058	63	0055	59	6
7	0027	94	0023	54	0131	77	0048	62	0053	60	7
8	0031	95	0018	54	0116	74	0039	62	0050	61	8
9	0036	96	0012	54	0100	72	0029	61	0047	62	9
10	0040	97	0007	54	0045	70	0019	60	0044	63	10
11	0044	98	0002	54	0029	67	0010	59	0041	63	11
12	0049	99	0156	85	0014	65	0000	58	0038	64	12
13	0053	100	0151	85	0157	92	0149	87	0036	65	13
14	0057	101	0145	85	0142	90	0140	86	0033	66	14

CIRCUIT BOARD SALE

RS-232C Serial Line Monitor
LED indicators show activity and polarity of the 7 most common signals. DB-25 male and female connectors mount directly on circuit board to form a compact 2" x 3" unit. Mounts in series with your RS-232C cable. Kit includes all parts, directions and tips for use. Commercial quality, double sided fiberglass board with plated through holes. Assembled and tested (SLM-1) 29.95
Kit (SLM-1K) 21.95
Board only (SLM-1NB) 6.95

Power Supply Board
Provides +5, +12 and -12 volts at 1 amp for your ham radio project. Uses 78xx series positive voltage regulators. Needs 2 transformer windings, 18-24 volts (1 center tapped). 3.58" x 4.58"
Assembled and Tested (PS-1) 21.95
Kit Less Xfms (PS-1K) 16.95
Board only (PS-1NB) 4.95

STD Bus Mother board
Single-sided fiberglass mother board. An excellent foundation for your STD bus computer. Mounts 12 of our 56 pin connectors. Provide your own card cage and save hundreds of dollars. 3.88" x 7.00"
Mother Board (MB-1) 15.95
Connectors (C56-125-ST) 3.00
MB-1 and 12 connectors (MB-SPC) 45.00

Please add \$2.00 per order shipping and handling. CA residents include tax.

Esoteric Engineering Incorporated ✓29
PO Box 33602, San Diego, CA 92103
(619) 569-7060



YOU EARNED YOUR CALL!
NOW DISPLAY IT PROUDLY
IN A TOP QUALITY
LACOSTE-TYPE KNIT SHIRT.

ONLY \$14.00 With your call in rich embroidery.

\$1.50 extra for first name. Choose from 10 great colors: rust, cream, brown, green, yellow, navy, lt. blue, aqua, white, and black.



Adult sizes only S-M-L-XL Club and dealer inquiries invited. Please add \$2.00 for P/H. Make check or money order payable to:

Coin Int'l Inc.
2305 N.W. 107 Ave.
Miami, Fl. 33172 ✓13



Allow 4 weeks for delivery Fl. residents add sales tax

THE BEST PLACE To Look For New & Used Equipment Buy-Sell-Trade Our 4th Year NUTS & VOLTS MAGAZINE



PO BOX 1111-G • PLACENTIA, CA 92670
(714) 632-7721 ✓137

JOIN THOUSANDS OF READERS NATIONWIDE, EVERY MONTH

U.S.A. SUBSCRIPTIONS
\$ 7.00 - 1 YR. 3RD CLASS MAIL
\$12.50 - 1 YR. 1ST CLASS MAIL
\$25.00 - LIFETIME - 3RD CLASS

With Free Classified Ad

FREE CATALOG



NEW!
CATALOG OF
HARD-TO-FIND
PRECISION TOOLS

✓354

Also contains test equipment plus wide selection of tool kits and cases

Jensen's new catalog is jam-packed with more than 2000 quality items. Your single source for hard-to-find precision tools and tool kits used by electronic technicians, scientists, engineers, instrument mechanics, schools, laboratories and government agencies. Send for your free copy today!



JENSEN TOOLS INC.
7815 S 46TH STREET PHOENIX, AZ 85040

BUY! SELL! TRADE!
COMPUTER & HAM EQUIPMENT

COMPUTER* TRADER
ANNUAL SUBSCRIPTION

\$15.00

Low Ad Rates — Mailed Monthly
Foreign Subscriptions - \$30.00 Year
FREE 50 Word Classified Ad with Subscription Order

COMPUTER TRADER*

Chet Lambert, W4WDR
1704 Sam Drive • Birmingham, AL 35235
(205) 854-0271
Sample Copy — \$1.00

APPLE II MORSE CODE INTERFACE

CW SOFTWARE FOR THE APPLE II
NO OTHER HARDWARE REQUIRED

- TONE DETECTION THROUGH CASSETTE INPUT
- SOFTWARE TUNEABLE CENTER FREQUENCY
- AUTOMATIC SPEED TRACKING: 6 TO 60 WPM
- SPLIT SCREEN DISPLAYS
- SEPARATE EIGHT LINE RX AND TX BUFFERS
- TX SPEED VARIABLE FROM 15 TO 60 WPM
- TX TONE THROUGH CASSETTE OUTPUT
- OPTIONAL SIDETONE THROUGH APPLE SPEAKER
- D.C. TX KEYING VIA GAME CONNECTOR
- TX/RX SWITCHING VIA GAME CONNECTOR
- BUILT IN PRINTER DRIVER
- REQUIRES DOS 3.3

CODE MACHINE.....\$29.95

RECEIVE ONLY VERSION

MODEM.....\$14.95

SHIPPING INCLUDED. CALIFORNIA RESIDENTS ADD SALES TAX. NO C.O.D. ORDERS PLEASE. FOREIGN SHIPPING ADD \$4.00.

COTEC

13462 HAMMONS AVE.--- SARATOGA, CA 95070



NEW! HF WATTMETER

- Digital Resolution (0.1 or 1 Watt)
- Wideband (160 through 10 meters)
- Wide range (QRP to 1999 Watts)
- Detachable (RF Sampler un-plugs)
- Battery Saver turns off minutes after RF disappears
- Price includes—Readout, HF Sampler, battery, VSWR nomogram and complete schematics.
- 90 day warranty

✓219

write or call:
e-tec P.O. Box 625, Marietta, OH 45750
1-(614)-374-2280



CB TO TEN METER CONVERSION KITS

10 METER FM—Limiter discriminator board with specific instructions to fit over 80 different AM & SSB chassis

SSB-AM KITS—Now in stock kits for most CB models—23 or 40 channels

NEW & USED—FM—SSB—AM converted C.B.'s in stock

ANEXTER MARK ANTENNAS—You saw them at Dayton. Now in stock the HW-3 three band helewhip that covers 10—15—20 meters with no traps

FREE CATALOG—Write or call today

INDEPENDENT CRYSTAL SUPPLY COMPANY

141 Rt. 6A, Box 183
Sandwich, Ma. 02563-0183
(617) 888-4302

✓78

COLLINS RECEIVERS

R-390/URR

0.5 to 32 MHz in 32 bands. AM, CW, Tone FSK through use of BFO. IF selectivity 100 Hz to 16 kHz. Impedance 600 ohms. Power input 110/220 VAC, 50/60 Hz, single phase. Dimensions 12 1/2 x 19 x 6 1/2 inches. Weight 75 lbs. Used, good working condition. Includes partial manual reproduction.



\$285

R-392/URR

0.5 to 32 MHz in 32 bands. AM and CW. Bandwidth 2, 4, and 8 kHz. B+ and Filament voltages 24 VDC. Power input 24 VDC @ 3 Amps. Dimensions 14 x 12 x 11 1/2 inches. Weight 52 lbs. Used, good working condition. Includes partial manual reproduction.



\$235

Prices F.O.B. North Hollywood. Allow for shipping. Write for free 56-page catalog

Davilyn Corporation
13406 Saticoy Street
North Hollywood, CA 91605
(213) 787-3334



✓256

We now have available a bunch of goodies too good to bypass. Items are limited so order today

MINI KITS - YOU HAVE SEEN THESE BEFORE NOW HERE ARE OLD FAVORITE AND NEW ONES TOO. GREAT FOR THAT AFTERNOON HOBBY.

FM MINI MIKE



A super high performance FM wireless mike kit! Transmits a stable signal up to 300 yards with exceptional audio quality by means of its built in electret mike. Kit includes case, mike, on-off switch, antenna, battery and super instructions. This is the finest unit available.

FM-3 Kit **\$14.95**
FM-3 Wired and Tested **19.95**

Color Organ

See music come alive! 3 different lights flicker with music. One light each for high, mid-range and lows. Each individually adjustable and drives up to 300 W runs on 110 VAC.

Complete kit, ML-1 **\$8.95**

Video Modulator Kit

Converts any TV to video monitor. Super stable, tunable over ch. 4-6. Runs on 5-15V, accepts std. video signal. Best unit on the market! Complete kit, VD-1 **\$7.95**

Led Blinky Kit

A great attention getter which alternately flashes 2 jumbo LEDs. Use for name badges, buttons, warning panel lights, anything! Runs on 3 to 15 volts. Complete kit, BL-1 **\$2.95**

Super Sleuth

A super sensitive amplifier which will pick up a pin drop at 15 feet! Great for monitoring baby's room or as general purpose amplifier. Full 2 W rms output, runs on 6 to 15 volts, uses 8-45 ohm speaker. Complete kit, BN-9 **\$5.95**

CLOCK KITS

Your old favorites are here again. Over 7,000 Sold to Date. Be one of the gang and order yours today!

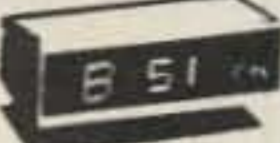

Try your hand at building the finest looking clock on the market. Its satin finish anodized aluminum case looks great anywhere, while six .4" LED digits provide a highly readable display. This is a complete kit, no extras needed, and it only takes 1-2 hours to assemble. Your choice of case colors: silver, gold, black (specify).

Clock kit, 12/24 hour, DC-5 **\$24.95**
Clock with 10 min. ID timer, 12/24 hour, DC-10 **\$29.95**
Alarm clock, 12 hour only, DC-8 **\$29.95**
12V DC car clock, DC-7 **\$29.95**

For wired and tested clocks add \$10.00 to kit price. SPECIFY 12 OR 24 HOUR FORMAT

FM Wireless Mike Kit



Transmits up to 300' to any FM broadcast radio, uses any type of mike. Runs on 3 to 9V. Type FM-2 has added sensitive mike preamp stage.

M-1 kit **\$3.95** FM-2 kit **\$4.95**

Whisper Light Kit

An interesting kit, small mike picks up sounds and converts them to light. The louder the sound, the brighter the light. Includes mike, controls up to 300 W, runs on 110 VAC. Complete kit, WL-1 **\$6.95**

Tone Decoder

A complete tone decoder on a single PC board. Features: 400-5000 Hz adjustable range via 20 turn pot, voltage regulation, 567 IC. Useful for touch-tone burst detection, FSK, etc. Can also be used as a stable tone encoder. Runs on 5 to 12 volts. Complete kit, TD-1 **\$5.95**

Universal Timer Kit

Provides the basic parts and PC board required to provide a source of precision timing and pulse generation. Uses 555 timer IC and includes a range of parts for most timing needs.

UT-5 Kit **\$5.95**

Mad Blaster Kit

Produces LOUD ear shattering and attention getting siren like sound. Can supply up to 15 watts of obnoxious audio. Runs on 6-15 VDC. Complete kit, MB-1 **\$4.95**

Siren Kit

Produces upward and downward wail characteristic of a police siren. 5 W peak audio output, runs on 3-15 volts, uses 3-45 ohm speaker. Complete kit, SM-3 **\$2.95**

Runs on 5-15 VDC. Low current (2.5ma) 1 min. month accuracy. TB-7 Kit **\$5.50**
TB-7 Assy **\$9.95**

SATELLITE TV KIT



image rejection, fully tunable audio to recover 'hidden' subcarriers, divide by two PLL demodulator for excellent threshold performance, tight tracking AFC to assure drift free reception, and of course, full 24 channel tunable coverage.

Build your satellite TV system around the R2B, close to ten thousand others already have and now it's available in kit form at a new low price. Order yours today.

THE POPULAR SAT-TEC RECEIVER IN KIT-FORM!

Featured in a Radio Electronics magazine cover story (May 82), the reliable R2B Sat-tec TV receiver is now operating in thousands of locations. The R2B is easy to build; pre-etched, plated boards with screened component layout assures accurate component placement and the critical IF section and local oscillator are pre-assembled and aligned! All parts are included for the R2B; attractive case, power supply, descriptive operating manual as well as complete assembly instructions. Features of the receiver include: dual conversion design for best

A complete Satellite TV System requires a dish antenna, LNA (low noise amplifier), Receiver and Modulator.
R2B Receiver Kit **\$359.00**
R2B Receiver, Wired and Tested **\$595.00**
120" K Avantek LNA **\$495.00**
RM3 RF Modulator **\$49.95**
Prices include domestic UPS shipping and insurance.

PARTS PARADE

IC SPECIALS

LINEAR

101	\$.35
124	\$1.50
180	\$1.50
155	\$.45
156	\$1.00
165	\$1.00
166	\$1.00
167	\$1.25
141	\$10.00
1458	\$.50
1900	\$.50
1914	\$2.95
1038	\$2.95

CMOS

011	\$.50
013	\$.50
046	\$1.85
049	\$.50
059	\$9.00
511	\$2.00
518	\$1.35
639	\$1.75

TTL

74S00	\$.40
7447	\$.65
7475	\$.50
7490	\$.50
74195	\$1.35

SPECIAL

11C90	\$15.00
10116	\$ 1.25
7208	\$17.50
7207A	\$ 5.50
7216D	\$21.00
7107C	\$12.50
5314	\$ 2.95
5375AB/G	\$ 2.95
7001	\$ 6.50

With info and specs **15/\$1.00**
8 Hole Balun Beads **5/\$1.00**

Resistor Ass't

Assortment of Popular values - 1/4 watt. Cut lead for PC mounting, 1/4" center, 1/8" leads, bag of 300 or more. **\$1.50**

Switches

Mini toggle SPDT **\$1.00**
Red Pushbuttons N.O **3/\$1.00**

Earphones

3" leads, 8 ohm, good for small tone speakers, alarm clocks, etc. 5 for \$1.00

Mini 8 ohm Speaker

Approx 2 1/2" diam Round type for radios, mike etc. **3 for \$2.00**

Slug Tuned Coils

Small 3/16" Hex Slugs turned coil. 3 turns **10 for \$1.00**

CAPACITORS

TANTALUM	ALUMINUM	DISK CERAMIC
Dipped Epox	Electrolytic	01.16V disk 20/\$1.00
1.5 uF 25V 3/\$1.00	1000 uF 16V Radial \$5.00	1.16V 15/\$1.00
1.8 uF 25V 3/\$1.00	500 uF 20V Axial \$5.00	001.16V 20/\$1.00
2.2 uF 25V 3/\$1.00	150 uF 16V Axial \$11.00	100pF 20/\$1.00
	10 uF 15V Radial 10/\$1.00	047.16V 20/\$1.00

Crystals

3.579545 MHZ	\$1.50
10.00000 MHZ	\$5.00
5.248800 MHZ	\$5.00

AC Adapters

Good for clocks, nicad chargers, all 110 VAC plug one end.

8.5 vdc @ 20 mA	\$1.00
16 vac @ 160mA	\$2.50
12 vac @ 250mA	\$3.00

Solid State Buzzers

small buzzer 450 Hz 86 dB, sound output on 5-12 vdc at 10-30 mA. TTL compatible. **\$1.50**

AC Outlet

Panel Mount with Leads **4/\$1.00**

Audio Prescaler

Make high resolution audio measurements, great for musical instrument tuning, PL tones, etc. Multiplies audio UP in frequency, selectable x10 or x100, gives 01 Hz resolution with 1 sec. gate time! High sensitivity of 25 mv, 1 meg input z and built-in filtering gives great performance. Runs on 9V battery, all CMOS.

PS-2 kit **\$29.95**
PS-2 wired **\$39.95**

600 MHz PRESCALER



Extend the range of your counter to 600 MHz. Works with all counters. Less than 150 mv sensitivity. specify -10 or -100.

Wired, tested, PS-1B **\$59.95**
Kit, PS-1B **\$44.95**

30 Watt 2 mtr PWR AMP

Simple Class C power amp features 8 times power gain. 1 W in for 8 out, 2 W in for 15 out, 4W in for 30 out. Max output of 35 W, incredible value, complete with all parts, less case and T-R relay.

PA-1, 30 W pwr amp kit **\$22.95**
TR-1, RF sensed T-R relay kit **6.95**

MRF-238 transistor as used in PA-1 8-10db gain 150 mhz **\$11.95**

Power Supply Kit

Complete triple regulated power supply provides variable 6 to 18 volts at 200 ma and +5 at 1 Amp. Excellent load regulation, good filtering and small size. Less transformers, requires 6.3 V 1 A and 24 VCT. Complete kit, PS-3LT **\$6.95**

RF actuated relay senses RF (1W) and closes DPDT relay. For RF sensed T-R relay TR-1 Kit **\$6.95**

OP-AMP Special

BI-FET LF13741 - Direct pin for pin 74 compatible, but 500,000 MEG input z, super low 50 pa input c, low power drain.

50 for only **\$9.00** 10 for **\$2.00**

Regulators

78MG	\$1.25	7812	\$1.00
79MG	\$1.25	7815	\$1.00
723	\$5.50	7905	\$1.25
309K	\$1.15	7912	\$1.25
7805	\$1.00	7915	\$1.25

Shrink Tubing Nubs

Nice precut pcs of shrink size: 1" x 1/4" shrink to 1/4" Great for splices **50/\$1.00**

Mini TO-92 Heat Sinks

Thermalloy Brand **5 for \$1.00**
To-220 Heat Sinks **3 for \$1.00**

Opto Isolators - 4N28 type \$1.50 ea.
Opto Reflectors - Photo diode + LED \$1.00 ea.

Molex Pins

Molex already precut in length of 7. Perfect for 14 pin sockets **20 strips for \$1.00**

CDS Photocells

Resistance varies with light, 250 ohms to over 3 meg **3 for \$1.00**

READOUTS

ND 359 4°C C	\$1.00
ND 507/510 5°C A	1.00
AAI 72/HP7730 33°C A	1.00
RP 7651 43°C A	2.00

TRANSISTORS

N3904 NPN C-F	15/\$1.00
N3906 PNP C-F	15/\$1.00
N4403 PNP C-F	15/\$1.00
N4410 NPN C-F	15/\$1.00
N4916 FET C-F	4/\$1.00
N5401 PNP C-F	5/\$1.00
N6028 C-F	4/\$1.00
N3771 NPN Silicon	\$1.50
N5179 UHF NPN	3/\$2.00
Lower Tab NPN 40W	3/\$1.00
Lower Tab PNP 40W	3/\$1.00
6PF 102/2N5484	1.50
IPN 3904 Type T-R	50/\$2.50
NP 3906 Type T-R	50/\$2.50
N3055	1.80
N2646 UJT	3/\$2.00

Diodes

5.1 V Zener	20/\$1.00
1N914 Type	50/\$1.00
1KV 2Amp	8/\$1.00
100V 1Amp	15/\$1.00

Crystal Microphone

Small 1" diameter 1/4" thick crystal mike cartridge **\$.75**

Coax Connector

Chassis mount BNC type **\$1.00**

9 Volt Battery Clips

Nice quality clips **5 for \$1.00**
1/4" Rubber Grommets **10 for \$1.00**

Parts Bag

Asst of chokes disc caps tant resistors, transistors, diodes, MICAs caps etc. sm bag (100 pc) **\$1.00** lg. bag (300 pc) **\$2.50**

Connectors

6 pin type gold contacts for mA-1003 car clock module price **.75 ea.**

Leds - your choice, please specify

Mini Red, Jumbo Red, High Intensity Red, Illuminator Red **8/\$1**
Mini Yellow, Jumbo Yellow, Jumbo Green **6/\$1**

Varactors

Motorola MV 2209 30 PF Nominal cap 20-80 PF - Tunable range - **.50 each or 3/\$1.00**

25 AMP 100V Bridge \$1.50 each
Mini-Bridge 50V 1 AMP 2 for \$1.00

DC-DC Converter

+5 vdc input prod. -9 vdc @ 30ma
+9 vdc produces -15 vdc @ 35ma **\$1.25**

Ceramic IF Filter

Mini **SOLD OUT** 7 kHz B.W **\$1.50 ea.**

Trimmer Caps

Sprague - 3-40 pf Stable Polypropylene **.50 ea.**

Mini RG-174 Coax

10 ft. for **\$1.00**

FACIT 4555 SERIAL PAGE PRINTER

The Facit 4555 alphanumerical serial printer is complete. Equipped with RS232C Interface, printing mechanism, control electronics, drive electronics, power supply and character generator. The adaptation electronics can be modified in four versions: Bit-parallel data transfer, CCITT (EIA, RS232C) for bit-serial data transfer and the current loop (TTY) interface also for bit serial data transfer. The Facit 4555 prints on ordinary paper and is adjustable for different paper widths and formats, 9.5" paper width with 66 lines per page or DIN A4 with 70 lines per page.

SPECIFICATIONS

Print speed	up to 60ch.s.	Char. spacing	2.54mm/1/10" 80ch/line
Printing mode	Incremental.		1.55mm/0.06" 132ch/line
Max. # of ch/line	80 alt. 132.	Char. Code	ECMA-6 7-bit coded char. set
Matrix	7 X 5 dot matrix.	Char. Set	63 Char. various national versions.
Char. Size Height	2.7mm/1/8"	Feed mechanism	Sprocket feed.
Char. Size Width	1.3mm/0.05" 132ch/line		
	2.1mm/0.083" 80ch/line		

THESE UNITS WERE PULLED OUT OF SERVICE IN GOOD WORKING CONDITION. WE CHECK EACH UNIT ON A RADIO SHACK TRS-80 COLOR COMPUTER.



PRINTER ONLY \$129.99

Printer with linecord, box of paper, inter-connect cable for TRS-80 COLOR COMPUTER. \$149.99

GENEVA CALCULATOR WATCH

This attractive watch has the following modes:
 Normal Time Setting,
 Calendar Setting,
 Daily Alarm Time Setting,
 Weekly Alarm Time Setting,
 Chronograph,
 Calculator.

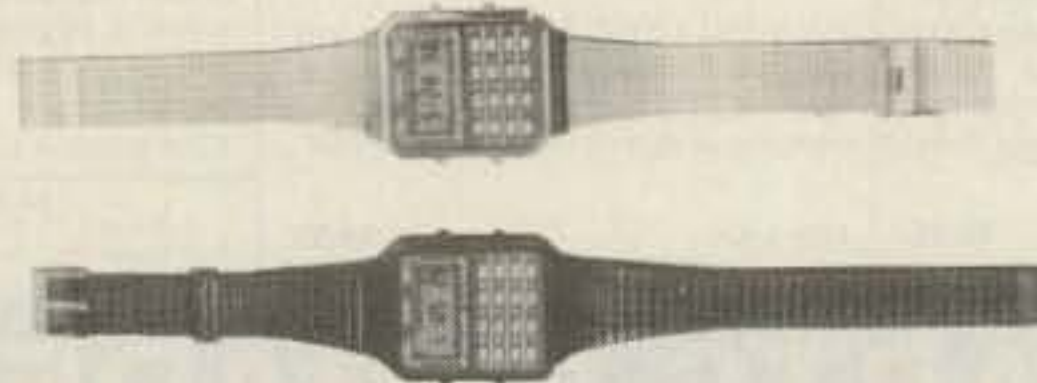

Featured in Black Plastic \$24.99 or Featured in Stainless Steel \$29.99

SILICON DIODES

MR751	100vdc	6Amps	10/\$5.00	100/\$38.00
MR510	1000vdc	3Amps	10/\$3.75	100/\$24.00
HEP170	1000vdc	2Amps	20/\$2.00	100/\$15.00
1N3209	100vdc	15Amps	\$2.00	10/ \$15.00
BYX21/200	200vdc	25Amps	\$2.00	10/ \$15.00
1N2138A	600vdc	60Amps	\$5.00	10/ \$40.00
DS85-04C	400vdc	80Amps	\$10.00	10/ \$80.00
1N3269	600vdc	160Amps	\$15.00	10/\$120.00
275241	300vdc	250Amps	\$20.00	10/\$175.00
7-5754	300vdc	400Amps	\$30.00	10/\$250.00
RCD-15	15KVDC	20ma.	\$3.00	10/ \$20.00
SMFR20K	20KVDC	20ma.	\$4.00	10/ \$30.00
1N4148	signal		30/\$1.00	100/ \$3.00

FEED THRU SOLDER RF CAPACTORS

470pf +-20%
5/\$1.00 or 100/\$15.00 or 1000/\$100.00
1000pf/.001uf +-10%
4/\$1.00 or 100/\$20.00 or 1000/\$150.00

E PROMS

2708 1024x1	\$2.00 each
2716 2048x8	\$4.00 each
27L32/25L32	\$10.00 each

FAIRCHILD 4116 16K DYNAMIC RAMS 200ns. Part # 16K75

25 For \$25.00 or 100 For \$90.00 or 1000 For \$750.00

HEWLETT PACKARD MICROWAVE DIODES

1N5711	(5082-2800)	Schottky Barrier Diodes	\$1.00 or 10 for \$ 8.50
1N5712	(5082-2810)	" " "	\$1.50 or 10 for \$10.00
1N6263	(HSCH-1001)	" " "	\$.75 or 10 for \$ 5.00
5082-2835		" " "	\$1.50 or 10 for \$10.00
5082-2805	Quad Matched	" " " per set	\$5.00 or 10 for \$40.00

**Toll Free Number
 800-528-0180
 (For orders only)**

MHz electronics

"All parts may be new or surplus, and parts may be substituted with comparable parts if we are out of stock of an item."

PRICES SUBJECT TO CHANGE WITHOUT NOTICE

"MIXERS"

WATKINS JOHNSON WJ-M6 Double Balanced Mixer

LO and RF 0.2 to 300MHz	IF DC to 300MHz	\$21.00
Conversion Loss (SSB)	6.5dB Max. 1 to 50MHz	WITH DATA SHEET
Noise Figure (SSB)	8.5dB Max. .2 to 300MHz	
Conversion Compression	same as above	
	8.5dB Max. 50 to 300MHz	
	.3dB Typ.	

NEC (NIPPON ELECTRIC CO. LTD. NE57835/2SC2150 Microwave Transistor

NF Min F=2GHz	dB 2.4 Typ.	MAG F=2GHz	dB 12 Typ.	\$5.30
F=3GHz	dB 3.4 Typ.	F=3GHz	dB 9 Typ.	
F=4GHz	dB 4.3 Typ.	F=4GHz	dB 6.5 Typ.	
Ft Gain Bandwidth Product at Vce=8v, Ic=10ma. GHz 4 Min. 6 Typ.				
Vcbo 25v	Vceo 11v	Vebo 3v	Ic 50ma. Pt.	250mw

UNELCO RF Power and Linear Amplifier Capacitors

These are the famous capacitors used by all the RF Power and Linear Amplifier manufacturers, and described in the RF Data Book.

5pf	10pf	18pf	30pf	43pf	100pf	200pf	1 to 10pcs.	\$1.00 ea
5.1pf	12pf	22pf	32pf	51pf	110pf	220pf	11 to 50pcs.	\$.90 ea
6.8pf	13pf	25pf	33pf	60pf	120pf	470pf	51 up	pcs. \$.80 ea
7pf	14pf	27pf	34pf	80pf	130pf	500pf		
8.2pf	15pf	27.5pf	40pf	82pf	140pf	1000pf		

NIPPON ELECTRIC COMPANY TUNNEL DIODES

		MODEL 1S2199	1S2200	\$7.50
Peak Pt. Current ma.	Ip	9min. 10Typ. 11max.	9min. 10Typ. 11max.	
Valley Pt. Current ma.	Iv	1.2Typ. 1.5max.	1.2Typ. 1.5max.	
Peak Pt. Voltage mv.	Vp	95Typ. 120max.	75Typ. 90max.	
Projected Peak Pt. Voltage mv.	Vpp Vf=Ip	480min. 550Typ. 630max.	440min. 520Typ. 600max.	
Series Res. Ohms	rS	2.5Typ. 4max.	2Typ. 3max.	
Terminal Cap. pf.	Ct	1.7Typ. 2max.	5Typ. 8max.	
Valley Pt. Voltage mv.	VV	370Typ.	350Typ.	

FAIRCHILD / DUMONT Oscilloscope Probes Model 4290B

Input Impedance 10 meg., Input Capacity 6.5 to 12pf., Division Ratio (Volts/Div Factor) 10:1, Cable Length 4Ft., Frequency Range Over 100MHz.
These Probes will work on all Tektronix, Hewlett Packard, and other Oscilloscopes.

PRICE \$45.00

MOTOROLA RF DATA BOOK

Lists all Motorola RF Transistors / RF Power Amplifiers, Varactor Diodes and much much more.

PRICE \$7.50

Toll Free Number
800-528-0180
(For orders only)

MHz electronics

"All parts may be new or surplus, and parts may be substituted with comparable parts if we are out of stock of an item."

PRICES SUBJECT TO CHANGE WITHOUT NOTICE

RF TRANSISTORS, MICROWAVE DIODES

PART	PRICE	PART	PRICE	PART	PRICE
1S2199	\$ 7.50	2N6083	\$ 13.25	CA2612 (TRW)	\$ 25.00
1S2200	7.50	2N6084	15.00	CA2674 (TRW)	25.00
2N1561	25.00	2N6094 /M9622	11.00	CA2881-1 (TRW)	25.00
2N1562	25.00	2N6095 /M9623	12.00	CA4101 (TRW)	25.00
2N2857	1.55	2N6096 /M9624	15.50	CA4201 (TRW)	25.00
2N2857JAN	2.55	2N6097	17.25	CA4600 (TRW)	25.00
2N2876	11.00	2N6136	21.85	CD1889	20.00
2N2947	18.35	2N6166	40.25	CD2545	20.00
2N2948	15.50	2N6201	50.00	CMD514AB	20.00
2N2949	3.90	2N6459	18.00	D4959	10.00
2N2950	4.60	2N6603	12.00	D4987M	20.00
2N3375	8.00	2N6680	80.00	D5147D	10.00
2N3553	1.57	2SC756A	7.50	D5506	10.00
2N3632	13.80	2SC781	2.80	D5827AM	20.00
2N3818	5.00	2SC1018	1.00	DMD6022	30.00
2N3866	1.30	2SC1042	12.00	DMS-2A-250	40.00
2N3924	3.35	2SC1070	2.50	HEP76	4.95
2N3927	17.75	2SC1239	2.50	HEPS3002	11.30
2N3950	25.00	2SC1251	12.00	HEPS3003	30.00
2N4072	1.80	2SC1306	2.90	HEPS3005	10.00
2N4127	21.00	2SC1307	5.50	HEPS3006	19.90
2N4427	1.30	2SC1760	1.50	HEPS3007	25.00
2N4428	1.85	2SC1970	2.50	HEPS3010	11.34
2N4957	3.45	2SC2166	5.50	HTEF2204 H.P.	112.00
2N4958	2.90	8B1087 (M.A.)	25.00	5082-0112 H.P.	14.20
2N4959	2.30	A50-12	20.00	5082-0253 H.P.	105.00
2N5090	13.90	A283B	5.00	5082-0320 H.P.	58.00
2N5108	4.00	ALD4200N (AVANTEK)	395.00	5082-0386 H.P.	POR
2N5109	1.70	AM123	97.35	5082-0401 H.P.	POR
2N5160	3.45	AM688	100.00	5082-0438 H.P.	POR
2N5177	21.62	BB105B	.52	5082-1028 H.P.	POR
2N5179	1.00	BD4/4JFBD4 (G.E.)	10.00	5082-2711 H.P.	23.15
2N5583	4.00	BFQ85	1.50	5082-3080 H.P.	2.00
2N5589	8.65	BFR90	1.30	5082-3188 H.P.	1.00
2N5590	10.35	BFR91	1.65	5082-6459 H.P.	POR
2N5591	13.80	BFW92	1.50	5082-8323 H.P.	POR
2N5635	10.95	BFX89	1.00	35826E H.P.	POR
2N5637	15.50	BFY90	1.00	35831E H.P.	29.99
2N5641	9.20	BGY54	25.00	35853E H.P.	71.50
2N5642	10.95	BGY55	25.00	35854E H.P.	75.00
2N5643	15.50	BGY74	25.00	HPA0241 H.P.	75.60
2N5645	13.80	BGY75	25.00	HXTR3101 H.P.	7.00
2N5646	20.70	BL161	10.00	HXTR3102 H.P.	8.75
2N5691	18.00	BLX67	11.00	HXTR6101/2N6617 H.P.	55.00
2N5764	27.00	BLY568CF	25.00	HXTR6104 H.P.	68.00
2N5836	5.45	BLY87	13.00	HXTR6105 H.P.	31.00
2N5842	8.00	BLY88	14.00	HXTR6106 H.P.	33.00
2N5849	20.00	BLY89	15.00	QSCH1995 H.P.	POR
2N5913	3.25	BLY90	20.00	JO2000 TRW	10.00
2N5922	10.00	BLY351	10.00	JO2001 TRW	25.00
2N5923	25.00	C4005	20.00	JO4045 TRW	25.00
2N5941	23.00	CA402 (TRW)	25.00	K3A	10.00
2N5942	40.00	CA405 (TRW)	25.00	MA450A	10.00
2N5944	9.20	CA612B (TRW)	25.00	MA41487	POR
2N5945	11.50	CA2100 (TRW)	25.00	MA41765	POR
2N5946	19.00	CA2113 (TRW)	25.00	MA43589	POR
2N6080	9.20	CA2200 (TRW)	25.00	MA43636	POR
2N6081	10.35	CA2213 (TRW)	25.00	MA47044	POR
2N6082	11.50	CA2418 (TRW)	25.00	MA47651	25.50

Toll Free Number
800-528-0180
(For orders only)

"All parts may be new or surplus, and parts may be substituted with comparable parts if we are out of stock of an item."

PRICES SUBJECT TO CHANGE WITHOUT NOTICE

MHz electronics

GaAs, TUNNEL DIODES, ETC.

PART	PRICE	PART	PRICE	PART	PRICE
MA47100	\$ 3.05	MRF503	\$ 6.00	PT4186B	\$ POR
MA47202	30.80	MRF504	7.00	PT4209	POR
MA47771	POR	MRF509	5.00	PT4209C	POR
MA47852	POR	MRF511	8.65	PT4566	POR
MA49558	POR	MRF605	20.00	PT4570	POR
MB4021	POR	MRF629	3.47	PT4571	POR
MBD101	1.00	MRF644	23.00	PT4571A	POR
MDO513	POR	MRF816	15.00	PT4577	POR
MHW1171	42.50	MRF823	20.00	PT4590	POR
MHW1182	48.60	MRF901	3.00	PT4612	POR
MHW4171	49.35	MRF8004	2.10	PT4628	POR
MHW4172	51.90	MS261F	POR	PT4640	POR
MHW4342	68.75	MT4150 Fair.	POR	PT4642	POR
MLP102	25.00	MT5126 Fair.	POR	PT5632	POR
MM1500	32.32	MT5481 Fair.	POR	PT5749	POR
MM1550	POR	MT5482 Fair.	POR	PT6612	POR
MM1552	50.00	MT5483 Fair.	POR	PT6626	POR
MM1553	50.00	MT5596 Fair.	POR	PT6709	POR
MM1614	10.00	MT5764 Fair.	POR	PT6720	POR
MM2608	5.00	MT8762 Fair.	POR	PT8510	POR
MM3375A	11.50	MV109	.77	PT8524	POR
MM4429	10.00	MV1401	8.75	PT8609	POR
MM8000	1.15	MV1624	1.42	PT8633	POR
MM8006	2.30	MV1805	15.00	PT8639	POR
MO277L	POR	MV1808	10.00	PT8659	POR
MO283L	POR	MV1817B	10.00	PT8679	POR
MO3757	POR	MV1863B	10.00	PT8708	POR
MP102	POR	MV1864A	10.00	PT8709	POR
MPN3202	10.00	MV1864B	10.00	PT8727	POR
MPN3401	.52	MV1864D	10.00	PT8731	POR
MPN3412	1.00	MV1868D	10.00	PT8742	POR
MPSU31	1.01	MV2101	.90	PT8787	POR
MRA2023-1.5 TRW	42.50	MV2111	.90	PT9790	41.70
MRF212/208	16.10	MV2115	1.55	PT31962	POR
MRF223	13.25	MV2201	.53	PT31963	POR
MRF224	15.50	MV2203	.53	PT31983	POR
MRF237	3.15	MV2209	2.00	PTX6680	POR
MRF238	12.65	MV2215	2.00	RAY-3	24.99
MRF243	25.00	MWA110	7.45	40081	POR
MRF245	34.50	MWA120	7.80	40281	POR
MRF247	34.50	MWA130	8.25	40282	POR
MRF304	43.45	MWA210	7.80	40290	POR
MRF315	23.00	MWA220	8.25	RF110	25.00
MRF420	20.00	MWA230	8.65	SCA3522	POR
MRF421	36.80	MWA310	8.25	SCA3523	POR
MRF422	41.40	MWA320	8.65	SD1065	POR
MRF427	16.10	MWA330	9.50	SS43	POR
MRF428	46.00	NEC57835	5.30	TP1014	POR
MRF450/A	13.80	ON382	5.00	TP1028	POR
MRF453/A	17.25	PPT515-20-3	POR	TRW-3	POR
MRF454/A	19.90	PRT8637	POR	UT0504 Avantek	70.00
MRF455/A	16.00	PSCQ2-160	POR	UT0511 Avantek	75.00
MRF458	19.90	PT3190	POR	V15	4.00
MRF463	25.00	PT3194	POR	V33B	4.00
MRF472	1.00	PT3195	POR	V100B	4.00
MRF475	2.90	PT3537	POR	VAB801EC	25.00
MRF477	11.50	PT4166E	POR	VAB804EC	25.00
MRF502	1.04	PT4176D	POR	VAS21AN20	25.00

Toll Free Number
800-528-0180
(For orders only)

"All parts may be new or surplus, and parts may be substituted with comparable parts if we are out of stock of an item."

MHz electronics

PRICES SUBJECT TO CHANGE WITHOUT NOTICE

COAXIAL RELAY SWITCHES SPDT

Electronic Specialty Co./Raven Electronics FSN 5985-556-9683 \$49.00
 Part # 25N28 Part # SU-01
 26Vdc Type N Connector, DC to 1 GHz.



Amphenol
 Part # 316-10102-8
 115Vac Type BNC DC to 3 GHz.

FXR
 Part # 300-11182
 120Vac Type BNC DC to 4 GHz.
 FSN 5985-543-1225

FXR
 Part # 300-11173
 120Vac Type BNC Same
 FSN 5985-543-1850

\$29.99

\$39.99

\$39.99

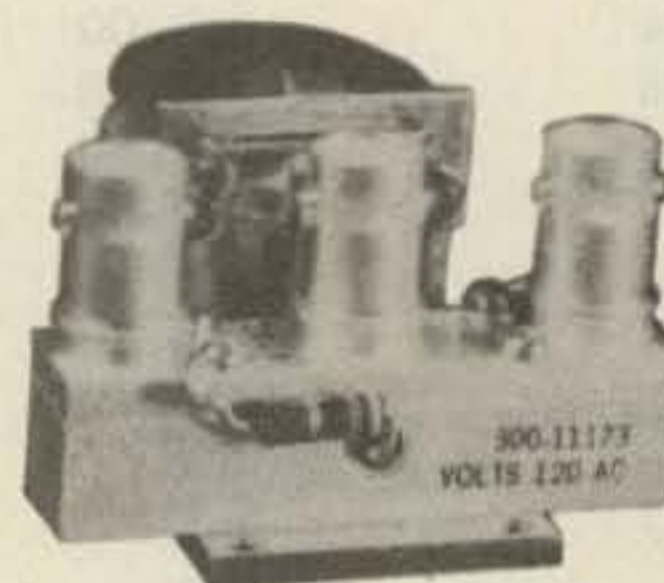
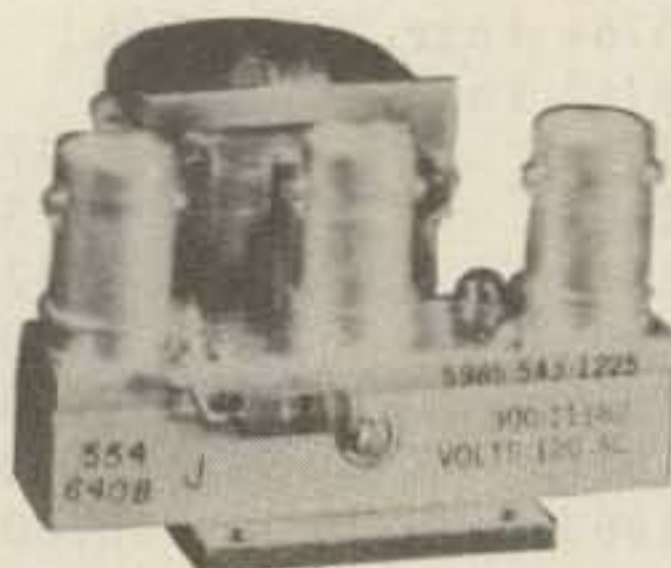
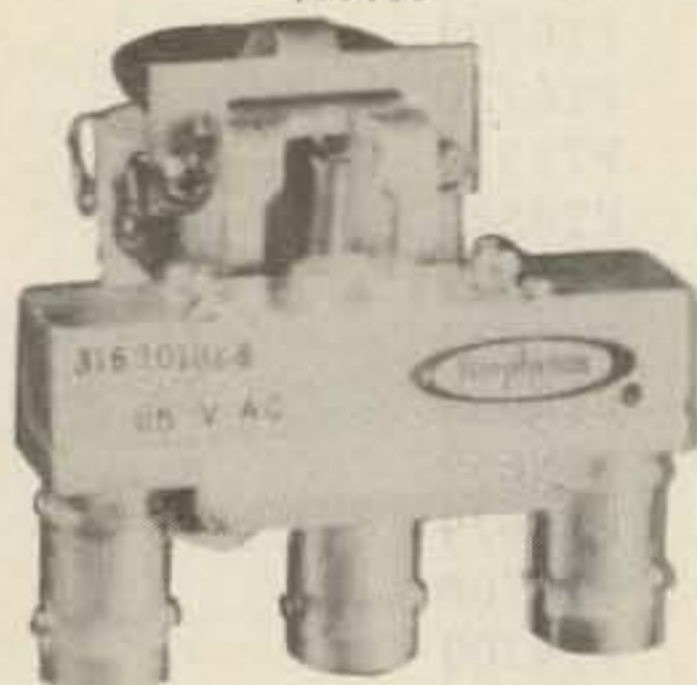

BNC To Banana Plug Coax Cable RG-58 36 inch or BNC to N Coax Cable RG-58 36 inch.

\$7.99 or 2 For \$13.99 or 10 For \$50.00

\$8.99 or 2 For \$15.99 or 10 For \$60.00

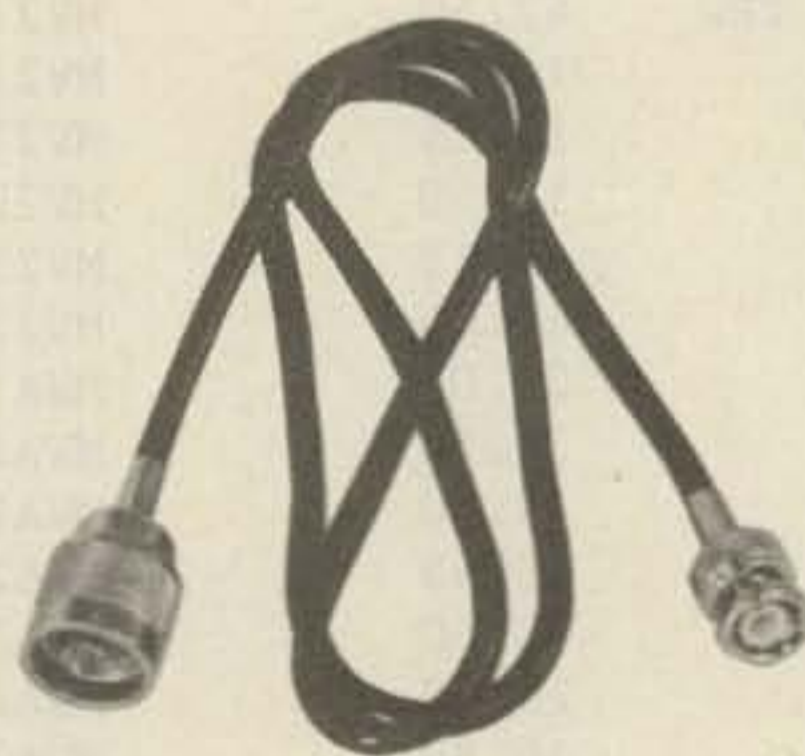

SOLID STATE RELAYS

P&B Model ECT1DB72

PRICE EACH \$5.00

Digisig, Inc. Model ECS-215

PRICE EACH \$7.50

Grigsby/Barton Model GB7400

PRICE EACH \$7.50

5vdc turn on

5vdc turn on

5vdc turn on

120vac contact at 7amps or 20amps on a 10"x 10"x .124 aluminum. Heatsink with silicon grease.

240vac contact 14amps or 40amps on a 10"x 10"x .124 aluminum. Heatsink with silicon grease.

240vac contact at 15amps or 40amps on a 10"x 10"x .124 aluminum. Heatsink with silicon grease.

NOTE: *** Items may be substituted with other brands or equivalent model numbers. ***

MHz electronics

"All parts may be new or surplus, and parts may be substituted with comparable parts if we are out of stock of an item."

Toll Free Number
 800-528-0180
 (For orders only)

PRICES SUBJECT TO CHANGE WITHOUT NOTICE

RECALL PHONE MEMORY TELEPHONE WITH 24 NUMBER AUTO DIALER

The Recall Phone Telephone employs the latest state of art communications technology. It is a combination telephone and automatic dialer that uses premium-quality, solid-state circuitry to assure high-reliability performance in personal or business applications. \$49.99



ARON ALPHA RAPID BONDING GLUE

Super Glue #CE-486 high strength rapid bonding adhesive. Alpha Cyanoacrylate. Set-Time 20 to 40 sec., 0.7 fl. oz. (20gm.) \$2.00



TOUCH TONE PAD

This pad contains all the electronics to produce standard touch-tone tones. New with data.

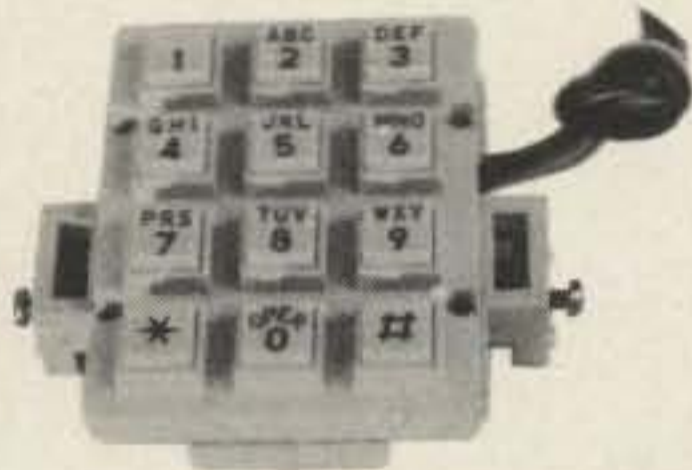

\$9.99 or 10/\$89.99

MITSUMI UHF/VHF VARACTOR TUNER MODEL UVE1A

Perfect for those unscrambler projects. New with data.



\$19.99 or 10/\$149.99

INTEGRATED CIRCUIT

		1 to 10	11up
MC1372P	Color TV Video Modulator Circuit.	\$ 4.42	\$2.95
MC1358P	IF Amp., Limiter, FM Detector, Audio Driver, Electronic Attenuator.	5.00	4.00
MC1350P	IF Amplifier	1.50	1.25
MC1330A1P	Low Level Video Detector	1.50	1.15
MC1310P	FM Stereo Demodulator	4.29	3.30
MC1496P	Balanced Modulator/Demodulator	1.50	1.25
LM565N	Phase Locked Loop	2.50	2.00
LM380N14	2Watt Audio Power Amplifier	1.56	1.25
LM1889N	TV Video Modulator	5.00	4.00
NE564N	Phase Locked Loop	10.00	8.00
NE561N	Phase Locked Loop	10.00	8.00

FERRANTI ELECTRONICS AM RADIO RECEIVER MODEL ZN414 INTEGRATED CIRCUIT.

Features:

1.2 to 1.6 volt operating range., Less than 0.5ma current consumption. 150KHz to 3MHz Frequency range., Easy to assemble, no alignment necessary. Effective and variable AGC action., Will drive an earphone direct. Excellent audio quality., Typical power gain of 72dB., TO-18 package. With data.

\$2.99 or 10 For \$24.99

NI CAD RECHARGEABLE BATTERIES

AA Battery Pack of 6 These are Factory New. \$5.00

SUB C Pack of 10 2.5Amp/Hr. \$10.00

Gates Rechargeable Battery Packs

12vdc at 2.5Amp/Hr. \$11.99

12vdc at 5Amp/Hr. \$15.99



MHz electronics

"All parts may be new or surplus, and parts may be substituted with comparable parts if we are out of stock of an item."

Toll Free Number
800-528-0180
(For orders only)

PRICES SUBJECT TO CHANGE WITHOUT NOTICE

"SOCKETS AND CHIMNEYS"

EIMAC TUBE SOCKETS AND CHIMNEYS

Part Number	Description	Price
SK110	Socket	\$POR
SK300A	Socket For 4CX5000A,R,J, 4CX10,000D, 4CX15,000A,J	\$520.00
SK400	Socket For 4-125A,250A,400A,400C,4PR125A,400A,4-500A,5-500A	260.00
SK406	Chimney For 4-250A,400A,400C,4PR400A	74.00
SK416	Chimney For 3-400Z	36.00
SK500	Socket For 4-1000A/4PR1000A/B	390.00
SK600	Socket For 4CX250B,BC,FG,R,4CX350A,F,FJ	51.00
SK602	Socket For 4CX250B,BC,FG,R,4CX350A,F,FJ	73.00
SK606	Chimney For 4CX250B,BC,FG,R,4CX350A,F,FJ	11.00
SK607	Socket For 4CX600J,JA	60.00
SK610	Socket For 4CX600J,JA	60.00
SK620	Socket For 4CX600J,JA	66.00
SK626	Chimney For 4CX600J,JA	10.00
SK630	Socket For 4CX600J,JA	66.00
SK636B	Chimney For 4CX600J,JA	34.00
SK640	Socket For 4CX600J,JA	36.00
SK646	Chimney For 4CX600J,JA	71.00
SK700	Socket For 4CX300A,Y,4CX125C,F	225.00
SK711A	Socket For 4CX300A,Y,4CX125C,F	225.00
SK740	Socket For 4CX300A,Y,4CX125C,F	86.00
SK770	Socket For 4CX300A,Y,4CX125C,F	86.00
SK800A	Socket For 4CX1000A,4CX1500B	225.00
SK806	Chimney For 4CX1000A,4CX1500B	40.00
SK810	Socket For 4CX1000A,4CX1500B	225.00
SK900	Socket For 4X500A	300.00
SK906	Chimney For 4X500A	57.00
SK1420	Socket For 5CX3000A	650.00
SK1490	Socket For 4CV8000A	585.00

JOHNSON TUBE SOCKETS AND CHIMNEYS

124-111/SK606	Chimney For 4CX250B,BC,FG,R, 4CX350A,F,FJ	\$ 10.00
122-0275-001	Socket For 3-500Z, 4-125A, 250A, 400A, 4-500A, 5-500A	(pair) 15.00
124-0113-00	Capacitor Ring	15.00
124-116/SK630A	Socket For 4CX250B,BC,FG,R, /4CX350A,F,FJ	55.00
124-115-2/SK620A	Socket For 4CX250B,BC,FG,R, /4CX350A,F,FJ	55.00
	813 Tube Socket	20.00

CHIP CAPACITORS

.8pf	10pf	100pf*	430pf
1pf	12pf	110pf	470pf
1.1pf	15pf	120pf	510pf
1.4pf	18pf	130pf	560pf
1.5pf	20pf	150pf	620pf
1.8pf	22pf	160pf	680pf
2.2pf	24pf	180pf	820pf
2.7pf	27pf	200pf	1000pf/.001uf*
3.3pf	33pf	220pf*	1800pf/.0018uf
3.6pf	39pf	240pf	2700pf/.0027uf
3.9pf	47pf	270pf	10,000pf/.01uf
4.7pf	51pf	300pf	12,000pf/.012uf
5.6pf	56pf	330pf	15,000pf/.015uf
6.8pf	68pf	360pf	18,000pf/.018uf
8.2pf	82pf	390pf	

PRICES: 1 to 10 - .99¢	101 to 1000 .60¢	* IS A SPECIAL PRICE: 10 for \$7.50
11 to 50 - .90¢	1001 & UP .35¢	100 for \$65.00
51 to 100 - .80¢		1000 for \$350.00

TUBE CAPS (Plate)

HR1, 4	\$11.00
HR2,3, 6 & 7	13.00
HR5, 8	14.00
HR9	17.00
HR10	20.00

WATKINS JOHNSON WJ-V907: Voltage Controlled Microwave Oscillator \$110.00

Frequency range 3.6 to 4.2GHz, Power output, Min. 10dBm typical, 8dBm Guaranteed. Spurious output suppression Harmonic (nf₀), min. 20dB typical, In-Band Non-Harmonic, min. 60dB typical, Residual FM, pk to pk, Max. 5KHz, pushing factor, Max. 8KHz/V, Pulling figure (1.5:1 VSWR), Max. 60MHz, Tuning voltage range +1 to +15volts, Tuning current, Max. -0.1mA, modulation sensitivity range, Max. 120 to 30MHz/V, Input capacitance, Max. 100pf, Oscillator Bias +15 +/-0.05 volts @ 55mA, Max.

Toll Free Number
800-528-0180
(For orders only)

"All parts may be new or surplus, and parts may be substituted with comparable parts if we are out of stock of an item."

MHz electronics

PRICES SUBJECT TO CHANGE WITHOUT NOTICE

TUBES

<u>TYPE</u>	<u>PRICE</u>	<u>TYPE</u>	<u>PRICE</u>	<u>TYPE</u>	<u>PRICE</u>
2E26	\$ 5.69	KT88	\$ 20.00	6562/6974A	\$ 50.00
2K28	100.00	DX362	50.00	6832	22.00
2X1000A	300.00	DX415	50.00	6883/8032A/8552	7.00
3B22	19.75	572B/T160L	49.00	6897	110.00
3B28/866A	7.50	592/3-200A3	144.00	6907A	75.00
3-500Z	102.00	807	7.50	6939	15.00
3-1000Z	400.00	811	10.00	7094	125.00
3CX1000A/8283	428.00	811A	15.00	7117	17.00
3CX1500A7/887	533.00	812A	35.00	7211	60.00
3X2500A3	200.00	813	50.00	7289/3CX100A5	34.00
3CX3000A7	490.00	829B	38.00	7360	11.00
4-65A/8165	45.00	832A	28.00	7377	67.00
4-125A/4D21	58.00	4624	310.00	7408	4.00
4-250A/5D22	75.00	4662	80.00	7650	250.00
4-400A/8432	90.00	4665	585.00	7695	8.00
4-400C/6775	95.00	5675/A	25.00	7843	58.00
4-1000A/8166	300.00	5721	200.00	7854	83.00
4B32	22.00	5768	85.00	7868	5.00
4E27A/5-125B	155.00	5836	100.00	7894	12.00
4CS250R	146.00	5837	100.00	8072	65.00
4X150A/7034	30.00	5861/EC55	110.00	8117A	130.00
4X150D/7035	40.00	5876A	25.00	8121	60.00
4X150G/8172	100.00	5881/6L6W	6.00	8122	100.00
4X250B	30.00	5893	45.00	8236	30.00
4CX250B/7203	45.00	5894/A	50.00	8295/PL172	506.00
4CX250F/G/8621	55.00	5894/B	60.00	8462	100.00
4CX250K/8245	100.00	5946	258.00	8505A	73.50
4CX250R/7580W	69.00	6080	10.00	8533W	92.00
4CX300A/8167	140.00	6083/AX9909	89.00	8560/A	65.00
4CX350A/8321	83.00	6098/6AK6	14.00	8560AS	90.00
4CX350F/J/8904	95.00	6115/A	110.00	8608	34.00
4X500A	282.00	6146	7.00	8637	38.00
4CX600J/8809	607.00	6146A	7.50	8643	100.00
4CW800F	625.00	6146B/8298A	8.50	8647	123.00
4CX1000A/8168	340.00	6146W	14.00	8737/5894B	60.00
4CX1500B/8660	397.00	6156	66.00	8873	260.00
4CX5000A/8170	932.00	6159	15.00	8874	260.00
4CX10000D/8171	990.00	6161	233.00	8875	260.00
4CX15000A/8281	1260.00	6291	125.00	8877	533.00
4PR60A	100.00	6293	12.00	8908	12.00
4PR60B/8252	175.00	6360	5.00	8930/651Z	71.00
4PR400A/8188	192.00	6524	53.00	8950	12.00
5CX1500A	569.00	6550	10.00		
6BK4C	6.00	6JM6	6.00	6LQ6 (Sylvania)	7.50
6DQ5	5.00	6JN6	6.00	6LU8	6.00
6FW5	6.00	6JS6B	6.00	6LX6	6.00
6GE5	6.00	6KG6/EL505	6.00	6ME6	6.00
6GJ5	6.00	6KM6	6.00	12BY7A	4.00
6HS5	6.00	6KN6	6.00	12JB6A	6.00
6JB5/6HE5	6.00	6LF6	6.00	6KD6	6.00
6JB6A	6.00	6LQ6 (GE)	6.00	6JT6A	6.00
				6KD6	6.00

NOTICE ALL PRICES ARE SUBJECT TO CHANGE WITHOUT NOTICE !!!
 TUBES MAY EITHER BE NEW OR SURPLUS CONDITION !!!

Toll Free Number
800-528-0180
(For orders only)

"All parts may be new or surplus, and parts may be substituted with comparable parts if we are out of stock of an item."

MHz electronics

PRICES SUBJECT TO CHANGE WITHOUT NOTICE

"FILTERS"

COLLINS Mechanical Filter #526-9724-010 MODEL F455Z32F

455KHZ at 3.2KHz wide. May be other models but equivalent. May be used or new, \$15.99

ATLAS Crystal Filters

5.595-2.7/8/LSB, 5.595-2.7/LSB
8 pole 2.7KHz wide Upper sideband. Impedence 800ohms 15pf In/800ohms 0pf out. 19.99

5.595-2.7/8/U, 5.595-2.7/USB
8 pole 2.7KHz wide Upper sideband. Impedence 800ohms 15pf In/800ohms 0pf out. 19.99

5.595-.500/4, 5.595-.500/4/CW
4 pole 500 cycles wide CW. Impedence 800ohms 15pf In/800ohms 0pf out. 19.99

9.0USB/CW
6 pole 2.7KHz wide at 6dB. Impedence 680ohms 7pf In/300ohms 8pf out. CW-1599Hz 19.99

KOKUSAI ELECTRIC CO, Mechanical Filter #MF-455-ZL/ZU-21H

455KHz at Center Frequency of 453.5KC. Carrier Frequency of 455KHz 2.36KC Bandwidth.
Upper sideband. (ZU) 19.99
Lower sideband. (ZL) 19.99

CRYSTAL FILTERS

NIKKO	FX-07800C	7.8MHz	\$10.00
TEW	FEC-103-2	10.6935MHz	10.00
SDK	SCH-113A	11.2735MHz	10.00
TAMA	TF-31H250	CF 3179.3KHz	19.99
TYCO/CD	001019880	10.7MHz 2pole 15KHz bandwidth	5.00
MOTOROLA	4884863B01	11.7MHz 2pole 15KHz bandwidth	5.00
PTI	5350C	12MHz 2pole 15KHz bandwidth	5.00
PTI	5426C	21.4MHz 2pole 15KHz bandwidth	5.00
PTI	1479	10.7MHz 8pole bandwidth 7.5KHz at 3dB, 5KHz at 6dB	20.00
COMTECH	A10300	45MHz 2pole 15KHz bandwidth	6.00
FRC	ERXF-15700	20.6MHz 36KHz wide	10.00
FILTECH	2131	CF 7.825MHz	10.00

CERAMIC FILTERS

AXEL	4F449	12.6KC Bandpass Filter 3dB bandwidth 1.6KHz from 11.8-13.4KHz	10.00
CLEVITE	TO-01A	455KHz+2KHz bandwidth 4-7% at 3dB	5.00
	TCF4-12D36A	455KHz+1KHz bandwidth 6dB min 12KHz, 60dB max 36KHz	10.00
MURATA	BFB455B	455KHz	2.50
	BFB455L	455KHz	3.50
	CFM455E	455KHz +5.5KHz at 3dB, +8KHz at 6dB, +16KHz at 50dB	6.65
	CFM455D	455KHz +7KHz at 3dB, +10KHz at 6dB, +20KHz at 50dB	6.65
	CFR455E	455KHz +5.5KHz at 3dB, +8KHz at 6dB, +16KHz at 60dB	8.00
	CFU455B	455KHz +2KHz bandwidth +15KHz at 6dB, +30KHz at 40dB	2.90
	CFU455C	455KHz +2KHz bandwidth +12.5KHz at 6dB, +24KHz at 40dB	2.90
	CFU455G	455KHz +1KHz bandwidth +4.5KHz at 6dB, +10KHz at 40dB	2.90
	CFU455H	455KHz +1KHz bandwidth +3KHz at 6dB, +9KHz at 40dB	2.90
	CFU455I	455KHz +1KHz bandwidth +2KHz at 6dB, +6KHz at 40dB	2.90
	CFW455D	455KHz +10KHz at 6dB, +20KHz at 40dB	2.90
	CFW455H	455KHz +3KHz at 6dB, +9KHz at 40dB	2.90
	SFB455D	455KHz	2.50
	SFD455D	455KHz +2KHz, 3dB bandwidth 4.5KHz +1KHz	5.00
	SFE10.7MA	10.7MHz 280KHz +50KHz at 3dB, 650KHz at 20dB	2.50
	SFE10.7MS	10.7MHz 230KHz +50KHz at 3dB, 570KHz at 20dB	2.50
	SFG10.7MA	10.7MHz	10.00
NIPPON	LF-B4/CFU455I	455KHz +1KHz	2.90
	LF-B6/CFU455H	455KHz +1KHz	2.90
	LF-B8	455KHz	2.90
	LF-C18	455KHz	10.00
TOKIN	CF455A/BFU455K	455KHz +2KHz	5.00
MATSUSHIRA	EFC-LA55K	455KHz	7.00

SPECTRA PHYSICS INC., Model 088 HeNe LASER TUBES

POWER OUTPUT 1.6MW.	BEAM DIA. .75MM	BEAM DIR. 2.7MR	8KV STARTING VOLTAGE DC
68K OHM 1WATT BALLAST	1000VDC +100VDC	At 3.7MA	\$59.99

ROTRON MUFFIN FANS Model MARK4/MU2A1

115 VAC	14WATTS	50/60CPS	IMPEDENCE PROTECTED-F	88CFM at 50CPS	\$ 7.99
105CFM at 60CPS	THESE ARE NEW				

MHz electronics

PRICES SUBJECT TO CHANGE WITHOUT NOTICE

Toll Free Number
800-528-0180
(For orders only)

"All parts may be new or surplus, and parts may be substituted with comparable parts if we are out of stock of an item."

HEWLETT PACKARD SIGNAL GENERATORS

606A	50KHz to 65MHz in 6 bands +-1%. Output level adjustable 0.1uV to 3V into 50 ohms. Built-in crystal calibrator. 400 -1000Hz modulation.	\$ 650.00
606B	Same as above but has frequency control feature to allow operation with HP 8708A Synchronizer.	\$1100.00
608C	10MHz to 480MHz, 0-1uV-1V into 50 ohms, AM, CW, or pulse modulation, calibrated attenuator.	\$ 500.00
608D/ TS510	10MHz to 420MHz, 0.1uV-0.5V into 50 ohms, +-0.5% accuracy, built-in crystal calibrator, AM-CW or pulse output.	\$ 375.00
608E	Improved version of popular 608C. Up to 1V output. Improved stability, low residual FM.	\$1450.00
608F	10MHz to 455MHz in 5 bands +-1% frequency accuracy with built-in crystal calibrator. Can be used with HP 8708A Synchronizer. Output continuously adjustable from .1uV to .5V into 50 ohms.	\$1100.00
612A	450-1230MHz, 0.1uV-0.5V into 50 ohms, calibrated output.	\$ 750.00
614A	900-2100MHz with many features including calibrated output and all modulation characteristics.	\$ 500.00
616A/ TS403	Direct reading and direct control from 1.8 to 4.2GHz. The H.P. 616A features +-1.5dB calibrated output accuracy from -3127dBm to -dBm. The output is directly calibrated in microvolts and dBm with continuous monitoring. Simple operation frequency diad accuracy is +-1% and stability exceeds 0.005% / C change in ambient temperature. Calibrated attenuator is within +-1.5dB over entire output band. 50 ohm impedance unit has internal pulse modulation with rep rate variable from 40 Hz to 4KHz, variable pulsewidth (1 to 10uSec) and variable pulse delay (3 to 300uSec). External modulating inputs increase versatility.	\$ 375.00
616B	Same as above but later model.	\$ 600.00
618B	3.8 to 7.6GHz range, with calibrated output and selection of pulse-FM or square wave modulation.	\$ 600.00
618C	Same as above but later model.	\$2200.00
620A	7 to 11GHz range, with calibrated output and selection of pulse-FM or square wave modulation.	\$ 750.00
620B	Same as above but later model.	\$2200.00
626A	10 to 15GHz, 10mw output power with calibrated output and pulse-square wave or FM modulation.	\$4200.00
8708A	Synchronizer used with 606B, 608F. The synchronizer is a phase-lock frequency stabilizer which provides crystal-oscillator frequency stability to 430MHz in the 608F signal generator. Phase locking eliminates microphonics and drift resulting in excellent frequency stability. The 8708A includes a vernier which can tune the reference oscillator over a range of +-0.25% permitting frequency settability to 2 parts in 10 to the seventh. Provides a very stable signal that satisfies many critical applications.	
	(With HP 606B or 608F)	\$ 350.00
	(Without)	\$ 450.00
EMC-10	ELECTROMETRICS EMC-10 RFI/EMI RECEIVER Low frequency analyzer covering 20Hz to 50KHz frequency range. Extendable to 500 KHz in wideband mode.	\$2500.00
NF-105F	Empire Devices Field Intensity Meter. Has NF-105/TA, NF-105/TX, NF-105/T1, NF-105/T2, NF-105/T3. Covers 14KHz to 1000MHz.	\$2100.00

ALL EQUIPMENT CARRY A 30 DAY GUARANTEE.

EQUIPMENT IS NOT CALIBRATED.

ORDERING INSTRUCTIONS

DEFECTIVE MATERIAL: All claims for defective material must be made within sixty (60) days after receipt of parcel. All claims must include the defective material (for testing purposes), our invoice number, and the date of purchase. All returns must be packed properly or it will void all warranties.

DELIVERY: Orders are normally shipped within 48 hours after receipt of customer's order. If a part has to be backordered the customer is notified. Our normal shipping method is via First Class Mail or UPS depending on size and weight of the package. On test equipment it is by Air only, FOB shipping point.

FOREIGN ORDERS: All foreign orders must be prepaid with cashier's check or money order made out in U.S. Funds. We are sorry but C.O.D. is not available to foreign countries and Letters of Credit are not an acceptable form of payment either. Further information is available on request.

HOURS: Monday thru Saturday: 8:30 a.m. to 5:00 p.m.

INSURANCE: Please include 25¢ for each additional \$100.00 over \$100.00, United Parcel only.

ORDER FORMS: New order forms are included with each order for your convenience. Additional forms are available on request.

POSTAGE: Minimum shipping and handling in the US, Canada, and Mexico is \$2.50 all other countries is \$5.00. On foreign orders include 20% shipping and handling.

PREPAID ORDERS: Order must be accompanied by a check.

PRICES: Prices are subject to change without notice.

RESTOCK CHARGE: If parts are returned to MHZ Electronics due to customer error, customer will be held responsible for all extra fees, will be charged a 15% restocking fee, with the remainder in credit only. All returns must have approval.

SALES TAX: Arizona must add 5% sales tax, unless a signed Arizona resale tax card is currently on file with MHZ Electronics. All orders placed by persons outside of Arizona, but delivered to persons in Arizona are subject to the 5% sales tax.

SHORTAGE OR DAMAGE: All claims for shortages or damages must be made within 5 days after receipt of parcel. Claims must include our invoice number and the date of purchase. Customers which do not notify us within this time period will be held responsible for the entire order as we will consider the order complete.

OUR 800 NUMBER IS STRICTLY FOR ORDERS ONLY
NO INFORMATION WILL BE GIVEN. 1-800-528-0180.

TERMS: DOMESTIC: Prepaid, C.O.D. or Credit Card

FOREIGN: Prepaid only, U.S. Funds—money order or cashier's check only.

C.O.D.: Acceptable by telephone or mail. Payment from customer will be by cash, money order or cashier's check. We are sorry but we cannot accept personal checks for C.O.D.'s.

CONFIRMING ORDERS: We would prefer that confirming orders not be sent after a telephone order has been placed. If company policy necessitates a confirming order, please mark "CONFIRMING" boldly on the order. If problems or duplicate shipments occur due to an order which is not properly marked, customers will be held responsible for any charges incurred, plus a 15% restock charge on returned parts.

CREDIT CARDS: WE ACCEPT MASTERCARD VISA AND AMERICAN EXPRESS.

DATA SHEETS: When we have data sheets in stock on devices we do supply them with the order.

MHZ electronics



(802) 242-3037
(602) 242-8916
2111 W. CAMELBACK ROAD
PHOENIX, ARIZONA 85015

Toll Free Number
800-528-0180
(For orders only)

"All parts may be new or surplus, and parts may be substituted with comparable parts if we are out of stock of an item."

48

NEW LOW-NOISE PREAMPS RECEIVING CONVERTERS TRANSMIT CONVERTERS

New low-noise microwave transistors make preamps in the 0.9 to 1.0 dB noise figure range possible without the fragility and power supply problems of gas-fet's. Units furnished wired and tuned to ham band. Can be easily retuned to nearby freq.



Models LNA(), P30, and P432 shown

Model	Tunable Freq Range	Noise Figure	Gain	Price
LNA 28	20-40	0.9 dB	20 dB	\$39.95
LNA 50	40-70	0.9 dB	20 dB	\$39.95
LNA 144	120-180	1.0 dB	18 dB	\$39.95
LNA 220	180-250	1.0 dB	17 dB	\$39.95
LNA 432	380-470	1.0 dB	18 dB	\$44.95

ECONOMY PREAMPS

Our traditional preamps, proven in years of service. Over 20,000 in use throughout the world. Tuneable over narrow range. Specify exact freq. band needed. Gain 16-20 dB. NF = 2 dB or less. VHF units available 27 to 300 MHz. UHF units available 300 to 650 MHz.

- P30K, VHF Kit less case \$14.95
- P30C, VHF Kit with case \$20.95
- P30W, VHF Wired/Tested \$29.95
- P432K, UHF Kit less case \$18.95
- P432C, UHF Kit with case \$24.95
- P432W, UHF Wired/Tested \$33.95

P432 also available in broadband version to cover 20-650 MHz without tuning. Same price as P432; add "B" to model #.

HELICAL RESONATOR PREAMPS

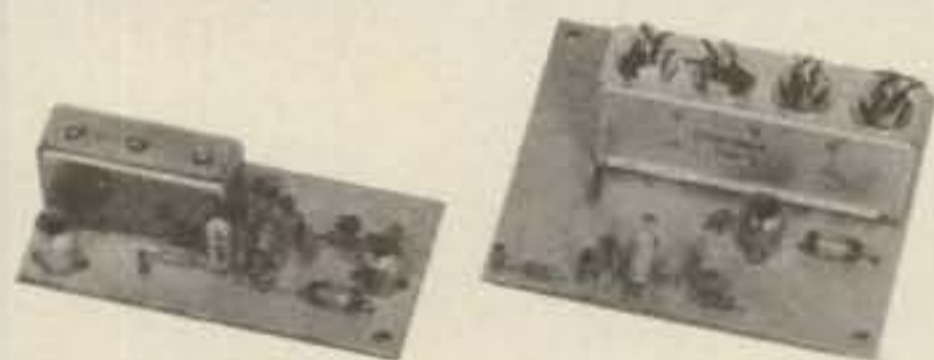

Our lab has developed a new line of low-noise receiver preamps with helical resonator filters built in. The combination of a low noise amplifier similar to the LNA series and the sharp selectivity of a 3 or 4 section helical resonator provides increased sensitivity while reducing intermod and cross-band interference in critical applications. See selectivity curves at right. Noise figure = 1 to 1.2 dB. Gain = 12 to 15 dB.

Model	Tuning Range	Price
HRA-144	143-150 MHz	\$49.95
HRA-220	213-233 MHz	\$49.95
HRA-432	420-450 MHz	\$59.95



Models to cover every practical rf & if range to listen to SSB, FM, ATV, etc. NF = 2 dB or less.

VHF MODELS	Antenna Input Range	Receiver Output
Kit \$44.95	28-32	144-148
Less Case \$39.95	50-52	28-30
Wired \$59.95	50-54	144-148
	144-146	28-30
	145-147	28-30
	144-144.4	27-27.4
	146-148	28-30
	144-148	50-54
	220-222	28-30
	220-224	144-148
	222-226	144-148
	220-224	50-54
	222-224	28-30

UHF MODELS	Antenna Input Range	Receiver Output
Kit \$54.95	432-434	28-30
Less Case \$49.95	435-437	28-30
Wired \$74.95	432-436	144-148
	432-436	50-54
	439.25	61.25

SCANNER CONVERTERS Copy 72-76, 135-144, 240-270, 400-420, or 806-894 MHz bands on any scanner. Wired/tested Only \$79.95.

SPECIAL FREQUENCY CONVERTERS made to custom order \$119.95. Call for details.

SAVE A BUNDLE ON VHF FM TRANSCEIVERS!

FM-5 PC Board Kit - **ONLY \$159.95** complete with controls, heatsink, etc. 10 Watts, 5 Channels, for 6M, 2M, or 220



Cabinet Kit, complete with speaker, knobs, connectors, hardware. Only \$59.95

REPEAT OF A SELLOUT!

While supply lasts, get \$59.95 cabinet kit free when you buy an FM-5 Transceiver kit. Where else can you get a complete transceiver for only \$159.95?

For SSB, CW, ATV, FM, etc. Why pay big bucks for a multi mode rig for each band? Can be linked with receive converters for transceive. 2 watts output.

	Exciter Input Range	Antenna Output
For VHF, Model XV2 Kit \$79.95 Wired \$119.95 (Specify band)	28-30	144-146
	28-29	145-146
	28-30	50-52
	27-27.4	144-144.4
	28-30	220-222*
	50-54	220-224
	144-146	50-52
	50-54	144-148
	144-146	28-30

	Exciter Input Range	Antenna Output
For UHF, Model XV4 Kit \$99.95 Wired \$149.95	28-30	432-434
	28-30	435-437
	50-54	432-436
	61.25	439.25
	144-148	432-436*

*Add \$20 for 2M input

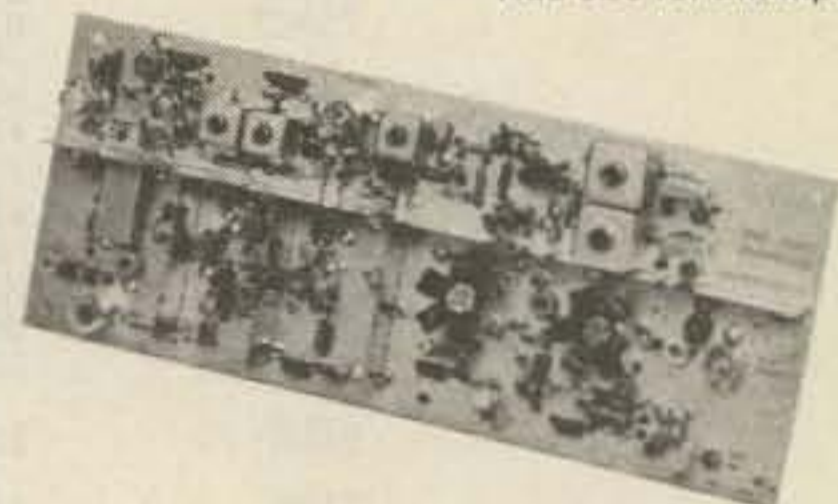

VHF & UHF LINEAR AMPLIFIERS. Use with above. Power levels from 10 to 45 Watts. Kits from \$69.95.

LOOK AT THESE ATTRACTIVE CURVES!

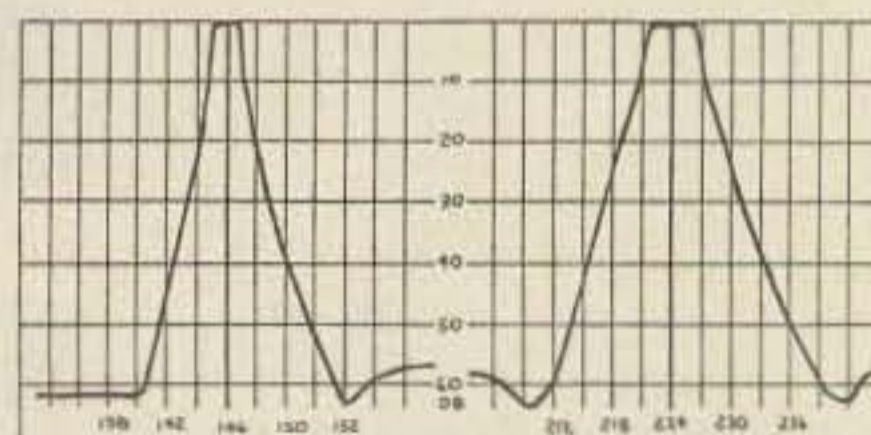

R144 & R220 Front Ends, HRA 144/220, & HRF-144/220

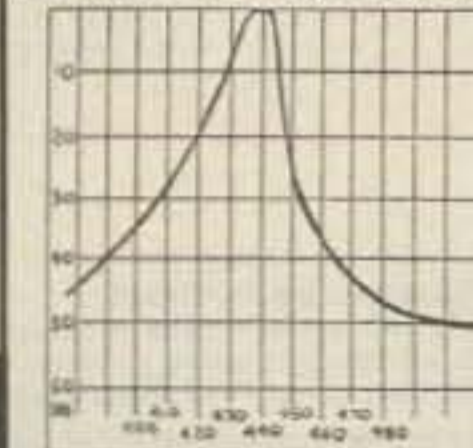

R451 Receiver Front End

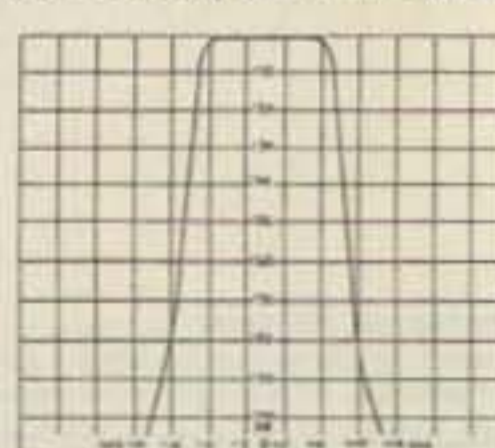

Rcvr I-F Selectivity

Typical Selectivity Curves of Receivers and Helical Resonators.

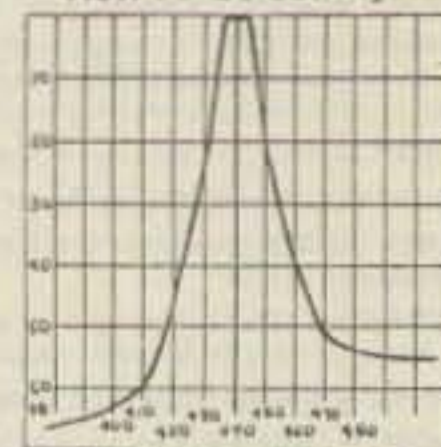

HRA-432, HRF-432

- Call or Write for **FREE CATALOG** (Send \$1.00 or 4 IRC's for overseas mailing)
- Order by phone or mail • Add \$2 S & H per order (Electronic answering service evenings & weekends) Use VISA, MASTERCARD, Check, or UPS COD.

hamtronics, inc.

65-X MOUL RD. • HILTON NY 14468
Phone: 716-392-9430

Hamtronics® is a registered trademark

**AT LAST —
A REPEATER
YOU CAN AFFORD!**

For years, Hamtronics® Modules have been used by individual hams and manufacturers to make repeaters. Now, in the Hamtronics tradition of top quality and superb value, we are proud to offer a complete repeater package.



JUST LOOK AT THESE PRICES!

Band	Kit	Wired/Tested
6M, 2M, 220	\$595	\$745
440	\$645	\$795

Both kit and wired units are complete with all parts, modules, hardware, and crystals.

CALL OR WRITE FOR COMPLETE DETAILS.

Also available for remote site linking/crossband & 10M.

FEATURES:

- SENSITIVITY SECOND TO NONE; TYPICALLY 0.15 uV ON VHF, 0.3 uV ON UHF.
- SELECTIVITY THAT CAN'T BE BEAT! BOTH 8 POLE CRYSTAL FILTER & CERAMIC FILTER FOR GREATER THAN 100 dB AT ± 12KHZ. HELICAL RESONATOR FRONT ENDS. SEE R144, R220, AND R451 SPECS IN RECEIVER AD BELOW.
- OTHER GREAT RECEIVER FEATURES: FLUTTER-PROOF SQUELCH, AFC TO COMPENSATE FOR OFF-FREQ TRANSMITTERS, SEPARATE LOCAL SPEAKER AMPLIFIER & CONTROL.
- CLEAN, EASY-TUNE TRANSMITTER; UP TO 20 WATTS OUT.

**HIGH QUALITY MODULES FOR
REPEATERS, LINKS, TELEMETRY, ETC.**

**INTRODUCING —
NEW 1983 RECEIVERS**

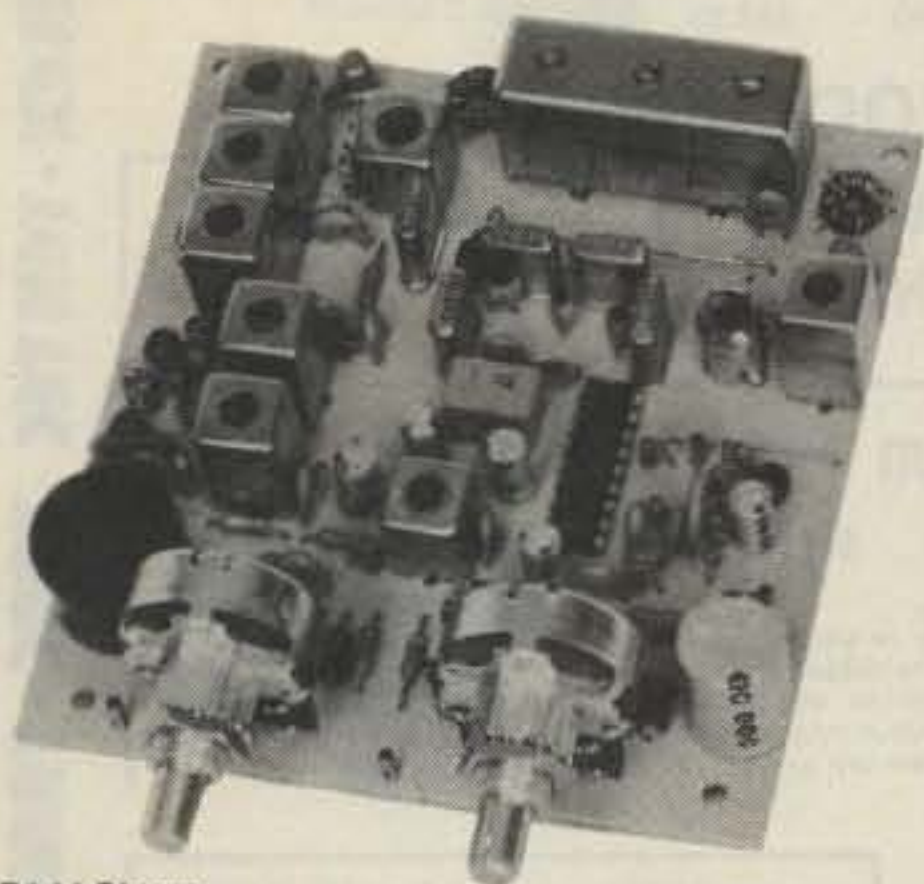

R144 Shown

- **R144/R220 FM RCVRs** for 2M or 220 MHz. 0.15uV sens.; 8 pole xtal filter & ceramic filter in i-f, helical resonator front end for exceptional selectivity (curves at left). AFC incl., xtal oven avail. Kit only \$119.95
- **R451 FM RCVR** Same but for uhf. Tuned line front end, 0.3 uV sens. Kit only \$119.95.
- **R76 FM RCVR** for 10M, 6M, 2M, 220, or commercial bands. As above, but w/o AFC or hel. res. Kits only \$109.95. Also avail w/4 pole filter, only \$94.95/ kit.
- **R110 VHF AM RECEIVER** kit for VHF aircraft band or ham bands. Only \$84.95
- **R110 UHF AM RECEIVER** for UHF uses, including special 259 MHz model to hear SPACE SHUTTLE. Kit \$94.95

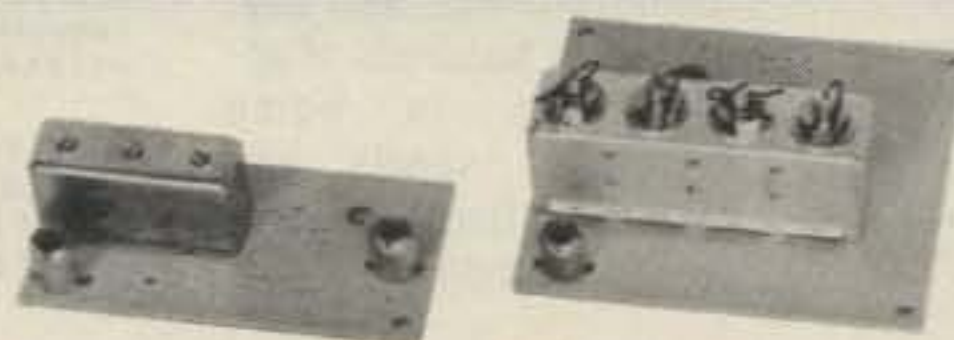

- **HELICAL RESONATOR FILTERS** available separately on pcb w/connectors.
HRF-144 for 143-150 MHz \$34.95
HRF-220 for 213-233 MHz \$34.95
HRF-432 for 420-450 MHz \$44.95

(See selectivity curves at left.)



- **COR KITS** With audio mixer and speaker amplifier. Only \$29.95.
- **CWID KITS** 158 bits, field programmable, clean audio. Only \$59.95.
- **DTMF DECODER/CONTROLLER KITS.** Control 2 separate on/off functions with touchtones®, e.g., repeater and autopatch. Use with main or aux. receiver or with Auto-patch. Only \$89.95.
- **AUTOPATCH KITS.** Provide repeater autopatch, reverse patch, phone line remote control of repeater, secondary control via repeater receiver. Many other features. Only \$89.95. Requires DTMF Module.
- **A16 RF TIGHT BOX** Deep drawn alum. case with tight cover and no seams. 7 x 8 x 2 inches. Only \$18.00.

**TRANSMITTERS AND
ACCESSORIES**



- **T51 VHF FM EXCITER** for 10M, 6M, 2M, 220 MHz or adjacent bands. 2 Watts continuous. Kits only \$59.95



- **T451 UHF FM EXCITER** 2 to 3 Watts on 450 ham band or adjacent. Kits only \$69.95.
- **VHF & UHF LINEAR AMPLIFIERS.** Use on either FM or SSB. Power levels from 10 to 45 Watts to go with exciters & xmtg converters. Kits from \$69.95.

hamtronics®

ANTENNA SPECIALISTS • AVANTI • AARAL PUBS • AMECO • BASH • BEARCAT • BENCHER • B&W • BIRD • CALLBOOK • COMMUNICATIONS
 SPECIALISTS • CUSHCRAFT • DRAKE • HAM KEY • HUSTLER • HY-GAIN • ICOM • KANTRONICS
 LARSEN • MFJ • MORGAIN • PANASONIC • RAMSEY • SHURE • SONY • TELEX • TEN TEC • TRAC • TRANSCOM • VAN GORDON • VOCOM

POPULAR VALUES FROM SPECTRONICS!

THEY'RE ALMOST GONE!

SAVE \$\$\$



**SONY ICF-2001
INSTANT-ACCESS
DIGITAL SHORTWAVE
SCANNER-RECEIVER**

NOW ONLY **\$199⁹⁵** ADD \$5.00 SHIPPING
CONT'L U.S.

~~List \$349.95~~

OUR 1983 CATALOG PRICE **\$249.95**

ORDER NOW! LIMITED QUANTITIES!

• AM-CW-SSB
 • 150 KHz-30 MHz • FM BROADCAST
 • PLL SYNTHESIZED WITH SCANNING AND MEMORY • AC ADAPTOR • 1 YEAR FACTORY LIMITED WARRANTY

Put Your Computer "On-The-Air"

The Interface™

List **\$169⁹⁵**
~~\$189.95~~

Plus \$3.00 Shipping



Your personal computer becomes a complete CW/RTTY/ASCII send and receive terminal with **The Interface** linking it to your transceiver.

If you own an Apple II or Apple II Plus, Atari 400 or 800, TRS-80 Color Computer, or VIC-20, **The Interface** will put your computer "On-The-Air".

Software for each system features split screen display, buffered keyboard, status display, and message ports. Attach any Centronics compatible printer for hard copy. Software is available, on diskette for the Apple and program boards for the others, at additional cost.

Apple diskette	Atari board	VIC-20 board	TRS-80C board	TI-99 board	VIC-20 Hamtext	Commodore 64 Hamtext
\$29.95	\$49.95	\$49.95	\$59.95	\$99.95	\$99.95	\$99.95

KEN-TEC 24-HOUR DIGITAL MILITARY TIME ALARM CLOCK



\$19⁹⁵ PLUS \$1.50 UPS

- 7" Red LED Numerals
- 24-Hr. Memory Alarm
- 1-Year Warrantee
- Drowse Control
- Dark Brown Walnut Grain
- 2 1/4" H x 6 1/4" W x 3 1/4" D

"easy-talk'r" VOX PORTABLE TRANSCEIVER



\$49⁹⁵ ea. plus \$3.00 shipping

- Up to 1/2 mile FM Transmitting
- "Hands free" VOX operation
- Light weight—less than 9 Oz.

B&W PORTABLE APARTMENT ANTENNA



\$43⁷⁵ plus \$2.00 shipping

FAMOUS "EAVESDROPPER" SW RECEIVING ANTENNA



\$59⁹⁵ plus \$3.00 shipping (Cont'l U.S.)

ICOM HEADQUARTERS

ICOM IC25A

**NEW! IC3AT (220 MHz)
IC4AT (440 MHz)**

ICOM IC2A, IC2AT

- Compact
- Quality Construction
- Versatile
- Affordable
- Wide Range of Accessories Available

CALL FOR PRICE & AVAILABILITY

Valuable aid for Amateur use in antenna installation, tuning/pruning, field day, etc., plus hundreds of applications in home business, sports and recreation. Uses 9 volt battery (not supplied.)

AMECO PREAMPS

add \$3.00 shipping (Cont'l USA only)

Model PLF-2	\$52.95
Model PLF-2E (240V)	\$57.95
Model PT-2	\$79.95
Model PT-2E (240V)	\$84.95

REPLACEMENT NICAD FOR WILSON/YAESU



\$26⁹⁵ plus \$2.00 shipping

Fits Wilson Mark II, and Mark IV plus Yaesu FT-207 500 MAH, 11.7 V. Nickel-Cadmium.

SUB-AUDIBLE TONE HEADQUARTERS

ENCODERS **\$29⁹⁵** plus \$2.00 shipping EACH (Cont'l USA only)

We stock Communications Specialists SS 32 and SS-32M encoders for most any mobile or hand-held applications including the very popular Icom Handhelds.

MORGAIN MULTI-BAND ANTENNAS



Add \$5.00 for shipping (Cont'l U.S.A.)

80-40HD/A 80/40 Mtr bands (69)	99.00	75-10HD/A 75/40/20/15/10 Mtr (66)	126.95
75/40HD/A 75/40 Mtr bands (66)	94.50	80-10HD/A 80/40/20/15/10 Mtr (69)	132.00

VOCOM FAVORITES

5/8 WAVE TELESCOPING ANTENNA \$19⁹⁵ Plus \$2.00 Shipping Cont'l USA

FAMOUS AVANTI THRU-GLASS MOBILE ANTENNA



\$32⁹⁵ plus \$3.00 shipping

mounts on glass and transmits and receives through the glass. Extremely low VSWR is achieved by adjusting special tuning slug on matching network inside the vehicle. Can be easily removed for car washes without special tools.

The Avanti On-Glass is the first two-way communications antenna that

NEW! 2.8 dbd GAIN BASE ANTENNA \$15⁰⁰ Please add 2.00 shipping any qty



Here's an inexpensive, omni-directional, 144-148 MHz. 1/2 wave antenna. Fits 1 1/4" mast, 50 ohm impedance. A real problem solver!

VoCom POWER POCKET

plus \$8.00 shipping (Cont'l USA)

\$199⁹⁵

Accepts any version of the IC-2A, applies its output to a wide band rf amplifier, and delivers 25 watts to your mobile antenna. Mobile talk-out power!



2C-025 AMP \$76⁵⁰ Plus \$3.00 Shipping

• 2 W In • 25 W Out

TO ORDER: CALL OR WRITE. MASTER CARD, VISA, MONEY ORDERS, PERSONAL CHECKS TAKE 3 WEEKS TO CLEAR. ACCEPTED. INTERNATIONAL ORDERS WELCOME, PLEASE REQUEST PRO FORMA INVOICE. ILLINOIS RESIDENTS ADD 6% SALES TAX.

HOURS: MON. THRU WED 9:30-6:00, THURS-FRI 9:30-8:00, SAT. 9:30-3:00

STOP BY AND VISIT WHEN IN THE CHICAGOLAND AREA!!



SPECTRONICS, INC

1009 GARFIELD ST. OAK PARK, IL. 60304

PHONE
(312) 848-6777

ramsey the first name in Counters!



9 DIGITS 600 MHz \$129⁹⁵ WIRED

PRICES:

CT-90 wired, 1 year warranty	\$129.95
CT-90 Kit, 90 day parts warranty	109.95
AC-1 AC adapter	3.95
BP-1 Nicad pack + AC Adapter/Charger	12.95
OV-1, Micro-power Oven time base	49.95
External time base input	14.95

The CT-90 is the most versatile, feature packed counter available for less than \$300.00! Advanced design features include: three selectable gate times, nine digits, gate indicator and a unique display hold function which holds the displayed count after the input signal is removed. Also, a 10MHz TCXO time base is used which enables easy zero beat calibration checks against WWV. Optionally, an internal nicad battery pack, external time base input and Micro-power high stability crystal oven time base are available. The CT-90, performance you can count on!

SPECIFICATIONS:

Range:	20 Hz to 600 MHz
Sensitivity:	Less than 10 MV to 150 MHz Less than 50 MV to 500 MHz
Resolution:	0.1 Hz (10 MHz range) 1.0 Hz (60 MHz range) 10.0 Hz (600 MHz range)
Display:	9 digits 0.4" LED
Time base:	Standard-10,000 mHz, 1.0 ppm 20-40°C, Optional Micro-power oven-0.1 ppm 20-40°C
Power:	8-15 VAC @ 250 ma

7 DIGITS 525 MHz \$99⁹⁵ WIRED



SPECIFICATIONS:

Range:	20 Hz to 525 MHz
Sensitivity:	Less than 50 MV to 150 MHz Less than 150 MV to 500 MHz
Resolution:	1.0 Hz (5 MHz range) 10.0 Hz (50 MHz range) 100.0 Hz (500 MHz range)
Display:	7 digits 0.4" LED
Time base:	1.0 ppm TCXO 20-40°C
Power:	12 VAC @ 250 ma

The CT-70 breaks the price barrier on lab quality frequency counters. Deluxe features such as; three frequency ranges - each with pre-amplification, dual selectable gate times, and gate activity indication make measurements a snap. The wide frequency range enables you to accurately measure signals from audio thru UHF with 1.0 ppm accuracy - that's .0001%! The CT-70 is the answer to all your measurement needs, in the field, lab or ham shack.

PRICES:

CT-70 wired, 1 year warranty	\$99.95
CT-70 Kit, 90 day parts warranty	84.95
AC-1 AC adapter	3.95
BP-1 Nicad pack + AC adapter/charger	12.95

7 DIGITS 500 MHz \$79⁹⁵ WIRED



PRICES:

MINI-100 wired, 1 year warranty	\$79.95
AC-Z Ac adapter for MINI-100	3.95
BP-Z Nicad pack and AC adapter/charger	12.95

Here's a handy, general purpose counter that provides most counter functions at an unbelievable price. The MINI-100 doesn't have the full frequency range or input impedance qualities found in higher price units, but for basic RF signal measurements, it can't be beat! Accurate measurements can be made from 1 MHz all the way up to 500 MHz with excellent sensitivity throughout the range, and the two gate times let you select the resolution desired. Add the nicad pack option and the MINI-100 makes an ideal addition to your tool box for "in-the-field" frequency checks and repairs.

SPECIFICATIONS:

Range:	1 MHz to 500 MHz
Sensitivity:	Less than 25 MV
Resolution:	100 Hz (slow gate) 1.0 KHz (fast gate)
Display:	7 digits, 0.4" LED
Time base:	2.0 ppm 20-40°C
Power:	5 VDC @ 200 ma

8 DIGITS 600 MHz \$159⁹⁵ WIRED



SPECIFICATIONS:

Range:	20 Hz to 600 MHz
Sensitivity:	Less than 25 mv to 150 MHz Less than 150 mv to 600 MHz
Resolution:	1.0 Hz (60 MHz range) 10.0 Hz (600 MHz range)
Display:	8 digits 0.4" LED
Time base:	2.0 ppm 20-40°C
Power:	110 VAC or 12 VDC

The CT-50 is a versatile lab bench counter that will measure up to 600 MHz with 8 digit precision. And, one of its best features is the Receive Frequency Adapter, which turns the CT-50 into a digital readout for any receiver. The adapter is easily programmed for any receiver and a simple connection to the receiver's VFO is all that is required for use. Adding the receiver adapter in no way limits the operation of the CT-50, the adapter can be conveniently switched on or off. The CT-50, a counter that can work double-duty!

PRICES:

CT-50 wired, 1 year warranty	\$159.95
CT-50 Kit, 90 day parts warranty	119.95
RA-1, receiver adapter kit	14.95
RA-1 wired and pre-programmed (send copy of receiver schematic)	29.95

DIGITAL MULTIMETER \$99⁹⁵ WIRED



PRICES:

DM-700 wired, 1 year warranty	\$99.95
DM-700 Kit, 90 day parts warranty	79.95
AC-1, AC adaptor	3.95
BP-3, Nicad pack + AC adapter/charger	19.95
MP-1, Probe kit	2.95

The DM-700 offers professional quality performance at a hobbyist price. Features include; 26 different ranges and 5 functions, all arranged in a convenient, easy to use format. Measurements are displayed on a large 3 1/2 digit, 1/2 inch LED readout with automatic decimal placement, automatic polarity, overrange indication and overload protection up to 1250 volts on all ranges, making it virtually goof-proof! The DM-700 looks great, a handsome, jet black, rugged ABS case with convenient retractable tilt bail makes it an ideal addition to any shop.

SPECIFICATIONS:

DC/AC volts:	100uV to 1 KV, 5 ranges
DC/AC current:	0.1 uA to 2.0 Amps, 5 ranges
Resistance:	0.1 ohms to 20 Megohms, 6 ranges
Input impedance:	10 Megohms, DC/AC volts
Accuracy:	0.1% basic DC volts
Power:	4 'C' cells

AUDIO SCALER

For high resolution audio measurements, multiplies UP in frequency.

- Great for PL tones
- Multiplies by 10 or 100
- 0.01 Hz resolution!

\$29.95 Kit \$39.95 Wired

ACCESSORIES

Telescopic whip antenna - BNC plug	\$ 7.95
High impedance probe, light loading	15.95
Low pass probe, for audio measurements	15.95
Direct probe, general purpose usage	12.95
Tilt bail, for CT 70, 90, MINI-100	3.95
Color burst calibration unit, calibrates counter against color TV signal	14.95

COUNTER PREAMP

For measuring extremely weak signals from 10 to 1,000 MHz. Small size, powered by plug transformer-included.

- Flat 25 db gain
- BNC Connectors
- Great for sniffing RF with pick-up loop

\$34.95 Kit \$44.95 Wired

ramsey electronic's, inc.



2575 Baird Rd. Penfield, NY 14526

PHONE ORDERS
CALL 716-586-3950

TERMS: Satisfaction guaranteed. Examine for 10 days, if not pleased return in original form for refund. Add 5% for shipping insurance to a maximum of \$10. Overseas add 15%. COD add \$2. Orders under \$10 add \$1.50. NY residents add 7% tax

DEALER DIRECTORY

Culver City CA

Jun's Electronics, 3919 Sepulveda Blvd., Culver City CA 90230, 390-8003. Trades 463-1886 San Diego. 827-5732 (Reno NV).

Fontana CA

Complete lines ICOM, DenTron, Ten-Tec, Mirage, Cubic, Lunar, over 4000 electronic products for hobbyist, technician, experimenter. Also CB radio, landmobile. Fontana Electronics, 8628 Sierra Ave., Fontana CA 92335, 822-7710.

Sacramento CA

TOWERS—galvanized steel stack/crankup and accessories. Northern California factory direct to you. California Antenna Systems, 6020 Windy Ridge Road, Shingle Springs CA 95682, 677-9540.

San Jose CA

Bay area's newest Amateur Radio store. New & used Amateur Radio sales & service. We feature Kenwood, ICOM, Azden, Yaesu, Ten-Tec, Santee & many more. Shaver Radio, Inc., 1378 So. Bascom Ave., San Jose CA 95128, 998-1103.

New Castle DE

Factory Authorized Dealer! Yaesu, ICOM, Ten-Tec, KDK, Azden, AEA, Kantronics, Santee. Full Line of Accessories. No Sales Tax in Delaware. One mile off I-95. Delaware Amateur Supply, 71 Meadow Road, New Castle DE 19720, 328-7728.

Preston ID

Ross WB7BYZ has the Largest Stock of Amateur Gear in the Intermountain West and the Best Prices. Call me for all your ham needs. Ross Distributing, 78 So. State, Preston ID 83263, 852-0830.

Bloomington IL

ROHN TOWERS—Wholesale direct to users. All products available. Write or call for price list. Also we are wholesale distributors for Antenna Specialists, Regency, and Hy-Gain. Hill Radio, 2503 C.E. Road Box 1405, Bloomington IL 61701-0887, 663-2141

Terre Haute IN

Your ham headquarters located in the heart of the midwest. Hoosier Electronics, Inc., #9 Meadows Center, P.O. Box 3300, Terre Haute IN 47803, 238-1456.

Western KY

Sell new and used equipment & service. L&S Radio, 307 McLean Ave., Hopkinsville KY 42240, 885-8071.

Framingham MA

ATTENTION HOBBYISTS & EXPERIMENTERS! Now there's a source for parts in your area. We carry audio, video, fans, batteries, capacitors, relays, transformers and much, much more. Open 6 days a week. Horizon Sales, Inc., 59 Fountain St., Framingham MA 01701, 875-4433.

Littleton MA

The Reliable Ham Store Serving N.E. Full line of ICOM & Kenwood, Yaesu HTs, Drake, Daiwa, B&W accessories. Curtis & Trac keyers, Larsen, Hustler, Telex/Hy-Gain products, Mirage amps., Astron P.S., Alpha Delta protectors, ARRL & Kantronics instruction aids. Whistler radar detectors. Full line of coax fittings. TEL-COM Electronic Communications, 675 Great Rd. (Rt. 119), Littleton MA 01460, 486-3400/3040.

Ann Arbor MI

See us for products like Ten-Tec, R. L. Drake, DenTron and many more. Open Monday through Saturday, 0830 to 1730. WB8VGR, WBSUXO, WD8OKN and WSRP behind the counter. Purchase Radio Supply, 327 E. Hoover Ave., Ann Arbor MI 48104, 668-8696.

Buffalo NY WESTERN NEW YORK

Niagara Frontier's only full stocking Amateur dealer. Also Shortwave, CB, Scanners, Marine, Commercial. Operating displays featuring Yaesu and others. Towers, Antennas, Sales and Service. DX Communications, 3214 Transit Road, West Seneca NY, 668-8873.

Amsterdam NY UPSTATE NEW YORK

Kenwood, ICOM, Drake, plus many other lines. Amateur Dealer for over 35 years. Adirondack Radio Supply, Inc., 185 West Main Street, Amsterdam NY 12010, 842-8350.

Columbus OH

The biggest and best Ham Store in the midwest featuring quality Kenwood products with working displays. We sell only the best. Authorized Kenwood Service. Universal Amateur Radio Inc., 1280 Aida Dr., Reynoldsburg (Columbus) OH 43068, 866-4267.

Scranton PA

ICOM, Bird, Cushcraft, Beckman, Fluke, Larsen, Hustler, Antenna Specialists, Astron, Avanti, Belden, W2AU/W2VS, AEA, Vibroplex, Ham-Key, Amphenol, Sony, B&W, Coax-Seal, Cover Craft, J.W. Miller/Daiwa, ARRL, Ameco, Shure. LaRue Electronics, 1112 Grandview St., Scranton PA 18509, 343-2124.

Mountaintop PA WILKES-BARRE AREA

VHF/UHF Equipment & Supplies—From HTs to kW Amplifiers, Transverters, Connectors, VHF/UHF/Microwave Linear Amplifiers, GaAs-FET Preamps, OSCAR Equipment, Low Noise Preamps, Antennas, Power Supplies. From: Lunar, Microwave Modules, UHF Units/Parabolic, ARCOS, Astron, F9FT-Tonna, Tama, DenTron, KLM, Mirage, Santee, Tokyo Hy-Power, Amphenol. Two Stamps for catalog. The VHF SHOP, Dept. S, RD 4, Box 349, Mountaintop PA 18707, 868-6565.

Dallas TX

IBM PC/Apple aftermarket products; hobbyists' electronics project kits; \$50.00 complete modem kit, subscription/satellite TV decoder kits, EPROM programmer/duplicator, popular memory IC testers, data sheets, application notes, and more than 6000 parts in stock. Semiconductors, discrettes, video products, tools. Please write for your free literature/catalog. Independent Electronics, 6415-06 Airline Rd., Dallas TX 75205.

Baltimore/Washington

Avantek transistors, amplifiers, oscillators and LNAs. Coaxial cable and connectors. Blonder Tongue dealer with Microwave laboratory. Applied Specialties, Inc., 10101G Bacon Drive, Beltsville, Maryland 20705. Wash. 595-5393. Balt. 792-2211. 7:30 a.m. to 6:00 p.m. Monday thru Friday.

DEALERS

Your company name and message can contain up to 25 words for as little as \$150 yearly (prepaid), or \$15 per month (prepaid quarterly). No mention of mail-order business or area code permitted. Directory text and payment must reach us 60 days in advance of publication. For example, advertising for the Oct. '83 issue must be in our hands by Aug. 1st. Mail to 73 Magazine, Peterborough NH 03458. ATTN: Nancy Ciampa.

PROPAGATION

J. H. Nelson
4 Plymouth Dr.
Whiting NJ 08759

EASTERN UNITED STATES TO:

	GMT:	00	02	04	06	08	10	12	14	16	18	20	22
ALASKA		14	14	7	7	7	7	7	7A	14	14	14	
ARGENTINA		21	14A	14	14	7	7	14	21	21	21A	21	
AUSTRALIA		21	14	14	7B	7B	7B	7B	7B	7B	14	21	
CANAL ZONE		21	14	14	7	7	7	7A	14	14	21	21	
ENGLAND		14	7	7	7	7	7	14	14	14	14A	14A	14
HAWAII		21	14	14B	7B	7B	7	7	14	14	14	14A	
INDIA		14	14B	7B	7B	7B	7B	14	14	14	14	14	
JAPAN		14A	14	7B	7B	7B	7B	7	7	7A	14	14	
MEXICO		14A	14	7A	7	7	7	14	14	14A	14A	14A	
PHILIPPINES		14	14	7B	7B	7B	7B	7B	14	14	14	14	
PUERTO RICO		14	7A	7	7	7	7	7A	14	14	14	14	14A
SOUTH AFRICA		7B	7B	7	7B	14	14	14A	14A	21	21	14	14
U. S. S. R.		7	7	7	7	7	7A	14	14	14	14	14	7B
WEST COAST		14A	14	7A	7	7	7	7	14	14	14	14	14A

CENTRAL UNITED STATES TO:

ALASKA		14	14	7A	7	7	7	7	7A	14	14	14	
ARGENTINA		21	14A	14	14	7	7	7A	14A	21	21	21A	21
AUSTRALIA		21	21	14	14B	7B	7B	7B	7B	7B	14	21	
CANAL ZONE		21	14	14	7	7	7	7	14	14	21	21	
ENGLAND		14	7	7	7	7	7B	14B	14	14	14	14	
HAWAII		21	14A	14	7	7	7	7	14	14	14	14A	
INDIA		14	14	7B	7B	7B	7B	7B	14B	14	14	14	
JAPAN		14A	14	14B	7B	7B	7B	7	7	7A	14	14	
MEXICO		14	14	7	7	7	7	7	7A	14	14	14	
PHILIPPINES		14	14	14B	7B	7B	7B	7B	14	14	14	14	
PUERTO RICO		14	14	14	7	7	7	7	14	14	14	14A	14A
SOUTH AFRICA		7B	7B	7	7B	7B	7B	14	14	14	14A	14	14
U. S. S. R.		7	7	7	7	7	7B	14B	14	14	14	14	7B

WESTERN UNITED STATES TO:

ALASKA		14	14	14	7	7	7	7	7	14	14	14	
ARGENTINA		21	14A	14	14	7	7	7B	14	21	21	21A	21
AUSTRALIA		21	21	21	14	14	14B	7B	7B	7B	14	21	
CANAL ZONE		21A	14A	14	7	7	7	7	14	14	21	21	
ENGLAND		14	7B	7	7	7	7B	7B	7B	14	14	14	
HAWAII		21A	21	14A	14	14	7A	7	7	14	14	14A	21
INDIA		14	14	14	7B	7B	7B	7B	7B	14	14	14	
JAPAN		14A	14	14	14B	14B	7B	7	7	7	7A	14	14A
MEXICO		14A	14	14	7	7	7	7	14	14	14	14	14A
PHILIPPINES		14A	14A	14	14B	7B	7B	7B	7B	14	14	14	14A
PUERTO RICO		14	14	14	7	7	7	7	14	14	14	14A	14A
SOUTH AFRICA		7B	7B	7	7B	7B	7B	7B	14B	14	14	14	14
U. S. S. R.		7	7	7	7	7	7B	7B	14B	14	14	14	7B
EAST COAST		14A	14	7A	7	7	7	7	14	14	14	14	14A

A = Next higher frequency may also be useful.

B = Difficult circuit this period.

First letter = night waves. Second = day waves.

G = Good, F = Fair, P = Poor. * = Chance of solar flares.

= Chance of aurora.

NOTE THAT NIGHT WAVE LETTER NOW COMES FIRST.

AUGUST

SUN	MON	TUE	WED	THU	FRI	SAT
	1	2	3	4	5	6
		FIG	FIG	FIG	P/F	P/F
7	8	9	10	11	12	13
FIG	FIG	G/G	G/G	G/G	G/G	F/F*
14	15	16	17	18	19	20
F/F*	P/F*	F/F	FIG	G/G	G/G	G/G
21	22	23	24	25	26	27
G/G	F/F	F/F	F/F	P/F	F/F	F/F
28	29	30	31			
F/F	F/F	P/F	P/F			

New

INTRODUCING . . . THE FT-980 CAT SYSTEM !!!



Join the computer revolution in Amateur Radio with the Computer Aided Transceiver
. . . the new FT-980 from Yaesu Electronics!

8-Bit microprocessor for greater operating flexibility.
High-voltage, all solid state transmitter PA for excellent linearity.
Keyboard entry of frequencies into any of twelve independent VFO/memory registers.
Amateur band transmit plus general coverage receive capability.
Full CW break-in with quiet solid state switching.
CW Spot switch on front panel.
Digital frequency display with resolution to 10 Hz. Digital readerboard-type coarse frequency sub-display.
Keyboard entry of sub-bands for Novice, General, or Advanced Class operators. Separate sub-bands may be programmed on each memory.
Up/Down scanning plus instant ± 5 kHz/step QSY from front panel.
SSB/CW/AM/FSK/FM operation built in. CW and AM Wide/Narrow selection using optional filters.
Wide dynamic range and noise floor maintenance provided by husky front end design and IF filter gain balancing.
10 Hz synthesizer steps. Quick frequency change via keyboard or scanning controls.
IF Notch filter at 455 kHz for interference rejection.

- Audio Peak Filter for narrow band CW signal enhancement.
- RX Audio Tone Control for signal laundering in AF line.
- Variable IF Bandwidth and IF Shift using cascaded filters.
- Memory storage of both frequency and operating mode.
- Pushbutton Memory Check feature for verification of memory frequencies without actually changing operating frequency in use.
- Pushbutton Offset Check feature for verification of memory-to-VFO frequency difference.
- Variable Pulse Width Noise Blanker.
- IF Monitor with front panel volume control.
- RF Speech Processor.
- Dual metering of Vcc, Ic, ALC, Compression, Discriminator Center, Relative PO, and SWR (Calibrated).
- Selectable AGC: Slow/Fast/Off.
- Separate RX-only antenna jack.
- Three FSK shifts built in.
- Optional Electronic Keyer Module.
- Optimization of audio passband for mode in use, for preservation of noise figure with changing bandwidth.
- Computer interface optional module available mid-1983, for remote transceiver control from personal computer terminal.

For a detailed brochure covering the FT-980 CAT System, call or write your Authorized Yaesu Dealer.

Price And Specifications Subject To
Change Without Notice Or Obligation

YAESU EST. 1958
The radio.



0183R

YAESU ELECTRONICS CORPORATION 6851 Walthall Way, Paramount, CA 90723 • (213) 633-4007
YAESU CINCINNATI SERVICE CENTER 9070 Gold Park Drive, Hamilton, OH 45011 • (513) 874-3100

One size fits all...

NEW



Ultra-compact and lightweight, priority, memory and band scan, 25 watts...

TM-201A

The KENWOOD TM-201A 2-meter FM mobile transceiver is designed to be the ultimate in compact size and lightweight, allowing maximum flexibility in automotive installations. New microprocessor controlled operating features, improved receive and transmit circuitry, a powerful 25 watts of RF output, and an easy-to-operate front panel control layout are packed into this new, ultra-compact radio, providing extended flexibility and ease of operation. The complete TM-201A system is supplied with a high quality external speaker, and a 16-key autopatch UP/DOWN microphone.

TM-201A FEATURES:

- **Ultra compact and lightweight**
Measures 5.6 (141)W x 1.6 (39.5)H x 7.2 (183)D, inch(mm), weighs 2.8 lbs., (1.25 kg.).
- **25-watt output, with HI/LO power switch**
Produces a powerful 25 watts RF output from a surprisingly compact design.
- **Dual digital VFO's built-in**
Covers 142.000 to 149.000 MHz in 5-kHz steps, includes certain MARS and CAP frequencies. A "MHz" key shifts the frequency in 1-MHz steps.
- **5 memories plus "COM" channel, with lithium battery back-up (est. 5 yr. life)**
Memories 4, 5, and the COM (common) channel store transmit and receive frequencies independently, for either odd or

standard repeater offsets. COM channel switch for instant recall of frequency and tone (with optional TU-3 tone encoder).

- **Priority alert scan**
With ALERT switch "ON," once every 6 seconds the unit scans back to memory channel 1 for approximately 0.3 seconds to monitor the activity on the priority channel (channel 1). A dual "beep" will sound if a signal is present on memory 1.
- **Memory scan/programmable band scan**
Scan skips memories in which no data is stored. UP/DOWN switch on microphone initiates band scan in appropriate direction. Memory 5, set band scan limits. Scanning stops on busy channel, resumes after 6 seconds or when the signal ceases. Scan delay prevents scan resume if signal fades or is momentarily interrupted.
- **Highly visible yellow LED frequency display**
The MHz decimal blinks while scanning, and the kHz decimal lights when VFO-B is in use. S/RF LED bar meter with "BUSY" indicator, "MR" (memory recall), "ALERT," and "ON AIR" LEDs.
- **High performance receive/transmit**
GaAs FET RF amplifier for high sensitivity with wide dynamic range. Transmit modulation characteristics selected for best sound and minimum distortion.
- **External high quality speaker supplied**
(No internal speaker)
- **16-key autopatch UP/DOWN microphone**
- **Repeater offset switch (± 600 -kHz or simplex) and reverse switch**

- **Audible "BEEPER" confirms operation**
- **Easy-to-install mobile mount**



Optional FC-10 frequency controller

May be easily connected to the TM-201A or TM-401A. Convenient control keys for frequency UP/DOWN, MHz shift, VFO A/B, and MR (memory recall or change memory channel). A green, easy-to-read, back-lighted LCD display indicates transmit/receive frequencies; memory channel number, ALERT, and SCAN (with blinking MHz decimal). Size: 4.4 (112)W x 1.4 (35)H x 0.9 (22)D, inch(mm). Weight: 3.5 oz. (100 g).

Other optional accessories:

- **TU-3** programmable two frequency tone encoder
- **KPS-7A** fixed station power supply

More information on the TM-201A and TM-401A is available from authorized dealers of Trio-Kenwood Communications 1111 West Walnut St., Compton, CA 90220.

TM-401A

70-cm FM ultra compact mobile transceiver

- **Dual digital VFO's covering 440-450 MHz**
Covers 10-MHz of 70-cm FM band in 25-kHz steps. MHz key for 1-MHz step.

- **Repeater offset switch, plus reverse switch**
 ± 5 MHz or simplex. Odd offset with memories 4, 5, and COM channel.
- **HI/LOW RF output power switch**
Selects 12 watts or 1 watt
- **Virtually same size and weight as TM-201A**
- **Other features similar to TM-201A**
The complete TM-401A

system is supplied with a high quality external speaker and a 16-key autopatch UP/DOWN microphone. Features five memories plus COM channel with lithium battery back-up, priority alert scan, memory and band scan. Optional FC-10 frequency controller and TU-3 two frequency tone encoder available.

KENWOOD

...pacesetter in amateur radio

