

# 73<sup>®</sup> Amateur Radio Today

SEPTEMBER 1999  
ISSUE #467  
USA \$3.95  
CANADA \$4.95



Art Bell W6OBB Gets Ready for Y2K

\*\*\*\*\*3-DIGIT\_231

## SYNTHESIZED VHF & UHF EXCITER & RECEIVER MODULES

Exciters and Receivers provide high quality nbfm and fsk operation. Features include:

- Dip switch frequency selection.
- Exceptional modulation for voice and ctcss.
- Very low noise synthesizer for repeater service.
- Direct fm for data up to 9600 baud.
- TCXO for tight frequency accuracy in wide range of environmental conditions.
- Next day shipping. No wait for crystals.

### EXCITERS:

Rated for continuous duty, 2-3W output.

**T301 VHF Exciter:** for various bands 139-174MHz, 216-226 MHz.

- Kit (ham bands only) ...\$109 (TCXO option \$40)
- Wired/tested, incl TCXO...\$189

**T304 UHF Exciter:** various bands 400-470 MHz.

- Kit (440-450 ham band only) incl TCXO ...\$149
- Wired/tested...\$189

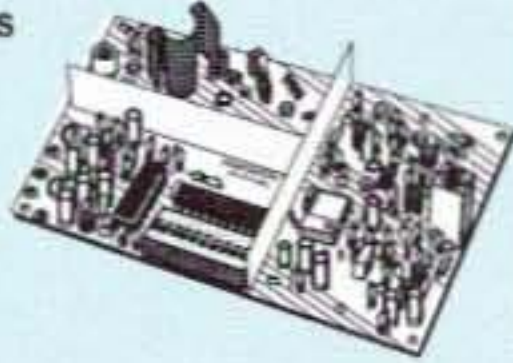

### RECEIVERS:

Very sensitive - 0.2µV.

Superb selectivity, >100 dB down at ±12 kHz, best available anywhere, flutter-proof squelch.

**R301 VHF Receiver:** various bands 139-174MHz, 216-226 MHz.

- Kit (ham bands only) ...only \$139 (TCXO option \$40)
- Wired/tested ...\$209 (includes TCXO)

**R304 UHF Receiver:** various bands 400-470MHz.

- Kit (440-450 ham band only) incl TCXO ...\$179
- Wired/tested...\$209

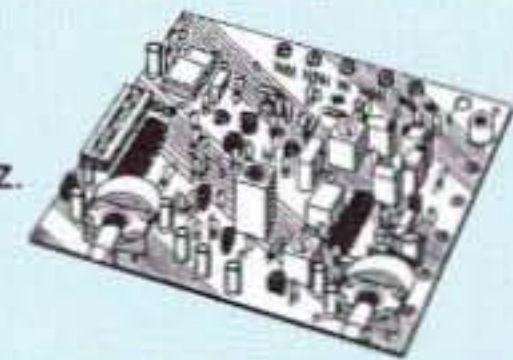

## TRADITIONAL CRYSTAL-CONTROLLED VHF & UHF FM EXCITERS & RECEIVERS

**FM EXCITERS:** 2W output, continuous duty.

- TA51: for 6M, 2M, 220 MHz ..... kit \$99, w/t \$169
- TA451: for 420-475 MHz. .... kit \$99, w/t \$169
- TA901: for 902-928 MHz, (0.5W out) ..... w/t \$169

### VHF & UHF POWER AMPLIFIERS.

Output levels from 10W to 100W.....Starting at \$99

### FM RECEIVERS:

- R100 VHF FM RCVR. For 46-54, 72-76, 140-175, or 216-225 MHz. .... kit \$129, w/t \$189
- R144 RCVR. Like R100, for 2M, with helical resonator in front end..... kit \$159, w/t \$219
- R451 FM RCVR, for 420-475 MHz. Similar to R100 above. kit \$129, w/t \$189.
- R901 FM RCVR, 902-928MHz ..... \$159, w/t \$219

## TRANSMITTING & RECEIVING CONVERTERS

No need to spend thousands on new transceivers for each band!

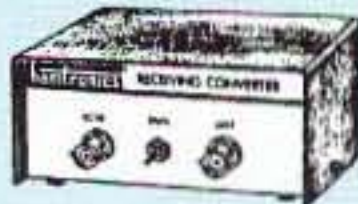

- Convert vhf and uhf signals to & from 10M.
- Even if you don't have a 10M rig, you can pick up very good used xmtrs & rcvrs for next to nothing.
- Receiving converters (shown above) available for various segments of 6M, 2M, 220, and 432 MHz.
- Rcvg Conv Kits from \$49, wired/tested units only \$99.
- Transmitting converters for 2M, 432 MHz.
- Kits only \$89 vhf or \$99 uhf.
- Power amplifiers up to 50W.



## LOW NOISE RECEIVER PREAMPS



### LNY-( ) ECONOMY PREAMP

ONLY \$29/w&t

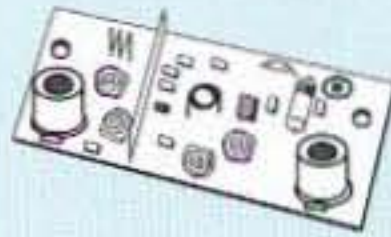

- Miniature MOSFET Preamp.
- Low noise figure.
- RCA jacks allow easy connection inside radios.
- Available for various bands from 28 to 450 MHz.

### LNP-( ) PRESELECTOR

ONLY \$39/w&t

- Eliminate intermod!
- Low noise preamp
- Sharp 3-section filter
- Available for bands from 137 to 170 MHz.

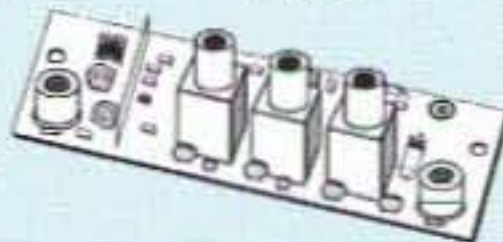

### LNG-( ) GAAS FET PREAMP

STILL ONLY \$59, wired/tested



- Make your friends sick with envy! Work stations they don't even know are there.
- Install one at the antenna and overcome coax losses.
- Available for 28-30, 46-56, 137-152, 152-172, 210-230, 400-470, and 800-960 MHz bands.

## SUBAUDIBLE TONE ENCODER/DECODER

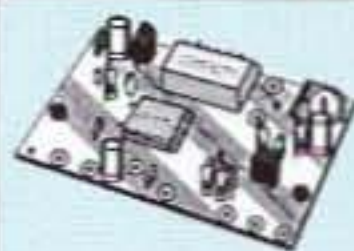

Access all your favorite closed repeaters!

- Encodes all standard CTCSS tones with crystal accuracy and convenient DIP switch selection.
- Decoder can be used to mute receive audio and is optimized for installation in repeaters to provide closed access. High pass filter gets rid of annoying rcvr buzz.
- TD-5 CTCSS Encoder/Decoder Kit ..... now only \$29
- TD-5 CTCSS Encoder/Decoder Wired/tested.....\$49

## WEATHER FAX RECEIVER

Join the fun. Get striking images directly from the weather satellites!



A very sensitive wideband fm receiver optimized for NOAA APT & Russian Meteor weather fax on the 137MHz band.

Covers all 5 satellite channels. Scanner circuit & recorder control allow you to automatically capture signals as satellites pass overhead, even while away from home.

See product review with actual satellite pictures in June 1999 QST, along with info on software and antennas.

- R139 Receiver Kit less case .....\$159
- R139 Receiver Kit with case and AC power adapter \$189
- R139 Receiver w/t in case with AC power adapter ...\$239
- Internal PC Demodulator Board & Imaging Software \$289
- Turnstile Antenna .....\$119
- Weather Satellite Handbook .....\$20

## WWW RECEIVER

Get time & frequency checks without buying multiband hf rcvr. Hear solar activity reports affecting radio propagation.



Very sensitive and selective crystal controlled superhet, dedicated to listening to WWW on 10 MHz. Performance rivals the most expensive rcvrs.

- RWWW Rcvr kit, PCB only .....\$59
- RWWW Rcvr kit with cabt, spkr, & 12Vdc adapter .....\$89
- RWWW Rcvr w/t in cabt with spkr & adapter .....\$129

## Get more features for your dollar with our REP-200 REPEATER

A microprocessor-controlled repeater with full autopatch and many versatile dtmf remote control features at less than you might pay for a bare bones repeater or controller alone!

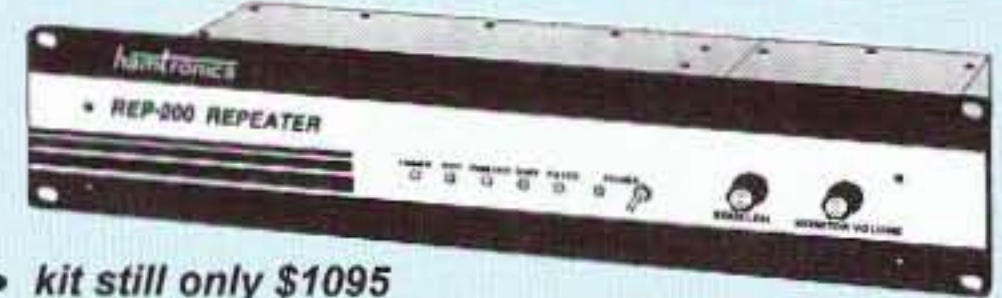

- kit still only \$1095
- factory assembled still only \$1295

50-54, 143-174, 213-233, 420-475 MHz. (902-928 MHz slightly higher.)

• FCC type accepted for commercial service in 150 & 450 MHz bands.

Digital Voice Recorder Option. Allows message up to 20 sec. to be remotely recorded off the air. Play back at user request by DTMF command, or as a periodical voice id, or both. Great for making club announcements! ..... only \$100.

REP-200C Economy Repeater. Real-voice ID, no dtmf or autopatch. .... Kit only \$795, w&t \$1195.

REP-200N Repeater. Without controller so you can use your own. .... Kit only \$695, w&t \$995.

## You'll KICK Yourself If You Build a Repeater

Without Checking Out Our Catalog First!

Hamtronics has the world's most complete line of modules for making repeaters. In addition to exciters, pa's, and receivers, we offer the following controllers.

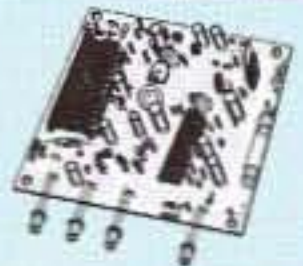

COR-3. Inexpensive, flexible COR module with timers, courtesy beep, audio mixer. .... only \$49/kit, \$79 w/t.

CWID. Traditional diode matrix ID'er. .... kit only \$59.

CWID-2. Eprom-controlled ID'er..... only \$54/kit, \$79 w/t.

DVR-1. Record your own voice up to 20 sec. For voice id or playing club announcements. .... \$59/kit, \$99 w/t.

COR-4. Complete COR and CWID all on one board. ID in eprom. Low power CMOS. .... only \$99/kit, \$149 w/t.

COR-6. COR with real-voice id. Low power CMOS, non-volatile memory. ....kit only \$99, w/t only \$149.

COR-5. µP controller with autopatch, reverse ap, phone remote control, lots of DTMF control functions, all on one board, as used in REP-200 Repeater. ....\$379 w/t.

AP-3. Repeater autopatch, reverse autopatch, phone line remote control. Use with TD-2. .... kit \$89.

TD-2. Four-digit DTMF decoder/controller. Five latching on-off functions, toll call restrictor. .... kit \$79.

TD-4. DTMF controller as above except one on-off function and no toll call restrictor. Can also use for selective calling; mute speaker until someone pages you..... kit \$49.

## WEATHER ALERT RECEIVER

A sensitive and selective professional grade receiver to monitor critical NOAA weather broadcasts. Good reception even at distances of 70 miles or more with suitable antenna. No comparison with ordinary consumer radios!



Automatic mode provides storm watch, alerting you by unmuting receiver and providing an output to trip remote equipment when an alert tone is broadcast. Crystal controlled for accuracy; all 7 channels (162.40 to 162.55).

Buy just the receiver pcb module in kit form or buy the kit with an attractive metal cabinet, AC power adapter, and built-in speaker. Also available factory wired and tested.

- RWX Rcvr kit, PCB only .....\$79
- RWX Rcvr kit with cabinet, speaker, & AC adapter .....\$99
- RWX Rcvr wired/tested in cabinet with speaker & adapter .....\$139

Buy at low, factory-direct net prices and save!  
For complete info, call or write for complete catalog.  
Order by mail, fax, email, or phone (9-12, 1-5 eastern time).  
Min. \$6 S&H charge for 1<sup>st</sup> lb. plus add'l weight & insurance.  
Use Visa, MC, Discover, check, or UPS C.O.D.



See SPECIAL OFFERS and view complete catalog on our web site:  
[www.hamtronics.com](http://www.hamtronics.com)  
email: [jv@hamtronics.com](mailto:jv@hamtronics.com)

Our 38<sup>th</sup> Year  
**hamtronics, inc.**  
65-D Moul Rd; Hilton NY 14468-9535  
Phone 716-392-9430

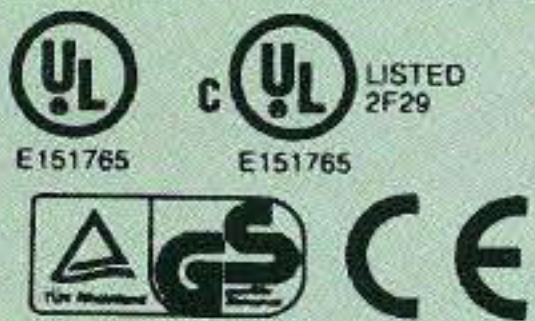

# ...POWER ON WITH ASTRON

SWITCHING POWER SUPPLIES...

**SPECIAL FEATURES:**

- HIGH EFFICIENCY SWITCHING TECHNOLOGY SPECIFICALLY FILTERED FOR USE WITH COMMUNICATIONS EQUIPMENT, FOR ALL FREQUENCIES INCLUDING HF
- HEAVY DUTY DESIGN
- LOW PROFILE, LIGHT WEIGHT PACKAGE
- EMI FILTER
- MEETS FCC CLASS B

**PROTECTION FEATURES:**

- CURRENT LIMITING
- OVERVOLTAGE PROTECTION
- FUSE PROTECTION
- OVER TEMPERATURE SHUTDOWN

**SPECIFICATIONS:**

INPUT VOLTAGE: 115 VAC 50/60HZ  
OR 220 VAC 50/60HZ  
SWITCH SELECTABLE  
OUTPUT VOLTAGE: 13.8VDC

**AVAILABLE WITH THE FOLLOWING APPROVALS: UL, CUL, CE, TUV.**



MODEL SS-10TK



MODEL SS-12IF



MODEL SS-18

**DESKTOP SWITCHING POWER SUPPLIES**

MODEL	CONT. (Amps)	ICS	SIZE (inches)	Wt.(lbs.)
SS-10	7	10	1 1/2 x 6 x 9	3.2
SS-12	10	12	1 1/2 x 6 x 9	3.4
SS-18	15	18	1 1/2 x 6 x 9	3.6
SS-25	20	25	2 1/8 x 7 x 9 1/8	4.2
SS-30	25	30	3 1/4 x 7 x 9 1/8	5.0



MODEL SS-25M

**DESKTOP SWITCHING POWER SUPPLIES WITH VOLT AND AMP METERS**

MODEL	CONT. (Amps)	ICS	SIZE (inches)	Wt.(lbs.)
SS-25M*	20	25	2 1/8 x 7 x 9 1/8	4.2
SS-30M*	25	30	3 1/4 x 7 x 9 1/8	5.0



MODEL SRM-30

**RACKMOUNT SWITCHING POWER SUPPLIES**

MODEL	CONT. (Amps)	ICS	SIZE (inches)	Wt.(lbs.)
SRM-25	20	25	3 1/2 x 19 x 9 1/8	6.5
SRM-30	25	30	3 1/2 x 19 x 9 1/8	7.0

**WITH SEPARATE VOLT & AMP METERS**

MODEL	CONT. (Amps)	ICS	SIZE (inches)	Wt.(lbs.)
SRM-25	20	25	3 1/2 x 19 x 9 1/8	6.5
SRM-30	25	30	3 1/2 x 19 x 9 1/8	7.0



MODEL SRM-30M-2

**2 ea SWITCHING POWER SUPPLIES ON ONE RACK PANEL**

MODEL	CONT. (Amps)	ICS	SIZE (inches)	Wt.(lbs.)
SRM-25A-2	20	25	3 1/2 x 19 x 9 1/8	10.5
SRM-30A-2	25	30	3 1/2 x 19 x 9 1/8	11.0

**WITH SEPARATE VOLT & AMP METERS**

MODEL	CONT. (Amps)	ICS	SIZE (inches)	Wt.(lbs.)
SRM-25M-2	20	25	3 1/2 x 19 x 9 1/8	10.5
SRM-30M-2	25	30	3 1/2 x 19 x 9 1/8	11.0



MODEL SS-12SM/GTX



MODEL SS-IDEFJ-98

**CUSTOM POWER SUPPLIES FOR RADIOS BELOW**

- EF JOHNSON AVENGER GX-MC41
- EF JOHNSON AVENGER GX-MC42
- EF JOHNSON GT-ML81
- EF JOHNSON GT-ML83
- EF JOHNSON 9800 SERIES
- GE MARC SERIES
- GE MONOGRAM SERIES & MAXON SM-4000 SERIES
- ICOM IC-F11020 & IC-F2020
- KENWOOD TK760, 762, 840, 860, 940, 941
- KENWOOD TK760H, 762H
- MOTOROLA LOW POWER SM50, SM120, & GTX
- MOTOROLA HIGH POWER SM50, SM120, & GTX
- MOTOROLA RADIUS & GM 300
- MOTOROLA RADIUS & GM 300
- MOTOROLA RADIUS & GM 300
- UNIDEN SMH1525, SMU4525
- VERTEX — FTL-1011, FT-1011, FT-2011, FT-7011

**NEW SWITCHING MODELS**

- SS-10GX, SS-12GX
- SS-18GX
- SS-12EFJ
- SS-18EFJ
- SS-10-EFJ-98, SS-12-EFJ-98, SS-18-EFJ-98
- SS-12MC
- SS-10MG, SS-12MG
- SS-101F, SS-121F
- SS-10TK
- SS-12TK OR SS-18TK
- SS-10SM/GTX
- SS-10SM/GTX, SS-12SM/GTX, SS-18SM/GTX
- SS-10RA
- SS-12RA
- SS-18RA
- SS-10SMU, SS-12SMU, SS-18SMU
- SS-10V, SS-12V, SS-18V

\*ICS - Intermittent Communication Service

# MFJ 1.8-170 MHz SWR Analyzer™

## Reads complex impedance . . . Super easy-to-use

**New MFJ-259B reads antenna SWR . . . Complex RF Impedance: Resistance(R) and Reactance(X) or Magnitude(Z) and Phase(degrees) . . . Coax cable loss(dB) . . . Coax cable length and Distance to fault . . . Return Loss . . . Reflection Coefficient . . . Inductance . . . Capacitance . . . Battery Voltage. LCD digital readout . . . covers 1.8-170 MHz . . . built-in frequency counter . . . side-by-side meters . . . Ni-Cad charger circuit . . . battery saver . . . low battery warning . . . smooth reduction drive tuning . . . and much more!**

**The world's most popular SWR analyzer just got incredibly better and gives you more value than ever!**

MFJ-259B gives you a complete picture of your antenna's performance. You can read antenna SWR and Complex Impedance from 1.8 to 170 MHz.

You can read Complex Impedance as series resistance and reactance ( $R+jX$ ) or as magnitude ( $Z$ ) and phase (degrees).

You can determine velocity factor, coax cable loss in dB, length of coax and distance to a short or open in feet.

You can read SWR, return loss and reflection coefficient at any frequency simultaneously at a single glance.

You can also read inductance in  $\mu H$  and capacitance in  $pF$  at RF frequencies.

Large easy-to-read two line LCD screen and side-by-side meters clearly display your information.

It has built-in frequency counter, Ni-Cad charger circuit, battery saver, low battery warning and smooth reduction drive tuning.

Super easy to use! Just set the bandswitch and tune the dial -- just like your transceiver. SWR and Complex Impedance are displayed instantly!

### Here's what you can do

Find your antenna's true resonant frequency. Trim dipoles and verticals.

Adjust your Yagi, quad, loop and other antennas, change antenna spacing and height and watch SWR, resistance and reactance change instantly. You'll know exactly what to do by simply watching the display.

Perfectly tune critical HF mobile antennas in seconds for super DX -- without subjecting your transceiver to high SWR.

Measure your antenna's 2:1 SWR bandwidth on one band, or analyze multiband performance over the entire spectrum 1.8-170 MHz!

Check SWR outside the ham bands without violating FCC rules.

Take the guesswork out of building and adjusting matching networks and baluns.

Accurately measure distance to a short or open in a failed coax. Measure length of a roll of coax, coax loss, velocity factor and impedance.

Measure inductance and capacitance. Troubleshoot and measure resonant frequency and approximate Q of traps, stubs, transmission lines, RF chokes, tuned circuits and baluns.

Adjust your antenna tuner for a perfect 1:1 match without creating QRM.

And this is only the beginning! The



### MFJ-224 MFJ 2 Meter FM Signal Analyzer™

Measure signal strength over 60 dB range, check and set FM deviation, measure antenna gain, beamwidth, front-to-back ratio, sidelobes, feedline loss in dB. Plot field strength patterns, position antennas, measure preamp gain,

**NEW**

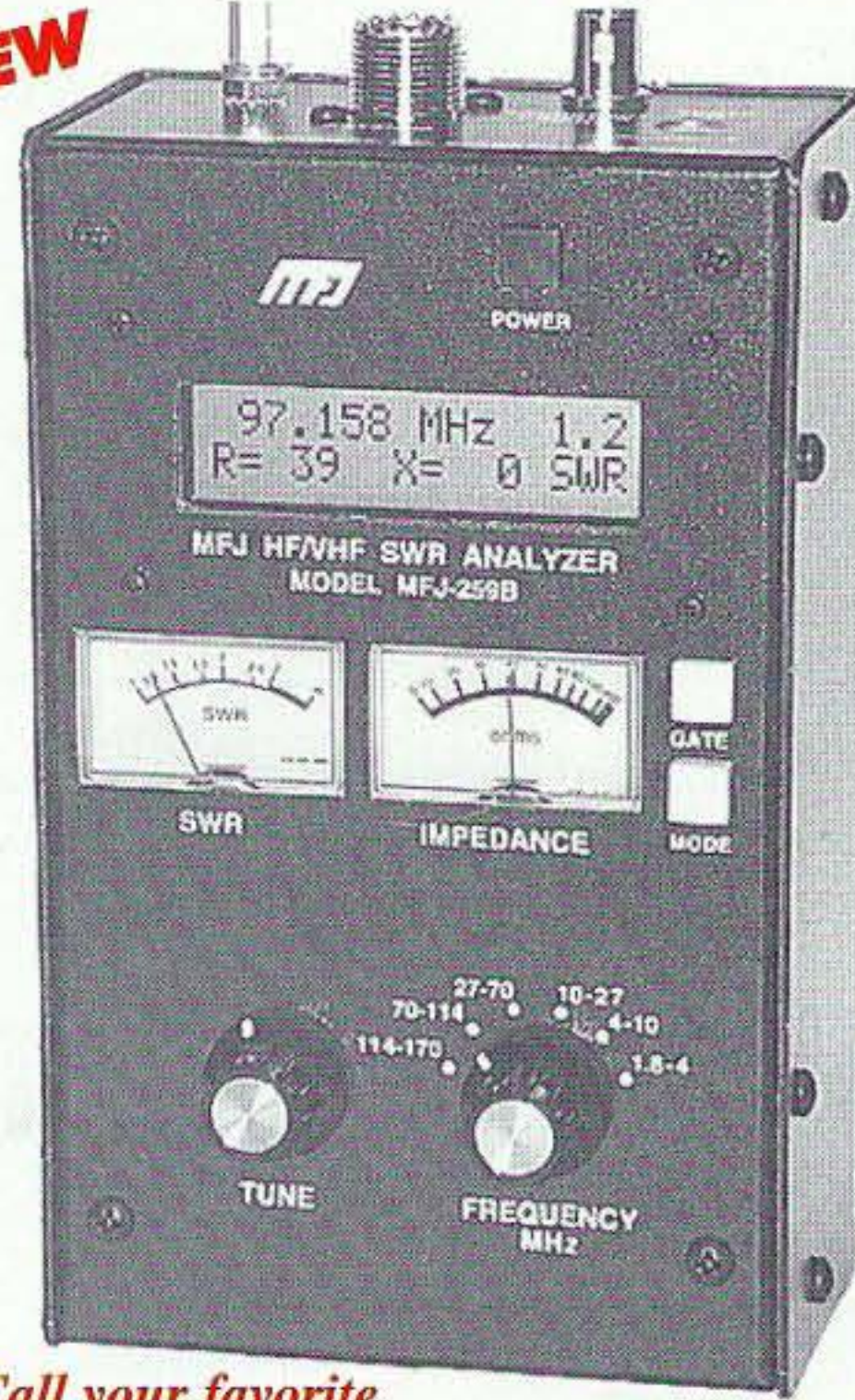

Call your favorite dealer for your best price!

MFJ-259B  
**\$259<sup>95</sup>**

MFJ-259B is a complete ham radio test station including -- frequency counter, RF signal generator, SWR Analyzer™, RF Resistance and Reactance Analyzer, Coax Analyzer, Capacitance and Inductance Meter and much more!

### Call or write for Free Manual

MFJ's comprehensive instruction manual is packed with useful applications -- all explained in simple language you can understand.

### Take it anywhere

Fully portable, take it anywhere -- remote sites, up towers, on DX-peditions. It uses 10 AA or Ni-Cad batteries (not included) or 110 VAC with MFJ-1315, \$14.95. Its rugged all metal cabinet is a compact 4x2x6<sup>3/4</sup> inches.

### How good is the MFJ-259B?

MFJ SWR Analyzers™ work so good, many antenna manufacturers use them in their lab and on the production line -- saving thousands of dollars in instrumentation costs! Used worldwide by professionals everywhere.

### More MFJ SWR Analyzers™

MFJ-249B, \$229.95. Like MFJ-259B, but reads SWR, true impedance magnitude and frequency only on LCD. No meters.

detect feedline faults, track down hidden transmitters, tune transmitters and filters. Plug in scope to analyze modulation wave forms, measure audio distortion, noise and instantaneous peak deviation. Covers 143.5 to 148.5 MHz. Headphone jack, battery check function. Uses 9V battery, 4x2<sup>1/2</sup>x6<sup>3/4</sup> in.

MFJ-209, \$139.95. Like MFJ-249B but reads SWR only on meter and has no LCD or frequency counter.

MFJ-219B, \$99.95. UHF SWR Analyzer™ covers 420-450 MHz. Jack for external frequency counter. 7<sup>1/2</sup>x2<sup>1/2</sup>x2<sup>1/4</sup> inches. Use two 9 volt batteries or 110 VAC with MFJ-1312B, \$12.95. Free "N" to SO-239 adapter.

### SWR Analyzer Accessories

#### Dip Meter Adapter

MFJ-66, \$19.95. Plug a dip meter coupling coil into your MFJ SWR Analyzer™ and turn it into a sensitive and accurate bandswitched dip meter. Save time and take the guesswork out of winding coils and determining resonant frequency of tuned circuits and Q of coils. Set of two coils cover 1.8-170 MHz depending on your SWR Analyzer™.

### Genuine MFJ Carrying Case

MFJ-29C, \$24.95. Tote your MFJ-259B anywhere with this genuine MFJ custom carrying case. Has back pocket with security cover for carrying dip coils, adaptors and accessories.

Made of special foam-filled fabric, the MFJ-29C cushions blows, deflects scrapes, and protects knobs, meters and displays from harm.

Wear it around your waist, over your shoulder, or clip it onto the tower while you work -- the fully-adjustable webbed-fabric carrying strap has snap hooks on both ends.

Has clear protective window for frequency display and cutouts for knobs and connectors so you can use your MFJ SWR Analyzer™ without taking it out of your case. Look for the MFJ logo for genuine authenticity!

MFJ-99, \$54.85. Accessory Package for MFJ-259B/249B/209. Includes genuine MFJ-29C carrying case, MFJ-66 dip meter adapter, MFJ-1315 110 VAC adapter. **Save \$5!**

### New! Tunable Measurement Filter™

MFJ-731, \$89.95. Exclusive MFJ tunable RF filter allows accurate SWR and impedance measurements 1.8 to 30 MHz in presence of strong RF fields. Has virtually no effect on measurements. Works with all SWR Analyzers.

### MFJ No Matter What™ warranty

MFJ will repair or replace (at our option) your MFJ SWR Analyzer™ for one full year.

**Free MFJ Catalog**  
Nearest Dealer . . . 800-647-1800

<http://www.mfjenterprises.com>

• 1 Year No Matter What™ warranty • 30 day money back guarantee (less s/h) on orders from MFJ

**MFJ** MFJ ENTERPRISES, INC  
Box 494, Miss. State, MS 39762  
(601) 323-5869; 8-4:30 CST, Mon.-Fri.  
FAX: (601) 323-6551; Add s/h  
Tech Help: (601) 323-0549

Prices and specifications subject to change. (c) 1998 MFJ Enterprises, Inc.

**More hams use MFJ SWR Analyzers™ than any others in the world!**

# THE TEAM

El Supremo & Founder  
Wayne Green W2NSD/1

Associate Publisher  
F. I. Marion

Associate Technical Editor  
Larry Antonuk WB9RRT

Nitty Gritty Stuff  
J. Clayton Burnett  
Priscilla Gauvin  
Joyce Sawtelle

### Contributing Culprits

Bill Brown WB8ELK  
Mike Bryce WB8VGE  
Joseph E. Carr K4IPV  
Michael Geier KB1UM  
Jim Gray W1XU/7  
Jack Heller KB7NO  
Chuck Houghton WB6IGP  
Dr. Marc Leavey WA3AJR  
Andy MacAllister W5ACM  
Dave Miller NZ9E  
Joe Moell K0OV  
Steve Nowak KE8YN/5  
Carole Perry WB2MGP

### Advertising Sales

Frances Hyvarinen  
Roger Smith  
603-924-0058  
800-274-7373  
Fax: 603-924-8613

### Circulation

Linda Coughlan

### Data Entry & Other Stuff

Christine Aubert  
Norman Marion

### Business Office

Editorial - Advertising - Circulation  
Feedback - Product Reviews  
73 Amateur Radio Today Magazine  
70 Hancock Rd.  
Peterborough NH 03458-1107  
603-924-0058  
Fax: 603-924-8613

Reprints: \$3 per article

Back issues: \$5 each

Printed in the USA

**Manuscripts:** Contributions for possible publication are most welcome. We'll do the best we can to return anything you request, but we assume no responsibility for loss or damage. Payment for submitted articles will be made after publication. Please submit both a disk and a hard copy of your article [IBM (ok) or Mac (preferred) formats], carefully checked drawings and schematics, and the clearest, best focused and lighted photos you can manage. "How to write for 73" guidelines are available on request. US citizens, please include your Social Security number with submitted manuscripts so we can submit it to you know who.

SEPTEMBER 1999  
ISSUE #467

# 73<sup>®</sup> Amateur Radio Today

## TABLE OF CONTENTS

### FEATURES

- 10 **PIC Key, PIC Key — UY5DJ**  
*This simple CW keyer is a great way to learn about PICs.*
- 16 **Y2K Portable J-Pole — WA8TXT**  
*What emergency will you need to handle?*
- 19 **Defogging Microstrips — WA9PYH**  
*An intro to microstripline filters.*
- 26 **Secrets of Transmission Lines — KE2QJ**  
*Part 2: Review of AC fundamentals.*
- 30 **Getting Your Foot in the Public Service Door — KN4HL**  
*Here's how to get your club involved — and appreciated.*
- 32 **Simple RF Signal Generator — W4LJD**  
*Add this handy piece of test gear to your bench.*
- 38 **Simple Direct-Conversion Receiver — Sellen**  
*For QRPers and receiver aficionados in general.*

### DEPARTMENTS

- WB6IGP 43 Above & Beyond
- 49 Ad Index
- 64 Barter 'n' Buy
- 57 Calendar
- KB7NO 45 The Digital Port
- W5ACM 50 Hamsats
- K0OV 54 Homing In
- 8 Letters
- W2NSD/1 4 Never Say Die
- 48 New Products
- KE8YN/4 52 On the Go
- W1XU/7 60 Propagation
- WB8VGE 53 QRP
- 6 QRX
- 63 Radio Bookshop

Web Page

[www.waynegrain.com](http://www.waynegrain.com)

E-Mail

[design73@aol.com](mailto:design73@aol.com)

**On the cover:** See Wayne's editorial beginning on page 4 for more on W6OBB. We are always looking for interesting articles and cover photos — with or without each other. Your name could be in this space *next* month, and our check could be on its way to *you!* You couldn't use a little extra cash?

**Feedback:** Any circuit works better with feedback, so please take the time to report on how much you like, hate, or don't care one way or the other about the articles and columns in this issue. G = great!, O = okay, and U = ugh. The G's and O's will be continued. Enough U's and it's Silent Keysville. Hey, this is *your* communications medium, so don't just sit there scratching your...er...head. FYI: Feedback "number" is usually the page number on which the article or column starts.

**73 Amateur Radio Today** (ISSN 1052-2522) is published monthly by 73 Magazine, 70 N202, Peterborough NH 03458-1107. The entire contents ©1999 by 73 Magazine. No part of this publication may be reproduced without written permission of the publisher, which is not all that difficult to get. The subscription rate is: one year \$24.97, two years \$44.97; Canada: one year \$34.21, two years \$57.75, including postage and 7% GST. Foreign postage: \$19 surface, \$42 airmail additional per year, payable in US funds on a US bank. Second class postage is paid at Peterborough, NH, and at additional mailing offices. Canadian second class mail registration #178101. Canadian GST registration #125393314. Microfilm edition: University Microfilm, Ann Arbor MI 48106. POSTMASTER: Send address changes to 73 Amateur Radio Today, 70 Hancock Rd., Peterborough NH 03458-1107. 73 Amateur Radio Today is owned by Shabromat Way Ltd. of Hancock NH.

**Contract:** By being so nosy as to read this fine print, you have just entered into a binding agreement with 73 Amateur Radio Today. You are hereby obligated to do something nice for a ham friend—buy him a subscription to 73. What? All of your ham friends are already subscribers? Donate a subscription to your local school library!

# NEVER SAY DIE

Wayne Green W2NSD/1  
w2nsd@aol.com

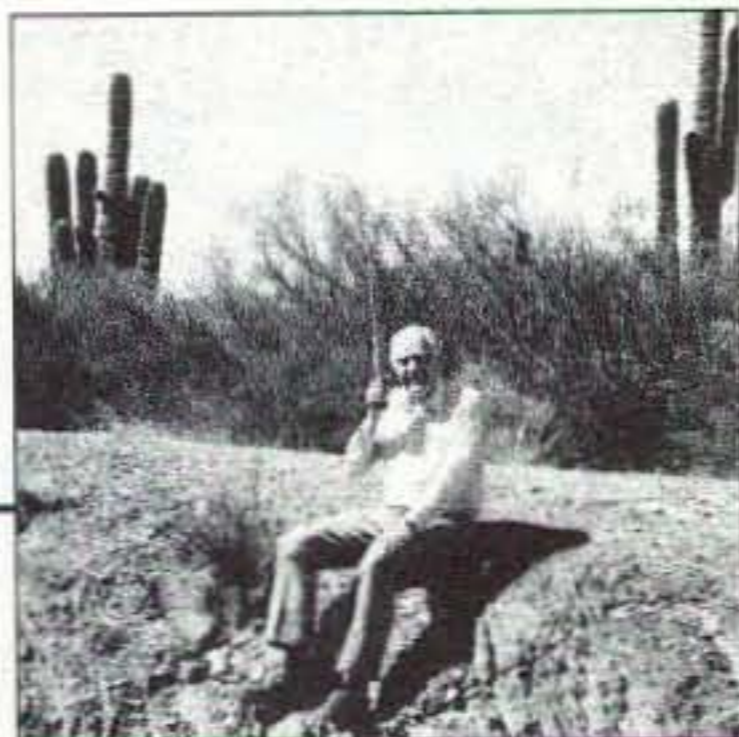

## Art Bell W6OBB

You probably don't spend much time listening to AM radio. But if you do, and you've ever tuned in at night, you've heard Art's coast-to-coast talk show "from the Kingdom of Nye" all up and down your dial. That's Nye County, Nevada, by the way.

In the East, his show is on the air five nights a week from 1 until 6 AM, which means that if you're a 9-to-5er, unless you turn on your radio during a sandbox visit, you'll probably never hear him. I keep a little Sony ICF-SW1, a 3" x 4" x 1" allband digital radio, by my bed, so all it takes is a push of the on-off button and I'm listening to WPTH out of Philadelphia on 1210, New York's WABC on 770, or WTAM Detroit on 1100.

On weekends, the show is a little shorter and consists mostly of repeats of his best shows.

The usual format has a news broadcast for about 8 minutes on the hour and half hour. The first hour of Art's show has him bringing you up to date on some of the latest happenings he thinks you'll want to know about. That's usually followed by listener call-ins, where they can discuss whatever they want. The next four hours normally feature an interview with a guest, and Art's been able to get some fascinating guests. I know I've learned a lot from them — and so have you, via my resulting editorials.

The topics covered are all over the lot — those strange contrails that are making us

sick, time travel, UFOs, contactees, alien technology, a space hotel in the works, those incredible crop patterns, ghosts, reverse speech, remote viewing, Area 51 visits, and so on.

No, of course I don't sit up five hours a night so I won't miss anything. I record the program every night. And you should be doing this, too. All you need is a cable between your AM radio and a VCR and you're in business. For the technically challenged, I have my \$5 Wayne Green's Bell Saver Kit (see p. 63) that includes the needed cable and complete instructions on connecting it and programming your VCR. In this way, you can listen to the show when it's convenient for you. You can fast forward through anything that doesn't interest you (like the news-casts). When there's a phone number or Web site address you want to note, you can rewind and get it. And if there's a guest you want to listen to again, or want to play for someone else to hear, you can save the tape, keeping a note of the time on the tape that you want to find. I have several boxes of tapes I've saved for reference. They're not quite as handy as books, but if you keep an index in your computer, they're easy to find. The T-120 tapes will record 6 hours, and you can find 'em for a buck, if you watch the ads.

Art is seriously geared up for the Y2K crisis, with an emergency generator, solar power, and wind power backup. You'll be hearing W6OBB on the bands even if

the power grid goes down for months.

Art does his program from his home in Pahrump, Nevada. You can watch him do the show, if you're up, via video on [www.artbell.com](http://www.artbell.com). You can also listen to it via his Web site and see a list of his coming and past guests. If you look me up you'll see that I've been a guest five times and we've talked about all sorts of things. You can even listen to these past shows.

I'm anxious to be on more so that we can talk up amateur radio and encourage more people to come into the hobby. Well, the ARRL doesn't seem to be doing a damned thing, so *someone* has to do it.

## Plummeting

The number of new licenses issued in January has dropped by almost 50% in the last two years. Hey, get out some graph paper and plot it for yourself. Plot 1553-1053-871 for the last three years and see where things are heading! The line hits zero around 2010.

The situation isn't any better when it comes to upgrades, either. They, too, are down 50% in the last two years.

Unless you can somehow force your ARRL director to make the League honor its responsibility to preserve the hobby, it looks like we're crashing and burning.

Why am I leaning so hard on the ARRL about this? Well, there are only two other interested parties, the FCC and the ham manufacturers. As far as the FCC is concerned,

amateur radio is an expensive nuisance, and the ham manufacturers are unorganized and apparently uninterested in whether the hobby continues or not.

Thus, whether amateur radio survives this crisis or not seems totally dependent on the ARRL taking some serious action. If they can't be forced to start promoting the hobby, we be gone.

There isn't any big secret about what needs to be done. I've written about it enough times, so I won't rehash my advice. Mostly, the League needs to figure out how to rebuild the high school radio club infrastructure they wiped out in 1964. That was our largest source of new hams.

It's going to be tough, for in addition to sports and TV, now we've got the Internet as a competitor for the teenagers. The League has to get kids to think of ham radio as cool. Now, there's a challenge!

## A Slight Tinkering

With the ARRL membership dropping almost 10% (plummeting) in the last year; with *QST* shrinking; with manufacturers and dealers going out of business all around the country; with the number of new Techs dropping about 30% in the last two years; with the number of Techs upgrading to General dropping even faster; I then look over the ARRL's comments to the FCC on restructuring the hobby and all I see them recommending is a slight tinkering. What does it take to get alarm bells to go off in the atrophied brains of the directors you keep on blindly reelecting?

For that matter, what is it going to take to get our old-timers to recognize that the world has changed and that if amateur radio is going to survive, it has to change, too? I'm talking major changes, not tinkering.

Fifty years ago, amateur radio made a lot of sense as a service. In addition to providing engineers and technicians

Continued on page 41

## World's Smallest TV Transmitters

We call them the 'Cubes'.... Perfect video transmission from a transmitter you can hide under



a quarter and only as thick as a stack of four pennies- that's a nickel in the picture! Transmits color or B&W with fantastic quality - almost like a direct wired connection to any TV tuned to cable channel 59. Crystal controlled for no frequency drift with performance that equals law enforcement models that cost hundreds more! Basic 20 mW model transmits up to 300' while the high power 100 mW unit goes up to 1/4 mile. Audio units include sound using a sensitive built-in mike that will hear a whisper 15 feet away! Units run on 9 volts and hook-up to most any CCD camera. Any of our cameras have been tested to mate perfectly with our Cubes and work great. Fully assembled - just hook-up power and you're on the air!

- C-2000, Basic Video Transmitter Cube..... \$89.95
- C-3000, Basic Video & Audio Transmitter Cube..... \$149.95
- C-2001, High Power Video Transmitter Cube..... \$179.95
- C-3001, High Power Video & Audio Transmitter Cube... \$229.95

## CCD Video Cameras



Top quality Japanese Class 'A' CCD array, over 440 line line resolution, not the off-spec arrays that are found on many other cameras. Don't be fooled by the cheap CMOS single chip cameras which have 1/2 the resolution, 1/4 the light sensitivity and draw over twice the current! The black & white models are also super IR (Infra-Red) sensitive. Add our invisible to the eye, IR-1 illuminator kit to see in the dark! Color camera has Auto gain, white balance, Back Light Compensation and DSP! Available with Wide-angle (80°) or super slim Pin-hole style lens. Run on 9 VDC, standard 1 volt p-p video. Use our transmitters for wireless transmission to TV set, or add our IB-1 Interface board kit for audio sound pick-up and super easy direct wire hook-up to any Video monitor, VCR or TV with A/V input. Fully assembled, with pre-wired connector.

- CCDWA-2, B&W CCD Camera, wide-angle lens..... \$69.95
- CCDPH-2, B&W CCD Camera, slim fit pin-hole lens..... \$69.95
- CCDCC-1, Color CCD Camera, wide-angle lens..... \$129.95
- IR-1, IR Illuminator Kit for B&W cameras..... \$24.95
- IB-1, Interface Board Kit..... \$14.95

## Mini Radio Receivers

Imagine the fun of tuning into aircraft a hundred miles away, the local police/fire department, ham operators, or how about Radio Moscow or the BBC in London? Now imagine doing this on a little radio you built yourself - in just an evening! These popular little receivers are the nuts for catching all the action on the local ham, aircraft, standard FM broadcast radio, shortwave or WWV National Time Standard radio bands. Pick the receiver of your choice, each easy to build, sensitive receiver has plenty of crystal clear audio to drive any speaker or earphone. Easy one evening assembly, run on 9 volt battery, all have squelch except for shortwave and FM broadcast which has handy SCA output. Add our snazzy matching case and knob set for that smart finished look.



- AR-1, Airband 108-136 MHz Kit..... \$29.95
- HFRC-1, WWV 10 MHz (crystal controlled) Kit..... \$34.95
- FR-1, FM Broadcast Band 88-108 MHz Kit..... \$24.95
- FR-6, 6 Meter FM Ham Band Kit..... \$34.95
- FR-10, 10 Meter FM Ham Band Kit..... \$34.95
- FR-146, 2 Meter FM Ham Band Kit..... \$34.95
- FR-220, 220 MHz FM Ham Band Kit..... \$34.95
- SR-1, Shortwave 4-11 MHz Band Kit..... \$29.95
- Matching Case Set (specify for which kit)..... \$14.95

## Tiny FM Transmitters



Gosh, these babies are tiny - that's a quarter in the picture! Choose the unit that's best for you. FM-5 is the smallest tunable FM transmitter in the world, picks up a whisper 10' away and transmits up to 300'. Runs on tiny included watch battery, uses SMT parts. FM-4 is larger,

- more powerful, runs on 5-12 volts, goes up to a mile. FM4,5 operate in standard FM band 88-108 MHz. FM-6 is crystal controlled in 2 meter ham band, 146.535 MHz, easily picked up on scanner or 2 meter rig, runs on 2 included watch batteries. SMT (surface mount) kits include extra parts in case you sneeze & lose a part!
- FM-4MC, High Power FM Transmitter Kit..... \$17.95
  - FM-5, World's Smallest FM Transmitter Kit..... \$19.95
  - FM-6, Crystal Controlled 2M FM Transmitter Kit..... \$39.95
  - FM-6, Fully Wired & Tested 2M FM Transmitter..... \$69.95

## Super Pro FM Stereo Transmitter

Professional synthesized FM Stereo station in easy to use, handsome cabinet. Most radio stations require a whole equipment rack to hold all the features we've packed into the FM-100. Set freq with Up/Down buttons, big LED display. Input low pass filter gives great sound (no more squeals or swishing from cheap CD inputs!) Limiters for max 'punch' in audio - without over mod, LED meters to easily set audio levels, built-in mixer with mike, line level inputs. Churches, drive-ins, schools, colleges find the FM-100 the answer to their transmitting needs, you will too. Great features, great price! Kit includes cabinet, whip antenna, 120 VAC supply. We also offer a high power export version of the FM-100 that's fully assembled with one watt of RF power, for miles of program coverage. The export version can only be shipped outside the USA, or within the US if accompanied by a signed statement that the unit will be exported.



- FM-100, Pro FM Stereo Transmitter Kit..... \$249.95
- FM-100WT, Fully Wired High Power FM-100..... \$399.95

## FM Stereo Radio Transmitters

No drift, microprocessor synthesized! Excellent audio quality, connect to CD player, tape deck or mike mixer and you're on-the-air. Strapable for high or low power! Runs on 12 VDC or 120 VAC. Kit includes case, whip antenna, 120 VAC power adapter - easy one evening assembly.



- FM-25, Synthesized FM Stereo Transmitter Kit.... \$129.95



Lower cost alternative to our high performance transmitters. Great value, tunable over FM band, plenty of power and manual goes into great detail about antennas, range and FCC rules. Handy kit for sending music thru house and yard, ideal for school projects too - you'll be amazed at the exceptional audio quality! Runs on 9V battery or power from 5 to 15 VDC. Add our matching case and whip antenna set for a nice 'pro' look.

- FM-10A, Tunable FM Stereo Transmitter Kit..... \$34.95
- CFM, Matching Case and Antenna Set..... \$14.95
- FMAC, 12 Volt DC Wall Plug Adapter..... \$9.95

## RF Power Booster

Add muscle to your signal, boost power up to 1 watt over a freq range of 100 KHz to over 1000 MHz! Use as a lab amp for signal generators, plus many foreign users employ the LPA-1 to boost the power of their FM transmitters, providing radio service through an entire town. Runs on 12 VDC. For a neat finished look, add the nice matching case set.



- LPA-1, Power Booster Amplifier Kit..... \$39.95
- CLPA, Matching Case Set for LPA-1 Kit..... \$14.95
- LPA-1WT, Fully Wired LPA-1 with Case..... \$99.95

## FM Station Broadcast Antenna

For maximum performance, a good antenna is needed. Properly tuned and matched antenna is fully PVC enclosed for weather protection and rugged use. Vertical or horizontal mounting, 'F' style connector, 5' long.



- TM-100, Tru-Match FM Station Antenna Kit..... \$39.95

## AM Radio Transmitter

Operates in standard AM broadcast band, set to clear channel in your area. AM-25 'pro' version is synthesized for stable, no-drift frequency and is settable for high power output where regulations allow, typical range of 1-2 miles. Entry-level AM-1 has tunable transmit oscillator, runs FCC maximum 100 mW power, expected range 1/4 mile. Both accept line-level inputs from tape decks, CD players or mike mixers, run on 12 volts DC. Pro AM-25 includes AC power adapter, matching case and bottom loaded wire antenna. Entry-level AM-1 has an available matching case and knob set for a finished, professional look. High level modulation for low distortion.



- AM-25, Professional AM Transmitter Kit..... \$129.95
- AM-1, Entry level AM Radio Transmitter Kit..... \$29.95
- CAM, Matching Case Set for AM-1..... \$14.95

# RAMSEY

## Binocular Special

Wow, did we nab a deal on these first rate binoculars! Absolutely identical to a famous big name brand here in Rochester, NY - but without 'their' name. Well made with fully coated optics, super nice rubber armored housing over hi-alloy aluminum, includes lens cleaner cloth, neck lanyard and carry case. 4 styles: roof prism 10x25 (10 power, 25 mm), 10x25 high performance roof prism ruby coated objective lens model for demanding use in bright sun, 10x25 high-end BAK-4 lens porro prism ruby coat with Tac-Grip housing, and Ultra-View 10x50 porro prism ruby coats. First quality, yet at a close-out price on the exact same units as the "Trademarked" units - but at half price!



- BNO-M, 8x21 Mini Monocular..... \$14.95
- BNO-1, 10x25 Roof Prism Binoculars..... \$24.95
- BNO-1EX, 10x25 Ruby Coated Porro Prism..... \$29.95
- BNO-2, 10x25 TacGrip Ruby Coat Porro Prism..... \$59.95
- BNO-6, 10x50 Ultra-View Ruby Coat Porro Prism... \$69.95

## World's Smallest FM Radios

Everyone who sees one of these babies says they just gotta have one! Super cute tiny FM radios have automatic scan/search tuning, comfortable ear bud earphones and we even include the battery. The pager style unit looks like a shrunken pager and even has an LCD clock built-in. You will be amazed at the crystal clear amazing sound! That's a quarter in the picture for size comparison - pretty tiny, huh?



- MFMT-1, World's Smallest FM Radio..... \$11.95
- PFMR-1, Pager Style LCD Clock & FM Radio..... \$12.95

## Speech Descrambler

Decode all that gibberish! This is the popular descrambler / scrambler that you've read about in all the Scanner and Electronic magazines. Speech inversion technology is used, which is compatible with most cordless phones and many police department systems, hook it up to your scanner speaker terminals and you're in business. Easily configured for any use: mike, line level and speaker output/inputs are provided. Also communicate in total privacy over telephone or radio, full duplex operation - scramble and unscramble at the same time. Easy to build, all complex circuitry contained in new custom ASIC chip for clear, clean audio. Runs on 9 to 15VDC. Our matching case set adds a professional look to your kit.



- SS-70A, Speech Descrambler/Scrambler Kit..... \$39.95
- CSS, Custom Matching Case and Knob Set..... \$14.95
- SS-70AWT, Fully Wired SS-70A with Case..... \$79.95
- AC12-5, 12 Volt DC Wall Plug Adapter..... \$9.95

## Call for our Free Catalog!

See our complete catalog and order on-line with our secure server at:

[www.ramseyelectronics.com](http://www.ramseyelectronics.com)

RAMSEY ELECTRONICS, INC.  
793 Canning Parkway Victor, NY 14564

Order Toll-free: 800-446-2295

Sorry, no tech info, or order status at this number

For Technical Info, Order Status  
Call Factory direct: 716-924-4560



ORDERING INFO: Satisfaction Guaranteed. Examine for 10 days, if not pleased, return in original form for refund. Add \$6.95 for shipping, handling and insurance. Orders under \$20, add \$3.00. NY residents add 7% sales tax. Sorry, no CODs. Foreign orders, add 20% for surface mail or use credit card and specify shipping method.

# QRX . . .

## FCC Sets New Vanity Fee

The cost of getting a vanity call sign is going up — but only a dollar. This as the FCC raises the fee to apply for an amateur radio vanity call sign from \$13 to \$14 starting September 10th.

By the way, the vanity call sign system is still gaining in popularity. The FCC says that it receives in excess of a thousand vanity applications per month.

Thanks to the FCC, via *Newsline*, Bill Pasternak WA6ITF, editor.

## Speaking of Which ...

Readers of our QRX column, along with many, many thousands of listeners elsewhere, via repeater, are well familiar with *Newsline*, amateur radio's hard-working, not-for-profit, totally independent, nonbiased news service. Well, although they haven't requested us to do so, we are here to ask you to lend them a hand financially.

Like most nonprofits of this type, they face a constant battle in making ends meet in order to provide their valuable service. So whaddya say? Let's help them start out the new millennium on solid footing by making as large a contribution as you can to: Newsline Support Fund, Post Office Box 660937, Arcadia CA 91066. Be sure to mention that you're a 73 reader, too, so we can show them how much *our* folks care about the ARS.

They'll thank you, we'll thank you, and so will believers in a free press everywhere ... Please do it today, while you're thinking about it.

## Abbott and Costello Meet Windows

*Costello: Hey, Abbott!*

Abbott: Yes, Lou?

*Costello: I just got my first computer.*

Abbott: That's great, Lou. What did you get?

*Costello: A Pentium II-266, with 40 megs of RAM, a 2.1 gig hard drive, and a 24x CD-ROM.*

Abbott: That's terrific, Lou.

*Costello: But I don't know what any of it means!*

Abbott: You will in time.

*Costello: That's exactly why I'm here to see you.*

Abbott: Oh?

*Costello: I heard that you're a real computer expert.*

Abbott: Well, I don't know ...

*Costello: Yes-sir-ee. You know your stuff. And you're going to train me.*

Abbott: Really?

*Costello: Uh-huh. And I am here for my first lesson.*

Abbott: OK, Lou. What do you want to know?

*Costello: I am having no problem turning it on, but I heard that you should be very careful how you turn it off.*

Abbott: That's true.

*Costello: So, here I am working on my new computer, and I want to turn it off. What do I do?*

Abbott: Well, first you click the Start icon, and then ...

*Costello: No, I told you I want to turn it off.*

Abbott: I know, you click the Start icon.

*Costello: Wait a second. I want to turn it off. I know how to start it. So tell me what to do.*

Abbott: I did.

*Costello: When?*

Abbott: When I told you to click the Start icon.

*Costello: Why should I click the Start icon?*

Abbott: To shut off the computer.

*Costello: I click Start to stop?*

Abbott: Well, Start doesn't actually stop the computer.

*Costello: I knew it! So what do I click?*

Abbott: Start.

*Costello: Start what?*

Abbott: Start icon.

*Costello: Start icon to do what?*

Abbott: Shut down.

*Costello: You don't have to get rude!*

Abbott: No, no, no! That's not what I meant.

*Costello: Then say what you mean.*

Abbott: To shut down the computer, click ...

*Costello: Don't say "Start"!*

Abbott: Then what do you want me to say?

*Costello: Look, if I want to turn off the computer, I'm willing to click the Stop button, the End button, and the Cease and Desist button, but no one in their right mind clicks the Start to stop.*

Abbott: But that's what you do.

*Costello: And you probably go at Stop signs, and stop at green lights.*

Abbott: Don't be ridiculous.

*Costello: I'm being ridiculous? Well, I think it's about time we started this conversation.*

Abbott: What are you talking about?

*Costello: I am starting this conversation right now. Good-bye!*

Thanks to the September 1998 electronic issue of the *TSRC Monitor*, the newsletter of the Twin States Radio Club, Mike Maynard WB1GRR, editor, via the November 1998 *ARNS Bulletin*.

## Groaners

Floating around the Internet (brace yourself):

*Two Eskimos sitting in a kayak were chilly, but when they lit a fire in the craft, it sank, proving once and for all that you can't have your kayak and heat it, too.*

Two boll weevils grew up in South Carolina.

One went to Hollywood and became a famous actor. The other stayed behind in the cotton fields and never amounted to much. The second one, naturally, became known as the lesser of two weevils.

*A neutron goes into a bar and asks the bartender, "How much for a beer?" The bartender replies, "For you, no charge."*

Two atoms are walking down the street and they run into each other. One says to the other, "Are you all right?" "No, I lost an electron!" "Are you sure?" "Yeah, I'm positive!"

*Did you hear about the Buddhist who refused his dentist's Novocain during root canal work? He wanted to transcend dental medication.*

A group of chess enthusiasts checked into a hotel and were standing in the lobby discussing their recent tournament victories. After about an hour, the manager came out of the office and asked them to disperse. "But why?" they asked, as they moved off. "Because," he said, "I can't stand chess nuts boasting in an open foyer."

*A doctor made it his regular habit to stop off at a bar for a hazelnut daiquiri on his way home. The bartender knew of his habit, and would always have the drink waiting at precisely 5:03 p.m. One afternoon, as the end of the workday approached, the bartender was dismayed to find that he was out of hazelnut extract. Thinking quickly, he threw together a daiquiri made with hickory nut and set it on the bar. The doctor came in at his regular time, took one sip of the drink and exclaimed, "This isn't a hazelnut daiquiri!" "No, I'm sorry," replied the bartender, "it's a hickory daiquiri, doc."*

A hungry lion was roaming through the jungle looking for something to eat. He came across two men. One was sitting under a tree and reading a book; the other was typing away on his typewriter. The lion quickly pounced on the man reading the book and devoured him. Even the king of the jungle knows readers digest and writers cramp.

*There was a man who entered a local paper's pun contest. He sent in ten different puns, in the hope that at least one of the puns would win. Unfortunately, no pun in ten did.*

A guy goes to a psychiatrist. "Doc, I keep having these alternating recurring dreams. First I'm a teepee, then I'm a wigwam, then I'm a teepee, then I'm a wigwam. It's driving me crazy. What's wrong with me?" The doctor replies: "It's very simple. You're two tents."

*A woman has twins and gives them up for adoption. One of them goes to a family in Egypt and is named "Emal." The other goes to a family in Spain; they name him "Juan." Years later, Juan sends a picture of himself to his birth mom. Upon receiving the picture, she tells her husband that she wishes she also had a picture of Emal. Her husband responds, "But they're twins—if you've seen Juan, you've seen Emal."*

Thanks (we think) to the September 1998 issue of the *SCCARA-GRAM*, the newsletter of the Santa Clara County ARA, Gary Mitchell WB6YRU, editor, via the February 1999 *ARNS Bulletin*.



## Spell Checker

Eye halve a spelling chequer  
It came with my pea sea  
It plainly marques four my revue  
Miss steaks eye kin knot sea.

Eye strike a key and type a whirred  
And weight four it two say  
Weather eye am wrong oar write  
It shows me strait a weigh.

As soon as a mist ache is maid  
It nose bee fore two long  
And eye can putt the air oar rite  
Its rarely ever wrong.

Eye have run this poem threw it  
Eye am shore your pleased two no  
Its let her purr fact in it's weigh  
My chequer tolled me sew.

— Sauce unknown

We adapted this from the February 1999 ARNS Bulletin, reprinted from the November 1998 issue of the Peconic ARC Newsletter, Ralph Grover NS2S, editor.

## Swifties

Remember Tom Swifties? Well, here are a few to keep you up late at night gagging.

"I can't believe I ate the whole pineapple!" said Tom dolefully.

"That's the last time I ever pet a lion!" said Tom offhandedly.

"I'll never sit on the tracks again," Tom said beside himself.

"That's the third electric shock I've gotten this week," Tom said, revolted.

"I'm never anywhere on time," Tom related.

"There is more than one way to skin a cat," Tom deferred.

"That car you sold me has defective steering." Tom said, straightforwardly.

"I've been on a diet," Tom expounded.

"I'll have to send that message again," Tom said remorsefully.

"I keep banging my head on things," Tom said bashfully.

"Look at that jailbird climb down the wall," Tom observed with condescension.

"I remember the Midwest being flatter than this," Tom explained.

"I'll have to dig another ditch around the castle," Tom sighed, remotely.

"I've lived through a lot of wind storms," Tom regaled.

"That's the third time my teacher has changed my grade," Tom remarked.

"I haven't caught a fish all day," Tom said without debate.

"That mink coat is on wrong side out," Tom inferred.

Continued on page 37

- DIP switch programmable
- Miniature in size
- 37 EIA tones, 27 non-standard tones from 33.0 to 254.1 Hz included
- Reverse Burst built-in
- Easy 3 wire hookup

SS-64 CTCSS Encoder  
.66" x 1.08" x .21"

SS-64 DIP Switch Programmable CTCSS Encoder \$28.95



TP-3200 Shared Repeater Tone Panel

TP-3200D Table Top Version

\$269.95 each

TP-3200RM-A Single Rack Mount version \$279.95 each

\*TP-3200RM-B Triple Rack Mount version \$279.95 each

\*Holds up to three TP-3200s

Call or write to receive our full Product Catalog or visit our Web site for complete information at:  
<http://www.com-spec.com>

- 51 CTCSS Tones
- 106 DCS Codes
- Supports 157 Repeater Subscribers
- On-Line Computer Help
- Repeater CW ID
- Air Time Loading & Analysis Graphs
- Signalling Formats: CTCSS DCS & DTMF

- Fully enclosed CTCSS encoder
- All 32 EIA tones from 67.0 to 203.5 Hz included
- Perfect for mobile / base applications



TE-32  
5.25" x 3.3" x 1.7"

TE-32 Multi-Tone CTCSS Encoder \$49.95

- Eight programmable, selectable messages
- Fully field programmable via included keypad
- Meets all FCC identification requirements



ID-8 Automatic Morse Code Identifier  
1.85" x 1.12" x .35"

ID-8 Automatic Morse Station Identifier \$69.95



**COMMUNICATIONS SPECIALISTS, INC.**  
426 WEST TAFT AVENUE • ORANGE, CA 92665-4296  
(714) 998-3021 • FAX (714) 974-3420  
Entire U.S.A. (800) 854-0547 • FAX (800) 850-0547  
<http://www.com-spec.com>

CIRCLE 10 ON READER SERVICE CARD

## Barry Electronics Corp.

WE SHIP WORLDWIDE  
WORLD WIDE AMATEUR RADIO SINCE 1950  
Your one source for all Radio Equipment!



WHEREVER I GO, I TAKE MY RADIO.  
SPECIALIST IN RADIOS:  
• BUSINESS • MARINE  
• AVIATION • HAM RADIOS  
• SCANNERS

### KENWOOD



TS-50S, TM-V7A, TH-235A, Kenwood Service Repair, TS-950SD, TH-73A (D), TS-570DG, TS-570SG, TS-870S, TM-742AD, TM-261A, TM-461A, TH-G71A, TH-D7A, TH-22AT

MARINE RADIOS  
ICOM M7, M3A, M11, M56, M710, M810, AVIATION PORTABLE ICOM A22, MOTOROLA, TRITON, MARINE

Surveillance Devices Available

Shortwave Receivers  
Drake • Grundig • JRC  
Sangean • Panasonic • Yaesu  
ICOM • Lowe • Kenwood

CB Radios Stocked  
148GTI, Washington, Ranger 2950-70, Antennas: Wilson, Antron, etc.  
Power mikes w/beeps - ECHO - SilverEagle etc.

Telephone Scramblers

ANTENNAS: A-S, AES, Cushcraft, Hy-Gain, Hustler, KLM, METZ, Urban, MODUBLOX, TONNA, Butternut, Multi-Band, Alpha Delta, ANLI, Antenna Specialist, Barker & Williamson, Comet, Diamond, GAP, Laresen, Etc.  
Watt-Meters Stocked.

ALINCO DJ-180, DJ-G5TY, etc.

Computer Interfaces  
Stocked: MFJ-1270B, MFJ-1274, MFJ-1224, Kam Plus, KPC-3, MFJ 1278T, PK-900, DRSI PRODUCTS DSP 2232

COMMERCIAL RADIOS STOCKED:  
• MOTOROLA • ICOM  
• MAXON • STANDARD,  
• YAESU • RELM etc.  
We serve municipalities, businesses, Civil Defense, etc. Portables, mobiles, bases, repeaters...

BARRY INTERNATIONAL  
FAX 212-925-7001 Phone 212-925-7000  
For Orders Call 1-800-990-2929  
Monday-Friday 9 AM to 6 PM  
Saturday 10-5PM / Sunday 11:30-5 PM

Subways: #6 Spring St. stop, N. or R. train to Prince St. stop  
F train to Houston St. stop.  
Bus: Broadway bus to Prince St. stop, Path train to 9th St./8th Ave.

SALES FINAL

KITTY SAYS: WE ARE OPEN 7 DAYS A WEEK

\*Sat. 10-5 \*Sun. 11:30-5 \*M-F 9-6 Come to Barry's for the best buys in town.

MOTOROLA SP50, SP21, GP300, GP350, P1225, M1225, M125, GM300, GR300 repeaters & SM50

Radios for Business, Governments, Consulates, Embassies. Stocked and Serviced. Overseas and Domestic Orders.

"YAESU HAM & VERTEX BUSINESS RADIOS" FT-51R, FT-10, FT-11, FT-2500, FT-3000, FRG-100B, FT-1000D, FT-50R, FT-840, FT-920, VXR-5000 Repeater 25 Watts, VHF/UHF Marine Mobile VX-100, VX-1R, VX-5R, FT-8100R, FT-847, FT-100, FT-90R

NEW — 220 MHz BUSINESS RADIOS WITH REPEATERS

MOTOROLA RADIOS EXPORT & DOMESTIC CALL FOR PRICES

• Cellular Phones  
• Shortwave Radios  
• Scanners  
• Best Prices

SHORTWAVE RECEIVERS STOCKED

Wide selection of SW & Amateur Publications

Antenna Tuners: MFJ, ICOM, KENWOOD, YAESU, VERTEX

COMMERCIAL & HAM REPEATERS STOCKED. WRITE FOR QUOTES

MOTOROLA AUTHORIZED DEALER KACHINA COMMUNICATIONS DEALER

RECHER PADDLES BALUNS, LOW PASS FILTERS IN STOCK

ASTRON POWER SUPPLIES Belden Wire & Cable, Int'l Wire

Overseas Telephone Systems for Rural Areas

AMPLIFIERS: Icom, Kenwood, Yaesu, RF concepts, Mirage, TE Systems, HF/VHF/UHF, AMERITRON, etc.

Telephone Autopatch

Fm & AM Broadcast Transmitters Stocked

Satellite Phones

NEXTEL Radios-5 burrough coverage in NY.

Save money on batteries. Call for Special Prices.

Barry's supplies all MFJ products Call us direct.

2 Meter, 440, 220MHz Band-Pass Filters from DCI

Garmin & Magellan Global Positioning Systems

For the best buys in town call: 1-800-990-2929

Los Precios Mas Bajos en Nueva York

WE SHIP WORLDWIDE! Export orders expedited. Special export prices.

ICOM

HAM, MARINE, BUSINESS AND AVIATION RADIOS

A-22, IC77, IC-707, IC-T2A, IC-Q7A IC-706MKIIG, IC-T7H, IC-W32A, IC-2100H, IC-746, IC-T8A, IC-2800, IC-T81A & IC-756. NEW F30LT/F40LT, V100

Business Radios: Motorola, ICOM, Maxon, Yaesu, Uniden, VX-400, VX-10

Marine ICOM: M3A, M1 Aviation ICOM: A22, A200

Electron Tubes 3-500z, 572B, 6JS6C, 12BY7A, & 6146B

FT-50R Yaesu

Save money on batteries. Call for Special Prices.

Barry's supplies all MFJ products Call us direct.

2 Meter, 440, 220MHz Band-Pass Filters from DCI

Amplifiers: Icom, Kenwood, Yaesu, RF concepts, Mirage, TE Systems, HF/VHF/UHF, AMERITRON, etc.

Telephone Autopatch

Fm & AM Broadcast Transmitters Stocked

Satellite Phones

NEXTEL Radios-5 burrough coverage in NY.

Save money on batteries. Call for Special Prices.

Barry's supplies all MFJ products Call us direct.

2 Meter, 440, 220MHz Band-Pass Filters from DCI

Amplifiers: Icom, Kenwood, Yaesu, RF concepts, Mirage, TE Systems, HF/VHF/UHF, AMERITRON, etc.

Telephone Autopatch

Fm & AM Broadcast Transmitters Stocked

Satellite Phones

NEXTEL Radios-5 burrough coverage in NY.

Save money on batteries. Call for Special Prices.

Barry's supplies all MFJ products Call us direct.

2 Meter, 440, 220MHz Band-Pass Filters from DCI

Amplifiers: Icom, Kenwood, Yaesu, RF concepts, Mirage, TE Systems, HF/VHF/UHF, AMERITRON, etc.

Telephone Autopatch

Fm & AM Broadcast Transmitters Stocked

Satellite Phones

NEXTEL Radios-5 burrough coverage in NY.

Save money on batteries. Call for Special Prices.

Barry's supplies all MFJ products Call us direct.

2 Meter, 440, 220MHz Band-Pass Filters from DCI

CIRCLE 41 ON READER SERVICE CARD

73 Amateur Radio Today • September 1999 7

# LETTERS

## From the Ham Shack

**Ronald Stier W9ICZ, Carmel IN.** While scanning your July editorial, I hit upon your request for input on the Kachina.

A long story short: Two years ago, I began to pursue my design and buildup of a digital transmitter and receiver. My intent was to provide a retirement income. A couple of boards and many hours of software later, I saw the Kachina ad. Subsequently there was a review in your publication. Some additional reading at the Kachina Web site convinced me to put the boards on the junk pile and go after the unit. It is a great rig.

Comparison testing with my Kenwood 940 provided readable signals that probably never got past the first stage of the Kenwood. The unit can be brought up quickly without knowing all of the bells and whistles. The software provides intuitive use. I did not get the hand-tuning knob and at this point see no reason to do so.

Since obtaining the unit, I have obtained two software upgrades from the Kachina Web site. Both have provided good improvements. The Web provides in-depth technical documentation on all aspects of the unit. It is heavy reading and requires good technical background.

One area that I would like to see improved is the automatic antenna tuner. In theory, it provides a wide range for matching. In practice, it does not, and I use my handy-dandy antenna tuner. The Smith chart readings and their retention make it very easy to readjust my vertical.

Wayne, I don't wish to bore you further, but I wanted to respond to your request because I think that the Kachina will be at my station for a long time.

*Here are some user comments I picked up from the Kachina Web site (www.kachina-az.com). If they'd get it so it would work with a Mac instead of a (ugh!) PC, I'd get one in a blink. I've been asking in my editorials for user comments on any new equipment anyone has tried and liked, but with few takers. Maybe this will chum the waters. ... Wayne.*

**Jim K2ZF.** I have had my Kachina a month now and am jumping for joy. It is truly one of the best radios I have ever owned. I have two other rigs sitting here on my desk and have not turned one of them on since I have received this radio, just amazing! The receiver is not deaf, it hears everything. I am CW-only here and am very critical about the CW performance of my radios. I have been known to buy a radio and sell it a few months later, not this one! One great radio, guys.

**David WB2KTM.** The service and wonderful way you treat Kachina owners is a breath of fresh air in this day and age. I know I will never regret my choice of new equipment upon returning to amateur radio after four years away from our hobby. I will be a proud 505DSP owner in my retirement years. Keep up the good work.

**Steven Weinstein K2WE.** Greetings, I have had my 505DSP for about 6 months now. It's an amazing piece of equipment. I just worked a 3B on 40 meters with one call. I could barely hear him on my old rig. He was perfect copy on the Kachina.

**Ward Trammell WA5RD.** The radio is a joy to operate. My amateur radio love at present is the digital modes, primarily PACTOR. The built-in digital filters make this operation the

easiest I have ever worked, and my RTTY operation dates back to 1948 as a Navy radioman. I like the radio so much, my old rig is for sale.

**Donald Urbytes W8LGV.** I believe this radio is the best on the market today, and I am proud to own a radio of this quality. Please keep up the good work.

**Bob Resconsin W1TRF.** There's just no way that I can tell you how happy I am, not only with my Kachina, but also with the response I've had with everyone out there. The radio is outstanding, and the organization is super!

**Jon Englert N2OSZ.** I've been meaning to write you for a very long time. First of all, I enjoy reading your editorials very much — keep up the good work. Also, you have been somewhat of an inspiration to me. I used to smoke two packs of cigarettes a day and did virtually nothing else. I quit smoking three years ago, now work out four times a week and run 6.5 miles five days a week. I am forty-three years old and have more energy than I did when I was twenty years old. I am running in 5k races now and coming close to placing. Can't imagine I would ever be doing this.

This summer, I picked up some old ham magazines at the local hamfest. They are mostly from the late fifties and early sixties. What surprises me the most is what hams were arguing about back then. The same stuff they argue about now! For instance, how high the words-per-minute [should be] to keep away the "lids"; taking away band space from undeserving Novices; I build therefore I'm better (Did these old guys really build that much?). You could probably print these same letters in your mag today, change the dates, and nobody would know the difference.

You are right, something needs to be done to keep this great hobby alive. Not a day

goes by that I don't devote at least a little thought to what I could be doing to advance the hobby. I don't think I would be giving much thought to it if not for your editorials. You keep writing and I'll keep thinking of things I can do.

By the way, I made Extra using your code tapes, not Brand X.

*Okay, if you insist, I'll keep writing. And you're right about the '50s hams not building. We built in the '30s because there were no commercially made transmitters, but we didn't know what we were doing. ... Wayne.*

**Teal Powell, Vallejo CA.** I love reading your Never Say Die. Some powder for your firecracker: In Marin county (one of the richest counties in the state), there is a town called Sausalito. Anyway, they spend more than twice as much per student than the average — \$13,000 — and they are in the bottom 10% of the state results-wise. My point is that money doesn't buy an education! Keep up your good work.

*Anyone who buys the teacher's union mantra about there being any correlation between school costs and SAT scores needs to read Inside American Education by Thomas Sowell, which I review in my Secret Guide to Wisdom. ... Wayne.*

**Ben Alabastro W1VM, Rutland VT.** After not receiving the mysterious April 1999 issue of your magazine, I almost got mad and wanted to cancel my subscription. But then I would be sorry. And then I would feel bad. And then I would have to beg to re-subscribe. And then I would be at your mercy. And then I would have to send you six QSL cards to beg you to let me re-subscribe. And then I would be sad if you didn't. So you see, by not having an April 1999 edition of your mag, I can still read it and not lose any sleep over the matter. 73

# VECTRONICS® kits

High-performance electronic kits . . . fun to build and use!

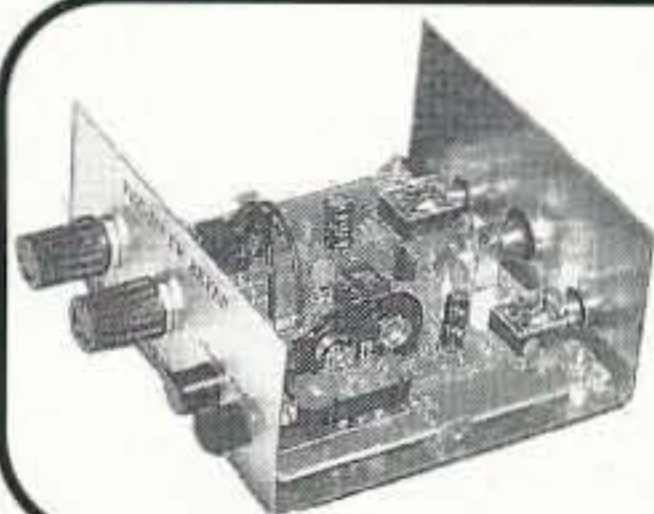

## Full featured CW Keyer Kit, \$24.95!

VEC-201K, the best electronic keyer bargain in ham radio! Send beautiful sounding Morse Code. Self-completing dot-dashes and dot-dash memory forgive timing errors -- makes sending CW easy and accurate. Front panel volume/speed (3-65 wpm) controls. Weight adjusts 25-75%. Sidetone (300 -1000Hz) has LM386 audio amp for external speaker/phones. Select Iambic A or B, fully automatic or semi-auto "bug" mode. Tune mode for tuning rig. RF proof. Sleep Mode battery saver. Use 9V battery. 1 1/4 x 4 x 3 1/2 in. *Simple skill level.* VEC-201K shown in optional case (vinyl cover top not shown), VEC-201KC, \$14.95

**Aircraft Receiver Kit** tunes entire voice aircraft band 118-136 MHz. Picks up air traffic 100 miles away. Track progress of incoming/outgoing traffic in your area, gain advanced weather information, and discover how the National Air Traffic System really works. Great way to learn about aviation. Use 9V battery. Drives external speaker/phones. 1 1/4 x 4 x 3 1/2 in. *Intermediate skill level.* Order VEC-131K, \$29.95.

**20/30/40/80 Meter Receiver Kits** give high performance! Covers entire band or tailor to cover desired portion. Copy CW/SSB/AM. NE602/ 612 mixer-oscillator, LM386 high gain audio amplifier. 1 1/4 x 4 1/4 x 5 1/4 in. *Moderate skill level.* Order VEC-1120K (20 Meters), VEC-1130K (30 Meters), VEC-1140K (40 Meters), VEC-1180K (80 Meters), \$29.95 ea.

**20/30/40/80 Meter QRP CW transmitter Kits** have variable crystal oscillator tuning, front panel switch selects 1 of 2 crystals. 1 crystal included. Transmit and Receive switch. Connect receiver. 1 1/4 x 4 x 3 1/2 in. *Intermediate skill level.* Order VEC-1220K (20 Meters), VEC-1230K (30 Meters), VEC-1240K (40 Meters), VEC-1280K (80 Meters), \$29.95 ea.

**Tunable SSB/CW Audio Filter Kit** has sharp four pole peak and notch filters. Zero in with frequency control & adjust bandwidth for best response. Tune frequency from 300-3000 Hz. Notch is an outstanding 50 dB. 1 Watt amplifier. Speaker/Phone jacks. 12 VDC at 300 mA. 1 1/4 x 4 1/4 x 5 1/4 in. *Intermediate skill level.* Order VEC-841K, \$34.95.

**Vectronics Comprehensive Soldering Course and Kit** is the best home study soldering course available! Includes theory, quizzes, PC board, tools, safety, techniques and materials. Get professional soldering skills and a fun blinking LED project. Gets you ready for "through-hole" PC board assembly and repair. *Simple skill level.* Order VEC-1500K, \$29.95. *New!*

**Super CW filter/amplifier Kit** has powerful 1 watt audio amplifier to drive speaker. 8 poles active IC filtering uses cascaded low-Q stages. 3 bandwidths: 80, 110, 180 Hz. Center frequency: 750 Hz. Up to 15 dB. Use 9-18VDC, 300 mA max. 1 1/4 x 4 x 3 1/2 in. *Simple skill level.* Order VEC-821K, \$29.95.

**Super SSB Audio Filter Kit** improves readability with 8 poles, optimizes audio bandwidth, reduces SSB splatter, low, hi-pitched interference, hiss, static crashes, background noise. Use 9V battery. 1 1/4 x 4 x 3 1/2 in. *Simple skill level.* Order VEC-830K, \$19.95.

**144/220/440 MHz Low-Noise Preamp Kits** soup up your antenna system. Helps pull in weak signals. Works wonders for scanner or ham-band receiver. Gives great low-noise performance and immunity from damaging electrostatic discharge. 1 x 1 1/2 in. *Simple skill level.* Order VEC-1402K (144 MHz), VEC-1422K (220 MHz), VEC-1444K (440 MHz), \$17.95.

Vectronics kits feature a professional quality epoxy glass PC board with solder mask and component legend, simple step-by-step instructions and highest quality components.

**CW Memory Keyer Kit** stores 512 characters in four 128 character non-volatile EEPROM message memories. Carry on entire QSOs by just pressing memory message buttons. True sinewave sidetone with soft rise and fall time eliminates harsh keyclicks. Has all features of VEC-201K CW Keyer Kit. 1 1/4 x 6 1/4 x 5 1/4 in. *Simple skill level.* Order VEC-221K, \$69.95.

**High-performance 2 Meter Preamp Kit** pulls weak signals out of noise. Solves three reception problems -- boosts signals using a 1-dB noise figure microwave transistor, provides razor-sharp bandpass filtering, eliminates unwanted electrical noises with built-in balun. Uses 9-14 volts DC. Tiny 1 1/2 x 3 x 1 in. fits in any size box. *Intermediate skill level.* Order VEC-1402DK, \$59.95.

**2/6/10 Meter FM Receiver Kits** let you tune into the world of ham radio. Catch all the action! Each covers the entire FM sub-band and runs off your 9 volt battery. Plug in speaker or headphones for loud clear reception. 1 1/4 x 4 x 3 1/2 in. *Intermediate skill level.* Order VEC-1002K (2 Meters), VEC-1006K (6 Meters), VEC-1010K (10 Meters), \$34.95 each.

**2 Meter Monitor Kit** receives 144-148 MHz. Low noise, high gain RF preamp gives you excellent 0.1 uV sensitivity. Air variable tuning capacitor has 8:1 reduction. Dual conversion superhet provides selectivity and stability. Automatically eliminates squelch tails. Built-in speaker, squelch, tone, volume controls. 19 1/4 in. telescopic whip. 9V battery. 2 x 4 1/4 x 4 in. *Intermediate skill level.* Order VEC-104K, \$79.95.

**5 Watt 2 Meter FM transmitter Kit** lets you transmit voice and data -- AFSK data (up to 1200 baud) and FSK data (up to 9600 baud). Jumper select reactance or direct FM modulators. Reliable Motorola NBFM transmitter IC and PA transistor. Crystal controlled (x8 frequency multiplication). -60 dBc spurs and harmonics. Use 12-14 VDC, 1.5 amps. 5-pin DIN microphone jack. 1 1/4 x 4 1/4 x 5 1/4 in. *Difficult skill level.* Order VEC-1202K, \$99.95.

**Ni-Cad/Ni-MH Battery Charger Kit** safely quick charges expensive batteries -- no overcharging -- many in less than an hour. HTs, cell phones, camcorders, lap top computers. Handles 1 to 12 cells. Charging status LEDs. Discharge before charge function reconditions batteries. Also removes memory effect. Runs on 12-15 VDC. 1 1/4 x 4 1/4 x 5 1/4 inches. *Moderate skill level.* Order VEC-412K, \$49.95.

**Shortwave Converter Kit** converts AM or AM/FM radios to shortwave receivers at a push of a button. Choose two 1 MHz bands between 3 and 22 MHz. Popular 13, 16, 19, 25, 31, 41, 49 and 60 Meters international broadcast bands. On/off bypass, NE-602/612 mixer-oscillator IC and tuned input circuit. Use 9 V battery. 1 1/4 x 4 x 3 1/2 in. *Intermediate skill level.* Order VEC-101K, \$27.95.

All metal cases for most kits, \$14.95. Add "C" for case to model #. Example: "VEC-201KC". Has knobs, hardware, rubber feet and brushed aluminum-looking front panel decal.



**Crystal radio set Kit** lets you relive the experience of early radio pioneers. This baby really works! Wind your own inductor, wire up the earliest radio circuit without soldering a thing and listen to the magic of radio that needs no power. Put up an antenna, connect a ground. Stations come in amazingly loud and clear. Includes antenna wire, sensitive earphone. 1 1/4 x 5 x 6 1/2 in. *Simple skill level.* Order VEC-121K, \$19.95.



**Shortwave Receiver Kit** lets you listen to the world! Covers 75/80, 49, 40, 30, 31, 20, 25, 22, 19, 17, 16, 15 and 13 Meter bands. Explore AM, SSB, CW, WWV, RTTY and Packet signals. Vernier reduction drive, smooth regeneration control, RF stage. Includes all metal cabinet. 2 earphone jacks. Use 9V battery. 2 1/2 x 7 x 6 in. *Intermediate skill level.* VEC-102K, \$59.95.



**QRP Transceiver Kits for 80/40/30/20 Meters** Great introduction to QRP, the hottest and fastest growing activities in ham radio. With this tiny transceiver, you'll discover what thousands of QRP enthusiasts already know -- you don't need a \$1000 radio to get on the air and communicate worldwide. All it takes is some simple circuitry using less energy than a pen-light bulb! You get VXO frequency control, broad-banded transmitter circuitry, solid one Watt plus output, shaped keying, .3 uV sensitivity, direct conversion receiver. Includes crystal for popular QRP calling frequency. 1 1/4 x 4 1/4 x 5 1/4 in. *Intermediate skill level.* Order VEC-1380K (80 Meters), VEC-1340K (40 Meters), VEC-1330K (30 Meters), VEC-1320K (20 Meters) \$59.95 each.



**Super CW Audio Filter Kit** gives you three bandwidths: 80, 110, 180 Hz. Eight poles gives super steep skirts with no ringing. Pull CW QSOs out of terrible QRM! Plugs into phone jack to drive phones. QRM down 60 dB one octave from center frequency (750 Hz) for 80 Hz bandwidth. Improves S/N ratio 15 dB. Use 9V battery. 1 1/4 x 4 x 3 1/2 in. *Simple skill level.* Order VEC-820K, \$19.95.



**AM Radio Transmitter Kit** lets you set up your own AM station and broadcast crystal clear programming from your studio with you as the disc jockey or talk show host. Play music from CD player, tape deck or other source. Choose clear frequency from 530-1750 KHz. Standard line level or microphone input. Easy CD, tape deck or mike mixers connect. Audio level adjustment. 1 1/4 x 4 x 3 1/2 inches. *Simple skill level.* Order VEC-1290K, \$29.95.

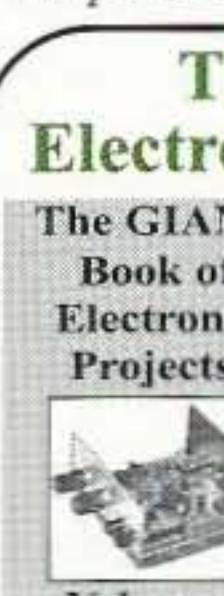

**The GIANT Book of Electronic Projects, Volume I.** Project book includes 19 exciting kits on this page. Has building tips, complete parts lists, parts placement and PC board layouts, test and alignment, operating instructions, in case of difficulty, theory and specs, schematics, cabinet layout and much, much more. Great school project book or gift for your favorite ham. Order VEC-1901, \$19.95.

Inspect and download our manuals from: <http://www.vectronics.com>

Order Toll-Free 800-363-2922  
• Fax: (601) 323-6551 • Tech: (601) 323-5800  
VECTRONICS, 300 Industrial Park Road, Starkville, MS 39759 USA • Add \$6 s/h

# PIC Key, PIC Key

*This simple CW keyer is a great way to learn about PICs.*

Vladimir A. Skrypnik UY5DJ  
Pravdinska - 58  
Kharkiv - 107  
Ukraine - 310107  
[uy5dj@yahoo.com]

**D**o you recall this phrase: "These simple projects should whet your appetite to learn more about the little PIC microcontrollers you see so frequently"? This comment preceded the article "Using PIC Microcontrollers in Amateur Radio Projects," by John Hansen W2FS, in the October 1998 issue of *QST*. This prediction was certainly true for me! Before reading that article, I was not at all familiar with PIC microcontrollers. To me, they were *terra incognita*. But the article encouraged me to begin learning about PICs by experimenting with programming and by producing my first projects. This article is a direct result of John Hansen's prediction.

PIC microcontrollers, a new generation of electronic components, provide us with fascinating possibilities of eliminating early-on rather large numbers of discrete elements by utilizing the power of programming to provide needed functions. The large printed circuit board, with its multiple conductors performing functional connections between parts of schematics, is supplanted by an invisible program stored in memory inside a single, small chip. The small size of a circuit board containing a

single PIC microcontroller, along with a very few discrete components to accomplish input/output functions, belies the latent power of the program stored within the PIC.

The main challenge for the PIC designer is to create a program to implement the project idea. This is a daunting first-time task—at least it seems so before you begin your study of microcontrollers. I have found that the best way to study is learning-by-doing. To begin with, all you need for your home lessons is David Benson's book (see Notes at end of article). This easy-to-understand manual will introduce you to PIC microcontrollers from the inside. Stepping from page to page, you will acquire increasing ability by learning to write simple programs and then checking them with the MPLAB media (see Notes).

## Algorithm of simple keyer program

Let's review how an ordinary keyer works. Let's assume that the keyer's output is connected to the transmitter keying circuitry. Inputs are connected to the left and right contacts of the keyer's paddle. Normally, the keyer is in the idle condition: The output is

open (or high) and the transmitter is not activated. When the operator presses the paddle handle to the "Dot" contact, the output becomes active and drives either a relay or a transistor connecting the keying circuit to ground and the transmitter starts sending a Morse code dot. The keyer supplies the appropriate length of the dot, as well as a pause in sequence. The durations of both the dot and the pause are equal. When the paddle returns to the neutral position, the keyer, once again, assumes the idle condition. If the paddle is pressed and held in the "Dot" position, the keyer performs a precise series of dots and pauses. The same is true when the operator presses the paddle to the "Dash" position. However, the length of a dash is three times longer than the length of a dot.

Forming precise dots, dashes, and pauses, as described above, will be accomplished by the PIC's program, and a coherent microcontroller program must have a coherent plan; such a plan is generally called an algorithm. **Fig. 1** depicts the algorithm for our project keyer. Referring to **Fig. 1**, keep in mind that the microcontroller, PIC16F84, has 5 lines of port A and 8 lines of port B.

Any line of port A or B can be used as either an input or an output. In this project, we will connect the dot and dash paddle contacts to the port A lines, which will function as inputs. Keyer output and piezo buzzer for audio monitoring will be connected to port B as outputs.

Now, let's examine the operation algorithm diagram, **Fig. 1**. All working steps are marked with rectangular boxes. Box "Start" is the point where the program will actually start to run. When supply voltage is applied to the keyer, the first step in the program is to instruct all port A lines to function as inputs. In the next steps, all lines of port B are instructed to function as outputs, and they also are switched to normal low output levels. Up to this point, the program has only prepared the PIC microcontroller. But continuing from this point, the program will begin to run in the normal idle operation of the keyer. This is marked by the label "BEGIN" on the diagram.

Let me digress a bit from the algorithm diagram and explain how certain dot, dash, or pause durations will occur in the keyer operation. PIC microcontrollers act by stepping under internal clock pulses. Every step is called out as a cycle. Each command instruction has some quantity of instruction cycles. I will not describe each one, or how many cycles it will require. I only want to point out that in order to produce a certain length of dot, we need to calculate how many instruction cycles the microcontroller will use for providing the operation, and how many to add for delaying cycles to establish the proper relationship between transmitting speed and Morse code elements. Delay duration depends upon the delay constants we will incorporate into the program. There are three different constants used: one each for the dot, dash, and pause. There are three counters nominated in the file register's internal memory area. To provide the desired delay, the constants will be put into their appropriate counters.

But let's now return to the algorithm. The box closest to the "BEGIN" label is initialization of the counters. Initialization means to clear counters

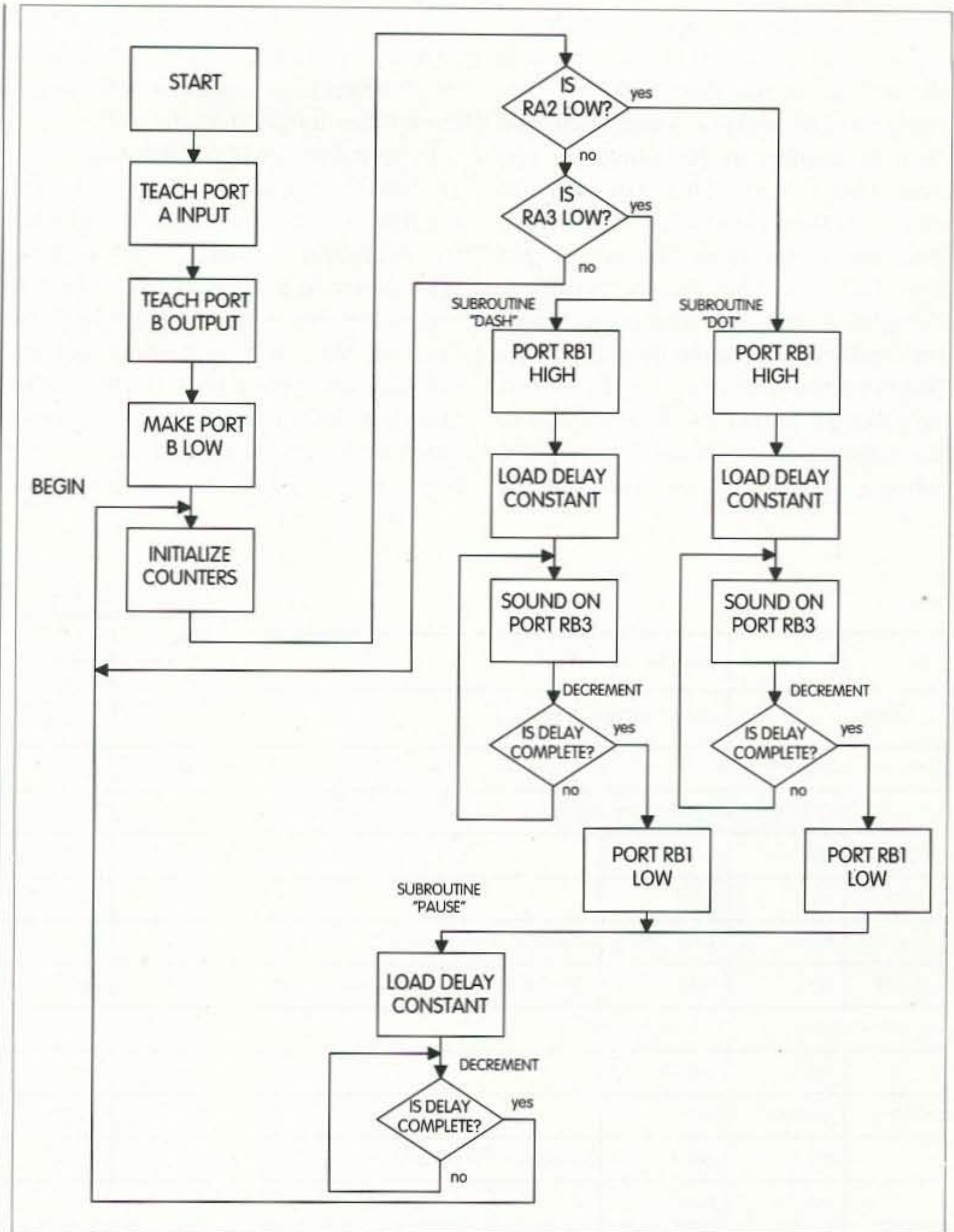

**Fig. 1.** Operation algorithm for the PIC-controlled keyer.

to make them ready for the next operation. The keyer program now sequentially checks to determine if the dot or dash paddle contacts are closed or not. First, it checks the dot input. If port line RA2 is low, the program will call the subroutine "Dot." This is depicted by the right comparison rhomb corner marked with "Yes." If not, RA2 is still high, which means that the dot paddle contact was not closed, and the program will go to check the status of the dash input. If the dash paddle contact is pressed to make port RA3 low (yes), the program will call subroutine "Dash" to form a dash. If not (the dash paddle contact not closed), it will return to the beginning point and continue to

run this loop until "Yes" (a dot or dash paddle contact closure) occurs on one of the comparison rhombs.

Let's consider what will happen when the dot is pressed and the keyer begins forming the duration of the dot mark to key the transmitter. First, we have to make the keying output port line RB1 go high. This will cause the transmitter connected to the keyer to start transmitting a dot.

The next box on the algorithm diagram tells us that we have to load the delay constant into the counter. After that, the program will start to generate a sound pulse sequence to operate the monitoring buzzer.

The next rhomb is for decreasing the

counter number by one unit and checking to see if it is equal to zero or not. If the answer is no, this loop will continue until the delay is completed, and then the number in the counter will be decreased to zero. This will cause an exit from this point to the "Yes" direction, and it will make the output port line RB1 low. This means that dot is completed and the transmitter stops transmitting. The same procedures are followed for producing the dash—except that the program will operate under the control of the "Dash" subroutine when it will find a low level on the

input port line RA3. The only difference is the delay constant, which is much larger to produce the dash that is three times longer than the dot.

In both cases, when either the "Dot" or "Dash" routine is completed, and the RB1 port line goes low, it will start the subroutine "Pause." This routine must generate a pause between Morse code elements equal to the length of one dot. Note that here we are not including the provision of the audio monitoring signal, which takes some amount of instruction cycles. This pause is controlled by another delay

constant—a bit larger one—than the one used for the dot. Subroutine "Pause" works in the same manner as the routines for forming the length of the dot and dash, except that it has its own unique constant loaded into its counter. The delay constant number in the pause counter is decreased by one unit until it is zero. When pause is completed, the program returns to the point labeled "BEGIN" to check for dot or dash inputs by the operator, and the keyer's PIC microcontroller continues to repeat this action until power is turned off.

;-----			
list		p=16f84	
__config		0x3ff3 ; RC clock oscillator	
;-----			
; CPU equates (memory map)			
porta	equ	0x05	
portb	equ	0x06	
count1	equ	0x0c	; for DOT delay constant
count2	equ	0x0d	; for PAUSE delay constant
;-----			
	org	0x000	
start	mov1w	0xff	
	tris	porta	; teach port A inputs
	mov1w	0x00	
	tris	portb	; teach port B outputs
	clrf	portb	; all port B lines low
;			
begin	clrf	count1	; initialize counters
	clrf	count2	
	clrf	count3	
;----- DOT -----			
	btfs	porta,2	; is RA2 low (dot pressed)?
	goto	dash?	
	call	dot	; calling subrouting DOT
	goto	begin	
;----- DASH -----			
dash?	btfs	porta,3	; is RA3 low (dash pressed)?
	goto	begin	
	call	dash	; calling subrouting DASH
	goto	begin	
;----- subroutine DOT -----			
dot	bsf	portb,1	; RB1=1, dot begins
	mov1w	d'12'	; delay constant
	movwf	count1	; load const to counter
rptdot	bsf	portb,3	; sound on
	bcf	portb,3	; sound off
	decfsz	count1,f	; decrement counter
	goto	rptdot	; not 0
	bcf	portb,1	; RB1=0, end dot
	call	pause	; start PAUSE subroutine
;----- subroutine DASH -----			
dash	bsf	portb,1	; RB1=1, dash begins
	mov1w	d'37'	; delay constant
	movwf	count3	; load const to counter
rptdsh	bsf	portb,3	; sound on
	bcf	portb,3	; sound off
	decfsz	count3,f	; decrement counter
	goto	rptdsh	; not 0
	bcf	portb,1	; RB1=0, end dash
;			
	call	pause	; start PAUSE subroutine
	return		
;----- subroutine PAUSE -----			
pause	mov1w	d'14'	; delay constant
	movwf	count2	; load counter with delay const
rptpau	decfsz	count2, f	; decrement counter
	goto	rptpau	; not 0
	return		; counter 0, end pause
;			
;----- END of program -----			
	end		

Table 1. An assembly language program for PIC keyer.

## An assembly language program

The assembly language program for the keyer is presented in Table 1. Assembler software will examine this program and ignore all lines beginning from the semicolon. Others perform assembly source code. This part will be assembled by MPASM, the compiler included into the MPLAB integrated development environment from Microchip. The assembler will convert readable text files into hexadecimal code for programming the PIC microcontroller.

The line beginning with the word "list" informs the assembler what type of a PIC microcontroller is used. The next line determines the type of internal clock oscillator built into the device. In this case, it is an RC-type oscillator.

The next five lines are equating statements which assign hexadecimal addresses to file registers in the PIC memory area. The line with ORG (origin) defines the address in memory where the program code starts.

The line with the label "start" in the first column of the program will teach all port A lines to function as inputs by loading hexadecimal FF (or binary 1111 1111) into a special tristate register. Actually, this instruction only needs five "1's," because port A has five input/output lines (named as RA0-RA4) in this type of PIC. Therefore, the three "1's" in the left "F" are functionally superfluous. In like manner, the program will teach all port B lines to function as outputs by loading hexadecimal 00 (binary equivalent is 0000 0000) into this register. The Port B register is also cleared, which means low level statements for each of the eight output lines RB0-RB7.

The label "BEGIN" shows the point where delay counters are cleared. When all three counters are ready, the program begins the "Dot" portion. Here the program checks for the low level at the input port RA2. Electrically, this point is wired to the dot contact of the paddle. If bit 2 of port A is high (paddle is not pressed to dot) in accordance with the instruction "goto," the program goes to the "Dash" portion.

However, if bit 2 of port A is low, the next executed instruction will be "call." This means call the Dot subroutine.

In the first subroutine, the line labeled as "dot," bit 1 of the port B is set to "1." This high level will activate the transmitter's keying circuitry to start transmitting a dot. The next two program lines load decimal value "12" (the delay constant) into counter 1. Following this step, the program begins to generate signals for the buzzer. Instruction "bsf" sets to "1" bit 3 of port B. If you remember, previously we made all port bits low. Now RB3 goes high and the buzzer produces one click. But in the next step instruction, "bcf" makes this output low, causing a new click. A fast repetition rate transforms the clicks into a tone.

Instruction "decfsz" decrements counter 1 contents by one unit and compares the result with zero. Until zero has been reached, the instruction "goto" loops to the label "rptdot" to produce new clicks, and continues to decrement the counter until the content of the counter becomes zero—then the following instruction "bcf" will make RB1 low. The dot is now over and the transmitter no longer transmits RF energy.

But subroutine "Dot" isn't over. Instruction "call" will execute another subroutine, "Pause." This begins by loading decimal value "14" (delay constant) to counter 2. The next instruction decrements this counter until the delay is complete and the counter is clear. Note that output port lines RB1 and RB3 are not used in this subroutine. We do not need to either key the transmitter or produce sound. We only need to get a standard length pause equal to the length of one dot. The pause for the audio signal is controlled by counter 2 and a much larger delay constant.

When subroutine "Pause" is over, instruction "return" returns us to subroutine "Dot." But the last instruction here also is "return," and the program goes back to the "Dot" portion. From there the program jumps to the point labeled "BEGIN" to initialize counters again, and starts checking which contact on the paddle is being pressed.

Subroutine "Dash" is the same as

# ALL ELECTRONICS CORPORATION

## 40 RPM Gearhead Motor

Pittman # GM8212C127-R2. Small, powerful gearhead motor.

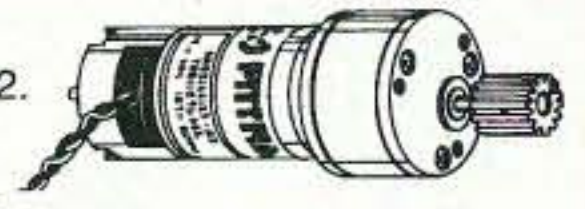

187:1 ratio. No load specs: 40 RPM @ 19.1 Vdc, 130 mA. 24 RPM @ 12 Vdc, 160 mA. Overall dimensions 3" long X 1.37" diameter. 0.185" (3/16") diameter X 0.75" long shaft. A brass 0.56" diameter gear with 16 cogs is fastened to the shaft. 17" leads.

CAT# DCM-135 **\$15<sup>00</sup>** each

10 for \$125.00

## Touchtone Keypad

Farbell# DU200P (A). Standard 12 button telephone keypad with touchtone (DTMF) circuitry. Field replacement for some GTE payphones. White plastic buttons with black numerals and letters. 11 color-coded leads, 9" long with spade lugs.

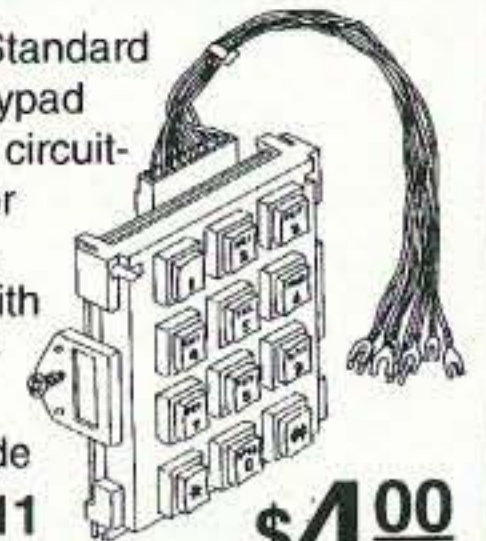

CAT # KP-11 **\$4<sup>00</sup>** each

25 for \$75.00

## Small Irregular Neodymium

Small arc shaped neodymium magnets with a shiny finish. Sizes vary. The smallest are 0.39" long x 0.15" x 0.085" thick. Some are slightly larger.

CAT# MAG-49 **4 for \$1<sup>00</sup>**

100 for \$17.00

## 20 Character X 4 Line LCD

Optrex # DMC 20434-CEM (PWB 20434-CEM) 5 x 8 dot format. 3" x 1" viewing area. 3.88" x 2.38" module.



Removed from new equipment, may have felt padding on metal bezel. 14 pin single row header is pre-attached. Includes spec/hook-up sheet.

CAT # LCD-46 **\$7<sup>00</sup>** each

10 for \$60.00

ORDER TOLL FREE

**1-800-826-5432**

CHARGE ORDERS to Visa, Mastercard, American Express or Discover

TERMS: NO MINIMUM ORDER. Shipping and handling for the 48 continental U.S.A. \$5.00 per order. All others including AK, HI, PR or Canada must pay full shipping. All orders delivered in CALIFORNIA must include local state sales tax. Quantities Limited. NO COD. Prices subject to change without notice.

CALL, WRITE FAX or E-MAIL for our **FREE** 96 Page CATALOG Outside the U.S.A. send \$3.00 postage.

MAIL ORDERS TO:  
**ALL ELECTRONICS CORPORATION**  
P.O. Box 567  
Van Nuys, CA 91408  
FAX (818)781-2653

www.allelectronics.com  
e-mail allcorp@allcorp.com

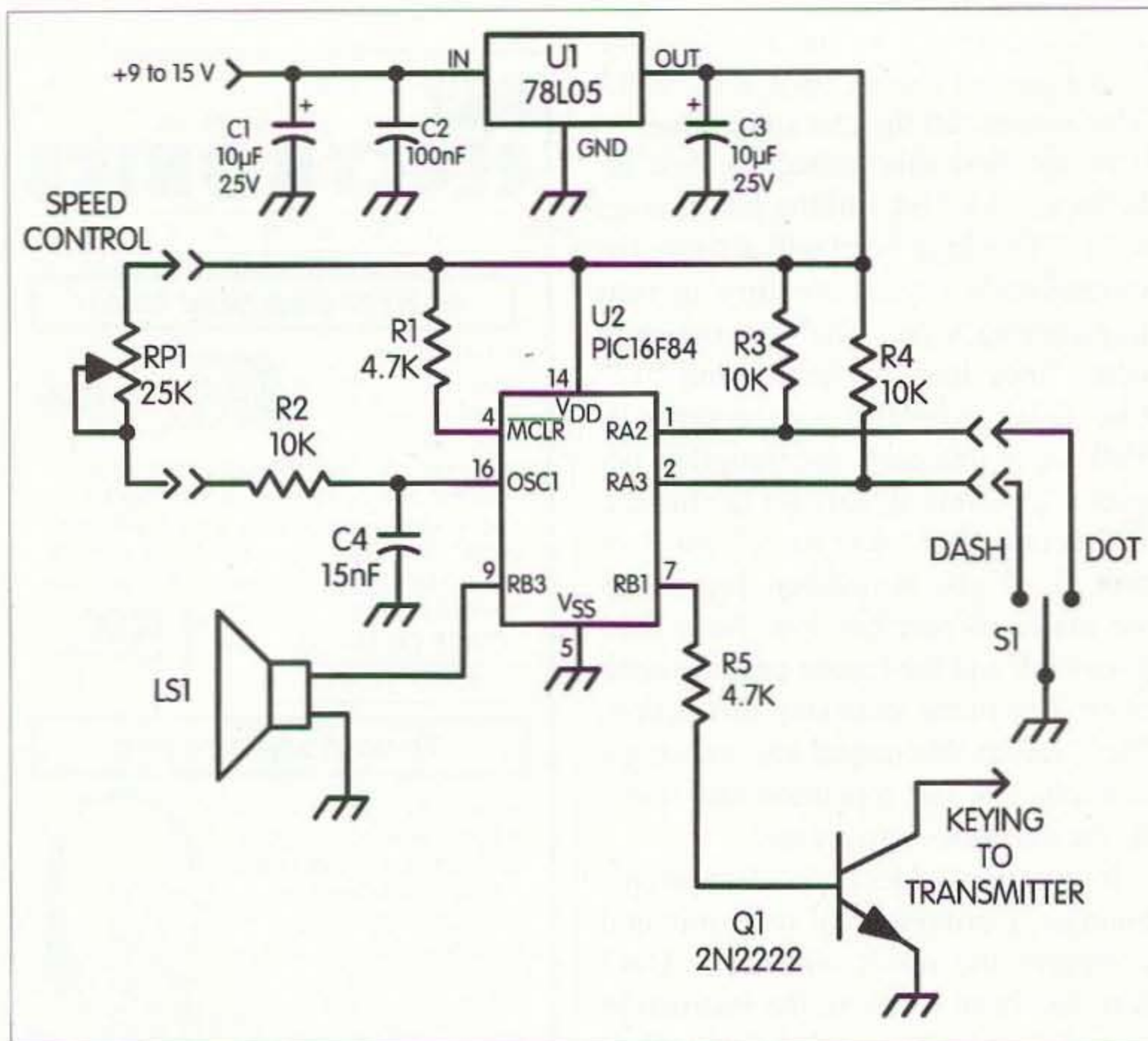

**Fig. 2.** Schematic of the simple PIC CW keyer. Unless otherwise specified, resistors are 1/4 W, 5% tolerance, carbon-composition or film units. Appropriate equivalent parts from Digi-Key (DK) can be substituted as shown in Table 2.

subroutine "Dot." It is followed by subroutine "Pause" as well. The only difference is in delay constant value. The decimal equivalent is "37," which makes the dash duration almost three times larger than the dot or pause.

### Circuit description

Refer to the schematic diagram, **Fig. 2.** The circuit is powered from +5 V voltage regulator U1. Capacitors C1 and C3 provide clear DC, and C2 is for suppression of incoming RF energy from the transmitter.

The keyer itself is microcontroller U2. Resistor R1 keeps the reset input on pin 4 high. Resistors R3 and R4 are pull-up resistors for inputs RA2 and RA3. They provide high idle level at the paddle's dot and dash contacts. Note that I do not specify left or right contacts on the paddle because that is a matter of the operator's taste.

Onboard components R2 and C4 together with outboard potentiometer RP1 are the RC circuitry for the internal clock oscillator. With the component values shown here, the transmitting

speed varies from approximately 5 wpm to over 30. To make a more narrow speed range, you may use a higher value of R2.

Signal from pin 7 of U2 is used for keying the transmitter. Q1 functions as a bipolar switch to key the transmitter keying circuitry. When port RB1 goes high it turns Q1 on, thereby connecting the collector network to ground. Resistor R5 is for limiting base current.

The piezo buzzer, connected to pin 9, monitors the transmitted Morse code text. There is another unusual function of the buzzer. You will notice that the buzzer's pitch is related to the clock speed of the microcontroller. When the operator varies the Morse transmission speed by rotating the knob on RP1, it will also vary the sound pitch. At first this may seem like a disadvantage, but the positive effect of this is to make it possible to estimate desired Morse speed just by listening to the pitch of the tone. The lower the tone of one dot, the lower the Morse speed. No need to overload the band with a series of dots to check the transmitting speed. This,

of course, is true only for the buzzer's tone, not for the signals heard from your station headphones! Your transceiver uses other methods to get a monitoring tone.

### Construction

The keyer was built on a 30 x 35 mm glass-epoxy single-sided PC board (see **Fig. 3**). If you notice my name and call sign, you will understand why metric sizes were cited. Customary English dimensions are approximately 1-1/4 x 1-3/8 inches. I am not familiar with companies outside of the Ukraine that produce custom boards in small quantities. However, I think it is normal practice for radio amateurs to make their own boards.

The assembled board can be installed into almost any transceiver. Limitations will be either not enough room in its case (which seems incredible) or some specific feature of the keying circuitry such as keying with high sink current or high voltage above ground. In this situation, transistor Q1 should be used to drive a small relay with open contacts. Don't forget to include a small silicon diode across the relay coil to manage the inductive spike when the relay coil is de-energized (and, of course, do ensure that

Parts List	
Designation	Part
S1	Any type CW keyer paddle
C1, C3	10 $\mu$ F, 25 V electrolytic or tantalum (DK P5148-ND)
C2, C4	Ceramic (C2: DK P4924-ND; C4: DK P4905-ND)
LS1	Piezo buzzer element (DK P9924-ND)
RP1	25 k potentiometer (DK CT2266-ND)
U1	78L05 small 5 V positive regulator (DK NJM78L05-ND)
U2	PIC16F84 microcontroller (DK PIC16F84-04/P-ND)
Q1	2N222 or any general purpose NPN silicon transistor (DK PN2222ADICT-ND)

**Table 2.** Parts list.



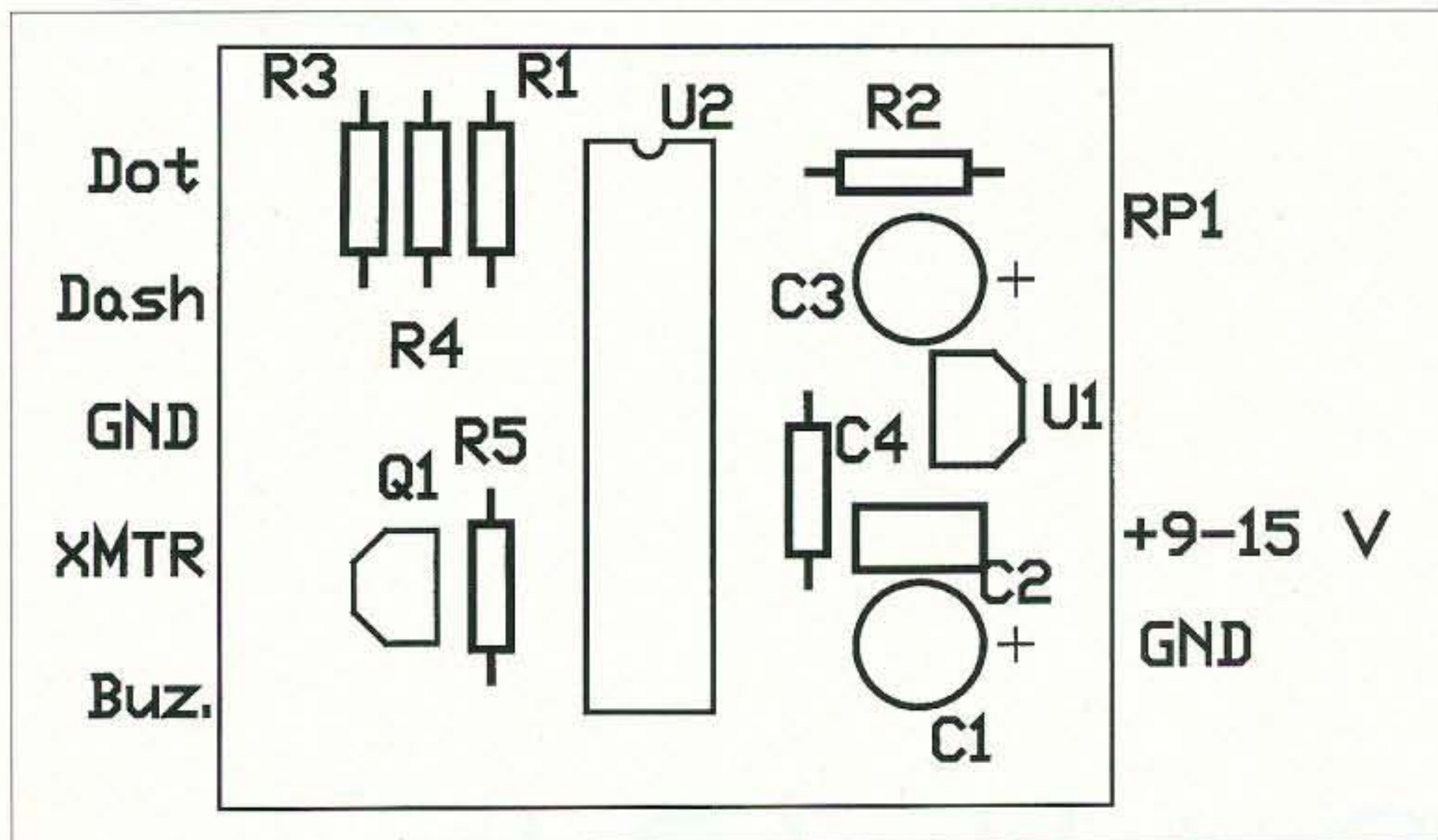

Fig. 3(a). PIC keyer printed circuit board, component side.

the polarity is correct and the diode is not DC conductive when the relay coil is energized).

It is wise to install the keyer board directly onto the keyer paddle assembly. This will ensure the shortest possible input wires, and keep it away from strong RF fields. A metal enclosure to further shield against RF energy in your shack is also a wise idea. The accompanying photo reveals that my keyer is an improvisation (which in the Ukraine is standard procedure due to the cost of living and scarcity of manufactured electronic parts). It is mounted on an old-fashioned telephone polarized relay modified as a paddle. But this is also the amateur radio tradition, and I'm sure you will conjure up your own unique improvisations.

### Programming

First of all, you have to work with your assembler program in Microchip's

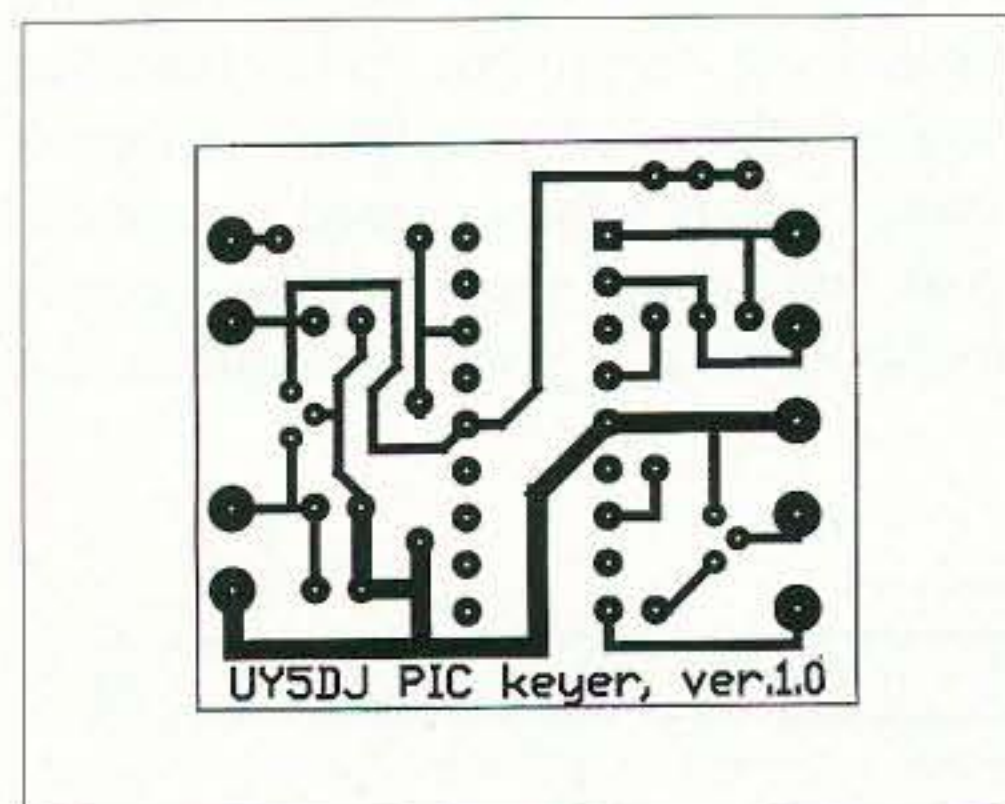

Fig. 3(b). PIC keyer printed circuit board, soldering side.

MPLAB software. This is the best environment for design and debugging your programs. This software can be obtained free from the Microchip Web site (see Notes). The assembler compiler MPASM is included in MPLAB and also supplied separately. It may be used to obtain source files for the programmer, but I prefer to use the whole MPLAB package. On the Web site, you will also find a manual for the newest version of MPLAB, with detailed explanations on how to work with this software.

The results of your work in MPLAB will be a file with extension \*.hex. It should be used in programming software PIX (see Notes, note 3). Also, you will need the programmer itself. I

**SAVE 47%!**  
on 12 months of 73  
**Only \$24.97**  
Call 800-274-7373

am using the simple serial port programmer, which was included (along with a detailed description and operating procedure) in W2FS's article.

### Summary

This simple keyer is an example of gaining knowledge and skills by self-study, experimentation, and construction—and you end up with a very useful station accessory as well! And, of course, like most amateur radio projects, the project itself is ripe for further improvements and modifications. Keep in mind that the program described in this short article utilizes only a very small part of PIC16F84 capabilities.

In closing, I would like to express my heartiest gratitude to my friend Dave Evison W7DE for his valuable remarks and comments.

### Notes

1. David Benson, "Easy PIC'n. A Beginner's Guide to Using PIC 16/17 Microcontrollers." Version 3.0, Square 1 Electronics, 1997.
2. Available at [<http://www.microchip.com>].
3. Available at [<http://home5.swipnet.se/~w53783>].

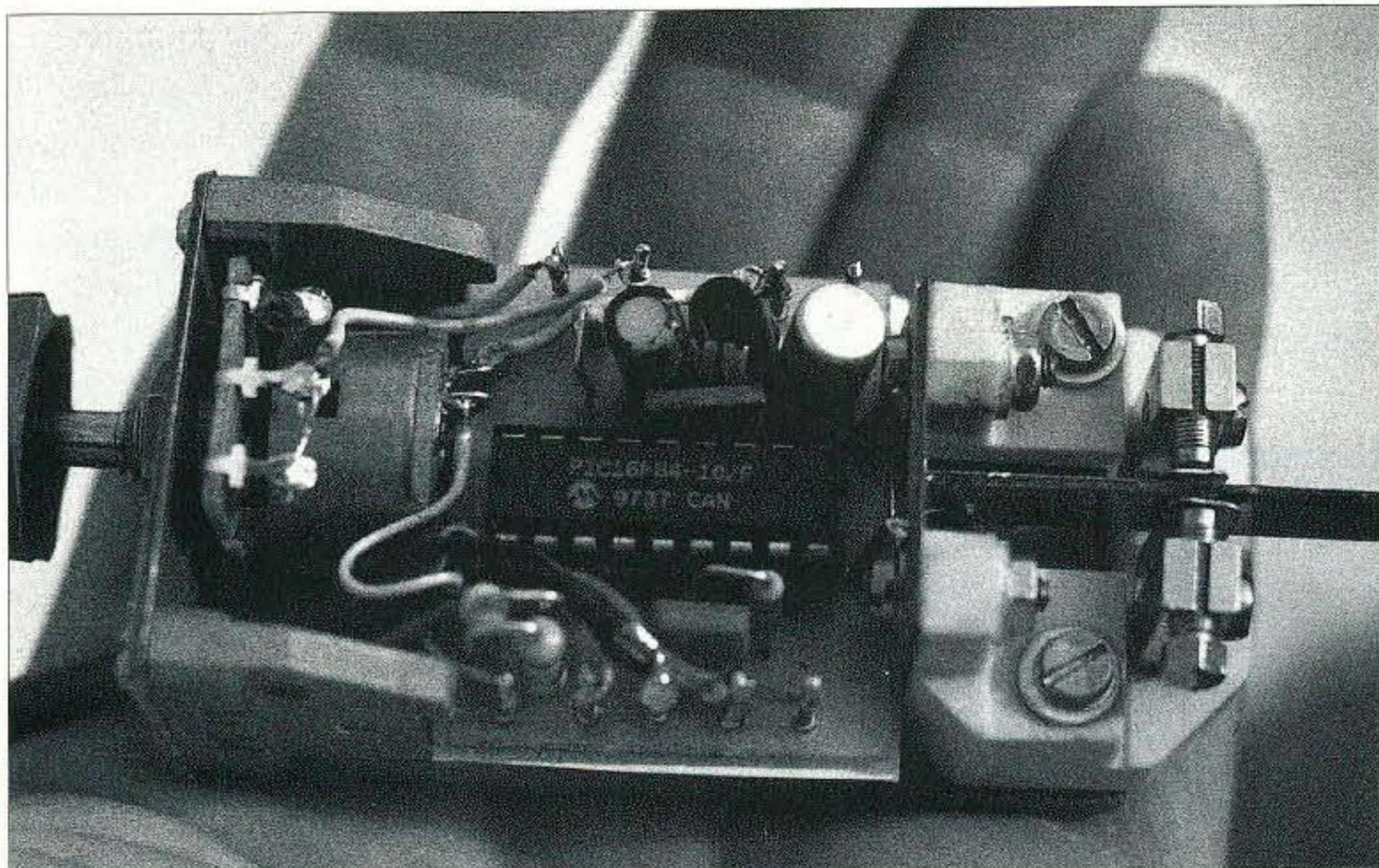

Photo A. PIC-based CW keyer.

# Y2K Portable J-Pole

*What emergency will you need to handle?*

Mike Agsten WA8TXT  
401 W. Bogart Road  
Sandusky OH 44870  
[lectrokit@sanduskyohio.com]  
[www.sanduskyohio.com/lectrokit]

For 2-meter portable use, I like the idea of having a full-size roll-up antenna available for situations where communication necessity outweighs the compact convenience of the usual rubber-flex antenna. Sometimes, we need to “get out” better! Roll it up and an antenna like this will fit perfectly in your Y2K emergency preparedness kit!

The portable, flexible J-pole is not a new idea; I’ve seen several over the past decade or so and tried most of them—but with mixed results. They did radiate after a fashion, but VSWR was much higher than expected, and band coverage was narrow or the coax tap point for a decent match was very picky and difficult to move. While moderate VSWR can be tolerated by

most handhelds, maximum power transfer always occurs when the source and load impedances are matched. Besides, high VSWR nags at me, even when overall results seem to be satisfactory.

The approach taken in this antenna is so old, it might be considered novel. I was browsing through an early radio book and noticed in a diagram that a half-wave Zeppelin antenna (the original J-pole) used link coupling between the transmitter and the quarter-wave matching section (which feeds the half-wave radiator). Aha! Link coupling ... I haven’t seen that tried, so here it is! It gives full band coverage on 2 meters, with VSWR less than 1.3—very broad.

My first attempt at construction used ordinary hookup wire for the link and plastic tape to hold it in place at the shorted end of the matching section. It worked fine but, realizing the difficulty of describing how to do it, I decided to use a PC board to “freeze” this

potentially critical portion of the antenna for easy duplication, convenience, and improved long-term stability (no tape to come unraveled!).

On the J-pole coupler PC board, the outermost U is actually the cold end of the quarter-wave matching section. Inside it is the link coupling loop and donut pads to mount the series tuning capacitor (3.5–20 pF, Mouser 24AA022 or equivalent). Pads are also provided to install a small fixed capacitor in parallel with the trimmer just in case the one you use is too small in value. The remaining small pad is for RG-58 (or equivalent) coax center conductor; the two larger pads nearby accept pigtailed from the coax shield, one on each side of the coax. The two isolated pads are drilled out to provide holes for coax strain relief. Use a nylon tie-wrap or small magnet wire wrapped around the coax and through these holes to secure it to the PC board. Now your connections



Photo A. Y2K portable J-pole antenna, coiled up and ready to go.

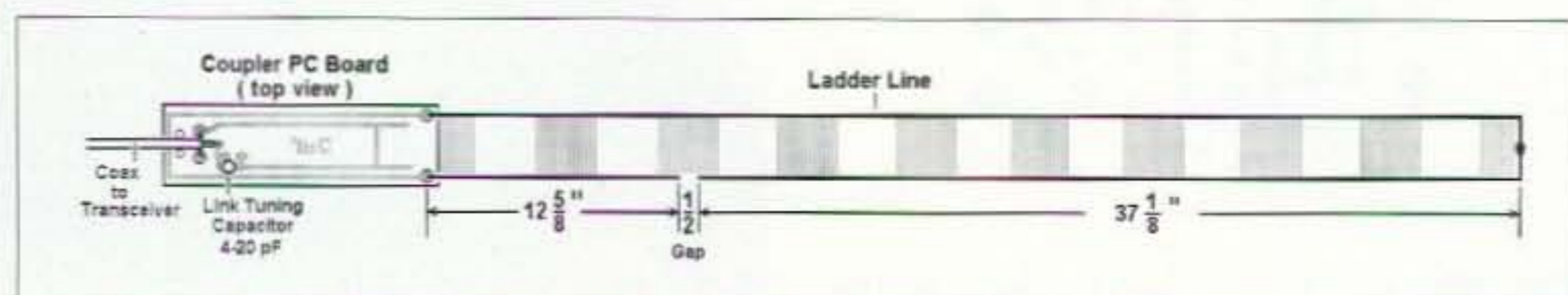

Fig. 1. Portable J-pole antenna for 2 meters.

are all secure, and nothing can move around or shift over time.

The coax cable may be any length you wish, fitted with a connector on the far end to mate with your transceiver. I chose a five-foot length with BNC connector for general use, but if you anticipate pulling this antenna up into a tree or some other support, use a longer piece of cable to gain that height advantage.

The remainder of the matching section and the half-wave radiator are fabricated from a single piece of plastic-covered ladderline, approximately 55 inches long. The type I used was a standard radio store item with conductors spaced 0.8 inches and roughly fifty percent dielectric fill in between, alternating between plastic spacers and air.

Measure 13 inches from one end of the line, and in the middle of the next spacer section beyond that point, make a 1/2-inch gap in one side of the line (the gap is placed in a spacer section so it won't weaken the structure as it would if you placed it in an air section). Now

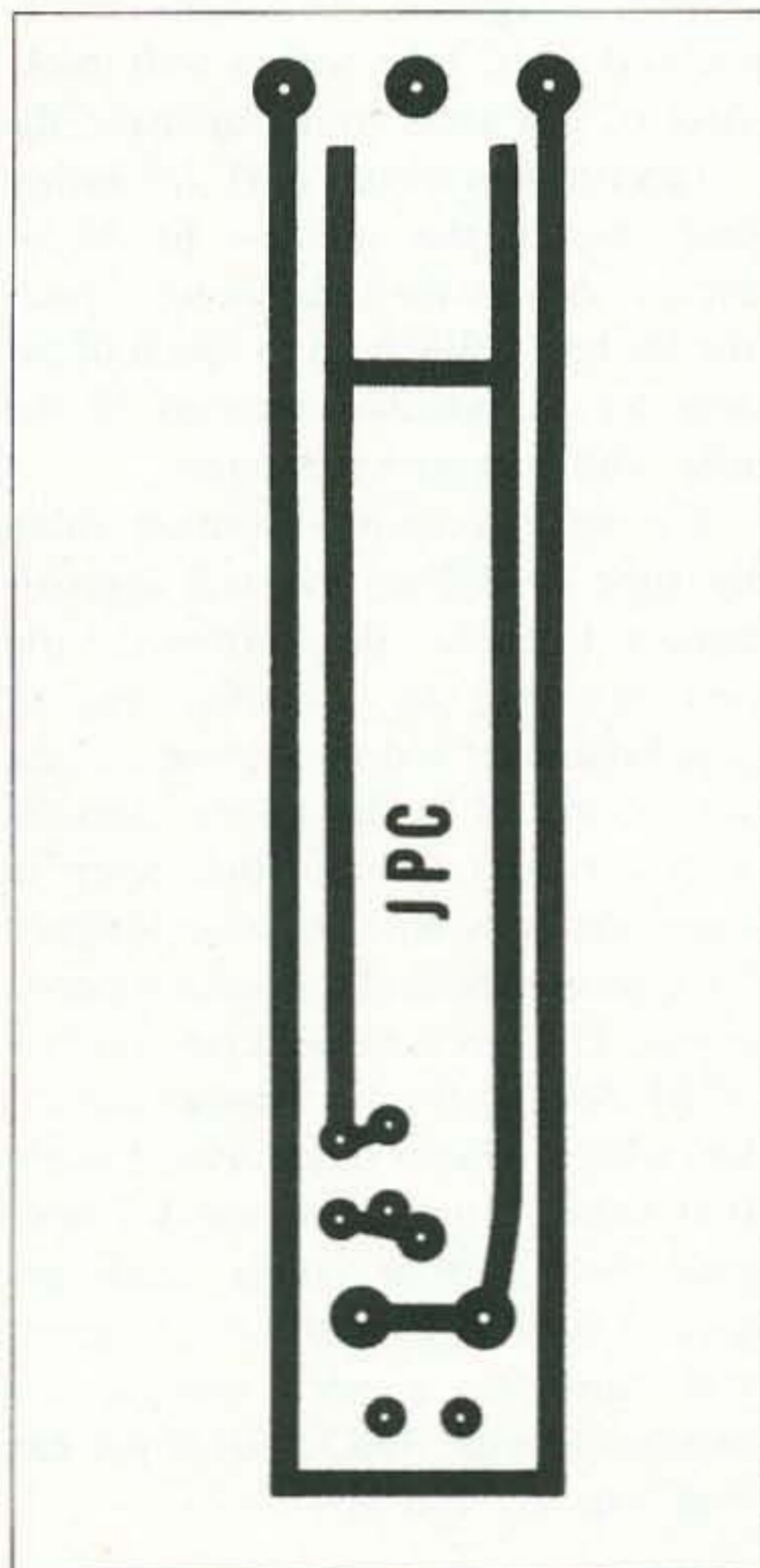

Fig. 2. Full-scale etching pattern.

## The Pouch

Protective carrying case for your HT. Tough, washable neoprene and nylon. Neoprene is tough stuff that absorbs shock like no leather case ever could!

Choose from neon red, lime, or royal.

State make and model of your HT.



All pouches \$18.50.  
With shoulder strap add \$5.00.  
Shipping & handling \$3.50.  
Send check or m.o. to:

**Omega Sales**

P.O. Box 376  
Jaffrey, NH 03452  
800-467-7237



**HamCall™ CD-ROM**  
U.S. & International - Over 1.5 million listings



When you order, you will receive a CD-ROM that is **less than 1 week old!** Clearly, the most comprehensive and current CD-ROM available.

### Latest Features

Choose font and color of data display.  
Displays flag and map for each country.  
Shows CQ, ITU zone, and continent.  
History list shows each callsign entered.

View & search interests of 14,000 hams.  
Search for club, military, RACES, vanity, silent keys, name, address, and more.  
Over 1,533,000 U.S. and International listings, 88,600 e-mail addresses, 4,000 photos and QSL cards, 26,000 vanity calls and 9,400 references to QSL managers.

Shows short & long path distance & bearing.  
Precise latitude/longitude for over 90% of addresses.  
HamCall is \$50.00, included is 6 months free access to our Internet Search Service - request when ordering.

HamCall USA - US listings only - \$25.00

HamCall Mousepad, with morse code reference - \$5.00

\$5.00 shipping per order. Your satisfaction guaranteed!  
Free 800 technical support - we won't let you fail.

**BUCKMASTER**  
6196 Jefferson Highway • Mineral, VA 23117 USA  
e-mail: info@buck.com  
540-894-5777 • 800-282-5628 • 540-894-9141 (fax)

CIRCLE 56 ON READER SERVICE CARD

## Amplifiers. ATU Down Converters & Hard to Find Parts

### LINEAR AMPLIFIERS

**HF Amplifiers**  
PC board and complete parts list for HF amplifiers described in the Motorola Application Notes and Engineering Bulletins:

AN779H (20W)	AN 758 (300W)
AN779L (20W)	AR313 (300W)
AN 762 (140W)	EB27A (300W)
EB63 (140W)	EB104 (600W)
AR305 (300W)	AR347 (1000W)

**2 Meter Amplifiers**  
(144-148 MHz)  
(Kit or Wired and Tested)

35W - Model 335A,  
\$79.95/\$109.95  
75W - Model 875A,  
\$119.95/\$159.95

### HARD TO FIND PARTS

- RF Power Transistors
- Broadband HF Transformers
- Chip Caps - Kemet/ATC
- Metalclad Mica Caps - Unelco/Semco
- ARCO/SPRAGUE Trimmer Capacitors

We can get you virtually any RF transistor!  
Call us for "strange" hard to find parts!  
**DIGITAL FREQUENCY READOUT**  
For older analog transceivers  
TK-1 (Wired and Tested) \$149.95

### ATU Down Converters

(Kit or Wired and Tested)  
Model ATV-3 (420-450)  
(Ga AS - FET) \$49.95/\$69.95  
Model ATV-4 (902-926)  
(GaAS - FET) \$59.95/\$79.95

For detailed information and prices call or write for our free catalog!

Phone  
(937) 426-8600  
FAX  
(937) 429-3811

**CCI Communication Concepts Inc.**

508 Millstone Drive • Beavercreek, Ohio 45434-5840  
e-mail: cci.dayton@pobox.com  
www.communication-concepts.com

### ADDITIONAL ITEMS

**Heat Sink Material**  
Model 99 Heat Sink (6.5" x 12" x 1.6"), \$24  
CHS-8 Copper Spreader (8" x 6" x 3/8"), \$24  
**Low Pass Filters (up to 300W)**  
for harmonics \$12.95  
Specify 10M, 15M, 20M, 40M, 80M or 160M  
**HF Splitters and Combiners up to 2KW**

## TOWERS & HAZER

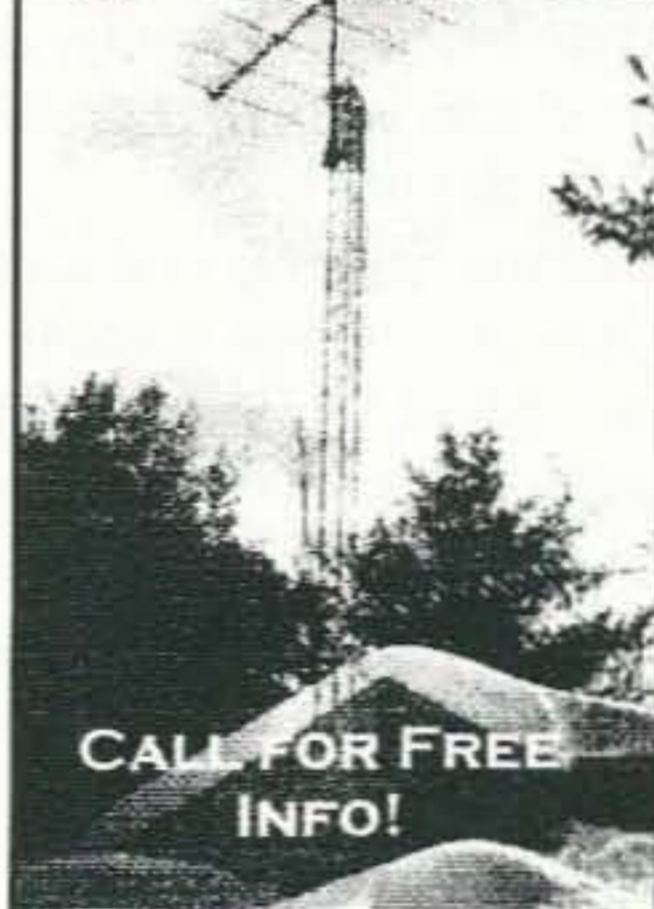

CALL FOR FREE INFO!

- ◆ Pre-Assembled sections made of 6061-T6 **anodized** aluminum and constructed of 18-8 stainless steel hardware
- ◆ Easy "Walk-Up" tower installation- No gin poles!
- ◆ Never Climb a Tower Again with the **Hazer!**

**Includes the Hazer-** The Hazer is a three sided elevator tram system that rides up and down the outside of your tower raising and lowering your antennas by simply turning a winch. Move your antennas and rotator systems out of danger, work on your setup at ground level, and much more!

**Complete Tower Packages Include:** 10 foot aluminum tower sections, concrete footing, hinge base for easy installation, Hazer, grounding kit, Kevlar guy kit and 48 state shipping!

**GLEN MARTIN ENGINEERING**

13620 Old Hwy 40 • Boonville, MO • 65233

**(660) 882-2734**

Call to get your **free** catalog. Visit us online at  
<http://www.glenmartin.com>

## DENVER AMATEUR RADIO SUPPLY

## KENWOOD



### TH-D7A

FM Dual Bander APRS and  
9600 Baud TNC Built-in



### TS-570D(G)

Full Featured HF Base  
(S) Model includes 6 meters

## YAESU



**NEW**

### FT-100

HF/6M/2M/430MHz  
Super Compact  
Transceiver

### VX-5R

50/144/430 MHz  
Heavy Duty FM  
Handheld



### FT-847

All Mode HF/50/144/430 MHz  
Unequaled Satellite Rig



## ICOM

### IC-706 MKIIG

HF/50/144/440 MHz  
Plus New Features  
& More Power



**NEW**



### IC-746

100 Watt HF/6M/2M  
Transceiver

### IC-2800H

Dual band, 50w/35w,  
Large, Color  
LCD Screen



Ameritron ADI Bencher Butternut MFJ  
Cushcraft Diamond MAHA Astron  
Kantronics Larsen Mirage Lakeview

Quotes & Orders 1-800-891-9199

Tech & Info (717) 336-6060

[www.denverradio.com](http://www.denverradio.com)

Route 272, Wabash Center  
1233 N. Reading Road  
Stevens, PA 17578  
Lancaster County

Located 2 miles south of the PA Turnpike exit 21 on Rt 272

M,T,F 9-6 W,TH 9-8 Sat 9-3

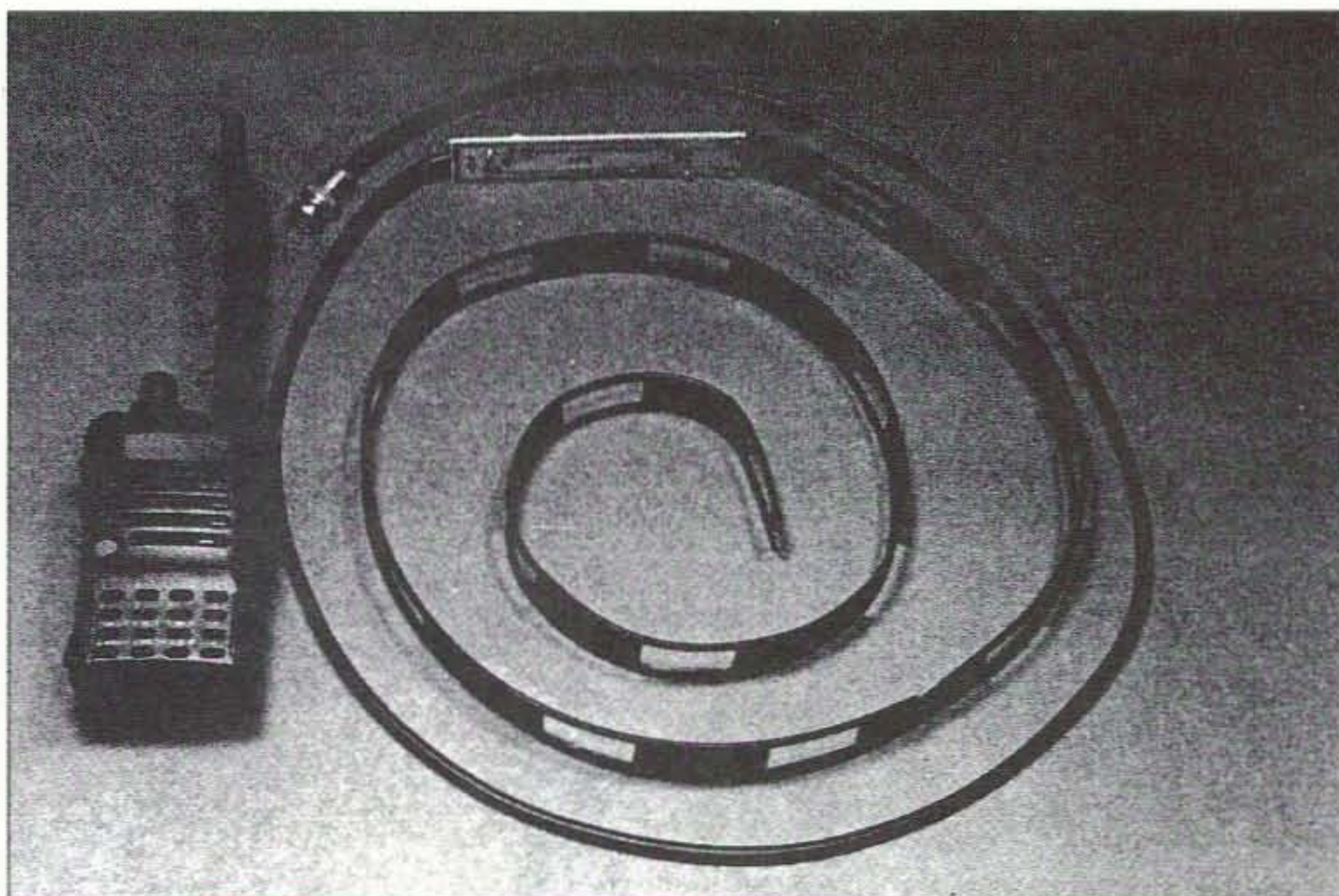

Photo B. Antenna detail.

measure 12-7/8 inches back toward the same end, cut the line, and remove 1/4 inch of insulation from each wire. Connect this end of the line to the large pads at the open end of the outer U on the coupler PC board. The distance between these pad connections and the beginning of the gap should be 12-5/8 inches.

From the other side of the gap, measure out 37-5/8 inches and cut the ladderline at that point. Remove 1/2 inch of insulation from each side of the line and bend the wires at right angles so that they touch each other. Solder them together. This makes the radiator just over 37 inches long, and connecting the two wires fattens it considerably for broadband performance. For suspending this antenna vertically, attach string, shoelace, or small rope of a length that will suit your needs.

With the antenna hanging in a clear area, adjust the link tuning capacitor for minimum VSWR while transmitting in the middle of the band. Reflected power should go down to zero or nearly so, and VSWR at the band edges should not rise much beyond 1.3 to 1 (at least that was the case in several units built and tested here).

Other types of parallel conductor transmission line, even TV twinlead, should work with this coupler PC board, but differences in propagation velocity will likely change the dimensions

somewhat—especially the distance from the coupler to the gap—so you may have to experiment.

If you're tempted to push this antenna into a piece of PVC tubing (with end cap) for use as a fixed station antenna, it will work—but not with the dimensions given. For use inside a 1-inch-i.d. PVC tube with a wall thickness of 1/8 inch, you can make the coupler-to-gap distance 11-7/8 inches and shorten the radiator to 34-3/4 inches. Adjust the link tuning capacitor for best SWR with as much of the antenna as possible inserted in the tube, and then push in the rest.

The antenna can be supported within the tube by drilling the wall approximately 18 inches down from the top and inserting an insulative pin or small-diameter rod through one of the air sections of the ladderline. Seal the holes to keep the rain out. Keep in mind that this antenna was designed for typical handheld transceiver power levels. Though it showed no evidence of RF heating (in the trimmer capacitor) with a 10 watt transceiver, I doubt if it would handle a whole lot more than that. If your power needs are greater than the 10 watt level, I suggest you substitute a mica compression trimmer like the ARCO 401 if you can find one.

Continued on page 36

# Defogging Microstrips

*An intro to microstripline filters.*

Jim Kocsis WA9PYH  
53180 Flicker Lane  
South Bend IN 46637

**T**his article describes microstripline filters. They perform the same functions as LC circuits but don't look anything like typical ones. I'll show you how to design and make your own. I retraced my steps as I was trying to develop one, so you wouldn't waste time and make the same mistakes I did. Let's try to remove some of the fog surrounding this topic.

I needed an input filter for a microwave downconverter that I built. It translates microwave frequencies to VHF. Without a filter at the RF input, the signal was noisy because the converter combined both the desired signal and the image noise in the output. I had seen microstripline filters in commercial equipment, but had no idea how to design them or how they worked. The filter I designed provides noise-free signals, whereas before the signal was covered with so much noise that it was useless.

These filters can be used in equipment for the 440, 902, and 1296 MHz ham bands and the 1691 MHz weather satellite band (my application). They are useful at higher frequencies if test equipment is available that can go higher.

## Theory

Microstripline filters can consist of several grounded 1/4-wavelength-long sections of printed circuit track on double-sided PC board. See **Photos A and B**. The energy in one element is coupled into the next element due to their close proximity. They resonate at

one frequency, just like a 1/4-wave antenna. The loss through the filter is determined by the spacing between the elements and the number of elements. The bandwidth decreases (gets sharper or narrower) as the spacing between elements is increased, and the loss

*Continued on page 20*

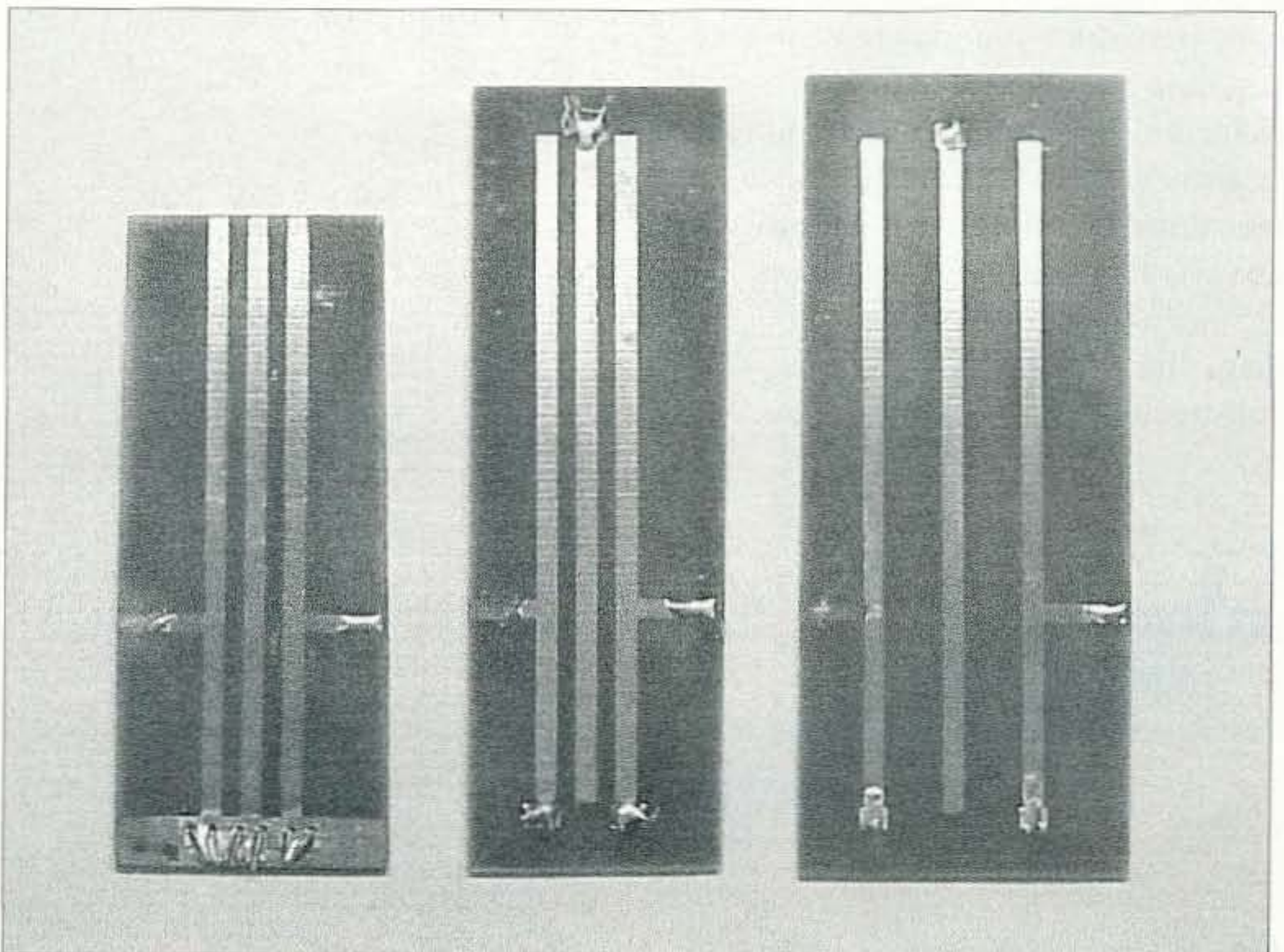

**Photo A.** From left, filters 1, 2, and 3.

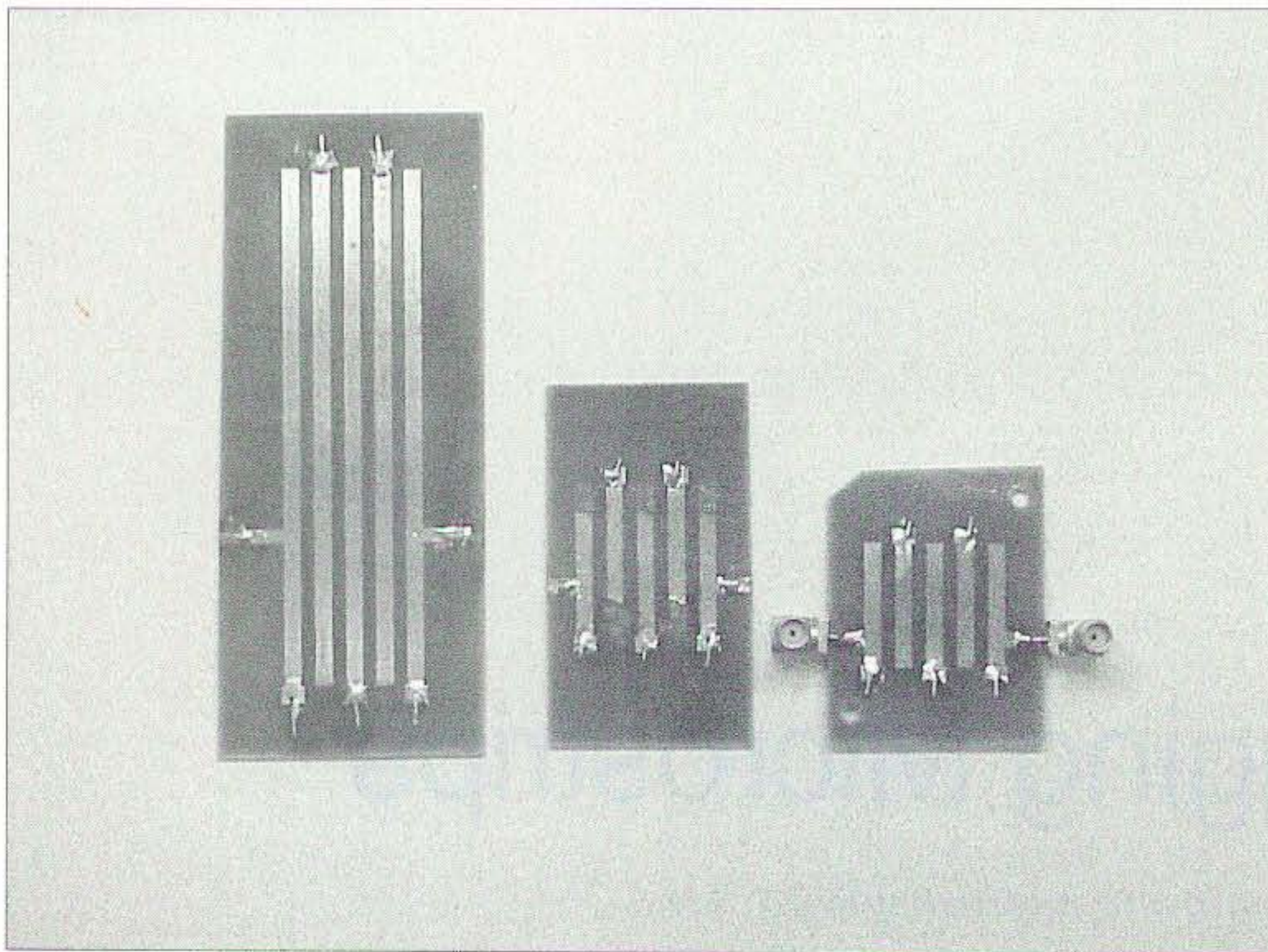

Photo B. From left, filters 4, 6 (filter 5 after trim), and 7.

## Defogging Microstrips

continued from page 19

increases as the spacing is increased. (Compare Figs. 3 and 4.)

The amount of loss you can tolerate and the bandwidth you require determines the spacing. You can add more elements and get a sharper filter curve (steeper sides on the filter response; compare Figs. 3 and 5), but more board space is required. If you want lots of rejection far from the passband and a wide passband, you may have to stagger tune the elements, making each element resonate at a slightly different frequency. There is no one filter configuration (number of elements and spacing) that is correct for every application.

Since the 1/4-wave lines (we'll call them lines instead of PC tracks) are constructed above a ground plane, the

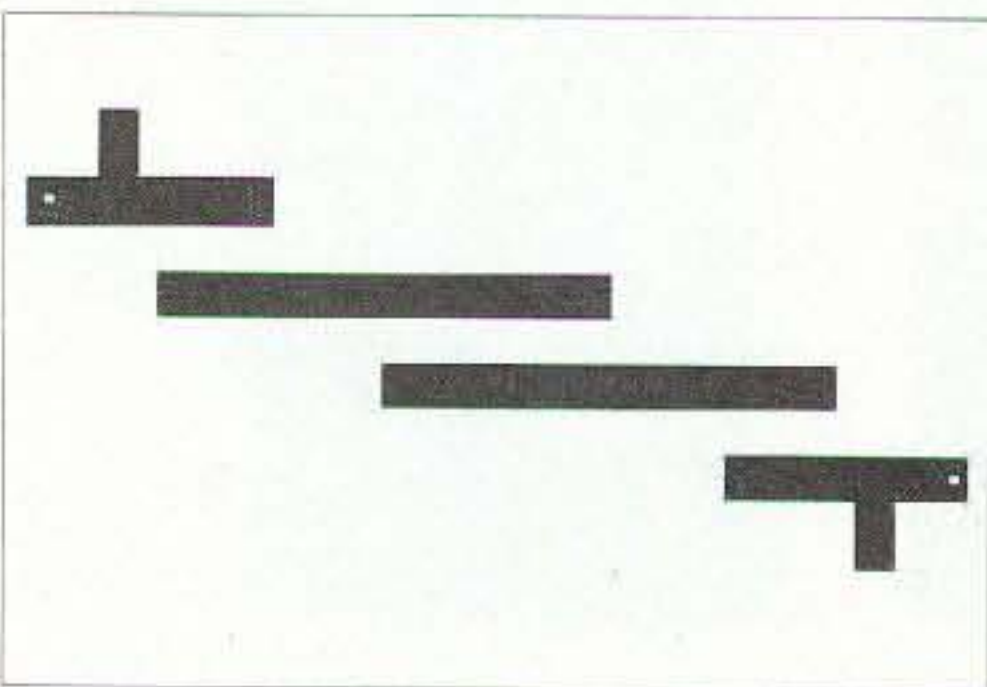

Fig. 1. Typical PC board artwork for "floating 1/2-wave" design.

board insulating material affects the velocity factor because it has a dielectric constant different from that of air. This makes the lines shorter than they would be if the dielectric was air.

In this article, I'll discuss two configurations of microstripline filters: comb and interdigital. In a comb configuration, all the lines are grounded at the same end. In an interdigital configuration, the grounded ends alternate. I obtained greater loss with a comb configuration. The graphs discussed later will demonstrate this higher loss.

There is a third type of configuration that I did not try. It uses 1/4-wave lines grounded at the input/output and 1/2-wave floating lines for the intermediate lines. See Fig. 1. I don't know whether this type has other desirable characteristics. See Ref. 3 for further details.

The actual lines should be 50 ohms impedance, because that provides a good match to other devices (the LNA, mixer, etc.). The input and output track should also be 50 ohms impedance. For 0.062-inch glass epoxy board, a 50 ohm line is 0.100-inch wide. The 50 ohms is determined by the line width and the type and thickness of substrate. A good article on determining the impedance of various thicknesses, substrates, and line widths was referenced by many other articles. See Ref. 1. To obtain the desired 50 ohm impedance, the input and output taps should be about 1/3 of the way up from the ground end.

## Development and design

The first thing I always do when starting a new concept is to go over all my old issues of *73 Magazine*, *Ham Radio*, *QST*, and the *ARRL Handbooks*. I also get *RF Design* at work and keep a file of articles that I think I might need in the future. After spending many hours searching for information on microstripline filters, I found one brief article in *Ham Radio* (Ref. 1), one page in the *ARRL UHF and Micro-*

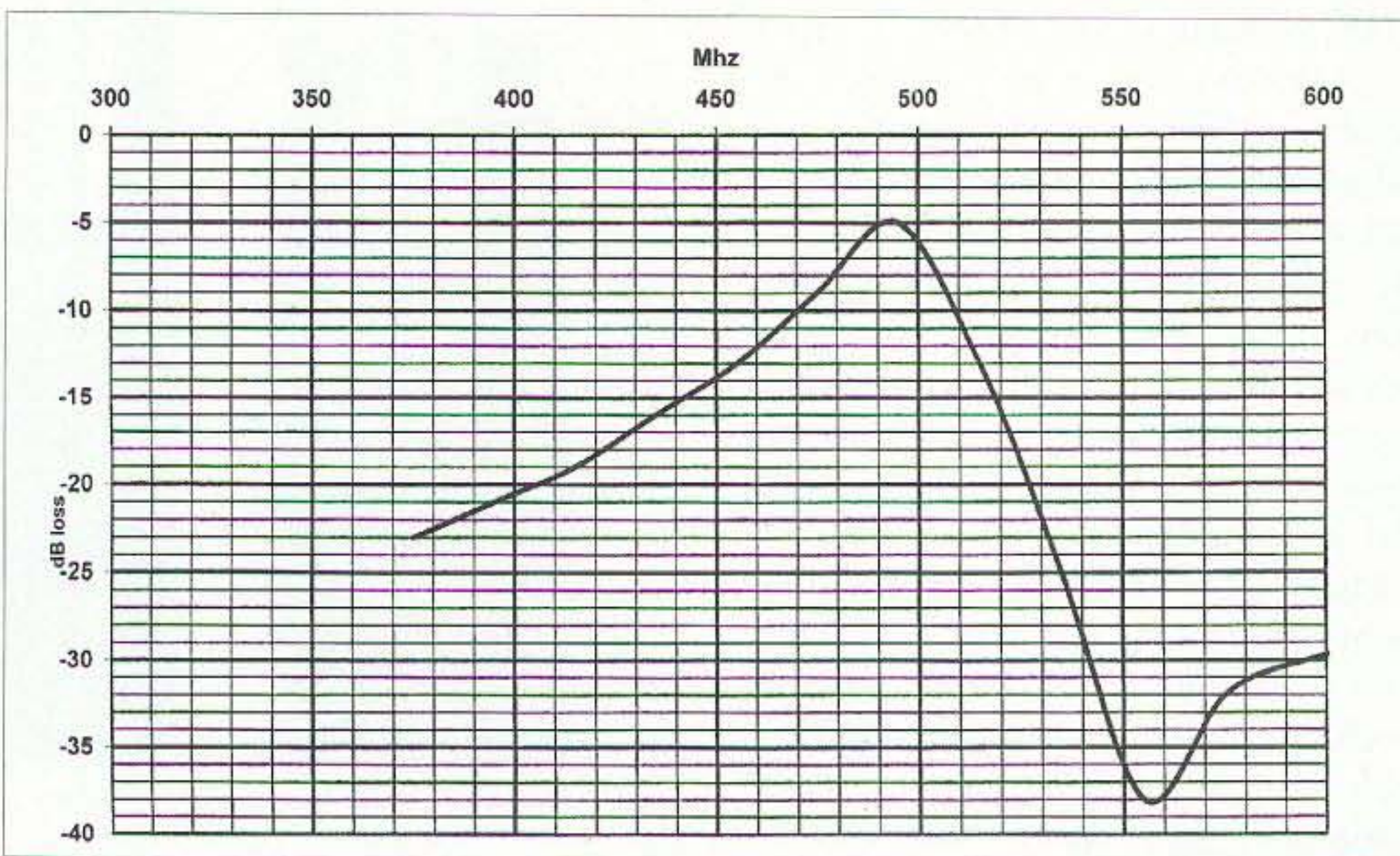

Fig. 2. Frequency response curve of filter 1, 3-pole, .100" spacing, comb configuration.

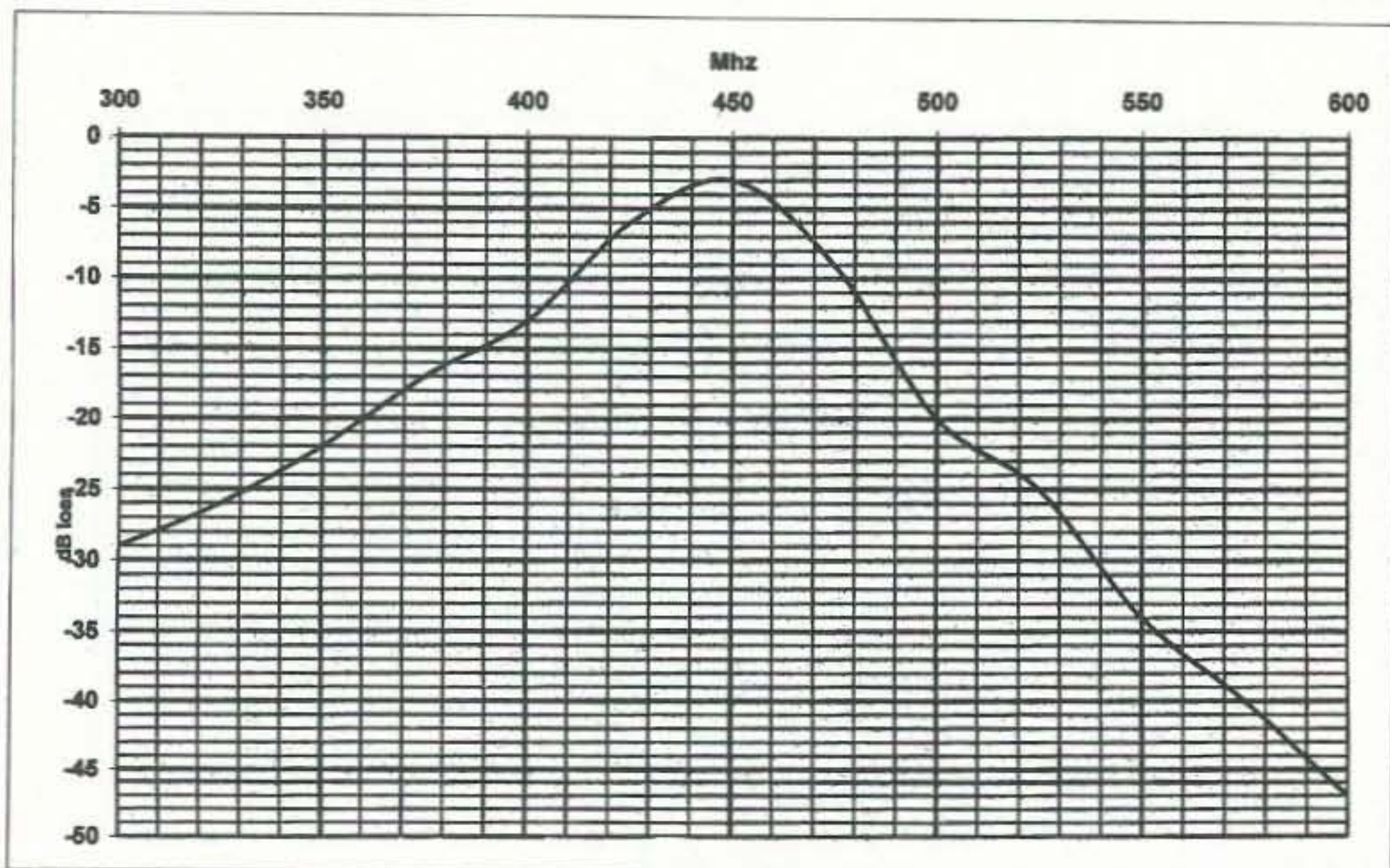

Fig. 3. Frequency response curve of filter 2, 3-pole, .100" spacing, interdigital configuration.

wave Experimenters Handbook (Ref. 2), two very technical articles in *RF Design* (Refs. 3 and 4), and some technical correspondence I had with Chuck Houghton WB6IGP about 7 years ago (he does the excellent Above and Beyond column in *73 Magazine*). One *RF Design* article didn't really explain how the filters function but was just a computer program you could purchase or enter yourself. The other *RF Design* article discussed a lot of theory I didn't understand. The *Ham Radio* magazine article showed a little of what I was looking for; it described 2- and 3-element filters and demonstrated that 3 elements produce a sharper filter than one with 2 elements. *The ARRL UHF*

and *Microwave Experimenters Handbook* listed an example of a filter but didn't provide much design information. The best guidelines I was able to obtain came from Chuck Houghton. He sketched out some notes in answer to questions I posed and said I would have to experiment with the design. The handwriting was on the wall! It was time to stop reading and start making some filters!

Where I work, we use DOX (Design of Experiment) and Taguchi methods wherein we vary one (or more) parameter(s) at a time to see the effects of each change on a given design. Using these techniques to develop the required filter, I would have to vary the

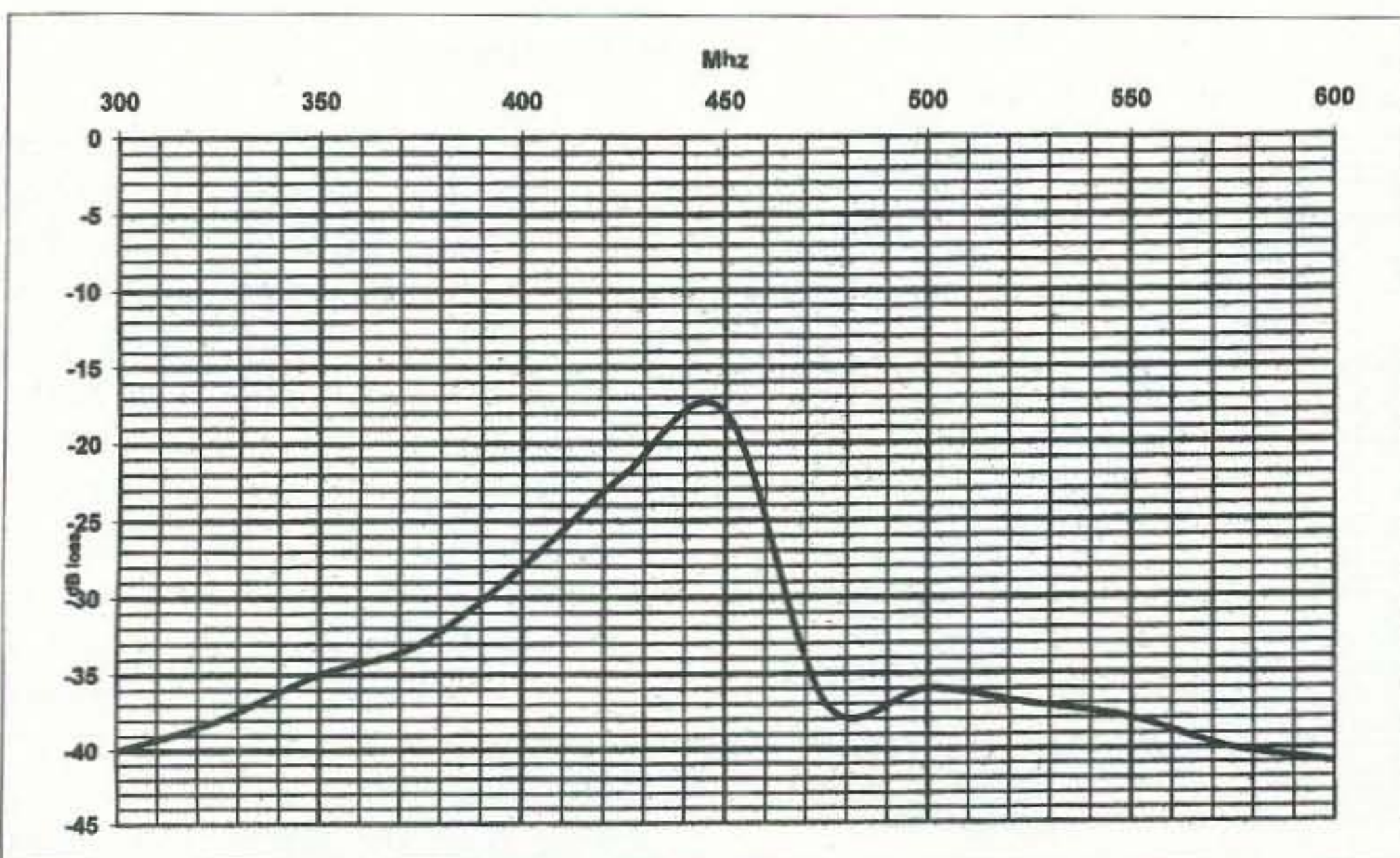

Fig. 4. Frequency response curve of filter 3, 3-pole, 5/16" spacing, interdigital configuration.

## LOW PROFILE HF ANTENNAS THAT REALLY WORK!

"Work the World Without Working Up the Neighborhood"

# ISOTRON

BILAL COMPANY

Call for a FREE Catalog:

719/687-0650

137 Manchester Dr.

Florissant, CO 80816

www.catalogcity.com

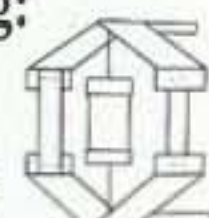

Go to Keyword Search & Type in: Isotron

CIRCLE 42 ON READER SERVICE CARD

## FREE!

## NEW CATALOG

CALL TOLL FREE: 1-800-JAN-XTAL

Quality Crystals and Oscillators for:

AMATEUR BANDS • CB • MARINE VHF  
SCANNERS • MICROPROCESSORS • PAGERS  
P.O. Box 60017 • Fort Myers, Florida 33906

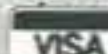

(941) 936-2397



# JAN Crystals

CIRCLE 242 ON READER SERVICE CARD

## Buying A Used Shortwave Receiver

A Market Guide to Modern S.W. Radios

### Buying A Used Shortwave Receiver

A Market Guide to Modern Shortwave Radios



- New 4<sup>th</sup> Ed.
- 20 Chapters
- 78 Pages
- 106 Photos
- Printed 11/98
- Covers last twenty years.
- 100 Receivers
- 50 Variants
- Includes portables & tabletops.
- \$5.95 (+\$2 ship)

Buying a used shortwave radio can provide great savings if you have the facts. This affordable market guide features the top 100 most sought after portables and tabletops produced in the last 20 years. Each radio entry includes: photo, specifications, features, ratings, plus new and used values.

For those with an interest in tube radios, commercial models or exotic foreign manufacturers, we suggest *Shortwave Receivers Past & Present - Third Ed.* \$24.95 (+\$3 ship)

universal radio inc.

Universal Radio

6830 Americana Pkwy.  
Reynoldsburg, OH 43068

◆ Orders: 800 431-3939

◆ Info: 614 866-4267

www.universal-radio.com

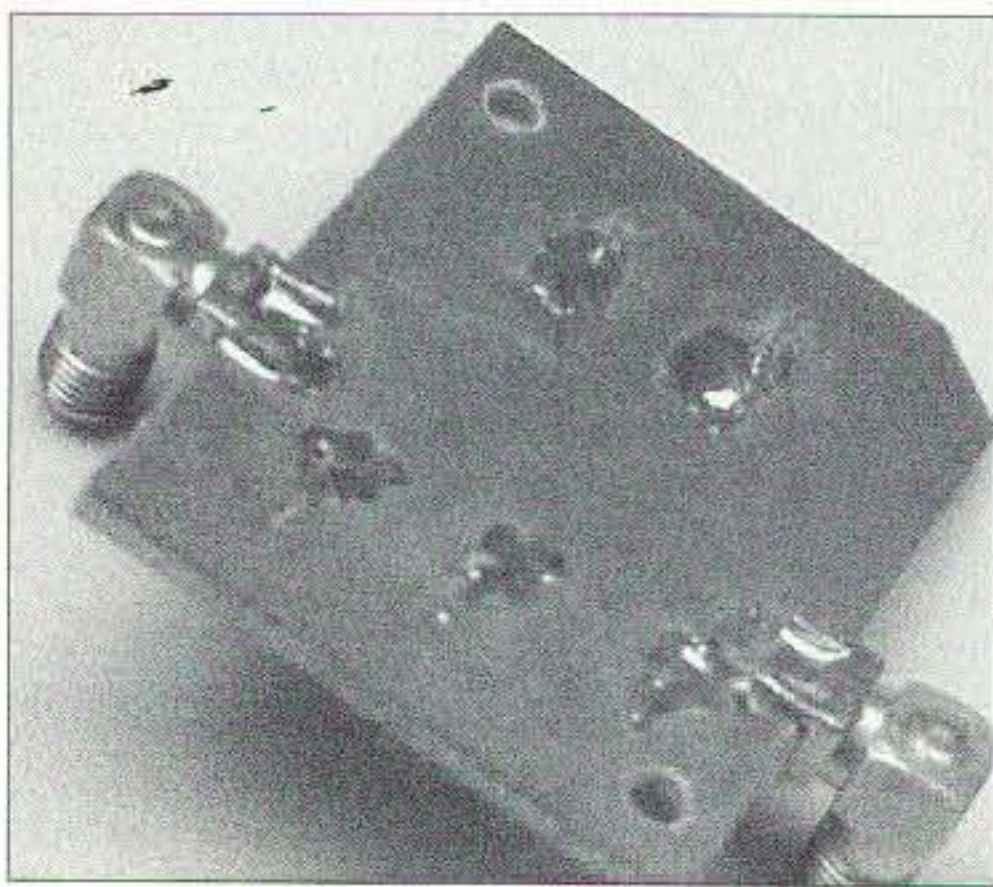

Photo C. Bottom view of SMA connectors.

spacing, try both interdigital and comb configurations, and vary the number of elements until I obtained the desired bandwidth and loss.

I began by building a filter that I could easily test and analyze with our commercial generator. Both the frequency and level can be set accurately. The first filter I built resonated at around 450 MHz, well within the range of both the spectrum analyzer and the commercial signal generator. I plotted the data showing the performance of each filter after it was built. I made more filters that had different spacing, a different configuration, and a different number of elements. Plots of filter performance vs. filter type are shown in Figs. 2 through 8. See also Photos A, B, and C.

Figs. 2 and 3 show the difference between comb and interdigital configurations. Comb filters have about 3 dB more loss than interdigital filters for a

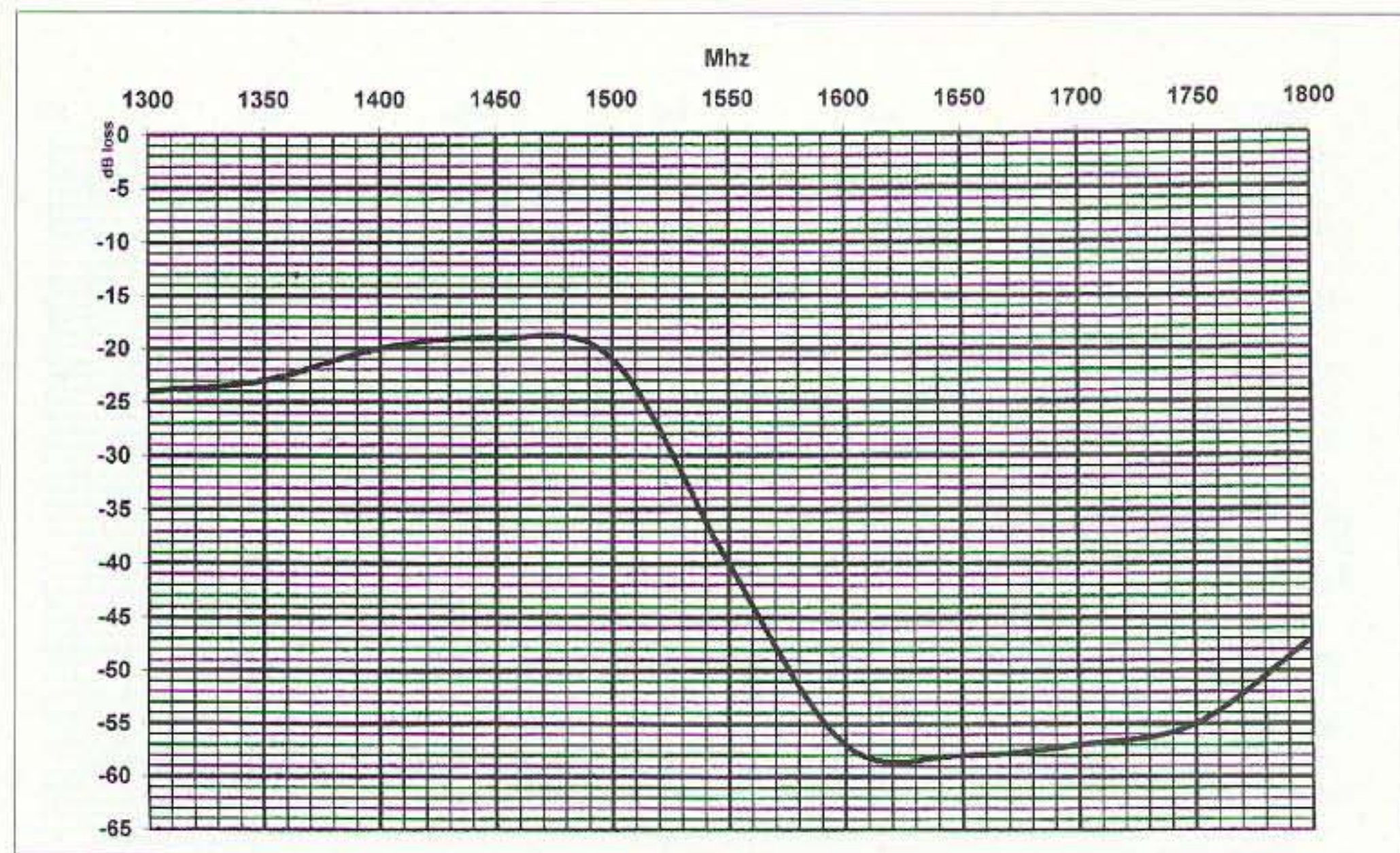

Fig. 6. Frequency response curve of filter 5, 5-pole, .100" spacing, interdigital configuration.

given spacing and number of elements. In Fig. 4 the lines were placed farther apart. Note that the loss at the pass frequency is very high (-17 dB). In Fig. 5 the number of elements was increased from 3 to 5. This change provided steeper sides, indicating more attenuation of undesired frequencies.

Fig. 6 shows a filter that has the proper spacing. It's an interdigital configuration and was purposely made too long so that it could be trimmed to resonate at the desired frequency (1691 MHz). After trimming, notice in Photo B(b) that the elements are no longer fully engaged. This showed up as more attenuation than I thought should be present (-10 dB), although the curve had the correct shape.

The only change to be made at this point was to change Fig. 7 so that the elements were more fully engaged with the correct length. The finished filter performance is shown in Fig. 8. While the final design does have more loss than I thought my receiver could tolerate, it actually worked fine as-is for my application. Later I'll discuss how to reduce the loss of the filter. If you must change the length of a filter element a significant amount to get it exactly on frequency, don't forget to move the input and output lines to 1/3 the distance from the ground end. This will retain the 50 ohm input/output impedances.

Filter line lengths for the frequencies I tested are as follows: 450 MHz—3.625 inches; 1400 MHz—1.00 inch; and 1691 MHz—0.85 inches.

### Making the filters

To compose the filter artwork I used the Paintbrush software that comes with Windows 3.1, Win95, and Win NT. You will have to turn on the coordinates (X,Y) to provide information on the position and dimensions of the filter elements. Use zoom so you can see each grid square. You should also have the gridlines turned on. This software will give you 0.01-inch resolution, which is adequate for this type of filter work and most other PC artwork you may need.

Select black for the color, then begin clicking along the outline of the track you need. After this use "fill" (the icon

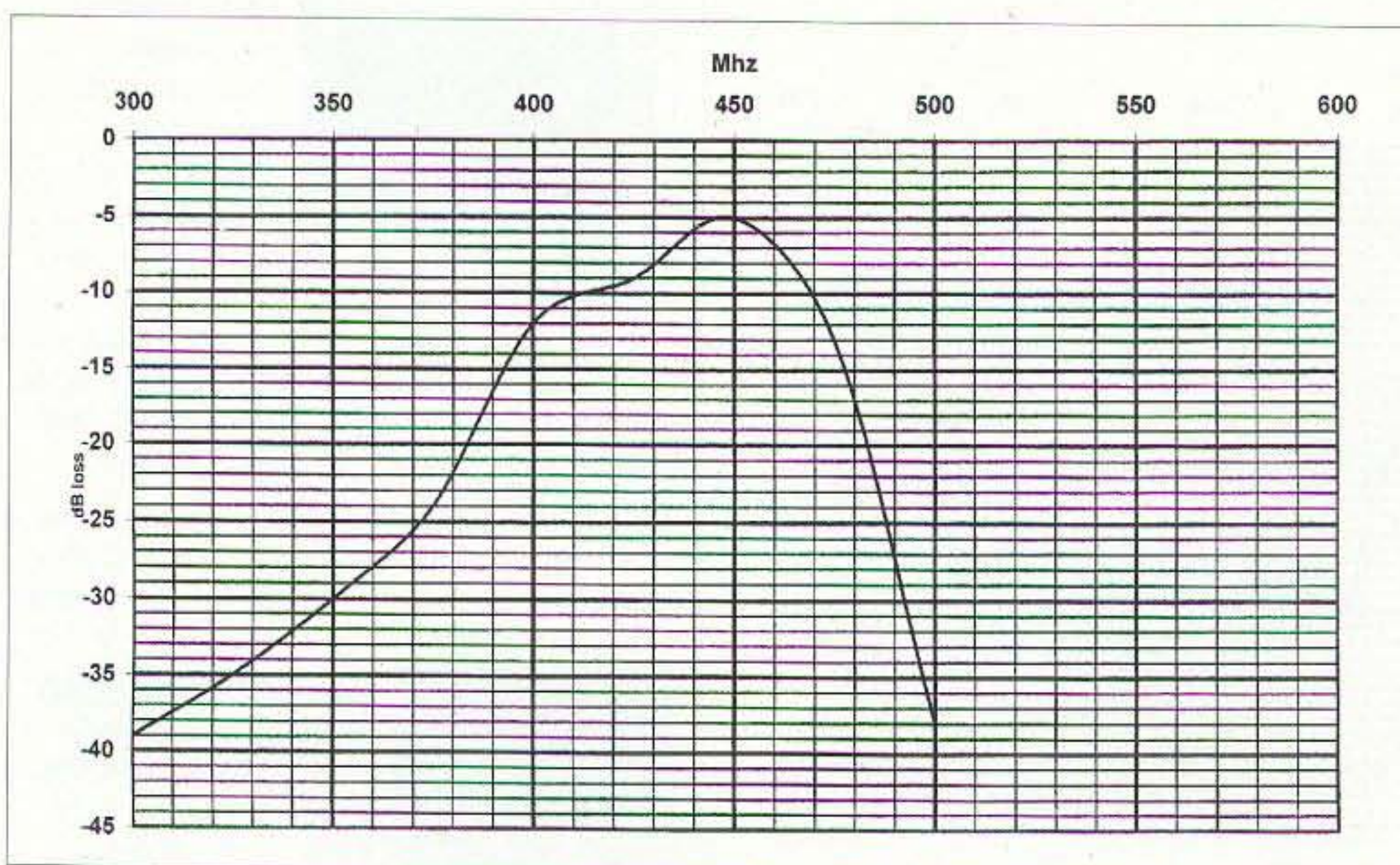

Fig. 5. Frequency response curve of filter 4, 5-pole, .100" spacing, interdigital configuration.



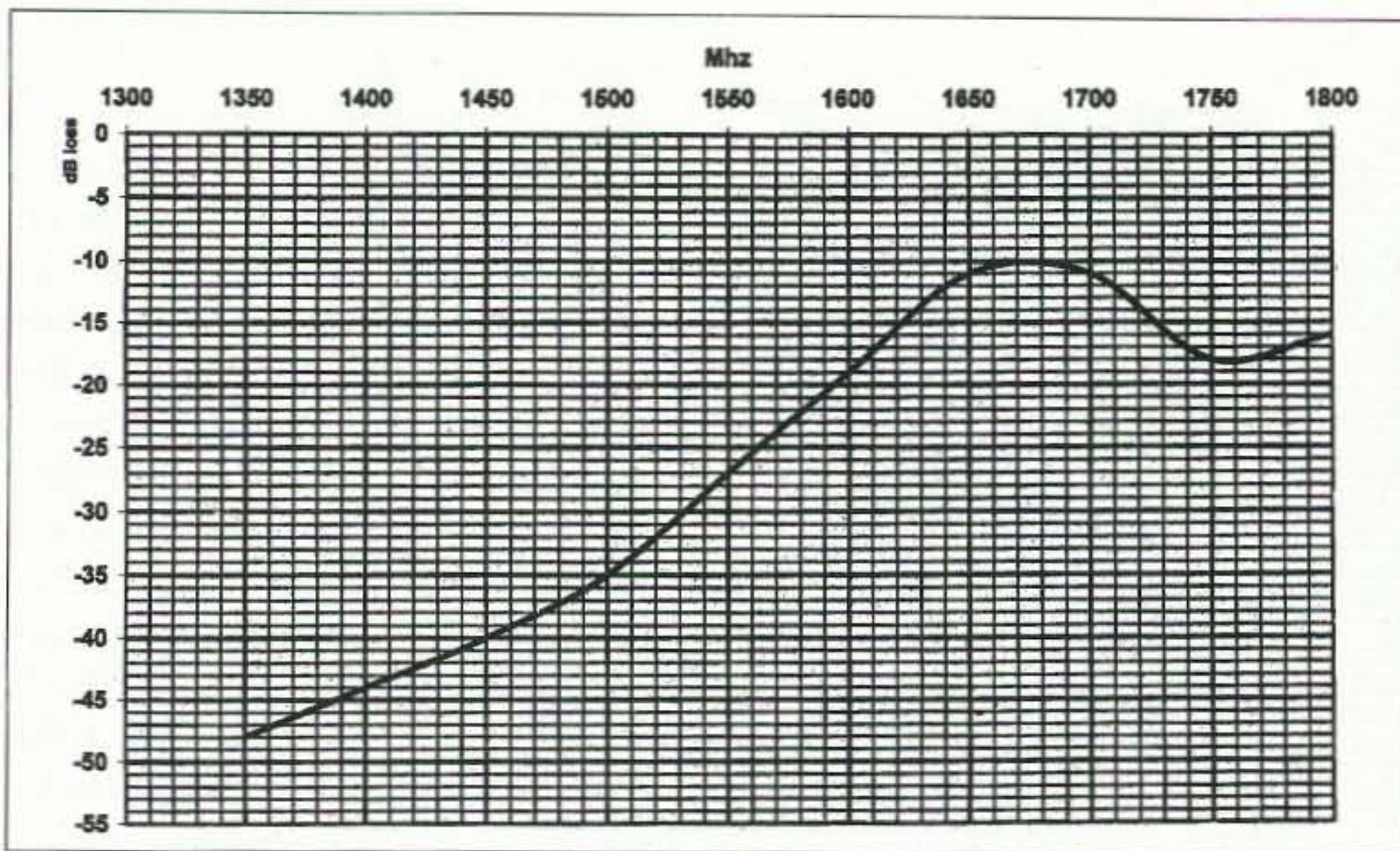

Fig. 7. Frequency response curve of filter 6; this is filter 5 trimmed to peak at 1691 MHz.

looks like paint being poured from a can) to complete that section of track. Make sure the outline is solid, or else the entire image will be filled in. (Use "undo" if you missed a grid square.) You should start near one corner, working out from that corner toward the center of the work area. The software provides a 6.4" x 4.8" working area. I recommend starting at an even-numbered grid square, say 100,100. That way you can make the track width the required 0.100 inches.

The spacing will be what you determine to be best for your application, and the length will be what you need. Note the difference between the coordinates of the upper left and lower right of a given track, and that will give you track width and length. For example, assume the upper left is 100,100 and the lower right is 300,110. Subtracting the first point from the second, you can determine that the track is 2 inches long and 0.100 inches wide. I recommend putting a single line "test pattern" near the edge of your board (away from the filter elements) that is exactly 1 inch long and has a short perpendicular line at each end. This test pattern is shown in Fig. 9. If this line is exactly 1 inch long on your printed artwork then the rest of the artwork is accurate. If not, then the rest of your artwork is wrong. Verify that you have the scaling set to 100%.

I used Press-n-Peel to transfer the artwork to double-sided board. This

product is very easy to use. It requires that you have a laser printer to print the track image on their special media. See Ref. 5. (I've used Press-n-Peel to make these filters and several other boards and only had problems the first time.)

After printing the track onto the special media, use a common clothing iron to transfer it to double-sided copperclad board. I've used both the paper-based and the blue plastic film

### WANT TO LEARN CODE?

**Morse Tutor Gold from G.G.T.E. is the answer for beginners and experts alike.**

\*Get the software the ARRL sells and uses to create practice and test tapes; and Morse Tutor Gold is approved for VE exams at all levels.

\*Since 1987, GGTE has guided nearly 20,000 hams and prospective hams around the world through proven structured lessons and a variety of character, word and conversation drills. Straight forward menus make the process simple and fun.

\*This program features easy and speedy self installation; random character drills with the characters you select; and you can create your own drills or import text files. You can type what you hear or copy by hand and see the results one line at a time. Pick the Farnsworth or the standard method; select the tone frequency most comfortable for you or select your code speed in tenths of a word per minute. For all DOS computers. You are always in command.

Certified by



Morse Tutor Gold uses your internal speaker or sound board. And, if you use a sound board Morse Tutor Gold supports volume control.

Sound Blaster and the Sound Blaster Compatibility Logo are trademarks of Creative Technology Ltd.



Available thru dealers, the ARRL, or send \$29.95 + \$4 S&H (CA residents add \$2.32 tax) to: GGTE, P.O. Box 3405, Dept. MS, Newport Beach, CA 92659 Specify 5 1/4 or 3 1/2 inch disk.

CIRCLE 193 ON READER SERVICE CARD

Serving the LORD Since 1987



**\$49.95!**

## THE POWER STATION

The POWER STATION is a 12v x 7 Amp/Hr gel-cell battery. It comes complete with a built in voltmeter, a wall charger and a cord for charging via automobiles. It powers most hand held radios at 5 watts for 2-4 weeks (depending upon how long winded one is). It will also run a VHF, UHF, QRP or HF mobile radio, such as the Icom 706 at 100 watts. There are no hidden costs. All that is required is a mobile power cord or HT cigarette lighter adapter.

The POWER STATION provides 12V from a cigarette lighter outlet and has two recessed terminals for hardwiring. A mini-phone jack with 3V, 6V, or 9V output can be used separately for CD player, Walkman, etc. The POWER STATION can be charged in an automobile in only 3 hours, or in the home in 8 hours. The charger will automatically shut off when the battery is completely charged. Therefore, The POWER STATION may be charged even when it has only been slightly discharged (unlike Ni-Cads that have memory). The charging circuit uses voltage sensing circuitry. Other brands are timed chargers, which always charge a battery a full cycle. If all that is needed is a partial charge, this damages a battery and shortens the life. The POWER STATION has a voltmeter that indicates the state of charge of the battery, not worthless idiot lights that declare "YOUR BATTERY IS NOW DEAD". The voltmeter can even be used to measure voltages of other sources.

Dealer Inquiries Invited

Send Check or M/O for Model 752 for \$49.95 + \$10.50 s/h. Include UPS-able address and tel. no. to:

**THE HAM CONTACT, P.O. BOX 4025, DEPT. 73**

**Westminster, CA 92684**

**WWW.HAMCONTACT.COM**

CA residents Add 7 3/4% Sales Tax. Canadian Residents Please Send U.S. Money Order & \$24.00 Shipping. If you wish more information please send a SASE with 3 stamps to the above address. E-mail: 73@hamcontact.com

INFO LINE: (714) 901-0573 FAX: (714) 901-0583. ORDERS ONLY (800) 933-HAM4.

SEE REVIEWS NOV '94 CO MAY '94 73



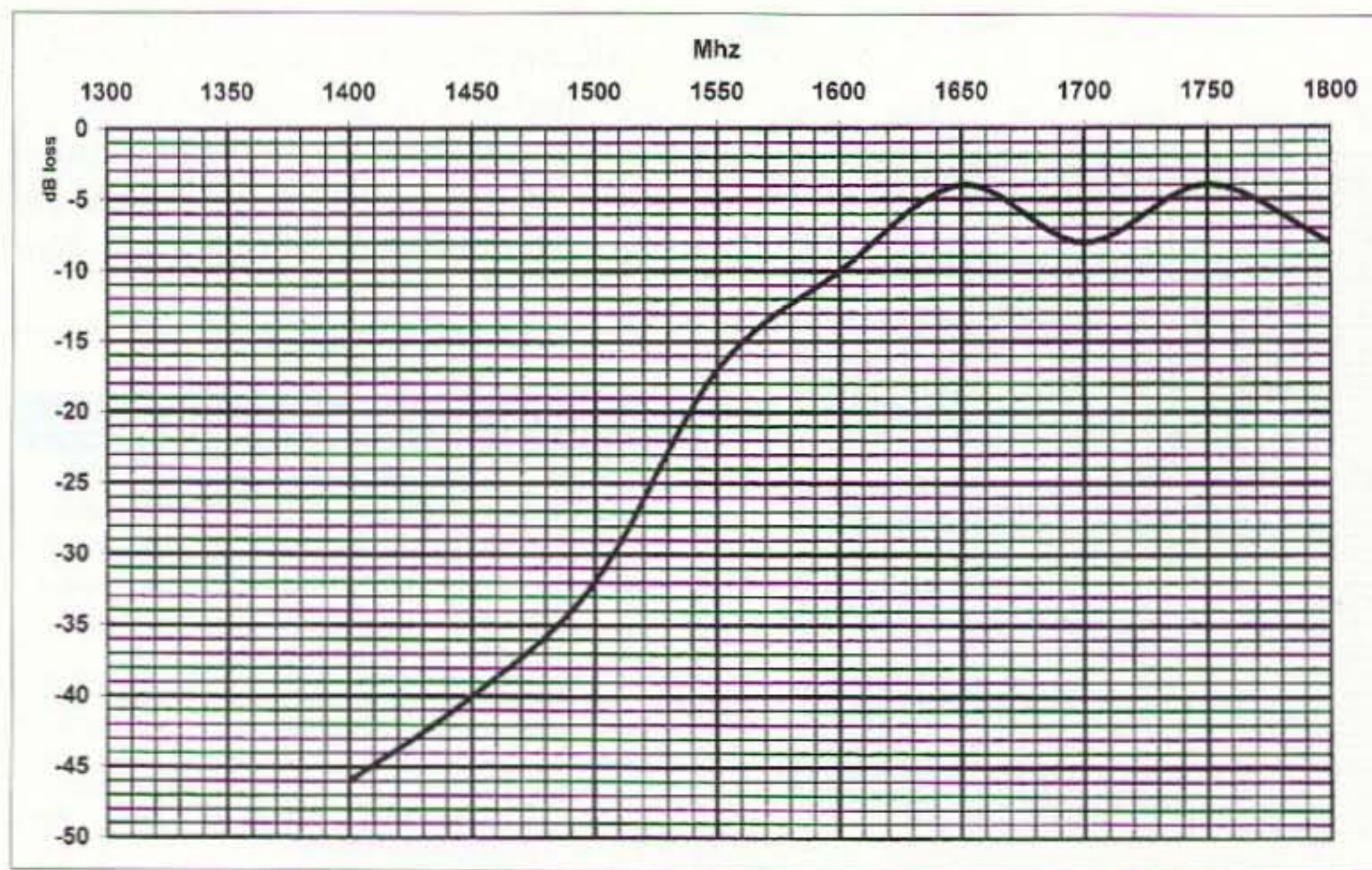

Fig. 8. Frequency response curve of filter 7, 5-pole, .100" spacing, interdigital configuration.

types, and prefer the latter. I use Scotch/3M Super 33+ electrical tape as a resist for the ground plane. Handle the board very carefully when attaching the tape. The track resist on the filter side can come off if you scratch it too hard. I used etchant from Radio Shack that I heated with a 100 watt spotlight held about 6 inches above a small plastic tray. Please *don't* pour the used etchant down the drain! It will eat metal (it ate the copper from your board, right?), so must be discarded properly at a hazardous material handling station.

To ground the one end of each filter element, I drilled a small hole (0.044-inch-diameter), pushed a small wire through, bent the wire over on both sides, and soldered it on both sides. Make sure that you are drilling all holes the same distance from the ungrounded end, or else the lines will be a different physical and electrical length, thus spoiling the shape and performance of the filter.

I don't know how close the end of each element can get to the edge of the board before filter performance starts to suffer. I used a minimum 1/2 inch spacing all around the board.

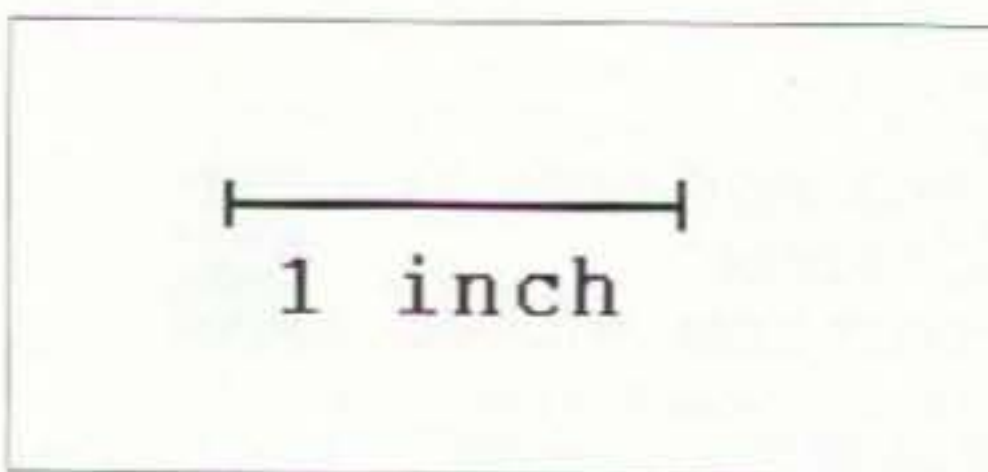

Fig. 9. Printer scaling test pattern.

### Testing the filters

Connect your signal generator to the spectrum analyzer and adjust the level of the generator (if yours is adjustable) until the display reads nearly full scale so you can use the full range of the analyzer. Then insert the filter to be tested in line between the analyzer and generator. Vary the frequency from the lowest to the highest frequency of interest. The lowest should be well below the "image" frequency of your converter if you are building a lowside injection converter.

The range over which you test the filter should include all frequencies you want to reject and pass. In my case, I wanted to pass 1691 MHz and reject 1416 MHz, since 1416 MHz is the "image" of 1691 MHz. The image frequency is two times the IF lower than the frequency you want to receive. [My IF is 137.5 MHz;  $1691 - (2 \times 137.5) = 1416$ .] Plot the frequency vs. level output every 25 MHz (more or less, depending upon what kind of resolution you need on your filter's performance).

Note that the level without the filter in line is the starting level. All the data points with the filter in line are below the starting level (negative dB). The filter ideally would have no loss (0 dB) at the center frequency and lots of loss (-40 dB or more) away from the center frequency. Plot the data points you took using axis scales as shown in Figs. 2-8. The plots shown here were

made using Excel software and data I recorded manually.

The HP generator I used only goes up to 1100 MHz. I needed a filter that operates at 1691 MHz, and I needed to test it well above 1691 MHz. To test above 1100 MHz, I used a POS-2000 VCO from Mini-Circuits (Ref. 6). The VCO costs \$20 (plus handling/shipping) and covers 1300 MHz to 2000 MHz with about 15 milliwatts output power. They make very good, rugged VCOs. They are all 50 ohm output impedance and cover frequencies from 10 MHz to 2000 MHz. Obtain the data sheet that covers the unit you use. They are tuned over the range with a pot as shown in Fig. 10.

You'll also need to design a simple circuit board for this "generator." The VCO's pins are all on 0.100" centers, so the layout is very simple. I recommend getting a copy of their *RF/IF Designers Handbook* and *VCO Designers Handbook*. See Ref. 6. They have extensive and very useful theory and practical design and construction information on various types of microwave components.

I used SMA-type connectors to couple signals in and out of the filters. I bought used ones at a hamfest for \$1 each. New ones cost \$10. They mount on the edge of the board as shown in Photos C and D.

### Summary and other changes

As you can see, I built a lot of filters. By keeping characteristics that helped performance (0.100-inch instead of 5/16" spacing, using an interdigital instead of comb configuration) and discarding ones that hurt performance, I was able to get close to the desired bandwidth and loss.

You will need access to a spectrum analyzer and a VCO at a minimum. If you don't own an analyzer, perhaps a broadcast engineer at a local TV/FM station (hopefully a ham) can let you use theirs. The VCO is adequate for the home experimenter. Of course, a generator is easier to use.

These filters are not made for transmitting applications. I don't know how much power they can handle, since my application was for receiving. I didn't have any equipment to measure SWR,

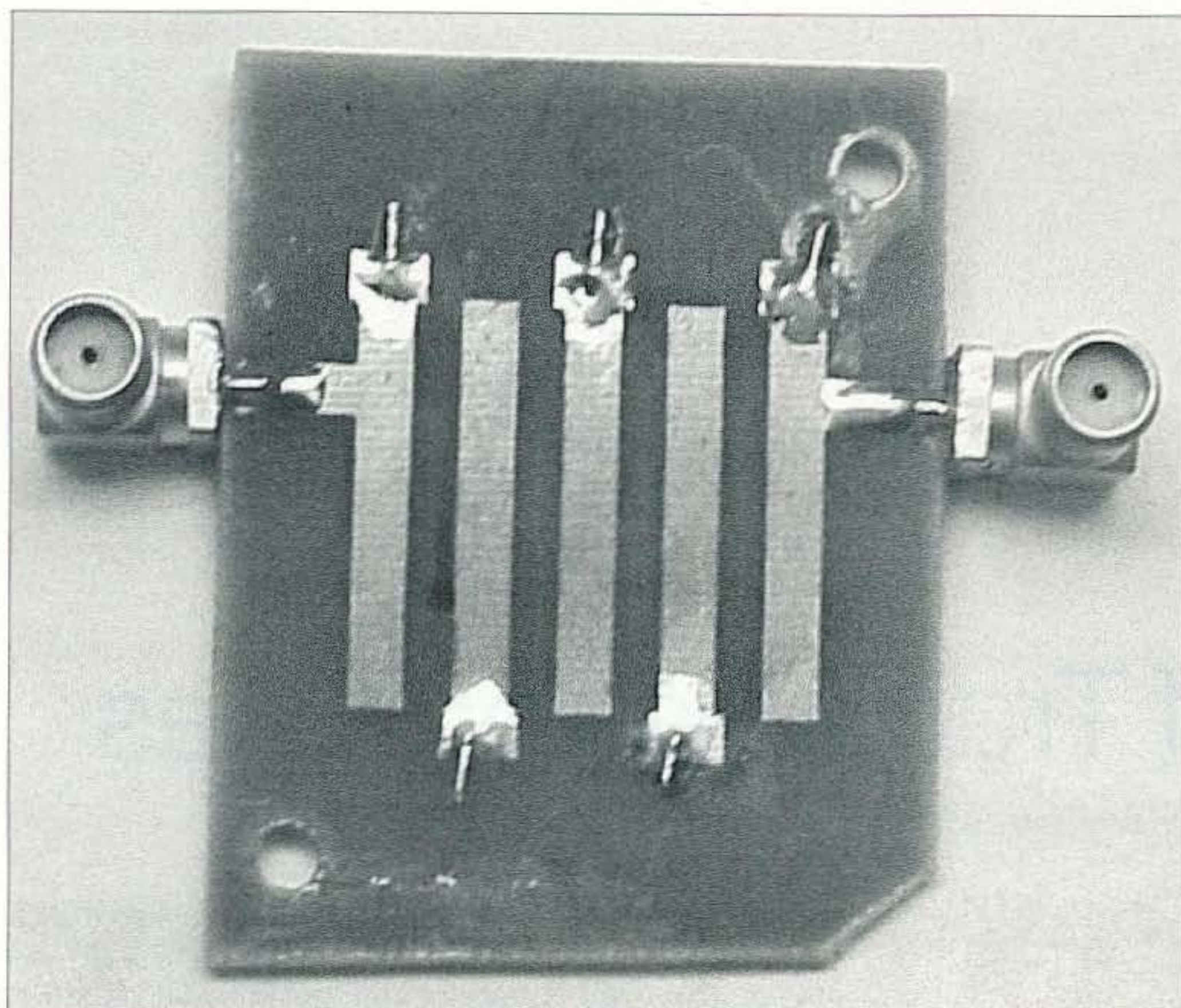

Photo D. Top view of SMA connectors.

so I couldn't determine the input and output impedances. They may be slightly different from 50 ohms and may be reactive (capacitive or inductive).

Tuning capacitors can be added at the ungrounded end of each line in the filter to allow the center frequency and passband to be varied or if you want to tune the filter exactly on the desired frequency. If you want to experiment with this feature, make sure you use high quality piston-type capacitors. Be aware that they are not cheap! I bought some at a hamfest just in case I needed them. They were \$5 each. That's \$25 for a five-element filter! I prefer to make the passband a little wider than I

really need—This ensures that the frequency you want to pass unattenuated will be in the passband. At the higher frequencies (over 1000 MHz), only a few picofarads of capacitance is needed to move the frequency of each line many megahertz. To increase the bandwidth by a large amount, the lines should be stagger tuned (each line is tuned to a different frequency so the overall response is a summation of the individual responses). This requires a tracking sweep generator that allows you to get an instant picture of the filter's response curve. I understand that tracking sweep generators are quite rare, so if you have access to one,

consider yourself very lucky! The alternative is to use your existing setup and plot the results of each tuning adjustment you make. Obviously, this requires infinite patience and good data taking/analysis skills.

The cost of materials is very low. Double-sided 0.062" glass epoxy circuit board is available at larger hamfests. The Press-n-Peel is the most expensive item you'll have to buy. It runs around \$1 for an 8-1/2 x 11 sheet. If you want to be real cheap (okay, conservative!), you can use part of a sheet of the Press-n-Peel taped to a full-sized sheet of regular printer paper. Run a test on regular paper to see where to tape the Press-n-Peel. Put this "carrier" paper in the printer paper bin and print your artwork.

I enjoyed making the filters, analyzing the data, and learning how each variable affected filter performance. If you decide to try the techniques described here, please write me and let me know how you did. I would enjoy hearing from you and am willing to provide help and share all my notes. Please send an SASE (thanks!)—I'll cover all the copying costs.

Many thanks to my wife Yvonne for proofreading the text of this article.

## References

1. *Ham Radio Magazine*, Dec. 1975, pages 46-49.
2. *ARRL Microwave & UHF Experimenters Handbook*, pages 8-31 and 8-32.
3. *RF Design*, Aug. 1995, pages 95-102, "Filter Synthesis & Analysis Program," software listing in article.
4. *RF Design*, Mar. 1989, pages 56-57, "A Parallel-Coupled Resonator Filter Program," software is \$25.
5. Press-n-Peel is available from Techniks, Inc., P.O. Box 463, Ringoes NJ 08851; (908) 788-8249.
6. Mini-Circuits, P.O. Box 350166, Brooklyn NY 11235-0003; (718) 934-4500; [www.minicircuits.com].

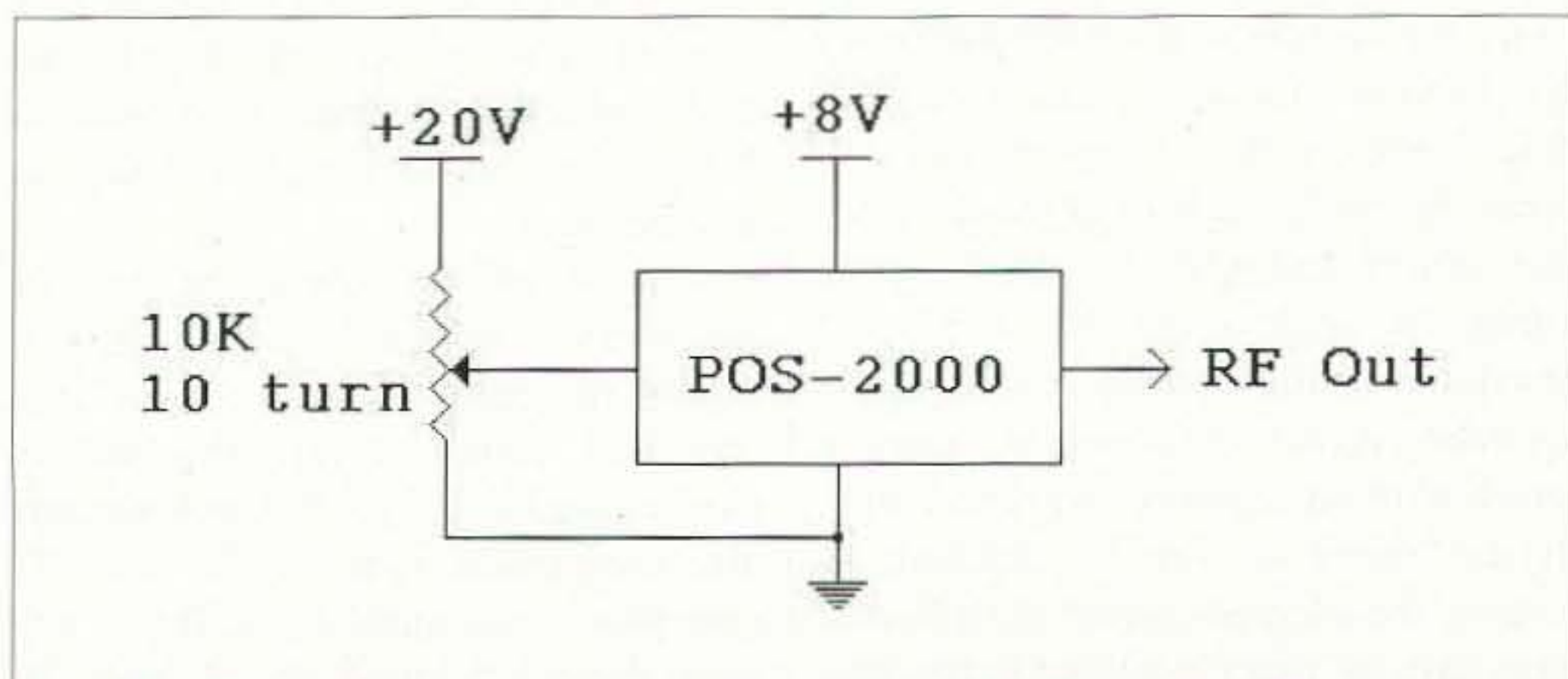

Fig. 10. VCO schematic.

Back Issues  
of  
*73 Magazine*  
Only \$5.00 Each!  
Call 800-274-7373

# Secrets of Transmission Lines

*Part 2: Review of AC fundamentals.*

Jack Kuecken KE2QJ  
2 Round Trail Drive  
Pittsford NY 14534  
[KE2QJ@Juno.com]

The original dynamo was an AC rather than a DC machine. However, alternating current seemed to be significantly less useful than direct current. One cannot charge a battery, conduct electrolysis, or electroplate with alternating current. Arc lights operate poorly on AC and welding is rendered more difficult. Furthermore, the behavior of circuits excited with alternating current was profoundly more difficult for investigators in the early 1800s to understand.

Probably the most puzzling item was the fact that Kirchhoff's Law was not obeyed.

In the circuit similar to Fig. 3 of Part 1 and equation 1-6, the value of  $i$  was not necessarily equal to the sum of  $i_1 + i_2 + \dots + i_n$ ; in fact, it was usually smaller. In a series circuit,  $E$  was not necessarily equal to  $E_1 + E_2 + \dots + E_n$ ; in fact, it was usually smaller, too. In addition, current would seem to flow in circuits where there was no connection. It is not hard to imagine that it would take a considerable amount of investigation to explain this behavior.

In 1820, Hans Christian Oersted found that an electric current flowing in a wire would deflect a compass. In the same year, François Arago found

that a helical coil of copper wire, otherwise nonmagnetic, would behave identically to a bar magnet when an electric current flowed through it. This work attracted the attention of André-Marie Ampère, who showed that there is a physical attraction between wires carrying currents flowing in the same direction and a repulsion between wire carrying currents in opposite directions. This is very easy to prove experimentally. The apparatus of Fig. 1 is easily made from a couple of screw eyes and a length of stiff copper wire. The stronger the current, the farther the bail will swing out.

Note that the battery polarity can be reversed without changing the result, since the current in both the stationary loop and the bail are reversed. A small transformer with a lamp in series to limit the current can be substituted for the battery and will also do the same thing. The angle of the bail will be proportional to the absolute value of the average current. By absolute value we mean without regard to algebraic sign. If the algebraic sign is included, of course, the average current is zero since you have as many positive as negative cycles.

## Electromagnetic induction

In 1829, Joseph Henry wound a layer of insulated wire on a U-shaped iron core and found that it made a very powerful magnet when energized. The illustration in Fig. 2 shows the electromagnet with a significant addition. Henry found that when the switch was closed, there was little or no sparking; however, when the switch was opened, there was a large and vigorous spark—much more energetic than could be obtained from the battery alone. In 1831, Michael Faraday found that a second winding not electrically connected to the first would show an electrical impulse when the battery was first connected and also when the circuit was opened. This is termed electromagnetic induction. A changing current in the primary circuit induces a voltage in the secondary

To duplicate the experiment, it is not necessary to wind a lot of wire, although this could be done using a large iron nail. Small, cheap transformers (for example, 12 V, 300 mA output) are often made with the "E" and "I" core pieces not interleaved. If you pry open the metal frame, the "I" will fall off in one piece. With a single D cell,

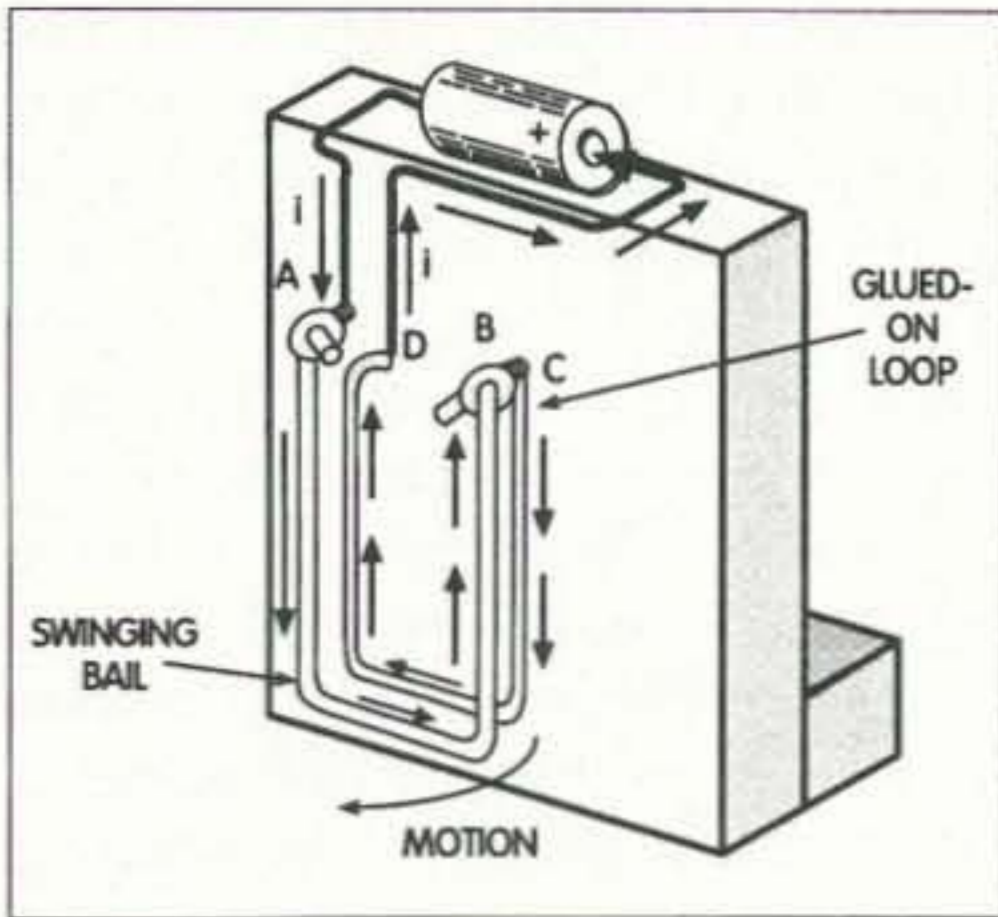

Fig. 1. When the circuit is closed, a "D" cell will drive about an ampere through the circuit and the bail will kick out sharply.

you can investigate the magnet properties and the primary sparking. With an analog voltmeter on the other winding, you can investigate the induction. The analog meter is specified because it shows transient voltages better. You can see how far the needle kicks, whereas a digital meter just flashes digits too fast to follow.

You really do not need a switch. You can open and close the circuit just by touching the wire to the battery. However, if you are holding both sides of the circuit when you break it, you can get a rousing shock even with just the 1.5 volt battery. The spark voltage is many times higher. We will get back to this shortly.

### Capacitance

Another property to be investigated is capacitance. When people were working with static electricity, a standard

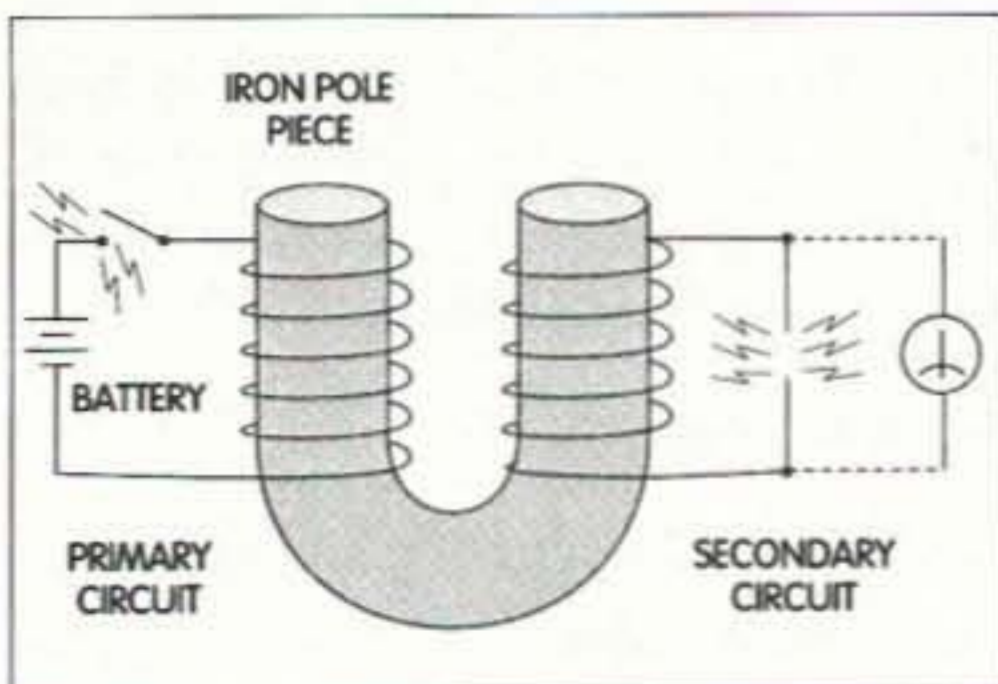

Fig. 2. The electromagnet and electromagnetic induction. When the current is established in the primary circuit, energy is stored in the magnetic field. When the current is interrupted, this energy is dissipated in the form of one or more arcs.

device used was the "condenser" or Leyden jar. The Leyden jar was a glass jar with foil on the outside and the inside with no electrical connection between them. There was usually an insulating cork with a rod sticking through that contacted the inside foil. With an electrostatic generator you could "charge up" the jar—and the spark that ensued when it was discharged was much more vigorous than what could be obtained from the electrostatic generator alone.

As an experiment, take a 9-volt transistor battery, an analog voltmeter with a 10 or 12 volt scale, and an electrolytic capacitor with a 1000 or 2000  $\mu\text{F}$  rating (of course, with a 9 or more volt rating). Touch one of the capacitor leads to the battery, and connect the other to the battery through the voltmeter, observing polarity. The voltmeter will initially jump to a 9 volt reading (it may even overshoot a bit) and then the voltage reading will taper off, eventually winding up at zero. The capacitor is now charged, and its voltage is equal to the battery voltage so the voltmeter reads zero.

Short the capacitor with something, and you will see a substantial spark. If you short the capacitor on a piece of printed circuit board, it may even blow a hole in the foil. Note that shorting the battery itself will not make a visible spark. The capacitor stored energy from the battery over a period of time and released it in a much shorter period—therefore the vigorous spark.

### Stored energy

In both the inductor and the capacitor, the energy is taken up relatively slowly and the spark is evidence of the sudden release of the stored energy. In the inductor, the energy is stored in building the magnetic field. This is a form of kinetic energy and quite analogous to the action of a hammer. You store energy of motion swinging the hammer, and the hammer imparts the energy to a nail in the few milliseconds that it takes for the nail to stop the hammer head. The energy stored in the inductor is:

Continued on page 28

## From MILLIWATTS to KILOWATTS™



### RF PARTS HAS IT!

Complete inventory for servicing Amateur, Marine, and Commercial Communications Equipment.

- Transmitting Tubes & Sockets
- RF Power Transistors
- VHF/UHF RF Power Modules
- Low Noise RF FET's
- Bird Electronics Wattmeters
- Doorknob Capacitors
- Chokes • Broadband Transformers

Se Habla Español • We Export

Visit our Web Site for latest Catalog pricing and Specials:  
<http://www.rfparts.com>

ORDERS ONLY	
1-800-RF-PARTS • 1-800-737-2787	
ORDER LINE • TECH HELP • DELIVERY INFO. 760-744-0700	
FAX 760-744-1943	TOLL-FREE FAX 888-744-1943
E-MAIL: <a href="mailto:rfp@rfparts.com">rfp@rfparts.com</a>	



**RF PARTS**  
435 SOUTH PACIFIC STREET  
SAN MARCOS, CA 92069

**208-852-0830**  
<http://www.rossdist.com>



Check Out Our Specials! We're On The Web.  
Over 8950 HAM Items in Stock. All Prices Cash FOB Preston  
ROSS DISTRIBUTING, 78 S. State Street, Preston, ID 83263  
Hours Tue.-Fri. 9-6 • 9-2 Mondays. Closed Saturday & Sunday

CIRCLE 254 ON READER SERVICE CARD



Keys, Bugs and Paddles from around the world!

- USA: Nye Speed-X
- Japan: Hi-Mound, GHD
- Russia: Key-8
- Spain: Llaves TA
- England: G4ZPY
- Germany: Schurr

Also Kits, Books, Tools and Software!

Morse Express FAX: (303) 745-6792  
3140 S. Peoria St. K-156 Orders: (800) 752-3382  
Aurora, CO 80014 E-mail: [hq@MorseX.com](mailto:hq@MorseX.com)  
(303) 752-3382 Web: [www.MorseX.com](http://www.MorseX.com)

CIRCLE 136 ON READER SERVICE CARD

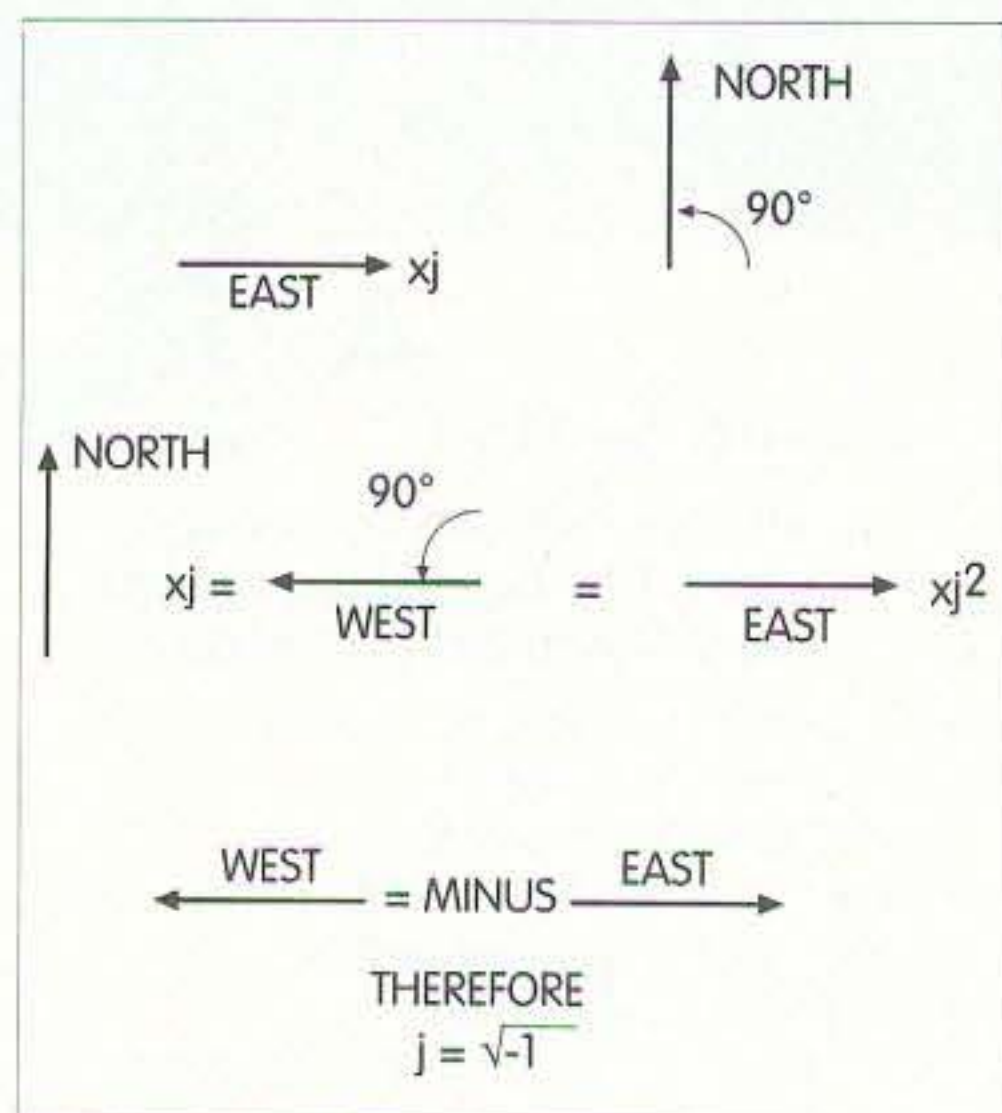

Fig. 3. The imaginary operator "j".

## Secrets of Transmission Lines

continued from page 27

$$W = (L \cdot i^2) / 2 \text{ joules or watt seconds} \quad \text{eqn (2-1)}$$

where

L is inductance in henrys  
i is current in amperes

If the inductance had been large enough and you measured the current when the connection was first made, you would see that the current started at zero and built up slowly. The rate at which the current builds is:

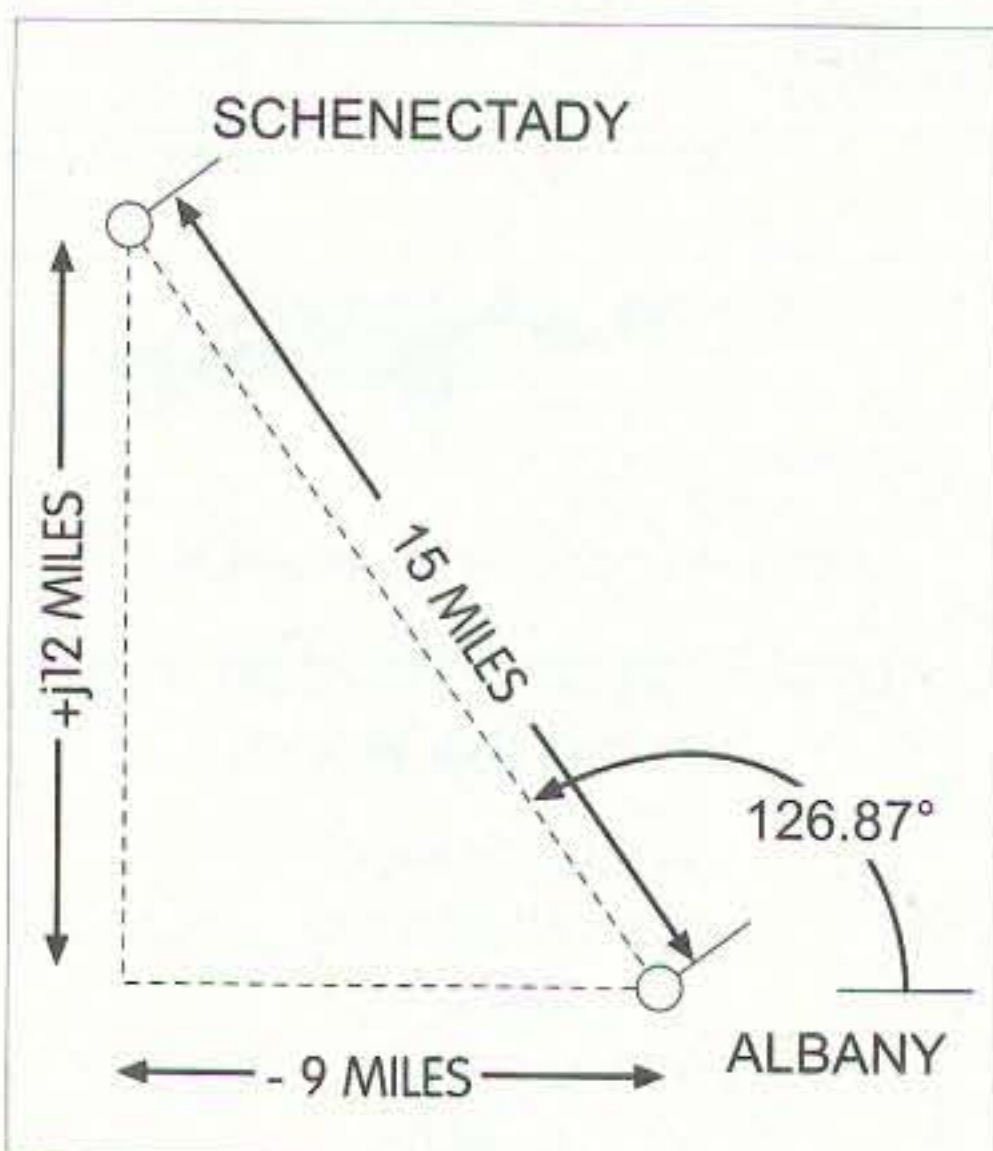

Fig. 4. The vector distance from Albany to Schenectady. If we define the plus direction as east and the +j direction as north, then the minus direction is west and the -j direction is south. The path, or vector distance, is  $-9 + j12$  miles, or  $15/126.87^\circ$  miles.

$$d/d_t = E/L \text{ amperes per second} \quad (2-2)$$

where

E = volts

L is inductance in henrys

On the other hand, the energy stored in the capacitor is potential energy. It is analogous to the energy stored in a spring when it is compressed or stretched. The energy in the capacitor is:

$$W = (C \cdot E^2) / 2 \text{ joules} \quad (2-3)$$

where

C is capacitance in farads

The voltage across the capacitor is given by:

$$E = Q/C \text{ volts} \quad (2-4)$$

where

Q = charge in coulombs

but Q is equal to the integral of  $i \cdot dt$ .

### A little AC math

In order to go through some of the subsequent explanations, it becomes necessary to resort to some vector algebra, which sounds a little more frightening than it actually is. Suppose that you tell the air traffic controller that you are departing at 200 mph. You haven't told him where to find you. At the end of an hour you could be anywhere on a circle of 200 mile radius. However, if you tell him that you are departing at 200 mph on a course of 90 degrees, he will know that at the end of an hour he will find you at a point 200 miles to the east.

The latter is a *vector* quantity. You know where it starts, how fast it is going, and in which direction. Quantities that have no direction—such as dollars, watts, temperature, and population—are called *scalars*.

One of the first things we have to find out about is the "imaginary" operator "j". Suppose that we wish to assign an operator that will rotate a vector 90 degrees in a counterclockwise

direction. Referring to Fig. 3, let us assume that we have a vector one unit long pointing east. If we apply the operator "j" once, the vector is now north. Applying the operator a second time leaves the vector west. But west is equal to minus east. Therefore,  $j \cdot j$  or  $j^2$  is equal to a minus one and  $j = \sqrt{-1}$ —and there is no such number!

Charles Proteus Steinmetz worked in the General Electric laboratories in Schenectady, New York. He was fond of saying that there is nothing more imaginary about imaginary numbers than there was about the distance between Albany and Schenectady.

Referring to Fig. 4, and defining + as east and +j as north, we see that we could describe the distance as  $-9 + j12$  miles.

Further, using the Pythagorean theorem we can compute the straight-line distance as:

$$\text{dist} = \sqrt{[(9 \cdot 9) + (12 \cdot 12)]} = 15 \text{ miles}$$

and

$$\text{angle} = 180 - \arctan(12/9) = 180 - 53.13 = 126.87 \text{ degrees}$$

The first of these descriptions is in rectangular or Cartesian coordinates and the second with a length and an angle is in polar coordinates. When vectors have to be added or subtracted, they are most easily done in rectangular coordinates. Vector multiplication and division are most easily done in polar coordinates.

Another useful relationship is Euler's equation. When we describe a vector such as the one above as 15 miles/126.87 degrees we see that this is really a shorthand way of describing Euler's equation as shown in Fig. 5. Euler's equation is a way of transforming between coordinate systems.

### Back to components

Now let us consider some AC cases. Our instantaneous AC voltage is described as:

$$V = V_0 \cdot \sin(\omega \cdot t) \text{ volts} \quad (2-8)$$

where

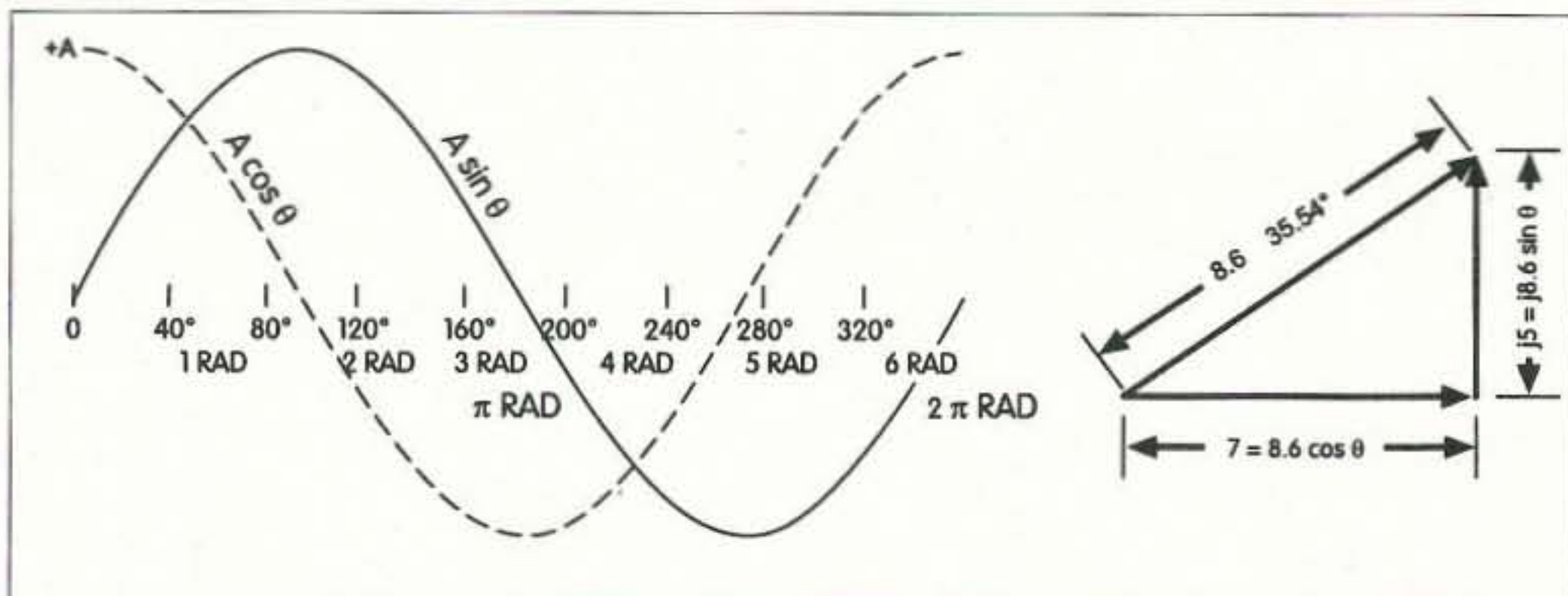

Fig. 5. Euler's equation. The symbol  $e$  represents the natural logarithm base, 2.718. The term  $Ae^{j\theta}$  describes the location of the tip of a vector of length  $A$  rotated through an angle  $\theta$ .

(2-5)  $Ae^{j\theta} = A \cos \theta + jA \sin \theta$   
 (2-6)  $Ae^{-j\theta} = A \cos \theta - jA \sin \theta$   
 (2-7)  $8.6 \angle 35.54^\circ = 8.6e^{j35.4^\circ}$

$V_o$  is the peak AC voltage  
 $\omega$  is angular frequency  $2\pi f$  in radians per second  
 $f$  is cycles per second, or hertz  
 $t$  is time in seconds

Note that we could have written this:

$V = V_o e^{j\omega t}$   
 (2-9)

And for the inductor, we noted in eqn (2-2) that:

$d_i/d_t = E/L$   
 and, rearranging,  
 $V = L(d_i/d_t)$   
 (2-10)

Note here that we have substituted the instantaneous voltage, and from (2-8):

$V_o \sin(\omega t) = L(d_i/d_t)$

and, rearranging,

$d_i = (V_o/L) \sin(\omega t) d_t$

Integrating gives

$i = -[V_o/(\omega L)] \cos(\omega t) + \text{constant}$   
 (2-11)

The constant can be neglected because it pertains to transient conditions and we are concerned only with steady-state conditions here.

Now, from the curves of Fig. 5, we see that:

$-V_o \cos(\omega t) = V_o \sin[(\omega t) - 90]$   
 (2-12)

Thus,

$i = [V_o/(\omega L)] \sin[(\omega t) - 90]$   
 (2-13)

What this tells us is that the inductor current lags the applied voltage by 90 degrees. In most AC problems we are interested in the average results over many cycles, and so we carry the  $(\omega t)$  term implicitly and simply neglect to write it down. Also, we learned that the operator "j" would rotate the vector by 90 degrees. Making use of both of these conventions, we may rewrite (2-13) as:

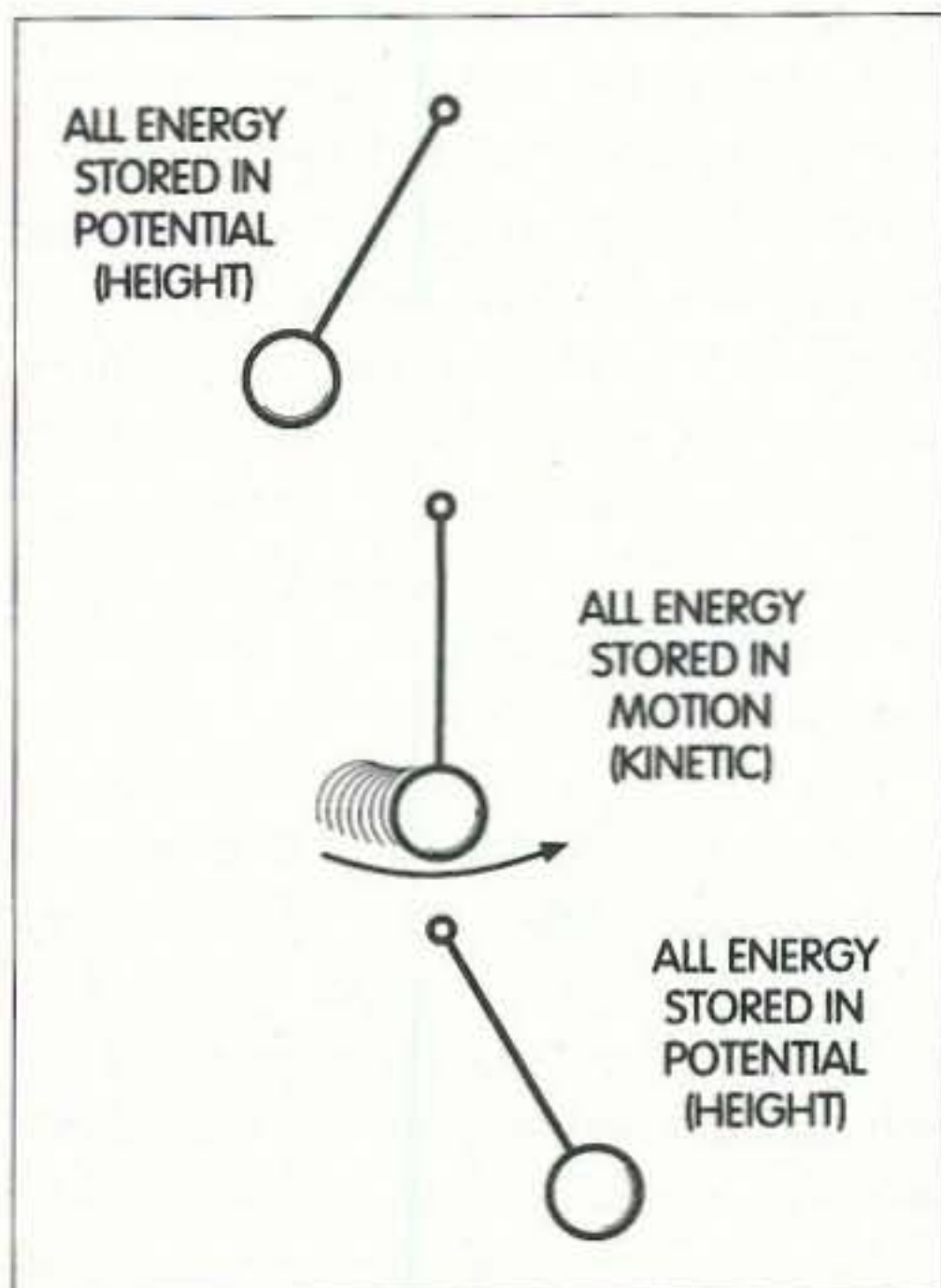

Fig. 6. The pendulum.

Continued on page 36

Pay TV and Satellite Descrambling  
 New ... Year 2000 Edition ... New

Pay TV and Satellite Descrambling 2000 has latest cable and satellite fixes, schematics, bullet blockers, cubes, etc. Pay TV Series Vol. 1-10 (300 pages) \$59.95. Hacking Satellite TV Video \$29.95. Monthly Newsletter Subscription with web access, \$34.95. Everything listed above \$99.95 (choose hard copy or CD-ROM). Find Anyone Anywhere: Using the Internet. Search public and private databases to get information on anyone. \$59.95. Catalog \$1.00.

Scrambling News  
 4798 S. Florida Ave., PMB #108  
 Lakeland, FL 33813-2181  
 941-646-2564. COD's are OK. Add \$6.

CIRCLE 36 ON READER SERVICE CARD

ORDER TODAY!

www.sescom.com

Rack Chassis					
MODEL	W x D x H in.	PRICE	MODEL	W x D x H in.	PRICE
1RU5	19 x 5 x 1.75	38.50	2RU17	19 x 17 x 3.5	70.00
1RU7	19 x 7 x 1.75	41.50	3RU5	19 x 5 x 3.25	52.25
1RU10	19 x 10 x 1.75	44.00	3RU7	19 x 7 x 3.25	57.25
1RU12	19 x 12 x 1.75	57.00	3RU10	19 x 10 x 3.25	65.00
1RU15	19 x 15 x 1.75	62.00	3RU12	19 x 12 x 3.25	70.00
1RU17	19 x 17 x 1.75	67.00	3RU15	19 x 15 x 3.25	75.00
2RU5	19 x 5 x 3.5	41.50	3RU17	19 x 17 x 3.25	80.00
2RU7	19 x 7 x 3.5	44.00	XTRA PANELS P & H		15.00
2RU10	19 x 10 x 3.5	46.75			
2RU12	19 x 12 x 3.5	60.00			
2RU15	19 x 15 x 3.5	65.00			

\$30.00 MINIMUM ORDER INCLUDES FREE SURFACE SHIPPING (U.S., CANADA & MEXICO)  
 FREE CATALOG OF ALUMINUM ENCLOSURES

© SESCO, INC. sescom@sescom.com  
 2100 WARD DR., HENDERSON, NV 89015 USA  
 ORDERS ONLY 800-634-3457  
 Tech Line 702-565-3993 (weekdays 8 am - 4 pm PST)  
 Office 702-565-3400 Fax 702-565-4828  
 FAX TOLL-FREE U.S. and Canada (Mexico dial 95 first) 800-551-2749  
 SESCO, INC. is not responsible for inadvertent typographical errors; prices and specifications subject to change without notice.

CIRCLE 167 ON READER SERVICE CARD

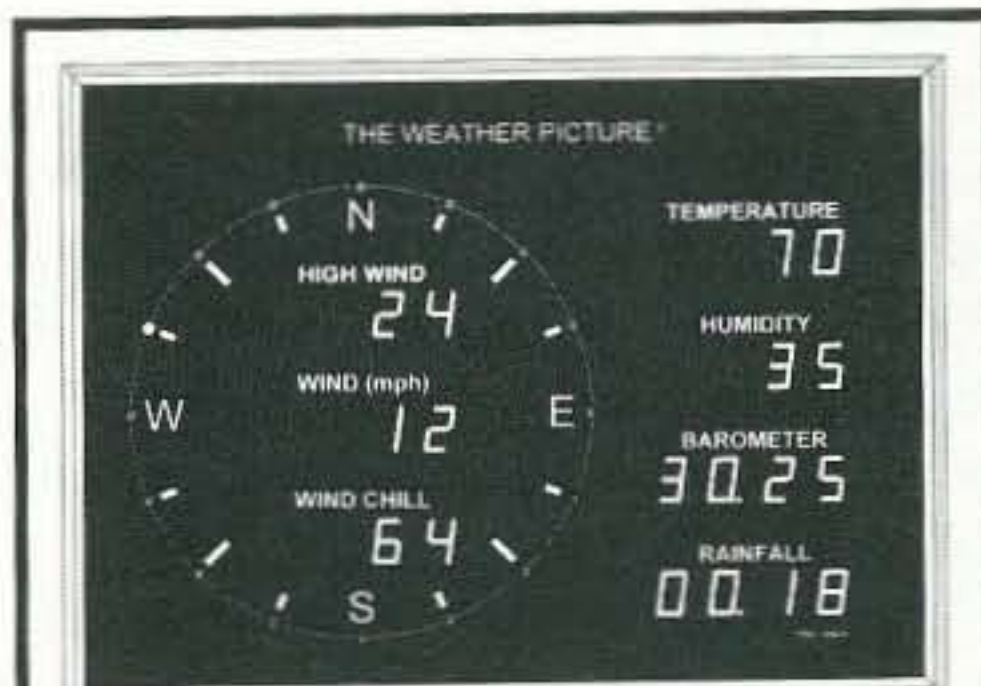

Size shown: 15 1/4" x 11 1/4"

Put the weather on your wall

The Weather Picture™ is an eye-popping new wall unit that continuously displays all the vital weather data you've pre-selected. Big red numerals are easy to read from across the room, day or night.

Available in 2 sizes, in an elegant brushed aluminum or solid teak frame. Teamed with our famous ULTIMETER® Weather Station, The Weather Picture System provides plenty of data to satisfy the most dedicated weather buff.

For complete details, write or call us TOLL-FREE at 1-800-USA-PEET.

Wireless display now available!

Visit our Web Site to see and actually try our Weather Stations:  
[www.peetbros.com](http://www.peetbros.com)

PEET BROS COMPANY

1308-9097 Doris Ave., Ocean, NJ 07712  
 Our 23rd year ©1999 Peet Bros.

# Getting Your Foot in the Public Service Door

*Here's how to get your club involved — and appreciated.*

Charles M. Seay, Sr. KN4HL  
106 South Main Street  
Dickson TN 37055

The January 1999 issue of *Law & Order* magazine contained an article describing the benefits to local police departments of operations with amateur radio clubs and their members. The circulation of this magazine is about 38,000, mainly to police chiefs and supervisors. January is dedicated to communications subjects, and amateurs are definitely communicators.

Yes, amateur radio operators are communicators. In fact, it's our specialty. Now is the time for local amateurs and amateur clubs to approach local police departments and other supervisory personnel about joint operations for special occasions. The occasion can be a parade, a school function such as a basketball or football game, or a county fair. Anywhere large crowds gather offers an opportunity for amateur radio operators to show local police departments how they can help conserve manpower. Police chiefs are interested in conserving manpower because it directly affects their department's budget.

During special events such as Halloween, parades, or school functions, all police departments are short-handed. Any free help will be gratefully accepted.

The hardest part is getting your first assignment. Police departments are political in nature and guard their turf vigorously. Explain to your local chief just what you or your club can do for their department. During school events, police officers are usually assigned to the activity. Those officers can't be everywhere. How many times have you heard of someone's car being broken into while the owner was in the gym watching the basketball game? It happens.

Just remember one thing. You are not police officers and have no police powers. You are communicators. Your group can patrol the parking areas to discourage anyone from breaking into parked vehicles. This activity not only provides a more secure area, but also frees up officers for more important duties such as answering emergency calls.

Designate one club member to be your local dispatcher with access to the communications center of the police department. Your group uses amateur frequencies to report any suspicious activity and the investigation is assigned to a uniformed officer. You've done your job. You've reported

what you have observed and you haven't tied up police frequencies that are probably monitored by the vandals and crooks.

After one or two successful joint operations, it will be a snap to expand your service into other areas of public safety.

Local emergency management agencies need people trained in communications when disasters strike. It might be the devastation of a flood, a tornado, or a toxic spill. Emergency management agencies need manpower to access damage reports or to notify people in areas of danger during a toxic spill. Amateur radio operators can provide a valuable service to these agencies, thereby freeing up police officers and other emergency personnel for more important jobs in protecting lives and property.

The jobs are out there. It is our job to cultivate the opportunities that present themselves. It takes time. Management personnel need to meet your club members. They must convince themselves that you and your club members are responsible and can handle the job.

As your club gains the confidence of your local agencies, other agencies



will be easier to approach with your ideas. You can use local department heads and supervisors as references. Once a local department has used your club for activities, other department heads will be more acceptable to joint ventures.

I must stress the importance of inviting your local chief or department head to your club meeting. Good relations with local government officials are your club's responsibility. Ask the chief to speak to your club members. He will be the key to a successful joint operation.

After an operation has been agreed upon, you must do what the chief or department head wants done in a professional manner—and no more. The one thing that chiefs fear is that a club member will get hurt, or show the department in a bad light. This kind of activity can devastate your club's relationship with a department. It will guarantee that you will not be asked to perform any other public services. In these kinds of operations, one bad apple spoils the rest.

Ask the chief, department head, or supervisor to provide training to club members before your planned activity. It will provide your club members valuable insight as to how that department wants the operations conducted and the department will be better satisfied that club members can handle the job.

After the operation, make sure you meet with the department head or chief to see if anything was done wrong. It will let the chief know that your club members are really trying to satisfy the requirements of the department.

Amateur radio operations in the name of public service to your local community are a bedrock of what our hobby is all about. It is the "service" in Amateur Radio Service. With more and more demand being placed upon our frequency spectrum, we *must* show that we as license holders are providing a valuable service to our local communities. This is one way of proving our worth.

Many amateur radio operators are

also trained weather spotters for the United States Weather Service. Even Doppler radar cannot see what the human eyeball sees. They provide information to meteorologists when conditions are present for the formation of severe weather. Weather spotters help make it possible for the weather service to issue warnings to people in the affected areas.

For the past several years, our local amateur radio club has participated with the local police department at Halloween. On many Halloween nights, our club members have driven around the city with very little to report. In the past we have reported fires, drivers driving in an erratic manner, and acts of vandalism. On those nights where there was very little to report, you must keep in mind that someone might be watching you and you may have kept them from doing something they might regret. The service club members provide may be twofold: observation

*Continued on page 37*



**Michigan Radio**  
SALES SERVICE

Local & Tech 1-810-771-4711, Service 1-810-771-4712, Fax Service 1-810-771-6546

**WE SHIP WORLDWIDE**

OPEN  
TUES, WED, THUR 10-6  
FRI 11-8  
SAT 10-3  
CLOSED SUN & MON



Terms do not include shipping. Price and availability subject to change without notice. Most orders shipped same day. COD's welcome (\$5.50 & shipping).

26014 Groesbeck, Warren, MI 48089  
**1-800-TRU-HAMM** (orders only)  
(800-878-4266)

Now on the World Wide Web

<http://michiganradio.com>

E-mail [mirad@mich.com](mailto:mirad@mich.com)



**KENWOOD**



**ICOM**



**YAESU**

Convert Excess Equipment to CASH • We buy good, clean, used equipment • Estate Sales

# Simple RF Signal Generator

*Add this handy piece of test gear to your bench.*

J. Frank Brumbaugh W4LJD  
P.O. Box 30 - c/o Defendini  
Salinas PR 00751-0030

A good RF signal generator covering from below the 160 meter band to above the 10 meter band with no skips in coverage is a very handy piece of test equipment for the service bench in the shack. Top quality, very well shielded signal generators can cost upward of \$1,000, but such extremes are not needed in the usual ham shack.

There are a number of commercial signal generators that are quite adequate but start at around \$150. That is too much money, especially when you can easily build a signal generator that is as good or better for no more than \$10 or \$15 in parts, not including the air dielectric tuning capacitor and enclosure. However, you can build from pieces of unetched printed circuit board a better shielded enclosure than you can buy, and you can do it for pennies.

The signal generator described here is at least as useful as a \$150 commercial model, yet it is very simple, easy to construct, and (best of all) requires very few common parts. The only difficult (read: expensive) component needed is the air dielectric tuning capacitor. As this is being written, many sizes are available from: Dan's Small

Parts and Kits, P.O. Box 3634, Missoula MT 59806.

I designed this signal generator to use a 150 pF tuning capacitor. Danny lists one at \$7.50. However, if you can find a 365 pF tuning capacitor from an old tube radio or at the bottom of some ham's junk box, it can be used in series with a 330 pF NPO disc capacitor in place of the specified 150 pF capacitor. Other combinations of variable and fixed series capacitors will also work. Or, you could tailor the four toroid inductances to cover the desired frequency ranges with whatever tuning capacitor you have available.

This signal generator (see **Figs. 1 and 2**) uses a Franklin oscillator at its heart. Although this oscillator requires two FETs, it is not only foolproof—it *has* to oscillate—but it is also the most stable wide range oscillator I have ever found.

Further, the Franklin oscillator uses no tapped coils, no capacitive voltage dividers, and no special parts. The parallel tank circuit is grounded, making band-switching simple, and the four toroid inductances are switched in individually to provide full coverage with overlaps between bands. There

are only four resistors, four capacitors, and two diodes needed to complete this two-FET oscillator, in addition to the tank circuit.

The oscillator is followed by an FET source follower for buffering, which drives an NPN bipolar broadband amplifier. This, in turn, feeds amplified RF through an impedance matching transformer and a -6 dB 50 ohm attenuator, providing RF at 50 ohms impedance, either direct or through a built-in switched attenuator, to a BNC output connector on the panel.

**Fig. 2** illustrates the attenuator. RF from the -6 dB attenuator, which terminates the active circuits, is fed through RG-174/U coax to one wiper of a dual wafer switch having at least seven positions. Attenuator resistors are wired onto the two wafers to provide from zero to -30 dB attenuation of the RF available from the signal generator. In addition, position 7 on this switch provides only a 51 ohm shielded resistance, which is applied across the receiver antenna connector when measuring internal receiver noise. This is not normally a part of a signal generator and is therefore optional. It is provided so a shielded 51 ohm

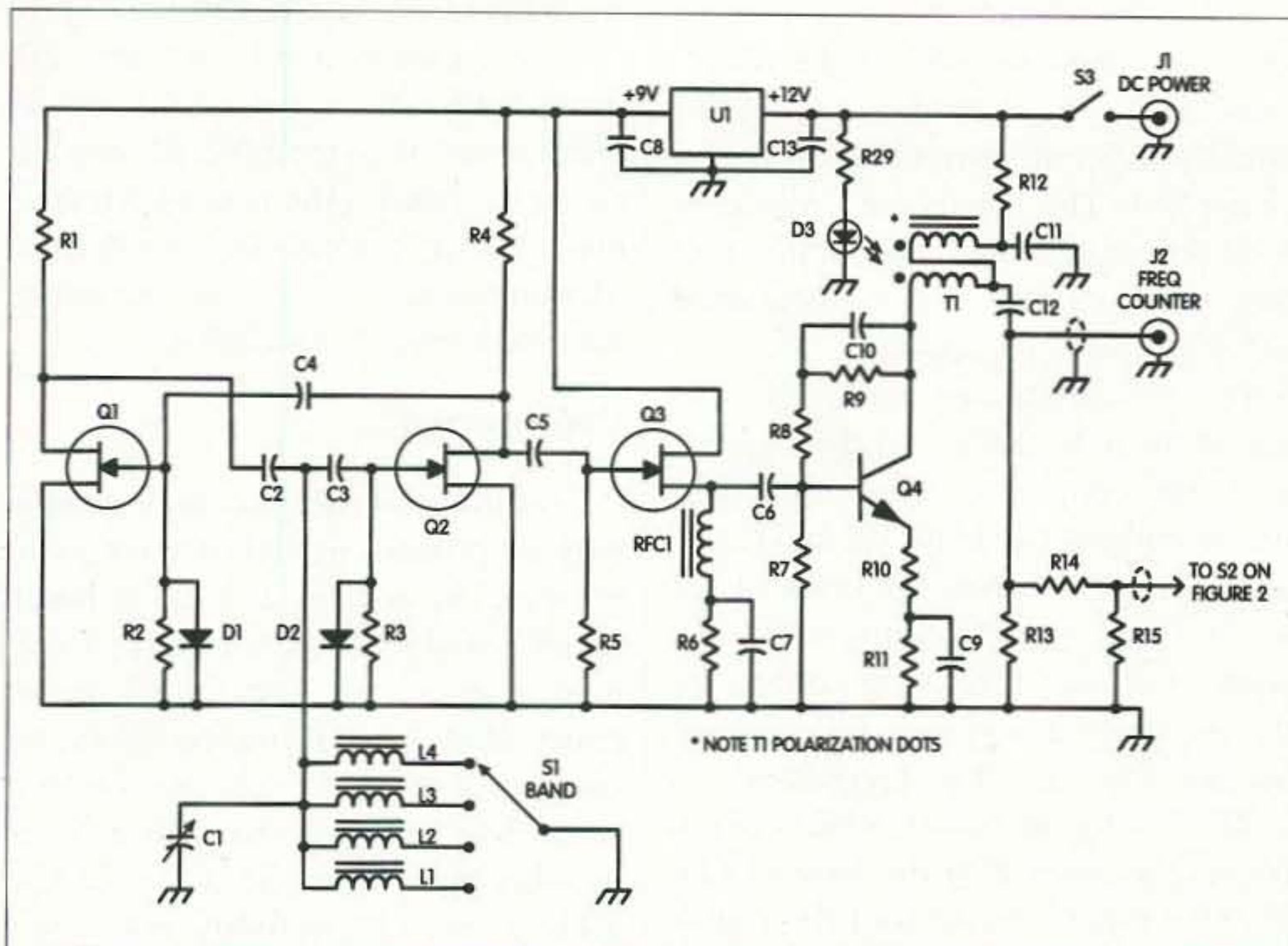

Fig. 1. Schematic diagram.

termination will be readily available whenever needed.

The wafer switch I used for the attenuator does not have a grounded shield between wafers, which would have been preferable. Because of this, there is bound to be some leakage between wafers that will affect the actual attenuation level. Still, it does provide different levels of attenuation and maintains the RF output at 50 ohms impedance.

### Specifications

Power supply: 12 to 15 VDC. At 13.8 VDC, current drain is 42 mA.

Frequency range: 1.6 to 32 MHz in four bands, as follows: band A, 1.6 to

3.43 MHz; band B, 3.4 to 7.4 MHz; band C, 7.3 to 17 MHz; and band D, 15.5 to 32 MHz.

RF output: At 50 ohms impedance, output is remarkably level. Band A: low end 1.47 Vp-p. At high end, 1.7 Vp-p. Band B: At low end, 1.98 Vp-p. At high end, 2 Vp-p. Band C: At low end, 2 Vp-p. At high end, 2.6 Vp-p. Band D: At low end, 2.8 Vp-p. At high end, 2.26 Vp-p. Note: These levels were measured as RMS voltages and calculated for peak-to-peak equivalents.

Attenuator (decibels): 0, -3, -6, -10, -20, -30.

Stability: Worst case measured at 30 MHz from a cold start, ambient temperature 82° F. Frequencies were measured at ten-minute intervals to an

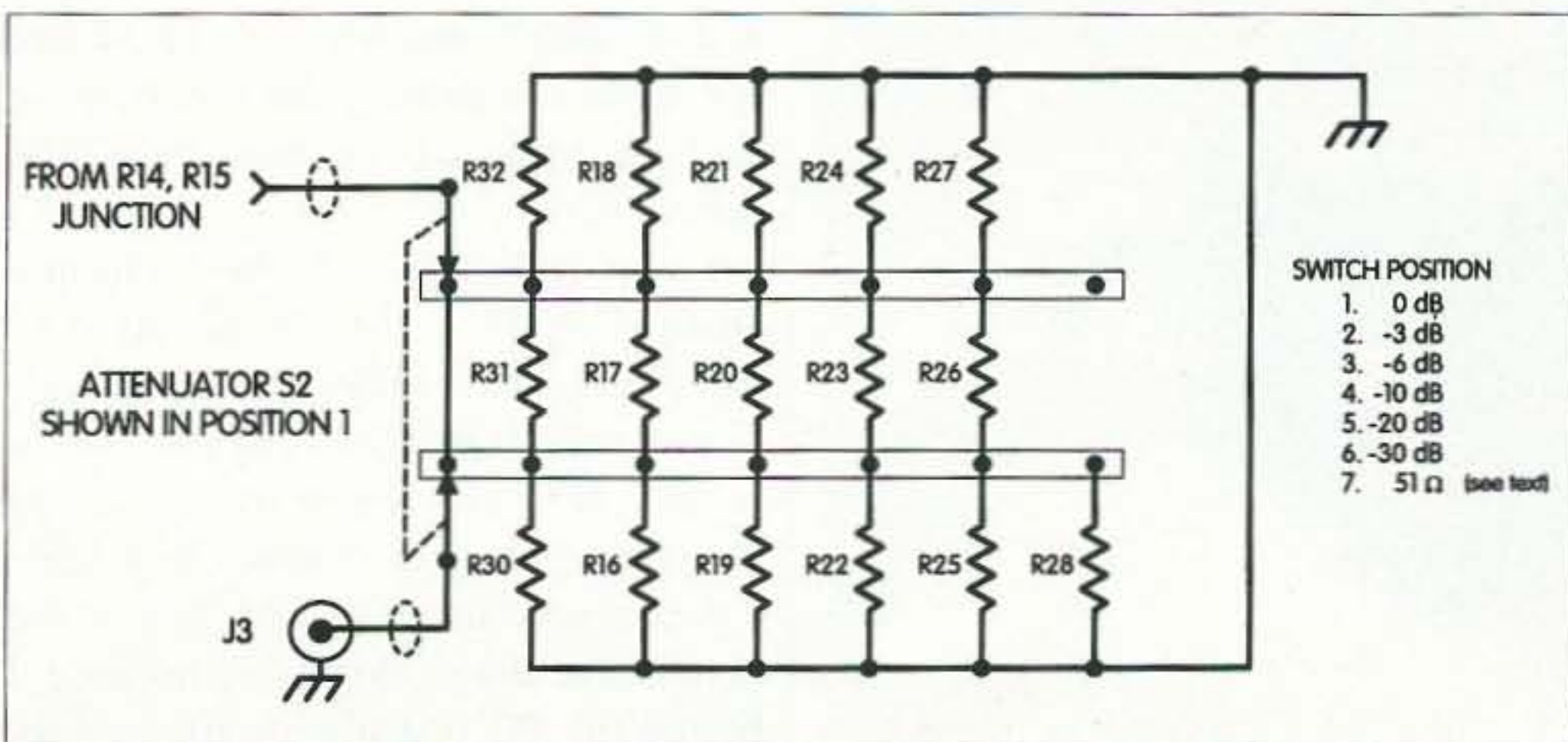

Fig. 2. Schematic diagram of step attenuator.

## INSURANCE

for

## AMATEURS

Insure all your radio and computer equipment.  
(except towers and antenna)  
**REPEATERS ARE WELCOME**

HAMSURE

E-Mail: [tom@hamsure.com](mailto:tom@hamsure.com)  
[www.hamsure.com](http://www.hamsure.com)

Toll Free **800-988-7702**  
Call anytime

Available only in 48 contiguous US states

CIRCLE 78 ON READER SERVICE CARD

PO Box 2748  
Eugene, Oregon 97402  
(800) 338-9058

DTMF: Decoder/Encoder, Display & ASCII Conversion  
Transmitter FingerPrinter & Mobile Adaptor  
Remote Relay Controllers & Relay Boards  
Custom OEM Design & Manufacturing  
Tel: (541) 687-2118 Fax: (541) 687-2492  
[Http://www.motron.com/](http://www.motron.com/)

CIRCLE 248 ON READER SERVICE CARD

CAPTURE IMAGES LIKE THIS DIRECTLY FROM SPACE ON YOUR PC!

- Internal Systems and Portable, External (Parallel Port) Systems Available for IBM Compatibles.
- Capture Full Satellite Resolution (2-3 Miles with NOAA Satellites!) with Either System.
- Professional Software with "Point and Click" User Interface, Mouse Support, Satellite Tracking, Zoom, GIF and Binary Output, False Colorization, Printer Support, Griding, IR Temperature Calibration, Animation, **Much More...**
- PLL Circuitry Automatically Provides Ruler Straight Images. No Complicated Timing Settings Required.
- Simple Antenna Used for NOAA and Meteor Satellites. **NO Dish Required.**
- SVGA to 1024x768x256.
- Receive High Resolution Images from NOAA, Meteor (Russia), GOES, and Meteor Satellites, and HF Fax.
- Receivers, Antennas, Downconverters, and Feedhorns also Available Separately or in Complete Systems.
- Internal Demodulator with Software only \$289. Multi-FAX Programmable Satellite Receiver. Just \$249!
- Call, Write, or Fax for Complete Information. Download the above and dozens of other images (as well as software and current orbital elements) from our web site at [www.multi-fax.com](http://www.multi-fax.com)

**MultiFAX**® 30 Steele Road  
Victor, NY 14564  
Voice: 716-425-8759(BBS after 5PM) Fax: 716-223-6198

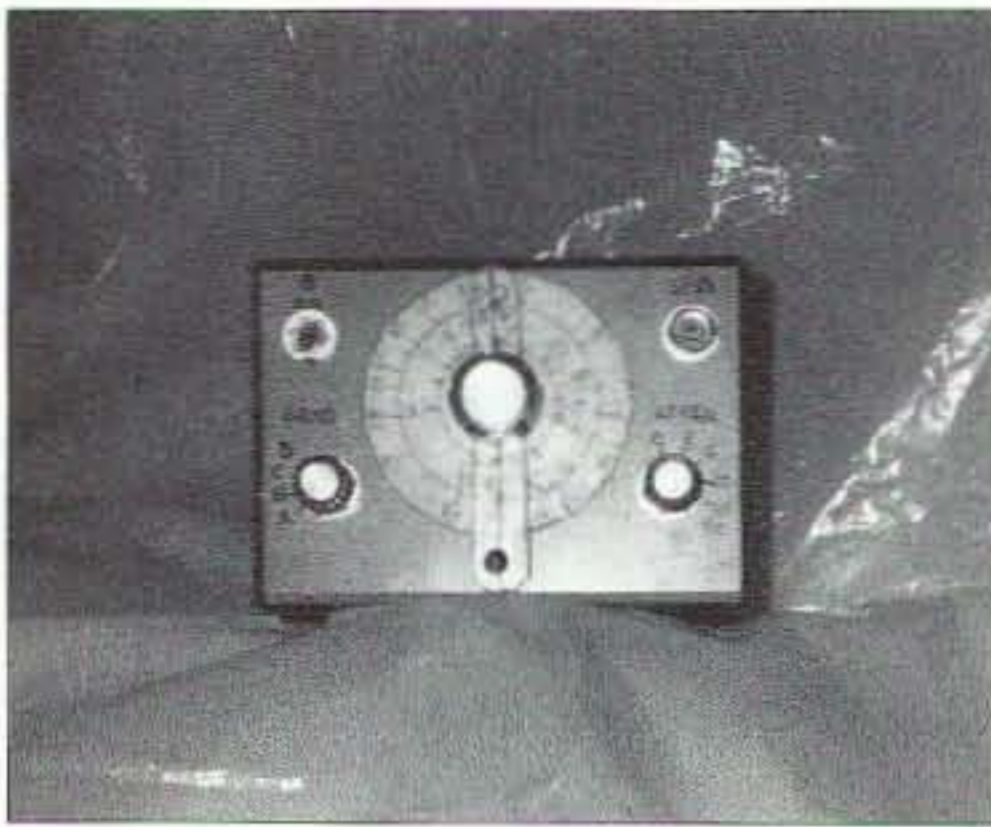

Photo A. Front panel view.

accuracy of  $\pm 100$  Hz and rounded off to the nearest kHz. After 30 minutes, the frequency had drifted down 72 kHz, or less than one quarter of one percent.

Stability is a result not only of the Franklin oscillator but also because of the very small amount of heat generated by the circuit. With 42 mA at 13.8 VDC, 0.58 watts of heat is generated, so once the signal generator has warmed up, there will be very little heat-induced drift. Aiding in thermal stability is the thermal inertia of the relatively large tuning capacitor, and the fairly large toroid cores in inductances L1 through L4. Because C1 and any one of the inductances are the only frequency determining components, only they can be affected by the small amount of heat generated by transistors and resistors.

### How it works

Q1 and Q2 are asymmetrically cross-connected in a way similar to an

astable multivibrator. Because of tolerances in resistors and slight differences in the FETs, the latter will draw slightly different current when power is applied. The capacitive cross-connections ensure that oscillation will begin immediately and be maintained as long as power is applied.

The parallel tuning tank, C1, and one of the inductances, L1 through L4, is lightly coupled to the oscillator at the junction of capacitor C2 and C3.

RF is coupled from the drain of Q2 to the gate of Q3, configured as a source follower. Operating voltage for the oscillator and source follower are provided by U1, a 9 volt regulator.

RF developed across RFC1 is capacitively coupled to the base of Q4, an NPN bipolar broadband RF amplifier essentially flat over the range of the signal generator and beyond. Negative feedback and emitter degeneration are incorporated to provide broadband amplification. The output impedance of Q4 is approximately 200 ohms. T1, a 4:1 impedance matching transformer, injects RF at about 50 ohms impedance to a -6 dB attenuator to provide a stable and solid 50 ohm RF output.

RF from the -6 dB attenuator is directed through RG-174/U coax to a connector on the rear of the enclosure for use in monitoring exact output frequency. Another short length of RG-174/U coax takes RF from the -6 dB attenuator to one wiper of a wafer on the attenuator switch. See Fig. 2. This switch selects from 0 dB (the output

from the -6 dB internal attenuator) to -30 dB in steps at -3, -6, -10, -20, or -30 dB. The wiper of the second wafer connects to the BNC RF connector on the panel. (The next switch position, number 7, selects only the shielded 51 ohm resistive termination for measuring receiver noise, if included.)

### Construction

I recommend using a small general purpose printed circuit board for greatest ease in wiring. I used a Radio Shack 276-150 PC board that provides more than enough room for all the circuitry as well as all four toroid inductances. Of course, you can build it "dead bug"-style if you wish. Just remember that frequencies as high as 30 MHz are present, so follow good engineering practice with short leads, and use the types of components specified in the parts list. When the inductances are trimmed to cover the exact ranges desired and wired into the circuit, use a non-acid containing "goop" or beeswax to secure them to the PC board so that they will not shift or break the fine wire used to wind them.

I used a 365 pF tuning capacitor from my junk box (the last one), with a 300 pF NPO capacitor in series with it for tuning. This method, while providing the desired capacitive range, tends to compress the high frequency ends of the dial. I bent up a bracket to mount the capacitor and added a Jackson Brothers vernier salvaged from an ancient Eico sweep generator. I used a circular dial plate left over from cutting a meter hole in another project, with white card stock adhered to one side, and arcs drawn and calibration added after construction. (These are not stipulated in the parts list, because each instrument is going to be a little different.)

I used a Ten-Tec TG-34 enclosure, about 4" x 4" x 3" high, for my own signal generator, although a case made of unetched printed circuit boards would allow discretion in the size of the panel (which determines how large a dial can be used) as well as provide better shielding. However, because I bolted my PC board with all circuitry on the left end of my tuning capacitor,

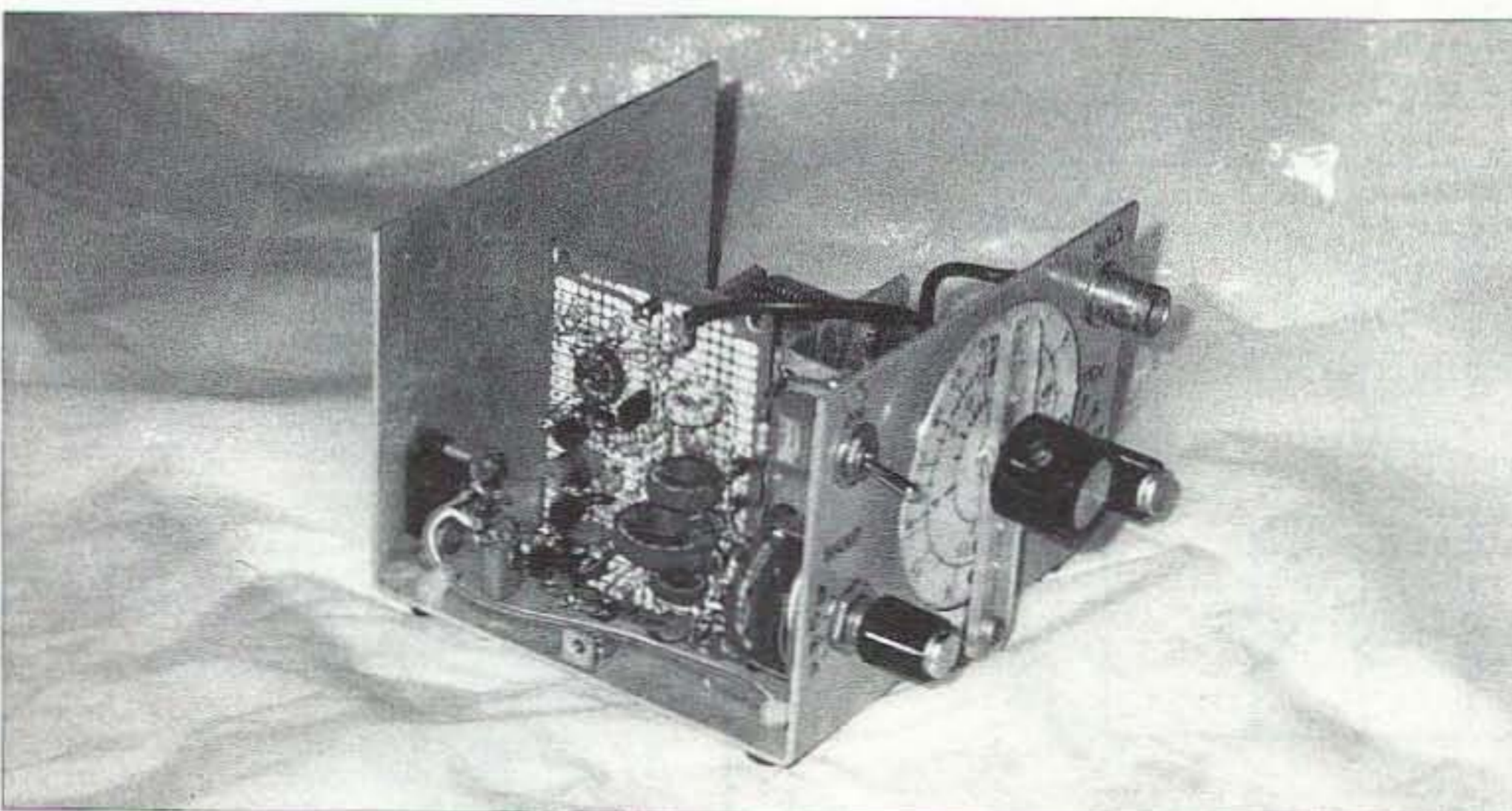

Photo B. Left side view. Entire circuitry is on small PC board, with band switch forward.

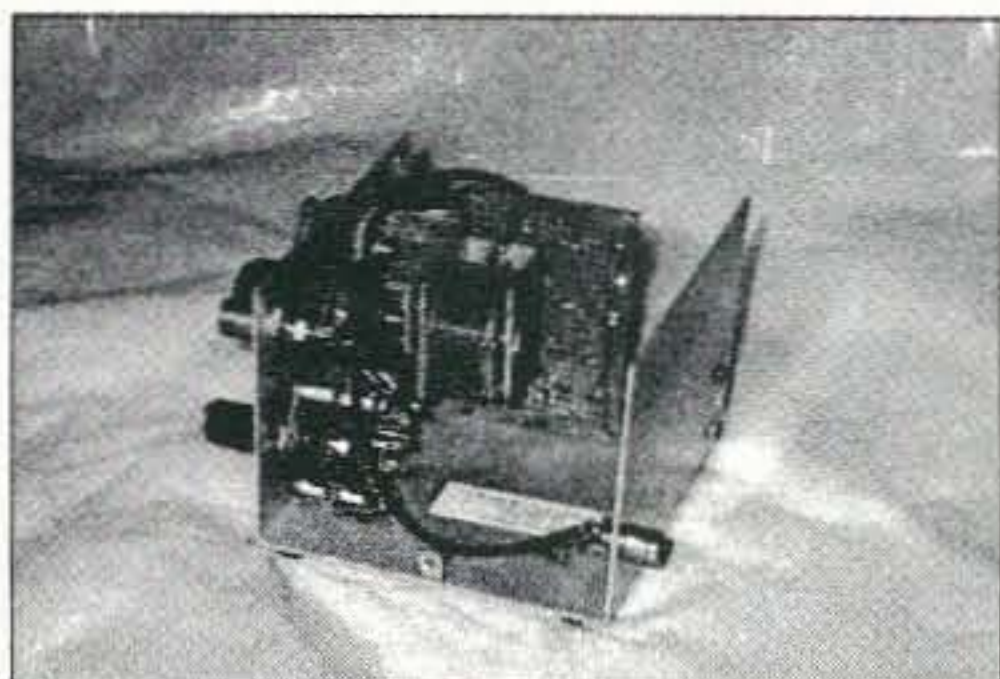

Photo C. Right side view showing attenuator switch and frequency counter connector.

and the inductances are all on toroidal forms, there is a little stray RF inside my enclosure. Probably only the stator of the tuning capacitor could be a source of stray RF in the enclosure, so I expect it is at least as well shielded as a \$150 commercial generator, and probably a bit better, especially considering the low level of RF being generated.

Because of tolerances—no two toroid cores of the same type are identical, and no two tuning capacitors rated identically are ever quite the same—the winding data given for L1 through L4 are what worked for me with my specific cores and particular tuning capacitor and series capacitor. Because your parts will be somewhat different, you may have to adjust the number of turns on each tuning inductance to get the proper frequency coverage and adequate overlap between bands.

I suggest using the winding data given, but adding a few turns before checking the frequency range of each band. Thus, I suggest you start with L1 on Band A, getting the low frequency limit a bit below 1.8 MHz, the low end of 160 meters, and then check the high frequency end. This becomes the frequency a bit higher than what you will set the low frequency end of L2 at to provide overlap. Continue in this manner with L3 and L4. Your actual bands will, no doubt, be somewhat different from mine, but as long as you can generate RF from less than 160 meters to more than 10 meters with no skips between bands, you will have a stable and very useful instrument.

#### General comments

In the parts list, resistors R13 through R27 and R30 through R32 are

first listed with the standard 1% resistance values for the attenuator, and then followed by a suggested 5% 1/4 watt resistor. Actually, little will be lost in an instrument this simple if you use the nearest 5% resistors in these locations.

However, for the purists out there, it is possible to make resistors of the exact values by carefully filing the bodies of lower value resistors while monitoring the value of resistance with an ohmmeter. To exclude dampness from the filed portions of resistors, apply some Q-Dope®, clear fingernail polish, or a product called “Hard As Nails” (used to overcoat nail polish). When all toroids are checked and cover the desired frequencies, use one of these products to coat them and hold the winding in place as well as to keep out moisture.

Q1 and Q2 *must* be the same type, and it is probably preferable that the same type be used for Q3. I used J309s, but 2N4416 or J308 should work as well. The 2N4400 I used for Q4 can be just about any small signal NPN transistor as long as the  $F_t$  is at least 300 MHz (and preferably higher).

*Do not* change the values or types of C2, C3, C4, C5, and C6, although if you cannot locate 18 pF NPO capacitors for C2 and C3, you can substitute 15 pF or 22 pF. However, both capacitors must be marked with the same value and be NPO. If you don't have an FT37-43 ferrite toroid for T1, you can use an FT50-43 with no change in windings.

Where a 0.1  $\mu$ F capacitor is shown in Fig. 1 in parallel with a resistor, use a monolithic capacitor, axial if possible, and solder it across the resistor before adding them to the circuit.

For most casual use around the shack, it will not be necessary to use the built-in attenuator. You can just wire a potentiometer between the junction of R14 and R15 to ground and connect the wiper to the BNC RF output connector on the panel. Adjusting the pot will change the RF level, but the impedance will no longer be 50 ohms. Or, if you have constructed the switched attenuator described in the *ARRL Hand-*

Continued on page 36

## Repeaters

On your freq tuned, plug & play  
6m, 2m & 440.. \$399.95 & \$499.95

### Repeater Controllers

RC-1000V .....\$259.95

### Micro Computer Concepts

8849 Gum Tree Ave

New Port Richey, FL 34653

727-376-6575 10 AM - 10 PM

e-mail: n9ee@akos.net

<http://home1.gte.net/k4lk/mcc>

CIRCLE 160 ON READER SERVICE CARD

## Base Station Blowout

- Low Band – Micor & Master II
- VHF – GE Master II
- UHF – GE Master II

All units tested, in cabinets, with power supply.

<http://www.versatelcom.com>

**VersaTel**  
COMMUNICATIONS

Orders: 800 456 5548

Info: 307 266 1700

FAX: 307 266 3010

CIRCLE 259 ON READER SERVICE CARD

[www.mouser.com](http://www.mouser.com)

Subscribe,  
download, or view  
catalog online!



800-992-9943

817-483-6828

Fax: 817-483-6899

[catalog@mouser.com](mailto:catalog@mouser.com)

958 N. Main St., Mansfield, TX 76063

**MOUSER**  
ELECTRONICS

CIRCLE 64 ON READER SERVICE CARD

Parts List	
Part	Description
R1, R4, R7	1k
R2, R3, R5	1 meg
R6, R11	100 ohms
R8	560 ohms
R9	3.3k
R10	10 ohms
R12	47 ohms
R13, R15-16, R18	150.5 ohms 1% (use 150)
R14, R17	37.3 ohms 1% (use 36)
R19, R21	96.2 ohms 1% (use 100)
R20	70.7 ohms 1% (use 68)
R22, R24	61 ohms 1% (use 62)
R23	247.5 ohms 1% (use 240)
R25, R27	53.2 ohms 1% (use 51)
R26	789.7 ohms 1% (use 820)
R28	51 ohms
R29	2.7k
R30, R32	292 ohms 1% (use 300)
R31	17.6 ohms 1% (use 18)
All resistors 1/4 W 5% unless otherwise noted.	
C1	150 pF air dielectr. tuning cap (see text)
C2-3	18 pF NPO disc (15 or 22 pF acceptable)
C4-5	100 pF COG monolithic capacitor
C6	56 pF COG or NPO disc
C7-13	0.1 μF monolithic, axial
D1-2	1N914, 1N4148, etc., silicon small signal diode
D3	LED, your choice
J1	DC connector, your choice
J2	connector for freq counter, your choice
J3	BNC panel-mount coax female connector
L1	FT37-61, 29T #30 (see text)
L2	T68-2, 45T #30 (see text)
L3	T50-2, 18T #30 (see text)
L4	T37-6, 11T #30 (see text)
Q1-3	J309 (see text)
Q4	2N4400, 2N4401, 2N2222, etc.
RFC1	1 mH RFC
S1	SP4T rotary switch
S2	2P dual wafer, 7 or more pos. Should have grnded shield between wafers.
S3	SPST toggle or slide switch
T1	FT37-43 12 bifilar turns #30
U1	78L09 regulator

book, you can use it outboard and not build-in the specified attenuator.

### Changes you might want to make

Frequency coverage can easily be extended above and below the specified ranges by adding additional inductances and positions on the band switch. Within reason, of course. It probably won't work at UHF!

If a higher level of RF output is desired, one or two MMIC wideband amplifiers can be added to maintain the 50 ohms output impedance. Or, for really higher RF output, you could build and install the four-stage RF amplifier described on page 135 of W1FB's *QRP Notebook*. It is flat from 1 to 40 MHz and provides 40 dB gain at 50 ohms impedance, but this may be too high for the internal attenuator.

As designed, this signal generator can also be operated portable with either a 9 V or 12 V battery. If a 9 V battery is used, eliminate U1. In this case, RF output will be lower and will decline as the battery ages.

If you desire, you could install an LCD frequency dial such as the "K1MG Digital Clock/Counter" available from Blue Sky Engineering Company, 400 Blossom Hill Road, Los Gatos CA 95032. Write for the current price—but be forewarned that this will probably cost about twice as much as the rest of the instrument. 73

### Y2K Portable J-Pole

*continued from page 18*

It remains to be seen whether the year 2000 will bring some special, urgent need for ham radio communications, but I see Y2K as a good excuse to review and upgrade my preparations for emergency communications. If Y2K turns out to be a dud, there's always another disaster waiting around the corner somewhere, sometime. If you get ready now, Murphy's Law dictates it will happen somewhere else (maybe)!

Note: A parts kit consisting of coupler PC board, trimmer capacitor, and ladderline is available. Order #JPK-2 from Lectrokit, 401 W. Bogart Rd.,

Sandusky OH 44870. The price is \$15 postpaid in the USA and Canada. Questions or comments? Please use my E-mail address shown above. 73

### Secrets of Transmission Lines

*continued from page 29*

$$i = [V_0 / (j \cdot \omega \cdot L)] \text{ amperes} \quad (2-14)$$

The term  $(j \cdot \omega \cdot L)$  is called the *inductive reactance*. It describes the opposition to AC current flow just as resistance does for DC in Ohm's law.

In practical inductors, there is always a resistance in the circuit too. Since the resistor tends to draw current in phase with the voltage, the terms combine as follows:

$$i = V / [R + (j \cdot \omega \cdot L)] \quad (2-15)$$

The term  $[R + (j \cdot \omega \cdot L)]$  is called *impedance*. Impedance plays the same role in relating voltage and current for AC as resistance plays for DC. We will see shortly that capacitance may also enter into impedance.

For the capacitor, we noted that:

$$V = Q/C \text{ volts}$$

where

Q = the integral of current with respect to time, measured in coulombs or ampere seconds

If the capacitor drew an average of one ampere in the first second, a half ampere in the second, and a quarter ampere in the third and so forth, then Q would be equal to  $1 + 1/2 + 1/4 + \dots$

Now, applying an AC voltage, we obtain:

$$V_0 \cdot \sin(\omega \cdot t) = Q/C \quad (2-16)$$

Differentiating the above expression with respect to t, we obtain:

$$d_Q/d_t = [V_0 \cdot \omega \cdot C \cdot \cos(\omega \cdot t)] \text{ amperes} \quad (2-17)$$

Note that if  $Q$  is the integral of current with respect to time, then  $dQ/dt$  is current.

Taking again the liberty that for most problems we are interested only in long-term averages we may write that for a capacitor:

$$i = V/[-1/(j\omega C)] \text{ amperes} \quad (2-18)$$

Note the similarity and the differences of the result for the inductor and the capacitor. Whereas the instantaneous current in the inductor is given by  $-\cos(\omega t)$ , the instantaneous current for the capacitor is given by  $+\cos(\omega t)$ . Also, where the inductive reactance is given by  $(j\omega L)$ , the capacitive reactance is given by  $-1/(j\omega C)$ . We also see that inductive reactance is directly proportional to inductance, whereas capacitive reactance is inversely proportional to capacitance. The reactances are usually referred to as  $X_L$  and  $X_C$  respectively.

An interesting case occurs in the event that  $X_L = -X_C$ . If the two elements are connected in parallel and both are theoretically perfect with no losses, it takes no current on the main line to excite a large current in both elements. The case is similar to the pendulum shown in Fig. 6.

At the end of the swing, all of the energy is stored in the form of potential energy like a capacitor. At the bottom of the swing, all of the energy is stored in the motion of the bob, like the magnetic field of the inductor. As the bob continues its swing to the other end of the travel, all of the energy is converted again into potential energy in the capacitor.

In the parallel circuit the energy simply sloshes back and forth between the inductor and the capacitor. If no losses existed in the circuit, and the pendulum dissipated no power, both would continue forever!

### Conclusion

Having seen some of the characteristics of reactive elements, next time we'll deal with some real circuits and discuss power factor, power dissipation in an alternating current circuit, and the difference between kilowatts and kilovars. 

## Getting Your Foot in the Public Service Door

*continued from page 31*

and prevention. With either type of activity, your club, the police department, and your community wins. You can feel good about doing your part. It's a great way to add value to your license and your hobby. It may also help protect our frequencies.

Make it a point to contact your local police chief or commissioner and talk with him about a joint activity with their department. If they have any questions about how well the operation works, ask them to call Chief Rick Chandler of the Dickson, Tennessee, Police Department at (615) 446-5403. He has been involved with our local amateur radio group for several years. There have been no complaints. 

## QRX

*continued from page 7*

"I won't let a flat tire get me down!" Tom said, without despair.

These appeared in the December 1998 issue of *Spurious Emissions*, the newsletter of the Indian River ARC, Roy Hill W6QCM, editor, and were reprinted in the February 1999 issue of the *ARNS Bulletin*. 

## WANTED! Cover Photos

For information  
call Joyce at  
1-800-274-7373

## Subscriptions to 73 Magazine

Only \$24.97 — 1 year  
\$44.97 — 2 years  
\$65.00 — 3 years\*

\*best buy (54% off cover price!)

Call 800-274-7373

## DIRECTION FINDERS

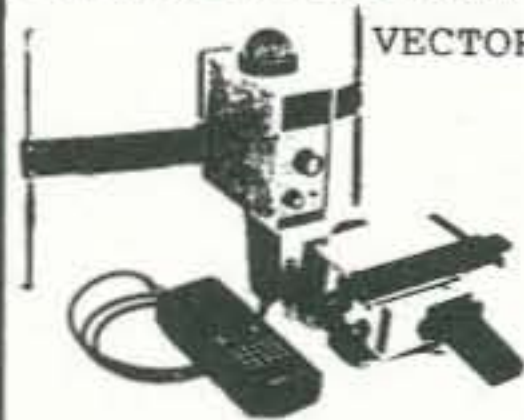

VECTOR-FINDER

HAND-HELD  
PHASE SENSE  
ANTENNAS FOR  
VHF DIRECTION  
FINDING. USES  
ANY FM RCVR.  
ARMS FOLD FOR  
STORAGE.

TYPE VF-142 144-220 MHZ \$139.95  
TYPE VF-142Q LEFT-RIGHT LEDS &  
AUDIO, 144-220 MHZ \$239.95  
TYPE VF-142QM SAME AS Q MODEL  
EXCEPT FREQ. 144-500 MHZ \$289.95  
TYPE VF-121Q 115-130 MHZ  
PLUS 121.5 MHZ ELT FREQ \$379.95  
CALL ABOUT HF DF, ADD \$4.50 S/H  
ATTENUATORS CA ADD TAX

### RADIO ENGINEERS

7969 ENGINEER RD, #102  
SAN DIEGO, CA 92111

619-565-1319 FAX 619-571-5909

CIRCLE 58 ON READER SERVICE CARD

## EVERY ISSUE OF 73 Amateur Radio Today on Microfiche!

The entire run of **73** from October 1960 through last year is now available. Over 800 fiche!

You can have access to the treasures of **73** without several hundred pounds of bulky back issues. Our 24x fiche have 98 pages each and will fit in a card file on your desk.

We offer a battery operated hand held viewer for \$150, and a desk model for \$260. Libraries have these readers.

The collection of microfiche, is available as an entire set, (no partial sets) for \$325, plus \$10 shipping (USA). Annual updates available for \$10, plus \$3 shipping/handling. Satisfaction guaranteed or money back!



**BUCKMASTER**

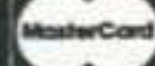

6196 Jefferson Highway  
Mineral, Virginia 23117 USA  
540:894-5777 • 800:282-5628  
Fax 540:894-9141  
e-mail: info@buck.com

CIRCLE 168 ON READER SERVICE CARD

## WANTED

Fun, easy to build projects  
for publication in **73**.

For more info, write to:

Joyce Sawtelle,  
73 Amateur Radio Today,  
70 Hancock Road  
Peterborough NH 03458.

# Simple Direct-Conversion Receiver

*For QRPers and receiver aficionados in general.*

Craig Kendrick Sellen  
c/o Mallard Meadows RHC  
476 Belmont St., Room 405  
Waymart PA 18472

**A**n essential ingredient for the newcomer in amateur radio is a good receiver, one that is sensitive enough to pick up signals that are down near the noise level, and selective enough to separate adjacent signals and provide clear copy. Without such a receiver, you can only look forward to "unanswered" CQs and lots of frustration. However, a good communications receiver can cost anywhere from \$250 to \$500, and most beginners don't have that kind of money. Even a good *used* receiver can cost \$150.

As an alternative, a direct-conversion receiver should be tried. It performs well over a range of 3.5 to 4.3 MHz on AM, SSB, and CW, and is easily constructed at a cost near \$30. Direct conversion is a much neglected type of design that can best be described by comparison with the more common system, superheterodyning.

In the superhet system (see **Fig. 1**), the first stage is an RF amplifier. This is followed by a mixer, where the signal is combined with the output of a local oscillator. The frequency of the latter is a certain amount above or below that of the RF, and the difference

is called the intermediate frequency. The output of the mixer contains a high-frequency component and a low-frequency component. These two signals are produced by superheterodyning—that is, combining two signals to produce one at a frequency equal to the sum of the frequencies of the original signals, and one at a frequency equal to their difference.

At this point, we filter out the high-frequency component and amplify the lower in a stage that has high gain and a narrow passband, which affords selectivity. The output of the IF amplifier is sent to a detector, which may be of two types: For AM reception, it is an envelope detector (a diode followed by a low-pass filter). For SSB and CW, a product detector that is really a second mixer, fed by a beat frequency oscillator (BFO), is used. The difference component of this heterodyning process is an audio signal that is then amplified through one or more stages and passed on to phones or a speaker.

As you can see, there are usually four or more stages that must be properly tuned in conjunction with each other for proper signal recovery in a

superhet receiver. Most quality communications receivers have two or three IF stages, with separate mixers, local oscillators, and tuned amplifiers for each stage. These complications drive the cost of receivers out of the reach of a large portion of newcomers to the radio hobby.

The direct conversion technique is a much simpler process. The block diagram of this system is shown in **Fig. 1**. The RF amp supplies the mixer with an amplified version of the signal received from the antenna. The mixer is also fed an RF signal of the same frequency as the incoming carrier from a local oscillator whose frequency is adjusted by the main tuning dial C26. The output of the mixer contains one audio frequency signal and one RF signal at twice the frequency of the original. The RF signal is then filtered out by a low-pass filter and we are left with an audio signal. This is then amplified by one or more stages of high gain, and the output is connected to a speaker or a pair of phones.

That's all there is to it. We have none of the complexities of dual- or triple-conversion superhet receivers, but do



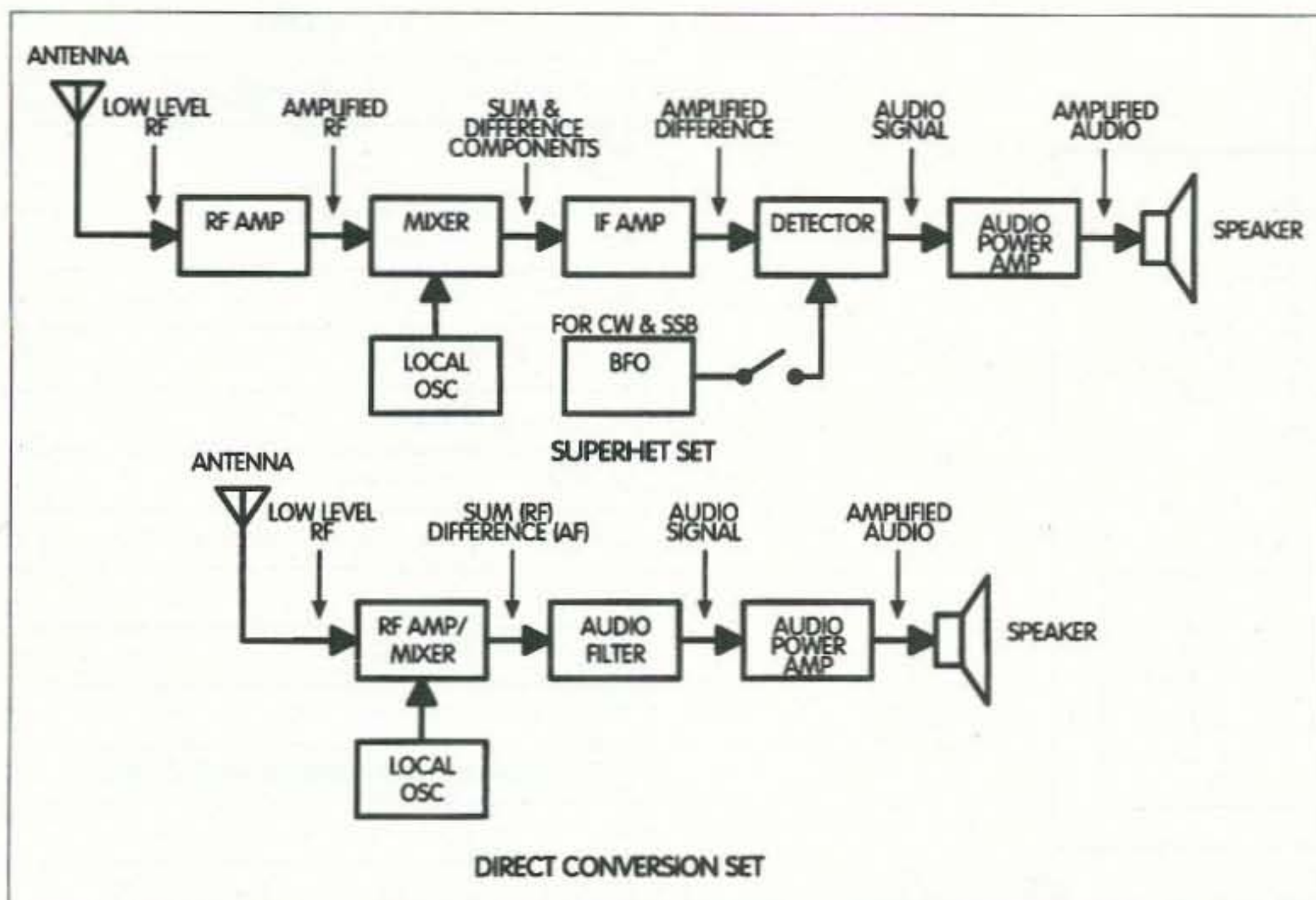

Fig. 1. Superhet (top) and direct-conversion sets compared.

have good sensitivity, and if we use a high-quality, narrowband audio filter, we have selectivity that will rival that of a superhet unit costing ten to twenty times more. The simplicity of operation is reflected in the ease of construction.

### Circuit operation

A comparison of the block diagram (Fig. 1) and the schematic diagram (Fig. 2) will point out a few differences. For economy's sake, an RF amplifier has been omitted from this receiver. However, the receiver is still sensitive enough to pick up many signals that would be missed with a cheap "communications-type" superhet model. Signals from the antenna are coupled to the MOSFET mixer, Q1, over the tuned LC circuit composed of L1, C1, and C2. Transistor Q2 is the local oscillator and its output is coupled through a small silver mica capacitor, C28, to the second gate of Q1. The antenna coil L1, and the oscillator coil L2, are wound on small toroidal cores, which is an effective way of attaining high Q circuits—the basis of the selectivity of the receiver's front end.

The other contributor of selectivity in a direct-conversion receiver is the audio filter. This filter performs two functions: It rejects the high frequency component of the mixer output, passing the audio signal, and it provides a

large part of the receiver's selectivity by virtue of its audio bandpass characteristics. In this circuit, L3, C5, C7, and

C8 comprise the low pass filter. Coil L3 is a variable TV-width coil, and the capacitors are of the mylar type. Capacitors C1, C25, C27, and C28 are NPO or silver mica types. Op amp IC1 is a conventional audio amplifier, and almost any op amp will work well in this circuit. Variable resistor R10 serves as a volume control in the standard voltage divider mode, and IC2 serves as an audio output amplifier. Any one of the common audio modules furnishing 0.5 to 1 watt output can be utilized for this purpose. If desired, a head-phone jack can be installed.

A power supply was not incorporated into the receiver. A suitable source supplying 500 mA at 12 V should be used. If you intend to use the receiver for portable operation, or don't wish to construct a supply, six to eight D cells in series will work fine. An inexpensive battery holder can be obtained for holding them. It is important to take care in observing polarities while connecting

### THE POCKET GENERATOR

5 Amp-Hr, Portable Gel-Cell and 110 VAC Inverter..... \$69.95+ \$10.50s&h  
ONLY 3" x 3.5" x 4" & Very Light Weight (3.5 Lb.) Perfect for Laptops, Chargers, Boom Boxes, Cameras, etc.

- AC Wall Charger
- 50 Watt Continuous/80 Watt Peak DC to AC Inverter Measures Only 1.25" x 2.5" x 3.25"
- 110 VAC Outlet Modified Sine Wave
- Shoulder Strap and Soft Carrying Case
- 12 VDC Cigarette Lighter Outlet
- DC Charging Cord

### THE POCKET STATION

Same as THE POCKET GENERATOR, But a Smaller, Lighter 3 OR 7 Amp-Hr Gel-Cell, Without the Inverter.....\$44.95 or \$54.95 +\$10.50s&h.



### 12 VDC to 110VAC INVERTERS

- Modified Sine Wave
- Great w / The POWER STATION or MEGA STATION
- Overload, Thermal, & Undervoltage Protection

Model	Cont. Pwr	Peak Pwr	Price
PC140	140 Watts	250 Watts	\$34.95*
PC300	300 Watts	500 Watts	\$49.95*
PP500	500 Watts	800 Watts	\$99.95*
PP1000	1000 Watts	2000 Watts	\$219.95**
PP1500	1500 Watts	3000 Watts	\$324.95**
PP2500	2500 Watts	4000 Watts	\$549.95***

\*\$10.50s&h \*\*\$12.50s&h \*\*\*\$14.50s&h

### CHARGE CONTROLLERS

- Flexcharge 12V x 7 Amp Controller.....\$59.95+\$8.50s&h
- Flexcharge 12V x 25 Amp Charge.....\$119.95+\$8.50s&h
- Charge Controllers for Multiple Battery Banks Also!

For Literature on Antennas, HT & Gel Batteries, Inverters Power Supplies, Etc., Send a large SASE w/3 stamps

### POWER STATION

- 12 Volt x 7 Amp/Hr Gel Cell Battery
- 12 Volt Cigarette Lighter Outlet
- 3, 6, & 9 Volt Output Jack
- Car & Wall Charger w/Auto Shutoff, Built-in Voltmeter
- 2 Hidden Terminals For Hardwiring Provide Up To 90 Amps (Short Circuit)



### MEGA STATION

- 17 Amp/Hr Gel Cell w/Heavy Duty Jumper Cables Provide up to 300 Amps Short Circuit
- Cigarette Lighter Output
- Charge Indicator Meter
- Car & Wall Charger w/Auto Shutoff



### SOLAR CELLS

All Wattage's & Sizes

- Rigid - 5, 11, 22, 32, 42, And 64 Watt Panels
- 5 Watt: \$105\* 11 Watt: \$179\*\*
- 22 Watt: \$219\*\*
- 32 Watt: \$269\*\*\* 42 Watt: \$329\*\*\*
- 64Watt: 449\*\*\*\*
- Flexible 5, 11 & 32 Watt Panels
- 5 Watt Flex: \$115\* 11 Watt Flex: \$189\*\* 32 Watt Flex: \$399\*\*\*
- Reverse Blocking & By-Pass Diodes
- Silicon Alloy Deposited on Stainless Steel. No Glass to Break
- Triple Junction Silicon Cells
- \*\$10.50s&h \*\*\$12.50s&h \*\*\*\$16.50s&h \*\*\*\*\$18.00s&h



### THE HAM CONTACT

P.O. Box 4025  
Westminster, CA 92684, Dept. 73  
INFO 714-901-0573  
FAX 714-901-0583  
ORDERS 800-933-4264  
E-MAIL: 73@HAMCONTACT.COM  
VISIT OUR BRAND NEW WEBSITE:  
WWW.HAMCONTACT.COM



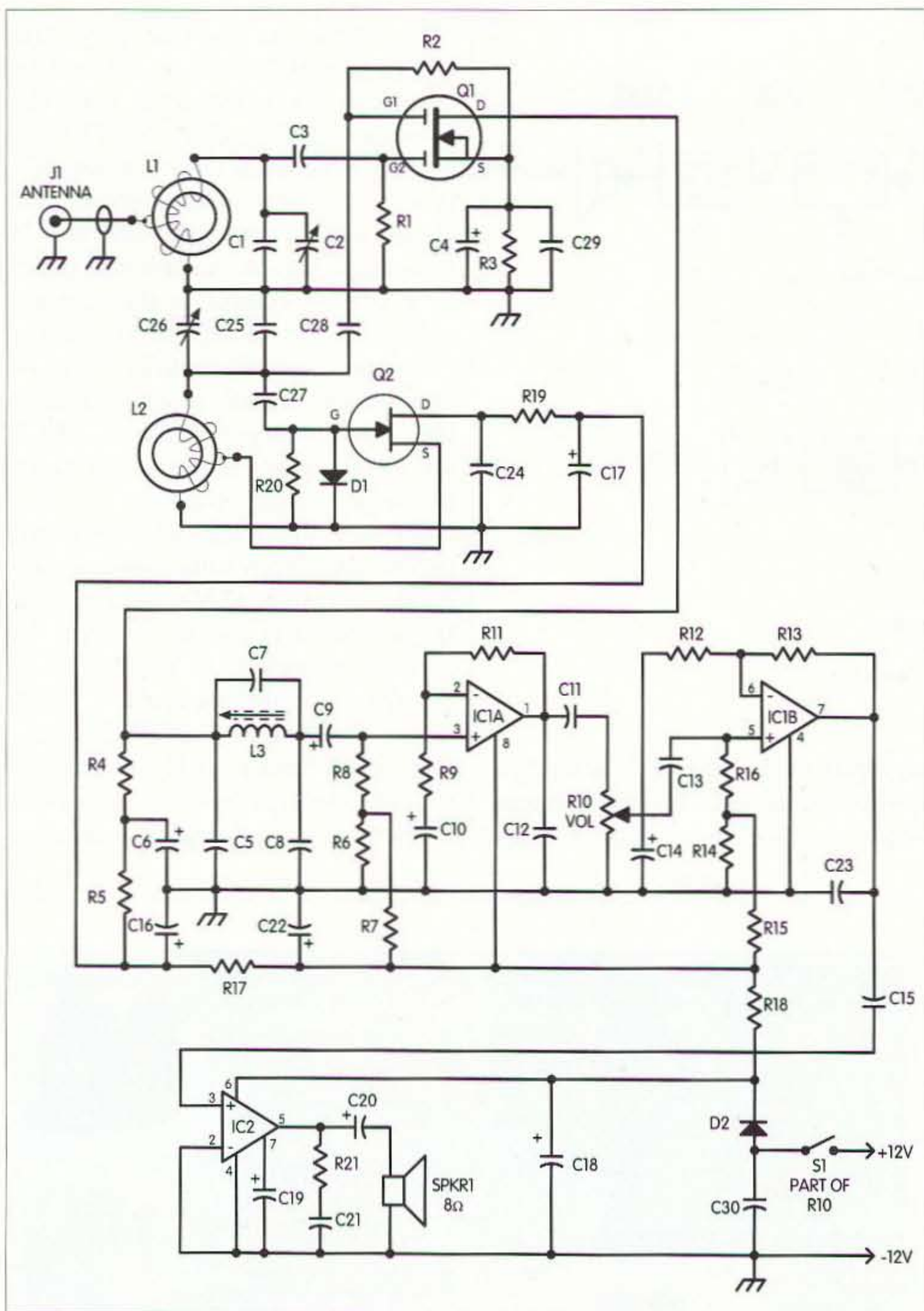

Fig. 2. Schematic.

the supply. To protect the sensitive semiconductors, diode D2 has been incorporated. If the wrong polarity is applied to the receiver, D2 is reverse-biased and will not conduct. If this diode is not installed, the FETs and ICs would be destroyed in the event of accidental reversal of power supply polarity. However, when incorrect polarity is applied, the receiver simply will not work, thanks to the protective action of D2.

### Using other frequencies

The receiver can also be used on other frequency bands. Only the LC

combination at the input of the mixer and the tuned circuit of the local oscillator need modification. For 40-meter operation, remove C1. Remove L2 and replace it with 15 turns of #22 enameled wire, wound uniformly spaced on a T50-2 toroid core and tapped 7 turns from ground end. Also, connect a 225-pF silver mica capacitor in parallel with C25.

For 20 meters remove C1 and wind a new oscillator coil L2 on a T50-2 toroid core. It should be 7-1/2 turns of

Table 1. Parts list.

### Parts List

Part	Description
R1-2, R8, R16	100k ohms
R3	560 ohms
R4	2.2k ohms
R5, R17-19	100 ohms
R6-7, R14-15	10k ohms
R9, R12	4.7k ohms
R10	10k pot w/ S1 SPST switch (fr. panel)
R11, R13	47k ohms
R20	27k ohms
R21	10 ohms
All resistors 1/4 W unless otherwise noted.	
C1	200 pF NPO disc or silver mica
C2, C26	100 pF var. tuning cap (fr. panel)
C3	22 pF disc
C4	22 $\mu$ F electro 16 WVDC
C5, C8	0.02 $\mu$ F mylar
C6	50 $\mu$ F electro 16 WVDC
C7	0.01 $\mu$ F mylar
C9, C10, C14	4.7 $\mu$ F electro 16 WVDC
C11, C13, C15, C30	0.1 $\mu$ F disc
C12	0.01 $\mu$ F disc
C16-18, C20, C22	100 $\mu$ F 16 WVDC
C19	10 $\mu$ F 16 WVDC
C21	0.05 $\mu$ F disc
C23-24	0.005 $\mu$ F disc
C25	180 pF NPO disc or silver mica
C27	47 pF NPO disc or silver mica
C28	4.7 to 5 pF NPO disc or silver mica
C29	0.01 $\mu$ F disc
All capacitors 50 V unless otherwise noted.	
Q1	dual-gate MOSFET RCA 40673, 3N140, or 3N141
Q2	2N3819 or MPF102
IC1	LF353 dual op amp
IC2	LM386 power amp
D1	1N914 signal diode
D2	1N4001 diode
L1	34T #22 enam. wire tapped at 11T from grnd
L2	34T #22 enam. wire tapped at 5T from grnd
L3	10 to 50 mH var. coil (Miller #6319) or color TV convergence coil from junk TV
L1 and L2 are wound on a T50-2 toroid core available from Palomar Engineers or Circuit Specialists. Q1, Q2, IC1, and IC2 are available from DC Electronics, P.O. Box 3203, Scottsdale AZ 85257.	

#22 enameled wire, evenly spaced and tapped 2-1/2 turns from ground end. Remove the 225 pF capacitor across C25 if it was installed for 40-meter operation.

For 10 and 15 meters, L1, the antenna coil, must be replaced with 8 turns of #22 enameled wire wound on a T50-2 toroid. The L2 coil must be replaced with 5 turns of #22 wire, tapped at 2 turns from ground end. In winding both coils, spread the turns to space them evenly around the forms. If you wish, some sort of band-switching or plug-in coils could be used.

### Alignment

Making sure that you observe correct polarities, connect a 12 V battery to the receiver. Connect a speaker and antenna to their respective jacks. Turn the audio volume control until you hear the "rushing" sound of the atmospheric noise. Rotate the preselector capacitor C2 slowly. At one point there will be a noticeable increase in sound in the speaker. Carefully adjust C2 for this peak. There is only one adjustment for receiver alignment, setting the value of inductance of L3. This prevents any RF components from local oscillator feedthrough or the heterodyne process from entering the audio stages of the receiver. The procedure is very simple. Adjust L3 until the tuning slug is positioned about halfway into the coil. This completes the receiver alignment.

### Using the receiver

As you tune across a band, keep the front end of the receiver resonant by adjusting the preselector capacitor C2. You will notice one basic difference in receiver operation between the direct-conversion receiver and a superhet. On the conventional receiver, there is a mode switch that must be adjusted for the type of signal you want to receive. When this switch is in the SSB/CW position, it activates the BFO and product detector. It is not possible to properly demodulate such signals when the switch is in the AM position, which directs the signal to a simple envelope detector.

With the direct-conversion receiver, no such switch is necessary and any signal (CW, AM, SSB, or FM) is properly detected just by adjusting the frequency of the local oscillator, which is accomplished by turning C26, the main tuning dial. Thus the direct-conversion receiver provides many advantages over the superheterodyne model. It is less expensive, easier to build, and simpler to operate. Try it, you'll like it!

### Reference

For interesting information by Joseph J. Carr on the theory of direct-conversion receivers, see *Popular Electronics*, August 1997, pages 39ff. 73

## NEUER SAY DIE

*continued from page 4*

to the then just budding electronics industry, we also provided 40,000 technically experienced men to our military when WWII started. I was one of them. I was there. The special electronic schools were packed with hams, both as instructors and as students — where we learned all about radio, radar, and sonar.

Hams developed and pioneered FM, NFM, SSB, SSTV, and so on. We were in the vanguard. It was our repeater systems that spawned cellular telephones.

But that was then and this is now. It's been decades since we've contributed much to society in payment for the use of tens of billions of dollars' worth of frequency spectrum. We're not even needed for emergencies unless the cellular phones — and that includes the new Iridium system — break down. I had an opportunity to try out Iridium with a call from a ski slope in Aspen to a good friend in Miami. Loud and clear, and all by satellite, at \$7 a minute.

We could still earn our salt if the ARRL directors would get off their numb butts and start promoting the hobby. When is the last time you saw amateur radio portrayed positively in a TV show? Or in a magazine article in a major magazine? In the news, for that matter? We've become the invisible hobby ever since the ARRL closed down virtually all high school radio clubs 35 years ago.

The one potential I see for amateur radio is as a way to get youngsters interested in high-tech careers. Before the League closed the high school radio

clubs, 80% of all new amateurs were teenagers, and that's according to an ARRL study at the time. Further, 80% of those went on to high-tech careers as a result of this interest. I remember when virtually all heads of electronics companies were hams.

But I've written about this endlessly, so it's probably snore material.

Are you a supporter of the League's efforts to do a little tinkering with our regulations? Do you care?

I proposed we cut the baloney and have one class of license. One. Splintering us up into six license classes has not helped strengthen the hobby, it's tended to help destroy it. And ditto the League directors and their continued pressure to maintain the code barriers. Phooey on them.

Paul Schleck K3FU, in his comments to the FCC, mentioned several Morse code myths: (1) It gets through when nothing else will. Bull, we've had technology that beats the heck out of CW for weak-signal communications. (2) CW takes up very little bandwidth. Fiddlesticks. It's the amount of data per unit bandwidth that counts. (3) Morse proficiency makes for better operators. If only! Our worst offenders have been Extra class hams. Only two people have ever been prosecuted for bad language on CB and put in prison. Both were Extra class hams. (4) High speed code exams keep down the crowding on HF bands. Nonsense, when things get crowded, we pioneer new communications systems and explore underused bands. HF crowding is no worse today than 60 years ago — and I was there. You know, if we'd change from SSB to DSB we could triple or better our occupancy, and with less interference. Unfortunately, Art Collins WØCXX put in the fix with generals LeMay and Griswald 40 years ago, and the G.E. brass refused to push Dr. John Costa's superior DSB system. Collins Radio made millions. Big business won over technology, as usual.

The ARRL tells the FCC that they're speaking for you, but unless you're a CW old-timer, that's a crock. Remember, 80% of all amateurs have had the opportunity and have refused to join the League. If the League opinions represented those of most amateurs, they'd have more like 80% of all hams as members. If you are not a member, when is the last time you got a survey from the League asking why? If you are a member, when is the last time you got a survey asking what you thought about something? I've been a member for 61 years and I'm still waiting for a survey. At least the FCC asks before they dump on us. The ARRL directors feel they

know more than we members do, so why should they bother to ask?

### Smoking

The 73 magazine building is right next to the Peterborough high school, so I see lots of kids walking past the place. A few are dressed well, but many are wearing baggy pants and baseball caps on backwards. When I see these kids, I know they are unable to think for themselves. They're busy copying what others do.

A distressingly high percentage of these baggy-pants kids are smoking as they walk by. Starting to smoke as a teen these days is a sure sign of incredible stupidity. Kids sure have to be really dumb to start a lifelong expensive addiction to a drug that is going to ruin their health and take years off their life.

Sorry, but I don't think much more of adults I see smoking. Tens of millions of smokers have managed to kick their addiction, which leaves the stupid and the people with weak wills as the remaining addicts.

Maybe you've noticed that the villains in the movies and on TV no longer wear black hats, they're smoking. When you see someone light up in a movie you know immediately that this is going to be one of the bad guys.

Back when Camels was advertising that doctors smoked 'em, it was smart to light up, and you'll see all of the now-dead movie stars smoking. And, like John Wayne, it killed most of 'em while they were still relatively young.

Thirty years ago or so, when I outlawed smoking in my company, I was one of the first. Back in 1965, I was giving away cancer-free matches at hamfests. I had 'em made up specially so they wouldn't light.

### The Wild West

Aren't you glad we live in a country with town, county, state, and federal police, backed up by town, county,

state, and federal courts — with town, county, state, and federal prisons? Aren't you glad we don't have to live like they used to in the lawless West that we've seen depicted in westerns?

That is, unless you do some reading. It turns out that the frontier West in the 19th century was a far more civilized, more peaceful and safer place than America today. They had private justice then and it worked. Our 13 colonies had little government law enforcement. It was done privately.

The sorry fact is that government hasn't been able to do much about crime. Studies have shown that having more squad cars or police on the beat, or even faster police response, has little effect on crime rates.

Are there other systems than ours around the world that work better? Of course there are. But ours has a life of its own. There's a huge constituency for continuing our present system of police, courts, and prisons, and no constituency for any alternatives, no matter how much better and less expensive they have been shown to be for the public and crime victims.

Read *To Serve and Protect* by Bruce Benson (\$37.50) to put the situation into perspective and see how you (and all of us) have been screwed again by government. Gee, what a surprise! I know it's hard to believe that a government service could be both ridiculously expensive and ineffective. Please name one government service that is not ridiculously expensive and ineffective. Just one, please.

### Sanctions

I know you're not going to believe it if I try to tell you that your government has been lying to you again — that it has been wasting billions of your money. So I'm not going to try to convince you. Instead, I ask that you invest a lousy \$9 and discover the sorry facts for yourself.

You may even get mad when you read how you've been hornswoggled again by the administration. This has

to do with the use of economic sanctions as a weapon of foreign policy. Sounds great, right? Well, that should be a clue right there if you're awake. Anyway, the Cato Institute has collected papers from some of the top brains who cite chapter and verse how sanctions have not only seldom been more than an irritant to the intended victim, but have instead cost us dearly.

Get *Economic Casualties: How U.S. Foreign Policy Undermines Trade, Growth, and Liberty*. ISBN 1-882577-75-2.

The message of *Economic Casualties* is clear and compelling: Unilateral sanctions are truly self-inflicted wounds. They do to us in peacetime what our enemies try to do to us in wartime.

Yeah, there goes Wayne, bothering you again over something you can't do anything about. Say, do your senators know who you are? I guarantee you mine know who I am. And they know I have a big word processor.

### Fuming

I clipped a little note from *Time* about a study of 4,000 Danish men which showed that mothers who smoke a pack or more a day are twice as likely to produce criminally violent sons. Those who smoked fewer cigarettes had less violent boys. The chemicals in smoke somehow permanently damage the fetal brain. If lung cancer, heart disease, and stroke aren't enough to scare you off smoking, perhaps this will.

Nicotine is a drug. Crack is a drug. Alcohol is a drug. Any drugs that get into a mother's bloodstream while she is pregnant are going to affect the development of the child, and the effects are going to be negative — such as lower intelligence, deformities, slower development, aberrant behavior, and so on. Do you really want to cripple your child even before it is born? Cripple it for life?

Researchers have shown that the use of drugs is not only harmful to babies, but will also alter both the sperm

and mother's eggs even before conception. Secondhand smoke is also a drug when breathed.

Hmm, both my father and mother smoked and drank. I wonder what I might have been like if I hadn't been damaged by those drugs when a baby. And by childhood inoculations.

### Buzzards

I looked up from my computer and there, in the front yard, were two big does and a baby deer. Bambi. They were cautiously munching on the hedge. Well, the snow had just melted a few days before and only one crocus had blossomed so far, so there wasn't a lot for the deer to eat.

While Sherry and I were watching the deer, Sherry called out that there were some turkeys in the pasture across the road. I got out the binoculars to get a closer look. They didn't look like turkeys, though they were big and black. But they were fanning out their wings in the morning sun and I've never seen turkeys do that. A closer look showed them feasting on something dead. Buzzards, not turkeys. Three on the ground and one circling lazily over them.

Hmm, were they eating one of our rabbits? I went across to the field and took a look. Nope, it was a dead raccoon. There was a lot of raccoon fur nearby, so it put up a fight before it got killed — probably by whatever has eaten most of the pet rabbits we had running around the house and barn. Coyotes, probably.

### Azomite

Plants seem to do as well as people when they get all of the minerals they were designed to use. If you'll read *The Secrets of the Soil* by Chris Bird, which I've reviewed in my "wisdom" guide, you'll find that in addition to the dozen ways I discussed last year in an editorial for getting plants to grow bigger, faster, and producing better

*Continued on page 61*

# ABOVE & BEYOND

## VHF and Above Operation

C. L. Houghton WB6IGP  
San Diego Microwave Group  
6345 Badger Lake Ave.  
San Diego CA 92119  
[clhough@pacbell.net]

### Microwave converter drivers and interfaces: part 2

This month, let's cover some of the trials and modifications of another 2 meter rig, the IC-202 SSB transceiver. Additionally, I will show some of the interface equipment used to tie together an IF transceiver and the microwave converter.

The interface equipment is necessary in addition to low power drive to protect the microwave mixer at all costs. While mixers can be home constructed (with difficulty), commercial mixers do provide better operation parameters (and therefore are hard to find and expensive). If you are lucky to come upon one for your converter for 5 or 10 GHz or higher frequencies, these are the mixers that are truly "unobtainium"!

Mixers above 1 GHz are not too shabby either, but are a little more plentiful in surplus. Home construction at these frequencies is quite a bit easier, as the physical 1/4-wave dimensions for lumped mixers make circuitry larger and easier to work with. For instance, a mixer for 2.3 GHz is about 2 inches square, while a 10 GHz mixer of similar design would be slightly larger. Stability and balance in mixer design become even more critical as frequency increases and circuitry size decreases.

Protection circuits for microwave converters and mixers is not complicated. A very easy-to-construct circuit proposed by members of the North Texas Microwave Society is quite easy to construct and affords very good protection for the converter. Instead of making a

direct connection between the converter and transceiver through switching a coax relay, the relay is retained but in the receive path an MMIC amplifier with 10 dB gain and an attenuator of 10 dB loss is inserted. In the transmit path, an attenuator of approximately 10 dB is inserted for 100 mW drive from the transceiver.

Remember, we are using low level mixers requiring a maximum of +7 to +10 dBm drive, and with a power output of 100 mW or +20 dBm we have some dBs to get rid of still. The power is quite low level and can be removed simply with 1/4-watt carbon resistors. The value of the attenuator is adjusted to take into account remote operations such as tower mounting the converter some 100 feet remote and being able to still get normal drive level to the converter so remotely situated.

The beauty of such a circuit is that in case of transfer failure (that is, you are transmitting into the receive path of the converter), you do not put power directly into the mixer IF port and possibly destroy it. In this failure scenario, you are now driving the 10 dB attenuator in the receive circuit and an MMIC amplifier backwards. I guarantee you, it's quite a lossy circuit and will fully protect the mixer from even much higher power in extreme conditions.

The transmit path (after RF detection and auto switching the IF path to transmit) is protected by the 10 dB attenuator. If high power is applied and switching takes place, the power is reduced 10 dB but is still too high for mixer safety. You can't protect from everything, but if you

reduce your driving transceiver to low power operation for microwave converter service, it will not be a problem. With the MMIC amp an attenuator in the receiver path and 10 dB attenuator in the transmit path with low power drivers will afford you protection for all of your microwave converters.

### IC-202 2-meter modifications

Modifications to the IC-202 SSB 2-meter transceiver for microwave converter use are not extensive and can be done fairly quickly. A little background on the ICOM IC-202 2-meter SSB transceiver: It's battery powered from 9 internal "C" cells or a 12 volt DC power source. Its main operation is USB only. There is a newer model, the IC-202S, which is more popular as it provides for both USB and LSB. I have the plain vanilla model and it required conversion to LSB, the designated mode for most operation on microwave. The mod here is quite simple: Order a HC-18 solder pin crystal for 10.701500 MHz and change the crystal in the carrier inject circuit.

I came upon a pack of NiCd "C" cells and have been using them ever since. Matter of fact, with the low power mod and high capacity NiCds I haven't charged the battery pack in 6 months and the radio continues to function quite well. I know that's pushing the batteries to extreme, but it's better than purchasing dry cells, which are not inexpensive. I picked up the "C" cell NiCd pack at a swap meet, removed the cells, and inserted them in the radio's battery clips and that was it. They have performed very well ever since, and quite reliably, I might add.

The low power modification to most rigs was stumbled upon many years ago when a blown transistor in a final amp stage proved quite difficult to find a replacement. Most standard replacement transistors have the collector tied common to the outside case for heat sinking

purposes. The device that was blown had the collector insulated from the TO-5 case. I could not find a replacement for this device anywhere. On a lark, I wanted to see how the remainder of the transceiver functioned on transceive, so I connected a few-pF capacitor from input to output of the final amplifier stage. Wow! It did the job, provided 100 mW of very nice power, and has ever since! What a stroke of luck — it functioned well not only for a simple test, but has been the main rig for Field Days ever since. The rig in question is an old Santec LS-202 hand-held multimode 2-meter transceiver that was obtained as a basket case that needed lots of repairs, as it came in parts.

It proved to be an act of love to restore this old Santec LS-202, as the synthesizer was dead, the audio circuit was dead, and wires were hanging out of its two clamshell parts. It also had the final transistor removed (probably the original trouble). The case was probably never put back together, and it just sat in this condition and was allowed to be bumped and banged into other things in the junk box until I came upon it in this sad state of repair. Was it worth repairing? Well, probably not, but then again, when do you run into a multimode handheld for portable operation? Had to give it a try.

Well, the radio was restored to service and the low power modification proved to be just what the doctor ordered to protect microwave converters and their expensive mixers. This was 7 years ago, and the old Santec is still functioning with its external audio gain pot and tape to hold the case and battery compartment together. Looks a little tired, but it still functions in a very trusty manner for USB, LSB, CW, and FM operations all on 2 meters at about 100 mW power output. Matter of fact, it still has the original 2 pF capacitor in place of the final transistor. As a finishing touch, I put a little RTV on to hold it in mid-air so it won't vibrate loose.

## The ICOM IC-202 conversion

Back to the low power modification to the ICOM IC-202 transceiver. With the rig converted to LSB by changing the crystal, output power is limited by inserting a resistor in the DC power lead to the final transistor collector. Maintain normal DC power to all other circuits including the driver transistor. A

2 watt resistor of a value in the 75 to 80 ohms range will do the trick when using a NiCd battery pack. If using full 12 volts, this value will have to be trimmed to suit power requirements. This value resistor will reduce the DC voltage under load to the final amp transistor to about 4 volts.

In my IC-202, the plain vanilla rig, cut circuit board strap "W22" going to feedthrough

capacitor C136, and place the resistor between these two points of connection. Stock operation is 12 volts on the collector and 3 watts CW/PEP SSB output, normally. After modification, with no drive there will be 12 volts on the collector, but when you speak into the mike and the transistor starts to draw current, the DC voltage will drop to about 4 volts, and power out will be near 100 mW. Verify the final power output setting you want for your application. I fudge a little in my setup and set power to a max of 125 mW, with maximum audio drive shouting into the mike for SSB operation. It's best to give it a test in a noisy atmosphere duplicating field conditions to check things out fully.

Now with a rig set to low power for converter use, there remains putting the rig on a specific frequency, and getting a crystal for the correct frequency is needed. With my IC-202 an early production model, the manual was not very clear on crystal parameters. This was a stumbling block for me originally, until I posted the question on a microwave Internet reflector, a great co-op information line to fellow microwavers. **Table 1** is one of several messages received covering the crystal information sought out on the Internet.

Peter's ICOM IC-202 manual was for the newer IC-202S, while my earlier model unit/manual was quite unspecific on the exact formulation to specify exact crystal specifications. My original manual covered schematic operation and basic information. The manual is quite exact, but minimal in crystal information to manufacture a crystal to specification. In any case, with help from the Internet (Peter G3PHO and others) and queries submitted to other amateur interest forums, I found the exact specification for the center frequency of operation.

The center frequency is the center of the 200 kHz full frequency range of operation per

band segment. The IC-202 covers via a variable crystal "VXO" circuit to obtain 200 kHz of frequency coverage per crystal. So for 145.0 MHz to 145.2 MHz, the center frequency is 145.1 MHz.

Here is another message, from Jean-Paul F5AYE:

Subject: IC-202  
From: Piller JPILLER@compuserve.com  
To: WB6IGP Chuck clhough@pacbell.net

Hello, Chuck:

Do you remember me, Jean-Paul F5AYE? I met you last holidays at Kerry's house. I hope that all is well for you and Kerry. I have some information about xtal for IC-202. F is center frequency, ex.: 144.000 to 144.200, xtal F is 144.100. IF is 10.7 MHz, theoretical frequency for the xtal is:  $(F - 10.7)/9$  but real frequency xtal is  $(F - 10.7)/9 + 0.02661$  MHz.

Here in Europe it's the most used TRX for SHF transverter. Here I used 4 and 1 in spare!

Best 73 to you and Kerry,  
F5AYE Jean-Paul

Just as Jean-Paul stated in the message above, it worked out to be exactly correct. Center frequency in MHz minus IF Freq. (10.7 MHz), divided by 9, plus .02661 MHz. This results in a 14.8 to 15.1 MHz crystal frequency. For my crystal for a center frequency of 145.1 MHz, the crystal frequency ordered was 14.959943 MHz in a pin crystal package for sockets (HC-25). I ordered my crystals from International Crystal Mfg. Co.'s (ICM) specification for the ICOM IC-202S per the formulation above. Cost of a new crystal was \$11.45. International Crystal's order phone is (800) 123-4567.

Installation of both crystals worked perfectly following the crystal adjustment of the VXO inductor and variable capacitor to set band edges for proper dial

**RE: ICOM IC-202 Xtals**  
**TO: clhough@pacbell.net**

The following crystal frequencies are taken from my IC-202 manual:

Center	Freq. Range	Type Crystal	Freq. Required (kHz)
144.100	144.0-144.2	HC18/U	14848.83
144.300	144.2-144.4	HC18/U	14871.06
144.50	144.4-144.6	HC25/U	14893.28
144.700	144.6-144.8	HC25/U	14915.50
144.900	144.8-145.0	HC25/U	14937.72
145.900	145.8-146.0	Hc25/U	15048.83

Quote from manual: "Installing certain combinations of crystals in the spare sockets can cause the output level to decrease ... as a result of absorption of some of the energy by the neighboring crystal." A slight realignment or even modification may be needed in some cases.

With the following center frequencies crystal in socket A, do not put anything in socket B:

144.5	144.9	145.9	
-------	-------	-------	--

With the following center frequencies crystal in socket B, do not put anything in socket A:

144.7	144.9	145.9	
-------	-------	-------	--

The following combinations work OK:

Range A	+ Range		
144.5	144.7		
144.5	144.9		
144.9	144.7		
145.9	144.7		

In my own IC-202, I have the two ranges 144.0-200, 144.200-400, then Range A blank. Range B is 144.8-145.00. Since I only use the 202 to drive microwave transverters, this gives adequate coverage. I have reduced the output of mine to 100 mW for transverter drive use. Please feel free to spread this info around to others who need it.

Peter G3PHO

Table 1. G3PHO message.

# THE DIGITAL PORT

Jack Heller KB7NO  
P.O. Box 1792  
Carson City NV 89702-1792  
[jheller@sierra.net]

You may recall last month's statement that I would give Jim Barber's ChromaSound program a try and let you know what I saw. What I saw is — it's terrific! You can download it and try it for yourself from the ChromaPIX Web site (see **Table 1**).

The program uses your 16-bit sound card with an audio cable from your receiver to the line-in jack on the card. That is all the external hardware there is: one cable. If you have been using ChromaPIX for SSTV, you should be set to go.

If you are like me, you have tinkered with every affordable interference reduction method available. You may have used filters so narrow for CW that they had to be turned off to tune for a new signal. I had one of those once upon a time and it showed me what an unstable receiver I was using back then. (Remember the days of bandspread? I had to keep one hand on the bandspread knob to keep pace with the drift!)

The ChromaSound program is an easy install. I installed it in Windows95™ just like it was "meant to fit in the place." Then I hunted around for instructions or a manual to print out. Not much available there. I found that there was some info on the Web site in the form of an FAQ

file. It is a good idea to read that file and possibly print it. There is good information about getting up and running.

However, ChromaSound is the epitome of the intuitive program. You will find buttons to click on with your mouse and they do exactly what you expect them to do. There are tabs to bring up filter screens for SSB, RTTY, SSTV, and CW. Within those windows are preformatted filters for various modes, with standard audio widths as may apply for the mode.

If you feel you can improve on the results for your particular "ear," all you need do is click on the tabs in the displayed envelopes and move the shapes around to where they do the most good for you. After you are done tinkering, you can save the new format to its own button for future use.

The first test, SSB, was in my opinion the toughest. I have used about everything available on the planet to make readable audio out of the confusing hash that comes from my speaker. Up 'til now, the most successful has been the little Timewave box. I am not going to say this program beats that, but, in fairness, it is right up there.

I was showing my wife, who studies and teaches voice, the squiggles on the screen and how

frequency calibration. It's always nice when something worked out well, and this was no exception. I am quite satisfied with the new crystals, and with restoration of this IC-202 SSB transceiver to a very useful tool for portable operation in conjunction with microwave converters.

While my IC-202 has some limitations, being only LSB in operation, it does have very nice VXO tuning (velvet smooth) dial operation, and this, along with the low power modifications for microwave converters, makes it a joy to use. 73 for now, Chuck WB6IGP. 73

wonderfully the program erased so many of the unwanted squiggles. She was unimpressed. The demo was not how singing people relate to sound; it seemed the only logical approach to me. A different music emanates from my speakers than from hers.

On the other hand, she was impressed when I picked out an unintelligible signal and then pressed buttons and twisted appropriate knobs until the audio was relatively free from surrounding noises and, most importantly, was sending understandable speech into the room. This is, after all, the goal of transmitting and receiving the spoken word — that the thought processes must transfer from one mind to the other. This was happening regardless of the state of the aforementioned squiggles.

One of the hazards of accumulating the frugal ham's computer

and accessories for the all-around whiz-bang digital ham shack is that some of the minor accessories tend to be resurrected from the junk box. In this case, I became woefully aware that the speakers attached to the output of the sound card are less than best quality.

I had to recall why that happened. When the sound card was installed several years ago, the furnished speakers had a well-deserved bad reputation. So bad were these speakers that within a few weeks they were replaced by some old-timers remaining from the days when AM radios were scavenged for parts.

The point of this is that when you expect to hear great quality from your computer sound card, that quality depends to a great extent on a good set of matching speakers. The other side of the coin is that even with these poorly matched speakers, the ChromaSound program delivered

## *The Nicd Lady Company*

**Individual Cells - Replacement Packs - Lead Acids  
Rebuilding Service - O.E.M. Assembly**  
for

**\*Handheld Radios \*Laptops \*Cellular Phones  
\*Camcorders\*Portable Scanners\*Test  
Equipment\*Power tools**

Check into our rebuilding service - Substantial Savings  
over **NEW!**

Convert your pack to **NiMH!** Same size pack -  
**HIGHER** capacity!

Call for a price list or visit our website:  
[www.nicdlady.com](http://www.nicdlady.com)

17052 Alameda Dr., Perris, CA 92570-8846

**(909) 789-0830**

**email:nicdlady@deltanet.com**

**FAX: (909)789-4895**



CIRCLE 141 ON READER SERVICE CARD

Current Web Addresses	
Source for:	Web address (URL)
HF serial modem plans + software	<a href="http://www.accessone.com/~tmayhan/">http://www.accessone.com/~tmayhan/</a>
SV2AGW free Win95 programs	<a href="http://www.forthnet.gr/sv2agw/">http://www.forthnet.gr/sv2agw/</a>
BayCom — German site	<a href="http://www.baycom.de/">http://www.baycom.de/</a>
Pasokon SSTV programs & hardware	<a href="http://www.ultranet.com/~sstv/lite.html">http://www.ultranet.com/~sstv/lite.html</a>
New Mode — PSK31 — Free download	<a href="http://aintel.bi.ehu.es/psk31.html">http://aintel.bi.ehu.es/psk31.html</a>
Baycom 1.5 and Manual.zip in English	<a href="http://www.cs.wvu.edu/~acm/gopher/Software/baycom/">http://www.cs.wvu.edu/~acm/gopher/Software/baycom/</a>
Source for BayPac BP-2M	<a href="http://www.tigertronics.com/">http://www.tigertronics.com/</a>
TNC to radio wiring help	<a href="http://prairie.lakes.com/~medcalf/ztx/wire/">http://prairie.lakes.com/~medcalf/ztx/wire/</a>
ChromaPIX & ChromaSound DSP software	<a href="http://www.siliconpixels.com/">http://www.siliconpixels.com/</a>
Timewave DSP & AEA products	<a href="http://www.timewave.com">http://www.timewave.com</a>
International Visual Communication Association — a non-profit organization dedicated to SSTV	<a href="http://www.mindspring.com/~sstv/">http://www.mindspring.com/~sstv/</a>
XPWare — TNC software with sample download	<a href="http://www.goodnet.com/~gjohnson/">http://www.goodnet.com/~gjohnson/</a>
Auto tuner and other kits	<a href="http://www.ldgelectronics.com">http://www.ldgelectronics.com</a>
TAPR — lots of info	<a href="http://www.tapr.org">www.tapr.org</a>
Creative Services Software	<a href="http://www.cssincorp.com">www.cssincorp.com</a>

**Table 1. Handy URLs.**

excellent, understandable audio. I did, however, have to crank up the sound card volume to the speakers so I could make out the message.

Most of you who use your sound card for music have already installed good speakers and will not experience the minor irritations I have. I have a different approach toward music than the true aficionado. Perhaps that comes from listening to so many hard-to-copy signals; maybe it follows that music must be expected to sound that way also.

The second test was much easier. I tuned to some CW signals and turned on the filter, and they all disappeared except one. I could see it, hear it, copy it. It was such a stark difference, I clicked the filter on and off a couple of times to be sure I was listening to the signal I saw on the monitor.

I approached some of the other modes with a little hesitancy because I was worried about the stability of running a

sound card program along with communications software. The reason was a crash I had experienced when I first attempted a screen shot and was bringing up a graphics program to process the file.

Rebooting the computer seemed to get rid of all the gremlins and I was able to get a file with a shot of the SSB signal envelope (which I chose not to use — I felt that the RTTY screen shot accompanying the article tells it all).

Finally, after much thought, I cabled the equipment to work as shown in the screen shot, and all went well with no crashes. I did keep the concurrently running programs to a minimum. That is my most common downfall. I minimize too many programs and leave them running, as there is often a need to go back to them throughout the day.

I did some of the experiments described later before this one and gained a new appreciation for the PK-232MBX. The ChromaSound DSP program

and the '232 seemed like they were made for each other. I didn't pick out any lurking, below-the-noise-level DX signals, but I found that the output audio frequency from the sound card was correct for the input of the '232 and there was no problem with amplitude adjustments.

### How the user works the program

The screen shot, as I mentioned, tells much of the story. There are tabs for formatted modes, SSB, CW, RTTY, and SSTV. The SSTV is under the tab labeled "Stock."

You may choose audio widths by selecting buttons on the various pages. There is an automatic notch that deletes the "tuner upper"-style signal and sends it packing so quickly you will think the guy turned off the rig. Also, there are noise limiter buttons that effectively reduce white noise in logical steps. The AGC button works as it should, and you will welcome it on occasion.

### Roll your own

If you want to improve on the situation, make changes for a different mode, or just plain experiment, you will find little tabs on the display envelope. Click and drag to your heart's content. Each move results in an instant change in the filtering characteristic. When you find something you want, you can save it to its own button for future use.

In a nutshell, this is the setup: ChromaSound needs audio from the speaker output of the radio to the "Line in" jack on the sound card; you will have to set the level from time to time to get the correct drive for the system. That was easy; I had a cable from the first days of using ChromaPIX for SSTV.

If there was a trick to the output, it wasn't much of one other than having to assemble a new cable. The "Line out" on the card uses a small stereo plug and I needed an RCA plug at the other end. This allowed me to plug into a test port I had used once upon a time when testing the Timewave DSP unit. This port is switchable and allows the audio to feed either through the DSP sound card or directly to the '232.

The tuning indicator on the '232 guides the user to precise tuning, and it was immediately obvious that the ChromaSound was doing its job. With the radio tuned correctly and the signal within the prescribed envelope on the DSP screen, the '232 tuning indicator is very clean and the copy is as near perfect as RTTY gets. With the filter turned off, any hash or adjacent signals become apparent both in a disturbance on the tuning indicator and in deterioration of the copy.

What this says, of course, is that the two programs flew well together in the same computer and did their respective jobs with no crashes or recognizable problems of any sort. Makes my day when things work like I expect.

I also tuned some PACTOR signals. There are no preset screens for PACTOR, but I



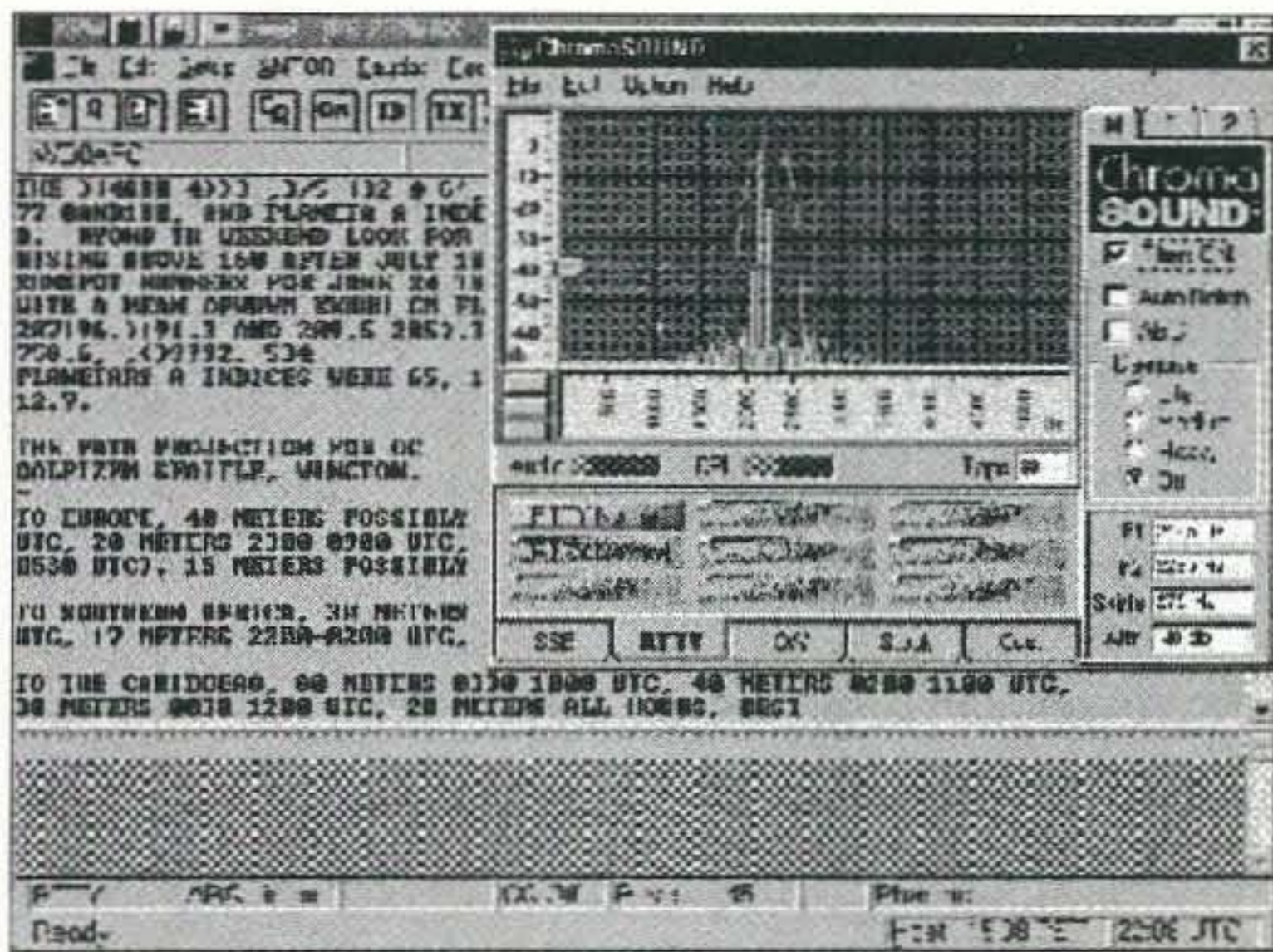

**Photo A.** This screen shot is ChromaSound in action filtering the RTTY propagation message from ARRL. The communication software, XPWare, is in the background, with the DSP program covering much of the upper right of the monitor. The filter continues to work if you click on the XPWare screen, which makes the entire screen available to the communications program. In this case, the audio signal is fed into the sound card where it is filtered, as evidenced by the clean signal display in the envelope. The output of the sound card is then fed to the PK-232MBX for demodulation, then to the serial port for the XPWare to decode and display the incoming message on the screen. See text for details of experiments and general tinkering with the many buttons.

simply used one of the SSB envelopes and changed its parameters to fit the need. The program works well there also. I wasn't linked, so the program was simply in the PACTOR "listen" mode. The point is that the filtered signal went to the '232 and was demodulated with no added problems.

Then, for the fun of it, I tuned a few CW signals while all this was working so well. That was also successful. I seldom use the '232 for CW, so it was interesting to note that the ChromaSound CW filter was so sharp that I had to turn it off so I could ease into the correct "curve" on the signal and get the '232 tuning indicator deflecting properly. Then I could turn on the filter, and this modern technology did its thing.

It continues to amaze me how CW can be decoded even though the "fist" may be less than perfect, if the equipment on the receiving end is up to it. I learned a long time ago, however, that if you want to work CW with this fancy stuff, you

had better follow along and be sure the print on the screen is correct. As soon as you count on it, it ain't. That last line must have been spoken first by a famous ballplayer — then it trickled down to this not-so-famous ham.

I mentioned earlier that I had tried another experiment with the ChromaSound DSP. At first, I was leery of trying to get too much working in the same computer, so I rigged up a feed from the "Line out" of the sound card to the serial modem I built a while back from the design by K7SZL (see Table 1).

This was successful to a point. I was able to demodulate the RTTY signals and feed them to HamComm software in the laptop. This eventually worked, but it was necessary to adjust frequencies between the filter envelope in the DSP program and the frequency the HamComm program was looking for to gain success. It worked, but it is definitely not a contest setup.

I also attempted CW as well as SSTV through the modem into the laptop, but apparently was a little shy of audio power for those modes. The copy wasn't there with the CW mode in HamComm, and the Pasokon SSTV (see Table 1) program did not recognize the existence of a signal. Both modes responded fairly well without the filtering. Part of the problem was signal strength from the antenna. I could hear the signals by ear, but there just wasn't enough audio above the hash noise to decode with the filter operating.

What I like most is the visible spectrum display. You can instantly see and hear the effects of any changes you make, either by clicking a button or modifying the envelope in the display. It is like having a scope plugged in that always tells you what is happening.

One other item on my mind this month is the PSK31 activity. Unfortunately, I do more reading than operating, but there are plenty of glowing reports for this new mode. Having tried it, I heartily recommend it to everyone. It is easy to get started. Download it from the Internet (see Table 1), follow the instructions, and have fun. It is a great low-power activity.

### To rest is to rust

My wife found this saying, and it is one of her favorites. That is what keeps us going — along with adequate lube on the proper joints.

If you have questions or comments about this column, E-mail me at [jheller@sierra.net] and/or CompuServe [72130,1352]. I will gladly share what I know, or find a resource for you. For now, 73, Jack KB7NO. 73

### Say You Saw It In 73

## TRANSMITTER LOCATION

New fixed site direction finders provide 2 degree accuracy, and include software for triangulation from a central control site. Mobile versions also available covering 50MHz to 1 GHz

### Doppler Systems Inc.

PO Box 2780 Carefree, AZ 85377  
Tel: (480) 488-9755 Fax: (480) 488-1295  
www.dopsys.com

European Marketing Director Denis Egan  
PO Box 2, Seaton, Devon EX12 2YS England  
Tel & Fax: 44 1297 62 56 90

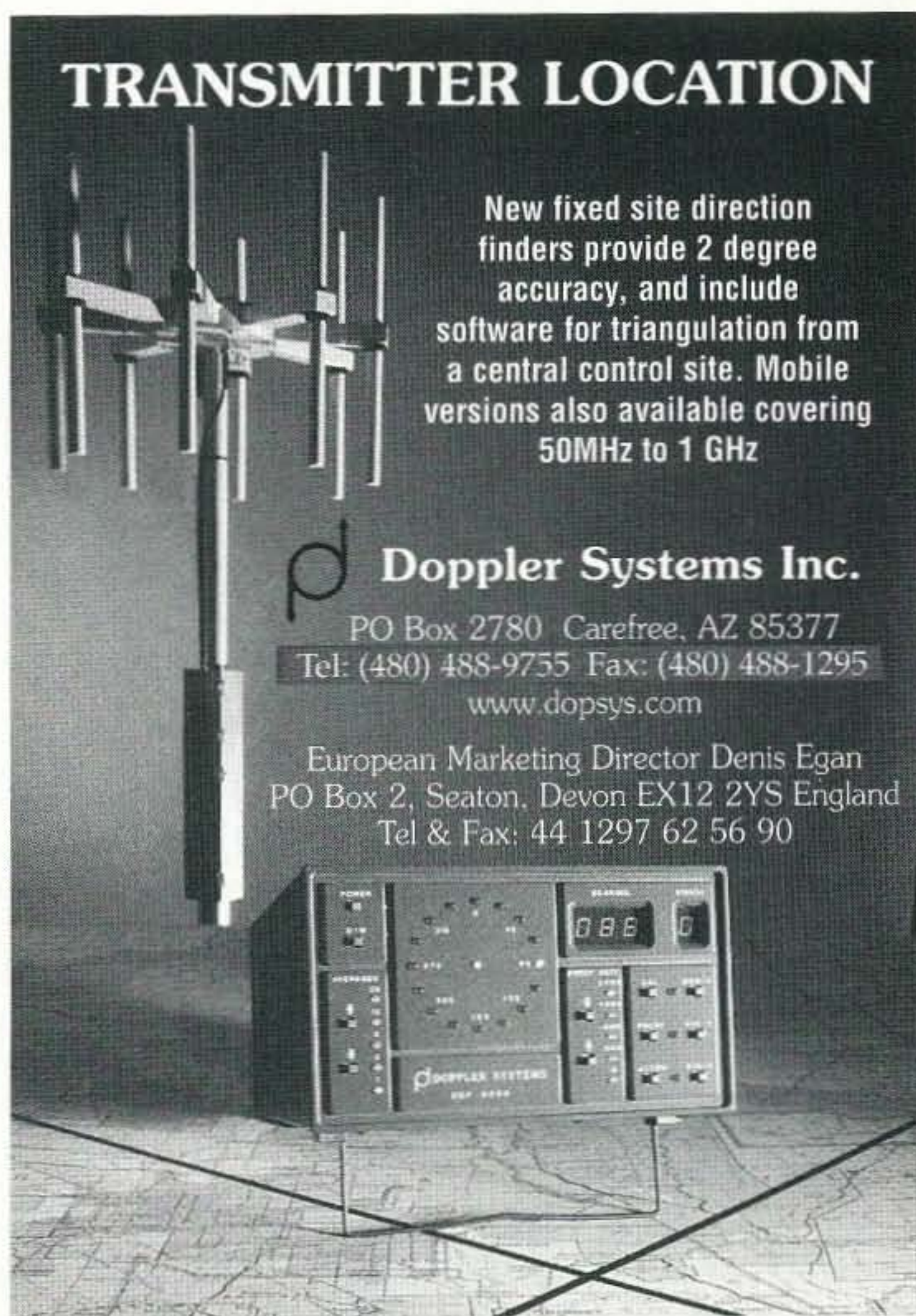

CIRCLE 13 ON READER SERVICE CARD

# NEW PRODUCTS



## Ladder Crystal Filters

by John Pivnichny N2DCH

**MFJ**

### Mini News from MFJ

• MFJ's super Ni-MH "AA" batteries have twice the power

of standard NiCds and can greatly extend the operating time of your electronic device. 1200 mAh, 1.2 V, and no detrimental memory effect as with NiCds. MFJ-92AA1, \$2.99 each. MFJ-92AA10, \$24.95, 10-pack.

• The MFJ-4125 Might-Lite™ is a great new streamlined-size 25 amp switching power supply for powering your HF transceiver, 2 meter/440 rig, accessories, and more. Super clean with less than 35 mV peak-to-peak ripple. \$109.95.

• MFJ's new dual-band VHF/UHF SWR/power meter is perfect for mobile rigs and HTs. Covers 144 and 440, measuring in three power ranges: 15 W, 60 W, and 200 W. MFJ-844, \$69.95.

• *Ladder Crystal Filters*, by John Pivnichny N2DCH, is the only book devoted entirely to the design and construction of crystal filters using crystals of just one frequency. BASIC routines simplify the design process, allowing you to quickly build a high quality crystal filter. 136 pages, paperback. MFJ-3509, \$14.95.

For further information about these or other MFJ products, contact MFJ Enterprises, P.O. Box 494, Mississippi State MS 39762; tel. (800)-647-8324; E-mail [mfj@mfjenterprises.com]; site [www.mfjenterprises.com].



### The Radio Badge

Now, the tiniest radios can go a step beyond the lapel microphone by being slid onto the

Radio Badge by Cutting Edge. Two strong pins hold your radio firmly to your jacket, shirt, hat, or you name it. At only 3 inches by 1-3/4 inches, the RB is very sturdy and stable, and fits the majority of new radios such as the Yaesu VX-1R. \$19.95. Cutting Edge Enterprises, 1803 Mission St., Ste. 546, Santa Cruz CA 95060; tel. (800) 206-0115; E-mail [cee@cruzio.com].

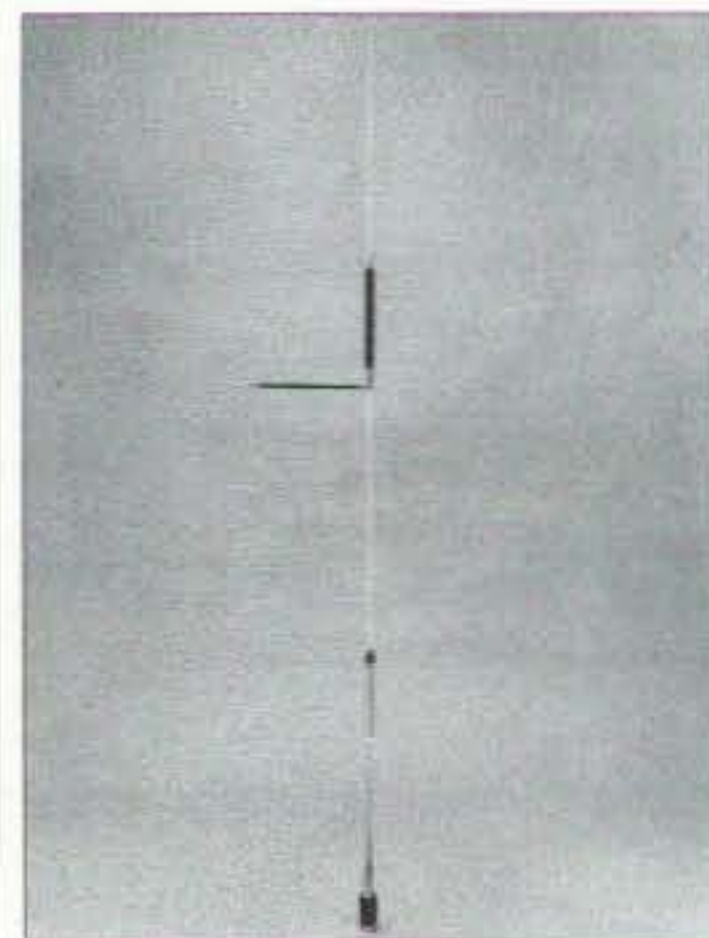

### New Mobile Antenna by Comet

Comet Antenna has modified their CA-HV to resonate on the 70cm band. Initially, the

CA-UHV is designed for operation on 6m/2m/70cm, and can be used as a tribander until HF operation is desired. It comes with HF tuning coils for 40/15/10m operation; 20m and 17m coils are available for purchase as well. You decide what band(s) you want to operate, and then add the appropriate coil(s) to the antenna, one vertically and the others horizontally. 6m/2m/70cm stays consistent regardless of which coils are added.

For further information, contact NCG Company, 1275 North Grove St., Anaheim CA 92806; tel. 714-630-4541; fax (714) 630-7024.



### Sescom's LAB Box-ITs

Here's a great giveaway from Sescom. Get a free sample (pretty small, but hey! it's free!) of one of their LAB Box-

IT enclosures just for the asking. This series consists of nine sizes with 25 optional pre-punched end panels for popular connectors. Easy to assemble; shipped flat; non-anodized/non-painted; economical; and great for making little test fixtures or small projects. Contact Sescom, Inc., 2100 Ward Dr. Henderson NV 89015-4249; tel. (702) 565-3400; fax (702) 565-4848; E-mail [sescom@sescom.com]. Offer expires December 20, 1999.

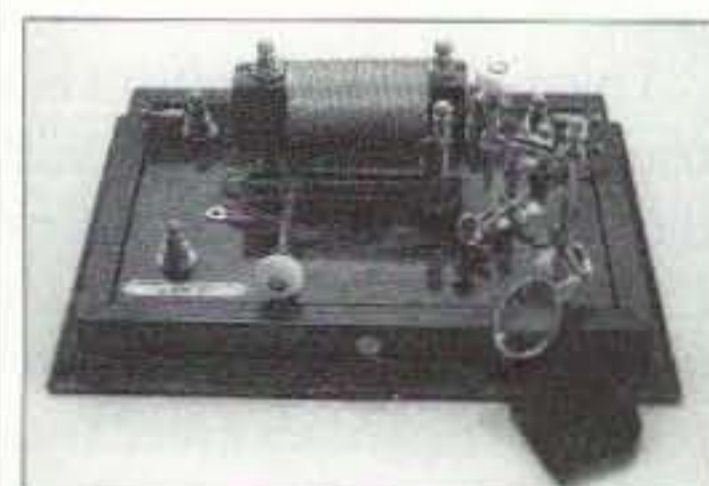

### Navy Model ZR-1 Crystal Radio Set

The design philosophy behind this beautiful radio by Tippecanoe was not for all-out performance, but to maximize the beauty that can be inherent in a simple crystal set. Set in a

frame of solid red oak, the base is made of 3/8-inch-thick Chinese Empress green marble. Hardware: brass. Catwhisker: phosphor bronze. End connectors: 24K gold-plated. You get the picture — even comes with a magnifying glass so that you old fogeys can see the whisker. Size: 8" D x 12" W x 7-1/4" H. Wt.: 7 lbs. For further details and price information, contact the Tippecanoe Radio Company, PO Box 321, Tippecanoe City OH 45371; tel. 937-667-9399.

### No Smoking Stickers

At ten cents each postpaid, these 3-inch by 5-inch Day-Glo orange "No Smoking" peel-off stickers are great for the shack or your next hamfest or what-have-you. Consumer Information Center, 258-1/2 Main St., POB 190, Lansing IA 52151-0190.

# ADVERTISERS' INDEX

R.S.#	page	R.S.#	page	R.S.#	page	R.S.#	page			
• All Electronics Corp.	13	• Glen Martin		136	Milestone Technologies	58	Radio Engineers			
16	Astron Corporation	1	Engineering	17	136	Morse Express	34	Ramsey Electronics		
41	Barry Electronics Corp	7	78	Hamsure	33	193	Morse Tutor Gold	23	• RF Parts	
42	Bilal Company	21	• Hamtronics, Inc.	CV2	248	Motron Electronics	33	254	Ross Distributing	
56	Buckmaster Publishing	17	42	Isotron	21	64	Mouser Electronics	35	36	Scrambling News
168	Buckmaster Publishing	37	242	Jan Crystals	21	• MultiFAX	33	167	Sescom, Inc.	
99	Communication Concepts, Inc.	17	158	Japan Radio Co.	CV3	• Omega Sales	17	• The Ham Contact	23	
10	Communications Specialists, Inc.	7	• Kachina Communications, Inc.	CV4	86	MFJ Enterprises	2	• The Ham Contact	39	
• Denver Amateur Radio Supply	18	316	MFJ Enterprises	9	• Peet Bros.	29	141	The Nicad Lady Company	45	
13	Doppler Systems, Inc.	47	• Michigan Radio	31	• Radio Book Shop	15	269	Tigertronics	49	
193	GGTE	23	160	Micro Computer Concepts	35	• Radio Book Shop	25	• Universal Radio	21	
						• Radio Book Shop	37	316	Vectronics	
						• Radio Book Shop	63	259	Versatel Communications	

When you buy products from these advertisers, please tell them that you saw their ads in 73.

Subscribe to 73 right now...call 800-274-7373 (9-5 Monday-Friday EST).

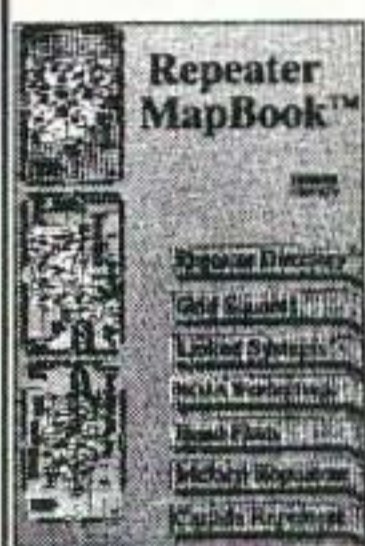

A perfect travelling companion. The Mapbook contains locations of hundreds upon hundreds of open repeaters throughout the U.S., Canada and Mexico. These detailed maps show all highways and major cities in each state. If you travel anywhere in the United States, this Mapbook will be the best investment you ever made!

\$9.95



New in this third edition book are world frequency maps to help you tune into a specific country, anywhere in the world. The new quick country guide will help you tune in almost any time of the day or night.

\$19.95



A true cornucopia of technical information for ham radio. Not only will you find the theoretical aspects, you will find real practical information presented in a no nonsense form. Equipment & Log Sheets, Charts, Tables showing: worldwide call signs, world times, shortwave listening frequencies, coax losses, CTCSS details, conversions, construction plans, emergency information, etc.

133 pages. \$14.95

Send check or money order plus \$3.50 shipping & handling to:

Omega Sales  
P.O. Box 376  
Jaffrey, NH 03452  
1-800-467-7237

## APRS® Made Easy!

APRS is a trademark of Bob Bruninga



Model TM-1  
\$89.95

### - GPS Tracking & Telemetry Module -

Introducing the low-cost solution to all your GPS tracking needs! Choose from the basic TM-1 Tracker or the TM-1+ MultiMode Tracker. Get all the details and prices on our web site at:

[www.gpstracker.com](http://www.gpstracker.com)



Call Or Visit Our Web Site!  
(541) 474-6700 Fax 474-6703



Tigertronics, Inc. 400 Daily Ln. P.O. Box 5210 Grants Pass, OR 97527

CIRCLE 269 ON READER SERVICE CARD

# HAMSATS

## Amateur Radio Via Satellites

Andy MacAllister W5ACM  
14714 Knights Way Drive  
Houston TX 77083-5640  
[amac@icsi.net]

Field Day offers an opportunity to test not only emergency preparedness communications, but also, for the satellite enthusiast, the challenge of making hamsat contacts from a remote location. Unlike normal short-wave operation, more preparation is needed for satellite work. The communications equipment and antennas must be checked for even minor problems since very often the received signals are weak and transponder loading is at its peak. If the Field Day site is far from home, orbital predictions must be recalculated for a different location, especially if beams are used.

### Field Day 1999

Last year AMSAT-OSCAR-10 was surprisingly good, and this year was nearly the same, but this 16-year-old hamsat can be quite unpredictable since the onboard computer gave out over a decade ago. A-O-10 provided many voice and CW contacts for those who pursued it. A few stations discovered that they could even make contacts through

A-O-10 with very simple portable yagis like the Arrow [<http://hometown.aol.com/Arrow146/index.html>]. A-O-10, with its high elliptical orbit, is still a great resource in the sky. And for those who are concerned about Y2K, A-O-10 not only doesn't care about the date, it doesn't even know. It is simply an uncontrolled, but functional mode "B" (70 cm up and two meters down) transponder in space.

The Fuji satellites, F-O-20 and F-O-29, were both in analog (voice and CW) mode for Field Day. Contacts were plentiful for those who were prepared for the exceptional Doppler shift associated with satellites with a UHF downlink. The 70-cm downlink signals can drift as much as 20 kHz in the course of an overhead pass. Satellite newcomers had problems keeping up.

The Russian RS hamsats did well. RS-13 provided contacts, as did RS-15. Usually RS-15 is very hard to use, but when receive conditions are good and the satellite's beacon is off, the

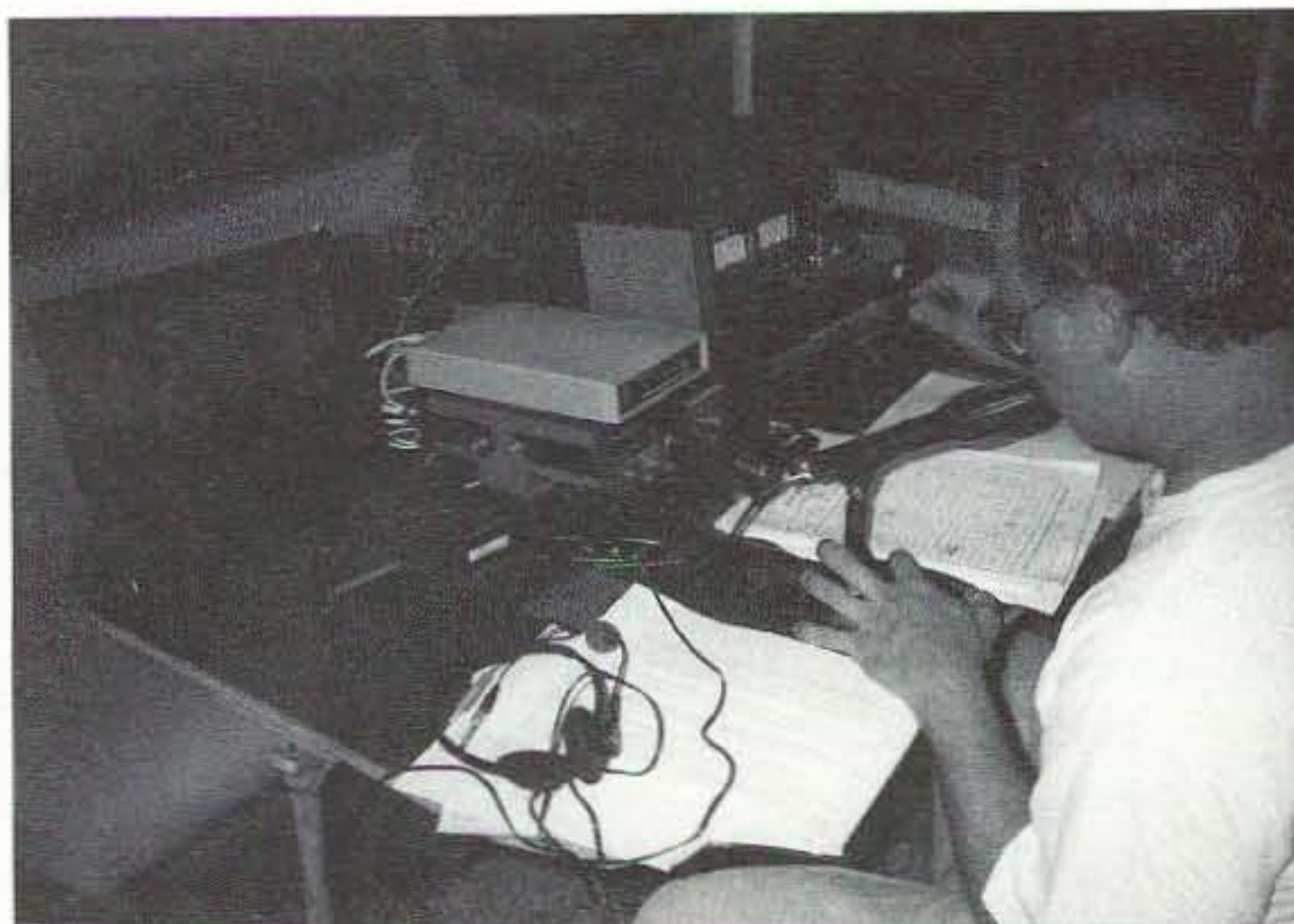

*Photo B. Mike WA5TWT enjoyed some quality A-O-10 contacts while working the K5DX satellite station near Brenham, Texas.*

results can be acceptable. For the Houston AMSAT Group, operating at the Texas DX Society site, several RS-15 mode "A" (2 meters up and 10 meters down) contacts were logged.

Operation via AMSAT-OSCAR-27 was, as expected, super crowded! This single-channel FM mode "J" (2 meters up and 70 cm down) repeater in the sky was working well even though it sounded like hundreds of stations were trying to access the satellite simultaneously. Perhaps the mass of signals is like that heard by shuttle astronauts when operating SAREX (the Shuttle Amateur Radio Experiment). The result is that only a few contacts are made, usually by the stations with the biggest antennas and the strongest transmitters. It was wild, but at least

it was entertaining. SUNSAT-OSCAR-35 was not available for Field Day, but if it had been, the results would have been similar.

The digital hamsats were doing reasonably well this year, but with KITSAT-OSCAR-23 gone, only two 9600-baud birds were on-line: UoSAT-OSCAR-22 and KITSAT-OSCAR-25. The relatively new Thailand satellite (TMSAT-OSCAR-31) was not available. With the recent addition of UoSAT-OSCAR-36 earlier this year, we expect Field Day 2000 to be better, and very different. While 9600 baud has become a standard digital hamsat speed, U-O-36 is capable of much more, up to 76.8 kbps (76,800 bits per second). Most access is expected to be at 38.4



*Photo A. The K5DX Field Day operation had a nice shaded hilltop spot for the satellite station.*

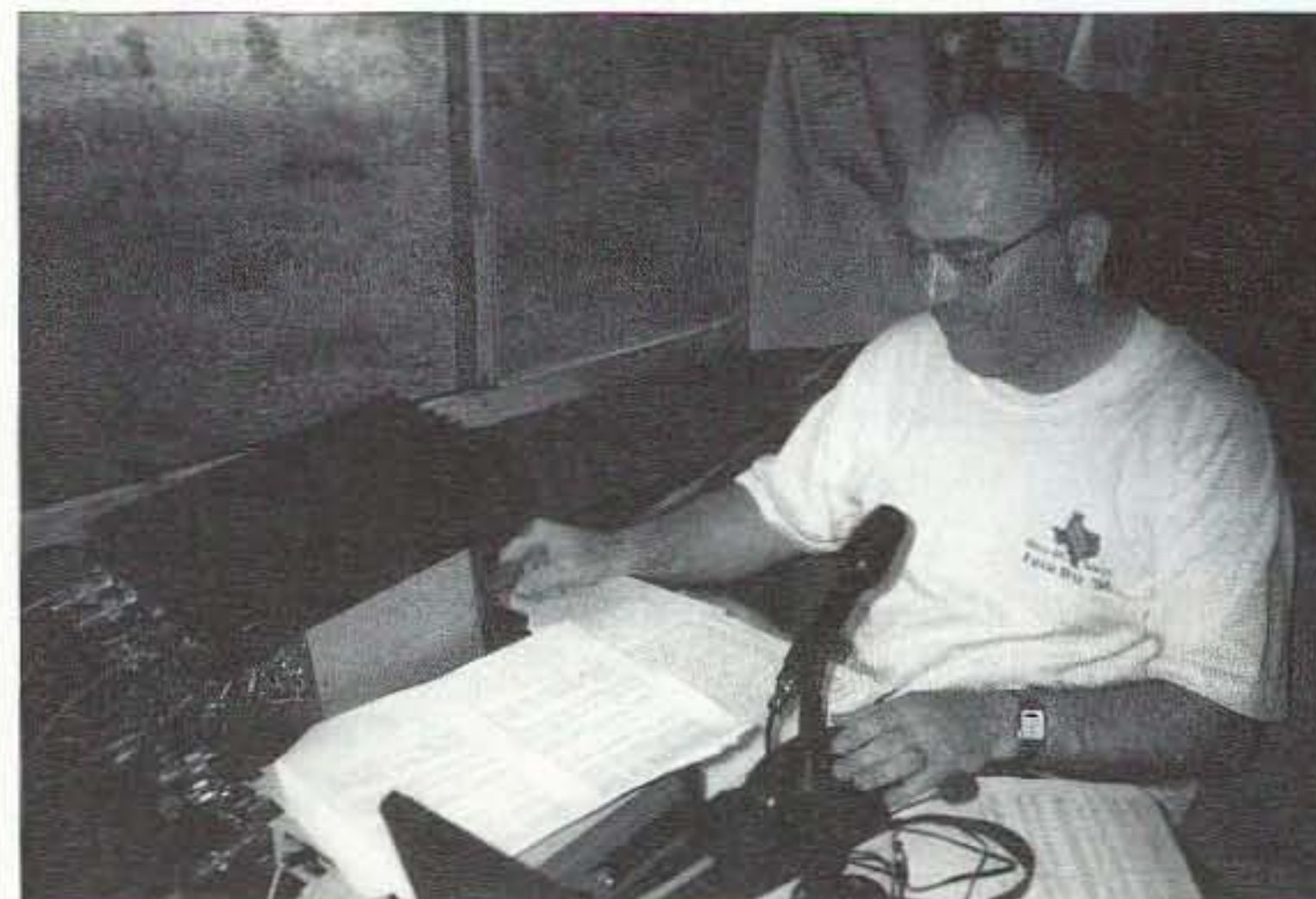

*Photo C. Mike N5MT checks out the CW setup at the K5DX satellite station during Field Day 1999.*



**Photo D.** The new Eagle Spitfire 454 10-meter HT is nearly identical in size with the much older Santec LS-202A 2-meter HT. Both are multimode radios with full band coverage.

kbps, but this will still require new gear for the home station, and field operation.

### Portable toys

Wouldn't it be nice to work satellites with only a handie-talkie and a short antenna? It's been done. The single-channel FM transponders (crossband repeaters) on satellites like A-O-27 and S-O-35 can be worked using only a single dual-band HT when conditions are optimum and usage is light. But what about the other satellites that don't use FM, but rather support CW and SSB for multiple simultaneous users? There is no single unit that you can buy off the shelf for crossband, hand-held SSB or CW, but now there's something close.

Several years ago, Santec introduced a multimode two-meter HT called the LS-202A. It ran about a watt of FM or SSB. Frequency control was by thumbwheel switches and VXO (variable crystal oscillator) and RIT (receiver incremental tuning) knobs. Slide switches selected modes and other functions. A small analog meter was used for S-meter readings in receive and battery condition during transmit. It was a nice, if rather rare, radio. Santec also marketed a mobile docking amplifier to

boost the power output to a bit over 30 watts. If you can find a used one that works, buy it, but be forewarned that some mechanical parts are proprietary and impossible to find.

The Santec LS-202A provided a great start for a two-unit mode "A" (two meters up and ten meters down) portable ground station. If SSB is not a necessity, quite a number of standard two-meter FM HTs can be used for mode "A" uplink work simply by connecting a code key into the external microphone connector and sending CW. Some HTs have excessive drift or chirp when used in this fashion. It's worth trying, though.

However, when the LS-202A came out, there was no comparable 10-meter HT on the market. Santec produced a number of HF handie-talkies under various names like Mizuho, Jim, and, in the U.S., AEA. The 10-meter version was called the MX-28S. The AEA model has the MX-28S name on top, but was sold as the AEADX Handy. Although it was a 10-meter transceiver for CW and SSB, it was designed for use in the lower part of 10 meters. The radio required a new crystal and some retuning to use it in the satellite portion of the band between 29.3 and 29.5. To get on the air without reworking a radio that really wasn't intended for use at the high end of 10 meters, it was a lot easier to just use a 10-meter mobile rig or a small digital shortwave receiver.

### The Eagle Spitfire 454

It sounds more like a good name for a CB rig, but the Eagle Spitfire 454 is a very recent, rather complex, all-mode (except CW) 10-meter handie-talkie. There have been a lot of new, unusual brand names showing up in the ham market in recent years. While most radios used to come from Japan, there are now rigs from all over the Far East. The Spitfire is custom manufactured for Copper Electronics of Louisville, Kentucky, in the Philippines.

Hams are always looking for all the features they can get in a radio for the lowest price. The Spitfire, as shipped, covers 28.0 to 29.7 MHz with AM, FM, LSB, and USB. It comes with an empty battery pack, a wall charger, a mobile power cable, a 9.5" base-loaded "duck" antenna, belt clip, hand strap, and a manual. The advertised price from Copper Electronics at [http://www.copper.com] is \$179.99.

The basic design of the radio is derived from its CB (Citizens Band) ancestry. Construction and appearance is similar to Alinco, ADI, and Cherokee HTs. The owner's manual looks like the Japanese radio manuals of the '60s. It is full of strangely worded sentences, some with rather cryptic meaning. The abbreviation CB shows up at least twice in reference to this ham rig, but fortunately the radio is very easy to use, with only a few hints needed to get it running on any 10-meter frequency and mode.

The battery pack is designed to hold nine size-AA cells. Alkaline or NiCd batteries may be used. The radio will also work with some ADI NiCd battery packs and their clones. The included wall charger is intended for use with NiCds. The mobile power cable has a cigarette lighter plug on one end and is also intended for use only with NiCds in the battery pack.



**Photo E.** A close-up of the Eagle Spitfire 454 10-meter HT. Most controls are buttons on the front or side of the radio.

The antenna that comes with the radio is only good for very local operation, but the connector on the radio is a standard BNC type. Attaching a decent long whip, mobile antenna, or even dipole is easy. Some CB magnet-mount mobile antennas can be easily moved to the 10-meter band simply by removing one or two turns from the loading coil.

For the satellite operator, tuning the Spitfire takes some practice. Main tuning is accomplished using UP and DOWN buttons located just above the PTT (push-to-talk) switch on the side. The default tuning increment is 10 kHz. To directly address 1 kHz, 10 kHz, or 100



**Photo F.** The older 2-meter multimode Santec LS-202A HT had pots and switches on the top to control operation.

# ON THE GO

## Mobile, Portable and Emergency Operation

Steve Nowak KE8YN/4  
1011 Peacock Ave. NE  
Palm Bay FL 32907-1371  
[ke8yn@juno.com]

This month we continue the discussion of the Y2K phenomenon. For the past few months, we've been looking at some of the implications that we hams might face next January. If you're a new reader, we have been operating on the assumption that *if* some computers have a problem when the year turns to 2000, then it is wise to prepare. The other assumption that we have been accepting is that such problems would be manifest in ways similar to what we see with other emergencies. This could include power outages of some type or communications problems. Therefore, the worst we will do is practice skills we will need at some point in the future for the next hurricane, tornado, snowstorm, etc.

One interesting discussion that I've heard lately concerns our current trend in manufacturing called "Just In Time" inventory control. This requires that inventory is never carried in advance of its need. Instead, parts arrive at the time they are needed to be included in the manufacture of the final product. This procedure reduces the costs associated with buying product before it is needed, which is very attractive to the accounting and finance types. On the other hand, it is totally dependent upon the supply chain working almost perfectly. Indications are that there is no widespread emphasis on stocking up on required material in case the Y2K bug causes some burps in the rail or trucking industries

or in the computers that track the orders and requirements at the plant. While this may not seriously affect us as communicators, it points out the fact that *if* there are problems associated with the Y2K event, some of them may be quite different from what people have encountered in the past. This may have less to do with the computer bug itself and more to do with changes in the way business conducts itself in this lean, mean, down-sized environment.

There are a few factors that may be different for us. One of the differences that may affect us in the next few disasters that we may be called upon to support involves the public perception of us. First, to most non-radio enthusiasts there is absolutely no difference between a ham and a CBer. In their eyes, we both use radios, we both put up ugly antennas, and we both mess up their TV. Second, the public is hungrier than ever for news, and we can expect a portion to use every means available, including listening to us, to keep up with changing events.

The first situation presents an important opportunity for us to educate the public. Most ham events, such as Field Day, do not truly catch the public's attention. We may get some publicity in the local paper or on the news, but the average citizen probably skips over those news stories since they may feel that they are not affected one way or the other by our efforts. To them, it is just a way for some guys with radios to have fun; while this is true, we all know there is more to it than just that.

During many real emergency situations, the public is not aware of the role we play. Part of this is because we are supporting such well-known disaster services as the local government, the Red Cross, the Salvation Army, and so forth. With the potential for Y2K problems, we have the opportunity to tell our fellow citizens what we will be doing if called upon to support in advance of the actual emergency. We have months to plan and execute our efforts to show our fellow citizens what we can and will do to help them. Talk

kHz steps, a control on the front of the radio called STEP must be pressed to highlight, with a cursor, the digits to be incremented: 1, 10, or 100 kHz. When in this mode, the radio will not increment beyond the segment being tuned. If the "ones" digit is being shifted, the other digits will not be affected. It's like adjusting the time on a digital clock where changing the minutes setting will have no effect on the hours. To get beyond the selected range, the default tuning of 10 kHz must be reinstated by pressing the STEP key until the cursor quits blinking. While there is a "clarifier" that works on SSB and AM, it only tunes a few kHz either side of the displayed frequency. However, it does make all the difference when tracking Doppler shift on RS-13. After some practice with a few contacts via satellite,

it gets easier to move the Spitfire around the satellite pass-band.

Receiver sensitivity is specified at 0.8 microvolts for 10 dB S/N (signal to noise). This is quite respectable. No preamp is needed, but the front end is prone to overload in locations with nearby HF transmitters, like on freeways around a lot of CB operators. Using headphones helps a lot for portable work.

Between satellite passes, the Spitfire does a very respectable job as a 10-meter transceiver. Power output on AM and FM is four watts. It is rated between six and seven watts on SSB. QRP enthusiasts are already working on a simple solution to make the rig transmit CW while in LSB or USB. For now, its use as a voice radio is quite satisfying.

For hams and other radio enthusiasts operating in foreign

countries that allow amateur-radio rigs to be used in other services, there are modifications to the Spitfire that allow it to go substantially below the 10-meter ham band to almost 25 MHz. Information on activating this "export" mode can be found on the Internet at the URL [<http://www.freeband.com/spitfire.html>]. To modify the radio, a very small surface-mount chip resistor has to be removed from the circuit board on the back side of the PTT switch. Then the radio has to be reset by shorting a circuit pad to ground. To get to the export mode, a combination of keys are then pressed according to the instructions at [[freeband.com](http://freeband.com)]. Once in the export mode, the radio's operation changes dramatically with a "band" display and a "channel" display. To get back to ham-only operation, the

combination of keys that were used to get to the export mode are now invoked again. Unless there is a really good reason to use the radio outside 10 meters, it is really a much more user-friendly radio to use in the native ham mode. Opening the radio to do the hardware modification also voids the warranty.

For less than \$200, shipping included, the Eagle Spitfire 454 is an excellent answer for the portable mode "A" hamsat station, and with the sunspot number increasing, a fun way to get on 10 meters from remote locations without lugging around a mobile or base-station transceiver. Check out Copper Electronics' Web site at [<http://www.copper.com>]. They have some other rigs and devices you probably haven't seen before that are just now showing up on this side of the Pacific. 75

## Low Power Operation

Michael Bryce WB8VGE  
SunLight Energy Systems  
955 Manchester Ave. SW  
North Lawrence OH 44666  
[prosolar@sssnet.com]

Well, the Dayton HamVention for 1999 is history. Everyone was blessed with great weather on all three days of the convention. Although I don't have the figures, the attendance seemed, at least to me, to be slightly higher than that of last year. Since the weather was so good, the flea market vendors did great! I sold almost 12 kW worth of solar panels during the three days of the convention.

Once again, the QRP ARCI held the Five Days in May technical forums. All the forums were sold out, with latecomers standing in the back. The annual banquet was held on Friday night, while Saturday night was for the vendors.

Wilderness Radio introduced their new SST CW transceivers. These rigs cover the CW portion of the three most popular QRP

bands. Of course, they are monobanders: You have to take your pick of either 40, 30, or 20 meters.

The SST or Simple Superhet Transceivers are the lowest priced and smallest members of the Wilderness Radio lineup. They come as a kit, and since they are so simple, the kits require basically less than half the pieces parts used by other rigs.

Since they are superhet receivers, you don't need to worry about hearing both sides of the CW signal. They have a three-pole crystal filter and an effective AGC circuit. Audio output has been optimized for "walking" headphones. There is no speaker, so phones are a must.

On the transmit side, you get two watts of VXO-controlled RF into a 50 ohm load. You also get QSK keying, transmit

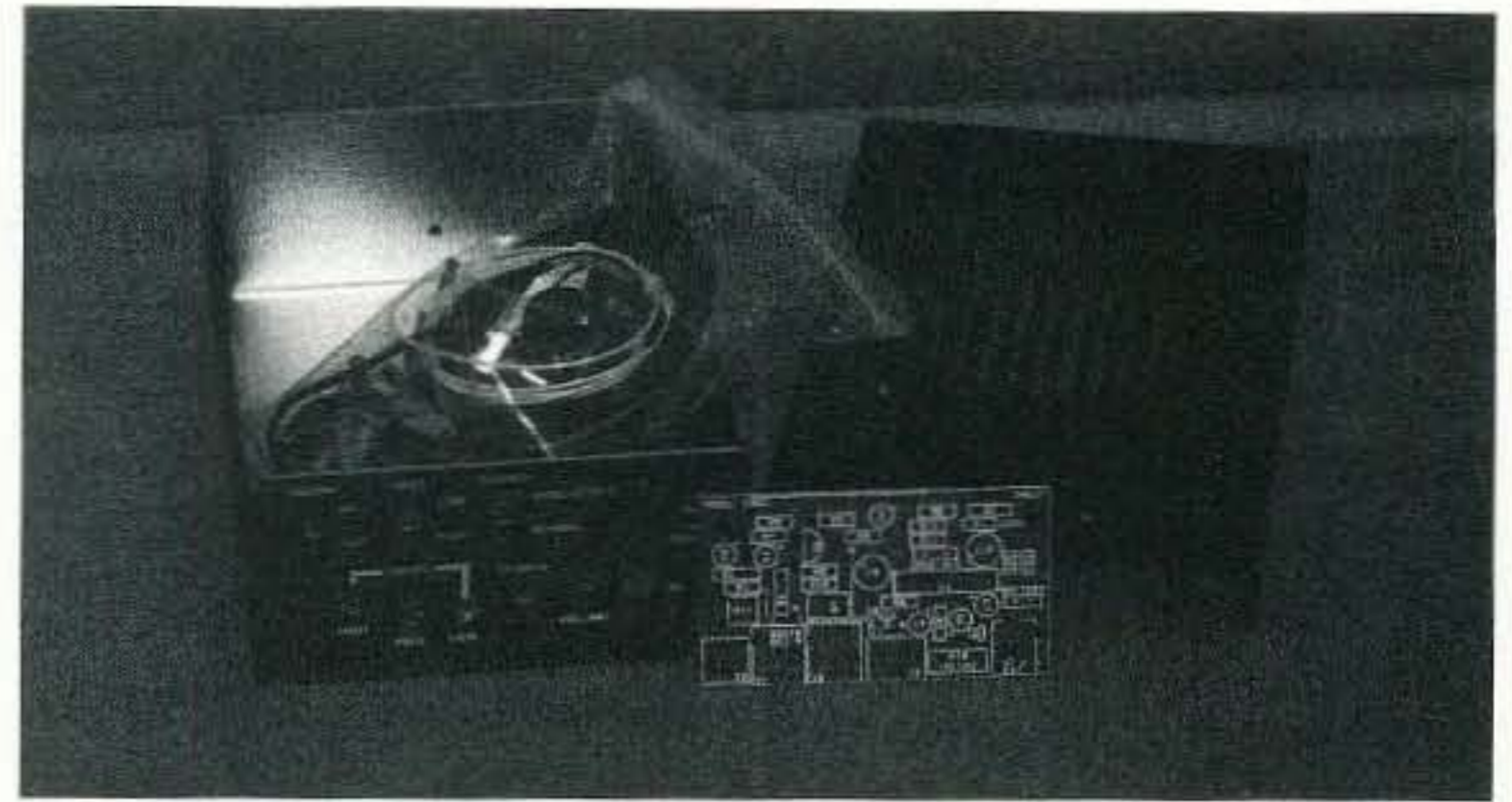

Photo A. The audio amplifier kit from Ten-Tec contains only one small PC board and a bag of parts.

monitoring, and great stability, thanks once more to that VXO.

The kits come complete with an unfinished aluminum enclosure and a "no wire" construction.

The SST would make a great rig to take along to the outback. It has a standby current demand of about 15 mA in the receive mode.

Best of all, the SST is only \$85, and that includes the case!

Dave Benson's Small Wonder Labs also introduced his newest rig. It's the DSW series transceiver. But this time around, Dave added a microprocessor to control the frequency and, at the same time, a CW output for the frequency! In a nutshell, it's based on his very popular

monoband transceivers. You can get one for the 160, 80, 40, 30, and 20 meters.

The rig is very small, and Dave told me there are only four toroids to wind. There are two relatively large surface mount inductors, but the rest of the surface mount components have already been commercially installed.

And Dave added .100" locking headers to connect the outside world to the DSW transceiver. There's also a companion enclosure if you're not into bending metal. Oh, yes: The price is \$90 for the kit and \$35 for the enclosure. You can order your own by dropping Dave a note at: Small Wonder Labs, 80

about a marketing opportunity — this is one in a lifetime!

Compare the potential "Just In Time" issue above with what hams are doing to prepare for any emergency and this one in particular. We are proactive by regularly planning and preparing for emergency situations as opposed to waiting for an event to occur. We routinely prepare before each storm season, but few potential disasters have caught the public's attention the way Y2K has. As news reporters are looking for Y2K story ideas, why not present what we are doing to prepare? This is an excellent time to point out that we are licensed by the federal government. One of our primary purposes specifically stated in the law is to provide emergency

communications! What other groups are so specifically tasked by the federal government? And, oh, by the way, this is one of the reasons that we are permitted to install large antennas — so that in the event of an emergency, we can communicate effectively. I strongly recommend that we do not pass up this opportunity to blow our own horn.

The second issue fits in with the first. People have always been hungry for news, which is why there are now a number of all-news stations on cable. The commercial operators have seized this opportunity to improve their own commercial success. How many "headlines" presented during prime-time television present any real information compared

to the number that are teasers designed strictly to entice people to tune in later. ("Six people died violently! We'll tell you who at eleven ...") News networks frequently broadcast conjecture, supposition, and theory to fill air time when the facts are not yet known. On the other hand, if we hams are providing communications service in any disaster, we are often the first to know what's going on. Skywarn is a prime example. Who is it who reports the hail, wind damage, etc., to the National Weather Service? We do, of course, and the information is passed along to the news media well after we are aware of it.

Some people already use scanners to track various public

service transmissions and routinely monitor our frequencies as well. If we publicize our role in disaster recovery, more people may decide to listen in to our transmissions. It may even be wise to include in press releases or news stories that these transmissions can be heard, and even include the frequencies. This may be helpful in demonstrating our importance to the community, but will also make it even more important to ensure that we operate in a professional and competent manner. The advantage is that if we present ourselves in a well-trained and professional manner before the end of the year — and do a good job on the air — we may be able to build a greater level of support for our hobby. 73

# HOMING IN

## Radio Direction Finding

Joe Moell P.E. K0OV  
P. O. Box 2508  
Fullerton CA 92837  
[Homingin@aol.com]  
[http://www.homingin.com]

### Dayton does DF

Remember the New Year's resolutions that you made as 1999 began? Have you fulfilled them? Perhaps you decided to try something new in ham radio, such as hidden transmitter hunting (also called T-hunting and foxhunting). I resolved to make the trip from California to Dayton for a first try at the Hamvention.

Until this year, I didn't have a good reason to go. Flea market? I can easily drive to three

big ham radio swap meets every month. Talks and exhibits? Our annual Southwestern Division bash (HamCon) is nothing to sneeze at. It always has good forums, plus great transmitter hunts with lots of prizes. So why travel to a hamfest almost two thousand miles away?

Last October, I got E-mail from Jim Elmore KC8FQY of West Chester, OH. He was helping to plan the biggest and best radio direction finding (RDF) activities for the 1999 Hamvention. Jim was teaming with



Photo A. Dick Arnett WB4SUV has a well-equipped mobile T-hunt setup including a doppler and a storage-scope display.

Dick Arnett WB4SUV of Erlanger KY and Bob Frey WA6EZV of Cincinnati to put on both the Foxhunt Forum and a whiz-bang foxhunt. He wouldn't take no for an answer.

I had been in E-mail contact with KC8FQY since he began

T-hunting in early 1997. Jim has worked very hard to learn the secrets of RDF, detailing his experiences in the "Confessions of a T-Hunter" pages of his Web site. WB4SUV and WA6EZV (Photos A and B) are serious RDF experimenters who are always



Photo B. The completed audio amplifier sits on top of the Drake SW8 receiver.

East Robbins Ave., Newington CT 06111. You can also contact Dave via E-mail at: [bensondj@aol.com].

I have plans for this rig, and I'll share them with you by the Dayton Hamvention 2000!

While I held on to most of my money, I did get one kit from Ten-Tec. It's a Utility Audio Amplifier, number 1252. The 1252 is a rugged portable audio amplifier kit that offers both high and low impedance inputs. The heart of the kit is the Signetics TDA2611A power audio IC. It can easily drive the internal speaker to 1.5 watts of

pure audio. In fact, Ten-Tec uses this very same audio chip in many of their rigs. Most of the QRP rigs I have built use the popular LM386 audio amplifier. Its output on a good day is about 200-400 mW of audio.

The 1252 has a preamplifier for driving low impedance inputs. You can switch this preamplifier in or out of the circuit if you use a high impedance input. An internal trimmer allows you to set the gain coming in from the high impedance input.

I also like the way the 1252 handles audio input signals. You have your choice of either an RCA or 1/8" mono input jacks.

Everything comes together in a painted and silk-screened box. You also have two choices to power the 1252: Use the internal 8 AA batteries or an external 12 volt DC source. A steering diode selects the external power supply if the input voltage is greater than that of the internal battery pack. I have not tried to use the amplifier with an AC-powered power supply.

Assembly of the 1252 is rather straightforward. Everything (except for the switches) is on one small single-sided PC board. Assembly consists of stuffing the board and wiring up the switches. Bear in mind, there are a lot of wires going in and out of the PC board to the switches.

All and all, the 1252 was a snap to assemble. Now that it's done, what can it do for you?

Well, Radio Shack sells an amplifier in a box. It's based on the LM386 and comes with a small speaker built-in. It works nice, but leaves a lot to be desired. The 1252, on the other hand, is industrial strength.

If you have experimented with a direct conversion receiver, then you know the importance of a good, stable audio chain. You can work on the RF sections, as the audio section is easily handled by the 1252.

The 1252 would make a great signal tracer, too. A .047 cap to isolate the 1252 from DC voltage in the test rig, and you'll

easily be able to track down the problem.

Ten-Tec included a "listening to energy" booklet and some extra pieces parts to play with. One is an induction pickup coil for amplifying telephone conversations. I use the pickup coil and the 1252 when I'm put on hold waiting for tech support from Microsoft. That way, I can go about doing what I need to do, while I listen to the voice on hold message telling me the all service technicians are busy. When it's my turn, I turn off the amplifier and pick up the phone. It's a cheap man's version of a speakerphone.

All and all, I like the 1252. It's going to be on my workbench for a very long time. It's about \$45 and well worth the price. Every QRP operator should have one in his or her shack.

If things work as I have planned, I'll have some real-life QRP camping tips for next time. Keep tuned!





**Photo B.** Bob Frey WA6EZV, an OK-KY-IN foxhunter and one of the hunt organizers, shows off his Roanoke Doppler antenna set.

ready to track down RF sources for fun and public service.

All three are members of OH-KY-IN Foxhunters, a very active group that draws RDFers from a three-state area to monthly T-hunts that usually start in Cincinnati. These intrepid folks do it all year long, and they like to hunt on foot as well as in their cars. As an example, the temperature was only 18 degrees Fahrenheit when the February hunt began. WA6EZV had put a transmitter in a park on the east side of the city. That T kept the hunters busy for only about a half hour, but they knew Bob had more in store for them.

Sure enough, there were four



**Photo C.** Tape-measure beams are very popular for on-foot fox-hunting. Joe Leggio WB2HOL shows his three-element version at the Dayton Foxhunt Forum.

more foxboxes within the park, all on different frequencies. To make sure that the four hunting teams didn't play "follow the leader," Bob told them that each team had to search for his QRP transmitters in a unique order. The first team was directed to find them 1-2-3-4, the next 2-3-4-1, and so forth. One fox was in a bush, another between the tires of a parked truck, the third inside some construction pipe, and the last was deep in a snowbank.

WB4SUV's team won that February event, so Dick had a chance to get even in March. Winter was still around at that time, so he made the hunters sniff in the snow once again. But first, they had to track down his main transmitter. It was at a nature preserve in Delhi, Ohio. Its dipole antenna was in a tree along the bank of the Ohio River. Three teams tried to approach the preserve from the Kentucky side and had a lot of backtracking to do. They were probably victims of the "river effect," which occurs when VHF signals reflect from multiple locations along a riverbank and give ambiguous bearings.

#### RDF extravaganza

For the 1999 Hamvention Foxhunting Forum, Jim, Dick, and Bob envisioned a 3-ring circus of RDF. Dale Hunt WB6BYU of Portland, Oregon,



**Photo D.** WA6EZV needed a bullhorn to get the attention of the crowd of foxhunters before the hunt started.

would relate his experiences at the 1998 ARDF World Championships in Hungary (see "Homing In" for January 1999). He would be assisted by Marvin Johnston KE6HTS of Santa Barbara, California, who was also part of the USA's traveling team.

Joe Leggio WB2HOL (**Photo C**) would do a show-and-tell of the many RDF projects he has built in the past four years, including foxboxes and rugged directional antennas. These projects are documented on WB2HOL's Web site. It would be my job to relate the adventure and intrigue of mobile T-hunting, southern California-style. I figured that

about ten dozen slides would do it.

Our OH-KY-IN hosts were invaluable at teaching us first-timers the appropriate survival skills for Dayton. The worst part was the parking, which is a l-o-n-g way from the arena. Fortunately, our hosts had passes and could deliver all of our paraphernalia directly up to the building. But watching a few tortured hams trying to carry their prize boat anchor purchases from the flea market all the way to their vehicles convinced me that next time, I should bring a wagon. For that muddy dirt parking lot, it will

*Continued on page 56*

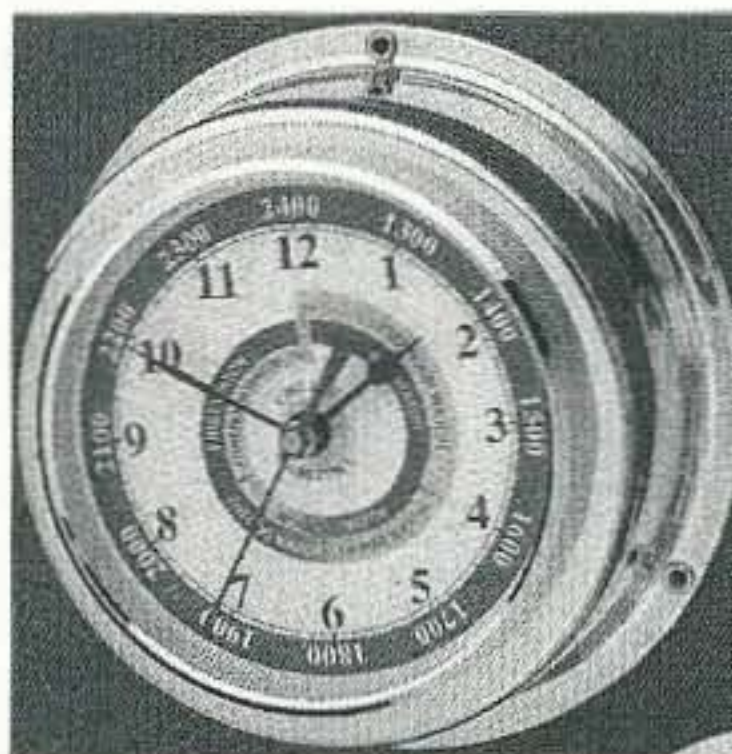

#### Chelsea Clock

Clockmakers since 1897  
The choice of The Coast  
Guard Foundation.

Quartz Clock

4" Dial

Beautifully hand-polished.  
Stamped brass case and  
bezel.  
Curved glass crystal.  
Wall or bulkhead mounting.  
Made so well they last from  
generation to generation!  
Order this month and save  
\$20!

**Your price \$75**

**Omega Sales**

**P.O. Box 376**

**Jaffrey NH 03452**

**1-800-467-7237**



**Photo E.** Yep, it's really in there. Richard Lorenzen WAØAKG holds a log transmitter, complete with numbered tag.

## HOMING IN

continued from page 55

need big wheels. Maybe a moon rover?

The Dayton flea market lived up to its reputation. Easily bigger than all three southern California monthly swap meets put together, it was far too much to cover in our limited available time. But we did manage to check out the booths of some suppliers of RDF stuff, including Dave Peleaz AH2AR and Fred Reimers KF9GX.

The only hitch in the Fox-hunting Forum was a last-minute time change from 1000 to 0815 hours on Saturday.



**Photo F.** First-prize winner was Dale Hunt WB6BYU of Portland, Oregon, who was the only one to find 11 of the 16 transmitters.

Because it began too early for many attendees who were still in line trying to get their tickets, the room filled up more slowly than predicted. By the end, though, there was a big crowd listening to WA6EZV wrap up the forum by promoting the Hamvention foxhunt, which would be held that afternoon.

## Exercise, fun, and prizes

I was glad to find out that this year's foxhunt was not for mobiles. The thought of putting RDF gear in a rental car did not appeal, nor did the prospect of competing against OH-KY-IN foxhunters on their home streets and highways. This Dayton foxhunt was all on foot, but it didn't demand Olympian abilities (**Photo D**).

The hunt area, across a highway from the convention site, included the exterior of a school building, a parking lot, and a field with a baseball diamond and large water tower. Each person was handed a card with individual frequencies of the 16 transmitters on this hunt. (I think all 16 were out there, but there were a couple that I never heard.) The goal was to find the most foxes in a 90-minute period.

Foxes could be found in any order. They were concealed inside sidewalk cracks, logs, old tire carcasses, and so forth (**Photo E**). A small black-and-gold label with a unique 3-digit number was next to each one, to be written onto the frequency card. There were no decoy labels. (Well, none that I encountered, anyway.)

Transmission times ranged from a few seconds each minute to continuous. Since all foxes were on separate frequencies, there was no problem of them QRMing each other. However, hunters had to program 16 frequencies into their HTs and scanners (32 if they used offset attenuation) for best efficiency.

Even busier were users of single-turndial ARDF sets such as the Russian Altai or Australian Ron Graham units (See "Homing In" for December



**Photo G.** Paul Gruettner WB9ODQ won second place and took home a new transceiver, along with the congratulations of WB4SUV and KC8FQY.

1997). Their owners were constantly twisting the tuning knob. Users of 1 MHz offset attenuators had their own problems, as some of the fox frequencies were spaced 1 MHz apart. What's more, there were plenty of simplex QSOs taking place in the Hamvention arena a quarter mile away. Many fox signals were so weak that you had to be within 50 feet to pick them up at all, even with a beam antenna.

Teaming and collaboration on the course was permitted, but there could be only two hunters on a team at most. A "one RDF antenna per team" rule was also in effect. This kept team members from hunting independently and then pooling their scores. But it allowed a hunter to have extra eyes to spot the tiny tags. I took advantage of this rule by inviting Richard Lorenzen WAØAKG to come along with me.

When my directional and signal strength indications told me I was very close to a fox, I would discreetly back away and let Richard surreptitiously uncover the tag and get the number. This made it less likely that the exact locations would be given away to someone watching me. In retrospect, it would have been smart to send him out running with just an HT, to see if he could catch a whiff of some of

the elusive very-QRP foxes. Then I could have finished tracking them down with the RDF gear.

After the 90 minutes of scurrying were over, it was time to tally the results. Winners were determined first by number of foxes found and second by speed. To judge speed and to avoid ties, each hunter had been encouraged to have his card checked regularly by course officials, who would mark the



**Photo H.** Lars Nordgren SMØOY is a champion foxhunter from Stockholm who couldn't miss the opportunity to go foxhunting at Dayton. Lars was one of the hosts of the 1994 ARDF World Championships in Sweden.

# CALENDAR

Listings are free of charge as space permits. Please send us your Calendar Event two months in advance of the issue you want it to appear in. For example, if you want it to appear in the December issue, we should receive it by October 31. Provide a clear, concise summary of the essential details about your Calendar Event.

## SEP 18

**LINCOLN, ME** The Bagley ARC of north central Maine will hold their 7th Hamfest at the Ella Burr School in Lincoln ME on Sep. 18th. VE exams will be held in the school complex. For further details, call Hamfest Committee Chairman Max Soucia at (207) 564-8943; or Sylvia Cockburn N1JNR, (207) 732-5185, Fax (207) 732-4211.

## SEP 18-19

**EL PASO, TX** The 1999 El Paso Southwest International Hamfiesta will be located at the Ysleta Independent Cultural Arts Center, 9600 Sims, El Paso TX. It will be open 8 a.m.-5 p.m. Sep. 18th, and 9 a.m.-1 p.m. Sep. 19th. Talk-in on 146.88. Please contact Craig A. Lyles KC7UXM, (915) 821-7501.

## SEP 24-26

**LANCASTER, NH** The United Way of Northern NH will sponsor the Lancaster Super Moose

Festival Hamfest and Computer Flea Market. This event will be held at the Lancaster Fairgrounds, Rte. 3, Lancaster NH. More than 200 hookups in the selling area. Miles of tailgating space. Large commercial vendor space. On-site parking. \$25 per night for camping space with hookup. General admission \$3 per day. Vendor fees for the weekend (tables not provided) include one weekend admission: (A) \$20 outside, no electricity; (B) \$30 outside, electricity; (C) \$50 for inside buildings. Make check payable to United Way of Northern NH, and mail to Lancaster Super Moose Festival, P.O. Box 614, Berlin NH 03570. Russ N1YZE is your contact person. Tel. (603) 752-3343; E-mail [unitedway@ncia.net]. Fax (707) 202-1871.

**PHOENIX, AZ** The ARRL and TAPR 18th Annual Digital Communications Conference will take place at the Holiday Inn Select Airport. Special DCC room rates are \$69/single and \$79/

double per night. When making reservations with the hotel be sure to indicate you are attending the ARRL and TAPR DCC in order to get the discount. Book your room ahead of time. The hotel provides transportation to and from the Phoenix Sky Harbor International Airport. Please arrange transportation needs ahead of time: Holiday Inn Select Airport (conference hotel), 4300 E Washington, Phoenix AZ 85034. Tel. (602) 273-7778; Fax (602) 286-1109. Pre-registration, before Sep. 1st, \$42. Registration after Sep. 1st or at the door, \$47. Saturday Evening Dinner, \$22. The 3rd Annual APRS National Symposium, Fri., 1 p.m.-7 p.m., \$25. Technical Seminar on HDTV, Fri., 5 p.m.-7 p.m., \$15. A PIC Design, Development, and Programming Seminar will be conducted by the TAPR PIC Development Team, Sun., 8:30 a.m.-2 p.m., \$20. Full info on the conference and on lodging can be obtained by contacting Tucson Amateur Packet Radio, (940) 383-0000; Fax. (940) 566-2544. E-mail [tapr@tapr.org]. The Web site is [www.tapr.org].

## SEP 25

**DAYTONA BEACH, FL** The ERARA and DBARA clubs have again joined together to bring you the 3rd annual Daytona Beach Hamfest and Computer Show, Sat., Sep. 25th, 9 a.m.-5 p.m., at the Embry Riddle Aeronautical Univ. campus on Clyde Morris

Blvd., just 1 mile south of International Speedway. Talk-in on 147.150(+600), starting at 7 a.m. Doors open 9 a.m. sharp. Lunch will be provided at modest cost by Embry-Riddle student organizations. Admission is \$5. For advance tickets send a check or money order along with an SASE to ERAU C/O Student Activities, 600 S. Clyde Morris Blvd., Daytona Beach FL 32114, before Sep. 10th. Handicap parking is provided. 6-ft. tables with power are \$7 for one, \$6 for each additional. 5-ft. tables are \$6 for one table, \$5 for each additional. All tables have power connections. Tailgate sites in the paved parking lot are \$3, no power. VE exams for all classes. There will be a hidden transmitter hunt (with a \$50 cash prize) at 4 p.m. You must have a paid admission ticket and sign up for the hunt before 4 p.m. to be eligible for the prize. Contact DBARA-Hamfest, P.O. Box 9852, Daytona Beach FL 32120; or E-mail [munseyj@mindspring.com]. Web pages are at [http://www.america.com/~dbara/] and [http://www.db.erau.edu/campus/student/club/erara].

**HORSEHEADS, NY** The Amateur Radio Assn. of the Southern Tier will present its 24th Annual Elmira International Hamfest-Computerfest on Sat., Sep. 25th, at the Chemung County Fairgrounds in Horseheads. Talk-in will be on 147.360, with an alternate frequency of 146.700 (in case the primary frequency is down). There

number of foxes found so far and the exact time. If two or more individuals/teams had the same number of foxes at the end, an earlier check time would place higher in the standings.

None of the participants found all 16 foxes. Winner of the hunt and a new voice/packet transceiver was WB6BYU (Photo F), who was the only one to find 11 of them. Dale, hunting alone, used the same VK4BRG ARDF receiver/antenna set that he took to the ARDF World Championships in Hungary last year.

Second place was Paul Gruettner WB9ODQ (Photo G)

of Nashville, assisted by Larry Christianson WB9SDD. Paul took home a new 6-meter mobile rig for his efforts. He later wrote, "We got off to a slow start. The first transmitter signal directed us straight towards the water tower. Upon getting there, we discovered it must have been a reflection because the signal then pointed back towards the school building. After digging through the bushes for a few more minutes, we found our first transmitter, against the school building, behind some hedges. Twenty minutes had passed. After that, things started to improve and our time between

finding transmitters started to shorten. Locations of ones we found included the base of a street light, a crack between a concrete walk and a building, and inside a small log amidst a wood pile."

Three entrants found ten foxes and three (including yours truly) found nine. I used an ICOM R10 scanner and active attenuator as described in "Homing In" for May 1998. Its 4 MHz offset was a big help in minimizing QRM from the hundreds of hams on the air nearby during the hunt. Coming all the way from Sweden was Lars Nordgren SMØOY (Photo H),

who found five. At the other extreme, a couple of hunters found only one fox, but they said they still had a fine time.

I'm glad I kept this New Year's resolution. It was great to spend three days with a bunch of friendly midwest hams who know how to have fun with RDF. No matter where you are, your RDF activities are of interest to 73's readers. Send your foxhunt stories and photos to the postal and E-mail addresses at the beginning of this article. All of the Web sites mentioned above are accessible by link from the "Homing In" Web site. 73

will be dealer displays of new equipment, and a large flea market area. Breakfast and lunch will be served on the premises. Admission is \$4 for advance tickets, \$5 at the gate. The event will run 6 a.m.-3 p.m., with VE exams starting at 9 a.m. For VE exam info, contact *John* at (607) 565-4020. Dealers, please call *Gary* at (607) 739-0134. For tickets, call *Dave* at (607) 589-7495.

#### SEP 26

**BOWIE, MD** The Foundation for Amateur Radio (FAR) will sponsor the 42nd annual F.A.R.Fest amateur radio hamfest on Sun., Sep. 26th, at Prince Georges Stadium, 1/4 mile south of the junction of US-50 on US-301 in Bowie (between Washington DC and Annapolis MD). Directions: From points north, take I-95 south to the Baltimore Beltway (I-695) to Exit 4 (I-97 South) toward Annapolis. On I-97 South, take Exit 7 (Route 3 South—Bowie/Odenton). Take Route 3 for approx. 11 miles. After passing under the Route 50 overpass, proceed to second traffic light and turn left into Stadium Drive. Note: Route 3 changes to Route 301 after you pass under Route 50. From points south, take I-95 North to Exit 104 (Route 301 North). Take 301 North past Upper Marlboro. Go through the traffic light at the Route 197 intersection (Rip's Country Inn will be on the right). At the next traffic light, turn right into Stadium Drive. From points east, take Route 50 West to Exit 13A (Route 301 South). At the second traffic light, turn left into Stadium Drive. From points West: From I-70 East, follow directions coming from points north. From Washington DC or the Capital Beltway: From DC, take New York Ave. to Route 50 East, or the Capital Beltway, Exit 19A (Route 50 East). Take Route 50 to Exit 11 (Route 197). Go south on Route 197 for approx. 1.5 miles to Route 301. Turn left onto Route 301 and remain in the right lane. Turn right at first traffic light into Stadium Drive. This hamfest location has a paved area that will accommodate over 700 tailgaters. Vendors and other sellers will be able to set up under the canopy of the stadium concourse. General admission \$5 at the gate. \$10 for

tailgating (admission ticket required). Vendors and other exhibitors should contact *Marry Morris N4TCI*, [radio@hotmail.com] or (703) 971-3905. Special Event Station W3PRL-AM will be on display. For general info on F.A.R.Fest '99, contact *Al Brown KZ3AB*, [amateurradio@hotmail.com] or (301) 490-3188. Talk-in on 146.520 MHz and 147.105 MHz.

**YONKERS, NY** The Metro 70 CM Network will host a Giant Electronic Flea Market Sep. 26th at Lincoln High School, Kneeland Ave., Yonkers NY, 9 a.m.-3 p.m., rain or shine. Free parking. No tailgating. Indoor flea market only. Donation \$6, kids under 12 free. Vendors, for advance table reservations, the 1st table is \$19, \$15 each additional table All tables 30 inches x 5 ft., or bring your own tables at \$14 for a 6-ft.-long space. Tables are \$25 each at the door, or \$20 for a 6-ft. space. Full payment is due with registration. Table setups are at 7 a.m. For registration, call *Otto Supliski WB2SLQ*, (914) 969-1053. Talk-in on 440.425 MHz PL 156.7; 223.760 MHz PL 67.0; 146.910 MHz; and 443.350 MHz PL 156.7. Mail paid reservations to *Metro 70 CM Network*, 53 Hayward St., Yonkers NY 10704.

#### OCT 1-2

**SPRINGDALE, AR** The NWAARC Hamfest '99 will be held at Jones Center for Families, 922 E. Emma Ave. (north of the airport), Fri., Oct. 1st, 7 p.m.-9 p.m.; Sat., Oct. 2nd, 8 a.m.-2 p.m. Setup both days. To pre-register for VE exams, contact *Doug MacDonald W4FH*, 684 Cliffside Dr., Fayetteville AR 72701-3813; tel. (501) 443-3359. Admission \$5. Tables \$6. Tailgate \$4. Free parking. For reservations or general info, contact *Northwest Arkansas ARC*, P.O. Box 24, Farmington AR 72730; or *Clarence Morrow KC5UEW*, Chairman, P.O. Box 264, Rogers AR 72757-0264. Tel. (501) 631-9231.

#### OCT 1-3

**LONG BEACH, CA** The ARRL Southwestern Div. Convention will be held aboard the Queen Mary Ocean Liner Hotel, Pier J in Long Beach CA. It is located at the south tip of the Long Beach Freeway and is only a short 1/2

hour drive from Los Angeles Internat'l. Airport. Banquet tickets are limited and you are advised to reserve seats early. For more info, please write to *HAMCOM*, P.O. Box 17864, Long Beach CA 90807, or visit them on the Web at [http://www.qsl.net/arrlsw/hamcom]. The featured banquet speaker will be *W. Riley Hollingsworth K4ZDH*, FCC Legal Advisor for Enforcement. He will speak Sat. evening, October 2nd. Film/Television producer *Dave Bell W6AQ* will be Master of Ceremonies for the event. In addition to speaking at the banquet, Hollingsworth will also host an open FCC Forum earlier in the day.

#### OCT 2

**POMPEY HILLS, NY** The Radio Amateurs of Greater Syracuse will hold the 43rd "RAGS 1999 Hamfest" at the Pompey Hills Fire Dept., just off Route 20, Sat., Oct. 2nd, 8 a.m.-2 p.m. Talk-in on 147.90/30. Admission \$5, 16 and older. Outside flea market spaces \$3. Indoor tables *must* be reserved, \$10 plus admission ticket. Mail payment to *RAGS*, Box 88, Liverpool NY 13088. Tel. (315) 469-0590. 8-ft. space, \$5 (bring your own table). Friday setup 4 p.m.-9 p.m., Saturday setup 6 a.m.-8 a.m. Tailgaters, \$3 10 x 20 ft. space, plus admission. Visit the Web site at [www.pagesz.net/~rags]. For VE exams, pre-register by Sep. 24th. Send name, address, phone number, test(s) you are applying for, to *Exams*, Box 15144, Syracuse NY 13215. Breakfast and lunch served 7 a.m.-1:30 p.m. by the Pompey Hills Fire Dept.

**WILLOW GROVE, PA** From 9 a.m. until 9 p.m. the Mt. Airy VHF Radio Club will present the 1999 Mid-Atlantic States VHF Conference at the Hampton Inn, 1500 Easton Rd., Willow Grove PA (Rte. 611, 1/4 mile below the Willow Grove Exit #27 of the PA Turnpike). Call (215) 659-3535 for room reservations. Conference registration is \$24 per person at the door, which includes an admission ticket for HAMARAMA, being held the following day. Contact *John Sortor KB3XG*, 1214 N Trooper Rd., Norristown PA 19403. E-mail [johnkb3xg@aol.com]. Tel. (610) 584-2489. See the Pack Rat Web

site at [http://www.ij.net/packrats] for location maps and additional info.

#### OCT 3

**WRIGHTSTOWN, PA** The Mt. Airy VHF Radio Club (Packrats) will hold its annual HAMARAMA on Sun., Oct. 3rd, at the Middletown Grange Fairgrounds, Penns Park Rd. (between Rtes. 232 and 413), Wrightstown PA. Open to the public at 7 a.m. for a \$5 donation. Doors open to vendors at 6 a.m. for outdoor tailgating spaces for \$10 each, plus general admission charge. Indoor spaces with 8-ft. tables available at \$15 each by pre-registration only. Sellers of new and used amateur radio equipment, electronic components and computer hardware/software vendors are invited to participate. Talk-in on 146.52 simplex. For more info, contact *Mark Schreiner NK8Q*, 662 Cafferty Rd., Ottsville PA 18942; E-mail [nk8q@amsat.org]; Tel. (215) 847-2285; or *Bob Minch N3XEM*, E-mail [raminch@bellatlantic.net]; Tel. (215) 822-0779.

#### OCT 8-11

**SAN DIEGO, CA** The 1999 AMSAT-NA Annual Meeting and Space Symposium will be at the Hanalei Hotel in the heart of San Diego's Mission Valley, Oct. 8th, 9th, 10th, and 11th. Hotel reservations can be made by calling 1-800-882-0858. Be sure to mention AMSAT to receive the \$85 per night discounted group rate. This rate is available for rooms reserved between Oct. 4th and Oct. 12th. The local contact for the AMSAT event is *Duane Naugle KO6BT*, [ko6bt@amsat.org]. There are many nearby attractions for entertainment and recreation, including the San Diego Zoo, [www.sandiegozoo.org], and Disneyland [disney.go.com/Disneyland/index.html].

#### OCT 10

**LIMA, OH** The Northwest Ohio ARC will host the Lima Hamfest & Computer Show, Oct. 10th, 8 a.m.-2 p.m., at the Allen County Fairgrounds in Lima OH. This location is 1 mile east on Rte. 309, off I-75, Exit 125/126. Free parking, large building, indoor

facilities. No alcoholic beverages allowed on premises. Free camping; electrical hookup \$10. Trunk sales, 12-ft and 24-ft areas, \$5, plus tickets. Tickets \$4 in advance, \$5 at the gate. 8-ft. tables, \$10 each, includes one free ticket. For table reservations, tickets, SASE to *N.O.A.R.C., P.O. Box 211, Lima OH 45802-0211. Tel. (419) 647-6321, or E-mail [Gas1950@AOL.com]*. Visit the Web site at [*www.Anglefire.com*].

**MASON, MI** Lansing Civil Defense Repeater Assn. and Central Michigan ARC will hold the LCERA & CMARC Hamfair and Computer Show at the heated Community Center in the NW corner of the Ingham County Fairgrounds in Mason MI. Take US 127 to the Kipp Rd. exit. Take Kipp Rd. East to the Fairgrounds. Ham gear, electronics, computers. Admission \$5 per person. Tables \$10. Trunk sales \$8. Plenty of parking, handicap parking available. Refreshments, overnight camping available. Vendor setup 6 a.m. Talk-in on 145.390(-600). Contact *Don Tillitson WB8NUS, (517) 321-2004; or Erv Bates W8ERV, (517) 676-2710*. Write to *LCDRA, P.O. Box 80106, Lansing MI 48908*. Send E-mail to [*w8erv@arrl.net*].

**WALLINGFORD, CT** The 7th Annual Nutmeg Hamfest & Computer Show, featuring the ARRL Connecticut State Convention, will be held (rain or shine) Oct. 10th, 9 a.m.–3 p.m. at the Mountainside Special Event Facility, High Hill Rd., Wallingford CT. Exit 15 Rte. 91 (North or South), follow signs. General admission \$6, children under 12, \$3. Inside spaces \$25, includes one 10 x 10-ft. booth, one 8-ft. table, one chair, and 2 free passes per vendor. Outside tailgate space, 30 ft. for \$15. Vendor setup starts at 6 a.m. Send payment to *Gordon Barker K1BIY, 9 Edge Wood Rd., Portland CT 06480. Tel. (860) 342-3258. E-mail [nutmeghamfest@qsl.net]*. Visit the Web site at [*www.qsl.net/nutmeghamfest*]. Proceeds from the event will help support public service, scholarship, and civic activities.

#### OCT 11

**BREMERTON, WA** The North Kitsap ARC of Silverdale WA will host a hamfest at President's Hall,

Kitsap County Fairgrounds, NW corner of Fairgrounds Road at Nels Nelson Rd. Talk-in on 146.62(-) offset PL tone 103.5(-) WWRA rpt., or 146.52 simplex. Admission \$5 for 12 and over, under 12 free. New and used equipment. Tables \$15 each with 1 free admission until Sep. 30th; \$20 each afterwards. Commercial spaces are \$30 each. Electrical connection \$2 per table. Contact *Marcie Stilwell KC7DAT, P.O. Box 2268, Silverdale WA 98383-2268. Tel. (360) 697-2797; E-mail [nkarc@yahoo.com]*.

#### OCT 16

**GODFREY, IL** The Lewis & Clark Radio Club will hold their Mid-west Amateur Radio & Computer Expo at the Lewis & Clark Community College in Godfrey IL, in the River Bend Arena. Free parking. Indoor flea market, commercial vendors, all handicap accessible. Doors open at 8 a.m. Setup Fri., Oct. 15th after 6 p.m., or Sat., Oct. 16th at 6 a.m. Tables \$10 each; call (618) 254-9465 for reservations. VE exams: Pre-registration is required for "No Code" exams. Walk-ins are okay for all other class exams. For pre-registration or info call *Rich Morgan KF9F, (618) 466-2306*. For info and tickets, write to *Lewis & Clark Radio Club, P.O. Box 553, Godfrey IL 62035; or call (618) 466-1909*. Talk-in on 145.230 and 442.225. E-mail [*N9WHH@ezl.com*]. Visit the Web site at [*http://WWW.EZL.COM/~LMILLER/LCRC.HTML*].

**GRAY, TN** The 15th Annual Tri-Cities Hamfest will be held by the Kingsport, Bristol, and Johnson City Radio Clubs, on Sat., Oct. 16th, at the Appalachian Fair Grounds, located off I-181 in Gray TN. A large drive-in indoor and outdoor flea market space is available. RV hookups. Admission is \$5. Mail inquiries to *P.O. Box 3682 CRS, Johnson City TN 37602*.

#### OCT 17

**KALAMAZOO, MI** The 17th Annual Kalamazoo Hamfest will be held at the Kalamazoo County Fairgrounds, starting at 8 a.m. Vendor setup at 6 a.m. Advance tickets \$3, \$4 at the door. Trunk sales \$5. For tickets/tables, send SASE to *Gary Hazelton N8GH, 75075 M-40, Lawton MI 49065*.

For contact or info, check the Web site at [*www.qsl.net/ka8blo/hamfest.html*]; or E-mail [*ka8blo@net-link.net*].

**SELLERSVILLE, PA** The RH Hill ARC Hamfest will be held at the Sellersville Fire House, Rte. 152, 5 miles south of Quakertown and 8 miles north of Montgomeryville PA. Talk-in on 145.31. Admission \$5. VE exams 10 a.m.–1 p.m., all classes. Please bring documents. Indoor flea market spaces \$12, table included. Outdoor spaces \$6, bring tables. For further info, call the Hamfest Hotline: *Linda Erdman (215) 679-5764; 2220 Hill Rd., Perkiomenville PA 18074*. Web site: [*HTTP://WWW.RFHILL.AMPR.ORG*].

#### OCT 23

**RICKREALL, OR** The Mid-Valley ARES, of Salem OR, will present its 5th Annual Swap-Toberfest and Amateur Radio Emergency Services Convention at the Polk County Fairgrounds on Sat., Oct. 23rd. Talk-in on the 146.86(-) rpt. Doors will be open for the convention 9 a.m.–3:30 p.m. Swap table setup will be 6–9 p.m. Fri. night, Oct. 22nd, and on Sat. morning, Oct. 23rd, at 7 a.m. Only 2 pre-registered participants allowed per table during setup; all must register. Self contained RV spaces available, \$10 per night. Commercial vendor space \$25 (for 2 tables). Mail to *Mid-Valley ARES, P.O. Box 13848, Salem OR 97309*. Pre-registrations post marked by Oct. 8th will receive an extra door prize ticket with each registration. Registrations received Oct. 16th or later will be held for pick-up at the door. Features include meetings and seminars. Additionally, emergency communications vehicles will be on display from Marion and Polk County Emergency Management, Civil Air Patrol, American Red Cross, the Oregon State Police, and others as available. Advance tickets \$5, \$6 at the door. Age 12 and under free. Non-power swap tables \$13 each (do not mix non-power with power). Power swap tables \$15 each. For more info contact *Bob Boswell W7LOU, (503) 623-2513; or E-mail to [w7lou@goldcom.com]*. To download a copy of the flyer and pre-registration form, surf the Net for [*http://www.teleport.com/~n7ifj/swaptobe.htm*].

### SPECIAL EVENTS, ETC.

#### SEP 25–26

**HAMPTON, VA** The VASC Amateur Radio Group, Inc., will operate KE4ZXW Sat., Sep. 25th and Sun., Sep. 26th, 0–2400Z on UO-22 or KO-25; 1500–2200Z at :00 on 7.265; at :15 on 14.265 and at :30 on 28.365. The occasion is to celebrate 4 full years of 9600-baud automatic satellite station operation, and amateur radio exhibit. To apply for an Anniversary QSL, SASE to *Ed Brummer W4RTZ, 108 Oyster Cove Rd., Yorktown VA 23692 USA*.

#### MIDDLE BASS ISLAND, LAKE

**ERIE OH** The Sandusky Radio Experimental League will operate their station W8LBZ for 24 hours from Middle Bass Island (OH004) in Lake Erie, starting at 16:00 UTC on Sep. 25th and ending at 16:00 UTC on Sep. 26th. Listen for them on 7.230, 14.235, and 28.350. Please QSL with an SASE to *W8LBZ, Sandusky Radio Experimental League, Inc., 2909 W. Perkins, Sandusky OH 44870 USA*. Visit their Web site at [*www.qsl.net/w8lbz*].

#### OCT 2–3

**CAMBRIDGE, MA** The Harvard Wireless Club is celebrating the 90th Anniversary of its founding by Professor George W. Pierce in early 1909. They will be on the air 1200Z–0000Z both days, 24 hours total. Frequencies ± will be: HF SSB—3.890, 7.270, 14.270, 21.370, 28.390. HF CW—35 kHz up from the lower band edges. VHF SSB—50.150, 144.200, 432.150. A special 90th Anniversary QSL will be sent to all those sending QSLs for contacts with the special event station. In addition, each QSL with an SASE enclosed will receive complimentary souvenir QSL cards from past W1AF DXpeditions: US1A, PJ1A, and PJ8H. Mail to *Harvard Wireless Club W1AF, Harvard University, 6 Linden St., Cambridge MA 02138, USA*. For further info, contact club officials at [*w1af@harvard.edu*]. The club's Web site is at [*http://www.hcs.harvard.edu/~w1af/splevent.html*].

#### 73 Ad Sales

Call  
1-800-677-8838

# PROPAGATION

Jim Gray W1XU/7  
210 E Chateau Circle  
Payson AZ 85541  
[jimpeg@netzone.com]

## September

This month is expected to provide some excellent DX opportunities on the HF bands, although Cycle 23 continues its sluggish and slothful ways and the solar flux index remains below 200 at the time of this report (June).

Your best days are expected to be 4-7, 12, 13, and 16-18. The poorest days are expected to concentrate at the end of the month between the 25th and the 30th, when you can expect a very disturbed magnetic field, poor signals (if any) on DX paths, high RF absorption and strong geophysical upsets on earth, including the possibility of a major hurricane during the last week. (See calendar.) *Semper paratus.*

## October

October does not begin well for DX signal propagation on the HF bands. As you can see from the calendar, propagation is expected to be Poor or Very Poor from the 1st through the 9th. A disturbed magnetic field and very upset ionosphere is likely to prevail during that period, and you may expect some other very pronounced geophysical effects on the 7th, 8th, and 9th.

"Conditions" should improve with chances for good DX propagation during the week between the 11th and 18th. However, strong geophysical disturbances will probably return with magnetic field upsets and an active ionosphere for the week between the 20th and 27th. A slight improvement and much better DX propagation is anticipated for the last three days of the month.

Your best opportunities for logging new and possibly rare countries will occur between the 12th and 17th and again on the 30th and 31st. Good luck and patience for the other days.

### Band-by-band forecast

#### 10-12 meters

Expect morning F2 path openings to Europe and Africa; on (G) days, midday path openings to South and Central America, and F2 path openings to Japan, Australasia, and the Pacific during the afternoon at your location. DX moves west as the day progresses.

#### 15-17 meters

Expect good DX paths to most areas of the world, with excellent openings from the northern hemisphere to Africa, South America, and the Pacific during hours of daylight and peaking during local afternoon. Good short-skip communication over 1000 miles will occur on (G) days.

#### 20 meters

Very good DX openings to all areas of the world from sunrise through the early darkness hours. The signals will peak an hour or two after sunrise at your location, and again during the afternoon. Short skip beyond about 700 miles will occur during daytime hours.

#### 30-40 meters

Good worldwide DX openings from sunset to sunrise should occur on (G) days. Noise levels (static) will be higher if

September 1999						
SUN	MON	TUE	WED	THU	FRI	SAT
			1 F	2 F	3 F-G	4 G
5 G	6 G	7 G	8 G-F	9 F	10 F	11 F-G
12 G	13 G	14 G-F	15 F-G	16 G	17 G	18 G
19 G-F	20 F-P	21 F-P	22 P-F	23 F	24 F-P	25 P
26 P-VP	27 VP	28 VP-P	29 VP-P	30 P		

thunderstorms occur, and can depress audibility. Short skip between 100 and 1000 miles will occur during daylight hours, and at distances beyond 1000 miles at night.

#### 80-160 meters

On 80, DX to the southern hemisphere and to Europe should occur after dark and during sunrise hours—limited, of course, by static noise levels.

Daytime short skip to about 350 miles, and beyond 500 miles after dark, will prevail on (G) days. On 160, no daytime propagation will occur due to ionospheric absorption of signals, but after dark, peaking around midnight and again during the predawn hours, you should be able to work many areas of the world. Short skip from 1000-2000 miles or so will prevail during the nighttime hours ...

EASTERN UNITED STATES TO:												
GMT:	00	02	04	06	08	10	12	14	16	18	20	22
ALASKA	15/17	20/30	-	-	-	-	20/30	20/30	-	-	-	15/17
ARGENTINA	20/30	20/30	40	40	-	-	-	-	-	10/12	10/12	15/17
AUSTRALIA	15/17	-	20/30	-	-	40	20/30	20/30	-	-	-	15/17
CANAL ZONE	15/17	20/30	40*	40*	40	-	20/30	20/30	20/30	10/12	10/12	15/17
ENGLAND	40	40	40*	40	-	-	20/30	15/17	10/12	10/12	20/30	20/30
HAWAII	15/17	20/30	20/30	40	40	40	20/30	20/30	-	-	10/12	10/12
INDIA	-	-	-	-	-	-	20/30	20/30	-	-	-	-
JAPAN	15/17	20/30	-	-	-	-	20/30	20/30	-	-	-	15/17
MEXICO	15/17	20/30	40*	40*	40	-	20/30	20/30	20/30	10/12	10/12	15/17
PHILIPPINES	-	-	-	-	-	-	20/30	20/30	-	-	-	-
PUERTO RICO	15/17	20/30	40*	40*	40	-	20/30	20/30	20/30	10/12	10/12	15/17
RUSSIA (C.I.S.)	40	40	-	-	-	-	-	15/17	15/17	20/30	-	-
SOUTH AFRICA	20/30	-	-	-	-	-	-	-	15/17	15/17	10/12	20/30
WEST COAST	40	80	-	-	-	-	-	20/30	20/30	20/30	15/17	40

CENTRAL UNITED STATES TO:												
GMT:	00	02	04	06	08	10	12	14	16	18	20	22
ALASKA	15/17	-	-	-	-	-	-	-	-	-	-	15/17
ARGENTINA	15/17	20/30	20/30	40	40	-	-	-	-	-	10/12	15/17
AUSTRALIA	15/17	20/30	20/30	20/30	-	40	80	-	-	-	-	15/17
CANAL ZONE	15/17	20/30	20/30	40*	40*	-	-	15/17	15/17	10/12	10/12	15/17
ENGLAND	-	40/80	40/80	-	-	15/20	15/17	15/17	20/30	20/30	20/30	-
HAWAII	15/17	20/30	20/30	40	40	40*	80	20/30	-	-	10/12	15/17
INDIA	-	-	-	-	-	-	-	20/30	-	-	-	-
JAPAN	15/17	-	-	-	-	-	-	-	-	-	-	15/17
MEXICO	15/17	20/30	20/30	40*	40*	-	-	15/17	15/17	10/12	10/12	15/17
PHILIPPINES	15/17	20/30	-	-	-	-	-	20/30	-	-	-	-
PUERTO RICO	15/17	20/30	20/30	40*	40*	-	-	15/17	15/17	10/12	10/12	15/17
RUSSIA (C.I.S.)	-	-	-	-	-	-	-	20/30	15/17	20/30	-	-
SOUTH AFRICA	20/30	-	-	-	-	-	-	-	-	15/17	15/17	20/30

WESTERN UNITED STATES TO:												
GMT:	00	02	04	06	08	10	12	14	16	18	20	22
ALASKA	10/15	15/17	15/17	20/30	20/30	20/30	40	40	-	-	-	15/17
ARGENTINA	10/15	20/30	20/30	40	-	-	-	-	-	-	15/17	10/15
AUSTRALIA	10/12	15/17	15/17	20/30	20/30	40	40	40	20/30	20/30	15/20	15/17
CANAL ZONE	20/30	20/30	40/20	40/20	40	-	-	20/30	15/17	15/17	10/12	10/12
ENGLAND	-	-	-	-	-	-	-	-	-	15/20	15/20	-
HAWAII	10/12	15/17	20/15	40	40*	40*	40	40	-	20/30	20/30	20/30
INDIA	15/20	15/20	-	-	-	-	-	-	20	-	-	-
JAPAN	10/15	15/17	15/17	20/30	20/30	20/30	40	40	-	-	-	15/17
MEXICO	20/30	20/30	40/20	40/20	40	-	-	20/30	15/17	15/17	10/12	10/12
PHILIPPINES	15/20	15/20	-	20/30	-	40	40	-	20/30	20/30	-	15/17
PUERTO RICO	20/30	20/30	40/20	40/20	40	-	-	20/30	15/17	15/17	10/12	10/12
RUSSIA (C.I.S.)	-	-	-	-	-	-	-	-	20/30	-	-	-
SOUTH AFRICA	20/30	20/30	-	-	-	-	-	-	-	15/17	15/17	20/15
EAST COAST	40	80	-	-	-	-	-	20/30	20/30	20/30	15/17	40

October 1999						
SUN	MON	TUE	WED	THU	FRI	SAT
					1 VP-P	2 P
3 P-F	4 F-P	5 P	6 P	7 P-VP	8 VP	9 VP-P
10 P-F	11 F-G	12 G	13 G	14 G	15 G	16 G
17 G	18 G-F	19 F-P	20 P-VP	21 VP	22 VP-P	23 P
24 P-VP	25 VP	26 VP-P	27 P	28 P-F	29 F-G	30 G
31 G						

but, as always, it will be limited by high static levels from thunderstorm activity.

Don't forget to work the *darkness path* ( $\pm 30$  minutes around local sunset).

Check the bands above and below the suggested ones for possible DX surprises. It's often a good idea to park your receiver on a seemingly unused

frequency and just wait. A DX station is very likely to pop up before any one else hears him, and you can snag a good catch.

Please note that the Band-Time-Country chart is the same for both September and October; (\*) indicates a possible 80 meter opening; and (-) indicates a difficult path. Good hunting! W1XU/7. 73

## NEVER SAY DIE

*continued from page 42*

tasting fruit and vegetables, that spreading about one pound of Azomite per ten square feet of garden will get plants to grow about three times faster. Even trees!

Azomite is some stuff they dig up out in Utah from what used to be an ancient sea-floor bed. More and more nursery suppliers are stocking it.

Now, I wonder what would happen if someone were to use all 13 of the plant growth enhancers I've written about so far, all at once?

By the way, there's a new printing of the soil book, which has been difficult to find. Call ASD at 800-243-1438 and tell 'em Wayne sent you.

## Collapse

Even listening to Gary North being interviewed by Art Bell about the ramifications of Y2K tends to almost get me thinking.

So what would happen if millions of people got worried enough about the potential problems the Y2K bug might generate to put aside some cash? You know, just in case?

There's enough cash in circulation to take care of little more than a small extra demand, and yes, I know about the \$50 billion the treasury is printing to try to meet the problem. Our whole money system is a house of cards. We get paid, we put our money into a bank and then draw checks on it. The bank's business is lending out our money and getting paid interest on the loans, so they lend out 97% of the money deposited. Everything works just fine until several depositors simultaneously withdraw their money. It doesn't take much of this before the well runs dry. Three percent.

So what will happen if there is even a slight panic and depositors start either drawing out some cash (just in case) or not making any more deposits, but continue

to pay their bills with checks? The banks will quickly run out of money and not be able to honor the checks. What will happen if people stop depositing their paychecks, but ask for cash instead? There will be no cash. What if cash-heavy businesses such as fast food restaurants start holding back some cash every day, you know, just in case. The whole banking system would collapse.

The interesting aspect of all this is that there is nothing the banks can do to avoid the coming problem!

I'm reminded of what happened in California right after a recent earthquake. Within a couple hours, every shelf in the local food stores had been picked clean.

## Panic Attack

The media are finally beginning to wake up to the potential ramifications of the Y2K problem. Maybe you read the recent *BusinessWeek* article, *Y2K Is Worse Than Anyone Thought*. Probably not. Why do I have to do your homework for you? Anyway, the gist of the article was that our major corporations are finally beginning to understand how serious the little computer bug can be for them and they're substantially upping their remediation budgets. The total Y2K cost now has gone over \$1 trillion! Company executives are beginning to panic as they realize that they've sent some boys to do a man's job. And one thing they can't stop is the ticking of the clock. Not even The Zipper can do that.

Economists are predicting a major stock market recession. So what will happen if enough people believe this and want to "get out of the market before the crash," looking to keep from losing their investments, and also to be in a position to buy back in when stocks are low? The market only goes up when there are more buyers than sellers. A panic could result in millions of sellers and no buyers. Crash!

Having been around in 1929 and the depression years

of the '30s, I remember that it took World War II to pull us out of the mess Congress got us into.

Hey, maybe if we ignore it, Y2K will go away. But, just in case, have you got an emergency rig handy?

## Hamburgers

Hamburgers have elbowed hot dogs and apple pie from the head of the American food chain. Well, it's no wonder almost everyone loves hamburgers. They're juicy and delicious. They also are a deadly concoction as far as your body is concerned.

How so? Well the beef is made from cows who have been fed growth hormones to speed their growth. They're fed the most fattening diet known to farmers because fat tastes good. It helps make the hamburgers juicy. But you also get a good slug of those hormones with your meat patty. You also get the adrenaline the cow generates when it is scared out of its wits as it is being killed. The hamburger roll is made of white flour, which has had every bit of nutrition removed. It has zero food value. That tiny shred of lettuce has almost no nutritive value either. The slice of pickle is from a dead cucumber soaked in brine. It also provides zero nutrition.

The meat is thoroughly cooked so all the germs it has gathered (e.g., salmonella) along the way will get killed. McDonald's doesn't want the bad publicity killing its customers quickly would generate. The human digestive system is not well equipped to digest cooked meat, so it tends to pass through the system, leaving its toxins and contributing most of the bad smells that we have to use Airwick to kill in the bathroom. The worse the smell, by the way, the more toxic the stuff you've been eating.

Say, have you read Robin Cook's *Toxin*? It has to do with a young girl dying a horrible death from E. coli after eating a hamburger, and the efforts of the restaurant chain and the meat industry to

cover up the situation. The book might even discourage you from eating so many Whoppers.

### Advice for Septuagenarians

With such a high percentage of the response to my last guest shot on the Art Bell show being from people in their 70s, I got to thinking about the special problem seniors have. Many are living on Social Insecurity, plus small pensions, unless they were downsized before their pensions could kick in. But no matter the circumstances, most seniors are interested in how they can make some extra money.

Beyond the age of 50, it is very difficult to ever get employment again. You're too old. So even people in their 50s are looking for money-making ideas. Indeed, there are thousands of scam artists out there trailing bait, looking to take advantage of this mushrooming group.

Yes, of course I have some advice for you, if you're a senior, or for you to pass along, if you know any seniors who need extra money.

Well, firstly, unless you've led a truly wasted life, you should, by now, be an expert in *something*. Thus you have the potential to either teach or advise others (a.k.a. consulting). One of the best ways to teach is to write a book. Then comes the question of how to promote and sell the book. My preference is by mail order. You can get the word out via a Web page on the Internet, through new product releases to appropriate magazines, and through book reviews in the magazines. I have a video which explains how to do things like that.

Articles published in magazines will also establish you as an expert. That'll help sell your book and also help get you consulting work.

If you've managed to work for 30 to 40 years without learning anything, maybe it's time to break the ice and start learning something. I've found that a year or two of serious reading and asking questions

can make a person an expert in almost any field that interests them. Even nuclear physics.

When I got interested in horseback riding, I took lessons and then more lessons. I read everything I could find. I got good enough to show horses, teach instructors, and was even asked to ride Ringling Brother's star performer, Starlit Night. I've a Professor of Horsemanship certificate. Bragging? Of course, but I wanted to prove a point.

When I got interested in skiing, I took lessons until I was able to handle even the most difficult of trails.

When it comes to learning, persistence counts far more than brains. Please, if you can, show me one member of Mensa who is successful in business.

Of course, if you abuse your body with poisons, poor nutrition, and dehydration, you're going to be hobbling around in a rest home in your 70s, not skiing Aspen with me. And you're going to have a lot more trouble selling your lifetime of expertise to people. You start out with pretty much the same model body as everyone else, so it's what you do in the way of maintenance that's going to count later on — just as it does with your car.

### Reviewers Needed

Between the tons (well, bushels) of mail resulting from my talk radio interviews and my procrastination on taking a super speed reading course, I'm pitifully backed up on reading "books you really should read" so I can review them for you.

And that put me in mind of the system I used when I was publishing *CD Review* magazine. There I asked the readers to review any new CDs they'd bought and rate them. The result was millions of ratings, which I dutifully reported in the magazine, and then compiled later for a catalog of all issued CDs, so in addition to the normal CD information, I also had the reader ratings listed. One result of all this work was that my readers were spending an

average of \$30 million a month buying the CDs I was recommending. The other result was that the six major labels (five foreign-owned) hated my magazine because we couldn't be bought or coerced. But they still had to advertise, even though we gave many of their CDs lousy ratings. Well, I've always been that way. When I published *80-Micro*, about the Radio Shack TRS-80, once they tried to influence what I was publishing, I refused to let them advertise any more. They sent an executive team to visit me, promising to behave, so I let them advertise again. Then, a couple months later, more pressure, so I told them that was that. No more advertising. Well, it was only four to six pages a month at about \$3,000 or so a page.

Oh, darn, there I go off on a tangent again.

Anyway, what I had in mind was that if you run across a book that you feel the readers (and I) are crazy if we don't read, please don't put the monkey on my back to read it and write a review. Write a review and send it to me. If you convince me, I'll publish it in 73. If you *really* convince me, I'll get a copy, read it, and add a review to my *Secret Guide to Wisdom*. What's in it for you, other than knowing that you've helped a lot of people? Well, how about a minuscule bribe of a \$10 credit toward buying my books.

There are a zillion books out there, but a painfully small number of them are really worth reading. I'm looking for books that will help me and my readers understand themselves, the world, and what we can do to improve it, and to improve their lives. Let's keep this to truly exciting books, okay? Surprise me.

### Politics

The presidential hopefuls have been flocking to New Hampshire, as they do every four years. Steve Forbes was up here with his socks off, testing the icy February waters. So

I had dinner with him. Well, to be honest about it, so did a couple hundred others, when Steve gave a talk to the Hudson Chamber of Commerce. But it gave me an opportunity to say hello, remind him of the compact disc I made for *Forbes* a few years ago, and the dinner we had together on his yacht. He said he remembered, but I suspect he was just being agreeable. I took the opportunity to slip him a summary of a new approach to campaigning which I think could keep him on the front pages for the next year. I was not surprised when nothing came of it. Loser.

Anyway, I got to talking with the chap sitting next to me and, you're going to find this hard to believe, but the subject of Y2K came up. He said that he thought it wasn't anything to worry about. Programmers will be able to fix the date problem in time. Music to my ears. Love it.

I reminded him of the time a couple years ago when a branch fell across a power line in a remote area and it collapsed the entire western power grid for hours. And the time the East Coast went black when a small power station in Ontario had a problem. I asked him what he thought might happen if the national grid failed. This would stop almost everything. No trains, no planes, no gas pumps working, no telephone, no cash registers in food stores, and so on. Without trains there would be no coal for generating power, and 75% of our power is made from coal. No businesses could operate, no banks, and so on. How could the government, without communications, get the power turned back on? It's a house of cards.

So what happens to the 7 million people in New York and all the other cities with no power, no food, no water, and no police? Maybe for weeks.

I think I worried him.

### Minimum Wages

With our labor union lobby-

*Continued on page 64*



# Wise Up!

Here are some of my books which can change your life (if you'll let 'em). If the idea of being healthy, wealthy and wise interests you, start reading. Yes, you can be all that, but only when you know the secrets which I've spent a lifetime uncovering.

.....Wayne

**The Bioelectrifier Handbook:** This explains how to build or buy (\$155) a little electrical gadget that can help clean the blood of any virus, microbe, parasite, fungus or yeast. The process was discovered by scientists at the Albert Einstein College of Medicine, quickly patented, and hushed up. It's curing AIDS, hepatitis C, and a bunch of other serious illnesses. The circuit can be built for under \$20 from the instructions in the book. \$10 (01)

**The Secret Guide to Wisdom:** This is a review of around a hundred books that will help you change your life. No, I don't sell these books. They're on a wide range of subjects and will help to make you a very interesting person. Wait'll you see some of the gems you've missed reading. \$5 (02)

**The Secret Guide to Wealth:** Just as with health, you'll find that you have been brainwashed by "the system" into a pattern of life that will keep you from ever making much money and having the freedom to travel and do what you want. I explain how anyone can get a dream job with no college, no résumé, and even without any experience. I explain how you can get someone to happily pay you to learn what you need to know to start your own business. \$5 (03)

**The Secret Guide to Health:** Yes, there really is a secret to regaining your health and adding 30 to 60 years of healthy living to your life. The answer is simple, but it means making some difficult lifestyle changes. Will you be skiing the slopes of Aspen with me when you're 90 or doddering around a nursing home? Or pushing up daisies? No, I'm not selling any health products. \$5 (04)

**My WWII Submarine Adventures:** Yes, I spent from 1943-1945 on a submarine, right in the middle of the war with Japan. We almost got sunk several times, and twice I was in the right place at the right time to save the boat. What's it really like to be depth charged? And what's the daily life aboard a submarine like? How about the Amelia Earhart inside story? If you're near Mobile, please visit the Drum. \$5 (10)

**Travel Diaries:** You can travel amazingly inexpensively - once you know

the ropes. Enjoy Sherry and my budget visits to Europe, Russia, and a bunch of other interesting places. How about a first class flight to Munich, a rented Audi, driving to visit Vienna, Krakow in Poland (and the famous salt mines), Prague, back to Munich, and the first class flight home for two, all for under \$1,000. Yes, when you know how you can travel inexpensively, and still stay in first class hotels. \$5 (11)

**Wayne's Caribbean Adventures:** More budget travel stories - where I visit the hams and scuba dive most of the islands of the Caribbean. Like the special Liat fare which allowed us to visit 11 countries in 21 days, with me diving all but one of the islands, Guadeloupe, where the hams kept me too busy with parties. \$5 (12)

**Cold Fusion Overview:** This is both a brief history of cold fusion, which I predict will be one of the largest industries in the world in the 21st century, plus a simple explanation of how and why it works. This new field is going to generate a whole new bunch of billionaires, just as the personal computer industry did. \$5 (20)

**Cold Fusion Journal:** They laughed when I predicted the PC industry growth in 1975. PCs are now the third largest industry in the world. The cold fusion ground floor is still wide open, but then that might mean giving up watching ball games. Sample: \$10 (22).

**Julian Schwinger:** A Nobel laureate's talk about cold fusion - confirming its validity. \$2 (24)

**Improving State Government:** Here are 24 ways that state governments can cut expenses enormously, while providing far better service. I explain how any government bureau or department can be gotten to cut its expenses by at least 50% in three years and do it cooperatively and enthusiastically. I explain how, by applying a new technology, the state can make it possible to provide all needed services without having to levy *any* taxes at all! Read the book, run for your legislature, and let's get busy making this country work like its founders wanted it to. Don't leave this for "someone else" to do. \$5 (30)

**Mankind's Extinction Predictions:** If any one of the experts who have written books predicting a soon-to-come catastrophe which will virtually wipe us all out are right, we're in trouble. In this book I explain about the various disaster scenarios, from Nostradamus, who says the poles will soon shift, wiping out 97% of mankind, to Sai Baba, who has recently warned his followers to get out of Japan and Australia before December 6th this year. The worst part of these predictions is the accuracy record of some of the experts. Will it be a pole shift, a new ice age, a massive solar flare, a comet or asteroid, a bioterrorist attack, or even Y2K? I'm getting ready, how about you? \$5 (31)

**Moondoggle:** After reading René's book, *NASA Mooned America*, I read everything I could find on our Moon landings. I watched the videos, looked carefully at the photos, read the astronaut's biographies, and talked with some of my readers who worked for NASA. This book cites 25 good reasons I believe the whole Apollo program had to have been faked. \$5 (30)

**Classical Music Guide:** A list of 100 CDs which will provide you with an outstanding collection of the finest classical music ever written. This is what you need to help you reduce stress. Classical music also raises youngster's IQs, helps plants grow faster, and will make you healthier. Just wait'll you hear some of Gotschalk's fabulous music! \$5 (33)

**The Radar Coverup:** Is police radar dangerous? Ross Adey K6UI, a world authority, confirms the dangers of radio and magnetic fields. \$3 (34)

**Three Gatto Talks:** A prize-winning teacher explains what's wrong with American schools and why our kids are not being educated. Why are Swedish youngsters, who start school at 7 years of age, leaving our kids in the dust? Our kids are intentionally being dumbed down by our school system - the least effective and most expensive in the world. \$5 (35)

**Aspartame:** a.k.a. NutraSweet, the stuff in diet drinks, etc., can cause all kinds of serious health problems. Multiple sclerosis, for one. Read all about it, three pamphlets for a buck. (38)

**One Hour CW:** Using this sneaky method even *you* can learn the Morse Code in one hour and pass that dumb 5wpm Tech-Plus ham test. \$5 (40)

**Code Tape (T5):** This tape will teach you the letters, numbers and punctuation you need to know if you are going on to learn the code at 13 or 20 wpm. \$5 (41)

**Code Tape (T13):** Once you know the code for the letters (41) you can go immediately to copying 13 wpm code (using my system). This should only take two or three days. \$5 (42)

**Code Tape (T20):** Start right out at 20 wpm and master it in a weekend for your Extra Class license. \$5 (43)

**Wayne Talks Not at Dayton:** This is a 90-minute tape of the talk I'd have given at the Dayton, if invited. \$5 (50)

**Wayne Talks at Tampa:** This is the talk I gave at the Tampa Global Sciences conference. I cover cold fusion, amateur radio, health, books you should read, and so on. \$5 (51)

**\$1 Million Sales Video:** How to generate extra million in sales using PR. This will be one of the best investments your business ever made. \$43 (52)

**Reprints of My Editorials from 73.**

**Grist I:** 50 of my best non-ham oriented editorials from before 1997. \$5 (71)

**Grist II:** 50 more choice non-ham editorials from before 1997. \$5 (72)

**1997 Editorials:** 148 pages. 216 editorials discussing health, ideas for new businesses, exciting new books I've discovered, ways to cure our country's more serious problems, flight 800, the Oklahoma City bombing, more Moon madness, and so on. \$10 (74)

**1998 Editorials:** 168 pages that'll give you lots of controversial things to talk about on the air. \$10 (75)

**Silver Wire:** With two 3" pieces of heavy pure silver wire + three 9V batteries you can make a thousand dollars worth of silver colloid. What do you do with it? It does what the antibiotics do, but germs can't adapt to it. Use it to get rid of germs on food, for skin fungus, warts, and even to drink. Read some books on the uses of silver colloid, it's like magic. \$15 (80)

**Wayne's Bell Saver Kit.** The cable and instructions enabling you to inexpensively tape Art Bell W6OBB's nightly 5-hr radio talk show. \$5 (83)

**Stuff I didn't write, but you need:**

**NASA Mooned America:** René makes an air-tight case that NASA faked the Moon landings. This book will convince even you. \$25 (90)

**Last Skeptic of Science:** This is René's book where he debunks a bunch of accepted scientific beliefs - such as the ice ages, the Earth being a magnet, the Moon causing the tides, and etc. \$25 (91)

**Dark Moon:** 568 pages of carefully researched proof that the Apollo Moon landings were a hoax. \$35 (92)

## Wayne Green

Box 416, Hancock NH 03449

Name \_\_\_\_\_ Call \_\_\_\_\_

Address \_\_\_\_\_

City-State-Zip \_\_\_\_\_

Use the numbers in the brackets or copy page and mark the books you want. Add \$3 s/h per total order in US, \$6Can, \$10 foreign. \_\_\_\_\_

Order total: US\$ \_\_\_\_\_ Phone (for CC orders) \_\_\_\_\_

MC/Visa for orders over \$10. # \_\_\_\_\_ Expire \_\_\_\_\_

www.waynegrn.com • phone orders: 603-525-4747 • fax: 603-588-3205 • w2nsd@aol.com

Yes! Put me down for a year of 73 for only \$25 (a steal). Canada US\$32. Foreign US\$44 by sea.

I'd like to get more romance into my dreary life so send me your How-To-Dance Videos catalog.

I need some industrial strength stress reduction so send me your Adventures In Music CD catalog

Allow 4 weeks for delivery except foreign, though we try to get most orders shipped in a day or two.

# Barter 'n' Buy

Turn your old ham and computer gear into cash now. Sure, you can wait for a hamfest to try and dump it, but you know you'll get a far more realistic price if you have it out where 100,000 active ham potential buyers can see it, rather than the few hundred local hams who come by a flea market table. Check your attic, garage, cellar and closet shelves and get cash for your ham and computer gear before it's too old to sell. You know you're not going to use it again, so why leave it for your widow to throw out? That stuff isn't getting any younger! The 73 Flea Market, Barter 'n' Buy, costs you peanuts (almost)—comes to 35 cents a word for individual (noncommercial!) ads and \$1.00 a word for commercial ads. Don't plan on telling a long story. Use abbreviations, cram it in. But be honest. There are plenty of hams who love to fix things, so if it doesn't work, say so.

Make your list, count the words, including your call, address and phone number. Include a check or your credit card number and expiration. If you're placing a commercial ad, include an additional phone number, separate from your ad.

This is a monthly magazine, not a daily newspaper, so figure a couple months before the action starts; then be prepared. If you get too many calls, you priced it low. If you don't get many calls, too high.

So get busy. Blow the dust off, check everything out, make sure it still works right and maybe you can help make a ham newcomer or retired old timer happy with that rig you're not using now. Or you might get busy on your computer and put together a list of small gear/parts to send to those interested?

Send your ads and payment to: **73 Magazine, Barter 'n' Buy, 70 Hancock Rd., Peterborough NH 03458** and get set for the phone calls. The deadline for the December 1999 classified ad section is October 10, 1999.

**President Clinton** probably doesn't have a copy of *Tormet's Electronics Bench Reference* but you should. Check it out at [[www.ohio.net/~rtormet/index.htm](http://www.ohio.net/~rtormet/index.htm)]*—over 100 pages of circuits, tables, RF design information, sources, etc.*

BNB530

**DFjr direction finder** and MicroPLL programmable transmitter (formerly Agrelo) are now back under new management! Check exciting new accessories and upgrades. Order online at [[www.swssec.com](http://www.swssec.com)] or call SWS Security at (410) 879-4035 (9-5 ET).

BNB220

**RF TRANSISTORS TUBES** 2SC2879, 2SC1971, 2SC1972, MRF247, MRF455, MB8719, 2SC1307, 2SC2029, MRF454, 2SC3133, 4CX250B, 12DQ6, 6KG6A, etc. **WESTGATE**, 1-800-213-4563.

BNB6000

**Cash for Collins:** Buy any Collins Equipment. **Leo KJ6HI**. Tel./FAX (310) 670-6969. [[radioleo@earthlink.net](mailto:radioleo@earthlink.net)].

BNB425

**MAHLON LOOMIS, INVENTOR OF RADIO**, by Thomas Appleby (copyright 1967). Second printing available from **JOHAN K.V. SVANHOLM N3RF**, SVANHOLM RESEARCH LABORATORIES, P.O. Box 81, Washington DC 20044. Please send \$25.00 donation with \$5.00 for S&H.

BNB420

**METHOD TO LEARN MORSE CODE FAST AND WITHOUT HANGUPS** **Johan N3RF**. Send \$1.00 & SASE. SVANHOLM RESEARCH LABORATORIES, P.O. Box 81, Washington DC 20044 USA.

BNB421

**Great New Reference Manual** with over 100 pgs of P/S, transistor, radio, op-amp, antenna designs, coil winding tables, etc. See details at [[www.ohio.net/~rtormet/index.htm](http://www.ohio.net/~rtormet/index.htm)] or send check or M.O. for \$19.95 + \$2.00 P&H to RMT Engineering, 6863 Buffham Rd., Seville OH 44273.

BNB202

**QSL CARDS**. Basic Styles; Black and White and Color Picture Cards; Custom Printed. Send 2 stamps for samples and literature. **RAUM'S**, 8617 Orchard Rd., Coopersburg PA 18036. Phone or FAX (215) 679-7238.

BNB519

**WANTED:** High capacity 12 volt solar panels for repeater. [[kk4ww@fairs.org](mailto:kk4ww@fairs.org)] or (540) 763-2321.

BNB2630

**COLLOIDAL SILVER GENERATOR!** Why buy a "box of batteries" for hundreds of dollars? Current regulated, AC powered, fully assembled with #12 AWG silver electrodes, \$74.50. Same, but DC powered, \$54.50. Add \$2.50 shipping. **Thomas Miller**, 314 South 9th Street, Richmond IN 47374.

BNB342

**ASTRON** power supply, brand-new w/warranty, RS20M \$99, RS35M \$145, RS50M \$209, RS70M \$249, **AVT**. Call for other models. (626) 286-0118. BNB411

**HEATHKIT COMPANY** is selling photocopies of most Heathkit manuals. Only authorized source for copyright manuals. **Phone:** (616) 925-5899, 8-4 ET. BNB964

**WOULD YOU LIKE TO MAKE \$1200** within the next 60 to 90 days, in communications? Sure you would. Check out my web page: [[http://www.excelir.com/glen\\_w](http://www.excelir.com/glen_w)].

BNB999

**Electricity, Magnetism, Gravity, The Big Bang.** New explanation of basic forces of nature in this 91-page book covering early scientific theories and exploring latest controversial conclusions on their relationship to a unified field theory. To order, send check or money order for \$16.95 to: American Science Innovations, PO Box 155,

Clarrington OH 43915. Web site for other products [[http://www.asi\\_2000.com](http://www.asi_2000.com)]. BNB100

**COLD FUSION! - FUEL CELL! - ELECTRIC BICYCLE!** Each educational kit: (Basic - \$99.95, Deluxe - \$199.95, Information - \$9.95.) **CATALOG** - \$5.00. **ELECTRIC AUTOMOBILE BOOK** - \$19.95. **KAYLOR-KIT**, POB 1550ST, Boulder Creek CA 95006-1550. (831) 338-2300.

BNB128

**TELEGRAPH COLLECTOR'S PRICE GUIDE:** 250 pictures/prices. \$12 postpaid. **ARTIFAX BOOKS**, Box 88, Maynard MA 01754. Telegraph Museum: [<http://wltp.com>]. BNB113

**Copies** - 73 Magazine Nov. '63 thru Dec. '78. *QST* Magazine Nov. '63 thru Dec. '78. *Ham* Magazine Mar. '68 thru July '79. *CQ* Magazine Dec. '64 thru Mar. '79. \$2.00 Each Copy plus shipping. W.L. Brown, Box 541, Sullivan's Island SC 29482. Tel. (843) 883-3574. BNB73

## NEVER SAY DIE

*continued from page 62*

ists spending what it takes to convince Congress to increase the minimum wage, the welfare of the public is, as usual, being lost in the process. Reliable studies have shown that when the minimum wage is raised, it destroys jobs for unskilled workers — who are mainly teenagers and young adults. It also increases the number of families below the poverty line. The net effect of increasing the minimum wage is to increase poverty rather than decrease it.

The last time the minimum wage was increased, 380,000 young workers lost their jobs, and that was almost 10% of the workers affected by the legislated wage increase. Thanks, Congress. And thank you, voters, for ignoring what your supposed representatives are doing with your money.

Have I got my facts straight? Check *Fortune*, October 12, 1998, page 66.

## Shots

I see that Bill Gates, who is suffering from the mountains of bad publicity the Microsoft anti-monopoly trial and his testimony have caused, has

his PR team working overtime to repair the damage. First it was a golf club commercial on TV. I somehow doubt that Bill needed the money, so there must have been some other reason for that. Then there was his appearance on the Rosie O'Donnell Show. And now he's giving \$100 million to help vaccinate people in developing countries. And that, in general, means Africa.

Getting through the insulating layers protecting Bill from the rest of the world isn't easy, but I wish someone could clue him in about the reality of inoculations. There are several well-researched books on the subject, and they all say the same thing — inoculations are a scam — a \$40 billion scam. Worse, there's strong evidence that AIDS was spread in Africa when millions were given TB vaccinations. Well, read Dr. William Douglass' book on the subject. And, as far as vaccinations being of value, please at least read the book by Dr. Walene James, *Immunitization — The Reality Behind the Myth*. Yes, I've reviewed it in a past editorial and it's in my *Secret Guide to Wisdom* (page 5).



# JST-245

## 160-10 Meters PLUS 6 Meter Transceiver



### *Fifteen reasons why your next HF transceiver should be a JST-245...*

- 1** All-Mode Operation (SSB, CW, AM, AFSK, FM) on all HF amateur bands and 6 meters. JST-145, same as JST-245 but without 6 meters and built-in antenna tuner.  
★ JST-145 COMING SOON ★
- 2** MOSFET POWER AMPLIFIER • Final PA utilizes RF MOSFETs to achieve low distortion and high durability. Rated output is 10 to 150 watts on all bands including 6 meters.
- 3** AUTOMATIC ANTENNA TUNER • Auto tuner included as standard equipment. Tuner settings are automatically stored in memory for fast QSY.
- 4** MULTIPLE ANTENNA SELECTION • Three antenna connections are user selectable from front panel. Antenna selection can be stored in memory.
- 5** GENERAL COVERAGE RECEIVER • 100 kHz-30 MHz, plus 48-54 MHz receiver. Electronically tuned front-end filtering, quad-FET mixer and quadruple conversion system (triple conversion for FM) results in excellent dynamic range (>100dB) and 3rd order ICP of +20dBm.
- 6** IF BANDWIDTH FLEXIBILITY • Standard 2.4 kHz filter can be narrowed continuously to 800 Hz with variable Bandwidth Control (BWC). Narrow SSB and CW filters for 2nd and 3rd IF optional.
- 7** QRM SUPPRESSION • Other interference rejection features include Passband Shift (PBS), dual noise blanker, 3-step RF attenuation, IF notch filter, selectable AGC and all-mode squelch.
- 8** NOTCH TRACKING • Once tuned, the IF notch filter will track the offending heterodyne ( $\pm 10$  KHz) if the VFO frequency is changed.
- 9** DDS PHASE LOCK LOOP SYSTEM • A single-crystal Direct Digital Synthesis system is utilized for very low phase noise.
- 10** CW FEATURES • Full break-in operation, variable CW pitch. built in electronic keyer up to 60 wpm.
- 11** DUAL VFOs • Two separate VFOs for split-frequency operation. Memory registers store most recent VFO frequency, mode, bandwidth and other important parameters for each band.
- 12** 200 MEMORIES • Memory capacity of 200 channels, each of which store frequency, mode, AGC and bandwidth.
- 13** COMPUTER INTERFACE • Built-in RS-232C interface for advanced computer applications.
- 14** ERGONOMIC LAYOUT • Front panel features easy to read color LCD display and thoughtful placement of controls for ease of operation.
- 15** HEAVY-DUTY POWER SUPPLY • Built-in switching power supply with "silent" cooling system designed for continuous transmission at maximum output.



*Japan Radio Co., Ltd.*

430 Park Ave., 2nd Floor New York, NY 10022 Phone: (212) 355-1180 Fax: (212) 319-5227

CIRCLE 159 ON READER SERVICE CARD

# The New Approach to HF Radio!

## The Kachina 505DSP Computer Controlled Transceiver

### Features:

- Works with any Computer Running Windows 3.1, 95 or NT
- Covers all Amateur HF Bands plus General Coverage Receiver
- IF Stage 16/24 Bit Digital Signal Processing (DSP)
- II DSP Bandpass Filter Widths from 100 Hz to 3.5 kHz (6 kHz in AM Mode)
- Band Activity Display with "Point and Click" Frequency Tuning
- On-screen Antenna "Smith" Chart, Logging Software and Help Menus
- Automatic Frequency Calibration from WWV or Other External Standard
- "Snapshot" Keys for Instant Recall of Frequencies and Settings
- Optional Internal Antenna Tuner

PC not included

**The Kachina 505DSP Computer Controlled HF Transceiver** After twenty years of building commercial transceivers in Arizona, Kachina has decided the time is right for a new approach to amateur radio. The Kachina 505DSP is nothing short of a revolution in HF transceivers.

**Why Use Knobs if You Have Windows?** The old-fashioned front panel has become too cluttered to be useful. Too many knobs, too many buttons. Kachina's 505DSP transceiver connects to your computer's serial port and is completely controlled under Windows™. With optional cables, the radio may be remotely located up to 75 feet away from your computer. Imagine combining a state-of-

the-art DSP transceiver with the processing power and graphics capabilities of your PC and you'll soon wonder why all radios aren't designed this way. Why settle for a tiny LCD display when your computer monitor can simultaneously show band activity, antenna impedance, heat sink temperature, SWR, forward and/or reflected power and a host of other information?

**16/24 Bit DSP/DDS Performance** In addition to 100% computer control, the Kachina 505DSP offers exceptional 16/24 bit DSP/DDS performance. IF stage DSP, "brick-wall" digital filtering, adaptive notch filters and digital noise reduction, combined with low in-band IMD and high signal-to-noise ratio, produce an

excellent sounding receiver. Sophisticated DSP technology achieves performance levels unimaginable in the analog world. The transmitter also benefits from precise 16/24 bit processing. Excellent carrier and opposite-sideband suppression is obtained using superior phasing-method algorithms. The RF compressor will add *lots* of punch to your transmitted signal without adding lots of bandwidth, and the TX equalizer will allow you to tailor your transmitted audio for more highs or lows.

**Seeing is Believing** American-made and designed, and able to stand on its own against the world's best, the 505DSP is bound to set the standard for all that follow. But don't take our word for it. Visit our website at <http://www.kachina-az.com> for detailed specifications, to download a demo version of our control software, or to see a current list of Kachina dealers displaying demonstration models in their showrooms.

**KACHINA**   
**COMMUNICATIONS, INC.**

P.O. Box 1949, Cottonwood, Arizona 86326, U.S.A.  
Fax: (520) 634-8053, Tel: (520) 634-7828  
E-Mail: [sales@kachina-az.com](mailto:sales@kachina-az.com)

Windows is a trademark of Microsoft Corp.  
Specifications and features subject to change without notice