

73 Amateur Radio Today

APRIL 2003
ISSUE #509
USA \$3.95
CANADA \$4.95

**CPO for
Masochists**

Handy Heat Probe

**Elusive
Ishmod
Espied?**

**Dumbing Down
"Smart" Batteries**

**Einstein
Antennas**

**What's Up
in the
Azores?**
page 27

*****3-DIGIT 231
#00000109389WR6# JUL76 234
JACK SPEER 45
BUCKMASTER PUBLISHING P 3

6196 JEFFERSON HIGHWAY
MINERAL VA 23117-3425

0 74851 08725 1

ALINGCO *Unleash The Power*

New



DR-620T VHF/UHF Dual-Band Mobile/Base

**First Amateur Twin Band Mobile To Support
Optional Digital Voice Communications***

- RX-VHF 108-173.995 MHz, UHF 335-480 MHz
- TX-VHF 144-147.995 MHz, UHF 430-449.995 MHz
- Receives Airband and Wide FM
- Front control unit separation (optional EDS-9 kit required)
- Advanced 10F3 digital mode with speech compression technology (EJ-47U required)*
- 200 memory channels
- Advanced EJ-50U TNC (optional) supports digi-peet mode
- Remote control features including parameter setting and direct frequency entry through the microphone
- Dual-Band receiver with V/U, V/V, U/U capability
- CTCSS/DCS encode/decode and European Tone-bursts
- OUTPUT: H/M/L-50/10/5 watts VHF
- OUTPUT: H/M/L-35/10/5 watts UHF



DR-605TQ VHF/UHF Dual-Band Mobile/Base **Full 2 Meter/440 Performance**

- 100 memory channels, + a "call" channel for each band
- CTCSS encoded+decoded and tone scan
- Cross-band repeat and full duplex capability
- 9600 bps packet ready with dedicated terminals
- Internal duplexer - one easy antenna connection
- RX-VHF 136-173.995 MHz, UHF 420-449.994 MHz
- TX-VHF 144-147.995 MHz, UHF 430-449.994 MHz
- MARS capability (permit required)
- OUTPUT H/L - 50/5 watts VHF, 35/5 watts UHF
- Time-out timer (ideal for repeater and packet operation)

DJ-V5TH VHF/UHF Dual-Band FM Transceiver

5 watts of output power, in a compact package.

- Alphanumeric Display, up to 6 characters
- TX-VHF 144-147.995 MHz, UHF 420-449.995 MHz
- 200 memory channels plus two call channels
- Full VHF + UHF Amateur Band Coverage
- Receive Range, (76 - 999MHz) includes Wide FM capability
- Up to 5 watts output, 3 output settings
- CTCSS encode+decode DTMF squelch and European Tone bursts
- 4 scan modes, 5 programmable scan banks
- MARS capability (permit required)



Ask your dealer
about the full line of
**Iron Horse antennas &
accessories!**



DJ-596T VHF/UHF Dual-Band HT with Digital Voice Option*

Loaded with features! The breakthrough design supports optional digital voice communications and you can easily switch the unit between analog and digital modes!

- Full 4.5 watts output VHF/4w UHF
- Powerful NiMH battery
- 100 memories in any combination of VHF or UHF channels
- Direct frequency input from keypad
- Each memory capable of "odd split" operation.
- Alphanumeric channel labels
- CTCSS/DCS encode+decode plus tone bursts
- Full 2m and 440 band coverage
- Accepts 6 to 16 VDC direct input
- Illuminated Keys and display
- Wide and narrow FM modes
- 10 autodial memories
- Theft alarm feature
- Optional EJ-40U Digital Voice Board!*
- Programming/Clone software available



Distributed in North America by Amateur Distributing LLC • 23 S. High St., Covington, OH 45318 • (937) 473-2840
Specifications subject to change without notice or obligation. *Digital communications require at least two similarly equipped transceivers. Digital mode may not be legal in some countries. See FAQ on digital at www.alinco.com. Products intended for use by properly licensed operators. Permits required for MARS use. Specifications subject to change without notice or obligation.

El Supremo & Founder
Wayne Green W2NSD/1

Associate Publisher
F. I. Marion

Executive Editor
Jack Burnett

Managing Editor
Joyce Sawtelle

Technical Editor
Hugh Wells W6WTU

Contributing Culprits
Mike Bryce WB8VGE
Jim Gray II
Jack Heller KB7NO
Chuck Houghton WB6IGP
Andy MacAllister W5ACM
Joe Moell KØOV
Steve Nowak KE8YN/0
Dr. Rick Olsen N6NR

Advertising Sales
Evelyn Garrison WS7A
21704 S.E. 35th St.
Issaquah WA 98029
425-557-9611
Fax: 425-557-9612

Circulation
Frances Hyvarinen

Data Entry & Other Stuff
Norman Marion

Business Office
Editorial - Advertising - Circulation
Feedback - Product Reviews
73 Amateur Radio Today Magazine
70 Hancock Rd.
Peterborough NH 03458-1107
603-924-0058
Fax: 603-924-8613

Reprints: \$3 per article
Back issues: \$5 each

Printed in the USA

73 Amateur Radio Today

TABLE OF CONTENTS

FEATURES

- 10 Right Fancy CPO — K8MKB**
A keyer from My Kid Brother.
- 20 Ham's Handy Heat Hunter — KC5MFY**
Let this temperature probe take your shack's temperatures.
- 23 Ozzie's Jupi-Loop — W5RK**
Use an aircore balun with your Ten-Tec Jupiter.
- 24 Ishmod Update — Trams**
- 27 Travels with Henryk — Part 11 — SMØJHF**
Adoring the Azores.
- 29 The Interrelationship of the Coriolis Force, the Helix Effect, and So-called Einstein Antennas — WAØKKC**
As usual, 73 takes you right to the cutting edge of ... er ... science.
- 30 Autobiography of Everyham — Part 2 — WB9YBM**
How many times do you see yourself in this story?
- 35 Hamfest Improvement 101 — WB9YBM**
How to make things better for everybody.
- 37 Pluses and Minuses of "Smart" Batteries — Buchmann**
We charged one of the world's leading experts with explaining, and here's his plug ... er, report.

DEPARTMENTS

- 54 Above & Beyond — WB6IGP**
49 Ad Index
64 Barter 'n' Buy
42 Calendar Events
44 The Digital Port — KB7NO
47 Hamsats — W5ACM
50 Homing In — KØOV
4 Never Say Die — W2NSD/1
48 On the Go — KE8YN/7
60 Propagation — Gray
1 QRX
63 Radio Bookshop

E-Mail
design73@aol.com

Web Page
www.waynegrain.com

QRX . . .

UK Ticket Changes

The amateur radio license structure in Great Britain is currently undergoing a major shakeup. There are currently 5 classes of amateur license dependent upon skill level and Morse proficiency. The callsign prefix denotes license class and geographical location within the UK.

The lowest class is the Foundation license. This requires a very basic knowledge of electronic theory, license conditions, interference avoidance and

operating practices. The ability to recognize Morse code is required, but no significant proficiency in sending or receiving. This gives access to all bands except 10 meters with a maximum power of 10 watts. The license is obtained by attending a weekend or evening training course. The callsign is in the form of M3XXX.

The next license class is Intermediate. This requires a more in-depth knowledge, plus the building of a

Continued on page 6

Manuscripts: Contributions for possible publication are most welcome. We'll do the best we can to return anything you request, but we assume no responsibility for loss or damage. Payment for submitted articles will be made after publication. Please submit both a disk and a hard copy of your article [IBM (ok) or Mac (preferred) formats], carefully checked drawings and schematics, and the clearest, best focused and lighted photos you can manage. "How to write for 73" guidelines are available on request. US citizens, please include your Social Security number with submitted manuscripts so we can submit it to you know who.

73 Amateur Radio Today (ISSN 1052-2522) is published monthly by **73 Magazine**, 70 Hancock Rd., Peterborough NH 03458-1107. The entire contents ©2003 by **73 Magazine**. No part of this publication may be reproduced without written permission of the publisher, which is not all that difficult to get. The subscription rate is: one year \$24.97, two years \$44.97; Canada: one year \$34.21, two years \$57.75, including postage and 7% GST. Foreign postage: \$19 surface, \$42 airmail additional per year, payable in US funds on a US bank. Second class postage is paid at Peterborough, NH, and at additional mailing offices. Canadian second class mail registration #178101. Canadian GST registration #125393314. Microfilm edition: University Microfilm, Ann Arbor MI 48106. POSTMASTER: Send address changes to **73 Amateur Radio Today**, 70 Hancock Rd., Peterborough NH 03458-1107. **73 Amateur Radio Today** is owned by Shabromat Way Ltd. of Hancock NH.



...POWER ON WITH ASTRON

SWITCHING POWER SUPPLIES...



MODEL SS-10TK



MODEL SS-12IF

SPECIAL FEATURES:

- HIGH EFFICIENCY SWITCHING TECHNOLOGY SPECIFICALLY FILTERED FOR USE WITH COMMUNICATIONS EQUIPMENT, FOR ALL FREQUENCIES INCLUDING HF
- HEAVY DUTY DESIGN
- LOW PROFILE, LIGHT WEIGHT PACKAGE
- EMI FILTER
- MEETS FCC CLASS B

PROTECTION FEATURES:

- CURRENT LIMITING
- OVERVOLTAGE PROTECTION
- FUSE PROTECTION
- OVER TEMPERATURE SHUTDOWN

SPECIFICATIONS:

INPUT VOLTAGE: 115 VAC 50/60HZ
OR 220 VAC 50/60HZ
SWITCH SELECTABLE
OUTPUT VOLTAGE: 13.8VDC

AVAILABLE WITH THE FOLLOWING APPROVALS: UL, CUL, CE, TUV.



MODEL SS-18

DESKTOP SWITCHING POWER SUPPLIES

MODEL	CONT. (Amps)	ICS	SIZE (inches)	Wt.(lbs.)
SS-10	7	10	1 1/2 x 6 x 9	3.2
SS-12	10	12	1 1/2 x 6 x 9	3.4
SS-18	15	18	1 1/2 x 6 x 9	3.6
SS-25	20	25	2 1/4 x 7 x 9 1/2	4.2
SS-30	25	30	3 1/4 x 7 x 9 1/2	5.0



MODEL SS-25M

DESKTOP SWITCHING POWER SUPPLIES WITH VOLT AND AMP METERS

MODEL	CONT. (Amps)	ICS	SIZE (inches)	Wt.(lbs.)
SS-25M*	20	25	2 1/4 x 7 x 9 1/2	4.2
SS-30M*	25	30	3 1/4 x 7 x 9 1/2	5.0



MODEL SRM-30

RACKMOUNT SWITCHING POWER SUPPLIES

MODEL	CONT. (Amps)	ICS	SIZE (inches)	Wt.(lbs.)
SRM-25	20	25	3 1/2 x 19 x 9 1/2	6.5
SRM-30	25	30	3 1/2 x 19 x 9 1/2	7.0

WITH SEPARATE VOLT & AMP METERS

MODEL	CONT. (Amps)	ICS	SIZE (inches)	Wt.(lbs.)
SRM-25M	20	25	3 1/2 x 19 x 9 1/2	6.5
SRM-30M	25	30	3 1/2 x 19 x 9 1/2	7.0



MODEL SRM-30M-2

2 ea SWITCHING POWER SUPPLIES ON ONE RACK PANEL

MODEL	CONT. (Amps)	ICS	SIZE (inches)	Wt.(lbs.)
SRM-25-2	20	25	3 1/2 x 19 x 9 1/2	10.5
SRM-30-2	25	30	3 1/2 x 19 x 9 1/2	11.0

WITH SEPARATE VOLT & AMP METERS

MODEL	CONT. (Amps)	ICS	SIZE (inches)	Wt.(lbs.)
SRM-25M-2	20	25	3 1/2 x 19 x 9 1/2	10.5
SRM-30M-2	25	30	3 1/2 x 19 x 9 1/2	11.0



MODEL SS-12SM/GTX



MODEL SS-10EFJ-98

CUSTOM POWER SUPPLIES FOR RADIOS BELOW

EF JOHNSON AVENGER GX-MC41
EF JOHNSON AVENGER GX-MC42
EF JOHNSON GT-ML81
EF JOHNSON GT-ML83
EF JOHNSON 9800 SERIES
GE MARC SERIES
GE MONOGRAM SERIES & MAXON SM-4000 SERIES
ICOM IC-F11020 & IC-F2020
KENWOOD TK760, 762, 840, 860, 940, 941
KENWOOD TK760H, 762H
MOTOROLA LOW POWER SM50, SM120, & GTX
MOTOROLA HIGH POWER SM50, SM120, & GTX
MOTOROLA RADIUS & GM 300
MOTOROLA RADIUS & GM 300
MOTOROLA RADIUS & GM 300
UNIDEN SMH1525, SMU4525
VERTEX — FTL-1011, FT-1011, FT-2011, FT-7011

NEW SWITCHING MODELS

SS-10GX, SS-12GX
SS-18GX
SS-12EFJ
SS-18EFJ
SS-10-EFJ-98, SS-12-EFJ-98, SS-18-EFJ-98
SS-12MC
SS-10MG, SS-12MG
SS-101F, SS-121F
SS-10TK
SS-12TK OR SS-18TK
SS-10SM/GTX
SS-10SM/GTX, SS-12SM/GTX, SS-18SM/GTX
SS-10RA
SS-12RA
SS-18RA
SS-10SMU, SS-12SMU, SS-18SMU
SS-10V, SS-12V, SS-18V



GET THE NEW CATALOG TODAY!

New Kits, New LPFM, New Cameras
www.ramseykits.com



WORK THE WORLD WITH A WATT...FOR ONLY \$99!

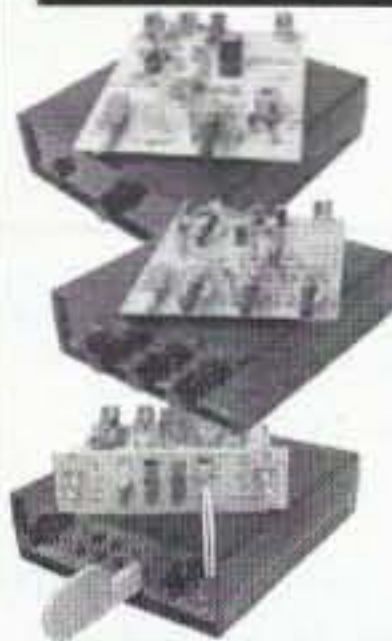

QRP TRANSMITTER

Available in 20, 30, or 40 Meters, these neat little transmitters put out 1 Watt!

HR RECEIVER

Available in 20, 30, or 40 Meters, 1.0 uV sensitivity rivals the big rigs...at a fraction of the price!

CW700 KEYER

With adjustable pitch & speed from 3-60 wpm, features true iambic keying and EPROM memory!

\$99 COMPLETE!

\$155 Sold Separately
 Visit www.ramseykits.com/qrp to order this special deal!

\$99 price includes QRP Transmitter kit, HR Receiver kit, and CW700 Micro-Memory Keyer kit, all the matching case & knob sets shown. Visit www.ramseykits.com/qrp to order this special deal!

35 WATT LPFM STEREO TRANSMITTER



- ✓ 35W RF output, VSWR protected
- ✓ Automatic audio & power controls
- ✓ Digital synthesized PLL
- ✓ Full front panel control
- ✓ 110/220VAC, 12VDC operation

Whether your application is export or LPFM, the PX1 has you covered. From the over-rated continuous duty power supply & power amplifier to the 2 line vacuum fluorescent display, your station will be the easiest to setup and the most reliable for continuous operation. Full microprocessor controls provide a "virtual engineer". Check out www.highpowerfm for full details.

PX1 35W Professional FM Stereo Transmitter \$1,795.95

TOUCH-TONE TONE GRABBER



- ✓ New-built-in RJ11 phone jack
 - ✓ Large memory holds over 500 numbers
 - ✓ Big bold 8 digit display, auto insertion of dashes
 - ✓ New-output latch jack
- Dialed phone numbers on the radio, repeater codes, control codes, anywhere touch-tones are used, you can read and store

them! All new design for 2002. Capture those tones with the TG2!

TG2 Tone Grabber Tone Reader Kit \$59.95
 CTG2 Matching Case & Knob Set \$14.95
 AC125 110 VAC Power Adapter \$9.95

ELECTROCARDIOGRAM HEART MONITOR



- ✓ Visible and audible display of your heart rhythm
 - ✓ Re-usable sensors included; just like visiting the hospital!
 - ✓ Bright LED "beat" indicator
 - ✓ Monitor output for oscilloscope display
- Enjoy learning about the inner workings of the heart while covering the stage by stage electronic circuit theory of ECG/EKG systems. Be heart smart and learn at the same time!

ECG1 Electrocardiogram Heart Monitor Kit \$34.95
 CECG Matching Case & Knob Set \$14.95
 AC125 110 VAC Power Adapter \$9.95
 ECGP10 Replacement Reusable Probe Patches (10-Pack) \$7.95

XLR TO RCA AUDIO CONVERTER



- ✓ Connect consumer outputs to XLR inputs
 - ✓ Left & right audio gain adjustments
- So you're trying to connect consumer audio outputs with RCA connectors (unbalanced) to XLR (balanced) inputs. Always a problem...Not anymore with the R2XL1!

R2XL1 Unbalanced to Balanced Audio Converter Kit \$49.95
 CR2XL Matching Case & Knob Set \$14.95
 PWR25 12VAC Power Adapter \$9.95

GIVEAWAYS & SPECIALS EVERY MONTH!

Register to receive our E-Mail specials and you will automatically be entered in our monthly drawing! New deals, new specials, new giveaways every month!

Register TODAY

www.ramseykits.com/specials

PROFESSIONAL FM STEREO RADIO STATION



- ✓ Synthesized 88 to 108 MHz with no drift!
- ✓ Built-in mixer - 2 line inputs and one microphone input!
- ✓ High power module available for export use
- ✓ Low pass filter for great audio response

Our FM100 is used all over the world by serious hobbyists as well as churches, drive-in theaters, and schools. Frequency synthesized PLL assures drift-free operation with simple front panel frequency selection. Built-in audio mixer features LED bargraph meters to make setting audio a breeze. The kit includes metal case, whip antenna and built-in 110 volt AC power supply.

FM100 Super-Pro FM Stereo Radio Station Kit \$249.95
 FM100WT 1 Watt, Wired Export Version \$399.95

SYNTHESIZED FM STEREO TRANSMITTER



- ✓ All new design & features for 2002!
 - ✓ Fully adjustable RF output
- Our #1 kit for years has just gotten better for 2002! Totally redesigned, the FM25B has all the features you've asked for. From variable RF output, F connector RF output jack, line input, loop output, and more.

Includes case, power supply, whip antenna, audio cables.
 FM25B Synthesized FM Stereo Transmitter Kit \$129.95

AUTOMATIC COLOR/BW IR CAMERA



- ✓ Color during the day, IR B&W at night!
 - ✓ Automatically turns on IR Illumination!
 - ✓ Waterproof to IP57 standards!
 - ✓ Black anodized housing with universal mount
- Best of both worlds! This video camera is a waterproof COLOR camera during the day. When the light level drops, it automatically changes to B&W and turns on its built-in IR illumination, with 10 IR LEDs. Powered by 12VDC and terminated with a professional BNC connector. B&W only model also available if color is not needed.

Both in heavy anodized black housing.
 CCD309 Color/B&W IR Waterproof Bullet Camera \$169.95
 CCD308 B&W IR Waterproof Bullet Camera \$109.95
 AC125 110 VAC Power Adapter \$9.95

MINI B&W CAMERA WITH IR ILLUMINATION



- ✓ Built in IR illumination!
 - ✓ Sees in total darkness!
- What a deal! This miniature B&W video camera has 6 high power IR LEDs built into it to provide illumination in total darkness! No need for external IR illuminators. Attractive black aluminum housing easily mounts at any angle with the built-in swivel bracket. Runs on 12VDC, and includes professional BNC output plug-in harness.

CCD303 Mini B&W IR Illuminated Camera \$59.95
 AC125 110 VAC Power Adapter \$9.95

Check out all our other new cameras at www.ramseykits.com



RAMSEY ELECTRONICS, INC.
 793 Canning Parkway
 Victor, NY 14564
 716-924-4560
sales@ramseykits.com



Order Today! 800-446-2295

www.ramseykits.com

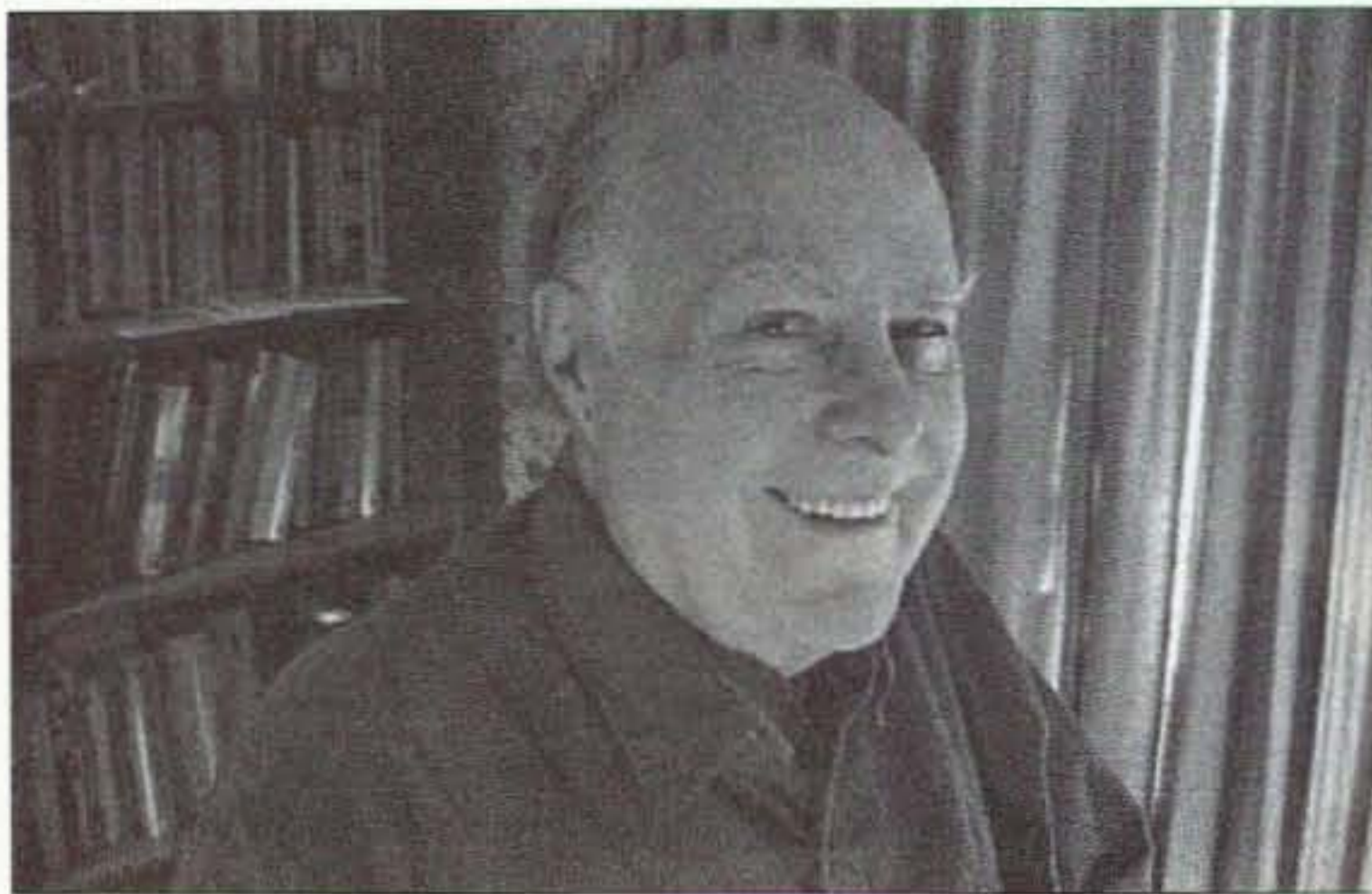

Wise Up & Beat the Odds

NEVER SAY DIE

Wayne Green W2NSD/1

w2nsd@aol.com

www.waynegreen.com

What a Waste!

Those lives of the seven *Columbia* occupants, I mean. The major media had a field day interviewing the grieving parents, but with not one word asking the real question ... why were those seven people up in near-Earth orbit? Do you know what they were doing up there? Have you a clue?

Being contrarian, I compare NASA's loss of seven people to what I consider the AMA's murder of several thousand Americans through what the law calls depraved indifference, just during the brief *Columbia* media therapized bathos flurry. And I don't think I'm exaggerating.

This whole space thing started back in 1957 when the Russians lofted *Sputnik*. This was when our rocket scientists were blowing up our rockets on the launching pads one after another. So we imported Wernher von Braun from Germany and managed to get *Explorer* into orbit. Then we heard that Yuri Gagarin was the first man in space. The later news that this was faked still isn't well known. But the news got newly elected President Kennedy upset. We must be the first to put a man on the Moon!

Our launch of Alan Shepard for a 15-minute space trip was a start in *Freedom 7*. NASA was on its way with around \$400 billion in today's dollars from Congress for the Moon project.

After contractor Rocketdyne's repeated failures to build an engine with enough power

for the Moon trip, the scenario I see was that the NASA brass had to either give up and everyone go home or go to Plan B. The eleven astronauts who didn't want to go along with B were soon eliminated through a series of "accidents." Plus one journalist who got too nosy also had to be eliminated (along with his wife and step-daughter).

As Nixon said later, "Just think how miserable it would have been if we had not had the space success when we were in the midst of Vietnam, then Watergate and all that."

We pulled off the Moon landings in the early 1970s using mostly 1950s technology.

What was NASA to do next? Nobody wanted to let go of the government teat, so they came up with the Shuttle.

On balance the Shuttle has been a huge mistake. The Shuttle was supposed to be safe, reliable, and be able to make a round trip every week at a cost of \$10 million each, replacing disposable rockets, and paying for itself by putting satellites into orbit.

The reality was an average of five trips a year at a cost of \$500 million each, while most of the satellites were still being lofted by Europe's Ariane single-use rockets.

But what about the boasted scientific experiments the Shuttles would make possible? The American Physical Society's Robert Park has said, "There is no experiment that has been done on the space shuttle that has made a significant difference to any field of science."

The Shuttle, a marvel of 1970s engineering, has been a hugely expensive bummer ... scientist and space industry welfare. And ditto the space stations. Hundreds of billions pffft. Hmm, let's see ... every billion Congress blows on waste like this means \$1,000 of your tax money.

Any complaints?

By the way, all of our orbiting satellites and the Shuttle trips have been in near-Earth orbit, well below the Van Allen Belt.

As John Carey said in the Feb. 17th *Business Week*, "...there's not much reason to keep the space station in orbit, except as a destination for the shuttle, and the shuttle has little utility but to ferry astronauts to the station." At \$500 million a whack?

Enter Jim McCanney

Jim is one of NASA's worst headaches ... a solidly credentialed scientist who refuses to toe the NASA secrecy line about the effect comets and Planet-X have had on the Earth in the past. Wait'll you read his book, *Planet-X, Comets & Earth Changes*, ISBN 0-9722186-0-2. It's an \$18 book and I've laid in some copies for Radio Bookshop (item #95), just in case you're interested in finding out more about how the government is lying to us.

Why all the lies? Well, what would you do if you knew that there's a good chance that every city on our coasts could be wiped out in a matter of minutes by a passing planet or comet? It would cause a panic beyond description.

Planet-X, also known from ancient records as Nibiru, as described by Zacharia Sitchin in his superbly researched books, and called Wormwood in the Bible, has a long history of creating havoc on its passes through the solar system.

Like? Sudden mountain building due to the gravity effects on Earth's mantle, shifting the tectonic plates around. Jim says our oil deposits arrived from a comet tail, not from decayed prehistoric plants, and that there's a lot more to be found.

What's the real story on the arrival of Planet-X? I wish I knew for sure. Mark Hazelwood, in his *Blindsided*, makes a good case for it passing by this spring, complete with a sudden pole shift (it's \$15 from Radio Bookshop, #94). Nancy Lieder (zetatalk.com) says it'll be May 15th, but the strong suspicion by several experts is that this is a NASA disinformation ploy.

The AMA at Work

Have you read about Dr. Semmelweis, the Hungarian physician? He's the doctor 150 years ago who was concerned over the terrible death rate of women who gave birth in hospitals compared to those using midwives and giving birth at home. He noticed that doctors assisting births had often come directly from doing an autopsy to the maternity ward without washing their hands. When he got his hospital to have the doctors wash their hands before

Continued on page 8

Big Savings on Radio Scanners

Uniden®

SCANNERS

AOR



Bearcat® 785DGV APCO P-25 Digital Ready with free deluxe scanner headset
CEI on-line or phone special price \$339.95
 1,000 Channels • 27 bands • CTCSS/DCS • S Meter
 Size: 6^{15/16}" Wide x 6^{9/16}" Deep x 2^{3/8}" High

New Product. Scheduled for initial release January 10, 2003. Order now.
 Frequency Coverage: 25.0000-512.0000 MHz., 806.000-823.9675MHz.,
 849.0125-868.9675 MHz., 894.0125-956.000, 1240.000-1300.000 MHz.

When you buy your Bearcat 785D state-of-the-art Digital Capable Trunktracker III package deal from Communications Electronics, you get more. The GV means "Great Value." With your BC785D scanner purchase, you also get a free deluxe scanner headphone designed for home or race track use. The Bearcat 785D has 1,000 channels and the widest frequency coverage of any Bearcat scanner ever. When you order the optional BC125D, APCO Project 25 Digital Card for \$299.95, when installed, you can monitor Public Safety Organizations who currently use conventional, trunked 3,600 baud and mixed mode APCO Project 25 systems. APCO project 25 is a modulation process where voice communications are converted into digital communications similar to digital mobile phones. You can also monitor Motorola, EDACS, EDACS SCAT, and EF Johnson systems. Many more features such as S.A.M.E. weather alert, full-frequency display and backlit controls, built-in CTCSS/DCS to assign analog and digital subaudible tone codes to a specific frequency in memory, PC Control with RS232 port, Beep Alert, Record function, VFO control, menu-driven design, total channel control and much more. Our CEI package deal includes telescopic antenna, AC adapter, cigarette lighter cord, DC cord, mobile mounting bracket with screws, owner's manual, trunking frequency guide and one-year limited Uniden factory warranty. For maximum scanning enjoyment, operate your scanner from your computer running Windows. Order Scancat Gold for Windows, part number SGFW for \$99.95 and magnetic mount antenna part number ANTMBC for \$29.95. Not compatible with 9,600 baud APCO digital control channel with digital voice, AGEIS, ASTRO or ESAS systems. For fastest delivery, order on-line at www.usascan.com.

Bearcat® 895XLT Trunk Tracker
 Manufacturer suggested list price \$499.95
Less -\$320 Instant Rebate / Special \$179.95
 300 Channels • 10 banks • Built-in CTCSS • S Meter
 Size: 10^{1/2}" Wide x 7^{1/2}" Deep x 3^{3/8}" High
 Frequency Coverage: 29.000-54.000 MHz., 108.000-174 MHz., 216.000-512.000 MHz., 806.000-823.995 MHz., 849.0125-868.995 MHz., 894.0125-956.000 MHz.

The Bearcat 895XLT is superb for intercepting trunked analog communications transmissions with features like TurboScan™ to search VHF channels at 100 steps per second. This base and mobile scanner is also ideal for intelligence professionals because it has a Signal Strength Meter, RS232C Port to allow computer-control of your scanner via optional hardware and 30 trunking channel indicator annunciators to show you real-time trunking activity for an entire trunking system. Other features include Auto Store - Automatically stores all active frequencies within the specified bank(s). Auto Recording - Lets you record channel activity from the scanner onto a tape recorder. CTCSS Tone Board (Continuous Tone Control Squelch System) allows the squelch to be broken during scanning only when a correct CTCSS tone is received. For maximum scanning pleasure, order the following optional accessories: PS001 Cigarette lighter power cord for temporary operation from your vehicle's cigarette lighter \$14.95; PS002 DC power cord - enables permanent operation from your vehicle fuse box \$14.95; MB001 Mobile mounting bracket \$14.95; EX711 External speaker with mounting bracket & 10 feet of cable with plug attached \$19.95. CAT895 Computer serial cable \$29.95. The BC895XLT comes with AC adapter, telescopic antenna, owner's manual and one year limited Uniden warranty. Not compatible with AGEIS, ASTRO, EDACS, ESAS or LTR systems.



Bearcat® 245XLT Trunk Tracker II

Mfg. suggested list price \$429.95/CEI price \$189.95

300 Channels • 10 banks • Trunk Scan and Scan Lists
 Trunk Lockout • Trunk Delay • Cloning Capability
 10 Priority Channels • Programmed Service Search
 Size: 2^{1/2}" Wide x 1^{3/4}" Deep x 6" High

Frequency Coverage:

29.000-54.000 MHz., 108-174 MHz., 406-512 MHz., 806-823.995 MHz., 849.0125-868.995 MHz., 894.0125-956.000 MHz.

Our Bearcat TrunkTracker BC245XLT is the world's first scanner designed to track Motorola Type I, Type II, Hybrid, SMARTNET, PRIVACY PLUS and EDACS analog trunking systems on any band. Now, follow UHF High Band, UHF 800/900 MHz trunked public safety and public service systems just as if conventional two-way communications were used. Our scanner offers many new benefits such as Multi-Track - Track more than one trunking system at a time and scan conventional and trunked systems at the same time. 300 Channels - Program one frequency into each channel. 12 Bands, 10 Banks - Includes 12 bands, with aircraft and 800 MHz. 10 banks with 30 channels each are useful for storing similar frequencies to maintain faster scanning cycles or for storing all the frequencies of a trunked system. Smart Scanner - Automatically program your BC245XLT with all the frequencies and trunking talk groups for your local area by accessing the Bearcat national database with your PC. If you do not have a PC simply use an external modem. Turbo Search - Increases the search speed to 300 steps per second when monitoring frequency bands with 5 KHz. steps. 10 Priority Channels - You can assign one priority channel in each bank. Assigning a priority channel allows you to keep track of activity on your most important channels while monitoring other channels for transmissions. Preprogrammed Service (SVC) Search - Allows you to toggle through preprogrammed police, fire/emergency, railroad, aircraft, marine, and weather frequencies. Unique Data Skip - Allows your scanner to skip unwanted data transmissions and reduces unwanted birdies. Memory Backup - If the battery completely discharges or if power is disconnected, the frequencies programmed in your scanner are retained in memory. Manual Channel Access - Go directly to any channel. LCD Back Light - An LCD light remains on for 15 seconds when the back light key is pressed. Autolight - Automatically turns the backlight on when your scanner stops on a transmission. Battery Save - In manual mode, the BC245XLT automatically reduces its power requirements to extend the battery's charge. Attenuator - Reduces the signal strength to help prevent signal overload. The BC245XLT also works as a conventional scanner. Now it's easy to continuously monitor many radio conversations even though the message is switching frequencies. The BC245XLT comes with AC adapter, one rechargeable long life ni-cad battery pack, belt clip, flexible rubber antenna, earphone, RS232C cable, Trunk Tracker frequency guide, owner's manual and one year limited Uniden warranty. Not compatible with AGEIS, ASTRO, ESAS or LTR systems.



Hear more action on your radio scanner today. Order on-line at www.usascan.com for quick delivery. For maximum scanning satisfaction, control your Bearcat 245XLT from your computer running Windows. Order Scancat Gold for Windows, part number SGFW for \$99.95 or the surveillance enhanced version with audio recording part number SGFWSE for \$159.95.

More Radio Products

Save even more on radio scanners when purchased directly from CEI. Your CEI price after instant rebate is listed below:

Bearcat 895XLT 300 ch. Trunktracker I base/mobile scanner.....	\$179.95
Bearcat 785D 1,000 channel Trunktracker III base/mobile.....	\$339.95
Bearcat BC125D APCO Project 25 digital software card.....	\$299.95
Bearcat 278CLT 100 ch. AM/FM/SAME WX alert scanner.....	\$139.95
Bearcat 250D 1,000 ch. Trunktracker III handheld scanner.....	\$339.95
Bearcat 245XLT 300 ch. Trunktracker II handheld scanner.....	\$189.95
Bearcat 248CLT 50 ch. base AM/FM/weather alert scanner.....	\$84.95
Bearcat Sportcat 200 alpha handheld sports scanner.....	\$159.95
Bearcat Sportcat 180B handheld sports scanner.....	\$139.95
Bearcat 80XLT 50 channel handheld scanner.....	\$99.95
Bearcat 60XLT 30 channel handheld scanner.....	\$74.95
Bearcat BCT7 information mobile scanner.....	\$139.95
AOR AR16BQ Wide Band scanner with quick charger.....	\$199.95
Sangean ATS909 306 memory shortwave receiver.....	\$209.95
Sangean AT818 45 memory shortwave receiver.....	\$139.95
Uniden WX500 Weather Alert with S.A.M.E. feature.....	\$39.95

AOR® AR8200 Mark IIB Radio Scanner

AOR8200 Mark IIB-A wideband handheld scanner/SPECIAL \$539.95

1,000 Channels • 20 banks • 50 Select Scan Channels
 PASS channels: 50 per search bank + 50 for VFO search
 Frequency step programmable in multiples of 50 Hz.
 Size: 2^{1/2}" Wide x 1^{3/8}" Deep x 6^{1/8}" High

Frequency Coverage:

500 KHz to 823.995 MHz, 849.0125-868.995 MHz, 894.0125-2,040.000 MHz
 (Full coverage receivers available for export and FCC approved users.)



The AOR AR8200 Mark IIB is the ideal handheld radio scanner for communications professionals. It features all mode receive: WFM, NFM, SFM (Super Narrow FM), WAM, AM, NAM (wide, standard, narrow AM), USB, LSB & CW. Super narrow FM plus Wide and Narrow AM in addition to the standard modes. The AR8200 also has a versatile multifunctional band scope with save trace facility, twin frequency readout with bar signal meter, battery save feature with battery low legend, separate controls for volume and squelch, arrow four way side rocker with separate main tuning dial, user selectable keypad beep/illumination and LCD contrast, write protect and keypad lock, programmable scan and search including LINK, FREE, DELAY, AUDIO, LEVEL, MODE, computer socket fitted for control, clone and record, Flash-ROM no battery required memory, true carrier reinsertion in SSB modes, RF preselection of mid VHF bands, Detachable MW bar aerial. Tuning steps are programmable in multiples of 50 Hz in all modes, 8.33 KHz airband step correctly supported, Step-adjust, frequency offset, AFC, Noise limited & attenuator, Wide and Narrow AM in addition to the standard modes. For maximum scanning pleasure, you can add one of the following optional slot cards to this scanner: CT8200 CTCSS squelch & search decoder \$89.95; EM8200 External 4,000 channel backup memory, 160 search banks. \$69.95; RU8200 about 20 seconds chip based recording and playback \$69.95; TE8200 256 step tone eliminator \$59.95. In addition, two leads are available for use with the option socket. CC8200A personal computer control lead \$109.95; CR8200 tape recording lead \$59.95. Includes 4 1,000 mAh AA ni-cad batteries, charger, cigarette lighter adapter, whip aerial, MW bar antenna, belt hook, strap and one year limited AOR warranty. For fastest delivery, enter your order on-line at <http://www.usascan.com>.

Buy with Confidence

Order on-line and get big savings

For over 33 years, millions of communications specialists and enthusiasts worldwide have trusted Communications Electronics for their mission critical communications needs. It's easy to order. For fastest delivery, order on-line at www.usascan.com. Mail orders to: Communications Electronics Inc., P.O. Box 1045, Ann Arbor, Michigan 48106 USA. Add \$20.00 per radio receiver for UPS ground shipping, handling and insurance to the continental USA. Add \$15.00 shipping for all accessories and publications. For Canada, Puerto Rico, Hawaii, Alaska, Guam, P.O. Box or APO/FPO delivery, shipping charges are two times continental US rates. Michigan residents add sales tax. No COD's. Your satisfaction is guaranteed or return item in unused condition in original packaging within 61 days for refund, less shipping, handling and insurance charges. 10% surcharge for net 10 billing to qualified accounts. All sales are subject to availability, acceptance, verification and authentication. Prices, terms and specifications are subject to change without notice. We welcome your Discover, Visa, American Express, MasterCard, IMPAC and Eurocard. Call anytime 1-800-USA-SCAN or 800-872-7226 to order toll-free. Call +1-734-996-8888 if outside Canada or the USA. FAX anytime, dial +1-734-663-8888. Dealer and international inquiries invited. Order your radio products from CEI today at www.usascan.com.

For credit card orders call
1-800-USA-SCAN

e-mail: cei@usascan.com

www.usascan.com

PO Box 1045, Ann Arbor, Michigan 48106-1045 USA

For information call 734-996-8888 or FAX 734-663-8888
 Price schedule effective December 2, 2002 AD #120202 © 2002 Communications Electronics Inc.

COMMUNICATIONS ELECTRONICS INC.
 Emergency Operations Center

Visit WWW.USASCAN.COM • 1-800-USA-SCAN

continued from page 1

radio receiver either from a kit or locally purchased components. The Intermediate license is available either as a Class A with Morse, or a Class B without Morse proficiency. Class A gives all bands with a maximum power of 50 watts and Class B gives all bands above 30 MHz at 50 watts maximum. Callsigns are in the M5XXX or 2E0XXX for Class A and 2E1XXX for Class B. As with the Foundation, a training course has to be attended to get the license.

The top (and original) license class is the Full license, again, available as Class A or B. The level of technical knowledge is broadly equivalent to the US Advanced class exam. The Morse requirement is to send and receive at 5 WPM. The maximum power levels are 400 watts PEP or 150 watts carrier. You will hear callsigns with G2XX, G3XX, G4XX, G5XX, G8XX, G0XXX, G2XXX, G3XXX, G4XXX, M0XXX for Class A, and G1XXX, G6XXX, G7XXX, G8XXX, M1XXX for Class B.

The callsign prefix may include a second letter if the station is not located in England, e.g., GW3 is in Wales, MM1 is in Scotland, 2U1 is in Guernsey, GJ8 is Jersey, MD3 is Isle of Man, and GI8 is Northern Ireland.

For a club station at a public event these second letters would be X for England, C for Wales, S for Scotland, P for Guernsey, H for Jersey, T for Isle of Man, and N for Northern Ireland. GB prefix calls are special event stations, GB3XX calls are repeaters, GB3XXX are beacons, and GB7XXX are packet nodes and BBS stations. Repeater, beacon, and packet BBS stations all require their own licenses. Nothing's simple in this country!

The UK Morse test is more challenging than in the US. A 5-minute passage in QSO format has to be received with no more than 6 errors and sent with no uncorrected errors whatsoever. Whilst Morse tests and Foundation courses are administered by clubs, the exams required for the Intermediate and Full license are administered by a national examinations body twice yearly.

Copy that, ol' chap?

Thanks to Nigel Gunn G8IFF, via the February 2003 issue of RF-Carrier, a monthly publication from The Dayton Amateur Radio Association.

RC Mag-Lift Train Takes Off ... Well, You Know What We Mean

The world's first magnetic levitation or mag-lift passenger train began running in Shanghai, China, on January 1st. The radio-controlled train reached 312 miles per hour in testing. In regular service it will carry passengers and freight at a

top speed above 250 miles per hour between Pudong International Airport and Shanghai's financial district. The distance is 30 miles, and the trip will take a mere 7 minutes — not even enough time to make a quick cell phone call.

Thanks to Technology Online, via Newline, Bill Pasternak WA6ITF, editor.

Edison and the X-Ray

Thomas Alva Edison was well known as an inventor of many things, but usually not the X-ray.

However, he did experiment with X-rays at great length. He secured more than 1,000 patents but never did he patent his X-ray devices. Yet mankind will long benefit indirectly from his many experiments and from tests made in his laboratory.

He said in an article he wrote for *Popular Mechanics* in 1903, "You cannot obtain energy without first supplying it from some other source." He believed that radium, thorium, and uranium were not energetic in themselves, but were made radioactive or fluorescent by the introduction of other energies.

His speculations were eventually replaced by Einstein's theory of the equivalence of mass and energy. Edison upheld Einstein's theory and based his experiments on this theory. Other researchers and entrepreneurs were conducting isolated experiments, but Edison had at his command the financial, human, and physical resources to make short work of long, tedious research.

William Randolph Hearst, editor of the *New York Journal*, sent Edison a special request. X-ray a human brain and send him the pictures. Edison believed physicians would find an instantaneous image of the human interior far more useful than an image on a plate, so he set out to build a better X-ray device. His lab conducted exhaustive tests on glass, vacuum, electrodes, and energy sources, to produce the best X-rays. In 1896 alone, his lab tested more than 8,000 substances.

The best brightness came from calcium tungstate. The result was that Edison improved what is now known as the fluoroscope, used to this day. He could not patent it because he was not the original inventor.

Although Roentgen first discovered the X-ray and the fluoroscope, it was Edison who put it on the market. Less than three months after Roentgen's announcement, Edison's fluoroscope was available for purchase on the open market at a low price. Edison also achieved his goal of producing a completely portable X-ray outfit, and Edison Portable became the Navy's first shipboard X-ray unit in 1898.

Despite the ray of hope he provided to medical science by radioactive substances, Edison experienced its dangers. "I am through with X-rays,

radium, and everything of the kind" he said in 1903. "Not only is my left eye badly affected by the Roentgen ray, but I am having all kinds of trouble with my stomach due, I believe, to leaning over the X-ray machine while experimenting."

Roentgen went on to win the first Nobel Prize in physics in 1901 for his discovery. Edison? He wrote an article about it for *Popular Mechanics*.

So the next time you come across the notion that Roentgen was the sole developer of X-rays, you'll be able to see right through it.

Thanks to the December 2002 issue of *The Modulator*, the news and views of the Fort Myers Amateur Radio Club, Inc.

TV Guide

According to the National Association of Broadcasters, approximately eighty-one million television sets in the U.S. receive programming exclusively from free, over-the-air TV stations. In comments filed with the Federal Communications Commission, the NAB noted that while the total number of television sets in the U.S. is 267 million, more than three out of every ten TV sets relies exclusively on "free TV" for programming. This means that the TV set is not hooked up to cable, satellite, or any other subscription TV service.

Other figures noted by the NAB say that twenty-five percent of all cable and satellite homes have at least one TV set in the household that receives signals solely from free TV. Also, 24 percent of African-American and 32 percent of Hispanic households rely exclusively on free TV for their television viewing.

The National Association of Broadcasters analysis was provided to the FCC as part of the Commission's "Annual Assessment of the Status of Competition in the Market for the Delivery of Video Programming." The NAB says that its comments demonstrate the considerable extent to which consumers still depend on over-the-air broadcast television signals.

Thanks to the NAB, via Newline, Bill Pasternak WA6ITF, editor.

Hackaround is Fair Play

We have all heard the expression, "Turn-around is fair play." One person who has just found that out is former computer hacker turned on-line security expert Kevin Mitnick N6NHG. That's because Mitnick's new company Web site has been — well — hacked.

The ham who holds the honor of being the world's best-known computer hacker suffered the indignity of having hackers break into his new security consulting company's Web site — twice. But news reports say that Kevin Mitnick N6NHG simply shrugged off the incidents as amusing,

and not serious enough for him to call authorities to investigate.

Two electronic break-ins took place. The first was on January 30th. In that one, a hacker calling himself "BugBear" added a page to Mitnick's corporate Web site that read "Welcome back to freedom, Mr. Kevin." This is probably a reference to Mitnick's probation, which had ended ten days earlier on January 20th. During his probation, Mitnick was barred from accessing the Internet, and this hack may have been more of a welcome home — in this case, home being the World Wide Web.

The latest incident took place over the weekend of February 8th and 9th, and was more of an on-line job application than a hack. In this case, a hacker in Texas broke in and asked Mitnick to hire him as the company's security officer.

Mitnick says that the hackers apparently exploited separate flaws in Microsoft's Internet server software. He says that the person responsible for the company's Web site failed to install patches available from Microsoft.

In neither instance did hackers vandalize the Web site. One said in an E-mail that he didn't do damage out of respect for Mitnick.

Mitnick's new organization is called Defensive Thinking, and it is located in Los Angeles. A company spokesman said that no customer

information was released nor was there any danger of information being compromised.

Thanks to Bruce Tennant K6PZW, via Newsline, Bill Pasternak WA6ITF, editor.

Spanning the Atlantic — and Above

Here's a story of history being celebrated — of the earliest days of radio being commemorated by the people of the 21st century. Those who were there said it was like the past catching up with the future on a cold day on Cape Cod, Massachusetts.

The event was the 100th celebration of the first-ever radio transmission from the United States being received in Europe. It was made by radio pioneer Guglielmo Marconi in 1903. And it was his daughter, Princess Elettra Marconi, who lent her voice to begin the 100th anniversary celebration of the first trans-Atlantic radio message.

She began the festivities in a brief contact with Ken Bowersox KD5KBP. That's Commander Ken Bowersox on board the International Space Station. A bit later, Bowersox spoke with Cape Cod area school children who asked questions about life in orbit. Both contacts were made possible by ARISS — Amateur Radio on board the International Space Station.

The January 18, 1903, contact by Guglielmo Marconi used an early form of hand-sent code to span the Atlantic. A short time later, Marconi predicted that man's voice would eventually span the globe using wireless. Now, precisely a hundred years later on a frigid January 18, 2003, Marconi's daughter returned to near the scene of that first contact and got to speak to a man in space. If he were alive today, Guglielmo Marconi would justly be proud.

Thanks to Bob Doherty K1VV, via Newsline, Bill Pasternak WA6ITF, editor.

New Class of Field Day Station

Amateur Radio's premier emergency preparedness operating event is changing. This, with word that the annual ARRL Field Day will gain another entry class for 2003.

Called Class F, these will be amateur radio stations which are set up and operate from emergency operations centers, or EOCs. The ARRL says that the change renews the emphasis of Field Day's 1933 origins as an emergency preparedness exercise as opposed to a routine contest.

Thanks to the ARRL, via Newsline, Bill Pasternak WA6ITF, editor.

Smart Choice! Smartuner!

Do **YOU** want to be heard? *OF COURSE!* Then use the SGC Smartuner™ - the *Essential* link between your **HF transceiver** and **antenna**. Matching at the transceiver is good, but matching at the antenna is better. SGC Smartuners are designed to do just that. They operate completely independently to provide the best match between the feed line and the antenna, eliminating SWR problems completely.

SGC Smartuners are designed to work with *any* transceiver (including the ICOM 802) and *any* antenna. They are fully automated, intelligent enough to select the best match between feed line and antenna in seconds and remember it so it can recall that match in milliseconds. The Smartuner sets the standard. It is the original and still the best.



Illustration from the original SGC Marine SSB Facebook, 1974

Once you've learned how the Smartuner works, you won't want anything else!



SG-230



No Compromise Communications



SG-231

Visit www.sgcworld.com for more information on the entire line of Smartuners

SGC Inc. 13737 SE 26th St. Bellevue, WA 98005 USA Tel: 425-746-6310 Fax: 425-746-6384
sgc@sgcworld.com www.sgcworld.com

NEVER SAY DIE

continued from page 4

assisting a birth the death rate fell from around 30% to almost zero.

The medical establishment reacted by cutting off his research funding, launching a vilification campaign and getting him fired.

In America the AMA followed suit by threatening to remove the license of any doctor caught washing his hands. Since they couldn't see germs, the belief in them was crazy. Superstition. It was almost 50 years and millions of unnecessary deaths before doctors were able to wash their hands in public before operations.

Little seems to have changed.

Diapers

The average baby uses up to 10,000 diapers by the time conventional toilet training is done. That comes out to about 20 billion disposable diapers for American kids a year that are being buried in landfill ... where it takes an estimated 500 years for them to biodegrade. That's around \$4 billion a year spent on disposable diapers.

Then there's cloth diapers, which eat up lots of electricity and water, and use tons of polluting chemicals being washed.

Some five million tons of disposable diapers go into U.S. landfills every year. This takes one billion trees a year, plus uses 3.5 billion gallons of oil in the manufacture.

All because American parents haven't bothered to learn how to toilet train their baby the easy, fast way. I'm talking within weeks of birth. I'm talking about a baby that doesn't make "mistakes" and is a lot happier than one carting around a load for hours.

Check out Laurie Boucke's *Trickle Treat*, if you can find a copy. ISBN 0-9625006-2-3. Try abebooks.com. That's where Sherry got a copy recently to give to my daughter Sage, who's having her first baby soon.

Toilet training can be accomplished within a few weeks of birth just by paying attention to the baby's natural elimination patterns ... like when it wakes up, after meals, before it goes to sleep and any time it begins to fret. It can be done positively and with no recriminations. A baby is happy when it's making Mother happy by cooperating with toilet training. It's a win-win situation which will avoid years of diapers and cleaning the baby's bottom ... and avoid possible long-term toilet problems.

Early-on the baby can be taught to make a distinctive sound or give a sign when it's ready to go. Just make that sound and give that sign every time you help the baby to pee, and another signal for a bowel movement. Read the book *Baby Signs*, which is reviewed on page 43 of my *Secret Guide to Wisdom*.

We really don't need more generations of constipated people.

A New Scam

This is a great one! It starts out when you receive a \$4 check in the mail. It doesn't say what for on the front, but on the back in teensy type it says over your signature: "Please send me an XXXX Savings Card and Kit as soon as possible. Cashing this check activates my membership to XXXX with all privileges included. I understand that after 30 days, the \$139.95 annual fee will be automatically charged to my credit card account on file. To ensure continuous service each year, XXXX will be automatically renewed at the then-current renewal rate and charged to my credit card account on file. I may cancel at any time for any reason and receive a pro-rated refund of my then-current paid annual membership fee. The \$4.00 check is mine to keep regardless." Signature _____.

Union Theft

While our notoriously liberal media made big headlines over the plundering of Enron,

et al., I'll bet you didn't see a word about the plundering of the Washington (DC) Teacher's Union by union President Barbara Bullock and a couple other officials. They are suspected of embezzling more than \$2 million of the member's dues (which are compulsory).

The FBI investigated and the list of Bullock's spending of the union funds as reported in a January Michelle Malkin newspaper column is staggering. \$20,000 mink coats, \$500,000 in clothing from Van Style, \$150,000 from Neiman-Marcus, a \$57,000 sterling set from Tiffany, \$40,000 from Saks, \$50,000 from Nordstrom, etc. It's a long list. Gee, what a surprise!

Damned Liars

All the histrionics about giving the rich a tax cut is crapola by either liars or the monumentally stupid. Both Kennedy and Reagan put through tax cuts and those gave us years of prosperity. Why? Because it's the rich who are making most of the money ... and paying the highest taxes. When the "rich" get a tax cut do they sit in their vaults like Scrooge McDuck and wallow in their money? Of course not.

Our country and the world are on a never ending escalator of inflation, so any money that isn't invested somewhere or spent rapidly loses its value. The rich spend or invest, and either of those paths creates more jobs. The stuff they buy has to be made, advertised, sold and serviced. Their investments make it possible for more businesses to get started or grow.

The rich? If your household income is over \$83,500 you are one of the "rich." You are in the top 20%. That's a couple making a little over \$40,000 each. If your income is \$150,000 you're in the top 5%! Wow! But you're not going to be buying any Rolls or yachts on that.

Both the Kennedy and Reagan tax cuts far more than made up for themselves by the increased tax revenues

which resulted from the increased business growth.

Instead of being jealous of the rich, why not become one of them. Once you get over the "job" mentality and start thinking in terms of starting your own business you'll be making money for yourself instead of someone else and you'll be amazed at the freedom you'll have ... and you'll have the money to enjoy it. It's all in my *Secret Guide to Wealth*.

The next time you hear a politician braying about tax cuts being for the rich, give the jackass a Bronx cheer. Say, isn't a jackass the symbol for the Democratic Party? Coincidence?

How to Kill a \$100,000,000 Goose!

Byte, once the largest magazine in America (maybe the world), died a quiet, almost unnoticed, death a couple years ago. Well, since the magazine was my brainchild, I noticed.

In January 1975 a tiny company, MITS, in Albuquerque, brought out a kit for hobbyists to make a computer. The Altair 8800 was designed around the new Intel 8080 chip. Since MITS had been advertising their four-banger calculator (\$129) in 73, I quickly bought an Altair kit and put it together. The only input was some toggle switches on the front panel, and there was zero software.

Next I bought a keyboard kit from Southwest Technical Products (SWTPC) in San Antonio and put that together. Neither MITS nor SWT could help me connect the keyboard to the computer, so I had to figure that out for myself.

One thing I didn't know was that Ed Roberts, the president of MITS, and the designer of the Altair, had never actually made it work. I discovered later that he expected hobbyists to figure out what was wrong and let him know so he could ship units which actually would work. Which they did.

Having watched the computer industry start with mainframe million-dollar computers made by IBM, Honeywell, RCA and a few others, and then grow enormously when Wang, Data General, DEC and others weighed in with minicomputers in the \$100,000 range, I saw the potential for growth for microcomputers which could bring the cost of computers down to \$10,000 and under.

Hmm, I decided I had to start learning about these contraptions. So I bought all of the computer books I could find and started reading. But I couldn't understand them! They were all college texts. Hey, there's going to be a need for thousands of newcomers to computers to learn about them ... something that explains them in simple language. A magazine.

Having recently turned an amateur radio hobby of repeaters from about a hundred in the country in 1969 into the biggest ham radio activity in the world with thousands of repeaters with 73 magazine and my *Repeater Journal*, and watched the hobby then be used to launch the cell phone industry, I knew the power of a magazine to help a new technology grow into an industry.

A magazine, I discovered, makes it so the pioneers in a new technology are able to communicate and thus speed up the technology's development. Further, it attracts newcomers to the field and brings them up to speed. It also attracts entrepreneurs who start making products in this field and are easily able to reach their potential customers. And that attracts more people, etc.

Okay, there's a need for a basic computer magazine. Since I didn't know squat about computers, I needed an editor. I started calling the editors of computer hobbyist newsletters, looking for an editor. Most weren't interested. Hey, it's just a hobby. I finally found one that agreed to give it a try. Now what?

I needed articles, subscribers, and a simple, catchy name. I came up with *Byte*, which said it all.

I called every company even remotely connected to computers. I outlined my plan and asked them to recommend potential authors and send me a list of anyone who had written for information.

I called the 73 authors who had written computer-oriented articles, asking them to get busy and submit articles to *Byte*.

Five weeks after my decision to start *Byte* the first issue went to press!

The new editor helped, but most of the work was done by the 73 staff. And me. I designed the logo, wrote the subscription letters, called potential advertisers, and a thousand other details.

The subscription mailing responses were amazing. Normally one expects about a 2% response. I was getting over 20%. I called the ham stores who were selling 73 and most of them signed up as dealers for *Byte*. We were off and running.

The Altair was announced in January. I started *Byte* in May and the first issue went to press in early July. The first copies from the printer arrived in August with a September 1975 cover date. I immediately flew out to visit MITS to

Say You Saw It in 73!

bring Ed Roberts magazine copies and solidify our advertising contract. I also visited Sphere in Salt Lake City, which had a Motorola 6800 chip-based system they were introducing. From there I stopped off in Ft. Worth to visit a company

Continued on page 26

Two Step Tuning Step One: Pick up microphone. Step Two: Transmit.

(Please note: HF Tuning doesn't get much easier than this.)



SGC Smartuner™

HF Automatic Antenna Couplers

"For me and my radio dollar, there isn't a better coupler made!"

Jack Huebschen N9XRO

Power Input: From 1.5W - Up to 500W*

HF Frequency Range: From 1MHz - Up to 60MHz*

Up to 4,000,000 element combinations*

Five Sensor Devices *Specs differ per model

"Undoubtedly the best piece of hamgear I have ever owned."

Ronnie Kane K9MNI

**Marine, Commercial, Amateur Radio,
Aviation, Special Applications**

Starting at \$179



SGC

www.sgcworld.com

Toll Free (800) 259-7331 • Tel (425) 746-6310 • Fax (425) 746-6384 • Email: sgc@sgcworld.com

Mailing: PO Box 3526, Bellevue, WA 98009 • Shipping: 13737 SE 26th St. Bellevue, WA 98005 USA

Copyright 2001 SGC, Inc.

Right Fancy CPO

A keyer from My Kid Brother.

The CPO, a/k/a code practice oscillator, has been a part of amateur radio for quite a long time now. I have no idea when the first one was built, or who built it for that matter. The fact remains, however, that the "code practice oscillator/CPO" has remained much the same since its inception.

The main — the only — purpose of the code oscillator is to provide a means of keyed on-off tones. Once CW is well mastered, the CPO is really of no further use!

CW comes in two parts: transmitting, and receiving!

Learning to receive is only half of the CW-learning experience. We are told that a dash is three times longer than a dot. The time interval between a dot and a dot (or a dash and a dash) for the letter "T" (or "M") is equal in time value to the length of a dot.

OK! Fair enough! So how do you measure that length of time? If you hold a dot for a given length of time, how do you know that you are holding the dot long enough? How do you know, for that matter, that the dash you send next is three times longer than the dot? Or too short maybe? Or even too long?

While learning to send CW in preparation for my Novice test, it occurred to me one day that learning to send CW has a lot in common with learning to play music — and the playing of music is a motor skill. CW sending, also like music playing, is a "motor skill," too. It uses only one tone, so unlike with music, you don't have the

dimension of "pitch" to deal with. However, as with playing music, you are dealing with sensing time (musicians call it a time feel)!

Developing a time feel in playing music is facilitated by practicing with a metronome, and practicing for an incredible amount of time (more than you want to know)! While I was working one day with a metronome, it became obvious to me that a note had to be held accurately for a given interval of time in music, in much the same way (in CW) that dots and dashes have to be "time accurate."

There are many different length-of-time notes in music, but only two different "note lengths" in CW — the dot and the dash (the verbal use of dit and dah bear witness to that fact). Well, you can't very well adapt a metronome to help in learning the sending of CW. However, playing a musical instrument, such as the bass fiddle, is a motor skill. Sending, the playing of, CW, is a motor skill also (although nowhere near as involved as playing the bass fiddle).

So the techniques that I used in learning to play music, modified, will work for the learning of CW "playing." This CPO, I believe, fills a void

in learning CW that has been there all along — that is, until now.

Back when I was in high school, a fellow student, David T. Holmes Jr. W8UMP, was two years ahead of me and had his General class license. He became my friend and amateur radio mentor. Dave volunteered his time, expertise, and patience (if you're out there Dave, thanks!) to teach me the necessary code and theory in order for me to pass my Novice test.

One day, while struggling with the code, it occurred to me to handle the task the same way as though I were learning to play a new piece of music, as already mentioned. Just practice the sending of CW the same way. Practicing, being patient, and persevering are also key ingredients in learning to play music. Remember, this CPO is for learning how to transmit CW. I know that there are those out there who have learned to receive the entire CW alphabet, numbers and punctuation, in under 150 microseconds — nice going! Transmitting CW, the other half of the CW communicating system, however, is another story.

Over the years, every now and then, memories of my Novice license preparation days come back to me —

particularly when I hear amateurs say that "musicians have the edge when it comes, to learning CW." If they do, I believe I can take the mystery out of it. The "edge" can be summarized by these three words: practice, patience, perseverance!

There, is a "rhythm to the code," it is said. In a manner of speaking, rhythm could be likened to the mirror image of timing: a time feel, which is akin to rhythm. The metronome is a mechanical device that could be thought of as a "time mark generator" used by musicians. It generates clicks (or pulses), signals if you will. The pulses/clicks are used to help in the development of a sense of rhythm because they occur on an accurate, regular basis.

A time sense, or time feel, is very important in playing music. It is equally important in sending CW. In music, some notes are long, (just as there is slow CW), and some notes are short — for instance, CW sent at 50 words per minute or more has a lot of short notes! So how much of a difference is there between a long note (dash) and a short note (dot), at any given speed? How do you learn to send/play the particular CW (dot, dash) character/note for the correct length of time, initially, and consistently thereafter?

Music teachers say that "a quarter note gets one pulse" (some teachers also say beat instead of pulse). What this means is that you start a note, and you hold that note for a measured interval of time, and you release. When practicing with the metronome, you start the note simultaneously with the first click, and hold the note till the second click occurs, and simultaneously release the note with the second click (golly, that's a lot like sending a dot in CW, isn't it?). Start the note with the first pulse, hold it, and release with the second pulse! Simple, isn't it? That note (time interval value-wise) is a quarter note. A half note is twice as long as a quarter note. You start the note with the first click of the metronome, and hold it till the second click occurs, and continue to hold it till the third click occurs, and simultaneously release (see the timing diagram). The note that is held twice as long as the

quarter note is called a half note. A half note is twice as long as a quarter note.

"OK, so how do I get a dash out of all of this?" you say. Well, note time lengths can be combined, or linked (musicians say tied). If you start with the first metronome pulse, hold it for the second pulse, continue to hold though, and release with the fourth pulse, you have a quarter note "tied" to a half note (in music it would be indicated as a half note with a dot beside it). If you link quarter and half notes, and analyze by counting clicks (without any separation), it adds up, clickwise, to four counts the time length of a dash.

There it is, analyzed. A dot, and a dash, which is three time intervals longer than a dot (notice the time indicators on the timing diagram). You can get a better understanding of what this is all about, with your fingers. Place your hand palm-down on the table, fingers spread. The fingers, represent clicks, the space between the fingers represents, "the 'on' time interval." The space between the index and second finger is the "interval" of a dot. You can animate a dot by tapping first the index finger, then the second finger (hum or whistle between taps). If you do that, you have a somewhat crude but accurate representation of a dot time length.

As was said, two clicks on a metronome result in a dot, time interval-wise. A dash is done in a similar manner, but notice that you need to add up the time interval spaces between the fingers. That turns out to be a "four count" on the fingers, or four pulses of a metronome. Start by tapping the first finger, and start humming and holding the hum until you tap the fourth finger — that's the length of a dash! This CPO transitions from the time marking aspect of a metronome to the generation of accurate-length-of-time tone intervals. Marking time, without time marks. Marking time-interval lengths by generating measured tones is what this fancy code oscillator does. When keyed, a tone stays on for a measured time interval. If you don't hold the key long enough, the dot/dash you send will end too soon. If you hold

ALL ELECTRONICS CORPORATION

12 Vdc 1.25 amp Power Supply

DVE # DSA-0151-12
2.1mm I.D. coax power plug.
Center positive. UL, CSA.

CAT # PS-1215

\$7²⁵
each



10 for \$6.95 each • 100 for \$6.50 each

Neo-Cylinder Magnet

Shiny, nickel plated neodymium cylinder. 0.25" diameter x 0.2" long.

CAT # MAG-76

2 for \$1⁰⁰

50 for 35¢ each
100 for 25¢ each



SHOP OUR ONLINE STORE
www.allelectronics.com

LEDs (Light Emitting Diodes)

SUPER BRIGHT RED 6,000 mcd T-1 3/4
CAT# LED-94 75¢ each
100 for \$50.00 - 1,000 for \$350.00

BLUE - water-clear 1,500 mcd T-1 3/4
CAT# LED-74 \$1.75 each
100 for \$115.00 • 1,000 for \$950.00

WHITE - water-clear 3,000 mcd T-1 3/4
CAT# LED-75 \$2.00 each
100 for \$165.00 • 1,000 for \$1300.00



10 Compartment Plastic Storage box

Transparent hinged plastic box with 10 compartments. Great for parts storage or display of small items. Outside dimensions 7" x 3.4" x 1.25". Friction-lock lid with dual clasps. Each box individually wrapped in a cardboard sleeve. CAT # SB-10

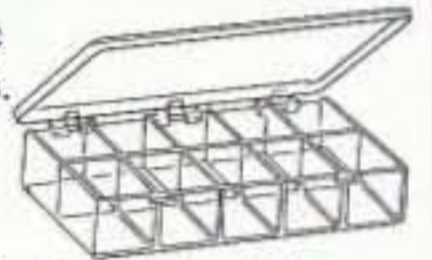

Case of 36 for \$30.60
(85¢ each)

\$1⁰⁰
each

ORDER TOLL FREE
1-800-826-5432

CHARGE ORDERS to Visa, Mastercard,
American Express or Discover

TERMS: NO MINIMUM ORDER. Shipping and handling for the 48 continental U.S.A. \$6.00 per order. All others including AK, HI, PR or Canada must pay full shipping. All orders delivered in CALIFORNIA must include local state sales tax. Quantities Limited. NO COD. Prices subject to change without notice.

CALL, WRITE
FAX or E-MAIL
for our **FREE**
96 Page
CATALOG
Outside the U.S.A.
send \$3.00 postage.

MAIL ORDERS TO:
ALL ELECTRONICS
CORPORATION
P.O. Box 567
Van Nuys, CA 91408
FAX (818)781-2653

e-mail allcorp@allcorp.com

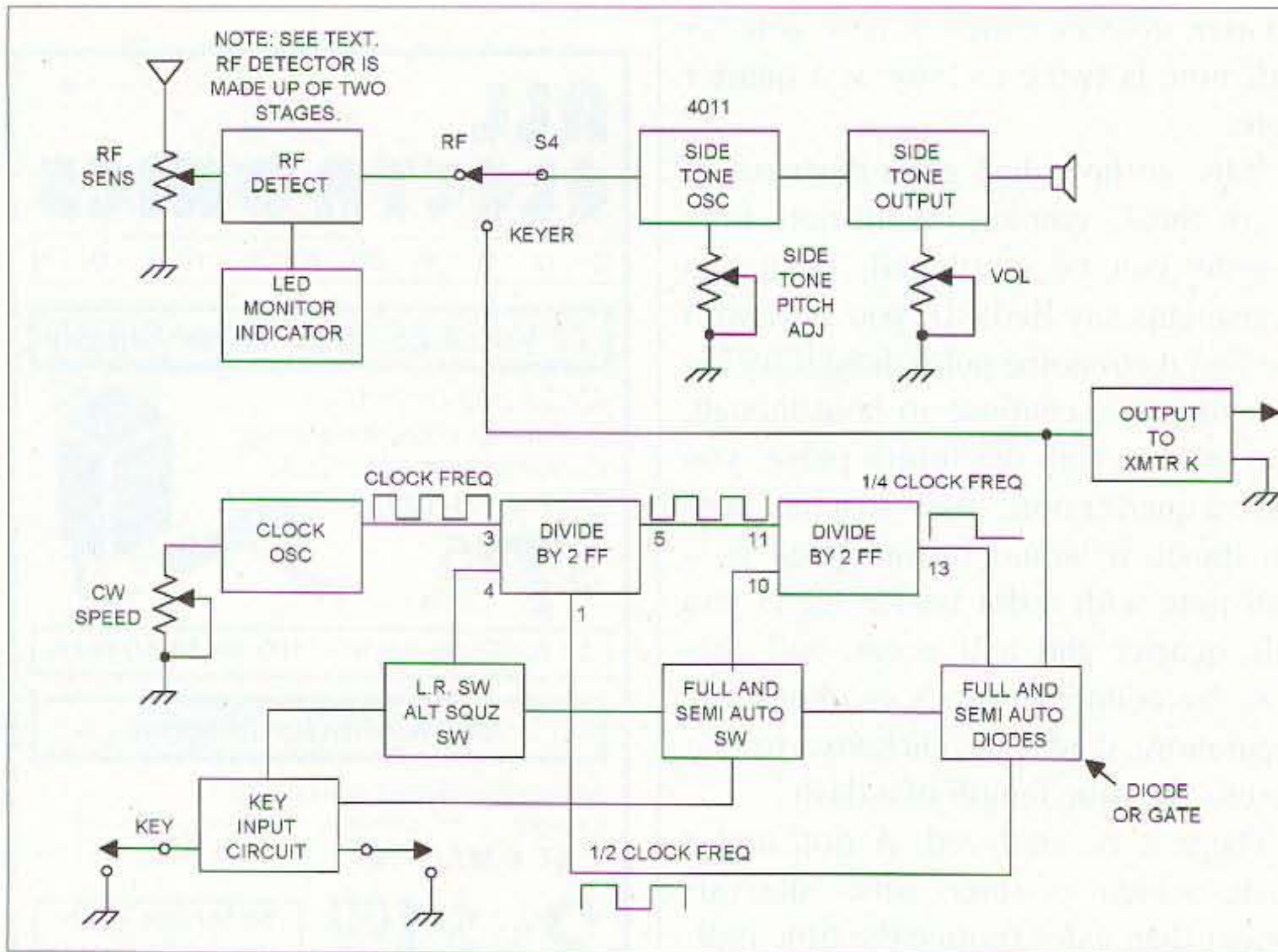

Fig. 1. Function block diagram.

the key too long, the dot/dash will end in the correct amount of time, and possibly the next dot/dash will start. You could say that this is dissecting CW, and looking at it under a microscope. I guess it is; however, this is done with the eventual goal of acquiring good CW sending technique. An important thing in operating CW, don't you think?. This code oscillator generates the tone between the "time mark" clicks, and in this way helps you develop a sense of CW rhythm.

This fancy code oscillator is more than just another "pretty face." For instance, it can be used for both full and semi-automatic keying. It has a provision for right-left-hand keying, squeeze/alternate keying. It also incorporates an RF keying monitor, with an LED indicator.

It can be used as a tutor to help in learning to use a "bug" or "straight key." The keying speed can be adjusted from below 5 wpm to over 50 wpm. It can key any transmitter. The right-/

left-hand switch was added thanks to my old Air Force buddy Dan Coyle of Dayton, Ohio. Dan is a leftie. He pointed out that the original was for the exclusive use of right-handed folks, so a right-left switch was included.

Using this CPO "forces" you to be CW-honest! Because the dots and dashes are not self-completing, you can't speed up or slow down, or short-change the time length of either dot or dash. You send good CW. That's why this CW-transmitting-tutor is similar to a music teacher, insisting that you do it right, and scolding you for "playing those quarter notes too short," or "rushing the whole notes."

The bare-bones circuit of this device first appeared in the Tab Book entitled *New IC FET Principles and Projects*, by Sessions and Tuite, copyright 1972, as project 14, "Integrated-circuit Keyer," on pg. 124. In the early '90s, I did a revamp and used different ICs because it made it possible to obtain all the parts at Radio Shack. The revamp was published in *Radio Fun* magazine in the early nineties. Only two of the four sections of the 4011 were used for the clock oscillator. It seemed a waste not to use the two other sections for a sidetone oscillator. Well, once we have a dedicated sidetone oscillator, why not devise a way to use a straight key? The sidetone could then be used as an old-fashioned code practice oscillator. While using the unit, it became obvious that the straight key option could also be used as a transmitter tune function. Why stop with a straight key option — why not have the sidetone incorporated as part of an RF monitor as well?

One day, while reading the mail on two meters, I heard the lament that "it would be nice to have a Vibroplex bug, but it takes practice in order to learn how to use those things." Well with the tune provision, and an electronic (double) key such as a Nye or Bencher or similar, this CPO can function as an electronic bug. You have (electronics-generated) automatic dots on one side, and manual dashes on the other side. You can slow the speed to a comfortable rate, set the switch to the TUNE/SEMI AUTO position, and use this

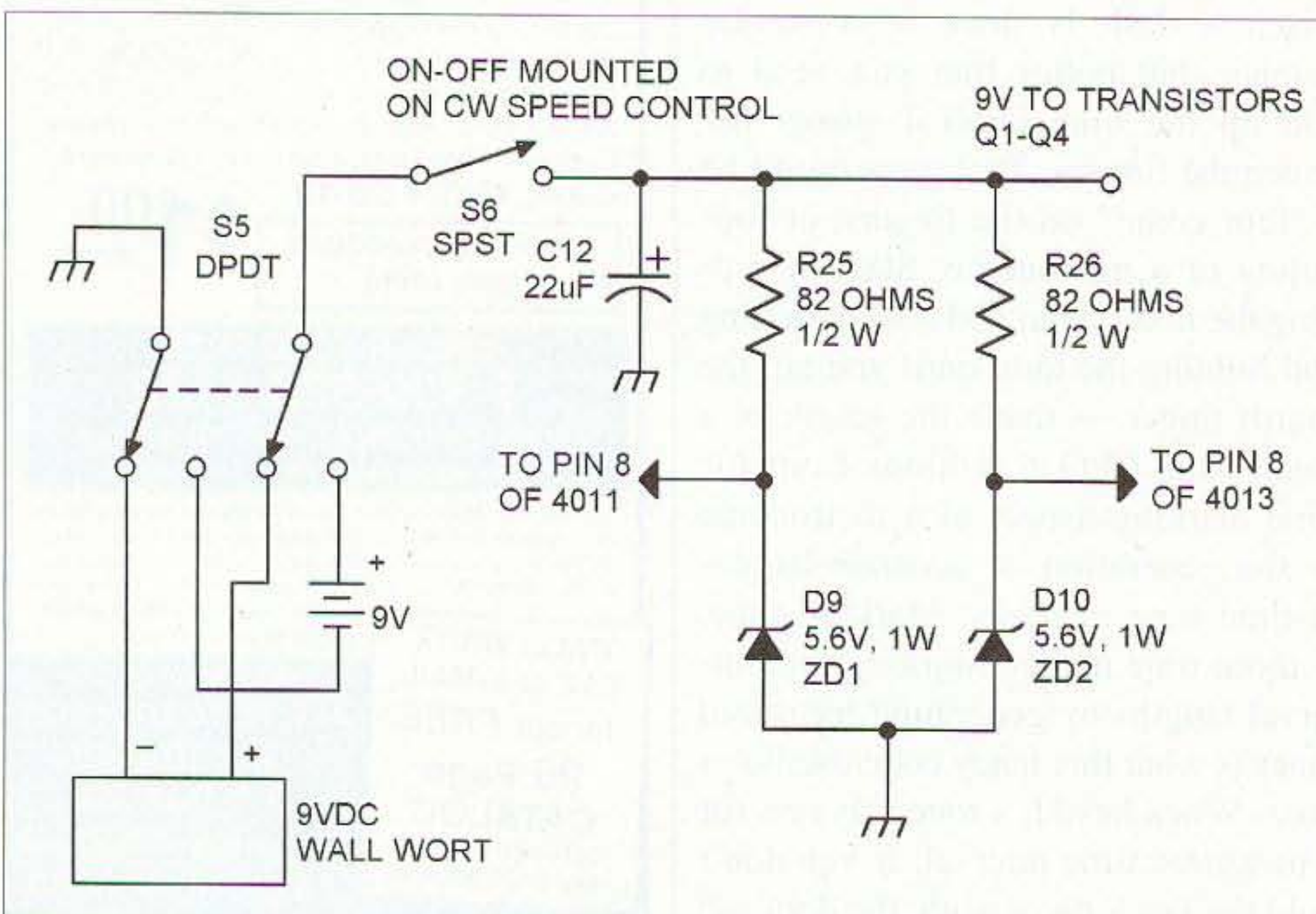

Fig. 2. Power supply connections.

CPO as a practice Vibroplex bug. Making the transition, then, to "the real thing," will be a lot easier.

Not only that, but the reverse is possible. The sidetone can be accessed, so that you can plug in the Vibroplex bug and you can practice, making for an easier electronic-to-the-real-thing bug transition. If you are completely new to amateur radio, plug in a straight, and the device can be used the same as an old-fashioned code oscillator. Included on the RF monitor side is an LED indicator. If you have a hearing defect — "are tone deaf" is how some describe it — the LED allows for visual CW. Other than egg in your beer, I can't think of anything else you can ask for.

How it works

Reference the schematic, block diagram, and signal flow diagram. The heart of the CPO is the clock oscillator portion of IC 4011. Its speed is adjusted by R12 in series with R13, and C8. R14 and R15 are also part of the circuit that makes up the user speed control adjustment. R15 is the front panel user control; R14 is an internal 20-turn trimmer speed limit-set pot. Refer to Fig. 1. 1/2 of the 4011 generates a signal which is fed to pin 3, 1/2 of the 4013 dual flip-flop (FF-A); the clock signal is divided by two by the first half of the 4013. The output, pin 1, of FF-A, is fed to the diode OR gate, the 1N914's. (See signal flow diagram also.)

The signal is impressed on point A (of the schematic as well as signal flow diagram), the base of Q6, which turns Q6 on and off. Q6 is the relay driver transistor (a 2N2222). Closing the dot key results in shorting pin 4 of FF-A to ground, resulting in the transmission of a dot. However, here's where things get more involved, with the operation of the second FF, and what contribution it makes.

The signal from the first half of the 4013 FF-A serves as a clock for the second half of the 4013. When the key is pressed on the dash side, pin 4 is shorted to ground and pin 10 of the 4013 is grounded through the diode D6. Closing either dot or dash key removes

the pull-up voltage provided by R16 as well as R19 (in the schematic). The pull-up voltage is necessary to ensure that the 4013 is held OFF at pin 1 when the key is opened.

Also, in generating a dash, the output of the first half of the 4013 is pins 2, 5. The output at pins 2, 5 is the same divided-by-two clock signal that is output at pin 1, only it's inverted. The pins 2, 5 signal serves as a "clock" for the second half of the 4013 FF-B. Again, this "clock" signal is divided by two by the second F-F B (as in timing diag. C).

The output of the second 4013 FF-B is fed to the diode OR gate; however, unlike the generated "DOT" as described above, that's only two thirds

of the DASH signal and there is no automatic output. There is no output, because a DASH can only be generated if both FF-A and FF-B are "turned on." FF-B is turned on by closing the dash key, shorting pin 4 of the 4013 to ground, which removes the pull-up voltage from pin 10 of FF-B. Both FF-A and FF-B are turned on by closing both keys at the same time, or through the inclusion of diode D6 in the schematic, and closing the DASH side of the key. Diode D6 can be switched in and out of the circuit by S2. This enables squeeze or alternate keying to be used.

In either case, the outputs of FF-A and FF-B are combined in the diode OR gate and produce a glorious

Amplifiers, ATU Down Converters & Hard to Find Parts

LINEAR AMPLIFIERS

HF Amplifiers
PC board and complete parts list for HF amplifiers described in the Motorola Application Notes and Engineering Bulletins:

AN779H (20W)	AN 758 (300W)
AN779L (20W)	AR313 (300W)
AN 762 (140W)	EB27A (300W)
EB63 (140W)	EB104 (600W)
AR305 (300W)	AR347 (1000W)

2 Meter Amplifiers (144-148 MHz)
(Kit or Wired and Tested)

35W - Model 335A, \$79.95/\$109.95
75W - Model 875A, \$119.95/\$159.95

HARD TO FIND PARTS

- RF Power Transistors
- Broadband HF Transformers
- Chip Caps - Kemet/ATC
- Metalclad Mica Caps - Unelco/Semco
- ARCO/SPRAGUE Trimmer Capacitors

We can get you virtually any RF transistor! Call us for "strange" hard to find parts!

DIGITAL FREQUENCY READOUT
For older analog transceivers
TK-1 (Wired and Tested) \$149.95

ATU Down Converters
(Kit or Wired and Tested)

Model ATV-3 (420-450)
(GaAs - FET) \$49.95/\$69.95
Model ATV-4 (902-926)
(GaAs - FET) \$59.95/\$79.95

ADDITIONAL ITEMS

Heat Sink Material
Model 99 Heat Sink (6.5" x 12" x 1.6"), \$24
CHS-8 Copper Spreader (8" x 6" x 3/8"), \$24
Low Pass Filters (up to 300W)
for harmonics \$12.95
Specify 10M, 15M, 20M, 40M, 80M or 180M
HF Splitters and Combiners up to 2KW

For detailed information and prices, call or write for our free catalog!

CCI Communication Concepts Inc.
508 Millstone Drive • Beavercreek, Ohio 45434-5840
e-mail: cci.dayton@pobox.com
www.communication-concepts.com

Phone (937) 426-8600
FAX (937) 429-3811

• MFJ • Kantronics • Daiwa • Comet • ARRL • Pryme • Iron Horse Antennas •

CALL FOR DETAILS

ICOM

IC-W32 Rugged, 2m/440MHz Handheld

IC-756 Pro II 160-6 meter, 100 watts

IC-706 MK II G HF-6m-2m-70cm Compact Multi-Band

IC-746 PRO HF-6m-2m 32bit IF-DSP

IC-T90 6m/2m/440 MHz HT

IC-V8000 75W, 2 meter mobile

IC-2720H 2m/70cm Mobile

RADCOMM RADIO

3300 82nd St. #E, Lubbock, TX 79423
Hours: 10-6 M-F 1-5 Sat Central Time
1-800-588-2426
806-792-3669 FAX 806-785-3699
www.rad-comm.com

Iron Horse Antennas • Kantronics • Daiwa • Comet • ARRL • Pryme •

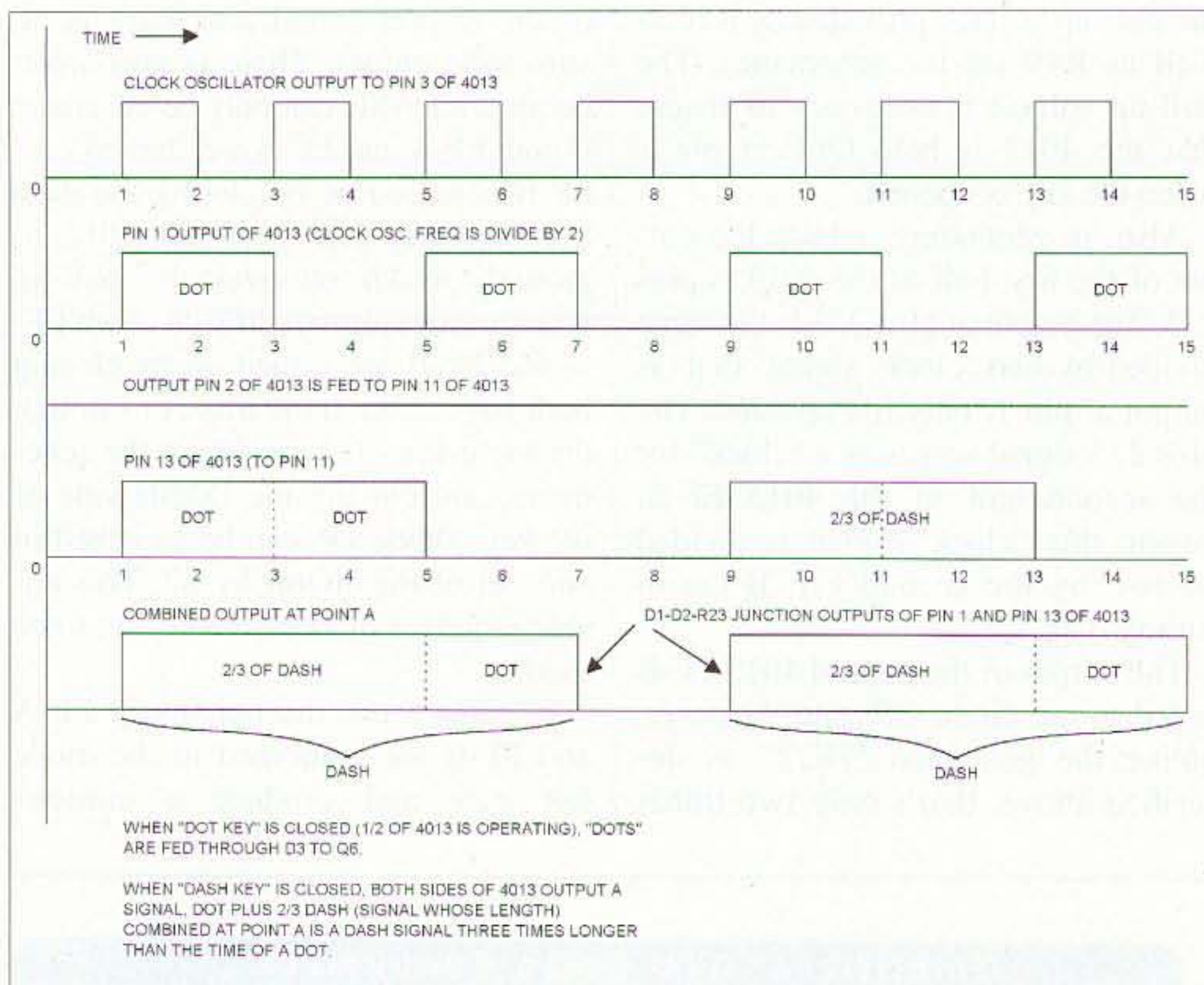

Fig. 3. Timing diagram.

TRANSMITTED perfect dash! The upper part of Fig. 1 shows a selectable (through S4) RF detector. It allows for using the sidetone oscillator while transmitting, or monitoring the signal transmitted by the transmitter, as part of the CPO (as you can see, this bad boy is more than just another “code oscillator”!) because it can provide an alternate means of monitoring a transmitted signal, other than the included sidetone generator.

The sidetone oscillator is made up of the other two of the four sections of the 4011. The clock and sidetone oscillator have exactly the same circuit configuration, except that the resistor and capacitor values are different. The sidetone pitch is adjustable; the nominal frequency is 750 Hz. The output of the side-tone oscillator is fed to the output transistor (speaker driver), direct-coupled. The sidetone output transistor is configured to “amplify” the square wave output of the sidetone oscillator. The transistor functions as a pulse amplifier — this configuration was chosen because it would operate well, with a minimum number of parts, at higher efficiency than a regular audio amplifier.

That’s also the reason a transformer is used in the speaker drive circuit. The

output transistor was required because of the lack of output level of the 4011. The on-off switch is mounted on the volume control. The keying relay K has a bypass (key click) capacitor across it. Relay K is an SPST reed relay; this particular unit is available at Radio Shack. Another reed relay could be used; however, the relay winding must be able to handle the collector current of Q6.

C10 and D5 make up a relay driver decoupling circuit. Q5 allows for direct keying during semi-automatic operation. When the key is closed, the forward bias is removed from Q5; the output goes high and the signal is fed through steering diode D7 through switch to the base of Q6 through current limiting resistor 23. D8 and C11 form a power supply decoupling circuit.

The power supply

The project started out using a single 9V battery. However, adding the sidetone oscillator made it absolutely necessary to design into the unit decoupling provisions for the V+ pins of the ICs. Without the parts used in the de-coupling network, specifically the zener diodes, really bad feedback occurs through the power supply. (See power supply.)

Without the zener diode circuit, the device operates like anything but a keyer. I initially tried the old standby, a resistor/capacitor de-coupling network, which proved to be woefully inadequate. One watt 5.1 volt 1 watt zeners are used; 1/2 watt zener diodes proved to be too small — they could not handle the current swing — but the larger-wattage zeners draw much more current. The circuit and components shown in Fig. 2 worked and were incorporated.

The device, overall, draws more current than I would like. Unfortunately, a single 9V battery will not last too long (three or four 9 volt batteries could be connected in parallel for longer operating time). AA or larger-size cells, six of them wired in series, are a good choice. Six C cells in series would be a good choice, too. They have a good energy-density to size ratio; however, they are large compared to AAs, but they do last considerably longer than AA cells. An AC battery switch is provided for batteries or a 9-volt “wall wart” power pack operation. A good, filtered, DC wall wart (about 800 mA) should do it.

How do we use this thing?

To start, set the switches for full automatic, and internal sidetone. Use any full automatic key. For that matter, you can probably make some sort of key lash-up using microswitches, if you have no key — or even two brass strips wired to act as dot dash keys will get you started. Set the right-/left-hand switch to send either dots or dashes when the “finger presses” that side of the key. In other words, you want to use the full automatic key as a single straight key one half at a time to have immediate access to either dot or dash control. Set the unit so that the fingers side is used in sending dots. The thumb controls dash transmission. A straight key alone can be used; however, a stereo plug must be incorporated and wired appropriately, and then you have to switch the right-left switch back and forth for the appropriate dot or dash side.

Here is the meat and potatoes of this CW smorgasbord.



Arkansas's Communication Store

1710 East Parkway
Russellville, AR 72801
Phone 479-967-8315
Fax 479-967-8317
1-888-315-7388

Kenwood, Icom, Alinco, ADI,
Police & Fire Communications Equipment,
Surveillance Electronics (Installed).
We sell amateur & commercial band radios.

www.rlselectronics.com

1. Start at a slow speed and do dots only — a few mistakes are acceptable — and *practice!* Stick with sending dots until you feel as though you could stay with the machine forever. How long this takes depends on the individual; everybody is different.

2. Then slow down the speed a little, and stay with the machine, etc.

3. Next, slow down a bit more. The reason to slow is to burn in a TIME INTERVAL FEELING! Remember, we are looking at dissected CW under a microscope.

4. Finally, the day arrives when you are ready to pick up speed. Increase your speed to something comfortable, where you just, just, start making mistakes; then practice some more.

5. Return to the slower speeds and practice slow-speed CW to retain what you established in the first four steps.

When you have that down, practice the dash next, the same way, and following steps 1 through 5. Warm up each day by starting at the slower speeds. When you have mastered the above for I and T, you have established a CW foundation. Next combine dot dash, or dash dot, it doesn't matter which, and practice A or N at a comfortable speed and, of course, follow steps 1 through 5, and that's the basic routine. Follow with the letters M, I, S, O, etc.

Keep in mind, and it's important enough to warrant repeating, that we're working to develop a timing sense. I guess it could be called CW rhythm. As stated before, it takes practice, perseverance, and patience.

The patience, for most, is to have patience with yourself. Boredom is for children. Talk about boring, if I had a nickel for every time I practiced a major scale, I'd be as rich as Bill Gates; well, maybe not quite. Once you have

A GREAT gift idea for yourself, your ham friend(s), or your child's school library

is a subscription to 73 Magazine ... only \$24.97!
Call 800-274-7373 or write to 70 Hancock Rd., Peterborough NH 03458

RIGrunner

Intelligent DC power panel

- Conveniently power your station with Anderson PowerPole® connectors.
- 40 Amps total, outlets to run all of your transceivers and accessories.
- Each and every outlet individually ATC fused with LED open fuse indicators.
- Precision LED and audio alert of safe, over or undervoltage, 4012 & 4008.
- No messy binding posts, frayed wires, black tape or short circuits.
- Safe, secure, hot connect, polarized, color keyed, unisex, connector system.
- Conforms to the ARES, RACES, RSGB recommended standard.
- Perfect for home, mobile, rover, portable, emergency and contest stations.

3 Models from \$49.95!



RIGblaster

Have more fun with your radio

The only no compromise sound card interfaces.

The easiest to set up, high quality, complete solution.

The best support too!
Read our user comments!

Internet remote base linking with EchoLink!



NEW RIGblaster pro complete info on the web

<http://www.westmountainradio.com>

West Mountain Radio de N1ZZ and K1UHF
18 Sheehan Avenue, Norwalk, CT 06854 (203) 853 8080

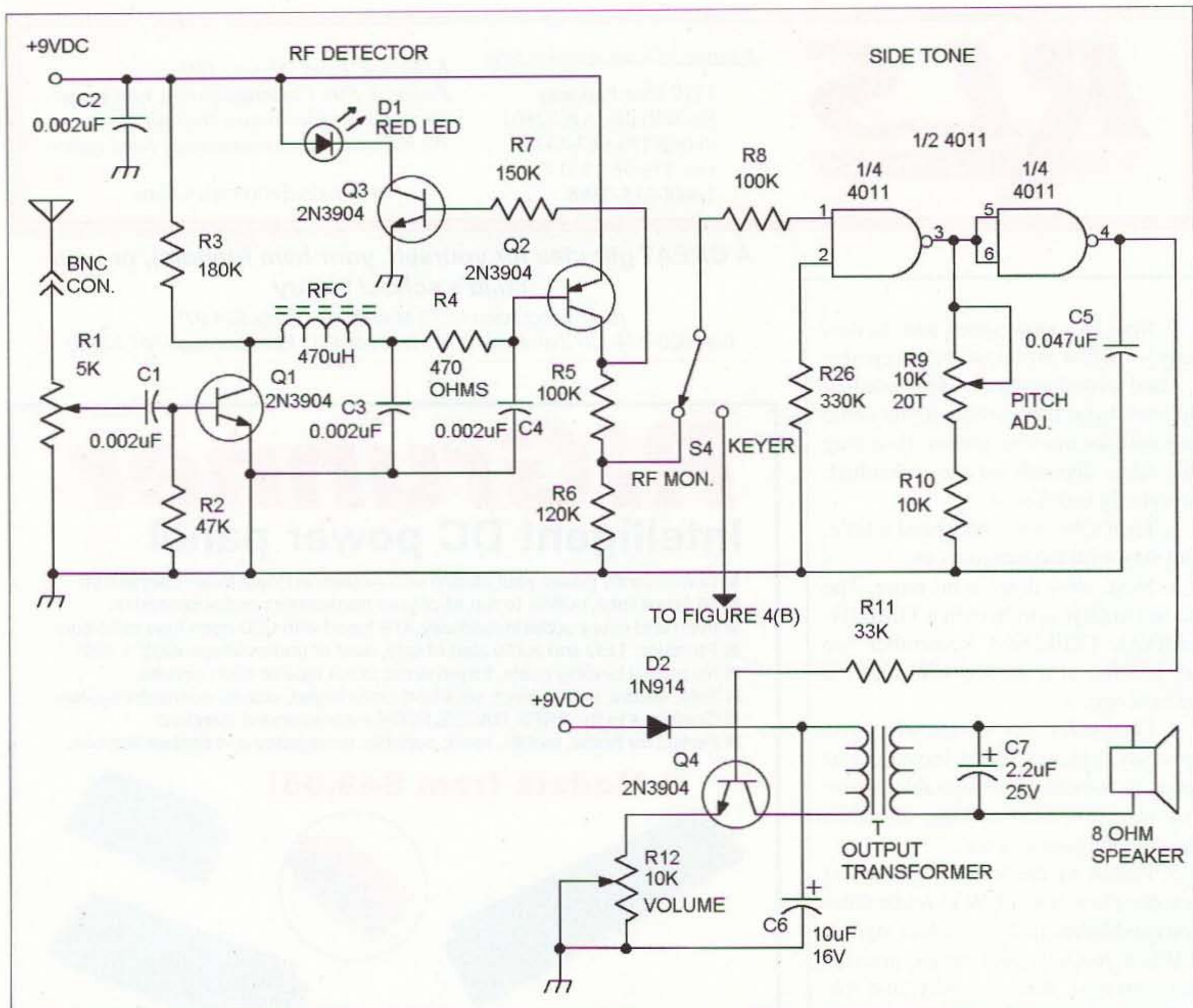

Fig. 4(a). Main schematic.

played a major scale there is nothing more to learn, intellectually; however, practicing scales on any musical instrument is vital if you want to play well. Boring? Go to agony and turn left! As you persevere and see the positive effect on your performance, it gets easier overall. The motor skill learning period gets shorter, and your CW sending gets better, and the speed takes care of itself.

As for the "CW is useless" crowd, I don't care how many new high tech communications gadgets come on the scene, CW is like oars (oars have been around even longer than CW, I'll bet) that you take along in a "row boat" that has an outboard motor hung on its stern. Those oars (you do take them along, don't you?) just might come in handy if the motor conks out.

But, but, oars are so slow, so low tech. CW, like the oars, may come in handy at some point in time, too, even though you have the latest microprocessor-controlled boat motor.

The ops who like CW find CW handy anytime. I have for years been using the essence of the above outlined method, in order to learn to play what at the time were rather difficult passages in a musical composition. The method works for music. Sending CW is nowhere near as involved as playing music!! Be patient with yourself. Practice the above method on a regular basis. And persevere, "stay with it." Who knows, in time you might even get the urge to learn to play the bass fiddle — well, it worked the other way around for me!

Musicians have "the edge" in learning CW. There's nothing special that musicians have that makes it easy for them to learn CW — they just know how to practice! Playing music is a motor skill. "Playing" CW is a "motor skill," too, but much less involved, and orders of magnitude simpler than playing music.

Construction of this project is straightforward, for the most part. I used perfboard because I had the right-size piece on hand. I like using sockets for transistors as well as ICs on perfboard, or on a PC board. Component layout is in general, not critical. The only thing that I found to be critical is the RF monitor circuit layout. Originally I constructed the monitor on the main circuit board; that necessitated

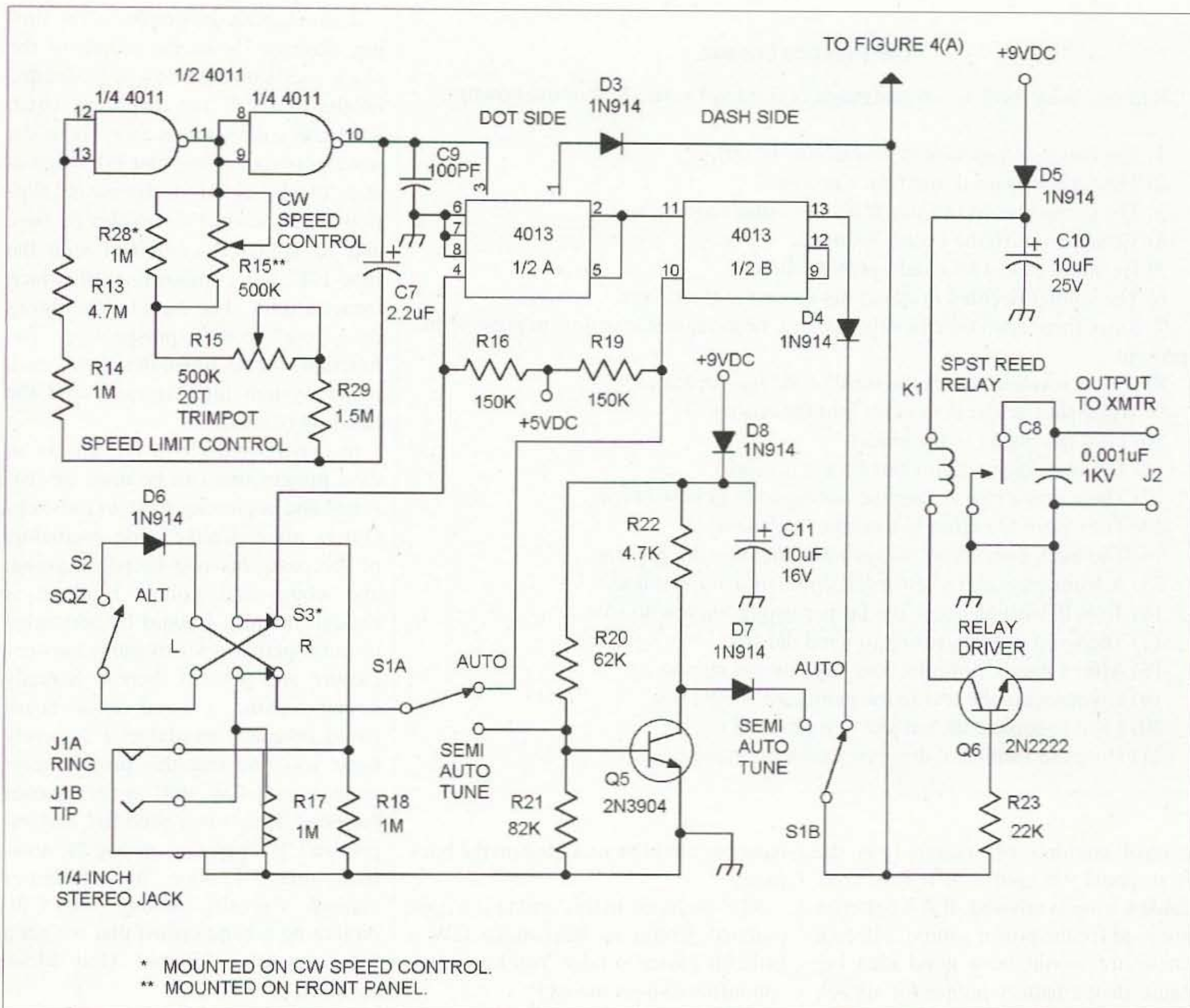

Fig. 4(b). Main schematic.

the component parts pieces to be too close. I found that there was stray electromagnetic coupling between transistors that rendered the detector circuit useless. However, the RF monitor circuit could be made close-spaced if proper shielding were used; also, that would make for a compact project. It's possible to build the RF monitor and sidetone circuit only, to be used as a standalone transmitter monitor. I found that the RF circuit transistors have to be separated at least one inch; otherwise, there is really bad, stray coupling. There is a serious interaction between transistors.

How the RF section works: An RF signal is fed from the pickup antenna through the RF sensitivity control, through C1, and is developed across

R2. Q1 behaves as an RF detector, and its output is filtered through the inductor L along with C3, R4, and C4. The filter section components are what facilitate broadband operation, i.e., 1 MHz to about 50 MHz. Q2 is a level shift amplifier and supplies a DC signal to gate the 4011 sidetone oscillator portion through the resistor R8. The DC output from Q2 is fed directly to Q3 through current limiting resistor R7. R5 and R6 form a voltage divider, which reduces the DC gate voltage to a safe value for the sidetone gate input pin 1.

I used a Radio Shack project box to house this beastie, which measures 5-3/4 by 5-1/4 by 2-3/4. Any other metal project box could be used; I don't think I'd use an ABS plastic box,

however. The layout for the most part is not critical, but it's best to keep the leads to the front panel controls as short and direct as possible.

The speaker, which I mounted on the front panel, could have been mounted on the side. Ventilation slots are cut into the cover, and it would not be necessary to cut a big hole in the front panel (isn't hindsight wonderful?). Not only that, it would also give more room to spread out the user controls. The back panel has the monitor pickup antenna connector (a BNC was used because it was lying on the workbench at the time) mounted on it, as well as the RF sensitivity control. Coaxial cable, in this instance, was not needed because of the short leads involved. There's no reason why the RF sensitivity

CW Practice Lesson

Reasons Why the English Language is Hard to Learn (Author unknown)

- 1) The bandage was wound around the wound.
- 2) The farm was used to produce produce.
- 3) The dump was so full that it had to refuse more refuse.
- 4) We must polish the Polish furniture.
- 5) He could lead if he would get the lead out.
- 6) The soldier decided to desert his dessert in the desert.
- 7) Since there is no time like the present, he thought it was time to present the present.
- 8) A bass was painted on the head of the bass drum.
- 9) When shot at, the dove dove into the bushes.
- 10) I did not object to the object.
- 11) The insurance was invalid for the invalid.
- 12) There was a row among the oarsmen about how to row.
- 13) They were too close to the door to close it.
- 14) The buck does funny things when the does are present.
- 15) A seamstress and a sewer fell down into a sewer line.
- 16) To help with planting, the farmer taught his sow to sow.
- 17) The wind was too strong to wind the sail.
- 18) After a number of injections my jaw got number.
- 19) Upon seeing the tear in the painting I shed a tear.
- 20) I had to subject the subject to a series of tests.
- 21) How can I intimate this to my most intimate friend?

control couldn't be mounted on the front panel. Of course, if it was, coax cable wiring is advised. If AA batteries are used for the power source, a deeper enclosure would be a good idea because then a battery holder for six AA

batteries could be mounted on the back panel.

Also included in this article is a code practice lesson to help make CW a little bit easier to take. You know that spoonful of sugar theory!!

A word about the graphics. The timing diagram shows the output of the clock oscillator and how it is divided by the first F-F, the output of which generates a dot straight away. How the inverter output of the first F-F behaves as a "clock" signal for the second flip-flop. The second F-F divides by two, and its signal is combined with the first F-F, the combination of which forms a dash. The signal flow shows this from another perspective. The function block illustrates how each major system interconnects, and the function of each.

In conclusion, all in all, this is an easy project that can be used by seasoned and beginning amateur radio operators alike. Unlike code oscillators of the past, this one keeps on going, and going and going! If there is enough interest, I could be persuaded to put together a kit of parts sans enclosure and pots. If there is a really strong demand, a wired circuit board could be made available. I sincerely hope you find that this project helps your overall CW skill in the manner intended. Here's to a good fist, and improved CW operating among the amateur ranks. I hope this generates enough curiosity among the CW-oughta-be-a-band crowd that we get a few converts. 73 and God bless, K8MKB.

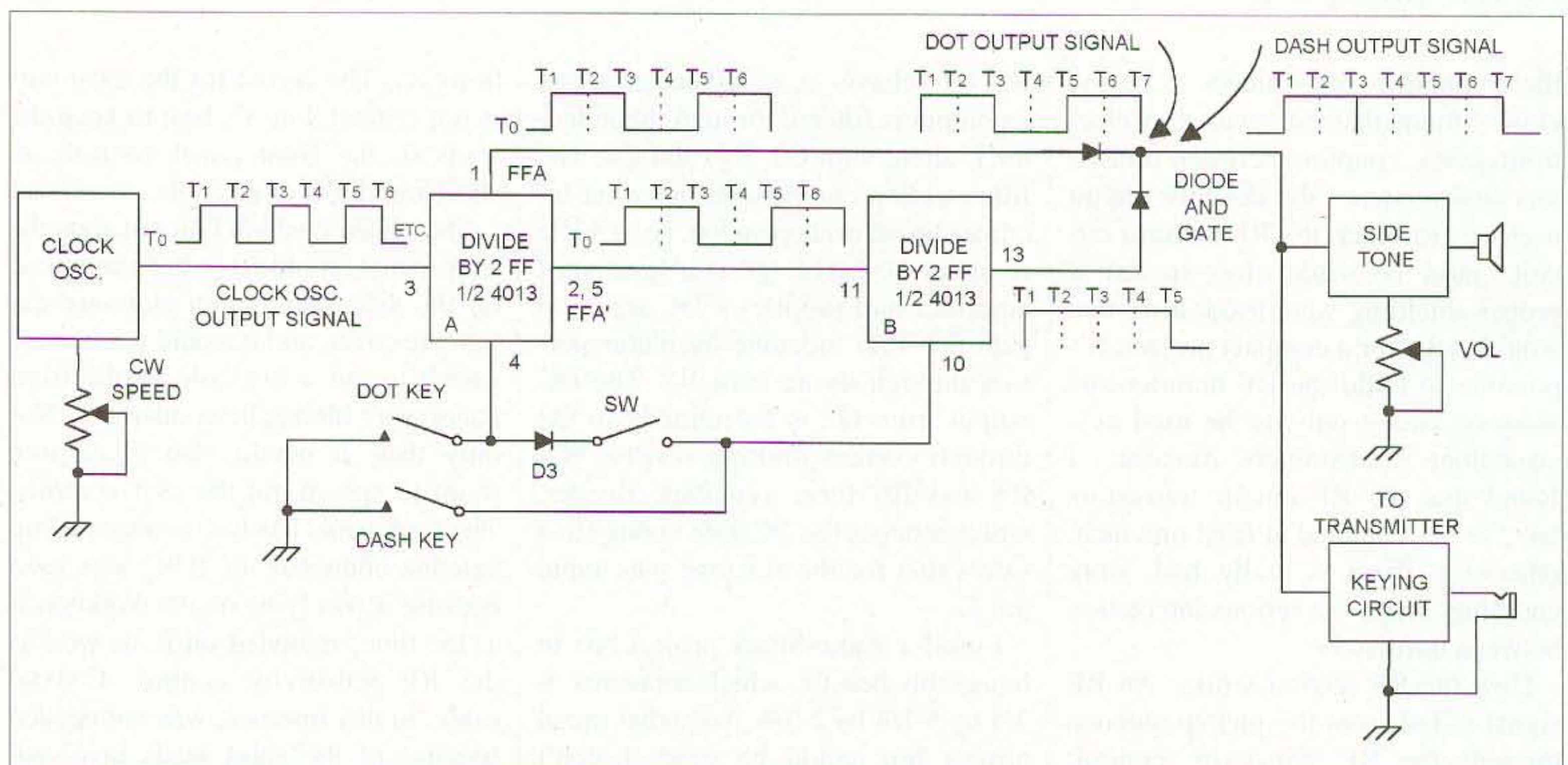

Fig. 5. Signal flow diagram.

Part	Description	Part	Description
R1	5k 1/2W pot	C1-C4	0.002 μ F
R2	47k	C5	0.047 μ F
R3	180k	C6, C10, C11	10 μ F electro
R4	470 Ω	C7	2.2 μ F axial electro
R5, R8	100k	C8	0.001 μ F 1 kV ceramic disc
R6	120k	C9	100 pF 50 V ceramic disc
R7, R16, R19	150k	C12	22 μ F radial electro
R9	10k 20T trimmer, top adjust	D1	Red LED
R10	10k	D2-D8	1N914
R11	33k	D9, D10	5.6 V 1/2W zener
R12	10k 1/2W audio taper pot, with SPST	Q1, Q3, Q4, Q5	2N3904
R13	4.7M	Q2	2N3905
R14, R17, R18, R28	1M	Q6	2N2222
R15	500k 1/2W linear taper panel mt. pot	IC1	4011 (osc. timing/clock) quad two-input NAND gate
R20	62k 2%	IC2	4013 F.F.
R21	82k	J1	1/4-inch stereo type
R22	4.7k	J2	1/4-inch single circuit type
R23	22k	S1, S3, S5	DPDT miniature
R24, R25	82 Ω 1/2W wirewound	S2	SPST miniature
R26	330k	S4	SPDT miniature
R27	500k 20T trimmer, top adjust	S6	On-off part of vol. control
R29	1.5M	Other	Screws, nuts, lockwashers, knobs, standoffs, penlight battery holder (for six batteries), enclosure, etc.

Notes: All resistors 1/4W unless otherwise specified. All capacitors 16 V unless otherwise specified. Output transformer and speakers available at Radio Shack.

Table 1. Parts list.

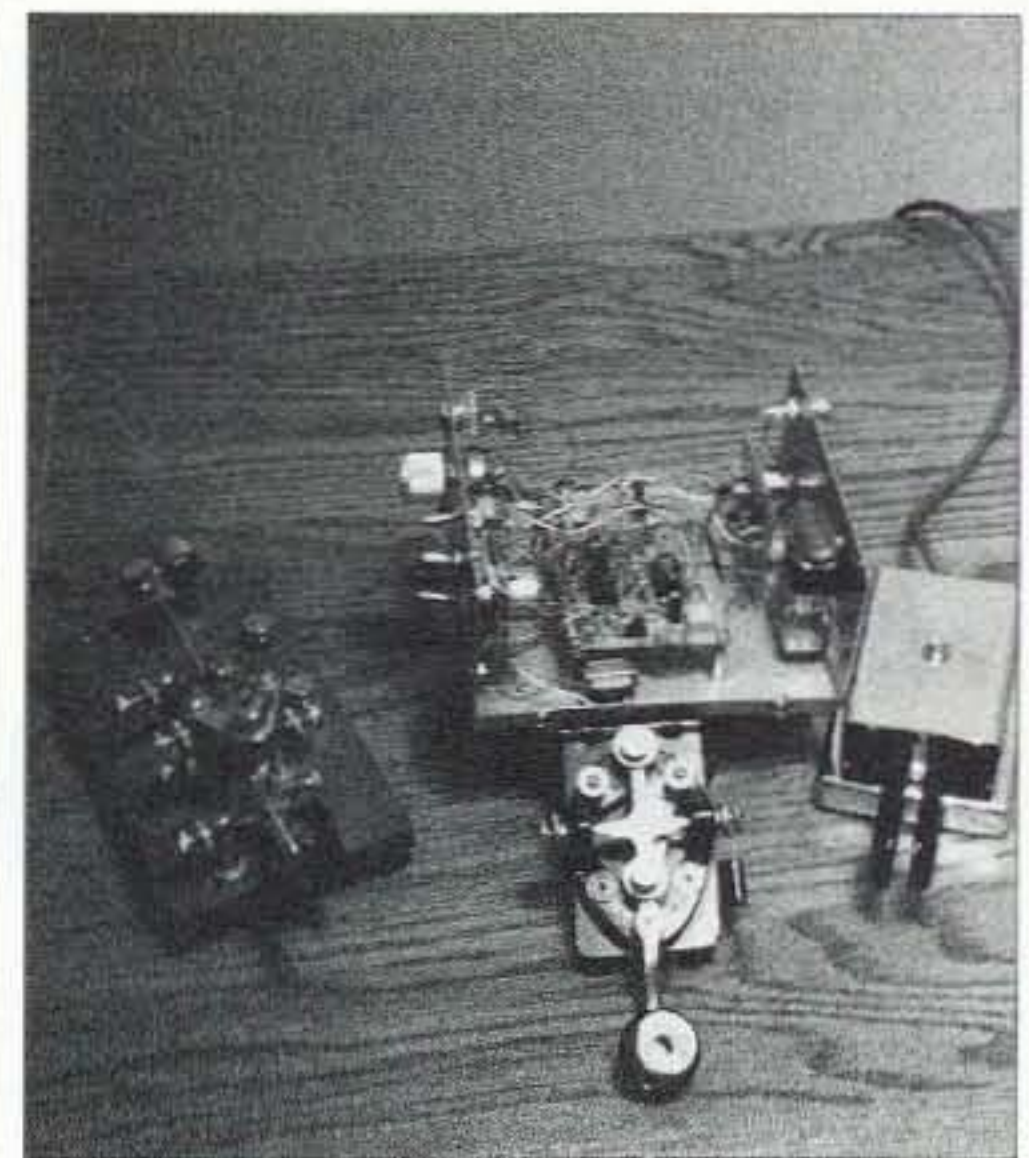

Photo A. A right fancy CPO.

Bibliography

1. *New IC FET Principles and Projects*, by Sessions and Tuite; TAB Books 1972.
2. *TTL Cookbook*, by Don Lancaster; SAMS publication.
3. *MOS Digital IC's*, by George Flynn; SAMS publication.
4. *Practical Design with Transistors*, by Mannie Horowitz; SAMS publication.
5. *CMOS-M Designer's Primer and Handbook*, by Jack Streeter and Robert M. Glorioso; E&L Instruments Inc. publication.

73

Subscriptions 800-274-7373

Ad Sales 800-677-8838

HamCall™ CD-ROM
U.S. & International - Over 1.63 million listings



We make a new HamCall every month! Clearly, the most current and complete CD-ROM available.

Latest Features

Choose font and color of data display. Displays flag and map for each country. Shows CQ, ITU zone, and continent. History list shows each callsign entered. Print labels in a variety of formats. View & search interests of 39,000 hams. Search for club, military, vanity, silent keys, name, address, and more.

Over 1,631,000 U.S. and International listings, 128,000 e-mail addresses, 4,000 photos and QSL cards, 37,000 vanity calls, and 20,000 references to QSL managers.

Shows path distance & bearing. Precise latitude/longitude for over 90% of addresses. HamCall is \$50.00, included is 6 months free access to our HamCall Internet Service - request when ordering.

HamCall Mousepad, with morse code reference, 7.5" x 8", blue with yellow letters. \$5.00+\$3 shipping. \$5.00 shipping (\$8 Int'l) per order. Your satisfaction guaranteed!



BUCKMASTER

6196 Jefferson Highway • Mineral, VA 23117 USA
e-mail: info@buck.com
540-894-5777 • 800-282-5628 • 540-894-9141 (fax)

- DIP switch programmable
- Miniature in size
- 37 EIA tones, 27 non-standard tones from 33.0 to 254.1 Hz included
- Reverse Burst built-in
- Easy 3 wire hookup

SS-64 CTCSS Encoder
.66" x 1.08" x .21"

SS-64 DIP Switch Programmable CTCSS Encoder \$28.95



TP-3200 Shared Repeater Tone Panel

TP-3200D Table Top Version \$269.95 each
TP-3200RM-A Single Rack Mount version \$279.95 each
*TP-3200RM-B Triple Rack Mount version \$279.95 each
*Holds up to three TP-3200s

Call or write to receive our full Product Catalog or visit our Web site for complete information at:
<http://www.com-spec.com>

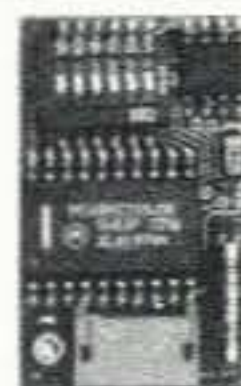

- 51 CTCSS Tones
- 106 DCS Codes
- Supports 157 Repeater Subscribers
- On-Line Computer Help
- Repeater CW ID
- Air Time Loading & Analysis Graphs
- Signalling Formats: CTCSS DCS & DTMF

- Fully enclosed CTCSS encoder
- All 32 EIA tones from 67.0 to 203.5 Hz included
- Perfect for mobile / base applications



TE-32
5.25" x 3.3" x 1.7"

TE-32 Multi-Tone CTCSS Encoder \$49.95

- Eight programmable, selectable messages
- Fully field programmable via included keypad
- Meets all FCC identification requirements



ID-8 Automatic Morse Code Identifier
1.85" x 1.12" x .35"

ID-8 Automatic Morse Station Identifier \$69.95



COMMUNICATIONS SPECIALISTS, INC.
426 WEST TAFT AVENUE • ORANGE, CA 92665-4296
(714) 998-3021 • FAX (714) 974-3420
Entire U.S.A. (800) 854-0547 • FAX (800) 850-0547
<http://www.com-spec.com>

Ham's Handy Heat Hunter

Let this temperature probe take your shack's temperatures.

Every ham shack should be equipped with a means for measuring equipment temperature. Too often we ignore the heat rise in our equipment. Building the probe assembly described here is a very practical way to deter a heat rise condition and to detect heat stresses imposed on our ham gear.

Fig. 1 shows the schematic of a Digital Multimeter Temperature Measurement Adapter that is ideal for measuring temperatures from -40 degrees to $+230$ degrees Fahrenheit. A few uses for this circuit include monitoring indoor and outdoor air temperature, water temperature, freezer temperature, radio and power supply heat sinks, or any other application requiring accurate temperature readings.

The temperature probe (refer to Fig. 2)

is plugged into J1 and a digital multimeter set on DC volts is connected to J2 and J3 on the adapter. The circuit drives a multimeter directly. This is especially useful when a temperature measurement is needed only occasionally. Using the multimeter to display temperatures eliminates the cost and need for a dedicated display.

Temperature is displayed at 10 mV per degree Fahrenheit. For example, a meter reading of 2.12 volts corresponds to a temperature of 212 degrees. Similarly,

a voltage of 0.325 V represents a temperature of 32.5 degrees and a measurement of -0.401 V denotes a temperature of -40.1 degrees Fahrenheit. Typical accuracy at room temperature is ± 0.8 degrees F. Over the entire temperature range, expected accuracy is ± 1.6 degrees F.

The circuit utilizes the LM34CZ temperature sensor from National Semiconductor. As stated above, it is capable of measuring temperatures from -40 to $+230$ degrees. If a temperature measurement range of -50 to $+300$ degrees F. is required, an LM34 may be substituted for the LM34C. When the temperature measured is between $+32$ and $+212$ degrees, a less expensive sensor (the LM34D) may be used in the temperature probe assembly. If more accuracy is desired, an "A" suffix part may be used (LM34A or LM34CA). These parts have a room temperature expected accuracy of ± 0.4 degrees F and a ± 0.8 degrees F tolerance over the whole temperature range.

Construction

First, construct the temperature probe assembly. Take the 6 ft. stereo cable and cut off one end near the connector.

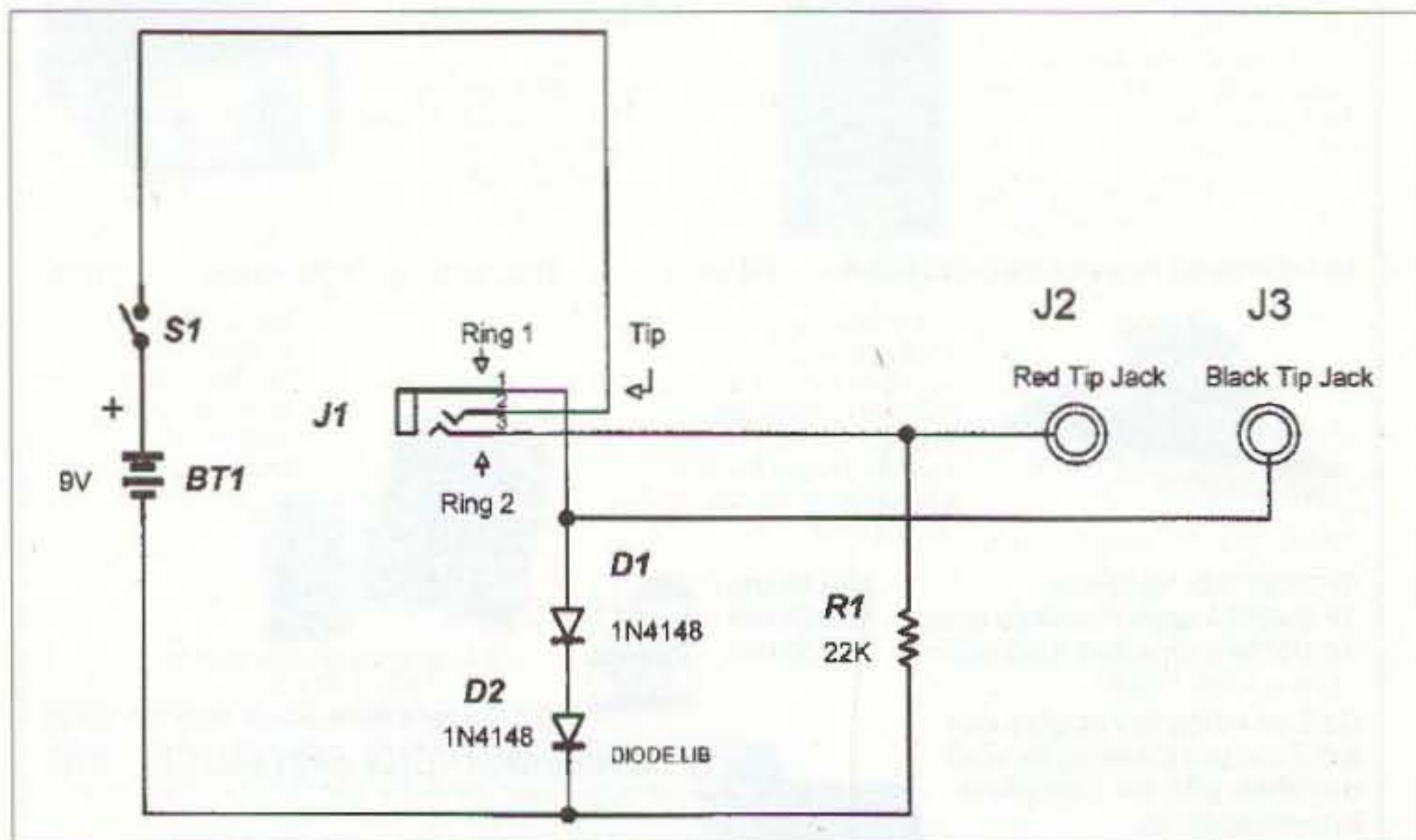
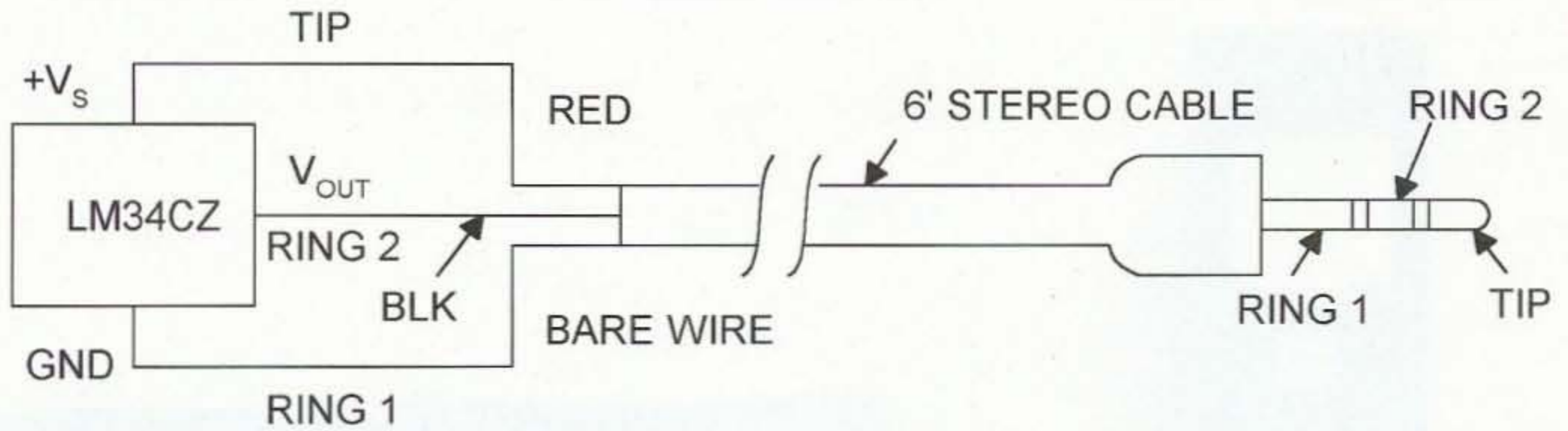
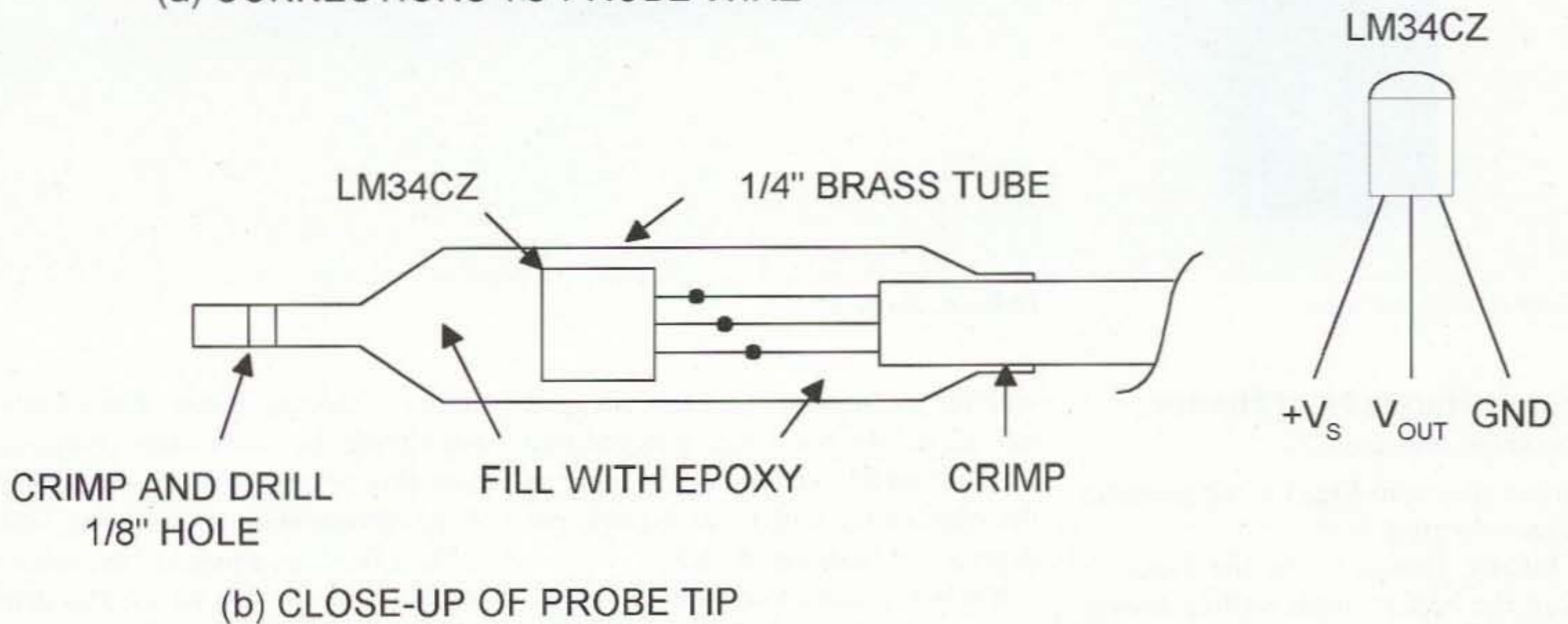

Fig. 1. Schematic of a Digital Multimeter Temperature Measurement Adapter.



(a) CONNECTIONS TO PROBE WIRE



(b) CLOSE-UP OF PROBE TIP

Fig. 2. Temperature probe assembly.

Strip the sleeve back about 1 inch. Attach the wires to the LM34CZ tem-

perature sensor as illustrated in Fig. 2a. Stagger the solder connections as

shown in Fig. 2b. Use a small piece of electrical tape to insulate the center wire of the sensor from the other two wires and use another piece of tape to wrap around all three leads. Next, cut a 1-3/4-inch-long piece of 1/4-inch-diameter brass (or copper) tubing. The tubing can be obtained at most hobby stores. Fill the tube with epoxy and insert the temperature sensor. Crimp the brass tube around the cable and crimp the other end flat. After the epoxy

has set, drill a 1/8-inch hole in the flat end of the probe assembly. This hole makes it easier to attach the temperature probe to the surface where the temperature is to be measured.

Drill holes in the case for J1, J2, J3, and S1 (see Fig. 3). J2 and J3 are red and black tip jacks. The jacks specified in the component list (Table 1) are the correct size for the tip plugs on most multimeter test leads. Banana jacks may be used instead of tip jacks. To use the banana jacks, larger mounting holes will be needed. If you make this substitution, be sure that there is still room to mount the power switch S1.

Utilizing banana jacks will require two test leads with banana plugs at each end to connect the multimeter to the Digital Multimeter Temperature Measurement Adapter. Mount J2, J3, and S1 to the case. Refer to the back of the phone jacks packaging for J1's terminal designations. Assemble the

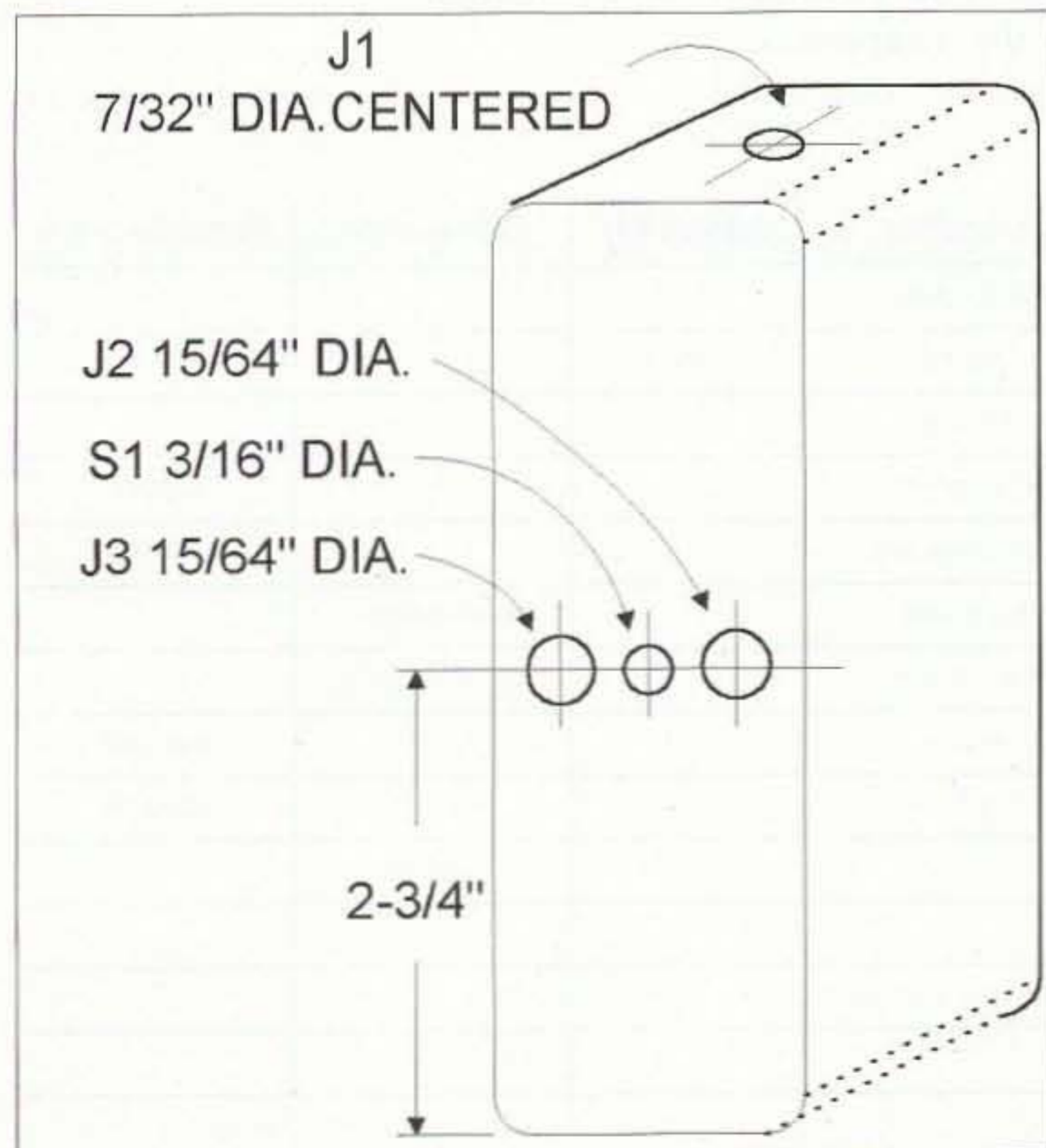

Fig. 3. Case hole locations.

Continued on page 22

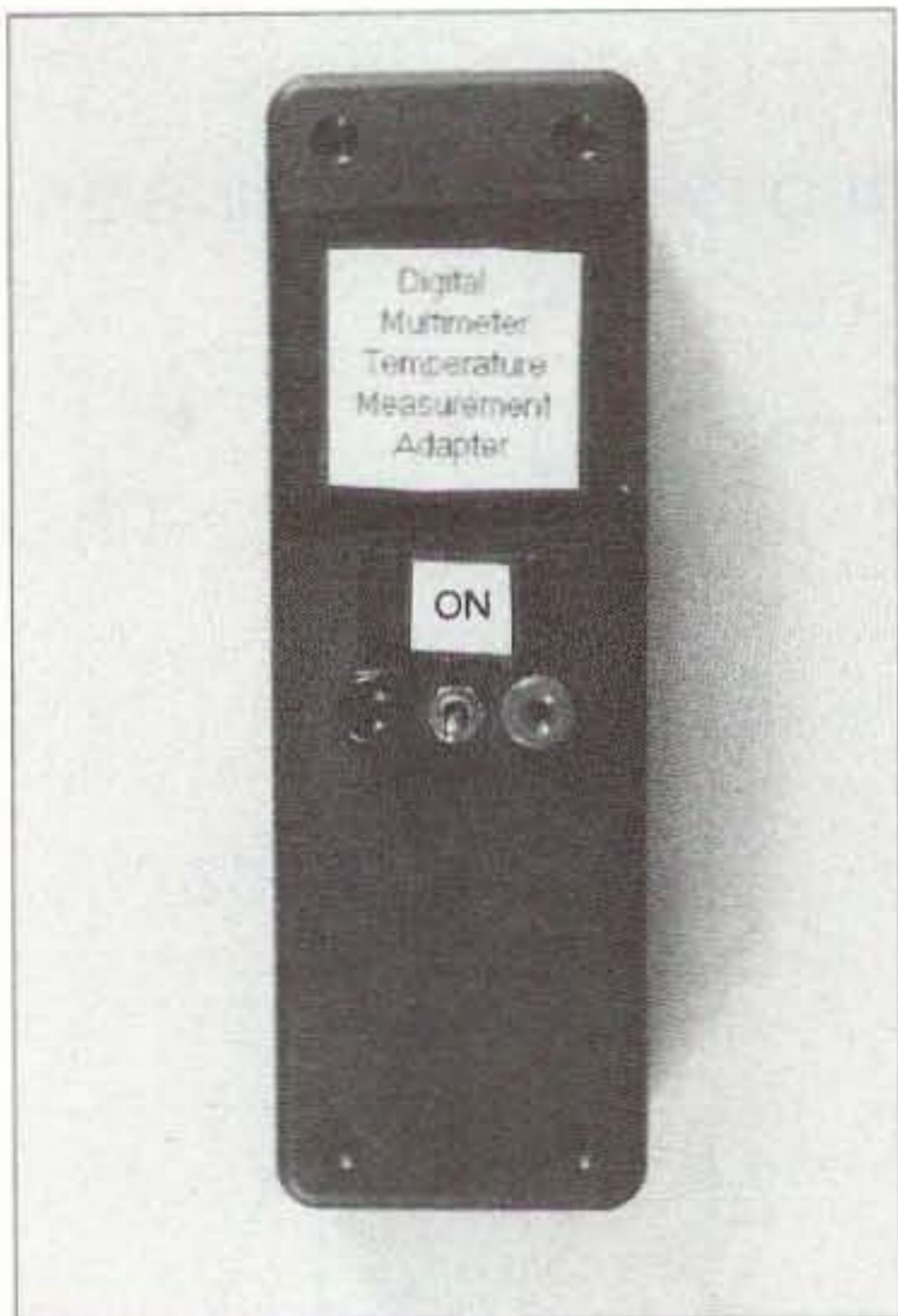

Photo A. Exterior view.

Ham's Handy Heat Hunter

continued from page 21

circuit shown in **Fig. 1** using point-to-point soldering.

Finally, mount J1 to the case. To keep the battery from rattling around in the case, place a piece of foam between the battery and the case. Next, attach the lid to the case with the screws provided.

Use

Plug the temperature probe into J1

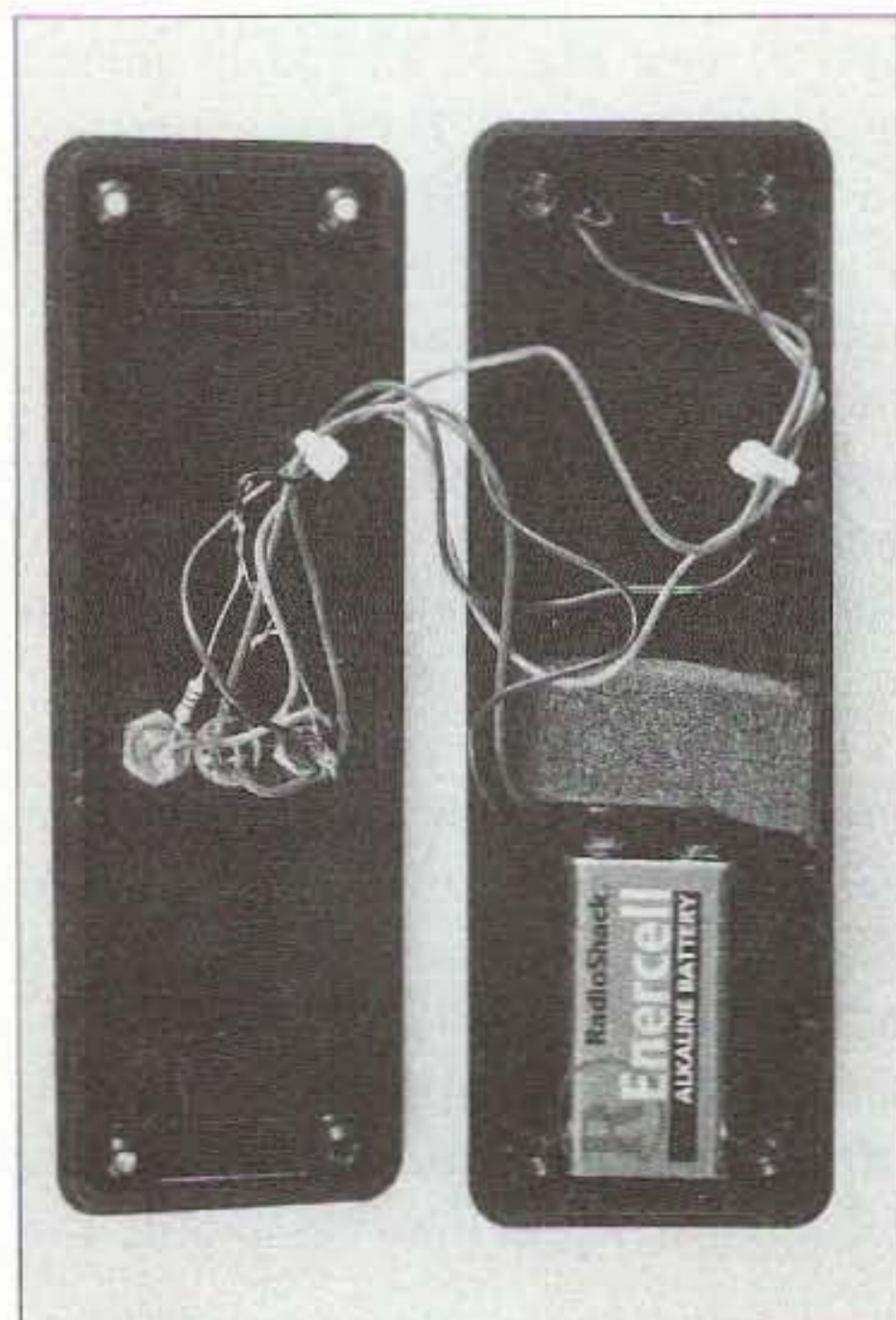

Photo B. Inside view.

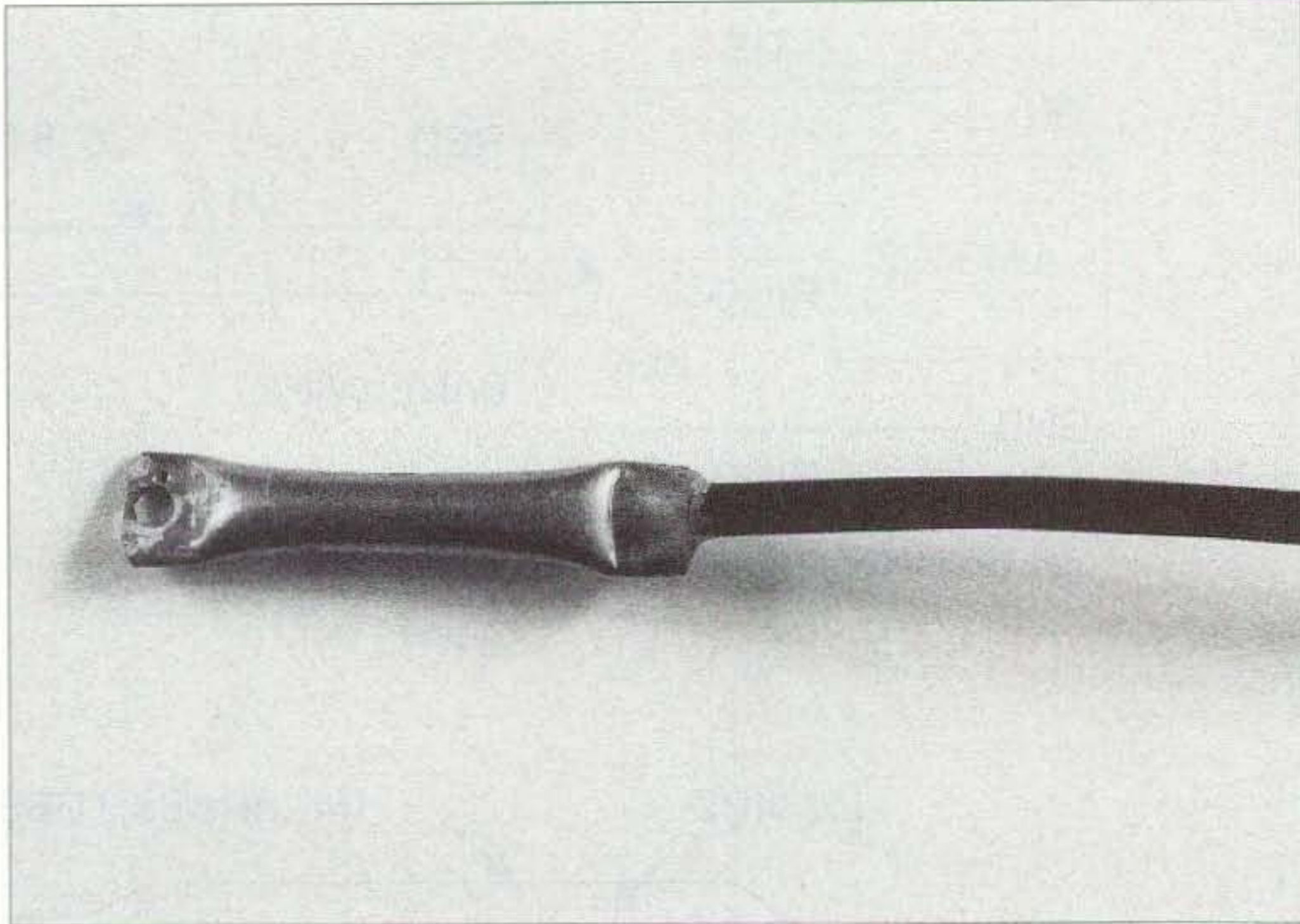

Photo C. Probe tip.

with the multimeter's red lead plugged into J2 and the black lead plugged into J3. Turn on S1. The voltage reading of the multimeter will be at 10 mV per degree F as mentioned earlier.

If it is necessary to measure temperature constantly, a digital panel meter can be used in place of a digital multimeter. Don't expose the temperature probe to conditions that are harmful to the brass tube or cable insulation.

In order to determine if the environment is harmful to the temperature probe assembly, save the one-inch

piece of cable insulation obtained when assembling the temperature probe. Expose this piece of plastic to determine if the environment is damaging to the cable. Likewise, a piece of the remaining brass tubing can be used to determine if the environment is corrosive to the brass. If it is determined that the temperature probe assembly can be damaged by the environment, it may be necessary to use a cable rated for these conditions.

Continued on page 56

Part	Description	Jameco P/N	Mouser P/N	Radio Shack P/N
R1	22k 5% 1/4W			
U1	LM34CZ	107094		
D1, D2	1N1418			
S1	SPST switch			275-624
J1	Stereo phone jack			274-249
J2	Red tip jack		530-105-0802-1	
J3	Black tip jack		530-105-0803-1	
Case	6x2x1			270-1804
Stereo cable	6 ft.			42-2387A
9 V battery clip			123-6006	
9 V battery				
Brass tube	1/4-inch diam. brass tube			
Hookup wire				
Epoxy				

Table 1. Component reference.

Ozzie Levin W5RK
100 Texas Ave. W. Apt. 1016
Webster TX 77598
[olevin@wt.net]

Ozzie's Jupi-Loop

Use an aircore balun with your Ten-Tec Jupiter.

Back in December of 2001, I purchased a Ten-Tec Jupiter Model 538 transceiver. I live in a senior citizen retirement condo that has 275 apartments. You can imagine how many electronic devices they have — everything from fire detectors in every room in every apartment to an electronic gate and security system. Not to mention all the TVs and stereos and a good number of people wearing pacemakers.

I had to be careful about how much power I could run and also what type of antenna to use. One thing about hams: "If there is a way to do it, we will find it." I live on the third floor of the condo (method to my madness!), so I had access to the attic. You have to also remember that there is no ground to attach the transceiver to — even all the water pipes are plastic. This presented a problem as far as interference was concerned.

The attic was partitioned off and I didn't have as much room as I hoped for. I first erected a 20-meter dipole, and although it worked fairly well, I could not operate 40 meters or the other high bands. I also had a problem with TVI on channel 2, despite the fact that we were on the cable system. The RFI was also getting into one of our telephones.

Although I liked the radio, it had no internal antenna tuner. Consequently, I had to use an outboard tuner to get a reasonable SWR. In the meantime, I received an E-mail memo from Ten-Tec saying that a built-in antenna tuner was available either in kit form or assembled for installation in the Jupiter. I opted for the kit because I love to do my own thing.

Now with the tuner installed and working, I wanted more than one-band operation. I put my thought processes to

work and decided to use a horizontal

Continued on page 56

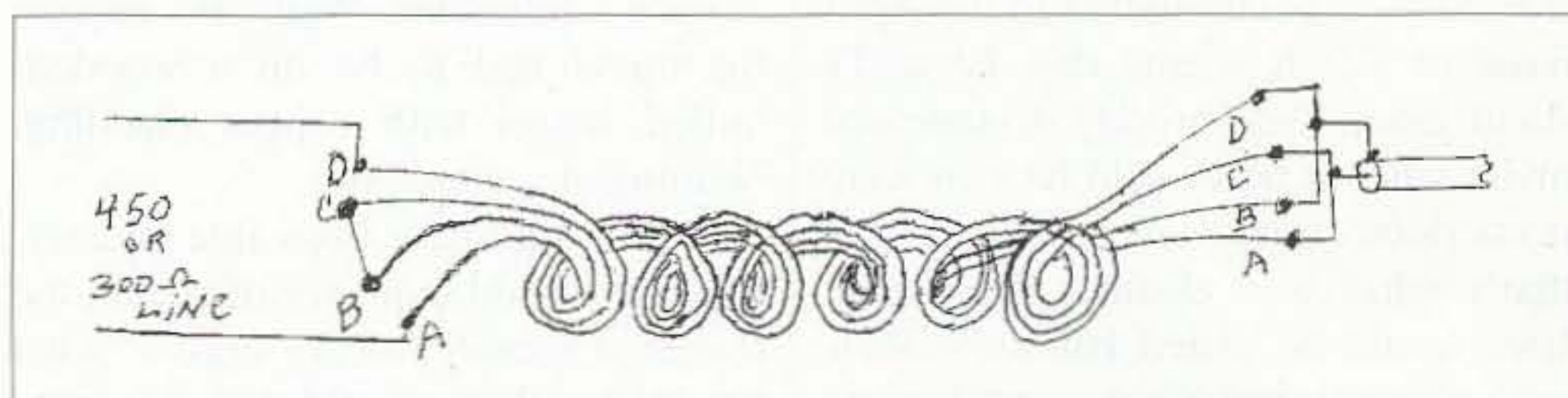

Fig. 1. Balun: four 10-ft. lengths of #14 coated wire; 1-inch-diameter PVC 16 inches long.

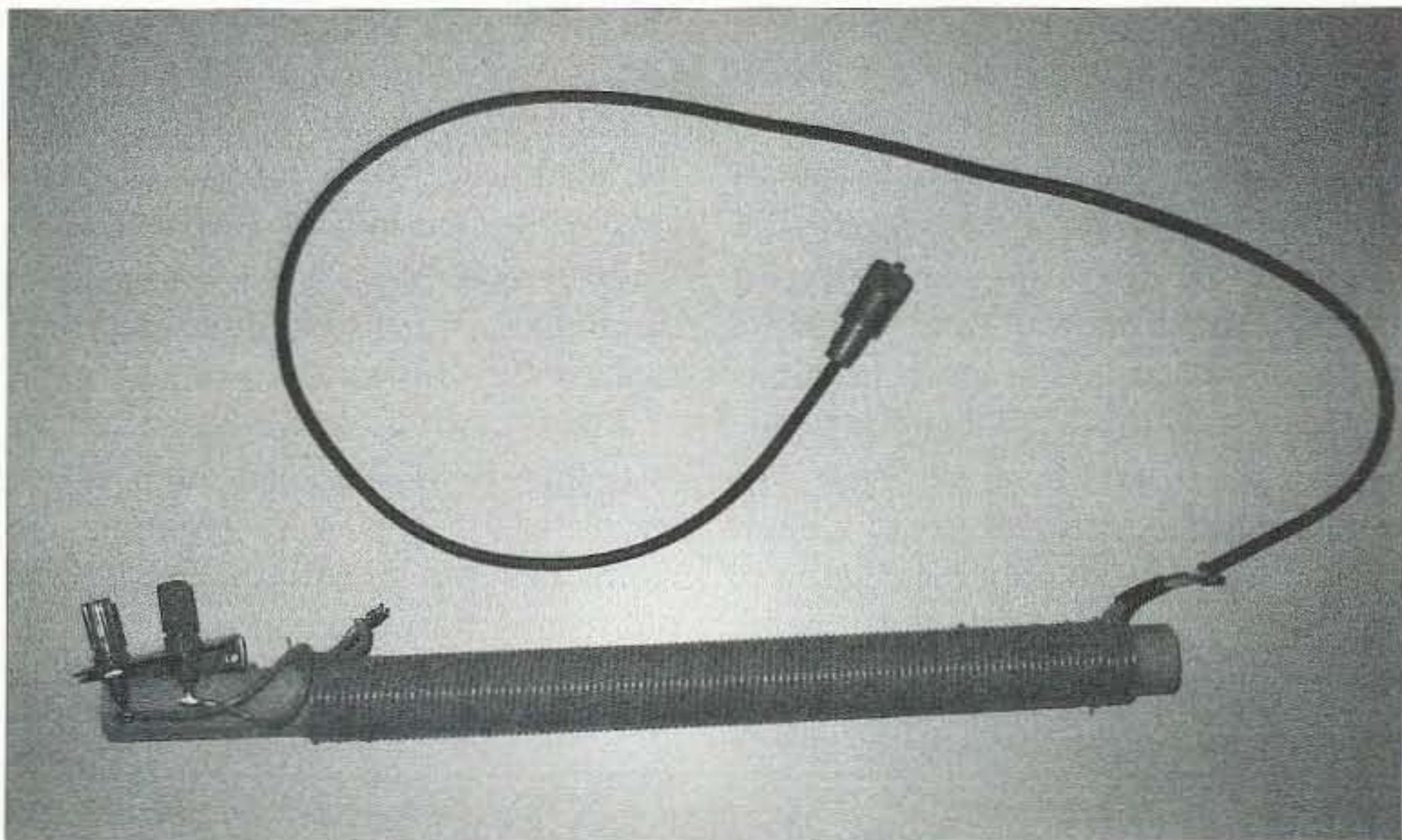

Photo A. The Jupi-Loop.

Ishmod Update

I have spent far too many years running down leads on the enigmatic Ishmod Kaduk. And it's gotten me nothing but trouble. Yet, here I am still chasing him. What a story he could tell us if we could only find him before he fails to return from one of his many potentially fatal journeys.

If you recall, way back in 1984, the original report of Ishmod's ill-fated DXpedition to an uncharted island — or better, rock in the Bay of Bengal — was chronicled in the April issue of 73. It seems that Ishmod's small group had abruptly disappeared under what at best could be said were mysterious circumstances. Or, at least that's what was gleaned from what later would be called Ishmod's Journal, a weathered diary found years later by an American tourist traveling in the East.

What happened with Ishmod was and maybe never will be clear. But it got under my skin, and has led me to spend a completely unreasonable amount of time trying to get to the bottom of it.

The whole affair has made me sort of crazy, because every time I get close to one answer, another three questions appear. I thought I'd placed the whole thing behind me about ten years ago when suddenly in 1999 I read a short news item in 73 about a connection to the elusive Ishmod possibly being sighted somewhere near Indonesia.

The 1999 report mentioned that an unknown member of Ishmod's original DXpedition had been asking about transportation to Easter Island from

the small village of Raba on the Indonesian island of Sumbawa, about 600 miles east of Jakarta. You might ask, as I did, why this request would catch anyone's attention. Well, the request for travel had to be on a wooden-hulled vessel with copper cladding. Nothing else would do.

From what I have been able to determine, in an odd sequence of events, the owner of a small grocery store — what we in the West would call a convenience store — one Tsrif Lirpa, in Raba, was also an amateur operator and had been leafing through some old copies of 73 before bundling them up to sell to a paper recycler who called at the island every three months or whenever he needed money. Lirpa's task in the back of his shop was interrupted by the tinkling of the small bell attached to the shop's front door.

When he went out front to greet his customer, he saw a small man whose intense dark eyes were scanning the store, and then fixed on a photo of an old fishing boat tacked to the wall behind the counter. The visitor told Lirpa that he'd been directed by a man mending nets on the pier that the shopkeeper might know where he could rent a boat for a couple of weeks. The

visitor insisted that the vessel had to be constructed of wood, have copper sheeting below the waterline, and a metal, preferably steel, mast.

The faded black and white photo on the wall showed a boat about 15 meters long propped up on wooden timbers in what looked like a primitive dry dock. It was hard to tell what the mast was made of. The photo looked like it must have been taken nearby, because the outline of the mountain peak behind the boat was obviously the same one that gave this stretch of coast its name: Trident. Though the photo was old, it was obvious that there was some kind of metal sheathing on the hull.

When Lirpa was unable to provide the visitor with any information about the boat in the photo because the latter had been hanging there when he'd bought the store years ago, the visitor asked about whether any other boats might be available in the area. The shopkeeper told him to try asking a person known by only the single name Mena, an old fisherman who lived about a mile down the beach in a weathered cottage. The visitor thanked Lirpa and, before leaving the store, asked to purchase the photo. Lirpa was

happy to make the sale and then went back to his magazine bundling task. That's when things got interesting.

Under subsequent questioning from Raba's lone policeman, Lirpa recalled that his customer carried an old leatherbound notebook because the sequence of letters on the cover reminded him of a callsign, though he didn't recognize it at the time. He also remembered seeing a coil or two of copper wire and what looked like a glass insulator protruding from a tear in the stranger's old backpack.

Lirpa had been quickly flipping through the back issues as he stacked them because he was looking for an old article on a certain kind of antenna once used by a local DXpedition. Lirpa's small plot of ground and limited income made him a keen experimenter with small, efficient antennas.

As the pages of the April 1984 issue of 73 blurred past, a photo of three men in a tent caught his eye. One of them looked like a younger version of the man who had just purchased the boat photo. He ran out the front of his store, looked down the sandy street in Mena's direction — and saw nothing but the sea and a pelican hovering in the wind.

That night, after he'd closed down the store, he went home with the issue of 73 tucked under his arm. He read through the article about Ishmod's Journal twice before his simple dinner and once afterward. He felt oddly uneasy about his photo-buying visitor, but eventually fell asleep.

The next morning, before leaving for work, he went on the air and eventually contacted a ham in California who relayed his report about the visitor to the 73 editorial offices. Ishmod's parents, who had all but given up hope on their son's whereabouts, were contacted, and they immediately flew from Chilka to Jakarta and then via a float plane and two small water taxis to meet with Lirpa at his store in Raba. They brought with them some photos of their son, Ishmod, along with a police forensics' photo-reconstruction of what their errant son might look like via a computer-aging program.

To their delight, Lirpa said that the

man visiting his store a week earlier looked very much like the computer image. Mena agreed when Ishmod's parents, Filia and Darjon Kaduk, showed him the police photo, but shrugged when asked where the man (apparently Ishmod) had gone after Mena told him that most of the boats these days were steel. He did tell Ishmod that there were a couple of tiny villages about ten miles east of Raba that used to have at least one fishing boat clad with copper, though this was years ago. Mena thought the boat had been a derelict and some of the locals had towed it in before it grounded on the nearby shoals.

Filia and Darjon rented a boat and a "captain" recommended by Lirpa, thanked him for his help, and said they were going to see what they could find. They returned four days later looking tired and discouraged, said good-bye, and caught the next water taxi leaving Raba. They told Lirpa that they were staying at the only hotel in Ujung Pandang on the island of Celebes.

That much of the story made it back to 73's editors and they contacted me to see if I could add anything from my years of searching. Well, once again my curiosity got the better of me. I took a leave of absence from work, much to the consternation of my boss, and got back on the road again. After several months of travel, and in an exhausted state, here's what I have to report:



Photo A. Ishmod in Raba?

Scrambling News

915 NW First Ave., Suite 2902, Miami FL, 33136
305-372-9427
www.scramblingnews.com

Pay TV and Satellite Descrambling 2002 - NEW! - satellite and cable. Includes latest information. \$19.95 plus \$1.75 shipping.
Hacking Digital Satellite Systems Video 2002 - New! - \$29.95 plus \$3.50 shipping.
Scrambling News Online - Online service for those interested in satellite television news. \$59.95/year. \$59.95/yr.
Pay TV and Satellite Descrambling Series CD-Rom - all 13 volumes over 300 pages. \$59.95 plus \$3.50 shipping.
Best Deal - Everything listed above for only \$99.95 plus \$3.50 shipping.

Say You Saw It in 73!

The New Pools!

Examination Test
Questions & Answers

The exact questions, multiple choices and answers for the Technician Class, General Class, and Extra Class operator's license.

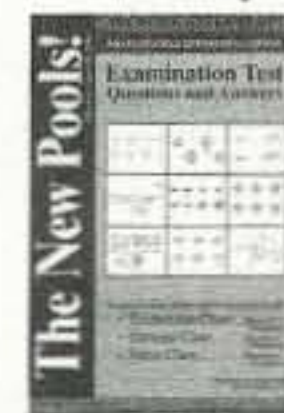

Only
\$9.95
Plus \$3.50 S&H

Omega Sales

P.O. Box 376
Jaffrey, NH 03452
800-467-7237



Ishmod still is out of my grasp, but that's not the half of it.

Here's how this episode began: After studying what correspondence I received from 73 and after several tries via international telephone operators, I contacted the Kaduks at their hotel and arranged to meet them. I took a flight to Singapore and then via an old Army buddy's connections caught a maintenance transport plane that made several stops but eventually landed on a tiny flat spot near Ujung Pandang. There, I managed to hitch a ride to the small hotel where Ishmod's parents were staying to think over what they should do next.

We shared a simple lunch at the hotel's "restaurant" and compared notes. Considering the time that had passed since either of them had seen Ishmod, and their many failed attempts to catch up with him, I was surprised at their resolve. Though their journey had taken them more than 20 miles beyond

Raba (at least that's what the "captain" had insisted as he apologetically increased the boat rental fee), they had only one slim lead after talking with dozens of villagers and fishing boats along the way.

Exhausted, and just before they turned back toward Raba, the Kaduks had talked with a man out diving for octopus. He remembered a stranger asking about boats with metal sides a few days earlier when he was working on his boat on the shore during low tide. He laughed because no one along the desolate coastline could afford a steel boat. But the man showed him a photograph of an old boat and then the diver understood. Paydirt.

He told the stranger that there was a man who lived in a cave about a kilometer inland up a small river who kept an old boat with some kind of metal on the sides. The fisherman gave directions to the stranger and went back to work.

Ishmod's parents went back to their room and I went down to the shore to look for transportation back to Sumbawa. I found a supply boat leaving in two days and arranged to be dropped off in Raba while the supply boat offloaded diesel fuel for the town's generators.

The next morning, when they awoke, the Kaduks noticed that something had been slipped under their rattan door. Upon closer inspection, it turned out to be a photo — recent, by the looks of it — of someone they immediately recognized as their long-lost son — aged, of course, but parents always know. Thing is, the image apparently showed Ishmod in some sort of a decontamination or moon suit outside Lirpa's store back in Raba. On his back can clearly be seen some sort of sprayer bottle or airpak. When I pointed these details out, for some reason the Kaduks became

Continued on page 88

NEVER SAY DIE

continued from page 9

developing game software, and while I was there I said hello to Ed Juge, one of my 73 advertisers. The copy of the magazine I left with Ed got him so excited that the next time I heard from him he had sold his ham store and was heading up Radio Shack's computer division.

My next stop was SWTPC in San Antonio, where I found them ready to announce their own computer kit.

None of 'em had any software yet, but Sphere was close with a BASIC emulator ... which was pathetically slow.

Byte took off like a rocket ... eventually ending up owned by McGraw Hill. That's a story I'll save for another day. I spent over \$100,000 getting the magazine started and never saw a dollar come back.

When McGraw Hill changed the magazine from a fundamental technical magazine to a business-oriented publication, the end was in sight. In its heyday, with around a half million circulation and over 300 pages of ads, I calculate the magazine was grossing over \$100 million a year.

I was not surprised to see it sink out of sight on the newsstands, and finally die. I put the death down to incredibly poor management.

After starting *Byte* I went on to start *Microcomputing*, and then *80-Micro*, the first computer-specific journal (Radio Shack TRS-80). Then *InCider* for the Apple, *Desktop Computing*, the first magazine written for the businessman instead of the computer hobbyist, *RUN* for the Commodore, and a few more. *80-Micro* did very well, running over 600 pages a month, 13 issues a year.

This was when I started hearing from several megapublishers who were interested in buying my five computer titles. Cutting to the chase, I sold out to IDG (*Computerworld*). Under their management my magazines lost their creativity, then their readers ... and blew away.

R's D Agrees!

Didja miss the July 2001 *Reader's Digest* article, "It's Never Too Late?" Subtitle: "You can reverse a lifetime of bad habits."

The article points out that when young we believe we are indestructible. That idea can be countered by standing naked in front of a mirror and seeing what you've done to your body. With the Department of Health reporting that only 1.5% of us are truly healthy, it is time to clean up your act.

It's time to eat right, get fit, lose that extra weight, stop smoking, and reduce

your stress. Hmm, isn't that what Uncle Wayne has been saying?

I'm getting email and snail from hundreds of people who have adopted what I recommend in my *Secret Guide to Health* and who are reporting major losses of weight, and without dieting. When you change to a raw food diet your body will go to its normal weight. You'll also notice that little annoyances like diabetes, arthritis, hypertension, and cancer fade away.

Fit? *R's D* likes my fast walking a half hour a day approach. They didn't mention rehydrating your cells with 8 to 10 glasses of pure water a day, but they should have.

98.5% of Americans now know that their assumption of indestructibility hasn't panned out. The standard American diet is a slow, but sure, killer.

Property Taxes

Since the Constitution of the United States says the government cannot take private property without compensation I should think that if anyone brought a suit against a state with a property tax that this would eventually go to the Supremes. Alas, the Supreme Court has a lousy record recently of upholding the Constitution, so, even

Continued on page 59

Henryk Kotowski SMØJHF
Sibeliusgången 28 XI
SE-164 77 Kista
Sweden
[henryk@sm0jhf.info]

Travels with Henryk — Part 11

Adoring the Azores.

This Portuguese overseas autonomic territory is located in the middle of the Atlantic Ocean, between Europe and North America. The archipelago consists of nine tiny islands of volcanic origin. The largest of them is Sao Miguel, and this is where I landed one winter Monday.

The climate, even in the middle of winter, is mild due to the warm waters of the Gulf Stream. And the amateur radio climate is very encouraging here. This island alone boasts at least 350 licensed hams. Not all of them are frequently on the air and not all of them use HF bands. VHF bands are popular both on the island and between the islands. Each of the islands has a distinctive prefix; Santa Maria lying south of Sao Miguel is CU1. Terceira, known for its U.S. military base, is northwest from Sao Miguel and is CU3. Other islands

are less active and with relatively low population.

My first contact with Azores prior to this visit was on the Internet. I looked up the [qrz.com] site and searched for hams living in Ponta Delgada, the destination of my last-minute low-budget flight. Filippe CU2BD (**Photo A**) responded to my E-mail query, and in spite of being a very busy person he could meet me and guide me to the local radio club (**Photo B**). A meeting attracted at least 10 members. The president of the local radio club is young Carreiro CU2IE (**Photo C**). The

club, CU2ARA, has a nice clubhouse (opposite the local jail) but no impressive antennas. On the other hand, there are many quite impressive antennas on the island. The largest one I could see was Eduardo CU2AF's 10-element Wilson array (**Photo D**). Eduardo lives very close to Ponta Delgada, in a village called Faja de Baixa, known for gorgeous pineapples. Eduardo grows pineapples but also does ceramics in his spare time. He is often in short-wave contests and it is easy to work him on the bands.

Filippe CU2BD, who acted my initial

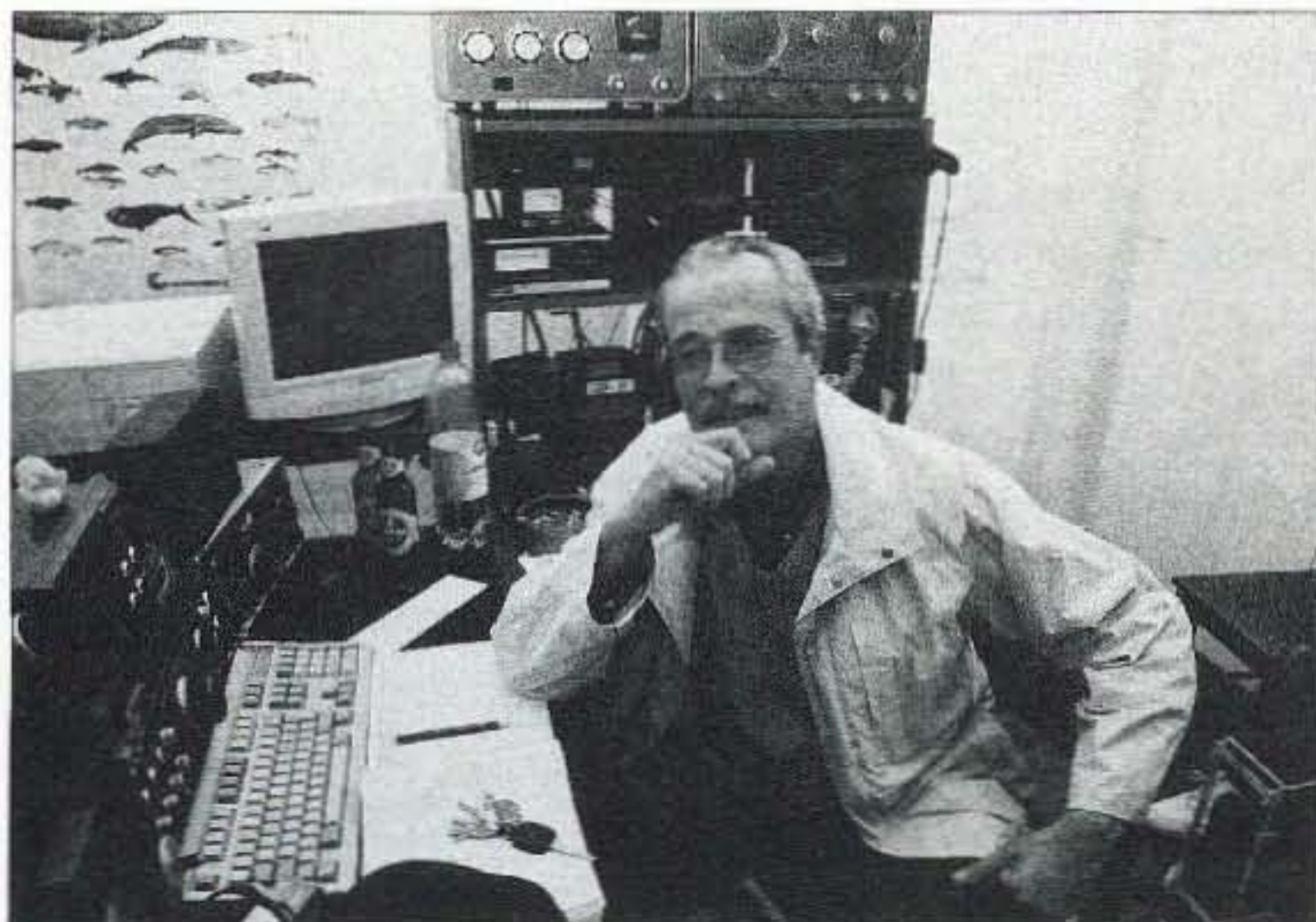

Photo A. Filippe CU2BD at home.



Photo B. A club meeting at CU2ARA, Ponta Delgada, Sao Miguel Island, Azores.



Photo C. Carreiro CU2IE, the president of the local radio club, CU2ARA, at the rig.

guide in Ponta Delgada, also has an impressive antenna (**Photo E**) downtown in the main city of the archipelago, in its old part where one can least expect a structure like this — but he is not active right now, pending his radio to be fixed. It has to be taken to mainland Portugal.



Photo D. Eduardo CU2AF and his 10-element Wilson antenna.



Photo E. Antenna of Filipe CU2BD in the old town of Ponta Delgada.

From mainland Portugal, I received an E-mail message before I left for Azores. It was Francisco CU2DX who works in Portugal. His father is CU2AA and they share a high antenna tower in the village of Livramento. When I passed by, Jacinto CU2AA was not at home, so I only have a picture from the distance (**Photo F**).

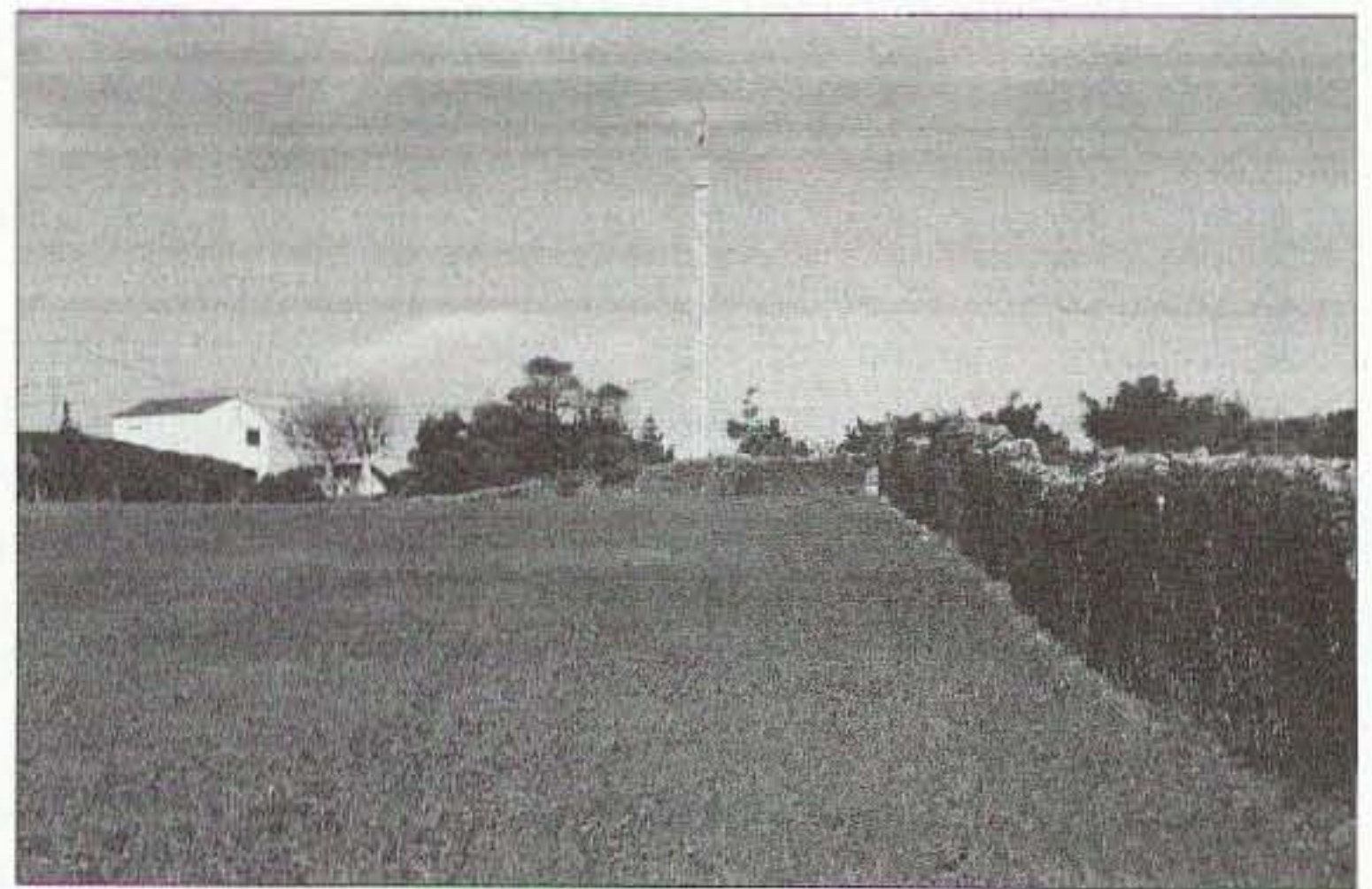

Photo F. Antenna of Jacinto CU2AA and Francisco CU2DX.

Another day I drove to a village called Furnas. There are hot springs, and Tony's Restaurant at the main square. Tony is CU2FX and on the back of his restaurant he has a pipe-supported Cushcraft array. Tony's well-equipped radio station is in the office (**Photo G**), and he has been a ham for about 15 years.



Photo G. Tony CU2FX in the office of his restaurant where he has his radio equipment.

Apart from being on the air myself from the island, I met quite a few local hams. I'd love to visit other islands — each of them is slightly different. It seems that our hobby is thriving here. One of the reasons is the authorities' point of view on amateur radio. After a major earthquake some 20 years ago, the local government finally grasped the benefits of ham radio for the society. Let's hope that authorities in other countries cease fearing amateur radio as being a dangerous and subversive activity. 73

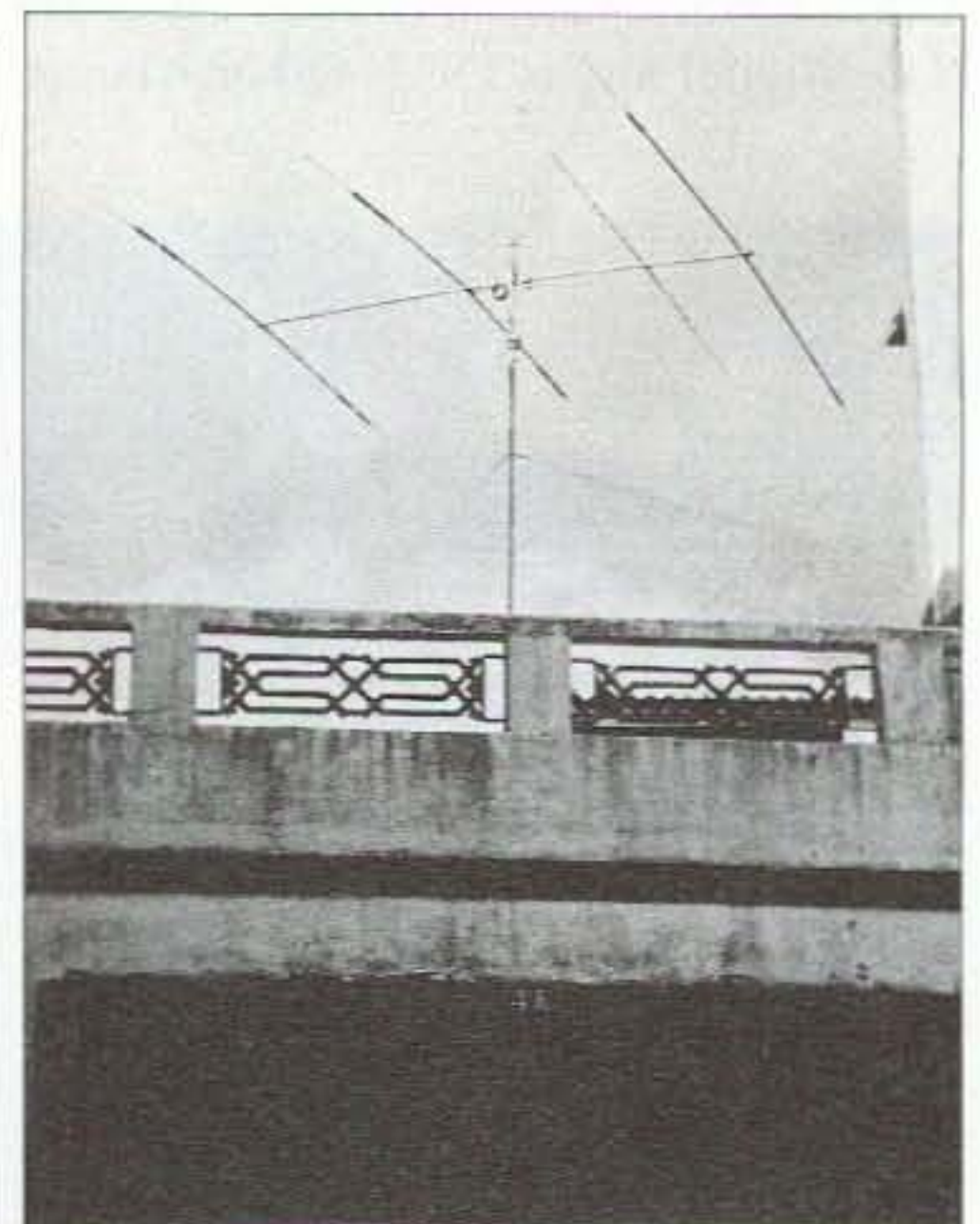

Photo H. Antenna of Tony CU2FX.

The Interrelationship of the Coriolis Force, the Helix Effect, and So-called Einstein Antennas

As usual, 73 takes you right to the cutting edge of ... er ... science?

Water goes down the toilet drain counterclockwise in the Northern Hemisphere, clockwise in the Southern Hemisphere, straight down at the Equator, and not at all if it's clogged. There is no way to change this law of nature, otherwise known as the Coriolis Force. If you force the water to change direction, it will always return to its natural state.

It has now been determined that RF travels down coaxial cable or wire in the same pattern as water down a drain. As for example, UHF antennas are designed as right or left helix, depending on the transmission involved. There are voids or non-RF sections in the spiral, just like a piece of string wrapped around a pencil. These voids of non-RF are wider spaced at low frequencies and closer together at high frequencies.

What can we do with the void or open sections? Send a second or third signal, etc., that's what. For example, numerous telephone calls are now sent at the same time, utilizing spaces or voids on wire or optic fibers.

What does all this have to do with radio? If you can send more than one RF signal at the same time down a wire (coaxial), then you can also extract or remove all the other signals but one, yours only, or in essence

eliminate all but the most severe noise QRM traveling down the voids. Voilà!

In Albert Einstein's equation, $E=mc^2$, a loss of energy means the total mass of the system decreases. Gravity grows stronger as two masses move closer together. In three dimensions, halving the distance quadruples the attraction. But for a particle existing in nine dimensions, halving the

Continued on page 57

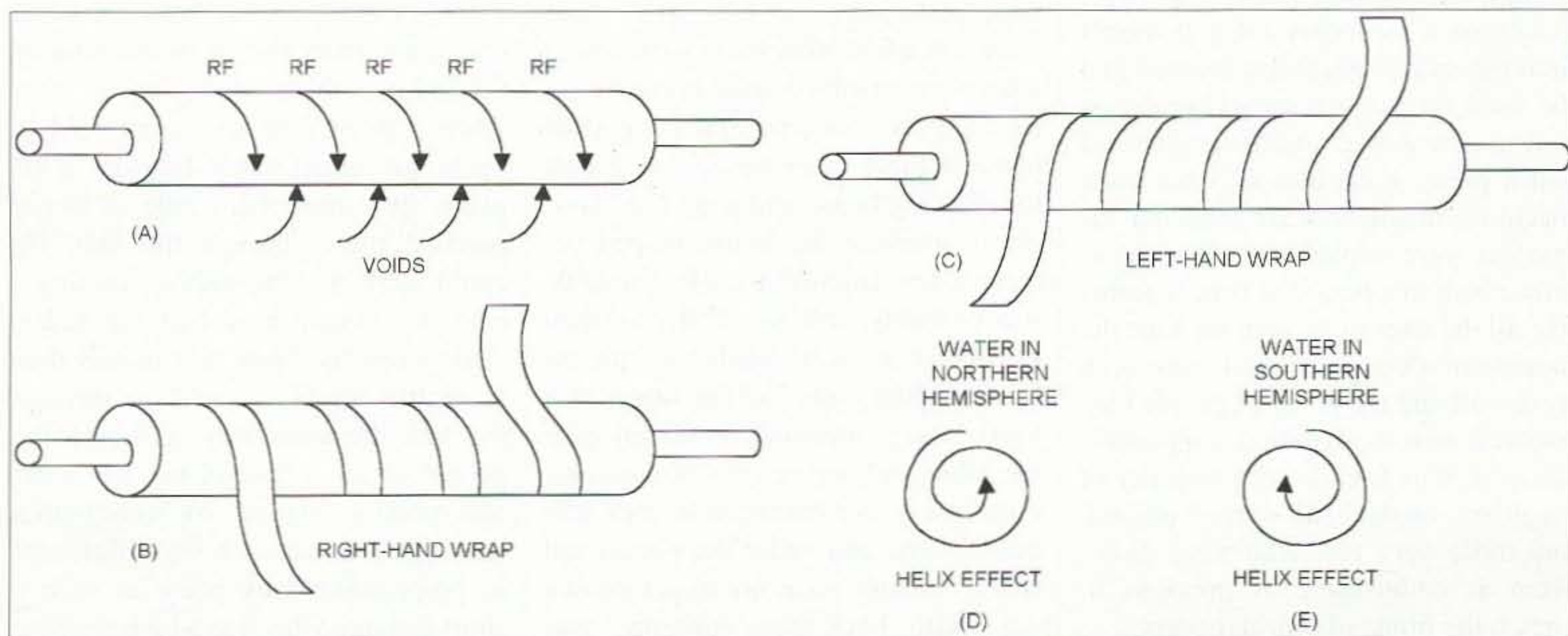

Fig. 1. (A) RF voids. (B) Right-hand wrap. (C) Left-hand wrap. (D) Helix Effect of water in Northern Hemisphere. (E) Helix Effect of water in Southern Hemisphere.

Autobiography of Everyham — Part 2

How many times do you see yourself in this story?

Shortly after college, my own career at Motorola started; I would go through four cars during the 9-1/2 years that I worked there (all except the first year, in Corporate Research and Development, I was in the communications department).

All cars except the first, a 1974 Mercury Comet, had 220 MHz and 11 meters installed in them; the Comet had 2 and 11 meters. The reason I mention the cars, at least in passing, is that each has associated with it its own unique memories of places traveled to, most for the sake of exploring 220 MHz propagation, and range tests of favorite repeaters; sometimes with, often without, a group of friends tagging along on some trip (if friends were along, range tests typically took a secondary role). It wasn't until the mid-1990s that it seemed that the need for range tests and propagation studies waned; everyone involved had a pretty good idea of what most machines in the area (at least our favorites) were capable of. Coincidentally, about that period of time it seems like all the sites to be seen (at least the tourist-attraction type) had been seen by myself and the group of people I associated with (both casual acquaintances as well as friends); the majority of "regulars" on the band weren't around, and those very few who were didn't seem as enthusiastic as previous to stretch the limits of repeater ranges.

Motorola also helped me to develop, at least obliquely, my home-brewing

career, in that after my first year in the factory, when I moved to a research department I had access to all those goodies a home-brewer needs: reference and data manuals for components, and a few actual cast-off components. By 1988, my tinkering had progressed to the point where the circuit ideas I developed were fit to be published in amateur radio magazines. Not just local club rags, but the magazines that saw worldwide distribution. Back then, particularly on 220 MHz, there were still a few other hams to be found who were involved with home-brewing their own circuits, so sharing ideas (even if these ideas never saw it past the drawing board and were used simply to exercise the brain) helped cement a few friendships. Most notable was probably with Ken N9HDX (then KA9BTJ); we were known to bug out of our houses and hunker down at a local eatery, spreading notes all over the table and diving into discussions. Fortunately, we managed to pick off-peak hours, and order the occasional snack or drink, so as not to get thrown out. (Also, back then "loitering" was not the huge offense it seems to have developed into in more recent times,

so once the waitresses knew we were harmless, we were left alone.)

Some of the circuit ideas we came up with during those brainstorming sessions were unconventional, to put it mildly; sometimes the results of putting those ideas into practice provided their own brand of surprises, as well. One such instance was a 10-meter FM to 220 MHz link I had experimented with. During band openings on 10 meters, my friend Joe would start to work someone on ten from his home (using ten watts and an indoor retuned CB whip), thirty miles away from where I lived with my parents. When the signal on ten would fade out at his place, he'd hear them fade in at my parents' place through the link. He could work stations without missing a beat, no matter how bad the fades. And, when the band was in less than favorable condition, he'd go through my link the other way, and give the people on ten a taste of my 130 watts and outdoor antenna. We were both a bit surprised that such big differences in propagation took place in such a short distance (this was a bit before the time, I think, that things like "diversity reception" became the big buzzwords,

and even then, diversity reception was something used primarily at higher frequencies and in commercial applications).

Creative operation wasn't necessarily limited to those operations involving home-brewed experimental circuitry. One example of such practice was a vacation my dad and I took in California. I had heard about the ham club operating from the *Queen Mary*, and while taking the tour of the boat, we broke off to be guest operators at the radio station. This was in the late summer of 1985; I had not yet gained too much experience with either club station operation, or special event stations (in spite of having been an active amateur radio operator for eleven years at that point), and I was not about to miss an opportunity at such a fine station. I managed to work one station in the Black Hills, before my dad grew impatient (I keep kidding him that he's not a real ham because of his lack of interest in getting active on the air). Fortunately, I had gotten at least one contact under my belt from that club station. The only thing missing was talking to the ship itself, at least for myself; my dad, as always, missed the point entirely. The club trustee said it was no problem; they were active on HF on a regular basis. Having missed them on HF for over a decade, I thought I'd better hedge my bets — this is where the creative operating came in. Shortly after I got back home, I was able to proudly show off a QSL card from the *Queen Mary*. I had worked the club station from the parking lot on two meters with my HT. I wonder how many others can boast that they worked the *Queen Mary* while using a rubber duck and less than two watts? Of course, hoping to encourage my dad into becoming a more active ham, I had held the HT up to his face two seconds after I made my contact, so he could also earn a QSL card from the *Queen*.

This was a time when handheld transceivers (HTs) had come into their own as viable radios, thanks to innovations seen in the mid- to late 1970s. Prior to this, portable transceivers were so bulky that they could not be worn clipped to a person's belt (or in the shirt pocket, as they developed in

the 1990s). Instead, they were so large that they were carried with a shoulder strap, similar to a woman's large purse. Thankfully they were already solid state by then; I shudder to think what portable tube gear would be like!

The weird and less weird

Vacations also can present unique operating challenges, especially if one looks for them (which I did). During our California trip, we hit the majority of tourist sites, which included Twin Peaks. There were many transmitter antennas right next to one of the peaks; I did it one better, and actually climbed to the top of one peak. 220 MHz had already become my favorite band by this point, and I had a fairly new 220 MHz HT. So, it was natural that I would try my DX contacts on that band. My first attempt got me into a repeater 80 miles away, with one watt and a 5/8-wavelength HT mounted antenna (I found out I could make it just as easily on low power as with high). The second contact on that band was to a repeater 30 miles away. I'm not sure what the distance records are for portable 220 MHz QRP, but I'd like to think we gave that record a good bit of competition.

Fortunately, there are also unique opportunities for operating in what the uninitiated might call "less weird" (as if we ever really got all that weird!). Thanks to a father who had been a private pilot for many years, I had the chance to operate aeronautical portable on several occasions. Back then (the 1980s and very early 1990s), things were still a bit more relaxed than today, as long as the ham equipment was independent of the aircraft's electrical and radio systems (my HTs certainly were), and caused no interference with aircraft operation. My dad and I carefully confirmed this, and I got the pilot's permission well in advance. There was no problem with amateur operations on an aircraft. My initial attempts included two band operation, two meters and 220 MHz. Distances achieved on both bands were relatively similar, and there were a few people on both bands in the area that seemed pleasantly surprised at the

chance to work a station that was aeronautical portable. Some thought it was aeronautical mobile, until I explained I was using a portable radio, portable antenna, portable power supply in the form of battery packs, with the associated power levels, there was certainly nothing mobile with the actual communications equipment being used. After that initial test, subsequent operation took place exclusively on 220 MHz, although by then a few people in northern Illinois and southern Wisconsin were getting used to aeronautical operation from a full-fledged mobile operator.

This came in the form of the owner of the Amateur Electronic Supply store in Milwaukee, Wisconsin. He had outfitted a business jet with a complete ham station; he'd take his friends along on flights and let them operate, usually reserving 220 MHz operation for himself. A few of the other regulars on 220 and myself looked forward to hearing him, and he got to recognize a few of us, too. Thanks to him, I received an invitation to tour his store and to come along on a future ride on his jet. Unfortunately I never had the opportunity to avail myself of the jet invitation, but when my dad and I took my cousin (who was visiting from Germany) to see the store, all three of us got the store tour. I later found out the owner got mad at not being told I was there; he had been in a meeting when we arrived, and we didn't want to interrupt him. It's unfortunate I never had the chance to take a look at his airplane; for permanent set-ups like that for the amateur radios, FAA approval had to be granted. To receive that, it had to be an impressive setup!

Fun times

Of course, even the more straight-laced operating can have its moment of fun. Just like I had to clarify to a few operators what I meant by "aeronautical portable" operation, a similar situation occurred when a sailboat owner made an appearance on one of the 220 MHz repeaters I frequented. I took that opportunity to sign "maritime portable," and he lost no time asking if I was swimming because I didn't

sound out of breath. Quite calmly I told him I was using my HT while in the bathtub, with a squeak or three from my rubber ducky (the yellow floating type, not the antenna on the radio) added in the background, for good measure.

The more subtle humor was not exempt from amateur radio, either. Before Ken's less-than-ideal health took its toll, we were known to head out the door to a mutually interesting event at a moment's notice. One such early event was a Fourth of July fireworks display he had heard about. This was one of the few times he drove, giving me the chance to grab the microphone and indulge in some 220 MHz activity, occasionally relaying a few messages from Ken to mutual friends. I'm not sure how we got around to the discussion of girlfriends, but at one point I admitted to a bit of bashfulness with women. Remembering my earlier comment about how I had been in the habit of carrying my 220 MHz HT with me, our friend Cliff WA9PDM, suggested that I wear a jacket over the HT's speaker/microphone, and we'd do a modern version of *Cyrano de Bergerac*, with Cliff taking the part of *Cyrano*.

Innocent bystanders aren't necessarily exempt from becoming victims of ham shenanigans, either (and I'm sure

this one's not an isolated case), this one involving a bit of wordplay. Friends of my parents were traders and sellers in the model and toy train industry. While they were selling at the local county fair grounds, the husband of that husband / wife team saw a sign, "HAMFEST", with an arrow pointing in the appropriate direction. He figured he would not have to worry about lunch; he'd just grab a slice of a porker, throw some bread around it, and be all set. When relating this story to my mom, she already had started grinning at this point of his story; laughter, being contagious, got her friend laughing so hard that he could barely finish the story of how he ended up at a ham radio flea market.

In spite of all of the activities caused by, or centered on, amateur radio operations, it seems surprising how few of these events required actual use of radio gear as a part of the actual activity. For example, even though I met Joe W9CYT through my operations on 220 MHz, the socializing that took place both with just Joe or with Joe and his wife did not mean we used radios as part of our socializing, nor did we always utilize radios as a communications link for our outings. I remember several lunch gatherings, discussions at his home, and hamfests as prime examples. The same can be

said of other friendships that developed through amateur radio; hamming was simply the catalyst. Ken and I, along with the occasional high school friends of mine whom we included, took part in several nature hikes, and all-night "brainstorming" sessions in the early years of my ham career.

These brainstorming sessions, if they can be called that, were an unusual twist to the raucous gatherings typical of high school- and college-aged people (we were at the late edge of the latter, when we started this type of get-togethers). Instead of launching on an entire night of carousing, drinking, and general troublemaking, we'd start off with something mundane, like enjoying the latest movie release on video, then proceed to tear it to shreds (regular reviewers couldn't hold a candle to us). Not only would we end up picking it to pieces, we'd end up creating rewrites. Somewhere through our discussion of rewrites, the discussions would take more than the usual amounts of twists and turns, debates about the script would take a side track through film-making (photography); before we were finished (at about three o'clock in the morning, after a start at about four in the afternoon), we would end up discussing something bizarre like the UFO phenomena after having watched a movie not even remotely related to that topic. After the fact, no one could remember how we got from one to the other, except that we had so much fun with a variety of interesting topics, we typically lost all track of time. How often can it be said that such a wide range of topics gets covered in just one party? It certainly made for some unusual, if not legendary, gatherings.

Not all get-togethers were that cerebral; there were a fair share of gatherings that tended to go from the bizarre to nearly slapstick in comedic quality. Here's a typical example: After a full day of some other activity, Ken and I decided to catch the latest science-fiction thriller in a local theater. For some reason, the previous function we were at ended early, allowing us a bit of extra free time once we got to the theater. There wasn't enough time to



Photo A. Assistant operator "Fluffy" maintains a listening watch while Klaus WB9YBM makes a run for coffee.

go anywhere else, and I wasn't about to just sit in the car. Then I realized I had a kite in the trunk of my car (this was way back when I still drove the 1974 Mercury Comet, which was slightly more prone than more recent cars to have curious odds and ends collecting in the trunk). Ken was already unleashing a nervous laugh as he saw my insane grin, knowing full well by now that these looks clearly indicated I had something up my sleeve. I wasn't about to make an exception in this case. It developed into peals of laughter as we launched the kite — black, with dark blue trim — into the night sky. That was not to be the end of it, though; a young-ish police officer, cruising the parking lot, started asking what we were up to. Fortunately, he was able to get into the spirit of things and tried to pick out the black kite against the now-black night sky. By now, other theater patrons were getting into the act, wondering what the officer was looking for with the squad car search light, and joining in the fun. By following the white string upwards at the proper angle, it was soon found. Realizing we were harmless, he joined us in a good laugh, and soon left. Luck was not with us for long, though; a short while later, a squad car with an older officer rolled up. Again we were asked what was going on. I'm not sure if, being older, he was being a "cranky curmudgeon," or if he was just having a bad day, but we were shortly convinced to get rid of the kite. I made sure to turn around, hold the kite in front of the squad car's headlights (even pointing to the offending kite), to let him know it was down, and on the way back to the trunk of my car. Fortunately, by now it was within about ten minutes of the movie's start, and no need to kill any more time. Even though the movie was good, it seemed like a bit of a let-down after our brush with the law. Although amateur radio, with its versatile nature, can be an interest all unto itself, one can immerse oneself in any subset of interests without fear of boredom. There are times, such as this, when events happen and experiences are shared with others and the line dividing

amateur radio and everything else can certainly blur.

While much is written about DXpeditions — radio expeditions to long-forgotten islands and such — one thing that needs to be clarified is that not all expeditions need to be to far-off or exotic places in order to be either interesting or of value to amateur radio. The aeronautical mobile operation mentioned earlier was only one example. Operating into different states from a single operating point well within Illinois, with nothing more than an HT and rubber duck antenna, was made possible through a trip into downtown Chicago. Operating from the observation deck of the Sears Tower allowed operation well into Michigan and Indiana. The lack of complexity of this expedition made it all the more fun. Of course, this was back in the 1980s; increased security and suspicion harbored by the current security guards has probably made even a simple undertaking like that more difficult. At least, it has shown us that expeditions do not need to haul along a warehouse of equipment in order to be successful, in spite of what the magazine pictures of other expeditions showed.

Not all of these expeditions had phenomenal results. In the late 1990s, initially hoping to gain permission to operate from the top of the lighthouse in Evanston, Illinois, operation was denied based on their insurance restrictions. Although all I was planning to take up was a 5-element beam built by Joe, a mobile radio, and power supply, they said insurance regulations would not allow it in spite of tours being given in the lighthouse during the tourist season. Not to be daunted, though, January 2002 saw a field test site go up in the parking lot right next to the lighthouse. In spite of the lack of height, the parking lot and nearby observation deck were about twenty feet or so above Lake Michigan; a tripod and wood support held the beam approximately ten feet farther up. Although there was a reasonably clear shot to the lake itself, about 50 feet or so east of the antenna, contacts into the state of Michigan remained illusive, as

FAIR RADIO SALES
ELECTRONIC MILITARY SURPLUS

12 FOOT MAST KIT
12 foot Fiberglass Mast Kit 3/4" x 1 3/8" Dia fiberglass mast sections, 8" top mast section for two 28 inch dipole elements and 16 feet of RG-58 coax with BNC connectors, one guy ring with ropes, three 9" stainless steel stakes, one 27" long mast base which is pushed into the ground, and O.D. green carrying bag with handle. Excellent for field day or other portable antenna use. 12 lbs sh. #MK-12, \$59.50 each; 2 for \$99.50 plus shpg.

30 Foot Mast Kit
30 Foot Mast Kit. Twelve AB-35 33" aluminum mast sections, AB-154 mast base, 6/ guy ropes, 2/ guy rings, 3/guy stakes, and a heavy duty nylon carrying bag various colors - sorry no choice. 32 lbs sh. All items listed above are in used condition except the mast sections and the bag which are unused. #ANT-KIT-30, \$145.00 plus shpg.

WEBSITE: fairradio.com
E-MAIL: fairradio@fairradio.com
PHONE: 419-227-6573 - **FAX:** 419-227-1313
2395 St Johns RD - Box 1105 Lima, OH 45802
VISA, MASTERCARD, DISCOVER accepted
Write for latest Catalog - Address Dept. 73

Capacitors - Motors - Relays - Power Supplies - Test Equipment
Radios - Antennas - Roller Inductors - Transformers - Wire - Tubes

LOW PROFILE HF ANTENNAS
NO Radials • No Motors • MORE ANTENNA than just a Coil & Whip

ISOTRON
BILAL COMPANY
Call for a FREE Catalog

2003 is our 23rd year in business!

719-687-0650 \$368.85
137 Manchester Dr. 80, 40, 20, 15 & 10
Florissant, CO 60 inches tall & 81816 32 inches across

www.rayfield.net/isotron

ICOM IC-756 Pro II



The impressive IC-756 Pro II covers HF plus 6 meters. The high resolution 5 inch TFT color display provides more operating information than ever, including a spectrum scope. The 32 bit floating point DSP provides crisp, clear reception with 41 built-in filters. The "Pro II" is the choice for serious DXers and contesters.

IC-746 Pro ✓ 160 to 2 Meters!



The IC-746 Pro covers 160-10 meters plus 6 and 2 meters with 100 watts on all bands. Call or visit our website for further details and pricing on this and other ICOM radios.

universal radio inc.
6830 Americana Pkwy.
Reynoldsburg, OH 43068
♦ Orders: 800 431-3939
♦ Info: 614 866-4267
www.universal-radio.com

did contacts north along the coastline into Wisconsin. Fortunately, there was better luck to the southeast, when the Valparaiso area of Indiana was heard. Inland range was also surprisingly good; with five watts into the antenna, a repeater about 40 to 50 miles to the west was accessed. It did not even take a whole squadron of amateur radio operators for the entire operation; my mom and I set the tripod up next to the car, and that was all we needed for the test.

While high sites for repeaters are sought after to maximize the communications range of repeaters, with plenty of bragging taking place by the owner when a coveted site is obtained, there are examples of bragging not being a good idea. One amateur employed in site installation on the Sears Tower in Chicago sneakily put his own repeater on the building, insisting on short transmissions and discouraging use of his machine by anyone but his closest friends. Since the repeater owner (according to a few sources) had no official permission to use that site for his repeater, he didn't want anyone to catch on to where the repeater was. Listening to the conversations and running a few very discrete tests on their own, other hams were able to conclude with reasonable certainty that the repeater was indeed on the Sears Tower. The repeater has since left the air, or at least that site. With the increase in RF signals since that time (the repeater was up briefly in the 1980s), it probably would have suffered from an overload in signals had it stayed on the air from that location.

Bedsprings and flagpoles

Even with the antenna legislation taking place in the 1990s to make city ordinances more "user friendly" to the amateur radio community, the process to allow antenna support structures has been notoriously slow. Over the years, I've heard several different methods by some very creative hams, and I'm sure there are more in circulation that haven't fully made the rounds yet. Loading up things like bedsprings and the radiators in homes circulating heating water for the winter were certainly

the more unusual, and not something I would recommend, out of safety concerns.

My favorite was told to me by a gentleman I spoke to on forty meters, relatively early in my ham career. He was living in a trailer park that did not allow antennas, although they did allow flagpoles. He had bought an extra-long fiberglass flagpole, receiving compliments on his patriotism for the extent he went to with this construction. Unknown to everyone else at the trailer park, though, was that he ran an antenna wire down the whole length of the flagpole, on the inside. On the bottom, he very discreetly put a ground rod next to the pole, attaching his coax center conductor to the antenna wire and the braid to the earth ground. Then, the coax was routed underground from the flagpole to under the trailer home, where he had his ham shack. The coax run from below-ground to inside his trailer was done underneath the trailer, where no one would see it. With an antenna tuner, he was able to work all his favorite bands.

My own antenna efforts had not been nearly as sneaky, although I still had to take advantage of a technical loophole. The city where I lived did not allow antenna towers. Fortunately, my parents' house still had a standard brick chimney, big and solid enough to mount a mast to. This led to the inverted "V" I used on 40 and 15 meters for many years, and a VHF antenna stuck to the top of the mast. Since the mast was not a permanent structure as the tower would be (at least in the estimation of the city), we had found an effective loophole to the antenna restrictions. Even if the city would have complained (they never did), it would have been very easy to take the antennas down for a few months — just long enough to appease the local government — and then discreetly put them back up a few weeks, or months, later. During the last few years when I was living at home, the occasional tuck-pointing of the chimney became necessary, with my dad complaining that the vibrations of the antenna mast caused during periods of high wind were to blame for the mortar between

the bricks beginning to deteriorate. He was kidding me that he should charge me for chimney repair; my reply was that I'd charge him for renting him my antennas — the chimney straps were the only thing holding the chimney together!

Basic concept

The public service aspect of amateur radio has shown itself to be a mixture of expected, and unexpected. The write-ups I've seen over the years in magazines, of amateurs providing communications at bicycle races, for instance, is certainly expected given the service aspect of amateur radio. What was unexpected for me was, at times, lack of service, when fellow hams failed to live up to the basic concept of this aspect of amateur radio. One such example took place in the early 1990s, when I saw a serious accident on an expressway. Attempts to get help from my mobile during ten minutes of calling for assistance on several different repeaters brought either total silence or apathy. I put the quick-connect citizens band antenna on my car, and got help on the first try. Again on the plus side, though, I've also been witness firsthand to the generosity of hams. While driving home in bad weather, Joe was the first to voluntarily postpone dinner in order to make sure I got home safe. When I told him I needed to take a break from the conversation to concentrate on the road and keep both hands on the wheel, his only request was for me to let him know when I got home, so he could have dinner. A few times I'd hedge my bets by telling him to go ahead to dinner even though I was still a mile or so from home; at that point I either could've walked home, or ducked into a nearby store to grab a taxi.

This is not to say I haven't been on the other side of the equation; I remember once I made the twenty-five mile trek home from work, only to get a call on the air from a ham a dozen miles past home, saying he needed a ride because his car broke down and

Continued on page 57

Hamfest Improvement 101

How to make things better for everybody.

What bothers you the most about hamfests? For any number of people you ask, you'll probably get at least twice as many suggestions for improvements. Since we want to keep answers to something practical for an article, let's filter out just a few suggestions specific to the basic function of what a hamfest is, and how to make it more successful.

Kee in mind that these ideas will vary a bit, to stay in line with the specific needs of any given hamfest. The size, type, and location of a hamfest will play a role in what it takes to make a hamfest successful. Let's take a look at a few universal constants that may lend themselves to any hamfest.

Your crew

Who's going to help you put on the hamfest? While you might be a genius at acquiring a site, coordinating details, and getting out the word about the event, there's the "human factor" that quite often gets neglected. At several hamfests I've been treated rudely by the guys in the orange vests directing traffic — your first line of contact between your organization and the attendees. The attendees are the ones leaving their money at the gate, to get in; they're also the ones telling their friends if your hamfest is worth getting to, or not. What's it worth putting your best foot forward? If you have someone with an "attitude" helping your club, you might want to consider putting him on kitchen duty — any place but out there offending the patrons!

Access

Most clubs have the 'fest location down pretty well, and the ones around here at least can manage to find a large open area where parking and display areas have plenty of room. There's still another form of access to be considered: radio access. Most clubs have a talk-in frequency on the club's repeater.

This is great if you're holding the hamfest in an area where the guy with a hand-held from inside his car can access the machine, but in most cases this isn't going to happen. Some of the smarter hamfests I've seen have two talk-in frequencies: one on the repeater (local ones aren't always available, so don't count on one being available in the place you're holding the hamfest), and a second frequency on simplex nearer the hamfest grounds. This serves a dual purpose in that once people get close to the hamfest grounds (usually at the county fairgrounds well outside of a city), by then out of range of the repeater, they can find extra help in getting to the hamfest grounds — in addition to leaving the repeater free to talk-in people coming from out of town.

At this point, we're still neglecting everything but the club's favorite band. Let's face it: No matter how much you like two meters, not everyone's going to flock to that band just on your say-so, especially not for the duration of only one or two hamfests per year. If you want to reach out to more attendees, talk to your club members and see who's got what for the other bands. If you can't get a member to loan you their 220 MHz (or 440 MHz) gear for another talk-in frequency, possibly you can encourage them to volunteer their services to operate their own gear during your event. If you want to get really creative (which might be especially necessary if you've got only one volunteer at a time to monitor all simplex talk in frequencies at once), you might want to consider wiring up a simple link between your transceivers and linking everything to one common frequency or local microphone.

Getting the word out

A few of the newer modes of operation that have sprung up over recent years can provide options to get the word out about a hamfest. Getting the information to the ham magazines is

most common, although the biggest mistake people may make is not realizing how far in advance they need it. Remember, the magazine has to get set up, shipped to the printers, and distributed all in time to get to people on time. Typically a two-month lead time is the minimum. The more industrious ham clubs will even send out members armed with fliers about their hamfest, to distribute at other hamfests. With all of the print shops springing up everywhere, finding one that can handle the quantity you need at the price you're willing to pay should not be difficult. I've even seen clubs do direct mailing of their fliers.

A less common form of getting the word out is packet radio, probably because a lot of the "old-timers" in various repeater groups haven't gotten comfortable with "them newfangled contraptions." The main cautionary

note is to limit distribution to only your end of the state, using commands like "NORIL" for northern Illinois; check with the head honcho of your local node if you're not sure how to do it. Some node trustees have been known to get mad at superfluous messages. One thing I noticed is that the wider an area a message is flooded across, the shorter the time the message will be saved by the packet boards. Keep this in mind as you try to achieve a balance between giving people enough advance notice to be able to plan to attend, and telling them so far in advance that they have time to forget about it.

Another technique that's slowly been catching on, which could stand to be used more often, is that many television and radio stations have free public service announcements (and you certainly can't beat that price!) that tell about upcoming events. I've

seen a pretty good variety of events being mentioned, from church picnics to model boat races and pretty much everything in between.

Conclusion

I realize not everyone is a "people person," either willing or able to practice positive public relations with the general population; this certainly provides a set of challenges to putting on a hamfest. In spite of this, there are plenty of ways we can improve what it is we're doing, as shown by the suggestions I've discussed. I'm sure there are a few I might have missed; I'd enjoy seeing those in a future "letter to the editor" (let's share them so we can all benefit!). I'm also curious to see what luck your club may have with the suggestions discussed in this article; feel free to drop me a note with your results. 73

208-852-0830 • Fax: 208-852-0833
<http://rossdist.com>

Over 9060 HAM Items in Stock! Visit Our Site Often for Specials!

RDC ROSS DISTRIBUTING COMPANY All Prices Cash
 78 S. State Street, Preston, ID 83263 FOB Preston
 Hours Tue.-Fri. 9:30-12:30-6 • Mon. 9:30-12:30-3:30 Closed Sat & Sun

Say You Saw It in 73!

The Gordon West Study Guides

Examination Test Questions & Answers for General Class and Extra Class with explanations of the answers

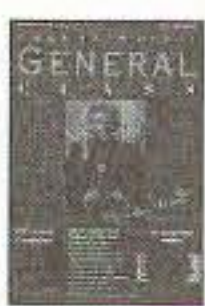
 General Class \$12.95 Plus \$3.50 S&H

 Extra Class \$14.95 Plus \$3.50 S&H

Omega Sales
 P.O. Box 376
 Jaffrey, NH 03452
 800-467-7237



 



Photo A. Frank WB9OHN provides entertainment as a clown for the kids.

Pluses and Minuses of “Smart” Batteries

*We charged one of the world’s leading experts with explaining,
and here’s his plug ... er, report.*

A speaker at a battery seminar remarked that, “The battery is a wild animal and artificial intelligence domesticates it.” An ordinary or “dumb” battery has the inherent problem of not displaying the amount of reserve energy it holds. Neither weight, color, nor size provide an indication of the battery’s state-of-charge (SoC) and state-of-health (SoH). The user is at the mercy of the battery when pulling a freshly charged battery from the charger.

Help is at hand. An increasing number of today’s rechargeable batteries are being made “smart.” Equipped with a microchip, these batteries are able to communicate with the charger and user alike to provide statistical information. Typical applications for “smart” batteries are notebook computers and video cameras. Increasingly, these batteries are also used in advanced biomedical devices and defense applications.

There are several types of “smart” batteries, each offering different complexities, performance, and cost. The most basic smart battery may only contain a chip to identify its chemistry and tell the charger which charge algorithm to apply. Other batteries claim to be smart simply because they provide protection from overcharging, underdischarging and short-circuiting. In the eyes of the Smart Battery System (SBS) forum, these batteries cannot be called “smart.”

What makes a battery “smart”? Definitions still vary among organizations and manufacturers. The SBS forum states that a smart battery must be able to provide SoC indications. In 1990, Benchmarq was the first company to

commercialize the concept of the battery fuel gauge technology. Today, several manufacturers produce chips to make the battery “smart.”

During the early nineties, numerous “smart” battery architectures emerged. They range from the single-wire system to the two-wire system and the system management bus (SMBus). Most two-wire systems are based on the SMBus protocol. Let’s look at the single-wire system and the SMBus.

The single-wire bus

The single-wire system is the simpler of the two and delivers the data communications through one wire. A battery equipped with the single-wire system uses only three wires: the positive and negative battery terminals and the data terminal. For safety reasons, most battery manufacturers run a separate wire for temperature sensing. **Fig. 1** shows the layout of a single-wire system.

The modern single-wire system stores battery-specific data and tracks battery parameters, including temperature, voltage, current, and remaining charge. Because of simplicity and relatively low hardware cost, the single-wire enjoys

market acceptance for high-end mobile phones, two-way radios, and camcorders.

Most single-wire systems do not have a common form factor; neither do they lend themselves to standardized

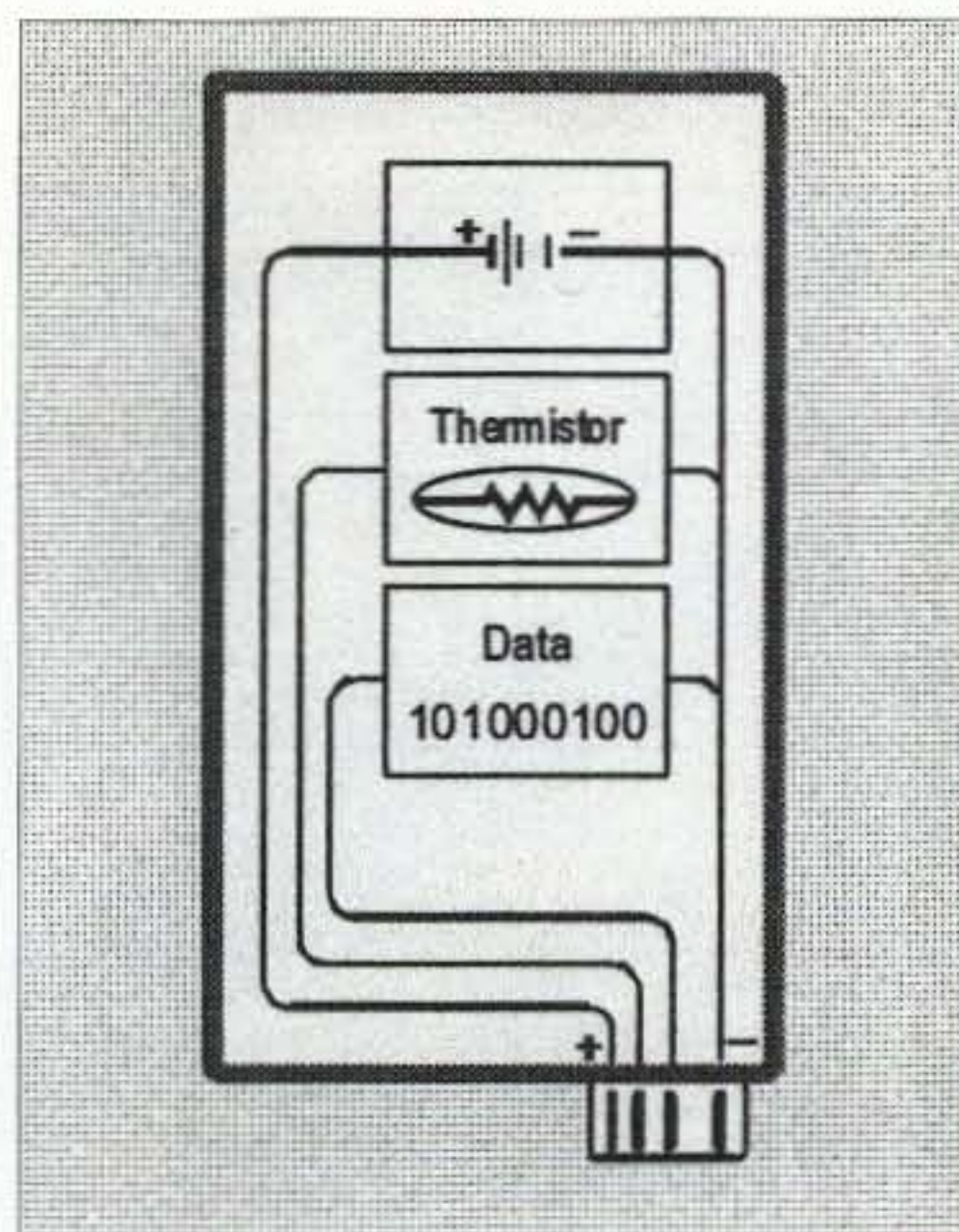

Fig. 1. Single-wire system of a “smart” battery. Only one wire is needed for data communications. Rather than supplying the clock signal from the outside, the battery includes an embedded clock generator. For safety reasons, most battery manufacturers run a separate wire for temperature sensing.

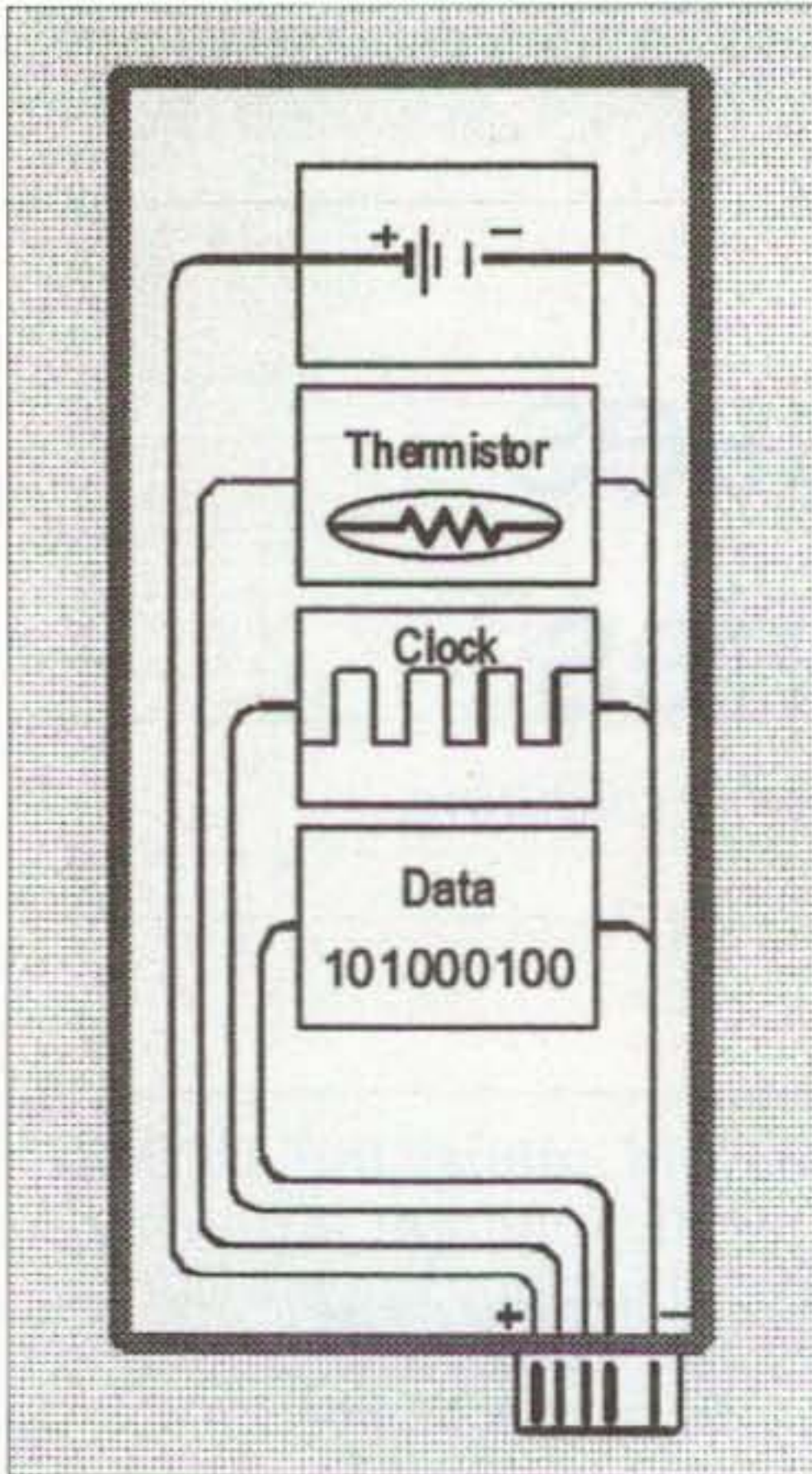

Fig. 2. Two-wire SMBus system. The SMBus is based on a two-wire system using a standardized communications protocol. This system lends itself to standardized state-of-charge and state-of-health measurements.

SoH measurements. This produces problems for a universal charger concept. The Benchmarq single-wire solution,

for example, cannot measure current directly; it must be extracted from a change in capacity over time.

On a further drawback, the single-wire bus allows battery SoH measurement only when the host is "married" to a designated battery pack. Such a fixed host-battery relationship is feasible with notebook computers, mobile phones, or video cameras, provided the appropriate OEM battery is used. Any discrepancy in the battery type from the original will make the system unreliable or will provide false readings.

The SMBus

The SMBus is the most complete of all systems. It represents a large effort from the portable electronics industry to standardize to one communications protocol and one set of data. The SMBus is a two-wire interface system: One wire handles the data; the second is the clock. It uses the I²C defined by Philips as its backbone.

The Duracell/Intel SBS, which is in use today, was standardized in 1993. In previous years, computer manufacturers developed their own proprietary "smart" batteries. With the new SBS specification, a broader interface standard is made possible. This reduces the hurdles of interfering with patents and

intellectual properties. **Fig. 2** shows the layout of the two-wire SMBus system.

In spite of the agreed standard, many large computer manufacturers, such as IBM, Compaq, and Toshiba, have retained their proprietary batteries. The reason for going their own way is partly due to safety, performance, and form factor. Manufacturers claim that they cannot guarantee safe and enduring performance if a nonbrand battery is used. To make the equipment as compact as possible, the manufacturers explain that the common form factor battery does not optimally fit their available space. Perhaps the leading motive for using their proprietary batteries is pricing. In the absence of competition, these batteries can be sold for a premium price.

The objective behind the SMBus battery is to remove the charge control from the charger and assign it to the battery. With a true SMBus system, the battery becomes the master and the charger serves as a slave that must follow the dictates of the battery. This is based on concerns over charger quality, compatibility with new and old battery chemistries, administration of the correct amount of charge currents, and accurate full-charge detection. Controlled charging makes sense when considering that some battery packs share the same footprint but contain different chemistries.

The SMBus system allows new battery chemistries to be introduced without the charger becoming obsolete. Because the battery controls the charger, the battery manages the voltage and current levels, as well as cut-off thresholds. The user does not need to know which battery chemistry is being used.

An SMBus battery contains permanent and temporary data. The permanent data is programmed into the battery at the time of manufacturing and includes battery ID number, battery type, serial number, manufacturer's name, and date of manufacture. The temporary data is acquired during use and consists of cycle count, user pattern, and maintenance requirements. Some of the temporary data is being



Photo A. 35- and 202-series "smart" batteries featuring SMBus. Available in NiCd, NiMH, and Li-ion chemistries, these batteries are used for laptops, biomedical instruments, and survey equipment. A non-SMBus ("dumb") version with same footprint is also available.

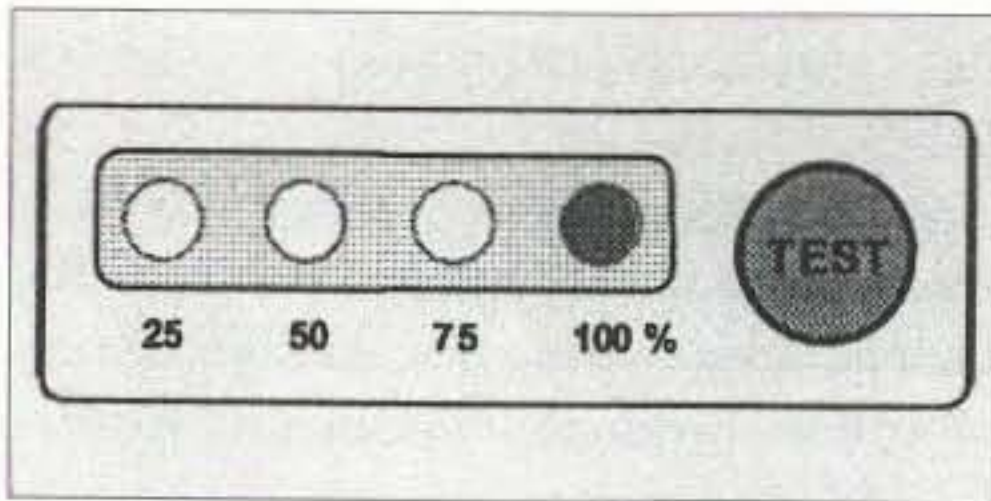

Fig. 3. State-of-charge readout of a "smart" battery. Although the state-of-charge is displayed, the state-of-health and its predicted runtime are unknown.

replaced and renewed during the life of the battery.

The SMBus is divided into Level 1, 2, and 3. Level 1 has been eliminated because it does not provide chemistry-independent charging. Level 2 is designed for in-circuit charging. A laptop that charges its battery within the unit is a typical example of Level 2. Another Level 2 application is a battery that contains the charging circuit within the pack. Level 3 is reserved for full-featured external chargers.

External Level 3 chargers are complex and expensive. Some lower-cost chargers have emerged that accommodate SMBus batteries but are not fully SBS-compliant. Manufacturers of SMBus batteries do not fully endorse this shortcut. Safety is always a concern,

but customers prefer these economy chargers because of lower price.

Serious industrial battery users operating biomedical instruments, data collection devices, and survey equipment, use Level 3 chargers with full-fledged charge protocol. No shortcuts are applied. To ensure compatibility, the charger and battery are matched and only approved packs are used. The need to test and approve the marriage between a specific battery and charger is unfortunate, given that the "smart" battery is intended to be universal.

Among the most popular SMBus batteries for portable computers are the 35 and 202 form factors. Manufactured by Sony, Hitachi, GP Batteries, Moltech, Moli Energy, and many others, these batteries work (should work) in all portable equipment designed for this system. **Photo A** shows the 35- and 202-series "smart" batteries. Although the 35 has a smaller footprint than the 202, most chargers accommodate both sizes. A non-SMBus ("dumb") version with the same footprint is also available.

Negatives of the "smart" battery

The "smart" battery has some notable downsides, one of which is price. An SMBus battery costs about 25% more than its "dumb" equivalent. In addition, the "smart" battery was intended to simplify the charger, but a full-fledged Level 3 charger costs substantially more than a regular dumb model.

A more serious drawback is maintenance requirements, better known as capacity relearning. This is needed on a regular basis to calibrate the battery. The engineering manager of Moli Energy, a large Li-ion cell manufacturer, commented, "With the Li-ion we have eliminated the memory effect, but are we introducing digital memory with the SMBus battery?"

Why is calibration needed? The answer is to correct the tracking errors that occur between the battery and the digital sensing circuit during use. The most ideal battery use, as far as fuel-gauge accuracy is concerned, is a full charge followed by a full discharge at a constant IC rate. In such a case, the tracking error would be less than 1% per cycle. In real life, however, a battery may be discharged for only a few minutes at a time and commonly at a lower C-rate than IC. Worst of all, the load may be uneven and vary drastically. Eventually, the true capacity of the battery no longer synchronizes with the fuel gauge and a full charge and discharge is needed to "relearn" or calibrate the battery.

How often is calibration needed? The answer lies in the type of battery application. For practical purposes, a calibration is recommended once every three months or after every 40 short cycles. Long storage also contributes to errors because the circuit cannot accurately compensate for self-discharge. After extensive storage, a calibration cycle is recommended prior to use.

Many batteries undergo periodic full

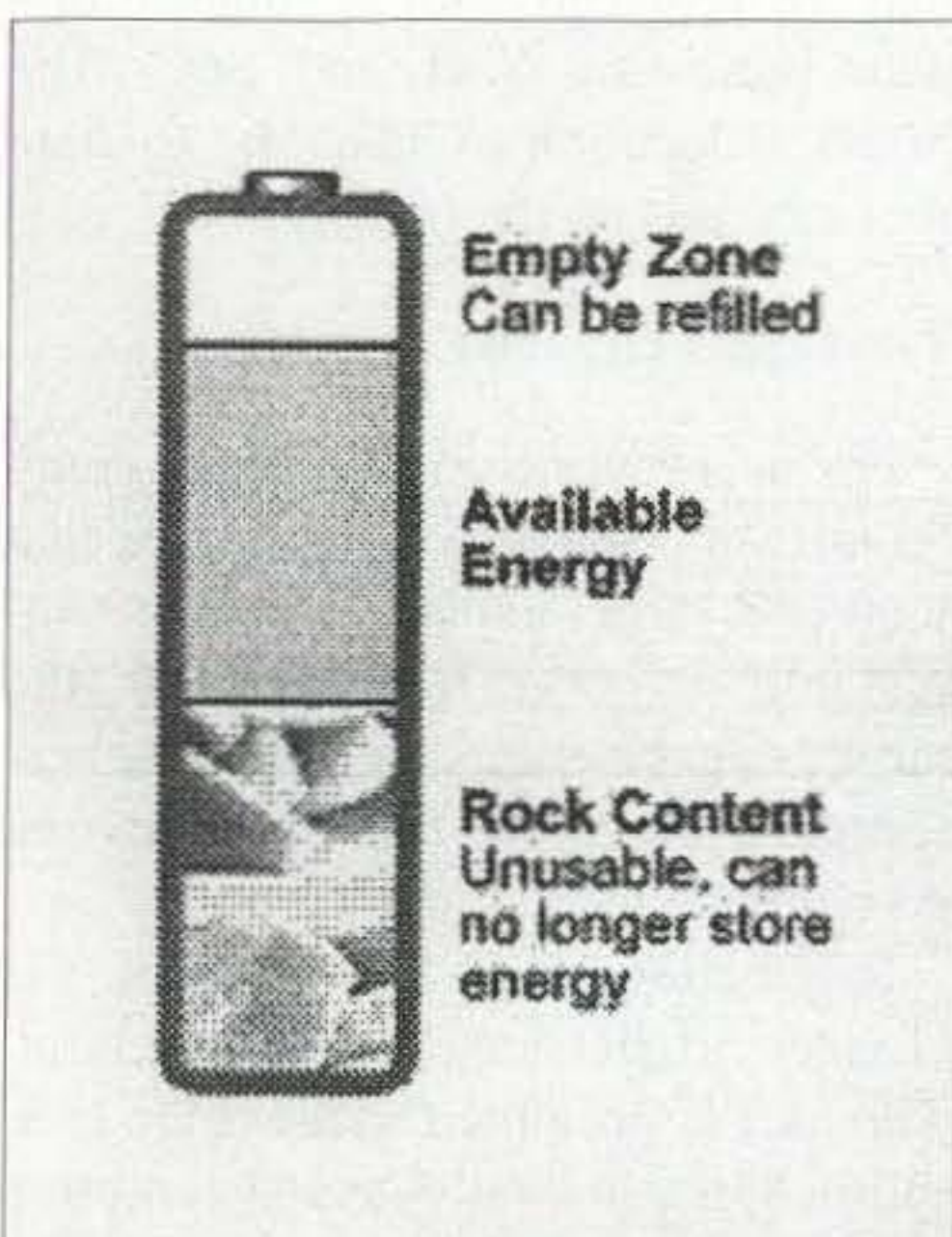

Fig. 4. Battery charge capacity. Three imaginary sections of a battery consisting of (top to bottom) available energy, empty zone, and rock content. With usage and age, the rock content grows. Without regular maintenance, the user may end up carrying rocks instead of batteries.

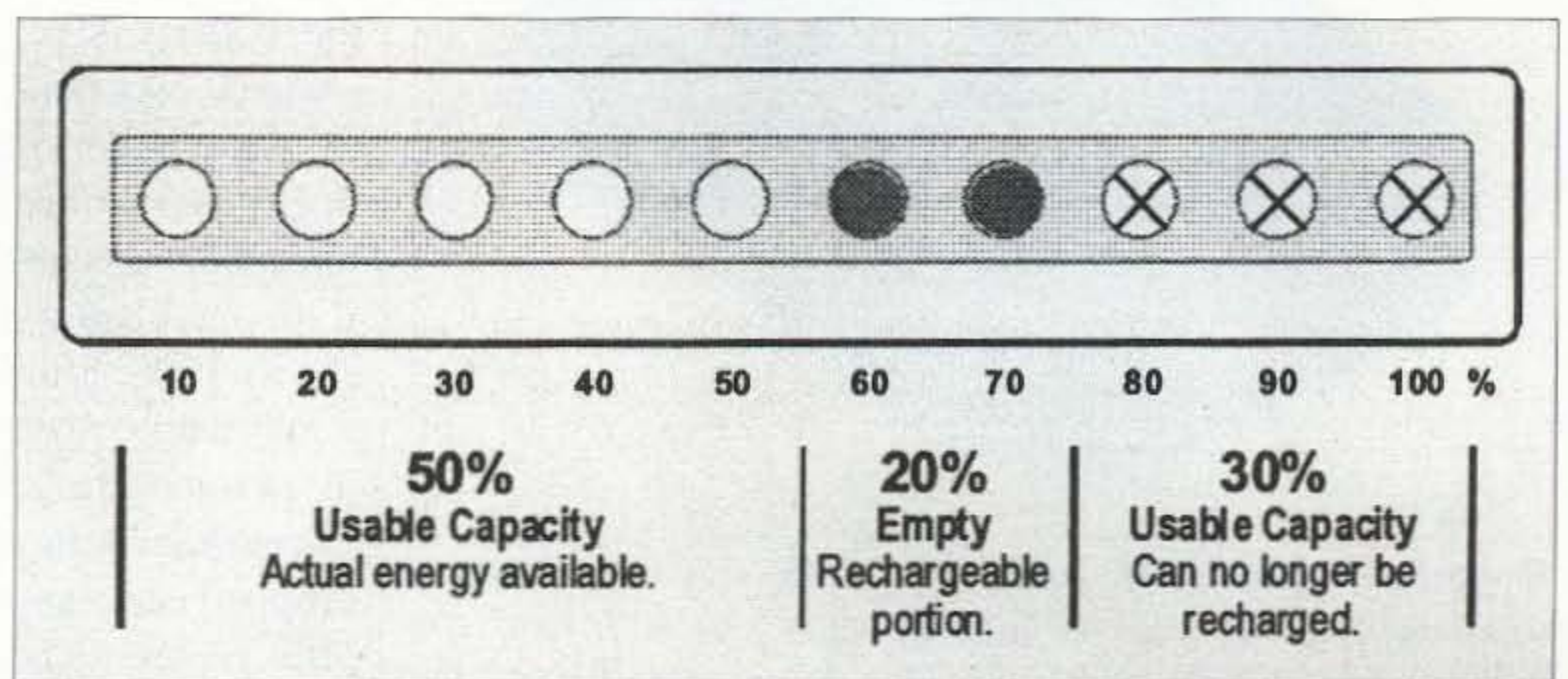

Fig. 5. Tri-state fuel gauge. The Battery Health Gauge reads the "learned" battery information available on the SMBus and displays it on a multicolored LED bar. The illustration shows a partially discharged battery of 50% SoC with a 20% empty portion and an unusable portion of 30%.

discharges as part of regular use. If this occurs regularly, no additional calibration is needed. If a full discharge reset has not occurred for a few months and the user notices the fuel gauge losing accuracy, a deliberate full discharge on the equipment is recommended. Some intelligent equipment advises the user when a calibrating discharge is needed. This is done by measuring the tracking error and estimating the discrepancy between the fuel gauge reading and that of the chemical battery.

What happens if the battery is not calibrated regularly? Can such a battery be used in confidence? Most "smart" battery chargers obey the dictates of the chemical cells rather than the electronic circuit. In this case, the battery will fully charge regardless of the fuel gauge setting. Such a battery is able to function normally, but the digital readout will become inaccurate. If not corrected, the fuel gauge information simply becomes a nuisance.

An additional problem with the SMBus battery is noncompliance. Unlike other tightly regulated standards, the SMBus protocol allows some variations. This may cause problems with existing chargers and the SMBus battery should be checked for compatibility before use. Ironically, the more features that are added to the SMBus charger and battery, the higher the likelihood of incompatibilities.

The need to test and approve the marriage between a specific battery and charger is unfortunate, given the assurance that the SMBus battery is intended to be universal. Ironically, the more features offered on the SMBus charger and the battery, the higher the likelihood of incompatibilities.

The state-of-charge indicator

Most SMBus batteries are equipped with a charge level indicator. When pressing an SoC button on a battery that is fully charged, all signal lights

illuminate. On a partially discharged battery, half the lights illuminate, and on an empty battery, all lights remain dark. **Fig. 3** shows such a fuel gauge.

While SoC information displayed on a battery or computer screen is helpful, the fuel gauge resets to 100% each time the battery is recharged, regardless of the battery's SoH. A serious miscount occurs if an aged battery shows 100% after a full charge, when in fact the charge acceptance has dropped to say 50% or less. The question remains: "100% of what?" A user unfamiliar with this battery

has little information about the runtime of the pack.

How can the three levels of a battery be measured and made visible to the user? While the SoC is relatively simple to produce, measuring the SoH is more complex. Here is how it works:

At time of manufacture, each SMBus battery is given its specified SoH status, which is 100% by default. This information is permanently programmed into the pack and does not change. With each charge, the battery resets to the full-charge status. During discharge, the energy units (coulombs) are counted and compared against the 100% setting. A perfect battery would indicate 100% on a calibrated fuel gauge. As the battery ages and the charge acceptance drops, the SoH begins to indicate lower readings. The discrepancy between the factory-set 100% and the actual delivered coulombs on a fully discharged battery is used to calculate the SoH.

Knowing the SoC and SoH, a simple linear display can be made. The SoC is indicated with green LEDs; the empty part remains dark; and the unusable part is shown with red LEDs. **Fig. 5** shows such a tri-state fuel gauge. As an alternative, the colored bar display may be replaced with a numeric display indicating SoH and SoC. The practical location to place the tri-state fuel gauge is on the charger.

The target capacity selector

For users who simply need a go/no go answer, chargers are available that feature a target capacity selector. Adjustable to 60%, 70%, or 80%, the target capacity selector acts as a performance check and flags batteries that do not meet the set requirements.

If a battery falls below target, the charger triggers the condition light. The user is prompted to press the condition button to calibrate and condition the battery by applying a charge/discharge/charge cycle. If the battery does not recover, a fail light indicates that the battery should be replaced. The green ready light at the end of the service reveals full charge and ensures that the battery meets the

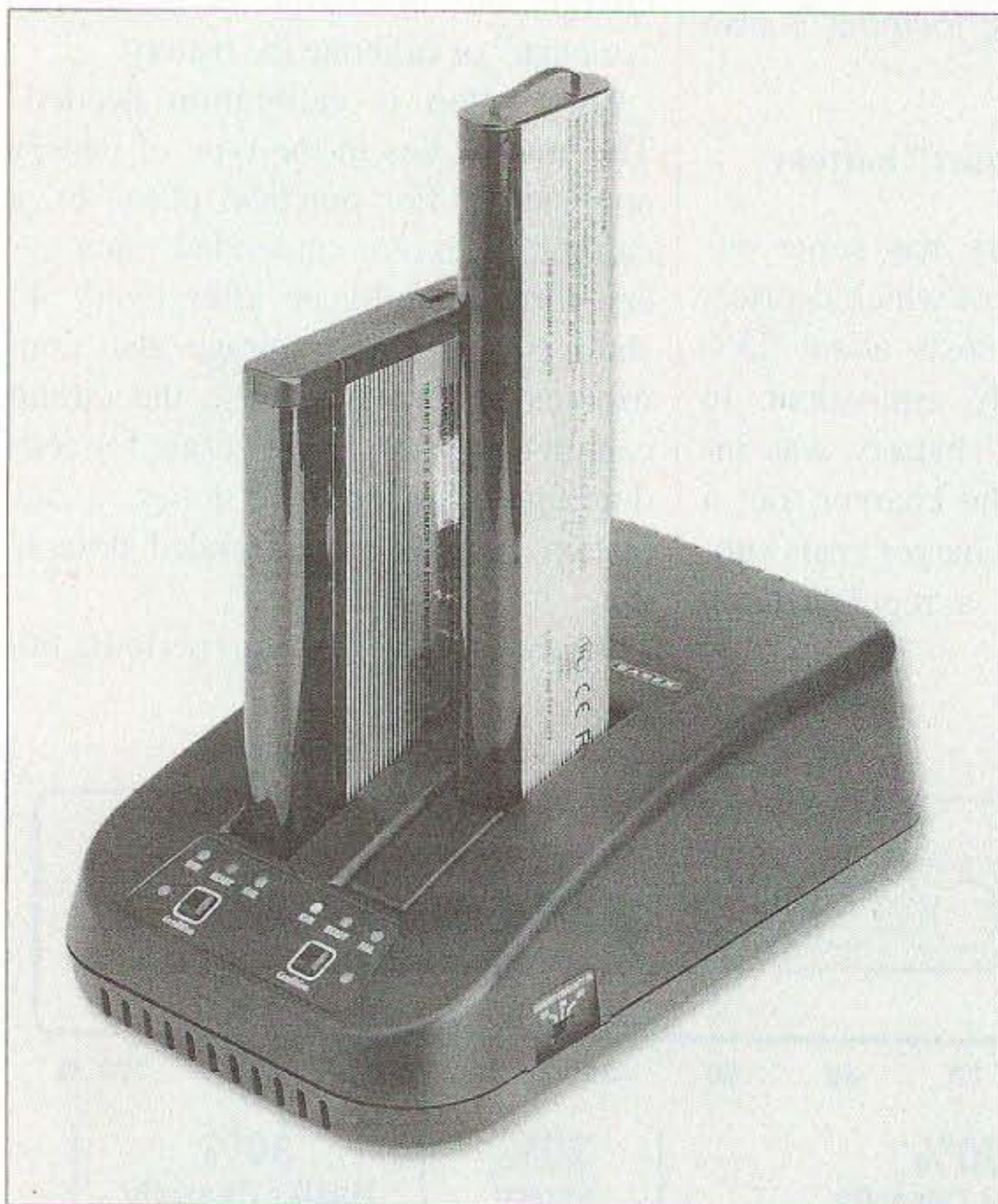

Photo B. The Cadex SM2+ charger. This Level 3 charger serves as charger, conditioner and quality control system. It reads the battery's true state-of-health and flags those that fall below the set target capacity. Each bay operates independently and charges NiCd, NiMH, and Li-ion chemistries in approximately three hours. "Dumb" batteries can also be charged, but no SoH information is available.

required performance level. **Photo B** illustrates a two-bay Cadex charger featuring the target capacity selector and discharge circuit. This unit is based on Level 3 and services both SMBus and "dumb" batteries. SoH readings are only available when servicing SMBus batteries.

By allowing the user to set the desired battery performance level, the question is raised as to what level to select. The answer is governed by the applications, reliability standards, and cost policies.

A practical target capacity setting for most applications is 80%. Decreasing the threshold to 70% will lower the performance standard but pass more batteries. A direct cost saving will result. The 60% level may suit those users who run a low budget operation, have ready access to replacement batteries, and can live with shorter, less predictable runtimes. It should be noted that the batteries are always charged to 100%, regardless of the target setting. The target capacity simply refers to the amount of charge the battery has delivered on the last discharge.

Summary

SMBus battery technology is predominantly used for higher-level industrial applications. Improvements in the "smart" battery system, such as higher accuracies and self-calibration will likely increase the appeal of the "smart" battery. Endorsement by large software manufacturers such as Microsoft will entice PC manufacturers to make full use of these powerful features.

"Smart" battery technology has not received the widespread acceptance that battery manufacturers had hoped for. Some engineers go so far as to suggest that the SMBus battery is a "misguided principle." Design engineers may not have fully understood the complexity of charging batteries in the incubation period of the "smart" battery. Manufacturers of SMBus chargers are left to clean up the mess.

One main drawback of the "smart" battery is high price. In the early 1990s, when the SMBus battery was conceived, price was not as critical as it is today. Now, buyers want scaled down products that are economically priced and perform the functions intended. In the competitive mobile phone market, for example, the features offered by the SMBus would be considered overkill.

In spite of teething problems and relative high costs, the "smart" battery will continue to fill a critical market segment. Unless innovative improvements are made and manufacturing costs are drastically reduced, this market will be reserved for high-level industrial applications only.

About the author

Isidor Buchmann is the founder and CEO of Cadex Electronics Inc., in Richmond (Vancouver), British Columbia, Canada. Mr. Buchmann has a background in radio communications and has studied the behavior of rechargeable batteries in practical, everyday applications for two decades.

Continued on page 58

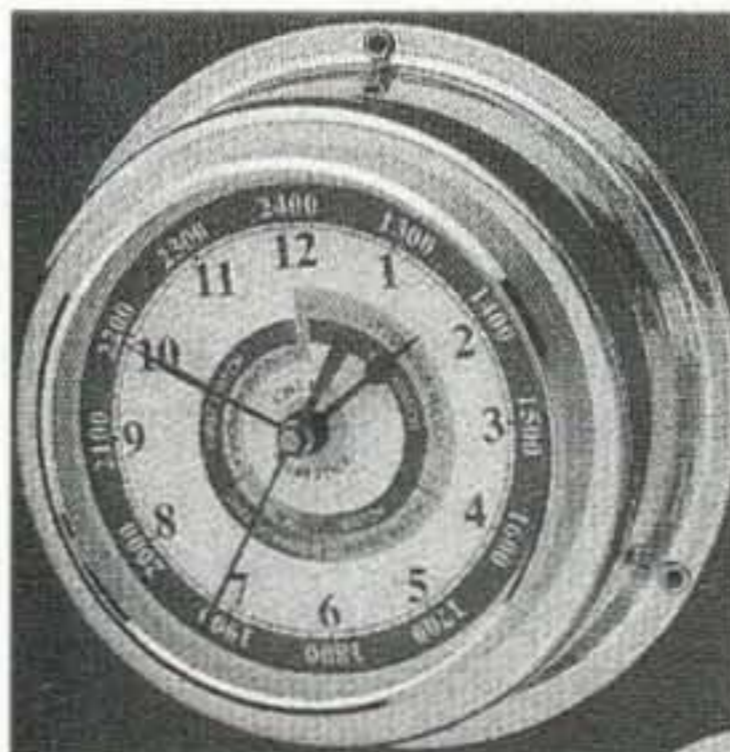

Chelsea Clock

Clockmakers since 1897
The choice of The Coast
Guard Foundation.

Quartz Clock

4" Dial

Beautifully hand-polished.
Stamped brass case and
bezel.
Curved glass crystal.
Wall or bulkhead mounting.
Made so well they last from
generation to generation!
Order this month and save
\$20!

Your price \$75

Omega Sales

P.O. Box 376

Jaffrey NH 03452

1-800-467-7237

If you're a No-Code Tech, and you're having fun operating, tell us about it! Other No-Code Techs will enjoy reading about your adventures in ham radio—and we'll pay you for your articles. Yes, lots of nice clear photos, please. Call Joyce Sawtelle at 800-274-7373 to get a copy of "How to Write for 73 Magazine."

TRANSMITTER LOCATION

New fixed site direction finders provide 2 degree accuracy, and include software for triangulation from a central control site. Mobile versions also available covering 50MHz to 1 GHz

Doppler Systems Inc.

PO Box 2780 Carefree, AZ 85377
Tel: (480) 488-9755 Fax: (480) 488-1295
www.dopsys.com

European Marketing Director Denis Egan
PO Box 2, Seaton, Devon EX12 2YS England
Tel & Fax: 44 1297 62 56 90

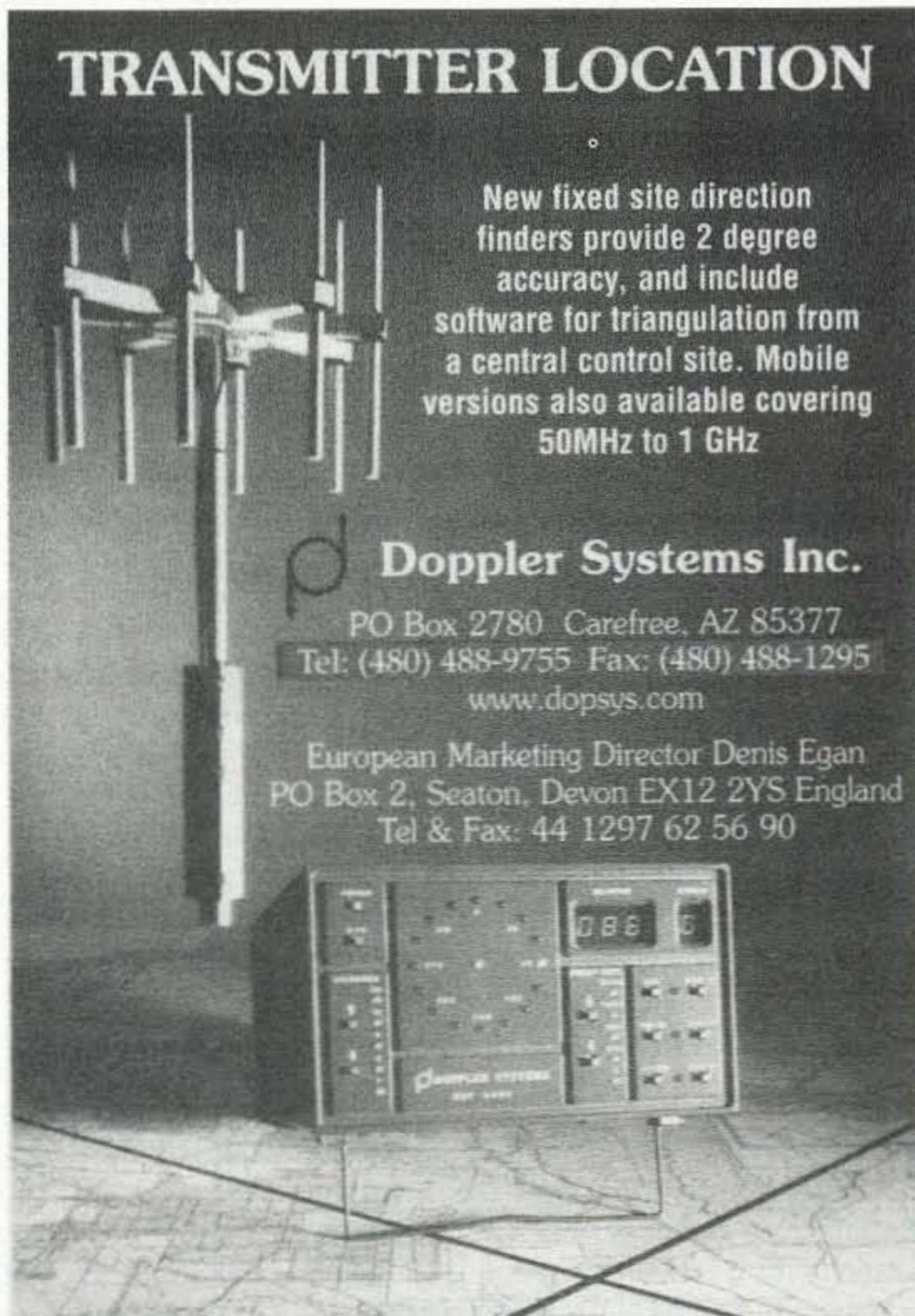

CALENDAR EVENTS

Listings are free of charge as space permits. Please send us your Calendar Event two months in advance of the issue you want it to appear in. For example, if you want it to appear in the July issue, we should receive it by April 30. Provide a clear, concise summary of the essential details about your Calendar Event.

MAR 18–MAY 31

WALL TOWNSHIP, NJ A series of OMARC-sponsored amateur radio classes began March 18th and will run through the end of May. Classes will be held at the InfoAge Center OMARC Diana site, Building 9116 on Marconi Rd., Wall Township. All classes will begin promptly at 6:30 p.m. each Tuesday night for the duration of the course. For directions to the site visit the Web at [<http://www.qsl.net/n2mo>]. For additional details on the classes and to sign up in advance, please contact Larry KB2RIS at [kb2ris@wmconnect.com], or Donna KC2GKQ at [djwilkins59@wmconnect.com]. VE exams are being offered to the public, at the same location, starting at 10 a.m. on April 5th, June 7, August 2nd, October 4th, and December 6th.

APR 9

LAS VEGAS, NV The annual National Association of Broadcasters Ham Radio Reception will take place 6 p.m. to 8 p.m. during the NAB Convention on Wednesday, April 9th. The reception venue is the Hilton Hotel adjacent to the Las Vegas Convention Center. Again this year the reception is co-hosted by *CQ Magazine* and Kenwood Communications. Visit [www.cq-amateur-radio.com] for more information about the convention. On-line registration is at [www.nab.org/conventions].

APR 13

RALEIGH, NC The Raleigh ARS will present its 31st Hamfest and Huge Electronic Fleamarket in the Jim Graham Bldg. at NCS Fairgrounds, Sunday, April 13th, from 8 a.m. to 4 p.m. Wheelchair access. Meetings will be held for ARRL, MARS, ARES and NTS. Full QSL checking. All activities will be held inside. Advance tickets are \$5 each, \$6 at the door. Tables and booths will be available. Free parking. RVs welcome. There will be a Hospitality Supper Saturday night. VE exams, WA4GIR, 919-387-9152. For other questions and business contact Jeff Wittich AC4ZO, 211 Dundalk Way, Cary NC 27511; phone 919-362-4787. E-mail to [ac4zo@arrl.net].

STOUGHTON, WI The Madison Area Repeater Assoc. will host the Madison Swapfest on Sunday, April 13th, at Mandt Community Center, Stoughton Junior Fair Grounds, on South Fourth St. Doors open at 8

a.m. Talk-in on 147.15. For more info contact Madison Area Repeater Assoc., P.O. Box 8890, Madison WI 53708-8890. Phone 608-245-8890. For fast access to more info, check the Web site at [<http://www.qsl.net/mara/>].

APR 19

MORGANTON, NC The 6th annual Catawba Valley Hamfest will be held Saturday, April 19th, starting at 8 a.m. at the Burke County Fairgrounds in Morganton NC. Lots of indoor and outdoor vendor space and free parking. The grand prize is a Yaesu FT-897. Check [www.cvhamfest.org] for complete details. This hamfest is being sponsored by the McDowell ARA and the Western Piedmont ARC.

APR 26

SONOMA, CA The Valley of the Moon ARC, W6AJF, will hold its annual ARRL Hamfest Saturday, April 26th, from 8 a.m. to noon. The hamfest will be held at the Sonoma Valley Veteran's Memorial Bldg., 126 First St. West, Sonoma CA, just one block north of the central Sonoma Plaza. Admission is free and hams are encouraged to bring the entire family. Registration for walk-in VE exams starts at 9 a.m. Testing for all license elements begins at 10 a.m. There will be an electronics swap meet with both indoor and outdoor spaces available. Setup will start at 7 a.m. Spaces \$10 each. Space for informational tables and displays will be made available at no charge for amateur radio organizations. The club will serve a full breakfast from 8 to 10 a.m., including eggs, pancakes, sausage, juice, and coffee or tea for \$5. Demonstrations will include an operating QRP station, AMSAT, a display of home-brewed equipment, and a beginners' DF transmitter hunt. VOMARC members will be on hand to help visiting hams register with the FCC through the Universal Licensing System so they can renew licenses and upgrade. VOMARC will also be participating in the "QRP to the Field" contest which will run during the hamfest. Guest operators are cordially invited to sit in and take a turn operating the club station. For a map and printed directions to the hamfest, send a business size SASE to VOMARC, 358 Patten St., Sonoma CA 95476. Talk-in will be on 145.35(-600) with a PL of 88.5. For more info call Darrel WD6BOR at 707-996-4494, or E-mail [wd6bor@vom.com].

WEST ORANGE, NJ The Irvington-Roseland Amateur Club will host an ARRL-sanctioned hamfest Saturday, April 26, 8:30 a.m. to 1 p.m. at West Orange High School, 600 Pleasant Valley Way, West Orange NJ. Talk-in on W2QR rptr. system, 146.415(+1.0) 85.4T; 224.480(-1.6) no tone; 447.875(-5.0) 156.7T or 146.520 simplex. The club Web page is at [www.qsl.net/k2gp]. Plenty of free parking. Ground level access. Rest room facilities. Food and refreshments. Something for everyone: amateur radio, computers, SWLers, electronic hobbyists. Admission is \$5 at the door, XYL/children under 12 admitted free. Pre-registered tables are \$12 for the first, \$9 for each additional. At the door tables are \$15 for the first and \$12 each additional. Add \$2 for limited number with electric. You must RSVP by April 11th; after that, first come first served. Sellers only admitted at 6:30 a.m. (no exceptions!). Special vendor parking lot. For more info, call Harvey Moskowitz W2YWC, at 973-994-0637; or E-mail [Harvmosk@aol.com].

APR 27

ARTHUR, IL The Moultrie Amateur Radio Klub will sponsor their 41st annual hamfest 8 a.m. to 12 p.m. at the Moultrie/Douglas County Fair Grounds on the south side of Arthur just off of Illinois Route 133, behind the high school. Talk-in will be on 146.055/.655 and 449.925/444.925 PL 103.5. Admission \$5 per person over the age of 14 years. Limited number of tables available at \$10 each, paid in advance. To reserve tables, or for info, write to M.A.R.K., P.O. Box 91, Lovington IL 61937; or call 217-543-2178 days and 217-873-5287 eves for info.

GALVA, IL The 4th annual W9YPS/AA9RO Hamfest will be hosted by the Area Amateur Radio Operators Club, 8 a.m. to 1 p.m. at the Galva IL National Guard Armory on 150 Morgan Rd. Advance 3-stub tickets \$5, 1-stub tickets \$7 at the door. 6 ft. tables \$10. Reserved tables not paid for by April 15th may be reassigned. Breakfast and lunch will be available. Talk-in on 145.490 - 88.5 PL. There is a large outdoor flea market area with handicap parking and the building is handicapped accessible. Some electricity is available, first come first served. Bring your own extension cords. Please contact [wd9hcf@arrl.net] for details about VE exams. For more info contact Mat Bullock W9SIX, 419 College St., Kewanee IL 61443,

[mbullock@theramp.net]; Phil Imes WD9IRE, 908 Zang Ave., Kewanee IL 61443, [kewphil@cin.net]; or Bill Anderson WA9BA, 920 W Division St., Galva IL 61434, [wa9ba@arrl.net].

MAY 3, 4

ABILENE, TX The Key City ARC will sponsor the ARRL West Texas Section Convention and its 18th annual Hamfest at the Abilene Civic Center, 1100 N 6th St., from 8 a.m. to 5 p.m. Saturday, and from 9 a.m. to 2 p.m. Sunday. Free parking. VE exams. Wheelchair access. Limited RV parking for a nominal fee. Tables \$7 each. Pre-registration \$7, must be received by April 29th; \$8 at the door. Talk-in on 146.160/.760. For reservations and info, contact Peg Richard KA4UPA, 1442 Lakeside Dr., Abilene TX 79602; phone 915-672-8889. E-mail to [ka4upa@arrl.net].

MAY 24

WINTERVILLE, NC The East Carolina Antique Radio Club Annual Swapfest will be held 8 a.m. to 3 p.m. at Kiwanis Club, 177 Forelines Rd., Winterville NC 28590. Free admission. Inside tables \$15, outside tailgate \$10, bring your own table/chairs. Setup will begin at 7 a.m. Drinks and hot dogs will be available. Contact Herman Schnur K4CTG, 3205 Brick Kiln Rd., Greenville NC 27858; phone 252-752-2264. E-mail [hschnur@cox.net]. Or contact William Engstrom, 218 Bent Creek Dr., Greenville NC 27834; phone 252-355-8732. E-mail [Wengstrom@vol.com].

MAY 31

WASHINGTON TOWNSHIP, NJ The Bergen ARA will sponsor its Annual Spring Hamfest on Saturday, May 31st, at the Westwood Regional Jr./Sr. High School, 701 Ridgewood Rd., Washington Township NJ. The location is approximately 15 minutes from the GW Bridge and 5 minutes from Paramus NJ. Talk-in on 146.19/.79. Vendors setup at 6 a.m. General admission 8 a.m. to 2 p.m. VE exams 8 a.m. to 10 a.m. only. DXCC card checking. Indoor and outdoor spaces are available. Lots of parking for tailgating. Admission is a \$5 donation (non-ham family members free). Vendors \$15 per space. Rest room facilities and refreshments available. For more info check the BARA Web site at [www.bara.org], or contact Jim Joyce K2ZO at [K2ZO@arrl.net], or call 201-664-6725.

SEP 25-28

SEATTLE WA Microwave Update 2003 organizers and the Pacific Northwest VHF Society are joining forces to host a joint conference in the Seattle WA area on September 25-28, 2003. Registrations for the joint conference will be accepted beginning April 1st. Cost of the registration will be \$40

prior to September 12th, and covers all three days. Single day or single event registrations are not available. Late registrations, including at the door, will be \$50. Registration forms can be downloaded at [www.microwaveupdate.org] or send an SASE to John Price N7MWV, 12026 81st Ave. NE, Kirkland WA 98034, and a form will be mailed to you. Completed registration forms and payment should be sent to the same address. Make checks payable to Microwave Update 2003. Joint conference sessions and the Saturday evening banquet will be held at the Everett Holiday Inn and Conference Center, a short drive north of downtown Seattle. Special rates have been arranged with the hotel for conference participants. Rooms are \$69 per night plus tax, a real bargain for the Seattle area! It is suggested that early reservations be made directly with the hotel at 425-337-2900. Be sure to mention "Microwave Update" to get this rate. Reservations must be made by August 21st for this rate.

"White papers" are currently being solicited from potential authors and speakers for publication in the 2003 conference proceedings. Topics specifically of interest to Microwave Update attendees, as well as those on VHF and UHF subjects usually associated with the annual Pacific Northwest VHF Conference are being solicited. Papers will be accepted until July 1st, 2003, to allow enough time for printing. White papers should be sent directly to Jim Christiansen K7ND, via E-mail at [k7nd@att.net]. MS Word format is preferred. Microwave Update 2003 and the Pacific Northwest VHF Society respectively, will be the sole judges of whether presentation requests and white papers are accepted.

If you are interested in making a session presentation at one of the Microwave Update 2003 sessions, please respond to NU7Z [nu7z@aol.com]. For presentations at the Pacific Northwest VHF Conference sessions, contact N7CFO at [n7cfo@ix.netcom.com]. LCD projection equipment will be available for those using PowerPoint presentations. Slides and video presentations can be accommodated with advance notice.

SPECIAL EVENTS, ETC.

MAY 2-4

MARTHA'S VINEYARD, MA The Fall River ARC will be having its 10th Annual Martha's Vineyard Gay Head Lighthouse DXpedition (IOTA NA-046) starting 14:00 UTC May 2nd and ending 17:00 UTC May 4th. Listen for W1ACT on 14.260, 21.260, 28.460 and 146.550. SASE for a QSL card via Roland Daignault N1JOY, 19 Davis Rd., Westport MA 02790. He can be reached by E-mail at [n1joy@arrl.net].

MAY 10, 11

KANSAS The Kurt N. Sterba Strange Antenna Challenge will start Saturday, May 10th at 10 a.m. Central (15:00 UTC) and end Sunday, May 11th at 7 p.m. Central (01:00 UTC). Main freq: 28.500± 20 kHz as per the QST listing. For more info check the Web at [http://www.leafwerks.net/n0ew/StrangeAntennas/kOs.html]. What are strange antennas? Use metal folding chairs, ladders, painting easels ... anything except wires or pipes. 73

HOUSTON AMATEUR RADIO SUPPLY

267 Cypresswood Drive • Spring, TX 77388

800-471-7373

Local: 281-355-7373

email: houstonamateurradio@prodigy.net

COMPLETE SALES & SERVICE

Yaesu, Icom, ALinco, ADI, Hustler, Cushcraft

Surplus Microwave Parts & Test Equipment

dudleylab.com

Visa/MC/Discover

732-240-6895

Toms River, NJ 08757

WANTED

Fun, easy-to-build projects for publication in 73.

For more info, write to:

Joyce Sawtelle,
73 Amateur Radio Today,
70 Hancock Road
Peterborough NH 03458.

73 Ad Sales

1-800-677-8838

MORSE Express

A Division of Milestone Technologies, Inc.

Everything for the Morse Enthusiast!

Keys, Bugs, Paddles, Keyers, Books, Kits, Tools, Software....

Free Catalog!

www.MorseX.com
(303) 752-3382

The Linux Nation

You might be just a little surprised, just as I was, at how many hams are already involved in using the Linux operating system in their shack computer. Once I started writing little blurbs about my experiences with Linux, I began to receive mail from many hams, most of whom were using Linux for various reasons and applications.

I am oriented toward using my shack computer for digital communications such as PSK31, MFSK, etc. Many hams are satisfied to do their logging and may have a QSL program and, of course, connect to the Internet. It matters little what operating system you use — there is a proportion of interest that demonstrates we all do not think alike even though we are involved in the same hobby.

You may be proficient already with the Linux operating system, or you may be sitting on the outside looking in as most of us have been. I have to admit, it is a challenge to break away from the Windows™ standard.

The truth is, Windows is way out in front in numbers of users, and if “everyone is doing it,” then the programmers write for the biggest group of users. I, by virtue of writing this column for so long, have acquired nearly every piece of ham software available, whether it be freeware, shareware, or commercial, most of it of the Windows persuasion. Plus, in order to put together what you see here every month, I have a sizable collection of what you might call officeware.

This Windows 98se-based system that I use has evolved to near bulletproof status as computer systems might be termed. I have all the Microsoft updates installed and a few tools from the “outside” that help keep the computer functional.

So why change?

Okay, to be perfectly honest, I am not really throwing the Windows machine out in the trash barrel. Nobody that I know of does that kind of rash action. I liken keeping the Windows system running much the same as “keeping my day job.” But it is

tempting, once I get to looking at what is up and running with the Linux desktop installation.

In Fig. 1, you see the KPSK software which does just what its name implies. It transmits and receives PSK31, and it does it intuitively as well as dependably. It is a well written, sophisticated piece of freeware for the use of hams.

While I was discovering the KPSK (and there are other ham software programs available), I was exposed to many other interesting and informative aspects of the Linux operating system. Of great interest is the fact that, if you are highly proficient with Linux, it is possible to obtain and set up a highly sophisticated office environment with no, or at least very minimal, investment. What I am saying is that the operating system and just about all the software you might ever need can be obtained free, and the really good part is that it's legal.

Free? ... Really?

All right— Before I turn this column into a forum to promote Linux, let me explain the position here. I have written a few pages worth of good information and placed it on the Web site. When the Web site comes up, click on the “Linux Project” button and you will get a brief summary of my experiences, including what I have found that worked for me in this particular situation, along with a number of things that did not work.

Although some of what I write today will include intricacies involved in getting a program to install and work for you under Linux, I am going to refer you to my Web site for more about the Linux adventure. Plus you will find links to ham Linux software and info you may find useful to help

in getting started in Linux with fewer headaches than I experienced.

KPSK — today's hot topic

There was, in the beginning, only one reason I wanted to get Linux going, and that was to have the ability to review ham software under the Linux system. It became a challenge and, as one ham remarked, I was getting a great education every time I overcame one of the hurdles along the way.

All that aside, I found there are several digital modes supported. I picked a good program to start with and there are several reasons for that statement. The most obvious is the fact that KPSK is a terrific program and when the time to put it on the air finally arrived, I found it a real pleasure to operate.

I first downloaded the program when I was experimenting with the little \$200 computer that came loaded with the Windows operating system. I was not very adept at using that machine as it arrived on my doorstep. It did what it was purported to do and that was go to the Windows Web site and easily download and install some of the specially prepared software available to run under the Linux system.

That part worked very slick, though I soon found it was quite limited unless I forked over some more bucks. Ignoring the plea for funding, I decided to try my hand at installing the KPSK in the system. This couldn't be too hard? I was to learn differently, and quickly.

Though Windows appears to be a regular Linux operating system complete with a KDE graphical user interface (GUI), there was no way it was going to allow installation of a source code package such as KPSK. One main missing ingredient was a

compiler. Then I began to learn ... and learn ... and learn. Fortunately, I found hams to lend a hand (Linux-using hams, of course).

As you can find on my Web site, the final combination for success was the installation of Red Hat 8. I am sure there are other combinations that offer success in other situations, but this does the trick at this shack with the aforementioned hardware.

Word of caution

The mention I made of a compiler is an absolute essential for the installation the way I approached it. So, when you are getting your Linux system installed, make sure you install anything referred to as a "development tool." That is how the compilers get installed.

You will find most of these Linux distribution disks have a "normal" recommended installation. Tell it you want something usually referred to as "custom." Take your time, go through each category and, if you have sufficient hard drive space, install anything that sounds useful in addition to the development tools. I was pleasantly surprised how many useful "packages" are available that do the same things as many of the expensive Windows titles I am used to using.

Before I go too far, you are soon going to find a need for an Internet connection with your Linux computer. There are several reasons you need the Internet connection. One is, of course, to download software. The other is to have access to answers to your computer problems on the same computer where the problems exist.

My first few transfers of the downloaded KPSK program was via floppy disk before installing a permanent working modem. Not bad, because you will find the program is compact, easily fitting on a floppy.

Here is where one of the advantages of the Red Hat 8 made itself known. (And I am led to understand the Mandrake distribution is at least as friendly.) The floppy worked the way we have become accustomed to floppy drives working in the Windows system. Well, almost. In regular Linux, there is a procedure called "mount" whereby many of the "common, everyday" peripherals we are used to using have to be mounted and the disk has to be mounted as well, before Linux will converse with them.

Red Hat 8 seems to overcome that language barrier almost automatically, allowing us to move files in and out of our new (to many of us) Linux system. I could see this was very necessary as I was looking forward to getting screenshots out of the Linux machine for the world to observe.

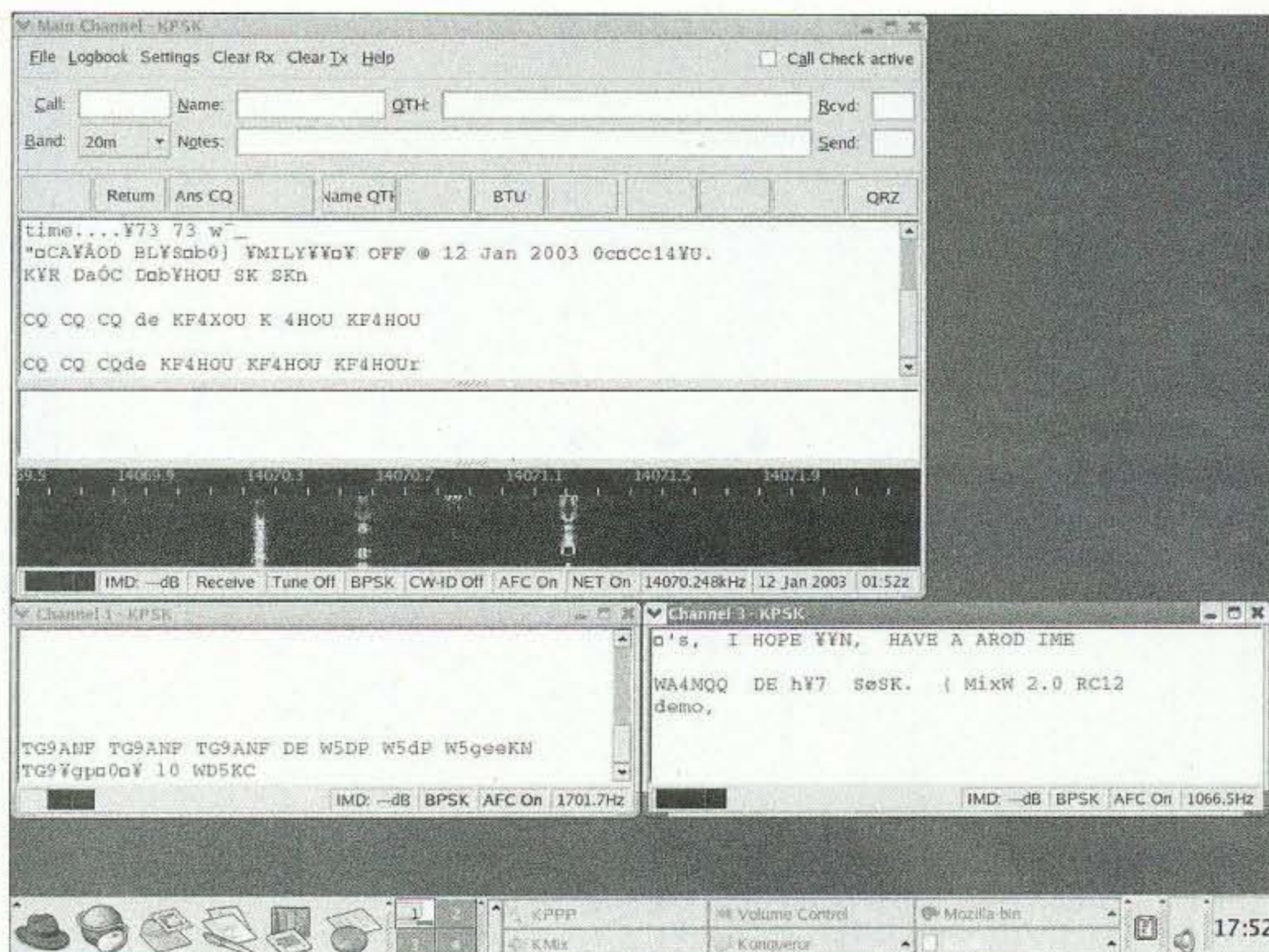

Fig. 1. KPSK screen #1 — The KPSK ver. 1.0 running under Linux is a highly intuitive as well as responsive piece of software. I decided to take this shot with no QSO in progress so I could concentrate on getting three signals decoding simultaneously. In practice, it resembles many of its Windows cousins. It is certainly as easy to use. It comes complete with its own mini-log (see text). You can develop any color scheme you wish in the waterfall as well as use of fonts and colors in the text boxes. The macros are easily written following straightforward instructions in the KPSK docs. You will use the little Call Check box in the upper right often as it grabs anything after "de" in the receive pane. That means you want it off when you transmit and your call is found in that pane. Simple to get used to. The main receive pane is tuned with a left mouse click, and the little auxiliary windows pop up on a right clicked trace. You can fine-tune any of the receive traces by simply activating (clicking on) the corresponding receive pane, then CTRL+ (left or right) Arrow. Slick. You will find shortcuts for such things as saving QSO to log by using the pull-down menus. I left the Red Hat task bar intact in this shot so you might get a glimpse of some not-too-foreign territory. A little reminiscent of Windows stuff. They try to make the Linux GUI not too much of a stretch for us slaves to that other platform.

Incidentally, the folks who have been making these GUIs for Linux users have not been dragging their feet. I expected the only way I was going to get files from one place to another would be by a series of unfamiliar DOS-like commands. Not so. Very early on, I discovered drag-and-drop exists in Red Hat and KDE (whew!). Didn't have to waste a lot of time with basics on my way to fun with hamware.

Install KPSK

Back to the KPSK install. The first thing necessary when you are ready to install the KPSK-1.0.tar.bz2 file (this is the one for KDE3) is to place it in your "Home" directory. All good things result from a good start. You will need to familiarize yourself with the file system in your Linux installation. In a lot of ways, it will remind you of the file tree in your Windows machine. And again, the GUI allows mouse-work to

maneuver through the tree. In the end, after this is installed correctly, your KPSK executable file will be in a subdirectory under your Home directory, and this keeps things in order.

If you are using KDE3 (stands for Konqueror Desk Environment) and have the downloaded file listed above, and have it placed as directed in your Home directory, you are ready to begin the process.

Now, you may have noticed the "if" statements above. Most Linux instructions contain many phrases starting with the words "if you have" because there are a lot of variations (variations, as in what you may have already installed, or have yet to install/replace; and "they" aren't done with the changes by a long reach).

I found several helps upon my entrance into this relatively foreign computer land. One of the best, in the beginning, was the documentation for the KPSK software

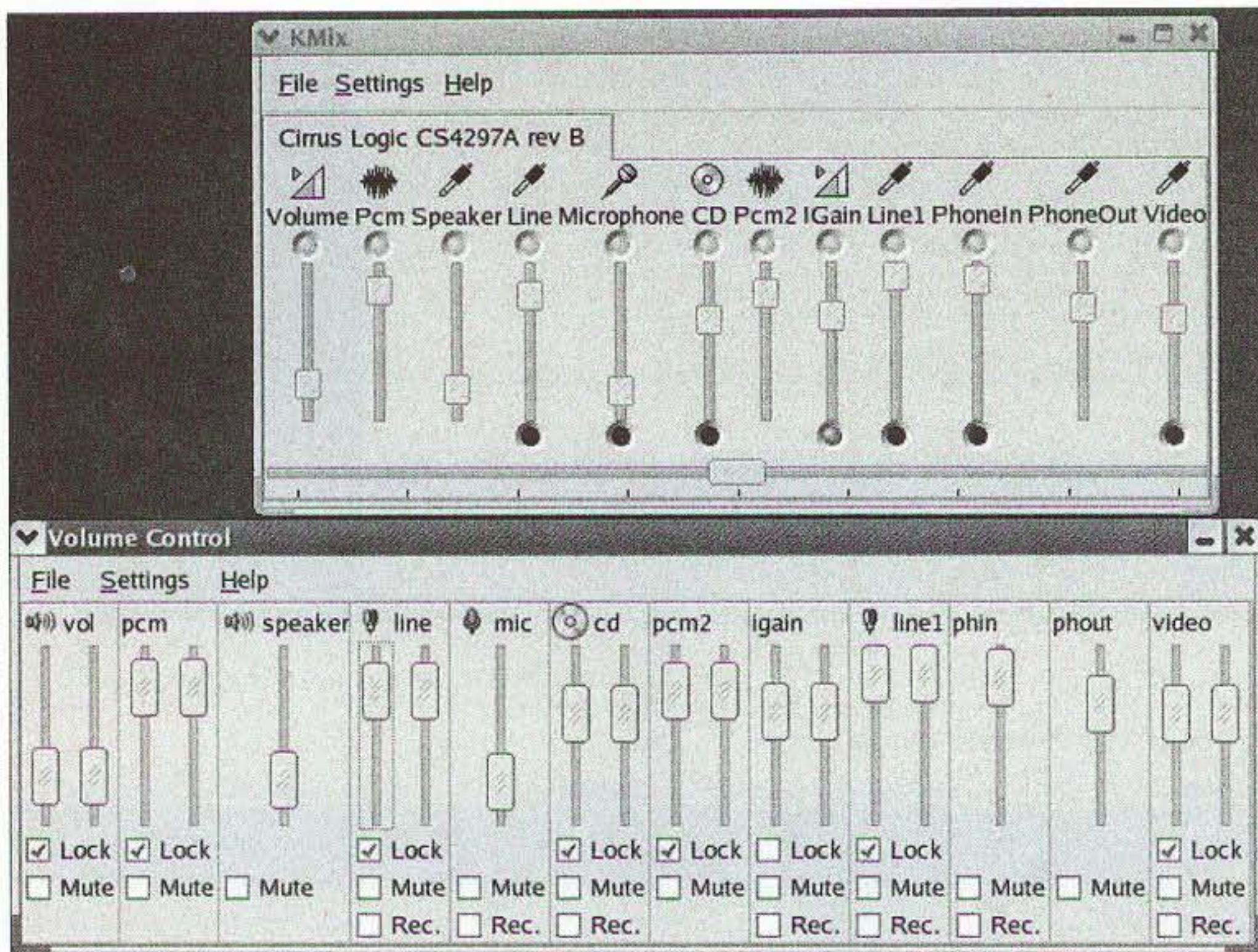

Fig. 2. KDE controls — screen #2. These are definitely more complex and differ from what we are used to in Windows control panels. But they work well. I found the volume control, which is my preferred method of setting zero ALC, very easy to zero in. I think my system is a bit lethargic in response time and found I was experimentally clicking on the various mixer controls in the “KMix” panel to determine which one had me receiving on the correct channel. It seemed to turn out that the I-gain control is correct. Either panel requires a bit of hunting and clicking due to a lack of readily available info, but it really is slick once you get the hang of it. It may look overly complex, but I think the idea is: the needs of the music lovers have been answered better here in two panels than with what takes many panels in Windows applications. And it answers my ham needs perfectly.

found on the first page you come to on the Web when you go to download KPSK. I downloaded and printed that and found it indispensable during installation and setup. You will soon find you have questions. I did, and I have many printed pages of E-mails in a three-ring binder that kept me going.

So, here are a few variations. If you are using a version of KDE2, you will want to download KPSK-0.9.3.tar.gz or possibly one of the earlier versions available on the download site. I was told that if I must use one of the earlier versions, the 0.9.3 worked best. You still place the file in your Home directory but the command to unarchive the files is different according to the extenders on the end of the file names.

As with all else in Linux, I found lots of instructions on this business of unpacking these files, but the following commands worked for me. I found I could enter them by using the Window dropdown menu in Konqueror and clicking “Show Terminal Emulator.” This placed a small window below the Konqueror display and I was able to observe everything going on from one view.

Type into the Terminal Emulator the command `jxvf kpsk-1.0.tar.bz2` (and hit Enter), if you are going to install version 1.0 into the KDE3 system. Or, if you are going to install one of the earlier versions such as 0.9.3 into the KDE2, then type `tar xzvf kpsk-0.9.3.tar.gz` (Enter). (Note: the italicized file names are for example. Use the file name of the file you are unpacking. The extender of the packed file determines the correct “unpack” command.)

If these operations are successful, you will find they take a fair amount of time to complete, as in several minutes. It is a big process and even with the 800 MHz CPU and the meager, but still large, 128M RAM and considerable swap area it is time consuming. If it ends too quickly, you can scroll back through the command lines of the unpacking process and find errors listed. In my case, on early attempts the compiler was missing and it stopped after not finding a “cc” or some variation of that tool.

I mentioned possibly using the earlier KDE2 that I had available under another installation of Red Hat 7.2 and this worked for me up to a point. That point was when I

decided the sound chip was not going to cooperate with the KPSK no matter how I attempted to configure with this RH 7.2 and the KDE2. This could possibly have been solved by a regular Linux guru, but I went on to a better (or simply happier?) clime.

The advantages of the subsequent RH 8 installation were enough so that I started to breathe normally again. Things almost worked like they were supposed to. You will find in the Install and Readme files instructions about running the “Make” command and then the “make install” command. This latter process only works if you login as “Root.”

Now, there was one more thing that was not working. I was having a problem with the soundcard. The soundcard would pass all the tests I could find except I could not decode received PSK signals. Then I read (all else failed) the documentation and found listed there that KPSK would not perform properly with the very soundchip (VIA VT82C686 AC97) installed on this motherboard.

This seemed like a simple thing to fix. I went down to the local store and got a new SoundBlaster SB16 card and installed it. Now I was ready. Well, not quite. Red Hat recognized this fine little plug ‘n’ play card except that it called it an Ensoniq, which was a little upsetting until I learned that was the correct ID in this international manufacturing community. Then all I had to do was find what the different method this version of Red Hat had for configuring the soundcard, bring up the Kmix mixer panel plus the volume control panel (see Fig. 2) and I was off to the races.

One of the neat little built-in bonuses with KPSK is a mini-log system. This system is quite limited, but allows you to keep track of your QSOs adequately. I say it is limited in that the log file does not lend itself to export. I think I have located a Linux-based

Continued on page 58

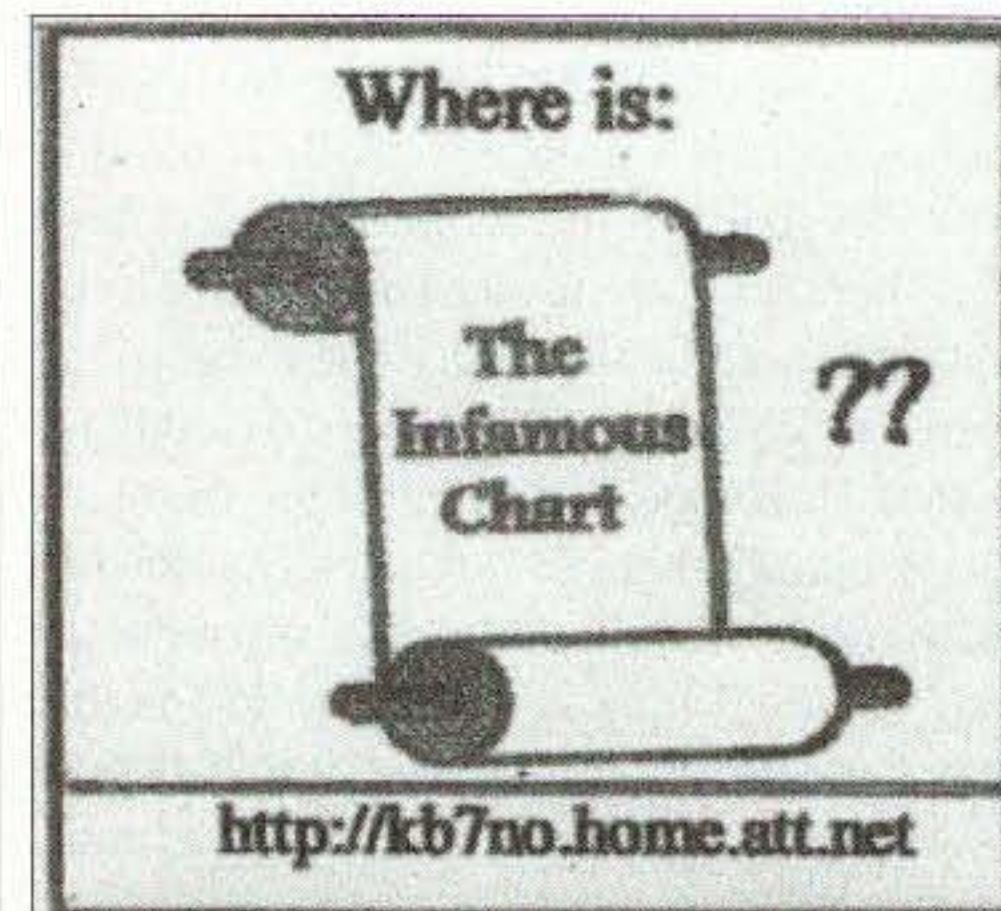

Some Good News from Space

How many satellites can you keep up with? How many can you work in a day? These have become real questions. Since AMSAT- OSCAR-7 was launched in 1974 (still on the air), we have had dozens of new OSCARs (Orbiting Satellite Carrying Amateur Radio) launched into orbit. There have also been quite a few RS (Russian Radio Sport) and other satellites. In December 2002 we got two more, AATiS-OSCAR-49 and Saudi-OSCAR-50.

The third launch of a converted Soviet SS-18 intercontinental ballistic missile (ICBM) under the joint Russian and Ukrainian DNEPR program took place on December 22, 2002. Six satellites were delivered to a 650 km (400 miles) circular orbit with a 65-degree inclination. They included UniSat-2 from the University of Rome, Italy; Rubin-2 (AO-49) from the OHB-System of Bremen, Germany; SaudiSat-1C (SO-50) from the Institute of Space Research in Riyadh, Saudi Arabia; LatinSat-A and LatinSat-B from the Aprize Satellite of Fairfax, Virginia; and a dummy satellite, built in the Ukraine, in place of the future Trailblazer Lunar spacecraft to be launched on a later flight.

The first-ever DNEPR launch occurred on April 21, 1999, and carried UoSAT-12 from Surrey Satellite Technologies, Ltd. of England. The second launch was on September 26, 2000. This flight carried SaudiSat-1A (SO-41), SaudiSat-1B (SO-42), TiungSat-1 (MO-46) from ATSB in Malaysia, and two other nonham satellites. The DNEPRs are doing a great job of taking hamsats into space.

The use of SS-18 ICBMs for satellite launches has proven to be an excellent use for missiles that would otherwise be scrapped or used for military purposes. The SS-18 is the world's largest ICBM and has proven very reliable over the last 20 years. The basic missile is ten feet in diameter and over 100 feet tall, and weighs 211 tons. These liquid-fueled rockets, even after modifications for orbital flights, are launched from silos at the Baikonur Cosmodrome in Kazakhstan, and can carry up to 3.7 metric tons to orbits from 300 to 800 km in altitude.

AO-49

This satellite seems to have many names. Hams now call it simply AO-49 or AATiS-OSCAR-49. AATiS is a German acronym for Arbeitskreis Amateurfunk und Telekommunikation in der Schule which means workinggroup for amateur radio and telecommunications in schools. To the rest of the world, the satellite is called RUBIN-2 from the Fuchs Group (OHB-System, OHB Teledata, Carlo Gavazzi Space and Orbcomm Germany). RUBIN-2 carries several experiments for technology tests and communications experiments.

The ham radio portion, built by the German ham group AATiS, is called SAFIR-M (Satellite For Information Relay). It was developed in close cooperation with the University of Applied Sciences in Pforzheim, Germany. Henning Rech DF9IC led the team. SAFIR-M is a store-and-forward digital system with optional voice beacon capability. The digital downlink is on 145.825 MHz FM packet at 9600 baud. The optional voice beacon also uses this frequency. The uplink is also FM packet, but is on 435.275 MHz at 1200 baud. The system callsign is DPØAIS. Many hams have been involved with AO-49 by downloading and decoding the telemetry, and participating in communications experiments as announced by the AATiS group. For now, just call it AO-49 and start monitoring.

SO-50

SaudiSat-1C, now Saudi-OSCAR-50, is the latest experimental, nonmilitary, satellite built by a team of Saudi scientists

at the Institute of Space Research at the Riyadh-based King Abdul Aziz City for Science and Technology in Saudi Arabia. The satellite program is supervised by Prince Turki ibn Saud ibn Mohammed. The primary mission of the satellite is to provide satellite imagery and data to provide remote sensing capabilities. These images from space are vital to research in agriculture, geography, cartography and natural disaster studies. Due to the small satellite successes of the SaudiSats, Saudi Arabia has

Continued on page 58

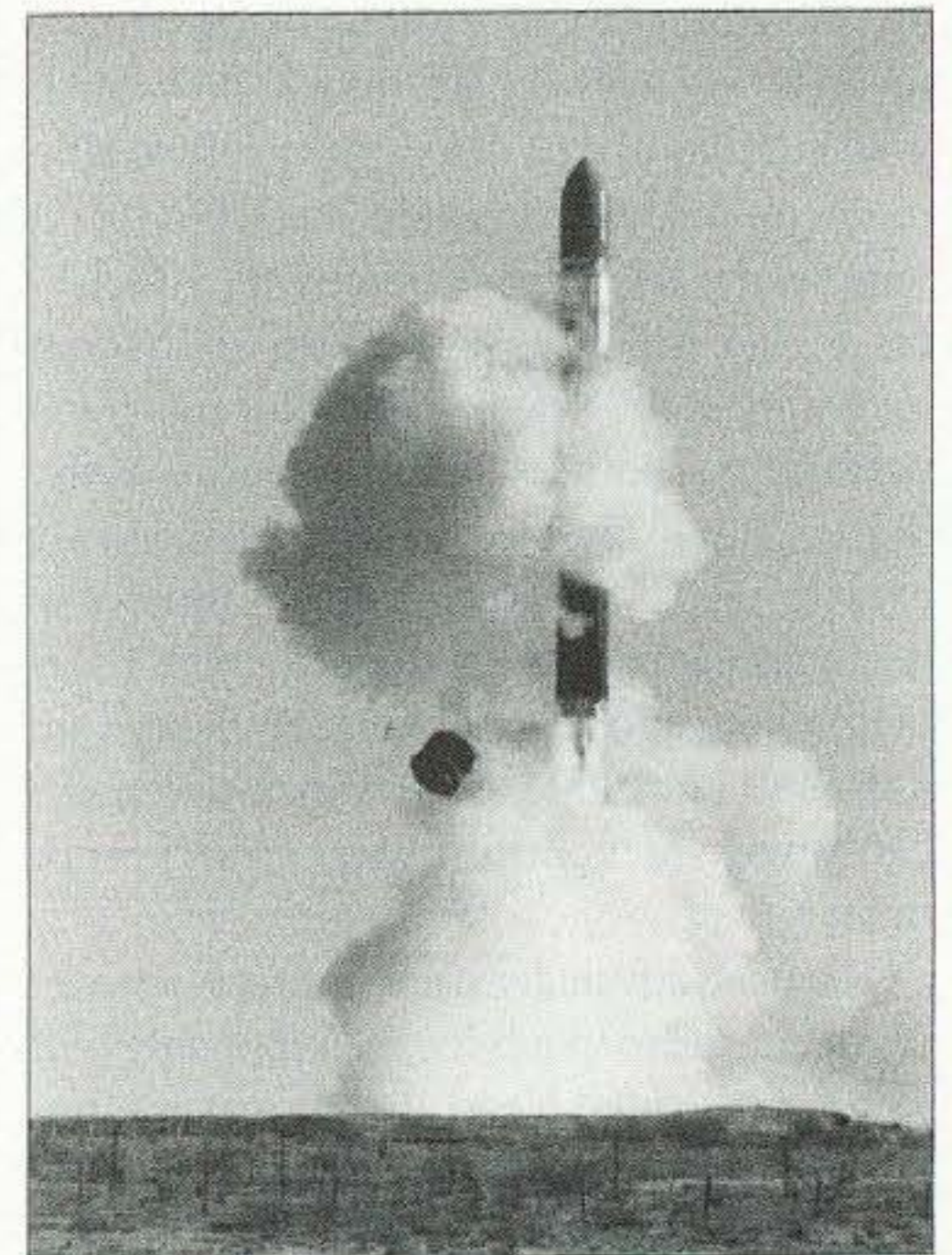

Photo A. The launch of the third converted SS-18 ICBM, under the joint Russian and Ukrainian DNEPR program, put AO-49 and SO-50 successfully into orbit from a missile silo in Kazakhstan.

Where Can I Find ...?

"Wow! Where in the world did you ever find that?" These are the words that make any ham proud of his new gadget. If you're new to amateur radio, you may not know where hams go to find the treasures that make the hobby so much fun.

Obviously, there is not a lot of ham radio equipment available at the local mall or Wal-Mart, but there are quite a few places you can go to find those things that make the hobby possible. Some are pretty obvious, while others are more obscure. Naturally there are advantages and disadvantages to each. For those of you who are new to the hobby, here are some of the places where you may want to invest a little time.

The first, and perhaps most obvious choice is the ham radio equipment dealer. If you live near a dealer, you have some distinct advantages over those who do not. A dealer offers a chance to actually look at and sometimes try out various types of equipment. After all, radios are not merely their technical specifications — the feel of the radio is a major contributor to how much you will like it. At a dealer, you will be able to check out and compare the features on various models from different manufacturers to see which best fits your individual operating style. Maybe computer control is essential, or perhaps it is the quality of the digital signal processor. Are the controls easy to read? As most of us get older this becomes a more critical requirement. I was taught long ago that "if you can't hear 'em, you can't work em." By the same token, if I can't read the control panel, I can't work them either!

The main advantage dealers offer is service. If you need expert advice, you probably will find it at a dealer. Need an optional component installed or have a technical problem? The service department at the dealer's will be there to support you. If you are moving up to a more advanced radio, the dealer will be the one who can offer you a trade-in on your old rig (if you can bear to part with it). Don't have the cash in your pocket? Most

dealers will happily process your credit card. A dealer can make a purchase as easy as necessary for you to leave the store with a carload of goodies. On the other hand, you may pay more for a particular item at a dealer, but providing service and maintaining inventory has a cost, and this value that the dealer has added may make the transaction much more beneficial to you.

The second choice is the local hamfest. Many amateur radio clubs host an annual event that provides a forum for the buying and selling of ham radio and other miscellaneous and sundry products. Someone cleaning out their shack may part with items at a fraction of their original price, and it could include just what you're looking for. While you may make a great deal, you may also walk for miles through the vendor area and not see anything you have on your list. Or, you may find something you never knew existed, and certainly never knew you needed, and happily take off in a new direction in the hobby.

Hamfests offer many other features. Usually there will be the opportunity to take the test for your license upgrade. You can stock up on SkyWarn or ARRL decals or get a name pin or ball cap with your callsign. It's also a great chance to meet those folks you talk with on the local repeater and see what they actually look like. You may be surprised that they don't look like what you expected — but then they will be equally surprised with you. If you don't live near a dealer, a hamfest may be your chance to see their offerings, as many dealers set up large booths at some hamfests. Usually they will have new, in-the-box products representing some of their most popular sellers. And, of course, there will be the ever popular credit card machine hooked up to a cell phone to ensure that you can quickly and easily take possession of your new equipment.

When I lived in Ohio, I could spend a fair number of weekends over the year at various hamfests. Now that I am in a more rural area, I don't expect to have as much opportunity to participate in the hamfest hunt. That is one of the downsides of hamfests — you have to be within a reasonable distance to enjoy one. One of the other downsides is that with the exceptions of dealers, most purchases are cash only and all sales are final. Nothing is perfect, but they sure are fun.

The local ham club offers a couple of other options for finding the perfect piece of radio gear. Many ham clubs offer tailgate parties on some weekends or in conjunction with their regular club meetings. Club members bring their offerings in the trunks of their cars or the backs of the SUVs, park in a designated area and have a mini-hamfest. Clubs also offer classified ads in their newsletters to help members buy and sell gear and many have on-the-air swap meets, usually on the local repeater. It has long been determined that items specifically aimed at amateur radio can be offered on the air. Even so, some clubs may impose the rule that prices are not to be discussed over the air.

With the World Wide Web, there are many additional opportunities available. Most dealers have Web pages that include their entire catalog, product data sheets, and brochures. You can also see what used, demo and consignment equipment is available. Naturally, you can place an order at the Web site with your handy-dandy credit card over a secure Internet link.

Many ham clubs have Web pages with swap and shop offerings, and there are often links to other clubs or other ham sites.

Continued on page 59

ADVERTISERS' INDEX

R.S.#	page	R.S.#	page	R.S.#	page	R.S.#	page	
• Alinco	CV2	10	Communications Electronics, Inc.	5	136	Milestone Technologies	43	
• Alinco	CV3		• Communications Specialists, Inc.	19	• Omega Sales	25	• Radio Book Shop	57
• All Electronics Corp.	11		• Doppler Systems	41	• Omega Sales	36	• Radio Book Shop	59
16 Astron Corporation	2		• Dudley Lab	43	• Omega Sales	41	• Radio Book Shop	63
• ATOC Amateur Distributing Corp.	CV2	13	• Fair Radio Sales	33	• Radcomm Radio	13	34 Ramsey Electronics	3
• ATOC Amateur Distributing Corp.	CV3	33	• Houston Amateur Radio Supply	43	• Radio Book Shop	15	• RLS	15
• Bilal Company	33	42	• Isotron	33	• Radio Book Shop	19	254 Ross Distributing	36
168 Buckmaster Publishing	19		• M ²	58	• Radio Book Shop	25	• Scrambling News	25
99 Communication Concepts, Inc.	13		• Michigan Radio	49	• Radio Book Shop	36	• SGC	7
					• Radio Book Shop	41	• SGC	9
					• Radio Book Shop	43	• Universal Radio	33
					• Radio Book Shop	53	• West Mountain Radio	15
							• Yaesu	CV4

When you buy products from these advertisers, please tell them that you saw their ads in 73.
 Subscribe to 73 right now...call 800-274-7373 (9-5 Monday-Friday EST).



Michigan Radio
SALES SERVICE

Local & Tech 1-810-771-4711, Service 1-810-771-4712, Fax Service 1-810-771-6546

WE SHIP WORLDWIDE

OPEN
TUES, WED, THUR 10-6
FRI 11-8
SAT 10-3
CLOSED SUN & MON



Terms do not include shipping. Price and availability subject to change without notice. Most orders shipped same day. COD's welcome (\$5.50 & shipping).

26014 Groesbeck, Warren, MI 48089
1-800-TRU-HAMM (orders only)
 (800-878-4266)

Now on the World Wide Web

<http://michiganradio.com>

E-mail mirad@mich.com



KENWOOD



ICOM



YAESU

Convert Excess Equipment to CASH • We buy good, clean, used equipment • Estate Sales

Two New Tools for T-Hunting

As the snow melts and the days warm up, it's time to plan for another season of hidden transmitter hunting, both in cars and on foot. This month, "Homing In" looks at two new items for your radio direction finding (RDF) arsenal and invites you to Ohio for USA's biggest foxhunt of the year.

My local ham radio store doesn't carry MRDF equipment. Yours probably doesn't, either. Maybe they all will someday, but for now, most foxhunting fans are building their own gear or ordering it by mail. Just becoming available are two items worth a close look.

New loop from Arrow

Al Lowe NØIMW, proprietor of Arrow Antennas,¹ has been interested in providing

equipment to foxhunters since he started his company. In previous years he has introduced some RDF-related products, including an offset attenuator and a yagi with adjustable element lengths and spacing to cover a wide frequency range. They were good products, but never caught on. Perhaps they were ahead of their time or just needed more advertising.

Arrow's current line of yagis appeals to a larger ham market, including backpackers and others who need lightweight portable

beams. The aluminum arrow shaft material in the elements makes them about half the weight of comparable yagis made from tubular aluminum. They're so much easier to carry in the field that the 146-3 two-element yagi, which weighs less than one pound, has become a favorite among some T-hunters for sniffing on foot at the end of the hunt.

The 440-3 model for 70 centimeters has only a 16-inch boom and is great for sniffing foxes on that band or tracking the third harmonic of two-meter signals. There's even an Arrow yagi with elements for both bands, the 146/437-10. With dual

feedlines, it's intended for satellite users but some hams like it for sniffing on the fundamental and third harmonic of two meters. If you need a beam for an "odd" frequency range, such as 172-173 MHz for the Saskatchewan Burrowing Owl monitoring project,² Arrow will make a custom 3-element yagi for you at a reasonable price.

Arrow's new loop antenna (Model FHL for \$59) is based on a proven design for the VHF aircraft band. Al came up with an improved method of construction, making it more rugged and insuring uniformity from loop to loop. It's not a resonant loop, so no tuning is needed. Non-resonant loops are less efficient, but they are directional over a very wide frequency range. This one should work anywhere between 40 and 215 MHz. I have checked it at several frequencies throughout that range with the setup in **Photo A**, and I obtained good directional nulls when I had an unobstructed path to the source.

Nulls? That's right. You get best bearings with small loops by using the minimum-signal pattern points, which are in the directions "through the loop." By "small" loops, I mean always less than one-third wavelength in circumference, and typically less than 0.1 wavelength. Because of its size and electrostatic shield, the Arrow loop behaves more like a coil than a wire antenna.

Just as with the rod antenna in your transistor AM radio, there are two directional nulls, 180 degrees apart. Nulls are much sharper than the broad peaks off the side. You'll have to figure out which of the two nulls is the right one. Sometimes it's easy (when you know the FM broadcast station you're seeking is on a hill, for instance). At other times, it's not. Parasitic elements like directors and reflectors aren't suitable for fractional-wavelength loop antennas like

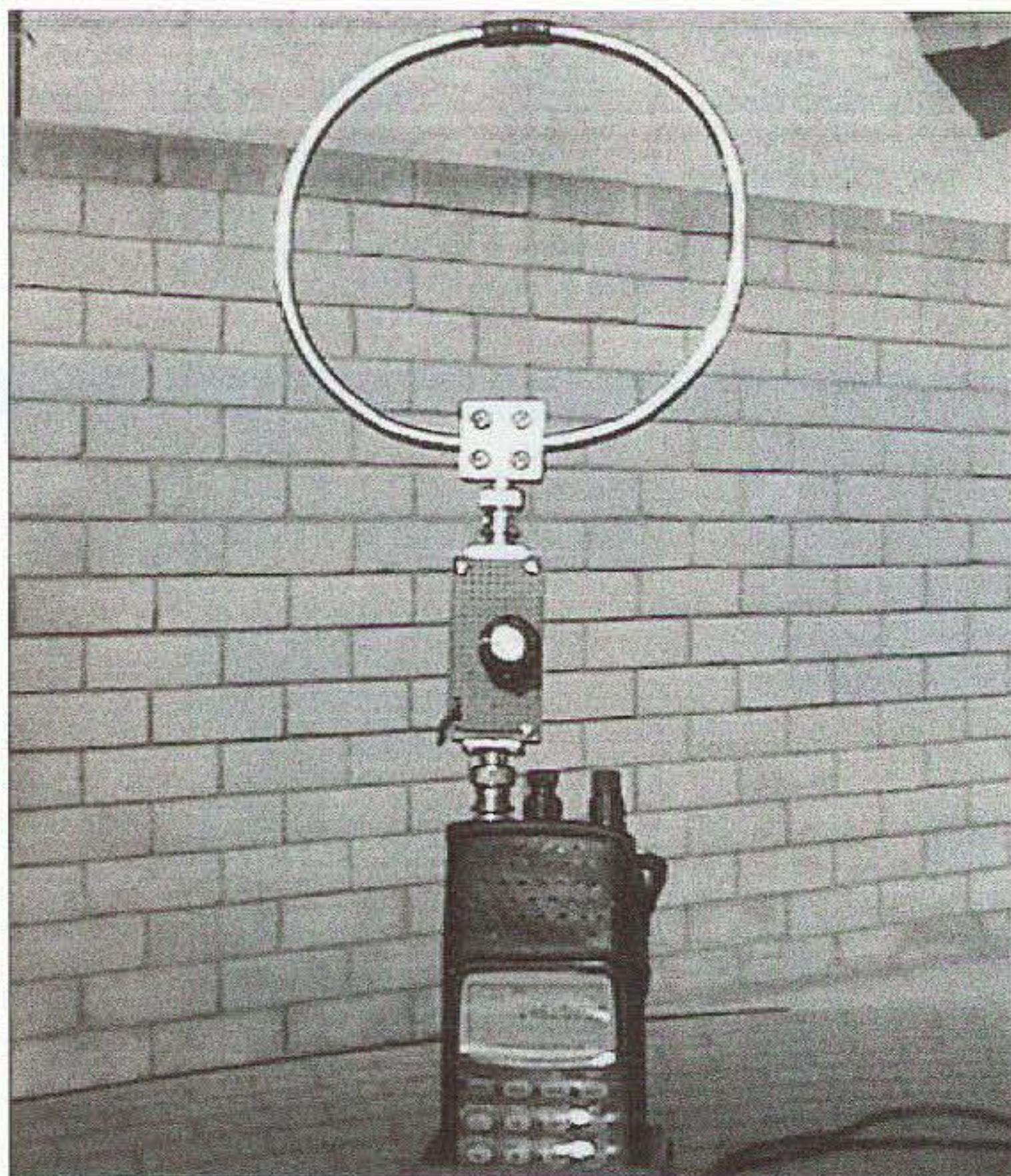

Photo A. Here's a way to get bearing lines over a wide range of VHF frequencies. Use the Arrow FHL loop, connected through a home-built offset attenuator to a wide-range receiver such as the Icom IC-R10. This loop is only available with a BNC type connector. (Photo by Joe Moell KØOV)

this. Shielding methods such as screens and metal plates won't make them unidirectional either.

Loops are not "high performance" antennas for VHF/UHF RDF because of their bidirectional nulls and reduced sensitivity as compared to beams. Signal reflections arriving at right angles to the direct signal will "fill in" the nulls, making it difficult or impossible to get useful bearings when they are present. But for special situations, such as the hunt for strong interference on a frequency for which you don't have a beam, a loop can do the job, and it's easy to carry in the "bag of tricks." For best results, take loop bearings in clear areas, away from your vehicle, other large metal objects and long wires. It's hard to tell the exact line of bearing by peering through the loop, so I recommend attaching a short non-metallic sighting stick, carefully oriented at right angles to the plane of the loop.

Since nulls become hard to detect when the signal gets very strong, you'll need an RF attenuator to pinpoint the signal source. Arrow Antennas sells a resistive attenuator with toggle switches, which is fine for mobile hunting with a beam. However, it's not suitable for use with a hand-held receiver, because strong signals enter directly through the case. The solution is to use an offset attenuator, which shifts a controllable fraction of the signal to another frequency. You can build one at home for about fifteen dollars. Offset attenuator plans and kit information are at the "Homing In" Web site.

Best Aussie sniffer ever

A handie-talkie with S-meter and an offset attenuator are all you need to get bearings and find foxes on two meters with your directional antenna. You can win some local hunts that way, but as you advance as an international-rules competitor, you'll appreciate special ARDF receiver sets with features to make you more efficient, such as a tone-pitch signal-strength indicator. I have described sets of this type by hams from Canada, Ukraine, Russia, and Australia over the years.

Of them all, the Aussies have been the first to incorporate the very latest receiver components and technologies. In 1999, Bryan Ackerly VK3YNG brought his unique microcontroller-powered receiver to the First IARU Region 2 ARDF Championships in Portland, Oregon (**Photo B**). Everyone was impressed, but his set was still experimental, not ready for production. Now the latest version, called Sniffer 4, is fully tested and available (**Photo C**). Sniffer 4 was

designed by foxhunters for foxhunters, and it shows.

Bryan's set doesn't receive DC to daylight like many HTs, but it covers 10 MHz in two chunks that include the full American two-meter band and the VHF aircraft band. Who will be the first to use it to find a wayward Emergency Locator Transmitter (ELT)? Frequencies are entered in the usual 4-digit way, so punching in "F6565" sets it to the USA T-hunting frequency of 146.565 MHz and "F2150" brings up the 121.5 MHz aircraft ELT frequency. A touch of the mode button changes the output between AM and FM reception on either band.

Australian foxhunters like tone-pitch signal strength indicators. They call it the whoopee mode because of the "wheeee-ooop" sound they make as the beam is swept across an incoming signal. Sniffer 4 has a high-sensitivity whoopee response, insuring the most accurate bearings possible for your directional antenna. You can use it with a yagi, quad, phased array, or even the Arrow loop.

The automatic attenuation feature requires a bit of self-training, but it's worth it. As you approach the fox and the signal gets stronger, Sniffer 4 automatically increases the input RF attenuation in range steps of about 15 dB each and beeps to tell you when a range change takes place. The single-digit indicator normally displays the current attenuation range. When the signal goes off-air, attenuation drops out in two seconds (which you can change between 1 and 5 seconds). This keeps you from missing a weak transmitter that might also be part of the hunt.

It may be hard to get used to not manually dialing in attenuation, but this never-miss-a-weak-T feature makes it worth trying. If you insist, you can disable the automatic ranging and step the attenuation by pushing a button. The



Photo B. Contact this chap if you want a Sniffer 4. He's Bryan Ackerly VK3YNG, shown here treating an ankle injury he got on the two-meter hunt at the IARU Region 2 ARDF Championships in Portland, Oregon, back in 1999. (Photo by Joe Moell KØOV)



Photo C. Sniffer 4 is built into a rugged epoxy case with a membrane keypad to make it relatively impervious to rain. But you have to take out four screws to change the batteries. (Photo by Joe Moell KØOV)

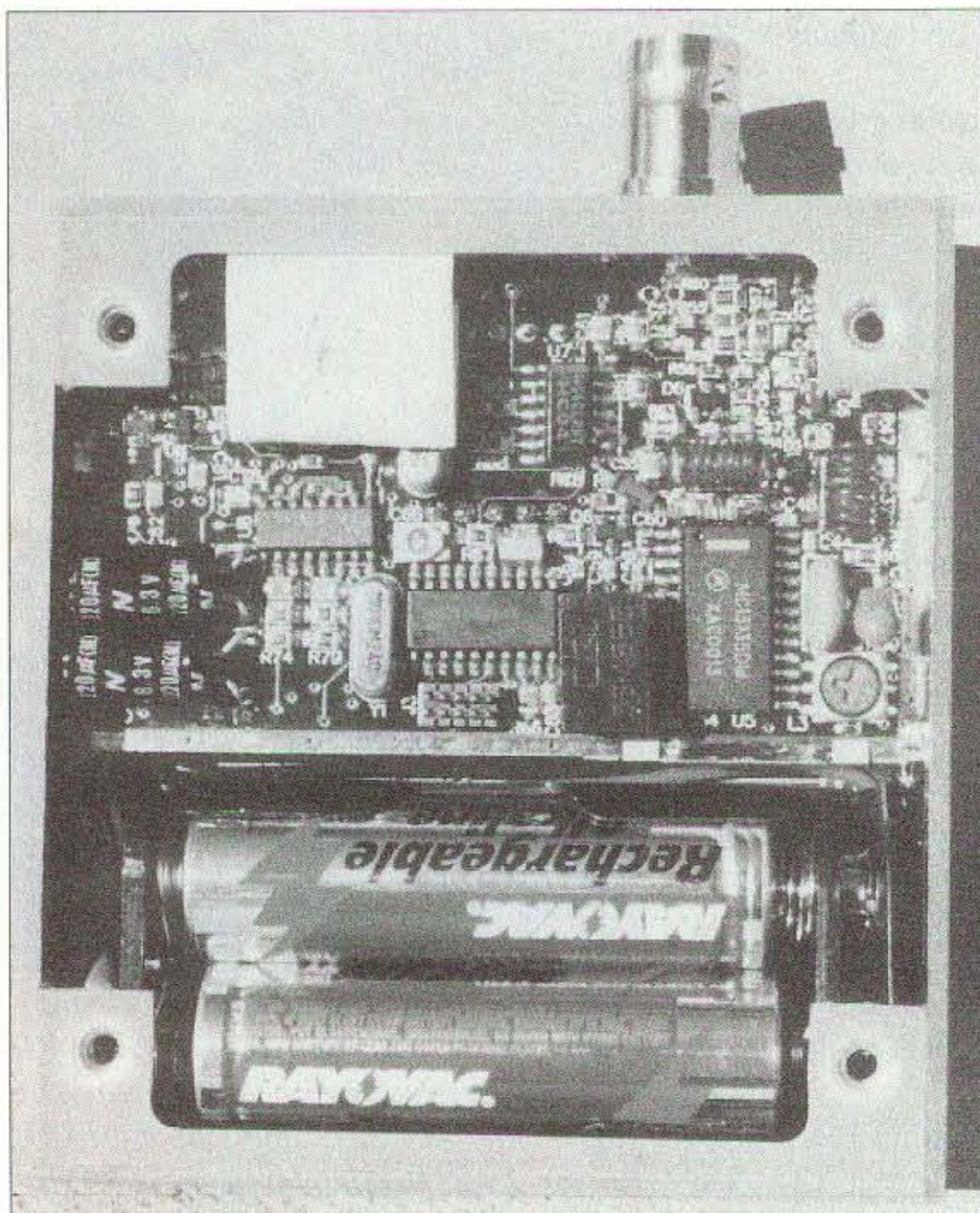

Photo D. Inside, Sniffer 4 is a rugged assembly of surface-mount parts. I'm glad I didn't have to build it! (Photo by Joe Moell KØOV)

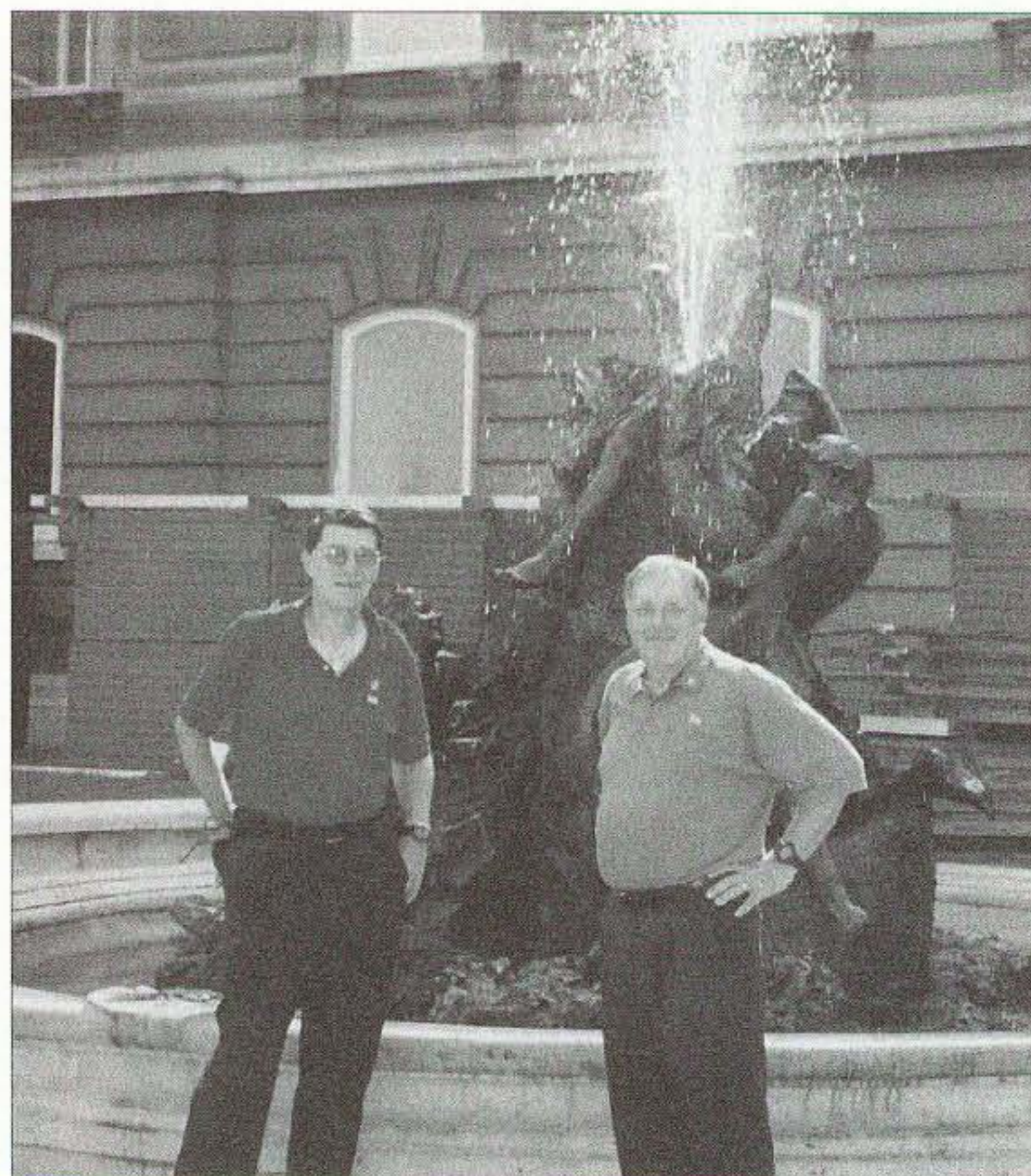

Photo E. Bob Frey WA6EZV (left) and Dick Arnett WB4SUV are co-chairs of the Third USA ARDF Championships, beginning July 30 near Cincinnati. They were also co-captains of Team USA at the 2002 ARDF World Championships in Slovakia. This snapshot is from that trip. (Photo by Bob Frey WA6EZV)

display digit is plenty bright in sunlight, and a sensor activates a reduced brightness mode for night hunts.

The term "sniffer" implies a receiver with reduced sensitivity and selectivity, intended primarily for closing in on strong signals. But in my tests, the audio strength indicator would easily detect a 2 microvolt signal on two meters. That's not quite as sensitive as most handie-talkies, but it's good enough to hear all the foxes on an international course when used with a 3-element beam. At the other end, a 100 millivolt signal (maximum output of my bench RF generator) only registered in the "5" range on the 9-step attenuator. So there should be no problem sniffing out high-power transmitters.

Even if you already have a complete mobile RDF setup, Sniffer 4 can add to it as a dedicated "You are here!" radio. Put it on the dash with a rubber ducky antenna and it will give you a running idea of how close you're getting. That's especially helpful if you hunt only with a Doppler set.

When you're listening to whoopee signal strength in the speaker, you can't hear the signal modulation. Depending on the hunt, you may not be able to tell which transmitter in a multi-T hunt is on the air. So Sniffer 4 supports stereo headphones. In one ear, you get whoopee tone, and in the other, signal audio. There are six frequency memories, enough for most hunts since you don't have to store extra frequencies for offset attenuation.

Two AA alkaline batteries will power Sniffer 4 for about three hours, depending on volume, indicator brightness, and whether you wear headphones. That's enough for an international-rules hunt. If you're willing to spend more, lithium batteries will keep it going for about 14 hours. I'm experimenting with Rayovac rechargeable alkaline batteries,³ charging them up promptly after every hunt. A pair of nickel-cadmium (Ni-Cd) or nickel metal hydride (Ni-MH) batteries in the supplied holder won't do, because their terminal voltages are too low.

Another option would be three cells in series, either alkaline, Ni-Cd, or Ni-MH. Sniffer 4 will operate at up to 5 volts, so this would give more "headroom" for voltage drop as batteries discharge. But there's not enough room for three AA-size cells inside — you would have to modify the unit for external DC power (**Photo D**). An indicator tells you when the batteries are getting low. If you forget and leave the unit on, it will shut itself off after ten minutes of inactivity, meaning no button pressed and no attenuation change.

But wait, there's more! Like most microprocessor-controlled radios, there are bells and whistles for advanced users, such as a memory to tell you the maximum attenuation value achieved since last frequency change or power-up. There's also a 0-to-99% battery-remaining indicator, automatic volume reduction when the battery gets low, and a low-tone whoopee option for persons with poor high-frequency hearing. For Scouts and other beginners, there is a reduced-functionality mode that simplifies operation.

Best of all for 5-fox international competitions is a built-in timer. Synchronize it to the start of fox #1 and it will beep a warning ten seconds before the end of each fox's transmission, then beep out the number of the next fox to transmit. At switchover time, it immediately resets the attenuation to minimum so you are ready if the next fox is weak.

At the last southern California radio-orienting practice session, I was one of four foxhunters who took Sniffer 4 sets on the 4-kilometer six-fox course. All of us were impressed with the features and performance. There were only two minor problems: The timer lost track of fox numbers because there were six of them, so we just ignored the number indications. Also a practice transmitter on

146.76 MHz caused QRM to the 146.565 MHz signals when it was within about 100 yards.

Sniffer 4 is a great example of gear that's designed by the innovative people who will be using it. As I write, it's available for a little over 200 US dollars, shipped directly from Ferntree Gully. With it comes a mini-CD containing the instruction manual and schematic in PDF form. The manual is also available for download on the Web.⁴

Cincinnati hosts the world

A great opportunity to use your sniffing gear, whatever type you prefer, is coming this summer. Start practicing now for the Third USA ARDF Championships, July 30th to August 3rd, near Cincinnati, Ohio. Medals are awaiting the best radio-orientees in nine age/gender categories, from 19-and-under to 60-and-older.

You may have passed through Cincinnati on your way to Dayton, but you may not have realized that it's a hotbed of foxhunting activity. Monthly mobile T-hunts have taken place in all four seasons for over 15 years, usually bounded by the Interstate 275 loop that includes about six hundred square miles of Ohio, Kentucky, and Indiana. Hence the club name: OH-KY-IN Amateur Radio Society. The club also holds on-foot hunts at picnics, hamfests, and Scout events.

More recently, these Cincinnati hams have developed their skills at radio-orienting under international rules. Three of them competed at the Second USA Championships last year in Pine Mountain, Georgia.⁵ Not only did they bring home four medals, they paid careful attention to how the events were organized and administered, so they can do just as good a job this summer.

As usual for a fully hosted multi-nation ARDF event, the USA Championships will get under way with a training day. Practice foxes will transmit on both 80 meters and two meters at Miami University in Oxford, Ohio. Next day, the competitors will be transported to a previously undisclosed location for the two-meter hunt. They will be given their orienting maps and individually timed as they set out on the course. The five foxes transmit for 60 seconds each in rotating sequence, sending an easy-to-recognize identification as explained many times previously in this column.

Winners will be the ones who find the most fox transmitters and navigate to the finish line in the least time. Besides their

maps, they will have a fox transmitter on a separate frequency to home in on at the end. Next day will bring a similar event in a different place with foxes on the 80-meter band. OH-KY-IN isn't giving any clues about course length, but typically it's 4 to 8 kilometers direct from the start to each fox in the shortest sequence and then to the finish. Your mileage may vary, as they say, depending on your RDF skills.

The International Amateur Radio Union (IARU) has designated this event as the Second IARU Region 2 ARDF Championships, which means that individual foxhunters are invited from all countries with IARU member societies. Despite the present uncertainties of international air travel, OH-KY-IN members are hoping to welcome visitors from both Europe and Asia, in addition to Canada and the USA. Last year, 14 states were represented at Pine Mountain — it would be great to have even more this year.

OH-KY-IN ARS co-chairs overseeing the plans are Bob Frey WA6EZV and Dick Arnett WB4SUV (**Photo E**). Both have a wealth of experience in the sport, having competed at the 2001 and 2002 USA National Championships, the 1999 IARU Region 2 Championships, and the 2000 and 2002 World Championships. Additional support will be provided by the Cincinnati Orienteering Group.

To make it easier for visitors, especially those from abroad, group housing and local transportation will be available. OH-KY-IN ARS has arranged for a block of double-occupancy rooms at Havighurst Hall, a co-ed dormitory at Miami University, close to five buffet dining halls on the campus. Alternately, attendees may arrange their own lodging and meals.

There will be plenty of champions in Cincinnati this summer, but everyone, champ or not, is invited to attend and participate. If you can walk or jog a 10 km race course, you have the stamina to complete an ARDF event. If you achieve good scores on orange orienting courses, you are well on your way to becoming a top-tier radio-orienter. All you need is some practice with direction-finding equipment. For that, why not organize the hams in your town to have some on-foot foxhunts. Get started now while there's plenty of time. To make sure you're committed, go to the Cincinnati Championships Web site [www.ardfusa.com] and sign up. Maybe you'll become an international champion!

Registering early will help OH-KY-IN to

plan the best possible events. If you're coming from outside the USA and need help getting a visa, it's important that you register by May 15.

For more RDF equipment suggestions and projects, plus the latest news of mobile and on-foot transmitter hunts in the USA, visit the "Homing In" Web site [www.homingin.com]. As always, I welcome your photos and stories of all the transmitter hunts in your area. Send them electronically or via the post to addresses at the beginning of this article.

Next month, it's back to my multipart "Homing In" series on Doppler RDF technology, delving into mobile Doppler antenna sets and the best ways to optimize their performance.

Notes

1. 604 West 17th Street, Cheyenne, WY 82001; (307) 638-2369; [www.arrow-antennas.com].

2. "Homing In: Squegging — Now It Helps Us Track the Birds," *73 Magazine*, January 2003.

3. "Homing In: A Rechargeable Alternative and the Dancing Buzz," *73 Magazine*, March 1999.

4. [www.users.bigpond.net.au/vk3yng/foxhunt/foxhunt.html].

5. "Homing In: Peak Performances in Pine Mountain," *73 Magazine*, July 2002, and "Homing In: USA ARDF Championships in Georgia — Part 2," August 2002. 73

Back Issues

of

73 Magazine

Only \$5.00 Each!

Call 800-274-7373

SAVE 47%!

on 12 months of **73**

Only \$24.97

Call 800-274-7373

Reprints

of

73 Magazine Articles

Only \$3.00 Each!

Call 800-274-7373

Conversion of Qualcomm "Lamb Chop" Transceiver Board to a 24192 Signal Marker

I picked up a converted 24 GHz transceiver from Sam K6VLM's (now a silent key) estate. Basic testing showed that the receiver put an increase in noise to the 432 IF system and I assumed it was functioning. Moreover, putting probes from my various power meters near the circular waveguide that normally feeds the dish antenna showed a power output on SSB operation.

For this power test I used an HP-432 power meter and a 478A thermistor power head calibrated to 12.4 GHz. It was both a test to see if the power meter head would respond to 24 GHz RF power and to see if the 24 GHz transceiver was actually transmitting.

I had to go about these routes of endeavor as I had nothing better to verify receiver operation, nor the ability to measure 24 GHz power or frequency. My power meter-calibrated RF thermistors had calibration to 18 GHz using the HP-8478 power meter head and 12.4 GHz for the HP-478 power head. Inasmuch as I only had one 8478 head and several 478 lower frequency heads, I would

gamble with the 478 power meter head and try to sense transmitter power from the 24 GHz transceiver to see if it was operational.

What was to be tried was a direct close position of the "N" connector of the 478 power meter thermistor head and the circular waveguide output of the 24 GHz transmitter. Keying the 24 GHz transmitter and slowly inching toward the circular waveguide, I discovered it was actually working. While not calibrated, it did record a +10 dBm power output and followed SSB voice nicely. Well, now, did we prove the operation of the 24 GHz transceiver that we were trying to verify, or was it all a fool's folly? Without a frequency meter that would respond

to 24 GHz, we could not measure frequency. We could use our spectrum analyzer, but calibration as to frequency was drifty at best. The spectrum analyzer would not show us accuracy to 24192.2 MHz.

We knew from these earlier tests that power was being generated and receiver conversion was taking place by the noise increase in the IF system transceiver. What, then, could be done with a limited test equipment budget?

The actual idea came from my partner, Kerry N6IZW. The idea was to build a fractional harmonic generator to allow receiving the subharmonic frequency source generated by a surplus synthesizer that we readily could confirm to be accurate in frequency—in other words, a frequency marker for the receiving portion of the system.

Taking stock of the surplus Qualcomm synthesizers we have available, it was decided to try to stay as close to the existing frequency scheme as possible. This scheme used a synthesizer at 2620 MHz and a final multiplied LO of 13.1 GHz. Working it out, we found that dividing 24192 by 9 produces a synthesizer frequency of 2688 MHz. We tried converting the synthesizer to 2688 MHz and using the stock multiplier that normally multiplied to 13.1 GHz, and it worked well. Slightly off frequency at 24 GHz by 15 kHz, but a very good marker. This accuracy problem can be taken care of easily by verifying the 10 MHz clock that drives the synthesizer and controls its accuracy. Improvements can be made to the unit by stripline peaking, and adjustments made to increase performance at 24 GHz.

Was it worth it to go through this to prove the operation of a 24 GHz transceiver? I feel it was. It found the problem in the local oscillator system being off frequency, proved the operation of the receiver, and gave a small measure of system performance and sensitivity. While it did not prove the transmitter to be operational on frequency, it did give a measure of confidence of transmitter operation, as the synthesizer that runs the receiver is used for transmit also. Having a test generator in the test bench arsenal has proven to be a valuable asset.



Photo A. Side view of Pecom 24 GHz converter. Waveguide circulators shown with left top transmitter board, right receiver board, and bottom center IF synthesizer at 2640 MHz in aluminum container. Main system controlled by 1/2 frequency LO at 10560 MHz synthesizer. Conversion by Sam K6VLM.

Back to the original testing of the Lamb Chop transceiver boards. I constructed a duplicate frequency marker system to verify my system and found it to be nonfunctional to the calibrated harmonic generator. While testing the system, I found that the PIC processor that loads the program into my Pecom 24 GHz transceiver LO synthesizer was not functioning and the synthesizer was outputting a free-running LO giving me the impression of receiver and transmitter operation — functioning, but far off frequency. Making a long story short, we determined that the PIC processor xtal (4 MHz) was defective and not starting the PIC processor-stored program to run the synthesizer. The system came up and functioned after we replaced the 4 MHz xtal in the PIC processor.

In the scheme of things, using the Lamb Chop board worked well, but it is overkill as it could be used for a 10 GHz transceiver, not just a marker. Other components could be utilized to perform the same function. A standard Qualcomm synthesizer and multiplier board could be used and would make the finished package smaller. These same units have been used for other frequencies and just have not been proven for this frequency of operation as of now. I see no reason that they would not function just as well as the Lamb Chop board described in this article. Following is the actual conversion I performed on the Lamb Chop board to convert it to a 24192 MHz marker.

Conversion of the Lamb Chop PC board

The Lamb Chop board is a complete transceiver intended for operation on Tx of 14 GHz and Rx of 12 GHz. It comes stock with a synthesizer programmed normally to 2620 MHz, which is multiplied 5 times to obtain the system LO of 13.1 GHz. The conversion is quite easy and requires only reprogramming the 3216 synthesizer chip from bus mode to pin-for-pin programming and changing a few pins by cutting them open with an X-acto knife. The new frequency of operation will be 2688 MHz. As this is very near the original operation frequency, no change to the VCO is required. I suggest a pretest prior to modifications, allowing a confidence in the basic board before modification takes place.

To do a pretest of board circuitry to eliminate troubles in conversion later, it is best to do a simple precheck of the operation of the VCO and multiplier. All that is required is a +12 volt supply at a half amp and a 10 MHz TCXO. Connect the +12 volt supply common to the TCXO center pin of three

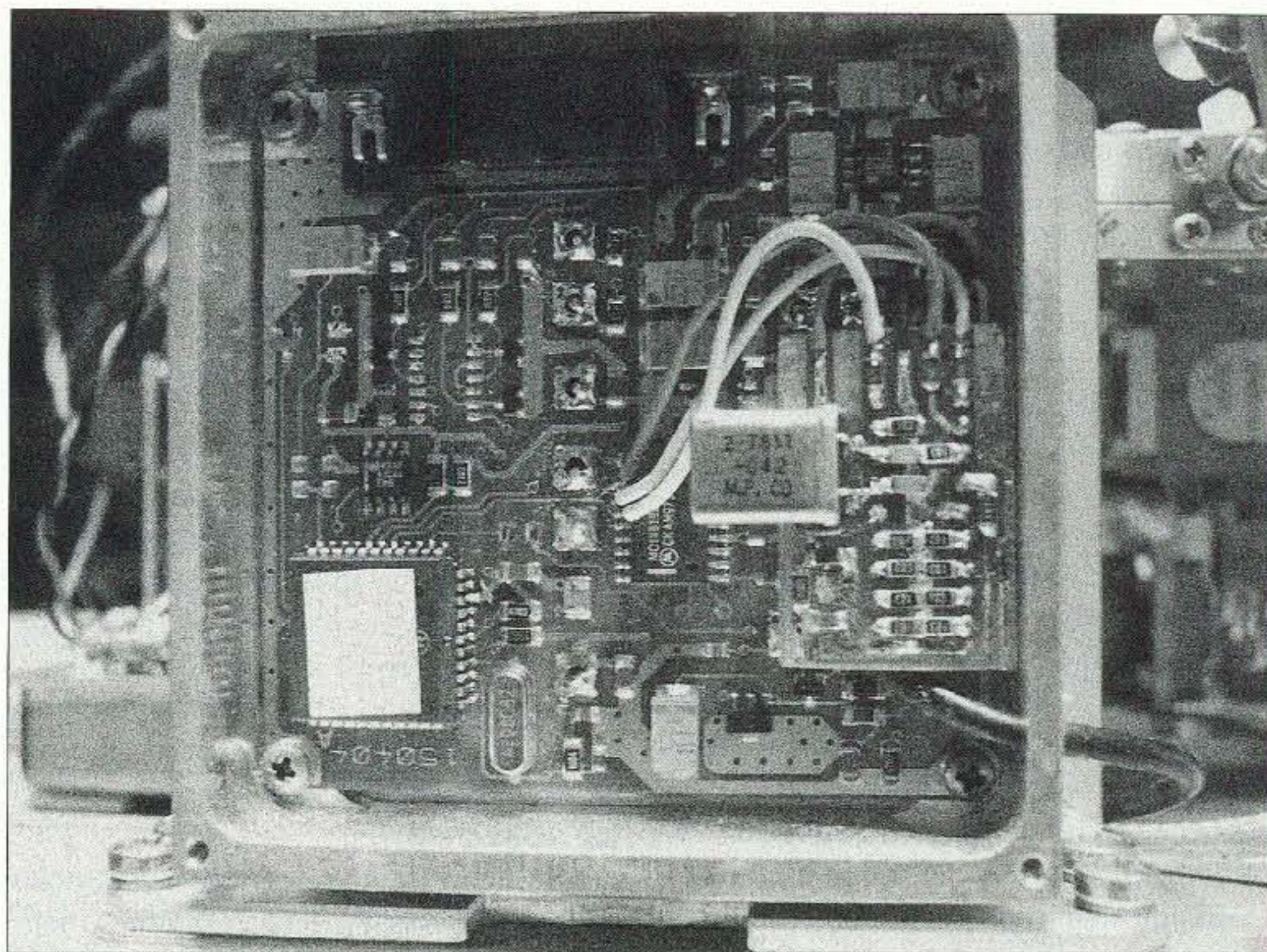

Photo B. Inside of 10560 MHz synthesizer, with PIC processor board added to modify synth for internal PIC processor control. Added new 4 MHz crystal to repair PIC processor for operation.

pins, and the top left coaxial connector solder pad. The top left solder pad is located by holding the Lamb Chop board with the cutout at bottom right.

Position the two solder pads for connections one top left (+12 volt DC) and one right top which is the 10 MHz TCXO drive input. For further confidence, just above the 3216-1 synthesizer chip there is a notch about 1/2 inch wide that allows access to a mounting bolt. Left of this by a half inch is the leftmost DC input contact. To the right about an inch is the 10 MHz input drive

point from the TCXO output pin three of three. Pin two is the DC input, and is the center of the three pins, Pin one is no connection. The TCXO's other two pins are both ground. In the cutout of the Lamb Chop board is a place to use RTV to affix the 10 MHz TCXO to the inside corner or use a small length of PC board material to bolt to the frame and two 4/40 bolts on the bottom of the TCXO. Either is just fine to prevent a dangling TCXO on jumper

Continued on page 56

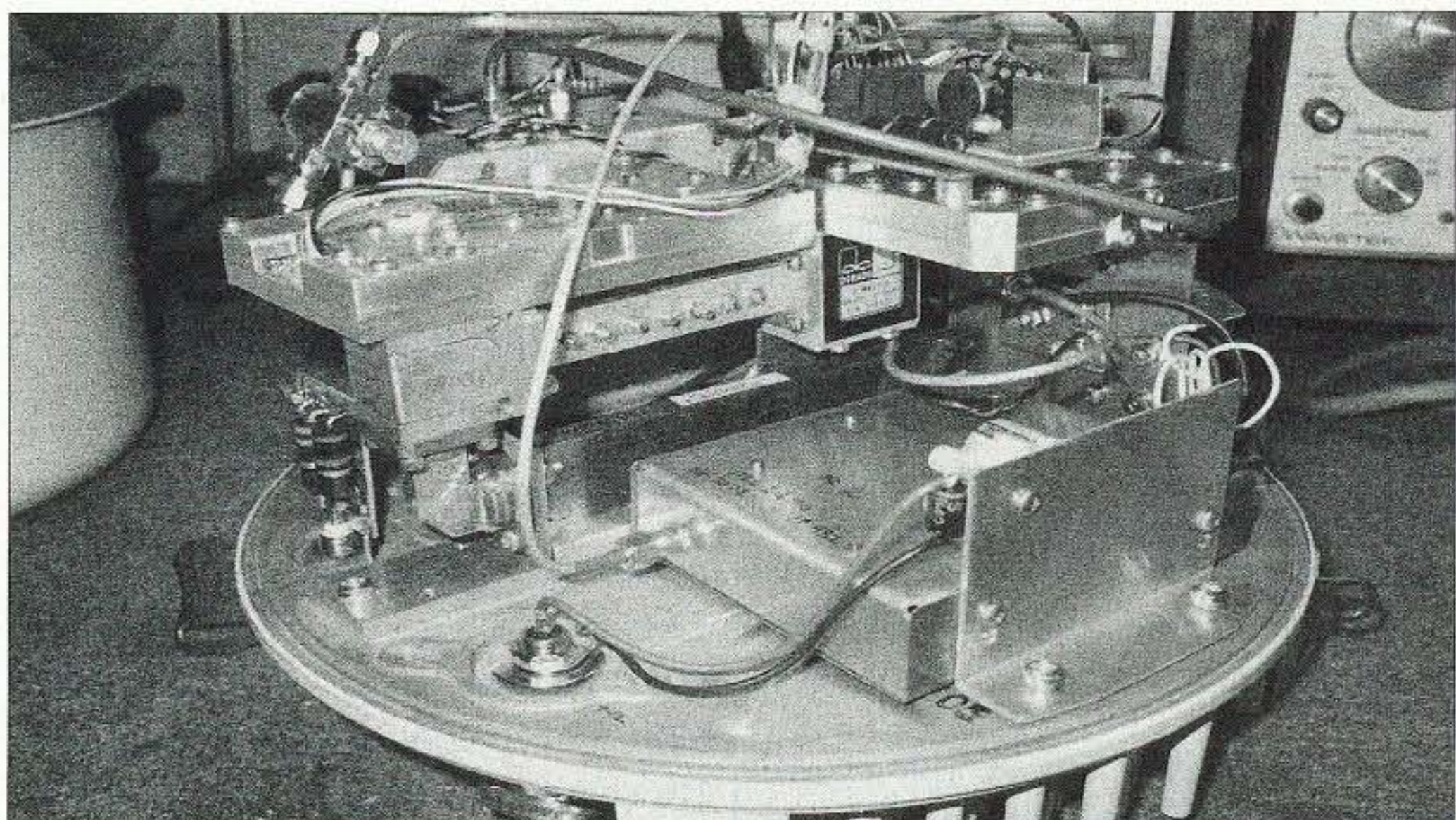

Photo C. Full view of converted Lamb Chop board for 24192 MHz marker frequency from 9th harmonic of synthesizer operating at 2688 MHz. Temporary plastic container houses batteries at 12 volts and cushion material to hold board for harmonic generator till a better one can be obtained. I obtained the plastic container at a 99 cents store.

ABOVE & BEYOND

continued from page 55

wires and coax cable. It dresses up the conversion a bit.

Remove the metal cover plate on the gold board, as it is not required in the conversion. If all is operating as expected, you should see 2620 MHz from the green board below the 3216-I synth chip and 13.1 GHz, the fifth harmonic of the output near the receive mixer circuitry on the gold board. DC current is about 1/2 amp at 12 volts. Once you are satisfied with basic operation, shut off the power and start reprogramming the pin-for-pin conversion.

The programming conversion to be done is as follows. Lift with an X-acto knife pins (4, on top of chip; 7, 8, 9, 10, 13, 14, 15, on side of chip; 19, 20, and 22, on bottom side of chip). Be sure to start counting pin #1 under the small dot above pin #1 which I call top face; side face counts #7 to #17; and bottom face counts from pin #18. Only pins lifted that require a TTL low require grounding — all other pins are left open (HIGH).

Ground can be found on pins #5 and #6, and pin #18. Wire ground starting with main ground pin #5-#6, and route ground connection wire to pins #7, #9, #10, #13, and #14. Connect ground on pin #18 to pin #20.

An open condition and TTL HIGH should be found on pins #8, #15, #19, and #22. This should reprogram your synthesizer for 2688 MHz, which provides the 9th harmonic for 24192 MHz.

Further mods include shorting across the original 13.1 GHz filter and replacing it with a 50 ohm strip line, and peaking the multiplier circuit for best harmonic operation for 24192 MHz. While I do not have a spectrum analyzer to observe output at 24192, I have started to use my 24 GHz receiver's IF system S-meter to show loose coupling output increases. It's not perfect, but produces a good note for SSB operation. It is stable to frequency and requires that the metal cover of the gold board be removed to allow maximum harmonic output to be injected into the ether. With a harmonic generator in the same garage and no direct connection, I was able to receive S7 on my IF transceiver, a Yaesu FT-817 at 432 MHz, on my 24 GHz downconverter some 5 feet away.

Operation is quite easy as with internal batteries that I added to a small plastic food container (obtained at a local 99 cents store), to house the Lamb Chop board, it worked quite well. The food container allowed RF to be radiated for pick up by the 24 GHz

receiver without affecting the synthesizer, and gives it a measure of protection for transportation and usage. The only external control on the plastic food container was a toggle on/off switch. I added an internal fuse holder for battery protection, and during periods of storage I pull the fuse. This allows protection for the charged batteries in case someone accidentally bumps the power switch on.

Well, there it is, this month's test adjunct for a 24 GHz marker test generator. Exact frequency control can be fixed by proper adjustment of the 10 MHz reference crystal oscillator. Specifics are not exact. If you like it as off-exact-frequency, just note where it's at and multiply to 24 GHz by multiplying the synthesizer frequency times 9 for exact frequency at 24 GHz; it's a matter of personal preference.

For references to other technical articles and the 10 GHz transceiver "Lamb Chop" board 10 GHz converter look at [<http://www.ham-radio.com/sbms/sd/>] on the Web. Look under technical papers from the San Diego Microwave Group for a plethora of articles on a full range of subjects from our group's members. This effort is hosted by The San Bernardino Microwave Society, on their Web page base ID at [<http://www.ham-radio.com>]. Take a look at this long-time Microwave Society's newsletters and other points of general interest dedicated to amateur microwave subjects. The material referenced in this article and the technical papers above are available from the AUTHOR to interested parties, for amateur radio use only. Please only contact the author for further information.

Well, that's it for this month's column. As always, I will be glad to answer questions on this and other related material. Please send E-mail to [clhough@pacbell.net], and I will try to give you a reply in a timely manner. 73, Chuck WB6IGP. 73

Ham's Handy Heat Hunter

continued from page 22

Modifications

Instead of a brass tube to house the LM34CZ, a glass vial may be used. Glass (as well as epoxy) is resistant to almost every environmental condition. However, care must be taken that the vial is not exposed to rapidly changing temperatures, as this could fracture the glass. These vials are commonly used to contain perfume samples and are

available at the perfume counter of most department stores.

Solder a three-conductor cable suitable for the probe assemblies environment to the temperature sensor. In order to use a different cable, the temperature sensor's leads are connected to the stereo plug as illustrated in Fig. 2. Fill the glass vial with epoxy, keeping air bubbles to a minimum. Next, insert the sensor into the vial. When the epoxy cures, this sensor can be used in almost any environment.

Now you have a simple way to measure temperature accurately — the Digital Multimeter Temperature Measurement Adapter. 73

Ozzie's Jupi-Loop

continued from page 23

loop and ladder line instead of coax, which would make it more efficient for use on the higher bands. It's a quieter antenna and can be used not only on the fundamental frequency it was designed for, but also on its harmonics, providing you didn't use a coax feedline.

I ran a not-so-symmetrical 35-foot loop, weaving it in and out of the rafters, and up and down, in order to get all the wire in. I had the external tuner, but now I wanted to use my built-in automatic tuner. Herein lies the problem: how to feed a balanced line with a transceiver that was designed for 52-ohm coax. First, I decided to wind a ferrite 4:1 balun — and it worked! I was able to tune and load everything from 40 to 10 meters, although I was not pleased with the SWR on some of the higher bands. After looking through a number of articles on how to feed a balanced line, I couldn't find anything that applied to a transceiver antenna tuner.

I decided to try an aircore balun. Not much is said about them in the antenna handbooks, least of all how to use them with a built-in antenna tuner. By using four equal lengths of #14 insulated wire 10 feet long, I wound the balun on a one-inch-outside-diameter piece of tubing I happened to have in my junk box.

Voilà! It worked! My Jupiter loop, or ... the Jupi-Loop! Here are the SWR figures when used with my antenna tuner: 40m — 1.7:1; 30m — 1.0:1; 20m — 1.0:1; 17m — 1.0:1; 15m — 1.0:1; 12m — 1.0:1; 10m — 1.0:1.

Forty meters was the only band that didn't show unity, but it was close enough. I decided I didn't want to trim the antenna, as it worked exceedingly well on 40 meters. I have over 225 countries worked, mixed all bands using CW, very limited SSB, but quite a few in the digital modes such as PSK, MFSK, RTTY, and HELL. All of this while running fairly low power, well below the 100 watt level.

I have had no complaints, and although I am (was?) operating stealth, I would normally hear people talking in the dining room — that's where everything is hashed out. I have never heard anybody complain about having a problem with their phones or other electronic devices. Mine are free of any RFI. 73

The Interrelationship of the Coriolis Force, the Helix Effect, and So-called Einstein Antennas

continued from page 29

distance increases the gravitational force by a factor of 256. The binding energy of a molecule is so small that the mass changes by just a few parts per billion, but the strong nuclear force linking the protons and neutrons in the nucleus of an atom is much more powerful than the electromagnetic forces that hold molecules together.

How do we do this? Simply by reversing the RF helix flow, counterclock wise or clockwise movement in the coaxial, or by reversing the gravitational pull of nature.

How? By wrapping the wire or coaxial with a flexible magnetic strip tape obtainable at Edmund's Scientific or Radio Shack. They are inexpensive and normally have 1,400 gauss strength — the higher the gauss, the better.

Magnets come in a variety of forces and types, some of which have been around since the beginning of time,

such as a natural lodestone magnet. Others include ceramic permanent magnets, electromagnets, ferromag magnets, rare earth, neodymium iron boron (NdFeB), and samarium cobalt (SmCo)-mix.

Coaxial cable is normally manufactured from copper or copper mix, so the magnets will not actually be attracted to or "stick" to the coaxial, but will work by the magnetic force acting through the coaxial. Obtain flexible magnetic tape with a sticky mastic backing, or adhere to the coaxial with electrician's or Scotch tape. With the flexible magnetic strips suitable for this, you will have to experiment and try right- or left-hand wrapping to see which works best for your specific frequencies involved.

The spacing of the magnetic tape will depend on the radio frequency in use, and for the best reception and noise removal coming down the coaxial. All of this is reciprocal, working to remove noise on receiving as well as transmitting. As with water going down a drain, you are simply electronically reversing the natural electron flow in the coaxial.

Due to the "skin effect," i.e., RF traveling along the surface of the wire, the higher you are in frequency the more noticeable the improvement will be. Each installation will be a custom experiment, both as to right- or left-hand helix wrapping, as well as spacing between the magnetic strips, based on the Earth's gravitational pull where you live, as well as your individual distance from the Earth's Equator due to the Earth's gravitational Helix Effect. The more magnetic tape you use, the more magnetic molecules will be involved with increased improvement due to additional high energy output of megagauss oersteds.

You also can experiment with electromagnets such as a bulk video and audio tape erasers. The thinner in diameter the coaxial, the more magnetic energy will travel to and through both the outside braid and also the center conductor itself. That, of course, can be compensated for by using stronger magnets with more gauss strengths.

All of this should result in a six- to

nine-decibel noise reduction on both receiving and transmitting, or one to one-and-a-half "S"-units in improvement.

So, the next time you flush something down the drain, remember this article. [*Hmmm ... ed.*] 73

Autobiography of Everyham — Part 2

continued from page 34

he was going somewhere in the direction of where I worked. Although it may not have been an emergency, driving those distances in rush-hour traffic even back then was not taken lightly (this was in the late '80s or early '90s). Fortunately, this was the only more serious assist I had been involved with; the rest have been relatively minor to date, in the form of rendering help with driving directions and technical advice.

What will be the future of ham radio? I doubt any of us have all that clear of an idea. At times, when I get fed up with some of the shenanigans I hear, I'm not even sure about my own future in ham radio. In spite of these variables, a few things will always stay the same: It's possible to have a well-balanced life, even when one particular interest — like ham radio — is heavily woven into the daily fabric of what we do. Secondly, even if I should get tired of the less than savory activity I hear out there to the point where I feel like tossing my gear out of the nearest window, the unique experiences I've had along the way will always be priceless. 73

Subscriptions to *73 Magazine*

Only \$24.97 — 1 year
\$44.97 — 2 years
\$65.00 — 3 years*

*best buy (54% off cover price!)

Call 800-274-7373

Pluses and Minuses of "Smart" Batteries

continued from page 41

The author of many articles and books on battery maintenance technology, Mr. Buchmann is a well-known speaker who has delivered technical papers and presentations at seminars and conferences around the world.

About the company

Cadex Electronics Inc. is a world leader in the design and manufacture of advanced battery analyzers and chargers. Their award-winning products are used to prolong battery life in wireless communications, emergency services, mobile computing, avionics, biomedical, broadcasting, and defense. Cadex products are sold in over 100 countries.

Note: This article contains excerpts from the second edition book entitled *Batteries in a Portable World — A Handbook on Rechargeable Batteries for Non-Engineers*. In the book, Mr. Buchmann evaluates the batteries in everyday use and explains their strengths and weaknesses in laymen's terms. The 300-page book is available from Cadex Electronics Inc. through [book@cadex.com], tel. 604-231-7777, or most bookstores. For additional information on battery technology, visit [www.buchmann.ca].

73

THE DIGITAL PORT

continued from page 46

log program but have not yet looked into its workings. Logs are important to most of us, and I am sure there is one available to answer our needs.

Incidentally, the little log system is based on a database that is available, free of course, and packaged with some Linux distributions. Berkeley Database, I believe is the name, and if it is in your Linux system, your log should work. I must be careful making too many promises, as one ham told me it needs to be the correct version of the database. Another one of those Linux "if" statements, and I do not recall what was correct except I know I fell into it and came up smelling good, which translates to: I have the correct flavor here.

As you may surmise, getting all this system together and working was one great challenge for me. Some hams were surprised that I had so many reversals. However, it was quite a learning experience and the pleasure to finally see it work is likely much more profound than if it had gone easily. I hope your introductory experience with Linux is a bit smoother.

Those pictures on the MFSK

I mentioned last time around about the new PIC mode in MixW MFSK, and I predicted we would be standing in line to use it. Well, yesterday that was as near true as I have seen. There were truly wall-to-wall signals just above the 14.080 frequency where most of the PIC action occurs. But, possibly, it was just a busy day for digital. I looked in on the PSK31 area and it was nearly as bad (or good?) even though the signal width is more accommodating for more users.

Anyway, there have been some of us who had problems getting rid of the slant

in these little images. And the slant was very pronounced in certain cases. Mine was a serious problem which became a bit embarrassing as I tried to sort it out.

I was one of those who was of the opinion I could use the "seat-of-the-pants" approach and eventually come out on top. Well, you can't — especially if your card settings are as out of whack as mine were. I got the receive slant seemingly well under control by-guess-and-by-gosh, but there was no way the transmit was even going to come close.

So eventually, the news came along, originally by a post on the MixW reflector from Nick UT2UZ, how to accomplish straightening the crooked pictures. It involves a basic, having to do with setting the sample rate on the soundcard at 11025 and not deviating from that setting. Then adjusting the RX ppm setting by use of the WWV method prescribed in the Help File. Finally, calculate the TX ppm by using a loop-back TX to RX with a calculator provided in the MixW software that gives you the constant to finish the job. I did it and was surprised — more than pleasantly. Perfection. I have included the instructions on my Web site for these adjustments.

That's about all for this month. Have fun, and keep those digital fires burning. 73, Jack [KB7NO@att.net].

73

HAMSATS

continued from page 47

joined the UN committee for space research for peaceful purposes.

The ham-radio portion of SO-50 is a Mode-J (two meters up and 70 cm down) FM transponder. Both uplink and downlink antennas are simple quarter-wave whips, one on top and the other on the bottom of the space frame. Power output on 70 cm is 250 mW. The satellite was tested during the first week of January, 2003, and was subsequently released for ham operation. The uplink is on 145.850 MHz. Since SO-50 shares the same uplink with AMRAD-OSCAR-27 and Saudi-OSCAR-41, the new hamsat requires that users transmit a CTCSS tone of 67 Hz for access. The downlink is on 436.800 MHz.

Contacts via SO-50

While most other FM satellites have a continuous downlink when active, SO-50 is more like an FM repeater with a very short squelch tail. This means that if you simply listen for the satellite, you may hear nothing

M²

**EXTRA, EXTRA!
M2 BUILDS
TRIBANDER**

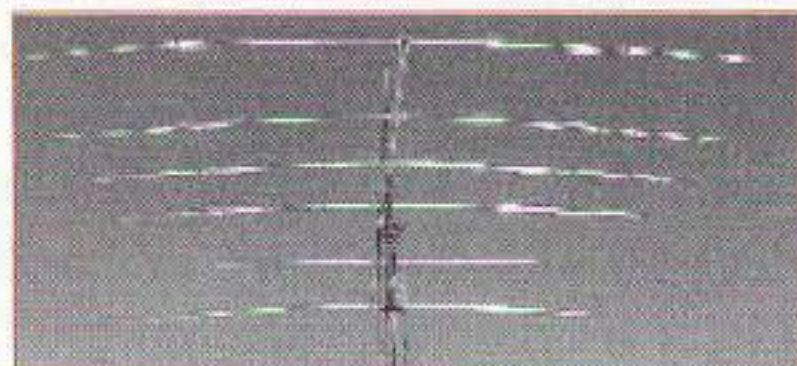

The tried and true KT34 series antennas have been made better using the latest computer modeling and mechanical design techniques to provide you with the best tribander performer available today. Just take a look!

**INCREASED FRONT TO BACK
INCREASED GAIN
MECHANICALLY SUPERIOR
ELECTRICALLY SUPERIOR
LOWER WIND LOAD THAN COMPETITORS
LESS WEIGHT THAN COMPETITORS
RATED AT 100 MPH WIND SURVIVAL
AND OF COURSE, NO POP RIVETS**

Contact us for our new catalog of
ALL the goodies!!
Can't wait? Visit our Website
@m2inc.com

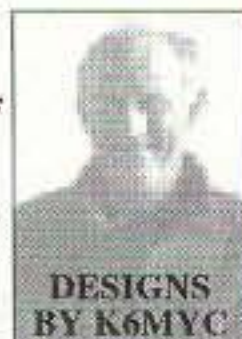

4402 N. Selland, Fresno, CA 93722
559-432-8873 Fax 559-432-3059
E-Mail: wyatt@m2inc.com
Website: www.m2inc.com



even though it is on and ready for use. You will need to transmit on the uplink (don't forget the 67 Hz tone) when the satellite is in range, while simultaneously listening and tuning around the downlink frequency. Even if you are doing everything right, don't be surprised if nothing happens. A control station must activate the satellite on every pass. For North America, the controller is near the east coast.

Passes are relatively short due to the low orbit, and the Doppler shift and antenna tracking requirements need some practice to make good contacts. At the beginning of an overhead pass, transmit about 2.5 kHz low and receive about 10 kHz high of the listed frequencies. When the satellite has passed, and is headed away, transmit a few kHz high and listen almost 10 kHz low. Low-elevation passes are not as difficult, and the receiver on SO-50 is very sensitive. The satellite's quarter-watt transmitter with whip antenna isn't quite enough for most HT work, but a decent home station with directional antennas does fine. Can you keep up with all of the operational hamsats in the sky? I doubt it, but take some time to check out our newest resources, and enjoy. 73

ON THE GO

continued from page 48

Sometimes these are repeats of what is offered in the club newsletter, but at other times you may find a more extensive collection of ham and associated gear, such as computers.

There are also dedicated virtual hamfests on the World Wide Web. The most widely known is probably [<http://www.qrz.com>], which provides not only a great virtual swap meet but also is a popular call-sign lookup site. Naturally there are others such as [<http://www.vhamfest.com>], and other, smaller sites. There are products for sale, and products wanted usually offered only by individuals as opposed to dealers. There are some good deals to be had, if you know what you are looking for. Some of the descriptions are sparse with only the brand and model number being listed, so if you're familiar with the specifics of a particular radio, you'll be well served.

Virtual hamfests are somewhat casual. If you find a product you like and send a note to the seller you may not get an answer in a timely fashion. This can be frustrating, but on the other hand, you can make some great deals.

And, of course, there are the on line

auction sites like e-Bay [<http://www.ebay.com>] that offer virtually anything that someone has to sell. There is a fair representation from the ham community and often a good selection. They do offer, in many cases, the ability to pay by credit card and have some degree of protection from fraud. Nothing is fool-proof, however.

On-line auctions can be frustrating, though. Some experienced auction participants not only hold back their bids until the last minutes of the auction but may even use software that automatically enters a bid at the last moment. More than once I've found an item interesting, but never had to explain it to my XYL because someone else outbid me in the final seconds.

Whether you are new to the hobby or expanding your options, there are many ways to find just what you need. If you've been working the local repeater with your handie talkie, why not check out the options for an HF mobile rig? How about six-meters for the commute to and from work? Maybe some items for your emergency "grab and go" kit.

Go out, have fun, and let me know what treasures you have found! 73

NEVER SAY DIE

continued from page 26

though the plaintiff would be absolutely right, he might lose.

When a state institutes a property tax it is instantly taking over ownership of all private property in the state — land and buildings. The "owner" is allowed to use the property within limits set by the state, county and town, but if the owner stops paying rent (tax), he's evicted and the property auctioned off to another renter.

One might try to argue that the state is providing certain services which could be considered as compensation. Not unless they are new services and provide a service comparable to the value of the property confiscated. Any other services were already being enjoyed (at least in some cases) by property owners, so they wouldn't count as compensation.

New Hampshire, with one of the highest property taxes in the country, has propagated the myth of low taxes because there have been no income or sales taxes. Well, almost none, as long as one doesn't count the room and meals tax, which nets the state over \$13 million a year.

By the time one adds up the profits

from the state liquor stores in every town and near every border, vehicle, snowmobile and boat licenses, fishing and hunting licenses, profits from the Cannon Mountain tramway and skiing area, The Flume, highway tolls, and who knows how many other revenue sources — oops, I almost forgot the state lottery — we could be in very good shape if we'd stop state employee bloat and stop wasting money on schools that are getting progressively worse as we spend more and more on them.

A Major Opportunity

Old-timers have undoubtedly forgotten by now my enthusiasm over 2m FM and repeaters in 1969, when I got so excited about them that I published hundreds of articles in 73, several books, the first repeater directory, and even started a special journal devoted to the subject. I got so excited about being able to make phone patches via a little HT while skiing down the New Hampshire and Aspen mountains that I predicted that the public would soon be using this technology to make phone calls from anywhere to anywhere.

When I first got excited there were a few dozen ham repeaters. A few years later we had thousands, covering most of the country, plus hundreds more all around the world. Heck, they even had one in Swaziland!

Our technology was soon commercialized by Motorola and G.E., and many of the repeater pioneers did very well, cashing in on the explosion of cellular telephones.

In 1975, when the first microcomputer kit was marketed, I quickly started the first magazine devoted to micros, hoping that I'd be able to duplicate my success with ham repeaters. Again, the pioneers did well. In 1976 Bill Gates left Harvard with a primitive version of BASIC he'd done for a class project and went to work for MITS, where I first met him a couple weeks later. He's done pretty well.

In August 1976 I heard about Steve Jobs and Steve Wozniak and their Apple, so I visited them in Jobs' home. Steve's done well, too.

Now I see a new technology that has the potential to turn into as big (or bigger) an industry as the personal computer. There's every reason to believe that the pioneers in this new field have

Continued on page 61

We pay \$CASH\$
(well, check)
for articles!
SEND FOR "HOW TO WRITE FOR 73"

A Note on the Shuttle

The Space Shuttle Columbia disintegrated over Texas a few hours ago, just 16 minutes from landing in Florida. By the time you read this, of course, two months will have passed and many of the details will have faded from memory. Nonetheless, I'll use this opportunity to express my condolences to the families, friends, and associates of the seven astronauts who perished today.

I am personally touched by this sad event since I spent dozens of hours in the cockpit of a commuter airliner during the early '90s with the brother of Shuttle Commander Rick Husband. The effects of this tragedy will certainly be felt far and wide; not least in the amateur radio community since three of the other STS-107 crew members were hams. They were Kalpana "KC" Chawla KD5ESI, David Brown KC5ZTC, and Laurel Clark KC5ZSU.

Many readers will remember that astronaut Owen Garriott W5LFL became the first amateur to broadcast from space in November 1983. That mission was also flown aboard the *Columbia* which was the first spacecraft in history to carry an amateur radio aboard as part of the official NASA payload.

As always, hams have responded to this tragedy with a helping hand, notably the Amateur Radio Emergency Service (ARES) members in Nacogdoches, Texas. According to some early reports, they have volunteered to help local officials and NASA to locate and catalog debris from the *Columbia* shuttle. The ARES volunteers are members of the Nacogdoches Amateur Radio Club, which apparently has had an ongoing relationship with the space program through the Space Amateur Radio EXperiment (SAREX) and the Amateur Radio on the International Space Station (ARISS) programs. I extend a personal commendation to the ARES members for their devotion to community service in the true spirit of radio amateurs everywhere.

Special Forecast

Solar activity is forecast to remain low for most of April, so Good

April 2003						
SUN	MON	TUE	WED	THU	FRI	SAT
		1 F	2 F-P	3 F-P	4 F	5 G
6 G	7 G	8 G	9 G	10 F-G	11 F-G	12 G
13 G	14 G	15 F	16 F-G	17 F	18 G	19 F-G
20 F-P	21 F-P	22 F-G	23 F-G	24 P	25 F-P	26 F-P
27 G	28 G	29 F-G	30 F-P			

EASTERN UNITED STATES TO:												
GMT:	00	02	04	06	08	10	12	14	16	18	20	22
Central America	(15) 20	(15) 20	20 (40)	x	x	x	(10)	(10)	(10-15)	10 (17)	10-15	12-20
South America	(17) 20	20 (40)	20 (40)	(20-40)	x	x	x	(10)	(10)	(10-15)	10-15	10 (20)
Western Europe	(20-40)	(30-40)	(30-40)	(40)	x	x	(15-20)	(10-20)	(10) 17	15-20	(15) 20	(20)
Southern Africa	(17) 20	(20-40)	(20)	(20)	x	x	x	x	(10)	10 (15)	12 (17)	(15-20)
Eastern Europe	x	(30-40)	(20-40)	(17-20)	(20)	x	x	(10-15)	(15)	(17-20)	(20)	(20)
Middle East	x	(20)	20	(20-40)	(40)	x	x	x	(10-15)	15	(17-20)	(20)
India/Pakistan	(17-20)	x	x	x	x	x	x	(15-17)	x	x	x	x
Far East/ Japan	(17-20)	(20)	x	x	x	x	x	x	x	x	x	(15)
Southeast Asia	(17-20)	x	x	x	x	x	(17-20)	(10-15)	x	x	x	x
Australia	(15)	(17-20)	x	x	x	x	(20-40)	(20)	(10)	x	x	x
Alaska	(15) 20	(20)	(20-30)	(30-40)	(40)	x	x	x	(15-20)	(10-20)	(10) 17	15-20
Hawaii	(15) 20	20	(20-40)	(20-40)	(40)	x	x	x	(15-20)	(10-20)	(10-20)	15-20
Western USA	15-20	20 (40)	20 (40)	(20) 40	(30-40)	x	x	(10-20)	10 (20)	10 (20)	10 (20)	(15) 20
CENTRAL UNITED STATES TO:												
Central America	(15-20)	20 (40)	20-40	20-40	(20-40)	x	(10-20)	10-20	10-20	10 (20)	10 (20)	10-20
South America	(15) 20	17-30	20 (40)	20 (40)	x	x	x	(10-20)	10 (20)	10 (15)	(10-20)	12 (20)
Western Europe	(20)	(40)	(40)	x	x	x	x	(15)	(15-17)	(15-20)	(17-20)	(20)
Southern Africa	20	(20)	(20)	(20)	x	x	x	x	(10)	(10-15)	(10-17)	(15-20)
Eastern Europe	(20)	(20)	x	x	x	x	x	(15)	(15-17)	(17-20)	(20)	(20)
Middle East	x	x	x	x	x	x	x	x	(15)	(15)	(20)	(20)
India/Pakistan	(17-20)	(15-20)	x	x	x	x	x	(15-20)	x	x	x	x
Far East/ Japan	(17-20)	(20)	x	x	x	x	x	x	x	x	x	(15)
Southeast Asia	(15-20)	x	x	x	x	x	x	(20)	(10-20)	x	x	x
Australia	(15-20)	(20)	x	x	x	x	x	(15-20)	(15-20)	15	15	15 (20)
Alaska	15-20	(15) 20	20	20 (30)	(30-40)	(40)	x	x	x	(10-20)	10-20	10 (20)
Hawaii	15-20	(15) 20	20 (40)	(30-40)	(40)	x	x	x	x	(10) 12	10-15	(10) 17
WESTERN UNITED STATES TO:												
Central America	10-20	15-20	15-30	(14) 40	20-40	(30-40)	x	(15-20)	10 (20)	10 (20)	10 (20)	10 (20)
South America	(10) 20	(15) 20	20 (40)	20 (40)	x	x	x	(10-20)	10 (20)	(10-15)	10 (15)	10 (20)
Western Europe	x	x	x	x	x	x	x	x	(15-17)	(15-17)	(17-20)	(17-20)
Southern Africa	(20)	(20)	(20)	(20)	(20)	x	x	x	x	(10-12)	(12) 17	(15-20)
Eastern Europe	x	x	x	(17-20)	(17-20)	x	x	(15)	(15)	(15-17)	(17-20)	(20)
Middle East	x	(20)	(20)	x	x	x	x	x	(15-17)	(20)	(20)	(20)
India/Pakistan	x	(17-20)	x	x	x	x	x	x	(15-17)	x	x	x
Far East/ Japan	10-20	(20)	x	x	x	(40)	(40)	x	x	x	x	(10-20)
Southeast Asia	(10-15)	(10-15)	x	x	x	x	x	x	x	(15-20)	(15-20)	(10-15)
Australia	(10-15)	(15)	(17-20)	x	x	x	x	x	(15) 20	(15-20)	(15)	(10)
Alaska	(10) 20	(15) 20	20 (40)	(20) 40	(30-40)	(40)	(40)	(40)	x	(10-15)	10-15	10-20
Hawaii	(15) 20	20	(20-40)	(20) 40	(30-40)	(40)	x	x	x	(10-20)	(10) 20	15-20
Eastern USA	15-20	20 (40)	20 (40)	(20) 40	(30-40)	x	x	(10-20)	10 (20)	10 (20)	10 (20)	(15) 20

Table 1. Band, time, country chart. Plain numerals indicate bands which should be workable on Fair to Good (F-G) and Good (G) days. Numbers in parentheses indicate bands usually workable on Good (G) days only. Dual numbers indicate that the intervening bands should also be usable. When one number appears in parentheses, that end of the range will probably be open on Good (G) days only.

(G) propagation conditions should predominate throughout the month. However, coronal hole effects are likely to cause some trouble and could strongly influence the HF bands, especially during the first few days. This will be followed by nearly two weeks of undisturbed conditions with only minor flares causing transient disruptions. The latter half of the month will be less consistent, with Fair-to-Poor (F-P) conditions prevailing about fifty percent of the time, but only the 24th is forecast to have Poor (P) conditions all day.

Although April is the month when DXing historically begins its inexorable slide into the summer doldrums, there are still lots of good opportunities to be found until late spring. The most promising band is 15 meters which will have worldwide "pipelines" spanning both the daytime and nighttime sectors. 10 meters should also start out fairly strong but will rapidly decline as the weeks pass, especially on paths to Europe. 20 meters is likely to be strong at night, but daytime paths will be unreliable a good part of the time. 40 meters should be in pretty good shape at night as well, but 15 and 20 will probably be more interesting due to lower noise levels.

Band-by-Band Forecast

10-12 meters

There should be decent opportunities into Europe, Africa, and Asia early in the month, but openings will decline rapidly as April progresses. Latin America and South America will be the mainstays and should remain workable from shortly after noon through early evening. Daytime short-skip can range from 1,000 to over 2,200 miles.

15-17 meters

Excellent worldwide propagation will be available from sunrise through mid-evening. Europe ought to be workable most of the day, even during late afternoon. Polar paths should provide good coverage in southern Asia, especially if you follow the sunrise grayline across the continent. Japan and the Far East might also be workable in the morning, with an occasional pipeline to Indonesia before noon. Short-skip will average between 1,000 and 2,100 miles.

20 meters

Expect strong and reliable conditions after dark. Only mediocre propagation will be found most days, but some excellent opportunities can still be found right after sunrise and late in the afternoon. The evening hours

after sunset should be the most fruitful however, with many interesting contacts in the Middle East and North Africa — especially during the hour before their local sunrise. Expect plenty of traffic from Eastern European stations to compete for those Middle Eastern contacts though. Short-skip will fluctuate between 500 and 2,300 miles.

30-40 meters

Good worldwide opportunities should be available from sunset to sunrise despite rising QRN (atmospheric noise). The Caribbean, Central America, and South America will be the mainstays with Australia and Southeast Asia providing most of the other opportunities. Short-skip at night can range from 500 to 2,500 miles but will be well under 1,000 miles during the day.

80-160 meters

Propagation on these bands is fading fast due to rising atmospheric noise levels, but opportunities will still be found in the southern hemisphere during the quieter periods. These are obviously nighttime bands with short-skip ranging from 1,000 to 2,000 miles, but daytime DX contacts can be made if you can work multi-skip paths toward northern South America. Daytime skip is limited to 250 miles, however. 73

NEVER SAY DIE

continued from page 59

the potential for becoming the next generation of zillionaires. Watch them from your couch as they parlay a few hundred bucks into vast fortunes, and have the most fun of their lives.

The Technology

Now that you can get a digital video camera, editing system and DVD burner for under \$3,000 instead of tens to hundreds of thousands, the lid is off for an explosion of new video products. It's a lot like the opportunities that we had when the first microprocessor chips arrived, bringing us a ten times drop in computer prices.

Mainframe systems were in the million dollar range. Then came minicomputers, which wiped out all but one of the mainframe makers (IBM) with their hundred thousand dollar systems. Next came the microcomputers (personal computers) in the ten thousand dollar bracket and they wiped out the minicomputer companies. There's nothing like a ten times drop in prices to generate a new industry and wipe out an old one.

Well, it's happening again, this time with video.

You saw what happened with *The Blair Witch Project*, right? That was a movie anyone with a thousand dollar digital video camera and an iMac \$1,500 computer could have made using a few friends for actors.

No, I'm not suggesting you get into competition with the big studios and duke it out with the distributors at the Cannes Film Festival. Not when there is a brand new totally undeveloped market out there crying for product.

The Crying Need

When home schooling hit the cover of *Time*, complete with a seven page article, that should have been enough to show up on the screen of even the most dormant of entrepreneurs as a blip. Big blip. The article reported that there are nearly a million kids being home schooled today, double that of five years ago.

Well, it's only logical, as more and more parents get fed up with the public school system's increasing inability to teach children reading, writing and arithmetic. The government school system is awful and getting awfuller. And the more money they've poured into it, the worse it's been getting.

The Opportunity

It's a double opportunity. Not only is there a million kid home schooling market for educational materials, but you've also got tens of millions of frustrated parents who'd love to find supplemental educational stuff to make up for the lousy textbooks and teachers public schools offer.

Desperately needed are video programs which are so much fun that kids will be nagging their parents to buy them — programs which help youngsters to understand all of the things they need to know to cope with the world. There's a need for programs which cover all of the stuff in the K-12 curriculum, plus a bunch more on the things schools should be teaching and aren't.

Our socialist public school system will be up against, for the first time, serious competition from entrepreneurs. Competition has been proven to improve product quality and lower its cost. And that's what is desperately needed today. Our children are being screwed by the government's schools. We're all paying a premium price for a poor and getting poorer product.

If you're interested in the details and want to get yourself into a screaming fit over what's happening, just read some of

the very-well-researched books about our school system.

Like? Gatto's *Dumbing Us Down* and *The Underground History of American Education*, Sowell's *Inside American Education*, Kramer's *Ed School Follies*, Iserbyt's *The Deliberate Dumbing Down of American Education* and Roche's *The Fall of the Ivory Tower*.

The market for well-done educational programs is far more than a million American home schooling families and a few million frustrated parents of public school kids who aren't learning — it's a worldwide market. Billions of parents need low-cost high-quality educational programs for their kids.

The Revolution

Imagine billions of children excitedly buying and swapping DVD programs just because learning is so much fun! The ten-year-old who gets interested in electronics will be able to learn the basics, and then go on to find out how radios, televisions, cell phones, faxes, computers, and so on work. No memorization, no exams. No grades. Just the excitement of learning. The work bench for building a power supply or a radio will be virtual, complete with all the needed tools and test equipment.

I learned about radios by starting with a chalk-and-talk lecture — then I went into a lab with a bunch of fiendishly disabled radios to repair. Wow, that was FUN! Now all that can be done in a virtual lab, complete with signal tracers, oscilloscopes, and test meters.

This new technology will force the public school system to either make major, major changes or be a relic of the past — like the bow and arrow for war and the horse for transportation.

So, are you going to bystand this revolution, or get in on the fun? The equipment needed to get going isn't very expensive, but you are going to need all of the creativity you've left after the public school system's 16-year effort to kill it.

I predict that in about twenty years we're going to start seeing a whole new generation of geniuses emerging, giving us fantastic art, music, and performances. With the bridge between the normal and the paranormal now being opened, we'll again be seeing some amazing new scientific breakthroughs.

Motivation

Kids just naturally want to learn. They're learning while they are still in the womb. Any parents who do not read *The Prenatal Classroom* by Carr and Lehrer are doing their child a lifetime disservice, as well as lowering their

child's IQ permanently. You can also substantially increase a baby's IQ by teaching it to sign when it is seven or eight months old — well before it can talk. Babies are busy learning every minute, and it takes a lot of punishment to put a stop to their thirst for knowledge. Ask any parent who's been through their children's "why?" age.

Psychologists tell us that most preschool children are highly creative — they learn at many times the rate of adults. But then both creativity and learning dramatically slow down when they enter public school. By the 3rd grade less than 5% of children are still creative, and learning levels are at the low they'll maintain through the rest of their lives.

In the early computer days I had a lab with 30 work stations for developing software for personal computers. I opened the lab evenings and weekends for local teenagers, who were so excited about computers that they brought sleeping bags so they could nap when they got too tired to sit up. My computer staff said these kids were like industrial vacuum cleaners with questions about the computers.

All you have to do is get kids interested in something and get the hell out of their way.

The Sudbury Valley School in Framingham (Mass.) has no classrooms, no curriculum, no memorization, no exams, and no marks. The kids aren't even separated into grades or by age. They have a great library for research, and a staff willing to teach anything a group of kids decide they want to learn. The result is kids who are outstanding and way ahead of public schoolers in creativity and learning ability, yet the school costs less than half as much as the nearby public schools to run. Read *Free At Last* by Daniel Greenberg.

The above-referenced books are reviewed in my \$5 *Secret Guide to Wisdom*, where you'll also find their sources.

Still At It

Keeping up with the Clintons is fun. As you know, Hillary, as the senator from New York, now benefits from the unbelievably generous retirement plan the Senate voted for itself. None of this Social Security stuff for them.

In order to qualify as New York residents, the Clintons bought a million-plus house in Chappaqua. They are, of course, entitled to Secret Service protection for life, so they built a house for the Secret Service residence. The Clintons charge the Secret Service rent that is about equal to their mortgage payments, so we taxpayers are paying for them to buy their home.

Wood Rat Problem

The *Chronicle of Higher Education* is concerned that Professor Janet Wright of Dickinson College can only do her wood rat research during the summer. It seems that wood rats are disappearing from some eastern states and no one knows why. Alas, Professor Wright is so tied up teaching during the academic year that she has to do her research during the summer.

When she solves the wood rat problem there will be an article in some academic journal which very few people will read. Wow!

Professor Michael Womack, a Macon State College biologist, has been kept busy counting mosquitoes for the Federal Emergency Management Agency. Carlow College's Professor Jane Dirks did a study of the ethnic backgrounds of people she meets, while walking her dog, which was presented at the national meeting of the American Anthropological Association. Earlham College's Professor Howard Richards devoted part of his summer vacation to "organizing a whole movement to reconstruct the world." Good-o.

Multiply that by tens of thousands of professors pursuing trivial research in the publish-or-perish academic world. And we're paying for this mountain of crapola.

Forty years ago most professors spent 12 to 15 hours a week in class. Today six hours a week is the norm. That means they need twice as many professors and twice as much money for salaries. More than twice, since professors' salaries have been going up much faster than inflation. And so have tuitions, surprisingly.

Will the 40-hour-a-week public ever wise up to this huge scam?

It's Your Money!

Our military, with the blessing of the White House and Congress, spent billions of our money invading Somalia to bring order. We left chaos. Billions more invading Haiti to restore democracy, but we left tyranny. Then came Kosovo to create a multiethnic democracy. Har-de-har. So what did the mightiest military power on earth spending billions of our money accomplish? Nothing positive.

Now we're going into Iraq, Again. If you're interested in the gory details, you might want to invest \$11 for the paper edition of *Fool's Errands* by Dempsey and Fontaine from Cato Institute, 1000 Mass. Ave NW, Washington DC 20001; 800-767-1241.

Continued on page 64

Wise Up!

Here are some of my books which can change your life (if you'll let 'em). If the idea of being healthy, wealthy and wise interests you, start reading. Yes, you can be all that, but only when you know the secrets which I've spent a lifetime uncovering.

.....Wayne

The Secret Guide to Health: Yes, there really is a secret to regaining your health and adding 30 to 60 years of healthy living to your life. The answer is simple, but it means making some serious lifestyle changes. Will you be skiing the slopes of Aspen with me when you're 90 or doddering around a nursing home? Or pushing up daisies? No, I'm not selling any health products, but I can help you cure yourself of cancer, heart trouble, or any other illness. Get this new, 2002 expanded edition (160p). \$10 (#04)

The Secret Guide to Wealth: Just as with health, you'll find that you have been suckered by "the system" into a pattern of life that will keep you from ever making much money and having the freedom to travel and do what you want. I explain how anyone can get a dream job with no college, no résumé, and even without any experience. I explain how you can get someone to happily pay you to learn what you need to know to start your own business. \$5 (#03)

The Secret Guide to Wisdom: This is a review of around a hundred books that will boggle your mind and help you change your life. No, I don't sell these books. They're on a wide range of subjects and will help to make you a very interesting person. Wait'll you see some of the gems you've missed reading. You'll have plenty of fascinating stuff to talk about on the air. \$5 (#02)

My WWII Submarine Adventures: Yes, I spent from 1943-1945 on a submarine, right in the middle of the war with Japan. We almost got sunk several times, and twice I was in the right place at the right time to save the boat. What's it really like to be depth charged? And what's the daily life aboard a submarine like? How about the Amelia Earhart inside story? If you're near Mobile, please visit the Drum. \$5 (#10)

Travel Diaries: You can travel amazingly inexpensively - once you know the ropes. Enjoy Sherry and my budget visits to Europe, Russia, and a bunch of other interesting places. How about a first class flight to Munich, a rented Audi, driving to visit Vienna, Krakow

in Poland (and the famous salt mines), Prague, back to Munich, and the first class flight home for two, all for under \$1,000? Yes, when you know how you can travel inexpensively, and still stay in first class hotels. \$5 (#11)

Writer's Guide: It's easy, fun, can pad your résumé, and impress the hell out of your friends. \$0 (#78)

Wayne's Caribbean Adventures: My super budget travel stories - where I visit the hams and scuba dive most of the islands of the Caribbean. You'll love the special Liat fare which let me visit 11 countries in 21 days, diving all but one of the islands, Guadeloupe, where the hams kept me too busy with parties. \$5 (#12)

Cold Fusion Overview: This is both a brief history of cold fusion, which I predict will be one of the largest industries in the world in the 21st century, plus a simple explanation of how and why it works. This new field is going to generate a whole new bunch of billionaires, just as the personal computer industry did. \$5 (#20)

Improving State Government: Here are 24 ways that state governments can cut expenses enormously, while providing far better service. I explain how any government bureau or department can cut its expenses by at least 50% in three years and do it cooperatively and enthusiastically. I explain how, by applying a new technology, the state can make it possible to provide all needed services without having to levy any taxes at all! Read the book, run for your legislature, and let's get busy making this country work like its founders wanted it to. Don't leave this for "someone else" to do. \$5 (#30)

Mankind's Extinction Predictions: If any one of the experts who have written books predicting a soon-to-come catastrophe which will virtually wipe most of us out are right, we're in trouble. In this book I explain about the various disaster scenarios, like that of Nostradamus, who says the poles will soon shift (as they have several times in the past), wiping out 97% of mankind. Okay, so he's made a long string of past lucky guesses. The worst part of these predictions is the accuracy record of some of the experts. Will it be a pole shift, a new ice age, a massive solar flare, a comet or asteroid, a bioterrorist attack? I'm getting ready, how about you? \$5 (#31)

Moondoggle: After reading René's book, *NASA Mooned America*, I read everything I could find on our Moon landings. I watched the NASA videos, looked carefully at the photos, read the astronaut's biographies, and talked with some readers who worked for NASA. This book cites 45 good reasons I believe the whole Apollo program had to have been faked. \$5 (#32)

Classical Music Guide: A list of 100 CDs which will provide you with an outstanding collection of the finest classical music ever written. This is what you need to help you reduce stress. Classical music also raises youngsters' IQs, helps plants grow faster, and will make you healthier. Just wait'll you hear some of Gotschalk's fabulous music! \$5 (#33)

The Radar Coverup: Is police radar dangerous? Ross Adey K6UI, a world authority, confirms the dangers of radio and magnetic fields, including our HTs and cell phones. \$3 (#34)

Three Gatto Talks: A prize-winning teacher explains what's wrong with American schools and why our kids are not being educated. Why are Swedish youngsters, who start school at 7 years of age, leaving our kids in the dust? Our kids are intentionally being dumbed down by our school system - the least effective and most expensive in the world. \$5 (#35)

Aspartame: a.k.a. NutraSweet, the stuff in diet drinks, etc., can cause all kinds of serious health problems. Multiple sclerosis, for one. Read all about it, two pamphlets for a buck. (#38)

\$1 Million Sales Video: The secret of how you can generate an extra million dollars in sales just by using PR. This will be one of the best investments you or your business will ever make. \$40 (#52)

Reprints of My Editorials from 73. Very few things in this world are as we've been taught, and as they appear. As an iconoclast I blow the whistle on the scams around us, such as the health care, our school system, our money, the drug war, a college education, sugar, the food giants, our unhealthy food, fluorides, EMFs, NutraSweet, etc.

1996 100 Editorial Essays: \$5 (#72)

1997 157 Editorial Essays: \$8 (#74)

1998 192 Editorial Essays: \$10 (#75)

1999 165 Editorial Essays: \$8 (#76)

2000 101 Editorial Essays: \$5 (#77)

2001 104 Editorial Essays: \$5 (#78)

Silver Wire: With two 5-in. pieces of heavy pure silver wire + three 9V batteries you can make a thousand dollars worth of silver colloid. What do you do with it? It does what the antibiotics do, but germs can't adapt to it. Use it to get rid of germs on food, for skin fungus, warts, and even to drink. Read some books on the uses of silver colloid, it's like magic. \$15 (#80)

Colloid Reprint. April 97 article on a silver colloid maker, history, and how to use the stuff. \$5 (#98)

Colloid Clips. Three 9V battery clips, 2 alligator clips & instructions. \$5 (#99)

AC-powered Colloid Kit: 12V power supply, silver wires, reprint, including priority mail shipment. \$37 (#82)

Four Small Booklets Combo: Super Organic Food: a trillion dollar new industry; Schools in 2020: another \$ trillion industry. Anthrax, a simple cure. Dowsing: why and how it works. \$3 (#86) My 1992 **We The People Declare War! On Our Lousy Government** book—360 pages and packed with ideas that'll get you all excited. Was \$13. While they last \$10. Just a few left, found in the warehouse. Last chance for this classic. (#06)

Stuff I didn't write, but you need: **NASA Mooned America:** René makes an air-tight case that NASA faked the Moon landings. This book will convince even you. \$30 (#90)

Last Skeptic of Science: This is René's book where he debunks a bunch of accepted scientific beliefs - such as the ice ages, the Earth being a magnet, the Moon causing the tides, etc. \$30 (#91)

Dark Moon: 568 pages of carefully researched proof that the Apollo Moon landings were a hoax—a capping blow for René's skeptics. \$25 (#92)

1982 General Class License Study Guides. Teaches the fundamentals of radio & electricity. Was \$7. I found a few in the warehouse. \$3, while they last. Great book! (#83)

Radio Bookshop

Box 416, Hancock NH 03449

Name _____ Call _____

Address _____

City-State-Zip _____

Use the numbers in the brackets or copy page and mark the books you want. Add \$3 s/h per total order in US (\$7 priority mail), \$6 Can, \$10 foreign. _____

Order total: US\$ _____ Phone (for CC orders) _____

MC/Visa for orders over \$10. # _____ Expire _____

www.waynegr.com • phone orders: 603-588-0107 • fax: 603-588-3205 • w2nsd@aol.com

Yes! Put me down for a year of 73 for only \$25 (a steal). Canada US\$32. Foreign US\$44 by sea.

I need some industrial strength stress reduction so send me your Adventures In Music CD catalog. Allow 4 weeks for delivery except foreign, though we try to get most orders shipped in a day or two.

Your e-mail address: _____

Barter 'n' Buy

Turn your old ham and computer gear into cash now. Sure, you can wait for a hamfest to try and dump it, but you know you'll get a far more realistic price if you have it out where 100,000 active ham potential buyers can see it, rather than the few hundred local hams who come by a flea market table. Check your attic, garage, cellar and closet shelves and get cash for your ham and computer gear before it's too old to sell. You know you're not going to use it again, so why leave it for your widow to throw out? That stuff isn't getting any younger!

The 73 Flea Market, Barter 'n' Buy, costs you peanuts (almost) — comes to 35 cents a word for individual (noncommercial!) ads and \$1.00 a word for commercial ads. Don't plan on telling a long story. Use abbreviations, cram it in. But be honest. There are plenty of hams who love to fix things, so if it doesn't work, say so.

Make your list, count the words, including your call, address and phone number. Include a check or your credit card number and expiration. If you're placing a commercial ad, include an additional phone number, separate from your ad.

This is a monthly magazine, not a daily newspaper, so figure a couple months before the action starts; then be prepared. If you get too many calls, you priced it low. If you don't get many calls, too high.

So get busy. Blow the dust off, check everything out, make sure it still works right and maybe you can help make a ham newcomer or retired old timer happy with that rig you're not using now. Or you might get busy on your computer and put together a list of small gear/parts to send to those interested?

Send your ads and payment to: 73 Magazine, Barter 'n' Buy, 70 Hancock Rd., Peterborough NH 03458 and get set for the phone calls. The deadline for the June 2003 classified ad section is April 10, 2003.

220 MHz Award; see W9CYT on WWW.QRZ.COM for information. BNB645

K8CX HAM GALLERY [<http://hamgallery.com>]. BNB620

TELEGRAPH COLLECTOR'S PRICE GUIDE: 250 pictures/prices. \$12 postpaid. **ARTIFAX BOOKS**, Box 88, Maynard MA 01754. Telegraph Museum: [<http://wltp.com>]. BNB113

New miniature oscillator modules are now available ... all under \$20 ... plus our great reference book is still for sale. Write to **RMT Engineering**, 6863 Buffham Road, Seville OH 44273 or see our Web site at [www.ohio.net/~rtormet/index.html]. BNB640

RF TRANSISTORS TUBES 2SC2879, 2SC1971, 2SC1972, MRF247, MRF455, MB8719, 2SC1307, 2SC2029, MRF454, 2SC3133, 4CX250B, 12DQ6, 6KG6A, etc. **WESTGATE**, 1-800-213-4563. BNB6000

METHOD TO LEARN MORSE CODE FAST AND WITHOUT HANGUPS Johan N3RF. Send \$1.00 & SASE. **SVANHOLM RESEARCH LABORATORIES**, P.O. Box 81, Washington DC 20044 USA. BNB421

Cash for Collins: Buy any Collins Equipment. **Leo KJ6HI**. Tel./FAX (310) 670-6969. [radioleo@earthlink.net]. BNB425

Browse our Web site and check out the "Monthly Special." TDL Technology, Inc. [www.zianet.com/tdl]. BNB500

MAHLON LOOMIS, INVENTOR OF RADIO, by Thomas Appleby (copyright 1967). Second printing available from **JOHAN K.V. SVANHOLM N3RF**, SVANHOLM RESEARCH LABORATORIES, P.O. Box 81, Washington DC 20044. Please send \$25.00 donation with \$5.00 for S&H. BNB420

Ham Radio Repair, Quality workmanship. All Brands, Fast Service. **Affordable Electronics**, 7110 E. Thomas Rd., Scottsdale, AZ 85251. Call 480-970-0963, or E-mail [HAM_SERVICE@AOL.COM]. BNB427

SATELLITE TV — Large selection of items at reasonable prices. We specialize in Big Dish TVRO C & Ku Band equipment. Check us out at [www.daveswebshop.com]. BNB646

HEATHKIT COMPANY is selling photocopies of most Heathkit manuals. Only authorized source for copyright manuals. **Phone:** (616) 925-5899, 8-4 ET. BNB964

WANTED: USED ROTORS, controls, CD-44, Ham-M, 2, 3,4, T2X, or larger. Call C.A.T.S., 1-800-3ROTORS BNB662

Electricity, Magnetism, Gravity, The Big Bang. New explanation of basic forces of nature in this 91-page book covering early scientific theories and exploring latest controversial conclusions on their relationship to a unified field theory. To order, send check or money order for \$16.95 to: American Science Innovations, P.O. Box 155, Clarington OH 43915. Web site for other products [http://www.asi_2000.com]. BNB100

COLLOIDAL SILVER GENERATOR! Why buy a "box of batteries" for hundreds of dollars? Current regulated, AC powered, fully assembled with #12 AWG silver electrodes, \$74.50. Same, but DC powered, \$54.50. Add \$2.50 shipping. **Thomas Miller**, 216 East 10th St., Ashland OH 44805. Web address [www.bioelectrifier.com]. BNB342

ANTENNA SCIENCE: Why do antennas radiate electromagnetic waves? Learn for yourself from this enlightening paper by **MAX RESEARCH**. Gain an understanding of the radiation mechanism of antennas! Written in a clear style for radio hobbyists, inquisitive amateurs and experimenters. \$4.95 ... ppd. Order from **MAX RESEARCH**, P.O. Box 1306, East Northport NY 11731. BNB426

WANTED: ANY MODEL Collins, working or not, including speakers, filters, options, 1-piece or collection. Bob, 651-354-5345 days: 651-345-3600 eves. E-Mail: rkemp@mr.net. BNB661

FREE!! HAM Radio and other CD-Roms and Disk catalog. **MOM 'N' POP'S SOFTWARE**, P.O. Box 15003-TH, Springhill, FL 34604-0111, 1-352-688-9108, visit: <http://www.momnpopsware.com> BNB660

SMART BATTERY CHARGERS and more, [www.a-engineering.com] BNB653

GET MORE OUT OF HAM RADIO! Books on all topics. Up to 15% off. Quality Technical Books. [<http://qtb.com/hamradio/>]. BNB665

NEVER SAY DIE

continued from page 62

Delighted!

Even though in my editorial essays I've reviewed the books by Ott and Lieberman on the importance of sunlight to your health, and even though their books are reviewed in my *Secret Guide to Wisdom* — I haven't been able to get you to go outside every day to get those all-important UVs into your eyeballs. And that's without any eyeglasses on. I threw out all my sun glasses after reading what they could do to my health — even Joe Sugarman's Blu-Blocker glasses.

Are you going to wait for God to smite you before you start taking care of your body? Yes, it's a nuisance to take off a half hour a day around noon to fast walk a couple miles and get those UVs. Hey, do you think your ancestors sat around their caves all day whittling sticks? They were out there in the sun running around. They chased game, gathered food, and killed as many of those damned Neanderthals as they could. That was hard work. And when it got dark they lay down and slept until it got light again. They weren't sitting around watching TV with a bowl of snack food or sitting in a bar somewhere.

UVs will keep you healthier and less depressed.

Alinco Delivers HF Adventure!

Alinco's HF Transceivers Deliver Incredible Performance at a Tiny Price

You're only a few hundred dollars away from a brand new Alinco HF Transceiver. That's right! Just a few hundred dollars gets you on the air with a big 100-watt signal, great audio and an easy-to-operate package that's perfect for base, portable or mobile operations. The Alinco DX-70 and DX-77 make it easy for everyone to enjoy HF with a dependable transceiver that's backed by Alinco's 1 year warranty.

The world of HF is calling. What are you waiting for?



Alinco DX-70TH Base/Mobile/Portable HF + 6 Meter Transceiver

- 100 watts SSB, FM & CW, 40 watts AM
- Continuous coverage HF receiver + full 6 meter coverage
- 100 memory channels
- Speech compressor
- Great CW rig, full QSK, semi or automatic break-in
- Standard narrow filter fights QRM on SSB, CW or AM
- Two VFO's and easy "split" operation
- Removable face for remote mounting.
- RIT / TXIT, IF shift
- Multi function control for easy operation

Alinco DX-77T Desktop HF Transceiver

- 100 watts SSB, FM & CW, 40 watts AM
- General coverage receiver 150 KHz ~ 30 MHz
- Two VFO's; easy "split" operation
- Standard speech processor
- Front panel speaker provides loud, clear audio
- Built-in electronic keyer 6 ~ 60 wpm
- Full QSK, 7-step semi break-in or auto break-in
- Enhanced Direct Digital Synthesis (DDS) eliminates need for SSB Narrow Filter
- Front panel connections for mic, key, speaker & phones



Options

- EDX-2 automatic wire antenna tuner
- EMS-14 desktop microphone
- DM-330 MVT switching power supply
- DM-340 MVT regulated power supply



Iron Horse Mobile HF antennas for Alinco and other HF transceivers

Order the Iron Horse IHF5S package from your dealer and go mobile fast!



IHF5S Mobile HF Antennas

IHTH-1
Optional
Trailer Hitch Mount



You get a package of 5 rugged, easily tuned antennas for 10, 15, 20, 40 & 75 meters from Iron Horse, a name recognized for its strength and dependability. Each has 3/8 x 24 threads and is rated for 500 watts. Order the IHKD3S 5 antenna quick disconnect mounting kit to make changing bands a quick and easy operation, just push, turn & go!

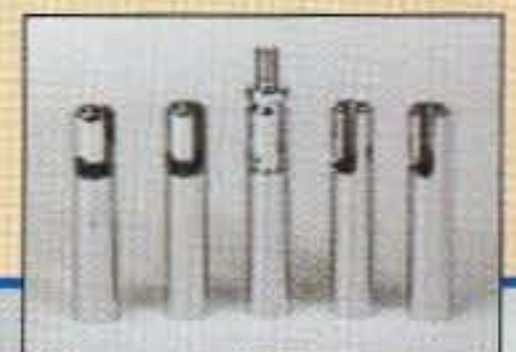

IHKD3S Quick
Disconnect Kit



www.ALINCO.com

Distributed in North America by ATOC Amateur Distributing LLC • 23 S. High St., Covington, OH 45318 • (937) 473-2840
Specifications subject to change without notice or obligation.

Products intended for use by properly licensed operators. Permits required for MARS/CAP use. Specifications subject to change without notice or obligation. All trademarks remain the property of their respective owners.

ULTRA-RUGGED, SUBMERSIBLE TRI-BAND MAGNESIUM HANDIE

Own the brightest star in the Ham Radio Galaxy! The exciting new YAESU VX-7R sets new standards in ruggedness, water resistance, and versatility, and its memory capacity is unparalleled. Own the VX-7R, and you'll own the best.

**TRUE DUAL RECEIVE
(V+V/U+U/V+U/HAM+GEN)**

WIDE-RANGE RECEIVER

MAGNESIUM CASE

**SUBMERSIBLE
(3 feet for 30 minutes)**

**OVER 500 MEMORY
CHANNELS**

**MIXED TONE (CTCSS/DCS)
CAPABILITY**

**INTERNET KEY FOR ACCESS TO
*WIRES***

Wide-Coverage Internet Repeater Enhancement System

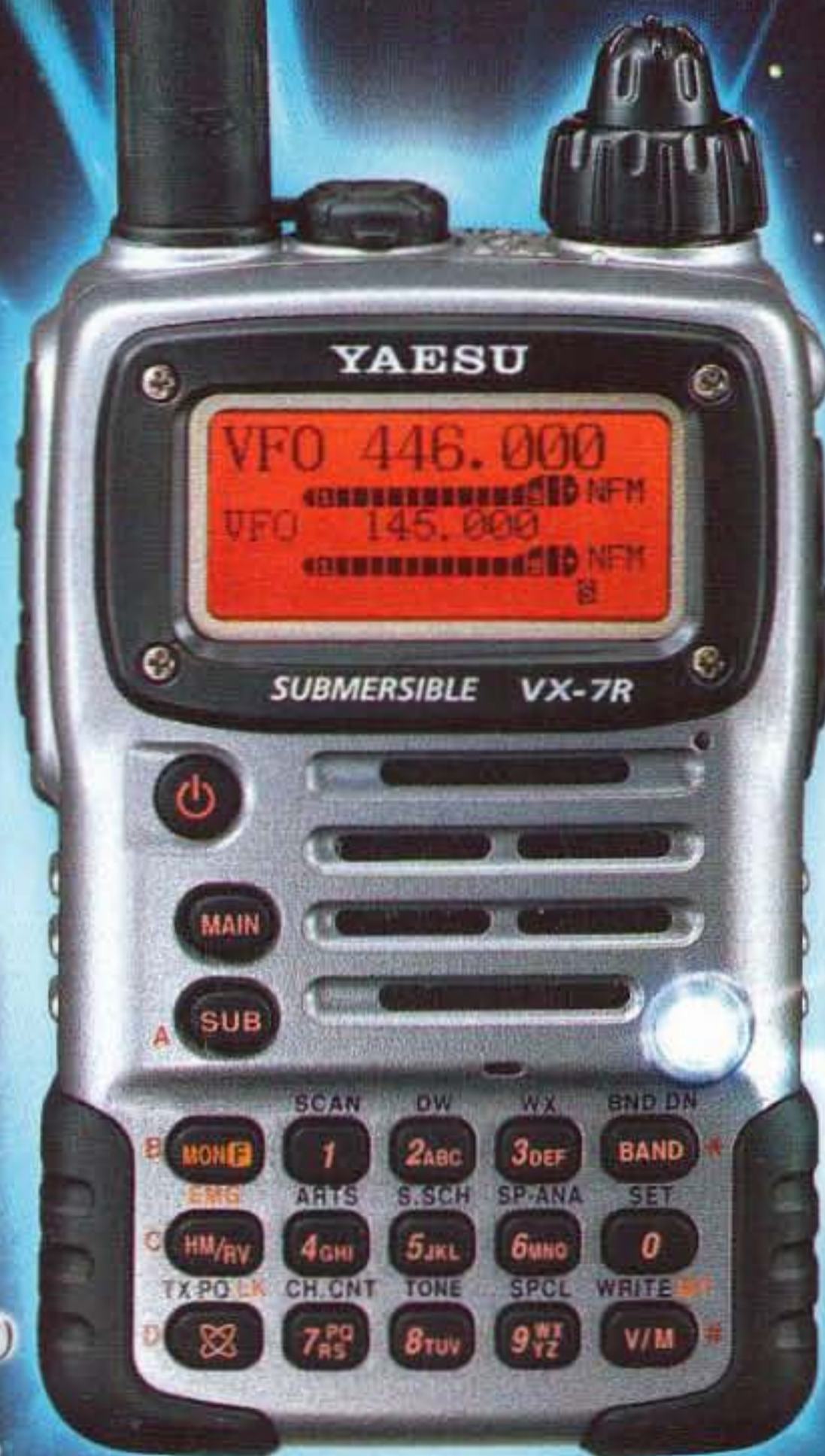

**SHORTWAVE BROADCAST
MEMORY BANK**

**WEATHER BROADCAST MEMORY
BANK WITH "SEVERE WEATHER"
ALERT**

MARINE BAND MEMORY BANK

MULTI-COLOR STROBE LED

**LOW-POWER 222 MHz TX
(U.S. version)**

RUBBER CASE PROTECTOR

VX-7R

50/144/430 MHz 5W FM Transceiver

Actual Size

For the latest Yaesu news, visit us on the Internet:
<http://www.vxstdusa.com>

Specifications subject to change without notice. Some accessories and/or options may be standard in certain areas. Frequency coverage may differ in some countries. Check with your local Yaesu Dealer for specific details.

YAESU
Choice of the World's top DX'ers™

Vertex Standard
US Headquarters
10900 Walker Street
Cypress, CA 90630 (714)827-7600