

# The **AMSAT**® Journal

Editor-in-Chief

Joe Neil Kornowski, KB6IGK

Assistant Editors

Bernhard Jatzeck, VA6BMJ

Douglas Quagliana, KA2UPW/5

W.M. Red Willoughby, KC4LE

Volume 39, Number 2

March/April 2016



## The Next Generation

[Carlos Pechiar, CX6BT, photo.]

### *in this issue ...*

AMSAT Announcements ..... 2

Apogee View ..... 3  
by Barry Baines • WD4ASW

Engineering Update ..... 6  
by Jerry Buxton • N0JY

ARISS Update ..... 8  
by Frank Bauer • KA3HDO

Member Footprints ..... 9  
by Nick Mahr • KE8AKW

Fox-1 L-band Upconverter ..... 10  
by Alfred Watts • AF5VH

ARISS Interoperable Radio  
System Upgrade ..... 11  
by Lou McFadin • W5DID

APRS Satellites, PSK31 and  
DTMF/Voice ..... 13  
by Bob Bruninga • WB4APR  
Dr. Mirek Kasal • OK2AQK  
Tomas Urbanec • OK2PNQ

AMSAT Phase 4 Ground  
Project Update ..... 18  
by Michelle Thompson • W5NYY

AO-85 Hooks a Father and Son in  
Uruguay ..... 20  
by Carlos Pechiar • CX6BT

AMSAT Field Day 2016 ..... 21  
by Bruce Paige • KK5DO

Working AO-85 Full Duplex  
with Chinese Handhelds ..... 22  
by Patrick Stoddard • WD9EWK

Amateur Radio's Very First  
Satellite – The Amazing Story of  
OSCAR-1 ..... 25  
by Keith Baker • KB1SF/VA3KSF

Periodicals  
POSTAGE PAID  
At Kensington, MD  
and at additional  
mailing offices

AMSAT-NA  
10605 Concord St., Suite 304  
Kensington, MD 20895-2526



# From portable handheld antennas to command/control arrays, M2 Antenna Systems can supply what you need.

WORLD CLASS PRODUCTS

**2MCP8A**  
2M CP YAGI



**436CP16**  
70CM CP YAGI

## The LEO-Pack

Are you ready for Fox 1C & 1D? Missing out on all the action on the latest birds? The M2 LEO-Pack is a great solution for LEO communication. You do not need an elevation rotator for casual operation, but elevation will allow full gain over the entire pass.

The 2MCP8A is a circularly polarized antenna optimized for the 2M satellite band. The 436CP16 has been designed for an optimum match and gain at the 70CM satellite band. A perfect system for a small home or portable system.

*\*See our review, QST March 2016 page 60.*

Need a bit more link margin? The 2MCP14, 2MCP22, 436CP30, 436CP42 antennas are HEO capable. Optional items are also available like the CB60 fiberglass cross boom, power dividers, polarity switches, phasing lines and complete H-Frame assemblies.



**2M-440XP-SS**  
2M 440 XP YAGI



**CB60**  
FG CROSSBOOM

M<sup>2</sup> offers a complete line of top quality amateur, commercial and military grade antennas, positioners and accessories.

We produce the finest off-the-shelf and custom radio frequency products available anywhere.

For high frequency, VHF, UHF and microwave, we are your source for high performance RF needs.

M<sup>2</sup> also offers a diverse range of heavy duty, high accuracy antenna positioning systems.

Whether your communication requirements are across town, around the world or beyond, M<sup>2</sup> has World Class Products to suit your application.

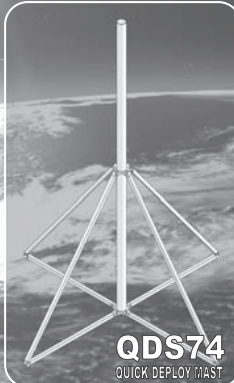

**QDS74**  
QUICK DEPLOY MAST



**AE1000 SERIES**  
AZ EL PEDESTAL

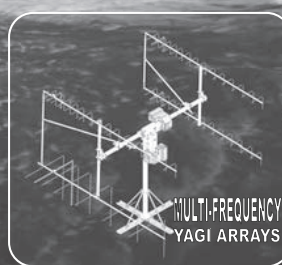

**MULTI-FREQUENCY**  
YAGI ARRAYS

M<sup>2</sup> products are proudly 'Made in the USA'

4402 N. Selland Ave.  
Fresno, CA 93722  
Phone (559) 432-8873  
sales@m2inc.com  
<http://www.m2inc.com>

*\*Prices subject to change without notice.*

## ANTENNAS POSITIONERS ACCESSORIES

### AMSAT Announcements

#### 2016 AMSAT-NA Board of Directors Nominations Notice

It is time to submit nominations for the upcoming AMSAT-NA Board of Directors election. Three directors' terms expire this year: Tom Clark, K3IO, JoAnne Maenpaa, K9JKM, and Lou McFadin, W5DID. In addition, up to two Alternates may be elected for one-year terms.

A valid nomination requires either one Member Society member or five current individual members in good standing to nominate an AMSAT-NA member for Director. Written nominations, consisting of the nominee's name and callsign, and each nominating individual's name, callsign and signature should be mailed to:

AMSAT-NA  
10605 Concord St., #304  
Kensington, MD 20895-2526.

As an alternative to traditional written nomination

submissions (the preferred method), the intent to nominate may be made electronically. This includes email, fax, or an electronic image of a petition. Electronic petitions should be sent to [martha@amsat.org](mailto:martha@amsat.org) or faxed to (301) 822-4371.

No matter what means are used, petitions MUST arrive no later than June 15th at the AMSAT-NA office. If the nomination is a traditional written nomination, no other action is required. If it is electronic, a verifying traditional written petition also MUST be received at the AMSAT-NA office at the above address within 7 days following the close of nominations on June 15th.

**ELECTRONIC SUBMISSIONS WITHOUT THIS SECOND, WRITTEN VERIFICATION ARE NOT VALID UNDER THE EXISTING AMSAT-NA BYLAWS.**

#### AMSAT's Mission

AMSAT is a non-profit volunteer organization which designs, builds and operates experimental satellites and promotes space education. We work in partnership with government, industry, educational institutions and fellow Amateur Radio societies. We encourage technical and scientific innovation, and promote the training and development of skilled satellite and ground system designers and operators.

#### AMSAT's Vision

Our Vision is to deploy satellite systems with the goal of providing wide-area and continuous coverage. AMSAT will continue active participation in human space missions and support a stream of LEO satellites developed in cooperation with the educational community and other amateur satellite groups.



# Apogee View

Radio Amateur Satellite Corporation (AMSAT-NA)  
10605 Concord St., Suite 304, Kensington, MD  
20895-2526

Telephone: 301-822-4376 – Toll Free: 888-322-6728

Facsimile: 301-822-4371

AMSAT-NA Club Callsign: W3ZM

AMSAT-NA Web site: <http://www.amsat.org>

## The AMSAT Journal Staff

**Editor-in-Chief:** Joe Neil Kornowski, KB6IGK,  
kb6igk@amsat.org

### **Assistant Editors:**

Douglas Quagliana, KA2UPW/5

Bernhard Jatzek, VA6BMJ

W. M. Red Willoughby, KC4LE

**Circulation:** Martha Saragovitz, martha@amsat.org

### **AMSAT-NA Board of Directors**

**Barry Baines, WD4ASW**, wd4asw@amsat.org

**Jerry Buxton, N0JY**, n0jy@amsat.org

**Tom Clark, K3IO**, k3io@amsat.org

**Drew Glasbrenner, KO4MA**, ko4ma@amsat.org

**Lou McFadin, W5DID**, w5did@amsat.org

**Bob McGwier, N4HY**, n4hy@amsat.org

**JoAnne Maenpaa, K9JKM**, k9jkm@amsat.org

First Alternate: **Mark Hammond, N8MH**,

n8mh@amsat.org

Second Alternate: **Bruce Paige, KK5DO**,

kk5do@amsat.org

### **AMSAT-NA Senior Officers**

**President:** Barry Baines, WD4ASW

**Executive Vice-President:** Open

**Treasurer:** Keith Baker, KB1SF/VA3KSF

**Secretary:** Paul Stotzter, N8HM

**Manager:** Martha Saragovitz

**Vice President, Engineering:** Jerry Buxton, N0JY

**Vice President, Operations:** Drew Glasbrenner, KO4MA

**Vice-President, User Services:** Open

**Vice President, Human Spaceflight:** Frank Bauer,  
KA3HDO

**Vice President, Educational Relations:** Joe Spier,  
K6WAO

### **Honorary Positions**

**Immediate Past President:** Rick Hambly, W2GFS

**President Emeritus:** Tom Clark, K3IO

**Founding President:** Perry Klein, W3PK

**Editorial Office:** Joe Neil Kornowski KB6IGK, 5317 Musket Ridge, Austin, TX 78759. Please e-mail Journal submissions to: [journal@amsat.org](mailto:journal@amsat.org), Editor's telephone: 512-574-1233 (cell). Advertising Office: AMSAT-NA Headquarters, 10605 Concord St., Suite 304, Kensington, MD 20895-2526, Telephone: 301-822-4376.

The AMSAT Journal (ISSN: 1407-3076) is published bi-monthly (Jan/Feb, Mar/Apr, May/Jun, Jul/Aug, Sep/Oct, Nov/Dec) by AMSAT-NA, 10605 Concord St., Suite 304, Kensington, MD 20895-2526. Telephone: 301-822-4376, fax: 301-822-4371. Periodicals postage paid at Kensington, MD and additional mailing offices.

**Postmaster:** Send address changes to The AMSAT Journal, 10605 Concord St., Suite 304, Kensington, MD 20895-2526.

Opinions expressed in The AMSAT Journal are those of the article authors and are not necessarily those of AMSAT-NA. Copyright © 2016 by AMSAT-NA. The Radio Amateur Satellite Corporation. AMSAT is a registered trademark. Reproduction of material from The AMSAT Journal by mechanical, electronic, photocopy or other means is prohibited unless written permission is obtained from The AMSAT Journal and the author.

The AMSAT Journal staff is always interested in article submissions. Whenever possible, submissions should be sent via e-mail to [journal@amsat.org](mailto:journal@amsat.org) using plain text or word processor files; photos or figures in TIF, GIF or JPEG formats. Kindly do not embed graphics or photos in your manuscript - we prefer receiving those as separate files. AMSAT-NA reserves the right to select material for The AMSAT Journal based on suitability of content and space considerations.

## Barry Baines • WD4ASW President wd4asw@amsat.org

As I write this column in early March, spring appears to be approaching. Temperatures are becoming more reasonable and the snow has disappeared. Of course, "Old Man Winter" may still make a last minute appearance for Easter (which is earlier this year), but at least we're enjoying relatively decent weather in the New England area at the moment. With major league baseball spring training in full stride, I look forward to the upcoming baseball season, as well, which is another reflection of the changing seasons.

From an AMSAT perspective, the transition from one season to the next is also a reflection of some interesting developments to share with you.

### An ARISS Milestone

As I write this, the Amateur Radio on the International Space Station (ARISS) Team just celebrated the 1,000th contact that took place on March 16. This contact involved the North Dakota Space Grant Consortium, which engaged second through fifth grade students from five middle schools in North Dakota and Minnesota. The contact took place at the University of North Dakota in Grand Forks, with an audience of over 500 attending. TV and newspaper reporters were on hand to witness the interaction between Astronaut Tim Kopra, KE5UDN, and the middle school students who were selected to directly participate in the contact. The event also was streamed live.

The 1,000th contact was conducted by telebridge, with amateur radio station W6SRJ, at Santa Rosa Community College in Santa Rosa, California, serving as the gateway station. Congratulations to Tim Bosma, W6MU, and Don Dalby, KE6UAY, who served as the radio operators for W6SRJ for the contact as well as to Charlie Sufana, AJ9N, who mentored the University of North Dakota Student Amateur Radio Association and the FORX Amateur Radio Club in the preparation and execution of the ARISS contact.

The first ARISS contact took place in 2000 and Charlie, AJ9N, was the lead operator for that event. Charlie's involvement with ARISS for all of these years is an example of the hard work and dedication of volunteers

who have made this program a success, touching hundreds of thousands of students around the world. ARISS volunteers have worked with crews from all 48 expeditions that have manned the ISS since it was placed in operation.

While ARISS has achieved a very significant milestone, the program continues to evolve in response to changing circumstances. Today, AMSAT and the ARRL, rather than NASA, manage the school selection process in the U.S.. Ham TV was first demonstrated in February, with the initial video downlink via amateur radio from the ISS involving a school in the United Kingdom communicating with British Astronaut Tim Peake, KG5BVI. Students asked questions through the normal VHF FM voice uplink, but viewed the astronaut's responses to their questions via a digital Ham TV downlink.

On February 25, AMSAT and NASA finalized a Space Act Agreement (SAA) that defines roles and responsibilities of both organizations with regard to the ISS Amateur Radio payload ("ISS Ham") that supports the mission of the ISS National Lab. William H. Gerstenmaier, Associate Administrator, Human Exploration and Operations on behalf of NASA signed the SAA. As AMSAT President, I signed the SAA on behalf of AMSAT.

The agreement continues the relationship first established in 1996, when the ARISS working group was created before the first space segment for the ISS was placed in orbit. The SAA defines three purposes for ISS Ham:

1. An ISS Program/National Lab/SCaN Science, Technology, Engineering & Mathematics (STEM) outreach activity inspiring students around the world to pursue careers in STEM by engaging amateur radio operators and the public worldwide through the use of amateur radio capabilities onboard the ISS
2. A facility for recreational crew use as part of crew psychological support, and
3. A capability for ISS emergency crew voice communications via amateur radio, NASA or Russian Very High Frequency (VHF) ground stations, as a backup to the onboard ISS voice communications systems.

Frank Bauer, KA3HDO, serves as AMSAT's VP-Human Space Flight and International Chairman for ARISS. Frank has been instrumental in guiding ARISS through the changes that have taken place with our relationships within NASA, as well as our



ARISS partners, and building a foundation for the long term continuation of ARISS. He served as the primary point of contact with NASA on the drafting of the SAA. Frank's leadership, coupled with his creating solid working relationships with key stakeholders has resulted in an enhancement of the NASA-AMSAT (along with ARRL) partnership for ARISS that provides the foundation for future evolution of the program; the SAA was a result of his effectiveness.

A significant amount of work remains to be done, along with fundraising to keep the program going well and developing the resources needed for future success. For example, any future enhancements to the amateur radio system on board ISS will require funding not only for acquiring and/or developing any equipment placed on board ISS, but also for completing NASA's safety certification process prior to authorization for placing that equipment on board the U.S. or European segment. Other expenses include travel and administrative costs associated with the program, given the international collaboration taking place, as well as the need to keep NASA and other stakeholders apprised of these accomplishments. "Metrics" is a key component of demonstrating the viability of the program. Both time and dollars are needed to provide these results on a timely and recurring basis. Fundraising will help pay these expenses.

Congratulations to the entire ARISS team on a significant milestone and for making such a huge impact on students around the world!

## AMSAT Engineering

February marked a significant milestone with both Fox-1Cliff and Fox-1D passing their environmental testing requirements. The tests were conducted at National Technical Systems in Orlando over a period of two weeks and involved a considerable amount of time by AMSAT volunteers to monitor the tests. The volunteers included Jerry Buxton (VP-Engineering), N0JY, Bob Davis (Fox Team Mechanical), KF4KSS, Burns Fisher (Fox Software Team), W2BFJ, Lou McFadin, W5DID, and Ed Krome, K9EK. Upon completion of testing, Jerry provided the test results to Spaceflight, Inc., which took additional time.

The bottom line is that both satellites are prepared for launch. We're now awaiting confirmation of a delivery date, which is contingent upon a launch date. The launch date has not been publicly revealed, but we do expect it to occur in the first half of 2016 on a SpaceX Falcon 9.

We've also been notified that the ELaNu proposal submitted by Vanderbilt's Institute for Space and Defense Electronics (ISDE) last November was approved in February. The CubeSat is designated as RadFxSat-2 by ISDE in the proposal, but we're more familiar with the designation Fox-1E.

Of course, we're thrilled by this news, as this project will be the fifth Fox-1 series satellite to fly. Fox-1E will be modified somewhat from earlier Fox-1 class satellites, as it is expected to use a linear transponder rather than FM.

We also appreciate Vanderbilt's support of our program, as ISDE has developed payloads for Fox-1A through Fox-1C. We have heard that ISDE is very excited about the data coming from AO-85, launched last October. Telemetry downloading, including scientific data, has been very successful and provided timely and useful data for ISDE. We're told that ISDE personnel have written a scientific paper based upon the data obtained from AO-85 that will be published later this year. We are very gratified to know that our strategy of integrating scientific payloads into our spacecraft is generating impressive results. AMSAT members should be proud of the results to date with AO-85, and we all look forward to the approaching launches of Fox-1 Cliff and Fox-1D by Spaceflight, Inc., in 2016 and RadFxSat-1/Fox-1B by ELaNu-XIV that is expected in January 2017.

## Orlando HamCation

One of February's highlights for me is the Orlando HamCation. The 2016 event took place the weekend of February 12-14 and also served as the 2016 ARRL National Convention. Unfortunately, I also had a conflict in Jacksonville that same weekend, so I drove down to Orlando Thursday evening to be at the HamCation when it opened and stay the entire day. I checked out of the hotel on Friday morning and got to the Central Florida Fairgrounds just before opening. I picked up my admission ticket at the "Will Call" window and proceeded to commercial exhibit building #1. I walked directly to the AMSAT booth that was set up by the team led by Dave Jordan, AA4KN, and featured a satellite station provided by John Papay, K8YSE. John also conducted a number of satellite demonstrations outside the commercial area, which drew some interest.

The weather was perfect on Friday and my impression is that the crowds were larger on Friday than in prior years. While I can only speak directly of my involvement on the first day, I'm told the AMSAT Forum on the second day, led by Drew Glasbrenner,

KO4MA, and Lou McFadin, W5DID, was well attended. If the memberships added and the dollars spent at the AMSAT booth at HamCation are any indication, interest in AMSAT is growing.

HamCation has some real positives going for it. For snowbirds, it offers an escape from "Old Man Winter." It is the first major hamfest of the New Year and has grown to the point that both sellers and manufacturers of all sizes have booths. For me, Orlando is "old home week," seeing friends who I've known since my days in Florida (which started in 1978) prior to moving north in 2004. Along with catching up with people, Orlando provides a good opportunity to interact with colleagues and visit with those who I've interacted with through AMSAT. And of course, the flea market can provide opportunities for finding items on my wish list at reasonable prices.

This past February also provided an opportunity to extend good wishes to three members of the ARRL Leadership Team as they stepped down from their posts. At the Richmond Frostfest on February 6, I saw Kay Craigie, N3KN, who had just stepped down as ARRL President the prior week. Kay has been very helpful to AMSAT in addressing regulatory issues, building relationships and recognizing the potential of our Phase 4-B project for emergency communications.

At HamCation, I extended good wishes to Dave Sumner, K1ZZ, who retires in April as the League's Chief Executive Officer after spending his entire career at ARRL. While I've served as AMSAT President, Dave has been very helpful in establishing a line of communication with the FCC on the question of CubeSat licensing in the Amateur Satellite Service. The IARU Satellite Advisor is heavily involved in coordinating frequencies in the Amateur Satellite Service. As an IARU official, Dave has also been very much involved behind the scenes, as the ARRL represents the U.S. within the IARU. Dave also attended the 2013 CubeSat Workshop, in part to learn more about university CubeSat projects, as well as to better understand the dynamics impacting these satellites.

I also spoke with Harold Kramer, WJ1B, who retired in February as the Chief Operating Officer of ARRL. I first met Harold in August 2009 when I went to Newington to give an overview of AMSAT to ARRL personnel so that they would be more informed about AMSAT's direction at that time and to establish working relationships within the League.



ARISS is a key area of cooperation between ARRL and AMSAT, and I highlighted ARISS' program in my presentation, given its impact on Education. In the years since that introduction, AMSAT and the ARRL have accomplished much together to enhance ARISS and highlight its impact on education. ARRL Education Manager Debra Johnson, K1DMJ, is part of the ARISS Executive Team and intimately involved with the school selection process developed by AMSAT and ARRL. She has collaborated with AMSAT's Education leadership team, now headed by Joe Spier, K6WAO.

HamCation also provided me an opportunity to make introductions to the new leadership team. You can imagine that for new ARRL President Rick Roderick, K5UR, and incoming ARRL CEO Tom Gallagher, NY2RF, HamCation was presumably a whirlwind of meeting scads of people and making first impressions. Both Rick and Tom expressed to me strong appreciation for AMSAT's satellite development programs, as well as the impact of ARISS. The "changing of the guard" is often a challenging time for any organization, but I expect that the working relationships that have been established with ARRL will continue to grow as AMSAT enhances its capabilities to keeping amateur radio in space.

## Dayton Hamvention

Preparations are in full swing for this year's edition of the Dayton Hamvention, May 20-22. Steve Belter, N9IP, is once again handling the logistical challenges of managing AMSAT's presence at Dayton. We'll be in the same spot as last year in Ball Arena, and we expect that the booth will feature displays from AMSAT Engineering, and ARISS, along with our normal contingent of AMSAT paraphernalia, including the 2016 edition of G. Gould Smith's *Getting Started with Amateur Radio Satellites* and the latest in AMSAT fashion wear.

If you're coming to Dayton and are willing to volunteer for a "stint at the booth" at some point during Hamvention, please contact Steve ([n9ip@amsat.org](mailto:n9ip@amsat.org)) and let him know your interest. Many volunteers are needed to staff the booth during this three-day event. No prior experience is necessary!

As a new member incentive at Dayton, we'll include a copy of the DVD *2012 AMSAT Space Symposium Proceedings*, which contains the papers not only from the 2012 Symposium but from every Symposium going back to 1986. For a person just joining AMSAT, this DVD will be a significant addition to that member's library of materials concerning amateur radio in space. Those of us who were

AMSAT members in 2012 may recall that we provided this DVD to every member in lieu of not receiving six issues of *The AMSAT Journal* that year. Consequently, renewing members will not receive this incentive UNLESS they were new members in 2013 or after. It doesn't make sense to give this DVD to those who have previously received it.

The AMSAT-TAPR Dinner on Friday Night will once again be at the Kohler Center. Our speaker this year is Michelle Thompson, W5NYV. She is the team leader developing the ground terminal for use with the proposed P4-B payload as well other future potential AMSAT HEO projects involving 6-Unit CubeSats. The title of her talk is, "It's Just Software, Right?" As the ANS-073 bulletin states, "She will survey the AMSAT Ground Terminal: Who, what, when, where, why, and how we're designing open source radio solutions for the next generation of AMSAT payloads."

The AMSAT Forum is scheduled for Saturday in Room 5 from 1115-1330. We expect to provide updates on AMSAT Engineering, share the latest on the status of the P4-B project, present the latest information concerning recently launched satellites, and hear about the latest developments with ARISS.

Satellite demonstrations conducted outside of Ball Arena have been one of our more successful efforts at Hamvention. Paul Stoetzer, N8HM, will be heading up that activity for us with assistance from a number of others. This is a great way to draw new interest in satellites from those who perhaps were reluctant to become involved with satellites. In addition, we'll have the "Beginner's Corner" at the AMSAT booth, where knowledgeable satellite operators will be available to answer questions and discuss working the birds.

We'll have both Arrow (with and without diplexers) and Elk antennas available at the booth. We also expect to have the LVB tracker available, and we'll be taking orders for the M-Squared LEO-Pack (VHF and UHF circular polarized antennas with cross boom, drop-shipped) We hope that the increasing interest in satellites coupled with the outdoor satellite demonstrations will help generate demand for these products.

If you're coming to Dayton, please drop by the AMSAT booth and attend the AMSAT Forum. It should be a great weekend. See ya in Dayton!



## Smile for AMSAT at Amazon.com

Select [smile.amazon.com](http://smile.amazon.com) when making your Amazon purchases and default to Radio Amateur Satellite Corporation as your chosen charity.

Want to put a smile on a satellite? When you make your purchases from Amazon, you can select a charity and Amazon will donate .5% of a qualified purchase towards your selected charity. AMSAT (Radio Amateur Satellite Corporation) is registered with Amazon Smile and you can select it as your preferred charity, which in turn will put a smile on our satellite efforts.

Once you have selected your Amazon Smile charity, when you go to **amazon.com**, it will remind you to go to **smile.amazon.com**. However, you can put everything you want in your cart at the original **amazon.com** site, then leave the site and go to **smile.amazon.com** and all your items will still be in your cart and make the purchase there. Or, just go to **smile.amazon.com** all the time. Your choice, only thing is if you forgot to pay at **smile.amazon.com**, AMSAT gets a goose egg instead of help towards a new satellite.

Remember, go to **smile.amazon.com** and select Radio Amateur Satellite Corporation as your charity of choice.

## eBay Sellers Donate to AMSAT

Are you an eBay seller? One item, ten items, or a full-time business you can donate a percentage of your winning bid to AMSAT. To do so, do not list your item with the basic listing tool, select advanced tools. eBay will give you a warning message that it is for large volume sellers, however this is where the eBay for Charity tool is found.

You can "select another nonprofit you love" and search for either AMSAT or Radio Amateur Satellite Corporation. Choose the percentage amount of the sale you would like to donate to AMSAT, and boom!. When your item sells and the winning bidder pays, eBay will deduct the percentage from your take and forward it to AMSAT.

Sometimes we are getting rid of our old equipment, sometimes selling something new. In any case, please consider giving a piece of the pie to a new satellite and choose AMSAT for your eBay Charity.



**Jerry Buxton • NØJY**  
**Vice President, Engineering**

## Fox-I Update

**A**s AO-85 continues to operate well, Fox-I Cliff and Fox-I D successfully completed environmental testing on February 8. They are now awaiting delivery to Spaceflight for integration onto the Sherpa platform.

As launches often do, however, ours is moving further out in time, and delivery/integration has not yet happened. That is good for us, as it allows us to keep the satellite batteries charged closer to the launch date than was the case with Fox-I A, which was delivered six months before launch. Fox-I Cliff/D launch is still scheduled to launch in the first half of 2016; so, if that holds, delivery will be happening soon.

The RadFxSat (Fox-I B) engineering model has been working for several weeks with the Vanderbilt University experiment boards under test. We have started building flight units for the remainder of the Fox-I bus systems and expect to have the flight unit working in June. As previously reported, the RadFxSat CubeSat Launch Initiative (CSLI) proposal was submitted in 2012 and selected in February 2013. We anticipate about a four-year interval from selection to launch, which is currently scheduled for January 20, 2017.

RadFxSat-2 (Fox-I E) was selected for launch in the latest round of CSLI! Vanderbilt University, in partnership with AMSAT, submitted a CSLI proposal in November 2015, and in February 2016, NASA announced that RadFxSat-2 will be given an ELaNa launch. NASA is still developing details of the mission, so we can't share specifics about the launch date yet. RadFxSat-2 is planned to carry a linear transponder as an "upgrade" to the standard Fox-I bus and will be the last of the Fox-I series of CubeSats. To make the linear transponder a reality, AMSAT Engineering needs experienced and dedicated RF volunteers. The timeframe is short, so we need help right now! Please visit the volunteer page at [ww2.amsat.org/?page\\_id=1121](http://ww2.amsat.org/?page_id=1121) if you can help.

## CQC and P4B

The Advanced Satellite Communications and Exploration of New Technology (ASCENT) Team continues development work on the Heimdallr Lunar Cube Quest Challenge project, a partnership between Ragnarok

Industries and AMSAT in which we will provide the communications package for the 6-unit CubeSat that will eventually orbit the Moon. AMSAT-NA has never before undertaken development of equipment hardy (and small!) enough to handle a mission like this, which presents some very interesting challenges.

One option for the communications package has been to use the DVB-S2x extension of DVB-S2. The big advantage to adopting the DVB-S2x standard is that it is well defined, well supported and has a wide range of modulation and coding combinations to support a wide variety of applications. For example, the Heimdallr satellite's lunar range will use the DVB-S2 Very Low SNR modulation and coding combinations to achieve reliable communications with signals up to 10 dB below the noise floor.

Using DVB-S2 provides a commonality with the AMSAT Ground Terminal (AGT) project and the current development for Phase 4B. This commonality is the linchpin of the AMSAT Ground Terminal design, as it is being created to handle these two existing projects as well as future AMSAT satellites using the desired new standard C and X band scheme. The entire Heimdallr project is right in line with the purpose of ASCENT and is generating new ideas that will help AMSAT keep smaller and more capable satellites or payloads in space.

Phase 4B is a partnership with Virginia Tech University brought to us and guided by our own AMSAT Board member Bob McGwier, N4HY. The Phase 4B payload will fly on a classified government mission, so we can disclose little about the payload. Some public information released lately through Virginia Tech suggests the primary goal is providing a 24/7 emergency communications access which, coupled with the multifaceted capability of the AMSAT Ground Terminal, will give amateur radio operators who are assisting agencies they serve through ARES and RACES the ability to provide direct digital communications using both data and voice. AGT's versatility will allow for installations from high speed/quality communications at existing disaster centers to lower speed portable single-dish field operations that easily can be transported and deployed. The prospects are very exciting not just from the emergency communications standpoint but in the development of, and experimentation with, high speed multi-channel communications both in the 24/7 geosynchronous environment and in the HEO environment, where AMSAT hopes to resume satellite operations.

What about the latest on P3E? First let me answer the question by saying that the P3E opportunity, which is another partnership with Virginia Tech, is still on the table and actively being pursued.

The truth is that we cannot share much at this time. This is probably a good place to remind and/or clarify the necessary conditions and restrictions that permeate the environment for our satellite projects and launches in the current era. Information restrictions, whether they are related to U.S. Government regulations on technology, which concern the safety of our country, or agreements made with launch service providers, which concern the competitive and proprietary aspects of the space industry, are standard and in play in every AMSAT project underway or in planning.

While AMSAT wants to and does share about all our projects just as any other amateur radio project, these constraints mean that information is now often minimized or delayed until such time as we are allowed to talk about it. In many cases, once we publish the space segment information into the "public domain," we are free to share and talk about our ideas and development. With projects like P4B and P3E, however, the path to orbit means that AMSAT members may never hear anything about the project until the announcement that the satellite is in orbit and available for use. I appreciate that takes some getting used to, just as it has for the Engineering Team and AMSAT Officers and board members, as far as our having to keep a lid on things. Please keep this in mind and share it with others who may be wondering if anything is going on and why it seems to take so long to get a project into orbit.

## L-Band Upconverter and AMSAT Ground Terminal Project

The above paragraph happily does not apply to most of the ground segment in our projects. In this issue, you will find an article written by Al Watts, AF5VH, in which he talks about the development of the L-band upconverter that I mentioned in the past as being developed to coincide with the launch of Fox-I Cliff and Fox-I D with their mode L/V capability. A project such as this does not fall under any of the restrictions of ITAR/EAR or any launch agreements, so the team is happy to be able to share information about the project, which was designed to provide many the opportunity to work L/V on Fox-I Cliff and Fox-I D.

The same applies to the AGT project. This project is completely open source and in



fact is available in its entirety on Github so that hams from around the world can help design and build the ground terminal. Michelle Thompson, W5NYV, has authored an article in this issue discussing that project.

To avoid confusion down the road, please note that the AGT project is also referred to in other vernacular as the "Phase 4 Ground" project and "P4B Ground Terminal" because of the original assignment of production for the Phase 4B mission. The names are analogous to the use of "soda", "pop", and "Coke" in that they are all used interchangeably to refer to the same thing. (My cousin used to call it "soda pop," perhaps to reinforce and ensure that our grandma knew what we wanted.)

### Made in America

While AMSAT is truly worldwide, there is uniqueness to AMSAT-NA that exists not so much by choice but by necessity. In past projects up through AO-40, many missions were achieved by a collaboration of AMSAT chapters working together. With the introduction of ITAR, AMSAT-NA had to withdraw from the P3E project and essentially became a sequestered organization as far as satellite development. While there are channels to work together with other AMSAT organizations, the realization of such collaborations is complicated such as to be useless. With the recent move of much of our type of satellite technology from ITAR to EAR, that has become a little less of a mess but still requires licensing that is beyond what we are able/willing to pursue right now.

And so we have the Fox-I Project, five satellites so far that are in fact 100% "Made in the U.S.A.!" Everybody is and should be proud of their country and so I say this with that pride and not to exclude any of our friends around the world, but mainly to point out to our members that we have been able to achieve some very good work entirely within the U.S.A. and in spite of the roadblocks we face. The trend continues with P4B and CQC, and in fact P3E but it must be recognized that P3E would not happen were it not for the generosity of AMSAT-DL donating the use of their existing P3E.

With the opportunity to pursue the L-band project and AGT as terrestrial amateur radio projects, we have opened the doors to working with our friends throughout the world again. Hopefully, the near future holds opportunities to team up on projects that will expand the use of AGT worldwide with collaborations on future satellites..

### See You in Dayton

There won't be another *Journal* issue before Dayton Hamvention, so I'm inviting you now to stop by the AMSAT exhibit in Ball Arena and visit us at the Engineering booth. This year we plan to have exhibits of the Fox-I project, an overview of all of our current projects, and a display of the AGT workings. This is a great opportunity for attendees to see what is going on and talk about what we are doing. To the extent that we are allowed to "talk about it"! I hope we see many of you there. 



Errata/Correction to "In Memory of Robert J. (Bob) Carpenter, W3OTC," Jan/Feb 2016 issue, p. 24 –

The incorrect sentence appeared as follows:

*In his early work there, he was instrumental in developing technology for passing message traffic via the short bursts of VHF frequency propagated by meteor shower ionization of the atmosphere.*

It should have read:

*In his early work in Boulder, he was instrumental in developing technology for passing message traffic via the short bursts of VHF frequency propagated by ionization from meteors in the atmosphere.*

## Support AMSAT

**AMSAT is the North American distributor of SatPC32, a tracking program designed for ham satellite applications. For Windows 98, NT, ME, 2000, XP, Vista, Windows 7, 8/8.1 & 10.**

Version 12.8c is compatible with Windows 7, 8/8.1 & 10 and features enhanced support for tuning multiple radios.

### Version 12.8c features:

- SatPC32, SatPC32ISS, Wisat32 and SuM now support rotor control of the M2 RC-2800 rotor system.
- The CAT control functions of SatPC32, SatPC32ISS and Wisat32 have been expanded. The programs now provide CAT control of the new Icom transceiver IC-9100.
- The main windows of SatPC32 and SatPC32ISS have been slightly changed to make them clearer. With window size W3 the world map can be stretched (only SatPC32).
- The accuracy of the rotor positions can now be adjusted for the particular rotor controller. SatPC32 therefore can output the rotor positions with 0, 1 or 2 decimals. Corrections of the antenna positions can automatically be saved. In previous versions that had to be done manually.
- The tool "DataBackup" has been added. The tool allows users to save the SatPC32 program data via mouse click and to restore them if necessary. After the program has been configured for the user's equipment the settings should be saved with 'DataBackup'. If problems occur later, the program can easily restore the working configuration.
- The rotor interfaces IF-100, FODTrack, RifPC and KCT require the kernel driver IOPort.SYS to be installed. Since it is a 32-bit driver it will not work on 64-bit Windows systems. On such systems the driver can cause error messages. To prevent such messages the driver can now optionally be deactivated.
- SuM now outputs a DDE string with azimuth and elevation, that can be evaluated by client programs. Some demo files show how to program and configure the client.

Minimum Donation is \$45 for AMSAT members, \$50 for non-members, on CD-ROM. A demo version may be downloaded from <http://www.dk1tb.de/indexeng.htm> A registration password for the demo version may be obtained for a minimum donation of \$40 for members and \$45 for non-members. Order by calling 1-888-322-6728.

The author DK1TB donated SatPC32 to AMSAT. All proceeds support AMSAT.



# ARISS Update – A New Era of Amateur Radio on the ISS!

**Frank Bauer • KA3HDO**  
**Vice President, Human  
Spaceflight Programs**

**W**OW! The ARISS International team's dedication and sustained volunteer service paid off big the past few weeks with not just a trifecta, but a "quadfecta" of phenomenal accomplishments and milestones. Efforts that have been years, and in some cases decades, in the making have now been realized. In a few short weeks, the ARISS team has:

- Inaugurated our first Ham TV downlink as an integral part of some school contacts
- Celebrated our 1000th contact between the crew on the International Space Station (ISS) and schools on Earth
- Signed a Space Act Agreement, the equivalent of a memorandum of agreement, between NASA and AMSAT on ARISS Roles and Responsibilities, and
- Obtained 2016 financial sponsorship and a strategic educational partner through the help and support of the Center for the Advancement of Science in Space (CASIS).

These accomplishments and milestones are integral to our future and touch on our major goals of "Inspiration, Exploration and Experimentation." They confirm the strong commitment we have with NASA and the other ISS space agencies. They show the tremendous interest and support from the ISS crew as these accomplishments could not be realized without them. Most importantly, they illustrate the great things that a dedicated, inspired international volunteer team can accomplish.

As I stop and reflect on what ARISS, through AMSAT, has accomplished, I am blown away. I am sure you are, too. So, repeat after me: WOW!

## Inauguration of Ham TV

On February 11, ARISS made history as it transitioned the HAMTV system, located in the Columbus module, from experimental to fully operational status. UK-ESA Astronaut Tim Peake, KG5BVI, inaugurated the Ham TV system with students at the Royal Masonic School, home of GB1RSM, in

Rickmansworth, England. ARISS-Europe team member Gaston Bertels, ON4WF, who, with Emanuele D'Andria, I0ELE, helped shepherd the Digital Amateur TV system into existence after it was first proposed more than 15 years ago, stated, "It was a historic event. The radio contact was enhanced with video! Tim Peake activated the Ham Video transmitter on board Columbus."

Peake has since activated Ham TV for several additional school contacts, including the Oasis Academy, U.K., on February 19, the Norwich Schools, U.K., on February 26, where Peake responded to a request for a wave and demonstrated weightlessness, answering questions while floating on his side, and at Gesamtschule Leverkusen Schlebusch, Germany, on February 29.

Special thanks go to ARISS team member Ciaran Morgan, M0XTD, who is coordinating the Ham TV efforts with Tim Peake and has worked with ARISS and the Tim Peake team on many excellent educational activities and educational venues to tie into ARISS. In discussing the historic first operational contact, Ciaran related, "Tim (Peake) had spent a considerable amount of his own personal time the evening before finding the camera and the cable between the Ham TV unit and the camera (which had been stowed during a clean up last year)." You can see Ciaran's reaction to the historic video at: [youtu.be/x3KpilFGQX4](http://youtu.be/x3KpilFGQX4)

The ARISS team recognizes and appreciates the extraordinary efforts that were required behind the scenes to make this event successful. Going back over 15 years -- before ARISS even had its first school contact -- our ARISS volunteers envisioned the use of TV downlink as a tremendous augment to our school voice contacts. They spring-boarded the ARISS "vision" from idea to video by performing the world's first amateur TV video downlinked simultaneously with VHF voice during an ARISS school contact! Congratulations to all who helped transform this dream into reality!

## 1000th ARISS Contact

As I write this article, ARISS just completed its 1000th contact. What a Milestone! On March 10, ISS Astronaut Tim Kopra, KE5UDN, linked-up with excited scholars at an event organized by the North Dakota Space Grant Consortium. During this historic 1000th connection, Kopra answered questions from 20 different pupils from kindergarten through graduate school. A member of the winning 10th grade team from the Space Grant's high altitude balloon competition last fall was

awarded one of the slots to interview Kopra. Summing up the essence of all 1000 ARISS connections, a University of North Dakota staff member observed:

Experiential learning has proven to be the most effective method of knowledge retention, so this [ARISS] experience would grant them [students] the skills necessary to be successful individuals in their future careers. The problem-solving, creativity, and perseverance required by radio communications are cross-disciplinary skills that students can utilize as they enter STEM fields and careers, enhancing the NASA-relevant workforce of North Dakota.

The NASA ISS Program Office produced several videos to celebrate the achievement of ARISS contact #1000 at:

- [www.youtube.com/watch?v=bTOiiBd2dCo&feature=em-uploademail](http://www.youtube.com/watch?v=bTOiiBd2dCo&feature=em-uploademail)
- [www.youtube.com/watch?v=DwtLkTpgNMM&feature=em-uploademail](http://www.youtube.com/watch?v=DwtLkTpgNMM&feature=em-uploademail)
- [youtu.be/Z-yHD9IVbH8](http://youtu.be/Z-yHD9IVbH8)

Also, see the comprehensive NASA article on the 1000th contact at:

**[www.nasa.gov/mission\\_pages/station/research/news/ariss\\_students](http://www.nasa.gov/mission_pages/station/research/news/ariss_students)**

By coincidence, Charlie Sufana, AJ9N, the lead station operator for ARISS Contact #1, was the mentor moderator for the 1000th contact. In an emotional end to the 1000th contact event, Charlie said, "I had the luck of the draw to be the control operator for ARISS contact number one back in December 21, 2000, and once again, the luck of the draw allowed me to be the mentor moderator for the 1000th contact. Here's to the next 1000!"

Since our first contact in December 2000, hundreds of thousands of students have participated in hands-on STEM learning that ARISS affords, and many millions from the general public have witnessed human spaceflight in action through an ARISS contact. My heartiest of congratulations to the ARISS international team and our ARISS stakeholders and sponsors on this phenomenal accomplishment!

## NASA Space Act Agreement

On February 25, a NASA Space Act Agreement between AMSAT-NA and NASA on behalf of the ARISS program was finalized and signed. Signatories included AMSAT President Barry Baines





and NASA's Associate Administrator for Human Exploration and Operations, William Gerstenmaier. The agreement outlines the Roles and Responsibilities of ARISS, NASA's ISS Program Office and NASA's Space Communication and Navigation (SCaN) organization. It protects the long-term use of the K6DUE telebridge station at NASA Goddard and the W5RRR telebridge station at NASA Johnson Space Center. It also provides a mechanism to transfer funding from the ARISS team into NASA to support the maintenance of the ARISS Operations role (Kenneth Ransom's task). This critically important document, the first bilateral agreement between NASA and ARISS in over 20 years, solidifies ARISS support within NASA.

### CASIS 2016 Sponsorship

We are working closely with CASIS on a transfer of grant funding to help sustain ARISS operations for 2016. NASA commissioned CASIS to manage and provide access to the ISS National Laboratory. This includes scientific, engineering and educational payloads. In 2015, the ARISS-US executive team submitted a proposal to CASIS requesting support and sponsorship. This year, the ARISS team received notice that we would be getting operations support funding from CASIS. The ARISS team also was recently invited to attend a CASIS STEM workshop. During this workshop, CASIS kicked off an ISS Academy initiative to better integrate the CASIS-sponsored STEM activities on ISS, including ARISS. We expect several benefits to come from this initiative. We will communicate these as this initiative matures.

### Fundraising

ARISS is exclusively responsible for garnering the funding necessary to keep its program alive. As such, we are soliciting ARISS donations from individuals as well as grants from corporations and foundations. Our two major fundraising campaigns are (1) Annual Operations Funding and (2) the Hardware Upgrade Capital Campaign. We will announce details of these campaigns at the Dayton Hamvention and through social media. Individuals can donate through the [www.amsat.org](http://www.amsat.org) website using the "ARISS donate" button on the AMSAT main page. Those who participate and donate \$100 or more to ARISS will receive a beautiful ARISS Challenge Coin. Please consider a generous donation to keep ARISS alive. Also, please let your friends know about our worthwhile work, and encourage them to donate, too. ARISS is all about piquing students' interest in science, technology, engineering, mathematics and the Amateur Radio Service

– all critically important for the future.

### On the Horizon

The Educational Proposal Window is Open until April 15. Go to the ARISS web site for more details. The SSTV commemoration of ARISS 15th & 20th anniversaries, postponed from December, is expected to start up in the springtime. Watch ANS, AMSAT-BB and [www.ariss.org](http://www.ariss.org) for updates. Stay tuned and thanks for listening! 

### Share Your Experiences as an AMSAT Member

As a way to better serve our readers, *The AMSAT Journal* is looking for you to share your satellite radio experiences, likes and dislikes, how you work the birds, and what you like about *The AMSAT Journal*. We'll publish a selection of responses in upcoming issues of the *Journal* under a column we're calling "Members Footprints." Photos are strongly encouraged! Thanks!

Please send the information requested below to [journal@amsat.org](mailto:journal@amsat.org) --

- Your Name
- Call Signs Held
- Primary Grid Square
- Favorite Satellite Contact
- First Satellite Contact
- First Satellite Ground Station Description
- Current Satellite Ground Station Description
- Reasons You Are an AMSAT Member
- Favorite AMSAT Memory (a satellite contact, symposium, engineering project, event that would never have happened without AMSAT, etc.)
- Favorite Topics Appearing in *The AMSAT Journal* (could include things like building a homebrew antenna, assembling a ground station, using tablets and smartphones, news of upcoming launches, portable operations, ARISS, etc.)

Please Provide a Hi-Resolution Photograph (see [www.amsat.org/?page\\_id=1709](http://www.amsat.org/?page_id=1709)).

## Member Footprints: Nick Mahr, KE8AKW

Grid: EN80  
Age: 15

Favorite satellite contacts: VY1RM, AL7PX

First satellite contact: Although I've used my dad's callsign in the past, the first contact with my callsign was K8YSE on SO-50.

Ground Station:

- A Yaesu FT-847 transceiver
- A 145 MHz Cushcraft 20EL satellite antenna, and
- A 436 MHz Hygain 30EL satellite antenna – all on a 50-foot dedicated satellite tower with 3 towers on the property.

Reasons for being an AMSAT member:

- Amateur radio on satellites was one of the first things my dad showed me to get me interested in the hobby, and it spiked my interest immediately. Hams in space? No way, I thought!
- I love the community and commitment of the AMSAT team and members.
- The missions AMSAT puts up are exciting and successful. I'm amazed that the lifespans of our amateur radio satellites are similar to those of government satellites.
- I'm excited every time I hear one of our own satellites zoom past me.
- Space is a general interest of mine.

Favorite AMSAT memories:

- Hearing the huge number of unique stations everyday on AO-51 and AO-27. There was never a dull moment on those birds as you always heard someone new or portable with minimal setups.
- Working Europe on the FM and SSB transponder on HO-68, and
- The bonding my dad and I shared working the satellites.

Favorite topics in the Journal:

- Exciting development of new AMSAT projects – really gets the hype going
- Hearing other operators' experiences on the satellites, and
- I really appreciate when an article is dedicated to discussing one specific satellite, like AO-85. 



# Fox I L-Band Upconverter

**Alfred Watts • AF5VH**  
**Awatts44@comcast.net**

**A**MSAT satellites Fox-I Cliff and Fox-ID, the third and fourth in the Fox-I series of FM CubeSats, will provide optional 23 cm (L-band) uplinks in addition to 70 cm uplinks. The L-band uplinks will be activated by ground command and not operate simultaneously with the 70 cm uplink. Recognizing that few available handheld or base station transceivers will operate in the 23 cm amateur band (1240-1300 MHz), AMSAT has started developing an L-band upconverter that is intended to allow operators to access the Fox-I L-band uplinks at reasonable cost. A volunteer engineering team is working on the L-band upconverter with guidance from Jerry Buxton, N0JY, Vice President Engineering. John Klingelhoefter, WB4LNM, provided an initial concept for the design and offered many valuable comments and suggestions as the effort has progressed.

The Upconverter Team:

- Bruce Herrick, WW1M
- Dan Hubert, VE9DAN
- Elizabeth Schenk, KC1AXX
- Dave Smith, W6TE
- Alfred Watts, AF5VH

The RF input for the upconverter will be provided by a 70 cm FM transmitter such as a handheld, mobile or base station transceiver. The upconverter input will include an attenuator with jumper-selectable attenuation suitable for the nominal 5 W from a handheld or up to 40 W from a base station transceiver. The upconverter output will be a 23 cm FM signal at up to 15 W. The absolute frequency deviation of the output will be the same as that of the input, or approximately one-third of the input deviation when expressed as a percentage of the carrier frequency.

The upconverter includes an 831 MHz local oscillator that is applied with the RF input to a double balanced mixer. A surface acoustic wave band-pass filter with a bandwidth of approximately 20 MHz follows the mixer to select the desired product. The 1268 MHz product is amplified in several stages followed by the output power amplifier and a low-pass filter. See Figure 1. The upconverter does not include any provisions for transmit/receive switching and is intended to be mounted at the ground station transmitting antenna. The upconverter will be powered by a nominal 13.8 V DC source at 8 amps. A modular switching power supply can be included with the upconverter for powering the unit from an AC source. The upconverter will rely on passive cooling which, in most ambient environments, should be adequate for the intermittent transmissions that are typical of

amateur radio satellite operations.

Nominal characteristics of the Fox-IC L-band upconverter:

Input	
Frequency	437 MHz
Mode	FM
Power	5-40 W
Output	
Frequency	1268 MHz
Power	15 W
Bandwidth	20 MHz
Power Requirements	
Voltage	12.5-17V DC
Current	10 A @ 15W Out

When used with a separate 2 m receiver and 70 cm transmitter, the upconverter should be installed near the antenna in the feed line from the transmitter. When used with a transceiver with a single RF input/output connection, such as a handheld unit, a 2 m/70 cm diplexer will be required. See Figure 2. Again, the upconverter should be mounted at the transmitting antenna. Some popular antennas used for amateur radio satellite operations include a diplexer that may be suitable for use with the upconverter. Appropriate diplexers are also available from several amateur radio equipment suppliers.

One attractive aspect of the 23 cm uplink is the availability of relatively compact higher gain antennas. A link margin analysis by

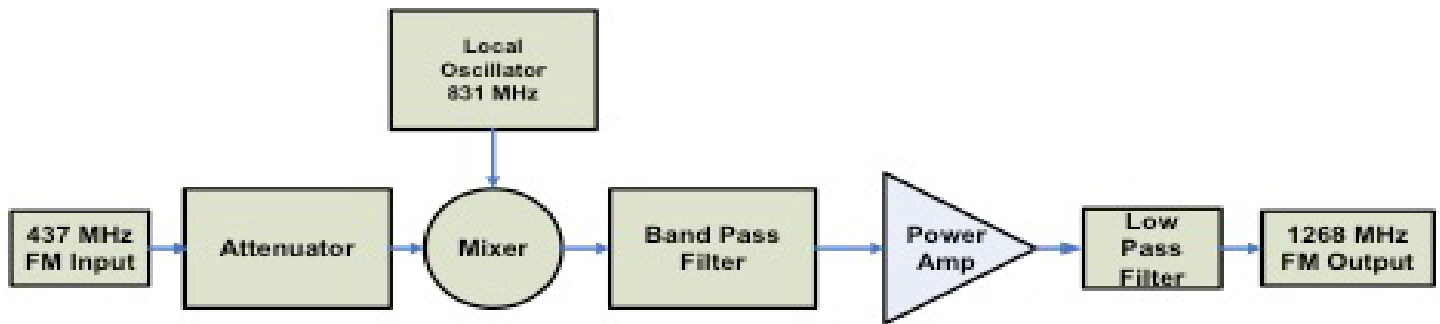

Figure 1 - Block diagram of the Fox-IC L-band upconverter

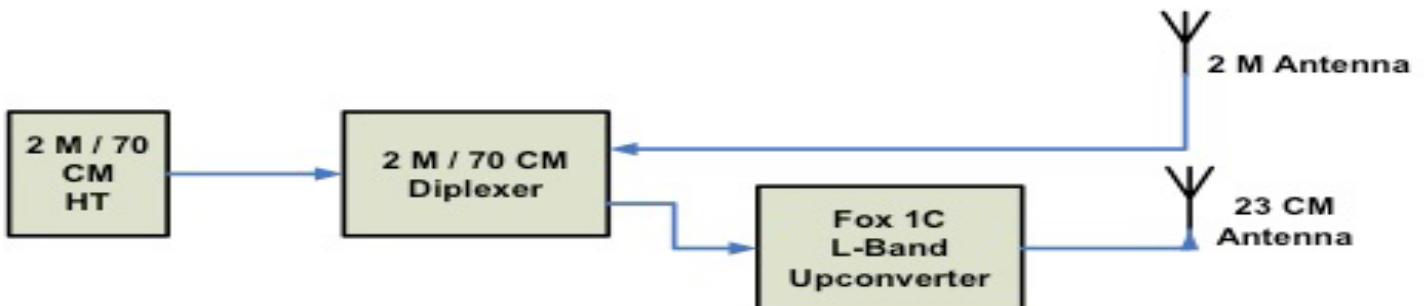



Figure 2 - Block diagram of a Fox-IC ground station using a handheld radio and the L-band upconverter

team member Elizabeth, KC1AXX, suggests that an uplink antenna gain of 15 dB will be required. Helical antennas of reasonable size can be considered at the uplink frequency. The impedance of such antennas is generally several hundred Ohms, which may require an impedance transformer. An article in the August 1963 issue of QST by W.O. Troetschel, K6UQH, describes a quad helix antenna with a 50 Ω impedance which would be suitable for tripod or tower mounting but might be awkward for hand pointing. A Yagi uplink antenna also is feasible and might be better for handheld pointing. One possibility may be modification of the popular Arrow antenna by drilling additional holes for a 23 cm Yagi with a gamma match. Of course, commercially available L-band antennas may provide an attractive alternative. For home brewers, helix and Yagi antenna calculators found online can assist with antenna designs. The relatively small size of appropriate antennas offers broad choices in materials and fabrication techniques.

A preliminary design and printed circuit board layout for the Fox L-band upconverter has been developed. The printed circuit board has two layers and uses mostly surface mounted parts. Fabrication of prototypes will follow for evaluation and testing of the design to ensure that it functions as desired and meets applicable FCC requirements. The development team is considering creation of upconverter kits for partial or complete assembly by the user. In any event, a goal of the effort is providing a design and device that will attract a large segment of the amateur radio satellite community and encourage many to move up-frequency and try L-band satellite communications. 



## ARISS Interoperable Radio System Upgrade

**Lou McFadin • W5DID**  
Member, Board of Directors

**Frank Bauer • KA3HDO**  
Vice President, Human  
Spaceflight Programs

### Overview

In January 2015, a team investigated replacing the Ericsson radio currently in the Columbus Module of the International Space Station (ISS) with a more capable unit. The top candidate was a Kenwood D710 radio with any needed power supply modules. The team met roughly twice a month through 2015, and the result was a proposal for consideration by the Project Selection and Use Committee with a recommendation to the ARISS-I delegates for consideration at the face-to-face meeting in Japan in August 2015.

### Members

The team consists of the following members:

Frank Bauer, Chair  
Lou McFadin, ARISS Chief Engineer  
Stefan Wagener, Member  
Dave Taylor, Member  
Kenneth Ransom, Member  
Kerry Banke, Member

### Actions

The team developed a top-level design considerations document that was the basis for input to a proposal to CNES (Centre National D'études Spatiales), the French space agency and member of European Space Agency, to obtain a dedicated Portable Power Supply (PPS, formerly known as KUPS) that would convert the ISS 120V DC to 28V DC. Since that proposal, the team has refined the design to consider two options for power supplies, the use of a dedicated PPS and the use of an ARISS-developed power supply.

The result is a robust system that will provide interoperability in the Russian Segment (FGB and Service Module) and the U.S. Operating Segment (Columbus Module). Any portion of the proposed system could be operated in either segment with proper cabling. It would also allow any other ARISS systems that are certified in one segment to be operated in the other segment after proper certification.

### Top-level System Requirements

1. Launch Kenwood D710 radio and supporting elements so ARISS-I has a high-power radio in the Columbus Module that is compatible with the D710 radio in the Russian Service Module.
2. All components shall be interoperable across all the ISS segments.
3. Include a power supply that can interface with the existing system in the Columbus Module (including the Ham TV) and be flexible enough for future systems.
4. Be compatible with the other ISS Ham system components (headsets, SSTV module, antennas, etc.), with connector adapters, if necessary.
5. Allow the D710 to be reprogrammed on orbit. Options to be considered are a small dongle, an Apple iPad with standard ISS software load, or a Windows tablet.
6. Provide enough flight-like hardware for training and system certification.
7. Include power system pass-throughs to maintain flexibility to bring in other options/future systems.
8. Provide flexibility for current and future capabilities/modes
  - Cross-band repeater
  - SSTV, and
  - Packet/APRS/Other digital techniques.
9. Minimize crew time: Provide options for possible later addition of remote control of system from the ground (i.e., provide interfaces, not necessarily implement at this time).
10. Minimize volume in ISS Columbus Module.
11. Ensure systems meet ISS and equipment thermal control:
  - Power supply,
  - D710.

### System Description

The proposal consists of a separate, ARISS/AMSAT-NA developed and built low voltage power converter that includes: the capability to convert directly either from the ISS 120V DC or 28V DC sources; a Kenwood D710 transceiver; necessary cables; certifications; and procedures. See Figure 1.

### ARISS Low Voltage Power Converter Description

This unit converts either the 28V DC provided by the PPS or the 120V DC ISS provides to the voltages needed for the actual inputs of the rest of the ARISS-I hardware. It would provide 13.8V DC for the Kenwood D710 and 5V DC at 2.1A for a set of four standard USB connectors for



# Columbus Module Ham Station with David Clark Headset

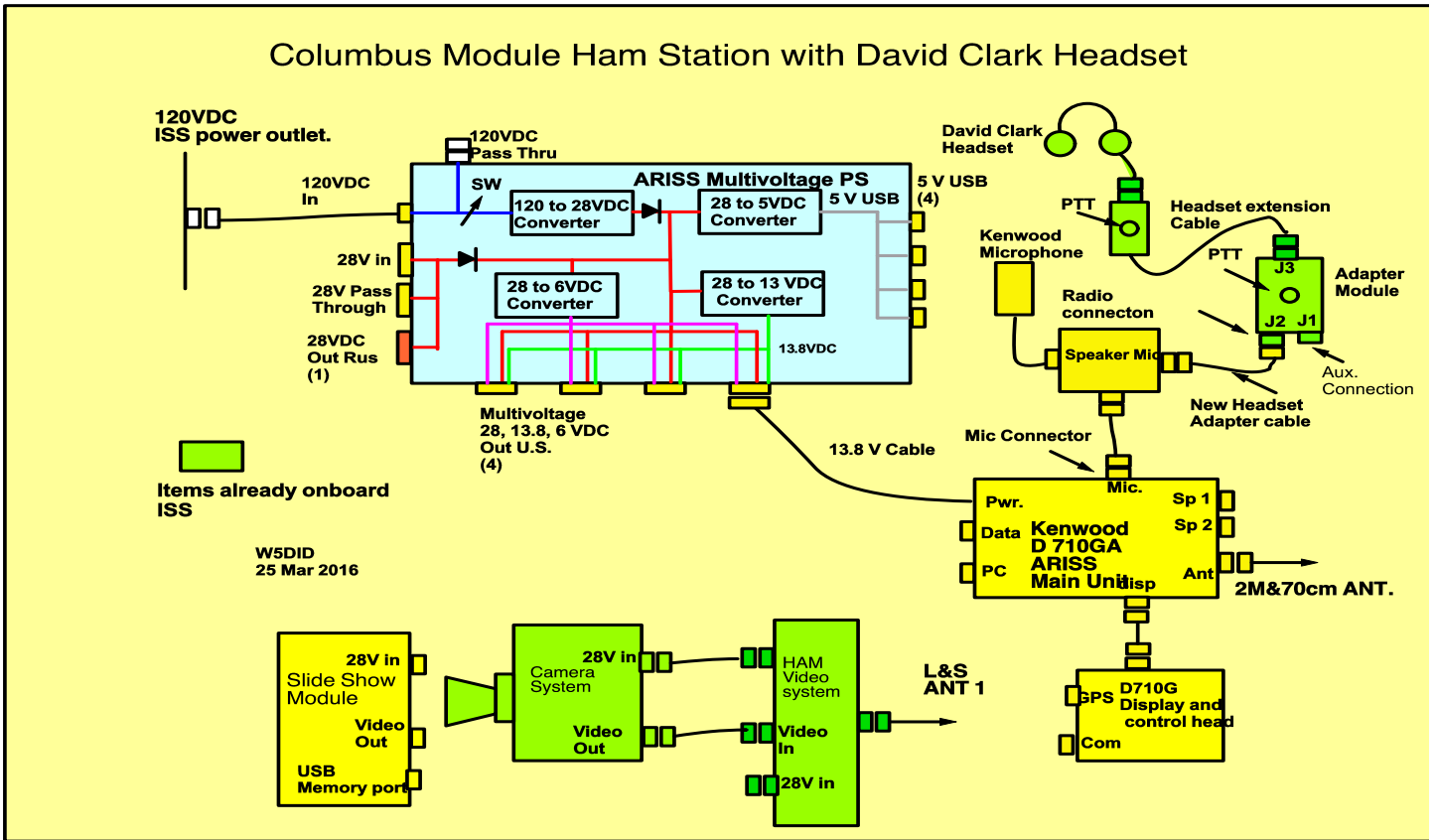

Figure 1 - Proposed

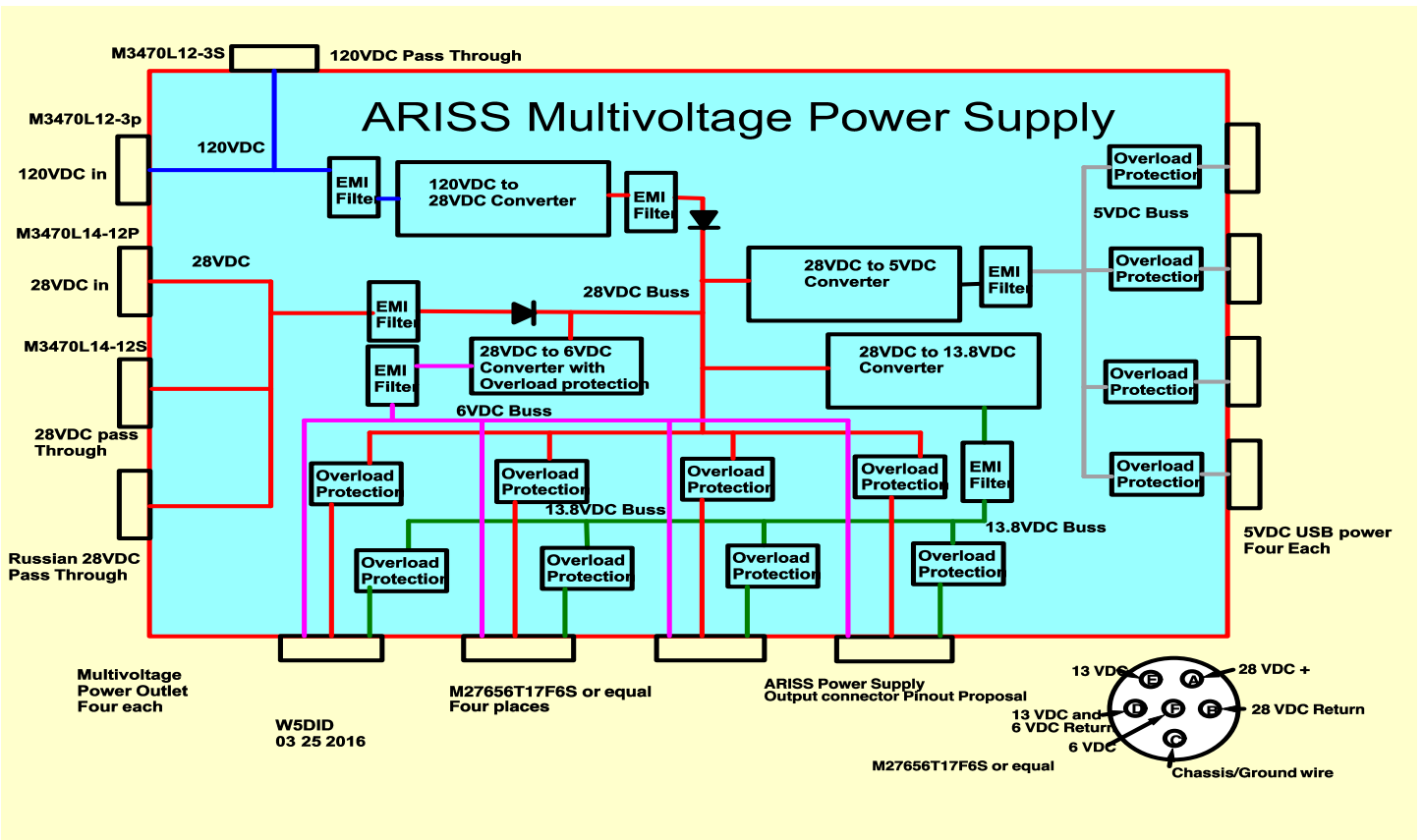

Figure 2 - Low voltage power supply more details

charging USB devices. It also would provide pass-throughs for 120 V DC and 28 V DC for additional equipment connections (so we do not tie up a 28 V DC connector), 3 standard U.S. 28 V DC connectors and 1 standard Russian 28 V DC connector. This would allow for the interoperability of Russian hardware in the Columbus Module.

### The D710 Plan

The ARISS hardware team, including Bob Bruninga, has been working with JVC Kenwood engineers, developing a plan for the ISS version of the D710 radio. The team decided this version would be a slightly modified version of the D710G A.

The Kenwood D710 in the Columbus Module will differ somewhat from the D710 that is currently in the Russian Segment:

1. It will either have a heat sink and fan to allow continuous operation or may be configured to attach to the new low voltage power supply (LVPS) that is being developed. In that case, the extra airflow from the LVPS will enable continuous operation of the D710G. The firmware changes will allow a longer timeout period to support cross band repeater function.
2. The D710G already has a simpler command set for entering the cross band repeat mode.
3. It will have different connectors for power, etc.
4. We may include a firmware modification to reduce maximum power output to 25 W.

### Launch mass estimates for whole system:

	Mass (kg)
PPS	3.97
28 V Low Power Voltage Supply	4.00
Kenwood D710	1.86
Cables	2.00
<b>TOTAL</b>	<b>11.83</b>

### Other Considerations

For each flight component (except PPS) there shall be the following 7 units, all identical to the flight unit:

- 1 - Flight
- 1 - Flight spare
- 3 - Training (1 for U.S./JSC and 2 for Russia)
- 2 - Engineering (2 units), for troubleshooting, procedure development, etc.

### Conclusion

The capability of the ARISS hardware onboard the ISS is continuously evolving. The simpler setup procedures from these changes will make operation easier for the crew. The quality of school and other contacts will be improved because of the higher RF power capability. The capability for supporting emergency backup for the ISS communications system will improve because of the higher power and the interoperability in both the U.S. and Russian segments.

This system builds upon past experience and hardware by re-using existing cables and equipment such as the David Clark headset and Russian power cables. By incorporating the David Clark headset into this design, we provide a new level of flexibility to the crew.

We are planning for both present and future needs. The new power supply and improved D710G are important components in that evolution.

This concept was presented to the ARISS-I delegates and attendees to the recent Tokyo meeting and was given their approval for continued development. 

**Book Your Cruise Now  
for Space Symposium!**

**November 10-14, 2016**

**For details, see:**

**[www.amsat.org/?page\\_id=4859](http://www.amsat.org/?page_id=4859)**



## APRS Satellites, PSK31 and DTMF/Voice

**Bob Bruninga • WB4APR  
WB4APR@amsat.org  
Dr. Mirek Kasal • OK2AQK  
Brno University  
Tomáš Urbanec • OK2PNQ**

### Abstract

**P**SAT (deployed May 2015) and the coming QIKCOM-2 satellites are offering new capabilities to the AMSAT experimenters that do not require special APRS capable radios. An HF rig and/or any walkie-talkie can be used. In addition to the usual APRS data transponder, PSAT also supports a multi-user PSK31 (10-meter uplink) text messaging transponder built by students at Brno University in the Czech Republic under the mentorship of Mirek Kasal, OK2AQK. The UHF downlink can be received on any FM radio and displayed on any laptop running any number of free PSK31 clients. The QIKCOM-2 module, scheduled to fly in early 2016, not only contains the APRS data relay, but also supports APRS uplink identification and messaging from simpler DTMF radios that get converted to APRS in the module while also giving voice feedback to the DTMF user.

### APRS Transponder

The main transponder on both PSAT<sup>1</sup> and QIKCOM-2<sup>2</sup> is a 1200 baud AX.25 packet radio relay similar to what has been flying on PCSAT<sup>3</sup> since 2001 and the ARISS experiment on the ISS<sup>4</sup>. Both of these missions deliver packets to users worldwide via the global network of volunteer ground stations shown in Figure 2. This network also feeds the two downlink capture pages, <http://pcsat.aprs.org> for PCSAT and <http://ariss.net> for the ISS. These pages display live maps of the most recent user position data and capture all message traffic between users.

### Maintaining the Global APRS Satellite Data Channel

We want to maintain as many space digipeaters as possible on the space packet frequency of 145.825 MHz in support of this experimental data channel to provide greater connectivity between users. The PSAT satellite pioneers the use of a simple \$250 off-the-shelf APRS MicroTracker from [www.byonics.com](http://www.byonics.com) that fits on one 3.4-inch square card shown in Figure 3. Their latest model has a 10 W power amp to make a CubeSat that can rival the ISS with downlink power.





Figure 1 - PSAT-1 with antennas deployed and QIKCOM-2 module with antennas stowed

## Global APRS Real-Time Connectivity (End-to-End Everywhere)

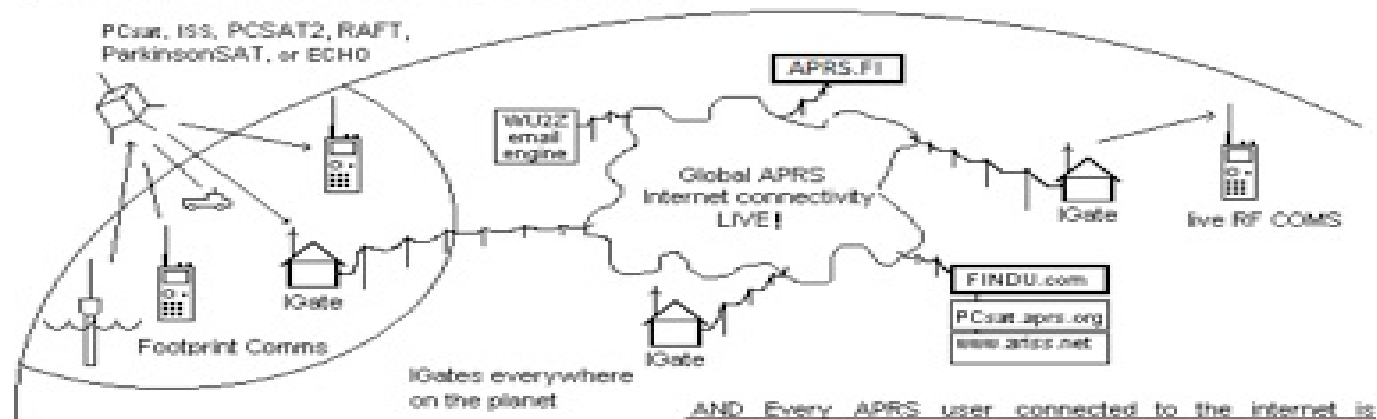

Figure 2 - The global APRS network consists of terrestrial, as well as internet and satellite, links.



Figure 3 - Byonics Micro-Trak TinyTrak 4 Xponder

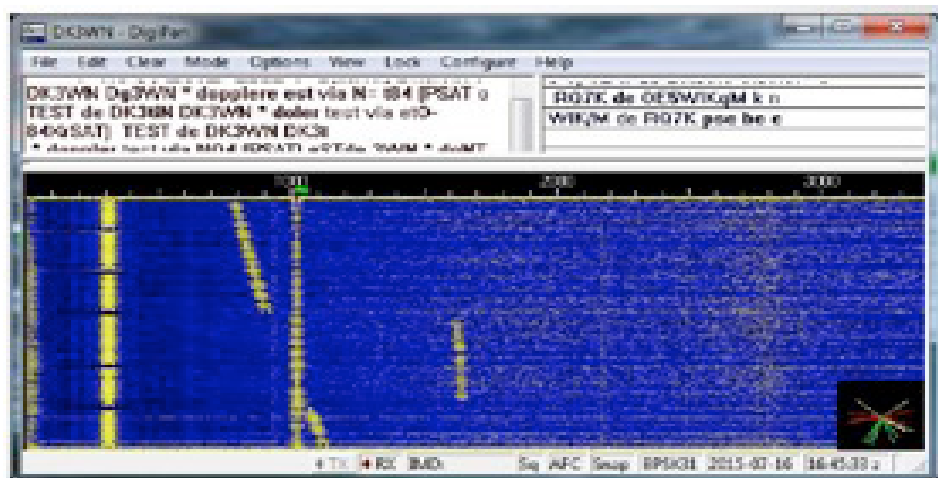

Figure 4 - Downlink waterfall shows stations with and without Doppler shift correction.

### PSK31 Transponder

The PSK31 multi-user FDMA transponder<sup>5</sup> experiment built at Brno University is similar to what we flew on RAFT<sup>6</sup> and PCSAT2<sup>7</sup>. The users on the ground see the full PSK31 waterfall as shown in Figure 4. As the UHF downlink is FM audio, the 18 kHz Doppler shift does not affect the individual PSK31 signals but only the FM receiver passband tuning. The users will simply retune their FM receivers 5 times during the pass in 5 kHz steps to stay in the passband.

The multiple PSK31 users transmit using SSB on the 10-meter uplink. There, the Doppler shift is linear but, because it is 14

times lower in frequency than the typical UHF downlink, the total Doppler shift is only about 1 kHz over the pass and typically on the order of about 1 Hz per second during the lower elevation portions of the pass. Most PSK31 software can track this rate. However, as the elevation gets higher, the rate of Doppler change increases to as much as 6 Hz per second, and most clients fail at 2 Hz per second and above.

To adjust for Doppler shift, Andy Flowers, K0SM, has written an uplink PSK31 application<sup>8</sup> that not only uses the satellite tracking elements to pre-adjust the uplink for it. As a separate program, it allows

the user to operate full duplex with the existing PSK31 software being used for downlink. Users of this application will appear fixed in the downlink waterfall, as shown by the vertical signal traces in Figure 4, and are easy to decode by everyone.

This PSK31 text messaging transponder allows messaging between up to 30 modest ground stations simultaneously in full duplex. HF uplink stations do not need gain antennas but can use a SSB transmitter with an output of about 100 W because of the range-gain match of the LEO orbit geometry, as shown in Figures 5 and 6.

The combination gives an uplink power variation per user of less than  $\pm 4$  dB over 90% of the duration of the pass.<sup>9</sup> Unfortunately, however, the 6-foot HF receive antenna is not cross-polarized, as shown in Figure 1, and so there will be periodic fades as the spacecraft tumbles. Figure 7 shows the challenge of getting all four antennas (VHF, HF & two UHF) to all meet at the one burn resistor.

### Structure

PSAT is a 1.5 unit CubeSat so that two spacecraft could be launched from the same P-Pod launcher. There was plenty of room for the Brno University PSK31 experiment. But all of the mass had to be concentrated at the center so that the spacecraft could spin about its long z-axis, as shown in Figure 8.

### Unique Power System

PSAT, with the four large and efficient solar cells per side, is designed around a unique battery system. With the total solar voltage per side only 3.2 volts (0.8 volts per multi-junction cell), we only can charge two NiCd cells per side. These four side-panel/NiCd-pairs that are separately

charged in parallel are operated in series for a total 9.6 V bus. This parallel charging reduces the failure mode of uneven charge balance that accumulates when entire strings are charged in series, but it requires the spacecraft to spin for even charging.

The offset color pattern on the side panels uses differential solar radiation pressure to spin the spacecraft. Once a minute, PSAT sends an easily readable sun vector telemetry in its S# packet shown in Figure 9. Here, PSAT is spinning about the z-axis at a little over 2 RPM with the z panel pointed relatively evenly at the sun.

### Spin Data

We have no control over the spin. The initial tip-off rates from the deployment soon decayed to as low as 0.2 RPM but then, during a season of full sun, began to spin up as high as 11 RPM before returning to a nominal 2.5 RPM, as of this writing. You can see from the design that the maximum spin torque is when the sun is broadside. See Figure 10. But the higher spin momentum keeps the spacecraft in that orientation while the orbit precesses. The sun is no longer perfectly on the side, and so the spin decays.

## QIKCOM-2 – APRS for Everyone

QIKCOM-2 not only includes the APRS digipeater for those with APRS radios, but it also includes a DTMF uplink receiver for users with only a radio and keypad so that everyone can participate. The DTMF user stores his callsign and grid in a DTMF memory and can send it at the press of a button when the satellite is in view. The spacecraft not only converts this DTMF report into an APRS packet on the downlink, so that the user is included in the APRS network distribution, but the spacecraft also repeats the message in voice so that all of the DTMF-only users can hear what is happening.

The DTMF is received with a Byonics DTMF micro-receiver and DTMF decoder chip, and then converted to APRS and speech with the DTMF/Speech board shown in Figure 11. The DTMF/Speech board consists of a BS2pe BASIC Stamp module, a SpeakJet voice synthesizer and a text-to-speech processor chip.

### DTMF Format

What makes all of this possible is the 16 digit key DTMF memories in most handheld

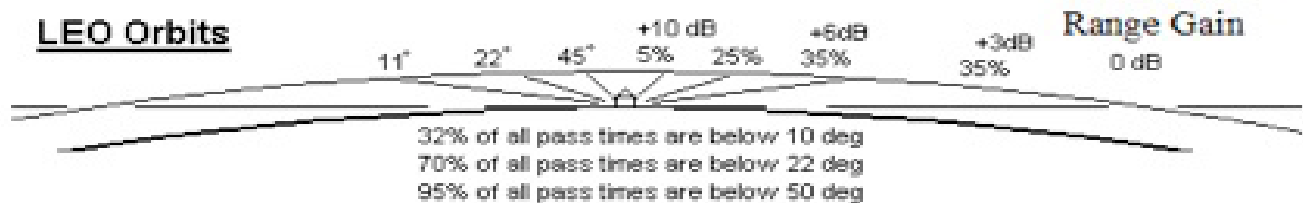

Figure 5 - The LEO geometry has over 10 dB of range gain as the satellite rises in elevation.

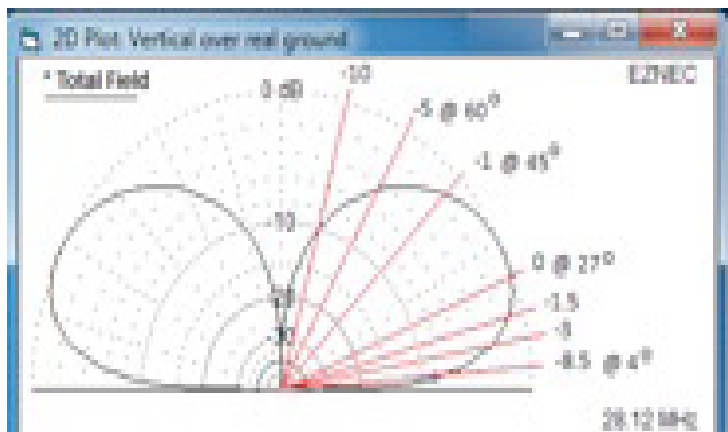

Figure 6 - Typical 10-meter vertical antenna pattern matches range gain of a typical LEO orbit.

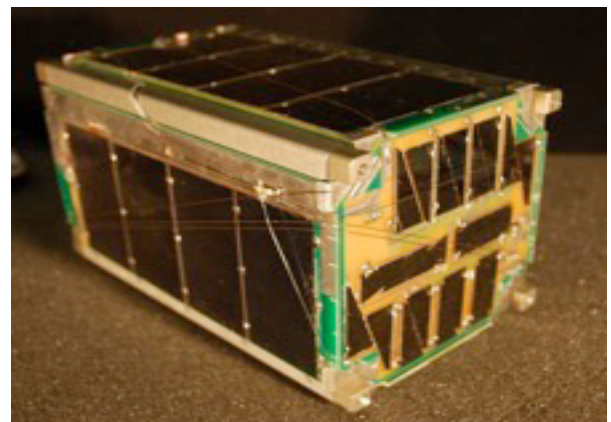

Figure 7 - The UHF, VHF and HF antennas on PSAT are all released by one burn resistor.



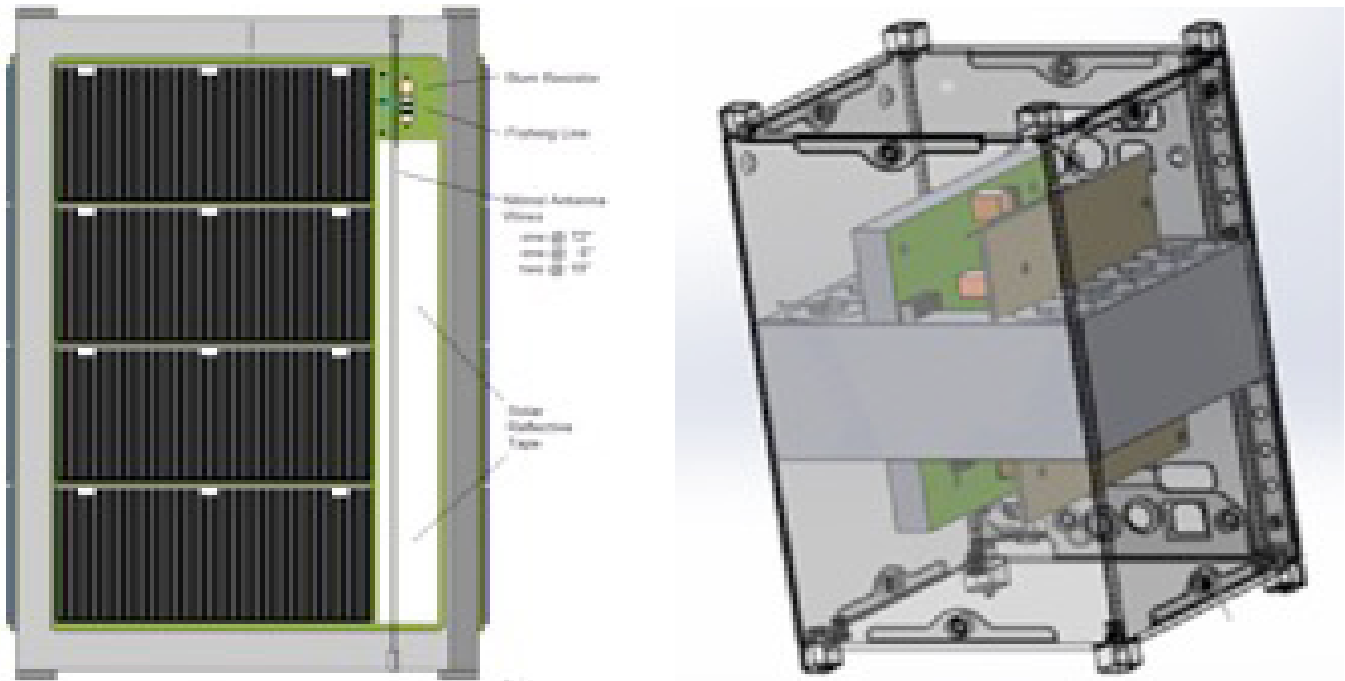

Figure 8 - The sides are black/white, and the mass is concentrated at the center.

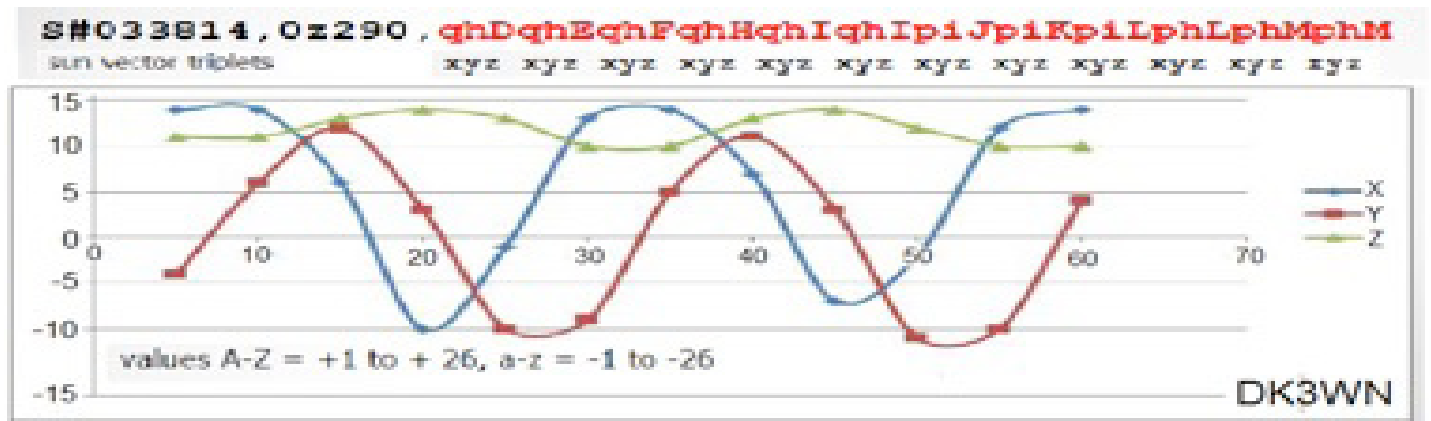

Figure 9 - PSAT spin data consists of alphabetic XYZ triplets that are easy to plot.

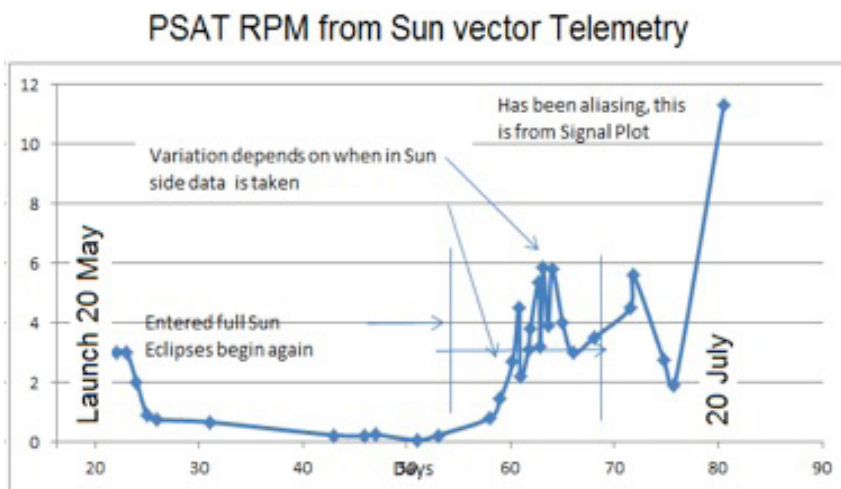

Figure 10 - PSAT spin data varies according to its alignment with the sun.

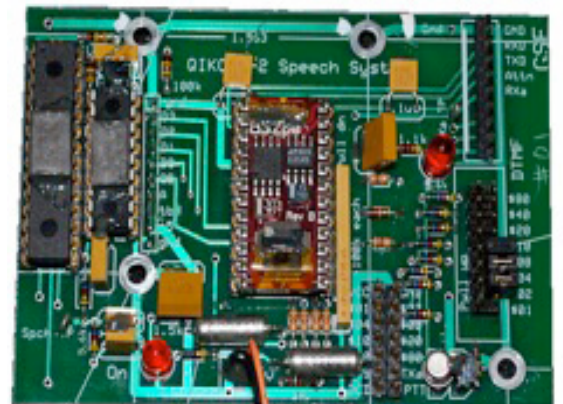

Figure 11 - DTMF speech board on QIKCOM-2



radios. QIKCOM-2 can store not only the full callsign, but also the grid in only 14 digits plus the starting \* and ending # key. The grid was compressed to 4 digits by noticing that only 99 grids actually have human populations in them, so the normal letter part of the grid can be reduced to two digits (00 to 99), according to Figure 12. The grid FM19 becomes 1819 because it is the eighth one in the U.S.A. group.<sup>1</sup>

### DTMF Callsign

Encoding the 6-character callsign would normally require 12 digits on a DTMF keypad. QIKCOM-2, however, can do it in 10. The first 6 digits are simply the 6 digits that match the letters. Then the next 4 decimal digits are the 12-bit binary number that represents 6 pairs of 2-bit representations of where the letter is on each DTMF key, as shown in Figure 13.

WB4APR is represented by call digits 924277. The location of W, for example, on its key is 1, B is the second letter on its key, and so on. Those six 2-bit locations are 120112. Since each location is between 0 and 3, they can be encoded in 2 bits each (powers of 4) and assembled left to right into a 12-bit binary number. To convert to decimal, take the first 2 bits times 1024, the next 2 bits times 256, the next 2 bits times 64, the next times 16, the next times 4 and

the last 2 bits times 1. Then add them up and get the 4-digit decimal "key code" (1558 in this example). These 4 digits are the only digits that need to be calculated and are added on the end of the 6-digit callsign to become 9242771558. Combining that with the 1819 grid square results in the full DTMF position report of \*18199242771558#.

On the spacecraft, this DTMF string gets converted to a "WB4APR Grid FM19" APRS formatted report and transmitted on the APRS downlink. The spacecraft then says: "GRID FM19 from WB4APR." This is a simple report that represents typical information hams exchange via satellites.

### DTMF Messages

We can also send text messages! We use the trick that most of what anybody says has already been said before. Thus, instead of spelling out every message to be sent, we simply store the top 99 on the spacecraft and then just call them up by number. Ham radio has always used this shortcut for frequent messages in the 47 standardized ARL Numbered Radiograms<sup>10</sup> plus a few dozen more we have added. We can communicate, therefore, quite well with just a 2-digit message number and a 2-digit modifier. These modifiers can be injected into any standard message that has a blank number field. For example, "1140"

means message number 11: "Establish amateur radio operations on 40 meters."

Just like the grid report, the entire message is converted to APRS packet format on the downlink and also spoken for the benefit of all the other DTMF-only users.

### Conclusion

We hope these two new spacecraft will not only contribute to better connectivity of the APRS space constellation of relay satellites, but will also excite many more hams who may only have access to PSK31 and/or their old reliable DTMF walkie-talkie. Now they, too, can communicate position and transmit text from anywhere on Earth.

### References

1. [aprs.org/psat.html](http://aprs.org/psat.html)
2. [aprs.org/qikcom-2.html](http://aprs.org/qikcom-2.html)
3. [aprs.org/pcsat.html](http://aprs.org/pcsat.html)
4. [ariss.net](http://ariss.net)
5. [aprs.org/psk31uplink2.html](http://aprs.org/psk31uplink2.html)
6. [aprs.org/craft/save-raft.html](http://aprs.org/craft/save-raft.html)
7. [aprs.org/pcsat2.html](http://aprs.org/pcsat2.html)
8. [www.frontiernet.net/~aflowers/dopplerpsk/dopplerpsk.html](http://www.frontiernet.net/~aflowers/dopplerpsk/dopplerpsk.html)
9. [aprs.org/PSK31/PSK31 Link Budgets for Psat-b.doc](http://aprs.org/PSK31/PSK31%20Link%20Budgets%20for%20Psat-b.doc)
10. [nts.ema.arml.org/node/30](http://nts.ema.arml.org/node/30) 

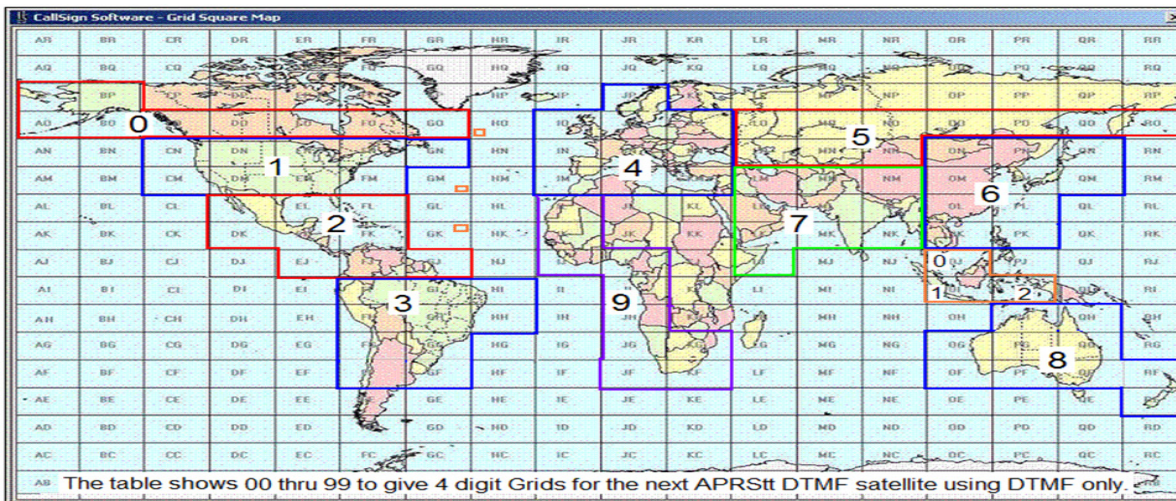

- 0x Canada  
00: AP, BP, AO, BO, CO  
05: DO, EO, FO, GO, OJ
- 1x USA  
10: CN, DN, EN, FN, GN  
15: CM, DM, EM, FM, OI  
25: FK, EJ, FJ, GJ, PI
- 2x C. America  
20: DL, EL, FL, DK, EK  
25: FK, EJ, FJ, GJ, PI
- 3x S. America  
30: FI, GI, HI, FH, GH  
35: HH, FG, GG, FF, GF
- 4x Europe  
40: JP, IO, JO, KO, IN  
45: JN, KN, IM, JM, KM
- 5x Russia  
50: LO, MO, NO, OO, PO  
55: QO, RO, LN, MN, NN
- 6x Japan, China  
60: ON, PN, QN, OM, PM  
65: QM, OL, PL, OK, PK
- 7x India  
70: LM, MM, NM, LL, ML  
75: NL, LK, MK, NK, LJ
- 8x Aus/NZ  
80: PH, QH, OG, PG, QG  
85: OF, PF, QF, RF, RE
- 9x Africa  
90: IL, IK, IJ, JI, JI  
95: JH, JG, KG, JF, KF

Figure 12 - The 99 populated grids can encode all of the XX populated lettered grids.

	F	M	1	9	W	B	4	A	P	R	
*	1	8	1	9	9	2	4	2	7	7	1
											1
											2
											0
											1
											1
											2
											1
											2

six 2 bit nos showing locations of 6 letters on keys  
then converted to 4 digit decimal

Figure 13 - The FM19 Grid reports from WB4APR encoded into 16 DTMF keys.

# AMSAT Phase 4 Ground Project Update

Michelle Thompson • W5NYV

I hate space. It's cold. Very cold. Deadly cold! It's hot. Hotter than hot. Deadly heat! The unrelenting radiation and unforgiving isolation result in an engineering tradition that demands onerous redundancy and cloistered conservatism. What's not to hate about something unsurvivable, untenable, intractable, uninhabitable, horrifically expensive to invade, and accessible only by a sparse few citizens that survive the training that only a few countries can afford?

I hate space because space is the enemy. The only rational choice is to hate the enemy, and enemies are to be fought. The trouble is that you can't really fight space. Eventually, space will destroy your work. You cannot do anything except design your best, test everything, cross your fingers, toss it up there, hope it succeeds, and celebrate when your mission exceeds its planned lifetime.

Launching things into space is what AMSAT has done, and done very well, for a long time. The organization has seen significant changes in technology, access to launches, types of launches, and types of communications over the past 46 years.

For the vast majority of these endeavors, the communication equipment required on the ground has been easy to build, purchase or adapt. The new generation of sophisticated projects, like Phase 4B, Phase 3E, and the Cube Quest, however, present digital communications challenges that we must overcome with a new generation of microwave radios.

## Digital Communications Complexity

*Phase 4 Ground supports payloads that include highly capable digital communications, such as Phase 4B, Phase 3E, and the Cube Quest Challenge, representing a significant step forward for AMSAT.*

Digital communications services require a much more complex receiver than traditional analog services. This is not telemetry crammed under voice or an experimental image mode that gets turned on once a quarter. These missions offer entire banks of fully-realized channels, allowing text, voice, voice memo, images, data, and possibly video to be exchanged between a wide variety of station types on the ground. If we do not provide real technical support,

quality tutorials, working equipment recipes for build-it-yourself, and excellent off-the-shelf purchase options to operators, then the satellite's capabilities will go unused.

We have a moral obligation to make good on the opportunities that we have been given. We are required to do all that can be done to provide accessible, relevant, fun, and rewarding communications access. This means that for all the amazing efforts by the payload team, all the stress of a high profile launch, and the mystery of regulatory hush, the real action is on the ground and should be done in the open.

We should invite commentary, critique and feedback. We should welcome the widest possible variety of volunteers and make it easy for them to participate. We should publish and share what we learn, design, and recommend, so that many others can build upon and improve the radio designs.

## Radios for AMSAT's "Five and Dime" Microwave Strategy

*Phase 4 Ground will produce an ensemble of open source solutions for the digital radio problem that the AMSAT microwave strategy poses.*

The amateur radio service has a space allocation in both 5 GHz and 10 GHz ("five and dime"), and that's where AMSAT's microwave satellite strategy is directed. AMSAT considered all the microwave bands, from 1.2 GHz through 24 GHz, and chose "five and dime" for a combination of technical and regulatory reasons. Choosing the right band for the job involves a lot of moving parts, with each alternative presenting various difficulties and challenges. The selection of "five and dime" resulted from substantial discussion and consideration.

*Phase 4 Ground is pursuing both a manufactured solution and developing a set of documents that fully enable motivated operators to build their own gear or assemble a station from commonly available parts and products.*

Prospective users really must have the option to buy a complete radio for the proposed digital satellite strategy to work. Our goal is nothing less than the creation of a world-class radio.

Those do-it-yourself operators who want an adventure in digital communications also must be provided access to the documentation required to build a complete station. Operators wanting to build a station from existing radio components, such as SDRs or commonly

available surplus gear, should be able to find the information on how to do that.

## Why Microwave?

One big reason for choosing microwave is the small size of high gain antennas, which are needed to overcome path losses to distant spacecraft. Perhaps even more important, it's the only way to get higher bandwidth transmissions. Microwave is the only place where digital modes with decent data rates can happen in amateur radio.

From a regulatory perspective, we either start using the microwave bands or we continue to lose them. Sustained and well-funded commercial interests seek to consume everything from 1 GHz to 6 GHz, and in some cases, beyond. There are no current satellite projects on 5 GHz or 10 GHz. We need to get up there and get active, or else.

We have an additional motive for pursuing digital microwave. This new radio also will work terrestrially, and will provide expanded choices and resources to the terrestrial amateur microwave community. Instead of a satellite, operators would use a "Groundsat" on a mountaintop or tower. Operators would get all of the services that the satellite code provides, but on the ground instead of in the air.

Terrestrial amateur activity on the microwave bands primarily consists of beacons and contests. Gear is often homebrew or purchased and then integrated into rigs from a few manufacturers. This means that there really isn't a lot of readily available amateur gear for 5 GHz and 10 GHz. Our goal is to change that. We aim to provide an ensemble of solutions, ranging from "u-build-it" to "u-buy it," and as many points in between as we can knock together and test.

The goal of developing a radio that is reconfigurable (and therefore reusable) for multiple payloads, as well as performing a modern terrestrial microwave role, is an ambitious one. Doing it with a geographically diverse volunteer team that must successfully interface and collaborate with multiple organizations, corporations, government, and a wide array of individuals, while maintaining focus and discipline, is a very tall order.

This project is risky, messy, multithreaded, and involves significant integration challenges. It is also well worth doing, incredibly rewarding, and will provide plenty of good designs as a side effect of the research and development required to make a quality radio. While the risks are substantial, the benefits exceed the risks.



## Progress to Date

We decided to separate the development of the radio from the development of the payload by creating a separate team for each. The two teams communicate through a common air interface document. This collaboratively developed document specifies the waveforms that are recognized by the radio on the ground and the payload in the sky.

In some aspects, the payload team calls the shots. That team is heavily restricted by the facts of life in space compared to the radio team, so we on the radio team must be able to accommodate them on things they cannot change or modify, like instructions they get or restrictions they are given from the primary payload.

In other aspects, we on the radio team define other parts of the interface in order to increase overall system capability or avoid an expensive problem on the ground. This is an ongoing process that requires excellent communication and skill to pull off.

Splitting the teams this way means that the payload team can continue to comply with strict ITAR controls without unnecessarily restricting discussions of the ground team. A separate ground team can then pursue a non-ITAR open source process that relaxes otherwise unnecessary restrictions.

For example, Phase 4 Ground can welcome volunteers that otherwise would not be able to participate, and we can publish documents that we otherwise would not be able to share. This allows us to take advantage of the widest possible range of engineering comment and critique. Being able to actively seek feedback and guidance improves our ability to produce quality work. It may not be any easier to do the work, because things worth doing are rarely easy, but we are better able to take advantage of the widest possible reading of our work. Being able to get quality advice saves enormously valuable time.

We have begun to define our system, and we have identified a framework. Phase 4 Ground uses Digital Video Broadcasting (DVB) standards from [www.dvb.org](http://www.dvb.org). These standards are widely adopted. The ones most relevant to us are the second-generation terrestrial television (DVB-T2) and second-generation satellite communications standards (DVB-S2 and the recent extension to DVB-S2 called DVB-S2X). Instead of simply using these standards to transmit television, we're using these standards to ship our data.

An additional standard that we're using is called Generic Stream Encapsulation (GSE). GSE provides a way to turn IP packets into data streams that are easily handled by the way DVB transmits data.

For Phase 4B, we are developing an adaptation of DVB-S2 that will allow stations with a wide variety of capabilities to efficiently use the satellite links to the best of each of their abilities. Our goal is to implement DVB-S2 in a way that allows the satellite to tailor transmissions to stations in a way that complements their individual capability and current link quality. This requires a variety of codes and modulations, along with the ability to sense when more or less coding or a different modulation type is required. This method is called Adaptive Coding and Modulation.

The idea here is for the satellite to recognize when a station needs a more durable signal, or can get by with less coding "armor." When a signal needs more help, the satellite adds more of the right type of redundancy, so that the information transmitted to the station is received with a low probability of error. When there is a strong enough signal that some redundancy can be skipped, the coding requirements can be relaxed. The benefit of all this work is that the amount of data that can get through the system, or system throughput, is optimized.

Using a high-quality and widely adopted standard like DVB-S2 provides a huge learning opportunity for all the volunteers involved. For Virginia Tech students directly involved with the payload development, the opportunity to learn current industry techniques and get real-world experience in implementing them provides a significant post-graduation advantage. For many of us on Phase 4 Ground, a similar opportunity exists to work with a state-of-the-art communications protocol that we might not otherwise get.

The DVB standards provide very well thought out solutions to the most common problems of digital transmission. However, the decision to adopt them does not mean we're anywhere near the finish line. Implementing the standard in a ham-centric way requires figuring out what parts of the standard are necessary, what are unnecessary, what needs to be modified, and what additional mechanisms need to be designed.

For Phase 3E, DVB-S2 will be proposed. For Cube Quest Challenge, DVB-S2X is being pursued. DVB-S2X is an extension to DVB-S2. The reason for selecting it is that it

contains very low signal to noise codes and modulations that will work for the very large path losses expected during the lunar mission.

Selecting, understanding and properly implementing a standard like DVB presents a substantial challenge. However, that's just the tip of the iceberg. The RF chain has many challenges. Remember the choice of frequencies? That 5 GHz uplink has a second harmonic that just happens to be within the range of the sorts of low noise block down converters that we'd really like to use on 10 GHz.

Even with a two-dish solution, with a separate 5 GHz uplink antenna and 10 GHz downlink antenna, the isolation between the two dishes is not perfect. This is a full duplex system. The side lobes for a typical parabolic dish are only down 20 dB or so. If an operator selects a booming 5+ watt power amplifier for the uplink, and doesn't manage to point the receive dish as well as he could, then what happens to the downlink? This is an area of active research.

Multiple solutions are being designed, built, and tested. Our expectation is to be able to provide a variety of designs. Some may work better in some ways than others. Some advantages will not be compelling to all operators. For example, for emergency communications or portable use, two dishes are not desirable. We're working on a single antenna solution for this. The challenge is isolation and filtering. In contrast to portable requirements, for fixed installations at home, two large dishes would seem to work perfectly. Our job is to document and explain as many different types of solutions as possible. Operators then will have the option of which one they want to experiment with.

## Access Control

Access control is another challenge presented by digital communication. Digital systems provide a means for identifying, authenticating, and authorizing access to a communications resource. Decisions on whether to do this, how to do this, how much of this to do, and what sorts of burdens are reasonable to inflict upon "the good users" in order to filter out "the bad users" are all part of the design process for Phase 4 Ground. Getting this right means that the satellite is easy to use but hard to abuse. Getting it wrong means people give up trying to use it.

We are incredibly fortunate to have very high-quality teams at Virginia Tech and Rincon dedicated to the creation



of the 4B payload. This project is the culmination of over a decade of groundwork by people like Bob McGwier, N4HY, and will require two or three years of work by Virginia Tech, all the companies involved, and AMSAT Phase 4 Ground.

The Phase 4 Ground team currently consists of nearly 60 volunteers who have signed up to work on the project. "Work" includes building equipment, calculating things that need calculating, path-finding the best existing solution to adapt to our project, reviewing documents for dumb mistakes, making communications happen, blank paper engineering, cheerleading, designing beautiful graphical user interfaces, evangelizing, fundraising, documenting, providing adult supervision, programming, meeting people that might provide services we need, updating the documentation, more programming, coming up with algorithms, and many other roles and responsibilities.

All our documents and software are and will be at our github account at [github.com/phase4ground](https://github.com/phase4ground).

Sign up to be an AMSAT technical volunteer at [www.amsat.org/?page\\_id=1096](http://www.amsat.org/?page_id=1096). You don't have to be an expert. You just have to want to become one. 🌐



## AO-85 Hooks a Father and Son in Uruguay

Carlos Pechiar • CX6BT

It was early January, a sunny summer morning here in Uruguay. I was sitting under a red umbrella on the eastern-most beach, next to the border with Brazil. While keeping an eye on my two sons playing in the ocean, I periodically restarted the scanner on my Baofeng handheld transceiver (HT), which kept sweeping from one end of the band to the other with the characteristic radio silence of a remote and sparsely populated place. Suddenly, to my surprise, the scanner stopped on a very clear and strong signal. The callsign indicated an Argentine station. First, I thought he was a nearby tourist working mobile, but then the male voice said he was operating from La Plata, Argentina, about 300 miles away. I heard him say "Alfa Oscar 85", and that rang a bell. A quick online search on my smartphone confirmed that I was listening to AMSAT's Fox-1 satellite.

I couldn't believe I was listening to a QSO between a "Lima Uniform" and a "Papa Yankee" on my cheap HT with no additional antenna. I stood up, ran to the waterline and gathered my kids to briefly explain what was happening. But I was the one most excited. During the following days, I listened to many QSOs over AO-85 during different times and conditions. Without an adequate antenna, however, I knew I wouldn't be able to participate in any of them. By that time, I already was hooked on getting into working the satellites.

Once back home in Montevideo, I downloaded pass prediction software and

built a very crude dual band handheld yagi out of wood and measuring tape. I wanted to get on the air as soon as possible, and, as someone once said, any antenna is better than no antenna at all. It became a matter of perfecting my orientation technique and fighting against the wind until I finally managed to make my first QSO over a satellite.

The day of my first AO-85 QSO, my older son, Felipe, helped me. Since then, when I get back from work, I take a look at the pass prediction software and, if the satellite is available, I go outside with him to try to make a new contact. Since the first time I listened to this satellite on the beach in January until now, my interest in satellite QSOs has continued evolving. On Twitter, I follow some fellow hams who are passionate about satellites,

I know that my setup, and especially my antenna, needs improvement and that, once this is done and my technique mastered, I will start working other satellites, too. In terms of my amateur radio knowledge and experience, I consider myself a relatively inexperienced ham radio operator. In the past, I was attracted only to the HF bands in phone mode. Most importantly, I have been aware of CubeSats for some years now since my brother was chief engineer of a state university project, the goal of which was to use only student development to put a satellite into orbit. The now-defunct Antelsat successfully completed that mission.

What struck me most from my encounter with AO-85 in January, and all that I have been learning so far on this subject, is how much easier operating through satellites is than it seems. Moreover, I recently started listening to a couple of ham radio oriented podcasts during my commuting time, and each one I hear reinforces my belief that this hobby is incredibly broad and extremely satisfying.

The only barrier is finding the right motivation. For me, the motivation is in the air. Just a couple of days ago, I had the opportunity to show some of my sons' friends how I could receive signals from a satellite. When I told them what was going to happen, they put aside all their connected mobile devices with their popular apps and came outside to look up to the sky and listen to the radio.

Today, I found my study material for the ham radio license exam and gave it to my son, Felipe. I told him that we would take a look at it together. Maybe he will become a ham, too. This will be a good year for my hobby. Sharing it with my son is the best part. 🌐



Felipe Pechiar helping his father, Carlos, CX6BT, with his first AO-85 QSO. [Carlos Pechiar, CX6BT, photo.]



# AMSAT Field Day 2016

**Bruce Paige • KK5DO**  
**Director of Awards and Contests**

It's that time of year again – summer fun and Field Day! Each year the American Radio Relay League (ARRL) sponsors Field Day as a “picnic, a campout, practice for emergencies, an informal contest and, most of all, FUN!” The event typically occurs during a 24-hour period on the fourth weekend of June. For 2016, the event takes place during a 27-hour period from 1800 UTC on Saturday, June 25, 2016, through 2100 UTC on Sunday, June 26, 2016. However, those who set up prior to 1800 UTC on June 25 may operate only 24 hours. The Radio Amateur Satellite Corporation (AMSAT) promotes its own version of Field Day for operation via the amateur satellites, held concurrently with the ARRL event.

This year should be easier than many years since we have about 10 transponders and repeaters available, with more possible before Field Day. Users should check the AMSAT status page at [www.amsat.org/status/](http://www.amsat.org/status/) and the pages at [www.amsat.org/?page\\_id=177](http://www.amsat.org/?page_id=177) for what is available in the weeks leading up to field day. To reduce the amount of time to research each satellite, see the current FM satellite table at [www.amsat.org/?page\\_id=5012](http://www.amsat.org/?page_id=5012) and the current linear satellite table at [www.amsat.org/?page\\_id=5033](http://www.amsat.org/?page_id=5033).

If you are considering ONLY the FM voice satellites like SO-50 for your AMSAT Field Day focus, please reconsider, unless you are simply hoping to make one contact for the ARRL rules bonus points. The congestion on FM LEO satellites is always

so intense that we must continue to limit their use to one QSO per FM satellite. This includes the International Space Station (ISS). You will be allowed one QSO if the ISS is operating voice. You also will be allowed one digital QSO with the ISS or any other digital, non-store-and-forward, packet satellite (if operational).

The message exchange format for the ISS or other digital packet satellite is an unproto packet to the other station (3-way exchange required) with all the same information as normally exchanged for ARRL Field Day (e.g., W6NWX de KK5DO 2A STX, KK5DO de W6NWX QSL 5A SDG, W6NWX de KK5DO QSL).

If you have worked the satellites on Field Day in recent years, you may have noticed a lot of good contacts can be made on some of the less-populated, low-earth-orbit satellites like FO-29, AO-7, or AO-73. During Field Day, the transponders come alive like 20 meters on a weekend. The good news is that the transponders on these satellites will support multiple simultaneous contacts. The bad news is that you can't use FM, just low duty cycle modes like SSB and CW.

## 2016 AMSAT Field Day Rules

The AMSAT Field Day 2016 event is open to all amateur radio operators. Amateurs must use the exchange as specified in ARRL rules for Field Day. The AMSAT competition is intended to encourage the use of all amateur satellites, both analog and digital. Note that no points will be credited for any contacts beyond the one allowed via each single-channel FM satellite.

Operators are encouraged not to make any extra contacts via these satellites (e.g., SO-50). CW contacts and digital contacts are worth three points as outlined below.



K2AA, South Jersey Radio Association (2015).



Nick Mahr, KE8AKW (2015).

## 1. Analog Transponders

ARRL rules apply, except:

- Each phone, CW, and digital segment on each satellite transponder is considered to be a separate band.
- CW and digital (RTTY, PSK-31, etc.) contacts count three points each.
- Stations are limited to one completed QSO on any single channel FM satellite.
- If a satellite has multiple modes, such as V/U and L/S modes, turned on, one contact each is allowed.
- If the PBBS is on - see Pacsats below.
- ISS counts 1 for phone and 1 for digital; contacts with the ISS crew will count for one contact if they are active. PCSat (I, II, etc.) (1 digital).
- The use of more than one transmitter at the same time on a single satellite transponder is prohibited.

## 2. Digital Transponders

We have only APRS digipeaters and 10 m to 70 cm PSK transponders [see Bob Bruninga's article in this issue].

Satellite digipeat QSOs and APRS short-message contacts are worth three points each, but must be complete and verified two-way exchanges. Remember, only one digipeat contact is allowed for the ISS and other satellites in this mode.

## 3. Operating Class

Stations operating portable and using



emergency power (as per ARRL Field Day rules) are in a separate operating class from those at home connected to commercial power. On the report form, simply check off Emergency or Commercial for the Power Source and be sure to specify your ARRL operating class (2A, 1C, etc.).

## Satellite Summary and Log Submissions

The Satellite Summary Sheet should be used for submission of the AMSAT Field Day competition and be received by KK5DO (email or postal mail) by 11:59 P.M. CDT, Monday, July 11, 2016. The preferred method for submitting your log is via e-mail to [kk5do@amsat.org](mailto:kk5do@amsat.org) or [kk5do@arri.net](mailto:kk5do@arri.net).

You may also use the postal service but give plenty of time for your results to arrive by the submission date. Add photographs or other interesting information that can be used in an article for The AMSAT Journal.

You will receive an email back from me within one or two days after I receive your email submission. If you do not receive a confirmation message, then I have not received your submission. Try sending it again or send it to my other email address.

If mailing your submission, the address is:

**Bruce Paige, KK5DO**  
Director of Awards and Contests  
PO Box 310  
Alief, TX 77411-0310.

Certificates will be awarded to the first place emergency power/portable station at the AMSAT Space Symposium and General Meeting in November 2016. Certificates will also be awarded to the second and third place portable/emergency operation in addition to the first place home station running on emergency power. A station submitting high, award-winning scores will be requested to send in dupe sheets for analog contacts and message listings for digital downloads.

You may have multiple rig difficulties, antenna failures, computer glitches, generator disasters, tropical storms, and there may even be satellite problems, but the goal is to test your ability to operate in an emergency situation. Try different gear. Demonstrate satellite operations to hams that don't even know the "hamsats" exist. Test your equipment. Avoid making more than one contact via the FM-only voice hamsats or the ISS, and enjoy the event! 🌐

## Working AO-85 Full Duplex with Chinese-Made Handhelds

**Patrick Stoddard • WD9EWK/  
VA7EWK**  
Director, Field Operations  
[wd9ewk@amsat.org](mailto:wd9ewk@amsat.org)

For many years, our FM satellites – SO-50, AO-27, AO-51, SO-67, HO-68, and even going back to UO-14 – were all V/U satellites. We transmitted to the satellites on 2 meters and listened to them on 70 centimeters. Other than the ISS cross-band FM repeater that operated in the mid-to-late 2000s in a U/V configuration, no U/V FM satellite has been available since SO-35 (“SUNsat”) between 1999 and 2001. Many radios, handhelds in particular, used to have the ability to work these satellites full duplex. This feature is not available in most handhelds now, even though some advertise it. With one exception for the handhelds in current production (the Kenwood TH-D72A), none of these handhelds can work the V/U FM satellites in full duplex. Working a U/V FM satellite full duplex is another matter, and, during the past year, I have seen some Chinese-made 2m/70cm FM handhelds that should be able to work a U/V FM satellite full duplex.

With AO-85, we now have a U/V FM satellite, and I have taken this opportunity to try a few of these Chinese-made handhelds to see how they handled working AO-85 full duplex. Since 2013, a few Chinese-made handhelds have been advertised as capable of operating cross-band full duplex. If true, this would be perfect for our FM satellites. With four of them I have tested, and will write about here, none of them could handle working SO-50 full duplex.

Working AO-85 is a different story. Radios like the TH-D72A can work AO-85 full duplex without problems. What I wanted to see for myself was whether these newer Chinese-made handhelds could do so. Knowing that we were getting a U/V FM satellite launched, I bought these four handhelds over the past 18 months:

- AnyTone TERMIN-8R
- Puxing PX-UV973
- Wouxun KG-UV8D, and
- Wouxun KG-UV9D

As I tried working AO-85 with each of these handhelds, I used the same settings for some key parameters to set a level playing field as much as I could. For example, each handheld was connected to my Elk 2m/70cm log periodic antenna. I transmitted in normal or “wide” FM while receiving in narrow FM, used tuning steps for both the uplink and downlink in 2.5 kHz steps (something most amateur handhelds do not support), and plugged an audio splitter into each handheld’s speaker jack feeding audio to an earpiece and an audio recorder. This allowed me to make a MP3 audio recording of what each radio heard from AO-85 and hear the downlink myself. I did not need to program any memory channels when working AO-85 with these handhelds. All four of them have two VFOs, and I used both when working AO-85.

In addition to the handheld/Elk combination, I connected my SDRplay SDR receiver to a VHF crossed dipole on a portable mast and tripod. The SDRplay was controlled by HDSDR on my 8-inch Windows 10 tablet. I had HDSDR write an RF recording of each AO-85 pass, so I could hear how each handheld sounded through the satellite on a separate receiver. Between using these handhelds and other radios, I found that I could hear myself through AO-85 with 4-5 W transmitter power when the satellite’s elevation



Left to right, the Puxing PX-UV973, AnyTone TERMIN-8R, Wouxun KG-UV8D, and Wouxun KG-UV9D. [Patrick Stoddard, WD9EWK/VA7EWK, all photos.]



was at least 20 degrees. I looked for passes where AO-85's elevation stayed above 20 degrees for a few minutes, so I had time to make calls and hopefully log some contacts with other stations.

Once I had established a baseline for how each handheld was configured to work AO-85, and had my independent receive setup operating alongside my handheld/Elk station, I was ready for testing. Before writing this article, I posted a series of updates on the AMSAT-BB list<sup>1</sup> as I tested each of these radios. Along with these posts, I included the recordings I made from each pass worked with these handhelds, as well as photos and other files from my Dropbox space<sup>2</sup>.

## AnyTone TERMN-8R

The AnyTone TERMN-8R came on the market in early 2015 but was ordered off the market by the FCC because of issues with its certification for use on GMRS and MURS frequencies. When used by licensed radio amateurs on the 2m and 70cm amateur bands, FCC certification is not required, provided the radio meets the technical requirements of FCC Part 97. I bought this radio because it was advertised as supporting cross-band full duplex operation, and I wanted to try it on a U/V FM satellite. I was pleasantly surprised at how well it performed.

I originally tried my TERMN-8R with AO-85 just before the AMSAT Symposium in Dayton. Unable to work any stations in that attempt, I tried again in late November after the satellite was commissioned. I made 5 contacts during a 48-degree pass over the Thanksgiving holiday weekend. I had no problems making those contacts, but I heard some noise early in the pass when I transmitted. This noise went away between AO-85's downlink gaining strength as the satellite went higher in the sky and twisting my Elk to improve the signal in the radio's receiver. One of the contacts, Sawson, KG6NUB, in northern California, was using



AnyTone TERMN-8R.

only 2 watts. When I played the recording from my SDRplay/HDSDR receive station, the audio from the TERMN-8R sounded good.

This radio may not be widely available because the TERMN-8R has yet to return to the U.S. market and is not sold overseas because it supports GMRS and MURS frequencies, which are not used outside of the U.S. If a satellite operator comes across one of these handhelds, it should be considered a viable option for working AO-85 (and any other U/V FM satellite) full duplex.

## Puxing PX-UV973

The Puxing PX-UV973 entered the market about two years ago, making it the oldest of the four handhelds I tested with AO-85. Like the other Chinese-made radios I tested, the dealers promoted it as having full duplex capability. This handheld also was the smallest of the four I tested, and the least expensive. I bought mine on Amazon.com for \$78 a couple of months before AO-85 was launched and tried it on an AO-85 pass in late November 2015. Its performance was lacking, and I did not see the need to try it on more passes.



PX-UV973.

Using the same settings for power and FM bandwidth (wide vs. narrow), I was able to work two stations during an AO-85 pass with maximum elevation of 57 degrees. Unfortunately, the PX-UV973's receiver was the worst of the four handhelds. The receiver was not desensitized while I transmitted, but it performed poorly, even with the stronger AO-85 downlink. Although I could hear myself as I transmitted, the other handhelds' receivers were much better. When I listened to the recording from my SDRplay receiver and HDSDR, my transmitted audio sounded acceptable.

In early 2014, I asked one of the dealers of the PX-UV973 for an opinion on using this radio to work SO-50 full duplex. I could not get a clear answer on this point for a couple of months, and now I understand why. The PX-UV973 may be a good radio for use with terrestrial repeaters or local simplex activity, but it is a poor performer for any FM satellite work.

## Wouxun KG-UV8D

The Wouxun KG-UV8D came on the market around the time of the 2014 Dayton Hamvention. I bought one shortly after that Hamvention. Although it is not capable of being used for full duplex operation with SO-50, I had opportunities to test it against the Fox-1A engineering model at two events later in 2014 (ARRL Centennial Convention in Hartford, 2014 AMSAT Symposium in Baltimore). This radio performed well when I tried it with the Fox-1A engineering model at these events, and I decided to keep it around my shack. With AO-85's launch, it came out of hibernation for my testing. By this time, the KG-UV8D had been replaced by the KG-UV9D, but some dealers still sell the KG-UV8D.



KG-UV8D

I tested my KG-UV8D on some passes during the first weekend after the AO-85 launch, as well as additional passes in late November. I found that I would hear some additional noise in the receiver whenever I transmitted. Not a lot of extra noise, and many times a twist of my antenna would make the additional noise drop in volume. On one pass, I heard what sounded like the Phoenix National Weather Service radio station on 162.550 MHz coming through on 145.980 MHz – a case of signals mixing in the HT's receiver. When I had the antenna lined up with the downlink reasonably well, I was able to hear myself clearly when transmitting through the satellite. The transmit audio recorded by my SDRplay/HDSDR receive station was also acceptable.

I would consider the KG-UV8D as capable of working AO-85 full duplex. Despite the extra noise and mixing I heard when I worked these passes, it was up to the task. Since Wouxun released the KG-UV9D a few months ago, I would not look to buy a new KG-UV8D.

## Wouxun KG-UV9D

The Wouxun KG-UV9D hit the market in early 2015, intended to be the replacement for the KG-UV8D. Currently in production, the KG-UV9D is sold by a variety of dealers in



and outside of the U.S. The U.S. versions have the 2.5 kHz tuning step, where most amateur 2m/70cm FM transceivers have 5 kHz as the smallest tuning step, and default to English on the screen and in the voice prompts when the radio is reset. Other versions of the KG-UV9D available online are made for the Chinese market, where the radio's default language is not English and the radio lacks the 2.5 kHz tuning step.



KG-UV9D.

During the evening of the second day AO-85 was in orbit (Friday, October 9, 2015), I worked two passes using the Wouxun KG-UV9D. The first of the two passes saw AO-85 rise to a maximum of 24 degrees elevation. Around the midpoint of this pass, I completed my first QSO via AO-85

with Tom, KA6SIP, in northern California. I could hear myself through AO-85 while transmitting, and I did not hear any receiver desensing. Later in the evening, I worked another AO-85 pass and logged QSOs with three more California stations.

After AO-85 was commissioned in mid-November, I repeated my test with the KG-UV9D. After a few weeks' experience working this satellite, I wanted to see if I could improve on my October testing results shortly after AO-85 was launched. I was not disappointed. I found I could get access the satellite using a combination of twisting my antenna and taking full advantage of the 2.5 kHz tuning steps for the uplink frequency. One of these mid-November passes was good for my log, with six contacts on a nice coast-to-coast pass.

Even though this radio is incapable of working SO-50 full duplex, it could be used with a second handheld for full duplex operation on that satellite. I do recommend the KG-UV9D as capable of working full duplex on AO-85, as well as any future U/V FM satellite.

To recap, I would rank these four radios in order of their performance, highest to lowest, in working AO-85 full duplex:

1. Wouxun KG-UV9D
2. AnyTone TERMN-8R
3. Wouxun KG-UV8D
4. Puxing PX-UV973

The Chinese-made handhelds have gradually improved their performance over the past few years. In my opinion, a radio amateur can reasonably expect the KG-UV9D to perform better than a radio like the PX-UV973 that has been on the market for a couple of years. Although there are other non-Chinese handhelds that perform better than even the KG-UV9D, like the Kenwood TH-D72A, the KG-UV9D is an option that doesn't come with a \$400 price tag like the TH-D72A. I enjoyed using these radios to work AO-85 passes, since my testing confirmed that low-power stations could successfully make contacts on this satellite. It takes a little more planning to work AO-85 with 4-5 W, but it is not impossible.

### Notes:

1. A recap of the posts I made to the AMSAT-BB list in October and November 2015 about these four handhelds can be found at: [amsat.org/pipermail/amsat-bb/2015-December/056269.html](http://amsat.org/pipermail/amsat-bb/2015-December/056269.html).
2. Files from these, and other passes, are available from my Dropbox space at: [dropbox.wd9ewk.net](http://dropbox.wd9ewk.net). 



KG-UV9D with SDRplay and tablet.





# Amateur Radio's Very First Satellite – The Amazing Story of OSCAR-1

**Keith Baker • KBISF / VA3KSF  
Treasurer**

Private groups of Amateur Radio operators around the globe have built and sent dozens of amateur radio communications and science satellites to orbit since the first, OSCAR-1, was launched on December 12, 1961. That date already held a special place in radio history as it was the 60th anniversary of the first radio transmission across the Atlantic Ocean. Indeed, on December 12, 1901, Guglielmo Marconi completed his now-famous transmission and reception of Morse code for the letter S -- three dots -- from England to Newfoundland.

The story of the first amateur radio satellite, however, actually began in April, 1959, less than two years after the former Soviet Union had orbited the very first artificial satellite, Sputnik 1. At about that time, the semiconductor columnist for *CQ Magazine*, Don Stoner, W6TNS, published a design for a 50 milliwatt, 2-meter transistorized transmitter that he had successfully tested across the San Bernardino Mountains of California, a distance of 120 miles. He

was absolutely amazed that such a tiny transmitter could be heard over that great a distance at that frequency. He soon realized that it probably would work just as well if it were 120 miles overhead in a satellite.

While discussing the details of his latest brainchild in his *CQ Magazine* column, he casually asked his readers: "Does anyone have a spare rocket for orbiting purposes?" He never dreamed that his flip comment would ever amount to much.

As it turned out, one of the radio amateurs employed by Lockheed at the time, Fred Hicks, W6EJU, read Don's article and began to think that, indeed, it just might be possible to find a launch for such a satellite through his association with Lockheed and the U.S. Air Force. At the time, the U.S. military was the only organization in the United States that was launching payloads into orbit.

After discussing his seemingly half-baked idea with an amazed and gratified Don, he and a group of similarly interested hams in the San Francisco Bay area of California formed what later became known as "Project OSCAR." In true military fashion, OSCAR was an acronym for "Orbiting Satellite Carrying Amateur Radio."

Fred and his group soon contacted the Southwest Division Director of the American Radio Relay League (ARRL) and the head of the Jet Propulsion Laboratory's Space Instrumentation System, Dr. Harry L. Richter, W6VZA. Plans then started to come together

for the very first amateur radio satellite.

In the true spirit of amateur radio, the Project OSCAR organization would later develop into an impressive group effort that included not only Don and Fred, but other well-known hams of the day including Hank Brown, W6HB, Bill Orr, W6SAI, George Jacobs, W3ASK, Nick Marshall, W6OLO, Chuck Townes, K6LFH, and Lance Ginner; K6GSJ, among others.

Taking the idea of OSCAR from concept to reality involved clearing a number of hurdles, the least of which was the fact that the launch opportunity being proposed for OSCAR 1 would involve what was at that time a very highly classified (i.e., Top Secret) U.S. military project called CORONA.

## The CORONA Program

Back in 1955, with Cold War anxiety skyrocketing, U.S. President Eisenhower made a remarkable proposal to his Soviet counterpart, Premier Nikita Khrushchev. He suggested that each country allow the other to conduct reconnaissance flights in the air and from space over each other's country, and that the imagery obtained be given to the United Nations. The Soviets, however, flatly rejected this "Open Skies" proposal, most likely because it would show just how inflated Khrushchev's boast was that his country was building nuclear-tipped Intercontinental Ballistic Missiles "like sausages." Thereafter, the United States and the Soviet Union proceeded separately to

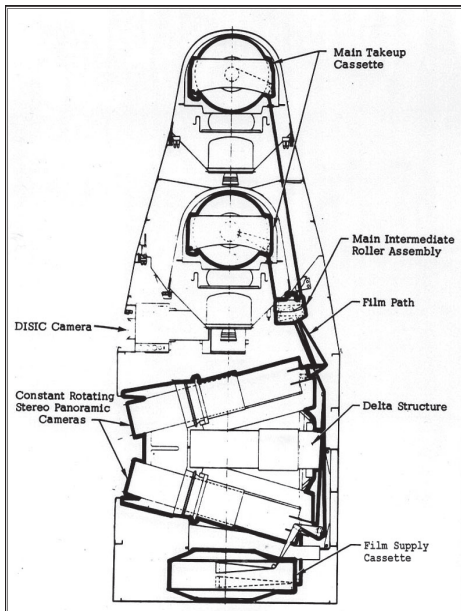

A block diagram of the CORONA upper stage. Exposed film wound into a canister at the vehicle's top for later ejection, de-orbiting and collection.

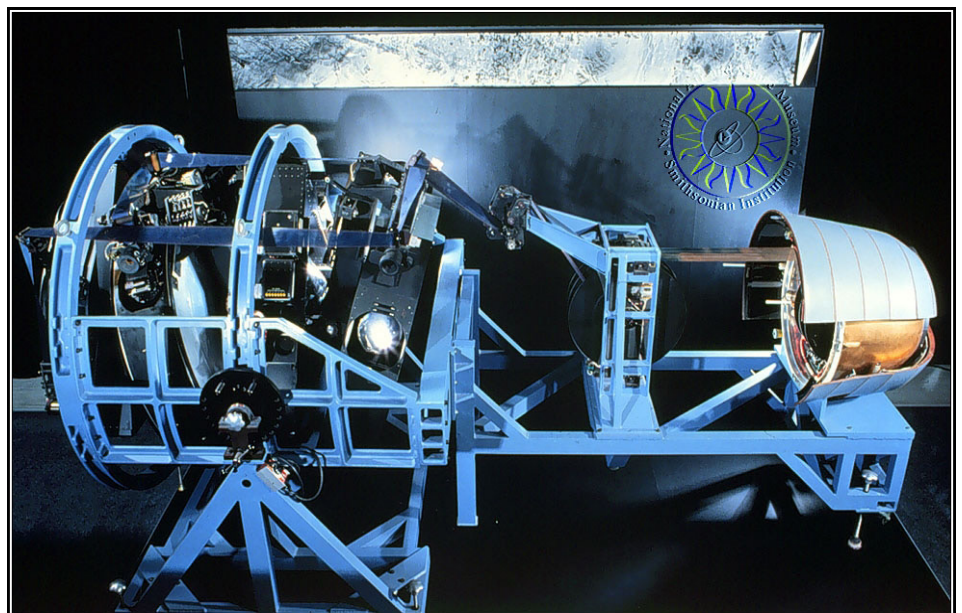

Full-size mockup of CORONA upper stage now displayed in the Smithsonian Institution. [Photo courtesy of Smithsonian Institution.]





Early CORONA imagery wasn't the greatest, but it was good enough to show the CIA's photo interpreters major features (e.g., this image of the Pentagon). [Photo courtesy of USAF.]



Exposed CORONA film was wound into its upper stage capsule that was later de-orbited and most often snagged in mid-air over the Pacific Ocean by a C-119 cargo plane. [Photo courtesy of USAF.]

learn about each other's capabilities in secret. As a result of Khrushchev's rebuff, in 1958, President Eisenhower approved a program that would answer questions about Soviet missile capabilities and replace risky U-2 reconnaissance flights over Soviet territory that an "Open Skies" approach would have provided. Instead, the CIA and the Air Force would jointly develop satellites to photograph denied areas from space. That program had both a secret mission and a secret name: CORONA. It was organized under the new Keyhole security protocols that, at the time, constituted one of the most secret security orders in American history.

CORONA was conceived in an era when facts about Soviet capabilities were scarce and fears were rampant. The size and nature of the Soviet threat back then were largely unknown, but many believed that Khrushchev's boasts were very real and that the U.S. was falling dangerously behind the U.S.S.R. in critical areas. Indeed, the Soviet threat grew in the imagination of the public as U.S. leaders debated the supposed bomber gap, the missile gap, and the science gap. By the late 1950's, the successful launch of the first Soviet Sputnik in 1957, along with subsequent launches of satellites far larger than anything the U.S. had orbited up to that time, raised public fears that the Soviets were developing scores of rockets

and huge satellites capable of dropping nuclear bombs on the U.S. from space.

## How It Worked

Largely as a result of these public pressures, the CIA and the U.S. Air Force developed this first-generation space program with great speed and tight secrecy. The CORONA vehicle was launched by a Thor booster, usually from Vandenberg AFB in California into a roughly polar orbit. It used an Agena spacecraft as the upper stage that also carried all the CORONA equipment. While in orbit, CORONA took photographs with a constant rotating stereo panoramic camera system (developed by Itek Corporation) and then loaded the exposed photographic film (specially made by Kodak for this purpose) into a recovery canister on the nose of the AGENA spacecraft. Resolution in early flight years was in the range of 35 to 40 feet. The canisters (known as "film buckets") were then separated, de-orbited and then recovered in mid air by specially equipped Air Force C-119 aircraft while floating back to Earth via parachute.

The CORONA system successfully photographed its first intelligence target on August 18, 1960, after a number of failures and then recovered the film capsule as it dropped from space. This happened only 110 days after the Soviets had shot down a U-2 spy plane piloted by Francis Gary Powers, an embarrassing setback for the U.S. that effectively ended all U-2 flights over Soviet territory.

By today's standards, the first images snapped by CORONA satellites from orbit looked fuzzy and distant, but technical advances soon produced sharper pictures. By 1972, CORONA was routinely delivering resolutions of 6 to 10 feet. By the 1970s, flights could remain on orbit for 19 days, provide accurate attitude, position, and mapping information, and return coverage of some 8,400,000 square nautical miles per mission.

Such photos held enormous significance for the course of the Cold War as they provided information that allowed US leaders to weigh the actual Soviet threat and measure their response. Even the very first photos from the CORONA project clearly debunked any remaining missile gap fears. If anything, the photos gave tangible proof that such a gap, if it had ever existed at all, was clearly very much in favor of the U.S. and that Khrushchev's "building missiles like sausages" remark was nothing but bunkum.

Given that these efforts were all conducted in secret, the wealth of satellite imagery

CORONA was providing U.S. intelligence experts couldn't be released to the general public to allay their missile gap fears. To do so at the time very easily might have upset the delicate balance of national security in an era when both the United States and Soviet Union possessed more than enough nuclear weapons to virtually annihilate each other many times over.

### **CORONA Firsts**

CORONA ushered in a whole series of technological firsts that contributed to advancements in other areas. The program taught US technicians how to recover objects from orbit--methods that were later adapted by NASA to recover astronauts. It also provided a fast and relatively inexpensive way to map the Earth from space. Before CORONA, cartographers had adequately mapped only a quarter of the Earth's surface. CORONA also provided the first stereo-optical images from space, which gave photo interpreters a 3-dimensional view of terrain. But, clearly, the most important contribution of the CORONA system to national security remains the intelligence it provided to U.S. military planners. CORONA routinely looked through the so-called Iron Curtain and helped lay the groundwork for later disarmament agreements and the eventual collapse of the Berlin Wall. In all, 144 Corona satellites launched, of which 102 returned usable photographs. These satellites produced over 800,000 images taken from space, and 2.1 million feet of film. Individual images on average covered approximately 10 miles by 120 miles.

### **CORONA Finally Revealed**

All of these fantastic technological accomplishments were very effectively kept from public view until President Clinton signed an Executive Order, on February 22, 1995, directing the declassification of intelligence imagery acquired by the first generation of U.S. reconnaissance satellites. The order provided for the declassification of more than 860,000 images of the Earth's surface, collected between 1960 and 1972. Today, all 800,000 images can be purchased for a fee via the U.S. Geological Survey website at: [eros.usgs.gov/#!/Find\\_Data/Products\\_and\\_Data\\_Available/Satellite\\_Products](http://eros.usgs.gov/#!/Find_Data/Products_and_Data_Available/Satellite_Products)

### **OSCAR I and CORONA**

Obviously, with such a highly classified project, keeping what the U.S. government was really up to with CORONA a secret was of utmost importance. So, the government came up with an effective cover story to feed to the public so as to disguise the real intent of the project from prying eyes. As

a result, the first CORONA satellites and their launches were deliberately cloaked in disinformation as being part of a scientific and space technology development project called the Discoverer program. And what better way to add to the cover story, and keep a highly classified project secret from prying eyes, than to carry along a satellite built, quite literally, by a bunch of amateurs in their basements and garages?

### **The Rest of The Story**

Indeed, that's exactly what happened! One of the key players in getting OSCAR-I into orbit was a California radio amateur named Lance Ginner, K6GSJ. Just like what often happens in our hobby, as a young up and coming aerospace engineer, Lance found himself in the enviable position of having his ham radio hobby fit seamlessly with the unique responsibilities of his day

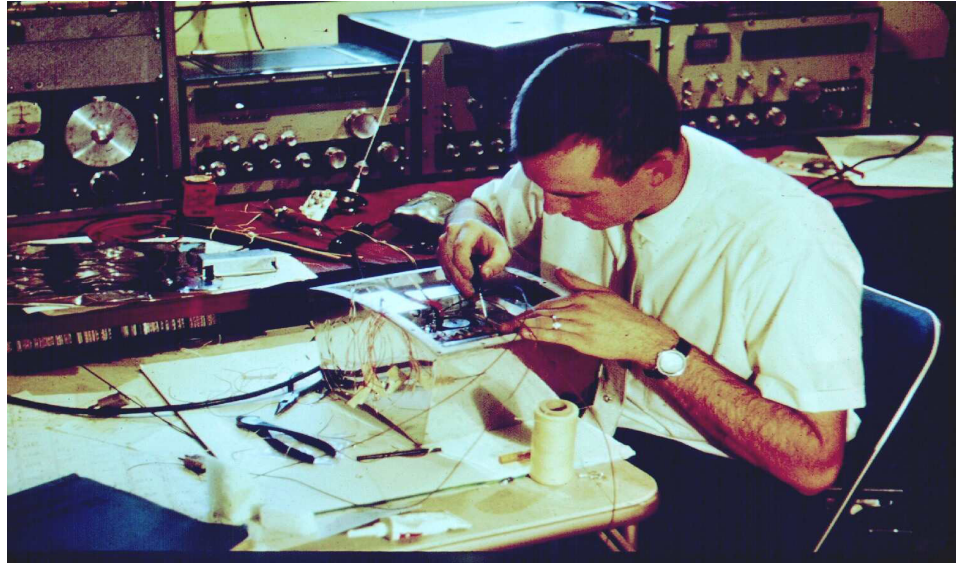

Lance Ginner, K6GSJ, performs the final wiring of the flight model OSCAR-I satellite on a card table set in the ham shack of his California home. [Photo courtesy of Project OSCAR.]

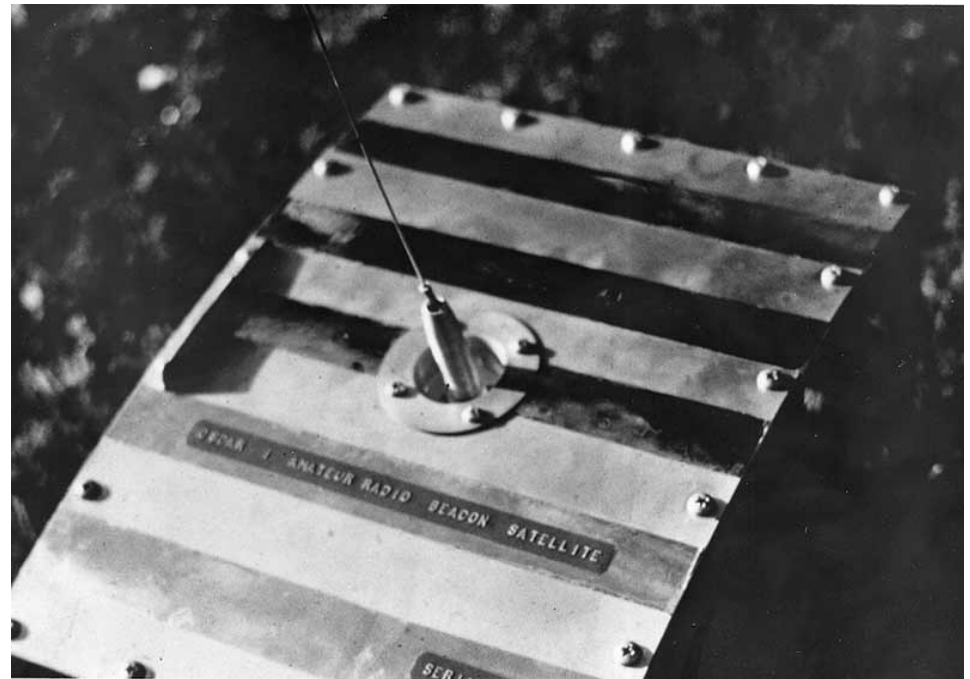

The plastic dymo label tape on the top of the flight model OSCAR-I satellite reads: "OSCAR I AMATEUR RADIO BEACON SATELLITE." [Photo courtesy of Project OSCAR.]





Lance Ginner, K6GSJ, looks over the carrying structure that will loft OSCAR-1 to orbit on the CORONA upper stage. Note the faint arrow pointing to OSCAR-1's \$1.15 Sears-Roebuck spring ejection mechanism. [Lance Ginner, K6GSJ, photo.]

job. Lance started work at the Lockheed Missiles and Space Company in Sunnyvale, California, in January 1960. He was 21 years old at the time and immediately put to work in the Agena vehicle checkout complex doing the final checks on the top-secret CORONA upper stage vehicles that would eventually carry their classified payloads into orbit. Initially, Lance was responsible for designing and building test aids to facilitate the final checkout of these satellites prior to their shipment to Vandenberg AFB, California for eventual launch.

About this same time, and being the active ham operator that he was, Lance became aware of the fledgling OSCAR project through his work association with Chuck Townes, K6LFH, and Nick Marshall, W6OLO, both of whom also worked at Lockheed. As a result, Lance soon found himself smack in the middle of what would later become a pioneering effort in the proud history of amateur radio.

## Politics

The highly classified nature of the main payload made getting the early OSCAR satellites approved for launch a highly politicized process. The challenges the Project OSCAR board faced in obtaining the necessary permissions for them to fly a home-built satellite on a classified space mission was absolutely daunting to say the least!

The idea of a small, erectable sub-satellite being carried and launched into its own orbit as a secondary payload was absolutely unheard of at the time. As a result, convincing the various U.S. government and contractor agencies involved in the CORONA project, such as the CIA and the Air Force, not to mention their bosses at Lockheed, that the very first object to test that idea should be one built by amateurs (who had no official credentials to do such things) was seen by CORONA project officials as a huge risk. Indeed, a premature release of the OSCAR satellite could keep the Agena satellite from deploying its booster adapter, thus bringing the main mission to a catastrophic, not to mention very expensive, end.

As a result, numerous meetings occurred with government and military representatives, including many well-connected hams at the ARRL and elsewhere, in an effort to obtain the necessary permissions for OSCAR-1 to fly. These discussions, along with the creation of an OSCAR-1 white paper, helped establish both the political and technical credibility the Project OSCAR team needed

to obtain the necessary permission to launch. Indeed, Lance later noted that obtaining the necessary bureaucratic efforts and permissions well exceeded those required to actually build the satellite.

## OSCAR-1 At A Glance

The OSCAR-1 satellite consisted of a small curved box that measured 9 inches by 12 inches by 6 inches and sported a single, spring-loaded, 2-meter whip antenna on its top surface. OSCAR-1 did not offer two-way communications. Rather, its non-rechargeable, battery-operated radio simply transmitted a Morse beacon with 140 Milliwatts of power on a frequency of 144.983 MHz. While 140 milliwatts doesn't seem like much power by today's standards, OSCAR-1's transmitter still put out some fourteen times the power of the 10-milliwatt radio carried in Explorer-1, America's very first satellite.

Even with this simple transmitter arrangement, some daunting technical risks remained to be overcome after launch in order to end up with an operating satellite



Bob Allison, WB1GCM, poses at the 2011 AMSAT Space Symposium in San Jose, California, with the backup OSCAR-1 satellite that he restored to working condition. [Keith Baker, KB1SF/VA3KSF, photo.]

in orbit. For example, back in 1961, no commercially available transistors could put out any real power at 144 MHz. So, the Project OSCAR experimenters resorted to a prototype part manufactured by Fairchild Semiconductor Corporation that was not even on the market yet. Indeed, as Lance later noted, back in those days, "You didn't have someone looking over your shoulder saying, you can't do it that way. That's because no one had ever done it before!"

For his part, Lance was directly involved in the construction of all the early OSCARS. In fact, Lance did most of the internal wiring of OSCAR-I in the basement of his California home, as well as all of the environmental testing and integration of the satellite onto the launch vehicle.

### OSCAR-I Firsts

OSCAR-I holds the record for not only being the very first non-military satellite, but also as the very first secondary payload ever to be launched into its own orbit from a rocket. As OSCAR-I was the first satellite to reach orbit as an auxiliary package ejected from a parent spacecraft, its ejection mechanism was of great interest to other scientific groups who also wished to place their own free flying satellites into orbit. When these groups approached the Air Force for such information, they were routinely advised to study the OSCAR-I design.

Even more amazing was that OSCAR-I's innovative ejection system, which was subjected to detailed stress analysis as well as careful mechanical and thermal balancing before launch, was all built around a \$1.15 cent spring purchased off the shelf from a local Sears and Roebuck store. In that sense, OSCAR-I ushered in the era of Commercial Off-the-Shelf (COTS) space hardware as well.

### Success!

On December 12, 1961, OSCAR-I's Discoverer-36 launch vehicle hurled the 10-pound satellite into an elliptical orbit ranging from 152 to 295 miles above the Earth's surface. Soon after launch, its 140 milliwatt beacon successfully activated and began beeping out the letters "HI" (the telegraphic laugh) on its 145 MHz downlink. However, besides being a beacon, there was also a bit of scientific value in OSCAR's Morse greeting in that the temperature inside the satellite controlled the relative speed of the message. Unfortunately, OSCAR-I's battery wasn't rechargeable and had only enough strength to power the transmitter for 22 days. During that brief time (by today's standards), nearly

600 radio amateurs in 28 nations around the globe made careful measurements of its downlink signal and forwarded their observations to the Project OSCAR data reduction center. Sadly, the satellite's low altitude allowed it only to stay in orbit for about 50 days. As a result, OSCAR-I slipped down into the atmosphere and burned up on January 31, 1962.

### Fast Forward 50 Years

As December 12, 2011 would mark the 50th anniversary of the launch of OSCAR-I, in commemoration of that event, laboratory engineers at the ARRL decided to refurbish a backup model that had been sitting in storage for many years at ARRL Headquarters. The model used for school demonstrations soon after the original one was launched had subsequently been donated to the ARRL for safekeeping. So, early in 2011, Bob Allison, WB1GCM, an ARRL test engineer, stepped up to the task and expertly "reverse engineered" the unit so as to get it back up and operating. He first displayed his restored handiwork at the ARRL Expo booth during the 2011 Dayton Hamvention®, much to the interest and amazement of attendees. Bob also brought the model along with him to the Radio Amateur Satellite Corporation's (AMSAT) Annual Meeting and Space Symposium held in San Jose, California, in November 2011. There, he once again set up the model, which began beeping its restored "HI" message to all attendees. (AMSAT is the follow-on organization that picked up much of the work of Project OSCAR back in the 1970s.)

During the Symposium, Bob also got a chance to interview Lance Ginner to discuss Lance's own ham radio beginnings along with his involvement in the building and launching of the early OSCARS. In

return, Bob told Lance of his own efforts to restore the OSCAR-I backup to working condition. This most interesting interview appears at [www.youtube.com/watch?v=HgKc2ZY3LCA&feature=youtu.be](http://www.youtube.com/watch?v=HgKc2ZY3LCA&feature=youtu.be)

Also, during the AMSAT meetings in San Jose, Bob was frequently heard commenting to the many viewers of his restoration efforts that he had been frustrated in his attempts to locate an original schematic of OSCAR-I's transmitter so as to restore the backup OSCAR-I satellite to its "absolutely original" operating parameters. That was, of course, until Lance Ginner walked into the room with a copy of the original OSCAR-I transmitter schematic tucked under his arm, and then handed it over to a (now broadly smiling) Bob Allison!

### Sources and References

Mark Morrison, "Amateur Radio And The Cosmos - Part 4," *CQVHF Magazine*, Spring 2010.

"Early Satellites in US Intelligence," *Remarks by Admiral William O. Studeman, Acting Director of Central Intelligence at the Signing of the Executive Order Declassifying Early Satellite Imagery*, February 24, 1995.

David Hartzell, "Between a Rock and Outer Space: Interview with OSCAR Pioneer Lance Ginner," *The AMSAT Journal*, September / October 2006.

Martin Davidoff, *The Radio Amateur's Satellite Handbook, 1998*, American Radio Relay League, Newington, CT, pp. 1-4.

[Editor's Note: An earlier version of this article was first published in *Monitoring Times*, May 2012.]

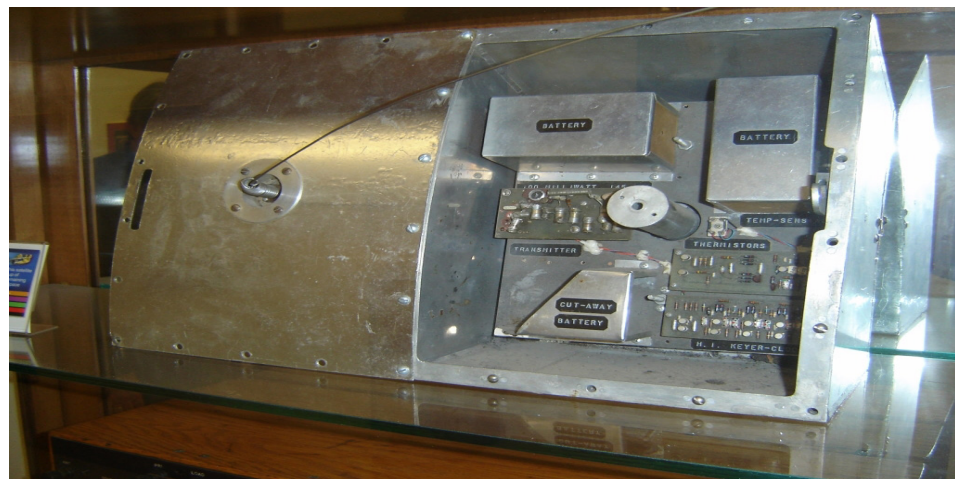

A close-up of the inner workings of OSCAR-I. [Keith Baker, KB1SF/VA3KSF, photo.]



## Rotor Controller Box/Boards



### LVB Tracker Box

- Reasonably priced and all profits go to AMSAT
- Serial interface standard
- USB interface may be easily added by user
- Open software
- Open architecture
- Built-in rotor interface cable with DIN connector
- Power supplied via the rotor controller cable
- Bi-directional interface allows the unit to read the rotor position
- LCD position readout
- Front panel manual control
- Self-programmable, allows for easy software upgrades
- Supported by the major tracking programs
- Uses GS-232A or Easycomm I/II protocols

Contact Martha at the AMSAT office 301-822-4376 to order.

The complete units will be built in groups, so get your orders in early. Units will be shipped as they become available.

Minimum donations requested for various

configurations:

- 1) Bare board - \$20 + S&H – no parts kits available
- 2) Custom Enclosure powder coat, silk-screened, drilled/punched - \$50 + S&H
- 3) Complete unit - board, serial output, rotor cable, LCD, enclosure - \$200 + S&H \*\*our most popular

Documentation for the LVBTracker can be found at: <http://www.LVBTracker.com>

Boards and complete units may be ordered from the AMSAT office at 301-822-4376 or from [martha@amsat.org](mailto:martha@amsat.org)



Visit the **AMSAT On-Line Store** for details on the updated **LVB Tracker Box**: <http://store.amsat.org/catalog>

## MacDoppler

The premier Satellite tracking and station automation application for the Macintosh - OS 9 & OS X

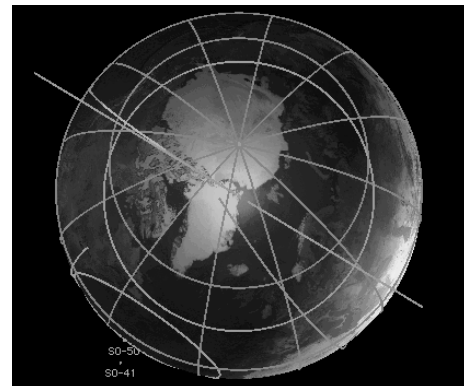

MacDoppler for Cocoa gives you a seat right in the heart of the Operations & Command Centre for every satellite in orbit, providing any level of station automation you need from assisted Doppler Tuning and Antenna Pointing right on up to a fully automated Satellite Gateway!

It will calculate the position and relative velocity of the satellites you are tracking and automatically adjust the Doppler shift on both transmit and receive as well as pointing your antennas with predictive dead spot crossing so that a pass is never interrupted.

A Universal Binary that runs native on Intel and PPC Macs and provides separate panels for the map (2D or 3D), the radio and rotor controls, a sorted table of upcoming satellite passes and a Horizon panel that graphs upcoming passes as a function of elevation over time.

**Now available from AMSAT at a special member discount donation!**

[martha@amsat.org](mailto:martha@amsat.org)  
10605 Concord St. Suite 304  
Kensington MD  
20895-2526 USA.  
(301) 822-4376, (301) 822-4371 (Fax)

**Dog Park Software Ltd.**  
[www.dogparksoftware.com](http://www.dogparksoftware.com)

## THE R.F. CONNECTION

"Specialist in  
R.F. Connectors and Coax"  
<http://www.therfc.com>

301/840-5477  
Fax 301/869-3680  
E mail: [rfc@therfc.com](mailto:rfc@therfc.com)

Order Line 800/783-2666  
Suite 11, 213 N. Frederick Ave.  
Gaithersburg, MD 20877



# AMSAT Fox-1Cliff & Fox-ID \$125,000 Launch Initiative Goal

AMSAT is excited to announce a launch opportunity for **BOTH** the Fox-1Cliff and Fox-ID Cubesats. In response to a breaking opportunity, AMSAT and Spaceflight, Inc. have arranged for Fox-ID to accompany Fox-1Cliff on the maiden flight of the SHERPA system on a SpaceX Falcon 9 in the 1st quarter of 2016.

AMSAT has an immediate need to raise funds to cover both the launch contract and additional materials for construction and testing for Fox-1Cliff and Fox-ID. We have set a fundraising goal of \$125,000 to cover these expenses over the next 12 months, and allow us to continue to keep amateur radio in space.

Fox-1Cliff and Fox-ID will provide selectable U/V or L/V repeater capabilities on separate frequencies once in orbit, and will be capable of downlinking Earth images from the Virginia Tech camera experiment.



Spaceflight's SHERPA System

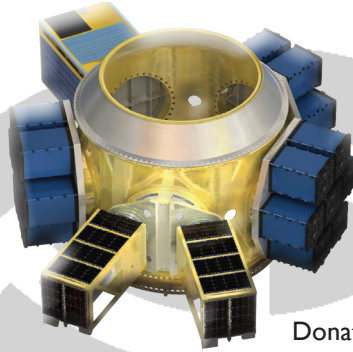

Spaceflight's SHERPA will deploy multiple cubesat payloads on-orbit

ISIS QuadPack Nanosatellite Dispenser



Donations may be made through the AMSAT webpage at [www.amsat.org](http://www.amsat.org), by calling (888) 322-6728 or by mail to the AMSAT office at 10605 Concord Street, Kensington, MD 20895, USA. Please consider a recurring, club, or corporate donation to maximize our chance of success with this mission.

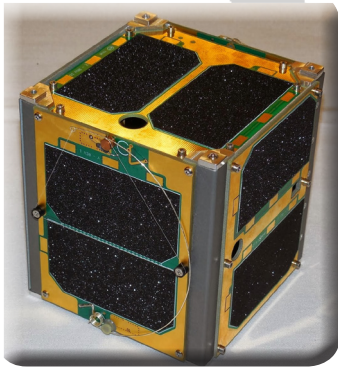

## AMSAT President's Club Support Fox-1Cliff and Fox-ID

Contribute to AMSAT directly through easy, automatic charges to your credit card. Since AMSAT is a 501(C)(3) organization donations may be USA tax deductible. (Check with your tax advisor.) To join contact Martha at the AMSAT Office by phone (888) 322-6728 in the US, or (301) 822-4376; e-mail [martha@amsat.org](mailto:martha@amsat.org).

**Your help is needed to get the AMSAT Fox-1Cliff and Fox-ID IU Cubesats launched on the Spaceflight's initial SHERPA flight in IQ 2016.**

For the latest news on Fox-1 watch our website at [www.amsat.org](http://www.amsat.org), follow us on Twitter at "AMSAT", or on Facebook as "The Radio Amateur Satellite Corporation" for continuing news and opportunities for support.

- |   |  |
|---|--|
| <b>Titanium Donors</b> contribute at least US \$400 per month | <input type="checkbox"/> \$400 / month   |
|   | <input type="checkbox"/> \$4800 one time |
| <b>Platinum Donors</b> contribute at least US \$200 per month | <input type="checkbox"/> \$200 / month   |
|   | <input type="checkbox"/> \$2400 one time |
| <b>Gold Donors</b> contribute at least US \$100 per month     | <input type="checkbox"/> \$100 / month   |
|   | <input type="checkbox"/> \$1200 one time |
| <b>Silver Donors</b> contribute at least US \$50 per month    | <input type="checkbox"/> \$50 / month    |
|   | <input type="checkbox"/> \$600 one time  |
| <b>Bronze Donors</b> contribute at least US \$25 per month    | <input type="checkbox"/> \$25 / month    |
|   | <input type="checkbox"/> \$300 one time  |
| <b>Core Donors</b> contribute at least US \$10 per month      | <input type="checkbox"/> \$10 / month    |
|   | <input type="checkbox"/> \$120 one time  |



# AMSAT is Amateur Radio in Space ... and YOU are AMSAT!

Seize opportunities to launch your amateur radio experience to new heights!

## ARISS Development and Support

AMSAT's Human Space Flight Team is looking for volunteers to help with development and support of the ARISS program:

- Mentors for school contacts
- Support for the ARISS web
- Hardware development for spaceflight and ground stations
- Help with QSL and awards certificate mailing.

To volunteer send an e-mail describing your area of expertise to Frank Bauer at: [ka3hdo@amsat.org](mailto:ka3hdo@amsat.org).

## AMSAT Internet Presence

AMSAT's information technology team has immediate needs for volunteers to help with development and on-going support of our internet presence :

- Satellite status updating and reporting.
- Add/delete satellites to ANS and the web as needed.
- Research and report satellite details including frequencies, beacons, operating modes.
- Manage AMSAT's Facebook and Twitter presence.

To volunteer, send an e-mail to Drew Glasbrenner, KO4MA at: [ko4ma@amsat.org](mailto:ko4ma@amsat.org).

## AMSAT Engineering Team

AMSAT Engineering is looking for hams with RF experience to prototype, build, and test the new Fox-1E linear transponder. The timeline is short, so jump in now to be a part of the fun and a successful mission!

We also need hams with microwave RF experience, attitude determination and control systems experience, and thermal engineering for the lunar CQC and future HEO CubeSats.

Help design and build hardware and software for the AMSAT Ground Station to be used for P4B, CQC, and P3E.

To volunteer, please describe your expertise using the form at [www2.amsat.org/?page\\_id=1121](http://www2.amsat.org/?page_id=1121).

## AMSAT User Services

AMSAT is looking for an on-line store co-manager to update and refresh the AMSAT Store web page when new merchandise becomes available or prices and shipping costs change.

- Add new merchandise offerings
- Delete merchandise no longer available
- Update shipping costs as needed
- Add periodic updates for event registrations
- Interface with the AMSAT Office

To volunteer, send an e-mail to Joe Kornowski, KB6IGK at: [kb6igk@amsat.org](mailto:kb6igk@amsat.org)

## AMSAT Educational Relations Team

AMSAT's Educational Relations Team needs volunteers with a background in education and classroom lesson development ...

- Engage the educational community through presentations of how we can assist teaching about space in the classroom.
- Create scientific and engineering experiments packaged for the classroom.
- Create methods to display and analyze experimental data received from Fox-1.

To volunteer send an e-mail describing your area of expertise to Joe Spier, K6WAO at: [k6wao@amsat.org](mailto:k6wao@amsat.org).

## AMSAT Field Operations

AMSAT's Field Operations Team is looking for satellite operators to promote amateur radio in space with hands-on demonstrations and presentations.

- Promote AMSAT at hamfests
- Setup and operate satellite demonstrations at hamfests.
- Provide presentations at club meetings.
- Show amateur radio in space at Dayton, Pacificon, Orlando Hamcation.

To volunteer, send an e-mail to Patrick Stoddard, WD9EWK at: [wd9ewk@amsat.org](mailto:wd9ewk@amsat.org)

You can find more information on the web:  
[www.amsat.org](http://www.amsat.org) – click AMSAT – then click Volunteer