

# Contents

- 1 Amateur Satellite History
  - 1.1 AMSAT
  - 1.2 Amateur Satellites Today
- 2 Satellite Transponders
  - 2.1 “Bent Pipe” Transponders
  - 2.2 Linear Transponders
  - 2.3 Digital Transponders
- 3 Satellite Tracking
  - 3.1 Satellite Orbits
  - 3.2 Satellite Tracking Software
  - 3.3 Getting Started With Software
  - 3.4 Orbital Elements
  - 3.5 Other Tracking Considerations
- 4 Satellite Ground Station Antennas
  - 4.1 Antenna Polarization
  - 4.2 Omnidirectional Antennas
  - 4.3 Directional Antennas
  - 4.4 Antenna Mounting
  - 4.5 Antenna Rotators
- 5 Satellite Ground Station Equipment
  - 5.1 Receive and Transmit Converters
  - 5.2 Transceivers
  - 5.3 VHF/UHF RF Power Amplifiers
  - 5.4 Typical Station Designs
- 6 Satellite Antenna Projects
  - 6.1 An EZ-Lindenblad Antenna for 2 Meters
  - 6.2 The W3KH Quadrifilar Helix
- 7 Satellite References and Bibliography
- 8 Earth-Moon-Earth (EME) Communication
  - 8.1 Background
- 9 EME Propagation
  - 9.1 Path Loss
  - 9.2 Echo Delay and Time Spread
  - 9.3 Doppler Shift and Frequency Spread
  - 9.4 Atmospheric and Ionospheric Effects
- 10 Fundamental Limits
  - 10.1 Background Noise
  - 10.2 Antenna and Power Requirements
  - 10.3 Coding and Modulation
- 11 Building an EME Station
  - 11.1 Antennas
  - 11.2 Feed lines, Preamplifiers and TR Switching
  - 11.3 Transmitters and Power Amplifiers
- 12 Getting Started
  - 12.1 Tracking the Moon
  - 12.2 System Evaluation
  - 12.3 Operating Procedures
  - 12.4 Finding QSO Partners
- 13 EME Notes and References
- 14 Glossary of Space Communications Terminology

# Space Communications

Radio amateurs point their antennas skyward to talk via communications satellites built by groups of interested and talented hams. In the first part of this supplement, Steve Ford, WB8IMY, provides some background and shows what you need to get involved with amateur satellites. The EME section, written by Joe Taylor, K1JT, discusses the requirements for successful contacts via the EME path. K1JT gratefully acknowledges input and advice for the EME section from Allen Katz, K2UYH, Marc Franco, N2UO, Peter Blair, G3LTF, Graham Daubney, F5VHX, Lionel Edwards, VE7BQH, Ian White, GM3SEK, Leif Asbrink, SM5BSZ and Rex Moncur, VK7MO. A glossary of space communications terms may be found at the end of this chapter. In previous editions, this material formed Chapter 30. Unless otherwise noted, references to other chapters refer to the chapters in the print version of the *ARRL Handbook*.

## 1 Amateur Satellite History

Many people are astonished to discover that Amateur Radio satellites are not new. In fact, the story of Amateur Radio satellites is as old as the Space Age itself.

The Space Age is said to have begun on October 4, 1957. That was the day when the Soviet Union shocked the world by launching Sputnik 1, the first artificial satellite. Hams throughout the world monitored Sputnik's telemetry beacons at 20.005 and 40.002 MHz as it orbited the Earth. During Sputnik's 22-day voyage, Amateur Radio was in the media spotlight since hams were among the few civilian sources of news about the revolutionary spacecraft.

Almost four months later, the United States responded with the launch of the Explorer 1 satellite on January 31, 1958. At about that same time, a group of Amateur Radio operators on the West Coast began considering the possibility of a ham satellite. This group later organized itself as Project OSCAR (OSCAR is an acronym meaning Orbiting Satellite Carrying Amateur Radio) with the expressed aim of building and launching amateur satellites. (See the sidebar "When Does a Satellite Become an OSCAR?")

After a series of high-level exchanges with the American Radio Relay League and the United States Air Force, Project OSCAR secured a launch opportunity. The first Amateur Radio satellite, known as OSCAR 1, would "piggyback" with the Discoverer 36 spacecraft being launched from Vandenberg Air Force Base in California. Both "birds" (as satellites are called among their builders and users) successfully reached low Earth orbit on the morning of December 12, 1961.

OSCAR 1 weighed only 10 pounds. It was built, quite literally, in the basements and garages of the Project OSCAR team. It carried a small beacon transmitter that allowed ground stations to measure radio propagation through the ionosphere. The beacon also transmitted telemetry indicating the internal temperature of the satellite.

OSCAR 1 was an overwhelming success. More than 570 amateurs in 28 countries forwarded observations to the Project OSCAR data collection center. OSCAR 1 lasted only 22 days in orbit before burning up as it reentered the atmosphere, but Amateur Radio's "low tech" entry into the high tech world of space travel had been firmly secured. When scientific groups asked the Air Force for advice on secondary payloads, the Air Force suggested they study the OSCAR design. What's more, OSCAR 1's bargain-basement procurement approach and management philosophy would become the hallmark of all the OSCAR satellite projects that followed, even to this day.

Since then, amateurs have successfully built and launched dozens of satellites, each one progressively more sophisticated than the last.

### 1.1 AMSAT

Much of the amateur satellite progress has been spearheaded by the Radio Amateur Satellite Corporation, better known as *AMSAT*. The original AMSAT was formed in Washington, DC in 1969 as an organization dedicated to fostering an Amateur Radio presence in space. The AMSAT model quickly became international with many countries creating their own AMSAT organizations, such as AMSAT-UK in England, AMSAT-DL in Germany, BRAMSAT in Brazil and AMSAT-LU in Argentina. All of these organizations operate independently but may cooperate on large satellite projects and other items of interest to the worldwide Amateur Radio satellite community. Because of the many AMSAT organizations now in existence, the US AMSAT organization is frequently designated AMSAT-NA.

Since the very first OSCAR satellites were launched in the early 1960s, AMSAT's inter-

## When Does a Satellite Become an OSCAR?

While worldwide AMSAT organizations are largely responsible for the design and construction of the modern day Amateur Radio satellites, the original "OSCAR" designation is still being applied to many satellites carrying Amateur Radio. However, most Amateur Radio satellites are not usually assigned their sequential OSCAR numbers until *after* they successfully achieve orbit and become operational. Even then, an OSCAR number is only assigned after its sponsor formally requests one.

For example, let's make up a satellite and call it ROVER. The ROVER spacecraft won't receive an OSCAR designation until (1) it reaches orbit and (2) its sponsor submits a request. Now let's presume that ROVER makes it into orbit and the OSCAR request is made and granted. ROVER is now tagged as OSCAR 99 and its full name becomes ROVER-OSCAR 99. You'll find, however, that many hams will abbreviate the nomenclature. Some will simply call the satellite ROVER, or OSCAR 99. They may even abbreviate its full name to just RO-99.

If a satellite subsequently fails in orbit, or it re-enters the Earth's atmosphere, its OSCAR number is usually retired, never to be issued again.

national volunteers have pioneered a wide variety of new communications technologies. These breakthroughs have included some of the very first satellite voice transponders as well as highly advanced digital "store-and-forward" messaging transponder techniques. All of these accomplishments have been achieved through close cooperation with international space agencies that often have provided launch opportunities at significantly reduced costs in return for AMSAT's technical assistance in developing new ways to launch paying customers.

AMSAT's major source of operating revenue is obtained by offering memberships in the various international AMSAT organizations. Membership is open to radio amateurs and to others interested in the amateur exploration of space. Modest donations are also sought for tracking software and other satellite related publications. In addition, specific spacecraft development funds are established from time to time to help fund major AMSAT spacecraft projects through donations. In addition to money, AMSAT makes creative use of leftover materials donated from aerospace industries worldwide.

AMSAT-NA has just one paid employee. The rest of the organization, from the president on down to the workers designing and

**Table 1**

### Currently Active Amateur Radio Satellites

Satellite	Uplink (MHz)	Downlink (MHz)	Mode
AMSAT-OSCAR 7		29.502	Beacon
		145.975	Beacon
		435.100	Beacon
	145.850 - 145.950	29.400 - 29.500	SSB/CW, non-inverting
AMSAT-OSCAR 27	432.125 - 432.175	145.975 - 145.925	SSB/CW, inverting
	145.850	436.795	FM repeater
AMSAT-OSCAR 51	145.920	435.300	FM repeater (67 Hz CTCSS required)
ARISS (ISS)	145.880	435.150	USB/FM voice
	145.880	2401.200	FM voice
	145.860	435.150	9600 bps digital
	145.860	2401.200	9600 bps digital
	1268.700	2401.200	FM voice
	1268.700	435.150	FM voice
	144.490	145.800	Crew contact, FM (Region 2/3)
	145.200	145.800	Crew contact, FM (Region 1)
BEESAT	145.990	145.800	Packet BBS
	145.825	145.825	APRS digipeater
	—	144.490	SSTV downlink
	437.800	145.800	FM repeater
	—	436.000	CW and GMSK beacon
CAPE-1	—	435.245	CW beacon
Castor	—	145.825	AX.25 beacon
Compass-One	—	437.275 (CW)	Telemetry
CubeSat-OSCAR 57	—	437.405 (packet)	Telemetry (incl images)
	—	436.8475 (CW)	Telemetry
CubeSat-OSCAR 58	—	437.490 (packet)	Telemetry
	—	437.465 (CW)	Telemetry
CubeSat-OSCAR 65	—	437.345 (packet)	Telemetry
	—	437.275	CW beacon
	—	437.475	AX.25 beacon
CubeSat-OSCAR 66	1267.6000	437.475	GMSK 9600 bps
	—	437.485 (packet)	Telemetry (incl images)
Cute-1-OSCAR 55	—	437.400	AFSK 1200 bps beacon
	—	436.8375	CW beacon
Dutch-OSCAR 64	—	145.870 (packet)	Telemetry
	435.530 - 435.570	145.880 - 145.920	SSB/CW, inverting
Fuji-OSCAR 29	145.900-146.000	435.800-435.900	SSB/CW
	—	435.7950	CW beacon
GeneSat-1	—	437.975	AFSK 1200 bps beacon and telemetry
Hope-OSCAR 68	145.825	435.675	FM repeater
	145.925 - 145.975	435.765 - 435.715	SSB/CW inverting
	145.825	435.675	1200 baud packet
ITUpSAT1	—	435.790	CW beacon
	—	437.325	FM CW and GFSK beacon
KKS-1	—	437.385	CW beacon
	—	437.445	AX.25 beacon
PRISM	—	437.250	CW and 1200 bps AFSK beacon
	—	435.352	CW beacon
RS-22	—	435.215, 435.315	CW beacon
RS-30	—	436.795	FM Repeater
Saudi-OSCAR 50	145.850	—	(67 Hz CTCSS required) CW and 1200 bps FSK
SwissCube beacon	—	437.505	—
Sumbandila-OSCAR 67	145.875	435.345	FM repeater
STARS	—	437.275	Beacon
	—	437.305	Beacon
	—	437.465	Beacon
	—	437.850	Beacon
	—	145.860	CW Beacon
VUSat-OSCAR 52	—	145.936	Carrier Beacon
	435.220 - 435.280	145.870 - 145.930	SSB/CW, inverting

Information from AMSAT — 14 June 2010. For information on current satellite status and satellite development programs, see [www.amsat.org](http://www.amsat.org).

building space hardware, all donate their time and talents to the organization.

## 1.2 Amateur Satellites Today

When this edition of the *Handbook* went to press, there were 15 active Amateur Radio satellites in orbit (see **Table 1**), not counting the Amateur Radio presence aboard the In-

ternational Space Station. All of these are low Earth orbiting (LEO) spacecraft that function either as communication relays or research platforms.

Hams have been longing for a high-orbiting "DX" satellite that would relay conversations across entire hemispheres. The last such satellite was OSCAR 40, which became silent in 2004. Unfortunately, it is becoming difficult for non-profit amateur satellite organizations

to build such complex, powerful birds while relying solely on member dues and donations, not to mention thousands of hours of volunteer labor. To make matters worse, launch opportunities for large satellites have become in-

creasingly scarce and prohibitively expensive.

The German AMSAT organization, AMSAT-DL, is building a high-orbit satellite that is presently known as Phase 3 Express. AMSAT-NA has been working on their ver-

sion of a DX bird known as Eagle. Neither satellite is complete at the time of this writing.

For the foreseeable future, Amateur Radio satellite activity will likely be confined to spacecraft in low Earth orbits.

## 2 Satellite Transponders

In its most basic form, a *transponder* is the satellite communications system that receives signals from the Earth, alters their frequencies, amplifies them, and sends them back to Earth. The word originates from *transmitter* and *responder*. The transponder is at the heart of every satellite's ability to relay signals. There are three transponder types currently in use.

### 2.1 "Bent Pipe" Transponders

A bent-pipe transponder is the simplest transponder design in terms of function. It receives a signal at one frequency and simultaneously retransmits it at another. The metaphor is that of a U-shaped pipe that captures an object coming toward it and redirects the object back to its source (Fig 1).

A terrestrial FM repeater is a typical example of a bent-pipe transponder. Earthbound repeaters monitor one frequency and retransmit on another, usually (though not always) within the same band. Thanks to their elevated antenna systems, sensitive receivers and considerable output power, terrestrial repeaters can extend the coverage of mobile or handheld FM transceivers over hundreds or even thousands of square miles.

Bent-pipe satellite transponders also function as FM repeaters (although they could just as easily relay other modulation modes such as SSB). Satellite repeaters lack the output power of terrestrial repeaters because power generation in space is a difficult proposition. But what satellite repeaters lack in output power they more than make up for in antenna elevation. Even something as meager as a  $\frac{1}{4} \lambda$  whip antenna can become a transmitting and receiving powerhouse when it is hundreds of miles above the planet.

The principle advantage of a bent-pipe transponder operating in the FM mode is that it is readily compatible with common Amateur Radio transceivers. Satellites such as AMSAT-OSCAR 51 and AMRAD-OSCAR 27 can be easily worked with the same transceivers you'd otherwise use to chat through a local FM repeater. It isn't uncommon to hear mobile and even handheld portable stations communicating through these satellites.

The principle *disadvantage* of a bent-pipe transponder is that it can relay only one signal at a time. Multiple signals on the satellite uplink frequency interfere with each other, usually resulting in an unintelligible cacophony on the downlink. Thanks to the "capture

effect" common to FM receivers, only the strongest signal will come through clearly. With only 10 or 15 minutes available during typical low-orbit passes, an inconsiderate operator running high power can use the capture effect to monopolize the satellite, effectively shutting out all other stations.

The solution to the bent-pipe problem is to

have a satellite that can relay more than one signal at a time. That requires a completely different sort of transponder.

### 2.2 Linear Transponders

Unlike a bent-pipe transponder that can relay only one signal at a time, a linear tran-

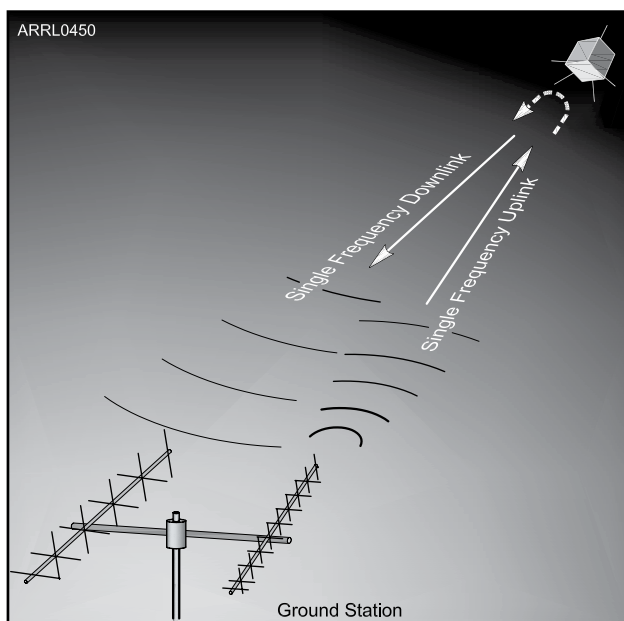

**Fig 1 — A bent-pipe transponder gets its name from the way it functions. It takes the received uplink signal and instantly relays it on the downlink back to its source. Bent-pipe transponders are most often found on satellites that function primarily as FM repeaters.**

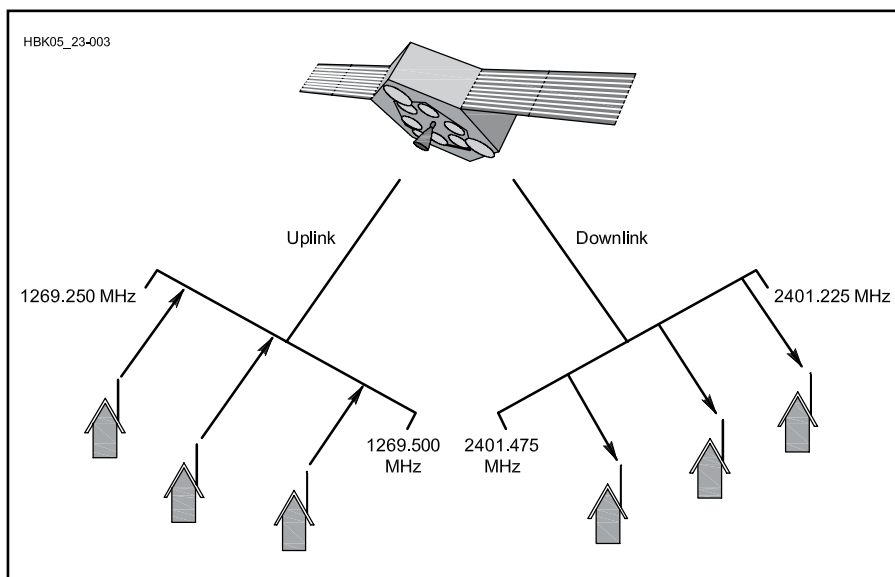

**Fig 2 — Linear transponders repeat all signals received in an entire slice of spectrum. This allows the satellite to relay many conversations simultaneously.**

sponder receives signals in a narrow slice of the RF spectrum (the *passband*), shifts the frequency of the passband, amplifies all signals linearly, and then retransmits everything back to Earth. Rather than relaying only one signal, a satellite equipped with a linear transponder can relay many signals at once (Fig 2).

From an operator point of view, linear transponders have an enormous advantage. With single-channel bent-pipe transponders, the user is obligated to finish a conversation quickly and clear the frequency so that someone else can make a contact. Not so with linear transponders. With the ample spectrum available through a linear transponder, there is more than enough “room” for everyone to communicate for as long as they please, or at least until the satellite travels out of range.

A linear transponder can be used with any type of signal when real time communication is desired. From the standpoint of conserving valuable spacecraft resources such as power and bandwidth, however, the preferred user modes are SSB and CW. Transponders are specified by first giving the approximate input frequency followed by the output frequency. For example, a 146/435-MHz transponder has an input passband centered near 146 MHz and an output passband centered near 435 MHz. The same transponder could be specified in wavelengths, as a 2 meter/70 cm unit.

### TRANSPONDER MODES

To keep linear transponder specifications as simple as possible, the satellite community often uses so-called *Mode* designators. In the early years of amateur satellite operation, these designations were rather arbitrarily assigned and bore little resemblance to the actual frequencies in use. Fortunately, the amateur satellite community has since settled on a newer series of transponder specifications

Table 2

#### Satellite Uplink/Downlink Mode Designators

##### Satellite Band Designations

- 10 m (29 MHz): H
- 2 m (145 MHz): V
- 70 cm (435 MHz): U
- 23 cm (1260 MHz): L
- 13 cm (2.4 GHz): S
- 5 cm (5.6 GHz): C
- 3 cm (10 GHz): X

##### Common Operating Modes (Uplink/Downlink)

- V/H (2 m/10 m)
- H/V (10 m/2 m)
- U/V (70 cm/2 m)
- V/U (2 m/70 cm)
- U/S (70 cm/13 cm)
- U/L (70 cm/23 cm)
- L/S (23 cm/13 cm)
- L/X (23 cm/3 cm)
- C/X (5 cm/3 cm)

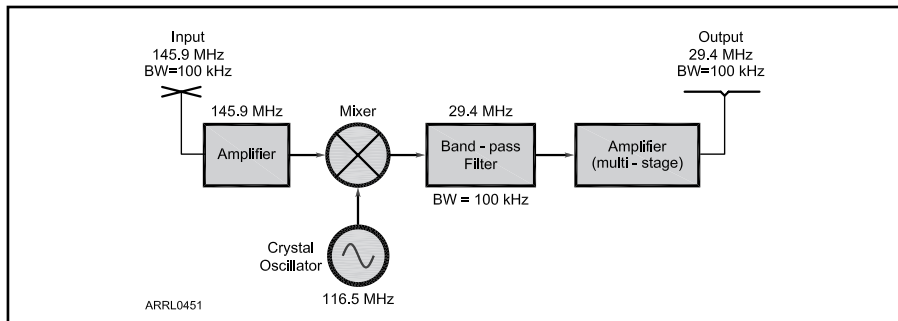

Fig 3 — A simplified block diagram of a linear transponder.

that are far more intuitive. For instance, in our previous example, the 2 meter band is tagged with the label “V” (for VHF) while the 70 cm band is labeled “U” (for UHF). Therefore, a transponder that listens on 2 meters and repeats on 70 cm is today usually called a Mode V/U transponder. See Table 2.

Transponder design is, in many respects, similar to receiver design. Input signals are typically on the order of  $10^{-13}$  W and the output level can be up to several watts. A major difference, of course, is that the transponder output is at radio frequency while the receiver output is at audio frequency. A block diagram of a simple transponder is shown in Fig 3. For several reasons, flight-model transponders are more complex than the one shown.

In spacecraft applications a key characteristic of a linear amplifier is its overall efficiency (RF output/dc input). Once we reach power levels above a few watts the use of class A, AB or B amplifiers cannot be tolerated. The power and bandwidth of a transponder must be compatible with each other and with the mission. That is, when the transponder is fully loaded with equal-strength signals, each signal should provide an adequate signal-to-noise ratio at the ground. Selecting appropriate values accurately on a theoretical basis using only link calculations is error prone. Experience with a number of satellites, however, has provided AMSAT with a great deal of empirical data from which it’s possible to extrapolate accurately to different orbits, bandwidths, power levels, frequencies and antenna characteristics.

In general, low-altitude (300 to 1600 km) satellites that use passive magnetic stabilization and omnidirectional antennas can provide reasonable downlink performance with from 1 to 10 W PEP at frequencies between 29 and 435 MHz, using a 50- to 100-kHz-wide transponder. A high-altitude (35,000 km) spin-stabilized satellite that uses modest (7 to 10 dBi) gain antennas should be able to provide acceptable performance with 35 W PEP using a 300-kHz-wide transponder downlink at 146 or 435 MHz. Transponders are usually configured to be *inverting* in order to minimize Doppler shift. This means, for example, that a signal with a frequency at

the low end of the uplink passband shifts to a corresponding point on the high end of the downlink passband. In the case of an SSB signal, the sideband modulation inverts as well—lower sideband on the uplink becomes upper sideband on the downlink.

### DYNAMIC RANGE

The dynamic range problem for transponders is quite different from that for HF receivers. At first glance it may seem that the situation faced by satellite transponders is simpler. After all, an HF receiver must be designed to handle input signals differing in strength by as much as 100 dB, while a low-altitude satellite will encounter signals in its passband differing by perhaps 40 dB. Good HF receivers solve the problem by filtering out all but the desired signal before introducing significant gain. A satellite, however, has to accommodate all users simultaneously. The maximum overall gain can, therefore, be limited by the strongest signal in the passband.

Considering the state-of-the-art in transponder design and available spacecraft power budgets, an effective dynamic range of about 25 dB is about the most that can be currently obtained. In earlier satellites, the receiver AGC was normally adjusted to accommodate the loudest user. As a result, stations 25 dB weaker were not able to put a usable signal through the spacecraft even though they might be capable of doing so when the AGC is not activated. In the ideal situation users would adjust uplink power so that spacecraft AGC is never activated.

The “power-hog” problem is a serious one. A single station running excessive power can effectively swamp a linear transponder. Far too often, an inexperienced operator may believe that cranking up transmit power will improve downlink signal strength. Instead, that increase in power only serves to depress the downlink signal levels of all other stations.

In the short-lived OSCAR 40 satellite, the designers tried an innovative approach to the power-hog problem with the addition of LEILA (*LEI*stungs *L*imit *A*nzeige [Power Limit Indicator]). LEILA’s computer continuously monitored the 10.7 MHz transponder IF passband. When an uplink signal

exceeded a predetermined level, the computer inserted a CW message over the offender's downlink. The message indicated to the transmitting station that the transponder was being overloaded, and served as an inducement for the offending station to reduce power until the CW signal disappeared. If the overloading signal continued, or exceeded an even higher preset level, LEILA activated a notch filter tuned to the offending station's frequency. LEILA turned out to be highly effective. If you suddenly heard CW being transmitted over your signal on the downlink, you knew you had to reduce power immediately or face the consequences.

Since the transponder is the primary mission subsystem, reliability is extremely important. One way to improve system reliability is to include at least two transponders on each spacecraft; if one fails, the other would be available full time. And there are significant advantages to *not* using identical units.

### 2.3 Digital Transponders

Digital transponders differ significantly from linear transponders. A digital transponder demodulates the incoming signal. The data can then be stored aboard the spacecraft (as in a packet mailbox) or used to immediately regenerate a digital downlink signal (as in a digipeater). The mailbox service is best suited to low altitude spacecraft. Digipeating is most effective on high altitude spacecraft. Like linear transponders, digital units are downlink limited. A key step in the design procedure is to select modulation techniques and data rates to maximize the downlink capacity. Using assumptions about the type of traffic expected, the designers select appropriate uplink parameters. An analysis suggests that the uplink data capacity should be about four or five times that of the downlink because

of "collisions" among signals trying to access the transponder.

For mailbox operation designers often use a PACSAT (*packet radio satellite*) model with similar data rates for the uplink and downlink, and they couple a single downlink with four uplinks. Fuji-OSCARs 12 and 20, and the MicroSat series ran both links at 1200 bps. These PACSATs contained an FM receiver with a demodulator that accepted Manchester-encoded FSK on the uplink. To produce an appropriate uplink signal, ground stations needed FM transmitters and packet radio modems known as terminal node controllers (TNCs) that were capable of generating the Manchester-encoded signal for the uplink.

The PACSAT downlink used binary phase-shift keying (BPSK) at an output of either 1.5 or 4 W. This modulation method was selected because, at a given power level and bit rate, it provides a significantly better bit error rate than other methods that were considered. One way of receiving the downlink is to use an SSB receiver and pass the audio output to a PSK demodulator. The SSB receiver is just serving as a linear downconverter in this situation. Other methods of capturing the downlink are possible but the two proven systems now operating use this approach.

During the heydays of the PACSATs, there were several TNCs designed specifically for this application. Over time the PACSATs have gradually gone out of service and those specialized TNCs have all but disappeared from the marketplace. The remaining digital satellite transponders use 1200 bps AFSK or 9600 bps FSK data transmissions for both uplink and downlink. This means that ordinary packet radio TNCs — the kind currently used for various terrestrial applications — can be used with these digital satellites as well.

be orbiting from pole to pole; smaller inclination angles mean that the satellite is spending more time at lower latitudes. The International Space Station, for example, travels in an orbit that is inclined about 50° to the equator. Satellites that move in these orbits frequently fall into the Earth's shadow (eclipse), so they must rely on battery systems to provide power when the solar panels are not illuminated. Depending on the inclination angle, some locations on the Earth will never have good access because the satellites will rarely rise above their local horizons. This was true, for example, in the days when the US Space Shuttles carried Amateur Radio operators. Shuttle orbits were usually inclined at low

## RUDAK

A discussion of digital transponders would not be complete without mentioning RUDAK. RUDAK is an acronym for Regenerativer Umsetzer für Digitale Amateurfunk Kommunikation (Regenerative Transponder for Digital Amateur Communications). Early RUDAK systems took a different approach to achieving the desired ratio of uplink to downlink capacity. The one flown on OSCAR 13 used one uplink channel and one downlink channel with the data rate on the uplink (2400 bps) roughly six times that on the downlink (400 bps). The 400 bps rate on the downlink was chosen because this was the standard that had been used for downlinking high-orbiting satellite telemetry since the late 1970s. Users already capturing telemetry would be able to capture RUDAK transmissions from day one. Unfortunately, the RUDAK unit on OSCAR 13 failed during launch.

A system known as RUDAK II was flown on RS-14/AO-21 and actually consisted of two units. One unit was similar to the RUDAK flown on OSCAR 13. However, the other unit, known as the RUDAK Technology Experiment (or RTX), was a new experimental transponder using DSP technology. It was essentially a flying test bed for ideas being considered for future high-orbit missions.

The RUDAK-U system flown on OSCAR 40 contained two CPUs, one 153.6 kbaud modem, four hardwired 9600 baud modems and eight DSP modems capable of operating at speeds up to 56 kbaud. The great advantages of modern RUDAK systems are their extraordinary flexibility. Through the use of digital signal processing, the RUDAK is able to configure itself into any type of digital system desired. Had OSCAR 40 survived, the plan was to use its RUDAK system to create a highly capable digital communications platform in space.

angles, which meant that Shuttles barely made it above the horizon for hams in the northern US and Canada.

A *sun-synchronous* orbit takes a satellite over the north and south poles. See Fig 4B. There are two advantages to a sun-synchronous orbit: (1) the satellite is available at approximately the same time of day, every day and (2) everyone, no matter where they are, will enjoy at least one high-altitude pass per day. OSCAR 51 is a good example of a satellite that travels in a sun-synchronous orbit.

A *dawn-to-dusk* orbit is a variation on the sun-synchronous model except that the satellite spends most of its time in sunlight and relatively little time in shadow.

## 3 Satellite Tracking

### 3.1 Satellite Orbits

Most active amateur satellites are in various types of low Earth orbits (LEOs) at altitudes that vary between approximately 350 km (the International Space Station) and 1300 km (OSCAR 29). There are satellites planned for future launch that will travel in the high Earth orbits (HEOs). At their closest approaches to Earth (their *perigees*), these satellites may come within 1000 km; at the highest points of their orbits (their *apogeas*), they will travel as far as 50,000 km into space. Let's take a brief look at several of the most common orbits.

An *inclined* orbit is one that is inclined with respect to the Earth's equator. See Fig 4A. A satellite that is inclined 90° would

OSCAR 27 travels in a dawn-to-dusk orbit. See Fig 4C.

The *Molniya* high Earth orbit (Fig 4D) was pioneered by the former Soviet Union. It is an elliptical orbit that carries the satellite far into space at its greatest distance from Earth. To observers on the ground, the satellite at apogee appears to hover for hours at a time before it plunges earthward and sweeps around the Earth at its closest approach. One great advantage of the Molniya orbit is that the satellite is capable of “seeing” an entire hemisphere of the planet while at apogee. Hams can use a

Molniya satellite to enjoy long, leisurely conversations spanning thousands of kilometers here on Earth. When this book was written, however, there were no active ham satellites traveling in Molniya orbits.

### 3.2 Satellite Tracking Software

The key to communicating through a satellite is being able to track its movements and predict when it will appear above your local horizon. Fortunately, we have sophisticated

software available that streamlines this task considerably.

You’ll find satellite-tracking software written for *Windows*, *Mac* and *Linux* operating systems. Several popular applications are listed in **Table 3**. When computers were first employed to track amateur satellites, they provided only the most basic, essential information: when the satellite will be available (AOS, acquisition of signal), how high the satellite will rise in the sky and when the satellite is due to set below your horizon (LOS, loss of signal). Today we tend to ask

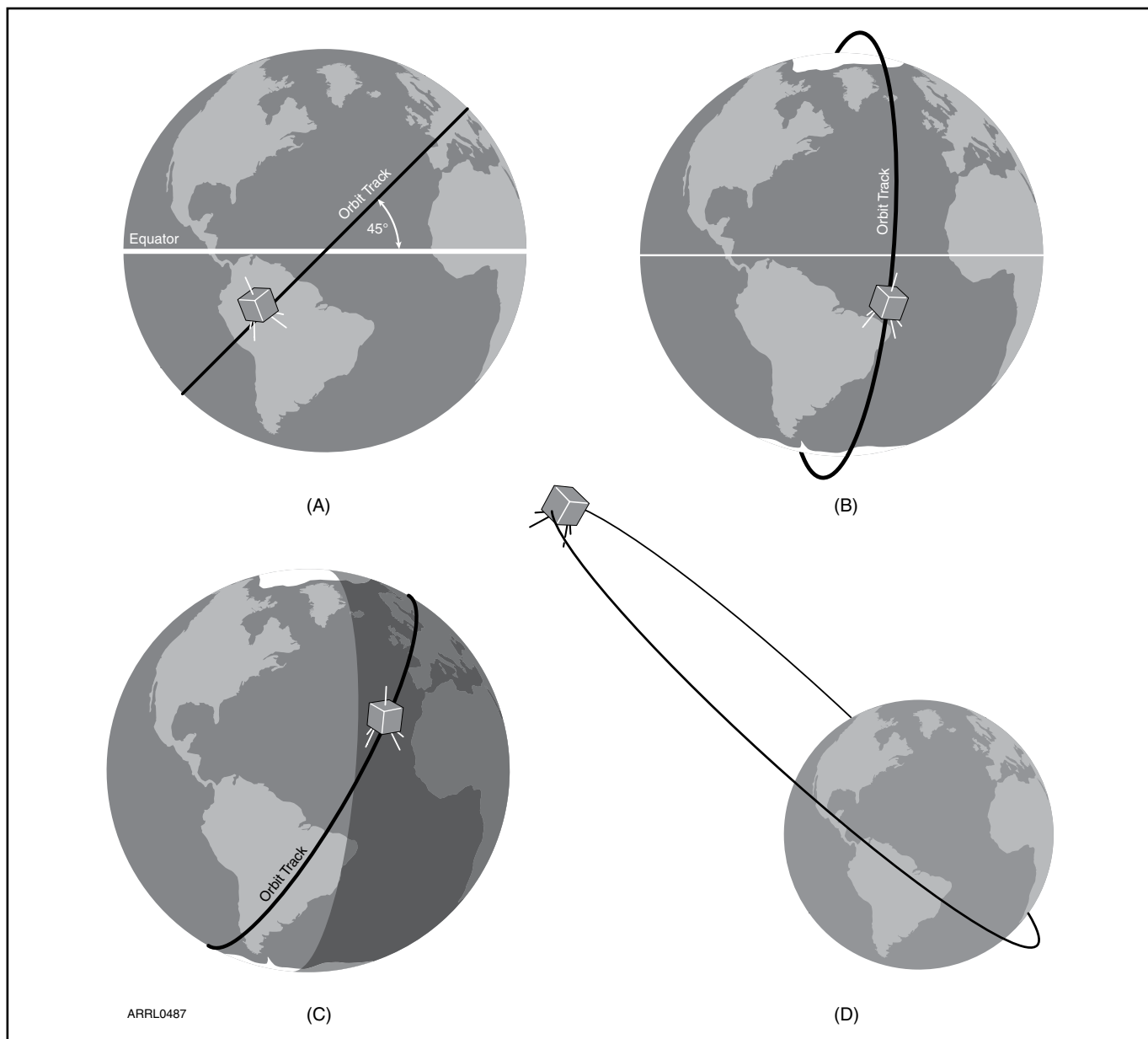

Fig 4 — At A, an *inclined* orbit is one that is inclined with respect to the Earth’s equator (in this case, 45°). At B, a *sun-synchronous* orbit takes the satellite over the north and south poles, allowing every station in the world to enjoy at least one high-elevation pass per day. At C, a *dawn-to-dusk* orbit is a variation on the sun-synchronous model except that the satellite spends most of its time in sunlight and relatively little time in eclipse. At D, the *Molniya* orbit is an elliptical orbit that carries the satellite far into space at its greatest distance from Earth (apogee). To observers on the ground, the satellite at apogee appears to hover for hours at a time before it plunges earthward and (often) sweeps within 1000 km at its closest approach (perigee).

**Table 3****A Sampling of Satellite Tracking Software**

Name	Source	Operating System	Radio Control?	Antenna Control?
Nova	<a href="http://www.amsat.org">www.amsat.org</a> (store)	Windows	No	Yes
SCRAP	<a href="http://www.amsat.org">www.amsat.org</a> (store)	Windows	No	Yes
SatPC32	<a href="http://www.amsat.org">www.amsat.org</a> (store)	Windows	Yes	Yes
SatScape	<a href="http://www.satscape.co.uk/classic.html">www.satscape.co.uk/classic.html</a>	Windows	Yes	Yes
MacDoppler	<a href="http://www.dogparksoftware.com/MacDoppler.html">www.dogparksoftware.com/MacDoppler.html</a>	Mac OS	Yes	Yes
Ham Radio Deluxe	<a href="http://hrd.ham-radio.ch">hrd.ham-radio.ch</a>	Windows	Yes	No
Predict	<a href="http://www.qsl.net/kd2bd/predict.html">www.qsl.net/kd2bd/predict.html</a>	Linux	No	Yes
WinOrbit	<a href="http://www.sat-net.com/winorbit">www.sat-net.com/winorbit</a>	Windows	No	No

a great deal more of our tracking programs. Modern applications still provide the basic information, but they usually offer many more features such as:

- The spacecraft's operating schedule, including which transponders and beacons are on.
- Predicted frequency offset (Doppler shift) on the link frequencies.
- The orientation of the spacecraft's antennas with respect to your ground station and the distance between your ground station and the satellite.
- Which regions of the Earth have access to the spacecraft; that is, who's in QSO range?
- Whether the satellite is in sunlight or being eclipsed by the Earth. Some spacecraft only operate when in sunlight.
- When the next opportunity to cover a selected terrestrial path (mutual window) will occur.
- Changing data can often be updated at various intervals such as once per minute — or even once per second.

A number of applications do even more. Some will control antenna rotators, automatically keeping directional antennas aimed at the target satellite. Other applications will also control the radio to automatically compensate for frequency changes caused by Doppler shifting.

Adding additional spacecraft to the scenario suggests more questions. Which satellites are currently in range? How long each will be accessible? Will any new spacecraft be coming into range in the near future? Obviously there is a great deal of information of potential interest. Programmers developing tracking software often find that the real challenge is not solving the underlying physics problems, but deciding what information to include and how to present it in a useful format. This is especially true since users have different interests, levels of expertise and needs. Some prefer to see the information in a graphical format, such as a map showing real-time positions for all satellites of interest. Others may prefer tabular data such as a listing of the times a particular spacecraft will be in range over the next several days.

There are also several Internet sites where

you can do your tracking online. This eliminates all the hassles associated with acquiring and installing software. The currently available online tracking sites are not as powerful or flexible as the software you can install on your PC, however. One interesting site of this type is maintained by AMSAT-NA and you'll find it at [www.amsat.org/amsat-new/tools/predict/](http://www.amsat.org/amsat-new/tools/predict/).

### 3.3 Getting Started With Software

There are so many different types of satellite software, and they change so frequently, it would be foolhardy to attempt to give you detailed operational descriptions in any book. The book would be obsolete a month after it came off the press!

Even so, there are a number of aspects of satellite-tracking software that rarely change. For instance, most programs will ask you to enter your station location as part of the initial setup process. Some applications use the term "observer" to mean "station location," but the terms are synonymous for the sake of our discussion. Sophisticated programs will go as far as to provide you with a list of cities that you can select to quickly enter your location. Other programs will ask you to enter your latitude and longitude coordinates manually.

When entering latitude, longitude (and other angles), make sure you know whether the computer expects degree-minute or decimal-degree notation. Following the notation used by the on-screen prompt usually works. Also make sure you understand the units and sign conventions being used. For example, longitudes may be specified in negative number for locations west of Greenwich (0° longitude). Latitudes in the southern hemisphere may also require a minus sign. Fractional parts of a degree will have very little effect on tracking data so in most cases you can just ignore it.

Dates can also cause considerable trouble. Does the day or month appear first? Can November be abbreviated Nov or must you enter 11? The number is almost always required. Must you write 2010 or will 10 suffice? Should the parts be separated by colons, dashes or slashes? The list goes on and on.

Once again, the prompt is your most important clue. For example, if the prompt reads "Enter date (DD:MM:YY)" and you want to enter February 9, 2010 follow the format of the prompt as precisely as possible and write 09:02:10.

When entering numbers, commas should never be used. For example, if a semi-major axis of 20,243.51 km must be entered, type 20243.51 with the comma and units omitted. It takes a little time to get used to the quirks of each software package, but you'll soon find yourself responding automatically.

Once you have your coordinates entered, you're still not quite done. The software now "knows" its location, but it doesn't know the locations of the satellites you wish to track. The only way the software can calculate the positions of satellites is if it has a recent set of *orbital elements*.

### 3.4 Orbital Elements

Orbital elements are sets of six numbers that completely describe the orbit of a satellite at a specific time. Although scientists may occasionally use different groups of six quantities, radio amateurs nearly always use the six known as Keplerian Orbital Elements, or simply *Keps*.

These orbital elements are derived from very precise observations of each satellite's orbital motion. Using precision radar and highly sensitive optical observation techniques, the North American Aerospace Defense Command (NORAD) keeps a very accurate catalog of almost everything in Earth orbit. Periodically, they issue the unclassified portions of this information to the National Aeronautics and Space Administration (NASA) for release to the general public. The information is listed by individual catalog number of each satellite and contains numeric data that describes, in a mathematical way, how NORAD observed the satellite moving around the Earth at a very precise location in space at a very precise moment in the past.

Without getting into the complex details of orbital mechanics, suffice it to say that your software simply uses the orbital element information NASA publishes that describe



**Table 4**

**Examples of Elements Used for Satellite Tracking**

(Download current elements for actual tracking use.)

**NASA Two-Line Elements for OSCAR 27**

AO-27  
1 22825U 93061C 08024.00479406 -.00000064 00000-0 -86594-5 0 8811  
2 22825 098.3635 349.6253 0008378 336.4256 023.6532 14.29228459747030

**AMSAT Verbose Elements for OSCAR 51**

Satellite: AO-51	Arg of perigee: 232.8417 deg
Catalog number: 28375	Mean anomaly: 126.5166 deg
Epoch time: 08024.16334624	Mean motion: 14.40594707 rev/day
Element set: 14	Decay rate: 7.0e-08 rev/day <sup>2</sup>
Inclination: 098.0868 deg	Epoch rev: 18752
RA of node: 056.7785 deg	Checksum: 310
Eccentricity: 0.0083024	

where a particular satellite was “then” to solve the orbital math and make a prediction (either graphically or in tabular format) of where that satellite ought to be “now.” The “now” part of the prediction is based on the local time and station location information you’ve also been asked to load into your software.

Orbital elements are frequently distributed with additional numerical data (which may or may not be used by a software tracking program) and are commonly available in two forms, NASA format and AMSAT format.

**UNDERSTANDING THE AMSAT FORMAT**

Let’s use the easier-to-understand AMSAT format example shown in **Table 4** to break down the meaning, line by line.

The first two entries identify the spacecraft. The first line is an informal *satellite name*. The second entry, *Catalog Number*, is a formal ID assigned by NASA.

The next entry, *Epoch Time*, specifies the time the orbital elements were computed. The number consists of two parts, the part to the left of the decimal point that describes the year and day, and the part to the right of the decimal point that describes the (very precise) time of day. For example, 96325.465598 refers to 1996, day 325, time of day .465598.

The next entry, *Element Set*, is a reference used to identify the source of the information. For example, 199 indicates element set number 199 issued by AMSAT. This information is optional.

The next six entries are the six key orbital elements.

*Inclination* describes the orientation of the satellite’s orbital plane with respect to the equatorial plane of the Earth.

*RAAN*, *Right Ascension of Ascending Node*, specifies the orientation of the satellite’s orbital plane with respect to fixed stars.

*Eccentricity* refers to the shape of the orbital ellipse. The closer this number is to 0, the more circular the orbit of the satellite tends to be. Conversely, an eccentricity value approaching 1 indicates the satellite is following

a more elliptically shaped orbital path.

*Argument of Perigee* describes where the perigee of the satellite is located in the satellite orbital plane. Recall that a satellite’s perigee is its closest approach to the Earth. When the argument of perigee is between 180 and 360° the perigee will be over the Southern Hemisphere. Apogee — a satellite’s most distant point from the Earth — will therefore occur above the Northern Hemisphere.

*Mean Anomaly* locates the satellite in the orbital plane at the epoch. All programs use the astronomical convention for mean anomaly (MA) units. The mean anomaly is 0 at perigee and 180 at apogee. Values between 0 and 180 indicate that the satellite is headed up toward apogee. Values between 180 and 360 indicate that the satellite is headed down toward perigee.

*Mean Motion* specifies the number of revolutions the satellite makes each day. This element indirectly provides information about the size of the elliptical orbit.

*Decay Rate* is a parameter used in sophisticated tracking models to take into account how the frictional drag produced by the Earth’s atmosphere affects a satellite’s orbit. It may also be referred to as rate of change of mean motion, first derivative of mean motion, or drag factor. Although decay rate is an important parameter in scientific studies of the Earth’s atmosphere and when observing satellites that are about to reenter, it has very little effect on day-to-day tracking of most Amateur Radio satellites. If your program asks for drag factor, enter the number provided. If the element set does not contain this information enter zero — you shouldn’t discern any difference in predictions. You usually have a choice of entering this number using either decimal form or scientific notation. For example, the number  $-0.00000039$  (decimal form) can be entered as  $-3.9e-7$  (scientific notation). The  $e-7$  stands for 10 to the minus seventh power (or  $10^{-7}$ ). In practical terms  $e-7$  just means move the decimal in the preceding number 7 places to the left. If this is totally confusing, just remember that in most situations entering zero will work fine.

*Epoch revolution* is just another term for the expression “Orbit Number” that we discussed earlier. The number provided here does not affect tracking data, so don’t worry if different element sets provide different numbers for the same day and time.

The *Checksum* is a number constructed by

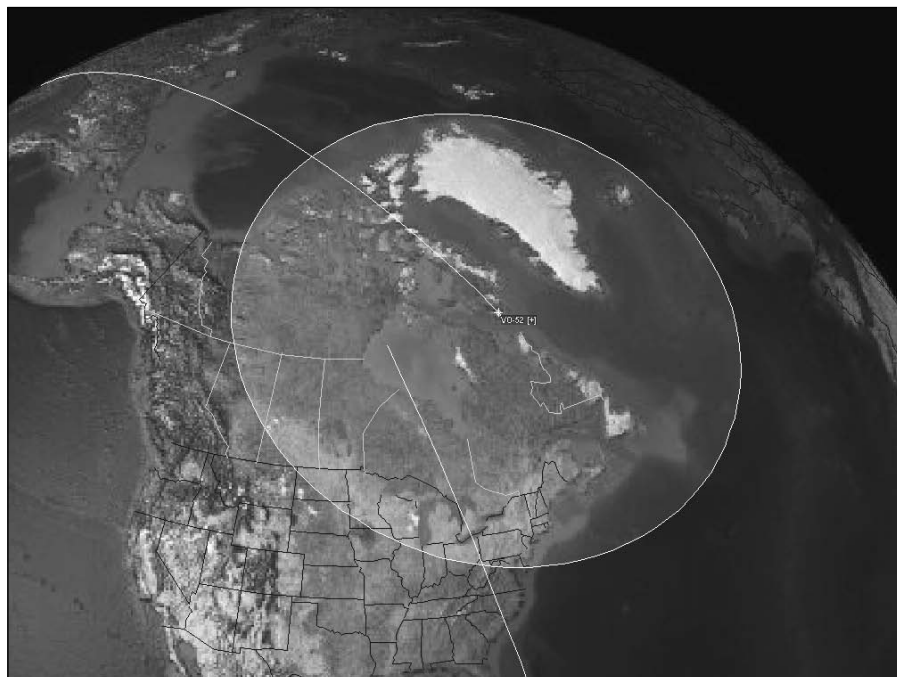

**Fig 5 — This image shows the circular footprint of OSCAR 52 as depicted by NOVA satellite-tracking software. The footprint indicates the area of the Earth that is visible to the satellite at any given time.**

the data transmitting station and used by the receiving station to check for certain types of transmission errors in data files. It does not bear any relationship to a satellite's orbit.

In the "old days" of satellite-tracking software you had to enter the orbital elements by hand. This was a tedious and risky process. If you entered an element number incorrectly, you would generate wildly inaccurate predictions.

Today, thankfully, most satellite-tracking programs have greatly streamlined the process. One method of entering orbital elements is to grab the latest set from the AMSAT-NA Web site at [www.amsat.org](http://www.amsat.org) (look under "Keps" in the main menu). You can download the element set as a text file and then tell your satellite-tracking program to read the file and create the database. Another excellent site is CelesTrak at [celestrak.com](http://celestrak.com). Your program will probably be able to read either the AMSAT or NASA formats.

If you're fortunate to own sophisticated tracking software such as *Nova*, and you have access to the Internet, the program will reach into cyberspace, download and process its Keps automatically. All it takes is a single click of your mouse button. Some programs can even be configured to download the latest Keps on a regular basis without any prompting from you.

### 3.5 Other Tracking Considerations

#### SATELLITE FOOTPRINTS

Many satellite tracking applications display not only the satellite track, but also the satellite *footprint*. A satellite footprint can be loosely defined as the area on the Earth's

surface that is "illuminated" by the satellite's antenna systems at any given time. Another way to think of a footprint is to regard it as the zone within which stations can communicate with each other through the satellite.

Unless the satellite in question is *geostationary*, footprints are constantly moving. Their sizes can vary considerably, depending on the altitude of the satellite. The footprint of the low-orbiting International Space Station is about 600 km in diameter. In contrast, the higher orbiting OSCAR 52 has a footprint that is nearly 1500 km across. See the example of a satellite footprint in Fig 5. The amount of time you have available to communicate depends on how long your station remains within the footprint. This time can be measured in minutes, or in the case of a satellite in a highly elliptical orbit, hours.

It is worthwhile to note that the size and even the shape of a footprint can also vary according to the type of antenna the satellite is using. A highly directional antenna with a narrow beamwidth will create a small footprint even though the satellite is traveling in a high-altitude orbit. This usually isn't an issue for amateur satellites, however.

#### A SATELLITE'S "PHASE"

Some satellites use operating schedules to determine which transponders and antennas are active at any given time. It is based on the *phase* of the satellite's *mean anomaly*, or *MA*. Many software applications can use this information to provide detailed predictions that tell you not only when the satellite will appear, but also which transponders will be active at the time.

The expression "anomaly" is just a fancy term for *angle*. Astronomers have traditionally divided orbits into 360 mean-anomaly

units, each containing an equal time segment. Because of the architecture of common microprocessors, it was much more efficient to design the computers controlling spacecraft to divide each orbit into 256 segments of equal time duration. Radio amateurs refer to these as mean anomaly or phase units. The duration of each segment is the satellite's period divided by 256. For example, a mean anomaly unit for OSCAR 13 was roughly 2.68 minutes. At MA 0 (beginning of orbit) and MA 256 (end of orbit) the satellite is at perigee (its lowest point). At MA 128 (halfway through the orbit) the satellite is at apogee or high point. See Fig 6.

Because radio amateurs and astronomers use the term mean anomaly in a slightly different way, there's sometimes a question as to which system is being used. Any confusion is minor and usually easily resolved. Most OSCAR telemetry with real-time MA values and schedules use the 256 system. The term "phase," and the fact that no numbers larger than 256 ever appear, are significant hints. Computer tracking programs designed for non-radio amateur audiences generally use the traditional astronomical notation. It's easy to determine when this is the case because the mean anomaly column will contain entries between 257 and 360.

If a satellite is using an MA-based transponder schedule, the schedule will be posted on the AMSAT-NA Web site at [www.amsat.org](http://www.amsat.org). (When this book was written there were no Amateur Radio satellites in orbit using MA scheduling, but this may change as currently planned satellites reach orbit.) Depending on its sophistication, your tracking software may allow you to enter this schedule data.

Schedules are generally modified every few months when satellite orientation is adjusted to compensate for changes in the sun

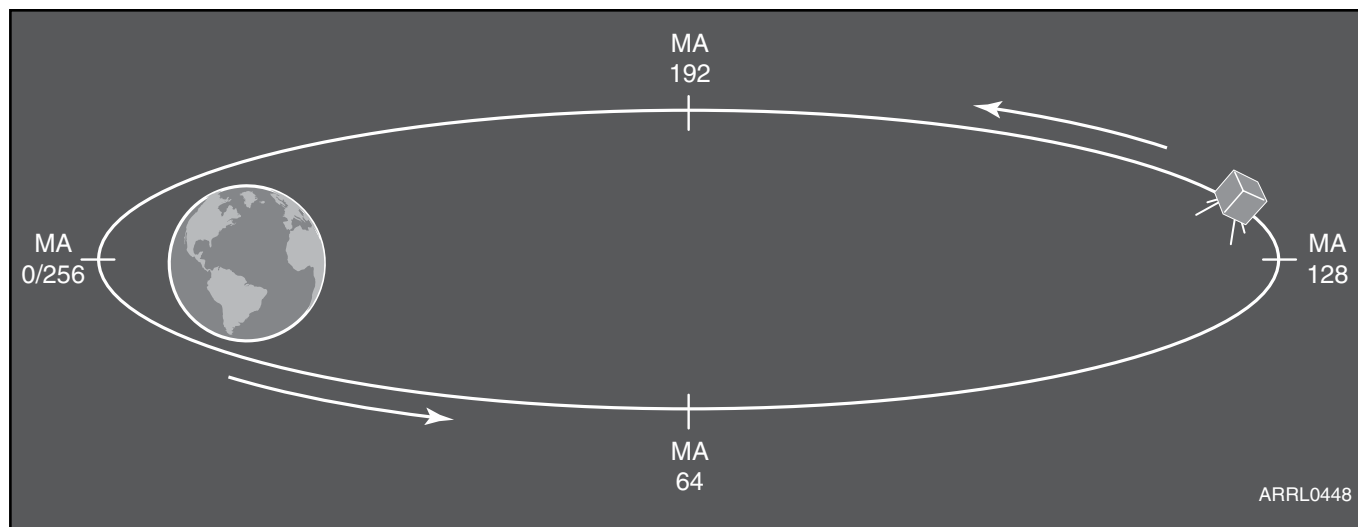
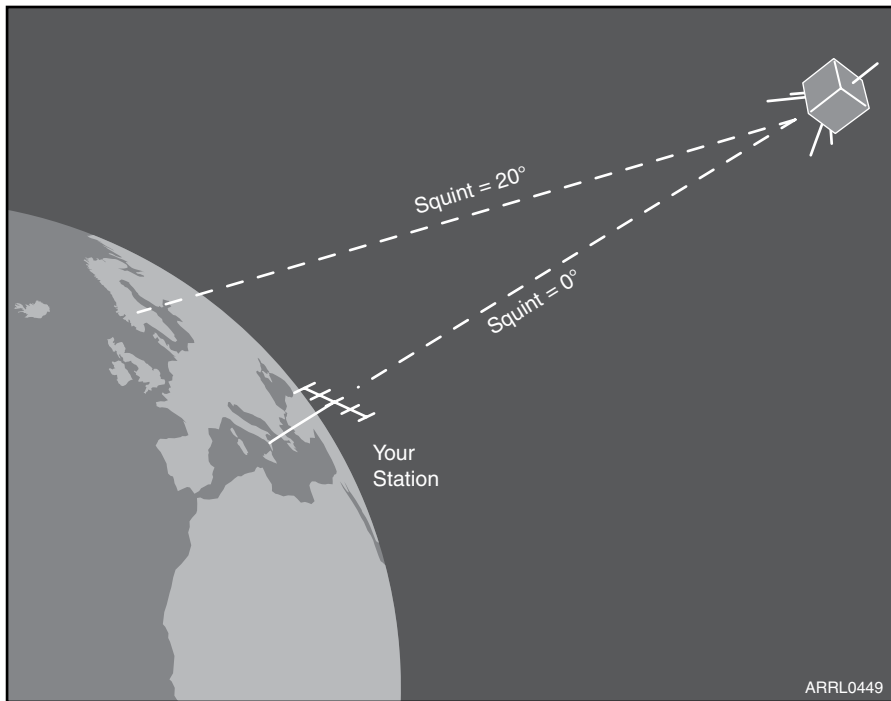

Fig 6 — Mean anomaly (MA) divides each orbit into 256 segments of equal time duration. Radio amateurs refer to these as "Mean Anomaly" or "Phase" units. The duration of each segment is the satellite's period divided by 256. For example, a mean anomaly unit for OSCAR 13 was roughly 2.68 minutes. At MA 0 (beginning of orbit) and MA 256 (end of orbit) the satellite is at perigee (its lowest point). At MA 128 (halfway through the orbit) the satellite is at apogee (or its highest point).



**Fig 7 — The squint angle describes how the directive antennas on a satellite (such as Phase 3 satellites) are pointed with respect to your ground station. Squint angles can vary between 0° and 180°. A squint angle of 0° means the satellite antennas are pointed directly at you, which, in turn, means good link performance can usually be expected. When the squint angle is above 20° signal level begins to drop.**

angle on the spacecraft. A typical schedule used for OSCAR 13, with its corresponding uplink (transmitting) and downlink (receiving) frequency band requirements, looked like this:

- Off: from MA 0 until MA 49
- Mode U/V (uplink on 70 cm/downlink on 2 meters): on from MA 50 until MA 128
- Mode U/S (uplink on 70 cm/downlink on 2.4 GHz): on from MA 129 until MA 159

Mode U/V (uplink on 70 cm/downlink on 2 meters): on from MA 160 until MA 255

If you wanted to operate Mode U/S, you needed to be at the radio when the satellite was between MA 129 and MA 159 in its orbit.

### SQUINT ANGLE

Another dilemma your software may help resolve is the *squint angle*. The squint angle describes how the directive antennas on a sat-

ellite are pointed with respect to your ground station. Squint angle can vary between 0° and 180°. A squint angle of 0° means the satellite antennas are pointed directly at you and that generally indicates that good link performance can be expected (Fig 7). When the squint angle is above 20°, signal level begins to drop and a disruptive amplitude flutter called spin modulation on uplinks and downlinks may become apparent.

Programs that include algorithms to calculate squint angle require information about the orientation or attitude of the satellite. This information is generally available from sources that provide the basic orbital elements and on telemetry sent directly from the satellite of interest. The parameters needed are labeled Bahn latitude and Bahn longitude. They are also known as BLAT and BLON or ALAT and ALON where the prefix “A” stands for attitude.

Programs that provide squint angle information may also contain a column labeled *Predicted Signal Level*. Values are usually computed using a simple prediction model that takes into account satellite antenna pattern, squint angle and spacecraft range. The model assumes a 0 dB reference point with the satellite overhead, at apogee and pointing directly at you. At any point on the orbit the predicted level may be several dB above (+) or below (–) this reference level.

You won’t need to be concerned about squint angle for most LEO satellites. It only becomes a factor with the high-orbit birds since they generally use directive antennas. As with MA scheduling, you’ll want to know that the satellite’s antennas are pointing at your location before you fire up your equipment. With the right kind of software, you’ll know well ahead of time.

## 4 Satellite Ground Station Antennas

Assembling a satellite ground station presents a different challenge compared to typical HF station setups. There are a number of variables that change depending on the types of satellites you hope to use. A ground station designed strictly for LEO satellites differs substantially from one intended for HEO birds. There are also issues surrounding computers and software, particularly if you plan to access digital satellites.

One aspect of your ground station with the greatest range of choice is your antenna system. To use most amateur satellites, you must transmit on one band (the uplink) and receive on another band (the downlink). Unless you are using a single, dual-band antenna, your

satellite station will require at least two antennas. Some satellite operators have several antennas so that they can operate on various uplink/downlink band combinations as the need arises.

### 4.1 Antenna Polarization

The *polarization* of a satellite antenna is an important factor, regardless of whether it is used for transmitting or receiving. Polarization is determined by the position of the radiating element or wire with respect to the Earth. A radiator that is parallel to the Earth radiates horizontally, while a vertical radiator radiates a vertical wave. These are so-called

*linearly polarized* antennas. If the radiating element is slanted above the Earth, it radiates waves that have *both* vertical and horizontal components.

For terrestrial VHF+ line-of-sight communication, polarization matching is important. If one station is using a horizontally polarized antenna and the other is using a vertically polarized antenna, the mismatch can result in a large signal loss under certain conditions. We don’t worry about polarization mismatches on HF frequencies because whenever signals are refracted through the ionosphere, as HF signals usually are, polarization changes anyway.

The problem with applying polarization

concerns to spacecraft is that the orientation of a satellite's antennas relative to your ground station is constantly changing. This often results in fading when the polarization of its antennas conflict with yours. This problem doesn't plague satellites exclusively. Aircraft, automobiles and all other moving radio platforms can suffer the same effects.

Fortunately, there is a "cure" known as *circular polarization (CP)*. With CP, wave fronts appear to rotate as they pass the receiving station, either clockwise (right-hand or RHCP) or counter clockwise (left-hand or LHCP). See **Fig 8**. The advantage of using circular polarization is that it can substantially reduce the effects of polarization conflict. Since the polarization of a CP antenna rotates through horizontal and vertical planes, the resulting pattern effectively "smooths" the fading effects, generating consistent signals as a result.

That said, your satellite ground station antennas do *not* need to be circularly polarized to be effective. Linearly polarized antennas, either horizontal or vertical, are perfectly useful. Some ground station antenna designs use slanted or "crossed" elements to mix the horizontal and vertical polarization components as discussed earlier. The goal of fine-tuning your antenna polarization is to give your station an edge, something that is important when you are dealing with weak signals from deep space. But, while circular polarization of your antennas may give your station a definite advantage, it isn't an absolute requirement.

#### 4.2 Omnidirectional Antennas

An ideal omnidirectional antenna radiates and receives signals in all directions equally. In the real world, most "omnidirectional" antennas have a certain amount of directivity. For example, a common ground plane antenna (**Fig 9**) is considered to be omnidirectional, but as you can see in **Fig 10** the radiation pattern is not uniform. Notice the deep null directly overhead. Signals will fade sharply as satellites move through this null, particularly during high-elevation passes.

Despite their low gain, omnidirectional antennas are attractive because they do not need to be aimed at their targets. This means that they don't require mechanical antenna rotators, which can add significant cost and complexity to a ground station. Omni antennas are also more compact than directional antennas for the same frequency. On the other hand, their low gain makes them practical only for LEO satellites that have sensitive receivers and relatively strong transmit signals.

Technically speaking, any type of omnidirectional antenna can be used for a satellite ground station. Hams have enjoyed satellite operations with simple ground planes, J-poles, "big wheels" and even automobile antennas. But for best results with an omni-

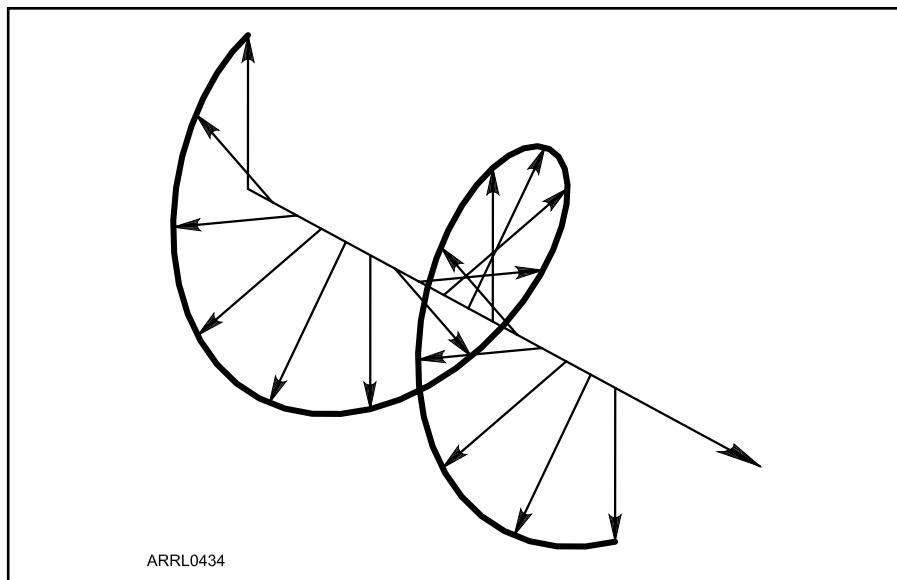

**Fig 8 — A circularly polarized wave front describes a rotational path about its central axis, either clockwise (right-hand or RHCP) or counter clockwise (left-hand or LHCP).**

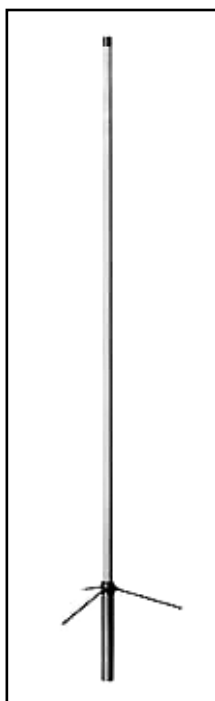

**Fig 9 — An ordinary ground plane antenna. This particular model is designed for terrestrial communications on 2 m.**

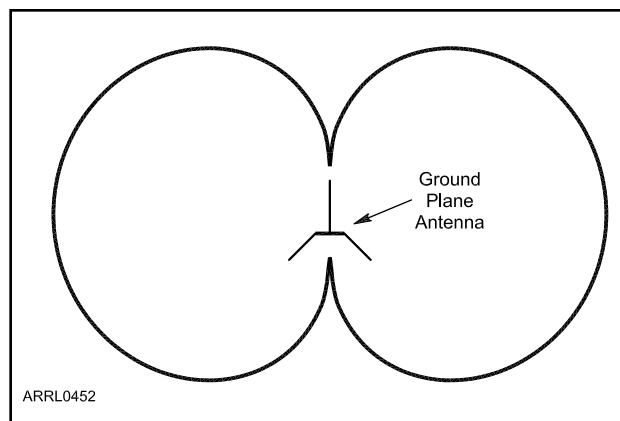

**Fig 10 — The simplified radiation pattern of a ground plane antenna. Notice the deep null directly overhead.**

based antenna system, you'll want a radiation pattern that minimizes the polarization conflicts and pattern nulls that can cause signals to fade. To this end, engineers have designed a number of omnidirectional antennas with these issues in mind.

#### THE EGGBEATER

The *eggbeater* antenna is a popular design named after the old-fashioned kitchen utensil it resembles (**Fig 11**). The antenna is com-

posed of two full-wave loops of rigid wire or metal tubing. Each of the two loops has an impedance of 100  $\Omega$ , and when coupled in parallel they offer an ideal 50  $\Omega$  impedance for coaxial feed lines. The loops are fed 90° out of phase with each other and this creates a circularly polarized pattern.

An eggbeater may also use one or more parasitic reflector elements beneath the loops to focus more of the radiation pattern upward. This effect makes it a "gain" antenna, but

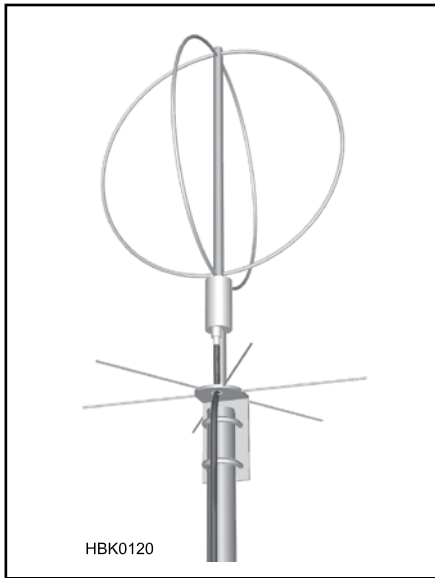

**Fig 11 — The eggbeater antenna is a popular design named after the old-fashioned kitchen utensil it resembles. The antenna is composed of two full-wave loops of rigid wire or metal tubing.**

that gain is at the expense of low-elevation reception. Toward the horizon an eggbeater is actually horizontally polarized. As the pattern rises in elevation, it becomes more and more right-hand circularly polarized. Experience has shown that eggbeaters seem to perform best when reflector elements are installed just below the loops.

Eggbeaters can be built relatively easily, but there are also a couple of commercial models available (see the advertising pages of *QST* magazine). The spherical shape of the eggbeater creates a fairly compact antenna when space is an issue, which is another reason why it is an attractive design.

### THE TURNSTILE

The basic *turnstile* antenna consists of two horizontal half-wave dipoles mounted at right angles to each other (like the letter “X”) in the same horizontal plane with a reflector screen beneath (Fig 12). When these two antennas are excited with equal currents 90° out of phase, their typical figure-eight patterns merge to produce a nearly circular pattern.

In order to get the radiation pattern in the upward direction for space communications, the turnstile antenna needs a reflector underneath. For a broad pattern it is best to maintain a distance of  $\frac{3}{8} \lambda$  at the operating frequency between the reflector and the turnstile. Homebrewed turnstile reflectors often use metal window-screen material that you can pick up at many hardware stores. (Make sure it is a metal, not plastic, screen material.)

Like their cousins the eggbeaters, turnstiles are relatively easy to build. In fact, building one may be your only choice since turnstiles are rarely available off the shelf.

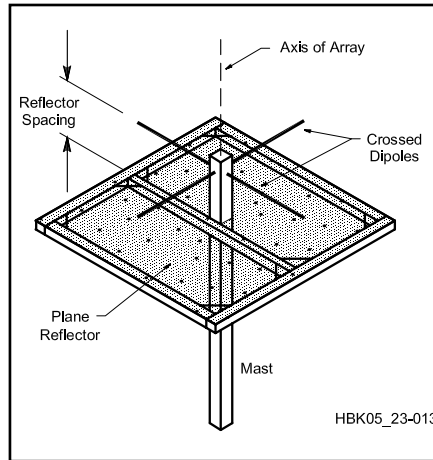

**Fig 12 — The basic turnstile antenna consists of two horizontal half-wave dipoles mounted at right angles to each other (like the letter “X”) in the same horizontal plane with a reflector screen beneath.**

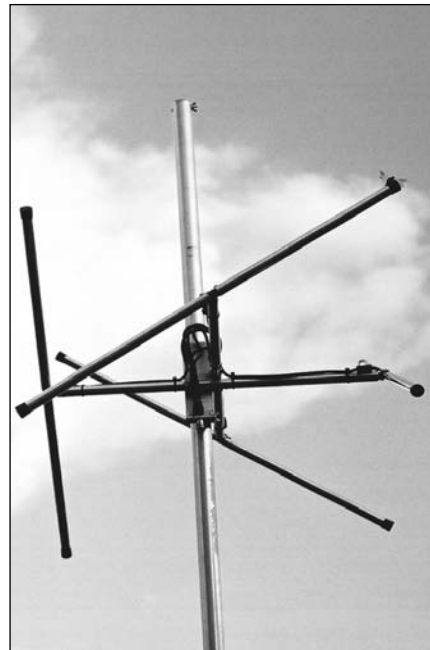

**Fig 13 — The EZ Lindenblad antenna designed by Anthony Monteiro, AA2TX.**

### THE LINDENBLAD ANTENNA

In a *Lindenblad* antenna (Fig 13), each dipole element is attached to a section of shorted open-wire-line, also made from tubing, which serves as a balun transformer. A coaxial cable runs through one side of each open-wire line to feed each dipole. The four coaxial feed cables meet at a center hub section where they are connected in parallel to provide a four-way, in-phase power-splitting function. This cable junction is connected to another section of coaxial cable that serves as an impedance matching section to get a

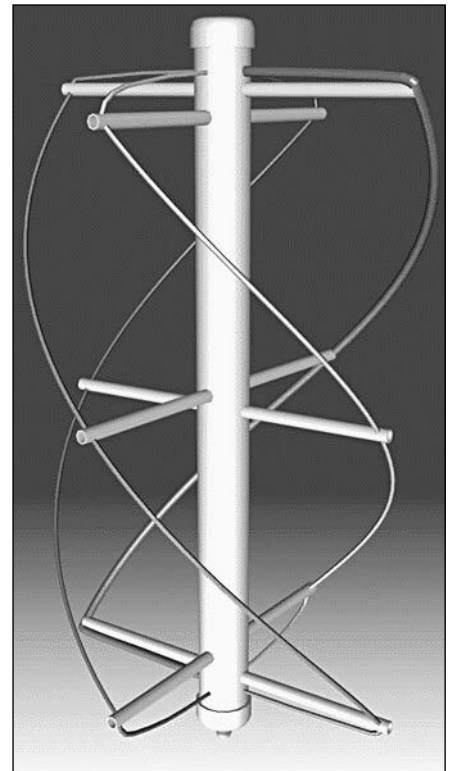

**Fig 14 — The quadrifilar helical antenna is comprised of four equal-length conductors (filars) wound in the form of a corkscrew (helix) and fed in quadrature.**

good match to 50 Ω. An innovative solution, the EZ-Lindenblad, is described later in this chapter. While certainly more elaborate than an eggbeater or turnstile, the Lindenblad creates a uniform circularly polarized pattern that is highly effective for satellite applications.

### THE QUADRIFILAR HELICOIDAL ANTENNA

The quadrifilar helical antenna (QHA) shown in Fig 14 ranks among the best of the omnidirectional satellite antennas. It is comprised of four equal-length conductors (filars) wound in the form of a corkscrew (helix) and fed in quadrature. The result is a nearly perfect circularly polarized pattern.

QHAs can be challenging to build since the filar lengths and spacing have to be precise. Even so, homebrewing a QHA can save you a substantial amount of money. This antenna is available off the shelf (they are favorites for maritime satellite links), but they can be costly. A version that can be built from readily available materials is described later in this chapter.

## 4.3 Directional Antennas

Gain and directivity are important antenna factors. These factors are maximized in *directional* antennas. In fact, the design goal of a directional antenna is to create a highly

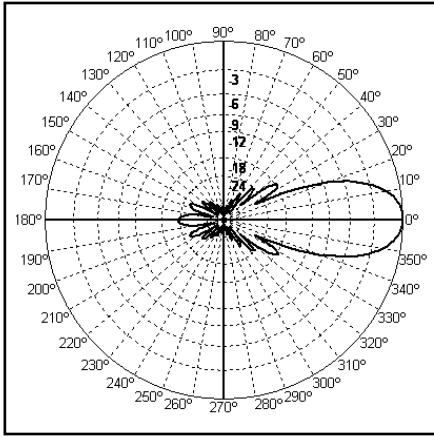

**Fig 15 — The design goal of a directional antenna is to create a highly directional pattern along its axis. This example shows the radiation pattern of a high-gain Yagi antenna.**

directional pattern along its axis (**Fig 15**). An ordinary flashlight is a reasonable analog for a directional antenna, although the pattern of a directional antenna isn't as well focused as a flashlight beam (antennas with parabolic reflectors come fairly close, though).

The chief advantage of a directional antenna is its considerable directivity and gain. When you are working with weak signals from spacecraft, you need all the gain you can get. Directional antennas are mandatory for high-altitude satellites when they are at apogee, nearly 50,000 km distant. They also are excellent for LEO birds, providing strong, consistent signals that omnidirectional antennas can rarely match.

But, a major disadvantage of a directional antenna is *also* its directivity! To achieve best results with a directional antenna, you must find a way to point it at the satellite you wish to work. This entails pointing it by hand, or by using an antenna rotator. If you were to simply leave a directional antenna fixed in one place, you would enjoy good signals only during the brief moments when satellites passed through the antenna's pattern. A rotator adds significant cost to a ground station and installing one isn't a trivial exercise. On the other hand, there is a way to reduce rotator cost, which we'll discuss later.

If you can afford a directional antenna and rotator system, you'll never regret the investment. When properly installed, it is vastly superior to any omnidirectional antenna you are likely to encounter.

## YAGI ANTENNAS

The familiar Yagi antennas used for VHF+ terrestrial operation can be used for satellite applications as well. However, keep in mind that the greater the directivity, the more focused (narrow) the antenna pattern. This translates to an antenna that must be aimed

at a satellite with a fair degree of accuracy. This can be a challenge when your target is a rapidly moving LEO bird.

The Yagi antennas you normally see are *linear* designs that are mounted in either horizontal or vertically polarized configurations. These same antennas can be successfully used for satellite work just as they are. However, there are ways you can optimize them to increase their effective performance.

The dipole elements of Yagi antennas radi-

ate linearly polarized signals, but remember that the polarization direction really depends on the orientation of the antenna to the Earth. If two Yagi antennas are mounted on the same support boom, arranged for horizontal and vertical polarization, and combined with the correct phase difference (90°), a circularly polarized wave results. Because the electric fields of the antennas are identical in magnitude, the power from the transmitter will be equally divided between the two fields.

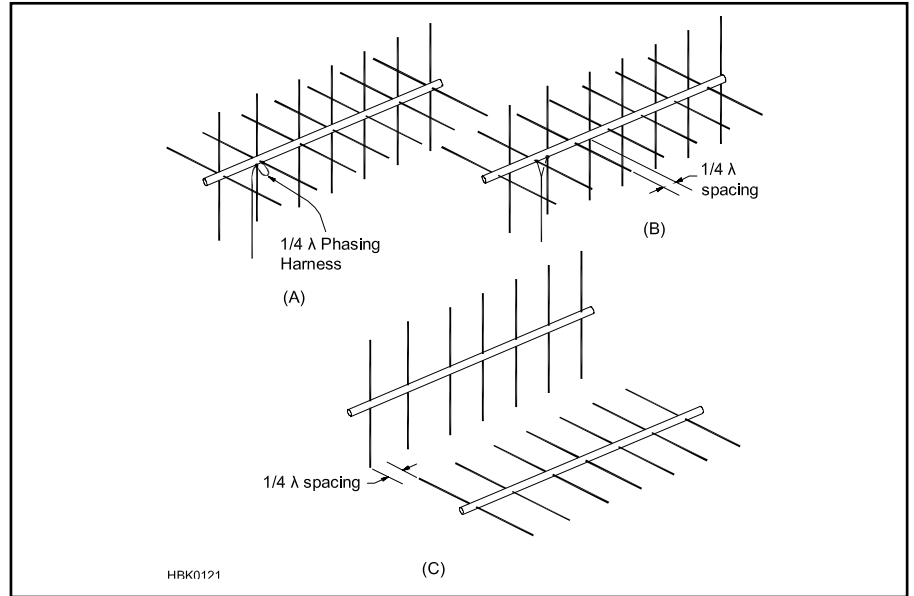

**Fig 16 — Evolution of the circularly polarized Yagi. The simplest form of crossed Yagi, A, is made to radiate circularly by feeding the two driven elements 90° out of phase. Antenna B has the driven elements fed in phase, but has the elements of one bay mounted 1/4 λ forward from those of the other. Antenna C offers elliptical (circular) polarization using separate booms. The elements in one set are mounted perpendicular to those of the other and are spaced 1/4 λ forward from those of the other.**

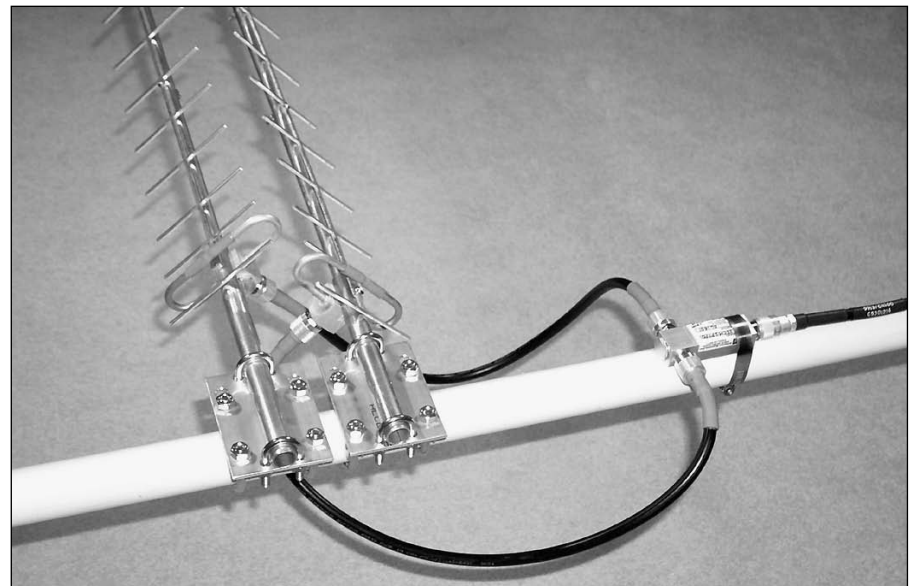

**Fig 17 — An example of offset crossed-Yagi circularly polarized antennas with fixed polarization. This example shows a pair of Yagis for L band (1296 MHz) mounted on an elevation boom. (KD1K photo)**

Another way of looking at this is to consider the power as being divided between the two antennas; hence the gain of each is decreased by 3 dB when taken alone in the plane of its orientation. This design is known as a *crossed Yagi*.

A 90° phase shift must exist between the two antennas and the simplest way to obtain this shift is to use two feed lines. One feed-line section is  $\frac{1}{4}\lambda$  longer than the other, as shown in **Fig 16**. These separate feed lines are then paralleled to a common transmission line to the station. However, therein lies one of the headaches of this system. Assuming negligible coupling between the crossed antennas, the impedance presented to the common transmission line by the parallel combination is one half that of either section alone. (This is not true when there is mutual coupling between the antennas, as in phased arrays.)

**Fig 17** shows a practical example of offset crossed Yagis for the 23 cm band.

So far we've been discussing single-band crossed Yagi designs to achieve circular polarization, or something close to it. If circular polarization isn't a top criterion, you may want to consider a *dual-band Yagi* that places linear Yagi antennas for two separate bands on the same support boom. While this design doesn't produce circular polarization, it partially makes up for that disadvantage in convenience and economics. The most common design combines antennas for 2 meters and 70 cm on the same boom (**Fig 18**). You can feed the antennas with two separate feed lines, or use single feed line and a *diplexer* (some manufacturers incorrectly call them *duplexers*) to separate the signals at the antenna, at the radio or at both locations (**Fig 19**). With a single 2 meter/70 cm Yagi antenna you can enjoy nearly all available amateur satellites. That single-purchase aspect makes them attractive for budget-conscious hams.

A type of Yagi that you may encounter for higher frequencies (typically 902 MHz and above) is the *loop Yagi* (**Fig 20**). In this design, the individual elements are bent into loops and mounted on a common boom. Despite their appearance, loop Yagis are linearly polarized antennas. Their advantage is that they create a substantial amount of gain in a relatively small physical space. Because of the sizes of the loops, however, loop Yagis are most practical and common at microwave frequencies.

### HELICAL ANTENNAS

Another method to create a circularly polarized signal is by means of a helical antenna. The axial-mode helical antenna was introduced by Dr John Kraus, W8JK, in the 1940s. **Fig 21** shows an example of a microwave helical antenna. A larger helical for 70 cm is shown in **Fig 22**.

This antenna has two characteristics that make it especially interesting and useful for satellite stations. First, the helix is circularly



**Fig 18** — Joe Bottiglieri, AA1GW, uses a dual-band Yagi to work a low-Earth orbiting FM repeater satellite with a handheld transceiver.

polarized. As discussed earlier, circular polarization is simply linear polarization that continually rotates as it travels through space. In the case of a helical antenna, this rotation is about the axis of the antenna. This can be pictured as the second hand of a watch moving at the same rate as the applied frequency, where the position of the second hand can be thought of as the instantaneous polarization of the signal. The second interesting property of the helical antenna is its predictable pattern, gain and impedance characteristics over a wide frequency range. This is one of the few antenna designs that have both broad bandwidth and high gain. The benefit of this property is that, when used for narrow-band applications, the helical antenna is very forgiving of mechanical inaccuracies.

Electrically, a helix looks like a large air-wound coil with one of its ends fed against a ground plane. The ground plane often consists of a screen of 0.8 to 1.1  $\lambda$  diameter (or per side for a square ground plane). The circumference of the coil form must be between 0.75 and 1.33  $\lambda$  for the antenna to radiate in the axial mode.



**Fig 19** — A diplexer made by the Comet Corporation. Diplexers can be used to separate or combine signals on different bands.

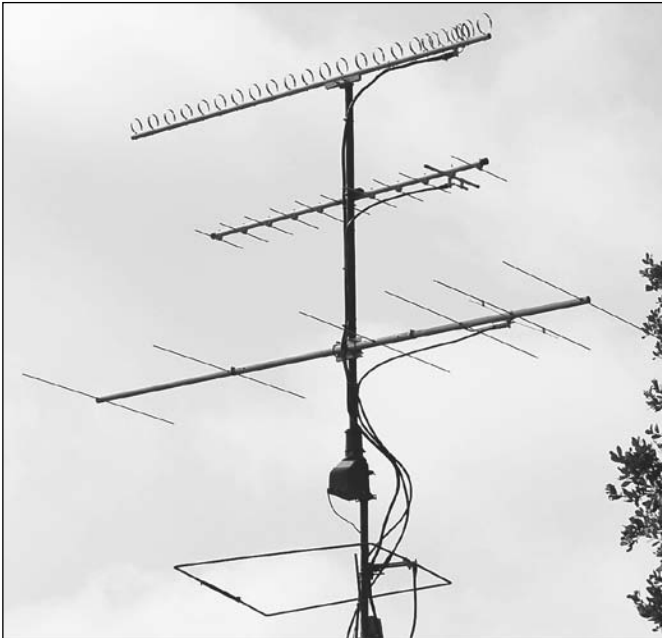

Fig 20 — This antenna stack includes a loop Yagi at the very top.

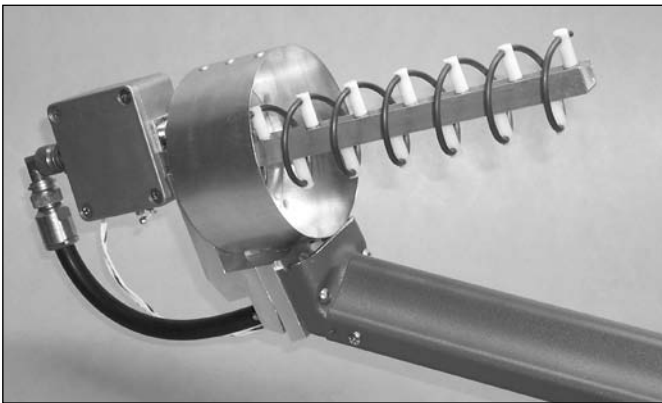

Fig 21 — A seven-turn LHCP helical antenna for a 2.4 GHz dish feed. This helical antenna uses a cupped reflector and has a preamplifier mounted directly to the antenna feed point. (KD1K photo)

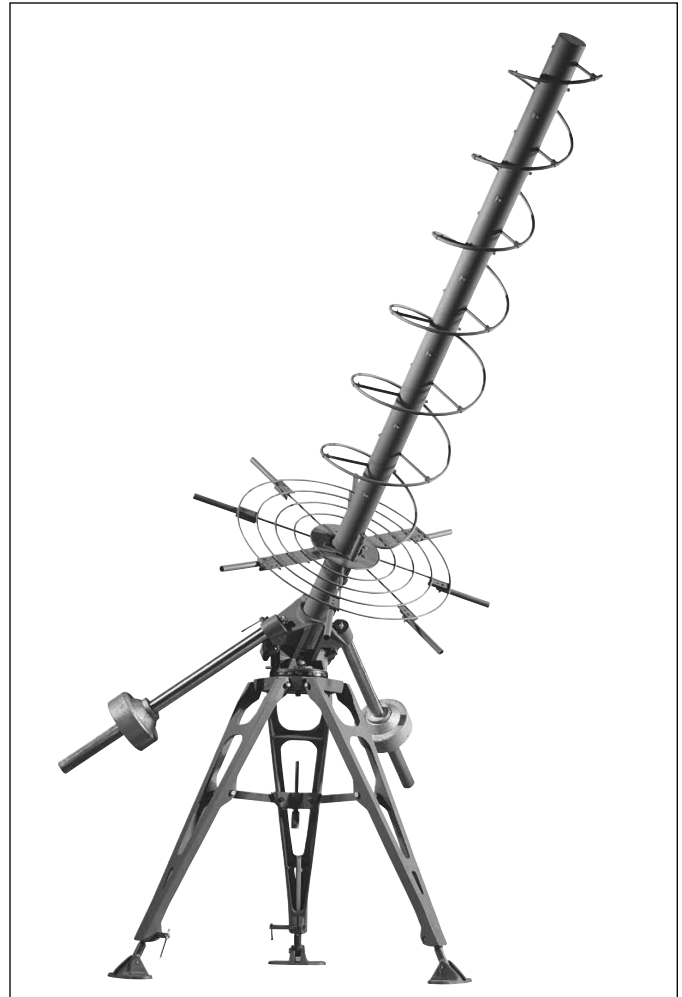

Fig 22 — A helical antenna for 70 cm.

The coil should have at least three turns to radiate in this mode. The ratio of the spacing between turns should be in the range of  $0.2126$  to  $0.2867 \lambda$ . The winding of the helix comes away from the cupped reflector with a counterclockwise winding direction for LHCP. A clockwise winding direction yields RHCP.

### PARABOLIC DISH ANTENNAS

A number of modern ham satellites now include microwave transponders and this has created a great deal of interest in effective microwave antennas. From the ground station “point of view,” antennas for the microwave bands are not only small, they pack a high amount of gain into their compact packages. Among the best high-performance antenna designs for microwave use are those that employ parabolic reflectors (so-called parabolic “dishes”) to concentrate the transmitted and

received energy.

Like a bulb in a flashlight, a parabolic antenna must have a *feed source* — the radiating and receiving part of the antenna — “looking” into the surface of the dish. Some dishes are designed so that the feed source is mounted directly in front of the dish. This is referred to as a *center-fed dish* (Fig 23). Other dishes are designed so that the feed source is off to one side, referred to as an *off-center-fed dish*, or just *offset fed dish*, as shown in Fig 24. The offset-fed dish may be considered a side section of a center-fed dish. The center-fed dish experiences some signal degradation due to blockage by the feed system, but this is usually an insignificantly small amount. The offset-fed dish is initially more difficult to aim, since the direction of reception is not the center axis, as it is for center-fed dishes.

The dish’s parabola can be designed so the

*focus point* — the point where the feed source must be — is closer to the surface of the dish, referred to a *short-focal-length* dish, or further away from the dish’s surface, referred to as a *long-focal-length* dish. To determine the exact focal length (F), measure the diameter of the dish (D) and the depth of the dish (d).

$$F = \frac{D^2}{16d}$$

The focal length divided by the diameter of the dish gives the *focal ratio*, commonly shown as  $f/D$ . Center-fed dishes usually have short-focal ratios in the range of  $f/D = 0.3$  to  $0.45$ . Offset-fed dishes usually have longer focal lengths, with  $f/D = 0.45$  to  $0.80$ . If you attach two small mirrors to the outer front surface of a dish and then point the dish at the sun, you can easily find the focus point



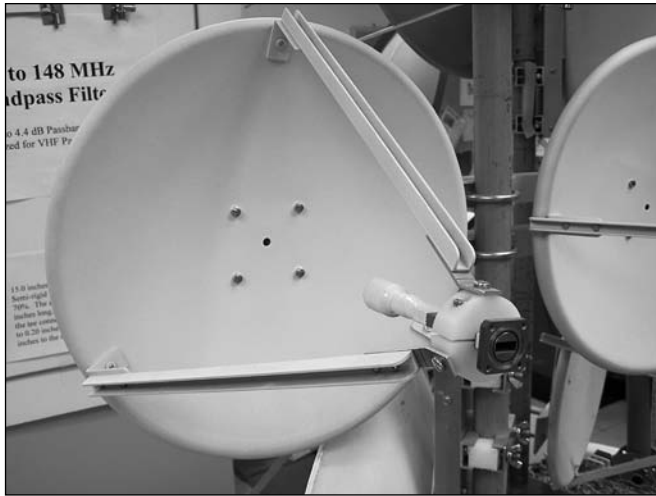

**Fig 23** — As you can see, the feed source is directly in front, making this a center-fed dish.



**Fig 24** — This is a good example of an offset-fed dish. Note the feed source at the bottom edge of the photo, pointing into the center of the parabola. Also note that this is a DirectTV satellite TV antenna that has been “repurposed” for Amateur Radio satellites!



**Fig 25** — The 2.4 GHz satellite downlink antenna at ARRL Headquarters station W1AW is a so-called “barbecue grill” dish antenna originally designed for the Multichannel Multipoint Distribution Service (MMDS). These inexpensive antennas can be assembled and installed in minutes.

of the dish. This is where you want to place the feed source.

To invoke the flashlight analogy again, the feed source should evenly illuminate the entire dish, and none of the feed energy should fall outside the dish’s reflecting surface. However, *no* feed system is perfect in illuminating a dish. These so-called “spillover losses” affect the gain by either under-illuminating or over-illuminating the dish. Typical dish efficiency is 50%. That’s 3 dB of lost gain.

A great feed system for one dish can be a real lemon on another. For example, if you can get your hands on a surplus offset-fed satellite TV dish, you may find a helical radiator is the best feed source. Designs range anywhere from 2 to 6 turns. The two-turn helices are used for very short focal-length dishes in the  $f/D = 0.3$  region, and the 6-turn helices are used with typically longer-focal-length ( $f/D \sim 0.6$ ), offset-fed dishes. Generally speaking, helix feeds work poorly on the short-focal

length dishes, but really perform well on the longer-focal length, offset-fed dishes.

Parabolic antennas can be made from commercial or military surplus, including satellite TV dishes that you can “repurpose” in the finest Amateur Radio tradition. You will also find ham dealers selling so-called *barbecue* dishes that were originally designed for the Multichannel Multipoint Distribution Service, or “wireless cable TV” (see **Fig 25**). MMDS antennas come with built-in feed sources at the focal points, so all you have to do is connect the feed line and go. These are among the most popular dish antennas for amateur satellite enthusiasts.

#### 4.4 Antenna Mounting

One beneficial characteristic of satellite antennas is that they can be installed close to the ground as long as the antenna can “see” as much of the unobstructed sky as possible. Signals to and from the satellite will already be traversing hundreds or thousands of free space. So, adding a few more feet of elevation to your ground station antenna won’t perceptibly improve the strength of those signals. What such an arrangement *will* do, however, is needlessly increase the length of coax (and corresponding line losses) between your transceiver and your antenna.

If your antennas already have an unobstructed view of the sky from the ground, you usually won’t need a tower or roof installation unless trees or buildings surround the antennas and block their upward view. Or, to put it another way, your antenna support only needs to be high enough to make sure the back end of the antenna array is far enough off the ground to prevent people from walking into it while it’s pointing straight up.

What’s more, and as we have already discussed, satellite antennas (particularly those of the circularly polarized variety) along with their associated rotators (discussed below) tend to create a more complex antenna arrangement than that used for ordinary HF or VHF/UHF terrestrial operation. So, mounting them close to the ground makes performing any needed adjustments or repairs a whole lot simpler.

#### 4.5 Antenna Rotators

If you plan to use directional antennas and don’t wish to manipulate them by hand, you will need to install an *antenna rotator* (**Fig 26**). Making the correct decision as to how much capacity the rotator must have is very important to ensure trouble-free operation.

Rotator manufacturers generally provide antenna surface area ratings to help you choose a suitable model. The maximum antenna area is linked to the rotator’s torque capability. Some rotator manufacturers pro-

vide additional information to help you select the right size of rotator for the antennas you plan to use. Hy-Gain provides an *Effective Moment* value. Yaesu calls theirs a *K-Factor*. Both of these ratings are torque values in foot-pounds. You can compute the Effective Moment of your antenna by multiplying the antenna turning radius by its weight. So long as the effective moment rating of the rotator is greater than or equal to the antenna value, the rotator can be expected to provide a useful service life.

There are several rotator grades available to amateurs. The lightest-duty rotator is the type typically used to turn TV antennas. These rotators will handle smaller satellite antennas such as crossed Yagis. The problem with TV rotators is that they lack braking or holding capability. High winds can turn the rotator motor via the gear train in a reverse fashion, requiring realignment. Broken gears sometimes result.

The next grade up from the TV class of rotator usually includes a braking arrangement, whereby the antenna is held in place when power is not applied to the rotator. Generally speaking, the brake prevents antenna misalignment or gear damage on windy days. If adequate precautions are taken, this type of rotator is capable of holding and turning a stack of satellite antennas, including a parabolic dish which, by its nature, presents considerable wind loading. Keep in mind that as rotators increase in power, they become more expensive.

### AZIMUTH/ELEVATION ROTATOR

Perhaps the ultimate in operating convenience is the *azimuth/elevation (az/el) rotator*. This rotator is capable of moving your antennas horizontally (azimuth) and vertically (elevation) at the same time. There are well-designed models available from Yaesu (Fig 27) and Alfa Radio (Fig 28). You can operate these rotators manually, or connect them to your computer for automated tracking. The downside is that az/el rotators tend to be expensive, typically on the order of \$600 or more at this writing.

If your budget can stand the strain, az/el rotators are clearly worth the investment. On the other hand, if cost is an issue, consider using a standard rotator instead. While a traditional rotator can only move your antennas in the azimuth plane (horizontally), you can strike a compromise by installing the antennas at a permanent 45° tilt (Fig 29). This configuration will allow you to work the vast majority of satellites with reasonable success. You won't be able to follow the satellite when it is overhead or near the horizon, but you'll enjoy the lion's share of every pass.

Regardless of which type you choose, proper installation of the antenna rotator can provide many years of dependable service.



**Fig 26 — A basic antenna rotator; the light-duty variety used to turn TV antennas. The wire exiting the bottom of the rotator housing is the multiconductor cable responsible for power and control.**

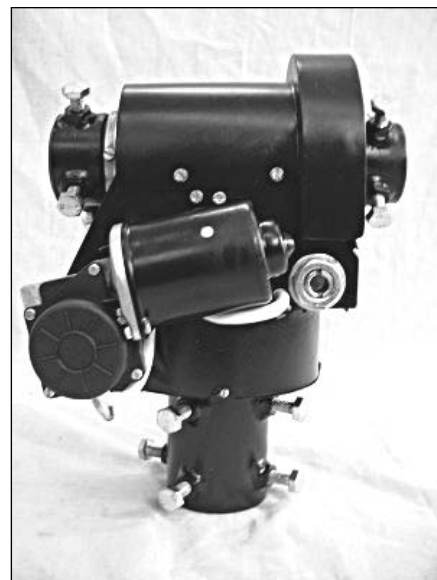
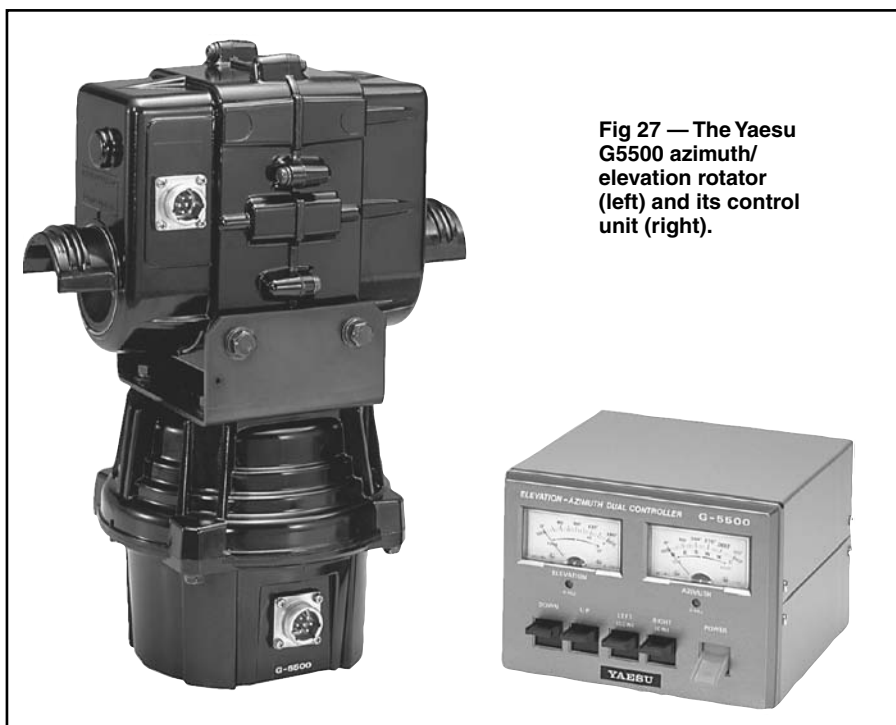

**Fig 28 — An az/el rotator made by Alfa Radio.**

Sloppy installation can cause problems such as a burned out motor, slippage, binding and even breakage of the rotator's internal gear and shaft castings or outer housing. Most rotators are capable of accepting mast sizes of different diameters, and suitable precautions must be taken to shim an undersized mast to

ensure dead-center rotation.

If you decide to install your rotator on a tower, it is desirable to mount the rotator inside and below the top of the tower as far as possible. A long mast (10 feet or so) absorbs the torsion developed by the antenna during high winds, as well as during starting and



**Fig 27 — The Yaesu G5500 azimuth/elevation rotator (left) and its control unit (right).**

stopping. Another benefit is mitigating the effect of any misalignment among the rotator, mast and the top of the tower.

A tube at the top of the tower (a *sleeve bearing*) through which the mast protrudes almost completely eliminates any lateral forces on the rotator casing. All the rotator must do is support the downward weight of the antenna system and turn the array. Some installations use a *thrust bearing* mounted to the tower to support the weight of the antenna and mast.

Don't forget to provide a loop of coax to allow your antenna to rotate properly and allow water to drip off. Also, make sure you position the rotator loop so that it doesn't snag on anything.

### COMPUTER CONTROL

As mentioned earlier, you can connect your rotator to your station computer and allow your satellite-tracking software to aim your antennas automatically (assuming your software supports rotator control). There used to be a number of commercial rotator/computer interface devices available for sale, but availability has dwindled over the years and those that remain tend to be expensive. An interface such as the Yaesu GS-232 (**Fig 30**) costs about \$600 at the time of this writing. If you combine it with a Yaesu azimuth/elevation rotator, you will have invested \$1300 total. Less expensive alternatives are now found as kits or homebrew devices. A good example is the G6LVB tracker interface at [www.g6lvb.com/Articles/LVB-Tracker/](http://www.g6lvb.com/Articles/LVB-Tracker/). If you're willing to build it yourself, you can probably put together an LVB unit for less than \$50. Do an Internet search and you'll no doubt uncover other homebrew interfaces.

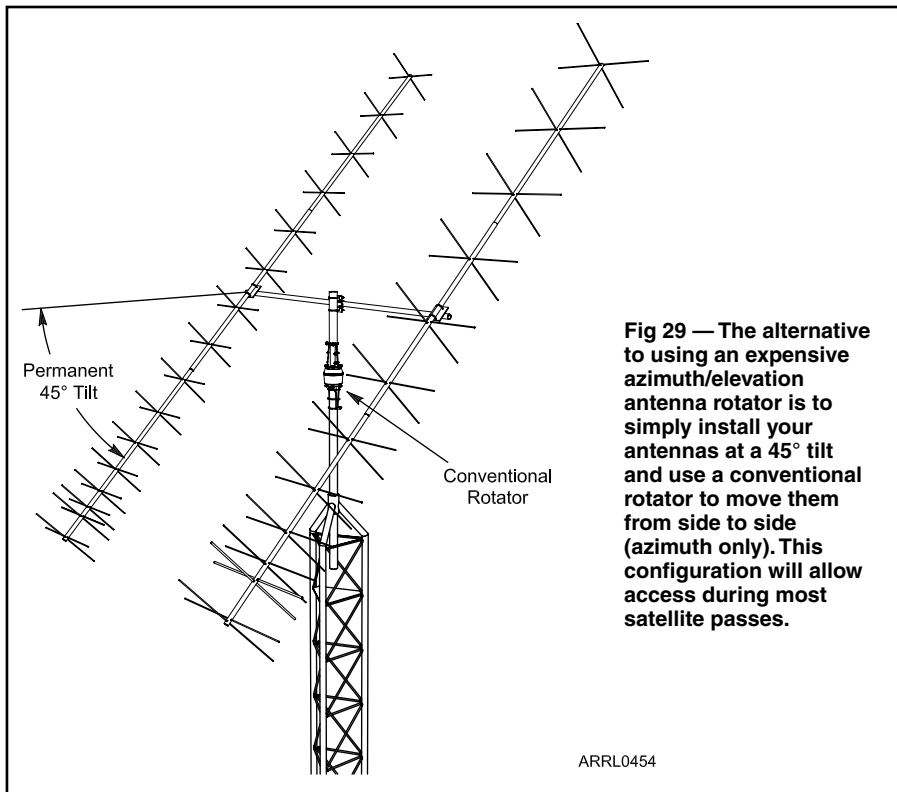

**Fig 29** — The alternative to using an expensive azimuth/elevation antenna rotator is to simply install your antennas at a 45° tilt and use a conventional rotator to move them from side to side (azimuth only). This configuration will allow access during most satellite passes.

ARRL0454



**Fig 30** — The Yaesu GS-232 allows your computer and satellite tracking software to automatically control the movements of compatible azimuth/elevation antenna rotators.

# 5 Satellite Ground Station Equipment

## 5.1 Receive and Transmit Converters

Signals from satellites can be exquisitely weak, which means they need as much amplification as possible to be readable. Unfortunately, there are a number of factors that may conspire to weaken your radio's ability to render a decent received signal....

- *You're using omnidirectional antennas.* As discussed earlier, omni antennas lack much of the signal-capturing gain of directional antennas.

- *The feed line between the antennas and the radio is long and/or contains "lossy" coax.* Remember that even with the best coax, the longer the feed line the more signal you'll lose, especially at higher frequencies.

- *You're trying to communicate with a high-orbiting satellite at apogee.* When a signal travels up to 50,000 km to reach your station, even the gain of a directional antenna may not be sufficient.

### PREAMPLIFIERS

The way to ensure that you have a useable received signal is to install a *receive preamplifier* (Fig 31) at the antenna. This is a high-gain, low-noise amplifier with a frequency response tailored for one band only.

When shopping for a receive preamplifier, you want the most amount of gain for the least amount of noise. Every preamplifier adds some noise to the system, but you want the least additional noise possible. A well-designed UHF preamplifier, for example, may

have gain on the order of 15 to 25 dB and a *noise figure* (NF) of 0.5 to 2 dB (less is better).

If your antennas are outdoors, look for preamplifiers that are "mast mountable." These preamplifiers are housed in weatherproof enclosures.

You will need to devise a means to supply dc power to the remote preamplifier. This can be as simple as routing a two-conductor power cable to the device. Alternatively, preamplifiers can be powered by dc sent up the feed line itself. Some transceivers have the ability to insert 12 V dc on the feed line for this purpose. If not, you can use a *dc power inserter* to inject power at the station and/or recover it nearer the antenna (see Fig 32). Some preamplifier designs include feed line power capability, so all you need is an inserter at the "station end."

If your preamplifier is going to be installed in a feed line that will also be carrying RF power from the radio, you'll need a model that includes an internal relay to temporarily switch it out of the circuit to avoid damage to the preamplifier when you're transmitting. Some preamplifiers include this relay and nothing more; it is up to you to provide

the means to energize the relay before you transmit. This is accomplished through a device known as a *TR sequencer*. A sequencer works with your transceiver to automatically switch the preamplifier out of the feed line before the radio can begin sending RF power (see Fig 33). A less complicated alternative is to purchase a preamplifier with *RF-sensed switching*. This design incorporates a sensor that detects the presence of RF from the radio and instantly switches the preamplifier out of harm's way. Note that RF-switched preamplifiers are rated according to the power they can safely handle. If you're transmitting 150 W, you'll need an RF-switched preamplifier rated for 150 W or more.

### DOWNCONVERTERS

As the name implies, a *downconverter*, also known as a *receive converter*, converts



Fig 31 — This receive preamplifier by Advanced Receiver Research gives signals a substantial boost before they travel down the coaxial cable to your radio.

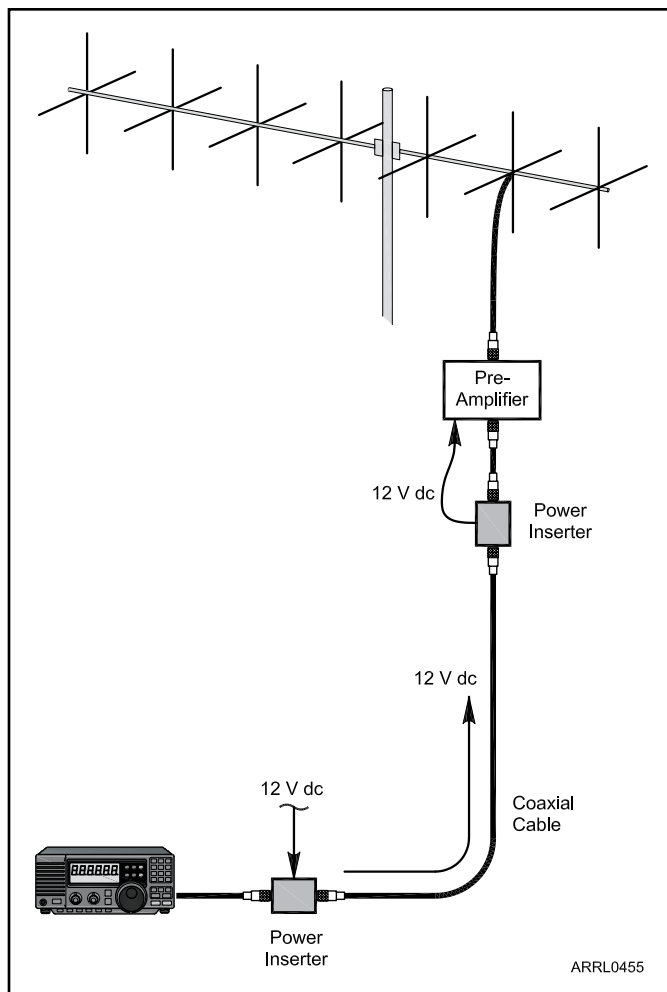
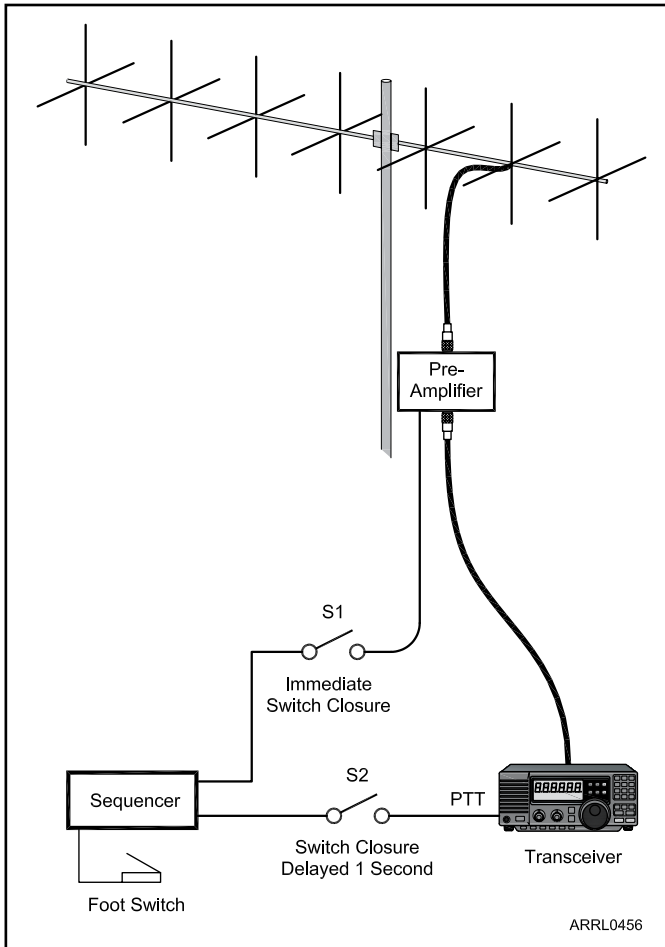
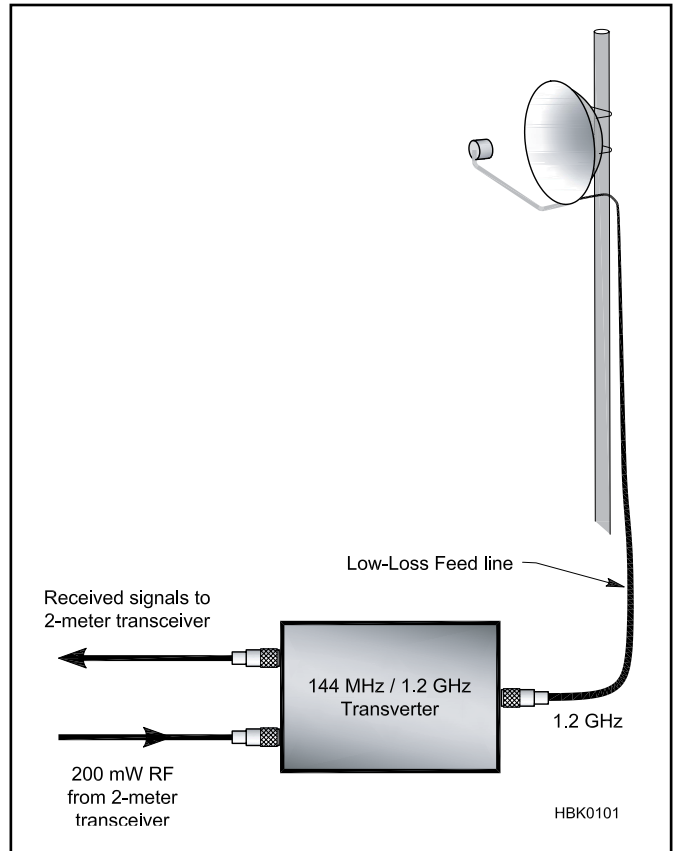

Fig 32 — A dc power inserter acts just as its name implies — it inserts a dc voltage to the coaxial cable at the station. The inserter is designed to block dc power from going "backward" to the radio. Instead, the power flows through the coax to the antenna where another inserter picks it off and supplies it to the device (a preamplifier, in this case). Both inserters pass RF with negligible loss.



**Fig 33** — In this simplified example, the sequencer is triggered when the operator presses the foot switch. It immediately closes switch S1, which activates a “bypass” relay in the receive preamplifier at the antenna, effectively removing it from the feed line circuit. One second later, the sequencer closes switch S2, which is connected to the transceiver PTT (Push To Talk) line, keying the radio and applying RF power.



**Fig 35** — In this example, the transverter is taking 1.2 GHz received signals and converting them to 2 m. When it’s time to transmit, the transverter takes RF at 2 m and converts it to 1.2 GHz.



**Fig 34** — This downconverter by Down-east Microwave converts signals at 2.4 GHz to 2 m. With its weatherproof enclosure, it is designed to be installed at the antenna.

ers, a downconverter was a popular means of receiving VHF and UHF signals by converting them to 10 meters (usually) for reception on an HF receiver. Today downconverters are used more often as a way to receive microwave signals, for example converting a range of frequencies at 2.4 GHz to 2 meters. A microwave downconverter works best when installed right at the antenna so that the microwave energy is immediately converted to a lower frequency before excessive feed line loss can occur. See **Fig 34**.

Like receive preamplifiers, downconverters are rated by their gain and NF (the lower the NF, the better). When it comes to installing a downconverter, all the same receive preamplifier issues apply. If the downconverter is installed outdoors it must be in a weatherproof enclosure. You must also supply dc power and be able to switch the downconverter out of the line if you are sending RF power to the same antenna.

one band of frequencies “down” to another. For example, a 2-to-10-meter downconverter would convert signals in a range from 144 to 146 MHz to 28 to 30 MHz.

In the days before HF/VHF/UHF transceiv-

## TRANSVERTERS

Transverters are related to downconverters in that they not only convert received signals, they convert transmitted signals as well. You can use a transverter to generate, say, a 1.2 GHz uplink signal when powered by RF energy from a 2 meter transceiver. The same transverter can convert 1.2 GHz downlink signals to 2 meters as well (**Fig 35**).

Transmit/receive switching in most transverters is accomplished through the use of an internal switch that is keyed through a sequencer. Some models provide automatic RF-sensed switching.

When working with transverters, one issue is supplying a safe level of RF power to the input. If your transceiver pumps out 50 W of power at 2 meters, for example, this is way too much RF for most transverters to handle. Unless the transverter has a built-in RF power attenuator, it is designed to deal with RF power levels on the order of *milliwatts* (typically 200 to 300 mW). If you are lucky enough to own a transceiver that features a transmit transverter port, you can obtain your milliwatt power levels there. If not, you’ll need to add an attenuator at the transverter input to reduce the RF output of your radio to safe levels.

## 5.2 Transceivers

There are many amateur transceivers that cover the VHF and UHF bands. Some popular radios offer all the HF bands as well. Some of these transceivers offer satellite-specific features, while others are oriented toward terrestrial operation.

### WORKING WITH FM REPEATER AND DIGITAL SATELLITES

Almost any dual-band (2 meter/70 cm) FM transceiver will be adequate for operating FM repeater satellites such as OSCAR 51, and for digital operating with the International Space Station or LEO orbiting birds as well (Fig 36). Getting started with a dual-band FM radio and a repeater satellite is a worthwhile option.

Most modern dual-band rigs offer a “high power” output setting around 50 W. That’s more than enough power to put a solid signal into a satellite with a directional antenna. It is also sufficient for omnidirectional antennas, including mobile antennas. (Yes, you can make contacts through FM repeater satellites while you drive!)

If you are considering digital operation, make sure to choose an FM transceiver that offers a data port. This will make it much easier to connect an external radio modem, such as a packet radio terminal node controller (TNC). There are even a few radios with TNCs already built in (Fig 37). Also, make sure the transceiver is rated to handle 1200 and 9600 baud data signals. Nearly all FM transceivers can work with 1200 baud, but 9600 baud is another matter. When in doubt, check the *QST* magazine Product Reviews. Look for the bit-error-rate (BER) test results.

You can use dual-band handheld transceivers to work the FM birds, but their RF output is so low (5 W or less) that you will definitely need to couple them to directional antennas to be heard consistently among the competing signals (Fig 38). What’s more, at this writing, most of the newer handhelds will *not* allow so-called true (or “full”) duplex operation. We will discuss what full-duplex means and why it is desirable for satellite work in a moment.

### WORKING WITH LINEAR TRANSPONDER (SSB/CW) SATELLITES

FM signals tend to be wide and, by design, FM receivers are forgiving of frequency changes. That fortunate characteristic makes it easy to compensate for Doppler frequency shifting as an FM repeater satellite zips overhead.

SSB and CW signals are much narrower, however, and when you’re working through a linear transponder satellite your signal is sharing the passband with several others. Not only do you need to adjust your receive (downlink) frequency almost continuously to keep the

SSB voice or CW sounding “normal,” you also have to stay on frequency to avoid drifting into someone else’s conversation. The most effective way to do this is to listen to your own signal coming through the satellite in

real time while you are transmitting on the uplink. This type of operation is known as *full duplex*.

You will find many multimode (SSB, CW, FM) transceivers that boast a feature labeled “cross-band split” or even “cross-band duplex.” Be careful, though. What you require is a radio that can transmit and receive on different bands *simultaneously*. Few amateur transceivers can manage such a trick!

As this book went to press, there were only two all-mode amateur transceivers on the market that were capable of full duplex operation: The VHF/UHF ICOM IC-9100 (Fig 39) and the all-band Kenwood TS-2000 (Fig 40). However, if you shop the used equipment market you’ll find excellent satellite radios such as the Yaesu FT-736 (Fig 41), the ICOM IC-820 and IC-910H, the Yaesu FT-726 and FT-847 along with the Kenwood TS-790. All of these transceivers have full-duplex capability.

Another option that some hams have used successfully is to exploit computer control of their ordinary non-duplex multiband transceivers to compensate for Doppler shift. Some satellite-tracking programs can automatically change the frequency of your radio during a pass. They do this by mathematically calculating the frequency shift and tweaking your radio accordingly. This solution for frequency stability isn’t as accurate as listening to your own downlink signal in full duplex, but it can work.

Another option is to use one transceiver for the uplink and a separate receiver or transceiver for the downlink. Some amateurs have even pressed old shortwave receivers into service along with VHF or UHF downconverters. They transmit with a 2 m or 70 cm SSB



**Fig 36 — The ICOM IC-2820 FM transceiver can receive and transmit on 2 m and 70 cm independently. With a dual-band FM rig like this, you can communicate through the FM repeater satellites, even while mobile.**



**Fig 37 — The Kenwood TM-D710 is a dual-band FM transceiver with a built-in packet radio Terminal Node Controller (TNC) for digital communication.**

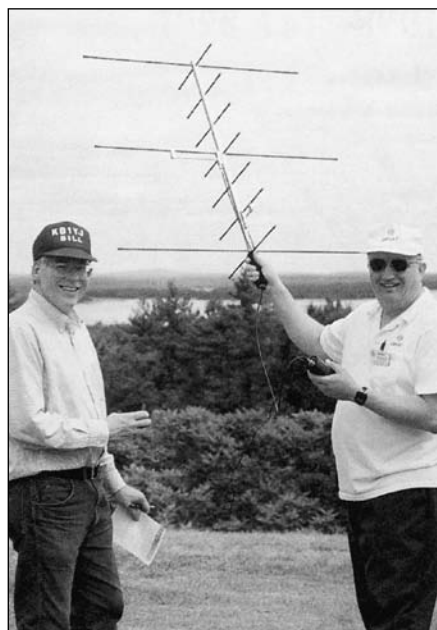

**Fig 38 — The hand-held “Arrow” gain antenna is popular for FM repeater satellite operations. (AMSAT photo)**



**Fig 39 — The ICOM IC-9100 is an HF/VHF/UHF transceiver with 23 cm available as an option.**



**Fig 40 — The Kenwood TS-2000 offers full HF coverage, plus VHF and UHF with full-duplex satellite capability.**



**Fig 41** — The Yaesu FT-736 is a legendary satellite transceiver. Although no longer manufactured, the '736 is still available on the used market.



**Fig 42** — A 150 W 2 meter RF power amplifier by Tokyo Hy-Power.

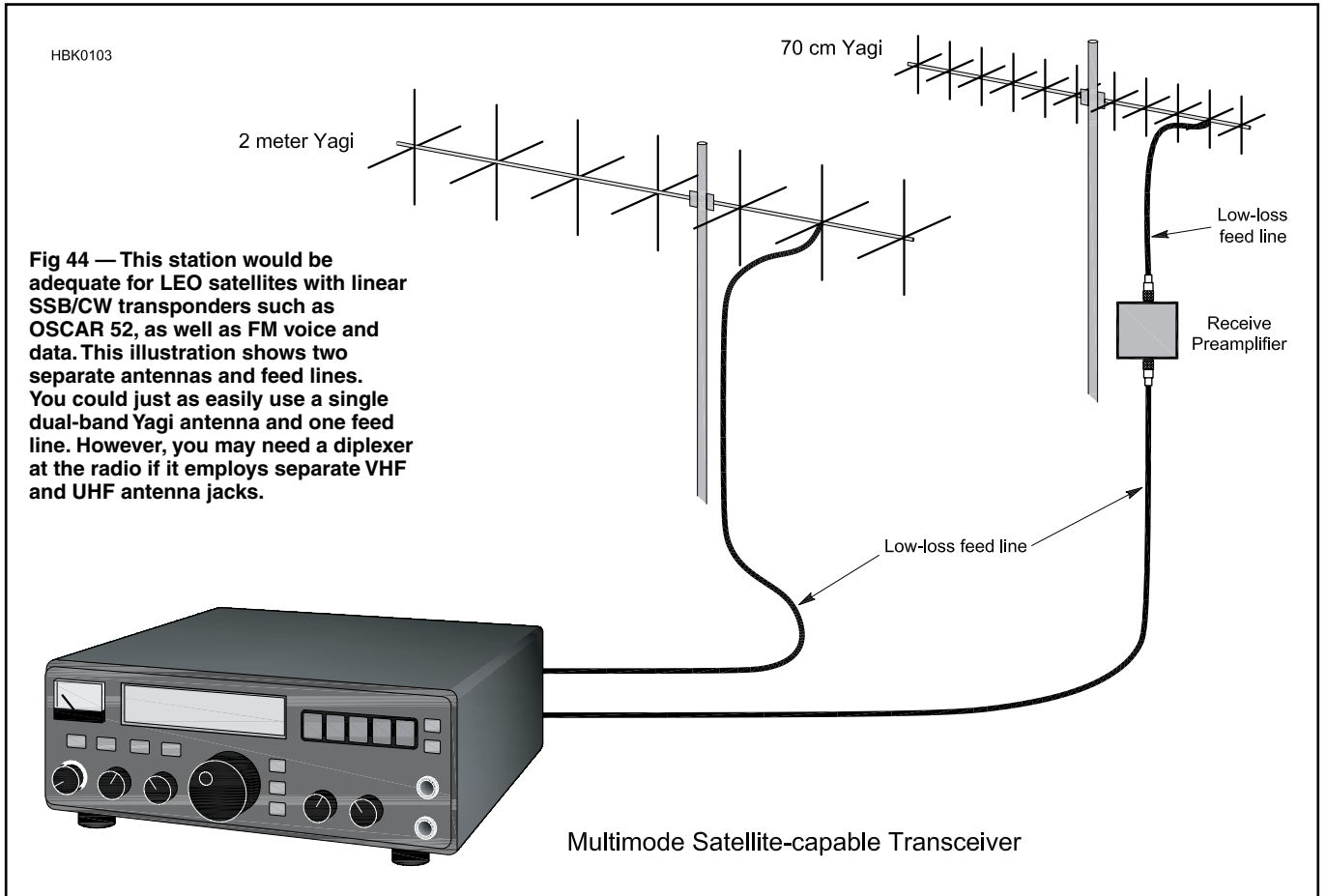
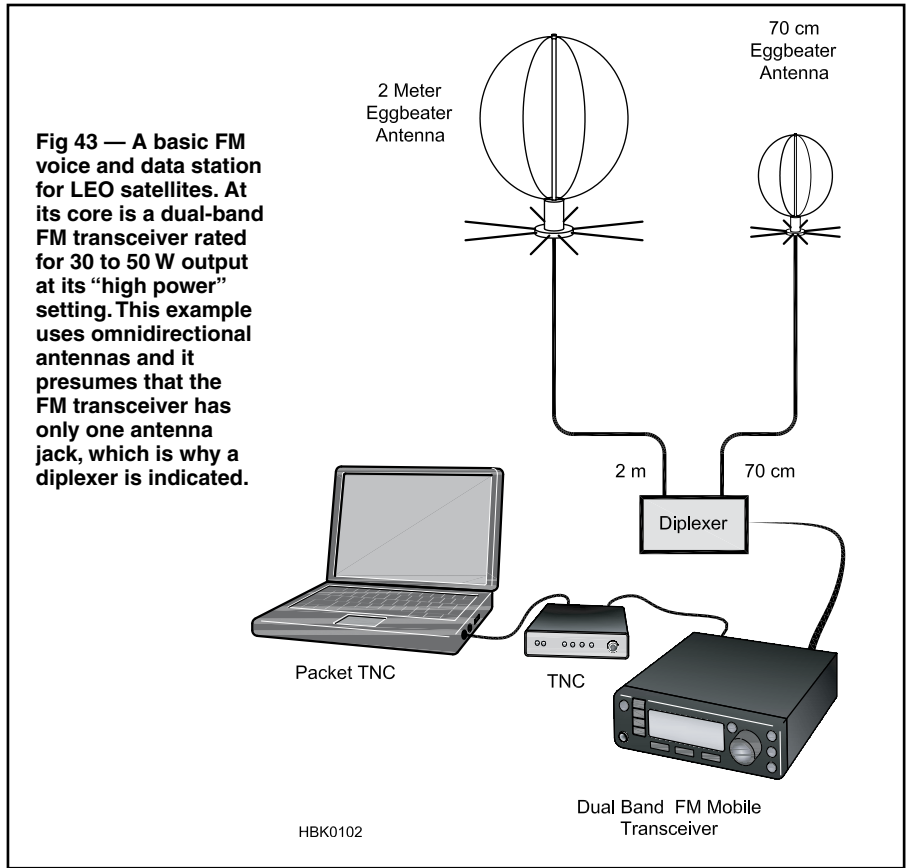

radio on the uplink while listening to their shortwave receiver/downconverter combo on the downlink.

If you are working a linear transponder satellite with an uplink at 1.2 GHz or higher, you'll likely have to take the transverter approach to getting on the air, although there are some transceivers that offer optional 1.2 GHz modules. Fortunately, satellite builders are well aware that most hams own 2 meter and 70 cm transceivers and they design new birds accordingly. Even transponders with microwave downlinks are usually configured with uplinks on 2 meter or 70 cm. So, if you purchase a VHF/UHF transceiver all you need to add is a downconverter to receive the microwave downlink.

### 5.3 VHF/UHF RF Power Amplifiers

If your chosen transceiver offers at least 50 W output on the uplink band, you won't need an RF power amplifier to bring your signal to a level that can be "heard" by a LEO satellite, especially if you are using directional antennas.

On the other hand, if you are using omni antennas, 100 or 150 W output may help considerably. And if your target is an HEO satellite orbiting at 50,000 km, 100 W or more, along with a directional antenna, is *mandatory*. If your transceiver lacks the necessary punch for the application, the solution is an external RF power amplifier.

How much power should you buy? In most cases, a 100 or 150 W amplifier is a good choice (Fig 42). As you shop for amplifiers, take care to note the input and output specifications. How much RF at the input is necessary to produce, say, 150 W at the output? Can your radio supply that much power?

Another consideration is your dc power supply. While a 25 A 13.8 V dc supply is perfectly adequate to run a 100 W transceiver, if you also decide to add a 100 or 150 W amplifier to your satellite station, the current demands will increase considerably. A separate power supply may be required to provide an *additional* 20 A (or more) to safely power the amplifier when both the transceiver *and* the amplifier are transmitting at the same time.

### 5.4 Typical Station Designs

There are so many station equipment options available, it may be helpful to outline a few typical station configurations.

Fig 43 illustrates a basic FM voice and data station for LEO satellites. At its core is a dual-band FM transceiver rated for 30 to 50 W output. The example uses omnidirectional antennas and it presumes that the FM transceiver has only one antenna jack, which is why a diplexer is indicated. Otherwise, you could run two separate coaxial feed lines back

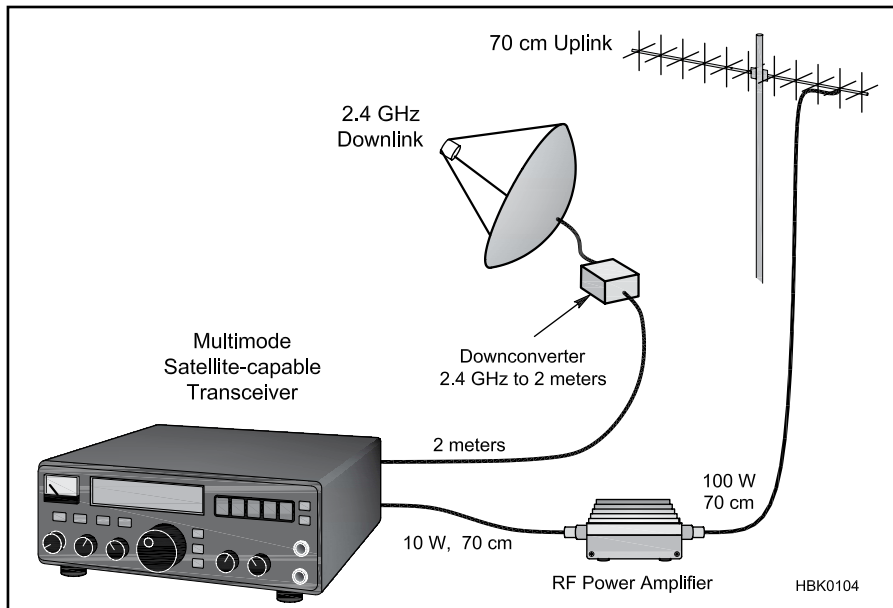

Fig 45 — This example illustrates a station designed to work a distant Phase III or IV satellite with a microwave downlink. It assumes that the uplink is at 70 cm and the downlink is at 2.4 GHz. Note the use of the downconverter to step the 2.4 GHz signal at the antenna down to 2 meters before it is fed to the radio.

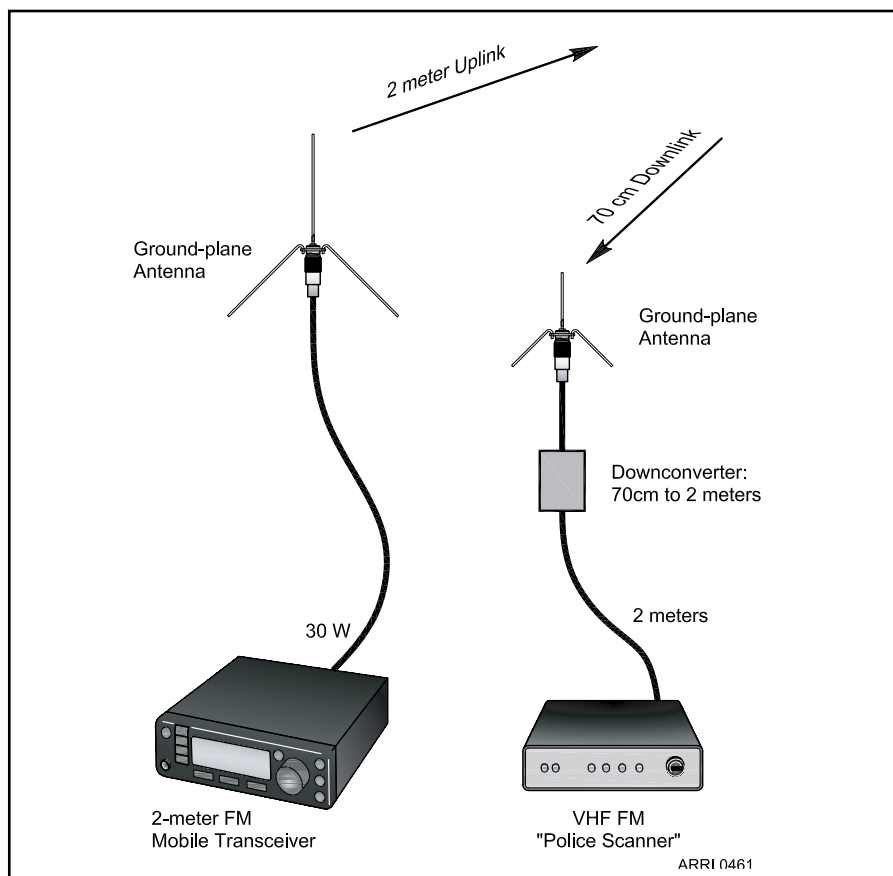

Fig 46 — Let's say that you want to work the low-orbiting FM birds, but you only have a 2 meter FM transceiver for the uplink and only a VHF FM "police scanner" receiver for the 70 cm downlink. You could use a downconverter for the 70 cm downlink, stepping the signal down to 2 meters for reception with the scanner.



to the radio.

The performance of this station can be substantially enhanced by adding directional antennas or a dual-band Yagi but, of course, that will require an antenna rotator (human or mechanical!).

In **Fig 44** we've stepped up to a multiband, multimode transceiver with full duplex capability and directional antennas. This station would be excellent for LEO satellites with linear SSB/CW transponders such as OSCAR 52, as well as FM voice and data. By adding an RF power amplifier (assuming the output of the radio is less than 100 W), this station

would be capable of working distant high-orbiting satellites as well.

Note that this illustration shows two separate antennas and feed lines. You could just as easily use a single dual-band Yagi antenna and one feed line. However, you may need a diplexer at the radio if it employs separate VHF and UHF antenna jacks.

**Fig 45** addresses at least one method to work satellites with microwave downlinks. It assumes that the uplink is at 70 cm and the downlink is at 2.4 GHz. It also assumes that the satellite in question is a high-orbiting spacecraft (note the RF power amp on the uplink).

Note also the use of the downconverter to step the 2.4 GHz signal at the antenna to 2 meters before it is fed to the radio. You can actually use this same approach for any combination of bands and radios. For instance, let's say that you want to work the low-orbiting FM birds, but you have only a 2 meter FM transceiver for the uplink and a separate VHF FM police scanner receiver for the downlink. You could use a downconverter for the 70 cm downlink, stepping the signal down to 2 meters for reception with the scanner (**Fig 46**).

## 6 Satellite Antenna Projects

### 6.1 An EZ-Lindenblad Antenna for 2 Meters

This easy-to-build antenna project by Anthony Monteiro, AA2TX, works well for satellite or terrestrial communication. It is circularly polarized yet has an omnidirectional radiation pattern (no rotator needed to track satellites). With most of its gain at low elevation angles, it is ideal for accessing LEO amateur satellites. It is good for portable operation or general-purpose use at home stations because its circular polarization is compatible with the linearly polarized antennas used for FM/repeater and SSB or CW operation.

This type of antenna was devised by Nils Lindenblad of the Radio Corporation of America (RCA) around 1940. His idea was to employ four dipoles spaced equally around a  $\lambda/3$  diameter circle with each dipole canted  $30^\circ$  from the horizontal. The dipoles are all fed in phase and are fed equal power. The spacing and tilt angles of the dipoles create the desired antenna pattern when the signals are all combined. After WWII, George Brown and Oakley Woodward, also of RCA, were tasked with finding ways to reduce fading on ground-to-air radio links at airports and built on Lindenblad's design.<sup>1</sup>

While the Brown and Woodward design is

clever and worked well, it would be difficult for the home builder to duplicate because of the need for the four-way, in-phase, power splitting function. Since amateurs generally want to use  $50\ \Omega$  coaxial cable feed line, we have to somehow provide an impedance match from the  $50\ \Omega$  unbalanced coax to the four  $75\ \Omega$  balanced dipole loads. Previous designs have used combinations of folded dipoles, open-wire lines, twin-lead feeds,

balun transformers and special impedance matching cables to try to get a good match to  $50\ \Omega$ . These in turn increase the complexity and difficulty of the construction.

#### THE EZ-LINDENBLAD

The key concept of the EZ-Lindenblad is to eliminate anything electrically or mechanically difficult. This leads to the idea of just feeding the four dipoles with coax cable



**Fig 47** — View of cross booms mounted to mast.

<sup>1</sup>G. Brown and O. Woodward Jr. *Circularly Polarized Omnidirectional Antenna*, RCA Review, Vol 8, no. 2, Jun 1947, pp 259-269.

and soldering the cables to a connector with no impedance matching devices at all. This would certainly be *easy* but we also want the antenna to work! Without the extra impedance matching devices, how is it possible to get a good match to 50  $\Omega$ ?

If we could get each of the four coax feed cables to look like 200  $\Omega$  at the connector, then the four in parallel would provide a perfect match to 50  $\Omega$ . We could do this if we used  $\frac{1}{4}\lambda$  sections of 122  $\Omega$  coax to convert each 75  $\Omega$  dipole load to 200  $\Omega$ . Unfortunately, there is no such coax that is readily available.

But we can accomplish the same thing with ordinary 75  $\Omega$ , RG-59 coax if we run the cable with an intentional impedance mismatch. By forcing the standing wave ratio (SWR) on the cable to be equal to 200/75, or about 2.7:1, we can make each cable look exactly like 200  $\Omega$  at the connector as long as we make them the right length. It is easy to make the SWR equal 2.7:1 by just making the dipoles a little too short for resonance. An *EZNEC* ([www.eznec.com](http://www.eznec.com)) antenna model can be used to determine the exact dipole dimensions.

The conversion from the balanced dipole load to unbalanced coax cable can be accomplished by threading each cable through a ferrite sleeve making a choke balun. The only remaining issue is the required length of the feed cables. With a Smith Chart or software, we can easily determine the required length of 75  $\Omega$  coax to provide a 200  $\Omega$  load. An *EZNEC* antenna model was used to simulate cutting the dipole lengths until the SWR on the line reached 2.7:1. The model showed that the dipole load impedance would then be 49 -j55  $\Omega$ . Plotting that value and the desired 200  $\Omega$  impedance at the connector on the chart and drawing a constant 2.7:1 SWR curve between the two impedance points, the length of the line needed is 0.374  $\lambda$ . (For more information about this process, see [www.arrrl.org/smith-chart](http://www.arrrl.org/smith-chart) or the *TLW* software provided with *The ARRL Antenna Book*.)

The EZ-Lindenblad was designed for a center frequency of 145.9 MHz to optimize its performance in the satellite sub band. At 145.9 MHz, a wavelength is about 81 inches and since the coax used has a velocity factor of 0.78, we need to make the feed cables  $81 \times 0.374 \times 0.78 = 23.6$  inches long.

It's imperative that stranded RG-59A foam PE dielectric coax be used. The solid-dielectric cable has a velocity factor of 66% and will not work. The author used part #RG59A-100 from [www.l-com.com](http://www.l-com.com). This is a 100 ft roll; for one antenna you could buy L-Com part # CCF59-12, a 12 ft jumper, and cut it to the required length. Belden 9259 is another suitable cable.

## CONSTRUCTION

This antenna was designed to be rugged and reliable yet easy to build using only hand

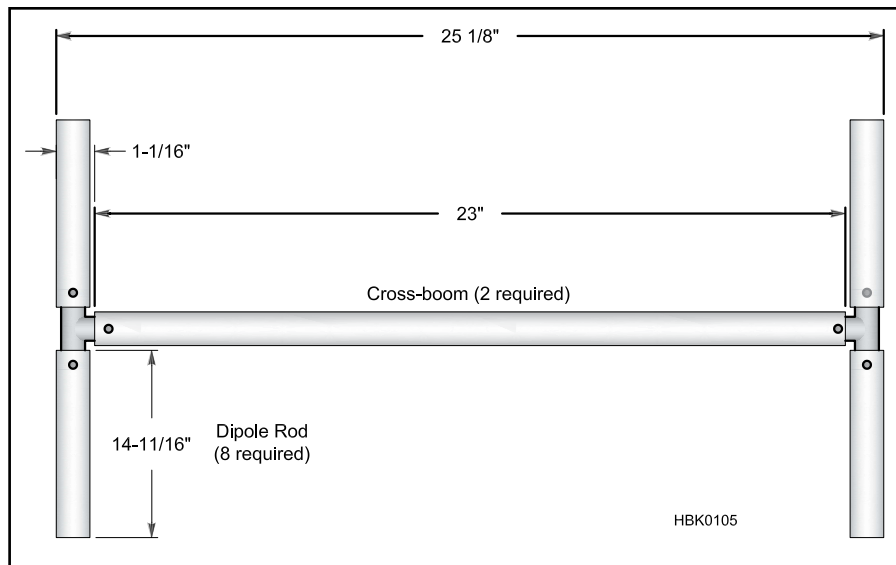

**Fig 48 — Dimensions of the dipoles and cross booms. The antenna requires two cross booms, with a dipole at each end of each cross boom (four dipoles total).**

tools with all of the parts readily available as well (see **Table 5**). Although not critical, the construction will be easier if the specified 17 gauge aluminum tubing is used since the inner wall of the tubes will be just slightly smaller than the outer wall of the PVC insert Ts used to connect them. If heavier gauge tubing is used, it will be necessary to file down the PVC insert Ts to make them fit inside the aluminum tubes.

Start by making a mounting bracket to mount the N-connector and the cross booms. Cut a  $\frac{5}{8}$  inch hole in one side of the short piece of angle stock and rivet or screw it to the bottom of the long piece of angle stock.

The completed bracket with the connector and cables attached can be seen in **Fig 47**.

Next, cut the aluminum tubing to make the cross booms and dipole rods as shown in **Fig 48**. Drill holes for the sheet metal screws at each end of the cross booms but do not insert the screws yet. Attach the cross booms to the long section of angle stock with rivets or screws. One cross boom will mount just above the other as can be seen in **Fig 47**. The cross booms should be perpendicular to the mounting bracket so that they will be horizontal when the antenna is mounted to its mast. Make sure that the centers of the cross booms are aligned with each other so that the

**Table 5**

### Required Materials

*Quantity one, unless noted.*

- Aluminum tubing, 17 gauge, 6 ft length of  $\frac{3}{4}$  in OD, quantity 3. Available from Texas Towers, [www.texastowers.com](http://www.texastowers.com).
- Aluminum angle stock, 8 in length of  $2 \times 2 \times \frac{1}{16}$  in
- Aluminum angle stock, 2 in length of  $2 \times 2 \times \frac{1}{16}$  in for mounting connector.
- Screws, #8  $\times \frac{1}{2}$  in aluminum sheet metal, quantity 12.
- Screws, #8  $\times \frac{1}{2}$  in aluminum sheet metal or  $\frac{3}{16}$  in aluminum rivets, quantity 12.
- PVC insert T-connector,  $\frac{1}{2} \times \frac{1}{2} \times \frac{1}{2}$  in grey for irrigation polyethylene tubing. LASCO Fittings, Inc. Part# 1401-005 or equivalent. Available from most plumbing supply and major hardware stores, quantity 4.
- Plastic end caps (optional), black  $\frac{3}{4}$  in, quantity 8.
- N-connector for RG-8 cable, single-hole, chassis-mount, female.
- Cable ferrite, Fair-Rite part #2643540002, quantity 4 (Mouser Electronics #623-2643540002).
- RG-59A polyethylene foam coax with stranded center conductor (Belden 9259 or equiv; *must* be foam PE dielectric with 78% velocity factor, not solid dielectric), 10 ft length.
- Copper braid, 4 in long piece.
- Ring terminal, uninsulated 22-18 gauge for 8-10 stud, quantity 4.
- Ring terminal, uninsulated 12-10 gauge for 8-10 stud, quantity 4.
- Heat shrink tubing for  $\frac{1}{4}$  in cable, wire ties, electrical tape, as needed.
- Ox-Gard OX-100 grease for aluminum electrical connections.

ends of the cross booms are all 11.5 inches from the center cross.

Make the dipoles by inserting a PVC insert T into two dipole rods. It should be possible to gently tap in the rods with a hammer but it may be necessary to file down the insert T a little if the fit is too tight. Applying a little PVC cement to the insert T will soften the plastic and make it easier to insert into the aluminum tubing if the fit is too tight. The overall dipole length dimension is critical so take care to get this correct as shown in **Fig 49**.

Drill holes for screws in each dipole rod but do not insert the screws yet. The screws will be used to make the electrical connections to the dipoles at the center. The screw holes should be about  $\frac{3}{8}$  inches from the end of the tubing.

The dipole assemblies are attached by gently tapping the PVC insert-T into the end of each cross-boom with a hammer. The dimensions are shown in Fig 48.

Next, temporarily attach the mounting bracket to a support so that each of the cross booms is perfectly horizontal. Measure this with a protractor. Now, using the protractor, rotate the dipole assemblies to a  $30^\circ$  angle with the right-hand side of the nearest dipole tilting up when you are looking toward the center of the antenna. Drill a small hole through the existing cross-boom holes into the PVC insert-Ts and then use the sheet metal screws to fasten the dipole assemblies into place. For a nice finishing touch, the dipole ends can be fitted with  $\frac{3}{4}$  inch black plastic end caps.

Next, make the four feed cables by cutting and stripping the RG-59A as shown in **Fig 50**. On the dipole connection side, unwrap the braid and form a wire lead. Apply the smaller ring terminal to the center conductor and use the larger ring terminal for the braid. At the other end of the cable, do not unwrap the braid but strip off the outer insulation. Slip a 1 inch piece of shrink wrap over the coax and apply to the dipole side. Next slip a cable ferrite over the cable and push all the way to the dipole end as far as it will go (ie,

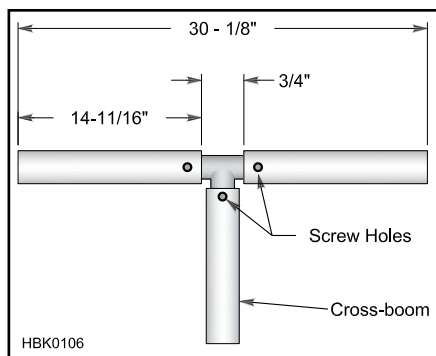

**Fig 49 — Dipole assembly dimensions.**

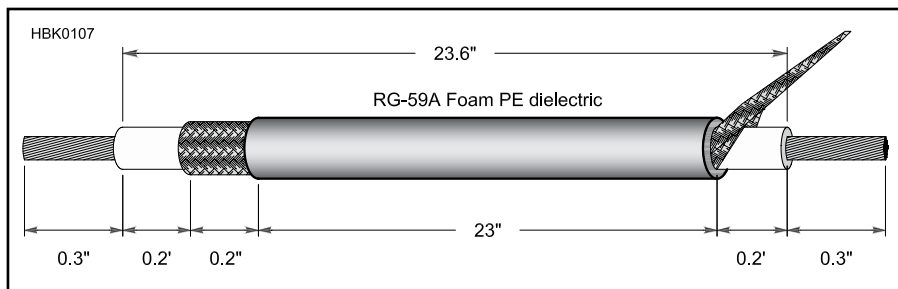

**Fig 50 — Feed cables stripping dimensions.**

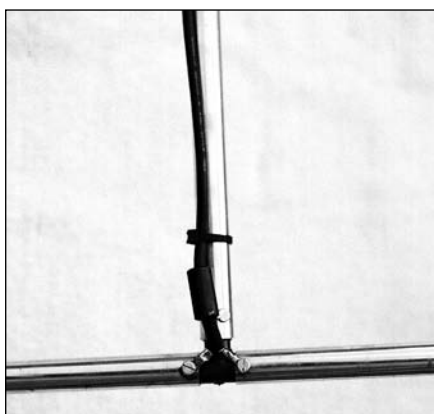

**Fig 51 — Close-up of dipole electrical connections.**

up to the heat-shrink tubing.) The fit will be snug and you may need to put a little grease on the cable jacket to get it started.

Prepare each dipole for its feed cable by first cleaning the area around the screw holes with steel wool and then applying Oxy-Gard or other corrosion resistant electrical grease. The coax center conductor goes to the up side of the dipole and the braid goes to the down side. To make a connection, put a screw through the ring terminal and gently screw into the dipole tubing. Do not overtighten the screws or you will strip the tubing. **Fig 51** shows the completed connections.

Apply Oxy-Gard around the hole for the N connector. Take the 4 inch piece of braid and put the end of it through the hole for the N connector. This provides the ground connection. Secure the N connector in the mounting hole to clamp the braid. Use a wire tie or tape to hold the four feed cables together at the connector ends. Make sure to align the cables so that all the ground braids are together and the center conductors all extend out the same amount. Do not twist the center conductors together. Carefully push the four cable center conductors into the center terminal of the N connector and solder them in place. Wrap the exposed center conductors of the cables and the connector with electrical tape.

Take the piece of braid that is clamped to the N connector and wrap it around the four exposed ground braids of the coax cables.

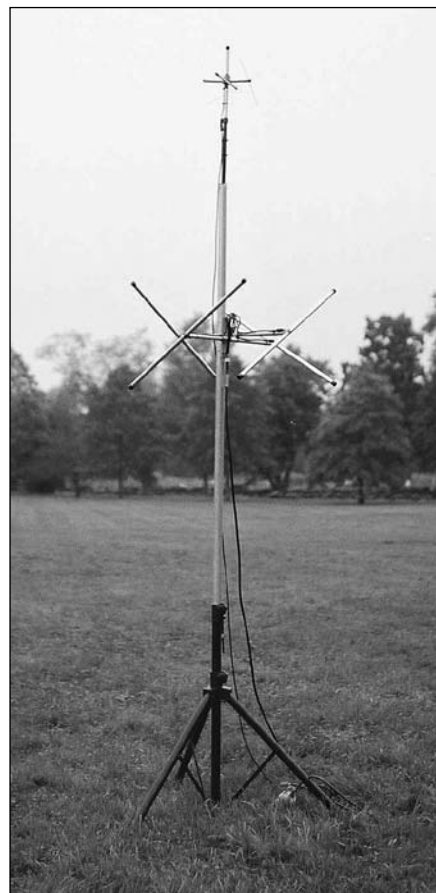

**Fig 52 — The EZ-Lindenblad as a portable or Field Day antenna. A 70 cm antenna is on the top.**

Solder them all together. This will take a fair amount of heat but be careful not to melt the insulation. After this cools, apply electrical tape over all the exposed braid and fix with wire ties. Secure the cables to the cross booms with wire ties.

The mounting bracket provides a way to attach the antenna to a mast using whatever clamping mechanism is convenient (eg, U-bolts). The author's antenna was intended for portable operation and the bracket was drilled to accept two #8 machine screws. These screws pass through a portable mast and the antenna is secured with wing nuts for easy setup. The completed portable antenna

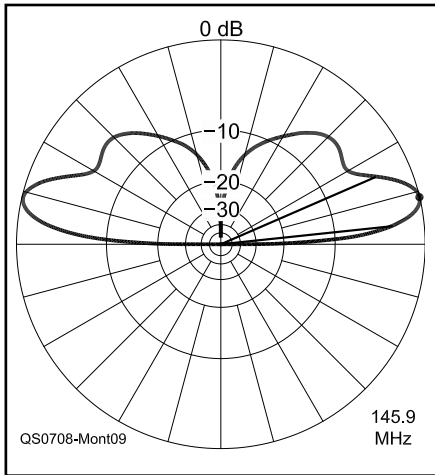

**Fig 53 — EZNEC elevation radiation pattern of Lindenblad antenna.**

is shown in **Fig 52**. The little antenna at the top is for 70 cm.

### PERFORMANCE

The antenna impedance match to  $50\ \Omega$  was tested using an MFJ-259B SWR meter, which was checked against an external frequency counter and precision  $50\ \Omega$  load. The antenna provides an excellent match over the entire 2 meter band. This antenna was designed to safely handle any of the currently available VHF transceivers and tested by applying a 200 W signal key down for 9 minutes, then checking the ferrites and cables for temperature rise.

The antenna radiation pattern predicted by the EZNEC model is shown in **Fig 53**. This is the elevation plot with the antenna mounted at 6 ft above ground although it can be mounted higher if desired for better coverage to the horizon. As shown in the plot, the pattern favors the lower elevation angles. The  $-3\ \text{dB}$  points are at  $5^\circ$  and  $25^\circ$  with the maximum gain of 4.8 dBic (dB with respect to an isotropic circularly polarized antenna) at around  $13^\circ$ . Most of the satellite pass elevations will be in this range and it is also the elevation at which the satellite provides the best chance for DX contacts. The antenna radiation is right-hand circularly polarized, which will work with virtually any LEO satellite that uses the 2 meter band.

The EZ-Lindenblad antenna has been used for SSB, FM and packet operation on a number of amateur satellites. A portable setup performed well on Field Day, an excellent test of any antenna as it is probably the busiest weekend of the year on the satellites.

## 6.2 The W3KH Quadrifilar Helix

If your existing VHF omnidirectional antenna coverage is “just okay,” this twisted an-

tenna project by Eugene F. Ruperto, W3KH, is probably just what you need! The ever-changing position of LEO satellites presents a problem for the Earth station equipped with a fixed receiving antenna: signal fading caused by the orientation of the propagated wavefront. This antenna provides a solution to the problem and can be used with weather satellites, or any of the polar-orbiting amateur satellites.

Several magazines have published articles on the construction of the quadrifilar helix antenna (QHA) originally developed by Dr Kilgus.<sup>1</sup> A particularly good reference is *Reflections* by Walt Maxwell, W2DU, who had considerable experience evaluating and testing this antenna while employed as an engineer for RCA.<sup>2</sup>

Part of the problem of replicating the antenna lies in its geometry. The QHA is difficult to describe and photograph. Some of the artist’s renditions leave more questions than answers, and some connections between elements as shown conflicted with previously published data. However, those who have successfully constructed the antenna say it is *the* single-antenna answer to satellite reception for the low-Earth-orbiting satellites.

### DESIGN CONSIDERATIONS

Experts imply that sophisticated equipment is necessary to adjust and test the antenna, but the author found it possible to construct successful QHAs by following a cookbook approach using scaled figures from a proven design. The data used as the design basis for the antenna described here were published in an article describing the design of a pair of circularly polarized S-band communication-satellite antennas for the Air Force and designed to be spacecraft mounted.<sup>3</sup> Using this antenna as a model, the author constructed QHAs for the weather-satellite frequencies and the polar-orbiting 2 meter and 70 cm amateur satellites with excellent results and without the need for adjustments and tuning. By following some prescribed universal calculations, a reproducible and satisfactory antenna can be built using simple tools.

UHF and microwave antennas require a high degree of constructional precision because of the antenna’s small size. For instance, the antenna used for the Air Force at 2.2 GHz has a diameter of 0.92 inch and a length of

1.39 inches! On the other hand, a QHA for 137.5 MHz is 22.4 inches long and almost 15 inches in diameter; for 2 meters, the antenna is not much smaller. Antennas of this size are not difficult to duplicate.

### ELECTRICAL CHARACTERISTICS

A half-turn  $\frac{1}{2}\ \lambda$  QHA has a theoretical gain of 5 dBi and a 3-dB beamwidth of about  $115^\circ$ , with a characteristic impedance of  $40\ \Omega$ . The antenna consists basically of a four-element, half-turn helical antenna, with each pair of elements described as a *bifilar*, both of which are fed in phase quadrature. Several feed methods can be employed, all of which appear complicated except the infinite-balun design, which uses a length of coax as one of the four elements.

To produce the necessary  $90^\circ$  phase difference between the bifilar elements, either of two methods can be used. One is to use the same size bifilars, which essentially consist of two twisted loops with their vertical axes centered and aligned, and the loops rotated so that they’re  $90^\circ$  to each other (like an egg-beater), and using a quadrature hybrid feed. Such an antenna requires *two* feed lines, one for each of the filar pairs.

The second and more practical method is the self-phasing system, which uses *different-size loops*: a larger loop designed to resonate *below* the design frequency (providing an inductive reactance component) and a smaller loop to resonate higher than the design frequency (introducing a capacitive-reactance component), causing the current to lead in the smaller loop and lag in the larger loop. The element lengths are  $0.560\ \lambda$  for the larger loop, and  $0.508\ \lambda$  for the smaller loop. According to the range tests performed by Maxwell, to achieve *optimum* circular polarization, the wire used in the construction of the bifilar elements should be  $0.0088\ \lambda$  in diameter.

Maxwell indicates that in the quadrifilar mode, the fields from the individual bifilar helices combine in optimum phase to obtain unidirectional end-fire gain. The currents in the two bifilars must be in quadrature phase. This  $90^\circ$  relationship is obtained by making their respective terminal impedances  $R + jX$  and  $R - jX$  where  $X = R$ , so that the currents in the respective helices are  $-45^\circ$  and  $+45^\circ$ . The critical parameter in this relationship is the terminal reactance,  $X$ , where the distributed inductance of the helical element is the primary determining factor. This assures the  $\pm 45^\circ$  current relationship necessary to obtain true circular polarization in the combined fields and to obtain maximum forward radiation and minimum back lobe. Failure to achieve the optimum element diameter of  $0.0088\ \lambda$  results in a form of elliptical, rather than true circular polarization, and the performance may be *a few tenths of a decibel* below optimum, according to Maxwell’s calculations. Using #10 wire translates roughly to an element diameter

<sup>1</sup>C. C. Kilgus, “Resonant Quadrifilar Helix,” *IEEE Transactions on Antennas and Propagation*, Vol AP-17, May 1969, pp 349-351.

<sup>2</sup>M.W. Maxwell, W2DU, *Reflections* (Newington: ARRL, 1990). [This book is out of print.]

<sup>3</sup>R. Brickner Jr and H. Rickert, “An S-Band Resonant Quadrifilar Antenna for Satellite Communication,” RCA Corp, AstroElectronics Div.

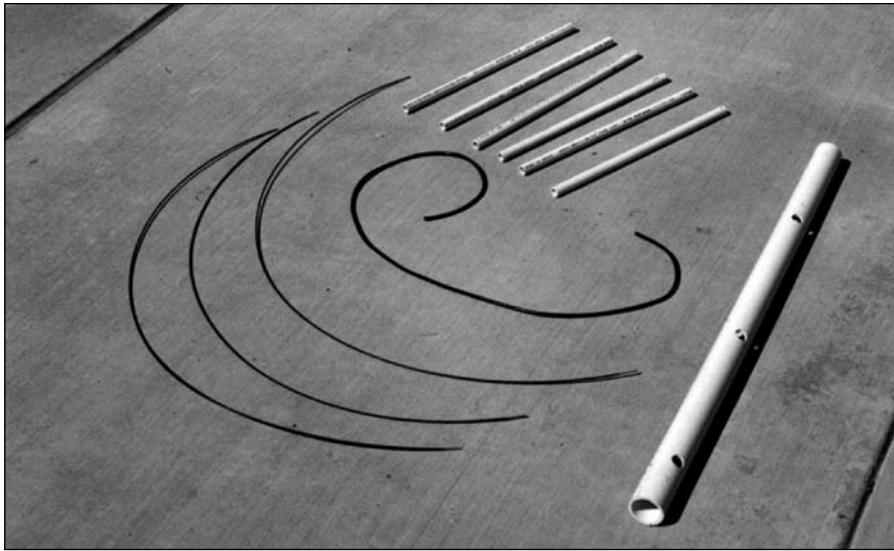

Fig 54 — The quadrifilar helix antenna (QHA) pieces, ready for assembly.

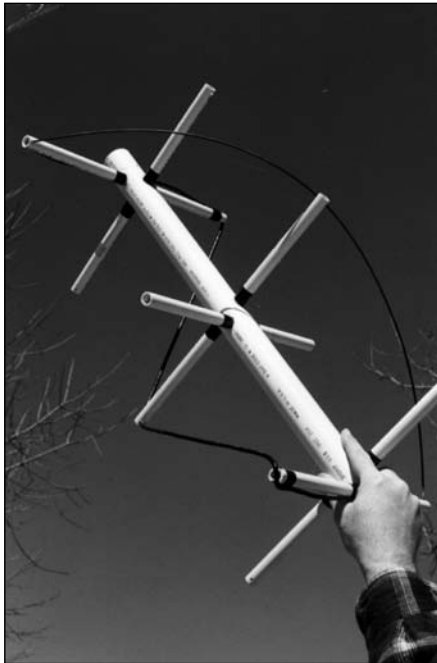

Fig 55 — The antenna with two of the four legs (filars) of one loop attached.



Fig 56 — This view shows the QHA with all four legs in place. The ends of the PVC cross arms that hold the coaxial leg are notched; the wire elements pass through holes drilled in the ends of their supporting cross arms.

of  $0.0012 \lambda$  at 137.5 MHz — not ideal, but good enough.

To get a grasp of the QHA's topography, visualize the antenna as consisting of two concentric cylinders over which the helices are wound (see Fig 54 through Fig 58). In two-dimensional space, the cylinders can be represented by two nested rectangles depicting the height and width of the cylinders. The width of the larger cylinder (or rectangle) can be represented by  $0.173 \lambda$  and the width of the smaller cylinder represented by  $0.156 \lambda$ . The length of the larger cylinder or rectangle can be represented by  $0.260 \lambda$ , and the length of the smaller rectangle or cylinder can be represented by  $0.238 \lambda$ . Using these figures, you should be able to scale the QHA to virtually any frequency. Table 6 shows some representative antenna sizes for various frequencies, along with the universal parameters needed to arrive at these figures.

### PHYSICAL CONSTRUCTION

Fig 59 shows the construction details. A 25-inch-long piece of schedule 40, 2-inch-diameter PVC pipe is used for the vertical member. The cross arms that support the helices are six pieces of  $\frac{1}{2}$ -inch-diameter PVC tubing: three the width of the large rectangle or cylinder, and three the width of the smaller cylinder. Two cross arms are needed for the top and bottom of each cylinder. The cross arms are oriented perpendicularly to the vertical member and parallel to each other. A third cross arm is placed midway between the two at a  $90^\circ$  angle. This process is repeated for the smaller cylindrical dimensions using the three smaller cross arms with the top and bottom pieces oriented  $90^\circ$  to the large pieces.

Using  $\frac{3}{8}$  inch-diameter holes in the 2-inch pipe ensures a reasonably snug fit for the  $\frac{1}{2}$ -inch-diameter cross pieces. Each cross arm is drilled (or notched) at its ends to accept the lengths of wire and coax used for the elements. Then the cross arms are centered and cemented in place with PVC cement. For the 137 and 146 MHz antennas, use #10 AWG copper clad antenna wire for three of the helices and a length of RG-8 for the balun, which is also the fourth helix. (Do not consider the velocity factor of the coax leg for length calculation.) For the UHF antennas, use #10 AWG soft-drawn copper wire and RG-58 coax. Copper

Table 6  
Quadrifilar Helix Antenna Dimensions

Freq (MHz)	Wavelength ( $\lambda$ ) (inches)	Small Loop -----			Big Loop -----		
		Leg Size ( $0.508 \lambda$ )	Diameter ( $0.156 \lambda$ )	Length ( $0.238 \lambda$ )	Leg Size ( $0.560 \lambda$ )	Diameter ( $0.173 \lambda$ )	Length ( $0.261 \lambda$ )
137.5	85.9	43.64	13.4	20.44	48.10	14.86	22.33
146	80.9	41.09	12.6	19.25	45.30	14.0	21.03
436	27.09	13.76	4.22	6.44	15.17	4.68	7.04



**Fig 57 — Another view of the QHA.**



**Fig 58 — An end-on view of the top of the QHA prior to soldering the loops and installing the PVC cap.**

clad wire is difficult to work with, but holds its shape well. Smaller antennas can be built without the cross arms because the wire is sufficiently self-supporting.

To minimize confusion regarding the connections and to indicate the individual legs of the helices, label each loop or cylinder as B (for big) and S (for small); T and B indicate top and bottom. Each loop can be further split using leg designators as B1T and B1B, B2T and B2B, S1T and S1B and S2T and S2B, with B2 being the length of coax and the other three legs as wires. For righthand circular polarization (RHCP) wind the helices *counterclockwise* as viewed from the top. This is contrary to conventional axial mode helix construction. (For LHCP, the turns rotate *clockwise* as viewed from the top.) See **Fig 60** for the proper connections for the top view. When the antenna is completed, the view shows that there are two connections made

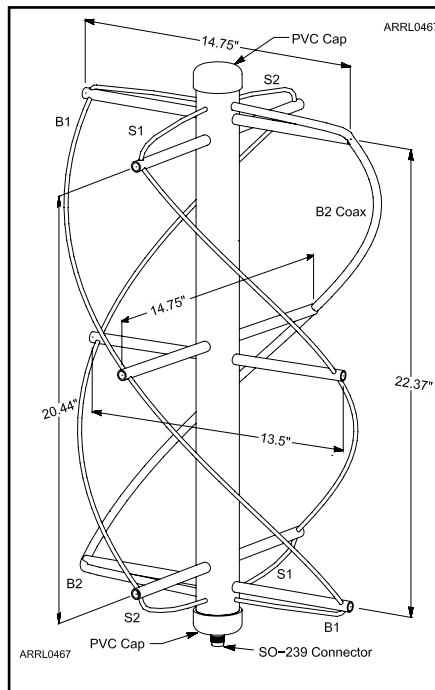

**Fig 59 — Drawing of the QHA identifying the individual legs; see text for an explanation.**

to the center conductor of the coax (B2) top. These are B1T and S1T, for a total of three wires on one connection. S2T connects to B2T braid. The bottom of the antenna has S1B and S2B soldered together to complete the smaller loop. B1B and the braid of B2B are soldered together. Attach an SO-239 con-

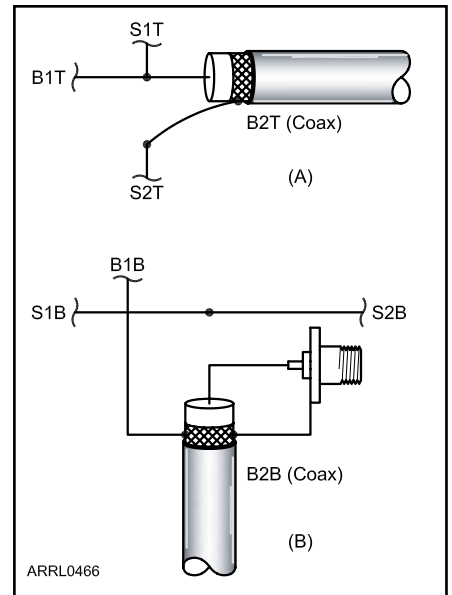

**Fig 60 — At A, element connections at the top of the antenna. B shows the connections at the bottom of the antenna. The identifiers are those shown in Fig 59 and explained in the text.**

ductor to the bottom by soldering the center conductor of B2B to the center of the connector and the braid of B2B to the connector's shell. The bottom now has two connections to the braid: one to leg B1B, the other to the shell of the connector. There's only one connection to the center conductor of B2B that goes to the SO-239 center pin.

Total price for all new materials—including the price of a suitable connector—should be in the neighborhood of \$10 or less.

## RESULTS

With a 70-foot section of RG-9 between the receiver and antenna, which is mounted about 12 feet above ground, and a preamp in the shack the author receives fade-free passes from the weather satellites. Although the design indicates a 3-dB beamwidth of 140°, an overhead pass provides useful data down to 10° above the horizon. The 70 cm antenna works fine for PACSATs, although Doppler effect makes manual tracking difficult. The weather-satellite antenna prototype worked better than expected and a number of copies built by others required no significant changes.

Thanks to Chris Van Lint, and Tom Loebel, WA1VTA, for supplying technical data to complete this project, and to Walt Maxwell, W2DU, for his review and technical evaluation and for sharing his technical expertise with the amateur satellite community.

# 7 Satellite References and Bibliography

## Books

S. Ford, WB8IMY, *The ARRL Satellite Handbook* (Newington: ARRL, 2008) *Getting Started with Amateur Satellites*, available from AMSAT-NA at [www.amsat-na.com/store/](http://www.amsat-na.com/store/).  
*Digital Satellite and Telemetry Guide*, available from AMSAT-NA at [www.amsat-na.com/store/](http://www.amsat-na.com/store/).

## Articles

P. Alvarez-Cienfuegos, EB4DKA and J. Montana, EA4CYQ, "A Better Way to Work Low Earth Orbit FM Satellites," *QST*, Feb 2009, pp 41-43  
 L.B. Cebik, W4RNL, "Circularly Polarized Aimed Satellite Antenna," *Antenna Options*, *QEX*, Sep/Oct 2007, pp 51-56.  
 P. Antoniazzi, IW2ACD, and M. Arecco, IK2WAQ, "Low-Profile Helix Feed for

Phase 3E Satellites: System Simulation and Measurements," *QEX*, May/June 2006, pp 34-39.  
 M. Spencer, WA8SME, "A Satellite Tracker Interface," *QST*, Sep 2005, pp 64-67.  
 L. Smith, W5KQJ, "An Affordable Az-El Positioner for Small Antennas," *QST*, Jun 2003, pp 28-34.

# 8 Earth-Moon-Earth (EME) Communication

EME communication, also known as *moonbounce*, has become a popular form of amateur space communication. The EME concept is simple: the moon is used as a passive reflector for two-way communication between two locations on Earth (see Fig 61). With a total path length of about half a million miles, EME may be considered the ultimate DX. Very large path losses suggest big antennas, high power and the best low noise receivers; however, the adoption of modern coding and modulation techniques can significantly reduce these requirements from their levels of just 10 years ago. Even so, communication over the EME path presents unusual station design challenges and offers special satisfaction to those who can meet them.

## 8.1 Background

EME is a natural and passive propagation phenomenon, and EME QSOs count toward WAC, WAS, DXCC and VUCC awards. EME opens up the bands at VHF and above to a new frontier of worldwide DX.

Professional demonstrations of EME capability were accomplished shortly after WWII. Amateurs were not far behind, with successful reception of EME echoes in 1953 and pioneering two-way contacts made on the 1296, 144 and 432 MHz bands in the 1960s. Increased EME activity and advances to other bands came in the 1970s, aided by the availability of reliable low-noise semiconductor devices and significant improvements in the design of Yagi arrays and feed antennas for parabolic dishes. These trends accelerated further in the 1980s with the advent of low-noise GaAsFET and HEMT preamplifiers and computer-aided antenna designs, and again after 2000 with the introduction of digital techniques. See the sidebar, "Amateur EME Milestones."

EME QSOs have been made on all amateur bands from 28 MHz to 47 GHz. Many operators have made WAC, WAS and even DXCC on one or more of the VHF and UHF bands. EME is now within the grasp of most serious VHF and UHF operators.

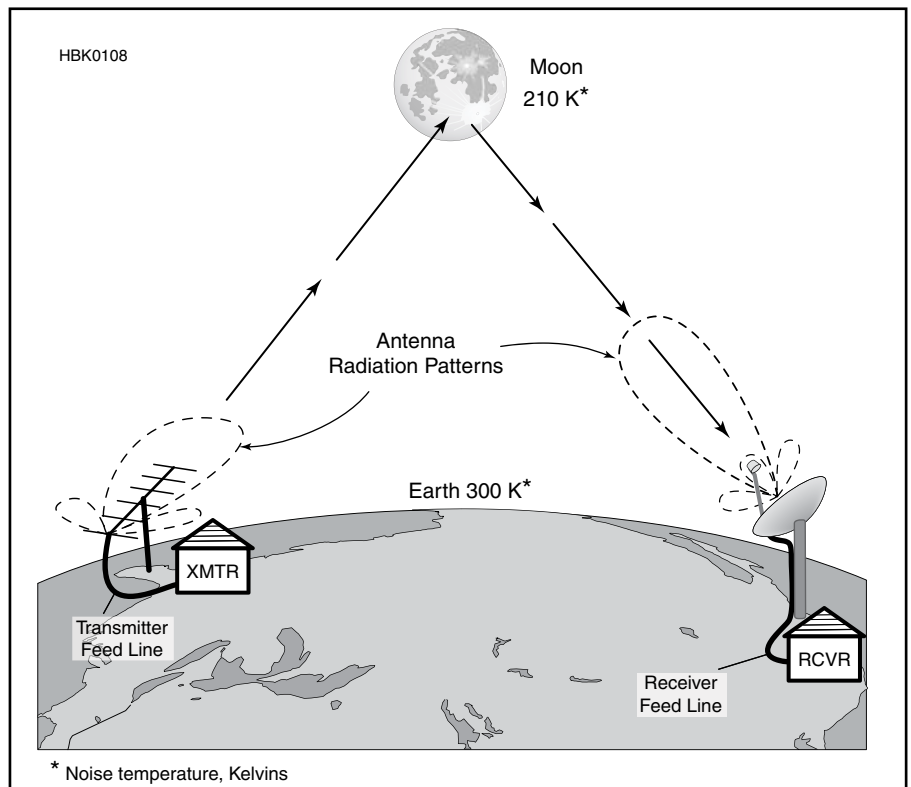

**Fig 61 — Schematic representation of major system components for a (one-way) EME path. This illustration also shows some of the factors contributing to system noise temperature, which is discussed later in the chapter.**

## Amateur EME Milestones

- 1953 W3GKP and W4AO detect lunar echoes on 144 MHz
- 1960 First amateur 2-way EME contact: W6HB works W1FZJ, 1296 MHz
- 1964 W6DNG works OH1NL, 144 MHz
- 1964 KH6UK works W1BU, 432 MHz
- 1970 WB6NMT works W7CNK, 222 MHz
- 1970 W4HHK works W3GKP, 2.3GHz
- 1972 W5WAX and K5WVX work WA5HMK and W5SXD, 50 MHz
- 1987 W7CNK and KA5JPD work WA5TNY and KD5RO, 3.4 GHz
- 1987 W7CNK and KA5JPD work WA5TNY and KD5RO, 5.7 GHz
- 1988 K5JL works WA5ETV, 902 MHz
- 1988 WA5VJB and KF5N work WA7CJO and KY7B, 10 GHz
- 2001 W5LUA works VE4MA, 24 GHz
- 2005 AD6FP, W5LUA and VE4MA work RW3BP, 47 GHz
- 2005 RU1AA works SM2CEW, 28 MHz
- 2009 GD0TEP works ZS6WAB, 70 MHz

# 9 EME Propagation

## 9.1 Path Loss

Path loss in free space is caused by nothing more than the spherical expansion of a radio wave as it propagates away from an antenna. An EME signal is attenuated as  $1/d^2$  (inverse distance squared) over the quarter-million mile path to the moon, and again as  $1/d^2$  on the return trip, for a net  $1/d^4$  path loss. Radio waves incident on the surface of the moon are often said to be “reflected,” although in fact they are partly absorbed and partly scattered by the irregular lunar surface. A full expression giving the EME path loss as a ratio of received power to transmitted power, assuming isotropic antennas at each end of the path, is

$$\ell = \frac{\eta r^2 \lambda^2}{64 \pi^2 d^4} \quad (1)$$

where

- r is the radius of the moon
- $\lambda$  is the wavelength
- d is the distance to the moon
- $\eta$  is the lunar reflection coefficient.

In this section we use the convention of lower-case letters to denote dimensionless ratios, and the corresponding upper-case letters to give equivalent values in dB. Thus, the EME path loss in dB is given for isotropic antennas by the expression

$$L = 10 \log \ell = 10 \log \left( \frac{\eta r^2 \lambda^2}{64 \pi^2 d^4} \right) \quad (2)$$

Inserting values  $r = 1.738 \times 10^6$  m,  $d = 3.844 \times 10^8$  m and  $\eta = 0.065$  gives the average path losses quoted in **Table 7** for the principal amateur EME bands. The need to overcome these very large attenuations is of course the main reason why EME is so challenging. The moon’s orbit is an ellipse, and its distance d varies by  $\pm 6.8\%$  over each month. Because of the inverse-fourth-power law in Equations (1) and (2), this change results in path-loss variations of  $\pm 1.1$  dB at the extremes of lunar distance, independent of frequency. The reflection of radio waves is of course not affected by the optical phases of the moon.

The dependence of path loss on  $\lambda^2$  suggests that EME should be nearly 20 dB more difficult at 1296 MHz than at 144 MHz. This conclusion is misleading, however, because of the assumption of isotropic antennas. If one uses transmitting and receiving antennas of gain  $g_t$  and  $g_r$ , expressed as ratios, the expected power  $p_r$  received as a lunar echo may be written as the product

$$P_r = P_t g_t g_r \ell \quad (3)$$

**Table 7**  
**Two-Way EME Path Loss with Isotropic Antennas**

Frequency (MHz)	Average Path Loss (dB)
50	-242.9
144	-252.1
222	-255.8
432	-261.6
902	-268.0
1296	-271.2
2304	-276.2
3456	-279.7
5760	-284.1
10368	-289.2
24048	-293.5

where  $p_t$  is the transmitted power. The standard expression for an antenna’s power gain is

$$g = 4\pi A / \lambda^2$$

where A is the effective aperture or collecting area. Gain in dBi (dB over an isotropic antenna) may therefore be written as

$$G = 10 \log (4\pi A / \lambda^2)$$

With  $P_r$  and  $P_t$  expressed in dB relative to some reference power, for example 1 W, we have

$$P_r = P_t + G_t + L + G_r \quad (4)$$

Thus, assuming a fixed size of antenna, such as a parabolic dish or Yagi array of effective frontal area A, the frequency dependence is reversed: for a given transmitted power, lunar echoes would be 20 dB stronger for every decade increase in frequency, rather than 20 dB weaker. Most practical situations fall somewhere between these two extremes of frequency dependence.

For reasons explained in detail below, amateur EME communication is feasible with roughly comparable degrees of difficulty over nearly two decades of frequency, from 144 MHz to 10 GHz. Not surprisingly, some very different techniques must be mastered in order to do successful EME at the lower and upper extremes of this wide frequency range — so the final choice of band(s) for EME is often determined by the interests, skills and resources of an individual operator.

## 9.2 Echo Delay and Time Spread

Radio waves propagate at speed c, the speed of light, very nearly equal to  $3 \times 10^8$  m/s. Propagation time to the moon and back is therefore  $2d/c$  or about 2.4 s at perigee, 2.7 s at apogee and 2.56 s on average. The moon is nearly spherical, and its radius cor-

responds to  $r/c = 5.8$  ms of wave travel time. The trailing parts of an echo, reflected from irregular surface features near the edge of the lunar disk, are delayed from the leading edge by as much as twice this value. In practice, most of the moon’s surface appears relatively smooth at the radio wavelengths used for amateur EME. Lunar reflections are therefore quasi-specular, like those from a shiny ball bearing, and the power useful for communication is mostly reflected from a small region near the center of the disk. At VHF and UHF frequencies, the effective *time spread* of an echo amounts to no more than 0.1 ms.

Reflection from a smooth surface preserves linear polarization and reverses the sense of circular polarization. At shorter wavelengths the lunar surface appears increasingly rough, so reflections at 10 GHz and above contain a significant diffuse component as well as a quasi-specular component. The diffuse component is depolarized, and significant portions of it arise from regions farther out toward the lunar rim. The median time spread can then be as much as several milliseconds. In all practical cases, however, time spreading is small enough that it does not cause significant smearing of CW keying or intersymbol interference in the slowly keyed modulations commonly used for digital EME.

Time spreading does have one very significant effect. Signal components reflected from different parts of the lunar surface travel different distances and arrive at Earth with random phase relationships. As the relative geometry of the transmitting station, receiving station and reflecting lunar surface changes, signal components may sometimes add and sometimes cancel, creating large amplitude fluctuations. Often referred to as *libration fading*, these amplitude variations will be well correlated over a *coherence bandwidth* of a few kHz, the inverse of the time spread.

## 9.3 Doppler Shift and Frequency Spread

EME signals are also affected by Doppler shifts caused by the relative motions of Earth and moon. Received frequencies may be higher or lower than those transmitted; the shift is proportional to frequency and to the rate of change of total path length from transmitter to receiver. The velocities in question are usually dominated by the Earth’s rotation, which at the equator amounts to about 460 m/s. For the self-echo or “radar” path, frequency shift will be maximum and positive at moonrise, falling through zero as the moon crosses the local meridian (north-south line) and a maximum negative value at moonset. The magnitude of



shifts depends on station latitude, the declination of the moon and other geometrical factors. For two stations at different geographic locations the mutual Doppler shift is the sum of the individual (one-way) shifts. Maximum values are around 440 Hz at 144 MHz, 4 kHz at 1296 MHz and 30 kHz at 10 GHz.

Just as different reflection points on the lunar surface produce different time delays, they also produce different Doppler shifts. The moon's rotation and orbital motion are synchronized so that approximately the same face is always toward Earth. The orbit is eccentric, so the orbital speed varies; since the rotation rate does not vary, an observer on Earth sees an apparent slow "rocking" of the moon, back and forth.

Further aspect changes are caused by the 5.1° inclination between the orbital planes of Earth and moon. The resulting total line-of-sight velocity differences are around 0.2 m/s, causing a *frequency spread* of order 0.2 Hz at 144 MHz. Like all Doppler effects, these shifts scale with frequency. However, measured values of frequency spread increase slightly more rapidly than frequency to the first power because a larger portion of the lunar surface contributes significantly to echo power at higher frequencies. Linear scaling would suggest frequency spread around 15 Hz at 10 GHz, but measurements show it to be several times larger.

From a communication engineering point of view, libration fading is just another example of the so-called *Rayleigh fading* observed on any radio channel that involves multiple signal paths — such as ionospheric skywave, tropospheric scatter and terrain multipath channels with reflections from buildings, trees or mountains. Interference effects that cause signal fading depend on frequency spread as well as time spread. Signal amplitudes remain nearly constant over a *coherence time* given by the inverse of frequency spread. In general, fading rates are highest (shortest coherence times) when the moon is close to the local meridian and lowest near moonrise and moonset. They also depend on the moon's location in its elliptical orbit.

Typical coherence times are several seconds at 144 MHz, a few tenths of a second at 1296 MHz and 20 ms at 10 GHz. At 144 MHz, intensity peaks lasting a few seconds can aid copy of several successive CW characters, but at 432 MHz the timescale of peaks and dropouts is closer to that of single characters. At 1296 MHz the fading rates are often such that CW characters are severely chopped up, with dashes seemingly converted to several dits; while the extremely rapid fading at 10 GHz can give signals an almost "auroral" tone. Skilled operators must learn to deal with such effects as best they can. As described further below, modern digital techniques can use message synchronization as well as error-correcting codes and other diversity tech-

niques to substantially improve the reliability of copy on marginal, rapidly fading EME signals.

## 9.4 Atmospheric and Ionospheric Effects

Propagation losses in the Earth's troposphere are negligible at VHF and UHF, although rain attenuation can be an important factor above 5 GHz. Tropospheric ducting of the sort that produces enhanced terrestrial propagation can bend signals so that the optimum beam heading for EME is directed away from the moon's center. Even under normal conditions, enough refraction occurs to allow radio echoes when the moon is slightly below the visible horizon. In practice, these problems are usually overshadowed by other complications of doing EME at very low elevations, such as blockage from nearby trees or buildings, increased noise from the warm Earth in the antenna's main beam and man-made interference.

The Earth's ionosphere causes several propagation effects that can be important to EME. These phenomena depend on slant distance through the ionospheric layer, which increases at low elevations. At elevation 10°, attenuation through the daytime ionosphere is generally less than 0.5 dB at 144 MHz, and nighttime values are at least 10 times lower. These numbers scale inversely as frequency squared, so ionospheric absorption is mostly negligible for EME purposes. Exceptions can occur at 50 MHz, and under disturbed ionospheric conditions at higher frequencies. Ionospheric refraction can also be important at 50 MHz, at very low elevations. Ionospheric scintillations (analogous to the "twinkling" of stars in the Earth's atmosphere) can exhibit significant effects at VHF and UHF, primarily on EME paths penetrating the nighttime geomagnetic equatorial zone or the auroral regions. Again, disturbed ionospheric conditions magnify the effects. The multipath time spread is very small, less than a microsecond, while frequency spread and fading rate can be in the fractional hertz to several hertz range. These scintillations can increase the fading rates produced by Earth rotation and lunar librations.

Much more important is the effect of Faraday rotation in the ionosphere. A linearly polarized wave will see its plane of polarization rotate in proportion to the local free-electron density, the line-of-sight component of the Earth's magnetic field and the square of wavelength. The effect is therefore greatest during the daytime, for stations well away from the equator, and at low frequencies. A mismatch  $\Delta\theta$  between an incoming wave's polarization angle and that of the receiving antenna will attenuate received signal power by an amount  $\cos^2\Delta\theta$ . As shown in **Fig 62**, polarization losses increase rapidly when the misalignment exceeds 45°.

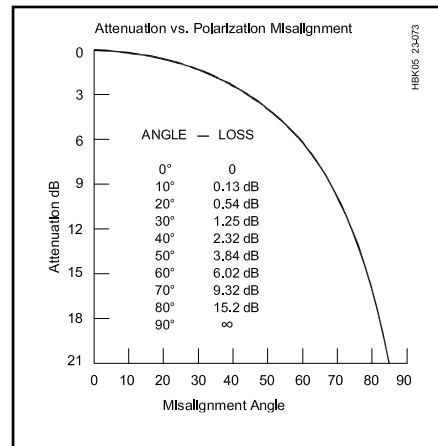

**Fig 62 — Attenuation caused by misalignment of a linearly polarized signal with the polarization angle of a receiving antenna. The attenuation increases rapidly for alignment errors greater than 45°.**

Because of the  $\lambda^2$  dependence, Faraday rotation is generally important for EME operation only at 432 MHz and below. The effect is cumulative for an outgoing signal and its returning echo, so a station transmitting and receiving with the same linearly polarized antenna will see its own echoes disappear whenever the total Faraday rotation is close to an odd integral multiple of 90°. Faraday rotation in the daytime ionosphere can amount to as much as a full turn at 432 MHz and many turns at 144 MHz. At 432 MHz the rotation may be essentially constant over several hours; on lower bands significant changes can occur in 30 minutes or less. Variations are especially noticeable near sunrise or sunset at one end of the path, where ionization levels are changing rapidly.

The Earth's spherical shape determines the orientation in space of a wave emitted or received by an antenna with horizontal (or other locally referenced) polarization angle. As discussed in detail below, when combined with Faraday rotation this effect can cause users of fixed-linear-polarization antennas to experience apparent one-way propagation.

A polarized radio signal reflected from the moon's rough surface is partially scattered into other polarization states, and a disturbed ionosphere can sometimes generate a mixture of polarization angles. As a consequence, fading caused by 90° polarization misalignments will not always produce deep nulls. Measurements show that at UHF and below, the cross-polarized scattered signal is usually 15 dB or more below the principal polarization. On the other hand, at 10 GHz and higher, where the lunar surface is much rougher in terms of wavelength, cross-polarized diffuse echoes may be only a few dB below the principal reflected polarization. These comments apply to both linear and circular polarization.

# 10 Fundamental Limits

## 10.1 Background Noise

EME signals are always weak, so considerations of signal-to-noise ratio are paramount. (Noise is also discussed in the **RF Techniques** chapter.) A received signal necessarily competes with noise generated in the receiver as well as that picked up by the antenna, including contributions from the warm Earth, the atmosphere, the lunar surface, the diffuse galactic and cosmic background and possibly the sun and other sources. (Refer to Fig 61, and think of adding a warm atmosphere just above the Earth, the sun somewhere beyond the moon, and galactic and extragalactic noise sources at even greater distances, filling the whole sky.) If  $P_n$  is the total noise power collected from all such noise sources expressed in dBW, we can write the expected signal-to-noise ratio of the EME link as

$$SNR = P_r - P_n = P_t + G_t + L + G_r - P_n \quad (5)$$

Since isotropic path loss  $L$  is essentially fixed by choice of a frequency band (Table 7), optimizing the signal-to-noise ratio generally involves trade-offs designed to maximize  $P_r$  and minimize  $P_n$  — subject, of course, to such practical considerations as cost, size, maintainability and licensing constraints.

It is convenient to express  $P_n$  (in dBW) in terms of an equivalent system noise temperature  $T_s$  in kelvins (K), the receiver bandwidth  $B$  in Hz and Boltzmann's constant  $k = 1.38 \times 10^{-23} \text{ J K}^{-1}$ :

$$P_n = 10 \log(kT_s B) \quad (6)$$

The system noise temperature may in turn be written as

$$T_s = T_r + T_a \quad (7)$$

Here  $T_r$  is receiver noise temperature, related to the commonly quoted noise figure (NF) in dB by

$$T_r = 290(10^{0.1NF} - 1) \quad (8)$$

Antenna temperature  $T_a$  includes contributions from all noise sources in the field of view, weighted by the antenna pattern. The lunar surface has a temperature around 210 K; since most antennas used for amateur EME have beamwidths greater than the moon's angular size, as well as sidelobes, the moon's effect will be diluted and noise from other sources will also be received. Sidelobes are important, even if many dB down from the main beam, because their total solid angle is large and therefore they are capable of collecting significant unwanted noise power.

At VHF the most important noise source is

diffuse background radiation from our Galaxy, the Milky Way. An all-sky map of noise temperature at 144 MHz is presented in the top panel of **Fig 63**. This noise is strongest along the plane of the Galaxy and toward the galactic center. Galactic noise scales as frequency to the  $-2.6$  power, so at 50 MHz the

temperatures in Fig 63 should be multiplied by about 15, and at 432 divided by 17. At 1296 MHz and above galactic noise is negligible in most directions. During each month the moon follows a right-to-left path lying close to the ecliptic, the smooth solid curve plotted in Fig 63. Sky background temperature behind

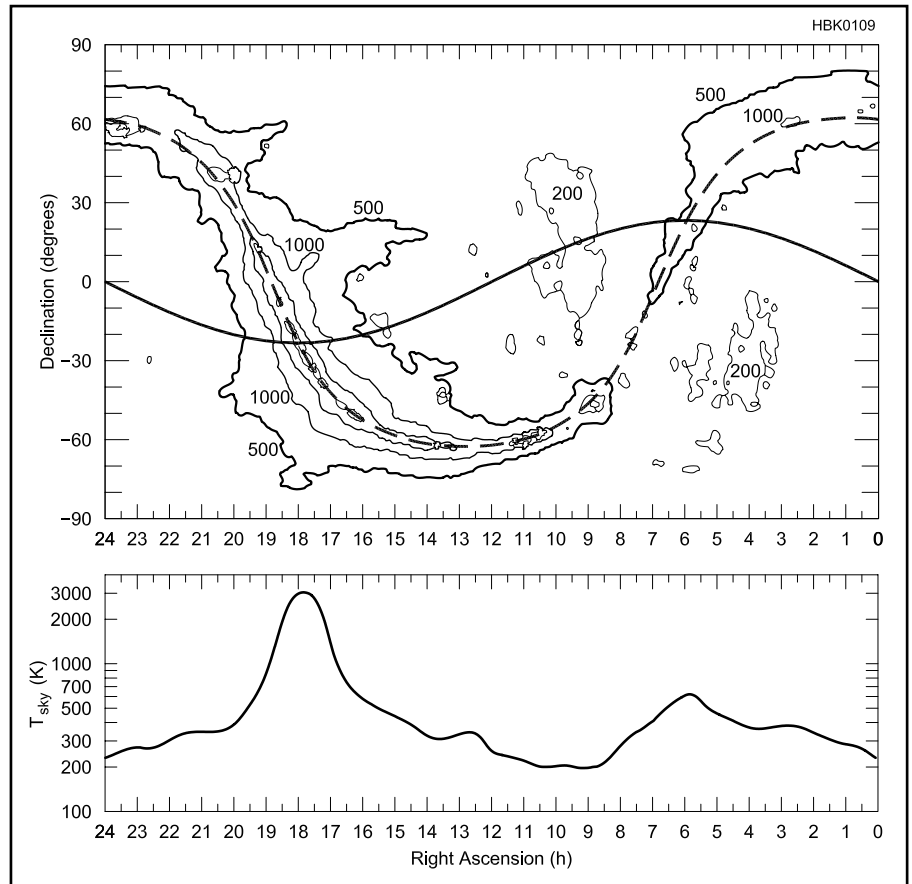

**Fig 63 — Top:** All-sky contour map of sky background temperature at 144 MHz. The dashed curve indicates the plane of our Galaxy, the Milky Way; the solid sinusoidal curve is the plane of the ecliptic. The Sun follows a path along the ecliptic in one year; the moon moves approximately along the ecliptic ( $\pm 5^\circ$ ) each month. Map contours are at noise temperatures 200, 500, 1000, 2000 and 5000 K. **Bottom:** One-dimensional plot of sky background temperature at 144 MHz along the ecliptic, smoothed to an effective beamwidth  $15^\circ$ .

**Table 8**  
**Typical Contributions to System Noise Temperature**

Freq (MHz)	CMB (K)	Atm (K)	Moon (K)	Gal (K)	Side (K)	$T_a$ (K)	$T_r$ (K)	$T_s$ (K)
50	3	0	0	2400	1100	3500	50	3500
144	3	0	0	160	100	260	50	310
222	3	0	0	50	50	100	50	150
432	3	0	0	9	33	45	40	85
902	3	0	1	1	30	35	35	70
1296	3	0	2	0	30	35	35	70
2304	3	0	4	0	30	37	40	77
3456	3	1	5	0	30	40	50	90
5760	3	3	13	0	30	50	60	110
10368	3	10	42	0	30	85	75	160
24048	3	70	170	0	36	260	100	360

the moon therefore varies approximately as shown in the lower panel of Fig 63, regardless of geographical location on Earth. For about five days each month, when the moon is near right ascension 18 hours and declination  $-28^\circ$ , VHF sky background temperatures near the moon are as much as 10 times their average value, and conditions for EME on the VHF bands are poor.

By definition the sun also appears to an observer on Earth to move along the ecliptic, and during the day solar noise can add significantly to  $P_n$  if the moon is close to the sun or the antenna has pronounced sidelobes. At frequencies greater than about 5 GHz the Earth's atmosphere also contributes significantly. An ultimate noise floor of 3 K, independent of frequency, is set by cosmic background radiation that fills all space. A practical summary of significant contributions to system noise temperature for the amateur bands 50 MHz through 24 GHz is presented in Table 8 and Fig 64 and Fig 65, discussed in the next section.

## 10.2 Antenna and Power Requirements

The basic circumstances described so far ensure that frequencies from 100 MHz to 10 GHz are the optimum choices for EME and space communication. Over this region and a bit beyond, a wide variety of propagation effects and equipment requirements provide a fascinating array of challenges and opportunities for the EME enthusiast. The enormous path-loss variability encountered in terrestrial HF and VHF propagation does not occur in EME work, and some of the remaining, smaller variations — for example, those arising from changing lunar distance and different sky background temperatures — are predictable. We can therefore estimate with some confidence the minimum antenna sizes and transmitter powers required for EME communication on each amateur band.

The necessary information for this task is summarized in Table 8 and Figs 64 and 65. Columns 2 through 6 of the table give typical contributions to system noise temperature from the cosmic microwave background (CMB), the Earth's atmosphere, the warm surface of the moon, galactic noise entering through the main antenna beam and sky and ground noise from an antenna's side and rear lobes. Antenna temperature  $T_a$  is a combination of all these contributions, appropriately weighted by antenna pattern; the system noise temperature  $T_s$  is then the sum of  $T_a$  and receiver noise temperature  $T_r$ , referred to the antenna terminals. Numbers in Table 8 are based on the fundamentals described in the previous section and on hypothetical antennas and receivers that conform to good amateur practice in the year 2009; they have

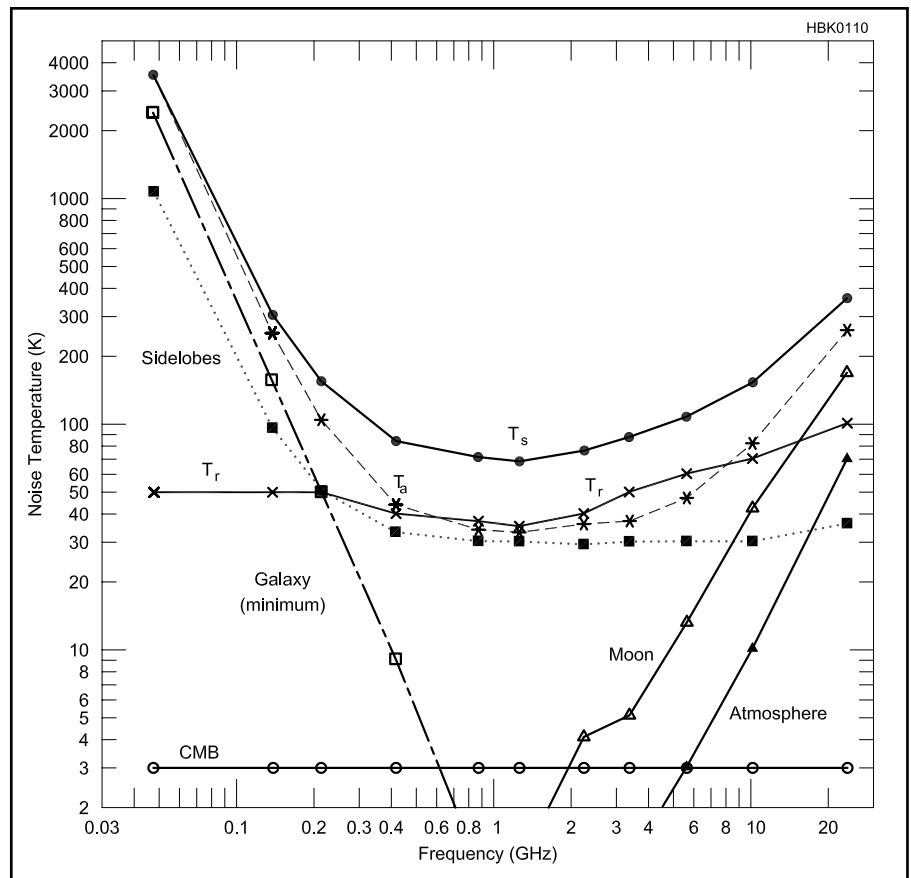

Fig 64 — Typical contributions to system noise temperature  $T_s$  as function of frequency. See text for definitions and descriptions of the various sources of noise.

been rounded to two significant figures. It is possible to do slightly better than these numbers — for example, by building antennas with lower sidelobe response or preamplifiers with still lower noise figure — but it's not easy!

The topmost curve in Fig 64 illustrates clearly why the frequency range from 100 MHz to 10 GHz is optimum for EME communication. Fig 65 shows that further reductions of  $T_s$  must come from lower  $T_r$  or better suppression of antenna sidelobes. There is nothing you can do about noise from the CMB, atmosphere, moon or Galaxy entering your main beam! For comparison, the very best professional receiving equipment achieves system noise temperatures around 20 K in the 1-2 GHz region — only a few dB better than current amateur practice. These systems generally use cryogenic receivers and very large dish antennas that can provide better suppression of sidelobes.

Having established reasonable target figures for system noise temperature, we can now proceed to estimate minimum antenna and power requirements for an EME-capable station on each amateur band. Rearrangement of Equations (5) and (6) yields the following relation for transmitter power  $P_t$  in dBW:

$$P_t = \text{SNR} - G_t - G_r - L + 10 \log(kT_s B) \quad (9)$$

Values for  $L$  and  $T_s$  can be taken for each amateur band from Tables 7 and 8. For illustrative purposes let's assume  $\text{SNR} = 3$  dB and  $B = 50$  Hz, values appropriate for a good human operator copying a marginal CW signal. (The 50 Hz effective bandwidth may be established by an actual filter, or more commonly by the operator's "ear-and-brain" filter used together with a broader filter.) For antennas we shall assume bays of four long Yagis for the 50 through 432 MHz bands, parabolic dishes of diameter 3 m on 1296 and 2304 MHz and 2 m dishes on the higher bands. Representative gains and half-power beamwidths for such antennas are listed in columns 3 and 4 of Table 9. Column 5 then gives the necessary transmitter power in watts, rounded to two significant figures.

A station with these baseline capabilities should be self sufficient in terms of its ability to overcome EME path losses — and thus able to hear its own EME echoes and make CW contacts with other similarly equipped EME stations. Note that the quoted minimum values of transmitter power do not allow for feed line losses; moreover, a CW signal with  $\text{SNR} =$

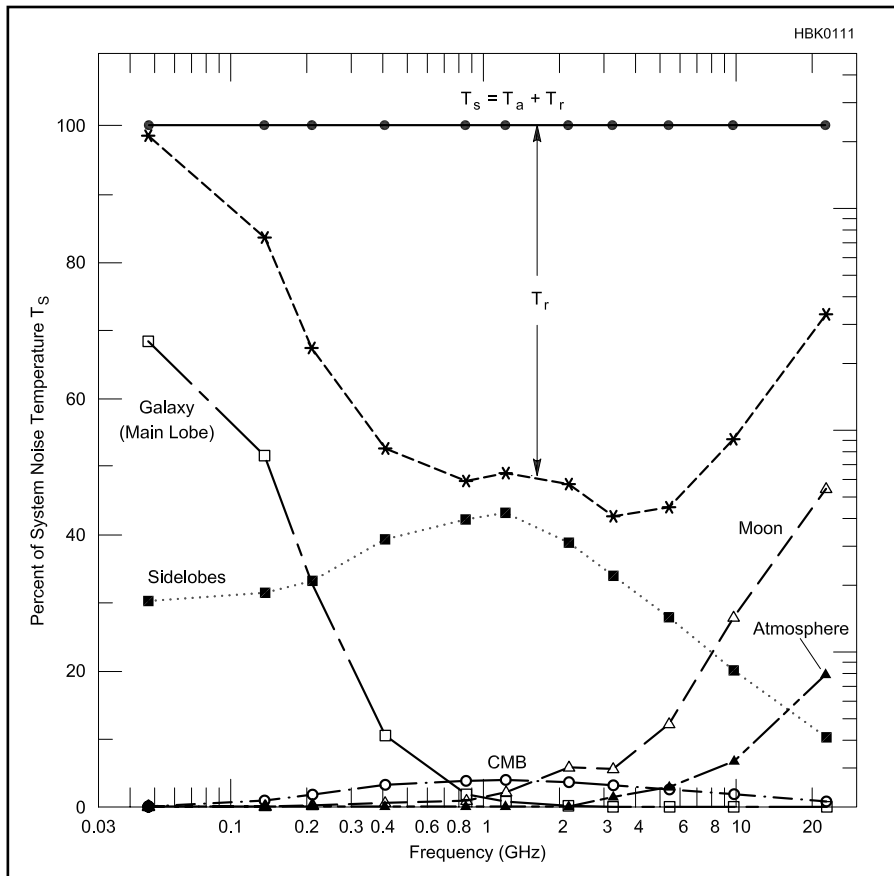

Fig 65 — Percentage contributions to system noise temperature as a function of frequency.

3 dB in 50 Hz bandwidth hardly represents “armchair copy.” At the highest frequencies, issues of oscillator stability and Doppler spreading might make the assumed 50 Hz bandwidth unrealistically narrow, thus requiring somewhat more power or a larger antenna. On the other hand, lower power and smaller antennas can be sufficient for working stations with greater capabilities than those in the table.

Other factors can reduce the minimum power or antenna gains required for successful EME, at least some of the time. One possibility, especially effective at 50 and 144 MHz at low moon elevations, is to take advantage of reflections from reasonably smooth ground (or better still, water) in front of your antenna. Often referred to as *ground gain*, these reflections can add as much as 6 dB to an antenna’s effective gain at elevations where the reflections are in phase with the direct signal. Another possibility is to use more efficient coding and modulation schemes than provided by Morse coded CW.

### 10.3 Coding and Modulation

International Morse code with on-off keying (OOK) is an excellent general purpose communication mode. It is easy to implement and performs well in weak-signal conditions. EME

operating procedures for CW usually include multiple repetitions so that essential parts of a bare-minimum QSO can be assembled from fragments copied on signal peaks. However, modern communication theory points the way toward modulation schemes significantly more efficient than OOK, codes better than Morse, and error-control methods more effective than simple repetition. Amateur experiments with these ideas have led to the current popularity of digital EME on the VHF and lower UHF bands. In general, an efficient digital mode designed for basic communication with weak signals will compress user messages into a compact form and then add redundancy in the form of a mathematically defined error-correcting code (ECC). Such codes can ensure that full messages are recoverable with high confidence, even when significant portions of a transmission are lost or corrupted.

A number of distinct sources may contribute to the improved performance of such a mode over CW. Multitone FSK (MFSK) is a more efficient modulation than OOK, in part because each received symbol is roughly the equivalent of a full character, rather than a single dot or dash. For equivalent messages, MFSK can therefore be keyed much more slowly than CW and detected in a much smaller bandwidth. Morse code is self-synchronizing at the character level (if a signal



Fig 66 — TF/DL3OCH used a rural road sign to help him give contacts with Iceland to a number of EME operators on 1296 MHz. Bodo has activated many DXCC entities on 1296 MHz EME by using JT65, a single long Yagi and a 100 W solid state amplifier.

is strong enough for letters to be recognized), but a Morse transmission contains no useful information for synchronizing a whole message. This fact makes it difficult to piece together copied fragments of a CW message being sent repeatedly.

In contrast, a synchronized digital transmission with ECC can encode the complete message into a new data format designed to enhance the probability that successful decoding will produce the message’s full information content, with everything in its

Table 9  
Typical Antenna and Power Requirements for CW EME

Freq (MHz)	Ant Type <sup>1</sup>	G (dBi)	HPBW (deg)	TxPwr (W)
50	4x12 m	19.7	18.8	1200
144	4x6 m	21.0	15.4	500
432	4x6 m	25.0	10.5	250
1296	3 m	29.5	5.5	160
2304	3 m	34.5	3.1	60
3456	2 m	34.8	3.0	120
5760	2 m	39.2	1.8	60
10368	2 m	44.3	1.0	25

<sup>1</sup>Example antennas for 50, 144 and 432 MHz are Yagi arrays with stated lengths; those for 1296 MHz and higher are parabolic dishes of specified diameter.

proper place. For the limited purpose of exchanging call signs, signal reports and modest amounts of additional information, digital EME contacts can be made at signal levels some 10 dB below those required for CW, while at the same time improving reliability and maintaining comparable or better rates of information throughput. Depending on your

skill as a CW operator, the digital advantage may be even larger.

Thus, digital EME contacts are possible between similar stations with about 10 dB less power than specified in Table 9, or with 5 dB smaller antenna gains at both transmitter and receiver. An excellent example is the highly portable EME setup of DL3OCH,

shown in Fig 66. With a single long Yagi (59 elements, 5 m boom, 21.8 dBi gain), a 100 W solid state amplifier and the JT65C digital mode,<sup>1</sup> this equipment has helped to provide dozens of new DXCC credits on 1296 MHz from countries with little or no regular EME activity.

## 11 Building an EME Station

### 11.1 Antennas

The antenna is arguably the most important element in determining an EME station's capability. It is not accidental that the baseline station requirements outlined in Table 9 use Yagi arrays on the VHF bands and parabolic dishes at 1296 MHz and above: one of these two antenna types is almost always the best choice for EME. The gain of a modern, well designed Yagi of length  $\ell$  can be approximated by the equation

$$G = 8.1 \log(\ell / \lambda) + 11.4 \text{ dBi}, \quad (10)$$

and stacks of Yagis can yield close to 3 dB (minus phasing line losses) for each doubling

of the number of Yagis in the stack.

For comparison, the gain of a parabolic dish of diameter  $d$  with a typical feed arrangement yielding 55% efficiency is

$$G = 20 \log(d / \lambda) + 7.3 \text{ dBi} \quad (11)$$

The gains of some nominal antennas of each type are illustrated graphically in Fig 67, which helps to show why Yagis are nearly always the best choice for EME on the VHF bands. They are light, easy to build and have relatively low wind resistance. Stacks of four Yagis are small enough that they can be mounted on towers for sky coverage free of nearby obstructions. Larger arrays of 8, 16

or even more Yagis are possible, although the complexity and losses in phasing lines and power dividers then become important considerations, especially at higher frequencies. Long Yagis are narrowband antennas, usable on just a single band.

We usually think of the linear polarization of a transmitted signal as being "horizontal" or "vertical." Of course, on the spherical Earth these concepts have meaning only locally. As seen from the moon, widely separated horizontal antennas may have very different orientations (see Fig 68). Therefore, in the absence of Faraday rotation an EME signal transmitted with horizontal polarization by station A will have its linear polarization misaligned at stations B and C by angles known as the *spatial polarization offset*. In Fig 68 the signal from A arrives with vertical polarization at B and at 45° to the horizon at C. Suppose C is trying to work A and  $\theta_s = 45^\circ$  is the spatial polarization offset from A to C. The return signal from C to A will be offset in the opposite direction, that is, by an amount  $-\theta_s$

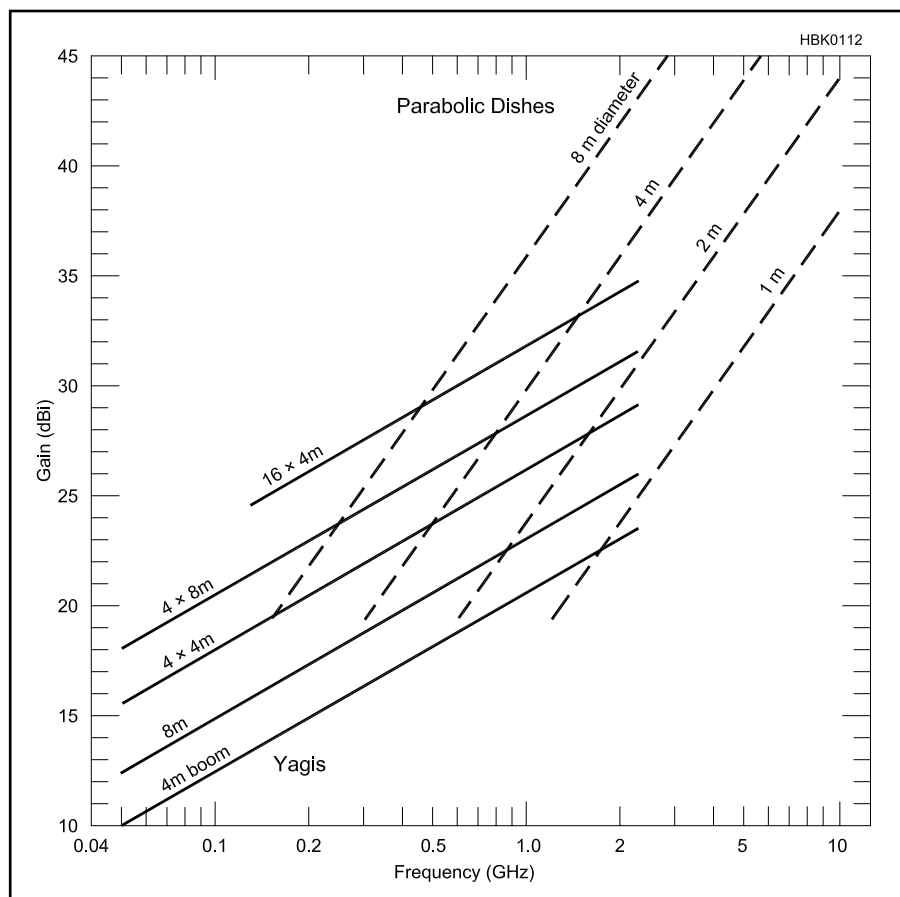

Fig 67 — Representative gains of practical Yagi antennas, arrays of Yagis and parabolic dishes as a function of frequency. Yagi arrays make the most cost-effective and convenient antennas for EME on the VHF bands, while parabolic dishes are generally the best choice above 1 GHz.

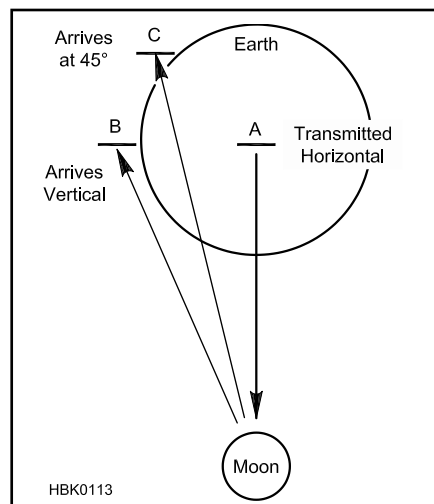

Fig 68 — The spherical Earth creates spatial polarization offsets for well-separated stations with horizon-oriented linear polarization. Here, a signal transmitted horizontally at A arrived with vertical polarization at B and midway between horizontal and vertical at C. When combined with Faraday rotation, offsets close to 45° can lead to apparent one-way propagation. See text for details.

## Computer and Internet Resources for EME

### Software for finding and tracking the moon:

*MoonSked*, by GM4JJJ, [www.gm4jjj.co.uk/MoonSked/moonsked.htm](http://www.gm4jjj.co.uk/MoonSked/moonsked.htm)  
*EME System*, by F1EHN, [www.f1ehn.org](http://www.f1ehn.org)  
*EME2008*, by VK3UM, [www.ve1alq.com/vk3um/index.html](http://www.ve1alq.com/vk3um/index.html)  
*SkyMoon*, by W5UN, [www.w5un.net](http://www.w5un.net)  
*GJTracker*, by W7GJ, [www.bigskyspaces.com/w7gj/](http://www.bigskyspaces.com/w7gj/)  
*WSJT*, by K1JT, [physics.princeton.edu/pulsar/K1JT/](http://physics.princeton.edu/pulsar/K1JT/)  
Web calculator: [www.satellite-calculations.com/Satellite/suncalc.htm](http://www.satellite-calculations.com/Satellite/suncalc.htm)

### Software for EME performance calculations:

*EMECalc*, by VK3UM, [www.ve1alq.com/vk3um/index.html](http://www.ve1alq.com/vk3um/index.html)

### Digital EME:

WSJT, MAP65: [physics.princeton.edu/pulsar/K1JT/](http://physics.princeton.edu/pulsar/K1JT/)

### Topical email reflectors:

Moon-Net: [www.nlsa.com/nets/moon-net-help.html](http://www.nlsa.com/nets/moon-net-help.html)  
Moon: [www.moonbounce.info/mailman/listinfo/moon](http://www.moonbounce.info/mailman/listinfo/moon)

### Beginner information:

W5UN: [www.w5un.net](http://www.w5un.net)  
EA6VQ: [www.vhfdx.net/jt65bintro.html](http://www.vhfdx.net/jt65bintro.html)  
W7GJ (EME on 50 MHz): [www.bigskyspaces.com/w7gj/](http://www.bigskyspaces.com/w7gj/)

### Technical references:

SM5BSZ: [www.sm5bsz.com/linuxdsp/linrad.htm](http://www.sm5bsz.com/linuxdsp/linrad.htm)  
W1GHZ: [www.w1ghz.org/antbook/contents.htm](http://www.w1ghz.org/antbook/contents.htm)  
GM3SEK: [www.ifwtech.co.uk/g3sek/eme/pol1.htm](http://www.ifwtech.co.uk/g3sek/eme/pol1.htm)  
and [www.ifwtech.co.uk/g3sek/stacking/stacking2.htm](http://www.ifwtech.co.uk/g3sek/stacking/stacking2.htm)  
F5VHX: [www.rfham.com/g8mbi/g8mbi/pol1.htm](http://www.rfham.com/g8mbi/g8mbi/pol1.htm)  
Dubus: [www.marsport.org.uk/dubus/eme.htm](http://www.marsport.org.uk/dubus/eme.htm)

### Chatrooms and Loggers:

NØUK: [www.chris.org/cgi-bin/jt65emeA](http://www.chris.org/cgi-bin/jt65emeA)  
ON4KST: [www.on4kst.com/chat/](http://www.on4kst.com/chat/)  
HB9Q: [hb9q.ch/joomla/](http://hb9q.ch/joomla/)

### Monthly Newsletters:

144 MHz, by DF2ZC: [www.df2zc.de/newsletter/index.html](http://www.df2zc.de/newsletter/index.html)  
432 and Above, by K2UYH: [www.nitehawk.com/rasmit/em70cm.html](http://www.nitehawk.com/rasmit/em70cm.html)

### Solar Flux data:

Archival: [www.ngdc.noaa.gov/stp/SOLAR/ftpsolarradio.html#noonflux](http://www.ngdc.noaa.gov/stp/SOLAR/ftpsolarradio.html#noonflux)  
Current: [www.ips.gov.au/Solar/3/4/2](http://www.ips.gov.au/Solar/3/4/2)

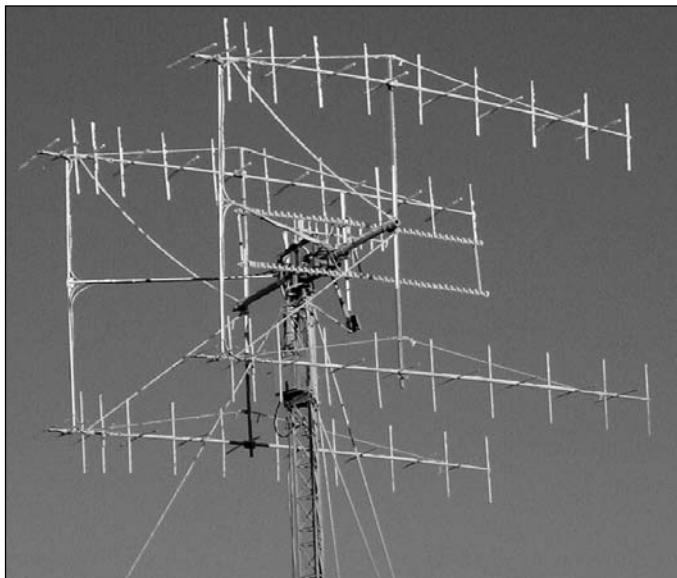

**Fig 70** — This 3 m TVRO dish with aluminum frame and mesh surface was outfitted for 1296 MHz EME as a joint effort by VA7MM and VE7CNF. The dual-circular polarization feed is a VE4MA/W2IMU design.

$= -45^\circ$ . The Faraday rotation angle  $\theta_F$ , on the other hand, has the same sign for transmission in both directions. Thus the net polarization shift from A to C is  $\theta_F + \theta_s$ , while that from C to A is  $\theta_F - \theta_s$ . If  $\theta_F$  is close to any of the values  $\pm 45^\circ, \pm 135^\circ, \pm 225^\circ, \dots$ , then one of the net polarization shifts is nearly  $90^\circ$  while the other is close to  $0^\circ$ . The result for stations with fixed linear polarization will be apparent one-way propagation: for example, A can copy C, but C cannot copy A.

Obviously no two-way contact can be made under these conditions, so the operators must wait for more favorable circumstances or else implement some form of polarization control or polarization diversity. One cost-effective solution is to mount two full sets of Yagi elements at right angles on the same boom. Arrays of such cross-polarized or “Xpol” Yagis make especially attractive EME antennas on the VHF and lower UHF bands because they offer a flexible solution to the linear-polarization misalignment problem. As an example, **Fig 69** shows the  $4 \times 10$  element, dual-polarization EME array at KL7UW. This antenna and a 160 W solid-state amplifier have accounted for hundreds of EME contacts with the state of Alaska on 2 meters.

At 1296 MHz and above, gains of 30 dB and more can be achieved with parabolic dishes of modest size. As a result, these antennas are almost always the best choice on these



**Fig 69** — Array of four 10-element, dual-polarization 144 MHz Yagis at KL7UW. Alaskan frost makes the horizontal and vertical elements stand out clearly. A pair of loop Yagis for 1296 MHz can be seen inside the 2 meter array.



**Fig 71 — Mounting arrangement, counterweights and az/el control system for the VA7MM 3 m dish.**

bands. Their structure does not depend on any radio frequency resonances, so in many ways dishes are less critical to build than Yagis. Element lengths in high-gain Yagis must be accurate to better than  $0.005 \lambda$ , while the reflecting surface of a dish need be accurate only to about  $0.1 \lambda$ . Mesh surfaces are attractive at frequencies up to at least 5 GHz, because of their light weight and lower wind resis-

tance. Openings in the mesh can be as large as  $0.05 \lambda$  without allowing much ground noise to feed through the surface. A parabolic antenna has a single feed point, so there are no losses in phasing lines or power splitters. You can use a dish on several bands by swapping feeds, and with suitable feed designs you can produce either linear or circular polarization, including dual polarizations. A very attractive

and convenient option is to transmit in one sense of circular polarization and receive in the opposite sense. Transmitting in right-hand circular (RHC) and receiving in LHC has become the standard for EME at 1296 and 2304 MHz, and will probably become the standard on higher bands as well.

As made clear in Fig 67, the 432 MHz band lies in a transition region where both Yagis and parabolic dishes have attractive features. Either four long Yagis or a 6 m dish can produce enough gain (about 25 dBi) to let you work many other EME stations on this band. Many linear-polarization systems are already in use — for good reason, since most amateur use of this band is for terrestrial communication — so converting everyone to circular polarization is impractical. Therefore, schemes have been devised to physically rotate dish feeds and even whole Yagi arrays to cope with the resulting polarization alignment problems. Another scheme is to use a dual-polarization dish feed or dual-polarization Yagis, as described above and increasingly used on 144 MHz. This approach has not yet gained wide popularity on 432 MHz, however.

#### ANTENNA PATTERN

A clean pattern with good suppression of side and rear lobes is important for all EME antennas — especially at 432 MHz and above, where excessive noise pickup through sidelobes can significantly increase  $T_s$ . For Yagi arrays you should use modern, computer-optimized designs that maximize  $G/T_s$ , the ratio of forward gain to system noise temperature. Be sure to pay attention to maintaining a clean pattern when stacking multiple antennas. First sidelobes within  $10\text{--}15^\circ$  of the main beam may not be a major problem, because

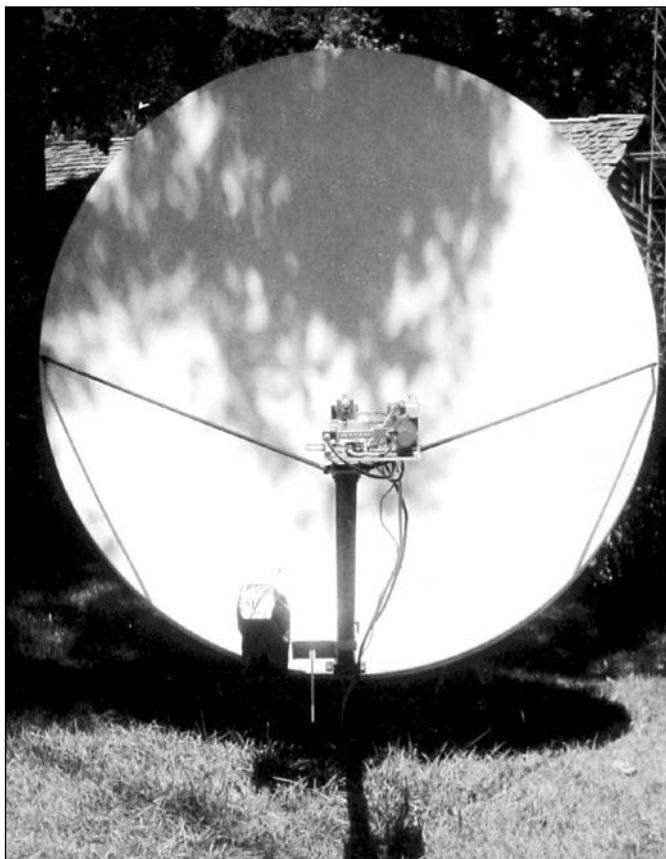

(A)

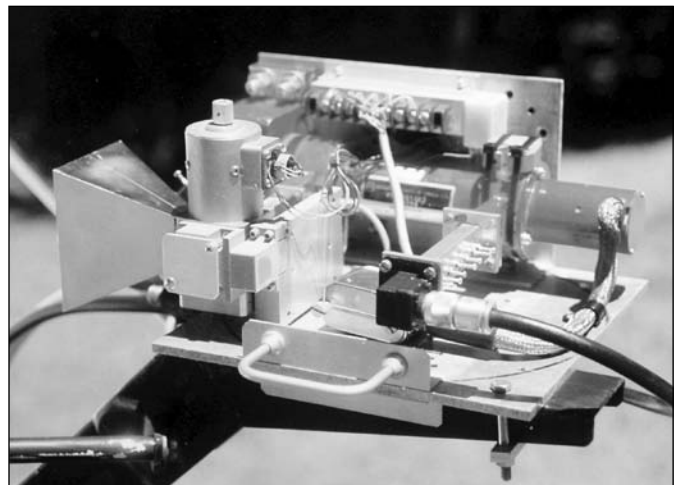

(B)

**Fig 72 — N4MW outfitted this 2.6 m offset parabolic dish for 10 GHz EME. Equipment mounted at the focus (close-up at B) includes low noise preamplifier, transverter, traveling wave tube (TWT) power amplifier and feed horn for 10 GHz.**

their solid angle is small and they will look mostly at cold sky when EME conditions are favorable. Side and rear lobes farther from the main beam should be suppressed as much as possible, however. Remember that even close-in sidelobes will degrade your receiving performance at low elevations.

For parabolic dishes,  $G/T_s$  is optimized by using a feed with somewhat larger taper in illumination at the edge of the dish than would yield the highest forward gain. Best forward gain is generally obtained with edge taper around  $-10$  dB, while best  $G/T_s$  occurs around  $-15$  dB. Edge taper of  $-12$  dB is usually a good compromise. Some good reproducible designs for dish feeds are described in references at the end of this section.<sup>2</sup>

### ANTENNA MOUNTS

EME antennas have high gain and narrow main beams that must be properly aimed at the moon in two coordinates. Although polar mounts (one axis parallel to the Earth's axis) have sometimes been used, by far the most popular mounting scheme today is the elevation-over-azimuth or *az/el* mount. Readily available computer software (see the sidebar, "Computer and Internet Resources for EME") can provide azimuth and elevation coordinates for the moon, and a small computer can also control antenna positioning motors to automate the whole pointing system.

For mechanical reasons it is desirable to place the antenna's center of gravity close to the intersection of the vertical (azimuth) and horizontal (elevation) axes. On the other hand, the mounting structure must not interfere with critical active regions of the antenna. Stacked Yagis are generally mounted so that metallic supporting members are perpendicular to the radiating elements or located at midpoints where the effective apertures of separate Yagis meet. Feed lines and conducting support members must not lie in the active planes containing Yagi elements, unless they run wholly along the boom. For dual-polarization Yagis, feed lines should be routed toward the rear of each Yagi and any mid-boom support members must be non-conducting. For EME there is nothing magical about using horizontal and vertical for the two orthogonal polarizations, and there are some advantages to mounting cross-Yagis with elements in the "x" rather than "+" orientation.<sup>3</sup>

Parabolic dishes are usually mounted from behind, with counterweights extending rearward to relieve torque imbalance on the elevation axis. Screw-jack actuators designed for positioning 1980s-style TVRO dishes can be readily adapted for elevation control.<sup>4</sup> Standard heavy-duty antenna rotators can be used for azimuth positioning of dishes up to about 3 m in size. Larger dishes may require heavier, one-of-a-kind designs for pointing control. **Figs 70 through 72** show examples of parabolic dishes in the 2-3 m range, neatly and

successfully outfitted for EME at VA7MM and N4MW.

### 11.2 Feed lines, Preamplifiers and TR Switching

Any feed line between the antenna and receiver introduces attenuation and noise, so at UHF and above it is vital that the low-

noise preamplifier (LNA) be mounted very close to the antenna terminals. At ambient temperature, every 0.1 dB of loss in front of the LNA adds at least 7 K to the effective  $T_p$ , and therefore to  $T_s$ . On bands where  $T_a$  is much lower than ambient, even 0.1 dB of attenuation can result in 0.5 dB loss of receiver sensitivity.

LNA gain should be sufficient to over-

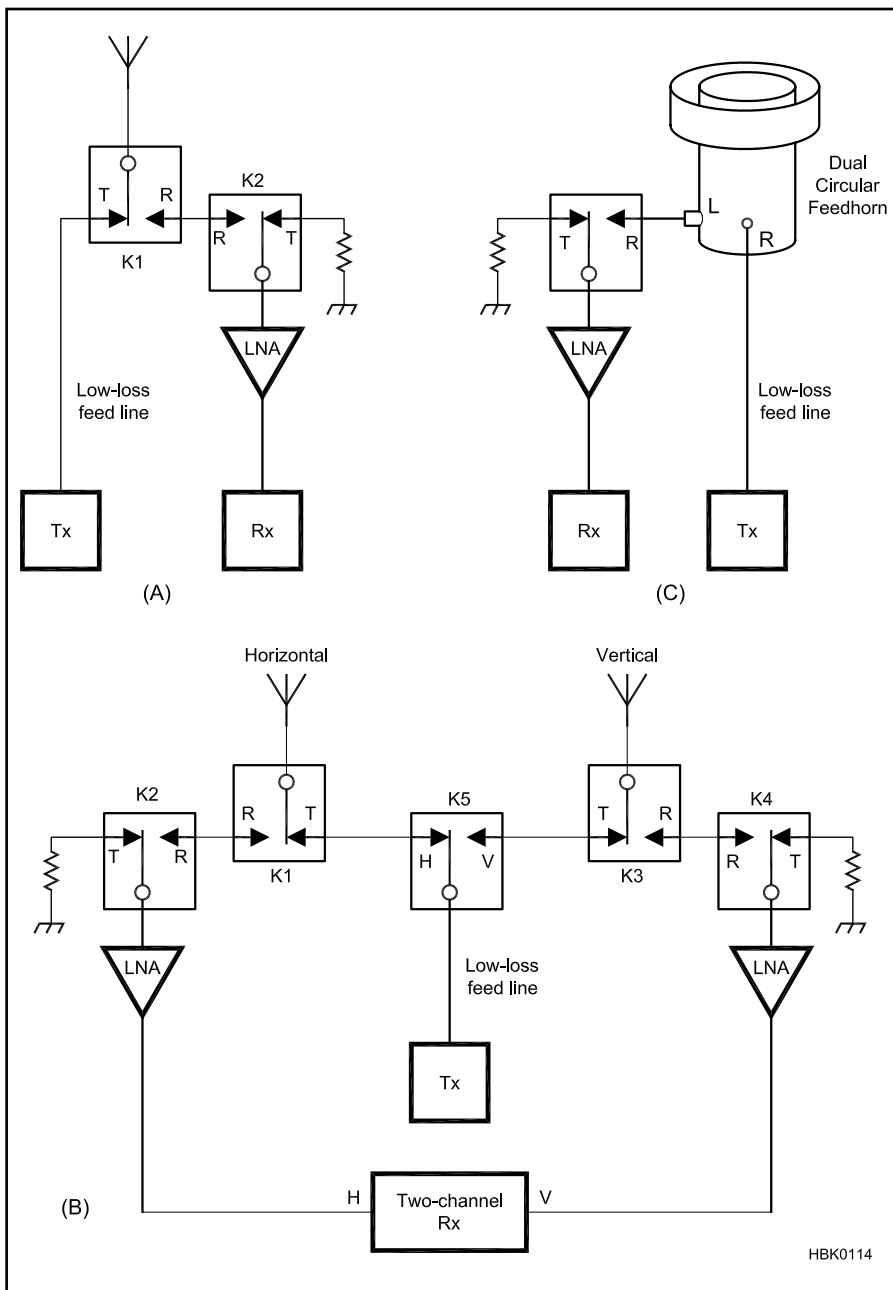

**Fig 73** — Recommended "front ends" for EME systems include low-noise preamplifiers (LNAs) mounted at the antenna and use separate feed lines for transmitting and receiving. Relay K2 shown in (A) may be omitted if K1 provides adequate isolation of the LNA while transmitting. An arrangement like that in (B) is recommended for a dual-polarization antenna such as an array of cross-Yagis. Transmitter power is sent to one polarization or the other, but received signals in both polarizations are amplified and sent on to a dual-channel receiver. Part (C) shows a suitable arrangement for circular polarization implemented with a two-port, dual-circular-polarization feed horn. In this case, no high-power TR relay is required.



come feed line losses and dominate the noise contributed by subsequent stages by at least 15-20 dB. Current practices usually employ one or, especially at 432 MHz and above, two low-noise GaAsFET or HEMT transistors in the preamplifier, with only a simple noise impedance matching circuit between the first active device and the antenna. Only if severe out-of-band interference is present should a narrow filter be placed ahead of the first LNA. Bandpass filtering is often desirable between LNA stages, and may be used without significant impact on system noise temperature. The feedhorn of a dish antenna can have a valuable high-pass effect that attenuates signals at lower frequencies.

The same antenna is generally used for both transmitting and receiving, so the LNA must be out of the line and protected when transmitting. Fig 73A illustrates a preferred switching arrangement that uses two separate feed lines: a low-loss line to carry transmitter power and a relatively inexpensive feed line from LNA to receiver. A high-power relay K1 at the antenna handles TR switching; a second relay, K2, may be used to protect the LNA in case the isolation at K1's receive port is inadequate.

Additional relays are required in order to make best use of a dual-linear-polarization system. Fig 73B shows an arrangement that lets you select either horizontal or vertical polarization for transmitting (via relay K5) and use both polarizations simultaneously for receiving. A dual-channel receiver can form a linear combination of signals in the two channels to match the polarization of a desired signal exactly, whatever its angle. Such optimization is readily accomplished in a receiver whose last stages are defined and implemented in software, as in the highly effective *Linrad* system designed by SM5BSZ.<sup>5</sup> For digital EME using dual-polarization antennas, *Linrad* and a software program called *MAP65* make an especially powerful combination for digital EME.<sup>6</sup>

With circular polarization you may not need a high-power TR relay at all. Fig 73C shows a typical arrangement with transmitter connected to one port of a feed horn providing both senses of circular polarization, and the LNA to the other port. Since the isolation between ports may be only 20 or 30 dB, a low-power relay protects the LNA during transmit periods. In all of these schemes, suit-

able sequencing should be used to assure that the LNA is disconnected before transmission can begin. Many amateurs find it best to use the energized position of TR relays on receive. When the station is not in use, preamplifiers will then be disconnected from the antenna.

### 11.3 Transmitters and Power Amplifiers

#### FREQUENCY STABILITY

Weak signals are best detected in a bandwidth no wider than the signal itself. As a consequence, EME systems must use stable oscillators. For best results with CW your frequency drift over a minute or so should be no more than 10 Hz at the operating frequency; with digital modes the ideal target may be several times smaller. Most modern transceivers are stable enough at VHF, but some only marginally so at UHF.

The crystal oscillators used in transverters may need temperature compensation for adequate stability; better still, they can be phase-locked to an external high-stability reference oscillator. A number of digital EME QSOs have been made on the 23 cm and 13 cm bands using only 5-10 W transmitter power and parabolic dishes in the 2-3 m range — much smaller systems than the baseline examples listed in Table 9 — but such contacts generally depend on having stabilized local oscillators. Especially for digital EME, where detection bandwidths less than 10 Hz are used, unstable oscillators lead directly to loss of sensitivity.

#### POWER OUTPUT

After frequency stability, the most important specification for an EME transmitter is power output. The maximum power practically achievable by amateurs ranges from 1500 W on the VHF and lower UHF bands down to the 100 W range at 10 GHz. Fortunately, the required power levels for EME (Table 9) are compatible with these numbers. At 432 MHz and below, triode or tetrode vacuum tubes with external-anode construction can provide ample gain and power output. Some popular tubes include the 4CX250, 8930, 8874, 3CX800, 8877, GU-74B, GS-23B and GS-35B. Amplifiers using one or a pair of these (or other similar tubes) can provide output powers rang-

ing up to 1000 or 1500 W on the 50 to 432 MHz bands. VHF and UHF power amplifiers based on solid state power devices have also become viable alternatives. Many amateurs have built amplifiers using these techniques, and commercial designs are available.

At frequencies above 1 GHz, transit-time limitations and physical structures prevent most high-power vacuum tubes from performing well. For many years planar triodes in the 2C39/7289/3CX100 family have been the mainstays of amateur 1296 MHz power amplifiers. Some higher power tubes for this band include the GI-7B, GS-15, TH347, TH308 and YL1050. The 2C39/7289/3CX100 tubes, as well as the GI-7B and GS-15, generally require water cooling at the power levels desirable for EME.

Solid-state power amplifiers are also available for the microwave bands. As prices come down and power levels increase, these units are becoming more popular with EME operators. Surplus solid-state amplifiers usable on the 902, 2304 and 3456 MHz bands have been attractive buys over the last few years, providing output power up to several hundred watts at reasonable cost. Two, four or even more units are sometimes used together to achieve higher output. At the highest EME frequencies surplus traveling wave tube (TWT) amplifiers can provide power levels up to several hundred watts.

#### RF SAFETY

One final point must be made in a discussion of high power amplifiers. Anyone who has thought about how a microwave oven works should know why RF safety is an important issue. Dangerous levels of radio frequency radiation exist inside and at short distances from power amplifiers and antennas. In normal operation, power density is highest in the immediate vicinity of small, low-gain antennas such as feeds for parabolic dishes. EME operators should be aware that ERP (effective radiated power) can be highly misleading as a guide to RF hazards. Somewhat counter-intuitively, a large, high-gain antenna helps to reduce local RF hazards by distributing RF power over a large physical area, thus reducing power density. Be sure to read the RF Safety section in the **Safety** chapter and pay attention to the RF protection guidelines there.

# 12 Getting Started with EME

Perhaps you already have a weak-signal VHF or UHF station with somewhat lesser capabilities than those recommended in Tables 8 and 9, and would like to make a few EME contacts before possibly undertaking the task of assembling a “real” EME station. On 144 and 432 MHz — probably the easiest EME bands on which to get started — you can visually point your single long Yagi at the rising or setting moon and work some of the larger EME stations. Your daily newspaper probably lists the approximate times of moon rise and moon set in your vicinity; many simple web-based calculators can give you that information as well as the moon’s azimuth and elevation at any particular time (see the sidebar, “Computer and Internet Resources for EME”).

These aids may be all you need to make your first EME contacts, especially if you take advantage of the weak-signal capabilities of an efficient digital mode. To optimize your chances of success, adapt your operating procedures to the prevailing standards that other EME operators will be using, as discussed below. For your first attempts you may want to make prearranged schedules with some established stations.

## 12.1 Tracking the Moon

For serious EME work you’ll want a more general way of keeping your antenna pointed at the moon. The Earth and moon complete their mutual orbit every 27.3 days, one sidereal month. The lunar orbit is inclined to the plane of the ecliptic, the Earth-Sun orbital plane, by 5.1°. Since the Earth’s equator is itself inclined at 23.5° to the ecliptic, the moon’s path through the sky swings north and south of the equator by as much as 28° in a monthly cycle (see Fig 63).

Predicting the moon’s exact position is a complicated problem in celestial mechanics, but is readily handled to sufficient accuracy by simple computer software. In general the problem can be reduced to 1) calculating the moon’s position on the sky, as seen by a hypothetical observer at the center of the Earth; 2) applying a parallax correction to yield the lunar position at a specified location on the Earth’s surface; and 3) converting the astronomical coordinates of right ascension and declination to azimuth and elevation at the specified terrestrial location.

Of course, the Earth’s rotation and moon’s orbital motion imply that the moon’s direction is constantly changing. Suitable computer software can follow these changes and generate the necessary commands to keep your antenna pointed at the moon. Several free or inexpensive software packages with moon-tracking features are listed in the side-

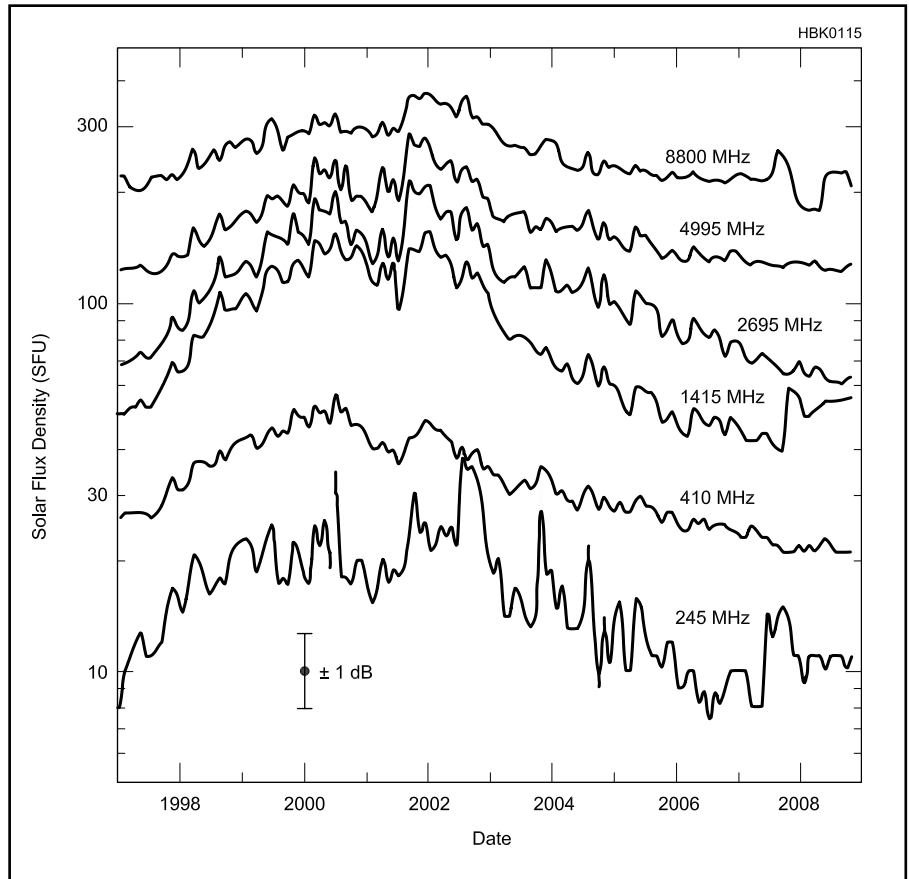

**Fig 74 — Monthly median values of solar flux density at six frequencies, over the 11 years of solar cycle 23. Original data are from the Sagamore Hill Observatory in Massachusetts. At the lower frequencies, and especially near solar maximum, day-to-day and even hour-to-hour upward variations can be an order of magnitude larger than those in the monthly medians.**

bar, “Computer and Internet Resources for EME,” and such facilities are built into the programs *WSJT* and *MAP65* widely used for digital EME. For good results you should aim for pointing accuracies of about ¼ of your half-power beamwidth or better.

## 12.2 System Evaluation

Careful measurements of your EME system’s performance can help to determine where station improvements can be made. Transmitter performance is essentially determined by power output, feed line losses and antenna gain. The first two can be measured in standard ways, but antenna gain is much more difficult. The most useful figure of merit for receiving performance is  $G/T_s$ , and while absolute measurements of either  $G$  or  $T_s$  separately are difficult, you can measure their ratio with useful accuracy and compare it with expectations. One technique particularly useful at 432 MHz and above is to use the sun as a broadband noise source. Point your

antenna at cold sky and then at the sun, and measure  $y$ , the ratio of received noise power in the two directions. Operate your receiver at maximum bandwidth with the AGC off, and if possible make the observations with the sun at elevation 30° or higher.

To calculate  $G/T_s$  from  $y$ , you will need a contemporaneous estimate of solar flux density at your operating frequency. Daily measurements of solar flux are obtained at a number of standard frequencies and made available online (see the sidebar, “Computer and Internet Resources for EME”); you can interpolate an approximate flux value for the amateur band in question. Solar flux densities vary with sunspot activity, and day-to-day or even hour-to-hour variations are especially large at lower frequencies and near solar maximum. Representative monthly median values for six frequencies are presented in **Fig 74** over sunspot cycle 23. As a starting point, you can estimate a value of solar flux for your band and a similar point in the sunspot cycle directly from Fig 74. Then, if  $S^*$  is the

solar flux density in units of  $W\ m^{-2}\ Hz^{-1}$  and  $y$  is expressed as a dimensionless ratio, the corresponding value of  $G/T_s$  in dB is given by

$$\frac{G}{T_s} = 10 \log \left( \frac{8\pi k(y-1)}{S^* \lambda^2} \right) \quad (12)$$

Solar fluxes are usually quoted in Solar Flux Units (1 SFU =  $10^{-22}\ W\ m^{-2}\ Hz^{-1}$ ), and with  $S$  in those units Equation (12) can be reduced to the simpler relation

$$\frac{G}{T_s} = 10 \log \left( \frac{3.47(y-1)}{S \lambda^2} \right) \quad (13)$$

Representative values of  $G/T_s$  and  $Y_{sun} = 10 \log y$  for the example antennas of Table 9 are given in columns 4 and 5 of Table 10. The tabulated values of  $Y_{sun}$  are based on quiet-sun flux densities typical of years near sunspot minimum.

Of course, receiving your own echoes from the moon provides the best guarantee that your equipment is capable of EME communication with comparable stations. Transmitting a few dashes, then standing by to hear your lunar echo some 2.5 s later, brings a thrill that most hams never forget. With suitable signal-processing software, echoes can be detected and measured even with relatively low-power equipment. Version 4.9.8 of the *WSJT* program (see the sidebar, “Computer and Internet Resources for EME”) includes an automated echo-testing facility that is useful for quantitative measurements even if your echoes are many dB below the audible threshold.

## 12.3 Operating Procedures

The more that’s known about likely structure, content and timing of a transmitted message, the easier it is to copy. EME signals are often near the threshold of readability, so it is highly desirable to standardize operating procedures and message structure, and to provide transmissions with enough redundancy to capitalize on signal peaks and bridge likely

gaps in reception.

You may wish to make your first EME QSOs with the aid of explicit schedules: that is, arrangements to attempt a contact with a particular station at a specified time and frequency. EME schedules usually state the duration of timed transmissions as well as starting time, transmitter frequency, and an indication of which station will transmit first. For a minimal QSO, message information is often reduced to the bare essentials of call signs, signal reports and acknowledgments. The signal report is sometimes reduced to a “yes or no” indication of whether both call signs have been successfully copied.

Remember to allow for Doppler shifts, especially at higher frequencies where the offset may exceed your received bandwidth. Most moon-tracking software used for EME can display the expected frequency shift for your own echoes as well as that for a distant station. In a scheduled QSO attempt, keep your transceiver set to the schedule frequency and use its RIT control to search for the other station around his expected Doppler shift. When looking for contacts at random, especially at 432 MHz and above, set your RIT to the expected Doppler shift of your own echoes. If a station you copy does likewise, you will find each other’s signals on the same frequency as your own echoes. Many operators also benefit from using a software-driven panoramic spectral display of the “waterfall” variety, which can make signal acquisition much easier.

### CW EME FORMAT

By convention, a minimal CW EME contact usually follows a format something like the sequence of messages in Table 11. If timed TR sequences are being used, the essential information is repeated for the full duration of a sequence.

The standard QSO procedures involve a number of different messages sent in sequence, and operators do not proceed to the next message until they have copied the essential information (call signs, signal report, acknowledgements) in previous messages. After call signs have been copied, a signal report is sent. Because CW dahs are easier to discern than dits, a default EME signal report (essentially meaning “I have copied both call signs”) is the letter O. A station receiving call signs and O responds with RO, and a final acknowledgment of a valid contact is signified by sending RRR .... On 432 MHz and above, the letter M is sometimes used as an alternative signal report meaning “both call signs copied with difficulty.” Of course, when signals are adequate for reasonably good copy normal RST signal reports can be used and other restrictions on message structure and timing relaxed.

In non-scheduled operation, it frequently happens (for example, in response to your

**Table 11**  
**Typical Messages in a Minimal EME CW Contact**

Period	Message
1	CQ CQ CQ DE W6XYZ W6XYZ ...
2	W6XYZ DE K1ABC K1ABC ...
3	K1ABC DE W6XYZ OOO OOO ...
4	W6XYZ DE K1ABC RO RO RO ...
5	K1ABC DE W6XYZ RRR RRR ...
6	W6XYZ DE K1ABC TNX 73 ...

CQ) that you can recognize and copy your own call more easily than the other station’s call. The sequence YYY... (for “Your call”) can be sent to ask a calling station to send his call only, repeating it many times. A contact is considered complete and valid when RRR has been received (after message number 5 in Table 11 has been received). However, at this point the other station does not know that his acknowledgment was copied, so it is normal to finish with something like message 6.

The conventional duration of transmit and receive periods is different on different bands and has evolved somewhat over time. On 50 and 144 MHz, stations usually transmit for one full minute and then receive for a full minute. On 432 MHz and above, schedules with 2.5-minute transmissions have been standard. The longer period gives stations with mechanically variable polarization adequate time to peak a received signal.

CW sending speed is generally around 12 to 15 WPM. Some operators find it helpful to use greater-than-normal spacing between complete letters. Keep in mind that characters sent too slowly may be chopped up by typical EME fading, while code sent too fast will be jumbled. When transmitting call sequences, send the other station’s call once, followed by “DE” and your own call once or twice. Then pause and repeat the sequence. This cadence sets a rhythm so that the receiving operator can anticipate when the missing parts of a message can be expected to arrive. Send with proper spacing; the use of a programmable keyer is especially helpful and encouraged. A signal buried in the noise and accompanied by fading is hard enough to copy, without the added complication of irregular sending.

### DIGITAL EME WITH JT65

Most digital EME is presently done with the JT65 protocol, as implemented in the computer programs *WSJT* and *MAP65* (see the sidebar, “Computer and Internet Resources for EME”). Like other popular digital modes, this one requires a personal computer with a sound card for audio input and output. JT65 uses structured message formats, a Reed Solomon error-correcting code with slightly more than five-fold redundancy and 1-minute TR sequences. Signal peaks and dropouts due to multipath fading do not affect individual char-

**Table 10**  
**Representative  $G/T_s$  and  $Y_{sun}$  for Example Antennas**

Freq (MHz)	Ant Type <sup>1</sup>	G (dBi)	$G/T_s$ (dB)	$Y_{sun}$ (dB)
144	4x6 m	21.0	-3.8	4
432	4x6 m	25.0	5.8	12
1296	3 m	29.5	11.1	11
2304	3 m	34.5	15.6	11
3456	2 m	34.8	15.3	9
5760	2 m	39.2	18.8	9
10368	2 m	44.3	22.4	11

<sup>1</sup>Example antennas for 144 and 432 MHz are Yagi arrays with stated lengths; those for 1296 MHz and higher are parabolic dishes of specified diameter.

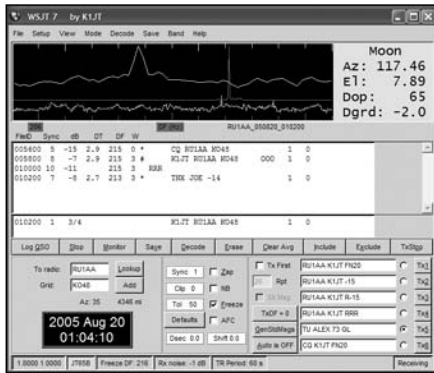

**Fig 75** — Screen shot of computer program *WSJT*.

acters or words, but rather the probability of decoding the whole message. The modulation is 65-tone frequency shift keying (65-FSK) with computer-generated audio tones modulating a single-sideband transmitter in USB mode.

As expected from the theory described briefly above, results show that JT65 contacts can be made at signal levels about 10 dB less than those needed for CW. The detection bandwidth implemented in the receiving software for JT65 sub-modes A, B and C is 2.7, 5.4 and 10.8 Hz, respectively. These may be compared with minimum bandwidths of 25-50 Hz for 15 WPM CW. Requirements on oscillator stability are therefore somewhat more stringent for JT65 than for CW.

Basic procedures for minimal JT65 contacts are very similar to those for CW, and a typical message sequence is shown in **Table 12**. Standard messages include space reserved for Maidenhead grid locators, so this information is normally exchanged along with call signs. Following CW practice, you should proceed to the next message in the QSO sequence only when information from the previous step has been copied. A default signal report may be sent as OOO, but many operators prefer to send and receive numerical signal reports (giving the signal strength in dB, relative to noise power in a standard 2500 Hz bandwidth) as measured by the re-

**Table 12**  
**Typical Messages in a JT65 EME Contact**

Period	Using Shorthand Messages	Using Long-Form Messages
1	CQ W6XYZ CN87	CQ W6XYZ CN87
2	W6XYZ K1ABC FN42	W6XYZ K1ABC FN42
3	K1ABC W6XYZ CN87 OOO	K1ABC W6XYZ -21
4	RO	W6XYZ K1ABC R-19
5	RRR	K1ABC W6XYZ RRR
6	73	TNX RAY 73 GL

ceiving software. Messages using such reports are shown in the final column of Table 12. Many additional details on the usage of JT65 can be found in documentation distributed with the *WSJT* program. **Fig 75** shows an example screen shot of K1JT finishing a contact with RU1AA via 144 MHz EME.

Keep in mind that digital EME techniques have been used for less than a decade and are likely to be still evolving. New protocols may be designed in the future using different types of ECC, different message structures, longer or shorter TR sequences, larger or smaller bandwidths, and so on. The latest information will likely be found online — for example, at some of the internet addresses listed in the sidebar, “Computer and Internet Resources for EME.”

## 12.4 Finding QSO Partners

At the time of this writing (early 2009) levels of EME activity are highest on 144 MHz. Almost any time the moon is above your horizon (excluding a few days each month when it is near the plane of the Milky Way), you can find JT65 EME signals in the frequency range 144.100 to 144.160 MHz — often dozens of them, especially on weekends. Hundreds of operators, worldwide, are “on the moon” regularly using JT65 on 144 MHz, and some of the larger stations have made EME contacts with more than 2000 other stations. Operating frequencies of particular stations are often posted on real-time loggers (see the sidebar, “Computer and Internet Resources for EME”). Explicit

schedules can also be made on the loggers, and this is a good way to initiate your first EME contacts. Don’t compromise a true EME contact by resorting to the logger after a QSO attempt has been started, however.

CW activity on the 144 MHz band, as well as most EME activity on higher bands in any mode, tends to be concentrated in activity weekends scheduled once each month when the moon is in a favorable location. After 144 MHz, the bands with most EME activity are 1296 and 432 MHz. On those bands random CW (and occasionally SSB) activity is mostly found between 5 and 30 kHz above the nominal sub-band boundary (for example, between 1296.005 and 1296.030), and digital activity is between .060 and .090, concentrating around .065 or .070. A hundred or more stations are typically active on these bands during the annual ARRL International EME Competition and in other major operating events.

The higher microwave bands, especially 2.3 and 3.4 GHz, have at least several dozen regularly active stations. On these and higher bands activity tends to concentrate around .100. Keep in mind that different band segments may be assigned in different parts of the world.<sup>7</sup> For example, North American stations use 2304.100, but some Europeans work around 2320.100. EME activity on the 50, 222 and 902 MHz bands is mostly done with prearranged schedules. The sidebar, “Computer and Internet Resources for EME” lists some resources that can help you to find schedule partners and the dates of EME contests and activity weekends.

## 13 EME References

- J. Taylor, K1JT, “The JT65 Communications Protocol,” *QEX*, Sep/Oct 2005, pp 3-12.
- M. Franco, N2UO, “Computer Optimized Dual Mode Circularly Polarized Feedhorn,” in *Microwave Update 2008*, ARRL, 2008, and [ok1dfc.com/EME/technic/septum/N2UO%20opt.pdf](http://ok1dfc.com/EME/technic/septum/N2UO%20opt.pdf); P. Wade, W1GHZ, “VE-4MA and Chaparral feeds with Septum Polarizers,” [www.w1ghz.org/antbook/conf/VE4MA\\_Chaparral\\_septum\\_feeds.pdf](http://www.w1ghz.org/antbook/conf/VE4MA_Chaparral_septum_feeds.pdf); G. Kollner, DL4MEA, “Designing a Super-VE4MA feed horn for 23 cm and 13 cm,” *Dubus*, 1/2007, p 33.
- L. Åsbrink, SM5BSZ, “The ‘+’ Configuration vs. the ‘X’ Configuration,” [www.sm5bsz.com/polarity/simplexw.htm](http://www.sm5bsz.com/polarity/simplexw.htm).
- D. Halliday, KD5RO (now K2DH), “Microwave EME Using a Ten-Foot TVRO Antenna,” *The ARRL UHF/Microwave Projects Manual*, Vol 1, 1996; M. Mattila, VE7CMK, and T. Haynes, VE7CNF, “Project Moonbounce: Earth-Moon-Earth Station VA7MM,” [www3.telus.net/public/va7mm/eme/](http://www3.telus.net/public/va7mm/eme/).
- L. Åsbrink, SM5BSZ, “Linrad: New Possibilities for the Communications Experimenter,” *QEX*, Part 1, Nov/Dec 2002 pp 37-41; Part 2, Jan/Feb 2003 pp 41-48; Part 3, May/June 2003 pp 36-43; Part 4, Sep/Oct 2003 pp 29-37; “Linrad with High Performance Hardware,” *QEX*, Jan/Feb 2004, pp 20-31; “Linrad Home Page,” [www.sm5bsz.com/linuxdsp/linrad.htm](http://www.sm5bsz.com/linuxdsp/linrad.htm).
- J. Taylor, K1JT, “MAP65: A Panoramic, Polarization-Matching Receiver for JT65,” in *Microwave Update 2007*, ARRL, 2007, and [physics.princeton.edu/pulsar/K1JT/MAP65.pdf](http://physics.princeton.edu/pulsar/K1JT/MAP65.pdf).
- Y. Mataka, JA4BLC, “Full Spectrum Receiver for 13 cm EME,” *Dubus* 3/2005, p 21.

# 14 Glossary of Space Communications Terminology

- AMSAT** — A registered trademark of the Radio Amateur Satellite Corporation, a nonprofit scientific/educational organization located in Washington, DC. It builds and operates Amateur Radio satellites and has sponsored the OSCAR program since the launch of OSCAR 5. (AMSAT, PO Box 27, Washington, DC 20044.)
- Anomalistic period** — The elapsed time between two successive perigees of a satellite.
- Antenna temperature** — Used in EME system evaluation, a measure of the noise picked up by the antenna from all noise sources in the field of view, weighted by the antenna pattern.
- AO-#** — The designator used for AMSAT OSCAR spacecraft in flight, by sequence number.
- AOS** — Acquisition of signal. The time at which radio signals are first heard from a satellite, usually just after it rises above the horizon.
- Apogee** — The point in a satellite's orbit where it is farthest from Earth.
- Argument of perigee** — The polar angle that locates the perigee point of a satellite in the orbital plane; drawn between the ascending node, geocenter, and perigee; and measured from the ascending node in the direction of satellite motion.
- Ascending node** — The point on the ground track of the satellite orbit where the sub-satellite point (SSP) crosses the equator from the Southern Hemisphere into the Northern Hemisphere.
- Az-el mount** — An antenna mount that allows antenna positioning in both the azimuth and elevation planes.
- Azimuth** — Direction (side-to-side in the horizontal plane) from a given point on Earth, usually expressed in degrees. North = 0° or 360°; East = 90°; South = 180°; West = 270°.
- Circular polarization (CP)** — Describes an electromagnetic wave in which the electric and magnetic fields are rotating. If the electric field vector is rotating in a clockwise sense, then it is called right-hand circular polarization and if the electric field is rotating in a counterclockwise sense, it is called left-hand circular polarization. Polarization sense is determined looking in the direction in which the wave is traveling.
- Cross-polarized** — Antennas that are aligned with their polarization at right angles or accept opposite senses of circular polarization.
- Descending node** — The point on the ground track of the satellite orbit where the sub-satellite point (SSP) crosses the equator from the Northern Hemisphere into the Southern Hemisphere.
- Desense** — A problem characteristic of many radio receivers in which a strong RF signal overloads the receiver, reducing sensitivity.
- Doppler effect** — An apparent shift in frequency caused by a change in distance between transmitter and receiver.
- Downlink** — The frequency on which radio signals originate from a satellite for reception by stations on Earth.
- Earth station** — A radio station, on or near the surface of the Earth, designed to transmit or receive to/from a spacecraft.
- Eccentricity** — The orbital parameter used to describe the geometric shape of an elliptical orbit; eccentricity values vary from  $e = 0$  to  $e = 1$ , where  $e = 0$  describes a circle and  $e$  approaches 1 for a very long, thin ellipse.
- EIRP** — Effective isotropic radiated power. Same as ERP except the antenna reference is an isotropic radiator.
- Elevation** — Angle above the local horizontal plane, usually specified in degrees. (0° = plane tangent to the Earth's surface at your location; 90° = straight up, perpendicular to the plane of the Earth).
- EME** — Earth-Moon-Earth (see also **Moonbounce**)
- Epoch** — The reference time at which a particular set of parameters describing satellite motion (*Keplerian elements*) are defined.
- EQX** — The reference equator crossing of the ascending node of a satellite orbit, usually specified in UTC and degrees of longitude of the crossing.
- ERP** — Effective radiated power. System power output after transmission-line losses and antenna gain (referenced to a dipole) are considered.
- ESA** — European Space Agency. A consortium of European governmental groups pooling resources for space exploration and development.
- Faraday rotation** — A rotation of the polarization of radio waves when the waves travel through the ionosphere, in the presence of the Earth's magnetic field.
- FO-#** — The designator used for Japanese amateur satellites, by sequence number. Fuji-OSCAR 12 and Fuji-OSCAR 20 were the first two such spacecraft.
- Geocenter** — The center of the Earth.
- Geostationary orbit** — A satellite orbit at such an altitude (approximately 22,300 miles) over the equator that the satellite appears to be fixed above a given point.
- Ground gain** — Reflections from the ground in front of an antenna can add as much as 6 dB to the effective gain at certain elevation angles.
- Groundtrack** — The imaginary line traced on the surface of the Earth by the subsatellite point (SSP).
- Inclination** — The angle between the orbital plane of a satellite and the equatorial plane of the Earth.
- Increment** — The change in longitude of ascending node between two successive passes of a specified satellite, measured in degrees West per orbit.
- Iskra** — Soviet low-orbit satellites launched manually by cosmonauts aboard Salyut missions. Iskra means "spark" in Russian.
- JT65** — A digital mode used for EME communications.
- Keplerian Elements** — The classical set of six orbital element numbers used to define and compute satellite orbital motions. The set is comprised of inclination, Right Ascension of Ascending Node (RAAN), eccentricity, argument of perigee, mean anomaly and mean motion, all specified at a particular epoch or reference year, day and time. Additionally, a decay rate or drag factor is usually included to refine the computation.
- LEO** — Low Earth Orbit satellite such as the Phase 1 and Phase 2 OSCARs.
- LHCP** — Left-hand circular polarization.
- Libration fading** — Rapid fading of EME signals caused by changing relative geometry of reflecting features on the moon's surface and an observer on Earth.
- LNA** — Low noise amplifier — a preamplifier mounted as close to the antenna terminals as possible for satellite and EME communication.
- LOS** — Loss of signal — The time when a satellite passes out of range and signals from it can no longer be heard. This usually occurs just after the satellite goes below the horizon.
- Mean anomaly (MA)** — An angle that increases uniformly with time, starting at perigee, used to indicate where a satellite is located along its orbit. MA is usually specified at the reference epoch time where the Keplerian elements are defined. For AO-10 the orbital time is divided into 256 parts, rather than degrees of a circle, and MA (sometimes called phase) is specified from 0 to 255. Perigee is therefore at MA = 0 with apogee at MA = 128.
- Mean motion** — The Keplerian element to

- indicate the complete number of orbits a satellite makes in a day.
- Microsat** — Collective name given to a series of small amateur satellites having store-and-forward capability (OSCARs 14-19, for example).
- Molniya** — Type of elliptical orbit, first used in the Russian Molniya series, that features a ground track that more or less repeats on a daily basis.
- Moonbounce** — A common name for EME communication in which signals are bounced off the moon before being received.
- NASA** — National Aeronautics and Space Administration, the US space agency.
- Nodal period** — The amount of time between two successive ascending nodes of satellite orbit.
- Orbital elements** — See *Keplerian Elements*.
- Orbital plane** — An imaginary plane, extending throughout space, that contains the satellite orbit.
- OSCAR** — Orbiting Satellite Carrying Amateur Radio.
- PACSAT** — Packet radio satellite (see *Microsat* and *UoSAT-OSCAR*).
- Parabolic (dish) antenna** — An antenna reflector that is a portion of a paraboloid of revolution. Used mainly at UHF and higher frequencies to obtain high gain and narrow beamwidth when excited by one of a variety of driven elements placed at the dish focus to illuminate the reflector.
- Pass** — An orbit of a satellite.
- Passband** — The range of frequencies handled by a satellite translator or transponder.
- Path loss** — The total signal loss between transmitting and receiving stations relative to the total radiated signal energy.
- Perigee** — The point in a satellite's orbit where it is closest to Earth.
- Period** — The time required for a satellite to make one complete revolution about the Earth. See *Anomalistic period* and *Nodal period*.
- Phase 1** — The term given to the earliest, short-lived, low Earth orbit (LEO) OSCAR satellites that were not equipped with solar cells. When their batteries were depleted, they ceased operating.
- Phase 2** — LEO OSCAR satellites. Equipped with solar panels that powered the spacecraft systems and recharged their batteries, these satellites have been shown to be capable of lasting up to five years (OSCARs 6, 7 and 8, for example).
- Phase 3** — Extended-range, high-elliptical-orbit OSCAR satellites with very long-lived solar power systems (OSCARs 10 and 40, for example).
- Phase 4** — Proposed OSCAR satellites in geostationary orbits.
- Polar Orbit** — A low, circular orbit inclined so that it passes over the Earth's poles.
- Precession** — An effect that is characteristic of AO-10 and AO-40 orbits. The satellite apogee SSP will gradually change over time.
- Project OSCAR** — The California-based group, among the first to recognize the potential of space for Amateur Radio; responsible for OSCARs I through IV.
- QRP days** — Special orbits set aside for very low power uplink operating through the satellites.
- RAAN** — Right Ascension of Ascending Node. The Keplerian element specifying the angular distance, measured eastward along the celestial equator, between the vernal equinox and the hour circle of the ascending node of a spacecraft. This can be simplified to mean roughly the longitude of the ascending node.
- Radio Sputnik** — Russian Amateur Radio satellites (see *RS #*).
- Reference orbit** — The orbit of Phase II satellites beginning with the first ascending node during that UTC day.
- RHCP** — Right-hand circular polarization.
- RS #** — The designator used for most Russian Amateur Radio satellites (RS-1 through RS-15, for example).
- Satellite pass** — Segment of orbit during which the satellite "passes" nearby and in range of a particular ground station.
- Sidereal day** — The amount of time required for the Earth to rotate exactly 360° about its axis with respect to the "fixed" stars. The sidereal day contains 1436.07 minutes (see *Solar day*).
- Sidereal month** — The Earth and moon complete their mutual orbit (with respect to fixed stars) every 27.3 days, one sidereal month.
- Solar day** — The solar day, by definition, contains exactly 24 hours (1440 minutes). During the solar day the Earth rotates slightly more than 360° about its axis with respect to "fixed" stars (see *Sidereal day*).
- Spin modulation** — Periodic amplitude fade-and-peak resulting from the rotation of a satellite's antennas about its spin axis, rotating the antenna peaks and nulls.
- SSP** — Subsatellite point. Point on the surface of the Earth directly between the satellite and the geocenter.
- System noise temperature** — Used in EME system evaluation, a measure of noise picked up by the antenna plus noise generated in the receiver.
- Telemetry** — Radio signals, originating at a satellite, that convey information on the performance or status of onboard subsystems. Also refers to the information itself.
- Transponder** — A device onboard a satellite that receives radio signals in one segment of the spectrum, amplifies them, translates (shifts) their frequency to another segment of the spectrum and retransmits them. Also called linear translator.
- UoSAT-OSCAR (UO #)** — Amateur Radio satellites built under the coordination of radio amateurs and educators at the University of Surrey, England.
- Uplink** — The frequency at which signals are transmitted from ground stations to a satellite.
- Visibility Circle** — The range of area on the Earth that are "seen" by a satellite. This is also called the "footprint" for that satellite.
- Window** — Overlap region between acquisition circles of two ground stations referenced to a specific satellite. Communication between two stations is possible when the subsatellite point is within the window.
- WSJT** — A suite of computer software that includes tools for EME communication.