

QST

DIGITAL EDITION



The National Association for
ARRL Amateur Radio®

February 2024 www.arrl.org
DEVOTED ENTIRELY TO AMATEUR RADIO

Remote Ready!



QST Reviews

Raddy RF75A
MW/HF/VHF Receiver

REZ Ranger 80 Portable
Antenna System

Owon XDM1241
Digital Multimeter

W2HVH Enclosures
Icom IC-705 Go-Bag

The radio... **YAESU**

Inherent Passion and Inspiration

Hybrid SDRs (Narrow Band SDR & Direct Sampling SDR)

2kHz RMDR 123dB+
2kHz BDR 150dB+
2kHz 3rd IMDR 110dB+

Ultra Low-Noise Local Oscillator System; 400MHz HRDDS (High Resolution Direct Digital Synthesizer)

2kHz Phase Noise -150dBc/Hz

VC-TUNE (Variable Capacitor Tune) signal peaking

Maximum Attenuation -70dB

3DSS (3-Dimensional Spectrum Stream) visual display view up to last 25 seconds of band conditions in real time

TX Signal Purity

TX Phase Noise -150dBc/Hz (TX 14MHz 2kHz separation)



* Microphone M-1: Optional

In Homage to the Founder of Yaesu – Sako Hasegawa JA1MP

FTDX 101MP

200W

HF/50MHz TRANSCEIVER

- External Power Supply with 3.94" (100mm) Front Speaker, FPS-101 included
- VC-Tune unit x 2 (MAIN and SUB bands) included
- 300Hz Crystal roofing filter (MAIN band) included
- 600Hz Crystal roofing filter (MAIN and SUB bands) included
- 3kHz Crystal roofing filter (MAIN and SUB bands) included

The Ultimate

FTDX 101D

100W

HF/50MHz TRANSCEIVER

- VC-Tune unit (MAIN band) included
- 600Hz Crystal roofing filter (MAIN and SUB bands) included
- 3kHz Crystal roofing filter (MAIN and SUB bands) included

YAESU
Radio for Professionals

YAESU USA
6125 Phyllis Drive, Cypress,
CA 90630 (714) 827-7600

For the latest Yaesu news, visit us on the Internet: <http://www.yaesu.com>

Specifications subject to change without notice. Some accessories and/or options may be standard in certain areas. Frequency coverage may differ in some countries. Check with your local Yaesu Dealer for specific details.

Carries the Yaesu genes for true RF performance

- SDR circuit emphasizes Receiving Performance
- Powerful RF Front-End & Low Noise Oscillator Enable Phenomenal Multi-Signal Receiving Characteristics*
 - RMDR : 113dB+ • BDR : 127dB+
 - 3rd IMDR : 102dB+ • TX Phase Noise : -143dBc/Hz
- Band-Pass-Filters dedicated for the amateur bands to eliminate out-of-band unwanted signals
- Built-in High-speed Automatic antenna tuner
- Effective QRM rejection by Dual-core DSP
- AESS (Acoustic Enhanced Speaker System) with SP-40 speaker to create High-fidelity audio output
- 3DSS, real-time 3-Dimensional Spectrum Stream presentation
- High Resolution 4.3-inch TFT Color Touch Panel Display
- VMI (VFO Mode Indicator) shows the current operating mode
- "PRESET" Mode functions most suitable for FT8 operation
- Equipped with the External Display terminal

*Multi-signal receiving characteristic: 14MHz band/2kHz separation
*TX Phase Noise: 100W, CW mode

FT-710 AESS

- Includes External Speaker SP-40

FT-710 Field

- Includes Carrying Belt
- To use the AESS function, External Speaker SP-40 (Optional) is required

- Display is not included. The image is shown with an optional third-party external display that may be connected using a DVI-D digital cable.



* Photo shows the FT-710 AESS

HF/50MHz 100W SDR TRANSCEIVER w/ SP-40

FT-710 Aess

Acoustic Enhanced Speaker System

HF/50MHz 100W SDR TRANSCEIVER

FT-710 Field

YAESU
Radio for Professionals

YAESU USA
6125 Phyllis Drive, Cypress,
CA 90630 (714) 827-7600

For the latest Yaesu news, visit us on the Internet: <http://www.yaesu.com>

Specifications subject to change without notice. Some accessories and/or options may be standard in certain areas. Frequency coverage may differ in some countries. Check with your local Yaesu Dealer for specific details.

Cushcraft MA-6B 6-Band Beam

Small Footprint -- Big Signal

2-Elements on 20/17/15/12/10/6 Meters!!!



MA-6B
\$1099⁹⁵

Cushcraft's latest MA-6B gives you 2-elements on 6 bands! Solid signal-boosting directivity in bantam size/weight.

It mounts on your roof or mast using standard TV hardware. It's perfect for exploring exciting DX without the high cost and heavy lifting of installing a large tower and a full-sized array. 7' 3" boom has less than 9' of turning radius. Contest tough -- handles 1500 Watts.

The unique MA-6B is a two-element Yagi on 20/17/15/12/10/6 Meters. It

delivers solid power-multiplying gain over a dipole on all bands. Automatic band switching and a super easy installation in a compact 26 pound package.

When working DX, what really matters are the interfering signals and noise you don't hear. That's where the MA-6B's impressive side rejection and front-to-back ratio really shines.

MA-5B, \$759.95. Like MA-6B but 5 bands: 20/17/15/12/10 Meters. 12/17M is a single element trapped dipole.

Cushcraft A-3S 10/15/20 Meter Tribander Beams

Only the best tri-band antennas become DX classics, which is why the Cushcraft World-Ranger A4S, A3S, and A3WS go to the head of the class. For more than 30 years, these pace-setting performers have taken on the world's most demanding operating conditions and proven themselves every time. The key to success comes from attention to basics. For example, element length and spacing has been carefully refined over time, and high-power traps are still hand-made and individually tuned using laboratory-grade



A-4S
\$899⁹⁵



A-3S
\$799⁹⁵

instruments. All this attention to detail means low SWR, wide bandwidth, optimum directivity, and high efficiency -- important performance characteristics you rely on to maintain regular schedules, rack up impressive contest scores, and grow your collection of rare QSLs!

It goes without saying, the World-Ranger lineup is also famous for its rugged construction. In fact, the majority of these sold years ago are still in service! Conservative mechanical design, rugged over-sized components, stainless-steel hardware, and aircraft-grade 6063 make all the difference.

The 3-element A3S/A3WS and 4-element A4S are world-famous for power-house gain and super performance. A-3WS, \$649.95, 12/17 M. 30/40 Meter add-on kits available.

Cushcraft R9 . . . 80-6M Vertical . . . No Radials . . . 1500W



R-9
\$799⁹⁵
80-6 Meters

R-8
\$699⁹⁵
40-6 Meters

Omni-Directional
low angle radiation gives incredible worldwide DX.

Cushcraft high performance R9 vertical gives you 9 bands without radials!

It's omni-directional low angle radiation delivers exciting and easy worldwide DX on all 9 bands: 75/80, 40, 30, 20, 17, 15, 12, 10 and 6 Meters with low SWR. QSY instantly -- no antenna tuner needed.

Use full 1500 Watts SSB/CW and Digital when the going gets tough to break through pileups/poor band conditions.

The R9 is super easy to assemble, installs

just about anywhere, and its low profile blends inconspicuously into the background in urban and country settings alike.

Compact Footprint: Installs in an area about the size of a child's sandbox -- no ground radials to bury with all RF-energized surfaces safely out of reach.

Rugged Construction: Thick fiberglass insulators, all-stainless steel hardware and 6063 aircraft-aluminum tubing is double or triple walled at key stress points to handle any-

thing Mother Nature can dish out. 31.5 feet tall, 25 lbs. Mounting mast 1.25 to 2 inches. Wind surface area is 4 square feet.

R8, \$699.95. Like R9 antenna but less 75/80 Meters.

R-8TB, \$119.95. Tilt-base lets you tilt your antenna up/down easily by yourself to work on.

R-8GK, \$99.95. Three-point guy kit for high winds.

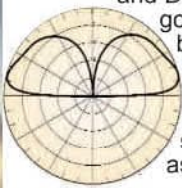

Matching Network

Matching Broadband matching transformer keeps VSWR low. Coaxial beam keeps RF off exterior of your case. All Stainless Steel Hardware

RF Choke DC grounds resistor to prevent static electricity from entering your shack. High strength, high power, low dielectric PC board material. SO-238 Feedpoint

Super Rugged Design

Stainless steel machine screws guarantee base integrity. Dual plate mount makes it easy to install counterpoises. Heavy duty stainless aluminum interface plate mount keeps your antenna up for years to come.



Cushcraft Dual Band Yagis

One Yagi for Dual-Band FM Radios

Dual-bander VHF rigs are the norm now, so why not compliment your FM station with a dual-band Yagi? Not

only will you eliminate a costly feed line, you'll realize extra gain for digital modes like high-speed packet and D-Star! Cushcraft's A270-6S provides 3 elements per band and the A270-10S provides 5 for solid point-to-point performance. Both pre-tuned. Assembly is a snap using fully illustrated manual.



A270-10S
\$239⁹⁵



A270-6S
\$199⁹⁵

Cushcraft Famous Ringos Compact FM Verticals

W1BX's famous Ringo antenna has been around for a long time and remains unbeaten for solid reliability. The Ringo is broadbanded, lightning protected, extremely rugged, economical, electrically bullet-proof, low-angle, and more -- but mainly, it just plain works! To discover why hams and commercial two-way installers around the world still love this antenna, order yours now!



AR-2
\$109⁹⁵



AR-6
\$159⁹⁵



AR-10
\$179⁹⁵

Call your dealer for your best price!

www.cushcraftamateur.com

Cushcraft
Amateur Radio Antennas

308 Industrial Park Road, Starkville, MS 39759 USA
Open: 8-4:30 CST, Mon.-Fri.

Call: 662-323-5803 • mjfcustserv@mjenterprises.com
Prices/specifications subject to change without notice/obligation. © Cushcraft, 2023.

Cushcraft . . . Amateur Radio Antennas . . . www.cushcraftamateur.com

Comet's primary tool for any antenna adjustment or diagnostic project...

CAA-500MarkII Antenna Analyzer

1.8-500MHz

The CAA-500MarkII combines the simplicity and accuracy of an analog instrument, PLUS...a full color LCD graphic display Resistive (R) and Reactive (X) components of impedance graphed and displayed numerically SWR readings in both graphic and numerical results.

Functions:

In addition to the display of antenna properties, SWR curves are plotted quickly, easily and accurately!

Auto band-sweep function:

Switch to the amateur band of choice and press "Sweep Center". The chosen band is swept and the SWR graphed in seconds!



Manual band-sweep function:

Select the band, select the center frequency, and select the bandwidth. Manually sweep the chosen frequency range and display the SWR graph.



Multiple Manual Band-Sweeps

Manually graph the user defined bandwidth multiple times and see the results overlaid in 5 selectable colors! Make antenna length, position, height above ground, gamma match adjustments, etc...and graph each adjustment in seconds, in a new color, without losing the previous graph!

Features:

Operates on 8-16VDC external power, 6 AA Alkaline or NiMH rechargeable cells • Trickle charger built in (only when using NiMH batteries) • Typical battery life: 9 hours of continuous operation • Battery level indicator • Selectable auto power-off time limit preserves battery capacity • SO-239 connector for 1.8-300MHz range • N-female connector for 300-500MHz range • Optional soft carry case sold separately: CAA-5SC

The perfect combination of analog and graphic information, designed in particular for antenna diagnostics and adjustments while on the roof, tower or in the field!

Call or visit your local dealer today!
www.natcommgroup.com | 800-962-2611



David A. Minster, NA2AA
Publisher

Becky R. Schoenfeld, W1BXY
Editorial Director

Dana Kasowitz, KC1SEB
Managing Editor

Leanna Figlewski, KC1RMP
Editor

Amanda Fahy
Sam Shaner
Assistant Editors

Paul Bourque, N1SFE
Contest Program Manager

Phil Salas, AD5X
Kai Siwiak, KE4PT
John Stanley, K4ERO
Technical Editors

Dave Casler, KE0OG
Steve Ford, WB8IMY
Jon Jones, N0JK
Bernie McClenny, W3UR
Rick Palm, K1CE
Barry Shackelford, W6YE
Pascal Villeneuve, VA2PV
Paul Wade, W1GHZ
Contributing Editors

Jodi Morin, KA1JPA
Assistant Production Supervisor

Maty Weinberg, KB1EIB
Production Coordinator

David Pingree, N1NAS
Senior Technical Illustrator

Janet Rocco, W1JLR
Advertising Sales Manager

Bob Inderbitzen, NQ1R
Director of Marketing & Innovation

Steve Ewald, WV1X
Field Organization Supervisor

9 Second Century

Keeping it Clean

30 The Un-Ugly Balun Form

John Portune, W6NBC, and Jim Bailey, W6OEK

32 The Scavenger Broadcast Band Blocking Filter

Stan Johnson, W0SJ

35 The 2-Meter Astroplane: Modifying a Forgotten 1970s Antenna

Francisco Gonzalez, T12LX

38 An RF-Sensing Relay

Jerry Spring, VE6TL

40 Product Review

Pascal Villeneuve, VA2PV

Raddy RF75A MW/HF/VHF Receiver; REZ Ranger 80 Portable Antenna System; Owon XDM1241 Digital Multimeter; W2HVH Enclosures Icom IC-705 Go-Bag



54 Amateur Radio: Science in Action

Andrew "Jim" Danielson, AC9EZ;
Jordan Marshall, NM9L, and Scott Bergeson

57 Celebrating 40 Years of Amateur Radio on Human Spaceflight Missions

Frank H. Bauer, KA3HDO

60 My Journey to Remote Operation: Station in a Box!

Dave Ingebright, WB7ELY

63 Copying Yesterday, Tomorrow: An NVIS Experiment

David A. Strohschein, N7LXR

66 "I Am Safe" Welfare Messages

David Wilma, KG7LEA



68 Rewarding Excellence with ARRL Awards

Mike Ritz, W7VO

77 2023 ARRL 10 GHz and Up Contest Results

Rus Healy, K2UA

79 2023 ARRL 222 MHz and Up Distance Contest Results

John "JK" Kalenowsky, K9JK

80 Volunteers On the Air Update

94 A Look Back — March 1974



An icon next to an article means there's bonus content in the digital edition at www.arrl.org/qst.



Columns

Ask Dave	52
Celebrating Our Legacy	99
Classic Radio	100
Club Station	82
Contest Corral	76
Correspondence	24
Ham Media Playlist	84
Happenings	70
How's DX?	86
Member Spotlight	13
Public Service	74
The World Above 50 MHz	88
Up Front	20
100, 50, and 25 Years Ago	102

Digital and Mobile Editions

ARRL members can access the digital edition via a link at www.arrl.org/qst, download our iOS app from the iTunes Store, and download our Android app from the Google Play Store.

Departments

ARRL Section Managers	16
ARRL Special Service Clubs	83
Certificate of Code Proficiency Recipients	81
Convention and Hamfest Calendar	91
Feedback	37
Field Organization Reports	75
Guide to ARRL Member Benefits	14
Ham Ads	124
Index of Advertisers	126, 127
Life Members	93
Officers, Division Directors, and Staff	15
QST Cover Plaque Award	65
This Month in QEX	85
Silent Keys	103
Special Event Stations	90
Strays	90
Volunteer Monitor Program Report	92
W1AW Qualifying Runs	81
W1AW Schedule	28

Write for QST

www.arrl.org/qst-author-guide
email: qst@arrl.org



Our Cover

Operating remotely offers flexibility that more hams are embracing in today's increasingly mobile world. In this issue's "My Journey to Remote Operation: Station in a Box!" Dave Ingebright, WB7ELY, walks us through his system, which allows him to operate any mode on 80 to 6 meters from wherever he has internet access. [Dave Ingebright, WB7ELY, photo]



QST (ISSN 0033-4812) is published monthly as the official journal of the American Radio Relay League, Inc., 225 Main St., Newington, CT 06111-1400, USA. Volume 108, Number 1. Periodicals postage paid at Hartford, CT, USA and at additional mailing offices.

POSTMASTER: Send address changes to: QST, 225 Main St., Newington, CT 06111-1400, USA. Canada Post Publications Mail Agreement #90-0901437. Canada returns to be sent to The Mail Group, 1501 Morse Ave., Elk Grove Village, IL 60007.

ARRL Membership and QST cannot be separated. All ARRL members have digital, online access to QST. Print subscriptions are available and sold separately. For ARRL members in the US, a subscription to QST via mail is \$25 per year. For libraries and institutions, a subscription to QST is available for \$84 per year; single copies \$7.

ARRL Membership is available to individuals at \$59 per year. A reduced rate is available for licensed radio amateurs under 26 years old, for \$30 per year. Membership is available to the immediate family of a member living at the same address, and to anyone who is legally blind, for \$12 per year. A complete list of dues rates is available at www.arrl.org/join. Foreign remittances should be by international postal or express money order or bank draft negotiable in the US and for an equivalent amount in US funds.

Copyright © 2024 by the American Radio Relay League, Inc. Title registered at the US Patent Office. International copyright secured. All rights reserved. Quedan reservados todos los derechos. Printed in the USA.

QST®, DXCC®, VUCC®, DX Century Club®, ARES®, Amateur Radio Emergency Service®, Logbook of The World®, LoTW®, and ARRL The National Association for Amateur Radio® are registered trademarks of the American Radio Relay League, Inc.

ARRL and QST in no way warrant the products described or reviewed herein.

QST is available to blind and physically handicapped individuals from the Library of Congress, National Library Service for the Blind and Physically Handicapped. Call 1-800-424-8567 or go to www.loc.gov/nls/.

Indexed by Applied Science and Technology Index, Library of Congress Catalog Card No: 21-9421.

To ensure prompt delivery, we ask that you periodically check the address information on your mailing label. If you find any inaccuracies, please contact Member Services at circulation@arrl.org or 860-594-0200.

Reprints and permissions: permission@arrl.org

Online Privacy Policy: www.arrl.org/online-privacy-policy

Telephone: 860-594-0200

Fax: 860-594-0259



Antenna Application and Innovation!

The ARRL Antenna Book

in its 25th edition is the ultimate reference for antennas, transmission lines, and propagation. It includes everything you need to construct your own antenna system, and provides useful advice on selecting, designing, building, testing, and installing antenna systems for every band.

Major Topics:

- Antenna Fundamentals
- Basic Antenna Types and MF and HF Antennas
- VHF, UHF, and Microwave Antennas and Specialty Applications
- Transmission Lines and Systems and Building and Maintaining Antenna Systems

New Projects:

- Set of HF OWA and 50 MHz OWA Yagi designs
- Slot antennas
- Portable satellite antennas
- Portable antenna systems for POTA and SOTA
- Transmitting chokes for VHF/UHF350 supplemental articles and projects.

Includes eBook! Download the fully searchable digital edition of the printed book, as well as nearly 350 supplemental articles and projects.

The ARRL Antenna Book, Hardcover Edition
ARRL Item No. 1755 | Retail \$79.95



Hardbound in black finish with silver foil embossing, this limited edition is the perfect companion to *The ARRL Handbook* 100th hardcover collector's edition.

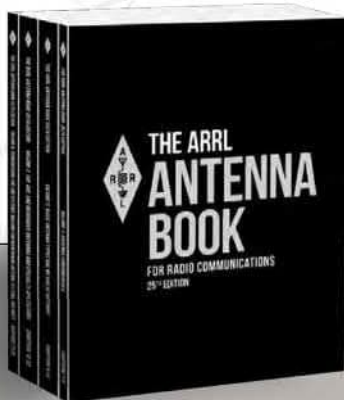
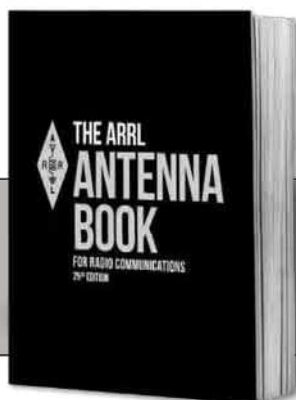

Softcover and four-volume
Antenna Book also available.
Retail \$69.95 each

Order online at www.arrl.org/shop | Call toll-free US 1-888-277-5289

SPACE PROBLEMS?

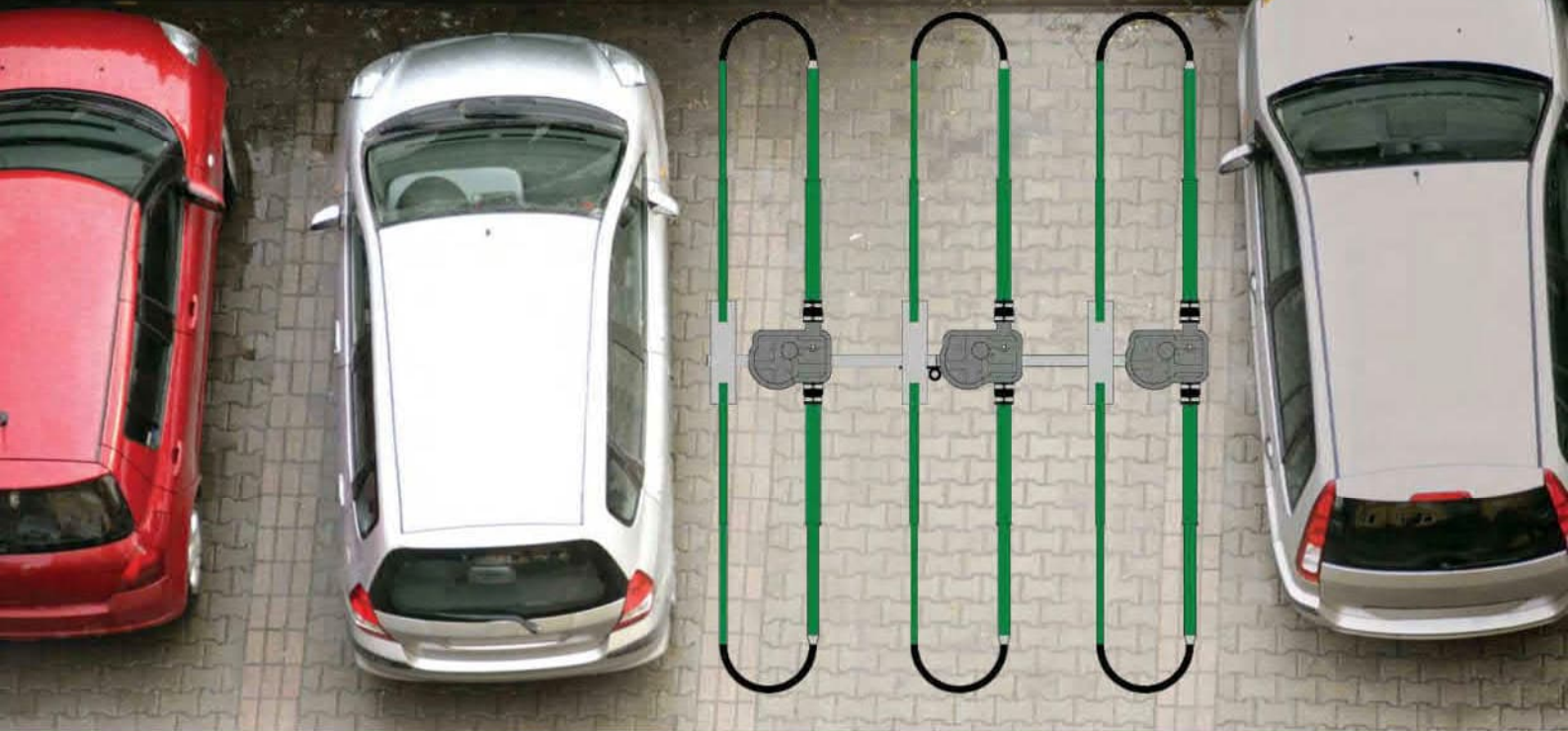

The DB11 Yagi provides high performance on 20m-6m (and every frequency in-between) while fitting in a space about the size of a parking spot!

DB11 Active Elements

Band	Elements
20	2
17	3
15	3
12	3
10	3
6	3

DB11 Antenna Specifications

Element Length	19 ft / 5.79m
Boom Length	11 ft / 3.35m
Turning Radius	10.5 ft / 3.2 m
Weight	63 lb / 28.5 kg
Frequency Range	13.9–54 MHz
Power Rating	3KW
Projected Area	11.08 sq ft / 1.03 sq m

The DB11 Yagi is a small antenna with BIG performance... "Park" the DB11 at your QTH and experience THE POWER OF SMALL!



FOR DETAILS ON PRODUCTS AND TO ORDER:
www.steppir.com 425-453-1910

Interested in the 30/40/60/80m bands?
Look no further than the SmallIR/BigIR/StealthIR verticals.
Special pricing when combined with a DB11 purchase!

DIAMOND ANTENNA

diamondantenna.net

When it comes to quality and performance, DIAMOND ANTENNA is the worldwide leader in VHF/UHF base and mobile antennas.

DIAMOND ANTENNAS help you get the most out of your on-air experience.

For all your base station and repeater needs, DIAMOND has an antenna that will work for you.

You've tried the rest, now own the best!

Here is a small sample of our wide variety of antennas

Model	Bands	Length Ft.	Max Pwr. Rating	Conn.
Dualband Base Station/Repeater Antennas				
X700HNA (4 section)	2m/70cm	24	200	N
X510HD (3 Section)	2m/70cm	17.2	330/250	UHF or N
X300A (2 Section)	2m/70cm	10	200	UHF or N
X200A (2 Section)	2m/70cm	8.3	200	UHF
X50A (1 Section)	2m/70cm	5.6	200	UHF or N
X30A (1 Section)	2m/70cm	4.5	150	UHF
Monoband Base Station/Repeater Antennas				
F23H (3 Section)	144-174 MHz (W/ Cut Chart)	15	350	UHF
F22A (2 Section)	2m	10.5	200	UHF
CP22E (Aluminum)	2m	8.9	200	UHF
F718A (Coax Element)	70cm	15	250	N
Dualband Mobile Antennas				
SG7900A	2m/70cm	62.2 in.	150	UHF or NMO
SG7500A	2m/70cm	40.6 in.	150	UHF or NMO
NR770H Series	2m/70cm	38.2 in.	200	UHF or NMO
MR77 Series	2m/70cm	20 in.	70	Mag Combo
AZ504FXH	2m/70cm	15.5 in.	50	UHF
AZ504SP	2m/70cm	15.5 in.	50	UHF
NR7900A	2m/70cm	57 in.	300/250	UHF
Monoband Mobile Antennas				
NR22L	2m	96.8 in.	100	UHF
M285	2m	52.4 in.	200	UHF or NMO

X700HNA Special Features:

- Heavy duty fiberglass radomes
- Four section assembly
- Overlapping outer shells for added strength
- Stainless steel mounting hardware & radials
- Strong waterproof joint couplings
- Type-N cable connection
- Wideband performance
- Highest gain Dual-band Base Antenna!



The Standard By Which All Others Are Judged



Diamond Antenna is a division of RF Parts Company

Second Century

Keeping it Clean

The ARRL Board of Directors overwhelmingly approved the creation of the Clean Signal Initiative in January 2022. The program is intended to bring ARRL technical experts together with manufacturers to push technology farther in pursuit of clean signals on the band. What exactly does that mean? It is evolving as we learn more by working together. Even more importantly for each of us, it means that we all must play an active role in the signals we emit every day.

When I first began to transition — away from what would generously be referred to today as “older gear” — to the newer breed of transceiver with RS-232 ports for CAT control, I was not very happy to learn that the radio I had selected had a problem. It was a known problem — namely, key clicks. When you put a signal with key clicks through an amplifier and a stack of Yagis, you can quickly discover there are people who are not very happy with you! Because it was a known problem, there were kits readily available to correct the problem. I dispatched the rig to a well-known expert to not only install the kit, but to put it through paces with some test gear to ensure that I would not be a bad actor in the next CW contest.

Have you spent any time on FT8? One of the things I have noticed about both FT8 and FT4 is that very well-known DXers and contesters are now operating with these modes. Activity has skyrocketed, and on most bands if you're looking for contacts, that's where they're hanging out. With the proliferation of FT8 has come a cadre of entry-level operators who don't understand how FT8 works. They're not understanding of the fact that these are audio signals. These signals must carefully be controlled to not go through audio processing, they must not be overdriven, and an understanding of how the computer and the radio are interfaced is fundamental to having a clean signal. It is commonplace to see signals with artifacts across the band. Overdriven audio can lead to the entire band being filled with hash. It is also commonplace to hear computer sound effects being transmitted along with an FT8 signal. All of this is unacceptable and requires a great deal of attention to detail. After all, if the band is open, your signal will be heard around the world — and this is especially true on FT8.

We had a learning experience recently in the ARRL Radio Lab, with one of the many new transceivers that has a built-in USB port that carries CAT control and audio between the radio and a computer. These radios are making connectivity incredibly easy, and reducing the burden of external boxes and cables from the operating position. What we discovered is that the signal we were transmitting was definitely not clean. This was the radio, as configured, out of the box. Doing some research before going any further, we discovered that we were not the only ones having this difficulty. It was going to take some careful “tweaking” of the various settings to get to a satisfactory signal. We've gone through

the process, and the signal we transmit is now something we can be happy with. This experience caused us to pause and wonder whether this is something, going forward, we need to integrate into QST Product Review Equipment Testing. We've decided that it is, and we're now discussing the parameters for testing the single cable interfaces on new radios.

While we were at it, we also stopped to look at what else we may be missing. The practice of accessing radios remotely is growing significantly. Manufacturers have used different mechanisms to support this, from a transceiver “faceplate,” to proprietary software, to custom boxes for carrying audio and CW between locations. An emerging design trend is a single ethernet connector, built either into the radio or through a companion interface box. How much data do these network connections carry? How well behaved are these connections on your local area network? We intend to experiment in these areas, and possibly add another area of equipment testing and review for these new transceivers, to understand how they behave on a network and over an internet connection.

Our Clean Signal Initiative is about collaboration and working together to get to a set of standards that we all can agree meet or exceed our expectations for quality on-the-air signals. But this is not something we need to wait on. Let's commit to doing our part individually. The responsibility of working to ensure that your signal (CW, digital, or sideband) is of a high quality ultimately falls on your shoulders. Don't let this hold you back! Work with your club members or reach out to the ARRL Technical Information Service for assistance. It's just another membership benefit you enjoy from ARRL.

Be radio active! Get on the air and make contacts, whatever the mode. Be a connector. Help people in the area, in your club, or on the air as they work toward excellent signal quality. And thanks for all the VOTA contacts in 2023! See you on the air throughout 2024.

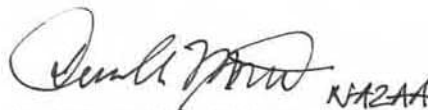

David A. Minster, NA2AA
Chief Executive Officer

hy-gain HF Beam Antennas

Hy-gain beams are *stronger, light-er, have less wind surface and last years longer*. Why? Hy-gain uses durable *footed* components -- massive boom-to-mast bracket, heavy gauge element-to-boom clamps, thick-wall swaged tubing -- no failures!

TH-11DX, \$1799.95.

11-element, 4.0 kW PEP, 10,12,15,17,20 Meters. *The choice of top DXers.* With 11-elements, excellent gain and 5-bands, the super rugged TH-11DX is the "Big Daddy" of all HF beams! Features low loss log-periodic driven array on all bands with mono-band reflectors, BN-4000 high power balun, corrosion resistant wire boom support, hot dipped galvanized and stainless steel parts.

TH-7DX, \$1599.95. 7-Element, 1.5 kW PEP, 10, 15, 20 Meters. 7-Elements gives you *the highest average gain of any Hy-gain tri-bander!* Dual driven for broadband operation without compromising gain. SWR less than 2:1 on all bands. Combined monoband and trapped parasitic elements give you an excellent F/B ratio.

TH-3MK4, \$869.95. 3-Element, 1.5 kW PEP, 10, 15, 20 Meters. Gives most gain for your money in full-power, full-size *hy-gain* tri-bander! Impressive gain and a *whopping* average front-to-back ratio and still fits on an average size lot. 95 MPH wind survival.

TH-3JRS, \$539.95. Compact 3-Element, 600 W PEP, 10, 15, 20 Meters. *Hy-gain's most popular and lowest-priced tri-bander fits smallest lot, 14.75 ft turning radius, 21 lbs.* Excellent gain and front-to-back let you compete with the "big guns"! 80 MPH wind survival.



hy-gain HF Verticals Antennas

Work amazing DX with these extremely low radiation angle omnidirectional antennas. All self supporting, 1500 Watts PEP SSB, low SWR. Heavy duty, slotted, tapered, swaged, aircraft quality aluminum tubing. Stainless steel hardware. Two year limited warranty.

AV-680, \$769.95. 9 Bands: (6, 10, 12, 15, 17, 20, 30, 40, 80 Meters). 26 ft., 18.5 lbs. *Our most popular vertical now has 75/80 Meters! Lets you work exciting DX with a low 17 degree radiation angle!* Easily mount on decks, roofs, patios. *No ground or radials needed.* Extra wide 2:1 SWR bandwidths. *Each band tunable.* Auto band-switching, handle 1.5kW, 80 MPH wind survival, low 2.5 sq. ft. wind surface. Aircraft aluminum tubing, stainless steel hardware.

AV-640, \$659.95. Like AV-680 less 80M. 25'1/2", 17'1/2 lbs.

AV-620, \$599.95. Like AV-640 less 40M. 22'2/10'1/2 lbs.

AV-14AVQ, \$299.95. (10, 15, 20, 40 Meters). 18 ft., 9 lbs. *Classic AV-14AVQ uses same trap design as famous Hy-Gain Thunderbird beams.* 3 air dielectric Hi-Q traps with oversize coils give superb stability and 1/4 wave resonance on all bands. Automatic bandswitching.

AV-12AVQ, \$219.95. (10, 15, 20 Meters). 13 ft., 9 lbs. Lowest priced *automatic bandswitching* tri-band vertical! Uses Thunderbird beam design air dielectric traps for extremely hi-Q performance in limited space.

AV-18VS, \$159.95. (10,12,15,17,20,30,40,80M). 18 ft., 4 lbs. *hy-gain's lowest priced vertical gives you 8 bands.* Easily tuned to any band by adjusting base loading coil.

See our website for even more hy-gain vertical antennas!

hy-gain Rotators . . . the first choice of hams around the world!

HAM-IV . . . \$799.95

The most popular rotator in the world! For medium communications arrays up to 15 sq. feet wind load area. 5-second brake delay! Test/Calibrate function. Low temperature grease permits normal operation down to -30° F. Alloy ring gear gives extra strength up to 100,000 PSI for maximum reliability. Indicator potentiometer. Ferrite beads reduce RF susceptibility. Cinch plug plus 8-pin plug at control box. Dual 98 ball bearing race for load bearing strength and electric locking steel wedge brake prevents wind induced antenna movement. North or South center of rotation scale on meter, low voltage control, max mast size of 2'1/16".

HAM-VI, \$999.95. For medium arrays up to 15 sq. ft. wind load. Like HAM-IV but has *new DCU-2 Digital Rotator Controller.* Just dial in your beam heading or let your computer control your antenna.

HAM-VII, \$1099.95. Like HAM VI but with *DCU-3* digital controller with *six programmable memories.*



Tailtwister T-2X . . . \$1099.95

For large medium antenna arrays up to 20 sq. ft. wind load. Choose *DCU-2 digital* controller (T-2XD2) or *analog* control box (T-2X) with *new* 5-second brake delay and *new* Test/Calibrate function. Low temperature grease, alloy ring gear, indicator potentiometer, ferrite beads on potentiometer wires, *new* weather-proof AMP connectors plus 8-pin plug at control box, triple bearing race with 138 ball bearings for large load bearing strength, electric locking *steel* wedge brake, N or S center of rotation scale on meter, low voltage control, 2'1/16" max. mast.

T-2XD2, \$1299.95. Tailtwister with *DCU-2 digital* controller.

T-2XD3, \$1399.95. Tailtwister with *DCU-3* digital controller with *six programmable memories.*

AR-40, \$539.95. For compact antenna arrays and FM/TV up to 3.0 sq. ft. wind load. Dual 12 ball-bearing race. Fully automatic.

CD-45II, \$599.95. For antenna arrays up to 8.5 sq. ft. Bell rotator design gives total weather protection. Dual 58 ball bearing race.



Digital Rotator Controller with 6 programmable Beam Headings

DCU-3 Digital Controller lets you program 6 beam headings! Gives fully automatic or manual control of hy-gain HAM or Tailtwister Rotators.

Push a memory button or dial in your beam heading or let *Ham Radio Deluxe* (or other program) control your DCU-3. Antenna automatically rotates precisely, safely to desired direction.

DCU-2, \$519.95. Like DCU-3 but less beam headings.



**DCU-3
\$639.95**

Replace Your Yaesu Rotator Controller

**YRC-1
\$459.95**



Replace your Yaesu rotator controller. More features and a much more robust controller that is far less prone to lightning damage. YRC-1 costs less than repairing your original Yaesu controller!

hy-gain VHF/UHF Antennas

VB-214FM, \$219.95. 14-element 2-Meter FM beam antenna provides exceptional front-to-back ratio and maximum obtainable gains.

VB-23FM, \$109.95. 3-element.

VB-25FM, \$129.95. 5-element.

VB-28FM, \$189.95. 8-element. Threaded stub for feedpoints. Accepts up to 2 inch mast.

DB-2345, \$159.95. Dual band 144 (3-elements) 440 (5-elements) MHz.



hy-gain

Antennas, Rotators & Towers 308 Industrial Park Rd, Starkville, MS 39759 USA

Sales/Tech: (662) 323-9538 • **FAX:** (662) 323-5803 Open 8-4:30 CST, Mon.-Fri.

Add Shipping. Prices and specifications subject to change. (C) 2023 hy-gain

Upgrade Your Antenna, Get The Best Mag Loop Today!



HG1 Deluxe MLA

Portable & Quick Setup

- 80m to 10m *
- 45W PEP
- LMR600 Radiation Loop
- Calibrated 6:1 Manual Tuning Dial

\$535

HG3 Pro MLA

Remote Control & Auto Tuning

- 80m to 10m *
- 45W PEP
- LMR600 Radiation Loop
- Integrated SWR Bridge

\$1,335

HG3 QRO-B MLA

Precision Remote Control & Auto Tuning

- 80m to 10m *
- 1000W PEP
- LMR600 Radiation Loop
- Integrated SWR Bridge

\$3,025

See what our users say on their Facebook Group **"PrecisionRF HG3 QRO"**

CONSIDER THESE BENEFITS IN YOUR NEXT MLA PURCHASE DECISION:

- 1 Stepper Motor Tuning**
Precision in Every Tune: Achieve repeatable and precise tuning with higher resolution. Optimized Signal Quality. Enjoy the lowest SWR for clear communication.
- 2 Microprocessor Control**
Control at Your Fingertips: Experience remote tuning for unparalleled convenience. Set the precise capacitor resonance value. Select bands quickly and seamlessly for spot-on tuning and minimal noise.
- 3 Integrated SWR Bridge**
Optimal Signal Strength: The integrated SWR bridge automatically scans for the lowest SWR, ensuring peak transmitter performance, minimal noise, and greater convenience.
- 4 Ideal for HOA Restrictions**
Setup Anywhere, Anytime: Easily deploy your mag loop in diverse locations. Freedom from elevation constraints, such as wire antennas. Great for HOA restrictions. Sets up easily in the attic.
- 5 QRO High Q Vacuum Capacitor and Loop**
High-Power with Minimal losses for the Best Performance: Vacuum capacitor and higher loop surface area deliver greater efficiency. Wide tuning range provides coverage of all popular HF bands.
- 6 Supported by Knowledgeable Hams**
Trusted Expertise: Choose a brand with a proven track record in the hands of knowledgeable hams. Dedicated Support: We are committed to providing comprehensive assistance and guidance for your mag loop setup.



SOTA-1 MLA \$435

- High-Q Capacitor
- 3:1 Reduction Dial
- 15W PEP
- LMR400 Radiation Loop
- Lightweight Nylon Bag



Bag holds everything including the tripod

Tested and proven on Mt. Kilimanjaro

Gear up for your next adventure with the SOTA-1 MLA – your perfect companion for SOTA expeditions. Crafted from durable and lightweight materials, making it easy to carry on your hiking adventures.

Key Features:

- **Lightweight Design:** Ideal for easy transport on your outdoor journeys.
- **Quick Deployment:** Get up and running swiftly for a seamless SOTA experience.
- **QRP Power:** 15W PEP for maximum radio performance with minimal gear weight.

Order your SOTA-1 MLA today and elevate your summit conquests with the best SOTA performance yet.

Visit [precisionrf.com](https://www.precisionrf.com) to purchase your next MLA today.

ORLANDO

HamCation®

2024



CENTRAL FLORIDA FAIRGROUNDS AND EXPO PARK
February 9th, 10th, & 11th



Host of the 2024 ARRL Florida State Convention

Start the 2024 Hamfest season by visiting the 2nd largest Hamfest in the United States. Come check out the latest in amateur radio electronics, accessories, and gear. Stroll thru the largest tailgate in the Southeast. Find great deals in our swaps building with more than 200 swap tables. You can even catch a great lecture or forum while you're here. Bring the family and spend some time before or after HamCation at one of our area attractions. Attending is so easy because we partnered with a select group of preferred hotels to provide you with great accommodations at special rates. So make HamCation your next vacation destination!

- Special Guest Speakers
- Over 150 Commercial Booths
- More than 200 Swap Tables
- Largest Tailgate in the Southeast
- Testing on Friday and Saturday
- Forums on Great Topics
- Onsite Scooter & Wheelchair Rentals
- Guest Friendly Florida Atmosphere
- RV Camping on Premises
- Free & Convenient Parking
- Visit Nearby Theme Parks
- Casual or Fine Dining Nearby

WWW.HAMCATION.COM

Friday/Saturday 9AM - 5PM, Sunday 9AM - 1PM.
Tickets are \$25 at the gate.

Orlando HamCation®
4046 N Golden Road STE 150
Winter Park, FL 32792
(407) 841-0874



Member Spotlight

Dragan Davkovski, KØAP

Dragan's amateur radio journey began in 1985 when he was 12 years old and living in what was then Yugoslavia. His middle-school teacher, who was also an instructor at the local radio club (YU5GBC), asked if any students might be interested in enrolling in Morse code classes. Dragan and a few of his classmates signed up, and 6 months later they passed their Novice license exams. As soon as he made his first contacts, Dragan was thoroughly hooked.

Few hams in the area could afford their own transceivers and antennas, so most of Dragan's operating occurred at the club. "Right from the start, my main interest was DX hunting and contesting. A good amount of my free time after school was dedicated to hanging out with my club friends and taking turns chasing DX," Dragan says.

With the breakup of Yugoslavia, Dragan became a citizen of Macedonia, a new DXCC entity. Dragan suddenly found himself on the receiving end of massive on-air pileups. In the early nineties, he upgraded his license and acquired the call sign Z32XX. "Now that I had phone privileges, all the contacts helped improve my English immensely," Dragan explained. "The entire world opened for me, gaining knowledge about different people and places."

In addition to his DXCC pursuits, Dragan discovered Islands on the Air. Chasing contacts with remote islands became yet another obsession.

In 1996, Dragan asked the late Mike Jakiela, NN6C, if he could become his QSL manager, and he agreed. "Mike and I became good friends," Dragan says. "He came to visit me in Macedonia twice, and he operated as Z38C. Mike was a kind and generous person. When he came the first time, he brought a Kenwood TS-850SAT transceiver, a



Heil headset, a keyer, a power supply, and other accessories. He donated everything to me before returning to the US. Thanks to Mike, I could finally set up a station at home."

Coming to the United States

Dragan found that life was becoming increasingly difficult in Macedonia. "The economy was not doing well, and the political situation was always on shaky ground," Dragan says. "In that climate, the prospect of making a decent living and enjoying a secure future did not look promising. Life in the United States, in contrast, seemed rich with opportunities."

In 2003, after submitting several applications to the American consulate for an immigration visa, Dragan received a Permanent Resident Card, better known as a "Green Card," and was finally able to immigrate to the US. The previous year he had married his wife, Svetlana, so they left Macedonia together to start a new life thousands of miles away.

They needed a sponsor in the US, someone who could assist with their transition. That critical role was as-

sumed by an amateur in Kansas, Jim Klingler, AAØMZ, a friend Dragan had made on the air. Jim helped complete the immigration paperwork and extended an invitation for Dragan and his wife to stay at his home.

Soon after their arrival, Jim introduced Dragan to local amateurs, and Dragan became a member of the Kansas City DX Club. In 3 months, he passed all the tests necessary to obtain his Amateur Extra license and acquired the call sign KØAP.

"We put down roots in Kansas and purchased a home in Olathe," Dragan says. "I was able to build a modest station and get on the air shortly afterward." Dragan credits Alex Tkatch, KU1CW, with playing a significant part in helping Dragan and his family settle into the area. "We became friends, and he got me involved in contest activities," Dragan says. "Several times we operated from NØNI's big contest station in Iowa and K5GO's station in Arkansas."

Life as an American Citizen

Dragan and his family established themselves quickly and relished their new lives. Dragan found employment as a systems design engineer for a major US cellular network provider. Today he evaluates over-the-air performance of wireless products to ensure they meet standards. Dragan says, "I have been extremely fortunate to work in a field that correlates closely with my amateur radio hobby. It is a win-win situation!"

Between his work schedule and the demands of raising two daughters, Dragan still finds time for radio. "Luckily, I have a supportive wife who understands my passion."

When he isn't on the air, Dragan enjoys exploring local trails on his bike. He also collects postage stamps.

Guide to Member Benefits



Join or Renew

www.arrl.org/join

Donate

www.arrl.org/donate

Benefits

www.arrl.org/benefits

Shop

www.arrl.org/shop

ARRL Online | www.arrl.org/myarrl

Create an online ARRL Member account, and get access to members-only benefits. Register at www.arrl.org/myARRL. Already registered? Log in at the top of the ARRL website.

ARRL Magazines | www.arrl.org/magazines

Members can access the digital editions of four ARRL magazines from a web browser and the free ARRL Magazines app available from Apple's App Store, Google Play, and Amazon Kindle. Members need a valid ARRL account to access the digital magazines, Periodicals Archive and Search, and the Product Review Archive. Print subscriptions are available and sold separately.

- QST – ARRL's monthly membership journal
- On the Air – for new and beginner-to-intermediate-level radio amateurs
- QEX – A Forum for Communications Experimenters
- NCJ – the National Contest Journal

E-Newsletters | www.arrl.org/opt-in-out

Subscribe to the weekly ARRL Letter, the monthly ARRL Current, and a variety of other e-newsletters and announcements for members. Keep up with ARRL News, publications, podcasts, and calendars.

Email Forwarding Service

Email sent to your arrl.net address will be forwarded to any email account you specify.

ARRL Learning Center | learn.arrl.org

This online learning environment is designed to help members get the most out of amateur radio. Courses, tutorials, and resources cover getting on the air, emergency communications, and electronics and technology.

Technical Information Service | www.arrl.org/tis

Call or email our expert ARRL Lab specialists for answers to all of your technical and operating questions.

Advocacy | www.arrl.org/regulatory-advocacy

ARRL supports legislation and regulatory measures that preserve and protect meaningful access to the radio spectrum. Our **ARRL Regulatory Information Branch** answers member questions concerning FCC rules and operating practices.

Logbook of The World – LoTW | www.arrl.org/lotw

Record your contacts and qualify for awards using ARRL's premier logging service.

Group Benefits* | www.arrl.org/benefits

ARRL Ham Radio Equipment Insurance Plan *US only

Find...

- ...a License Exam Session | www.arrl.org/exam
- ...a Licensing Class | www.arrl.org/class
- ...a Radio Club (ARRL-affiliated) | www.arrl.org/clubs
- ...a Hamfest or Convention | www.arrl.org/hamfests

Interested in Becoming a Ham?

www.arrl.org/newham
newham@arrl.org | Tel. 1-800-326-3942 (US)

Connect with ARRL

ARRL The National Association for Amateur Radio®
225 Main Street, Newington, CT 06111-1400 USA
1-860-594-0200, or 1-888-277-5289 (toll-free US only)
Mon. – Thurs. 8 AM to 7 PM EST, and Fri. 8 AM to 5 PM EST, except holidays

FAX 1-860-594-0259, email hq@arrl.org
Contact ARRL: www.arrl.org/contact-arrl



Website: www.arrl.org
Facebook: [@ARRL.org](https://www.facebook.com/ARRL.org)
X: [@arrl](https://twitter.com/arrl), [@w1aw](https://twitter.com/w1aw), [@arrl_ares](https://twitter.com/arrl_ares)
Threads: [@arrlhq](https://www.threads.net/@arrlhq)
Instagram and Instagram TV: [@arrlhq](https://www.instagram.com/arrlhq)
YouTube: [ARRLHQ](https://www.youtube.com/ARRLHQ)
LinkedIn: www.linkedin.com/company/american-radio-relay-league

The American Radio Relay League, Inc.

ARRL The National Association for Amateur Radio® in the United States: supports the awareness and growth of Amateur Radio worldwide; advocates for meaningful access to radio spectrum; strives for every member to get involved, get active, and get on the air; encourages radio experimentation and, through its members, advances radio technology and education; and organizes and trains volunteers to serve their communities by providing public service and emergency communications (*ARRL's Vision Statement, adopted in January 2016*).

ARRL is an incorporated, noncommercial association without capital stock chartered under the laws of the State of Connecticut, and is an exempt organization under Section 501(c)(3) of the Internal Revenue Code of 1986. Its affairs are governed by a Board of Directors, whose voting members are elected every 3 years by the general membership. The officers are elected or appointed by the Directors.

ARRL is noncommercial, and no one with a pervasive and continuing conflict of interest is eligible for membership on its Board.

"Of, by, and for the radio amateur," ARRL numbers within its ranks the vast majority of active amateurs in the nation and has a proud history of achievement as the standard-bearer in amateur affairs.

A *bona fide* interest in Amateur Radio is the only essential qualification of membership; an amateur radio license is not a prerequisite, although full voting membership is granted only to licensed amateurs in the US.

Membership inquiries and general correspondence should be addressed to the administrative headquarters: ARRL, 225 Main St., Newington, Connecticut 06111-1400 USA.

Officers, Division Directors, and Staff

As an ARRL member, you elect the Director and Vice Director who represent your Division on ARRL policy matters. If you have a question or comment about ARRL policies, contact your representatives listed below.

Officers

Founding President 1914-1936
Hiram Percy Maxim, W1AW

President
Rick Roderick, K5UR*
P.O. Box 444, Vilonia, AR 72173
501-988-2527; k5ur@arrl.org

First Vice President
Michael N. Raisbeck, K1TWF*
85 High St.
Chelmsford, MA 01824
978-250-1235; k1twf@arrl.org

Second Vice President
Bob Vallio, W6RGG
18655 Sheffield Rd.
Castro Valley, CA 94546
510-537-6704; w6rgg@arrl.org

International Affairs Vice President
Rod Stafford, W6ROD
5155 Shadow Est.
San Jose, CA 95135
408-238-4671; w6rod@arrl.org

Chief Executive Officer and Secretary
David A. Minster, NA2AA*
225 Main St.
Newington, CT 06111
860-594-0404; dminster@arrl.org

Treasurer
John Sager, WJ7S

Chief Financial Officer
Diane Middleton, W2DLM

Staff

Director of Operations
Bob Naumann, W5OV

VEC Manager
Maria Somma, AB1FM

Field Services Manager
Mike Walters, W8ZY

Radiosport & Regulatory Information Manager
Bart Jahnke, W9JJ

Laboratory Manager
George Spatta, W1GKS

Director of Emergency Management
Josh Johnston, KE5MHV

Membership Manager
Marc Spardello, W1NJ

Director of Marketing & Innovation
Bob Inderbitzen, NQ1R

Marketing Operations Manager
Jason Leonard

Retail Sales & Marketing Manager
Jackie Ferreira, KB1PWB

Advertising Sales Manager
Janet Rocco, W1JLR

Public Relations & Outreach Manager
Sierra Harrop, W5DX

Director of Publications & Editorial
Becky R. Schoenfeld, W1BXY

Education & Learning Manager
Steve Goodgame, K5ATA

Director of Development
Kevin Beal, K8EAL

Development Operations Manager
Christina Lessard, KC1TDM

Controller
Thomas Bell, KC1MHQ

Human Resources Manager
Luci Goodwin

*Executive Committee Member

Atlantic Division

www.atldiv.org
Robert B. Famiglio, K3RF
P.O. Box 9, Media, PA 19063
610-359-7300; k3rf@arrl.org

Vice Director: Marty Pittinger, KB3MXM
4 Pegram Rd., Owings Mills, MD 21117
410-356-7899; kb3mxm@arrl.org

Central Division

www.central.arrl.org
Carl Luetzelschwab, K9LA
1227 Pion Rd., Fort Wayne, IN 46845
260-637-6988; k9la@arrl.org

Vice Director: Brent Walls, N9BA
2151 E. Bomar Ln., Greenfield, IN 46140
317-557-7224; n9ba@arrl.org

Dakota Division

www.arrldakota.org
Bill Lippert, AC0W
2013 6th Ave. SE, Austin, MN 55912
507-993-9181; ac0w@arrl.org

Vice Director: Lynn Nelson, W0ND
3204 Willow Ln. SE, Minot, ND 58701
701-833-1000; w0nd@arrl.org

Delta Division

www.arrldelta.org
David A. Norris, K5UZ
907 Evening Sunset Cir., Redfield, AR 72132
870-613-1606; k5uz@arrl.org

Vice Director: Ed B. Hudgens, WB4RHQ
1441 Wexford Downs Ln., Nashville, TN 37211
615-630-2753; wb4rhq@arrl.org

Great Lakes Division

www.arrl-greatlakes.org
Scott Yonally, N8SY
258 Valley Hi Dr., Lexington, OH 44904
419-512-4445; n8sy@arrl.org

Vice Director: Roy Hook, W8REH
6611 Steitz Rd., Powell, OH 43065
w8reh@arrl.org

Hudson Division

www.hudson.arrl.org
Nomar Vizcarrondo, NP4H
P.O. Box 245, Tenafly, NJ 07670
917-443-2664; np4h@arrl.org

Vice Director: Ed Wilson, N2XDD
P.O. Box 483, Shirley, NY 11967
631-484-8826; n2xdd@arrl.org

Midwest Division

www.arrlmidwest.org
Art Zygielbaum, K0AIZ*
6601 Pinecrest Dr., Lincoln, NE 68516
402-421-0840; k0aiz@arrl.org

Vice Director: Dave Propper, K2DP
747 Old Bonhomme Rd., University City, MO
63132, 314-225-5167; k2dp@arrl.org

How to Contact ARRL Staff

To send an email to any ARRL Headquarters staff member, put his or her call sign (or first initial and last name) in front of @arrl.org. For example, to send to Hiram Maxim, First President of ARRL, use w1aw@arrl.org or hmaxim@arrl.org.

New England Division

<https://nediv.arrl.org>
Fred Kemmerer, AB1OC*
39 Baldwin Ln., Hollis, NH 03049
603-413-5400; ab1oc@arrl.org

Vice Director: Phillip E. Temples, K9HI
125 Coolidge Ave. #803
Watertown, MA 02472-2875
617-331-0183; k9hi@arrl.org

Northwestern Division

www.arrlnwdiv.org
Mike Ritz, W7VO
33643 Burma Rd., Scappoose, OR 97056
503-987-1269; w7vo@arrl.org

Vice Director: Mark J. Tharp, KB7HDX
P.O. Box 2222, Yakima, WA 98907
509-952-5764; kb7hdx@arrl.org

Pacific Division

www.pacific.arrl.org
Kristen McIntyre, K6WX*
900 Golden Wheel Park Dr., #85, San Jose, CA
95112, 510-703-4942; k6wx@arrl.org

Vice Director: Anthony Marcin, W7XM
6836 Boulder Canyon St., North Las Vegas, NV
89084, 702-984-9589; w7xm@arrl.org

Roanoke Division

www.arrl-roanoke.com
Dr. James Boehner, N2ZZ*
525 Barnwell Ave. NW, Aiken, SC 29801-3939
803-641-9140; n2zz@arrl.org

Vice Director: Bill Morine, N2COP
101 Windlass Dr., Wilmington, NC 28409
910-452-1770; n2cop@arrl.org

Rocky Mountain Division

www.rockymountaindivision.org
Jeff Ryan, K0RM
9975 Wadsworth Pkwy. K2-275
Westminster, CO 80021
303-432-2886; k0rm@arrl.org

Vice Director: Dan Grady, N2SRK
8706 S. Buchanan Way, Aurora, CO 80016
720-236-7397; n2srk@arrl.org

Southeastern Division

www.facebook.com/ARRLSoutheasternDivision
Mickey Baker, N4MB
14764 Black Bear Rd., West Palm Beach, FL
33418, 561-320-2775; n4mb@arrl.org

Vice Director: Jeff Beals, WA4AW
P.O. Box 1584, Loxahatchee, FL 33470
561-252-6707; wa4aw@arrl.org

Southwestern Division

www.kkn.net/n6aa
Richard J. Norton, N6AA
21290 West Hillside Dr., Topanga, CA 90290
310-455-1138; n6aa@arrl.org

Vice Director: Edward Stearns, AA7A
7038 E. Aster Dr., Scottsdale, AZ 85254
480-332-8255; aa7a@arrl.org

West Gulf Division

www.westgulfdivision.org
John Robert Stratton, N5AUS
P.O. Box 2232, Austin, TX 78768-2232
512-445-6262; n5aus@n5aus.com

Vice Director: Lee H. Cooper, W5LHC
2507 Autrey Dr., Leander, TX 78641
512-658-3910; w5lhc@arrl.org

ARRL Section Managers

The 15 Divisions of ARRL are arranged into 71 administrative *Sections*, each headed by an elected *Section Manager* (SM). Your SM is the person to contact when you have news about your activities, or those of your radio club. If you need assistance with a local problem, your SM is your first point of contact. He or she can put you in touch with various ARRL volunteers who can help (such as Technical Specialists). Your SM is also the person to see if you'd like to become a Section volunteer. Whatever your license class, your SM has an appointment available. Visit your Section page at www.arrrl.org/sections.

Atlantic Division DE, EPA, MDC, NNY, SNJ, WNY, WPA

Delaware: Steven Keller, KC3DSO, 803 Meadow Brook Ln., Milford, DE 19963-3000; 240-515-0620; kc3dso@arrrl.org

Eastern Pennsylvania: Bob Wilson, W3BIG, 2223 West Helms Manor, Upper Chichester, PA 19061-3325; 484-836-9367; w3big@arrrl.org

Maryland-DC: Chris Van Winkle, AB3WG, 24 Tattersaul Ct., Reisterstown, MD 21136-2431; 240-755-4257; ab3wg@arrrl.org

Northern New York: Rocco Conte, WU2M, 152 W. Bush Rd., Gloversville, NY 12078-6405; 518-848-9028; wu2m@arrrl.org

Southern New Jersey: Tom Preiser, N2XW, 177 Bowsprit Rd., Manahawkin, NJ 08050-5001; 609-618-0224; n2xw@arrrl.org

Western New York: Laura Mueller, N2LJM, 2011 E. Main St., Falconer, NY 14733 716-338-3122; n2ljm@arrrl.org

Western Pennsylvania: Joe Shupienis, W3BC, P.O. Box 73, Falls Creek, PA 15840-0322; 814-771-3804; w3bc@arrrl.org

Central Division IL, IN, WI

Illinois: Thomas Beebe, W9RY, 3540 Market Rd., Marion, IL 62959-8940 618-534-6282; w9ry@arrrl.org

Indiana: Bob Burns, AK9R, P.O. Box 808, Brownsburg, IN 46112 317-520-1188; ak9r@arrrl.org

Wisconsin: Jason Spetz, KC9FXE, E5910 490th Ave., Menomonie, WI 54751-5644 715-231-7722; kc9fxe@arrrl.org

Dakota Division MN, ND, SD

Minnesota: Bill Mitchell, AE0EE, 7412 Colfax Ave. S., Richfield, MN 55423 510-529-5658; ae0ee@arrrl.org

North Dakota: Ralph Fettig, N0RDF, 6650 County Rd. 12 W., Minot, ND 58701-3003 701-822-3467; n0rdf@arrrl.org

South Dakota: Chris Stallkamp, K10D, P.O. Box 271, Selby, SD 57472-0271 605-848-3929; k10d@arrrl.org

Delta Division AR, LA, MS, TN

Arkansas: James D. Ferguson, Jr., N5LKE, 1500 Lauren Dr., Searcy, AR 72143-8477 501-593-5695; n5lke@arrrl.org

Louisiana: Matt Anderson, KD5KNZ, 75510 Henderson Rd., Covington, LA 70435-0618; 225-806-2524; kd5knz@arrrl.org

Mississippi: Malcolm Keown, W5XX, 64 Lake Circle Dr., Vicksburg, MS 39180 601-636-0827; w5xx@arrrl.org

Tennessee: David Thomas, KM4NYI, 205 Linford Rd., Knoxville, TN 37920 865-654-5489; km4nyi@arrrl.org

Great Lakes Division KY, MI, OH

Kentucky: Charles O'Neal, KE4AIE, 301 Autumn Ridge Rd., Glasgow, KY 42141-9699 502-680-0539; ke4aie@arrrl.org

Michigan: Larry Camp, WB8R, 71 Oakdale Ln., Coldwater, MI 49036-1200 517-617-4883; wb8r@arrrl.org

Ohio: Tom Sly, WB8LCD, 1480 Lake Martin Dr., Kent, OH 44240-6260 330-554-4650; wb8lcd@arrrl.org

Hudson Division ENY, NLI, NNJ

Eastern New York: John K. Fritze, Jr., K2QY, 4 Normanskill Blvd., Delmar, NY 12054-1335; 401-261-4996; k2qy@arrrl.org

NYC-Long Island: Jim Mezney, W2KFV, 38 Appletree Ln., Carle Place, NY 11514-1336; 516-315-8608; w2kfv@arrrl.org

Northern New Jersey: Bob Buus, W2OD, 8 Donner St., Holmdel, NJ 07733-2004 732-946-8615; w2od@arrrl.org

Midwest Division IA, KS, MO, NE

Iowa: Lelia Garner, WA0UIG, 145 Front St., Robins, IA 52328-9718 319-213-3539; wa0uig@arrrl.org

Kansas: Ronald D. Cowan, KB0DTI, P.O. Box 36, La Cygne, KS 66040 913-757-4456; kb0dti@arrrl.org

Missouri: Cecil Higgins, AC0HA, 27995 County Rd. 220, Hermitage, MO 65668-8493 417-493-8208; ac0ha@arrrl.org

Nebraska: Matthew N. Anderson, KA0BOJ, 14300 NW 98th St., Raymond, NE 68428-4254; 402-480-5515; ka0boj@arrrl.org

New England Division CT, EMA, ME, NH, RI, VT, WMA

Connecticut: Bud Kozloff, W1NSK, 223 Gallows Hill Rd., Redding, CT 06896-1413 203-939-3708; w1nsk@arrrl.org

Eastern Massachusetts: Jon McCombie, N1ILZ, 75 Northwest St., Eastham, MA 02642 508-246-4982; n1ilz@arrrl.org

Maine: Philip Duggan, N1EP, 195 Kansas Rd., Milbridge, ME 04658-3120 207-598-5397; n1ep@arrrl.org

New Hampshire: Peter Stohrer, W1FEA, 9 Gladstone St., Concord, NH 03301-3130 603-345-1470; w1fea@arrrl.org

Rhode Island: Nancy Austin, KC1NEK, P.O. Box 4941, Middletown, RI 02842-0941 401-935-3070; kc1nek@arrrl.org

Vermont: Paul N. Gayet, AA1SU, 11 Cherry St., Essex Junction, VT 05452 802-878-2215; aa1su@arrrl.org

Western Massachusetts: Raymond Lajoie, AA1SE, 245 Leominster Rd., Lunenburg, MA 01462-2031; 978-549-5507; aa1se@arrrl.org

Northwestern Division AK, EWA, ID, MT, OR, WWA

Alaska: David Stevens, KL7EB, 8521 Golden St., Apt. 4, Anchorage, AK 99502 907-242-6483; kl7eb@arrrl.org

Eastern Washington: Jo Whitney, KA7LJQ, P.O. Box 2222, Yakima, WA 98907 509-952-5765; ka7ljq@arrrl.org

Idaho: Dan Marler, K7REX, 6525 W. Fairfield Ave., Boise, ID 83709 208-914-8939; k7rex@arrrl.org

Montana: Kevin Kerr, W1KKG, P.O. Box 69, Plains, MT 59859-0069 406-242-0109; w1kkg@arrrl.org

Oregon: Scott Rosenfeld, N7JI, 3662 Vine Maple St., Eugene, OR 97405-4473 541-684-9970; n7ji@arrrl.org

Western Washington: Monte L. Simpson, W7FF, P.O. Box 3008, Silverdale, WA 98383 360-633-7665; w7ff@arrrl.org

Pacific Division EB, NV, PAC, SCV, SF, SJV, SV

East Bay: Mike Patterson, N6JGA, P.O. Box 30627, Walnut Creek, CA 94598 925-200-8300; n6jga@arrrl.org

Nevada: John Bigley, N7UR, 2420 Palora Ave., Las Vegas, NV 89121-2157 702-498-5829; n7ur@arrrl.org

Pacific: Alan Maenchen, AD6E, 2164 Kamaile St., Wailuku, HI 96793-5458 408-382-1008; ad6e@arrrl.org

Sacramento Valley: Dr. Carol Milazzo, KP4MD, P.O. Box 665, Citrus Heights, CA 95611-0665; 916-259-3221; kp4md@arrrl.org

San Francisco: Dr. Antonis Papatsaras, AA6PP, 48 Bayo Vista Ave., Larkspur, CA 94939-1006; 415-861-5053; aa6pp@arrrl.org

San Joaquin Valley: John Litz, NZ6Q, 1434 Douglas Rd., Stockton, CA 95207-3536 209-331-3078; nz6q@arrrl.org

Santa Clara Valley: James Armstrong, NV6W, 2048 Paseo Del Sol, San Jose, CA 95124-2048; 408-679-1680; nv6w@arrrl.org

Roanoke Division NC, SC, VA, WV

North Carolina: Marvin K. Hoffman, WA4NC, P.O. Box 2208, Boone, NC 28607 828-964-6626; wa4nc@arrrl.org

South Carolina: John Gendron, NJ4Z, 3052 Devonshire Dr., Rock Hill, SC 29732-9260 704-649-2210; nj4z@arrrl.org

Virginia: Jack Smith, KE4LWT, 515 New Life Dr., Ruckersville, VA 22968-3045 662-523-0000; ke4lwt@arrrl.org

West Virginia: Dan Ringer, K8WV, 18 W. Front St., Morgantown, WV 26501-4507 304-292-1999; k8wv@arrrl.org

Rocky Mountain Division CO, NM, UT, WY

Colorado: Amanda Alden, K1DDN, 230 Glenmoor Rd., Canon City, CO 81212-7705 719-315-0434; k1ddn@arrrl.org

New Mexico: Bill Mader, K8TE, 4701 Sombrette Rd. SE, Rio Rancho, NM 87124 505-250-8570; k8te@arrrl.org

Utah: Pat Malan, N7PAT, 10102 S. Redwood Rd. #95401, South Jordan, UT 84095 801-413-7438; n7pat@arrrl.org

Wyoming: Garth Crowe, Sr., WY7GC, 2342 Sagewood Ave., Casper, WY 82601-5018 307-689-1340; w7gc@arrrl.org

Southeastern Division AL, GA, NFL, PR, SFL, VI, WCF

Alabama: Dennis Littleton, K4DL, 2230 Bishop Rd., West Blocton, AL 35184-4246 205-718-4410; k4dl@arrrl.org

Georgia: David Benoist, AG4ZR, 190 Fox Hall Crossing E., Senoia, GA 30276-3481 404-290-0470; ag4zr@arrrl.org

Northern Florida: Scott Roberts, KK4ECR, 2361 Oak Hammock Ln., Orange Park, FL 32065; 904-759-7812; kk4ecr@arrrl.org

Puerto Rico: Rene Fonseca, NP3O, Urb Santa Isidra 4 G8 Calle 6, Fajardo, PR 00738-4145; 939-579-4134; np3o@arrrl.org

Southern Florida: Barry M. Porter, KB1PA, 14555 Sims Rd., Apt. 258, Delray Beach, FL 33484; 561-499-8424; kb1pa@arrrl.org

Virgin Islands: Fred Kleber, K9VV, P.O. Box 24275, Christiansted, VI 00824-0275; k9vv@arrrl.org

West Central Florida: Michael Douglas, W4MDD, 2527 Apple Blossom Ln., Wauchula, FL 33873; 863-585-1648; w4mdd@arrrl.org

Southwestern Division AZ, LAX, ORG, SB, SDG

Arizona: Rick Paquette, W7RAP, 1600 W. Sunkist Rd., Tucson, AZ 85755-9561 520-425-6877; w7rap@arrrl.org

Los Angeles: Diana Feinberg, A16DF, P.O. Box 4678, Palos Verdes Peninsula, CA 90274-9618; 310-544-2917; a16df@arrrl.org

Orange: Bob Turner, W6RHK, P.O. Box 973, Perris, CA 92572 951-236-8975; w6rhk@arrrl.org

San Diego: Dave Kallenborn, N8KBC, 630 Alber St., Chula Vista, CA 91911 619-616-8758; n8kbc@arrrl.org

Santa Barbara: John Kitchens, NS6X, P.O. Box 178, Somis, CA 93066 805-216-2569; ns6x@arrrl.org

West Gulf Division NTX, OK, STX, WTX

North Texas: Steven Lott Smith, KG5VK, 125 Contest Ln., Ben Franklin, TX 75415-3830; 318-470-9806; kg5vk@arrrl.org

Oklahoma: Mark Kleine, N5HZR, 2651 84th Ave. SE, Norman, OK 73026 405-410-6756; n5hzz@arrrl.org

South Texas: Stuart Wolfe, KF5NIX, 408 Cedar Grove Rd., Rockdale, TX 76567 512-660-9954; kf5nix@arrrl.org

West Texas: H. Dale Durham, W5WI, P.O. Box 375, Buffalo Gap, TX 79508 830-719-9000; w5wi@arrrl.org

Pull Out the Muscle!



Hear the roar and feel the POWER! Get that POWER you need to really bust through the pileups, win a few contests, work the world!!! Ameritron amplifiers will go a long way towards making those dreams a reality. We got an amplifier for every budget!

AMERITRON . . . 800 Watts . . . \$1499!

More hams use Ameritron AL-811/H amplifiers than any other amplifier in the world!



AL-811H
\$1499
Suggested Retail
4-Tubes, 800 Watts

that can't be matched by un-neutralized tubes.

You get a quiet desktop linear that's so compact it'll slide right into your operating position -- you'll hardly know it's there . . . until QRM sets in. And you can conveniently plug it into your nearest 120 VAC outlet -- no special wiring needed.

You get all HF band coverage (with license) -- including WARC and most MARS bands at 100% rated output. Ameritron's *Adapt-A-Volt*™ hi-silicon core

power transformer has a special buck-boost winding that lets you compensate for high/low power line voltages.

You also get efficient full size heavy duty tank coils, slug tuned input coils, operate/standby switch, transmit LED, ALC, dual illuminated meters, QSK with optional QSK-5, pressurized cooling that you can hardly hear, full height computer grade filter capacitors and more. 13³/₄Wx8Hx16D inches.

AL-811, \$1399.

Like AL-811H, but has three 811A tubes, 600 Watts output.

Only the Ameritron AL-811H gives you four fully neutralized 811A transmitting tubes. You get absolute stability and superb performance on higher bands

AL-811
\$1399
Suggested Retail
3-Tubes, 600 Watts

AMERITRON no tune Solid State Amplifiers

ALS-500M 500 Watt Mobile Amp



ALS-500M 500 W
\$1199
Suggested Retail
PEP/400 W
CW out-

put, 1.5-22 MHz, instant bandswitching, no tuning, no warm-up. SWR, load fault, thermal overload protected. On/Off/Bypass switch. Remote on/off control. DC current meter. Extremely quiet fan. 13.8 VDC. 9Wx3¹/₂Hx15D in., 7 lbs. **ALS-500RC, \$89, Remote Head.**

ALS-606S 600 Watt 160-6M Amp

600
Watts
PEP/
500W

ALS-606S
\$2599
Suggested Retail



CW output, 160-6M with automatic instant bandswitching. Desktop. 9³/₄Wx7Hx14¹/₂D". 14.2 lbs. Only 4 dB below 1500W -- less than an S-unit! **ALS-606, \$2799**, like ALS-606S above, but has transformer power supply.

Desktop Kilowatt Amplifier



Whisper quiet desktop amp plugs into 120 VAC to give full kilowatt SSB PEP output. Ameritron's exclusive

AL-80B
\$2299
Suggested Retail
DynamicALC™ doubles average SSB power out and *Instantaneous RF Bias*™ gives cooler operation. All HF bands. 850 Watts CW out, 500 Watts RTTY out, extra heavy duty power supply, 3-500G tube, 70% efficiency, tuned input, Pi/Pi-L output, inrush current protection, dual Cross-Needle meters, QSK compatible, 48 lbs. 14Wx8¹/₂Hx15¹/₂D". **2-year Ameritron warranty.**

ALS-1306 1200W 1.5-54 MHz Amp



ALS-1306
\$3999
Suggested Retail

Ameritron's highest power solid state FET amplifier gives you automatic bandswitching plus HF and 6-Meter coverage! Get 1200 Watts PEP output on all bands, including 6-Meters. No tuning, no warm-up, no tubes to baby and no fuss! Eight rugged MRF-150 power FET's give outstanding reliability and long time service. Just 100 Watts drive gives you the full rated power! Measures a compact 10Wx6¹/₂Hx18D inches. Just 22 lbs.

Near Legal Limit™ Amplifier



AL-572
\$2399
Suggested Retail
Near Legal Limit™ amp gives you 1300W PEP SSB power output for 60% of the price of a full legal limit amp! Four rugged 572B tubes. Instant 3-second warm-up, 120 VAC. Desktop 14¹/₄Wx8¹/₂Hx15¹/₂D". 160-15M. 1000 Watt CW output. Tuned input, instantaneous RF Bias, dynamic ALC, parasitic killer, inrush protection, cross-needle meters, multi-voltage transformer.

HF Amps with 3CX800A7 tube



AL-800NT
\$2799
No tube, 1250W Suggested Retail

AL-800HNT
\$2999
No tubes, 1.5 kW Plus Call for Quote

Desktop 3CX-800A7 tubes cover 160-15M, WARC bands. Adjustable slug tuned input, grid protection, ALC control, vernier reduction drives, hefty 32 lb. transformer, high capacitance computer grade filter capacitors. Multi-voltage, dual cross-needle meters. 14¹/₄Wx8¹/₂Hx16¹/₂D".

AMERITRON full legal limit amplifiers

AMERITRON legal limit amps use a super heavy duty power transformers capable of 2.5 kW!

Most powerful



AL-1500NT
\$3899
No Tube

Ameritron's most powerful amplifier uses the herculean 3CX1500/8877 ceramic tube. 65 watts gives full legal output -- loafing with a 2500W power supply.

Toughest



AL-1200NT (No Tube)
\$3799
Suggested Retail

Ham radio's toughest tube -- the *Eimac*™ 3CX1200Z7. 50-Watt control grid dissipation. Super heavy duty power supply loafs at legal power -- delivers more than 2500 Watts PEP two tone output for a 1/2 hour.

Classic -- Dual 3-500Gs



AL-82
\$3999
Suggested Retail

Gives full legal output using a pair of genuine 3-500Gs. Competing linears using 3-500Gs can't give you 1500 Watts because their lightweight power supplies can't use these tubes to their full potential.

Ameritron brings you the finest high power accessories!

ARB-704 amp-to-rig interface . . . \$79



Protects rig from keying line transients. Easy rig hookup.

RCS-4 Remote Coax Switch...\$199

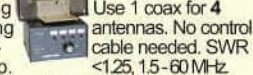

Use 1 coax for 4 antennas. No control cable needed. SWR <125, 15-60 MHz. I useable to 100 MHz.

RCS-8V Remote Coax Switch...\$279



Replace 5 coax with 1! 1.2 SWR, 250 MHz. Useable to 450 MHz. <.1 dB loss. 1kW@150MHz.

RCS-10 Remote Coax Switch...\$259



Replace 8 coax with 1! SWR<1.3 to 60 MHz. **RCS-10L, \$299** with lightning arrestors

AMERITRON®

. . . the world's high power leader!

116 Willow Road, Starkville, MS 39759
TECH (662) 323-8211 • FAX (662) 323-6551
8 a.m. - 4:30 p.m. CST Monday - Friday
For power amplifier components call (662) 323-8211
<http://www.ameritron.com>
Prices and specifications subject to change without notice. © 2023 Ameritron.



RI Grunners

12V DC POWER DISTRIBUTION

SAFE

Each connection is individually fused and each fuse has a blown LED indicator and an RFI protection capacitor!

CONVENIENT

Using properly crimped Anderson Powerpoles® as genderless connectors is the easiest option for DC Power.

SIMPLE

Anderson Powerpoles® are the simplest way to hook up all of your equipment and organize your shack!

HORIZONTAL MODELS

Powerpole connectors exit through bottom edge allowing tidy wall or under-dashboard cabling.

OPTIONS LIKE USB AND VOLT AMP METER



4007U

The 4007U model of RI Grunner is equipped with all of the standard features you know and love, like Anderson Powerpoles, RFI protection and Blown Fuse LEDs, and has the great addition of Over/Under Voltage LED Lights, On/Off switch, USB ports and volt/amp meter!

Specific Models may include: USB Charging, Volt/Amp Display, On/Off Switch, Master Port control, PWRguard cutoff for under/over voltage, web-based monitoring and control, and Over/Under voltage indicators



262-522-6503 EXT 35
sales@westmountainradio.com

westmountainradio.com/QST224

NEW

ELECRAFT® KH1

**HAND-HELD,
5-BAND TRANSCEIVER**

YOUR E-TICKET TO ADVENTURE

KH1 Features

- ▲ 40-15 m bands; 6.7-22 MHz SWL
- ▲ CW mode; 5 watts, all bands
- ▲ ATU includes whip & high-Q inductor for 20/17/15 m*
- ▲ 2.5 AH Li-Ion battery & internal charger*
- ▲ CW decode & 32K TX log
- ▲ Scan/mini-pan feature
- ▲ Real-Time Clock
- ▲ Weights only 6 oz (less batt)
- ▲ Speaker
- ▲ RIT, XIT, & VFO lock



KX LINE: KX2/KX3

ELECRAFT® FULL-FEATURED ULTRA-PORTABLES 100W WITH MATCHING AMP

KX2 Ultralight Grab-and-Go Station Perfect for SOTA & Field Operations

- ▲ 5.8" x 2.8" x 1.5" (weight: 13 oz.)
- ▲ 80-10 meters (9 bands)
- ▲ SSB / CW / Data/ AM / FM
- ▲ Up to 12 W TX
- ▲ Internal 2.6 Ah Li-ion battery*
- ▲ Built-in mic for HT-style operation
- ▲ Wide-range internal ATU*



KX3 Compact 160-6 Meter, All-Mode Transceiver

- ▲ Best-in-class performance
- ▲ 7.4" x 3.5" x 1.7" (weight: 1.5 lbs.)
- ▲ Matching PX3 panadapter*
- ▲ 160-6 meters plus 2 or 4 m*
- ▲ SSB, CW, AM, FM, Data
- ▲ Up to 15 W TX
- ▲ Wide-range internal ATU*

MAKE WAVES IN STYLE WITH THE NEW K-LINE

K4 DIRECT-SAMPLING SDR AND KPA1500 LEGAL-LIMIT AMP

K4 Features

- ▲ High-Performance Direct Sampling SDR
- ▲ Comprehensive I/O
- ▲ 7" color screen with touch and mouse control
- ▲ 3 antenna jacks
- ▲ Single or dual RX panadapter
- ▲ Full remote control via Ethernet
- ▲ ATU with 10:1+ range
- ▲ Up to 5 receive antenna sources

KPA1500 Features

- ▲ 1500 W • Very compact design
- ▲ Built-in ATU with dual antenna jacks
- ▲ Compatible with nearly any transceiver – custom cables available 160-6 meters
- ▲ CE for Europe

**K4 & KPA1500
Now Shipping!**



ELECRAFT®

*Options

For complete features and specifications, visit elecraft.com | Sales@elecraft.com | 831.763.4211

Up Front

Heathkit Vintage Station Restored

"I had so much fun putting together this Heathkit SB series vintage station," says Jerry Svoboda, KB2QIU. Over the last 2 years, Jerry found the SB-401 transmitter, SB-301 receiver, SB-650 frequency display, SB-610 station monitor, SB-600 speaker, and HD-1410 keyer/paddle and restored them to good working condition. The mic is an Astatic 10-DA.



DIY Restoration

Bill Jones, K8CU, patiently restored this Bird 43 wattmeter by hand-polishing the aluminum with sandpaper. As a final touch, he applied a translucent powder coat, giving it a unique finish and distinctly vintage look.



The Bird 43 wattmeter in three states: (left to right) the original, polished aluminum only, and with a translucent gold powder coat.

First Century Heathkit

James Fox, N7ENI, shares a memory from the "First Century." This Heathkit coffee cup sat next to his HW-8, and the T-shirt was worn with pride during the early '80s.

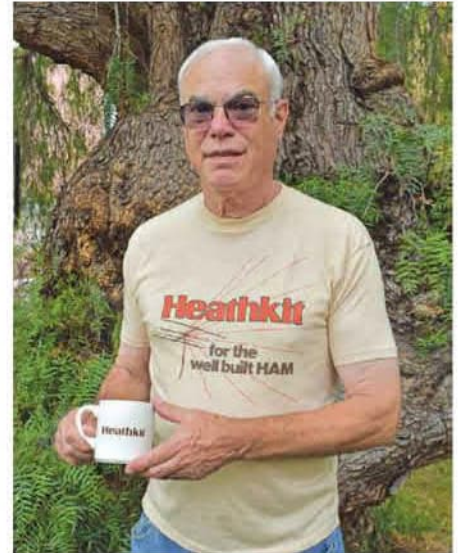

QST Sportswear?

Fred Baumgartner, K0FMB, saw this while skiing at Copper Mountain Ski Resort in Frisco, Colorado. No, ARRL isn't expanding its product line. QST 92 is a line of Salomon light-weight skis.



If you see something ham-related out in the world, take a photo of it and send it to "Up Front" at upfront@arrl.org.

FOR THE THRILL OF THE HUNT.

We're for every corner of the earth. So much so it's led to revolutionizing the ham radio industry as the leader in software-defined radios (SDRs) design. Because when you're looking to connect with people and places that may or may not even be on the map, you better have the best partner in technology on the planet. Contest season is upon us, and it's time to prepare your station. To learn more about our boundary-pushing products, visit FlexRadio.com.



FlexRadio

Find Everywhere

GO. SEEK. FIND.





DAYTON 2024 HAMVENTION®

Expanding Our Community



Greene County Fairgrounds & Expo Center
Xenia, Ohio

Get Your Tickets Online NOW!
\$26 in advance or \$30 at the gate

May 17 - 19, 2024

- Exhibits & Flea Market
- Forums & Activities
- Networking & More!

hamvention.org

Meet us at Hamvention® for the 2024 ARRL National Convention



Program Highlights

- Special Exhibits and Guests
- Presentations and Forums
- ARRL Program Representatives
- ARRL Store. Get 2024 ARRL Field Day gear!



2024 ARRL Youth Rally at Hamvention® Saturday, May 18

Hands-on ham radio activities, discovery, sharing, and fun!
Advance online registration required (ages 11 – 21; includes t-shirt, lanyard, and badge)

Hamvention will provide admission tickets at no cost for these ARRL pre-registered Youth Rally attendees.

Register for the Youth Rally
at www.arrl.org/expo



ARRL
events

Download the ARRL Events app to find booths, exhibits, forums, maps, hourly prize drawings, and more!

Get the full 2024 ARRL National Convention Program at www.arrl.org/expo

Heard It | Worked It | Logged It

THE ULTIMATE SETUP FOR YOUR SWEEPSTAKES CONTEST

November Sweepstakes



ICOM

PRINCIPAL AWARDS SPONSOR



IC-7300
HF / 6M SDR Transceiver



IC-7610
HF / 6M SDR Transceiver
*New Pre-Distortion Firmware



IC-7851
The Ultimate HF / 6M Transceiver

For the love of **ham radio.**



www.icomamerica.com/amateur
insidesales@icomamerica.com

©2024 Icom America Inc. The Icom logo is a registered trademark of Icom Inc.
All specifications are subject to change without notice or obligation. 31597

ICOM

Correspondence

Letters from Our Members

Attracting Young People to Amateur Radio

When hams are asked, “How can we attract young people to the hobby?” almost every answer I hear includes some version of “We need to make it relevant to them, given young people can hear broadcasts and connect with people around the world via the internet.” The internet negates what brought many young people to amateur radio in the past. For many of us, our interest was first sparked by coming across a short-wave radio and then stumbling upon people talking on the amateur bands or hearing Morse code. Today, these short-wave broadcast stations are all but gone, and Wi-Fi and cell phones have made long-distance communications routine.

There is always the motto, “When all else fails,” to bring up when teaching younger generations about amateur radio emergency services. But there aren’t a lot of teenagers and college students on community emergency response teams. How do we reach out and get younger generations more active? What is your club doing to reach out to this segment? How can we be a relevant hobby to young people?

Parts of our hobby/service are near the forefront of technology. Robotics in schools and their associated competitions are big these days. Budding student technologists who can solve problems and create robots are well suited to become hams. What is amateur radio’s challenge for these students? Perhaps it’s foxhunting, mesh networking, or satellite communications. Maybe we can invent a new activity, something like programming, monitoring, and guiding radio-controlled cars or boats on long-distance treks.

Our hobby can be intimidating to some at first glance. Maybe we need to change our entry license to cut out more of the math and science and focus only on operations and rules, a bit on RF propa-

gation, a survey of a few digital modes, safety, and a very simple chapter on how to get on the air. Let the General level be the first place they get into math, components and circuits, RF theory, etc. Getting a license opens a lifetime of learning for many; therefore, we should make the first step even easier.

Perhaps we need to make our hobby/service easier to access by putting amateur radio clubs (in addition to the ARRL Teachers Institute) in schools, creating interest, and starting/sponsoring school radio clubs. We all have different interests in other non-radio activities and communities, which can be a vast network of connections to potential new licensees. Now, go forth and promote.

David A. Okrent, W7DAO
Seattle, Washington

The November 2023 Issue in the Spotlight

■ I have been trying to encourage my grandkids to get into the amateur radio craft, and this issue is ideally suited for that purpose. The article “Ham Radio in Virtual Reality” was inspirational to them, and having call signs displayed on the avatars was a plus. The “Youth in Contesting” article was especially interesting to my two older grandsons, because we took my mobile Icom IC-706MkIIIG, tuner, and Bushcomm Highlander 8 Tapped Mobile Whip Antenna on a magnet mount in our Jeep and did a POTA activation at Neal Smith National Wildlife Refuge on Thanksgiving morning. My grandkids range in age from 8 to 17 and are all STEM-oriented. The two eldest have begun studying for the Technician license and plan to take the test soon.

Hank Ortega, KG5TKV
Kerrville, Texas

■ As an enthusiastic YouTuber with a strong presence in the virtual reality/metaverse realm, I was thrilled to come across the article “Ham Radio in Virtual Reality.” These platforms have the power to bridge distances by virtually

presenting a perfect medium to highlight amateur radio. It’s heartening to see two of my passions intersect in a manner that enriches the experience of both. I eagerly anticipate the innovations such collaborations will usher in!

Hideki Saito, WU7J
Issaquah, Washington
Life Member

Ham Radio Estate Planning Resource

I just read with great interest Scott Freeberg’s, WA9WFA, letter “Why I Sold 99% of My Ham Radio Collection” in the November 2023 issue of *QST*. It made me think of ARRL Director of Development Kevin Beal, K8EAL, who is working on an excellent program to provide guidance for family members who don’t know what to do with ham equipment.

The program consists of a workbook that describes equipment and its conditions and the avenues to best dispose of, donate, and sell equipment. This takes a lot of burden off of the family when there are more important tasks to attend to.

Our club, the Cascades Amateur Radio Society, invited Kevin to do a virtual presentation through Zoom, which resulted in some very good suggestions. He also mentioned that *The ARRL Estate Planning Workbook* is downloadable from www.arrl.org/estate-planning-workbook.

Kudos for establishing this program and making speakers like Kevin available to clubs.

Dale H. Cole, K8TS
Jackson, Michigan

Send your letters to letters@arrl.org. We read every letter received, but we can only publish a few each month. We reserve the right to edit your letter for clarity, and to fit the available page space. Letters published in “Correspondence” may also appear in other ARRL media. The publishers of *QST* assume no responsibility for statements made by correspondents.



Get Exclusive **Amateur Radio Products** Fast and Easy

Save money and enjoy faster shipping when you purchase products from manufacturers sold exclusively in North America through DX Engineering: AlexLoop, Ciro Mazzone, Hamplus, InnovAntennas, OptiBeam, microHAM, Phonema, RM Italy, WiMo, DX Commander, and many more.

Plus, shop for time-tested equipment from DX Engineering and our family of brands, including Butternut Antennas, Comtek, Hi-Z and TW Antenna.

Make the Change to a More Satisfying Ham Radio Purchasing Experience

- Easy ordering by phone or web
- Products from over 170 leading manufacturers
- Friendly customer service from hams with a combined 1,000+ years in amateur radio
- Fastest shipping in the industry
- Responsive and ongoing technical support
- Not 100% happy? We make it right!



Order by Phone

800-777-0703 Country Code: +1
9 am to midnight ET, Monday-Friday
9 am to 5 pm ET, Weekends



Order Online

www.DXEngineering.com
Most orders over \$99 ship free
Request a Free Catalog



Tech Support

330-572-3200
DXEngineering@DXEngineering.com
9 am to 7 pm ET, Monday-Friday
9 am to 5 pm ET, Saturday



OnAllBands.com is dedicated to educating and informing the Amateur Radio community.



NEW A POTA book for park activators and hunters!

Participants in **Parks on the Air®** (POTA) have built one of the most vibrant on-air communities in contemporary ham radio. Park hunters comb the airwaves for activators operating from the lawns of sprawling public mansions, stoops at urban historic sites, forest glades, rocky mountaintops, seaside beaches, and just about any state or federal park in the country — and many entities abroad.

The Parks on the Air Book gives you a look at the setups and processes of 14 operators from a variety of skill levels and backgrounds and offers advice and motivation for taking your radio out to a park. Each chapter includes a detailed gear list so you can see exactly what your fellow operators are using, whether they're leaders of the pack or just getting started with POTA. Setups cover satellite operating, QRP, urban backpack portable, wire antennas for POTA, and more.

Full-Color Format!

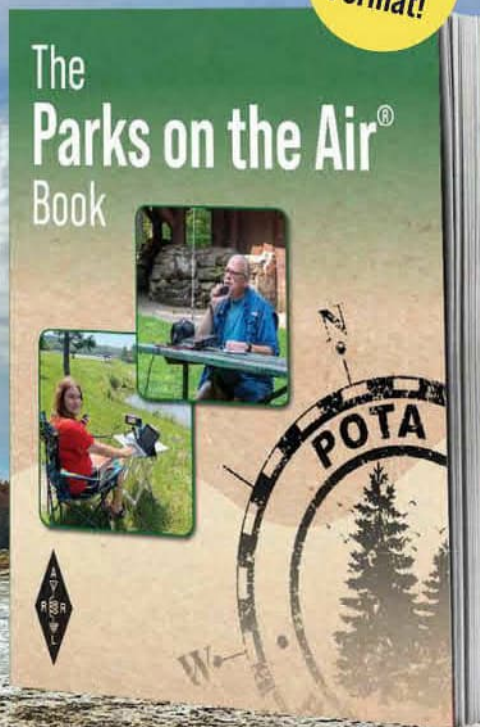

This book provides insight and expertise in a beautiful, full-color format, brimming with photos that celebrate ham radio and the wonderful, shared resource of our state and national parks.

ARRL Item No. 1748

Member Price \$19.95 ~~Retail \$22.95~~

LDG Electronics

The Innovators of High Quality Automatic Tuners, Baluns & Ununs

LDG has a complete line of autotuners, baluns, ununs and accessories that have been relied upon by countless operators. Trust the innovators. Trust LDG!



Best Value
Best Service
Best Warranty
Nobody Beats LDG!



ANAHEIM, CA: 800-854-6046 | ATLANTA, GA: 800-444-7927 | DENVER, CO: 800-444-9476
MILWAUKEE, WI: 800-558-0411 | NEW CASTLE, DE: 800-644-4476 | PHOENIX, AZ: 800-559-7388
PLANO, TX: 877-455-8750 | PORTLAND, OR: 800-765-4267 | SACRAMENTO, CA: 877-892-1745
SALEM, NH: 800-444-0047 | WINTER SPRINGS, FL: 800-327-1917 | WOODBRIDGE, VA: 800-444-4799

HAMRADIO.COM



W1AW Schedule

PAC	MTN	CENT	EAST	UTC	MON	TUE	WED	THU	FRI
6 AM	7 AM	8 AM	9 AM	1400		FAST CODE	SLOW CODE	FAST CODE	SLOW CODE
7 AM-12 ⁴⁵ PM	8 AM-1 ⁴⁵ PM	9 AM-2 ⁴⁵ PM	10 AM-3 ⁴⁵ PM	1500-2045	VISITING OPERATOR TIME				
1 PM	2 PM	3 PM	4 PM	2100	FAST CODE	SLOW CODE	FAST CODE	SLOW CODE	FAST CODE
2 PM	3 PM	4 PM	5 PM	2200	CODE BULLETIN				
3 PM	4 PM	5 PM	6 PM	2300	DIGITAL BULLETIN				
4 PM	5 PM	6 PM	7 PM	0000	SLOW CODE	FAST CODE	SLOW CODE	FAST CODE	SLOW CODE
5 PM	6 PM	7 PM	8 PM	0100	CODE BULLETIN				
6 PM	7 PM	8 PM	9 PM	0200	DIGITAL BULLETIN				
6 ⁴⁵ PM	7 ⁴⁵ PM	8 ⁴⁵ PM	9 ⁴⁵ PM	0245	VOICE BULLETIN				
7 PM	8 PM	9 PM	10 PM	0300	FAST CODE	SLOW CODE	FAST CODE	SLOW CODE	FAST CODE
8 PM	9 PM	10 PM	11 PM	0400	CODE BULLETIN				

W1AW's schedule is at the same local time throughout the year. From the second Sunday in March to the first Sunday in November, UTC = Eastern US time + 4 hours. For the rest of the year, UTC = Eastern US time + 5 hours.

◆ Morse code transmissions: Frequencies are 1.8025, 3.5815, 7.0475, 14.0475, 18.0975, 21.0675, 28.0675, 50.350, and 147.555 MHz.

Slow Code = practice sent at 5, 7½, 10, 13, and 15 WPM.

Fast Code = practice sent at 35, 30, 25, 20, 15, 13, and 10 WPM.

Code bulletins are sent at 18 WPM.

For more information, visit us at

www.arri.org/w1aw

◆ W1AW Qualifying Runs are sent on the same frequencies as the Morse code transmissions. West Coast qualifying runs are transmitted by various West Coast stations on CW frequencies that are normally used by W1AW, in addition to 3590 kHz, at various times. Underline 1 minute of the highest speed you copied, certify that your copy was made without aid, and send it to ARRL for grading. Please include your name, call sign (if any), and complete mailing address. Fees: \$10 for a certificate, \$7.50 for endorsements.

◆ Digital transmissions: Frequencies are 3.5975, 7.095, 14.095, 18.1025, 21.095, 28.095, 50.350, and 147.555 MHz.

Bulletins are sent using 45.45-baud Baudot, PSK31 in BPSK mode, and MFSK16 on a daily revolving schedule.

Keplerian elements for many amateur satellites will be sent on the regular digital frequencies on Tuesdays and Fridays at 6:30 PM Eastern time using Baudot and PSK31.

◆ Voice transmissions: Frequencies are 1.855, 3.99, 7.29, 14.29, 18.16, 21.39, 28.59, 50.350, and 147.555 MHz. Voice transmissions on 7.290 MHz are in AM double sideband, full carrier.

◆ Notes: On Fridays, UTC, a DX bulletin replaces the regular bulletins. W1AW is open to visitors 10 AM to 3:45 PM Monday through Friday. FCC-licensed amateurs may operate the station during that time. Be sure to bring a reference copy of your current FCC amateur license. In a communication emergency, monitor W1AW for special bulletins as follows: voice on the hour, teleprinter at 15 minutes past the hour, and CW on the half hour.

W1AW code practice and CW/digital/phone bulletin transmission audio is also available real-time via the *EchoLink Conference Server W1AWBDCT*. The conference server runs concurrently with the regularly scheduled station transmissions. The W1AW Qualifying Run texts can also be copied via the EchoLink Conference Server.

During 2024, Headquarters and W1AW are closed on New Year's Day (January 1), Presidents Day (February 19), Memorial Day (May 27), Independence Day (July 4), Labor Day (September 2), Veterans Day (November 11), Thanksgiving and the following day (November 28 and 29), and Christmas Day (December 25).



KENWOOD

Versatile and Flexible Radio Returns with
a New Look and Soaring Functions
That'll Thrill Amateur Radio Enthusiasts.



NEW TRIBANDER **TH-D75A** 144 / 220 / 430 MHz TRIBANDER

Key Features

- **APRS® Protocol¹ compliant**
To exchange GPS location data and messages in real-time.
- **D-STAR™ with Simultaneous Reception on DV mode**
Compatible for transferring voice and digital data over D-STAR networks.
- **Reflector Terminal mode to access D-STAR Reflectors**
- **USB Type-C for Data Transfer and Charging**
- **Built-in Digipeater (a digital repeater) station to transmit received data**
- **Built-in GPS unit**
- **Easy-to-read Transflective Color TFT Display**
- **Call Sign Readout**
- **Tough & Robust - meets IP54/55 Standards**
- **Wide-band and multi-mode reception**
- **Built-in IF Filter for comfortable reception (SSB/CW)**
- **DSP-based Voice Processing and Reputable KENWOOD Custom Tuned Sound Quality**
- **Bluetooth®, microSD/SDHC Memory Card Slot for flexible link with a PC**

*1: APRS® (The Automatic Packet Reporting System) is a registered trademark of TAPR (Tucson Amateur Packet Radio Corp.)

*2: D-STAR is a digital radio protocol developed by JARL (Japan Amateur Radio League).

All other company names, brand names and product names are registered trademarks or trade names of their respective holders.

Specifications, design, and availability of accessories may vary due to advancements in technology. Actual product colors may differ from photograph due to photography or printing conditions. Brand or product names may be trademarks and/or registered trademarks of the respective holders.

The content of this document is based on information available at the time of its publication and may be different from the latest information.

This device has not been authorized as required by the rules of the Federal Communications Commission. This device is not, and may not be, offered for sale or lease, or sold or leased, until authorization is obtained.

The Un-Ugly Balun Form

Build baluns for 160 – 6 meters using these 3D-printed frequency-customizable bobbins.

John Portune, W6NBC, and Jim Bailey, W6OEK

This article explains how to build two 3D-printed coax balun bobbins that eliminate tie wraps, mounting holes in the form, or messy adhesive to secure the coax. Information for 3D-printed mounting brackets is included as well. See Chapter 23.10 in the 100th edition of *The ARRL Handbook* for details on 3D printing.

The Design

These much-improved 3D-printed bobbins (see the lead photo) are easily customized for any frequency between 160 and 6 meters. That's because the body of the bobbin is not 3D-printed but is a short length of 2- or 4-inch PVC pipe (see Figure 1). The printed ends are glued to the PVC pipe. Figure 2 shows two sizes: one for RG-8X (Mini-8) and one for RG-8 coaxial cable. The smaller bobbin also works with RG-58 coaxial cable.

A Handy Coax Balun Design Calculator

Turns and pipe lengths (see Tables 1 and 2) were developed using the coax balun calculator at <https://tinyurl.com/b2sjcxv9>. We added one additional turn



Pole-mounted 160-meter un-ugly balun.

because the calculator outputs a center-to-center winding length. The calculator needs the following data:

- Form diameter: 2 inches of PVC with a 2.375-inch outer diameter, or 4 inches of PVC with a 4.5-inch outer diameter



Figure 1 — End caps and body pipes. Note ramps on rings to keep turns together.



Figure 2 — Completed small 40-meter and large 80-meter un-ugly baluns.

Band	uH	Turns	PVC (inches)
160	17.7	30	7.7
80	9.1	17	4.6
40	4.5	10	2.9
20	2.3	6	2
10/6	1.1	4	1.5

Band	uH	Turns	PVC (inches)
160	17.7	17	7.7
80	9.1	10	4.9
40	4.5	6	3.2
20	2.3	4	2.4
10/6	1.1	2.6	1.9

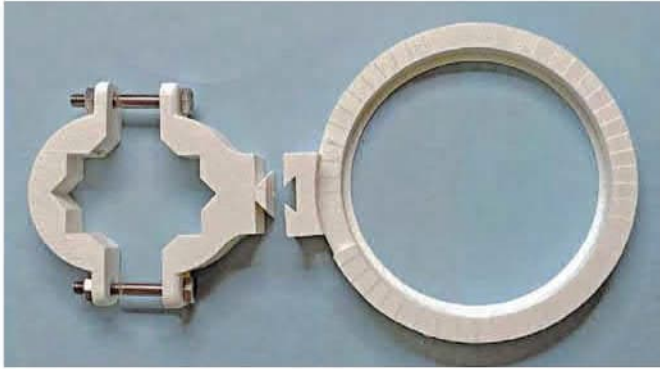

Figure 3 — A 3D-printed mounting bracket for a large balun attached to an end cap with #10-24 × 1-inch stainless-steel screws.

- RG-8X Mini coaxial cable: 0.242 inch or 0.2 inch without insulation
- RG-8 coaxial cable: 0.405 inch or 0.38 inch without insulation

The body pipe lengths were calculated from the number of turns multiplied by the diameter of the coax, plus an extra 0.8 inch for the pipe to reach the stops in the end caps. The nominal industry standard diameter for RG-8 coaxial cable is 0.405 inch. In practice, however, coaxial cable may vary. It's wise to measure yours with a caliper and add to or subtract from the table dimension, particularly if your coax is slightly larger.

Mounting the Balun

Figure 3 shows a heavy-duty 3D-printed mounting bracket for the larger bobbin. A single bracket at the top is adequate for a 6- through 40-meter balun. Two are best for an 80- or 160-meter balun. The smaller coax balun is light enough to be self-supported by the coax or zip-tied to a nearby support.

Connectors may be installed at the ends of the coax, or the balun may be inserted directly into the existing antenna feed line without connectors. If so, each turn of RG-8 will require 16 inches of feed line. Mini-8 coax will need roughly 8.25 inches per turn.

Construction

Polylactic acid (PLA) plastic filament is acceptable for printing. The end caps and the mounting brackets are heavy duty and will tolerate reasonably long-term UV exposure. Polyethylene terephthalate glycol (PETG), acrylonitrile butadiene styrene (ABS), or acrylonitrile styrene acrylate (ASA) may also be used; white or clear is preferable.

- 1 Cut the PVC body pipe to the length shown in Tables 1 and 2 for the design frequency (the lowest frequency on which the balun will be used).
- 2 Glue on one end cap using clear RTV silicone or polyurethane Gorilla Glue. Allow the glue to set.
- 3 Insert one end of the coaxial cable under the securing tab. Leave a sufficient amount of coaxial cable if you're adding a connector.
- 4 Wind on the turns. You may wish to first apply RTV adhesive lengthwise along the PVC pipe under the turns.
- 5 Pass the final turn of coax under the securing tab, and apply glue to the second end cap. Install it and snug up the turns.
- 6 Allow the glue to set.

Frequencies

In general, baluns, including these un-ugly baluns, can be used on higher frequencies than the design frequency. For example, an 80-meter balun is suitable across the entire HF spectrum and on 6 meters. The extra turns merely provide greater choking impedance.

You can obtain the 3D-printer files (.stl) by emailing w6nbcmail@gmail.com.

All photos by the authors.

John Portune, W6NBC, has been licensed since 1965. He received a BS in physics from Oregon State University in 1960. He is retired from KNBC Channel 4 in Burbank, California, where he was a broadcast television engineer and instructor. He is a member of the Satellite Amateur Radio Club at Vandenberg Space Force Base. John has been published in *QST*, *World Radio*, and *73* magazines. He is active on HF, VHF, and UHF — SSB, AM, CW, FM, and digital modes — and he is an AMSAT satellite user. He is a frequent speaker at ham clubs (see www.w6nbc.com for topics and to sign up). John can be reached at jportune@aol.com.

Jim Bailey, W6OEK, has been a licensed amateur radio operator for more than 64 years. He retired from a local electronics company in Santa Maria, California, where he was an engineer and maintenance supervisor. He is also a member of the Satellite Amateur Radio Club at Vandenberg Space Force Base. Jim can be reached at w6oek@comcast.net.

For updates to this article, see the *QST* Feedback page at www.arrl.org/feedback.



The Scavenger Broadcast Band Blocking Filter

A solution to front-end overload from nearby AM stations.

Stan Johnson, WØSJ

During one of my ham radio operations, I saw almost 2 V peak to peak when I connected my scope to my 160-meter antenna! No wonder I needed 20 dB of attenuation to keep the receiver front end from overloading. Radio stations that are 10,000 W don't make good neighbors. I needed an AM broadcast band blocking filter that had at least 20 dB attenuation at 1650 kHz, could pass the 160-meter band with minimum attenuation, and was easy to duplicate because many other local hams have the same problem. I was able to scavenge radio parts from various places and create the scavenger broadcast band blocking filter.

The receive-only version of the filter (see Figure 1) uses commonly available inductors that look almost like resistors. The transmit version (see Figure 2) uses toroids. The generic schematic in Figure 3 is used for both types of filters; only the component values change. A filter using the little inductors can be used only on receive, but the toroid-based filter can be used on transmit and receive. Use more or fewer LC circuit pairs in the center section based on your required stop-band attenuation — I've used up to 15 pairs. See Figures 4 and 5 for the effect on AM broadcast band signals.

The Receive-Only Filter

Dipped silver mica capacitors are recommended for both filters. Use 1% values or sort them to make all the capacitors as close as possible to the same value. Inner inductors (up to 13 total) are 2.7 uHy. The receive filter needs up to 12 pairs of capacitors (750 pF with a 30 pF in parallel) to achieve a value

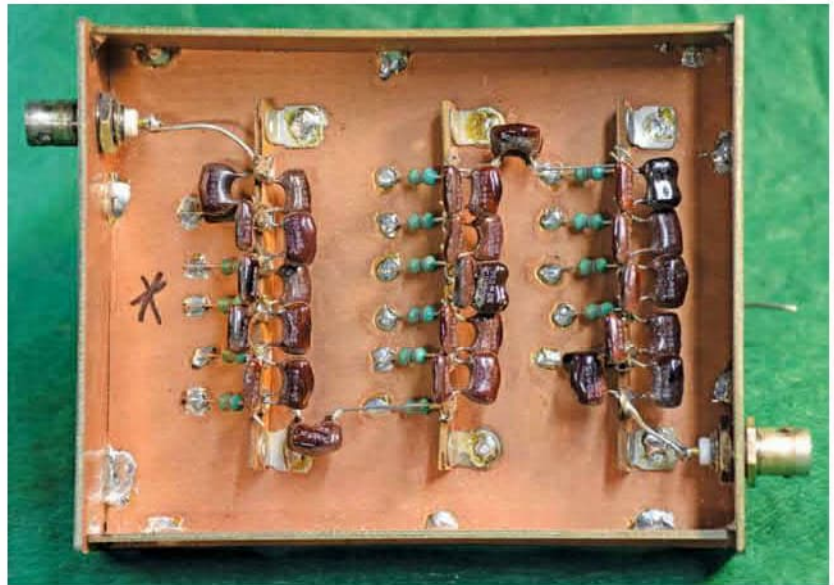

Figure 1 — The receive-only filter.



Figure 2 — The transmit-capable filter.

of 780 pF. The best way to obtain the inductors is to buy a bag of 50 and sort them. Usually, they're $\pm 10\%$ and are affordable on eBay. The end inductors are 3.3 uHy. The interior inductors are sorted to 2.7 ± 0.05 uHy. The end capacitors are 1500 pF. I used an Almost All Digital Electronics L/C Meter IIB, but there are more affordable LC meters for sale on eBay.

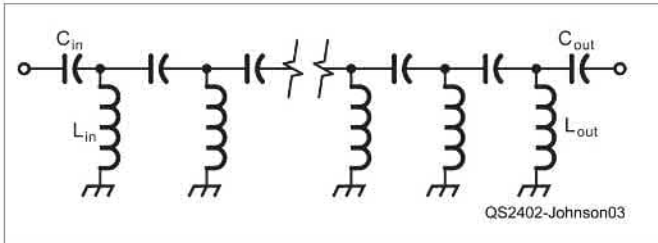

Figure 3 — Schematic for both filter types. The total number of LC pairs is variable based on needed attenuation. C in and C out are 1500 pF, and L in and L out are 3.3 uHy for all versions.

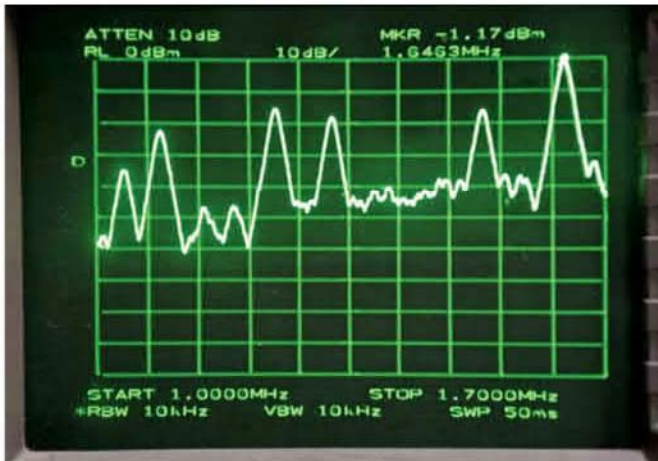

Figure 4 — AM band signals without filter.

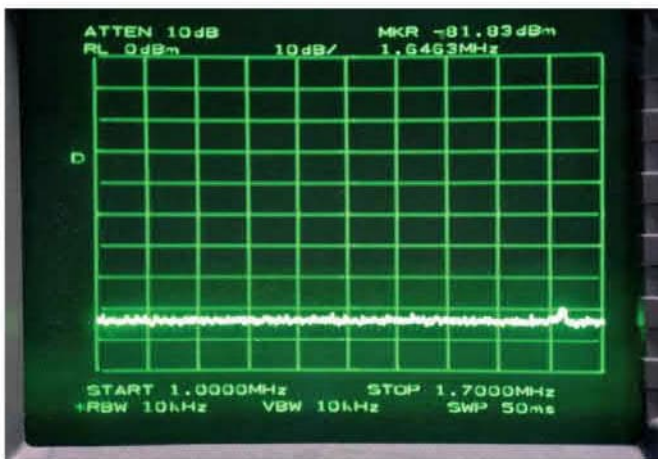

Figure 5 — AM band signals through the receive filter.

For a nice-looking attenuation curve, components should be about the same value. The better job you do with matching them, the better your attenuation curve will look. The part values on the ends of the filter are not as critical as the center sections. Building the enclosure out of printed circuit board (PCB) allows short connections to ground. If you use terminal strips, they can be conveniently

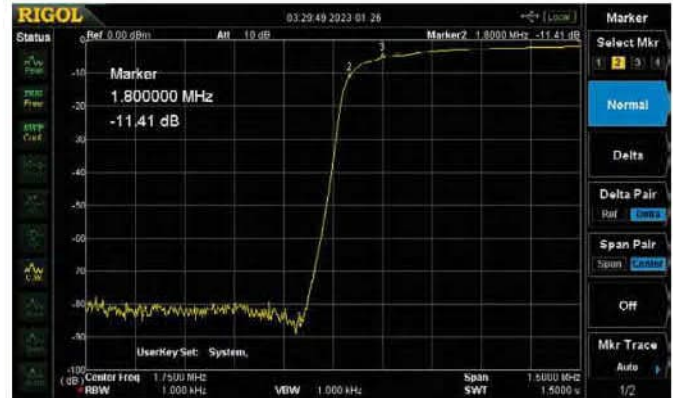

Figure 6 — The measured response of a 13-pair receive-only filter. Marker 1 at 1650 kHz is buried in the noise. Marker 2 shows the bottom end, and marker 3 shows the center of the 160-meter band. The loss in the 160-meter band doesn't affect reception, as both signal and noise will be attenuated.

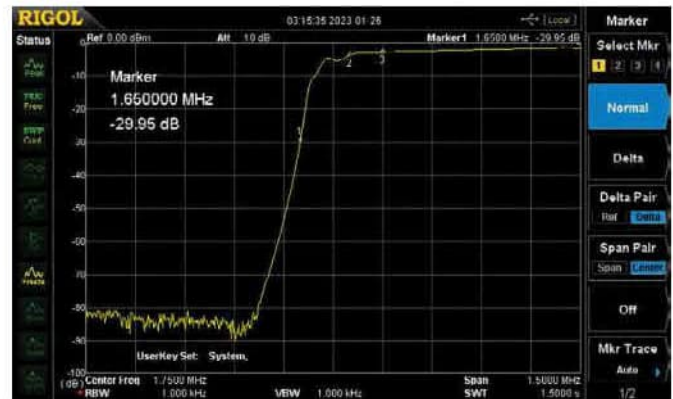

Figure 7 — Response of the transmit filter.

soldered to the PCB. In case your radio doesn't have a separate receive input, the receive-only filter can be bypassed with a pair of relays controlled by a 12 V on-transmit output from the radio. Don't forget to put diodes across the relay coils to prevent the inductive spike from damaging your radio. The response is shown in Figure 6.

The Transmit Version

After several receive-only filters were built and installed around the area, my fellow scavenger of radio parts, Curtis Wilson, NK0T, constructed a filter using toroids. To avoid the need for bypassing relays, he wanted to build a filter that could be used on transmit as well as receive. The filter has been in use for several months without any problems.

The transmit filter has up to nine inner capacitors of 820 pF. There are up to 10 inner inductors that are 2.7 uHy (toroids) and are made from 17 turns of wire

Table 1 — Typical Performance of the Transmit Filter on Amateur Bands

MHz	dB Loss	SWR
1.8	3.17	1.5
1.85	1.45	1.3
1.9	1.73	1.1
1.95	1.55	1.1
2.0	1.17	1.1
3.5	0.35	1.4
3.75	0.32	1.6
4.0	0.42	1.4
7.15	0.41	1.2
10.1	0.13	1.3
14.2	0.25	1.2
18.1	0.04	1.3
21.2	0.04	1.3
28.5	0.03	1.3

on a T68-7 toroid core. Each inductor is tuned to the specified value by spreading the turns out or compressing the turns together. The end inductors are made from 19 turns. You may want to apply some glue to keep the turns in place. The Micrometals Mix 7 has a slightly lower permeability, but it's more stable with temperature than the commonly used Mix 2. Looking at the transmit version attenuation plot in Figure 7, you can see that this filter meets the requirements of more

than 20 dB attenuation at 1650 kHz. Marker 2 is at the bottom and marker 3 is at the center of the 160-meter band. It was tested with 100 W, but I would not recommend using it in the lower end of the 160-meter band. Be sure to spread the components out to give them some breathing room. The insertion loss and SWR for each of the HF bands are shown in Table 1, and the response is shown in Figure 7. Yet another version of the transmit filter is shown in Figure 8. The larger toroids allow for greater power without overheating the ferrite.

Customizing for Your Needs

Depending on the frequency of your radio station, the filter break-point frequency can be moved down

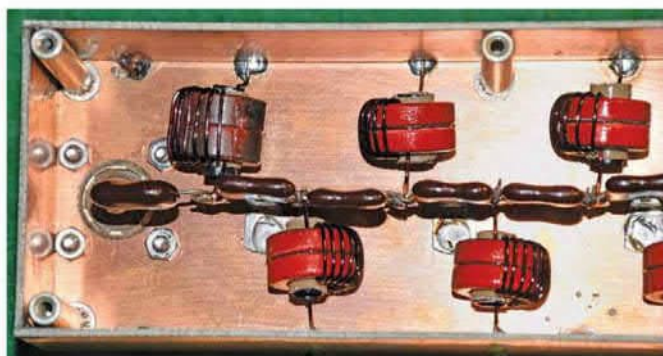

Figure 8 — One end of a version using larger toroids for greater power in the transmit mode.

See QST in Depth for More!

Visit www.arrl.org/qst-in-depth for the following supplementary materials and updates:

- ✓ One more version of the filter
- ✓ More detailed, close-up construction pictures
- ✓ Additional performance plots
- ✓ A scan of 160 meters with and without the filters
- ✓ Circuit files for *LTspice* and *Qucs* circuit analysis programs

by increasing the inner capacitor values, possibly giving you less attenuation on the low end of the 160-meter band. Large changes may require changing the inductor values to maintain a 50 Ω impedance. The broadcast band blocking filter can be customized to fit the needs of your location. Two free programs were used to model the filters and can be downloaded at www.analog.com/en/design-center/design-tools-and-calculators/ltspice-simulator.html and <https://sourceforge.net/projects/qucs>. Circuit files are available on the QST in Depth web page (www.arrl.org/qst-in-depth).

Nearby AM broadcast stations can be kept out of your receiver front end with these filters. An eastern Iowa ham lives about four blocks from a transmitter site, and the 160-meter band was totally unusable, and 80 meters was difficult without the filter. With the filter, the radio station is no longer a problem.

All photos by the author.

Stan Johnson, W0SJ, was first licensed in 1961 and upgraded to his Amateur Extra-class license in 1968. He has an electronics degree from Iowa State University and a physics degree from the University of Northern Iowa. Stan's career began at Bell Telephone Laboratories and ended at the John Deere Product Engineering Center where he was a scientist and engineer. Since retiring in 2001, Stan enjoys building things, mostly out of junk. He can be reached at w0scavengesjunk@gmail.com.

For updates to this article, see the QST Feedback page at www.arrl.org/feedback.



The 2-Meter Astroplane: Modifying a Forgotten 1970s Antenna

A 2-meter version of the Astroplane HF antenna provides excellent performance at a compact size.

Francisco Gonzalez, TI2LX

Condo life in Costa Rica requires some sacrifice if you're a ham; it is not easy to get permission to install antennas. With that in mind, I revisited the Avanti Astroplane (expired US patent no. 779,942), a half-wavelength antenna designed by Louis J. Martino and patented in the early 1970s. The Astroplane is a vertical dipole with the top element reduced by an eighth-wavelength capacitance hat. The lower element comprises two quarter-wavelength elements that flare downward, ending in a quarter-wavelength closed loop. This antenna primarily radiates from the top, and it has a low radiation angle (10 – 15 degrees) and a gain of 4 dBi. I decided to scale this antenna up to the 2-meter band (see the lead photo), as these features and its small size would allow me to hide it almost anywhere in my condo.

For Windows users, software for calculating Astroplane dimensions at any frequency is downloadable at www.sourceforge.net/projects/astroplane-calculator. You can also use an online version of the calculator in English or Spanish at www.revistaqso.com/avantieng. Figure 1 shows the calculated dimensions for 146 MHz. From these dimensions, I created a model in *MMANA-GAL* (www.gal-ana.de/basicmm/en), a software package co-written by Makoto Mori, JE3HHT. The resulting model, available at www.arrl.org/qst-in-depth, indicates a 2:1 standing wave ratio (SWR) bandwidth of almost 10 MHz. Figure 2 shows the radiation pattern — note the low maximum radiation angle.

Constructing the Modified Astroplane

The final antenna dimensions are shown in Figure 3. I didn't use the top capacitance hat, so the top element is twice as long as the value in the calculation. According to the patent, this increases the antenna's bandwidth. I used ½-inch aluminum tubing for the top



The Astroplane antenna modified for 2 meters.

ASTROPLANE

Avanti Astroplane

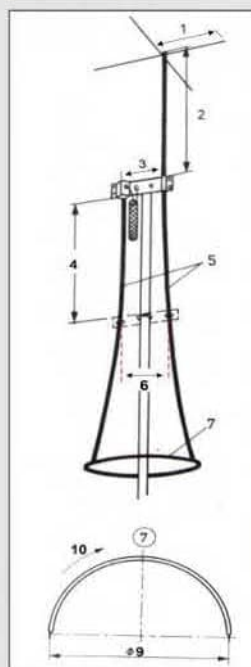
Frequency **146**
 cm inches **CALCULATE**

1	4.3	inches
2	8.4	inches
3	1.1	inches
4	8.7	inches
5	17.2	inches
6	2.3	inches
9	5.6	inches
10	8.8	inches

Specifications

GAIN : 6.2 dBi / 4.05 dBd
 IMPEDANCE : 45 + j 0 OHMS
 VSWR : 1:1.1 (50 OHMS)
 MAX GAIN ELEVATION ANGLE : 4.2 deg
 OMNIDIRECTIONAL

Figure 1 — A screenshot of the calculated antenna dimensions for 2 meters.

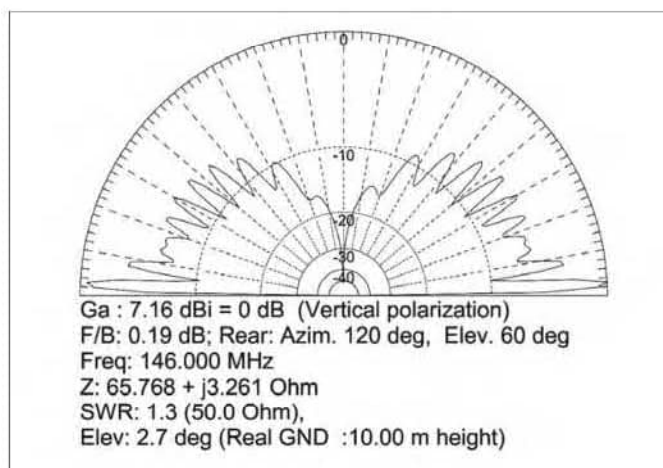

Figure 2 — The modified Astroplane's radiation pattern.

element, which also works well as the mast. You can slit the upper few inches of the 17-inch section of $\frac{1}{2}$ -inch PVC pipe and use a stainless-steel hose clamp to attach it to the $\frac{1}{2}$ -inch aluminum tube. The two side arms that constitute the bottom part are made of $\frac{3}{8}$ -inch aluminum tubing. Cut slits into both ends of each tube section so that small sections of $\frac{1}{2}$ -inch aluminum tubing can be used to permit length adjustment for minimum SWR. Use stainless-steel hose clamps to hold them in place. To make the

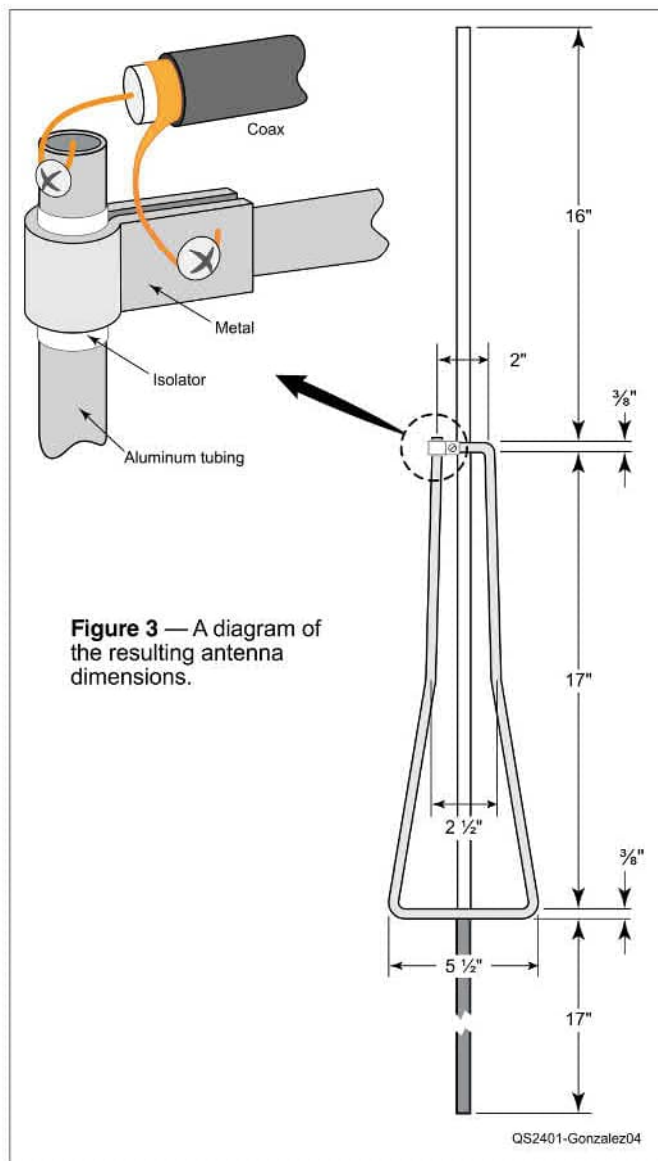

Figure 3 — A diagram of the resulting antenna dimensions.

circle at the base of the antenna, form a 19-inch-long, $\frac{3}{8}$ -inch-wide aluminum or stainless-steel strip into a 5.5-inch circle and secure it with stainless-steel screws. Flatten one end of each side arm, and then attach the arms to the circle with more stainless-steel screws (see Figure 4).

Finally, Figure 5 shows the details of the feed point. The center conductor of the coax connects to one arm of the bottom section, while the shield connects to the other side and the top section. A small section of PVC isolates the feed point. For proper operation, it is important to leave a quarter wavelength of clearance underneath the bottom circle, devoid of any metal objects. The overall size of the antenna, including the minimum mast length, is a bit less than $\frac{3}{4}$ of a wavelength, or around 51 inches for the 2-meter band.



Figure 4 — A close-up of the loop attachment. The supporting strap across the bottom is PVC insulating material.



Figure 5 — A close-up of the feed-point details.

Because I simply translated the measurements from the original antenna to 2 meters, the final dimensions can vary a bit from the calculated ones. To minimize SWR, adjust the length of the top element and the two bottom elements. Center the SWR while trying to keep roughly the same proportional length between the top and bottom elements.

Performance and Bonus Resonance

This antenna works well, both for simplex operation and for covering all the repeaters in Costa Rica's Central Valley. It also resonates in the 70-centimeter band. However, while I didn't run any tests other than activating a local repeater, I don't expect the 70-centimeter antenna pattern to have the low radiation angle achieved on 2 meters.

Feedback

- In the November 2023 issue of *QST*, an error was made that has since been corrected in the digital edition. In the "Ask Dave" column, the caption for Figure 1 should read "Conceptual 160-meter vertical antenna. An antenna can be shortened by adding inductive loading at the bottom and capacitive loading at the top. The capacity hat consists of spokes perpendicular to the antenna. Note the primary radiator in this vertical antenna is the vertical mast." *QST* regrets this error.
- In the December 2023 issue of *QST*, an error was made that has since been corrected in the digital edition. In "Voice Processing and Ham Radio" by Lindy Williams, K6EB, root-mean-square (RMS) was incorrectly used to refer to RF output power, which is an undefined quantity. RF power is measured as average power, or peak envelope power (PEP), depending on the type of output signal. The RMS voltage level is what is used to calculate RF power. One formula for calculating power is $P = V^2/R$, where V is the RMS value of the RF voltage, R is the load resistance (or impedance, which is usually 50Ω), and P is the average power an SSB signal produces. *QST* regrets this error.

See *QST* in Depth for More!

Visit www.arrl.org/qst-in-depth for the following supplementary materials and updates:

- ✓ The *MMANA-GAL* model file

All photos provided by the author.

Francisco Gonzalez, TI2LX, was initially licensed in 1985 as TI5LX. He is an electronics engineer and a low-power and antenna experimenter, and he has worked as a laser field service engineer for 20 years. Francisco is a member of the Radio Club de Costa Rica. He also enjoys operating HF digital modes, VHF, and UHF FM voice. You can reach Francisco at franciscoti5lx@gmail.com.

For updates to this article, see the *QST* Feedback page at www.arrl.org/feedback.



- In the December 2023 issue, "The OH3JF 5/8-Wavelength Vertical Dipole" by Heikki "Henry" Tamminen, OH3JF, contains incorrect antenna dimensions in multiple places. In Figure 1 on page 32, all instances of "33 feet" should be "30 feet, 6 inches." In the caption for Figure 1, "66 feet" should be "61 feet." Lastly, on page 33, the first bullet point under the "Measurements and Materials" subhead should read, "61 feet of 50Ω coaxial cable (Ecoflex 10 or RG-213)." These errors have since been corrected in the digital edition.

- In the January 2024 issue, the first paragraph of "The World Above 50 MHz" column contains an incorrect name and call sign. The second sentence and the beginning of the third sentence should read, "The W8S team on Swains Island made 6-meter Earth-Moon-Earth (EME) contacts with KJ9I and Gary, K9RX (EM85), who was the second ham to work W8S, followed by N0TB. Gary applauded..." This has since been corrected in the digital edition.

An RF-Sensing Relay



The ON AIR sign. The text on the right lights up when RF is detected.

Let RF energy do the switching for you.

Jerry Spring, VE6TL

For my birthday, a ham friend gave me a sign that reads, “ON AIR,” and is illuminated by two LED lights (see the lead photo). Powered by 12 V dc, the red LED highlighting the “ON AIR” text can be turned on when the circuit closes via a two-pin terminal block on the back of the sign. The text that reads, “Calling CQ CQ CQ VE6TL,” always glows blue. There are many such signs available online, or you can make your own.

The schematic that came with my sign suggested adding a transmitter-keyed relay or a switch/relay to turn on the red LED (see Figure 1). After a bit of research, I used a Schottky diode to convert RF energy to a dc voltage in order to key the sign. I found that by using an Arduino microcontroller, the dc voltage from the diode can be measured, and if it exceeds a specified threshold, the voltage can turn on a relay to complete the LED circuit for the ON AIR text. Experimentation would be needed to determine the sensitivity of the circuit and adjust the voltage threshold in the Arduino sketch.

The complete circuit that I developed for this task is shown in Figure 2. The RF-sensing circuit is located in the upper-left portion of the schematic. A few feet of hook-up wire wrapped 10 turns around the coax coming from the transceiver were suitable as the RF input (J1). I used a 1N5711 Schottky diode that I had on hand, but other suitable diodes include 1SS99, ND4991, HP423, HP8472, HP8554, 1N58xx, and 1N6263. The output from the diode (D1) is fed to analog input A2 via pin 25 on the Arduino ATmega328P chip.

I also made the relay circuit from on-hand parts, including a common 5 V relay (K1): SRD-05VDC-SL-C. In the middle-left of the schematic, a general-purpose NPN transistor (Q1) functions as a switch to drive the relay.

The base of Q1 connects to pin 19 (digital pin 13 on the Arduino). When an RF signal that exceeds a specified threshold is detected by the Arduino, it will send a HIGH signal to Q1, which allows current to flow through the coil of K1 (pins 2 and 5), and which closes the connection between pins 1 and 3. The other components are located in the lower-left portion of the schematic, as a 5 V dc regulator allows the device to be connected to 12 V dc. A 16 MHz crystal and two 22 pF capacitors serve as the clock input for the Arduino chip.

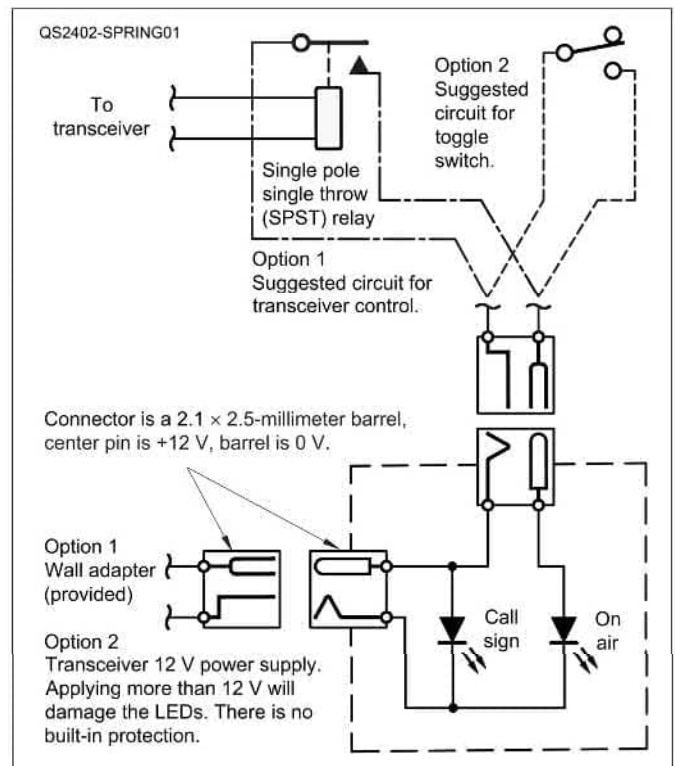

Figure 1 — The schematic that was included with the sign, redrawn for clarity.

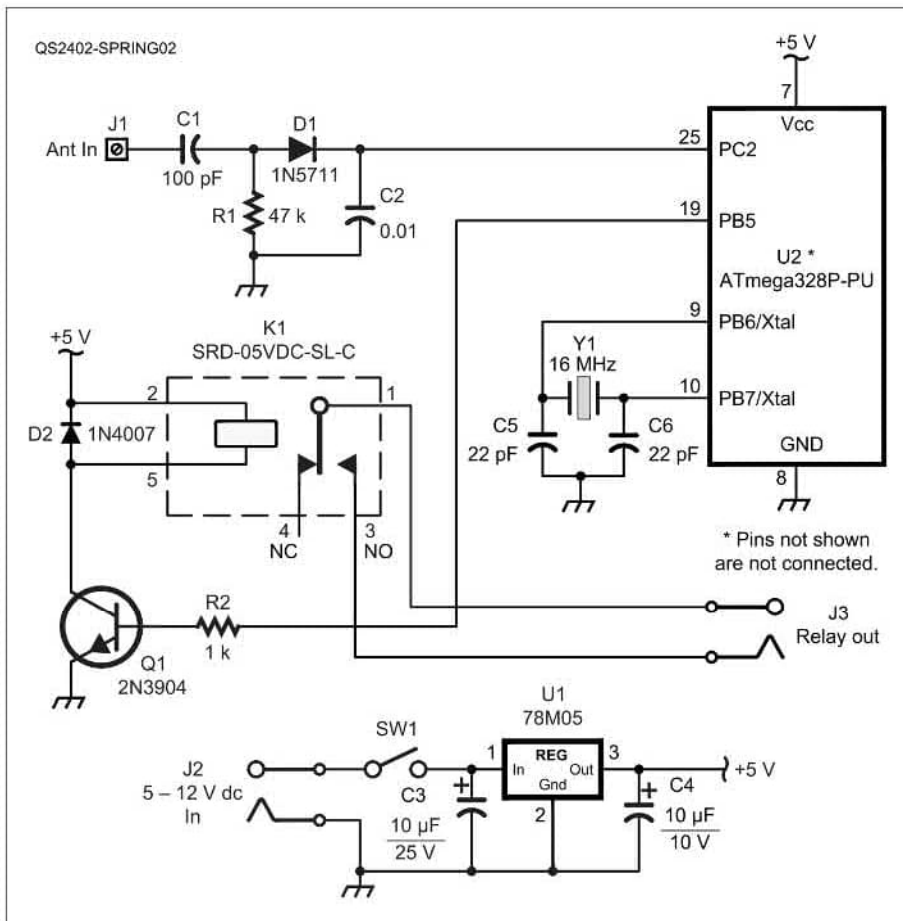
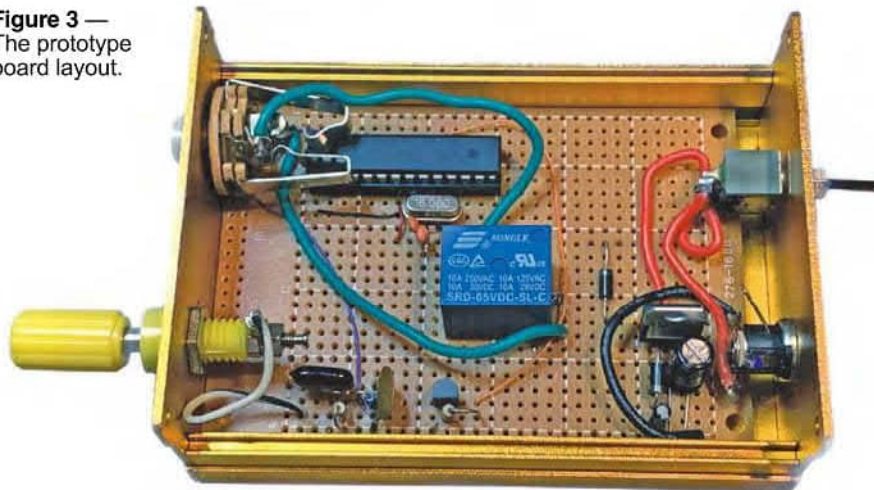

Figure 2 — The Arduino-based RF sensing schematic.

Figure 3 — The prototype board layout.



I used a standard prototyping board for construction. Figure 3 shows the prototype enclosure with the cover removed. On the finished enclosure, I used a stereo headphone jack for the relay connection because the two non-grounded pins could be used to key the LED circuit in the sign.

The Arduino Sketch

The Arduino sketch, provided at www.arrrl.org/qst-in-depth, is simple and features additional comments. With the antenna connected to pin A2 (pin 25 on the Arduino chip), I used the serial monitor to determine the

minimum threshold to key the relay when transmitting. With a minimum power output of 15 W on HF bands from 10 to 160 meters, I found that a value of 20 worked well. When not transmitting, the values I saw on the monitor were generally less than 6 or 7. When transmitting at 200 W or more, the values measured on pin A2 were much higher than 200. Every setup is different, so this value can be changed as needed. One advantage of using an Arduino-type approach is that it is easy to incorporate timing delays. Here, I did not want the sign to turn on and off with each dot and dash I send on CW, so I specified a 2-second delay before shutting off the red LED.

This circuit can turn on and off any number of devices. The relay is rated for 120 V at up to 7 A, and it could possibly turn on a more powerful light.

See QST in Depth for More!

Visit www.arrrl.org/qst-in-depth for the following supplementary materials and updates:

- ✓ The Arduino sketch

All photos provided by the author.

Jerry Spring, VE6TL, was first licensed at 16 years old in Windsor, Ontario, Canada. He earned a physics degree from York University in 1980, and he later worked for a major oil company in Calgary, Alberta, as an exploration geophysicist. In 2004, Jerry began restoring vintage radios, homebrewing equipment, DXing, contesting, working with Arduino, studying propagation and solar physics, and other ham-related pursuits. In addition to self-publishing a ham radio humor book, *Hogwash for Hamsters*, he has authored articles for *The Canadian Amateur*, the *K9YA Telegraph*, and *QEX*. Jerry can be reached at jspring@telus.net.

For updates to this article, see the **QST Feedback** page at www.arrrl.org/feedback.



Product Review

Raddy RF75A MW/HF/VHF Receiver

Reviewed by Steve Ford, WB8IMY
wb8imy@arri.net

To characterize the Raddy RF75A as a portable receiver would not quite do it justice. I think the word “pocket” is a more accurate description. At merely 3.6 × 2 × 1 inches, the RF75A can slide into any pocket with ample room to spare.

Upon seeing this radio for the first time, you might think it is a toy, but that would be inaccurate as well. The RF75A is not a high-performance receiver, but it is equipped with features that place it above many others — and it includes an Apple/Android control app (more about the app later).

The RF75A comes complete with earbuds, a USB-C charging/data cable, an external clip-on wire antenna, and a carrying bag. There is also printed documentation, though the English text is a clumsy translation from Mandarin and is occasionally more confusing than helpful.

As you can see in the lead photo, the Raddy’s buttons are quite small, and the backlit display is tiny as well. Even so, I didn’t have much difficulty manipulating the buttons or reading the display.

If you start exploring the radio without first browsing the manual, you’re likely to make the same startling mistake I did. There is an orange button on the side of the RF75A that looks like a handheld transceiver’s push-to-talk switch. I turned on the RF75A, and out of little more than pure habit, I squeezed that button. I was greeted with an ear-splitting siren that I desperately scrambled to silence (another button squeeze did the trick). I presume this feature is for emergencies should you run into trouble while carrying the Raddy on an outing in the woods or wherever. The same switch activates a bright LED flashlight on the top of the radio. Different squeezes, different outcomes.



Another word of caution concerns the RF75A’s built-in antenna. It is a 13-inch-long telescoping whip, and I believe it is the thinnest whip antenna I’ve ever encountered. I can’t emphasize enough how fragile it is. The antenna requires careful handling, especially when it is being retracted. If one pushes downward from the top, there is a high probability the antenna will bend and break. Instead, it is best lowered by pulling on the bottom segments.

Bottom Line

The Raddy RF75A is designed for casual listening. It does a fair job on VHF, but it’s not for serious shortwave listening. Its low cost makes it a great little receiver for on-the-go, recreational enjoyment.

Table 1
Raddy RF75A MW/HF/VHF Receiver,
FCC ID: 2APU9-HRD-787

Manufacturer's Specifications
 (*not tested by the ARRL Lab)

Frequency coverage	0.520 – 1.71 MHz, 4.75 – 21.85 MHz, 30 – 199.975 MHz, 64 – 108 MHz (broadcast)
Power requirement	USB-C power and internal battery of 3.7 V, 1 A
Modes of operation	AM, FM (NFM and WFM)
MicroSD card	For storage of MP3, WAV, and WMA formats, 256 GB maximum
Bluetooth	Version 5.0, with remote control capabilities, compatible with iOS and Android for remote control only, no Bluetooth audio
Telescopic antenna length	13 inches
Size (height, width, depth)	3.62 × 2.09 × 1.02 inches
Weight	0.23 pound

*Due to the lack of external antenna port, this receiver couldn't be tested in the ARRL Lab.

The whip antenna is used for VHF listening; it is all but useless at lower frequencies. That's where the clip-on wire antenna comes into play. For AM broadcast listening, I was pleased to discover that the RF75A has an internal ferrite bar antenna.

Note that the RF75A does not provide stereo FM, even when using earbuds. This is a strictly monaural radio. Also, reception on HF and MW is limited to AM only. For radio specifications, see Table 1.

If you'd rather not use earbuds, the RF75A offers a 1.5-inch speaker rated at 3 W. As with the siren, this speaker can produce surprisingly loud audio. The audio isn't high quality, but it is perfectly adequate.

Speaking of audio, the RF75A includes a slot for a microSD memory card. The radio can support cards with capacities as high as 256 GB. Yes, you can place MP3 audio files on a card and play them through the Raddy — no surprise there. What is quite cool, however, is that you can also record received signals to the memory card, as you'll see later.

More Buttons

There are a total of nine buttons on the Raddy. The **ON/OFF** button is at the top, followed by the button that allows you to choose the band. You tune the radio by pushing the up- and down-arrow buttons on the side. The volume control consists of two buttons on the front.



Figure 1 — A screenshot of the Raddy RF75A Bluetooth remote application.

Short presses of the **LOCK** button trigger several functions, such as HF band switching and the memory card player mode. A brief tap of the power button when the radio is off turns on the display light and displays the clock; a second press turns on the radio. With the radio on, a quick press mutes the radio or pauses the music play, and a long press turns the radio off.

The display color changes according to the band and mode. Bluetooth mode is dark blue; weather band is red; VHF and FM are green; AM broadcast is purple; HF is yellow; and if you are playing audio from the memory card, the display is light blue.

Although direct frequency entry is possible within the app, the radio itself offers only the up and down tuning buttons. A long press on a tuning button starts the scanning mode. If you hold the button down even longer, the scan rate goes into what I might call hyper mode. It will scan through the HF range, for example, in about 10 seconds! And the RF75A can zip through VHF in about 25 seconds. As you've probably guessed, the radio can automatically fill its memory slots while scanning, but with just 100 memories they can fill quite rapidly. Many of those memories will turn out to have locally generated nonsense signals, of course. It is much better to program the memories yourself.

About the App

The free app, known as *Radio-C*, is a feature that sets the RF75A apart from many other receivers (see Figure 1). The wireless control app makes it much easier to manipulate the Raddy, and it adds features and functions that are not available through the physical buttons.

In fact, the recording function I mentioned previously is available only through the app. All it takes is a tap on the app to begin recording whatever the RF75A is receiving at the moment. (If you don't have a memory card installed in the radio, the app will warn you.) The only downside of this feature is that it does not include date or time stamps in the resulting file names. If you create several files, you'll likely have no idea which file contains what content until you listen to it. You can listen to the files through the Raddy, or download them to your computer via the USB-C connection.

With the app you can program frequency memories (and easily label them). The app also displays detailed signal strength and signal-to-noise ratio information. You can even sync the radio's clock to your mobile device with a single press on an app button.

As ingenious as the *Radio-C* app is, it came with one disappointment. The app does not support audio over its wireless Bluetooth connection to the radio. So, while you can control the Raddy from the app, you must have the radio nearby to listen to it. It would have been nice to be able to enjoy the RF75A's audio through the app as well.

Performance

On VHF and FM, the RF75A did a fair job of picking up local signals. I was even able to listen to a few local ham repeaters. However, the VHF tuning increment is fixed at 25 kHz; I had to resort to direct frequency entry through the app to get the exact repeater frequencies I wanted.

The lack of FM stereo reception was a bit irksome. On the other hand, the additional cost necessary to add

stereo decoding to a single-speaker radio may have placed the Raddy at a price disadvantage compared to the competition.

For HF, I used a test lead to attach my outdoor dipole antenna to the radio. The resulting performance didn't set the world on fire, but I was able to hear the stronger broadcast stations, along with WWV. Even though reception is restricted to AM, I couldn't help but punch in 14.074 MHz to see what I might hear. It seems like the FT8 frequencies are always active, and sure enough, the Raddy picked up an abundance of warbling signals.

The RF75A surprised me on medium wave. Its little ferrite bar pulled in quite a few AM broadcast signals during nighttime listening — more than I would have expected. The antenna is sharply directional, so you need to rotate the radio at times to improve reception.

I should mention that the RF75A's rechargeable battery capacity is specified at 1000 mAh. The radio draws a maximum of 800 mA, but unless you are listening continuously at deafening volume, the battery should last at least a couple of hours. I found this to be the case.

Conclusion

The Raddy RF75A is designed strictly for casual listening. If you are hunting for weak signals, this is not the radio for you. I would not recommend it for serious shortwave listening, for instance.

That said, the RF75A is a great little receiver for on-the-go, recreational enjoyment. Its tiny size and feature-packed app makes it attractive for those willing to accept the Raddy's performance limitations. For amateurs, it may also serve as a convenient test radio for troubleshooting VHF FM or HF AM transmissions, or for tracking down nearby interfering signals.

Manufacturer: Radioddity, 36 Berkley Dr., Newark, DE 19702, www.radioddity.com. Price: \$53.

REZ Ranger 80 Portable Antenna System

Reviewed by John Leonardelli, VE3IPS
jleonardelli@arrl.net

The Toronto Portable Radio Operators Group recently undertook field operation experiments spanning the 80- and 60-meter frequencies. After testing various setups, including horizontal loops and low-profile dipoles, which proved cumbersome to deploy due to their fairly large size requirements, I sought a more compact and straightforward solution. I needed a self-supporting, multi-band antenna without needing an antenna tuner, and it needed to be quick to put up and take down.

At the 2023 Dayton Hamvention, I encountered a production prototype of the REZ Antenna Systems Ranger 80 at the DX Engineering booth. The robustness and heft of its main coil base and its overall build quality left a lasting impression during my 8-hour drive home. Contrary to my initial assumption, it wasn't just another backpack antenna; I was informed that it covered 80 meters and up using the same coil. This versatility is a distinct advantage, as my other antennas require additional coils for sub-40-meter coverage. Although it was not available for sale in May 2023, Mike Giannaccio, W5REZ, assured me that it would be ready for shipping in a few months, and he delivered on his promise.

The REZ Ranger 80 is a standout choice for operators in search of a top-tier, portable antenna tailored for performance in both portable and emergency field operations. With its superior craftsmanship and user-centric design, the Ranger 80 is an ideal pick for radio enthusiasts and amateur radio emergency communication teams, offering extensive coverage across ham radio bands. It features a base loaded-coil design with a longer-than-typical vertical radiator to maximize signal radiation.

In an electrically short vertical, moving the loading coil higher (as in center loaded) is almost always an improvement because it raises the point of maximum current, where the majority of the radiation takes place. Achieving this properly, with coverage of the lower 80- and 60-meter HF bands, can be challenging. The coil assembly in the center would be too heavy in this case. However, the primary objective here is convenience and wide coverage in a single tuning coil. The Ranger 80 base coil design can provide coverage down to 80 meters with no design constraints. You can further enhance radiation efficiency by using a longer radiator, and this is where the 9-foot whip element comes into



play. Through field testing and comparisons against other electrically short vertical antennas, I can affirm that this antenna performs as advertised. For a more in-depth understanding of how electrically short verticals behave, *The ARRL Antenna Book for Radio Communications* is a valuable resource.

Benefits

The Ranger 80 speaks volumes about REZ Antenna Systems' dedication to premium craftsmanship, rugged durability, and construction. They proudly claim "precision-made reliability." Crafted with top-grade materials, including a CNC-machined Delrin body with black anodized 6061 aluminum and all stainless-steel hardware, including corrosion-resistant alloys and fortified connectors, this antenna exudes quality from every angle. Its sturdy construction ensures it can weather the harshest field conditions with ease.

Portability is a key feature of the Ranger 80. With the tuning coil, weighing in at just over 3.3 pounds, it is

Bottom Line

The quality "precision-made reliability" and ability to cover 80 and 60 meters in a portable vertical antenna with several mounting options make the REZ Ranger 80 a great choice for portable operators.

Table 2 — REZ Ranger 80 Portable**Antenna System****Manufacturer's Specifications
(not tested by the ARRL Lab)**

Maximum SSB power input	200 W
Maximum digital power input	100 W (50% duty cycle)
Band coverage	15 to 80 meters (an optional whip is available for 10 and 12 meters)
Bandwidth at VSWR 2:1 or less:	
80 m	67 kHz
40 m	355.5 MHz
20 m	1.86 MHz
17 m	3.25 MHz
15 m	3.185 MHz
Antenna impedance	50 Ω
Antenna connector	SO-239
Minimum antenna whip length	17 inches
Maximum antenna whip length	9.3 feet
Loading coil length	21 inches
Whip mount thread pitch	3/8-24
Base mounting stud thread pitch	3/8-24
Radial system	4 × 33 feet with banana plug
Weight	See text.

heavier than its competitor's offerings and epitomizes convenience for on-the-go operations. Whether you're establishing a temporary base camp during a camping trip or operating in a park, the Ranger 80's form factor guarantees swift and efficient deployment. The Ranger 80 comes fully assembled and includes a premium 3-day MOLLE backpack to keep everything organized. Just open the package, add your coaxial cable, and get right on the air.

Setting up the Ranger 80 is a breeze, thanks to its user-friendly design. With clear and concise instructions and straightforward assembly, even those with limited technical expertise can deploy it confidently. Replacement parts and accessories to enhance your antenna are easily available and reasonably priced.

Thanks to the quick-deploy radial system, you'll be making contacts in no time.

Frequency Coverage

Designed for use on the ham radio bands, the Ranger's adjustable tuning coil allows for fine-tuning from 80 to 15 meters with the included military whip. Add 12 and 10 meters by purchasing the optional light-duty telescoping whip.

What's in the Box?

With the kit, you will find in the box the Ranger 80 tuning coil base with radial puck (3.3 pounds), a heavy-duty military whip (0.75 pound), a stainless-steel ground spike (0.75 pound), four 33-foot radials with silicone

wire ties, a premium 3-day MOLLE military backpack, and an aluminum tripod (1.5 pounds). For more specifications, see Table 2.

Components

This antenna comprises four primary components: the base loading or tuning coil, a radiator whip, a counterpoise, and a mount. The loading coil is 21 inches long and has a diameter of 2¼ inches. It weighs 3.3 pounds, attesting to its premium build quality. Stainless-steel 14-gauge wire can handle power typically used in base stations (100 W) with ease. Tuning adjustments are made by sliding the tuning ring up or down based on the frequency. You can also fine-tune the standing wave ratio (SWR) by sliding the tuning ring sideways along the coil wire. If you operate on 80 meters, then you slide it down, and for higher bands, move it closer to the top. The contact point for the coil is managed by a slider ring, and you can hear the clicks as the contact pad makes contact with each wire. The contact pad is larger than expected, designed to increase the contact area to improve efficiency. The base unit also has the standard SO-239 connector for the radio connection. The machined radial puck screws onto the base and allows up to eight counterpoise wires.

The black painted radiator whip is comprised of seven elements (made of brass and stainless steel) and has a length of 9.3 feet. It folds down to 17 inches for easy packing. This is very similar to the standard AT-271B/PRC antenna used in the military. It is a great antenna choice, as it is rugged, and the brass joints make excellent contact. The SWR does not vary in the blowing wind. It is advisable to assemble the whip antenna from the bottom and disassemble from the top. The inner wire is spring-loaded to keep it taut when deployed. The 3/8-24 UNF threading means you could use the whip in an antenna mount on its own or with other antenna systems. The system includes four counterpoise wires fitted with a standard 4-millimeter banana plug. The ability to provide increased radiating efficiency on the lower bands requires longer wires, and they are ideal at 33 feet. I also found the 18-gauge stranded copper wire easy to deploy and kink-free. Silicone-grade straps keep everything coiled. Personally, I tend to prefer line winders, and I plan to experiment using shorter counterpoise lengths. I am adding four more radials to my kit, as this will increase the radiation efficiency. Naturally, you would lay out the wires in a spoke-and-wheel configuration, but in a tight parking lot, I just zigzagged as needed, and it didn't seem to affect performance at all.

REZ Antenna Systems offers two mounts: a ground spike and a custom tripod. The ground spike is suitable

for soft to medium soils. It is made from stainless steel and has the standard thread. It's also heavy, at $\frac{3}{8}$ inch in diameter and 17 inches long. I suggest you use a rubber mallet to place it in the ground before attaching the tuning coil. The included instruction sheet offers pictures and deployment instructions.

The three-legged tripod, called the [Z] Pod, is ideal for sidewalks, gravel trails, and pavement. This heavy-duty tripod features a $\frac{3}{8}$ -24 mounting thread, a tie-down loop, and a carabiner to hang a weight or tie the tripod down. The $\frac{1}{2}$ -inch-diameter aluminum legs ensure a stable platform. This worked well, and I had no concerns of tipping over, but in strong winds, use the tie-down loop with a tent stake or 10-pound dumbbell. I couldn't find the carabiner until I noticed it was attached to the backpack. The height of the tripod is 12 inches (see Figure 2).

Military Backpack

The military backpack is the standard 3-day design with lots of pockets, an expansion zipper, MOLLE straps, and tough water-resistant fabric. It also offers detachable waist straps to help with a heavy load-out. They could have fit all of this into a plastic tube for storage and carrying, but the backpack allows other items to be taken with you when outside playing radio. In fact, I can fit a tent and a sleeping bag as well. I am sure I can easily fit an Icom IC-7300 or Yaesu FT-991A as well. If you choose to do so, make sure to protect the radio from scratches; I suggest a well-padded

pouch. I was lucky enough to use a plastic tripod shipping tube for the spike and tripod, and the coil is in a nylon sleeve for protection. Yes, there is a pocket for a laptop and water bottle. I test-fitted some PowerFilm foldable panels and was glad they fit inside with a Bio-Enno battery and Buddipole solar controller.

You can fit the antenna components inside the backpack, but you can also attach them to the side pockets and use the straps to keep everything tight and neat.

Testing Results

I used my typical approach to test out its suitability for my needs, and it exceeded all expectations. I filled the empty pockets with coax, an SWR meter, a battery, and some snacks, and I grabbed the big handle, took the Icom IC-7200 radio in a Pelican box, and pointed the SUV to the nearby park.

I pushed the spike into the soccer field, attached the tuning coil with the radial puck, laid out the four counterpoise wires, and attached the whip. I checked the SWR and saw that I needed some adjustment. I found moving the tuning slider down was for lower frequencies (needed higher inductance value) and up for 20 meters (needed less inductance value). I found the sweet spot for 20 meters a few inches from the top of the coil, with an SWR of 1.5, and the Icom IC-7200 was hearing signals from the southern states. I broke into a net (usually not good ham radio etiquette), but the net controller took pity on me and gave me a 5-9 report. I thanked him profusely, telling him I was testing an antenna at the park. Oklahoma and Texas gave me 5-8s and 5-9s. Once I knew it worked well on 20 meters, I checked into the Ontario Amateur Radio Service net on 3.755 MHz. I slid the coil adjuster a few inches off the bottom and clicked up and down until I got the SWR down to 1.5. I did manage a 5-7 out to Ottawa (217 miles away), which made sense as I was running 50 W and the net controller was using a dipole. I checked 60 meters, clicking a few steps up the coil until I got the SWR where I wanted it. It took seconds to do this. I now know where the slider needs to be for the bands I want to use, so I can set it up quickly. As a reminder, coverage above 15 meters is explained in the manual. The soccer field operation using the ground spike was a success.

The next day, I had the same experience, except I used the [Z] Pod tripod on the sidewalk beside the parking lot for Parks on the Air. The antenna was stable and did not need a tie-down, but I suggest using one anyway for safety reasons. I had to ensure I had room to deploy due to the counterpoise wires being 33 feet long. The tripod deployment was quick and easy, and I made



Figure 2 — The Ranger 80 [Z] Pod tripod at work.

contacts on 20 meters using the same settings from the previous outing.

One of my primary goals was to have an antenna I could deploy that included 80 and 60 meters without extra parts, and the Ranger 80 did this.



Figure 3 — The Ranger 80 using the antenna on a Jaws clamp.

My last test was to see if I could use the system with a bicycle as my mode of transport. There are a couple of nearby parks that are a reasonable distance to cycle to, and I didn't have panniers or care to use them for these outings. While the system is heavier due to its extreme build quality, the backpack made it effortless. This time I stored the Icom IC-703+ (in the middle pocket in a Domke fabric wrap), a water bottle (in a side pocket), and a windbreaker, and I rode to the park. The backpack is padded and quite comfortable, and it also has detachable waist straps. I left

the tripod at home, knowing I would hike into a clearing and be able to use the ground spike.

I ran some WSPR tests on 20 meters (100 mW) with poor conditions in the afternoon and compared it to a center-loaded antenna that was a few feet shorter. The Ranger 80 was picked up by 35 stations and had five

extra stations below 650 miles and KA7OEI-1 reporting from 2,717 miles. The center-loaded antenna was picked up by 20 stations with nothing below 650 miles, but did reach a bit farther at 3,340 miles to WF7U. VE1NN reported the Ranger 80 but not the comparable at 1,200 miles. The Ranger 80 was also about 3 – 6 signal-to-noise ratio units better in some bearings and a bit less in others. In practical terms, the two antennas are roughly the same, as the propagation may not be equal in all bearings. I am confident that regardless of where the loading coil is located, the results are similar, and you will make contacts.

I did try the antenna using a Workman QRCS3 Jaws clamp on a picnic table, and it worked out well (see Figure 3). The Ranger 80 antenna base is heavier than other antennas, so ensure that the clamp holds and the swivel bracket is tight.

Conclusion

The REZ Antenna Systems Ranger 80 sets the standard for excellent build quality in a portable antenna design. Its precision-made construction, wide frequency range, increased reliability due to premium materials, and ease of use make it an outstanding choice for both amateur radio enthusiasts and emergency response teams. Investing in the Ranger 80 means investing in peace of mind, knowing you have a high-quality antenna ready for any portable field operation. It provides 80- and 60-meter capability, and with more than 11 feet of radiator length, it provided improved transmit efficiency over a shorter 8-foot vertical antenna design.

Manufacturer: REZ Antenna Systems LLC, 3422 Business Center Dr., Ste. 106-101, Pearland, TX 77584, www.rezantenna.com. Price: \$550.

Owon XDM1241 Digital Multimeter

Reviewed by Paul Danzer, N1II
n1ii@arri.net

The XDM digital multimeter front-panel layout is very similar to the Owon digital oscilloscope reviewed in the December 2023 issue of *QST* — specifically, the organization of a display on the left (in this case, a 3.5-inch TFT LCD screen with soft switches just to its right), mode selection pushbuttons in one group, and system control buttons in another group.



There are four test probe input jacks along the bottom right: a black common jack, a red low-current jack, a red 10 A jack, and a red multi-mode input jack.

Weighing about 2.2 pounds, it is a compact fit on a workbench, and the bottom is designed to keep it from sliding around. The front panel is approximately $7\frac{3}{4} \times 3\frac{1}{8} \times 2\frac{3}{8}$ inches.

The active area of the front screen is approximately $3\frac{1}{2}$ inches measured on the diagonal. While taking these measurements, APO kicked in. The acronym APO is not covered in the brief instruction manual, but it apparently stands for “automatic power off.” It can be disabled or set to $\frac{1}{2}$, 1, or $1\frac{1}{2}$ hours, thus preserving the internal battery charge when you forget to shut the unit off (as may happen). A separate model, the XDM1041, is ac powered but otherwise similar to this XDM1241 lithium-powered unit reviewed here.

What’s in the Package?

In addition to the main unit, two 36-inch test leads terminated in pointed probes are included. Each probe also has an insulated alligator clip that may be slid onto the probe. Some might find the alligator clip a bit difficult to squeeze open. Take care when attaching the clip to the probe to make sure they make contact inside the insulated sleeve. I must admit that the design of the insulated alligator clips is not the best I’ve seen.

Two cables are included. One is for connection to a personal computer. It has a USB-A connector on the computer end and a USB-B connector for the multimeter (see Figure 4).

The second cable has a USB-A connector for a USB voltage source and a 5.5-millimeter barrel connector that mates with the dc power input on the right of the rear panel. There is an additional USB-C socket next to the power jack. Below it is an LED (to be discussed later).

A pamphlet titled “Quick Guide” provides support information. The web address on the front cover of the

Bottom Line

The Owon XDM1241 is a complete and handy benchtop unit. Although information on this unit is not easily available online, most functions are easy to use without having to learn long strings of commands.

Table 3 — Owon XDM1241 Digital Multimeter Manufacturer’s Specifications (not tested by the ARRL Lab)

dc voltage	1000 V max
True RMS ac voltage	750 V max*
dc current	10 A max
True RMS ac	10 A max*
Resistance	50 M Ω
Diode	3,000 V†
Continuity	1000 Ω ††
Frequency range	10 Hz to 60 MHz
Capacitance range	50 nF to 50 mF
Temperature	Requires type K sensor (not supplied)
Display	Five digits (see text)
Record interval	15 ms to almost 10,000 seconds (see text)
Record length	1,000 points (see text)

* Requires minimum to be measured

† Not defined; believed to be test voltage

†† Value adjustable

An insert titled “Technical Specifications” is included with the Quick Guide. It contains a full list of selectable modes with the accuracies for each parameter scale selected.

pamphlet does not always work; instead, go to www.owontech.com and select “Download,” where you will find a more complete manual for a similar unit, XDM1141, which has the same modes but different limits. At the time of this writing there was no online manual for the 1241. For accuracies and resolutions, use the table that comes as an insert in the Quick Guide.

Plug It In and Turn It On

Initially the battery may have to be charged. Using the supplied power cord and a USB source, the red LED on the rear of the unit will turn from red to green when fully charged; it may take 1 to 3 hours. Blinking red means a charge fault.

Pressing the **ON/OFF** button at the top left of the unit for a few seconds will reward you with a colored hori-



Figure 4 — The Owon XDM1241 rear panel has the 5 V dc power connector jack on the right; a similar model replaces this subassembly with a 120 V ac line voltage connector.

zontal bar across the center of the display followed by the initial screen set to V dc. Included with the Quick Guide is an insert listing the available test modes and accuracies; Table 3 is a summary of the modes and their available ranges. The supplied insert, labeled “Technical Specifications,” breaks the modes down to ranges and their accuracies.

In several places in the literature and on the face of the unit is the text “55,000 Counts.” This seems to mean that the unit is based on a digital counter, with a display that can use up to five digits, and the greatest numerical value this counter and display combination can show is 55,000.

The test probe jacks on the bottom edge of the front panel are clearly labeled. All measurements are with respect to the black common terminal. The two current jacks are labeled **FUSED**, and the **1000 V** limit on the other input jack, used for measurements other than current, is labeled to remind you of the limit.

Temperature measurements require a type K thermocouple that is not supplied. Most available thermocouples found online cost \$15 and up and connect with a two-prong spear connector. Because there is no matching jack on this unit, I tested it by taking the type K thermocouple from another multimeter in my shack, which has a specific jack for the thermocouple. Connecting the two-prong thermocouple plug to the supplied test probes, I found the readings were in line with those I saw with the other meter.

Pick Your Measurement

The normal setup for this unit is auto ranging. This means you do not have to worry about what scale to use unless you want to see fewer significant digits. As an example, you want to measure the voltage of a battery. Pressing the selector switch on the top right, labeled **V**, selects the voltage menu. This measurement selector switch has two labels — in this case indicating ac or dc. Repeatedly pressing the switch toggles between ac and dc.

Suppose the battery results in a reading of **12.275 VDC** on the display. On the right of the front panel is a button labeled **RANGE**. Pressing it selects either auto range or manual. In the manual mode, the two accompanying vertical arrows are used to select the range. Press the up arrow once, and the display reads **012.27 VDC**; press up again, and it reads **0012.2**. After restoring the reading to automatic (back to showing **12.275 VDC**), pressing the down arrow results in a display of overload. This means you have now moved the range measurement maximum value to less than

the connected 12 V and no reading is possible until you restore the range to over the voltage being measured.

The Menus Have Menus

If you look at a modern piece of equipment, you will see the same pattern — a selection of what you want to do followed by a set of available settings, quite often as a list adhering to the soft switches. The soft switches are usually on the right side of the display. Each soft switch may have several settings, or it may have its setting selectable by arrow keys or a rotary control. The top and bottom lines of the display are usually occupied by text indicating the selected settings.

Because the item being measured or seen is stored as data in memory, there are several other common keys, which are a set of five gray keys on the right center of the panel: **RUN/STOP** takes the current reading and freezes it in memory; **MATH** gives you a listing of the mathematical functions the unit can do with the data; and the system button labeled **UTILITY** sets system settings, such as display brightness, language, and other selections that are not dependent on the specific item you want to measure.

Use the Menus to Select and Adjust a Mode

Most ohmmeters have a continuity checker, which replaces the ohmmeter and tells you if two wires or points are shorted. But how shorted? The continuity tester built into this multimeter lets you use the continuity position with a threshold you can set.

The upper right function selection button has three graphic labels (left of the power button). Press once and it is a straight ohmmeter, press twice and it is a continuity tester, and press a third time and it is a diode tester.

To set the threshold, select the continuity test position. You can tell the position selected by looking at the top right corner of the display, which will say **CONT**. Pressing the first soft switch turns the beep tone on or off; set it to **ON**. Press the soft switch below it (**THRESHOLD**), and you will be able to set the threshold between 1 Ω and 1000 Ω . There are four digits that can be changed by pressing the **RANGE** button on the right end of the panel. This selects which of the four digits to adjust.

Next, a digit's value is set by the up and down arrows. For example, use **RANGE** to select the first (leftmost) digit and the arrow keys to put a 0 in this place. Press

the **RANGE** button again and you can put a 3 in the second place. Repeat this process and put 0 in the last two places. The threshold is now set to 0300. If the meter senses values above 300 Ω , the beeper stays off; under 300 Ω , the beeper sounds.

This is the usual pattern of mode selection. Press one of the white buttons in the top six to select the item to be measured. Confirmation of your selection shows up at the top of the listing on the right side of the display. Then a combination of the remaining soft switches, the **RANGE** button, and the arrow keys allows setting of the mode and mode adjustments, if any.

A Few More Buttons and Selections

The gray **RUN/STOP** button near the center of the panel does exactly what its name says. Press this button, and the display and all activity stops. This is accomplished by interrupting the trigger that enables a measurement. The display is frozen until you release it by pressing the button again.

DUAL is another selection that can be very useful. Following the steps in the user manual, one measurement is routed to the main part of the display and a second measurement to the bottom line of the display. Only certain combinations of measurements can be displayed simultaneously.

The **MATH** button supplies several functions calculated on the stored data points. These include maximum, minimum, and average. On voltage measurements only, dB/dBm can also be calculated. Again, step-by-step instructions for all of these functions are given in the downloaded user manual.

Store 1,000 Measurements

Because the multimeter is based on a microprocessor

or equivalent and memory, it is no surprise that a set of measurements can be stored. There are two storage modes: manual and automatic. The manual mode is a three-step process described in the Quick Guide. The measured values displayed on the front panel in groups of nine can be kept or deleted as needed.

The automatic mode takes more steps. You must set up the interface and decide how many points you want to save (up to 1,000) and the interval between readings (15 ms to 9999.99 seconds). There is also a multi-step process to transfer the stored points to a computer. The steps are outlined in the online user manual (in the section on communication interface).

The connecting cable is included in the package. The installation parameters needed on the multimeter end of the cable can be found in the online user manual. On the PC end, the software needed is listed in the download section of the Owon website for the product family XDM1000. By searching through several pages of available software, the installation information can be downloaded. The next step requires additional downloading of a set of software from National Instruments and installing it. End to end, this entire process may take quite a bit of time!

In Summary

This complete multimeter takes advantage of its digital heritage by putting a host of functions, including data storage, in a very handy benchtop unit. Most functions are readily found and designed to use without having to learn long strings of commands.

Manufacturer: Fujian Lilliput Optoelectronics Technology Co., Ltd. No. 19, Heming Road, Lantian Industrial Zone, Zhangzhou 363005 P.R., www.owontech.com. Available at online retailers. Price: \$166.

W2HVH Enclosures Icom IC-705 Go-Bag

Reviewed by Pascal Villeneuve, VA2PV
va2pv@arrl.org

I attended Orlando Hamcator for the first time ever in February 2023. Whenever I visit a hamfest, I always look for something new. While visiting the Swaps Building, I stumbled upon something that caught my attention, the Icom IC-705 Go-Bag. As a proud owner of this radio, I wanted one, but unfortunately Ralph Sangat-ald, W2HVH, the owner, told me that it was





Figure 5 — The inside of the IC-705 Go-Bag with the AH-705 automatic antenna tuner.



Figure 6 — The W2HVH Enclosures IC-705 Go-Bag.

sold out. Then he showed me how the kit was built from the inside of the bag (see Figure 5), which just increased my desire to have one. Ralph told me that he first built a kit for himself and then a few more, and the 2023 Hamcation event was a sort of test to see if there was any interest. It looked like it was a big success, as in the first few hours of the first day, he was sold out and taking preorders. At the time, he didn't have a website, but now it's online and operational.

I really wanted to bring home an IC-705 Go-Bag. Fortunately, I was on vacation in the area for another week, and because Ralph lived in Florida, he offered to build me a kit after Hamcation. I was able to pick it up before I left for my cold Canadian province.

Bottom Line

The W2HVH Enclosures IC-705 Go-Bag is a clever setup with a high-quality build. Having the IC-705 in this Go-Bag not only protects the radio but also provides many operating advantages, and once it's in there it may stay there forever.

Description

The W2HVH Enclosures IC-705 Go-Bag consists of a Gator Cases bag (see Figure 6) with a custom-built aluminum chassis that goes into it (see Figures 7 and 8). The well-made and sturdy chassis also includes two rack-mount-type handles, one on each side, which protect the IC-705 and all the external ports. The handmade and custom design is a tight fit, and your gear won't fall out of it. The bag can accommodate not only the IC-705 radio but also the Icom AH-705 automatic antenna tuner. The mounting hardware and wiring are ready — you just need to install your radio and the tuner (if you have one), and you're ready to go.

My kit included a 3 Ah Bioenno lithium-ion battery, allowing the radio to operate at full power (10 W). There's also an optional kit that is available with a 4.5 Ah battery. Please note that the radio needs to have its own battery attached, and it will be charged by the Bioenno battery when the main switch is turned on, which also increases the operating time. My kit came with a shoulder strap for the bag, spare fuses, spare hardware, and all the necessary cables prewired for the IC-705 and the AH-705 tuner.

Operating with the Go-Bag

The first thing I noticed is that with the included battery, the radio lasts a long time. On average, I operate around 1.5 to 2 hours, and I've never run out of power. In about 1.5 hours of operation on FT8 at 5 W, I still had 13.1 V. Ralph told me that after 4 hours running FT8 between 5 and 7 W, the 3 Ah battery is still at 12.6 V. So, the 3 Ah battery provides enough power for most of us. The radio doesn't seem to get too warm. I usually don't operate outside when it's very hot, but keep in mind that there's always the option to pull the aluminum chassis out of the bag for more ventilation.

I really like the layout configuration and the kit size. It's very convenient and fits perfectly on my electric bicycle rear rack (see Figure 9).

The kit is also perfect to bring with me when I'm out camping in my RV. I own the Bioenno battery charger (BPC-1502DC), but you can buy it separately from Bioenno Power (www.bioennopower.com). You can charge the battery while operating the radio, which is very convenient, as I don't have to carry any external power supply. You will find the measurement details in Table 4.

When connecting the Icom microphone, you will notice that the audio will come out of the mic instead of the radio speaker, so for those like me who prefer the

Table 4
W2HVH Enclosures Icom IC-705 Go-Bag
Manufacturer's Specifications

Dimensions (width, depth, height)	14 × 7 × 7 inches
Weight	4.2 pounds
Battery	3.0 Ah Bioenno battery (optional 4.5 Ah)
External battery connection	Anderson PowerPoles and a 2.1-millimeter charging port
Computer connectivity	USB-B data port for computer connection
External connections	Mic, speaker, key, and send
Antenna connector	UHF SO-239
Included accessories	Shoulder strap, spare fuses, spare hardware, antenna tuner control cable, and radio-to-tuner RF cable



Figure 9 — The IC-705 Go-Bag on my electric bicycle rear rack.



Figure 7 — Top view of the interior custom-built aluminum chassis of the IC-705 Go-Bag.



Figure 8 — Bottom view of the interior custom-built aluminum chassis of the IC-705 Go-Bag.

audio from the radio, just unplug the 3.5-millimeter wire from the radio (inside the enclosure). This way, you can still connect both microphone wires on the case for a sturdier connection while having the audio come from the radio speaker, and there's no loose cable while operating.

When I removed the aluminum chassis from the bag, it also fit perfectly in one spot of my shack shelf. It looks nice and is always ready to go (see Figure 10).



Figure 10 — The aluminum chassis out of the IC-705 Go-Bag, fitting perfectly on my shack shelf.

Conclusion

W2HVH keeps improving his kit, and a Go-Bag version for the IC-905 is now available on the manufacturer's website.

The IC-705 Go-Bag not only protects the radio, but it offers many operating advantages, like its included battery allowing the full 10 W operations. It also provides easy access to all radio ports without the need to pull the radio out. Since I got this Go-Bag, my IC-705 has never left it. It will probably stay in there for a long time, as the bag is convenient for my operating needs.

Manufacturer: W2HVH Enclosures, www.w2hvh.com.
Price: IC-705 Go-Bag (3 Ah battery), \$450; IC-705 Go-Bag (4.5 Ah battery), \$480; IC-905 Go-Bag (4.5 Ah battery), \$525.

Ask Dave

Get more information from the “QST: Ask Dave” YouTube playlist at <https://bit.ly/3z2MBMI>.

Hams Love Antennas

Installing an Antenna on a Metal Roof

Q Zachary Barfield, KJ5CUA, asks: Can I mount my quad-band mobile antenna (for 10, 6, and 2 meters, and 70 centimeters) on my metal roof, or will it be impossible to tune on 10 meters? Also, I’m currently building a $\frac{1}{2} \lambda$ wire dipole to put up around the roof. Will the metal cause problems with it? I am a brand-new Technician.

A The radio you have is likely FM only. If that is the case, you will find plenty of activity on 2 meters and 70 centimeters, but activity will be rarer on 6 and 10 meters. When you upgrade to General, a modern HF radio (the Icom IC-7300 or the Yaesu FT-710 are popular examples) will cover 6 and 10 meters with FM just as well, plus you will have the capability of all other modes.

Almost all FM activity uses vertical polarization. Multiple antennas that cover the four bands are available. All of them are verticals with an included counterpoise, so you only need a mast for mounting. It’s okay to put these antennas on or near your roof. The antenna’s pattern will change a bit depending on where it is, but not too much, so you can mount the antenna based on convenience.

The vertical nature of the antenna and the horizontal roof can coexist nicely. This is not true of a horizontal dipole held away from the roof by a matter of inches or even feet. It will interact with the roof strongly and be nearly impossible to tune. I suggest reorienting your dipole so that one end is a few feet away from the roof and the other end is over your yard to a tree or other support.

You can hold off on the dipole until you have your General license. Once you upgrade, you can continue to use your existing radio on the bands you like and then explore an HF radio.

Troubleshooting an End-Fed Half-Wave Antenna

Q Bob Crawford, KA0YKC, asks: I have difficulty running my end-fed half-wave (EFHW) antenna on all frequencies except 17 and 20 meters. I am using a manual tuner. It will tune once, but then must be completely re-tuned. The 49:1 balun is mounted on a mast. I placed a loop of several turns of coaxial cable just before the connection to the unun, and the coax runs from there to my

radio. I also have a counterpoise wire attached to the 49:1 unun. Why is my EFHW antenna not working?

A While it is true that some sort of counterpoise wire is required, the counterpoise is usually on the outside of the coax shield. When you run RF through a coax, the energy generally stays inside the coax. The two conductors are the copper skin of the wire in the center and the inside of the coax shield. RF does not penetrate the inner wire or the coax shield. RF energy tends to flow on the outside surface of the metal conductor without penetrating. The outside of the coax shield acts as a separate wire. This can cause the outside of the coax to radiate RF and can also act as the counterpoise to the antenna. The issue is that this radiation can go back to the radio and cause problems.

The choke balun that you created by coiling several turns of coax together can prevent the current on the outside of the coax shield from propagating down to the shack, so you will have to use something else for the counterpoise. The length of the separate wire you have attached to the counterpoise connection point can drastically affect tuning.

I suggest doing the setup shown in Figure 1. Remove the counterpoise and uncoil the coax. Make sure that the outer shield of your coax is grounded before it enters your shack. Run coax from your antenna to a barrel connector and

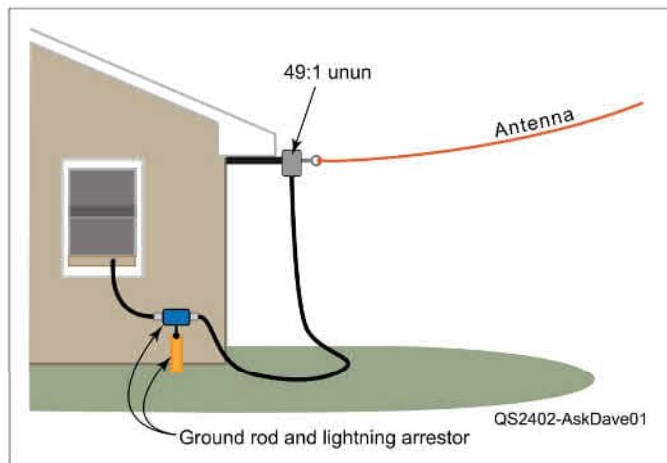

Figure 1 — An easy way to set up an EFHW antenna. The outer coax shield acts as the counterpoise for the antenna. The lightning arrester on the ground rod grounds the outer shield.

another coax from the other end of the barrel connector to your rig. Then, use a hose clamp to clamp the barrel connector to the ground rod. The coax from your ground rod to the unun should be a bit long. Better yet, a lightning arrester attached to your ground rod, and running coax from the antenna to the lightning arrester and then to your radio will also accomplish grounding.

If the EFHW antenna works, you should not need a tuner for any band. On 80 meters, the antenna tends to cover just the low part of the band where you will find FT8 and CW. It should tune well on the bands above that, except for 60 meters. The length of the antenna wire from the unun to the end insulator will be about 125 feet. Many hams do not have enough space for this length of wire, so you can make the wire approximately 65 feet long. This will tune on 40, 20, 15, and 10 meters. The overall length of the antenna is a compromise between the different bands. You can determine the length that tunes best on the bands you operate. The standing wave ratio should be under 3:1 across all the bands the antenna covers except the upper half of 10 meters.

Removing Common-Mode Current on Coax Shield

Q Mark Leathers, N0GDB, asks: If a station's coax is properly grounded by lightning protection, should there be voltage or a current on the shield in the direction of the radio?

A The lightning arrestors should be located very close to or mounted on the ground rod. If there is any common-mode current on the outer shield of the coax, it will be shunted to the ground by the lightning protector. Unless you want RF on the outside of the shield between the antenna and the ground, it's often helpful to put a balun at the antenna feed point or wrap a few loops of coax together, which will keep RF off the shield. If you do not keep RF off the shield, the outside of the coax can radiate, which should be avoided with most antennas. If you put up a dipole and connect the coax directly to the antenna wires, you will have some current outside the coax shield. However, I have found that this works fine on simple dipoles I've made. As noted in the first question, the one situation where you want the outside shield of the coax to be part of the antenna is when feeding an EFHW antenna. The lightning protectors must be firmly attached to the ground rod to work properly.

Gamma Matches

Q Jeffrey Canipe, KM4MEJ, asks: I came across your gamma match video on YouTube, which was very helpful. Are the mast and all the associated elements connected directly to each other, or is everything insulated? In other words, if the boom is aluminum, does it need to be insulated from the other elements, or are they all grounded to the boom? I understand the gamma match is insulated from everything.

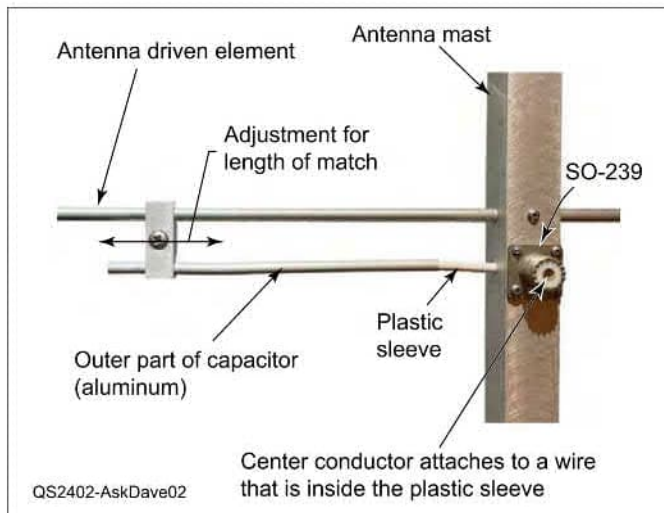

Figure 2 — The various parts of a gamma match. The key benefit of the gamma match is that it directly connects unbalanced coax with the balanced driven element.

A Figure 2 shows the gamma match on my 2-meter Yagi antenna. One of the benefits of the gamma match is it does the conversion between the unbalanced coax and the balanced Yagi. It can be used with any antenna, including a tower. One drawback is that the gamma match only works on the band for which it is designed. Many Yagi antennas are made of elements attached to a boom. The boom is the horizontal part that holds up the elements. The longest element is the reflector, then the driven element, and then one or more shorter directors. All of these are at dc ground. However, things are much different for RF. Some manufacturers or homebrewers will insulate all the elements from the mast, but it's personal preference.

The gamma match consists of a capacitor and a lead, which connects to the antenna driven element some distance from the mast. The coax connector is atop the mast, and the outer shield of the coax is attached directly to the mast. The coax center conductor is connected to a rod inside a tubular plastic shield. Around the shield is an aluminum tube, which forms a capacitor. The capacitor is connected to the driven element, as shown in Figure 2. Two things must be done when tuning the antenna. First, make sure the distance of the center wire inserted into the sleeve is adjustable, and second, make the point at which this connects to the antenna adjustable. Once this is set up, you usually won't have to tune it again. Yagi antennas are often made to work on multiple frequencies. The gamma match works on a single band, so multiband Yagi antennas are often fed differently.

Send your questions to askdave@arrl.org. I answer some questions here, and some via videos on my YouTube channel (www.youtube.com/davecasler), or during my weekly livestream on Thursdays at 6:45 to 8:15 PM Mountain Time on my channel.

Amateur Radio: Science in Action



Ham radio operators join forces with researchers for a wildlife telemetry experiment.

Andrew “Jim” Danielson, AC9EZ; Jordan Marshall, NM9L, and Scott Bergeson

The Amateur Radio Service, and by extension amateur radio operators, have a long and proud history of pushing the envelope when it comes to the science of radio communications. From medical devices to satellites, the Amateur Radio Service continues to be involved in a variety of fields and interests, including scientific research and public service.

How Researchers Can Use Ham Radio

One clear example of the overlap between the amateur radio hobby and scientific research is the practice of wildlife radio telemetry (see the lead photo). Since the 1950s to 1960s, radio telemetry has been used by scientific researchers as a means of tracking radio-tagged wildlife. Radio telemetry allows scientists to trace or track the movements of an animal without needing to be physically present and within eyesight of it.

Galen Burrell, a graduate student from Scott Bergeson's lab, using radio to conduct bat telemetry research in northeastern Indiana. [Deanne Jensen, photo]

The practice of tracking radio signals using a small receiver and handheld antenna is better known in amateur radio circles as *foxhunting* — an operating activity that involves hams splitting into two groups: a fox and its hunters. The fox transmits a signal from an undisclosed location for a set period, while the hunters attempt to locate it using only amateur radio direction finding (radio telemetry) techniques. Once the fox has been located, some participants take the hunt a step further by tasking hunters with finding a micro fox — an even smaller, low-power transmitter hidden somewhere near the main fox.

The biggest difference between researchers tracking wildlife using radio telemetry and radio amateurs tracking a fox transmitter is that the transmitter isn't moving, whereas wildlife is. The techniques and equipment used for these two practices are similar. A large number of amateur radio foxhunts use a signal on the 2-meter band, and many wildlife telemetry researchers use transmitters in the VHF or UHF region, with frequencies extending from just above the 2-meter band (approximately 150 MHz), all the way past the 70-centimeter band. Similar antennas (usually portable directional Yagis) are also used.

Merging Radio and Science

In the summer of 2022, Jim Danielson, AC9EZ, conducted a wildlife telemetry research project with Jordan Marshall, NM9L, and Scott Bergeson, both of whom are faculty members of the Department of Biological Sciences at Purdue University Fort Wayne (PFW). This project was inspired by the academic work of Scott, who uses wildlife telemetry to study several species of bats in the Midwest. As part of his research, Scott utilizes small transmitters (with frequencies in the 150 MHz range) that are attached to the backs of captured bats. These bats are released and then tracked by Scott and his students, identifying the bats' habitats and areas of activity.

The tracking equipment that's used consists of several commercially made portable Yagi antennas, as well as a commercial receiver. The wildlife transmitters' signals usually consist of a simple carrier emitted at regular intervals (again, similar to a micro fox transmitter in a foxhunt).

Jim's research project had two main goals: analyze the performance of homebrew Yagi-Uda antennas and their use for receiving telemetry signals, and analyze the performance of an inexpensive, soft-

“The biggest difference between researchers tracking wildlife using radio telemetry and radio amateurs tracking a fox transmitter is that the transmitter isn't moving, whereas wildlife is.”

ware-defined radio (SDR) dongle and its possible utility by wildlife telemetry researchers. The SDR used was a popular model sold online for \$25 to \$30.

For the first research goal, we constructed multiple Yagi-Uda antennas. The first Yagi was made out of aluminum tubing purchased at a local big-box home improvement store, and the antenna dimensions were calculated using the free antenna modeling program *4NEC2*. It had custom-designed, 3D-printed brackets made of polylactic acid-style material. We built the second and third Yagis following the traditional tape-measure construction, and they consisted of ½-inch PVC tubing and a 1-inch-diameter tape measure. The only differences between Yagis two and three were the length of the elements and the spacing between the elements. We determined the element lengths and spacing by using *4NEC2*.

For testing purposes, we placed a small beacon transmitter in different locations near the PFW campus to simulate a roosting bat. We connected the different homebrew Yagis to the commercial telemetry receiver and were able to record some approximate signal strength readings. The results were promising, with the final tape-measure Yagi yielding the strongest signal receptions. This was an important result, as it indicated the possibilities of homebrew Yagis and their use by professional researchers.

One interesting design flaw that revealed itself during the experiment was the lack of any kind of homebrew baluns on the Yagis. During the course of testing the individual Yagi antennas, it became clear that the different feed-line lengths were affecting the tuning of the antennas. This was probably due to the fact that a Yagi antenna has a balanced feed point, whereas coaxial cable (which was used to feed each antenna) is an inherently unbalanced type of feed line. Because an imbalanced feed line was feeding a balanced feed point, there is a strong pos-

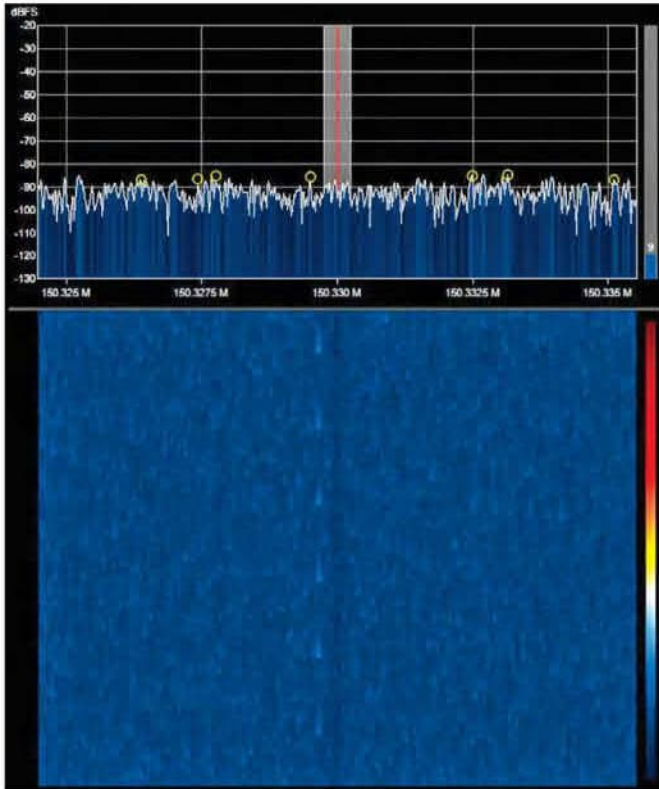

Figure 1 — A screenshot of the RTL-SDR dongle using SDR# software to receive the wildlife telemetry beacon from approximately 1 kilometer away. The SDR was set to CW mode with a 500 Hz filter. The frequency of the beacon was 153.330 MHz. Click here to hear a more detailed explanation of the results of AC9EZ's experiments. [Andrew "Jim" Danielson, AC9EZ, photo]

sibility that the radiation patterns and gain specifications for each Yagi design didn't match the calculated models, as the feed line was acting as part of the antenna. A balun at the feed point could improve the performance of each Yagi, although further research is required to see how much of an effect such a balun would have on the antennas.

For Jim's second research goal, the beacon transmitter was again placed at different locations off campus. At the receive site on campus, the SDR dongle was connected to a laptop. The main goal was to see how well the SDR dongle received the low-power beacon transmitter's signal, and determine to what extent the beacon's signal could be tracked visually. These tests yielded multiple results. The beacon's signal could be seen clearly on the software's waterfall display (similar to observing FT8 or other digital mode signals). Adjustment of the RF gain and waterfall frequency resolutions enabled the

beacon's signal to be received visually, even if no audible signal was detectable (see Figure 1). It was determined that the utility of SDR technology, and its use in wildlife telemetry, is a possibility with a beacon's signal being received from distances above 2 kilometers.

Another factor to consider with the use of SDR technology in wildlife telemetry is that most researchers rely on audibly detecting a wildlife telemetry signal. This audio detection method has its drawbacks because it requires a telemetry signal powerful enough to be physically detected as audio. However, as demonstrated by amateur radio digital modes like FT8 and JT65, a radio signal can be detected visually before it is audible. For wildlife telemetry researchers, this could mean that wildlife telemetry signals could be visually detected by SDR receivers and software before audio detection methods are applied, possibly extending the range by which researchers can receive telemetry signals.

Looking Ahead

As Jim moves forward with his research, he hopes to continue applying the techniques and training he's received as an amateur radio operator to the research he conducts as a student.

Andrew "Jim" Danielson, AC9EZ, is a student at PFW. He's an Amateur Extra-class licensee and has been licensed since 2012. Jim received his WAS, DXCC, and WAC awards; served as a volunteer special event operator for SKCC, NAQCC, and CWops, and served as the youth/ATNO pilot station for the 2019 A35JT DXpedition to the Kingdom of Tonga. He is a proud member of ARRL, SKCC, NAQCC, CWops, Fort Wayne Radio Club, and Fort Wayne DX Association. Jim enjoys building antennas for his home and portable station, pursuing photography, reading books, and playing and writing music on the violin, piano, and pipe organ. Jim can be reached at dfile13@hotmail.com.

Jordan Marshall, NM9L, is a professor of plant biology at PFW, with research interests in forest structure and composition, disturbance ecology, and invasion biology. He is a member of ARRL and participates in POTA as a hunter and an activator. Jordan can be reached at marshallj@pfw.edu.

Scott Bergeson is an assistant professor of animal biology at PFW. His research interests focus on the impacts of disturbances on endangered and at-risk animals, such as bats, weasels, and alligator snapping turtles. Scott has used telemetry to study the spatial ecology of numerous bat species throughout the world. He can be reached at bergesos@pfw.edu.

For updates to this article, see the [QST Feedback page](https://www.arrl.org/feedback) at www.arrl.org/feedback.



Celebrating 40 Years of Amateur Radio on Human Spaceflight Missions



The launch of space shuttle *Columbia* on November 28, 1983.

Thanks to one astronaut who started it all, amateur radio continues to bring us closer to the stars.

Frank H. Bauer, KA3HDO

It has been 40 years since National Aeronautics and Space Administration (NASA) Astronaut Owen Garriott, W5LFL (SK), pioneered extraterrestrial amateur radio on November 28, 1983. During flight STS-9 aboard space shuttle *Columbia*, Garriott conducted internal science investigations for the Spacelab 1 mission and made the first-ever ham radio contact from space. This event transformed the way astronauts and earthbound people communicate. Today, Amateur Radio on the International Space Station (ARISS) maintains ham stations on the ISS, and

many astronauts are licensed operators. Spaceflight technology and amateur radio have both significantly evolved in 40 years; perhaps the next 40 will bring operations to commercial space stations, the moon, or even Mars.

W5LFL's Impact on Human Spaceflight and Amateur Radio

Owen Garriott worked closely with ARRL, the Radio Amateur Satellite Corporation (AMSAT), and NASA officials to bring ham radio on his missions. In the

early 1970s, his request to operate while on the Skylab space station was not approved, but Garriott would not be discouraged from trying again. The international ham community waited for STS-9 with anticipation, and W5LFL was finally on the air 2 days after launch. Many could hear Garriott's voice booming on 145.55 MHz FM, but no one could work him because of the pileup around this ultimate DX station. That changed on December 1, 1983, the third day of STS-9, when he made history by communicating with Lance Collister, W7GJ (then WA1JXN), of Frenchtown, Montana. The following is Garriott's dialogue during the contact:

...US west coast and calling CQ. Calling CQ North America. This is W5LFL in *Columbia*. In another 30 seconds, I'll be standing by. Our spacecraft is in a rotation at the moment, and we're just now getting the antenna pointed down somewhat more toward the Earth. So, I should be able to pick up your signals a little bit better in the next few minutes. So, W5LFL in *Columbia* is calling CQ and standing by. Go ahead.

Hello W1JXN, WA1 Juliet X-Ray November, this is W5LFL. I picked up your signals fairly weakly. I think our attitude is not really the best as yet, but you're our first contact from orbit. WA1 Juliet X-Ray November, how do you read? Over.



Owen Garriott, W5LFL (SK), operating his Motorola MX-300 handheld.

This groundbreaking exchange directly opened human spaceflight to the general public in a way that had never been possible. Indeed, even non-hams could participate while hams served as control operators. Prior to this contact, only mission control personnel or heads of state (US presidents, for instance) could talk to astronauts in space.

Garriott said that one of his primary motivations for bringing ham radio to space was "to encourage technical careers on Earth." ARISS continues his legacy by facilitating communications between students and ISS astronauts to educate youth in science, technology, engineering, and mathematics (STEM) subjects.

The historic event also proved that volunteers could successfully build and operate a ham radio station

for a human spaceflight vehicle. Under the leadership of Lou McFadin, W5DID, a team of hams secured formal permission from NASA to fly Garriott's amateur station as a payload on the *Columbia*. The station consisted of a battery-powered Motorola MX-300 2-meter FM handheld, a signal adapter module, and a custom-built loop antenna.

Amateur Radio's Impact on Human Spaceflight

The barriers overcome by Garriott's ham radio exploits made way for outstanding opportunities in future missions. After STS-9, Shuttle Amateur Radio Experiment (SAREX) volunteers conducted an ever-increasing cadence of human spaceflight/ham radio activities. These included achieving technological firsts through radio experimentation, earning frequent flyer payload status on the Space Shuttle, making astronaut contacts in schools and museums, deploying satellites, establishing international ham radio presences on the Russian space station Mir and the ISS, and more.

Millions of people, many of them young, have participated in astronaut radio contact activities conducted by SAREX, the Mir International Amateur Radio EXperiment, and ARISS teams. Each of these events, along with pre-contact education initiatives, has encouraged youth around the

world to study and pursue careers in STEM. ARISS currently supports 60 – 90 international contacts a year between astronauts in orbit and educational groups on the ground. In addition, the program supports 24/7 multimode ham radio operations — voice repeater and automatic packet reporting system (APRS) — in multiple locations on the ISS.

Amateur radio's positive impact on human spaceflight extends not only to those on Earth, but to those in space. The stations on the Space Shuttle, Mir, and the ISS have provided huge psychological benefits for onboard astronauts. Being able to talk to family, friends, and anyone else on the air can ease feelings of homesickness and isolation during missions. Ham technology has enabled crews to send text messages via APRS and blog via the packet bulletin



Former NASA astronaut Ron Parise, then WA4SIR (SK), employing the packet bulletin board system while in orbit.

board system long before other means of communication were available. Independent of NASA communication systems, radio amateurs were the first to send color pictures to and from the Space Shuttle with slow-scan television and video uplinks to humans in space. The 2006 ARISS SuitSat initiative, in which a retired Orlan space suit was fitted with a transmitter and launched into orbit, resulted in a cottage industry of CubeSat deployments from the ISS. And, at key junctures, amateur radio has provided vital backup communications on human



Former NASA astronaut Tony England, WØORE, was the first to use SSTV from space. This is an image of himself on flight STS-51-F aboard space shuttle *Challenger*.

spaceflight vehicles. What a comprehensive set of accomplishments from a group of volunteers sponsored by ARRL, AMSAT, Amateur Radio Digital Communications, and many other international amateur radio societies!

40th Anniversary Celebration

On February 23 – 24, 2024, volunteer teams, astronauts, amateur radio leaders, educators, space enthusiasts, and space agency officials will gather at NASA's Kennedy Space Center (KSC) for The Positive Impact of Amateur Radio on Human Spaceflight: 40th Anniversary Conference. We will celebrate the past 40 years of ham radio in space and

share our excitement about what else is to come. The conference will be held at the KSC's Center for Space Education (CSE), which is located at the KSC Visitor Complex. Tours of KSC landmarks and the Visitor Complex will be provided on February 22, and in the evening on February 23, there will be a gala dinner under the Apollo Saturn V rocket. The annual ARISS Delegates meeting will also be held at the CSE on February 20 – 21. For more information, please visit www.ariss.org.

All photos provided by NASA.

Frank H. Bauer, KA3HDO, was first licensed in 1974. He is the Executive Director of ARISS-USA, an educational 501(c)(3) nonprofit that enables students to use amateur radio to communicate and interact with astronauts on board the ISS. His ARISS responsibilities include leading the ARISS international team as the International Working Group Chair, encompassing STEM education in their activities, and handling space operations and spaceflight hardware development efforts. Frank received bachelor's and master's engineering degrees in aeronautics and astronautics from Purdue University. His aerospace career spans more than 45 years within NASA and private industry, including previous positions as NASA's Chief Engineer for Exploration Systems (Moon to Mars) at NASA Headquarters and Chief of the Guidance, Navigation, and Control Division at NASA's Goddard Space Flight Center's Greenbelt and Wallops Flight Facilities. Frank can be reached at frank.bauer@ariss-usa.org.

For updates to this article, see the [QST Feedback page](#) at www.arrl.org/feedback.



My Journey to Remote Operation: Station in a Box!

A remotely controlled operating setup with one transceiver.

Dave Ingebright, WB7ELY

For the last couple of years, I have been tantalized by all the available equipment for remote-controlling a ham station. Operating my home station in rural Washington while on vacation or from my winter home in Arizona sounded intriguing. I've tried various stealth, attic, balcony, and temporary antennas, but with poor grounds, high noise levels, and HOA restrictions, I've never had much luck.

Recently, I thought about an unused S-0 station sitting out in the countryside and began wondering if I no longer needed a shack full of radio equipment. I thought, "Why not control my entire home station with one good remote-controlled radio setup?" The station could be in my detached garage, closer to the antennas, and be controlled over the home local area network (LAN) from the desk in my office. Running one full-function radio would certainly declutter my office. This way, I could have a reliable radio system at home and the opportunity to hit the **ON** button and operate 80 to 6 meters using any mode wherever there is internet access.

My shack PC could run the rest of my ham applications and any other networked remote controls I wanted to add. Plus, my coaxial cable antenna runs would be shorter and give my station better performance. A major reconfiguration would simplify my operating position and still allow me to experiment with remote amplifiers, remote relays, multiple antennas, and even beams and rotors.

The Right Equipment

After researching remote-controlled radio systems and available software schemes, I decided on the Remoterig RRC-1258MkIIIs from Microbit. The Remoterig was specially developed to remote-control amateur radio stations via the internet in a user-friendly and cost-effective way. The Remoterig units are normally used in pairs. One is connected to the radio, and the other is connected to the control panel. This system is unique because a PC is not needed. The microphone,



The front of the remote station in a box as it was being wired. Note the small fuse block to power the RRC box. From top to bottom: the 12 V power supply, RRC radio unit, and TS-480SAT transceiver in a mobile mount bracket. The top interior shelf shows the holes for flow-through cooling.

speaker, internal keyer, and a couple of COM ports are all handled by the two units, each one connected to a network.

The 1258 model can be configured to work with most amateur radios available from Icom, Kenwood, Yaesu, and Elecraft. The RRC system requires a radio transceiver with a detachable front panel or a network jack. The radio control panel connects to the control unit, and the radio connects to the radio unit. Jumpers need to be hooked inside the RRCs to correspond to your radio's make and model.

Each RRC system runs on 10 to 18 V dc and has an ethernet jack to connect your network. I bought the optional Wi-Fi board and installed it in the control RRC unit for extra flexibility. I followed the owner's manual and configured the boxes to work with my Icom IC-706 transceiver. The system's menus allow adjusting for



The back of the station in a box as it was being wired.

varying internet quality connections, including cell-phone connections.

Because my Icom IC-706 transceiver has a detachable front panel, it was a good candidate for the system's first test. The only problem was that the separation cable had to be modified and fitted with RJ45 plugs. I carefully cut and spliced the cable and held my breath as I powered things up for the first time. It worked well. I liked that the control panel acted like it was directly connected to the radio, but the radio was 100 feet away, located in the garage, and now closer to the antennas.

I wouldn't say it's all plug-and-play, but I had the system working over my home LAN without much trouble. I even set up a temporary 2.4 GHz radio link and ran the radio at my neighbor's house, which was on the hill behind my house. When I tried to get the outside internet access working through my home router and firewalls, it wouldn't work. I got on the RRC forum and met Mitch, DJ0QN (SK), who was happy to help me configure the detailed menus, my firewalls, and the port forwarding settings on my home router.

For this project I chose to use the Kenwood TS-480 (www.kenwood.com/usa/com/amateur/ts-480sat), as it has all the latest features and fit into my budget. It is a solid 100 W radio with a good-looking, elegant stand-alone control panel.

The Build

The next step was to design and build the permanent radio portion of the remote system. Good practice dictates that the whole radio installation should emphasize attention to detail and safety.

For my operational needs, the remote system should be in a safe, secure, and well-ventilated box containing the power supply, transceiver, RRC, and a muffin fan. All the dc wiring needed to be short, fused correctly, and the right gauge of wire for a permanent, trouble-free installation. The different signal paths, such as the network, audio, data, and other signal wiring inside the box, were separated and tied off with zip ties. I wanted the configuration of the main part of the remote station to be as stable as I could make it.

On the outside, the coax runs, grounding, and antennas needed to be installed so there would be little or no maintenance. Eventually, I installed the antenna coaxial cables in underground conduits and ran them to my three antennas.

I built the box from plywood and cut three interior shelves sized for the main modules (power supply, RRC, and transceiver). I drilled 2-inch holes for draw-through airflow around the main parts and through the shelves. Removable smoked Plexiglas covers were used to close off the front and rear of the box.



The completed station in a box with Plexiglas. Note the coax antenna plugs, ground wire, network, and power cables.



The Elecraft amplifier and antenna tuner are on the right. Dave Ingebright, WB7ELY, used the remote clients downloaded from the manufacturer's website to monitor the other equipment.

Seven 1-inch air-intake holes on the bottom of the covers provided enough capacity for the 4-inch muffin fan to pull cooling air up through the shelves and out of the box. A pair of handles finished the top because the box weighed about 20 pounds and would be difficult to move otherwise. I felt that air filtering was not needed but certainly could be added later.

The station in a box worked well and looked good, but I soon realized I needed a web relay to control the fan, operate a coax relay, and switch power on the antenna tuner and amplifier. I decided on a WebRelayQuad by ControlByWeb (www.controlbyweb.com). This remote-controlled four-relay switch came with four hefty relay outputs controlled independently by any computer connected to the network. This was the piece I needed to expand the remote station's capabilities.

For the initial test, I mounted the switch on a scrap piece of wood with a terminal strip. Setting up the web relay was simple, and I was able to build a custom menu within a few minutes. It connected to my network using its own IP address without any trouble. For outside internet access, I had to subscribe to a dynamic domain name system. I chose www.dyndns.org, but there are many providers out there. I bookmarked the web relay on the station PC, and during operating sessions, I would turn on the fan and control the other equipment as needed.

Everything worked as expected, and I was happy to have a solid station configuration and be able to concentrate on operating and making contacts. My station in a box ended up sitting on a shelf under my work-

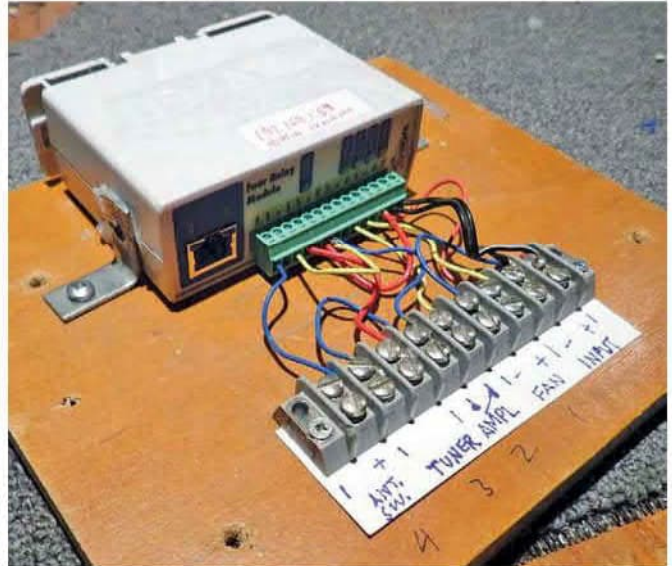

The web relay and terminal strip mounted to a scrap piece of wood for testing.

bench in the garage. Because the transceiver was now in another place, I had to pay more attention to the metering on the control panel, as this was my only indication of power output, standing wave ratio, and quality of my signal.

This project forced me to look at my amateur station differently. The station components and wiring had to be more permanent than my usual "hook it up and try it out" method. I am very satisfied with this durable station, and I've learned a lot about internet networking, TCP/IP protocols, and, most of all, having patience while working through networking difficulties. In the end, I have an extraordinary station that I can operate from anywhere in the world and one that will grow with my future equipment and operating skills.

All photos by the author.

Dave Ingebright, WB7ELY, has been a ham since 1976. He holds a General-class license and is active on the HF+6 bands. Dave holds an Electronics Technician certificate from DeVry University, an Electronics Technology degree from Shoreline Community College, and an FCC General Radiotelephone license. Dave spent 15 years as an electronics technician and retired as a flightline manager with Boeing Co. In his spare time, he is a tireless designer and builder of electronic gadgets. Dave holds a patent on an optically isolated intercom system for flight test aircraft. You can reach him at daveingeb@comcast.net.

For updates to this article, see the [QST Feedback page](#) at www.arri.org/feedback.



Copying Yesterday, Tomorrow: An NVIS Experiment



A view of the author's portable, automated software-defined radio (SDR) CW receiver (PASCR) system's receive dipole strung between two Joshua trees.

With his curiosity sparked by wartime radio communications, N7LXR made an automated system to study near vertical incidence skywave.

David A. Strohschein, N7LXR

Several years ago, I learned of the British Army's World War II-era special operations unit, the Long Range Desert Group (LRDG). The unit provided reconnaissance, conducted raids, and facilitated radio communications throughout the Libyan Desert. As a field-expedient antenna enthusiast, I am particularly interested in the LRDG's ability to maintain contact between stations that were hundreds to thousands of kilometers apart. They operated CW via low-power radios (Wireless Set Number 11s) and Windom antennas erected on their trucks. Their communication success led me to experiment with low-power transmissions from remote Nevada to a station beyond ground-wave range and not in my line of sight — a textbook near vertical incidence skywave (NVIS) situation.

Setting Up PASCR

My friends and I sometimes camp for several days at a time in southeastern Nevada. So, in the summer of 2022, I thought our next trip would be an excellent chance to run my low-power NVIS experiment be-

tween arbitrary locations in the desert. I initially planned to schedule contacts with another ham within a couple hundred miles and beyond the ground-wave range of my transmitting site. However, I also wanted to transmit at random times throughout the trip. Even if I found another ham, asking them to constantly monitor their station for that long would be unrealistic. My solution was to create a portable, automated software-defined radio (SDR) CW receiver (PASCR; see Figure 1).

I had previously worked with a HackRF One SDR peripheral running *GNU Radio* software, and I also had a Raspberry Pi (RPI) 4 single-board computer on hand. I began by installing the *PiSDR* software distribution on the RPi. *GNU Radio* comes pre-installed on this distribution, which made system development easier. After a bit of internet research and review of single sideband (SSB) receiver theory, I used a HackRF One to write a *GNU Radio* flow graph that formed the core of my SDR. I also used wall power and a connection between the SDR and my home station's antenna system for initial testing. After con-

firming that the SDR was properly receiving and recording, I addressed the issue of portability.

I set up a solar panel and a lithium battery along with a PiJuice HAT for power control and a real-time clock. I also developed software that enabled the PiJuice to control the RPi's boot-up and shutdown processes. I designed the system to record for 5 minutes on the hour, 20 minutes past the hour, and 20 minutes before the hour, only during daylight. Once started, it would repeatedly turn on, receive on 7.078 MHz, record, and then turn off. After successfully testing the system between the White Mountains in New Hampshire and my home on the Massachusetts coast, I was ready to deploy it to the southwest.

Because the area in which I planned to install PASCOR wasn't fully secluded, I needed a discreet antenna that would be easy to deploy and transport. My final criterion was that it shouldn't require any intervention once in place and operating. I found a design by Claude Jollet, VE2DPE, the 44-foot linear-loaded dipole antenna, to be an excellent fit.

PASCOR in the Field

After development and home testing, PASCOR was ready for field testing. I chose a receive site in an area north of Mesquite, Nevada. At the site, I found

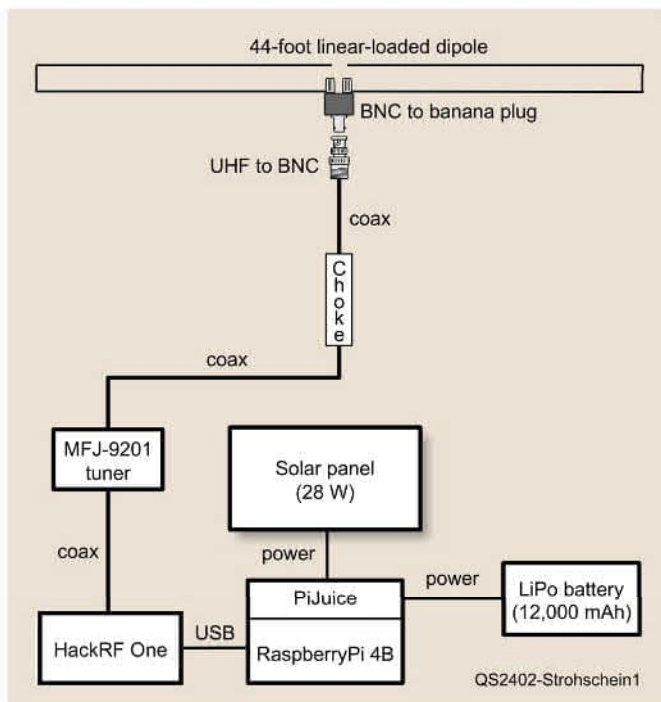

Figure 1 — A diagram of PASCOR.

some Joshua trees to use as supports for the ends of the dipole. I erected the antenna only 1 meter above the ground to reduce visibility. Placing a short wooden dowel below the middle of the loaded dipole limited its sag. After this, I connected the antenna feed to one end of an in-line choke, and then I connected the other end of the choke to coax that ran to an MFJ-9201 QRPocket tuner. Next, I connected the other tuner output to the HackRF One's antenna input. With the RF and SDR equipment set up, it was time to connect the power system.

I leaned a small, foldable solar panel against some vegetation so that it faced south; its output was fed to the PiJuice HAT on the RPi. I also connected a 12,000 mAh lithium polymer battery to the PiJuice. I placed the HackRF One, tuner, RPi, and battery in a small cardboard box to protect them from sun and sand. I made last-minute software updates and adjusted some software parameters on PASCOR before leaving it to quietly run among the rabbitbrush and cholla cacti.

The next day, my friends and I set up camp near a canyon about 80 miles away from the PASCOR site. Large mountain ranges separated us from the receive location. The canyon's downstream direction roughly pointed toward PASCOR, so I placed the dipole broadside to that direction and used its orientation for antenna alignment. I used guy lines to anchor the dipole ends to vegetation and boulders on either side of the canyon, which put the center of the antenna about 12 feet above the ground. A mast made of PVC pipe and a wooden dowel supported

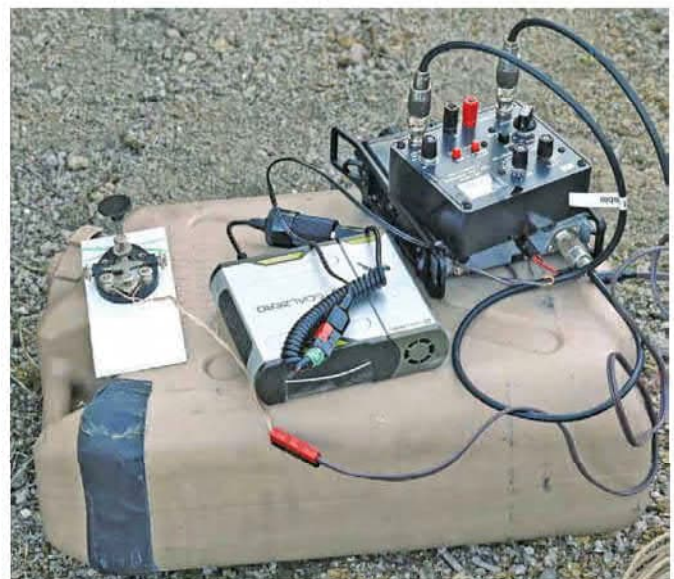

Figure 2 — The author's transmit station. A 5-gallon water jug serves as a table for the equipment.

the 1:1 balun and leveled the antenna. Coax connected the balun to an MFJ-9219 tuner, which was connected to a Yaesu FT-817ND (see Figure 2). I powered the entire system with a Goal Zero power bank. Once I completed the setup, I used a straight key to send several short transmissions at different times throughout the camping trip. I hoped my eventual review of the recordings would show how the communication path on 40 meters changed during the days that followed.

PASCR Recording Playback

My friends and I packed up and left 4 days later to recover the PASCR system. When I had a moment to review the recordings, I opened my field radio log and picked the first transmission time. PASCR automatically time-stamped each recording. I queued up the file, crossed my fingers, and listened. At first, there was nothing. Then, I remembered I waited a minute or so into PASCR's receive window to ensure that my transmission would be recorded in full. After fast-forwarding the audio, there it was, "CQ CQ CQ DE N7LXR N7LXR N7LXR."

It worked! I had a proven way to set up a remote, automated receive site to evaluate antennas and communication paths. The recordings also provided a record of how changing ionospheric conditions are related to transmission time with respect to the solar diurnal cycle. Overall, I was pleased with PASCR's performance during its first field deployment. It maintained power and dutifully operated from installation to recovery. Potential future work will address improving setup and recording with multiple antennas.

All photos provided by the author.

David A. Strohschein, N7LXR, has been a ham since 1988. Though he has dabbled with SSB voice and digital modes, he spends most of his time operating CW. His earlier ham activities involved field-expedient HF antennas in the mountains and deserts of Utah. David still predominantly operates on the HF bands using NVIS communications, and he has recently started to integrate SDR technology into his amateur radio operations. David can be reached at strohsch@gmail.com.

For updates to this article, see the *QST* Feedback page at www.arrrl.org/feedback.



Congratulations

November 2023
QST Cover Plaque Award Winner

Oryx "Rucio" Gazella, KØRYX

In his article, "Ham Radio in Virtual Reality," Oryx describes the Neos Amateur Radio Association's virtual reality Field Day experience in the metaverse, including the tools the club used to get there.

QST Cover Plaque Awards are given to the author or authors of the most popular article in each issue. *You* choose the winners by casting your vote online at

www.arrrl.org/cover-plaque-poll

Log in now and choose your favorite article in this issue!

Ham Radio in Virtual Reality



A group of radio amateurs and virtual reality enthusiasts joined forces in an effort to merge their two worlds by developing a ham radio interface for operating within the metaverse.

Oryx "Rucio" Gazella, KØRYX

During the COVID-19 pandemic, many clubs used virtual conferencing tools to remain active when meeting in person wasn't possible. While these tools are great alternatives to in-person interactions, they flatten our three-dimensional (3D) world into two dimensions. In an effort to stay in a 3D world, some hams turned to virtual reality (VR) as a means to connect.

Rise of the Metaverse

VR is a computer simulation of a 3D environment that's typically experienced by wearing a headset containing stereoscopic displays (display devices capable of conveying depth), and handheld controllers tracked in the 3D space. Although VR equipment is not required, the immersive experience it offers can be well worth the investment. Manufacturers like Meta, Valve, and HTC offer various models of VR equipment ranging from \$300 to more than \$1,000, depending on equipment features.

VR equipment is connected to a PC that runs the simulation software. The PC and software are responsible for rendering the environment and performing other tasks, such as connecting people (also known as *players*) together over the internet. The simulation software is colloquially referred to as the *metaverse*. Metaverse players choose a unique username, similar to a call sign, to log in to the platform. This username is how you're identified. My metaverse username is Rucio.

In the metaverse, you pilot a virtual character known as an *avatar* — a digital representation of how you appear to others within the metaverse. Avatars are highly customizable and often are an important part of someone's virtual identity. A variety of human and

Cover: NARA members FoxBox, Rucio, Hisan Akimori, and Stiles Jackie operated 20-meter voice at NARA's first Field Day event in 2022. VR allowed them to be together for the event, even though they were miles apart.

“I Am Safe” Welfare Messages

With the help of ham radio, members of the public can find comfort during emergencies by sending well-being messages to loved ones.

David Wilma, KG7LEA

Seattle, Washington, has a network of more than 135 neighborhood hubs (read the January 2020 “Public Service” column by John T. Young, K7JY, for more information) where neighbors can gather during emergencies to share information and resources after the disruption of normal services. Hams are beneficial at each hub, exchanging messages with the city, other hubs, and other response groups; distributing public service information, and providing situational awareness.

Welfare messages via radio are of a lower priority than response and recovery traffic but are of the greatest importance to residents. Members of the Seattle Emergency Communication Hubs and hams developed the “I Am Safe” welfare messaging process that utilizes Winlink Global Radio Email®, the National Traffic System (NTS), and Radio Relay International (RRI).

The Winlink Express radiogram template was improved to meet the needs of the Seattle hubs. A working group was organized by Hub Captain Cindi Barker, KD7KSH; Bill Thomassen, N6NBN; Amateur Radio Emergency Service® (ARES®) members; ARRL Western Washington Section Manager Monte Simpson, AF7PQ, and RRI Affiliated Programs Manager Steve Hansen, KB1TCE. Steve worked with the Winlink Development Team, while Oliver Dully, K6OLI, and Greg Kruckewitt, KG6SJT, worked on the message templates. The result was an RRI quick welfare message template that includes 14 short messages proposed by the Northwest Washington chapter of the American Red Cross. An offline clone of this template can be used by volunteers assisting Winlink operators to create messages for Winlink. The existing RRI welfare radiogram was upgraded to fit this new procedure.

Organization and Process

First, a sender approaches hub volunteers for assistance, then fills out a paper intake form with their

“I Am Safe” message		
Date:	10 JULY 2023	Time: 0905
YOUR Name:	LUCAS FRANCISCO	
Whom would you like to contact?	LOUISE PHENIMEISTER	
Email address?	PREPYU@GMAIL.COM	
Phone number?		
Circle one: Cell phone Landline	If cell phone, do you know their carrier?	
Street address:		
City, State, Zip		
Number(s):	(see back side) 25 total word limit for entire message	
Additional text	ALL ARE SAFE AND STAYING WITH FRIENDS. WILL CALL WHEN I CAN. I LOVE YOU	
Jun 2023	Entered <input type="checkbox"/>	

Sample intake message completed by a sender at a neighborhood emergency communications hub.

name, the known address of their out-of-area contact, and a message. The volunteer reviews it for completeness and legibility (an important step identified in beta testing) before the sender leaves.

Intake forms are sorted according to their address types — email addresses, cell phone numbers with their carrier name, landline numbers, cell phone numbers without carriers, and postal addresses. The forms go to a volunteer digitizer who creates a message using one of the two templates. These templates work in any browser and contribute information for files to be imported into Winlink. A thumb drive with the files goes to the hub’s Winlink operator for upload into a Winlink message. Volunteers and hub operators work out the best process for sending the messages.

Message Types

Emails are the easiest to send because information from the intake form can go into a Winlink message with the sender’s name in the subject field and can be sent via a local remote message server gateway. The RRI quick welfare message template simplifies this. Seattle Auxiliary Communications Service (ACS) maintains eight gateways using VARA FM on UHF.

Cell phone messages can be routed through the carrier's domain to appear on the addressee's phone or device. The sender's name appears in the subject field to distinguish the message from spam. The RRI quick welfare message template has a carrier selection feature that automatically populates the email address. A list of carrier domains is also included in the written instructions at each hub.

If the sender has only a postal address, a landline, or a cell phone without a carrier, the message is sent via the Winlink RRI welfare radiogram template. The sender can select one of 14 pre-written messages, or they can compose their own using 25 characters or less. The template populates the message with the Winlink/RRI gateway region tactical address and the radiogram. The regional liaison operator picks up the messages and forwards them through traffic network stations.

Testing, Testing, and More Testing

At Field Day 2022 in Seattle, visitors completed test messages that were forwarded to real addresses across the country via Winlink and the NTS, as well as to emails and devices. This familiarized traffic handlers with the process and led to the development of the quick welfare template.

Ten stations were utilized during a full-scale exercise in March 2023. Several dozen operators were given messages and the written procedure, then entered data from paper forms into Winlink messages that went to a simulated addressee. This confirmed the proof of concept, identified enhancements to the templates, and fine-tuned the procedure, which resides at every hub and is distributed to ACS and ARES volunteers for their go-boxes.

Lessons Learned

It's not necessary to train operators in this process because they'll follow the written procedure. But you should brief them on equipment they may be unfamiliar with. It might be more effective for them to use their own laptops with software installed and properly configured for the radio. However, this method preserves the use of the same call sign in messages and a single digital record of traffic.

If the hub operator doesn't have Winlink capability, paper intake forms and thumb drives can be hand-carried to stations that do. Hams at home can be an important resource. Seattle ACS maintains a roster of

Sample Winlink RRI quick welfare message.

home HF stations that can forward Winlink traffic if local remote message server gateways are unavailable. The new RRI Winlink templates allow data to be saved. These text files are bundled into a zip file at the hub, attached to a Winlink message, and sent peer to peer via VHF and UHF to the HF station. The message includes instructions for populating templates and forwarding traffic to distant gateways.

Any message using the Roman alphabet can be sent via Winlink. Messages in other alphabets can be scanned and attached as images, as long as the email address is in Roman characters.

Template Access

The "I Am Safe" message serves the response and recovery mission of the Federal Emergency Management Agency's National Preparedness Goal. Residents and their families will find comfort during a difficult time with the help of amateur radio.

The templates are in the Winlink Template Manager and on thumb drives in every hub box, along with the written procedure. The procedure is also available at <https://radiorelay.org>.

All images by the author.

David Wilma, KG7LEA, is Deputy Director and Emergency Coordinator for Seattle ACS in Washington and was first licensed as a General-class operator in 2014. His career in law enforcement and public service, where he gained his push-to-talk experience, lasted more than 30 years. David can be reached at davidwilma@comcast.net.

For updates to this article, see the [QST Feedback page](https://www.arri.org/feedback) at www.arri.org/feedback.



Rewarding Excellence with ARRL Awards

Do you know someone worthy of an award?
Visit www.arrl.org/arrl-award-nominations to nominate them today!

Mike Ritz, W7VO

We all know an amateur who has gone above and beyond the call of duty to support and enhance the ham radio community, at a local, regional, or even global level. These exceptional hams are the ones who raise their hands at meetings when somebody asks, "Who would like to take on this task?" They volunteer consistently without hesitation. They are the ones who innovate new technologies disruptive enough to change how we think the hobby can bring us together despite our physical and station limitations. These individuals, at all levels, are the epitome of volunteerism in its purest and most valuable form — exceptional service to all amateurs.

For years, ARRL has had a robust operating awards program that many of us are familiar with. One of the well-known operating achievement awards is the Worked All States (WAS) Award, for which an amateur may be rewarded for having confirmed contacts in all 50 states. Other awards include the prestigious DX Century Club (DXCC) Award and the DXCC Honor Roll, which many have spent their entire amateur career pursuing. This article, however, focuses on the special annual ARRL Awards Program for extraordinary amateurs and others who make a difference for all.

ARRL's Programs and Services Committee is responsible for vetting candidates for these ARRL awards. In my tenure as a committee member, I have noticed that each year, many of these awards have gone un-



 Sam Lovett, KI5RSV, discusses receiving the 2023 Hiram Percy Maxim Memorial Award. Click here to hear his story.

awarded because there haven't been any nominations for them. I doubt that there isn't anybody out there deserving of these awards. A better explanation might be that our members may not know such awards exist. For many of them, the nominations come from ARRL members. I hope to remove this barrier by reviewing the various service awards available for nomination by ARRL members.

The ARRL service awards are divided into four categories: Education Awards, Media/Public Relations Awards, Technical Awards, and Distinguished Service Awards. Descriptions of several awards can be found on the next page.

Help Promote the Awards

Look around your local or regional amateur radio community, and help ARRL recognize and reward the very best of the best among us. There are exemplary amateurs you probably know who deserve to be recognized for what they do to mentor, engage, and educate us all. This level of commitment is the epitome of volunteerism in its purest and most valuable form.

Mike Ritz, W7VO, has been an ARRL Life Member for more than 40 years. He was first licensed in 1974 as WN6HKP. In November 2018, Mike was elected Director of the ARRL Northwestern Division, and in January 2020, he was elected Vice President of the ARRL Foundation. Mike is currently the Chair of the ARRL Programs and Services Committee. He can be reached at w7vo@comcast.net.

For updates to this article, see the [QST Feedback](#) page at www.arrl.org/feedback.



These ARRL awards are given to honor excellent service in furthering the goals of the association and amateur radio.

Education Awards

Hiram Percy Maxim Memorial Award

Named for the Founding President of ARRL, this award goes to a licensed radio amateur under age 21 who has made exemplary contributions to amateur radio and the local community. Nominees must be current ARRL members. **Nomination deadline: March 31, 2024.**

ARRL Herb S. Brier Award for Instructors and Teachers

Honoring Herb S. Brier, W9AD (SK), ARRL sponsors this award in conjunction with the Lake County Indiana Amateur Radio Club to recognize the very best in amateur radio instruction and recruitment. The award goes to a licensed radio amateur and ARRL member who is an ARRL-registered volunteer instructor or ARRL-registered professional classroom teacher. **Nomination deadline: March 15, 2024.**

Technical Awards

ARRL Microwave Development Award

This award recognizes a radio amateur or group of radio amateurs who contribute to the development of the amateur radio microwave bands. **Nomination deadline: March 31, 2024.**

ARRL Technical Service Award

This award recognizes a radio amateur or group of radio amateurs who provide amateur radio technical assistance or training to others. **Nomination deadline: March 31, 2024.**

ARRL Technical Innovation Award

This award recognizes a radio amateur or group of radio amateurs who develop and apply new technical ideas or techniques in amateur radio. **Nomination deadline: March 31, 2024.**

Public Relations Awards

ARRL Philip J. McGan Memorial Silver Antenna Award

Honoring Phil McGan, WA2MBQ (SK), this award recognizes a radio amateur and ARRL member who has demonstrated leadership in successfully promoting amateur radio to the public. **Nomination deadline: March 31, 2024.**

ARRL Bill Leonard Award

Honoring Bill Leonard, W2SKE (SK), three annual awards are given to professional journalists or journalistic teams whose outstanding coverage highlights the enjoyment, importance, and public service contribution of the Amateur Radio Service. The award is given

in three media categories: audio, visual, and print. **Nomination deadline: March 31, 2024.**

Distinguished Service Awards

Knight Distinguished Service Award

Honoring Joe T. Knight, W5PDY (SK), the award recognizes exceptional contributions by a Section Manager to the health and vitality of ARRL. **Nomination deadline: March 31, 2024** (for consideration during the July ARRL Board meeting).

George Hart Distinguished Service Award

Honoring George Hart, W1NJM (SK), the award recognizes an ARRL member's lifetime of activities within the ARRL Field Organization, including the National Traffic System and the Amateur Radio Emergency Service®. **Nomination deadline: November 1, 2024.**

Highlighting the 2023 George Hart Distinguished Service Award

Public Service is one of ARRL's five pillars, and the George Hart Distinguished Service Award honors the work member-volunteers put in to use their license privileges to serve others. Jo Ann Keith, KA5AZK, of Diana, Texas, received this award in 2023.



Jo Ann Keith, KA5AZK, receiving the George Hart Distinguished Service Award. Pictured from left to right: ARRL West Gulf Division Director John Robert Stratton, N5AUS; Jo Ann Keith, KA5AZK, and ARRL North Texas Section Manager Steven Lott Smith, KG5VK. [Zogail Smith, KB5KBE, photo]

Keith is the Manager of the 7290 Traffic Net, a public service traffic net that has been in operation since 1953. According to ARRL North Texas Section Manager Steven Lott Smith, KG5VK, who nominated her for the award, Keith has a long history of volunteer work, dating back to her youth when she served as a candy striper. Smith said, "Jo Ann has always placed service to others before [her]self. She is the lifeblood of the 7290 organization, which just received an award for their 70th year of service last month."

This Distinguished Service Award is named in honor of George Hart, W1NJM, a long-time Communications Manager at ARRL Headquarters and Chief Developer of the National Traffic System. The Board of Directors may present the award to an ARRL member whose service to ARRL's Field Organization is of the most exemplary nature.

Happenings

WRC-23 Reaches Acceptable Conclusion on 23-Centimeter Issue

The International Telecommunication Union (ITU) World Radiocommunication Conference 2023 (WRC-23) was held from November 20 to December 15, 2023, in Dubai, United Arab Emirates.

The International Amateur Radio Union's (IARU's) primary effort in the conference focused on agenda item 9.1b, which addressed amateur use of the 23-centimeter band and co-frequency use by several radionavigation-satellite service (RNSS) systems in the 1240 – 1300 MHz band.

IARU's work, which began 4 years ago with a preparatory study in the ITU Radiocommunication Sector (ITU-R) to address this agenda item, has finally come to a close. IARU's engagement in the ITU-R working parties, study groups, and WRC preparatory meetings ensured that the amateur services were properly represented during the development of two published ITU-R reports: M.2513 and M.2532. An ITU-R Recommendation, M.2164, followed these, which formed the basis of the discussions at WRC-23.

During the WRC-23 deliberations, strong positions were expressed by all parties involved. The result is a well-supported compromise for a footnote in the Radio Regulations regarding amateur and amateur satellite service operation in the 1240 – 1300 MHz range. The footnote reminds administrations and amateurs of the need to protect the primary RNSS from interference, and it provides guidance for administrations to allow both services to continue



IARU President Tim Ellam, VE6SH, offers thanks to Barry Lewis, G4SJH, for his success in leading IARU's work on agenda item 9.1b. From left to right: WRC-23 Sub-Working Group 4B7 Chair Dale Hughes, VK1DSH; IARU Vice President Ole Garpestad, LA2RR; IARU President Tim Ellam, VE6SH; IARU 9.1b Team Lead Barry Lewis, G4SJH, and IARU Secretary Joel Harrison, W5ZN.



operating in this portion of the spectrum.

Administrations are the bodies that govern amateur radio in their respective countries, such as the Federal Communications Commission (FCC) in the US.

The compromise was formally adopted on December 8, 2023, and it was not subject to further consideration during the final week of WRC-23.

IARU President Tim Ellam, VE6SH, noted:

This is a very good result for the amateur services. The decision reached at WRC-23 on this agenda item makes no change to the table of allocations nor incorporates by reference M.2164 into the Radio Regulations. The addition of a footnote that provides guidance to administrations in the event of interference to the RNSS is a good regulatory outcome for amateurs and the primary users of this band.

Conference attendees also agreed to suppress Resolution 774, which closes the issue and satisfies the agenda item.

ARDC Grant Funded Upgrades to University Amateur Radio Club

With a grant of almost \$200,000 from Amateur Radio Digital Communications (ARDC), and private donations of more than \$20,000, the University of Scranton Amateur Radio Club based in Scranton, Pennsylvania, has installed new amateur radio equipment and antennas for its station, W3USR.

The station is now located on the fifth floor of the university's Loyola Science Center, and it features state-of-the-art operating positions with heavy-duty controllers, all-mode transceivers, speakers, desktop microphones, and other components that allow students to operate on amateur radio frequencies. A 40-foot tower with a high-frequency antenna for 14, 21, and 28 MHz has been installed, as well as VHF/UHF satellite and microwave antennas — some with rotating mounts.

The ARDC grant was awarded to the university's Physics and Engineering Department Assistant Professor Dr. Nathaniel Frissell, W2NAF, and the private donations were made by Dr. Mary Lou West, KC2NMC; Ed Hayes, N6XEM, and Jeff DePolo, WN3A. Dr. Frissell said the impact of the new station means everything to the club. "When you can bring a group of stu-



A crane lifts an antenna into place for W3USR's new location. [Byron Maldonado photo]

dents into a new facility like this one, the impact makes a lasting impression that will allow them to fully experience amateur radio," he said.

Dr. Frissell added that the first radio contacts have been made, and the station is working on 10, 15, and 20 meters, with additional installation work remaining. An additional room on the same floor holds equipment and antenna connections, and it will be used as a lab for controlled Ham Radio Science Citizen Investi-

gation (HamSCI) space research projects. The new capabilities of W3USR will also allow ongoing and future HamSCI research projects to be undertaken by Dr. Frissell and university students.

W3USR was founded in the spring of 2020 with the purpose of educating students about the ionosphere and the importance of radio communication. The club regularly participates in the ARRL Collegiate Amateur Radio Program.

ARDC and ARRL Announce \$2.1 Million for the Next Generation of Amateur Radio

Amateur Radio Digital Communications (ARDC) and the ARRL Foundation announced a 3-year commitment, with more than \$2.1 million in combined funding, to support scholarships for radio amateurs, radio technology for classroom teachers, and amateur radio club grants. This commitment reinforces a strong, shared vision between ARRL and ARDC to invest in the future of amateur radio by supporting the next generation of radio amateurs.

"ARRL and ARDC share a common vision for the future of amateur radio,"



said ARRL Foundation President David Norris, K5UZ. "The [ARRL] Foundation exists to support the next generation of radio amateurs, and we are proud to collaborate with ARDC to make these programs possible."

Since its inception in 2020, the ARDC Scholarship Program at the ARRL

Foundation has helped nearly 100 amateur radio operators pursue their educational goals. The renewed commitment will result in more than 200 scholarships, ranging from \$5,000 to \$25,000, that will be awarded over the next 3 years. This competitive scholarship program is run through the ARRL Foundation Scholarship Program, and recipients who demonstrate academic excellence and financial need can use this funding for tuition, room and board, books, and other fees essential to advancing their education. More information on eligibility and application deadlines can be

found at www.arrl.org/scholarship-program.

The ARRL Foundation Club Grant Program was introduced in 2022 with initial funding from ARDC. Thanks to this next round of collaboration, the Club Grant Program will continue in 2024. Club grants are critical to the future of amateur radio because clubs recognize the importance of helping

licensees become active in amateur radio. ARRL encourages clubs to apply for funding to support programs in one of the available categories, such as ham skill development; science, technology, engineering, and mathematics (STEM) education through amateur radio, and others. More details about this program will be provided through upcoming informational

sessions and at www.arrl.org/club-grant-program.

Additional funding from ARDC will extend the effectiveness of ARRL outreach programs to teachers and schools, including the ARRL Teachers Institute on Wireless Technology. Funds will be used to purchase equipment that will allow students to have hands-on STEM experiences through radio technology.

ARRL Teachers Institute Grad Prepared Students for Ham Radio Contact with Astronaut

ARRL recently celebrated the success of an ARRL Teachers Institute on Wireless Technology graduate. On December 11, 2023, students at Harbor Creek Senior High School in Harborcreek, Pennsylvania, led an Amateur Radio on the International Space Station (ARISS) contact after Harbor Creek Senior High School Assistant Principal Drew Mortensen, AC3DS, completed ARRL's TI-1: Introduction to Wireless Technology program. Mortensen, Allen Lombardozzi, KC3TGY, and Elaine LaFuria, KC3SFY, have led the development of a robust amateur radio program at the school.

Fifteen of the students who participated in the ARISS contact are licensed amateur radio operators. Since applying for the contact in November 2022, Harbor Creek has seen 16 students earn their amateur radio licenses. As of press time, three of them are studying to earn their General-class licenses, and three more are studying for their Amateur Extra-class licenses. Mortensen expressed gratitude for the ARRL Youth Licensing Grant Program, which reimburses the \$35 amateur radio licensing fee to those younger than 18 years old, for helping to lower the barrier to entry for students.



Teachers downlink images from a National Oceanic and Atmospheric Administration Geostationary Operational Environmental Satellite during the ARRL Teachers Institute on Wireless Technology. [Sierra Harrop, W5DX, photo]

Students at the Harbor Creek School District Advanced Technologies Group, KC3SGV, regularly meet and fill the meeting space to maximum capacity. ARRL Education and Learning Manager Steve Goodgame, K5ATA, expressed excitement about the school's success in promoting amateur radio, stating, "The program at Harbor Creek Senior High School

is a shining example of the impact the ARRL Teachers Institute on Wireless Technology can have on students."

If you are interested in supporting science, technology, engineering, and mathematics education through the Teachers Institute on Wireless Technology, visit www.arrl.org/givetostem.

ARRL RF Safety Committee Published New Document

Radio amateurs now have a new tool from ARRL to help answer questions about their stations. Neighbors of amateur radio operators are sometimes concerned about transmissions and radio frequency exposure from amateur stations. The ARRL RF Safety Committee, with their international counterparts at the Radio Society of Great Britain, the Irish Radio Transmitters Society, and the Swedish Society of Radio Amateurs, has developed a new set of guidelines to help amateurs talk to their neighbors about RF exposure.

Chairman of the ARRL RF Safety Committee Greg Lapin, N9GL, said the new informational PDF found on the ARRL RF Exposure web page at www.arrl.org/rf-exposure, Helping Amateurs Interact with Neighbors Asking About Radio Transmissions, was developed after a year of discussions about RF safety. Lapin said:

Neighbors may be alarmed by some of the misinformation about RF safety that is available from a variety of sources. By following the exposure regulations from the Federal Communications Commission, we can be confident that our families and neighbors are safe.

He added that RF exposure regulations are based on decades of trustworthy research. He also encouraged all amateur radio operators to perform exposure assessments for their stations to make sure they meet those regulations.

Section Manager Nomination Notice

To all ARRL members in Illinois, Indiana, Maine, Northern Florida, Oregon, Santa Clara Valley, Vermont, and Wisconsin. You are hereby solicited for nominating petitions pursuant to an election for Section Manager (SM). Incumbents are listed on page 16 of this issue.

To be valid, a petition must contain the signatures of five or more full ARRL members residing in the Sections concerned. It is advisable to have a few more than five signatures on each petition. A sample nomination form is available on the ARRL website at www.arrl.org/section-terms-nomination-information. Nominating petitions may be made by facsimile or electronic transmission of images, provided that upon request by the Field Services Manager, the original documents are received by the manager within 7 days of the request. It is acceptable to submit signatures that have been sent via email or mail under the following guidelines: The petition copies must be made from the original form supplied by ARRL or downloaded from the ARRL website. The form must be exactly the same on both sides (i.e., autobiographical information should appear exactly the same on all copies). All forms/copies must be submitted together.

Candidates may use any of the available electronic signature platforms such as DocuSign, Dropbox Sign, and Signed PDF. Candidates who use an electronic signature platform to be nominated, as described above, do not have to send original paper copies of the nominating documents. The packet that is sent to ARRL Headquarters must be complete. Multiple files or emails for a single petition will not be accepted.

We suggest the following format:

(Place and Date)

Field Services Manager, ARRL
225 Main St.
Newington, CT 06111

We, the undersigned full members of the _____ ARRL Section of the _____ Division, hereby nominate _____ as candidate for Section Manager of this Section for the next 2-year term of office.

(Signature _____ Call Sign _____ City _____ ZIP _____)

Any candidate for the office of Section Manager must be a resident of the Section, an amateur radio licensee of Technician class or higher, and a full member of ARRL for a continuous term of at least 2 years immediately preceding receipt of a nominating petition. Petitions must be received at Headquarters by 4:00 PM Eastern Time on March 8, 2024. If more than one member is nominated in a single Section, ballots will be mailed from Headquarters no later than April 1, 2024, to full members of record as of March 8, 2024, which is the closing date for nominations. Returns will be counted on May 21, 2024. Section Managers elected as a result of the above procedure will take office on July 1, 2024.

If only one valid petition is received from a Section, that nominee shall be declared elected without opposition for a 2-year term beginning July 1, 2024. If no petitions are received from a Section by the specified closing date, such Section will be resolicited in the July issue of QST. A Section Manager elected through the resolicitation will serve a term of 18 months. A Section Manager vacancy occurring between elections is filled through appointment by the Field Services Manager. — *Mike Walters, W8ZY, Field Services Manager*

SM NOMINATION RESOLICITATION:

Because no nomination petitions were received for the Kansas and New Mexico Section Manager elections by the nomination deadline of September 8, 2023, nominations are hereby resolicited. See above for details.

Public Service

EmComm and the ITU Telecommunication Development Sector

The International Telecommunication Union (ITU) is a specialized agency of the United Nations that deals with information and communication technologies. It puts on the World Radio-communication Conferences (WRC) and promulgates the international table of frequency allocations and radio regulations, among many other missions. (The FCC writes the domestic rules and frequency allocations based on the international table.) This month, we'll discuss the international scheme of things in the context of our bailiwick emergency communications.

Understanding the ITU

Most countries are Member States of the ITU and generally agree to be bound by its decisions on the usage of the radio frequency spectrum. It works to promote communications infrastructure in the developing world, coordinates assignment of satellite orbits, and works on communications technology in the context of global issues, such as climatology and cybersecurity. There are three sectors of the ITU: Radiocommunications (ITU-R), Telecommunication Development (ITU-D), and Telecommunication Standardization (ITU-T). The International Amateur Radio Union (IARU) is a Sector Member of ITU-R and ITU-D. At WRC, IARU represents the amateur service for spectrum protection and acquisition (when possible) and serves as our international community's sentinel.

ITU-R Study Groups and Working Parties consider spectrum allocation issues, arrive at consensus, and draft recommendations ahead of the WRC, but the ITU-D integrates tele-

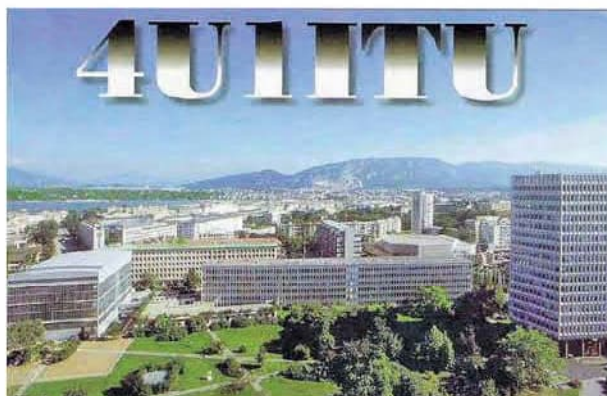

ITU headquarters and the International Amateur Radio Club, 4U1ITU, are located in Geneva, Switzerland.

communications and information technology in disaster prediction, detection, and alerting. IARU representatives' principle mission is to ensure that ITU members appreciate and understand the role of amateur radio in worldwide disaster communications.

ITU-D Study Group 1 met last October in Geneva, with ARRL International Affairs Vice President and IARU Emergency Communications Special Advisor Rod Stafford, W6ROD, in attendance. In the meeting, Stafford discussed direct-to-handset, which is an item that deals with smartphones accessing satellite services during telecommunications emergencies. He reported that he has "seen a steady trend by the satellite interests to 'develop' a market for their ability to provide communications during natural disasters and other disruptions of the telecommunication landscape." He concluded by saying:

Definitely a lot of competition [with] the amateur radio role in emergency communications and, of course, they have vast sums of money to expand their role and

publicize [it] in emergency communications. The situation lends a lot of support for the theory that if we, as amateurs, are to maintain our spectrum, that we need to rely [on more than just] our emergency communication services role[s]. We need to continue to promote amateur radio as a valuable path to getting involved in ICTs and increase the incorporation of amateur radio in the STEM educational world.

Stafford also noted that the ITU Telecommunication Development Bureau supports countries in the development of their National Emergency Telecommunication Plans (NETPs). During discussions that led to a model NETP, Stafford highlighted the role of amateur radio by participating in workshops dealing with NETPs and developing exercises and drills for testing emergency communications systems. Visit www.itu.int for additional information.

IARU and Emergency Communications

IARU member-societies organize and train their members and local clubs to be ready to respond in times of need. Each of the three IARU

regional organizations — organized to broadly mirror the structure of the ITU and its related regional telecommunications organizations — has an emergency coordinator whose mission is to support those efforts and to coordinate international assistance as required. The *IARU Emergency Telecommunications Guide* (www.iaru.org/wp-content/uploads/2020/01/emcommguide_1sept2016.pdf) is a resource for member societies.

IARU is also associated with the International Federation of Red Cross and Red Crescent Societies, with whom they hold a formal memorandum of understanding.

Easement of International Emergency Response

An example of the excellent work performed by the IARU and ITU is found in the Tampere Convention on the Provision of Telecommunication Resources for Disaster Mitigation and Relief Operations, a treaty that allows humanitarian organizations to provide telecommunications more quickly when an international disaster strikes. The treaty eliminated roadblocks to moving telecommunications personnel and equipment into and within disaster areas. Delegates to the Intergovernmental Conference on Emergency Telecommunications (ICET-98) adopted it in 1998 in Tampere, Finland. “The Tampere Convention has broader purposes but is an important building block in IARU’s efforts to improve recognition of the Amateur [Radio] Service in providing emergency communications for disaster relief,” an IARU spokesman said.

ITU then-Secretary-General Yoshio Utsumi pointed out that until the Tampere Convention, regulatory barriers often impeded the ability of humanitarian organizations to deploy telecommunications equipment across borders in an emergency, and delays have cost lives. “With this convention, relief workers can make full use of today’s telecommunication tools, which are essential for the coordination of rescue operations,” Utsumi said.

The first treaty of its kind, the Tampere Convention calls on signatory countries to facilitate prompt telecommunication aid to mitigate a disaster’s impact. It covers installation and operation of telecommunication services and waives regulatory barriers, such as licensing requirements and import restrictions, as well as limitations on the movement of humanitarian teams. The pact also grants immunity from arrest and detention to those providing disaster assistance and exempts them from taxes and duties.

An ITU-R Sector Recommendation — Disaster Communications in the Amateur and Amateur-Satellite Services — is another vehicle to formalize amateur radio’s role in international emergency and disaster mitigation. It encourages the development of robust, flexible, and independent amateur radio networks that can operate from emergency power and provide communication in natural disasters.

In Conclusion

The Amateur Radio Emergency Service® and other EmComm-oriented amateur group members can learn about the often-overlooked patchwork of international amateur radio leaders and leading international organizations that often form the bedrock of our own domestic programs and services.

Field Organization Reports

November 2023

Public Service Honor Roll

This listing recognizes radio amateurs whose public service performance during the month indicated 70 or more points in six categories. Details on the program can be found at www.arri.org/public-service-honor-roll.

574 WA7PTM	177 KC8YVF	129 N2DW	K3YAK AA3SB KB8GUN N1LAH W1TCD	86 KA2GQQ
495 AD8CM	175 K9LGU WO2H	127 W5WMC	99 N3KRX	84 KB1NAL KB1TCE N2GS
439 KO4KUS	170 AG9G N4CNX W4DNA	125 KB9IME K1CFI W1FEA K3JL	98 W4NHO KC3MAL	81 W4TTO
382 W7PAT	168 WB8YYS KV8Z	124 W8IM	97 KB1NMO	80 KR4ST W9BGJ KABBJA AE2Y N1CVO
325 W7EES	155 KB3YRU KC8WH	120 KD0HHN WC4FSU KA9QWC KY2D	96 KA2HZP	79 W4PXE WB8RGE KB4OLY KB0DTI NT1N AA3N K2MTG N8OD KA1G
340 N9VC	150 KM4WHO	120 WA1URS W2AH WA4VGZ WA3QLW	95 W2ARP KF7GC	78 W7FSC
280 N2LC	149 WM2C	118 AC0KQ	94 KF5IVJ KB8PGW	77 A17B WB4ZDU
260 KD2LPM	144 KB8RCR KD8UUB	117 KT5EM	93 K5ANP	75 W7MIN N2TSO K8RDN
256 KE8BYC	142 KC8T	115 KB5PGY	92 WB8SIQ	74 W3ZR
255 KT2D	140 W0PZD	113 KC1HHO	91 K1HEJ	72 N7DMB K1STM W5XX
245 W0PZD	137 AC8NP	110 KF5IOU AD4DO	90 K4FHR KB9GO KC9UC KT5SR AB9ZA K8ED WA3QPX W4EDN W4KX WX2DX N8MRS W8GSR KL7RF K8KRA KB8HJJ WB8MAL	71 KA0DBK
240 WM5N AC8NP	136 KE8DON	110 NW3X K1UAF W1INC WB8TQZ KB2QO N1IQI W1RVY KC1KVY	89 KT4WX N0ET N1PZP WW3S	70 K5OB K4DH
215 KF5OMH N8SY	135 W2PAX KC9FXE KO4OL WD8USA KE4RS N1ILZ	102 KG5AOP KF0BPN	88 W8WX KN4WX	
206 N12W	130 KR4PI WB9WKO	100 NX9K KG5NNA K28Q WB8RJW W2OOD WA2BBS N3GE W1KX		
198 W9EEU K1XFC	130 KR4PI WB9WKO	100 NX9K KG5NNA K28Q WB8RJW W2OOD WA2BBS N3GE W1KX		
190 ND8W	130 KR4PI WB9WKO	100 NX9K KG5NNA K28Q WB8RJW W2OOD WA2BBS N3GE W1KX		
185 W9GRG N5MKY	130 KR4PI WB9WKO	100 NX9K KG5NNA K28Q WB8RJW W2OOD WA2BBS N3GE W1KX		
180 K8AMH	130 KR4PI WB9WKO	100 NX9K KG5NNA K28Q WB8RJW W2OOD WA2BBS N3GE W1KX		

The following stations qualified for PSHR in October 2023, but were not acknowledged in this column yet. NA2G 120, K1CFI 118, K6HTN 110, N7IE 95, N7UWX 87, N6IET 86.

Section Traffic Manager Reports

The following Section Traffic Managers reported: AK, AR, AZ, CO, CT, DE, EMA, ENY, EPA, GA, IN, KS, KY, LA, MDC, ME, MI, MO, MS, NC, ND, NE, NFL, NH, NLI, NNJ, NNY, NTX, OH, OR, RI, SD, SFL, SJV, STX, TN, WCF, WI, WMA, WPA, WV, WWA, WY.

Section Emergency Coordinator Reports

The following Section Emergency Coordinators reported: AL, AR, CT, EPA, GA, KY, MI, NFL, NLI, NM, NNJ, NNY, NV, PAC, SCV, SNJ, STX, TN, VA, VI, WMA, WPA, WWA.

Brass Pounders League

The BPL is open to all amateurs in the US, Canada, and US possessions who report to their SMs a total of 500 or more points or a sum of 100 or more origination and delivery points for any calendar month. Messages must be handled on amateur radio frequencies within 48 hours of receipt in standard ARRL radiogram format. Call signs of qualifiers and their monthly BPL total points follow.

NX9K 1,053, W2AH 1,048, WA3QLW 829, WB9WKO 723, KW1U 640, KB9GO 503.

Contest Corral

February 2024

Check for updates and a downloadable PDF version online at www.arrl.org/contest-calendar.

Refer to the contest websites for full rules, scoring information, operating periods or time limits, and log submission information.

Start - Finish		Bands	Contest Name	Mode	Exchange	Sponsor's Website		
Date-Time	Date-Time							
1	0000	2	0300	7	Walk for the Bacon QRP Contest	CW	Max. 13 WPM; RST, SPC, name, mbr or pwr	qrptest.com/pigwalk40
1	1800	1	2200	28	NRAU 10m Activity Contest	CW Ph Dig	RS(T), 6-char grid square	nrau.net/nrau-contests-in-general
1	2000	1	2200	1.8-28,50	SKCC Sprint Europe	CW	RST, SPC, name, mbr or "none"	www.skccgroup.com
3	0000	4	2359	1.8-28, VHF/UHF	Vermont QSO Party	CW Ph Dig	RS(T), VT county or SPC	www.ranv.org/vtqso.html
3	0001	4	2359	28	10-10 Int'l Winter Contest, SSB	Ph	Name, mbr or "0," SPC	www.ten-ten.org
3	1200	4	1200	1.8-28	European Union DX Contest	CW Ph	RS(T), EU union region or ITU zone	www.eudx-contest.com
3	1200	4	1200	3.5-28,144	F9AA Cup, CW	CW	RST, serial	www.site.urc.asso.fr
3	1200	4	2359	3.5-28	Mexico RTTY International Contest	RTTY only	RST, XE state or serial	rtty.fmre.mx
3	1400	3	2359	1.8-28	Minnesota QSO Party	CW Ph Dig	Name, MN county or SPC	www.w0aa.org/mnqp-rules
3	1400	3	2359	1.8-28	FYBO Winter QRP Sprint	CW Ph Dig	RS(T), SPC, name, power, temperature	azscqrptions.org
3	1600	3	1900	3.5	AGCW Straight Key Party	CW	RST, serial, class, name, age	www.agcw.de
3	1600	4	2359	1.8-28	British Columbia QSO Party	CW Ph	RS(T), BC district or SPC	www.orcadxc.org
4	0000	4	0359	3.5-14	North American Sprint, CW	CW	Other's call, your call, serial, name, SPC	ncjweb.com
5	2000	5	2130	3.5	RSGB 80m Club Championship, SSB	Ph	RS, serial	www.rsgbcc.org
6	0200	6	0400	3.5-28	ARS Spartan Sprint	CW	RST, SPC, power	arsqrp.blogspot.com
7	2000	7	2100	3.5	UKEICC 80m Contest	Ph	6-char grid square	www.ukeicc.com
7	2300	11	2300	1.8-14	AWA Linc Cundall Memorial CW Contest	CW	RST, eqpt. year, input power	www.antiquewireless.org
10	0000	11	2359	3.5-28	CQ WW RTTY WPX Contest	Dig	RST, serial	www.cqwxrtty.com
10	1100	10	1300	7,14	Asia-Pacific Spring Sprint, CW	CW	RST, serial	jsfc.org/apsprint/aprule.txt
10	1200	11	1200	1.8	KCJ Topband Contest	CW	RST, JA prefecture or district code	www.kcj-cw.com
10	1200	11	1200	1.8-28	Dutch PACC Contest	CW Ph	RS(T), PA province or serial	pacc.veron.nl
10	1200	11	2359	1.8-28,50	SKCC Weekend Sprintathon	CW	RST, SPC, name, mbr or "none"	www.skccgroup.com
10	1500	11	1500	1.8-28	OMISS QSO Party	Ph	RS, SPC, mbr (if any)	www.omiss.net
10	1900	10	2300	1.8	RSGB 1.8 MHz Contest	CW	RST, serial, UK district code (if UK)	www.rsgbcc.org
11	1300	11	1700	3.5,7	Balkan HF Contest	CW Ph	RS(T), serial	arabih.ba
12	0100	12	0300	1.8-28	4 States QRP Group Second Sunday Sprint	CW Ph	RS(T), SPC, mbr or power	www.4sqrp.com
12	1300	16	2359	All, except WARC	ARRL School Club Roundup	CW Ph Dig	RS(T), class (I/C/S), SPC	www.arrl.org/school-club-roundup
14	0000	14	2359	1.8-7	PODXS 070 Club Valentine Sprint	Dig	Name, OM or YL, SPC	www.podxs070.com
14	0130	14	0330	3.5-14	NAQCC CW Sprint	CW	RST, SPC, mbr or pwr	naqcc.info
14	1900	14	2000	3.5	DARC FT4 Contest	FT4	RST, 4-char grid square	www.darc.de
14	2000	14	2130	3.5	RSGB 80m Club Championship, Data	Dig	RST, serial	www.rsgbcc.org
15	0000	16	0300	14	Walk for the Bacon QRP Contest	CW	Max. 13 WPM; RST, SPC, name, mbr or pwr	qrptest.com/pigwalk20
15	1900	15	2000	3.5-14	NTC QSO Party	CW	Max. 25 WPM; RST, mbr or "NM"	pi4ntc.nl/ntcqp
17	0000	18	2359	1.8-28	ARRL International DX Contest, CW	CW	RST, SP or power	www.arrl.org/arrl-dx
17	0000	18	2359	All, except WARC	YLRL YL-OM Contest	CW Ph Dig	Serial, RS(T), SPC	ylrl.org/wp/yl-om-contest
17	1200	18	1159	1.8-28	Russian PSK WW Contest	Dig	RST, 2-letter oblast or serial	www.rdrclub.ru
18	2300	19	0100	1.8-28	Run for the Bacon QRP Contest	CW	RST, SPC, mbr or power	qrptest.com/pigrun
21	1900	21	2030	3.5	AGCW Semi-Automatic Key Evening	CW	RST, serial, 2-digit year first used a bug	www.agcw.de
22	2000	22	2130	3.5	RSGB 80m Club Championship, CW	CW	RST, serial	www.rsgbcc.org
23	2200	25	2200	1.8	CQ 160m Contest, SSB	Ph	RS, SP or CQ zone	www.cq160.com/rules.htm
24	0600	25	1800	3.5-28	REF Contest, SSB	Ph	RS, French department or serial	concours.r-e-f.org
24	1300	25	1300	3.5-28	UBA DX Contest, CW	CW	RST, ON section or serial	www.uba.be
24	1500	25	0159	1.8-28,50	South Carolina QSO Party	CW Ph Dig	RS(T), SC county or SPC	scqso.com
24	1800	25	0559	3.5-28	North American QSO Party, RTTY	Dig	Name, SPC+DC	www.ncjweb.com
24	1800	25	0559	3.5-28	NA Collegiate Championship, RTTY	Dig	Name, SPC+DC	www.w9smc.com/nacc
25	1400	25	1700	3.5-28	High Speed Club CW Contest	CW	RST, mbr or "NM"	www.highspeedclub.org
25	1500	26	0100	3.5-28, 50,144	North Carolina QSO Party	CW Ph Dig	NC county or SPC	ncqsoparty.org/rules
26	2000	26	2130	3.5-28	RSGB FT4 Contest	FT4	Signal report	www.rsgbcc.org
28	0000	28	0200	1.8-28,50	SKCC Sprint	CW	RST, SPC, name, mbr or "none"	www.skccgroup.com
28	2000	28	2100	3.5	UKEICC 80m Contest	CW	6-char grid square	www.ukeicc.com

There are a number of weekly contests not included in the table above. For more info, visit: www.qrpfoxhunt.org, www.ncccsprint.com, and www.cwops.org. All dates and times refer to UTC and may be different from calendar dates in North America. Contests are not conducted on the 60-, 30-, 17-, or 12-meter bands. Mbr = Membership number. Serial = Sequential number of the contact. SPC = State, Province, DXCC Entity. XE = Mexican state. Listings in blue indicate contests sponsored by ARRL or NCJ. The latest time to make a valid contest QSO is the minute listed in the "Finish Time" column. Data for Contest Corral is maintained on the WATBNM Contest Calendar at www.contestcalendar.com and is extracted for publication in QST 2 months prior to the month of the contest. ARRL gratefully acknowledges the support of Bruce Horn, WATBNM, in providing this service.

2023 ARRL 10 GHz and Up Contest Results

This year's ARRL 10 GHz and Up Contest weekends took place August 19 – 20 and September 16 – 17, 2023.

Logs Received by Call Area	
Call Area	Entries
W0	17
W1	21
W2	18
W3	5
W4	6
W5	8
W6	25
W7	5
W8	13
W9	7
VE	16

Top Ten Scores			
10 GHz Only		10 GHz and Up	
Call	Score	Call	Score
N0UK	42,753	K9PW	74,127
VE3KH	41,605	VA3ELE	61,982
W0ZQ	39,841	K6ML	61,619
K0HAC	39,386	W2FU	57,744
N2WK	38,802	VA3TO	57,673
WB0LJC	37,386	K6MG	52,228
KB8U	34,640	K8ZR	51,545
N2JMH	32,927	WA2TMC	50,737
W8BYA	31,908	AF1T	50,016
N1DPM	26,922	VE3SST	49,210

Top Unique Call Leaders			
10 GHz		10 GHz and Up	
Call	Unique Calls	Call	Unique Calls
VE3KH	57	K8ZR	91
N2WK	49	K2DH	90
N2JMH	48	W2FU	82
N1DPM	45	K9PW	80
K2AXX	39	AF1T	79
AA1I	39	W1MKY	78
VE3EG	38	KB8VAO	77
NR2C	38	WA2TMC	75
W1FKF	38	VA3ELE	72
W1AIM	37	N2MG	72

Full Results Online

You can read the full results of the contest online at <http://contests.arrl.org>. You'll find detailed analysis and more play-by-play, along with the full line scores. Improve your results by studying your log-checking report, too.



Thomas Tumino, N2YTF, completed his first contacts on 10 GHz during the 2023 ARRL 10 GHz and Up Contest. He completed 10 contacts, with his best DX being a pair of 255-kilometer contacts with Dale, AF1T, and Mickie, W1MKY, on Martha's Vineyard. [Thomas Tumino, N2YTF, photo]

Call Area Leaders

10 GHz		10 GHz and Up	
Call	Score	Call	Score
Area 0			
N0UK	42,753	Area 0	
W0ZQ	39,841	KO0Z	9,235
K0HAC	39,386	AF4JF	4,730
WB0LJC	37,386		
KC0P	25,250		
Area 1			
N1DPM	26,922	Area 1	
W1AIM	20,986	AF1T	50,016
AA1I	20,540	W1MKY	48,417
W1FKF	16,088	W1GHZ	41,867
K1CA	9,801	N1JEZ	30,175
		K1RZ	28,359
Area 2			
N2WK	38,802	Area 2	
N2JMH	32,927	W2FU	57,744
K2AXX	23,393	WA2TMC	50,737
NR2C	20,287	K2DH	46,946
N2ZN	12,144	N2MG	35,846
		K0SM	34,704
Area 3			
K3TUF	16,157	Area 3	
NG3W	14,681		
WA3GFZ	14,285		
W3IPA	1,204		
W3HMS	640		
Area 4			
W3IP	18,184	Area 4	
WA4PGI	3,752	N9ZL	1,659
K4QF	2,900		
W4YN	848		
N8KH	101		
Area 5			
W5VY	2,506	Area 5	
AD5JK	2,398	W5LUA	12,605
WQ5S	1,390	AA5C	9,610
WA5TKU	904	KM5PO	9,575
		AA5AM	6,555
Area 6			
N6VHF	14,293	Area 6	
N6VI	13,014	K6ML	61,619
N7DA	10,734	K6MG	52,228
N9RIN	9,398	W6QIW	37,873
AG6KG	8,860	N9JIM	26,592
		W6BY	20,907
Area 7			
N6RMJ	18,708	Area 7	
KC7OOY	568	W7GLF	702
K7MDL	539		
KD7UO	349		
Area 8			
KB8U	34,640	Area 8	
K8DP	14,836	K9PW	74,127
KE8RJU	9,443	K8ZR	51,545
K8YSE	5,493	KB8VAO	38,367
W8RU	4,085	W8ISS	15,063
		K2YAZ	11,715
Area 9			
W8BYA	31,908	Area 9	
K9JK	25,184	W9SZ	20,789
K0KFC	17,600	WA9TT	16,123
AA9IL	5,131	K9TMS	11,073
Area 15 (Canada)			
VE3KH	41,605	Area 15 (Canada)	
VE3EG	21,718	VA3ELE	61,982
VE3FN	18,782	VA3TO	57,673
VE3MSC	18,205	VE3SST	49,210
VE3HPC	6,555	VE2UG	37,315
		VE3SMA	30,505

Top Ten QSO Leaders

10 GHz	
Call	Total QSOs
N0UK	176
N2WK	170
VE3KH	169
W0ZQ	165
K0HAC	165
WB0LJC	157
N2JMH	143
KB8U	135
KC0P	129
K2AXX	118
10 GHz and Up	
Call	Total QSOs
K9PW	336
VA3ELE	251
K8ZR	247
VA3TO	237
K6ML	228
W2FU	228
K2DH	210
VE3SST	207
WA2TMC	201
VE3SMA	175

Best DX by Band in Kilometers

10 GHz		75 GHz	
Call	Best DX	Call	Best DX
W8BYA	945	KB8VAO	58
WQ0P	945	K8ZR	58
KB8VAO	884	K2DH	9
VE3FN	884	VE4MA	5
KO0Z	842	VE4SA	5
AF4JF	842		
K6MG	783	123 GHz	
N6ARA	783	Call	Best DX
AF1T	716	VE4MA	5
W1MKY	716	VE4SA	5
24 GHz		300+ GHz	
Call	Best DX	Call	Best DX
W6BY	293	AF1T	8
K6MG	238	W1MKY	8
K6ML	238	K1RZ	8
W2FU	235	K2WHC	8
WA2TMC	235		
K2DH	235		
K2UA	235		
K2TER	235		
N2MG	235		
W1GHZ	204		
47 GHz			
Call	Best DX		
K2DH	140		
VA3ELE	140		
VA3TO	140		
AA5C	121		
W2FU	121		
VE2UG	114		
KB8VAO	114		
K9PW	101		
VE3SST	77		
K8ZR	77		

Entries by Year

Year	GHz	Entries
2023	10 GHz	93
2023	10 GHz and Up	48
2022	10 GHz	98
2022	10 GHz and Up	56
2021	10 GHz	91
2021	10 GHz and Up	45
2021	Checklog	1
2020	10 GHz	76
2020	10 GHz and Up	46
2019	10 GHz	110
2019	10 GHz and Up	34
2018	10 GHz	98
2018	10 GHz and Up	45
2017	10 GHz	85
2017	10 GHz and Up	42
2016	10 GHz	89
2016	10 GHz and Up	42
2015	10 GHz	85
2015	10 GHz and Up	37
2014	10 GHz	86
2014	10 GHz and Up	26
2013	10 GHz	73
2013	10 GHz and Up	27
2012	10 GHz	78
2012	10 GHz and Up	37
2011	10 GHz	87
2011	10 GHz and Up	29
2010	10 GHz	88
2010	10 GHz and Up	31
2009	10 GHz	77
2009	10 GHz and Up	31
2008	10 GHz	77
2008	10 GHz and Up	27
2007	10 GHz	77
2007	10 GHz and Up	38
2006	10 GHz	76
2006	10 GHz and Up	39
2005	10 GHz	95
2005	10 GHz and Up	36
2004	10 GHz	94
2004	10 GHz and Up	42
2003	10 GHz	105
2003	10 GHz and Up	37
2002	10 GHz	106
2002	10 GHz and Up	32

The next ARRL 10 GHz and Up Contest will be held August 17 – 18 and September 21 – 22, 2024.

Best Terrestrial DX by Band

Call	Band (km)	Distance	Call	Band	Distance (km)
W8BYA	10 GHz	945	K8ZR	75 GHz	58
WQ0P	10 GHz	945	VE4MA	123 GHz	5
W6BY	24 GHz	293	VE4SA	123 GHz	5
K2DH	47 GHz	140	AF1T	300+ GHz	8
VA3ELE	47 GHz	140	W1MKY	300+ GHz	8
VA3TO	47 GHz	140	K1RZ	300+ GHz	8
KB8VAO	75 GHz	58	K3WHC	300+ GHz	8

2023 ARRL 222 MHz and Up Distance Contest Results

The most recent ARRL 222 MHz and Up Distance Contest was held August 5 – 6, 2023.

Regional Winners

Regions are defined in the contest rules (www.arrl.org/222-mhz-and-up-distance-contest). Category key: R — Unlimited Rover; S — Single Operator, Fixed, and M — Multioperator, Fixed.

Region	Category	Call	Score
1	R	KA7RRA/R	1,594
	S	VA7SC	7,924
2	R	W7IMC/R	8,297
	S	KE7VUX	202
3	S	KC6ZWT	2,805
	M	K6MI	2,499
4	S	NJ7A	426
	S	KE6GFI/R	147
5	S	WO1S	1,576
	M	KC5MVZ	224
6	S	WB0HHM	834
	R	AF4JF/R	2,321
7	S	WQ0P	27,682
	R	W5VY/R	27,236
8	S	W5LUA	11,888
	R	K9JK/R	1,920
9	S	K2DRH	9,081
	M	WD9EXD	31,764
10	R	KC0P/R	18,501
	S	K0AWU	24,532
11	R	VE3SST/R	33,105
	S	N2JMH	85,611
12	M	VE3MIS	32,839
	R	AG4V/R	26,917
13	S	AJ6T	12,433
	R	NV4B/R	27,282
14	S	WA4GPM	6,123
	S	W8ZN (K1RZ, op)	82,375
15	R	WB2SIH/R	12,403
	S	WB2RVX	34,614
16	M	N3NGE	69,660
	R	W1RGA/R	36,728
17	S	K1TEO	156,722
	M	KV1J	24,592

Affiliated Club Competition

Club	Score	Entries
Medium		
Mt. Airy VHF Radio Club	446,129	14
North East Weak Signal Group	391,625	13
Rochester VHF Group	213,215	7
Ontario VHF Association	187,765	6
Northern Lights Radio Society	114,023	10
North Texas Microwave Society	48,985	3
Society of Midwest Contesters	33,937	8
Pacific Northwest VHF Society	18,910	8
Arizona Outlaws Contest Club	3,454	5

Top Ten Scores

Rover		Single Operator		Multioperator	
W1RGA/R	36,728	K1TEO	156,722	N3NGE	69,660
VE3SST/R	33,105	N2JMH	85,611	VE3MIS	32,153
NN3Q/R	31,524	W8ZN (K1RZ,op)	82,375	WD9EXD	31,764
NV4B/R	27,282	AF1T	74,740	WW2Y	30,997
W5VY/R	27,236	K1WHS	61,430	KV1J	24,592
AG4V/R	26,917	VE3ZV	58,632	K6MI	2,499
KC0P/R	18,501	WZ1V	55,899	N2SLN	1,052
N0HZO/R	18,126	N1JEZ	54,344	N1SOH	846
WB2SIH/R	12,403	N2WK	51,101	KC5MVZ	224
KJ1K/R	9,958	WA3DRC	42,804		

The next ARRL 222 MHz and Up Distance Contest will be held August 3 – 4, 2024.

Full Results Online
 You can read the full results of the contest online at <http://contests.arrl.org>. You'll find detailed analysis and more play-by-play, along with the full line scores. Improve your results by studying your log-checking report, too.



Allen Zimmerman, K3WGR, operated in the Rover category in the 2023 ARRL 222 MHz and Up Distance Contest using the call sign NN3Q/R. Allen and Russ Lamm, NN3Q, have used the rover van and Russ' call sign for 17 years. Their nine-band effort yielded them 51 contacts, with their best DX being a 557-kilometer contact with Dana Shtun, VE3DS. [Allen Zimmerman, K3WGR, photo]

Volunteers On the Air Update



In this VOTA installment, we are working on summarizing the 2023 VOTA year-in-review tallies. This involves processing and checking point accumulations for those who activated two or more call signs eligible for the participants' volunteer points. We anticipate the final report will be in the April 2024 issue of QST.

To see which states have reported their portable operations, check out <https://contests.arrl.org/docs/2023-VOTA-State-Activations-Schedule.pdf>.

Listed below are initial QSO tallies from recent W1AW portable state activations, as of December 13:

Awaiting Logs

- W1AW/5 New Mexico (March 22 – 28)
- W1AW/7 Arizona (August 30 – September 5)
- W1AW/5 New Mexico (October 4 – 10)
- W1AW/6 California (October 11 – 17)
- W1AW/4 Alabama (October 18 – 25)

Logs Received

- W1AW/4 Alabama (June 7 – 13) = 1,347 QSOs
- W1AW/4 Kentucky (August 2 – 9) = 2,932 QSOs
- W1AW/5 Oklahoma (August 16 – 22) = 289 QSOs
- W1AW/0 Colorado (September 13 – 19) = 7,889 QSOs
- W1AW/4 Tennessee (September 20 – 26) = 2,314 QSOs
- W1AW/1 New Hampshire (September 20 – 26) = 1,144 QSOs
- W1AW/3 Pennsylvania (September 20 – 26) = 4,104 QSOs
- W1AW/5 Texas (September 20 – 26) = 1,209 QSOs
- W1AW/1 Connecticut (September 27 – October 3) = 4,911 QSOs
- W1AW/4 North Carolina (September 27 – October 3) = 2,948 QSOs
- W1AW/7 Nevada (September 27 – October 3) = 965 QSOs
- W1AW/3 Washington, DC (October 4 – 10) = 1,361 QSOs
- W1AW/0 Missouri (October 11 – 17) = 4,907 QSOs
- W1AW/4 Georgia (October 11 – 17) = 4,328 QSOs
- W1AW/0 Nebraska (October 18 – 24) = 6,272 QSOs
- W1AW/4 Alabama (October 18 – 24) = 1,347 QSOs
- W1AW/4 Virginia (October 25 – 31) = 1,724 QSOs
- W1AW/5 Arkansas (October 25 – 31) = 1,118 QSOs
- W1AW/8 Michigan (October 25 – 31) = 2,601 QSOs
- W1AW/0 Iowa (November 1 – 7) = 1,983 QSOs
- W1AW/1 Massachusetts (November 1 – 7) = 4,954 QSOs
- W1AW/8 West Virginia (November 1 – 7) = 1,112 QSOs

- W1AW/0 Kansas (November 8 – 14) = 2,261 QSOs
- W1AW/3 Maryland (November 8 – 14) = 3,568 QSOs
- W1AW/7 Wyoming (November 8 – 14) = 1,918 QSOs
- W1AW/KL7 Alaska (November 15 – 21) = 3,225 QSOs
- W1AW/5 Mississippi (November 15 – 21) = 1,415 QSOs
- W1AW/7 Washington (November 15 – 21) = 3,580 QSOs
- W1AW/1 Rhode Island (November 29 – December 5) = 3,587 QSOs
- W1AW/3 Delaware (November 29 – December 5) = 1,288 QSOs
- W1AW/4 Florida (November 29 – December 5) = 3,805 QSOs
- W1AW/KP4 Puerto Rico (November 29 – December 5) = 6,790 QSOs
- W1AW/5 Louisiana (December 6 – 12) = 4,869 QSOs

VOTA Leaderboard Functionality Updates

- The leaderboard (<https://vota.arrl.org/leaderboard.php>) was updated to allow filtering by US or state only, and to list overall and state rank.
- The search-by-call-sign feature on the leaderboard now provides participant ranking overall within the country and state.
- Participant call signs have been hyperlinked to www.qrz.com for easy lookup.
- A MY VOTA page (<https://vota.arrl.org/my-info.php>) has been added to show overall and state rank information, W1AW portable states contacted, the W1AW portable states still needed to achieve all 50, the schedule of when they are on next, and QSO details (with cursor over points) for more information.
- VOTA certificates are here! We will collect all W1AW portable activation log uploads and all volunteer final uploads for 2023 QSOs on January 31. At that time, look for your final numbers on participation certificates and access your Worked All States certificate (if all 50 states were worked) at <https://vota.arrl.org/certificates.php>.

Follow what other VOTA participants are discussing on Facebook at www.facebook.com/hashtag/volunteersontheair.

To follow state activation dates, the leaderboard, and related activities of VOTA, visit <https://vota.arrl.org>.

Send your comments, suggestions, stories, and photos to vota@arrl.org.



Certificate of Code Proficiency Recipients



This month, ARRL recognizes merit and progress in Morse code proficiency on the part of the following individuals, who have achieved proficiency at the following rates, in words per minute.

August 2023

Charles W. Campbell, K0CWC	10
Mark C. Guenther, WB7TLK	10
Joseph L. Kelly, N9SV	10
Daniel H. Pressler, KF2HP	10
Wayne W. Wagner, WA3DHM	10
Joseph S. Gershon, N0HOV	20
Keith A. Marang, W4AFB	30
John D. Kelley, K4WY	40
Joseph W. Parskey, NJ1P	40

September 2023

Ralph E. Duncan, N7WWY	10
David G. Gower, W7JMG	10
Nathan T. Lyons, N8HWV	10
Ryan B. Massey, WB6EQK	10

Thomas F. Wentworth, W8LA	10
Christopher J. Brown, NY9X	15
Erich C. Fitschen, KQ4BBC	15
William G. Homsany, KG6COH	15
Nathan T. Lyons, N8HWV	15
Bruce Garrett, AC4CW	20
Joseph W. Chapman, NV1W	25
Dain Webster, K7SXN	25
Ron Kinney, KC0ZPS	25
Michael J. Kerezi, W3ASW	40

October 2023

Joseph P. Kononchik, KS1I	20
---------------------------	----

November 2023

Eric D. Benjaminson, WA9CEK	10
Paul K. Earhart, WD4OQH	10
Paul K. Earhart, WD4OQH	15
Alfred F. Hanzl, K2AL	15
Jerry W. Kerns, K6FN	15
Jerry W. Kerns, K6FN	20
John P. King, KA2F	20
David A. Rose, N8GZ	20
Robert D. Spearman, N5VUC	20
James C. Stekas, K2UI	20
Jerry W. Kerns, K6FN	25
John P. King, KA2F	25
Scott T. McNutt, N3ADP	25
Donald W. Brown, W0AF	30

Congratulations to all of the recipients.

February 2024 W1AW Qualifying Runs

W1AW, the Hiram Percy Maxim Memorial Station at ARRL Headquarters in Newington, Connecticut, transmits Morse code Qualifying Runs to assist ham radio operators in increasing and perfecting their proficiency in Morse code. Amateur radio operators can earn a Certificate of Code Proficiency or endorsements by listening to W1AW Qualifying Runs.

February Qualifying Runs will be transmitted by W1AW in Newington, Connecticut, at the times shown on 1.802.5, 3.581.5, 7.047.5, 14.047.5, 18.097.5, 21.067.5, 28.067.5, 50.350, and 147.555 MHz. The West Coast Qualifying Runs will be transmitted by KH6TU on Wednesday, February 28, at 7 PM HST (0500 UTC on February 29) on 7047.5 and 14047.5 kHz. Unless indicated otherwise, sending speeds are from 10 to 40 WPM.

Amateur radio operators who participate in Qualifying Runs may submit proof of 1 minute of the highest speed they have copied in the hope of qualifying for the Certificate of Code Proficiency, or an endorsement to their existing certificate. Legibly copy at least 1 minute of text by hand, and mail the sheet to: W1AW Qualifying Runs, 225 Main St., Newington, CT USA 06111. Include \$10 (check or money order) if this is a submission for your initial Code Proficiency certificate; \$7.50 if you are applying for an endorsement (available for speeds up to 40 WPM). Your test will be checked against the actual transmissions to determine if you have qualified.

Members of the North Fulton (Georgia) Amateur Radio League (<https://nfarrl.org>) are offering to subsidize the total cost of a Code Proficiency certificate or endorsement submission for any individual age 21 years and

younger, and who reside in either the US or Canada. Participants who wish to make use of this offer should indicate on their Qualifying Run submissions they are age 21 or younger, and certify as such via their signature. Eligible participants are not required to send any fee with their Code Proficiency submissions.

For more information about Qualifying Runs, please visit www.arrl.org/qualifying-run-schedule.

For information about how to qualify for the Certificate of Code Proficiency, please visit www.arrl.org/code-proficiency-certificate.



W1AW Qualifying Runs — February 2024

(All times are in Eastern Standard Time.)

Monday	Tuesday	Wednesday	Thursday	Friday
		2/7 4 PM – 2100Z 10 – 35 WPM	2/8 10 PM – 0300Z (2/9 – UTC) 10 – 40 WPM	2/9 9 AM – 1400Z 10 – 35 WPM
	2/13 4 PM – 2100Z 10 – 35 WPM		2/15 9 AM – 1400Z 35 – 10 WPM	2/16 10 PM – 0300Z (2/17 – UTC) 10 – 35 WPM
Presidents' Day	2/20 10 PM – 0300Z (2/21 – UTC) 35 – 10 WPM	2/21 9 AM – 1400Z 10 – 35 WPM	2/22 7 PM – 0000Z (2/23 – UTC) 10 – 35 WPM	2/23 4 PM – 2100Z 10 – 40 WPM
2/26 7 PM – 0000Z (2/27 – UTC) 10 – 35 WPM	2/27 10 PM – 0300Z (2/28 – UTC) 10 – 40 WPM		2/29 4 PM – 2100Z 35 – 10 WPM	

Club Station

An Indiana Club's Approach to Introducing Ham Radio to Young People

Members of the Northeastern Indiana Amateur Radio Association (NIARA), W9OU, noticed that many local radio-related events, as well as their membership, were lacking youth representation. In this month's column, NIARA member John Maag, KD9QDL, shares how they built a trailer to showcase the many facets of ham radio and inspire youth involvement.

Because we don't have a clubhouse, NIARA felt the best way to introduce ham radio to younger generations was by bringing it to them. While club members communicate via <https://groups.io>, this wasn't conducive to reaching the public and diversifying our membership with youth members. NIARA's fully equipped portable training center allows us to travel directly to schools and events, exposing ham radio to the Boy Scouts of America, Girl Scouts of the USA, and Explorer Scouts. We've also been able to bring it to ARRL Field Day, Parks on the Air® activations, special event stations, local fairs, and other community-based projects and events.

Trailer Design and Equipment

Our project started with a grant proposal that we sent to Amateur Radio Digital Communications. After putting together a spreadsheet, we figured out that we needed around \$29,000 to build the trailer and purchase equipment that showcased all that one can do with ham radio. Grant approval took approximately 3 months.



More than 50 people came to check out NIARA's trailer at the 2023 Fort Wayne Hamfest in Indiana.

We determined that we needed a dual-axle 7 × 14-foot trailer to give us enough room for three operator and logger stations — two positions for HF operations and one position for VHF, UHF, and GMRS operations — and to provide the necessary storage space. It would also give us enough room for a power station consisting of four 100 W solar panels, four 100 Ah lithium iron phosphate batteries, an exterior ac plug, a transfer switch, a solar charge controller, a battery charger, a 2000 W pure sine wave inverter, and a dual circuit breaker for ac and dc power. Storage areas were also needed for the radios, miscellaneous equipment, coaxial cable, and antennas. To demonstrate different modes, we wanted each station to have a Windows 10 computer with a 20-inch monitor.

As a club, we decided to include equipment from a variety of manufacturers: a Yaesu FT-991A, an Icom IC-7300, a Yaesu FTM-400 UHF/VHF Fusion with a Signalink for Winlink, an AnyTone AT-D578UV III Plus capable of VHF/220 MHz/DMR, and a Retevis GMRS radio. We also incorporated a Yaesu DR-2X repeater for UHF that's capable of Fusion mode. This is beneficial for operating demonstrations, it can also be used during Field Day, and our Amateur Radio Emergency Service® group can use it for disaster support or to support a local event.

The HF radios have an 80-, 40-, and 20-meter dipole antenna, a Buckmaster seven-band off-center-fed antenna, and a Buddipole™ Deluxe Package antenna kit. Four 25-foot carbon fiber push-up poles were needed for the antenna setups, with mounting points at the four corners of the trailer. Four 50-foot coaxial cables are used for the antenna systems. Both HF radios have an MFJ-949E Versa Tuner and a RigExpert AA-600 antenna analyzer for tuning the antenna's systems for the trailer radios.

The radio systems use voice and digital modes. Each station has an NUC compute stick with Windows 10 and a wireless keyboard and mouse. TVs with HDMI inputs are used for the computer monitors. We chose TVs because that would also allow us to view local TV stations during an emergency.

Putting It All Together

After purchasing the trailer, Jeff DeLucenay, KB9QG; John Rostorfer, WG9K, and I (John Maag, KD9QDL) re-enforced the internal walls using $\frac{3}{8}$ -inch plywood. We also added foam insulation to the ceiling and covered it with $\frac{1}{4}$ -inch plywood.

The first thing that needed to be defined was the power system. In addition to the radios' power system, the computers use 12 V dc power, and the repeater can use 12 V dc and/or 120 V ac. The 120 V ac power consists of an external connector for line power, a cut-over switch, and a 2000 W pure sine inverter, and it powers the TVs, a coffee maker, and a water cooler. To protect the dc and ac power, a split fuse panel is used for power distribution.

We laid out the trailer based on how the equipment will be stored while traveling, the power distribution, where the radios will be located on a tabletop, and the necessary antenna storage. We squared off the nose of the trailer for the power system and radio storage, and we painted the plywood and cabinet structure. Then we installed water-proof linoleum flooring so the floor can be easily cleaned.

We attached a tabletop for the radio bench and installed it using angle brackets and a support board. I built cabinet doors with whiteboard and attached them with 40-pound pull magnetic latches to ensure they won't open during travel. Above the TV monitors, we mounted cabinets to store masts, antennas, and a Buddipole, as well as mounted cabinets on the wall behind the radio bench to store extra parts and equipment for the trailer. The radio equipment is stored up front on foam pieces for protection while traveling. We wired the lighting to remote switches and put it on a separate fused circuit.

In order for the radio cables to reach the outside antennas, I built a coaxial cable feed-through panel for seven coaxial cables and one Cat5 cable. The coax was labeled with colored tape on the inside of the trailer and on the feed-through mount on the exterior weatherproof box.

NIARA's Trailer in Action

After 13 weeks, it was finally finished. Our trailer allows us to teach people of all ages about the hobby, but our main focus is on the younger generations. Club members are always available to answer questions and help get visitors on the air using our equipment. So far, it seems that most of the youth we've introduced to ham radio have been primarily excited to learn about digital modes.

At the beginning of the year, we plan when and where to take the trailer. We've found success with reaching out to various schools and upcoming events and asking if we can bring the trailer to demonstrate how to use amateur radio, but sometimes we're invited places as well. In 2023,



The inside of NIARA's fully equipped ham radio trailer.

we were invited to the Fort Wayne Hamfest, and more than 50 visitors previewed our trailer. Several hams even asked if we could bring it to one of their events!

More build photos and details are available on our website at www.w9ou.org/digital-communication-trailer-updates. If you have any questions, you can email me at jdmaag6101@gmail.com.

All photos by John Maag, KD9QDL; Jeff DeLucenay, KB9QG, and Dave Southern, KC9YY.

Write for "Club Station"

QST's "Club Station" column is a designated space for clubs to share specific and practical ideas about what has contributed to their success, in the hope that the information will help other clubs grow and thrive. Visit www.arrrl.org/qst-club-station-guidelines-and-profile-form for more information, including author guidelines and a Club Profile Form (this form is required in order for "Club Station" submissions to be considered complete).

ARRL Special Service Clubs

ARRL offers the Special Service Club (SSC) program for clubs that demonstrate that they're working to improve the amateur radio community by completing special projects, holding license classes, and working with local groups on events, among other activities. Visit www.arrrl.org/ssc-application for more information about this program. Below is a list of new and renewing SSCs as of November 20, 2023.



Renewing SSCs

Mecklenburg ARS, W4BFB

Toledo Mobile Radio Association, W8HHF

Gloucester County ARC, W2MMD

South West Idaho ARC, K7SWI

Hazel Park ARC, W8HP

Clark County ARC, W7AIA

Charlotte, NC

Toledo, OH

Pitman, NJ

Nampa, ID

Hazel Park, MI

Vancouver, WA

Ham Media Playlist

Ham Radio Tube — A Focus on Portable Operating

Mike, K8MRD, the host of the YouTube channel we'll be focusing on this month, says his father, Gary, W4GRD, originally planted the seed of interest in radio. Mike also recalls living through the great blackout of 2003, during which much of the northeastern United States was without power. He didn't enjoy the feeling of being disconnected, so he purchased a Baofeng UV-5R and downloaded materials to study for his Technician license test. Shortly after making those purchases, Mike found an ARRL VE session and passed his exam.

Finding Mentors and Becoming One

Like many new hams today, Mike found his mentors online in the form of YouTube content creators. He explored channels such as Ham Radio Crash Course, HamRadioConcepts, KG6HQD Jerry, and more, and learned about amateur radio and how to use his gear. It wasn't until some time later, when he started meeting local hams on the repeater, that he could actually talk to someone and ask questions.

Jason Vierik, W8ZZU, became a mentor to Mike, and they often talked for hours on the repeater. Mike's love of portable operating can be credited to Jason, who took Mike out for a portable operation. Mike notes that this was before Parks on the Air (POTA), so making contacts as a portable operator was different than it is today. Mike took it all in, taking what he learned and filing it away for later. Not long after this, Mike joined the South Lyon Area Amateur Radio Club, N8SL, and operated his first ARRL Field Day. Through his new club, Mike met another Mike, W8MSC, who was a system administrator for a new program at the time — POTA.

Since those days of learning about POTA from others, Mike, K8MRD, has become a mentor in his own right. He launched his YouTube channel as a creative outlet, a means for him to document his journey in ham radio. Initially created as "K8MRD Radio Stuff," Mike's channel has since been renamed "Ham Radio Tube" (<https://www.youtube.com/@hamradiotube>).

The Joy of POTA

Mike tries to have fun while creating content. He regularly posts videos about POTA, which is one of his favorite activities. In one such video, titled "6 Parks, 2 States, 1 Day | Epic Parks on the Air Rove" (<https://tinyurl.com/k8mrd-pota>), Mike took a friend, Ryan, KF8IV, to Louisiana to begin a day of activating parks. Ryan had hunted parks in every state except Louisiana, so they took care of that with a quick simplex contact inside the park to give Ryan the last state he needed to have hunted all states. Then, they continued to activate another park in Louisiana before making their way into Texas to finish up the rove. Mike also created a course in the ARRL Learning Center (<https://learn.arrl.org>) to teach beginners how to prepare for and activate a park — one way he has chosen to help introduce more operators to the POTA program.

Getting Youth Involved in Amateur Radio

Mike tries to help new hams whenever he can, and when those new hams are youth, he has been known to go the extra mile to help. On more than one occasion, Mike has provided multiple handheld radios to my former students so they could get on the air as soon as they were licensed. He has shown up at hamfests and handed over a box of gear meant for kids. On another occasion, he secretly arranged with several manu-



Mike, K8MRD, and Ryan, KF8IV, activating a park as part of a two-state POTA rove.

facturers and dealers to put together a video called “Ham It Forward” (<https://tinyurl.com/k8mrd-hamitforward>), in which two young operators were given a set of equipment so they could have their own gear to activate parks. Jherica, KI5HTA, and Leah, KD9LFZ, were given HF radios, antennas, and Bioenno batteries so that they could activate parks and eventually pay it forward themselves.

Mike has a passion for helping young people and new hams engage in amateur radio. He has had live-streams while operating HF on the 10-meter band, encouraging those who may have had a bit of mic fright to pick it up and give him a call. Mike understands that for many young people, the cost of entry can be prohibitive, so he strives to show them affordable ways to get on the air.

For the Love of Antennas

Antennas are another love of Mike’s. When Mike makes a video about a POTA activation, he makes sure to point out and talk about the antenna he is using. He enjoys testing antennas, building antennas, and comparing them in operation. Mike loves antennas so much, he actually made a video titled “Help!! I Have An Antenna Problem!” (<https://tinyurl.com/k8mrd-antennas>), which is about his collection of antennas. In this video, Mike details his mobile antennas, permanent antennas, portable antennas, and the numerous antennas that are still sitting around his shack. How many antennas does Mike have? You’ll have to watch the video to find out.

Mike truly believes that there is always something new to learn in this hobby. The reason that Mike makes videos today is so that others can learn as well. Many HamTubers make review videos, but few cover the finer details people need to be successful. Mike enjoys teaching other hams about things such as how to get an antenna into a tree, how to log contacts, how to



Mike, K8MRD, smiling at the collection of antennas he has accumulated.



Mike, K8MRD, showing how to easily get a wire antenna into a tree using an arborist throw line.

choose an appropriate battery, and more. One such example is the video titled “Weaver Arborist Throw Line | Deploy A Wire Antenna Quickly” (<https://tinyurl.com/k8mrd-tree>). Mike not only reviews a product, but teaches viewers how to use it to make putting up antennas easy.

Whether you’re interested in POTA, antennas, batteries, or something else, chances are that Mike will have something for you on Ham Radio Tube.

This Month in QEX

QEX magazine is a forum for the free exchange of ideas among communications experimenters. All ARRL members can access the digital edition of QEX as a member benefit (www.arrl.org/magazines). Print subscriptions are available and sold separately; see www.arrl.org/qex.

Coming up in the January/February 2024 issue of QEX:

- Marcel De Canck, ON5AU (SK), presents Part 2 of *EZNEC Pro+ v.7.0* and *AutoEZ*.
- Alan Victor, W4AMV, applies post-detection filtering to improve receiver sensitivity.
- Eric P. Nichols, KL7AJ, in his Essay #20 discusses *Numerical Electromagnetic Code*.
- Riccardo Gionetti, I0FDH, describes a tracking generator adapter for low frequencies.
- Jeff Anderson, K6JCA, updates his L-network equations for impedance transformation.

QEX is edited by Kazimierz “Kai” Siwiak, KE4PT (kswiak@arrl.org), and is published bimonthly.

Would you like to write for QEX? We pay \$50 per published page for full articles and QEX Technical Notes. Get more information and an Author Guide at www.arrl.org/qex-author-guide.

How's DX?

CEØZ — Juan Fernández Islands

The Juan Fernández Islands form an archipelago that includes Robinson Crusoe Island, Santa Clara Island, and Alejandro Selkirk Island. The first two islands share Islands on the Air (IOTA) reference number SA-005, but Alejandro Selkirk, which has never been activated before, is SA-101. The archipelago is located about 670 kilometers (362 miles) west of mainland Chile. The islands are famous for being the site where Scottish privateer Alexander Selkirk was marooned for 4 years; his story likely inspired Daniel Defoe's novel *Robinson Crusoe*. The Juan Fernández Islands are currently inhabited by about 900 people, none of whom are active amateur radio operators.

DXCC History

The Juan Fernández Islands were not on the original postwar DXCC list published in the February 1947 issue of *QST*. In the October 1958 issue, ARRL announced the addition of the Juan Fernández Islands “by virtue of point 2 as explained in the May 1955 *QST*, page 68.” Said point in that issue asked, “Does it have adequate geographical separation from a parent nation?” The October 1958 announcement also stated that “DXCC credit will be given starting December 1, 1958, for creditable confirmations dated on or after November 15, 1945.”

The Valparaiso Radio Club's CEØZG activation in November 1958 was one of the first operations from the archipelago. Traditionally, CEØZ has been the prefix for the Juan Fernández Islands. There have been several operations there (mostly DXpeditions) in each decade since its addition to the DXCC list, and active hams have lived on Robinson Crusoe Island during the 1980s, 1990s, and 2000s. As of press time, CEØZ ranks number 58 on Club Log's DXCC Most Wanted List.

Upcoming CBØZA DXpedition

In June 2023, Marco A. Quijada, CE1EW (SK), announced plans for a February 2024 DXpedition to Juan Fernández Archipelago National Park on Robinson Crusoe Island. The team was expected to include



Nicolas Herrera, XQ1KZ; Pablo Carlini Cortes, CE1KV; Guillermo Guerra, XQ3SA; Dercel Gonzalez “Willy” Williams, XQ3SK; Mike Crownover, AB5EB; Ezequiel “Ez” Prado, HI3R; Jose Vicens, NP4G; Zoli Pitman, HA1AG, and Trey Garlough, N5KO, with Marco as the team leader. Unfortunately, Marco became a Silent Key in November 2023, at only 50 years young. The CBØZA team said they will press on with the DXpedition “to honor him and make his last wish come true.” Since the original announcement, Mike Crownover, Sr., AD5A; Hal Turley, W8HC, and Steve London, N2IC, have joined the team, and Nicolas, Guillermo, Zoli, Trey, and Pablo have dropped out. They will be on the air as CBØZA on February 10 – 24, 2024. Activity will be on single sideband (SSB), CW, RTTY, FT8, and Earth-Moon-Earth on 6 and 2 meters. They plan to be on 1.8 – 144 MHz as well. Bob Schenck, N2OO, will be handling the QSL duties. For more information, visit the CBØZA team's QRZ web page at www.qrz.com/db/cb0za, as the original CBØZA website can no longer be updated.

DX News from Around the Globe

8R — Guyana

In May 2023, Jamie Williams, MØSDV, and Philipp Springer, DK6SP, announced that a team of “four young, ambitious DXpeditioners” will be active from the Republic of Guyana in February 2024.



Tomi Varro, HA8RT, and Sven Lovric, DJ4MX, will be joining Jamie and Philipp on the DXpedition. Within a few days following the announcement, the Northern California DX Foundation donated \$5,000 to the young operators; their ages range from 21 to 25 years old. They will be operating as 8R7X from “a small farm in the countryside” located about 35 kilometers southeast of Georgetown, the country's capital. It should be a quiet area with ample space for transmit and receive antennas. They will have four stations with amplifiers in addition to a backup fifth rig. Plans are to operate on CW, SSB, RTTY, and FT8 on 160 – 6 meters.

There is only one active amateur radio operator in Guyana, which currently ranks number 100 on Club Log's

DXCC Most Wanted List. In Asia, it is ranked number 10 on CW. Guyana is also number 140 on 6 meters. The 8R7X team will be focusing on the low bands, and they plan on conducting a multi-operator effort during the ARRL International DX CW Contest on February 17 – 18. They prepared an operating guide for FT8 users at www.8r-2024.com/general/ft8-guide. For more general information about the DXpedition, visit their website at www.8r-2024.com.

7O – Yemen

In November 2023, there were two surprise DXpeditions in Yemen. Both operations took place on Socotra Island, which is currently much safer than the mainland. Those of you who missed the 7O8AD/7O8AE and 7O73T operations will get another chance to work Yemen, as Vlad Zencak, OK2WX, announced in November 2023 that he will be active from Socotra Island as 7O2WX from January 25 to February 12, 2024. 7O ranks number 44 on Club Log's DXCC Most Wanted List. He will focus on the low bands (160, 80, and 40 meters) using an Elecraft K4 transceiver, an Icom IC-7300 transceiver, and an SPE Expert 1.3K-FA amplifier. Vlad will also have verticals for 160, 80, and 40 meters as well as a six-band Spiderbeam Yagi for the higher bands. He anticipates uploading contacts during the DXpedition so that everyone who works him can verify that their contacts are in the log. On January 26 – 28, he plans to participate in the CW portion of the CQ World Wide 160-Meter Contest. Ant Cannataro, IZ8CCW, will be handling all the QSL duties. Check out Vlad's website at www.mdxc.support/7o2wx.



3X – Guinea

Jean-Philippe Paulino, F1TMY, has been in Conakry, Guinea, since August 2021. He was first active as 3X2021, and then his call sign was changed to 3X1A in January 2022. Jean-Philippe is active on 3.5 – 50 MHz on SSB and FT8, and he is continuing to work on his CW skills. Jean-Philippe will remain in Guinea until July 2026. You can directly QSL via Club Log's online QSL request.

JD1/M – Minami Torishima

Take Kanno, JG8NQJ, who works at the weather station on Minami Torishima, will return to the island around mid-January 2024 and stay for 3 months. He will be on

the air in his spare time as JG8NQJ/JD1, mostly on CW and with some FT8 activity. Take typically operates between 0700Z and 0900Z and 2100Z and 2300Z — sometimes for longer during the weekends. You can QSL via Susumu “Sin” Sanada, JA8CJY.

VP2M – Montserrat

Thaire Bryant, W2APF, is once again planning to spend a few months on Montserrat. He'll be on the northwest coast on January 11 – April 11, 2024, as VP2MDX. Thaire will use an Elecraft K4D and a KPA500 in addition to a Buddipole hexbeam and doublets for 80 – 30 meters. You can listen for him on 3.5 – 50 MHz on CW, SSB, FM, and FT8, and you can QSL directly to Thaire or via Logbook of The World (LoTW).

CN – Morocco

Yannick Delatouche, F6FYD, is active from Marrakech, Morocco, as CN2YD until March 15, 2024. He's using a Yaesu FT-847 and a vertical. At some point during his stay, he hopes to take a side trip to one of the islands in the Safi/Essaouira/Agadir region group (IOTA reference group AF-065). Operators can QSL directly or use a QSL bureau.

7Q – Malawi

Don Jones, K6ZO, has been in Embangweni, Malawi, since October 2023. In November, he was quite successful on 6 meters as 7Q6M due to propagation into the eastern US. Don is also active on 160 meters, and he will remain in Malawi until at least May 13. You can QSL directly or via LoTW.

FJ – St. Barthelémy

Phil Bettan, K2LIO, is the only resident amateur radio operator (FJ4WEB) on the island. He installed a 6-meter dipole and can often be found running 100 W on SSB on 50.110 MHz. Phil is currently not active on CW or FT8. Direct QSLing is accepted.

Wrap-Up

That's it for this month, with special thanks to Don, 7Q6M (K6ZO); Marco, CE1EW; Philipp, DK6SP; Yannick, F6FYD; Rick Dorsch, HC1MD/2; Sin, JA8CJY; Jose, NP4G; Vlad, OK2WX; Thaire, W2APF, and The Daily DX. Keep sending your DX news, photos, and other tidbits to bernie@dailydx.com. Until next month, see you in the pileups! — *Bernie, W3UR*

The World Above 50 MHz

Double CME Impacts

Two coronal mass ejections (CMEs) struck Earth on November 4 – 5, 2023. The double blow created a strong, G3-class geomagnetic storm with an aurora that was seen as far south as Lubbock, Texas! They also sparked aurora contacts on the VHF and UHF bands and enhanced F-layer propagation on 6 meters. The first CME struck Earth's geomagnetic field at 0905Z on November 4. Roger, VE1SKY (FN74), worked 3B8FA (LG89) at 1404Z. Steve Sacco, NN4X (EL98), logged 3B8FA and was in to Suriname. Jim, K5ND (EM12), worked PJ2/KB7Q and PJ2CF. Greg, AA5C (EM13), had several good decodes of VU2CPL. The second CME hit that afternoon. This time, there was strong one-hop F2 on 6 meters for the western half of North America to the Caribbean and northern South America. I, NØJK, was operating mobile in EM29 with 10 W and a whip antenna, and I logged J35X (FK92) at 2055Z on FT8. John Lock, KFØM (EM17), worked V26OC (FK97) at 2130Z. 8P2K, HH2AA, 9Z4Y, FG8OJ, and KP4EIT were also active around this time. Carl Luetzelschwab, K9LA, sent me a copy of the Austin, Texas, ionosonde reading that showed a huge spike in the F2 maximum usable frequency (MUF) from 1900 to 2100 UTC on November 5, which correlated with the opening.

As the geomagnetic storm was subsiding on November 6, there was a strong opening from North America to

South America. Stations in Argentina, Brazil, and Uruguay were worked by those in the continental US as far north as Idaho. Dan, K7SMA (DN13), logged LU1WFU (FE64), whom I logged a few minutes later. Dan also worked ZL1RS at 2130Z, followed by ZL1SG and ZL1AKW. The next day, Glenn Johnson, WØGJ (EN43), said, "At 1600Z, 6 meters roared to life! Here in eastern WØ land, many South African stations [were] worked along with A25R. ZS6WN noted he runs 100 W to a five-element Yagi at 18 meters high." Mike King, KMØT (EN13), logged ZD7CTO, and Matt Trott, K7BG (DN94), worked A25R (KG36) at 1738Z. VE1SKY logged A25R and ZD7CTO.

6-Meter EME and F2 Activity

Earth-Moon-Earth (EME) has allowed hams who reside beyond the F-layer zones to work DX stations on 6 meters. Don, 7Q6M (KH67), worked KJ9I on November 5 for his third contact on 6-meter EME. Last year, he worked W6UC and NJ6P via EME on 6 meters, and he made many F-layer contacts with stations in North America during November. On November 8, Don worked hundreds of North American stations, including WZ1V, WA2FZW, KD2CYU, K4SO, and WØGJ. Rich Zwirko, K1HTV (FM18), copied Don's signal as strong as +29 dB. Ken, WB2AMU (FN30), copied Don on 50.110 MHz single sideband. Don noted that the band was open to North America until 2000Z, and he was received as far west as New Mexico.

On the Bands

50 MHz. On November 1, Jackson Cox, WØXR (DM22), worked ZD7CTO at 1700Z. Rich, K1HTV, said 3B9FR answered his call on November 13 while he was running only 22 W. On November 8, Martin, PJ4MM (FK52), made many European and Middle Eastern contacts on 40 MHz. On November 12, he worked 4W8X on 6 meters. Jim, K5ND (EM12), worked LU7VB 2 days later. In the evening on November 16, sporadic E appeared from the midwest to the northeast. I noted that K1LO and KA1W were in with strong signals. KL7HBK (BO49) in Alaska received a signal from LU9AEA at 2214Z. Nelson, KD2CYU, worked stations in Uruguay and Argentina on November 17. Lance, W7GJ, and then Dave, KJ9I, followed by N7IP and NØTB, worked the 4W8X DXpedition in Timor-Leste via EME.

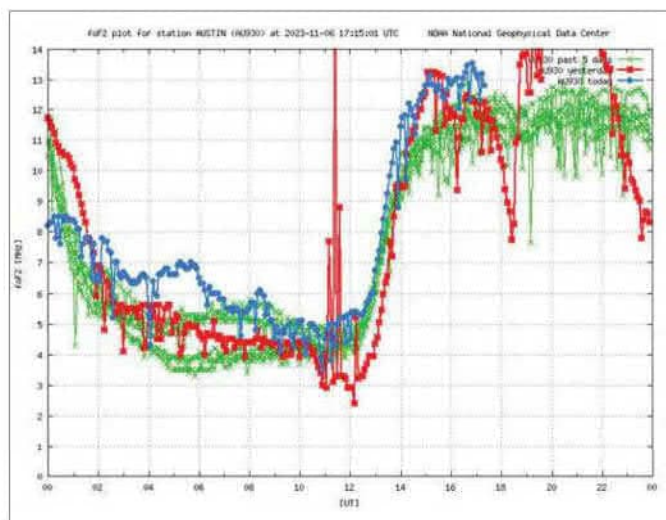

The Austin, Texas, ionosonde reading sent by Carl Luetzelschwab, K9LA. The data for November 5, 2023, is in red; it corresponds to the strong F2 opening on 6 meters. [NOAA National Geophysical Data Center]



The PSK flags showing Wynand Wolmarans', V51WW, 6-meter opening to the midwest on November 22, 2023. [www.pskreporter.info/pskmap]

A CME was predicted to hit Earth on November 18 – 19, but it missed. However, on November 22, the K index increased to 5 and a minor geomagnetic storm occurred. This was enough to nudge the F-layer MUF above 50 MHz from North America to Ecuador. Here in Kansas, HC2AO, HC2FG, and HC1MD/2 were in with strong signals at around 1530Z. After they faded out, PJ4MM (FK52) appeared and I logged him at 1614Z. V51WW in Namibia had a strong opening to the upper midwest at the same time; Minnesota and Wisconsin were the hot spots. The small footprint suggested a possible sporadic-E link. The opening extended as far west as Missouri.

Another CME struck Earth's magnetic field earlier than predicted at 0852Z on November 25. The Kp index became 4 as daylight set in for North America. Stations in the eastern US had an F2 opening to the Caribbean and the Canary Islands. The F2 hot spot moved west as the day progressed. At around 1500Z, KP4AJ was in to the midwest, followed by PJ4MM (FK52) to my, N0JK (EM28), station. The Kp index later rose to 6, and 6 meters opened from Hawaii to the western half of North America, and as far east as Oklahoma at around 2230Z. KH6HI (BL01) and NH6Y (BL10) were in to the opening.

On November 26, Paul, WG0G (EN35), found V51WW at 1612Z with “-06 dB signals.” K1HTV made eight transatlantic contacts with stations in Spain and three with stations in Portugal at 1535Z. He said that the European signals were stronger on his stacked Yagi array when it was in the “both in phase” position — this created a lower angle of radiation. Nelson, KD2CYU (FN20), noted

signals from Portugal and Spain, too. Jim DeYoung, N80Q (FM07), noted the same as Nelson, in addition to HC2FG. A transcontinental 6-meter opening took place over North America that same afternoon. K1TOL (FN44) and WW1L (FN55) spotted stations in California and Arizona. The last time such an F2 opening occurred on 6 meters was in 2015. On November 27, Nelson and Roger, VE1SKY (FN74), had stations in Ireland, England, Northern Ireland, and Scotland in at around 1350Z. High solar flux and low geomagnetic activity tend to support transatlantic openings.

144 MHz. Lance Collister, W7GJ, completed the first North America/

Timor-Leste 2-meter contact with 4W8X via EME at 0718Z on November 22. Martin, PJ4MM, was active on 2-meter EME during the last 2 weeks of November. He had been using a four-Yagi array of 13-element loop-fed arrays. Martin's log has more than 60 2-meter EME contacts.

Here and There

Jim Wilson, K5ND, wrote an updated edition of his book about 6 meters, *Magic Band Revealed*. He said it has “everything you need to know for 6-meter amateur radio DXing.” The book starts with a review of 6-meter propagation illustrated with some fascinating maps, and then it discusses equipment, antennas, and software, including *WSJT-X*. It offers insight into operating techniques, such as making MSK144 meteor-scatter contacts, in addition to covering VHF awards and contesting topics. *Magic Band Revealed* is available as a paperback on Amazon and as a free PDF at www.k5nd.net/magic-band-revealed-ebook-download.

An older but useful book about 6 meters is *Six Meters: A Guide to the Magic Band*, by Ken Neubeck, WB2AMU. In this one, Ken covers 6-meter antennas, radios, propagation, and operating techniques, though it was published prior to the availability of *WSJT-X*. More information about the book is available at www.goodreads.com/book/show/16166671-six-meters.

“Is 6 Meters the Best Ham Radio Band???” is a video about the band posted on Rob Zielfelder's, N1NUG, YouTube channel, SevenFortyOne. You can watch it at www.youtube.com/watch?v=iH45Af2MbU.

Special Event Stations

Working special event stations is an enjoyable way to help commemorate history. Many provide a special QSL card or certificate!

Jan. 13, 1700Z – 2359Z, NI6IW, San Diego, CA. USS Midway Museum Ship. **Last NVA MIG Shot Down by USS Midway F-4**. 7.250 14.320; PSK 14.070; D-STAR on PAPA System repeaters. QSL. USS Midway Museum Ship, 910 N. Harbor Dr. COMEDTRA, San Diego, CA 92101. www.qrz.com/db/ni6iw

Feb. 2 – Feb. 4, 1800Z – 2100Z, K9S, Westby, WI. Vernon County Amateur Radio Club. **101st Snowflake Ski Jumping Tournament**. 3.865 7.265 14.265. E-certificate. snowflakejump@yahoo.com.

Feb. 8 – Feb. 11, 1323Z – 1323Z, K4ICA, Veneta, OR. YL International Sideband System (YLISB). **61st Anniversary of the YL System**. 7.230 – 7.260 – 14.340. QSL. John Ellis, W5PDW, 2623 Huffsmith Conroe Rd., Magnolia, TX 77354. www.ylssystem.org

Feb. 10, 1700Z – 2100Z, WE7GV, Green Valley, AZ. Green Valley Amateur Radio Club. **Churches on the Air**. 14.242 14.262 14.282. Certificate & QSL. Tom Lang, 1085 W. El Toro Rd., Sahuarita, AZ 85629. www.gvarc.us

Feb. 10, 1700Z – 2359Z, NI6IW, San Diego, CA. USS Midway Museum Ship. **Commemorating the End of Operation Desert Storm**. 7.230 14.320; 14.070 PSK31; D-STAR on PAPA System repeaters. QSL. USS Midway Museum COMEDTRA, 910 N. Harbor Dr., San Diego, CA 92101. www.qrz.com/db/ni6iw

Feb. 10, 1730Z – 2200Z, N4SCV, Gainesville, FL. Sons of Confederate Veterans Camp 1424. **Lee Jackson Celebration**. 7.214 14.314. QSL. Ron Lewis, KN4ZUJ, 14714 NW 144th St., Alachua, FL 32615. www.gatorscv.com

Feb. 10 – Feb. 29, 0000Z – 0000Z, NV7AL, Las Vegas, NV. American Legion Paradise Post 149 and 40&8 Voiture 306. **75th Anniversary of Merci Train Boxcar**. 7.074 7.250 14.074 14.250. QSL. Robert Bencsko, 2548 Fort Lauderdale Dr., Las Vegas, NV 89156. *Watch for us on DX Summit*. www.qrz.com/db/nv7al

Feb. 11 – Feb. 19, 0000Z – 2359Z, W7P and W7P/Ø, Flagstaff, AZ. Northern Arizona DX Association. **Ten-Year Countdown to the 100th Anniversary of the Discovery of Pluto**. 7.290 14.090 14.290 21.290. Certificate & QSL. W7P c/o NADXA, 6315 Townsend Winona Rd., Flagstaff, AZ 86004. www.nadxa.com

Feb. 17 – Feb. 19, 1600Z – 2300Z, WØJH, Stillwater, MN. Stillwater Amateur Radio Association. **Ice Station WØJH — Frozen Minnesota Lake Portable**. 3.860 7.260 14.260 21.360. E-certificate. w0jhice@outlook.com, www.qrz.com/db/w0jh, or www.radioham.org

Feb. 17 – Feb 24, 0000Z – 2100Z, W9MID, Franklin, IN. Mid-State Amateur Radio Club. **40th Anniversary**. 7.227 14.265. QSL. Chris Frederick, 255 Hillendale Dr., Greenwood, IN 46142. www.midstatehams.org

Feb. 18 – Feb. 19, 1500Z – 2000Z, K4US, Alexandria, VA. Mount Vernon Amateur Radio Club. **George Washington's Birthday**. 7.042 7.242 14.042 14.242. QSL. MVARC, P.O. Box 7234, Alexandria, VA 22307. www.mvarc.org

Feb. 18 – Feb. 24, 1700Z – 1900Z, WØCXX, Cedar Rapids, IA. Collins Amateur Radio Club. **Engineer's Week at Collins Aerospace**. 7.180 14.263 21.380 28.380. QSL. Engineer's Week at Collins Aerospace SES, 1110 Lyndhurst Dr., Hiawatha, IA 52233. *The times will be during lunch breaks; however, club members may operate at other times during these days, especially Sunday, Feb. 18 and Saturday, Feb. 24.* www.qrz.com/db/w0cxx

Feb. 19 – Feb. 24, 0001Z – 2359Z, W57G, Monitor, WA. Columbia Basin DX Club. **George Washington's Birthday**. 7.222 7.260 14.255 14.322. Certificate & QSL. Brian Nielson, 11650 Rd. 1 SE, Monitor, WA 98836. www.cbn.homestead.com/ws7g.html

Feb. 19 – Feb. 29, 0000Z – 0000Z, N4T, Mount Joy, PA. Molly & Friends. **Dry Tortugas & The Florida Keys 2024**. 14.336; SSB, CW, FT8/FT4, and satellites. QSL. Molly Sauder, 1509 Pinkerton Rd., Mount Joy, PA 17552. *Here's your chance for a rare grid as well as ARLHS, IOTA, POTA, USI, and WLOTA. Spot via POTA and DX Summit.* mollyandfriends6@gmail.com

Feb. 24, 1400Z – 2200Z, WØEBB, Leavenworth, KS. Kickapoo QRP Amateur Radio Club. **20th Annual Freeze Your Keys Winter Operating Event**. CW: 7.035 14.058; SSB: 7.240 14.325. QSL. Gary Auchard, WØMNA, 34058 167th St., Leavenworth, KS 66048. w0mna74@gmail.com or www.qrz.com/db/w0ebb

Certificates and QSL cards: To obtain a certificate from any of the special event stations offering them, send your QSO information along with a 9 × 12-inch self-addressed, stamped envelope (3 units of postage) to the address listed in the announcement. To receive a special event QSL card (when offered), be sure to include a self-addressed, stamped business envelope along with your QSL card and QSO information.

Special Events Announcements: For items to be listed in this column, use the ARRL Special Events Listing Form at www.arrl.org/special-events-application, or email information to events@arrl.org.

Submissions must be received by ARRL HQ no later than the 1st of the second month preceding the publication date; a special event listing for **May QST** would have to be received by **March 1**. In addition to being listed in *QST*, your event will be listed on the ARRL Web Special Event page. **Note:** All received events are acknowledged. If you do not receive an acknowledgment within a few days, please contact us. ARRL reserves the right to exclude events of a commercial or political nature.

You can view all received Special Events at www.arrl.org/special-event-stations.

Strays

QST Congratulates...

Slade Cargill, K2HBI, on the publication of his book *Electric Shock Drowning: Causes and Prevention*. Slade's work on this topic derives from his lifelong interests in electronics, ham radio, and electrical safety. The book is available on Amazon.

Convention and Hamfest Calendar

A = AUCTION
D = DEALERS / VENDORS
F = FLEA MARKET
H = HANDICAP ACCESS
Q = FIELD CHECKING OF QSL CARDS
R = REFRESHMENTS
S = SEMINARS / PRESENTATIONS
T = TAILGATING
V = VE SESSIONS

Abbreviations

Spr = Sponsor
Tl = Talk-in frequency
Adm = Admission

Arizona (Green Valley) — Feb. 24 **HRT**

7 AM – noon. *Spr*: Amateur Radio Council of Arizona. Valley Presbyterian Church, 2800 S. Camino Del Sol. *Tl*: 146.550 (simplex). *Adm*: Free. www.gvarc.us

Colorado (Brighton) — Feb. 18 **DFHRTV**

9 AM – 1 PM. *Spr*: Rocky Mountain Ham Radio, Inc. Adams Co. Fairgrounds, 9755 Henderson Rd. *Tl*: 147.15 (100 Hz). *Adm*: \$6. www.rmham.org

Florida (Brooksville) — Feb. 17 **DHQRTV**

8 AM – 1:30 PM. *Spr*: Hernando Co. ARA. Sand Hill Scout Reservation Dining Hall, 11210 Cortez Blvd. (Hwy. 50). *Tl*: 146.715. *Adm*: \$6. www.hcara.org

Florida (Fort Walton Beach) — Mar. 8 – 9 **DFHRTV**

Fri. 4 PM – 6 PM, Sat. 8 AM – 4 PM. *Spr*: Playground ARC. NW Florida Fairgrounds, 1958 Lewis Turner Blvd. *Tl*: 444.450 (100 Hz). *Adm*: \$8. www.w4zbb.org/hamfest-2

The Positive Impact of Amateur Radio on Human Spaceflight: 40th Anniversary Conference

February 22 – 24, Merritt Island, Florida

DHRS

Thurs. 5 PM – 7 PM, Fri. 9 AM – 4 PM, Sat. 9 AM – 5 PM. *Spr*: ARISS. Kennedy Space Center Complex - Center for Space Education: Astronauts Memorial Foundation, M6-306 405 State Rd. *Adm*: See web page. www.ariss.org/overview.html

Florida (Sebring) — Feb. 17 **FHRT**

8 AM – 1 PM. *Spr*: Highlands Co. ARC. Lake Josephine First Baptist Church, 111 Lake Josephine Dr. *Tl*: 147.045 (100 Hz). *Adm*: \$5. Email: rbg695@hotmail.com

Georgia (Dalton) — Feb. 24 **DFHRTV**

8 AM – 2 PM. *Spr*: Dalton ARC. North Georgia Fairgrounds, 500 Legion Dr. *Tl*: 145.230 (141.3 Hz). *Adm*: \$5. www.qrz.com/db/w4drc

Indiana (La Porte) — Feb. 24 **DFQRTV**

7 AM – 1 PM. *Spr*: La Porte Co. ARC. La Porte Civic Auditorium, 1001 Ridge St. *Tl*: 146.610 (131.8 Hz). *Adm*: \$8. www.lpcarc.org

Iowa (Perry) — Feb. 24 **DFHQRSV**

8 AM. *Spr*: Hiawatha ARC. National Guard Armory, 2930 Willis Ave. *Tl*: 145.190 (114.8 Hz). *Adm*: \$10. www.qsl.net/kd0neb

Kentucky (Cave City) — Mar. 2 **DFHRTV**

7:30 AM. *Spr*: Mammoth Cave ARC. Cave City Convention Center, 502 Mammoth Cave St. *Tl*: 146.94 (114.8 Hz). *Adm*: \$5. www.ky4x.org

ARRL LOUISIANA STATE CONVENTION

March 8 – 9, Rayne, Louisiana

DFHRSV

Fri. 3 PM – 8 PM, Sat. 8 AM – 2 PM. *Spr*: Acadiana DX Association. Rayne Civic Center, 210 Frog Festival Dr. *Tl*: 147.040 (103.5 Hz). *Adm*: \$10. www.acadianadx.org

Maine (Augusta) — Feb. 10 **FHRV**

8 AM – noon. *Spr*: Augusta ARA. Calumet Club, 334 W. River Rd. *Tl*: 146.52 (simplex). *Adm*: \$5. Email: grszadis@aol.com

Massachusetts (Chicopee) — Mar. 2 **DFHRTV**

8:30 AM – noon. *Spr*: Mt. Tom Amateur Repeater Association. Castle of Knights, 1599 Memorial Dr. *Tl*: 146.94 (127.3 Hz). *Adm*: \$10. www.mtara.org

Massachusetts (Marlborough) — Feb. 17 **FHRTV**

9 AM – 1 PM. *Spr*: Algonquin ARC. 1LT Charles W. Whitcomb School, 25 Union St. *Tl*: 446.675 (88.5 Hz). *Adm*: \$5. www.n1em.org

Michigan (Livonia) — Feb. 17 **DFHR**

8 AM – noon. *Spr*: Livonia ARC. Monaghan Banquet Center, 19801 Farmington Rd. *Tl*: 145.350 (100 Hz). *Adm*: \$5. www.livoniaarc.com/larc-annual-swap-and-shop

Michigan (Traverse City) — Feb. 10 **DFHRTV**

8 AM. *Spr*: Cherryland ARC. St. Elizabeth Ann Seton Middle School, 1601 N. Three Mile Rd. *Tl*: 146.86 (114.8 Hz). *Adm*: \$5. www.cherrylandarc.com/?page_id=56

Minnesota (St. Cloud) — Feb. 17 **DFHQRSV**

9 AM – 1 PM. *Spr*: St. Cloud ARC. St. Cloud National Guard Armory, 1710 Veterans Dr. *Tl*: 147.015 (100 Hz). *Adm*: \$10. www.w0sv.club/hamfest

New Jersey (Clinton [Annandale]) — Mar. 9 **DFHRTV**

8 AM. *Spr*: Cherryville Repeater Association. North Hunterdon Regional High School, 1445 Rte. 31. *Tl*: 147.375 (151.4 Hz). *Adm*: \$7. www.qsl.net/w2cra

North Carolina (Concord) — Mar. 8 – 9 **DFHQRS**

Fri. 3 PM – 7 PM, Sat. 8:30 AM – 4 PM. *Spr*: Mecklenburg ARS. Cabarrus Arena & Events Center, 4751 Hwy. 49 N. *Tl*: 146.655. *Adm*: \$12 Advance, \$14 door. www.charlottehamfest.org

ARRL NORTH DAKOTA STATE CONVENTION

February 24, Bismarck, North Dakota

DFHRSV

8 AM – 1 PM. *Spr*: Central Dakota ARC. Bismarck Public School Career Academy, 1221 College Dr. *Tl*: 146.85. *Adm*: Donation. www.cdarcnd.com

Ohio (Elyria) — Mar. 10 **DHRTV**

9 AM – noon. *Spr*: Northern Ohio ARS. Lorain Co. Community College, 1005 Abbe Rd. N. *Tl*: 146.70 (110.9 Hz). *Adm*: \$7. Email: winterhamfest@noars.net

Oklahoma (Sayre) — Mar. 10 **FHRTV**

8 AM – 5 PM. *Spr*: West-Central Oklahoma ARC. Beckham Co. Activity Center, 310 E. Main St. *Tl*: 146.76 (88.5 Hz). *Adm*: \$10. www.sites.google.com/view/wcoarc/hamfest14

Pennsylvania (South Park Township) — Feb. 25 **DFHRTV**

8 AM – 3 PM. *Spr*: Wireless Association of South Hills ARC. Home Economics Bldg., 3735 Buffalo Dr. *Tl*: 146.955 (131.8 Hz) and 443.650 (131.8 Hz). *Adm*: \$5 donation. www.n3sh.org

Tennessee (Tullahoma) — Mar. 9 D F H R S T V

8 AM – 2 PM. *Spr:* Middle Tennessee ARS. First Methodist Church, 208 W. Lauderdale St. *Tl:* 146.700 (114.8 Hz). *Adm:* \$10. www.qsl.net/mtars

Texas (Harlingen) — Feb. 24 D F H R S V

8 AM – noon. *Spr:* Rio ARC. Sunshine RV Park, 1900 Grace Ave. *Adm:* Free. www.rioarc.org

Texas (Orange) — Feb. 24 D F H R S T V

7:30 AM – 2 PM. *Spr:* Orange ARC, Jefferson Co. ARC. Orange Co. Convention & Expo Center, 11475 FM 1442. *Tl:* 147.180 (103.5 Hz). *Adm:* \$10. www.qsl.net/w5nd

ARRL WEST GULF DIVISION CONVENTION

March 1 – 2, Rosenberg, Texas

D F H Q R S T V

Fri. Noon – 6 PM, Sat. 8 AM – 3 PM. *Spr:* Brazos Valley ARC. Fort Bend County Fair Grounds, 4310 S. TX-36. *Tl:* 146.94 (167.9 Hz). *Adm:* \$10 Advance, \$15 door, under 12, scouts, military, first responders in uniform, free. www.houstonhamfest.org

ARRL VERMONT STATE CONVENTION

February 24, Colchester, Vermont

D F H S T V

8 AM – 1 PM. *Spr:* Radio Amateurs of Northern Vermont. Hampton Inn, 42 Lower Mountain View Dr. *Tl:* 145.15 (100.0 Hz). *Adm:* \$7 Advance, \$12 door. www.ham-con.org

Virginia (Vienna) — Mar. 10 D H Q R T

6 AM – 2 PM. *Spr:* Vienna Wireless Society. Oakton High School, 2900 Sutton Rd. *Tl:* 146.52 (simplex). *Adm:* \$10 plus small service fee, \$15 door. www.viennawireless.net/wp/events/winterfest

Washington (Puyallup) — Mar. 9 D F H R V

9 AM – 3 PM. *Spr:* Mike & Key ARC. Washington State Fairgrounds Pavilion, 110 9th Ave. SW. *Tl:* 146.82/22 (103.5 Hz). *Adm:* \$12. www.mikeandkey.org/flea.htm

West Virginia (Charleston) — Mar. 9 D F H R S V

9 AM – 2 PM. *Spr:* Charleston Area Hamfest & Computer Show, Inc. Beni Kedem Temple, 100 Quarrier St. *Tl:* 145.35 (91.5 Hz). *Adm:* \$10. www.w8gk.org

Wisconsin (Onalaska) — Mar. 2 D F H R V

8 AM – 12:30 PM. *Spr:* Mississippi Valley ARA. Onalaska American Legion, 731 Sand Lake Rd. *Tl:* 147.090 (131.8 Hz) or 146.460 (simplex). *Adm:* \$5. www.mvara.net

To All Event Sponsors

Before making a final decision on a date for your event, you are encouraged to check the Hamfest and Convention Database (www.arrrl.org/hamfests-and-conventions-calendar) for events that may already be scheduled in your area on that date. You are also encouraged to register your event with HQ as far in advance as your planning permits. See www.arrrl.org/hamfest-convention-application for an online registration form. Dates may be recorded up to 2 years in advance.

Events that are sanctioned by ARRL receive special benefits, including an announcement in these listings and online. Sanctioned conventions are also listed in *The ARRL Letter*. In addition, events receive donated ARRL prize certificates and handouts. Once the form has been submitted, your ARRL Director will decide whether to approve the date and provide ARRL sanction.

The deadline for receipt of items for this column is the **1st of the second month preceding publication date**. For example, your information must arrive at HQ by **March 1** to be listed in the **May** issue. Information in this column is accurate as of our deadline; contact the sponsor or check the sponsor's website for possible late changes, driving directions, and other event details. Please note that postal regulations prohibit mention in QST of games of chance, such as raffles or bingo.

Promoting your event is guaranteed to increase attendance. As an approved event sponsor, you are entitled to special discounted rates on QST display advertising and ARRL web banner advertising. Call ARRL's toll-free number at 1-800-243-7768, or email ads@arrrl.org.

Volunteer Monitor Program Report

The Volunteer Monitor (VM) Program is a joint initiative between ARRL and the FCC to enhance compliance in the Amateur Radio Service. This is the November 2023 activity report of the VM Program.

◆ As a result of his operation on 28.277 MHz from St. Kitts and Nevis, during which he engaged in contacts with numerous US stations, an operator in New Jersey received an advisory notice cautioning him that US stations have no voice privileges on 28.277 MHz. Voice privileges for US stations on 10 meters start at 28.300 MHz.

◆ Advisory notices were sent to operators in North and South Carolina concerning excessive bandwidth on 75 meters. Section 97.307(a) of Commission rules states that no station shall occupy more bandwidth than necessary for the information rate and emission being transmitted.

◆ A Technician-class operator in Kentucky was sent an advisory notice concerning FT8 operation on 14.074 MHz. Technician licensees have no data privileges on 20 meters. A Technician-class licensee in California was issued an advisory notice for FT8 operation on 40 meters. Technicians have only CW privileges on that band.

◆ A Technician-class licensee in Michigan received an advisory notice for FT8 operation on 15 meters. Technicians have only CW privileges on that band.

◆ An advisory notice was issued to an operator in Virginia for operation with an expired license on 10 meters. A repeater operator in West Virginia received an advisory notice for operating with an expired license and causing interference to a coordinated repeater.

◆ Good operator commendations were issued to a licensee in Texas for operating the N5VET Special Event station and making special effort to contact students from various elementary schools, and to an operator in Conway, South Carolina, for sustained dedication to the Grand Strand Amateur Radio Club repeater, having served as net control for 2,000 sessions.

◆ The VM Program Administrator participated in one meeting with the FCC.

The totals for VM monitoring during October 2023 were 2,598 hours on HF frequencies, and 3,145 hours on VHF frequencies and above, for a total of 5,743 hours. — *Thanks to Volunteer Monitor Program Administrator Riley Hollingsworth, K4ZDH*

Life Members

Elected December 7, 2023

Michael D. Adams, N1EN
Jose Manuel Alvarez, EA6UE
Leon W. Amstutz, WB9BAT
Tor Andersen
Scot Andre, NI5I
Kevin C. Andres, KD9QJA
Jon Anhold, KM8V
Robert S. Babcock, N4RF
Edward A. Banner, KE8BIT
Foster Bass, W2TI
David Ben Basat, 4X1WH
Dennis A. Bergstrom, KB7VU
Jared Bloomer, KW4JLB
Daniel L. Bowles, KC5GR
Blake J. Brady, KG5UZW
Sally L. Brannen, WB9RA
Eric H. Bull, W7EHB
Daniel E. Camp, AF7O
Douglas A. Carroll, WM7I
Wilson Adiel Caselli, K1MIJ
David H. Chenault, W5CWT
William D. Chesney, N8SA
Donald J. Chisholm, K8BB
Ronald G. Clayton, W5ADA
William J. Conrad, W4PHO
Wendell Reed Cotton, N1WC
James Lawrence Davis, KE0LD
Ryan C. Davis, K6KRU
Mark A. Deger, KG6IFQ
Jeffrey S. DeGidio, KE0NPT
Victor Denisov, N6DVS
Jay R. Denney, WD9JR
Gregory T. Douds, K4CUA
Leon Dudicz, SP5DL
Carl E. Durnavich, W9OO
James J. Edmonds, WA1KPG
Susan J. Edmonds, N2GNN
John W. Einberger, NA0A
Jack L. Espinal, KY4EA
Robert Brock Estes, WF4J
Frank M. Etzler, N8WXQ
Francis M. Evans, K0AM
Thomas N. Ferguson, KW7TF
Nicholas Fitz, KD9YFO
George L. Fluck, W2RIU
Steven E. Fook, K2EJ
Robert W. Frankland, KK0RF
Kirk J. Garber, W5KKG
Larry Gardiner, N8UXI
Robert H. Gast, Jr., NX6RG
Dale R. Geisweidt, N3ILH
Shawn C. Gendle, W4STT
Gill Gilliland, Jr., W4BXA
Susan Gordon
Jack Haefner, NG2E

Richard Harrison, AE6VA
Heath A. Harvey, AC1LF
Brynn E. Hebert, KG5KRV
Emily Hedberg, KF0GNS
Sarah W. Hedberg, KE0YXG
Andy Henry, K5XT
William T. Herzberg, AA8WH
William F. Heybruck, W4EDN
Raymond M. Higgins, W2RE
Steven R. Hill, NQ8T
Bradley T. Hinton, K4BTH
Elbert W. Huber, Jr., K5EWH
William A. Huckaba, NA5WH
John H. Hunt, Jr., K7XE
Jeff Jipson, KO4TDA
Steven M. Johnson, WB4WNO
Gary B. Jones, W4HX
Robert DeForrest Jones, Jr., KD8YAX
Thomas W. Karabees, Jr., WD4ESX
Brian A. Keefe, K3BAK
David S. Kelly, KJ5AHN
David L. Kerr, KA4GSR
John T. Knott, N4JTK
Caroline N. Kuebert, KM4VCO
Aaron W. LaFramboise, AK6CV
Jeffrey J. Lambert, WR5E
Brandy R. Lang, WE9L
Bernard Lecoeur, F1ETB
James E. Ligman, WA9PEG
James A. Lind, N0FPP
Stephen A. Makrecky, N1SO
Robert Lee Martin, WB2KTG
Mike McCarthy, AG7MM
James D. McCartney, NE5TX
David A. McQueen, KK0M
James N. Meade, NO0B
Michael P. Metroka, WB8BZK
Mark J. Milanowski, KA9PKW
Marion J. Miller, W0RBO
Michael Miller, KN4VA
Alain Minard, F5LIW
Daniel T. Minnick, AG7AE
Edward J. Miracco, KJ4PRT
Anthony T. Mixon, K0MIX
Don Moore, KM0R
Shawn M. Morgan, W0FW
Richard W. Mote, WF7F
Leslie Murray, KB1LVW
Daniel L. Musgrave, WD8RMG
Emilio Ng Lee, HP2NG
Edward W. Nowlin, III, K6NCC
Lyndon E. Opdyke, WA9JLD
David E. Pearson, KJ4YQK
William B. Peirano, KE8WYL
Jerry P. Peppers, W8JPP

Will E. Perkins, W1ZRV
Henry A. Pownall, W4FWR
Casey T. Price, K4CEE
David Propper, K2DP
James Quigley, K0JQ
Robert Donald Rand, WV5Q
Monte A. Rathbun, KA0MR
Kenneth A. Reiss, KA1HVR
Mark E. Rensi, W7MER
Michael P. Saltmarsh, KA1CJI
Alvin Sanders, KM6GXG
Ramon E. Santiago Rivera, KP4RSR
Craig E. Savage, W10R
Edwin T. Scallon, NN1ES
Daniel L. Schaffner, KD6OJD
Carol L. Scholl, K3LEA
James A. Sellers, KW4MO
Eric Shalov, KJ6ARC
Zachariah Silver, KB1LVX
Geoffrey J. Sima, KD7MWN
David G. Simpson, KE3XN
Michael D. Snyder, KA7IKR
Kerry W. Steffens, W0ON
Clark F. Stelzig, K7FJU
Michael J. Stutzer, KD0FDJ
Seth Anthony Szymanski, NN3X
Douglas B. Tabor, N6UA
Shane M. Thompson, KC8NYH
Paul K. Tuley, N3BUH
Harsha Venkatesh, NG1V
David Wade, KD2NZS
William T. Wall, KC3QVR
Arthur L. Walsh, Jr., AA1HO
Kevin K. Ward, K3XN
Jason Warren, WE8L
Katherine Warren, KE8YHH
John C. Westmoreland, AJ6BC
Edwin B. Whitworth, KJ4KKB
John A. Wilcox, KF0ANF
John M. Wilson, KC3NTS
Peter K. Witherow, W7PTR
Rodney F. Youngblood, Jr., W5RFY
Andrew C. Zacharias, K2ZAK



A Look Back

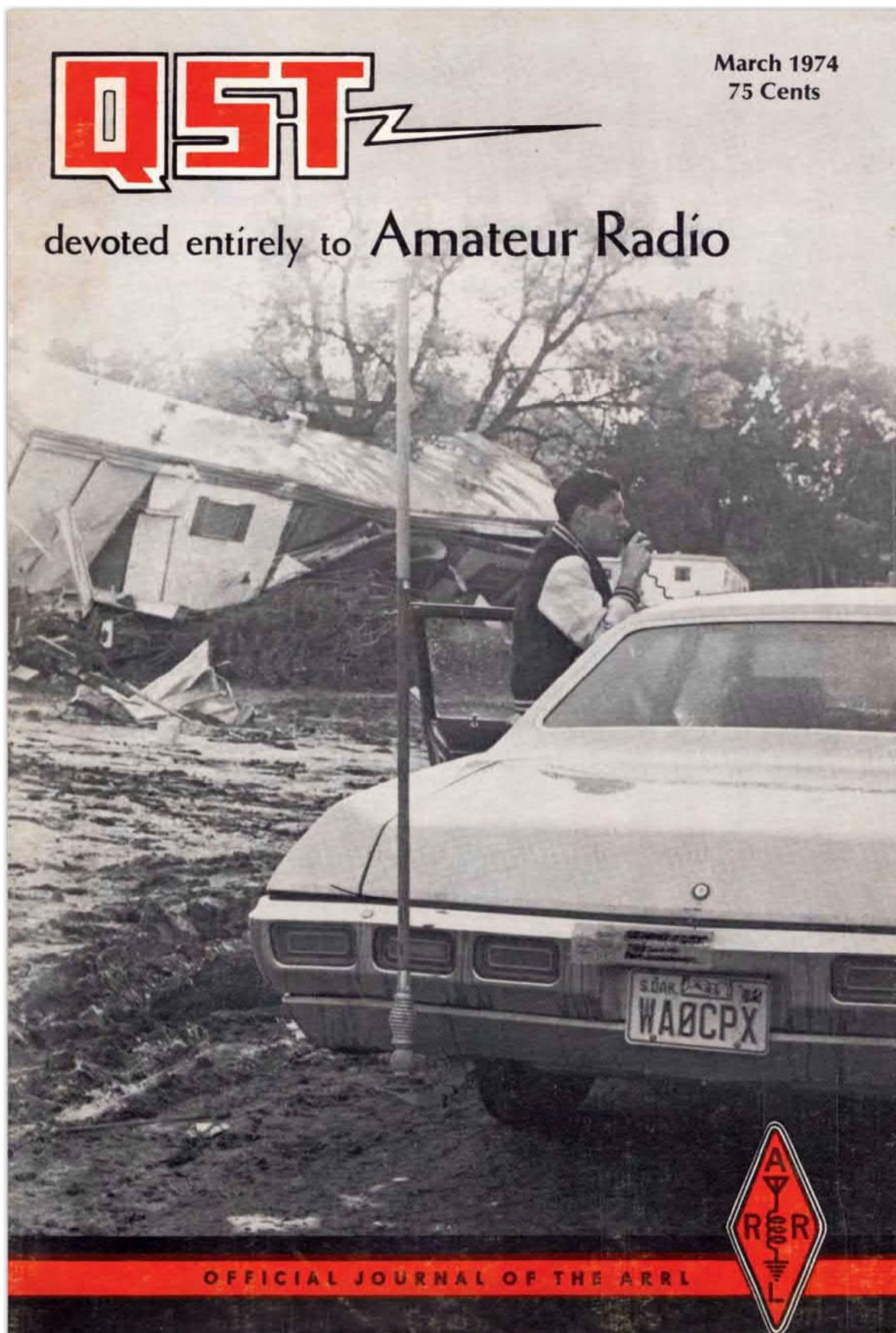

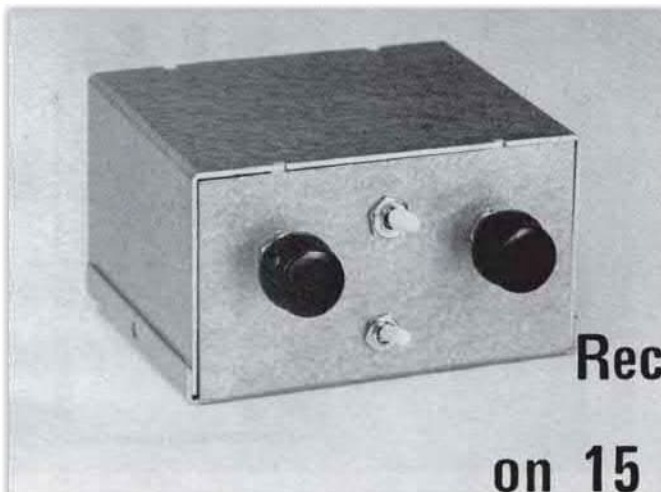

• *Beginner and Novice*

Improving Your Receiver Performance on 15 and 10 Meters

BY LEW MCCOY,* WIICP

MANY OF the lower priced receivers, or second-hand models that Novices use, leave much to be desired when operated in the 15- and 10-meter bands. Usually the tuning rate is too fast, sensitivity is poor and stability is lacking. On the other hand, these receivers can do a reasonably fair job of covering 80 meters. It might be added that no amount of work or changes to the receiver proper are worth the expense and effort to make such a receiver a good performer on the higher bands. However there is a method, and it isn't complicated, to step up the performance of such receivers on 15 and 10 meters. This consists of using a *converter* ahead of the receiver. This article describes the "hows and whys" of converter operation and shows how to build a simple, but high-performance, unit.

What a Converter Is

Simply the type of converter we are talking about is a combination of electrical circuits that *converts* an incoming signal to a lower frequency. Let's explain that in a little more detail. Fig. 1 is a block diagram of how a converter works. With

* Novice Editor, *QST*

incoming rf energy from the antenna, say at 21,100 kHz, the signal is amplified first in a radio-frequency amplifier stage. The boosted signal is then fed to a mixer stage. Also being fed into the mixer is some rf voltage which is obtained from a crystal-controlled oscillator. This energy is at 25,000 kHz. The output signal, or rather signals, from a mixer stage are the sum or difference frequencies of the energies applied to the mixer in this case 21,100 and 25,000 kHz. We are interested in the *difference* frequency 25,000 minus 21,100 or 3900 kHz. This new energy (i-f, or intermediate frequency) can be fed to our receiver the latter being tuned to 3900 kHz. Our i-f energy will be treated by the receiver as if it were an 80-meter signal.

Why Do It?

As we pointed out earlier, these poorer receivers will work well enough on 80, but not the higher bands. By converting the signal to 80 meters, you will have a much slower tuning rate (bandspread), much more sensitivity (the converter provides signal gains of as much as 20 decibels), and better stability.

The decision to make the converter will depend on how well your receiver performs on 15 and 10 meters. Check the number of turns of your tuning knob for 450 kHz (the width of the 15-meter band) on 15 then count the turns for the same number of kilohertz on 80 meters. One receiver we checked had a difference of nearly four complete turns for the same coverage. Does your receiver sound insensitive on 15 and 10? If it does, you need the converter.

The Circuit

Fig. 2 is the circuit diagram of the unit. We should point out that this converter has a rather unusual feature which, to our knowledge, is the first time it appears in print. One of the objectives of our staff is to design equipment for the

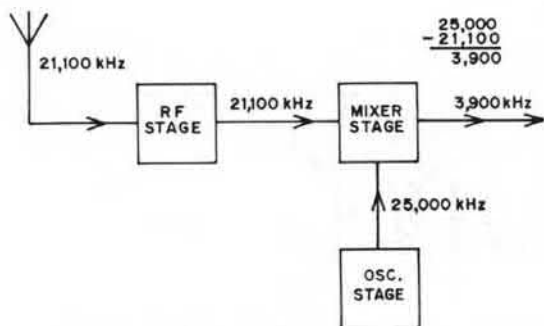

Fig. 1 — This block diagram shows the frequency relationship of converter

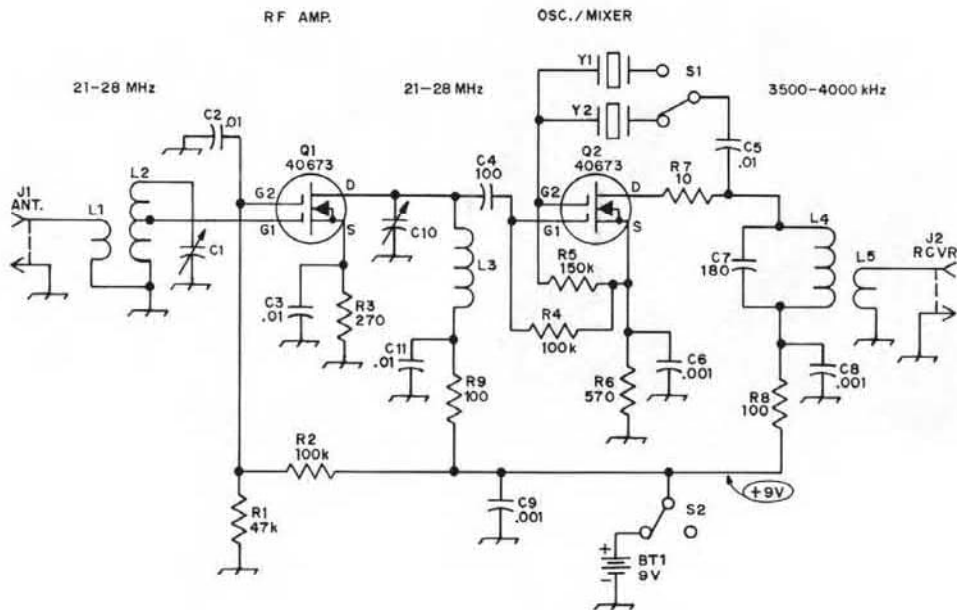

Fig. 2 — Circuit diagram of the 15- and 10-meter converter. Unless otherwise noted, all capacitors are disk ceramic. Resistors can be either 1/2 or 1/4 watt. Part numbers not listed below are for text reference and layout purposes only.
 BT1 — 9-V transistor battery
 C1 C10 — 365-pF variable, modified as per text (Radio Shack part No. A1-233)
 C4 — 100-pF silver mica.
 C7 — 180-pF silver mica.
 J1, J2 — Phono jack.
 L1 — 3 turns of No. 22 or 24 enam. wire wound at the ground end of L2.
 L2, L3 — 7 turns of No. 22 or 24 enam. wire wound on an Amidon T-50-2 toroid core. The tap for G1 of Q1 is placed two turns from ungrounded end of L2.

- L4 — 55 turns No. 30 or 32 enam. wound on an Amidon T-50-2 toroid core.
- L5 — 10 turns of No. 30 or 32 enam. wound over ground end of L4.
- Q1 Q2 — Dual-gate MOSFET RCA 40673.
- S1 — Single-pole, double-throw toggle switch.
- S2 — Single-pole, single-throw toggle switch
- Y1 — For 15-meter coverage, 17,500-kHz crystal for 10 meters, 24,500 kHz (International Crystal type F-700 or equiv.)

Note: Most of the components can be obtained from Radio Shack stores. The 40673s are available by mail from Nurmi Electronic Supply 1727 Donna Rd., West Palm Beach, FL 33401. The toroid cores are available from Amidon Associates, 12033 Otsego St., N. Hollywood, CA 91607.

newcomer, using the simplest circuitry possible, with a minimum number of components, without sacrificing performance. In this converter, dual-gate MOSFETS (40673s) are used. Normally, three transistors would be required, one for the rf stage, one for the mixer, and another for the oscillator. WISL of our staff suggested that it might be possible to use a *single* 40673 as both a mixer and oscillator. Frankly, we had doubts about being able to obtain proper mixer performance, but they vanished when we found the circuit worked — and very well! This eliminates the need for another 40673, resulting in a saving of parts and lower cost for the converter.

For the technically minded the performance figures for the converter might be interesting. The converter was tried with three different receivers, all of which performed poorly on 15 and 10 meters. Using a signal generator, it was noted that these receivers required a signal input on the order of 1 to 2 μV to produce a barely audible signal. With the converter, sensitivity was improved so that only 0.1 μV produced

a plainly audible signal on the two bands. There was some concern that combining the oscillator and mixer in a single device would result in either too little or too much oscillator-voltage injection into the mixer. However, there was no evidence of this, also, at least ten different crystals were tried in the circuit, and all performed well. The highest rf gate voltage noted on gate 1 was about 4, well within the ratings of the device.

Construction Information

In last month's *QST* a simple breadboard method of construction¹ was described. This technique is a simple one, so it was used here. Copper circuit board is separated into squares by drawing a hacksaw blade across the copper foil, just enough to remove the copper covering and exposing the board. The main section for the converter is a piece of board 3-1/4 inches (8 cm) long by 1 inch (2.5 cm) wide, consisting of two rows of squares, 10 squares to the row. This piece is glued to another

¹Leslie, "Breadboard Revisited," *QST* Feb., 1974.

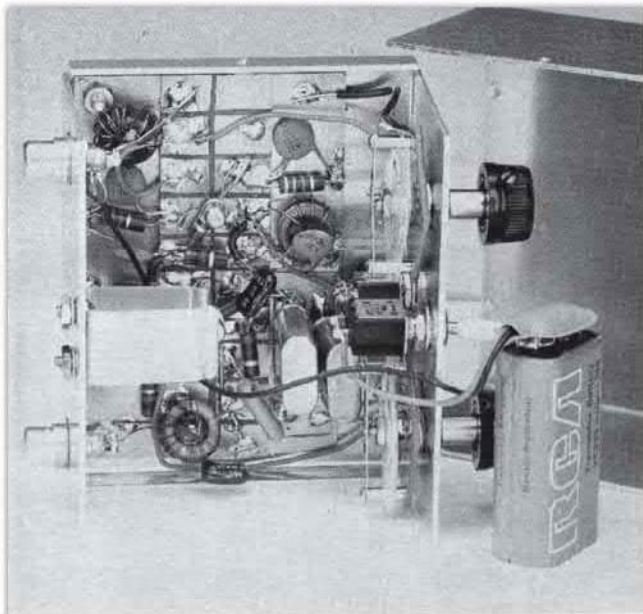

Inside view of the converter. The two peaking capacitors, C1 and C10 are on either side of the power switch. The two crystals are visible just below the power switch. The phone jack at the top rear is the antenna input and the bottom jack is for receiver input.

board, 2-1/4 inches (5.5 cm) wide. (See the photograph.)

The converter is housed in a Minibox, 2 x 3 x 3-1/2 inches (5 x 7.6 x 8.8 cm). The copper circuit board is installed on the bottom of the box and the controls are mounted on the face of the housing. When soldering any of the components to the individual squares or pads, apply heat from the iron to the pad *first* along with a small amount of solder. Then solder the component lead to the pad. Some newcomers tend to use too much solder and too much heat. You'll find that with a little practice, soldering with this type of construction will be very easy.

The two variable capacitors, C1 and C10, have a total capacitance of 365 pF each, as they come from the store. This is considerably more capacitance than is required to tune 15 and 10 meters, and the tuning rate will be better if they are

modified. It is a simple matter to modify them by removing stator and rotor plates. You'll find there are three screws holding the plates in place. Remove the screws carefully (don't drop and lose them!) and then remove the plates and spacers one at a time. Remove 5 stator and 5 rotor plates from each capacitor. If you want to try the capacitors before removing the plates, of course you can. However, we found that it was hard to separate the "peak" tuning points for each band.

Tune-up

One problem we found was that the converter had some instability but this was cured when we bolted the copper chassis board to the bottom of the cabinet. No doubt this trouble was because of poor ground connections. Make up a short length of shielded cable to go from the converter to the receiver antenna terminals. The cable only needs to be long enough to reach between the two units but it must be shielded cable to prevent pickup of unwanted 80-meter signals. A short length of RG-58/U cable is satisfactory. With the converter turned off, you should not be able to hear 80-meter signals leaking through.

Turn on the converter and tune your receiver to the part of the 80-meter band that gives you the correct coverage area for either 15 or 10 meters. You can calculate this from the information in Fig. 1. Peak both C1 and C10 for maximum background noise and also peak the antenna trimmer of your receiver. If you don't observe any increase in background noise, check the wiring of the converter to make sure you didn't make any mistakes. Don't be discouraged if you don't hear signals on 15 or 10 meters. At the present time, we are approaching a sunspot minimum and there will be long stretches in time where neither 15 nor 10 meters will be open for skip signals. QST

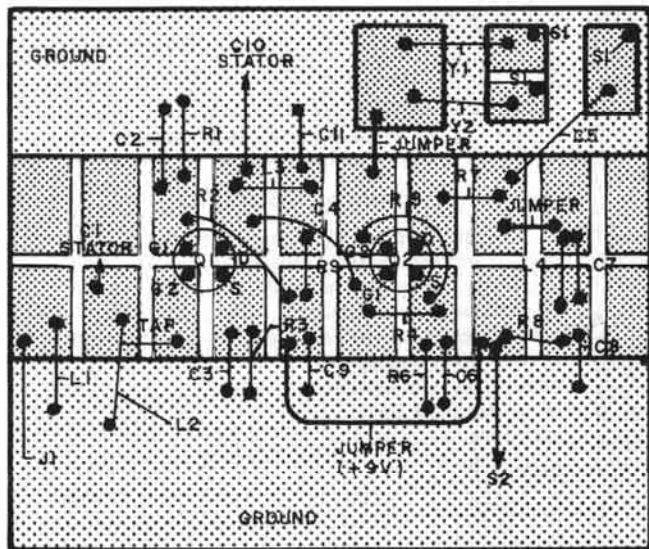

Fig. 3 - Component layout details.

QST for

A Frequency Extender for Electronic Counters

BY ABRAM L. WINTERS,* WA4FGN

MANY AMATEUR and MARS stations include 100-kHz or 1-MHz frequency counters such as the Berkeley-Beckman model 7150 and 7160 EPUT meters or the Hewlett-Packard model 523CR electronic counter. These counters are quite useful, although limited in range to audio frequencies. The upper frequency limit of such instruments can be multiplied ten times through the use of an integrated-circuit prescaler. This device divides the applied frequency by ten and supplies an output suitable for application to the counter. Therefore, the prescaler produces a signal at one MHz when the input is ten MHz. The unit shown in the accompanying schematic diagram can accept signals to approximately 11.5 MHz at levels from 0.4 to 2.0 V pk-pk and produces an output of 3.5 V pk-pk.

Construction

The use of integrated circuits simplifies construction and reduces the size. If desired, the unit and its power supply can be built on a small piece of Vectorbord and mounted inside the counter. No special precautions need be observed in the construction other than the normal practice of keeping leads neat and short. For those not accustomed to working with integrated circuits, it is recommended that dual in-line packages and sockets be used.

Appropriate substitutions can be made provided that the essential characteristics are maintained. Note that only one of the four gates of the SN7400N is needed. This IC was used because it was available; however a dual-gate IC could be

* 1735 Nursery Road, Clearwater, FL 33516.

employed instead. The unused input must be connected to +5.5 volts. When using a substitute IC be certain that the appropriate power supply voltage changes are made, if required, and that the substitutions are capable of operation at 10 MHz.

Operation

The wave form to be measured is applied to the amplifier, a high-speed differential comparator. This amplifier produces pulses which are applied to the 7400 gate. The output of the gate is in the form of 4-volt pulses to drive the 7490 decade divider.

Power Supply

Because both positive and negative voltages are required, a 24-volt power supply is used and the various operating voltages are derived from a Zener-diode voltage divider. Note that -5.5, +5.5 and +11 volts are all obtained from the same supply by placing the ground at the junction of diodes VR2 and VR3. All grounds shown in the prescaler must be connected to this junction.

The author's unit was fabricated on Vectorbord with a common ground tie point for the signal circuits. The 24-volt power was provided from a regulated dc supply. However a 24-volt transformer operating into a full-wave rectifier with a large filter capacitor on the output should be adequate since the load will not vary appreciably. The circuit shown draws approximately 60 mA, most of which flows through the Zener diodes. The unit has been operated successfully with both the Hewlett-Packard and Berkeley-Beckman counters. QST

Fig. 1 - Schematic diagram of the frequency prescaler

- U1 - Differential-comparator IC; Fairchild μ A710 (U5B771031X) Motorola MC1710, or equiv
- U2 - Quad 2-input NAND gate IC. Signetics N7400A, Motorola MC7400P Texas Instruments SN7400N or equiv.
- U3 - Decade-counter IC. Signetics N7490A, Motorola MC7490P Texas Instruments SN7490N or equiv

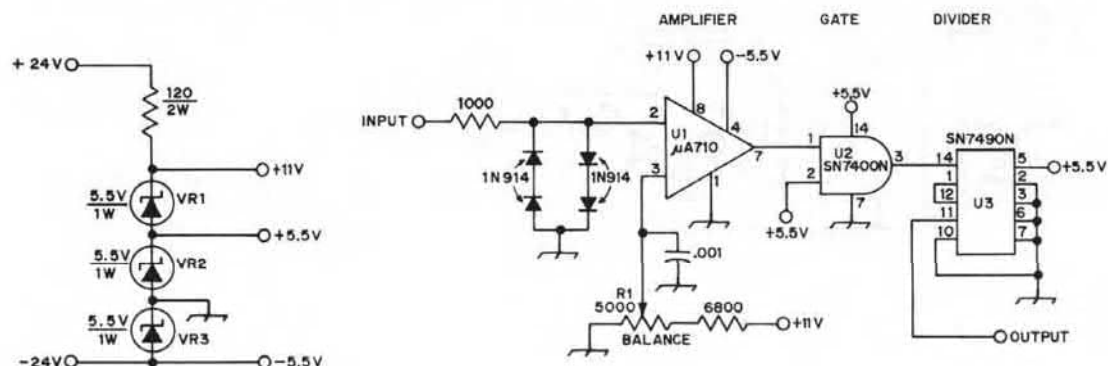

Celebrating Our Legacy

Hidden Treasure: A National NC-300 with a Secret

In 1993, a coworker was cleaning out his basement and offered to give me a 1960s National NC-300 tube receiver. Someone had bought it at an estate sale and eventually gave it to my coworker, who stored it for 10 years until he gave it to me. What I didn't know was that the radio held a secret.

The NC-300 sat in my garage for nearly 2 years before I brought it into my shack and plugged it in. I expected to hear audio hum, but the tubes lit up, the dial lamps glowed, and slowly, the radio came to life on 20 meters with beautiful CW and SSB signals. I was surprised at how well it worked!

I needed to open it up to clean the intermittent band switch. As I lifted the front of the cabinet to look for mounting screws, I heard a sliding noise, followed by a light *thunk* from the inside of the radio. I lifted the lid and peered inside but didn't see anything. While hunting for the rear chassis mounting screws, again I lifted the back of the radio and heard the sliding and *thunk* noise again. I opened the lid and looked inside the radio. The NC-300 has a 1-inch separation between the cabinet and the side of the chassis, and in one corner, there was a folded-up piece of paper. I pulled it out and saw that it was a \$20 bill! I felt around the opening but didn't find anything else.

I lifted the front of the radio to access the mounting screws and heard another sliding noise. Like before, money was in the corner, but this time it was \$35 rolled up tightly. After some additional cabinet shaking, the receiver yielded around \$90. I reveled in my good fortune, not understanding why there was money in the radio, and I proceeded to remove the chassis from the cabinet.

As I pulled the front panel and chassis out of the cabinet, more money started

falling on the floor! Looking into the chassis, I saw money stuffed on both sides of the cabinet, from the front to the back. The original owner must have been using the NC-300 as a piggy bank for several years, likely saving up for their next radio purchase.

Each of the bills was rolled up tightly. Some rolls consisted of a single bill, while others had two or three. There were several \$1, \$5, \$10, and \$20 bills, all dated from 1963 to 1969. After unrolling and counting the money, it added up to \$497!

I used some of the money to purchase a 1960s Johnson Viking Valiant tube transmitter to pair with the NC-300. I enjoyed 25 years of wonderful CW and AM operation with the Valiant and NC-300 and sold them in my big radio downsizing. Strangely enough, I kept the rest of the 1969 cash and still have it.

I look back on that receiver and transmitter pair with fondness and am grateful for that 1960s ham who was using the NC-300 as a piggy bank because they bought me the Viking Valiant.

Scott Freeberg, WA9WFA
Saint Paul, Minnesota
Life Member

The Enduring Thrill of CW

In May 1949, I received my General-class license. I heard CW on the short-wave bands and met two ham friends in high school who (along with my Instructograph and some CW off the air) helped me get into this fascinating hobby. I have never tried 2 meters or



The "piggy-bank" National NC-300 with the Johnson Viking Valiant. [Scott Freeberg, WA9WFA, photo]

much phone. At first, I operated on AM and later SSB and then remained on HF. I have tried all types of antennas and have enjoyed DX. My 1949 station had an 80- and 40-meter modified Aircraft Radio Corporation ARC-5 transmitter and a National NC-57 receiver. Two years later, I upgraded to a Collins 75A-1 receiver and a Collins 32V-2 transmitter. I think there were many folks like me back then who started with a surplus of equipment from the war, which was readily available and inexpensive. I never lost the thrill of distant contacts on CW. That was, and is, radio for me.

Tomm Shockey, W2BFE
Union, Maine

Send reminiscences of your early days in radio to celebrate@arrl.org. Submissions selected for publication will be edited for space and clarity. Material published in "Celebrating Our Legacy" may also appear in other ARRL media. The publishers of QST assume no responsibility for statements made in this column.

Classic Radio

The EICO 723: A Classic Novice Transmitter

The EICO 723 was a popular Novice transmitter during the 1960s. There was a demand for inexpensive transmitters at that time, when many of us baby boomers obtained our Novice licenses. Back then, Novice operators were limited to 75 W RF power, CW was the only mode approved for HF operation, and there were only crystal-controlled transmitters. Because it met these requirements, the 723 became a successful product for EICO. I made many CW contacts on 40 and 15 meters with the 723 when I was a Novice in 1962 and 1963.

The Electronic Instrument Company (EICO) was formed in 1945 and was originally located in Brooklyn, New York, but later moved to Long Island City. Along with amateur radio equipment, their products included oscilloscopes, tube testers, signal generators, and other test equipment. Many electronics students in the '60s and '70s used EICO oscilloscopes in their labs. EICO also manufactured quality hi-fi audio components. Their amateur radio products included the 60 W EICO 723 CW transmitter and the upgraded EICO 720 transmitter that produced 90 W CW or AM. All of their amateur radio products were available factory-built or in kit form.

Specifications

The 723 used three vacuum tubes, an oscillator, a final amplifier, and a rectifier. It covered five bands — 80, 40, 20, 15, and 10 meters — and used quartz crystals to control its frequency. With the proper crystal, it could transmit on the small slices of the CW spectrum that were allocated to Novice operators (3700 – 3750 kHz, 7150 – 7200 kHz, and 21,100 – 21,250 kHz).

The 723's power output was specified as an optimistic 60 W on CW. It could also provide 50 W of plate-modulated AM using the EICO 730 — a high-level universal modulator driver that was sold separately as a kit for \$49.95 or assembled for \$79.95. There was no built-in variable frequency oscillator (VFO), but the EICO 722 was an accessory VFO model that was available for \$44.95 as a kit and \$59.95 wired.

While most radios at this time had a horizontal form factor, the 723 was smaller and squarer at 8.5 × 6 × 11.25 inches — it didn't take up much room on a small operating desk. Most rigs were black or gray, but the 723's case was



The EICO 723 transmitter. [Photo courtesy of www.radiomuseum.org]

brown with a tan surround. The front control panel was brown with tan knobs and white edging, and the numeric and lettered control settings were also marked in white. The meter was tan with a white faceplate. The entire cabinet had small holes on the top and sides of the case for additional ventilation (a cooling fan wasn't required). It weighed 15 pounds with its iron power supply transformer. In 1961, it cost \$49.95 as a kit and \$79.95 factory-assembled. Its discrete components were mounted on a copper chassis, a signature feature of most EICO amateur radio products.

Power Supply

The 723's power supply required 117 V ac and consumed 140 W. The power supply used a transformer with separate secondary windings for the 6 V tube filaments, the 500 V B+, and a 5 V filament winding for the GZ34 rectifier tube that was a more rugged version of the 5AR4 rectifier. The B+ rectifier's filter network consisted of a swinging choke with two 40 mF electrolytic capacitors in series after the choke. The octal accessory socket in the rear of the radio was provided with 6.3 V, and there were 117 V ac available at the rear socket to activate an external relay that switched the antenna between the separate transmitter and receiver.

your choice of 2 GREAT **EICO**[®] TRANSMITTERS...



designed
by Hams...
for Hams...



to the highest
Ham standards

**90-WATT
CW TRANSMITTER #720**
Kit \$79.95 Wired \$119.95
*U.S. Pat. #D-184,775
"Top quality"—ELECTRONIC
KITS GUIDE.
Ideal for veteran or novice.
"Clean" 90W CW, 65W AM-
phone with EXT plate modu-
lation. 80 through 10 meters.

**80-WATT
CW TRANSMITTER #723**
Kit \$49.95 Wired \$79.95
"Compact, well-planned lay-
out. Clean-sounding, abso-
lutely hum-free carrier;
stable." — ELECTRONICS
WORLD.
Perfect for novice or ad-
vanced ham needing low-
power standby rig. "Clean"
80W CW, 50W AM-Phone with
EXT plate modulation. 80
through 10 meters.

**TRANSISTOR CODE PRACTICE
OSCILLATOR #706**
Complete with battery
Select variable
tone, flashing light,
or both together.
Phone jack for private
use. Efficient speaker
clean loud signals.
Kit \$8.95 Wired \$12.95

New!
**VARIABLE
FREQUENCY
OSCILLATOR
(SELF-POWERED)
#722**
Approaches
crystal stability,
80 through
10 meters.
Kit \$44.95
Wired \$59.95

**CITIZENS BAND
TRANSCIVERS
770 Series**
Superhet, pre-
aligned xmitter
osc; match an-
tennas by variable
"pi" network. Single
& multi-channel models.
From Kit \$79.95 Wired \$109.95

**HIGH-LEVEL
UNIVERSAL
MODULATOR-
DRIVER #790**
Kit \$49.95 Wired \$79.95
Delivers 50W undistorted audio for
phone operation. Can plate-modu-
late transmitters having RF inputs
up to 100W. Unique over-modu-
lation indicator. Cover E-5 \$4.50.

**GRID
DIP
METER
#710**
Kit \$29.95 Wired \$49.95
Includes complete set of coils
for full band coverage. Continu-
ous coverage 400 kc to 250 mc.
500 μ A meter.

**PEAK-TO-PEAK
VTVM #232**
& exclusive
***UNI-PROBE**
Kit \$29.95
Wired \$49.95
VACUUM TUBE VOLTMETER #221
Kit \$25.95 Wired \$39.95

**DC-5MC
LAB & TV 5"
OSCILLOSCOPE
#460**
Kit \$79.95
Wired \$129.95
5" GENERAL PURPOSE SCOPE #427
Kit \$69.95 Wired \$109.95

**DYNAMIC
CONDUCTANCE
TUBE
& TRANSISTOR
TESTER #686**
Kit \$69.95 Wired \$109.95
TUBE TESTER #625
Kit \$34.95 Wired \$49.95

**RF SIGNAL
GENERATOR
#324**
(150kc-435mc)
Kit \$26.95
Wired \$39.95
**TV-FM SWEEP GENERATOR
& MARKER #368**
Kit \$69.95 Wired \$119.95

EICO
ELECTRONIC INSTRUMENT CO., INC.
3300 NO. BLVD., L.I.C. 1, N. Y.
Export Dept., Roburn Agencies, Inc.
431 Greenwich St., N. Y. 13, N. Y.

EICO, 3300 N. Blvd., L.I.C. 1, N. Y. QST-12
 Send free Catalog & name of neighborhood distributor.
 Send free "Short Course for Novice License." Send 36-page STEREO HI-FI GUIDE; 25c enclosed for postage & handling.
 Name _____
 Address _____
 City _____ Zone _____ State _____
 Add 5% in the West.

ENGINEERS: Excellent career opportunities in creative electronics design. Write to the Chief Engineer.
 This EICO ad appeared in the December 1962 issue of QST and in the 1963 edition of *The Radio Amateur's Handbook*.

Oscillator

The 723's oscillator used a 6CL6 pentode vacuum tube as an electron-coupled Colpitts crystal oscillator that produced stable frequency control. At this time, a Novice CW operator transmitted only on the specific frequency of the crystal that was plugged into a socket on the front panel. According to EICO, the oscillator design had a high harmonic output that allowed a single crystal to be used for multiple bands. Operators could use 80-meter crystals for 80-, 40-, and 20-meter operation, and 40-meter crystals could be used on 40, 20, 12, and 10 meters. However, it wasn't as easy as EICO's manual implied, because multiplying a crystal's frequency didn't always put the transmit-

ter in the correct portion of the higher-frequency band.

Final Amplifier

The final amplifier used a rugged 6DQ6-B vacuum tube in a class-C configuration. Along with its use in amateur radio transmitters, 6DQ6s were commonly used as horizontal deflection tubes in black and white televisions. The 6DQ6-B was used as a straight-through RF amplifier on all bands, except for on 10 meters, where it also functioned as a frequency doubler. The 723 manual stated that "a variable-tuned, band-switching pi-network tank circuit is used to match the final amplifier to the various loads... A variable 900 mmf capacitor is connected across the output of the pi-network for controlling the degree of loading the antenna or other load." There was a slide switch on the rear that could add a 0.001 mF capacitor if more capacitance was required. EICO claimed that this circuit could match output impedances from 50 to 1000 Ω — a very wide range.

Operating the Transmitter

Operating the 723 was a little more complicated than today's modern transceivers. After setting the band switch to the proper band and plugging in a key, an antenna, and a crystal, the operator moved the four-position rotary switch to the TUNE position, pressed the key, and adjusted the grid current to no more than 2 mA with the GRID TUNING control. The meter was then set to PLATE, which read the plate current of the final amplifier. The function switch was then set to TRANSMIT. After pressing the key, the operator then repeatedly dipped the PLATE TUNING for minimum current, while gradually increasing the ANTENNA LOADING until the plate current increased to a maximum of 120 mA, indicating full power.

This process was actually easier than it sounds because the transmitter made a humming noise and vibrated slightly when the final amplifier was not properly matched to the antenna.

In Conclusion

With its simple design, low cost, and ease of operation, the EICO 723 met the needs of many Novice operators in the 1960s, but it appears that EICO abandoned the amateur radio market by 1970. They most likely couldn't compete with the influx of Japanese transceivers that were coming onto the market.

100, 50, and 25 Years Ago

February 1924

- The cover shows two sleepy-looking hams in the ham shack, ready for the “early-morning relay.”
- With amateur radio on the move around the world, “Editorials: International Amateur Radio” proclaims the need for an International Amateur Radio Relay League. Several articles appear in this issue that seem to validate the editorial, including “The Progress of Transatlantic Amateur Communication” by K.B. Warner, 1BHW, and “An Amazing World’s Record” by F. Basil Cooke.
- S. Kruse, 10A, explains how to improve plain two-circuit regenerative tuners in “Low Loss Tuners.”
- An account of the President’s holiday greeting route is summarized in “Coolidge’s Holiday Greetings to MacMillan Travel Via Amateur Radio” by K.B. Warner, 1BHW.
- An improved, inexpensive, efficient, and fool-proof high-voltage rectifier is shown in “The Improved ‘S’-Tube Rectifier” by James L. Jenks, Jr.
- The first need in amateur construction work is to know how to use tools. H.F. Mason, 1ID, discusses soldering in “The Amateur Builder: Solder and Soldering.”
- Adopted December 18, 1923, and published for member information, is “The New Constitution of the A.R.R.L.,” outlining the updated Constitution Articles and By-Laws.



February 1974

- It’s not a new kind of antenna! The cover shows a wind generator. The story about creating a system for generating your own power using the wind is in “Energy Crisis” by Jim Sencenbaugh, K6TPS.
- “It Seems to Us...ARRL Government” recounts the prelude to the Amendments to the Constitution made after Secretary Warner’s 1923 field trip, where he found that many members felt isolated from the course of ARRL affairs. The new democratic scheme was reported 50 years ago in QST, and carried a call for nominations of candidates.
- An easy project for tracking down the source of problems in a transmitter is shared in “A Versatile Scope for the Radio Amateur” by Charles P. Townsend, WA4DCN.
- “If amateurs want better public understanding of our value, we must blow our own horn,” say Bill Lowenberg, W2OOJ, and Dee Logan, WB2FBF, in “Doing Amateur Radio Publicity From Alpha to Zulu.”
- Oscar 7 — what it is and how to use it are explained in “Oscar 7 and Its Capabilities” by Joe Kasser, G3ZCZ/W3, and Jan A. King, W3GEY.

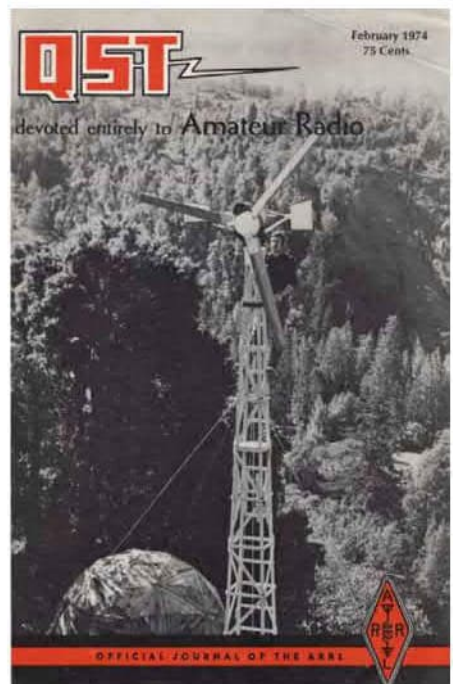

February 1999

- The cover features a photo of the easy-to-build 2-meter scanning receiver described in Steve Hageman’s article “A Synthesized 2-Meter FM Receiver with PC Control.”
- Referencing the EMC column in December 1998 *RadCom*, David Sumner, K1ZZ, highlights the importance of removing RF pollution in “It Seems to Us...Pollution.”
- As rescue workers scrambled to find survivors, hundreds of amateur radio operators worked tirelessly behind the scenes to assist a wide variety of served agencies. The story is in “The Crash of SwissAir Flight 111: Amateur Radio at the Scene” by Al Penney, VO1NO/VE1.
- Working the world from a pair of exotic, potentially new countries, this father-son duo racks up some serious QSO totals. Bob Ferrero, W6RJ, and Robert Ferrero, W6KR, share their story, as told to John G. Troster, W6ISQ, in “The Great DX Adventure — To the Australs and Marquesas.”
- A new filter that can give you an extra boost is shown in “Second-Harmonic-Optimized Low-Pass Filters” by Ed Wetherhold, W3NQN.
- Inexpensive and readily available parts make a sturdy dipole center insulator/hanger, explains Paul Pagel, N1FB, in “A Heavy-Duty Homemade Dipole Insulator.”
- In his “Op-Ed: A Raucous Cacophony! Oh, the Beauty...,” Steven J. Meyers, W0AZ, shares his opinion on recognizing the beauty of our ardor for things related to radio.



Silent Keys

It is with deep regret that we record the passing of these radio amateurs:

vAB1AM **Perdion**, Thomas G., Cheshire, CT
•AA1BH **Donoghue**, Susan C., Springfield, MA
KB1BSK **LaMore**, David E., Storrs, CT
♦W1DNZ **Harney**, Fred J., Jr., Salem, MA
WB1HGL **Hague**, James N., Franklin, MA
v♦WA1OOP **Ricker**, Charles E., Bristol, CT
vK1PIG **Rigoulot**, Martin W., Fayette, ME
vK1XZ **Kelly**, James, Marlborough, CT
N2CLC **Madden**, Everett, Stepentown, NY
v♦K2CWM **Myers**, Curtis W., Swedesboro, NJ
NO2J **Walters**, Charles H., Big Flats, NY
vK2KRF **Chooljian**, John, Hackensack, NJ
•KA2KTX **Place**, Harry, Ridgewood, NJ
vN2LPR **Troolin**, Nicholas M., Millville, NJ
v♦W2MLS **Snuffer**, Michael L., Nampa, ID
KA2WCU **Miller**, Ralph R., Hamburg, NY
KC2YKW **Votava**, Emil W., Tivoli, NY
v♦W3BOI **Mickelson**, James P., Tidioute, PA
KB3COU **Rhoades**, Kathryn A., Philadelphia, PA
KK3H **Mitnik**, James M., Butler, PA
K3JLB **Stewart**, James L., Oil City, PA
KB3MBR **Stallings**, Richard L., Hagerstown, MD
v♦N3TO **Short**, Robert B., Denver, CO
N3TQB **Tennill**, Charles E., Simpsonville, KY
vN3WKT **Carlson**, Raymond J., Pensacola, FL
NQ3Z **Randall**, William, Monkton, MD
K3ZW **Hecker**, Paul D., Rockford, IL
KC4ARR **Mayo**, Bobby W., Hillsborough, NC
v♦AD4AV **Garrett**, Carlos W., Boones Mill, VA
WA4BGH **Douglas**, Joan E., Haines City, FL
KI4BKC **Thurber**, David C., Raleigh, NC
vKA4BOB **Davisson**, Robert A., Palm Beach Gardens, FL
♦N4BPH **Shepherd**, Paul L., Soddy Daisy, TN
KT4BW **Tiffany**, Peter A., Fairfield Glade, TN
♦W4DHT **Turner**, Drexel H., Fayetteville, OH
K4DNG **Gainer**, Daniel N., Knoxville, TN
AD4DZ **Conrad**, David E., Melbourne Beach, FL
vW4GNB **Britten**, Gary N., Wilmore, KY
W4GNT **Popko**, Edward S., II, Woodstock, NY
vWA4IAQ **Barbrow**, Charles "Jack" W., Jr., Saltville, VA
KE4ISW **Rogers**, Michael L., Richmond, KY
v♦WB4UI **Miller**, Gedney W., Jr., Columbus, GA
KF4JTO **Petway**, Ronald W., Benton, KY
KI4KQP **Baldwin**, Benjamin E., Arden, NC
WB4LGC **Caudill**, LeRoy, Morehead, KY
KQ4NA **Stagg**, Jim, Greensboro, NC
vW4NFB **Frey**, William R., Florence, KY
vKD4OKT **Delwiche**, Robert R., Mills River, NC
♦KP4PS **Serrano Quinones**, Pedro R., Rio Piedras, PR
vKJ4QDN **Holt**, Walter C., Woodbury, TN
KO4RHW **Canon**, Aubrey N., Palatka, FL
vW4TQH **Johnson**, Charles E., Mercer Island, WA
KC4UVA **Grupp**, Rick C., Chino Valley, AZ
W4WNG **Melton**, David B., The Villages, FL
vKM4WUU **Walker**, Robert L., Sr., Virginia Beach, VA
vK4WVU **Nofsinger**, Harold O., Martinsville, VA
KJ4YOT **Gantt**, Larry W., Roswell, GA
W4ZZY **Chastain**, John D., Jasper, GA

v♦W5DET **Thompson**, Doug, Alto, NM
vAE5ER **Robinson**, Cecil R., Jr., Mineral Wells, TX
v♦K5EWT **Mastin**, Theo A., Jr., Albuquerque, NM
vW5GJG **Jennings**, Clarence, Cibolo, TX
KC5KKV **Wrzesinski**, Mary E., Fort Worth, TX
K5MMA **Danner**, Charles A., Marble Falls, TX
KG5NJG **Robinson**, Thomas M., Troy, TX
vK5QZ **Alden**, Charles F., III, Edmond, OK
vK5REJ **Alcorn**, Paul, Henrietta, TX
vKM5SY **Irwin**, Donald G., Boerne, TX
vAB5TB **Welsh**, George S., Santa Fe, TX
•KI5XK **Gooch**, Perry L., Farmington, NM
KG5YWO **Ross**, Vicki L., Paris, TX
WA5ZEK **Goodwin**, John L., Fort Smith, AR
•WB6AWO **Fritz**, Richard D., Enumclaw, WA
vKJ6BLL **Stumpf**, Lawrence, Riverside, CA
•KC6RFB **Sipple**, Mary R., De Pere, WI
vKK6RQG **Whitney**, Larned S., Benicia, CA
•KG6SNV **Muschi**, Mario L., San Francisco, CA
v♦KF6UT **Steinkraus**, Ray C., Winston-Salem, NC
KC7BMZ **Stear**, Jo Ann, Santa Barbara, CA
vKC7EQU **Arnold**, Martin F., Sr., Sequim, WA
v♦W7HGK **Coulombe**, Art E., Walla Walla, WA
KL7IPD **Webb**, James S., Juneau, AK
K7JA **Margelli**, Charles "Chip," Garden Grove, CA
vWF7J **Loesche**, Walter H., Cottonwood, AL
KB7JBL **Balasz**, Dean R., Sr., Washington, UT
vWA7JJW **Ferris**, Joseph L., Cornelius, OR
vW7KTO **Gaffney**, Thomas E., Jr., Mercer Island, WA
WA7KYM **Hansen**, Duane L., Florence, AZ
♦♦N7MB **Bill**, Michael, Bloomington, IL
KA7OJW **Wall**, Raymond L., Bountiful, UT
KJ7YY **Satterfield**, John E., Jr., Caldwell, ID
v♦W7ZVV **Spak**, Stephen G., Mercer Island, WA
N8ATZ **Russ**, Terry E., Massillon, OH
KB8BXI **Hance**, Mercedes M., Milford, OH
KB8CVR **Cornwell**, Richard L., Independence, WV
v♦KC8DKF **Bartz**, Joseph M., Jr., Wadsworth, OH
vW8DLZ **Jensen**, Kenneth A., Bay Village, OH
W8DRZ **Snell**, James A., Jr., Vermilion, OH
W8FWG **Turner**, George R., Laurium, MI
WA8GLS **Smith**, Gary L., Tiffin, OH
vN8HRY **Bernie**, William A., Dayton, OH
v♦W8INO **Gunderman**, Robert J., Hillsboro, OH
vKD8LH **Rush**, Clinton, Jr., Hamilton, OH
v♦W8MSK **Wittkoski**, Jerome V., Grand Rapids, MI
KC8MSN **Lones**, Wayne A., Loris, SC
v♦N8OQC **Eisenman**, Andrew F., Fairlawn, OH
N8OVV **Bak**, Vincent J., Cleveland, OH
v♦AE8P **Travis**, Jack R., Lancaster, OH
vW8PRG **Greenland**, Phillip R., Columbus, OH
v♦K8PSK **Easterling**, Glenn D., Coolville, OH
N8PXW **Korenz**, James F., Uniontown, OH
vW8QAJ **Roberts**, Lewis H., Akron, OH
v♦KC8QMH **Beauchamp**, Harold E., Jr., Essexville, MI
WA8RCK **Blausey**, Richard H., Willow Spring, NC
N8RN **Newman**, Roy T., Tipp City, OH
vK8RSU **Russell**, Michael E., Maumee, OH
vKB8TFO **White**, Larry R., Wayne, OH
KD8V **Amman**, Scott A., Milford, MI
♦W8YLN **Atkinson**, Kevin B., Roanoke, VA

KB8YSR **Baiker**, Robert A., New Philadelphia, OH
vKB8ZEQ **Gramer**, Danny D., Reed City, MI
v♦N9AUX **Bourque**, Adrian R., Wausau, WI
WD9BOB **Inboden**, Robert D., Mount Vernon, IL
vKB9BRV **Dittmer**, Ralph A., Mundelein, IL
W9CGZ **Finder**, Earl F., Urbana, IL
W9DXC **Miller**, Michael G., Marion, IN
KC9FQE **Nelson**, Walter "Kevin," Ottawa, IL
vK9GRO **Brook**, Alan "Jim," Normal, IL
vK9HBR **Vaerewyck**, Eugene G., Tarentum, PA
♦KF9JK **Fico**, John M., Auburndale, FL
KE9K **Cannova**, Joseph S., Freeport, IL
W9LIZ **Schroeder**, Christine, Watseka, IL
AA9LR **Parton**, Vernie N., Whiteland, IN
KB9OLL **Gruenwald**, James H., Joliet, IL
KB9OZR **Rust**, Ronald K., North Judson, IN
v♦KC9PMW **Bradbury**, Mark A., Greenwood, IN
♦♦KA9QPN **Ciciora**, Thomas T., Sandwich, IL
vKB9RPS **McCracken**, Charles S., Lebanon, IN
vWB9TOE **Cooper**, David L., Fernandina Beach, FL
♦WB9USA **Alexander**, C. Kurt, Yorktown, IN
WA9WBY **Richards**, Harold I., Princeton, IL
WB9WHI **Kleemann**, Bradford M., Madison, WI
WB9ZAA **Cook**, Fred W., Lincoln, IL
♦WA9ZJI **Goble**, David A., Aurora, IL
W0BBF **Bainey**, Brad H., Annandale, MN
vWA0COG **Combellick**, Glenn R., Littleton, CO
WA0EEG **Paige**, Robert E., Parker, CO
K0GVX **Pfeiffer**, G.W., Shakopee, MN
W0HIO **Dittmar**, George T., Lancaster, OH
vWA0HWZ **Peterson**, Vern H., Cottage Grove, MN
vAA0IQ **Harwood**, Claude J., Glasco, KS
W0JAW **Huston**, Richard N., Arvada, CO
KF0NSM **Noriega**, Alycia A., Topeka, KS
W0OG **Rosine**, Lawrence L., Leawood, KS
W0PCP **Kent**, William R., Winona, MN
KE0PGJ **Surig**, Rollin K., Las Cruces, NM
KB0RDL **Wilcox**, Laird M., Olathe, KS
vWA0TYS **Haake**, Timothy P., Saint Peters, MO
vN0TZG **Alexander**, James W., Minneapolis, MN
KA0UFI **Rumelhart**, Michael R., Vermillion, SD
W0ULU **Schmidt**, Fred W., Cottage Grove, MN
vW00W **Haines**, Richard L., La Crescent, MN
vWB0YLO **Kinzly**, Karl L., Aurora, CO
♦VE3DY **Grant**, Gordon A., Ottawa, ON, Canada

- ♦ Life Member, ARRL
- ♦♦ Current Diamond Club
- v Veteran
- Former call sign

For information on how to list a Silent Key in QST, please visit www.arrl.org/silent-key-submission-guidelines.

Note: Silent Key reports must confirm the death by one of the following means: a copy of a newspaper obituary notice, a copy of the death certificate, or a letter from the family lawyer or the executor. Please be sure to include the amateur's name, address, and call sign. Allow several months for the listing to appear in this column.

HAM RADIO OUTLET®

WWW.HAMRADIO.COM

See us at HAMCATION - Booths 024-028!



FTDX101MP | 200W HF/50MHz Transceiver

- Hybrid SDR Configuration • Unparalleled 70 dB Max. Attenuation VC-Tune • New Generation Scope Display 3DSS • ABI (Active Band Indicator) & MPVD (Multi-Purpose VFO Outer Dial) • PC Remote Control Software to Expand the Operating Range • Includes External Power With Matching Front Speaker



FT-710 Aess | HF/50MHz 100W SDR Transceiver

- Unmatched SDR Receiving Performance • Band Pass Filters Dedicated for the Amateur Bands • High Res 4.3-inch TFT Color Touch Display • AESS: Acoustic Enhanced Speaker System with SP-40 For High-Fidelity Audio • Built-in High Speed Auto Antenna Tuner



FTM-500DR | C4FM/FM 144/430MHz Dual Band Xcvr

- Front Firing Acoustically Enhanced Speaker System • True Dual Band Operation, C4FM/C4FM Digital D-D Dual Receive • 2.4" High-Resolution Full-Color Touch Panel Display • Built-in High Precision GPS Receiver • Wireless Operation Capability with Optional Bluetooth® Headset



FTDX10 | HF/50MHz 100 W SDR Transceiver

- Narrow Band and Direct Sampling SDR • Down Conversion, 9MHz IF Roofing Filters Produce Excellent Shape Factor • 5" Full-Color Touch Panel w/3D Spectrum Stream • High Speed Auto Antenna Tuner • Microphone Amplifier w/3-Stage Parametric Equalizer • Remote Operation w/optional LAN Unit (SCU-LAN10)



FT-891 | HF+50 MHz All Mode Mobile Transceiver

- Stable 100 Watt Output • 32-Bit IF DSP • Large Dot Matrix LCD Display with Quick Spectrum Scope • USB Port Allows Connection to a PC with a Single Cable • CAT Control, PTT/RTTY Control

FT-70DR C4FM/FM 144/430MHz Xcvr

- System Fusion Compatible • Large Front Speaker delivers 700 mW of Loud Audio Output • Automatic Mode Select detects C4FM or Fm Analog and Switches Accordingly • Huge 1,105 Channel Memory Capacity • External DC Jack for DC Supply and Battery Charging



FT-991A | HF/VHF/UHF All Mode Transceiver

- Real-time Spectrum Scope with Automatic Scope Control • Multi-color waterfall display • State of the art 32-bit Digital Signal Processing System • 3kHz Roofing Filter for enhanced performance • 3.5 Inch Full Color TFT USB Capable • Internal Automatic Antenna Tuner • High Accuracy TCXO

FT-5DR C4FM/FM 144/430 MHz Dual Band

- High-Res Full-Color Touch Screen TFT LCD Display • Easy Hands-Free Operation w/Built-In Bluetooth® Unit • Built-In High Precision GPS Antenna • 1200/9600bps APRS Data Communications • Supports Simultaneous C4FM Digital • Micro SD Card Slot



FTM-300DR | C4FM/FM 144/430MHz Dual Band

- 50W Output Power • Real Dual Band Operation • Full Color TFT Display • Band Scope • Built-in Bluetooth • WiRES-X Portable Digital Node/Fixed Node with HRI-200



FT-65R | 144/430 MHz Transceiver

- Compact Commercial Grade Rugged Design • Large Front Speaker Delivers 1W of Powerful Clear Audio • 5 Watts of Reliable RF Power Within a compact Body • 3.5-Hour Rapid Charger Included • Large White LED Flashlight, Alarm and Quick Home Channel Access



FTDX101D | HF + 6M Transceiver

- Narrow Band SDR & Direct Sampling SDR • Crystal Roofing Filters Phenomenal Multi-Signal Receiving Characteristics • Unparalleled - 70dB Maximum Attenuation VC-Tune • 15 Separate (HAM 10 + GEN 5) Powerful Band Pass Filters • New Generation Scope Displays 3-Dimensional Spectrum Stream



FT-2980R | Heavy-Duty 80W 2M FM Transceiver

- 80 watts of RF power • Large 6 digit backlit LCD display for excellent visibility • 200 memory channels for serious users



FTM-200DR | C4FM/FM 144/430MHz Dual Band

- 1200/9600bps APRS® Data Communications • 2" High-Res Full-Color TFT Display • High-Speed Band Scope • Advanced C4FM Digital Mode • Voice Recording Function for TX/RX



FTM-6000R | 50W VHF/UHF Mobile Transceiver

- All New User Operating Interface-E20-III (Easy to Operate-III) • Robust Speaker Delivers 3W of Clear, Crisp Receive Audio • Detachable Front Panel Can Be Mounted in Multiple Positions • Supports Optional Bluetooth® Wireless Operation Using the SSM-BT10 or a Commercially Available Bluetooth® Headset



- RETAIL LOCATIONS - Store hours 10:00AM - 5:30PM - Closed Sunday
- PHONE - Toll-free phone hours 9:30AM - 5:30PM
- ONLINE - WWW.HAMRADIO.COM
- FAX - All store locations
- MAIL - All store locations

YAESU
The radio

ANAHEIM, CA
(800) 854-6046

PORTLAND, OR
(800) 765-4267

PHOENIX, AZ
(800) 559-7388

MILWAUKEE, WI
(800) 558-0411

WOODBIDGE, VA
(800) 444-4799

WINTER SPRINGS, FL
(800) 327-1917

SACRAMENTO, CA
(877) 892-1745

DENVER, CO
(800) 444-9476

PLANO, TX
(877) 455-8750

NEW CASTLE, DE
(800) 644-4476

SALEM, NH
(800) 444-0047

ATLANTA, GA
(800) 444-7927

HAM RADIO OUTLET®

WWW.HAMRADIO.COM

Winter Springs, FL Sales Event - Feb. 8, 2024!



IC-9700 | All Mode Tri-Band Transceiver

• VHF/UHF/1.2GHz • Direct Sampling Now Enters the VHF/UHF Arena • 4.3" Touch Screen Color TFT LCD • Real-Time, High-Speed Spectrum Scope & Waterfall Display • Smooth Satellite Operation



IC-905 | VHF/UHF/SHF All Mode Portable

• GPS-Controlled Oscillator for Ultimate Frequency Stability • Separate Controller & RF Unit Configuration • Industry First 144 MHz to Microwave Transceiver • Wideband 50 MHz Span Real-time Spectrum Scope • Full D-STAR Functions



IC-V3500 | 144MHz FM Mobile

• 65W of Power for Long Range Communications • 4.5 Watts Loud & Clear Audio • Modern White Display & Simple Operation • Weather Channel Receive & Alert Function



IC-7851 | HF/50MHz Transceiver

• 1.2kHz "Optimum" roofing filter • New local oscillator design • Improved phase noise • Improved spectrum scope • Dual scope function • Enhanced mouse operation for spectrum scope



IC-705 | HF/50/144/430 MHz All Mode Transceiver

• RF Direct Sampling • Real-Time Spectrum Scope and Waterfall Display • Large Color Touch Screen • Supports QRP/QRPP • Bluetooth® and Wireless LAN Built-in



ID-50A | VHF/UHF D-STAR Portable

• High Visible LCD with Backlight Function • Find Nearby Repeaters with the Built-In GPS • Easy D-STAR Settings for Beginners • Voice Recorder Function • Share Pictures in DV Mode



IC-7300 | HF/50MHz Transceiver

• RF Direct Sampling System • New "IP+" Function • Class Leading RMDR and Phase Noise Characteristics • 15 Discrete Band-Pass Filters • Built-In Automatic Antenna Tuner



IC-7100 | All Mode Transceiver

• HF/50/144/430/440 MHz Multi-band, Multi-mode, IF DSP • D-STAR DV Mode (Digital Voice + Data) • Intuitive Touch Screen Interface • Built-in RTTY Functions

IC-V86 | VHF 7W HT

• 7W Output Power Plus New Antenna Provides 1.5 Times More Coverage • More Audio, 1500 mW Audio Output • IP54 & MIL-STD 810G—Rugged Design Against Dust & Water • 19 Hours of Long Lasting Battery Life • 200 Memory Channels, 1 Call Channel & 6 Scan Edges



IC-7610 | HF/50 MHz All Mode Transceiver

• Large 7-inch color display with high resolution real-time spectrum scope and waterfall • Independent direct sampling receivers capable of receiving two bands/two modes simultaneously



IC-2730A | VHF/UHF Dual Band Transceiver

• VHF/VHF, UHF/UHF simultaneous receive • 50 watts of output on VHF and UHF • Optional VS-3 Bluetooth® headset • Easy-to-See large white backlight LCD • Controller attachment to the main Unit



IC-T10 | Rugged 144/430 MHz Dual Band

• Disaster Ready - Excellent Fit for Your Emergency Bag • Loud Audio - New Speaker Design • Long Battery Life - Up to 11 Hours • FM Broadcast & Weather Channels



IC-R8600 | Wideband SDR Receiver

10 kHz to 3 GHz Super Wideband Coverage • Real-time Spectrum Scope w/Waterfall Function • Remote Control Function through IP Network or USB Cable • Decodes Digital Incl P25, NXDN™, D-STAR • SD Card Slot for Receiver Recorder



ID-5100 AD | VHF/UHF Dual Band Digital Transceiver

• Analog FM/D-Star DV Mode • SD Card Slot for Voice & Data Storage • 50W Output on VHF/UHF Bands • Integrated GPS Receiver • AM Airband Dualwatch

ID-52A | VHF/UHF D-STAR Portable

• Bluetooth® Communication • Simultaneous Reception in V/V, U/U, V/U and DV/DV • Enriched D-STAR® Features including the Terminal Mode/Access Point Mode • UHF (225~374.995MHz) Air Band Reception



- RETAIL LOCATIONS - Store hours 10:00AM - 5:30PM - Closed Sunday
- PHONE - Toll-free phone hours 9:30AM - 5:30PM
- ONLINE - WWW.HAMRADIO.COM
- FAX - All store locations
- MAIL - All store locations



FOLLOW HRO ON SOCIAL MEDIA



twitter.com/HamRadioOutlet
facebook.com/HROHamRadioOutlet
instagram.com/HamRadioOutlet
youtube.com/HamRadioOutlet

“No act of kindness, no matter how small, is ever wasted.”

- Aesop



rt SYSTEMS
RADIO PROGRAMMING MADE EASY
LaGrange, Georgia | 800-476-0719
www.rtsystems.com



MANUFACTURING FOR RADIO SINCE THE BEGINNING



- Racks & Cabinets, Shelves, Panels, Outlet Strips
- Small Cases & Project Boxes
- Transformers



RACKS & CABINETS



TRANSFORMERS



SMALL CASES

Technical Data, Drawings, List of Stocking Distributors:

www.hammondmfg.com



ARRL
The National Association for
Amateur Radio®

THANK YOU

for your ongoing support of amateur radio and ARRL. We look forward to serving you as a member of the ARRL community in 2024.

MFJ Power Supplies

World's Best and Largest Selection of Clean, NO RF Hash, no RFI power supplies are designed for ultra-reliable ham radio! High duty cycles on switchers for long Digital mode transmissions!

75-Amps, \$379⁹⁵

MFJ-4275MV high-current switching power supply gives 75A max/70A continuous. Great for ALS-500M amplifier. Adjustable output 4-16 VDC/ 110/220 VAC. Binding posts, quick connects, *PowerPoles*[®], cigarette lighter socket on front. Battery charger gives charging current of 20A max, 5A continuous. 9³/₄Wx5¹/₂Hx9¹/₂D". Only 10.5 lbs.

45-Amps, \$259⁹⁵

MFJ-4245MV Switching power supply gives 45A surge/40A continuous. 9-15 VDC out. 85-260 VAC in. Low ripple, highly regulated. 5-way posts, cigarette lighter, quick connects. 5 lbs., 7¹/₂Wx4³/₄Hx9D".

25-Amps, \$169⁹⁵

MFJ-4225MV Switching power supply gives 25A surge, 22A continuous. Adjustable 9-15 VDC output, 85-260 AC input. Large 3" dual Amp/Volt meters, binding posts, cigarette lighter socket. 3.7 lbs., 5¹/₂Wx4¹/₂Hx6D".

MFJ PowerPole[®] Splitters

MFJ-1104, \$59⁹⁵ *PowerPole*[®] Splitter, 30 Amp fused input, outputs fused at 25, 10, 5A. Open fuse indicator. 2³/₄Wx3¹/₄Hx1¹/₂D".

MFJ-1107, \$79⁹⁵ 40A fused binding posts input, 4 fused *PowerPole*[®] outputs, two 2.1 mm center positive power jacks.

MFJ-1106, \$74⁹⁵ One in, six out *PowerPoles*[®]. 30A total. 7 sets of mating connectors included.

\$159⁹⁵

30A, 4-16V Adjustable, *PowerPoles*[™], and binding posts, Volt/Amp Meter ...

Ham Radio's Best Seller!



MFJ-4230MV, \$149⁹⁵ Binding Posts on back.

MFJ-4230MPF, \$159⁹⁵ *PowerPoles*[®] on front of unit.

MFJ-4230DMP, \$189⁹⁵ Like MFJ-4230MVP but has bright orange digital Volt/Amp display.

MFJ-4230MVP is ham radio's best compact switching power supply -- just 5Wx2¹/₂Hx6D" and 3 lbs. Takes up little room on your operating position and perfect for home station, field day, DXpeditions, camping, hiking or for your next business trip or vacation. Gives 25A continuously or 30Amps surge at 13.8 VDC. Voltage is front panel adjustable 4-16 VDC. Selectable input voltage of 120 or 240 VAC at 47-63 Hz lets you carry it with you and use it worldwide. Front panel rocker switch lets you choose Amp/Volt meter for continuous monitoring. Cool operation with excellent 75% efficiency. Extra low ripple and noise is less than 100 mV. It's quiet! Continuous air flow gently cools the power supply and a heat sensor increases fan speed if the temperature rises above 70 degrees celsius. Over-voltage and over-current protection fully protects your transceiver and has ALARM LED. DC output is 5-way binding posts on front **and** *PowerPoles*[™] on back. Power your HF, VHF, UHF rig and accessories with ease.

25-Amps, \$129⁹⁵

MFJ-4125 gives 25A surge, 22A continuous. 13.8 VDC switcher. 5-way binding posts on front and quick connects on back. 3.5 lbs.

35-Amps, \$199⁹⁵

MFJ-4035MV 19.2 lb. transformer, 35A max, 30A continuous. 1-14 VDC out, 110 VAC in. Highly regulated, 1% load, 1 mV ripple. 5-way posts, cig lighter. 9¹/₂Wx6Hx9³/₄D".

28-Amps, \$129⁹⁵

MFJ-4128. 28A surge, 25A continuous. 13.8 VDC. AC input is 85-135/170-260 VAC. 5-way binding posts, cigarette socket.

25-Amps, \$139⁹⁵

MFJ-4125P. 25A surge, 22A cont. 13.8 VDC switcher. 2-pair *PowerPoles*[®], 5-way posts, quick connects. 3¹/₂ lbs.

15-Amps, \$99⁹⁵

MFJ-4115. 17A surge, 15A cont. 13.8 VDC. 110/ 220 VAC. 3³/₄Wx2¹/₄Hx7³/₄D", 1.5 lb. 5-way posts.

MFJ-4215MV, \$119.95.

Like MFJ-4115 but has backlit volt/amp meters.

MFJ High Current DC Multi-Outlet Strips

Power multiple transceivers/accessories from a single DC power supply

MFJ-1118, \$119⁹⁵ Power two HF and/or VHF rigs and six accessories from rig's 12 VDC supply. 35A high-current and 15A accessory binding posts, Voltmeter, on/off switch. Master fuse, RF bypass. 12¹/₂Wx2³/₄Hx2¹/₂D".

MFJ-1116, \$99⁹⁵ Like MFJ-1118 but 15A total, 8 pairs 5-ways. "On" LED, 0-25 VDC voltmeter.

MFJ-1112, \$79⁹⁵ Like MFJ-1116 but 6 pairs 5-way posts, no meter/switch. 12¹/₂Wx2³/₄Hx2¹/₂D".

MFJ-1117, \$94⁹⁵ High-current. Powers four HF/VHF radios simultaneously -- 2 at 35A each, 2 at 35A combined. 8Wx2Hx3D".

MFJ-1129, \$169⁹⁵ 10 outlets. Installed fuses: two 1A, three 5A, three 10A, two 25A, one 40A. Outlets 1, 2, 4-8 are *PowerPoles*[®]. Outlet 3 is a 35A high current post, outlet 9, 10 are 15A posts. Switch, voltmeter. 12¹/₂Wx1¹/₄Hx2¹/₂D".

MFJ-1128, \$159⁹⁵ 12 fused *PowerPoles*[®], three 1A, four 5A, four 10A, one 25A, one 40A. Switch, Meter.

MFJ-1126, \$129⁹⁵ 8 fused *PowerPoles*[®]: a 1A, three 5A, two 10A, one 25A, one 40A. Switch, Voltmeter. 9Wx1¹/₂Hx2³/₄D".

MFJ-1124, \$109⁹⁵ 4 pairs 35A *PowerPoles*[®], 2 pairs 35A high current posts.



MFJ Enterprises, Inc. 300 Industrial Pk Rd, Starkville, MS 39759
Phone: (662) 323-5869 • Tech Help: (662) 323-0549 • FAX: (662) 323-6551 8-4:30 CST, Mon.-Fri.

Add shipping. Prices and specifications subject to change. (c) 2024 MFJ Enterprises, Inc.

• 1 Year No Matter What[™] warranty • 30 day money back guarantee (less s/h) on orders direct from MFJ





GREEN HERON ENGINEERING LLC

RT-21 DIGITAL ROTATOR CONTROLLERS

Unmatched Performance for any Rotator



RT-21 Rotator Packages

- RT-21 with Yaesu & M2 Orion Rotators

RT-21 internal Wi-Fi Option

- Control your rotator from ANYWHERE using a web browser

WIRELESS NETWORK CONTROLS

- Internet access for switches and rotators
- Eliminate cables and tethered control boxes
- Create customized on-screen controls
- Great circle maps



GH Everywhere Base and Remote



- USB and wireless relay controls
- Options: outdoor enclosures and external antennas

Select-8 Wireless Remote Coax Switch

- Built-in GHE Wireless
- Powered through the coax
- Tower leg Mount
- Amphenol RF connectors



www.greenheronengineering.com

(855) 217-9093

Propagation Know-How

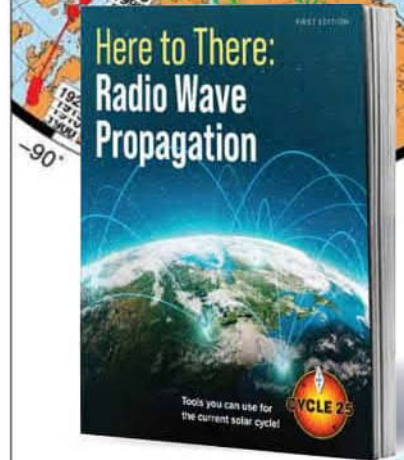

Learn more about what's going on in the ionosphere and how it impacts operating. Understanding conditions and how to predict them will improve your time on the air.

Topics Include:

- Fundamentals of Radio Wave Propagation
- The Sun and Solar Activity
- Sky-Wave, or Ionospheric, Propagation
- VHF and UHF Non-ionospheric Propagation
- Propagation Predictions for HF Operation
- VHF and UHF Mobile Propagation

Here to There:
Radio Wave Propagation
Item No. 1731 | Retail \$22.95
Member Price \$19.95

www.arrl.org/shop



ARRL
The National Association for
Amateur Radio®

Morse Made Easy™

MMX Transceiver 80/40/20
DMX-40 Transceiver

- Decodes beneath the noise floor
- Keyboard to keyboard texting
- Operational simplicity
- Low power



Look for us at
HamCation
February 9th-11th
Booth 63/64

PreppComm
Amateur Radio
www.PreppComm.com

Air Boss Antenna Launcher

www.olaotechnologies.com

See Video



Tactical Radio Carrier



- Protect
- Package
- Deploy
- Stackable

www.tac-comm.com



EAGLE ONE
ANTENNA, LLC

Multi-Band Vertical HF Antenna

- Operate 80-6 meters with a tuner
- Easy and quick assembly
- Collapsed length of 4 feet:
- Extended length of 31 feet
- Will handle full legal power
- Many accessories available

www.eagleoneantenna.com



Got Noise?! MFJ has answers

Noise-Cancellers Wipe Out Interference

Null out all types of noise!!! Severe

power line noise from arcing transformers and insulators, fluorescent lamps, dimmers, touch controlled lamps, computers, TV birdies, lightning, garage door openers, electric drills, motors, industrial processes. It's much more effective than a noise blanker because interference much stronger than a desired signal can be completely removed without affecting the desired signal. All modes -- SSB, AM, CW, FM, frequencies from BCB to lower VHF.

Null out strong QRM on top of weak rare DX! Null out a strong local ham or AM broadcast station to prevent your



expensive receiver from overloading.

Use as an adjustable phasing network. Combine two antennas to give you a powerful receive station and have a

MFJ-1026
\$259⁹⁵

variety of directional patterns. MFJ-1026 simply plugs between

your transmitting antenna and your transceiver. To null, you adjust the amplitude and phase potentiometer controls for a minimum S-meter reading or low noise. To peak, push reverse.

Use built-in active or external antenna. *Constant Amplitude Phase Control™* makes nulling super easy -- snag that rare DX you have missed.

RF-sense T/R switch auto bypasses your rig when you transmit. Adjustable T/R delay time. Use 12 VDC or 110 VAC with MFJ-1312D, \$19.95. 6½X1½X6¼ inches.

MFJ-1025, \$239.95. Like MFJ-1026, less the built-in active antenna. Use external antenna connection.

MFJ Ultrasonic Receiver with parabolic reflector pinpoints power line noise

HF and VHF operation can be affected by noise, makes it hard to hear weak stations, adds to fatigue. Often, noise comes from power lines. Power companies are willing to help with issues, but don't have equipment or trained personnel to locate it. MFJ aids in finding noise generated by corona discharge and arcing components. Acoustic receiver is tuned to 40 KHz. 18" diameter plastic dish gives a narrow beamwidth to pinpoint noise sources less than 12" at 50 feet. Also listen to nature: bats, birds, and insects!



MFJ-5008
\$219⁹⁵

MFJ Power Line Noise Finder

Walk or drive around with these handheld power line noise meters to search out leaky insulators, loose hardware and corroded ground lines quickly. Track noise right down to the pole, transformer or insulator, or other source. Operates in 135 MHz region where activity in minimum and radiation from corona/arcing is more localized. 0.3 uV sensitivity and wide-range AGC for noise level meter -- over 70 dB!

MFJ-852
\$159⁹⁵

MFJ-1767, \$99.95. Adds 3-element beam to MFJ-852.

MFJ-856, \$209.95. Combination of MFJ-852 noise finder and MFJ-1767 three-element beam antenna.

MFJ Low-Noise Receiving Mag Loop

Clearly hear signals 50 KHz to 30 MHz you never knew existed. Power line noise and static disappears. Rotating the MFJ-1886 eliminates interfering signals or greatly peaks desired signals. Excellent antenna and preamplifier balance gives deep null. Gives excellent strong and weak signal performance without overload. Fully protected state-of-the-art push-pull Gali MMICs preamplifier gives high dynamic range, low IMD and 25 dB of low noise gain. Use inside or outside.



MFJ-1886
\$329⁹⁵

Receive Loop with Biastee

Reduce Harmonics, Avoid TVI with MFJ Low Pass Filters

Suppress TVI, RFI, telephone, other interference by reducing unwanted harmonics to your antenna. Your HF signal still passes through with low loss so you snag that rare DX! *Keep the wife and neighbors happy!*

MFJ-702B, \$54.95. 200W. SWR below 1.5 to 30 MHz.
MFJ-704, \$119.95. 1500W. SWR below 1.3 to 30 MHz.
MFJ-705, \$219.95. 2500W. SWR below 1.3 to 30 MHz.



MFJ Clamp-on RF Ammeters

Clamp-On RF Ammeters quickly snap over wires and cables to measure RF currents flowing in antenna elements, radials, ground wires and on outside of coax. Tune counterpoises, radials, ground systems. Study/optimize antennas for peak performance. Find peaks/nulls. MFJ-854 has five calibrated ranges to 3 Amperes, including sensitive 30 mA range. MFJ-853, \$79.95. Like MFJ-854, Ranges: 0.3, 1, 3 A. Mini size. MFJ-853H, \$89.95. 3/10/30 A ranges. MFJ-805, \$129.95. Check RFI on cables up to 1/4" dia. VLF to VHF.

MFJ-854
\$159⁹⁵



MFJ AC Line Filter/Protector

Filters and reduces AC power line RFI, hash, noise, transients, surges generated by computers, motors, RF transmitters, static/lightning by 30 db and up to 60-80 dB with ground. Fast, nano-second overvoltage protection. Provides inductive isolation, capacitive decoupling, RFI rejection, overvoltage protection of common mode, differential signals. Rejects/shunts undesired signals to ground. 12Wx3½Hx2D".



MFJ-1164B
\$134⁹⁵

Ferrite RFI Suppression Chokes

MFJ-700A4, \$19.95. .275" diameter 4-Pack
MFJ-700B4, \$19.95. .402" diameter. 4-Pack
MFJ-700C4, \$34.95. .528" diameter 4-Pack
MFJ-700D4, \$39.95. .750" diameter 4-Pack



MFJ Enterprises, Inc. 300 Industrial Pk Rd, Starkville, MS 39759
Phone: (662) 323-5869 • Tech Help: (662) 323-0549 • FAX: (662) 323-6551 8-4:30 CST, Mon.-Fri.

Add shipping. Prices and specifications subject to change. (c) 2024 MFJ Enterprises, Inc.

• 1 Year No Matter What™ warranty • 30 day money back guarantee (less s/h) on orders direct from MFJ



Looking for...
 Customized cable
 assemblies?
 Unique colors?
 Personalized
 marker labeling?



We have everything you need.

713-492-2722
 info@abrind.com
 abrind.com



HANDBOOK 100

**Hardcover
Collector's Edition**



The commemorative **collector's edition** of **Handbook 100** is strikingly hardbound in a textured black finish with silver foil embossing.

It includes a special insert looking back across decades of content that built *The Handbook's* reputation as a "must-have" reference for the radio experimenter.



ARRL Item No. 1571
 Retail \$79.95

handbook.arrl.org

ADVANCED SPECIALTIES INC.

YAESU
The radio

www.advancedspecialties.net

BIG ONLINE CATALOG



VX-6R
Triband
Submersible
Hand Held



FTM-300DR
Dual-Band Digital

AMATEUR RADIO EQUIPMENT &
 ACCESSORIES · SCANNERS
 ANLI · COMET · UNIDEN · YAESU

(201)-VHF-2067

114 Essex Street, Lodi, NJ 07644

Closed Sunday & Monday

Starlink® RV Pole Kits

Plus Antenna Masts and Mounts for ECOM
 Great for wire antennas!

Made in
 America!



Hitched4fun.com

Fun and affordable kits from Pacific Antenna



Tracer Injector



Tenna Dipper II



Micro Attenuator



Mini SWR Indicator

See our selection of quality
 Kits starting at \$5

www.qrpkits.com

W5SWL Electronics

Premium Quality RF Connectors Order Direct!

Wide Selection of Connectors

- UHF & N
- BNC & SMA
- Mini-UHF & FME
- TNC & C
- MC MCX & MMCX
- QMA SMB & SMC
- DIN & Low PIM
- Reverse Polarity
- RF Adapters
- Bulkheads

And Much More!

- Dave's Hobby Shop by W5SWL
- Ham Radio Gadgets
- RF & Technical Parts
- New & Surplus Materials

Order at www.W5SWL.com

Ships Fast From The Arkansas River Valley

MFJ . . .the World Leader in Ham Radio Accessories!

MFJ Dummy Loads & SWR/Wattmeters

Dummy Loads

World's most popular Dry 300 Watt HF /VHF Dummy Load

Air-cooled, non-inductive resistor in a perforated metal housing; Has SO-239 connector. Full 300W for 30 seconds. Derating curve to 5 minutes. SWR below 1.1:1 to 30 MHz, 1.5:1 to 650 MHz. Compact 2¹/₄x2¹/₄x7 inches. MFJ-260CN, \$79.95. With type "N" connector.



MFJ-260C
\$69⁹⁵

Dry 1.5 kW HF/VHF/UHF Dummy Load

Ham radio's most versatile 1.5 kW 50 ohm dry dummy load covers DC to 650 MHz. SWR 1.1:1 to 30 MHz, 1.3:1 to 650 MHz. Handles 1500W for ten seconds, 100W for 10 minutes. 3Wx3Hx9D in. SO-239 connector. MFJ-264N, \$139.95. With type "N" connector.



MFJ-264
\$129⁹⁵

Oil-Cooled 1 kW CW, 2 kW SSB 50-Ohm VersaLoad™

Run 1KW CW or 2 KW PEP for 10 minutes. Run continuous duty with 200 Watts CW or 400W PEP. Transformer oil included. SWR 1.2:1 to 30 MHz. Low SWR to 400 MHz. SO-239 connector. Safety vent with cap, carrying handle. 7¹/₂Hx6⁵/₈D in. MFJ-250X, \$79.95. No transformer oil.



MFJ-250
\$119⁹⁵

500 MHz, 100 Watt Dummy Load

Connects directly with built-in PL-259. Finned aluminum air-cooled heatsink. 15 Watts continuous, 100W peak. SWR < 1.5:1, DC-500 MHz. 1⁵/₈ inch round by 3 inches long. MFJ-262B, \$79.95. PL-259. 35 Watts continuous, 200W for 5-seconds. SWR < 1.2:1 DC-1 GHz.



MFJ-261
\$39⁹⁵
With PL-259
DC to 500 MHz

MFJ 2500W fan-cooled Dry Load

MFJ's 2500 Watt fan cooled load handles legal limit amps, 2500W average one minute on, ten minutes off, 300W continuous. DC- 6 Meters. SWR <1.25, 30 MHz; <1.4, 30-60 MHz. Detailed power curve. 12 VDC or 110 VAC. 8¹/₄Wx4Hx 9¹/₂D in. SO-239s. 5 pounds.



MFJ-265
\$299⁹⁵

Switchable RF Dummy Load

Select 16.6, 25, 50, 100, 150 Ohm dummy loads. Test/calibrate your wattmeters, SWR accuracy. At 50 Ohms it handles 300 Watts for 30 seconds with SWR < 1.1, 60 MHz. SO-239. 4¹/₂Wx2¹/₄Hx6¹/₂D in. Optional 12 VDC/110 VAC adaptor, MFJ-1312D, \$24.95.



MFJ-251
\$209⁹⁵

3 GHz, 300 Watts Dry Dummy Load

New high-tech metal film resistor on large heavy-duty air-cooled heatsink. 300 Watts for ten seconds and 125W continuously. SWR < 1.1, 1 GHz; <1.2, 1.5 GHz; <1.5, 3 GHz. N-connector. 10³/₄Wx2¹/₄Hx5¹/₄D inches.



MFJ-263
\$169⁹⁵

1.5kW Dry Dummy Load/SWR/Wattmeter

Tune up your transceiver, linear amplifier or antenna tuner into a safe 50 Ohm dummy load at full power. Then instantly switch to your antenna and monitor SWR, forward and reflected power on lighted cross-needle meter. 300/3000 Watt ranges. DC-60 MHz. Test/tune Xceivers, amps, tuners, baluns, filters, coax, stubs.



MFJ-267
\$239⁹⁵

SWR/Wattmeters

Compact Cross-Needle SWR/Wattmeters

Large 3-inch lighted Cross-Needle meter covers 1.8-200 MHz in 30/300W power ranges. Read forward, reflected power, SWR simultaneously. 3¹/₄Wx3¹/₄H x3¹/₄D in. SO-239 connectors. MFJ-842, \$79.95. 140-525 MHz, 15/150W.



MFJ-822
\$79⁹⁵

High-accuracy 1.8-60 MHz Digital SWR/Wattmeter

Highly accurate! Auto-ranging select 25W, 250W, 1500W ranges with full 10-bit resolution. Frequency compensated data insures highest accuracy. True peak/average forward/reflected power, SWR and frequency are simultaneously displayed on backlit LCD and large 3-inch lighted cross needle meter. Peak hold. LED, buzzer, amplifier-bypass alerts and protects your amplifier when SWR is high and toggles extra relay. 6¹/₂Wx2⁵/₈Hx6D". MFJ-826B, \$239.95. No meter, ampr bypass, control relay.



MFJ-828
\$299⁹⁵

MFJ GrandMaster™ SWR/Wattmeters

GrandMaster™ SWR/Power Meters are the Cadillacs of ham radio! Large 3¹/₄x1¹/₄ inch precision illuminated meter gives easy wide-angle viewing of SWR, forward or reflected power. 7¹/₂Wx3³/₈Hx4¹/₄D in. SO-239s. MFJ-870, \$119.95. 1.6-60 MHz. 30/300/3000 Watt ranges. MFJ-874, \$179.95. 1.8-525 MHz. 5/20/200 Watt ranges.



MFJ-870
\$119⁹⁵

MFJ giant 6.5 inch SWR/Wattmeter

World's largest HF+6M SWR/Wattmeter has giant 6¹/₂ inch meter! Extra-long scales gives highly accurate SWR/power 1.8-54 MHz. Huge numbers make reading easy. True peak or average forward and reflected power. 20/200/2000 Watt ranges. 9 Volt battery, 12 VDC or 110 VAC with MFJ-1312D, \$34.95. 7Wx5¹/₂Hx5D in. SO-239s.



MFJ-868B
\$199⁹⁵

VHF SWR/Wattmeter plus Field Strength

World's most popular -- and most affordable -- VHF SWR/Wattmeter. Read SWR, forward and reflected power over 144-220 MHz in two ranges, 30/300W. Built-in field strength meter for 1-220 MHz. 4¹/₂Wx2¹/₄Hx3D".



MFJ-812B
\$59⁹⁵

Compact Digital SWR/Wattmeters

Displays forward, reflected power, SWR (1.6-60 MHz) and battery all in a single glance! Large 1/2" forward power digits and 5/8" reflected/SWR digits! 0-200W. Power/backlight on/off. SO-239s. MFJ-847, \$139.95. 125-525 MHz, 0-120W. MFJ-849, \$229.95. Large 3.5" bright orange LCD displays SWR, forward/reflected power. 1.5-525 MHz, 200W, HF/VHF-UHF switch.



MFJ-845
\$139⁹⁵

MFJ HF QRP SWR/Wattmeter

Read forward, reflected power 1.8-50 MHz, 0-5W. Also reads SWR, relative power 100 mW to 50W. SO-239s. 4¹/₂Wx 2¹/₄H x3D".



MFJ-813
\$59⁹⁵

VHF/UHF SWR/Wattmeter

Lighted Cross-Needle, SWR/Watts, 144/220/440 MHz, 30/300W Forward power, 6/60W Reflected power.



MFJ-862
\$99⁹⁵



MFJ Enterprises, Inc. 300 Industrial Pk Rd, Starkville, MS 39759
Phone: (662) 323-5869 • Tech Help: (662) 323-0549 • FAX: (662) 323-6551 8-4:30 CST, Mon.-Fri.

Add shipping. Prices and specifications subject to change. (c) 2024 MFJ Enterprises, Inc.

• 1 Year No Matter What™ warranty • 30 day money back guarantee (less s/t) on orders direct from MFJ



ANC-4+ Now Shipping!

- Ham Radio Outlet www.hamradio.com
- R&L Electronics www.randl.com
- Japan Communication www.jacom.com
- Radio Parts Japan www.radio-part.com

***NEW! ANC-4+**



ANC-4+ Antenna Noise Canceller

The familiar, rugged ANC-4 now with:

- External TX/RX control - great for QRP operation
- Continuously Adjustable TX hang time
- Noise amp front end protection
- TX LED indicator
- SMT construction w/ gold-plated PCB
- Heavy steel laser-cut housing for precise tuning and mechanical stability

Kill Noise before it reaches your receiver!
Great for suppressing power line noise, plasma TV noise & many other local electrical noises.



Navigator

The Premier Sound Card Modem!

See *QST Short Takes Review - May 2014-P. 62*

- Quiet - hear what others miss!
- Proven USB Sound Card built-in
- Precise FSK
- Genuine K1EL Winkeyer CW IC
- Complete - Six FTDI COM ports
- Universal Rig Control for every radio
- Works well with HRD, M110A, Fldigi, FT8 & many more software programs
- Front-Panel Audio & CW controls
- USB connected and powered
- Convenient - No annoying jumpers!



PK-232SC+

Multimode Data Controller*

- RTTY
- Packet
- Pactor
- CW
- PSK31 & all the Sound Card modes!

**Upgrade any PK-232 to the PK-232SC with New Lower Combo Pricing for SC & DSP Upgrade!*

Customize your PK-232 installation with our complete line of upgrades, accessories and cables.

100,000 sold - All-time top selling data controller!

- Single USB connection to computer
- USB Sound Card built-in
- 3-Way Rig Control built-in - logic level, RS-232 & USB!
- Computer isolated from radio
- Real FSK & AFSK
- keyboard CW - send and receive
- Dual Port - two radios at same time!

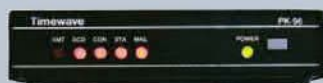

PK-96/100 USB Packet TNC

1200/9600 bps AX.25 Packet
Available with USB or RS-232 connection

- HamLinkUSB™ USB-to-RS-232 Adapter
Proven FTDI Chip. 9 and 25 pins for all radios, TNCs, Rotor Controllers & more!

- HamLinkUSB™ Rig Control+
C-IV, CAT, RTS (PTT, FSK or CW) for sound card software
Perfect for HRD owners with simple sound card adapters

MFJ

G5RV Antennas

Operate all bands 10 thru 160 Meters with a single wire antenna!



MFJ-1778 The famous G5RV antenna is the most popular ham radio antenna in the world! It's an efficient, all band 102 foot long antenna --

shorter than an 80 Meter dipole. Has 32.5 foot ladder line matching section ending in

SO-239 connector for your coax feedline.

Use horizontally or as Inverted Vee or Sloper with just one support. 1500 Watts.

Operate all bands 80-10 Meters with an antenna tuner and even 160M with ground.

Fully assembled with ceramic end and fiberglass center insulators. *Hang and Play™* -- add coax, rope to hang and you're on air!

MFJ-1778M, \$79.95. Half-size, 52 foot G5RV JUNIOR for limited space. 40-10 Meters with tuner. Full 1500 Watts.

MFJ All Band Classic Doublet

MFJ 102 foot all band doublet covers 160-6 Meters with balanced line tuner. Super strong custom fiberglass center insulator relieves stress on 100 foot ladder line. Glazed ceramic end insulators. 1500 Watts.



MFJ-1777 \$129.95

RF Isolator



MFJ-915 RF Isolator prevents unwanted RF from traveling on the outside of your coax shield into your transceiver. This unwanted RF can cause painful RF "bites" when you touch your microphone or volume control, cause your display or settings to go crazy, lock up your transceiver or turn off your power supply. In mobile installations, stray RF could cause your car to do funny things even blow your car computer. Clear up these problems, plug an MFJ-915 between your antenna and transceiver. 1.8-30 MHz, 1500 Watts. 5x2 inches.

MFJ-919, \$84.95. 4:1 current balun, 1.5 kW. **MFJ-913, \$49.95.** 4:1 balun, 300 Watts.

True 1:1 Current Balun & Center Insulator



MFJ-918 True 1:1 Current Balun/Center Insulator forces equal radiator currents in dipoles for true dipole radiation pattern. Reduces coax radiation and field pattern distortion -- your signal goes where you want it. Reduces TVI, RFI and RF hot spots. *Don't build a dipole without one!* 50 hi-permeability ferrite beads on high quality RG-303 Teflon™ coax and Teflon™ SO-239. 1.5kW 1.8-30 MHz. Stainless steel hardware. 14 gauge stranded copper wire is directly connected to your antenna. 5x2 inches. Heavy duty weather housing.

2-Position Antenna Switch

MFJ-1702C, \$69.95. 2-position antenna switch, lightning surge protection, center ground. SO-239s.

Lightning surge protectors. MFJ-270, \$27.95. 400W. **MFJ-272, \$37.95.** 1500 W. Gas discharge tube shunts 5000 amps peak. < 0.1 dB loss. 1 GHz. SO-239s.

MFJ-16C06, \$9.95. 6-pack glazed ceramic end/center ant. insulators.

MFJ-16B01, \$24.95. Molded high-strength center insulator. SO-239.

MFJ-16D01, \$9.95. 450 Ohm fiberglass end/center insulator with ladder line stress relief and SO-239 mount.

MFJ-18H100, \$69.95. 100 feet, 450 Ohm ladder line, 18 gauge copper clad.

80-10 Meter End-Fed Half Wave antenna

Cover all HF bands with one single wire and no tuner!



MFJ-1982HP, \$129.95

No tuner needed!

All band 80-10M EFHW antenna

Get-on-the air on all bands 80-10 Meters with just one wire and one support (pole or tree) and no tuner or long counterpoise.

Installs anywhere in minutes! Rugged insulated-wire radiator prevents detuning when contacting limbs/branches. "No-snag" end insulator slides over branches, leaves.

Toss over a high limb for inverted-V or sloper or go vertical with an inverted-L.

Dark jacketed wire is virtually invisible -- *don't let antenna restrictions keep you off the air!* Great for emergencies.

EFHWs naturally resonate on the 1/2-wave fundamental frequency and odd/even harmonics. Covers 80/40/30/20/17/15/12/10 Meters without traps, stubs or resonators.

Broad-band matching transformer at feed point gives SWR so low you may

never need a tuner. Compensating inductor optimizes SWR. 800 Watts SSB/CW. 132 feet jacketed antenna wire.

More 80-10 Meter Models

MFJ-1982MP, \$99.95. Like MFJ-1982HP but handles 300 Watts.

MFJ-1982LP, \$89.95. Like MFJ-1982MP but handles 30 Watts.

EFHW 40-Meter Models

MFJ-1984HP, \$109.95. Like MFJ-1982HP but 40-10M. 66 feet jacketed wire.

MFJ-1984MP, \$89.95. Like MFJ-1982HP, but handles 300 Watts.

MFJ-1984LP, \$79.95. Like MFJ-1982MP, but handles 30 Watts.

Dual Band Dipoles



MFJ-17758
\$129.95
80/40 Meters

MFJ-17758, \$129.95. Operate 80/40 Meters with a short 85 foot dipole. Full-size on 40 Meters

with ultra-efficient end-loading on 80 Meters. 1500 Watts. Super-strong custom molded center insulator with SO-239 connector and hang hole. Ceramic end insulators. 7-strand, 14 gauge hard copper wire. *No tuner needed!*

MFJ-17754, \$89.95. Like MFJ-17758 but is only 42 feet. Operate 40/20 Meters. Full-size on 20 Meters, ultra-efficient end-loading on 40 Meters. 1500 Watts.

Single Band Dipoles



MFJ-1779A
\$99.95
160M, 265 ft.

MFJ-1779B
\$79.95
80-40M, 135 ft.

MFJ-1779C
\$59.95
20-6M, 35 ft.

Ultra high quality center fed dipoles give years of trouble-free service.

Custom injection-molded UV-resistant center insulator has built-in SO-239 and hanging hole. Glazed ceramic end insulators. 7-strand, 14-gauge hard copper antenna wire. 1500 Watts. Use horizontally or as sloper or inverted vee. Simply cut to length with provided cutting chart.

OCFD Dipoles



MFJ-2012
\$109.95
1500 Watts

MFJ-2010
\$89.95
300Watts

No tuner needed! MFJ

Off-Center Fed Dipoles use MFJ's exclusive *ExactRatio™* RF broadband transformer to give low SWR and maximum bandwidth on 40/20/10/6 Meters. A Guanella current balun kills feedline radiation, pattern distortion, SWR shifts, RFI and noise pickup. Install anywhere and get the same predictable performance regardless of feedline length. You get ground reinforced gain over verticals. Use horizontally, inverted vee, sloper. 98% efficient, 14 gauge, 7-strand copper wire, ceramic end insulators.

MFJ

MFJ Enterprises, Inc. 300 Industrial Pk Rd, Starkville, MS 39759

Phone: (662) 323-5869 • Tech Help: (662) 323-0549 • FAX: (662) 323-6551 8-4:30 CST, Mon.-Fri.

Add shipping. Prices and specifications subject to change. (c) 2024 MFJ Enterprises, Inc.

• 1 Year No Matter What™ warranty • 30 day money back guarantee (less s/h) on orders direct from MFJ



MFJ Weather-Proof Window Feedthrough Panels

Weather-proof window feedthrough panels bring HF/VHF/UHF antennas, balanced lines, random wire antennas, ground, DC/AC power and Rotator/Antenna Switch Cables into your ham shack without drilling through walls!



Inside View



Outside View

MFJ Weather-Proof Window Feedthrough Panels mount in your window sill. Lets you bring all your antenna connections into your ham shack without drilling holes through walls.

Simply place in window sill and close window. One cut customizes it for any window up to 48 inches. Use horizontal or vertical. Connectors are mounted on inside/outside stainless steel plates and attached to a 4 ft. long, 3 1/2" high, 3/4" thick pressure-treated wood panel.

Real Western Red Cedar wood is naturally resistant to rot, decay and insects -- lasts longer, maintenance free. Pitch and resin free for a wide range of beautiful finishes or leave it in its naturally beautiful raw finish. Edges sealed by weather-stripping. Seals and insulates against all weather conditions. Includes window locking rod.

Inside/outside stainless steel plates ground all coax shields. Stainless steel ground post brings ground in.



MFJ-4603
\$129.95

MFJ-4603 Universal Window Feedthrough Panel

Four 50 Ohm Teflon[®] SO-239 coax connectors let you feed HF/VHF/UHF antennas at full legal power limit.

A 50 Ohm Teflon[®] coax N-connector lets you use any antenna up to 11 GHz including 450 MHz, UHF, satellite, moon bounce and 2.4/5.8 GHz Wi-Fi antennas.

A 75 Ohm, 1 GHz F-connector makes it easy to bring in television, satellite, HFD cable TV and FM radio signals.

A pair of high-voltage ceramic feedthrough insulators lets you bring in 450/300 Ohm balanced lines directly to your antenna tuner.

Has random/longwire antenna ceramic feedthrough insulator.

5-way binding posts let you supply 50 Volts/15 Amps DC/AC power to your outside antenna tuners/relays/switches.

Stainless ground post brings in ground connection, bonds inside/outside stainless steel panels together and drains away static charges.

MFJ's exclusive Adaptive Cable Feedthru[™] lets you bring in rotator/antenna switch cable, etc. without removing connectors (up to 1 1/4 x 1 5/8 in.) Adapts to virtually any cable size. Seals out rain, snow, adverse weather.



3 Coax, Balanced Line, Random Wire

Best Seller! 3 Teflon[®] coax connectors for HF/VHF/UHF antennas. Separate high voltage ceramic feed-thru insulators for balanced lines and long wire/random wire. Stainless steel ground post.



MFJ-4601
\$89.95

4 Balanced Line, 2 Coax

4 pairs of high-voltage ceramic feed-thru insulators for balanced lines and 2 coax connectors.



MFJ-4600
\$124.95

5 Cables, any-size

5 Adaptive Cable Feedthrus[™]. Pass any cable with connector: 2 cables with large connectors up to 1 1/4 x 1 5/8 inches and 3 cables with UHF/N size coax connectors. Seals out weather.

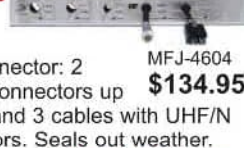

MFJ-4604
\$134.95

All-Purpose FeedThru/CableThru[™]

Stacks MFJ-4603 and MFJ-4604! Gives you every possible cable connection you'll ever need through your window without drilling holes in wall -- including UHF, N and F coax connectors, balanced lines, random wire, ground, DC/AC power and cables of any size for rotators, antenna switches, etc.



MFJ-4605
\$199.95

6 Coax

6 high quality Teflon[®] coax connectors for HF/VHF/UHF antennas. Stainless steel ground post. Full 1500 Watts.



MFJ-4602
\$104.95

Bring cables thru eave of your house



MFJ-4616 shown with vent (not included) it replaces. Six Holes
\$49.95



MFJ-4613 shown with vent (not included) it replaces. Three Holes
\$34.95



Replace standard house eave/soffit air vents with these MFJ AdaptiveCable[™] Plates.

Bring in coax, rotator, antenna switch, power cables, etc. of nearly any size up to 1 1/4 x 1 5/8".

Sliding plates, rubber grommets adjust for virtually any cable size to seal out adverse weather, insects and varmints. Use existing vent hole, mounting screws and screw holes.

MFJ AdaptiveCable[™] Wall Plates



MFJ-4614 (Four Holes)
\$79.95



6.95Wx6H[™]
MFJ-4612 (Two Holes)
\$49.95

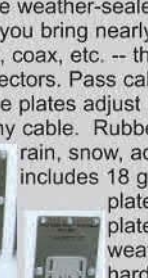

MFJ-4611 (Single Hole)
\$34.95

MFJ's exclusive weather-sealed AdaptiveCable[™] Wall Plates let you bring nearly any cable -- rotator, antenna switch, coax, etc. -- through walls without removing connectors. Pass cable connectors up to 1 1/4 x 1 5/8". Slide plates adjust hole size to weather-seal virtually any cable. Rubber grommet seals out rain, snow, adverse weather. Kit includes 18 gauge stainless steel plates for wall side, sliding plates, rubber grommets, weather stripping and hardware. Models for one, two and four cables.



MFJ Enterprises, Inc. 300 Industrial Pk Rd, Starkville, MS 39759

Phone: (662) 323-5869 • Tech Help: (662) 323-0549 • FAX: (662) 323-6551 8-4:30 CST, Mon.-Fri.

Add shipping. Prices and specifications subject to change. (c) 2024 MFJ Enterprises, Inc.

• 1 Year No Matter What[™] warranty • 30 day money back guarantee (less s/h) on orders direct from MFJ





"Best thing since sliced bread!"

More hams use MFJ analyzers than all others in the world!

MFJ-259D . . . World's Most Popular Antenna Analyzer!



MFJ-259D **New and improved, now covers 280 KHz-230 MHz!**
\$349⁹⁵

World famous MFJ-259D gives you a complete picture of your antenna's SWR and Complex Impedance.

MFJ-259D is a complete ham radio test station including frequency counter, RF signal generator, **SWR Analyzer™**, RF Resistance/Reactance Analyzer, Coax Analyzer, Capacitance/Inductance Meter and more!

Read Complex Impedance as series resistance and reactance (R+jX) or as magnitude (Z) and phase

(degrees).

Determine velocity factor, coax cable loss in dB, length of coax and distance to short/open.

Read SWR, return loss and reflection coefficient at any frequency simultaneously.

Read inductance (uH) and capacitance (pF) at RF frequencies.

Large easy-to-read two line LCD screen and side-by-side meters clearly display your information.

Built-in frequency counter, Ni-MH/Ni-CD charger circuit, battery saver, low battery warning, smooth reduction

drive tuning.

Super easy-to-use! Just set the bandswitch and tune the dial -- just like your transceiver. SWR, Complex impedance displayed instantly!

Fully portable, take it anywhere -- remote sites, up towers, on DX-peditions. Use 10 AA or Ni-Cad or Ni-MH batteries (not included) or 110 VAC with MFJ-1312D, \$19.95. Rugged metal cabinet, 4x2x6^{3/4}".

MFJ-249D, \$329.95.

MFJ-249D does everything MFJ-259D does with digital display only.



MFJ-269D . . . 280 KHz - 230 MHz plus 415-470 MHz, 12-bit A/D

New and improved. Now covers 280 KHz to 230 MHz and 415 to 470 MHz and 2200 Meter band!

Instantly gives you a complete picture of your antenna.

Read SWR, return loss, reflect-ion coefficient, match efficiency at any frequency simultaneously.

Read Complex Impedance (100 KHz to 230 MHz) as series equivalent resistance and reactance (Rs+jXs) or as magnitude (Z) and phase (degrees). Also reads parallel equivalent resistance and reactance (Rp+jXp).

Determine velocity factor,

MFJ-269D **\$449⁹⁵**

coax loss in dB, length of coax and distance to short or open in feet (it's like a built-in TDR).

Coax Calculator™ calculates coax line length in feet given degrees and vice versa for any frequency, velocity factor. **Measure**



SWR and loss of coax with any characteristic impedance (280 KHz to 230 MHz) from 10 to over 600 Ohms.

Measures inductance in uH and capacitance in pF at RF frequencies, 100 KHz to 230 MHz.

High contrast LCD gives precision readings and two side-by-side analog meters make antenna

adjustments smooth and easy.

12-bit A/D converter gives much better accuracy and resolution than common 8-bits -- **MFJ-269D exclusive!**

Built-in frequency counter, battery saver, low battery warning, Ni-Mh/NiCd charge circuit. 4Wx2Dx6^{3/4}", 2 lbs. Use ten aA batteries or 110 VAC with MFJ-1312D, \$19.95.

MFJ-269DPRO™ SWR Analyzer

MFJ-269DPro, \$519.95. Like MFJ-269D, but UHF range covers **430 to 520 MHz**. For commercial work.



300/150 Watt Tuner

300W (6-1600) 150W (6-3200 Ohms)

MFJ-993B **\$329⁹⁵**

Automatically tunes unbalanced and balanced

antennas, ultra-fast automatic tuning and has 20,000 **VirtualAntenna™** memories. Has multiple antenna connections and antenna switch, efficient L-network, select 300 Watts (6-1600 Ohms impedance matching or 150W (6-3200 Ohms). 1.8-30 MHz, 4:1 balun, analog Cross-needle SWR/Wattmeter, backlit LCD, remote control port. Handles 300/150 Watts SSB/CW and digital.



MFJ-225 1.5-180MHz continuous Two-Port Graphic Analyzer

Out in the field, the MFJ-225 is a compact completely **self-contained handheld graphing analyzer**. On the bench it becomes a full-fledged two-port (S21) desktop machine when teamed up with your PC. Using powerful IG-miniVNA freeware, you'll run de-tailed data analysis and print out stunning color-graphic plots to document your work! **Built-in back-lighted 3-inch LCD graphic display**. Make fine adjustments using full-screen easy-to-view SWR bargraph, capture vivid swept displays for SWR, impedance, re-turn loss, phase angle, more. DDS generator.



MFJ-225 **\$399⁹⁵**

SWR Analyzer Accessories

A. MFJ-29D/MFJ-39D, \$39.95. Carrying Pouch for MFJ-259D/269D.

B. MFJ-92AA10, \$59.95. 10-Pk 2500 mAh Ni-MH Supercells.

C. MFJ-66C, \$59.95. Dip coils, set of two covers 1.8-230 MHz.

D. MFJ-731, \$134.95. Tunable Analyzer Filter, 1.8-30 MHz, for strong RF fields.

E. MFJ-917, \$39.95. 1:1 Current balun for SWR Analyzers to test balanced line antennas, other loads.

F. MFJ-7737, \$8.95. PL-259 to BNC Female.

G. MFJ-7727, \$9.95. PL-259 to SMA Female.

H. MFJ-5510C, \$19.95. 12VDC cigarette lighter adapter.



MFJ Enterprises, Inc. 300 Industrial Pk Rd, Starkville, MS 39759

Phone: (662) 323-5869 • Tech Help: (662) 323-0549 • FAX: (662) 323-6551 8-4:30 CST, Mon.-Fri.

Add shipping. Prices and specifications subject to change. (c) 2024 MFJ Enterprises, Inc.

• 1 Year No Matter What™ warranty • 30 day money back guarantee (less s/h) on orders direct from MFJ



Master Digital Radio Easily, Connect More, Stay Prepared

with BridgeCom's Plug and Play Package

Pre-programmed and ready to go right out of the box! Be on the air in under 10 minutes!

The package also comes with free access to BridgeCom University which has hundreds of videos and tons of information that will teach you the ins-and-outs of your radio allowing you to take your ham radio journey to the next level!

BridgeCom SYSTEMS

Use code "PNP25" at checkout to get \$25 off the Plug and Play Package! Head over to bridgecomsystems.com to check it out!

HF WIRE ANTENNAS

BULLET™ End Feds with WARC bands, Loop, Z56BKW, Off Center Fed antennas from QRP to Kilowatts. Termination Resistors for BBTD, T2FD.

Baluns/Ununs/Hybrid Combo—100 to 5 KW, 100 KHZ-180 MHz for all antenna types

Coax Noise Filters, Line Isolators, Feed Line Chokes—keep RFI and noise off your coax!

On-line Tutorials for antenna selection, design and installation—Download free RFI tip sheet

Palomar-Engineers®.com
760-747-3343

Dual Band 2M/440 and other models

EmComm, Satellite work, long distance simplex and repeater use.

Elk Antennas Log-Periodic Antennas for the Radio Amateur

Jim@ElkAntennas.com
www.ElkAntennas.com

RF Connectors & Gadgets

Parts • Products • More

www.W5SWL.com

PROMOTING THE USE OF TEN METERS SINCE 1962

Ten-Ten International Net, Inc.

Awards - QSO Parties - Special Events - Paperchasing

NETS DAILY (except Sunday) on 28.380 and 28.800 at 1800z

CHECK US OUT ON THE WEB
www.ten-ten.org / www.10-10.org

1349 Vernon Ter San Mateo CA 94402-3331

Mosley

AIRCRAFT GRADE ALUMINUM ELEMENTS & BOOMS and STAINLESS STEEL HARDWARE

STRONG!

Snow, ice or rain are no match for Mosley Quality!

...built to last!

Mosley antennas are

- * **pre-tuned,**
- * **pre-drilled,**
- * **and color-coded**

for ease of assembly which means...

- * **NO MEASURING!**

...*"a better Antenna!"*

REQUEST A CATALOG

Call 800-325-4016

www.mosley-electronics.com

SUPPORT

ARISS STAR

Amateur Radio on the International Space Station

The ARISS *STAR* Keith Pugh Memoriam Project honors ARISS Technical Mentor Keith Pugh, W5IU (SK), and seeks to improve ARISS US STEM education via robotics — with telerobotics adding a wireless accent.

Middle and high school-aged students will discover the benefits and excitement of ham radio while learning radio technology and communication.

Your support of this program is needed, please give directly to ARISS at

<https://www.ariss.org/ariss-star.html>

MFJ...the World Leader in Ham Radio Accessories!

MFJ 1500 Watt Remote Auto Tuner

Place this MFJ-998RT remote tuner at your antenna to match high SWR antennas/long coaxes – greatly reduce losses for high efficiency

... Match 12-1600 Ohms, 1.5 kW, SSB/CW/Digital, 1.8-30 MHz ... Match coax/wire antennas ... Weather-sealed ... Remotely powered thru coax ... Amplifier, radio, tuner protection ... Output static/lightning protection ... StickyTune™ always tunes when power folds back ... DC power jack ...



MFJ-998RT
\$949.95

Tune your antenna at your antenna

Get greatly reduced losses and high efficiencies with long coax runs and high SWR antennas with this **new MFJ-998RT 1.5 kW Remote Antenna Tuner.**

Weather-Sealed

A tough, durable weather-sealed ABS cabinet with over-lapping lips, sealing gasket and stainless steel chassis protects the MFJ-998RT from all kinds of weather.

No Power Cable Needed!

No power cable needed – remotely powered through coax. Includes MFJ-4117 Bias-Tee with on/off switch for station end of coax. Has 12 VDC jack for power cable, if desired.

Fully Protected

MFJ exclusive algorithms protect your tuner, radio and RF power amplifier from damage.

Automatic inductor and capacitor limiting prevents tuning extreme loads which can destroy your tuner.

Your tuner will not tune if more than 75 Watts with SWR greater than 3:1 is applied or if more than 125 Watts is applied.

Tuner output is static electricity and lightning induced surge protected.

MFJ exclusive StickyTune™

Very high SWR can fold back transmitter power and prevent tuning caused by extreme differences in loads (example: changing bands and other conditions).

But MFJ exclusive StickyTune™ always tunes with a simple on/off power cycle and re-transmit.

Tunes Coax fed and Wire Antennas

Tunes both coax fed and wire antennas. Has ceramic feed-through insulator for wire antennas. 2 kV Teflon® insulated SO-239 – prevents arcing from high SWR.

High Power, Highly Efficient

A highly efficient L-network matches 6-1600 Ohms at full 1500 Watts legal limit SSB/CW and Digital, 1.8 to 30 MHz with Hi-Q Ls, Cs.

MFJ-998RT Learns as you Operate

As you operate, the MFJ-998RT automatically tunes for minimum SWR and remembers your frequency and tuner settings. The next time you operate on that frequency and antenna, its tuner solution is restored in milliseconds and you're ready to operate!

Highly Intelligent, Ultra-fast Tuning

MFJ InstantRecall™ recalls stored tuning solutions from 10,000 memories. For new frequencies, MFJ Intelli-Tune™ measures your antenna impedance and instantly determines the correct matching components. If antenna impedances cannot be measured, MFJ AdaptiveSearch™ searches only the relevant components that can match your antenna giving you ultra-fast tuning.

Field upgradeable firmware. Requires 12-15 VDC at 1.4 Amps maximum or 110 VAC with optional **MFJ-1316, \$44.95.** Weighs 9.5 lbs. 13 1/4"W x 6 3/4"H x 17 1/2"D inches.

160-6 Meters 43 foot Vertical Antenna

Operate all bands 160-6 Meters at full 1500 Watts with this self-supporting, 43 foot high performance vertical! Assembles in less than an hour. Low profile blends in with sky and trees – barely see it. Entire length radiates. Exceptional low angle DX performance on 160-20 Meters and very good performance on 17-6 Meters. Telescope it shorter for more effective low angle radiation on 17-6 M if desired. One of these wide range MFJ automatic tuners at the antenna easily matches all bands 160-6 Meters. There's no physical tuning adjustments on the antenna – you simply put it up! Requires ground system, at least one radial, more the better. Includes balun and base mount. **MFJ-1932, \$64.95.** All band ground radial system.



MFJ-2990
\$469.95

600W Remote IntelliTuner™

MFJ-994BRT – perfect for 600 Watt SSB/CW amplifiers like Ameritron's AL-811/ALS-600/ALS-500M. Matches 12-800 Ohms. Coax/wire antennas, 1.8-30 MHz. Fully weather-sealed for outdoor use. Remotely powered through coax. Tough, durable, built-to-last cabinet, 9 1/4"W x 3H x 14 1/4"D inches, 4 lbs. Includes MFJ-4117 BiasTee Power Injector.



MFJ-994BRT
\$499.95

300W Remote IntelliTuner™

MFJ-993BRT handles 300 Watts SSB/CW and digital. Has extra-wide 6-1600 Ohm impedances. Coax/wire antennas, 1.8-30 MHz. Fully weather-sealed for remote outdoor or marine use. Remotely powered through coax. Tough, durable, built-to-last cabinet measures 9 1/4"W x 3H x 14 1/4"D inches. Weighs just 4 pounds. Includes MFJ-4117 BiasTee Power Injector.



MFJ-993BRT
\$399.95

200W Remote IntelliTuner™

MFJ-926B, 200 Watts SSB/CW/Digital, 6-1600 Ohms, Coax/wire antennas, 1.8-30 MHz. Includes BiasTee.



MFJ-926B **\$299.95**

MFJ No Matter What™ Warranty

One year **No Matter What™** Warranty
30 Day Money Back Guarantee
(less s/h) on orders direct from MFJ.



MFJ Enterprises, Inc. 300 Industrial Pk Rd, Starkville, MS 39759

Phone: (662) 323-5869 ■ Tech Help: (662) 323-0549 ■ FAX: (662) 323-6551 8-4:30 CST, Mon.-Fri.

Add shipping. Prices and specifications subject to change. ©2024 MFJ Enterprises, Inc.

• 1 Year No Matter What™ warranty • 30 day money back guarantee (less s/h) on orders direct from MFJ



MFJ_998RT_061512_120823DS

W5SWL Electronics

Premium Quality

RF Connectors

Order Direct!

Wide Selection of Connectors

- UHF & N
- BNC & SMA
- Mini-UHF & FME
- TNC & C
- MC MCX & MMCX
- QMA SMB & SMC
- DIN & Low PIM
- Reverse Polarity
- RF Adapters
- Bulkheads

And Much More!

- Dave's Hobby Shop by W5SWL
- Ham Radio Gadgets
- RF & Technical Parts
- New & Surplus Materials

Order at www.W5SWL.com

Ships Fast From The Arkansas River Valley

We stock the rugged 1KW transistor and parts for the 2M and 88-108MHz amplifier designs. We also stock the NXP MRF101 LD MOS transistors.

RF TRANSFORMERS

2—54MHz

COAX WIRE



RF400



RF600



RF800



RF1000



RF2000

FLEXIBLE

- TC-12 - 10.7 ohm
- TC-18 - 17.1 ohm
- TC-20 - 18.6 ohm
- TC-22 - 21.7 ohm
- TC-24 - 26.8 ohm
- SM250-50 50 ohm

SEMI-RIGID

- UT-141C-25 25 ohm
- 260-4118-0000 25 ohm



Communication Concepts, Inc.

508 Millstone Drive, Beavercreek, OH 45434-5840

Email: ccl.dayton@pobox.com

www.communication-concepts.com

Phone (937) 426-8600

Established in 1979



Type "U"
2 to 300MHz

Microcontroller Projects for Amateur Radio

By Jack Purdum, W8TEE,
and Albert Peter, AC8GY

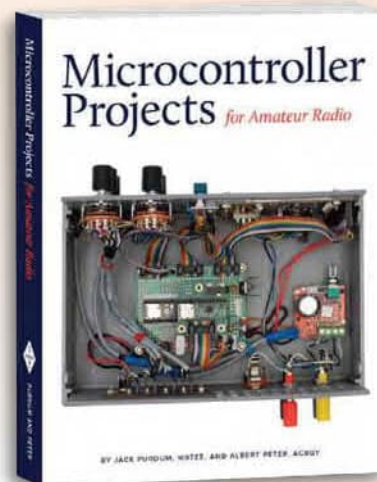

All the information you need to build fascinating projects using the Arduino, STM32 ("Blue Pill"), ESP32, and Teensy 4.0 microcontrollers.

Unfamiliar with C or C++ programming? No problem. *Microcontroller Projects for Amateur Radio* provides all the introduction you need to build projects such as a programmable power supply, a signal generator, a DSP mic processor, and more!

Member Price \$34.95

Retail \$39.95

www.arrl.org/shop



ARRL
The National Association for Amateur Radio®

LiFePO4 Batteries

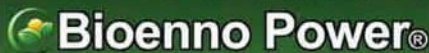

sale@bioennopower.com

(888) 336-7864

www.bioennopower.com

Foldable Solar Panels

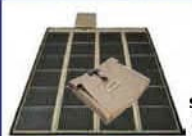

PowerFilm.
Made in the USA SOLAR

5 to 220 Watts

sales@californiipc.com

(877) 487-1213

CaliforniaPC.com

Tigertronics *Signalink™* USB

When it comes to sound card interfaces, nothing beats the *Signalink USB's* combination of performance, value, and ease of use! Whether you're new to Digital operation, or an experienced user, the *Signalink USB's* built-in sound card, front panel controls, and simplified installation will get the job done right the first time—and without breaking the bank! The *Signalink USB* supports virtually all sound card digital and voice modes, and works with virtually all radios. It is fully assembled (made in the USA!) and comes complete with printed manual and all cables. Visit our website today and see what all the buzz is about!

Operate the WSJT-X FT8 mode plus most other sound card modes including VARA, PSK31, RTTY, SSTV and CW to name a few!



(800) 822-9722

(541) 474-6700

Order your *Signalink* today at
www.tigertronics.com

Tigertronics 154 Hillview Drive Grants Pass, Oregon 97527

MFJ...the World Leader in Ham Radio Accessories!

MFJ Tuners

Ham Radio's Most Popular 300 Watt Antenna Tuner

More hams use MFJ-949s than any other antenna tuner in the world!

Why? Because the world's leading tuner has earned a worldwide reputation for being able to match just about anything.

Full 1.8-30 MHz Operation

Tune your antenna for minimum SWR! Works 1.8-30 MHz on dipoles, verticals, inverted vees, random wires, beams, mobile whips, shortwave receiving antennas...Use coax, random wire, balanced lines. Has heavy-duty 4:1 balun for balanced lines.

Custom inductor switch

Custom designed inductor switch, 1000 volt tuning capacitors, Teflon® insulating washers and proper L/C ratio gives you arc-free

no worries operation up to 300 Watts PEP transceiver input power.

The MFJ-949E inductor switch was custom designed to withstand the extremely high RF voltages and currents that are developed in your tuner.

8-Position Antenna switch

Antenna switch lets you select two coax fed antennas, random wire/balanced line or dummy load through your MFJ-949E or direct to your transceiver.



MFJ-949E **\$279.95**

Plus Much More!

Full size built-in non-inductive 50 Ohm dummy load, scratch-proof Lexan multi-colored front panel, 10⁵/₈ x 3¹/₂ x 7 inches. Superior cabinet construction and more!

MFJ-948, \$259.95. Econo version MFJ-949E. Has all features except for dummy load.

Lighted Cross-Needle Meter

Full size 3-inch lighted Cross-Needle Meter. Lets you easily read SWR, peak or average forward and reflected power simultaneously. Has 300 Watt or 30 Watt ranges.

QRM-Free PreTune™

MFJ's QRM-Free PreTune™ lets you pre-tune your MFJ-949E off-the-air into its built-in dummy load! Makes tuning your actual antenna faster and easier.

No Matter What™ Warranty

Every MFJ tuner is protected by MFJ's famous one year **No Matter What™** limited warranty. We will repair or replace your MFJ tuner (at our option) for a full year.

More hams use MFJ tuners than all other tuners in the world!

MFJ-989D Legal Limit Tuner



MFJ-989D **\$539.95**

New, improved MFJ-989D legal limit antenna tuner gives you better efficiency, lower losses and a new true peak reading meter. Easily handles full 1500 Watts SSB/CW, 1.8-30 MHz, including MARS/WARC bands. Six position antenna switch, dummy load. New 500 pF air variable capacitors. New improved AirCore™ Roller Inductor. New high voltage current balun. New crank knob. 12⁷/₈ x 6H x 11⁵/₈D inches.

MFJ-986 Two knob Differential-T™



MFJ-986 **\$479.95**

Two knob tuning (differential capacitor and AirCore™ roller inductor) makes tuning foolproof and easier than ever. Gives minimum SWR at only one setting. Handles 3 KW PEP SSB amplifier input power (1.5 KW output). Gear-driven turns counter, lighted peak/average Cross-Needle SWR/Wattmeter, antenna switch, balun. 1.8 to 30 MHz. 10³/₄W x 4¹/₂H x 15 in.

MFJ-962D Compact kW Tuner



MFJ-962E **\$399.95**

A few more dollars steps you up to a kW tuner for an amp later. Handles 1.5 KW PEP SSB amplifier input power (800W output). Ideal for Ameritron's AL-811H! AirCore™ roller inductor, gear-driven turns counter, pk/avg lighted Cross-Needle SWR/Wattmeter, antenna switch, balun, Lexan front, 1.8-30MHz. 10³/₄ x 4¹/₂ x 10⁷/₈ in.

MFJ-969 300W Roller Inductor Tuner



MFJ-969 **\$319.95**

Superb, AirCore™ Roller Inductor tuning. Covers 6 Meters thru 160 Meters! 300 Watts PEP SSB. Active true peak reading lighted Cross-Needle SWR Wattmeter, QRM-Free PreTune™, antenna switch, dummy load, 4:1 balun, Lexan front panel. 10¹/₂W x 3¹/₂H x 9¹/₂D inches.

MFJ-941E Super Value Tuner



MFJ-941E **\$239.95**

Most for your money! 300 Watts PEP, 1.8-30 MHz, lighted Cross-Needle SWR/Wattmeter, 8 position antenna switch, 4:1 balun, 1000 volt capacitors, Lexan front panel. 10¹/₂W x 2¹/₂H x 7D in. **MFJ-941EK, \$209.95.** Tuner Kit -- Build your own!

MFJ-945E HF/6M Mobile Tuner



MFJ-945E **\$189.95**

Extends your mobile antenna bandwidth so you don't have to stop, go outside and adjust your antenna. Tiny 8 x 2 x 6 in. Lighted Cross-Needle SWR/Wattmeter. Lamp and bypass switches. Covers 1.8-30 MHz and 6 Meters. 300 Watts PEP. **MFJ-20, \$14.95,** mobile mount.

MFJ-971 Portable/QRP Tuner



MFJ-971 **\$179.95**

Tunes coax, balanced lines, random wire 1.8-30 MHz. Cross-Needle Meter. SWR, 30/300 or 6 Watt QRP ranges. Matches popular MFJ transceivers. Tiny 6 x 6¹/₂ x 2¹/₂ in.

MFJ-901B Smallest Versa Tuner



MFJ-901B **\$149.95**

MFJ's smallest (5 x 2 x 6 in.) and most affordable wide range 200 Watt PEP Versa tuner. Covers 1.8 to 30 MHz. Great for matching solid state rigs to linear amps.

MFJ-902B Tiny Travel Tuner



MFJ-902B **\$149.95**

Tiny 4¹/₂ x 2¹/₄ x 3 inches, full 150 Watts, 80-6 Meters, has tuner bypass switch, for coax/random wire. **MFJ-904H, \$199.95.** Same but adds Cross-needle SWR/Wattmeter and 4:1 balun for balanced lines. 7¹/₄ x 2¹/₄ x 2³/₄ inches.

MFJ-16010 Random Wire Tuner



Operate all bands anywhere with MFJ's reversible L-network. Turns random wire into powerful transmitting antenna. 1.8-30 MHz. 200 Watts PEP. Tiny 2 x 3 x 4 in.

MFJ-16010 **\$109.95**

MFJ-9201 QRPocket™ Tuner



MFJ-9201 **\$79.95**

80-10 Meters, 25 Watts. 12 position inductor, tune/bypass switch, wide-range T-network, BNCs. 4W x 2⁵/₈H x 1¹/₂D inches. **MFJ-9201, \$79.95**

MFJ-921/924 VHF/UHF Tuners



MFJ-921/924 **\$149.95**

MFJ-921 covers 2 Meters/220 MHz. **MFJ-924** covers 440 MHz. SWR/Wattmeter. 8 x 2¹/₂ x 3 in.

MFJ-931 Artificial RF Ground



MFJ-931 **\$159.95**

Eliminates RF hot spots, RF feedback, TVI/RFI, weak signals caused by poor RF grounding. Creates artificial RF ground or electrically places far away RF ground directly at rig. **MFJ-934, \$299.95,** Artificial ground/300 Watt Tuner/Cross-Needle SWR/Wattmeter.



MFJ Enterprises, Inc. 300 Industrial Pk Rd, Starkville, MS 39759

Phone: (662) 323-5869 ■ Tech Help: (662) 323-0549 ■ FAX: (662) 323-6551 8-4:30 CST, Mon.-Fri.

Add shipping. Prices and specifications subject to change. ©2023 MFJ Enterprises, Inc. • 1 Year No Matter What™ warranty • 30 day money back guarantee (less s/h) on orders direct from MFJ



MFJ_949E_092308_QST_120823DS



The Most Complete Printed Directory of On-the-Air Repeaters!



Repeaters are almost everywhere. There are more than 20,000 repeaters in the United States alone. The best way to find repeaters in your area or while traveling is with the **2024 ARRL Repeater Directory**®.

Look up repeaters and see their input and output frequencies, plus find out whether they are analog FM repeaters, or one of the digital machines.

- 26,500 listings organized by state/province, city, and operating mode
- Digital repeaters, including FUSION, D-STAR, DMR, NXDN, and P25 systems
- HF, VHF/UHF, and microwave band plans
- Convenient 6x9 spiral bound format lies flat

New hams often use the *Repeater Directory* to find local activity after purchasing a new handheld radio. Public service volunteers often keep a copy nearby.

ARRL Item No. 1854 | Retail Price \$19.95

Repeater listings appearing in *The ARRL Repeater Directory*® are provided by RFinder Inc. If a repeater has been omitted or a listing is inaccurate, contact RFinder directly.

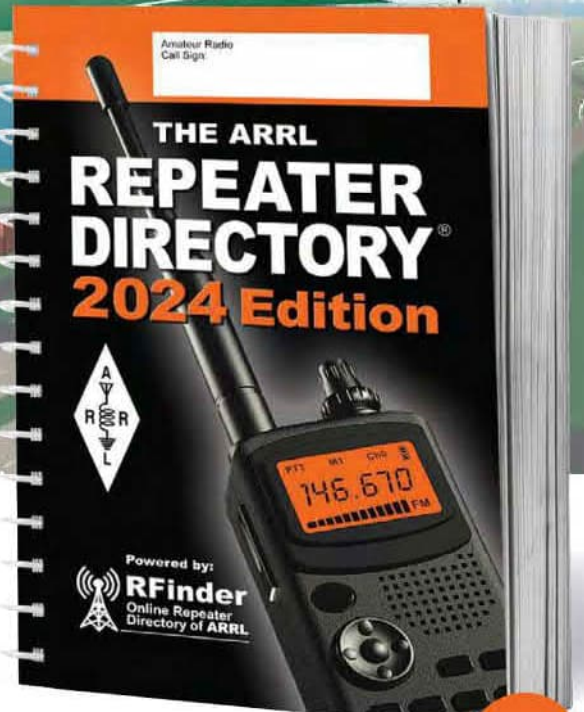

Covering repeater systems
throughout the US and Canada

NEW!

Order online at www.arrl.org/shop | Call toll-free 1-888-277-5289

MFJ Deluxe Code Oscillator

IN STOCK!



Wow!

MFJ-557, \$69.95

MFJ-557 lets you practice sending Morse Code at home, work, in your car, outside on the picnic table, anywhere. Volume adjusts from barely audible to full classroom sound. Black Morse straight key on a non-skid heavy steel base -- stays put and doesn't move around while sending. Built-in speaker, adjustable contacts. Use 9V battery, not included. Compact 8.5Wx3.75Hx2.25D inches.

MFJ-550
\$34.95 Key only.

MFJ CW Reader and Keyer Combination

Plug MFJ's CW Reader with Keyer into your transceiver's phone jack and key jack.

Now you're ready to compete with the world's best hi-speed CW operators -- and they won't even know you're still learning the code! 5-99 WPM.

Automatic speed tracking. Large 2-line LCD shows send/receive messages. Use pad-

dle or computer keyboard.

Easy operation. Front panel speed, volume controls, 4 message memories, type ahead buffer, read again buffer, adjust weight/sidetone, speaker. RFI free.

MFJ-551, \$59.95. RFI suppressed keyboard, a must to avoid RFI problems.

MFJ-464
\$259.95
(Keyboard, paddle not included.)



MFJ Pocket-Size CW Reader™ and Code Tutor

MFJ-461, \$119.95. Place this tiny pocket size MFJ Morse Code Reader near your receiver's speaker and watch CW turn into solid text messages as they scroll across an easy-to-read LCD. No cables to hook-up, no computer, no interface, nothing else needed! Practice by copying along with the MFJ-461. Learn the code and increase your speed as you instantly see if you're right or wrong. Eavesdrop on interesting Morse QSOs from hams all

over the world. MFJ's *AutoTrak™* automatically locks on, tracks and displays CW to 99 WPM. Serial port lets you display full screen CW text on your computer monitor with your computer and terminal program. Tiny 2 1/4 x 3 1/4 x 1", 5 1/2 oz. Fits in your shirt pocket, take it anywhere. Use 9 Volt battery.

MFJ-564 Iambic Paddles \$109.95

Deluxe iambic paddles. Tension/contact spacing adjustments, steel bearings, precision frame, non-skid feet. Chrome (MFJ-564). Black (MFJ-564B). **MFJ-561, \$34.95.** Tiny iambic key.

MFJ-418, \$119.95. Morse Code Tutor. Learn Morse code anywhere! Copy letters, numbers, prosigns or any combination or words or QSOs. ARRL/VEC format. Go from zero code speed to a high speed *CW Pro!* High contrast LCD, built-in speaker.

MFJ-419 CW Elmer \$169.95

MFJ-419 is a pocket-sized multi-function training tool for learning to receive and send Morse Code with a straight key. Helps you learn & send clean CW.

MFJ-407E Deluxe CW Keyer \$129.95

MFJ Curtis-Keyer has all modes, dot-dash memories, jam-proof spacing, weight, sidetone, built-in speaker. Speed, weight and tone controls and tune, semi-auto and on/off are on front panel.

MFJ-401E Econo CW Keyer \$109.95

Front-panel volume/speed controls (8-50 wpm), tune switch. Internally adjust weight/tone. Solid state keying. Tiny 4x2x3 1/2 inches.

MFJ-422E Keyer/Paddle \$249.95

MFJ CW keyer and Iambic Paddle combo lets you send smooth, easy CW. Front panel volume/speed (8-50 WPM), built-in dot-dash memories, speaker, sidetone.

New! Ver. 3.0

MFJ-1234C-EBP . . . Remotely operate your transceiver from anywhere in the world!



modes: SSB, CW, FM, digital. WSJT-X, Fldigi are installed.

Control via the internet-- radio, rotor, CW keying, VoIP, digital, logging, spot monitoring, callbook lookup.

Look-up calls using included FCC database or optional QRZ sub. Monitor DX spots for un-worked or unconfirmed calls.

Design, maintain multiple logs. Upload

ADIF logs to ARRL LoTW server. Send CW from mobile device, keyboard or paddle.

Includes email, word processing, spreadsheet programs, 1000's of Linux programs. Modify, program RigPi features using text editor.

MFJ-1234C-EBP requires a Raspberry Pi-4 or 3B+ provided by you.

TECH HELP

- <https://rigpi.groups.io>
- <https://rigpi.net>

Plug & Play FT-8 and all Digital Modes!

MFJ-1205, \$129.95. Plug & Play all digital modes! Specify your radio when ordering and just plug USB cable into your computer. Download *free* software from internet and operate: FT-8, JT4, JT-65, JT6M, FSK441, WSPR, PSK-31, EchoLink, APRS, CW, RTTY, packet, AmTOR, more. Easy-to-set transmit/receive levels. Transformer isolated audio, PTT sensing eliminates adjustments. Universal, never obsolete.

Use any web browser on your phone, iPad, tablet, laptop, desktop even a Kindle!

Use nearly any rig with CAT control. All

MFJ Enterprises, Inc. 300 Industrial Pk Rd, Starkville, MS 39759
Phone: (662) 323-5869 • **Tech Help:** (662) 323-0549 • **FAX:** (662) 323-6551 8-4:30 CST, Mon.-Fri.

Add shipping. Prices and specifications subject to change. (c) 2024 MFJ Enterprises, Inc.

• 1 Year No Matter What™ warranty • 30 day money back guarantee (less s/h) on orders direct from MFJ



MFJ Magnetic Loop Antennas

Build your own Mag loop!



MFJ-1786
\$659⁹⁵

10 to 30 MHz including WARC and MARS bands, 150 Watts. Includes remote controller.

MFJ-1788
\$719⁹⁵

7 to 22 MHz including WARC and MARS bands, 150 Watts. Includes remote controller.

MFJ 36-inch magnetic loop antenna lets you operate 7 to 22 MHz or 10 to 30 MHz continuously -- including the WARC and MARS bands! Easily handles a full 150 Watts on SSB/CW/Digital for any transceiver.

Ideal for limited space. Apartments, small lots, motor homes, attics, trailers.

Work exciting DX with low angle radiation and local close-in contacts with high angle radiation when mounted vertically.

Super easy-to-use! MFJ remote control auto tunes to your desired band. Fast/slow tune buttons, Cross-Needle SWR/Wattmeter lets you quick-

ly tune to your exact frequency. No control cable needed.

World's most efficient small loop antenna has all welded construction, welded butterfly capacitor with no rotating contacts, large 1.050 inch diameter aluminum radiator -- gives you highest possible efficiency.

Every capacitor plate is welded for extremely low loss and polished to prevent high voltage arcing. Nylon bearing, anti-backlash mechanism, limit switches, continuous no-step DC motor gives smooth precision tuning. Heavy-duty ABS plastic housing has ultraviolet inhibitor protection.

MFJ-1782, \$599.95. Like MFJ-1786 but fast/slow tune man. control.

MFJ-1780, \$429.95. 20-10 M, 150W Portable 24x24x24" box fan loop with handle. Fast/slow tune control. See QST July 2019.

MFJ-1780XX, \$429.95. Like MFJ-1780, auto band control.



New 40-15M and 30-10M 300W High Efficiency Welded Loop Antennas

Carry it anywhere! Easy carry handle, fold-out feet, tripod mount bracket. Portable, lightweight 36x36x4". Deluxe semi-auto controller with SWR/Wattmeter, no control line needed. Welded Low loss butterfly air-variable capacitor. 300W SSB.

MFJ-1784, \$659.95. 40-15 Meters.

MFJ-1783, \$599.95. 30-10 Meters.

Motorized Butterfly Capacitors

Super low loss butterfly capacitors, no rotating contacts, all plates welded with no mechanical electrical contacts. Anti-backlash mechanism. DC motor with gear reduction box. Handles at least 150 Watts SSB/CW/Digital.

1. p/n: 282-1786, \$189.95. 11-128 pF.

2. p/n: 282-1788, \$249.95. 15-260 pF.

3. p/n: 80-1786-2SM, \$249.95.

Auto band selecting remote controller with SWR/Wattmeter.

4. p/n: 80-1782-2, \$79.95.

Manual remote control, fast/slow tune buttons.

Butterfly Capacitors

5. MFJ-19, \$99.95. 2-67 pF.

6. MFJ-23, \$139.95. 18-136pF.

7. p/n: 729-0142, \$19.95.

6:1 vernier gear reduction drive for loop tuning capacitor.

8. 36-inch Aluminum Circular Loop with Integrated welded capacitor and mast mounting brackets

p/n: 10-1786-11, \$129.95. 1.05 inch OD heavy duty tubing.



MFJ Magnetic Loop Tuners, 150 Watts

C Turns wire or coax into a small, high efficiency multi-band transmitting magnetic loop antenna!

B Work the world 3.5 to 30 MHz with a full 150 Watts SSB/CW/Digital. No ground, radials or counterpoises needed.

A New larger matching capacitor is 313 pF. Increases matching range. Butterfly capacitor has no rotating contacts.

Very quiet receiving antenna -- you'll hardly notice static crashes. High-Q reduces QRM, overloading, harmonics. Perfect for apartments, antenna restricted areas and portable operation.

A 13' wire loop covers 30-20 Meters (4' for 17-10M; 7' for 20-15M; 28' for 60-40M; 50' for 80M). Tune any shape loop -- circle, square, rectangle, etc.

A wire length gives about 1.5 to 1 frequency range (i.e. 7-10, 18-28 MHz).

Easy-Carry handle. Mount for PVC Cross loop support on cabinet top. Included tripod/mast mount.

A. MFJ-936C, \$389.95. Antenna current meter, Cross-Needle SWR/Wattmeter. 9 1/4"Wx5 1/2"Hx9 1/2"D".

B. MFJ-935C, \$299.95. Antenna current meter. 6 1/4"Wx5 1/2"Hx9 1/2"D".

C. MFJ-933C, \$279.95. 6 1/4"Wx5 1/2"Hx9 1/2"D".



QRP Mag Loop Tuner

MFJ-9232 Turns wire around a bookcase, window, tree, etc. into a small, high efficiency transmitting loop antenna! Operate 40-10 Meters with included flexible wire loop (80/60 Meters with your bigger loop). No counterpoises, radials, ground needed. 25 Watts. Very quiet reception. Hi-Q reduces QRM, overload, harmonics. Great for apartments, antenna restrictions, portable ops.

\$69⁹⁵

AR-500 \$199⁹⁵

VIDEOS: https://m.youtube.com/results?search_query=MFJ-9232

Antenna Rotator

Perfect for magnetic loops, VHF/UHF, small HF beams, TV, FM antennas. Weather-proof cast aluminum housing with precision all metal gears, steel thrust bearings and automatic braking. Includes rotator, controller, remote control, clamps, hardware. 12 Memories. Digital display.

110/220 VAC.

\$199⁹⁵

MFJ Low-Noise Receiving Mag Loop

Clearly hear signals 50 KHz to 30 MHz you never knew existed. Power line noise and static disappears. Rotating MFJ-1886 eliminates interfering signals or greatly peaks desired signals. Excellent antenna and preamplifier balance gives deep null. Gives excellent strong and weak signal performance without overload. Fully protected state-of-the-art push-pull Gali MMICs preamplifier gives you high dynamic range, low IMD and 25 dB of low noise gain. Use inside or outside.



MFJ-1886 \$329⁹⁵
Receive Loop with Bias-Tee

MFJ Tripods/Masts

Strong, black steel triangular braced base. Non-skid feet, strong mast locks. **MFJ-1919, \$129.95.** Supports 100 lbs. Extends a whopping 7.8 ft. Base spreads up to 4.8 sq. ft. 1.4" dia. mast. Collapses to 54" by 6" diameter. 9 3/4 lbs.

MFJ-1919EX, \$199.95. Tripod plus mast. 18' extended. 5' collapsed. 1/8" wall, 3/4" dia. top, 1 1/2" dia. bottom. 15 lbs.

MFJ-1918, \$84.95. 6' extended. 38" collapsed. 6 3/4 lbs.

MFJ-1918EX, \$129.95. Small tripod with extension mast. 9 1/2', 3.8 ft. collapsed. 3/4" top, 1" bottom. 6.5 lbs.

MFJ Enterprises, Inc. 300 Industrial Pk Rd, Starkville, MS 39759
Phone: (662) 323-5869 • Tech Help: (662) 323-0549 • FAX: (662) 323-6551 8-4:30 CST, Mon.-Fri.

Add shipping. Prices and specifications subject to change. (c) 2024 MFJ Enterprises, Inc.

• 1 Year No Matter What™ warranty • 30 day money back guarantee (less s/h) on orders direct from MFJ



MFJ QRP!



MFJ-9232
\$69.95

QR Pocket™ Loop Antenna Tuner

Drape a wire around a bookcase, window, tree or other object and attach both ends to this MFJ QR Pocket™ Loop Antenna Tuner. It instantly turns into a small, high efficiency multi-band transmitting loop antenna!

Operate 40-10 Meters with included flexible wire loop (80/60 Meters with your bigger loop). No ground, radials or counterpoises needed. 25 Watts.

It's a very quiet receiving antenna. Its

hi-Q reduces QRM, overload, harmonics.

Perfect for apartments, antenna restricted areas and portable operation. Tune any shape loop -- circle, square, rectangle, etc.

Adjust tuning and matching capacitors for minimum SWR and operate.

BNC for transmitter, wing nut posts for loop wire. Tiny 2 1/4"Wx4Hx2 1/4"D inches.

MFJ-9234, \$69.95. Like MFJ-9232 but connects directly to your transceiver SO-239 antenna connector.



VIDEOS: https://m.youtube.com/results?search_query=MFJ-9232

QRP Antenna Tuner

MFJ-9201,
\$79.95. Tunes any antenna

80-10 Meters, 25 W. 12-position hi-Q inductor, tune/bypass, variable antenna and transmitting matching capacitors, BNC connectors. Tiny 4Wx2 3/8"Hx 1 1/2"D inches -- MFJ-9201, rig and antennas easily fit into a backpack or briefcase for vacation, SOTA, hikes, etc.



MFJ Walk-About 80-6M Antenna

MFJ-1899T, \$99.95. Perfect for QRP radios like FT-817, KX3, Xiegu, others. Covers all bands 80-6 M including WARC. Ten section telescoping whip (52" extended, 7" collapsed). 12" base loading coil with Wander Lead. Whip/coil unscrews for easy storage. 25Watts. BNC.

MFJ-7703, \$10.95
BNC/PL-259 elbow.
MFJ-7760, \$9.95.
BNC/BNC elbow.



MFJ Single Band Walk-Abouts

Each is 51 inches extended and collapses to 5.5 inches. Handles 25 Watts. BNC.

MFJ-1806T (6M) \$39.95
MFJ-1810T (10M) \$39.95
MFJ-1812T (12M) \$49.95
MFJ-1815T (15M) \$39.95
MFJ-1817T (17M) \$39.95
MFJ-1820T (20M) \$39.95
MFJ-1830T (30M) \$49.95
MFJ-1840T (40M) \$49.95
MFJ-1880T (80M) \$49.95

QRP Tuner/Dummy Load/Wattmeter

New!

MFJ-9219, \$119.95. This new MFJ-9219 is everything you need for your QRP rig and antenna. Great for backpacking QRP adventures! The SWR/Wattmeter, Dry dummy load and QRP antenna tuner are all in one small 3x3x1.5 inch cabinet!



80-10M End-Fed Half Wave Antenna



MFJ-1982LP, \$89.95. Get on the air quick! 30W, 132' wire. No tuner needed.

33' Telescopic Portable Mast

MFJ-1910, \$119.95. Fiberglass.

3 3/4' ft collapse, 3.3 lbs. Twist and lock into place.

17' Telescopic Whip

MFJ-1979, \$69.95. Stainless steel, collapses to 27".
MFJ-1977, \$59.95. 12 ft. stainless steel, 26" collapsed.
MFJ-1976, \$49.95. 10 ft. stainless steel, 20" collapsed.

Portable/Collapsible 5.3-54 MHz Ant.

MFJ-1898, \$149.95. 60/40/30/20/17/15/12/10/6M in one antenna!!! Great for POTA, SOTA or DXpedition! Two sections collapse to 1.25x11.5". 125W PEP SSB. Telescopes to 103 inches.



Mini Switching QRP Power Supply

MFJ-4103, \$89.95. 13.8 VDC at 2.89 Amps (40 Watts). FT-817 adapter.



MFJ 500 MHz Dummy Load

MFJ-261, \$39.95. Finned aluminum, air-cooled heatsink 50 Ohm dummy load. 100W peak, 15W average. DC to 500 MHz, 1.15:1 SWR. 1 1/8" dia. by 3" long.



CW Straight Key

MFJ-550, \$34.95. Morse Code straight key. Adjustable spacing and spring tension. Durable plastic base with mounting holes.



SWR/Wattmeter Dummy Load



MFJ-9218, \$59.95. Resistive SWR Meter protects output transistors with 3:1 maximum SWR when tuning your antenna. 5/10/20 Watt power ranges. Tune/Bypass switch, BNC input and output connectors. Covers 1.8 to 60 MHz. Rugged tiny case fits any where 4 1/2"Wx2 1/4"Hx2 3/4"D".

QRP WattMeter/Dummy load



MFJ-9214, \$49.95. Check true QRP output power with this sensitive QRP Wattmeter with built-in 50 Ohm dummy load. Also tests battery condition. Reads 5W full scale 1.8-150 MHz. BNC male connects directly to your rig. 2Wx2 1/4"Hx1 1/2"D". MFJ-7737, \$8.95. BNC female to PL-259 adaptor.

QRP SWR/Wattmeter

MFJ-9213, \$59.95. Read SWR, forward, reflected power in three ranges: 5, 30, 100 Watts on calibrated meter scale. Bruene bridge insures uniform accuracy over 1.8-50 MHz and allows you to leave in-line for continuous monitoring without insertion loss. BNC for transmitter/antenna. 4 1/2"Wx2 1/4"Hx2 3/4"D inches.



MFJ QR Pocket™ 4:1 Balun

MFJ-9211, \$39.95. 4:1 current balun for feeding balanced dipole/antenna to 50 Ohm coax. Binding post, BNC.



Artificial Ground



MFJ-9231, \$89.95. Tune your counterpoise and ground to greatly increase your radiated power.



MFJ Enterprises, Inc. 300 Industrial Pk Rd, Starkville, MS 39759

Phone: (662) 323-5869 • Tech Help: (662) 323-0549 • FAX: (662) 323-6551 8-4:30 CST, Mon.-Fri.

Add shipping. Prices and specifications subject to change. (c) 2024 MFJ Enterprises, Inc.

• 1 Year No Matter What™ warranty • 30 day money back guarantee (less s/h) on orders direct from MFJ



Ham Ads

Please contact the Advertising Department at 860-594-0255 or hamads@arri.org for further information or to submit your ad.

QST Ham Ads on the Web
Updated Monthly!

www.arri.org/ham-ad-listing

Club/Hamfests/Nets

CW INSTRUCTION via internet video conference classes. VISIT longislandcwclub.org

Emergency Ham Net. Forming a new group, free membership. Have fun and push the frontiers of digital radio. www.emergencyham.net

Friend of BILL W meets Thur on 14.316 @ 12:30 ET. Daily Meeting on QSO NET on 21.350 @ 11:30 Eastern Time. More info please visit HAAM Group website www.qsl.net/haam.

SOCIETY OF WIRELESS PIONEERS - Professional brasspounders on land, sea, and air from the time of spark to solid state preserved photos, stories, schematics, letters, cartoons, catalogs, books, and manuals to keep radio history alive. Website showcases **early ham stations**, naval communications history, SOS events, and more, all free. www.sowp.org

Property/Vacation/Rentals

A CARIBBEAN SAINT KITTS "V4" DX RENTAL. See V47JA on QRZ.com and email: W5JON@sbcglobal.net for Ham Discount information. John W5JON/V47JA

A DX Apartment available in VP9 with rigs and antennas. Email: ed@vp9ge.com for details.

Beautiful outdoor Idaho! Spacious low populated areas. Abundant recreation opportunities. Moderate four season climate. Thinking of buying or selling? Contact Ron Bishop, W7IM, Keller Williams Realty Boise. 208-870-6075. Ron@BoiseBargains.com

CAPE COD real estate for hams, buy or sell, John Strome, KC1MLR, ColdwellBanker associate, john.strome@nemoves.com, 508-527-0499

COLORADO CHALET with ham gear for weekly rental, www.lostcreekcabin.com. WØLSD, Buena Vista, CO.

Hams Looking to purchase or sell real estate in Connecticut? Please contact Licensed Ham and Realtor, Claude Cousins, Sr. N1QAE, Berkshire Hathaway Home Services, claudecous@gmail.com, 860-989-2113

MAINE year-round Ham Station. www.CottagebytheDam.com

Retiring to Florida? Looking for a resort-like, award winning 55+ active adult community with a vibrant, active Amateur Radio Club with three community repeaters? Contact WB8ZNL, Doug Bennett, Realtor - Arista Realty Group, for more information. 317-418-4273

Thinking about selling my ham friendly home in Metro Louisville. Rohm 25G up 30 feet with a InnoVAntennas XR7C along with my ham station. AI4VK Randy Kehrt randallkehrth@hotmail.com

www.peidxlodge.com

Antique/Vintage/Classic

6 Meter legacy by K6EDX K6MIO. www.bobcooper.tv

ANTIQUÉ WIRELESS ASSOCIATION - the largest international organization for historic radio enthusiasts. Publishes the quarterly AWA Journal and annual AWA Review on all aspects of collecting and history of communications. AWA produces the famous annual AWA Convention and sponsors the world renowned Antique Wireless Museum. Only \$35/year USA, \$40/year elsewhere. Antique Wireless Association, PO Box 421, Bloomfield, NY 14469. Website: <http://www.antiquewireless.org>

AR88 Excellent condition with LM7 Frequency Meter. Spare tubes available. ericbforsyth@gmail.com

Awesome Technology & Stem Museum - www.cyberengineer.info

Six Decades of Amateur Radio www.kk4ww.com

Vintage Radio, Ham Radio and Military Radio Repair. www.mcveyelectronics.com 845-561-8383

WANTED PRE-1980 MICROCOMPUTERS for historical Museum www.kk4ww.com

QSLCards/Call Sign Novelties

Flaunt your call! www.HAMFLAGS.com

Get Top Quality Full Color UV Coated QSL Cards direct from the printer. Chester QSL Cards by Chester Press. Call 800-748-7089 for samples, email info@chesterpressinc.com or visit thechesterpressinc.com/QSL website.

www.QSLCONCEPT.com Custom designed QSL Cards. FREE Design, FREE Shipping, FREE Stock Photo.

General

RF CONNECTORS & GADGETS

Parts - Products - More
www.W5SWL.com

#1 AMATEUR CALLSIGN DVD! HamCall contains over 2,400,000 world-wide callsigns, 10,400,000 archive callsigns. Supported by most logging programs. Six FREE monthly internet updates and HamCall.net Gold online access included. Visa/MC/Discover 800-282-5628 <http://hamcall.net>

#1 Amateur website for useful links and downloadable information: www.kb9at.com

Amateur and High-End Audio Equipment Repair. Email: seecumulul@gmail.com, AJ4UY, SMD Rework Services.

ATTENTION YAESU-FT 10218,000hrs, 30yrs, 800+ FT-102's Repaired. Have every part. AM-FM/board. \$25/hr. Parts@cost. Relays lifetime warranty. 954-961-2034 NC4L www.w8kvk.com/nc4l

Build your own Yagi! - W5EES.COM

CALL SIGN T-SHIRTS, COFFEE MUGS AND CAPS! See my store KA7UNW at www.etsy.com/shop/KA7UNW or just Google KA7UNW

Custom LED Call Signs. www.ledboothsign.com 408-315-4573 Phone

GAIN the EDGE with NARTE Certification - NARTE gives you the competitive edge with individual certification in Electromagnetic Compatibility, Electromagnetic Discharge Control and Telecommunications. Industry-recognized certification required or desired by more than 400 corporations nationwide. Call 1-800-89-NARTE or visit www.inarte.org. NARTE offers the premier EMC/EMI, ESD, Telecommunications and Wireless certification to professional technicians and engineers.

Get the FCC "Commercial" Radiotelephone License: The highest-class Telecommunications Certification! Fast, inexpensive, Guaranteed Home-Study. Command Productions. Please visit: www.LicenseTraining.com (800) 932-4268

HAM KITS for sale at www.HeckKits.com L/C Meter, SWR Bridge, ESR Meter, 2-Tone Gen, FET DIP Meter.

ISOTRON ANTENNAS FOR 160 - 6 METERS! Efficient, rugged and resonant. Please visit WWW.ISOTRONANTENNAS.COM. wd0eja@isotronantennas.com 719/687-0650.

KB6NU'S "NO NONSENSE" LICENSE STUDY GUIDES have helped 1000's get their first license and upgrade to General or Extra. They can help you, too. KB6NU.COM/STUDY-GUIDES/

MicroLog-By-WA0H .. Easy to use logging program .. Free download .. www.wa0h.com

PRINTED CIRCUIT BOARDS for projects shown in QST, QEX, HR, ARRL HB, 73 and more. Custom boards available. FAR Circuits, 18N640 Field Ct, Dundee, IL 60118; fax/phone 847-347-2432; www.farcircuits.net; mail@farcircuits.net

Radio Shack HTX-100 Repair. Free Estimates. KA1HVR - www.HTX-100.com

RF SUPERSTORE

Connectors, Adapters, Antennas,
Coaxial Cable and more!
High Quality, Low Cost, Ham Friendly
WWW.RFSUPERSTORE.COM

Rohn Tower, telescoping poles, tripods and antenna parts delivered to your door.

www.antennapartsoutlet.com

Soldering-desoldering-hand tools-ESD how can we help? www.technimark-inc.com and E-Bay store-ebay.com/str/technimarkinc

Start to read fast CW in your head! Begin to hear whole words sent in fast CW! Soon reading is easy! <https://www.hearcwwords.com>

Tactical Portable Accessories for Yaesu 450D, DX-10, 817ND, 857D, 897D, 891, 991A, ICOM 7300, 7200, 7000, 706/703 and 9700. W0MSN www.portablezero.com

Universal Aluminum push up towers. Same day shipping. www.antennapartsoutlet.com

WANTED: Kenwood DK-520 Digital Adapter Kit. b52ewo54@gmail.com or 484.474.2167

Xcellent Amateur and Monitor Logging from **DXtreme!** Click www.dxtreme.com

Build an Antenna Kit



...and Get on the Air!

Get ready to drill, fasten, and solder with this popular **End-Fed Half-Wave Antenna Kit**. This antenna kit is popular with portable operators, and works on 10, 15, 20, and 40 meters.

Why an EFHW?

The antenna performs nearly as well as a dipole but requires suspending only one end up in a tree or similar placement. It's so easy to build and deploy!

EFHW Antenna Kit

Item No. 0612 | Retail \$79.95

www.arrl.org/shop



WOLF RIVER COILS LLC
SILVER BULLET ANTENNA PRODUCTS



Silver Bullet Antenna

STAINLESS STEEL ANTENNA COILS FOR HOME, MOBILE OR STEALTH

- Vertical Antenna Easy Set up and Take down
- Odophone Dipole Antenna
- TIA System (Take It Along) Quick Set up
- TIA SOTA for the Backpacker
- Stainless Steel collapsible whips 213, 102, 78 inches

**See You at Hamcation
Orlando FL
February 9-11, 2024
Booth 56 & 57**

www.wrcoils.com

**RF Connectors
& Gadgets**

Parts • Products • More

www.W5SWL.com

www.SwapMyRigs.com
Modular Rig VGA-Cable Mobile Separation Kit

Shock or Car Separation up to 175'

Swap rigs without ever changing cables. One cable replaces three regardless of make or model. \$89.99 complete with 15' VGA cable. AE4S, LLC

- **Highest Gain**
Proprietary Design Improvement
- **Lowest SWR**
Verified In *CQ Magazine*
- **Wider Bandwidth**
- **Lifetime Guarantee**
- **Everything You Need**
for a Fully Functional Antenna



VHQHEX.COM
THE KING OF HEX BEAMS

sales@vhqhex.com Tel 603-731-7935 Fax 603-784-5036



CHATTANOOGA, TENNESSEE

1.833.456.4673

**We Are Your One Stop
Radio Shop**

**Still Struggling With
Your 20-Year-Old
Repeater Controller?**



**More Power, More Features
Less Money**

**State-of-the-Art Repeater
Controllers and Accessories**

Arcom

Aurora, OR 97002 (503) 678-6182
www.arcomcontrollers.com

DTMF decoder board with eight relays

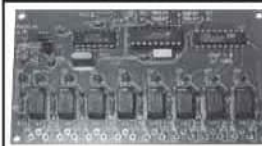

Remote control eight devices via radio audio. Password protection against unauthorized entry. Unique board ID. Comes assembled with relays. 4.5" x 2.5".

Intuitive Circuits, LLC
Voice: (248) 588-4400
<http://www.icircuits.com>

DTMF-8 \$119.00
Visa • MC • Prepayment



Janet Rocco, W1JLR, Advertising Sales Manager
 Toll Free: 800-243-7768
 Fax: 860-594-4285
 E-mail: ads@arrl.org
 Web: www.arrl.org/ads

Get Started in POTA!

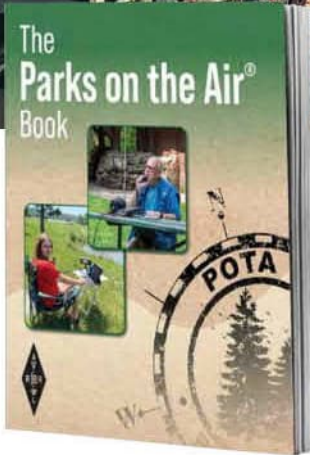
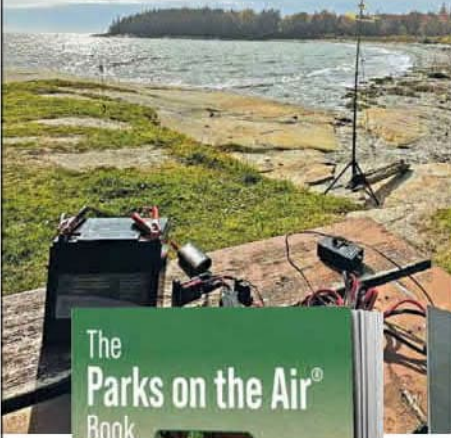

Think outside the shack!
 You never know what exciting
 adventure awaits. Fresh air,
 beautiful scenery, wildlife, and
 new friends are waiting for you.

Topics Include:

- Multi-park roves
- QRP operation
- Satellite operation
- Surefire wire antennas
- Activating urban parks
- CW and POTA

Parks on the Air® Book

Item No. 1748 | Retail \$22.95
 Member Price \$19.95

www.arrl.org/shop



QST Index of Advertisers

ABR Industries™ – www.abrind.com	110
Advanced Specialties – www.advancedspecialties.net	110
Air Boss Antenna Launcher – www.olahtechologies.com.....	108
Ameritron – www.ameritron.com	17
Arcom Communications – www.arcomcontrollers.com	125
ARRL – www.arrl.org	6, 20, 26, 106, 108, 110, 118, 125, 126
ARISS – www.ariss.org	116
Bioenno Power – www.bioennopower.com	118
BridgeCom Systems – www.BridgeComSystems.com	116
California Peripherals & Components, Inc. – www.Californiapc.com.....	118
ChattRadio – www.chattradio.com.....	125
Communication Concepts, Inc. – www.communication-concepts.com.....	118
Cushcraft – www.cushcraftamateur.com.....	2
Dayton Hamvention® – www.hamvention.org	22
Diamond Antenna – www.diamondantenna.net.....	8
DX Engineering – www.DXEngineering.com	25
Eagle One Antenna – www.eagleoneantenna.com.....	108
Elecraft – www.elecraft.com	19
Elk Antennas – www.ElkAntennas.com.....	116
FlexRadio Systems – www.flex-radio.com	21
Green Heron – www.greenheronengineering.com	108
Ham Ads – www.arrl.org/ham-ad-listing	124
Ham Radio Outlet – www.hamradio.com	104, 105
Hammond Mfg. Co. – www.hammondmfg.com.....	106
Hy-Gain – www.hy-gain.com	10
ICOM America – www.icomamerica.com	23
Intuitive Circuits, LLC – www.icircuits.com	125

TUBES

- 100% Tested
- 1-year Warranty
- Matched Groups

800-421-4219 (ext 119)
www.PentaLabs.com

BevFlex-4X Low Band RX Antenna System

Configure as a switchable, bi-directional Beverage, BOG, Flag, EWE, or VE3DO low noise receive antenna system. Build the optimal version to fit your location. Feed the Beverage and BOG configurations at the point closest to the shack, not just at the ends.

Also antenna switching, CW keyers, PC-radio digital modes interface, and more!

www.unifiedmicro.com

Member Services Contact Information:

Toll Free: 888-277-5289
 Fax: 860-594-0303
 E-mail: circulation@arrl.org
 Web: www.arrl.org

Kenwood Communications – www.kenwoodusa.com..... 29, Cover 4
LDG – 410-586-2177..... 112
MFJ Enterprises – www.mfjenterprises.com– 107, 109, 111, 113, 114, 115, 117, 119, 121, 122, 123
Mosley Electronics – www.mosley-electronics.com..... 116
NCG Company – www.natcommgroup.com..... 3, 128
OCI-Olds Communications Inc. – www.ocicom.com 127
Orlando Hamcation® – www.hamcation.com 12
Pacific Antenna – www.qrpkits.com 110
Palomar Engineers – www.Palomar-Engineers.com 116
Penta Laboratories – www.pentalabs.com 126
PreciseRF – http://preciserf.com 11
PreppComm – www.preppcomm.com 108
RF Parts Company – www.rfparts.com 127
RT Systems – www.rtsystems.com 106
Starlink® RV Pole Kits– www.hitched4fun.com 110
SteppIR Communications Systems – www.steppir.com..... 7
Tac-Comm – www.tac-comm.com..... 108
Ten-Ten International Net, Inc. – www.ten-ten.org 116
Tigertronics – www.tigertronics.com 118
Timewave Technology, Inc. – www.timewave.com 112
Unified Microsystems. – www.unifiedmicro.com..... 126
VHQHEX.com. – www.vhqhex.com 125
W5SWL Electronics – www.w5swl.com..... 110, 116, 118, 125
West Mountain Radio – www.westmountainradio.com..... 18
Wolf River Coils. – www.wolfrivercoils.com 125
Yaesu USA – www.yaesu.com 1, Cover 2

Filters
Ham - Commercial - Band Pass
www.ocicom.com

From **MILLIWATTS**
 To **KILOWATTS**SM
In Stock Now!

**Semiconductors
 for Manufacturing
 and Servicing
 Communications
 Equipment**

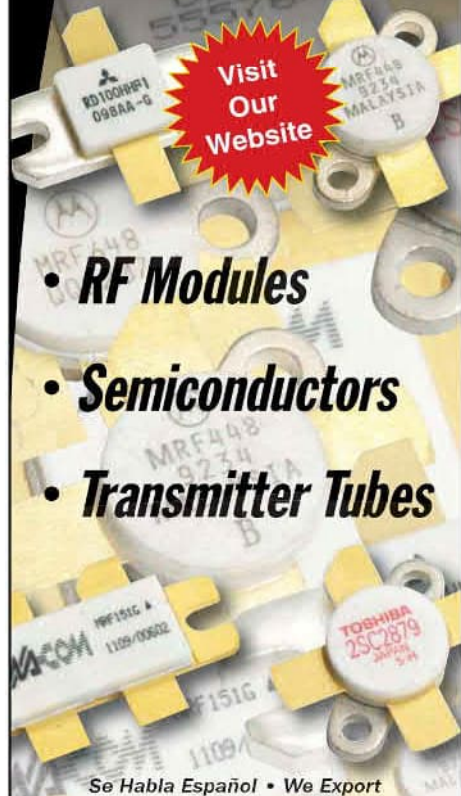

- **RF Modules**
- **Semiconductors**
- **Transmitter Tubes**

Phone: **760-744-0700**
 Toll-Free: **800-737-2787**
 (Orders only) **800-RF PARTS**
 Website: **www.rfparts.com**
 Fax: **760-744-1943**
888-744-1943
 Email: **rfp@rfparts.com**



★CHA-250HD VSWR Characteristics

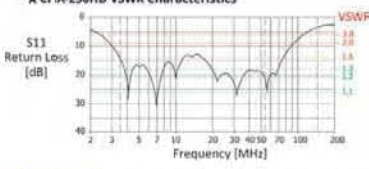

CHA-250HD - No Antenna Tuner Needed!

The Comet CHA-250HD is the updated version CHA-250B. The top aluminum section has been replaced with a solid whip for greater flexibility and less strain on the lower 4 aluminum sections in high winds.

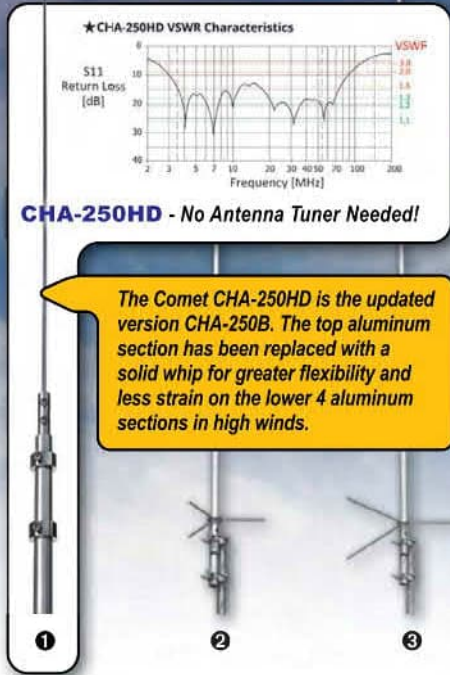

CTC-50M Window Gap Jumper
No more drilling or open windows!



Base Antennas

1 **COMET CHA-250HD BROADBAND 80M THROUGH 6M VERTICAL ANTENNA**

A newly designed broadband vertical with NO GROUND RADIALS. EXTREMELY easy to assemble, requires no tuning or adjustments and VSWR is under 1.5:1 from 3.5-57MHz! • TX: 3.5MHz – 57MHz • RX: 2.0– 90MHz • VSWR is 1.5:1 or less, continuous • Max Power: 250W SSB/125W FM • Impedance: 50 Ohm • Length: 23' 5" • Weight: 7 lbs. 1 oz. • Conn: SO-239 • Mast Req'd: 1" – 2" dia. • Max wind speed: 67MPH

2 **COMET GP-3 DUAL-BAND 146/446MHZ BASE REPEATER ANTENNA**

Wavelength: 146MHz 6/8 wave • 446MHz 5/8 wave x 3 • Max Pwr: 200W • Length: 5'11" • Weight: 2lbs. 9ozs. • Conn: Gold-plated SO-239 • Construction: Single-piece fiberglass

3 **COMET GP-6 DUAL-BAND 146/446MHZ BASE REPEATER ANTENNA**

Wavelength: 146MHz 5/8 wave x 2 • 446MHz 5/8 wave x 5 • Max Pwr: 200W • Length: 10'2" • Weight: 3lbs. 8ozs. • Conn: Gold-plated SO-239 • Construction: Fiberglass, 2 Sections

4 **COMET GP-9 / GP-9N DUAL-BAND 146/446MHZ BASE REPEATER ANTENNA**

BEST SELLER! • Wavelength: 146MHz 5/8 wave x 3 • 446MHz 5/8 wave x 8 • Max Pwr: 200W • Length: 16' 9" • Weight: 5lbs. 11ozs. • Conn: GP-9 Gold-plated SO-239 • GP-9N Gold-plated N-type female • Construction: Fiberglass, 3 Sections

5 **COMET CX-333 TRI-BAND 146/220/446MHZ BASE REPEATER ANTENNA**

Wavelength: 146MHz 5/8 wave x 2 • 220MHz 5/8 wave x 3 • 446MHz 5/8 wave x 5 • Max Pwr: 120W • Length: 10'2" • Weight: 3lbs. 1oz. • Conn: Gold-plated SO-239 • Construction: Fiberglass, 2 Sections

6 **COMET GP-15 TRI-BAND 52/146/446MHZ BASE REPEATER ANTENNA**

Wavelength: 52MHz 5/8 wave • 146MHz 5/8 wave x 2 • 446MHz 5/8 wave x 4 • Max Pwr: 150W • Length: 7'11" • Weight: 3lbs. 1oz. • Conn: Gold-plated SO-239 • 2MHz band-width after tuning (6M) • Construction: Single-piece fiberglass

7 **COMET CTC-50M WINDOW GAP JUMPER**

Avoid drilling holes or leaving windows open/unlocked. Flat coax easily forms to window frame. Low loss SO-239 on each end, 15 inch length.

• Max Pwr: HF 100W PEP / VHF 60W FM / UHF 40W FM / 900-1300 MHz 10W FM

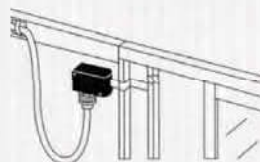

CAA-500MarkII 1.8-500MHz Antenna analyzer

The CAA-500MarkII combines the simplicity and accuracy of an analog instrument, PLUS...a full color LCD graphic display • Resistive (R) and Reactive (X) components of impedance graphed and displayed numerically • SWR readings in both graphic and numerical results.

Operates on 8-16VDC external power, 6 AA Alkaline or NiMH rechargeable cells • Trickle charger built in (only when using NiMH batteries) • Typical battery life: 9 hours of continuous operation • Battery level indicator • Selectable auto power-off time limit preserves battery capacity • SO-239 connector for 1.8-300MHz range • N-female connector for 300-500MHz range

The perfect combination of analog and graphic information, designed in particular for antenna diagnostics and adjustments while on the roof, tower or in the field!

CAA-55C

Protect your CAA-500MarkII from moisture, shock, dents and dings!

Shoulder strap included.





Preserving Memories and the Cultural Value of W1AW

Make your gift to W1AW today!

W1AW, the Hiram Percy Maxim Memorial Station, is more than just a building. To many ARRL members, it possesses cherished memories of past visits, the excitement of making contact with a landmark station that is still operating daily, and stories that add value to our community's future.

If you value this irreplaceable station and want to contribute to ensuring it is preserved for the enjoyment of hams now and in the future, please donate to the W1AW Endowment Fund.

Give today at www.arrl.org/w1aw-endowment-fund or call 860-594-0228



ARRL The National Association for
Amateur Radio®

Many memories and stories of amateur radio are within the walls of W1AW. We'd love for you to share the story of your visit or contact and what W1AW means to you.

Write to us at development@arrl.org.

The EVENT HORIZON OF DX TS-990S

Dual TFT Display & Dual Receiver HF/50 MHz Transceiver



The main receiver has an IP3 in the +40 dB class, and the sub-receiver is the already famous TS-590S receiver. Capable of receiving two signals at once, on different bands. 7-inch and 3.5-inch color TFT displays allow displaying of independent contents. Simplification of complex operations at a glance. Make no mistake, this is not a toy. Finally a serious tool is available for getting the very most from your hobby - of course it's a Kenwood.

- Covers the HF and 50 MHz bands.
- High-speed automatic antenna tuner.
- USB, Serial and LAN ports.
- Various PC applications (free software): ARCP-990 enabling PC control, ARHP-990 enabling remote control, and ARUA-10 USB audio driver.
- Clean 5 to 200 W transmit power through the 50 V FET final unit.
- Built-in RTTY and PSK.
- Three Analog Devices 32-bit floating-point arithmetic DSPs.
- DVI output for display by an external monitor (main screen display only).



Scan with your phone to
download TS-990S brochure.



www.kenwood.com/usa



ISO9001 Registered
UKAS Quality Management System

KENWOOD

Customer Support: (310) 639-4200
Fax: (310) 537-8235