

ARRL Laboratory Expanded Test-Result Report

ICOM IC-746 Pro

Prepared by:

American Radio Relay League, Inc.
Technical Department Laboratory
225 Main St.
Newington, CT 06111
Telephone: (860) 594-0214
Internet: mtracy@arrl.org

Order From:

American Radio Relay League, Inc.
Technical Department Secretary
225 Main St.
Newington, CT 06111
Telephone: (860) 594-0278
Internet: reprints@arrl.org

Price:

\$7.50 for ARRL Members, \$12.50 for non-Members, postpaid.

Model Information:

IC-746 Pro Serial #: 01484
QST "Product Review" May, 2002

Manufacturer:

ICOM America
2380 116th Ave NE
PO Box C-90029
Bellevue, WA 98004
Telephone: 425-454-8155

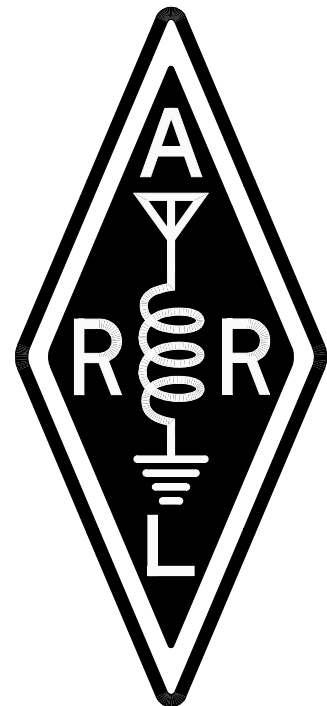

Table of Contents:

Introduction	3
Transmitter Output Power	4
Transmitter Output Power Results	5
Current Consumption	5
Transmit Frequency Range	6
CW Transmit Frequency Accuracy	6
Spectral Purity	7
Spectral-Purity Graphs	8
Transmit Two-Tone IMD	11
Transmit IMD Graphs	12
SSB Carrier and Unwanted Sideband Suppression	15
CW Keying Waveforms and Sidebands	15
Keying Waveforms	16
Keying Sideband Plots	16
CW Keyer Speed Range	19
Keyer Sidetone Frequency	19
Transmit/Receive Turnaround Time	19
Transmit Delay Time	19
Transmit Composite Noise	20
Transmit Composite Noise Graphs	20
Receiver Noise Floor	21
Receive Frequency Range	22
AM Sensitivity	23
FM SINAD	23
Antenna Port Isolation	24
Blocking Dynamic Range	24
Two-Tone 3rd-Order IMD Dynamic Range	26
Third-Order Intercept	27
Swept Dynamic Range Graphs	28
Second-Order Intercept	30
In-Band Receiver IMD	30
FM Adjacent Channel Selectivity	31
FM Two-Tone 3rd-Order Dynamic Range	32
IF and Image Rejection	32
Audio Output Power	33
Audio Hiss	33
IF and Audio Frequency Response	33
Squelch Sensitivity	34
S-Meter Sensitivity	34

Introduction

This document summarizes the extensive battery of tests performed by the ARRL Laboratory for each unit that is featured in *QST* "Product Review." For all tests, there is a discussion of the test and test method used in ARRL Laboratory testing. For most tests, critical conditions are listed to enable other engineers to duplicate our methods. For some of the tests, a block diagram of the test setup is included. The ARRL Laboratory has a document, the *ARRL Laboratory Test Procedures Manual*, that explains our specific test methods in detail. While this is not available as a regular ARRL publication, it may be downloaded from our web page.

Most of the tests used in ARRL product testing are derived from recognized standards and test methods. Other tests have been developed by the ARRL Lab. The ARRL Laboratory test equipment is calibrated annually, with traceability to National Institute of Standards and Technology (NIST).

The units being tested are operated as specified by the equipment manufacturer. Equipment that can be operated from 13.8 volts (nominal) is also tested for function, output power and frequency accuracy at the minimum specified voltage, or 11.5 volts if not specified. Also, units that are capable of mobile or portable operation are tested at their rated temperature range, or at -10 to +60 degrees Celsius in a commercial temperature chamber.

ARRL "Product Review" testing represents a sample of only one unit (although we sometimes obtain an extra sample or two for comparison purposes). This is not necessarily representative of all units of the same model number. It is not uncommon that some parameters will vary significantly from unit to unit. The ARRL Laboratory and Product Review editor work with manufacturers to resolve any deviation from specifications or other problems encountered in the review process. These problems are documented in the Product Review.

Transmitter Output Power

Test description: One of the first things an amateur wants to know about a transmitter or transceiver is its RF output power. The ARRL Lab measures the CW output power for every band on which a transmitter can operate. The equipment is also tested on one or more bands for any other mode of operation for which the transmitter is capable. Another purpose of the Transmitter Output-Power Test is to measure the dc current consumption at the manufacturer's specified dc-supply voltage, if applicable.

Many transmitters are de-rated from maximum output power on full-carrier AM and FM modes. In most cases, a 100-watt CW/SSB transmitter may be rated at 25 watts carrier power on AM. The radio may actually deliver 100 watts PEP in AM or FM but is not specified to deliver that power level for any period of time.

In almost all cases, the linearity of a transmitter decreases as output power increases. A transmitter rated at 100 watts PEP on single sideband may actually be able to deliver more power, but as the power is increased beyond the rated RF output power, adjacent channel splatter (IMD) usually increases dramatically.

Key Test Conditions:

Termination: 50 ohms resistive, or as specified by the manufacturer.

Block Diagram:

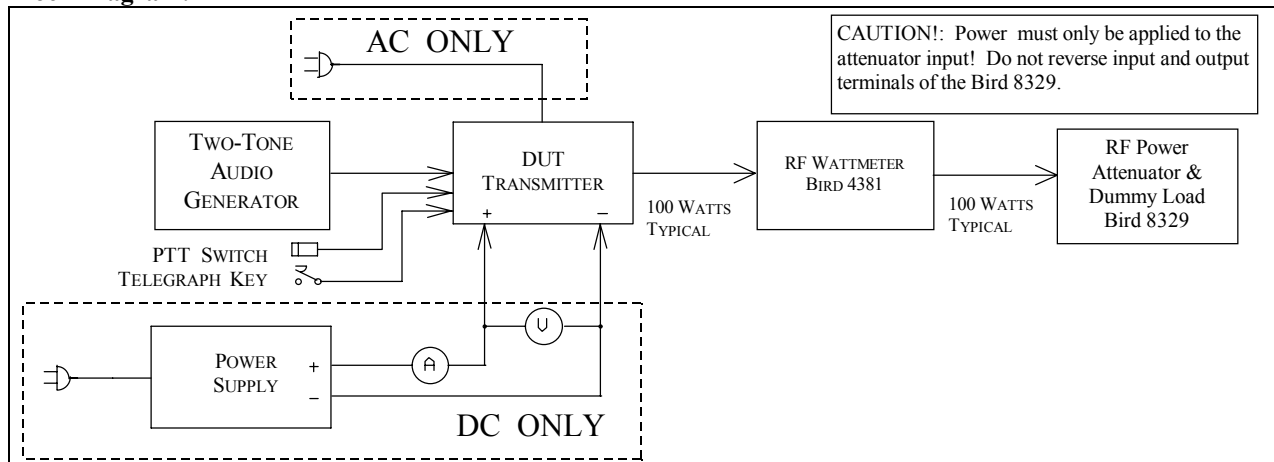

Transmitter Output Power Results

NOTE!: If comparing this table against the table from the IC-746 (Sept 98 QST), please be sure you have a recent copy of the expanded report for the IC-746, as the original report contained incorrect data for the high power output.

Frequency Band	Mode	Unit Minimum Power (W)	Measured Minimum Power (W)	Unit Maximum Power (W)	Measured Maximum Power (W)	Notes
1.8 MHz	CW	See note 1	2.0 W	“100”	103.4 W	1, 2
3.5 MHz	CW	–	2.2	–	107.7	
3.5 MHz	AM	–	1.0	–	39.1 W carrier	
7.0 MHz	CW	–	2.2	–	109.8	
10.1 MHz	CW	–	2.3	–	110.6	
14 MHz	CW	–	2.3	–	110.7	
14 MHz	USB	–	2.2	–	108.0	
18 MHz	CW	–	2.3	–	110.4	
21 MHz	CW	–	2.2	–	107.0	
24 MHz	CW	–	2.2	–	109.9	
28 MHz	CW	–	2.2	–	109.3	
28 MHz	FM	–	2.3	–	110.1	
50 MHz	CW	–	1.8	–	103.3	
50 MHz	FM	–	2.3	–	105.0	
50 MHz	AM	–	1.2	–	38.6 W carrier	
50 MHz	SSB	–	2.1	–	103.4	
144 MHz	CW	–	2.4	–	97.4	
144 MHz	FM	–	2.9	–	98.7	
144 MHz	AM	–	1.3	–	39.5 W carrier	
144 MHz	SSB	–	2.6	–	97.1	

Notes:

1. Unit's power meter consists of LED segments; minimum power showed 0 segments lit.
2. The unit showed LED segments reaching a fixed display label reading 100 at full power.

Current Consumption

(DC-powered units only)

Test Description: Current consumption can be important to the success of mobile and portable operation. The ARRL Lab tests the current consumption of all equipment that can be operated from a battery or 12-14 vdc source. The equipment is tested in transmit at maximum output power. On receive, it is tested at maximum volume, with no input signal, using the receiver's broadband noise.

Current Consumption:

Voltage	Transmit Current	Output Power	Receive Current	Lights?	Notes
13.8 V	19.8 A	110.7 W	1.9 A	ON	

Transmit Frequency Range

Test Description: Many transmitters can transmit outside the amateur bands, either intentionally, to accommodate MARS operation, for example, or unintentionally as the result of the design and internal software. The ARRL Lab tests the transmit frequency range inside the screen room. Most modern synthesized transmitters are capable of operation outside the ham bands, but spectral purity is not always legal outside the bands, so caution must be used. In addition, most other radio services require that transmitting equipment be type accepted for that service. Amateur equipment is not legal for use on other than amateur and MARS frequencies.

Test Results:

Frequency	Low-Frequency Limit	High-Frequency Limit	Notes
160 M	1.800 000 MHz	1.999 999 MHz	
80 M	3.500 000 MHz	3.999 999 MHz	
40 M	7.000 000 MHz	7.300 000 MHz	
30 M	10.100 000 MHz	10.150 000 MHz	
20 M	14.000 000 MHz	14.350 000 MHz	
17 M	18.068 000 MHz	18.168 000 MHz	
15 M	21.000 000 MHz	21.450 000 MHz	
12 M	24.890 000 MHz	24.990 000 MHz	
10 M	28.000 000 MHz	29.700 000 MHz	
6 M	50.000 000 MHz	54.000 000 MHz	
2 M	144.000 000 MHz	148.000 000 MHz	

CW Transmit Frequency Accuracy

Test Description: Most modern amateur equipment is surprisingly accurate in frequency. It is not uncommon to find equipment operating within a few Hz of the frequency indicated on the frequency display. However, some units, notably "analog" units, not using a phase-lock loop in the VFO design, can be off by a considerable amount. Frequency is also measured at minimum output power, low supply voltage (12 volt units only) and over the operating temperature range (mobile and portable units only). Non-portable equipment is not tested in the temperature chamber.

Test Results:

Unit Display Frequency	Supply Voltage	Temperature	Measured Frequency Full Output Power	Notes
14.000 000 MHz	13.8 V	25 C	13.999 995 MHz	
50.000 000 MHz	13.8 V	25 C	49.999 980 MHz	
144.000 000 MHz	13.8 V	25 C	143.999 948 MHz	1

Notes:

1. Measured frequency at low power output was 7 Hz lower on 2M.

Spectral Purity

Test Description: All transmitters emit some signals outside their assigned frequency or frequency range. These signals are known as spurious emissions or "spurs." Part 97 of the FCC rules and regulations specify the amount of spurious emissions that can be emitted by a transmitter operating in the Amateur Radio Service. The ARRL Laboratory uses a spectrum analyzer to measure the spurious emission on each band on which a transmitter can operate. The transmitter is tested across the band and the worst-case spectral purity on each band is saved to a file on disk. Spectral purity is reported in dBc, meaning dB relative to the transmitted carrier.

The graphs and tables indicate the relative level of any spurious emissions from the transmitter. The lower that level, the better the transmitter is. So a transmitter whose spurious emissions are -60 dBc is spectrally cleaner than is one whose spurious emissions are -30 dBc.

Key Test Conditions:

Unit is operated at nominal supply voltage and temperature.

Output power is adjusted to full power on each amateur band.

A second measurement is taken at minimum power to ensure that the spectral output is still legal at low power.

The resolution bandwidth of the spectrum analyzer is 10 kHz on HF, 100 kHz on VHF, 1 MHz on UHF.

Block Diagram:

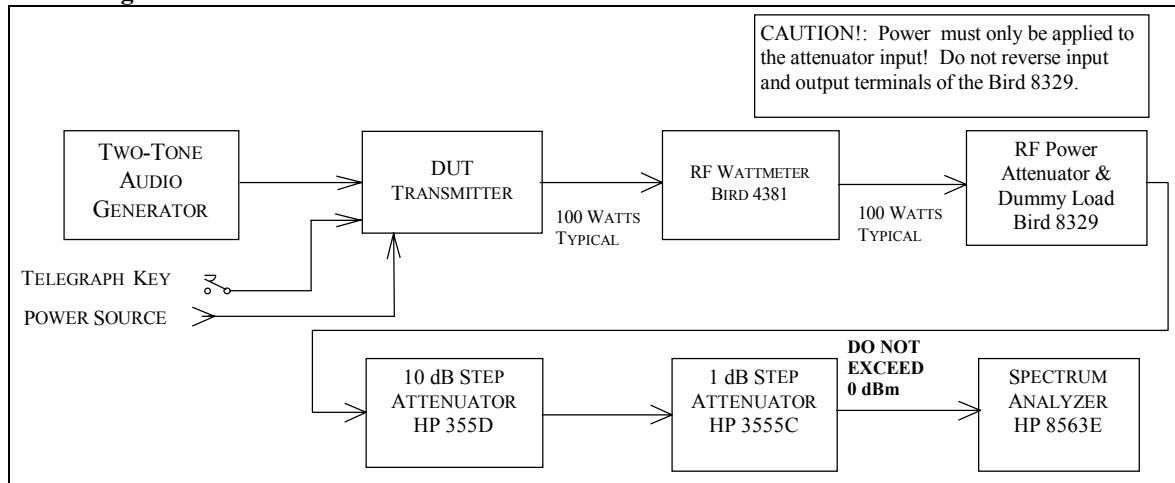

Spectral-Purity Graphs

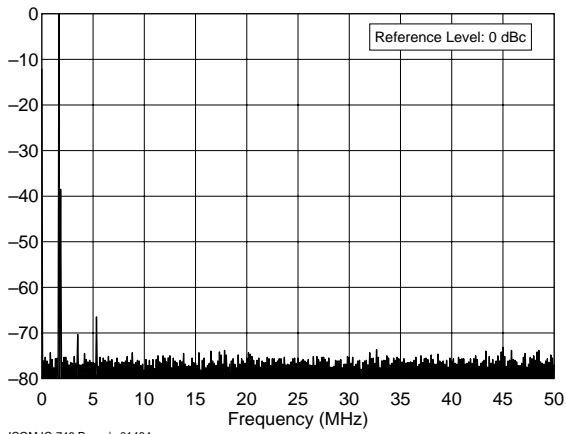

ICOM IC-746 Pro, s/n 01484
1.8 MHz Band, Spectral Purity, 100 W
I:\PRODEV\TESTS\IC746PRO\746PRSLO.TXT

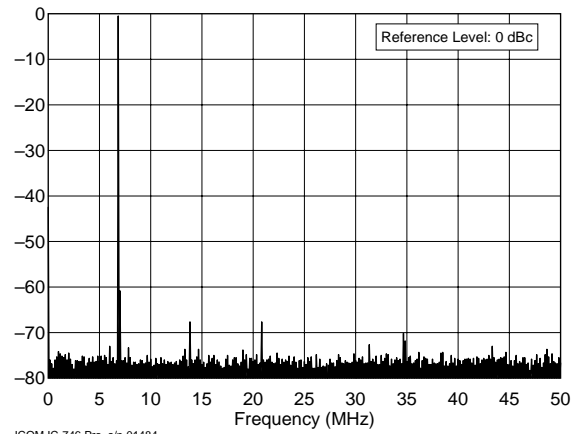

ICOM IC-746 Pro, s/n 01484
7.0 MHz Band, Spectral Purity, 100 W
I:\PRODEV\TESTS\IC746PRO\746PRS40.TXT

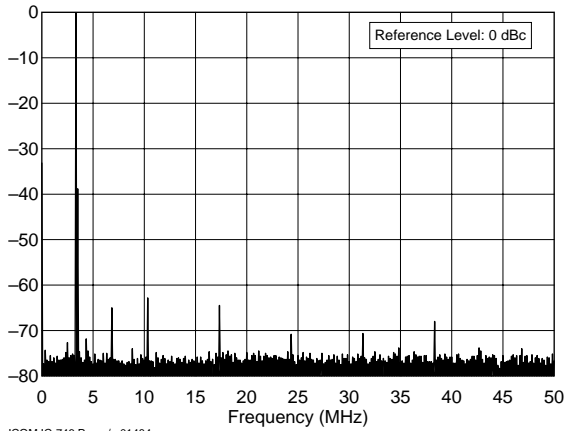

ICOM IC-746 Pro, s/n 01484
3.5 MHz Band, Spectral Purity, 100 W
I:\PRODEV\TESTS\IC746PRO\746PRS80.TXT

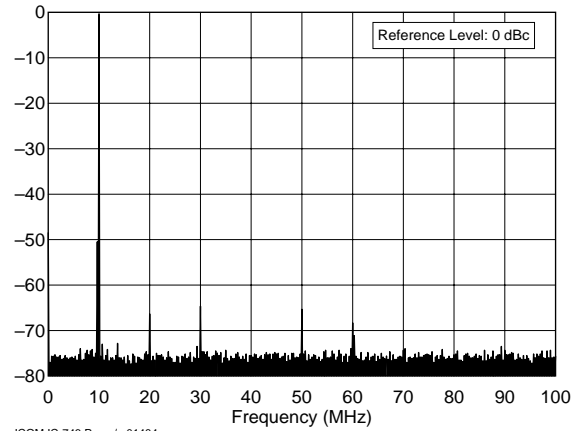

ICOM IC-746 Pro, s/n 01484
10.1 MHz Band, Spectral Purity, 100 W
I:\PRODEV\TESTS\IC746PRO\746PRS30.TXT

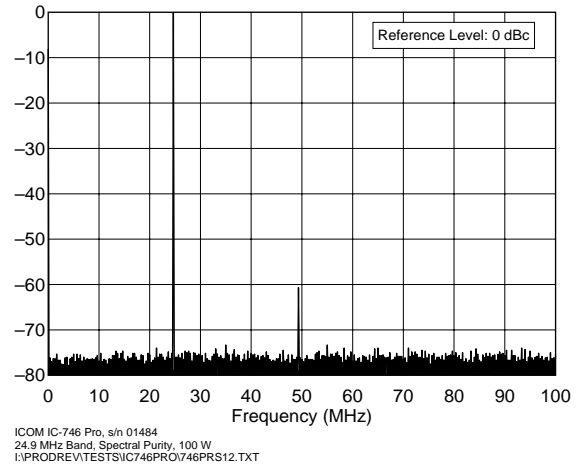
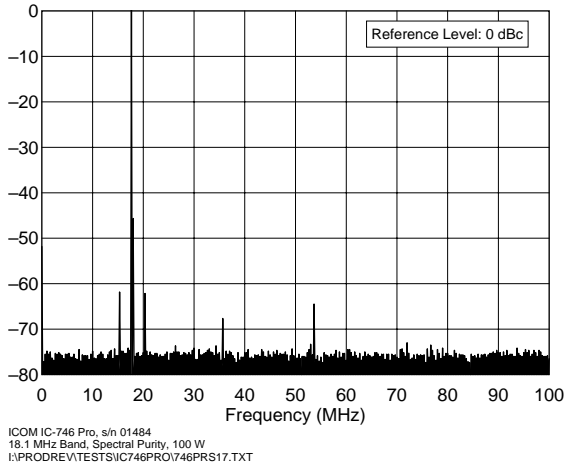
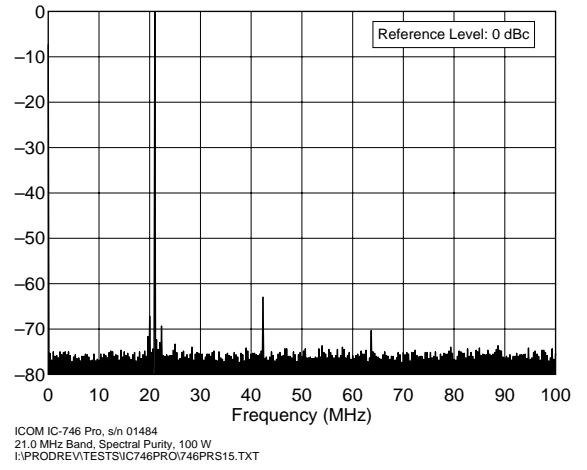
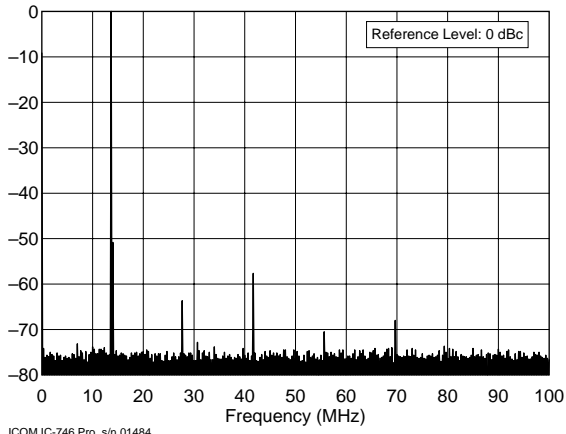

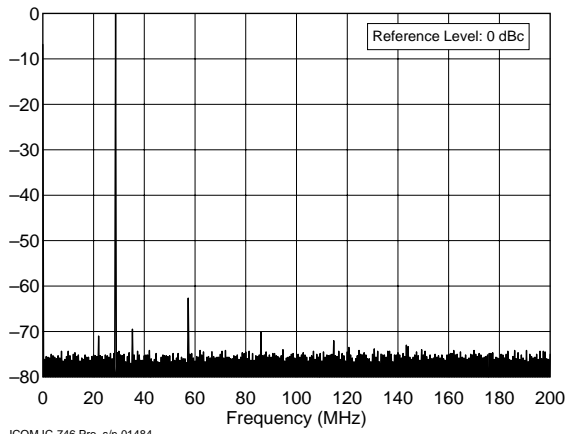

ICOM IC-746 Pro, s/n 01484
 28.0 MHz Band, Spectral Purity, 100 W
 I:\PRODREV\TESTS\IC746PRO\746PRS10.TXT

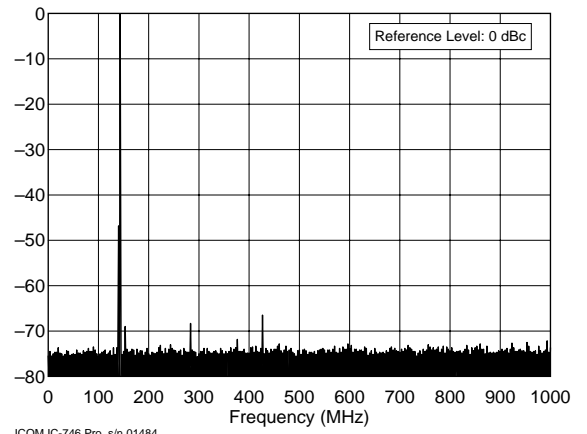

ICOM IC-746 Pro, s/n 01484
 144.0 MHz Band, Spectral Purity, 100 W
 I:\PRODREV\TESTS\IC746PRO\746PRS2M.TXT

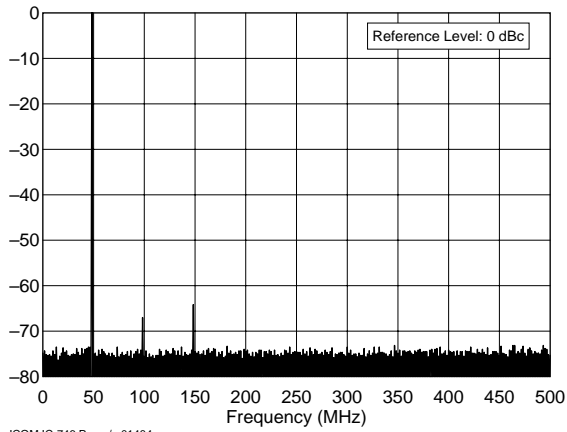

ICOM IC-746 Pro, s/n 01484
 50.0 MHz Band, Spectral Purity, 100 W
 I:\PRODREV\TESTS\IC746PRO\746PRS6M.TXT

Transmit Two-Tone IMD

Test Description: Investigating the sidebands from a modulated transmitter requires a narrow-band spectrum analysis. In this test, a two-tone signal is used to modulate the transmitter. The spectral display shows the test tones plus some of the IMD products produced by the SSB transmitter. In the ARRL Lab, frequencies of 700 and 1900 Hz is used to modulate the transmitter. These frequencies were selected to be within the audio passband of the typical transmitter, resulting in a meaningful display of transmitter IMD. The intermodulation products appear on the spectral plot above and below the two tones. The lower the products, the better the transmitter. In general, it is the products that are farthest removed from the two tones (typically > 3 kHz away) that cause the most problems. These can cause splatter up and down the band from strong signals.

Key Test Conditions:

Transmitter operated at rated output power. Audio tones and drive level adjusted for best performance. Both audio tones adjusted for equal RF output. Level to spectrum analyzer, -10 dBm maximum. Resolution bandwidth, 10 Hz

Block Diagram:

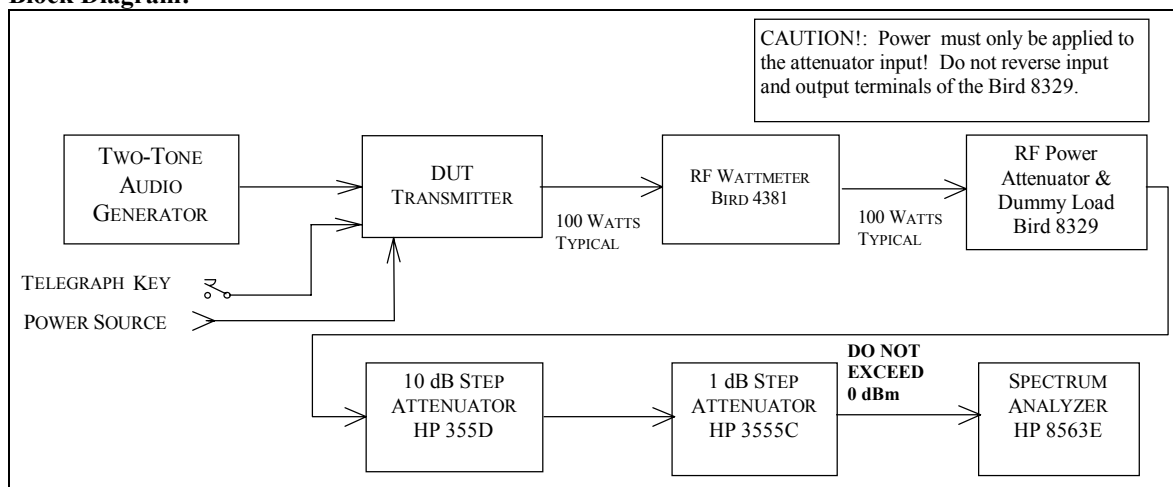

Transmit IMD Graphs

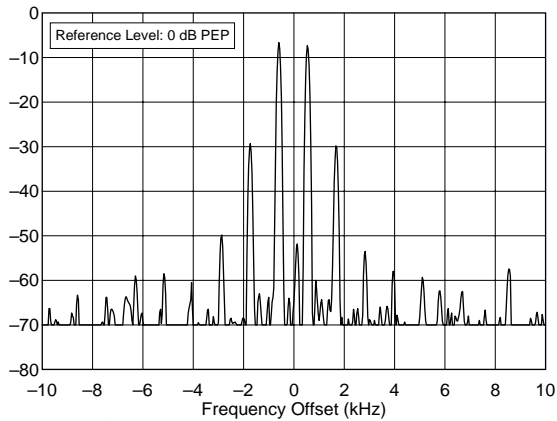

ICOM IC-746 Pro, s/n 01484
1.850 MHz, Transmit IMD, 100 W
I:\PRODEV\TESTS\IC746PRO\746PRI10.TXT

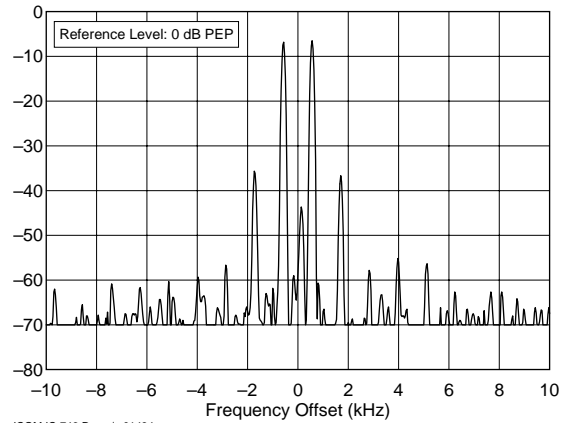

ICOM IC-746 Pro, s/n 01484
7.250 MHz, Transmit IMD, 100 W
I:\PRODEV\TESTS\IC746PRO\746PRI40.TXT

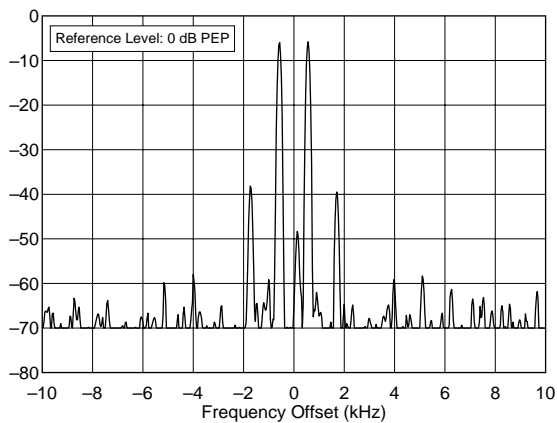

ICOM IC-746 Pro, s/n 01484
3.900 MHz, Transmit IMD, 100 W
I:\PRODEV\TESTS\IC746PRO\746PRI80.TXT

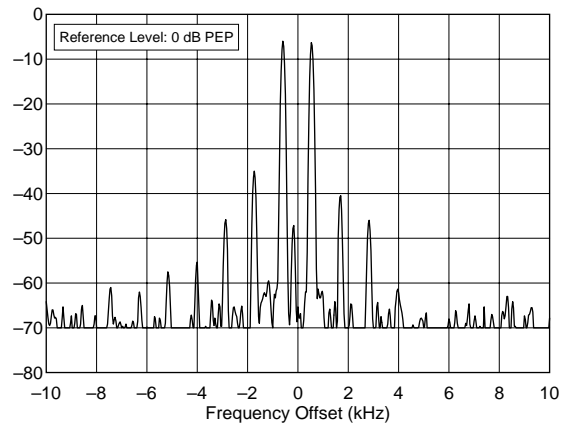

ICOM IC-746 Pro, s/n 01484
10.120 MHz, Transmit IMD, 100 W
I:\PRODEV\TESTS\IC746PRO\746PRI30.TXT

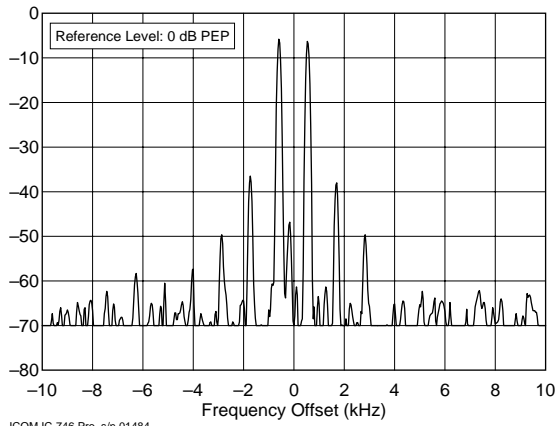

ICOM IC-746 Pro, s/n 01484
 14.250 MHz, Transmit IMD, 100 W
 I:\PRODREV\TESTS\IC746PRO\746PRI20.TXT

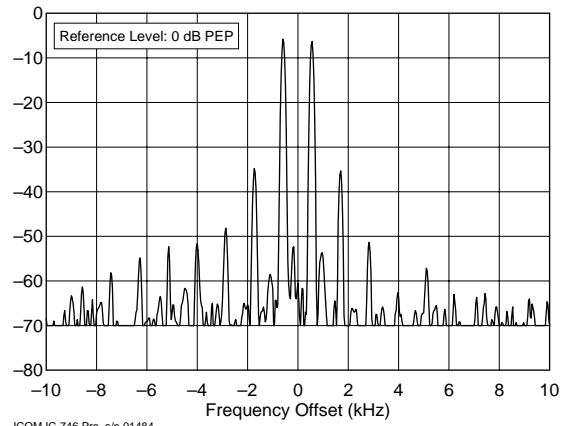

ICOM IC-746 Pro, s/n 01484
 21.250 MHz, Transmit IMD, 100 W
 I:\PRODREV\TESTS\IC746PRO\746PRI15.TXT

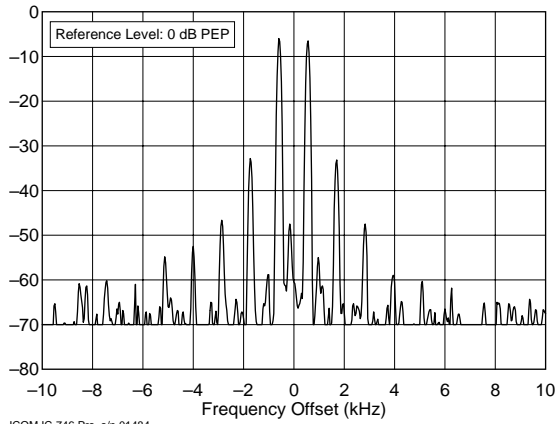

ICOM IC-746 Pro, s/n 01484
 18.120 MHz, Transmit IMD, 100 W
 I:\PRODREV\TESTS\IC746PRO\746PRI17.TXT

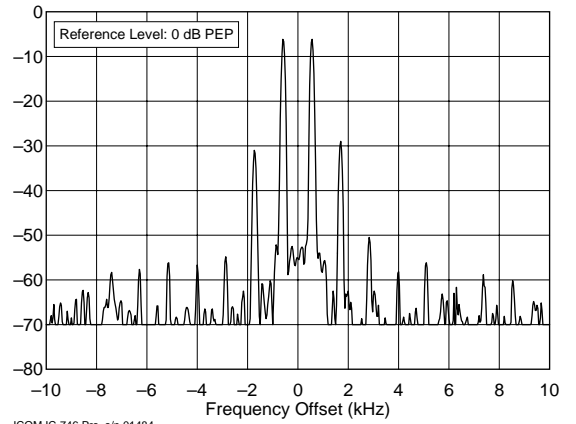

ICOM IC-746 Pro, s/n 01484
 24.950 MHz, Transmit IMD, 100 W
 I:\PRODREV\TESTS\IC746PRO\746PRI12.TXT

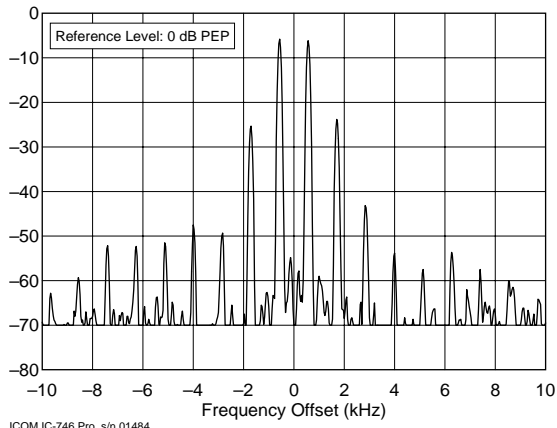

ICOM IC-746 Pro, s/n 01484
 28.350 MHz, Transmit IMD, 100 W
 I:\PRODREV\TESTS\IC746PRO\746PRI10.TXT

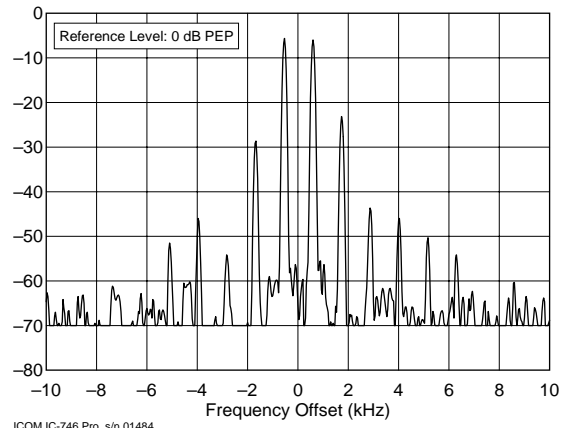

ICOM IC-746 Pro, s/n 01484
 144.200 MHz, Transmit IMD, 100 W
 I:\PRODREV\TESTS\IC746PRO\746PRI2M.TXT

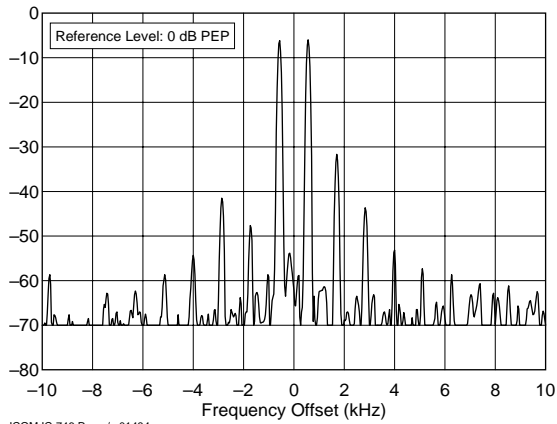

ICOM IC-746 Pro, s/n 01484
 50.200 MHz, Transmit IMD, 100 W
 I:\PRODREV\TESTS\IC746PRO\746PRI6M.TXT

SSB Carrier and Unwanted Sideband Suppression

Test Description: The purpose of the SSB Carrier and opposite-sideband Suppression test is to determine the level of carrier and unwanted sideband suppression relative to Peak Envelope Power (PEP). The transmitter output is observed on the spectrum analyzer and the unwanted components are compared to the desired sideband. The level to the spectrum analyzer is -10 dBm nominal. The measurement bandwidth is 100 Hz. The greater the amount of suppression, the better the transmitter. For example, opposite sideband suppression of 60 dB is better than suppression of 50 dB.

Test Results:

Frequency	Carrier Suppression	Opposite Sideband Suppression	Notes
14.2 MHz USB/LSB	-68/-68 dB PEP	-70/-70 dB PEP	
50.2 MHz USB/LSB	-60/-67 dB PEP	-68/-70 dB PEP	
144.2 MHz USB/LSB	-67/-66 dB PEP	-67/-67 dB PEP	

CW Keying Waveforms and Sidebands

Test Description: The purpose of the CW Keying Waveform Test is to determine the shape of the transmitter's RF output envelope in the CW mode. If the transmitter under test has several CW modes, (VOX, QSK) these are also tested. A picture of the oscilloscope screen is taken of the results. The first and second dits are shown in all modes.

If the rise or fall times become too short, the transmitter may generate key clicks. Most click-free transmitters have rise and fall times between 1 and 5 ms. However, key clicks are most often generated by sudden transactions in the keying envelope (e.g., "square corners"), so a short rise or fall time is not a guarantee of clicks.

The absolute values of the on delay and off delay are not critical, but it is important that they be approximately the same so that CW weighting will not be affected. Some transmitters used in the VOX mode exhibit a first dit that is shorter than subsequent dits. Other transmitters can show significant shortening of all dits when used in the QSK mode. The latter will cause keying to sound choppy.

This test also measures the sidebands generated by the transceiver on high speed CW. This is an indication of the degree to which a transmitter may exhibit 'key clicks'. The transmitter is keyed at 60-wpm by an external circuit. The sidebands are measured on the spectrum analyzer using a resolution bandwidth of 300 Hz, and a long sweep time (30 seconds) so the worst-case spectrum is captured.

Key Test Conditions:

The transmitter is operated at room temperature at rated output power into a 50-ohm resistive load. The power supply voltage is nominal.

Figure Notes (Figures on next page):

1. Each figure 'A' shows the keying waveform from the oscilloscope. The top trace is the voltage on the keying line of the transceiver (the external keying circuit uses an open-collector transistor in its output). A low voltage on this line indicates the transmitter "key down" condition. The second trace is the actual transmitter output. The horizontal axis is 10 ms/division, and the keying rate is 60 wpm. The first and second dits are shown, and some traces also show the beginning of the third dit
2. Each 'B' figure shows the keying sidebands from the spectrum analyzer for a continuous string of dits at 60 wpm.
3. Figures 1A and 1B show the transmitter output in QSK mode with a "4 ms" rise/fall time setting on the transmitter (default).
4. Figures 2A and 2B show the transmitter output in semi-QSK, with a 4 ms rise/fall time setting.
5. Figures 3 through 8 show the output for rise/fall time settings of 2 ms, 6 ms and 8 ms, each in QSK and semi-QSK, respectively.

Keying Waveforms

Figure 1A

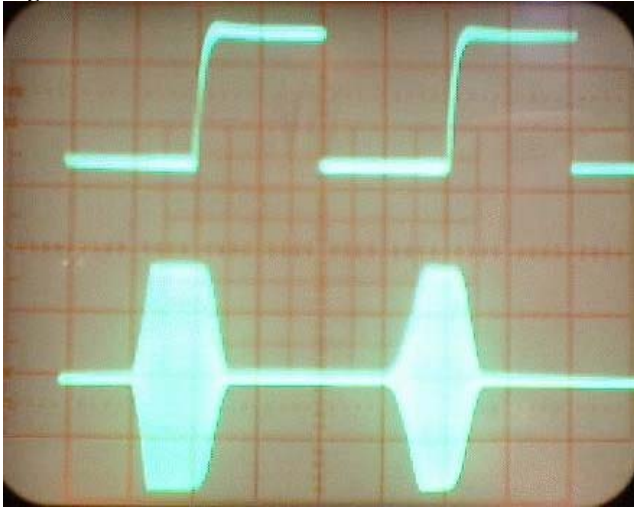

Figure 2A

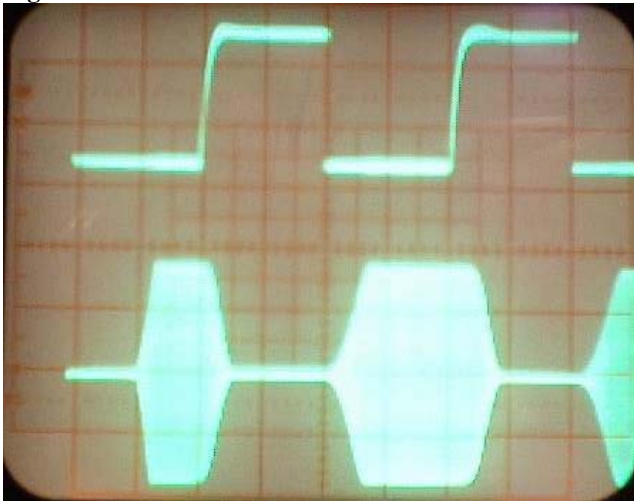
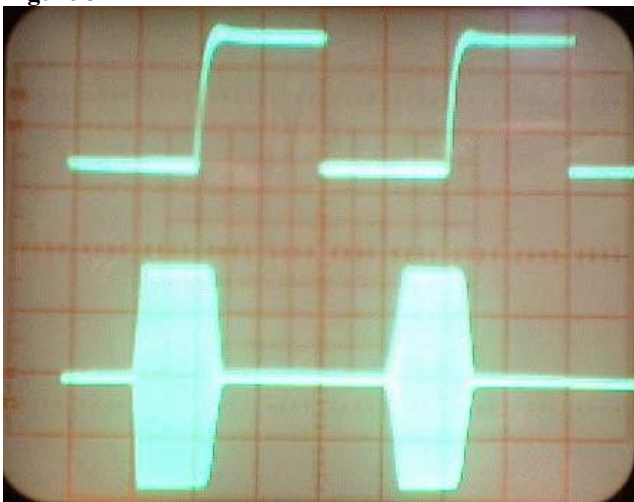

Figure 3A



Keying Sideband Plots

Figure 1B

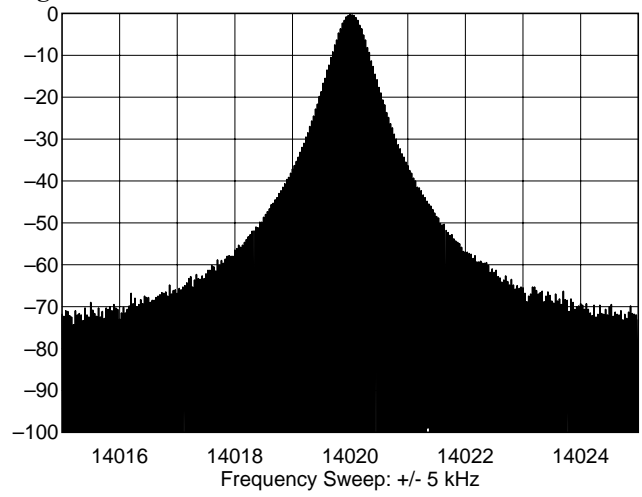

Figure 2B

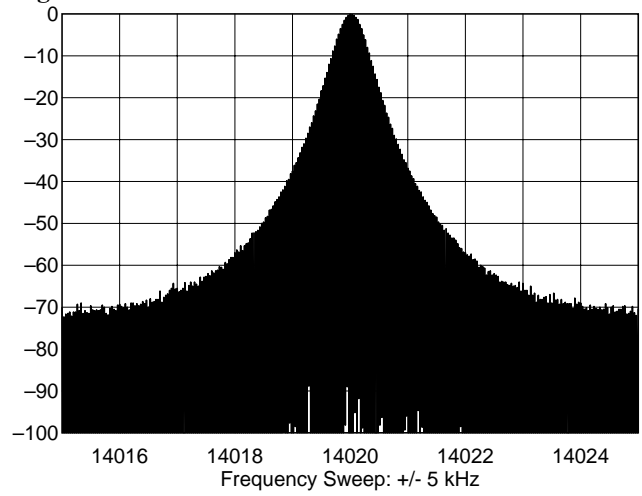

Figure 3B

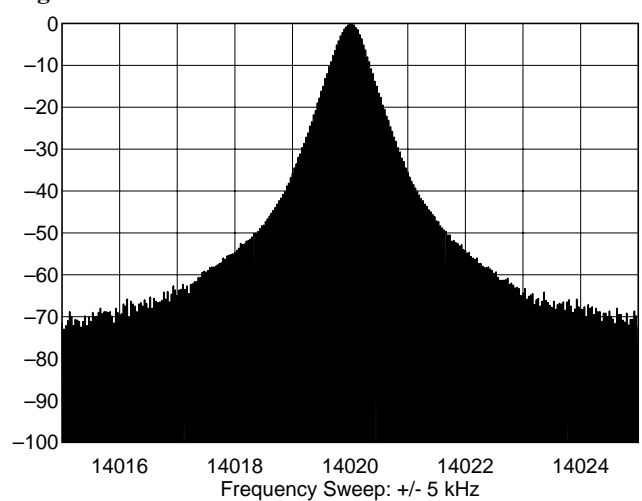

Figure 4A

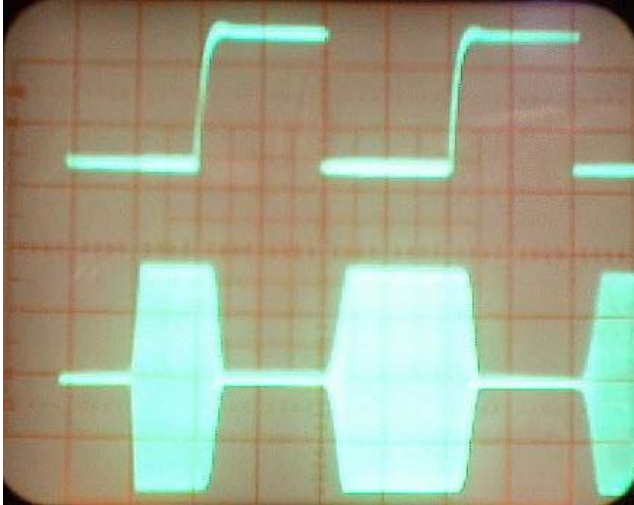

Figure 4B

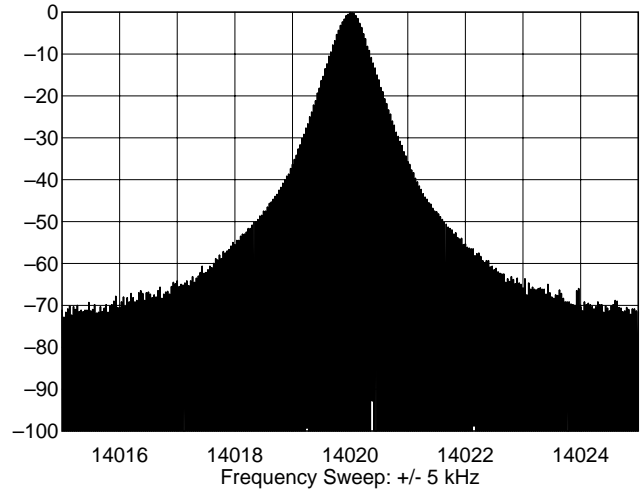

Figure 5A

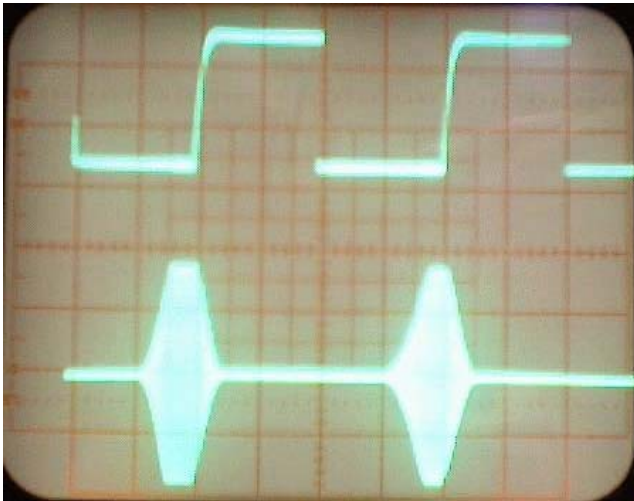

Figure 5B

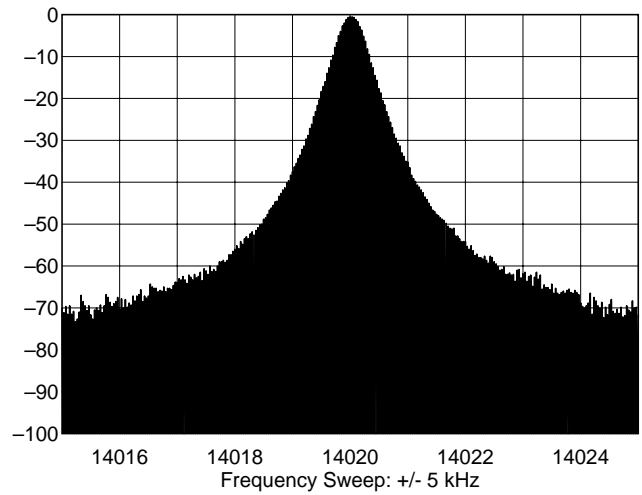

Figure 6A

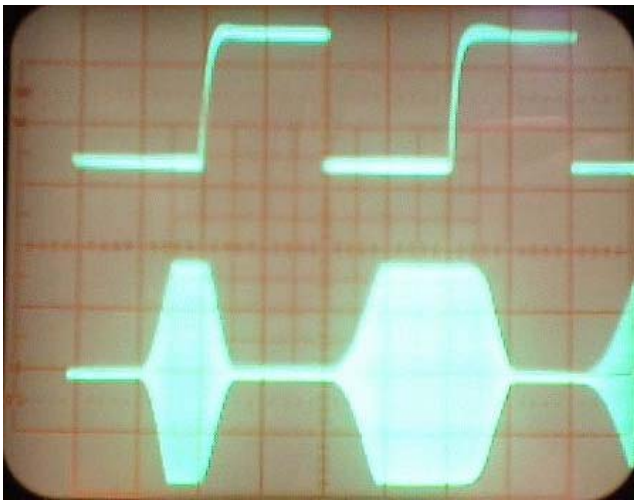

Figure 6B

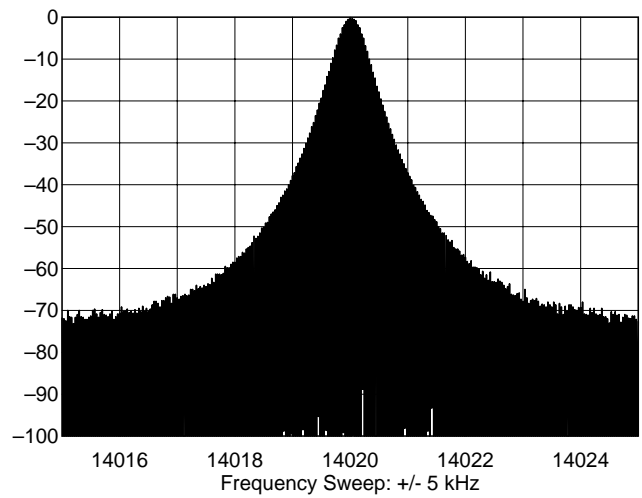

Figure 7A

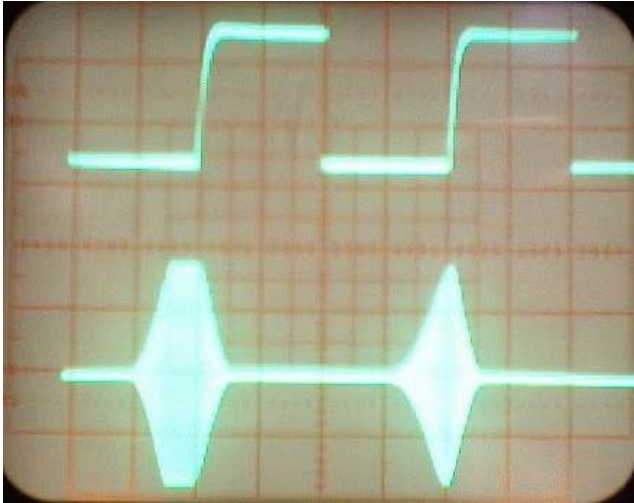

Figure 7B

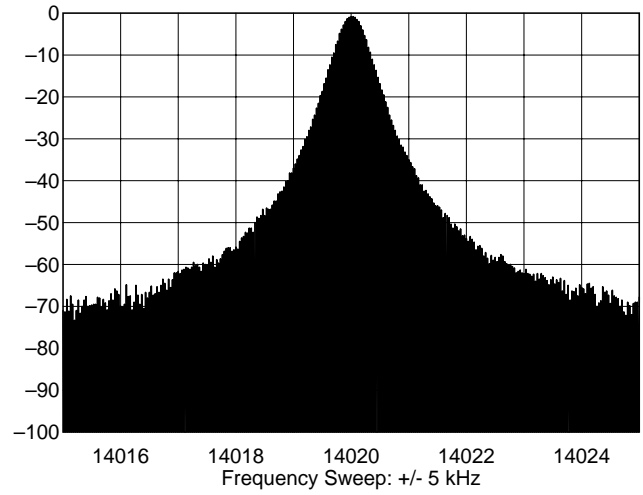

Figure 8A

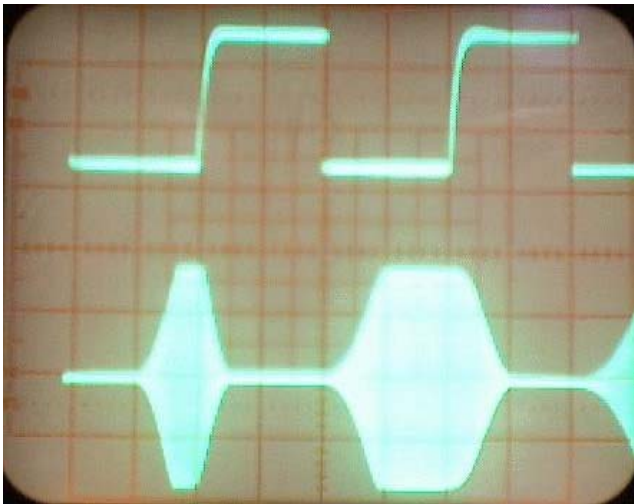
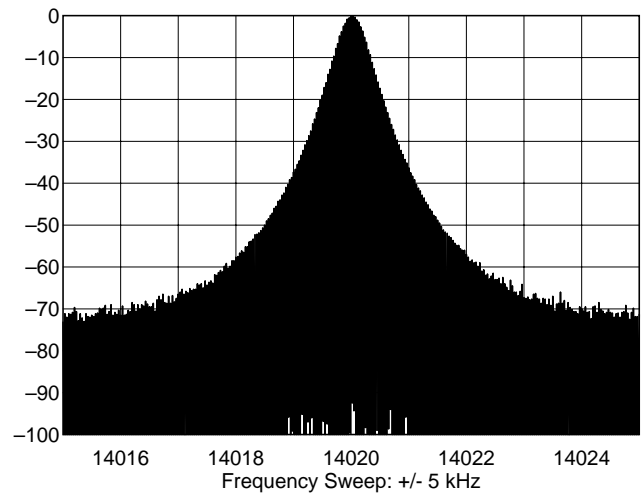

Figure 8B



CW Keyer Speed Range

Test Description: This test measures the speed of the internal keyer on transmitters so equipped. The keyer is tested at minimum, midrange and maximum speeds and the time from dit to dit is measured using an oscilloscope and used to calculate the speed using the "Paris" method of code speed calculation. (In the Paris method, the word "Paris" is used as the standard word to calculate words per minute.)

Test Results:

Min WPM	Max WPM	Mid WPM	Notes
6.2 wpm	40 wpm	25 wpm	

Keyer Sidetone Frequency

Test Description: This test measures the audio frequency of the keyer sidetone.

Test Result:

Default pitch	Minimum	Maximum	Notes
625 Hz	300 Hz	900 Hz	

Transmit/Receive Turnaround Time

Test Description: The purpose of the Transmit/Receive turnaround test is to measure the delay required to switch from transmit mode to receive mode.

Test Results:

Frequency	T/R Delay AGC Fast	T/R Delay AGC Slow	Notes
14.02 MHz	18.0 ms	16.0 ms	1, 2

Notes:

1. T/R delay less than or equal to 35 ms is suitable for use on AMTOR.
2. Times on 6M and 2M are similar.

Transmit Delay Time

Test Description: The purpose of the Transmit Delay test is to measure the time between PTT closure and 50% RF output. It is measured on SSB, modulated with a single tone and on FM, unmodulated.

Test Results:

Frequency	Mode	Delay	Notes
14.2 MHz	SSB	35.0 ms	
29.2 MHz	FM	12 ms	
50.2 MHz	FM	12 ms	
144.2 MHz	FM	14 ms	

Transmit Composite Noise

Test Description: The purpose of the Composite-Noise Test is to observe and measure the phase and amplitude noise, as well as any spurious signals generated by the device under test transmitter. Since phase noise is the primary noise component in any well-designed transmitter, it can be assumed, therefore, that almost all the noise observed during this test is phase noise. This measurement is accomplished by converting the output of the transmitter down to a frequency about 10 or 20 Hz above baseband. A mixer and a signal generator used as a local oscillator are used to perform this conversion. Filters remove the dcomponent as well as the unwanted heterodyne components. The remaining noise and spurious signals are then observed on the spectrum analyzer. The lower the noise as seen on the plot, the better the transmitter.

Key Test Conditions:

Transmitter operated at rated output power into a 50-ohm resistive load.

Transmitter operated at room temperature.

Frequencies from 2 to 22 kHz from the carrier are measured.

Ten sweeps are averaged on the spectrum analyzer to reduce noise.

Block Diagram:

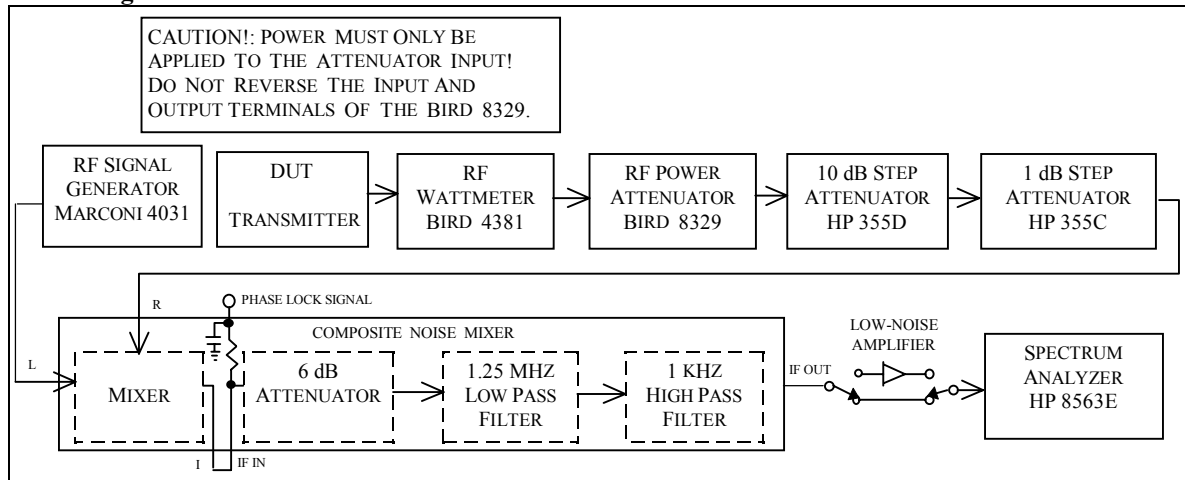

Transmit Composite Noise Graphs

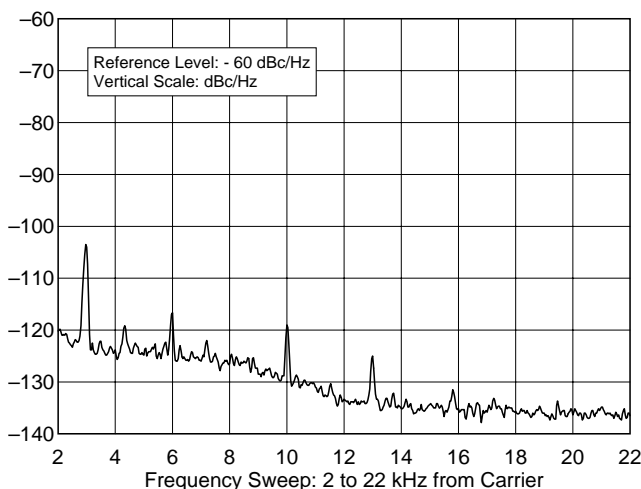

ICOM IC-746 Pro, s/n 01484
3.520 MHz, Phase Noise, 100 W
I:\PRODREV\TESTS\IC746PRO\746PRP80.TXT

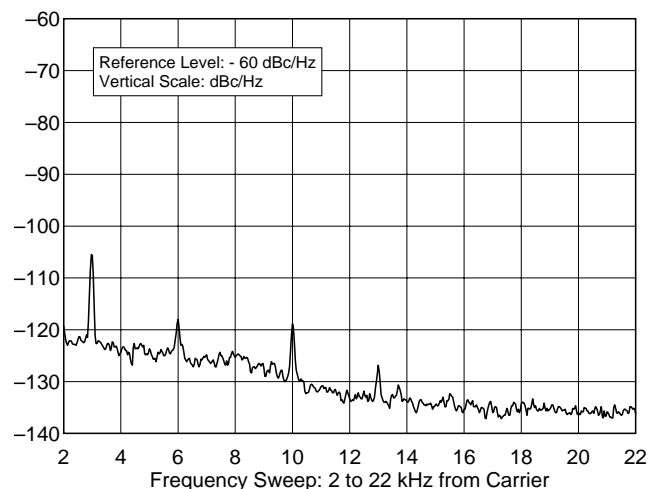

ICOM IC-746 Pro, s/n 01484
14.020 MHz, Phase Noise, 100 W
I:\PRODREV\TESTS\IC746PRO\746PRP20.TXT

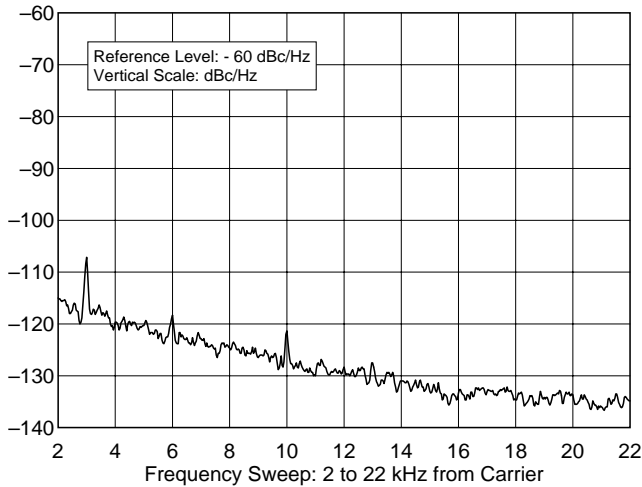

ICOM IC-746 Pro, s/n 01484
50.020 MHz, Phase Noise: 100 W
I:\PRODREV\TESTS\IC746PRO\746PRP6M.TXT

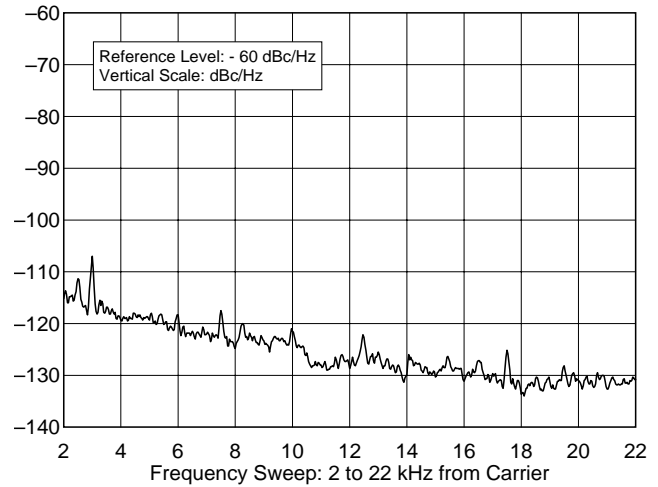

ICOM IC-746 Pro, s/n 01484
144.020 MHz, Phase Noise: 100 W
I:\PRODREV\TESTS\IC746PRO\746PRP2M.TXT

Receiver Noise Floor (Minimum Discernible Signal)

Test Description: The noise floor of a receiver is the level of input signal that gives a desired audio output level that is equal to the noise output level. This is sometimes called "minimum discernible signal " (MDS), although a skilled operator can detect a signal up to 10 dB or so below the noise floor. Most modern receivers have a noise floor within a few dB of "perfect." A perfect receiver would hear only the noise of a resistor at room temperature. However, HF receiving systems, the noise of the system usually exceeds that of the receiver. In most cases, external noise is many dB higher than the receiver's internal noise. Making the receiver more sensitive will only allow it to hear more noise. It will also make it more prone to overload. In many cases, especially in the lower HF bands, receiver performance can be improved by sacrificing unneeded sensitivity by placing an attenuator in front of the receiver. The more negative the sensitivity number expressed in dBm, or the smaller the number expressed in voltage, the better the receiver.

Key Test Conditions:

Source impedance (generator) of 50-ohms. Receiver audio output to be terminated with specified impedance.
Receiver is tested using 500 Hz bandwidth, or closest available bandwidth to 500 Hz.

Block Diagram:

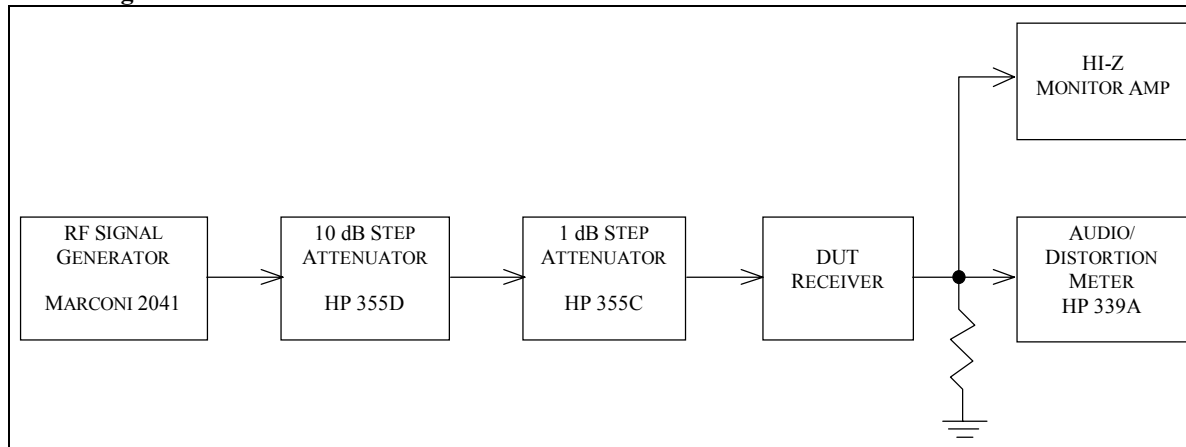

Noise Floor:

Frequency	Preamp OFF MDS (dBm)	Preamp One MDS (dBm) ⁶	Preamp Two MDS (dBm) ⁷	Notes
1.02 MHz	-121.6	N/A	N/A	1
1.82 MHz	-132.4	-139.7	-141.0	
3.52 MHz	-132.4	-140.2	-142.0	
7.02 MHz	-131.9	-139.6	-141.6	
10.12 MHz	-132.2	-139.0	-141.4	
14.02 MHz	-131.9	-139.5	-142.0	
18.088 MHz	-132.0	-138.8	-141.7	
21.02 MHz	-132.0	-139.3	-142.4	
24.91 MHz	-132.5	-140.1	-142.2	
28.02 MHz	-132.1	-139.3	-141.3	
50.02 MHz	-127.7	-138.1	-140.9	
144.02 MHz	-133.1	-141.8	N/A	5

Notes:

1. Preamp not selectable on 1 MHz.
5. Only one 2M preamp.
6. Preamp One's design range is 1.8-54 MHz.
7. Preamp Two's design range is 21-60 MHz, but some amplification is provided on lower frequencies.

Receive Frequency Range

Test Description: This test measures the tuning range of the receiver. The range expressed is the range over which the receiver can be tuned. Most receivers exhibit some degradation of sensitivity near the limits of their tuning range. In cases where this degradation renders the receiver unusable, we report both the actual and useful tuning range.

Test Results:

Minimum Frequency	Minimum Frequency MDS	Maximum Frequency	Maximum Frequency MDS	Notes
30 kHz	-79.4 dBm	60 MHz	-121.3 dBm	1
108 MHz	-136.1 dBm	174 MHz	-140.4 dBm	

Notes:

1. Tuning ranges: 30 kHz - 60 MHz, 108 MHz - 174 MHz.

Other Test Results

Frequency	Sensitivity Preamp OFF	Notes
100 kHz	-109.2 dBm	
250 kHz	-117.2 dBm	

AM Sensitivity

Test Description: The purpose of the AM receive Sensitivity Test is to determine the level of an AM signal, 30% modulated at 1 kHz, that results in a tone 10 dB above the noise level (MDS) of the receiver. Two frequencies, 1.020 MHz and 3.800 MHz are used for this test. The more negative the number, expressed in dBm, or the smaller the number expressed in voltage, the better the sensitivity.

Test Results:

Frequency	Preamp OFF	Preamp One	Preamp Two	Notes
1.02 MHz	5.89 μ V	N/A	N/A	1
3.9 MHz	1.6 μ V	0.623 μ V	0.512 μ V	
53 MHz	2.16 μ V	0.932 μ V	0.602 μ V	
120 MHz (aircraft)	5.43 μ V	0.976 μ V	N/A	2
146 MHz	1.32 μ V	0.530 μ V	N/A	2

Notes:

1. Preamp not available at 1 MHz.
2. Only one preamp on VHF (108-174 MHz).

FM SINAD

Test Description: The purpose of the FM SINAD and Quieting Test is to determine the following:

The 12 dB SINAD value.

SINAD is an acronym for "Signal plus Noise And Distortion" and is a measure of signal quality. The exact expression for SINAD is the following:

$$\text{SINAD} = \frac{\text{Signal} + \text{Noise} + \text{Distortion}}{\text{Noise} + \text{Distortion}} \quad (\text{expressed in dB})$$

If we consider distortion to be merely another form of noise, (distortion, like noise, is something unwanted added to the signal), we can further reduce the equation for SINAD to:

$$\text{SINAD} = \frac{\text{Signal} + \text{Noise}}{\text{Noise}} \quad (\text{expressed in dB})$$

If we now consider a practical circuit in which the signal is much greater than the noise, the value of the SIGNAL + NOISE can be approximated by the level of the SIGNAL alone. The SINAD equation then becomes the signal to noise ratio. The approximation now becomes:

$$\text{SINAD} = \frac{\text{Signal}}{\text{Noise}} \quad (\text{expressed in dB})$$

For the 25% level of distortion used in this test, the SINAD value can be calculated as follows:

$$\text{SINAD} = 20 \log (1/25\%) = 20 \log 4 = 12 \text{ dB}$$

The more negative the number, expressed in dBm, or the smaller the number, expressed as voltage, the better the sensitivity.

SINAD Test Results:

Frequency	Preamp OFF	Preamp One	Preamp Two	Notes
29.0 MHz	0.555 μ V	0.254 μ V	0.224 μ V	1
52.0 MHz	0.860 μ V	0.335 μ V	0.214 μ V	
146.0 MHz	0.489 μ V	0.180 μ V	N/A	

Notes:

- 15-kHz bandwidth for all results in this table.

Antenna Port Isolation

Test Description: This test measures the RF isolation between the active (selected) antenna port and the other available antenna ports. This isolation can be important where the unselected port is connected to an antenna that is resonant (or near resonant) on some of the same frequencies as the main antenna. Isolation of 60 dB or better is considered good.

Test Results:

Frequency	Selected Port	Unselected Port	Isolation (dB)	Notes
14 MHz	1	2	71.2	
14 MHz	1	VHF	112.8	
14 MHz	2	1	85.5	
14 MHz	2	VHF	113.3	
146 MHz	VHF	1	93.6	
146 MHz	VHF	2	87.2	

Blocking Dynamic Range

Test Description: Dynamic range is a measurement of a receiver's ability to function well on one frequency in the presence of one or more unwanted signals on other frequency. It is essentially a measurement of the difference between a receiver's noise floor and the loudest off-channel signal that can be accommodated without measurable degradation of the receiver's response to a relatively weak signal to which it is tuned. This difference is usually expressed in dB. Thus, a receiver with a dynamic range of 100 dB would be able to tolerate an off-channel signal 100 dB stronger than the receiver's noise floor.

In the case of blocking dynamic range, the degradation criterion is receiver desense. Blocking dynamic range (BDR) is the difference, in dB, between the noise floor and a off-channel signal that causes 1 dB of gain compression in the receiver. It indicates the signal level, above the noise floor, that begins to cause desensitization. BDR is calculated by subtracting the noise floor from the level of undesired signal that produces a 1-dB decrease in a weak desired signal. The greater the dynamic range, the better the receiver performance. It is usual for the dynamic range to vary with frequency spacing.

Key Test Conditions:

AGC is normally turned off; the receiver is operated in its linear region. Desired signal set to 10 dB below the 1-dB compression point, or 20 dB above the noise floor in receivers in which the AGC cannot be disabled. The receiver bandwidth is set as close as possible to 500 Hz.

Block Diagram:

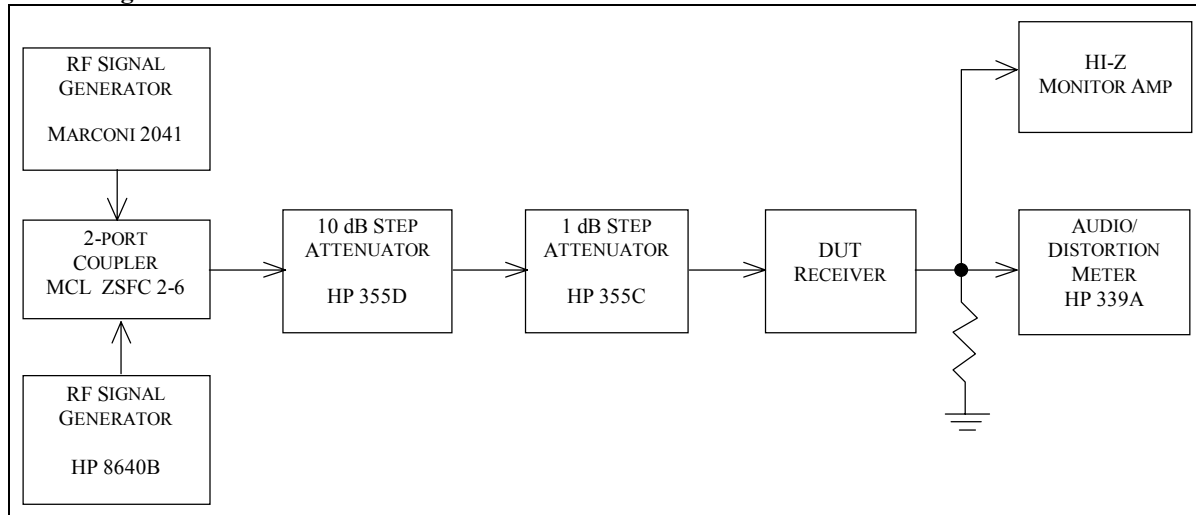

Blocking Dynamic Range Test Result:

Band	Spacing	Preamp OFF	Preamp One	Preamp Two	Notes
1.82 MHz	50 kHz	–	–	126.5	1, 2
3.52 MHz	50 kHz	–	–	126.8	
3.52 MHz	20 kHz	124.5	120.6	117.1	
3.52 MHz	5 kHz	99.8	95.7	92.5	
7.02 MHz	50 kHz	–	–	126.2	
14.02 MHz	100 kHz	134.6	–	127.2	
14.02 MHz	50 kHz	–	–	127.7	
14.02 MHz	20 kHz	125.0	122.6	117.9	
14.02 MHz	5 kHz	100.0	97.7	92.9	
21.02 MHz	50 kHz	–	–	127.7	
28.02 MHz	50 kHz	–	–	126.8	
50.02 MHz	50 kHz	–	–	1267.8	
50.02 MHz	20 kHz	126.7	124.2	120.9	
50.02 MHz	5 kHz	101.1	98.8	95.7	
144.02 MHz	50 kHz	–	117.8*	N/A	
144.02 MHz	20 kHz	113.7*	111.7*	N/A	
144.02 MHz	5 kHz	99.9	88.4	N/A	

Notes:

1. Receiver bandwidth set to 500 Hz for all tests.
 2. 100 and 50 kHz data taken with preamp two on only (except for 144 MHz, where there is only one preamp).
- * Indicates that measurement was noise limited at values shown.

Two-Tone 3rd-Order IMD Dynamic Range

Test Description: Two-tone IMD Dynamic Range (IMD DR) measures the impact of the intermodulation of two strong (undesired) signals within a receiver. IMD is the production of spurious responses resulting from the mixing of two or more undesired signals in a receiver. Two-Tone IMD DR is the difference, in dB, between the noise floor and the strength of two equal off-channel signals that produce a third-order product equal to the noise floor.

This test determines the range of signals that can be tolerated by the receiver while producing essentially no undesired spurious responses. To perform the 3rd Order test, two signals of equal amplitude and spaced a given distance (such as 20 kHz) apart, are injected into the input of the receiver. If we call these frequencies f_1 and f_2 , the third-order products will appear at frequencies of $(2f_1-f_2)$ and $(2f_2-f_1)$. The greater the dynamic range, expressed in dB, or the higher the intercept point, the better the performance.

Key Test Conditions:

Sufficient attenuation and isolation must exist between the two signal generators. The two-port coupler must be terminated in a load that exhibits a 20-dB or better return loss at the coupler output. The receiver is set as close as possible to a 500 Hz bandwidth.

TT IMD DR Block Diagram:

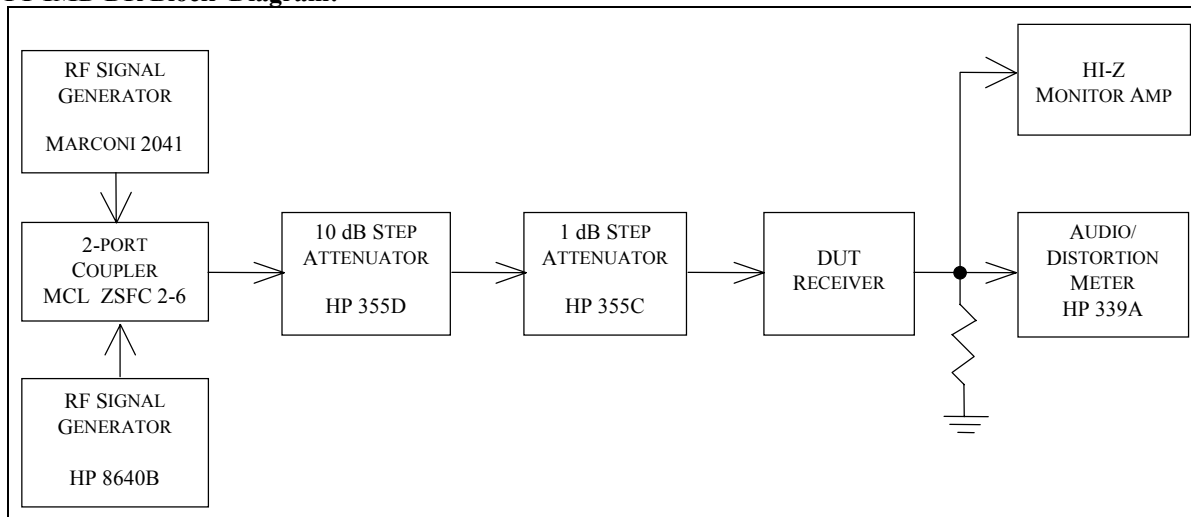

Two-Tone IMD DR Test Result Summary:

Band	Spacing	Preamp OFF	Preamp One	Preamp Two	Notes
1.82 MHz	50 kHz	–	–	91.0	1
3.52 MHz	50 kHz	–	–	92.0	
3.52 MHz	20 kHz	97.4	95.2	91.0	
3.52 MHz	5 kHz	76.4	73.2	71.0	
7.02 MHz	50 kHz	–	–	91.6	
14.02 MHz	100 kHz	100.9	–	93.0	
14.02 MHz	50 kHz	–	–	92.5	
14.02 MHz	20 kHz	96.9	95.5	92.0	
14.02 MHz	5 kHz	74.9	73.5	71.0	
21.02 MHz	50 kHz	–	–	93.4	
28.02 MHz	50 kHz	–	–	91.3	
Continued on	next pg.				

Band	Spacing	Preamp OFF	Preamp One	Preamp Two	Notes
50.02 MHz	50 kHz	–	–	92.9 dB	
50.02 MHz	20 kHz	97.7 dB	96.1 dB	91.9 dB	
50.02 MHz	5 kHz	76.7 dB	75.1 dB	72.9 dB	
144.02 MHz	50 kHz	–	88.8 dB	N/A	2
144.02 MHz	20 kHz	84.1 dB	88.8 dB	N/A	2
144.02 MHz	5 kHz	75.1 dB	61.8 dB	N/A	2

Notes:

1. Receiver bandwidth set to 500 Hz for all tests.
 2. 100 and 50 kHz data taken with preamp two on only (except for 144 MHz, where there is only one preamp).
- * Indicates that measurement was noise limited at values shown.

Third-Order Intercept

Test Description: Third-order intercept (IP3) is not actually a separate test, but is part of the IMD Dynamic Range test. The third-order response of the receiver can be characterized (ideal) as a straight line with a 3:1 slope. The "on-channel" response of the receiver would be a line with a 1:1 slope. Any two lines of differing slope will have a point at which they intersect. However, the "intercept" of the third-order and on-channel responses is at a level far higher than the strength of signals receivers can normally handle. Thus, it has to be calculated rather than measured.

The IP3 calculation can be based on a variety of signal levels. One common level is the noise floor (aka "mds") - however, at this level, noise can cause a non-linear response in the real-world circuits of the receiver. Also, it should be noted that IP3 is generally considered to be a measure of a receiver's strong-signal handling ability, thus it is most appropriate to calculate this with signal levels well above the noise floor. In the ARRL Lab, signal levels of S5 are used for the IP3 calculation.

Third-Order Intercept Summary:

Band	Spacing	Preamp OFF	Preamp One	Preamp Two	Notes
3.52 MHz	20 kHz	+19.15 dBm	+7.25 dBm	-2.25 dBm	1
3.52 MHz	5 kHz	-17.60 dBm	-28.75 dBm	-33.75 dBm	
14.02 MHz	20 kHz	+20.00 dBm	+9.30 dBm	-1.80 dBm	
14.02 MHz	5 kHz	-18.25 dBm	-28.2 dBm	-35.55 dBm	
50.02 MHz	20 kHz	+22.50 dBm	+12.25 dBm	-1.15 dBm	
50.02 MHz	5 kHz	-13.50 dBm	-25.25 dBm	-31.15 dBm	
144.02 MHz	20 kHz	-6.45 dBm	-5.35 dBm	N/A	2
144.02 MHz	5 kHz	-19.95 dBm	-39.10 dBm	N/A	2

Notes:

1. Receiver bandwidth set to 500 Hz for all tests.
2. 100 and 50 kHz data taken with preamp two on only (except for 144 MHz, where there is only one preamp).

Swept Dynamic Range Graphs

The following page shows one of the highlights of ARRL test result reports -- swept graphs on receiver two-tone, third-order IMD dynamic range and blocking dynamic range. These graphs are taken using National Instruments LabWindows/CVI automated test software, with a custom program written by the ARRL Laboratory.

Dynamic range measures the difference between a receiver's noise floor and the receiver's degradation in the presence of strong signals. In some cases, the receiver's noise performance causes receiver degradation before blocking or a spurious response is seen. In either case, if the noise floor is degraded by 1 dB due to the presence of receiver noise during the test, the dynamic range is said to be noise limited by the level of signal that caused the receiver noise response. A noise-limited condition is indicated in the *QST* "Product Review" test-result tables. The Laboratory is working on software changes that will show on the test-result graphs which specific frequencies were noise limited. These will be incorporated into future test-result reports.

Being "noise limited" is not necessarily a bad thing. A receiver noise limited at a high level is better than a receiver whose dynamic range is lower than the noise-limited level. In essence, a receiver that is noise limited has a dynamic range that is better than its local-oscillator noise. Most of the best receivers are noise limited at rather high levels.

The ARRL Laboratory has traditionally used off-channel signals spaced 20 kHz from the desired signal. This does allow easy comparisons between different receivers. There is nothing magical about the 20-kHz spacing, however. In nearly all receivers, the dynamic range varies with signal spacing, due to the specific design of the receiver. Most receivers have filter combinations that do some coarse filtering at RF and in the first IF, with additional filtering taking place in later IF or AF stages. As the signals get "inside" different filters in the receiver, the dynamic range decreases as the attenuation of the filter is no longer applied to the signal. Interestingly, the different filter shapes can sometimes be seen in the graphs of dynamic range of different receivers. In the case of the ARRL graphs, one can often see that the 20-kHz spacing falls on the slope of the curve. Many manufacturers specify dynamic range at 50 or 100 kHz.

The computer is not as skilled (yet) at interpreting noisy readings as a good test engineer, so in some cases there are a few dB difference between the computer-generated data and those in the "Product Review" tables. Our test engineer takes those number manually, carefully measuring levels and interpreting noise and other phenomena that can effect the test data. (We are still taking the two-tone IMD data manually.)

The graphs that follow show swept blocking and two-tone dynamic range. In the blocking test, the receiver is tuned to a signal on 14.020 MHz, the center of the graph. The X axis is the frequency (MHz) of the undesired, off-channel signal. In the two-tone test, the receiver is tuned to a signal on 14.020 MHz, the center of the graph. The X axis is the frequency of the closer of the two tones that are creating intermodulation.

Swept Blocking Dynamic Range

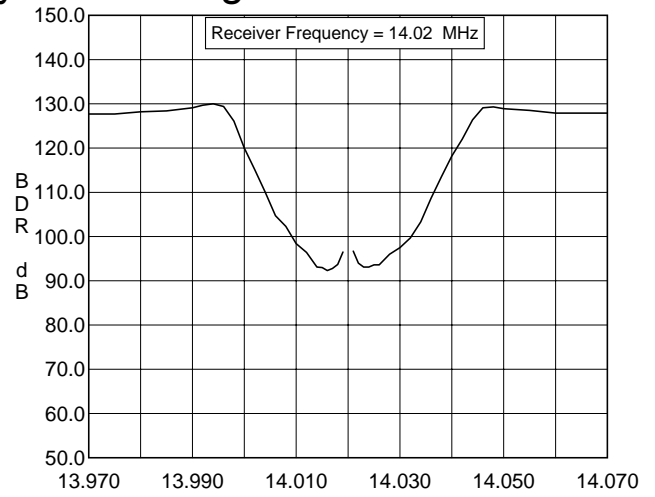
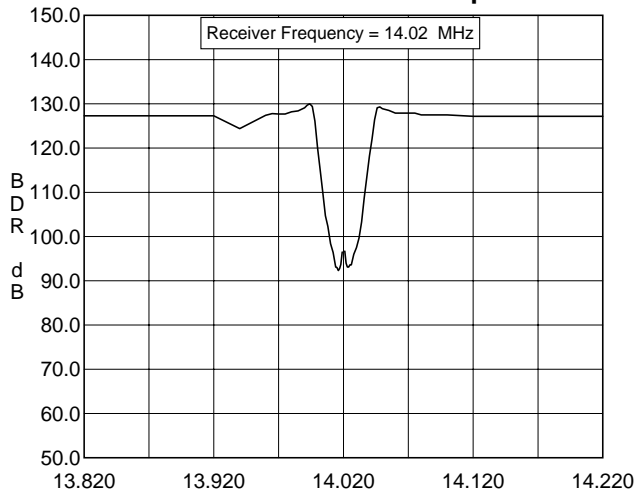

Swept Two-Tone, Third-Order IMD Dynamic Range

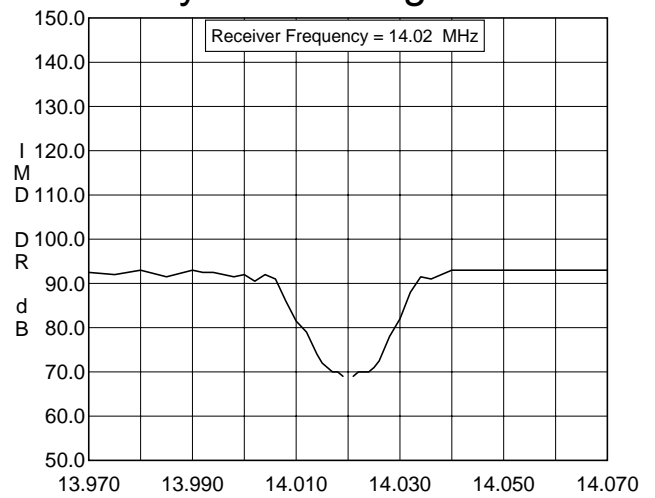
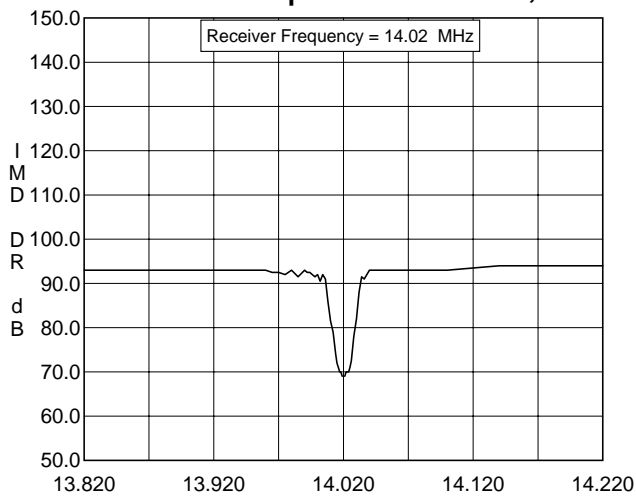

Second-Order Intercept

Test Description: This test measures the amount of 2nd-order mixing that takes place in the receiver and calculates an intercept of the second order response with the on-channel response. Signals at 6 and 8 MHz are presented to the receiver and the resultant output at 14 MHz is measured.

Test Results:

Frequency	Preamplifier	Mode	IP2 (dBm)	Notes
14.02 MHz	Off	CW	+72.0	
14.02 MHz	One	CW	+71.0	
14.02 MHz	Two	CW	+53.9	

In-Band Receiver IMD

Test Description: This test measures the intermodulation that occurs between two signals that are simultaneously present in the passband of a receiver. Two signals, at levels of 50 μ V (nominally S9), spaced 100 Hz are used. The receiver AGC is set to FAST. The receiver is tuned so the two signals appear at 900 Hz and 1100 Hz in the receiver audio. The output of the receiver is viewed on a spectrum analyzer and the 3rd- and 5th order products are measured directly from the screen. The smaller the products as seen on the graph, the better the receiver. Generally, products that are less than 30 dB below the desired tones will not cause objectionable receiver intermodulation distortion.

Key Test Conditions:

S9, and S9 +40 dB or S9 +60 dB signals

Receiver set to SSB normal mode, nominal 2 - 3 kHz bandwidth

Block Diagram:

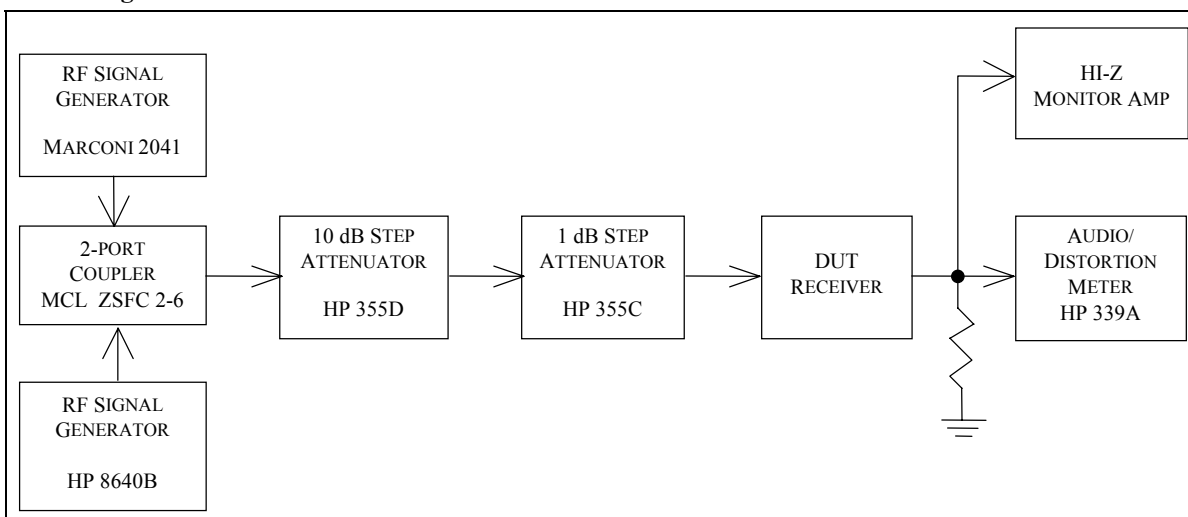

In-Band Receiver IMD Graphs

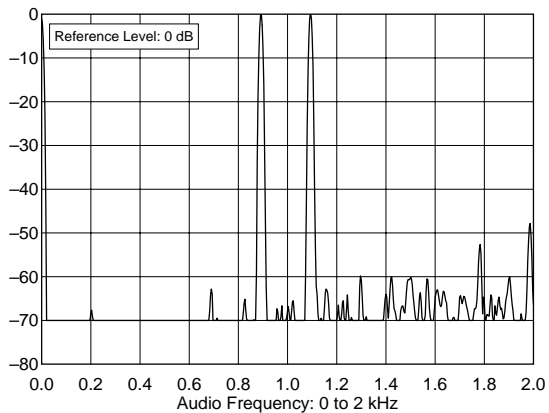

ICOM IC-746 Pro, s/n 01484
14.020 MHz, AGC Fast, S9 In-Band Receiver IMD
I:\PRODEV\TESTS\IC746PRO\746PR16F.TXT

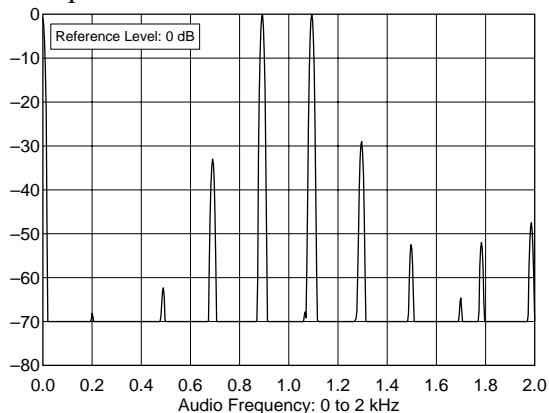

ICOM IC-746 Pro, s/n 01484
14.020 MHz, AGC Fast, S9+60 In-Band Receiver IMD
I:\PRODEV\TESTS\IC746PRO\746PR16F.TXT

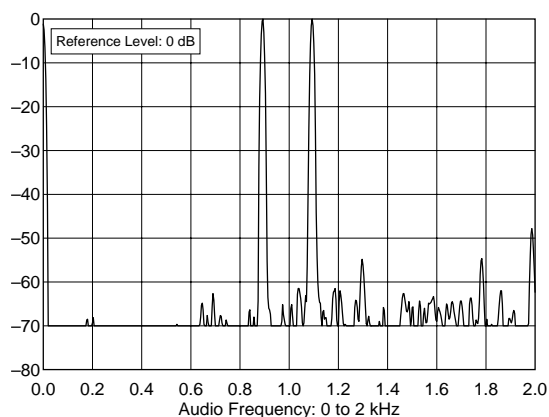

ICOM IC-746 Pro, s/n 01484
14.020 MHz, AGC Slow, S9 In-Band Receiver IMD
I:\PRODEV\TESTS\IC746PRO\746PR16S.TXT

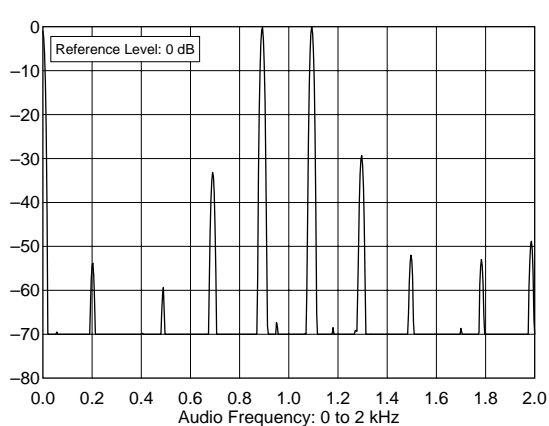

ICOM IC-746 Pro, s/n 01484
14.020 MHz, AGC Fast, S9+60 In-Band Receiver IMD
I:\PRODEV\TESTS\IC746PRO\746PR16F.TXT

FM Adjacent Channel Selectivity

Test Description: The purpose of the FM Adjacent Channel Selectivity Test is to measure the ability of the device under test receiver to reject interference from individual undesired signals while receiving various levels of desired signal. The desired carrier signal will be at 29.000 MHz, modulated at 1000 Hz, and the offending signal will be located at adjacent nearby frequencies with 400 Hz modulation. (NOTE: The SINAD Test in 5.3 must be performed before this test can be completed.) The greater the number in dB, the better the rejection.

Test Results:

Frequency	Preamplifier	Frequency Spacing	Adjacent-channel rejection (dB)	Notes
29.0 MHz	Two	20 kHz	76.6	
52 MHz	Two	20 kHz	77.4	
146 MHz	On	20 kHz	73.3	

FM Two-Tone 3rd-Order Dynamic Range

Test Description: The purpose of the FM Two-Tone 3rd Order Dynamic Range Test is to determine the range of signals that can be tolerated by the device under testing the FM mode while producing no spurious responses greater than the 12-dB SINAD level. To perform this test, two signals, f_1 and f_2 , of equal amplitude and spaced 20 kHz apart, are injected into the input of the receiver. The signal located 40 kHz from the distortion product being measured is modulated at 1,000 Hz with a deviation of 3 kHz. The receiver is tuned to the Third Order IMD frequencies as determined by $(2f_1-f_2)$ and $(2f_2-f_1)$. The input signals are then raised simultaneously by equal amounts until 25 % distortion, or the 12 dB SINAD point, is obtained. Frequencies 10 MHz outside the amateur band are used to test the wide-band dynamic range. The greater the dynamic range, the better the receiver performance.

Test Results:

Frequency	Preamplifier	Frequency Spacing	Dynamic Range (dB)	Notes
29 MHz	ON	20 kHz	76.6*	1
52 MHz	ON	20 kHz	77.4*	
52 MHz	ON	10 MHz	113.4	
146 MHz	ON	20 kHz	73.3*	
146 MHz	ON	10 MHz	97.4	

Notes:

1. Receiver bandwidth is 15 kHz for all tests in this table.

* Test is noise limited. In FM, this results in a reading that is somewhat inaccurate. The actual dynamic range is probably a few dB worse than the figures indicated. While this sounds opposite of what one would expect, because the test is based on a SINAD measurement, the presence of noise means that it takes a stronger signal to have a product equal to the measured noise floor, resulting in a number that appears better than it would be if there were no noise.

IF and Image Rejection

Test Description: This test measures the amount of first IF and image rejection for superhetrodyne receivers by determining the level of signal input to the receiver at the first IF (or image frequencies) that will produce an audio output equal to the MDS level. The test is conducted with the receiver in the CW mode using the 500 Hz, or closest available, IF filters. Any audio filtering is disabled and AGC is turned OFF, if possible. The greater the number in dB, the better the image rejection.

Test Results:

Frequency	Preamplifier	Mode	First IF Rejection	Calculated Image Frequency	Image Rejection (dB)	Notes
14.020 MHz	ON	CW	122.5	142.93 MHz	124.2	1
50.02 MHz	ON	CW	121.2	178.93 MHz	118.3	
144.02 MHz	ON	CW	86.1	272.94 MHz	121.2	

Notes:

1. First IF is 64.455 MHz.

Audio Output Power

Test Description: This test measures the audio power delivered by the receiver. The manufacturer's specification for load and distortion are used. For units not specified, an 8-ohm load and 10% harmonic distortion are used.

Test Results:

Specified Distortion	Specified Load Impedance	Audio Output Power	Notes
10% T.H.D.	8 ohms	2.3 W	

Audio Hiss

Test Description: This test measures the audio output power at minimum volume with no signal. It gives an indication of the noise (often referred to as "hiss") generated by the audio stages of the receiver.

Test Results:

Specified Load Impedance	Hiss Level	Notes
8 ohms	0.165 mV (ac)	

IF and Audio Frequency Response

Test Description: The purpose of the IF + Audio Frequency Response Test is to measure the audio frequencies at which the receiver audio drops 6 dB from the peak signal response. The frequency-response bandwidth is then calculated by taking the difference between the lower and upper frequency.

Test Results:

IF Filter Use/Unit Mode	Nominal Bandwidth Hz	Low Freq (Hz)	High Freq (Hz)	Difference (bandwidth)	Notes
CW	500	329	917	588	1
USB	WIDE	62	1803	1741	2
LSB	WIDE	60	2929	2869	
AM	NARROW	76	3058	2982	

Notes:

1. High and low audio frequencies on CW vary with the pitch control.
2. -60 dB selectivity was also checked on USB, with a result of 3316 Hz.

Squelch Sensitivity

Test Description: The purpose of the Squelch Sensitivity Test is to determine the level of the input signal required to break the receiver's squelch at the threshold. This number is not usually critical. A result anywhere between 0.05 and 0.5 μV is usually useful.

Test Results:

Frequency	Preamplifier	Mode	Threshold	Notes
29.0 MHz	One and Two	FM	0.070 μV	
52 MHz	One and Two	FM	0.114 μV	
146 MHz	One and Two	FM	0.092 μV	
14.2 MHz	One and Two	SSB	6.24 μV	

S-Meter Sensitivity

Test Description: The purpose of the S-Meter Test is to determine the level of RF input signal required to produce an S9 and S9+20 dB indication on the receiver S meter. This test is performed with the receiver in the CW mode at a frequency of 14.200 MHz. The IF filter bandwidth is set to 500 Hz, nominal. A traditional S9 signal is a level of 50 μV (an old Collins receiver standard). The Collins standard S unit was 6 dB. This is, however, not a hard and fast rule, especially for LED or bar-graph type S meters.

Test Results:

Frequency	Preamplifier	S Units	μV	Notes
1.02 MHz	OFF	S9	240	
14.2 MHz	OFF	S9	81.5	
14.2 MHz	ONE	S9	27.5	
14.2 MHz	TWO	S9	12.0	
52 MHz	OFF	S9	126	
52 MHz	ONE	S9	30.2	
52 MHz	TWO	S9	15.3	
146 MHz	OFF	S9	57.5	
146 MHz	ON	S9	6.38	