

CQ

JULY
1956
50c

RADIO AMATEURS' JOURNAL



Paste a photo of your shack here

ANNOUNCING

Collins Gear Reduction Tuning Knob
for

new *fine* **tuning**

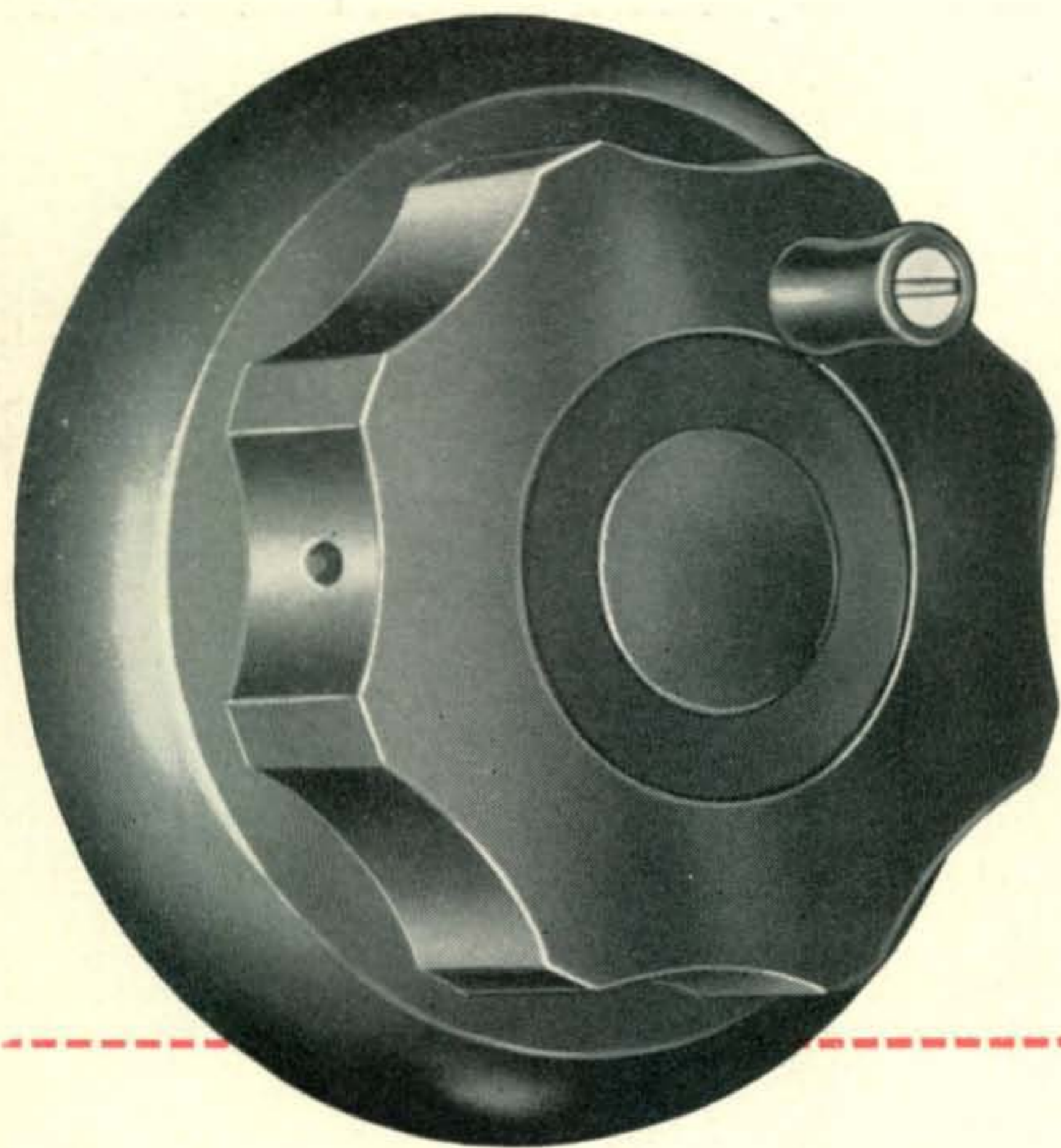

New ease and accuracy in Sideband tuning are featured in Collins Gear Reduction Tuning Knob for the 75A-4 and KWS-1.

Operating on a 4 to 1 ratio, this quality accessory to the top SSB transmitter-receiver team eliminates the Dial Drag and has no detectable backlash. After simple installation, you'll experience smoothness unsurpassed in tuning any type signal—SSB, CW or AM. The Knob is also adaptable for best tuning of the earlier models in the 75A series.

Available soon at your nearest distributor—\$15.00.

It's easy, smart to own Collins

You can now operate the finest SSB station while taking up to 18 months to pay small installments. This is a *sound investment* with Collins' consistently top trade-in value and the resulting low cost per day. Ask your Collins distributor for the figures today.

Visit Collins exhibit at the National ARRL Convention in San Francisco July 6, 7 and 8.



Collins

CREATIVE LEADER IN COMMUNICATION



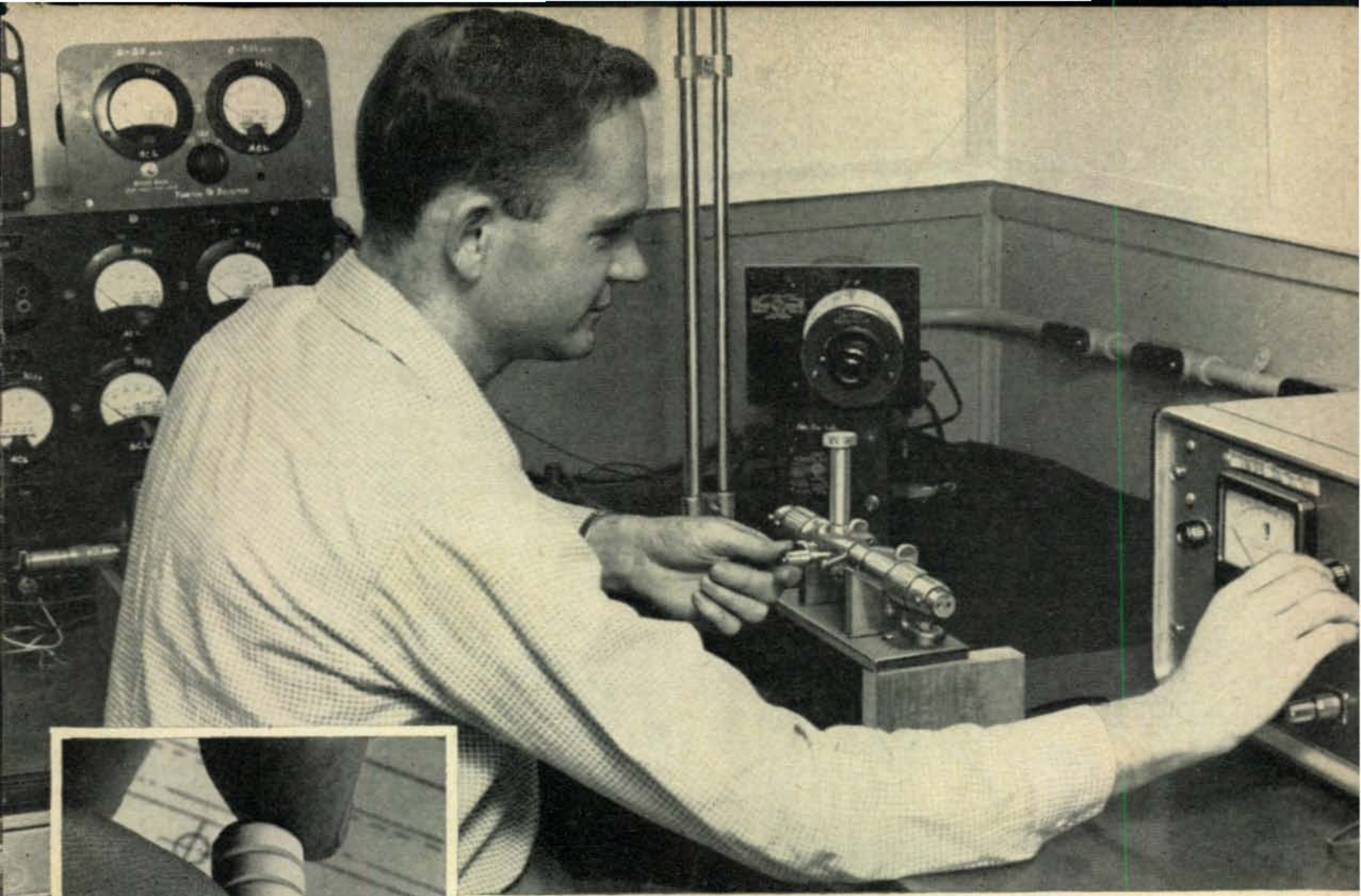

Left: smallest receiving tube—a General Electric 6BY4, only $\frac{3}{8}$ " high! **Above:** Robert Bailey tests a micro-miniature tube at 900 megacycles for noise factor and power gain.

Amateur know-how is asset to W4JZO in development work on G-E micro-miniatures!

ROBERT BAILEY, W4JZO, is a development engineer in General Electric's Owensboro, Ky., receiving tube plant. His work centers on u-h-f, and he has taken active part in the design of G-E micro-miniature tubes—new ultra-compact metal-ceramic types with outstanding performance. A TV-tuner triode, the 6BY4 is the first micro-miniature, with others to follow.

U-h-f designers are helping to shape the electronic world of tomorrow. According to Bailey, they need the amateur's willingness to search for new solutions to new problems. Bailey strongly endorses ham philosophy as an approach to

creative effort in his field. He stresses this in a G-E engineering course he conducts, and takes every opportunity to keep active as a ham by working the 75, 40, 20, and 10-meter bands with mobile phone equipment he has designed.

W4JZO has been a radio amateur since 1946. Like hundreds of other hams who design, build, and test G-E tubes of all types, he brings to his work extra experience and resourcefulness—qualities reflected in a superior G-E product. Buy the tubes that hams help build! Your G-E tube distributor stocks them. *Tube Department, General Electric Company, Schenectady 5, N. Y.*

Progress Is Our Most Important Product

GENERAL  **ELECTRIC**

Calibration on the nose . . .



Thanks to PR's

100 K.C. FREQUENCY STANDARD

A dependable secondary frequency standard is a MUST for today's amateur station . . . to determine band-edge . . . to keep the VFO and receiver properly calibrated. Now you can buy a really dependable, commercial-quality PR 100 Kc. Crystal at reasonable cost. The Type Z-6A is hermetically sealed, razor-accurate, unconditionally guaranteed. Get it at your jobber.



PR

Crystals



USE **PR** AND KNOW WHERE YOU ARE

PETERSEN RADIO COMPANY, INC.
2800 W. BROADWAY • COUNCIL BLUFFS, IOWA

EXPORT SALES: Royal National Company, Inc., 8 W. 40th Street, New York 18, N. Y.

Wayne Green, W2NSD Editor

Jim Morrisett, K2OLK Associate Editor
 Art Brothers, W7NVY/2 Associate Editor
 R. C. Spenceley, KV4AA DX Editor
 Walt Burdine, W8ZCV Novice Editor
 Sam Harris, W1FZJ VHF Editor

George Jacobs, W3ASK Propagation Editor
 Byron Kretzman, W2JTP RTTY Editor
 Louisa B. Sando, W5RZJ YL Editor
 William I. Orr, W6SAI Contributing Editor
 Bob Adams, K2DW SSB Editor

Feature Articles

6 Meter TVI filter	21	How not to	58
Hiding a Transmitter	22	Solder on Glass	59
SSB Modulator	24	Pony Express	60
CW Filter Limiter	32	Two Wire Beam Control	62
Gonset G-66, review	35	Solder is Strong Enough	63
A Quad Yagi for 2 Meters	36	CHU	64
Lazy Quad for Low Freq's	38	Frequency Stability	65
The KWS-2, Detroit version	39	Trailer Ham	68
Low Capacity Transformers	40	Trailer Beam	70
FS Meter for the Blind	43	6-Meter Converter	72
Whiteface	45	2-Meter Demon	75
Yasme	46	AF Selectivity	78
LU2ZY DXpedition	52	How Much Real RF?	78
Transistor Circuitry	54	7th Annual YL-OM contest	80
RI report	96		

Departments

Propagation Chart	79	Scratchi	6
SSB	81	VHF	86
YL on vacation (YL-OM scores)	80	RTTY	90
DX	82	Novice	on vacation

Miscellaneous

de W2NSD	10	QSL contest	85
Letters to the Editor	14	CQ World Globe	115
CQ World Atlas	127		

S. R. Cowan **Publisher**
 J. Stillman Advertising Representative
 Jack N. Schneider Advertising Representative
 R. A. Cowan Advertising Representative

D. Saltman Production Manager
 H. Weisner Circulation Manager
 Thomas M. Smith Draftsman
 C. W. Gardner, Jr. Editorial Production

Branch Advertising Office

Ted E. Schell, 2700 West 3rd St., Los Angeles 5, Calif.
 DUnkirk 2-4889
 James D. Summers, 400 N. Michigan Ave., Chicago 1, Ill.
 SUperior 7-1641

Foreign Subscriptions

England: RSGB, New Ruskin House, Little Russe'l St., London WC 1.
 Australia: Technical Book Co., 297 Swanston St., Melbourne C1, Victoria, Australia.

CQ—(title Reg. U. S. Post Office)—is published monthly by Cowan Publishing Corp. Executive and Editorial offices, 67 West 44th Street, New York 36, N. Y. Phone MUrray Hill 7-2080. 2nd Class Mail privileges authorized at New York, N. Y. Subscription rates in U.S.A., Possessions, APO FPO, Canada & Mexico. 1 year \$4.00; 2 years \$7.00; 3 years \$10.00. Pan-American and Foreign, 1 year \$6.00; 2 years \$11.00; 3 years \$16.00. Single copies 50 cents. Printed in U.S.A. Entire contents copyright 1956 by Cowan Publishing Corp. CQ does not assume responsibility for unsolicited manuscripts.

POSTMASTER: SEND FORM 3579 to CQ, 67 WEST 44th ST., NEW YORK 36, N. Y.

HEATHKIT
DX-100
 PHONE AND CW

transmitter

KIT

FEATURES

Design proven through actual signal reports.



Only top-quality components used throughout.



5-point TVI suppression, and pi network output to match 50 to 600 ohms.



Detailed construction manual for simplified assembly.



100 watts output on 160, 80, 40, 20, 15, 11, and 10 meters.



Attractive and functional physical design.

The Heathkit Model DX-100 Transmitter is rapidly becoming the "standard" ham rig in its power class. The high quality and outstanding performance it offers can be matched only in equipment costing many dollars more. It features a built-in VFO, modulator, and power supplies, and is bandswitching for phone or CW operation on 160, 80, 40, 20, 15, 11, and 10 meters. The kit includes a detailed construction manual, the cabinet, all tubes, pre-wound coils, and all other parts necessary for construction.

Push-pull 1625 tubes are used to modulate parallel 6164 tubes for RF output in excess of 100 watts on phone, and 120 watts on CW. May be excited from the built-in VFO or from crystals. Features pi network output circuit, illuminated VFO dial and meter face, and 5-point TVI suppression. High grade, well-rated parts supplied. Schematic diagram and technical specifications on request.



MODEL
 DX-100

\$189⁵⁰

Shpg. Wt. 107 Lbs.

Shipped Motor Freight unless otherwise specified. \$50.00 deposit required on all C.O.D. orders.

HEATHKIT
antenna coupler
 KIT

MODEL
 AC-1

\$14⁵⁰

Shpg. Wt. 4 Lbs.



In addition to matching a low power transmitter to an end-fed long wire antenna, this antenna coupler incorporates a 3-section low-pass filter, to attenuate output above 36 mc and reduce TVI. Handles up to 75 watts, 10 through 80 meters. 52 ohm coaxial input—tapped inductor and variable capacitor—neon RF indicator. Ideal for use with the Heathkit AT-1 Transmitter.

HEATHKIT
grid dip meter KIT

The Model GD-1B is a time-proven instrument. It will enable you to accomplish literally hundreds of jobs on all types of equipment. Frequency range is from 2 mc to 250 mc. A 500 ua meter is employed for indication, and a sensitivity control and headphone jack are provided. Includes pre-wound coils and rack. Indispensable for the ham, serviceman, and engineer. Extra coils available to extend frequency down to 350 kc.



MODEL
 GD-1B **\$19⁵⁰**

Shpg. Wt. 4 Lbs.

HEATHKIT
antenna impedance
 meter KIT



MODEL AM-1
\$14⁵⁰

Shpg. Wt. 2 Lbs.

Used with an RF signal source, the AM-1 will enable you to match your antenna-receiver-transmitter system for optimum operation. Will double as a phone monitor or relative field strength meter. Uses 100 ua meter, and covers 0 to 600 ohms. Frequency to 150 mc.

**HEATH
 COMPANY**

A Subsidiary
 of Daystrom, Inc.

BENTON HARBOR 12, MICHIGAN

HEATHKIT

communications-type all band receiver KIT

Slide-rule dial
—electrical
bandsread—ham
bands marked.
Slug-tuned coils and
efficient IF trans-
formers for good
sensitivity and
selectivity.
Transformer-
operated power
supply for safety
and high efficiency.

The Model AR-3 receiver features new high-Q slug-tuned coils, new layout, and new-type IF transformers. The result is high sensitivity and selectivity and better image rejection on all bands.

Transformer-type power supply, electrical bandsread, RF and AF gain controls, antenna trimmer, AGC, BFO, headphone jacks, socket for Q multiplier, 5½" PM speaker and illuminated dial.

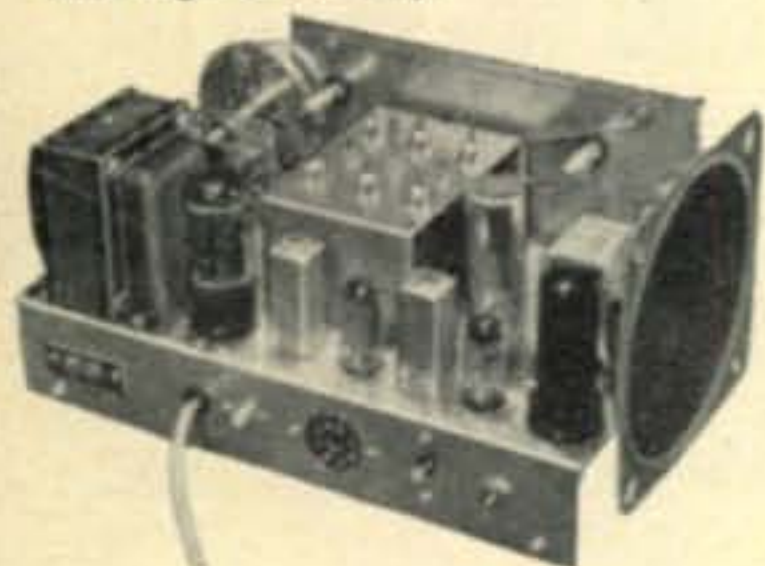

SPECIFICATIONS:

Frequency Range—550 kc to 30 mc on four bands.
Tube Complement—1—12BE6 oscillator and mixer • 1—12BA6 IF amplifier • 1—12BA6 second detector, AVC, first audio amplifier and reflex BFO • 1—12A6 beam power output • 1—5Y3 full wave rectifier



\$27⁹⁵ (Less Cabinet)
MODEL AR-3

Shpg. Wt. 12 Lbs.

CABINET: Fabric-covered cabinet available. Includes aluminum panel, speaker grille, and protective rubber feet. Measures 12¼" W. x 6¼" H. x 7¾" D. No. 91-15. Shpg. Wt. 5 Lbs. \$4.50.

HEATHKIT

CW amateur transmitter KIT

Single-knob
bandswitching
for 80, 40, 20, 15,
11, and 10 meters.
Panel meter monitors
final grid or plate
current.

Plate power
input
25-30 watts.

Best dollar-per-
watt buy on the
market.

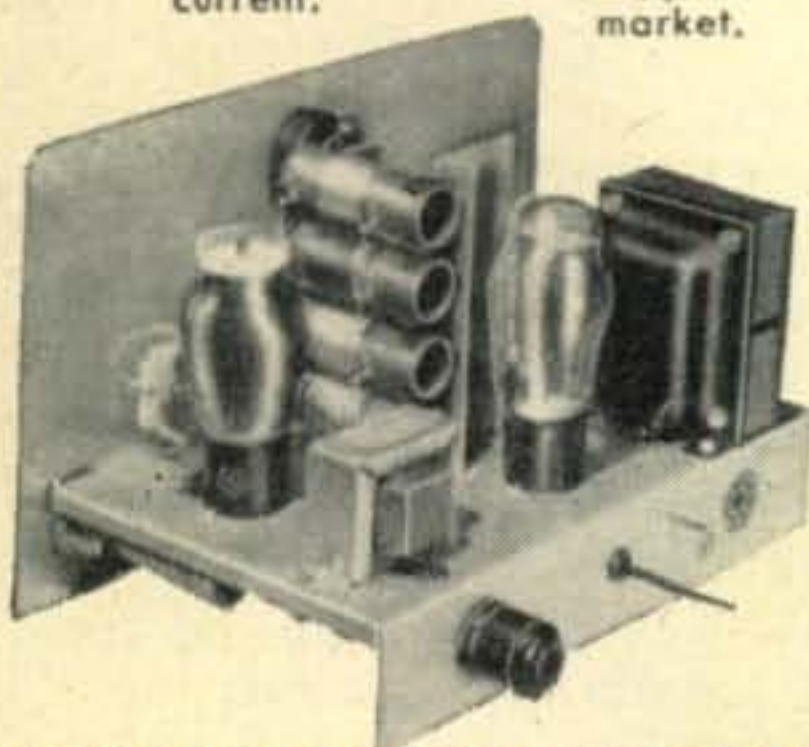

The AT-1 is complete with its own power supply, and covers 80, 40, 20, 15, 11, and 10 meters with single-knob bandswitching. Designed for crystal or external VFO excitation. Incorporates key-click filter, line filter, copper plated chassis, pre-wound coils, 52-ohm coaxial output, panel meter, and high quality components throughout. Easy to build, even for the beginner. Employs 6AG7 oscillator and 6L6 final. Up to 30 watts power input.



\$29⁵⁰ **MODEL AT-1**
Shpg. Wt. 15 Lbs.

SPECIFICATIONS:

RF Amplifier Power Input... 25-30 watts
Output Connection... 52 ohms
Band Coverage... 80, 40, 20,
15, 11, 10 Meters
Tube Complement:
5U4G... Rectifier
6AG7... Oscillator—Multiplier
6L6... Amplifier—Doubling

OA2 voltage
regulator tube
for stability.

6AU6 electron-
coupled Clapp
oscillator.

Covers 160-80-40-
20-15-11-10 meters.

Smooth-acting,
illuminated and pre-
calibrated dial.

Copper plated
chassis—aluminum
case—profuse
shielding—cer-
amic coil forms,
switch wafers,
and tuning con-
denser insulation.

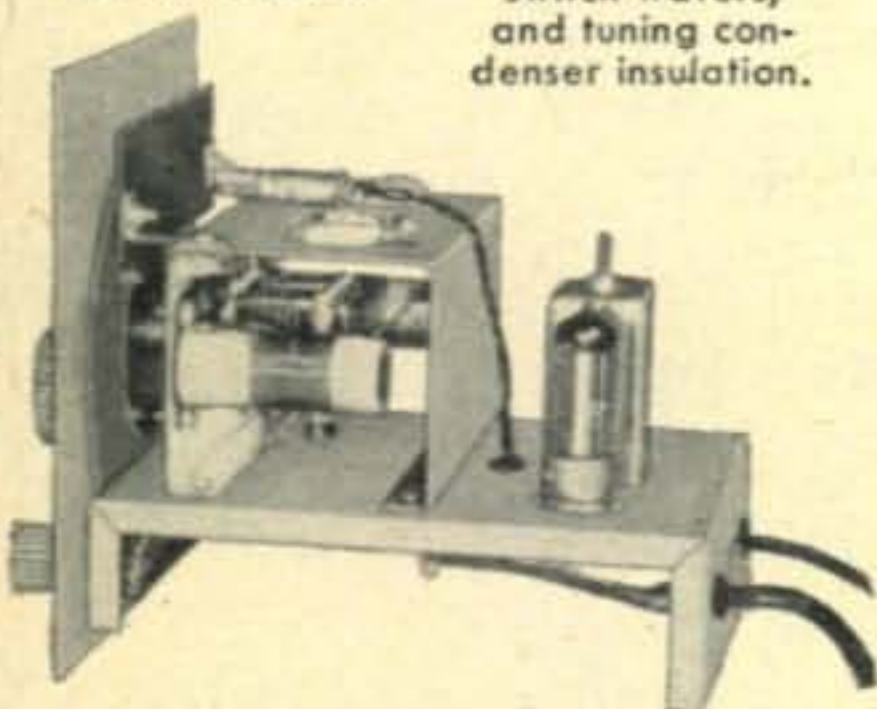

HEATHKIT vfo KIT

The Model VF-1 features illuminated and pre-calibrated dial scale. Cable and plug provided to fit the crystal socket of any modern transmitter. Covers 160-80-40-20-15-11 and 10 meters with 3 basic oscillator frequencies. Better than 10 volt average RF output on fundamentals. Derives operating power from transmitter power supply. Has VR tube for stability. Go VFO for more operating enjoyment.

MODEL
VF-1

\$19⁵⁰

Shpg. Wt.
7 Lbs.



SPECIFICATIONS:

Output Frequencies—1750-2000 kc, 7000-7425 kc, 6740-6808 kc. Calibrated Bands—160-80-40-20-15-11-10 meters. Tube Complement—6AU6 Oscillator OA2 Voltage Regulator. Power Requirements—250-350 VDC @ 15-20 ma. and 6.3 VAC @ .45 A.

ORDER DIRECT FROM THIS AD... OR WRITE FOR FREE CATALOG. Describes more than 65 interesting "build-it-yourself" projects. Amateur equipment, hi fi amplifiers, and the complete Heathkit line of test instruments. Get yours today!

**HEATH
COMPANY**

A Subsidiary
of Davstrom, Inc.

BENTON HARBOR 12, MICHIGAN

Designed for



Application



SHAFT LOCKS

In addition to the original No. 10060 and No. 10061 "DESIGNED FOR APPLICATION" shaft locks, we can also furnish such variations as the No. 10062 and No. 10063 for easy thumb operation as illustrated above. All types are available in bright nickel finish to meet Signal Corps requirements or black oxide to meet Navy specifications.

**JAMES MILLEN
MFG. CO., INC.**

MAIN OFFICE AND FACTORY
**MALDEN
MASSACHUSETTS**



Feenix, Ariz.

Deer Hon Ed:

Well, here are your grate old geenyus and inventor riting you again. Yes indeedy, lovable old Scratchi, coming to you by curtasy Hon. Uncle Sam's males. Hashafisti Scratchi, champeen of the down-trodden amchoor, hero of the masses—Hon. Ed., are I detecking a snicker from you? Can it be that you are disbulleeving?

Scratchi are feeling reel chipper, so I proving to you. Remembering in October, 1949, when Five-Meter Bootlegger Club are taking me to big western rodeo, and trying to foxey old Scratchi by entering him in bronco-busting contest? That are when Scratchi are winning third place by riding Old Slicky Black Lightning. Of course, it are true that are catching my chaps and spurs in the stirrups so can't getting off horse even if wanting to, but that not taking away from Scratchi being hero.

Or how abouts in July, 1950, when are getting trapped in dentists office, and making reel slicky transmitter out of diathermy machine—even using operating table as rotory beem. Peeples heering Scratchi's QRR and coming to rescue me. Even getting big rite-up in local newspapers.

Remembering Mumbo-Jumbo, the witch-doctor feller what living in south of North Borneo? Contacting him in September, 1953, and he making fancy noises over air and giving rain rityoual, and next thing you knowing Feenix are having 1/c rainstorm so hard the cows needing snorkle tooobs. Even Hon. Guvner of state trying to getting Scratchi to having Mumbo Jumbo giving rain to hole state. This are most embarassing, on acct. Scratchi not keeping log, and not recalling Mumbo Jumbo's call letters. So here Scratchi only parshul hero, on acct. only Feenix getting big rain.

And how about in November, 1953, you scoffer feller? That are when Scratchi reely being big-times hero. Are teeching see-w to young gentelfellows going to skule at dood ranch, and are heering sum signals on amchoor band what coming from left feeld. To making

[Continued on page 8]

PROFESSIONAL EFFICIENCY

*For the first time
commercial broadcast styling in one*
COMPLETE AMATEUR RADIO STATION

hallicrafters

model SR-500

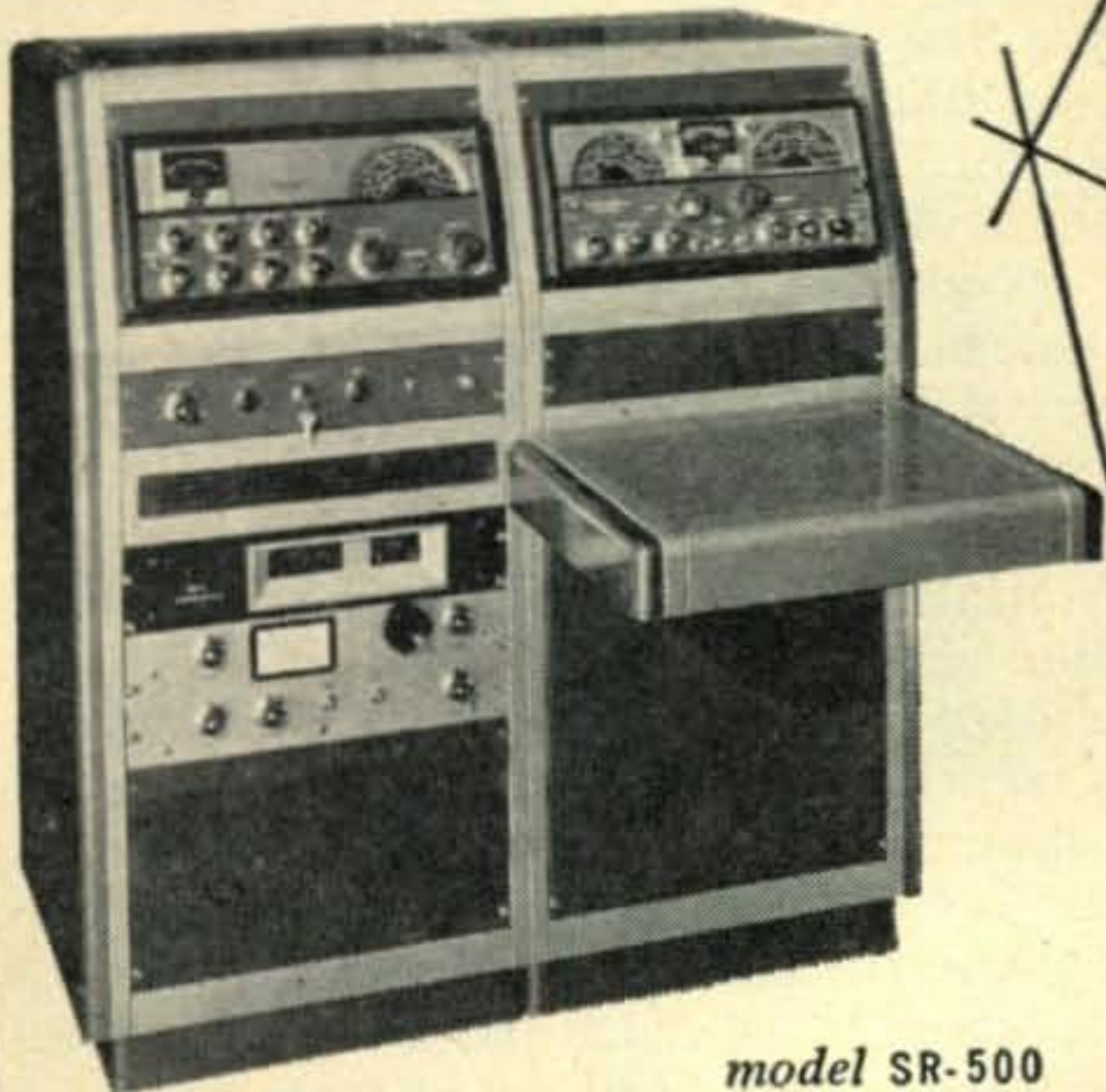

model SR-500

A completely contained unit in a handsome console cabinet—transmitter/exciter, linear power amplifier, receiver—affording the finest in V.F.O. or crystal. SSB, AM and CW transmission and reception. You need supply only the antenna, microphone and AC power. All the wiring is complete, and external connections are provided for antennae and microphone. The transmitting and receiving units are located for maximum efficiency in coordinated operation. A special communications speaker is positioned above the operating shelf directly in front of the operator. Console is mounted on casters and is easily expandable. Three blank panels provided in the basic cabinet for installation of any additional equipment desired. All safety and protective features incorporated. Completely enclosed, fused with the main power relay controlled by a key lock. Entire back of cabinet is enclosed and perforated for maximum ventilation and heat dissipation. \$1495.00

hallicrafters

4401 W. Fifth Avenue • Chicago 24, Ill.



*model HT-30
transmitter/exciter*

Built in V.F.O. reads directly in kilocycles. V.F.O. stability is equal to most crystals—.009%. There are also provisions for 1 crystal for fixed frequency operation. Selective filter system is same used by commercial communications companies for reliable sideband selection to assure continued suppression of unwanted side band energy (down 40 db or more) and distortion products. New 50 db range meter for constant monitoring of r-f output and carrier suppression. Voice control system built in with adjustable delay and anti-trip features. Front panel controls allow selection of AM, CW, and upper or lower side band. \$495.00



*model SX-100
receiver*

"Tee-Notch" Filter provides a stable non-regenerative system for the rejection of unwanted heterodyne in SSB. The "Tee-Notch" also produces an effective steepening of the already excellent 50 mc i-f pass band (made famous in the SX-96). Upper or lower side band selectable by front panel switch. Notch depth control for maximum null adjustment • Antenna trimmer • Plug-in laboratory type evacuated 100 kc quartz crystal calibrator—included in price • Second conversion oscillator crystal controlled—greater stability through crystal control and additional temperature compensation of high frequency oscillator circuits. \$295.00



*model HT-31
linear power amplifier*

Continuous frequency coverage from 3.5 mc to 30 mc • Pi-network output for efficient harmonic and T.V.I. suppression • Major T.V.I. suppression built in • Does not require an antenna tuner as will feed loads from 50 to 600 ohms • Full metering of all important circuits, including input in watts • Employs two 811-A zero bias triodes in parallel. The input system is designed to be fed from a 50-70 ohm unbalanced line and requires a maximum of 10 watts drive on 80 meters. The grid tank circuit is balanced to provide all band neutralization. \$395.00

How To Pass FCC COMMERCIAL RADIO OPERATOR License Exams



Free . . .

Tells where to apply and take FCC examinations, location of examining office, scope of knowledge required, approved way to prepare for FCC examinations, positive method of checking your knowledge before taking the examination.

GET YOUR FCC TICKET IN A MINIMUM OF TIME!

Get this Amazing Booklet **FREE**



An FCC License Can Be Your Guarantee of Success in Electronics

TELLS HOW . . .

1. Tells how thousands of brand-new, better paying radio-TV-electronics jobs are now open to FCC License Holders.
2. Tells how we guarantee to train and coach you until you get your FCC License.
3. Tells how our amazing Job-Finding Service helps you get the better paying job our training prepares you to hold.



GET ALL 3 FREE!

MAIL COUPON NOW!

CLEVELAND INSTITUTE OF RADIO ELECTRONICS
Desk CQ-17, 4900 Euclid Bldg., Cleveland 3, Ohio
(Address to Desk No. to avoid delay)

I want to know how I can get my FCC ticket in a minimum of time. Send me your FREE booklet, "How to Pass FCC License Examinations" (does not cover exams for Amateur License), as well as a Sample FCC-type lesson and the amazing new booklet, "Money-Making FCC License Information." Be sure to tell me about your Television Engineering Course.

Name Age

Address

City Zone State

FOR PROMPT RESULTS SEND AIR MAIL

Special tuition rates to members of the U. S. Armed Forces
Electronic Training also available to Canadian Residents

SCRATCHI

[from page 6]

long story short one, Scratchi are catching spy of smuggling ring. Getting bundle of bux for reward monies. Of certain you recalling that, Hon. Ed? How many spies you been catching resently? Ha!

Of course, if you reeding letters I sending you in past few yeers you knowing that Scratchi are gratest inventor since Macaroni, and I can proving that to, so taking that smile off your Hon. Face and listening.

How abouts invenshun what doing away with TVI? I riting you abouts it in April, 1949. All each ham are needing is small rig what transmitting TV signal on all channels. Using monoscope which are transmitting this message: Dew to Tecknickel Difficulties the Pattern May Be Disturbed From Time to Time During the Next Hour. Hon. Ed., you can't beeting that. When amchoor wanting to go on air, he turning on TV rig and putting that signal on all nayberhood TV reseervers for few minutes on each channel, then he going on air. Even if having TVI, all naybors thinking TV stayshuns having tecknickle trubbles. Weren't that a reel slicky?

In June, 1950, Scratchi even telling You S. Govvimints how to delivering A-bombs. Scratchi are discovering how to attracking bugs with small radio transmitter. So all having to do is feed bugs small peece of U-299, or whatever they calling that yuranium stuff, then airplanes are dropping small radio transmitter over enemy lines. Transmitter attracking bugs. When enuf bugs, each with small peece of yuranium in them, getting to transmitter, hole place going up in smoke. Are proolly getting medal for that idea, only no ones being able to figgure how to feeding yuraniums to the bugs.

If you not being so skotch with your monies, and sending me many bux in April, 1952, we'd both be rolling in doe. That are when Scratchi desineing all-band transmitter with no plugin coils and no band-change switch. Just using one 160 meters crisstal and having outputs on all bands. Of course, it are reel fooler. Hee hee, Hon. Ed., it are only small rig what having so many harmonicks it radiating on all bands!

And what about the speshul sodder that not melting, or the famous Scratchi SPLAT sistem (March 1953 I riting you on that), or the matching networks what matching anything to anything—or are I boring you with details?

I knowing you not being able to saying that Scratchi are not 1/c grate antenna expert. In March 1948 telling everybuddys how to using raleroad tracks for antenna. In May, 1954 wanting everybuddys to riting congressman to having white lines down middle of roads made of conducting paints so can using as mobile antennas. Hon. Ed., you certainly remembering Hon. Big Idea, the HFS antenna, which work-

[Continued on page 98]

INTEVIEW

table-top kilowatt amplifier

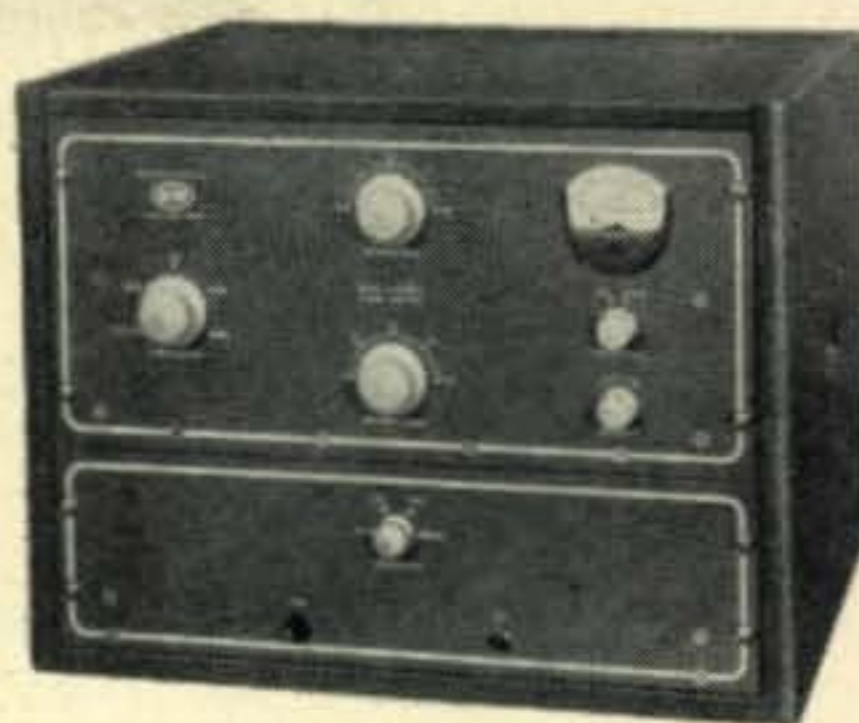

The B&W Model L-1000-A is a carefully engineered Grounded Grid Linear Amplifier with a power packing punch which will stand out in signal eloquence whenever the going gets rough. The clean design eliminates unnecessary circuits, yet all essentials have been included to give you long, dependable performance.

Just consider these features: 1,000 watts input SSB, 875 watts CW . . . completely self-contained including power supply! . . . bandswitching on all amateur bands 80 to 10 meters inclusive . . . pi-network final . . . broadbanded input—requires no tuning . . . all operating controls on front panel . . . controllable bias supply . . . completely shielded for TVI suppression . . . requires only 80 watts r.f. excitation . . . ideal for use with any transmitter nominally rated at 100 watts such as B&W 5100 Series, Collins 32V Series, Johnson Viking I & II, etc.

MODEL 5100-B A SUPERLATIVE AM-CW TRANSMITTER



- high level push-to-talk AM telephony . . . 140 watts input • clean CW keying - break-in on all bands . . . 180 watts input • sparkling SSB . . . 180 watts input . . . when combined with the 51SB-B single sideband generator • bandswitched throughout • integral VFO or crystal frequency control • coverage of 80 through 10 meter amateur bands • ideally suited to drive L-1000-A Linear Amplifier.

Net Price \$475.00

MODEL 51SB-B GENERATOR FOR SUPERLATIVE SSB



- fully bandswitched
- voice operated control • push-to-talk • speaker deactivating circuit
- powered by 5100-B transmitter
- no wiring required
- TVI suppression • unitized construction.

Net Price \$265.00

MODEL 370 ADAPTER FOR RECEPTION YOU NEVER DREAMED POSSIBLE



- truly outstanding SSB reception, select upper or lower sideband at the flip of a switch
- true single signal CW operation suppresses unwanted heterodynes by 50db
- selects either sideband of an AM signal
- may be combined with any communications receiver
- normal operation of your receiver is not disturbed in any way.

Net Price \$131.50

WRITE FOR LITERATURE OR SEE THESE FINE PRODUCTS
AT YOUR DISTRIBUTOR'S
Prices subject to change without notice.

B & W

BARKER & WILLIAMSON, INC.
237 Fairfield Avenue, Upper Darby, Pa.

... de W2NSD

NEVER SAY DIE

The Underground

I see where some Aussies have been delving around in caves using low power two meter transceivers for communication to the surface and from cave to cave. The results achieved were beyond all expectations with good solid signals being heard from flea power rigs through hundreds of feet of ground. It seems to me that W6LLP, W6CLW, and other ham spielunkers should get hot with this and see what really can be done. The last I heard it was supposed to be impractical to shoot radio waves through terra firma. If this has been repealed there should be a few million dollars waiting for the practical applications of it with regards to radar hunting for oil, minerals and lemurites. Somebody get out my chain ladder and Gonset.

Publicity

One of the things our poor old hobby needs more than anything else is some advertising. We would be in a lot better position if more people had some inkling of what ham radio is and what sort of service it performs. In line with this need *CQ* will undertake to help in any way it can to get news of our hobby into newspapers, on the radio, etc. In order to do this we must first have your help. The general story of ham radio is interesting, but it is important to have a specific incident or anecdote to get the story started. The recent hubub over the increased activity of the Russian stations is a good example of this. Every now and then something of good general interest takes place . . . the next time you hear of such an event send it in to *CQ* on the double.

When ham radio saves a life, participates in a disaster, or is connected with anything of real news value let us know right away.

Other information will be of value too . . . such as incidents where families keep in communication over long distances regularly, where someone meets over the air and eventually gets married, and things of that nature. Let us know of all the famous hams you can think of, along with their call letters. Anybody in the public eye. There must be at least one Congressman with a ticket. Maybe several mayors, actors, etc. Lots of etc. How about well known writers? Cartoonists? Like Bandel Linn, W4HXL, who executed (?) the cover this month. How

about desperados? Have we any of the better class crooks in our ranks? Does anybody know Anastasia's call?

Jim and I

Are tired of taking all the blame for errors in captions in *CQ* and we think you should know that a third unsteady hand has been added to the creaking oars. Back in the March *CQ*, page 112, I outlined the qualifications for advanced obscurity on the *CQ* payroll. Shortly thereafter a modest telegram came saying, "YOU COULD ONLY HAVE BEEN TALKING ABOUT ME IN YOUR EDITORIAL EXCEPT YOU UNDERESTIMATE ME SO." This retiring lad got the job. He packed his two meter kilowatt, his Model 26, and a huge trailer full of other gear and moved from Salt Lake City to NYC to become W7NVY/2. The next time you find a mistake in *CQ* complain to Art Brothers.

Battery Eliminator

The more test equipment I get the smoother things seem to run. The latest addition was a Heath Battery Eliminator. Now I wonder how I ever got along without it! Every now and then I had to lug out a spare car battery for checking something, now all I do is hook up the Heath. Within the first two weeks in the shack it was put to use in bringing the car battery to top charge, recharging an old spare that had been kicking around, adjusting a regulator, checking out some six and twelve volt relays, checking the Gonset G-66 receiver, testing and aligning my old car receiver, testing a marine transmitter-receiver, and some minor jobs. Since the Eliminator has an ammeter as well as a voltmeter I was able to find out exactly how much current the various gadgets on the car draw as well as the mobile equipment. Hardly a day goes by that I don't yank it off the shelf for something.

Flexible Meters

I get a special kick out of putting the information in one of our articles to use myself. In this case it was WINPL's article in the May issue which made it easy to use five identical 0-500 voltmeters for my 500 watt two meter final. I left two intact to measure the grid and screen voltages. The other three were modified

[Continued on page 12]

EIMAC 4-65A

**Versatile
Compact
Rugged**

TYPICAL OPERATION

	CW	AM	SSB
Plate Voltage	3000v	2500v	3000v
Driving Power	1.7w	2.6w	0
Power Input	345w	275w	195w

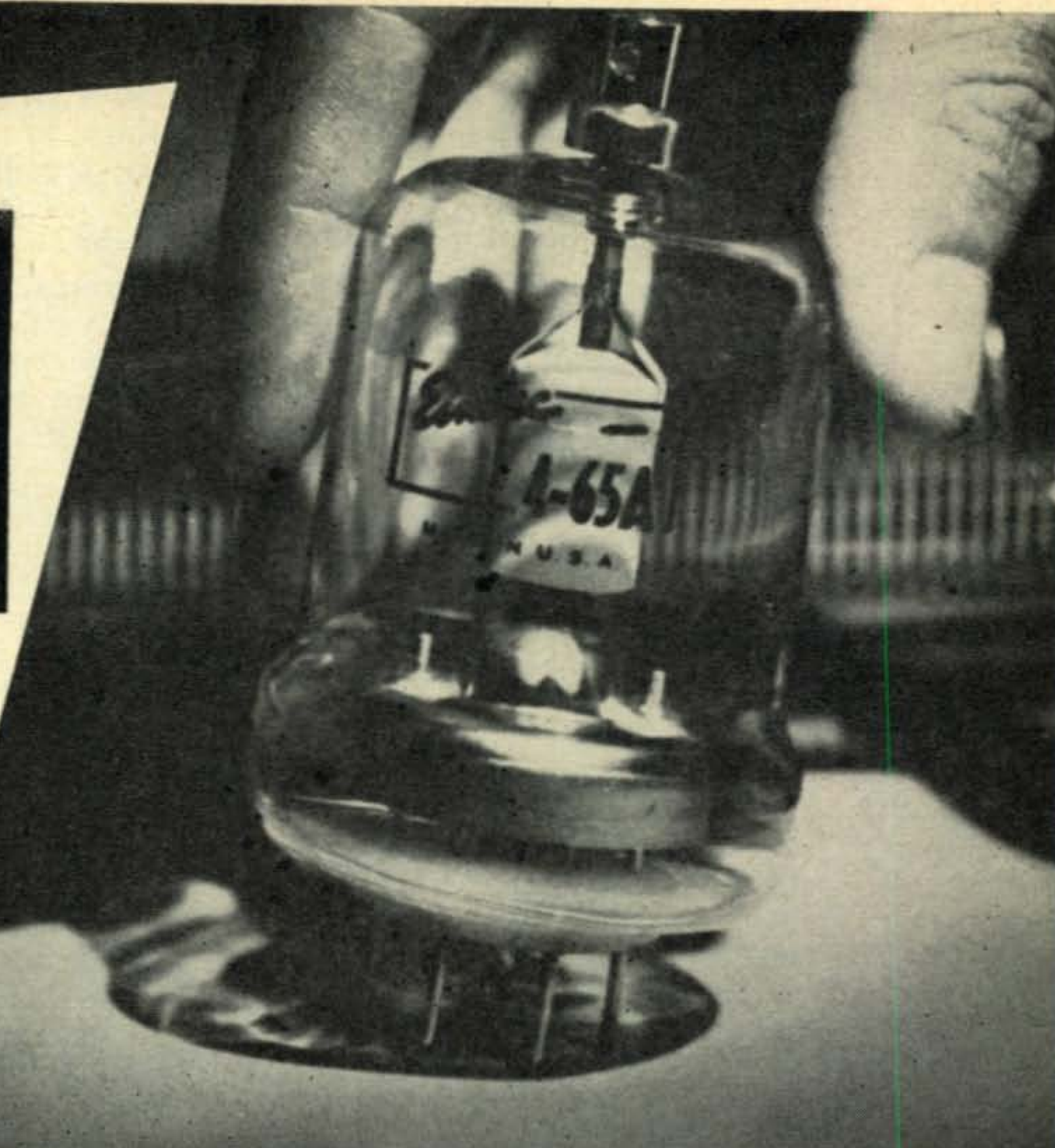

For low to medium powers, mobile or fixed station, the Eimac 4-65A is truly one of the most versatile tubes in amateur use today. The least expensive and smallest of the Eimac internal-anode tetrodes, this compact, rugged tube is ideal for all-band CW, AM, and SSB rigs.

Short, heavy leads and low interelectrode capacitances contribute to stable, efficient operation of the 4-65A at high frequencies. The tube operates over a wide range of plate voltages — 600 to 3000 volts with power inputs from 90 to 345 watts — and as with all Eimac tetrodes, it requires low driving power and simplifies transmitter construction.

For mobile use, the radiation-cooled 4-65A is a natural. Its instant heating filament eliminates battery drain during stand-by periods. And through application of filament and plate power simultaneously, no warm-up periods are required.

For further information on the 4-65A, write the Eimac Amateur Service Bureau or visit your Eimac distributor.



EITEL-McCULLOUGH, INC.

SAN BRUNO, CALIFORNIA
The World's Largest Manufacturer of Transmitting Tubes

EDITORIAL

[from page 10]

to read the grid, screen, and plate currents. No difficulties were encountered, though the construction of my Model 301 meters was somewhat different from that described in the article.

16½" of Twin Lead

Once the half gallon was on the air I found that most of the neighborhood TV sets just about collapsed. My best DX was a poor distraught woman two blocks away who was getting me on radio, TV and Hi-Fi. This nasty turn of events might discourage some, it did me. Even my TV practically jumped off the table when I crunched on the powerhouse. Just for kicks I tried the first-aid measure: 16½" length of twin lead hung from the TV set antenna terminal with the other end open and hanging down. Presto: no more TVI. I then went on the air day and night for three days telling all and sundry to pick up their filters for free at my house. Quite a few called for them and not one has ever come back or called again. I rechecked with a few of the worst cases and they reported that they no longer could hear me.

For your edification, the 500 watts works out wonderfully. I have worked all sorts of DX

I never could have hooked with my low power. When I push that button everyone hears me. Now I have to get busy and knock together one of those low noise preamplifiers so I can hear who is calling me.

W2NSD Travels Again

Next month I'll be able to tell you a bit about the West Gulf Convention in Galveston which came about in the middle of June. As this is written my trip down there is still two weeks off and I am anticipating it. After the Convention I expect to spend a couple days visiting W5YVJ on his ranch in Houston. As a rabid hoss lover I can hardly wait to get there.

In July I'll be out to the National Convention in San Francisco. I haven't been there for ten years . . . it'll be fun to get around and see the town again. From there I'll go down to L.A. for a few days and then back to steaming old NYC again to put the finishing touches on our special September issue. I'm open to invitations to skin dive, water ski, or horseback ride out there.

Scratchi Centennial

One hundred episodes of Scratchi! No matter what cigarette you smoke Scratchi is far and away the most popular feature in *CQ*. A note
[Continued on page 112]

HEATHKIT **NEW** DX-35



MODEL DX-35

\$56⁹⁵

Shpg. Wt. 24 Lbs.

phone and cw transmitter KIT

- Built-in modulator for phone operation.
- Bandswitching on 80, 40, 20, 15, 11 and 10 meters. Pi network output coupling.
- Switch selection of three crystals—provision for external VFO excitation.
- Attractive and functional physical design.

This brand new transmitter model provides phone and CW operation on 80, 40, 20, 15, 11, and 10 meters. Plate power input to 65 watts on CW and controlled carrier modulation peaks to 50 watts on phone. Completely bandswitching.

Employs two-stage 12AX7 speech amplifier, 12AU7 modulator, 12BY7 oscillator, 12BY7 buffer, and 6146 final. The buffer stage assures plenty of drive to the final on all bands. Pi network output coupling employed for easy antenna loading. Switch selection of crystals. Crystals changed without removing transmitter cabinet. Husky power transformer and choke are potted, and the circuit is well shielded. Meter indicates final grid or plate current.

Truly a remarkable transmitter package for the price. Ideal both for the novice and for the more experienced operator.

Send for free 1956 Heathkit Catalog describing more than 65 interesting "build-it-yourself" projects.

**HEATH
COMPANY**

A Subsidiary
of Daystrom, Inc.

BENTON HARBOR 12, MICHIGAN

HEATHKIT "Q" multiplier KIT

Provides extra selectivity for separating signals, or will reject one signal to eliminate heterodyne. Effective Q of 4,000 for sharp "peak" or "null." Tunes any signal within receiver IF. Operates with 450 to 460 kc IF. Will not function with AC-DC type receivers. Requires 6.3 VAC at 300 ma, and 150-250 VDC at 2 ma.



MODEL QF-1

\$9⁹⁵

Shpg. Wt.
3 Lbs.

HOW MUCH SHOULD YOU PAY FOR A GOOD ROTARY BEAM?

The only true measure of value is (a) performance and (b) amount of aluminum per dollar cost. Study these specifications—compare them—and you too will agree, along with thousands of hams, that GOTHAM beams are best!

TYPE OF BEAM. All Gotham beams are of the full half-wave plumber's delight type; i.e., all metal and grounded at the center. No wood, tuning stubs, baluns, coils, or any other devices are used.

GAIN. Gotham beams give the maximum gain obtainable. Our 2-element beams give a power gain of four (equivalent to 6 db.); our 3-element beams give a power gain of seven (8.1 db.); and our 4-element beams give a power gain of nine (9.6 db.)

FRONT-TO-BACK RATIO. We guarantee a minimum F/B Ratio of 19 db. for any of our 2-element beams; 29 db. for any of our 3-element beams; 35 db. for 4-element beams.

MATCHING. Matching of the transmission line to the beam is extremely simple and quick. Everything is furnished and the matching is automatic. No electronic equipment or measuring devices are required.

ASSEMBLY AND INSTALLATION. No special tools are required for assembly and installation. Entire job can be done by one man in less than an hour. Full instructions are included with each beam.

MAST. Any Gotham beam can be mounted on a simple pipe mast. Diameter of the pipe should be between 3/4" and 1 1/8".

STANDING WAVE RATIO. A very low SWR of approximately 1.5 to 1 will result from following the instruction sheet, depending on the height above ground and the surrounding area. If an SWR indicator is available, Gotham beams can be quickly and easily adjusted to 1.1.

STANDARD AND DELUXE BEAMS. Standard beams in the 6, 10 and 15 meter bands use 5/8" and 3/4" tubing elements; the deluxe models for these bands use 7/8" and 1". In 20 meter beams, the standard has a single boom, while the deluxe uses twin booms.

WHAT WILL A GOTHAM BEAM DO? A Gotham beam will amplify the transmitted and received signal tremendously and will greatly reduce noise and QRM.

NEW VERTICAL ANTENNAS

ENGINEERED VERTICAL ANTENNAS for 40 meters, 80 meters, 160 meters. Gotham proudly announces three vertical antennas for unsurpassed performance on 40 meters, 80 meters, and 160 meters. Each antenna is absolutely complete, can be assembled in less than two minutes and requires no special tools or electronic instruments for adjustment and operation. Radiation is omni-directional, with maximum radiation at the very low angles necessary for DX operation. These three vertical antennas have been developed over a period of three years in response to requests by hams for efficient, fool-proof, small-space, low-cost antennas for 40, 80, and 160 meters. Two 12 foot lengths of tubing and loading coil in each vertical antenna. Literature available.

- # V40 vertical for 40 meters.....\$14.95
- # V80 vertical for 80 meters.....\$16.95
- # V160 vertical for 160 meters.....\$18.95

HOW TO ORDER: Send coupon with check or money order directly to GOTHAM or visit your local distributor. Immediate shipment by Railway Express, charges collect. Foreign orders accepted. Some leading distributors who handle GOTHAM beams: Offenbach & Reimus, Curle, M. N. Duffy, Alltronic, Purchase Radio, Low Bonn Co., Henry Radio, Evans, Gib's Ham Gear, Hobe's Radio, Western Electronics, Harris Radio, Capitol Radio, Kinkade, Johannsen, W. H. Edwards Co., World Radio Labs, Graham Electronics, Geo. D. Barbey Co., Hudson Radio, Selectronic, Radio Electric Service, Ken-Els Radio, NRM Wholesale Radio.

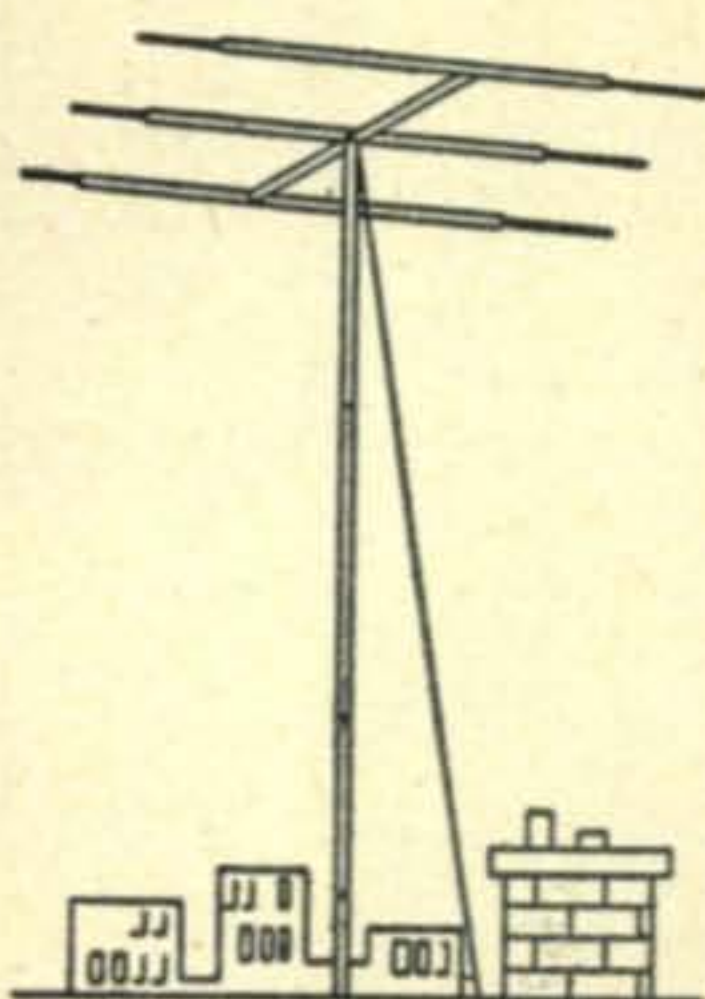

This Full Size Gotham Cost Only \$21.95 And Brought In 87 Foreign Countries, All Continents And 30 Zones On 35 Watts!

MAIL THIS COUPON TODAY! 10-DAY MONEY BACK GUARANTEE

GOTHAM

107 E. 126th ST., NEW YORK 35, N. Y.

Enclosed find check or money-order for:

- | | | |
|--|--------|--|
| 2 METER BEAMS | | |
| <input type="checkbox"/> Deluxe 6-Element | \$9.95 | <input type="checkbox"/> 12-El \$16.95 |
| 6 METER BEAMS | | |
| <input type="checkbox"/> Std. 3-El Gamma match | 12.95 | <input type="checkbox"/> T match 14.95 |
| <input type="checkbox"/> Deluxe 3-El Gamma match | 21.95 | <input type="checkbox"/> T match 24.95 |
| <input type="checkbox"/> Std. 4-El Gamma match | 16.95 | <input type="checkbox"/> T match 19.95 |
| <input type="checkbox"/> Deluxe 4-El Gamma match | 25.95 | <input type="checkbox"/> T match 28.95 |
| 10 METER BEAMS | | |
| <input type="checkbox"/> Std. 2-El Gamma match | 11.95 | <input type="checkbox"/> T match 14.95 |
| <input type="checkbox"/> Deluxe 2-El Gamma match | 18.95 | <input type="checkbox"/> T match 21.95 |
| <input type="checkbox"/> Std. 3-El Gamma match | 16.95 | <input type="checkbox"/> T match 18.95 |
| <input type="checkbox"/> Deluxe 3-El Gamma match | 22.95 | <input type="checkbox"/> T match 25.95 |
| <input type="checkbox"/> Std. 4-El Gamma match | 21.95 | <input type="checkbox"/> T match 24.95 |
| <input type="checkbox"/> Deluxe 4-El Gamma match | 27.95 | <input type="checkbox"/> T match 30.95 |
| 15 METER BEAMS | | |
| <input type="checkbox"/> Std. 2-El Gamma match | 19.95 | <input type="checkbox"/> T match 22.95 |
| <input type="checkbox"/> Deluxe 2-El Gamma match | 29.95 | <input type="checkbox"/> T match 32.95 |
| <input type="checkbox"/> Std. 3-El Gamma match | 26.95 | <input type="checkbox"/> T match 29.95 |
| <input type="checkbox"/> Deluxe 3-El Gamma match | 36.95 | <input type="checkbox"/> T match 39.95 |
| 20 METER BEAMS | | |
| <input type="checkbox"/> Std. 2-El Gamma match | 21.95 | <input type="checkbox"/> T match 24.95 |
| <input type="checkbox"/> Deluxe 2-El Gamma match | 31.95 | <input type="checkbox"/> T match 34.95 |
| <input type="checkbox"/> Std. 3-El Gamma match | 34.95 | <input type="checkbox"/> T match 37.95 |
| <input type="checkbox"/> Deluxe 3-El Gamma match | 46.95 | <input type="checkbox"/> T match 49.95 |

(Note: Gamma-match beams use 52 or 72 ohm coax. T-match beams use 300 ohm line.)

NEW! RUGGEDIZED HI-GAIN 6, 10, 15 METER BEAMS

Each has a TWIN boom, extra heavy beam mount castings, extra hardware and everything needed. Guaranteed high gain, simple installation and all-weather resistant. For 52, 72 or 300 ohm transmission line. Specify which transmission line you will use.

- Beam #R6 (6 Meters, 4-El).....\$38.95
- Beam #R10 (10 Meters, 4-El).... 40.95
- Beam #R15 (15 Meters, 3-El)..... 49.95

Name
Address
City Zone State

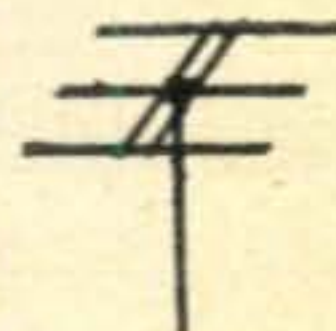

A precision coils and 10 meter shorting bar. See them at your distributors now.
The "original" coils sold with a money-back guarantee

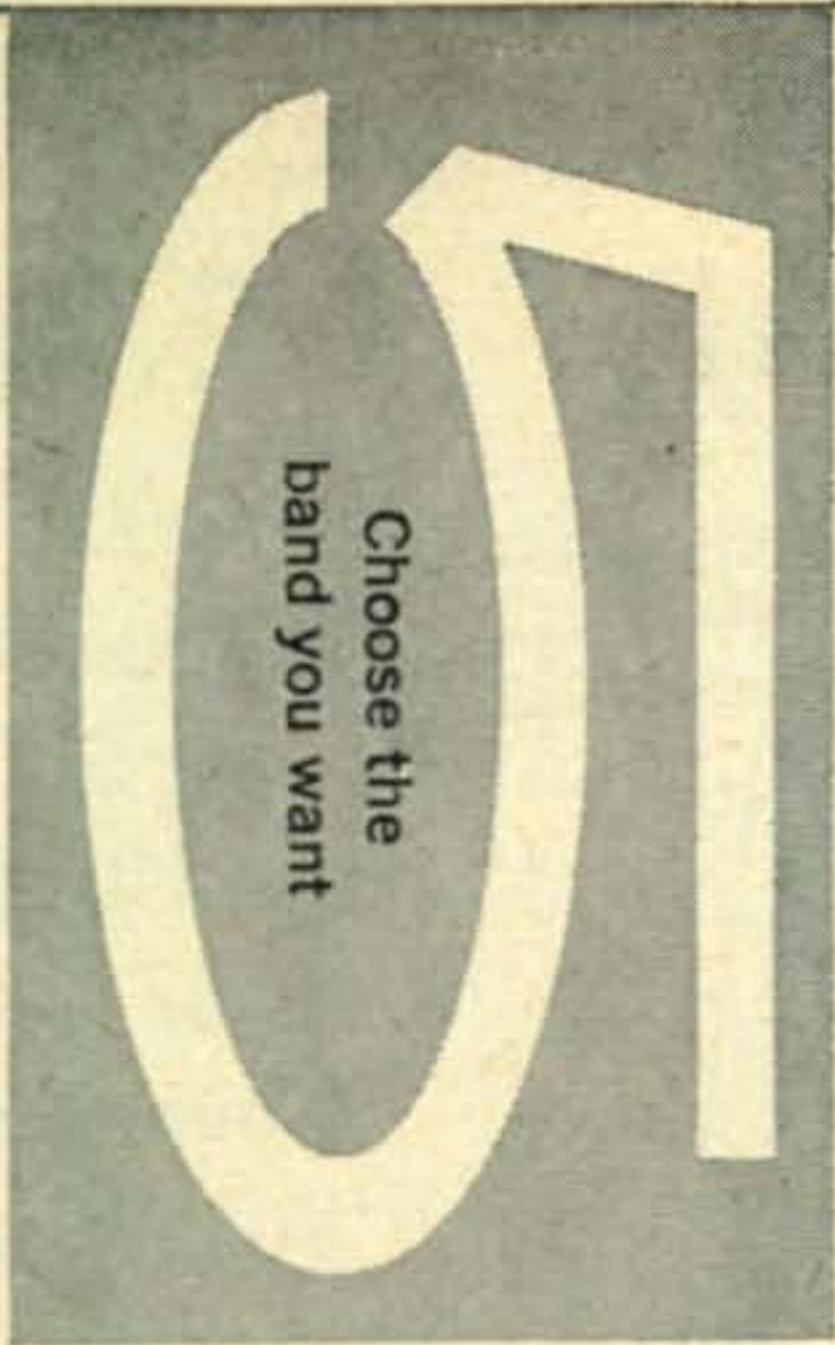

Choose the
band you want

the

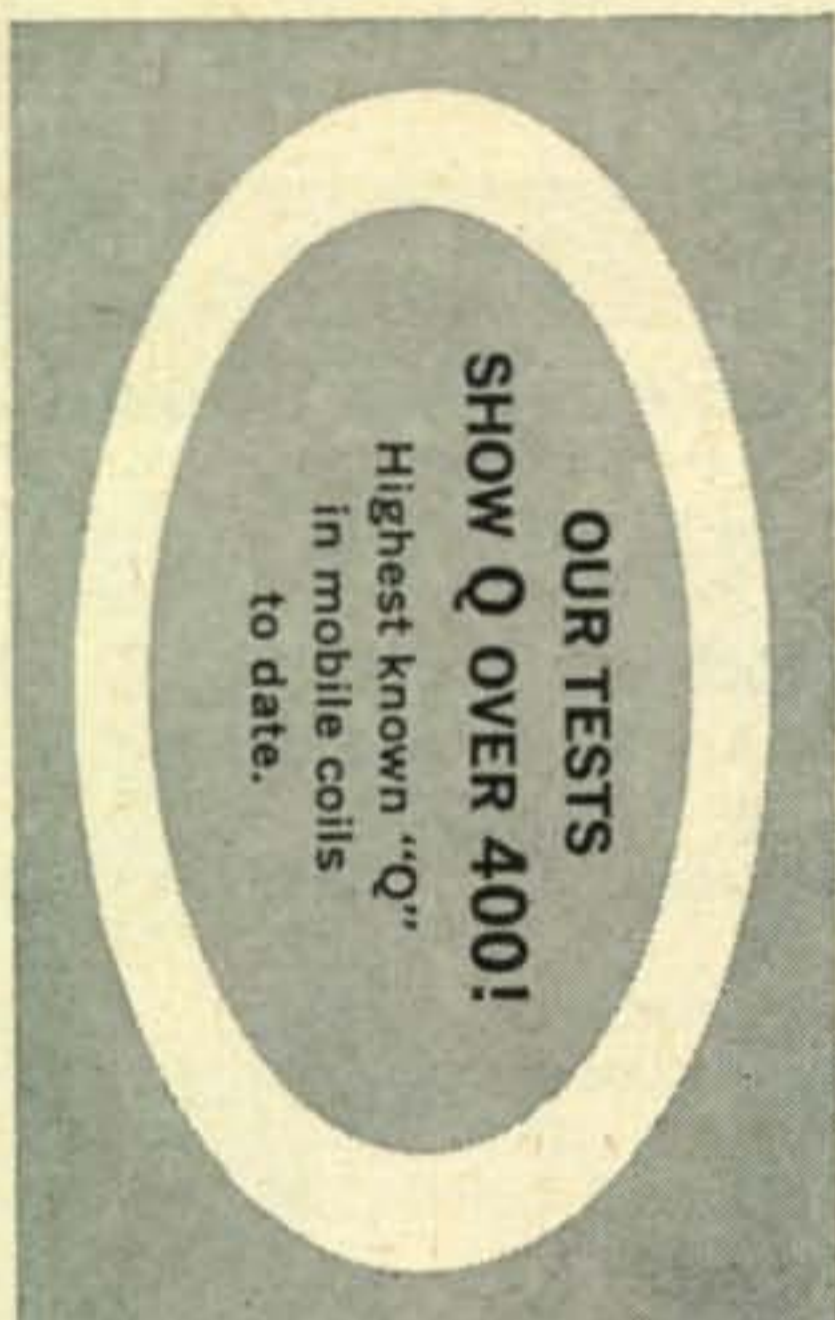

OUR TESTS
SHOW Q OVER 400!
Highest known "Q"
in mobile coils
to date.



Use with 60" whip,
36" base section. Coils can
be tuned without pruning for
maximum efficiency with your
installation. Instructions
enclosed with each
coil.

series

DAVIS ELECTRONICS

4002 W. Burbank Blvd., Burbank, California



Write for FREE Literature

Letters . . .
to the editor

Dear Sir:

We are writing you at the request of Mr. Willard B. Guimont, W6YMD.

Some months ago your magazine carried a letter to the editor concerning the lawsuit filed by the Pacific Palisades Civic League, Inc. and other persons against W6YMD to permanently enjoin him from erecting a telephone pole support for his rotary beam antenna. The amateurs of the Nation generously came to his assistance and the matter has been in and out of court for almost a year.

We are now pleased to announce that the case has been settled. The provisions of the settlement permit W6MYD to erect his antenna system and pledge the cooperation of the residents of the area to the elimination of TVI and BCL. We feel that this settlement, while it entails some restrictions as to future antennae, is a major victory for the right of amateurs to use their own property as they see fit in the pursuit of their hobby. Inasmuch as the case did not go to the Appellate Court there will be no legal precedent established. It is our belief that every additional antenna system permitted to stand strengthens the case of every amateur who meets opposition in the future.

Howard F. Sheperd, Jr., W6QJW
Attorney At Law
1124 Rowan Building
Los Angeles 13, Calif.

Dear Wayne:

The following method of coupling coaxial lines into a command receiver has resulted in an increase of sensitivity of from 3-5 db on a 3-6 ms BC-454 used on its original frequency. When used as a tunable i.f. for a crystal controlled 2 meter converter the gain is about 6 db.

Most articles on conversion of command equipment merely suggest the substitution of a coaxial connector for the original antenna binding post, but a tremendous loss of sensitivity was noted when using low impedance feed lines.

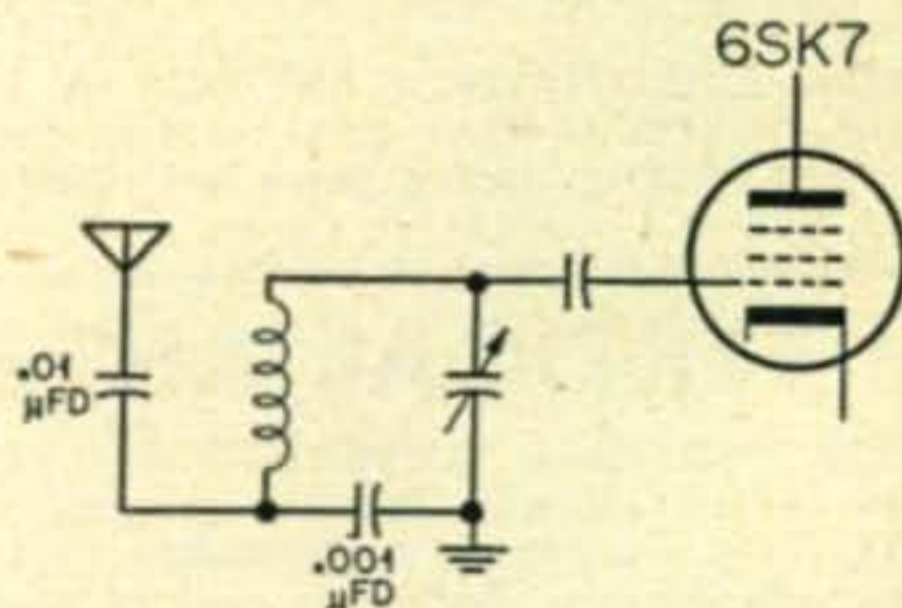

The series condenser from the antenna post should be removed and a .01 μ fd connected from the antenna input to the terminal on the antenna coil socket that is grounded to the condenser frame. At the same time remove the solid tinned ground wire and put a .001 μ fd disc ceramic in series with the coil to ground.

The changes are shown above. Components whose parts values are not shown are original parts and are shown for the sake of clarity.

Total time for these modifications comes to about thirty minutes.

The dividend in results is tremendous. This scheme has been tried in a BC-946 which is used as an i.f. for a Tri-Band with results similar to those obtained with the BC-454.

The same can also be done with any receiver. It is a convenient means of coupling without the bother of winding and pruning primary coils. More ambitious workers can experiment with the value of the little panel mounted "align input" condenser which may result in still further improvement.

Dan Rosenbaum, W2JCI

[Continued on page 18]



Morrow MB-560

"MORE TALK POWER"

... per watt in a 60-watt transmitter, just 4" high
90-watt CW, 60-watt Phone

Here's just what the amateur world has been waiting for—an all-band transmitter of advanced design that is rugged, compact and handsome enough for either mobile or desk-top operation.

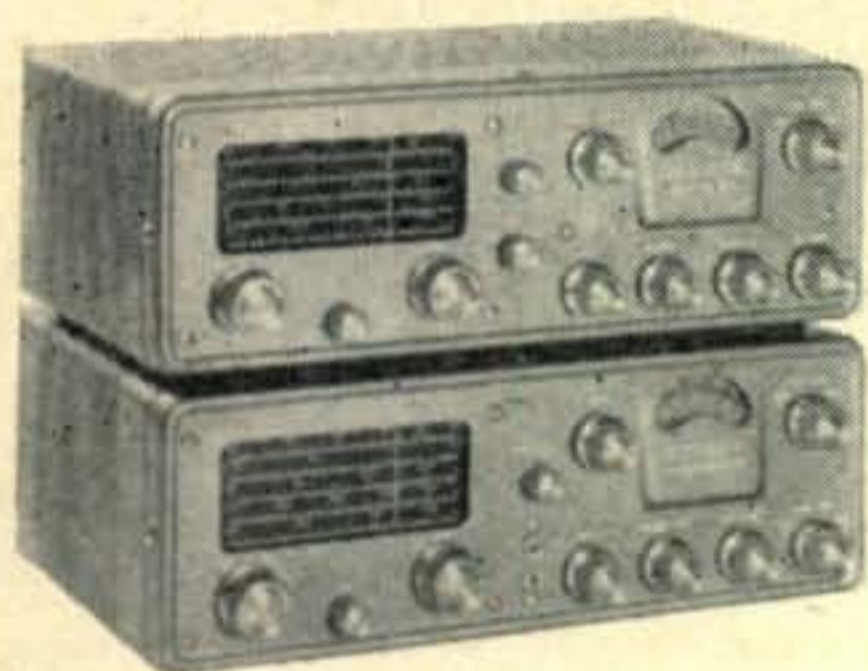

EXTREMELY STABLE. Advanced circuitry assures rock-bound stability. Built-in VFO covers 80, 40, 20, 15 or 10 meters. Exciter is isolated and completely shielded.

EASY TO OPERATE. All tuned circuits gang-tuned. Metered circuits clearly metered on front panel.

PI-NETWORK OUTPUT. Separately tuned in final stage.

POWERFUL. 65 watts to a 6146. Speech limiting gives "more talk power" per watt in this advanced design.

COMPACT. Only 4" high, 11³/₄" long, 7¹/₈" deep. Case is beautifully finished in hammertone.

Amateur net, \$214.50

FOR CONVENIENT TERMS, SEE YOUR JOBBER

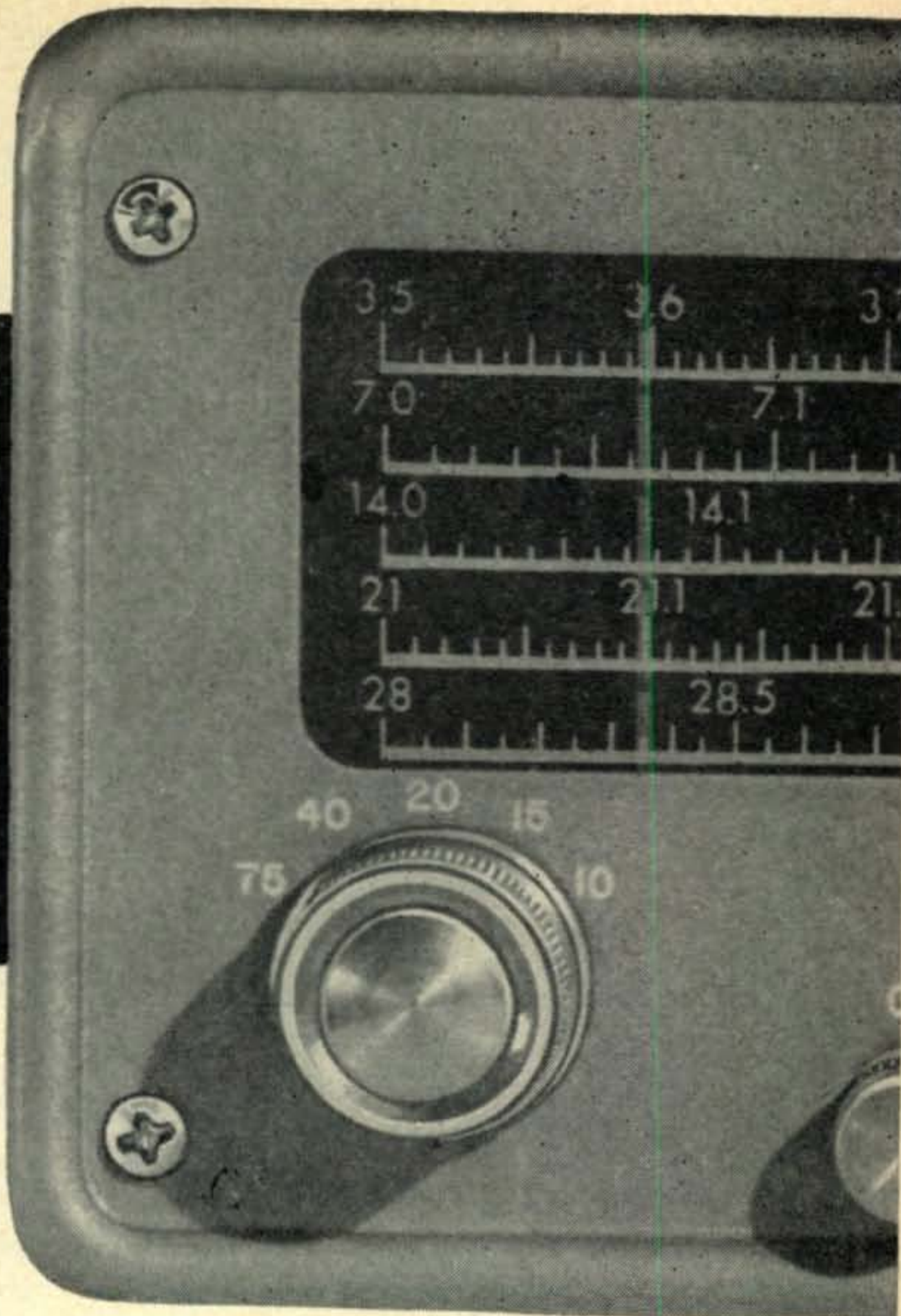

Matched Accessory Equipment



MOR-5 RECEIVER

13 tubes, 20-tube performance. Extreme stability and sensitivity.

Amateur net \$224.50



RVP-250 POWER SUPPLY

Mobile vibrator pack for MOR-5 and exciter of MB-560.

Amateur net \$39.50

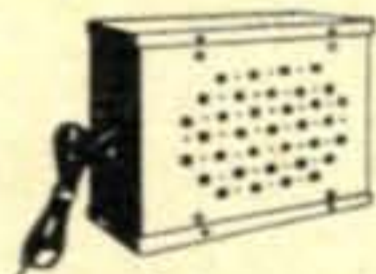

SH-7 SPEAKER

5"x7" speaker in sturdy hammertone case. Amateur net. \$11.50

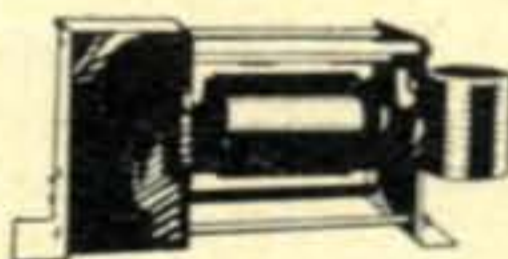

MLV-50 INDUCTOR

Motor driven for remote control tuning of whip. Amateur net. . . . \$24.95



FS-1 FIELD STRENGTH METER

Measures field intensity.

Amateur net \$19.50

FREE DATA SHEETS — WRITE TODAY!



MORROW

radio manufacturing co.

2794 MARKET STREET • SALEM, OREGON

801 Dominion Bldg., Vancouver, B. C.

Prices and specifications subject to change without notice.

Another outstanding new Viking transmitter . . .

The "FIVE HUNDRED"

**500 WATTS PHONE and SSB* . . .
600 WATTS CW!**

*VFO
and Exciter
gang tuned*



*P.E.P. Input with Auxiliary SSB Exciter

The Viking "Five Hundred" is a complete 500 watt transmitter for the 80 through 10 meter amateur bands. All exciter stages are ganged to the VFO tuning . . . unit is designed throughout for outstanding operating convenience and flexibility. The "Five Hundred" consists of two compact units: an RF unit small enough to place on your operating desk beside your receiver; and a power supply/modulator unit so compact it may be placed in most any convenient location. All operating controls are located on the front panel of the RF unit within easy reach of the operator.

The Viking "Five Hundred" has been designed for either crystal or VFO control. Instant bandswitching, the "Five Hundred" is effectively TVI suppressed and filtered . . . contains a Pi-L network output circuit, with silver plated final tank coil, capable of loading virtually any

antenna system. Safety and protective features include: a tamper-proof, key-operated mainswitch; cabinet interlocks; excitation and bias failure protection; fused filament and plate supplies; and high voltage time delay.

Other Features: Built-in VFO is temperature compensated and extremely stable; high gain audio circuit with push-to-talk control; timed sequence keying which applies wave shaping to the keyed amplifier stages for perfect "make" and "break" on your keyed signal; low level audio clipping.

The Viking "Five Hundred" is available completely wired and tested or as an easy-to-assemble kit. The RF unit is housed in an 18 gauge steel cabinet, finished in attractive maroon and grey with green nomenclature. Power supply cabinet is finished in maroon enamel. Dimensions: RF unit — 11 $\frac{1}{8}$ " x 21 $\frac{1}{8}$ " x 17 $\frac{3}{8}$ ". Power Supply — 10 $\frac{7}{8}$ " x 20 $\frac{3}{8}$ " x 15 $\frac{3}{4}$ ". Total Shipping Wt.: 200 lbs.

Cat. No. 240-500. Viking "Five Hundred" Kit complete with tubes, less crystals, key and microphone

\$649⁵⁰

Amateur Net

Cat. No. 240-500-2. Viking "Five Hundred" wired and tested w. 1 tubes, less crystals, key and microphone.

\$799.50 Amateur Net

NOTE: Scheduled for September delivery — prices subject to revision at time of delivery.

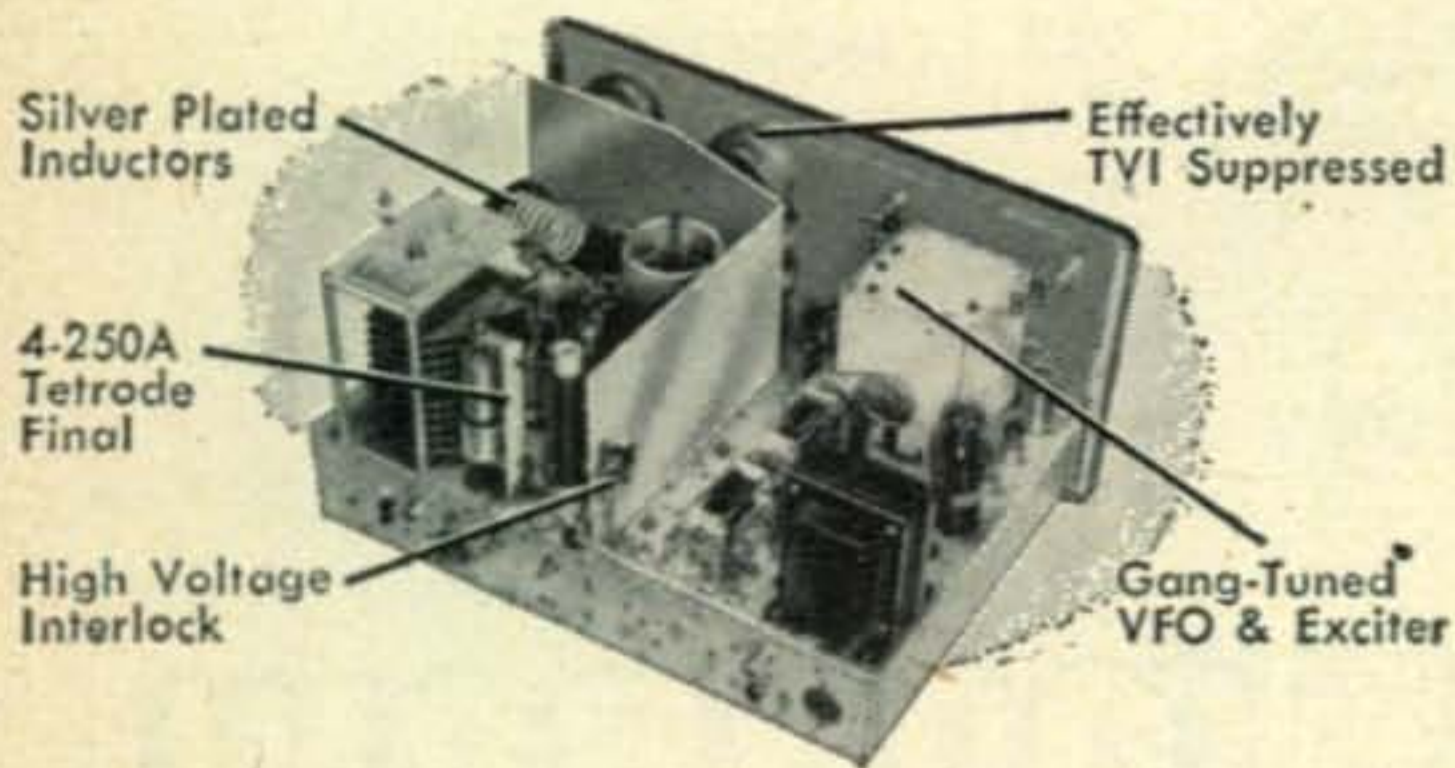

E. F. Johnson Company

2930 SECOND AVENUE SOUTHWEST • WASECA, MINNESOTA

Capacitors • Inductors • Knobs • Dials • Sockets • Insulators • Plugs • Jacks • Pilot Lights

See your distributor

Johnson Amateur Equipment is sold only through Authorized Johnson Distributors—most offer convenient time payment plans. For complete information see your distributor.

NEW for VHF!

the Viking "6N2"

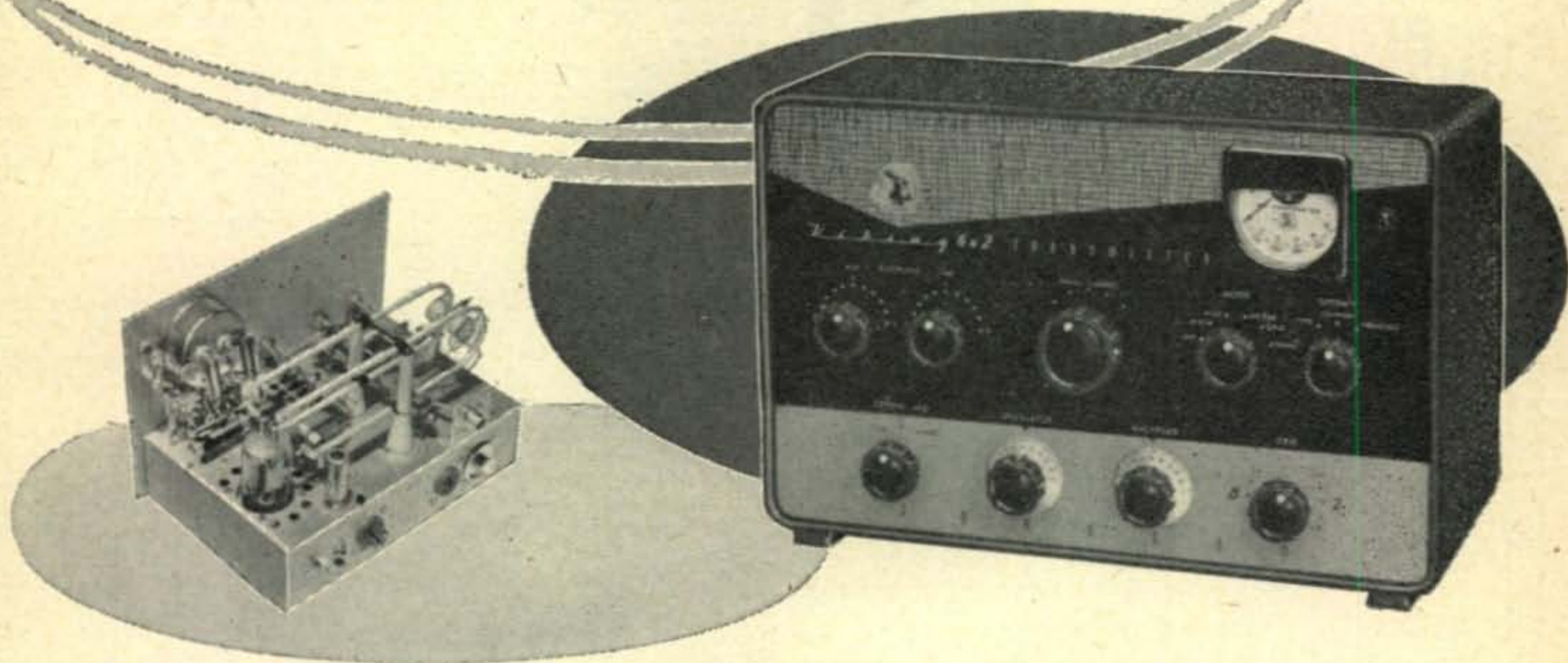

150 watts CW input . . . 100 watts AM phone!

This compact new VHF transmitter offers instant band-switching coverage of both 6 and 2 meters. Completely shielded and TVI suppressed, the "6N2" may be used with the Viking "Ranger," Viking I, Viking II, or similar power supply-modulator combinations capable of at least 6.3 VAC at 3.5 amp., 300 VDC at 70 ma., 300 to 750 VDC at 200 ma. and 30 or more watts of audio. Power input is rated at 150 watts CW and 100 watts AM phone . . . cathode keying results in excellent waveform.

The Viking "6N2" may be operated by external VFO or built-in crystal control. 8 to 9 mc. crystals are used in a pentode oscillator, which doubles in the plate circuit. This avoids tricky overtone circuits, eliminates critical adjustment and prevents frequency output which is not harmonically related to the fundamental of the crystal. VFO operation may be obtained by simply plugging in an external VFO with an 8-9 mc output and turning the VFO/Crystal switch to the VFO position. Provision for zeroing the VFO is also provided.

The final amplifier uses a type 5894 dual tetrode in a push-pull circuit . . . final tank is a dual band device and requires no switching when changing bands. High efficiency is obtained by the use of silver plated balanced tank circuits with parallel lines for maximum efficiency on 2 meters.

TUBE LINE-UP

6U8 (Pentode Section) — Crystal — Oscillator — Doubler
6U8 (Triode Section) — Tripler 5894 Final Amplifier
6360 Tripler-Driver 6AQ5 Clamper

The Viking "6N2" is available completely wired and tested or as an easy-to-assemble kit. All tuning controls are located on the front panel . . . all circuits are metered for easy tune-up. Cabinet is finished in attractive maroon and grey with green nomenclature. Complete kit includes assembly instructions, photographs, diagrams, and step-by-step wiring directions. Wiring, all necessary hardware furnished — no drilling or metal work necessary. Dimensions: 13 $\frac{1}{8}$ " x 8 $\frac{3}{8}$ " x 8 $\frac{1}{2}$ ". Shipping Weight: 14 pounds.

Cat. No. 240-201. Viking "6N2"
Kit with tubes, less crystals, key
and microphone.

\$99.50

Amateur Net

Cat. No. 240-202-2. Viking "6N2" wired and tested with
tubes, less crystals, key and microphone.

\$129.50 Amateur Net

NOTE: Scheduled for August delivery — price subject to
revision at time of delivery.



E. F. Johnson Company

2932 SECOND AVENUE SOUTHWEST • WASECA, MINNESOTA

Capacitors • Inductors • Knobs • Dials • Sockets • Insulators • Plugs • Jacks • Pilot Lights

Engineers Wanted

For unusual engineering and technical
employment opportunities . . . write to
our engineering department.

YOU name it ..

the Super **15** 's *got IT!*

**15's the DX band...
and it's terrific!**

**7.9 db.
Gain**

Now! A 3 element, 15 meter beam engineered to give you all the DX you have ever dreamed about!

**F/B
20 db.**

Design features of the "Super 15" assure you peak performance...always!

**SWR
1.2/1**

Full length parasitic reflector and director elements are teamed with a driven element shortened to permit use of a coupling transformer. This provides perfect match to 52 ohm coax line and an exceptionally efficient and convenient coupling.

Pre-tuned

Mosley high standard of construction has the acclaim of Hams the world over...true beam performance at a low-low price.

- 7.9 db or better
- F/B 20 db or better
- 10' aluminum boom
- SWR 1.2/1 or better at resonant freq.
- Max. Element length 23'11"
- Wt. assembled 22 lbs.
- Wind surface area 8.5 sq. ft.
- Wind load 170 lbs.

Model S-153 less mast & rotor

Amateur Net **\$45.28**

Mosley Electronics, Inc.

8622 ST. CHARLES ROCK ROAD, ST. LOUIS 14, MISSOURI

LETTERS [from page 14]

Dear Wayne:

The transistor article in May CQ was interesting stuff—but I hate to see remarks such as, "experimenting with making transistors is something few hams are going to be able to do." This doesn't jibe with an account in the Short Wave Magazine for February 1954, in which transistor-making experiments by G3HMO were described. Best DX was reported as some 35 miles with the first experimental models; and I believe there were follow-up articles in this fine British magazine. Let's not take such an extremely negative attitude from the start: after all, amateur radio operators are known for doing those things that "can't be done!"

How about an article on making your own transistors at home. . . . I understand some American hams have done so with germanium taken from the 1N34A crystal diode.

Neil A. Johnson, W2OLU
10 North 10 Ave.
Mount Vernon, N. Y.

Dear Sir:

As you may know, increasingly, 2 and 6-meter Gonset Communicator type equipment is being used for local communications links for several reasons including portability, lack of QRM, difficulty of enemy jamming in this frequency region, etc.

There is an increasing interest in FCC policy regarding non-attended relay transmitters operated in the amateur bands, and the possibility of using the inexpensive Gonset Communicators on fixed CD frequencies adjacent to the amateur bands. To my knowledge these matters have not been covered by either QST or CQ.

I wonder if you could cover these matters in one or a series of articles on the Amateur and CD in CQ?

Roger H. Decker, K6JFD
2809 Garden Ave.
Concord, Calif.

Ed: There is?

Phone Patch

Dear Wayne:

You really started something when you printed a part of my letter on phone patches (Page 51 of the Feb. issue).

The letters, asking for more information, started coming in just as I was leaving for Tokyo. I now have over two hundred to answer. Received two letters from home yesterday and there are still more coming in.

How about putting two short notices in CQ telling all them Hams that I have too many to answer individually but I will draw up the circuit, make up two lists of parts suppliers and give other pertinent data in an article in the near future?

Am now on Okinawa doing some telephone engineering work. My own telephone system is being set up for dial conversion. (Incidentally, we don't operate in Clayton, just live there and have an office there).

Richard R. Mann
Western States Telephone Co.

FCC Public Notice

On the 20th of July, 1956, the FCC has ordered all Standard (AM), FM and TV broadcast stations in the United States to go off the air for purposes of conducting a CONEL-RAD drill.

This drill will begin at the following times in your respective time zones:

- 3:10 PM EST
- 4:10 PM EDST
- 2:10 PM CST
- 3:10 PM CDST
- 1:10 PM MST
- 2:10 PM MDST
- 12:10 PM PST
- 1:10 PM PDST

The drill will be in operation for 15 minutes only and only stations authorized to operate on 640 or 1240 kc will be on the air at that time.

[Continued on page 108]

Really Different!



with **SIX CONTROLS**
devoted exclusively

to
*Single-signal
reception*

Hammarlund's new
HQ-150

Channelized reception... in the new HQ-150, the crystal filter can be used to peak a desired signal and suppress an undesired signal. In combination with the Q-multiplier, a maximum of two undesired signals can be suppressed at variable points within either or both sidebands. Three of these endless operational combinations are—

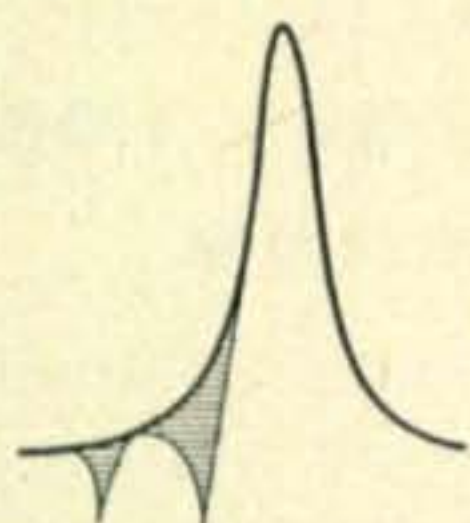

Both suppressing QRM
in lower sideband.

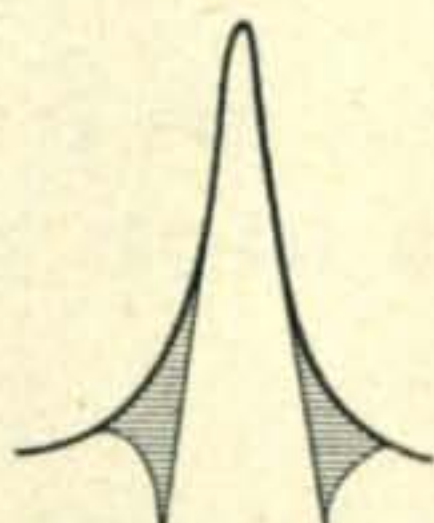

Each suppressing QRM
in both sidebands.

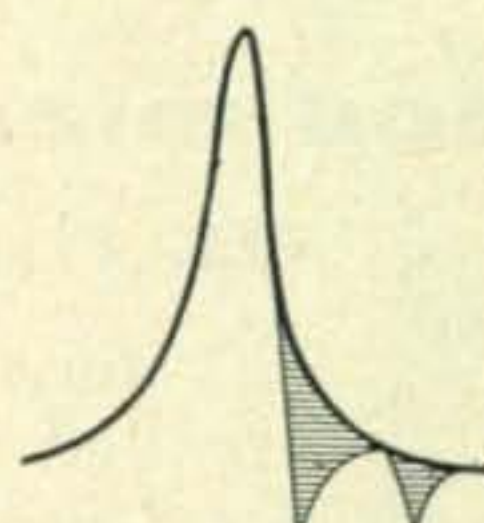

Both suppressing QRM
in upper sideband.

**Yes, the Hammarlund HQ-150 Communications Receiver is really different—
and much better than other receivers in its price class!**

The one big difference is the incorporation of a Q-multiplier, plus the Hammarlund crystal filter. This means virtually unlimited combinations of peaking or nulling operational advantages which are not included in any other receiver at any price.

The built-in crystal filter and Q-multiplier, together with unexcelled bandsread tuning, will result in more solid contacts in today's crowded hambands. If you're looking for a receiver that's **really different**, take a look at the Hammarlund HQ-150—operate it! It has all the inherent quality typical of the HQ series, plus outstanding operational advantages found in no other receivers.

Write for complete technical details...

ask for Bulletin No. C-756.

Only
\$294⁰⁰



Established 1910

HAMMARLUND

MANUFACTURING COMPANY, INC.,

460 West 34th Street, New York 1, N. Y.

INTERNATIONAL DIVISION: 13 East 40th Street, New York 16, N. Y.

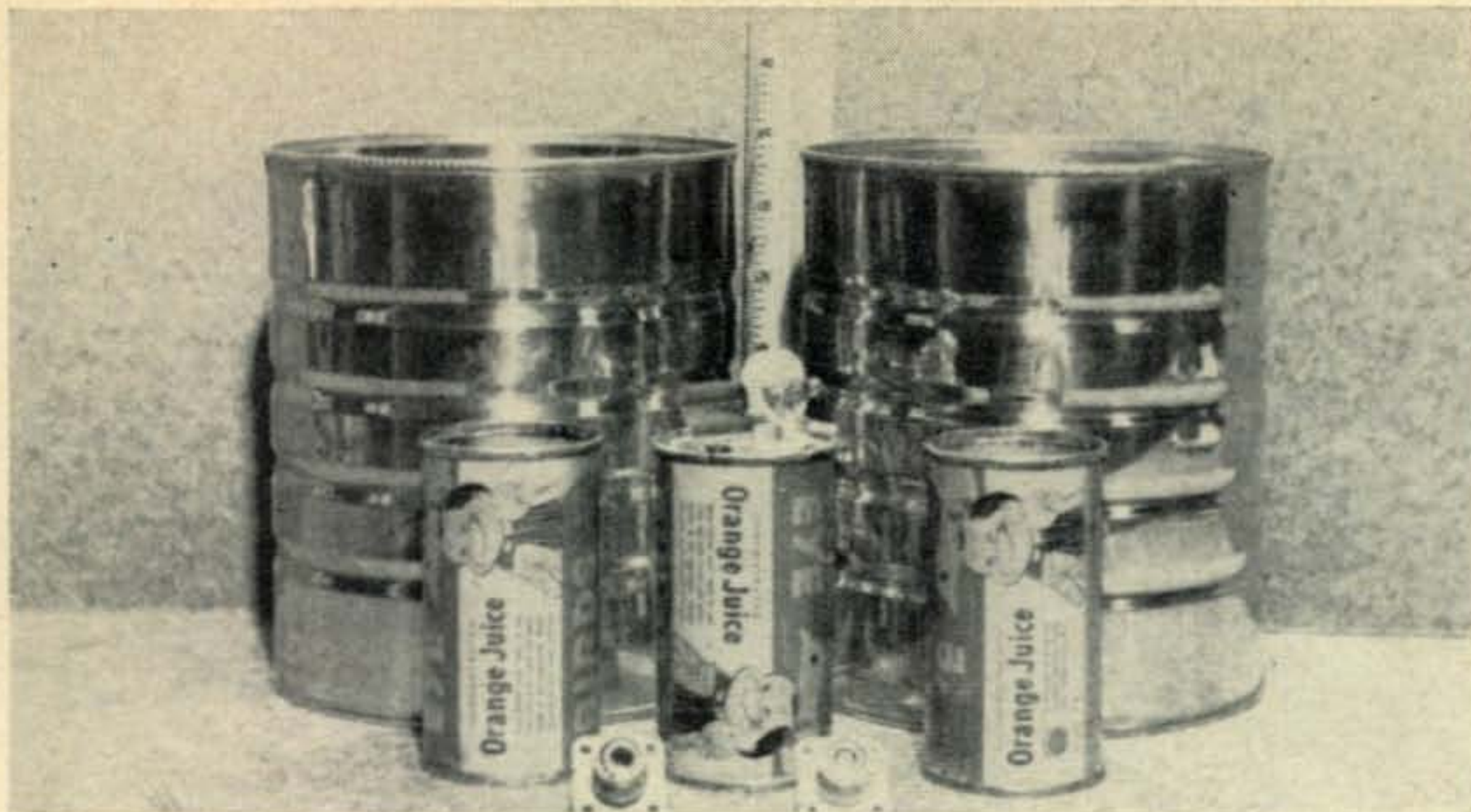

Materials needed
for filter

a real can-do project for Six . . .

Six Meter TVI Filter

Robert B. Kuehn, WØHKF

641 S. Saratoga St., St. Paul, Minn.

When the extremely simple but effective cavity TVI filter for 2 Meters appeared in *CQ*¹ no time was lost in duplicating it with gratifying results. Later, becoming interested in 6-meter operation, the thought naturally arose, 'why not a cavity type filter for 6 Meters too?'

The re-entrant resonator is in effect a shortened quarter-wave length of coax line placed in series with the antenna and tuned to resonance by a loading capacitor connected from the inner conductor to the outer shell. Thus tuned it is very sharply resonant and passes energy only at its fundamental frequency, all other harmonics and spurious radiations being shorted to ground.

With all due respect for K2CWO's equations and Bird Termaline wattmeter (neither one of which have I the slightest acquaintance with) I gathered together a selection of tin cans and set to work with a 12-inch schoolboy ruler. Of necessity ignoring the caution that "We work with the outside diameter of the inner conductor and the inside diameter of the outer conductor," two varieties were picked out that seemed to approach the optimum ratio for coax line. The large cans, two of which are needed for the 6-meter filter, measure 6 inches in diameter by 7 inches tall. The three frozen fruit juice containers, which comprise the inner conductor, are 2 inches in diameter by 3¾ inches long. Both sizes are commonly used for foods of all kinds and are universally available. The shiny cans shown in the photographs were not 'ordered special from the manufacturer' but picked out of a dump, washed and rubbed with

below: the completed filter

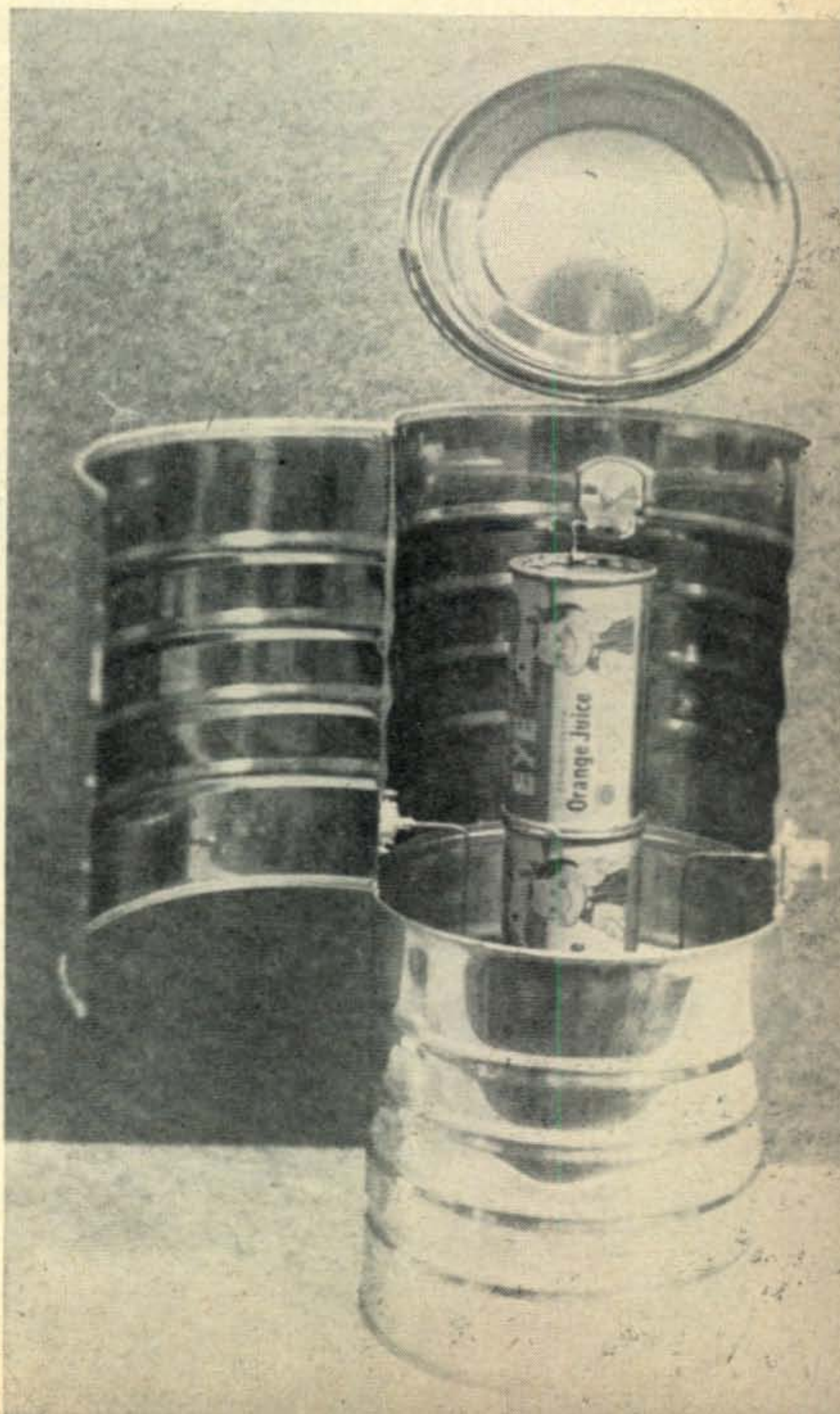

¹Robert Schlesinger, K2CWO "Cavity TVI Filter," July 1954, *CQ*, page 14.

[Continued on page 94]



ANT



XMTR



Hiding A Transmitter

R. B. Schnick, W3VAG

Riderwood, Md.

"Calling all contestants in the Maryland Mobile Radio Club hidden transmitter hunt, this is W3VAG portable three," shouted this fellow seated at a picnic table. Surely those picnickers not familiar with ham activities who passed by this table were tempted to call the little men in white coats to fetch this fellow hollering to no one in particular. They wouldn't understand that with an F-1 button hidden under your shirt you had to shout in order to

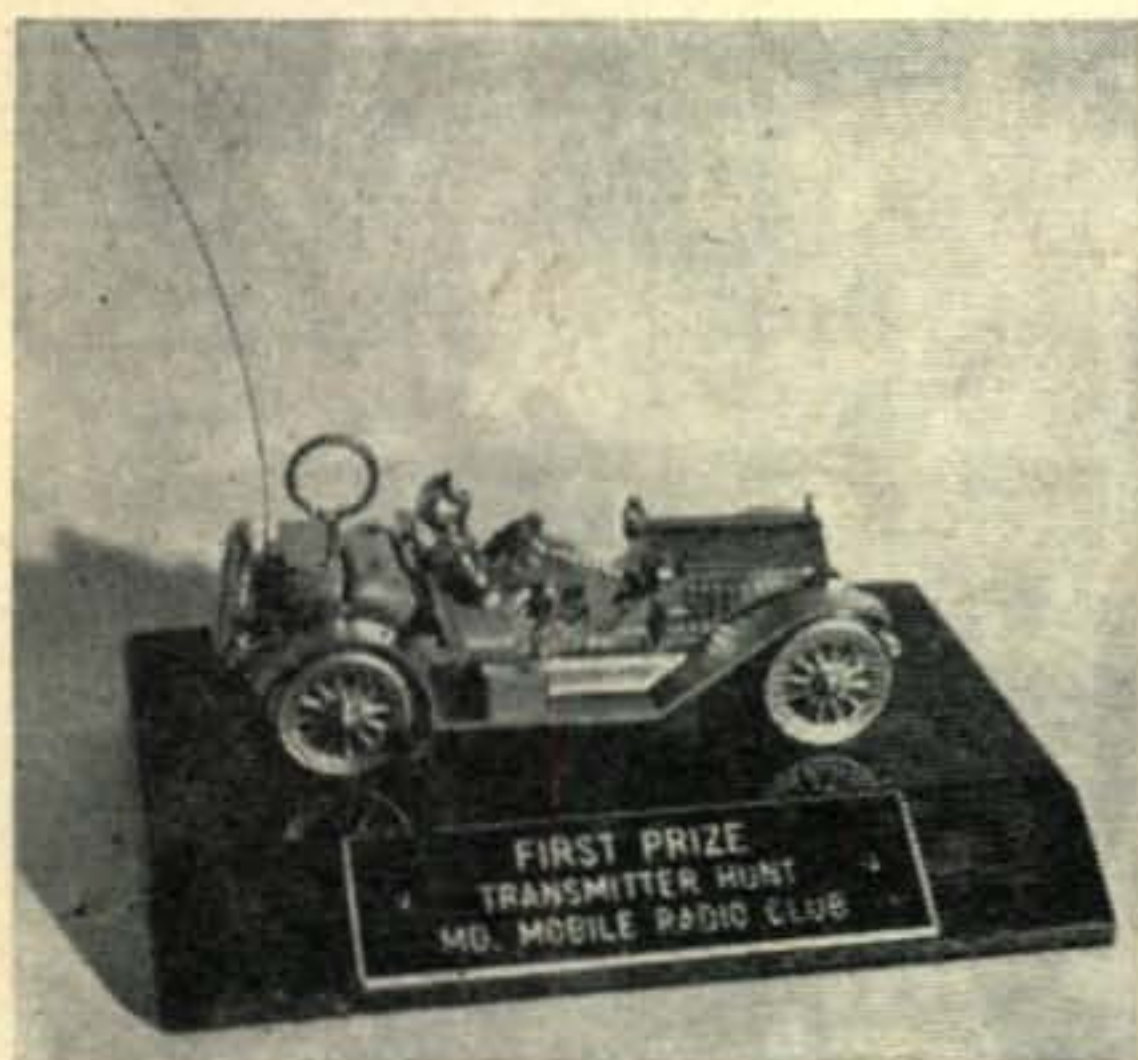

move those carbon granules. Nor would they have known that the line (hook-up wire) on that fishing rod was loaded with a couple of watts RF.

As a matter of fact, those funny people running around with earphones on their heads and gadgets in their hands who kept stretching their necks looking up into trees, didn't know the fishing rod was hot either. Ron, W3VLL, and I planned to put on a definitely different hunt

← This innocent looking group of picnickers include Hal, W3YPM, the smallest harmonic of W3VAG, and Dick Prather, W3BOM.

this time and we did it. Here was proof positive. The boys had been in the area an hour and some walked within ten feet of the hidden transmitter and still they suspected nothing. The little transmitter (version of the "28-9" CQ, May, 1953), powered by the quiet running PE-101 dynamotor and its battery, were cuddled down there in the box by the picnic table. The coax to the fishing-rod antenna and its radials were buried under the grass. The control cable and mike cable also ran underground and then up inside the clothing of the operator. Best of all, the operator (W3YPM) and his helpers, were all complete strangers to those hunting for the transmitter.

Finally, W3QLF, with undying faith in his snooper, built up enough courage to ask these strangers if he might look inside the box there by their table—that was it, all over. W3TFR and W3LMC followed suit. The boys really earned their trophies and we wished we had one for everybody who participated. Almost two and one half hours to find a transmitter hidden four miles from the starting point and most of the hunting was done on foot. ■



an Unusual SSB Modulator

The **balanced modulator** is the heart of most single sideband transmitters. It is generally operated at relatively low radio frequencies, and may be used to modulate or "beat" voice frequencies against a carrier wave to produce double sidebands minus the carrier frequency. It may also be employed at higher radio frequencies to allow frequency conversion of the single sideband (SSB) signal, while providing substantial rejection of the mixing signal from the local oscillator.

The balanced modulator may be thought of as an electronic switch wherein the carrier frequency is switched on and off at the frequency of the modulating signal. Either vacuum tubes or metallic diodes may be used for such a switching circuit. A balanced modulator circuit employing two triode tubes is shown in *Figure 1*. The carrier frequency $f(c)$ is applied to the grid circuit so that the impressed signal is in phase on both grids of the modulator, while the modulating frequency $f(m)$ is applied to the grid circuit of the triodes so as to produce a phase reversal of the signal of 180° between the two grids.

When the signal in the plate circuit of the balanced modulator is examined, it will be found that the carrier frequency $f(c)$ is absent. The pulses of plate current caused by the grid signal of $f(c)$ cancel each other out, making the net result zero in the output plate circuit. Thus any variation in grid signal voltage that is applied to both tube grids in parallel and in the same phase will cancel out in the push-pull plate circuit.

The modulating frequency $f(m)$ is applied to the grids of the balanced modulator in a push-pull manner. However, the modulating frequency is usually in the audio frequency range, and the tuned plate tank circuit offers little load impedance to such low frequencies. Thus, neither $f(m)$ nor $f(c)$ appear in the plate circuit of the balanced modulator. However, when both $f(c)$ and $f(m)$ are applied to the grid circuit of this stage, the plate circuit will contain signals that are grouped either side of the carrier frequency. These frequencies are equal to the carrier frequency plus and minus the modulating frequency, and may be termed a *double sideband suppressed carrier signal*.

Fig. 9. Low frequency stages are at the left of the chassis. The 6BA6 is in the foreground, with the 6AR8 balance potentiometer behind it. To the rear are the 6AR8, the audio level control and the 12AX7 speech amplifier. To the right of the Mechanical Filter are the 80 meter mixer and oscillator stages. The conversion crystal is inside the small shield can. At the right are the cascode buffer and parallel 6AG7 stages, with the 80 meter tank coil in the foreground.

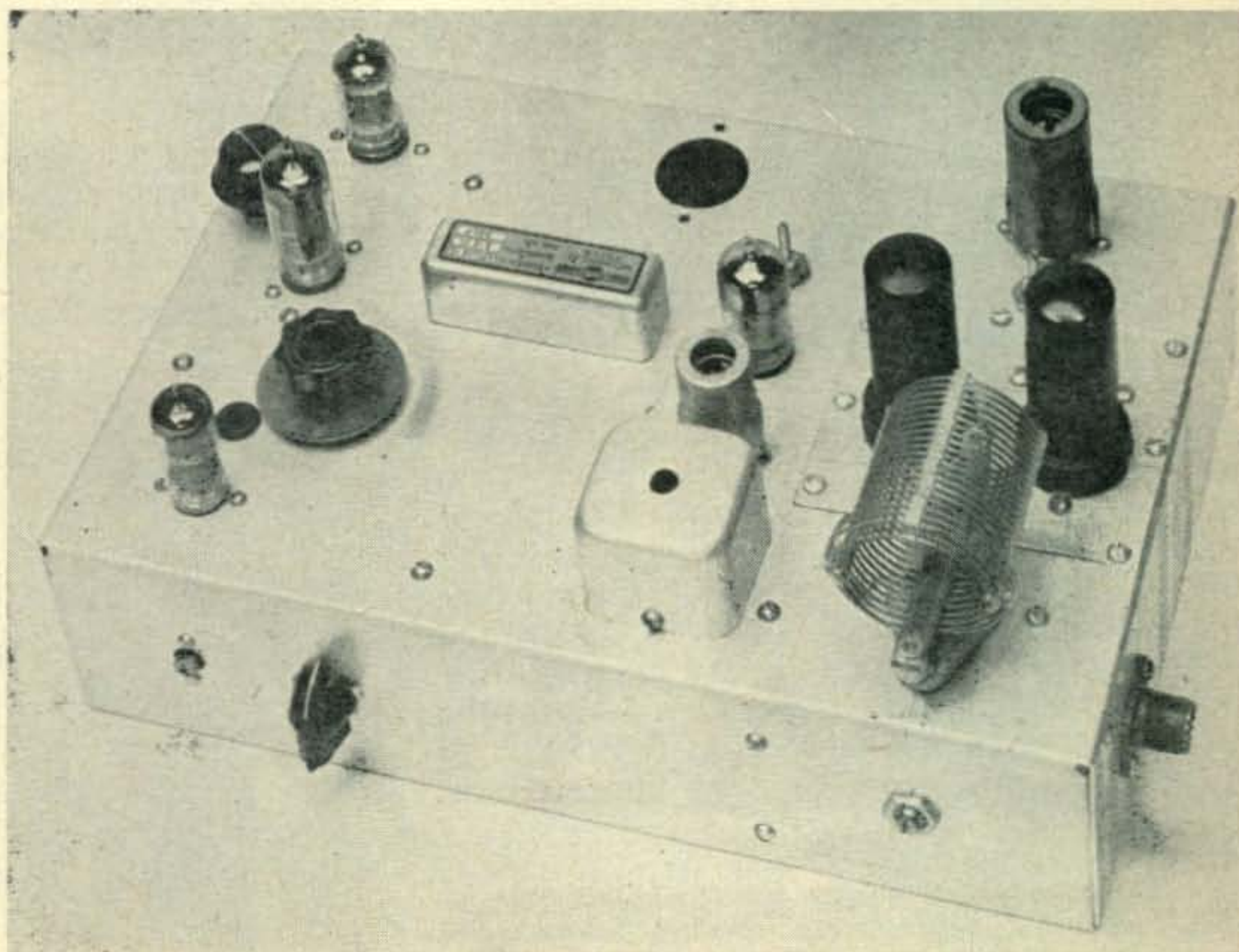

The balanced modulator is acting as a switch tube, switching the carrier $f(c)$ on and off at the modulating frequency $f(m)$.

If the resulting two sidebands are passed through a suitable filter, one of the sidebands may be passed and the other rejected. A *single sideband suppressed carrier signal* will then be observed at the output of the filter.

Diode Modulators

The double triode tube may be eliminated, and the circuitry rearranged to allow the use of four metallic diodes connected as a shunt-quad modulator, as shown in *Figure 2*. When balanced diodes and transformers are used, the carrier pulses across diodes X1-X2 are balanced out by the equivalent pulses of opposite polarity that appear across diodes X3-X4. The carrier frequency $f(c)$ therefore does not develop in the output circuit. Application of a modulating voltage to the quad alternately cuts off one pair of diodes, then the other pair

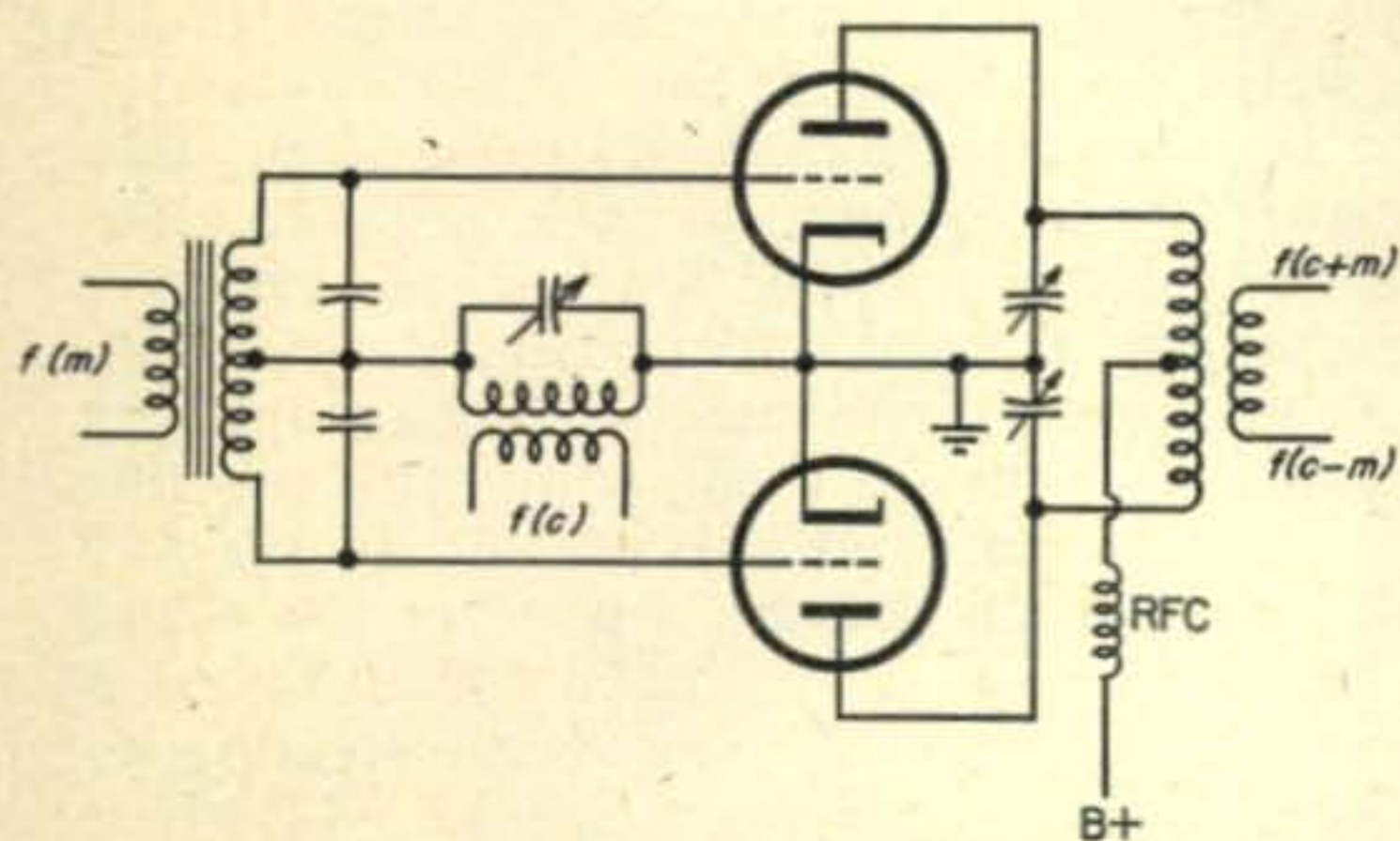

Fig. 1. Basic push-pull balanced Modulator. The output from a modulator (mixer) of this type consists of frequencies equal to the carrier frequency plus and minus the modulating frequency. Neither the carrier frequency or the modulating frequency appear in the output circuit.

as the polarity of the modulating signal reverses itself on each half-cycle. The shunt-quad may thus be thought of as a double-pole double-throw electronic switch, operating at the frequency of $f(m)$.

For conditions of highest linearity, the diodes are to be preferred over the vacuum tube modulators. However, the cost of improvement in linearity is obtained only at circuit complexity. It is necessary for conditions of good linearity to have low impedance input and output circuits to such a quad. The varying load imposed by the quad upon the carrier frequency generator can often lead to instability of the oscillator, or perhaps to frequency modulation of the oscillator. Coupling of the carrier oscillator to such a low impedance quad is best done through some type of isolating stage, such as a cathode follower. This entails the use of an additional tube. In like

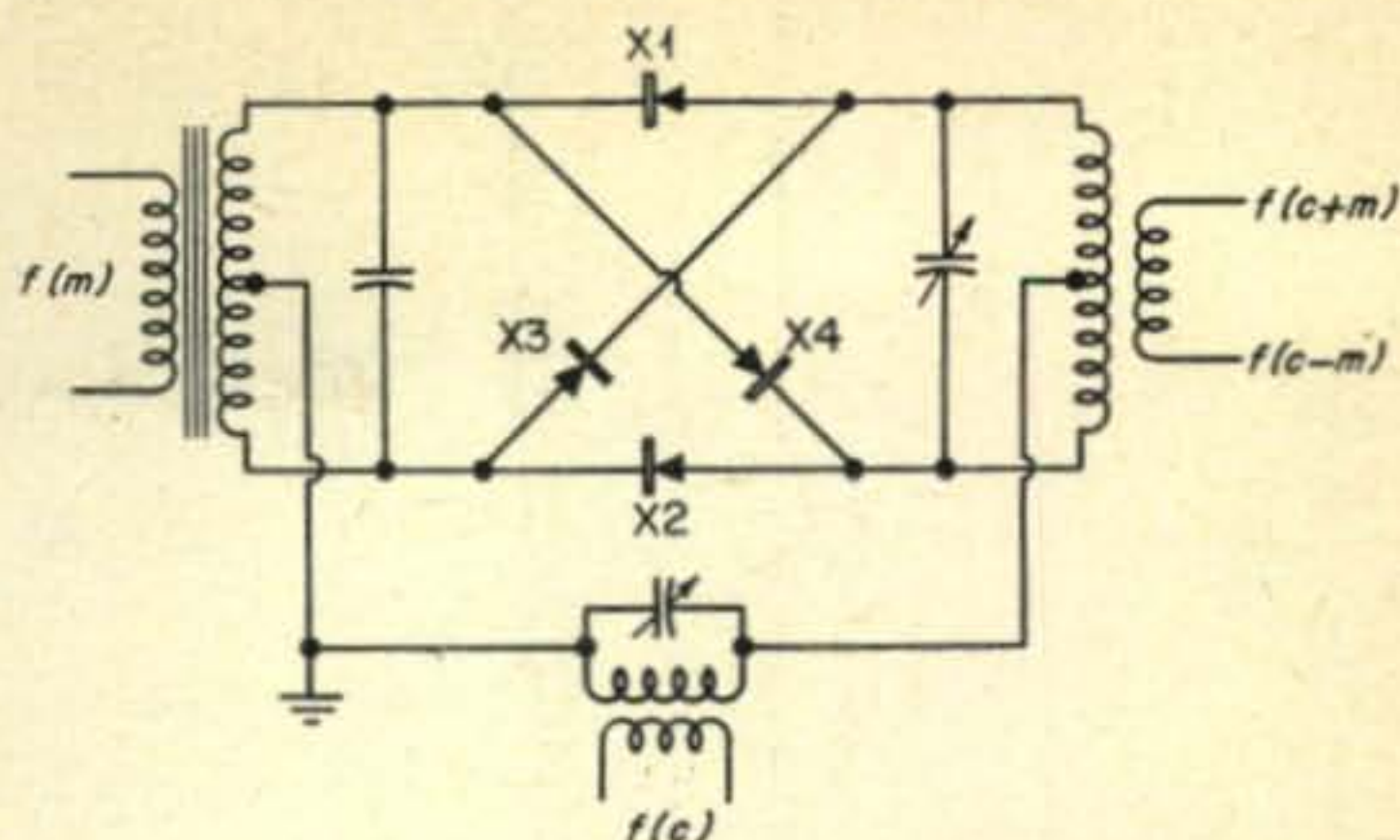

Fig. 2. The "ring" or shunt-quad Modulator. Employing four metallic diodes, this modulator is capable of low distortion performance if the input and output circuit impedances are held at a low level.

manner, it is necessary to provide a low impedance source for the modulating signal, $f(m)$. The use of a cathode follower or an impedance matching transformer between the audio driver and the quad modulator is a necessity. If it would be possible to obtain the excellent linear operation of the diode modulator in a circuit of high input and output impedance, the design of a simple balanced modulator would be greatly simplified.

The 6AR8 Switch Tube

The thought that the balanced modulator operates as an electronic switch offers interesting and novel applications of one of the new tubes that has recently been released for color television purposes. Such a tube is the General Electric 6AR8 Sheet Beam tube, whose general characteristics are listed in *Figure 3*.

The 6AR8 is a miniature double plate sheet-beam tube which incorporates a pair of balanced deflectors to direct the electron beam to either of the two plates, and a control grid to vary the intensity of the beam. The tube is designed to be used as a synchronous detector in color television receivers, and as an electronic switch in the burst gate circuit of such receivers. When the 6AR8 is employed as a synchronous detector, it is used as shown in *Figure 4*. The focussing electrodes of the tube form the electron stream into a sheet beam which is attracted to the plates of the 6AR8 tube by virtue of the positive potential applied thereto. Between the electron gun and the plates, the electron beam passes between two deflecting electrodes. Depending upon the voltages applied to the deflectors, the beam will be directed entirely to either one or the other of the two plates, or be proportioned between them. The frequency of the signal applied to the deflectors determines the rate at which the plate current is switched between the two plates. The magnitude of the plate current is determined by the negative voltage that is ap-

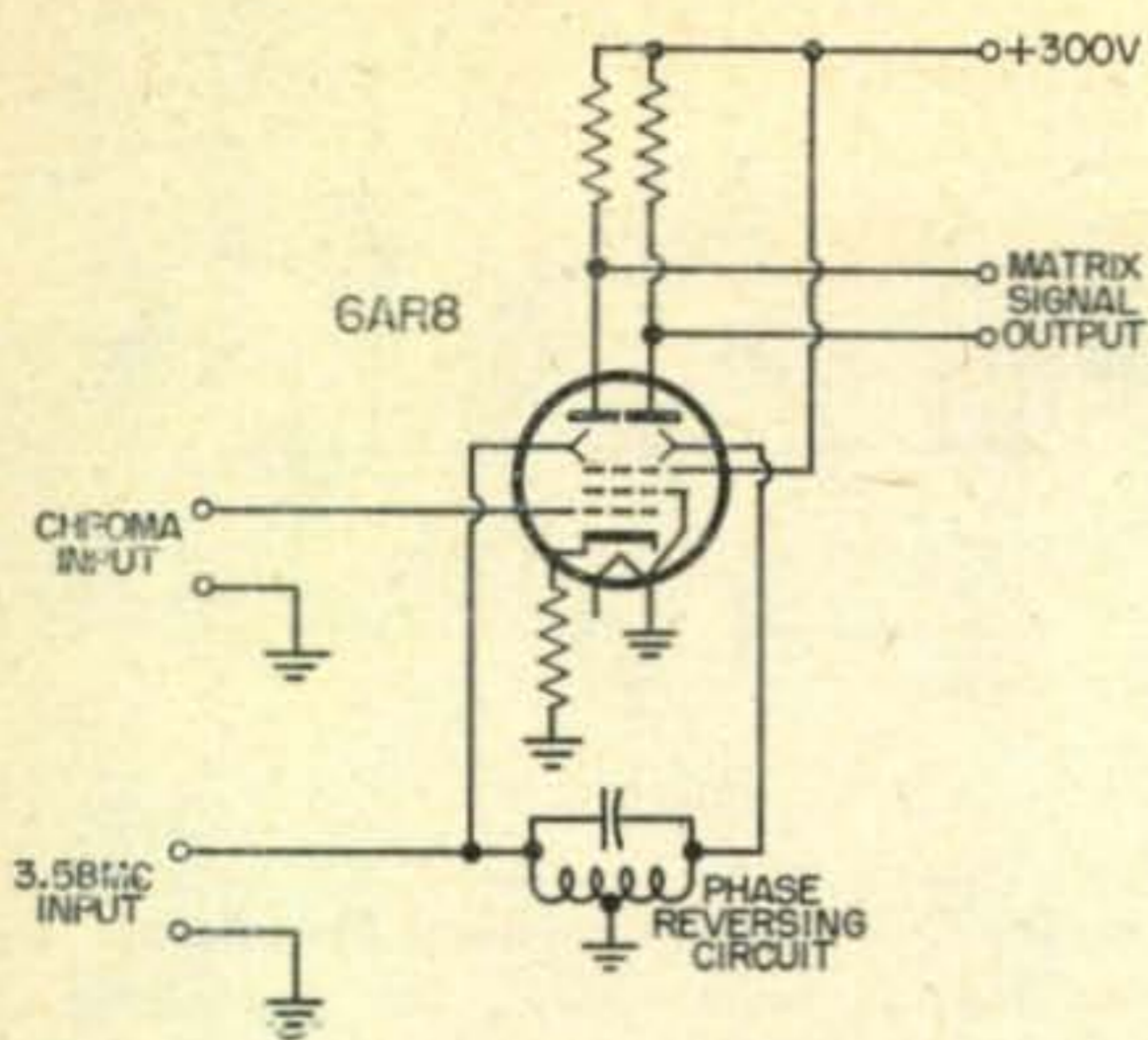

Fig. 4. The 6AR8 tube as employed for TV service as a synchronous detector.

plied to the #1 control grid. The 6AR8 tube may be considered as equivalent to a voltage controlled single pole double-throw switch through which a current, the magnitude of which is also voltage-controlled, flows. The transfer characteristics of this interesting tube are shown in *Figure 5*.

In color TV service, the deflecting electrodes are switched at a frequency of 3.58-Mc., the push-pull switching voltage being obtained from a balanced resonant circuit connected between the deflecting electrodes, as shown in *Figure 4*. The Chroma input is applied to the control grid of the 6AR8, and the resulting output signal for the Matrix is taken across the two plate load resistors of the tube.

The 6AR8 as a SSB Balanced Modulator

The 6AR8 may be divorced from its color TV applications and used as a balanced modulator for SSB work. The linearity of the transfer characteristic shown in *Figure 5* would indicate that the linearity of this tube when used in a suitable balanced modulator circuit would be excellent. A simplified circuit suitable for SSB work is shown in *Figure 6*. The r.f. carrier is applied to the control grid of the 6AR8, modulating the electron beam at the frequency of the applied signal. In the exciter to be described, this frequency is 455 k.c. The electron stream then passes through the deflection plates towards the collecting plates. A push-pull audio signal is applied to the deflection electrodes, switching the electron beam back and forth between the two collector plates at an audio frequency rate. The exciting r.f. signal is applied in "single-ended" fashion to the 6AR8 circuit, and is balanced out in the push-pull plate circuit configuration. To obtain maximum conditions of balance, the plate potential of the 6AR8 is applied through the arm of a potentiometer, the ends of which are attached to the two plates of the tube. By adjusting this control for maximum rejection at the carrier frequency, more than 40 db. of plate circuit carrier rejection may be obtained.

The main advantage of the 6AR8 when used as a balanced modulator is that it works well when the input and output circuits are of relatively high impedance. One-half of a 12AX7 may be employed as an audio phase inverter to supply push-pull audio signals to the deflection plates. Usual values of plate and cathode load resistors may be employed in the phase inverter circuit, without fear of excessive circuit loading by the balanced modulator stage. It is not necessary to use a low- μ triode with the accompanying low values of plate and cathode load resistance, such as is necessary when driving a metallic diode modulator.

In addition, there is very little reaction between the mixing oscillator and the balanced modulator. Many balanced modulators impose a non-linear load upon the mixing oscillator. If this oscillator is a variable frequency device, frequency modulation will occur during the mixing process. This action produces a peculiar low frequency "growl" on the SSB signal which is most annoying, and difficult to cure. This effect is entirely absent when the mixing oscillator is coupled to the 6AR8 modulator. The high impedance circuits of this stage allow the use of simple input circuits, and also allow the use of the Collins Mechanical Filter to separate the wanted and unwanted sidebands.

Simple precautions must be taken to prevent the 455 k.c. energy from being coupled into the audio system, and into the rest of the SSB equipment. Each deflection plate of the 6AR8 is bypassed to ground with a 100 uufd. mica condenser, and 10,000 ohm series isolating resistors are placed between the 12AX7 phase inverter and the balanced modulator. This

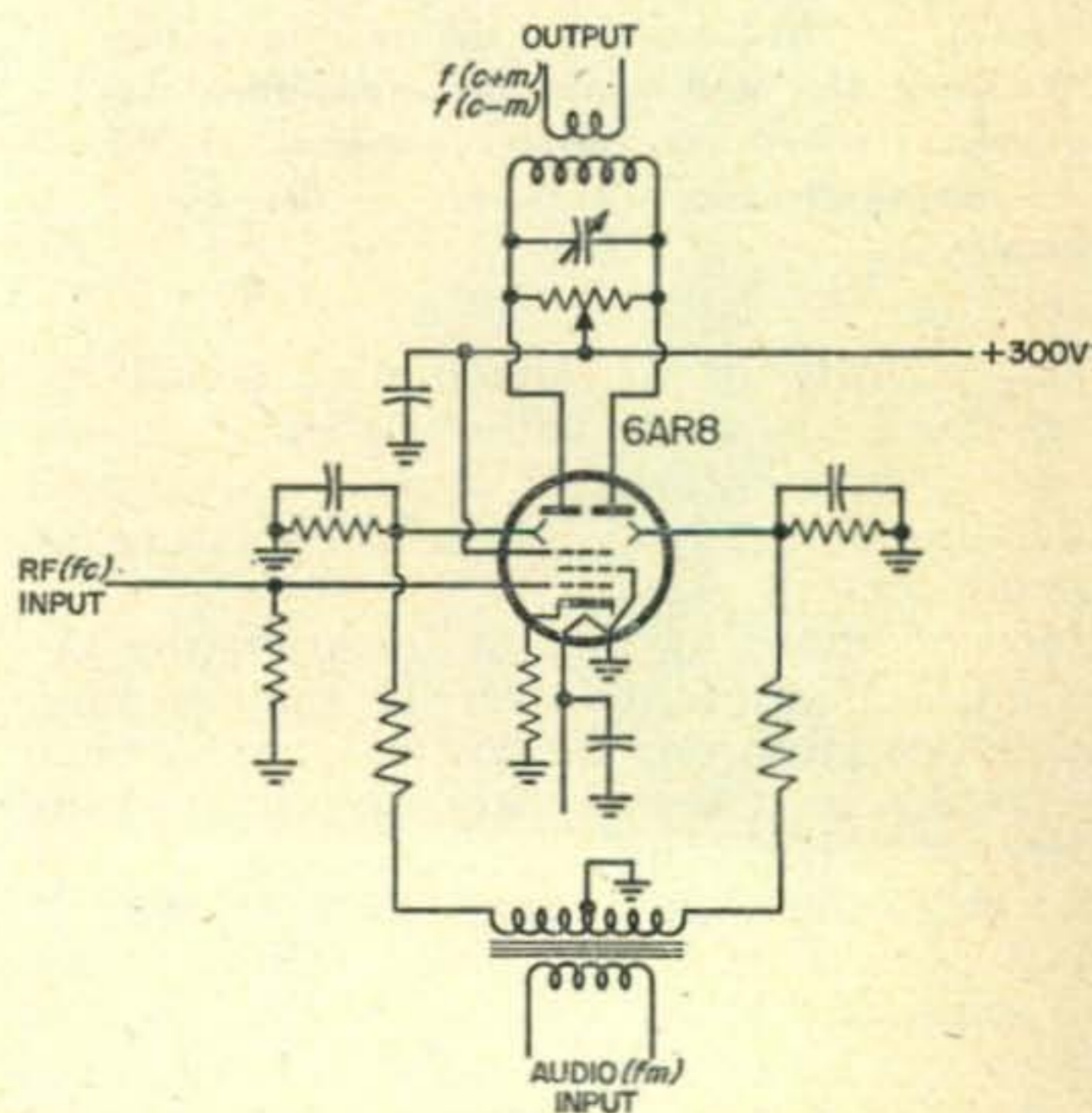
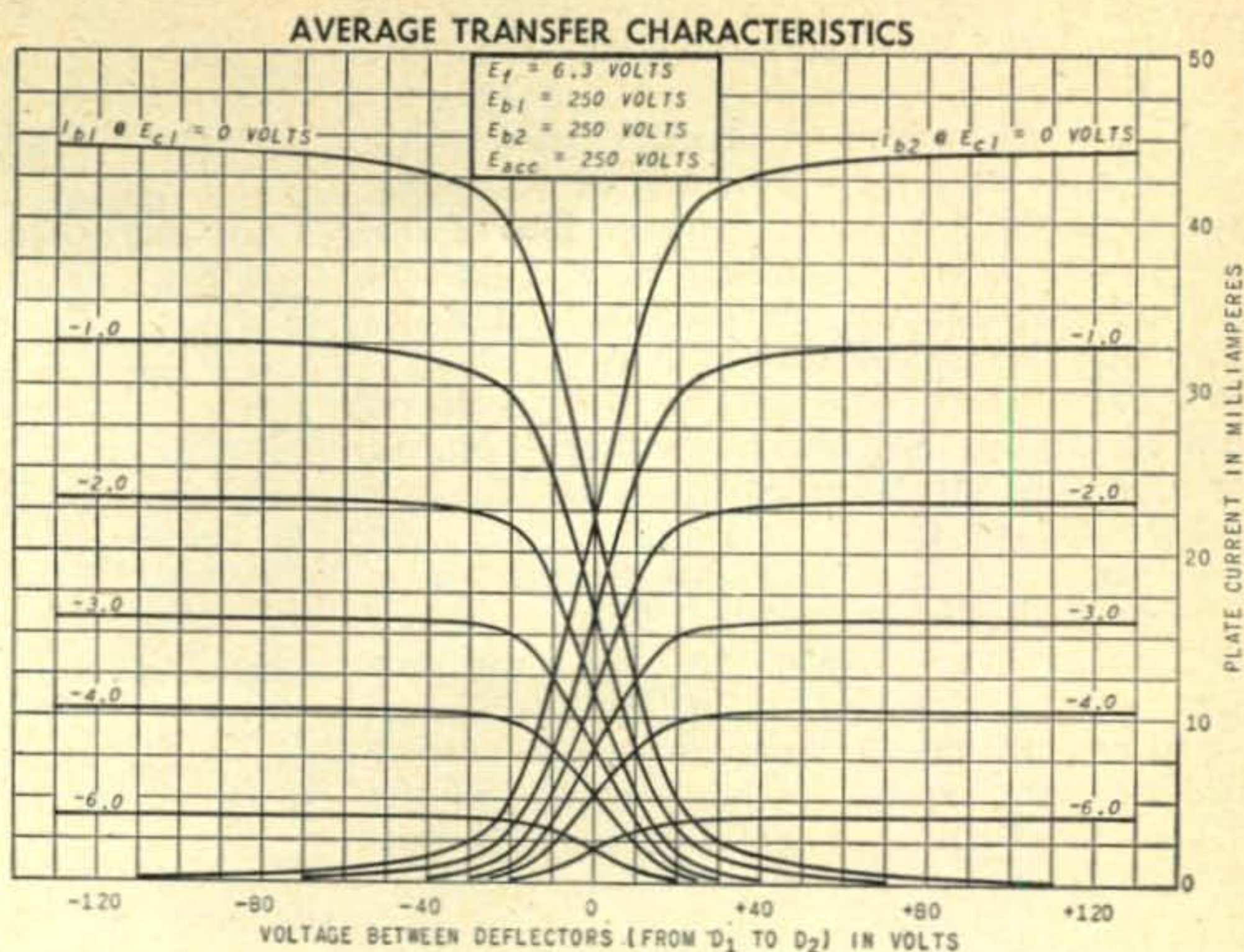

Fig. 6. The 6AR8 used as a balanced Modulator R.F. input is applied to the control grid, and push-pull audio to the deflection plates. The output circuit contains a double-sideband suppressed carrier signal.

Fig. 5. Transfer characteristic of 6AR8 Sheet Beam Tube. Note the linear transfer characteristic over the deflection voltage range of -15 to +15 volts.



simple filter provides sufficient isolation between the circuits.

Pin #5 of the 6AR8 is a common connection to one leg of the filament and to the suppressor electrode and shield within the tube. It is necessary to ground this pin for proper operation of the tube. The other filament pin (#4) is bypassed to ground with an .01 ufd. ceramic condenser to prevent energy leakage via the filament line. For best plate circuit balance, the cathode of the 6AR8 is unbypassed.

The Sideband Filter

The Collins F455D-31 Mechanical Filter is used to provide rejection to the carrier frequency and to the unwanted sideband. This unit is an electromechanical bandpass filter consisting of an input transducer, a resonant mechanical section comprised of a number of metal discs, and an output transducer. The input and output transducers serve as electrical-to-mechanical and mechanical-to-electrical coupling devices and do not affect the selectivity characteristics of the filter, which are determined by the metal discs. An electrical signal applied to the input terminals is converted into a mechanical vibration at the input transducer by means of magnetostriction. This mechanical vibration travels through the resonant mechanical section to the output transducer, where it is converted by magnetostriction to an electrical signal which appears at the output terminals of the filter.

For voice operation, a passband of approximately 2500 cycles is needed. Accordingly, the 3.1 k.c. bandwidth Mechanical Filter is used, having a passband as shown in Figure 7. The shape factor of this passband (ratio of bandwidth at 60 db. to bandwidth at 6 db.) is less than 2.25 to 1. The frequency of the beating

oscillator is set so that the carrier is placed at one of the "20 db. points" on the filter curve. The oscillator frequencies for these points are approximately 453.5 k.c. and 456.6 k.c. By moving the oscillator from one frequency to the other either one of the two sidebands may be placed outside the passband of the filter and rejected.

The SSB signal appearing at the output of the filter may be converted to the frequency of use and amplified to the desired level.

A Practical SSB Exciter using the 6AR8

A 12AX7, 6AR8 and 6BA6 form the framework of a simple filter-type exciter as shown in Figure 8. A maximum audio signal of 0.10 volts, r.m.s. is required at the input grid of the 12AX7 audio amplifier for 5 watts of peak SSB output on 80 meters. The 12AX7 tube serves as a voltage amplifier and phase inverter, while the 6AR8 acts as the balanced modulator. The beating oscillator is a 6AU6 whose frequency is variable over the range of 450 to 460 k.c. A double sideband suppressed carrier is generated by the 6AR8 tube, and one sideband is rejected by the Collins Mechanical Filter which follows the modulator stage. The output of the filter is at a frequency of 455 k.c. A 12AT7 double triode mixer stage follows the filter, beating the SSB signal against a 3355 k.c. crystal conversion oscillator. The resulting SSB signal is on 3810 k.c. The SSB signal is amplified by a 12AU7 connected as a cascode amplifier, driving in turn a parallel connected pair of 6AG7's operating class AB1. These tubes deliver a SSB signal of about 5 watts peak power with negligible high order distortion products.

An audio signal of 0.10 volts r.m.s. (easily obtained from the usual variety of crystal microphone) is amplified in the two 12AX7

stages, producing a peak audio voltage of 22 volts to ground between each deflection plate of the 6AR8 (measured at pins 1 and 2). This is sufficient for complete electron beam swing at plate and accelerator potential of 300 volts. Approximately 5 volts of negative bias is applied to the 6AR8, resulting in a quiescent plate current of 6 ma. per section and a deflector current of less than 1 ma.

A peak-to-peak r.f. voltage of 3 volts is required from the 6BA6 electron coupled oscillator. The circuit shown is a modification of the standard Clapp arrangement, wherein the cathode r.f. choke has been replaced by a 1600 ohm composition resistor. This eliminates a bulky r.f. choke, and at the same time provides better waveform from the oscillator. Poor waveform in the low frequency beating oscillator can degrade the performance of the balanced modulator to a great degree. The out-

Parts List for Figure 8

- | | |
|---|--|
| C1—100 μfd variable ceramic padder Centralab 823-DN | L4—Bud 40-JEL (for 80 meter operation) |
| C2—30 μfd variable. Bud LC-1642 | RFC-1 — 4 microhenry. J. W. Miller 5221 |
| C3-C4—.002 μfd silver mica | RFC-2, RFC-3—2½" millihenry. National R-100 |
| C5-C6—250 μfd mica. Series tuning capacitors for mechanical filter | PC—50 ohm, 1 watt resistor, wound with 10 turns #22e. wire |
| C7—130 μfd mica. Parallel tuning capacitor for mechanical filter | MF—Collins 455 Kc mechanical filter, type 455-D31 |
| C8—Output tuning capacitor. 150 μfd Bud MC-1856 | R1—Audio level control, 0.5 meg |
| L1—2½ mh r.f. choke. National R-100 | R2—Modulator balance control, 3000 ohms |
| L2, L3—National XR-50 form, 22 turns #18e. ½" diam, ¾" long | All .01 condensers are centralab ceramic type DD |

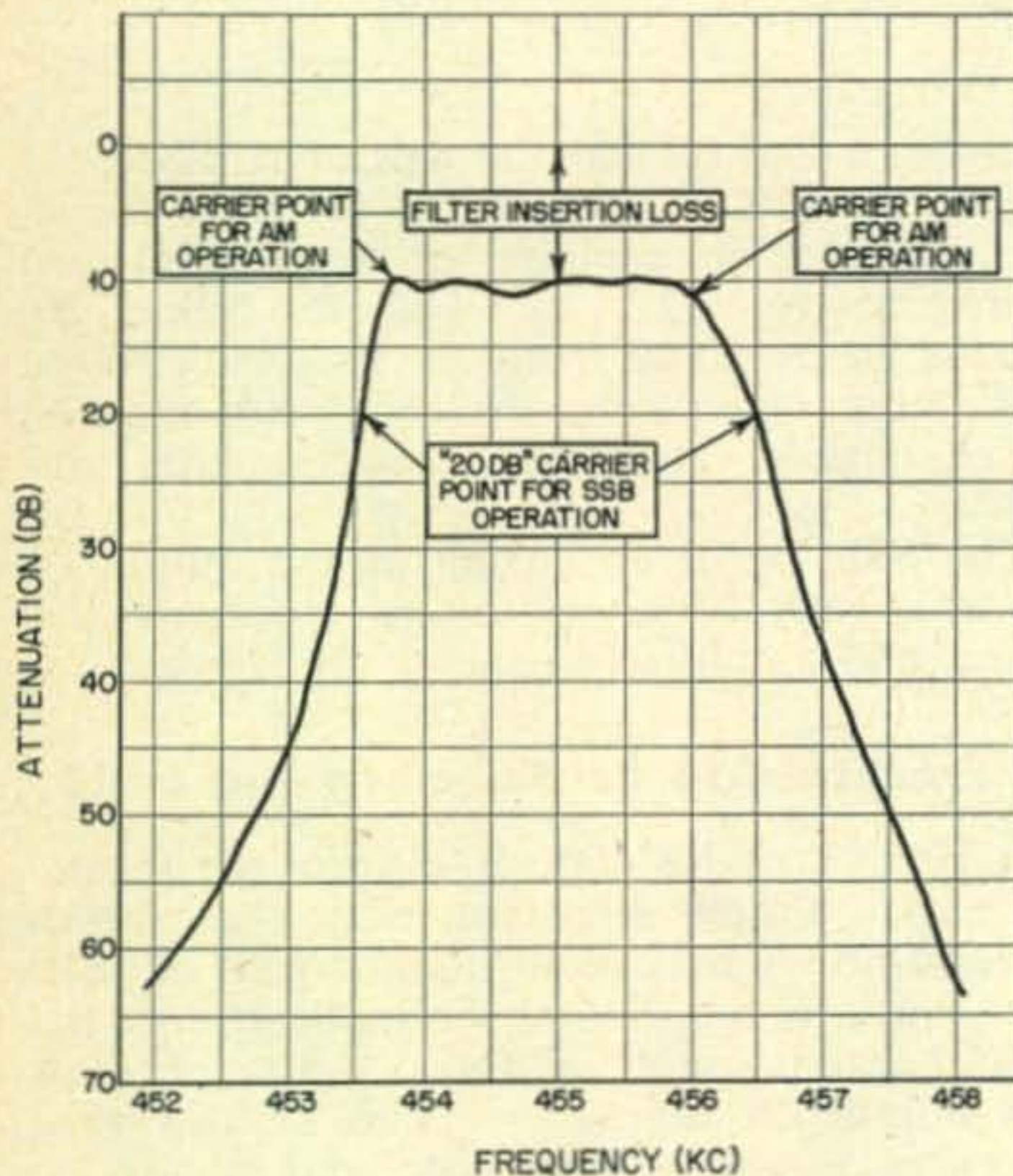

Fig. 7. Passband of Mechanical Filter

put from the oscillator is taken from the cathode, since only a small mixing voltage is required.

It is interesting to note that in the usual balanced modulator circuit the ratio of r.f. voltage to audio voltage is of the order of 10/1, or 20/1. That is, the carrier voltage must be 10 to 20 times the amplitude of the modulating signal for best linearity. Here, the situation is reversed. The modulating signal is just about 20 times greater than the carrier signal. Since the two signals are applied to different electrodes of the modulator tube, the old 10/1 or 20/1 ratio does not hold true.

Sufficient isolation must be provided in the power leads to prevent signal leakage between various stages. Since both the 6BA6 low frequency oscillator and the 6AR8 modulator are

“hot cathode” circuits, it is imperative that the filament supplying these tubes be close to ground potential at the carrier frequency of 455 k.c. A 0.1 ufd. condenser is placed across the filament leads of the 6BA6 oscillator, and a 0.01 ufd. ceramic condenser is placed across the filament pins of the 6AR8 socket. In addition a small r.f. choke is placed in the filament line between these two tubes and the high frequency portion of the exciter. As a final step, the B-plus line is bypassed with a 0.5 ufd. condenser, and is decoupled from the rest of the exciter with a 1,000 ohm decoupling resistor.

The Low Frequency Oscillator

The 6BA6 oscillator is variable over a range of about 10 kilocycles at 455 k.c. This allows the operator to change sidebands by moving the oscillator frequency from one side of the passband of the mechanical filter to the opposite side. It is possible to transmit an amplitude modulated signal consisting of the carrier and either the upper or lower sideband by placing the carrier at one edge of the filter passband. For normal SSB operation, the oscillator is placed on the slope of the passband, close to the 20 db. attenuation point, as shown in Figure 7.

Fig. 3. The 6AR8 Sheet Beam Tube. Designed for TV synchronous detector service, the 6AR8 may also be employed as a balanced modulator for SSB service.

Heater Voltage:
6.3 volts, 0.3 amp.
Envelope—T6½

- Pin Connections**
- 1—Deflector #2
 - 2—Deflector #1
 - 3—Accelerator grid
 - 4—Heater
 - 5—Heater, shield, focus electrode
 - 6—Control grid #1
 - 7—Cathode
 - 8—Plate #2
 - 9—Plate #1

BASE DIAGRAM, 6AR8

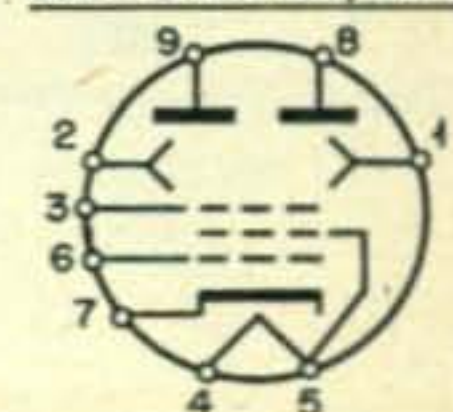

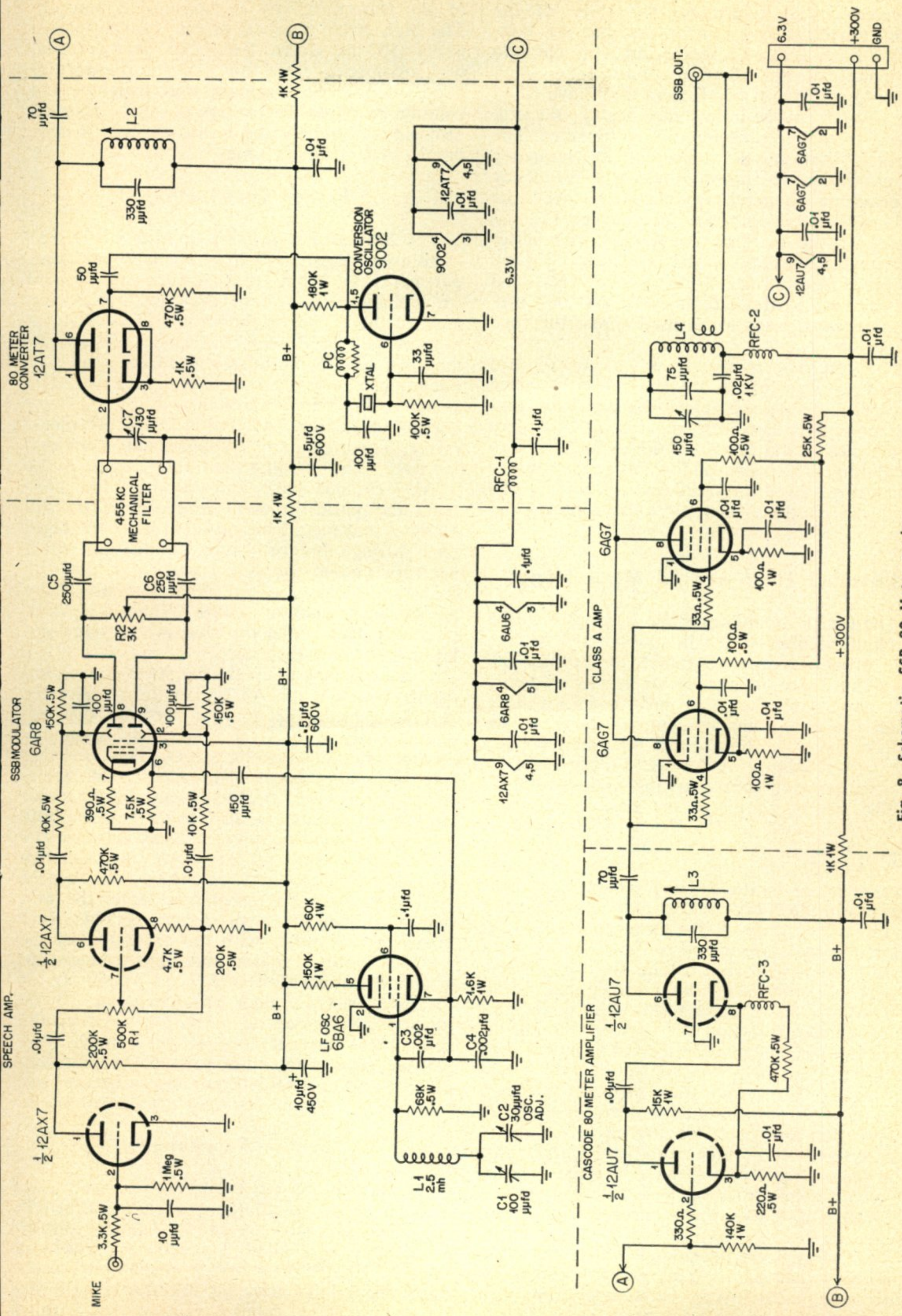

Fig. 8. Schematic, SSB 80 Meter exciter.

The Q of the inductance used in the oscillator grid circuit determines the value of the silver mica padding condensers that are connected from grid to cathode and from cathode to ground of the 6BA6 oscillator tube. With a low-Q coil, these condensers may have to be decreased from the indicated value to .001 ufd. apiece to maintain oscillation of the stage. The effect of these condensers upon the frequency of oscillation is minor, since the frequency determining elements are placed between the coil and chassis ground. The larger the capacity of the padding condensers, the better will be the stability of the oscillator. A good quality 2½ millihenry r.f. choke (National R-100) used in this circuit will allow .002 ufd. padding condensers to be used across the tube elements.

The resonant frequency of the 6BA6 grid circuit is determined by the series padding condenser connected across the oscillator tuning condenser. Too little capacity at this point in the circuit will cause the 6BA6 stage to stop oscillating. The remedy for this is to remove a few turns from the oscillator coil and to add sufficient padding capacity to restore oscillation.

Sideband Filter and 80 Meter Stages

The 6AR8 modulator stage is coupled to the mechanical filter which is series tuned to provide proper impedance match to the modulator. The value of the series tuning capacity will vary with the type and model of filter used. The series capacity removes the d.c. plate voltage from the filter coils. As stated earlier, the carrier balance of the 6AR8 stage is set by a potentiometer control in the plate circuit.

The output circuit of the mechanical filter is parallel tuned to 455 k.c. A SSB signal of about 0.2 volts peak is obtained at this point. A 12AT7 double triode is employed as a conversion mixer to the 80 meter band. The SSB signal and the 3-Mc. mixing carrier are applied to individual grids of the triode sections, and the two signals are mixed in the common plate circuit which is tuned to the sum frequency, which falls within the 80 meter phone band. A 12AU7 cascode stage follows the mixer and amplifies the SSB signal to a level suitable to drive the parallel 6AG7 tubes to a peak power of about 5 watts.

The 12AU7 cascode stage provides a voltage gain of about 90 without the need for parasitic suppression and/or stabilizing circuits that are usually needed in high gain pentode circuits. The plate circuit of the cascode stage is high-C, which helps to further reject the fundamental signal of the crystal controlled conversion oscillator.

The parallel connected 6AG7 output stage employs screen parasitic suppression and series grid resistors to insure stable operation. The stage is not neutralized and tends to be slightly

regenerative, raising the intermodulation figure of the transmitter by a measurable amount. The high order products of the transmitter are about 30 db. down from the peak output, which compares favorably with the majority of good amateur SSB signals, and which sets a shining example for some of the mediocre SSB signals that can be heard on the amateur bands from time to time.

Exciter Construction

The SSB exciter is built upon a 8"x12"x3" aluminum chassis which is divided into compartments to insure that various signals and r.f. voltages stay where they belong. A top view of the exciter is shown in *Figure 9* and a bottom view in *Figure 10*. The 12AT7 speech amplifier, 6AR8 modulator and 6BA6 low frequency oscillator are in one compartment. The center compartment contains the 9002 conversion oscillator and the 12AT7 80 meter mixer. The remaining compartment is divided in two. The smaller section contains the 12AU7 cascode stage, and the larger half contains the parallel 6AG7 amplifier stage. All filament and plate leads to these last two stages pass through bulkhead-type condensers which are mounted in the shield partitions, insuring that the shields are not "short circuited" by power lead coupling loops. When a bottom plate is placed under the chassis, the stage isolation is of a high order.

It is necessary to shield the 9002 conversion oscillator and the 12AT7 mixer tubes, or there will be undesirable coupling around the mechanical filter between the low frequency stages and the 80 meter stages. This coupling will tend to mask the excellent skirt selectivity of the filter. A shield over the 80 meter conversion crystal is also needed. A minute amount of stray coupling existed between the conversion crystal and the 6BA6 low frequency oscillator tube, even though they were located six inches apart on the chassis. After the unit had been run for a time, tube shields were placed on all tubes with the exception of the 6AG7's, with a measurable improvement in sideband suppression and skirt selectivity of the filter. When a filter provides some 80 db. of unwanted sideband rejection, as does the mechanical filter, it does not take much stray leakage around the filter to ruin the passband of the unit. Careful attention to details will reduce this unwanted coupling to a minimum.

Exciter Adjustment

Adjustment of the exciter is relatively simple. The 6BA6 oscillator is so tuned that 455 k.c. falls at mid-scale on its tuning control, which may be labelled "Upper-Lower Sideband selector". The SSB signal at the output of the mechanical filter may be introduced into the i.f. section of a monitor receiver by a short

length of coaxial line. The oscillator may then be heard as it is tuned across the passband of the mechanical filter. The 80 meter conversion oscillator may now be monitored for operation, and the low frequency oscillator may be heard on 80 meters as it passes across the filter "window".

The next step is to adjust the balance potentiometer in the plate circuit of the 6AR8 stage for minimum 80 meter carrier at the SSB frequency. The sideband oscillator is then tuned just outside the filter passband, and an audio signal is applied to the exciter. If available, a sine wave of about 2000 cycles should be used, at a level of less than 0.1 volt, r.m.s.

The signal heard at the 80 meter SSB frequency should be a steady carrier with little trace of the 2000 cycle tone. Any tone that may be heard is a result of the sideband beating with the residual carrier and with high order distortion products. When received on a superhetrodyne receiver with no beat oscillator, the SSB test signal with pure tone modulation should sound like a carrier, with perhaps just a trace of light tone modulation.

The output circuit of the mechanical filter should be tuned for maximum SSB signal, as should the plate circuit of the 12AT7 mixer. The 12AU7 cascode amplifier is next plugged in, and the plate circuit of this stage adjusted for maximum SSB signal. The same step is followed for the 6AG7 stage. The 6AG7's may be loaded with an automobile headlight lamp which will serve as a dummy load. The bulb will light to about one half brilliance under full SSB output. When voice modulation is applied to the exciter, the signal should be completely unintelligible until the receiver BFO is turned on and properly adjusted. The speech should be clear and crisp, and no "buckshot" should appear in the spectrum where the rejected sideband lies. Care must be taken to make sure that the amplifier stages are not

tuned to the frequency of the 9002 conversion oscillator, since these tuned circuits offer the only rejection to this signal.

When modulation is removed from the SSB exciter, the lamp load should go out. Any residual glow is an indication of carrier leakage, or of leakage of the conversion oscillator signal through the amplifier stages.

By pushing the exciter, almost 10 watts of output may be obtained, but the higher order distortion products increase sharply in value and the SSB signal is adorned with undesired products falling in the unwanted sideband, and outside the limits of the wanted sideband. At a conservative level of 4 or 5 watts, the signal is clean and sharp.

Conclusion

The exciter is a simple unit to get working, the important adjustments being the setting of the carrier-null potentiometer in the 6AR8 stage. The exciter may be tuned up with the S-meter of the station receiver. If a good audio oscillator is at hand, the null control may be adjusted by merely tuning it for minimum intermodulation on the 80 meter signal, or minimum 80 meter carrier when the 6BA6 oscillator stage is in the center of the passband. A little experience will show the best position of the oscillator on the filter slope.

The output of the exciter is sufficient to drive a pair of 807 or 6146 tubes to 100 watts or so. It has also been used to drive a Class AB1 4-400A to about 500 watts on 80 meters.

The author wishes to thank Chandos Rypinski, W6RDR, of *Electronic Industries, Inc.*, Burbank, Calif. for his original suggestion of this application of the 6AR8 tube and for his subsequent design suggestions, and the Tube Division of the *General Electric Co.* for supplying pre-production samples of the 6AR8 tube. ■

Fig. 10. The output amplifier and cascode stages are in the left hand compartments. The center compartment contains the mixer and oscillator stages. At the right are the low frequency and audio stages. The mechanical filter (atop the chassis) bridges the right hand compartment shield. The input circuit of the filter falls in the low frequency compartment, while the output circuit falls in the mixer compartment.

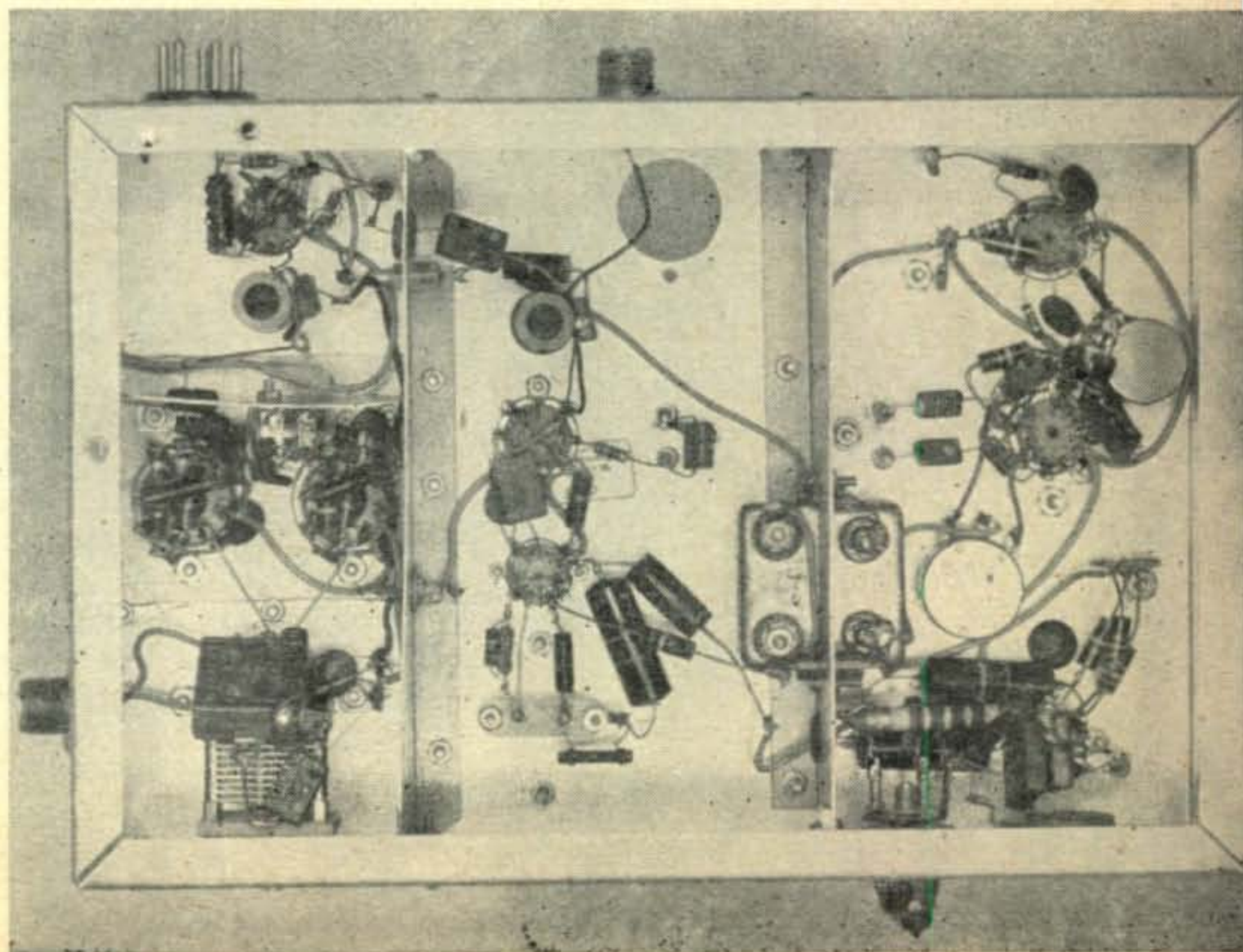

a Filter-Limiter

for C-W Reception

Allan M. Ferres

267 West 11th Street
New York City 14

If noise limits the number of your c.w. contacts, this audio filter-limiter will help. It is non-ringing and requires no receiver modifications. It is not a revolutionary new device, but it does cut both receiver and outside noise considerably and it is inexpensive and simple to put together.

Filters to reduce the audio bandwidth of c-w receivers usually use an LC parallel resonant circuit or a sharp cut-off low-pass pi network. Unless the parallel resonant circuit is properly loaded, the resultant ringing is often as annoying as the noise it attempts to eliminate. Un-

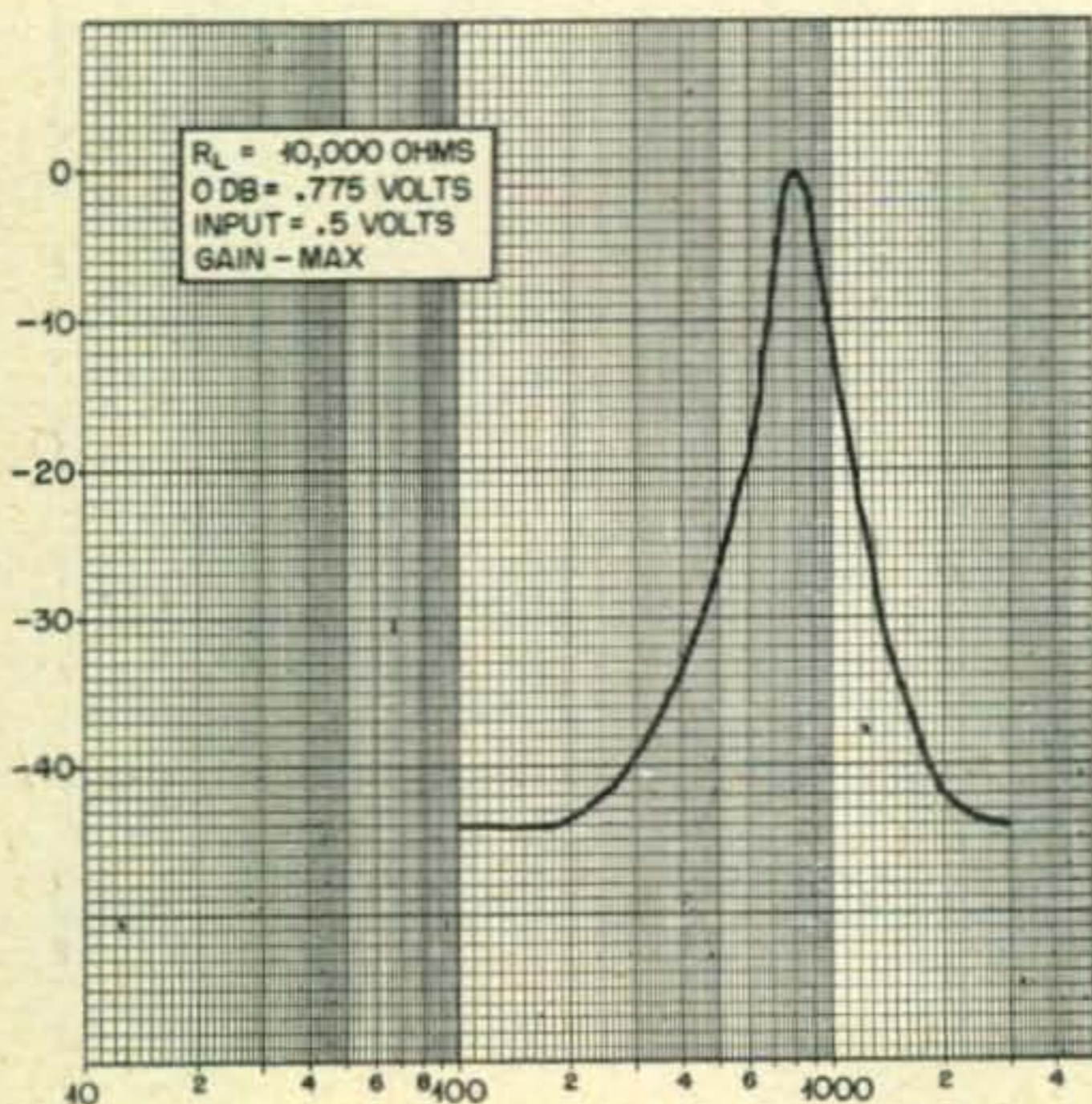
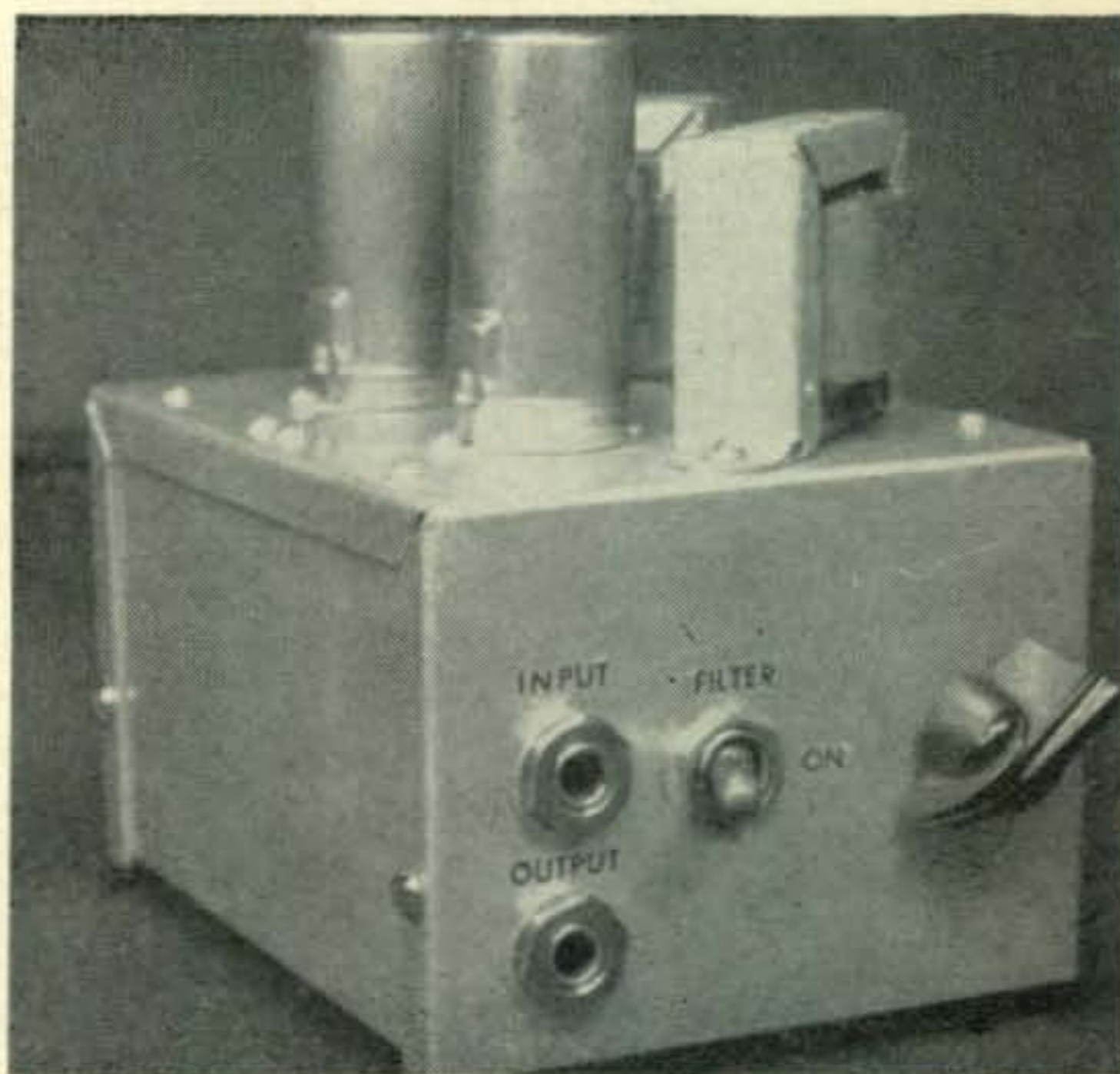

Fig. 1. Frequency response

fortunately this proper loading widens the pass-band of the circuit and tends to defeat the purpose of the filter. A well designed low-pass network is free of this trouble, but receiver hum and low-frequency man-made noise are not adequately reduced. The more complicated phase-shift, feedback type of circuit, such as the "Select-O-Jet", can be more effective than either of the above, but requires additional tubes to provide adequate limiting.

The filter-limiter described here consists of two tuned amplifiers in cascade, separated by a cathode-coupled limiter. Each tuned stage is one-half of a 12AU7 with the load divided between the plate and cathode circuits. The cathode load is shunted by a series LC circuit which offers a low impedance at its resonant frequency. At resonance, therefore, the degeneration produced by the cathode load is minimum and the gain of the stage is maximum. The part values have been chosen to produce a maximum stage gain of one. Although the Q of each tuned circuit is low enough to prevent ringing at the

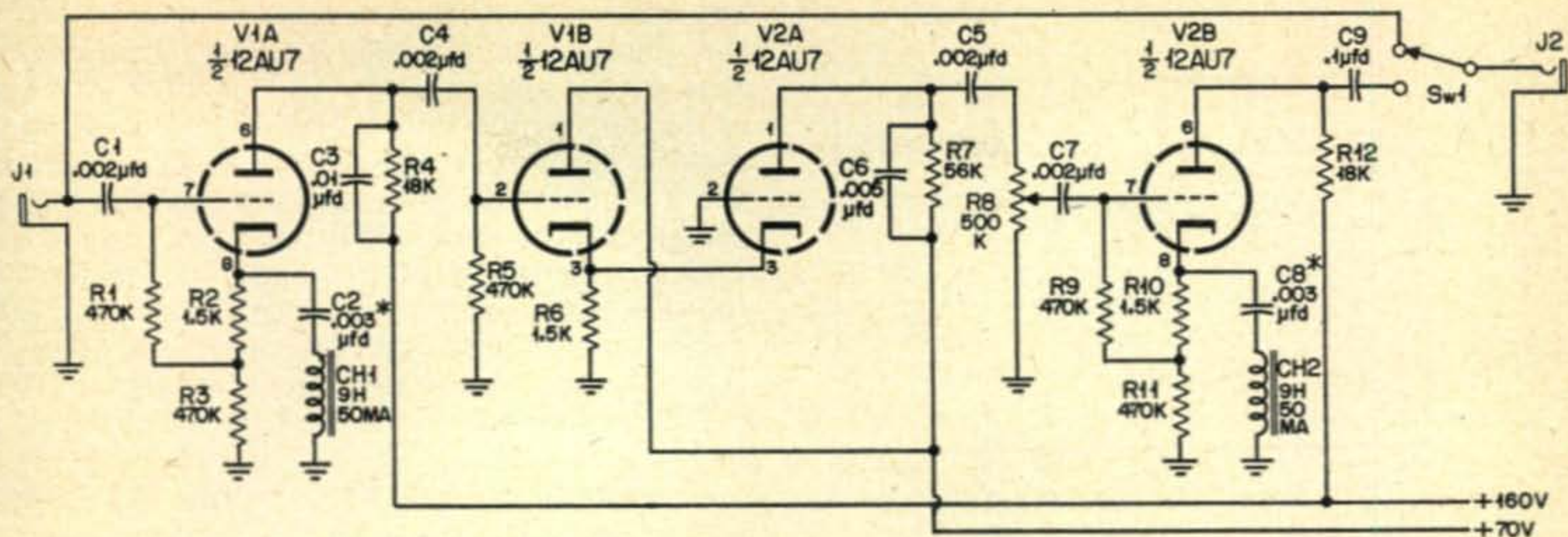

Fig. 3. Schematic for the Filter-Limiter

resonant frequency, a slope of 34 db per octave is obtained. This is a good compromise between noise rejection and ease of operation. The overall frequency response of the unit is shown in Figure 1. Too sharp a response curve may cause difficulty in holding the signal when receiver or transmitter frequency drift is encountered.

The function of the limiter is to prevent noise and signal from exceeding a definitely established maximum. This relieves the operator from the strain of having to contend with the ear-shattering crashes of noise bursts, key clicks or strong interfering signals. The limiter also employs a 12AU7 connected in a cathode-coupled circuit. The limiting characteristics, shown in the input/output voltage curve of Figure 2, indicate that limiting starts at about one volt input and that the output voltage cannot exceed one and three-quarter volts with the gain control of the unit at maximum.

The filter-limiter shown in the photographs was built in a 3 x 4 x 5" aluminum case and the power supply in a 2 1/4 x 2 1/4 x 5" case. The power supply, Figure 4, must be on a separate chassis from the filter-limiter in order to prevent hum pickup between the power transformer and the tuned circuit chokes. The com-

Parts List

- | | |
|---------------------------|--------------------------------|
| R1, R3, R5, R9, R11— | C2, C8—.003 μ fd., mica |
| 470,000 ohm 1/2 w. res. | cond. (see text) |
| R2, R6, R10—1500 ohm | C3—.01 μ fd., 200 v. cond. |
| 1/2 w. res. | C6—.005 μ fd., 400 v. |
| R4, R12—18,000 ohm 1/2 | cond. |
| w. res. | C9—.1 μ fd., 200 v. cond. |
| R7—56,000 ohm 1/2 w. res. | CH1, CH2—9. hy., 50 ma. |
| R8—500,000 ohm audio- | choke (Stancor C-1215) |
| taper pot | S1—s.p.d.t. toggle switch |
| C1, C4, C5, C7—.002 | J1, J2—open circuit phone |
| μ fd., 400 v. cond. | jack |
| | V1, V2—12AU7 tube |

plete unit draws only about two milliamps at 160 volts and .6 amps at 6.3 volts. If this power is to be obtained from a supply now in use, R15 and C12 should be included on the filter-limiter chassis. Because of the narrow bandwidth and the low gain of the unit, no special wiring precautions need be taken nor is shielded wire necessary for any of the connections. All resistors and condensers are mounted on the four Cinch-Jones type 2010 ten-terminal strips, which are attached to the bottom of the chassis. After the first model was built, it was found that it would have been more convenient to mount the input and output jacks on the back drop of the chassis and to move the on-off switch, S1, to the left side of the front panel. It is suggested that the builder make these

Filter-Limiter, bottom cover removed

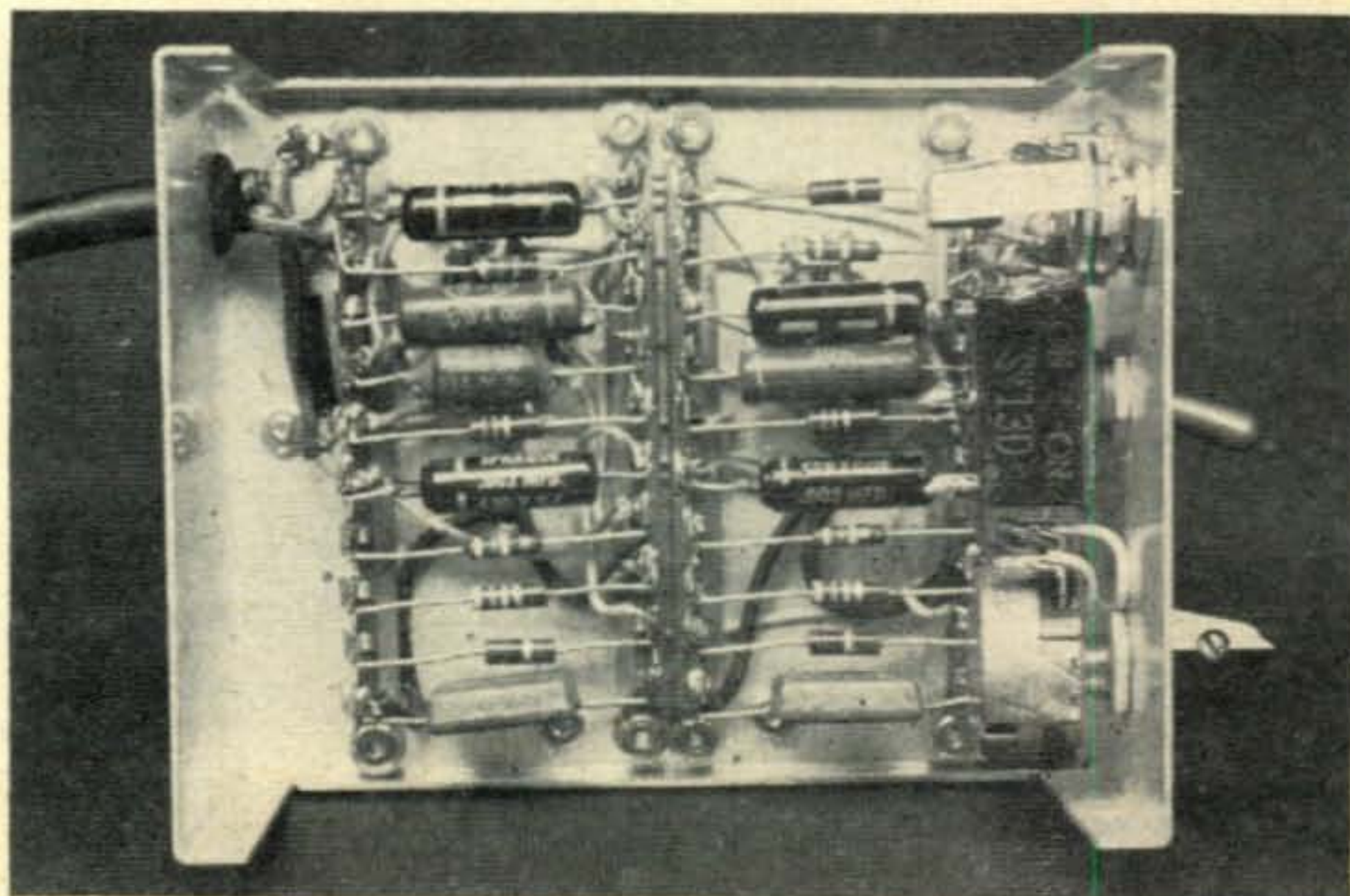

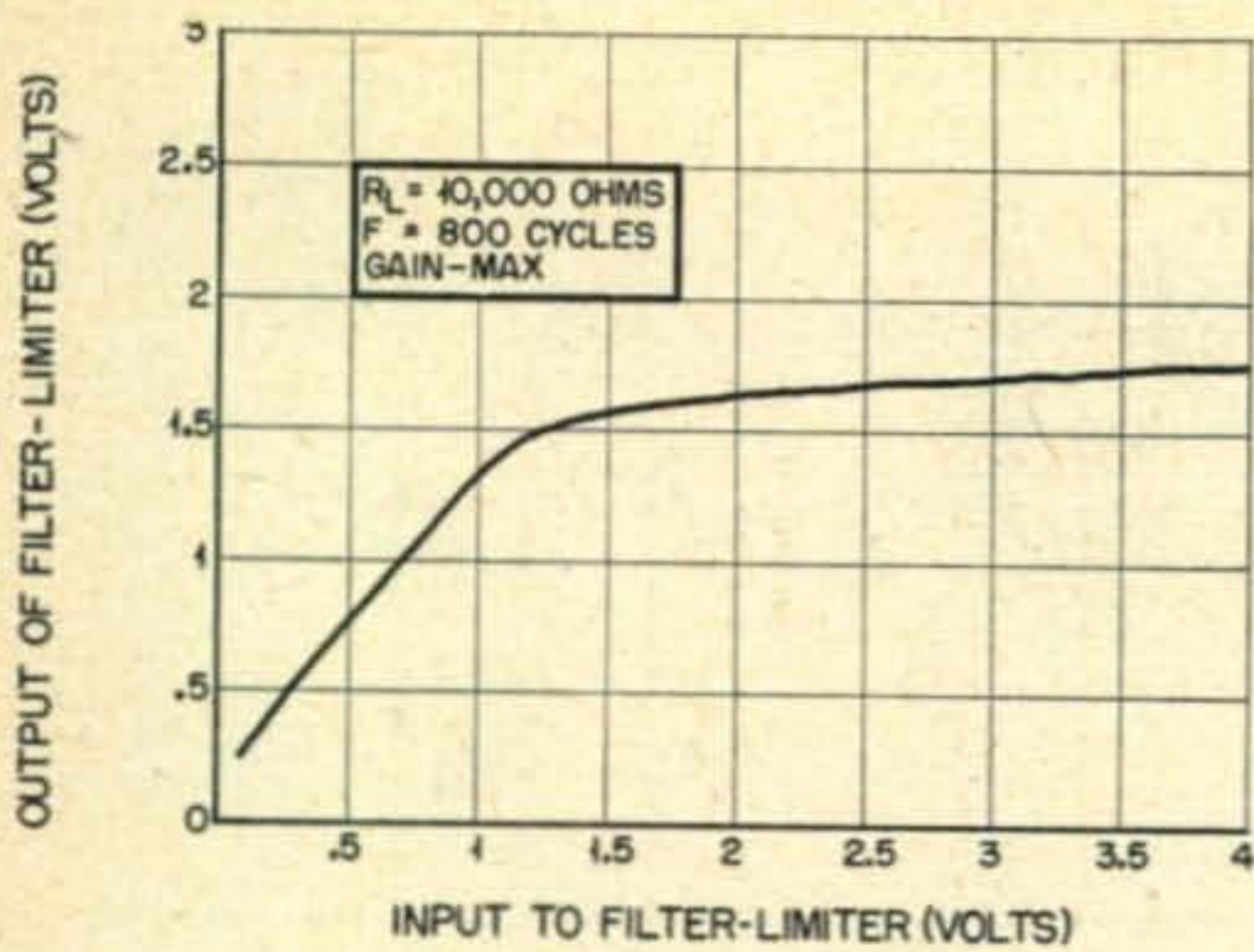
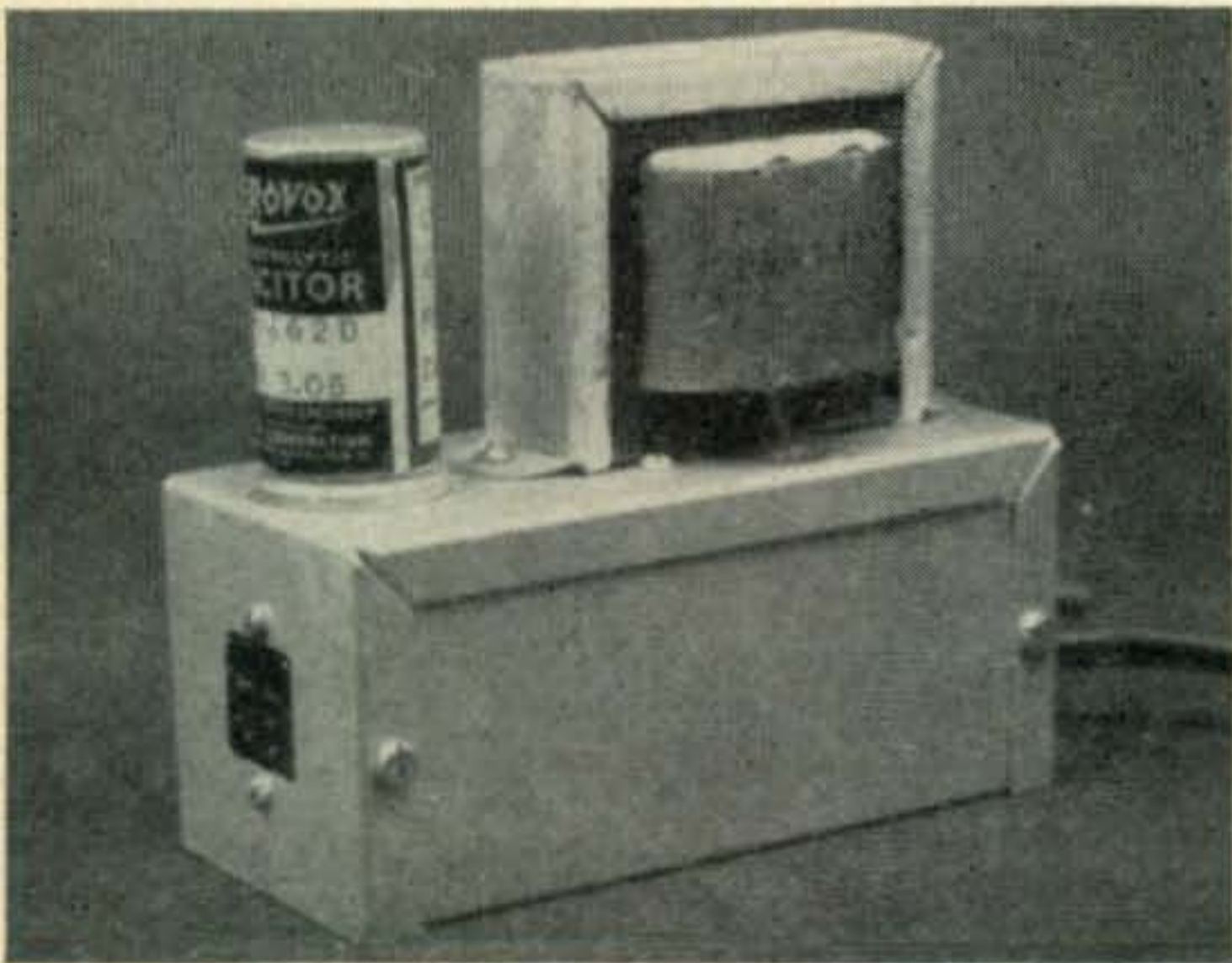

Fig. 2. Limiter characteristics

changes as the front panel would then be less crowded. The two chokes are mounted at right angles to each other to reduce the coupling between them.

The circuit diagram, *Figures 3 & 4*, requires little explanation. Except for *C2* and *C8*, no part values are critical. 10% tolerance resistors and ordinary paper tubular condensers can be used, except as noted below.

Although 20% tolerance mica condensers can be used for *C2* and *C8*, the sharpest peak will be obtained if these two condensers are selected to tune the two chokes to exactly the same frequency. The author has found that less



Miniature power supply for the Filter-Limiter

operator fatigue occurs when copying code with an 800-cycle note, but any tone between about 700 and 1200 cycles can be used if preferred. The circuit, of course, should be tuned to the preferred tone.

Tuning

Before tuning the circuit, the wiring of the filter-limiter should be completed except for *C2* and *C8*. Connect an output meter or an ordinary a-c volt-meter to the output jack, *J2*, and set the gain control to maximum. Feed an 800-cycle signal into the input jack, *J1*. If an audio oscillator is not available, beat the b.f.o. of the receiver to the station's v.f.o. or frequency standard so as to produce a tone of

approximately 800 cycles, and connect *J1* to the phone jack of the receiver. Temporarily wire in *C8* and short out *R3*. Reduce the 800-cycle tone to the lowest level which will give a useable reading on the output meter. Now vary the frequency of the tone to produce the highest reading on the meter. If this tone is close to 800 cycles, wire in *C8* permanently. If too high or too low, try other condensers until the 800-cycle peak is obtained. The next step is to remove the short across *R3* and try various values of *C2* so that the highest output is obtained at the peak frequency.

To obtain best results from the filter-limiter some experimenting with the receiver controls will be necessary. It is important not to set the receiver gain controls too high or the signals will go too far into limiting, causing an apparent increase in noise level. The selectivity

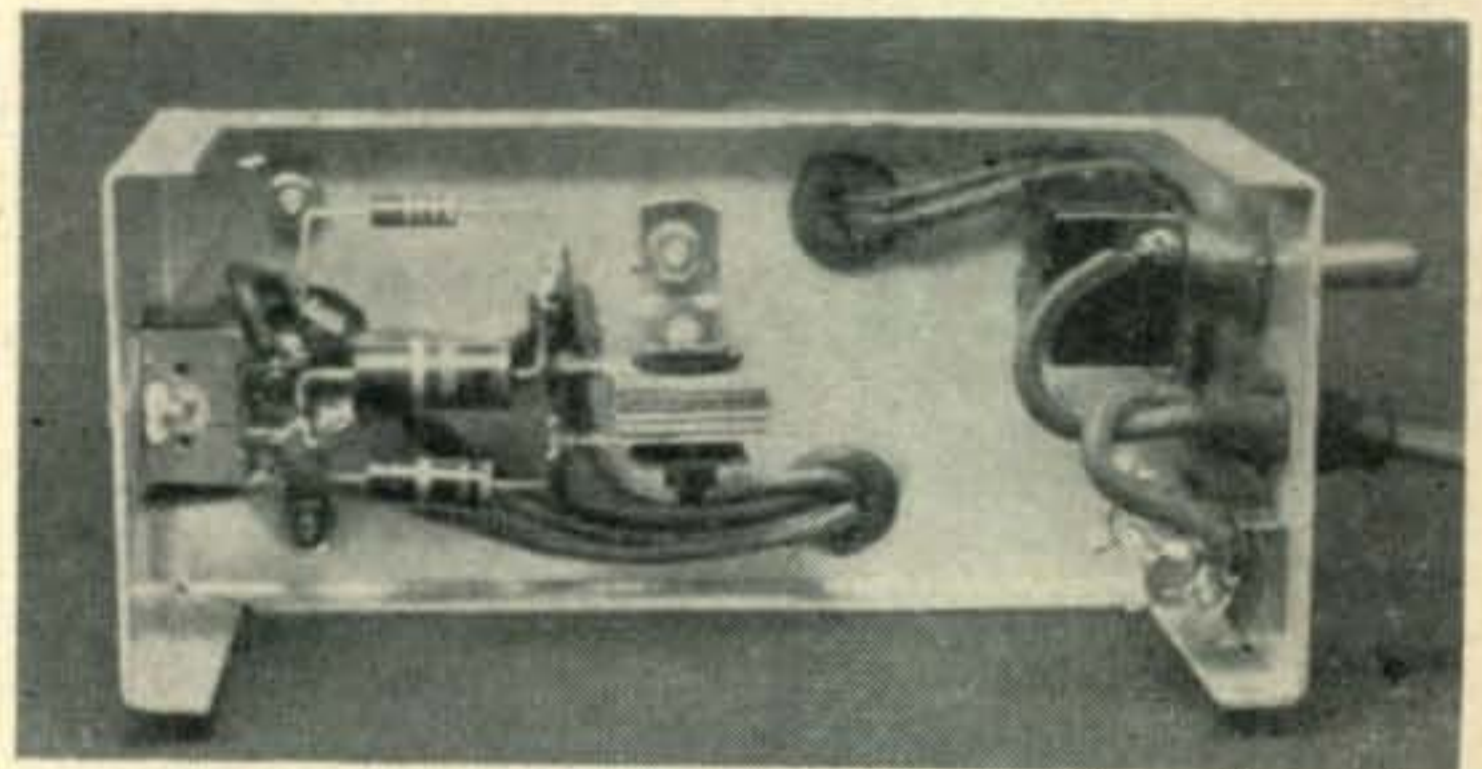

Power supply, bottom cover removed

should be set to as broad a position as interfering signals will allow. The gain control on the filter-limiter is adjusted for comfortable headphone level, but no higher than necessary.

It cannot be predicted in advance exactly how much noise reduction this filter-limiter will provide in any given case, but if noise does interfere with code reception, then enough improvement will be furnished to make the use of the unit well worthwhile.

The author wishes to thank Mr. Benjamin N. Lazarus, W2JB, for his suggestions and help in testing this "Filimiter" at his station in midtown Manhattan which must be one of the noisiest locations in the country. ■

Power Supply Parts List

- | | |
|--|---|
| R13—47 ohm 1 w. res. | T1—Power trans. 125 v. half wave @ 50 ma., 6.3 v. @ 2 amps. (Stancor PA-8421) |
| R14—10,000 ohm 1 w. res. | S2—s.p.s.t. toggle switch |
| R15—47,000 ohm 1 w. res. | Rect.—20 ma. selenium rectifier |
| C10, C11, C12—30/30/10 μ fd., 150 v. elec. cond. | |
| F1— $\frac{1}{2}$ amp fuse | |

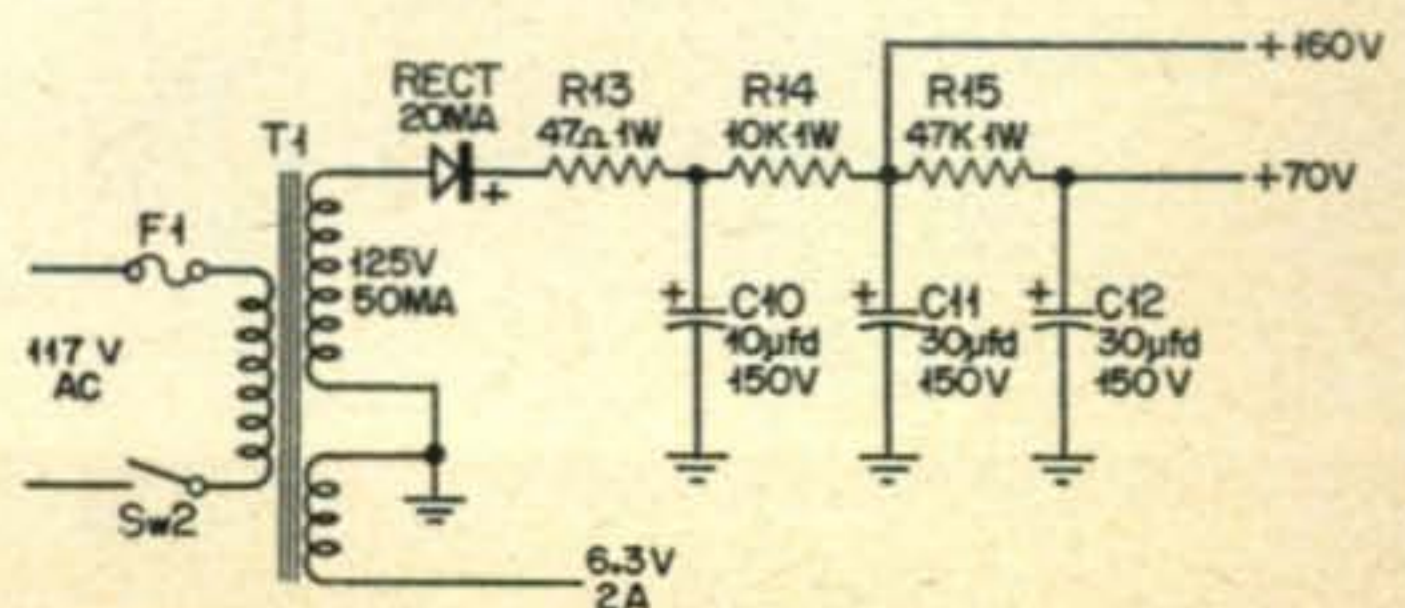

Fig. 4. Filter-Limiter power supply

The Gonset G-66 Receiver

Wayne Green, W2NSD

Editor CQ

The G-66 has been on test for well over a month as this is written. It took a great amount of will power to wait this long, for the inclination after only one day's test was to sit down and let everyone in on the amazing results. But since you find out more about a piece of equipment as you live with it, that first flush of elation and optimism usually passes. This one hasn't.

The more I use the G-66, the more in awe I am. Here is a tiny receiver that will stand up there right along with the best on the market. Car receivers are normally expected to be sensitive so it comes as no surprise to find that you can hear anything with this mite that you can pick up with a \$600 communication receiver. It is *hot*. Tested in the car there was a marked improvement over the previous receiver which has served well for the last two years.

My previous mobile setup consisted of an all-band converter, separate i-f strip with audio and speaker, and broadcast receiver. All this took up quite a bit of room and probably cost over double the G-66 tag. The G-66 is a complete communications receiver with all ham bands and the broadcast band built in. Further, the power supply works from either 6 or 12v battery, or house current.

But I've just been teasing you along. The greatest news about this receiver is the stability. If I hadn't tested it myself, I would never have believed it. In talks with other mobileers and SSB'ers, one factor has always been a stumbling block for mobile SSB: No one had found a receiver that would not drift excessively during normal operation of the car. I had in the past managed to work a few SSB stations, but I usually had to have one hand on the BFO knob. It was enough of a problem to discourage any extensive SSB installations in the car. This was unfortunate, for everyone that has tried mobile SSB has found it to be **the** answer to nearly all the complaints of the mobileers.

The G-66 has a clever gain control that is a combination of a.f. and r.f. With this system



you only have one knob to work and don't run into cockpit trouble. Once you tune in the SSB station he stays tuned in, even with the generator going on and off. I tested the receiver with battery voltages of from five to nine volts and the change in the SSB voice was negligible. Used in the shack there was no difference between the operation of the G-66 and the regular station receiver. I tuned in an SSB station and changed from battery to a.c. and the voice never quavered.

The one place where you have to take a bit of sacrifice for size and price in this unit is in variable selectivity. The selectivity of this unit is ideal for mobile operation, but for home use where you have two hands available you might want to add a Q-multiplier to narrow down the 3½-kc passband. Make it a 265-kc Q-multiplier. The G-66 is a double conversion receiver with a 265-kc second i.f. This low frequency i.f. makes for good selectivity.

There are too many features to point up in this article. Inspection of the literature on the G-66 will probably give you adequate instruction along this line. The design is beautiful, there is loads of bandspread, no backlash to the dial, simple bandswitching, provision for VFO zeroing, muting connections, simple dial recalibration system, S-meter, excellent noise limiter, good BFO, phone jack, and what else do you want? The price tag on the receiver is \$169.50; the power supply (6-12-115) is \$39.95. ■

ULTRA MODULATION

Want to put 225 watts of audio on a little old 50-watt carrier? I mean without messing up the whole south end of the band and setting the videos for miles around a-flutter? 'Tis possible. The villain in the piece, of course, has always been the negative half cycle, and the Ultra Modulation Company claims for their unit complete control of the negative half cycle of the modulation unit for the first time in radio history. With this unit, audio power up to 5 times the carrier power has been successfully used, with bandwidth never in excess of a conventional 100% modulated carrier. A newly-patented system is at the heart of this system that succeeds where others failed. And, brother, 225 watts of modulation on a 50-watt carrier will give you a lot more punch than many AM Kw's now on the air. Try it and see. For the lowdown on Ultra Modulation, drop a line to Ultra Modulation Company, P.O. Box 485, Red Bank, New Jersey.

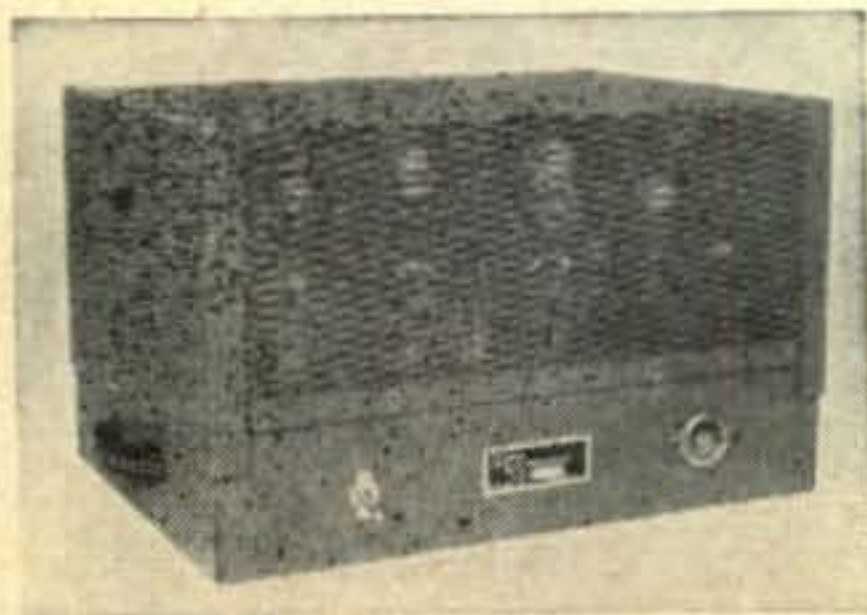

a five element

Quad Yagi

Richard A. Jensen, W2MGF

26 Sanders Road
Nixon, New Jersey

for two meters

Here is a beam that is easy to make, easy to adjust, and easy to erect. It has the gain of beams considerably larger in size. This lightweight simple array can be mounted on a standard TV mast and rotator where the larger more bulky arrays require a tower and a heavy duty (expensive) rotator. There are no phasing lines to be adjusted and no impedance matching transformers are necessary when 75 ohm coax is used.

Quads have been a source of confusion for some time. Though there have been several articles in print on the subject, few hams have felt that these published versions exploited the full possibilities of such a device. The January 1955 *QST* article on a twenty meter Quad using two single turn loops aroused my curiosity as to the results of throwing in a director in addition to the reflector.

Investigation of the use of director loops was started in April 1955 with construction of a six meter beam using a Cubicle Quad with one director loop spaced at 0.2 wavelength. The six meter beam worked quite well and it was my belief that a worthwhile increase in gain was attained by adding a director loop. Further investigation of what could be done with more than one director was carried out on 144 mc rather than at 50 mc. To distinguish the design of this beam from others I decided to call it a Quad Yagi which is appropriate since it is a

Quad beam with a number of parasitic elements as in a Yagi beam.

Facts & Figures

All of the information presented was found experimentally. Spacings of the elements were adjusted for optimum forward gain except for the reflector which was determined for best front to back ratio and is 0.2 wavelength, the same as was used in the earlier Cubicle Quad beams. Closer reflector spacing resulted in slightly lower gain and a broader pattern, while larger spacing caused a more rapid decrease in the gain but also generated minor lobes at the back corners. Spacing of the directors was adjusted for best forward gain and turned out to be $\frac{3}{8}$ wavelength.

A dipole with a diode and a millimeter calibrated in db was used as a field strength meter to make gain measurements. Several measurements were made of the gain over a reference dipole at two different locations and a gain of between 13 to 14 db was obtained. This is about what can be obtained with a "Twin Five" Beam that is properly phased.

A rough plot was made of the field pattern of the beam and is shown in *Fig. 2* in comparison with a barefoot Cubicle Quad antenna to show the decrease in beam width caused by the addition of director loops. The front-to-back ratio was found to be about 45 db and the

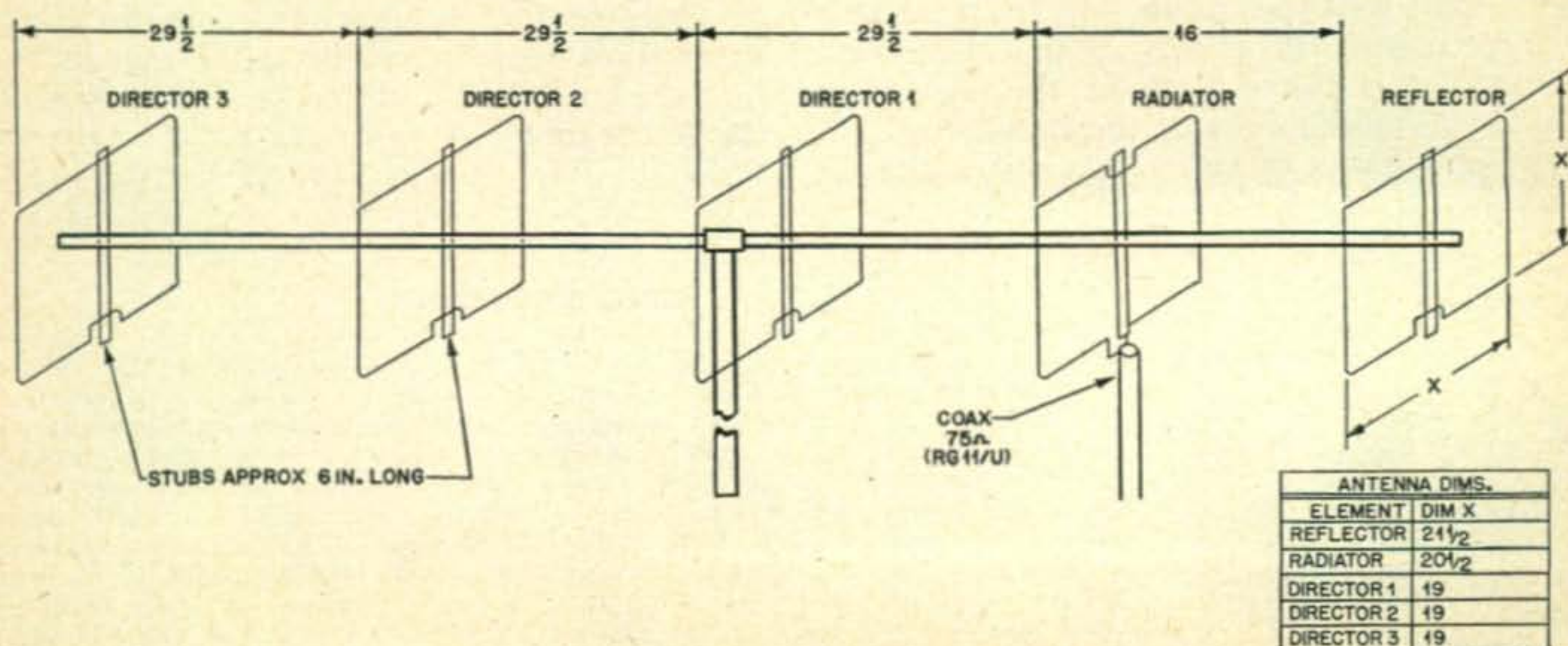
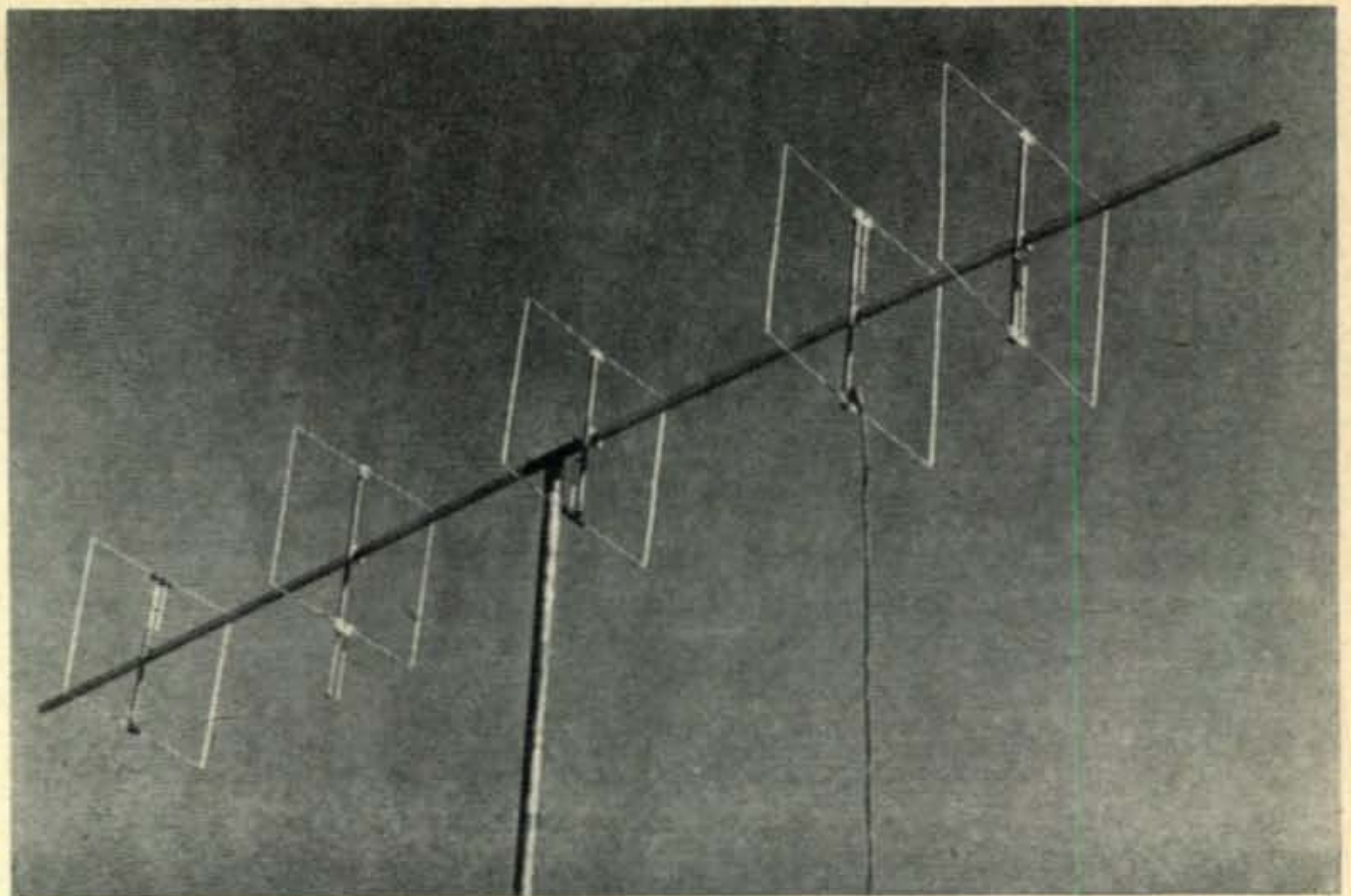

Fig. 1. Construction information

Completed beam at
W2MGF



front-to-side ratio was close to 60 db. The beam width at the half power points was about 30° in the horizontal plane and about 20° in the vertical plane.

Measurements of the S.W.R. with 75 ohm coax was made over the two meter band and was 1.04 at the frequency for which the beam was tuned. It increased to 1.5 at the high frequency end of the band. With the directors spaced at 1/4 wavelength the S.W.R. was 1.02 at the low and rose to 1.4 at the high frequency end of the band. Fig. 3 shows the curves ob-

were all made the same length and their stubs had sufficient tuning range for proper adjustment.

Construction

The construction of the beam is quite simple and can be made from readily available materials at low cost. All materials can be obtained from the local hardware or radio supply store at a cost of less than ten dollars. In figure #5 one loop is shown in detail. Dimensions of each loop is tabulated on fig. 1. Aluminum solid clothes line wire was used for the elements and is supported by 1/2" fibre tubing. Dowel rod can be substituted for the support if it is treated to resist the weather. The aluminum brackets which hold the wire to the support are formed from sheet aluminum, and the mounting boom is 1" dia. aluminum tubing both of which are sold in hardware stores by Reynolds "Do-It-Yourself" aluminum. Suitable mounting clamps for attaching the loops to the boom and also clamps for mounting the beam to the mast can be obtained at most T.V. supply houses.

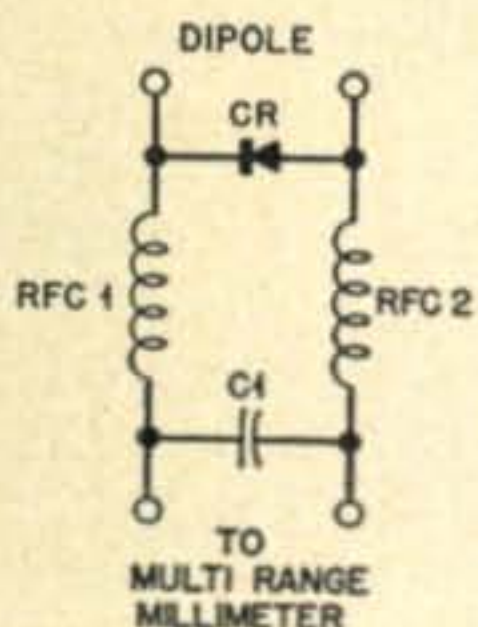

CR-1N34
RFC 1, RFC 2-1MH
C1-.0001µMFD

Fig. 4. Tuning indicator.

tained from these measurements. An unbalanced feed was used for the sake of simplicity, however a Balun should give better current distribution in the driven loop and might bring about a slight improvement of the gain.

Not only was the impedance match good over the 144 mc band, but the gain was constant across the band. The beam, though adjusted at 144 mc, performed equally well up to 148 mc.

From the experimental work with the Quad Yagi it was found that loop dimensions can readily be calculated. The length of the driven loop is one wavelength and its length is $L(\text{feet}) = \frac{984}{f(\text{mc})}$. This is longer than that of a straight wire in free space, which is due to it having no end effects. The design of my beam was calculated for loops slightly shorter than for free space length to allow each element to be tuned with a short stub. Directors

[Continued on page 118]

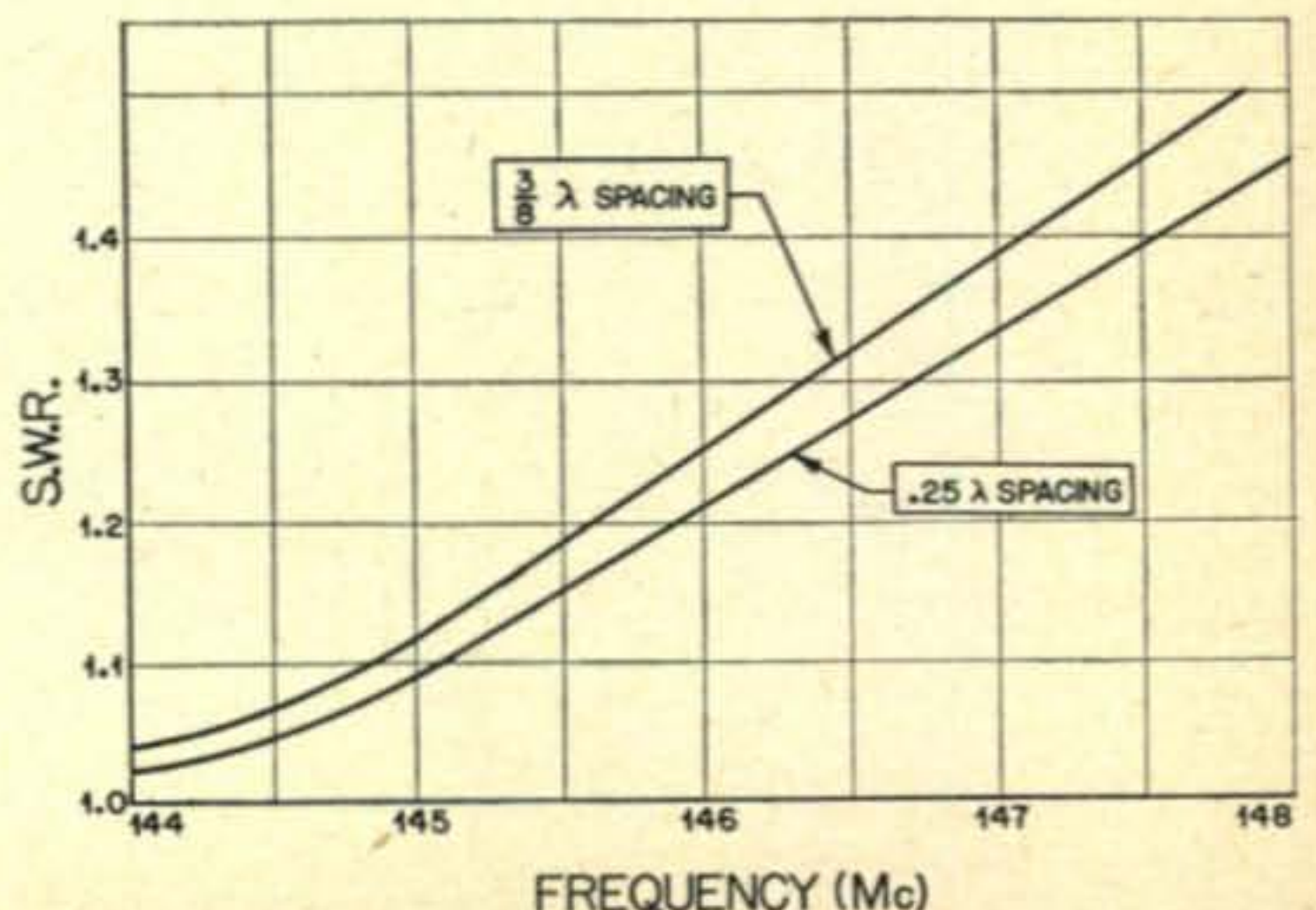
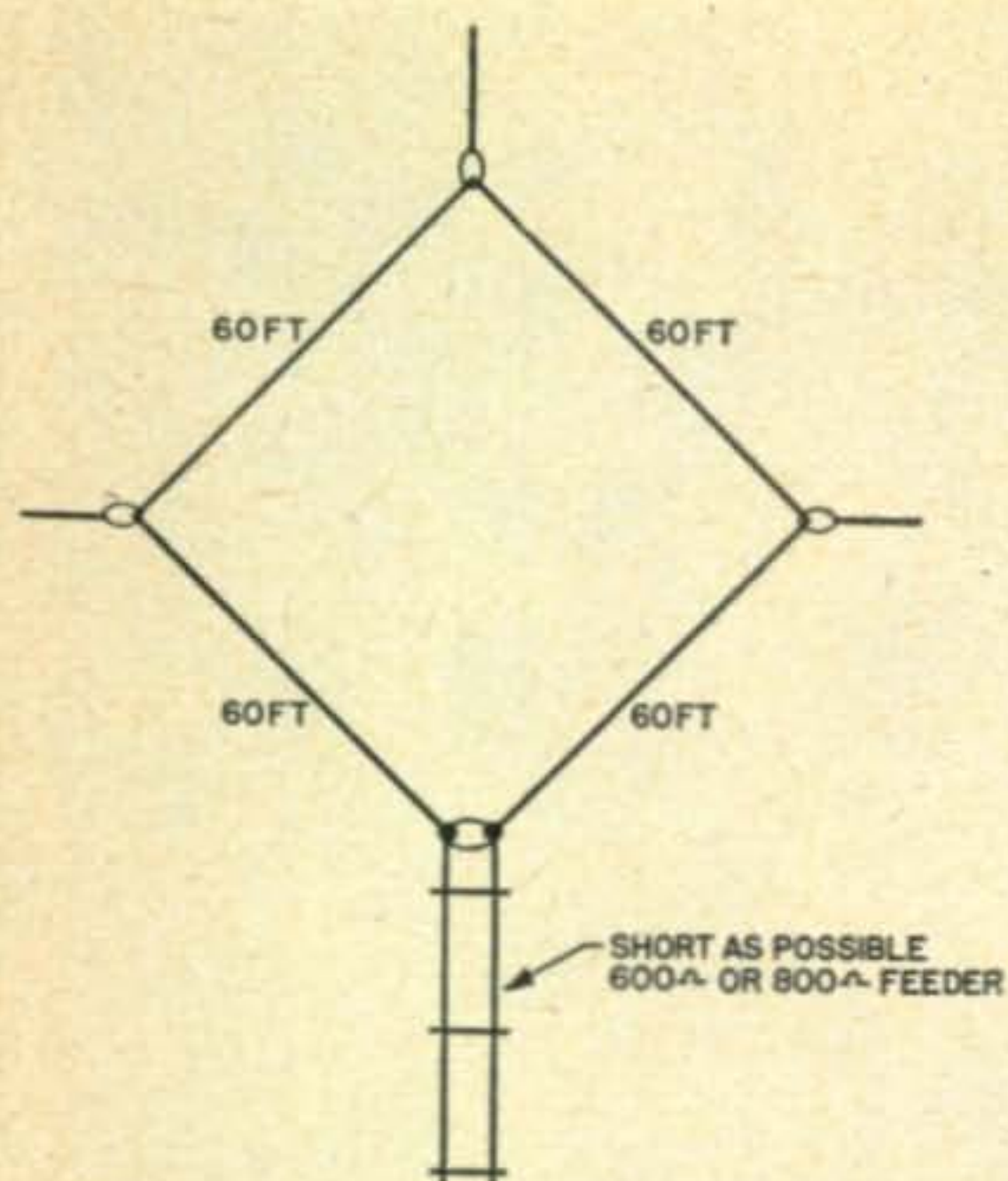

Fig. 3. S.W.R. v. frequency change.

Lazy Quad

M. F. "Doug" DeMaw, W8HHS

9601 South 47th Road,
Cadillac, Mich.



Since the opening of the 75 and 20 meter phone bands to General Class use, the QRM situation has become so severe that the old familiar phrase, "Armchair Copy", is being heard more infrequently as time passes. This seems to be particularly true on the 75 meter phone band. Night time band conditions seem to be especially trying these days. The most fortunate operators who do maintain a higher average of solid contacts are equipped with the higher power and more elaborate antenna systems. But what of the fellows with restricted space for antennas? Those of us who for either economical or various practical reasons, do not run high power, in fact in many cases run less than 100 watts input? Generally speaking, unless being blessed with an occasional run of good fortune (such as enjoying a particularly good location or one of those crazy unexplainable hot antennas) we just don't stand a chance when conditions are crowded.

The antenna to be described is not new in principle nor is it difficult to erect or use. How-

ever, it seems to be one of the most neglected ideas of the present era. The antenna will not produce any unusual results as far as DX is concerned, but on statewide contacts up to 400 miles it has proven itself to be far superior to the half wave doublet 45 feet in the air and much more desirable than a 375 foot, wave and a half long wire. The antenna in question is the full wave loop (closed loop type). This antenna erected in a horizontal plane produces principally high angle radiation, don't wince when you read this. I realize that the modern day trends seem to be more and more toward low angle radiators for DX work. This article is intended for those who want to maintain more solid local and net QSO's.

The natural properties of a full wave loop indicate that the maximum amount of radiation occurs at right angles (or perpendicular) to the plane that the antenna is mounted in. Therefore it is safe to assume that if the loop were mounted parallel to the ground, the maximum effective radiation would be straight up into the sky. This situation upon further thought seemed like an ideal condition for those good solid, local, short haul contacts. After making a few simple calculations I rounded up 240 feet of antenna wire and some insulators and went to work. A few natural supports such as trees and buildings were well situated for erecting the antenna in a square configuration. The maximum available height was only 25 feet, but for the sake of experimentation I decided this would be adequate for the initial check. The completed antenna was 60' on a side and as nearly level with respect to the ground as possible. A short length of 600 ohm open wire line was used to feed the antenna from the upstairs location of the shack.

Coupling Methods and Loading

Considerable experimentation became necessary in order to achieve proper antenna loading. Figure 2 shows the two most desirable methods used. The antenna manual states that the feed point impedance on a full wave closed loop is in the vicinity of 50 ohms. This was tried with RG8-U and proved to be totally unsuccessful. A system of series tuning was finally decided upon and the transmitter loaded readily.

[Continued on page 120]

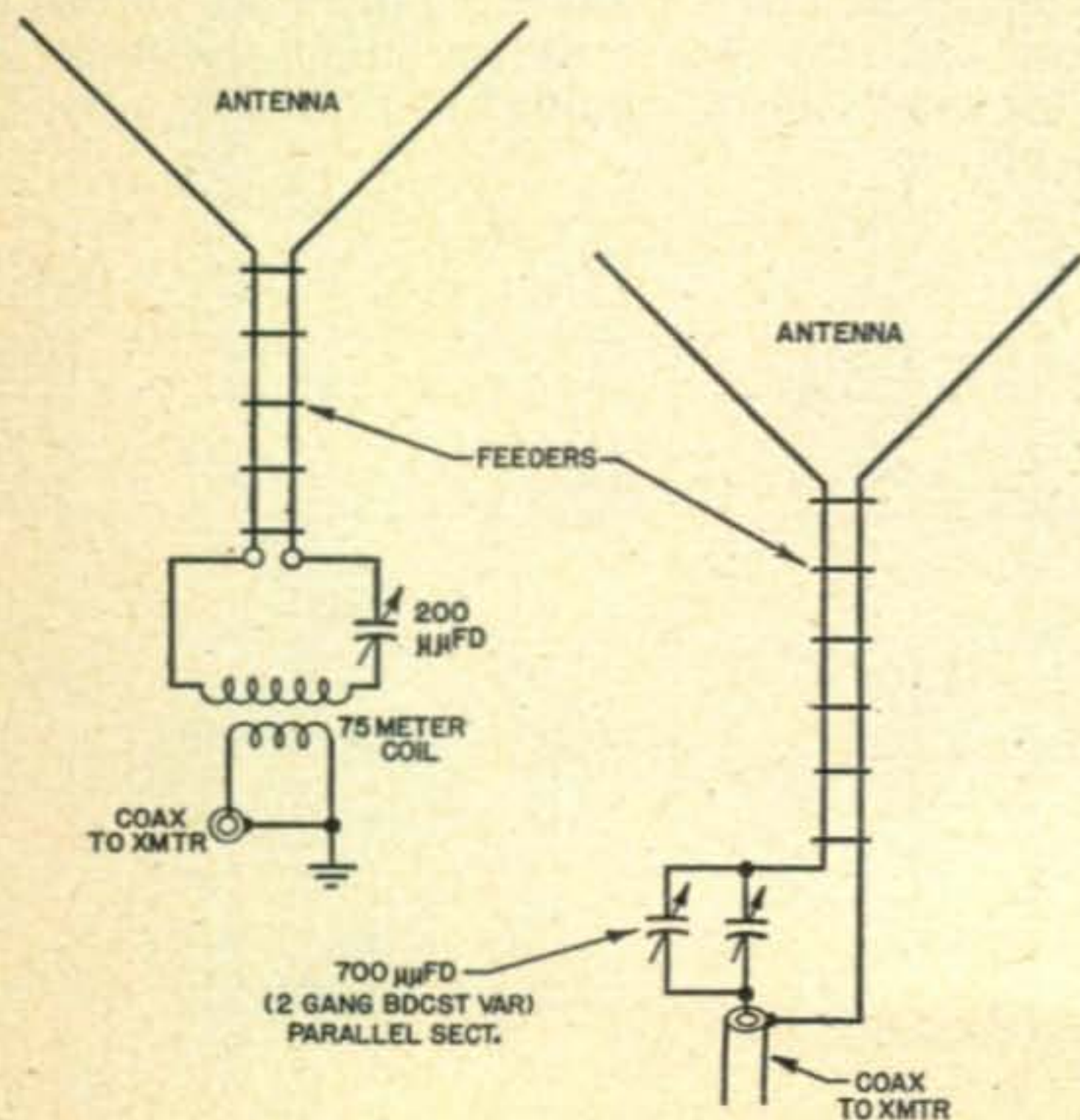
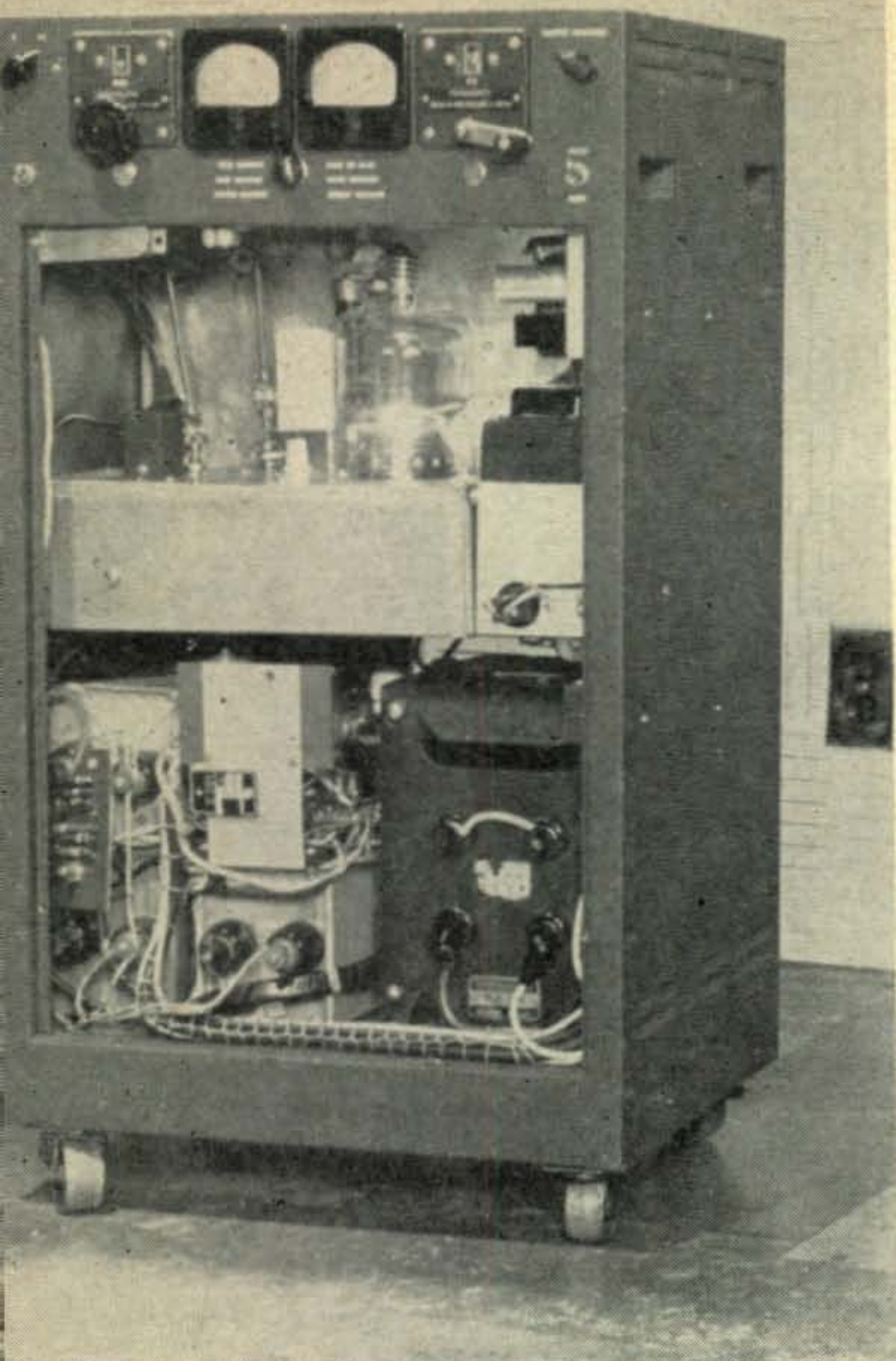

Fig. 2. Loading.



A few of your readers might be interested in a quick rundown on my new linear. I won't go into the circuit for that is pretty standard. The cabinet comes from the *Collins* KWS-1 power supply unit and was picked up here in Detroit. I understand that more of these may be available in the future. A 36" relay rack would have given a bit more working space, but the other was handy.

The amplifier works from 80 through 10 meters and the whole works is in the cabinet: plate, screen, and grid bias power supplies. An Eimac 4-400A was used, but many other tubes could have been substituted. The left hand meter measures all circuit currents and voltages plus one position for antenna loading. The right hand meter reads plate current. Write Eimac for info on running their tubes linear, it is available for the asking.

The linear can be driven AB₁ or AB₂ with most commercial SSB exciters. The output circuit is a pi network with a variable inductor and a *Jennings* vacuum variable capacitor. This gives a maximum of 1500 $\mu\mu\text{fd}$ and a minimum which will load a coax fed ten meter beam without switching. The inductor and condenser are geared together to provide a constant Q of 15 throughout the range.

So, there is one way to put together a linear. I'll leave the details to you on building yours. ■

One Man's Linear

Haven't you built a linear yet?

John W. Govier, W8QNW

18670 Gilchrist
Detroit 35, Michigan

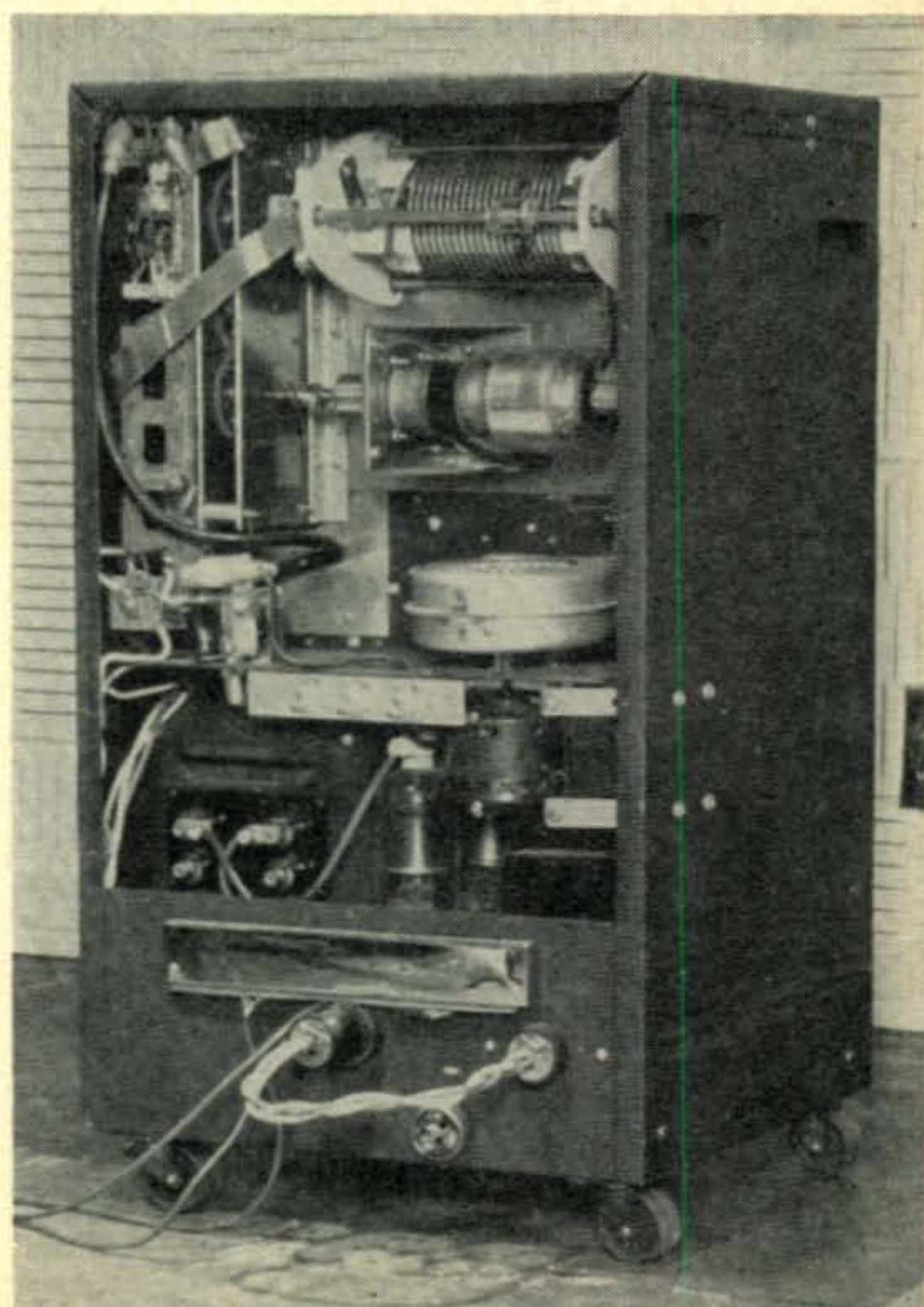

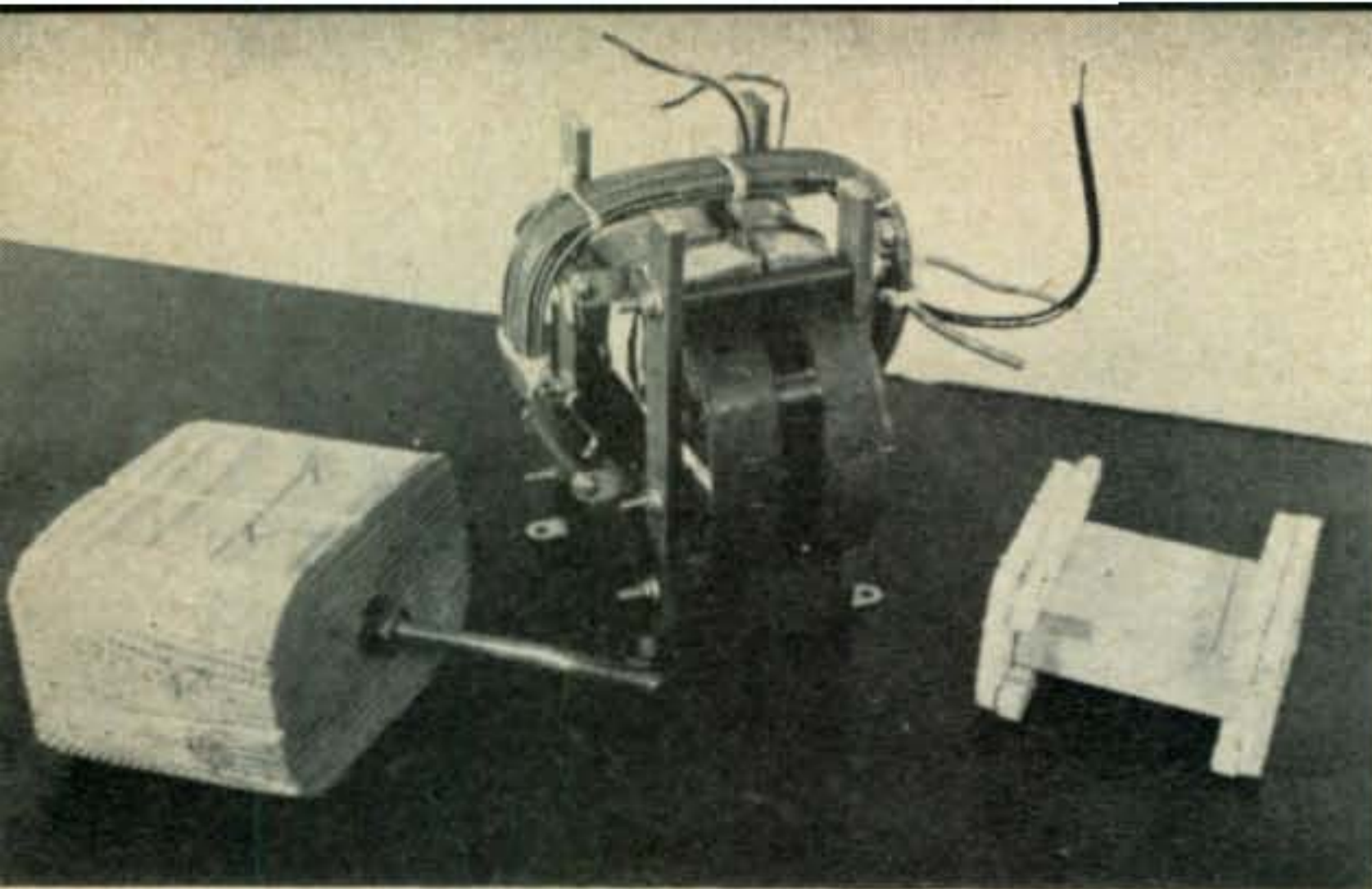

The completed transformer before application of varnish and the two wooden block forms used for winding primary and secondary.

C. B. Adelman, K6EYB

760 Via Marin
San Lorenzo, California

Low Capacity Transformers

for Grounded Grid Applications

Anyone who has had plans to build a high power final must certainly have read the recent series on grounded grid linears with a great deal of interest. This writer began collecting parts for such a final, but when it came to the procurement of the low capacity filament transformer, it appeared there would be some difficulty. After a long and exhaustive search of the local surplus stores, the conclusion was that they wouldn't become available through those channels. Now our supply of catalogs is pretty extensive, but searching them revealed that none of the manufacturers are producing them, at least for distribution to jobbers or wholesalers. A quotation on such a transformer was obtained from a local manufacturer, but the cost of building a single unit was prohibitive. Apparently, if we were going to go ahead with the project, we would have to go back to the now almost unheard of practice of winding our own.

It is not difficult to find information on the design and construction of power transformers, but most of it is for the conventional type and if any data exists on low capacity transformers, it must be in the hands of those manufacturers who built them for the military. A low capacity transformer is merely one which has its secondary far enough removed from its primary to give a minimum of capacitance to the grounded leg of the source of a.c. In removing the secondary in this fashion, the regulation under load would naturally be less than in a transformer whose secondary is in close proximity to the primary. Lack of information on what could be expected made the design difficult, but finally a secondary was constructed with enough taps so that the proper voltage under load would be obtained. After the regulation was determined, a new secondary was then wound so that excess turns would be eliminated and the capacitance to the

primary would be at a minimum. In actual practice, manufacturers have achieved most efficient designs through the same methods since a practical transformer always differs slightly from the ideal, and such things as number of turns per volt and core area are determined from experience.

How to figure it

To avoid repetition of theory which can be found in any handbook, only the information necessary to design such a transformer will be shown here. The first consideration is the cross sectional area of the core and this may be calculated as follows:¹

$$(1) \quad A = \frac{\sqrt{E_s I_s}}{5.58} \quad \begin{array}{l} E_s = \text{Secondary Voltage} \\ I_s = \text{Secondary Current} \end{array}$$

After determining the core size to be used, the number of turns in the primary are found from the formula:

$$(2) \quad N = \frac{E_p \times 10^8}{4.44 f B A}$$

Where:

E_p = Line voltage

N = No. of turns

f = Frequency of supply source in cycles

B = Flux density in line per square inch

A = Core cross section (net) in square inches

The quantity B is determined by the type of material to be used in the core, but for core materials now available a figure of 90,000 is usually used. Remember that A is *net* area and a stacking or space factor must be applied for laminated cores. If a core were fabricated from an old transformer core and a good grade of varnish applied to the laminations, this factor would be about 90% with .014 material. The other relationships which apply are:

$$\frac{N_p}{N_s} = \frac{E_p}{E_s}$$

This merely is another way of saying that the number of primary and secondary turns is in direct proportion to the primary and secondary voltages. The current in primary and secondary windings, however, is in inverse proportion to the respective voltages or:

$$(4) \quad \frac{I_p}{I_s} = \frac{E_s}{E_p}$$

which, of course, assumes no losses as in the ideal case. Actually, the primary current will be the sum of the current as found from (4) above, plus the current required to magnetize the core and such current as necessary to account for other losses.

Specifically

The transformer described in this article contemplates using a single 813 in the final, therefore, it must deliver 10 volts at 5 amps. Using formula (1), the net core area is found to be 1.27 square inches. To provide for spacing the secondary far enough away from the primary, a "C" type core must be used with a comparatively large "window." To build such a core might appear to be quite a job at first, because if .014 silicon sheet were used and the laminations for a "C" type core cut from it to give a square cross section of $1\frac{1}{8}$ " x $1\frac{1}{8}$ ", one would have to lay out and cut over 150 "L" shaped pieces, apply varnish, then stack the core inside the windings and bolt them together. Cutting all this material might make the job seem to be not worth the effort. A little research turned up information on standard cores which simplified the problem considerably. There is now available a line of standard tape wound cores of a superior magnetic material², which eliminates much of the work of transformer building and results in a better, more efficient job. The core selected for the transformer for an 813 has a core cross section of $\frac{3}{4}$ " x 2" and window dimensions of $1\frac{3}{8}$ " x 3". These cores are split through the middle, windings may be made on a form

and then assembled on the core. After assembly, the core is strapped with a steel strapping machine such as is used in many packaging operations and which should be available in almost every community. If a strapping machine is not available, it is a simple matter to make a strap of sheet metal, rivet angles to each end, and then bolt it together.

Having determined the core size, the number of primary turns were calculated, using a flux density of 94,000 lines per square inch and a space factor of 95% as specified by the core manufacturer. A greater flux density was used here to improve the regulation. Actually, the flux density could have been as high as 110,000 without danger of saturation. With a line voltage of 120, the primary should have 320 turns. Using the direct ratio in (3), the number of secondary turns was then found to be 26 turns.

The proper size of wire in power transformers is usually determined by using cross sectional areas of between 700 and 1,000 circular mills per amp. Since slightly over .5 ampere will be flowing in the primary, #20 wire was used. In the secondary, a #14 single glass covered formex wire was used. The heavier insulation was used to avoid the necessity of using fish paper between the layers of the winding, thereby decreasing the buildup and adding to the ease of winding. A double cotton covered enamel wire would probably do the job as well. Since 26 turns of #14 amounts to somewhat more than 30 feet of wire, a resistance drop must be allowed for and assuming regulation to be approximately 90%, the number of secondary turns was finally set at 28.

Construction

After collecting the materials, two wooden forms were fabricated for the primary and secondary. The primary form was made to the exact cross section of the core and the length of the winding was made 2". We secured a piece of 1/16" "Spauldite" laminated phenolic material and formed it to the primary form allowing 1/32" for the strap. Heavy fish

Completed transformer before application of varnish. The secondary is tied to the fibre tubing to prevent movement. Note isolation of the center tap (black insulation) from other turns by fish paper.

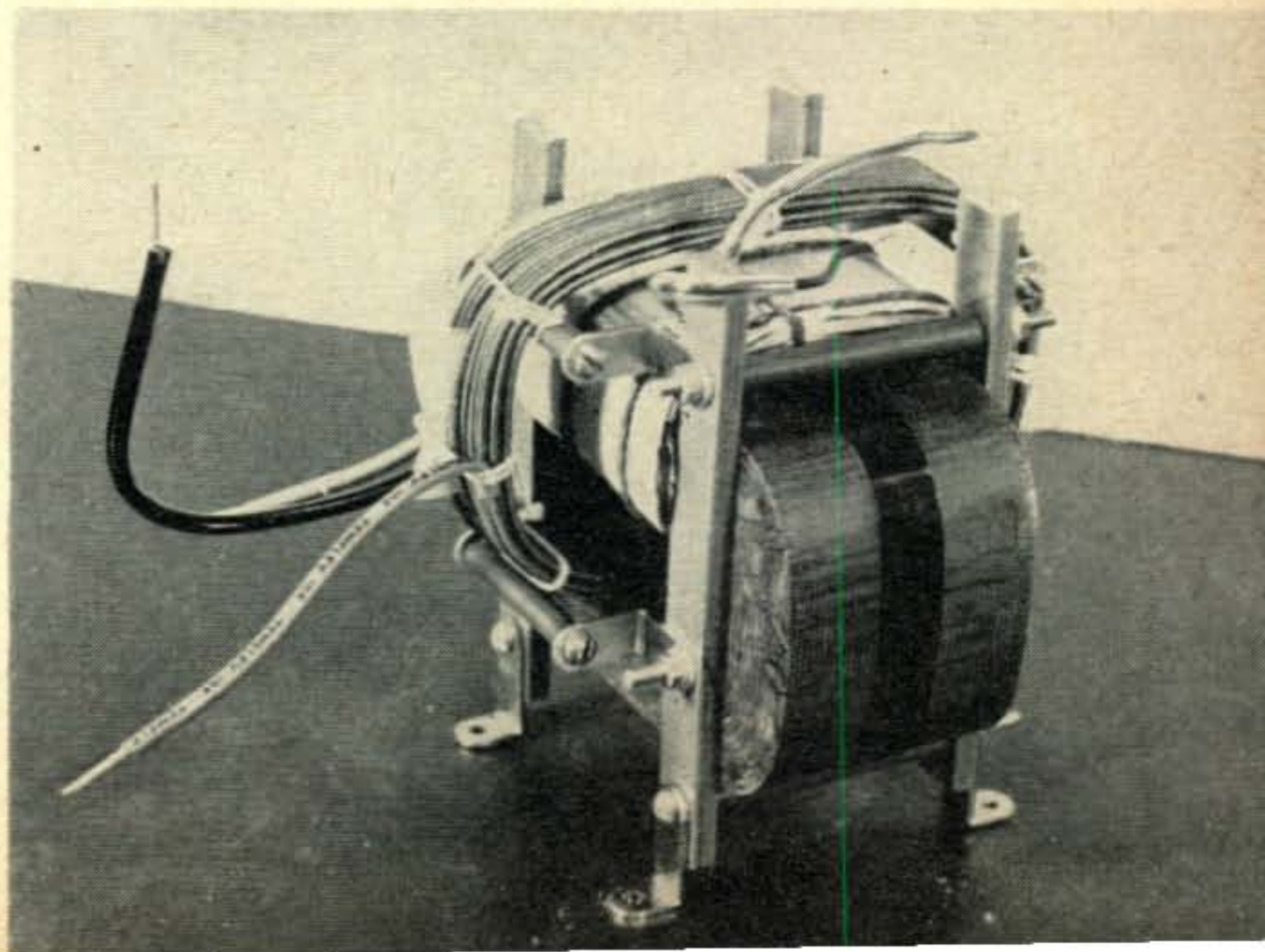

paper or fibre can also be used for this tube but provision for the strap and easy removal of the winding must be made. The phenolic material was chosen because it forms easily with the application of heat and resists deformation when the winding is done. A $\frac{1}{4}$ " threaded rod was passed through and bolted to the form, then passed through a piece of 2 x 4 clamped in a vise, and the form was then turned with a wood brace. Between each primary layer a piece of .005" fish paper was laid.

After running a few capacity calculations, it was decided to space the secondary $\frac{1}{2}$ " from the primary. If the width of the winding is 1", the capacity should then be somewhere in the neighborhood of 10 $\mu\mu\text{fd}$. The inside dimensions of the secondary, allowing for primary buildup, should be $2\frac{1}{2}$ " x 4". The secondary form was made of a block $2\frac{1}{2}$ " x 4" x 3" and the corners rounded to a $\frac{3}{4}$ " radius. The secondary was tapped at 14 turns.

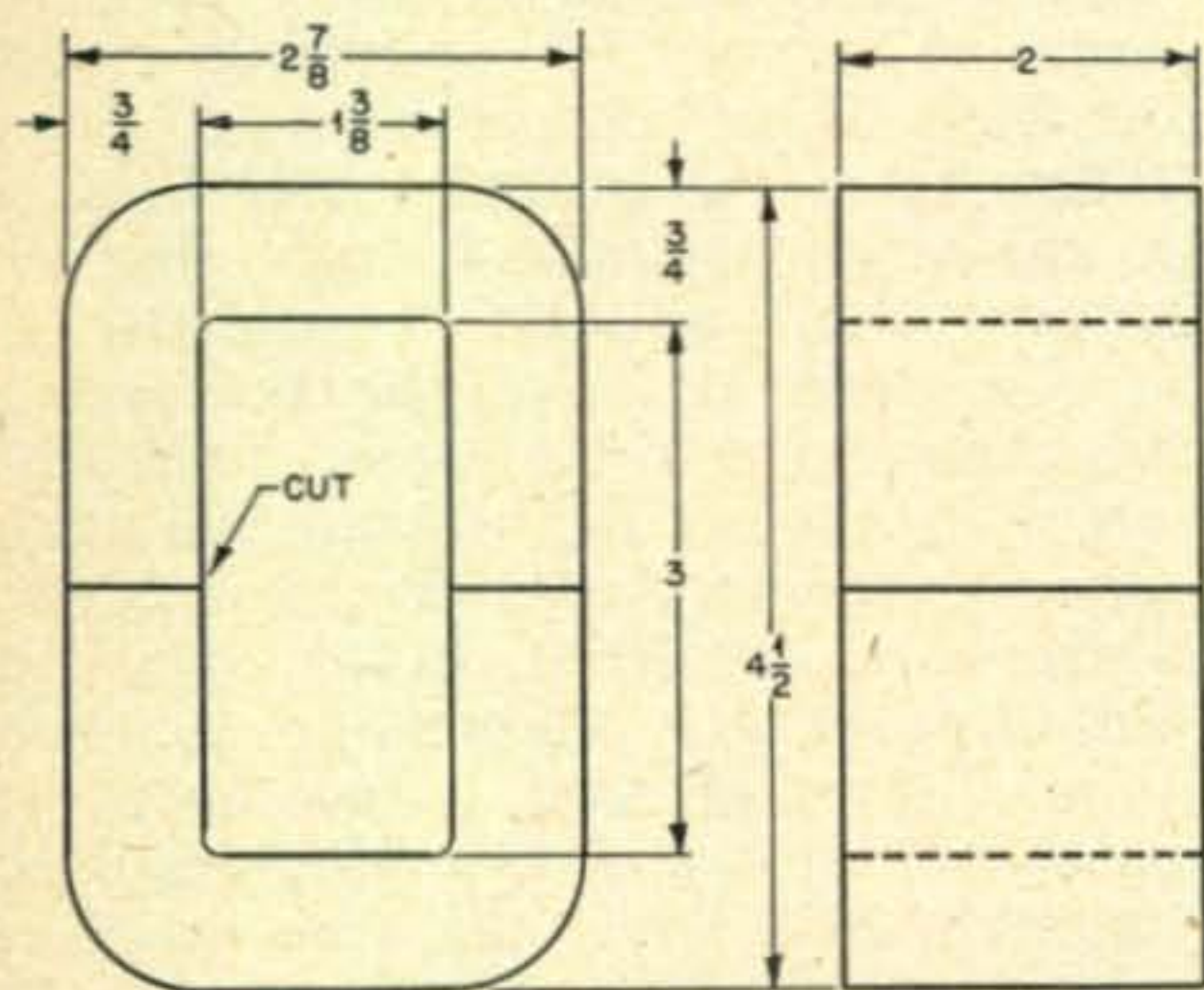

Siler AA-19 Core used in building low Capacity transformer

After assembling the windings on the core, four pieces of laminated phenolic material $\frac{1}{2}$ " x $\frac{3}{16}$ " were cut 5" long, drilled and bolted together through the core with $\frac{3}{16}$ " brass rod. No drilling should be done on the core itself. Angles were used for feet and for holding the $\frac{1}{4}$ " fibre tubes which support the secondary as shown in the illustration. It is better to use short screws threaded into the fibre rods instead of long screws or rods since heating will occur in every piece of steel in the magnetic field. Both the primary and secondary are tied with waxed twine to prevent displacement of turns during handling. After assembly, the entire unit was dipped in *Formvar* and baked at 275° for four hours. This will add strength to the secondary, make the whole unit stronger mechanically, and damp out 60-cycle hum. Shellac can be used in place of formvar with some sacrifice of mechanical strength. It is well to check voltage across the secondary and from each end of it to the center tap before finally wrapping it up to make certain no mistakes have been made in winding. The line voltage at this QTH is close to 120

so if yours is 115 or less, it might be necessary to refigure the number of turns in the windings.

Testing

Results obtained from the unit were as follows:

I _s	SECONDARY		
	E _s	EI	Regulation
0	10.8		
4.9	10.2	49.98	94.4%
9.3	9.5	88.35	88%

I _p	PRIMARY	
	E _p	Efficiency
0.49	121	84.3%
0.88	121	83%

After checking the unit out with one 813 on the line, the regulation looked so good it was thought that perhaps it had been overdesigned, so out of curiosity another 813 was added and the second group of figures was obtained. After running for over an hour under this load, the primary started to get hot and although the secondary probably would take this load because of the high quality formex and glass insulation, it is considered that eventual breakdown of the primary insulation might occur if the high temperature was sustained for any length of time. It is possible, however, that the windings can be redesigned, the flux density increased, and the same core might be used in a transformer designed to supply two tubes. The capacity was checked on a bridge and was found to be about 4 $\mu\mu\text{fd}$. This figure is lower than the design figure and the difference was attributed to the fact that the winding was slightly narrower than 1" and the spacing was increased since the primary buildup was a little less than anticipated.

After completion, the cost was figured and it came to slightly less than the cost of a conventional type filament transformer delivering the same power. Voltage breakdown is higher than we could possibly measure and the efficiency compares favorably with the advertised efficiency of low capacity transformers used for antenna lighting systems (89%). All in all the project is well worthwhile since only about two hours is required to put the whole thing together after all of the problems have been worked out.

Like everything else, if you want your cake you can't eat it and in this type of transformer the sacrifice is in its size. The unit takes up a space of $4\frac{1}{2}$ " x 5" x 5". This seems big and looks bigger, but when one considers that in a GG final there are no bias and screen supplies you are still ahead costwise and spacewise. ■

1. *Radiotron Designers Handbook*
 2. *Arnold Engineering Company*, 3450 Wilshire Boulevard, Los Angeles 5, California, and 350 Fifth Avenue, New York City, New York

Designed to help blind hams tune their rigs, here is an easy to build gadget that can be used by anyone to simplify transmitter tuneup.

R. W. Jones, W6EDG

735 Donax Ave.,
Palm City, California

An Audible Field Strength Meter

Blind hams have a handicap that few of us can appreciate: they can not read meters.

During a visit to the shack of KN6MTN I noticed that the tuning controls were taped down with Scotch tape. Phil told me that he asked friends to tune his transmitter and then taped the dials in position. It was not a good method, in my opinion, because of possible changes in loading with rain, vibration or other factors. Indeed, a quick check of tuning disclosed that his transmitter was not properly "dipped", and Phil had been operating with the transmitter functioning at much less than peak output.

Later I talked it over with W6OQY and we decided to build Phil some type of tuning instrument. A check through my old *CQ's* brought up an issue I remembered seeing several years ago, and I reread the article on W9WEU's "Oscar".¹

The "Oscar", however, was a milliammeter and I felt that Phil could do better with something that would give him an indication of maximum output—and permit him to tune both the transmitter and the antenna tuner. What was needed was a field strength meter that could be operated *sans video*.

We first thought of a conventional field strength meter with the glass removed from the meter so the operator could feel the needle, "reading" the values on raised marks similar to those on Phil's special wrist watch. Good idea?—well, the first model was a failure. I tried tuning my own transmitter while feeling the meter, with my eyes shut. I could feel the meter needle and I could tell how far up scale it moved, but it still didn't seem right. The instrument was too fragile, and it was hard to detect small changes in meter readings. It didn't seem to be the best approach, or even a good one.

One of Phil's remarks lead us into building the meter that really worked. He simply mentioned that he could hear tires singing on pavement before he could hear the engine of an approaching automobile. We wanted some type of audio unit.

The Circuit

The final design is shown in *Fig. 1*. A small neon bulb relaxation oscillator supplies an audio tone to the headphones. The tone is the indicating medium: A dip in the tone's frequency indicates some r.f. has been picked up and rectified by the instrument. The greater the amount of r.f., the lower the tone. The r.f. for the tuned circuit of *L* and *C1* is picked up with a small antenna and coupled to the tuned circuit through capacitor *C3*.



Philip Leonard, KN6MTN, tunes his field strength meter to resonance.

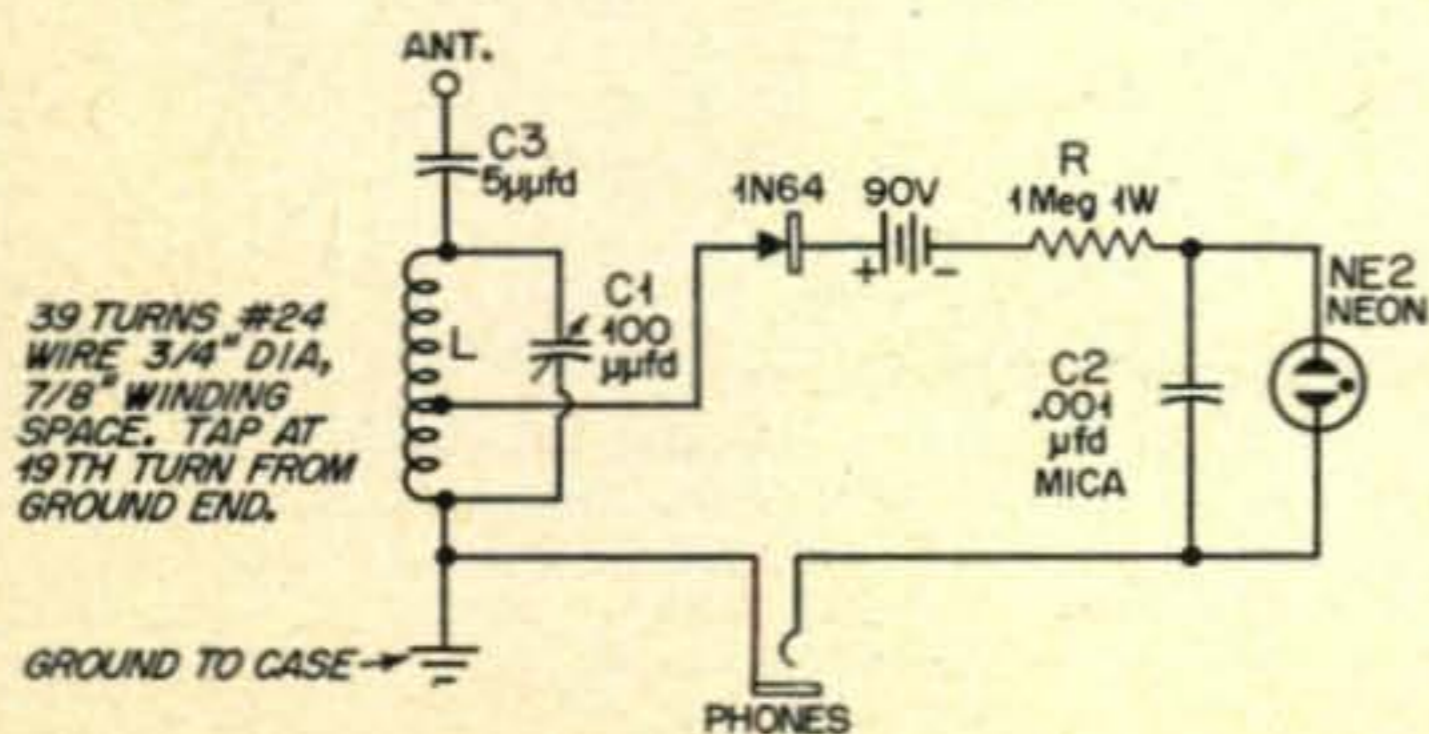

Schematic for the "blind" FS Meter

The return circuit for the relaxation oscillator is back through the crystal diode and through half the tuned circuit. This is one case where a crystal diode does a job that a vacuum tube could not do. The back resistance of a crystal diode is not infinitely high as in a good vacuum tube, and that back resistance (measured at 65,000 ohms in this 1N64) allowed the current to flow and make this little gem possible. The forward resistance of the diode was measured at 50 ohms.

1. *CQ*, July 1948, Page 22: *Oscar*, A Milliammeter for the Sightless Amateur, by H. S. Brier W9EGQ and V. O. Christian W9WEU



FS Meter, cover removed

The basic circuit is simple: a relaxation oscillator operating from the B battery with the crystal diode rectifying r.f. from the tuned circuit and applying a d.c. bucking voltage in series with the relaxation oscillator. The stronger the signal picked up by the field strength meter's antenna, the greater the bucking voltage and the lower the tone. The circuit was tried with aiding voltages, giving a rise in the audio tone when a signal was tuned in, but my ear—and Phil's too—seemed to respond better to a decrease or dip in the tone.

In practical use the signal is first tuned in on the field-strength meter. There will be a sharp dip in the audio tone's frequency as *C1* is tuned through resonance. With *C1* left tuned to resonance, the transmitter controls are ad-

justed for lowest tone in the phones. The instrument is very sensitive and will allow critical adjustment of the transmitter's output stage and antenna tuning network.

This model tunes only 40 and 80 Meters. A band-switching model could easily be built, and one will be built here when Phil graduates from the Novice ranks and wants to work other bands.

Pickup Antenna

The gadget must have a pickup antenna. KN6MTN uses a fifteen foot piece of wire around the molding of the room. Too much antenna will cause the relaxation oscillator to stop due to excessive bucking voltage. Too little antenna will result in not enough change in the indicating tone. The pickup antenna must be adjusted to suit the field strength of the transmitter. It should be in the field of the transmitting antenna and removed from r.f. fields present in the transmitter.

I believe this type instrument could be used on a multi-stage set up. If the blind operator has all the settings for each band for a transmitter such as a *Ranger* or a *DX-100*, then uses this device to peak each of the controls while listening to the output, he could easily tune such a transmitter. Another possibility would be to install output jacks connected to small probes near each stage's tuned circuit. This would enable the operator to plug into the transmitter stages progressively and tune each to resonance, and—if necessary—choose the proper doubling frequency. For such use a band-switching field strength meter could be built with raised marking for each band.

This unit, used in conjunction with W9WEU's audio milliammeter, could give the blind ham almost complete tuning facilities. Including that very important check on the amount of radiated output. ■

Hammarlund HQ-140-XA

"Now, that's the good old HQ-140-X. What's it doing there?" Look closely and you'll find that this improved model of the 140 is designated the HQ-140-XA. A tough receiver to improve on, but Hammarlund claims they strained to the utmost and came up with a few refinements which will make it worth your while to hie thee on down to the local Electron-Handlers Shoppe for a closer examination. The XA is highly sensitive and has a ruggedized but smooth-operating tuning dial which permits extremely accurate logging. But don't let all this produce a sensation of uneasiness in the region of your negotiable assets. The HQ-140-XA, "Although incorporating extremely marked advances" over the 140-X, can still be bought for money. Why not get the dope from Hammarlund Mfg. Co., 460 West 34 St., New York, N. Y.



New National Dial Illuminator

Recognize this? It's the backside of the famous National Type MCN Dial, with something added: a slick little dial lamp that rides along with the dial pointer, just behind the translucent dial. Dubbed the "Blue Chip" (don't ask me why) Dial Illuminator Kit, this bit of hardware comes complete with a #51 panel light for 6-volt operation, hooks up in instants (of course, if you want it to show through the other side, you'll have to make a 2" x 3½" rectangular cut-out in the panel behind the dial face). You'll want to leave the overhead lights off in your shack, just to show off this *chic* accoutrement. Probably pay for itself in the first month, n'est ce pas? Made by National Co., Inc., 61 Sherman St., Malden 48, Mass.



Expedition To Whiteface

Helen Harris, WIHOY

P.O. Box 2502, Medfield, Mass.

An expedition had been planned. (These words should go on my gravestone as an epitaph.) This time we made a few preparations in advance by writing the Chamber of Commerce in Saranac Lake, New York, and asking which was the highest peak of the Adirondack range and whether we might obtain permission to set up our radio gear at that point. By return mail we received the information that Mt. Marcy was the highest peak, but they didn't think we would wish to use that spot as we would have to carry all of our radio gear on our backs over a very narrow and dangerous trail for a distance of something over a mile. They suggested that we might like to use the top of Mt. Whiteface which had a road to the peak and thus would be much better for setting up our gear.

After exchanging endless letters, we finally received a telegram giving us full permission to use the Mt. Whiteface peak and telling us with whom to get in touch when we arrived in the city of Saranac Lake. We were all packed ready to leave and were just waiting for the final word. We had figured on leaving the following morning at crack of dawn, however, by crack of dawn we were practically at our destination. As usual the O.M. just couldn't hold out until daylight, so at midnight I roused the children from their beds, packed them together with their blankets in the car, picked up the dog and away we went.

We were no more than fifteen miles from home when we got a flat tire on the trailer that was carrying the radio gear. Sam changed the tire in the dark and from then on we had our fingers crossed 'cause that wasn't the tire we had expected to go.

With two hungry kids, two greedy adults and a dog who ate everything in sight we decided that if we wanted to get anywhere and home again we'd have to economize while on the trip. We did our own cooking. (We still can't look Cheerios and frankfurters in the face.)

When we arrived in Saranac Lake we went to the Chamber of Commerce. The pair of gentlemen waiting to greet us gave one look and weren't so sure that they wanted us on their mountain-top. However, since the children looked well-fed and the dog didn't look



abused they probably decided we couldn't be quite as tough as we looked. We were given a letter of introduction to the ranger who was stationed at the fire tower on the mountain, directions on how to get there and a key to the toll-gate at the foot of the mountain.

We had just reached the camping grounds and were wrestling with the tent (borrowed), when a gentleman in uniform came over and lent us a hand in setting up the camping equipment. He introduced himself as Hiram Denton, a Forest Ranger. I have never met such accommodating people as the Rangers. We've met them on several occasions and they always put themselves out considerably to help.

Hi, as we were soon calling him, took the children under his wing and explained to them about camping in the mountains. He promised that he would take them to his lean-to up the mountain and show them some of the wild animals that came to visit him. He insisted on going up the mountain with us that same day to point out different views from the top and help Sam set up his equipment. To our great joy, he suggested that Sam use the fire-tower and the power-lines which were running to the tower. This idea saved lots of work and the noise of the generator.

After the gear had been set in place Hi suggested that he show us his lean-to which

[Continued on page 92]

Yasme -

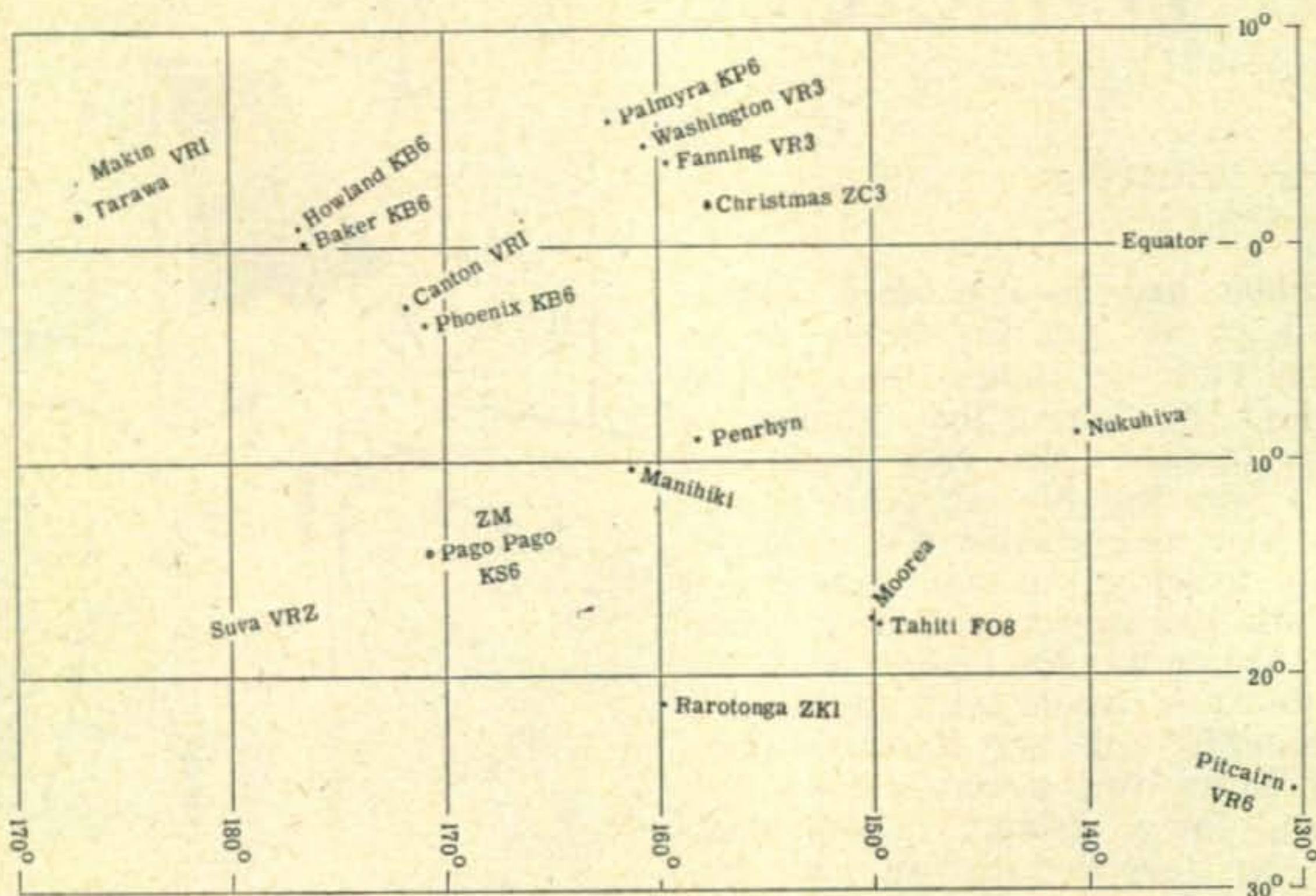

- Tahiti to Canton Island

All good things in life somehow come to an end. So there I was preparing to leave Tahiti after one of the most enjoyable stays of my whole trip.

Most of you know what it's like to leave true friends behind. In my short stay I had made many, and leaving them is one of the unhappy things that I have to contend with on a voyage such as mine. I must admit that it is always the departure from a place where I have been made welcome and given every opportunity to have a good time that is the toughest part.

The hazards of the sea are many, and can inevitably be handled either by brains or brawn; parting is a trouble of the heart. Oh, let's not get all sentimental, I ain't built that way.

Needless to say, all the assistance I required to put the Yasme in trim was readily volunteered by my many friends. During the last week prior to departure, the Yasme was a hive of activity whilst everyone did what they could to assist in those many tiny jobs that take so much time. I will not discuss the thousands of odd jobs that are essential to fit a small boat in readiness for sea, but one needs every bit of assistance that can be obtained, and here that presented no problem.

Numerous invitations came for last suppers and dinners, etc., but time was moving along too fast to accept them all. Finally I went to my old friends' place out in the country for a real Tahitian dinner with dancing and singing afterwards for some hours. Food and wine were there in plenty, but 'though I took my fill of the grub, I had learned my lesson regarding the Tahitian beer, and I left it strictly alone . . . having no intention of finding myself with a hangover the following morning. The party packed in around midnight, mainly at my request, and I wended my way back to the old Yasme for my last night aboard in Papeete.

At 0700 local time around twenty of my friends arrived laden with bananas, grapefruit, pineapples and other local fruits. I feel very sure I had sufficient fruit there to supply a crew of ten men, still with a surplus. Where to stow it all was quite a problem, but finally it got piled in the main saloon, all over the floor and on the bunks, to be moved later. Where, I just didn't know or care about at the moment . . . It became impossible to move in that cabin, but since all the work was on deck, no inconvenience was caused.

Hauling Anchor

Hauling up the anchor was quite a problem, though manpower was available in plenty. One doesn't haul up sixty fathoms of chain and a heavy anchor that has been embedded in coral and mud for three months without some sort of bother. These Tahitian lads are pretty tough, but it took us all of an hour to get that chain and anchor aboard. It was a real mess, having developed a variety of marine life on its entire length, and Oh brother did it hum. There was no time to clean it and remove all the seaweed, so it had to be stowed in the chain locker as it was, and it was well over two weeks before the smell finally subsided sufficiently for me to go into the cabin without almost passing out.

Somehow or another, departure time was delayed owing to the usual unforeseen circumstances, and I decided to wait till after lunch time to buzz off. This decision was favorable to everyone there, so we all tramped off in a large bunch to the local cafe for chow. Back to the boat, and by this time, the crowd had materially increased, everyone came up putting garlands of flowers around my neck and crowns of flowers on my head until I looked like a walking flower show. With the arrival of others came more gifts of fruit until the decks of the Yasme were covered. I could hardly walk from one end of the deck to the other without

falling over a stem of bananas. Everyone was talking at once in Tahitian and trying to move around on the Yasme, so you have a good idea of the chaos aboard.

Time was passing so I cast off the lines holding Yasme to another yacht, and with my crowd of friends aboard I cruised around in tight circles until, out of the distance, the pilot boat came steaming up with my good friend the Port Captain aboard.

No Dry Eyes

Well, this was it . . . all my friends very reluctantly clambored aboard the pilot boat, and there was I standing despondently in the cockpit. There wasn't a dry eye among us, and that means me too. Then, very slowly, the pilot boat pulled ahead and guided me through the pass of Papeete, and, the old Yasme chugged along feeling, I am very sure, as unhappy as I. We passed through that reef infested water out into the open sea . . . whether to return or not, who knows?

My garlands I threw over the side in the custom of the Island, but whether they floated back to shore again to signify my return I shall never know. In my heart I know I will return again some day.

Once clear of all dangers and with ample sea room, up went my very poor excuses for sails. For three weeks prior to departure I had

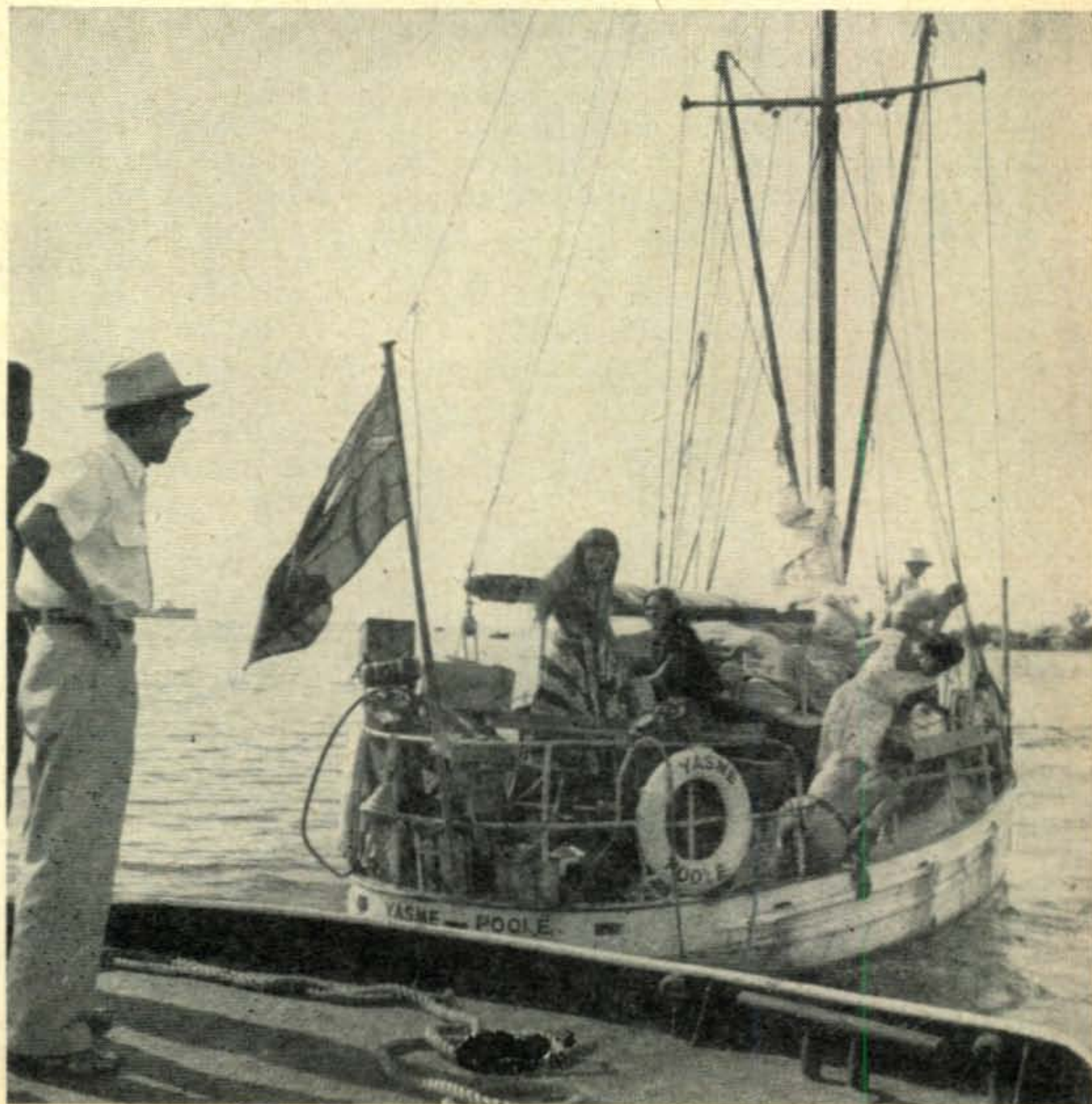

Final inspection of the Yasme before departure from Tahiti

worked solidly on them to make them look like sails, but as I hoisted #1 jib it ripped right across, even though the breeze was light. The mainsail managed to creep its forlorn way up the mast until it reached the top, and although it got there without incident, I could see that given the slightest provocation, it would collapse. The thing was to prevent its flapping too much. I knew whilst the wind remained steady it would hold out and at that time the wind, what there was of it, was steady. But there was a bad swell on, the aftermath of a recent cyclone in the Fiji area.

Swell Time to Go

Hardly a day to start a voyage. Quite frankly, I should have known better than to leave directly after a cyclone . . . there is always a lack of wind, and also a big swell, but then I wasn't to know that when I had originally planned my date of departure . . . I was to regret later my decision to leave on sked. There we were, the Yasme and I, on our way with plenty of pleasant memories of the past, nevertheless in a crestfallen mood.

Trimming the sails to get the Yasme to sail herself is always a lousy job at the start of a voyage and it invariably takes a couple of hours to get her balanced just right. This just wasn't my day. I tried everything I knew, but the wind fluctuated so much she just wouldn't stay on course more than a few minutes at a time. Finally the wind gave up the ghost altogether and we were without anything to steady us. This set us into a 45° roll, which threw the fruit in the cabin all over the place, and tossed innumerable bits of gear around the ship into inaccessible places, not to be found again for many moons . . . good job I had my wooden leg screwed on and glass eye in place at the time.

I finally stuck the iron horse on . . . engine, to you, and soon we were chuffing along on the usual three cylinders . . . three bangs and a

pop; around three knots; hardly pleasant, but at least it cut down that roll and moved us along in the right direction.

Nightfall came. There was a deathly silence except for the infernal clatter from the engine, and astern, in the distance, the lights of Papeete shone out as though to give me a last farewell. The sky was brilliant with the myriads of stars and the moon, just risen, made a silvery glow over the whole sea . . . all I needed was a breeze, and then we should have perfect sailing conditions . . . but that wasn't to be. Sleep and I didn't keep company that night. My initiation back to the ocean, the awful smell from the rotten seaweed on the anchor chain, the heat from the engine and my utter misery at leaving my friends were hardly conducive to sleep, so I just sat there in the cockpit with the tiller in my hand, being sprayed with an oily mist from the exhaust of Yasme.

I kept looking astern, even though I realized it was only making me feel more despondent. The urge was strong and it was a very unhappy Danny that sat there around midnight with his thoughts, gazing at the very faint outline of that wonderful fantastic place Tahiti with all of its charm and gayety. How I wished at that time the mast would snap or something would happen to necessitate my return, but no, apart from the lack of wind, everything went fine, and I could find no logical excuse to return.

That night nothing was done at all barring steering the boat. No skeds, no cooking, in fact, no nothing, and I think you can all understand why.

Daybreak brought a slight breeze, and also a hunger too, but first, get the . . . I nearly called them sails . . . up. This time they actually went up without ripping, and with the engine now silent we cruised along at a steady four knots. We were in silence except for that eternal swish of the bow wave and the faint hum of the propeller freewheeling.

To prepare food in the cabin was out of the question due to the awful stench, so I tore into the load of fruit and drank dozens of cups of coffee to brighten up the old head. Checked sked book, but nothing until 0230 GMT with Dick KV4AA, then Joe FO8AB, Jock ZL2GX, and finally Wowie KB6BA on Canton Island. It was a long time for me to wait to pour out my troubles and cry on someone's shoulder. There was no point in firing up the rig as the band was dead. So I just sat there doing nothing and making myself feel worse than ever . . . how can a guy get like that? Oh well, I realized that it would all wear off in the end, but it was hell waiting for that time to elapse and the weather conditions did not give me any opportunity to do anything else except just sit and think of Tahiti . . . in any case, it made me feel better to feel miserable, so what the heck.

I made some semblance of order in the cabin. In other words I picked up everything



Danny manages a wan smile before tearing himself away from Tahiti



that happened to be in the way and slung it into a heap on one side of the cabin, thereby leaving one side clear and the other a mixture of fruit, books, radio gear, clothing, and a load of wire that had come unwound from its coil. A tangled mess, but I couldn't have cared less.

Getting back to sea routine again presented no problem and the entire crew remained free from seasickness, regardless of the aroma below and the rolling of the boat . . . all we had to do now was to get the old brain clear and endeavor to forget the past. At long last it was time to fire up the rig and sked Dick. Oh boy! someone to talk to, even though it was only cw . . . that rig certainly takes the solitude out of this deal.

Skeds

The *Onan* started without a protest, and right on time Dick came blasting through on frequency with his Viking KW. Just to hear his signal with that certain touch that no other ham seems to possess pushed up my morale 100%. All my troubles seemed to disappear in a few seconds. I think Dick must have known how I felt, as he broke one of his hard and fast rules and came on fone for me. Perhaps you don't realize what it's like to hear a friend's voice under my circumstances, but I can assure you, it was worth a million bucks. That QSO was the beginning of the end of my gloom period, and shortly afterwards the wind came up, the sails stopped ripping, and even the seaweed stopped making the boat smell like a garbage heap. The *Yasme* seemed to cheer up too, and before very long I started singing, which although it makes me feel good, certainly annoys the birds and keeps the sharks at a respectable distance. Whilst in this mood I got the whole

stack of grub organized, then sat back and waited for my next sked to turn up with Joe. Late as usual . . . Tahitian style, Joe came on, off frequency too, but he was there . . . good old Joe, one of my best friends. When it came my turn to return to his report, my throat became paralyzed, a lump seemed to be blocking my voice altogether, and when he told me my girl friend was there in the shack it was quite a few minutes before I could get out what I wanted to say.

Darn it all, as much as I got a kick out of hearing their voices, it knocked me right back into the depths of despondency again. It was sure good to hear those voices again and I wouldn't have exchanged that QSO for anything in the world. Joe's final or *bon soir* and *bon voyage* and the promise to QSO again later put me back on top of the world and then I just sat back and waited for Jock to come on.

Right on frequency he was with a 15 db over 9 signal as per usual. His cheery voice, which is known to so many of you, also helped to kill the gloom. What a variety of sensations I was experiencing that day. To hear his infectious laugh, his always cheerful voice, and that typical "By Golly" expression; how could anyone remain unhappy? Very soon I was laughing with him, I must admit he certainly knows how to bring a body out of the depths of despair . . . how I enjoy my QSO's with Jock.

Straight after Jock's final, Howie came through on CW from Canton Island. Conditions being OK, we went on fone, but oh the QRM! I must have knocked years out of his VFO in getting him to shift frequency every few minutes.

These four skeds were kept every day, and while I would have loved to continue transmitting all the time, as I did in the crossing

from Panama, my gas was strictly limited, and weather conditions were hardly suitable to spending hours on the rig.

Becalmed

Two days out and Moorea still in sight! The wind, which up to now had been variable, dropped altogether and there we were, stationary, with hardly a ripple on the water. It seemed sacrilege to destroy the complete silence and gentle sway of the Yasme with the clatter and heat of the engine, but hanging around in that spot wasn't getting us anywhere. All the time there was a terrific westerly set of the current pushing me off course, so I had no alternative but to start up the engine again.

That calm seemed to last for ever . . . never a semblance of a breeze, and that poor little engine ran continuously for four days, gradually getting hotter and hotter, and running increasingly more erratic. I didn't dare stop it, even to top up with oil, as I knew it would never start again. We had left Tahiti with only three cylinders operating and as time went on it was barely firing on one, but still using the same amount of gas as for four. My gas supply was getting dangerously low, and what with the engine in that state and no wind, you will have some idea of the spot I was in.

I began to wonder whether it would be better to return to Tahiti for more gas or carry on in the hope that some wind would ultimately rise.

On sked that day with Dick I discussed the whole thing, but no solution was arrived at. Later, when I had sked with Jock, ZK1BS broke in and informed me that he had heard of my difficulty and that the local government in Rarotonga had arranged right away to have a drum of gas shipped from Manihiki to Penrhyn atoll, which was around the half way mark for me. This news cheered me considerably. Later, Joe told me that there was no more gas available in Tahiti. I had by that time reached the point where, to return to Tahiti would have been just as difficult as going ahead to Canton.

Now before we go any further I want all you landlubbers to understand the general situation: There was a strong current setting the Yasme to the West at a rate of about 25 miles per day. Without wind or engine Canton Island would be impossible to reach, so it wasn't a question of just stooing around the joint amusing the sharks and sunbathing until a wind came up. I had to keep moving else Canton Island wouldn't be seeing me that year.

Now Penrhyn Island was considerably north of my actual course, and as time went by I realized that, even knowing the gas was there, with the tiny amount of power I had available and no wind, it would be impossible to make. A QSO with ZK1BS informed me that the gas had originally been at Manihiki, which was right smack on my course, and had been taken

from there to Penrhyn since they thought I was going to call there. Now there wasn't *any* gas left at Manihiki, what a joke!

Yes, it was a great big joke, but I wasn't laughing. I checked on my gas supply and found I could cover around 400 miles with the engine running at its normal efficiency . . . that is, on three cylinders with the fourth piston being pushed along by the others.

I realized then there was but one alternative: to strip the engine down completely and do my best to get it running better. Many of you fellows sitting back in your overstuffed armchairs with a miniature workshop in the garage and every facility available when you turn around may say, "Why, that's no problem" . . . but you just don't *know*. You haven't seen the installation of Yasme's engine, which although nicely situated for normal maintenance and minor repairs (if you don't mind getting your arm burnt now and again) is far from being nicely organized for the major work which I was contemplating.

Engineering Officer

Now I won't go into all the gory details such as barked knuckles, odd fingers lost here and there, etc. Removing the cylinder head without damaging the gasket, getting valve springs compressed without a special tool to do the job in a boiling hot cabin with the ship rolling

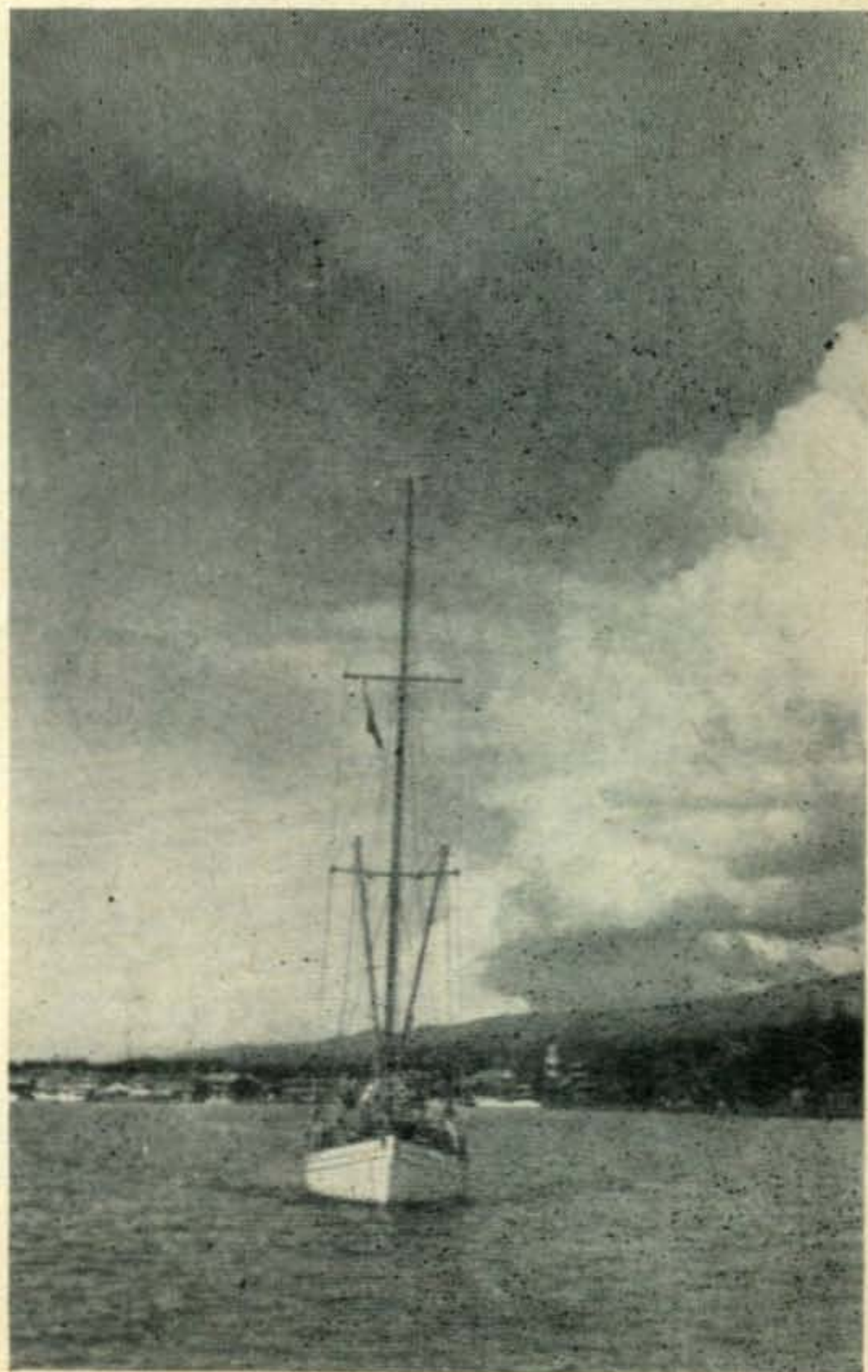



all over the show was far from being a simple matter. Every time I put a spanner, an engine part or a nut down, although it would only be left for a couple of seconds, you could bet your bottom dollar that when I went to pick it up, there it was . . . *gone*. In one particular instance which is still vivid in my mind, a special nut dropped into the bilge. This meant lying full length in the saloon, getting my arm worked in between water pipes, wiring and many projecting parts of the engine to reach that hole called the bilge. This struggle took maybe 15 minutes, and my arm seemed to lose itself in the maze of pipes and what have you. Finally, my hand reached a soft greasy mess . . . I'd struck oil . . . that meant I had now found the surface of the bilge water. Now to get to the bottom of it. With my arm stretched to its fullest extent I still had a long way to go. Somehow or another I managed to squeeze my shoulder down into the hole and fumble around in this glutinous mess. I encountered something else. Wondering what I had discovered I slid my shoulder and arm out gingerly, ripping off about three layers of skin, and found a spoon I had lost about a month ago.

Well, after counting ten, I made the big dive again. It was a little easier this time since the entire upper portion of my body had a layer of black oil on it and my arm sort of oozed around all the corners. In my travels around the bilge I discovered three pencils, one eraser, a fork, a comb without any teeth, one fish hook, a very defunct spud, but *no nut*.

By this time, my temper was getting just a little frayed. I considered removing the entire engine to find the nut, but after considering a little further thought that maybe it would be

easier to look in the junk box for another. Naturally I found every type of nut, bolt, and washer except the right one. Finally I decided that when the time came to replace the nut I would just ignore the fact that it was missing. Perhaps the engine would go better, who knows.

By then every possible part of the galley, cockpit and myself, had become coated with this black gooey substance. It didn't look too good, but then it's good for the wood and will keep the termites out . . . it's nice to think that, but underneath those thoughts were others which told me that the whole darn mess had to be cleaned up.

Time was creeping on. I had started this project around 6 a.m., and with the arrival of dusk I was working in semi darkness (the batteries were down). That didn't really matter since I didn't know what the heck I was doing. If a piston happened to get put in upside down the engine would run backwards . . . maybe, and I could just turn the boat around and we could go . . . coming, if you get what I mean.

Later, much later

Well, to make a long story longer, I did by sheer luck finally get the engine together around three the following morning. Apart from a big end bearing and two piston rings I had nothing left over and the engine looked exactly the same as when I'd started. I couldn't find where to put bearing and piston rings, so, since I had noticed earlier that there was quite a lot of space under the inspection cover of the gear box I unscrewed that and dropped the odd pieces inside . . . out of sight, out of mind.

Now, the big moment had arrived. Everything seemed OK so I took a deep breath and pressed the starter button. I pressed the button again, and kept on pressing until I nearly pushed the button through the panel. Apart from a dismal moan from the starter and a horrible death rattle from the solenoid there was not a bleat from the engine. It then penetrated this befuddled brain of mine that maybe the batteries were too weak to push the engine over. Considering the amount of power the engine gave me an ordinary flashlight battery should have spun the starter like a top, but there I was, with a completely assembled engine just bursting to send its deep throated roar into the silence of the night, and not a whistle in the batteries.

This famous engine of mine cannot be hand started like a normal one, so that meant I would have to charge the batteries from the auxiliary charging plant. I have had this plant ever since it graduated from being a motorcycle engine and a car generator and it has always started without a murmur. This time it joined the general engine strike and although I pulled that starter cord until I wore out my arm, it just wouldn't have it. On one pull the

[Continued on page 98]



South Sandwich Islands

Jose M. Ahumada, LU8CW

P. O. Box 3347
Buenos Aires, Argentina

In the interests of DX'ing the *Radio Club Argentino* gets together a DXpedition every year to visit one of the Argentine zones in Antarctica. These trips furnish information for people who might plan to stay all year round in these remote spots, and provide useful data on propagation conditions from these areas and the ability of radio equipment to stand up under difficult conditions.

Since there was already some permanent radio operation from the Antarctic continent, South Shetland and the South Orkneys, it was decided to put the South Sandwich Islands on the radio map for the first time. Questions arose as to landing on the islands since they have seldom been visited by anyone, reportedly being surrounded by rocks and thus almost inaccessible. All these worries were dispelled, plus the problem of how to finance such a journey, by the Argentine Navy.

On November 23rd, 1955 we sailed on board the icebreaker ARA San Martin. We stopped off at Antarctica, the South Shetland

and South Orkney Islands and made a few contacts from each of these stops. Finally we arrived at the South Sandwiches.

We got the radio equipment, fuel and supplies ashore in a small boat, just narrowly missing several jagged rocks in the plunging surf. The South Sandwiches now had a population of three, all hams, no doubt the highest concentration of hams ever to constitute the population of an entire country. The three of us were Lt. Dick Hermelo LU4ZY, Mike Villafane LU3ZY, and myself LU2ZY (each of us had our own private call area).

The ice breaker left for other duties as we set up our radio equipment. Before long we were on the air and had contacted ZP5AY, LU9AX, LU9DBI, CE3BM, CE3LN, LU4DMG, LU9AAX, CE3JJ, LU4BW, ZS1BK, ZS2ND, W1FH, ZS6AJW, and CX2CO. We set up the tents, got out the sleeping bags (goose feathers), and made ready to take down meteorological data. We worked in shifts, exploring the island, observing the animals and birds who make their home there, and making as many contacts as possible.

Our precise location was latitude 59° 27' south and longitude 27° 16' west on Thule Island, the most southerly of the group. The island was roughly pear shaped with a plateau about one half mile by one mile at the point. We set up our camp on this plateau. Behind us was a mile-high mountain with an enormous



ARGENTINE ANTARTIC ZONE
First Dx Expedition to
SOUTH SANDWICH **LU2ZY**
Thule Isl - Lg: 27° 16' W - Lt: 59° 27' S

To WZNSD
Ur RS _____
On _____ Mc _____
The _____ 195 _____
At _____ LUtime _____
Best 73 & Dx _____
Joe
J. M. AHUMADA - P. O. Box 3347 - BUENOS AIRES

DX Expedition:

LU2ZY

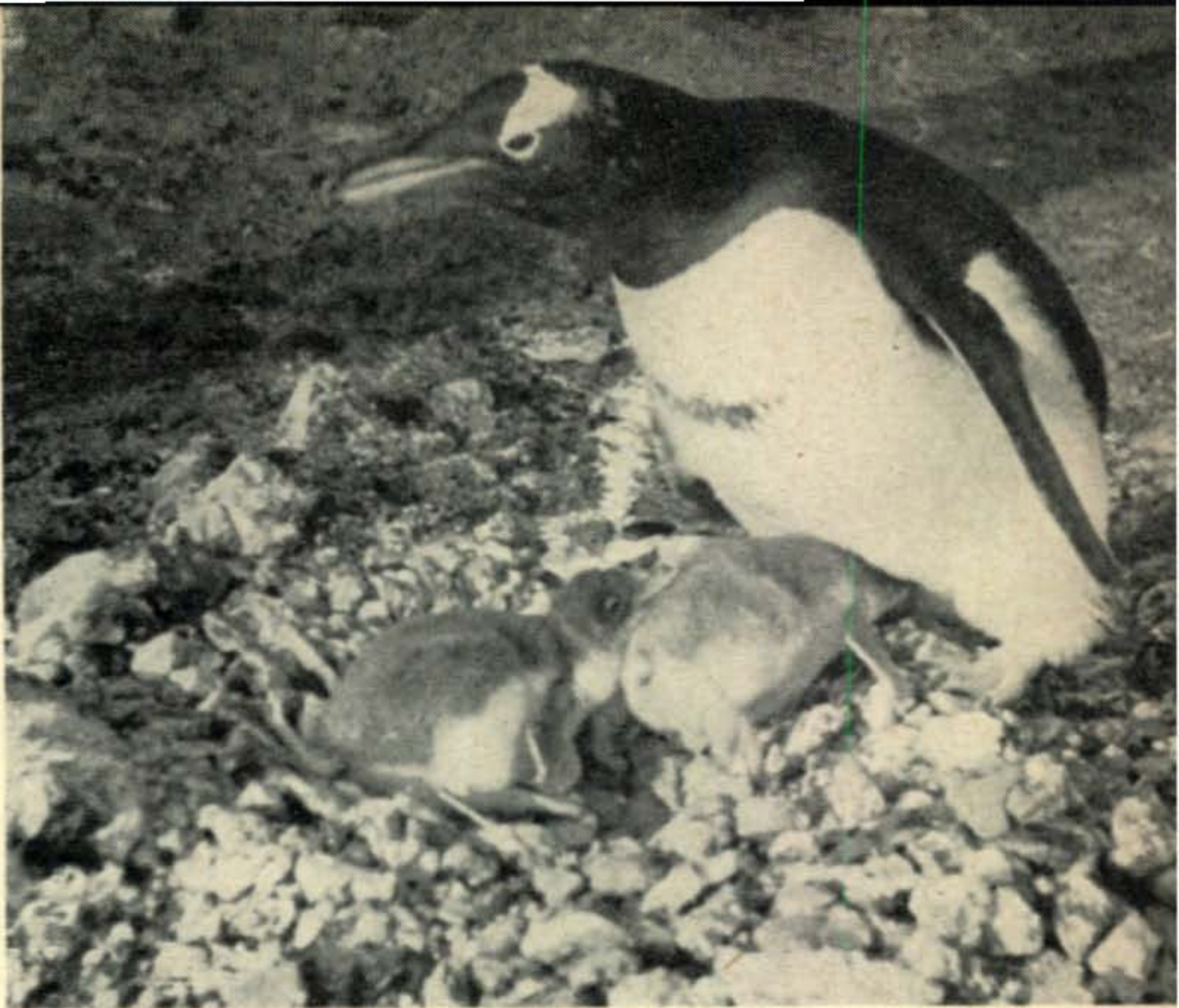

glacier which emitted grumbling noises continuously as it slowly melted in this thawing season. The cold was intense, but it was the wind that was the real villain and quite a danger to the antennas. Gusts of over 110 mph were measured. While in QSO with PY2CK our tents blew away and left us with one provision hut for our beds, kitchen and radio shack.

Our equipment consisted of a Collins 75A2 and 32V2 plus an SX71. We used a beam for 20 Meters and a long wire for the other bands. All told we made 1664 QSO's, with 45 being on 40 Meters, 1455 on 20, 90 on 15, and 74 on 10 Meters. Ten and Fifteen were very erratic and the only dependable band turned out to be Twenty Meters. Few South Pacific and European stations were heard, but America and Africa came in well. Perhaps you would be interested in a few more statistics:

First stations on each continent: W1FH, ZP5AY, VS6CG, GM3DHD, ZL2GX, and ZS1BK.

771 W's were contacted, of which nearly 50% were W6's. 140 of these were phone QSO's 631 cw.

With amateurs from all over the world as our company, we never felt alone. The local population consisted primarily of about

300,000 penguins. These birds made a constant noise muttering to themselves. Now and then one would wander into the shack, listen to the noises from the receiver, and walk away shaking his head. Between snowstorms we managed to shoot a few seals, one of which turned out to be a Furrier Seal, thought to be extinct in the last century.

Just as we were really getting started towards our Worked All Amateurs certificate things started to happen. The islands were volcanic in origin and we had smelled the sulfurous gasses from time to time, but we didn't expect anything serious to turn up. All of a sudden our island started shaking and jumping and a neighboring island exploded with very high jets of incandescent lava coming from several mouths and falling into the sea with a great hissing, crashing sound and forming huge pink clouds. We waited no longer. With the penguins and seals leaving for safer waters, we sent out a hurried SOS which brought the Navy into ac-

[Continued on page 98]



Transistor Circuitry

by H. F. Priebe, Jr. W2TGP
192 Mills St.
Morristown, N.J.

The recent appearance of the transistor on the electronic scene has created a great amount of enthusiasm throughout the electronic industry. Examining a list of some of the transistor's unique characteristics will show why this intense interest exists. The transistor is rugged, small in size, instant operating and efficient. These features lead us to believe that among its many applications it has significant importance in miniature, portable electronic equipment such as receivers and transmitters.

The radio experimenter and radio enthusiast have been exposed to a wide variety of transistor information. Although a sufficient amount of transistor circuit information has been comprehensive, it has lacked a simple language approach. The transistor gadget type of circuitry has been very interesting but has omitted a lot of do's and don'ts about the transistor. It is hoped the material presented here will enable

the radio enthusiast or experimenter to get the "feel" of transistor circuitry in the fewest and simplest words.

Two Types

Often in articles about transistors both the point-contact transistor and the junction transistor have been discussed in the same text. The two types of transistors are quite different. The junction transistor has better stability, more gain, better efficiency and a better noise figure. The junction transistor is by far the most popular to date. Consequently, the presentation here will deal with junction transistors only and when a transistor is mentioned it is a junction transistor.

The tendency, in many transistor articles, has been to use vacuum tube analogies to get across transistor circuitry. These analogies are

MFG.	TYPE	MAXIMUM RATINGS				AVERAGE CHARACTERISTICS (AT 25°C)									
		COLLECTOR VOLTAGE VOLTS	COLLECTOR CURRENT MA	COLLECTOR DISSIPATION AT 25°C	AMBIENT TEMPERATURE C°	COLLECTOR VOLTAGE VOLTS	EMITTER CURRENT MA	COLLECTOR RESISTANCE (MINIMUM) MEGOHMS	BASE RESISTANCE OHMS	EMITTER RESISTANCE OHMS	CURRENT AMPLIFICATION FACTOR (MINIMUM)	COLLECTOR CUTOFF CURRENT (MAXIMUM) μA	COLLECTOR CAPACITANCE pF	NOISE FACTOR DB	FREQUENCY CUTOFF MC
TEXAS INSTRUMENTS INCORPORATED	200	30	5	50	50	5	-1	.4	150	22	9	10	15	26	.9
	201	30	5	50	50	5	-1	.4	170	22	19	10	17	23	1.1
	202	30	5	50	50	5	-1	.4	200	35	49	10	19	20	1.3
HYDRO-AIRE	CQ-1	-40	-10	150	50	-6	1.0	.5	200	30	.9	20		33	.5
RAYTHEON	CK721	-22	10	33	50	-6	1.0	2.0	700	25	45	6		22	
	CK722	-22	10	33	50	-6	1.0	2.0	250	25	12	6		30	
	CK723	-22	10	33	50	-6	1.0	2.0	350	25	22	6		25	
RADIO RECEPTOR	RR-88	-50													

Fig. 1



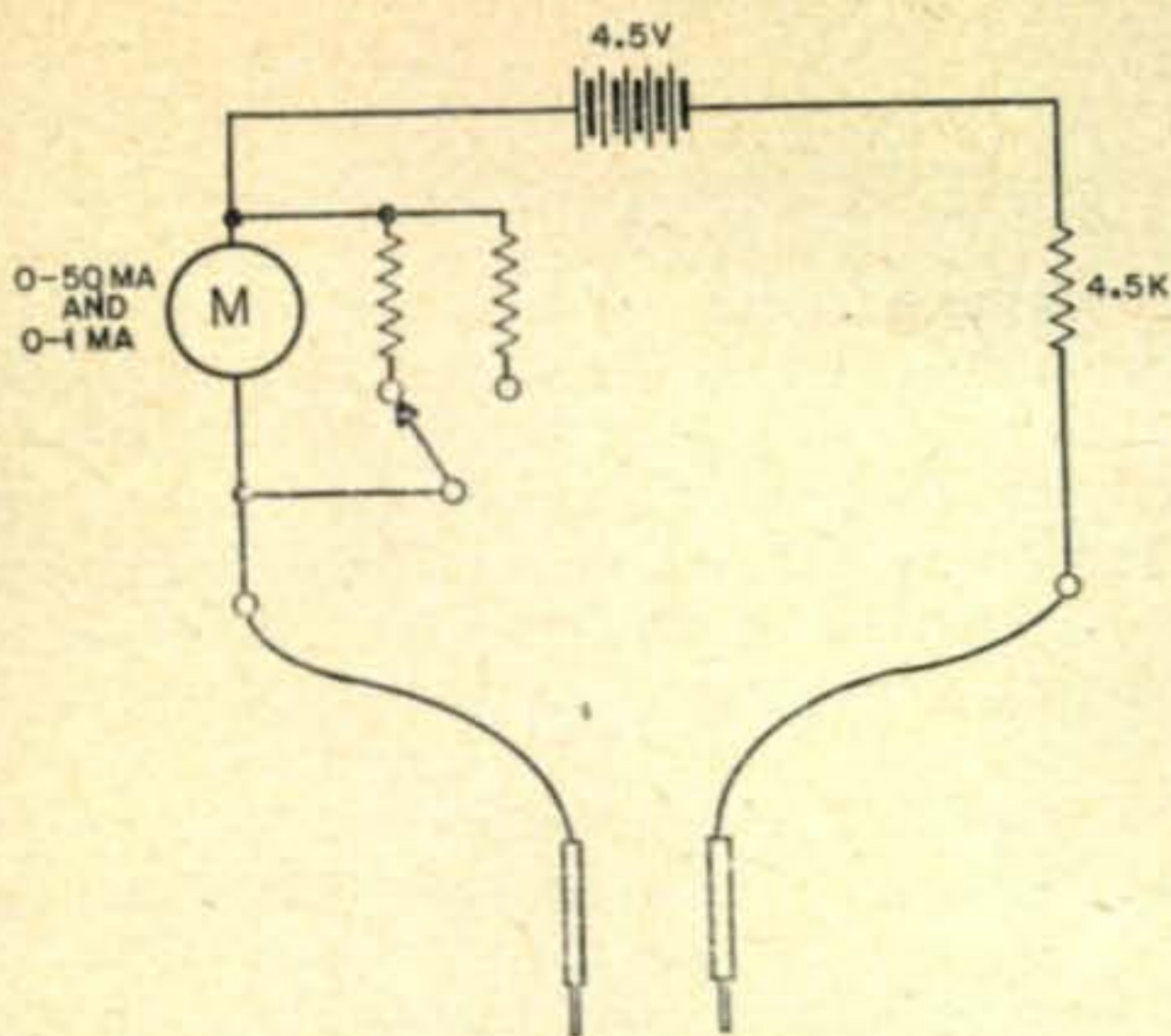

Fig. 2

not necessary. To be perfectly fair for every similarity to vacuum tubes that would be cited it would require mentioning the exceptions as well as the dissimilarities. The presentation here describes the transistor in its own terms, those of a semiconductor and no analogy to the vacuum tube will be made.

If you are not one of the venturesome individuals that has purchased a transistor (remember

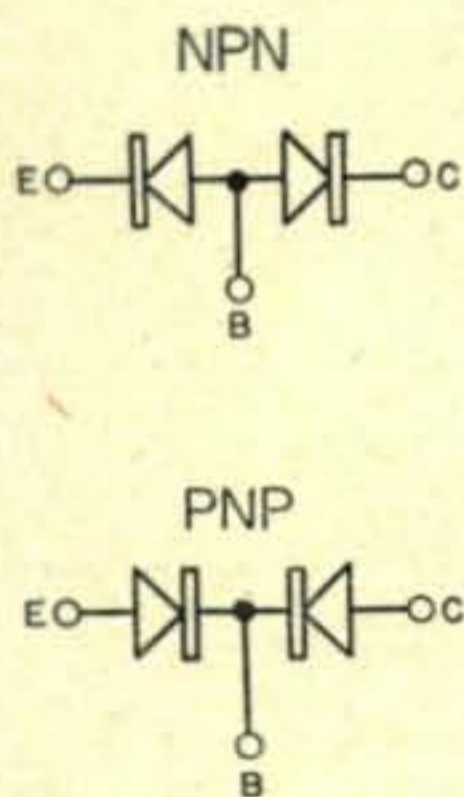

Fig. 3

now it is a junction transistor) at least make believe that you have and follow us through the steps as we acquaint ourselves with some of the transistor's important characteristics. Figure 1 is a list of some of the available transistors and their maximum ratings and average characteristics.

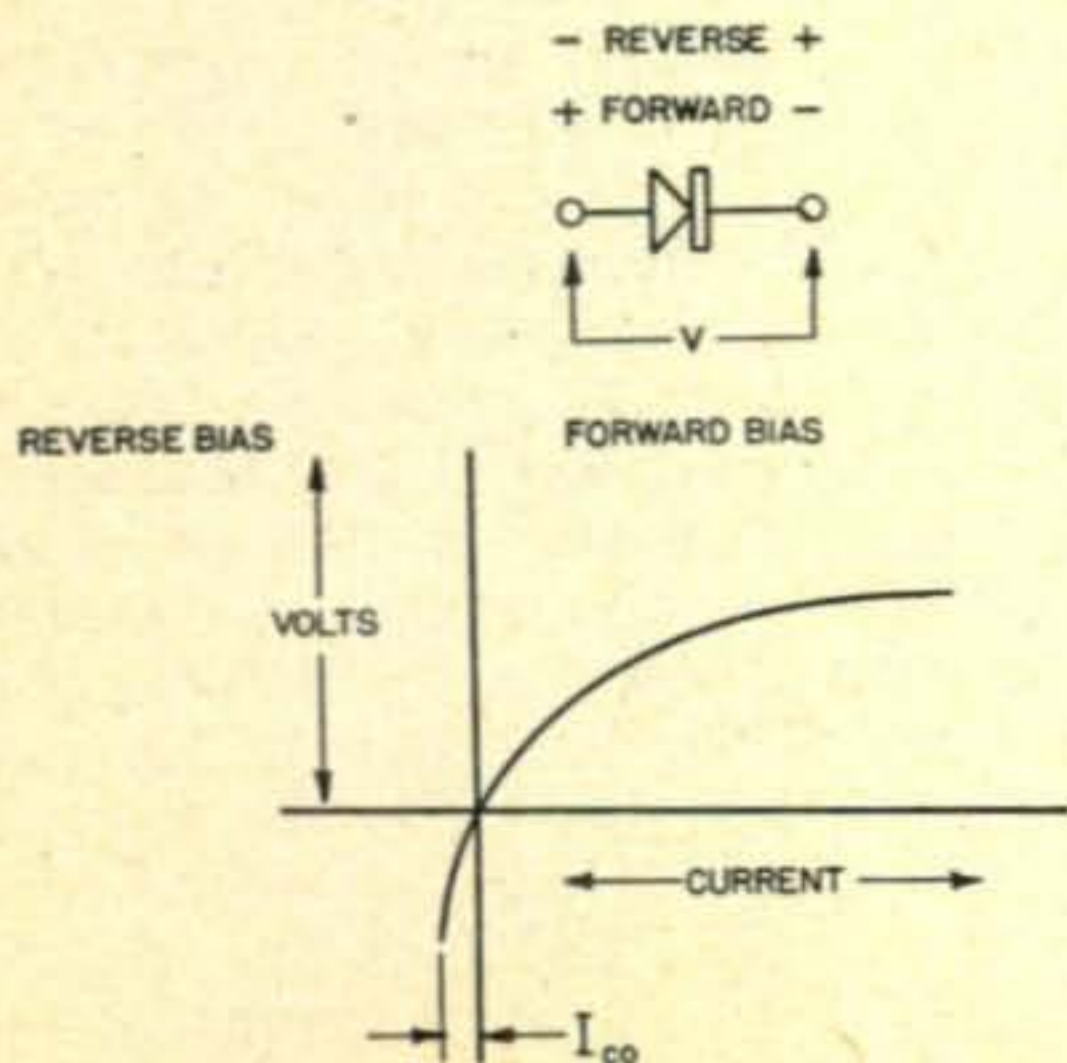

Fig. 4

Test Circuit

A few simple dc measurements will tell us enough about the transistor to explain its operation in dc and low frequency (audio range) circuits. To make these tests a set-up like the one shown in Figure 2 is used. It is important that a high impedance source (constant current) be used for these measurements rather than a voltage source (battery directly). This can more readily be appreciated when the characteristics of transistors are explained. Briefly, the transistor is essentially a current device; if we were to use a constant voltage source directly, for measuring the currents they would be limited only by the resistance of the tran-

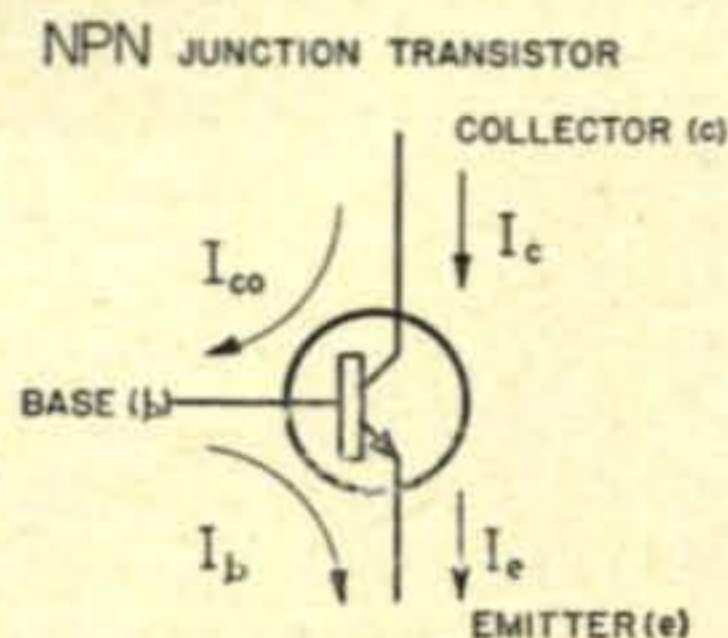

Fig. 5

sistor and this could be disastrous, for the transistor. Thus a simple d.c. test-set to provide a constant current for low impedances is made of the following components: A 4.5 volt battery, a 4.5 K ohm resistor and a combination micro-milliamperemeter (0-50 or 0-100 μ a and 0-1 ma) all connected in series with the test leads as shown in Figure 2. The current and voltage at the two terminals of our test-set are: At low impedance, a maximum current of 1 milliamperemeter is available (low voltage

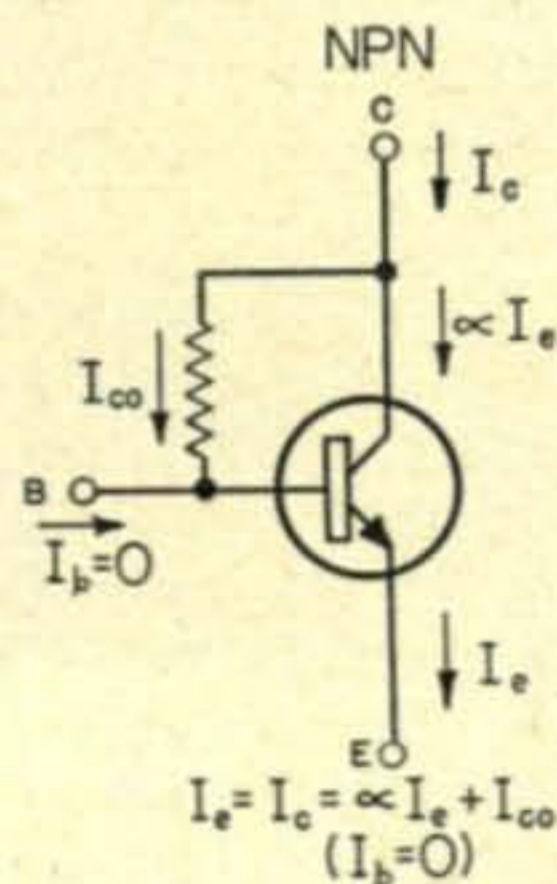

Fig. 6

of course) and with low currents (where the I-R drop across the 4.5 K resistor is negligible) nearly 4.5 volts is available.

Using the test set-up shown in Figure 2, we measure between the base and either of the other two terminals (emitter or collector) of the transistor. We find that the properties exhibited are exactly the same as if we were measuring a semiconductor diode, say a 1N34 or similar, with which we are all familiar. This is true for both PNP and NPN types, the difference between the two is that they exhibit exactly opposite reactions when the same polar-

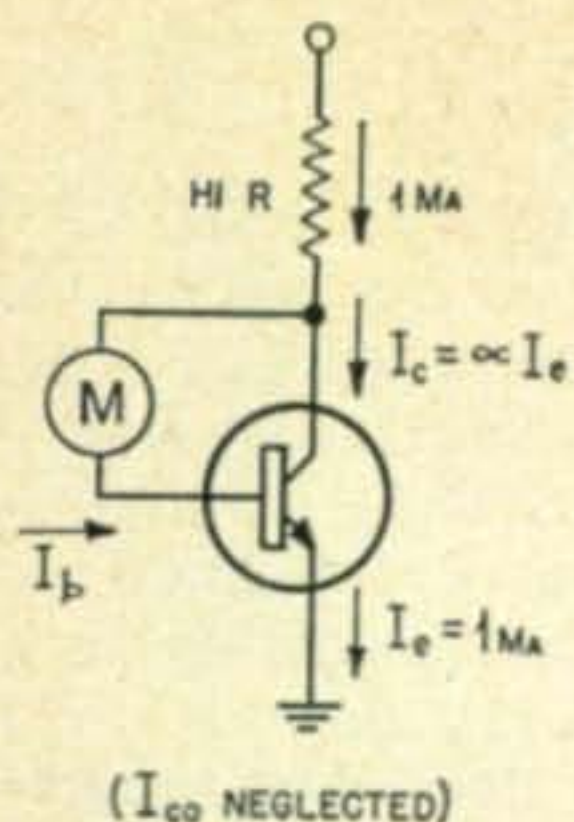

Fig. 7

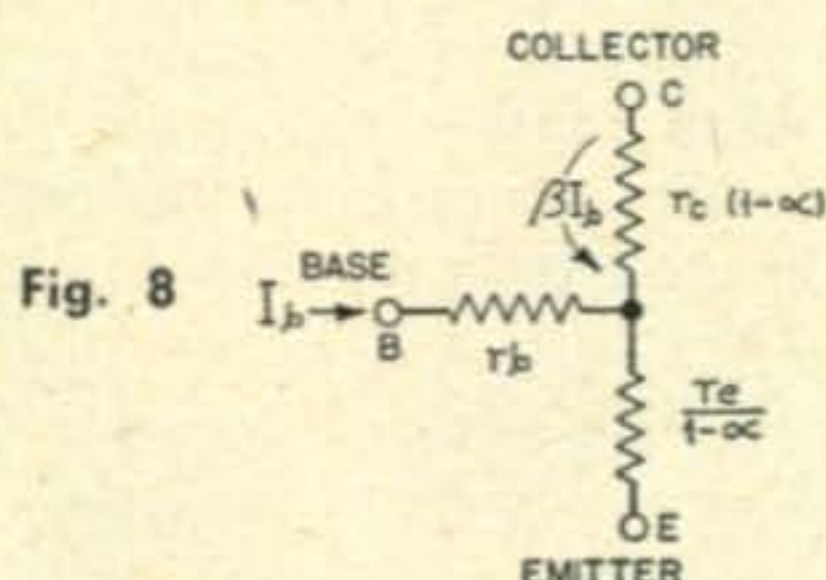

Fig. 8

ity from our test-set is used. Amplifying the above statement a bit—when the polarity applied from our test-set is positive on the base and negative on either the collector or the emitter of an NPN transistor we notice that the current is near maximum or 1 ma. in our case. This is called “forward biased”; it is this bias condition that gives us the low impedance. In contrast to the previous statement when the polarity applied to the transistor is negative on the base and positive on the collector or emitter of an NPN transistor, we notice that the current is very small. This is called “reversed biased”. A PNP transistor will exhibit the same conditions when the polarities are opposite to those used for the NPN. Now if we represent the above characteristics with semi-conductor diode symbols they will take the form shown in *Figure 3*.

Semi-Conductor Features

Since the transistor resembles in many ways the semi-conductor diode, let's review the characteristics of such a diode. As the applied voltage is varied from reversed to forward bias conditions, the voltage vs. current plot will take the form shown in *Figure 4*. As shown in the figure the current I_{co} , on the left bottom, remains nearly constant as the voltage is increased. This reverse current, or saturation current in semi-conductor diodes, is called I_{co} (collector to base with emitter open) in transistors. Not all manufacturers give a value for I_{co} . Usually when the maximum value for I_{co} is given a typical value will also be given. Most germanium transistors have an I_{co} of $10\mu a$ or less at room temperature ($25^\circ C$). The temperature at which the I_{co} measurements are made is given because I_{co} is very temperature sensitive. Approximately, I_{co} doubles for every $10^\circ C$ rise in temperature. So for an I_{co} of $10\mu a$ at $25^\circ C$ we can expect approximately $20\mu a$ I_{co} at $35^\circ C$. The presence and variation of I_{co} is very important and its effect should be

examined in each application of the transistor. Using our simple test-set connected between base and collector, positive on the collector and negative on the base of an NPN, and just the reverse for a PNP, will give us the value of I_{co} for the particular transistor. Leaving the test-set connected to the transistor and holding the transistor firmly between the thumb and fingers, to raise the temperature of the unit, will show this increase in I_{co} with a rise in temperature, providing the ambient temperature is reasonably below the body temperature.

The current in the forward direction (low impedance) of a semi-conductor diode as shown in *Figure 4* changes nearly exponentially as the applied voltage is increased. The forward resistance is nearly the same for all units and is given approximately by $R_{forward} = \frac{26}{I}$ where I is the current in milliamperes.

Up to now the transistor has looked pretty much like a couple of diodes. The following measurement will show the amplifying characteristic (a) that makes this pair of diodes a transistor. If we measure between the collector

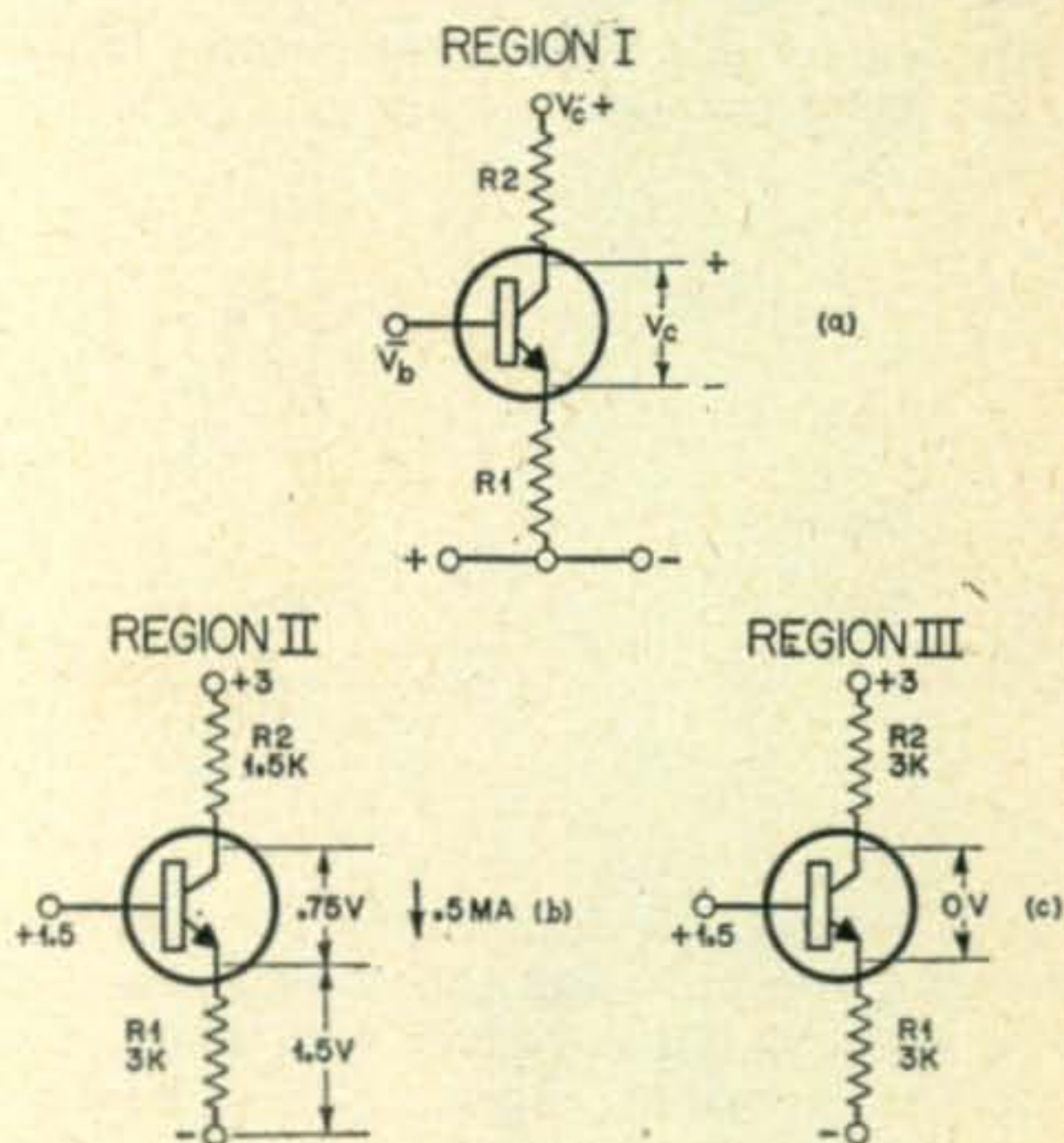

Fig. 9

and emitter with positive on the collector and negative on the emitter of an NPN transistor (negative on the collector and positive on the emitter of a PNP) we are likely to read anywhere from near zero to a maximum of 1 ma. If more than one transistor is available, measure several of them as mentioned above and notice the wide variation. This variation exists in the normal case and is not so surprising when the currents in the transistor are analyzed. The currents in a transistor as defined here are shown for an NPN transistor in *Figure 5*. I_c is the collector current, I_{co} is the collector-to-base current with the emitter open, I_b is the injected base current and I_e is the emitter current which is the sum of the base current, I_b and collector current I_c .

Amplification Factors

Compare I_{co} , remember it was measured previously, to the current measured between the collector and emitter which we will call I_c . It is the amplifying characteristic of the transistor that has given us this value of I_c which is many times the value of I_{co} . Assigning the symbols of $\frac{1}{1-\alpha}$ to represent the current multiplication experiences above we can say $I_c = I_{co} \frac{1}{1-\alpha}$. From this we evaluate α ,

$$\alpha = 1 - \frac{I_{co}}{I_c}$$

(This assumes that the transistor is not saturated. Otherwise equations would not hold.)

It may take a while to get used to I_{co} ; a sometimes convenient way to visualize I_{co} is to think of it as arriving at the base from the collector through some additional path that actually by-passes the heart of the transistor. *Figure 6* shows the above-mentioned analogy and defines the currents. Note, I_c is made up of $\alpha I_e + I_{co}$.

Another method to measure α is by the connection shown in *Figure 7*. Since the current I_e is fixed at 1 ma., $I_b + I_c = 1$

$$I_c = \alpha I_e = \alpha$$

(I_{co} neglected)

(The meter reads $(1-\alpha)$, subtracting this from 1 gives α .)

We now have approximate values for two important characteristics of the transistor, α and I_{co} . Also, we have found I_{co} is temperature sensitive and it is not the same for all transistors.

Equivalent Circuit

Let's take a closer look at the transistor. We know that we can describe the transistor action in terms of an equivalent circuit. This equivalent circuit is developed from 3 or 4 terminal network measurements taken while treating the transistor as a "black box". One form of the equivalent circuit is shown in *Figure 8*. From our previous experiments we know that this

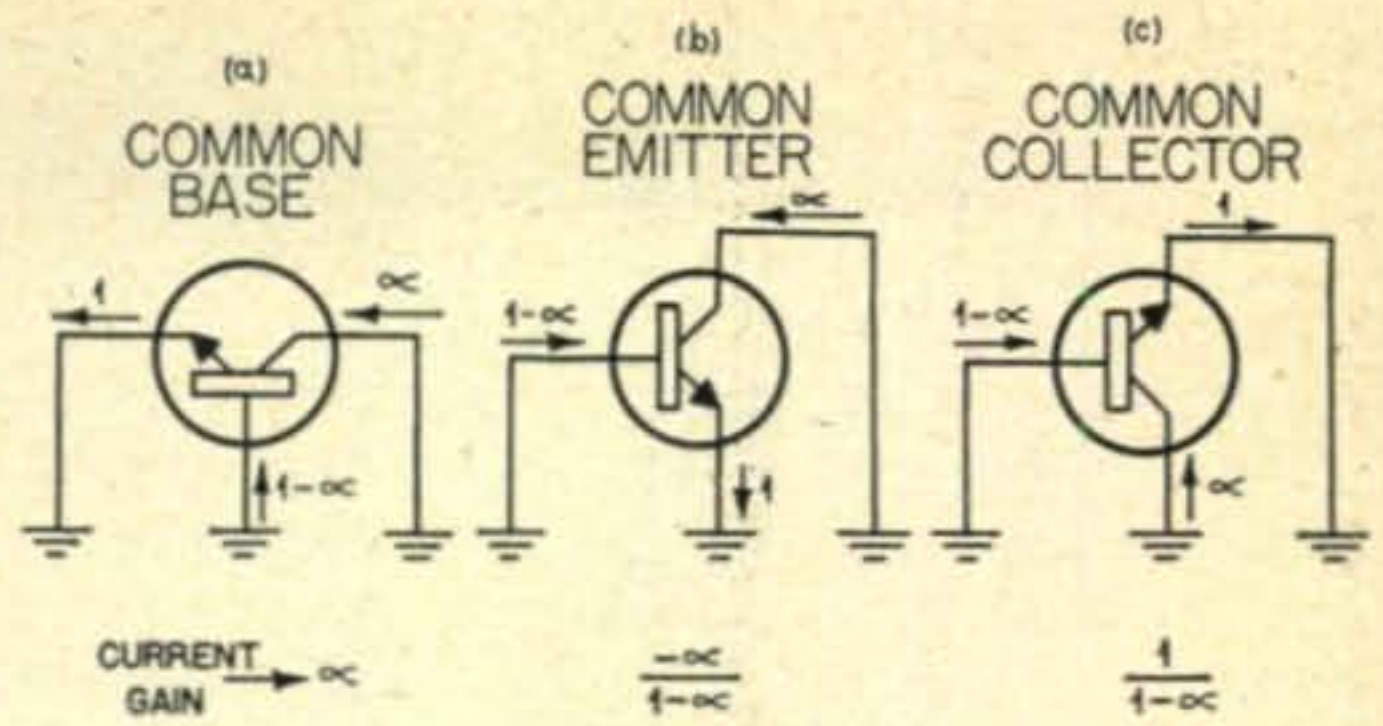

Fig. 11

equivalent circuit does not fully describe the transistor, but it does describe the transistor reasonably well when just the active region is considered. The normal bias conditions for an NPN common emitter stage operation such as a linear amplifier is a positive potential applied between collector and emitter and a small positive potential applied to the base. The transistor's operation can be divided into three regions and they are:

Region I, collector current cut-off or collector voltage saturation. Stated in terms of the potentials applied to the terminals the conditions are emitter "junction" (diode) reverse biased and collector junction reverse biased.

Region II, active region, sometimes called linear region. The emitter junction is forward biased and the collector junction is reverse biased.

Region III, collector current saturation, or collector voltage cut-off. The emitter junction is forward biased and the collector junction is also forward biased.

Examples of NPN transistor stages operating in each of the three regions are shown in *Figure 9*. If NPN transistor stages were biased as shown in the examples they would be operating in the regions indicated. *Figure 10* shows the various regions of operation graphically. The parameters, collector voltage vs collector current are shown.

Linear Region Operation

The linear region, Region II, is of most interest to us here. The other two regions of operation, most pertinent to switching and pulse circuits, are mentioned so as to show the bias and other conditions that might result in improper operation of a linear stage. The examples in *Figure 9* are to give an idea of what happens to a linear amplifier if one parameter is altered without due regard for other parameters. The transistor bias condition shown in part (b) of *Figure 9* places the operating point in Region II. A positive potential of 1.5 volts is applied to the base through a low dc impedance path (suitable ac impedance so as not to shunt the input signal) and with the emitter resistance R_e of 3K will result in an emitter current of .5 ma. (The base and emitter voltages are approximately equal.) To get the maximum voltage swing at the collector, with

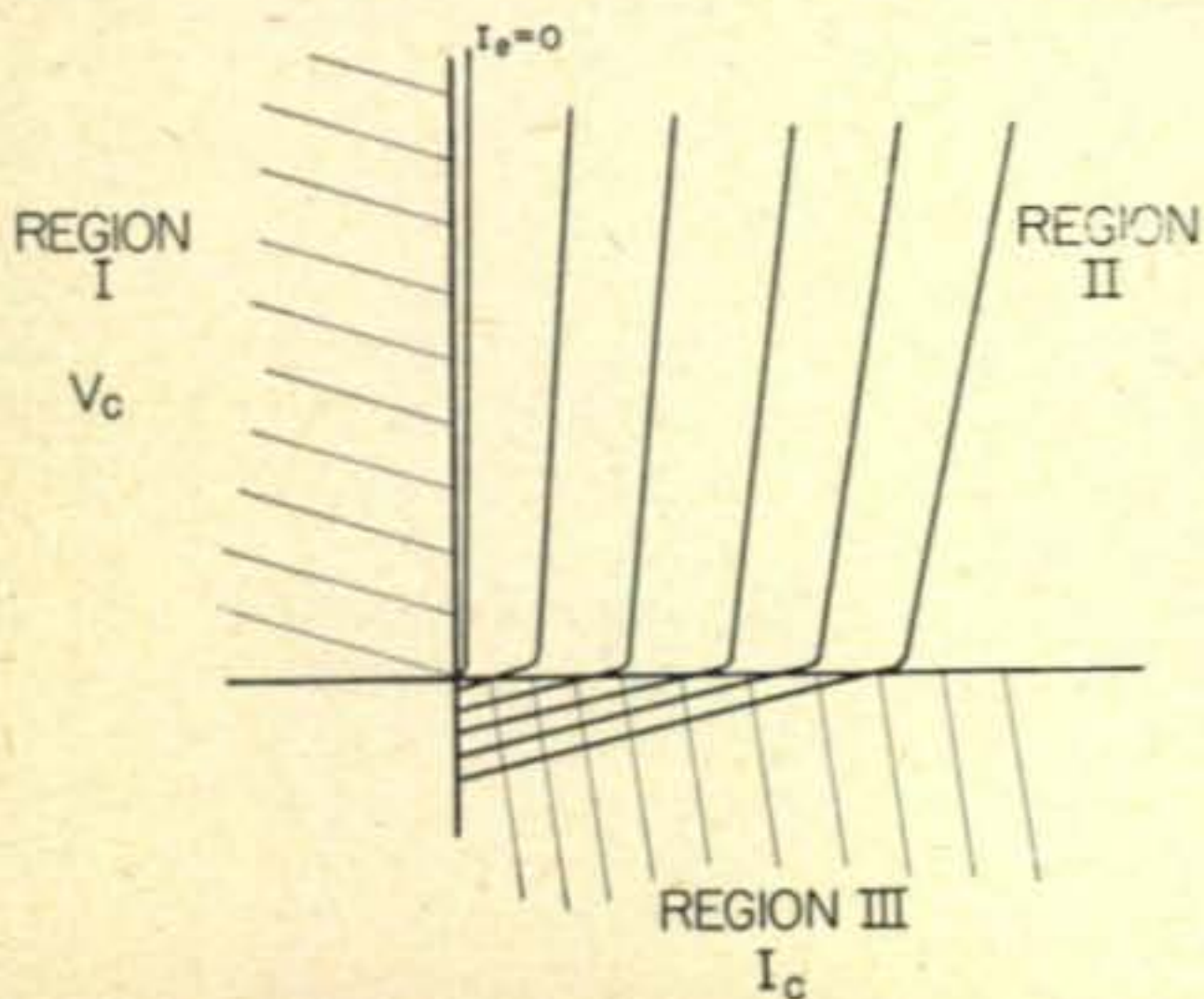

Fig. 10

VC of 3V and I_c approximately equal to I_e , R_2 will be 1.5K. If for example R_2 was made larger than 3K the voltage between the collector and emitter would be zero or nearly so and the transistor would be in region III, (part C Figure 9) that of collector current saturation. This simply states that all of the current available at the collector of the transistor is passing through it. If a sine wave signal was applied to the base with R_2 of 3K the output signal would be a half sine wave. They would be positive pulses because at the input *additional* current supplied by the input signal would have little effect on the output. The negative half cycles would reduce the base current and thereby reduce the collector current by $\beta = \left(\frac{\alpha}{1-\alpha}\right)$. Now, if the bias potential

applied to the base is reversed as shown in part (a) of Figure 9 the collector current is zero (neglecting I_{co}) and any signal applied to the base would have to exceed 1.5 volts to appear in the output. This bias condition places the transistor in region I. The stage is cut-off (sometimes referred to as blocked) for input voltages that are less than 1.5 volts.

Most of the aforementioned material has been with the transistor connected in a common emitter (sometimes called grounded emitter) connection. There are three basic connections of the transistor: (1) common base or grounded base (2) common emitter, grounded

emitter and (3) common collector, grounded collector. These connections are shown in Figure 11; only the currents are shown to simplify explanation of the current gains. If, in the circuits, we assume an input applied to the left and the output on the right, we can derive an expression for the current amplification of each. If the currents of emitter and collector are 1 and α respectively, obviously the base currents must be $1-\alpha$ as shown to satisfy Kirchoff's current law. Dividing the output currents by the input currents we obtain the current gains as follows: For the common base we get α , for the common emitter connection we get $\frac{-\alpha}{1-\alpha}$ and for the common collector we get $\frac{1}{1-\alpha}$.

The grounded base and grounded collector have no phase shift from input to output and the sign of the current gain expressions is positive.

For the grounded emitter there is 180° phase shift and the sign of the current gain expression is negative. Figure 11 shows the above examples with their respective current gain expressions.

The material presented here has been of a very general nature. The intent is not to provide design formulas but to develop an understanding of transistor circuitry that will enable the newcomer to more readily understand more exact design principles. ■

how NOT to

In designing a power supply, don't make this grim mistake.

Here you see an almost innocent-looking combined B+ and negative bias supply. This is OK, *unless* you try to switch the B-supply by a commonly-used center-tap switch. When this is attempted, a brilliant but wholly unwelcome pyrotechnical display will result. Reason? Take a look at the circuit. With the cen-

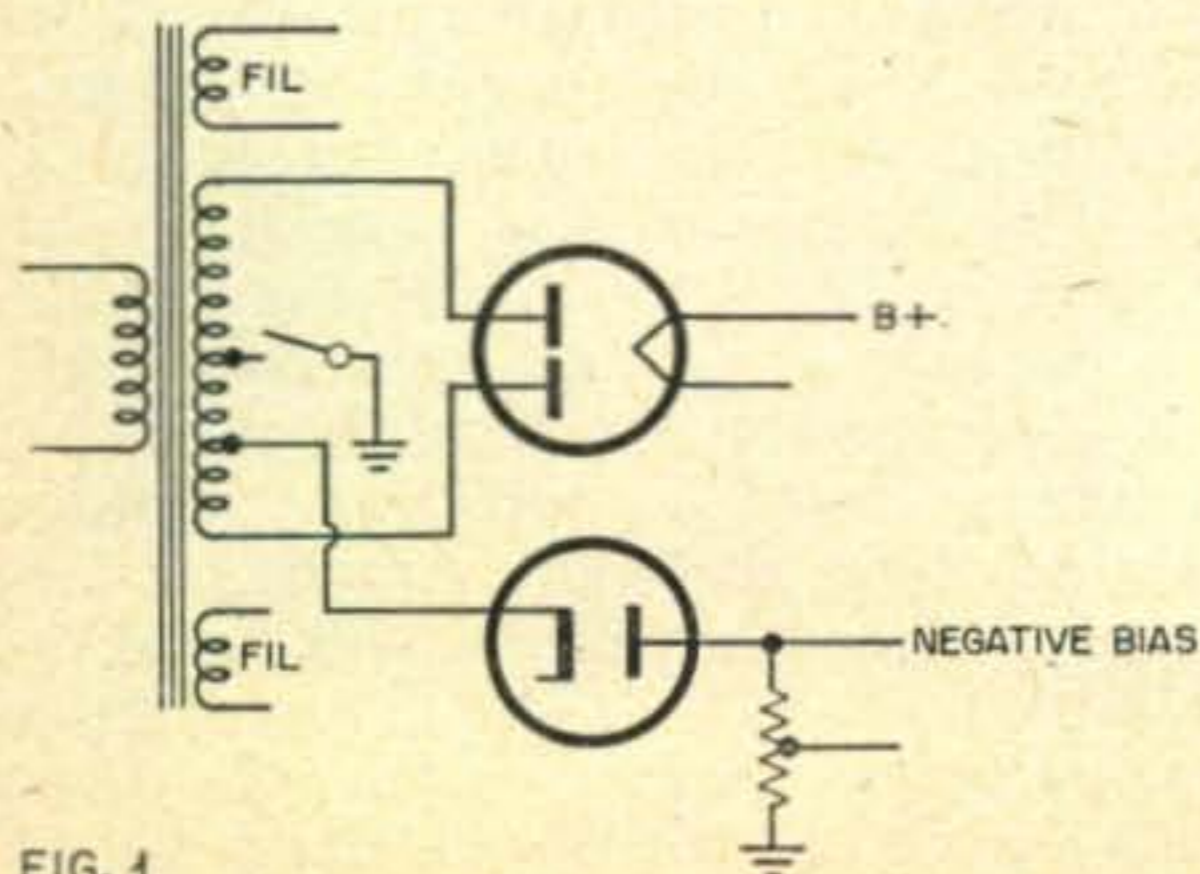

FIG. 1

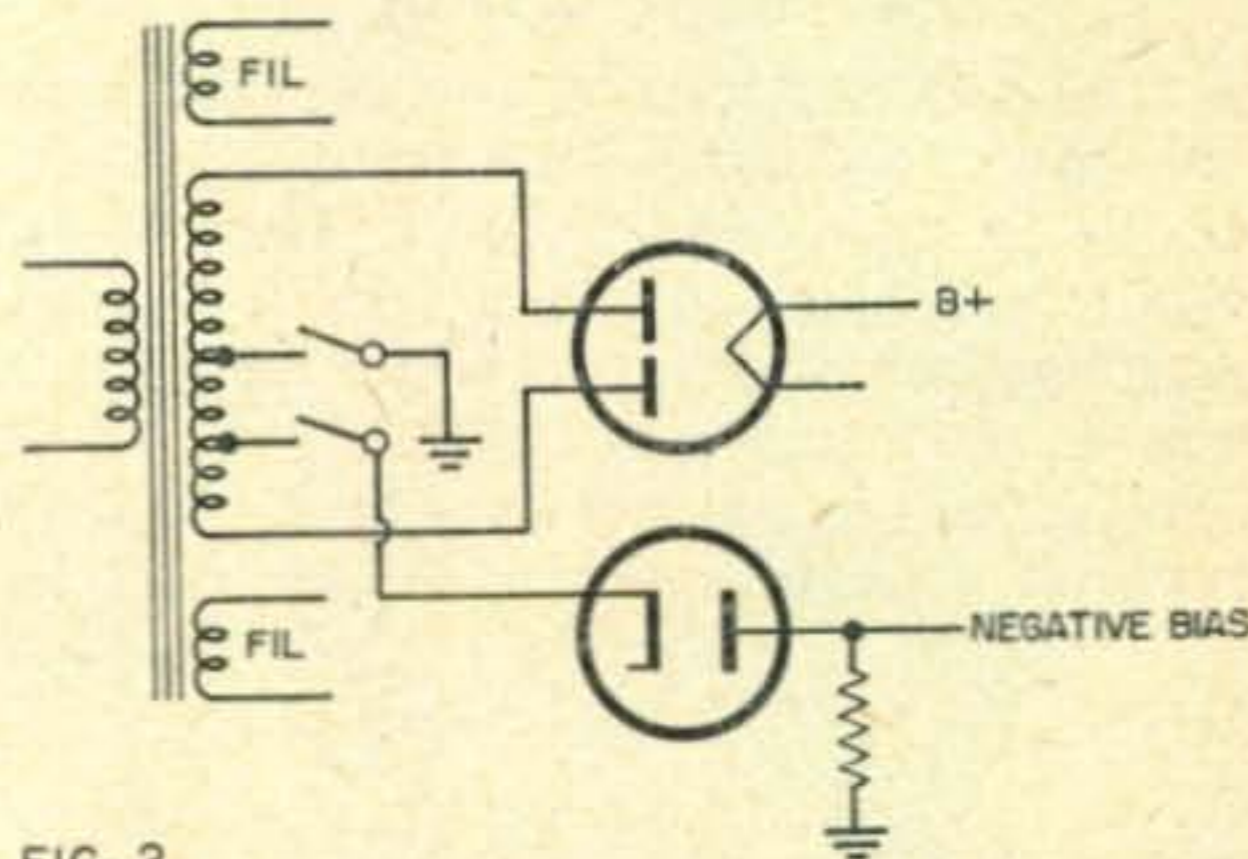

FIG. 2

tertap ungrounded, the diode of the bias rectifier is suddenly handed the entire plate current of the main supply, and at voltages much higher than those for which the ordinary bias rectifier is designed. Poof!

To avoid this, the standby switch can be changed to include a set of contacts to open the lead from the transformer tap to the bias rectifier. Or, of course, a separate transformer can be used to supply voltage for the bias supply, such as a reverse-connected filament transformer tapped across the regular a-c filament leads.

• W2EEJ

L to r, upper row: barosilicate glass, titanium, molybdenum, aluminum, tantalum, stainless steel, tungsten, ceramic, cobalt; lower row; sample of Wood's metal, tinned stainless steel, "loaded" grinding wheel

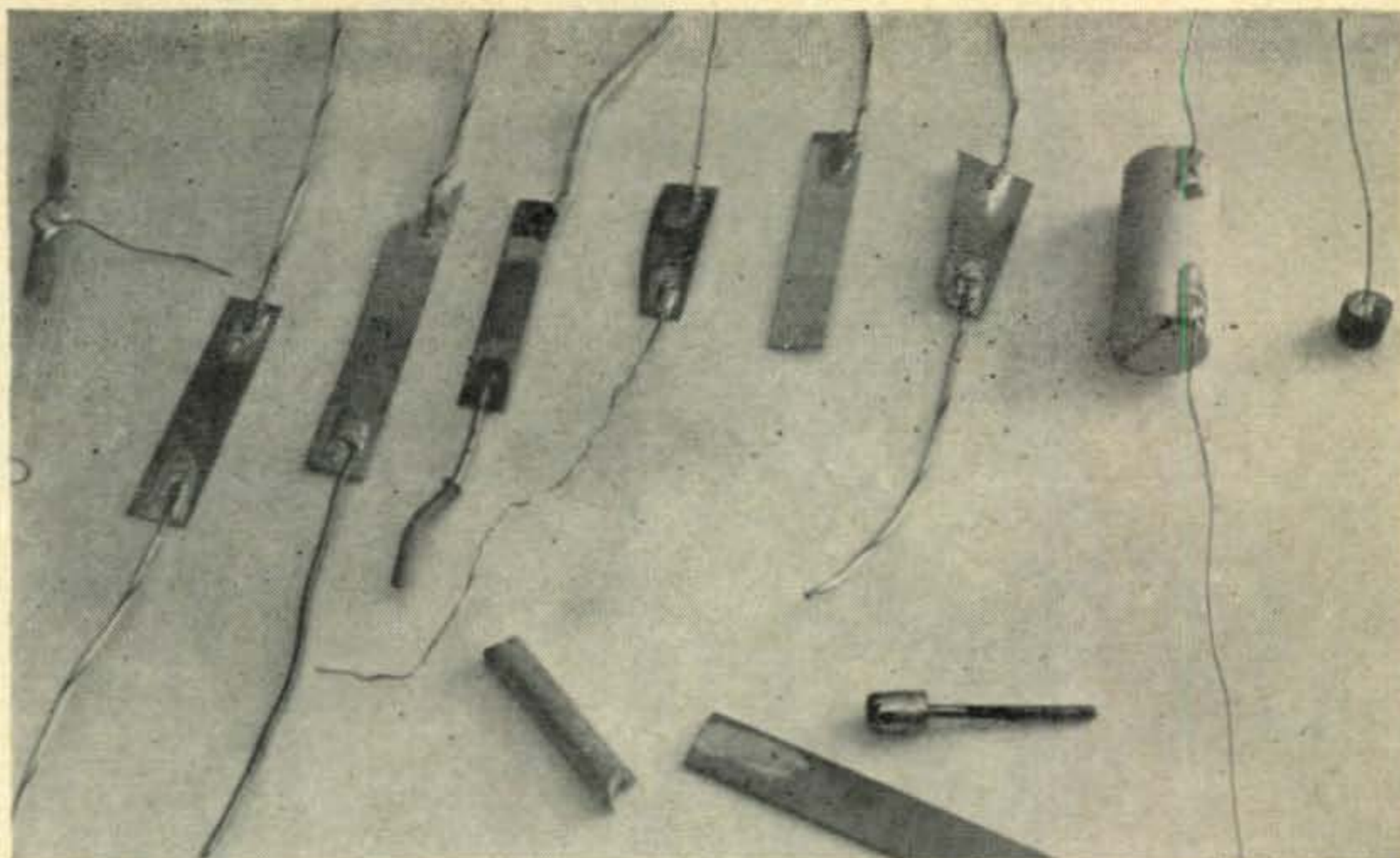

Reprinted from Chemical and Engineering News, Jan. 30, 1956

Soldering on Glass

Joseph C. McGuire was at work in the Los Alamos Scientific Laboratory's chemistry and metallurgy division studying the use of ultrasonics to solder difficult materials. In attempting to clean up some unsuccessful joints with a grinding wheel (something apprentice mechanics are taught not to do), he noticed that not only did the wheel get gummed up with the soldering alloy, but also a brightly tinned surface which looked solderable was left.

Investigating further, he found that the tinned surface was indeed solderable; the joints so formed were stronger than those made by the ultrasonic method. Extending his experiments, he found that such difficult or "impossible" materials as glass and cobalt were also solderable in this way.

The aircraft and electronics industries, laboratory equipment makers, and the do-it-yourselfers will find McGuire's method a boon. Soldering of such materials as aluminum, stainless steel, glass, and ceramics is possible without use of special equipment. McGuire used a medium grit grinding wheel, $\frac{1}{4}$ inch in diameter and $\frac{1}{2}$ inch long, mounted on a $\frac{1}{8}$ -inch diameter shaft. Size of the wheel is not critical but the type used by McGuire seems best. Several wheel compositions were tried by the researchers; they all seemed equally good. Additionally, the two surfaces need not be of the same material: metals, soft glass, boro-silicate glass, and ceramics have been soldered in any combination.

For the do-it-yourselfers, here's how:

The grinder is turned on and the abrasive wheel (preferably preheated by grinding metal or the use of heat) is brought to bear on a soft solder such as Wood's metal or 60-40 lead-tin. The soft solder melts and flows onto the surface of the wheel, "loading" it and incidentally making it useless for its customary purpose until it has been trimmed down. The solder-loaded wheel is then applied to the surface to be soldered until a slight amount of abrasion has taken place, using the pressure ordinarily used in grinding. The heat of friction again melts the soft solder, which flows onto the freshly abraded surface and forms an intimate contact.

After this tinning operation, soldering is done in the usual manner with standard 50-50 lead-tin solder. An effort should be made to keep the hot iron from the subsurface layer of base metal. The joint should be heated either by applying the hot iron to some adjacent part of the metal which is not tinned, and the solder then applied in wire form directly to the tinned surface, or the solder applied to the iron bringing the hot drop of solder down to the tinned area without having the iron come into actual physical contact with the base metal. Workers at the lab say this is particularly important when soldering titanium, niobium, and tantalum. The other surface is also given the new treatment if it is a material not ordinarily "wetted" by solder. No soldering flux, surface

[Continued on page 121]



Capt. White (L) re-receives pouch from Dr. "Bob" Ward.

Pony Express 1956

Bernard Paul, W5YVJ

Lazy "P" Ranch
Houston, Texas

First the sonic barrier fell, then the four minute mile, and now the 75 year old Houston-to-Austin Texas horseback record has fallen! When the news was flashed around the globe to the anxiously waiting fans, an important sidelight was largely overlooked. Namely, HAM RADIO HAD COME THRU AGAIN! Ham radio, that is, in the guise of the Sheriff's Mounted Posse and the Sheriff's Emergency

Communication Corps, both of Harris County, Texas.

The distance between Austin and Houston is 165 miles and the previous record was 11½ hours. A horseback run between these two cities under any circumstances is quite a trick since the two points are separated by dozens of small towns, several largish cities, and countless overpasses, underpasses, Buicks, Cadillacs, Rolls-Royces, bars, frozen custard joints, and other manifestations of Twentieth Century Texas Culture. In order to break the record, a high degree of coordination was required of all participants as well as the assorted townspeople along the way. After all, even in Texas, a guy on a pinto pony galloping thru a cloverleaf intersection on a Saturday morning is bound to cause some talk, if not a few traffic snarls.

The ostensible excuse for all this bruhaha was to deliver an invitation to the Gov. of Texas, Allen Shivers, to the Greatest Livestock Exposition and Rodeo which was being held



Bernard Paul, W5YRJ, President of Sheriff's Mounted Posse watches Governor Allan Shivers read his invitation.

in Houston beginning the 28th of last January. Incidentally, Shivers was speaking in Fort Worth the morning of the run so it was imperative that we get him to Austin in time to meet the last rider carrying the message. In a way it might have been a much funnier story if Shivers couldn't have made it after all the mad galloping and shouting but the soreheads in the crowd insisted that we see to it that he be present. So just as when any other problem arises in Texas, a BIG OIL MAN was consulted as to what to do about getting the Governor from one place to another. The OIL MAN knew what to do instantly. He and his family had planned a picnic for that weekend in Acapulco and they were going to use his sport-type DC-3, but he could easily change his plans and use his family-type DC-7, thus enabling him to lend us the DC-3 and two spare pilots to fly the Governor to Austin in time to meet the 2 p.m. mail-horse from Houston.

The Texas Highway Patrol represented by Capt. Rose agreed to help us out and they also volunteered three patrol cars to accompany the riders in laps of about 55 miles each. A nice touch was added when the Harris County Emergency Corps sent along a nice white ambulance to trail the riders. The Mayor of Brenham, Texas, Reese Lockett, whose town was on the route, offered to set up the whole crowd to breakfast when they galloped thru. Since Brenham was about 75 miles along the trail he had plenty of customers for his bacon and



W5YRJ/M

eggs which he and his city council fried up personally in a huge Texas-Style pan. The coffee was hot and good.

I should explain that the riding was done by members of the Sheriff's Mounted Posse of Harris County. They are a mounted group deputized and ready for any kind of action, provided it's on horseback. There are about 100 members who come from all professions and trades from around the Houston area who are bound together by the love of horseflesh and open air. Operating two man teams, the posse rode the race on a relay basis. One member of the team would ride while the other, and his horse, was transported ahead about a mile. The first rider would pass the message

[Next page]

Standing l. to r.; W5RPH, Jack; W5RMX, Dick; W5SDR, Ed; W5LOF, Musty; W5EKT, Wes; W5ENT, Ralph; W5YVJ, Paul; Gov. Shivers;; W5URM, Red; W5PBX, Bo; W5URJ, Chris; W5FDZ, Brown.



on to his partner who would then ride ahead a mile and hand on the pouch to a new pair of riders. He then joined his partner and horse in the trailer which would drive them about thirty miles up the route to begin the cycle all over again. In this way each rider carried the mail about six times. All trailers were numbered so the radio cars could check on progress and keep track of who was doing what at any given moment. Ham radio was represented by six radio cars carrying two ops each. They ranged the entire route patrolling assigned areas keeping in constant contact from one end of the trail to the other noting progress and coordinating traffic control. A most necessary duty. The pace car was equipped with a Sheriff's *Link* 2 way communicator and 50 watts of signal on 3855 kc. Radio car #1 contained W5FDZ and W5PBX; they were responsible for setting the horses out at measured miles. Car #2 contained W5ENT and W5RMX and acted as assistant to Car #1. Car three stayed midway between Pace car and Number 1 and acted as a check point for the riders, this car was operated by W5EKT and W5LOF. W5URU and W5URM were in #4 running two miles ahead of Pace Car. Their job was to alert the riders on the trail of the

approaching pouch. The Pace car itself drove alongside the rider and protected him from traffic as he rode on the shoulder of the road thru the pitch darkness. He directed traffic at intersections and in general ran interference for the mounted man. Trailing behind the whole pack was car #5 manned by W5SDA and W5RPH. They remained with the riders as they loaded their mounts into the trailers (which was sometimes rough with tired horses), and notified the lead car that all was on the road. During the dark night hours we identified ourselves on the air as "Pony Express Net," which no doubt confounded many a guy tuned into 3855 at the other end of the skip.

Once we got on the road, we never stopped and the thing went off without a major hitch. We rolled into Austin 9 hours and forty minutes after we had started from Houston 165 miles down the trail. Eight screaming motorcycle police escorts led us thru town to the appointment with the Governor on the Capitol lawn where with due ceremony the hand painted scroll and invitation was delivered. After the pomp had subsided, all hands strolled over to a leading steakhouse and sailed into the finest Kansas City (I have to give the devil his due) steaks in town. We all had a ball. ■

Two Wire Control for Selecting Beams

This unusual and simple device is used at CX2AY to switch any of four different rotary beams, supported on a single mast and fed by a single coaxial cable. It is very simple, requiring only two wires between shack and tower. It consists of a 2-pole 4-position switch (S_A, S_B) which selects the desired antenna, 3 selenium rectifiers, 110 V. 60 ma. each (S_1, S_2, S_3), two 110 V. a.c. relays, one 2-pole 2-position (Ry_1) and the other 1-pole 2-position (Ry_2), a 150 ohm 10 w. resistor (R_1) and two 3000 ohms 2 w. resistors (R_2, R_3). The system is fed with 110 V. a.c.

Relays Ry_1, Ry_2 , with their respective selenium rectifiers S_2 and S_3 and resistors R_2, R_3 are placed at center of boom, and switch S_A, S_B , rectifier S_1 and resistor R_1 are located at any convenient position in the shack, so there are only two wires, besides the coaxial cable which go to the antennas.

Operation of the system is as follows: in position 1 of S_A, S_B , both relays are energized with 110 V. a.c. so they close and antenna 1 is connected to transmitter. This is the position the diagram shows. Position 2: pulsating d.c. flows, rectified by S_1 ; through the winding of Ry_2 . This closes and antenna 2 is connected

to transmitter. In position 3 S_A, S_B reverses the polarity of S_1 , so Ry_1 closes, Ry_2 opens and antenna 3 is connected. Finally, position 4 cuts the a.c. on the windings of both relays, so antenna No. 4 is connected to transmitter. Resistors R_2, R_3 prevent buzzing of the relays, due to pulsating d.c. peaks which appear in positions 1, 2 and 3.

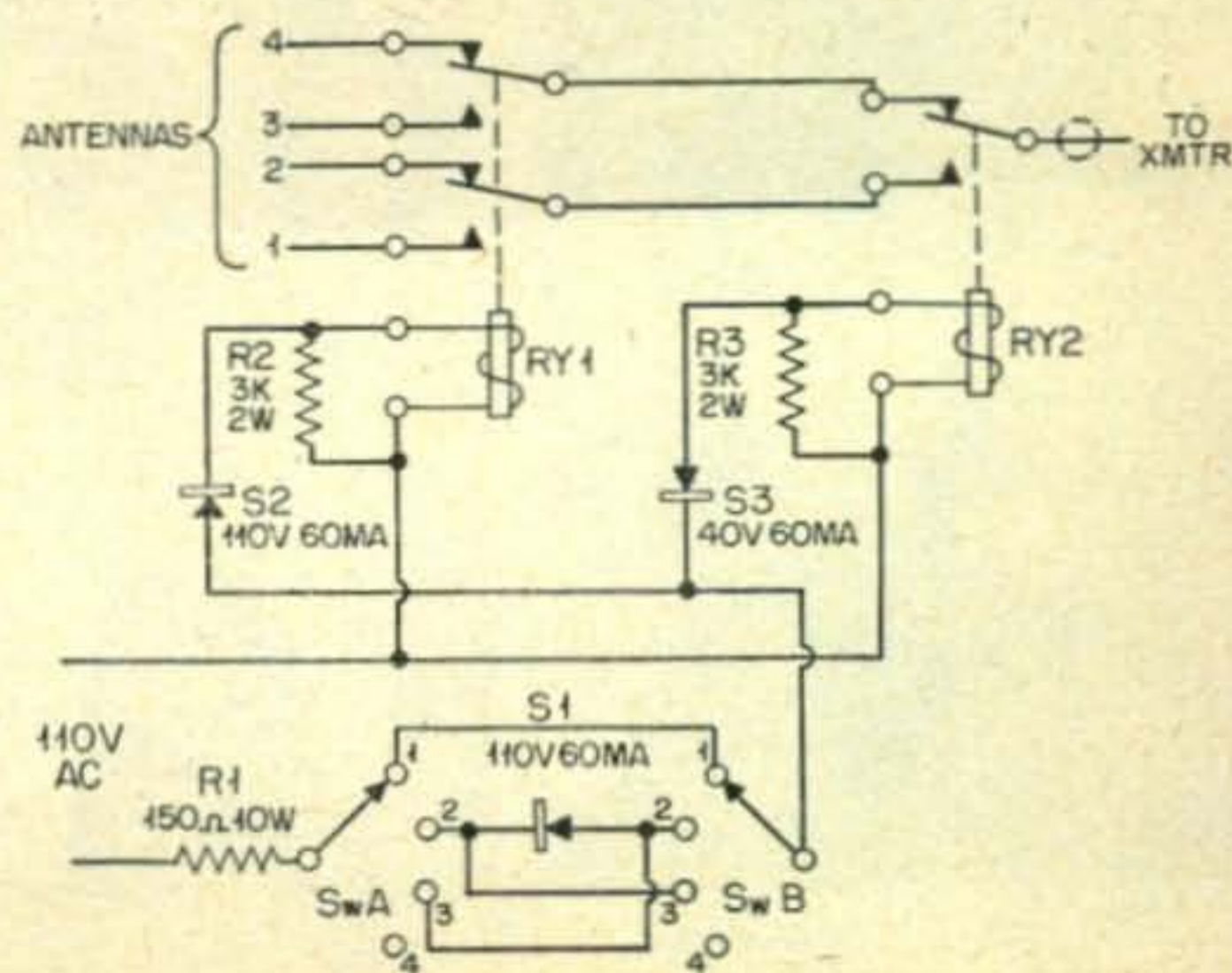

Enrique Abal, CX2AY

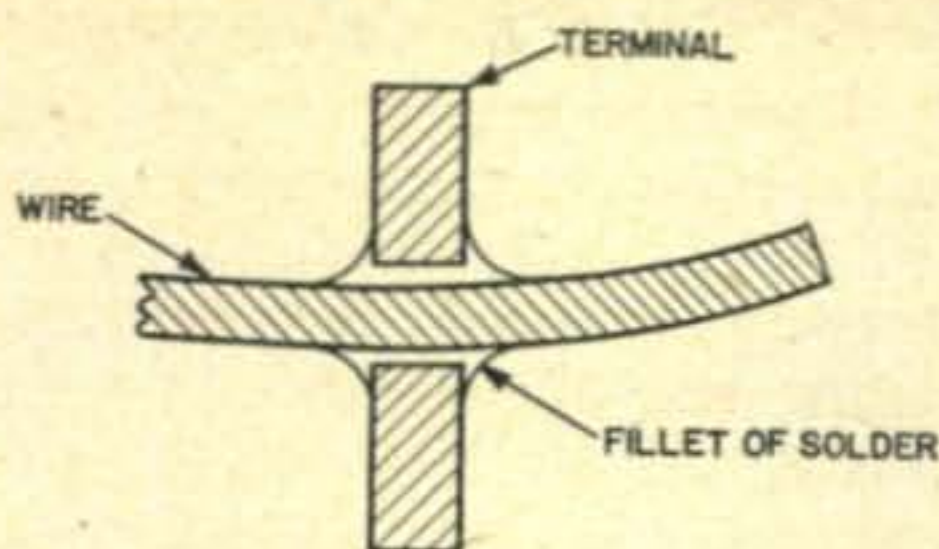

Horizontal cross section through an eyelet or tube socket type terminal showing the pigtail or wire adequately soldered.

Vertical cross section through a stud or wrap-around terminal showing the lead adequately soldered.

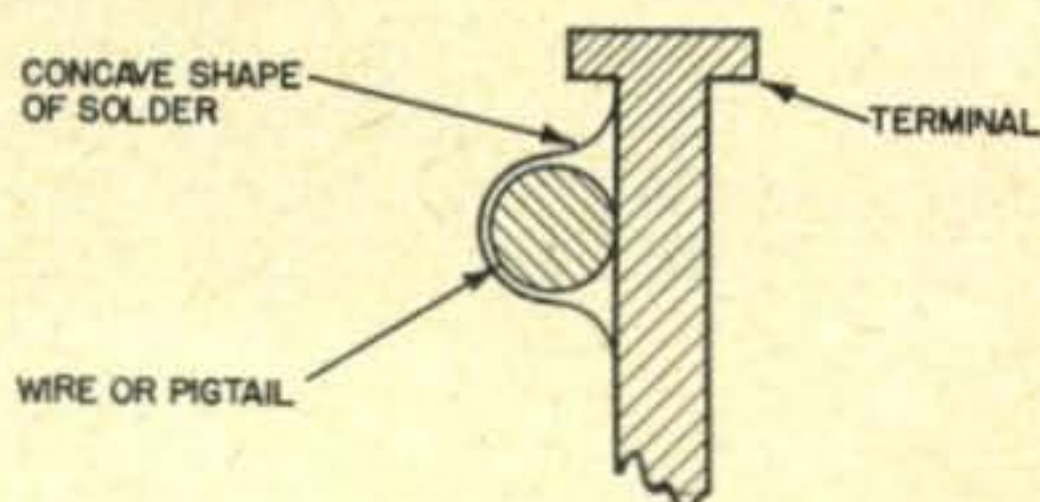

Solder is Strong Enough

J. Roy Smith, W6WYA

2052 Venice Street
San Diego 7, Calif.

In the handbooks we read, "Except where absolutely necessary, solder should never be depended upon for the mechanical strength of the joint; the wire should be wrapped around the terminals or clamped with soldering terminals." This is not true. It's unnecessary to make wrapped joints at the terminals before you apply the solder. Solder alone is strong enough to hold the connection together if a little common sense and care is used in soldering.

How many times have you tried to salvage some surplus gear and you spent most of your time trying to untie the solder soaked knots commonly understood as dependable soldered connections? How many times have you tried to repair or modify your factory made ham equipment and had trouble getting those crimped joints loose; perhaps you damaged parts in getting them loose.

Everyone has taken for granted the need for such mechanical joints, assuming they were necessary. People have said that solder is weak. It's true that soft solder will not support the pull of pliers in a man's hand. But, it will support small parts, pigtails and circuitry in all electronics equipment, whether you build it or your favorite manufacturer builds it for you.

Tests and Theory

Laboratory tests have been made at a government laboratory to determine just how necessary those mechanical joints are.

Simple soldered connections were made by just laying the wires against the terminals and

soldering in place. These connections were put through the paces of shock and vibration, frying and freezing, even far more than that required of military equipment. Would you believe it, these connections held without failure and without need of the usual mechanical joints.

What reasons have you heard for making mechanical joints before soldering? One has been that the solder is weak and that the wrapped or crimped mechanical joint is needed to relieve the strain on the solder or prevent the joint from coming loose. Let's think about this a bit. Before we can have a failure or falling away, we must first have a relative movement between the parts comprising the joint. In any soldered connection the solder has "frozen" the lead or wire in place. The pigtail or lead to the soldered joint is the only part that can move, hence any failures should be there. That's exactly what happened in the laboratory tests; some pigtails broke between the soldered joint and the parts but no soldered joints failed. Since the wires and pigtails are far weaker than the soldered joint, any further work on the joint to make it stronger is unnecessary; like "gilding the lily."

Another reason given for wrapped joints is that in case the solder doesn't take, the wrapped joint makes the necessary continuity. Again, let us back up and take another look. Joints, not properly soldered, corrode in time, get noisy and intermittent or even open up. Without the usual bird-nested wrap it is easy to see that the joint is or is not soldered; you can

find a defective joint.

You see, people have had a false security in the mechanical wrapped joint. Such a connection does not make it any better. Crimped joints, before the application of solder, do not build quality in your ham gear. They are a complete waste of time, effort and expense. We have been "penny wise and pound foolish."

The Way to Do It

If we have been doing it wrong, then how should we do it? Well, it's very simple, but the recommended method depends upon the type of terminals we use. The terminals used most often in ham equipment are designated as "eyelet" terminals. That is, the terminals have holes for the wires, as in tube socket terminals. Other terminals occasionally used are slotted terminals and stud or wrap-around terminals. The preferred soldering method varies with the type of terminal.

Now with the eyelet terminal, simply insert the wire or pigtail through the hole about 1/16 inch beyond and then solder in place. If the terminal is to connect more than one wire, it is preferable to wait until all wires are in place before soldering. If the terminal is slotted, put the wires in the slot and solder. On stud or wrap-around terminals, bend the wires or pig-tails in a right angle and just a bit more around the terminal and solder. Do not bend the wire more than a single half turn or "U" turn or we will be back with the old style wrapped joints.

It is a good idea to leave an extension (except in high voltage circuits) on the wire about 1/16 inch or so in length beyond the soldered joint. This extension is useful for holding the wires and parts in place until soldered; bending this extension aside beyond the terminal holds them in place.

Of course, we must still use all the rules for good soldering. The wires and terminals must be clean, free from corrosion, grease, dirt and lint. The terminals must be heated sufficiently until the solder melts and flows as it is touched against the terminal and wires. A bare minimum of solder should be used; just enough to flow in between the leads and the terminal. The grade of solder is not critical so long as the only flux used is resin.

Check the Results

The soldered connection can be tested visually and mechanically. If you can see that the solder has tinned the surface of both the terminal and the wire, that the flow of solder has formed a "fillet" in a concave shape, you are assured of a good continuous soldered connection. If the solder bulges, look further. It may indicate a resin joint, a cold solder joint or just excess solder. A good soldered connection is bright and shiny. A chalky appearance probably means the wires moved as the solder was setting. An unsoldered connection can be seen if there is no clutter of

wrapped and knotted wires. On the mechanical test, if the wire moves, it *ain't* been soldered yet.

Advantages

The advantages of this simpler method are many. Your equipment is easier to wire; it takes less time. Manufacturer "A" or "B" can spend less money on wiring and more on things more important such as stable oscillators or quality parts. You can be sure of no noisy or intermittent joints. Most important of all, you can repair or modify equipment with less difficulty, less likelihood of damaging parts in removing wires and leads. This enables you to use parts over and over again, and why shouldn't you? Parts cost money.

Mr. Manufacturer, please make connections this way in my future receiver and other ham equipment. You, Mr. Manufacturer, have been working too hard on connections and causing me much trouble later when repairs became necessary.

I have been making soldered connections this way in my mobile equipment for at least ten years and I have never had a soldered joint fail. You make them this way too and yours will not fail either. A government laboratory tested many many such connections under exaggerated environments without failures of soldered connections. ■

CHU--More Time Signals

That WWV monopoly has been shattered. Starting back in January Canada has been sending time signals from station CHU in Ottawa on 3330 kc, 7335 kc, and 14670 kc. which will probably sneak through the edge of the dial on some ham-band-only receivers. The time is announced once each minute by voice. The signal consists of 1/4 second pulses of 1000 cycle tone. The beginnings of the pulses mark the seconds. The first pulse of

CHU DOMINION OBSERVATORY
OTTAWA CANADA

THANK YOU FOR YOUR
REPORT OF THE DOMINION
OBSERVATORY'S VOICE
TIME SIGNAL ON:

3330 kc.
7335 kc.
14670 kc.



each minute is longer. Pulses are sent for fifty seconds, then the voice announcement is followed by the next series of pulses. The voice announces the minute coming up. The frequencies involved are not to be considered as standards. The time pulses are accurate to a few hundredths of a second. ■

Stability In The VFO

John W. Campbell, Jr., W2ZGU

Editor, Astounding Science Fiction, 304 E. 45 St., New York, N. Y.

The term "VFO" has become standard ham slanguage; unfortunately too many oscillators on the air are, indeed, *variable* even more than they are *adjustable*. What's wanted, of course, is an adjustable frequency oscillator that will not vary.

There is going to be no circuit diagram with this discussion—because the work I've done on the VFO problem indicates that a circuit diagram is of relatively little help in achieving a really stable and accurately adjustable unit; shop drawings would be far more suitable.

Why a shop drawing would mean more to oscillator stability than circuit diagrams is the thesis of this discussion; the *geometry is the one thing that is important in achieving oscillator stability*.

In trying to figure out problems, it's handy to borrow the techniques of the research scientist. When a chemist wants to study an element, to determine its properties, the first thing he seeks to do is to prepare a *pure* sample of that element.

The real test of an audio amplifier is its ability to handle a square wave.

Each of these research test efforts is based on taking the extreme case—the technique of going to the ultimate, limiting extreme, and studying what happens there. The chemist wants *pure* glopium for his research, so he can make sure that what he finds as a property belongs to glopium and nothing else. The audio hi-fi addict wants to test with a square wave, because that is the extreme case of transient response problems; it whams the amplifier system with two violent transients per cycle, and if the unit has any tendency to ring, it will have every possible opportunity to do so.

The extreme case is a handy way of testing an idea—by taking it to the extreme, to see what happens.

In the case of a VFO, let's consider a one that has been built as a bread-board unit. The coil, condenser, and all the wiring are out on top. Set it to, say, 3.950 megacycles with your face 2 feet from the board, and—this is literal fact!—if you wiggle your eyebrows, it shifts frequency.

Wiggle one of the wires on the bread-board, and the beat note in the receiver goes *woo-woo-woo*, but good.

Now make up a unit with a padding condenser using the sole of a discarded shoe for a dielectric. It'll make a fairly good hygrometer; every time the humidity changes, so does the frequency.

Well, we can use an air dielectric; we'll

mount one plate on a nice ceramic insulator, and suspend the other on a handy war-surplus screen-door spring. If nobody causes any vibration whatever, it'll be pretty stable. Of course, it'll also act as a lo-fidelity f-m modulator if you talk near it.

Taken to these extremes, the nature of the factors that cause instability in VFO's is clear enough. Trouble is, people tend to forget that the extreme stability we want *is itself an extreme*. A good, workable, moderate degree of oscillator stability is easy to achieve; the little midget portable radio receivers do that. Their oscillators are pretty fairly decently stable. But when some ham wants to use a VFO on 2 meters, and wants to keep the drift below, say 100 cycles—that's extremely extreme. You're demanding a stability better than 1 part in a million. Achieving that is just as extreme, in its own way, as using old shoe leather dielectric, or spring-mounted condenser plates. You're going to have to take extreme measures if you want that order of stability in your VFO—and you do, actually.

Exactness Counts

Now notice this: I didn't mention what circuit that odd breadboard set-up used. Maybe it was Hartley, maybe a Clapp, or perhaps a tuned-grid-tuned-plate circuit. It makes no difference whatsoever, does it? No matter what electronic circuit was used, the thing will be just exactly as lousy as its construction. If you've got the coil dangling on the end of a loosely hung wire, the electronic circuit doesn't count for anything; it'll be a slop-happy oscillator.

But we can go even further than the recognition that bad construction will make any oscillator unstable; geometry determines frequency, *not electronics*.

That statement sounds cockeyed, I know—but it isn't. Consider the typical quartz-crystal oscillator; the *geometry* of the quartz slice determines its natural frequency—and because that geometry is enormously rigid, the circuit used external to the crystal has very minor effect on the frequency.

But much of the effect of the external circuit is determined by the geometry of that circuit! If a triode oscillator tube is used, coupling from oscillator circuit to load must directly involve one of the active elements of the oscillator; if a pentode oscillator is used, the *geometry* of the pentode allows the use of the electron-coupled output circuit.

The capacity of a condenser is determined by the area of the plates, their distance apart, and the dielectric constant of the space between—it's purely a geometrical problem. The dielectric constant itself, turns out to be a matter of atomic-molecular geometry; the extremely high dielectric constant of the titanium dioxide ceramics is due to the fact that the titanium atom can undergo strong displacement in the crystal lattice formed by the oxygen atoms around it.

The inductance of a coil, again, is a matter of the number of turns, the diameter of the turns (which means the area enclosed) and the length of the coil. Varying any one of these factors varies the inductance — and they're purely geometrical factors.

Exactness Counts

Now if you want to put a thread on a 1/8th inch thick brass rod, so you can put a 6-32 hex nut on it, any sloppy old die can cut a satisfactory 6-32 thread for that purpose. But suppose you want to cut a thread on a steel shaft for use in making a micrometer? For this, you don't use 75¢ dies; you use a precision tool-maker's lathe.

When you're trying to make a VFO that's capable of micrometer accuracy—you don't use standard, sloppy right-angle drive gears, for example. You don't use dial-cord drives, either. You're trying to get 1 part per million accuracy—and brother, you can't have 1 part per thousand accuracy of your components, and expect a part per million accuracy in the resultant.

I have a VFO, the result of many, many, preceding experiments, that has a stability of 1 part per 2,000,000 over a two-hour test. Its warm-up drift is about 10 cycles at 4,000,000 cycles, and is completed in about 10 minutes. It uses a simple Hartley circuit, with an untuned buffer amplifier followed by a buffer-doubler stage. It can be reset within 50 cycles at 4,000,000 cycles. The output is 30 milliwatts into a 72 ohm coax—which is adequate to drive a 6AG7 hard enough to drive a pair of 813's to 500 watts output on 75 meter phone. A 6AU6 can be driven to act as a doubler, and drive a 6SJ7 more than enough to get full drive in an 832 push-push doubler driving the 813's on 10 meters.

Item: You do NOT need 5 watts output from a VFO; that's what an exciter unit is for. And a 6SJ7 or 6AU6 gives plenty of output to drive high-power-sensitivity tubes; it does not take a 6L6 to drive the grid of a 6L6, you know. Many ham rigs use outrageously inefficient low-level stages, which contributes to harmonic problems, but doesn't contribute a thing to satisfactory operation. A 6AG7 can be driven far more than enough for normal exciter purposes by 30 milliwatts; operating in Class A, a 6AG7 takes practically zero milliwatts, and will give a 130 volt swing across a 3500 ohm resistor!

Then a high-precision VFO does not have to be a power stage system; don't use your micrometer as a screw jack for lifting your automobile, either. A chronometer is not a suitable source of mechanical energy; it's designed for something else, and won't make a satisfactory power source for a kitchen batter-mixer.

Keep the power-level in the VFO *low*; the precision unit I have operates with 28 volts on plates and screens. If I were redesigning and rebuilding now, I'd build around the 1.5 volt, 25 milliamperes filament tubes intended for battery operation. Even using 6.3 volt 300 ma. heater type tubes, there's so little heat generated in the VFO unit that I use *no* temperature compensation; radiation to and from the room environment is adequate, because I've used a good, roomy cabinet—primarily because the black crackle finish of said cabinet offers a couple of square feet of heat-dissipating surface.

Instead of temperature compensation, I have the whole VFO in a thermostatically controlled oven. The thermostat is on the wall, and the oil-burning furnace maintains the temperature very easily within about 4 degrees.

Look, friend; your house *is* a thermostatically controlled oven! Make your VFO operate at room temperature, and you'll have all the advantages of thermostatic control.

No temperature compensation can work perfectly; the different parts of a VFO will heat at different rates, no matter how hard you try to prevent it. The only thing to do is to come as close to no-heat-input as you can, so that there won't be any temperature change to compensate for. If you'll do all your power-amplification in the exciter, where it belongs, instead of trying to make the VFO do two jobs, getting rid of the heat problem is simple. Don't have any—or have so little it doesn't have detectable effect.

Incidentally, the heat output of three of the 1.5 volt, 25 milliamperes battery type filamentary tubes, running with a more-than-adequate 75 volts on plate and screen is about on the same order as the heat radiated from your own body at a distance of two feet! Getting the heat generation inside the VFO box lower than that, then, is futile. And trying to compensate for that order of heating is also futile—merely leaning toward the VFO would throw off the compensation!

Any VFO is OK

I don't care what your favorite VFO circuit is; I like the Hartley for cathode-heater type tubes, and the tickler-coil type for filamentary tubes. But use anything you like; it's unimportant, actually. The shop-notes, the mechanical structure which is the geometrical structure, are far more important than the circuit diagram. It doesn't matter too much what particular lay-out you use, so long as the layout is rigid to the degree of accuracy you want in the VFO. If you want a part per million stability—then

you've got to have one part per million or better stability in the mechanical structure.

Now this isn't part per million *accuracy* in construction; it's part per million *stability*. My VFO is hand-carved, and the 1/4"-drill I use has worn-out, sloppy bearings, so the accuracy is definitely low. My "hole-mover-over" (small rat-tail file) is one of my most needed tools. That's not what counts; what counts is that the chassis the VFO structure is built on is a piece carved off of a 1/8th inch thick aluminum relay rack panel. It's supported only at one place—along the front edge, where it was bent down a half-inch and bolted to the light sheet-steel cabinet front. The VFO structure is mounted on the aluminum slab, with *all* r-f wires made of heavy-gauge buss-bar type wire (1/8th inch thick copper) and mounted on ceramic stand-offs. It's *rigid*. The coil is mounted on the condenser itself; there's bound to be movement, since no material is absolutely rigid, but the set-up is such that the whole VFO system moves *as a unit*. There is no way that pushing on the cabinet, for example, can stress the VFO chassis. You can *move* the chassis, but because of the one-point mounting, you can't *stress* it.

The VFO shielding can is mounted on the chassis, of course; the VFO-to-cabinet capacitance is cut off, so that movement of the VFO chassis with respect to the cabinet has no effect. The VFO's actual shielding moves with the chassis, with the VFO, and hence doesn't change the geometry of VFO-to-grounded-metal.

The real problem

The real Grade A Stinker problem is, of course, the condenser and drive mechanism. There, so far as home-workshop goes, you've had it. You can't make the condenser mounting-and-drive mechanism with the needed precision. Further, you can't buy a drive gear and a condenser, and mount them together—unless you also have precision machine shop work as a second hobby. The condenser mounting and drive must be carved out of heavy, blocky chunks of metal; it must have that 1-in-a-million rigidity. The bearings must be centered with extreme accuracy, or, as you tune the condenser, stresses will be applied to the shaft that will act one way when tuning up in frequency, and the opposite way when tuning down. It's a mechanical-geometry problem.

The coil problem isn't very tough. With no temperature change to worry about, mechanical rigidity is the only problem. I find that the Air Dux and B & W Miniductors work fine, if you slip the 3/4" size inside the 1" size, and polystyrene cement the two together, mounting the whole unit on a polystyrene strip. The finished system is rigid enough, when stand-off mounted either on the condenser, or on the heavy-duty chassis, to give the needed stability. With a ceramic coil form, there's the gimmick of winding the wire on the coil, while keeping it as hot

as you can handle without getting the coil form all smeared up with pieces of seared skin, and then letting the cooling after it's all wound shrink the wire immovably on the coil-form. (A Variac and a heavy-current filament transformer can keep a considerable length of #18 copper wire quite warm. Ten amperes will do, fifteen is too much.)

I tried, incidentally, winding a coil out of that buss-bar wire. It was a hellish job, and didn't do a bit better than the B & W Miniductor; when your oscillator is running a total power of 5 to 10 milliwatts, you don't overheat even a #22 wire. Again—the buffer is the place where power output begins; you don't *need* power in a VFO oscillator.

In padding condensers, the thing that counts is not precision of value—you're going to calibrate the oscillator anyway. Stability, not accuracy, is what you need. The silvered mica jobs are stable. Ceramic padders may do . . . but the silvered micas are superior.

Gears

Commercial precision tuning condensers are expensive; Cardwell's beautiful little condenser, specially designed for precision oscillators, sells for around \$80. Commercial instrument makers wouldn't pay that money for them if they didn't appreciate the reality of the problems involved.

National makes a magnificent unit, using the HRO type dial drive, and a fine precision condenser attached, for about \$30. Incidentally, the condenser and drive must, for optimum results, be built as a unit; you can't get the precision you want by buying dial drive and condenser separately, and home-hitching them.

The tuning condensers used in the ARC-5 series of transmitters have excellent worm-drive-and-condenser systems; if you can lay hands on one of them, it'll do a fine job for you, but it isn't built with the massive solidity you really want. Even the ARC-5 series receiving condensers are pretty good units, though they, too, lack the massive rigidity that would be ideal.

There was a tuning unit designed for use in tanks; the double condenser units, once upon a time, were selling in surplus, in the original, unopened sealed tin boxes, for \$2.98. Them days is definitely gone forever; I've heard that people are offering \$15 for the worm-and-gear from those jobs alone. They are, of course, ideal for VFO use . . . if you can find some innocent sucker who'll sell you one. They have all the delicate fragility of the tanks they were meant to be used in; they've got solid brass end-plates about a quarter of an inch thick, and if dropped ten feet onto a concrete floor will probably crack the floor. They were intended to maintain calibration under the rugged conditions of an army tank, and for precision VFO's they're wonderful.

[Continued on page 91]

Sgt. J. George Loos, Jr., W5LFG

Mal Pais Court, Carrizozo, N. M.

Trailer Ham



It is doubtful if there is a pipe-dreaming amateur in existence that hasn't leaned back in the old operating chair, stared deeply into the glow of a mercury vapor tube, and dreamed of hooking a house trailer (complete with new Zilch 999 receiver and a kw transmitter, naturally) to the family chariot and driving into the jungles of Puerto Tango. Whether you have dreamed, or wondered about, or actually contemplated either taking a trip, vacationing, or living full time in a trailer (called "mobile homes" by the more elite) here are some facts, opinions, and actual incidents of operation from a house trailer.

After being confronted with the rent housing situation on the east coast, the XYL (who incidentally is W5TSE) and I decided that we would take the big plunge and purchase one of these homes on wheels. We found we could purchase a trailer complete with furniture, kitchen stove, refrigerator and all the trimmings for about half as much a month as comparable rent in that locale. Upon investigation we found that a new trailer with plumbing and a complete bathroom runs about \$100 per foot of trailer length including all the fixtures and furniture. This seems to be more or less standard across the nation. Used trailers prices seem to vary considerably throughout the country. Don't have the idea that you will save any money while you are traveling with a trailer. People have approached me many times with such statements as, "You must save a lot of money in food and motel bills when you take your trailer along." I would be glad to pay their food and motel bills if they would pay for the extra gasoline that I burn, not to mention the tremendous wear on my car's clutch and back tires. Even with all the disadvantages it is nice to be able to move all your belongings, including your home, within 30 minutes. Not to mention the fact that you are assured you will have a place to live upon arrival at your destination. One other thing; It's Yours—All yours!

Parks

About now would be a good time to discuss some of the aspects of where you are going to park your trailer while you are living in it. If you are going to dwell a hundred miles from civilization in the northwoods or the Gobi desert then I am sure you will have no trailer parking problems. Incidentally, if you do plan to live along these lines don't forget that a gasoline driven generator will be needed. A good old 110 volt put-put is a good thing to have while living in a trailer since they come in mighty handy for overnight stops along the road when en-route between semi-permanent locations. I have seen some very nice put-put installations just forward of the trailer body on the frame.

If you plan your operations a little closer to civilization a trailer park is by far your best bet. Like everything else, trailer parks come in three sizes: good, bad, and indifferent. Even in the smaller communities the good ones are available along with the other types. In most trailer parks the farthest you are likely to be from another trailer will be about twenty feet (unless the proprietor has several vacancies). Hold on now, don't take those aspirins yet. Even in such close quarters to the next trailer, an astounding thing will happen! No TVI! Incredible? Well not quite, since almost all of the modern trailers are covered with aluminum and well bonded you are operating within an excellent shield. Also, you neighbors on all sides live and operate their TV sets within their own shields. By the way, some of the better trailer parks have underground wiring, which virtually eliminates BCI and line noise. During the past year I have operated from four different trailer parks in different parts of the country, and at one of these locations I was over 100 miles from the nearest TV station. To date I have not had one case of TVI.

In some instances, during the evening hours,

the line voltage may drop to a fairly low value. This is due to the fact that trailers usually have a large number of electrical appliances and some trailer park wiring systems are not adequate to carry the extra load of all the electric hot water heaters on during the time everyone is washing the evening dishes. This is the exception rather than the rule and if you do run into an extreme case, a variac hooked to the ham gear to boost the voltage would solve the problem. So far, I have not run up against a case of line voltage so low that called for such drastic measures.

What Rig?

Now, let's take a look at the equipment situation. I have seen half-gallon¹ to jigger² power rigs installed in trailers. There is not much use in telling you what kind of transmitter or receiver to use in a trailer, because as any self-respecting red-blooded ham would do, you will use what you dog-gone please anyway. If you plan on running much over 100- to 150-watts on phone, be sure and check the 110 volt wiring in your trailer. Most trailers have smaller wire than you would normally find in a house, and this may necessitate a separate wiring circuit for high power operation. Unless you like to buy a new rig every time you move be sure that the rig is properly secured before you take-off on a cross-country jaunt. If your gear is not substantially bolted down, place it on the floor and put some kind of padding around it. Under any circumstances do not put it on the bed or divan (I could tell you a sad tale of woe about trying this, but your tears might make the pages stick together). There is quite a bit of vibration in a trailer while it is in motion, and although you won't be able to notice it, this vibration will cause loose objects in the trailer to slide and shift around quite a bit. Just where to locate the rig in a trailer is strictly a matter of choice (and the XYL's approval). Since trailers differ considerably in respect to interior design, you will have to use your ingenuity. Probably the nicest trailer installation that I have seen was built into a small closet about the width of a relay rack. When the closet door was opened a desk top dropped down directly in front of the rig. The rig here runs about 100 watts on 80- thru 10-meters AM and CW.

Sky-Wires

Antennas presented quite a problem at first. Since trailers are quite thick and constructed so that it is not practical to bring the feed-line thru a window or wall, this presented a problem. After discussing the situation with a telephone installer I found that they brought their lines thru the floor. (Yes Siree, they put tele-

phones in trailers.) The feedline hole can be drilled in some inconspicuous place in the floor, such as under a bed, and plugged up with a small cork if and when you decide to remove it. Although I have been in places where it would have been possible to put up a good sized V-beam or rhombic, I have found a multi-band vertical very handy and practical. The vertical in use consists of a number of surplus 3 foot antenna sections that screw together and are mounted on a surplus base insulator which is bolted to the side of the trailer by means of an "L" bracket. The antenna is fed at the base as a quarter-wave using the trailer body as a groundplane. At semi-permanent installations I ground the trailer body to a cold water pipe or ground stake. To get a quarter-wave on 10-, 15-, and 20-meters, I just screw the proper number of sections together to get the right length. On 40- and 80-meters I screw six of these sections together, which gives me an 18 foot vertical, a loading coil is then inserted at the base to make up for the lack of length needed to achieve a full quarter wave vertical.

This antenna is easily taken down and stored for moving. Since it is against the law to ride in a trailer that is in motion you might as well take the antenna down while moving. Another good point about having the antenna removable is that you may mount it higher on the trailer body without worry of losing it on low trees or underpasses and such. I also use a two element 15 meter beam that can be taken down small enough to place in the trailer along with its 30 foot telescoping TV mast. The beam is an exact copy of the one designed and constructed by W6SAI.³ You may desire to supplement the vertical on some bands with other antennas, depending on the space you have available, but the vertical is handy to have and works out very nicely. I might add that I have never had any trouble from trailer park managers about putting up antennas, in fact some have eagerly assisted me in my skywire raising ventures.

Although it is not too well known, the number of amateurs using this type home is certainly on the increase. I have found only a few trailer parks that didn't contain at least one active ham. A number of these trailer parks had several active hams. Considering that most of these parks had from 25 to 50 trailers, this is a pretty high percentage of amateur populace. Most of the amateurs in trailer parks live in trailers due to the fact that their jobs require frequent to occasional movement of their ham shacks. Needless to say they find it a convenient way of living.

Well, I hope to see you pull your trailer into a trailer park that I am in, but if you're running a kilowatt please don't park next to my 15 meter beam! ■

¹A half-gallon rig has the capability of one-half kw input to the final r-f stage.

²A jigger powered rig depends on the size jigger used.

³"20 Meter DX With A 2 Element Beam," William I. Orr, W6SAI, CQ, October 1953, page 11.

Bob Bain, W5CRK

1721 Western
Fort Worth, Texas

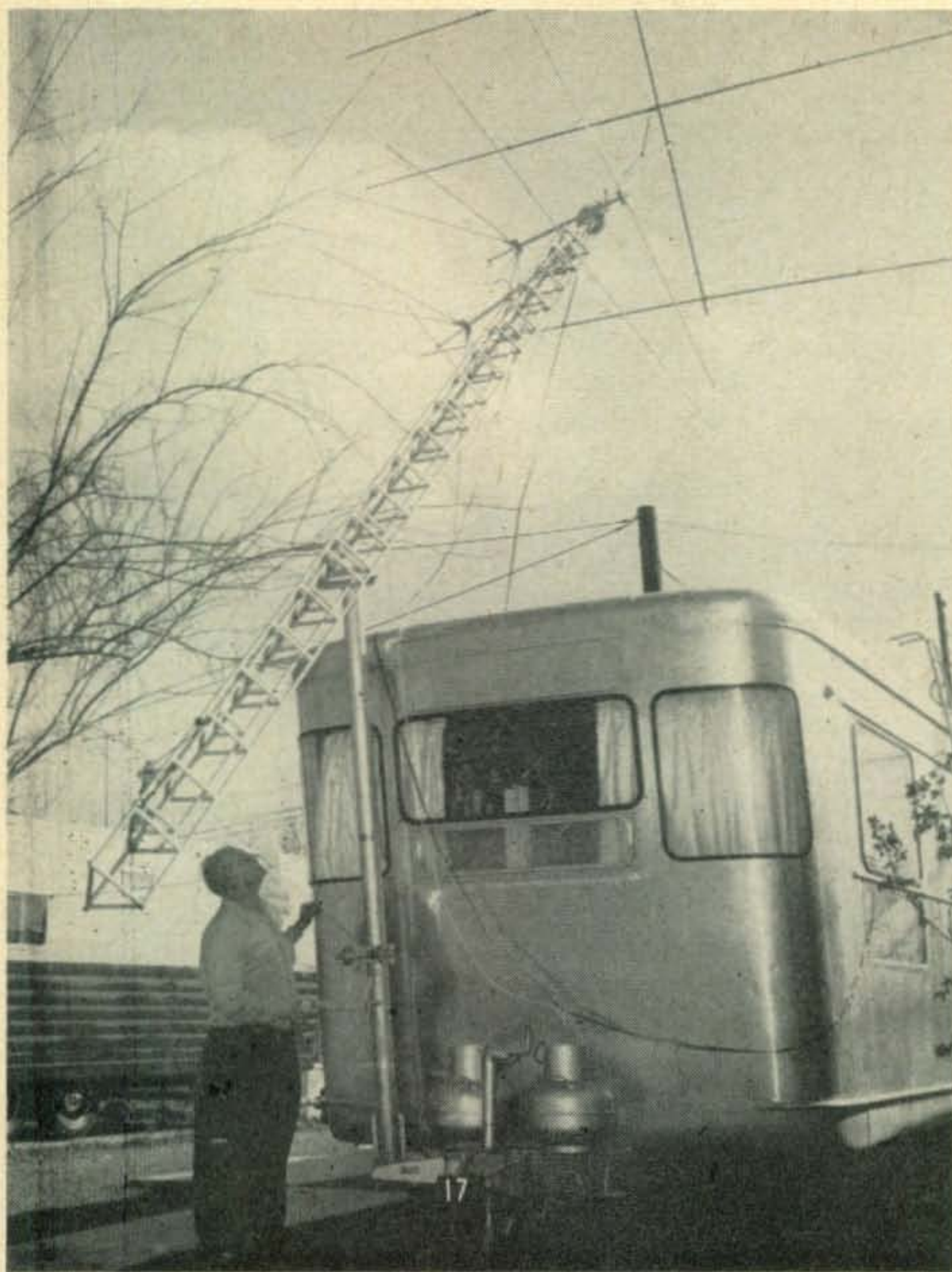

Keith lowers the tower. Note how the tower support is tied to the main frame of the trailer (left of butane bottles) and to top frame of the trailer. Mounting methods would vary with different trailer homes, no doubt.

Trailer Beam

Problem: Beam installation for fixed/portable operation from a house trailer with the following requirements:

1. One man erection and removal of beam
2. Means of transporting tower when in motion
3. Sturdiness

Keith W. Ingalls, W8RXC, confronted with the above situation came up with this idea which might prove informative to others.

At first Keith used a mobile whip and loading coil arrangement (still in use on lower frequencies) for his operation whenever he and his wife settled down for a stay in trailer parks throughout the country. But ten meters started showing signs of life. While many contacts and some DX can be achieved with a whip, it

is a generally accepted fact that a beam makes it easier to fill pages of log books with solid contacts.

Utility companies take a dim view of people using their poles as masts, and there is not too much room for guy wires in the space allotted individual trailers in most parks. With a shortage of skyhooks on the surplus market, there arose a slight problem of how to keep a beam up in the air.

The answer was found in one of the crank-down, tilt-over lightweight TV towers. Mounted on the front end of the trailer, with the base support welded to the main frame of the trailer and to the top frame (which had to be beefed up), the tower provides a place for one of the popular three element full-size 10 meter beams, complete with rotator.

As shown in the illustrations, Keith also managed to make a neat installation of his rig in one of the storage cabinets of his "living room."

For traveling on the highway, Keith simply lowers the tower to its 20 foot length, tilts the tower, removes the beam and rotator, and secures the tower to the trailer's roof. The whole operation including removing feed lines, etc., takes approximately 30 minutes. In traveling position the tower protrudes over the towing car's top leaving no overhang at the rear of the trailer. According to Keith, by the time his XYL has the coffee pot stored and the interior of the trailer made shipshape for travel, he has the tower lashed and associated gear stored.

Sturdiness? While visiting in Fort Worth, Texas, there were gusty winds with velocities reaching 45 mph. The beam and tower swayed a bit. Once the tower was lowered to the 20 foot level at night. Another time it was left extended to the 40 foot level and no trouble experienced.

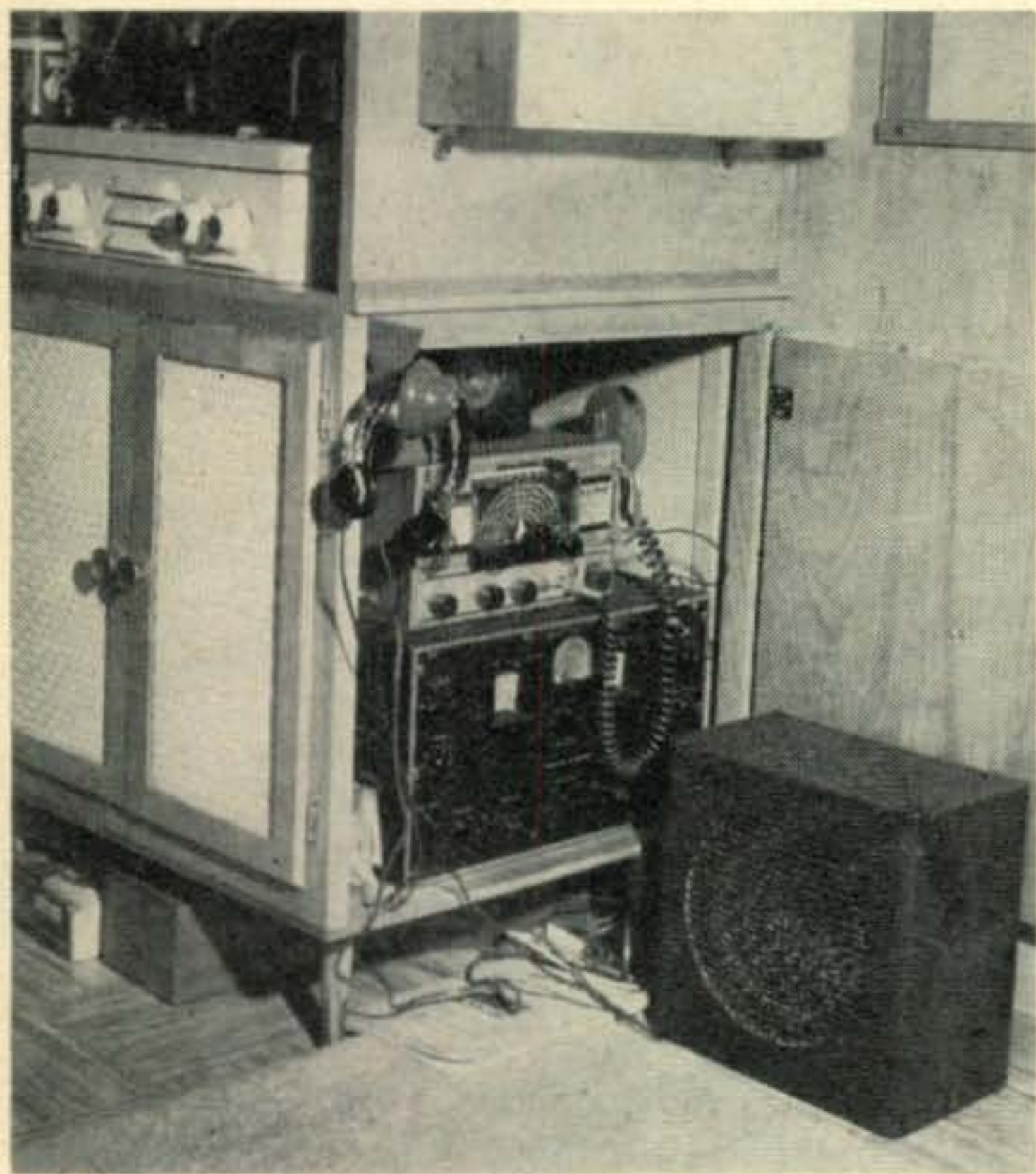

Neatly stashed conveniently close to the kitchen, W8RXC's rig takes so little room that his XYL does not object! When on the road, the speaker is stored in the cabinet on the left.

With tower lowered from its extended height of 40 feet, Keith grabs another crank and tilts it over the roof of his trailer. The beam, rotator and TV antenna are removed and stored inside while on the road. Tower lays flat atop trailer roof and is secured for traveling.



Comfortably located in his "mobile living room" with filaments merrily glowing, Keith renews acquaintance with a W7 he met in person on a previous trip.

The installation has made the trip from Florida to Texas. Managers of trailer parks have given no difficulty. No specifications on the installation have been given as each individual trailer would no doubt call for a slightly different approach.

But if you are contemplating a trip in a traveling home there's no need to leave the beam behind. You can take it with you. Besides, it provides a handy place to hang the TV antenna for the XYL. ■



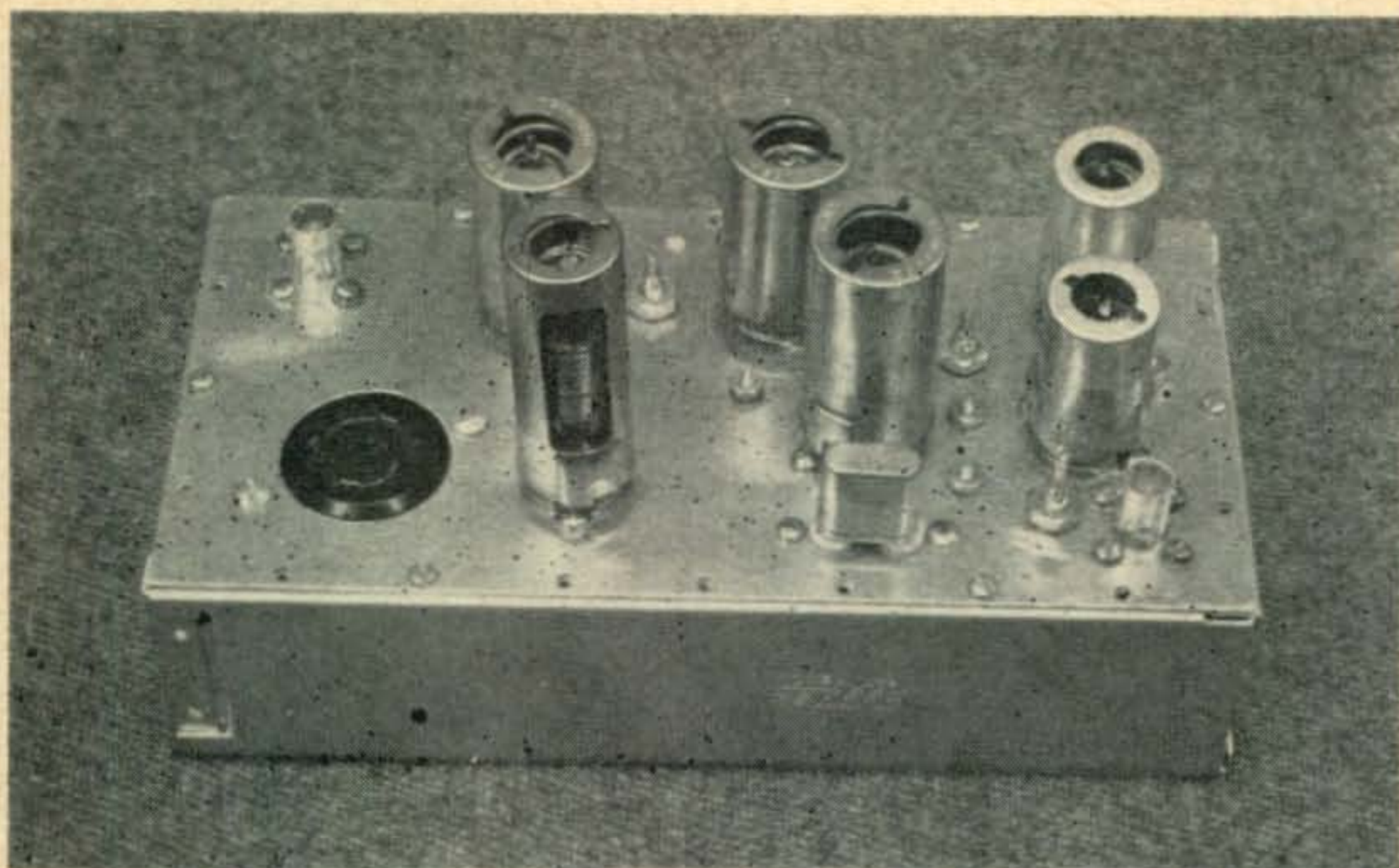

Wayne C. Taft, W1WID

35 Myrtle Street
Belmont, Massachusetts

A Low Noise Converter for 50 Megacycles

Since the opening of the six meter band to the Technician class of license last spring, the activity on that band has been on the increase in most areas. Also a contributing factor to this increase in activity is the possibility of more DX due to the upswing of the sunspot cycle. Those who remember the DX of the late forties on six will also remember the enthusiasm with which the latest improvements were added to rigs as new VHF circuitry and components were made available. This continuous improvement of gear has been widespread on the higher VHF bands, but such improvements of 50 mc gear were not so numerous when the DX ceased. Much work has been done to build better and lower noise converters for 2 and 1¼ meters, especially since the larger tube manufacturers have introduced several low noise tubes for VHF and UHF television receivers. Since these tubes are being mass produced for TV, they are quite inexpensive and a VHF converter using them is now well within the budget of the average ham. The converter to be described is perhaps

one of the first attempts to use these new tubes on our lowest VHF band.

The tube used is the RCA 6BC4 which was intended to be used as a grounded-grid r-f amplifier in UHF television receivers. It is a triode with a gm of 10,000 μ mhos, and therefore a very low equivalent noise resistance. Using two of these new tubes in a conventional cascode circuit, a noise figure under 2 decibels was obtained at 50 mc. It should be pointed out that such a low noise converter would be of little use in a noisy location, but that it is a worthwhile project for the VHF man who has a quiet location, or who intends to use his six meter converter as an i-f strip for 420 and 1215-mc converters.

The 6BC4 cascode r-f amplifier is more or less conventional. The biasing arrangement for these tubes may seem a bit unusual, but it is merely a d-c stabilization circuit which keeps the plate current of each stage constant over a wide range of tube characteristics. This feature is desirable as the noise figure is dependent upon plate current. The 10-ohm resistors used in paralleling the grids reduce the possibility of parasitics due to lead resonances.

A double tuned circuit of the Tee variety is used between the r-f amplifier and mixer. This type of double tuned circuit is easier to adjust and construct than any of the others at this frequency. The double tuned circuit offers better skirt selectivity than does the low-Q single tuned variety and goes a long way toward eliminating images and i-f pickup.

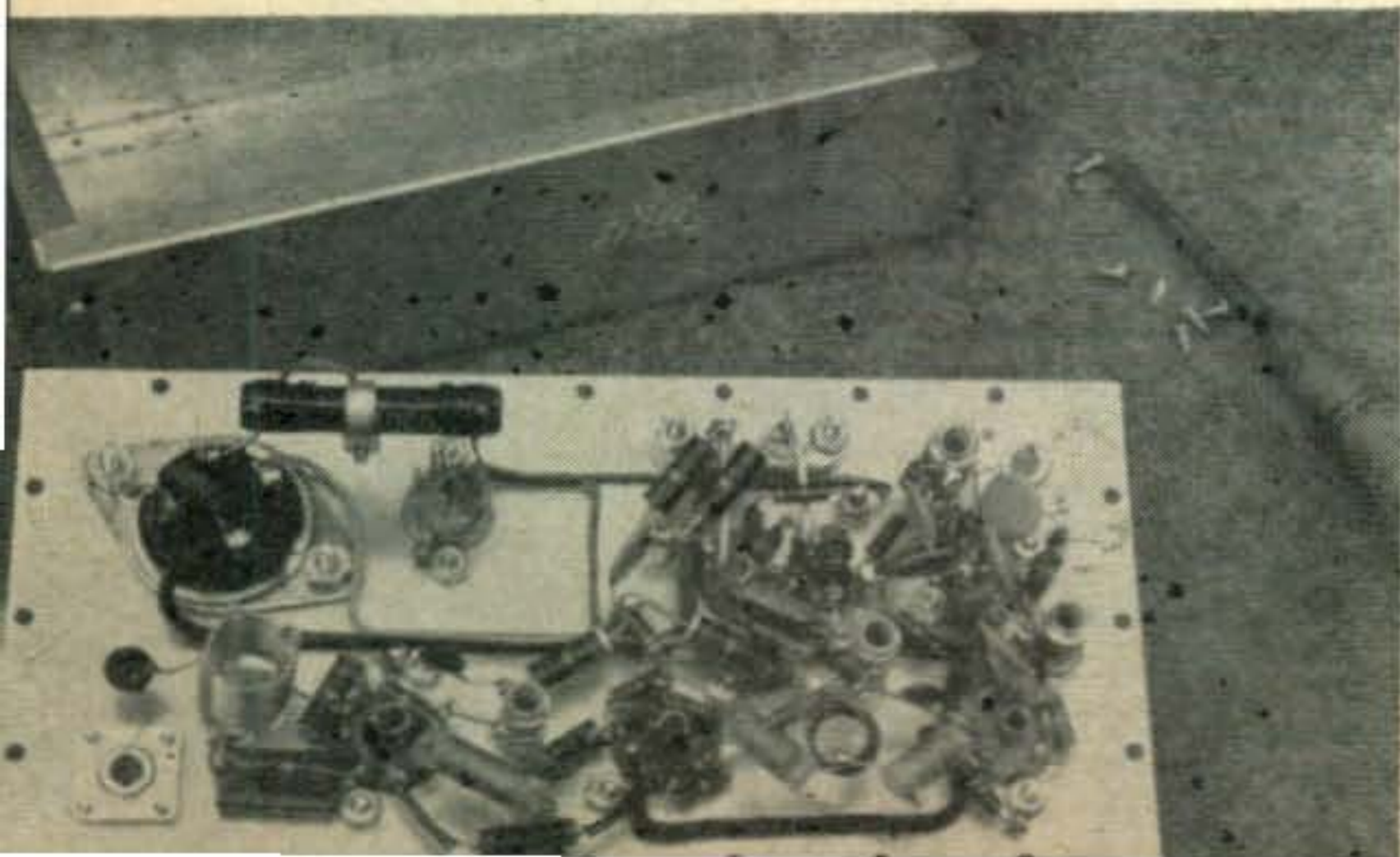

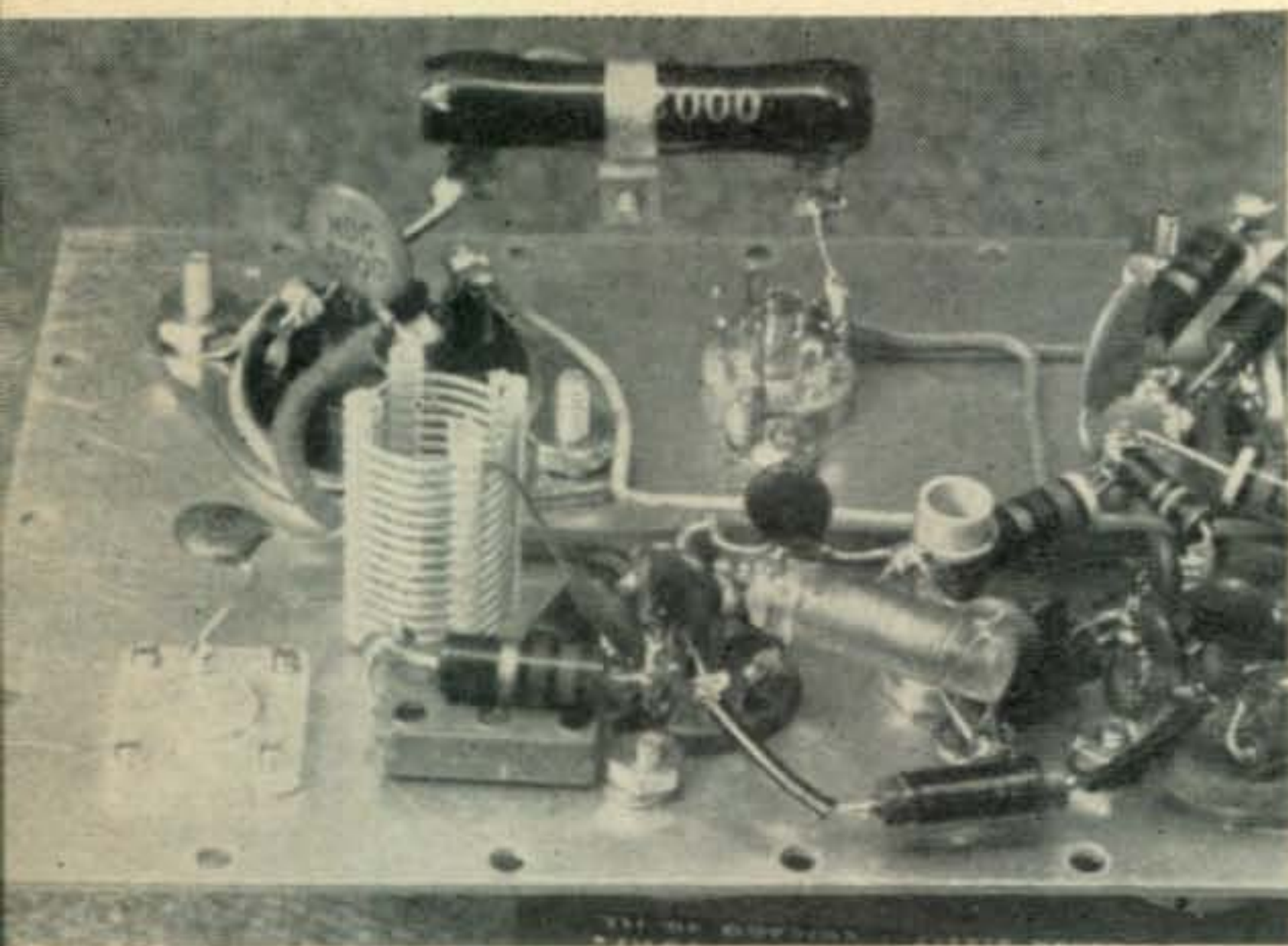

converter to work properly. Adjustment is simplicity in itself with the proper equipment. All that is necessary is an *accurately calibrated* grid dip meter. First, be sure that all tubes and shields are in place, and that nothing is connected to the input and output jacks. Check the frequency of *L1*—it should be somewhat lower than 50 mc—somewhere in the vicinity of 48 mc will provide the optimum noise figure. *L1* and *L2* should require no adjustment if the coil specifications are followed closely. The adjustment of *L3* is not critical; it may be dipped to the center of the band. To adjust *L4* and *L5*, first disconnect one end of *L5* and dip *L4* to 51.5 mc. Then reconnect *L5* to the circuit and disconnect one end of *L4*. Dip *L5* to 51.5 mc and reconnect *L4* to the circuit. This completes the adjustment of the r-f stages. To adjust the i-f stages, disconnect one end of the 2.7 K resistor across *L7* and one end of the 8.2 K resistor across *L8*. *L7* is then dipped to 10.3 mc while *L8* is dipped to 13.5 mc. Reconnect the loading resistors, and this adjustment is complete. Finally, dip *L9* to 40 mc. When power is applied to the converter *L9* should be adjusted for minimum mixer plate current. This method of aligning the converter should yield quite good results, however a more accurate job could be done with a noise generator and a sweep generator with a scope.

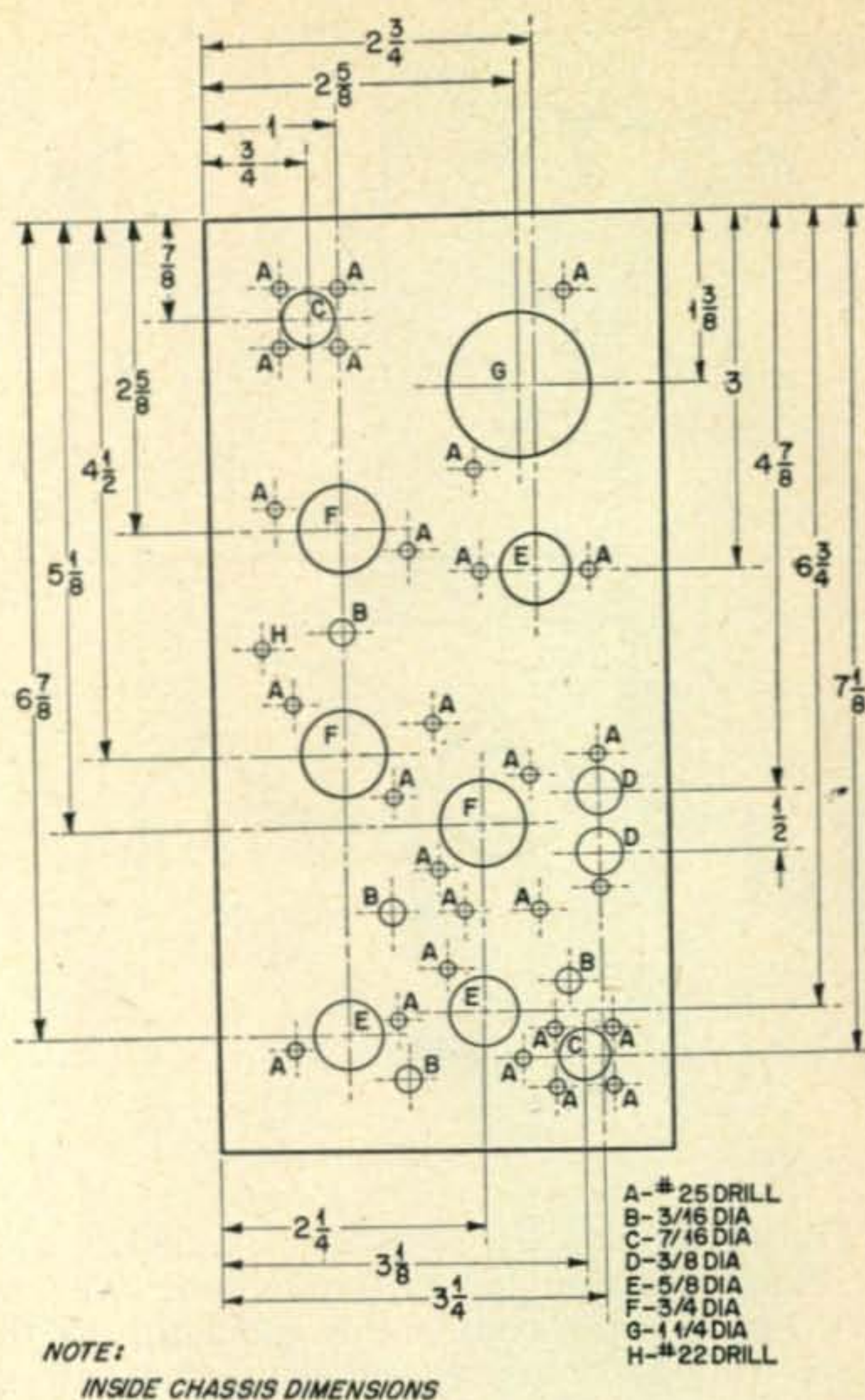
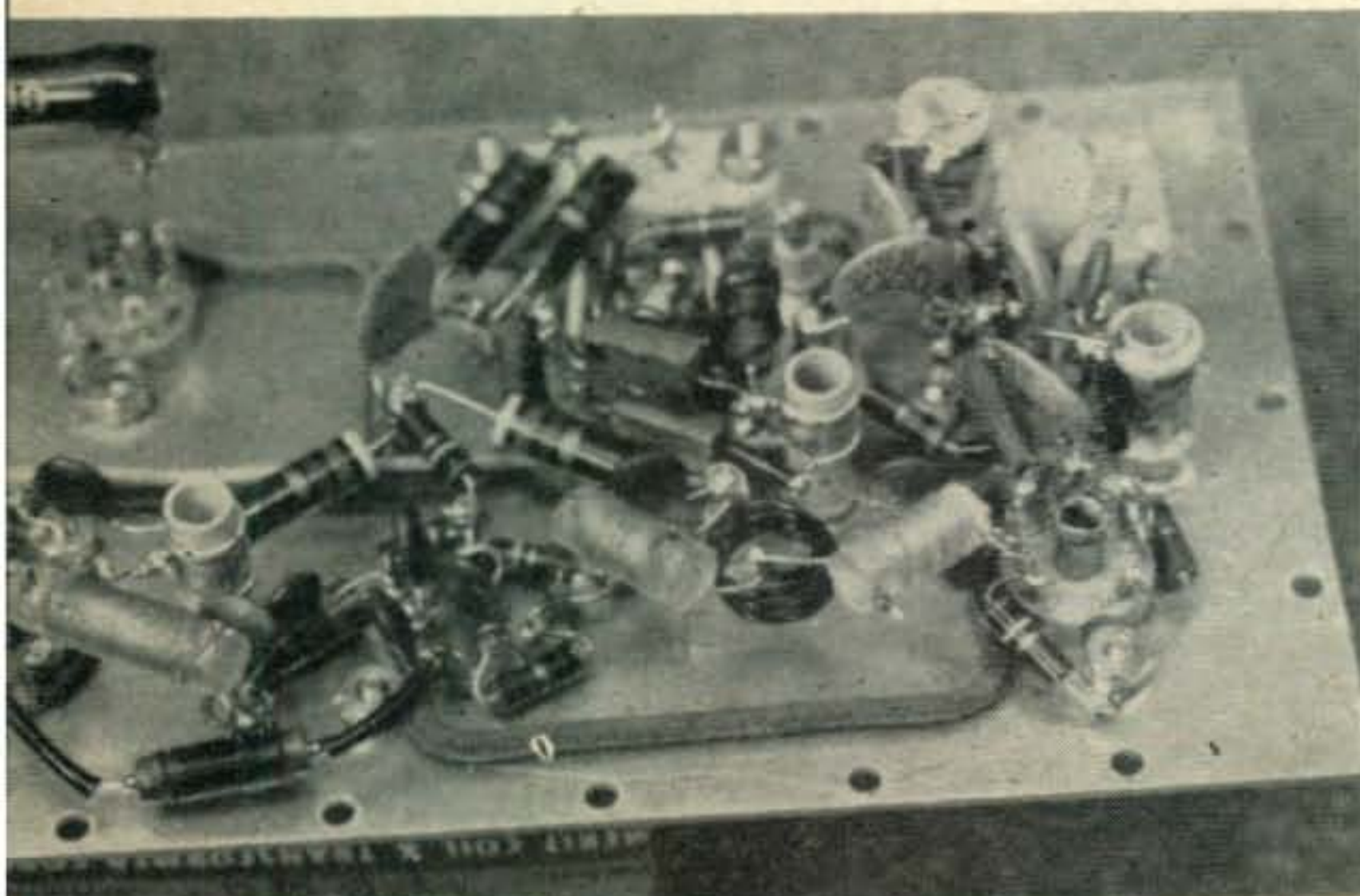

The power requirements are 6.3 volts @ 1 amp. and 250 volts @ 50 ma. If a 150 volt regulated supply is available, the OA2 and its dropping resistor may be eliminated.

Like most crystal controlled converters, this one is not without a few spurious responses. They have, however, been reduced to a minimum. With the receiver tuned to 51 mc, the response at 29 mc (10 meters) is 35 db down, the response at 69 mc (Channel 4) is 55 db down, and the response at 91 mc (F-M band) is 72 db down. The second harmonic of the oscillator produces the latter two responses. Of these responses, only the one at 69 mc gave any trouble at the writer's location. This was because of a strong local TV station on channel 4. The interference was completely eliminated by a parallel-tuned series trap in the antenna lead. Note that if the i.f. were 14-18 mc, the same trouble would occur with channel 2. No trouble has been experienced with 10 meter images as yet, but a simple high-pass filter would no doubt eliminate this sort of interference if it did occur. I-F pickup is apparently non-existent. In the writer's model, only 2 or 3 weak birdies can be found—all above 51 mc—which is not bad considering the large number of VHF services operating in the Greater Boston area.

The writer wishes to thank Mr. Henry H. Cross, W1OOP, for his many helpful suggestions in the design of this converter. ■

You still not on two?

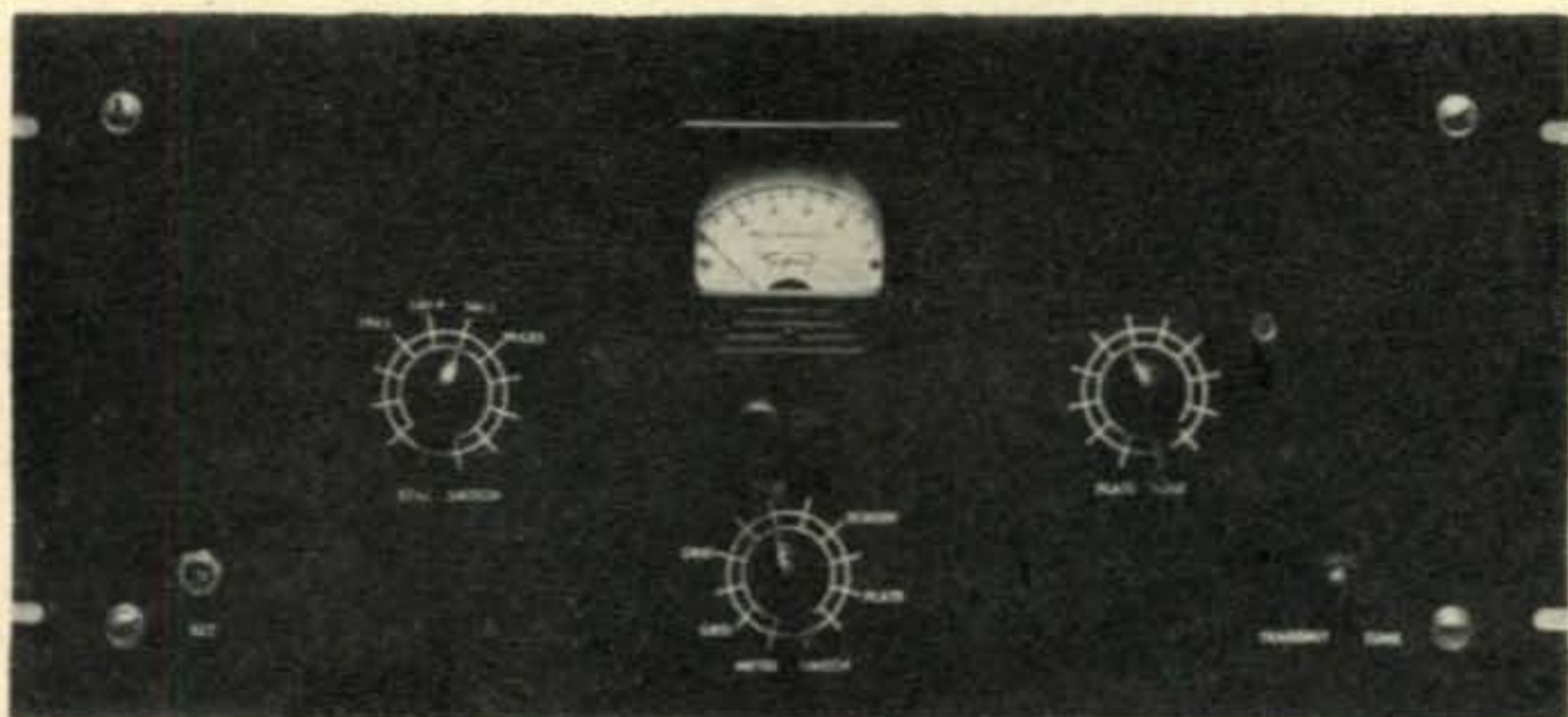

Two Meter Demon

Here is an exciter utilizing but three tubes that will fit both the finances and the final. Less power supply, thirty dollars will cover all parts including meter and chassis. As a driver it will do for any kilowatt final you have in mind; or as a transmitter in the 90 to 100 watt range it will be hard to beat. It will easily drive a pair of 4-125A's, or even a pair of 826's to their maximum input. Circuit-wise it is simple and is a demon for power output. The pictures show quite clearly the placement of parts and wiring so a step-by-step description is deemed unnecessary. The chassis shown is 7" x 17" x 2" but a smaller one could be used where space is at a premium.

Blocked grid keying is employed in the 2E26 tripler plus cutoff bias for the 829B which provides smooth, click-free CW keying.

The Oscillator employs the Robert Dollar Circuit. The 12AZ7 was chosen over a 12AT7 as the most efficient of the two. The first triode

section acts as a tripler, the second section as a doubler. XR-50 slug tuned coil forms were used in these sections to give broad tuning. Once set they can be forgotten for a 600 kc frequency change. The oscillator section will give 1 to 1.2 grid mils of drive to the grid of the doubler section when the oscillator tripler section is peaked to resonance. The same amount of drive will show at the grid of the 2E26 tripler. Grid current on the 829B will run from 6 to 8 mils.

The grid circuit of the 829B is untuned but resonates with the series-tuned 2E26 plate tank. Tuning here is quite sharp but when once set will not need retuning over a frequency change of 600 kilocycles.

The plate tank of 829B is quite different from the average VHF tank, being made from silver plated #10 soft drawn copper wire bent to form a rectangle measuring 3" high and 1 3/4" wide. It would be wise to grid dip this

Al Hays W5JQU
Bill Bonnell W5CVW

3820 Hamilton Drive
Ft. Worth, Tex.

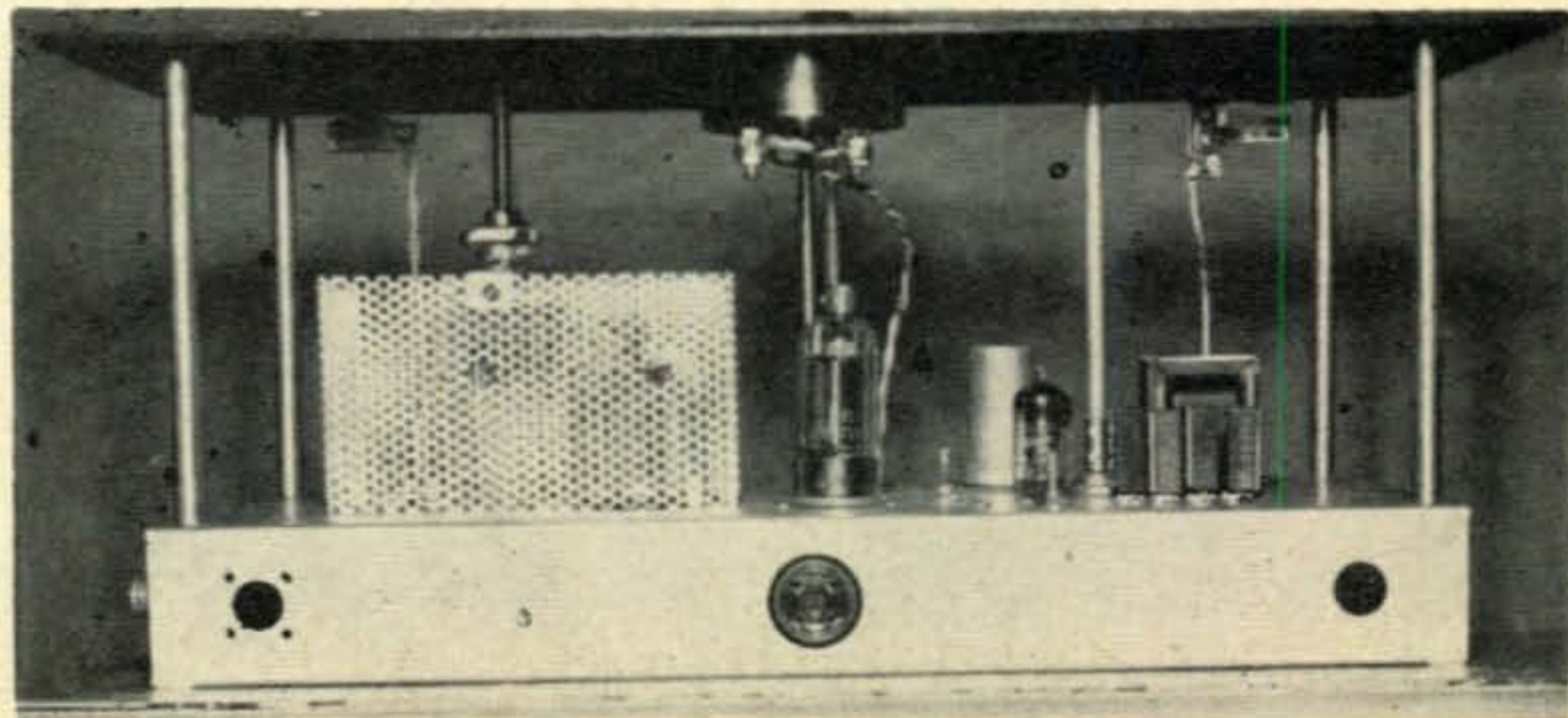

tank and prune the coil to give at least $\frac{3}{4}$ meshing of the plates of the tank condenser at 144 mc. The shielding around the tube and coil did not appreciably change the frequency of the tank. A BFC-12 (butterfly) condenser is used to tune the square tank. This condenser is a must for this circuit since its construction lends symmetry to the tank and plate leads. The condenser was ordered from *Hammarlund* at a cost of about \$1.80. The output link is made from the same size wire bent to form a "U" shaped coil $2\frac{1}{4}$ " high and 1" wide and spaced 1" from the tank coil. Closer coupling is not necessary. One side of this link is tuned to ground through a 3.9-50 μmfd . APC condenser mounted underneath the chassis. Note the loading condenser from the opposite side of this coil to the coax shield. Don't forget it: it is quite necessary. Tuning of this link really puts the grid mils into the final, a secret weapon, more or less! The silver plated wire is well worth while, too. Once tuned, this link need not be touched over a very wide frequency range.

The 829B tube is shielded with a piece of copper bent to form a rectangle $2\frac{3}{4}$ " wide, $3\frac{1}{4}$ " high, $5\frac{3}{4}$ " long, with the sides drilled or punched out to provide circulation of air around the tube. The top of this shield is left open. The butterfly condenser is mounted flush with the top by means of a copper strap drilled at its center to take the condenser shaft. The rotor is grounded to this strap with a small piece of copper shim stock. Be sure to ground the rotor in this manner to keep the 829B from taking off. Otherwise it needs no external neutralizing. The plate tank is soldered to and supported by the lugs on one side of the butterfly condenser. Plate leads to the tube are soldered to the opposite lugs of the condenser. The entire shield, condenser and tank is then bolted to the chassis. Plate voltage is fed at the center of the bottom portion of the "U" shaped tank through a Z-144 choke. A hole is drilled in the chassis, large enough to

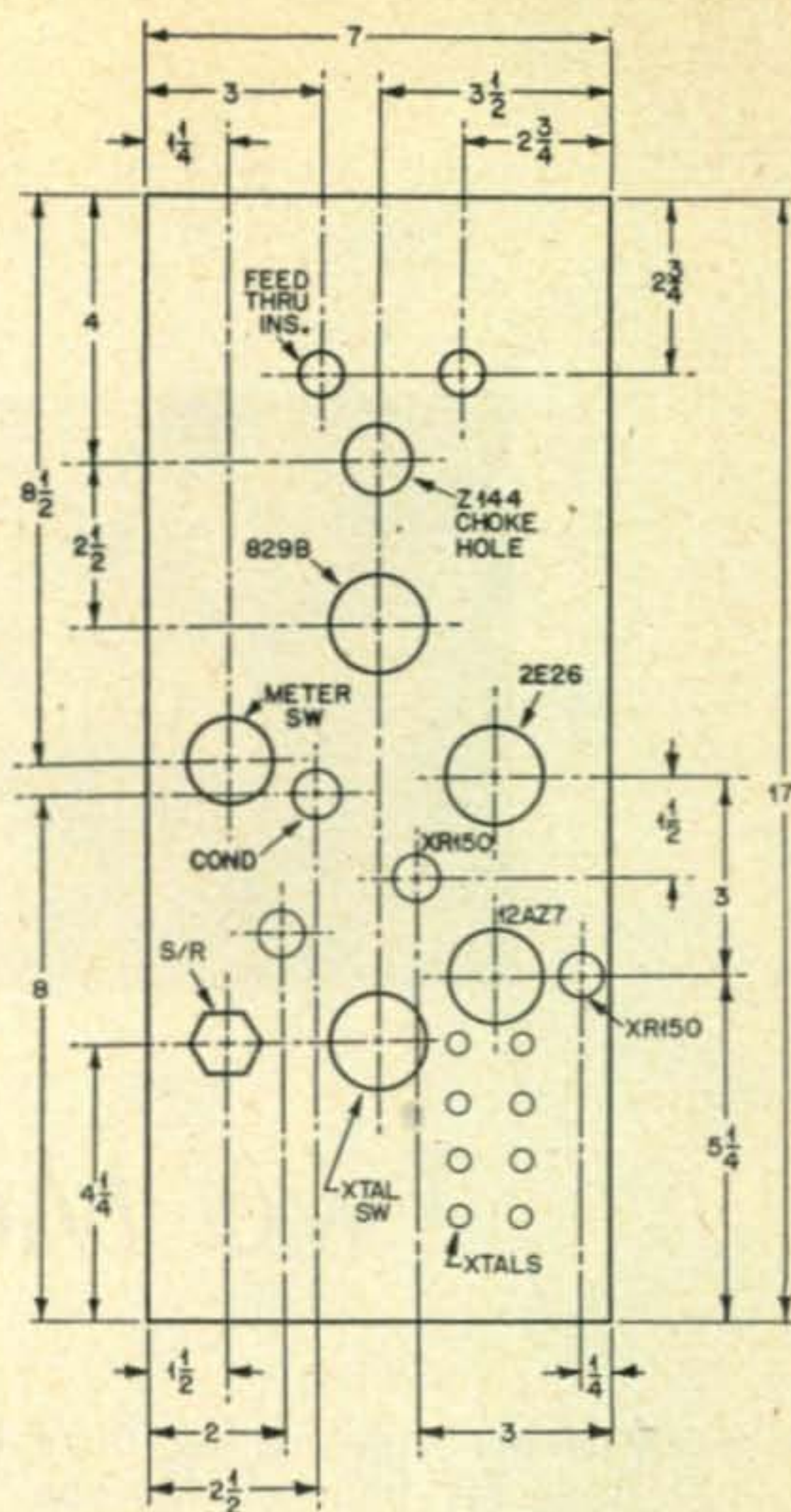

give adequate clearance to this choke. The other end of the choke is supported underneath the chassis with a tie point lug.

Plate voltage for the 2E26 is obtained through a dropping resistor from the 829B plate supply. 400V on the 2E26 plate will produce 6-8 grid mils on the 829B. When used as a driver the 829B plate current will be approximately 150 mils. Keying is performed by providing 130 volts of bias to the grid of the 2E26 and 30 volts bias to the 829B. A Merit A2904 transformer supplies this bias, rectified by a selenium rectifier and filtered by a 30 μfd . 150V condenser. The 10,000 ohm 25 w re-

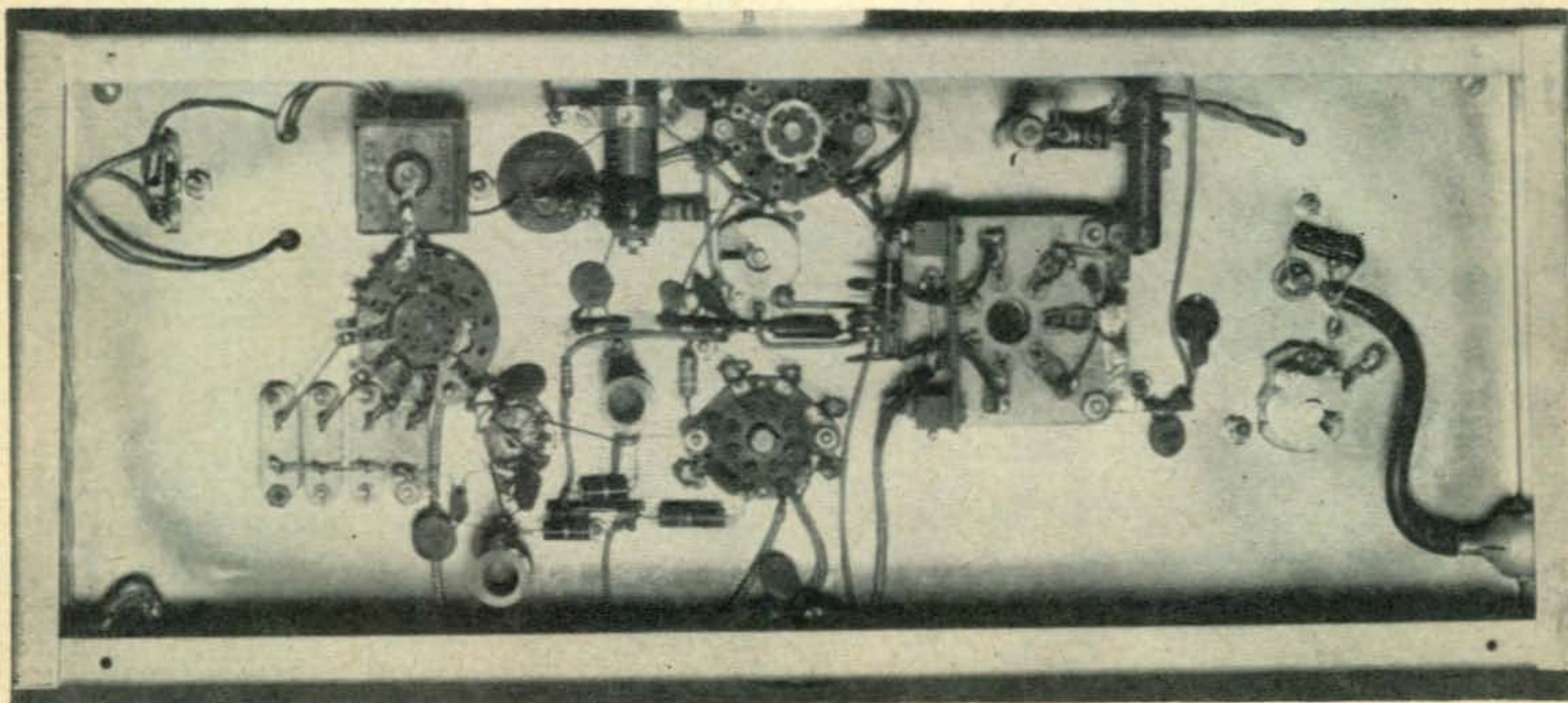

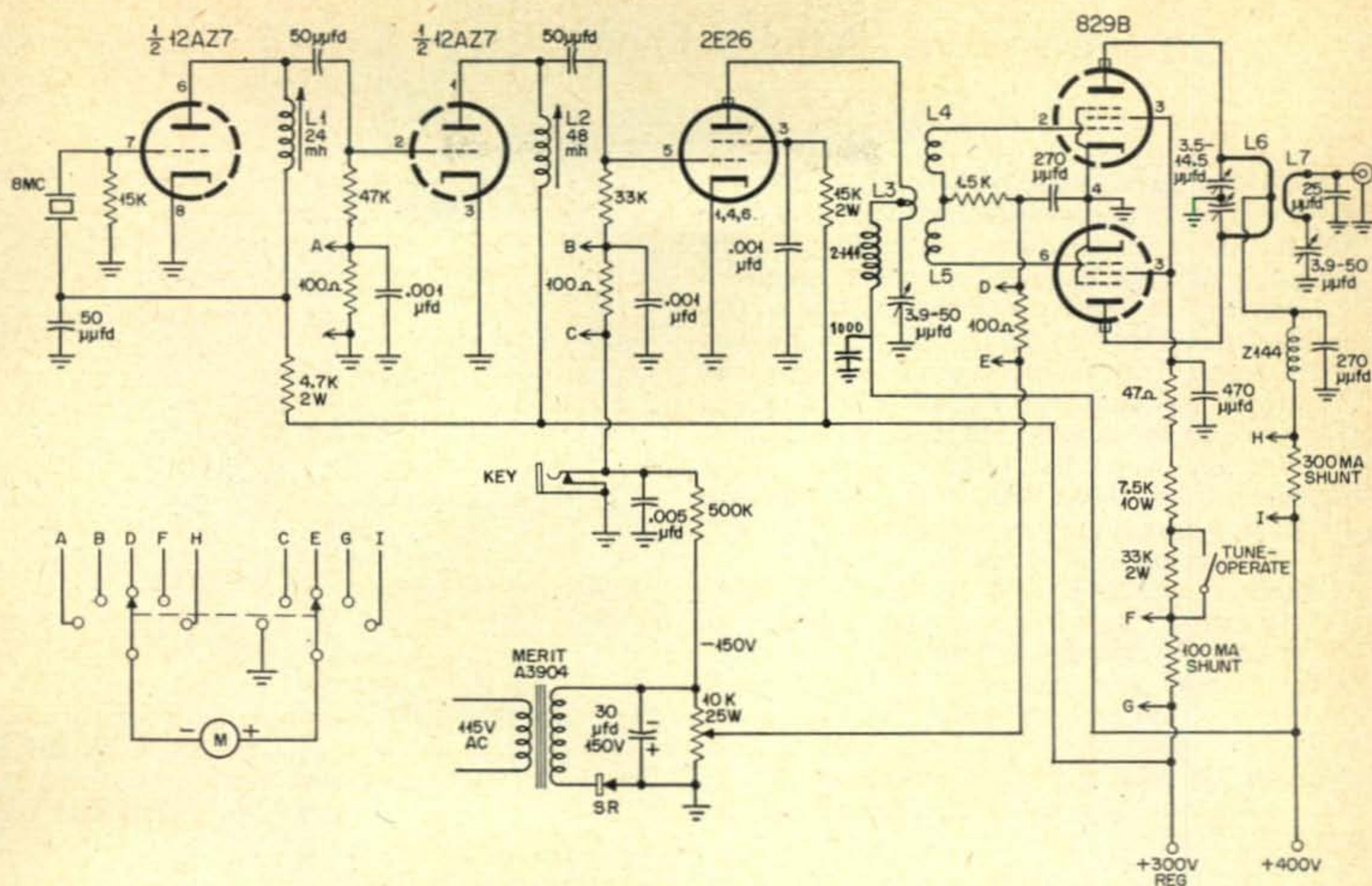

sistor provides both the keying and bias voltages required. This bias pack can be placed under the chassis in any convenient spot.

Metering of the various stages is made available with either pin jacks or meter switching. Your choice here. As shown in the diagram, metering is accomplished at the grid of the second section of the 12AZ7, grid of the 2E26 and grid, screen and plate of the 829B.

Tuning procedure is very simple. With tubes and crystal in place, filaments warmed up, turn high voltage on, key down, check grid current to the second grid of the 12AZ7 for 1-1.2 mils. Adjust slug of first XR-50 coil to obtain this drive, being careful not to "pull" the crystal at resonance. Back off a little when the crystal begins to pull. Then check 2E26 grid current for 1-1.2 mils by adjusting the XR-50 slug in the 12AZ7 doubler section. Next check 829B grid current by tuning the series-tuned plate coil of the 2E26. Be careful here as tuning is quite sharp. Once set however, it will need no retuning over a 600 kc frequency change. Resonate the 829B plate tank, being sure the output link has been connected to a suitable load, such as a lamp bulb or your final amp. Finally, adjust the output link tuning condenser for maximum output and you are in business with ample drive for that KW or a nice 90-100 watts input as a low-powered rig. The 829B runs nicely with plate voltages up to 650. However, 400-500 volts will be sufficient when the rig is used as an exciter.

A word about the power supply. A 300 volt regulated supply should be used to power the oscillator plate and the screen of the 2E26. This supply is regulated with a pair of VR-150

Parts List

- | | |
|---|--|
| L1—16T. #20 enameled on $\frac{3}{8}$ " dia. slug tuned form. | $\frac{1}{2}$ " dia., spaced $\frac{1}{2}$ dia. of wire. |
| L2—7T. #20 enameled on $\frac{3}{8}$ " slug tuned form. | L4, L5—1T. each, #12 bare copper, $\frac{1}{2}$ " dia., wound at ends of L3. |
| L3—5T. #12 bare copper, | L6, L7—See text. |

tubes in series. The starting resistor value for these tubes is 300 ohms 10w. Unless regulated voltage is supplied to the oscillator there will be a noticeable chirp to the keyed signal, caused by a drop in the power supply voltage when the transmitter takes load, and a resultant change in the oscillator feed-back voltage. The regulated supply eliminated the chirp entirely. A separate 400-500 volt plate supply should be used for the 2E26 and 829B. Certainly this exciter can take on many shapes and sizes since placement of parts is not too critical. We hope the layout shown will suit your fancy since some amount of planning went into the placing of parts to give the shortest leads and direct grounds possible. May the little Demon excite your final to the legal limit. We hope it will do the job for you it has here.

The hole in the panel to the right of the plate tuning condenser was made to tune the output link condenser with a TV type plastic tuning wand. Also beneath the milliammeter is another hole to provide tuning for the 2E26 plate 829B grid coils. The tuning wand is shown inserted here in the picture.

The excellent pictures of the rig were made by Bob Bain, W5CRK.

The exciter has been on the air for the past six months and no bugs have developed so far. In fact it seldom needs any retuning, proving that it is indeed a stable little rig. ■

Inexpensive Audio-Frequency Selectivity

With few exceptions, owners of all but the most expensive communications receivers have felt the need of additional selectivity for the reception of radiotelegraph signals through interference. One approach to the solution to this problem has been the application of band-pass filters designed for the passage of 1020-cps Low Frequency Radio Range signal while rejecting voice-frequency signals. These filters are quite effective if the input and the output impedances are those with which the unit was designed to function. Other impedances cause a drastic reduction in the filtering action.

Another approach, and one less subject to the vagaries of impedance mismatch, is the use of peaked-response headphones. It is not generally known, but the military forces made considerable use of such devices, and many are available on the surplus market at very reasonable cost. Of course, the problem, as always, is in knowing what type to select. The accompany-

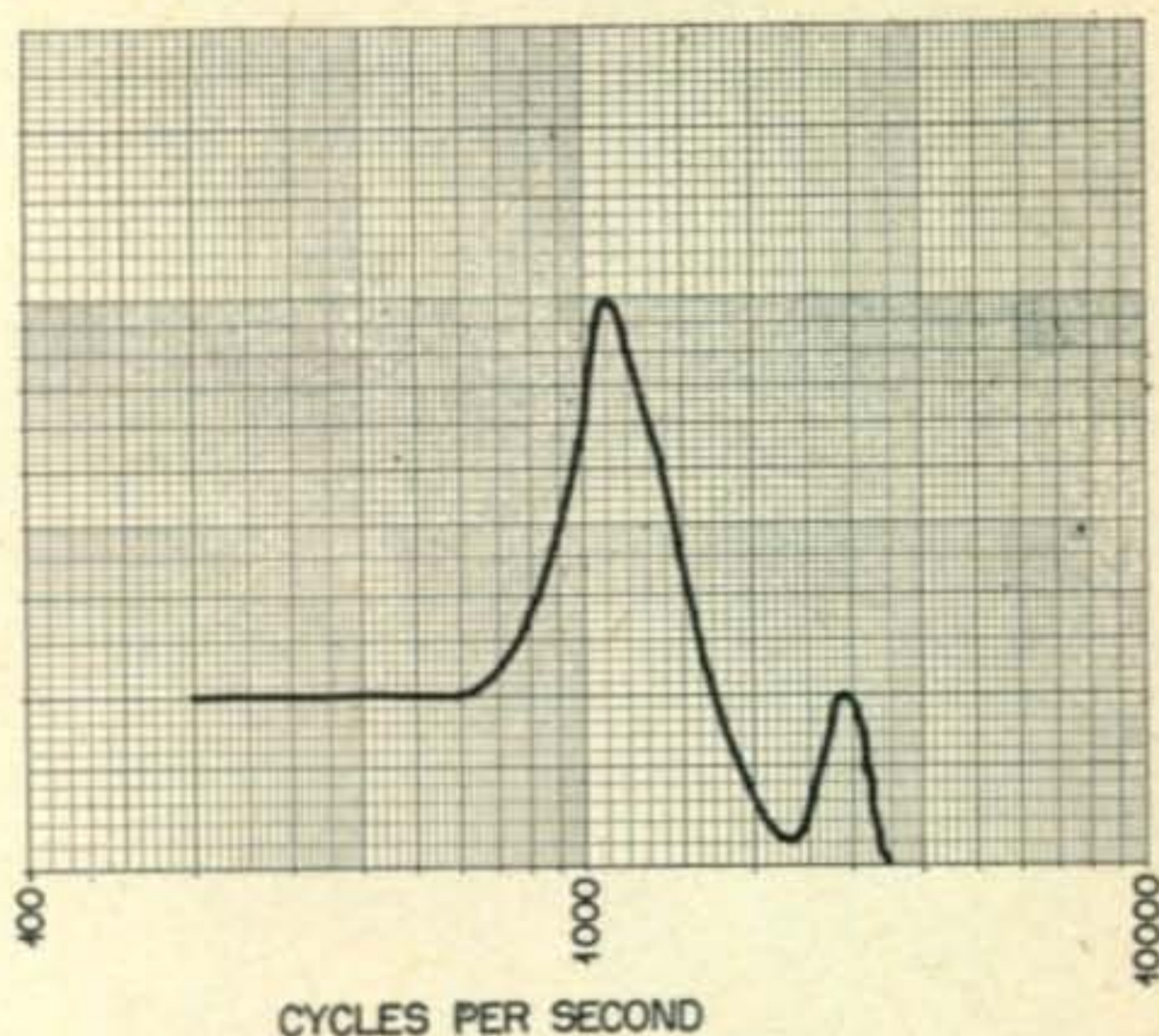

ing figure shows the response curve for Headset P-16 and for Units R-2, R-2A, R-3, R-13, R-14, and R-15. Note how nearly it approaches the ideal.
CARL DRUMELLER, W5EHC

how much Real RF?

Down through the years I have become increasingly frustrated and annoyed by the method of reporting amateur transmitter power. Here is a typical example of the present system:

A station contacted on the 75 meter band reports, among other things, that he is running 100 watts to a voltage-fed Hertz. His signal strength at my station is S7. Another station in the same town and with the same type of antenna breaks in and also reports that he is running 100 watts—but his signal strength is over S9. It is possible that one has a much better location than the other, but the discrepancy in signal strengths happens too often to make this the logical answer.

Let us examine the problem a little more closely. When a station says that he is running 100 watts input, what he actually means is that the voltage on the plate of his P.A. stage is, say, 1000 volts, and the plate mills are 100. This is absolutely meaningless in terms of power output. As a concrete case, take my own transmitter on 75 meters. When all stages are tuned right on the nose, it shows a power input to the final of 50 watts. If I remove the grid drive to the final the power input jumps up to 60 watts, but not an ounce of r.f. gets

into the antenna. Hence it is possible to get any value of r.f. into the antenna, from zero to maximum, depending on the amount of grid drive to the final, the plate efficiency, Q of the coils, efficiency of feed line, matching of antenna, etc.

It is granted that equipment for the actual measurement of power output is beyond means of the average amateur, but there is a simpler method. In almost every case the final of a transmitter is first resonated without an antenna, loop, or line being connected, by dipping the plate current meter to as low a value as possible. This reading should be noted, and is called X . Then the antenna is coupled to the final and further adjustments are made to the antenna coupler, pi-network, matchbox, etc. The new reading is then noted on the plate milliammeter and is called Y . When X is subtracted from Y and multiplied by the plate voltage of the final, we have the watt-power which is leaving the plate circuit. True, it may be going only into the transmission line, partly into the line and partly into the antenna, or only into the coupler, but at least it is r.f. going somewhere. Hence, the efficiency, or lack of it, in the antenna system, which includes the coupling to the final plate, will be shown by the reports received from other stations. If the apparent power output is high and the signal reports are low, then it can be safely assumed that the power is not leaving the antenna, but is being dissipated somewhere along the line, which should call for a re-examination of the whole antenna system.

H. H. GLOSTER, VE3IT

PROPAGATION CHART: July

George Jacobs
W3ASK

Last Minute Forecast

Short wave propagation conditions are expected to be good throughout the month of July except during the periods of July 9-10, 17-18, and 22-23, when moderate disturbances are likely to occur.

EASTERN USA TO:	ALL TIMES IN EST			
	10 Meters	15 Meters	20 Meters	40/80 Meters
Western Europe	1300-1600 (1)	0700-1100 (1) 1100-1400 (2) 1400-1800 (4) 1800-2000 (2)	2200-0200 (2) 0200-0800 (3) 0800-1200 (1) 1200-1500 (2) 1500-2200 (4)	1800-2000 (2) 2000-0100 (3) 2100-2300 (2)*
Southern Europe & North Africa	1400-1800 (2)	0700-1300 (3) 1300-1800 (4) 1800-1930 (2)	0400-0700 (3) 0700-1300 (2) 1300-1600 (3) 1600-2200 (4) 2200-0300 (2)	1800-2030 (3) 2100-2300 (4) 2300-0200 (2) 2100-0100 (2)*
Near & Middle East	NIL	0700-1100 (1) 1100-1300 (2) 1300-1700 (3)	0300-0600 (2) 1300-1600 (2) 1600-2200 (4) 2200-0000 (2)	1900-2300 (2) 2000-2200 (1)*
Central & South Africa	1500-2100 (2)	1200-1400 (1) 1400-1600 (2) 1600-2000 (4) 2000-2200 (2)	1400-1600 (1) 1600-1800 (3) 1800-2300 (4) 2300-0300 (3)	2100-0000 (3) 2200-2200 (2)*
South America	0600-1100 (1) 1100-1500 (2) 1500-1800 (3) 1800-2000 (2)	0500-0900 (3) 0900-1500 (2) 1500-1700 (3) 1700-2000 (4) 2000-0200 (2)	0100-0600 (3) 0600-1600 (2) 1600-1800 (3) 1800-0100 (5)	1900-2200 (2) 2200-0500 (3) 2000-0400 (2)*
South East Asia	NIL	1500-1700 (1) 1700-2100 (2) 0600-0830 (1)	0530-0900 (2) 1700-2100 (1) 2100-0100 (2)	NIL
Australasia	1900-2200 (1)	0700-0900 (1) 1600-1900 (1) 1900-2200 (3) 2200-2330 (1) 2200-2330 (1)	0200-0600 (2) 0600-0800 (4) 0800-0930 (2) 1800-2200 (2) 2200-0200 (4)	0200-0630 (2) 0300-0500 (1)*
Guam & Pacific	NIL	1700-1900 (1) 1900-2300 (2)	0000-0200 (3) 0200-0600 (1) 0600-0830 (2) 2200-0000 (2)	0000-0200 (1)
Japan & Far East	NIL	1630-2130 (2)	0200-0600 (1) 0600-0800 (3) 1800-2100 (2) 2100-0200 (3)	2300-0200 (1)
Greenland	NIL	1100-1400 (1) 1400-1900 (3) 1900-2100 (2)	0600-1500 (2) 1500-2100 (3) 2100-0600 (2)	1900-0300 (2) 0300-0500 (1) 2200-0100 (1)*

WESTERN USA TO:	ALL TIMES IN PST			
	10 Meters	15 Meters	20 Meters	40/80 Meters
Europe & North Africa	NIL	0900-1300 (1) 1300-1500 (3) 1500-1800 (1)	1400-1700 (1) 1700-1900 (2) 1900-2200 (3) 2200-0000 (1)	1800-2100 (1) 1830-2030 (1)*
Central & South Africa	NIL	2100-0000 (2) 1000-1400 (2) 1400-1800 (3)	1400-1600 (2) 1600-1900 (3) 1900-2100 (2) 2100-0000 (3)	1800-2200 (2) 1900-2100 (1)*
South America	0800-1200 (3) 1200-1800 (4) 1800-2000 (2)	0500-0700 (3) 0700-1200 (2) 1200-1600 (4) 1600-2000 (5) 2000-0200 (3)	0000-0500 (3) 0500-0800 (2) 0800-1300 (1) 1300-1600 (2) 1600-0000 (5)	1800-2100 (2) 2100-0300 (3) 0300-0600 (2) 2000-0100 (2)*
Guam & Mariana Islands	1400-1800 (2) 1800-2200 (3)	0800-1200 (3) 1200-1900 (2) 1900-2200 (3)	0600-1000 (4) 1000-1200 (2) 1200-2000 (1) 2000-2200 (2) 2200-0600 (3)	0000-0600 (3) 0100-0400 (2)*
Australasia	1200-1500 (2) 1500-1700 (3) 1700-1900 (4) 1900-2100 (2)	1100-1400 (2) 1400-1800 (1) 1800-2000 (3) 2000-2300 (4) 2300-0200 (2)	0000-0400 (4)VK 0400-1100 (1) 1100-1300 (2) 1800-2100 (2) 2100-0000 (4)ZL	0200-0600 (3) 2300-0400 (2)*
Japan, Okinawa & Far East	1200-1600 (1) 2000-0000 (2)	0000-0200 (2) 0700-1200 (3) 1200-1900 (2) 1900-0000 (4)	2200-0400 (4) 0400-0600 (3) 0600-0800 (4) 0800-1000 (3) 1000-2200 (2)	0100-0400 (2) 0200-0330 (1)*
Philippine Islands & East Indies	0900-1100 (1) 1400-1900 (1) 1900-2300 (2)	0800-1100 (3) 1100-1500 (2) 2100-2300 (1) 2300-0200 (2)	2300-0200 (1) 0200-0600 (2) 0600-0900 (3) 0900-1200 (1)	0400-0600 (1)
Malaya & South East Asia	0900-1400 (2) 1400-1800 (1) 1800-2300 (2)	0700-1400 (3) 1400-2200 (1) 2200-0200 (2)	0000-0200 (1) 0200-0600 (2) 0600-0800 (3) 0800-1300 (2)	0400-0700 (1)
Hong Kong, Macao & Formosa	1200-1800 (1) 1800-2200 (2)	0700-1000 (4) 1000-1500 (3) 1500-2100 (1) 2100-0200 (3)	0000-0300 (2) 0300-0600 (4) 0600-1200 (2) 1200-1400 (1)	0100-0600 (2) 0300-0500 (1)*

CQ PROPAGATION CHART (SHORT-SKIP)

CENTRAL USA TO:	ALL TIMES IN CST			
	10 Meters	15 Meters	20 Meters	40/80 Meters
Western Europe	NIL	0700-1000 (1) 1000-1400 (2) 1400-1730 (3) 1730-1930 (2)	2100-0000 (3) 0000-0600 (2) 0600-1300 (1) 1300-1600 (2) 1600-2100 (4)	1800-0100 (2) 1930-0000 (1)*
Southern Europe & North Africa	1200-1600 (1)	0700-1200 (2) 1200-1700 (4) 1700-2000 (2)	2300-0300 (2) 0300-0500 (3) 0500-1400 (1) 1400-2100 (4) 2100-2300 (3)	1900-0100 (3) 2000-0000 (2)*
Antarctica	1500-1700 (2)	1200-1500 (2) 1500-1730 (3)	1000-1200 (1) 1700-1900 (3) 1900-2130 (2) 0100-0400 (1)	2200-0500 (2) 2300-0400 (1)*
Central America & Northern S. America	1000-1300 (2) 1300-1800 (4) 1800-2000 (2)	0600-0900 (4) 0900-1400 (3) 1400-1600 (4) 1600-2000 (5) 2000-0600 (3)	0300-0600 (3) 0600-0900 (4) 0900-1400 (3) 1400-1700 (4) 1700-0300 (5)	1800-2200 (2) 2200-0400 (4) 0400-0630 (2) 1930-0300 (2)*
South America	0900-1200 (2) 1200-1600 (4) 1600-2000 (3)	0600-0900 (4) 0900-1400 (3) 1400-1600 (4) 1600-2200 (5) 2200-0600 (3)	0200-0800 (3) 0800-1400 (1) 1400-1600 (3) 1600-0200 (5)	1900-0400 (3) 0400-0630 (2) 2030-0300 (2)*
Japan & Far East	NIL	1600-1800 (2) 1800-2200 (3)	0600-0900 (2) 1600-1900 (2) 1900-0200 (3) 0200-0600 (1)	0200-0600 (1)
South East Asia	NIL	1600-2200 (3)	0600-0900 (2) 1700-0000 (2)	NIL
Hawaii	1700-2200 (2)	1000-1400 (2) 1400-1700 (3) 1700-2200 (4) 2200-0100 (2)	0100-0300 (3) 0300-0700 (2) 0700-1000 (3) 1000-1600 (2) 1600-0100 (5)	2230-0700 (4) 2330-0600 (3)*
Australasia	1700-2200 (2)	1600-1800 (2) 1800-2200 (3) 2200-0000 (2) 0630-0900 (1)	0200-0400 (2) 0400-1000 (3) 1800-2200 (2) 2200-0200 (4)	0100-0700 (3) 0200-0600 (2)*

BAND (METERS)	DISTANCE (MILES)			
	50-250	250-750	750-1300	1300-2400
10	NIL	0800-1200 (2) 1200-2000 (1)	2000-0900 (1) 0900-1200 (4) 1200-2000 (2)	0900-1200 (2) 1200-0900 (1)
15	NIL	0600-1200 (3) 1200-2000 (2)	2000-0600 (2) 0600-1600 (4) 1200-2000 (3)	0900-1400 (3) 1400-2300 (4) 2300-0900 (1)
20	NIL	0500-1000 (3) 1000-1500 (4) 1500-2200 (3) 2200-0500 (2)	0800-1600 (4) 1600-2200 (5) 2200-0800 (2)	0700-0900 (4) 0900-1500 (3) 1500-0000 (5) 0000-0700 (3)
40	0600-1000 (3) 1000-2000 (5) 2000-2200 (4) 2200-0100 (2)	0000-0500 (4) 0500-0800 (5) 0800-1200 (4) 1200-1700 (3) 1700-0000 (5)	0200-0800 (4) 0800-1000 (3) 1000-1700 (1) 1700-1900 (3) 1900-0200 (5)	0600-0800 (3) 1800-2000 (3) 2000-0600 (4)
80	0500-1100 (5) 1100-1800 (3) 1800-0000 (5) 0000-0500 (4)	0600-0800 (4) 0800-1800 (1) 1800-2000 (3) 2000-0600 (5)	0500-0700 (2) 2000-2200 (2) 2200-0500 (5)	0400-0600 (2) 2000-2200 (2) 2200-0400 (4)
160	1700-2100 (4) 2100-0500 (5) 0600-0900 (4)	1900-2100 (2) 2100-0500 (4) 0500-0700 (2)	2100-0400 (3)	2200-0400 (2)

SYMBOLS FOR NUMBER OF DAYS CIRCUIT PREDICTED TO OPEN:

(1) 1-4 days (2) 5-11 days (3) 12-18 days (4) 19-26 days (5) over 26 days

* Indicates time of possible 80-meter openings.

The CQ Propagation Charts are based upon a CW radiated power of 150 watts and are centered on Washington, D. C., St. Louis, Mo., and Sacramento, California. These forecasts are calculated from basic ionospheric data published by the CRPL of the National Bureau of Standards and are valid through August 15, 1956. The "Short Skip" Charts are based upon a radiated power of 75 watts and times are indicated in Local Standard Time. All forecasts are based upon a predicted smoothed sunspot number of 120 centered on July, 1956. The Swiss Federal Observatory reports that the monthly Zurich sunspot number observed during April was 105, resulting in a provisional 12-month smoothed sunspot number of 68 centered on October, 1955.

Results: 7th Annual YL-OM Contest

Louisa B. Sando, W5RZJ

Jicarilla Apache School
Dulce, New Mexico

Congratulations to W4HLF, Arlie Hager, for again making the highest aggregate score for YLs in the YL-OM contest held in March. In the phone section Arlie made 26,880. points working 336 contacts in 64 sections. On CW she made 15,936.25 points working 209 contacts in 61 sections. Total score: 42,816.25. This is the third time win for Arlie and she now gains permanent possession of the big silver cup donated by WIBFT.

For the OMs, K2DSW, Robert Panek, placed high in aggregate score. On phone he made 1,292.50 points with 47 contacts in 22 sections. On CW he made 2,058.75 points with 61 contacts in 27 sections. Total score: 3,351.25. YLRL Vice President W9YBC, Gloria, informs us that the former OM aggregate score gold cup has been retired by default. In place of it YLRL as purchased a silver cup which will be awarded to K2DSW on a permanent basis.

Highest Phone Awards

1st YL phone—W1SCS, Ruthe Ferguson—30,622.
2nd YL phone—K5BNQ, Doris Anderson—29,050.
3rd YL phone—W4CWV/LKM, Annette Thompson—27,710.

1st OM phone—W9CMC, Rodney Starkweather—1,715.

2nd OM phone—W6FGJ, Edmund Nies—1,462.5
W8AJW, Jack Siringier—1,462.5

(A tie. W8AJW retires this cup on a three-time win. Another cup will be purchased and awarded to W6FGJ.)

3rd OM phone—W6JVA, Richard Maringer—1,100.

Highest CW Awards

1st YL CW—W4BLR, Kay Anderson—17,272.5
2nd YL CW—W3YTM, Mildred Wright—15,000.
3rd YL CW—VE3AJR, Dell Daykin—14,082.5
1st OM CW—K2KDW, Everett Oren—1,750.
2nd OM CW—W3MAX, Dick Houston—1,725.
3rd OM CW—W9BZW, George Hanus—1,687.5
W9GOC/SZR, Alfred Laun—1,687.5

W9YBC comments that she received 59 YL phone logs and 65 YL CW logs, though logs indicated that 279 YLs participated in the contest. From the OMs she received 90 phone logs and 130 CW logs. Here are the rest of the scores:

YL Phone					
W1CEW	4,060.	K2CUQ	617.5	W3MDJ	10,500.
W1QON	975.	K2GCD	1,331.25	W3MSU	96.25
W1RLQ	1,820.	K2LTN	1,569.	W3UTR	3,375.
W1SCS	30,622.	W2OWL	142.5	W3VNN	12,350.
W1VXC	1,211.25			W3YTM	7,650.
W1VYH	224.	W3MAX/OQF			
W1YNI	2,840.		14,962.5	W4CWV/LKM	27,710.

W4GBT	(conf.)	W6QGX	21,902.	W9LOY	3,075.
W4HLF	26,880.	W6QMO	1,312.5	W9SYX	143.75
W4KYI	25,350.	W6WRT	1,460.	W9UON	5,010.
W4RLG	2,007.5			W9YBC	(conf.)
		W7BHZ	12,201.25		
K5BNQ	29,050.	W7CPQ	2,730.	KØACC	8,815.
W5DRI	10,803.75	W7MUT	3,607.5	KØBFS	8,027.5
W5EGD	8,872.5	W7TGG	(conf.)	WØFVE	2,100.
W5RZJ	40.			WØSZH	8,251.
W5SPV	8,878.	W8DNF	(conf.)		
W5WUX	6,550.	W8KLZ	99.	KG4AC	10,692.
		W8MBI	857.5		
W6EHA	2,420.			KL7ALZ	525.
K6EXQ	13,781.25	K9AMD	3,045.		
K6HVC	11,015.	W9KSZ	860.	KP4ZV	5,293.75
W6JZA	23,456.25	W9LDK	470.		
W6NAZ	(conf.)			KZ5VR	9,030.

YL CW

W1BBS	343.75	K2DKL	(conf.)	W4BLR	17,272.5
W1FTT	(conf.)	K2DSL	1,137.5	W4CCN	5.
W1RLQ	11,300.	W2EBW	5,580.	W4EJQ	9,045.
W1VOE	(conf.)	K2INQ	280.	W4GBT	(conf.)
W1VXC	4,578.75	W2MWY	4,488.	W4HLF	15,936.25
W1WPX	4,720.			W4KYI	11,160.
W1YNI	4,312.5	W3NHI	368.	W4RLG	9,327.5
W1YPH	5,760.	W3QPJ	9,897.5	W4TIE	100.
W1YYR	7,315.	W3TSC	3,936.	W3ARK	1,530.
		W3UTR	4,717.5	W3AXT	851.
W2BNC	(conf.)	W3VNN	7,393.75	W3BIP	580.
K2CUQ	(conf.)	W3YTM	15,000.	W3CIN	900.
K2DXD	3,000.				

[Continued on page 116]

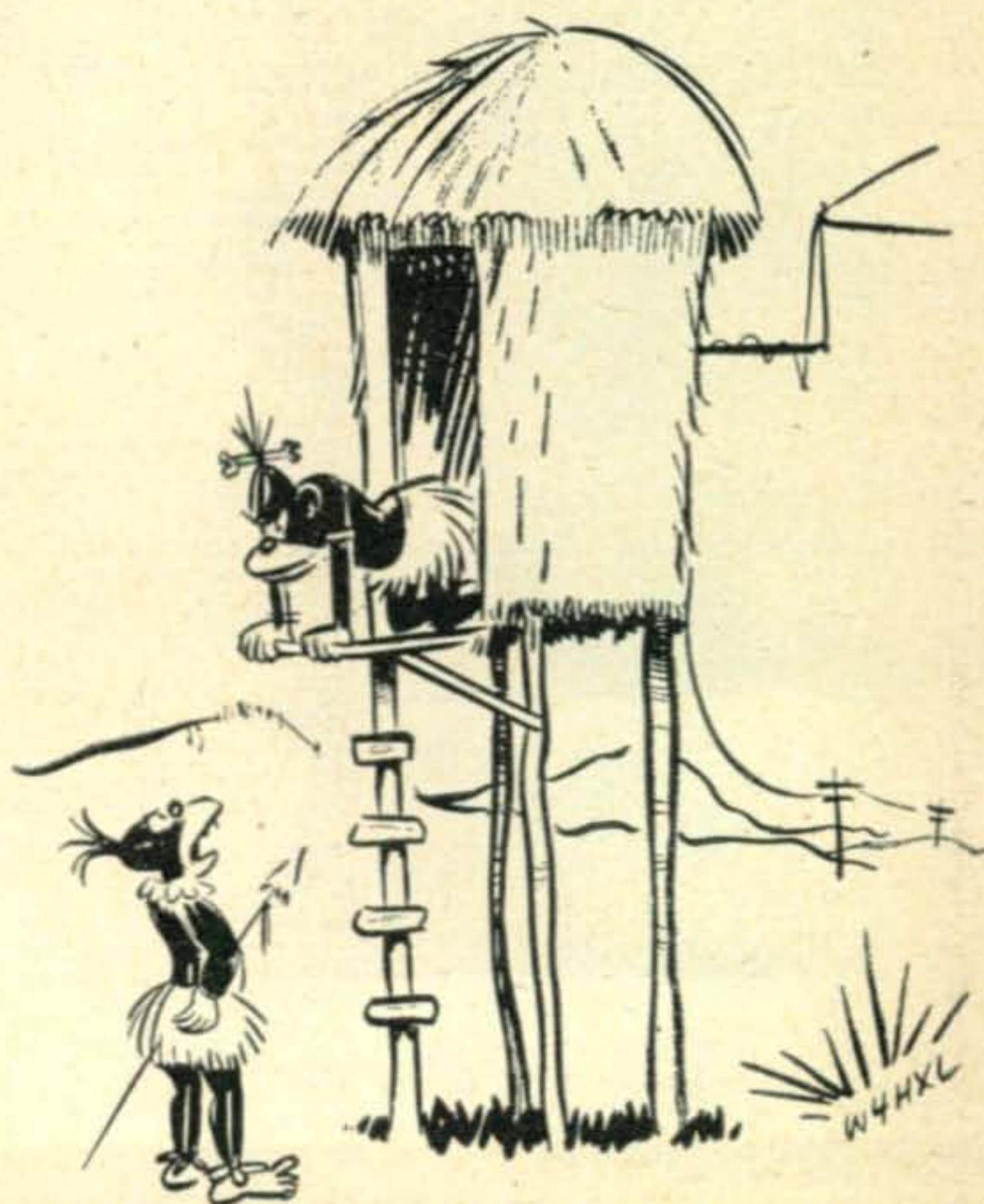

"My transmitter is all right! It's that darned 15 Megacycle I.F. you got!"

The logo consists of the letters 'S', 'S', and 'B' arranged in a descending staircase pattern from top-left to bottom-right. The letters are white and set against a solid black rectangular background.

Bob Adams, K2DW

245 Revere Road
Roslyn Heights, New York

We hope you enjoyed the first Single Sideband column in the June issue. We will continue to report news of interest about SSB, together with photographs of outstanding stations and operators.

Ron, G6LX will conduct a column in Short Wave Magazine entitled "SSB Topics," which indicates the popularity of SSB in Great Britain. Activity on the higher frequency bands is increasing rapidly now that conditions have improved. European stations are heard in the U. S. A. all evening long. Australian and New Zealand signals sound like locals on the East Coast from 2200 until 0900 EST. Fifteen is becoming a very popular band for SSB and is the best bet for a six continent round-table. Seventy-five is still popular for short haul round-tables and for the nightly meeting of the "Klan."

Twenty Meters

KC4USA at the South Pole continues to run hundreds of successful phone patches. KC4USV is also active and his first phone contact from Ross Island was with WØURU. GW3EHN, Oscar is expecting his SSB exciter

and hopes to be the first SSB in Wales. OH2OJ, Sam is putting a big signal into the U. S. A. from Helsinki. F9HF, Peter is on SSB in Paris. I1BAO, Peter has a new final with parallel 4-125 A's. SM5OH is very active in Sweden, as is SM5FA. KP4AAO and KP4ES are keeping Puerto Rico well represented. 5A2TP went SSB in Libya and is giving the boys a new country. DL3JM, Werner went to 20 with a crystal filter and 813 final, after several years on 75. He reports other German Nationals are building exciters and will soon be on the air. DL4MQ has a new exciter and is getting a big kick out of SSB. VK4AB, Ramsey told your conductor that he has made many W contacts on SSB with 1½ watts input. ZS6AIY, Len has his new linear perking and has enjoyed many fine contacts. Empty, ZS6KD reports considerable activity in South Africa. There are ten stations active in Johannesburg and several new ones almost ready to go. ZS3E is on most every evening from 1630-1900 GMT. KX6BB, in the Marshall Islands is heard nightly around 0830 GMT. ZL3PJ has been working many G stations. CE2HV has a new kilowatt. HC2PP has been working into the States.

Fifteen Meters

Ted, G3GKF has been scheduling W4NQN, W9RUK, WØDRD, and KH6AR daily on 21245 kc at 1830 GMT. G2ALM, G3BFP, G3BXI, G3HJK and G6LX have taken part in these tests. Jimmy, CX5AF is very active most evenings and is being hotly chased by those who still need South America for a Sideband WAC. CE2HV has worked DL5YU. W4DGW/MM, Earl on the SS Del Campo off the coast of South America has been working into Europe. VS6DA made a brief appearance, using a low power phasing ring.

Ten Meters

G6LX reports ZS6OY, W1CLS and WØCXX have been heard during periods when the ten meter band has been dead for AM. Many DX stations are known to be building new VFO's and high level mixers.

We trust that you will forward, to the writer, any information which you believe will be of interest to the readers of this column. We would also like to have photographs of SSB stations and operators, as well as unusual QSL cards.

73, Bob, K2DW

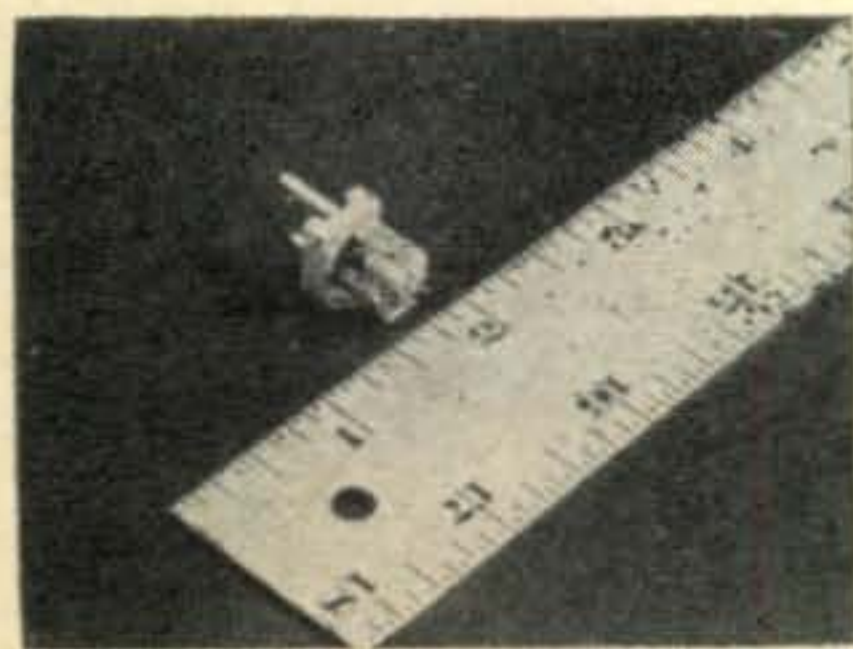

Subminiature Trimmer

Ultra super special wow-is-it-little midget condenser. Halt! if you've been searching high and low to find a condenser for that scale-size radio for the children's doll house. This is it. For tab mounting on dip-soldered printed wiring boards or screw-mounting on conventional chassis, these wee trimmer capacitors measure just 25/64" x 7/16" x 17/32", in 1.2-5 μfd , 1.2-10 μfd , or 1.5-15 μfd . Sturdy ceramic, with silver-plated stator, rotor and spring assemblies. Adjusted by screwdriver slot in shaft. Bulletin TR-123 on this new Series 75 Subminiature Trimmers will tell you the whole story. Write Radio Condenser Co., Davis & Copewood Streets, Camden, New Jersey.

DX

Gathered and reported by
R. C. "Dick" Spenceley, KV4AA
Box 403, St. Thomas, Virgin Islands

YASME QSL Cards via KV4AA

In an effort to provide the YASME with a new set of sails and additional gear, an item appeared in the DX column, May CQ, requesting that a dollar contribution accompany each QSL for Danny. This would result in a prompt return VR1B QSL via airmail. Subsequently this was amended in a form letter to all contacting stations (W, K, VE and U. S. possessions) who did not enclose a dollar. This letter read in part "should you be one who feels that contributions should not be made as a matter of principle or for financial reasons, we can promise you a card, via bureau, when the trip is over in some two years' time." I believe the vast majority of DX'ers understand that our motives in this direction were only to keep this very interesting trip on a going basis so that the appearance of Danny would be guaranteed from many other rare spots.

On the other hand, a few complaints have been received of a mild nature with one "hot" one hinting that Danny and myself are getting rich off the deal which will ultimately lead to the corruption and downfall of Ham Radio, if not to its complete demise.

In an effort to strike a happy medium, which, it is hoped, will be acceptable to all, the following QSL procedure will be adopted for all YASME stops after VR1B. Contributions of a dollar or more are requested. This will result in a direct air-mailed QSL to the station contacted with the arrival of his card and consistent with the arrival of Danny's logs (we shall endeavor to provide rapid QSL service by obtaining logs via radio contact). Other stations contacting him and submitting QSL will receive Danny's card via bureau within a reasonable period of time. Such cards should be dispatched within six months of the receipt of contactee's card which is, more or less, a normal time lapse in comparative expeditions.

Last Minute Items

A new station, FB8BI, is located on Juan de Nova Island about 100 miles west of Madagascar in the Mozambique Channel. It is manned by two VQ8 boys, Pierre on CW and Jean on phone. The QRI is T7 on CW and we understand that Jean is the more rabid ham. It is not known if this spot will be a separate country (from Madagascar). They should be there about a year . . . The Finnish S.A.R.L. has taken steps in hopes that Aaland Island will be given separate status . . . K4AMV/KS4 is active on Swan Island. QSL's go via Tampa, Fla . . . ZD8SC has been skedding W6SAI, Tuesdays at 2200 GMT, 21155 kc . . . W2EQS hopes to be on with a FP8 call between August 6th and 20th . . . FE8AE (ex-FF8AN) has been active from French Togoland 1900 to 2100 GMT, 14075. QSL's go to Marcel Veber, Box 408, Douala . . . K6JQJ advises CR1ØAA's cards should go to: Ruy Trinitade, c/o P.O. Dili, Portuguese Timor . . . FB8BK should be heard from the Glorieuse Isles shortly . . . YN1CAA has been very active on 14090 around 1200 GMT. QSL via U. S. Embassy, Managua . . . Via VQ4AQ we learn that a DX trip is planned by some VQ4 boys which will take them to VQ1, VQ9, VQ7, the Amirante Group and other islands. A gas generator and 100 watt rig will be used . . . DL3SZ advises that IT1ZGY will be on from the Pelagic Islands (Good for W.A.E.) from June 15th to 22nd . . . VQ3CF will spend a year in England and then return to VQ4-land . . . OK1MB (via K6JQJ) says that the Russians CAN contact the USA but the news hasn't gotten around to them yet! . . . All former OE13 stations can obtain their QSL's by writing: Signal Section, Headquarters SETAF, APO 168, N.Y. . . . DL1CR, DL3AO, DL9CI and DJ1BP will spend a week in Luxembourg August 5th or August 12th. They will be on CW exclusively 3.5 thru 28 Mcs . . . CE3AG advises that CEØAD has been active on CW on several freqs. between 14000 and 14100. The call, CEØAC, has also been used. Cards go via CE Bureau . . . Two local hams in Dutch St. Martin will have their transmitters on the air should they be successful in obtaining their licenses. Examinations were due on or about June 7th.

HB9J, Jean Lips, was the recent recipient of WAZ No. 321



Our heartiest congratulations to the following stations upon their achievement of WAZ:

- | | | | |
|---------|---------------------|-------|--------|
| No. 320 | HENRY B. VAN VOORST | | |
| | | W9HUZ | 40-237 |
| No. 321 | JEAN A. LIPS | | |
| | | HB9J | 40-228 |
| No. 322 | HAROLD E. STRICKER | | |
| | | W8WZ | 40-223 |

Cards from Bob Ford, AC4RF, were responsible for the completion of all the above. HB9J is



ISREX, Edi, of Mogadiscio, Somalia.



Nev Jackson, VQ5GC
(soon to be VQ9)

the first HB to join this select group while W9HUZ is the tenth W9 and W8WZ is the eleventh W8. We also welcome HB9J to the "phone only" group with a score of 36-172.

AVES ISLAND EXPEDITION, YVØAA: We are advised by YV5BX that the date for this trip has been pushed ahead due to the availability of government transportation. The group, which includes twelve YV amateurs, will leave Venezuela on the evening of June 12th and are due to arrive at Aves on June 14th. Gear will be set up and YVØAA will participate in a local YV contest which will terminate at noon on June 17th at which time YVØAA will commence general contacts on a continuous basis (24 hours per day) until midnight of June 24th. All band operation is planned on phone and CW. 6 and 2 meters will also be covered. Simultaneous two band operation will take place if QRM difficulties can be overcome satisfactorily. Aves Island is a small 1500 yard long dot in the eastern Caribbean about 100 miles due West of the British island of Dominica. It is steadily decreasing in size as rough seas wash away its coral formation. This Venezuelan possession is a bird sanctuary and, in the Winter months, plays host to millions of birds which blanket the place. There seems no doubt that Aves will qualify as a separate country as it is a considerable distance from Venezuela and in a different hemisphere. QSL's should go via Radio Club Venezolano, Post Office Box 2285, Caracas.

ZANZIBAR, VQ1JO: Mal Geddes, ZE3JO, informs us that he will be active on Zanzibar Island from August 13th to September 4th. VQ1JO will run a British B2 Mark III Transmitter/Receiver with an input of approximately 20 watts. 14 Mcs, CW, will be used exclusively. Mal has already booked boat passage, hotel, etc. and sees no reason why the trip will not take place. 100% QSL'ing is guaranteed upon his return to Southern Rhodesia. ZE3JO is ex-G2SO.

Electronic Love

If she wants a date—	Meter
If she comes to call—	Receiver
If she wants an escort—	Conductor
If she's cheating—	Detector
If she's fat—	Condenser
If she's thin—	Feeder
If she's extravagant—	Limiter
If she's in error—	Rectifier
If her hands are cold—	Heater
If she fumes and sputters—	Insulator
If she's ugly—	Transformer
If she's bossy—	Resistor
If she's slow—	Accelerator
If she's bored—	Exciter
If she refuses—	Rejector

Tks to W3UXX and NavShips 900-100
Mar. '45

SEYCHELLES ISLANDS, VQ9: Neville Jackson, VQ5GC, has finally received a permit to operate at this QTH. He will spend ten days there in late September or early October. To make this trip possible \$300 is being sent VQ5GC to defray



AC5PN, Chhawna, says "don't laugh" but these are my working clothes, plus sword and dagger. AC5PN is on Saturdays and Sundays around 1200 GMT, 14090/14052. (25 watts)

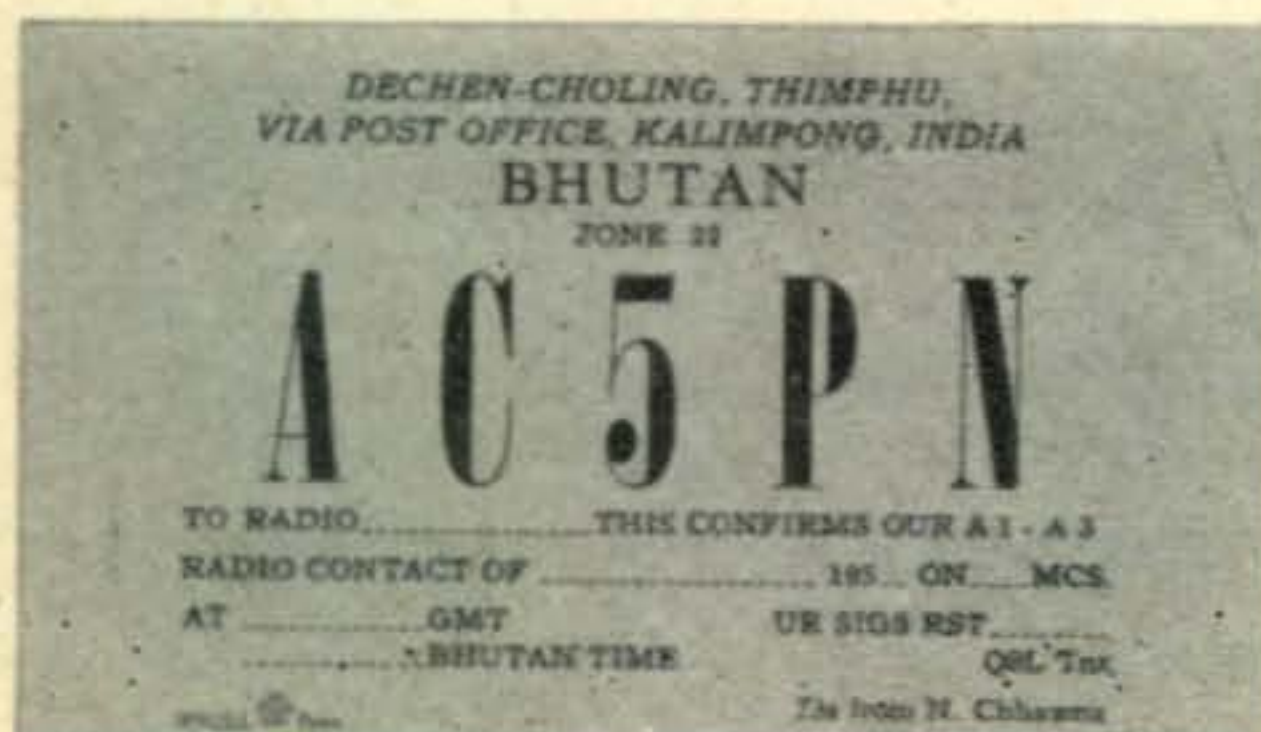

A batch of these have gone forward to Chhawna thanks to W9NDA.

partial costs. In order that we may be reimbursed it is requested that small contributions be forwarded in advance or with QSL on an entirely voluntary basis. Should amounts in excess of this sum be received they shall be entered in a fund for the purpose of furthering other worthwhile DX'peditions. This will replace the dollar-per-QSL basis which, tho efficient and relatively painless, is felt by some might lead to abuses if consistently promoted. W and VE QSL's go via KV4AA.

SOCCORRO ISLAND, REVILLAG IGEDO GROUP, XE4A: Via W9FKC and the West Gulf Bulletin we hear that a group of WØ's were due to appear at this spot, some 500 miles off the West coast of Mexico, on or about June 5th. The call will be XE4A and it is understood that it will qualify as a separate country.

LUXEMBOURG, LX: ON4QX advises that a group of ON4's have received their permit and were due to be on from a QTH near Wiltz, Luxembourg, on June 9th and 10th. Calls used bore the suffix "LUX" ie: ON4QX/LUX, ON4TQ/LUX. An attempt to obtain a license to operate from Vatican City, at a later date, is being made by this same group.

YASME EXPEDITION, VR1B, etc.: As this is read Danny should be on his way to Nauru Island with a possible short stop at one of the islands in the Gilbert and Ellice group. The call at Nauru will be VK9TW. I know the DX gang will want to pass a vote of thanks to Danny for his considerable efforts in giving most of us a new country. VR1B contacts will probably total over 4000! Thanks to contributors and donations of gear from radio manufacturers the YASME now has enough ham equipment to guarantee his appearance on the air from all stops. Of note is his latest acquirement, an ELDICO 500 watt linear amplifier, to go with his SSB-100A. Both of these items were given, on a loan basis, through the generosity of Eldico's W2UOL. This gear will insure a potent signal at those stops where sufficient local current capacity is available to allow its use. It also heightens the possibility of that first Sideband DXCC! Those who have followed the YASME stories in CQ will realize that Danny's major problem stemmed from the rotten condition of his sails. Through the efforts of W2NSD an entire set of new "ORLON" sails should now be adorning the YASME. While the manufacturer of these sails generously gave us a half-price deal, the cost of material, making and air-freight was imposing and added up to considerably more than the odd \$1,000.00 contributed, to date, for VR1B QSL's! With the major items of sails and equipment now behind us the expedition may now be maintained at a much more modest cost. Cards, resulting from VK9TW's activity will be dispatched by KV4AA promptly, via bureau, unless direct QSL is made possible by the enclosure of a self-addressed stamped envelope. It should be understood that QSL'ing is dependent on the periodic arrivals of VK9TW's logs. Please

continue your contributions so that this expedition may continue its success. Danny wishes to express his sincere thanks to the many who have helped him and promises to do everything humanly possible to hit *every* rare spot along his way. After the Nauru operation the YASME will proceed to the Solomon Islands, VR4, and then, after a stop at Darwin, Australia, to CR1Ø, VU5, etc.

DX Notes

Four new licenses have been granted in Gibraltar, ZB2Q, ZB2R, ZB2S and ZB2T. QSL's go care of Officers Mess, RAF, New Camp . . . CR1ØAA appears near 14084 daily from 1200 to 1500 GMT with T7/8 signal. The name is Ruy and he says Portuguese Timor but won't give exact QTH . . . UC2AA says QSL via box 547, Sofia, Bulgaria . . . DX'peditions are being planned by W5CFG, W6NJU, W9OWZ, W9ZTD, W9PPS and W2EIK for this Summer. Goals include Swan Island, Navassa Island, Corn Island and the Serrana Bank. Should a state department call be obtained for Corn Island it might qualify for a new one . . . Viet-Nam may soon be legally represented. Should his contract be approved a well-known W3 will go there and run a KW on SSB, CW, etc. A guaranteed ham license is a stipulation of the contract . . . MP4QAL, Qatar, will QRT soon but says that MP4QAP will be active . . . old MP4BAD is now DL2UY . . . F7ER and gang still plan 3A2 trip . . . FB8YY may soon be active from Terre Adelie (Antarctica) . . . W5CFG reports K4AMV/KS4, 14099, 0100 GMT . . . W7PHO now has JZØPS logs. JZØPS can receive mail at this QTH: Kees Andre, Pasudu, PPSS, Makassar, Indonesia (Station location is in Hollandia, New Guinea) . . .

YJ1AA is very active, near 14090, at 1130 GMT . . . Via W5FXN we hear that FU8AA now has a good receiver and is on 21 Mcs. Saturdays and Sundays . . . FU8AC is very active on phone 14 and 7 Mcs . . . Via the South Calif. Bulletin we are advised that VK6MK and W6ITH contemplate a trip to ZC3, VQ9, ZS2 or VU5. VK6MK can get the license with allowance for W6ITH to operate. Nothing definite yet . . . Via the West Gulf Bulletin, W5ZZR, reporting on KC4U-Antarctic operation says: All stations will be using KWS-1 transmitters and 75A4 receivers on SSB, AM and CW. At present KC4USA and KC4USV are active. KC4USA is at little America and KC4USV at Mc Murdo Sound. About December, or sooner, KC4USB, Marie Byrd Land, and KC4USN, at the geographical South Pole, will be active. Mail from these stations cannot be received until the ships return in 1957. All QSL's will be answered. Send your cards to: Staff Comm. Officer, Task Force 43, Room 831, Old P. O. Building, 12th and Pennsylvania Ave., N. W. Washington, D. C. . . . FB8BR says that FR7ZA works next door from him. No hope for activity from FR7-land for some time . . . SVØWN, Crete, will be on until November. He prefers the low end of 14 on CW and runs a BC-610 plus Collins RX. Says other Crete stations will appear.

This is a "vacation" column so other features have been omitted this month.

73, Dick, KV4AA

July QSL Contest Winner

Even in black and white OA4AI's card looks good, taking top honors this month, with another Peruvian running a close second. Hmmm . . . another DX winner. What happened to the old U. S. of A. cards?



and runners up...





Lee Waite, W2FBZ, 6-meter top scorer in New Jersey.

SCORES: April VHF Contest

First figure designates number of contacts, second figure the number of counties worked, third figure the total score. Winners in each state are in bold-face type.

144 Mc.

ALABAMA

W4VU0 9 6 54

CALIFORNIA

W6AJF 81 20 1620
 W6MLN/6 106 20 2120
 W6GYN/6 68 20 1360
 K6HYX 15 5 112.5
 K6LRN/6 30 9 270
 KN6PUR 109 6 654
 KN6PKU 115 7 1207.5
 W6MFI 52 14 728
 K6DTR/6 50 15 750
KN6QZU 78 19 2223
 W6HIR 2 2 4
 K6EUD 200 7 1400

CONNECTICUT

WN1FBL 13 3 39
 WN1FHP 75 16 1800
 W1VSI 13 5 97.5
 WN1GAV/1 44 10 440
 W1ECI 39 7 409.5
 W1WHR/1 38 8 304
 W1COT 17 7 119
 W1FPF/M 21 5 157.5
 W1NBP 16 9 216
 W1ZIC 55 9 742.5
 W1UIZ 34 16 544
 W1VSI 73 13 1423.5

DELAWARE

W1JSM/1 1 1 1

FLORIDA

W4WHF 11 3 49.5
 KN4EAC 12 4 44

GEORGIA

W4ABP 7 3 21

ILLINOIS

W9AAG 21 19 399
 W9CT 44 9 396
 WN9YMP 22 4 88

W9FTT 53 8 636
W9QKM 78 32 2496
 W9OSQ 14 1 14
 W9MHL 56 9 756
 W9ADO 19 4 76
 W9TKR 23 7 161
 W9MYC 61 10 915
 W9KCV 14 4 56
 W9QKE 60 8 720
 KN9APQ 52 8 624
 W9ILR/9 15 3 45
 KN9BBK 51 12 612
 W9ORH 73 14 1022
 W9TTI 65 10 650

INDIANA

KN9AQP 48 12 864
 W9HVV 40 6 240

IOWA

W0WQQ 18 11 198
 W0OLY 19 9 171
 W0VMN 7 6 42

KANSAS

W0QDH 5 5 25

KENTUCKY

W4WNH 9 8 72

LOUISIANA

KN5EFS 6 2 18
W5ZSP 12 4 66

MAINE

W1BBB 9 2 27
 W1LHA 13 9 117
 W1LKW 1 1 1.5

MARYLAND

W3GKP 36 18 648
W3YHI 71 37 2627
 W1JSM/M 12 8 96

MASSACHUSETTS

WN1IJQ 97 10 1455
 W1CNM 24 8 192
 W1QPU 71 10 1065

W1RUD 134 44 5896
 W1IHV/M 57 9 513
 WN1FMW 40 5 300
 W1VXW 66 9 594
 W1PSG 60 14 1260
 W1VYS 11 4 44
 W1AHE 28 7 196
 W1AQE 75 17 1175
 W1QXE 30 6 180
 W1YLV 33 8 264
 W1PLX 80 34 2720
 W1RFU 36 17 612

MICHIGAN

W8URO 14 4 56
 WN8EYJ 30 7 315
 W8CVQ 29 15 435
W8DX 86 48 4128
 W8BGY 20 4 80
 W8GYU 20 4 80
 W8JXU 32 6 192
 W8ARR 39 18 702
 W8PT 24 14 334
 W8IPS 7 3 21

MINNESOTA

W0DXY 9 6 54
 KN0BNS 1 1 1

MISSOURI

KN0DBQ 20 6 180
K0DOK 27 8 216

NEBRASKA

KN0DFQ 17 4 102
K0B00 17 4 153
 K0BTG/0 16 5 80

NEW HAMPSHIRE

W1FZ 5 1 5

NEW JERSEY

W2JSE/2 7 7 49
 K2ICE 76 21 2394
 W0ETJ/2 82 45 3690
 W2TBD 62 29 1798
 KN2MYQ 51 16 1224
 W2AMJ 62 42 2604
 K21TP 100 22 3300
 K2HOD 52 16 832

K2KFJ 31 11 511.5
 K2DCF 46 17 782
 KN2PTJ 35 9 472.5
 K2KED 45 7 315
 K2AWY/2 121 27 3267
 K2JVX 70 21 1470
W201B 146 30 4380
 W2RGV 4 4 16
 K2LFO 6 2 12
 KN2ODO 114 19 3249
 W2AQQ 36 11 594
 KN2RNU 45 11 495
 KN2RXW 1 1 1
 W2SJB 25 13 325
 KN2QXX 81 12 1458
 K2BKU/2 95 29 4132.5
 W1JSM/M 5 4 20
 W2CXY 23 19 437
 W2PWX 83 31 2573

NEW YORK

K2HQI 44 6 396
 W2PST/2 23 5 115
 W2PST 16 6 96
 W2RXG 72 43 3096
 W2BLN/2 20 9 180
 K2DEM 16 8 192
 K2DLM 54 13 1053
 KN2ODL 20 7 210
 W2WDO 33 9 297
 W2WFB 64 32 2048
 KN2MXT 62 20 1860
 W2FEN 15 4 90
W2NSD 114 46 5144
 KN2RHG 12 6 72
 KN2MYS 13 7 136.5
 W2CTA 20 6 120
 KN2QLT 45 13 585
 K2IJX 56 24 1400
 K21EJ/2 110 35 3850
 W2UIS 20 5 100
 K2ERQ 31 12 372
 KN2MPY/2 5 2 10
 KN2MPY 8 1 12
 K2FCG 21 7 147
 W2ZPL 52 12 936
 KN2RDI 56 10 840
 K2EQO 18 9 243

OHIO

W8JOY 34 7 238
 W8SFG 73 47 3431
 W8NAF 67 22 1474
 W8HXT 53 28 1484
 W8LOF 63 31 1953

W8BMO	15	4	60
W8WYU	23	3	103.5
W8BTK	46	29	1334
W8KDW	51	23	1173
W8IPZ	10	6	60
W8DPW	52	12	936
W8ILC	74	21	2331
W8WEN/8	37	17	629
KN8EAQ	29	12	522
W8GZV	96	55	5280
W8LAH	41	23	943
W8IPT	41	8	492

OREGON

W7WTQ	17	10	255
W7UDN	26	9	234
W7SEZ	30	10	300

PENNSYLVANIA

W3TDF	161	50	8050
W3KWH	5	4	20
W2AFJ/3	20	9	270
W3CLQ	72	18	1296
W3LXM	38	13	741
W3LHG/3	65	21	1365
W3DEX	30	12	360
W3WHK/3	4	2	8
W3CPT	50	13	975
W3IMW	40	11	440
WN3FTP	109	22	3300
W3HYO	87	12	1566
W3ULB	82	24	1968
W3WIP/M	37	17	629
W3DTH	47	12	564
W3ZVK	132	29	5742

SOUTH DAKOTA

W0RSP	7	5	35
-------	---	---	----

RHODE ISLAND

WNIFEQ	4	2	8
WIWED	17	5	85
W1FZJ/1	107	35	3745
W1UEF	16	6	144

CANADA

VE3BOW	32	7	224
VE3DIR	56	28	1568
VE3DWW	27	6	162
VE3AIB	58	26	1508
VE3BRO	23	8	184
VE3DXR	35	9	315
VE3BHZ	22	5	110
VE3DUU	29	6	174
VE3DFY	22	5	110
VE3DNE	39	8	312
VE3BGT	13	4	52
VE3DSU	27	17	459
VE7AOG	7	2	14

50 Mc.

ARKANSAS

W5ZVF	1	1	1
-------	---	---	---

CALIFORNIA

K6QQL	39	5	292.5
W6SRE	8	1	8
W6BWG	8	5	40
K6HYW/6	96	14	1338
K6BO	113	8	904
W6MFI	85	13	1105
K6KUF/6	134	10	1340
W6VWK	85	15	1275
W6ZOP	200	9	1800

COLORADO

W0FKY	22	16	352
-------	----	----	-----

CONNECTICUT

W1LGE	16	8	128
-------	----	---	-----

DELAWARE

W3CGV	18	15	270
-------	----	----	-----

MARYLAND

W30TC	46	30	1380
W3PZK	8	4	32
W3DMS	38	18	1026
W3KMV	37	23	851

MASSACHUSETTS

W1GWP	40	10	400
W1HOY	113	30	3390
W1YPK	79	22	1738
W1LUW	15	5	75
W1HUH	8	4	47
W1OOP	60	19	1140
W1VYS	9	4	36
W1TTG/1	26	12	312
W1WYZ/1	14	37	518
W1DVF	45	12	540
W1IFW	10	4	40
W1CIX	27	9	243
W1PX	30	15	675
W1QXE	17	7	119
W1FOS	125	38	4750
W1RFU	29	18	522
W1LMU	40	5	200
W1GRW	37	15	555
W1CAS	10	6	60

MICHIGAN

W8ESR	32	13	624
W8HJR	36	11	396
W8SSO	30	12	360
W8QLO	14	5	70
W8VYG	16	3	48

MISSOURI

K0DGG	39	12	468
W0ODI	44	7	462
W0BPM	27	4	108
W0PXO/O	11	5	55
W0WKG	15	3	45

NEW HAMPSHIRE

W1IQD	2	2	4
W1FZ	16	8	128

NEW JERSEY

W2FBZ	108	33	3564
K20MI	12	5	60
W2RGV	12	7	84
K2AWY/2	77	20	1540
K2LFO	17	7	119
K2BKU/2	47	14	987
W20RA	26	12	312

NEW MEXICO

W5KWP	15	12	180
-------	----	----	-----

NEW YORK

K20IL	59	20	1180
K2ERQ	16	9	144
W2BVU	3	3	9

OHIO

W8QLB	22	7	154
W8SGX	36	22	792
W8MXR	9	3	27
W8PKC	30	16	480
W8SVU	27	14	378
W8IED	14	5	70
W8IFZ	11	3	33
W8RKL	34	18	612
W8INQ	12	7	84

OREGON

W7PGS	11	4	66
W7INX	15	7	105
W7SEZ	11	6	66

PENNSYLVANIA

W3UBO	34	24	816
W3KWH	14	10	140
W3LHG/3	26	14	364
W3UQJ	15	9	202.5
W3YRB	20	11	330
W3AMO	35	14	735
W3KJM	19	14	266
W3TIF	1	1	1

RHODE ISLAND

WIUHE	38	10	380
WIWED	28	10	280
WIWTR	30	12	360
W1CPC	33	11	363

TEXAS

W5FEG	6	7	112
W5BXA	11	8	88

UTAH

W7YDZ	4	3	18
W7QDJ/7	1	1	1

VERMONT

WIWID/1	99	27	2673
---------	----	----	------

VIRGINIA

W4UCH	38	22	836
W4OLO	2	2	4
W4JCJ	16	7	112
W4WIS/4	34	11	374

WASHINGTON (state)

W7FEG	38	9	342
W7LHL	8	3	24
K6AXV/T/M	8	4	32
W7PRW	18	7	126
W7YGI/7	7	2	14

WISCONSIN

W9JFP	47	18	846
-------	----	----	-----

220 Mc.

NEW JERSEY

W2RGV	10	7	70
W2DZA	8	6	48
W2BVJ	3	3	9

VERMONT

WIWID/1	3	3	9
---------	---	---	---

MASSACHUSETTS

W1RFU	2	2	4
-------	---	---	---

CONNECTICUT

W1LGE	1	1	1
-------	---	---	---

**AIRBORNE
144 Mc.**

W8UAT/8	75	35	2625
W8PTF/8	65	27	1755
W1GYU/1/2/3	144	42	6048



W3ZVK, second highest scorer in Pa. Rig is a Gonset Communicator, antenna a 5-element beam 20 feet high, QTH is 520 feet above sea level.

TENNESSEE

W4THM/4	22	13	286
---------	----	----	-----

VERMONT

W1MMN	16	13	208
-------	----	----	-----

VIRGINIA

W4JCJ	40	20	800
-------	----	----	-----

WASHINGTON

W3YHI	71	37	2627
-------	----	----	------

WASHINGTON (state)

W7LHL	37	12	444
W7AVM	1	1	1
W7ZOB/7	4	1	4

WISCONSIN

W9ILR	15	3	45
-------	----	---	----

GEORGIA

W4WWQ	2	2	4
W4IKK	7	4	28

ILLINOIS

W9AGG	7	3	21
K9AUN	25	9	337.5
K9AVZ	17	6	102
W9AFP	40	21	840
W9YOI	32	10	320

INDIANA

W9HPO	20	16	480
W9BRN	76	45	3420

IOWA

W0USQ	30	16	480
W0SMJ	21	17	357
W0WOQ	14	3	42

MAINE

W1DEO	55	32	1760
W1GKJ	11	9	99



W2RGV, Top Scorer on 220



Reported by

Sam Harris, W1FZJ

P. O. Box 2502, Medfield, Mass.

Calling Frequencies

At least a quarter of the letters we receive from you mention the establishment of a national calling frequency on Two Meters and a goodly number of them ask for the same thing for Six. The presently established national calling frequencies for these bands as set forth by our own ARRL (145,350 and 50,550) are probably satisfactory for the purpose for which they were intended, but—and herein lies the rub. . . .

The DX-minded boys want a frequency where they can park their receivers and be assured that when the band is open they will hear some evidence of it. They are not monitoring the band for the purpose of establishing a local contact (the obvious way to do this is to put forth a general call of inquiry).

The ragchewing and mobile boys are looking for a frequency where they can be assured that a call will bring an answer. Obviously these two divergent purposes cannot be served by one frequency.



W2O1B, 2-meter winner in New Jersey. Antenna in a 40-element beam (8 5-el yagis).

The Dayton "R-F Carrier" has suggested that the two-meter band be monitored on 144.990 and 145.080. These frequencies are for the benefit of those who are looking for a contact. The VHF DX Guild has suggested the use of 144.250 for those high-power, "low end of the band" operators who really don't want to talk to anybody but still like to keep their feedlines warm.

On Six Meters, the "general call for a contact" frequency remains the same as recommended by



W3TDF, top man on 2 in Pa.

the ARRL. DX seekers claim to support 50.010 as an alert frequency.

Let's give these frequencies a try and remember to observe the "contact and vacate" rule.

CW Band for Two Meters

By now I'm sure that you have all heard that the efforts to get the ARRL to recommend a cw band for Two Meters were unsuccessful. The board did, however, recommend that a study be made of the advisability of such a move. (I can't resist observing that if the boys at headquarters would keep abreast of things, there would be no need for a study to be made. They should already know the answer).

It is obvious that the DX boys on Two Meters want a cw band. It is equally obvious that the way for them to get it is by doing instead of com-

plaining. It has been my observation that the loudest proponents of a cw band on the low end of the band generally discuss the problem while running a k.w. of phone on the low end (They are generally pointing out that a gentleman's agreement will never work because the guy next door always operates phone on the low end).

The solution is very simple. All proponents of cw on the first 500 kc of Two Meters must adhere to a strict rule. NEVER (*not* Hardly Ever, but NEVER) operate phone in the cw band. NEVER answer a phone call in the cw band. ALWAYS write your ARRL director on the first of each month asking what he has done and is doing about obtaining ARRL sanction for a two-meter cw sub-band. If the ZL's can do it on Eighty Meters, it's obvious that the W's can do it on Two Meters.

W9BRN, Indiana winner on 6. 300 watts to a 4-125A, with a 4 over 4 yagi at 60 feet.

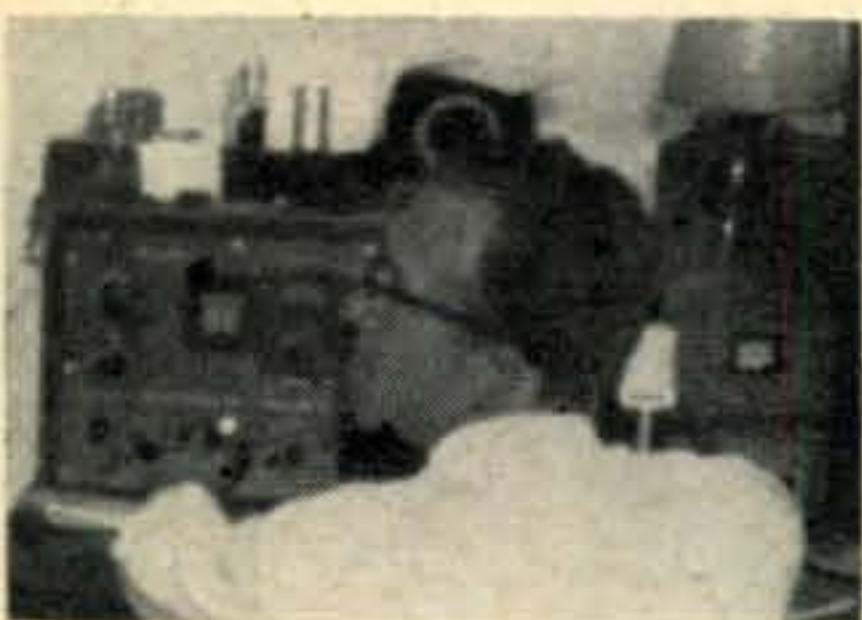

Ohio 2-meter winner W8GZW. Xmtr: pr 826's. Rcvr: pr 6AJ4's feeding HQ-129X. Ant: 20 elements at 55 feet.

CQ Summer Contest

The success of the last VHF Contest has given us the urge to have another one during the summer when the mountain-toppers can get out and do their bit.

WHEN? The summer contest will be held on the 18th and 19th of August. Starting time will be 200 p.m. local standard time on Saturday. Contest ends at midnight local standard time on Sunday, August 19th.

HOW? The summer contest will be operated under the same rules as the Spring contest with the following changes:

(1) Contest will be open for multi-band operators as well as single-band stations.

(2) Single-band operators may make contacts on any VHF band as long as the majority of their contacts are made on the band for which their score is submitted. Only one contact per station can be scored, and a given county can only be used as a multiplier once. Multiple contacts can be scored only if the station contacted is operating portable and has changed his QTH by twenty-five miles or more.

(3) Multi-band stations must make contacts on at least three of the VHF bands. Contacts can be made with any station once on each band and

the county multiplier is the sum of the counties worked on each band. For instance you can work W100P on Six, Two, 1.4 and 0.7 for a total of four contact points and a county multiplier of four (If you can get him to operate portable twenty-five miles or more from his house, you can do it all over again).

(4) A special trophy is being prepared for the station turning in the highest multi-band score. This trophy to remain in the possession of the winner until the next contest at which time it will be again awarded to the high-scoring multi-band station. Permanent possession can be achieved by winning three times in a row.

Complete rules for the contest will be in the next issue. Gird your loins, polish your antennas and get ready for a real do.

Moon Bounce

By the time you read this our Moon Bounce transmissions will be in full swing. Transmission schedules and frequency in use can be obtained by sending a request to ye old P.O. Box 2502, Medfield, Massachusetts.

From the Two Meter & Down Radio Club of Southern California:

"We have settled the date for our annual Picnic. As you probably know, this is the one big thing for our club in the entire year. It cements the relationship between all the Clubs in this area. We have the usual xmtr hunts, games, prizes and raffle. It has been in the past one of the bigger hamfests in this area; we hope to keep it that way. The date is the 12th of August; the place is Buena Park, California. I will answer any and all requests for information regarding our Clubs' activities."

73, Sam, W1FZJ



RTTY

as reported by

Byron H. Kretzman, W2JTP

9620 160th Ave., Howard Beach 14, N. Y.

CQ Far East. That's the call that has gone out from W6SEW/J. John Porep reports that he has been in Japan for the past year or so, and is quite interested in having any RTTYers contact him if they should pass through Toyko (W6SEW was active on 40 meter RTTY from Oakland, California). John writes that he would like to serve as "... a sort of Far East RTTY Center with the purpose of gathering news from those engaged or interested in amateur RTTY operation, assisting others in building up converters, helping to make trades, and in general make a lot of new friends." Apparently, more surplus *Teletype* gear is available over there than in the States! John also says that

AMATEUR RADIOTELETYPE CHANNELS

National, FSK (mark frequencies; space 850 cycles lower) 3620, 7140, 27,200, 29,160, 52,600 kc.

National, AFSK (2125 cycles mark; 2975 cycles space) 27,200, 147,960 kc. calling & autostart 147,138 kc. repeater & duplex

California, AFSK 147,850 kc. calling & working

Washington, D.C. AFSK 147,960 kc. calling & autostart 147,495 kc. working

Chicago, AFSK (FM) 147,700 kc. calling & working

Detroit, AFSK (FM) 147,300 kc. calling & working

New York, AFSK 147,960 kc. calling & working

he is "registered" with the U. S. Army in Japan, so he can legally purchase and/or sell any of this equipment. If you are fortunate enough to get to Japan, John's address is 1-1 Sanbancho, Chiyodaku, Tokyo. His telephone number is (33)1288. Some very pleasant memories of Japan were recalled by W6SEW's, as your RTTY Editor was a "guest" of the Signal Corps there in 1945-46.

Tuning FSK

"How do you tune in FSK, properly?" This question has been very nicely answered by W1FGL. Here is the answer, just as Al so neatly put it: "I find that some of the newcomers in the field of RTTY are not aware of the importance of obtaining the proper adjustment between the main tuning dial and the b.f.o. of their receivers.

"The common practice is to simply tune around until an RTTY signal is heard and then adjust either the main dial or the b.f.o. until a *mark* tone of 2125 cycles is fed into the converter. This frequently results in the main dial being improperly set with respect to the pass-band of the receiver. If the receiver has an S-meter, (and what receiver doesn't, today) the proper procedure is as follows: Turn off the b.f.o. and set the receiver for AM reception, which activates the S-meter. Tune to a steady *mark* signal (your own VFO is the best source of this) and adjust the main dial for maximum S-meter reading.

"Now switch the FSK circuit to space. In all probability the S-meter will move to a lower reading. With the *space* signal still on, adjust the main tuning dial so that the S-meter reading is about half way back to its maximum reading. Change the FSK to *mark* again and see if the S-meter stays steady. If it doesn't, again adjust the main dial until a point is found where the S-meter does not move when the FSK is switched from *mark* to *space* and back. Having found this adjustment of the main dial, leave it alone and then turn on the b.f.o. This will probably in most receivers disable the S-meter, (the NC-300 in SSB position leaves the S-meter working, which is an advantage of this receiver for RTTY) but this will not matter. Now adjust the b.f.o. so that the correct audio tone for *mark* is obtained.

"From then on the b.f.o. should not be moved from that spot and all future tuning of the receiver in looking for RTTY signals is done with the main dial, setting the main dial to obtain the correct *mark* tone. The result of this procedure is to obtain the same signal output from the receiver on both *mark* and *space*. It is surprising how much crystal filter can be used with most receivers when using this line-up method, thus getting full advantage of the receiver's selectivity. Of course it is essential that the receiver be thoroughly warmed up before commencing the adjustment for any subsequent drift, particularly in the b-f-o oscillator, will upset the pass-band setting."

Across the Nation

The San Francisco area is now operating an AFSK RTTY net on 6 meters, according to K6IOG and his XYL, K6PMK. Operation is on 50.7 Mc.

with transmitter powers from 10 to 500 watts. Most of the fellows, K6BAO, W60WQ, K6KF, and K6QAX, for example, are using Model 26's. K6IOG has a 4-element beam up in the air 60 feet, and is making plans for a 6-element job.

W7JLF has been copying RTTY on the 15-meter band around 21.1 Mc. He reports that W7LPM in Seattle works that band regularly, working WØDTY in Denver and a W8 in Detroit.

W9QBH is now Pfc. Robert J. Hajek, 9393 TSU, Det. #1, box 174, White Sands Proving Grounds, New Mexico. (Drop him a line, will you, fellows?) Bob finds no MARS RTTY activity down there (!?) but has a 6 meter mobile 'phone rig in his car. His father, W9ECA, is still on 6 meter RTTY, though.

W2SMX at Farmingdale, W2GWL at Lake Ronkonkoma (both on Long Island), K2IPR in Neptune City, New Jersey, and W1VIY of Trumbull, Connecticut, are active on 147.96 Mc. with high power, big beams (horizontal, naturally), and super-hot receiving equipment. At present they are using AFSK, with FSK contemplated in the near future. They have been pointing their super-sensitive sniffing gear up Boston way, but nothing has been heard from the Boston RTTY gang, so far. *Sam, where are you?* Both W2SMX and W2GWL have heard a strange FSK signal using 5 kc. shift with the *space* on 144.06 Mc. and the *mark* on 144.065 Mc. It apparently is horizontal polarized and comes from the direction of Boston. Anybody know anything about this?

Just about the most active RTTY station from the third call area is W3KYR. It seems that anytime W2JTP chases the brown fox or a few RY's on 3620, W3KYR comes back with that walloping signal. This is the station of the St. Mary's Boys' Club in St. Mary's, Pennsylvania. Fred, W3LGK, does most of the operating. We hope to have a picture and story on this station very soon. Watch for it.

Comments

Your RTTY column is in somewhat reduced form this summer month, due to vacations, etc. Next month we continue the "RTTY Principles & Practice" section with the inside dope on tape gear. *CW traffic men—be sure to catch this.*

Are you having difficulty working FSK on 80 meters because of the high level of static that prevails in the summer time? W2JTP is now using a receiver on 3620 kc. that has a 6SA7 linear (product) 2nd detector preceded by a 6SJ7 i-f limiter. No claims for performance are made as yet, but its use does make listening less nerve-wracking. Suggested is a plug-in adaptor to go into the "NBFM" adaptor socket provided in several of the larger communications receivers.

Let's hear from you; if not on 3620 kc. or 147.96 Mc. try Uncle's Postal service. It's pretty good, too. All letters are answered as soon as possible. If you would like to see your RTTY shack in CQ, send along a glossy print. Anything up to an 8" by 10" will be gratefully received. 73, Byron, W2JTP

FREQUENCY STABILITY

[from page 67]

But the essence of my song is this: it doesn't matter what circuit you use, or what lay-out you use, or what specific components you use—so long as they are components that will *stay* that way. High-Q is NOT necessary; you can make a coil out of wire solder, if you like, and if you keep the geometry of that coil constant—the frequency will remain stable.

The only reason the high-Q of the quartz crystal makes for stable oscillators is that quartz has an exceedingly high mechanical rigidity; since practically all the r-f energy in the oscillator circuit is going to be stored in the quartz crystal, and that crystal has great rigidity of characteristics, it dominates the sloppiness of the rest of the circuit.

But if the whole circuit is made equally rigid as to characteristics, then the high-Q of the crystal would be unimportant.

Use bare copper wire for the r-f circuits; air's a wonderful dielectric, and if the wire's bare, you won't be tempted to let it slop around loose.

Use high-quality by-pass condensers; they're in the r-f circuit, and a by-pass condenser with a crummy dielectric will be just so much crummy dielectric in the r-f circuit. ■

Radio Communications & TV Instructors Needed

Minimum Educational Qualifications:

H. S. Graduate (technical, vocational or academic major) plus 5-7 yrs. appropriate trade experience.

Maximum Age: 60

Salary: \$3900 to \$7600 in periodic increases.

Examinations: Theory, Practical, Oral English, Physical & Medical.

Working Time: Approx. 180-200 days per yr. Daily, 6 hrs 20 mins (incl. lunch)

Employer: Board of Education, City of New York, High School Division.

Contact Monroe M. Freedman, Administrative Assistant, Samuel Gompers Vocational & Technical High School, 145th St. & Southern Blvd, Bronx 55, N. Y. phone: MOtt Haven 5-0950.

National Convention in San Francisco

July 6-7-8 will see a mighty influx of us amateurs into the Bay City for a general con-fab, exhibits, talks, dances, and plenty of etc. You are going to be there, aren't you? Sure you are. Send \$9.50 right now to cover everything to the National Amateur Radio Convention, 391 Monterey Blvd., San Francisco 12, California. Special XYL tickets will be available too. Prizes start with a Collins KWS-1! Gather ye at the Civic Auditorium and the Whitcomb Hotel across the street.

WHITEFACE

[from page 45]

was down the mountain a piece. We drove about a mile down the road and then pulled off to the side. With a bit of shoving from Sam and Hi I went down that mountain-goat's path. I'm not kidding either. On one side of the path was mountain, straight up; and on the other side was mountain, straight down. The path itself must have been all of twenty inches wide. I am very proud of the fact that I did take time off, by the time I was halfway along the path, to start worrying about the children. Hi told me not to bother about them, they were doing all right. The children skipped along the path as though it were a city sidewalk.

When we did arrive at the lean-to, we found that there was also a small cabin which Hi used rather than go down the mountain when the weather was bad. It was a beautiful spot with none of the comforts of home and lots of privacy. Hi made us some coffee while we were resting from the trip down the path. Later he took the children along some of the paths leading farther down the slope. By the time they came back I had geared myself to face the trip back up.

That evening it started to rain. Sam was undecided as to whether he should go to the tower and get on the air until Hi settled it by coming to see what was delaying Sam and by informing him that it wasn't raining on top of the mountain. The mountain top was in the clouds at night and they were usually storm clouds. It must have taken a great deal of courage to turn on the rig in the middle of the storms that hit every night. The lightning flashed all around and a number of times even struck the legs of the tower.

After two days of storms our tent was ripped and the cots had given up the ghost. Still, I was enjoying myself and the children were having a wonderful time. Sam slept all day. When the last cot gave way Sam had to take notice of the situation. After all, that was his cot. We discussed going home, but Hi came along right then and insisted that we use his lean-to up the mountain so that when it rained we could move into the cabin. There

was nothing I wanted to do less than move into the lean-to, but having the well-being of my O.M. at heart I agreed to the shift of temporary QTH.

After three nights spent in the tower in the electrical storms poor Sam still hadn't had a contact on two meters. That night the great event happened. He made contact with a station that was mobile in the air and another with a station somewhere in Massachusetts. It made the whole trip worth while for Sam. However that was the extent of the contacts from Mt. Whiteface.

The following day we decided to take a quick trip to Connecticut to visit some of the VHF gang. I thought we'd be back at camp for the night, and got a surprise to find that by night-time we still weren't very close to our destination. We pulled off the road, set up our kerosene stove, cooked a few hot-dogs, made cocoa and coffee and then settled down for the night.

Some well meaning citizen, passing in the middle of the night, thought there had been an accident. He kept going and reported it at the next town along the highway. It is a shock to be waked up with a flashlight shining in your face. After we explained our presence he went on his way.

In the morning after breakfast, we started off and it wasn't long until we arrived at our destination in Connecticut. You guessed it, the fellow was away on vacation and wouldn't be home for another week!

We had left most of our gear in the cabin on Mt. Whiteface so we had to go back to collect it. Naturally a terrific storm was in progress when we arrived back at the cabin. It was some trip slipping and sliding down that goat's path. Later, when I had just bent over to pack something in the last carton lightning struck. It followed the phone line down the path, struck the phone with a loud clang, then jumped from the phone to a water pail three inches away from me. I survived, barely.

We did enjoy ourselves even though the radio part of the trip was practically a flop. The children saw a number of things including the wild animals that Hi had promised. And me? I had a wonderful time relaxing from the normal wear and tear of every-day living. (?)

YL Net Picnic

W4HLF, Arlie, announces that the 75-meter YL net of which she is NCS will hold its annual picnic at Big Meadow on Skyline Drive in Virginia on August 19. Bring your family and a picnic basket. Each YL is asked to bring an inexpensive gift, preferably something she has made, to exchange. For additional information or reservations at Big Meadow, write to Charlott Burgess, Reservation Clerk, Va. Skyline Co., Inc., Luray, Va.

New Club Rates Announced

Have the Secretary of your club drop a card to:
Harold Weisner, Circulation
CQ Magazine
67 West 44th Street
New York 36, N. Y.

and ask for the new Secret Appallingly Low Club Subscription Rates. He will try to get these to your club while you are still young. Don't forget to give your club mailing address, eh?

YOU HAVEN'T REALLY HEARD

SSB

CW

AM

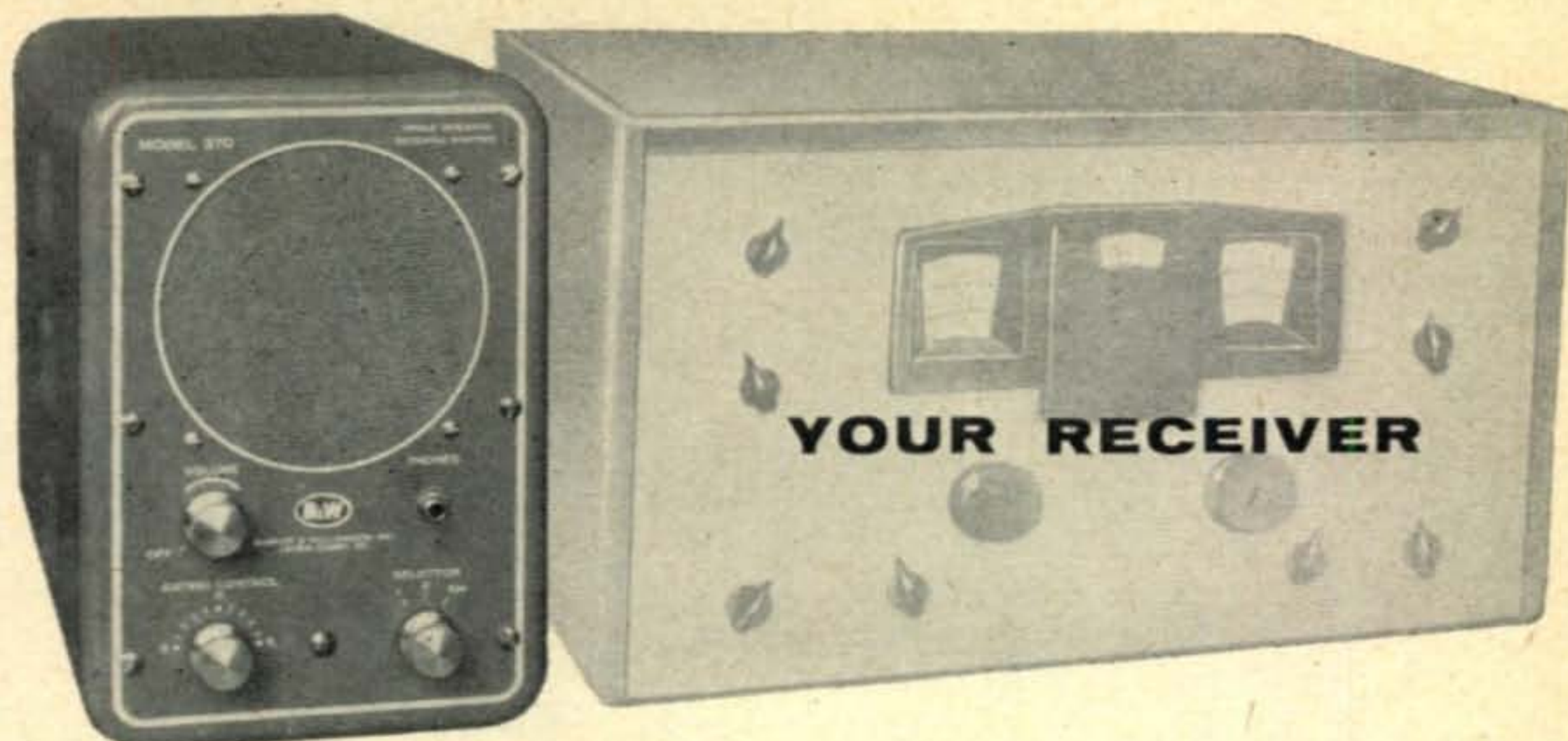

UNTIL YOU HEAR IT ON THE B & W ADAPTER!

The B & W Model 370 Adapter can be easily hooked up to your present receiver to give you reception which you never dreamed possible before.

SSB

Truly superlative SSB reception—far better than the so-called SSB built into many of today's receivers. The model 370 adapter not only lets you select the upper or lower sideband by a flip of a switch, but it *also effectively rejects all other unwanted signals.*

CW

The model 370 provides true single signal operation . . . suppresses unwanted heterodynes by 50 db, and you can select either side of zero beat merely by flipping a switch—no tuning required. No trouble at all to copy a weak station even with a local KW as close as 300 cycles.

AM

The "370" lets you tune either sideband of an AM station and still read the signal without any noticeable attenuation. Many times more effective than crystal selectivity. QRM just disappears.

You can add this adapter to all communications sets without, in any way, changing the receiver characteristics.

A precision 20 kc torodial type filter with a 3 kc passband provides extreme skirt selectivity. Unwanted signals outside the passband are suppressed by a

minimum of 50db. The entire unit is self-contained with power supply and a 7" dynamic speaker. Get your distributor to give you a demonstration, or write for complete information contained in the new B & W Catalog.

B & W

BARKER & WILLIAMSON, INC.

237 Fairfield Avenue, Upper Darby, Pa.

TV Filter [from page 21]

automobile chrome polish in order to make a more pleasing picture.

The tuning capacitor is a *Hammarlund* APC-100 air trimmer. Although ordinary coax connectors are shown, the popular (and cheaper) Motorola plugs will work just as well. A two-foot length of #8 wire completes the modest parts list.

Presumably your 6-inch cans will have bottoms but no tops, since it is generally necessary to cut off the top to empty the can and there is no good reason for the original user to remove the bottoms. The first step in constructing the filter therefore is to remove and save the bottom of one of the cans. Next solder together the three small cans one on top of another and fasten the stack securely to the center of the large container. Good electrical contact over a large area is important here. I used 6 or 8 sheet metal screws through the bottom, reinforced by soldering around the edge.

Drill holes of appropriate size opposite each other near the bottom edge of the remaining 6-inch can and mount the coax connectors. The coupling loops are formed of the #8 wire and extend from the connectors horizontally to within 1/2 inch of the inner conductor of the resonator, then straight down and out through two holes drilled in the bottom of the unit. The APC trimmer is spotted at any convenient point where the stator terminals will extend near the top rim of the inner conductor when the filter is assembled.

Solder the two 6-inch cans together, then turn the unit upside down and solder the ends of the coupling loops where they extend through the bottom. Connect the trimmer stator to the edge of the inner conductor. The rotor of course is grounded to the outer shell.

Theoretically, increased efficiency should result by distributing this capacity all around rather than lumping it in one spot. This could be done by using four 25 μfd . trimmers equally spaced in a circle, connected to 4 different points on the inner conductor.

The resonant frequency of the filter can then be checked with a grid-dipper loosely coupled to the trimmer stator connection. High Q will be indicated by a very sharp dip. Resonance in the 6-meter band should occur with about 75 or 80 μfd . effective capacity. Lacking a grid-dipper, the resonant point can be found just as well by listening to the receiver or watching the plate meter on the transmitter. Little or no retuning of the plate tank condenser of the transmitter should be necessary after peaking the filter. Variation of coupling for proper loading is accomplished by bending the coupling loops closer or farther away from the inner conductor. Finally, solder on the top, retune slightly if necessary, and the cavity TVI filter is complete.

Checking the transmitter output with a light bulb for a dummy load both with and without the filter will disclose little or no discernible loss in power. While the re-entrant filter will do much to suppress TVI, like all other anti-TV I devices it is not a cure-all in itself, but requires the backup of careful design in all other parts of the transmitter. It will prevent unwanted energy from going out the antenna, but it cannot prevent radiation from other parts of a poorly-shielded or inadequately-filtered transmitter.

Although the finished dimensions of the 6-meter model may appear somewhat bulky, if it means the difference between TVI-free operation and remaining off the air, as well it might, then room can always be found for it somewhere in the shack! ■

Montana

Scenic Hamfest, on beautiful Lake McDonald in Glacier National Park. Special events, contests, prizes—Cabins, camping and trailer space available. Come as you are and bring the XYL and family for an enjoyable visit to lovely Montana. This is the 21st annual Hamfest—to be held Saturday and Sunday, July 21-22, at Apgar Camp Ground, West Glacier, Montana. For further information write Frank Hart W7UPR, Rt. 1, Sunset Drive, Kalispell, Montana, secretary-treasurer Glacier Park Hamfest.

Minnesota

The Saint Cloud, Minnesota Mike and Key Radio Club is holding their annual Hamfest family picnic on August 5th at Wilson Park, located in East Saint Cloud on the banks of the Mississippi, across the river from the hospital. All modern facilities, shelter house, picnic tables, playground equipment, swimming beach and free coffee will be served. Signs will be posted on all highways.

Activities will include—Registration prizes, Hidden Transmitter Hunt, Mobile Field Strength Contest, Oldest Ham present, Ham from the furthest distance and games with prizes for the XYL and Harmonics so bring the family.

Registrations start at 10 A.M. \$1.00 per call includes the family.

For further information please contact WØRVO Bob Molitor 315-7th Ave. North.

Penn

The South Hills Brass Pounders and Modulators, Inc. wish to announce their 18th annual Hafest to be held on Sunday, August 5th, at Totem Pole Lodge, South Park, Pittsburgh, Penna. Festivities start at 12 noon till ? For the past seventeen years all who have attended have had a whopping good time. The inevitable Swap and Shop plus demonstrations and activities for young and old will make this the outstanding ham event of the year. PRIZES GALORE. Games to keep the Jr. Op. busy. Contests to occupy the XYL. Plenty of picnic space. Plan now to attend. Register in advance and save. Pre-registration ends July 21, 1956. Make checks payable to South Hills Brass Pounders and Modulators, Inc. Send \$1.50 to S. J. Zolinas W3QWW 423 Parkwood Rd. Pittsburgh 10, Penna. Tickets \$2.00 at the door. Novice tests will be given, bring your examination papers. Club station W3PIQ will operate on 29.2 mc to "zero in" the mobiles. See you at the hamfest.

Maryland EPN Annual Picnic

Contests, ladies and children's programs, rummage sale, prizes, and of course eating will be featured at the annual picnic of the Maryland Emergency Phone Net at Braddock Heights Park, Braddock Heights, Maryland (5 miles west of Frederick, Md., on U. S. 40A), Sunday, July 22, from 10 a.m. 'til? For advance registration: C. C. Worsley, W3TYJ, 104 Northwood, Silver Spring, Md. 50c per, children under 12 free.

Single Sideband Adapter- **GSB-1**

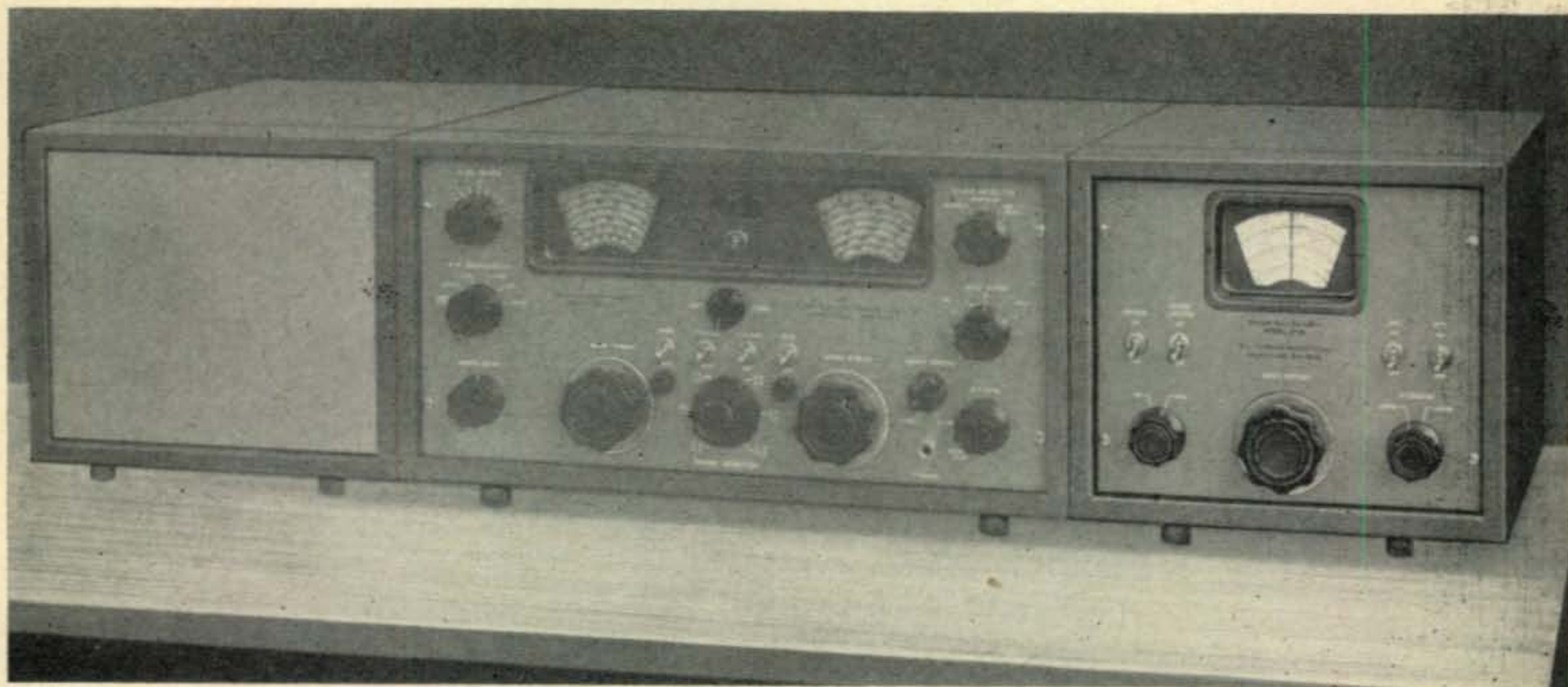

The TMC Model GSB-1, Single Sideband Adapter is a filter type slicer permitting accurate and simple tuning of SSB signals.

The 455 Kc input is converted to a low frequency by means of a mixer and oscillator combination which allows selection of either sideband. The difference frequency is fed to a carefully designed and manufactured bandpass filter, which restricts the band width to 3 Kc at the 6 db points. This filter is so effective that the skirt width at 40 db is only 4.5 Kc. The filter output, in turn, is fed through a second mixer, or product detector, where it is combined with a stable 17 Kc local oscillator. The result is once again passed through a filter having a cutoff at 5 Kc, thus eliminating all unwanted mixer products. The output is a relatively noise and interference free audio signal.

The TMC Model GSB-1 contains a number of features which make it a more useful device. Since single sideband signals require critical frequency adjustment, this unit has been provided with electrical band spread which reduces tuning to the point of greatest simplicity and ease. In addition, AVC is provided within the Model GSB, over and above that which already exists within the receiver, thus serving to further prevent powerful local stations from overloading the slicer. A noise limiter, which reduces impulse peaks, has also been included in this unit.

The Model GSB-1 although originally designed for use with the Model GPR-90 receiver (which already provides the proper terminals) may be used with any receiver which will provide .3 volts (rms) R.F. input at approximately 455 Kc and where access to an audio grid is available.

Illustrated with the GSB-1 (right side) is the TMC Receiver GPR-90 (center) and the companion speaker - Bulletin 179Q.



The TECHNICAL MATERIEL CORPORATION

TMC Canada, LTD.
OTTAWA, ONTARIO

MAMARONECK, NEW YORK.

TMC Single Sideband
Adapter GSB-1
(Bulletin C-194)
Complete with all
instructions
AMATEUR NET

\$149.50

FRONT PANEL CONTROLS:

- Power ON/OFF Switch
- AVC ON/OFF Switch
- SSB-AM Selector Switch
- Upper or Lower Sideband Selector Switch
- Noise Limiter ON/OFF Switch
- AVC FAST/SLOW Switch
- Main Tuning

SPECIFICATIONS:

FREQUENCY RANGE:

452-458 Kc.

TYPE OF RECEPTION:

AM, SSB (Upper or Lower), CW

IF INPUT VOLTAGE:

0.3 volts rms (normal) for 0.3 volts rms audio output.

IF INPUT VOLTAGE RANGE:

0.1-10 volts rms (with AVC).

AVC CHARACTERISTIC:

With 40 db change in input signal, output remains constant within 9db

INPUT IMPEDANCE:

High-from IF.

OUTPUT IMPEDANCE:

To match audio grid.

INPUT POWER:

115 volts, 50/60 cycles, 46 watts.

CABINET SIZE:

12" wide x 10" high x 15" deep.
Matches GPR-90 for height & depth

RADIO INTERFERENCE BUREAU FOR LOS ANGELES
1216 W. First Street, Los Angeles, Calif.
ANNUAL REPORT FISCAL YEAR 1954-55
HISTORY OF INVESTIGATIONS

A. C. Modulation	20	Garage door opener	3
Address incorrect	8	Having no trouble	7
Air conditioning unit	4	House wiring	24
Aquarium heater	16	Ignition (automobile)	8
Auto call signal	1	Medical—diathermy	9
Beauty/barber shop equipment	2	Moved	12
Building material	13	Neon	45
*Cleared, cause unknown	384	Power system	284
Cross modulation	33	Power—other than D. W. P.	192
Distance—short wave	1	Radio receiver	136
Door bell transformer	40	Radio receiver installation	4
Electric adding machine	6	Refrigerator	43
Electric blanket	8	Refrigerator butter compartment ..	51
Electric drill	6	Sewing machine	7
Electric fence	19	Station—amateur	47
Electric fan	4	Station—other than amateur	5
Electric flasher button	4	Street light	15
Electric insect killer	1	Telephone system	2
Electric light bulb	3	Television receiver	204
Electric range	2	Television receiver installation	90
Electric saw	12	Television receiver radiation	91
Electric shaver	8	Thermostat—Heating pad	449
Electric shaver rectifier	6	Thermostat—Miscl.	9
Electric sign	2	Traffic flasher	2
Electric sign flasher	14	Universal motor	22
Electric typewriter	1	Violet ray (Pasteuray)	4
Electric vibrator	4	Voltage	35
Electric washing machine	2	Welder	13
Fluorescent light	70	225 card (unable to contact)	34
Furnace igniter	1	**TOTAL 2542	

(*) "Cleared—cause unknown" includes all investigations where the interference disappeared before source was located.

(**) Discrepancy in total of summary from total work orders completed is due to more than one cause of trouble being found on one work order, or one cause of trouble affecting more than one customer.

Good-bye 160

By unanimous order, the FCC on May 17 passed new rules prohibiting 160 meter operation as of July 9 in the following areas: Texas, east of 99° West and south of 32° North, Louisiana, Mississippi, Alabama, Georgia, Florida, Puerto Rico, Virgin Islands, Alaska and Guam.

Other areas presently using 160 meter operation remain unchanged.

It is interesting to note the logic utilized by the FCC in easing us out of these bands. First, the Gulf of Mexico Loran chain was changed from 1950 to 1850 kilocycles because of harmful interference to the maritime mobile use of 2009 kilocycles on the west coast of Florida. The new Loran frequency of 1850 kc was then placed in a position of being interfered with by amateurs in the low frequency 160 meter band. Therefore, the amateurs had to go.

The FCC also uses as reasons for barring amateurs in the above areas the original stipulation placed when they granted 160 operation, that they could change the frequency allocations as they saw fit with no invited comments from the public as this would be contrary to the public interest. To quote the FCC "The public interest, convenience and necessity will be served" by these changes. The commission also is requesting that all amateurs comply with this order on a voluntary basis immediately upon receipt of this information.

Ham Scholarship

The Lakeland Amateur Radio Society of 1709 Mockingbird Lane, Lakeland, Florida, is in the process of setting up a Scholarship Fund for outstanding and needy students in any field of the Physical Sciences. This fund came about as a result of the death of Eric V. Erickson, W4VIE and is to carry his name. Any suggestions or comments in the formulation of this scholarship fund will be appreciated and comments are invited by the Florida gang in the establishment of this worthy Amateur project.



MOBILE TWINNS

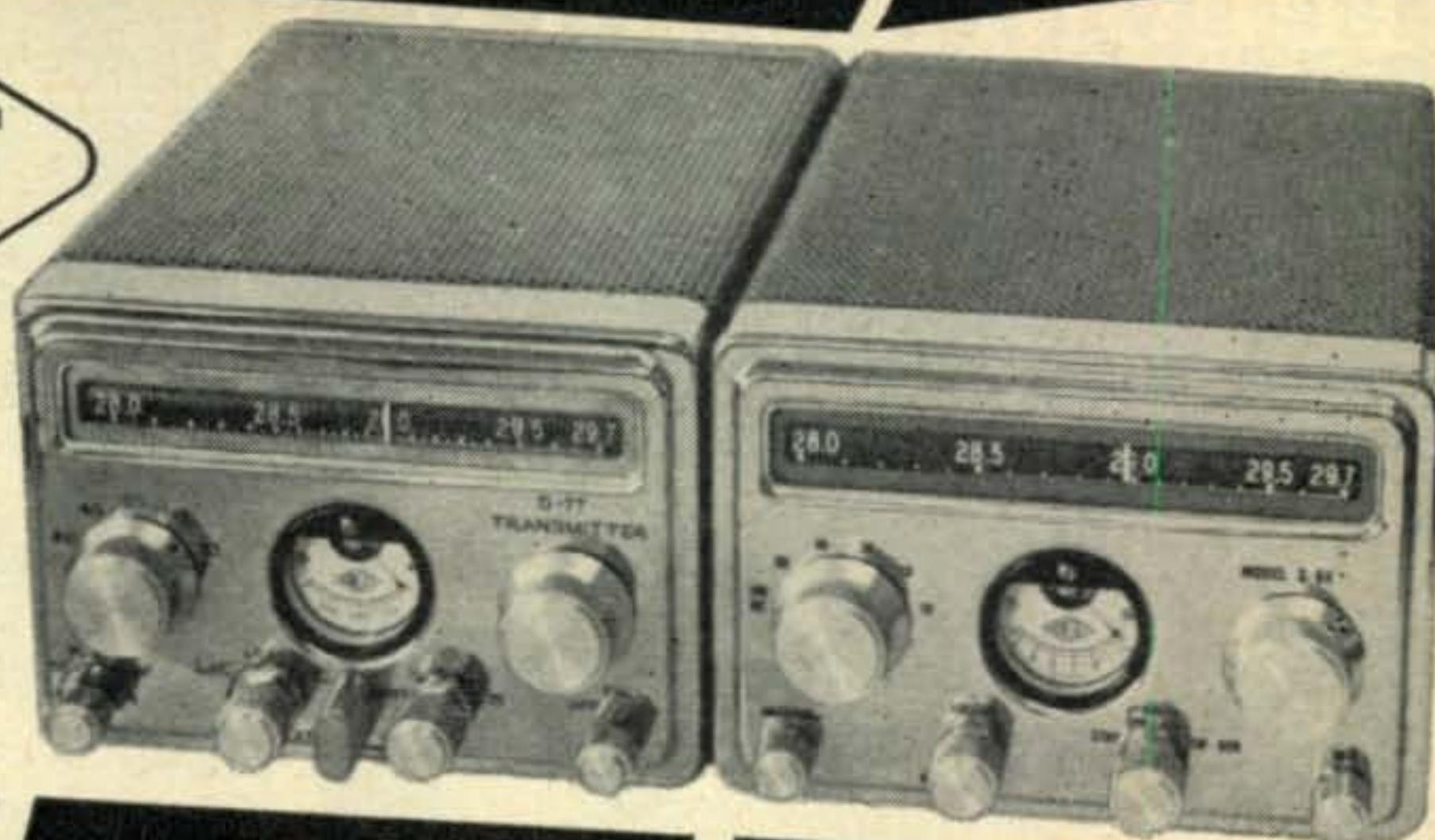

G-77
MOBILE
TRANSMITTER

G-66
MOBILE
RECEIVER

Gonset's new Mobile Twins, G-66 Receiver and G-77 transmitter, represent the perfect mobile combination. Outstanding multi-band performance—beauty of appearance—finger-tip control—6 and 12 volt operation—compactness without compromise! Typical Gonset dollar-for-dollar value—real "owner satisfaction".

G-66 RECEIVER



6 BANDS: 540-2000 kcs. 3500-4000 kcs. 7000-7300 kcs. 14,000,14,350 kcs. 21,000-21,450 kcs. 28,000-29,700 kcs.

AM, CW, SSB RECEPTION. Highly stabilized HF and BF oscillators and xtl controlled 2nd conversion oscillator.

STEEP SKIRT SELECTIVITY: 265 kc 2nd I.F. 8 high Q tuned circuits. 3.5 kc I.F. bandwidth at 6 db down.

DOUBLE CONVERSION ALL BANDS: 2050 kc 1st I.F. Double input tuning (3 tuned circuits) on high bands for high image rejection.

AVC—Noise limiter—Panel S meter—antenna trimmer—BFO pitch—Audio-RF gain control—slide rule dial—3 watts audio.

G66 RECEIVER... (less power supply).....(#3046).....net 169.50
"3 way" (6V-12V-115V AC) Universal power supply/speaker..net 39.95

G-77 TRANSMITTER



FREQUENCY RANGE: 80-40-20-15-10 meters. VFO or xtal, switchable. Highly stable VFO, each band spread over most of slide rule dial.

FULL BANDSWITCHING: Exciter ganged with VFO, pi network output.

POWER INPUT: 50-60 watts, modulated. CW provisions, 6146 tube in output. New modulator has integral speech clipping. High gain speech for PA-type dynamic, reluctance, ceramic or xtl mikes.

POWER SUPPLY: Heavy-duty, vibrator, 6 and 12V DC. Output voltage 500-600V full load, Selenium rectifier, low drain both on standby and transmit. Power supply is a separate compact unit.

GONSET CO. 801-SOUTH MAIN STREET, BURBANK, CALIF.

recommended
reading...

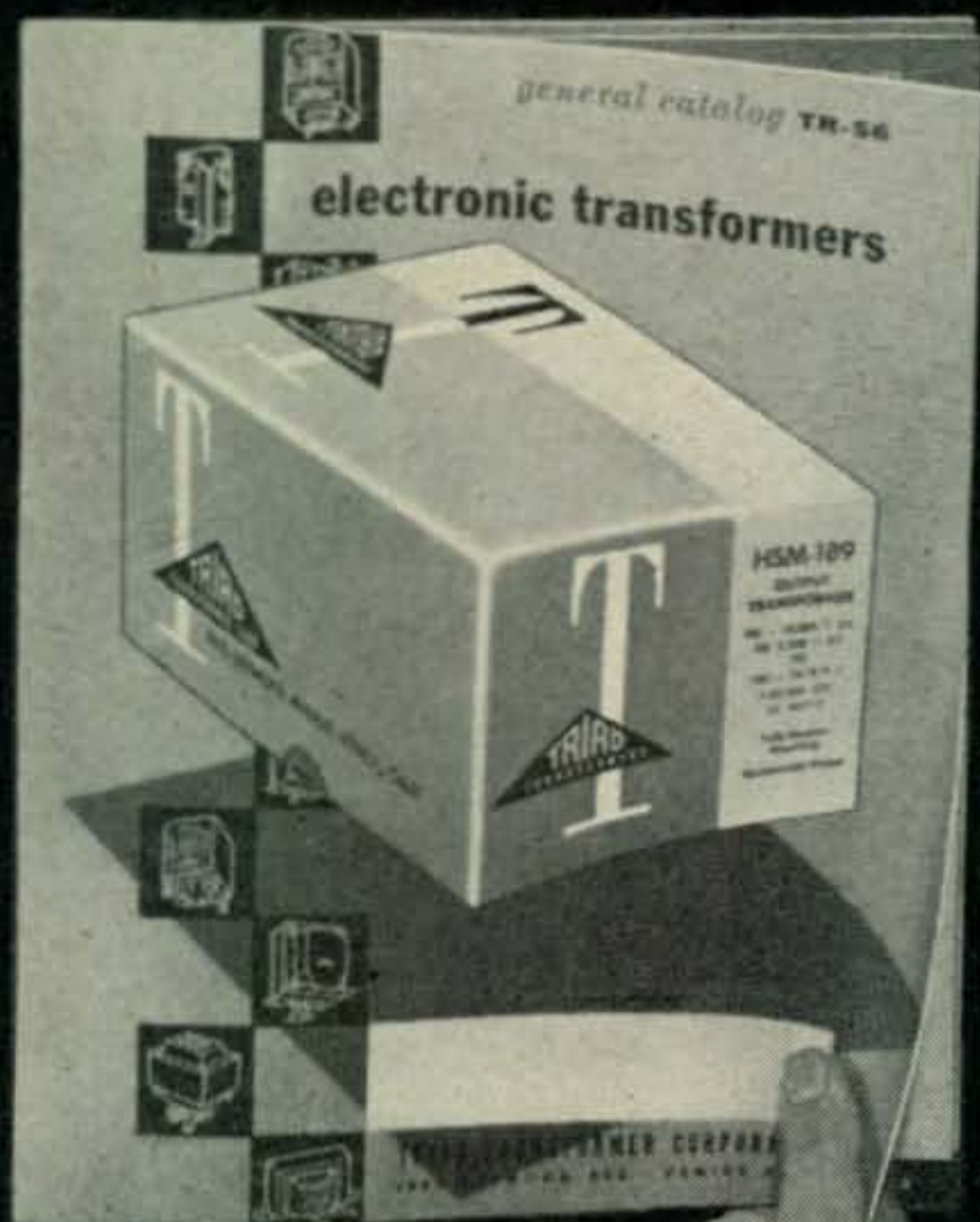

for
transformer
buyers

who want
the best—

NEW TRIAD
GENERAL CATALOG TR-56
Listing the complete line
of transformers that
have made TRIAD
“the symbol of quality”
.. including 76 new items.

NOW AVAILABLE from
your distributor or write

4055 REDWOOD AVE. • VENICE, CALIFORNIA



LUZZY [from page 53]



tion. We were rescued by helicopters, equipment and all, and taken to a naval transport ship. From there we flew to Buenos Aires and we're mightily glad to be able to look at each other and shake hands over an expedition well done.

We wish that we had been able to stay longer and give everyone a contact with this rare country. We thank all of you who in one way or another backed us up. ■

SCRATCHI

[from page 8]

ing on all bands with same gain, controlling freakwency with twisk of rist—if not, seeing my letter of September, 1955.

But I knowing you convinced by now, so letting me telling you abouts my newest, my gratest—Gracious to Goodness, Hon. Ed., I forgetting what I going to telling you!!

Which reminding me. I been riting you letters longsame time now. Howcomes you never answering me?

Respectively yours,
Hashafisti Scratchi

YASME

[from page 51]

knot parted company with the end of the rope as I pulled and I took a beautiful backward dive into the cockpit.

Another One

Well, I hated to admit it, but after diagnosing the trouble I discovered that a valve was sticking. There we were with another engine to strip down. Still no wind, but now the sea had developed an unrhythmic roll which was tough for me to synchronize my body with . . . I sort of leaned to port when I should have leaned to starboard, and any sailing types among you will realize that can be fatal. On several occasions I nearly went over the side. This wouldn't have mattered too much because the ship was dead still and even the sharks had become disinterested with the lack of activity of the Yasme.

[Continued on page 100]

THE NEW FO-6

6 METER and 2 METER

Oscillator Assembly!



the Sure-Fire way to achieve
STABLE CRYSTAL CONTROL with High Frequency Crystals

IT'S A 3-WAY UNIT! . . .

- 1 **MIDGET 6 METER TRANSMITTER**—Provisions are made for separate B+ connections to the buffer stage for modulation.
- 2 **DRIVER UNIT** for a higher power 6 meter transmitter. Will work into 5763 tube which will provide ample drive for a 6146 final. For 2 meter operation the pentode section of the 6U8 tube may be used as a tripler, or the unit can operate straight through on 48 MC and drive a 5763 tube as a tripler.
- 3 **RECEIVER LOCAL OSCILLATOR FOR 2 METERS.** By using the pentode section of the FO-6 as a tripler, this unit will provide injection voltage for 2 meter converters.

6U8 Tube
Crystal Oscillator Range
 48 MC to 54 MC
Output 50-54 MC or 144-148 MC
 (Specify When Ordering)
Crystal Required—3rd Overtone
 Type FA-5
Plate Voltage—250 volts @ 20ma



Filament Voltage—6.3 volts @ 450 ma
Size—2" x 2 3/4" x 2 3/4"

HOW TO ORDER: For fastest possible service, crystals and Oscillator Assemblies are sold direct. When cash accompanies order, International pre-pays postage. Otherwise, shipment made C. O. D.

Kit (less tube and crystal)	5.95
Complete wired and tested with tube (less Crystal)	9.95
Crystal Type FA-5 48-54 MC (Specify frequency when ordering)	3.90

International CRYSTAL MFG. CO. Inc.

18 N. LEE PHONE FO 5-1165 OKLAHOMA CITY, OKLA.

Actual Size CF-500

EIMAC FINGER STOCK

... for sliding contacts and
electrical weather stripping

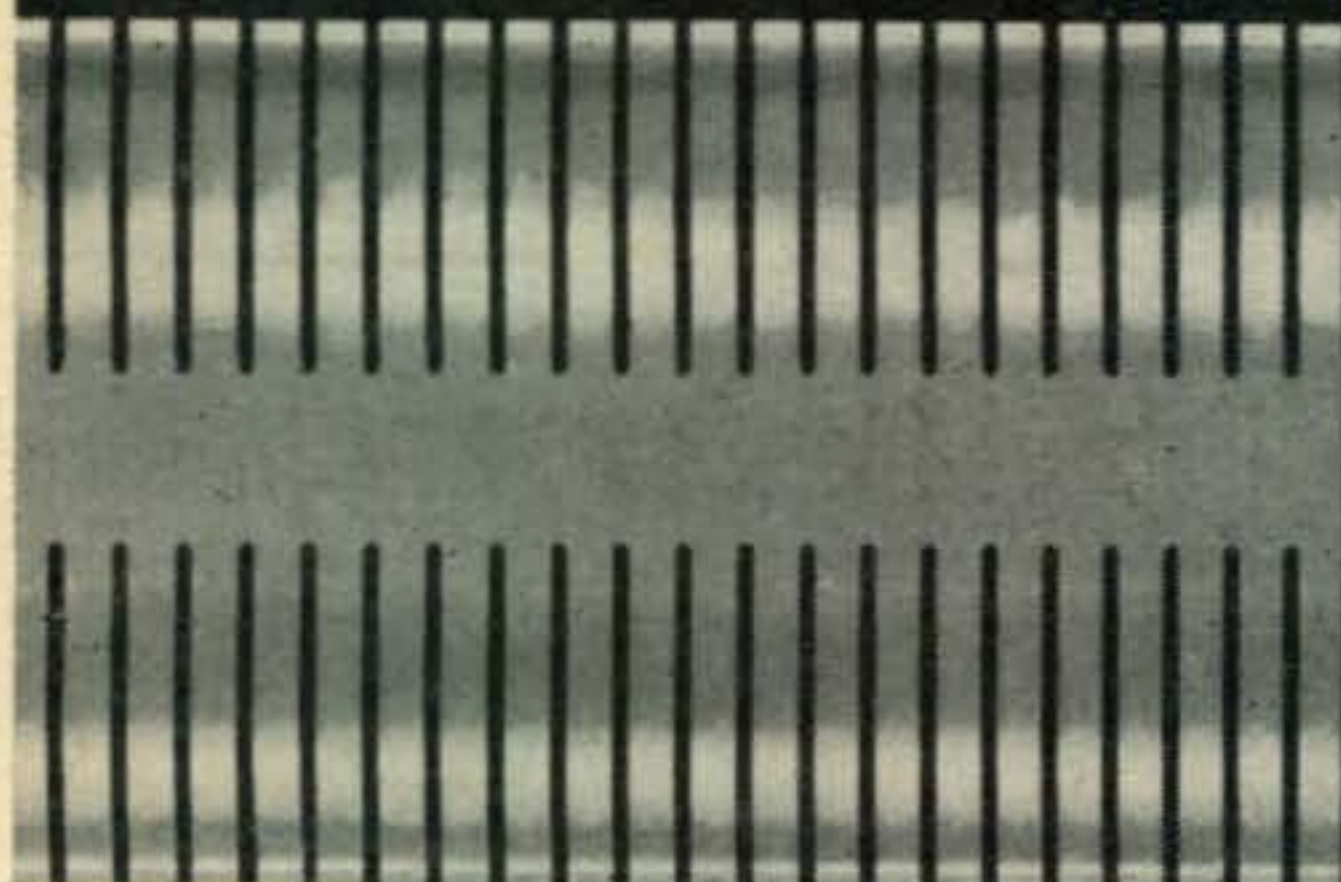
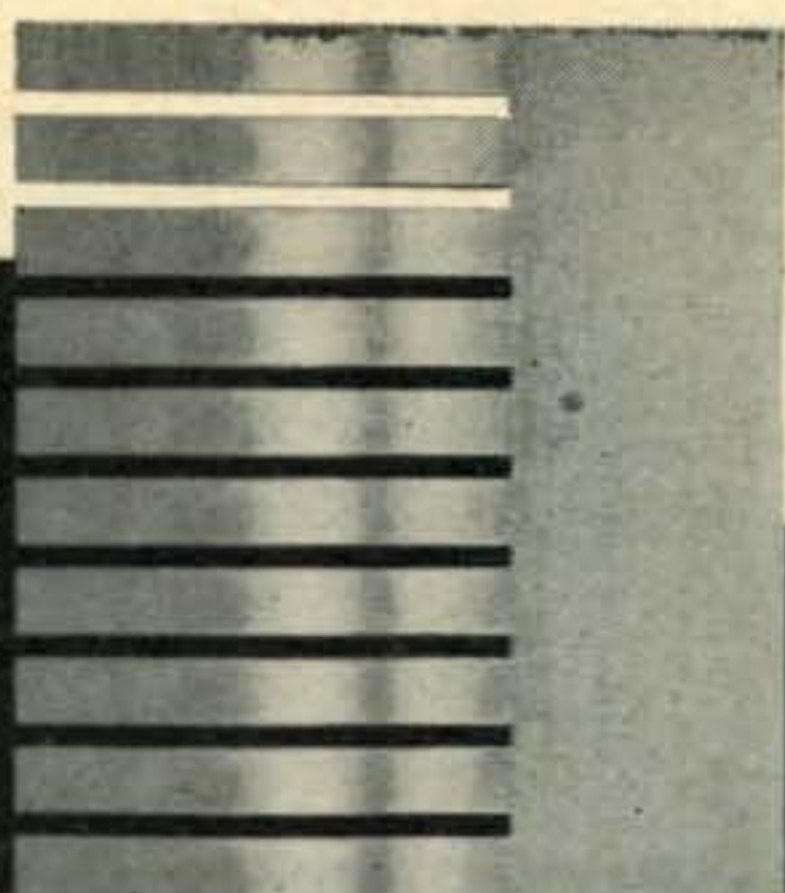

Actual Size CF-400

Eimac preformed finger stock is the inexpensive, efficient answer to many circuit and equipment design problems . . . Used for efficient electrical contact in high-frequency tuning devices, in coaxial tube sockets, for electronic weather stripping around access doors in equipment, and for dozens of other purposes, resilient silver-plated EIMAC finger-stock is outstanding.

EIMAC finger stock is accurately heat-treated to maintain uniform mechanical properties, can be fitted around a 1/2-inch radius, and may be fastened by screws, rivets, clamps or soft soldering.

A size for every need —

Single Edge	Width	Double Edge	Width	Klystron Types
CF-100	17/32	CF-200	13/16	CF-700
CF-300	31/32	CF-400	1 17/32	CF-800
CF-500	1 3/8	CF-600	2 1/4	



For further information
write our Application
Engineering Department.

EITEL-McCULLOUGH, INC.
SAN BRUNO CALIFORNIA
The World's Largest Manufacturer of Transmitting Tubes

[from page 98]

Back to work. Working on deck, whilst it is much cooler, is also much darker. The show must go on, so down came the motor and the sticky valve was fixed. This time I was a little more fortunate in what was left over and only had a couple of small nuts. I realized that they must have come from the engine somewhere. I discovered a small hole in the top of the engine which, when you take out the spark plug, has lots of room inside. I naturally came to the conclusion that the nuts must belong somewhere inside there and accordingly dropped them in. At least I knew they wouldn't get lost and I could always fit them in the right place later on.

Lady luck smiled on me. After flooding the carburetor the little engine needed only one pull to start it, and apart from the rattle of the two nuts (which became quite musical in the end) it ran very smoothly.

I kept it going until the batteries were oozing with amps. In fact, they oozed so much that acid got pumped out of them all over the place. I realized this was happening when I had a look at them with a match . . . the explosion of the battery gas loosened three teeth. The time was ripe to press that button again.

Off with the charging plant and once again the suspense of pushing that button . . . This time there was a high pitched whir, a few wheezes, a whine, a couple of clonks, and a faint chugging with a limp. I knew then that the engine was actually going. As she gradually warmed to the task of keeping going the speed increased, and there at last I had succeeded in making something work. . . .

Amazing Discovery

After she was running I opened up the inspection cover where I had stuck the odd bits that were left over and found that the coffee grinder action in the gear box had nicely mashed up all the parts. I must admit that it ran quieter than it had for a long time . . . think I'll patent the idea.

By this time it was daylight and my old friends the sharks had joined the convoy, complete with pilot fish on their noses. All my tiredness had gone, so after removing the best part of the grease from the galley and feeding it to the sharks, I got cracking on some grub.

Oh boy, was it good to sit out there in the early morning sunshine with a plate of eggs and spuds, and loads of coffee. There was that chilly bite in the air that comes in the early morning in the tropics, and it was really exhilarating to sit there and rest whilst the Yasme churned her way through the water at a steady 4 to 5 knots.

I don't know how long I just sat there meditating, but I reckon I had earned a rest. That day, apart from skeds, was devoted to just

[continued on page 102]

Engineering writers work with research and development engineers during formation stages of new equipment to produce clear, concise technical manuals, for use in maintenance and training, as well as specialized handbooks for USAF aircrews.

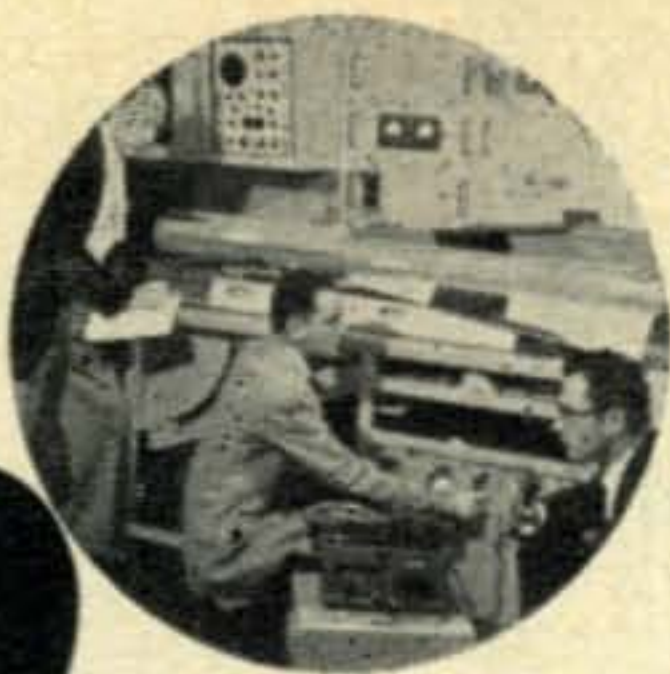

AIR FORCE, NAVY AND AIRFRAME CUSTOMERS RECEIVE FULL-TIME SERVICE AND INSTRUCTION ON FIRE CONTROL SYSTEMS AND GUIDED MISSILES.

ENGINEERING WRITING

Hughes maintains a highly trained organization of expert engineering support to the armed services and airframe manufacturers using the Company's equipment, wherever operational bases or plants are located. Each of the engineers devoted to this work holds a degree in electrical engineering or physics, and is experienced in electronics equipment maintenance or design. These men are assigned to five separate divisions of the department: Engineering Writing, Training School, Field Engineers, Technical Liaison, Field Modification.

HOW HUGHES SUPPORTS ITS PRODUCTS FOR MAXIMUM FIELD PERFORMANCE

TRAINING SCHOOL



A completely staffed and equipped school is operated to train qualified military and company personnel in maintaining Hughes equipment. Instructors are graduate engineers or physicists with backgrounds in development work or university instruction.

FIELD ENGINEERS

The field engineer works with squadron officers in training maintenance personnel, and in the provisioning of spare parts and test equipment, and provides liaison to the laboratory design groups resulting in continuous product improvement and reliability.

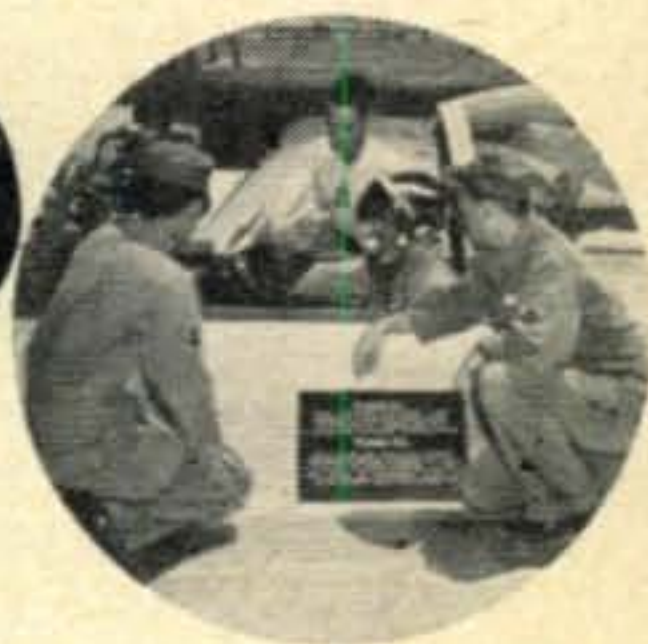

TECHNICAL LIAISON

Engineers are assigned to manufacturers whose aircraft employ Hughes fire control systems, and are responsible for pre-installation testing of the systems. They work with airframe designers in cases where their operational knowledge bears on equipment installation problems.



ENGINEERS AND PHYSICISTS

If you feel that you are qualified for any of the above positions, send us your resume and qualifications.

SCIENTIFIC STAFF RELATIONS

RESEARCH AND DEVELOPMENT LABORATORIES

Hughes Aircraft Company
Culver City,
Los Angeles County,
California

FIELD MODIFICATION

Hughes policy is not only to get reliable equipment into the field promptly and in sufficient amount, but to modify and develop this as soon as field information and test data become available. Engineers correlate information from the field and indicate engineering changes to the Research and Development Divisions.



HUGHES

VACATIONING IN SOUTHERN CALIFORNIA? YOU ARE INVITED TO VISIT HUGHES.

Cramped For Space?

**NOW...a maximum of signal
a minimum of antenna**

WESTERN GEAR'S NEW COAXIAL-TENNA

- matches 72 ohm coax
- high efficiency, excellent radiation pattern
- expertly machined, strong aluminum construction
- built in brass coaxial connector; Coaxial-Tenna mounts on 3/4 inch pipe

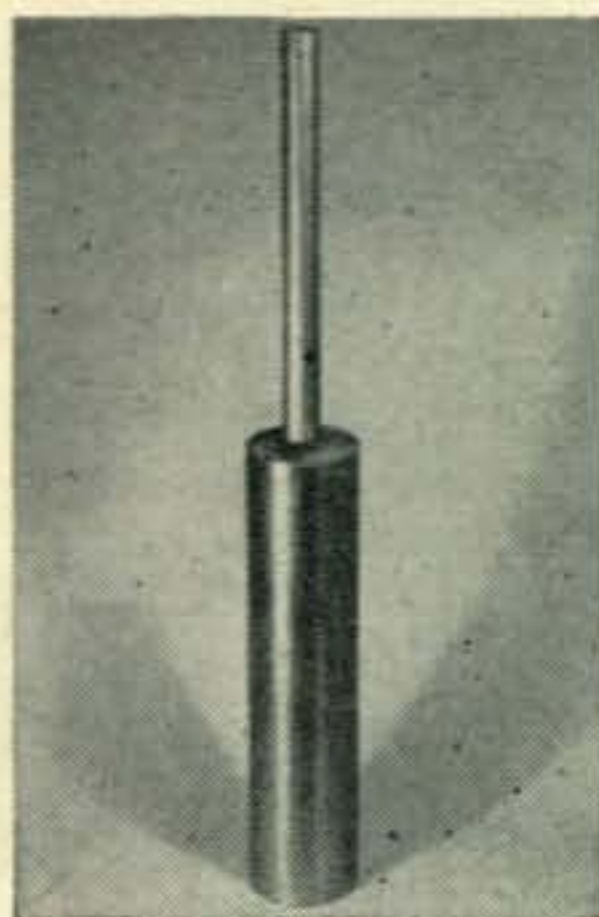

DELTA-TENNA GROUND PLANE

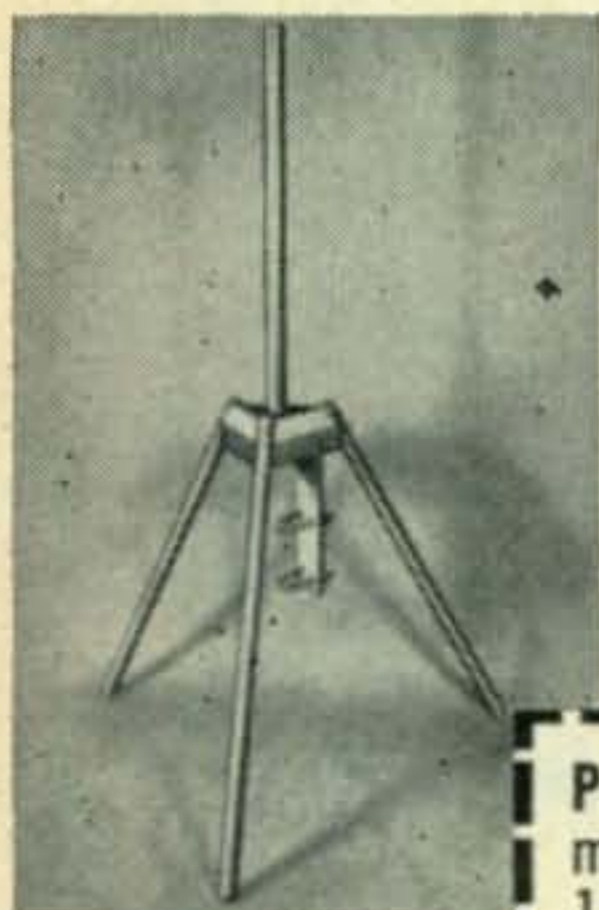

- matches 52 ohm coax
- gold anodized elements
- uniform loading characteristics over an entire amateur band
- meets or exceeds all FCDA specs

Prices (either type) \$19.95 (2 mtr.), \$24.95 (6 mtr.), \$29.95 (10-11 mtr.). Can be supplied for any commercial or amateur frequency from 25-465 megacycles. In stainless steel or brass at extra charge.

Available through any major parts house or send your check or money order direct, allowing 8 lbs. (10-11), 6 lbs. (6), or 2 lbs. (2) for shipping charges.

**WESTERN GEAR CORPORATION
ELECTRO PRODUCTS DIVISION**

132 W. Colorado Street • Pasadena 1, California

"The difference is reliability" • Since 1888

WESTERN GEAR
Corporation

ENGINEERS AND MANUFACTURERS



[from page 100]

plain sitting. As the sun got lower I had that feeling that comes with successful accomplishment. The engine had run smoothly all day. Just before dusk set in I felt a faint breeze against my bare back. At first it was hardly discernible and I thought it was imagination, but ten minutes later I really felt it. Being a pessimist I refused to think it would stay, so I just sat there and ignored it, not daring to hoist the sails and have the wind die again . . . Half an hour later the wind made itself felt to such an extent that I couldn't ignore it. I nipped smartly along the deck and hoisted everything she could carry, even a couple of shirts and an odd sheet. The wind continued to blow with ever-increasing force so I stopped the engine.

Squalls

How that wind blew! It certainly made up for all the time it had been asleep. I got down those sails that didn't blow themselves out, leaving just the tattered mainsail and a small jib up. We really churned through the water at 6 to 7 knots. The seas which had been calm up to then developed into 10 foot waves on the beam. The old Yasme lifted herself proudly over every one, never once taking a drop aboard. This was real sailing at last, the sort you read about in books but very seldom see or experience. I had that feeling that this wind had come to stay, and I was right too . . . how it blew, and how happy it made me to feel that we didn't have to worry about the gas situation any more. I knew then that, providing I did not use the radio more than one hour a day, I should be OK. I felt sure that the trade wind had come to stay. From the time that breeze came up until 24 hours later we covered 150 miles by sights. We had a certain amount of assistance from the current, but I could tell by the log astern and the noise of the propeller freewheeling that we were piling up the sea miles.

From then on squalls became more frequent, concentrating around midnight and two in the morning . . . just to be plain cussed. For the uninitiated, a squall is something that can be seen in 99 cases out of 100, and usually does not cause any bother providing one takes reasonable care. However dark the night, one can always see the squall that is going to hit you coming up on the windward side. The sky is always blacker in that area. Some hit you within five minutes of sighting and others take as much as an hour to creep up. The result is the same: A wind of gale force hits your ship and unless you either run before it or shorten sail it is possible to lose your mast or a sail.

As you all know, my sails were in a pitiful state, so I had to be ready for every squall that popped up. When the first puff came, I had, through long association with these squalls,

[Continued on page 104]

abacus



昨日之最好者

honorable ancestor of the UNIVAC

In theory many centuries have gone into the development of the Univac®. Only recently, at Remington Rand Univac, has it achieved product perfection. The tremendous strides forward in the past few years are due to the imagination and creative genius of the scientists and engineers of Univac. Recognized leaders in the field of electronic computer systems, they are the men *who set the standards for others to follow*. You can become a member of this team

... where ambition and professional skill find their reward in limitless opportunities in an expanding organization.

Immediate openings for:

FIELD LOCATION ENGINEERS with a college degree in a scientific or engineering field and experience in electronics. Extensive electronic background may substitute for some college. Many opportunities for rapid advancement.

FIELD LOCATION TECHNICIANS with technical school background and preferably some experience in electronics. These positions can lead to full engineering responsibility.

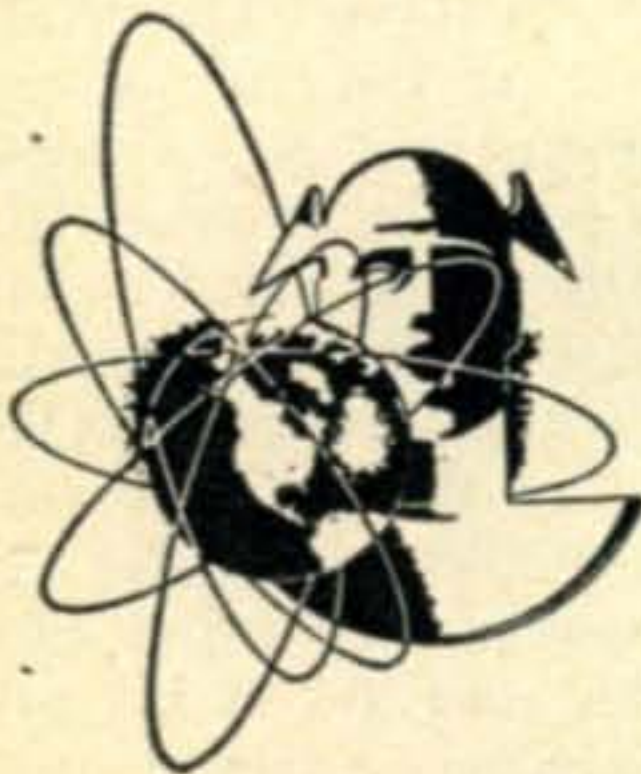

Send complete resumé to

Remington Rand Univac

DIVISION OF SPERRY RAND CORPORATION

AT ANY ONE OF THESE THREE PLANT LOCATIONS

MR. D. A. BOWDOIN
Dept. MP-21
2300 W. Allegheny Ave.
Philadelphia, Pa.

MR. KURT PINKE
Dept. MS-21
1902 W. Minnehaha Ave.
St. Paul W4, Minn.

MR. FRANK KING
Dept. MN-21
Wilson Avenue
South Norwalk, Conn.

© Registered in U. S. Patent Office



MATCHED MINIATURE METERS

Gorgeous new line—not surplus! Only 1 1/2" square. 1 1/2" hole. Handsome black calibration on white face. 2% accuracy D'Arsonval movements. Guaranteed!

DC Microamperes: 0-50 . . . \$5.95. 0-100 or 100-0-100
\$5.50. 0-200 . . . \$4.95. 0-500 . . . \$4.50. DC
Milliamperes: 0-1, 0-100, 0-200, 0-300, 0-500, any one
\$3.50. DC Volts: 0-15, 0-30, 0-500, any one . . .
\$3.50. DC amps: 0-10 . . . \$3.95. RF amps: 0-3 . . .
\$5.95. AC Volts: 0-15 or 0-150, either one . . . \$3.95.

THIS MAY BE YOUR LAST CHANCE . . .

to steal the very best, most popular 2 METER RECEIVER ever released by the Armed Forces!! Best for Novice! Best for Generals! Best for C.A.P.! Best for C.D.! Best for VHF air communications! R-28/ARC-5, 100-156 MC., with all 10 tubes, plus schematic and modification instructions to change from 4-channel fixed tuned to continuous tuning. Ask your buddies about this super-sensitive, super-selective, super-heterodyne receiver. Excellent condition.

R-28/ARC-5 Only . . . **\$9.95**

RE-TUNE 30 WATT TV XMTR TO 220 OR 440

Or start your own TV station! Four 8025 uhf triodes, 2 as 250-385 mc P-P osc drive 2 as PA which is grid-mod by 3-tube video, and plate-mod by 3-tube sync amplifiers. A super-terrific buy, new, with all tubes.

only . . . **\$15.75**

GRAB-BAG ITEMS! GET 'EM WHILE WE GOT 'EM!

SPRING-COIL CORDS. Brand new . . . \$.69
BC-709 AMPLIFIER. New . . . 1.95
NAVY BEAM FILTER. Eliminates QRM. New . . . 1.95
12" SPEAKER. Dyn. New95
ARR1 RECEIVER: New . . . \$4.95 Used . . . 2.95
ARR2 RECEIVER: Used, less tubes. Only . . . 2.95
RT7/APN1: Used, less tubes, wobulator and dyn. . . 2.95
BC-1206 BEACON RECEIVER: Used, less tubes . . . 1.95
ID6/APN4: Less tubes and crystal. Special. Only . . . 9.95
46ACJ RECEIVER: New. With tubes. \$9.95. LESS
TUBES . . . 6.95
APX-1: Used, less dyn. and tubes. Ea. \$3.95. TWO for 8.00

COMMAND GEAR: YOU FIX DENTS & ADD TUBES!

BC-456 MODULATOR: Each. \$1.95. 2 for . . . \$3.50
3-4 MC TRANSMITTER: Each. \$2.95. 2 for . . . 5.00
4-5.3 MC TRANSMITTER: Each \$2.25. 2 for . . . 3.95
5.3-7 MC TRANSMITTER: Each \$2.25. 2 for . . . 3.95

RADAR FILAMENT TRANSFORMER SPECIAL: 110 V. 60
cyc. pri. 11 VCT @ 200 amp. output. Great for
welding, etc. Only . . . **\$19.95**

THE BEST PORTABLE MOBILE 10 & 61

The best for back-pack and automobile. 28-80 MC, AM. Modifications necessary for amateur use are easy and explicitly shown in simple instruction sheet furnished with your order. This is the famous Marine Corps' TBY. Original power supply not included, but power supply which you can use is spelled out in these instructions.

Transceiver Unit only, excellent, used condition,
with tubes. Special . . . **\$14.95**

COMBO DEAL: The above transceiver and instruction sheet
PLUS headset and microphone and AN75 Antenna
all for only . . . **\$24.95**

WIDE-PASS TEST SCOPE & 455 KC PANADAPTOR

Both in one compact unit! Brand new—with schematic! The only modification required is to replace only one power transformer with 60 cy. units. We show you how to find in your hell box and how to connect. ID-60/APA-10.

A gem that cost govt. \$1,000! Yours for only . . . **\$49.50**

DESK-TYPE CRYSTAL MIKES: Brand new! . . . **\$2.95**
Only . . .

BULLET-TYPE CRYSTAL MIKES: Extra wide
range. Only . . . **\$4.25**

FREQUENCY METER AND TEST OSCILLATOR!

115 V., 50-800 cy. power supply. In freq. meter section, crystal oscillator beats VFO. Osc. section puts out sine or pulse modulated RF. With tubes, headset, cords, adapters, radiators, etc. and INSTRUCTION BOOK.
LU-3, 465-498.5 MC. . . . \$19.95
LU-1, 470-493.5 MC. . . . 17.95

IF YOU DON'T SEND FOR OUR FREE FLYER
YOU'LL NEVER KNOW WHAT YOU'RE MISSING!

All shpts. FOB whse. Send 25% dep. with all C.O.D. orders. Item sub. to prior sale & change of price without notice. Min. order \$2.50.

ARROW SALES, INC.

Western Mailing Address:

BOX 3007-CQ, NORTH HOLLYWOOD, CALIF.

Central Mailing Address & Sales-Showroom:

2441 S. MICHIGAN AVE., Dept. CQ, CHICAGO 16, ILL.

California Distributors' Stores

G. L. Electronics Inc., 1633 Venice Blvd., Los Angeles
P.A.R.T.S., INC., 2005 Empire Ave., Burbank

found that I could just manage to get everything onto the deck in the three minutes before the full blast hit me. This gave me a chance to stay below and rest, even if I didn't really sleep soundly.

I did on one occasion decide to run before a squall, thinking it would only last a short time. It kept up for almost an hour and blew me miles off course . . . miles I could ill afford to spare. Coming into the wind would have left no sails, solving the problem of sewing. It certainly wouldn't get me Canton, so I took no more chances. There was no dearth of wind now, even though it never blew from the same direction for more than six hours at a time. The seas piled up to fantastic heights, and, being on the beam, made life really uncomfortable aboard. I had been used to the seas always being astern in most of my voyaging. Providing I could keep the sails stuck together and that I could sight Canton Island, I had no further worries.

I was in constant contact with KB6BA. I was able to get weather reports from him, but they didn't help much since whatever happened I couldn't do anything about it. The trip continued uneventfully except for the usual ripped sails. I think you kind people will understand exactly why I had to ignore your very numerous calls while I was at sea. I had to measure every drop of gas and conserve enough to run the engine in the event of emergency. I would have taken on more gas in Tahiti, but the cost was prohibitive, as it was with everything else there. I really thought I had ample supplies to last the short distance of 1700 miles. I had never known the trade winds to remain quiet for such a long time before so I don't think I could be entirely to blame . . . let's blame the wind . . . it can't answer back.

Now this Phoenix group of islands into which I was heading are strictly coral atolls which means, in most cases, the land itself has a maximum height of around ten feet. Some have coconut trees which help to sight them, but Phoenix Island and Canton have no trees at all, and can only be seen from the deck of a small ship like mine around 5 to 7 miles off. You can see that the navigation has to be fairly accurate to hit them. The tide and current charts are about as helpful as an old boot since they say the current has a westerly set of 10 to 25 miles a day. That makes it easy to lay off a course on the chart, and means at the end of a day's run, according to the charts, I can be as much as 15 miles off course. Finding a tiny coral atoll under these circumstances didn't make me feel any too optimistic. I did talk to the British Resident Commissioner on Canton through KB6BA and asked his advice on these currents. He kindly informed me that not even the local fishing boats knew anything

[Continued on page 106]

**HERE
'TIS!**

**The PALCO
BANTAM 65**



The smallest,
most compact
**MOBILE
TRANSMITTER**
with 65W-Phone
90W-CW

MOBILE POWER



**NEW
SAFETY
FUSING**

- 500 V.D.C. at 225 MA. Perfectly filtered.
- Instant Start—No Waiting.
- No battery drain when on standby.
- Low current—low voltage switching.
- Heavy duty components for dependable, long life operation.
- No ventilation problems. Mount on fire-wall near battery.

MODEL 606—6 V.D.C. Kit.....\$32.50
MODEL 612—12 V.D.C. Kit.....\$35.50
FACTORY WIRED, either model \$7.50 extra
Combination 6 and 12 V.D.C.—115 V. AC
Model also available. We can supply power
cables of any required length.



The PALCO BANTAM 65 is only 4" high, 8" wide, 8 3/4" deep—leaves you lots of leg room. The separate modulator section on a 2" x 2 3/4" x 11" chassis may be mounted in any convenient location. The exclusive new "tune up" meter was designed with highway safety in mind. No more stooping, no more squinting—you'll like this new idea!

OTHER OUTSTANDING FEATURES

- Built-in VFO with 2 xtal positions.
- Either 6 or 12 volt filament supply plate supply 450-600 volts @ 250 MA.
- Complete bandswitching 10 thru 80 meters.
- Gang tuned VFO and exciter stages.
- Efficient pi-section output.
- Provisions for mounting standard coax relay.
- Separate inputs for high impedance or carbon mikes.
- Break-in CW operation.
- AB₁ modulation employing negative peak clipping.

NOVICES! Use the BANTAM 65 as a fixed rig now—as a mobile when you get your "General".

BANTAM 65, complete with tubes and power connectors.....\$159.50

For additional information, see your distributor, or write to . . .

PALCO ENGINEERING

FRANKFORT, INDIANA

BASSETT VACUUM COILS

Pat. Pend.

PROVEN PERFORMANCE! EXTREMELY HIGH "Q"!

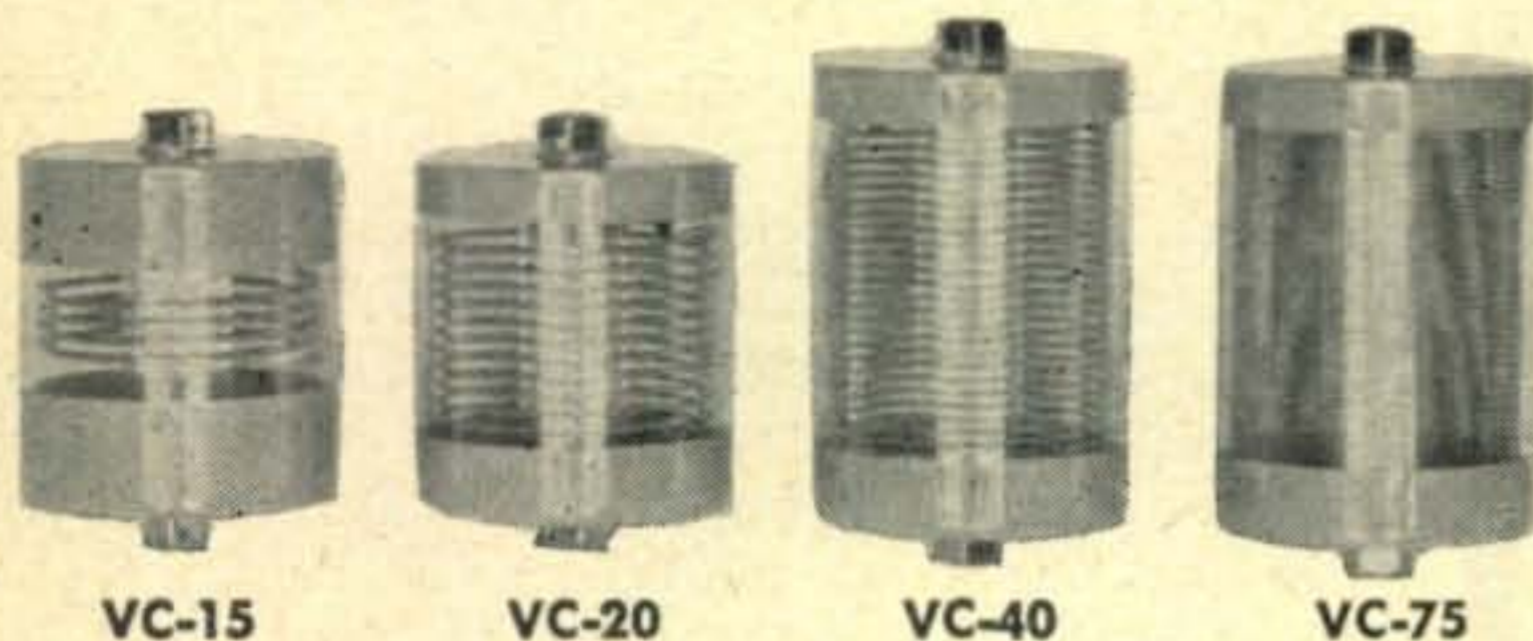

- The only genuine hermetically sealed antenna loading coils.
- Evacuated and filled with pure helium.
- Impervious to rain and weather. Always super efficient.
- Unconditionally guaranteed.

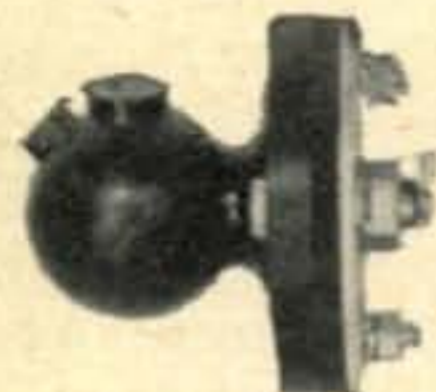

Fiberglass top rods
Anodized base rods
Mobile base mounts

See Sept. 55 CQ or write for brochure

REX BASSETT, INC.

Bassett Building

Fort Lauderdale, Fla.

Biggest Trading Times at ALLIED Bring You Best Deals on Reconditioned Ham Gear

Get Our BIG VALUE Lists



Everyone's trading high, wide and handsome with ALLIED these days, and that means we have on hand outstanding buys in exceptionally fine reconditioned Ham gear. There's a wide choice of money-sav-

ing, top-condition receivers, transmitters, mobile equipment, converters—high quality equipment in fine operating order—available to you at a fraction of the original purchase price. Be sure to send for our list of reconditioned equipment today—and see for yourself the kind of values we offer—values made possible by the biggest trade-in business in our history. To get your copy of this big, value-packed list—just drop a card to Allied Radio Corp., 100 N. Western Ave., Dept. 16-G-6, Chicago 80, Ill. By the way, if you're thinking of a trade, tell us what you've got and what you want—you'll be surprised at our terrific offer.

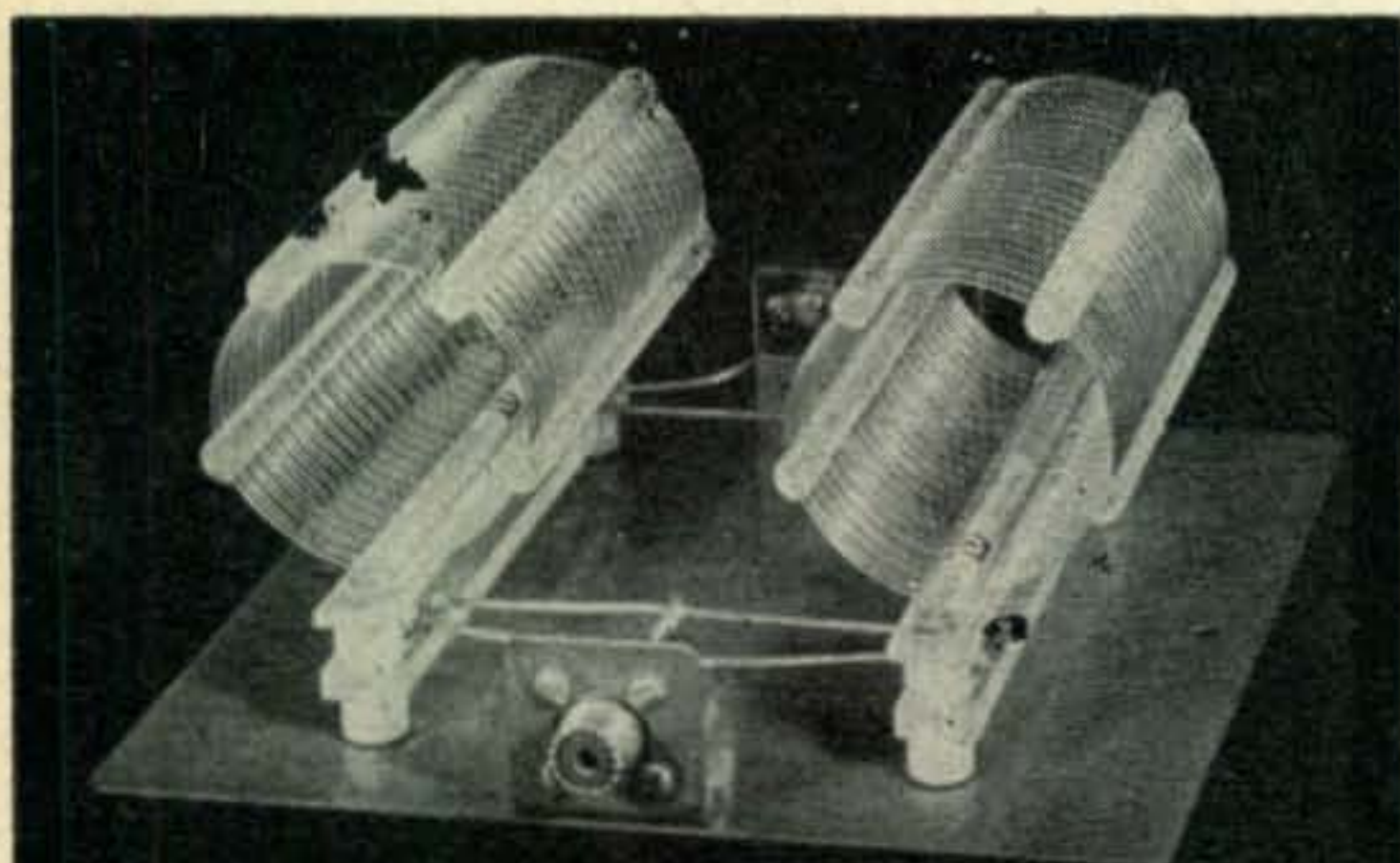

air dux BALUN

The Air Dux Balun consists of a pair of bifilar wound coils which are used for impedance matching from transmitter to antenna without adjustment from 10 through 80 meters. A metal mounting plate is available. For further information, brochures, and free inductance calculator, write

illumitronic
sunnyvale



engineering
california

[from page 104]

about them. That made everything easy for me. . . . I would either hit Canton on the nose, or miss it by 15 miles . . . really fine business.

That day, I took my usual sights, and according to the first one, Phoenix Island should be within 5 miles on the port hand so, just to check my navigation, I nipped out onto the deck and had a look around. Well, it really shook me because right where my sights said I was . . . I actually *was*, and there as large as life, just peeping above the horizon was a golden strip of land. Sometimes it disappeared beneath the waves as the Yasme dropped into a trough, and then as we rose like an elevator the island appeared again. It was exciting and reassuring to know that my first landfall was correct. I suddenly realized that it was now noon local time and I would arrive at Canton Island in the hours of darkness. I considered going to Phoenix and waiting so that I would arrive at Canton in daytime. On second thought, they have plenty of lights on Canton so maybe heading for it in the dark will be an asset. There would be a full moon to help too. I didn't realize then how wrong I was.

Phoenix Island as a stopping place was out anyway since I had no chart. I wasn't even sure whether it was inhabited. Over the rig I told Howie that I had sighted Phoenix and would allow 30 miles westerly current set to make the next part of the journey of 76 miles. I won't go into all the details of why I allowed that extra amount, but I did.

Lost Island

I passed on the dope that I should arrive around midnight, given favorable wind. The wind was strong, but the seas held me up considerably. Howie explained that the aircraft beacon was visible for over 25 miles *if* there were any clouds, but if there were no clouds it would only be visible for about 7 miles. Naturally every cloud around Canton Island was on vacation. . . . I don't know where they were, but they certainly weren't in the place I wanted them. I realized that this was going to be a sort of hit or miss stunt, and if by chance I lost the island in the night, I should just have to wait around as near as I could until I could get some more sights. Radio contact with Howie was made every half hour and it was decided that the airdrome would put on all their landing lights when I reckoned I was close enough to sight the glow from them.

I checked the log astern, and figured that I should be somewhere around 20 miles off the Island, but even though I climbed that mast dozens of times, not a light could be seen. The sky remained clear and brightly lit by the moon just to make things more difficult for me. I had heard of sailing ships that had missed Canton Island in the past and owing to the strength of the current, had been unable to

return to it, so you can imagine my feelings at that time. I realized that with my pip-squeak engine and ribby sails there wouldn't be much hope for me if I went past.

Howie's signal had built up and I could hear the aircraft beacon blatting out with all its 2 KW. I knew the place was mighty close, just couldn't see it.

The time had come when I reckoned that I should be able to sight the loom of the aerodrome lights, so I nipped into the cabin and gave Howie the signal to switch on.

I shot out of the cabin and shinned up the mast like a monkey, but although I strained my eyes and scanned the horizon the full 360 degrees around the boat not a thing could be seen. I told Howie that I would send up a signal flare and maybe he would see it and thereby give me a bearing. Using the usual time arrangement I sent up two flares and then I shot back into the cabin to wait for a report from Howie. He had climbed his antenna mast to get a greater range of visibility, but after a little while back came a negative report.

What wouldn't I have given for a nice load of cumulus clouds to wander across the island! My field of visibility was only 3 miles from the deck, the light on the island around 25 feet, that meant I should sight the light 7 miles off. The Island was 9 miles long which meant I could hit the Island first, travel two miles overland, then sight the light. A good idea, but not very practicable. The suspense was killing me when the British Resident Commissioner, Mr. Laxton, had the bright idea of going to the end of the Island with his Land Rover and shining the headlights out to sea.

I knew then that, according to Confucius (or was it another ball player), that unless I sighted something pretty soon, there was going to be an awful grinding sound, and the Yasme Expedition would be over. I decided to start up the engine just to be on the safe side with that extra bit of power available.

This was it; I lashed the tiller, put the old tub on course, and then went out on deck and climbed the mast with the binoculars wrapped around my neck. I clung to the mast with the wind going full blast and every movement of the ship multiplied ten fold, scanning the horizon for that elusive light.

Minutes passed . . . they seemed like hours, still nothing to see . . . was that a light ahead? . . . no, it couldn't be, absolutely impossible . . . too low, now it's moving . . . is it? . . . now it's gone. There, I knew I was imagining it, one sees all sorts of things under strain. The binoculars had misted up and I was getting this confounded glinting on the surface of the sea from the moon.

Must have another look without the binocs this time. Trying to hold myself on the mast with one hand and control the binocs with the other was too tough. Why did I bring the darn

[Continued on page 126]

**COMMUNICATION &
RADAR PERSONNEL**
Electronic Background

**WANTED
NOW**

**PHILCO . . .
World's Largest
Field Service
Organization**

. . . is the pioneer in the servicing of electronic equipment for BOTH industry and government. In all areas of the United States, and in nearly every section of the world, PHILCO men are at work on vital communications installations.

ELECTRICAL ENGINEERS AND TECHNICIANS

. . . at all levels and in all fields of electronics are needed for long range, challenging and really interesting assignments, guaranteed to utilize the fullest skills of men who are specialists in the Design, Maintenance and/or Instruction of others in Communication, Radar and Sonar Equipment.

Men . . . who can qualify for our important projects are assured that there is no other company offering more fully paid benefits to its employees . . . PLUS valuable family insurance and hospitalization programs . . . PLUS top pay, special assignment bonuses and a planned, fully integrated program for merit and faithful service salary increases.

TODAY . . . is the time to evaluate your past and present growth potential against the FUTURE. Write NOW for the PHILCO EMPLOYMENT STORY.

PHILCO

TECHREP DIVISION

22nd & Lehigh Ave., Phila. 32, Pa.

FIRST In Income and Employee Benefits!



400 watts P.E.P. input with more stability, better linearity. Only 20 watts drive. Free from parasitics and harmonic radiation, permitting operation in fringe TV areas. Ideal for portable use. Especially effective for SSB; also delivers high quality signal on AM, FM and CW. Designed around four Modified 1625 Tetrodes. Low impedance, untuned input circuit simplifies multiband operation on 75, 40, 20 and 15 meters. See articles in June, 1955, *QST* and 1956 *Radio Amateur's Handbook* (p. 306).

SATISFACTION GUARANTEED

PRICE \$169.95
(\$19.95 down, \$14.50 per month)
ALSO AVAILABLE
Modified 1625 Tetrodes \$3.75 each

P & H ELECTRONICS—424 Columbia, Lafayette 2, Ind.

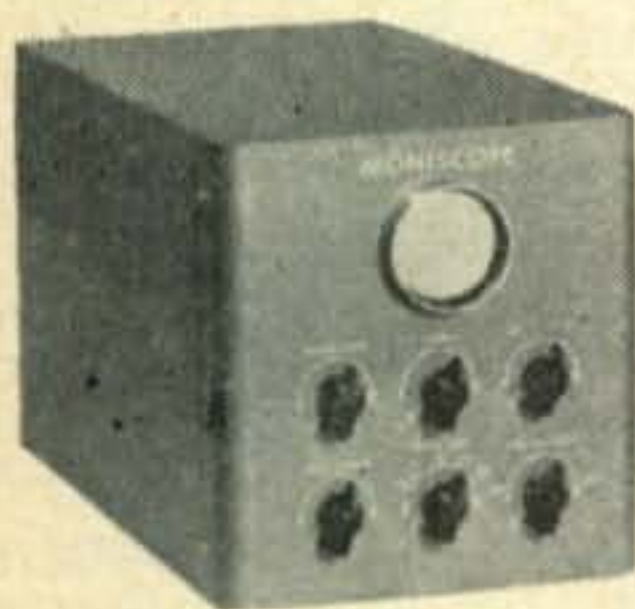

- Automatic changeover
- Sine or trapezoid pattern ...
- Automatic brightness control ...
- Works on SSB ...

NOW!

Monitor Both Transmitted and Received Signals

Here at last for the amateur radio operator is a compact modulation monitor. Any novice can use the Moniscop. Monitors continuously from 3.8 to 30 MC. No connection needed at the transmitter — only one to the receiver. See your dealer now.

Representatives wanted—Inquiries invited

Write on your letterhead.

AMERICAN ELECTRONICS SERVICE

3603 East 10th Street • Long Beach, California

letters [from page 18]

Dear OM:

Take a look at page 90 of your May issue. My call is W8FGX not W8FXG as erroneously listed in three different locations in this issue.

After finally winning a spot in this contest such publicity makes it hard for me to convince the O.W. that DX contests are not for the birds. Seriously OM, I got a big kick out of the contest and would appreciate the correct call on my winners certificate.

Jacob W. Schott, W8FGX
3110 Costello Avenue
Cincinnati, Ohio

Dear Wayne:

Every once in a while a guy gets so frustrated he could lay down and kick the floor with his heels like a 2 year old.

He builds a piece of miniature gear and finds he can't meter it without plugging in something or typing up a VTVM. All he wants is something to say "yes or no" or "more or less."

Miniature meters are fine, but they usually lack the sensitivity for many applications, and are apt to be expensive. The only real solution is a miniature electron eye indicator.

After 20 years of puttering, I located a real miniature eye which is only 1 1/4" long (rather 1 1/2" including pins) and 3/4" in diameter. The price?—eight fat bucks. The sensitivity—ouch!!, you still need a d.c. amplifier to push it for ave applications, requiring another tube nearly as big.

Querying two large manufacturers on how come no sensitive miniature electron eye tube—results one answer common to both—limited market!! To this I say and you may quote me "Nuts."

I guess the fellow who said what he did about the better mousetrap didn't figure on tube manufacturers.

Bill Fishback, W1IKU
Old Comers Road,
Chatham, Mass.

P.S. Or maybe I'm just out in left field!!

A Lamp For Your Station

Here is how you can have your Station Call Letters, an "On the Air" indicator, and illumination for your station clock combined into a modern ornamental lamp.

All you need is a set of gummed foil letters 1/2 inch high, costing a dime at your 5 & 10; a sheet of onion-skin paper or thin typing paper and a rubber band; an empty glass jar; a cardboard disk; cord, plug and bulb.

The construction steps are simple. Arrange your call letters on the onion-skin paper. On the next line place "ON" and on the third line "AIR." Mine filled a space 3"x3". Wrap the paper around the jar (peanut butter, string beans, mayonnaise or what have you eaten lately?) and hold in place with rubber band or pressure-sensitive

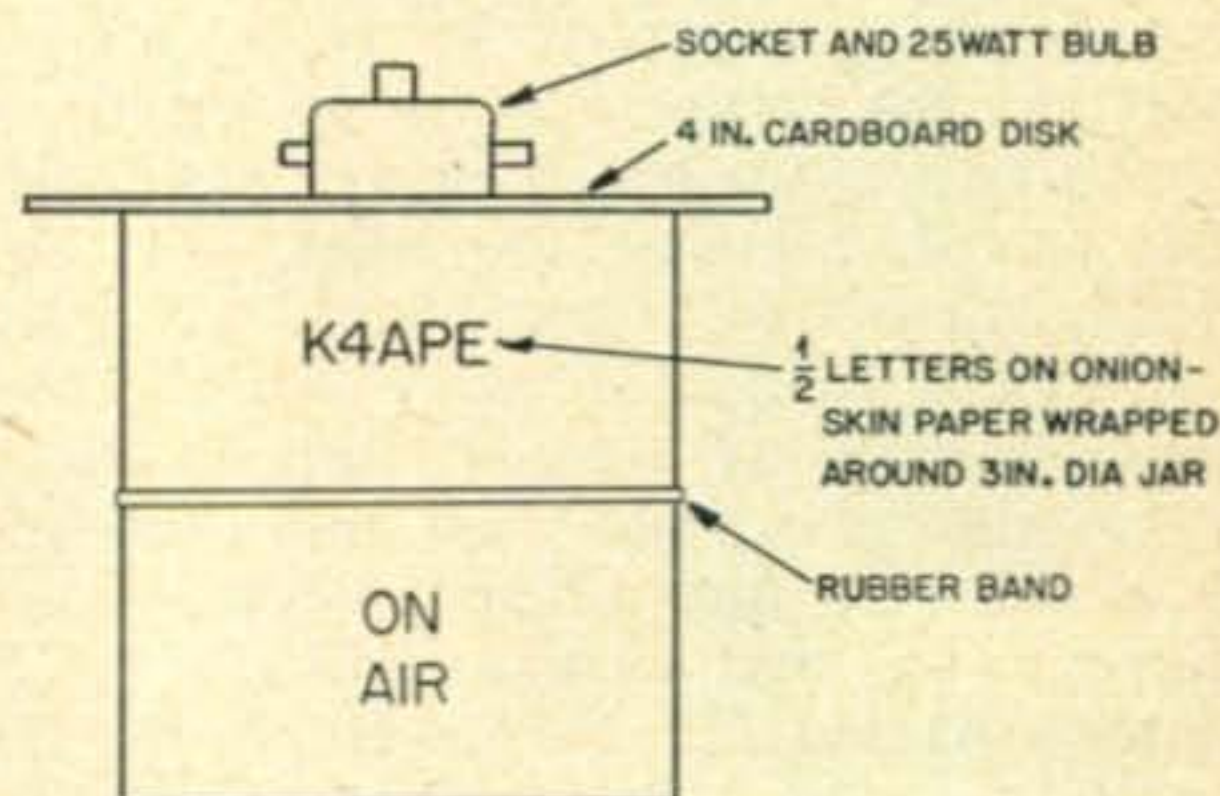

tape. Cut from cardboard a 4" disk. Cut a hole in the center 1 1/4" diameter. Insert brass socket with push-button switch into the disk. Use a 25watt lamp. Place disk over opening of jar with bulb inside. The bulb then gives a diffused light through the paper. Your call letters and "ON AIR" stand out prominently.

Other possible arrangements include using a pilot light bulb and socket connected to the filament winding of your transmitter, applying foil letters directly to the glass jar, lettering on the jar with nail polish.

—Louis A. Josephson, K4APE

Dear Sir:

We should be grateful if you could let us have some publicity in your esteemed magazine.

[Continued on page 110]



SINGLE SIDEBAND TECHNIQUES

by Jack N. Brown, W3SHY

This is the latest addition to the "CQ Technical Series." Over 2000 Hams took advantage of our pre-publication offer and are now probably sitting back enjoying Jack's breezy style of telling the full story of SSB. This book is a continuation of Jack's series "Getting Started on Single Sideband." In this book he goes on to describe two different SSB transmitters and several items of useful test equipment, and throws in a good background on how to keep your SSB signal clean. This is the only book of its kind on the market. Some may try last-minute imitations, but they'll never equal it.

112 pages . . . \$1.50

Radio Amateurs' MOBILE HANDBOOK

by William I. Orr, W6SAI

Going Mobile? This manual is indispensable. It covers in logical step by step form all facets of Mobile Operation. This book is the only complete source of such information and is not just a collection of reprints of magazine articles. No other book or manual tells you how to adjust your car regulator, information worth many times the price of the book and little known even in automotive circles. Written in the usual Orr style, the book is both thorough and easy to understand. The book is filled with valuable information nowhere else available and is profusely illustrated with photographs and diagrams. Invaluable.

192 pages . . . \$2.00

CQ, THE RADIO AMATEURS' JOURNAL

by well-known Hams and authors from around the world

New format, new cover, new material, better articles are the by-words at the CQ Editorial offices. Reacting to the hundreds of letters received during the past summer on "what I want in CQ," the editors put their heads together and came up with this NEW looking CQ. Regardless of what month you choose out of the next 12 or 24, CQ will contain first-rate material from the best authors in the Ham game. Your subscription is a guarantee (a money saving one at that) you will be among the first to see these features.

(See Page 117 for subscription blank)

CQ YEARLY BINDERS

Stamped or Plain

Wondering what to do with your loose copies of CQ? That's easy. Get a CQ binder at a ridiculously cheap price and have them at your fingertips. Why dig around under the desk, or in some old box to find an important CQ schematic? Put your CQ issues immediately in a steel reinforced red fabric binder and keep them orderly and handy. When ordering be sure to specify whether you want yours stamped for a particular year, or just plain.

\$3.50 each

CQ Magazine

CQ-7

67 West 44th Street, New York 36, N.Y.

I enclose \$_____ for which please send me:

_____ copies of your "Mobile Handbook" at \$2.00/copy.

_____ copies of your "SSB Techniques" at \$1.50/copy.

_____ CQ Yearly Binders. Years to be stamped

_____, _____, _____, or plain .

Add 3% Sales Tax in New York City.

My correct address is: (Please Print)

_____ (name) _____ (call)

_____ (street or avenue)

_____ (city) _____ (zone) _____ (state)

Really SILENT A-C Relays

By DOW

Model DKC

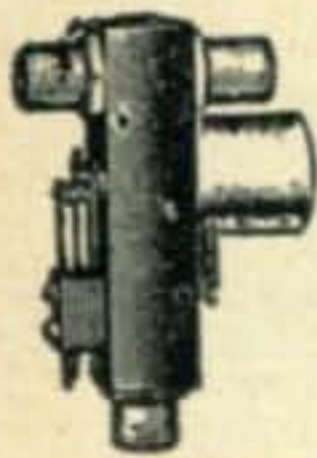

1000 WATTS
Length 4 1/2",
width 3"

← Silent A-C magnet prevents hum modulation of carrier — A-C types guaranteed as quiet as D-C.

Special connector protects your receiver ← from R.F. during transmission (Optional).

Transmit contact-pressure over 75 grams, making the 1000 w. rating very conservative. Causes negligible change in SWR up to 100 Mc.

DKF rigid adapter for external chassis mounting, \$1.85



AC types (All Volt.) Amateur net.....\$10.50
DC types (All volt.) Amateur net..... 9.50

See your distributor. If he has not yet stocked Dow Co-axial relays, order from factory. Send check or money order or will ship COD. Prices net FOB Warren, Minn. Shipping Weight 9 oz. Dealers' inquiries invited. Literature on request.

Add \$1 for external switch (Optional)

Add \$1 for special receiver protecting connector (Optional)

THE DOW-KEY CO., INC.

WARREN, MINNESOTA

Distributed in Canada by
Canadian Electrical Supply Co. Ltd.
275 Craig St., W. Montreal, Quebec

letters [from page 108]

The London Members Luncheon Club is an informal gathering of Members of the RSGB, who meet for lunch once a month, usually on the third Friday, at the Bedford Corner Hotel, Bayley Street, Tottenham Court Road London W.1., and we should like the opportunity of inviting, as our guests any of your readers who happen to find themselves in London at any time.

We have during the past 12 months, had over 25 visitors from overseas, but we feel that there must be many more who do not know of our activity, and a short notice in your magazine would no doubt help to bring it to the notice of others.

A telephone call to me at Ruislip 2763 or to RSGB hq at Holborn 7373 from any who are in England and who can find the time to lunch with us would be a great help.

Thanking you.

73,
Frank W. Fletcher, G2FUX
Ruislip, Middlesex,
England

Danger: Blasting Caps

Dear Wayne,

Perhaps you will remember me as the author (?) of "The I's Have It" which appeared in your September 1955 issue.

I hope that the readers of your magazine can be advised of the dangers of operating either fixed or mobile in the vicinity of any operation making use of electrical blasting.

Keep electric blasting caps and conduct blasting operations at distances from operating radio transmitters and antenna equal to or greater than those in this table:

Station wattage	Safe Distance (ft.)
30	100
100	200
250	500
1,000	1,000
5,000	2,000
50,000	5,000
over	10,000

This is because the caps and pigtails act as pick-ups to RF, which in turn can cause the caps to explode.
Howard Millbourn, W4WBC
Arlington 7, Va.

Printed Ckts.

Dear Mr. Morrisett:

I just finished reading the third article in your recent series concerning Printed Circuits. I would like to commend your magazine for presenting this excellently written and informative series of articles.

Printed Circuits and more specifically etched-wire printed circuits are becoming increasingly important in industrial electronics for rather obvious reasons. There has been a sorry lack of information printed about this medium in the amateur and ham publications. The service which you have performed will permit many hams and amateurs to become acquainted with and more importantly to make use of the advantages Printed Circuits has to offer. The educational job you have done is appreciated by those interested in the progress and development of electronic techniques.

Once again congratulations on a job well done.

Al Geduld
TECHNIQUES, INC.

"G" Mobile Operation

Mobile operation is on the upswing in England ever since the GPO has allowed the G hams to operate mobile some two years ago. Difficulties of mobile operation here are many. First is the lack of space in the small cars used here and second, most all of our gear is home made as commercial stuff just is not to be had.

The most popular freqs. are top and 2, with contacts up to 40 miles away not uncommon any where in England on 2. Top is used for local net working. Eighty and 10 meters is slowly becoming more popular as conditions improve but on 80m, QRM is terrific from 9RM service and contacts are not often to be had there.

Power is restricted to 10 watts on 160 meters but despite this contacts up to 100 miles are not uncommon.

Official recognition of the value of mobiles in emergency use is slow but each emergency that we assist in brings the official mind a little more knowledge that we are around. This so much that among hams, the Radio Amateurs Emergency Network is now an organization of some interest.

[Continued on page 114]

FREED OFFERS FOR IMMEDIATE DELIVERY FROM STOCK MIL-T-27A STANDARD PULSE and AUDIO TRANSFORMERS

PULSE TRANSFORMERS									
Cat. No.	Block'g. Osc.	Int. Coupl'g	Low. Pow. Out.	Pulse Voltage Kilovolts	Pulse Duration Microseconds	Duty Rate	No. of Wdgs.	Test Volt. KVRMS	Char. Imp. Ohms
MPT1	✓	✓	✓	0.25/0.25/0.25	0.2-1.0	.004	3	0.7	250
MPT2	✓	✓	✓	0.25/0.25	0.2-1.0	.004	2	0.7	250
MPT3	✓	✓	✓	0.5/0.5/0.5	0.2-1.5	.002	3	1.0	250
MPT4	✓	✓	✓	0.5/0.5	0.2-1.5	.002	2	1.0	250
MPT5	✓	✓	✓	0.5/0.5/0.5	0.5-2.0	.002	3	1.0	500
MPT6	✓	✓	✓	0.5/0.5	0.5-2.0	.002	2	1.0	500
MPT7	✓	✓	✓	0.7/0.7/0.7	0.5-1.5	.002	3	1.5	200
MPT8	✓	✓	✓	0.7/0.7	0.5-1.5	.002	2	1.5	200
MPT9	✓	✓	✓	1.0/1.0/1.0	0.7-3.5	.002	3	2.0	200
MPT10	✓	✓	✓	1.0/1.0	0.7-3.5	.002	2	2.0	200
MPT11	✓	✓	✓	1.0/1.0/1.0	1.0-5.0	.002	3	2.0	500
MPT12	✓	✓	✓	0.15/0.15/0.3/0.3	0.2-1.0	.004	4	0.7	700

AUDIO TRANSFORMERS								
Catalog No.	Application	Impedance				BC Current		Max. Level dBm
		Prim. Ohms	CL	Sec. Ohms	CL	Prim. P. Side MA	Max. Unbal. MA	
MGA1	Single or P.P. Plates to Single or P.P. Grids	10K	✓	50K Split	✓	10	10	+15
MGA2	Line to Voice Coil	600 Split		4, 8, 16		0	0	+33
MGA3	Line to Single or P.P. Grids	600 Split		125K	✓	0	0	+15
MGA4	Line to Line	600 Split		600 Split		0	0	+15
MGA5	Single Plate to Line	7.5K 4.5T		600 Split		40	40	+33
MGA6	Single Plate to Voice Coil	7.5K 4.5T		4, 8, 16		40	40	+33
MGA7	Single or P.P. Plates to Line	15K	✓	600 Split		10	10	+33
MGA8	P.P. Plates to Line	24K	✓	600 Split		10	1	+30
MGA9	P.P. Plates to Line	60K	✓	600 Split		10	1	+27

Send For Complete Instrument & Transformer Catalog

FREED TRANSFORMER CO., INC.
1721 WEIRFIELD ST., BROOKLYN (RIDGWOOD) 27, N.Y.

Companion Unit

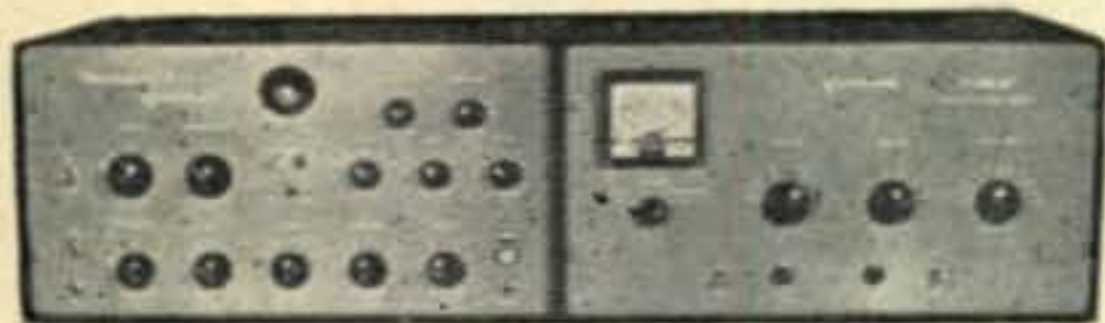

new
new
new

P-400-GG

Grounded Grid Linear Amplifier



new
new
new
NEW!

"Phasemaster-II"

the ultimate for AM — PM — CW and SSB — 75 W PEP output — completely bandswitched 160 thru 10M — wide pi network output — built in 3500 cycle audio filter — complete shielding — no critical external balance controls — no mixer tuning **ELIMINATES OUT OF BAND** operation — rounded corner black crackle cabinet with gray front panel with white lettering — 9 1/4" H x 17 1/4" W x 11 1/8" D — a complete wired tested and **ALIGNED** audio thru balanced modulator subassembly furnished with kit allows transmitter to be built as simply as a CW rig.

W and T \$329.50 Kit \$279.50

See Your Dealer or Write for Literature

CHECK THESE OPERATING FEATURES:

- ✓ Utilizes 4 — 6CN6 grounded grid hi-mu tubes. Low cost in replacement.
- ✓ Requires less than 20 W PEP driving power.
- ✓ Wide range Pi network output circuit and Bandswitching 80M thru 10M.
- ✓ Exclusive power switching circuit makes it impossible to apply plate voltage before filaments are turned on.
- ✓ Exclusive metering circuit reads GRID Ma. PLATE Ma. WATTS Input and WATTS Output directly in WATTS on the meter.
- ✓ Complete built in power supply gives 1250 V DC 380 MA with 30 MFD filter capacity for maximum dynamic plate supply regulation.

W and T **\$269.50**

Immediate Shipment



SAD?

because you weren't able to get your

1956 Radio Electronic MASTER



Be happy — ham! You can still get your MASTER buying guide . . . 341 catalogs in one bound volume — if you act fast. Despite severe shortages, we've located distributors with extra MASTERS on hand. And what's more . . . you'll only pay the \$2.95 distributor price instead of the regular \$7.50.



1456 pages

- 100,000 items
- Complete descriptions
- Specifications — Prices
- 11,000 illustrations
- 350 mfrs.
- 8 x 11", 6 lbs.

Send the coupon TODAY! Tomorrow you'll be able to compare specs and prices on all the latest gear.

The Radio-Electronic MASTER, 110 Lafayette St., N.Y.C. 13
Here's my \$2.95. Please rush my copy of the 1956 MASTER. CQ-7

Name

Address

City Zone State

HARVEY has it...
for **IMMEDIATE DELIVERY**

New **ELECTRO VOICE 664**



Cardioid Dynamic Microphone

Exclusive E-V 'Variable D' (variable distance) design operates on principle of multiple sound paths to the diaphragm, resulting in phase and amplitude conditions that provide a uniform cardioid

pattern at all frequencies and a response curve from peaks or dips over the entire 60-13,000 cps range. In amateur phone communication this means a useful power increase of up to 12 db at 100% modulation over conventional peaked microphones, as well as considerably more effective rejection of unwanted sounds in the shack than with commonly-used non-directional microphones. Ambient noises of all types, feedback, reverberation, blasting and boominess are drastically cut. Working distance from microphone is increased. Output level -55 db. 150 ohm and high impedance. Switch easily changed to relay control, if desired.

Model 664, without stand..... \$49.50
Model 419, Desk Stand..... 6.00

Harvey Ships Everywhere In the World

Prices Net, F.O.B., N.Y.C. Subject to change without notice

HARVEY RADIO CO., INC. Established 1927

103 West 43rd St., New York 36, N. Y. • JUdson 2-1500

SAVE HOURS OF WORK

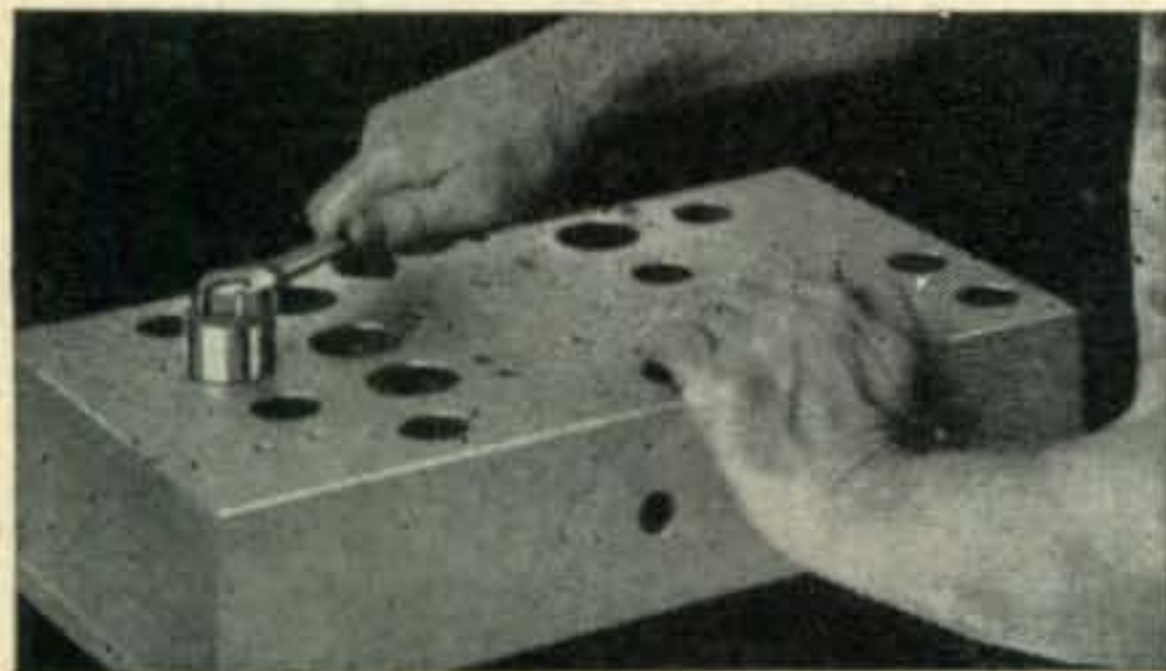

quickly make round, square, key and "D" openings with Greenlee Radio Chassis Punches

In 1½ minutes or less you can make a smooth, accurate hole in metal, bakelite or hard rubber with a GREENLEE Punch. Easy to operate... simply turn with an ordinary wrench. Wide range of sizes. Write for details. Greenlee Tool Co., 2367 Columbia Ave., Rockford, Ill.

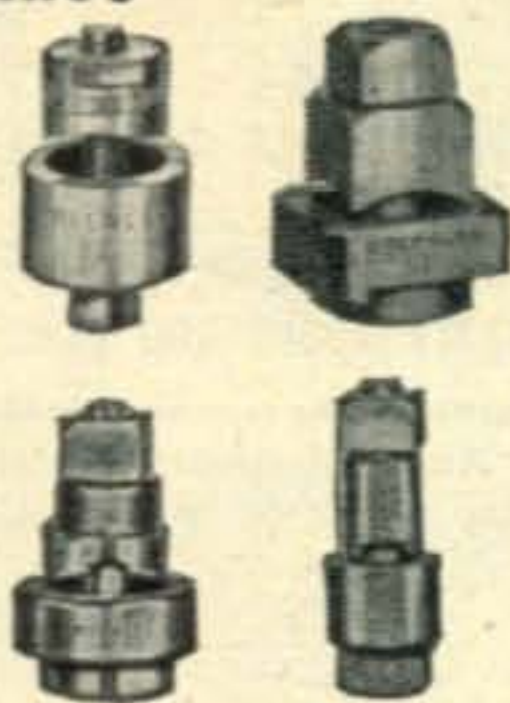

EDITORIAL

[from page 12]

from the author suggested that we celebrate this mil(e)stone by publishing a book containing the "Hundred Best Scratchi." I have for several months been contemplating putting out a "Best of Scratchi" booklet, but my notion was to make it slightly more selective. So, you Scratchi lovers, back to the stacks, pile through the file, and send some sort of communication to me regarding which are the greatest. Remember, *CQ* cannot be sued if you die laughing. That is a risk you'll have to take. Lemmeno pronto whichu like.

We'll put the book out faster if you start ordering it right away. I don't know what the final price of it will turn out to be, but it will probably be between a dollar and two dollars. You send a dollar right now and I'll see that you get a copy at no further cost when it comes off the press. All those sending in loot right away will get *autographed* copies! Be the first in your neighborhood, etc. When you send the dollar please mention what it is for so I don't go out and spend it for a present.

At every ham club the first question asked is, "Who writes Scratchi?" When I moved in on Dick Spenceley for a few days last winter the first question he asked when he got me alone was, "Say, just who does write Scratchi?" After so many years of carrying on this mystery it seems only fair that on the occasion of the 100th episode that the author should come out from behind that dialect and be introduced. If by any chance Dick happens to open this issue to the editorial by mistake he will at long last find out that the author is an old friend of his, someone he never suspected. As a matter of fact quite a few of you know him by another even more famous pen name.

The gang out in Phoenix have been going around in circles for several years now and still haven't really decided for sure who it is. They eye each other at meetings and try to trip each other up with trick questions. Things were pretty hot there for a while when there were a couple fellows who wouldn't come right out and say they weren't Scratchi.

Gentlemen, the fellow who writes Scratchi is

(Continued on page 137)

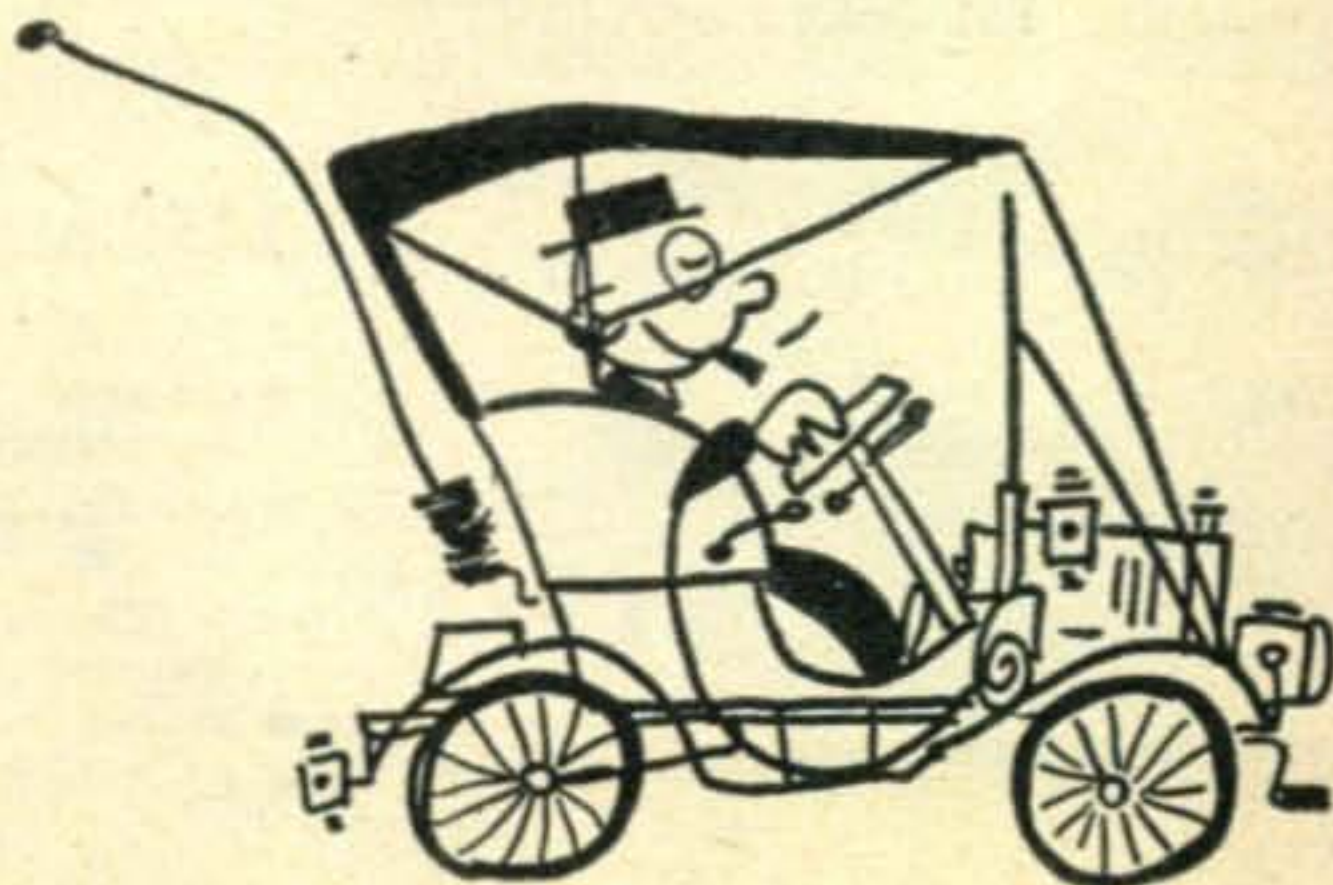

TREMENDOUS CRYSTAL CLEARANCE SALE!

Save Money—Order in Package Quantities!

All crystals tested and guaranteed to oscillate. Please include 20¢ postage and handling charge for every 10 crystals or less. Minimum order \$2.50. No. C.O.D's.

PACKAGE DEAL No. 1

25 Assorted FT-243 45 Assorted FT-241A
15 Assorted FT-171B 15 Assorted CR-1A

100 Crystals *Our Choice* \$8.95

Assorted.....Regular value \$66.00

PACKAGE DEAL No. 2

FT-241A Crystals for Single Sideband
370 KC-538 KC

35 Crystals *Our Choice* \$3.49

Assorted.....Regular Value \$14.00

PACKAGE DEAL No. 3

HAM BAND CRYSTALS — FT-243

For operating on 80, 40, 20, 15, 10, 6 and 2 meters—on either fundamentals or harmonics.

25 Crystals *Our Choice* \$6.95

Assorted.....Regular Value \$20.00

FT-243 RANGE
3655 KC - 8733 KC

FT-241A RANGE
370 KC - 538 KC

FT-171B RANGE
2030 KC - 3995 KC

CR-1A RANGE
5910 KC - 7930 KC

INDIVIDUAL CRYSTALS • Indicate 2nd choice—Substitution May Be Necessary

Low Frequency — FT-241A for SSB, Lattice Filter etc., .093" Pins, .486" SPC, marked in Channel Nos. 0 to 79, 54th Harmonic and 270 to 389, 72nd Harmonic. Listed below by Fundamental Frequencies, fractions omitted.

FT-243 — .093" Dia. — .486" SPC

49¢ each—10 for \$4.00

49¢ each—10 for \$4.00						79¢ each—10 for \$6.50	
370	393	415	485	508	531	400	462
372	394	416	487	509	533	440	463
374	395	418	488	511	534	441	464
375	396	419	490	512	536	442	465
376	397	420	491	513	537	444	466
377	398	422	492	514	538	445	469
379	401	424	493	515	540	446	470
380	402	425	494	516		447	472
381	403	426	495	518		448	473
383	404	427	496	519		450	474
384	405	431	497	520		451	475
385	406	433	498	522		452	476
386	407	435	501	523		453	477
387	408	436	502	525		455	479
388	409	438	503	526		457	480
390	411	481	504	527		458	
391	412	483	506	529		459	
392	414	484	507	530		461	

4035	5700	6300	6950	7710	8310
4080	5706	6306	6975	7725	8316
4165	5740	6325	7450	7740	8320
4190	5750	6340	7473	7750	8630
4280	5773	6350	7475	7766	8690
4330	5775	6373	7500	7773	
4340	5780	6375	7506	7775	
4397	5806	6400	7520	7800	
4445	5840	6406	7525	7806	
4490	5852	6425	7540	7825	
4495	5873	6673	7550	7840	
4840	5875	6675	7573	7841	
4852	5880	6700	7575	7850	
4930	5892	6706	7583	7873	
4950	5906	6725	7600	7875	
5030	5925	6740	7606	7900	
5327	5940	6750	7625	7906	
5360	5955	6773	7640	7925	
5385	5973	6775	7641	7940	
5397	6206	6800	7650	7950	
5437	6225	6825	7660	7975	
5485	6240	6850	7673	8250	
5500	6250	6875	7675	8273	
5660	6273	6900	7700	8300	
5675	6275	6925	7706	8306	

79¢ each—10 for only \$6.50

CR-1A SCR 522- $\frac{3}{4}$ Pin, $\frac{1}{2}$ " SP	FT-171B — BC-610 Banana Plugs, $\frac{1}{4}$ " SPC					
5910	7380	2030	2220	2360	3202	3995
6370	7480	2045	2258	2390	3215	
6450	7580	2065	2260	2415	3237	
6497	7810	2082	2282	2435	3250	
6522	7930	2105	2290	2442	3322	
6547		2125	2300	2532	3550	
6610		2145	2305	2545	3945	
7350		2155	2320	2557	3955	

79¢ each—10 for \$6.50

3655	6150	6550	7306	8350	8650
3735	6173	6573		8375	8690
3990	6175	6575	7425	8383	8700
6025	6185	6600	7440	8400	8733
6040	6200	6606	8290	8425	
6042	6440	6625		8450	
6050	6450	6640		8475	
6073	6473	6650	8173	8500	
6075	6475	7000	8175	8525	
6100	6500	7025	8200	8550	
6106	6506	7075	8225	8575	
6125	6525	7125	8275	8600	
6140	6540	7150	8280	8625	

SUN
PARTS DISTRIBUTORS, LTD.

514 TENTH ST.
N.W., Wash., D. C. Dept. Q.

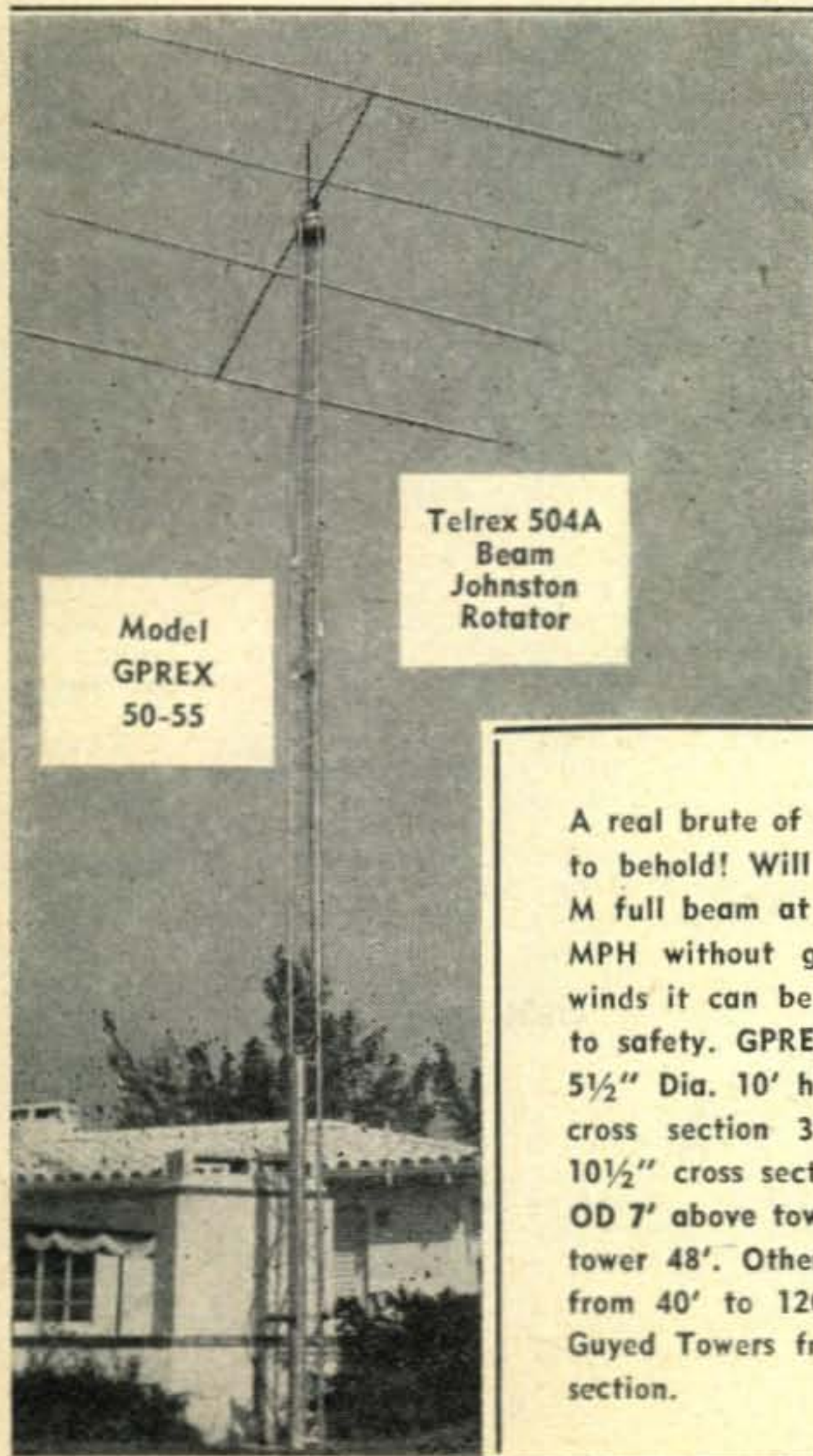

HEAVY DUTY STEEL TOWERS Built Especially for Ham Beams

(Not just another TV Tower)

- CRANKS UP AND DOWN—TILTS OVER
- 25 DIFFERENT TYPES—40' TO 60'
- FREE STANDING—NO GUY WIRES—NO CONCRETE
- 80'—100' 120' CRANK-UP, TILT-OVER TOWERS
—THESE MUST BE GUYED

A real brute of a Tower—yet a beauty to behold! Will support a 4 elem. 20 M full beam at 50' in winds up to 70 MPH without guys. In case of high winds it can be quickly cranked down to safety. GPREX, 50-55. Ground Post 5 $\frac{1}{2}$ " Dia. 10' high. Lower Section 14" cross section 31' high. Top Section 10 $\frac{1}{2}$ " cross section 21' high. Mast 1.9 OD 7" above tower. Extended height of tower 48'. Other size crank-up towers from 40' to 120' \$90 up. 7 Sizes of Guyed Towers from 6 $\frac{1}{2}$ " to 30" cross section.

SEND TODAY FOR FREE CATALOG

Dept. HQ.
E-Z WAY TOWERS
P. O. Box 5491, Tampa, Florida
Send me your FREE catalogue on the following towers:
 AM Radio Television
 Ham Radio Two-Way Communication
I am interested in a tower.....ft. high.
I will use a.....antenna.
(State type and model)
Type of Rotor.....
Name.....
Address.....
City..... State.....

E-Z WAY TOWERS Inc.
P. O. Box 5491 • Tampa, Fla.

NON-METALLIC GUY LINE — PERFECT FLEXIBLE INSULATOR — REVOLUTIONIZES HAM RADIO & TV ANTENNA SYSTEMS

Non-inductive, non-conducting, non-absorbing Glas-Line isolates systems from directional arrays, rhombics, etc.



The new main insulator of W3UCT. The Glas-Line is between the two egg insulators running to the lower left. The copper link between the center egg insulator and the upper right egg insulator is for the dead-end feeder of a Zepp antenna.

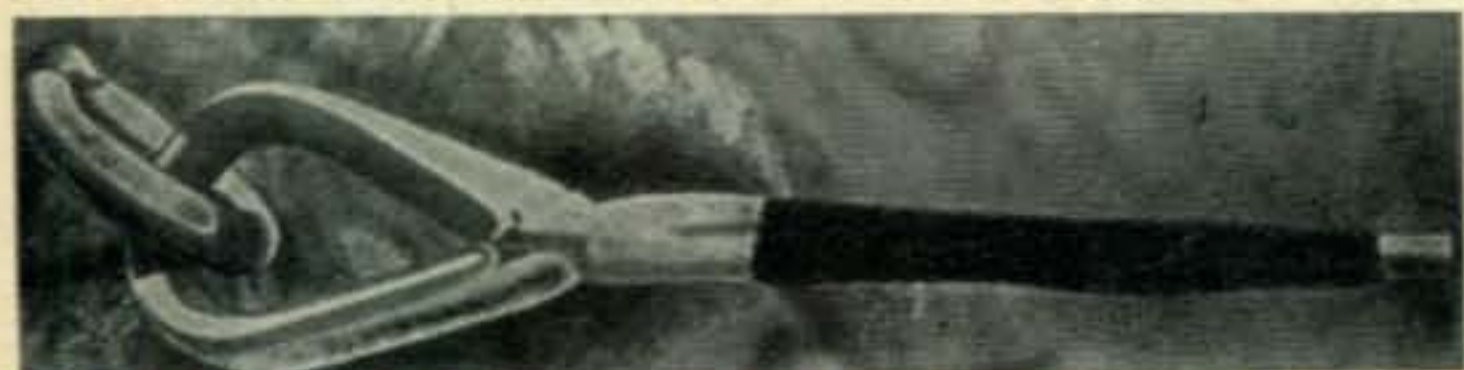

View of an open thimble and eye bolt for coupling the Glas-Line guy wire to a tree.

GLAS-LINE cannot rot, will not shrink, stretch or sag . . . has high breaking strength of over 500 pounds. GLAS-LINE IS AVAILABLE IMMEDIATELY. ONLY \$2.89 PER 100'. Send 50c postage.

GLAS-LINE

P. O. BOX #2 RIVERDALE 71 NEW YORK

DISTRIBUTOR INQUIRIES INVITED

ROHN

"Superior Design"

TOWERS & ACCESSORIES

... for your every need

ROHN is one of the largest and most complete-line manufacturers of towers of all types; many especially designed for amateur radio use. ¶ Heavy-duty towers are available—self-supporting to 66 ft.; or guyed up to 200-300 ft. Available in hot-dipped galvanized finishes. ¶ The Rohn line also features a special "fold-over" tower, and other necessary accessories—including rotator platform for antenna, insulator sections and dozens of other items ideally suited for your use.

FREE! Write for literature and name of nearest Rohn Representative and source of supply. Rohn Products are conveniently available coast-to-coast.

ROHN Manufacturing Company

116 Limestone, Bellevue, Peoria, Ill.

"Pioneer designers and manufacturers of all type towers."

letters [from page 110]

Mobile rallies have attracted up to 100 cars with resulting QRM on the rallying freq. and grand times had by all. Even one motor scooter complete with 5 watt rig, six foot center leaded whip and intercom from passenger to driver showed up.

Occasional contacts are made on 10 with US mobiles and the operator that has done it is in some what of a bragging position as this type of thing is not too common yet.

Cliffe Metcalf G3DQ
Radio Society of Great Britain

Command Set

Dear Sir:

Just a short word of appreciation of the fine work you are doing at CQ. Now and then a magazine prints an article which is worth a whole year's subscription. Such, among others, I consider "Command Set Roundup" which appeared some time ago, and "The Novice Q'5er" in CQ for last January. One of the boys here (with a bit of help) built one. A bit of trouble was encountered from the fact that the Q'5er was pretty well battered up and had a few things wrong with it. Sluggtuned coils of the proper range were used for the converter as those specified were not obtainable locally.

The results are positively amazing. A short test found the Q'5er pulling in signals inaudible on my old BC348. Thanks for printing such a helpful article. The only remark I might venture on contributions such as this is to impress the author with the fact that our present generation of beginners don't know anything at all about world-war-vintage gear, and that as a rule they do not have access to former copies of CQ or QST.

Think I will look into the S'9er too. Sounds good. CQ is a bit of a pioneer? Grid dip meter, Antennascope, Q Multiplier, etc.—

Brother Eymard
(W1UTA/DCN)
Mount St. Charles Academy
Woonsocket, Rhode Island

Dear Wayne:

In response to your editorial in April 1956 CQ:

The North Penn Amateur Radio Club monitors 28,888 mc nearly all day every day and for sure every evening. We always welcome mobileers and would like to be listed in any sort of directory of this type. We cover the Montgomery County, Philadelphia and Bucks County area.

E. C. Pressler, W3ZXV, Sec'y
NORTH PENN AMATEUR RADIO CLUB
Fairview Village
Pennsylvania

DX QSL's

Dear Wayne:

What does it cost to QSL? I didn't realize what it can cost a DX station until I worked XP7 NG, Glen Van Voohis. Glen has been in the Bahamas about two years and I was his QSO number 5617.

When he said that he had QSLed every QSO I asked him about the expense. He wasn't bragging or complaining, but he did comment that the cost for the two years was close to \$600!

I'm working on a DXCC and prevail upon DX stations for cards. But from now on when I don't get them I'll understand how expensive it can be.

Jack Edwards W4-DXJ
Greenville, NC

Ed note: Send along international postage coupons for those DX cards fellows.

Clubs Only

Hi Wayne:

Enclosed you will find a copy of the last issue of our Club Bulletin (3 pages) of which I am the editor.

The name is not final as yet; we are in the process of having a contest for the paper as well as a QSL card for the Jayhawk Amateur Radio Society of Wyandotte County, Kansas. Our Club call is KØDLE.

I will gladly put any other Club in the U.S. on our mailing list if they would like to receive our little effort to the publishing world. Would also like to be put on the mailing list of each and every Club reading this article. Our circulation now is 200.

Robert M. Summers, KØBXF
2817 Roosevelt
Kansas City 4, Kansas



Whose Shack?

#2 of a series: Famous Hams using the CQ World Globe

As you can plainly see, we are practically giving away World Globes this month. Close scrutiny of the above photograph will furnish you a x10 handicap by narrowing the possibilities down to one call area. Wow, huh? So fill out your entry in the Mammoth CQ Guess Whose Shack This Is World Globe Contest right away. Remember, if you guess correctly Whose Shack This Is, you *win* a beautiful full-color CQ World Globe, plus a one-year extension or new CQ subscription! (negligible service charge of \$19.94)

(Non-sleuths may still purchase the Globe and Subscription for the regular outrageous price of \$19.95. Such sloth is not to be encouraged. Industry has its reward. A penny saved is a penny earned. A bird in the hand is worth—uh, a stitch in t—a rolling sto—well, anyhow, there's a great wealth of reliable folk data to substantiate this view.) So let's see that old Contest Spirit, boy. Get in there and Pitch! Dig up that little old entry fee and get into the Big Contest!

CQ Magazine
67 W. 44 Street
New York 36, N. Y.

CQ-7

Gentlemen: Enclosed please find \$19.95. Please send me the beautiful CQ World Globe *plus* a one-year new renewal subscription to CQ. This shack belongs to.....
If I'm right, please refund the difference.

Name Call

Street Address

City Zone State

NYC residents add 3% sales tax.

FREE

1956 CATALOG

WORLD RADIO LABORATORIES

"The World's Largest Distributor of Amateur Radio Equipment"

Jam packed with bargains — everything in Radio, TV, and Hi Fi — for Handyman, Ham, Experimenter or Serviceman!

- Pay Only 10% Down
- Easy Terms
- Liberal Trade-Ins
- Save Over 50% on Recond. Equipment
- Over 800 Guaranteed Reconditioned Items



WORLD RADIO LABORATORIES

3415 W. Broadway — Council Bluffs, Iowa
Leo I. Meyerson PERSONALIZED SERVICE

MAIL HANDY COUPON

WORLD RADIO LABORATORIES, INC. C-7
3415 W. Broadway — Council Bluffs, Iowa

Free 1956 Catalog Recond. Eq't. List
 3'x4' U. S. Radio Map 25c

NAME _____
ADDRESS _____
CITY _____ STATE _____

NEW CATALOG!

- INDUSTRIALS! • EXPERIMENTERS! • HAMS!
- ENGINEERS! • LABS! • NOVICES!

Are You on Our Mailing List?
If not, write us today for free copy!

MINIATURE HAND CRANK GENERATOR

Latest type, light weight. From recent model field phone. Many uses. Brand new. **\$1.49**

Terrific buy! CHEST MIKE. Used. Ea. 49¢

HI-FI PERMA-FLUX HEADSET: Annular grooved plastic fibre cones with voice coil as in speakers. Chamois ear pads. Gives finest music reproduction. Brand new in original carton. Special. Only **\$7.95**

NEW CATALOGUE NO. 110 IS OFF THE PRESS!
All items F.O.B. L.A. Prices subj. to change without notice. Calif. buyers add tax. Send 25% deposit with C.O.D. orders.

Get your free copy today!

J. J. GLASS ELECTRONICS CO.

1624 S. Main St. Los Angeles 15, Calif.

LMB BOX CHASIS OFFERS FREE inside LMB BOXES

10 tested kit diagram projects for the builder. Each one of these kit diagrams built by a recognized expert. Kit projects are complete in every detail. Circuit diagram, photo of project both front and rear photo. Rear photo shows wiring and parts. Detailed instructions for building, complete parts list and approximate cost. Complete to build except parts and your distributor can supply the parts. Ask your distributor for the list of LMB kit Diagram Projects. If he does not have them, write to

LMB 1011 Venice Blvd.
Los Angeles 15, Calif.

[from page 80]

7th YL-OM Contest Scores

K5ADQ	11,428.75	W3DDV	701.25	W0WAJ/Ø	708.75
W5EGD	8,268.75	W3MDO	228.	W0WXG	270.
W5KEC	6,555.	W3OP	135.	W0YJM	712.5
K6BUS	1,272.	W3QLW	191.25	W0ZZT	220.
W6EHA	585.	W3RRI	30.		
K6HVC	2,400.	W3VWJ	551.	EA4CR	(conf.)
W6NAZ	(conf.)	W3YLL	468.75	VO6N	130.
W6PCA	2,963.5	W3UZS/4	78.75		
W6QMO	3,112.5	W3ZHQ	472.5		
W6WSV	123.75			OM CW	
		K4ARP	697.5	W1AJZ	630.
W7COX	6,732.	W4CHK	510.	W1FEA	540.
W7PTX	2,343.75	W4CVO	412.5	W1JYH	400.
W7PUV	281.25	W4DKE	350.	W1LQ	480.
		W4JUJ	585.	W1NLM	800.
W8KLZ	2,242.5	W4WRH	332.5	W1OPZ	123.75
W8MBI	250.	W4WSF	393.75	W1QMM	475.
W8QOQ	13,340.	W4WZT	64.	W1RFC	520.
W8UAP	6,355.			W1WEE	(conf.)
		W5FHL	(conf.)	W1WMH	270.
W9JUJ	12,431.25	W5LVM	920.		
W9LDK	(conf.)	W5ZWR	90.	K2BE	(conf.)
W9LOY	926.25			W2BVN	438.75
W9MLE	3,465.	K6DAC	945.	K2CKW	80.
W9MYC	1,211.25	W6DAC	212.5	W2CPA	140.
W9SYX	680.	W6FGJ	1,462.5	K2DEM	68.
W9UON	2,520.	K6HBA	210.	W2DMU	(conf.)
W9USR	315.	W6IDY	308.	W2DRM	(conf.)
W9WZL	12,090.	W6JVA	1,100.	K2DSW	2,058.75
		W6KNS	40.	W2EMW	648.
K0BFS	13,005.	K6OHM	60.	K2EWR	472.5
W0KJZ	6,191.25	W6PAL	688.75	W2FLD	850.
W0ZWL	78.75			K2GTC	855.
		W7KOI	292.5	K2HXR	945.
KL7AZI	1,080.	W7SFK	787.5	W2ICO	475.
		W7YNO/7	260.	K2INZ/VE3	187.5
KP4ZV	4,440.			K2JAE	450.
		W8AJW	1,462.5	K2JDD	15.
KZ5KA	4,320.	W8IXG	(conf.)	K2KDW	1,750.
		W8JAX	(conf.)	K2KFJ	220.
VE3AJR	14,082.5	W8RAB	1.25	W2LRJ	(conf.)
		W8SDD	15.	W2MCO	35.
VE5DZ	1,534.	W8SVL/6	55.	W2NIY	783.75
		W8UPH	7.5	K2OPJ	562.5
		W8UVD	468.75	K2PDO	(conf.)
				K2PIC	157.5
		OM Phone		W2SAW	1,352.
W1BFB	560.	W9ATW	(conf.)		
W1BNS	1,080.	W9BBB	90.	W3CN	(conf.)
W1FEA	96.25	K9BJV/W0HAW		W3DDV	525.
W1LQ	87.5			W3HH	(conf.)
W1OPZ	56.25	W9BYZ	(conf.)	W3KQD	406.25
W1PKQ	(conf.)	W9CMC	1,715.	W3MAX	1,725.
W1ULS	573.75	W9CNF	31.25	W3MDO	1,176.
		W9GIL	212.5	W3NRE	(conf.)
W2BVN	96.25	W9ITM	100.	W3OP	800.
W2COB	945.	W9NLF	52.5	W3QLW	450.
K2DEM	302.5	W9OMM	783.75	W3RRI	9.
W2DMU	(conf.)	W9SZR	697.5	W3RYV	123.75
K2DSW	1,292.5	W9TKR	761.25	W3SIJ	275.
W2DTZ	(conf.)	W9UQB	11.25	W3WHK	300.
W2FLD	500.	W9UTL	112.5	W3YLL	742.5
W2GVV	(conf.)	W9VOD	297.5	W3YUW	637.5
K2HXR	577.5			W3ZHQ	1,025.
W2MCO	712.5	W0AIN	37.5	W3ZSX	345.
K2MTL	261.25	W0BLH	446.25		
K2OPJ	375.	W0CDL	(conf.)	K4APN	(conf.)
K2PIC	637.5	W0GAX	90.	K4ARP	540.
K2PPB	100.	W0IUB	468.75	W4CHK	1,023.75
		W0QWS	100.	W4HFU	356.25
W3AXT	24.	W0SGG	20.		

[Continued on page 118]

W5CIN/5/7/Ø Expedition

On April 7, 1956 three stations were set up at the junction of four states and three call areas. W5WKW, W5SGC and W5CIN hauled their equipment over the rough trail leading to the corner of Arizona, Utah, Colorado and New Mexico and over the weekend made 139 stations eligible for a special certificate.

KE-93

*Small, highly efficient,
full fledged, 12 tube
all-band or fixed station
mobile receiver.*

Extreme stability under shock and vibration, wide temperature excursions and wide power source voltage excursions. Fully capable of mobile in motion side band reception on all bands. Full automatic noise *SILENCER* (not a limiter). Also effective sharp cut-off squelch circuit.

Write for descriptive literature



Band #1	550 to 1650 KC
Band #2	1650 to 3500 KC
Band #3	3500 to 4030 KC
Band #4	6990 to 7310 KC
Band #5	13970 to 14360 KC
Band #6	20990 to 21450 KC
Band #7	27950 to 30000 KC

*Watch for announcement of our new
matching transmitter
—REVOLUTIONARY!*

PIERSON-HOLT ELECTRONICS
2308 W. WASHINGTON BLVD., VENICE, CALIF.

Precipitate

that urge you've been struggling with for yea these many months. Go ahead and subscribe. So you get *CQ* for a lot less. It's all right with us.

One year, \$4

Two years, \$7

Three years, \$10

in U.S., Possessions, APO & FPO, Canada & Mexico.
Pan-America and all other foreign: 1 yr. \$6; 2 yrs. \$11; 3 yrs. \$16.

CQ Magazine
67 W. 44 St.
New York 36, N.Y.

CQ-7

Enclosed is \$..... for a year new renewal subscription to *CQ*,
to be sent to:

Name..... Call.....

Address

City..... Zone..... State.....

SURPLUS

3" SCOPE—Conventional Scope #830 mfgd by Triumph to Navy specs, with wobulator 115 v 60 cycle input, Exc. cond. with manual guaranteed. **\$29.95**
(A sellout on our last ad)

Rush your order for a complete scope at less than the price of a kit.

TELESCOPING MAST SECTION MS-53. Threaded on both ends to permit telescoping to any desired length. Each rod is 1 meter (38 3/4") Sturdy flexible steel with brass ends. Unlimited possibilities. Brand new.

Sold only in lots of 6 for **\$2.75**

CRYSTAL CONTROLLED SUPERHET. Recvr R-82/ARW-20x, 14 volt dyna. 11 tubes, "S" meter xtal, 8 x 9 x 11 **\$14.95**
—new

ALL COMMAND SERIES IN STOCK

Revs. All Excellent Condition. All with tubes and Crystals.

190-550—w/dyn. \$10.95

3-6 MC—w/dyn. 6.95

6-9 MC—w/dyn. 6.95

XMTRS. ALL EXCELLENT COND. ALL WITH TUBES.

2.1-3 Mc \$5.95

3-4 Mc 6.95

4-5.3 Mc 5.95

5.3-7 Mc **\$6.95**
S.S.B. These Brand New

7-9.1 Mc \$6.95

Handset TS-13 (W/Cables) Like New **\$5.95**

Microammeter—0-50 ua DC Hermetic seal New

2 1/2" RD **\$5.95**

SPECIAL

BC-458, 5.4-7 Mc transmitter, used condition. Perfect for conversion to SSB at an all time low. **2 for \$5.00**

MODULATION XFORMER, 20 watt, P.O.T.C.S. transceiver, Stancor 95A10, Also used as 1:1 isolation, Boxed \$1.95

FILA XFORMER, 24v, 1.5A, Compact FB all surplus gear \$1.95

FILA XFORMER, 5v, 13A, new \$2.95

TUBE TYPE 1625 (SSB types)—Dozen \$2.25

REX RADIO SUPPLY

88 Cortlandt St.
New York 7, N. Y.

[from page 116]

W4JUJ	1,210.	W8JAX	(conf.)	W9TKR	1,380.
W4WRH	813.75	W8JWX	31.25	W9YDQ	96.25
W4WSF	402.5	W8KPL	323.	W9YYG	243.75
W4ZPR	100.	W8RAB	143.	W9UTL	11.25
W4ZQK	900.	W8SDD	852.5	W9ZA	488.75
		W8SVL/6	15.		
W5GIF	52.5	W8UMP	675.	W0AIN	110.
W5ZWR	487.5	W8UPH	325.	K0AXH	297.5
		W8UVD	630.5	W0BQM	(conf.)
W6ACL	101.25	W8YPT	192.5	W0CDL	(conf.)
W6CLZ	110.			W0DUW	(conf.)
W6DAC	750.	K9BJV/W0HAW		W0GAX	1,045.
W6JVA	1,178.75		735.	W0IUB	875.
K6OHM	90.	W9BZW	1,687.5	W0QWS	488.75
W6QXF	(conf.)	W9CHD	420.	W0SGG	488.75
W6YBV	(conf.)	W9CNF	308.75	W0YJM	1,531.25
		W9CXY	1,017.5	W0YRY	531.25
W7CJZ	456.	W9GIL	20.	W0ZBL	1,025.
W7FZB	11.25	W9GOC/SZR			
W7VIU/7	540.		1,687.5	VE2CP	373.75
		W9ITM	616.25	VE2IL	123.75
W8AJW	260.	W9KA	1,050.		
W8AQ	920.	W9KLD	725.	VE3AVS	320.
W8BDO	112.5	W9LNQ	1,207.5		
W8BMX	11.25	W9NH	520.	VE6SX	292.5
W8EKK	210.	W9RKP	231.		
W8JAE	(conf.)	W9RQF	807.5	VO6N	35.

QUAD YAGI

[from page 37]

Tuning the Beam

Tuning is easy. You will need a horizontal dipole with a diode and milliammeter connected as shown in Figure 4. The beam and pick-up

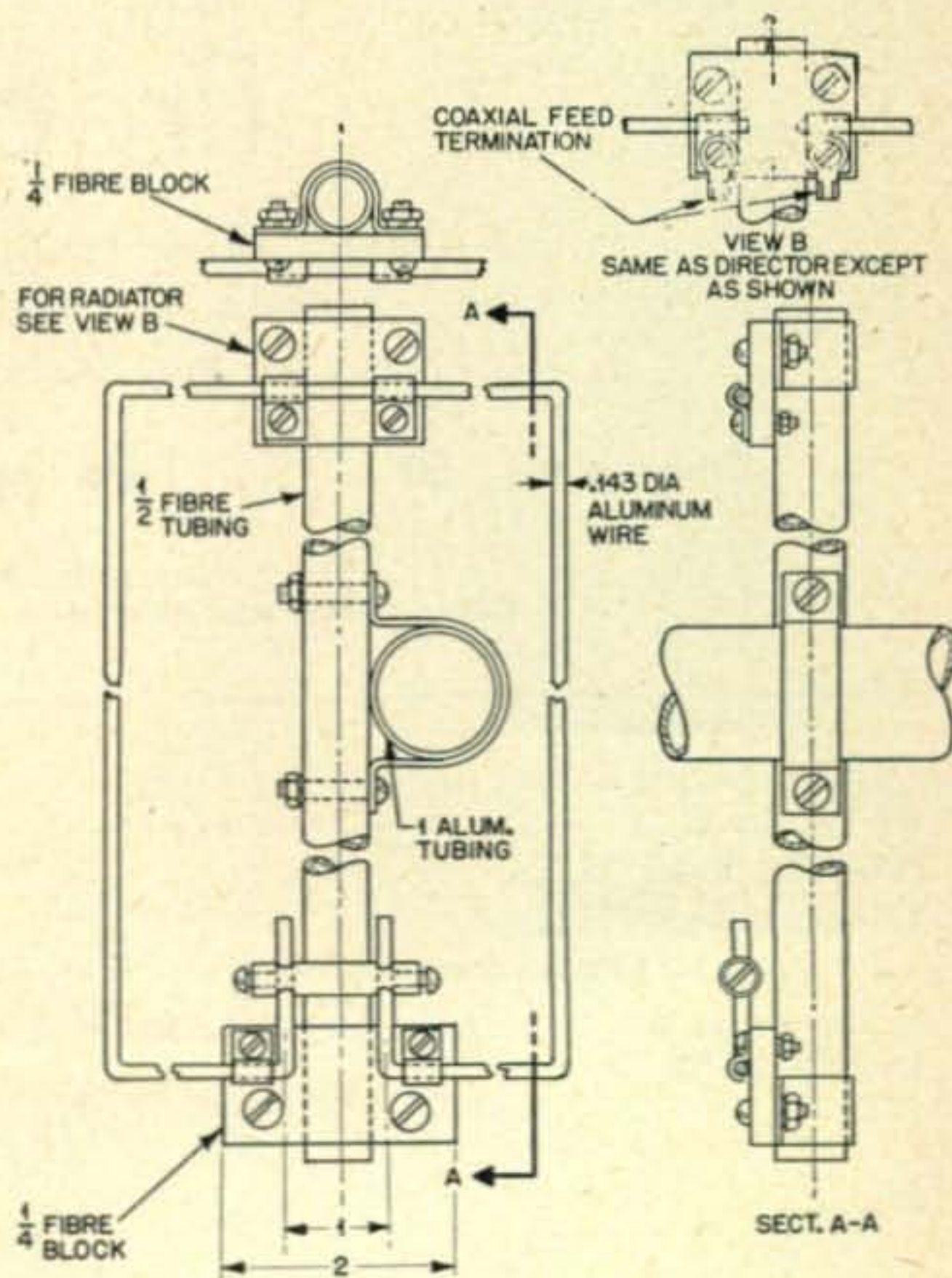

Fig. 5. Detail of one loop.

dipole should be set up about ten wavelengths or more apart, depending upon the power fed to the beam, and the procedure outlined below should be followed.

EASY TO LEARN CODE

It is easy and pleasant to learn or increase speed the modern way — with an **Instructograph Code Teacher**. Excellent for the beginner or advanced student. A quick, practical and dependable method. Available tapes from beginner's alphabet to typical messages on all subjects. Speed range 5 to 40 WPM. Always ready, no QRM, beats having someone send to you.

ENDORSED BY THOUSANDS!

The **Instructograph Code Teacher** literally takes the place of an operator-instructor and enables anyone to learn and master code without further assistance. Thousands of successful operators have "acquired the code" with the **Instructograph System**. Write today for full particulars and convenient rental plans.



INSTRUCTOGRAPH COMPANY

Dept. C., 4701 SHERIDAN RD., CHICAGO 40, ILL.

HALLICRAFTERS S-106



\$59.95
FOR A GOOD
DEAL —
AND A GOOD
DEAL MORE!

WRITE OR CALL "DOC"—RIGHT NOW!

LOW DOWN PAYMENT

HIGH TRADES—EASY TERMS

FAST — PERSONAL — SERVICE

M. H. DOSSETT CO. 355 N. COLUMBIA ST.
FRANKFORT, INDIANA

1. Set stubs of directors to shortest length.
2. Adjust driven loop for maximum meter reading.
3. Tune reflector loop for minimum reading with beam turned 180°.
4. Adjust first director, then each successive director for maximum reading.
5. Readjust driven loop for minimum S.W.R. or for maximum field strength which should coincide.

Adjustment of the reflector will have to be made with either the pickup dipole closer to

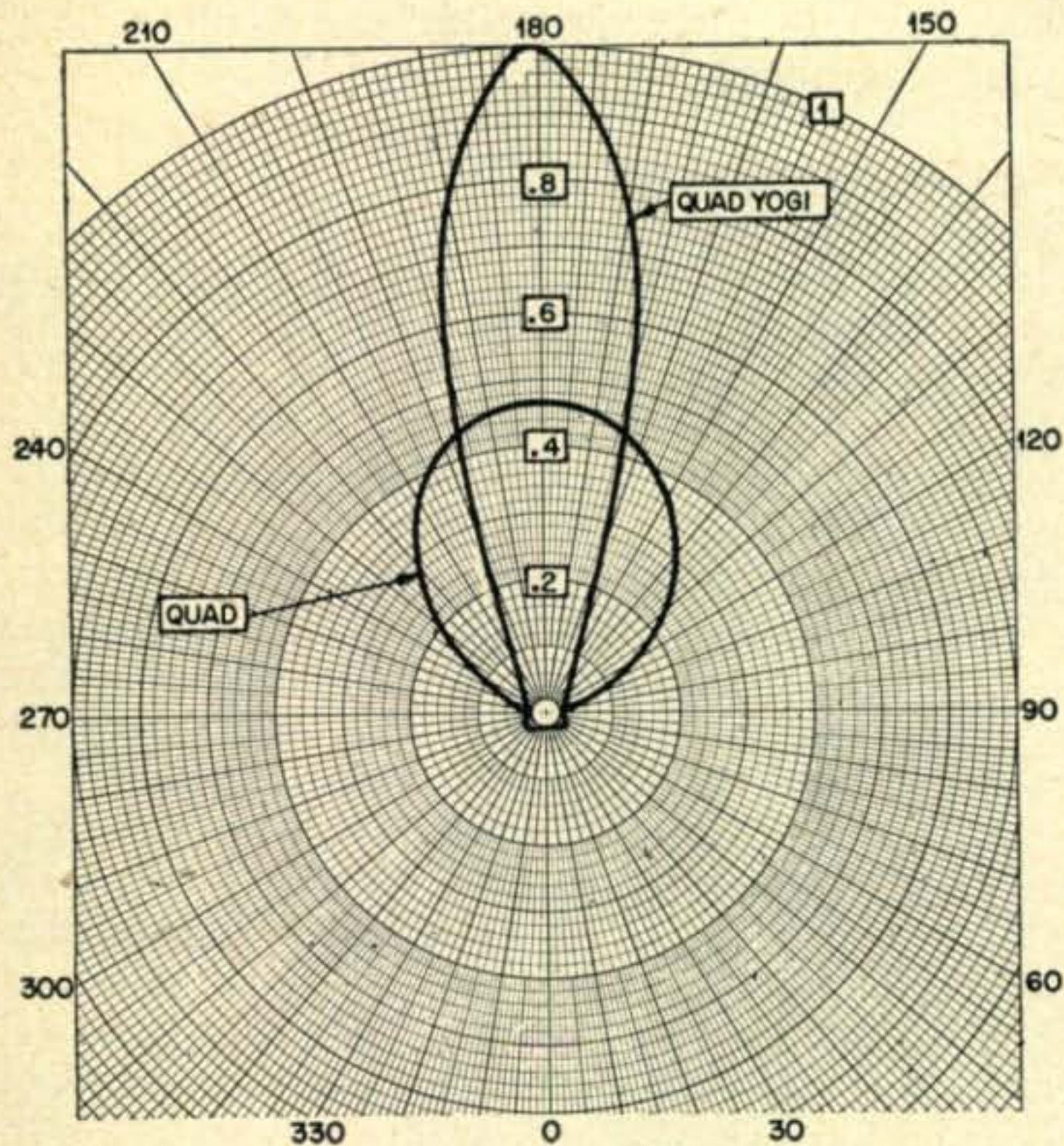

Fig 2. Reference gain.

the beam or a more sensitive meter. The adjustment of the elements are not critical except for the reflector which needs careful adjustment to obtain the best front to back ratio.

Operating Results

After several months of use on two meters the Quad Yagi has given very good results. Performance has been about equal to that obtained with a 20 element array consisting of two "Twin Fives" stacked horizontally. No direct comparison was made of the two beams since the 20 element beam blew down last fall which was one of the reasons for designing a new beam.

Future work on the Quad Yagi is anticipated and plans are to construct two seven element beams which will be stacked vertically. Work is presently being done to obtain more information on the behavior of the loops and an attempt is being made to analyze why and how it works.

I wish to extend my sincere appreciation to the people who have assisted me in this work and especially to Mr. Carl Schneideler (W2AZL) who has been most cooperative and helpful. ■

DX-MINDED? —this is for you!

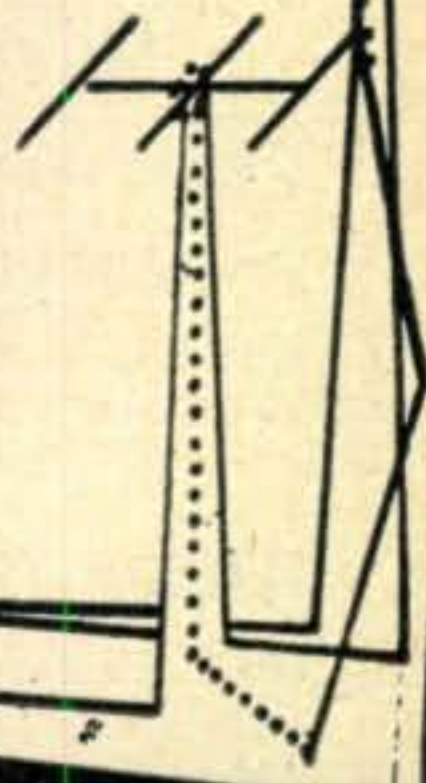

BEAM ANTENNA HANDBOOK

by William I. Orr, W6SAI

The first complete text entirely devoted to construction, installation and evaluation of rotary beam antennas. Eliminate "guesswork" in antenna construction and adjustment. New matching systems. Dimensional charts for beam design for 6, 10, 11, 15, 20 and 40 meter bands.

PARTIAL CONTENTS . . . true array gain figures . . . angle of radiation . . . SWR measurements . . . operating bandwidths of parasitic beams . . . matching systems . . . the new omega match . . . complete dimension charts for all bands . . . construction information and photos . . . new antenna assembly techniques . . . simple beams for the novice . . . six meter beams . . . how to evaluate your beam . . . best element spacing for maximum gain . . . sources of materials for beam antenna construction . . .

RADIO PUBLICATIONS INC.
DANBURY RD., WILTON, CONN.

Please rush _____ copies of BEAM ANTENNA HANDBOOK at \$2.70 per copy to:

Name _____

Street _____

City _____ State _____

Enclosed: check cash m.o.

Build your own transformer
with the NEW
TENSOR TRANSKIT

This kit enables you to build any one of the following:

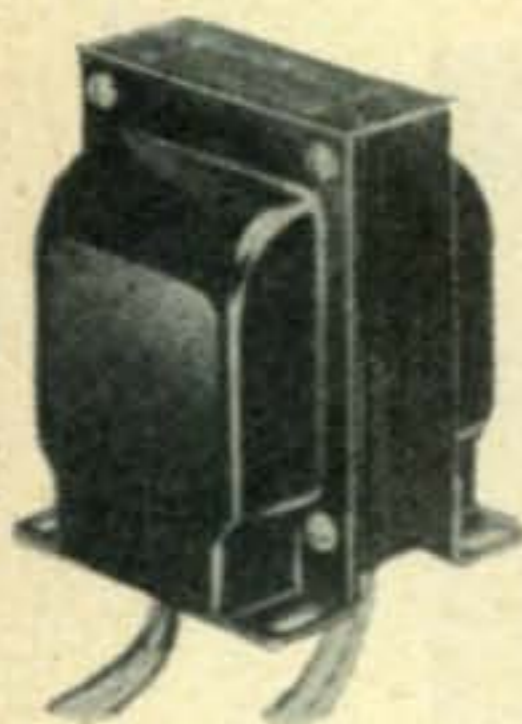

\$9.95

f.o.b. BKLYN

Shipping Wt: 16 lbs.

Complete parts supplied including wire, laminations, housings, etc. and step by step simplified assembly instructions.

TENSOR ELECTRIC DEVELOPMENT CO.
1873 Eastern Parkway, Brooklyn 33, N. Y.

- 1) Modulation Transformer for use with any pair of push-pull tubes with up to 120 Watts of audio power for plate modulating Class C R.F. amplifiers. Instructions furnished for all popular tubes and impedances.
- 2) Plate Power Transformer for use in any 150 Watt R.F. or Audio Amplifier. Instructions furnished for obtaining various voltages and currents.
- 3) Choke for use in full wave rectifier: 8 HY at 300 MA.
- 4) Swinging Choke for use in full wave rectifier. 5/20 HY at 30-300 MA.

Lazy Quad [from p. 38]

Results

A CQ at 5 PM immediately raised a station in Detroit, a distance of 200 miles. The signal report with 50 watts input was 40 db over 9 in Detroit. Very little or no QSB was evidenced on our signal. The received signal of the Detroit station was free of noticeable QSB and 35 db over 9. After these figures were established, I immediately connected the regular station antenna (referred to in Feb. CQ as a drooping doublet or here in Michigan as a modified inverted V) to the transmitter and made a most gratifying check. Our signal in Detroit dropped to 15 db over 9 and severe QSB was present on the signal with so called, "selective fading". The received signal exhibited the same reduction in strength. Heavy QSB was also noticed. (I am by no means selling the inverted V short. This antenna for general use and DXing on 75 is still tops with me). Several additional contacts have been made within a 400 mile radius and the same results by comparison with the regular station antennas has been observed. Further, during nighttime conditions I find that outside signals are greatly reduced in amplitude and nearby signals are stronger thus aiding greatly in QRM reduction.

This antenna might be compared in principle to the driven element of the cubical quad with the ground acting somewhat as the missing reflector. The great difference being that the signal is radiated skyward rather than toward the horizon. This being the case, it would seem ideal that the loop should be mounted .2 wavelength above ground (48') for the optimum gain figure of the quad antenna. Or perhaps an even better idea would be to construct a reflector of wire and place it below the driven element. The same tuning procedure should apply through the use of a stub. Placing a field strength meter beneath the reflector it should be possible to tune the stub for minimum backward radiation.

Another useful innovation of this loop which I have tried is to open the far end and treat the system as a small rhombic for the higher frequencies. This worked out most satisfactorily on 10 and 15 meter DX contacts even though the antenna was not electrically the proper length. Incidentally, full wave loops do not have to be square in layout. They can be diamond shaped or round or what have you and seem to work equally well. They can also be reduced in size by winding the wire double. I experimented with one which was only 2 feet on a side and contained 6 turns. I worked into Detroit (200 mi.) at mid-day and was copied Q5 and S9. This was only 3 S-units less than the reference antenna. This might show some good promise for mobile and portable installations.

I don't know what you will think of the whole idea, but it won't cost much to try it. If you want more solid communication locally and want to reduce outstate QRM you should find this most acceptable. ■



BUY

Heathkit, Johnson Viking, Tecraft and other equipment wired and tested. New Heath DX-35 (illustrated) wired and tested immediate delivery \$86.95. Custom 6 meter 100 watt transmitters available. New LE-CO 6 meter VFO now available. Free list new and re-conditioned equipment.

J. LYNCH, ELECTRONIC CO.
P.O. Box 54, Glen Oaks Branch, Floral Park, N. Y.

RTTY TELEWRITER CONVERTER RTTY

To receive amateur or commercial radio teletype messages, you need: 1. Your radio receiver. 2. Telewriter Converter, which plugs into the phone jack. 3. Polar Relay. 4. Teletypewriter (used commercial equipment available at low prices) Telewriter Converter with tubes and power supply, wired and tested. \$89.50. Polar Relay \$10.50. Write or phone: TOM, W-1-AFN.

ALLTRONICS, BOX 19, BOSTON 1, MASS.
(RICHMOND 2-0048)



New "Call-Letter Kit"

Order your call in neat 2 inch die cut letters and base. Just the thing for your shack—you assemble. Letters: 3/32" showcard stock. Base: Select quality wood.

Price \$1.00 Postpaid
TRUART PRODUCTS CO.
Dept. A, Box 676
Spring Lake, Michigan

GET INTO ELECTRONICS

You can enter this uncrowded, interesting field. Defense expansion, new developments demand trained specialists. Study all phases radio and electronics theory and practice: TV; FM; broadcasting; servicing; aviation, marine, police radio. Prepare for good pay. 18-month course. Graduates in demand by major companies. H.S. or equivalent required. Begin January, March, June, September. Campus life. Write for Catalog.

VALPARAISO TECHNICAL INSTITUTE
Dept. A Valparaiso, Indiana

SOLDERING ON GLASS

[from page 59]

cleaning, or pretreatment is used.

When working with such materials as soft glass and ceramics, the best tinning is accomplished with a mixture of Wood's metal and 50-50 indium-tin. However, when soldering glass to glass or ceramics to ceramics, it is necessary to use flame or furnace heating to get enough heat to the surfaces to be joined.

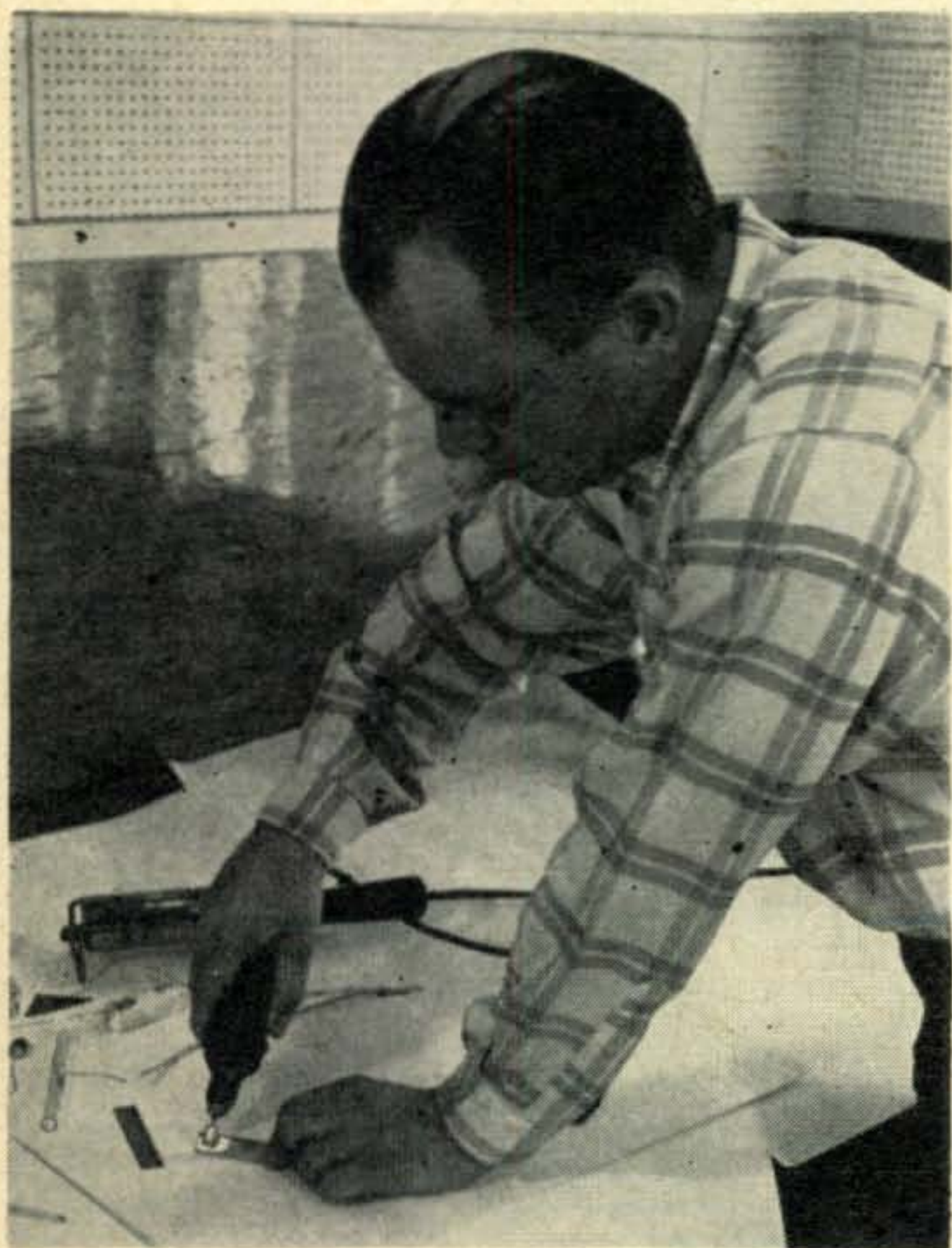

Joseph C. McGuire shows grinder used to buff on solder to glass.

With glass the technique is said to be most satisfactory for fastening electrical connections and similar light work. This also applies to ceramic materials. The process is not intended for fastening problems that might better be handled by a good glue. Failure to deposit a satisfactory coating with Wood's metal on glass indicates that the wheel was too cold when loaded or was not completely loaded with Wood's metal. If rotational speed is too high, the Wood's metal is laid down as a black deposit on the glass and the solder will not adhere. When speed is cut down, a shiny coating can be deposited. ■

Convention in Hawaii

The Annual Hawaiian Territorial Amateur Radio Convention is to be held on the island of Maui July 14 & 15, with a pre-Convention gettogether the night of July 13. Sponsored by the Maui Amateur Radio Club, Hahului, Maui, T. H.

BARGAINS in QUALITY CRYSTALS BY MANUFACTURER AMATEUR BAND CRYSTALS

All in standard FT 243 holders

1500 KC to 2000 KC.....	\$2.00 each
2001 KC to 8800 KC.....	\$1.25 each
8801 KC to 9005 KC.....	\$1.50 each
9006 KC to 11000 KC.....	\$2.00 each

Choose Any Kilocycle from the Above

We specialize in novice, club and net frequency crystals to your EXACT specified frequency.

NONE OF THE ABOVE ARE SURPLUS CRYSTALS—
BUT MAY BE IN SURPLUS HOLDERS

WE PAY POSTAGE ON THE ABOVE CRYSTALS

SSB FILTER CRYSTALS

NEW SURPLUS • PLATED TYPE

54th and 72nd harmonic types in FT 241A holders
All Channels 370 KC to 534 KC (except 500 KC)
50 cents each

500 KC	\$1.25
--------------	--------

Add 5¢ per crystal postage

FREQUENCY STANDARD CRYSTALS

Glass enclosed types with octal bases.
NO SURPLUS EXCELLENT TEMP. COEFF.

100 KC or 1000 KC

\$4.50 each or 5 for \$20.00

Add 5¢ per crystal postage

MINIMUM ORDER \$2.00 NO C.O.D.'s.

Same Day Service!

Satisfaction Guaranteed or Your Money Back!

Above Prices Effective After July 1st, 1956

CRYSTALS INCORPORATED
ODELL, ILLINOIS

GET YOUR COMMERCIAL TICKET EASIER WITH ...

Kaufman's

RADIO OPERATOR'S LICENSE
Q AND A MANUAL

The BEST book for
FCC License Preparation

Covers elements 1 thru 8.

The only book with complete discussion
of answers to every technical question
in the FCC Study Guide. Makes it very
easy to answer multiple choice
questions! Used by more than 60
leading schools. Only \$6.60 at
jobbers, bookstores or
direct from.

JOHN F. RIDER PUBLISHER, INC.
480 CANAL ST., N.Y. 13, N. Y.

HQ for the 5 TOP NAMES in
**STANDARD
 BRAND TUBES**
 AT SENSIBLE PRICES!

New handy air-mail order blank fresh off the press! Lists revg. xmtg. special purpose tubes, diodes, transistors, etc.
WRITE FOR YOUR FREE COPY TODAY!

0B3/VR90	\$.85	250TL Surp	14.00	829B	8.50
0C3/VR105	.75	HK253	6.50	830B	.70
0D3/VR150	.75	276G	8.50	832	4.00
2C39A	9.00	304TH Surp	8.75	838	.70
2C43	8.50	304TL Surp	10.50	866A	1.25
2C53	10.25	339A	10.00	872A	1.25
2E31	1.90	350A	3.00	874	.60
2E35	1.95	412A	3.90	918	1.65
3D21A	3.95	GL-575A	10.00	CK-1007	.75
3BP1	1.00	717A	.50	1500T Surp	75.00
3DP1	3.30	723A/B	9.00	5551/FG271	37.50
4-750A Surp	60.00	750TL Surp	50.00	5641	6.00
4E27	8.50	803	2.00	5643	8.00
4PR60A Surp	50.00	805	5.00	5647	5.00
4X150A Surp	22.50	807	1.20	5656	6.00
4X150G Surp	32.50			5663	1.25
4X500A	50.00			5670	1.10
4X500F Surp	85.00			5676	1.25
5BP1	2.50			5678	.90
5FP4	3.95			5812	1.50
5FP7	1.20			5814	.80
6AK5	.75	809	2.25	5819	39.00
6C21	17.00	811	3.00	5820 (1con)	185.00
6K4	2.25	811A	3.85	5894/AX9903	19.00
6SN7WGT	1.95	812	3.50	5915	.80
7GP4	10.00	812A	3.50	6161	
RK-65/5D23	7.50	815	1.50	(RCA-JAN)	70.00
100TH Surp	6.50	816	1.00	8008/872A	3.95
203A	2.50	826	.65	8020 Surp	1.25

**807W/5933
 \$2.85**

We stock over 1,000 other types . . . write.

EXTRA! SPECIALS! EXTRA!

5812	Hytron (improved 2E30) singles, \$1.00	By the pair, each	75c
357A	W. E. high power final bottle (worth \$50.00). singles, \$10.00	By the pair, each	\$7.50
307A	highly improved 2E25 (a real buy!) singles, \$1.20	By the pair, each	95c
5654	(6AK5W) rugged, long-life 6AK5. FB for mobile. Use in place of 6AK5 directly. Each		\$1.40
2E26	The old work horse of mobile radio.	Special each	\$3.20

Tube Cartons • Stackers • 2 Color or White
 Write for free price list & sample

**NOW! FOR THE FIRST TIME!
 A 1000 WATT SSB AMPLIFIER KIT
 AT A SENSIBLE PRICE!**

A complete set of electronic components including chassis, meter, tubes, chokes, transformers, condensers, etc. Everything you need to build the real FB 1000 watt SSB amplifier described in CQ, February 1956 issue, pages 27 & 29. (Includes two 803 tubes.) All parts, complete, (less hwr. & plug-in coll). PREPAID IN U.S.A. (No Cod) **\$85.00**

Matching Power supply for above (kit) **\$65.00**
COMBINATION! BOTH ABOVE KITS \$139.50

SSB LOW CAPACITY FILAMENT XFMR.

Secondary, 10 vet @ 10 amps. Primary, 115 V. 60 cy. For use with 803's, etc. Brand new, currently mfg'd. stock. Designed for SSB use but may be used in AM/CW circuits too. SPECIAL **\$13.95**

TUBE CHECKER SPECIALS!

HICKOCK model 550X. Mutual Conductance Type. Used, worn, but in good operating condition	\$39.50
PRECISION model 920 (Combo, checker & analyzer) used, in good operating condition	\$37.50
PRECISION model 912 (same as 920 less analyzer) used, in good operating condition	\$33.00

OTHERS! LISTED ON "GREEN SHEET" — SEE BELOW

FILTER CHOKE SPECIAL!

HEAVY DUTY. 10 H. @ 500 Ma. High voltage insulation. Wght. 34 lbs. Herm. sealed. NEW **\$5.50**

Write for "BARRY'S GREEN SHEET!" Bargains galore in Variacs, Relay racks, Xmters, Rcvrs, Tube checkers, Freq. meters, etc., etc., etc. Even some of our office equipment! Write. Free!

TERMS: 25% with order, balance C.O.D. All merchandise guaranteed. F.O.B., N.Y.C.

BARRY ELECTRONICS CORP.
 Dept. 6-C

512 Broadway, N. Y. 12, N. Y.
 Call us day or night 24-hour telephone service
Walker 5-7000

The Ham Shop

RATES: 25c per word per insertion for commercial business organizations.
 5c per word per insertion for individuals on a non-commercial basis.
 MINIMUM CHARGE \$1.00.

CLOSING DATE: 25th of the 2nd month preceding date of issue.

MAIL: Your typewritten copy with full remittance should be sent to CQ Magazine, 67 West 44th St., New York 36, N. Y. Attention: Classified Ad Dept.

NOTE: The products and services advertised in this section are not guaranteed by the publisher of CQ.
 Telephone orders not accepted.

FOR SALE

FREE LIST! New and reconditioned receivers, transmitters, etc. One hundred big bargains every month. Highest trade-in allowance. Write today! Dossett, W9BHV, 855 Burlington, Frankfort, Indiana.

CRYSTALS: FT-243's—3500 to 8700 KC ± 2 KC, \$1.00 each. .01% setting, \$2.00 each. Hundley Crystal Co., 2951 North 36th, Kansas City 4, Kansas.

PERSONAL HAM SUPPLIES! Pocket printer—name, call, address (ink pad included)—\$1.00. 500 miniature labels—name, call, address—\$1.00. Lucite desk wedge, name or call, gold on black—\$2.75. All postpaid. Santer, 544 East 6th St., New York 9, N. Y.

FOR SALE: Several books of schematic diagrams of popular surplus gear, including BC-348, R-28/ARC-5, and many others. Will sell cheap. S. Consalvo, 4905 Roanne Drive, Washington 21, D. C.

DXCC DIRECTORY: \$1.00 postpaid anywhere. W8YHO.

MULTI BAND-ANTENNA, 80-40-20-10, horizontal centered, low SWR line. Patented. Write Lattin Radio Laboratories, Owensboro, Kentucky.

FOR SALE: Collins KW-1, perfect condition, like new; 110 foot special heavy duty aermotor tower. All offers considered. K2HLB.

TWIN SET precision screwdrivers (9 pieces) underwriters laboratory approved, \$1.00 complete. White Company, 1730C Flatbush Avenue, Brooklyn, N. Y.

FABRICATED CHASSIS and panels described in this magazine available. Send for prices. Chicago Electronic Laboratories, 1214 W. Madison Street, Chicago 7, Illinois.

SAVE! BUY surplus direct from Government at tremendous savings, radio, electronic equipment, parts, power tools, machinery, hundreds others. List, \$1.00. Box 169CAF, East Hartford 8, Conn.

PERFORATED ALUMINUM sheet, .051, 5/64" OD holes, 1/8" centers. \$1.20 sq. ft. cut to size. Send for listing on beams, aluminum tubing, etc. Radcliff's, Fostoria, Ohio.

SELL CHEAP: \$65 disc recorder, good condition, need money. A steal for only \$20! Stephen Pinion, Route #2, Bedford, Va.

COLLINS TDO: cold 500w auto-tune xmt; pr 813's; pi-net final; will load any antenna; 2-18 mc, convertible to cover 15 and 10 if desired; CW, tone, A-3 emission, built in Collins phone patch; no TVI; 110/220 input; complete in Utah; \$500 cash; info write box AB, CQ.

"S" METERS for Communicators. No cutting, soldering, or disassembling. Also new and used Gonset Communicators, Linear Amplifiers, VFO's, G-66's, Transmitters, etc. Graham Company (W1KTJ), Stoneham, Mass., St-6-1966.

BRAND NEW HRO-60 for sale; purchased new May 6, 1956. First \$400.00 takes it. Also have Collins 3 KC Mechanical Filter & plug-in adapter unit for 75A-1. \$37.50. George M. Barnes, W8WGA, 3451 Ridge Ave., Dayton 4, Ohio. Phone: ORegon 0409.

SELL: A-1 Converted 2M 522 rcvr xmtr less PWs \$25., A-1 S40-A with "S" mtr \$70., WN3FQC, 45 N. Marshall, York, Pa.

TREMENDOUS BARGAINS: New and reconditioned Collins, Hallicrafters, National, Johnson, Elmac, all others. Completely reconditioned with new guarantee. Hallicrafters S38 \$29.00; S40A \$69.00; S40B \$79.00; S85 \$89.00; S76 \$119.00; SX71 \$149.00; SX42 \$149.00; SX96; SX100; National SW54 \$29.00; NC88 \$79.00; NC98 \$109.00; NC125 \$129.00; NC183 \$189.00; Super Pro \$99.00; HQ129X; Collins 75A1; 75A2; 75A3; 75A4; 32V3; Viking Ranger, Viking II; AF-67; mobile receivers, transmitters, converters, many other items. Easy terms. Shipped on approval. Write for list. Henry Radio, Butler, Missouri.

"DO IT Yourself." Aluminum tubing, castings, stampings, etc. to make your own 2, 6, 10 and 20 meter arrays. Completely assembled 6 meter 5 element Yagi beams, \$14.95; 2 meter 6 element, \$6.95. Wholesale Supply Co., Lunenburg 1, Mass.

NOVICE STATION: AT-1, \$25; S-77, \$50; or both for \$70. Also SW-54, \$25. Excellent Condition. W7BMI, Box 68, Billings, Montana.

ELMAC MOBILE rig-PMR6A, AF67, PSR-6, PE103A, antenna, coax relay, S meter, racks and 210KK mike. Complete in excellent condition, used 5 months. Johnny Gray, W5IQA, Box 505, Daingerfield, Texas.

BARGAINS: with new Guarantee: S-38D \$35.00; S-77 \$69.00; S-47 \$49.00; Lysco 600 \$69.00; S-27 \$79.00; SX-28A \$149.00; S-76 \$109.00; SX-71 \$139.00; HRO-60 \$319.00; HQ-129X \$149.00; HQ-140X \$189.00; NC-173 \$139.00; NC-183 \$169.00; NC-183D \$269.00; HRO-50TI \$279.00; SOJ \$9.95; National HRO50T \$199.50; Collins 75A2 \$299.00; Sonar VFX 680 \$14.95; Eldico TR75TV \$35.00; HT-17 \$24.50; EX Shifter \$35.00; Globe Scout 40A \$69.50; Globe Trotter \$49.50; HT-18 \$49.00; Harvey-Wells Sr. \$69.00; Elmas PMR6 rec. \$89.00; PSA-500 \$19.95; Johnson Matchbox \$39.50; Viking VFO \$29.50; Viking II \$229.00; Globe King 500 \$495.00; Globe King 400A \$299.00; 32VI \$275.00; 32v2 \$349.00; and many others. Free Trial. Terms financed by Leo, W0GFQ. Write for catalog and best deals to World Radio Laboratories, 3415 West Broadway, Council Bluffs, Iowa.

GONSET 6 Meter Communicator 6/115 v with mike, antenna and crystal, excellent condx. \$199.00. T32 push-to-talk desk mike with coil cord, \$9.50; T17 mike with coil cord, \$5.50. W3FKJ, Box 50, Factoryville, Penna.

SELL: MOHAWK Midgetape pocket recorder like new. Best offer takes it. W9PQY, Lloyd F. Lindell, 1829 E. 7th St., Superior, Wis.

PLASTIKASE RUBBER STAMP, 75c, your call name and address, Economy with pad, \$1. Top quality with handle, \$1.50. Pad 35c. Elkay Stamps, Box 5-WT, Toledo 12, Ohio.

SELL: 4X150A complete with Eimac air system socket and jacket, instruction sheet and service report. This tube has less than six hours operating time. \$45. Dave Potter, W2GZD, Pines Lake Drive, Paterson 2, Pines Lake, N. J.

GOING TO College. Sell: New bug, \$12; 10 M walkie talkie, \$10; BC-453, converted, \$10; ARC-5 VFO, \$4; BC-455, converted, \$5. 25W mod w/pa, \$25; power supply, delivers 600, 300, 210 reg VDC, 6.3 and 12.6 VAC, \$20; misc. tubes and parts free. N. Schein, K2ECD, 125 E. 18 St., Brooklyn 26, N. Y.

FREE LIST! Of reconditioned equipment and bargains. Write to "Terry," W9DIA, Harris Radio Corp., Fond du Lac, Wisconsin.

FOR SALE: Johnson Viking KW \$1250. Write W9DIA, "Terry," 168-7th Str., Fond du Lac, Wis.

BARGAINS GALORE! Cleaning shack. 100TH's—\$3 ea. 250TH's—\$5 ea. Tubes unused. Meissner Signal Shifter—\$30. Hundreds of other bargains. Send for list. W9JEQ, 124 North E Street, Monmouth, Illinois.

FOR SALE: CQ's and QST's, 1949-1954 inclusive. No issues missing, complete, like new condition. A. Martinica, 3723 Magnolia Ave., Chicago 13, Ill.

SELL: FACTORY-wired Globe Scout 65A with Heathkit VFO. \$85.00. Also Harvey Wells TBS-50C, \$50.00. Len Morgan, K5BGG, 327 South Tenth, Baton Rouge 2, La.

RECEIVER: HQ140X with matching Speaker—Hardly used—\$190.00. Write G. J. Began, 1008 S. 4th St., Effingham, Illinois.

NEW—CENTRAL Electronics 20-A SSB Exciter \$220.00, also model B slicer \$80.00, each wired and tested by engineer. Louis Bremer, 7704 Old Harford Road, Baltimore 14, Maryland.

GARDINER AUTOMATIC sender, twelve rolls tape, slightly used. Best offer over \$12; Audio oscillator \$3. extra. Gale, W1BD, Waterford, Conn.

FOR SALE: National HRO 60. Complete, like new. George Lambrette, 1023 W. G. River, Williamston, Mich.

SELL: NEW 4D32 Tube, \$14.00 Postpaid; 40 W modulator with power supply, \$25.00; Tecraft 2 meter converter, \$28.00; Millen 90281 Power supply, \$45.00; Millen 90810 UHF transmitter \$75.00. Roy Sawdey, 5255 Harper, Solon, Ohio.

SELL HEATHKIT AT-1, antenna coupler, modulator for AT-1, A-1 condition. Make an offer. Wayne Erla, 70 Woodbury Road, Burlington, Vermont.

FOR SALE: PE103 \$15; Simpson VOM260 \$20; Hickok 215VTM \$35; Simpson capacity bridge \$13; CDC3 Decade 10 MFD \$8; Johnson SWR bridge \$5; Cleaning house—meters, transformers, tubes. List on request. Williams, 546 Washington Avenue, Nutley, N. J.

SELL: HEATHKIT AR-2 with cabinet, \$25; Triumph 3" scope #841, \$25. Advance keying relay, \$3. K2KLL, 1514 East 10 Street, Brooklyn, N. Y.

MARINE, AIRCRAFT Crystals. Marine frequencies, transmitting \$2.95, Receiving \$2.50. Specify holder pin dimensions. Aircraft 3023.5 Kc. \$2.95 FT-243. Airmailed. Crystals since 1933. C-W Crystals, Box 2065, El Monte, Calif.

VFO, BEACH Mfg. Corp. 80 meter with power supply \$8.50. Command receivers without tubes 6.0 to 9.1 Mc. \$1.75. ARC-5 transmitters used good with tubes 4.0 to 5.3 Mc. \$3.75. Have much other gear, write for list. R. E. Woods, W6KEG, 2142 Parkway Dr., El Monte, Calif.

SELL 2M Communicator II with Mike; excellent condition \$150.00; Box AB, CQ.

LEECE-NEVILLE mobile system, 7 volt, 100 amp. alternator, rectifies, 100-0-100 ammeters, mounting bracket, belt and connecting harness, \$39.50. 120 volt, 60 cycle, 3,000 watt self excited generator, \$79. William Hudson, K2PNR, 179 Steinmetz, Schenectady, N. Y.

LEECE-NEVILLE 6-volt 100-amp system, alternator, rectifier, regulator ammeter harness and mounting bracket \$37.50. Pair pogo-stick walkie-talkies 75 meters with PE 157 power supplies, \$22.50. North-American radio-control 27½ mc transmitter brand new with instruction book and batteries, \$20.00. Transmitting coils B&W 40JVL, 20JEL, 10JVL and 10MCL 75 watts brand new in boxes, \$1.00 each. Outboard 16" plastic hydroplane and outboard electric motor brand new \$4.00. 1-KW 0-150 volt Variac with meter \$15.00. BC728A 2-volt vibrator receiver \$10.00. Elmac A54H \$75.00. W4YBL, Box 85, Pineville, N. C.

WANTED

WANTED: BC-788 400 mc Trans-receiver, I-152 cathode ray indicator, R-101/ARN-6 receiver, AS-313 loop with glass cover, APS-13 Trans-Receiver. Cash or trade. George McCauley, Mineola, New York.

WANTED FOR CASH: Old radio receivers, crystal sets, old wireless parts, catalogs, books. Please write W6MEA, 2341 Ivyland, Arcadia, California.

SELL YOUR back issues of CQ. We will pay 10c each for all issues before March 1954, in good condition. Send them to Circulation Dept., CQ Magazine, 67 West 44th St., New York 36, N. Y.

WORLD TRANSCRIPTIONS with 200 and 300 prefix numbers. Offer \$5 to \$10 for early items. James Orlando, Dickerson Run, Pa.

WANTED: 2 copies of instruction manual for Collins 75A-1 receiver. Pay \$1.00 each. W2MOF, 6-13 Canger Place, Fairlawn, N. J.



W2RID reports...

SUCCESSFUL use of ham station equipment depends on knowledge. Here are books which will make you a more successful ham station operator.

ELECTRONICS TECHNOLOGY SERIES edited by Alex. Schure, Ph.D., Ed.D.

- RC & RL TIME CONSTANT.....Only \$.90
- FM LIMITERS & DETECTORS.....Only \$.90
- FREQUENCY MODULATION.....Only \$.90
- CRYSTAL OSCILLATORS.....Only \$1.25
- A-M DETECTORS.....Only \$1.25
- LIMITERS & CLIPPERS.....Only \$1.25
- MULTIVIBRATORS.....Only \$.90
- R-F TRANSMISSION LINES.....Only \$1.25
- AMPLITUDE MODULATION.....Only \$1.25
- BLOCKING OSCILLATORS.....Only \$1.25

Buy these books now from your jobber, bookstore, or write:
In Canada, all price, 5% higher.

JOHN F. RIDER PUBLISHER, 480 Canal Street, New York 13, N. Y.

2, 6, 10 — Meter MOBILE EQUIPMENT

MOTOROLA, R.C.A., G.E., LINK, etc. 30-50 Mc., 152-172 Mc. Used Commercial F.M. Communications Equipment Bought & Sold. Complete two-way sets meeting F.C.C. Licensing Requirements for taxicabs, Police, Fire, etc. \$169.00 and up.

Motorola F.M. Receivers, Double Conversion \$55.00 each
Motorola F.M. Transmitters 45.00 each

COMMUNICATIONS ASSOCIATES
10 Northampton St., Boston, Massachusetts
Telephone: Highland 5-1385



R.F. CURRENT INDICATOR

A "MUST" for every amateur. Quickly tune your transmitter by indicating relative field strength. Also useful as an audio monitor or output meter. Operates on any frequency, is portable and does not require batteries. At your distributor or order direct.

Amateur Net \$9.85
ALCO ELECTRONICS MFG. CO.
3 Wolcott Ave., Lawrence, Mass.

NEW!



New 15-Watt CW-Fone Transmitter
160, 80, 40, 20, 15, 10 Meters Tuned Osc. Grid-Plate Metering, Xformer coupled plate mod. Includes tubes, meter, cabinet, all parts. 30% dwn. Bal. C.O.D. Plus postage.
MF-2 Kit with instructions.....\$29.95
MF-2W Wired & Tested.....\$37.95
115 V AC P.S. (wired).....\$19.95
6 or 12 V DC Vibrapak (wired).....\$23.95

Additional Information Free

BAND GUARD ELECTRONICS

32219 Rosslyn

Garden City, Mich.

AN/APR-4 TUNING UNITS WANTED

TOP PRICE PAID. Also Frequency Meters TS-173, 174, 175, and 323, and other good quality surplus equipment; General Radio, L&N and other standard laboratory equipment and instruments, Weston meters, etc.; technical manuals.

ENGINEERING ASSOCIATES
424 Patterson Road Dayton 9, Ohio

WANTED: COLLINS 75A1; Central California replies only; W6RLP, 32 Willow Road, Menlo Park, Calif.

\$200.00 OR MORE for Tuning Units TN-54/APR-4 (2,000-4,000 Mc.). Also need parts, etc. Engineering Associates, 434 Patterson Road, Dayton 9, Ohio.

AN/APR-4 tuning units, ARC-3, ARC-1, good surplus and commercial laboratory items wanted. W8KTL, Far Hills Branch, Box 26, Dayton 9, Ohio.

WANTED: TUBES—Boxed and unboxed transmitting, receiving, and special-purpose industrial types such as Klystrons, etc. Will also buy excess test gear, Hickok tube checkers, Variacs, etc. Will pay cash or swap you for choice equipment and tubes. B. N. Gensler, W2LNI, 330 West 11th Street, New York 14, N. Y.

WANT COMMERCIAL PP 4-125A Two Meter Final such as RCA 250 watt FM unit. Box 4798G, CQ, 67 West 44 St., New York 36.

WANTED: SX25 Receiver in excellent condition and working order. Herb Wade, R3, Malta, Ohio.

AIRCRAFT ELECTRONICS Needed: BC-788, I-152, ARN-7, ARC-3, ARC-1—or any type airborne electronics. ELECTRONIC TUBES NEEDED: Broadcast (water and air cooled), transmitting, receiving (in quantity only), Magnetrons, Klystrons, etc. TOP PRICES Paid! Write or phone description for immediate action. Robert Sannet, W6REX, 1524 S. Edris Dr., Los Angeles 35, Cal. Phone: CRestview 1-3856.

WANTED: APR-4 tuning units, ARC-1, ARC-3, ARN-6, ARN-7, BC-788C, JB-70, ART-13, BC-221, BC-312, BC-342, I-152, BC-610-E, Tech manuals. Cash or trade for new Johnson, Hallicrafters, Hammarlund, National, Telrex, Elmac, Gonset, Morrow, Fisher, Kuehne, Harmon-Kardon, etc. Write: Tom, W1AFN, Alltronics, Box 19, Boston 1, Mass. Richmond 2-0048. Stores: 44 Canal, Boston, 60 Spring, Newport, R. I.

HAMFESTS

THE CLEVELAND Area Council of Amateur Radio Clubs will hold an all day basket picnic at Granger Lake Park on Sunday, July 29, 1956. Prizes, games for all, plenty of fun. Bring the kiddies and XYL. Registration 1 P.M. Prize drawings at four PM. Admission \$2.50 per family. Granger Lake is located on Medina County Route #21 between U. S. Route 21 and Ohio Route 94. Contact W8PCJ for additional information.

HAMFESTERS RADIO Club 22nd Annual Picnic, the Liveliest and Friendliest Gathering in the Midwest, August 12, 1956, at Santa Fe Park, near Chicago. See July Hamfest Calendar or write W9IWR for information.

ILLINOIS-HAMFESTERS Radio Club is holding their 22nd Annual Picnic at a new site, on Sunday, August 12, 1956, Santa Fe Park, at 9100 So. Wolf Road. Site can be reached from the East by taking Route 4A (Archer Ave.), to 87th St. in Willow Springs and turn West to the Grove. From the West take Route 66 to 79th St., East to Wolf Road. Kiddie rides, convenient parking right at one of the many tables, modern facilities, and plenty of shade are some of the features of the Park. Radio displays, Prizes, Food and Refreshments. Space to bring your equipment for sale or trade. Events for Kiddies and Grownups at the liveliest and friendliest gathering in the Midwest. Advance Donations \$1.00, \$1.25 at the Gate. Contact W91WR for tickets or information.

SWAP OR SELL

SWAP HIGH quality chinchilla breeding stock for good quality ham gear. What do you have? W0USE, H. S. Clements, Route 3, Box 645, Golden, Colorado.

PHOTO HAMS: Swap or Sell: Rolleicord V, Rolleikin 35, 2 lite strobe, 5x7, complete darkroom and accessories. Want DX-100, 20-A, etc. Also: SW-54 \$25, AT-1 \$20.00, AC-1 \$7, "hum free" fone patch \$10, S-40 \$60, ATD 100w rig, fone, 160 thru 20, 3 pwr supp, TVI'd \$90. W9TGH, 320 Greenwood, Greencastle, Ind.

SALE-TRADE: 6-inerteen filled 2-0-2 (4MFD) Condensers, 10,000 volts D.C. working, \$40 each F.O.B. or trade factory wired central 20A S.S.B. Exciter. . . . W8NFD.

SELL OR SWAP: RME HF 10-20 Converter, New condx, \$45 and Millen R-9NR with 10, 15 and 20M coils, \$15. Need antenna tuner, bridge, recorder or what have you? Jim Beswick, W4YHF, 411 Pine Tree Fr., Smyrna, Ga.

SELL COLLINS 800-cycle mechanical filter for 75A4 \$25.00 or swap with \$10.00 for forthcoming 2.1 kc filter. Do not use CW. W2MZF.

BRAND NEW 10 watt Ship-to-shore phone, 12 volt power supply, \$125.00. ARC-5 transmitters T20, 4-5.3 MC; T21, 5.3-7 MC; with all tubes and crystal. Used \$3.50, new \$4.50. Power supply for TCS 110/220 AC, 60 cycle with cables \$50.00. ATJ television transmitter with all tubes \$7.50. Cash or trade. John Meshna Jr., 580 Lynn St., Malden 48, Mass.

SWAP OR SELL: plug in selectivity, with Collins 3.1 KC mechanical filter exact duplicate of unit pictured on page 19 of March 53, CQ. This unit custom made. I want a variable vacuum condenser rated minimum 7500 V at approximately 10 to 400. P. Powell, Medical & Surgical Clinic. Laredo. Texas.

QSL's

OUTSTANDING QSL samples 25¢. (refunded). Sackers, P.O. Box 218, Holland, Michigan.

QSL's—"Brownie" W3CJI, 3110 Lehigh, Allentown, Pa. Samples, 10¢, with catalogue, 25¢.

QUALITY QSL's. Samples, 10¢. Lee, W5CZA, Box 7171, Oklahoma City, Oklahoma.

QSL-SWL's! Quality cards. Samples 10¢. Malgo Press, Toledo 14, Ohio.

QSL's: IMPRINTED book matches and memo pads, free samples. W2SUN, Bayville, N. J.

QSL's—SAMPLES Free. Bolles, 5531 Burnet Road, Austin, Texas.

QSL-SWL's high quality. Reasonable prices. Samples. Write, Bob Teachout, W1FSV, 204 Adams Street, Rutland, Vermont.

QSLs. SAMPLE, dime. Print Shop, Corwith, Iowa.

SWLs-QSLs—Free samples, send stamp, Del Gaumont, 161 Mechanic, Southbridge, Mass.

QSLs—COLORFUL new designs. Samples free. Rogers, K0AAB, 737 Lincoln Avenue, Saint Paul 5, Minnesota.

MISCELLANEOUS

RECEIVERS REPAIRED and aligned by competent engineers, using factory standard instrument. Hallcrafters, Hammarlund, National, Collins-authorized service station. Our twentieth year. Douglas Instrument Laboratory, 176 Norfolk Avenue, Boston 19, Mass.

LOGIC COMPUTERIZED. Use industry as analog training kit. 10¢ sample, Increment Research, Wanaque, N. J.

INSTRUCTION

INCREASE CODE SPEED. New method. Free particulars. D. H. Rogers, Gough Ave., Ivyland, Pa.

PORT ARTHUR COLLEGE, Port Arthur, Texas. Electronics Courses for FCC licenses. Low tuition, dormitory, own station. Enrollment Monthly.

TAPE RECORDER code courses. Novice courses—3 tapes, \$11.00; other practice tapes various speeds. None other comparable. Send for information. Tapedcode, Box 31, Langhorne, Pa.

BECOME A radio amateur. Free information on how to pass Code and Theory FCC Examination. American Electronics, 1203 G Bryant Avenue, New York 59, N. Y.

HOT OFF THE PRESS! "Tape Recorders & Tape Recording" by Harold D. Weiler, author of "High Fidelity Simplified." 192 fact-filled pages with the answer to every tape recording problem. 13 chapters, over 100 illustrations covering sound, microphone techniques, recording from records, radio & TV editing and splicing, how sound effects are made, adding sound to slides and movies—to mention but a few. Order now for immediate delivery. \$2.95 for paper back edition; \$3.95 for cloth bound deluxe edition. Send check or money order payable to Audio Fair Publishers, 299 Madison Ave., New York 17, N. Y.

A ... Always
B ... Buy
C ... Columbia

THE BEST-EST BUYS IN BATTERIES!

NT-6. Miniature. Wet cell 6 V.
3 amp. Brand new..... \$1.95
6 V. @ 15 AH: Wet cell. 4¼x4¼x6".
Brand new. Special. Only..... \$3.95
WILLARD 25-2: Wet cell. New..... \$2.95
WILLARD 20-2: Brand new. Hot buy!..... \$1.95

NEW! BOXED! COMMAND TRANSMITTERS!

2.1-3 MC.....\$4.95 5.3-7 MC.....\$3.95
4-5.3 MC..... 3.95 7-9 MC..... 5.95

CD-307 EXTENSION CORD FOR HEADSET: **95¢**
6 ft. Brand new. 3 for \$2.75. EACH
CHAMMOIS EAR MUFFS: New. 3 Pr. for \$1.00.
PER PAIR..... 39¢

HEAVY DUTY MAGNET

With keeper. 8x6x2¼". Out of Magnetrons. **\$4.95**
New. Ea.

IT'S TUBE TIME @ COLUMBIA! ALL NEW!

2D21.....\$.99	70L7.....\$.95
6AG5......50	807W..... 1.99
6C4......50	826......50
6J6......50	872A..... 1.50
6V6......50	958A......49

5-IN-1 COMBINATION SAW SET: One full-carved handle, 5 saw blades, plastic bag. **\$1.25**
New. Set.

BRAND NEW! CO-AX CONNECTORS

BARREL TYPE, feed-through, extension connectors. 4 for \$2.89. Each..... **50¢**
INFINITE IMPEDANCE CONNECTORS: 4 for only \$1.49. All brand new. Each..... **39¢**

BRAND NEW CONDENSERS

5 mfd @ 7,500 v.....\$3.95	10 mfd @ 600 v......89
1 mfd @ 5,000 v..... 3.95	10 mfd @ 1,500 v..... 2.99
2 mfd @ 4,000 v..... 4.95	15 mfd @ 1,000 v..... 2.95
4 mfd @ 3,000 v..... 4.95	15 mfd @ 2,000 v..... 4.95

98¢ BRAND NEW TOOLS! 98¢

6, 8, or 10" Adjustable Pipe Wrench..... Ea. 98¢
13-Piece Twist Drill Set..... 98¢
6-Piece Magnetic Screw Driver Set..... 98¢
7-Piece Socket Wrench Set..... 98¢

All orders FOB Los Angeles. 25% deposit required. All items subject to prior sale. MINIMUM ORDER \$3.00. OPEN FRIDAY NITE TILL 10 P.M.

Columbia

ELECTRONICS
2251 W. WASHINGTON BLVD.
LOS ANGELES 18, CALIFORNIA

CONALERT MONITORS CONELRAD



- Fail-Safe
- Meets FCC Requirements
- 5 Channels
- FCDA Approved
- Low Cost
- Effective as of Jan. 2nd, 1957—

**MANDATORY FOR OPERATORS
OF ALL RADIO TRANSMITTERS!**



For complete information write:
ENGINEERING CORP.

2984 Middlefield Road
Palo Alto, California

Crystals

BUY NOW AND SAVE UP TO 90%

NEW LOW PRICES! NEW SAVINGS!
Get the dope!

NOVICE, FT-243
FT-171, FT-241,
FT-249, DC-34/35
SHIP BAND, MISC.

SAME DAY SERVICE!
.....
SATISFACTION GUARANTEED!
.....
OVER 5,000 FREQUENCIES!

SEND FOR FREE CATALOG

"The House of Crystals"
U. S. CRYSTALS, Inc.
1342 S. La Brea Ave. Los Angeles 19, Cal.

Protect your BEAM...

from: • Salt spray
• Weather • Chimney fumes

Easy-to-apply compound, keeps your Beam operating like *Brand New*—for years!

ALSO IDEAL FOR: ♦ Antenna Hardware ♦ Terminal Connections ♦ Rotor Housings ♦ All metal parts

See your nearest Ham Dealer!

with



No. E101 Antenna Coat
Enough to protect one full-size 20 meter beam or several TV antennas.
NET PRICE \$1.94
No. E46 Antenna Coat
Solvent ½ pint can \$.69

Mosley Electronics, Inc.
417 ST. CHARLES ROCK ROAD, ST. LOUIS 14, MISSOURI



PLYTUBULAR BEAMS

THE GREATEST ADVANCE IN ROTARY BEAM DESIGN OF THE PAST 20 YEARS.

See your distributor or write

TENNALAB-QUINCY, ILLINOIS



FOR FULL DETAILS
SEE PAGE 9
JUNE 1956-CQ



TURN COUNT DIAL
Registers Fractions to 99.9 Turns

Groth FOR roller inductances, INDUC-TUNERS, fine tuning gear reducers, vacuum and other multiturn variable condensers. One hole mounting. Handy logging space. Case: 2" x 4". Shaft: ¼" x 3". TC 2 has 2 1/8" dial—1 5/8" knob. TC 3 has 3" dial—2 5/8" knob. Black bakelite.

TC 2 \$4.20—TC 3 \$4.75—Spinner Handle 75c extra
Add 8¢ for Parcel Post

R. W. GROTH MFG. CO.
10009 Franklin Ave. Franklin Pk., Illinois

[from page 107]

things up with me anyway, They're too heavy and cumbersome, and I can't see through them anyway.

One minute I was atop a wave and into the trough on the next, all the time waiting for the crash that would denote the end of the Yasme . . . and me. Still staring ahead . . . yes, there is a light there. It's flashing. I must control myself and count the seconds it stays off or on . . . which way is it, I just can't remember . . . and now I fathom my brain to try to think what the light actually does on the Island. Is it 5 secs on and 10 off, or is it round the other way . . . is it colored or red? My brain was in a turmoil, but the light was there. Somehow the flashes weren't regular . . . some were 5 seconds long . . . others 15; then I tumbled to it, it was Mr. Laxton with his car on the Eastern tip of the Island, and I was right on course. Canton Island was exactly where it was put on the chart.

In no time at all I shot into the cabin and was screaming incoherently to Howie that I had sighted the car lights. I acknowledged Mr. Laxton's lights with a series of flashes from my mast head light and then told Howie that I should be in within the next two hours.

Now, I didn't care about using gas, and, with the engine going flat out, and all canvas pulling we went along like a train. The dull light from the watery moon permitted me to see the reef infested shores. It was as well I had stuck on the engine for as soon as I got in the lee of the Island I could feel a terrific current pulling me into the shore. The wind swung around and there was quite a tussle resetting the sails for the new direction of the wind. I managed to keep well clear of all dangers, even though it was a tough job to keep well clear of those wicked looking reefs.

Shortly after sighting the car lights the aircraft beacon popped up to keep me company, so there were plenty of lights then to guide me in.

Out of the distance two tiny navigation lights materialized, and slowly the faint outline of a tiny launch came toward me. As promised, Mr. Laxton, Howie and the Island Manager, Mr. Zvolanek and a fine Gilbertese crew were aboard to greet me. Everyone clambored aboard while I was still under way, leaving one man on the launch to guide me in. In no time at all my sails had been stowed and the anchor made ready, with everyone talking at once. Soon the anchor was deeply embedded in Canton Island coral.

What a greeting to have from complete strangers! It was only after everything had quieted down that I realized the great strain I had undergone in those previous few hours. All I wanted to do was to collapse and sleep. So ended another little trip and another little episode in my life.

It was impossible for me to enter the pass

into the lagoon owing to the 14 knot tidal stream surging through, so we lay there until 7:30 a.m. and then, with the aid of everyone, the anchor was hauled in . . . I should say the anchor chain, the anchor is still in the bottom of the ocean somewhere around there . . . the shackle snapped with the great strain that was put on it at the time. That was the second we had lost in the voyage from home.

Soon we were chugging through the pass straight into the lagoon. With all hands on the lines we soon had the Yasme moored snug and safe alongside the little dock there.

Epilogue

Now, before I complete this little episode let me tell any of you lads and lassies that have the good fortune to contact Howie KB6BA that he is one of the finest fellers I have ever had the good fortune to be associated with. His assistance in getting all my radio gear ashore and set up in his own shack made it possible for me to be on the air with a VR1 license within 24 hours after my arrival on Canton Island. As you can realize, he cannot work his own rig while I am on the air, and that means that during my stay here he will just have to sit back and watch me operate. We are both in the same shack . . . he operating KB6 and I, VR1 . . . rather unique. One evening we both went on the air and as he finished a contact he just passed the chap over to me. . . . I am willing to bet it's the first time in history that those particular hams worked two rare stations all in one go. I expect that W2FSN/2, W8BHW, K6KJQ and W4ZH are feeling quite pleased with themselves over this rare contact. We did not continue with this owing to the time factor, but it was fun while it lasted.

Now, we come to the cream of the whole thing. When I arrived the first thing I saw on the shack table was one of the nicest presents I have seen for many moons . . . A Collins 75A-4 receiver. This had been presented to the Yasme expedition by Art Collins, WØCXX. Many of you lads can thank Art for this as without it I should never have managed to pick you out of the QRM.

I think you will all agree that it was a wonderful gesture. I sincerely hope that with its aid I can do a better job than ever and give many of you a new country. . . . Thank you, Art.

Well fellow Hams and Hammesses, thank you all for your support of this expedition. I have appreciated your good manners over the air, and if things continue this way, there is no reason at all why most of the interested ones shouldn't make QSO with me.

Now, the time has come when I must return to the rig so, until we meet again at the next rare spot . . . 73's, all the best for the future DX.

Danny . . . VR1B . . . at Canton Island, South Pacific Ocean.

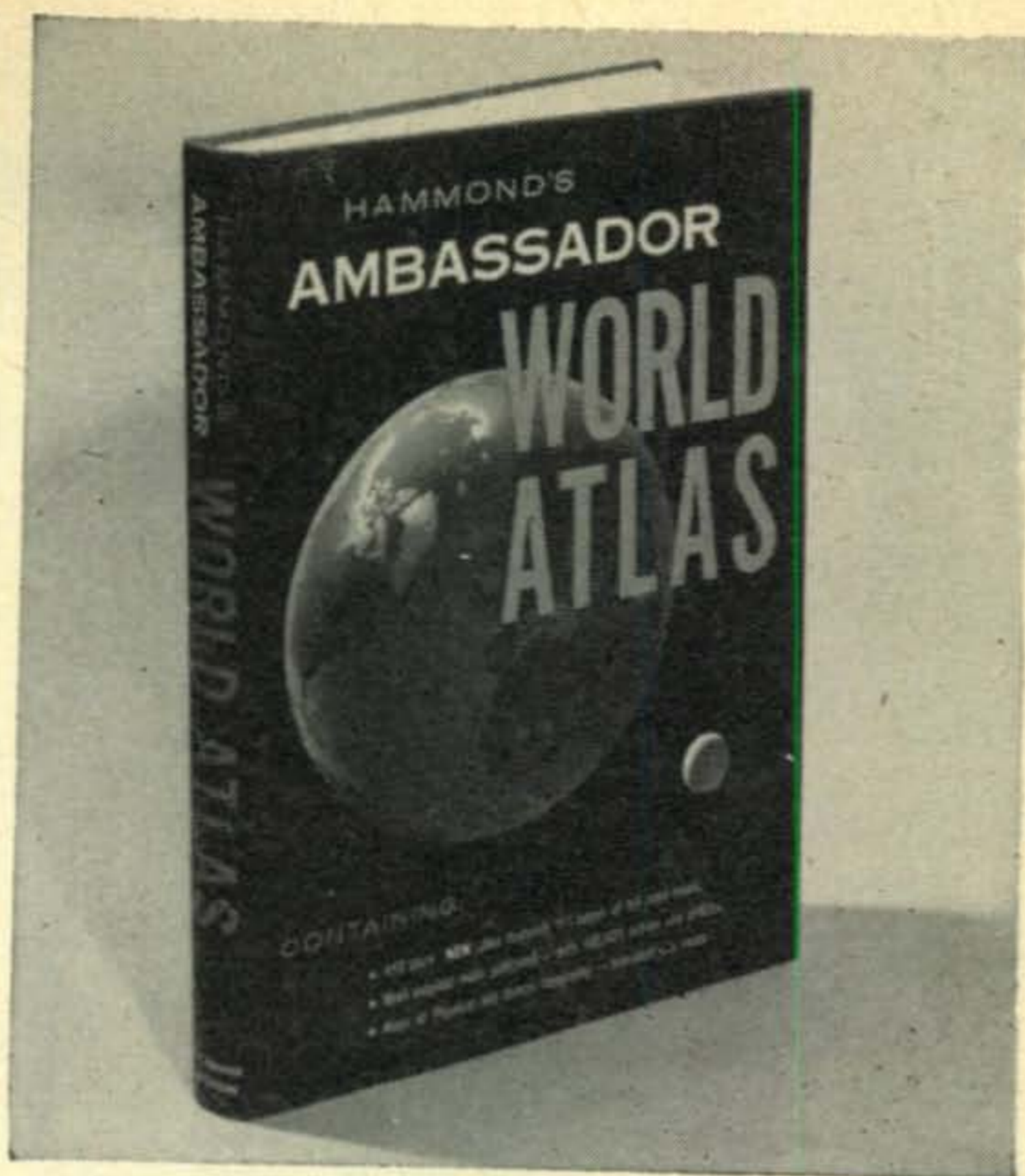

Special Offer

Beautiful full-color maps in great profusion. Important, detailed information, which correctly memorized, will put you one up on even the most eminent geographers. Only \$12.50, wow! Year's subscription to CQ included.

CQ Magazine
67 W. 44 St.,
New York 36, N. Y.

CQ-7

Gentlemen:

Please send me (postpaid) the New Ambassador World Atlas plus a one year new
 extension subscription to CQ. I enclose
 check money order for \$12.50.

(name)

(call)

(street address)

(city)

(zone)

(state)

N.Y.C. residents add 3% sales tax

AMATEUR CRYSTAL Headquarters

CRYSTAL HOLDER DATA

FT-243 and FT-241-A holders have 1/2" pin spacing (2 of either of these crystals will plug into any standard octal tube socket). DC-34 holders have 3/4" pin spacing—sockets available when ordered with crystals, each at **25¢**

NOVICEBAND

80 meters within 1 kc of specified frequency—3701 to 3749 kc in DC-34 or FT-243 holders—(specify holder wanted) **79¢**

40 METERS

From 7152 to 7198 kc within 1 kc of specified frequency in FT-243 holders only **79¢**

2-6-10-15-20-40-80 Meter Ham Bands in DC-34 or FT-243 holders (specify holder wanted) **79¢**

STOCK CRYSTALS

Send postcard for free list of frequencies. FT-241, DC-34, FT-243, FT-171, each **50¢**

SPECIAL CRYSTALS

Crystals ground and etched to exact frequency, using electronic counter, in FT-243 holders with 1/2" pin spacing. From 3000 kc to 9000 kc.

.05% tolerance \$1.35 ea. .01% tolerance \$1.50 ea.
.005% tolerance \$2.50 ea.

Crystals ground and etched to exact frequencies in DC-34 holders with 3/4" pin spacing. From 1691 kc to 4600 kc.

.05% tolerance \$1.35 ea. .01% tolerance \$1.50 ea.
.005% tolerance \$2.50 ea.

STOCK CRYSTALS

In FT-243 holders—5675 kc to 8650 kc in 25 kc steps each, **50¢**

FT-241 LATTICE CRYSTALS

In all frequencies from 370 kc to 540 kc—**50c**
500 kc Crystals—**\$1.00** 455 kc Crystals—**\$1.00**

Texas Crystals

The Biggest Buy in the U.S.

8538 W. GRAND AVENUE · RIVER GROVE, ILL.
ALL PHONES—GLASTONE 3-3555

Terms: All items subject to prior sale and change of price without notice. All crystal orders MUST be accompanied by check, cash or M.O. WITH PAYMENT IN FULL. NO C.O.D.s. Postpaid shipments made in U.S. and possessions only. Add 5¢ per crystal for postage and handling charge

CQ Ad Index

Alco Electronics Mfg. Co.	124
Allied Radio Corp.	106
Alltronics	120
American Electronics Service	108
Arrow Sales, Inc.	104
Band Guard Electronics	124
Barker & Williamson	9, 93
Barry Electronics Corp.	122
Basset, Rex, Inc.	105
CQ Handbooks	109
CQ Subscriptions	117
CQ World Atlas	127
CQ World Globe	115
Cleveland Institute of Radio Electronics	8
Collins Radio Company	Cover 2
Columbia Electronics Sales	125
Communications Associates	124
Crystals, Inc.	121
Davis Electronics	14
Dossett, M. H. Co.	118
Dow-Key Company	110
E-Z Way Towers, Inc.	113
Eitel-McCullough, Inc.	11, 100
Electro-Voice, Inc.	19
Engineering Associates	124
Freed Transformer Co., Inc.	110
General Electric Company	1
Glas-Line Company	114
Glass, J. J. Co.	116
Gonset Company	97
Gotham Hobby Corp.	13
Greenlee Tool Co.	112
Groth, R. W. Mfg. Co.	126
Hallicrafters Company	7
Hammarlund Mfg. Co., Inc.	20
Harvey Radio Company, Inc.	112
Heath Company	4, 5, 12
Hughes Research & Dev. Labs.	101
Illumitronic Engineering	106
Instructograph Company	118
International Crystal Mfg. Co.	99
Johnson, E. F. Co.	16, 17
Kaar Engineering Corp.	125
LMB Box Chassis	116
Lakeshore Industries	111
Lynch, J. Electronic Co.	120
Millen, James Mfg. Co., Inc.	6
Morrow Radio Mfg. Co.	15
Mosley Electronics	18, 126
National Company, Inc.	Cover 3
P & H Electronics	108
Palco	105
Petersen Radio Company, Inc.	2
Philco	107
Pierson-Holt Electronics Co.	117
RCA Tubes	Cover 4
Radio Publications, Inc.	119
Remington Rand Univac	103
Rex Radio Supply Co.	118
Rider, John F., Publisher	121, 124
Rohn Manufacturing Co.	114
Sun Parts Distributors, Ltd.	113
Technical Material Corp.	95
Tennalab	126
Tensor Electric Development Co.	120
Texas Crystals	128
Triad Transformer Corp.	98
Truart Products Co.	120
U. S. Crystals	126
United Catalog Publishers	111
Valparaiso Technical Institute	120
Western Gear Corporation	112
World Radio Laboratories, Inc.	116

a progress
report . . .

ACHIEVEMENTS IN ELECTRONICS *by* National 1955-1956

For 42 years, National Company has enjoyed an outstanding reputation as a leading manufacturer of communications receivers and components. Less widely known to hams, but equally important, are National's endeavors in other fields. These add up to an impressive total of achievement in vital areas of national defense, scientific research, advanced communications, and standardization of time and frequency measurement. The following paragraphs outline briefly some of the major contributions National Company has made in these fields.

A New Standard of Measurement of Frequency and Time



ATOMICHRON . . . the first commercially feasible atomic primary frequency standard . . . is typical of the advanced research and engineering that typifies National Company these days. Because it is a full order of magnitude more precise and stable than any primary frequency standard now available, the National ATOMICHRON opens new horizons of accuracy for navigation, crystal calibration, frequency monitoring and control, and elapsed time measurement. For example, its use in communications can effect a substantial increase in the number of channels available in the now-crowded radio spectrum.

Advancing Scientific Knowledge

One of National's recent achievements was having its HRO-60 communications receiver selected to accompany Ohio State University's scientific expedition to Viet Nam for observation of a total solar eclipse. Eleven HRO-60's were used in a communications net extending from Khartoum to Formosa, and an HRO-60 served as the monitor receiver to insure satisfactory recording of time signals from WWV, some 10,000 miles away!



Amateur Communications



National's NC-300 communications receiver has been the talk of the hams since before its introduction in 1955 . . . and no wonder! It is designed specifically to serve only

the amateur bands. It is the first receiver ever designed after a search for "dream receiver" design suggestions from hams. And it sells for an amazingly low price, in spite of all its extra-value features.

Perhaps you'd like more information about events at National Company that insure continued progress in the design and construction of superior quality electronic equipment. If so, simply write for a copy of the informative 8-page brochure, "Take a Look at the New National Company." Ask for Bulletin CQ-7.



Advances in Specialized UHF Communications

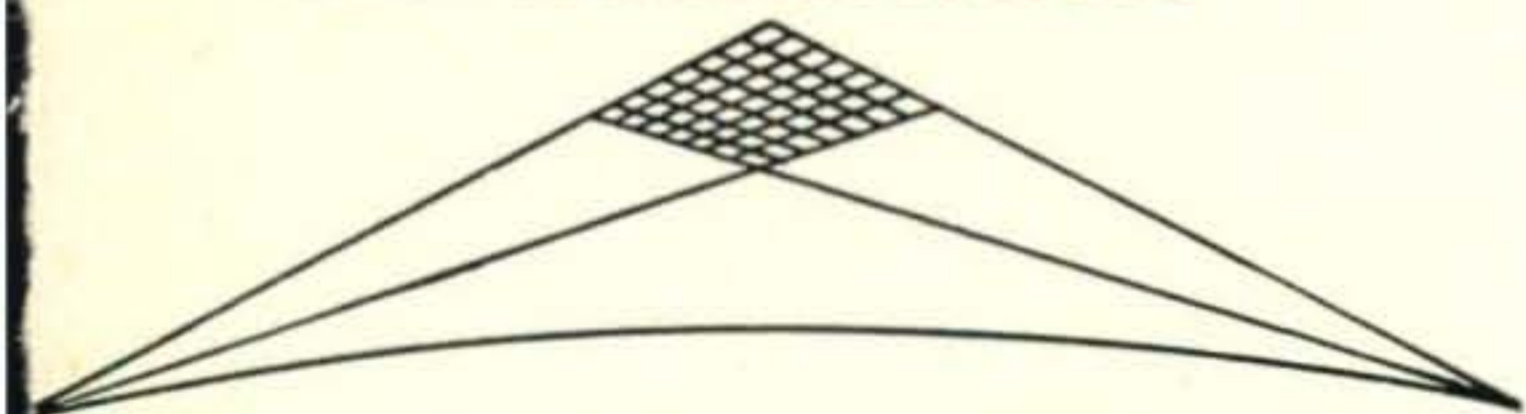

National TRANS-HORIZON "scatter" propagation systems are now in active use in installations including the nation's first "Texas Tower" offshore radar station. National Company provides both Tropospheric and Ionospheric TRANS-HORIZON systems, the former effective on all types of signals at distances up to 400 miles, and the latter for pulse signals for transmission over 500-mile distances.

Electronics for Defense

National Company is also active in both development and manufacture of a variety of electronics devices for National Defense use. Typical products include a low-powered portable radar system for Semi-Military use; an exceptionally stable "Stabilidyne" receiver of revolutionary design; automatic alarm systems for radar receivers; radar search receivers; and digital data transmission equipment.

National

COMPANY, INC. 61 SHERMAN STREET, MALDEN 48, MASS.

 *tuned to tomorrow*

Leading Amateur Designs

...USE RCA TUBES



RCA-6146—Up to 90 watts ICAS input on CW: 67.5 watts on 'phone. Full input to 60 Mc. Reduced input up to 175 Mc (for example, an RCA-6146 handles 48 watts input on 2-meter 'phone).

RCA-6146 in the "final" of the Heathkit DX-35. Transmitter rating: 65 watts input, CW—50 watts, 'phone.

You are looking in on the "business end" of the DX-35—Heathkit's new bandswitching transmitter for cw and 'phone. A single beam-power RCA-6146 does the job—and *what a potent signal this tube delivers!*

Here are a few practical reasons why RCA high-perveance power tubes like the RCA-6146 are preferred by amateur and commercial designers; (1) RCA tubes give you the power you want at reasonable plate voltages. (2) They have a great reserve of emission. (3) RCA power tube designs are time-proved; *RCA tubes are conservatively rated to give economical, dependable performance.*

Whether you are planning new gear—or "re-tubing" your present rig for improved overall performance—use RCA tubes for maximum satisfaction. Your RCA Tube Distributor handles the complete line. For a technical bulletin on the 6146, write RCA, Commercial Engineering, Section G15M, Harrison, N.J.

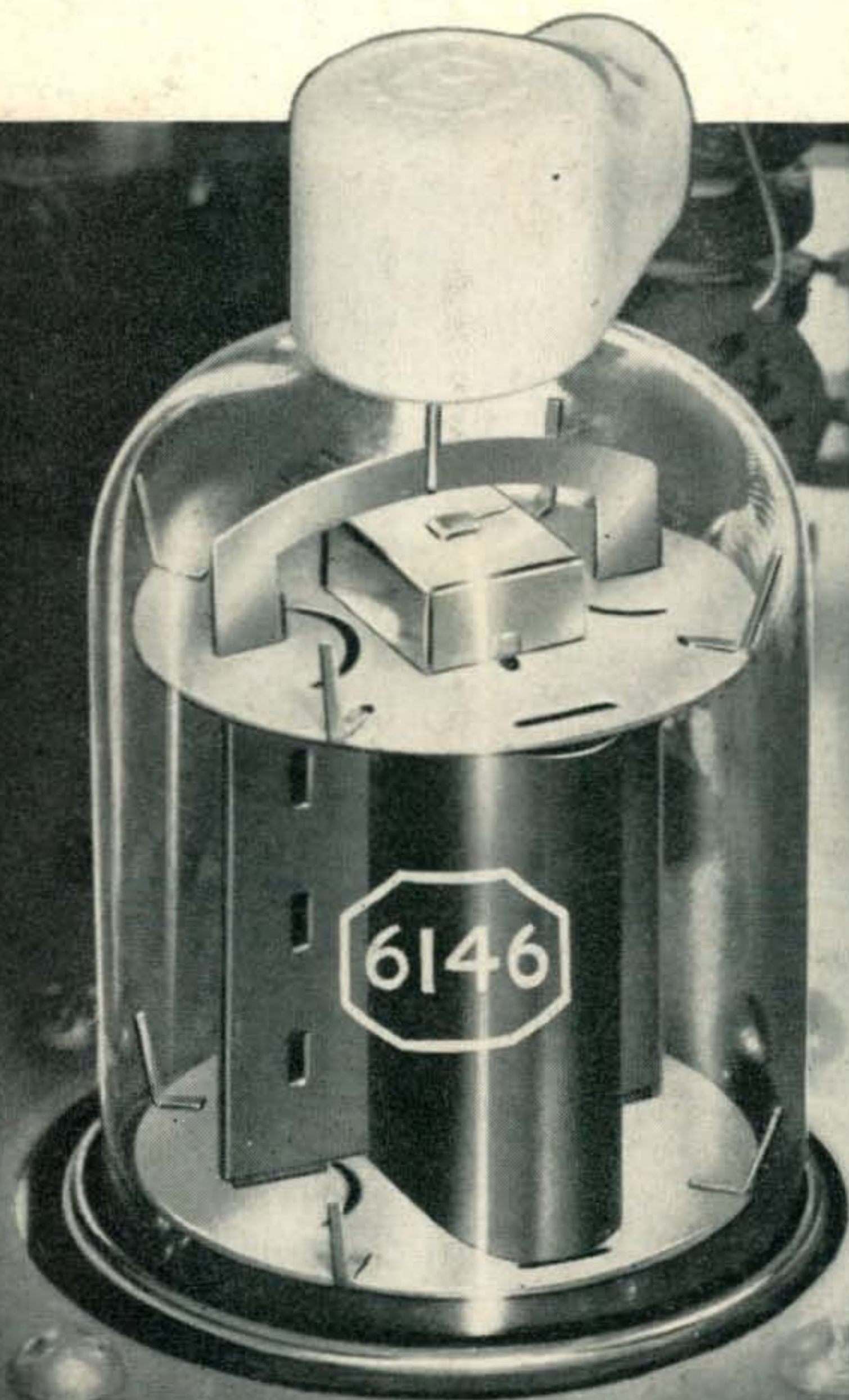

TUBES FOR AMATEURS

RADIO CORPORATION OF AMERICA • HARRISON, N. J.