

CQ

1958

ANNUAL

the radio amateurs' journal •

November

\$1



HERE'S FACT—NOT THEORY

why the "Pacemaker-Thunderbolt" team is your best HIGH POWER LINEAR BUY!

The "Pacemaker-Thunderbolt" power team will deliver:

1. More power output to a wider range of antenna systems than any other exciter and high power linear amplifier combination!
2. . . . and it will deliver this power-packed signal at less dollars per watt than any other exciter and high power linear amplifier combination!

Provides superb performance and many unique operating and engineering features!

VIKING "PACEMAKER" TRANSMITTER/EXCITER

An outstanding power bargain when used as a transmitter or exciter! 90 watts SSB P.E.P. and CW input . . . 35 watts AM. Unique circuitry uses only 1 mixer for improved spurious signal rejection greater than 50 db. Balanced range audio. Highly stable built-in VFO gives complete coverage of bands without crystal switching or re-tuning. Instant bandswitching 80, 40, 20, 15 and 10 meters. VOX and anti-trip circuits. Wide range pi-network output. Effectively TVI suppressed. With tubes and crystals.

Cat. No. 240-301-2 . . . Wired Amateur Net \$495.00

VIKING "THUNDERBOLT" AMPLIFIER

Rated at 2000 watts P.E.P. input SSB; 1000 watts CW; 800 watts AM linear! Continuous coverage 3.5 to 30 mcs. —instant bandswitching. May be driven by the Viking "Ranger", "Pacemaker" or other unit of comparable output. Drive requirements: approx. 10 watts Class AB₂ linear, 20 watts Class C continuous wave. Employs two 4-400A tetrodes in parallel, bridge neutralized—wide range pi-network output. With tubes.

Cat. No. 240-353-1 . . . Kit Amateur Net \$524.50
240-353-2 . . . Wired \$589.50

Unit	Power input in watts		Cost in dollars per watt	
	SSB † (P.E.P.)	CW	SSB (P.E.P.)	CW
Viking "Pacemaker-Thunderbolt"	2000	1000	\$.54	\$1.08
Brand "I"	1000	1000	2.09	2.09
Brand "II"	2000*	1000	.74	1.47
Brand "III"	1250	1000	1.23	1.54

*Manufacturer does not publish rating; however, 2000 watts P.E.P. input represents maximum legal limit under average operating conditions.

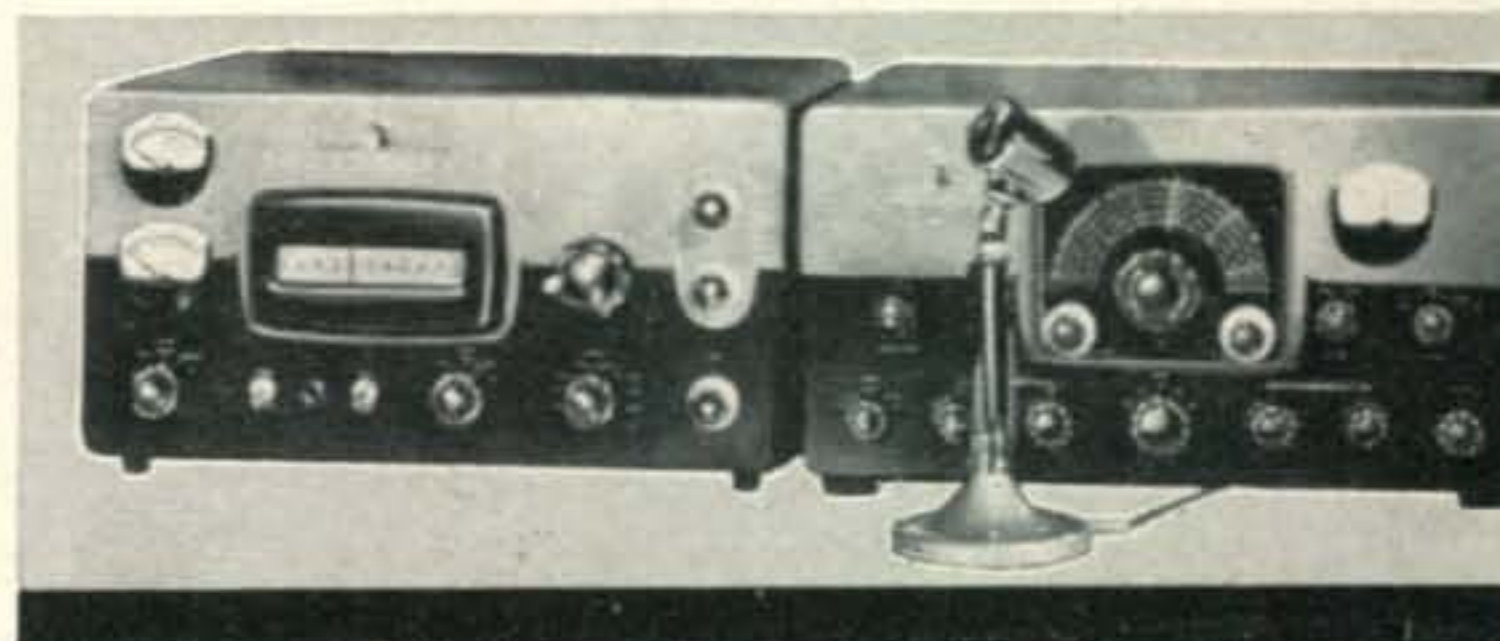

For the strongest signal on the band!



Unequaled 100% broadcast-type high level amplitude modulation!
Full 2000 watts SSB input—1000 watts CW and AM!

VIKING "KILOWATT"

Brilliantly designed, and engineered specifically for high power operation, the Viking "Kilowatt" is the *only* power amplifier available which will deliver a signal with the authority of maximum legal power in all modes!

Class C final amplifier operation provides plate circuit efficiencies in excess of 70%. Final amplifier utilizes two 4-400A tetrodes in parallel, bridge neutralized — wide range pi-network output. Continuous coverage 3.5 to 30 megacycles.

For unsurpassed enjoyment with every contact an unforgettable experience . . . step up to the very finest . . . the thrilling Viking "Kilowatt"!

Cat. No. 240-1000 . . .

Wired and tested with tubes Amateur Net \$1595.00

Matching accessory desk top, back and three drawer pedestal.

Cat. No. 251-101-1 FOB Corry, Pa. \$132.00

†The F.C.C. permits a maximum of one kilowatt average power input for the amateur service. In SSB operation under normal conditions this results in peak envelope power inputs of 2000 watts or more depending upon individual voice characteristics.

For easy terms
see your
Johnson Distributor



E.F. Johnson Company

2940 SECOND AVENUE S.W. • WASECA, MINNESOTA

For further information, check number 1 on page 194.

There's a PR for every Service!

AMATEUR



40, 80 and 160 Meters, PR Type Z-2

Rugged. Low drift, fundamental oscillators. High activity and power output. Stands up under maximum crystal currents. Stable, long-lasting, permanently sealed; ± 500 cycles.....\$2.95 Net

20 Meters, PR Type Z-3

Third overtone oscillator. Low drift. High activity. Can be keyed in most circuits. Fine for doubling to 10 and 11 meters or "straight through" 20 meter operation; ± 500 cycles.....\$3.95 Net



24 to 27 Mc., PR Type Z-9A

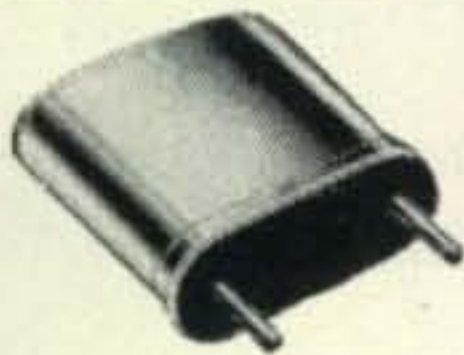

Third overtone; multiplies into either 2-meter or 6-meter band; hermetically sealed; calibrated 24 to 27 mc., ± 3 kc.; .050" pins.

\$4.95 Net

50 to 54 Mc., PR Type Z-9A

Third overtone; for operating directly in 6-meter band; hermetically sealed; calibrated 50 to 54 mc., ± 15 kc.; .050" pins.

\$6.95 Net



SPECIAL TYPES

Commercial Crystals available from 100 Kc. to 70 Mc. Prices on request.

Type Z-1, AIRCRAFT

3023.5 Kc., .005%.....\$3.45 Net

Type Z-1, MARS and CAP

Official assigned transmitter frequencies in the range.

Calibrated to .005%. 1600 to 10000 Kc. \$3.45 Net

Type Z-6A

FREQUENCY STANDARD

To determine band-edge. To keep the VFO and receiver properly calibrated.

100 Kc. \$6.95 Net



PR PRINTED OSCILLATOR KIT

Has many uses—

- As 100 Kc. Marker
- As 1000 Kc. Marker for Check Points up to 54 Mc.
- As Foundation Circuit for Low Frequency SSB Crystals

Assembled in minutes. Kit contains everything but 6BA6 oscillator tube and crystal.

Each \$4.50 Net



Type 2XP

Suitable for converters, experimental, etc. Same holder dimensions as Type Z-2.

1600 to 12000 Kc. (Fund.) ± 5 Kc. . . . \$3.45 Net

12001 to 25000 Kc. (3d Mode) ± 10 Kc. . . . \$4.45 Net

VHF Type Z-9R, Aircraft



For Lear, Narco and similar equipment operating in the 121 Mc. region, requiring crystals in 30 Mc. range.

Each \$4.95 Net

Type Z-9A RADIO CONTROLLED OBJECTS

27.255 Mc., .005% . . \$4.25 Net



Type Z-1 TV Marker Crystals

Channels 2 through 13 \$6.45 Net

3100 Kc. . . . \$2.95 Net

4100 Kc. . . . \$2.95 Net

4.5 Mc. Intercarrier, .01% 2.95 Net

5.0 Mc. Sig. Generator, .01% 2.95 Net

10.7 Mc. FM, IF, .01% 2.95 Net

ALL PR CRYSTALS ARE UNCONDITIONALLY GUARANTEED. ORDER FROM YOUR JOBBER.

PETERSEN RADIO COMPANY, INC.

2800 W. BROADWAY • COUNCIL BLUFFS, IOWA

EXPORT SALES: Royal National Corporation, 250 W. 57th Street, New York 19, N. Y., U. S. A.

For further information, check number 3 on page 194.

Designed for



Application



90672

The No. 90672 ANTENNA BRIDGE

The Millen 90672 Antenna Bridge is an accurate and sensitive bridge for measuring impedances in the range of 5 to 500 ohms at radio frequencies up to 200 mc. It is entirely different in basic design from previous devices offered for this type service inasmuch as it employs no variable resistors of any sort. The variable element is an especially designed differential variable capacitor capable of high accuracy and permanency of calibration over a wide range of frequencies. A grid dip meter such as the Millen 90651 may be used as the source of RF signal. The bridge may be used to measure antenna radiation resistance, antenna resonance, transmission line impedance, standing wave ratio, receiver input impedance and many other radio frequency impedances. By means of the antenna bridge, an antenna matching unit may be adjusted so as to provide the minimum standing wave ratio on the radiation system at all frequencies.

**JAMES MILLEN
MFG. CO., INC.**

MAIN OFFICE AND FACTORY
**MALDEN
MASSACHUSETTS**



Wayne Green, W2NSD *editor*

department editors

Tom Aalund, K2VBI *overseas publications*
Bob Adams, W3SW *sideband*
Frank Anzalone, WIWY *contest calendar*
Don Chesser, W4KVX *dx*
Ken Grayson, W2HDM *surplus*
Sam Harris, W1FZJ *vhf*
George Jacobs, W3ASK *propagation*
Byron Kretzman, W2JTP *rtty*
Marvin Lipton, VE3DQX *club bulletins*
Louisa Sando, W5RZJ *yl*
Charles Schauers, W6QLV *ham clinic*
Don Stoner, W6TNS *novice &
semiconductors*

contributing editors

E. L. Klein, W4UHN *printed circuits*
Norman McLaughlin, W3LNT *grounded grids*

CQ, the Radio Amateurs' Journal is published for active hams by active hams. Not affiliated with any clubs or other political groups, CQ endeavors to be a true and honest reporter for those interested in the hobby. Suggestions for improvement are welcomed.

Authors would do well to send for the CQ Style sheet which will explain our confused system of abbreviations and symbols. The article "Author Author" (October 1952 CQ) tells all about how to write articles for CQ, how much we pay, etc. Reprints of this article are available from CQ if you have been improvident in keeping up your radio library.

CQ CERTIFICATES:

The WPX Award is granted for two-way contact with certain number of amateurs in different prefixes of the world. Full details are contained in the WPX Record Book which is available for 15c from CQ. Application forms are free.

The WAZ Award is granted for contacting all of the amateur zones of the world. Current standings of amateurs working for this award will be found in the DX column. A DX Zone map of the world is available free from CQ. Send stamped envelope.

TECHNICAL INFORMATION:

Please check the 11-year cumulative index which was published in the January 1956 CQ for information about articles in past issues of CQ. The December 1956 and 1957 CQ yearly indexes will bring you up to date. Most back issues are available at \$1 from us. Check our "Back Issue" ad for details on those not available. Reprints of the Cumulative Index are available free. For further information see the Ham Clinic column.

DISCLAIMER:

The authors and editors do the best they can to make everything as correct as possible in the articles. If for any reason any of them should happen to goof we hasten to point out that everything is experimental and we guarantee nothing.

<For further information, check number 4 on page 194.

CQ—The Radio Amateur's Journal

November, 1958

vol. 14 no. 11

300 West 43rd Street, New York 36, N. Y.

QRG? Where Am I?	K6EAW	32	Next Step—Space Portable	VE3ANY	71
Amateur Satellite Recording	Dearborn	33	Self-Monitoring Made Easy	W2WLR	73
The Birdcage	W6PQW	34	The Parametric Amplifier	W1FZJ	74
Anodized Heat Sinks	W5IXV	36	Report on the Hammarlund HQ-170	W4WQT	76
Improving the Regenerative Superhet	W5DF	38	CQ Tests the Heliwhip	TYM	80
The Wandering Sideband	W4RQR	40	They Melt	WØEXC, KNØLJO	81
Positive, Screen-Grid Protection	W5EHC	45	Recording of Earth Satellites	W5LFM	82
Mobile Madness	W9SKF	46	Mixer Trimmers	KNØLJO, WØEXC	83
Plastic Covers	W8FAZ	47	10 Tube Super	WØEXC, KNØLJO	84
Variable Modulation for Heath SG-8	Ives	48	4CX1000A Linear Amplifier	W6HHN	92
Automation	K2HCB	50	Allband Attic Antenna	W4NJF	96
One Of These Days	W2YRW	51	One Tube Walkie-Talkie	W8WLM	98
Simplified, Screen-Grid Modulation	W7EPM/6	52	Three Band Interlaced Beams	W4RQR	102
Another Set of Rules	K6DXW	53	500 Volt Mobile Power Supply	W3LMC	104
Ye Old Timer Quiz	Rockaway Valley R. C.	54	"AC" Coil for HRO-50T1	VE6WT	128
The Complete Remote Control	WØDKC/2	56	Don't Let These Fool You	W2EEJ	140

DEPARTMENTS

de W2NSD	9	Letters to the Editor	31	Surplus Conversions	114
Scratchi	16	Oops, We Goofed	105	DX	116
Club Bulletins	18	Mars Bulletins	106	YL	131
Overseas Echoes	22	Contest Calendar	107	Propagation	134
New Amateur		SB	108	VHF	136
Equipment	28, 129, 141	RTTY	110	Novice	next month
		Ham Clinic	112	Semiconductors	next month

Special Feature: Distributor Listing 119

Branch Advertising Offices:

Ted E. Schell, 2700 West 3rd Street, Los Angeles 57, Calif. DUmkirk 2-4889.

Charles W. Hoefler, 1664 Emerson Street, Palo Alto, Calif. DAvenport 4-2661.

publisher S. R. Cowan
production manager Bill Gardner, Jr.
circulation manager Harold Weisner
editorial production David Fish
advertising representative Jack Schneider
advertising representative Dick Cowan
classified advertising Kate Gerace

CQ—(title registered U.S. Post Office) is published monthly by Cowan Publishing Corporation. Executive and editorial offices at 300 West 43rd Street, New York 36, N. Y. Telephone JUDson 2-4460. Second Class Postage paid at New York, N. Y.

SUBSCRIPTION RATES: U.S.A. and Possessions, APO, FPO, Canada and Mexico: one year \$5.00; two years \$9.00; three years \$13.00. Pan-American and foreign: one year \$6.00; two years \$11.00; three years \$16.00.

FOREIGN SUBSCRIPTIONS: Great Britain: RSGB, New Ruskin House, Little Russell St; London WC 1, England. Australia: Technical Book Co., 297 Swanston St., Melbourne C 1, Victoria, Australia.

Printed in U.S.A. Entire contents copyright 1958 by Cowan Publishing Corporation. CQ does not assume responsibility for unsolicited manuscripts.

Postmaster: Send Form 3579 to CQ, 300 West 43rd Street, New York, N. Y.

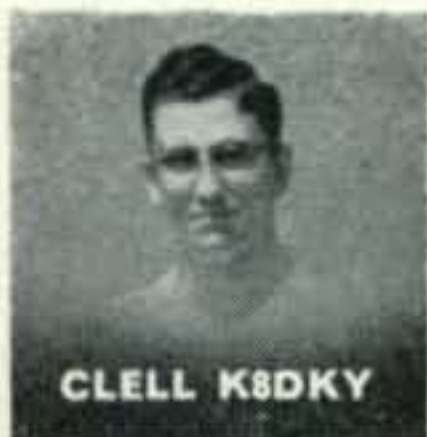

CLELL K8DKY



DAR K8ADS



DICK K9BMJ/8



DOUG K8GNA



AL W8HTX



REX K8GND



FRED K8GMV



ERNIE W8VPM

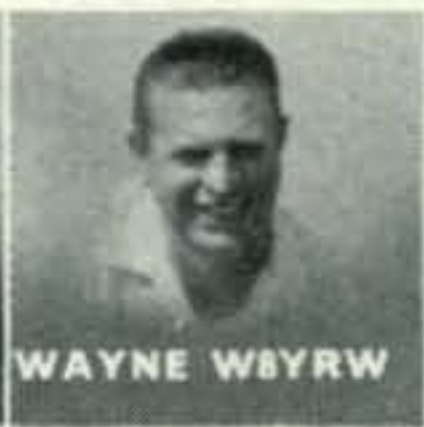

WAYNE W8YRW



FRANK W8WUN



AL K8BLL

All of these licensed radio amateurs make important contributions to the Heath line of fine ham kits. In a sense, they are your personal representatives within the company, because their design ideas and performance preferences reflect not only their own "on-the-air" experiences, but those of the amateur fraternity with which they are in constant contact. With this kind of representation in Benton Harbor, you can continue to rely on high-performance Heathkit amateur radio equipment designed by hams, for hams!

HEATH *hams work to bring you*



CHUCK K8CJI



ROGER MACE (W8MWZ)
SENIOR HAM ENGINEER
HEATH COMPANY

HEATHKIT 50-WATT CW TRANSMITTER KIT

MODEL DX-20

\$35⁹⁵.



If high efficiency at low cost in a CW transmitter interests you, you should be using a DX-20! It employs a single 6DQ6A tube in the final Amplifier stage for plate power input of 50 watts. The oscillator stage is a 6CL6, and the rectifier is a 5U4GB. Single-knob band-switching is featured to cover 80, 40, 20, 15, 11 and 10 meters, and a pi network output circuit matches antenna impedances between 50 and 1000 ohms to reduce harmonic output. Designed for the novice as well as the advanced class CW operator. The transmitter is actually fun to build, even for a beginner, with complete step-by-step instructions and pictorial diagrams. All the parts are top-quality and well rated for their application. "Potted" transformers, copper-plated chassis, and ceramic switch insulation are typical. Mechanical and electrical construction is such that TVI problems are minimized. If you desire a good clean CW signal, this is the transmitter for you! Shpg. Wt. 19 lbs.

HEATHKIT "APACHE" HAM TRANSMITTER KIT

- Newly Designed VFO—Provision For S.S.B. Adapter
- Modern Styling—Rotating Slide Rule Dial

MODEL
TX-1

\$229⁵⁰

Shipped motor freight unless otherwise specified. \$50.00 deposit required on C.O.D. orders.

Fresh out of the Heath Company laboratories, the brand-new "Apache" model TX-1 Ham Transmitter features modern styling and is designed as a handsome companion to the also-new Heathkit "Mohawk" receiver. The "Apache" is a high quality transmitter operating with 150 watt phone input and 180 watt CW input. In addition to CW and phone operation, the "Apache" features built-in switch selected circuitry providing for single-sideband transmission through the use of a plug-in external single-sideband adapter. These Heathkit adapters will be available in the near future. A compact, stable and completely redesigned VFO provides low drift frequency control necessary for single-sideband transmission. An easy-to-read slide rule type illuminated rotating VFO dial with vernier tuning provides ample bandspread and precise frequency setting. Simple band-switching control allows flip-of-the-wrist selection of the amateur bands on 80, 40, 20, 15 and 10 meters (11 M with crystal control). The "Apache" features adjustable low level speech clipping and a low distortion modulator stage employing two of the new 6CA7/EL-34 tubes in push-pull class AB operation. Time sequence keying is provided for "chirpless" break-in CW operation.



The final amplifier is completely enclosed in a perforated aluminum shielding for greater TVI protection and transmitter stability. Cabinet comes completely preassembled with top hatch for convenient access without taking chassis out of cabinet. Die-cast aluminum knobs and front panel escutcheons add to the attractive styling of the transmitter. Pi network output coupling matches antenna impedances between 50 and 72 ohms. Incorporates all the refinements necessary with many "plus" features for effective and dependable communications. Shpg. Wt. 115 lbs.

...top quality at lowest prices!

HEATHKIT "MOHAWK" HAM RECEIVER KIT

- All Critical Circuits Prewired and Aligned
- Crystal Controlled Oscillators for Drift-Free Reception

MODEL
RX-1

\$274⁹⁵

Shipped motor freight unless otherwise specified. \$50.00 deposit required on C.O.D. orders.

Outstanding results can be expected with the new "Mohawk" receiver which is designed to combine all the necessary functions required in a high quality communications receiver. A perfect companion for the Heathkit "Apache" transmitter, the "Mohawk" features the same wide-band slide rule type vernier tuning and covers all of the amateur bands from 160 through 10 meters on seven bands with an extra band calibrated to cover 6 and 2 meters using a converter. External receiver powered, accommodations are available for these converters which will be available in Heathkits soon. The "Mohawk" is specially designed for single-sideband reception with crystal controlled oscillators for upper and lower sideband selection. A completely preassembled, wired and aligned front end assures ease of assembly. All critical wiring is done for you insuring top performance. This 15-tube receiver features double conversion with IF's at 1682 kc and 50 kc. Five selectivity positions from 5 kc to 500 CPS. A



bridged T-notch filter is employed for maximum heterodyne rejection. Complete accuracy is obtained with the use of a built-in 100 kc crystal calibrator and the set features 10 db signal-to-noise ratio at less than 1 microvolt input. S-meter and many other fine features built-in for top-notch signal reception. Shpg. Wt. 90 lbs.

HEATH COMPANY

A Subsidiary of Daystrom, Inc.

**BENTON HARBOR 12,
MICH.**

HEATHKIT PHONE & CW TRANSMITTER KIT



MODEL
DX-40

\$64⁹⁵

The DX-40 incorporates the same high quality and stability as the DX-100, but is a lower powered rig for crystal operation, or for use with an external VFO. Plate power input is 75 watts on CW, permitting the novice to utilize maximum power. An efficient, control-carrier modulator for phone operation peaks up to 60-watts, so that the rig has tremendous appeal to the general class operator also. Single-knob switching covers 80, 40, 20, 15, 11 and 10 meters. Pi network output coupling makes for easy antenna loading, and pi network interstage coupling between the buffer and final amplifier improves stability and attenuates harmonics. A line filter is incorporated for power line isolation. The efficient oscillator and buffer circuits provide adequate drive to the 6146 final amplifier from 80 to 10 meters, even with an 80-meter crystal. A drive control adjustment is provided, and the function switch incorporates an extra "tune" position so that the buffer stage can be pretuned before the final is switched on. A switch selects any of three crystals, or a jack for external VFO. High quality D'Arsonval meter for tuning. Shpg. Wt. 26 lbs.

HEATHKIT DX-100 PHONE & CW TRANSMITTER KIT

MODEL
DX-100

\$189⁵⁰

Shipped motor freight unless otherwise specified. \$50.00 deposit required on C.O.D. orders.

You get more for your transmitter dollar when you decide on a DX-100 for your ham shack! Recognized as a leader in its power class, the DX-100 offers such features as a built-in VFO, built-in modulator, TVI suppression, pi network output coupling to match a variety of antenna impedances from 50 to 600 ohms, pi network interstage coupling, and high quality materials throughout. Copper plated 16-gauge steel chassis, ceramic switch contacts, etc., are typical of the kind of parts you get, in assembling this fine rig. The DX-100 covers 160, 80, 40, 20, 15, 11 and 10 meters with a single band-switch, and with VFO or crystal operation on all bands. RF output is in excess of 100 watts on phone and 120 watts on CW, with a pair of 6146 tubes in parallel for the final amplifier, modulated by a pair of 1625 tubes in parallel. VFO tuning dial and panel meter are both illuminated for easy reading, even under subdued lighting conditions. Attractive front panel and



case styling is completely functional, for operating convenience. Designed exclusively for easy step-by-step assembly. No other transmitter in this power class combines high quality and real economy so effectively. Here is a transmitter that you will be proud to own. Time payments are available! Shpg. Wt. 107 lbs.

more fine ham gear from the pioneer

HEATHKIT GRID DIP METER KIT



A Grid Dip Meter is basically an RF Oscillator used to determine the frequency of other Oscillators, or tuned circuits. Numerous other applications such as pretuning, neutralization, locating parasitics, correcting TVI, adjusting antennas, designing new coils, etc. Features continuous frequency coverage from 2 MC to 250 MC, with a complete set of prewound coils, and a 500 ua panel meter. Has sensitivity control and a phone jack for listening to the "Zero-Beat". It will also double as an absorption-type wave meter. Shpg. Wt. 4 lbs.

Low frequency coil kit: two extra plug-in coils extend frequency coverage down to 350 KC. Shpg. Wt. 1 lb. No. 341-A \$3.00

MODEL GD-1B

\$21⁹⁵

HEATH COMPANY

A Subsidiary of Daystrom, Inc.

BENTON HARBOR 12,
MICH.

HEATHKIT ALL-BAND COMMUNICATIONS-TYPE RECEIVER KIT

Ideal for the short wave listener or beginning amateur, this Receiver covers 550 KC through 30 MC in four bands. It provides good sensitivity and selectivity, combined with fine image rejection. Amateur bands are clearly marked on the illuminated dial scale. Features transformer type—power supply—electrical band spread—antenna trimmer—separate RF and AF gain controls—noise limiter—internal 5½" speaker—head phone jack and AGC. Has built-in BFO for CW reception. An accessory power socket is also provided for connecting the Heathkit model QF-1 Q Multiplier. Will supply 250 VDC at 15 ma

and 12.6 VAC at 300 ma. Shpg. Wt. 12 lbs. Cabinet: Fabric covered cabinet with aluminum panel as shown part 91-15A. Shpg. Wt. 5 lbs.

MODEL AR-3

\$29⁹⁵.

HEATHKIT ELECTRONIC VOICE CONTROL KIT

Here is a new and exciting kit that will add greatly to your enjoyment in the ham shack. Allows you to switch from Receiver to Transmitter merely by talking into your microphone. Lets you operate "break-in" with an ordinary AM transmitter. A terminal strip is provided for Receiver and speaker connections and also for a 117 volt antenna relay. Unit is adjustable to all conditions by sensitivity and gain controls provided. Easy to build with complete instructions provided. Requires no transmitter or Receiver alterations to operate. Shpg. Wt. 5 lbs.

MODEL VX-1

\$23⁹⁵.

HEATHKIT "Q" MULTIPLIER KIT

This fine Q Multiplier is a worthwhile addition to any communications, or Broadcast Receiver. It provides additional selectivity for separating signals, or will reject one signal and eliminate a hetrodyne. Functions with any AM Receiver having an IF frequency between 450 and 460 KC that is not AC-DC type. Operates from your Receiver power supply, and requires only 6.3 VAC at 300 ma (or 12.6 VAC at 150 ma), and 150 to 250 VDC at 2 ma. Simple to connect with cable and plugs supplied. Effective Q of approximately 4000 for sharp "peak" or "null". A tremendous help on crowded phone or CW bands. Shpg. Wt. 3 lbs.

MODEL QF-1

\$9⁹⁵.



ALL-BAND RECEIVER



ELECTRONIC VOICE CONTROL

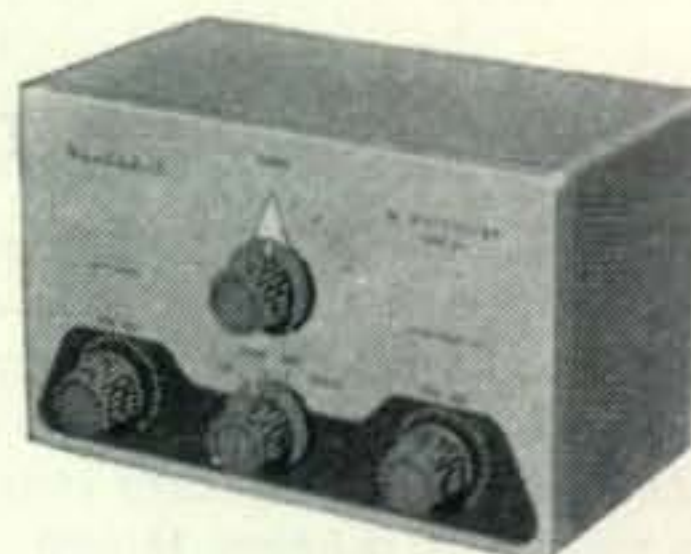

"Q" MULTIPLIER

NOTE: \$10.65 WHEN ORDERED WITH AR-3 BECAUSE OF EXCISE TAX.

...in do-it-yourself electronics!

HEATHKIT "AUTOMATIC" CONELRAD ALARM KIT

Designed to give instant warning whenever a monitored station goes off the air, the CA-1 automatically cuts the AC power to your transmitter, and lights a red indicator. Works with any radio receiver; AC-DC—transformer operated—battery powered, so long as the receiver has AVC. A manual "reset" button is provided to reactivate the transmitter. Incorporates a heavy-duty 6-ampere relay, a thyratron tube, and its own built-in power supply. A neon lamp shows that the alarm is working. Simple to install and connect with complete instructions provided for assembly and operation. Shpg. Wt. 4 lbs.

MODEL CA-1

\$13⁹⁵.



"AUTOMATIC" CONELRAD ALARM

HEATHKIT VARIABLE FREQUENCY OSCILLATOR KIT

Enjoy the convenience and flexibility of VFO operation by obtaining this fine variable frequency oscillator. It covers 160-80-40-20-15-11 and 10 meters with three basic oscillator frequencies. Better than 10 volt average RF output on fundamentals. Requires 250 volts DC at 15 to 20 ma, and 6.3 VAC at 0.45 a, available on most transmitters. It features voltage regulation for frequency stability, and has illuminated frequency dial. VFO operation allows you to move out from under interference and select the portion of the band you want to use without having to be tied down to only 2 or 3 frequencies through the use of crystals. "Zero in" on the other fellows signal and return his CQ on his own frequency! Shpg. Wt. 7 lbs.

MODEL VF-1
\$19.50



VARIABLE FREQUENCY OSCILLATOR

HEATHKIT REFLECTED POWER METER KIT

A necessity in every well equipped ham shack, the model AM-2 lets you check the match of the antenna transmission system, by measuring the forward and reflected power or standing wave ratio. Handles up to one kilowatt of energy on all bands from 160 to 2 meters, and may be left in the antenna system feed line at all times. Input and output impedances for 50 or 75 ohm lines. No external power required for operation. Meter indicates percentage forward and reflected power, and standing wave ratio from 1:1 to 6:1. Shpg. Wt. 3 lbs.

MODEL AM-2
\$15.95

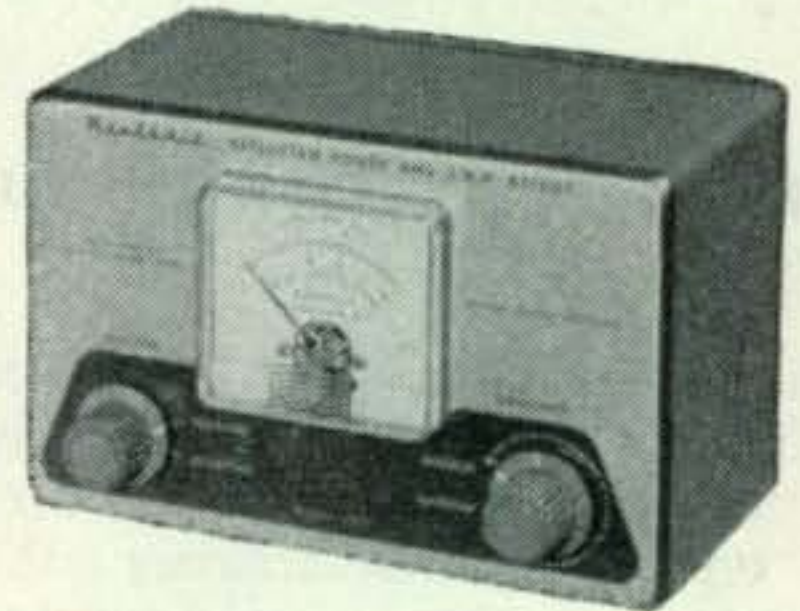

REFLECTED POWER METER

HEATHKIT BALUN COIL KIT

This convenient transmitter accessory has the capability of matching unbalanced coax lines, used on most modern transmitters, to balanced lines of either 75 or 300 ohms impedance. Design of the bifilar wound Balun Coils will enable transmitters with unbalanced output to operate into balanced transmission line, such as used with dipoles, folded dipoles or any balanced antenna system. Can be used with transmitters and Receivers without adjustment over the frequency range of 80 through 10 meters. Will handle power inputs up to 200 watts. Shpg. Wt. 4 lbs.

MODEL B-1
\$8.95

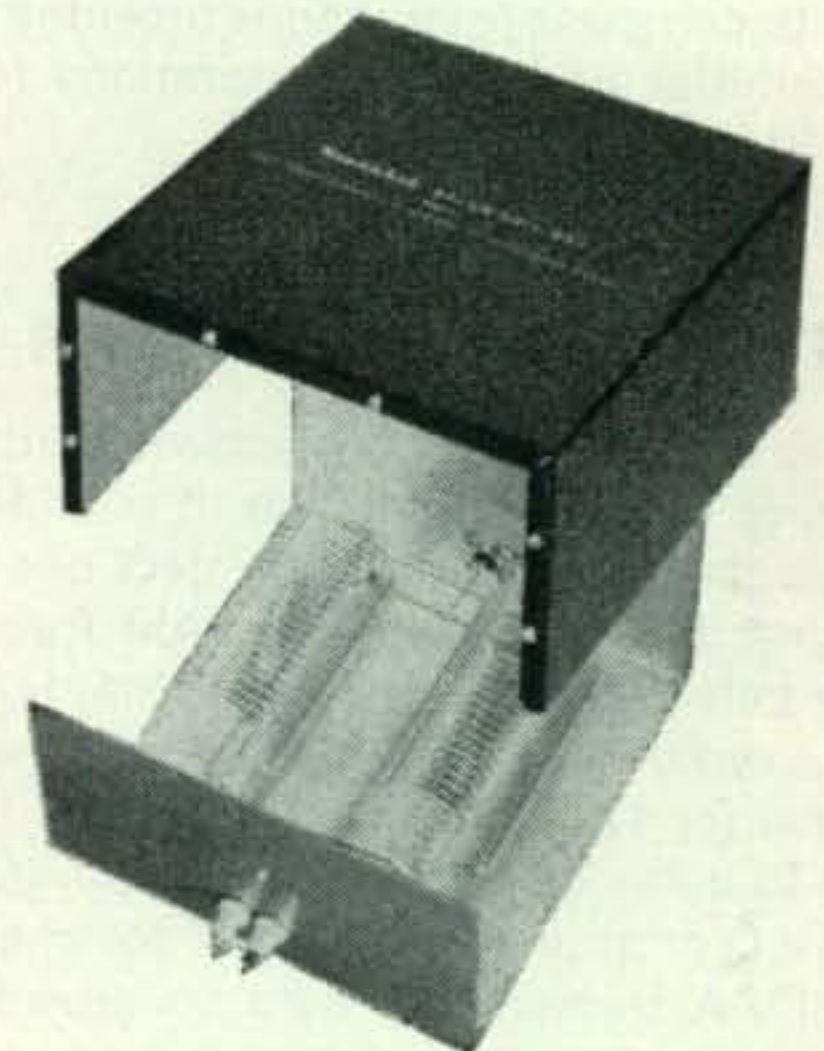

BALUN COIL

save 1/2 or more . . . with **HEATHKITS**



**FREE
1958
Catalog**

Send for this Free informative catalog listing our entire line of kits, with complete schematics and specifications.

Rush Free 1958 catalog.

HEATH COMPANY

BENTON HARBOR 12, MICH. a subsidiary of Daystrom, Inc.



name _____

address _____

city & state _____

QUAN.	ITEM	MODEL NO.	PRICE

\$_____ enclosed. Parcel post, include postage—express orders are sent shipping charges collect. All prices quoted are Net F.O.B. Benton Harbor, Mich. and apply to Continental U.S. and Possessions only. All prices and specifications subject to change without notice.

For further information, check number 5 on page 194.



. . . de W2NSD

never say die

Two things worry me about ham radio. They worry me not just because I can see them happening, but because I see them happening and don't know what to do about it. Though they have all been brought up many times before, it struck me that by making an issue of them I might stir up some discussion and ideas which would result in some positive suggestions which might serve to stem the tide.

(1) We don't build any more. The number of hams who build any of their own gear is dwindling into one over infinity squared. And don't you try to count kit assembling as building either . . . it isn't and you know it. As our ranks of home constructors thin we also fall to a lower technical level as a group. In this our own growth is annihilating us by providing a large enough market for our commercial exploitation. It just isn't economically sound to buy anything but commercial equipment any more.

In CQ I try to counter this trend as much as possible by publishing construction articles and surplus conversions. Surplus conversions are one way to get your soldering iron into some radio equipment without worrying about what your modifications will do to the resale value. But obviously the trend has not changed and some better plan must be devised if we are to mend our ways. Perhaps you can solve the problem? Perhaps there is something that can be offered, promised, threatened, etc., which will encourage more hams to discover the thrill and excitement of building their own gear. It must be something which will appeal to everyone and not just a contest for the best home-made rig, etc.

(2) Most QSO's are a crashing bore. This theme has been played for years in the letters column. The result of all the attention lavished on it is that things are getting worse than ever. Thank heavens for sideband and the remaining stand of old timers who have sought refuge there from the rig describers who vfo up and down the bands looking for some hapless station so they can again repeat their well

[Continued on page 14]



Ed Piller, W2KPQ, the recipient of the Army Award for his work in the establishment of the SSB Technical MARS Network, with Mike Ercolino, W2BDS, owner of Telrex, watch as I tell them how we sunk some of the ships pictured on the Drum battle flag during my tour of duty on the sub (1943-45). Official U.S. Navy photographs



Ev Mayer, KP4KD, QSL manager for Puerto Rico, who I last saw when I dropped in at his shack for a quick visit on my way back from the Virgin Islands, looks on unbelievably as I describe how the stern planes got stuck one time when we made a dive at emergency speed and almost lost control of the boat, going over a hundred feet below the boat's safe depth. Official U.S. Navy photographs

New!

hallicrafters

"2 and 6"



World's first complete two and six meter radio station...
features transistorized, built-in power supply

COMPLETE SPECIFICATIONS

General description: The SR-34 is designed for either AM or CW and combines, for the first time in one compact package, the complete functions of a two *and* six meter radio station. It operates on 115-V. A.C., 6-V. D.C., or 12 V. D.C. and features a highly efficient transistorized power supply for the 6 and 12 volt operation.

Exclusive features: The perfect unit for short-range portable, fixed or mobile communication, the SR-34 meets—and exceeds—F.C.D.A. matching-fund specifications. The crystal sockets and transmitter tuning controls are concealed behind a panel which may be sealed to prevent tampering. Instantaneous selection of desired voltage possible and also "crossbanding" between the two and six meter bands. The specially designed cover has mounting clips for two-band antenna, owner's microphone, and cords.

Both receiver and transmitter may be used for C.W.; key jack and adjustable B.F.O. are provided. Drip-proof case is specially designed for safe outdoor use.

The transmitter is crystal-controlled; up to four crystals may be switch-selected. A fifth position on this switch permits external V.F.O. operation. Band selection also is front-panel controlled.

The receiver is a double conversion superhetero-

dyne, having a quartz crystal controlled second oscillator. This offers outstanding selectivity and high image rejection. Highest stability is obtained through separate oscillator and R.F. sections for each band.

All receiver functions provided—S-meter B.F.O., ANL, etc. Sensitivities average 1 microvolt on both bands. Transistorized power supply eliminates noisy, erratic operation encountered with vibrator-type power supplies.

Front Panel Controls: *Receiver:* Band Selector (49-54 mc., 143.5 to 148.2 mc.); Main Tuning; Sensitivity; Audio Volume; B.F.O. Pitch; Squelch Level; Headphone Jack. *Transmitter:* Function Switch (P.A., Rec., Cal., AM, CW); Power On/Off; Band Switch; Crystal Selector and V.F.O.; Oscillator Tuning; Doubler Tuning; Tripler Tuning; Final Tuning; Final Loading; Meter Switch.

Power output: 6 to 7½ watts on 2 meter, and 7 to 10 watts on 6 meter AM or CW, 100% mod. negative peak clipping. *Rear Apron:* Speech input level control; key jack; P.A. speaker terminals; mic. selector (high Z or carbon); mic. input; A.C. and D.C. fuses; power plug.

Available with convenient terms from your Radio Parts Distributor.

Export Sales: International Division, Raytheon Manufacturing Co., Waltham, Massachusetts
For further information, check number 6 on page 194.

The new ideas in communications

are born at . . .



In our 25th year of service

hallicrafters

Chicago 24, Illinois



**SX-101
MARK III**

Weigh this one against all comers!

The most important single standard of receiver performance is—your own judgement. And the one sure way to judge is to *compare*, not only on paper, but by an *actual demonstration at your distributor's*.

We'll stack the new SX-101 MARK III against *any amateur band receiver*—in overall performance and long-life reliability.

We're betting that you will, too.

Look for and compare these features

- Utmost mechanical and electrical stability.
- Complete coverage of 7 amateur bands: 160, 80, 40, 20, 15, 11-10 meters.
- Exclusive crystal-controlled upper/lower sideband selection.
- S-meter functions with A.V.C. off/on.
- Tee-notch filter.
- Built-in crystal calibrator.

PLUS: Band in use individually illuminated . . . antenna trimmer . . . dual conversion . . . full gear drive from tuning knob to condensers . . . five steps of selectivity from 500-5,000 cycles . . . many more features. *Available with convenient terms from your Radio Parts Distributor. See him today!*

Export Sales: International Division
Raytheon Manufacturing Company
Waltham, Mass.

Meets F.C.D.A. Specifications

For further information, check number 7 on page 194.

*The new ideas in communications
are born at . . .*

hallicrafters

Chicago 24, Illinois



In our 25th year of service

NEW! 27 MC TRANSCEIVER

FOR THE NEW "CLASS D" CITIZENS BAND



WIDE APPLICATION

- ★ HOME
- ★ OFFICE
- ★ INDUSTRY
- ★ FARM
- ★ BOATING

ANY CITIZEN CAN SECURE A LICENSE

without examination or code test by filling out form 505 (packed with each transceiver) and forwarding to the F.C.C.

MEETS ALL F.C.C. REQUIREMENTS . . .

MAXIMUM FINAL INPUT 5 WATTS. FULL AM MODULATION. .005% CRYSTAL TOLERANCE. CRYSTAL CONTROLLED TRANSMITTER ON ANY ONE CHANNEL.

PLUS . . .

DOUBLE CONVERSION SUPERHET RECEIVER. 115V AC OPERATION. ALSO AVAILABLE FOR 6 OR 12V DC OPERATION. FULL 2 WATT LOW DISTORTION AUDIO OUTPUT. COVERS ALL CHANNELS.

COMPLETE . . .

WITH ANTENNA AND MICROPHONE,
READY TO OPERATE.

\$89.95

International Crystal Mfg. Co. INC.

18 N. LEE • OKLAHOMA CITY, OKLA.

For further information, check number 8 on page 194.



Optical comparator measures Eimac ceramic envelope component.

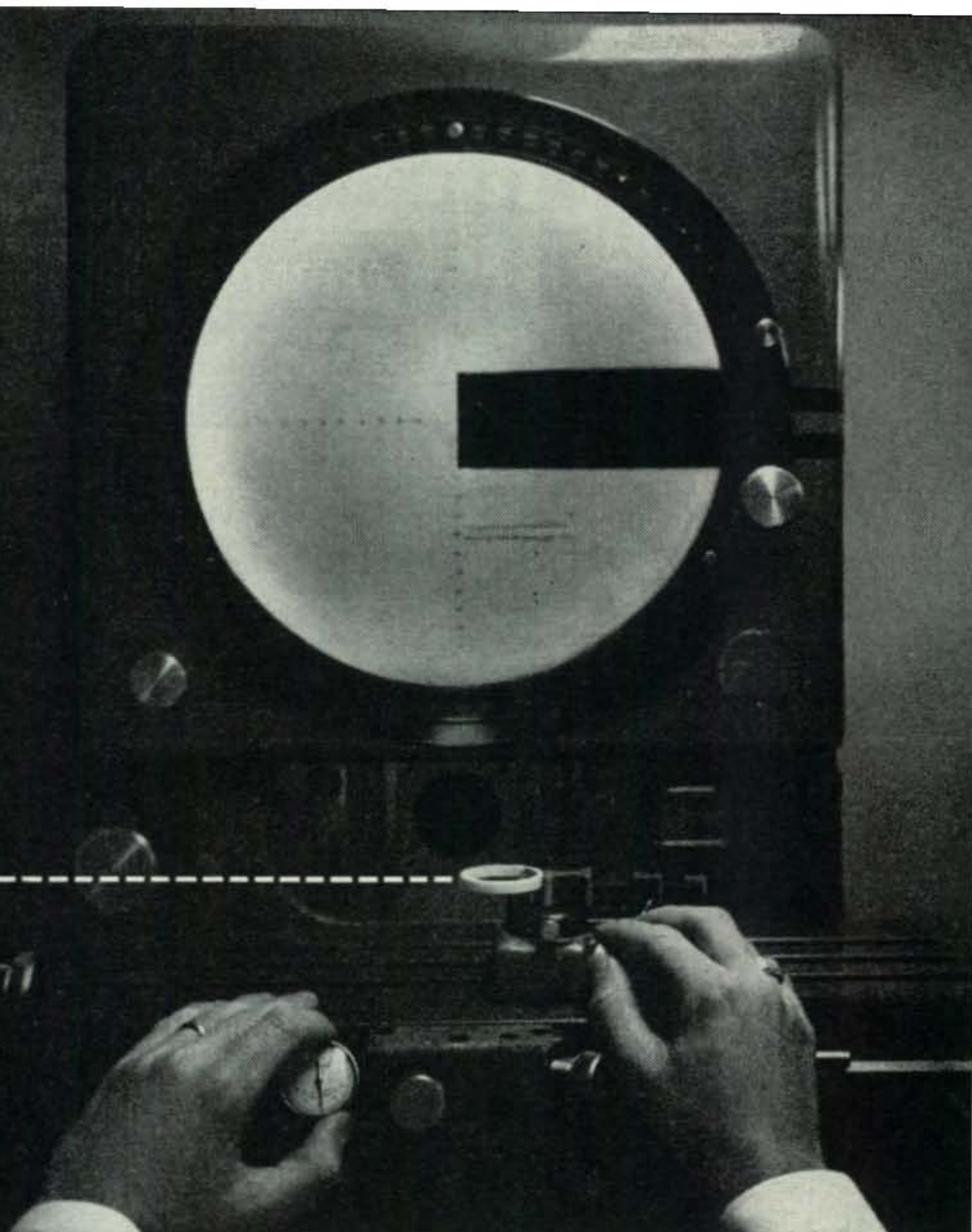

Sixth in a series describing the advantages of ceramics in electron tubes. Previously discussed: impact, heat, vibration, compactness, dielectric loss.

Exact Dimensional Uniformity... Is an Eimac Ceramic Tube Extra

Electrode spacing is critical in modern high-performance vacuum tubes. Dimensional uniformity of the material used for the vacuum envelope has a direct effect on the accuracy of this spacing. The high alumina ceramic rings used in Eimac stacked-ceramic tubes can easily be held to tolerances of ± 50 millionths of an inch at production speeds. This degree of accuracy is not possible with glass techniques in high speed production.

Accurate control of ceramic envelope materials results in greater tube-to-tube uniformity of both mechanical and electrical characteristics. It permits close control of small electrode spacings necessary in the production of reliable tubes for UHF operation.

Other important advantages of Eimac ceramic tubes are: resistance to damage by shock or high temperature; compactness without sacrifice of power; ability to withstand rigorous processing techniques that lead to exceptional tube reliability, uniformity and longevity.

Whether you build or buy your transmitter, reliable Eimac tubes will give you maximum watt-hours per dollar.

Write our Amateur Service Department for a copy of the booklet, "Advantages of Ceramics in Electron Tubes."

EITEL-McCULLOUGH, INC.
SAN CARLOS, CALIFORNIA

Eimac First with ceramic tubes that can take it
For further information, check number 9 on page 194.



Products Designed and Manufactured by Eimac

Negative Grid Tubes
Reflex and Amplifier Klystrons
Traveling Wave Tubes

Vacuum Tube Accessories
Vacuum Switches
Vacuum Pumps

Includes the most extensive line of ceramic electron tubes.

How To Pass FCC COMMERCIAL RADIO OPERATOR License Exams

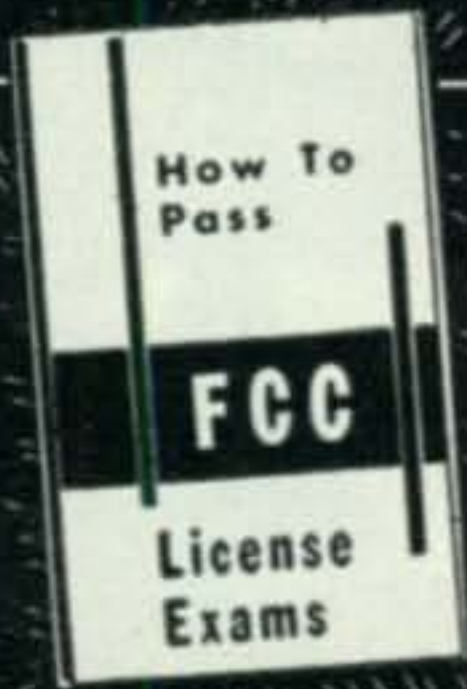

Free . . .

Tells where to apply and take FCC examinations, location of examining office, scope of knowledge required, approved way to prepare for FCC examinations, positive method of checking your knowledge before taking the examination.

GET YOUR FCC TICKET IN A MINIMUM OF TIME!

Get this Amazing Booklet

FREE



TELLS HOW . . .

1. Tells how thousands of brand-new, better paying radio-TV-electronics jobs are now open to FCC License Holders.
2. Tells how we guarantee to train and coach you until you get your FCC License.
3. Tells how our amazing Job-Finding Service helps you get the better paying job our training prepares you to hold.

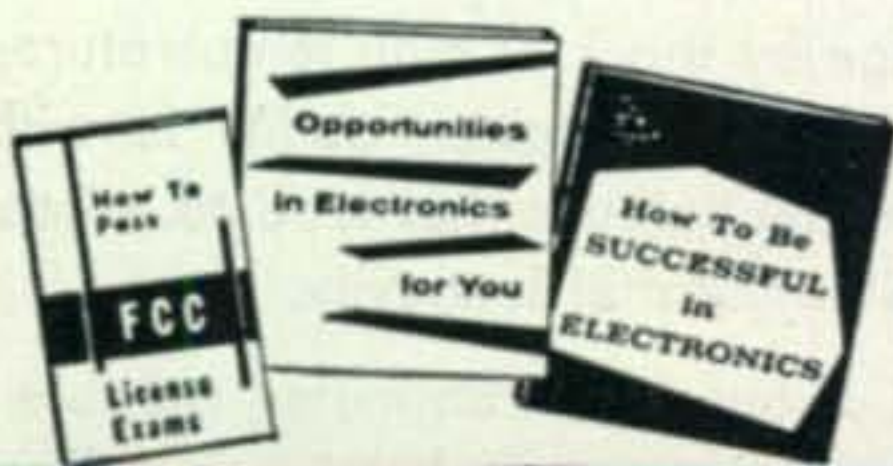

GET ALL 3 FREE!

MAIL COUPON NOW!

CLEVELAND INSTITUTE OF RADIO ELECTRONICS
Desk CQ-46, 4900 Euclid Bldg., Cleveland 3, Ohio
(Address to Desk No. to avoid delay)

I want to know how I can get my FCC ticket in a minimum of time. Send me your FREE booklet, "How to Pass FCC License Examinations" (does not cover exams for Amateur License), as well as amazing new booklet, "Successful Electronics Training."

Name Age

Address

City Zone..... State.....

FOR PROMPT RESULTS SEND AIR MAIL

CQ-46

de W2NSD [from page 9]

rehearsed station description.

All of us were pretty shaky when we first got on the air and suffered from mike fright. The usual solution to this difficulty is to work out a memorized spiel which gives the impression of glibness and competence. So what did you talk about on your last few contacts? Don't sit there feeling guilty and hating me . . . we're all in the same bucket. But we don't have to be. Now if some of you fellows who have some training in psychology, etc., would turn your mind to the problem I'll bet you could come up with an article or two which would give all of us some good hints on how to plunge into a conversation with some chap we've never met.



Jules Madey, K2KGJ, recipient of a recent Navy Award for his work in phone patching for the Navy stations on Antarctica, operates the KWM-1 aboard the USS Drum (SS-228) during the National Convention in Washington, D.C. Filling out the K4NAA cards in the foreground is Tom McCullough, W1HRO. Chap in background gave call of KC4AF, obviously a fake.

Official U.S. Navy photographs

Usually I try to mention several hobbies during my first couple transmissions in case the other chap has a mutual interest. This frequently results in some very interesting contacts, but this is a clumsy system and often misses. I'm sure that some of our readers can work out a reasonably foolproof system for us. How about it?

Our Shared VHF's

The Air Force got a little nervous about my editorial a couple months back when I mentioned that the government services who are going to share our frequencies with us will be using powers on the order of ten to twenty megawatts. Seems that the "government" in this case is them. They dusted off a small

[Continued on page 168]

Quality...

UNSURPASSED — ANYWHERE NEAR THE PRICE!



HQ-170

HQ-170

For the amateur who wants the very finest in SSB receivers. Contains all the functions necessary for solid contact in today's crowded bands. 17-Tube superheterodyne. Dual and triple conversion. Separate vernier tuning. Adjustable 60 db notch filter. 6, 10, 15, 20, 40, 80 and 160 meter amateur bands.

\$35900 *

HQ-160

You could pay twice as much, and get no more than the general-coverage HQ-160 quality. Dual conversion. 540 KCS to 31 MCS. SSB. Q-Multiplier. Electrical bandspread. Separate stabilized BFO. Crystal calibrator. Adjustable 60 db notch filter. 13-Tube superheterodyne. Crystal-controlled 2nd IF.

\$37900



HQ-160

Here's the pair that's making history in amateur radio. Never before has so much genuine quality and performance been offered at such low prices. Now the amateur can choose the one he wants and be sure that he's getting the very best buy in either a straight ham band or general coverage receiver.

*Telechron clock-timer, \$10 extra.



Established 1910

HAMMARLUND

HAMMARLUND MANUFACTURING COMPANY, INC.
460 West 34th Street, New York 1, N. Y.

For further information, check number 10 on page 194.

November, 1958 • CQ • 15



FROM TRIAD



SPECIAL FILAMENT TRANSFORMERS

Included in their quality construction is Triad's exclusive "Climatite" treatment for moisture protection and elimination of lamination noise. Write for Catalog TR-58.

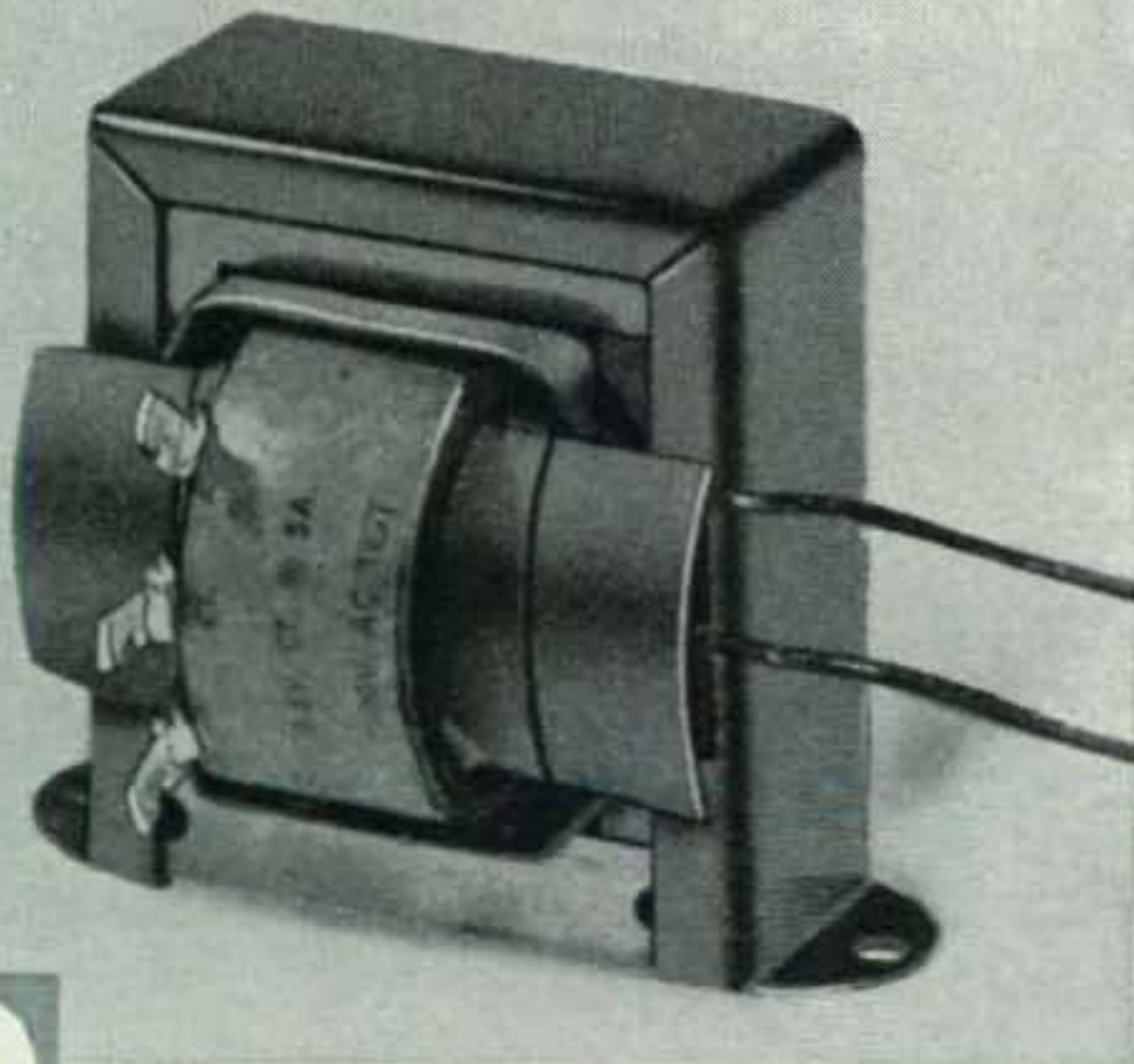

Type	Secondary Volts	Secondary Amperes	Test Volts
F-10U	5.0 CT.	14	10000
F-71U	2.5 CT.	10	10000
F-72Z	2.5 CT.	5	7500



TRIAD TRANSFORMER CORP.
 4055 REDWOOD AVE. | B12 E. STATE STREET
 VENICE, CALIFORNIA | HUNTINGTON, INDIANA

A SUBSIDIARY OF LITTON INDUSTRIES
 For further information, check number 11 on page 194.



Feenix, Ariz.

Dear Hon. Ed:

Aren't you thinking it are unfair when things happening all around you, and yet you can't doing those things? I meening it only taking little forsite and you not getting into this at all. What are that old saying—an ounce of prevenshun saves a stitch in nine!

Like taking this new stereo craze. Stereo tape recorders, stereo LP records, stereo playback heds for your fonygrafs, stereo speakers, stereo earfones—next thing you knowing they be selling stereo heering-ades. Okeh, so I saying, why not having stereo amchoor radio?

Of coursey you can doing it the hard way. You can using cupple single-sideband xmitters, one on upper and other on lower sideband, and having amchoor at other end having cupple single-sideband reseevers, feeding on to one earfone and other to other earfone. Scratchi figyuring out the bux involved and desiding not to doing it the hard way.

Also another way to doing it. Can putting cupple different xmitters on air at same times. Like saying one on twenty fone and other on ten fone. Having amchoor on other end using cupple reseevers, and you all set. Of coursey, having to have skip just rite so both ten and twenty sigs getting thru, otherwise getting monaural stereo, and Hon. Ed., nothing more sterile than monaural stereo.

Scratchi thinking about that kind sistem reel hard, but finely desiding that having plenty TVI with one rig on air, without putting cupple on at same time. Besides, how often you finding amchoor at other end with cupple reseevers?

No indeedy, no need doing hard way when can finding easy way. So here are detales on STEW sistem I thinking up. (STEW are standing for Stereo The Easy Way).

This are complicayted to explane, so watching carefooly. Let's assuming you are amchoor "A". You calling seek-you fone-patch local. When getting answer, finding out tellyfone number of other amchoor and calling him on tellyfone. You telling him that when you calling seek-you on your rig he should also turning on rig and putting your voice from fone line out over the air. Now you having one end of stereo.

[Continued on page 155]

More "WORKABLE WATTS" per dollar from **GLOBE** electronics

"The World's Fastest Growing Line of Amateur Radio Equipment"

540w AM & CW; 700w max. on DSB or SSB (P.E.P.) Input



Globe King 500C

Completely Bandswitching 10-160M

W/T: \$795.00

Relay-controlled; built-in antenna relay, VFO, commercial type compression circuit. Separate power supply for modulator. Time sequence keying.

350w CW, 275 AM, 450w SSB (P.E.P.) Input

Globe Champion 300A



W/T: \$495.00
Kit: \$399.00

Bandswitching 10-160. Built-in VFO, Pi-Net output, 48-700 ohms, push-to-talk, antenna changeover relay, time sequence keying, compression circuit. Kit with preassembled VFO.

Plate Modulated . . . Globe Scout 680A



W/T: \$119.95
Kit: \$99.95
65w CW
50w AM

Self-contained, bandswitching, 6-80M, with built-in power supply. Pi-Net 10-80M, link-coupled on 6M. High level modulation. Forward Look.

90w CW for 10-160M Globe Chief 90A



W/T: \$74.50
Kit: \$59.95

Forward Look cabinet, bandswitching Xmtr. Built-in power supply. Pi-Net. Provisions for external VFO.

Bandswitching 6 & 2M Xmtr. Globe Hi-Bander



Power Input:
60w CW;
55w AM
on Both
6 & 2M

W/T: \$149.95 Kit: \$129.95

Regulated screen supply. 4-stage RF section allowing straight through operation. Good harmonic and TVI suppression. RF Stages metered. Provisions for mobile use. 52-72 ohm coax output. New duo-band final tank circuit eliminates switching.

100w PEP DSB Input, Suppressed Carrier
40w AM, 50w CW

Sidebender DSB-100



W/T: \$139.95
Kit: \$119.95

Complete transmitter, bandswitching 80-10M. Min. 45db carrier suppression. 3-stage RF section, pi-net; speech clipping. Inverse neg. feedback. Ceramic band and function switches. Narrow bandwidth. Forward Look.

Globe's VOX Model 10

For voice operated control, with extra contacts for auxiliary circuits. Plug in socket at rear of DSB Xmtr. Adaptable for Scout, Champ and similar Xmtrs.

W/T: \$24.95 Kit: \$19.95

QT-10: Anti-trip accessory for VOX.

W/T: \$9.95

VFO 755A

160-10 Meters



W/T: \$59.95
Kit: \$49.95

For 10-160M; output on 40 & 160M. Vernier drive with shock absorbing features. Self-contained, well-filtered power supply with voltage regulation.

VFO 6-2



W/T: \$59.95
Kit: \$49.95

Perfect zero beat. Built-in power supply with voltage regulation. Drives 6 & 2M Xmtrs. Temp. compensated. Ideal for Hi-Bander. Sideband stability.

Model 666 for 6M, w/t only, \$49.95

Power Attenuator PA-1



Use with Xmtrs. up to 70w input; for swamping drive to linear amplifiers. Three power reduction positions. Coax input and output. W/T: \$10.95

Antenna Tuner with VSWR Bridge

Globe Matcher Sr.



W/T: \$79.50
Kit: \$69.50

Shielded Cabinet

For Xmtr. with final RF input up to 600w, 80-10M. Fixed link coupling in output. Coax input, 2-wire balanced output. Monitor SWR between Tuner and Xmtr.

Globe Matcher Jr., AT-3

For input to Xmtr. of 100w CW, 75w fone or less. Substantial harmonic attenuation. Unbalanced output. Self contained.

W/T: \$15.95 Kit: \$11.95

Grounded Grid, Class B or C
6-80 Meters

Globe Linear LA-1

W/T: \$124.50 Kit: \$99.50



Complete with well-filtered power supply. 200w input AM Class B. 300w DC or 420 PEP input Class B linear SSB or DSB. 300w Class C for CW. Pi-Net 80-10M. 52 ohm Pi-Link coupled on 6M. Extensively TVI-protected.

Versatile Modulator

Plate Modulator UM-1



Modulates RF inputs up to 100w.

W/T: \$49.95

Kit (less tubes): \$32.50

Class A or AB₂ modulator, driver for higher power modulator, PA Amplifier. Matches output impedances 500-20,000 ohms. Carbon or crystal mike usable. Perforated steel cover. \$3.00 extra. Supplies 10-45w audio output. Ideal for use with Chief.

Controlled Carrier Type

Screen Modulator Kit

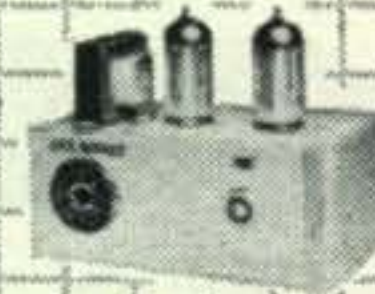

Ideal for use with Globe Chief. Permits radio-telephone operation at small cost. Self-contained. Connections, instructions, printed circuits, etc. supplied.

Kit: \$11.95

6 Meter Converter

Compact, stable, crystal converter for receivers tuning output frequencies 10-14mc. Cascode RF stage, band-pass coupling, shielded input and output, high sensitivity. Crystal for 10-14mc output supplied.

W/T: \$27.50 Kit: \$19.95

Power Booster PB-1

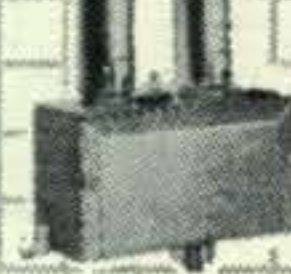

For straight through operation on 6M (plugs internally into Globe Scout); approx. 50% more power output, while attenuating harmonic and further suppressing TVI.

W/T: \$21.95 Kit: \$14.95

Peak Limiting Pre-Amplifier

Speech Booster FCL-1

W/T: \$24.95 Kit: \$15.95



Perfect for Scout, Hi-Bander & other Xmtrs. Clips and filters speech frequencies at pre-set amplitude. Response: 300-3500 cycles. Increases modulation intensity.

See Your Favorite Distributor
For the Full Line From



3417 W. BROADWAY
COUNCIL BLUFFS, IOWA

For further information, check number 12 on page 194.

CLUB BULLETINS

Marvin D. Lipton, VE3DQX

311 Rosemary Road, Toronto 10, Ontario, Canada.

The August issue of QRM, the monthly bulletin of the Tri-County A.R.A.'ssn. Inc., headlined a column about the "New Mr. Ohm." The club appoints one of its members "Mr. Ohm" for one meeting. The fifth person to introduce himself to "Mr. Ohm" wins a free prize. Since "Mr. Ohm's" identity is kept secret, a member is compelled to shake many hands if he intends to win the coveted prize. This is an excellent means of promoting closer ties among club members.

The RF Propagation Soc. of Canada, in its publication, RF, told of a Hamfest breakfast that was televised over CHCT-TV. The program, which was viewed in Calgary and Lethbridge on Sunday, August 24 at 1015 AM, was the first of its type to be produced anywhere in the world. It's encouraging to learn that hams are finally getting on TV the right way. Hi.

Doris "Butch" Singer, K9IXD, editor of Hawk's Eye View, Hoosier Amateur Women's Klub, mailed in a clipping from the Sunday Indianapolis Star Magazine. More than a page of the Sunday paper was devoted to the activities of the Indiana YL operators. A number of good pictures illustrated the article, which helped inform the public of our fascinating hobby. To the gals of Indiana we tip our hats for such splendid publicity.

While the above members of our News Service were furthering the cause of Amateur Radio, we happily welcomed these club bulletins into our ranks: **Parka Hi Lites**, Polar A.R.K., QUA-W4HHO, Charleston A.R.C. Inc., **Keystone Karrier-Wave**, Okinawa A.R.C., **Mobile Sixers R. C. NEWS**, Mobile Sixers R.C., **Ham Fax**, South East A.R.C. Inc., **Bandspread**, Cedar Valley A.R.C., **North Kent Radio**, North Kent Radio Soc., (England), and **The Spritzer**, The Lancaster Radio Transmitting Soc.

73 Marv. VE3DQX.

CQ NEWS, the official news release of the Club Bulletin Department, is issued monthly to full and associated members of the CQ News Service. Editors of Amateur Radio Club Publication are invited to join the News Service gratis. Amateur Radio Clubs not publishing bulletins may become associated members free of charge by notifying this Department. Contents of CQ NEWS are extracted from affiliated club bulletins. Associated members are granted full membership upon publication of a club paper.

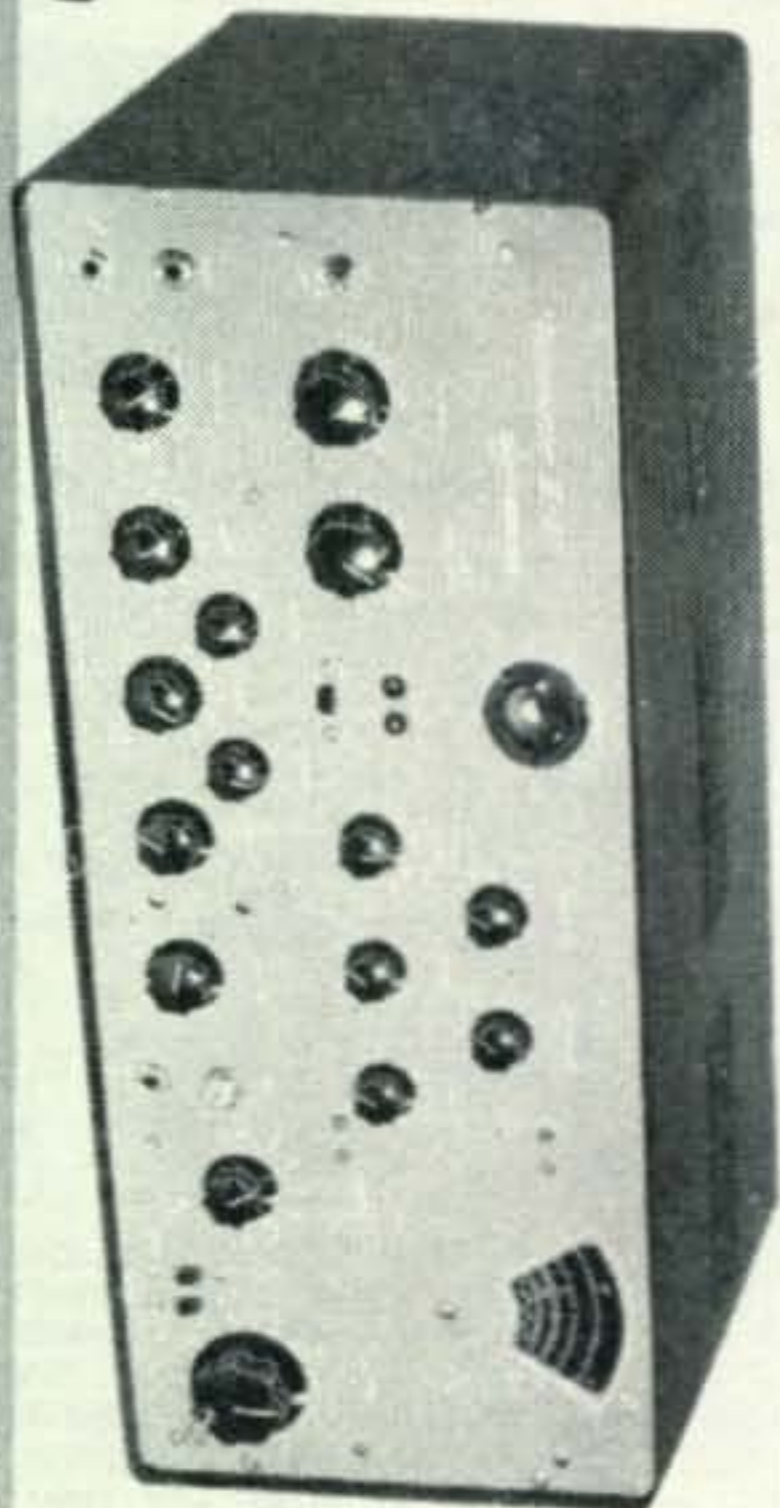

"Phasemaster II-B" +

P-400 GG =

AMATEUR NET \$459.00

AMATEUR NET \$269.50

+

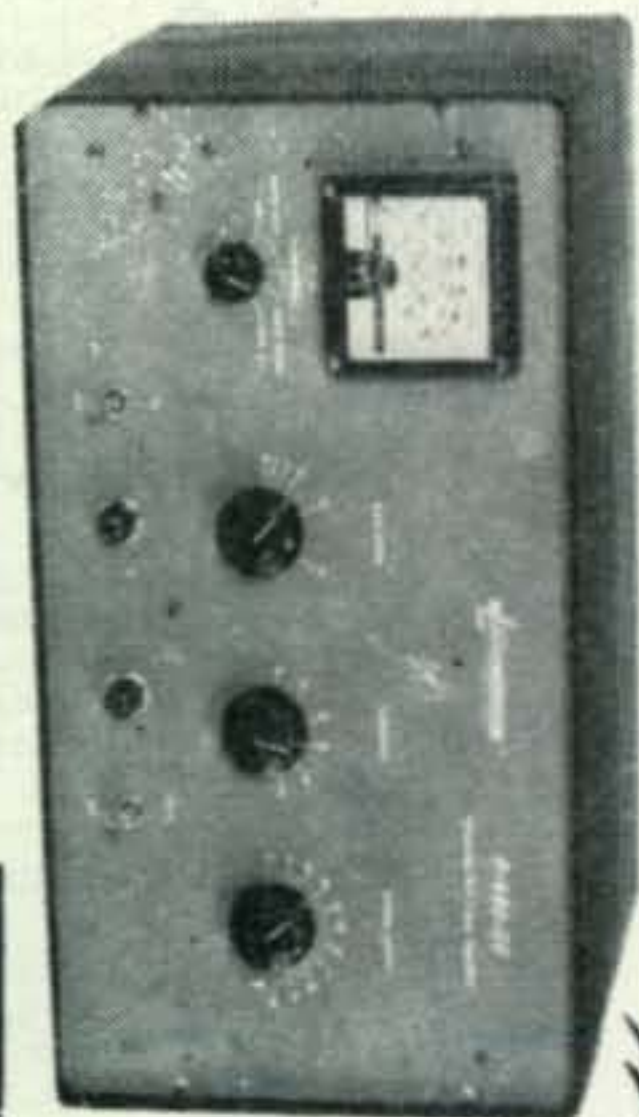

400
watts

= \$728.50

COMPLETE WITH BUILT IN V.F.O.

See Your Dealer or Write Us....

Lakeshore INDUSTRIES
MANITOWOC, WISCONSIN
MANUFACTURERS OF PRECISION ELECTRONIC EQUIPMENT

COMPLETE COMMUNICATIONS SYSTEMS

FROM 5 ^{TO} 50 Kilowatts
WATTS

Designed and Manufactured by TMC for

SSB • DSB • ISB • CW • MCW • AM • FS

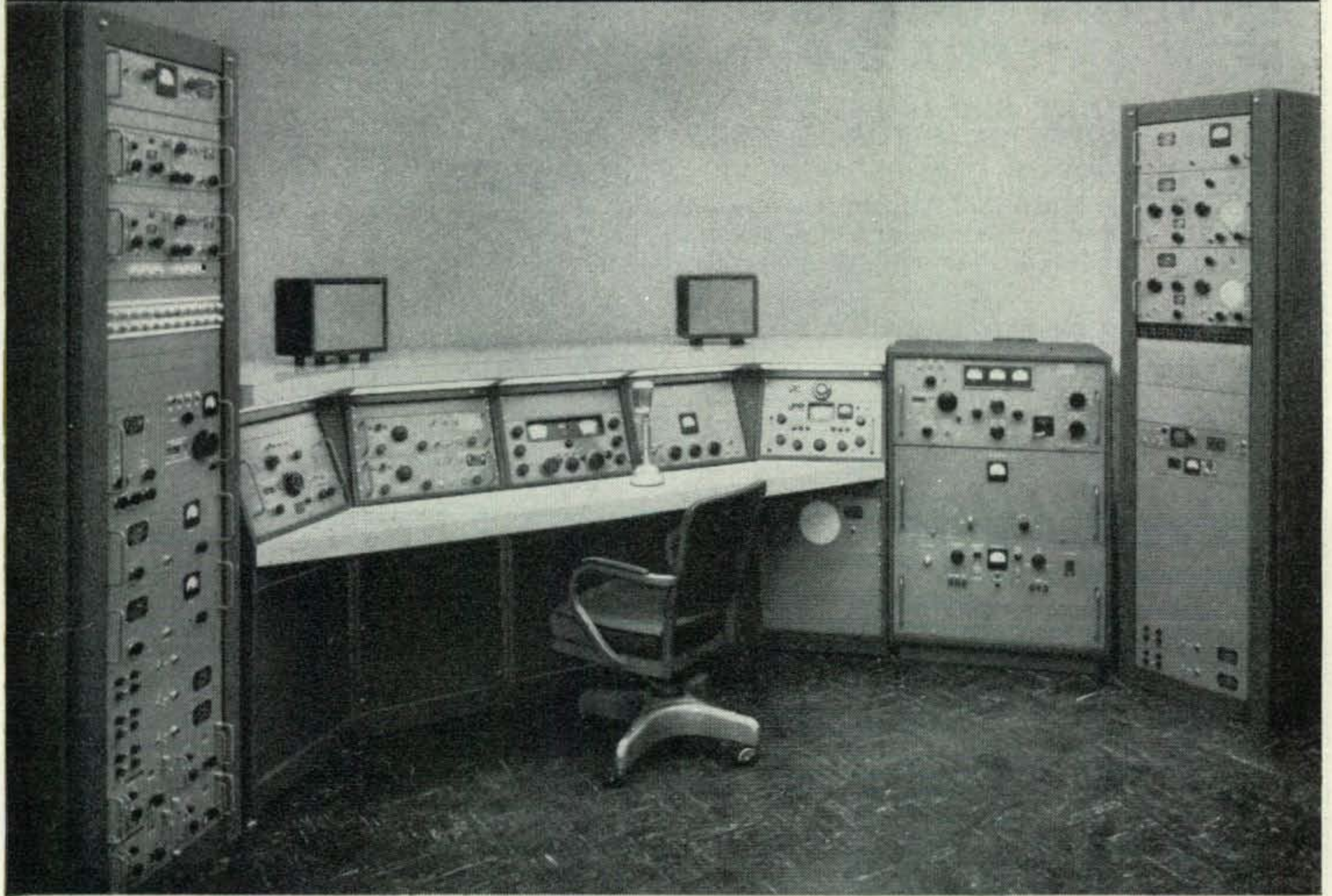

This station was delivered last month for use in one of our Military Installations.

Complete Communications Systems—not just “pieces.” TMC can provide any or all the transmitting and receiving equipment you need, from power line to antenna, over the frequency range 2 to 32 mc. Incidentally, we also sell the “pieces.” TMC can provide the building blocks for complete systems or our products will integrate with any existing system of standard equipment.

The engineers will be glad to talk it over with you. Call us any time.



The TECHNICAL MATERIEL CORPORATION

IN CANADA
TMC Canada Ltd., Ottawa, Ontario

Main Office: MAMARONECK
NEW YORK

For further information, check number 14 on page 194.

November, 1958 • CQ • 19

BUILD A BETTER BEAM

Cesco

WITH
BEAM ANTENNA HARDWARE AND
ANTENNA ACCESSORIES

Some of the World's Most Outstanding

UNIVERSAL "Oxen Yoke" BEAM ANTENNA CLAMP

FOR ELEMENT SIZES $\frac{3}{4}$ "- $\frac{7}{8}$ "-1"- $1\frac{1}{8}$ "- $1\frac{1}{4}$ "- $1\frac{1}{2}$ "
in. Dia. FOR BOOM SIZES $1\frac{1}{2}$ "- $1\frac{5}{8}$ "- $1\frac{3}{4}$ "-2"-
 $2\frac{1}{4}$ "- $2\frac{1}{2}$ "- $2\frac{3}{4}$ "-3 in Dia.

Completely Universal All Interchangeable
Parts — For Continuous or Cut Elements
at Center — All Channel Lock Assembly

COMPLETE CLAMP
Consisting of

- 1 ea. Element Clamp
any size
- 1 ea. Yoke (any size)
- 1 ea. "U" Bolt (size
A, B, or C)

AMATEUR NET

\$2.29 each

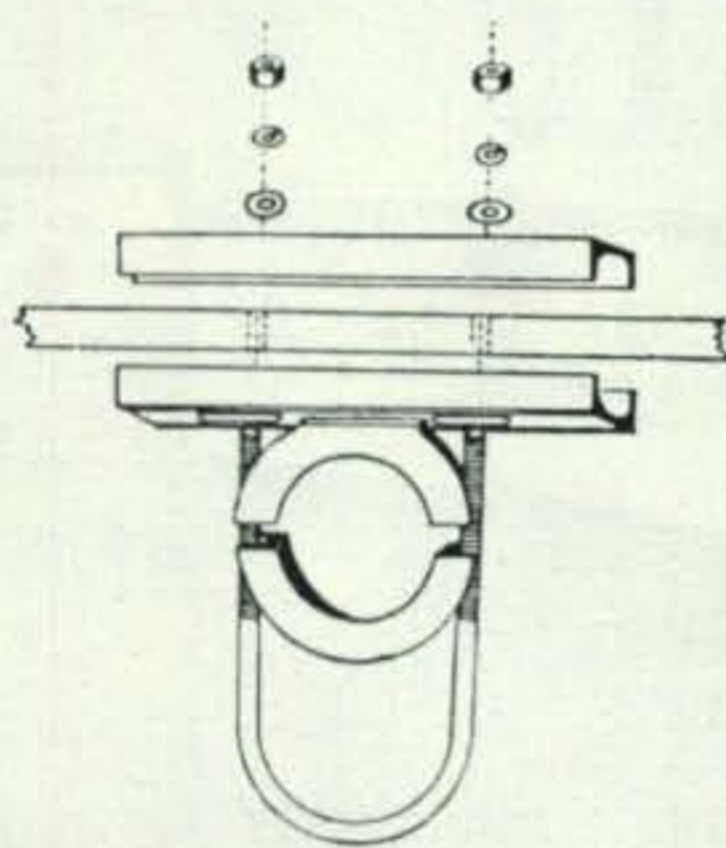

ANTENNA CLAMP
ASSEMBLY

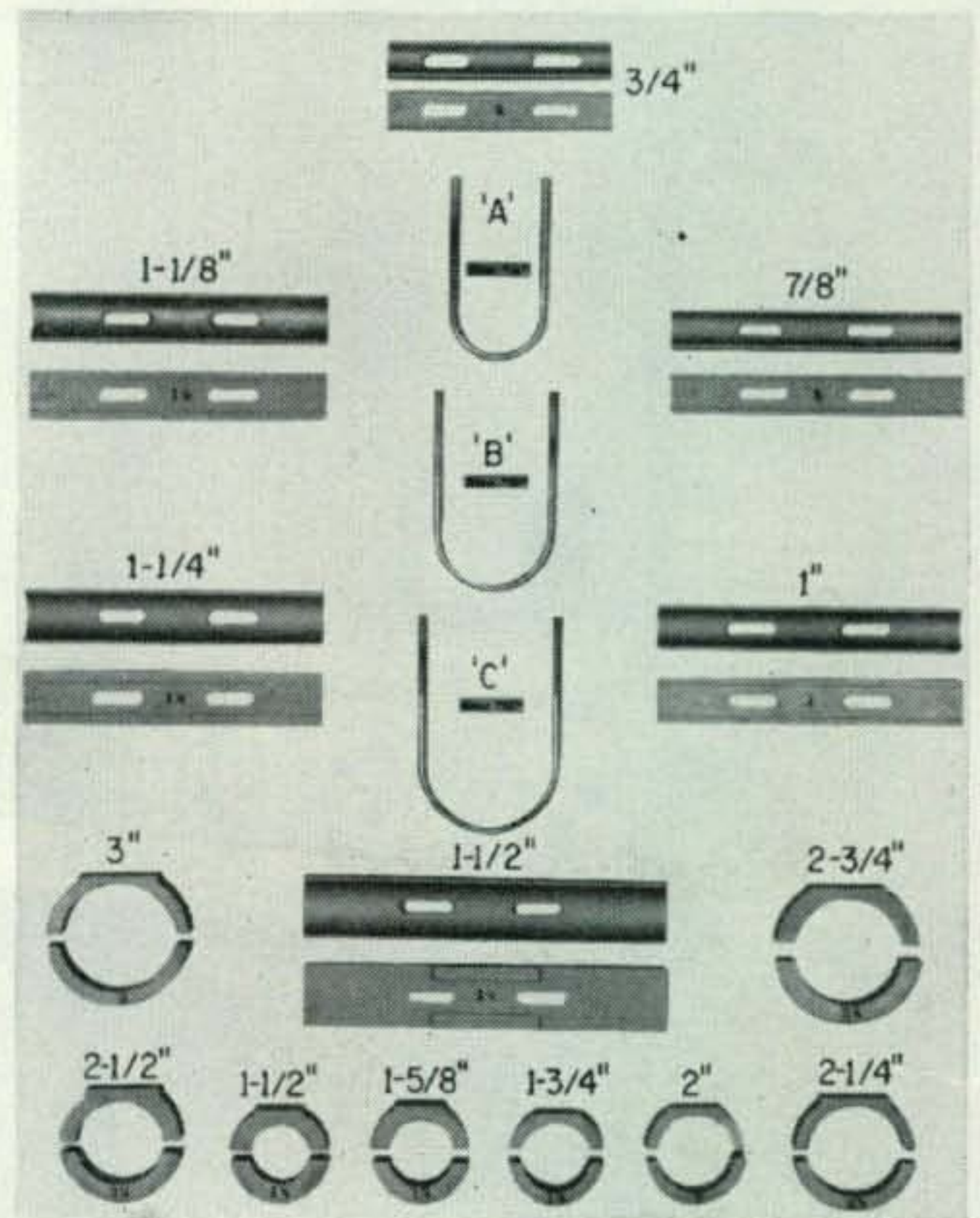

UNIVERSAL BOOM MOUNTINGS

FOR BOOM SIZES

$1\frac{1}{2}$ "- $1\frac{5}{8}$ "- $1\frac{3}{4}$ "- $2\frac{1}{4}$ "- $2\frac{1}{2}$ "- $2\frac{3}{4}$ "-3 in. Dia
For two mast sizes $1\frac{1}{4}$ " or $1\frac{1}{2}$ " inch

AMATEUR
NET

Complete mounting consist of: 2 ea. Mast plates
(either $1\frac{1}{4}$ " or $1\frac{1}{2}$ "). 2 ea. Boom Yokes (as required).
2 ea. "U" bolts (size A, B or C).

\$5.95



HEAVY DUTY UNIVERSAL BOOM MOUNTING

FOR WATER PIPE OR TUBING MAST
FROM 2 TO 3 INCH

Universal to any boom or mast size, by selection of
proper yokes. When used with water pipe mast a $\frac{1}{2}$ "
step-up ratio in yokes is used (i.e. $1\frac{1}{2}$ " water pipe uses
2" yoke and so forth). All channel lock assembly. For
single or stacked arrays.

AMATEUR
NET

\$8.95

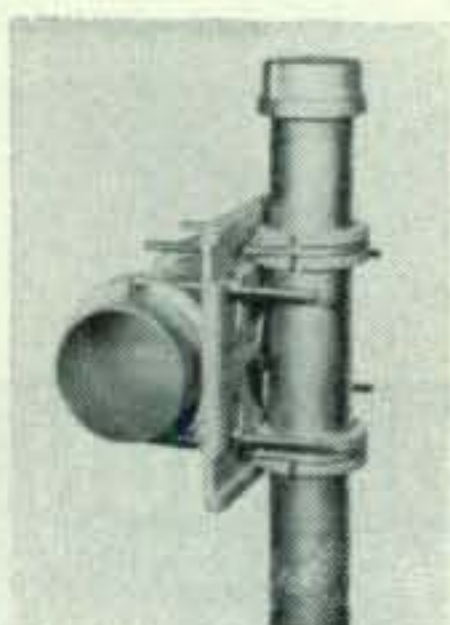

Complete mounting consist of: 1 ea. Universal mount-
ing plate. 4 ea. Yokes (size required). 4 ea. "U" bolts,
size A, B or C.

More than two years was spent in the design and development of this line of antenna hardware and accessories. These rugged, durable cast aluminum alloy fittings makes beam building easy as A-B-C. Most any type or design of antenna can be fabricated.

Signals are from Custom Made Antennas

Reactance Gamma Match

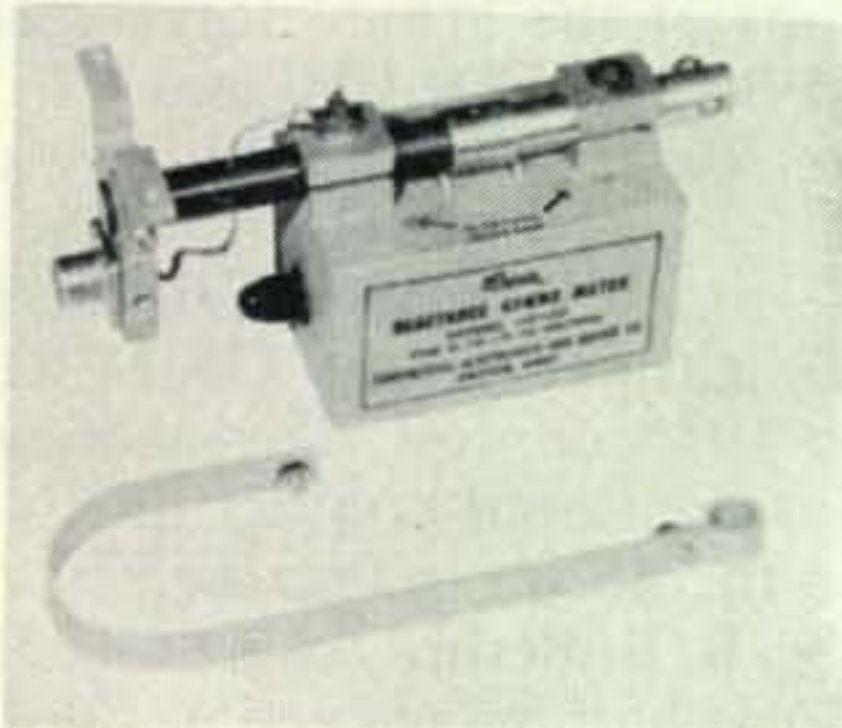

For 6-10-15 and 20 meters DESIGNED FOR COAXIAL LINES FOR PERFECT UNITY. POWER TO 1000 WATTS AND OVER. The ideal match for unbalanced line to balanced antenna. Will fit CESCO "Oxen Yoke" clamp. Provisions are also made for mounting to boom when other than CESCO Oxen Yoke antenna clamps are used. Makes antenna tuning extremely easy. Tune in five minutes. Gamma unit becomes part of gamma line. Shipped with complete installation instructions and easy tuning method.

AMATEUR NET **\$14.95** EA.

QUAD MOUNT

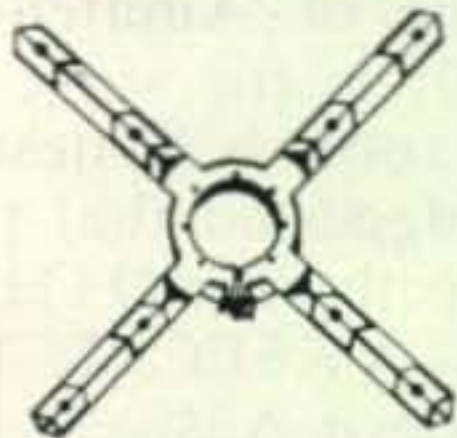

A one piece durable aluminum alloy cast spider for mounting quad arms to boom. Spiders are angle shape which permits use of bamboo or aluminum tubing sizes from 1" to 1 1/2" diameter. Hub is 2" diameter, convenient clamp type permitting alignment adjustments after assembly. Boom drilling not required. Designed for use with popular 2" aluminum irrigation tubing boom.

AMATEUR NET **\$6.95** EACH

COMPLETE QUAD ARM KITS

Consisting of 5 ft. lengths 1 1/4" aluminum tubing swagged to 1" diameter and with fibreglass telescoping inserts. Available for dual 10 and 15 meters and/or 20 meter or all band construction. Write for details and prices.

If not at your dealer send orders direct or write for national and export dealer listing.

COAX DIPOLE DRI-FIT CONNECTOR

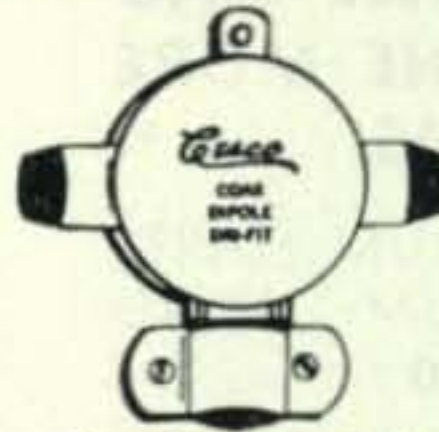

Handles Power to Maximum Legal Limits

The most ideal connector ever made for dipole antennas. Install in minutes. Completely moisture proof. For use with coax cables RG-8, RG-58, RG-11, RG-59 and 300 ohm twin tubular. Has eye pull up for inverted V's. One piece aluminum alloy construction. Weighs only 2 oz.

Amateur Net **\$2.95** ea.

SMALL YAGI CLAMP



For 220 and 144 mc antennas. A one piece aluminum casting for standard 3/8" T.V. antenna elements. Will fit drilled boom 1", 1 1/8" or 1 1/4" Diameter.

Amateur Net less hardware **29c** ea.

HEAVY DUTY YAGI CLAMP

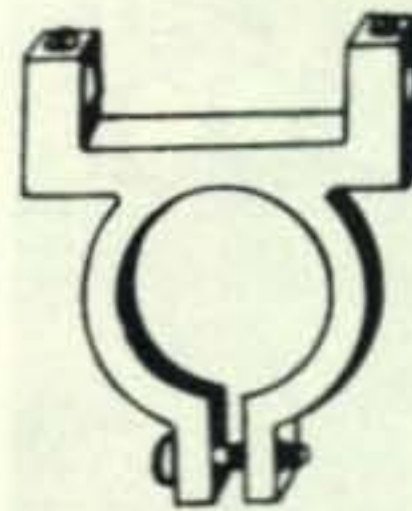

For 2, 6 and 10 meter antennas. One piece aluminum alloy casting for standard 3/8" rolled T.V. elements as used on X antennas. For 1 1/4" tubing boom. Boom drilling not required. Element holds can be drilled out to 1/2" for 6 meter and light weight 10 meter construction.

Amateur Net complete with hardware **.69**

ELEMENT EXTENDING CLAMPS

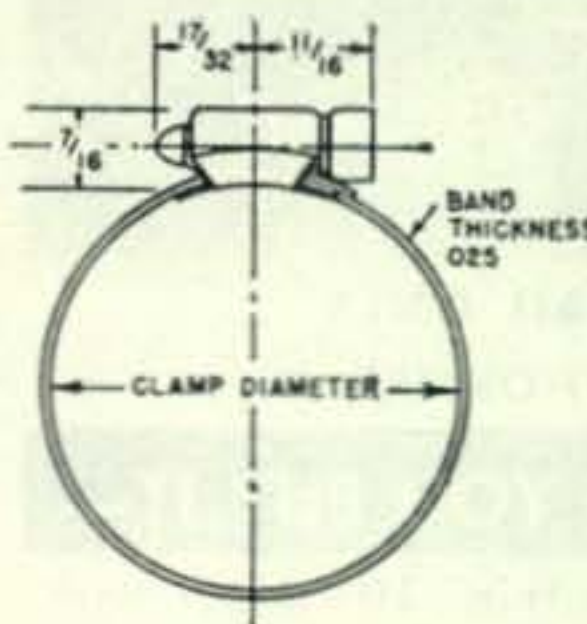

All stainless steel, for clamping inserted end sections of elements to main center element. Available in two sizes Part number 6410 for elements 3/4" to 1" dia. Part number 6416 for 1" to 1 1/2" dia. elements. Either Size

Amateur Net **.59**

BEAM ELEMENTS

Complete fabricated beam elements for 10, 15 and 20 meters. Made of 1 1/4" aluminum tubing center section taper swagged to 1" with 1" inserts. 20 meter elements are ply tubular center section. Each element sufficient in length to serve as a director, dipole or reflector.

Band	Amateur Net
10	\$10.95 ea.
15	14.95 ea.
20	19.95 ea.

CONTINENTAL ELECTRONICS & SOUND COMPANY
6151 DAYTON LIBERTY ROAD DAYTON, OHIO

OVERSEAS ECHOES

Thomas K. Aalund, K2VBI

Box 13, Roslyn, L. I., New York

Last month we mentioned that we are maintaining records of the latest QTH listings. We now also have the complete listings, as of August 1958, for HB and HE. In this connection it might be of interest to you to know that while most Swiss ham calls are HB9, you may also find some HB4 calls. These are operated as club stations of the armed forces. The calls are HB4FA, FB, FC, FD, FE, and FF. This information we located in **Old Man**, August 1958, HB.

1250 mc DX? DL6MH/p worked OK1KDO/p (operated by OK1VR) during the Polni Den 1958 contest. They believe this to be the first international contact on that band, according to the above magazine.

The **RSGB Bulletin**, August 1958, G, has a four and a half page article with the title "Amateur Television System Engineering," by M. Barlow, ex G3CVO/T. Among other things we were very interested to note that the British Amateur Television Club has established certain standards for connectors, B+ voltages, signal levels, etc., and this naturally assures the possibility of interchanging components between various members of the club for testing purposes. A very sensible idea.

VK6EC/T continues his series of design and construction articles about amateur television in the July issue of **Amateur Radio**, VK. A video mixer unit is the subject of this article, while the next one will describe the master monitor. It is suggested that persons interested contact him directly, the QTH being as follows: E. E. Cornelius, VK6EC/T, 157 Wood Street, Inglewood, Western Aus.

If you are having difficulty in getting official permission to operate amateur radio in certain locations, we want to make your mouth water even more by telling you that VE1BZ has recently been appointed Lieutenant-Governor of Prince Edward Island. He was one of the first VE's to use SSB and by now he should be operating directly from Government House. This information was contained in the "SSB Topics" column of **The Short Wave Magazine**, August 1958, G.

From **Der Funkamateer**, July 1958, DM, we note that zone 23 contains the call UAØWA. This adds to rumors about the existence of that station in zone 23. For a while even some magazines from behind the shielding (iron curtain to you) suspected this to be an invented call. The same issue also gives a detailed listing of zone locations of all UA9 and UAØ calls. It might interest you to know that in most

**IF YOU RUN 500 WATTS OR LESS,
HERE'S THE TRIBANDER FOR YOU!**

MODEL TB-500
CASH PRICE.
49.95



BUDGET TERMS:
ONLY **4.70**
A MONTH

**SAME QUALITY MATERIAL AND
CRAFTSMANSHIP AS IN THE MORE
EXPENSIVE HORNET BEAMS!**

14' STEEL BOOM • ALL ALUMINUM HARD-
WARE • 6061-T6 ALL ALUMINUM TUBING
3 BANDS — 10 - 15 - 20

SO LIGHT A TV ROTATOR WILL HANDLE IT.
PRE-TUNED AND EASY TO INSTALL.

ONE FEED LINE — HANDLES 500 W. USES
HORNET'S EXCLUSIVE WEATHER-SEALED TRAP
DESIGN*.

*Pat. Pending

**OLD TIMER
WSII
SAYS**

"I'VE WORKED THE WORLD
WITH MY HORNET TRIBANDER
AND LOW POWER."



WE SELL BY DIRECT MAIL ONLY
ORDER DIRECT FROM HORNET

TRY THE TB-500 BEFORE YOU BUY IT—

If fully satisfied, pay \$4.70 within 10 days and
\$4.70 per month for 11 months.

MAIL COUPON NOW—NO MONEY REQUIRED WITH ORDER

HORNET ANTENNA PRODUCTS CO. P. O. BOX 808 • DUNCAN, OKLA.	MY CALL LETTERS ARE: _____
Please rush the new Model TB-500 HORNET TRIBANDER for a 10-day free trial period. If fully satisfied, I agree to pay \$4.70 within ten days and \$4.70 per month for 11 months.	
<input type="checkbox"/> I will pay cash if fully satisfied	Name _____
<input type="checkbox"/> I will pay \$4.70 within 10 days and \$4.70 per month for 11 months.	Address _____
	City _____ State _____

ABSOLUTELY NO RISK ON YOUR PART

WRITE FOR
**FREE
ILLUSTRATED
CATALOG**

THE BEAM WITH A STING

HORNET

Antenna Products Co.

P. O. BOX 808 • DUNCAN, OKLA.

For further information, check number 16 on page 194.

HERE'S YOUR CHANCE

to get a



transmitter that:



B&W 5100-B TRANSMITTER
CERTIFIED BY FCDA
ITEM NO. T-32

- Covers All Bands from 80-10 Meters
- Permits VFO or Crystal Control on All Frequencies
- Provides Versatility for AM, CW and SSB with the 51SB-B
- Features Built-in TVI Suppression
- Has Components Conservatively Rated for Maximum Output
- And . . . All at the Lowest Cost for Comparative Value



5100-B \$525

There isn't a transmitter on the market that gives you more versatility than the B&W 5100-B . . . regardless of price. In spite of superb performance, the 5100-B is as competitive in cost and often under many comparable units.

Designed for discriminating hams, the 5100-B is engineered to the highest degree by professionals. Layout and circuitry are skillfully designed to assure a minimum of harmonics and distortion.

As a basis for novice or oldtimer the 5100-B is perfect for future addition of SSB by plugging in a B&W 51SB-B. If you're ready for maximum power you can add the B&W L-1000-A Grounded

Grid Linear Amplifier. This addition will give you 1000 watts peak envelope SSB-875 watts CW and 375 watts linear AM phone.

Here's your chance to get on the air with a top-quality signal. Buy a B&W Model 5100-B transmitter today. If you want additional information, before you buy, see your favorite "ham" dealer or write the factory direct.

Complete
assembly
5100-B, 51SB-B



Barker & Williamson, Inc.

For further information, check number 17 on page 194. Bristol, Penna.

OTHER B&W AMATEUR EQUIPMENT: Transmitters AM - CW - SSB • Single Sideband Generators • Single Sideband Receiving Adapters • Dip Meters • Match Masters • Frequency Multipliers • Low-Pass Filters • T-R Switches • R.F. Filament Chokes • Transmitting R.F. Plate Chokes • Audio Phase Shift Networks • Band Switching Pi-Networks • Cyclometer-type Counters • Antenna Co-axial Connectors • Baluns • Variable Capacitors • Fixed and Rotary Type Coils • Band Switching Turrets • Standard Inductor Materials • Miniductors • Complete line of Amateur Air-wound Plug-in Coils • Variable Plug-in Links • Faraday Shielded Links • Misc. Coil Mounting Assemblies • Misc. Frequency Marked Dial Plates • Misc. Knobs • Ceramic Jack and Plug Bars

NO COILS!

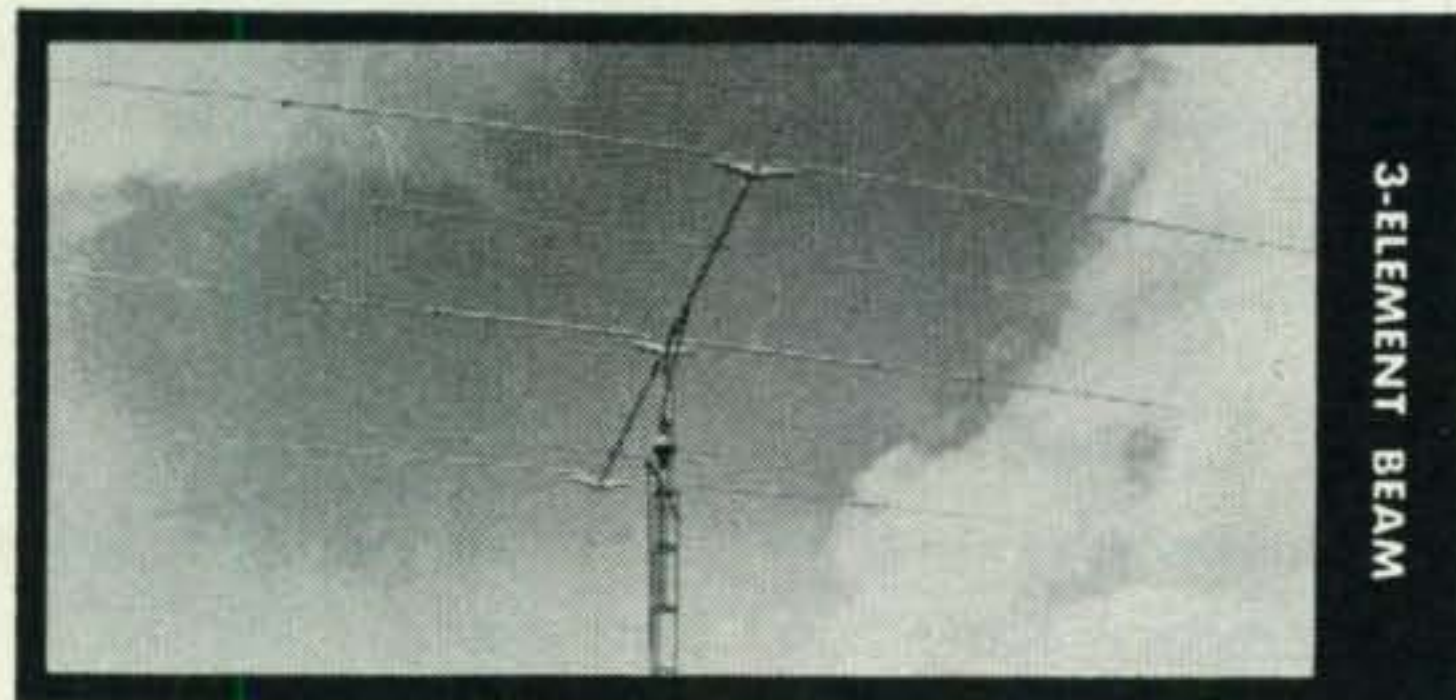

3-BANDER BEAMS



Now...GONSET 3-Bander Beams give you outstanding performance on three bands...10, 15 and 20 meters. Operate electronically...3-Banders do not use coils! Even the best coil has some loss, and losses in a poor coil can be excessive. Coil-less antennas give you more signal for a given power. Dielectric losses are greatly minimized by the elimination of coil forms and other large dielectric masses. The exclusive concentric element design provides quick electronic disconnect, essential for instant and automatic change from band to band. All elements are pre-cut to length. Before erection, sturdy tuning sleeves are set quickly to factory-specified positions, then clamped securely. Just set 'em and forget 'em!

WEATHERPROOF!



3-Bander element junctions are completely sealed against moisture by weather-resistant silicone rubber "boots".

GAIN...VSWR...FRONT-TO-BACK RATIO...WEIGHT...FEED.

FORWARD GAIN. (typical)
 3-ELEMENT: 10 meters, 8.4 db. 15 meters, 8.1 db. 20 meters, 8.2 db.
 2-ELEMENT: 10 meters, 5.3 db. 15 meters, 4.9 db. 20 meters, 5.0 db.
 VSWR (typical) either beam: Not more than 1.4 to 1 across phone or C.W. band segments at heights greater than 35 feet.
 FRONT TO BACK RATIO. 3-element, 24-28 db. 2-element, 14-18 db.
 WEIGHT: 3-element, 65 pounds. 2-element, 35 pounds.
 FEED: Both beams are fed with single RG8/U cable.

3-element, #3220-B 124.50
 2-element, #3219-B 84.50

Send for name of your nearest Gonset dealer

GONSET BURBANK, CALIF
 DIVISION OF YOUNG SPRING & WIRE CORP

countries behind the shielding you are dealing with a club station and not with one operated by an individual if the first letter after the prefix is K and it is a three-letter call. Two letter calls usually indicate individual stations. Among the information in the above magazine was the note that UAØGP/Ø is or has recently been operating in zone 23.

We recently received from VERON, the amateur radio organization of PA, a batch of their monthly bulletin **DX Nieuws**, and found same very interesting. Latest contests, QTH of rare new DX stations, a listing of available diplomas are only a part of the very compact but very informative bulletin. The bestfilled 12 to 18 (number of pages varies from month to month) we have had the pleasure to read in a long while.

The Short Wave Magazine, September 1958, G, describes a very neat two-meter transmitter of 75 watts. The power supply and modulator are also described and detailed construction and lay-out notes are supplied in the article, which is from the pen of G3CGQ. American equivalents are available for the tubes used.

Frequently others know more about you than you do yourself—this has been said more than once and we find it to be true. We know that we have more radio amateurs in the United States than in any other country, but does that also mean that we have the highest amateur population density? Not at all. In his August editorial in the above magazine G6FO does some analyzing of amateur population density and comes up with some interesting figures. Picking out a few of them we find that we have 11.7 amateurs for every 10,000 of population in the United States. Very nice, but still only second best. In New Zealand the figure is 12.0 and this is the highest in the world.

In view of the forthcoming Geneva conference conventions are being held around the world, and the DARC, as host club of the IARU Region I convention covers the proceedings and results of this convention in detail in the **DL-QTC**, DL, September 1958. We note with pleasure that there are indications in most European countries to maintain a *Status Quo* as far as the frequency allocations for amateurs are concerned. The special call DLØIARU was assigned to the station operating at the convention and appropriately enough it caused some very special BCI. The PA-system in the main convention hall was turned on and the opening ceremony was about to start, but the speaker did not have much of a chance as at the same time DLØIARU started operations and the long mike cable of the PA-system worked as an antenna. The result was that the convention was accidentally, but appropriately enough, opened with the "CQ—CQ—CQ—from DLØIARU" feeding through the PA-system.

73, Tom



1958

RADIO-ELECTRONIC MASTER

(22nd edition)

biggest most authoritative buying
guide ever published

TV - RADIO - AUDIO - ELECTRONICS

Completely catalogs over 150,000 standard electronic parts and equipment necessary for amateur and industrial applications. It places at your fingertips 350 factory prepared catalogs in one bound volume.

only \$3⁵⁰
at your distributor

1584 pages
The world's largest and
most referred to electronic
buying guide contains...

direct-from-the-factory pro-
duct information covering
150,000 items produced by
350 manufacturers

- ★ complete descriptions
- ★ specifications
- ★ prices
- ★ 11,500 illustrations

When you BUY... DESIGN... ASSEMBLE... REPAIR

You can immediately find out... What product best fills your needs? How does it compare with other makes? What does it look like? What does it cost? ...because the MASTER is systematically arranged in 18 product sections with all similar products grouped together.

Save time and money when you buy, design, repair or assemble, you'll save money and time by getting the right product to do the job because you are shopping in the electronic supermarket—The MASTER. Its product-packed pages give complete information on communications receivers, transmitters, hi-fi components, cabinets, racks, chassis, keys, crystals, microphones, and many hard-to-locate items not usually shown in the smaller, incomplete catalogs.

Remember, no matter what product or component you require... **YOU FIND IT FASTER IN THE MASTER!**

Get your 1958 MASTER today at local parts distributor or order direct. Act now — the supply is limited.

The Radio-Electronic MASTER 60 Madison Avenue, Hempstead, New York

*Here's my \$3.50. Please rush me the 1958 MASTER, Official
Buying Guide of the Electronic Parts and Equipment Industry.*

Name.....

Address.....

City..... Zone..... State.....



TWO-WAY RADIO

communications equipment

VHF-FM FOR:

MOBILE
AIRCRAFT
MARINE
MOTORCYCLE
PORTABLE
BASE

VHF-AM FOR:

AIRPORT VEHICLES
GROUND STATIONS
POINT-TO-POINT

VHF

ANTENNAS
REMOTE CONTROLS
ACCESSORIES



COMCO'S ALL NEW

"580 FLEETCOM"

VHF-FM MOBILE RADIO

The new "580" is compact, light weight, has high performance, and features an original concept in Mobile equipment packaging by combining the control head, speaker, and transistorized power supply in one small easily mounted case assembly.

FEATURES

★ **HIGH PERFORMANCE** . . . meets "split channel" technical requirements, all FCC and FCDA requirements.

★ **FULL POWER OUTPUT** . . . 35 Watts in 25-50 Mcs. 25 Watts in 144-174 Mcs.

★ **BUILT-IN RELIABILITY**...Preproduction Models field tested in 5 states and 3 foreign countries before starting production.

★ **SMALL AND LIGHT WEIGHT**...Chassis in case 13"x9⁵/₁₆"x5¹/₂". Control-power Supply-Speaker case 5"x5"x3³/₁₆". Complete Mobile installations 24 lbs.

★ **EASY TO INSTALL** . . . "Two-unit" package so small most installations are under dash.

★ **LOW COST** . . . Complete mobile package

\$398 f.o.b. factory

★ **EFFICIENT** . . . Transistor power supply gives high efficiency. Total standby drain 5.25 amp.

★ **INTERCHANGEABLE CHASSIS** . . . Mobile transmitter-receiver chassis instantly interchangeable with base stations in simplex systems.

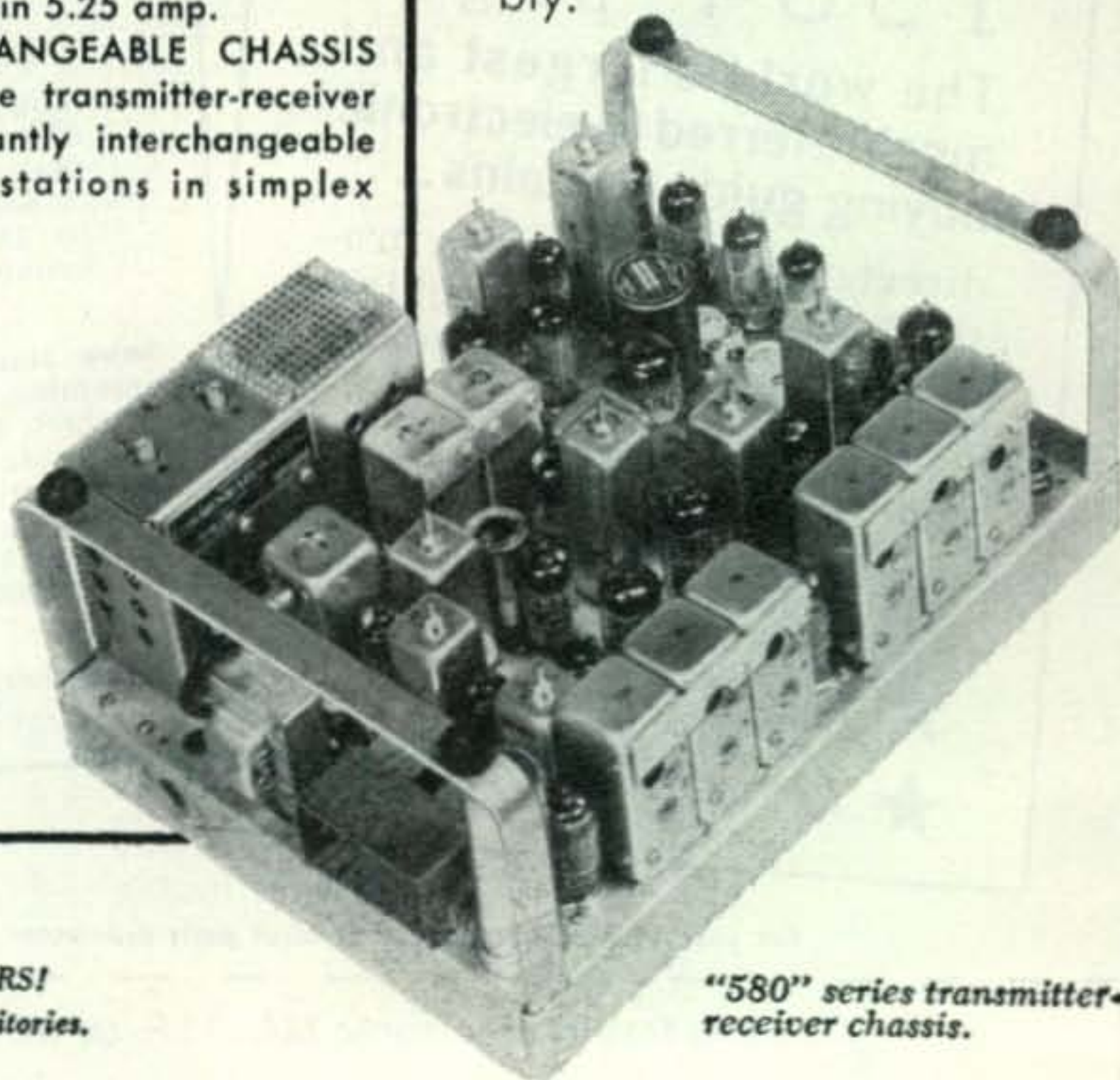

"580" series transmitter-receiver chassis.

ATTENTION DEALERS!
Write for available territories.



DESIGNERS AND MANUFACTURERS OF

RADIO COMMUNICATIONS EQUIPMENT

COMMUNICATIONS COMPANY, Inc.

FOUNDED 1938

CORAL GABLES, MIAMI 34, FLORIDA

For further information, check number 19 on page 194.

FASTER
OR
R LONGER SERVICE LIFE
 MORE VERSATILE...
 INSTALLATION

Insist on

TRI-EX

HAM AND INDUSTRIAL TOWERS

Tri-Ex Towers offer to the ham the ultimate in communication towers. Rugged x-sway bracing. Certified welds. New Tri-Ex SX Series keeps you in the air — on the air at a much lower cost.

It's NEW - SX Series Semi-Crankup

Self-supporting to 71 feet. Models to 105 feet with one set of guys. New telescoping bolt-together design. Install it with our 9 to 1 winch. Your array—what have you—put it on. Hold it with a Tri-Ex and you're on the beam — fits any rotator.

CONSTELLATION HZR SERIES

Little to be said here — it's a proven fact the constellation is the ultimate. You will never regret owning a constellation. Stay in contact longer, even when the skip is on with the utility of raising, lowering and rotating. It's true! See for yourself.

Send for our new FREE catalog on all types of crank-up and stationary, guyed and self-supporting towers for industrial communications, ham and TV.



TRI-EX TOWER CORPORATION

127 East Inyo Street Tulare, Calif.
 MURdock 6-3411 — TWX TLR 71U

**SEND
 TODAY
 FOR FREE
 CATALOG**

TRI-EX TOWER CORPORATION
 127 EAST INYO STREET TULARE, CALIF.

Please send me without obligation your FREE tower catalog.

NAME

ADDRESS

CITY..... STATE.....

For further information, check number 20 on page 194.

New Amateur Equipment

Making Your Own Beams

Many of us, reading all these articles on building beams, would really like to have a try at some of these newey designs. We'd also like to save a little money over the price of a commercial array. All this has been easyfied by Cesco with their new line of beam antenna hardware.

They have five different types of gadgets which do just about everything you could ask . . . beamwise. Starting at the end of the beam they have "Element Extending Clamps". These clamps are used to hold two telescoping elements together and come in two sizes to cover from $\frac{3}{4}$ " to $1\frac{1}{2}$ " diameter elements. They have a worm screw construction so they can be tightened with a screw driver. 59c each.

Next are the element clamps which come in sizes to fit pipe or tubing from $\frac{3}{4}$ " to $1\frac{1}{2}$ " diameter. These are cast aluminum alloy pieces which form fit the tubing allowing the element to be attached to the boom. For the boom attachment they have cast yokes in all sizes from $1\frac{1}{2}$ " to 3" diameter. To hold the units together they have three sizes of "U" bolts which cover all situations from $1\frac{1}{2}$ " to 3".

For instance, to mount an element on a boom you would need an element clamp, a yoke, and a "U" bolt. Price is \$2.29 total, for any size.

There is still the problem of fastening the boom to the mast. This is taken care of with the \$5.95 boom mounting set of two mast plates ($1\frac{1}{4}$ " or $1\frac{1}{2}$ "), two boom yokes ($1\frac{1}{2}$ " to 3") and two "U" bolts. For really big arrays there is a heavy duty boom mounting set which will fasten any size boom up to 3" to any size mast up to 3".

All you need is the tubing, a hack saw to cut it to the right size and some of these clamps and you are in business.

While we're noting the hardware made by Cesco we should mention their small Yagi clamps for VHF beams which will hold $\frac{3}{8}$ " elements on a 1" to $1\frac{1}{4}$ " boom (29c each) and the heavier duty clamps for 69c.

Quad? For \$6.95 you can get an aluminum alloy cast spider for mounting the quad arms on a 2" aluminum irrigation tubing boom. See Ad on page 20 & 21.

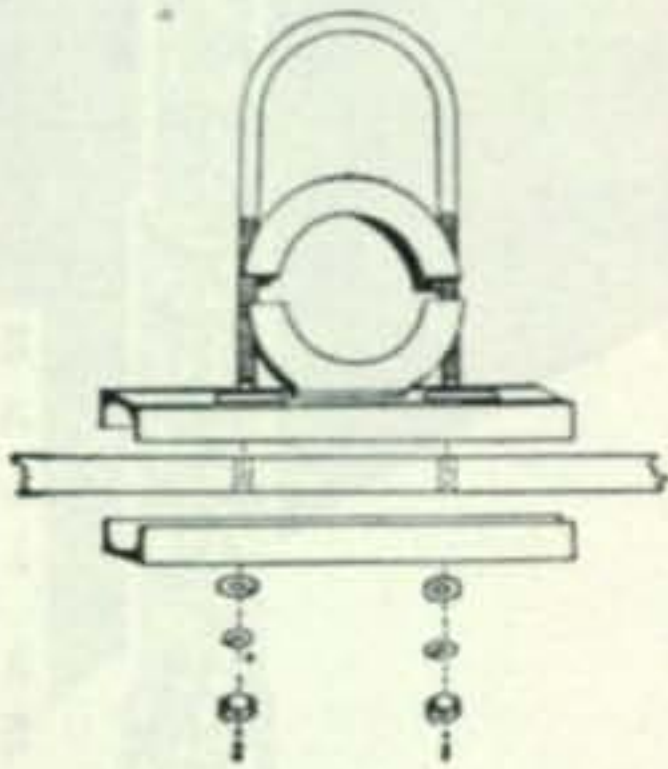

B & W Balun

This new balun by Barker & Williamson, Model 725, feeds a 75 ohm unbalanced line to a 300 ohms balanced line over the range 1.5 to 30 mc. It will handle a 1000 watts on AM or CW and up to 4 KW PEP on SSB. This is an ideal unit for coupling the low impedance coaxial output of a transmitter to a 300 ohm multiband antenna system. More facts? Gouge out D on page 194 for details.



1 KW Coil Assembly

Illumitronic Engineering has a new Air Dux coil designed for pi output circuits. The high frequency coil sections are silver plated for high tank circuit efficiency. A complete technical sheet is included with each coil. There are two sizes available: 500 and 1000 watt. Tell you what, iffen you'd be interested in perusing a brochure on these and other Air Dux coils, ziggie F on page 194.

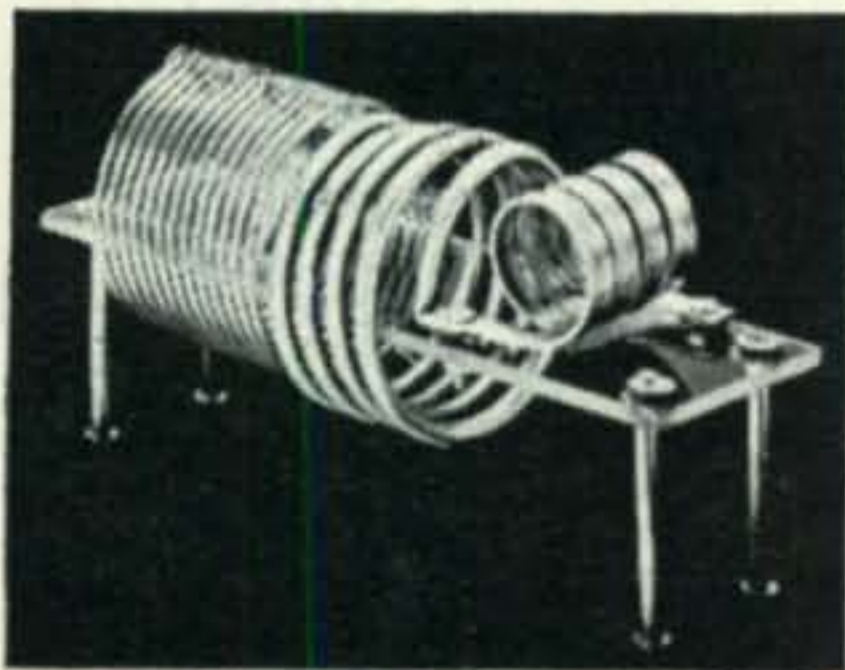

Shorty BC Whips

Most of us technological hep types like to sport the newer gimmicks. Fie on the ham who still uses one of those old fashioned BC whips on his car. Ugh! Particularly when there is a do-hinke which you can use to replace it which will unsettle the peasants. Like you can replace it with one of these Electrend Coiltennas (like a loading coil, like) or you can clunk off your present whip at about 3" above the quick and screw on the Coiltenna with 15" whip. Particularly effective for those who have discovered sports cars. Taggle G on page 194 for tepid scoop.

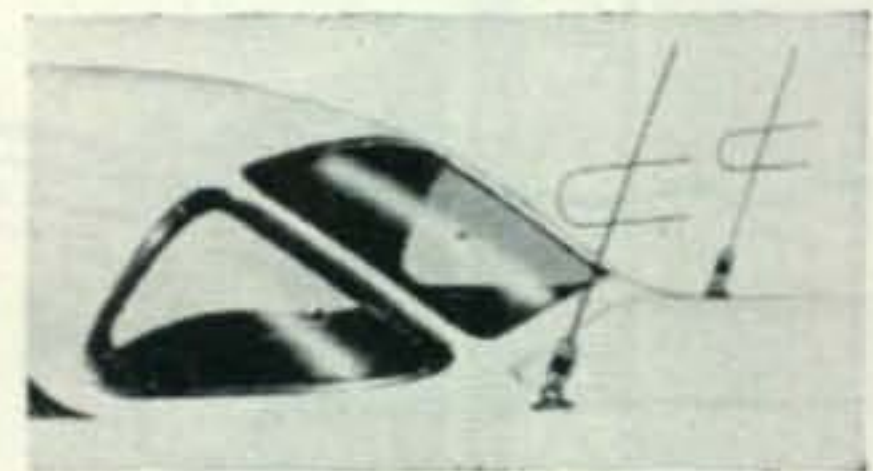

Six from Twelve

Rue Products has given Ohm's Law some serious exercise and come up with a resistor for dropping your 12 volt battery voltage down to the 6 volts you really need. The resistor is mounted in a sturdy steel box and the terminals are all marked for input and output at three current drains . . . 4, 6, and 8 amps. Cost is \$4.98. In case there are any details we have overlooked you can cross out H on page 194 and we'll get Rue Products to send you all the info they can think of.

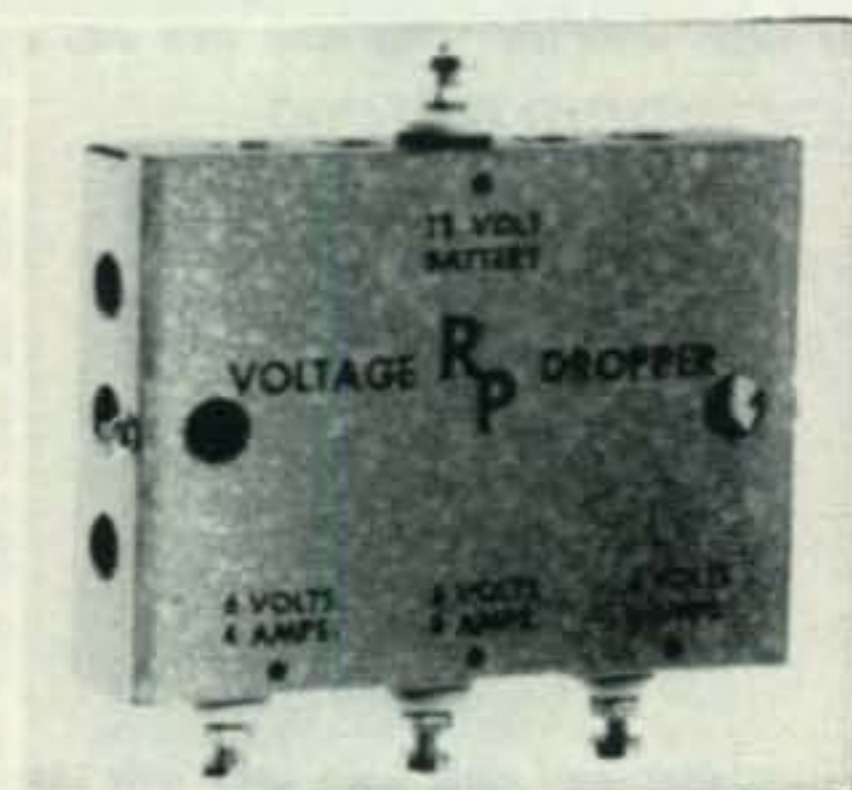

HEAVY DUTY MOBILE BASE MOUNTS

NEW!



MMW-3AE

MMW-3APS

Engineered for Greater Performance
The last word in modern design for strength and service in universal swivel bases. Easy installation, mounts watertight on any surface. With template. Positive locking, any position. Ebony Finish \$6.95 Polished Finish \$7.95
Ebony Finish, S. S. Hardware \$8.95
Polished Finish, S. S. Hardware \$9.25

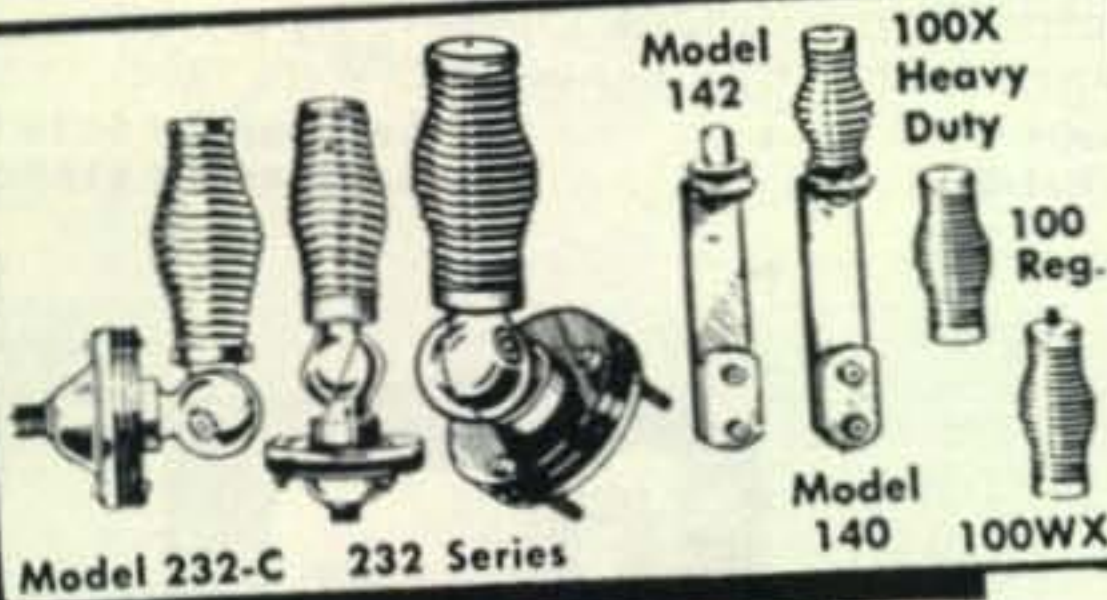

Model 232-C 232 Series

Model 140 100WX

NEW MULTI-BAND ANTENNA COILS

New Plug-In type coils for the Ham, designed to operate with a standard 3' base section and standard 5' whip

THE ARISTOCRAT

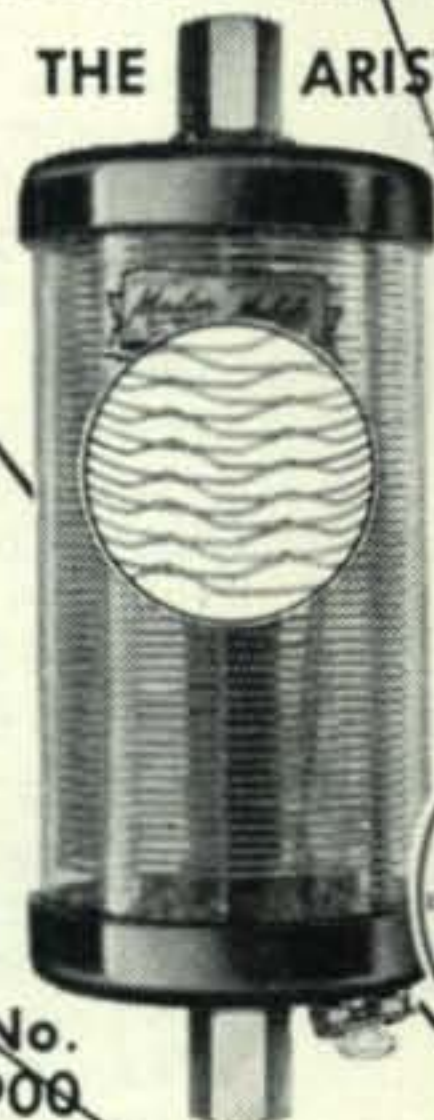

No. 900

10-15-20-40-75 METERS

THE VICTORY



No. 999

10-15-20 METERS

- Rigidly tested & engineered—found to have "Q" of 525
- Handles 500 Watts input
- Operates into a 52-ohm cable
- Positive contact—noise-free, trouble-free operation
- Weathersealed
- Factory pre-tuned—no adjustments needed

YOUR CHOICE

Amateur Net

\$14.95

Now! 2 New Coils... just plug in and presto! your coil is ready for operation on the desired band! No switches, no sliding contacts, no loose connections. Built and pre-factory tested in Master Mobile's own laboratories.

Leaders in the Design and Manufacturing of Mobile Communication Equipment & Antennas

NEW! from Master Mobile

NEW HEAVY DUTY MOBILE SPRINGS

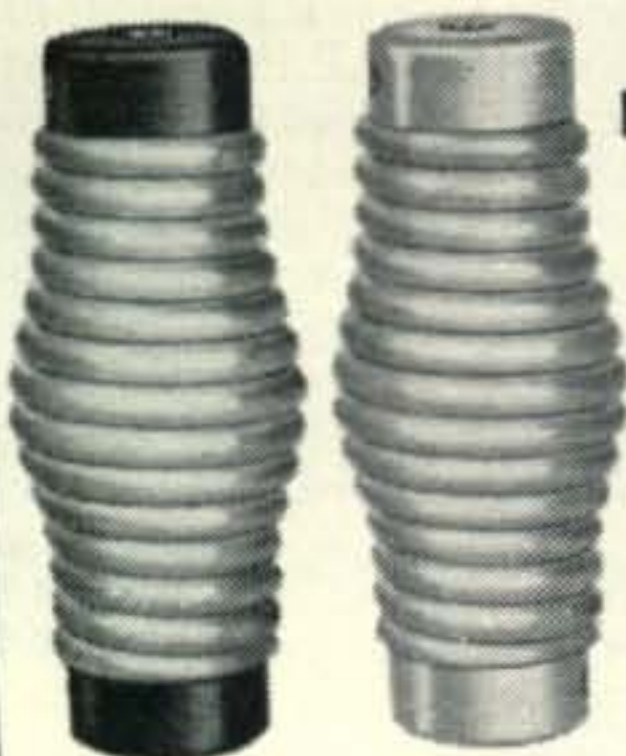

MMW-7

MMW-7SS

PROTECTS YOUR MOBILE ANTENNA

Heavy duty flexible mounting spring mounts on the base and holds the antenna. Special flexible "give" spring prevents sharp impacts and breakage. Lockwashers included.

MMW-7 Cad. plated, black painted ends \$4.50
MMW-7HC Heavy Cad. plated—Extra Protection \$5.50
MMW-7SS Deluxe Stain. Steel \$8.95

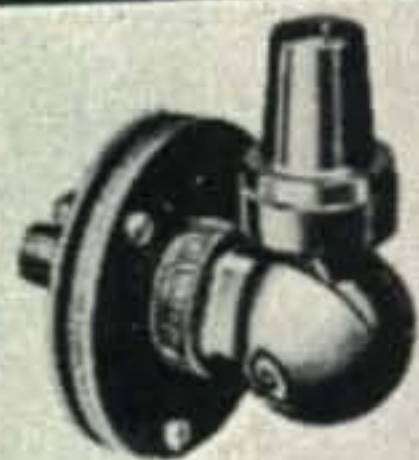

No. 321 BODY MOUNT

Swivel base body mount, less spring. Specially constructed diagonal ball joint for maximum strength. Amateur Net **\$7.95**

NEW! SLIM-JIM

ALL-BAND BASE LOADING ANTENNA COIL

FOR

10
11
12
15
20
40
80

METERS

NO. B-1080

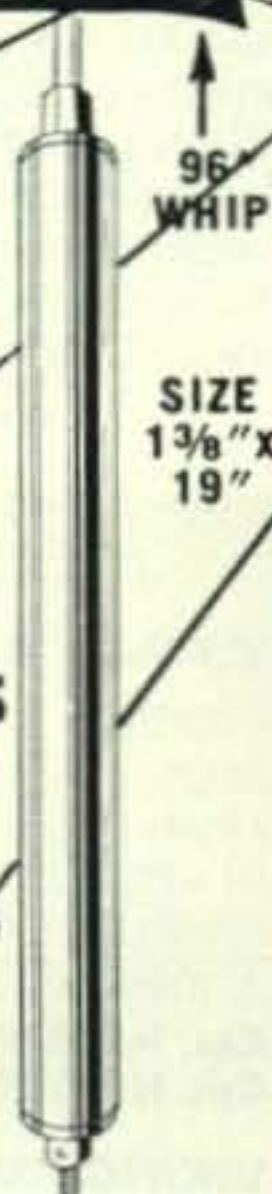

96" WHIP

SIZE 1 3/8" x 19"

Positive action, just slide whip in or out to loading point and lock nut into position. **\$17.95**



Automatically tunes the entire band from the drivers seat!

MASTER MATCHER & FIELD STRENGTH METER

6 or 12 volt models **\$24.95**

BUMPER MOUNTS WITH NEW X-HEAVY DUTY CHAINS

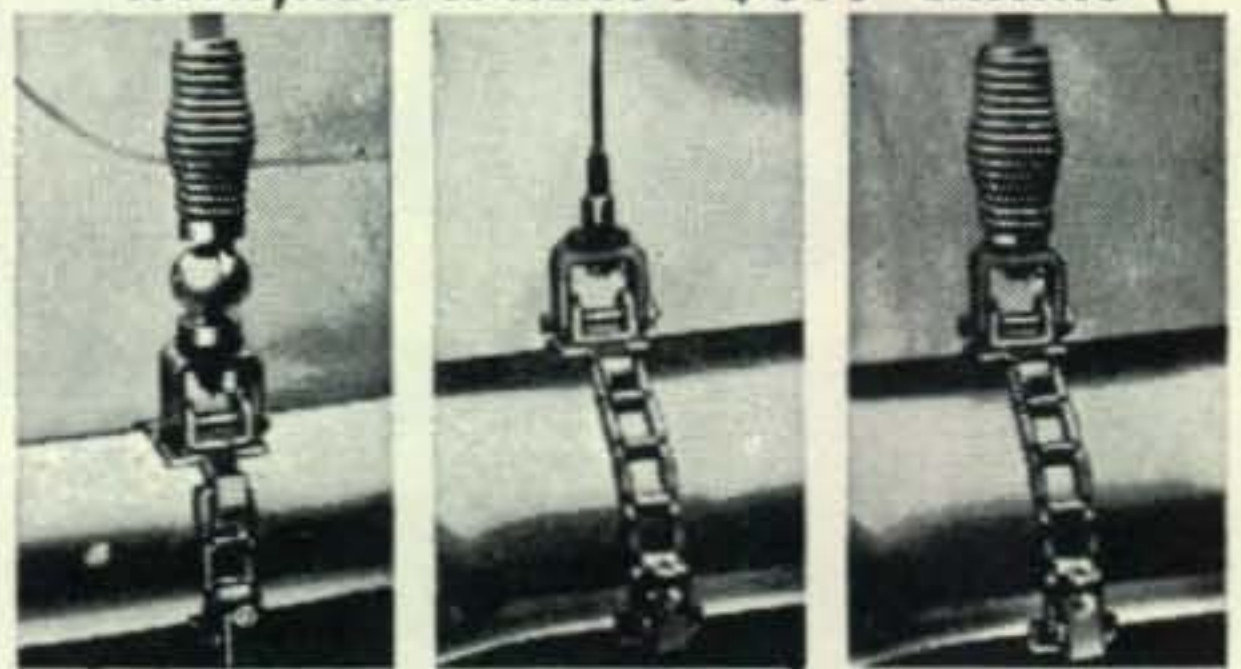

No. 444 \$17.80

No. 445 \$7.95

No. 446 \$13.45

EMERGENCY • COMMERCIAL • AMATEURS



Master Mobile Mounts, Inc.

1306 BOND STREET • LOS ANGELES 15, CALIF.

AT LEADING RADIO JOBBERS EVERYWHERE

For further information, check number 22 on page 194.



Viking Transmitters — More Effective Watts per Dollar!

VIKING "NAVIGATOR" TRANSMITTER/EXCITER

More than a novice transmitter—also serves as a flexible VFO-Exciter delivering enough RF power to excite most high powered amplifiers on CW and AM! 40 watts CW input—6146 final amplifier tube—wide range pi-network output. Built-in VFO or crystal control—bandswitching 160 through 10 meters. Timed sequence keying. TVI suppressed and filtered. Complete with tubes, less crystals.

Cat. No. 240-126-1...Kit..... Amateur Net \$149.50
Cat. No. 240-126-2...Wired and tested.... Amateur Net \$199.50

VIKING "ADVENTURER" TRANSMITTER

Perfect for the novice or experienced amateur! 50 watts CW input—instant bandswitching 80 through 10 meters. Crystal or external VFO control. Rugged 807 final amplifier tube—wide range pi-network output. Clean, crisp keying. TVI suppressed. Complete with tubes, less crystals.

Cat. No. 240-181-1...Kit..... Amateur Net \$54.95

VIKING "6N2" TRANSMITTER

This compact VHF transmitter punches your signal out with 150 watts CW and 100 watts phone input. Instant bandswitching 6 and 2 meters. Completely shielded and TVI suppressed, the "6N2" may be used with the Viking "Ranger," Viking I, Viking II, or similar power supply/modulator combinations. Operates by crystal control or external VFO with 8-9 output. With tubes.

Cat. No. 240-201-1 Kit..... Amateur Net \$129.50
Cat. No. 240-201-2 Wired..... Amateur Net \$169.50

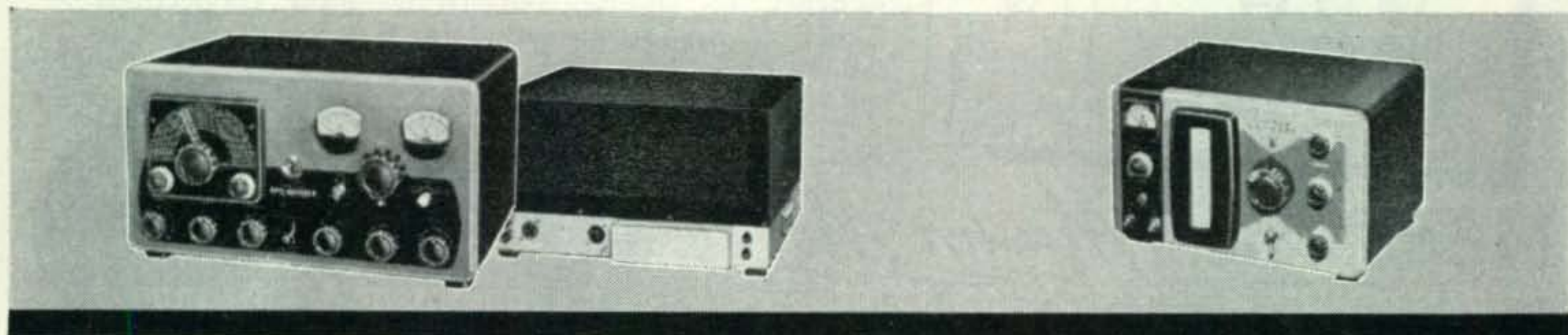

VIKING "FIVE HUNDRED" TRANSMITTER

Rated 600 watts CW input . . . 500 watts phone and SSB (P.E.P. with auxiliary SSB exciter)—instant bandswitching 80 through 10 meters! Compact RF unit designed for desk-top operation—power supply modulator unit may be placed in any convenient location. All exciter stages ganged to VFO tuning. High gain push-to-talk audio system. Operates by crystal control or highly stable, built-in VFO. Class C 4-400A final amplifier provides plate circuit efficiencies in excess of 70% with unequalled broadcast-type high level amplitude modulation. Wide range pi-network output circuit with silver-plated final tank coil will load virtually any antenna system. Low level audio clipping—effectively TVI suppressed and filtered. With tubes.

Cat No. 240-500-1...Kit..... Amateur Net \$749.50
240-500-2...Wired..... \$949.50

VIKING "COURIER" AMPLIFIER

This power-packed Class B linear amplifier is rated 500 watts P.E.P. input with aux. SSB exciter—500 watts CW and 200 watts AM! Continuous coverage 3.5 to 30 mcs. May be driven by the Viking "Ranger," "Pacemaker" or other unit of comparable output. Drive requirements: 5 to 35 watts. Employs two 811A triodes in parallel—wide range pi-network. TVI suppressed. With tubes.

Cat. No. 240-352-1...Kit..... Amateur Net \$244.50
240-352-2...Wired..... \$289.50



VIKING "RANGER" TRANSMITTER/EXCITER

Superbly engineered . . . delivers solid audio punch! This popular 75 watt CW or 65 watt phone transmitter also serves as an RF/audio exciter for high power equipment. Built-in VFO or crystal control—instant bandswitching 160 through 10 meters. 6146 final amplifier—wide range pi-network output. Timed sequence keying. TVI suppressed. With tubes, less crystals.

Cat. No. 240-161-1...Kit..... Amateur Net \$229.50
Cat. No. 240-161-2...Wired and tested..... Amateur Net \$329.50



VIKING "VALIANT" TRANSMITTER

Here's effective power, wide flexibility, and many unique operating features combined in a compact desk-top transmitter! 275 watts input CW and SSB (P.E.P. with auxiliary SSB exciter) and 200 watts phone. Instant bandswitching 160 through 10 meters—built-in VFO or crystal control. Final amplifier utilizes three 6146 tubes in parallel—wide range pi-network output. Silver-plated final amplifier inductor—built-in low pass audio filter—low level audio clipping. With tubes, less crystals.

Cat. No. 240-104-1...Kit..... Amateur Net \$349.50
Cat. No. 240-104-2...Wired and tested..... Amateur Net \$439.50

For easy terms
see your
Johnson Distributor



E. F. Johnson Company

2940 SECOND AVENUE S. W. • WASECA, MINNESOTA

For further information, check number 23 on page 194.

Letters . . . to the editor

Letters

Dear Wayne:

I have written so many letters. None of them have yet been printed. You guys probably write them yourselves. I'll bet you a subscription to QS . . . er ah I mean CQ, that you won't print this letter. Hah.

(reluctantly) yours,

Bruce Dembling, K2DQU

Harold, send this chap one of our handy new high priced subscription forms . . . he owes us a subscription.

Reciprocity

Dear Wayne:

I have read with interest remarks in recent issues of CQ about steps to grant reciprocal licensing facilities in the U.S., and stories such as those of Dr. J. A. Crutchfield, W7GFM, on "Frustration in VQ5" (August CQ). I would draw attention to those, like myself, who are resident aliens in this country not yet qualified for U.S. citizenship.

The attitude of the U.S. Government is the same as that of most others in refusing to grant amateur licenses to non-citizens. Yet surely in taking steps to grant reciprocity, the U.S. would have an opportunity to make a small but tangible contribution towards improved international relations.

It can only be assumed that the widespread policy amongst governments of granting licenses only to citizens arises from an unreasonable fear of the security risks involved in a more liberal attitude. In this country at least the rigorous checks on aliens routinely made before admission to the privileges of permanent residence make such a problem negligible. It must also be obvious that any maliciously minded person can secure and operate a radio transmitter clandestinely here and elsewhere with little risk of immediate detection.

It may be that the question of licenses for resident aliens is in a different category from the granting of permits to temporary visitors or transients. Indeed, it would seem that an alien admitted to permanent residence is, by the very nature of his stated intentions on entering this country, not unreasonable in seeking an opportunity to submit to an examination for an amateur license, and that this should be granted only after proof of technical competence.

These remarks are not offered in a spirit of carping criticism of the regulatory bodies in this country. Indeed the FCC regulations relating to amateur operation are a model of wise foresight and liberality that only those who have operated amateur stations elsewhere can appreciate.

I hope that you will see fit to give this letter some publicity through your columns.

W. Ross Adey, M.D.
ex-VK5AJ
ex-G3GPC
ex-VK3AJL
2311 Parnell Ave.,
Los Angeles 64, Calif.

Well Ross, the question of security has been brought up several times, but your answer is certainly logical; if anyone wants to use a clandestine transmitter there isn't much to prevent him. The exclusion of aliens from getting FCC licenses stemmed from labor unions and their desire to protect American radiomen from being displaced by imported foreign labor who would work for lower wages. There was no thought of "security" at the time the law was formulated.

Dear Sir:

A short while ago, I had a very pleasant QSO with "Mac," W4PEY. We were discussing the "CQ DX" calls from "W" land and we both agree, along with many other European amateurs, it only causes nothing but a mass of QRM on 20 meters, especially CW.

FB. With all the CQ DX's you can imagine what a Here in Europe the "W's" are blasting in here every pile-up it causes here. Many amateurs here will not answer a "W" calling "CQ DX."

So all you "W's" who always call CQ DX PSE try to eliminate all the unnecessary QRM, here and stateside, and try to make operating on twenty meters more pleasant and enjoyable for the amateurs stateside and overseas.

TU 73's

A/lc James P. Fodor, DL4RZ
6911th Radio Grp. Mobile
APO 175, New York, New York

Sure, you don't like the QRM that goes with all us Statesiders calling "CQ DX," but will you DX stations go to the length of not answering such calls? We find that we usually get answers when we call "CQ DX," so why should we stop?

Shocking

Dear Wayne:

I'm with W8DPJ in the letters section of August CQ. I got a dose of the same thing—1500 volts and I am 'quite sure that you won't catch me doing some of the foolish things I've done before any longer. It is really too bad that all of us thick skulled fellows have to almost get killed before we start to think about what the currents we are often so close to can really do to you. They can do plenty—take it from someone who has personally tried it! Those white complexions and bleeding hands that W8DPJ talks about are no fun. I'm just glad I'm still around to be a little more careful from now on. Even with that mean 110 volts that nobody gives much credit to as being able to kill you.

73,

Ray L. Sullivan, K5GHP
1011 South Glasgow Dr.
Dallas 23, Texas

KC4AF

Dear Wayne:

All KC4AF QSL's have now been sent out. The total is 3490! This includes cards sent with no return postage which were sent through the ARRL QSL bureaus. We have a few cards with no dates or times which means we will have to go through all of the logs. It might be a good idea to insist on GMT times on future contest and DX logs. Many of the cards show GMT times and local dates, which really loused us up.

The QSL gang, headed by W8JIN, W8TJM and W8JJW, really did a fine job. Our logs show 6493 contacts from Navassa and 949 from the Empress for a total of 7442.

Jake Schott, W8FGX
Cincinnati, Ohio

Transformers

Dear Mr. Green:

I have recently seen some letters to the editor concerning hams who wish to wind their own modulation transformers, but can't find a suitable core material available. . . .

I spoke to my uncle, who is president of National Moldite, about this. He told me that National Moldite doesn't sell on a retail basis, but if the hams contact me and tell me what type of transformer they wish to make, he will try to help them out.

The information which I need is: frequency application (if for other than audio frequencies), Physical dimensions, permeability stability desired—and depending on application, Q . . .

Being a ham myself, I hope that I can help out the radio amateurs who are faced with this core problem. Requests which are sent directly to National Moldite will not be handled. All requests should be addressed to my home QTH at 6 Cooke Avenue, Carteret, N. J.

Richard C. Weiss, K2QLV

QRG? Where Am I?



Roy A. McCarthy, K6EAW

737 W. Maxzim
Fullerton, California

This might be the plaintive bleat of a poor little lost sheep, or perhaps a Novice whose receiver calibration isn't of the \$500 class, or even an experienced Ham who likes to roll his own. Well, we can't help the poor little lamb, but the Novice and others can locate themselves quite readily with this handy dandy calibrator.

The usual way of finding out where we are, in or out of the band, is more or less the following. A crystal oscillator on the band edge and trusting to the receiver calibration for the rest, or a 100 kc or 1000/100 kc crystal osc. This is of course sufficient to meet FCC requirements, and for more accurate interpolation a 10 kc multivibrator is sometimes used, at least the ARRL handbook says so.

Well, why not a more direct way of getting those 10 kc markers up into the ham bands? It sounds easy, just modulate a band edge xtal with 10 kc signal. It works fine too, else this article wouldn't have been born. In my case, I use a 7 mc xtal oscillator (with harmonics) mixed with a ten kc oscillator (with harmonics). The result is a splurge of 10 kc markers throughout 40, 20, 15 & 10 meters, with a good band edge check point to boot. If you have an ear which is reasonably accurate in estimating up to 5 kc, it's simple to pinpoint your frequency between these 10 kc markers.

Circuit wise, an inexpensive junction transistor is used in the 10 kc oscillator, followed by a 1R5 mixer—crystal oscillator. Battery operation was used for portability and instant operation on throwing the switch. However, in the breadboard circuit a 6BE6 was used also and it performed nicely. A point to consider though

is that there is less heating effect causing possible drift with the battery operated 1R5. Since the unit is not in constant use, battery life can be expected to be quite long. Approximate current drains are, 2N107, 60 Microamperes; 1R5 plate, 130 Microamperes; 1R5 screen, 1.05 Milliamperes; filament, 50 Milliamperes. A separate battery is used on the transistor for stability and it runs continuously.

The 10 kc oscillator can be calibrated in a variety of ways, such as on a Berkely counter, oscilloscope or "dead beating" a series of broadcast stations, (SW1, should be closed, and also the crystal oscillator operating, since the tube loads the transistor circuit slightly. The harmonics of the 10 kc osc. are weak but usable up to 1,000 kc for this check.) or you can even just count the number of beats between 7,000 and 7,300 kc on your receiver bandsread dial, and come pretty close.

The use of the calibrator isn't limited to the
[continued on page 170]

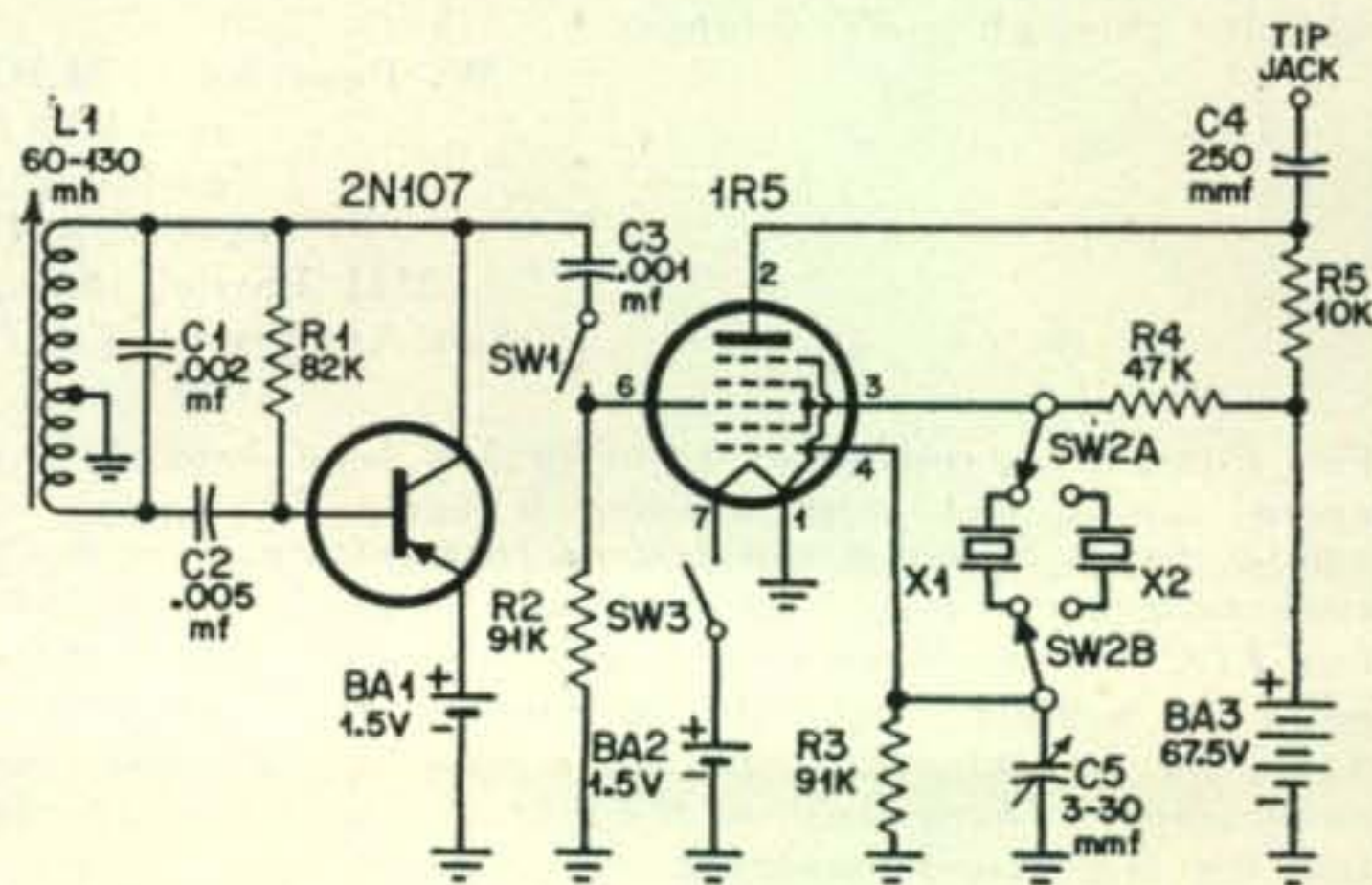

Amateur Satellite Reception and Recording

F. K. Dearborn

Geophysics Research Directorate
Air Force Cambridge Research Center
Air Research and Development Command
Laurence G. Hanscom Field
Bedford, Massachusetts

The response of amateurs and others to the request for measurements of the U. S. Satellite signals has been gratifying and, as was expected, has provided valuable information. I would like to review very briefly the two major fields of measurements that may be undertaken by independent investigators such as amateurs and SWL's.

The first field is that of doppler measurement which requires the use of receiving equipment of a high degree of frequency stability. It must not be subject to either local or beat oscillator drift nor age frequency pulling effects. These measurements, then, require the use of a crystal controlled heterodyne oscillator at the carrier frequency, or a subharmonic thereof, or a receiver whose internal construction provides a comparable stability. These measurements can and are being made by various amateurs and the data obtained will be of value in many cases.

The second major contribution is the direct recording of telemetry signals from the satellite transmitters. We have had occasion to request the loan of quite a few amateur tape recordings of satellite telemetry signals which were recorded at what was considered to be critical periods. It has been noted that in all cases they suffer from one particular defect—the use of an heterodyne oscillator either at the carrier or intermediate frequency. It is likely that in most cases the heterodyne oscillator was used for doppler measurement purposes.

Simultaneous doppler measurements and telemetry reception by the same receiver tend to be incompatible. Assuming an amplitude modulated transmission, two reasons may be advanced to support this statement:

1. A beat oscillator produces its strongest output signal by heterodyning against the carrier frequency itself. The fact that this frequency varies because of receiver instability and/or doppler shift makes it exceedingly difficult to remove with a filter. If the heterodyne falls within a desired telemetry channel and close to the telemetered frequency, the data

[Continued on page 186]



Reading left to right, Frederick A. Brown and the Author, both of Air Force Cambridge Research Center.

Reading left to right, Lorenzo Johnson, Wentworth Institute, and the author.

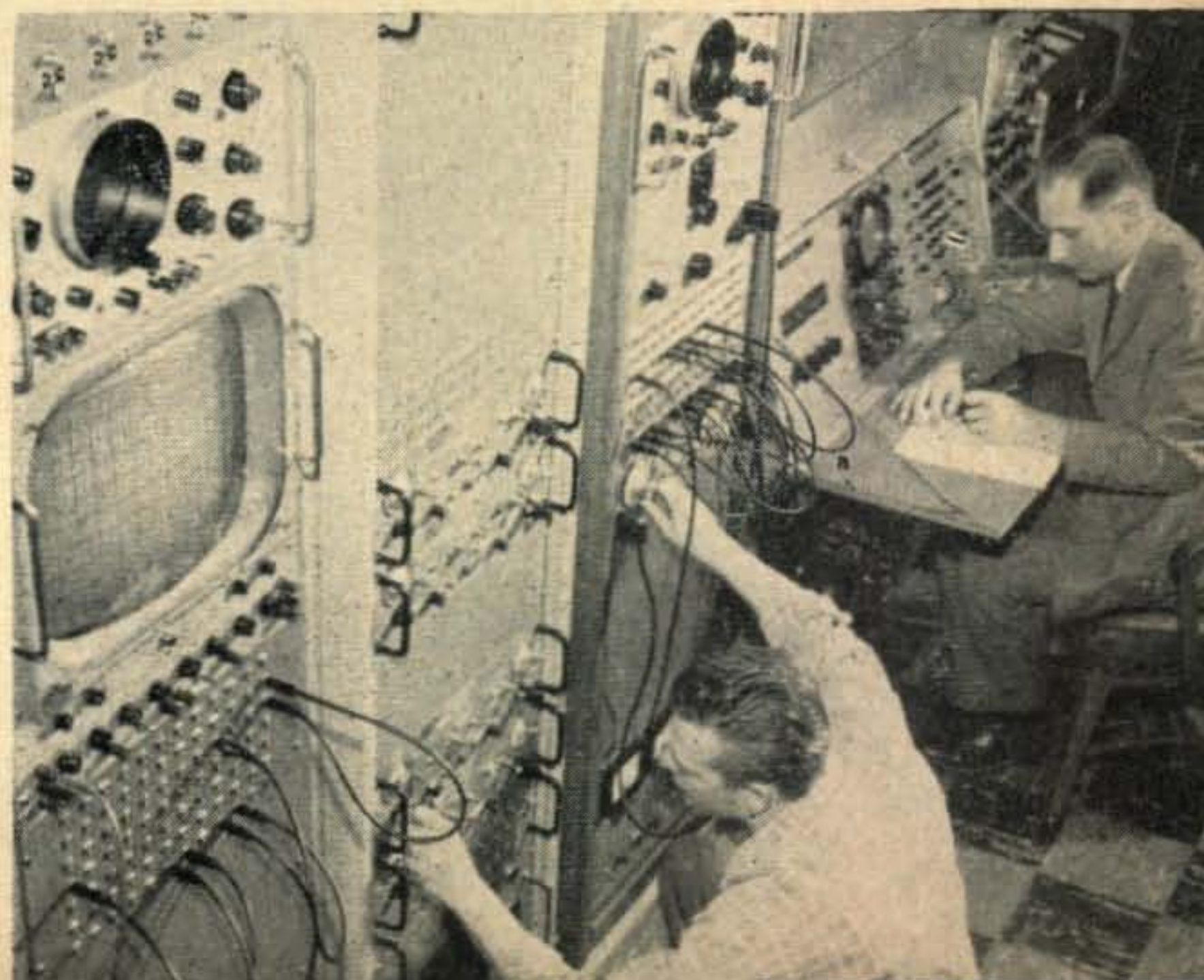

The Birdcage

by LEE SHAKLEE, W6PQW

130 Hubbard Ave., San Lorenzo, Calif.

It IS an intriguing name, isn't it?

Sorry to say, however, I can't take credit for the appellation. It was called a "Stacked Twin-3" to begin with, but since it perched near a thoroughfare and was easily visible from it, and since quite a number of imaginative Hams travelled that route—well, the "Birdcage" it became.

And quite an antenna it was, too. It towered gauntly into the sky, impressively dwarfing mere Yagi arrays—and not only in size, either.

But I'm getting ahead of myself. It all began one day in the early part of 1946. For months I'd been using my post-war version of the single Twin-3, a duplicate of the antenna which I'd fallen in love with in the halcyon days before WW Two on both Ten and Twenty meters. It had been a performer then, and it was living up to expectations now.

Like most Hams, though, I wasn't satisfied. I wanted more. Well, why not TWO of the little gems, stacked. *Two of 'em? One above the other? Sure, why not? How you gonna rotate it? Oh, it can be done. (This last, vaguely.)*

And thus it was that the project began. Slowly, the ideas jelled. It was the physical construction which kept throwing rocks into the lawnmower. The elements, for example, should be maintained in a taut condition even with aging and the inevitable stretching of the wire of which they were to be made. Bamboo poles were out. It was a known fact (through sad, previous experience) that bamboo will quickly sag, drooping the elements below it like a limp bowstring.

Ah-ha! How about a *taut* bowstring? And on top, so the weight will tend to increase the tension? *What's to keep it from flopping sideways? Anchor it in the middle. Maybe, but will the ends stay put?*

All right, then, we'll make the "bow", itself, out of material which can't flop to either side—and that settled that. The "bows" (see fig. 1) were constructed of 1x6 pieces of clear redwood. Three egg insulators at each end secured the wires of the dipoles, with jumpers placed in such a manner as to create a long, squatty "S" out of the entire configuration.

The over-all length, including that of the two jumpers, was computed from the formula 480 over Fmc times three.

The reason for the odd-ball number (480) instead of the usual 468, or the free-space figure of 492, is that end effects were considered to be that of a single-wire dipole, while the length was that of three of them. A compromise was struck (and proved to be amazingly accurate).

Now, the two dipoles of a Twin-3 should be spaced about an eighth-wave apart in order to match an open-wire feedline through the two quarter-wave matching sections of the same impedance. A perfect match could be obtained by varying the spacing between the dipoles, and without impairing the gain. But we're dealing with high impedance here. Slight variations have negligible effect on the match.

With this in mind—and remembering that there would be four quarter-wave transformers joined at the feedpoint instead of the usual two—it was decided to hold to eighth-wave spacing on each Twin-3. The closer the spacing here, the lower the impedance. The lower the impedance at the center of each three-wire dipole, the higher the impedance presented to the feedpoint a quarter-wave away. And with four such impedances in parallel—well, it was decided to keep it high for obvious reasons.

In time-honored fashion (time-honored to me, that is, on all prior Twin-3's), the eighth-wave booms were five foot 2x2's. The 1x6 "bows" mounted to the booms with angle brackets, as in fig. 2.

Fig. 3 shows the single Twin-3 element, its dimensions and its feed-point. By golly, it was shaping up!

Yeah, but it still has to be rotated. Remember?

Ugh! That's right. But a ray of hope! Since the antenna is bi-directional, it only needs to be rotated through 180 degrees in order to obtain full azimuthal coverage. And THAT, my little unseen kibitzer, pins a different tail on the donkey.

Hinges—plain, old, ordinary gate hinges—will turn through 180 degrees. And they'll hold up a barn.

Yeah!

Thus it was that (with a since-abandoned abhorrence for metal supporting structures) a 4x4 redwood pole 20 feet long was selected to

[Continued on page 167]

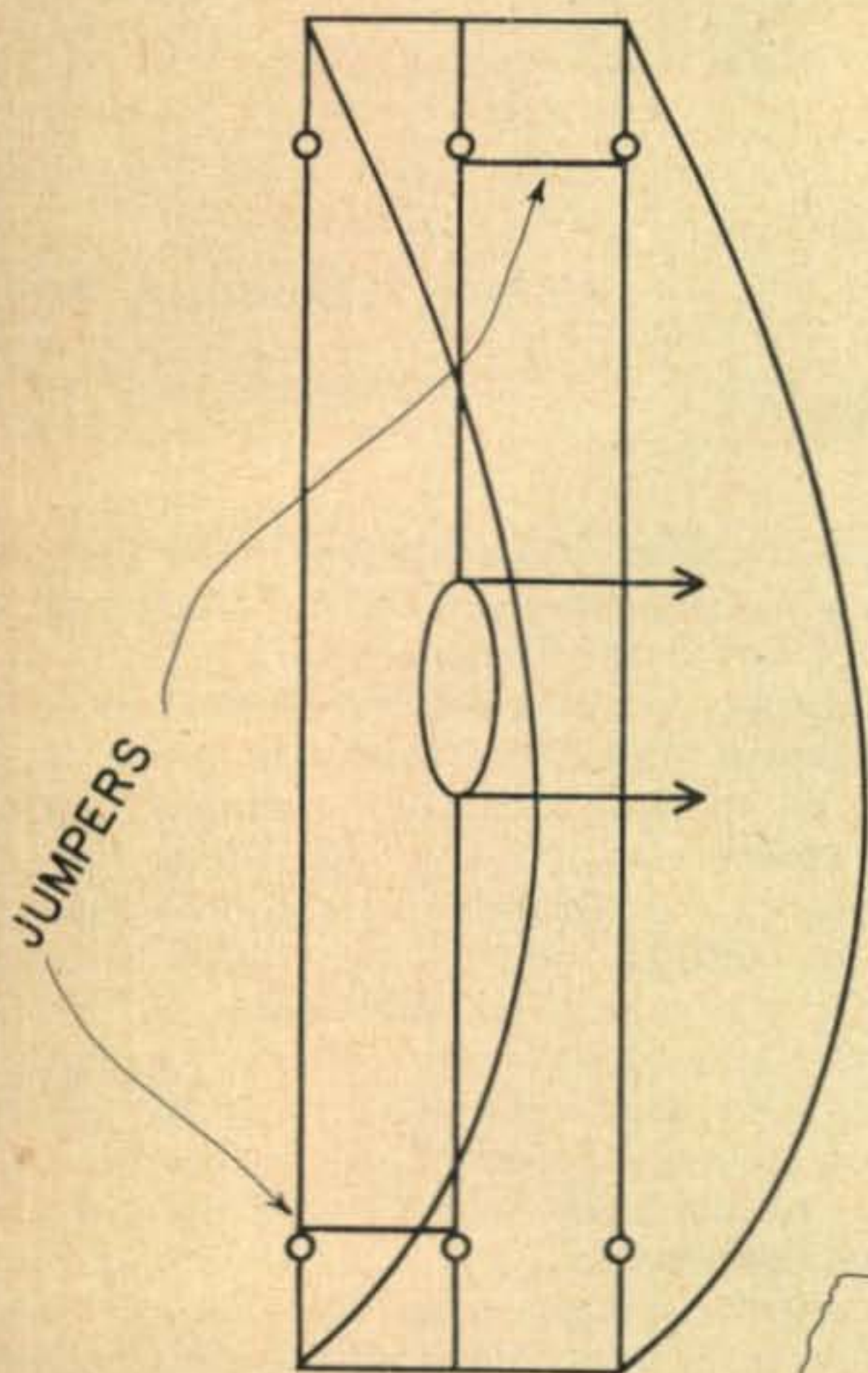

Fig. 1

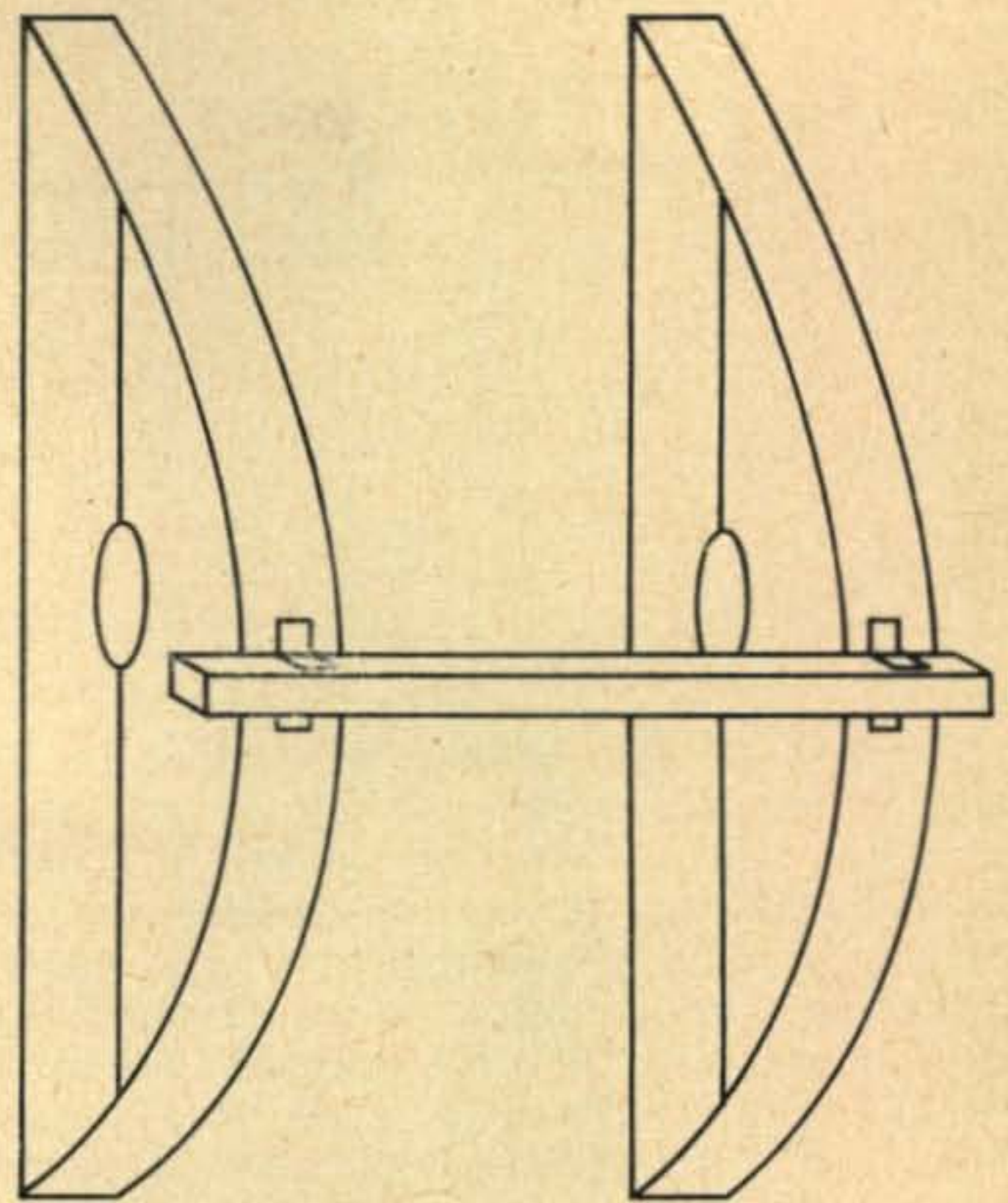

Fig. 2

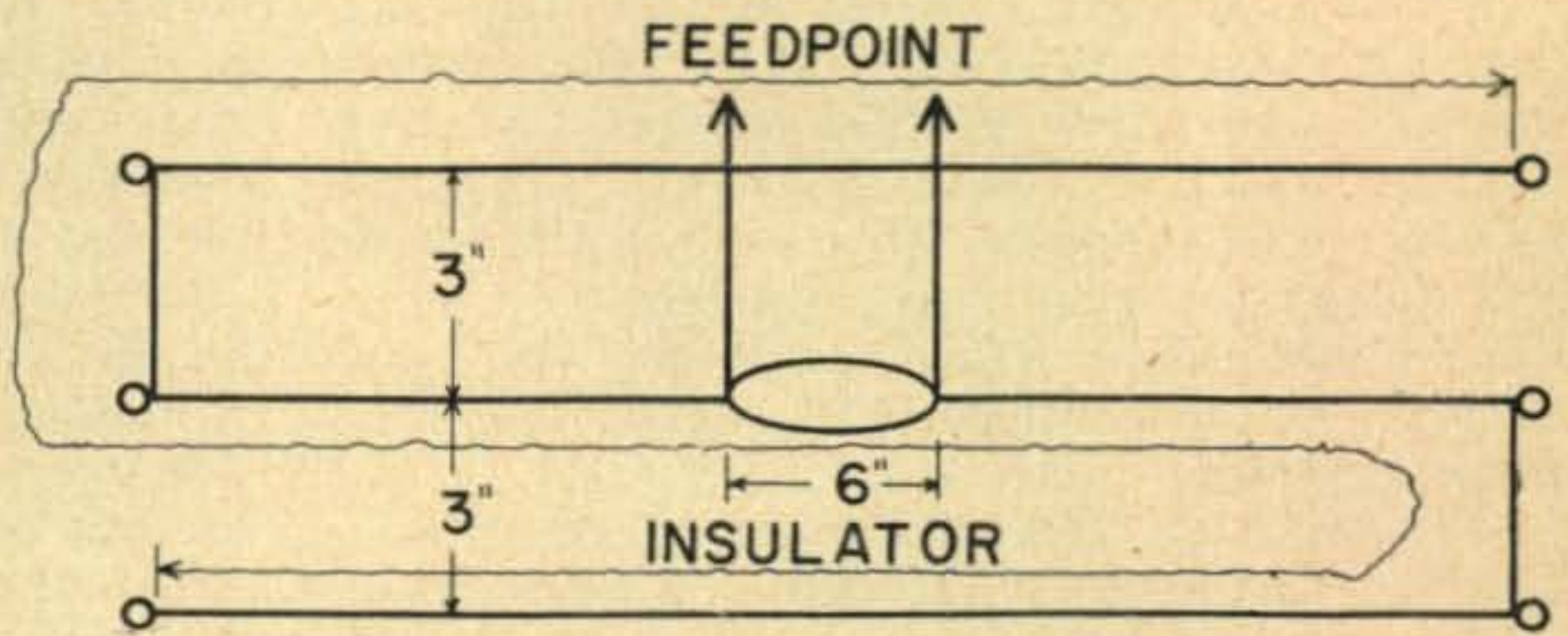

Fig. 3

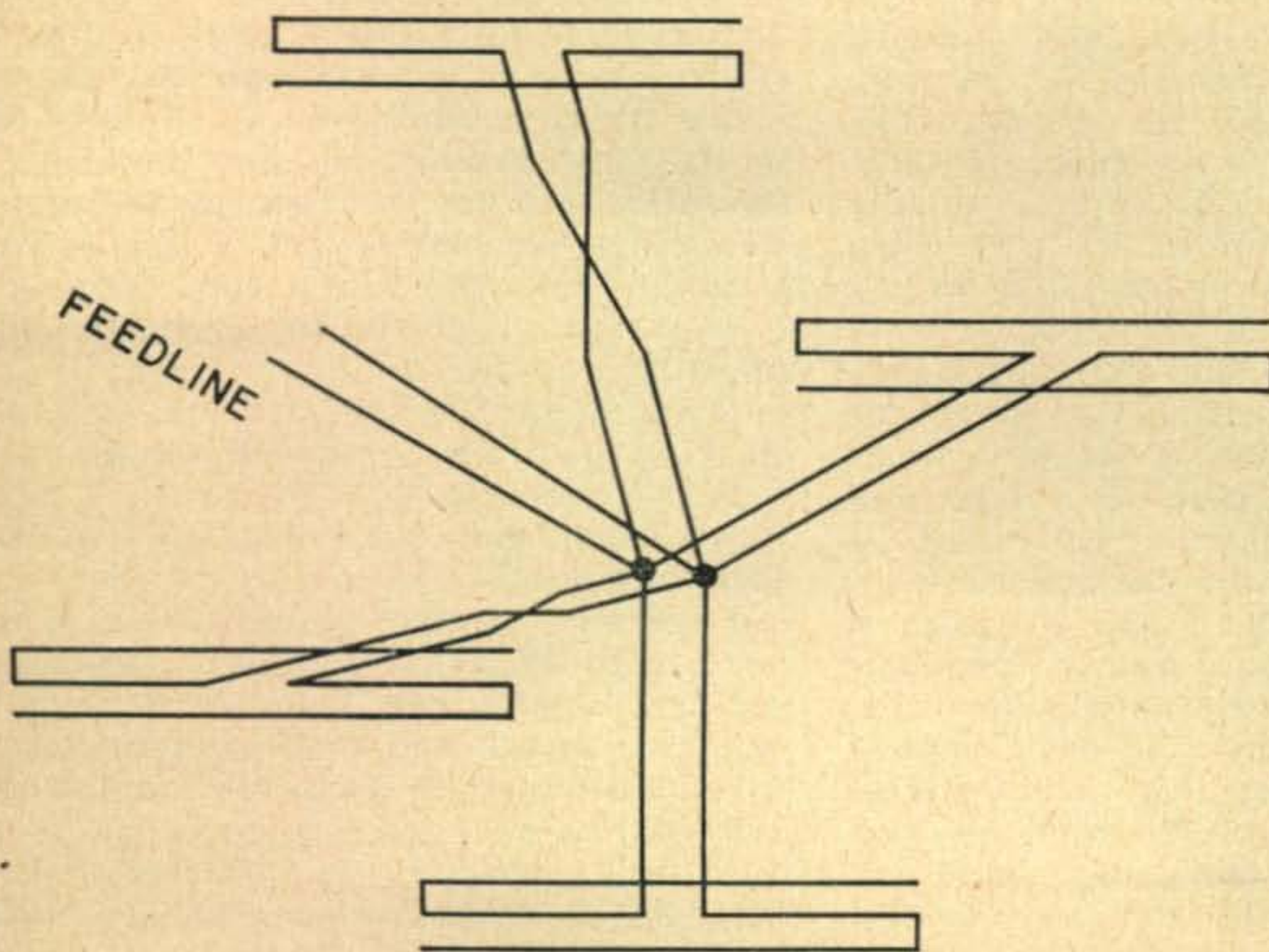

Fig. 4

Anodized Heat Sinks

William E. Bradford, W5IXV

Radio Station KSST
Sulphur Springs, Texas

Throughout the history of electronics the radio amateur has been characterized by his ability to absorb into his hobby practically every technical success in engineering, research and mass production. In a large number of instances he has found uses and capabilities the manufacturer never suspected. When the designers proudly rated the type 10 triode (the bifocal set will remember that one) at 18 mils of plate current, they never suspected that some DX hungry ham was going to remove the base, dunk it in a fruit jar full of oil, and load it up to his favorite color.

But within recent years the amateur has found his ingenuity severely taxed. (Magnetrons are nice, but how much can you say in a microsecond?) And judging from the comment on the bands it appears that far too few of us are willing to accept the challenge and show the manufacturers a few new tricks with transistors. (At this point you can start writing your nasty rebuttal to the editor.)

Yet much of this reluctance about transistors was justified. What can you do with a gadget that will stand only a handfull of volts and practically no current a'tall? The ham who used to read his log by the light from the plates of his pair of 45's gave up in disgust when he read the specifications (a cowardly thing to do) and found that germaniums—like geraniums—start to wilt at something like 40° centigrade. (40° centigrade is just slightly cooler than the temperature of the XYL when she sees what the soldering iron did to the dining room table.) So, by the time you add other little things like poor high frequency response, high noise level, and a theory of operation that made about as much sense as Khrushchev (who ever heard of a hole that drifts around, even in germanium) most of us decided to stick with the vacuum tube.

Those were the early days; the transistor is growing up. Noise is way down. Frequency response in some models approaching the microwaves. Some types with current ratings in amperes. Sure, they're not ready for the final stage of the California KW, but the new power transistors in a mobile modulator will let the rf tubes hog all the high voltage, and the new self switching transistor circuits that make plate voltage out of battery voltage

promise to be the nicest thing that's happened to ham radio since somebody (ham, by the way) invented the crystal filter.

So we get enthused over each new article about power transistors until the author begins to discuss thermal runaway, ambient temperatures, heat sinks and stuff like that. But wait a minute . . . grandpappy cooled his 10's down by getting the heat out of the tube and into the oil, and after all, from an oil bath to a heat sink is little more than a generation.

This heat sink—it's just a chunk of stuff held in thermal contact with the mounting surface of the transistor to give the transistor heat somewhere to go. Generally speaking the larger the heat sink (and we'll admit this is over-simplified) the more efficient it is at holding the transistor heat down. A slab of thick aluminum is a good heat sink—so is a heavy gauge aluminum chassis.

Now, at this point we get into *word* troubles. The word "base" is used to define both the bottom of the case in which the transistor is enclosed *and* an electronic base which is the part of the transistor drawn as a vertical line in the symbol. In the 2N107 and most other low power transistors the two bases are tied together, and there is no problem. The trouble begins with power transistors such as the 2N278 where the base comes out as a prong with an insulated lead attached, and the collector is internally tied to the case of the transistor. This difference between an electrical base and a thermal base can turn a good transistor into a poor paperweight. In any event, for the purposes of our discussion the word "base" will only be applied to the thermal base of the shell of the transistor and has nothing to do with its "innards".

Assuming that our power transistors have their collectors connected to the thermal base, our problems are half solved if we use transistor circuits involving grounded collectors. Just drill the appropriate holes in a smooth flat chunk of metal, goo it up with silicon grease if you wish, bolt the transistor down firmly . . . and start wiring. Unfortunately most circuits do it the hard way. If the collector of the transistor has to go somewhere else electrically before it goes to ground mechanically (or thermally) then we are going to have to find ourselves

a little bit of insulation before we get to the drilling and bolting and wiring and fuse blowing stage.

Most of the do-it-yourself articles suggest that the home constructor separate the transistor from the chassis or heat sink with a piece of mica a couple of mils thick. A mil, in this case, is a unit of measure, and one mil is thinner than the ham on a drugstore sandwich. And since ham is a poor insulator, this is not the solution we need. In fact, let's face it, practically every usable *electrical* insulator is also an excellent *heat* insulator. Sure, within limits, you can take a good electrical insulator and shave it down until it's forced to be a good conductor of heat, but when you reach that point you're dealing with thousandths of an inch, and that's even narrower than the space between the edge of the band and the first CQ, especially when you're splitting it with the XYL's kitchen knife. So that's where anodizing comes in—which is why we are here in the first place.

Anodizing is simply a process of changing the *surface* of a piece of aluminum into aluminum oxide. Most oxides are undesirable. If it happens to iron, it's called rust, but aluminum oxide is a thin, tough, insulating surface to which we can thermally attach, yet electrically insulate, our transistors.

Anodizing

To anodize our aluminum we merely need to expose its surface to free oxygen (not molecules—just atoms). The most practical way is to immerse our surface in a sulphuric acid solution and establish a positive voltage on it in relation to another piece of aluminum also in the same solution. Free oxygen will be generated on the surface of the positive plate, will combine with the aluminum, and become anodized. Those are hydrogen bubbles you'll see coming from the other piece.

Let's start at the beginning and try some. You can either anodize the surface of the heat sink itself or you can anodize washers to put between the heat sink and the transistor base, or if you wish you can anodize only a *part* of the heat sink, simply by only putting that part of it in the solution. Me—I like the washers. You can make them a little larger than necessary and bend up the ends for cooling fins; if you anodize both sides you have a double insulating surface for added protection (matter of fact, it's pretty hard *not* to anodize both sides).

First, choose a piece of aluminum that's completely free of burrs, rough spots, gouges and stuff like that. This oxide is thin, and the smallest nick is like a chisel that can punch thru your anodized surface when you clamp the transistor down. My favorite washer material is aluminum disc recording blanks. Steal (or borrow, if necessary) one from some broad-

cast station or recording studio after they've finished with it. Put it in a sink full of *hot* water, leave it for about ten minutes, and then peel off the acetate. You now have a flat, polished surface that you can comb your hair by, if any. Some aluminum kitchen utensils and some chassis have almost as good a surface, but don't think that you're going to smooth off a beat up chunk of stuff out of the Junk box unless you're a heck of a lot better smoother than I am.

Now, keeping in mind those nicks and scrapes, take your washer, heat sink or chassis, and mark and drill the mounting and terminal holes for the transistors. Make them large enough for any necessary insulated sleeving as needed. On transistors with mounting studs like the 2N278 you'll need enough room in the hole for bakelite tubing or spaghetti. Sure, the inside of the hole will also be anodized, but the threads in the stud can cut thru it easily. After you drill the holes for the studs and leads, remove all burrs and projections. Try a sharp pocket knife and work carefully, paring around each hole until it tapers in smoothly from the flat surface. In the case of the anodized washers you will also want to cut them to shape and do any necessary bending at this point. The outside edges of these washers should also be rounded in slightly and de-burred to prevent insulator punch thru.

If you're sure it's deburred, clean it up. Soap and water if it's really a mess. Acetone or clean thinner for the final treatment. Lay off the XYL's nail polish remover, most of it contains oil. We want to anodize aluminum, not finger prints.

Now we need a container for the acid we're going to brew up. A pyrex dish, fruit jar, gold fish bowl (take the fish out first) or other non-metallic container is fine. If the XYL is out of town you can use aluminum cookware for a pot, in which case the pot can act as that other chunk of aluminum.

Acid H₂SO₄

At this point see your druggist, tell him you'll be careful, and buy some commercial sulphuric acid, specific gravity about 1.85. (the bottle will be heavier than it looks). We need to dilute this to about 1 to 1 by adding water. (The acid in an almost fully discharged car battery is about 1.1, by the way.) The simple way to do this is to put about seven or eight times as much water in the pan as acid. But—**put the water in first.** I've forgotten why, but that's what everybody says, and I'm getting too old to experiment. So, pour the acid into the water—slowly. It tends to sputter, bubble and get warm. Wear your old trousers. (I learned the hard way.) It's also advisable not to do this in the middle of the living room rug. If you can't get full strength

[continued on page 200]

Improving the 4 Tube Regenerative Superhet

A. D. Mayo, W5DF

209 Conti Street
Jackson, Mississippi

A 4 tube superhet using three crystals was described in CQ July 1958. One problem that was recognized was the incomplete rejection of spurious signals. Another problem was the fact that the tuning rate was faster on 14 mc, and the stability was poorer on this band than the others. Rather than fool around with additional tuned circuits, another stage was added.

The stage consists of the pentode section of a 6U8 tube. The input circuit was shifted over to take care of the grid tuning of this stage. For the mixer grid tuning, a switch was installed to connect to either one of two mica trimmers. One trimmer was peaked on 7 mc and the other on 3.5 mc. It is not necessary to tune this stage with a variable because the spread in coverage is small.

For 14 megacycle coverage, the rf stage was used as a crystal controlled converter stage.

The mixer is then operated on 3.5 mc. In order to effect conversion of the 14 mc incoming signal to a 3.5 mc tunable i-f frequency, 10.5 mc injection is required. This can be obtained with a 10.5 mc crystal, using the triode part of the 6U8.

One of the ideas in the construction of this set was simplicity. The simplest way to get 10.5 mc is to take off a harmonic of the beat oscillator which is operating on 1749 kc. The sixth harmonic is 10,494 kc. There is an error of 6 kc here but this is no stumbling block. All we do is insert a tuned circuit in the plate of the pierce circuit of the beat oscillator. This consists of 40 turns on the small slug forms we are using. It is shunted with 20 mmfd fixed condenser.

This gives plenty of energy at 10.5 mc for
[Continued on page 181]

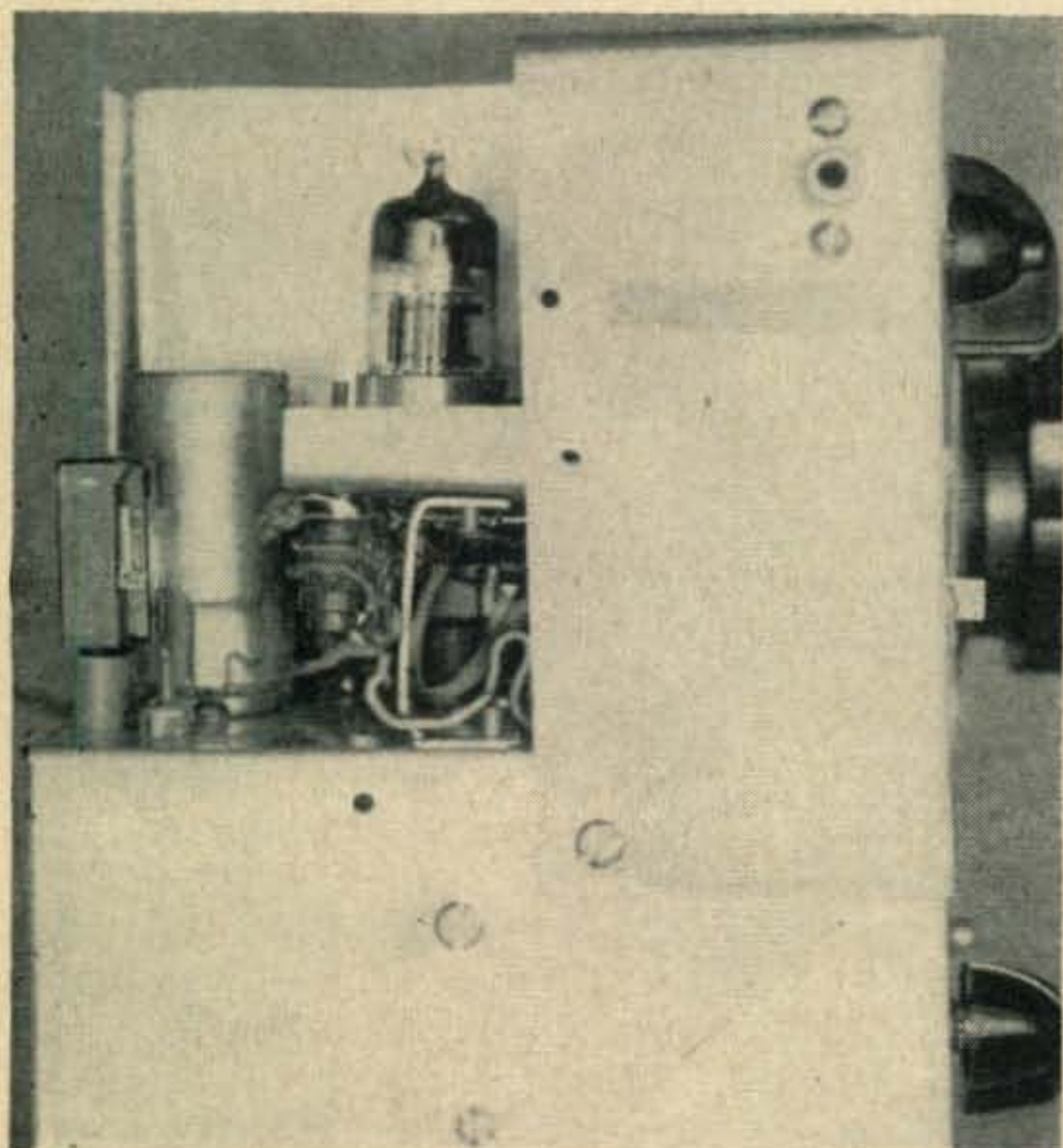

Side view of double-decked RF stage. The tube on the chassis itself is the 6U8 IF and detector tube. The crystal is for the regen detector.

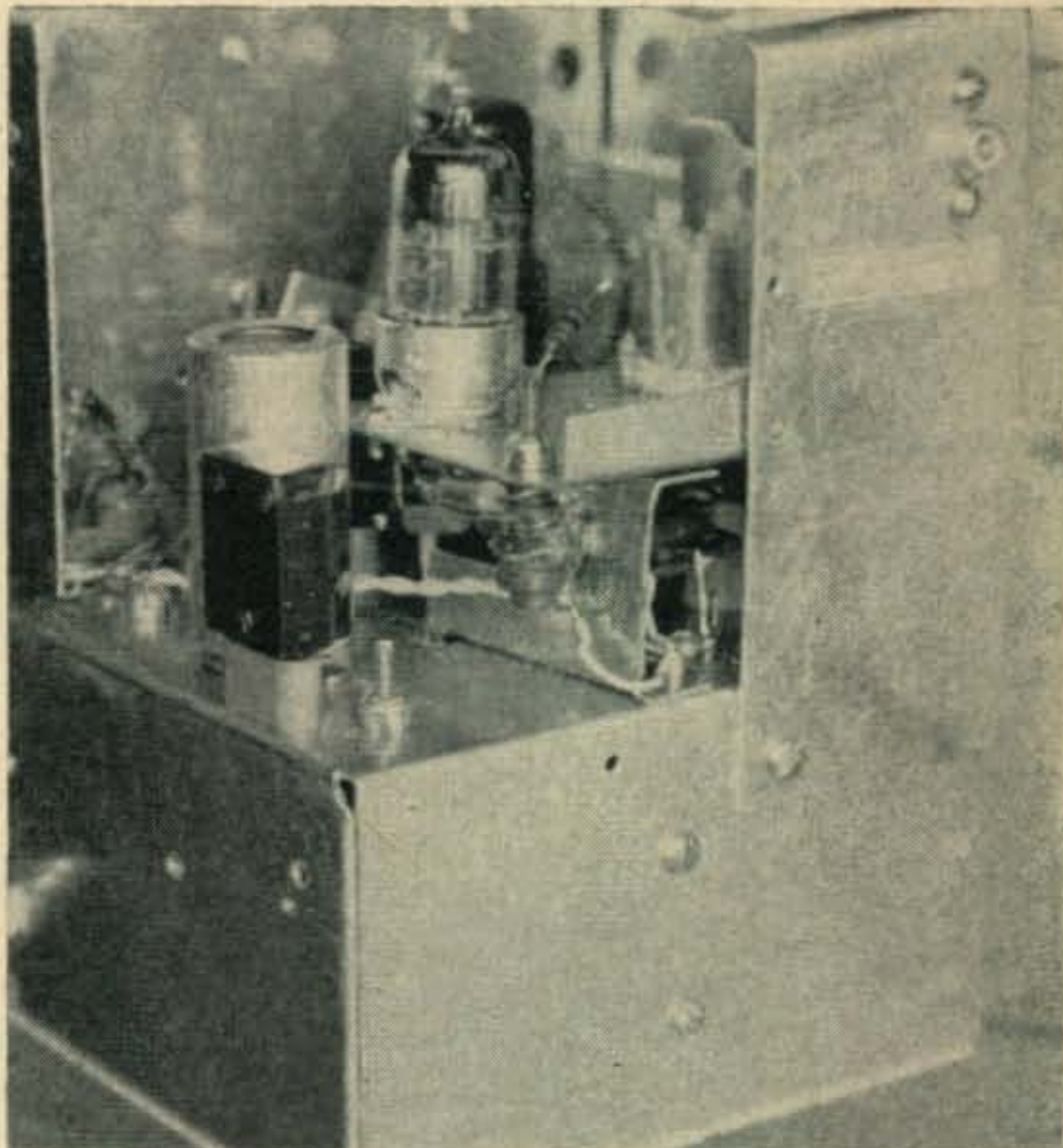

6U8 RF stage on small double-decked chassis. The 10.5 mc injection coil is visible under chassis.

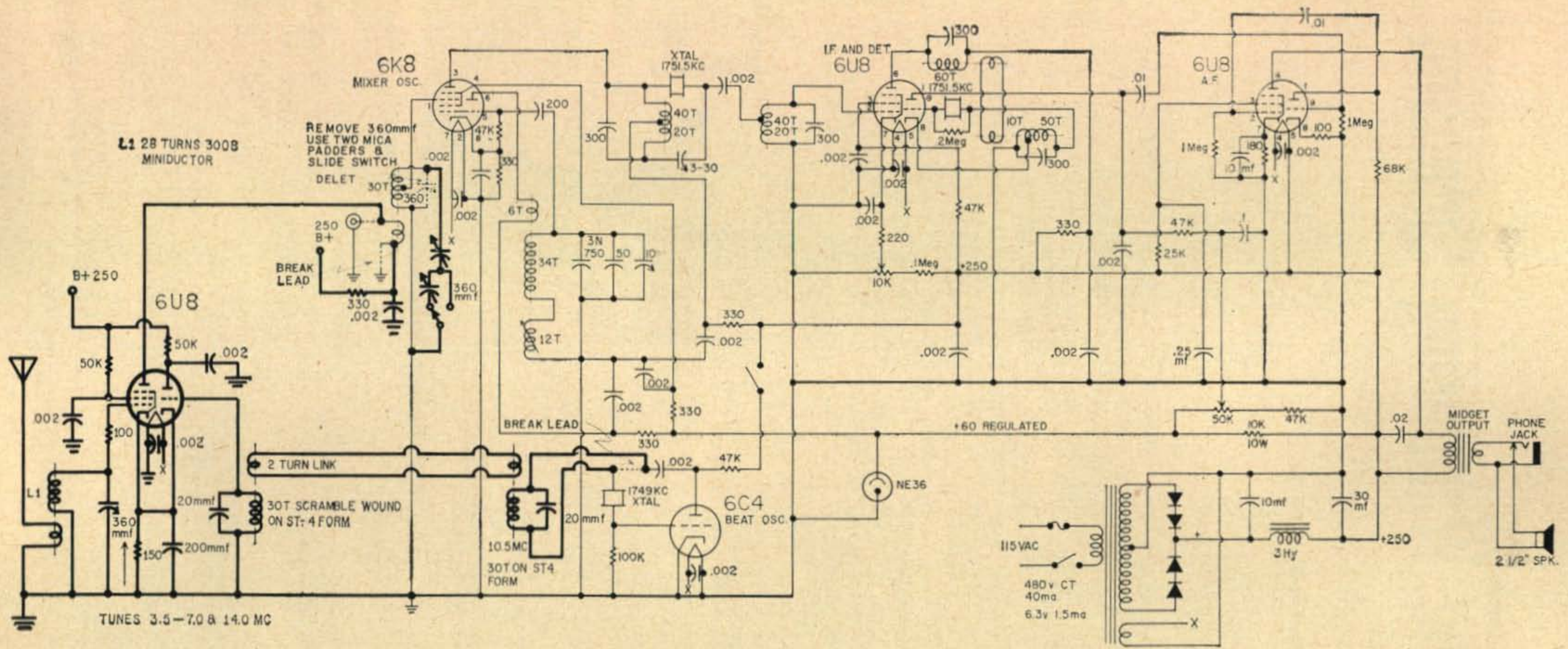

Fig. 1—Bold wiring indicates the additional circuit wiring and components. Dotted lines indicate wires and components to be removed.

The Wandering Sideband

Lt. Col. R. H. Mitchell, W4RQR

5804 Accomac Street
Springfield, Virginia

The idea of the wandering sideband was born in the refreshment area of the Bel-Air Hotel at Piarco Airfield in Trinidad. I was down there as pilot on a training flight for the Navigation School of our Training Group. While sipping a lemonade, I was reading Bob Adams' sideband column which mentioned that several of the SSB gang were approaching DXCC, and, naturally, it occurred to me that it was too bad I didn't have a rig along to give a few of the boys a shot at "2XSSB" from some of the islands we go into on our stops. There was a distinguished-looking gentleman sitting next to me, and, as people sometimes do in refreshment areas, he asked me what I was reading. After he heard what it was, he mentioned that he was a functionary in the British West Indies Federation. Two or three lemonades later, we were fast friends.

Naturally, I asked him about the possibility of getting licenses to operate in some of the islands in the Federation under the US Armed Forces agreements. (It has been possible for a few of the US military in those countries to get licenses.) Another lemonade or so later, he decided that I must be on duty there, since I was on official temporary orders, and things looked rosy. He told me to whom I should write in several of the countries regarding licensing.

So, I got permission from our Group C.O.,



South Caicos harbor

Col. L. S. Moore (a ham in the spark days) to carry along a rig on our navigational training flights, when space was available, and to operate when I could during our crew rests. Help was lined up for the operating. Herman Jolitz, W4DCQ, the phone DX contest king of a few years back, is a civilian electronics engineer attached to our Group. Phil Rima, W4NZG, who was associated with me in putting a couple of SSB stations on from Japan, is NCOIC of our electronics shop. Both were eager to help in operating. I had my 75A4 and homebrew SSB exciter available for equipment—the final and power supplies were too bulky to carry along—but we wanted a better



W4DCQ at VP5AB

transmitter, as the exciter was too low-powered. Arrangements were made to borrow a commercial SSB rig of reasonable power, and we decided to buy a multi-band vertical for an antenna. It looked as though the project was in high gear.

Unfortunately, my attempts at licensing met with delay and failure. My BWIF friend's interpretation of the rules wasn't upheld in the various countries to which I wrote. So, after two months, I started writing to some of the active hams in countries that had had no SSB activity to ask permission to set up a rig at their location. Several favorable replies were received, and we were ready to start operating

on the second weekend of the 1958 ARRL phone contest. Suddenly, it developed that the 100-watt SSB rig we had hoped to borrow wasn't available, so we had to depend on my exciter. Its 15-watt output didn't look imposing, so we started a frantic search for a decent linear. Dalton-Hege Radio Supply Co. of Winston-Salem, N.C., had a used HT-33 available, which they generously loaned us. Then, it developed that we couldn't find a multi-band vertical within a couple of hundred miles, and had to leave for our first trip with all the wire and coaxial cable we could find, so that we could string up dipoles.

We got into South Caicos on the afternoon of March 7th. Jim Bassett, VP5AB, was at the field to meet us. He had the constable, who

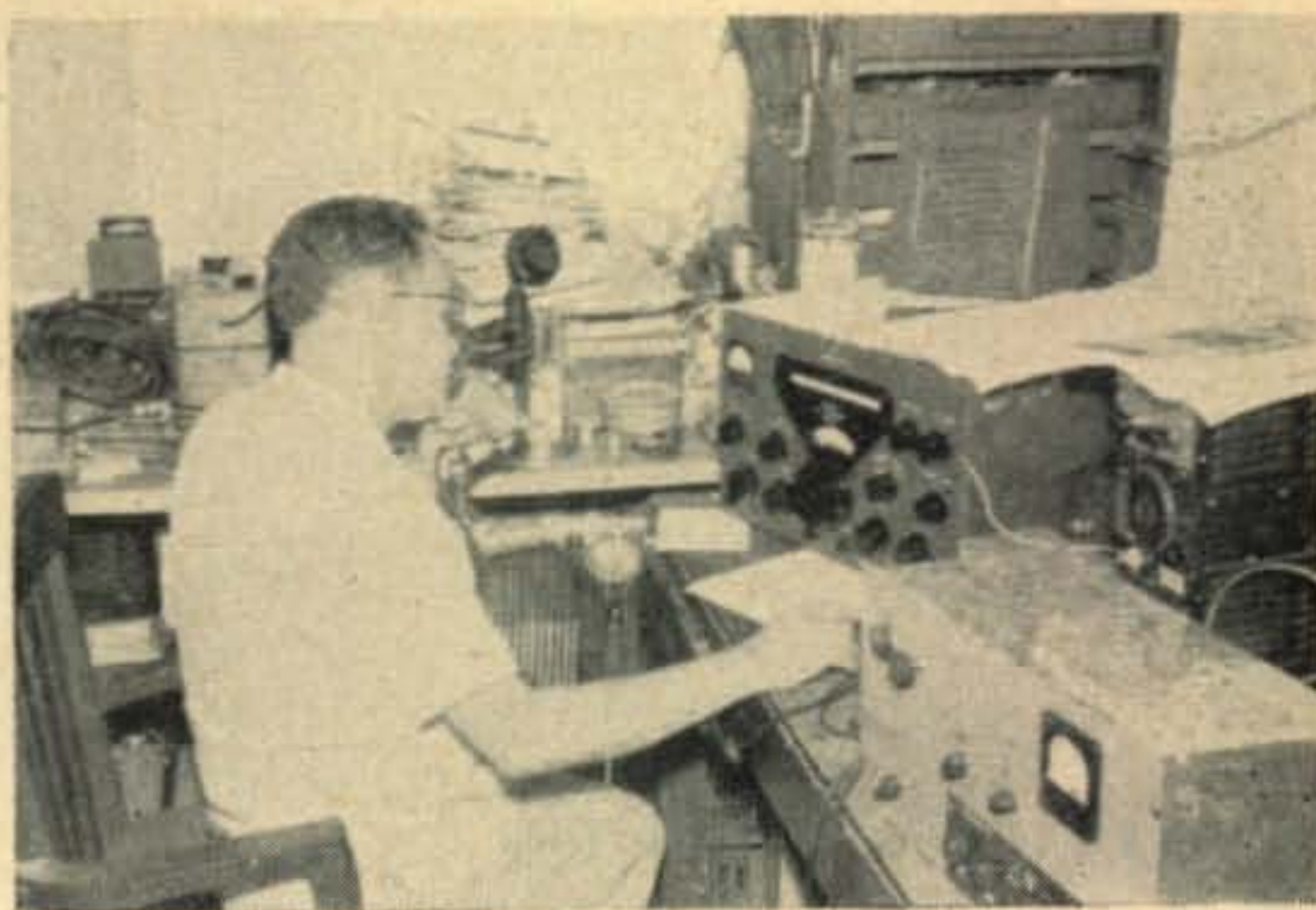

VP4TE



VP6LT, VP6KL, VP6ZX, W4DCQ

doubles as customs agent, and one of the three operating trucks on the island with him, and we immediately went to Jim's quarters at the PAA radio station. Incidentally, Jim is a 19-year-old native of South Caicos. He got started in radio with the help of the PAA operators there, and with the added assistance of a correspondence course, got his ham ticket and became chief op for PAA on South Caicos. He has a DX-35 and several other pieces of home-built and kit equipment, and has been giving a new country to a number of hams.

We were delayed somewhat in getting on, as my v.f.o. had jumped frequency and had to be reset. Too, we had no instruction book for the HT-33 and had to figure out how to get it going. Naturally, the trouble was in the cockpit, and after we found the bias-cut-off relay, we were in business. Jim's power limit was 150 watts, so we ran the rig on tune, which is not what the HT-33 was designed for, but it still performed nobly.

Our first contact was on 20 with W4IYC, who had built the first radio station on the island, during WWII. (It was later blown down by a hurricane which virtually levelled the island.) Then we switched to 15, and the party was on. When 15 faded, we went back to 20. At midnight, EST, we switched to 80, and worked stations as far as W6, and were called by KH6's whom we couldn't hear through the

mess. The first—and loudest—station heard on 80 and was the 50-over-9 signal of W4DCQ with a friend of his at the mike. Then we dropped to 40. One lone contact reported us 40-and-over-9 in Maryland, but the 40-meter boys didn't seem interested in DX, so we went back to 20, swinging up to 15 and 10 when they opened in the morning. We finally had to quit at 10 a.m. on the 8th. We packed and got down to the field and the plane came in at 11. We went to Puerto Rico for fuel, intending to go on through to Barbados, where VP6LT and VP6ZX were waiting for us. Unfortunately, the field at Barbados was listed as closed for repairs so we spent the night in Puerto Rico. The next morning we got up at 4 a.m., and got under way. Eric, VP6LT, and Claude, VP6ZX, were at Seawell Field to meet us, and got us through customs quickly. They told us that they'd made arrangements to get the field opened for us the night before, so we had wasted 14 hours. Incidentally, Eric is an engineer with the telephone company and handles the exchanges, while Claude is with the electric company as an engineer, and they are two of the finest gentlemen I've ever met.

We got on at noon from VP6LT's home, and made two quick contacts. Then the phone rang. It was the local radio inspector telling Eric that an SSB signal was all over the 13-meter broadcast band. Claude dashed home to check, and found the SSB signal. During the next couple of hours, we almost rebuilt the exciter. Finally Claude called to see if we were still on. We were installing shielded power leads at the time, and the rig was stone-cold. It developed then that the signal was from a commercial SSB station. So, we started up again and continued until 7 am on the 10th, when we had to pack again and come home. One extremely unfortunate incident developed. Several stations told us we were not the first VP6 on sideband—that they had worked VP6AR on SSB. After thorough checking, it was found that the station claiming to be VP6AR was a phony. After we got home, we got notes from a number of stations saying they had worked VP6AR on SSB, and hadn't

called us, so others would have a chance at VP6 during our limited time. (If the phony cares to identify himself, he can collect a number of QSL cards from Eric, who is the VP6 manager, and from the Radio Inspector in Barbados.)

The equipment used at VP6LT was again the 75A4, my exciter, the HT-33, and dipoles, plus Eric's 15-meter 3-element rotary. The power limit was 300 watts, and we were able to use the HT-33's capabilities a bit better. A number of the active VP6 hams came to see the gear, and most of those were interested in seeing the HT-33. Seems that it was the first kilowatt rig that had ever been in Barbados. They were all quite impressed with it. So am I. This table-top k.w. linear business has been sneaking up on us, and they are a decided improvement over the old seven-foot high, five-hundred pound rigs, especially for those of us who have to move around often. We all found the HT-33 extremely easy to tune and handle, although it took a few minutes to get used to the idea of not having a loading control.

My next scheduled hop was over the weekend of March 21st, and, fortunately, it was going to Trinidad and Jamaica, so I packed the gear again. Herman and Phil had to go to Europe on another trip, so I didn't have their operating help. (I also had to give up the second weekend of the ARRL cw DX contest to make the trip, after having rolled up over 500 contacts in the first weekend, which made my wife consider sending me to see the headshrinkers.) We arrived in Trinidad on the afternoon of the 21st. VP4TE's son, Malcolm, VP4GM, met me and took me into town. He and I set up the gear at VP4TE, and were starting on the first contact when Louis, VP4TE, arrived from his work at the record processing plant. Louis is in charge of Cook-Caribbean Ltd., and is responsible for the pickup on a number of the steel-band and Calypso records we hear in the States, as well as for the processing of our records for distribution in the West Indies. This is only a small part of his credits, however—former "wireless officer" (equivalent to our FCC licensing and monitoring superintendents); former Chief Signal Officer for the British Army in the Caribbean Theater, builder, owner, and operator of the first broadcast station in British Guiana; first VP3 ham; engineer-in-charge of pioneering airline communication stations in South America; to mention a few. To these, we can now add the first VP4 on SSB, and I'd be willing to bet, the first South American who will work into the States on 144 mc, with the gear he's installing.

We used only my exciter during the first night at VP4TE, as we'd taken the HT-33 back to Dalton-Hege when we got back from Barbados, and hadn't been able to get back to borrow it again. Again, operation was started on 15, with the switch to 20 when 15 went



VP5RS at work.

out. At midnight EST, we were again on 80, and heard W4DCQ booming through. He was one of the few who was able to copy my 15 watts through the QRN on 80. I went to bed again, as I'd been up for 30 hours. The next morning, we set Louis' 813 up as a linear, and really got into business. Stan, VP4TI, came over and helped us with the operating. We took quite a bit of time off so I could demonstrate the tuning of phasing rigs to Louis and Stan, both of whom will be on SSB soon. While this cost a number of contacts, those should be more than compensated for by future VP4 SSB activity. We finally shut down at 0200 on the 23rd, packed, and went to bed. Louis got me up at 0530 and hauled me out to the field.

We had to stop in Puerto Rico again for fuel, and then had to change a set of spark plugs. This delayed us for a bit, but we got into Jamaica by 1600 of the 23rd. There, I knew we wouldn't be the first Jamaica station on SSB, as VP5MU, who has since returned to England, did some SSB work last year. However, a great many stations needed Jamaica. Sam VP5RS, was at the field to meet us and cleared us through customs. We stopped to see several of the hams, including VP5DX, president of the Kingston club, who also had offered to let us set up on SSB from his house. We finally made it out to Sam's house, which he describes as a bathroom attached to a hamshack. It is located at Spanishtown, the old capital city of Jamaica, and is 14 miles from Kingston. The house is a ham's dream—everything in it is aimed at the enjoyment of ham radio, and the affair winds up with a 584-foot per leg rhombic aimed at the States. We tied Sam's Valiant on the exciter and got started about 1930. We had to fight low line voltage and 40-cycle current there, and I had to modify my power supply to get enough voltage to the VR tubes to keep the v.f.o. from drifting 500 cycles every transmission. Conditions were poor, and we had to leave 15 early. However, 20 was open, and we were doing fine there. At midnight, we switched to 80 again, and worked a number of the boys.

Again, W4DCQ's booming signal led the pack. Then we went back to 20, where we stayed until 0200. We went on for an hour again before breakfast, then had to pack, and went back to the field, thereby wasting a few hours of Sam's high-priced time. (Sam is the owner of an electronics importing firm, and handles Motorola mobile products, among other lines.) Once again, the ham who helped us put SSB on for the gang was one of the leaders in local ham radio. Currently, Sam is probably best known as the first VP5 on six meters, where he has provided a number of US hams with a new country. One of the things he showed us in his shack was a TV set receiving pictures from Cuba, which makes an old VHF'er think about the possibility of 144 mc work between Jamaica and the States.

We got back to Cherry Point, N.C., that night without event. We'd hoped to get out again in another couple of weeks. However, the combination of a number of circumstances—breakdown in correspondence in one direction; the appearance of several new SSB countries that we had thought to go to, through some fine DXpeditions and some regular activity; changes in flight schedules, etc., prevent our going out until the first weekend in May. By the time I'd returned from the Jamaica run, it was apparent that my exciter was unsatisfactory for our purpose. Some of the reasons have been mentioned already. Two other glaring faults had appeared, too. First, I had to readjust the exciter after every ride in the planes to keep the signals in the band and on SSB. Next, I was the only one who knew enough about it to change bands, which necessitated my staying up all the time to handle band-changing. So, I wrote to Hallicrafters and asked them to lend me an HT-32 for the duration of our expeditions. Hallicrafters replied that they'd be happy to lend me an HT-32 to help some new SSB countries on the air, and where did I want the rig sent? Three days later, I was in Glenview, Illinois, on one of



W4RQR at FG7XE.

our scheduled administrative runs, and borrowed a car from a friend to drive into Chicago to pick up the rig. Three minutes after I arrived at the Hallicrafters office, I was standing out in front again with an HT-32 and a dazed look from the speed and efficiency with which the transaction had been completed. In the meantime, W4UQU at Dalton-Hege had the channels hot to get me a Hy-Gain 14AV multi-band vertical. We tried it and the HT-32 at my home shack before going out on another trip. Despite the IPOIO factor, the HE-32 worked the first time we turned on the switch, and the antenna had the SWR that Hy-Gain claimed for it, and it looked as though our equipment difficulties were over.

They were. We hit Martinique on the afternoon of May 2nd. Andre, FM7WT, was at Lamentin Airport to meet us, and after a lengthy procedure of going through customs, he whisked us off to his house. We set up the vertical on one of his bamboo poles, using guy wires and radials that had been cut in advance. We were on the air within an hour of the time we arrived at his house. The combination of the HT-32 and the 14AV resulted in an extremely simple-to-handle setup, and any ham we showed the gear to could tune it and operate it with about a two-minute checkout. This was a tremendous improvement over the old setup where we had to flip several switches on the exciter, retune a linear, change antennas, and curse a bit to change bands. Herman and Phil were along again to handle their share of the operating, and Andre also pitched in. Andre is an inspector for Radio Central at Lamentin, which is about three miles from the airfield. Unfortunately, his house is about fourteen miles from town. I stayed with Andre, while Herman and Phil stayed in a hotel in the principal town, Fort-de-France. This necessitated some long treks back and forth when the boys wanted to assist Andre with the operating. By the time we left, Herman's cab bill resembled the national debt. However, with all that talent available, we stayed on the air from 1700 on the 2nd until 0900 on the 4th, when we had to pull everything down again for the trip to Guadeloupe. We lost several hours of operating time on the 3rd because of some violent tropical storms. First, it was necessary to shut the blinds through which the antenna lead was run to keep the rain out of the gear. Then, the line power started going off every few minutes. It would come back on again within five or ten minutes, but when it did, it would surge up to 180 volts or so momentarily, and the dial lights on the 75A4 and the HT-32 would flare up like headlights. After this happened a couple of times, we decided to fold up until the power stabilized, and Andre and Madame Meunier took me into Fort-de-France to show me the town and the old fort. After a pleasant afternoon, we went back to Lamentin and got back on the grind,



FG7XE ssb (M. Fabre's house)



VP6LT (second trip)

with only a few interruptions caused by power failures. During the period at Martinique, we worked about six-hundred stations, which was our best effort to date. For the first time, we started working a few of the boys on cw, when the SSB activity ran low. We attributed the improved result to better equipment, since none of us had improved our operating since the last time out.

So, we said a fond farewell to Andre and Madame Meunier at the field and leaped off for Guadeloupe. Upon landing there, we were almost overwhelmed with the hospitality shown us. Ed Dilme, an employee of the US Weather Bureau on loan to the French, met us. The US consul in Martinique had already phoned ahead for our accommodations, and we were set up in the only hotel in Point-a-Pitre, principal town on Guadeloupe. Georges, FG7XE, was also at the plane to meet us, and gave us a fine letter from the airport commandant, M. Emile Fabre, in which he told us that the facilities of the airport were at our disposal, and that we were to set up in his house. Thus, we were able to get on the air by 1430, which is a pretty short time lapse from 0900, considering the fact that we had land transportation time in Martinique, customs clearance there, filing of flight plans, flying, clearing thru customs in Guadeloupe, and getting set up again. M. Fabre's quarters are right on the airport at Le Raizet, which helped considerably in the time factor. We used the metal roof of his house for a ground plane, which saved time in putting up radials—especially since the pre-cut radials were still in Martinique. The FG7XE operation resulted in our greatest number of contacts per hour. We worked over five-hundred stations between 1430 on the 4th and 1000 on the 5th. A number of stations were worked on cw again, but principal activity was on SSB. At FG7XE, we used Herman, Phil, Georges, and myself as operators, and a new name appeared. Jim Perrigoue, our flight radio operator on the trip had been licensed as a ham a few days before, and was sporting the call K4UYM. On the way to Guadeloupe, he asked me if it would be okay if he operated a

bit. I was dubious as to his ability to handle the hot circuit we were expecting, but figured he could try it for a while. Jim has had considerable experience with the snappy operating done on the transoceanic aircraft radiophone circuits. As the gear was so simple to operate, he was handling an operating shift like an old contest man within a few minutes of the time he sat down in front of the gear, and we had another operator.

That evening, M. Fabre came in from a trip to Basse-Terre, and we had the extreme pleasure of several interesting hours with him. M. Fabre is quite an individual. An accomplished linguist, English is only one of the languages he speaks fluently. He is a pilot, and is interested in radio, among many other things. Last year, he spent several months in the States and has managed to interest a couple of companies in investing in top-notch resort hotels in Guadeloupe. His combination of ability, drive, and charm is little short of amazing. Georges, FG7XE, works for M. Fabre at Le Raizet. He is an enthusiastic ham, and I expect that he will do a great deal in the near future to alleviate the shortage of FG7 activity.

Unfortunately, we had to leave Guadeloupe on the morning of the 5th.

We then encountered the first trouble with our new equipment—Georges liked the Hy-Gain vertical so much, we had to leave it with him. (This meant we had to get another, which hadn't been an easy job before.) I hope that Georges enjoys the 14-AV as much as we did. So, we loaded the gear again and headed for home. After sixteen hours of flying around the Caribbean, we made it safely. When we got back, I immediately sent a letter to Hy-Gain asking them to ship me another 14-AV, enclosed a check, and asked them to bill the antenna to Dalton-Hege.

Hy-Gain did their best to get the antenna to me in time for the next trip. However, the antenna arrived about three hours after our takeoff. This was over the weekend of May 18th. We had been scheduled to go to San Juan and St. Thomas, but the schedule was

[Continued on page 176]

Positive, Low-Cost Screen-Grid Protection

Put those "Buck-a-Bushel" surplus relays to good use

Carl C. Drumeller, W5EHC

5824 N.W. 58th St.
Oklahoma City 12, Okla.

When fed from a source of good voltage regulation, the screen-grid current of a tetrode or pentode tube soars to dangerous values when the plate voltage is removed. Lack of control-grid excitation causes the plate current to become excessive unless corrective measures are taken. The use of a clamp tube can control the latter situation, but tubes are prone to failure, and one hesitates to set one tube to guard another without elaborate "fail-safe" precautions.

By the use of two low-cost surplus dc relays, one can secure positive protection from loss of either grid r-f excitation or plate voltage. The only additional items required are a switch, a dial lamp (with mount), and a tapped bleeder resistor.

articles are wired into the control-grid and the

The schematic diagram shows how these screen-grid circuits of a typical pentode r-f stage. The grid resistor, R_1 , is reduced by the amount of the d-c resistance of relay RY_1 ; which should be a sensitive, high-resistance relay, such as the ones salvaged from marker beacon receivers. If your tube normally draws more than a few milliamperes, it may be necessary to shunt the relay with a wire-wound rheostat in order to adjust it so as to drop open at the desired minimum grid current. The other relay, RY_2 , does not need to be so sensitive, but should close when the screen-grid current exceeds 150% of its normal value. It will be noted that when the relay is actuated, the screen-grid voltage is applied through a dial light (a 60-ma one is about right for a single 813) and a normally-closed spring-return SPST switch to a husky resistor. This resistor should be selected so as to bleed enough current to keep the relay firmly actuated. It is

tapped at about mid-point so as to supply a much-reduced voltage to the screen-grid. This enables the operator to proceed with his tuning until a correct and safe condition is achieved. Then he simply presses the switch, which breaks the circuit and restores normal screen-grid voltage.

To sum up, RY_1 holds the plate current to a very low figure by keeping the screen-grid voltage disconnected until the r-f excitation has reached a predetermined value. If the screen current becomes excessive, RY_2 reduces the screen voltage to a safe value and illuminates a warning light; this condition is maintained until a re-set switch is actuated. ■

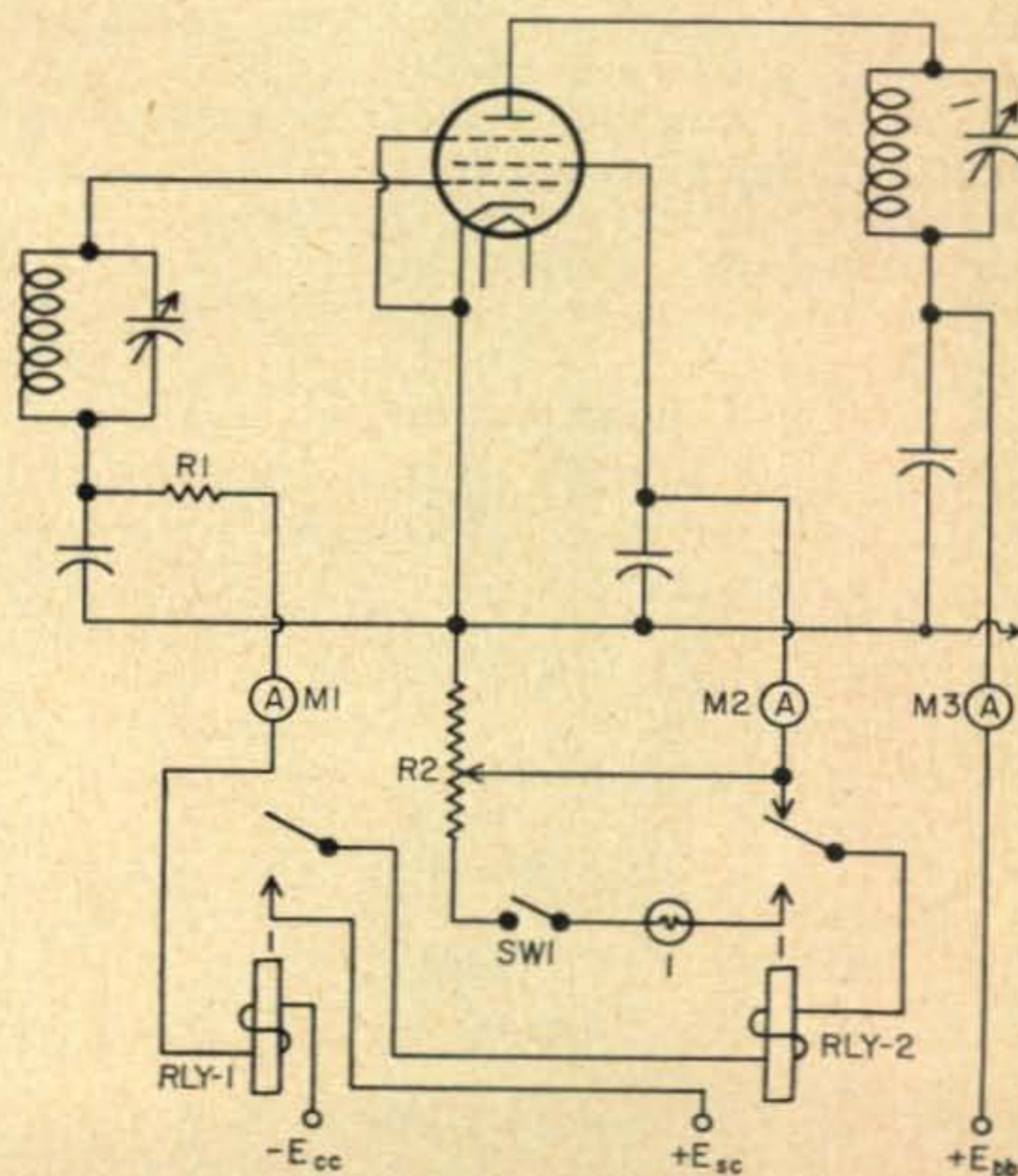

Mobile Madness—the Telethon

N. A. Krohne, W9SKF

5458 N. Long Island Dr.
Milwaukee 9, Wisconsin

Amateur radio clubs are constantly looking for publicity. It's not easy since few projects seem to capture a newspaper's imagination.

However, with the advent of television, a new form of charity appeal arose—the telethon. Various entertainment personages are assembled before the TV cameras for a program lasting from one day to the next. During this time, appeals are made to the public for contributions to the charity being represented.

Those pledging money to the drive may phone their contribution to one of several telephone numbers located at the scene of the telecast. Radio amateur mobiles are often used to collect these pledges.

With this, and publicity, in mind, the West Allis Radio Amateur Club jumped at the chance of offering their services to a local telethon and its sponsors.

From our trials and experience, have emerged the following suggested methods for obtaining smooth and efficient operation.

Advance Men

Appoint two members to act as a publicity team. They make the initial approach to the telethon sponsors and offer the amateur's services. From then on their duty is to maintain contact with other publicity teams connected with the program. One man should keep a running account of the ham participation. The information is thus readily available to the newspapers and amateur radio publications.

Base Station

Establish a crystal controlled base station capable of continuous operation, preferably away from the scene of the telethon. This will allow function of the control center with relatively little outside interference. A ground-plane antenna or similar vertical radiator should be used in order to favor the mobiles and eliminate beam rotation.

A large map of the operations area mounted on plywood or beaverboard with a street location guide will prove helpful. Zones can be marked off with string supported by pins.

Size of the various zones, as well as the number of them, will vary according to population density, accessibility and where the most

calls are likely to be made. To facilitate operations, the map should be laid flat on a table that is accessible from at least three sides.

Prepare a "pledge book," two, if the control center is located other than at the scene of the telecast. A dime-store spiral notebook will do nicely. Starting with the first page, consecutively number the blank lines to about three-hundred. These numbers are then referred to as message numbers regardless of who handles the information recorded in the pledge book. One book is retained for control center use, while the other is placed with a telephone operator at the scene of the telecast.

Pledge slips for control center use consist of blank pieces of paper about three by four inches in size. If possible, mimeograph them to provide the following entries: *Mag. No.*—, *Name*—, *Address*—, *Amount*—, *Time Rec'd*—, *Mobile*—, and *Not Collected*. Cross out the word which does not apply.

Operations

Flag-pins are used to assist control center personnel with the quick location of mobiles in the various zones. Call letters are printed or typed on small paper strips and attached to straight or common pins with the aid of Scotch tape. These pins are then stuck in the map at the last address called in by that mobile.

The local telephone directory is a handy item to aid in verifying suspected business pledges. At times, an official of some company will phone in a pledge giving his name, but the address of his firm. Consultation of the phone book will show up the discrepancy. Request the telethon people to find out if someone will be at the address listed on the pledge. Useless driving is thus spared the mobiles.

A direct telephone line is needed between the control center and the scene of the telecast when the control center is located some distance away. Try to arrange this matter with the telethon sponsors about a week in advance, if possible. These people will pay for the service if convinced that the control center must be located some distance from the telethon. They will also provide an operator at their end of the line. However, do not take this for granted.

Food should not be overlooked. The con-

tinuous coffee system will suffice for liquid refreshment. If you doubt this, then ask some hoarse-voiced net op after three or four hours of feverish activity about the subject.

Mobiles

Provide each mobile with a street map of the area marked off in zones corresponding to the control center map. In addition, supply an official receipt book registered in that operator's name and call. These should be furnished by the telethon sponsors. Make sure that each mobile operator is equipped with a notebook to record messages as they come in to him.

Now let's see how all of this works. "Zero" hour arrives and the telethon begins. The TV stations will make announcements that pledges of twenty-five dollars or more (or like amount) will be picked up by an amateur radio car if the contributor so desires. Relax, things will be dull for about an hour, but then the calls will start coming into the control center.

The required information is recorded in one pledge book and delivered to the control center via the direct telephone line, where it is again recorded in the second pledge book. A pledge slip is filled in and handed to one of the two board or map men.

He in turn checks the map for the mobile call nearest the address on the slip. These call letters are written in and the slip is placed in front of the transmitter operator who dispatches the information to that mobile. The pledge slip is then placed in the "OUT" file or a container bearing the mobile's call letters.

When any mobile operator has made a collection, he merely hops on the air long enough to give his call letters. That is, if the frequency is clear at the time. Upon clearance from the dispatcher, the mobile operator then states whether or not a certain message number has been delivered.

The dispatcher notes this information on the pledge slip bearing that message number and hands the slip to the other boardman. He in

turn marks the map with that mobile's flag-pin as "the last address visited by that mobile".

From there, the pledge slip is given to the control center's telephone operator who will check it off in the pledge book and notify the other telephone operator that the pledge has, or has not, been collected. This type of triple checking pays off, it also notifies the telethon representatives, and thus the public, that the hams are on the job.

Incidentally, the direct telephone line is a handy means to prod the telethon announcers into giving the amateurs proper publicity.

All told, five men are required to maintain control center operations during the peak of activity, a transmitter op, two boardmen, a telephone operator and one relief man. Light traffic loads result in the use of four men, while two can handle the quiet hours.

In the case of the West Allis Radio Amateur Club, "zero" hour was 9:00 PM. Between that time and 1:00 AM, fifteen mobiles took adequate care of the requests. Only two were needed from then until 8:00 AM the next day. As the telethon gained momentum, more and more mobiles were required until there were twenty-five in the field during the last four hours or so of the telecast.

The traffic pattern should be much the same regardless of the size of the area served. However, the actual numbers of men and equipment required will vary. The West Allis Radio Amateur Club accommodated an area of approximately 240 sq. mi. and one million population.

Watch out for extensions of time. If the program is scheduled to end at a certain hour, and the goal has not been reached, brace yourself, you will be at it for another hour or two. Although the show does go off the air, the hams will still be batting the ether around for quite awhile until the last message has been "delivered".

Do not pass up the SWL's and Novices of the group. These fellows come in mighty handy
[Continued on page 175]

Plastic Protective Covers

by Joseph Zelle, W8FAZ

Today many radio parts are being packaged in plastic bags which have been sealed electronically. These small discarded plastic bags can be put to many uses. They are excellent for protecting parts from dust and grime. They are excellent for safekeeping screws, nuts, washers, etc. temporarily, while working on or repairing gear. They are excellent for providing weather-proof covering to rf connectors exposed on roofs, antenna masts,

etc. A rubber-band helps to keep the bag closed and fastened in place.

Cut them carefully at one end with sidecutters. Open enough to remove the part enclosed. Keep these bags handy in a nearby bin. Then watch how you will save time by not having to look for strayed accessories! Protected connectors, too, will be clean and untarnished, ready for the next experiment, measurement, or project. ■

Variable Modulation Percentage for the Heathkit SG-8

Ronald L. Ives

251 Lincoln Avenue
Palo Alto, California

The Heathkit type SG-8 signal generator is an excellent example of a modern general purpose signal generator. The incorporated modulated cathode follower not only gives a low-impedance output so arranged that the loading has negligible effect on the radio frequency output, but also reduces the frequency modulation common to most signal generator designs.

In a number of experimental applications, for which this instrument was not specifically designed, the fixed modulation percentage (about 50) is not entirely satisfactory. For a wide variety of tests involving squelch devices, special detectors, and voice-operated controls, variable modulation would be most desirable. For the testing and setting of overmodulation indicators, load limiters, and splatter suppressors, a greater audio output, permitting overmodulation, would be helpful. Either or both of these changes can be incorporated into the model SG-8 with very little work, at low cost, and without impairing any integral function of the instrument.

Circuit of the SG-8 signal generator is shown

in fig 1. The 6C4 triode is the modulator, and is connected as a Colpitts oscillator. AF output is tapped off the plate (terminal 5) and fed to the grid of the cathode follower through a resistive network. When the modulation switch is thrown to "EXT" position (as shown in fig 1), the 6C4 functions as an AF amplifier, an external modulating signal may be introduced at "AF IN" and its amplitude varied by the potentiometer (L, in fig 1). With the modulation switch at "INT" position, the audio oscillator not only modulates the rf output through mixing in the cathode follower, but is also accessible and variable through the same potentiometer (L) at the "AF OUT" terminal.

When the cathode follower is modulated, and no external af load is connected to the signal generator, potentiometer L is without function. This knob, consequently, is available for use as a modulation percentage control through a suitable ganging arrangement.

Modulation percentage can be reduced by tapping down on the plate resistor of the 6C4, here 5600 ohms. No stock potentiometer of

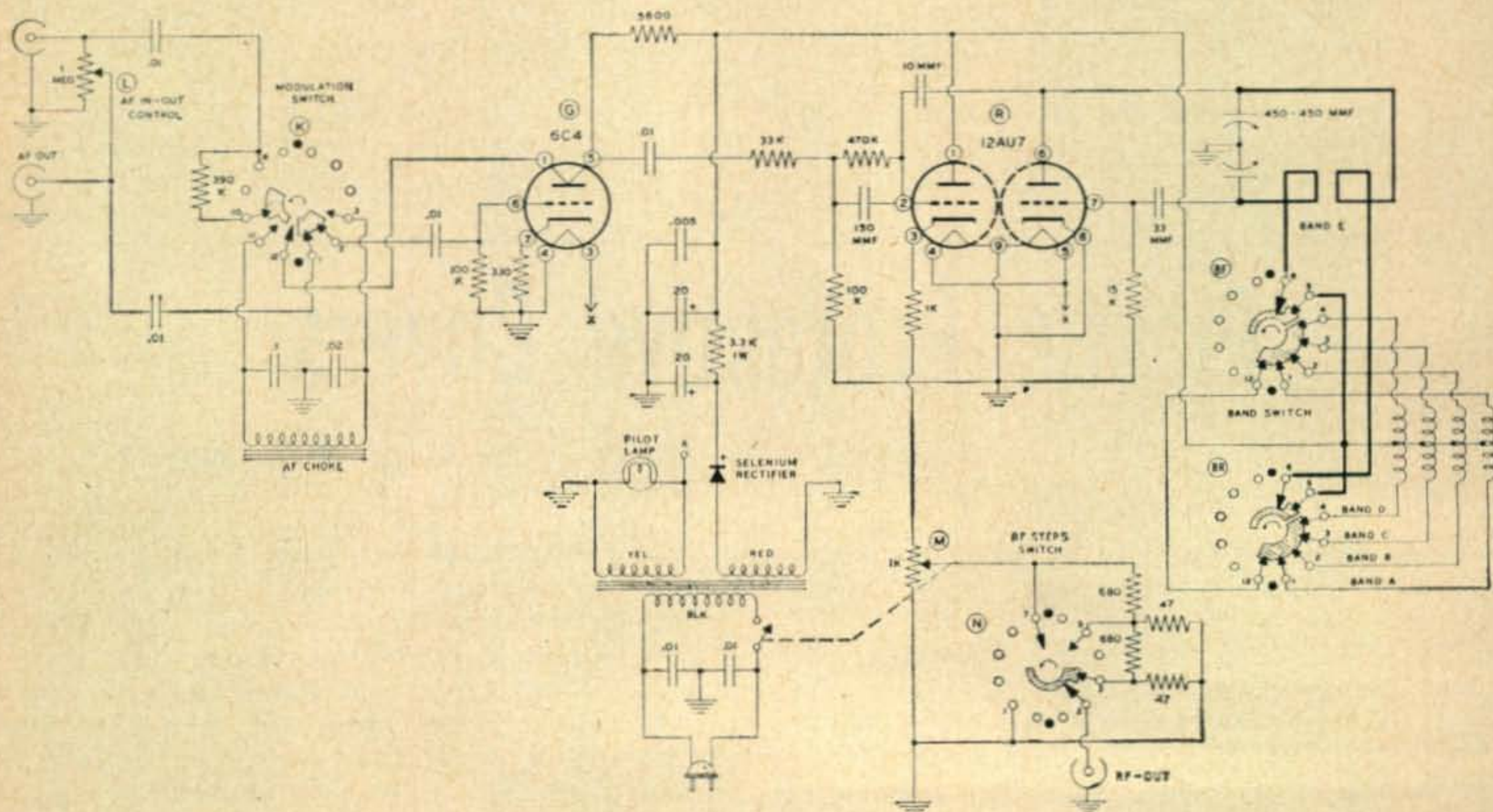

Fig. 1—Circuit of the Heathkit SG-8.

5600 ohms being available, we can shunt a 10,000 ohm pot with a fixed resistor of 15,000 ohms, obtaining a 6,000 ohm variable resistor, which is suitable for this application.

Output of the 6C4 audio oscillator is very much greater than is needed to modulate the cathode follower, and must be attenuated to prevent overmodulation. This is done by means of an R-C network in the grid circuit of the output tube. Grid return of the cathode follower is also provided by this network, which additionally functions to prevent bleeding off of the rf to either ground or the modulator circuit. Modulation percentage is most simply increased by using a larger af input condenser (initially 150 mmfd). Optimum value, found by experiment, seems to be about .005 mfd, which permits considerable overmodulation. Slightly more modulation can be obtained by substituting rf chokes for the 100,000 and 33,000 ohm resistors in the network, but this change is not recommended, as it costs about \$1.00 per additional percent gain, and makes the circuit resonant, due to distributed capacitance, at one or more frequencies in the operating range of the instrument.

With these facts at hand, it is possible to install variable percentage modulation in the SG-8 by the addition of only three components. These are:—

- 1—dual potentiometer, 1 megohm and 10,000 ohm sections.
- 1—.005 mf disc ceramic condenser.
- 1—15,000 ohm 1 watt carbon resistor.

Parts "left over" after the change are one 1-megohm potentiometer and one 5600 ohm resistor.

Circuit changes are indicated in fig 2, the added components being shown by heavy lines.

The circuit change can be made quickly and easily in accord with the following instructions. "Heathkit" location designations are used where necessary.

- Remove chassis from cabinet.
- Remove "AF IN-OUT" knob.
- Remove control nut and nickel washer from control L (1 meg. pot.)
- Push control shaft back through panel hole, but do not disconnect control leads.
- Shorten shaft of dual potentiometer to same length as that of control L.

Insert dual potentiometer (1 megohm and 10,000 ohms) in hole formerly occupied by control L, using same lock washer, nickel washer and control nut sequence as before, and position terminals identically.

Transfer leads from old control to 1 megohm section of new control in identical sequence (S).

Disconnect .01 mfd. lead from G-5 (plate of 6C4), splice on a short lead, insulate it with sleeving, and connect to terminal 2 of 10,000 ohm section of new control (S).

[Continued on page 175]

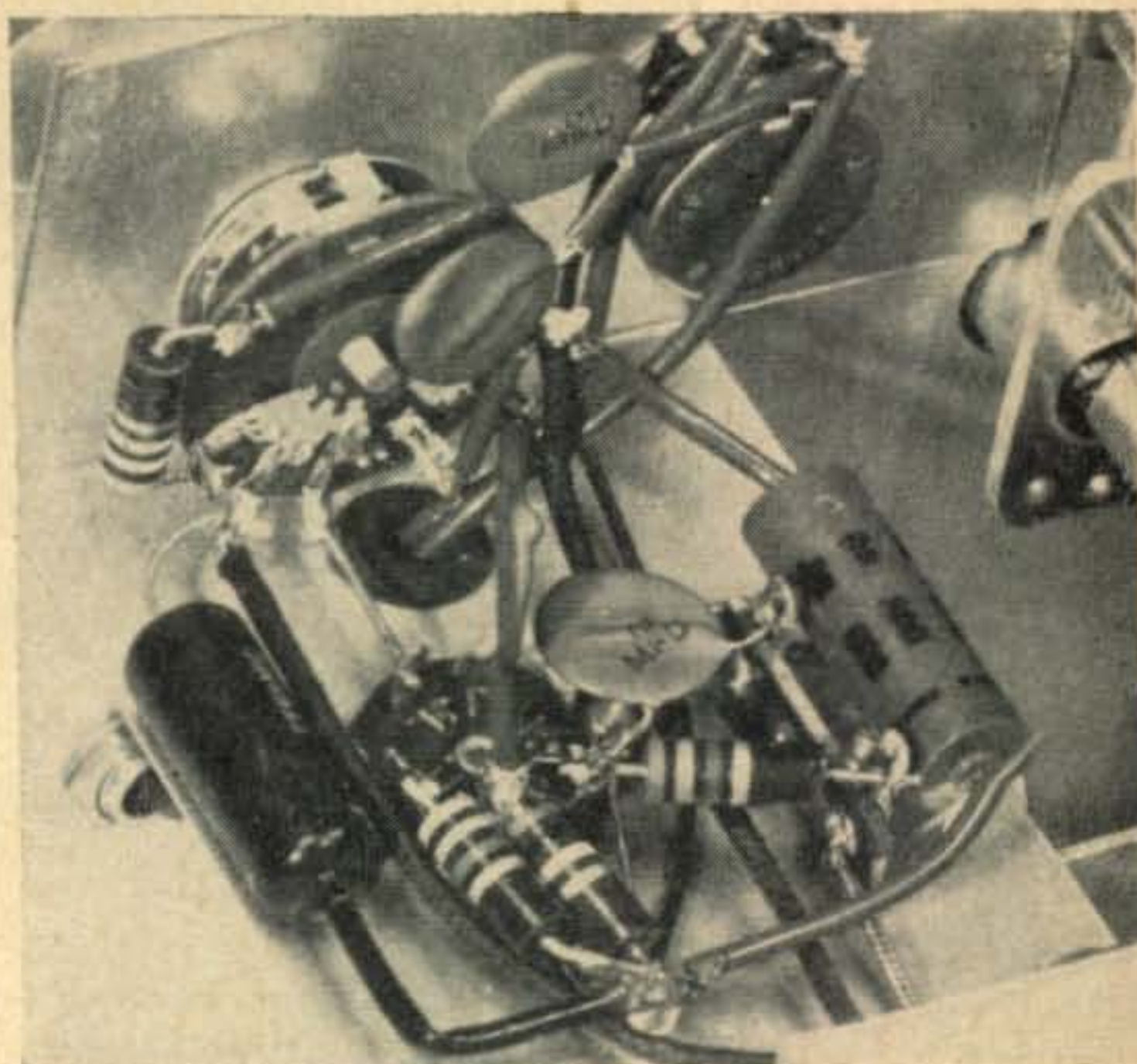

Before modification.

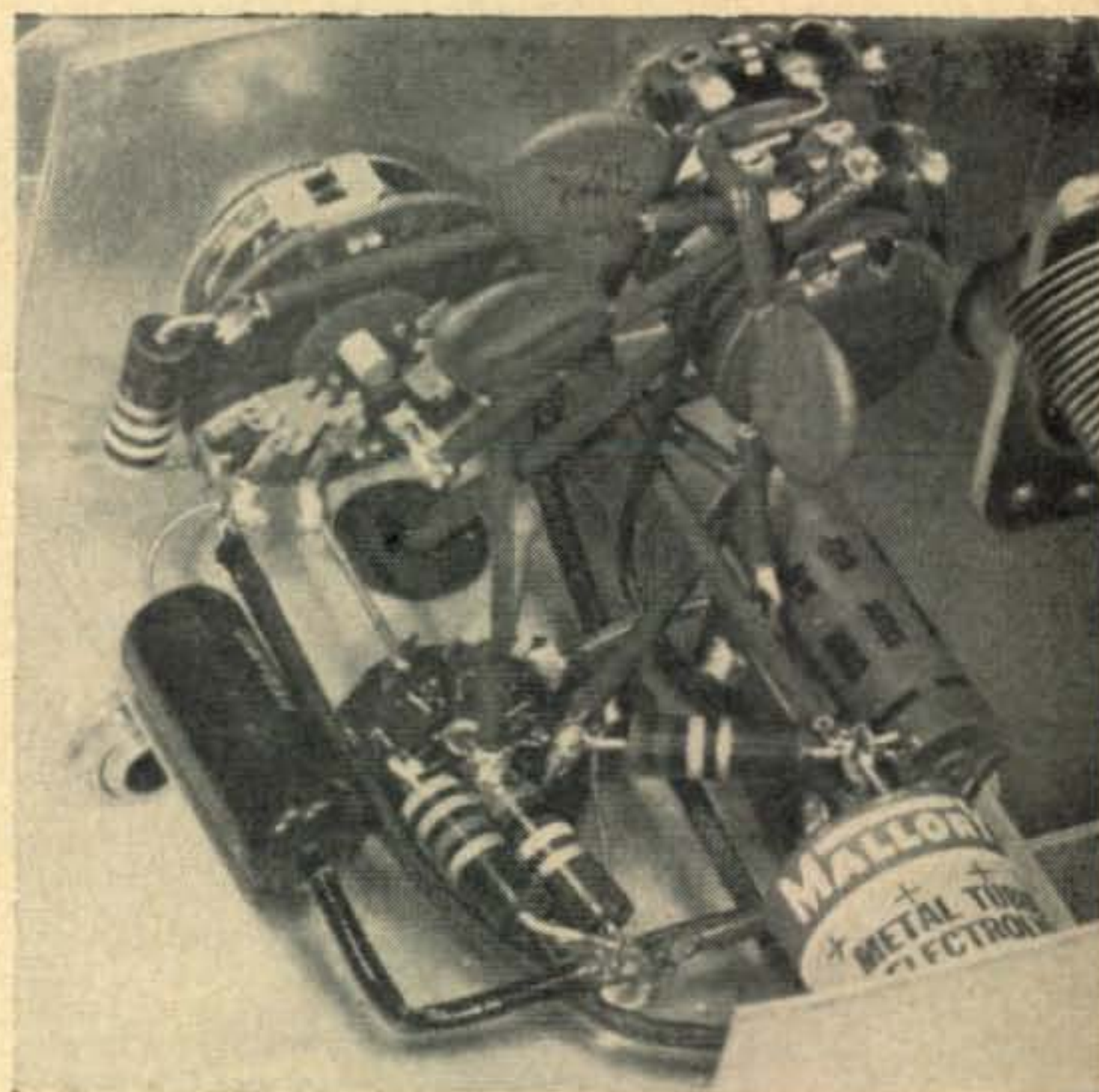

After modification.

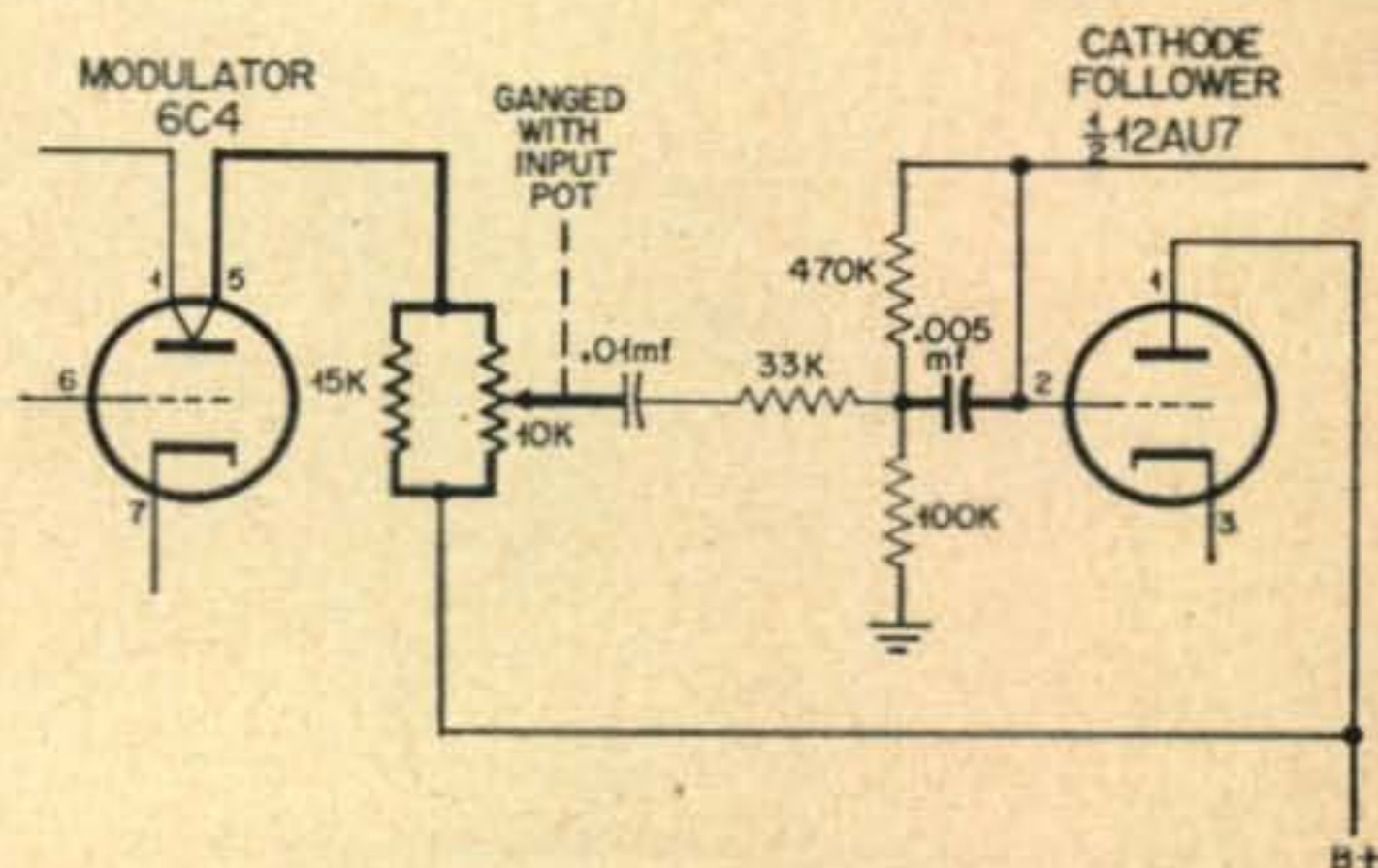

Fig. 2—Necessary circuit changes. The added components are indicated by the heavy lines.

Automation

Bryant Andrews, K2HCB

34 Oak Street
Tenafly, N.J.

If an amateur were to work an average of but one station a day, in all probability he would spend upward of three hundred hours calling CQs in his lifetime. The transmission which replies to an answered CQ is usually standard, that is: report, QTH, and handle. This transmission would be repeated, verbatim, by an active amateur over 15,000 times. I have found a simple solution to this boring repetition for the CW operator. Summed up in one word it is automation, or, a machine to run a machine.

Some 'phone men have been employing tape recorders to call their CQ's for some time. Why not use the same device on CW?

The first problem is how can a key be operated by the sound output of a recorder. However, this problem disappears immediately when it is remembered that the recorded signal is in the form of electrical impulses at the recorder's output. These impulses can quite simply be fed into a relay which in turn keys the transmitter.

A test of the output of the tape recorder here, a *Webcor* 210, showed that the output was just sufficient to drive a discarded telephone relay which had been gathering cobwebs and dead spiders for several years. However, since the relay is DC, and the output from the recorder is naturally AC, a rectifier from the scrap box was inserted. A DPST switch was also added, as shown in the diagram, both to turn off the rectifier filaments and to disconnect the relay from the transmitter if it should stick.

The adjusting of the relay was the hardest part of the entire set up, for the contacts must be far enough apart to avoid arcing, yet close

enough to assure that even the fastest dit will close the circuit. It is also necessary to have the spring return of the relay tight enough and the driving signal sufficiently strong to cause the contacts to change position rapidly in order to suppress key clicks.

Once assured that the unit was functioning properly, I recorded a two minute CQ followed directly by the much repeated transmission, leaving a blank for the signal report. The relay was then wired in parallel with the key and the rectifier hooked up to the transmitter power supply and my robot keyer was ready to go to work.

After starting the recorder and turning on the transmitter, I monitored with the receiver and was pleased to find the keying nearly click free and fully readable. What's more, I had ample time to fill in the log properly without being forced to write with one hand while transmitting with the other.

At the end of the call I stopped the tape and threw the transmitter switches. To my utter amazement I had an answer, or rather, the robot had an answer. When the caller signed, I sent his call by hand and started the tape which proceeded to send "de K2HCB . . ." and continue from there. By the time I had my contact filled into the log the robot operator was sending "ur RST. . . ." In the blank I filled in 579 twice. Timing was good and the robot picked up with "hr in Tenafly . . ." while I looked up the contact in the call book.

As the tape wound up with the usual "so wat sa om?" I was forced to go to work and fill in the two calls. To my intense joy he returned with "r r, solid copy," obviously completely ignorant of the fact that he had been copying a machine.

He became very interested when I later explained the apparatus, so I went one step further. I recorded his next transmission and then played it back to him through the relay and my transmitter. Not only was it completely copyable, but it gave him an accurate representation of his own keying patterns.

Woe be to the next lid who calls K2HCB, for he will have an exact taste of his own medicine. In the meantime, the robot operator will continue to take care of form transmissions while I relax and think up witty sayings for the second go around. ■

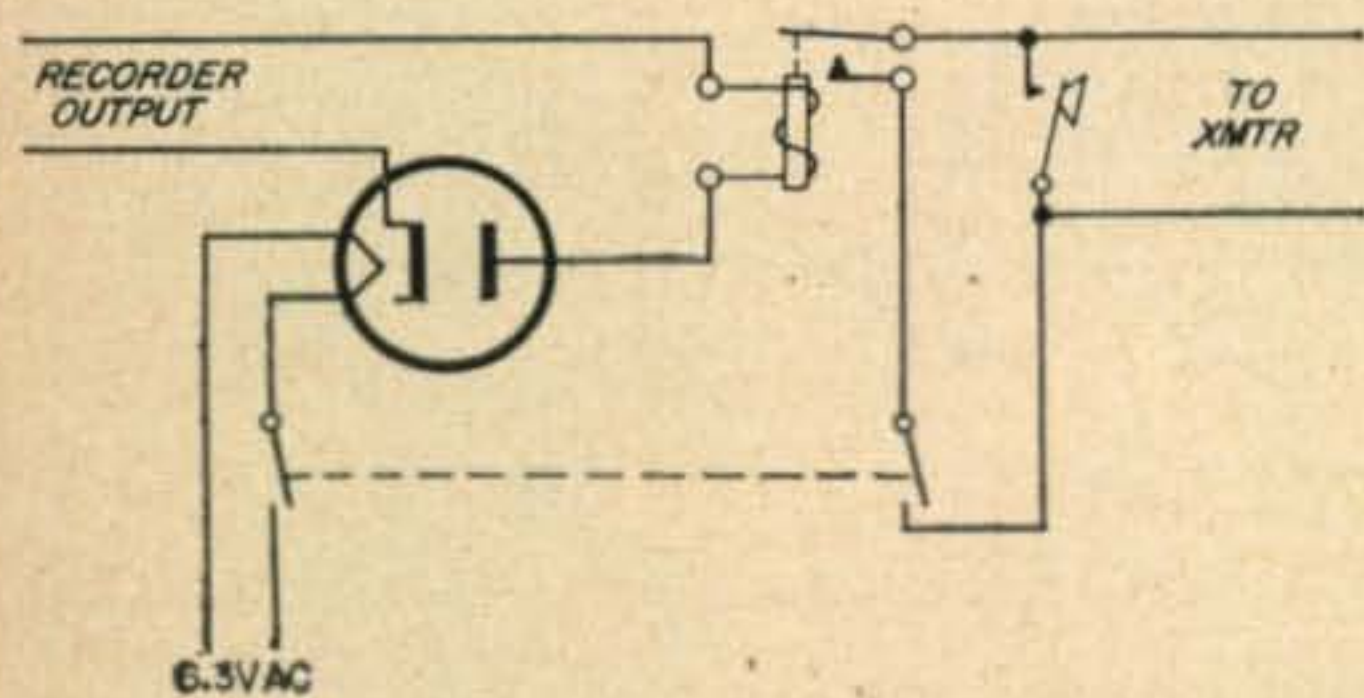

Fig. 1—Automatic keyer circuit. Try a selenium and eliminate the filament wiring.

ONE OF THESE DAYS

J. Wesley Sammis, W2YRW

300 S. Woodstock Drive
Haddonfield, New Jersey



"One of these days—POW— To the moon." How many times have we heard this expression used in jest? For those who delve into the realms of electricity, including amateur radio, this remark, in jest, could become a great big reality, in fact way past the moon—**forever**.

Most of you respect voltage, but do you always respect current as much? Chances are you do not. Whether it's current or voltage **beware**.

A few facts are important to this discussion.

1. The **amount** and **duration** of current flow determines severity of shock, not voltage.¹
2. **Freeze-on** current is important in all considerations.
3. Under certain conditions, as little as 50 volts can produce freeze-on² current.
4. The condition of the outer skin (i.e. dry or wet) is important and affects the amount of body resistance.
5. The **freeze-on** current span is between 15 and 25 ma. (Milliamperes).
6. **VENTRICULAR FIBRILLATION** can occur between 75 and 100 ma. (This is usually **FATAL**).
7. The average body resistance³ (chiefly from the outer skin) can be as high as 90,000 ohms per square cm, when **dry**.
8. The average body resistance (chiefly from the outer skin) can be as low as 900 ohms per square cm when the outer skin is wet due to water or perspiration.
9. The inner skin offers negligible resistance.

The application of ohm's law will show how these facts can be most important. Suppose you get across 75 volts of potential and, at the time, your body resistance is 5,000 ohms. Therefore, ohm's law applies.

$$E = IR \text{ or } I = E/R$$

Substituting

$$I = \frac{75 \text{ Volts}}{5,000 \text{ Ohms}} \\ = 15 \text{ ma}$$

Referring to #5 above, we find that this is within the range of **FREEZE-ON**. Unable to release, the current would continue to flow on, the outer skin would blister from burning, the outer resistance drops to almost zero, the

current flow would increase, ventricular fibrillation sets in, **RESULTS: USUALLY FATAL**.

Now don't go putting a volt-ohm meter to yourself to increase body resistance and then sticking your finger on a low voltage power supply, in order to test this theory. It has been done all too many times, by someone who didn't want to do so and who—became a statistic.

Treat your currents and voltages kindly and with respect and you will be around a long time to enjoy your hobby and your friends will enjoy your company.

MAKE THESE YOUR HAM-SAFE CODE⁴

1. **GROUND** both stationary and portable⁵ equipment.
2. Use interlocks to break circuits.
3. Don't wear jewelry, including watches (while working on equipment).
4. Provide warning signs for visitors to the shack and working areas—(for **yourself** too).
5. Test with power **OFF**, if possible. (How good a technician are you?)
6. **First on—Last off**, should be your grounding rule.
7. If working alone, let someone in the house know about it! A once in a while check could save your life.
8. Know and inform your family on artificial respiration.

To paraphrase the oft quoted commercial—**DON'T BE HALF SAFE—USE CAUTION TO BE SURE—YOU STAY ALIVE.** ■

1. Reference Material:

- 16 Steps to Safety In Electronics, G. A. Endrich. Safety Maintenance, November 1957, P. 14.
- C. F. Dalziel, E. Ogden and C. E. Abbott, "Effects of Frequency on LET-GO CURRENTS," Transactions AIEE Vol. 62, 1943.
- FIRST AID, American National Red Cross, Fourth Edition Revised 1957.
- That point where victim loses muscular control and is unable to release his grasp.
- Changes with individual, his physical condition, etc.
- The author has a limited supply of these rules on QSL card size for the shack. While the supply lasts, free for the asking with a return, self-addressed envelope.
- Scopes, signal generators, other such testing devices.

Simplified, Fool-proof Screen-grid Modulation

Wm. S. Skeen, W7EPM/6

426 Northumberland
Redwood City, California

Screen-grid modulation—with the exception of clamp tube systems—has always enjoyed a rather poor reputation, deservedly so, in many cases. Transformers which will match the impedances encountered are quite often not available, and attempts to approach 100% modulation usually result in objectionable distortion. The system described here avoids these two most serious drawbacks, while offering many advantages in addition to surprisingly good audio quality. Nothing unique or revolutionary is involved. It may be simply described as paralleling the modulator plate with the screen-grid of the final r-f amplifier, with the common d-c supply fed through an ordinary filter choke. More simply yet, Heising screen-grid modulation!

Probably the chief advantage of this type modulation is that it "sounds good" regardless of operating conditions. While modulation percentage will vary, no distortion results from wide variations in r.f. excitation, bias, or plate loading. This is not too surprising when we remember that Heising systems are incapable of reducing to zero, or cutting off the carrier, thus eliminating the chief cause of "splatter."

The average filter choke has enough self-capacitance to by-pass the higher audio frequencies. Besides restricting the width of the sidebands to the useful speech frequencies, other advantages ensue. The modulator may be overdriven, so as to produce clipping action. Ordinarily, it would be necessary to provide a filter to avoid excessive harmonic distortion, but the choke does its own filtering, and the corners of the square waves are nicely rounded, in the modulation envelope. We thus have the high "talk power" of clipper-filter systems, without the associated circuitry.

Observation on a scope reveals that the modulation peaks remain substantially constant, regardless of carrier level. The carrier may be reduced to quite low levels, leaving the positive peaks considerably more than twice the carrier level, with total sideband power better than the 50% obtained with 100% modulation. No distortion results, since the carrier never reaches cutoff.

As a single 813, or alternatively a 5-125B is used at this station, discussion of operating conditions will be limited to tubes of this

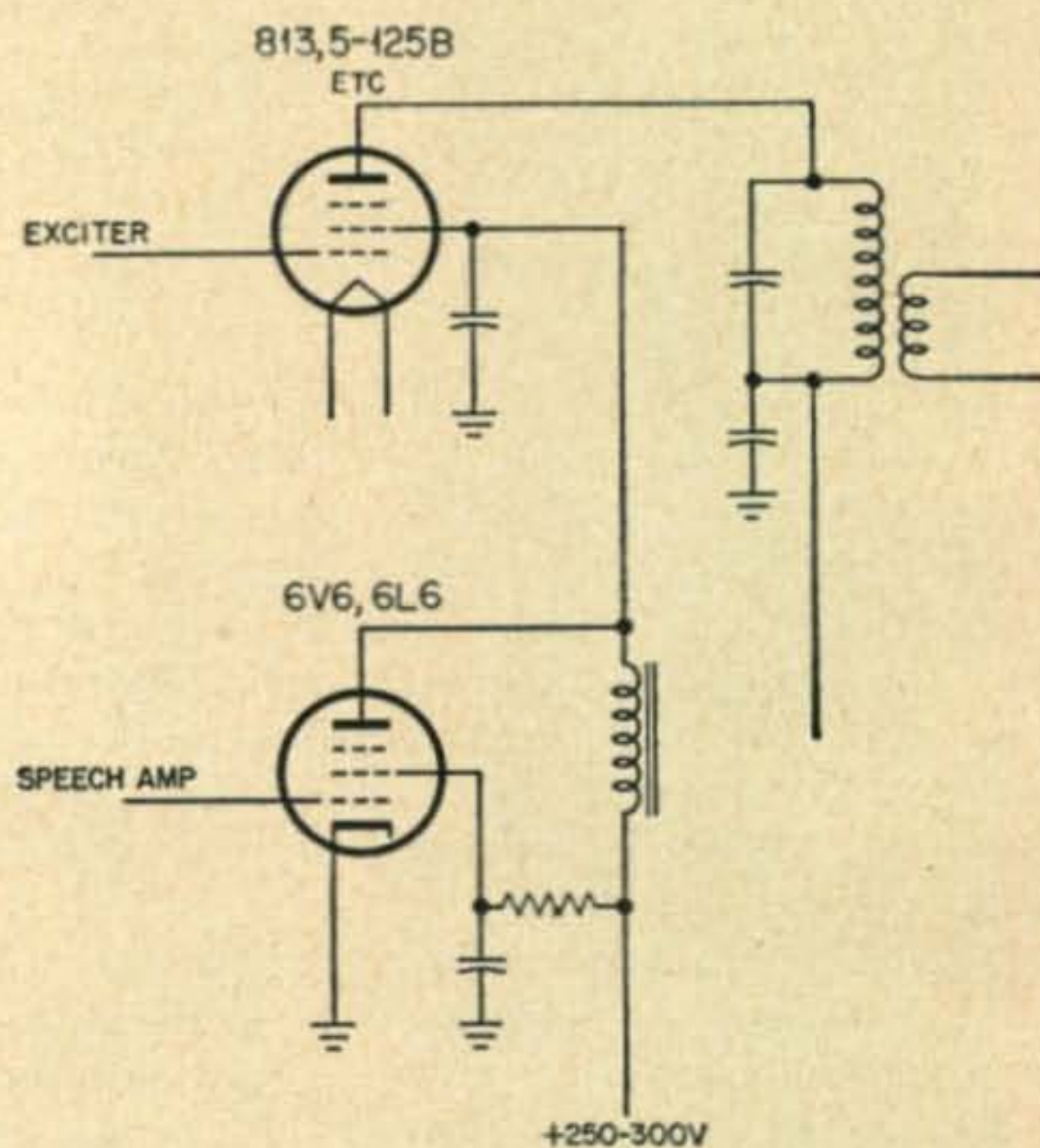

class. The system is of course applicable to other tetrodes or pentodes, with the exception of the newer oxide cathode types, where reverse screen current is often encountered. At this point, it may be wise to mention that the use of a fixed screen supply is pre-supposed. A screen dropping resistor of proper size with a large filter condenser might work, but is not advised.

With 1500-2000 V on the plate of an 813, excitation should be reduced for a plate current of about 100 ma. While not essential, the grid bias may also be reduced to between 100 & 120 V. Plate loading should be adjusted for 4 to 5 ma. of screen current. More than this will result in rapidly decreasing modulation percentage. Screen current will commonly swing up to 7 or 8 ma. on peaks. With 250-300V for the modulator plate and final screen-grid, ample modulation will be obtained with a pentode, such as a 6V6 or 6L6.

Under these conditions, the final will be operating at about 40% efficiency, and the 125 watt dissipation of the tube will not be exceeded. The carrier may be reduced even further, as mentioned previously, with a resultant increase in modulation percentage, but whether less carrier with increased modulation is better than more carrier with less modulation is a question that could lead to considerable discussion. In any event, I have used

[continued on page 175]

ANOTHER Set of Rules

J. D. Heumphreus, K6DXW

3819 Sunset Road #4
Santa Barbara, California

"What-dya-mean, I'm violating an ordinance? Listen, I've got an FCC license, and this is none of your darn business!" It is doubtful that this will ever happen, but in addition to Federal licensing and operating requirements, there is another set of rules that have the amateur operator in mind. At present, the enforcement of these rules is not very strict; nevertheless it is well that we have a knowledge of them.

What are these other rules, and why do they affect us? These regulations are the group of articles known to electrical contractors and inspectors as the National Electrical Code. This code is the standard of the National Board of Fire Underwriters and applies to all electrical wiring and apparatus as recommended by the National Fire Protective Association. Now comes the catch: this code is incorporated into most county and city electrical ordinances either entirely or by reference.

The section of the code which we, as amateurs, are concerned with is Article 810. This article states in part: "This article shall apply to radio and television receiving equipment and to amateur transmitting equipment." That means us, gang. Let's take a look at this portion of the code and see what it has to say. We're not likely to be pinched or called on the carpet if we don't conform to the specifications of the code, but most of the rules are good safety and operating practices anyway.

Antenna Systems

The code requires antenna and lead-in wires to be of high strength, corrosion resistant material, such as hard copper, aluminum, or copper-clad steel. It does allow use of soft- or medium-drawn copper for lead-in where the maximum span is less than 35 feet. The antenna must be of at least 14 gauge where the maximum span is less than 150 feet. If the maximum span is over 150 feet, 12 gauge is required. The code further specifies that antenna wires not be attached to poles or structures carrying wires with voltages in excess of 250 volts. If attached to metal structures, the structures must be permanently and effectively grounded. Each conductor of a

lead-in must be provided with a lightning arrestor, except that in the case of co-ax cable, if the outer shield is permanently grounded, no arrestor is needed.

Grounds

We have already encountered a favorite saying of the Underwriters: "permanently and effectively grounded". "Permanent" means just that. A length of cable is not permanently grounded just because it is attached to a grounded transmitter or antenna tuner. The ground must be attached directly to the cable sheath. Lightning arrestors are also protection against fallen power lines coming in contact with an antenna, or against a transmitting antenna sagging and contacting a receiving antenna. "Effectively grounded" is a bit more involved. This refers to the code article on grounding, a topic all in itself. Let's see how this applies to ham transmitters.

Grounds are divided into two groups; protective and operating. The protective ground is the ground return from the lightning arrestor, and must be as large as the lead-in wire. It should be run to ground in as direct a line as possible. The operating ground is the ground for the equipment. This is the ground we miss when we find a few volts difference between the mike and the receiver. This can be a bit painful if we happen to have our hands on the receiver and get the mike too close to our lips. This ground must be of at least 14 gauge or equal. 1/8" tinned braid has the same area as #14 wire; personally I like to use 3/8 or 1/2 inch braid. The grounding conductor should be run to ground in as short a length as possible. It need not be insulated wire, but should be covered where subject to possible mechanical injury. It may be tacked to the supporting surfaces. It should be connected to a water system where possible, or to a grounding electrode if water pipes are not handy. Some amateurs have found that a ground wire buried a few inches under the ground directly under the transmitting antenna has considerably improved low frequency operation, especially in dry areas.

A new device has recently appeared on the
[Continued on page 171]

The Old Timer Quiz

Rockaway Valley Radio Club

TRUE or FALSE

T F

- | | |
|--|--|
| <p>1. The potential at any point is the work done on a unit positive test charge in bringing it from infinity to the point in question. — —</p> <p>2. Since a radio amateur license is a federal document, it is illegal to photograph it, or make photostats, photocopies or duplicate it by any means, or have such a duplicate in your possession. — —</p> <p>3. In a conductor of virtually zero resistance that has a direct current flowing through it, the electrons travel at the speed of light approximately 186,000 miles per second. — —</p> <p>4. The energy represented by an electron moving through a difference of potential of one volt is called an electron-volt. — —</p> <p>5. The theoretical impedance at the base of a 1/4 wave whip mounted on the rear deck of an auto is 36 ohms (or very close to it.) — —</p> <p>6. A battery can be likened to an electron pump which produces a surplus of electrons at its negative terminal and a deficiency of electrons at its positive terminal. — —</p> <p>7. The cross-section of a wire in circular mils is the square of the diameter in mils. — —</p> <p>8. -40°C equals -40°F — —</p> <p>9. A circuit has an inductance of 1 henry if a constant current of 1 ampere maintains an induced emf of one volt in it. — —</p> <p>10. If a pure resistor, a pure capacitor and a pure inductor are connected in parallel the "Q" of the combination is given by $Q = \frac{WL}{R}$ where $W = \frac{I}{\sqrt{LC}}$ — —</p> <p>11. Persons holding a valid "Restricted Radiotelephone Operators Permit" (3rd class) may operate a properly licensed Amateur Radio Station provided a currently licensed Amateur is standing by. — —</p> | <p>12. It is illegal for a properly licensed person to operate a properly licensed mobile amateur radio station without having a properly functioning device within the car that can give an indication in the event of a Conelrad Radio Alert. — —</p> <p>13. If you own a properly licensed Amateur Station you may legally destroy it if you wish, without surrendering your license privilege. — —</p> <p>14. If you operate a properly licensed walkie-talkie in an open convertible which is on a ferry boat in a harbor you must identify yourself as "Portable-Mobile-Maritime-Mobile." — —</p> <p>15. If you anticipate mobile operation during a vacation trip away from home in excess of 48 hours you must give prior written notice to the Engineer in Charge of the radio inspection district in which such mobile operation is intended. — —</p> <p>16. The property of an inductor is to oppose the change of current. — —</p> <p>17. Joules = Newtons x meters — —</p> <p>18. Our nearest star Alpha in Centaur group is about 3 1/2 light-years distant. (This isn't electronics but you must admit it's interesting.) — —</p> <p>19. The phase velocity of wave fronts often exceeds the speed of light. — —</p> <p>20. The speed of electrical energy in a coaxial transmission of RG58/AU (72) is about 2/3 that of the speed of light, therefore the electrical length of a 1/4 wave transmission line should be about .66 that of a 1/4 wave antenna. — —</p> <p>21. $Ae^{j\theta} = A \angle \theta = A \sin \theta + jA \cos \theta$. — —</p> <p>22. As far as a receiver is concerned, there is no difference between a frequency modulated signal (FM) and a phase modulated signal (PM) if both are modulated by the same complex (voice or music) audio. — —</p> |
|--|--|

In the following questions the carrier powers are equal.

23. Based on a comparison of *Signal to Noise*, a 100% modulated SSB signal with completely suppressed carrier will be 8 times more effective than a 100% modulated conventional DSB (AM) signal. — —
24. Based on a comparison of *Signal to Noise*, a phase modulated signal with a modulation index of 5 will be 25 times more effective than a 100% modulated conventional DSB (AM) signal. — —
25. Based on a comparison of *Signal to Noise*, a frequency modulated signal with a deviation ratio of 5 will be 75 times more effective than a 100% modulated conventional DSB (AM) signal. — —

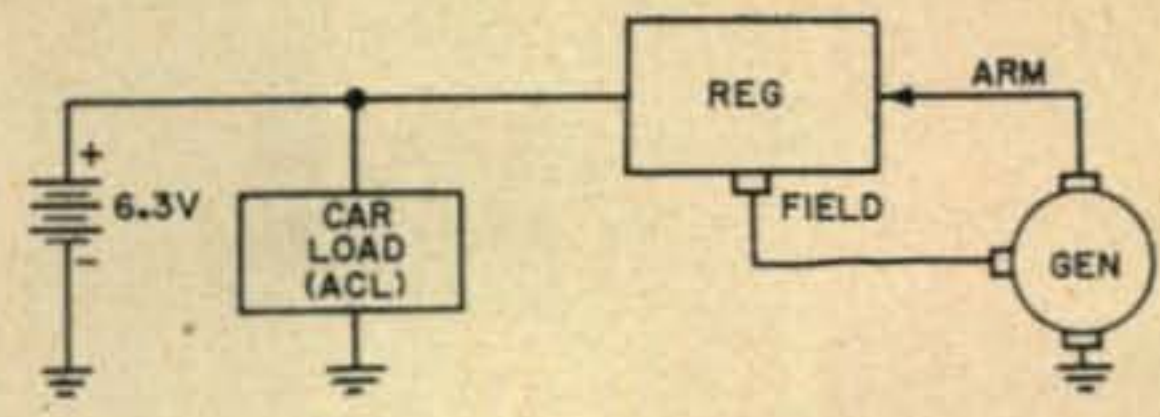

6. If in the afore question the regulator was omitted and the field terminal grounded, would the generator armature current increase or decrease as the battery becomes charged?
7. If a 115 CPS NON-SYNCHRONOUS vibrator of a 6.6 volt D.C. typical auto radio is removed and a 60 CPS AC voltage is applied as shown below what should be the value of the AC voltage applied in order to obtain normal B+?

Computations

1. What is the effective resistance of this combination in ohms?

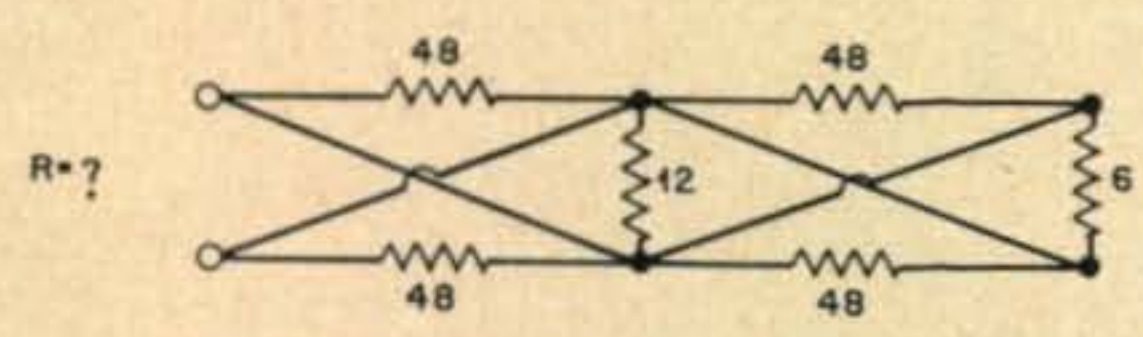

2. What is the current flowing in this circuit in amperes?

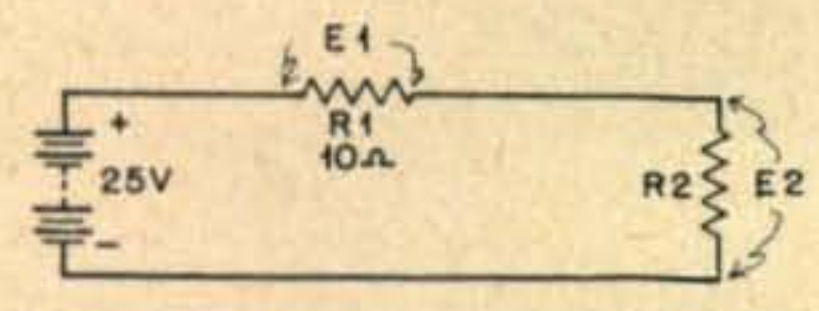

NOTE: R2 IS DISSIPATING 10 WATTS

3. A radar operator flying in a high speed jet parallel to a straight run of high tension towers notices that the number of blips he sees every 225 seconds is numerically equal to the speed of the jet in miles per hour. How far apart are the towers? (in feet)
4. What is the name given to this type of antenna?

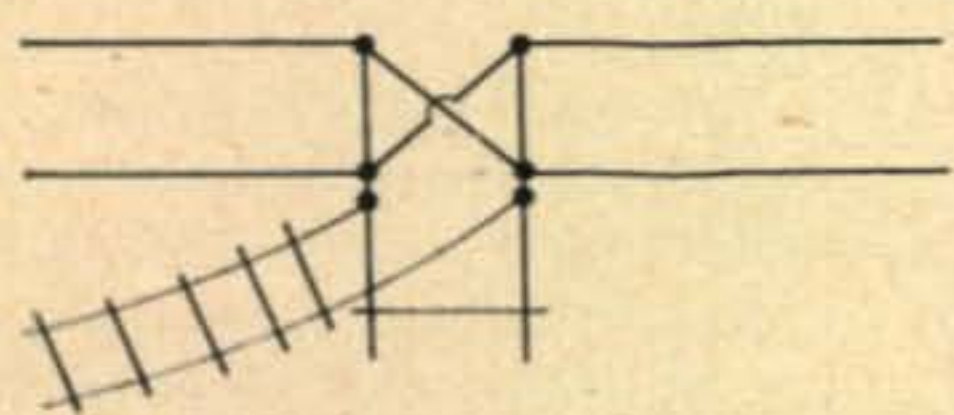

5. Below is a block diagram of a typical automotive electrical system. As the battery approaches full charge, does the internal resistance of the battery increase or decrease as far as the generator is concerned. Assume normal regulator action and constant speed and constant external load.

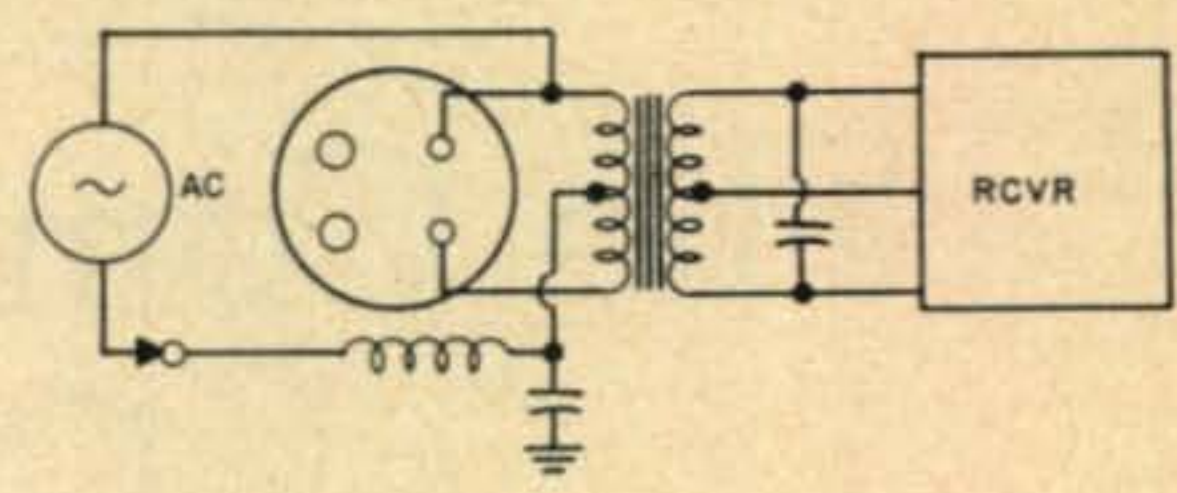

Approximate

- | | |
|-----------|----------|
| (a) 13.2v | (d) 4.9v |
| (b) 6.6v | (e) 3.3v |
| (c) 6.3v | (f) 3.0v |
8. Is the voltage leading or lagging the current in the circuit below?

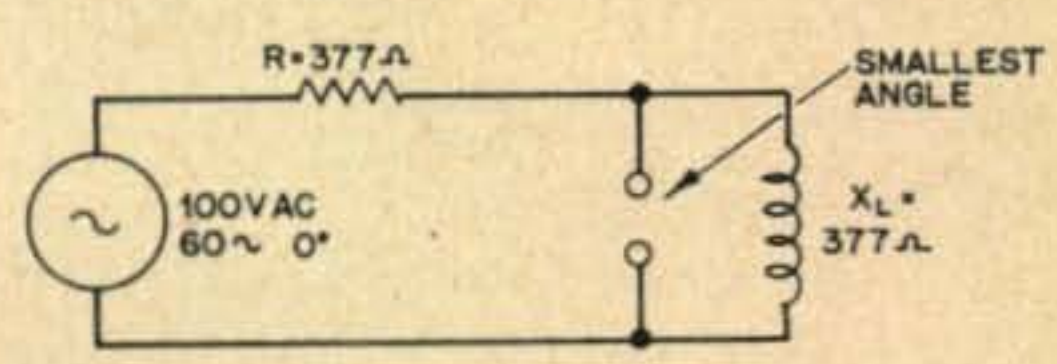

9. When a capacitor is discharging through a resistance, the time constant is the time in seconds that it takes for the capacitor to:
 - (a) lose 63 per cent of its voltage
 - (b) lose 37 per cent of its voltage
 - (c) discharge to zero
 - (d) discharge to a voltage given by the original starting voltage divided by RC
 - (e) discharge to a voltage given by the original starting voltage divided by 5RC
10. In a properly operating class "C" amplifier which is modulated 100% by a single sine wave tone, the maximum instantaneous peak power in the envelope is:
 - (a) same as carrier power
 - (b) twice carrier power
 - (c) four times carrier power
 - (d) eight times carrier power

For correct answers meander on over to page 189.

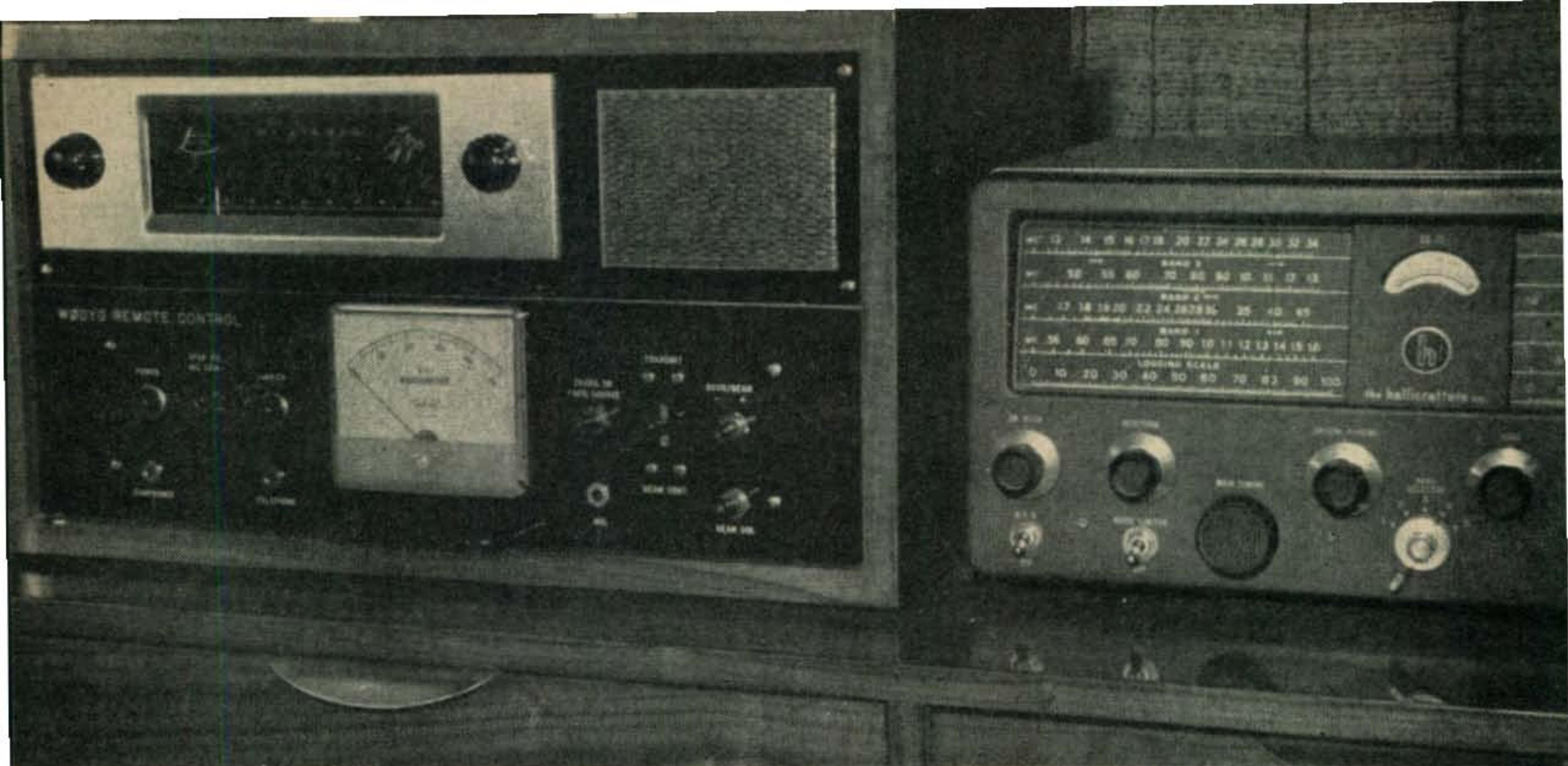

The Complete Remote Control

Dale L. Moudy, WØDKC/2

695 Boelsen Drive
Westbury, N. Y.

Foreword:

The remote control system for a complete amateur station described in this article, while it probably will not be duplicated by too many amateurs, may be the inspiration for many amateurs to improve their operating locations. The application of remote control to amateur radio can bring more satisfying operation to a ham using a poor location or living in an area where extensive antenna systems are prohibited by ordinance or zoning laws. A small plot of ground undesirable for other uses could become an excellent station location. A small building, built by the ham himself, requiring no heat or utilities except for electric power and large enough for the necessary equipment, is all that is required. The monthly telephone line charge per mile will vary in different parts of the country but \$3.00 should be close to average.

Operating an amateur radio station in today's crowded bands, whether it be for DX-ing, traffic handling, or rag-chewing, can be a great deal more satisfying if the operating location approaches the ideal. The desired site should be sizeable in area, clear of large surrounding objects, offer low susceptibility to TVI, and most important of all—suffer as little as possible from man-made noise and interference.

By contrast to the above, with the exception of a coal mine interior, the poorest operating location used by amateurs today is perhaps in the downtown office and store building section in a large city. The level of man-made interference and signal absorption of this type of location limits contacts to only the strongest signals on any band and relegates dx contacts to the limbo of all forgotten things!

If we designate an operating location meeting, as nearly as possible, the ideal require-

ments above as A, and the poorest location as B,—it would not require a Sherlock Holmes to deduce that if operation from a B location is a necessity, one solution would be to operate equipment located at A from B. . . . elementary my dear Watson.

This was the problem, the reasoning, and the solution behind the successful design and construction of the remote control system for WØDYG. The operating location is in an office on the eighth floor of a downtown office building in the heart of the Omaha business district. The transmitter site available was the radio station KOWH transmitter site located approximately six miles northwest of downtown Omaha. With the exception of the 500 foot high broadcast tower used on 660 kc and the incoming high voltage transmission line, there are no high obstructions. The roof of the transmitter building located near the center of the forty acre site was available for the erection of antennas.

The first method of remote control used one channel of the twenty available in the Schafer Remote Control System employed by radio station KOWH. This method had serious drawbacks however, since the meter readings of the broadcast transmitter at regular intervals would result in loss of control of the amateur transmitter, and if the operator neglected to return the equipment to channel four, the loss of control was of a semi-permanent nature. This system too, only solved a portion of the problem of operation from a poor location since only the transmitter was remotely located. It was like one lick on a candy sucker, one always wants more . . . so the control requirements were listed and evaluated and this article describes the equipment designed and constructed to fulfill them.

The desired functions of the control system were as follows:

1. Control of main ac, both ON and OFF.
2. Control transmitter carrier, both ON and OFF.
3. Change transmitter frequency within the band.
4. Tune the receiver.
5. Rotate the directional antenna arrays.
6. Indicate direction of the antenna arrays.
7. Change band of operation.
8. Only one telephone line to be used.

Of the eight requirements listed, only number seven was discarded as being impractical. However, band changing is possible and one method of its accomplishment will be outlined at the conclusion of the article.

Additional requirements were decided upon for the remote control operating unit at the operating position as follows:

1. Unit to be small and compact but not miniaturized.
2. Unit to present an appearance compatible with the general furnishing of the office.
3. Unit to have a telephone patch available

with automatic changeover from send to receive.

These requirements were added to the functions already decided upon and the equipment in the photographs and drawings was constructed and placed in operation.

Remote Control Operating Unit

The remote control operating unit is shown in the photos and in figs. 1 and 2. The unit is divided into five separate sections although they are all interdependent and form the complete operating position. They are the microphone line amplifier, the receiving audio amplifier, power supplies and associated switching, telephone patch, and the indicating meter circuits. These will be described and discussed when necessary, in the order given.

Physically, the remote control unit shown in the photos is of "drawer" type construction, using an inverted 17x10x4 aluminum chassis. The amplifiers are constructed on the back with the tubes and transformers extending toward the rear of the cabinet. A vertical shelf located about midway across the chassis contains all power supplies, adjusting pots, and relay K3. The front panel contains the two pilot lights, concentric volume controls, key switches S1 through S4, and the 50 micro-ampere meter. The chassis is mounted on full suspension drawer hardware for easy removal and access. After disconnecting the ac, speaker, and telephone line, the drawer assembly may be lifted clear of the sliding supports and removed. The panel above the control unit contains a Fisher AM-80 hi-fi broadcast tuner and a 4 x 6 oval speaker. The hi-fi amplifier used with the tuner together with a speaker selector switch are in the cabinet below. Beside the cabinet containing the remote control unit is the Hallicrafters SX-71 receiver used as an off air monitor as required by the FCC.



The remote control unit in its withdrawn position for adjustment. The unit will lift clear of the tracks for complete removal.

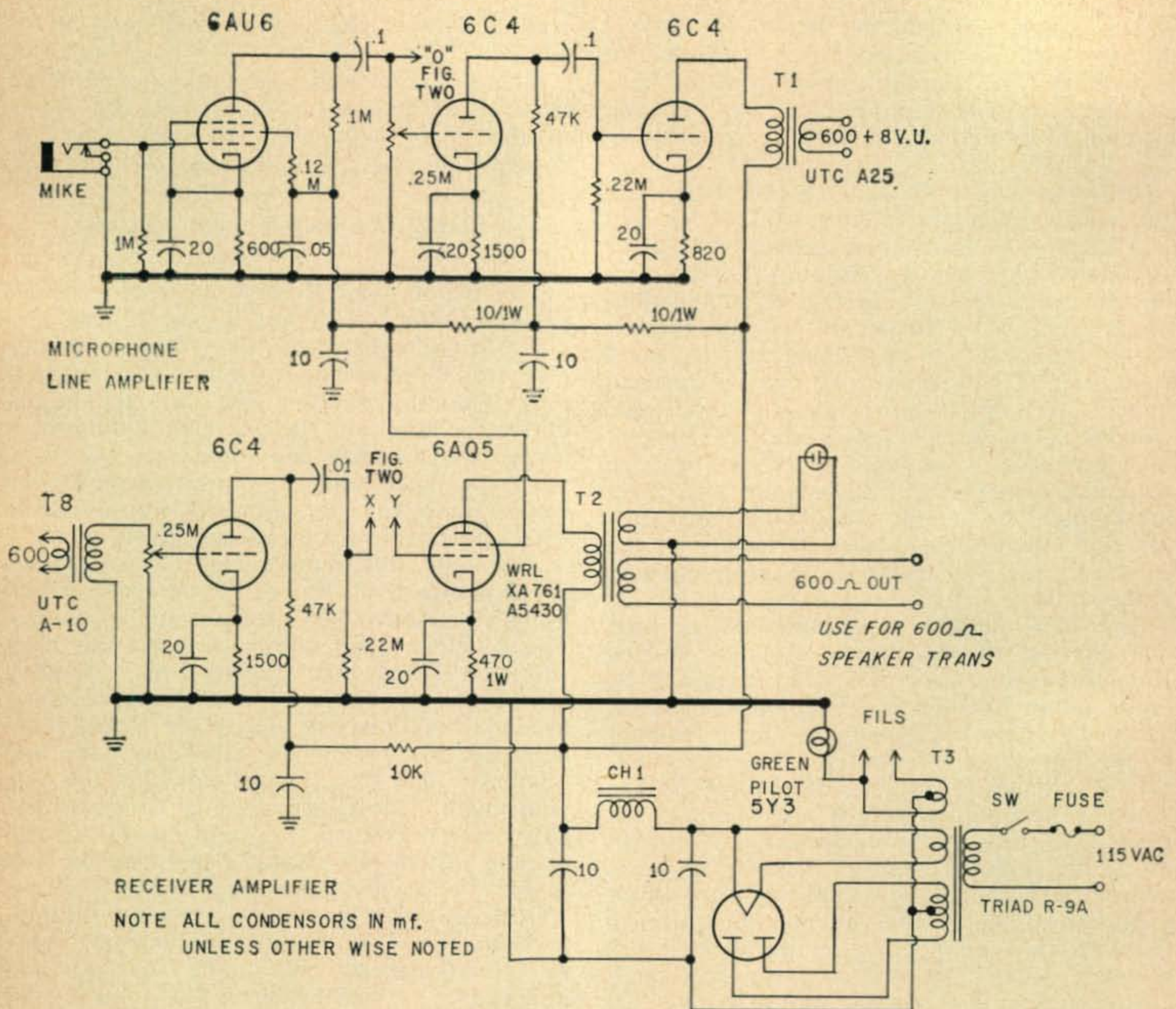

Fig. 1—Both volume controls in the receiver amplifier are mounted concentrically with the power switch on the rear. This unit shares the remote control chassis with Fig. 2.

The purpose of the microphone line amplifier is to raise the output level of the microphone to a level of plus eight VU for transmission via the telephone line to the transmitter. The circuit is more or less standard, using a 6AU6, 6C4, 6C4, with a high impedance input for crystal or dynamic microphones, and a 600 ohm output impedance.

The receiving audio amplifier serves to increase the incoming line level from the remotely located receiver to that sufficient for loud speaker operation. A relatively low gain amplifier accomplishes this purpose as shown in fig. 1, using a 6C4 and 6AQ5. The amplifier has output impedances of 600 and 8 ohms.

A common power supply is utilized for both amplifiers and uses a 5Y3GT full wave rectifier with condenser input filter system. Adequate decoupling is provided by the liberal use of ten-thousand ohm resistor and ten mfd condenser combinations.

Since the voltages for relay operation at the transmitter must be available in various com-

binations, including polarity reversal, three separate supplies are required. Two of the supplies are identical, using a 24 volt filament transformer, bridge connected selenium rectifiers, and single condenser filter. The third supply is identical except for the addition of a filter choke and additional filter condenser, followed by a retard coil or audio choke. The purpose of this audio choke is to prevent the low impedance of the output filter condenser appearing across the output of the microphone line amplifier and destroying its response. Each power supply has an output voltage adjusting pot and a metering jack for measuring load current. The current taken from the supplies is tabulated in the function chart for the operating remote control unit and is shown in Chart I, on page 66.

Control Methods

Before discussing the actual switching circuitry in the unit, a brief explanation of the

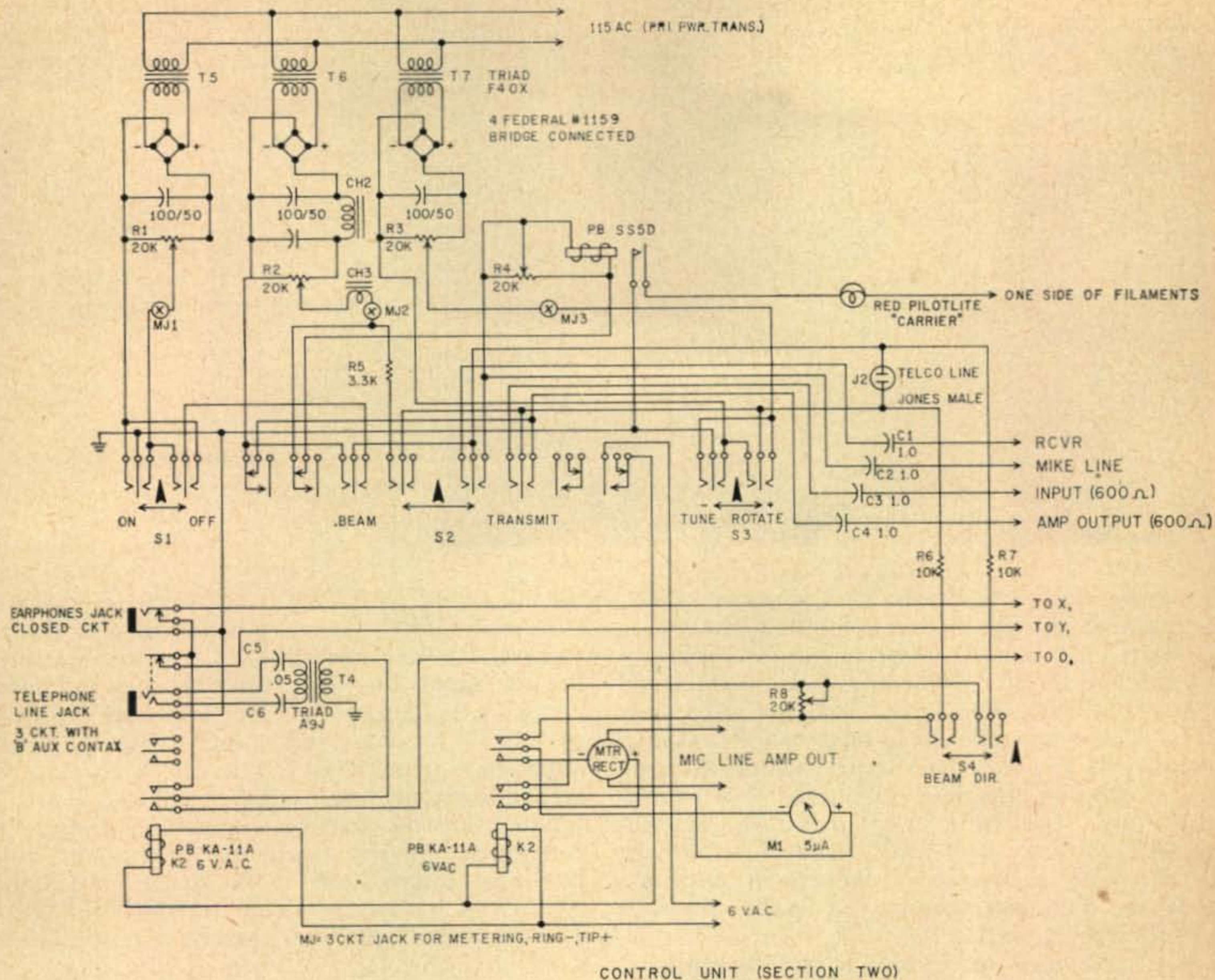

Fig. 2—Schematic of the second section of the remote control unit. Letters X, Y and O at lower right side of drawing are to be connected to similarly designated points in Fig. 1.

method of control is in order. In the full use of a single telephone line, consisting of two physical wires from one point to another, we actually have three dc paths available. They are between the two wires of the pair and from each wire of the pair to ground. These three dc paths will give us three functions. It is readily apparent that if polarity reversal is used in conjunction with polarized relays we immediately double the available functions to six.

Before continuing, the definition of a function, in relation to relay systems, is a physical movement or electrical change in one direction only. In other words ON is one function and OFF is another, etc.

One method of securing additional functions is to sacrifice one function from actual operation and use it to change two available functions to other uses. This procedure furnishes a net gain of one function. Another method of gaining functions in simple relay systems is to utilize time delay relays to change an available function to another use after a definite passage

of time.

Other methods of increasing functions are available including using a suitable pulsing dial and stepping relays resulting in a gain of from ten to forty-four functions. The conclusion however, is reached that even the most simple system of remote control can be allowed to grow overly complex for the job required of it. It is therefore imperative that we "say when", or the equipment is in danger of becoming too involved for simple and reliable operation and may therefore jeopardize the pleasure and advantages of operating by remote control.

The switching system at the remote control operating unit, shown in fig. 2, is comparatively simple and a brief description should suffice. All control switching is accomplished by three key switches, S1, S2, and S3. In the following description L1 and L2 refer to respective sides of the telephone line.

Switch S1 in the ON position applies a positive voltage between L1 and ground and through the use of time delay relays at the transmitter unit becomes the frequency change

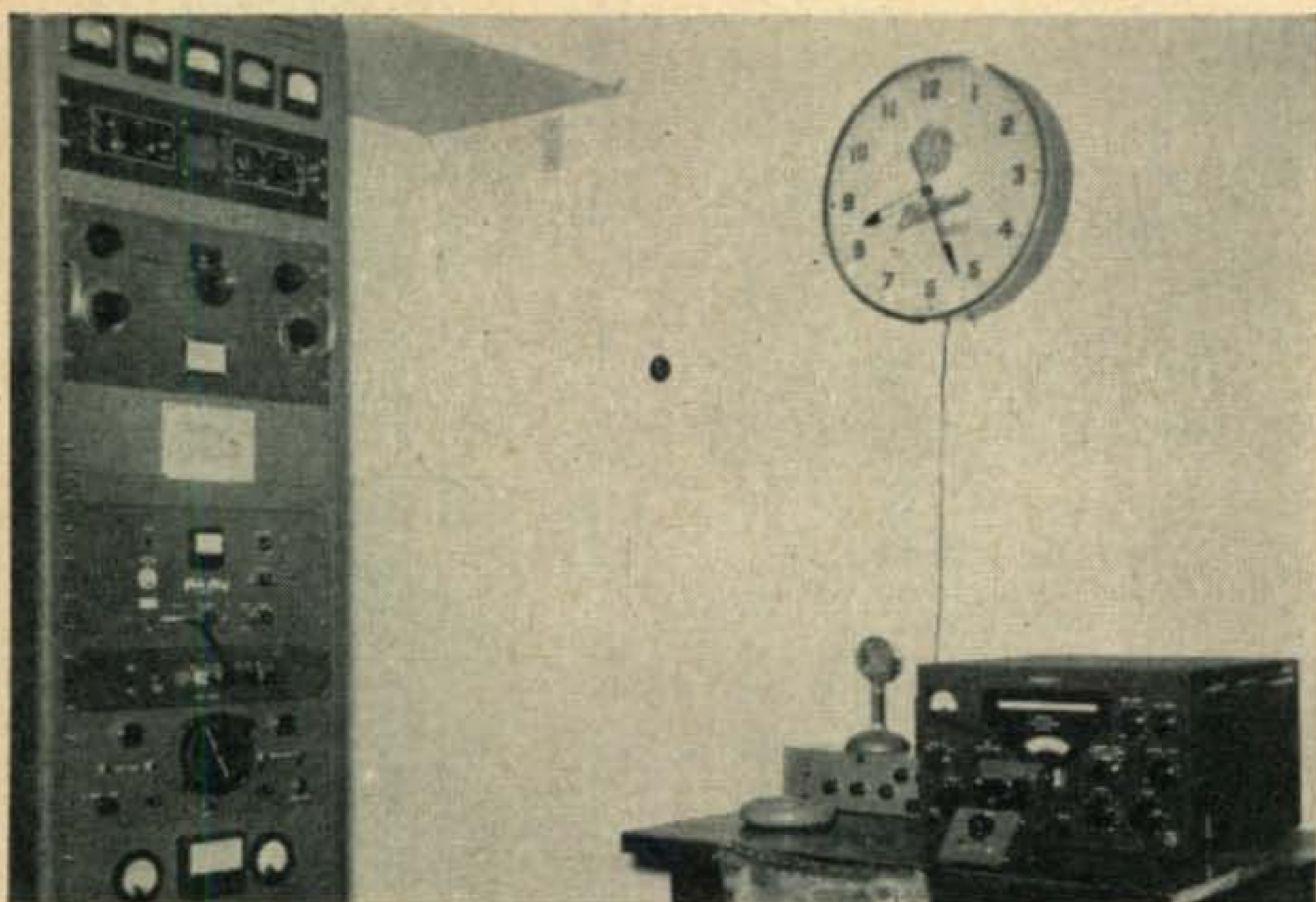

Overall view of the transmitter and local operating position.

function. Switch S1 in the OFF position applies a negative voltage between L1 and ground.

Switch S2 is a standard telephone type key switch and the particular one used is a Western Electric 479JR. This key switch was used simply because it happened to be on hand and any equivalent key may be used providing its contact pileup is adequate. One readily available substitute would be a Switchcraft Telever 60324L which has four form C contacts actuated on each side of the center position.

In the **Transmit** position, S2 applies positive voltage to L1 and negative to L2. Simultaneously it connects the output of the microphone line amplifier to the telephone line via the two 1.0 mfd audio coupling condensers which isolate the transformer secondary from the relay operate voltage; it disconnects the telephone line from the input of the receiving amplifier; and operates the telephone patch and meter relays through an additional set of contacts. The operation of these relays will be discussed later. The carrier pilot light relay, K3, is operated by the line current, when in the **Transmit** position, and is adjusted to just pull in by means of R4 in shunt with its coil.

In the **Beam** position of S2, positive voltage is applied to L2 and negative to L1. The 3.3k resistor in series with positive from the power supply is to hold the line current to the same approximate values as that resulting when the carrier pilot light relay is operated in the **Transmit** position.

Switch S3 in the **Minus** position, applies a negative voltage between L2 and ground, and causes the receiver to be tuned lower in frequency, or the beam antennas to be rotated counter clockwise, depending on the position of S2. Switch S3 in the **Plus** position applies a positive voltage between L2 and ground, performing the reverse functions of those for the **Plus** position. Switch S1 and S3 are both Switchcraft 3037 lever switches.

The telephone patch relay in the de-energized position connects the headphone output of

the receiving amplifier to the high impedance winding of T4, a Triad A9J line to grid transformer. The line winding of T4 is connected to the telephone line jack through two 0.5 mfd coupling condensers. In the **Transmit** position of S2, K1 is energized, transferring the high impedance winding of T4 to the high side of the microphone line amplifier volume control. When using the telephone patch, operation is completely by the telephone instrument and the local microphone is not used. The loud speaker is muted by virtue of the open grid connection to 6AQ5 to prevent acoustic feedback.

Relay K2 in the de-energized position connects the meter, when S4 is closed, through R6 and R7 to the telephone line. The meter is adjusted by means of the shunt potentiometer, R8, to coincide with the selsyn direction reading at the transmitter. Switch S4 is necessary so that beam direction will be read only during the time S1, S2, and S3 are not operated. Operation of S1, S2, or S3 to any position, when S4 is closed, will pin the meter in one direction or the other. While the meter may not be permanently damaged, it is not the best treatment in the world for a 50 micro-ampere meter. Judicious use of S4 will prevent this occurrence.

This completes the description of the remote control operating unit and we now travel over the more than six miles of telephone line to the equipment we are controlling and see what these voltages of different polarity do to accomplish their mission.

Transmitter Control Units

Control is applied to a kilowatt transmitter operable on all amateur bands, eighty through ten meters. Details of the transmitter will not be given here but a brief description of the major units follows so the reader may more easily visualize the installation.

At the top of the rack is the antenna change-

over relay, plate voltage meter multiplier, and B & W low pass filter. The top panel is the metering panel for the power amplifier and contains the grid current, screen current, cathode current, plate voltage, and power output meters. Next is a Millen three inch oscilloscope for modulation monitoring. Below the 'scope is the band switching power amplifier using a pair of Amperex 6156/4-250A's with pi-network tank circuit tuned by a vacuum variable condenser. The cooling blower is behind the blank panel immediately below the amplifier.

The exciter is a World Radio Laboratories Globe Chief with the crystal changing unit mounted immediately below. The panel with the I-82-B selsyn indicator and switches for local control is the main relay unit. The auxiliary relay unit and beam rotator control relays are behind the panel containing the pa filament voltmeter, volume unit meter, and dc voltmeter for the local calibration of the dc beam direction indicating system. Below the relay units is the pa grid bias and screen voltage unit. The unit in the bottom of the rack is a 3000 cycle low pass filter and a pair of parallel connected 836 tubes in a high level clipper. Modulated high voltage is obtained from a separate unit using a pair of 833A's in Class B.

A sixteen hundred watt fifty ohm dummy antenna is available for testing the ham transmitter. It is made up of ten 500 ohm, 160 watt, non-inductive Ohmite resistors mounted in a shielded enclosure together with a 0-8 rf ammeter.

All cabling to the local operating table is through a one inch conduit terminated in a surface mounted wall box. In addition to the Collins 75-A4 receiver, a hi-fi ten-watt amplifier and local carrier control are on the table. The amplifier serves to raise the incoming line level to that required at the modulator driver input and also as the local microphone pre-amplifier. A level of plus 12 VU is required to drive the modulator.

Remote Control Relay Units

The remote control equipment at the transmitter is constructed in various units, designated, main relay, auxiliary relay, crystal changing, beam control, and ac control. This construction assembly would not be recommended for duplication, the construction of the system by units being brought about by the desire to maintain operation throughout the various stages of construction. The units could therefore be most easily combined into one integrated unit for connection to any transmitter.

Physically, all relay units are mounted on Bud "bathtub" chassis of various sizes catalogued as CB-1371 through CB-1377. Several of the smaller units have been bolted together so the removal of a front panel will not let a chassis become loose.

Referring to figs. 3, 4 and 5 throughout the following description, the functions will be discussed in as nearly their operating order as possible.

ON Function: The positive voltage arriving between L1 and ground energizes relay K3 because of conduction of D3, a 1N34A crystal diode. Its contacts energize the ON coil of the latching relay K8. The contacts of K8 turn on all modulator and hv rectifier filaments and also energize relay K16. The contacts of K16 furnish ac power to the outlet strip in the rack furnishing power to all other units. All ac switching is accomplished in the hot side of the ac supply line, the ground side being uncontrolled. Two seconds following the application of ac power, the contacts of relay K13 and K14 transfer the contacts of relay K3 to the crystal changing solenoid, K18. After this occurs, further operation of the On key will step K18 through the six crystals available. It will be noted in examining the K18 circuit that the first crystal change step actuates the exciter unit. This is done so the receiver can be tuned

The Collins 75A-4 receiver showing the tuning motor in place and ready for remote operation. The two push button switches are for local motor testing. The speed control rheostat was disconnected after installation of a vernier drive unit between the motor and the receiver dial. The hi-fi amplifier used for speech input is shown to the left of the receiver. Local carrier control, in parallel with that on the transmitter control panel, is mounted atop the amplifier and is out of sight behind the receiver.



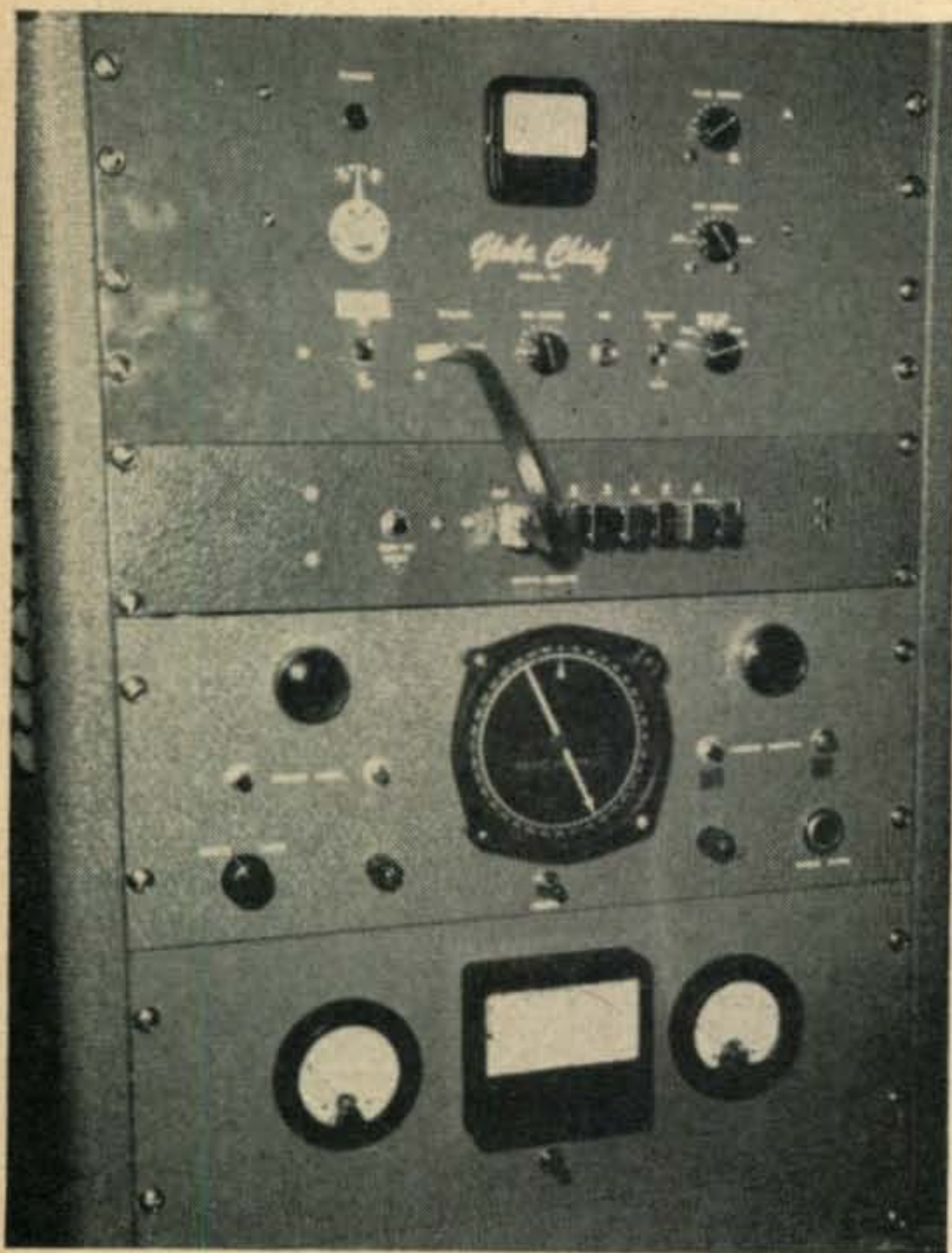

The panel containing the I-82-B selsyn indicator is the local transmitter control panel and immediately above is the crystal changing panel with 300 ohm ribbon to the World Radio Laboratories Globe Chief used as the exciter.

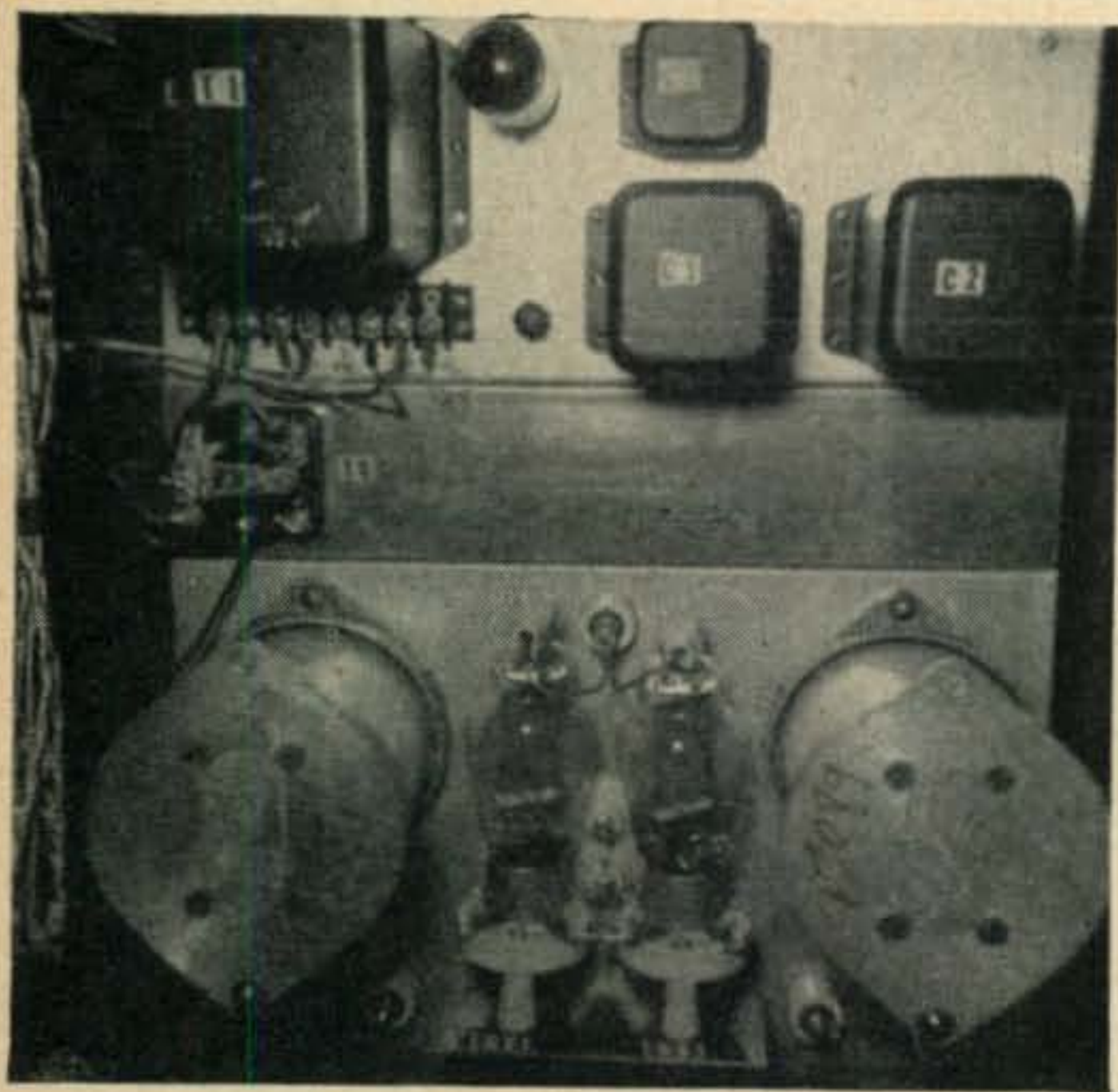

Included for interest but not pertinent to the article is this photo of the pa screen and bias supply and the two 836 diodes used in the high level clipper. The splatter chokes are inside the chassis, the two large mica condensers, with them, are a part of the 3000 cycle low pass filter.

to the operating frequency and makes it possible to more easily visualize the receiver tuning from the remote control point. The next crystal change step turns off the exciter but remains on the crystal just selected. The solenoid of K18 operates on about 100 volts, provided by selenium rectifier SR1, and its shaft rotates in 30° steps. The two switch wafers are single pole 12 position, connected to perform as described.

Off Function: A negative voltage arriving between L1 and ground energizes relay K4, through D4, and its contacts energize the **Off** coil of K8, shutting down all ac to the transmitter.

Tune Function: The voltage arriving between L2 and ground will energize either relay K5 or K6, depending on polarity. The contacts of K5 and K6 control the tuning motor through the back contacts of relay K7A, the Tune/Rotate select relay, when it is de-energized. The tuning motor is a Bodine Type KCI-22RC and through its self-contained gear train develops 75 inch ounces of torque at a shaft speed of 5.7 rpm.

Beam-Rotate Function: Voltage arriving across the line with L2 positive energizes relay K2, its contacts then energize relays K7A and K7B. Relay K7A transfers the contacts of relays K5 and K6 to the beam rotation relays K19 through K22, and the beam may then be rotated by operating S3 at the control unit. K7B opens L1 so that it is disconnected from relays K3 and K4. This is necessary to prevent their operation during rotation of the beam. This would occur since during the beam rotation functions, voltage is applied both across the line and from L2 to ground. In the **Plus** direction the two voltages add and would operate relay K3, resulting in a change in frequency.

Transmit Function: Voltage arriving across the line with L1 positive energizes relay K1, its contacts energizing relays K10A and K10B. Relay K10A disconnects the receiver from the telephone line and connects the input of the transmitter line amplifier in its place. The telephone line is isolated from both equipment by C2 and C3. Relay K10B operates relays K11 and K12, both Agastat pneumatic time delay relays, which in turn provide proper sequence operation of carrier relay K9 and antenna changeover relay K17. The switching sequence is such to delay application of the carrier until one-half second after operation of the antenna relay. When relay K10B releases, the carrier is removed, followed in one-half second by transfer of the antenna back to the receiver. This circuitry was provided to protect the antenna relay contacts when handling high power.

Two directional indicating systems are mounted on the antenna tower. An I-82-B selsyn indicator and its associated selsyn trans-

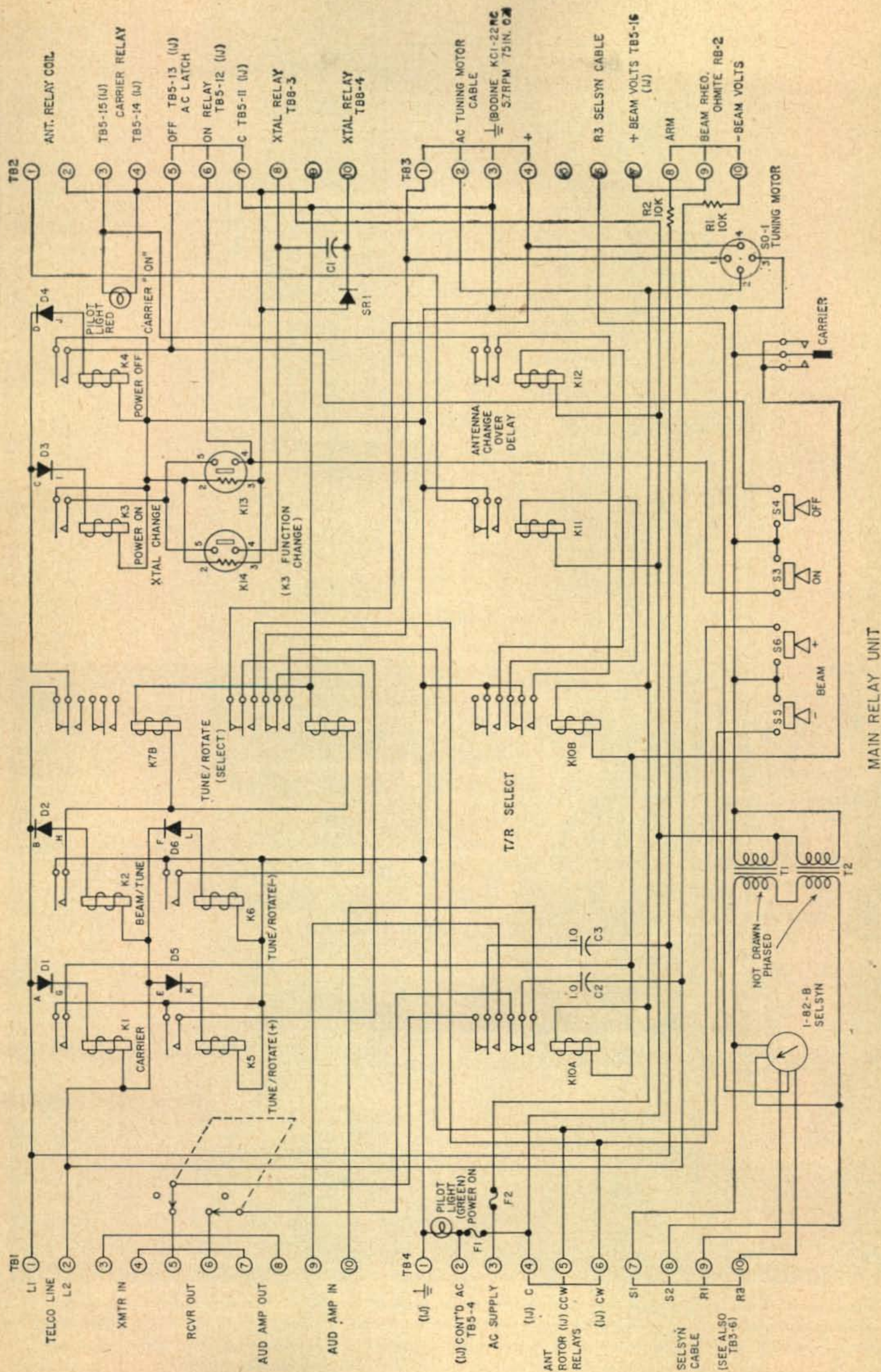

Fig. 3—Schematic of the main relay unit. The designation (U) at the terminal board indicates internal jumpers between units. The letter designations at the selenium rectifiers indicate Vector Turret terminals.

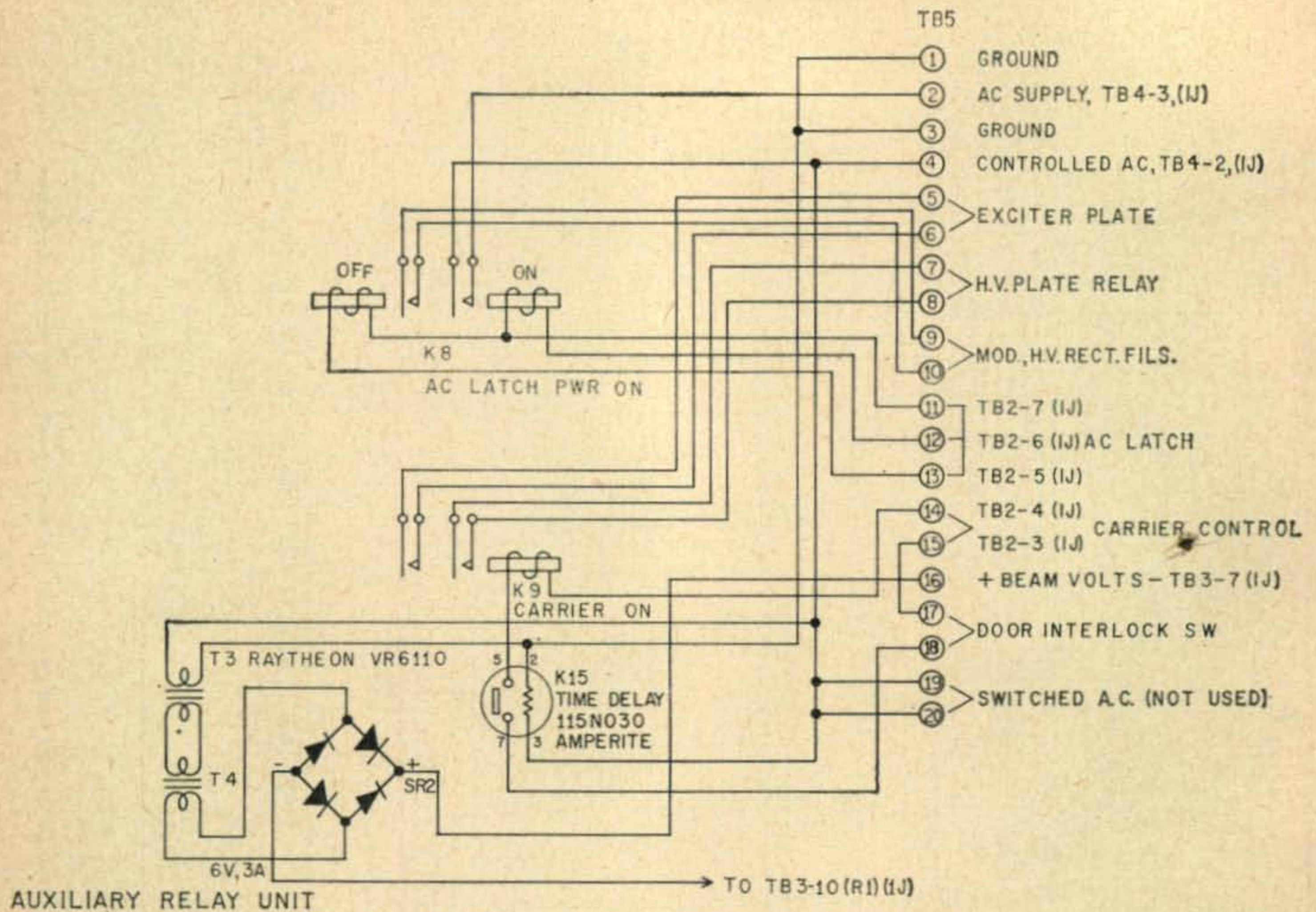
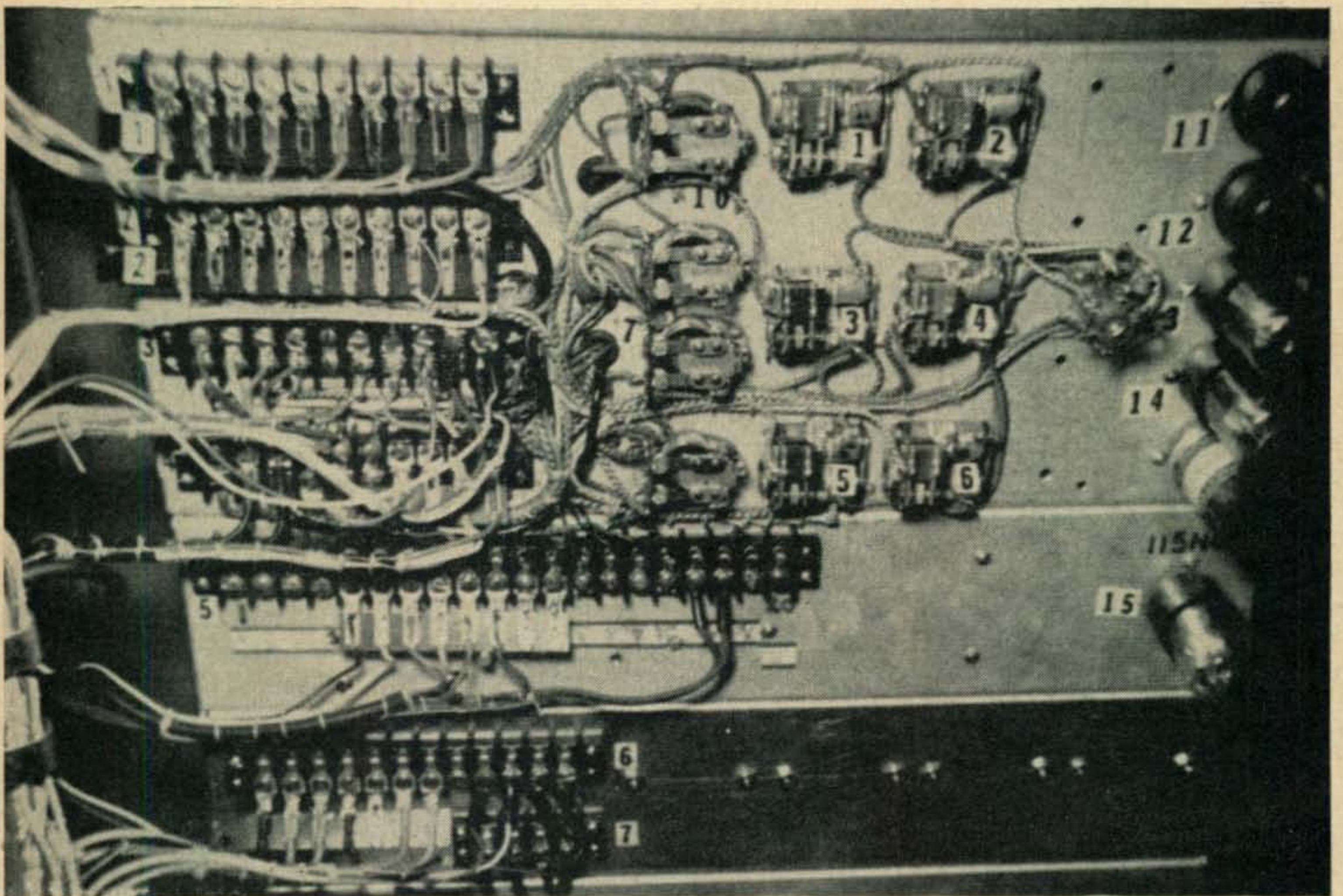

Fig. 4—Circuit of the Auxiliary Relay Unit.



This rear view of the relay panels shows the mounting of some of the relays. The rear mounting provides easy access for maintenance while relays requiring less servicing are mounted inside the bathtub chassis. Relays 11 and 12 were originally Amperite vacuum types and were replaced by Agastat units mounted on the side of the rack and connected with adaptor cables.

INTRODUCING COLLINS

S/

LINE OF SSB AMATEUR EQUIPMENT





COLLINS S/LINE — — HALLMARK OF SUPERIORITY IN SINGLE SIDEBAND

To its distinguished series of single sideband amateur radio systems, Collins now adds the S/Line. This attractive, completely new line combines the quality and performance of the KWS-1, 75A-4 and KWM-1. Individual S/Line units on which several system configurations can be built are the 32S-1 Transmitter, 75S-1 Receiver, 30S-1 Linear Amplifier, 516F-2 Power Supply, 312B-4 Speaker Console and 312B-3 Speaker.

32S-1 TRANSMITTER

The 32S-1 Transmitter has a nominal output of 100 watts for SSB or CW operation on all amateur bands between 3.5 and 29.7 mc; input power is 175 watts PEP on SSB or 160 watts on CW. The 32S-1 may also be used without modification to excite the 30S-1 Linear Amplifier.

The transmitter covers the entire spectrum from 3.5 to 30 mc except for the 5.0 to 6.5 mc range. Crystal sockets, crystals and band switch positions are provided for 10 200 kc bands, with the standard amateur configuration equipped for: 3.4-3.6, 3.6-3.8, 3.8-4.0; 7.0-7.2, 7.2-7.4; 14.0-14.2, 14.2-14.4; 21.0-21.2, 21.2-21.4, 21.4-21.6. Crystal sockets and band switch positions also are provided for three 200 kc bands between 28 and 29.7 mc, with a crystal supplied for 28.5-28.7

mc. A fourteenth position, corresponding to the WWV position on the receiver, can be used for one additional 200 kc band in the 9.5-15.0 mc range, if desired.

The 32S-1 features: Mechanical Filter type of sideband generation; stable, permeability tuned VFO; crystal controlled high frequency oscillator; RF inverse feedback for improved linearity; automatic load control for higher average talk power, and provision for switching to transceiver operation with the 75S-1 Receiver controlling the transmitter frequency.

The associated 516F-2 Power Supply is housed separately in a matching cabinet with ample room for additional station accessories. Power supplies for 115 v ac and 12 or 28 v dc employed with the KWM-1 Mobile Transceiver may also be used for the 32S-1.

32S-1 Price\$590.00
(Less Power Supply)

75S-1 RECEIVER

The 75S-1 provides SSB, CW and AM reception on all amateur bands between 3.5 and 29.7 mc. It is capable of coverage of the entire HF spectrum between 3.5 and 30 mc by selection of the appropriate high frequency beating crystals.

The standard amateur configuration includes crystal sockets, crystals and band switch positions for: 3.4-3.6, 3.6-3.8, 3.8-4.0; 7.0-7.2, 7.2-7.4; 14.0-14.2, 14.2-14.4; 21.0-21.2, 21.2-21.4, 21.4-21.6. Crystal sockets and band switch positions are also provided for three 200 kc bands between



28 and 29.7 mc with one of the sockets equipped with a crystal for 28.5 to 28.7 mc. A crystal and band switch position is also provided for 14.8-15 mc for reception of WWV and WWVH for time and frequency calibration data.

Features incorporated in the new receiver include: dual conversion with crystal controlled first beating oscillator; bandpass first IF; stable, permeability tuned VFO; RF amplifier designed to minimize cross modulation products; Mechanical Filter; product detector; excellent AVC characteristics for SSB reception with full RF gain; 150 volt B+ for vacuum tube plates; silicon diodes instead of a conventional high vacuum rectifier; selection of three degrees of selectivity — Mechanical Filters for 2.1 or 0.5 kc, or conventional IF transformers for AM.

The VFO and HF crystal oscillator in the 75S-1 may be used to control transmitter frequency through the use of two plug-in patch cords. The ac power supply for the 75S-1 is self-contained. However, the 12 or 28 v dc supplies for the KWM-1 may be utilized, as with the transmitter, and a power connector at the rear of the 75S-1 disables the internal supply when the external supply is used.

75S-1 Price (2.1 kc Filter only) ..\$495.00

30S-1 LINEAR AMPLIFIER

The 30S-1 is a single tube, grounded grid linear amplifier with frequency coverage consistent with the 32S-1 and 75S-1. It provides the full legal power input for SSB (1 kw average) or 1 kw

input for CW, requiring 70 to 100 watts excitation (from the 32S-1 or KWM-1, for example). The amplifier tube is the Eimac 4CX1000A.

RF inverse feedback is employed for better linearity, and automatic load control voltage is fed back to the 32S-1 or KWM-1.

The power supply for the 30S-1 is located in the lower portion of the cabinet. There is also a compartment for the 516F-2 Power Supply used with the 32S-1.



FULL LEGAL INPUT ON SSB, 1 KW ON CW



312B-4



312B-3



516F-2



516E-1

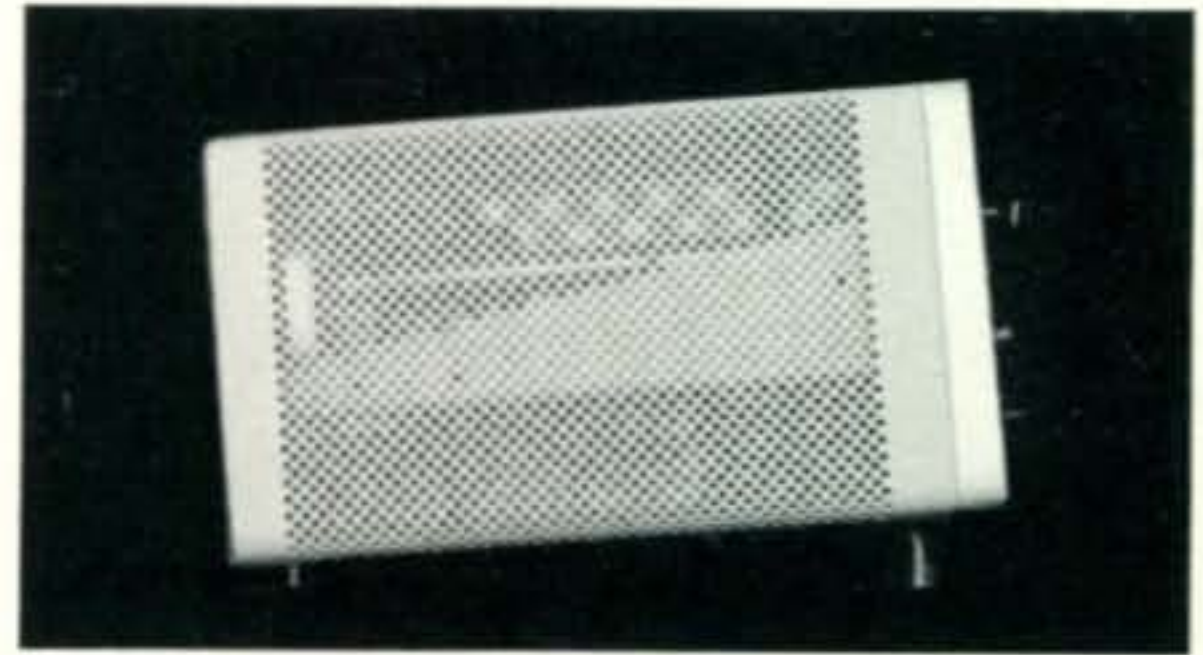

S/Line Tilted Mounting

ACCESSORIES

312B-4 SPEAKER CONSOLE

This unit integrates system control of the 32S-1, 75S-1 and accessories.

It contains a speaker; an RF directional wattmeter with 200 and 2000 watt scales for measuring antenna and transmission line performance; a hybrid-type phone patch for voice operated interconnection of the telephone line to transmitter and receiver, and several station control functions.

A FUNCTION switch provides selection of: NORMAL station operation; RECEIVE ONLY, with transmitter audio circuits disabled, and

TRANSMIT ONLY, with receiver disabled and transmitter VOX actuated. A PHONE PATCH switch enables connection of the telephone line to the radio equipment or disablement of transmitter and receiver audio circuits.

312B-4 Price\$185.00

312B-3 SPEAKER

The 312B-3 includes a 5" x 7" speaker and connecting cable, housed in a cabinet attractively styled to match receiver and transmitter.

312B-3 Price\$27.50

516F-2 AC POWER SUPPLY

Providing all voltages for the 32S-1, this unit operates

from 115 v, 50-60 cps. It is housed in a matching cabinet and may be mounted on the desk top or in an out-of-the-way location. Space is available behind the front panel grill for custom mounted station accessories.

516F-2 Price\$105.00

516E-1 DC POWER SUPPLY

Operating from 12 v dc, the 516E-1 provides all required voltages for the 32S-1 and 75S-1 for mobile or portable operation. Circuits are completely transistorized for maximum efficiency and minimum maintenance. A 28 v dc supply, the 516E-2, may also be used with both units.

516E-1 Price\$262.00

COMPLETE DETAILS IN S/LINE BROCHURE

see the **S/line** at your
Collins dealer during S/month
Nov. 8 - Dec. 8

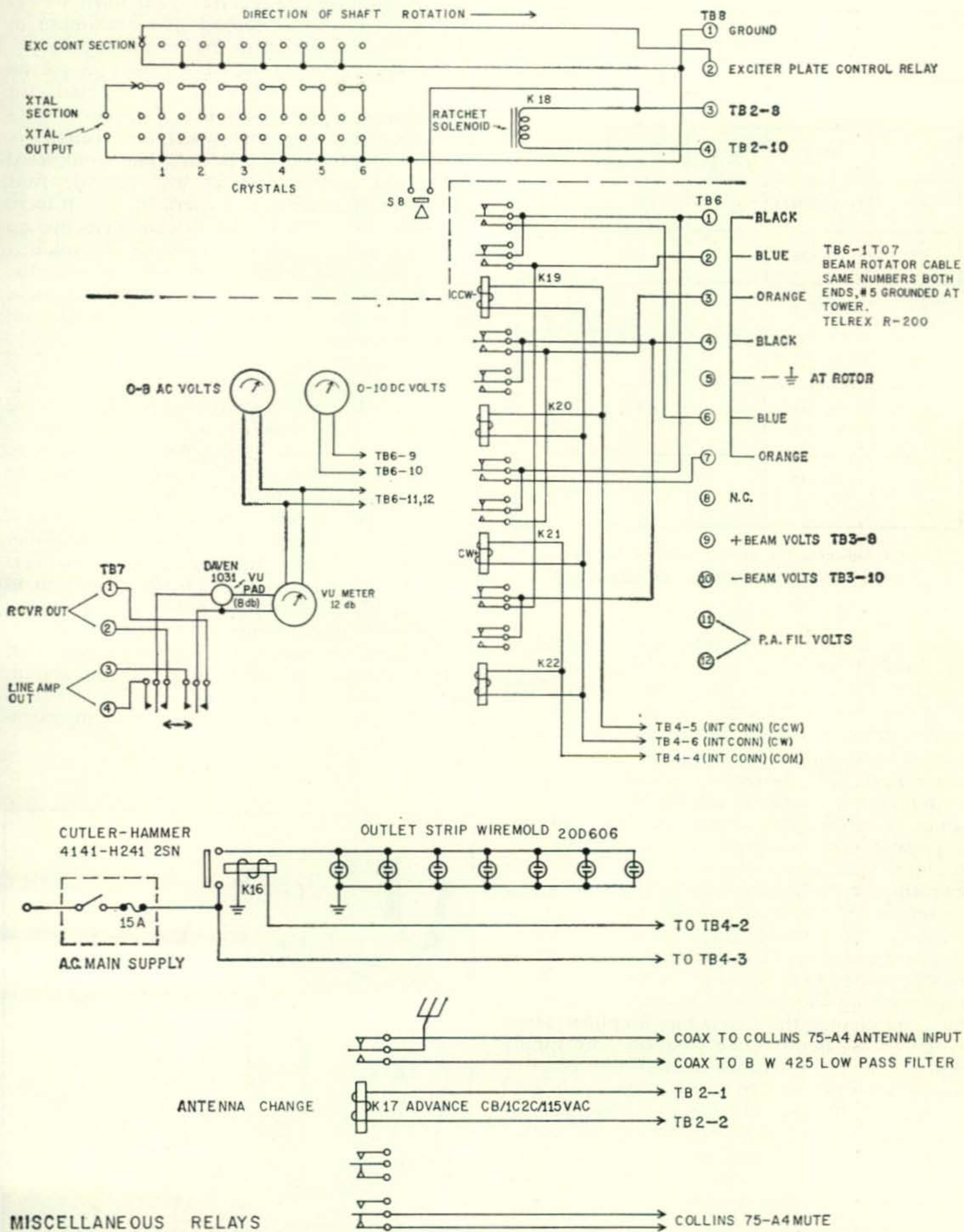

Fig. 5—Schematics of the crystal changer, beam control unit, miscellaneous meter and relay units.

mitter is used for local operation and for calibration of the dc system. The dc system utilizes an Ohmite RB-2 beam direction rheostat, with the resultant voltage impressed into the center of the telephone line through R1 and R2. Fig. 6 is simplified schematic of the remote direc-

tion indicating system. The maximum current available for remote reading is approximately fifty-five microamperes when the low voltage power supply is adjusted for an output of seven volts. At first glance it would appear that a great deal more indicating current would

Switch	Position	Current		
		MJ1	MJ2	MJ3
S1	ON	2.0		
S1	OFF	2.0		
S2	TRANSMIT		2.6	
S2	BEAM		2.5	
S3	MINUS			1.8
S3	PLUS			1.8
S2 S3	BEAM MINUS		2.7	1.4
S2 S3	BEAM PLUS		2.4	1.4

Chart I indicates the correct settings for the remote control unit. (Page 58 and 59)

be available until it is remembered that relays K1 through K6 form several shunt paths for the current. In practice the operation is about as stable as can be expected considering the small current involved, being as low as one-quarter microampere when the beam direction is near 178°. Instability, apparently caused by induction currents in multi-paired telephone cables, amounting to about one microampere is present and accepted. The error amounts to about 5 degrees and can be corrected when operating by adjusting the maximum meter reading at 180° by means of R8.

All remote control functions are duplicated at the transmitter for local operation. It is only necessary to place S1 in the **Local** position, disconnecting the receiver from the telephone line, and change the audio line amplifier input switch to the microphone position. The tuning motor can be lifted aside and the receiver operated normally. The transmitter audio level is adjusted by use of the VU meter or by means of the Millen 3" oscilloscope connected across the transmission line. To restore the equipment to remote operation the reciprocal of the aforementioned must be accomplished

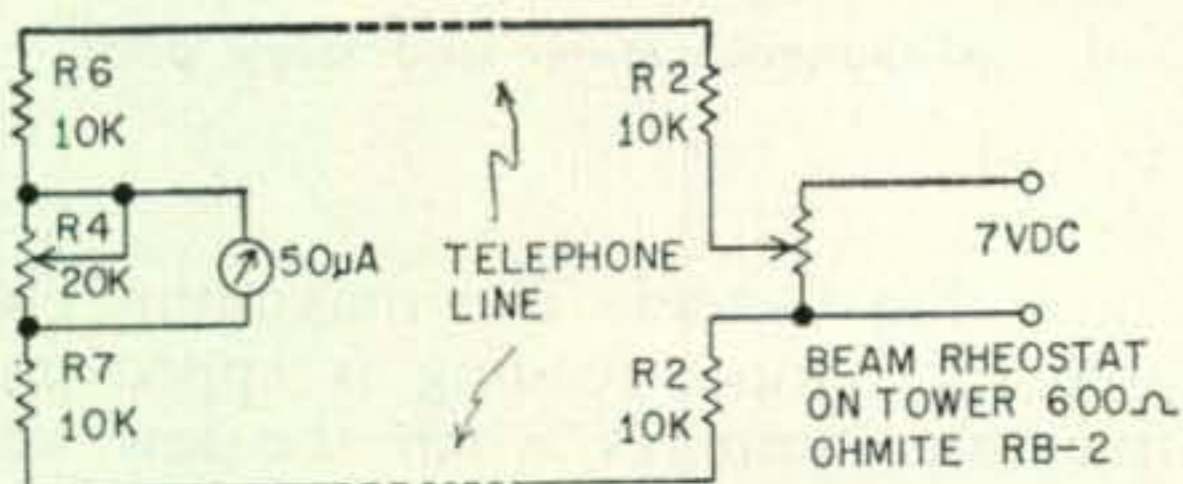

Fig. 6—Simplified circuit of the beam position indicator.

and in addition the receiver gain must be returned to its proper setting so a maximum of plus 8 VU is applied to the telephone line.

The six element Telrex beam now in use on ten meters at WØDYG was erected for temporary use following the destruction by a tornado of a thirty foot tower and Telrex six element twenty meter beam. The completed permanent antenna layout will provide four elements on twenty, five elements on fifteen, six elements on ten, and fifteen elements on two, all being Telrex arrays. The building, tower and mast heights combine to place the two meter beam seventy feet above ground level. The twenty meter array will be lowest at 52 feet with the fifteen and ten meter arrays spaced equi-distant between.

Band changing mentioned near the beginning of the article can be accomplished by providing additional relays which would operate while in the transmit mode. They would operate to change the function of K5 to actuate a stepping relay to energize additional transmitter and receiver combinations. The transmitters would be relatively simple exciter-power amplifier combinations but the additional receivers become rather expensive. The relay system to perform the necessary switching of audio, crystal switching, tuning and control would become quite extensive. It really isn't worth it!

In summation it can be said that the system just outlined and described provides what is desired of it in furnishing excellent ham operation from a poor operating location.

[Continued on page 170]

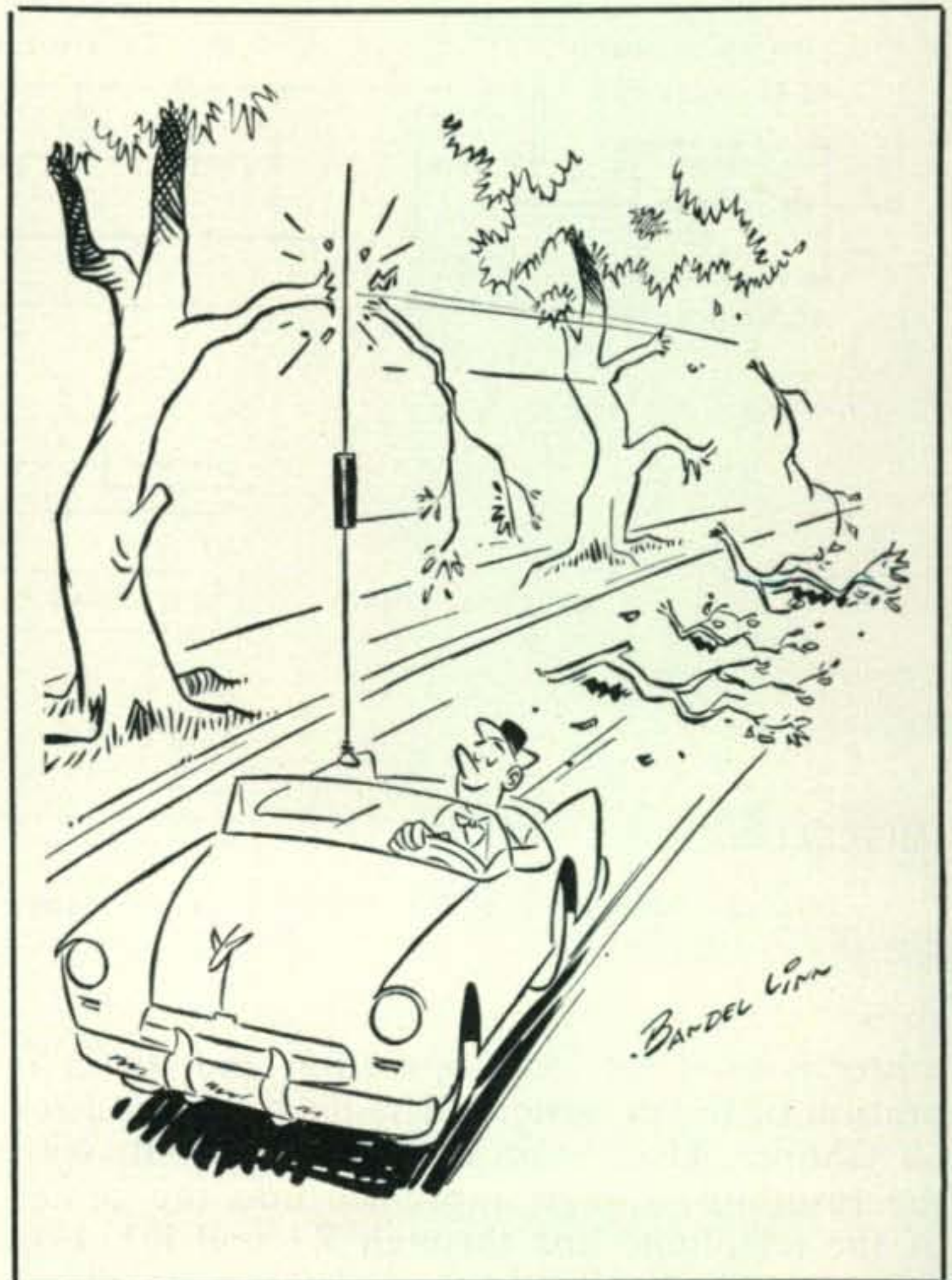

Next Step—Space Portable

by **R. G. Coleman, VE3ANY**

27675 Pickford Ave.
Livonia, Michigan

Ever since Don Mix, then 1TS, operated the first ham portable with the McMillan Arctic Expedition in 1923, expeditions and amateur radio have gone hand-in-hand. Amateur sponsored expeditions have put many remote areas on the air and have provided rare DX for their brother hams. Our next great frontier is outer space. Plans are under way today for the exploration of the planets. What problems will beset the ham who operates portable on Man's first trip away from Mother Earth?

According to present plans, the first manned trip into interplanetary space will be preceded by the establishment of satellite stations, to be used as jumping-off points. The personnel of an advanced space station is expected to number upwards of two hundred, comprised mainly of scientists and engineers. Such a group might well count amongst its members enough hams to form a club. A club just naturally must have a club station. The communications crew of a space ship will, no doubt, be hams. Portable operation will result.

Transportation

Transporting amateur equipment will likely be classified as unessential and strongly restricted. Lightweight transistor and printed circuit rigs that could be carried as personal luggage are not likely to be useful over any great distance. How then is the space ham to indulge in his hobby? A feasible way would be for some far-seeing Project Chief to include amateur frequencies amongst those available on Government communications equipment. Then, as has been done on many installations it only remains for the space ham to arrange to use this equipment during off-hours.

Frequencies

A primary consideration is the choice of frequencies. It is probable that very little hamming will be done on the usual short wave bands. Nearly all signals on frequencies from 3.5 to 30 megacycles, originating on Earth, will be refracted and returned to earth by our ionosphere. During times of sunspot maximum activity this range may be extended to somewhat above 59 mc since part of the time VHF signals also are returned to Earth. This may apply

to work from the surfaces of other planets, for we have reason to believe that ours is not the only one to have an ionosphere.

The region from 50 to 450 megacycles, at first glance, appears to be practical. However, there is a limitation in regard to this range of the spectrum that has yet to be resolved. The new art of Radio Astronomy makes use of emanations called "radio noise" generated by solar, galactic and inter-galactic sources. This noise peaks at various broad bands, some within the VHF spectrum. Our atmosphere and ionosphere filters this noise and not all of it reaches the Earth. In outer space this noise could reach a very high level, and could be the limiting factor in receiver sensitivity. Such radio noise could well limit VHF communication in space to certain "noiseless" bands.

Except for a few noise peaks from 3000 to 30,000 mc, microwaves are relatively unaffected by the atmosphere, the ionosphere or space noise. High-gain beam antennas for these frequencies are reasonably simple structures. It is probable that the future for space communication lies in this region of the spectrum. Due to size limitations, high-gain beam antennas of a portable or easily erected type are ruled out for the very low frequencies. Long distance space communication on these bands is improbable.

Line of Sight

All space radio, regardless of frequency, will depend upon a line-of-sight path. With no aid from atmospheric bending or ionospheric refraction, radio waves will behave like light, and objects will interrupt and scatter them. Working from a space vehicle in the region of a planet will at times necessitate moving many thousands of miles to gain a vantage point for contact with an otherwise out-of-sight location. An amateur in a colony on the Moon, located on the floor of a crater, would have to set up a reflector to be used at times to keep certain planets in sight and provide a relay. The erection of reflectors, and antennas on low-gravity airless bodies, such as our Moon, should not be too difficult. Techniques have already been worked out. Erection of even large parabolic antennas would be aided by low-gravity conditions, and need not be beyond

the capabilities of a determined amateur radio group.

However, due to the line-of-sight stigma, contact with heavenly bodies will not be a continuous procedure. A rigid schedule of operating times will have to be set up, based on celestial mechanics. A glance at fig. 1, position 1, will show that when Venus or Mars is in line with the Earth, the only contact possible will be from Venus night to Earth day, and from Earth night to Mars day. Near opposition, position 2, Mars day to Earth day contacts only will be possible. During Earth night Mars will be nowhere in sight. Similar comparisons could be made for the other planets, when the conditions for contact would depend upon the time of day and the position of the planet in its orbit around the Sun. Far from being a tenuous cloud of flaming gas, the Sun, with its tremendous mass, its strongly ionised chromosphere and intense magnetic field, would cause bending and deflection of signals. It has been estimated that this "blind spot" would extend for approximately 15 degrees each side of the Sun, as viewed from Earth. If such is the case, there would be times when the Planets would be blanked out and communication would be impossible. For instance, if the Earth stood still, as can be seen from fig. 1, Mars would be incommunicado for 57 days of its 687 day year. Venus would be blanked out for 18 days, and in the case of distant Jupiter "quiet hours" would last for 360 days. But the Earth moves also, and these times would be somewhat shorter than shown here. Nevertheless, there would be periods when relaying via some transponder station out of line with the Sun, would be necessary.

Distances

Astronomical distances are great in terms of Earth miles. A signal, originating on Earth would be scattered very thin by the time it reached Jupiter's Ganymede or Saturn's Titan, both larger than our moon and both likely bases for closer study of these huge planets. Consider a typical parabolic beam antenna of, say, 100 square feet in area and a beam width of 3 degrees. This condition would be satisfied by a parabola of slightly over 11 feet in diameter, with 25 wavelength aperture as operated on the amateur 2300 mc band (although sharper beams are possible by increasing the frequency and the diameter, a space ship is not likely to have much larger, and an Earthbound ham would not likely be able to summon up the power necessary on much higher frequency.) By the time a signal, originating on Earth from such an antenna, reached Jupiter, the signal would be spread over 495.2 million square miles of space. For Saturn it would cover 1665 million square miles. Think of the infinitesimally small part of this signal an antenna of only 100 square feet capture area would receive at a distance from Earth of the

planet Saturn. There are 278,784 times 100 square feet in just one square mile. But we are dealing with 1665 million square miles. It works out to an attenuation of approximately 464,175,360,000,000 times down! Obviously some very high-gain receiving equipment will be needed at both ends of the link. Since the planets of our Solar System all lie in a relatively narrow flat plane, the ecliptic, this situation can be improved by the use of a flat fan-like beam, concentrated in one plane. Even so, sharpness of beam pattern and power gain, plus high power, will be a deciding factor in received signal strength, to a much greater extent than it is here on Earth.

If communication is to be established at all, it will require the accurate aiming techniques used in astronomy. Broadcasting will be out of the question. Calling another ham for a relay or a sked will require that he not only be tuned to your exact frequency, but also aimed to your exact position in space. Automatic tracking will be necessary to maintain signal strength. Antenna bearing will have to be continually corrected for revolution of the body on which the antenna is mounted, and relative movement of both ends of the link. An astronomical almanac will become a necessary part of a space ham's literature.

Doppler

Another factor, already recorded on signals from the Explorer, Vanguard and Sputnik satellites, a well-known phenomenon to those who have monitored the "Collins Collosus" on 49.8 mc., and the cause of the garble on aurora reflected signals, is the frequency shift caused by the doppler effect. Meteors cause a readily detectable frequency change on signals reflecting from their ionised trails. Meteors enter our atmosphere at speeds from 25 to 40

[Continued on page 168]

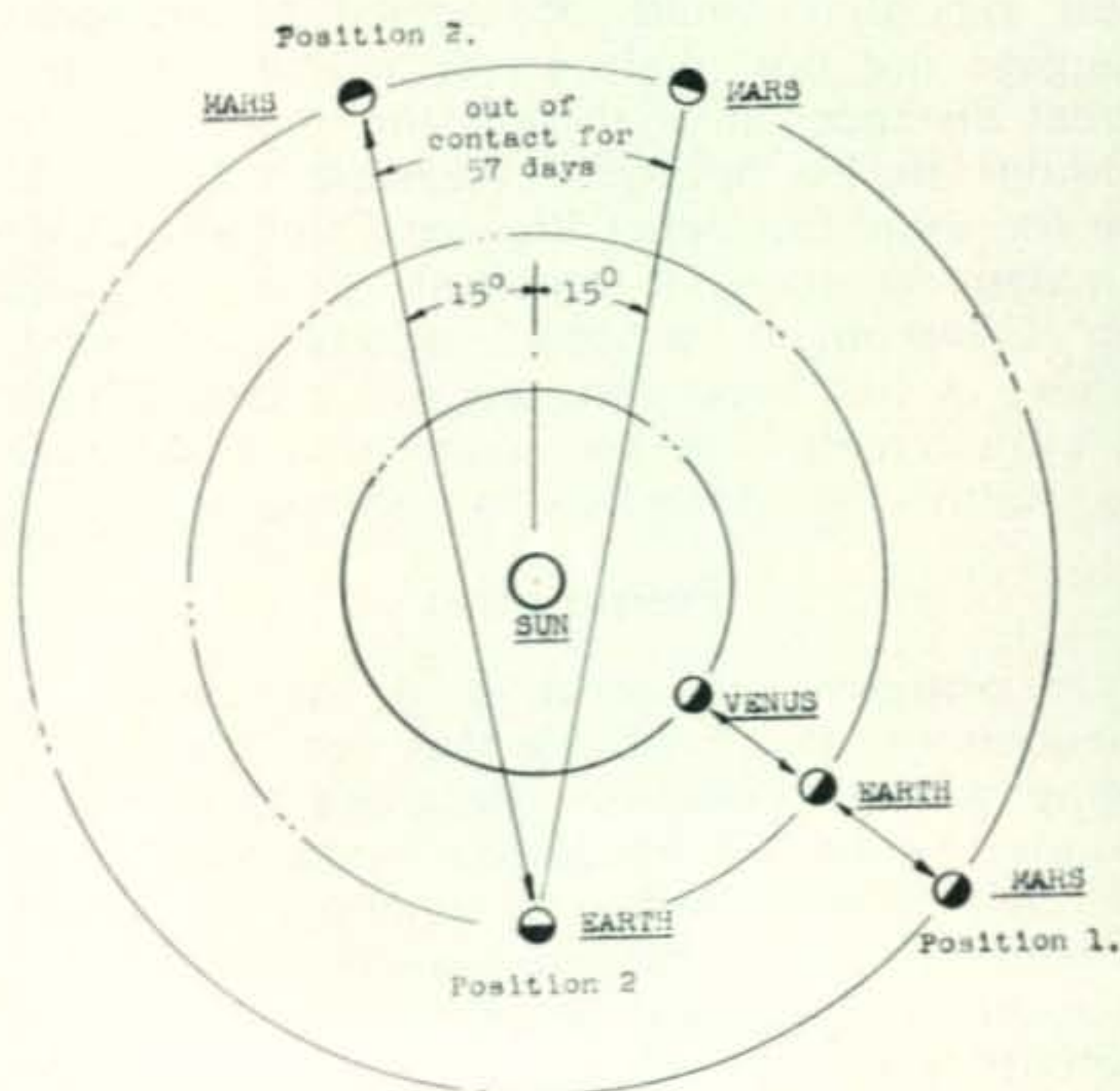

Figure 1

Self-Monitoring Made Easy

by a *Gimmick*

George Bonadio, W2WLR

373 East Ave.
Watertown, New York

Imagine tuning yourself in on your own receiver, just like many other signals, at a little over S9. Check your own stability, your splatter, your distortion, (especially if you have a scope) just like the other fellows do for you.

I know, the F.C.C. regulations require; but how many operators do! This gimmick lets one do it easily, quickly and frequently.

A short, external to a receiver input system, can reduce the incoming signal about 40 to 60 db. This is not enough reduction for the monitoring process. Around 100 db of subdoping is required. By placing a short from the first rf grid to ground, a loss of up to 140 db at 160 meters to 100 db at 10 meters is usually accomplished.

Thus the gimmick.

This is easier done than said.

One needs to bend slightly the end plate on the rotator of the antenna trimmer condenser, so that for about 180° of the rotation this plate is shorted to the stator plate. One must think how this goes, to see that only 180° of the operation is affected. Care must be taken to avoid bending too much, which would require bending back. This loosened the base solder on mine. When I resoldered I loosened another plate. After I got it back to normal, I used just a corner of the plate to make the bend.

This has worked for 5 years without trouble. My antenna circuit looks directly into a non-shorting coax relay with the hot signal going by. On all bands, using the gimmick, my 100 watts output lies between S9 and S9 + 40 db.

If, however, one does not have an antenna trimmer, he needs one, and fig 1 illustrates how to connect it. A Cardwell Trim Air PL6003 has a practical tuning range of less than 3 to over 30 mmfd. An additional advantage is that antenna reactances may be tuned out, and a better signal strength be realized, especially above 7 mc.

It's nice to be able to tune either side of one's own signal and be sure that there is no splatter there. Any splatter will appear as it does around the signal on the air. It's good to know to be sure. ■

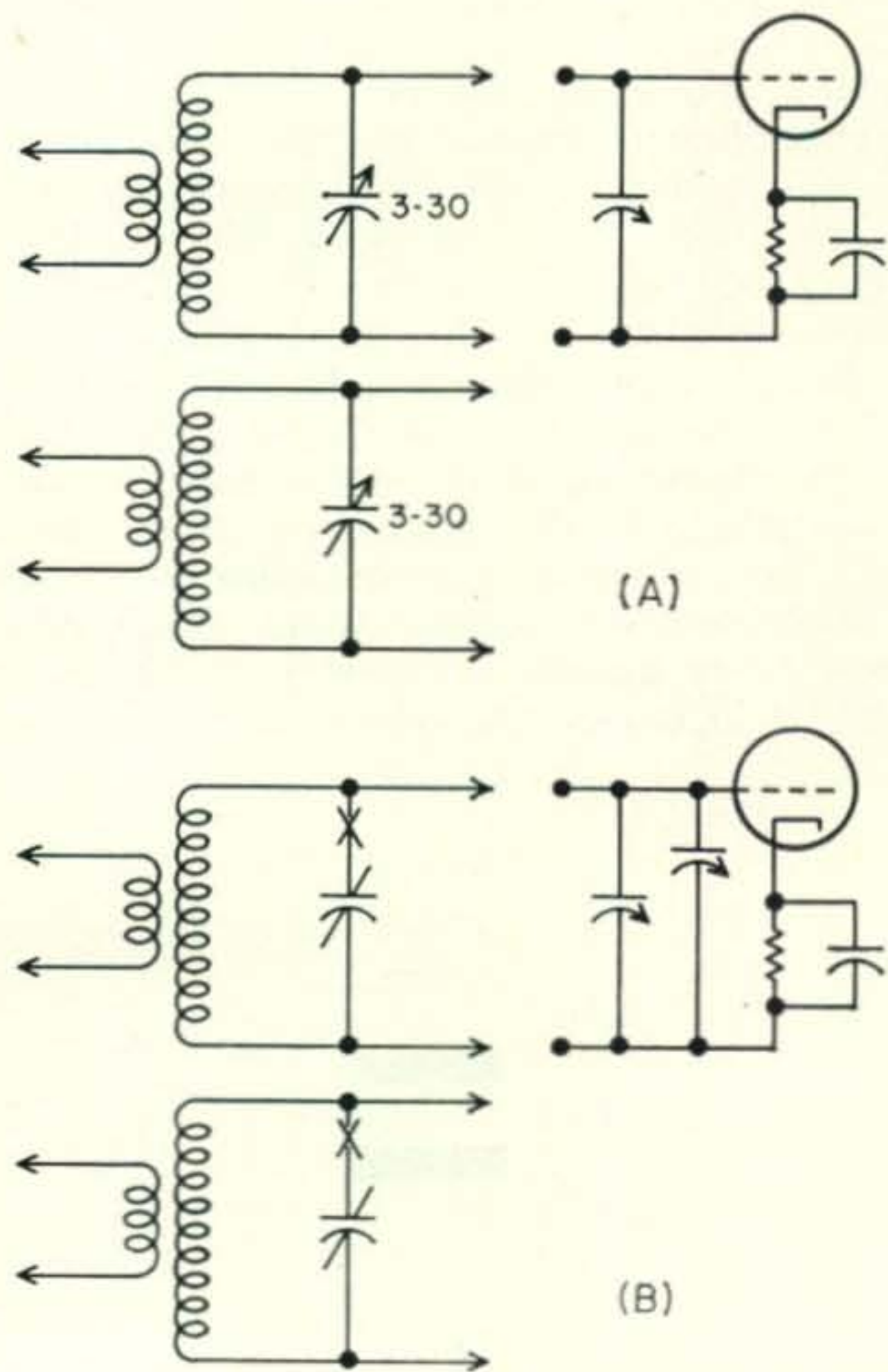

Fig. 1—Diagram A shows each coil with an individual trimmer condenser, but no antenna trimmer. Circuit B shows the removal of the individual trimmers and the inclusion of an air-tuned trimmer in the first rf grid.

THE PARAMETRIC AMPLIFIER

F. S. Harris, W1FZJ

Box 2502 Medfield, Mass.

A number of papers and articles dealing with parametric amplifiers have been published. None of these have dealt with a practical device which could be used in a system.

In addition to presenting the construction and operating details for a useable 2 meter preamp it is hoped that this article will get the ham fraternity "into the act" as it were, putting their great wealth of inventiveness to work on the further development of the device.

For the uninitiate, a parametric amplifier is a device which amplifies. In particular it amplifies weak signals at VHF and microwave frequencies. It will of course amplify at low frequencies (even audio) but really comes into its own at those frequencies where vacuum tubes are either not working at all, or are providing noise figures no better than could be obtained with crystal mixers alone.

It is not the purpose of this article to explain the need for good noise figures. It can however be pointed out that as frequency increases the noise which your antenna sees is decreasing. From this it can be shown that what is considered an adequate noise figure on a six meter receiver would not be taking full advantage of the band capabilities on two meters, and so on up the spectrum.

Unfortunately vacuum tubes, and consequently noise figures, are getting worse as frequency is increased. Advances in vacuum tube

design have made it possible to get noise figures on two meters which are bordering on MUNF (maximum useable noise figure). The parametric amplifier should extend this borderline MUNF relationship up into the microwave region.

Construction

The construction of your parametric amplifier begins with a coax line filter. A skeleton view is shown in fig. 1 and a dimensional view in fig. 2. The dimensions given are for use on the two meter band. The same device scaled to any other band will work as well. Fig. 3 and 4 show the details involved in mounting the varactor and tuning the coax tank. The dimensions given were taken from an actual working model. They should not, however, be construed as optimum. (It is true for instance, that the same coax tank, capacity loaded to resonate at six meters, gave equally good results both in gain and noise figure.) The input and output links should provide a match for the feedline. The resultant coax tank should, when inserted in series with the feed line to your receiver and resonated to the receiver frequency, act as a band pass filter with little or no change in receiver sensitivity

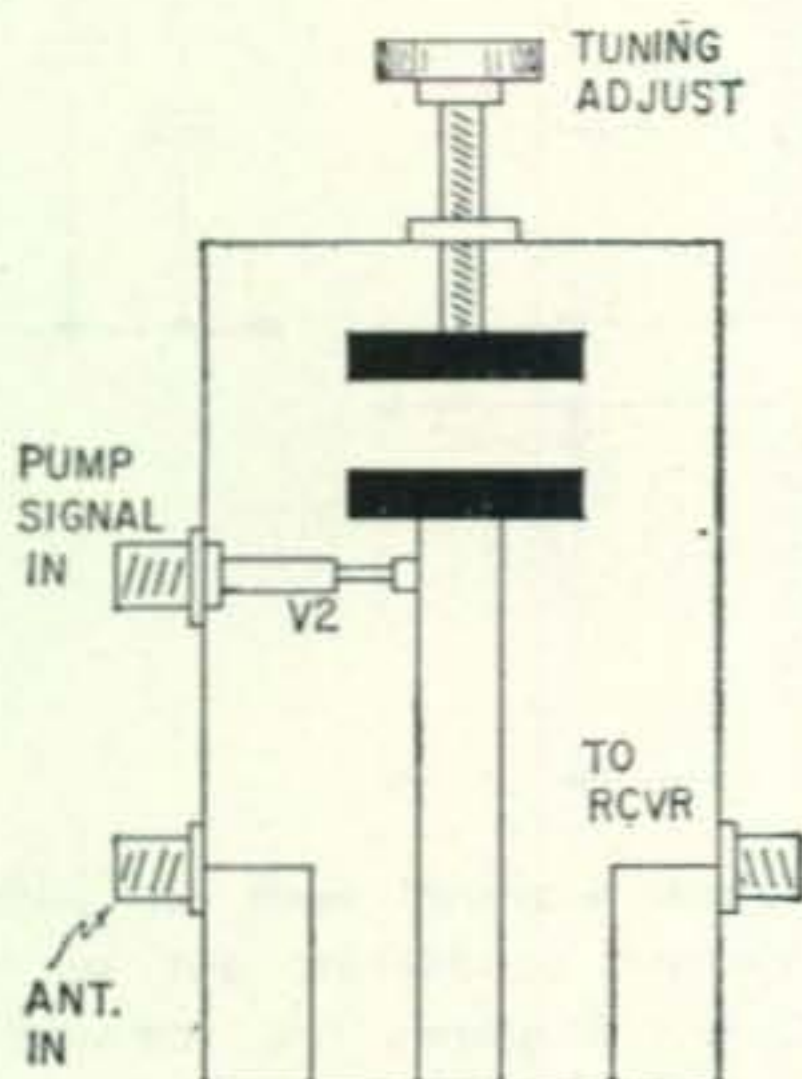

Fig. 1

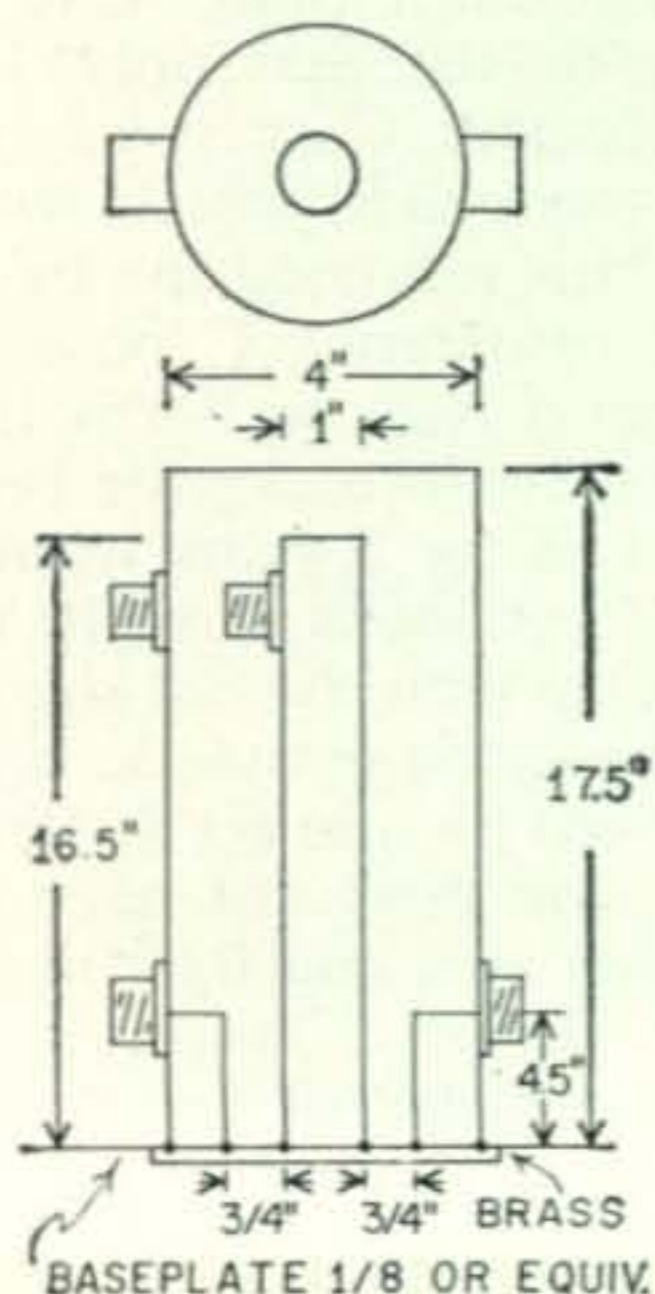

Fig. 2

or noise figure. (If your present station equipment includes such a filter you have the job half done.) The varactor mounting as shown in fig. 4 takes advantage of the fact that the type N connector center pin provides a snug fit for the varactor pin. The object is to get the varactor mounted between the top (approx) of the center conductor and the sidewall with as little series inductance as possible. Bypassing of the sidewall end of the varactor is provided, on two meters, by the inherent capacity of the type N connector and the coax line which goes to the pump oscillator. (On six meters some additional capacity proved advantageous.)

Material

The material used to fabricate the coax tank will depend on your pocketbook and scrounging ability. The particular device described was part of a surplus frequency meter labeled BC 1168 A. Material is silver plated brass. A copper coax tank would certainly work, and on the lower bands a tomato can type of thing would probably give useable results.

Pump Oscillator

The construction of a pump oscillator is not covered in this article. Specifications for this oscillator are as follows: Center frequency, twice the signal frequency. Tuning range: 5% above and below the center frequency. Power input: adjustable in the 100 mw to 1 watt range. Stability: warm up drift of 0.2% is satisfactory. Calibration: at least 1% intervals.

In short, any well designed LC oscillator using tubes such as 6J6, 6C4, 12AT7 etc. will be satisfactory. The tuning control should be calibrated so that it can be reset to a predetermined frequency. The actual calibration in frequency is only for convenience in taking data and getting the amplifier set up. Link coupling from the oscillator is recommended for convenience in adjusting the output level. It is important that the coupling arrangement provide a dc return for the varactor.

Adjusting and Tuning (or Making It Go)

There is no exact procedure for tuning up the parametric amplifier. On the other hand experience has shown a general procedure which if followed, tends to give the most consistent results.

The first step is to tune the coax tank to

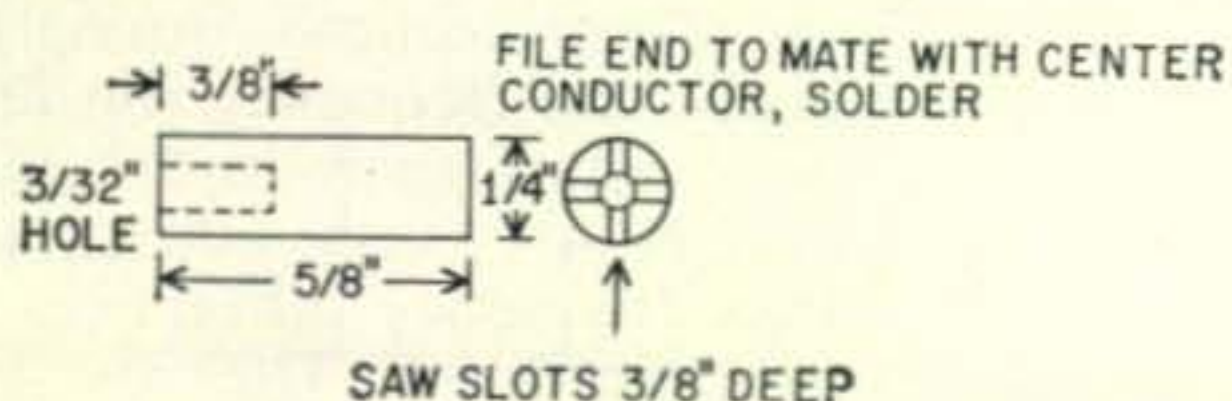

Fig. 3

the signal frequency with the varactor and pump coax in place. (pump oscillator turned off.) The simplest way to accomplish this is to tune in a signal with the tank disconnected, insert the tank in series with the feedline and adjust the tuning until the signal is at a maximum. If your coax tank and its attendant coupling links are properly adjusted there should be no deterioration in signal strength or signal to noise ratio. If you pass through a maximum with the tuning adjustment and the signal is appreciably weaker than it was without the coax tank in place it is likely that the coupling links are not adjusted properly. Judicious bending, pushing or squeezing of the links should result in a more optimum coupling adjustment. If the signal cannot be peaked with the tuning adjustment, you have not followed the dimensions closely enough. If the signal starts to get stronger with the capacitor all the way in, your center conductor is too short and vice versa. If too short, a small fixed or variable padder can be installed in parallel with the adjustable capacitor. If it is too long, you will just have to shorten it.

Having achieved a satisfactory adjustment of the tank, it is now time to turn on the pump oscillator. The pump frequency should be adjusted to approximately twice the signal frequency and the coupling moved in and out while observing the signal strength. A number of startling developments will occur. The desired result is to have the received signal increase in strength. You have three adjustments at your disposal. The pump frequency, the coax tank tuning and the pump amplitude. Leaving the tank tuning at the previously determined maximum signal adjustment, the pump amplitude should be increased slowly while the frequency is moved back and forth around the $2f$ frequency. The received signal should increase in strength as observed on your output or signal strength indicator. This adjustment procedure should be followed until the amplifier breaks into oscillation. Pump coupling should then be decreased until oscillation stops and increased to a point about 6 to 10 db below the oscillation point. At this adjustment

[Continued on page 159]

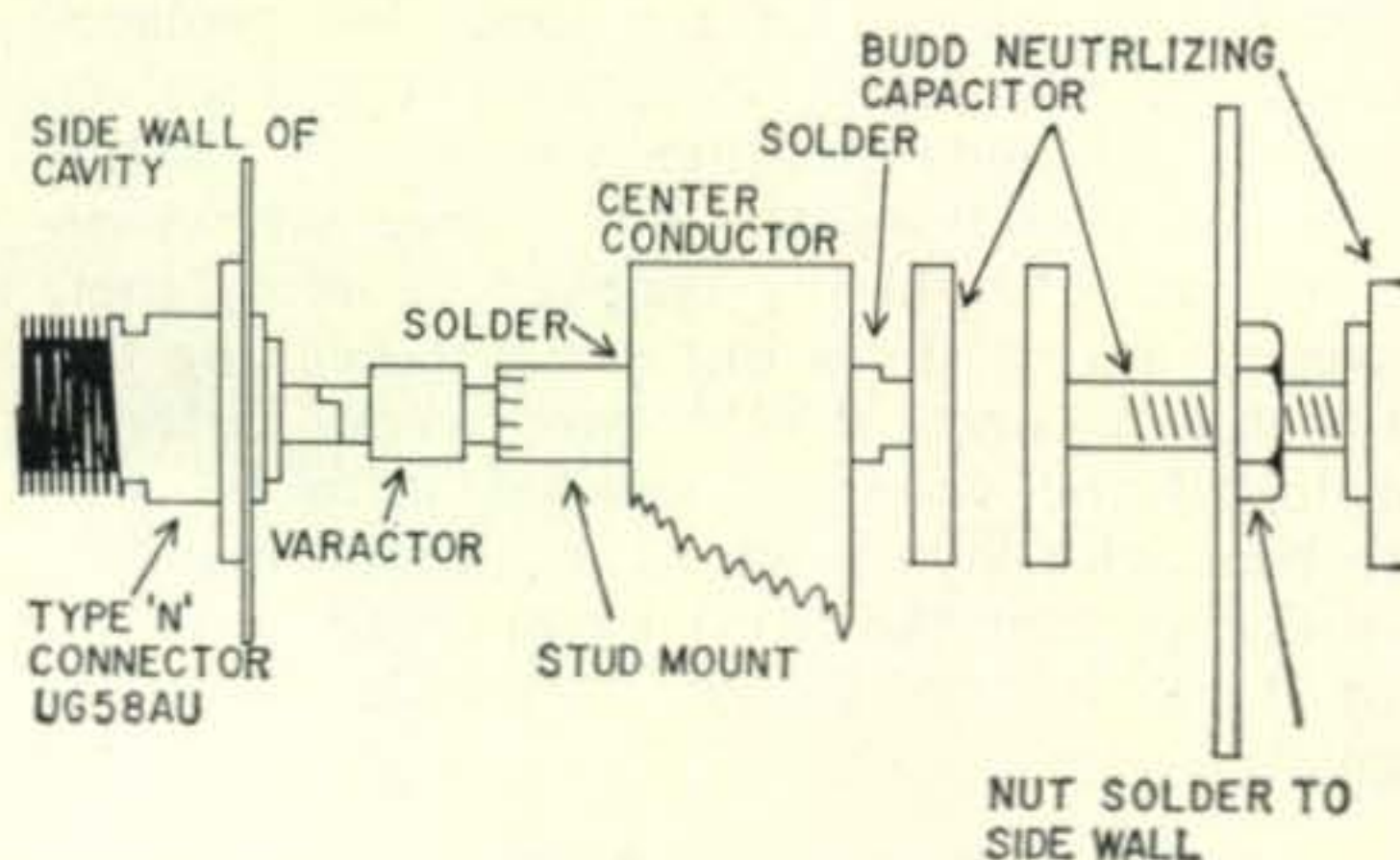

Fig. 4

A Reader Reports on the

Conway L. Wilson, W4WQT

Route 5 (Lafayette Pike)
Clarksville, Tennessee

Hammarlund HQ-170

- (1) The receiver is quite *versatile*. AM, CW and SSB all tune in easily.
- (2) The mechanical stability of the receiver is excellent.
- (3) The electrical stability or drift after warm-up is as good, if not better, than any present day receiver using the same general type front end.

The HQ-170 is a big receiver on a heavy duty chassis with excellent workmanship. It seems to be designed for ease of maintenance. It weighs 38 pounds and is 10½" High by 19" Wide by 13" Deep. On the rear panel there are terminals for a 3.2 ohm speaker; terminals for balanced or unbalanced antennas with a separate set of terminals for a 6-meter antenna; a jack for external send-receive relay connections; a fuse holder and two S-meter adjust pots. The send-receive relay would break a regulated 105 volts dc to front-end screen circuits and to the S-meter amplifier plate circuit.

The front panel contains an array of some twenty items. Evidently some human engineering was used in planning the control locations because once you learn the potential use of each control you find that those controls used most often are placed in the most easily used position.

The physical construction left me with one minor complaint. In order to get to the Crystal Calibrator for calibration against WWV or in order to get to any of the tubes for replacement it is necessary to remove the receiver from its cabinet. In other words . . . where is the cotton-picking top lid? Three screws on the rear panel hold the receiver in its cabinet, however, and it slides out easily. Checking the calibrator against WWV two weeks after I purchased the receiver, showed it to be still zero beat with WWV on 10 mc. Small wonder, considering that the crystal employed is a low drift 0.005% crystal and the voltage used is regulated.

The Frequency Coverage

The HQ-170 is a "ham-band only" receiver

with complete coverage of all bands from 160 through 6 meters. The coverage is broken up into two dials. One dial has part of the bands on it while the other has the other bands and an extra 0 to 100 Arbitrary Scale. The two dials, which move at the same time and are controlled with one tuning knob, are calibrated with 5 kc divisions on 160 through 20 meters, 10 kc divisions on the 15 meter band, 20 kc divisions on the 10 meter band and 50 kc divisions on the 6 meter band. By offering "ham bands only," stability is made possible and of course anytime a receiver is stable, selectivity can be offered, but more about this later. The coverage of each band is 1.8 to 2 mc, 3.5 to 4 mc, 7 to 7.3 mc, 14 to 14.4 mc, 21 to 21.6 mc, 28 to 30 mc and 50 to 54 mc. Thus the 15-meter band provides short-wave broadcast coverage, including the Voice of America.

Selectivity

Since the receiver is extremely stable it can offer razor sharp selectivity. The response curves approach mechanical filter skirt selectivity. The selectivity is certainly offered in a versatile way. You are never tied down to one or two degrees of selectivity with this receiver. The band-pass is variable from a 500 cycle bandwidth for cw up to a full 6 kc bandwidth for clear channel AM. You can select either the upper or lower sideband and have a choice of either 0.5, 1, 2 or 3 kc selectivity. You can switch in both sidebands and have a choice of either 1, 2, 4 or 6 kc selectivity. This makes a total of 6 different degrees of selectivity.

Band-Pass Tuning

The Vernier Tune Control allows tuning up to 3 kc above or below the frequency the Dial is set on. The control offers an 8 to 1 tuning ratio with calibration points every 500 cycles. With a little practice, frequency differences of 50 cycles or less can be read. The readings taken from calibration points under the control knob pointer on the front panel are very

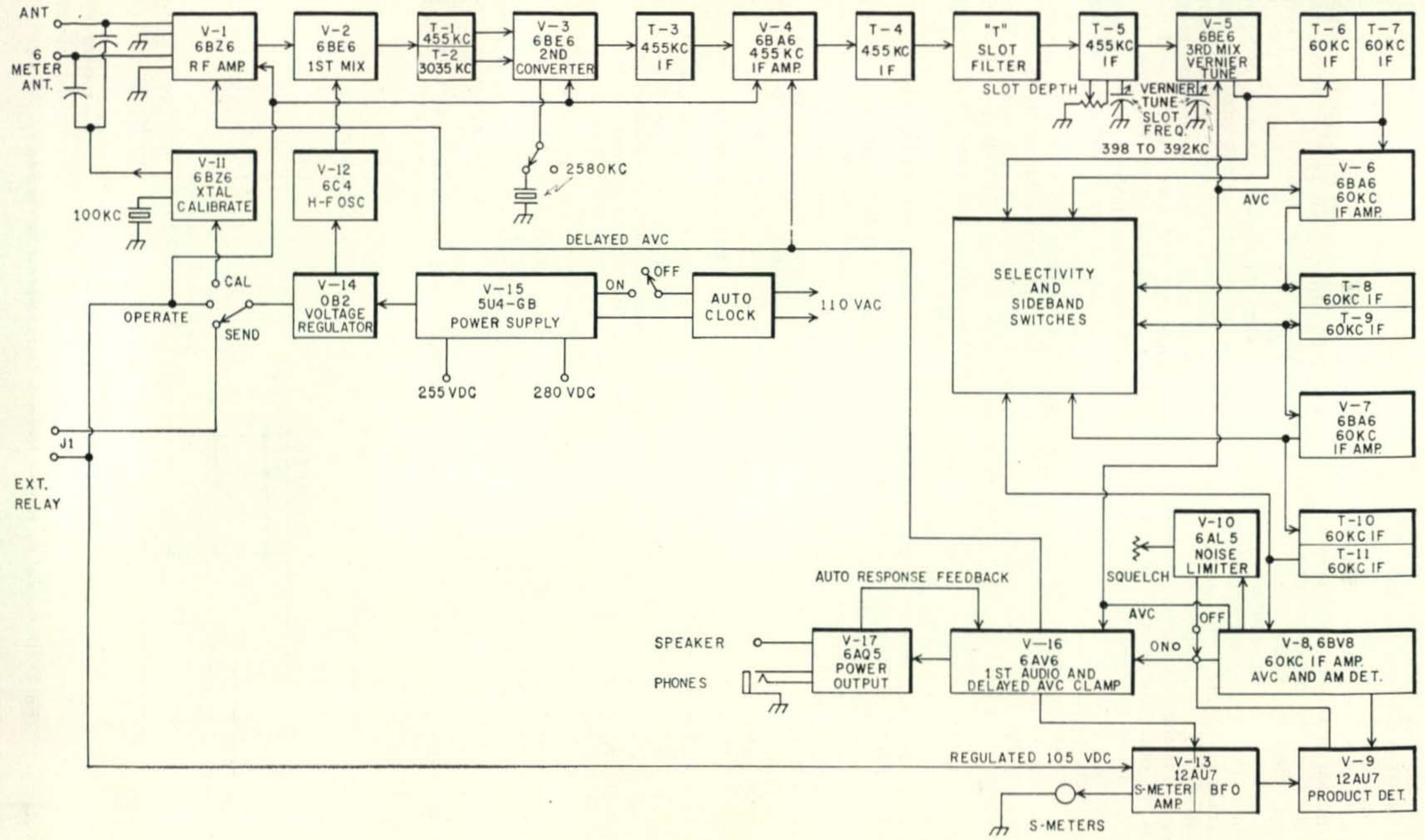

Fig. 1—Detailed block diagram of the Hammarlund HQ-170.

accurate. Features of this type can only be useful on receivers that offer stability. This receiver is so stable you can pound on the cabinet without effecting zero-beat. The band-pass tune feature opens the way for ham-band enjoyment you may have never known.

This type of band-pass tuning, which I shall term "Electrical Single Mixer Band-Pass Tuning," should not be confused with the type used in the Collins receivers. It can best be explained by saying it is possible to tune around in the 455 kc band-pass and present what you find to the 60 kc upper/lower or twin bandpass. In other words, you do not move the original tuned in signal or frequency for it stays where you tuned it in on the tuning dial. In effect, it allows you to sneak a look as far as 3 kc above or below that dial reading and do so without disturbing the main tuning dial frequency setting.

For example, let us assume you are the NCS of either a CW or Phone net. You could set the dial on the Net frequency and with the Vernier Band-Pass Control be able to tune in stations as far as 3 kc above or below the Net frequency without disturbing the dial setting. You can even tell the "culprits" how far off the Net frequency they are and give the reading in cycles. You can tell a station how "wide" he is on the band. It also offers real ease of tuning for SSB signals. Stations a few cycles apart can be tuned in without disturbing the dial. The 8-to-1 tuning ratio is a wonder.

The Detectors

A normal diode "envelope detector" is built in for those desiring to detect AM signals in that manner. A linear product detector is switched in for cw and SSB reception. The double-triode product detector recovers intelligence from an rf signal with the least amount of distortion under large variations of input signal strength. Although the bfo covers a range of 2 kc above or below the 60 kc i-f, I leave mine set for 60 at all times. This keeps the dial reading correct at zero beat. The bfo

circuit uses the well known high stability Clapp circuit.

The AVC Circuits

At long last you can join an SSB roundtable with both strong and weak stations and set back and enjoy the "conflab" without keeping one hand on the rf gain control. The AVC switch offers three speeds of AVC decay time. All three use very fast attack time. The S-meter reads at all times and gives readings accurate enough to relate to those desiring a report of this type. The Fast AVC can be used on cw with no overloading effect. The Slow AVC is good for SSB roundtables if there is a large variation between signal strengths. No signals are distorted nor did I have to ride the gain control. Of course the AVC can be switched out at any time and although the S-meter still reads, the readings are not accurate. The S-meter is calibrated to 40 db over S-9 and is adjusted so that a signal input of 50 microvolts gives a reading of S-9.

The Crystal Calibrator

It is accurate. It is turned on with a switch on the front panel and zero-beat is obtained with bfo on at or near some 100 kc multiple frequently. If the dial is off a few cycles there is a Dial Scale Reset knob on the front panel to set the dial for accurate readings.

The Noise Limiter

The noise limiter is a good one. A 6AL5 functions as a positive and negative noise pulse-clipping limiter and a front panel control can be set for the degree of limiting desired. The control, when advanced, is used as a squelch for AM signals.

Audio Amplifier

One watt of undistorted output is provided to 3.2 ohm speaker connections or to an ear-phone jack on the front panel. A 6AV6 driver and 6AQ5 output tube is used in the audio

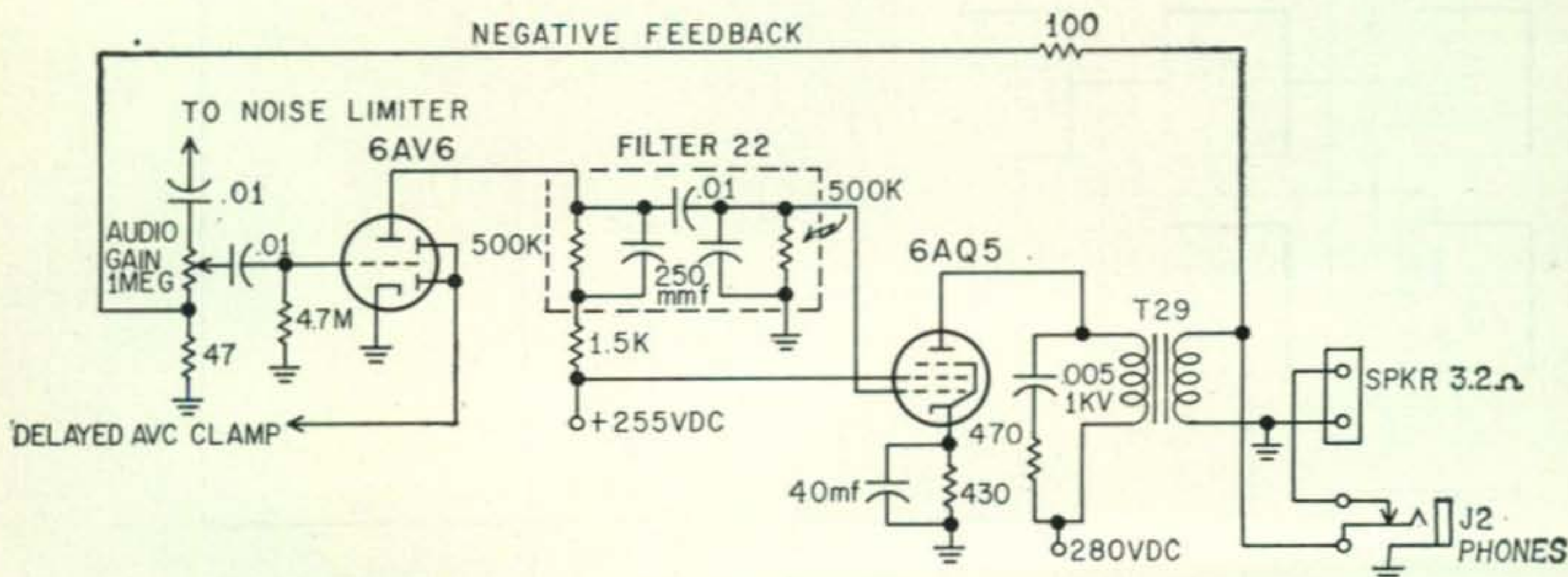

Fig. 2—Schematic of the variable feedback "Auto Response" audio amp.

circuit. A variable negative feedback is used with maximum feedback on strong signals for high quality reproduction and less feedback on weak stations to narrow the response for a maximum signal to noise ratio. The circuit is automatic and is called "Auto-Response." The circuit is shown in fig. 2 for those who care to modify their present receiver or put the circuit into a home brew receiver.

The Slot Filter

The Slot-Filter response curve tells the story about this "must" feature. The razor-sharp slot can be magically tuned around anywhere plus or minus 5 kc over the band-pass. It gives better than 40 db attenuation to the unwanted heterodyne or interfering cw signal. Another control, the Slot-Depth Control, can be used to balance the unwanted signal down to a total of 60db. This type circuit, called a Bifilar "T" Trap by Hammarlund, is a must for present day crowded bands.

The Clock

The receiver evaluation could not be complete without mention of the clock which comes as an "extra" for \$10. This gadget can eliminate warm up drift from bothering your operation, remind you that it is "Net" time, etc. You have only to set the clock to turn on the receiver about 30 minutes prior to your normal operation time and the receiver will be warmed up and ready to go with drift-free operation.

And That's Not All

Yes, there are still more features that must be mentioned. There is the antenna compensator that permits compensation for leading effects of the antenna or transmission lines. There is the sensitivity, with an average 1.5 microvolt AM signal producing a 10 to 1 signal to noise ratio or an average 0.5 microvolt cw signal doing the same thing. There is the double conversion that is used on the 160 and 80 meter bands with the two i-fs being 455 kc and 60 kc. There is the triple conversion used on all the other bands with a crystal controlled second mixer that gives an i-f of 3035 kc. There is the extremely stable hf oscillator that operates on the high side of the signal on all bands except 6 meters. There are the low-loss sockets, coil forms, and bandswitch wafers; plus temperature-compensating capacitors; and the regulated dc to the oscillator circuits which all help to provide the high degree of stability so vital to any selective receiver. The drift, after warm-up, is less than 0.01%. I measured only about 700 cycles drift during a 20-minute warm-up from a cold start.

There is the unique method of sideband selection. It is accomplished by shifting the
 [Continued on page 157]

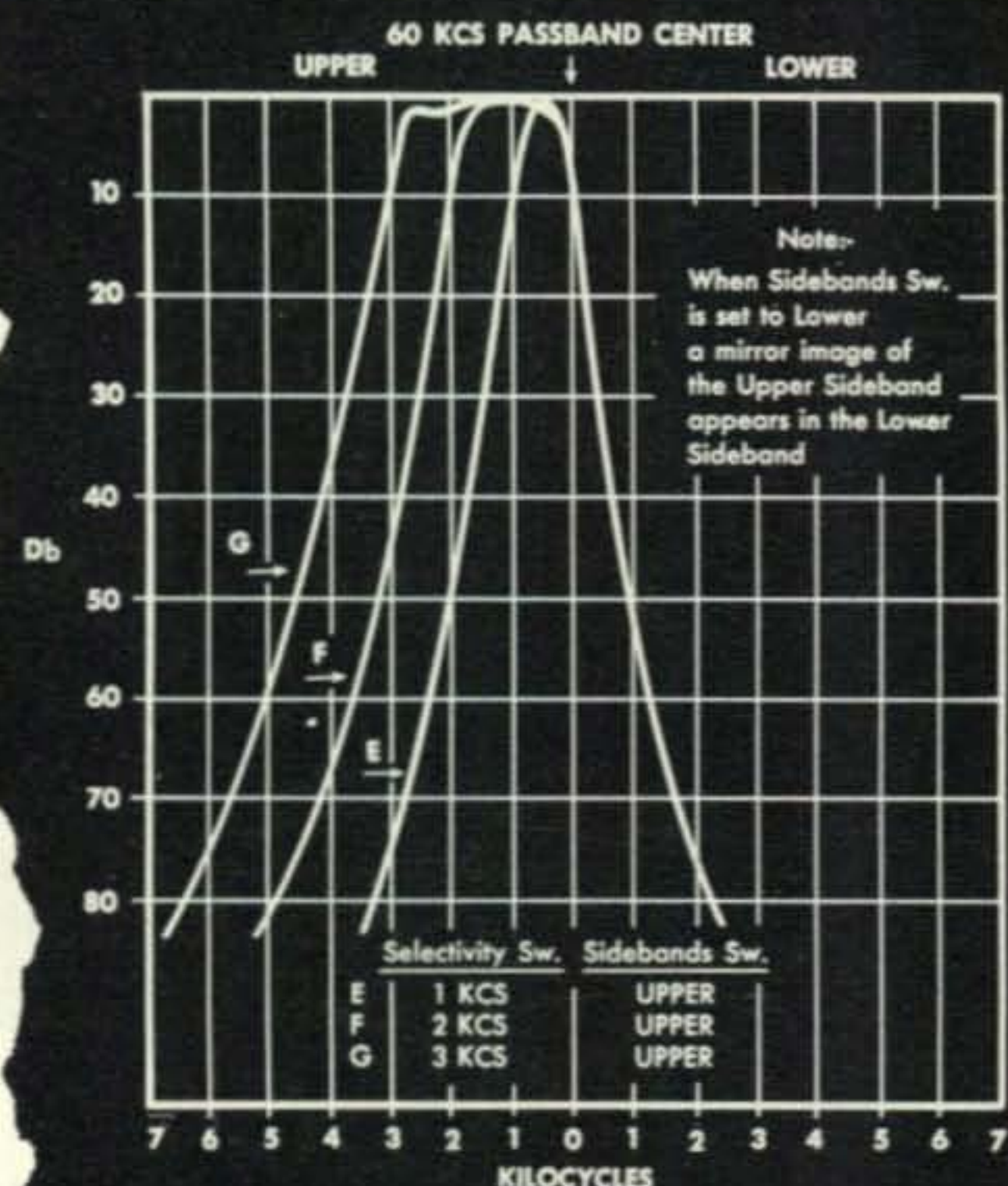
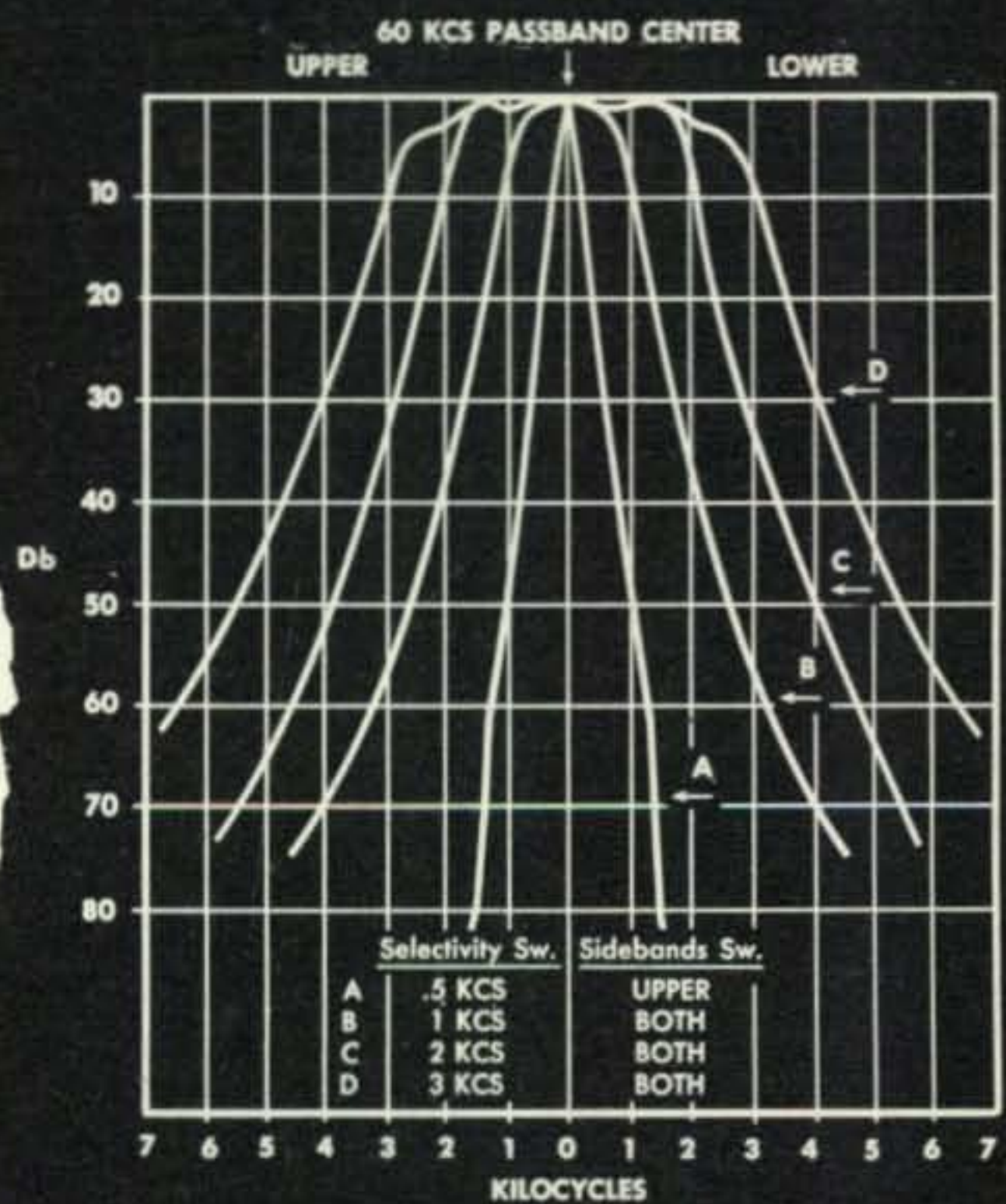
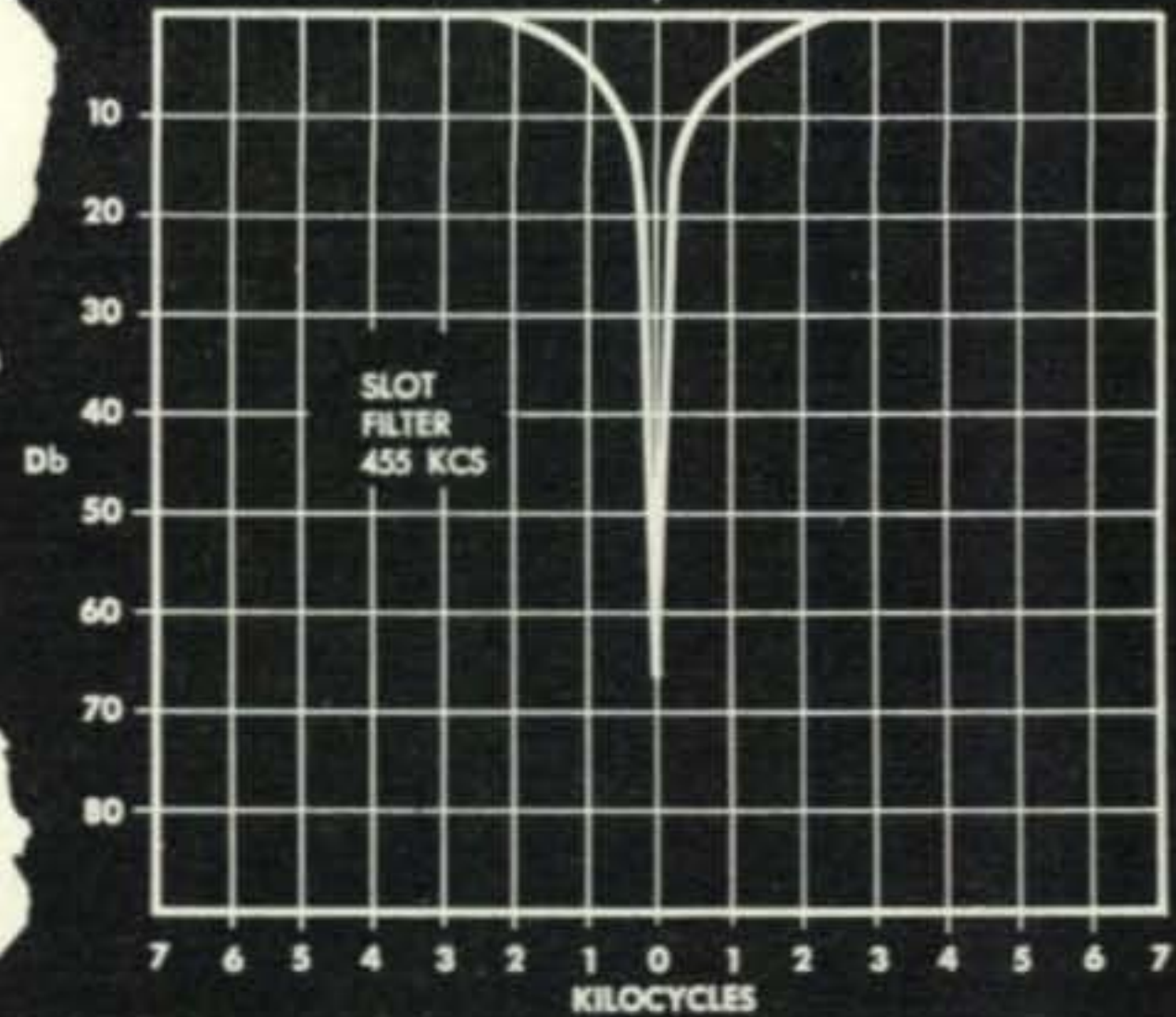

CQ Tests the Heliwhip

TYM (The Young Man)

Some of the most frustrating experiences in my ham radio history have been tied in with my attempts to use short antennas on my mobile installations. When the all-band tapped coils came out I rushed right out and invested in a completely new antenna system: bumper mount, aluminum bottom section, adjustable coil, and top section. It worked pretty well for a few days and then began to behave erratically.

Soldering of more permanent leads on the coil shorting button didn't help. Finally I gnashed my teeth at the manufacturer and was given a new (and much more tricky to use) wiper arm which would reach out and grab hold of just one turn of the coil rather than shorting two turns. Except at night when you were lucky to get the thing moved where you wanted it without bending the coil badly. And still it was erratic.

When I finally got around to buying a new car I decided to start over again with something a bit more promising. This turned out to be the *Rafred* remotely tuned antenna. This was a real pleasure to use and gave me very little trouble. Switching from band to band was quite simple and signal reports were satisfactory.

Then came the sport car. After driving around a couple of the little sports cars I just couldn't stand to drive around my great big Ford Country Squire Station Wagon any more. The difference in handling was fantastic . . . driving could be *fun*.

Naturally I had to put ham gear into the Porsche, when it came. And then came the problem of the antenna. Sure, on the great big bumbling old station wagon I could mount anything at all without it looking too badly. But on the new little bug I couldn't put one of those eight foot poles with a big coil in the middle. Not only would it look silly, but it would slow me down a good five miles an hour in the higher speeds.

So, what about those new Heliwhip antennas? A quick trip to the local distributor and I was all set with the four foot long 10 meter whip plus the base mounting insulator (made by the same company). I was a bit worried about the base mounting since I didn't want to use one of those big black jobs that are so popular on my little car.



The Heliwhips are made by spiral winding the antenna around a fiberglass tapered rod. They have units for 10 through 80 meters. The bandwidth of the 10 meter model is 1000 kc, while the 80 meter unit only covers 60 kc. The final tuning of the whips can be adjusted by removing some of the top turns of the whip, an easily accomplished procedure. The bandwidth is governed by the limits of 2:1 SWR.

Well, how did it work? I haven't worked a lot of DX with it yet, but I am able to work out when the band is open running 15 watts and it seems to load up nicely over the whole 10 meter band. Local contacts are excellent and I always get exceptionally good signal reports. The Mark Mobile base mount HWM-1 fits right in the hole left by the broadcast antenna and is not out of place even on my small car. The four foot antenna is entirely in keeping with the car size and should be welcome by any ham who doesn't want to attract too much attention to his mobile operation.

The only inconveniences I have had as a result of the Heliwhip are the drag at high speeds which cut down my top speed by about three miles an hour and the noise generated by the whip as I get up to 80 and 90 miles an hour. The whip flexes about eight inches as I approach optimum cruising speed (90) and the whistling is pretty loud. This should not be much of a problem for users of Detroit Chrome since it is not safe to drive them that fast.

The Mark Mobile Heliwhip, to sum it up, is a reasonably priced short antenna which works quite well and will satisfy the ham or XYL who wants a bit more dignity while driving. ■

THEY MELT

L. W. Fletcher, WØEXC

Larry Teien, KNØLJO

338 South Albert
St. Paul 5, Minnesota

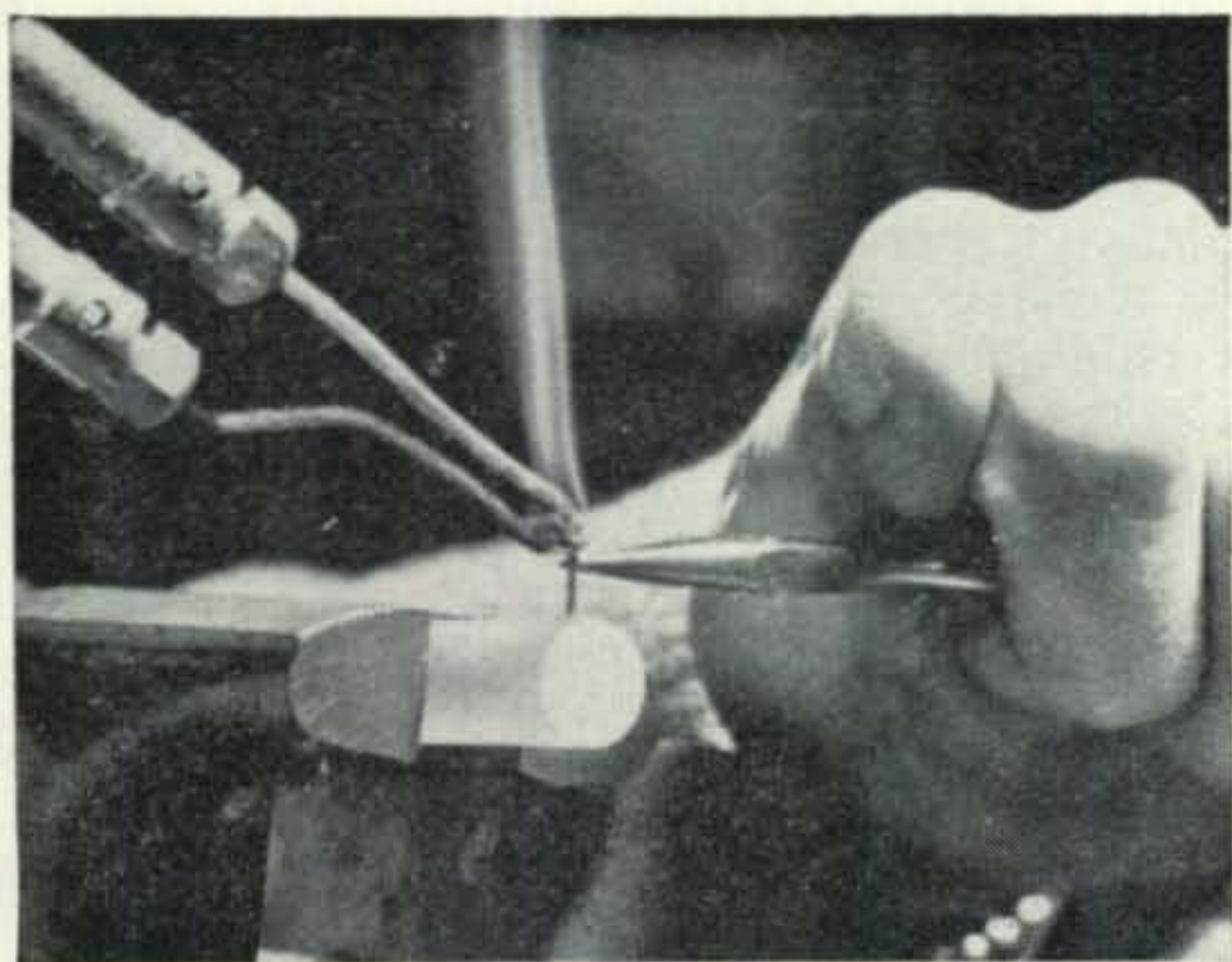

Fig. 1—Place the rod in a steady holder such as a vise. Don't squeeze the rod too much. Tin the brad, then hold it in position above the rod with a long nose pliers. Use a soldering gun to heat the head until the point of the brad becomes hot enough to melt the rod. The brad will easily press into place under low heat and will "freeze" in the rod as it cools.

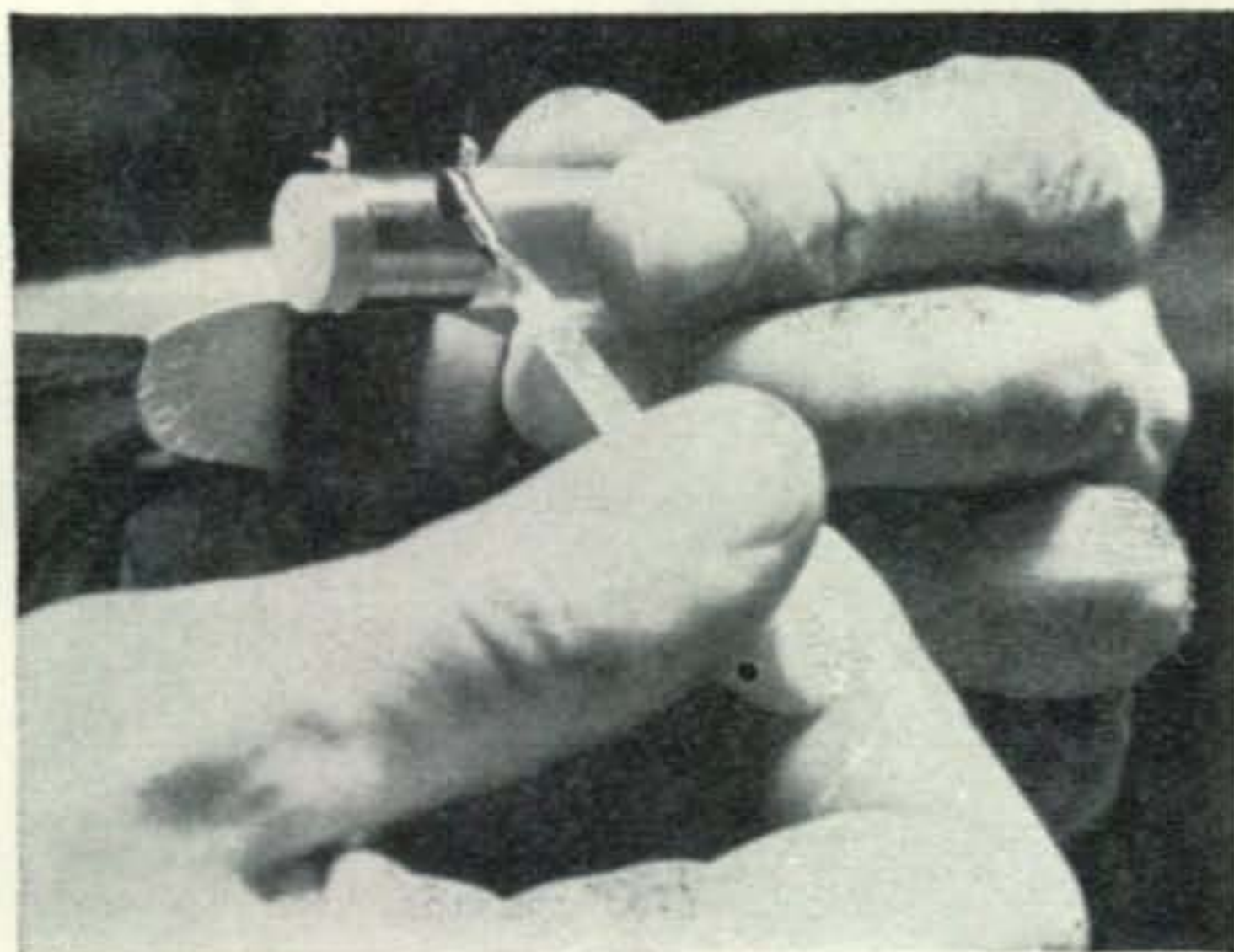

Fig. 3—When the wire is attached and soldered to the other brad, paint the coil with dope.

Here is a way to sink coil terminal brads into polystyrene rods without using small diameter drills so often broken. The polystyrene heats during the drilling and then freezes when you stop. The drill breaks when you try to free it.

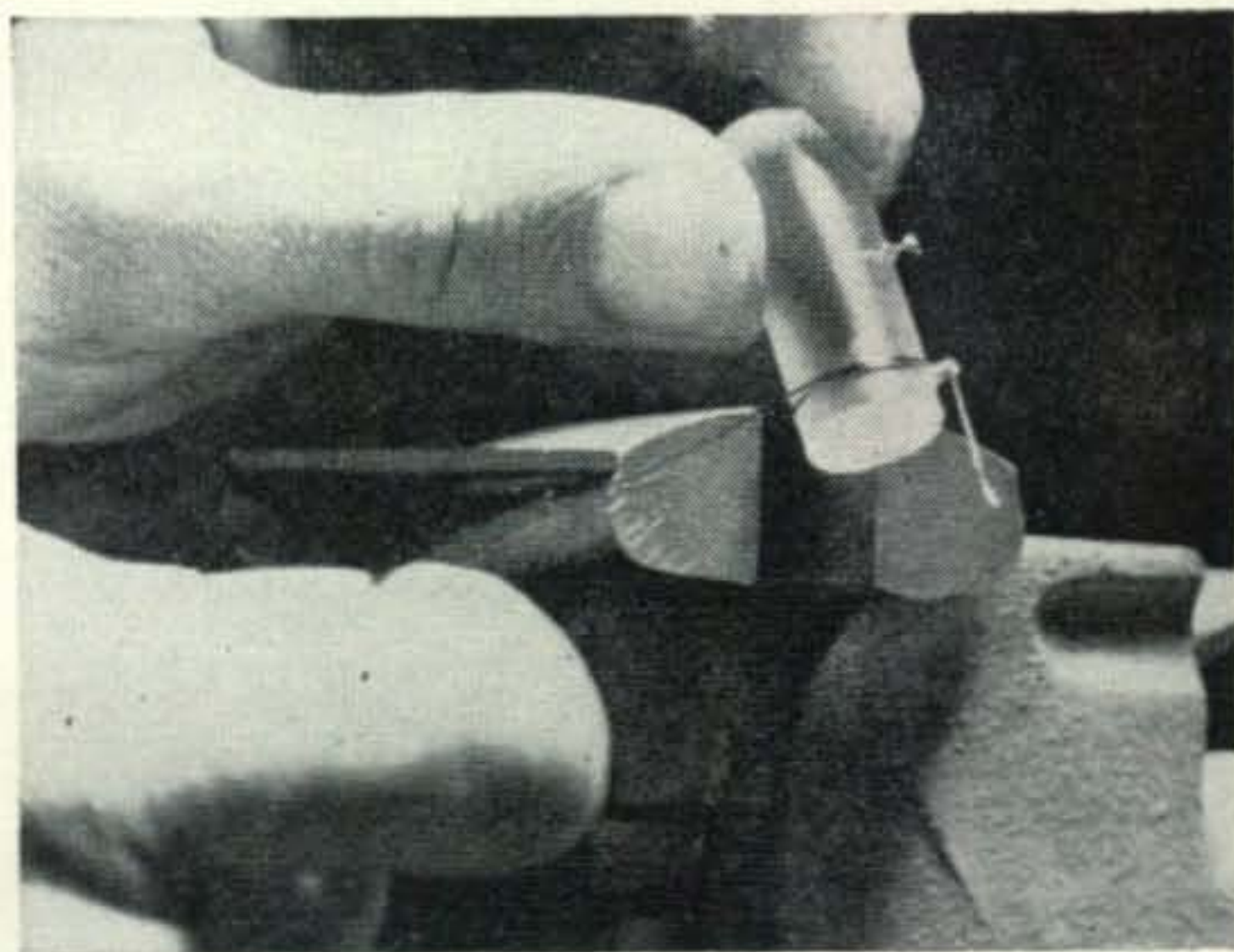

Fig. 2—Leave the head about 1/16 above the rod. Sink another brad where it is calculated that the coil will end. Scrape insulation from the end of the wire. Then attach and quick-solder it to the first brad. Wind the coil.

Graphic Recording of Earth Satellites

Calvin R. Graf, W5LFM

207 Addax Drive
San Antonio 1, Texas

The radio passings of the Sputniks, Explorers and Vanguards have been monitored in many different ways. High speed audio tape recordings and high speed graphic chart recordings of signal intensities have been made. The majority of the set-ups required a fair amount of equipment to provide almost a cycle-by-cycle account of the passings. The system to be described in this article is a simple but interesting way to keep track of any satellite passings on a minute-to-minute basis and yet provide continuous 24 hour unattended operation.

The system operates in the following manner. A receiver is tuned to 40.002 mc or 108 mc. In the case of the Sputniks, many ionospheric effects are noted at 20.005 mc so this frequency should be avoided. The rectified i-f output of the receiver is used to drive a graphic strip chart recorder such as the Esterline-Angus, Varian, Brush, Texas Instruments, etc., operating at a slow chart speed (2-5 inches per

hour). Those recorders with dc amplifiers can be driven directly from the rectified i-f output, AVC, or the "S" meter terminal voltage. The E-A recorder requires one ma through 1500 ohms to operate to full scale. This can usually be obtained by rectifying the i-f output with a crystal diode and then applying it to the recorder input. An increase in rectified voltage can be obtained by placing a parallel circuit tuned to the i-f before the diode. The circuit is shown in fig. 5.

A portion of the amplitude vs. time recordings for two consecutive days are shown in figs. 1 to 4. These are of Sputnik I taken on 40.002 mc using a vhf receiver with recorder output and a vertical folded dipole above a ground screen. The receiving location was San Antonio, Texas. Chart speed is 3 inches per hour with vertical divisions every 15 minutes.

Two radio passings are noted in the evening and two passings in the morning. Several things

[Continued on page 156]

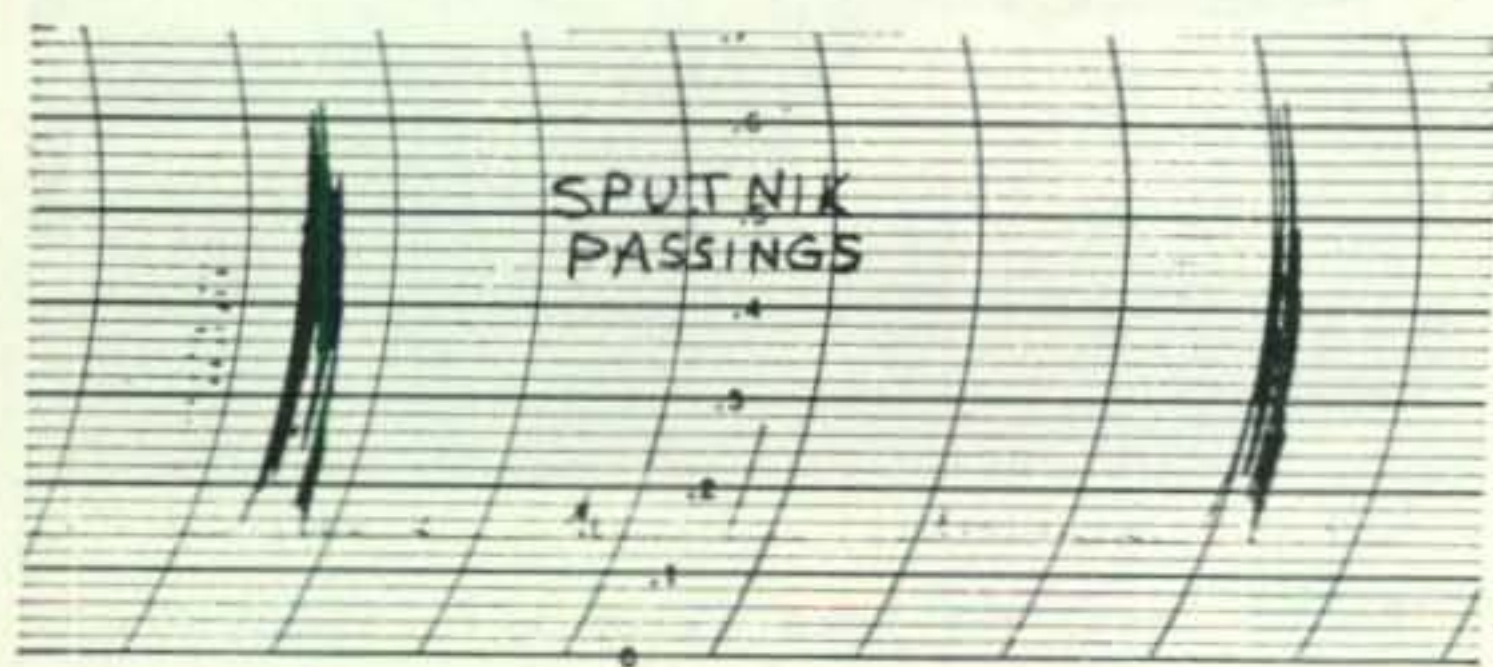

Fig. 1—October 21, 1957 PM passing.

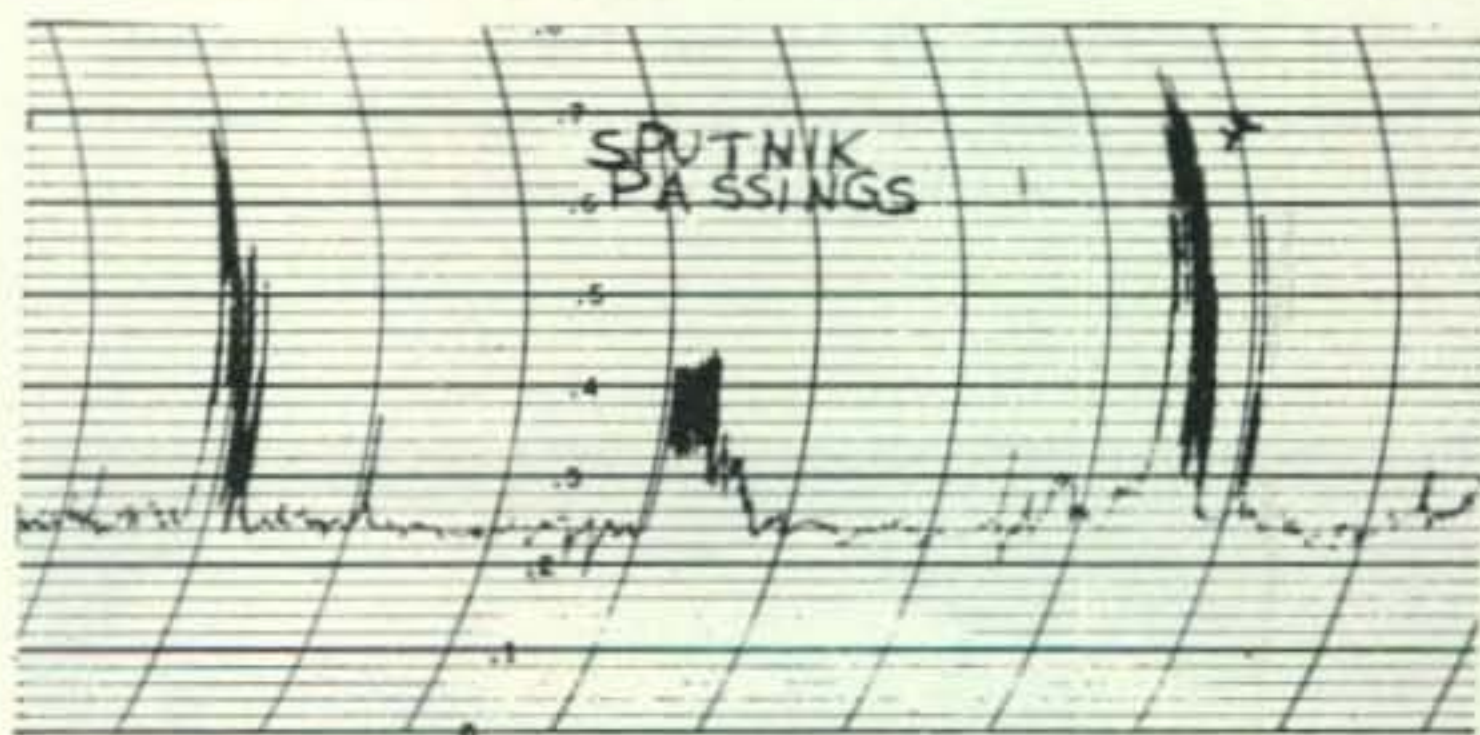

Fig. 3—October 22, 1957 PM passing.



Fig. 2—October 22, 1957 AM passing.



Fig. 4—October 23, 1957 AM passing.

Readjusting Mixer Trimmers

L. W. Fletcher, WØEXC
Larry Teien, KNØLJO

338 South Alberta Street
St. Paul, Minnesota

The main problem in adjusting the mixer trimmer of a receiver is to get the mixer to "track" the oscillator. All across each ham band it should be away from the oscillator frequency by the value of either the first or only i-f.

This is a practical impossibility. Therefore you must either balance the tracking over the band to the best of your ability, or peak the tracking on the part of the band you desire.

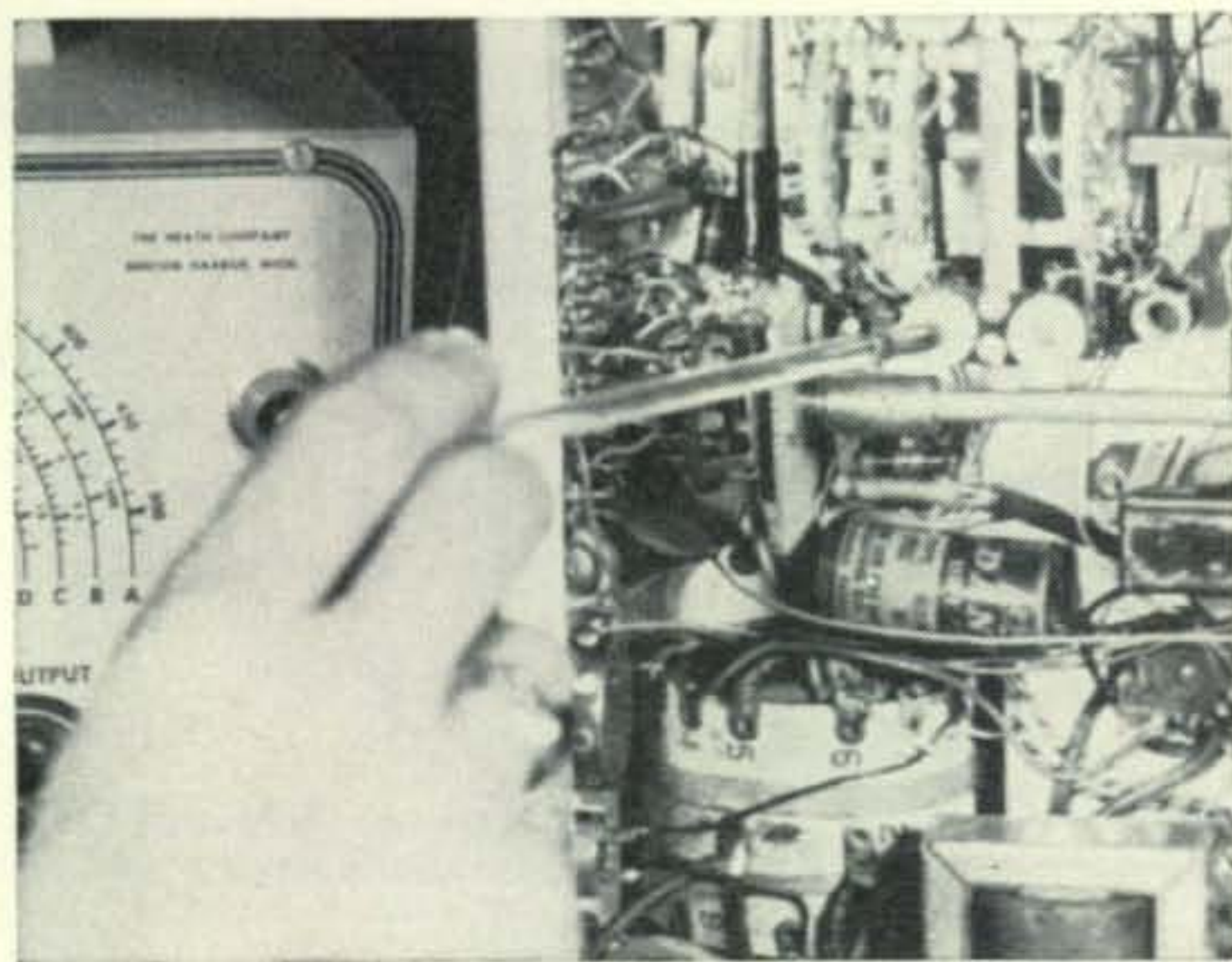

Fig. 1—Feed a signal generator signal at the frequency of the low end of the ham band into the plate of the rf tube. Adjust the trimmer capacitor for maximum S-meter reading, or maximum swing of a vacuum tube voltmeter connected to the avc bus.

Then feed the signal at the frequency of the high end of the band. There will be a difference in readings. If the second reading is very low, readjustment the mixer trimmer for maximum reading, noting whether capacitance is added or subtracted. This must be determined from the specific trimmer capacitor used.

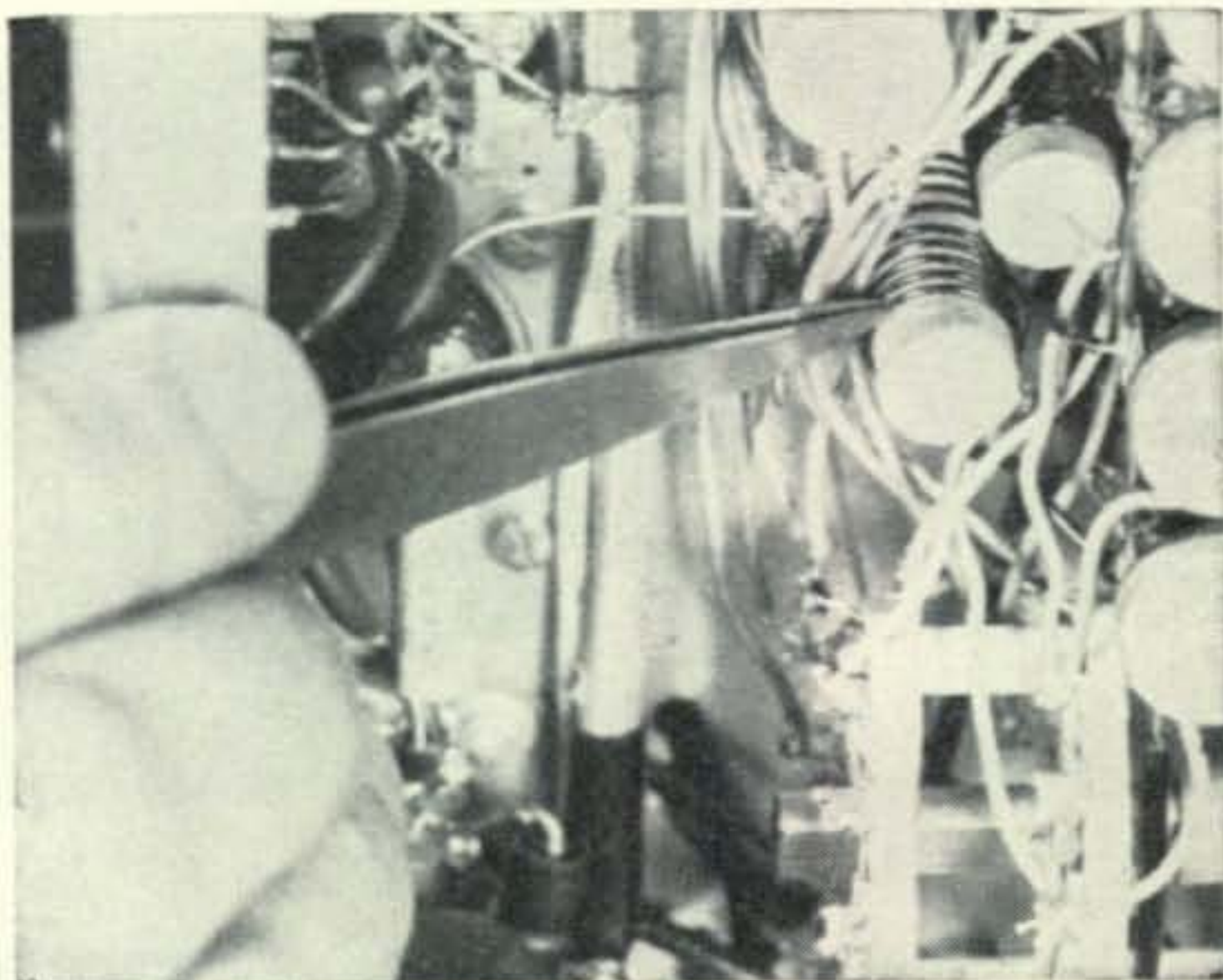

Fig. 2—If more capacitance is added, the mixer is tracking too slowly and the mixer coil turns must be spread slightly. If the capacitance is decreased to get maximum readings, the mixer is tuning too fast and the coil turns must be squeezed together.

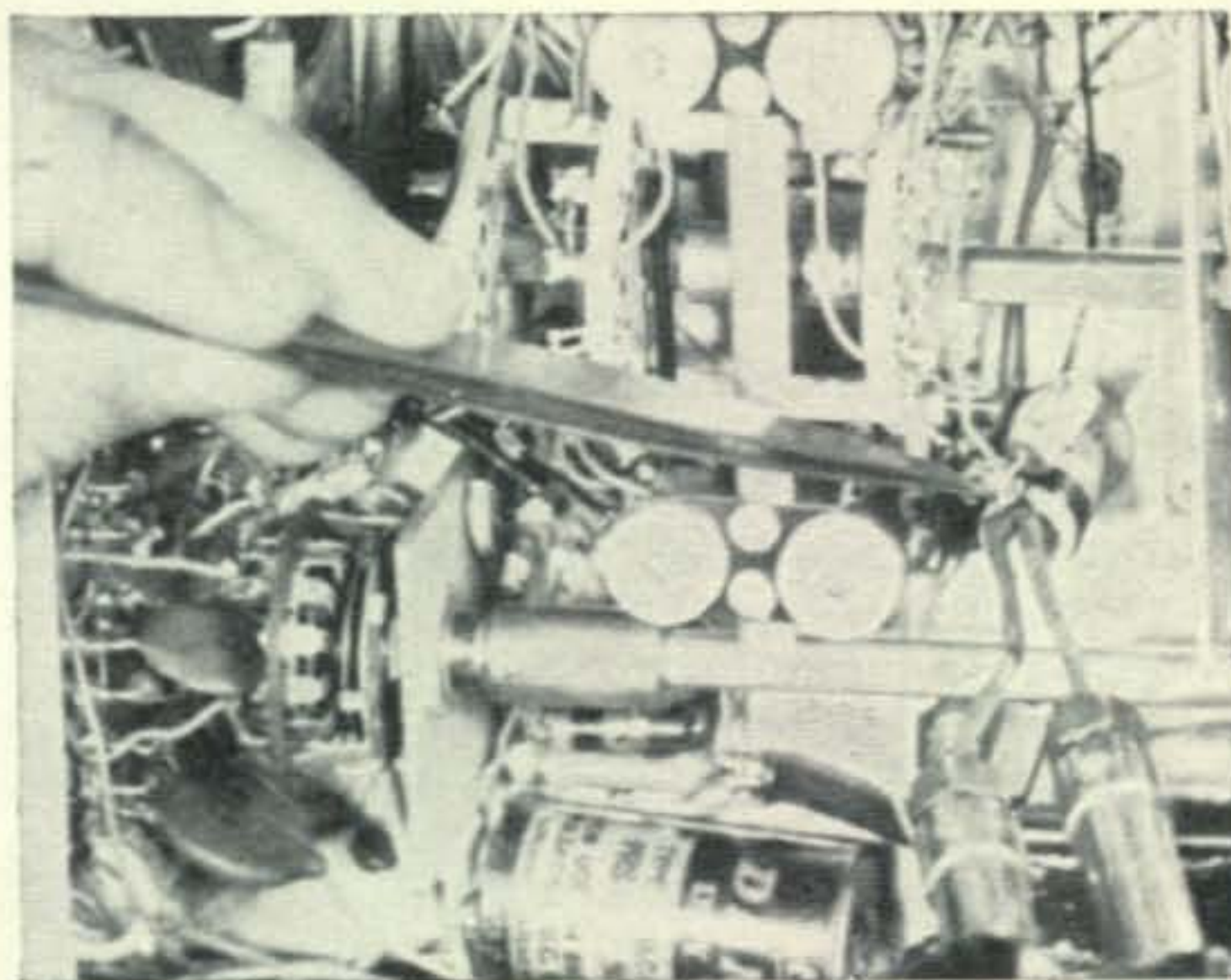

Fig. 3—Sometimes the cut-and-try method with fixed capacitances may be required to do the job, similar to the one shown here being added to an oscillator coil.



THE TEN TUBE SUPER DUPER SUPER

L. W. Fletcher, WØEXC

1017 Goodrich Avenue
St. Paul, Minnesota

Larry Teien, KNØJLO

338 South Albert Street
St. Paul, Minnesota

If you're one of many hams with a yen to build a really selective receiver that's convenient in size, you are at this moment as little as \$75 and the construction time away from having your own. The cost will depend upon how heaping is your parts box.

This double conversion, ham band receiver took first prize at a recent St. Paul Radio club building contest. It covers phone, cw, or SSB on six ham bands and MARS with 3 kc selectivity. The cabinet is just 7" high, 14" wide, and 8" deep.

The first i-f is 2 mc, the second is 85 kc. There are eleven tubes. The use of only one bandswitch wafer, in the oscillator simplifies coil wiring and adjustment. Most internal wir-

ing is standard RETMA color coded with telephone company switchboard scrap wire.

Mixer and tuning coils are wound on polystyrene rods. Oscillator coils are wound on ceramic forms with adjustable powdered iron slugs.

Components used are good quality parts-box specials wherever possible. The dimensions and values given are those used in the prize-winning receiver. When these are critical, fundamental principles are also mentioned. This avoids difficulties when you modify according to personal preference or available parts.

Your XYL's ears will be less pink if you check the parts list and get together everything

you will need before you start.

Here's How

Center the front panel on the chassis (see fig. 1). This panel also serves as the front of the cabinet, if used. Drill or punch $\frac{1}{8}$ " holes and temporarily bolt the panel onto the chassis with 6-32 bolts $\frac{1}{2}$ " long.

Through the lower face of the panel and front of the chassis, drill seven $\frac{3}{8}$ " holes for the six switches and the phone jack. Be sure to center the bandswitch hole.

Remove the panel from the chassis. Through the panel, drill one $\frac{3}{8}$ " hole for the rf gain control. Drill another for the tuning dial where shown in fig. 1 if the dial will be of the cord drive system, as shown in photo. Punch a hole for the S-meter, if used. Drill a starting hole through the panel and carefully cut out the window for the dial with a power saw or hand hack saw. Trim rough edges with a file. Permanently remount the panel on the chassis.

Cut a rectangular hole through the top of the chassis for the dial cord drum, if cord drive is used. Lay out the hole with pencil and cut it out with a hacksaw if a square hole cutter is not available.

Gather all parts to be mounted on top of the chassis in preparation for the part-positioning "checker game."

The three-gang, 25 mmfd per section, tuning

capacitor can be bought as a widespaced FM tuning capacitor, or made. This one was taken from a surplus Beacon 200-400 kc BC-1206 receiver and the trimmers were removed.

The capacitor plates were modified as follows: On each stator section, plates 1, 2, 4, 5, 7, 8, 10, 11, and 12 were removed. On each rotor section, plates 1, 2, 3, 5, 6, 8, 9, 10, and 11 were removed.

Adjustment screw holes were retapped for mounting with 6-32 screws. This capacitor proved to have extremely good stability even on six- and ten-meters.

"Checkers"

Make a "checker board" by taping a large sheet of paper on the top of the chassis. Rules of the "game" are simple but important.

The problems in double conversion are:

1) To keep the crystal oscillator away from the front end to maintain short plate and grid leads and to minimize crystal radiation into the front end wiring.

2) Mount the front end components close together to assure short leads for proper inductance in the tuned circuits on high frequencies.

In order from front to back (see fig. 2), mount the 6BA6 rf, 6J6 oscillator, and 6BE6 mixer tubes. The 6BA6 should be close behind the 6J6.

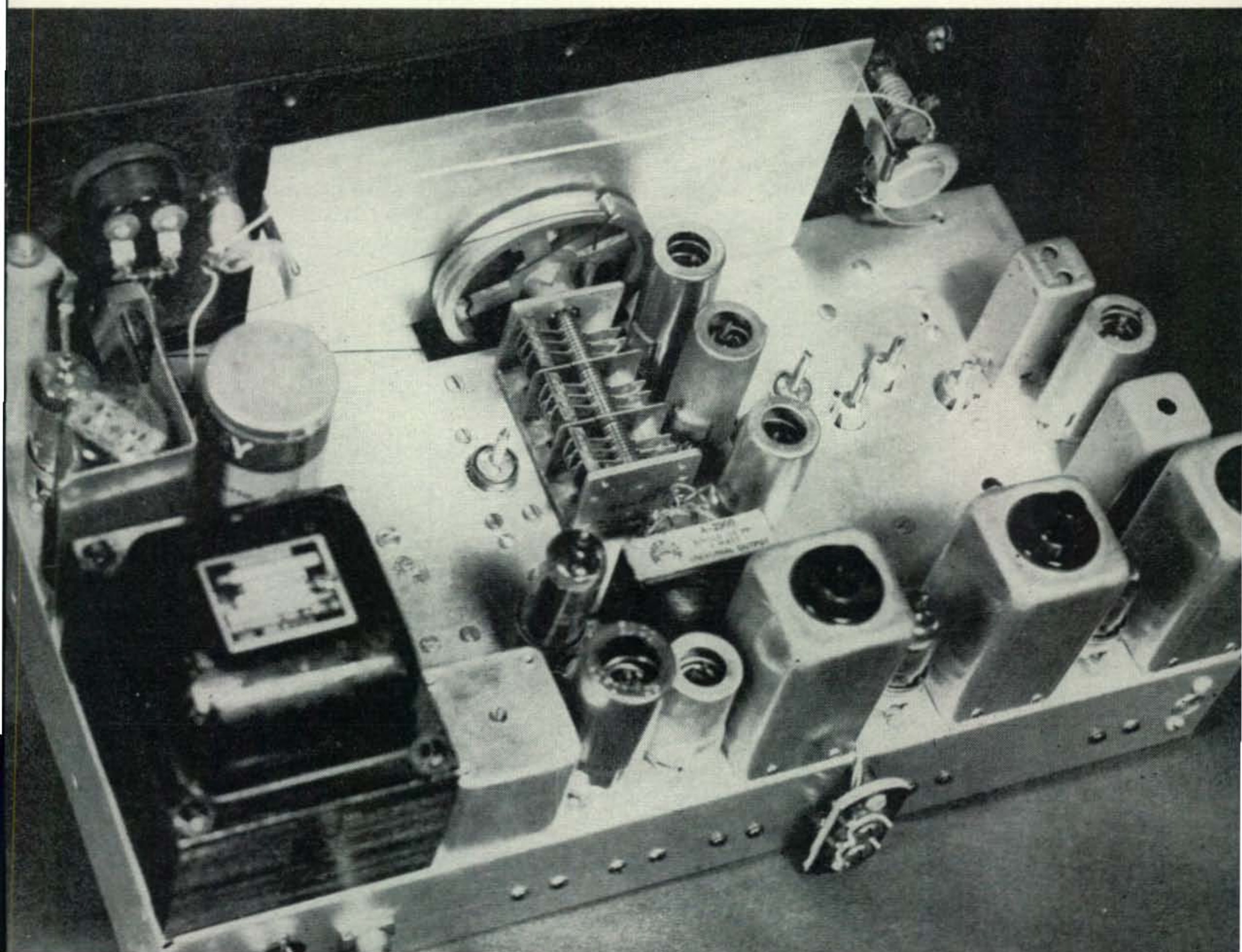

Place the power transformer in the right rear corner.

Place the first i-f transformer can in the left rear corner. Use the holes in the plate below each can to mark mounting holes on the paper. From the center of the can, draw a line on the paper parallel with the edge along the rear of the chassis. Other components should be centered on that line (see photo).

The 6AQ5 power amplifier tube goes in front of the 12AT7 audio-bfo tube.

The second converter stage should be compact and close to the i-f can in the left corner to assure short leads. The 2 mc i-f can may be purchased or may be a 455 kc i-f can modified by removing a few turns at a time and checking with a grid dip meter until the can resonates at 2 mc.

Place the output transformer close to the 6AQ5 but away from the strong fields of the power transformer.

The 5Y3 rectifier tube is placed at the edge of the chassis to keep heat away from other components.

Position the remaining components on top of the chassis as seen in fig. 2. and the photos.

Shift the components around until they are in desired locations—this is playing “checkers.”

With a punch, mark the positions of the holes for the components. There is no need to scratch the surface of the chassis with pencil marks.

Be sure to line up tubes so grid and plate leads are short.

Remove the paper, drill or punch holes accurately, and mount the parts.

Underside

On the bottom of the chassis (see fig. 3) the parts must also be “played with” for final positioning, but the chassis underside must be visible so you know where you have mounted

parts on the top. No paper “checker board” is therefore necessary.

Place, but do not mount, the two dividers which separate components of the rf, oscillator, and mixer.

The bandswitch is among the most difficult parts to line up properly. To aid installation and alignment, the shaft was cut between the first and second dividers and joined with a 1/4" shaft coupling. It might be more convenient, however, to mount the coupling ahead of wafer S1c and the first divider.

Place the dividers one at a time against the inside of the panel and circle the bandswitch hole from the front with a pencil to get the hole size and position for the bandswitch shaft. Be sure to allow room nearby for the avc switch. Drill a 3/8" hole in each divider at the pencil circle to allow clearance for the 1/4" shaft.

Run the bandswitch shaft through the second divider and mark holes for mounting the wafer screws. Drill the holes.

Mount Controls on Front Panel

The bfo-acv-mvc switch components are mounted on an L-shaped bracket. The shaft hole is measured identical to those for the dividers. Mount the switch as close to the 12AT7 as possible.

Dual type trimmers for oscillators and mixers were used because they were readily available and convenient to mount. If singles are used, mount the mixer trimmers on the second divider and mount the oscillator trimmers on the first divider. There should then be a lip along the top of the first divider.

Make pencil marks through the holes, then drill and mount.

The two dividers are mounted on the chassis. Be sure the bandswitch shaft is at right angles to the panel to prevent binding. Line up the

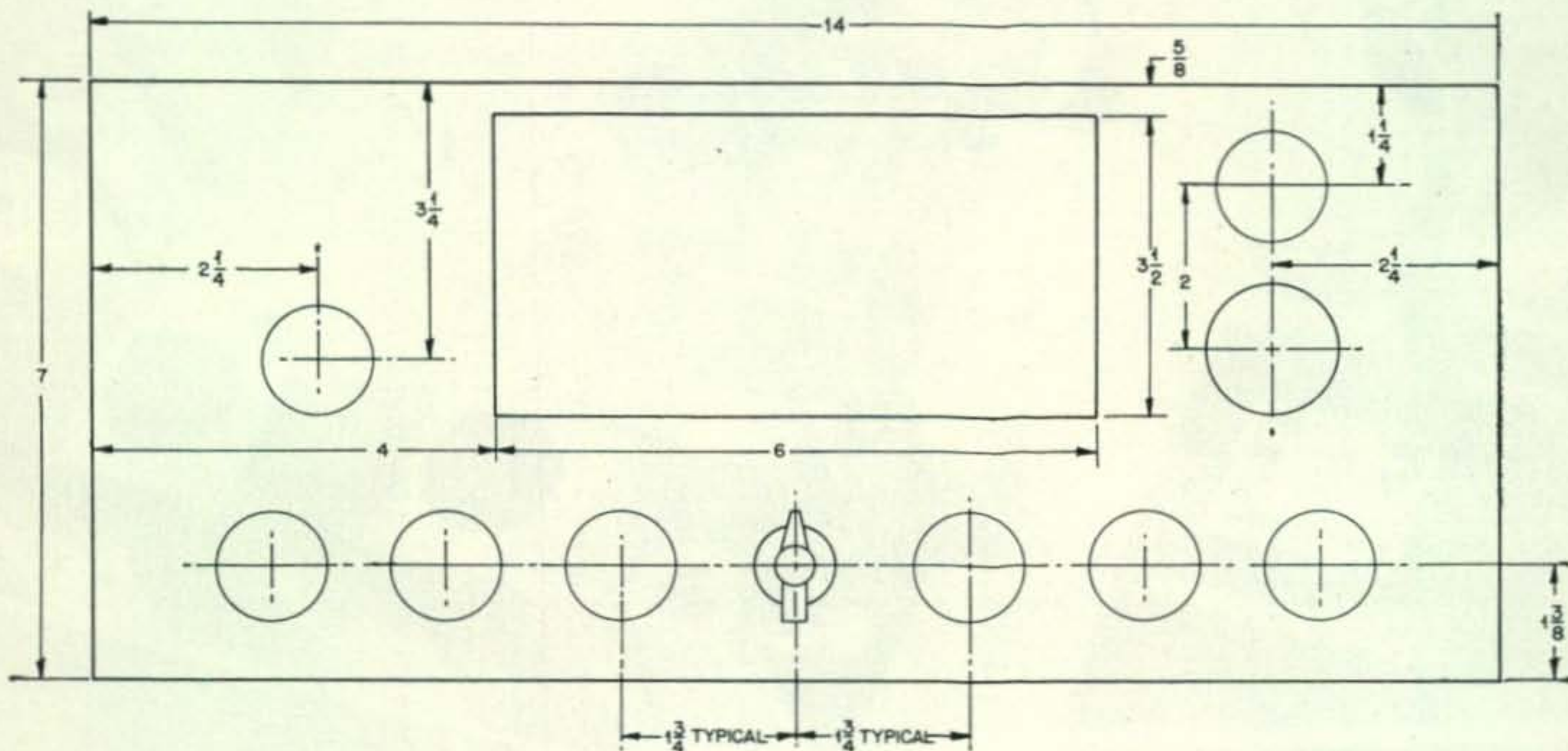

Fig. 1—Front panel layout for the super super.

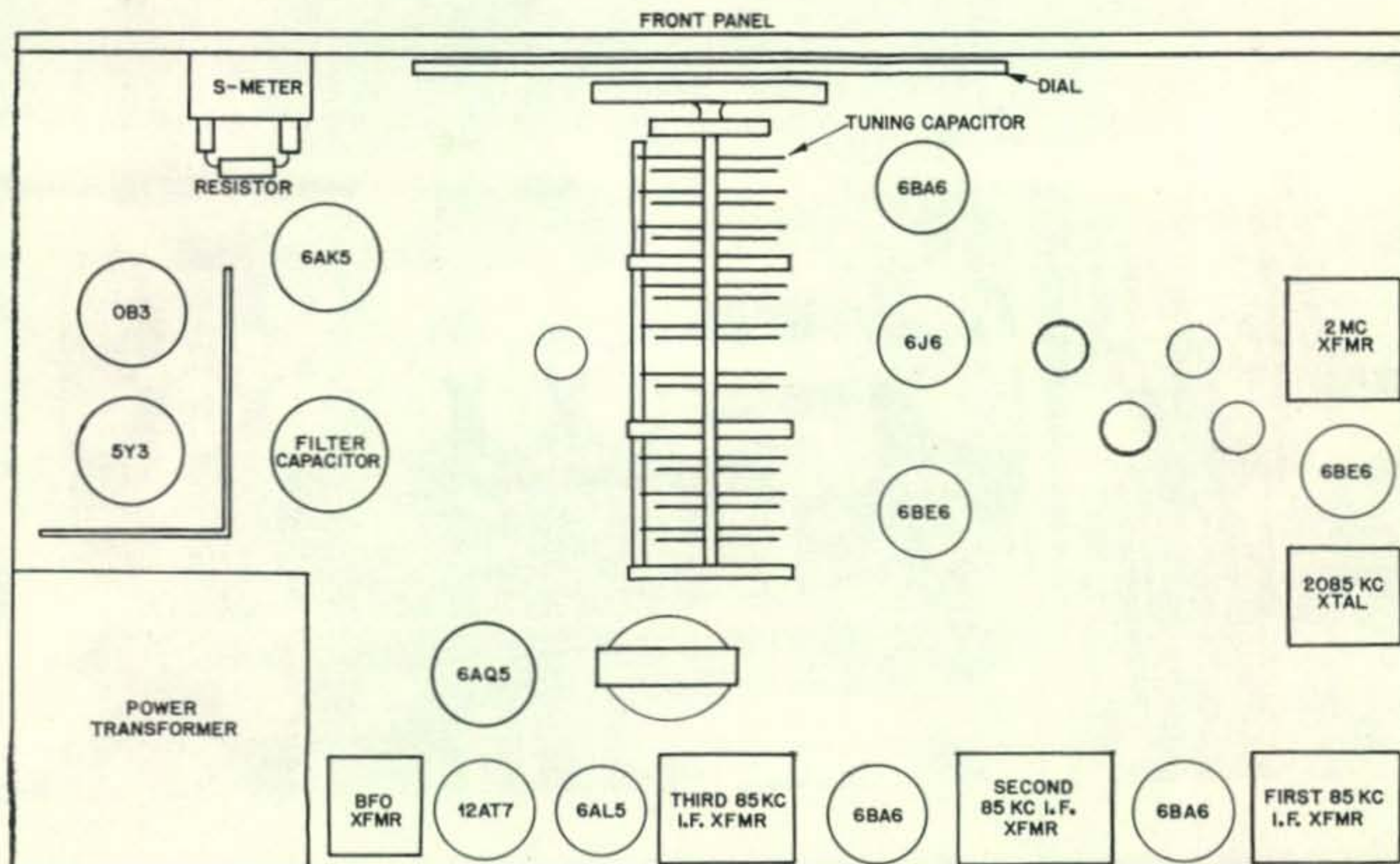

Fig. 2—Top view of chassis.

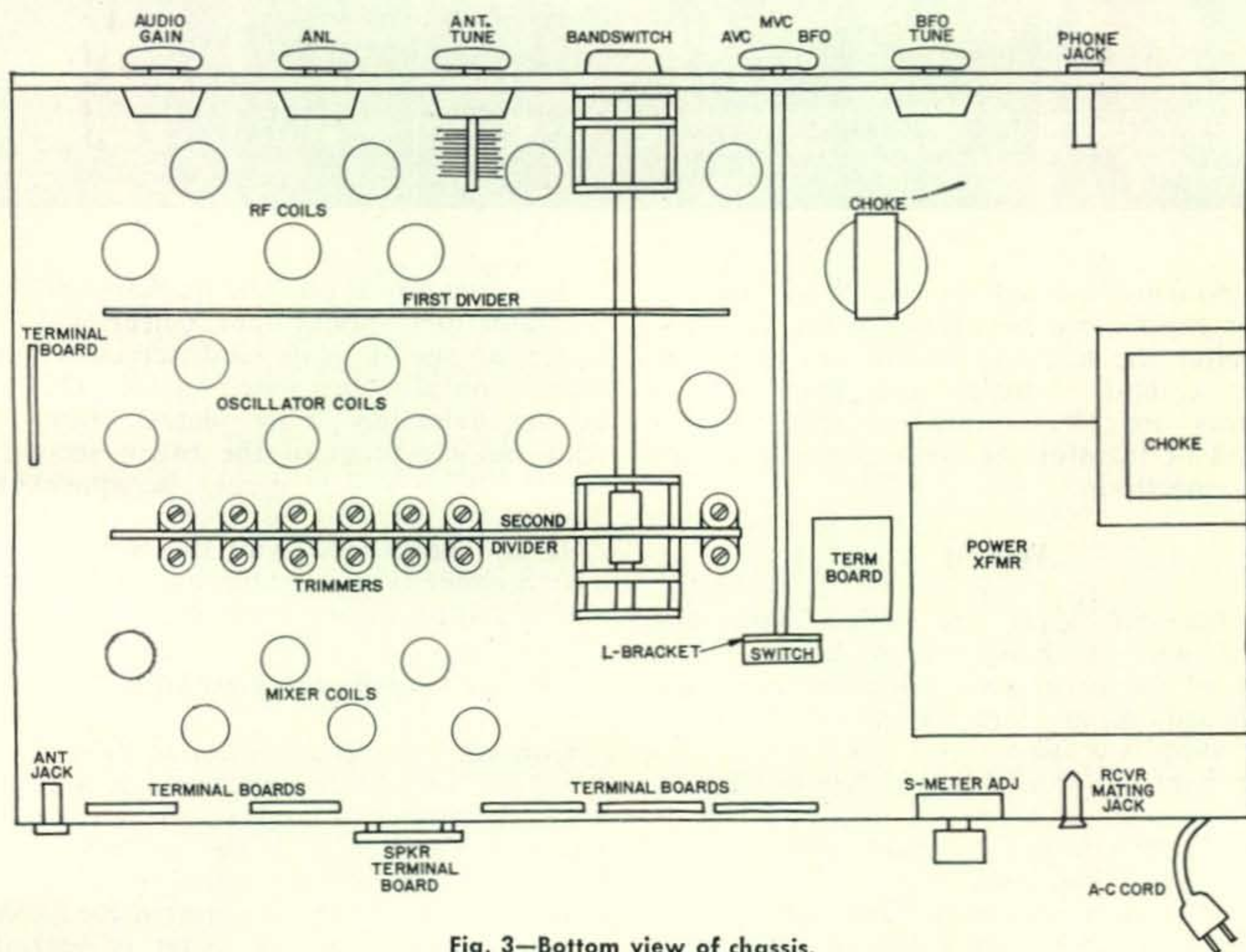

Fig. 3—Bottom view of chassis.

holes, drill, and mount with bolts and nuts. Use four mounting holes in the lower lip of each divider. The first divider should be about half way between the panel and the second divider.

Mount the L-shaped bracket on the bfo-avc-mvc switch at the same time. Be sure the shaft is at right angles to the panel.

Mount the power supply filter chokes where

there is room. One went horizontally at the side of the chassis, the other vertically on the bottom.

Most of the resistors are mounted on eight small terminal boards taken from a Command set BC-453 receiver, but there was no room for an oscillator or mixer board. Mount the boards close to their respective tubes for short leads.

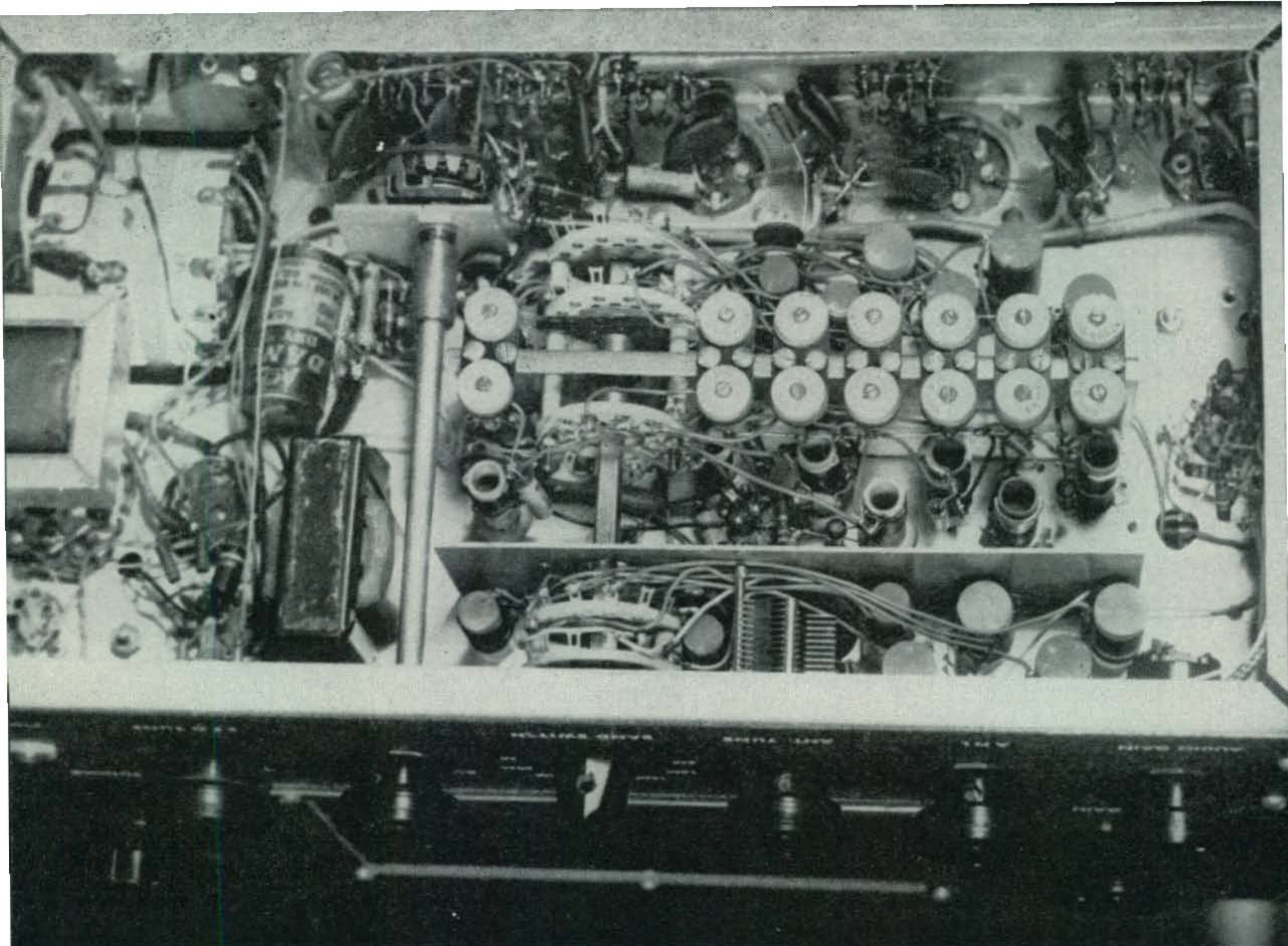

Components located on the back of the receiver chassis can be placed in the available space after the terminal boards are mounted.

Avc, cathode, screen, and plate bypass capacitors are all mounted directly on the tube and i-f transformer connections to assure short connections.

Wiring

All filament leads are wired with #18 stranded wire to handle high current. The balance of the wiring was telephone company switchboard scrap wire. Standard RETMA color coding was used.

First, wire the ac and power supply circuits. Shield with metallic braid, all long audio leads to the volume control, automatic noise limiter switch, and phone jack.

Filament leads are next. One side of the filament is grounded on a lug at each tube, the other side is run directly to the power transformer, as shown in fig. 5.

Then in order, wire the power amplifier, first audio, bfo, detector, avc, anl, first i-f stage, and second i-f stage.

Time to Test

Check B+ to B- with ohmmeter. Readings should be no lower than 50,000 ohms.

Turn the power on. The filament and voltage regulator tube should light. Check with a voltmeter to see if plate and screen voltage is present on all tubes wired so far. This should be approximately 220v plates, 100v screens with the exception of the 6BE6 second converter screen which should be approximately 20v dc.

If all checks out, wire the S-meter circuit. The S-meter is a valuable aid in later testing and adjusting of the receiver.

Apply the First Signal

Connect a signal generator to the primary of the 2 mc i-f transformer through a 10 mmfd mica capacitor and hook up the speaker to the receiver. Feed in a 2 mc modulated signal. With the gain on the signal generator wide open, the 2 mc i-f can is adjusted for maximum S-meter reading. As the meter is peaked, the signal generator gain should be reduced.

The three 85 kc i-f transformers are adjusted in a similar manner.

Tune the signal generator back and forth across the i-f frequency. If the S-meter shows more than one peak, one or more of the transformers are not tuned to resonance and should be retuned. Normally, the signal can be heard through the receiver when the gain on the signal generator is turned almost all the

Complete diagram of the super duper super.

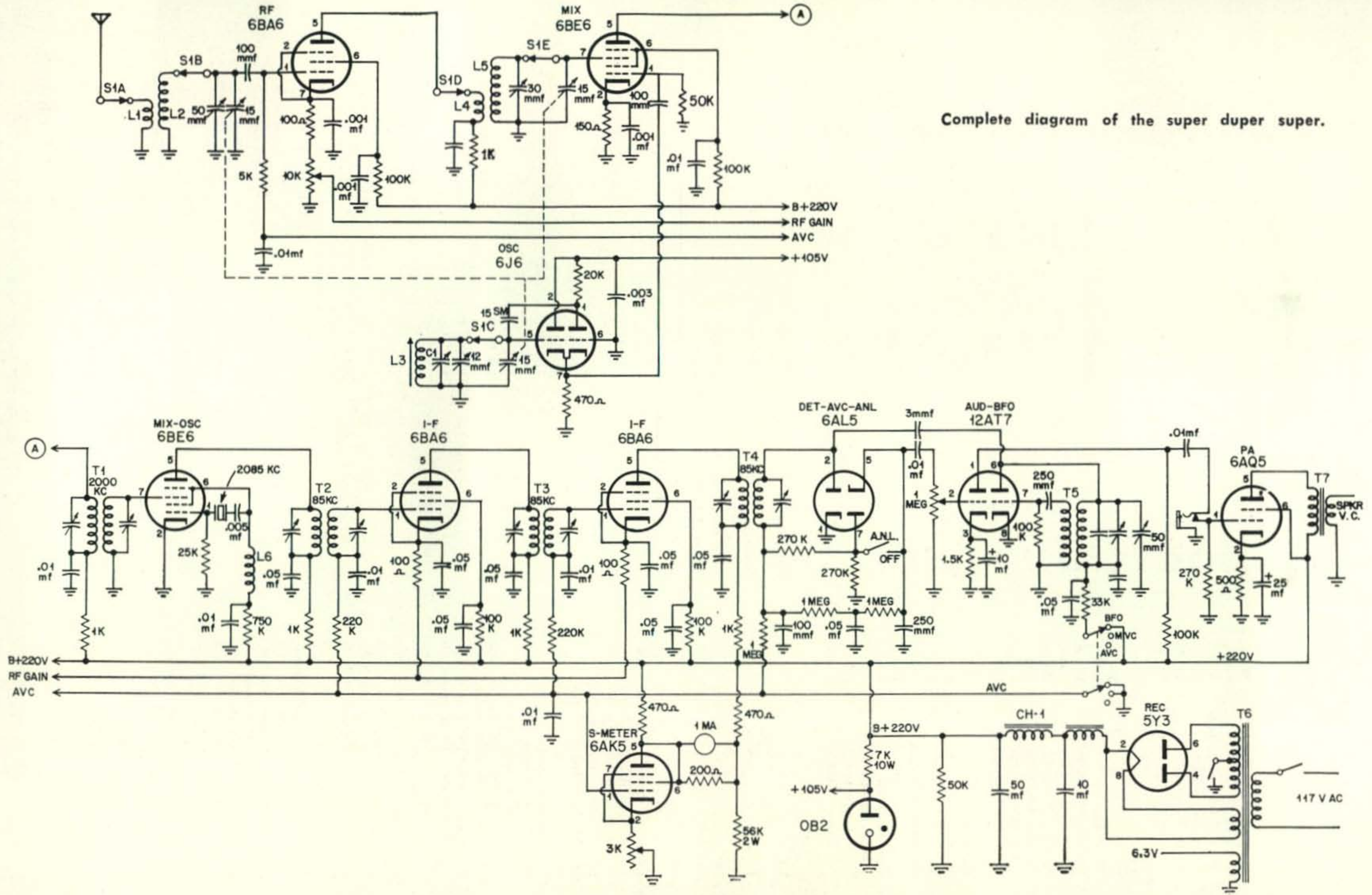

	6 METERS	10-METERS	15-METERS	20-METERS	40-METERS	80-METERS
L₁						
Turns	3	5	7	6	8	15
Wire Size	#26	#26	#26	#26	#26	#30
Spacing of Turns	Wire diam.	Wire diam.	Close spaced	Close spaced	Close spaced	Close spaced
Spacing From L ₂	Wire diam.	Wire diam.	1/16"	1/8"	1/8"	1/8"
Wound On L ₂ Bottom	Yes	Yes	Yes	Yes	Yes	Yes
Form Diameter	3/8"	3/8"	3/8"	1/2"	1/2"	1/2"
Form Length	1 1/4"	1 1/4"	1 1/4"	1 1/4"	1 1/4"	1 1/4"
Length of Winding	3/16"	3/16"	3/16"	3/16"	3/16"	3/16"
L₂						
Turns	5	9	12	14	33	60
Wire Size	#26	#26	#26	#26	#26	#30
Spacing of Turns	Wire diam.	Wire diam.	Close spaced	Close spaced	Close spaced	Close spaced
Spacing From L ₁	Wire diam.	Wire diam.	1/16"	1/8"	1/8"	1/8"
Wound Above L ₁	Yes	Yes	Yes	Yes	Yes	Yes
On Same Form						
Length Of Winding	1/2"	1/2"	1/2"	1/2"	7/8"	7/8"
L₃						
Turns	6	8	11	18	27	40
Wire Size	#26	#26	#26	#26	#26	#30
Spacing Of Turns	Wire diam.	Close spaced	Close spaced	Close spaced	Close spaced	Close spaced
Ceramic Iron Slug Form	Yes	Yes	Yes	Yes	Yes	Yes
Form Diameter	1/4"	3/8"	3/8"	3/8"	3/8"	3/8"
*C ₁ Silver Mica	None	15 mmf	10 mmf	30 mmf	45 mmf	15 mmf
L₄		Same as L ₁				
L₅		Same as L ₂				
L₆		1 Pie of 2.5 mh RF choke with turns removed to resonate at 2085 kc.				

PARTS LIST

Quantity	Capacitors	Resistors	Resistor Boards	Tube Sockets	Crystal	Switches	Other Parts
9	0.01 mfd 100 VDC Disc	3	270K 1/4 watt				
8	0.05 mfd 400 VDC Disc	3	1MEG 1/4 watt				
1	005 mfd 400 VDC Disc	1	1500 ohm 1/4 watt				
3	001 mfd 400 VDC Disc	1	33K 1/4 watt				
1	003 mfd 400 VDC Disc	1	500 ohm 1 watt				
1	100 mmf mica	2	470 ohm 1 watt				
2	250 mmf mica	1	200 ohm 1/4 watt				
1	15 mmf silver mica	1	56K 2 watt				
1	10 mf 100 VDC Electrolytic	1	50K 25 watt				
1	25 mf 100 VDC Electrolytic	1	7K 10 watt				
1	10 mf 400 VDC Electrolytic	1	3K WW 1 watt Pot				
1	50 mf 400 VDC Electrolytic	1	1MEG Pot Audio Taper with Switch				
1	3-section variable capacitor 25 mmf/section (BC-1206)	1	10K Pot WW 1 watt				
1	50 mmf variable ANT. TUNE						
1	25 mmf variable BFO TUNE						
6	3 to 12 mmf trimmers NPO (Osc)						
6	5 to 30 mmf trimmers N750 (Mix)						
1	3 mmf mica						
	Coil Forms						
1	1/4" iron slug core, ceramic						
5	3/8" iron slug core, ceramic (1 more if MARS band used)						
6	3/8" by 1 1/4" polystyrene rods						
6	1/2" by 1 1/4" polystyrene rods (2 more if MARS band used)						
	Resistors						
1	115K 1/4 watt						
6	100K 1/4 watt						
3	100 ohm 1/4 watt						
5	1K 1/4 watt						
1	150 ohm 1/4 watt						
1	20K 1/4 watt						
1	470 ohm 1/4 watt						
1	25K 1/4 watt						
1	750K 1/4 watt						
2	220K 1/4 watt						
			Resistor Boards				
			8				
				Tube Sockets			
				10	7 pin min. tube sockets		
				1	9 pin min. tube socket		
				1	8 pin min. tube socket		
					Crystal		
				1	2085 kc crystal in small can		
					Switches		
				1	2-pole, 3-position with 8" shaft and 1/4" coupling		
				1	SPST rotary		
				1	7-position with 7" shaft and 1/4" coupling		
				5	1-pole, 7-position ceramic wafers		
					Other Parts		
				1	2 mc i-f Transformer		
				3	85 kc i-f Transformer (from BC-453)		
				1	85 kc bfo can (from BC-453)		
				1	2 watt output transformer		
				1	power transformer, 300v 90 ma 5v 2a, 6.3—4 A.		
				1	S-meter, 0-500 M amp		
				2	2H 70 ma choke		
				1	closed circuit phone jack		
					Chassis 7" by 13" by 2" aluminum (BUD or ICA)		
					Panel 7" by 14" steel (BUD or ICA)		
					Cabinet 7" by 14" by 8" (BUD or ICA)		

way down.

Wire in the 6J6 first converter oscillator.

NOTE: The procedures that follow will be used to construct and test each band.

The six-meter band oscillator is wound as indicated in Table I. It can be hand wound on a 1/4" diameter ceramic slug.

Install the coil as close to the 6J6 as is practical. Turn the power on again and check the tuning of the oscillator by listening on an accurately calibrated receiver or with a calibrated wave meter. It should tune from 48 mc to 52 mc.

If the oscillator tunes too high, adjust the iron slug in the oscillator coil to bring the frequency down. If this does not put the oscillator on the right frequency, some fixed capacitance may have to be added by cut and try method (with small capacitors), or by adding more turns to the coil.

If the oscillator tunes too low, try adjusting the iron slug. If this is not enough, spread the turns on the coil form. If still not enough, try removing one or two turns and retuning.

When the oscillator tunes the right frequency, it is time to wire the mixer. Mixer coils were wound on polystyrene rods according to Table I. Cut the rods to the right length, as given in the table. Also find the brad spacing as determined by the length of the winding listed, and find the space between coils if more than one is to be wound on one form.

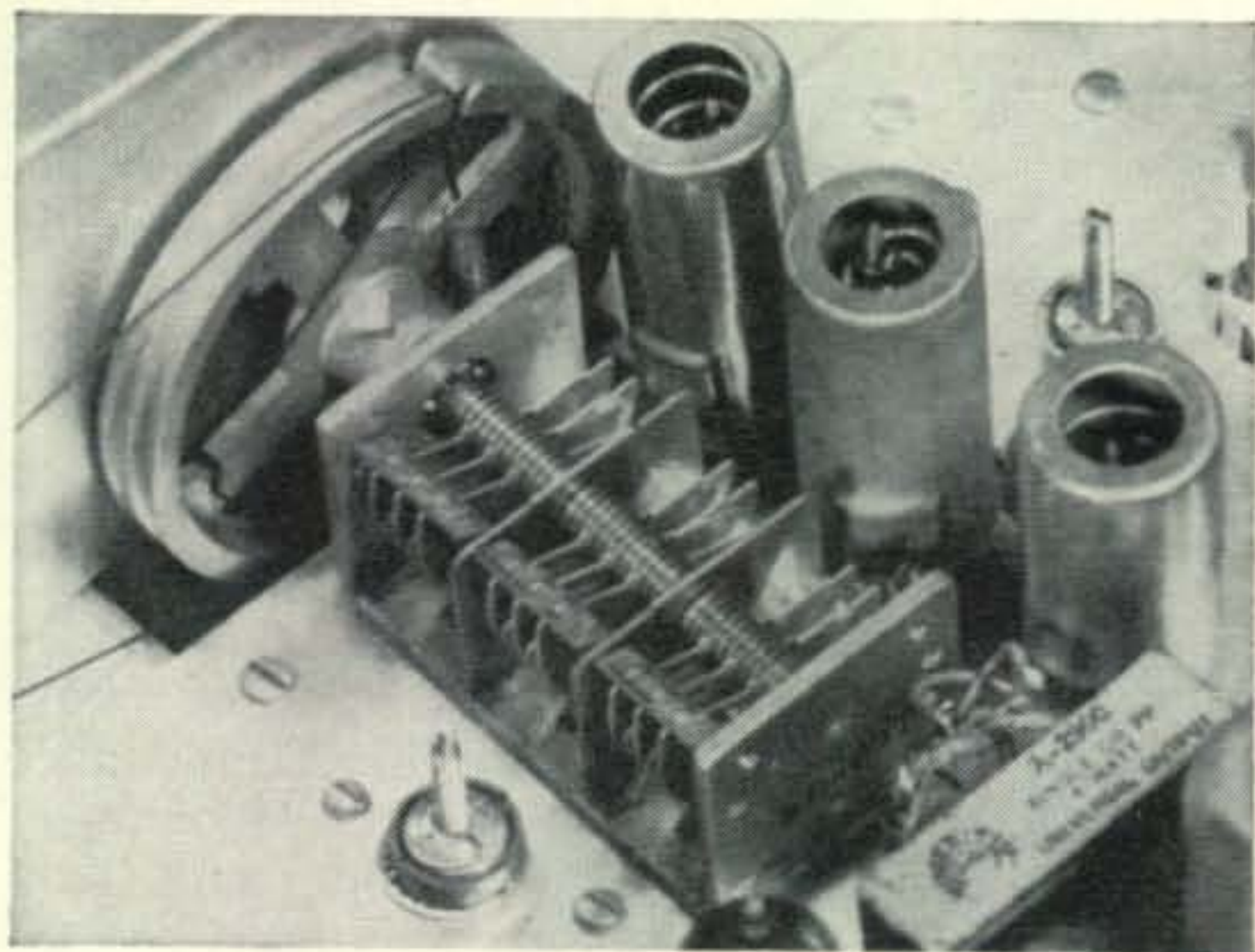

Tuning condenser showing the plates retained. Behind, from left to right, are the 6BA6, 6J6, and 6BE6

These rods were tapped for 4-40 screws for mounting. Then tin and sink coil holding brads in the rod. Avoid using small-diameter drills for brad holes, as they may easily be broken (see "They Melt" in this issue, for an easy system). With reasonable care, there should be little trouble with larger drills for the mounting tap.

Leave the head of the brads about 1/16" above the rod. Scrape insulation from the end of the wire and wrap the wire around the brad. Solder them quickly so the polystyrene is not

heated too much.

If a coil does not require many windings you may twist the rod with one hand and feed the wire with the other. If many windings are needed, insert a screw stud in the tapping hole and tighten a hand-drill on the stud. Put the drill handle in a vise. Turn the drill crank with one hand and feed the wire with the other.

NOTE: Don't answer the phone half way through or you'll have to start over again for sure!

Cut the wire at the correct number of windings, and hold the coil tight so it doesn't unwind. Remove insulation from the end of the wire, wrap it around the brad, and solder quickly as before. When through, paint all coils with coil dope.

Test the wired 6BE6 first converter with a voltmeter to see if the plate voltage is 200-250v and screen voltage is 80-100v. If ok, the mixer should be tuned.

Connect the signal generator to the plate of the 6BA6 through a 10 mmfd capacitor. Use minimum gain to get sharpest tuning. Feed in the signal at 50 mc and tune the receiver until the signal is heard through the speaker and seen on the S-meter. Adjust the trimmer capacitor for maximum S-meter reading.

Set the signal generator at 54 mc and repeat the procedure above but at 54 mc.

NOTE: S-meter reading for 54 mc will be different from the 50 mc reading. But if the 54 mc reading is very low, readjust according to "Readjusting Mixer Trimmer", in this issue. When the mixer stage is satisfactory proceed to the rf stage.

Wire the rf stage. Test by feeding a generator signal into the antenna jack through a 10 mmfd capacitor. Check at 50 mc and 54 mc as for the mixer, above.

RF coils are wound on polystyrene rods identical to those of the mixer, as given in Table I. Do not worry about critical adjusting as with the mixer. This is done with the variable capacitor called **Antenna Tune** on the front panel.

The six-meter coil is mounted closest to the 6BA6 and bandswitch wafer S1b to eliminate long leads.

Other Bands

Use this outline for each band:

1) Oscillator is tuned to the frequencies given in Table II using another receiver to pick up the signal.

2) Mixer is tuned to the frequencies given in Table II. If adjustments are needed, see "Readjusting Mixer Trimmer," in this issue.

3) RF stage for each band is wired and tested.

[continued on page 153]

A 4CX1000A Linear Amplifier

(A Calm, Cool, Casual, Kilowatt)



Irwin R. Wolfe, W6HHN

3467 Rambow Drive
Palo Alto, Calif.

This is an age of specialization! As in other fields, the trend in the electronics industry towards specialization has become more and more evident in recent years. It permits a higher degree of efficiency for a device and is often less costly and more compact than a general purpose item.

In amateur communication equipment this trend is noticeable in the greater popularity of the amateur band receiver over the general coverage types. There are also many power amplifiers being marketed that are designed for linear operation only. These amplifiers all use general purpose tubes with operating values adjusted for class AB operation. In conforming with the general trend toward specialization, the 4CX1000A has been designed specifically for use as a linear amplifier. It is a high permeance tube requiring rather low plate voltage for efficient performance. This permits a saving in high voltage power supply component costs and minimizes high voltage insulation problems.

This tube was found to have good linearity characteristics, was easy to drive and had more than adequate rated anode dissipation for maximum power operation.

It is an external anode ceramic tube that is half the size of a general purpose glass tube of similarly rated anode dissipation. The 1000 watt linear amplifier described here, was built to use this tube solely as a SSB amplifier. The components for the amplifier and the power supplies were selected to handle the actual power requirements encountered with SB voice modulation. This, incidentally, permitted using lower wattage units than would be necessary in other modes of operation since the power duty

cycle of voice transmission is less than 50% of sine wave modulation.

The grid can be driven directly from a side-band generator that can deliver about 25 watts. It can also be driven by a very low (5 to 10 watts) powered exciter through selectable tuned grid circuits. The compactness of the tube and components enabled the amplifier to be built into a small enough unit to possibly interest the high power mobile operators. A separate power supply is used which connects to the amplifier through a multi-wire cable. The amplifier is a comparatively light weight job and is smaller than the average communications receiver.

The output circuit employs the familiar pi network. The values were selected to obtain a minimum Q of 12 at a tube load impedance of 1500 ohms and an output impedance of 52 ohms. Fairly high values of input and loading capacitors were required. The input capacitor chosen was an extremely compact vacuum variable with a voltage rating of 5000 volts and a capacity range from 5 to 500 mmfd. The output loading capacitor is an air spaced variable with a maximum capacity range of 1500 mmfd. At 3.5 mc a 1000 mfd fixed capacitor is connected in parallel with the loading capacitor by the bandswitch.

The coil used in this circuit is made of edge-wise wound copper ribbon. Adjustable taps connect from the coil to the bandswitch and the switch progressively shorts more of the windings as the higher frequency bands are selected. The frequency range covers the amateur bands from 3.5 to 29.7 mc. A 52 ohm low pass filter and directional coupler are installed between the loading capacitor and the co-axial

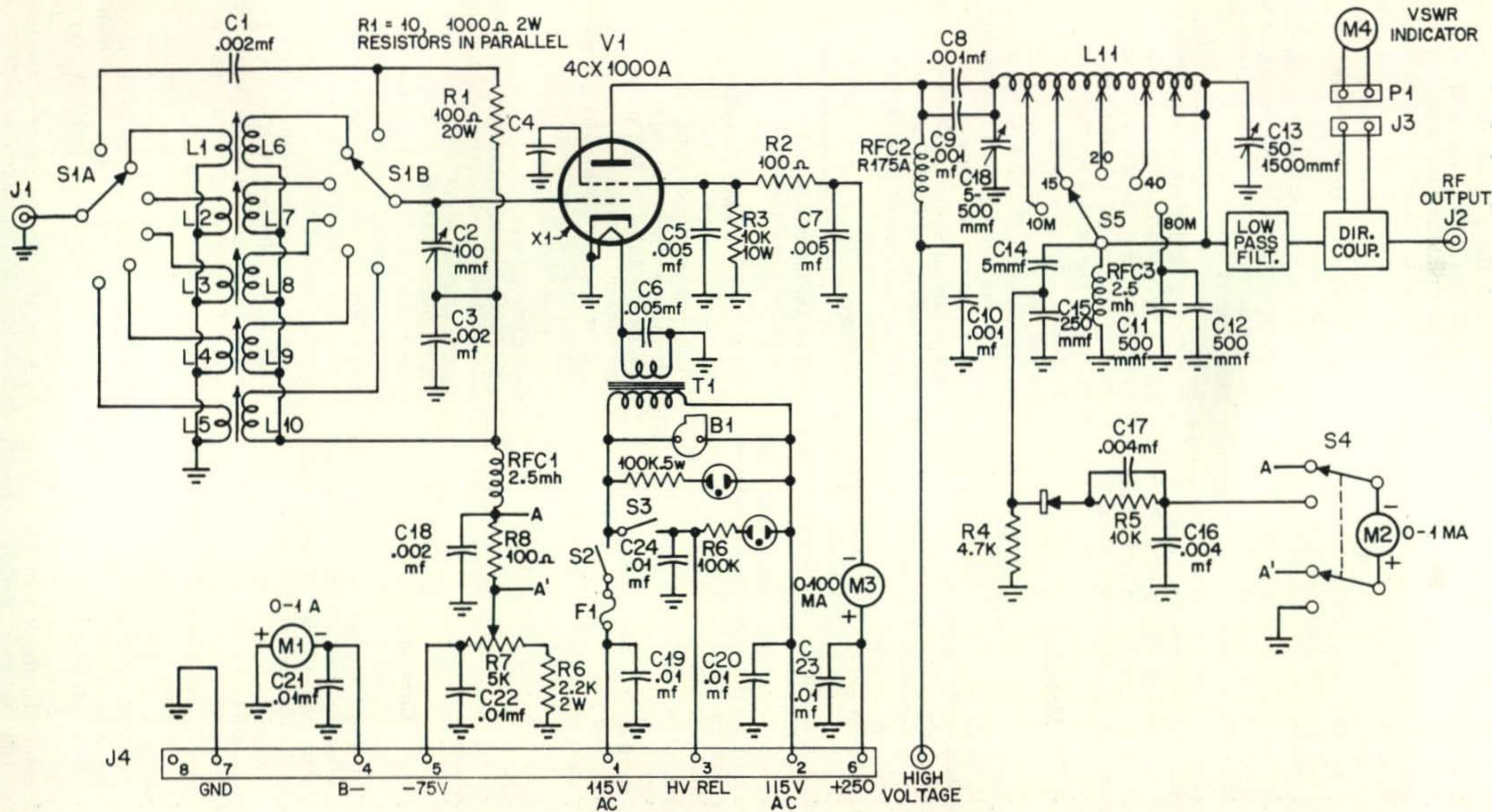

Fig. 1—Circuit diagram of a kilowatt final employing a 4CX1000A.

output terminal for the antenna. A shielded microphone type of receptacle on the rear of the amplifier is provided to connect to a SWR indicator.

As previously mentioned, the input circuit can be selected for either direct drive or through a tuned circuit bandswitch. In the direct drive position, the exciter voltage is capacitively coupled to the grid and a 100 ohm terminating resistor connects from grid to rf ground. In the tuned grid position, a band selector switch chooses any one of five slug tuned coils. These coils all have coupling links that connect to the rf input through the grid bandswitch. A 100mmfd variable capacitor is used to resonate the grid coils. The grid coils are of the miniature type, but are adequate, since very little power is handled.

Metering

Three meters are used, with one of them doing double duty. The plate and screen currents are continuously monitored. A 10,000 ohm resistor is connected from the tube socket screen terminal to ground. This will cause the screen milliammeter to read 25 to 30 milliamperes when screen voltage (250 to 300 volts) is applied. With low rf excitation the screen current becomes negative and the indicated screen current will go towards zero.

With increasing excitation, the screen current increases to a positive value and adds to the "resting" screen current. A switch selects the O-1 milliammeter to read either grid current or comparative amplifier output. In the GRID position, a one ohm resistor is placed in parallel to the O-1 milliammeter to increase its range to 5 ma. full scale. A sampling of the rf output is obtained by a capacity divider from the rf output to ground and this voltage (about 2 volts) is rectified by a germanium diode, filtered and applied to the O-1 milliammeter when the selector switch is in output position.

Controls

The lower left hand toggle switch marked ON-OFF, applies ac line voltage to the filament transformer and blower. It also applies line voltage to the bias and screen rectifier and to the high voltage rectifier tube filaments. A neon indicator lamp above the switch indicates when the switch is ON. The toggle switch to the right marked STANDBY-TRANSMIT, connects both the screen and high voltage to the tube when it is in TRANSMIT position. An indicating neon lamp above it lights when it is ON. The control to the right of the STANDBY-TRANSMIT switch is the grid tuning capacitor and directly above it, the grid coil band selector. To the left of the O-1 dc milliammeter, the selector switch connects

the meter to read either Grid current or rf Output. To the right of the meter, a control potentiometer adjusts the grid bias voltage to the proper plate resting current. The right side of the panel has the controls for the pi-network tuning. The vacuum plate tuning capacitor is operated by a counter type of dial and the loading capacitor uses a friction type of vernier dial.

The pi tuning coil switch is marked for the bands from 3.5 to 28 mc. As can be seen from the photograph, the chassis containing the tube and rf components is set back a few inches from the front panel. The filament transformer and meters as well as the power control circuits are in this area and are shielded from the rf field. An aluminum cover encloses the top and sides to complete the amplifier shielding. The blower is attached to the chassis containing the grid circuit and tube socket. Rubber is used in its mounting to reduce blower noise. With the base plate in place, the grid chassis is completely closed and is under pressure from the blower. The air escapes through an air system socket designed for this tube, cooling its base and anode. A chimney helps direct the air flow directly to the tube anode cooling fins.

All power leads enter the chassis through an eight terminal heavy duty receptacle at the rear of the amplifier and are all by-passed to ground there to minimize TVI.

Power Supplies

The power supplies for the amplifier are built in two units. The high voltage supply is built into a 12½" x 19" panel and the regulated screen and bias supply is built into a 7" x 19" panel. Both units are mounted into a 21" x 19" cabinet which may rest on the floor. Each supply has a dc voltmeter. An 8 wire cable connects it to the Linear Amplifier, with the high voltage lead run separately along the multi-wire cable. The high voltage rectifier uses a pair of 866A rectifiers with a single section filter. The filter capacitor is made large enough to provide sufficient current storage for the peak current demands.

The power supply for the screen uses electronic regulation and the voltage range is adjustable from 200 to 350 volts. The bias supply uses a line isolation transformer and a half wave selenium rectifier. An LC filter is used with a gas discharge tube for voltage stabilization. Overload protection is provided by an over current relay in the negative return of the plate transformer to ground. This relay is shunted by a rheostat that may be adjusted to make it operate at any pre-determined current value. The screen, bias and high voltage primary circuits are all fused. A 30 ma bleeder is connected from the high voltage to ground to keep the filter capacitors discharged with

[Continued on page 151]

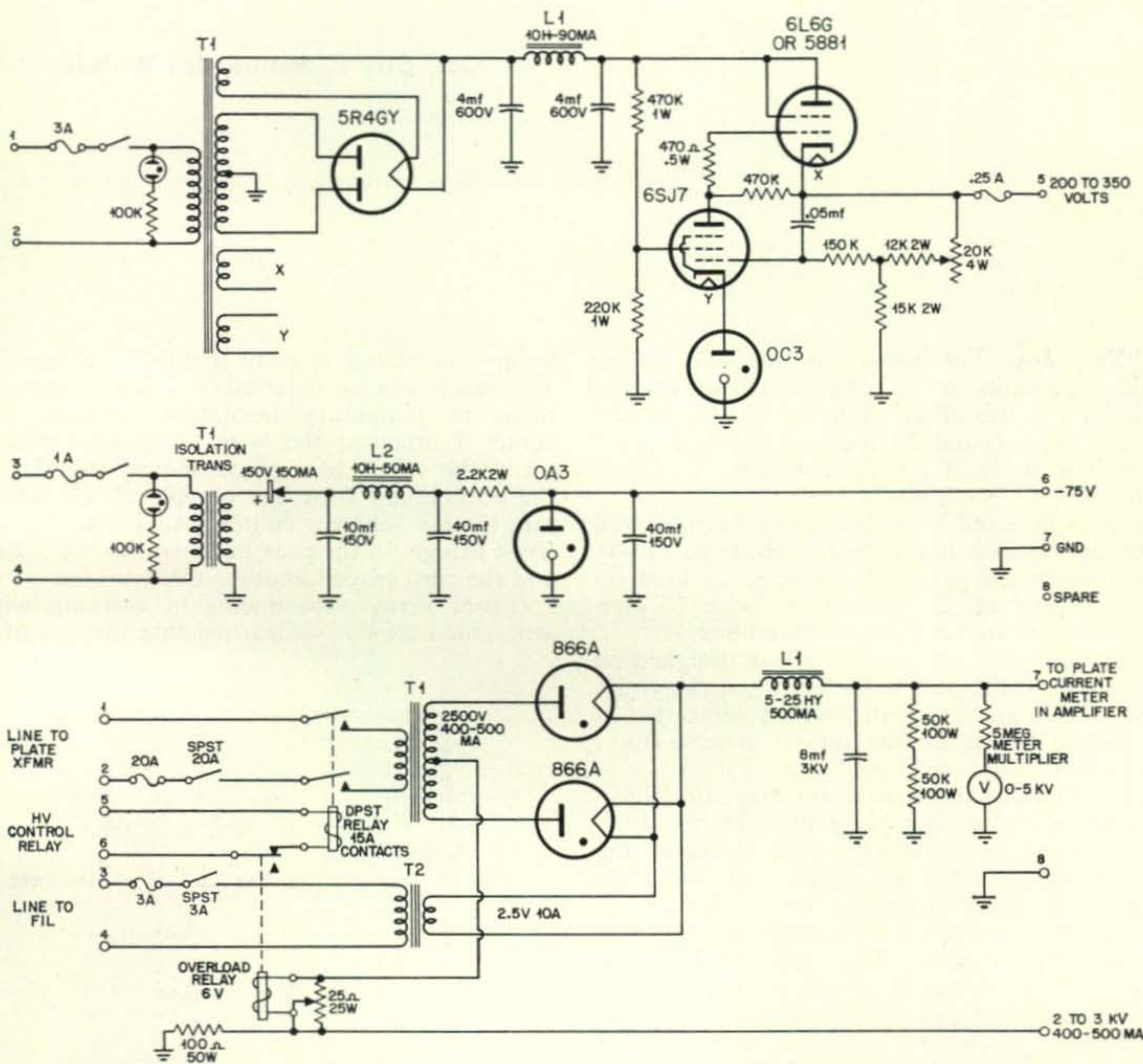
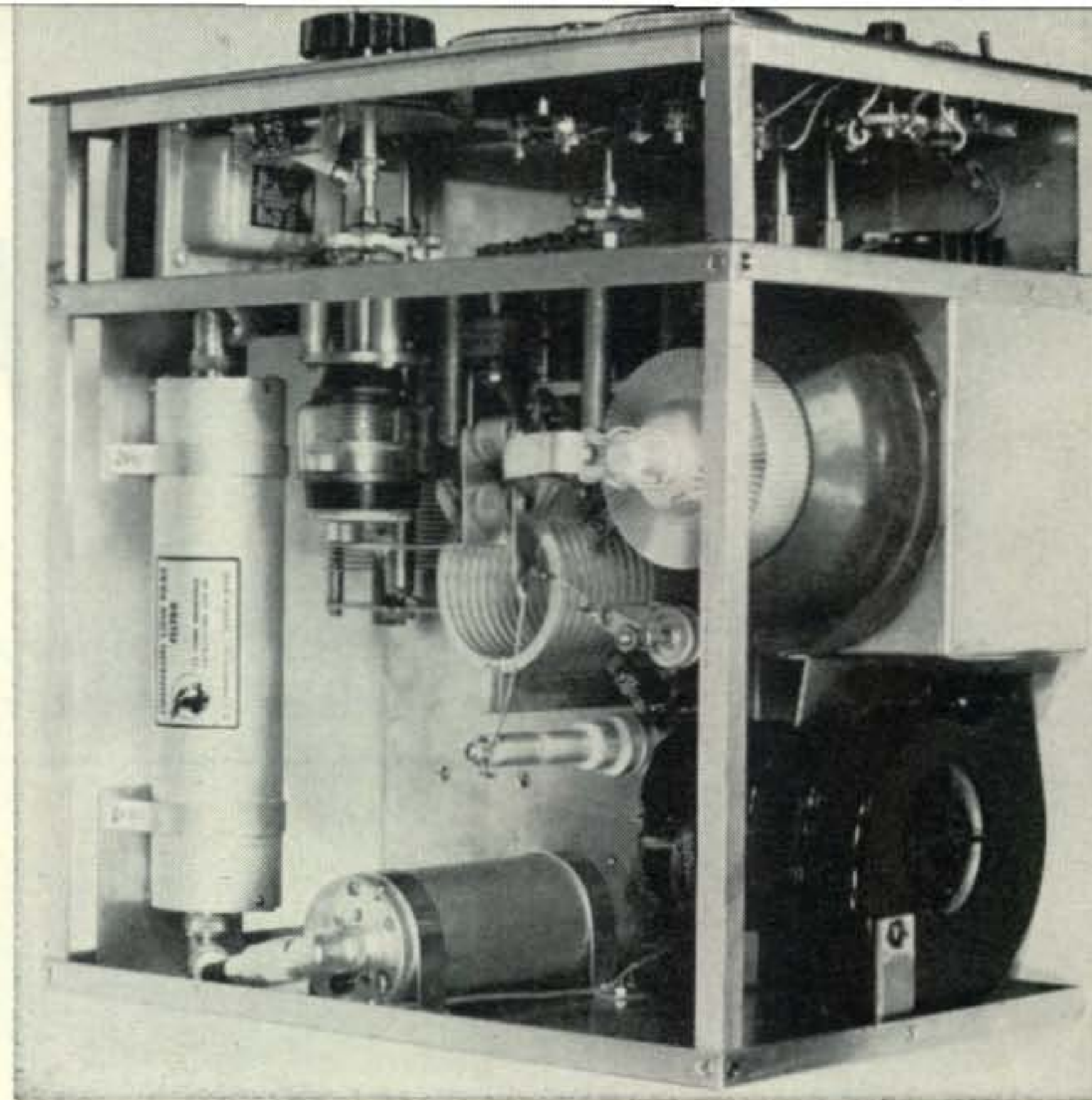
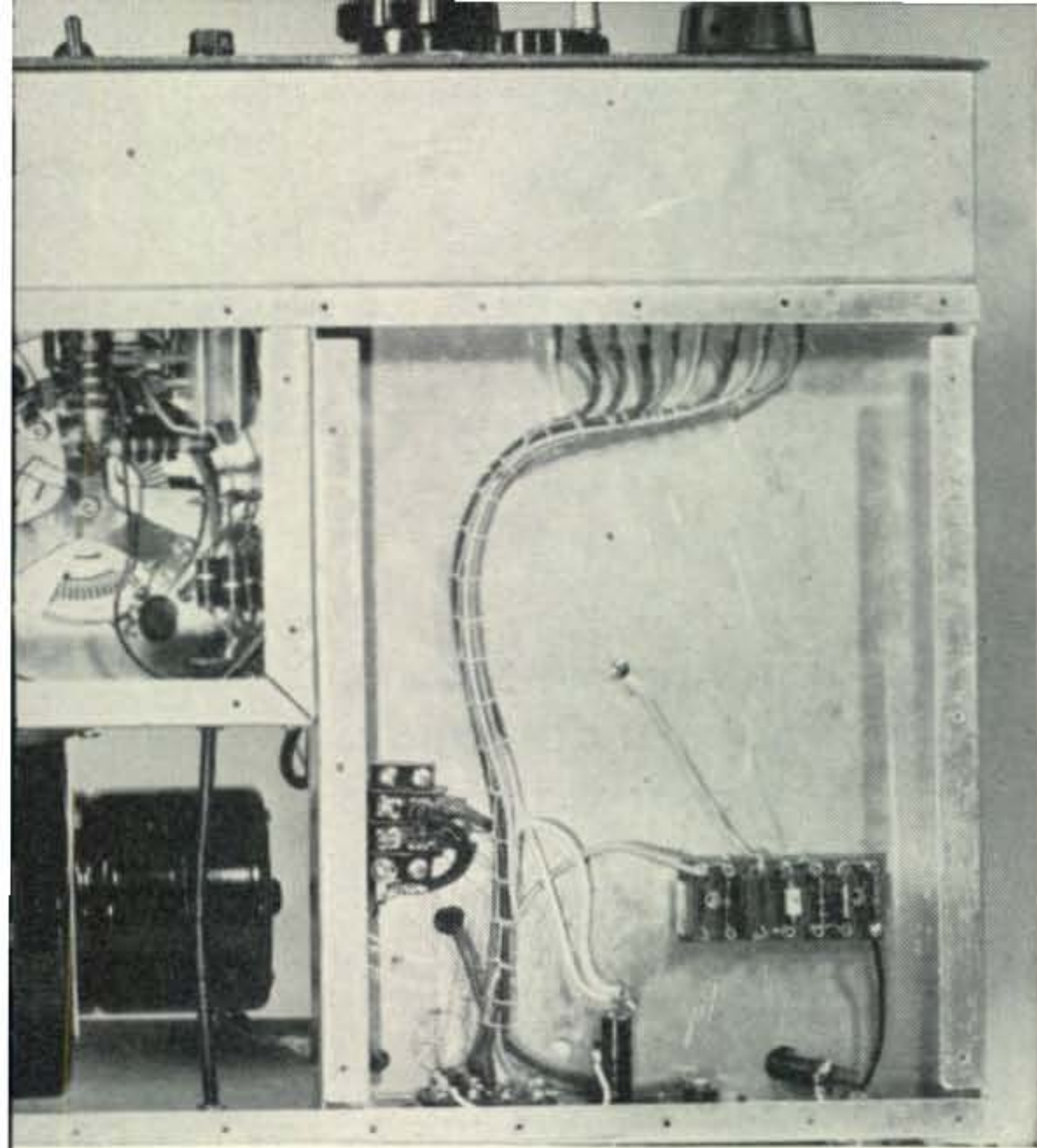

Fig. 2—Circuits of the screen, bias and high voltage supplies. The screen supply is electronically regulated and the bias supply is stabilized. The high voltage B minus and B plus terminal designations are reversed. (#7 & 2-3 KV)

An Allband Attic Antenna

Here is a bright ray of hope for the amateur who can't erect an outdoor antenna and wants to work all bands.

Cdr. Gay E. Milius, Jr., W4NJF

3445 S. Wakefield Street
Arlington 6, Virginia

"Yes, Joe, I'm using an antenna in the attic . . . thanks for the compliment on the signal, Joe . . . this affair works on 10, 20, 40 and 75 . . . yes, I said 75 too . . . guess I could have built in 15 if I had wanted to . . . how's it made? . . . well, it's like this . . ."

It's an inverted V on 20 meters, trapped and extended to look like a duck's wishbone on 40. It's further trapped and extended to load on the high end of 75 and it's fed with 75 ohm twin lead through a Johnson Matchbox.

Although this attic antenna was designed on paper by W3FZ and W3WXA to work on 20, 40 and 75 meters, I discovered later that it loads and functions fine on 10 meters. But I don't know why.

As all attics vary in size and shape the physical length of the wire is peculiar to my situation and won't be discussed here. However, the method of construction, tuning, and the traps should not differ from one installation to another. The traps act as insulators for their respective frequencies. They also shorten the physical and electrical length of the antenna while the overall length is further modified by the angles which you will have to put in the wire to get it in the attic.

I started by stringing a 20 meter dipole, using 7-22 bare antenna wire, parallel to the rafters at one end of the attic (fig. 1). The feed

point was placed directly under the ridgepole. The result was an inverted V. I used pieces of lucite as temporary insulators while in the center I attached the wires to a coax fitting set in the center of a piece of poly (fig. 2). In the preliminary feed line of RG 59/U, which ran to the Johnson Matchbox, I inserted an SWR bridge. In the coax between the Matchbox and the rig I placed another SWR bridge.

(From many experiments in working with attic antennas I have learned that the use of a

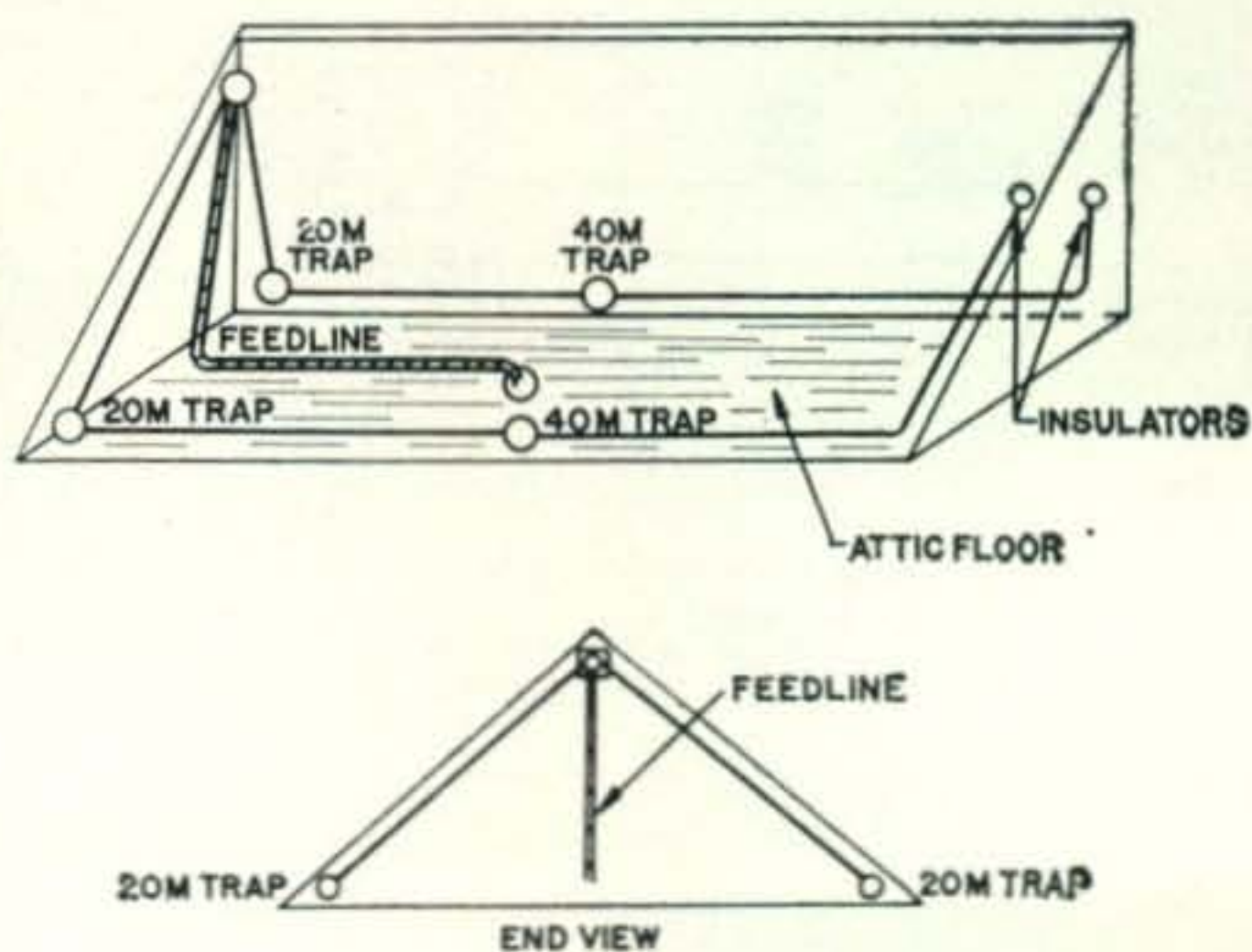

Fig. 1

grid-dip meter with or without an antennascope is not very satisfactory. It is usually difficult to reach the center of the antenna, the proximity of surrounding matter may cause unbalance, and the grid-dipper must continually be checked against some frequency meter or a well calibrated receiver.)

By patiently trimming the antenna I achieved a flat line as indicated on both bridges. Incidentally, I did not cut the wire. I folded it back so that it could be extended later if necessary. I found that when the antenna was a certain length both lines would be flat at the desired frequency. As soon as this length was reached I replaced the temporary insulators with traps.

The traps are inductances parallel tuned for 14.150 mc. I started making them by hacksawing a section of ten turns from an Airdux 2006T coil (fig. 3). One turn at either end I used as leads. I used a piece of poly about 4½ inches long and a little less than 2 inches wide for the supporting insulator. A piece of poly rod 1 inch in diameter and 4½ inches long will do. I bored two holes at either end of the poly: one about ½ inch from the end and the second about ¾ inch from the first. The outer holes are larger than the inner holes because the antenna wire is fed through them to make connection with the trap. Then I inserted the leads from the coil into the inner set of holes and bent them under and through the outer holes. I laid a 37 mmfd capacitor, 3 KV (or higher rating for power over 200 watts), on the supporting insulator, inside the coil, and soldered it across the coil. With the hacksaw I carefully loosened ¼ turn of the coil on each end so that it could be bent outward for fine adjustment (as shown in fig. 3).

It proved necessary to place the trap in a clear spot away from any metal when grid-dipping it for the center of the 20 meter band. For close adjustment I bent outward the free end ¼ turns. For the second trap I made a Chinese copy of the first. When finished, they had 7½ turns.

With the 20 meter traps attached, I checked the array for 20 meters. There should have been no change in the previous loading adjust-

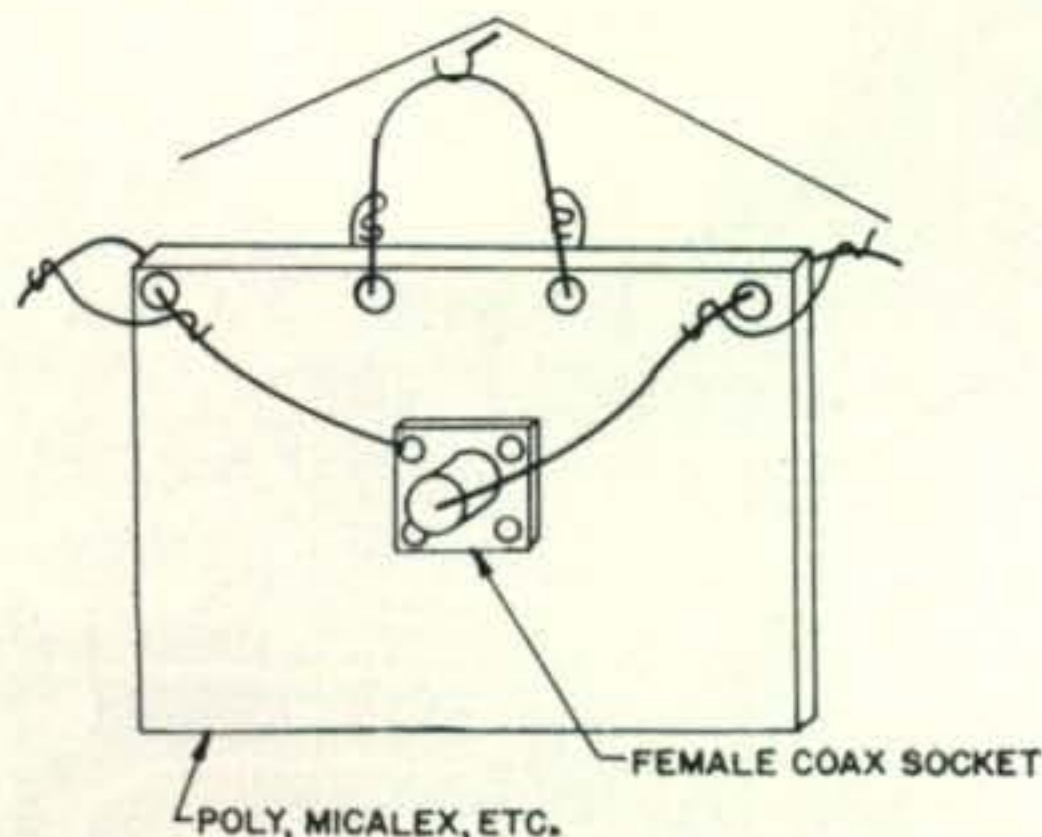

Fig. 2

ments at the Matchbox or transmitter. And there were none! So I added about 10 feet of 7-22 wire to each of the traps and stretched it out, being careful not to make sharp bends. (All the bends were made with a radius greater than 4 inches.) I adjusted this system for the center of the 40 meter band by shortening the wire I had added. The 40 meter section coming at right angles to the 20 meter inverted V and parallel to the attic floor gave the duck's wish-bone design.

When the 40 meter section was adjusted I added the 40 meter traps at either end. They are fashioned in the same manner as the 20 meter traps. I cut a section of Airdux 2408T coil about 13 turns. The insulator was made the same size as before. This time I used a 47 mmfd capacitor. The finished coil emerged as 11 turns. I grid-dipped it and set it for the center of the 40 meter band. A Chinese copy was easy to construct.

With the traps in place I tested the antenna on 40 meters. Again, there should be no change in adjustments if the traps were tuned correctly, and, again, I found none. I guess I was lucky.

Next, I added to each 40 meter trap one half of the remaining wire from my original 100 foot roll of 7-22 and stretched it around the attic fastening an insulator at the ends. Don't worry, you probably will have too much wire anyway because I found that I had to fold up almost 4 feet from either end to bring the resonance from 3.56 mc to 3.95 mc.

(Will some genius devise a means for me to add more wire when I want to QSY down to the lower depths of 80 meters? I'm tired of continually climbing up into the attic to unfold the ends of this antenna.)

When I had the entire thing adjusted to my satisfaction, I crossed my fingers and replaced the coax with .75 ohm transmitting twin-lead. (It was simple to solder a male coax fitting to the end of the twin-lead.) I was anxious to effect a balanced feed line to the Matchbox. Apparently I achieved my goal as I found no difference in loading and I cannot light neon bulbs on the feeders.

This antenna is quite broad on all bands except 75 meters. It has resulted in many contacts which I'd not have been able to make with other clumsy indoor devices. I was really intrigued when it loaded across the 10 meter band and worked out well although quite directional broadside. I surmise that if someone wanted to include 15 meters he could do so by starting with a 15 meter dipole and inserting 15 meter traps before the 20 meter traps. ■

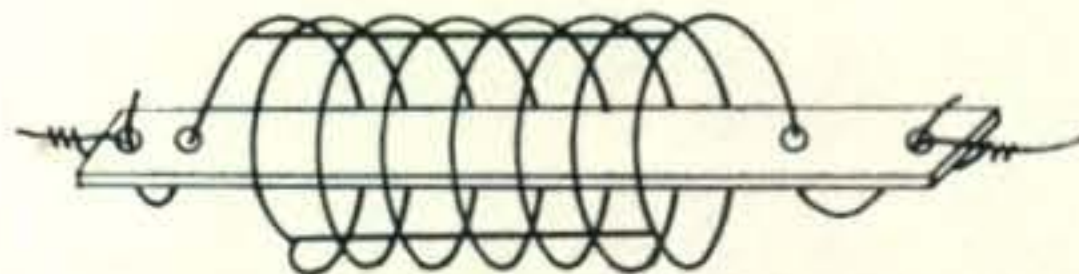

Fig. 3

One tube walkie-talkie

Anthony J. Kalilich, W8WLM

Box 2236
Cleveland 9, Ohio

Let's go portable! Here is a easy to build portable Walkie-Talkie unit using one tube, with approximately a 3 mile range on 10 meters. This unit is a separate receiver and transmitter Walkie-Talkie using only one tube which is manually switched from one circuit to another with the use of a 6 pole, 2 position lever or rotary switch. The switch is mechanically mounted on a 3" X 4" printed circuit board, which contains the circuitry and mounting supports for the necessary parts to comprise the main section of the unit.

Transmitter

The transmitter circuit is the equivalent of an xtal controlled tri-tet oscillator-frequency doubler, in this case operating on 10 meters.

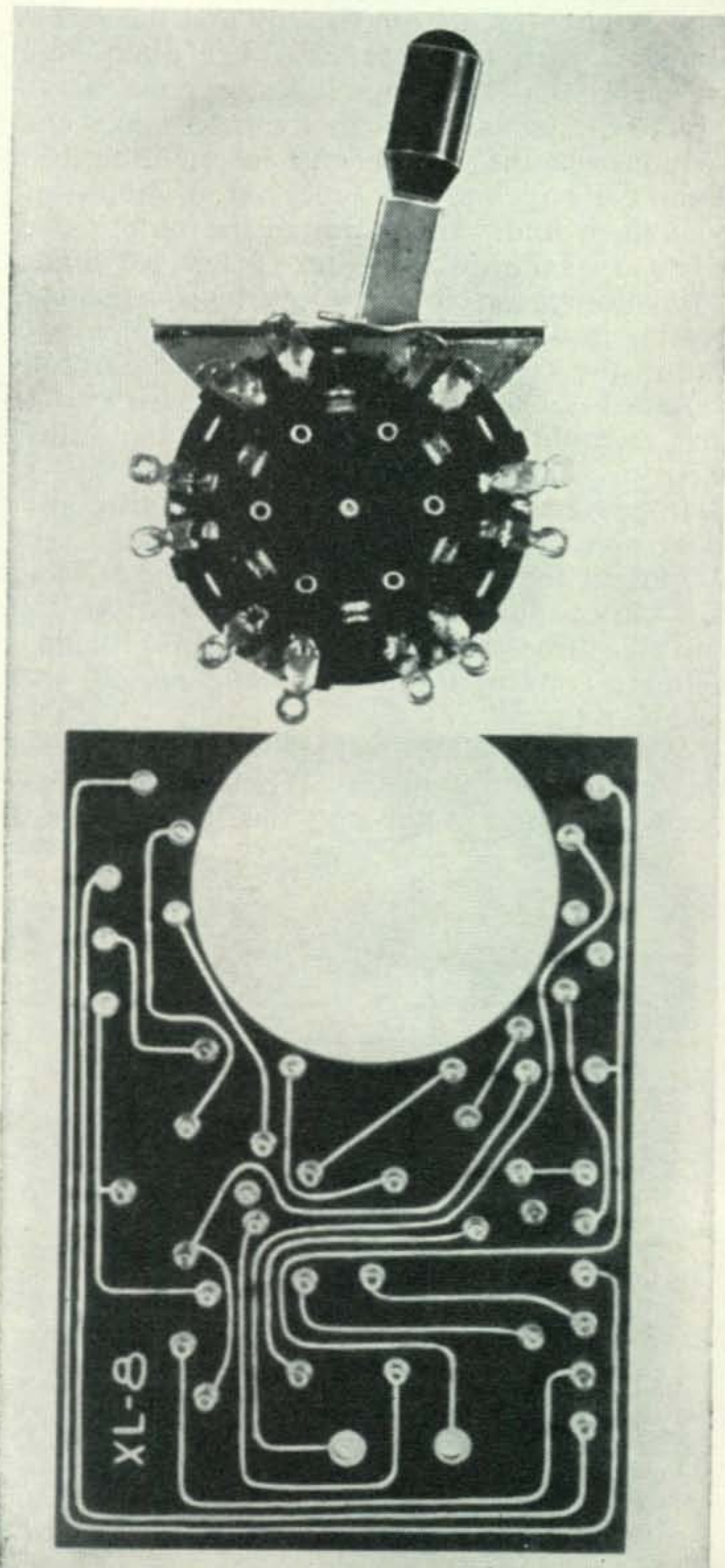

A 20 meter xtal is used, which is doubling to 10 meters in this unit, however, a 40 meter xtal can be used, and the frequency quadrupled down to 10 meters with just as good results. To operate on 6 meters, the unit would double, using a 25 megacycle xtal for best performance. To change bands, the cathode coil, and the plate coil would have to be changed and the antenna shortened. Modulation is accomplished by varying the suppressor grid voltage. The grid being biased 7.5 volts negative, with the secondary of the mike transformer connected in series, adds and subtracts from this bias voltage, thereby resulting in modulation of the carrier. This method provides ample modulation for this unit, with good quality.

Receiver

The receiver circuit is a super-regenerative self-detecting unit, one of the most sensitive receiver circuits known. The ear phone is used as the plate load of the tube, thus it should

be at least 1000 ohms or more to operate properly. The microphone is a standard F-1 cartridge. If it is desired to operate a mike handset instead, a phone jack can be mounted on the box and a fixed plate load of 1000 ohms or more can be used, and capacity coupled to the ear phone. The mike circuit can be the same, but a shielded cable should be used with this arrangement.

The regeneration control is a 1 meg pot with a DPST, switch (S2&S3) mounted on the back of the pot (R-3). This switch turns the unit on and off.

The receiver coil is wound on a 1/2" form, (close-wound), with the feedback coil wound over it, so that the plate and the grid ends of the coils are over each other. These coils are wound in the same direction and in phase with each other, thereby causing the circuit to oscillate.

The antenna link coil is loosely wound over the coil form so that it can be moved up and down the coils for the best performance.

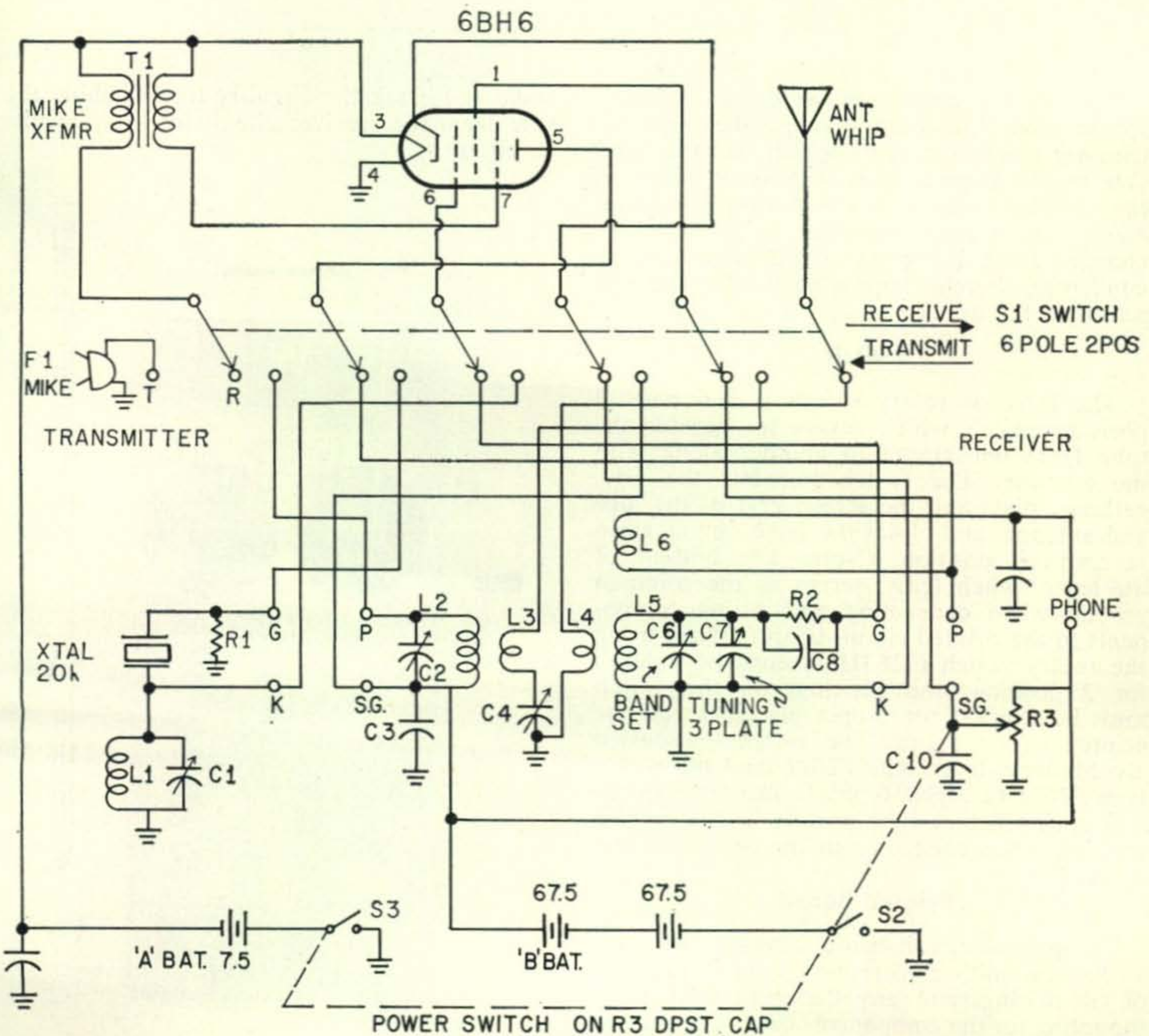

Fig. 1

Parts List

Resistors

- R 1—22K $\frac{1}{2}$ w
R 2—2.2 Meg. $\frac{1}{2}$ w
R 3—1.Meg. Pot (Centralab # B-69)

Capacitors

- C 1, C 2, C 4, C 6—5-50 mmfd trimmer
C 3, C 5, C 8—500 mmfd Mica 200 volts
C 7—5-25 mmfd variable 3 plate
C 9—100 mmfd Mica 200 volts
C10—.001 mfd 200 volts

Switches

- S 1—6 pole 2 pos. Mallory Switch-Lever #7262L or Rotary #3263J
S 2, S 3—Power Switch DPST, mounted on R 3 Pot. Centralab #KB-2

Components

- T-1 Microphone Transformer Stancor A-4747 or equivalent
F1 Carbon Microphone or equivalent
Earphone—1000 ohms or more
Antenna—3 Section car whip—approx. 66 inches long
Xtal—20 Meter (See Text)
V1—6BH6
"A" Battery—7.5 volts (Eveready #717)
"B" Battery—(2) 67 $\frac{1}{2}$ volts (Eveready #467)
Metal Box—4 $\frac{1}{2}$ x 3 x 9 $\frac{1}{2}$
Dial Plates—Mallory Switch index 0-10

- Knobs—Mallory Pointer type
Battery clips—
Decals—1 inch gold transfer type
Etched Printed Circuit Board—XL-8 Special See Text

Coil Data

10 Meters

- L1—18 Turns $\frac{1}{2}$ " Dia. #24 Enameled
L2—10 Turns $\frac{1}{2}$ " Dia. #24 Enameled
L3— 4 Turns #24 Enameled, wound on L2 (Cold End)
L4— 2 Turns #24 Plastic covered wound on L5 (Loose wound)
L5— 8 Turns $\frac{1}{2}$ " Dia. #24 Plastic covered—close wound
L6— 4 Turns #24 Plastic covered wound over L5—windings in same direction—close wound

6 Meters

- L1—10 Turns $\frac{1}{2}$ " Dia. #24 Enameled
L2— 6 Turns $\frac{1}{2}$ " Dia. #24 Enameled
L3— 3 Turns #24 Enameled, wound on L2 (Cold End)
L4— 2 Turns #24 Plastic covered wound on L5 (Loose wound)
L5— 6 Turns $\frac{1}{2}$ " Dia. #24 Plastic covered—close wound
L6— 3 Turns #24 Plastic covered wound over L5—Windings in same direction—close wound.

The switch and printed circuit board are available from the author.

The tuning condenser serves as a band-spread control, since it is in parallel with the trimmer condenser (C6) which sets the band you are to receive, thus making it easier to tune and hold signals in. (Note: For receiving 6 meters, the tuning condenser (C7) should be changed from a 3 plate to a 2 plate variable condenser, thereby improving the band-spread action of the unit.)

Switch

The lever or rotary switch is a 6 pole, 2 position switch which serves to transfer the tube from one circuit to another along with the antenna. The switch transfers the grid, cathode, plate and the screen grid of the tube and antenna, and closes the mike circuit when in transmit position. (Note: The bottom of the lever switch (case) serves as the common ground when connecting and wiring components to the printed circuit board.) When using the rotary switch (3263J), it must be indexed for 2 position, and the lugs on the switch must be selected for proper placement on the printed circuit board. The switches discussed are Mallory, lever type 7262L and the rotary type 3263J (a 3 pos. 6 pole). The lever switch is a spring action type, resting in the receive position when connected in the unit. (See end of text)

Printed Board

The printed circuit board serves as the chassis for the unit's construction, containing 80% of the wiring, and provides easy mechanical mounting for the components used. The printed circuit was designed to mechanically support the transmit-receive switch (S1) and directly

make and break the circuitry for switching the tube from the receiver circuit to the transmitter circuit.

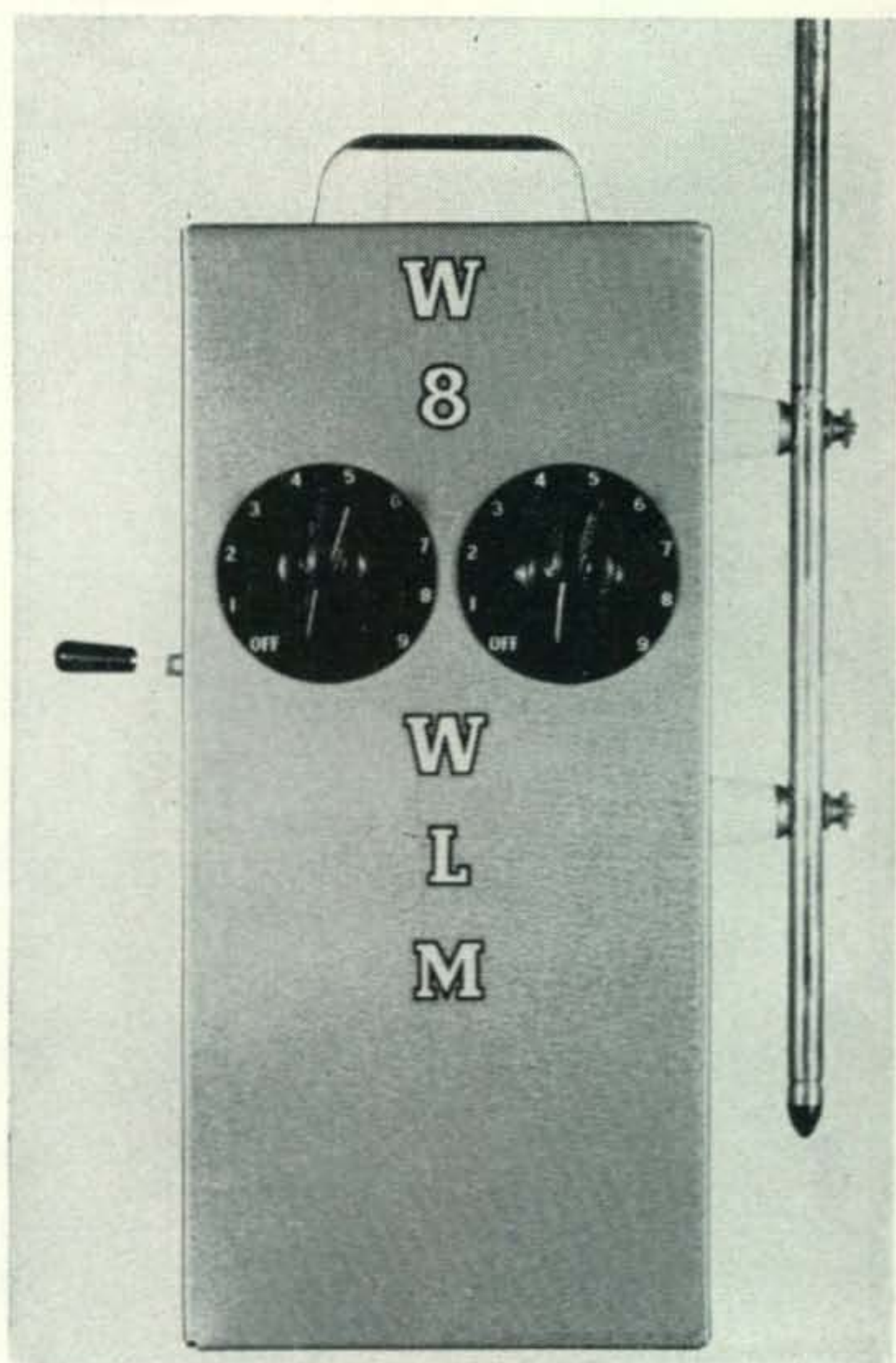

Front view of the Walkie Talkie showing the antenna mounting method and positioning of the T-R Switch.

The mounting of the switch and the component parts on the printed circuit board is done on small pin stakes crimped to the circuitry of the board. All parts are soldered to these stakes, and through the stakes connect directly to the printed circuit, eliminating wiring and unnecessary capacity in the circuit. The printed circuit insures a stable fixed circuit and eliminates trouble with loose connections and makes the unit less susceptible to hand-capacity or detuning. (Care must be taken when soldering, that no solder is splashed on the printed wiring.)

The circuitry on the board is plated to make good contact and resist corrosion, when soldering and mounting the parts. The only wiring done on the board, is connecting a few jumper leads to complete the circuitry of the transmit-receive switch, and the insertion of leads from the remote parts, such as the battery, mike, ear phone and transformer. The board is supported in the metal box by the switch (receive-transmit) and the tuning controls mounted on the front of the unit.

Another purpose of the switch is to provide a mounting for the tube socket and make possible the switching of the tube elements to either circuit. The contacts on the switch are designed to support the tube, thus reducing lead length.

All coils and parts are mounted on the top side of the printed circuit board, with only the trimmer condensers and a few small parts mounted on the underside. The trimmer condensers are placed on the bottom side of the board for ease of tuning the unit. To do this, the batteries are removed, and placed outside of the box, and using a small insulated screwdriver, the unit is set in the band (receiver) and the transmitter tuned.

Construction Information

The photo shows the construction of the printed circuit board (XLB) with the pin stakes crimped in position for mounting the parts. The top side of the board shows the cut-out, 1 $\frac{3}{4}$ inch dia. hole, and mounting stakes around the hole, which support the switch (S1) and make electrical contact to the leads on the printed circuit.

Xtal pins are phone tip jacks drilled out to enable xtal pins to fit, however, a xtal socket can be used instead and fastened to the board. The pin stakes used were Cambridge-Teramic, which were turned over with a small hand swager to fasten them to the board.

The trimmer condensers used can be old i-f trimmers or padders from surplus gear. The tuning condenser (C7) is a 3 plate variable, which can be cut down from a larger one, and serves as a band-spread when tuning. The mike is an F-1 with a threaded screw carbon container, which was unscrewed and reas-

sembled through the door of the metal box, thus making it self supporting plus a good electrical ground for the mike circuit. The ear phone is also mounted on the door of the box, but the mounting screws were changed to brass, otherwise the magnetic circuit of the phone would be shorted out through the box. **Brass screws** must be used to mount the phone.

The battery clips were used to make up the battery cable and a piece of plastic tubing was used to hold the cable together when routing it in the unit.

The metal box used was purchased from the local 5 & 10 for 89¢ and was intended for use as a small tool box. We suggest a metal box of some sort be used for this unit, thus insuring good shielding and easy tuning of the antennas. If trouble is encountered tuning the antenna, a small loading coil can be inserted in series. The antenna used was a 3 section car whip which extended to about 66 inches, and collapsed to 22 inches.

Tuning

Transmitter—The tuning of the transmitter is very simple. All that is needed is a communications receiver with an S meter. The cathode coil, plate coil, and the antenna circuit are all tuned using the "S" meter on the receiver, (no antenna on communications receiver), for maximum indication. If the S meter reads full scale, use rf gain control on receiver to reduce the reading, or back away from the receiver. All tuning adjustments for the unit are on the underside of the printed circuit. Retuning is necessary only if a great frequency change in the xtal is made, (from one end of the band to the other). An insulated screwdriver should be used for adjusting. (Be sure to extend the antenna to its full 66 inches.)

Receiver—The tuning of the receiver, and setting it in the band to receive, is also done with a communications receiver. Being of the super-regenerative type, of receiver, it must oscillate in order to operate. The communications receiver is set to the middle of the band, then, by tuning trimmer condenser (C6) of the super-regenerative circuit, we will radiate a signal that can be heard in the receiver. Having now set the receiver to the center of the band, the main tuning condenser (3 plate variable (C7)) will band spread and tune the entire band.

Conclusion

This unit has an approximate range of 3 miles on 10 meters and the range of the receiver is unlimited. It has been used on CD drills, hidden-transmitter hunts, Soap-Box Derby, Field-Day and parade activities locally. There are many more activities that one can adapt this unit to, and find pleasure in operating portable. ■

THREE-BAND INTERLACED BEAMS

Maj. R. H. Mitchell, W4RQR

Route 2, Box 80
Newport, North Carolina

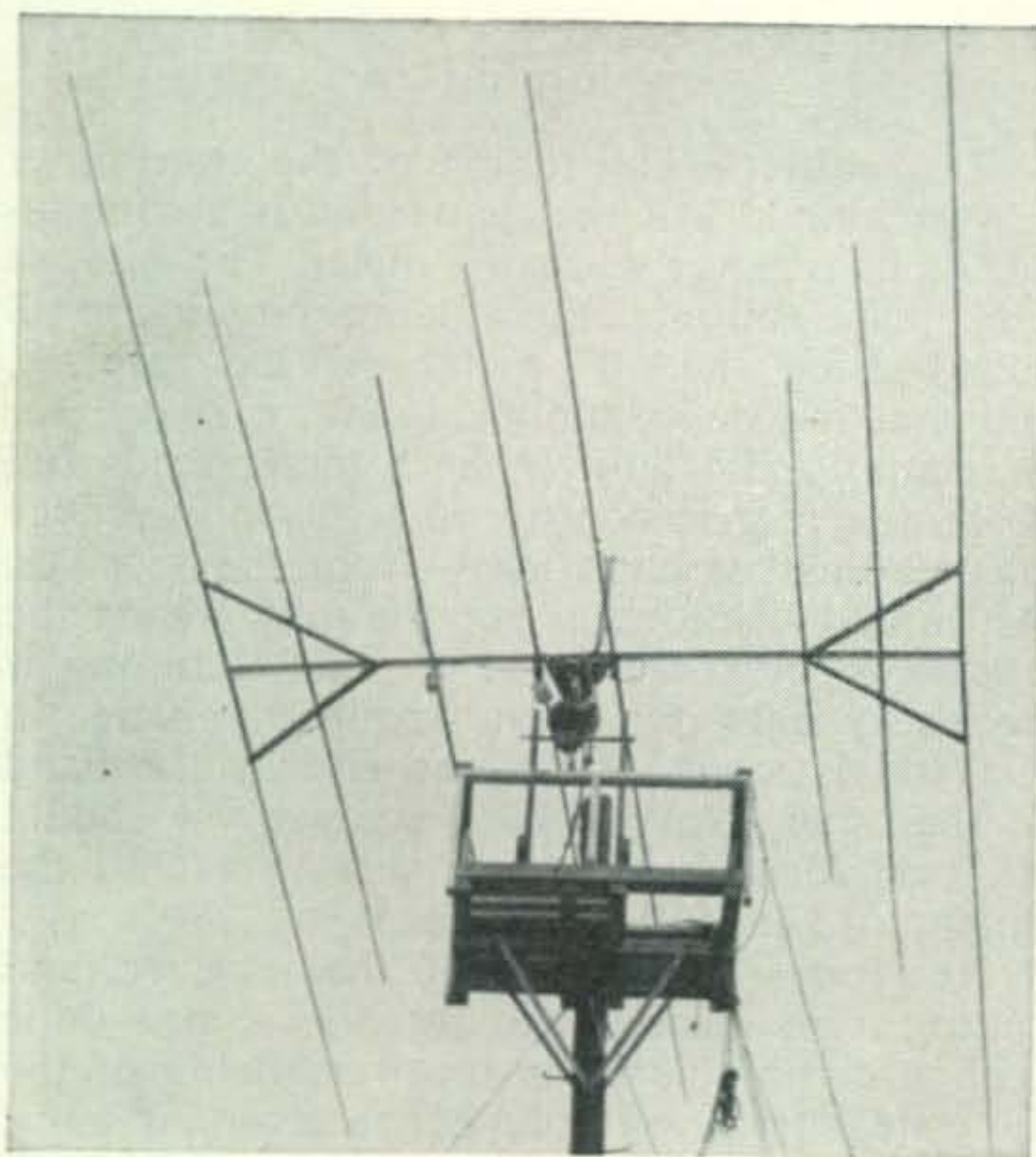

Original installation in Japan.

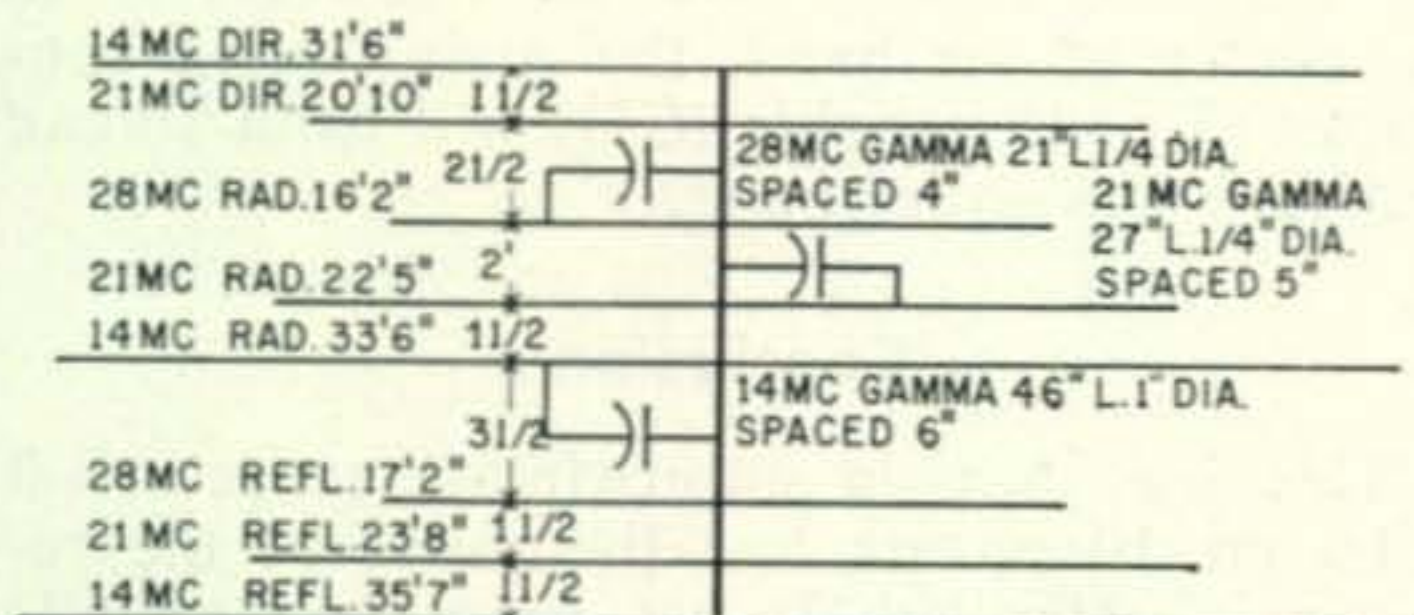

Fig. 1—The elements are constructed of 1 1/2" tubing at the centers, tapering to 1" at the ends. Gamma capacitors of RG-8/U, 28 mc, 11"; 21 mc, 18"; 14 mc, 32".

After the construction—and successful operation—of a two-band interlaced rotary beam at W5DWT¹, one question kept bothering me. Others asked it too. "Why didn't you make it a three-bander while you were at it?" The only logical answer is that at the time of construction, considerable doubt was entertained that the two-bander would be successful.²

Naturally, when the interlaced beam worked so well, there was considerably less question as to whether the three-bander would work. About that time, I found myself on a long tour of temporary duty in Japan with the call KA2EC, a portable kilowatt, a receiver, and no antenna. The obvious move was the construction of the three-bander.

Procurement of materials in Nippon presented quite a problem, and the beam had to be a compromise. Eventually, two 14-foot 1 1/2" X 3/16" dural angles and some badly bent tubing from a couple of old typhoon-damaged

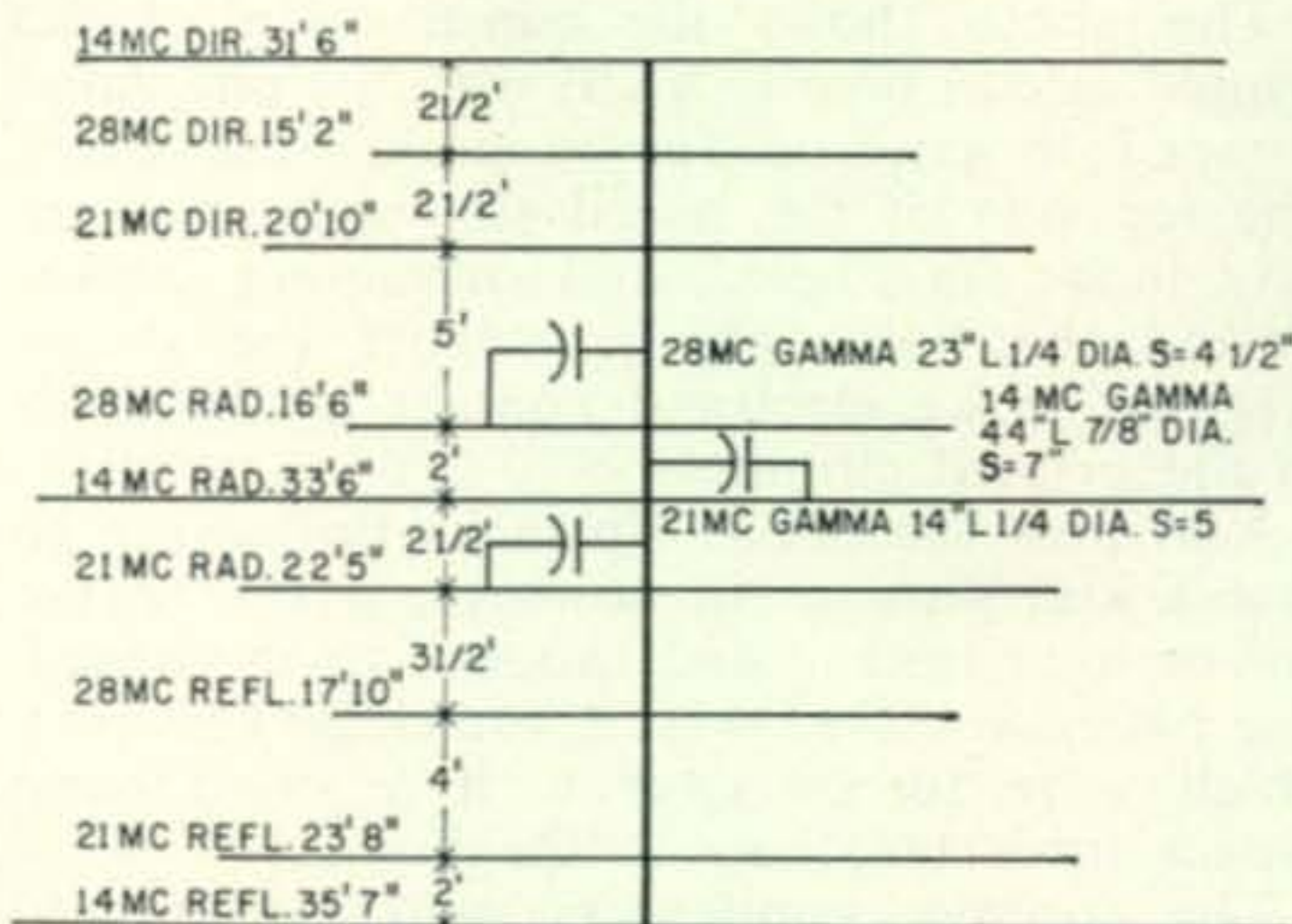

Fig. 2—The element construction for 14 and 28 mc; 1" tubing at the centers tapered to 7/8" at the ends. 21 mc, 3/4" at the center to 5/8" at the ends. Gamma capacitors are of RG-8/U; 28 mc, 13"; 21 mc, 47"; 14 mc, 42".

beams were found. After considerable straightening and splicing, enough tubing was available for sets of three elements for 14, 21, and 28 mc. However, the short boom necessitated by the fourteen-foot angles seemed to rule out the use of all nine elements. With the 14/21 mc beam, it had been found that about 1½ foot separation between interlaced elements was necessary to prevent interlocking loading and s.w.r. fluctuations as the elements blew about in the wind. We finally decided to try three elements on 14 and 21 mc, and two on 28 mc. The layout shown in fig 1 resulted. The two 14-foot angles were riveted together to form the boom. One-inch aluminum angle crossarms were riveted to the flat surface of the boom to hold the elements. The crossarms were five-feet long for 14 mc, and three-feet long for 21 and 28 mc. A three-foot pipe was mounted on top of the boom, and guy wires were run from the top of this to the outer ends of the outer crossbraces to add rigidity. Four-foot 1x2's were run from the boom to the ends of the crossbraces. Previous experience with this type of guying had proved that if something of this nature isn't done, the outer elements would soon be bowed in toward the center. Wooden braces were used in preference to metal because we weren't sure just how much the length of the elements would be changed by a large closed loop at the center of the elements.

The question of what element length to use was solved quite simply. We used our old formulas for the three-element beams: reflector $500/F$; radiator $=468/F$; and director $=444/F$. For the two-element 28 mc section, element lengths were set to an *Editors and Engineers Radio Handbook* formula: reflector $=490/F$; and radiator $=462/F$. (The reflector-radiator combination was decided upon for 28 mc in preference to the currently popular .1-wavelength spaced radiator-director arrangement, because it made a better boom arrangement.)

Gamma matches were decided upon because I prefer the coaxial-fed gamma to any other feed system. Plastic boxes were used for the housings for the receiving variables employed to tune out the gamma reactances.

Fortunately, while the beam was being built, a 45-foot pole appeared in a strategic spot, and a platform was built on it. The beam was raised into position and tuned. It was found necessary to increase the 14-and 21-mc radiators by a few inches, and to change the gamma lengths slightly, but the beams all tuned up beautifully. S.w.r.'s ran well under 1.5 to 1 across 14 and 21 mc, and dipped to 1 to 1 at 14150 and 21200 kc. On 28 mc, the s.w.r. was about 1.5 to 1 at 28 mc, 1 to 1 at 28.5 mc, and from 29 to 29.7 mc fluctuated be-

[Continued on page 130]

1. "20 and 15, Rotary," CQ, December, 1955.
2. "Design Notes on a Four-Band Rotary," QST, December, 1955.

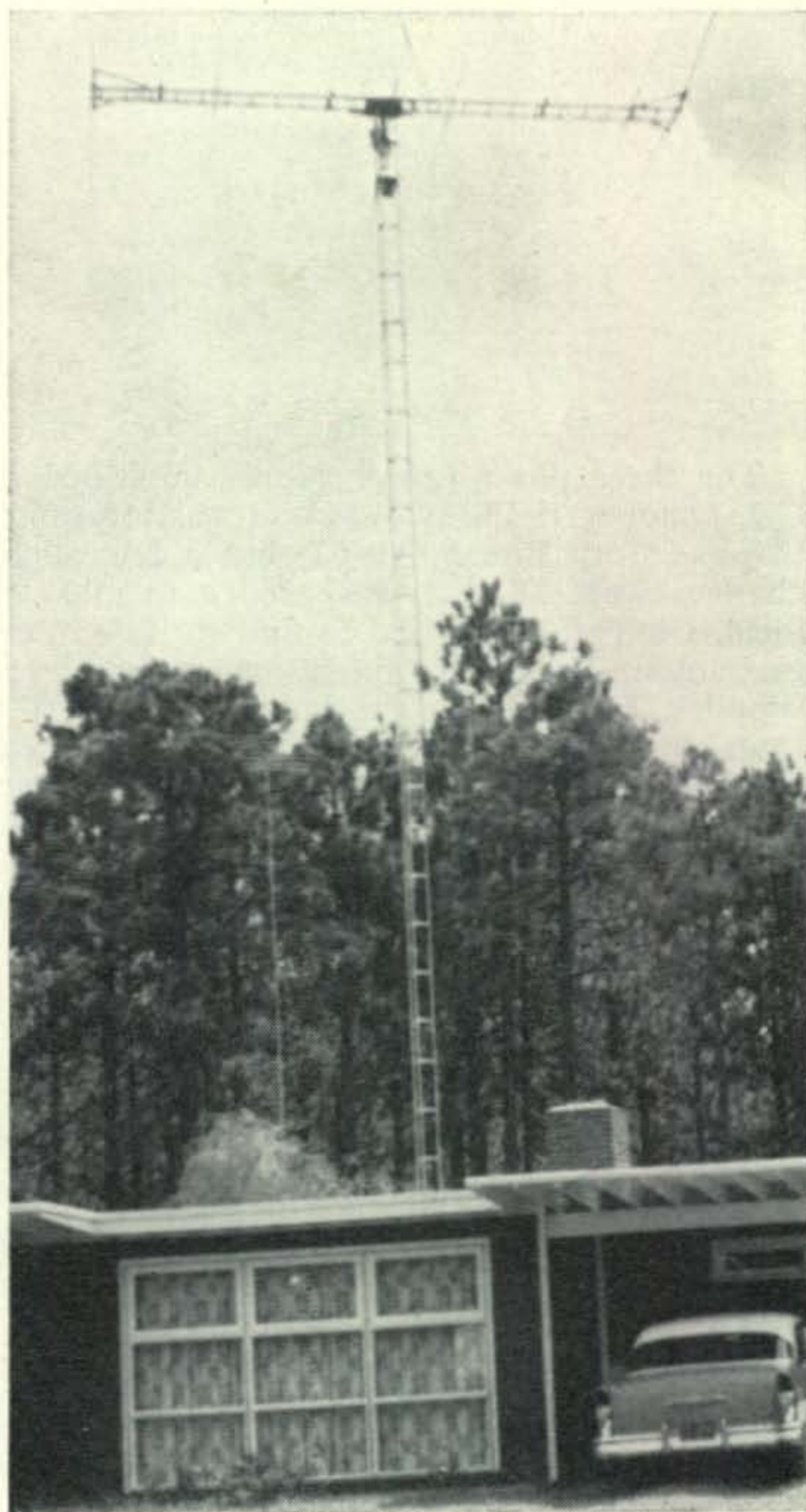
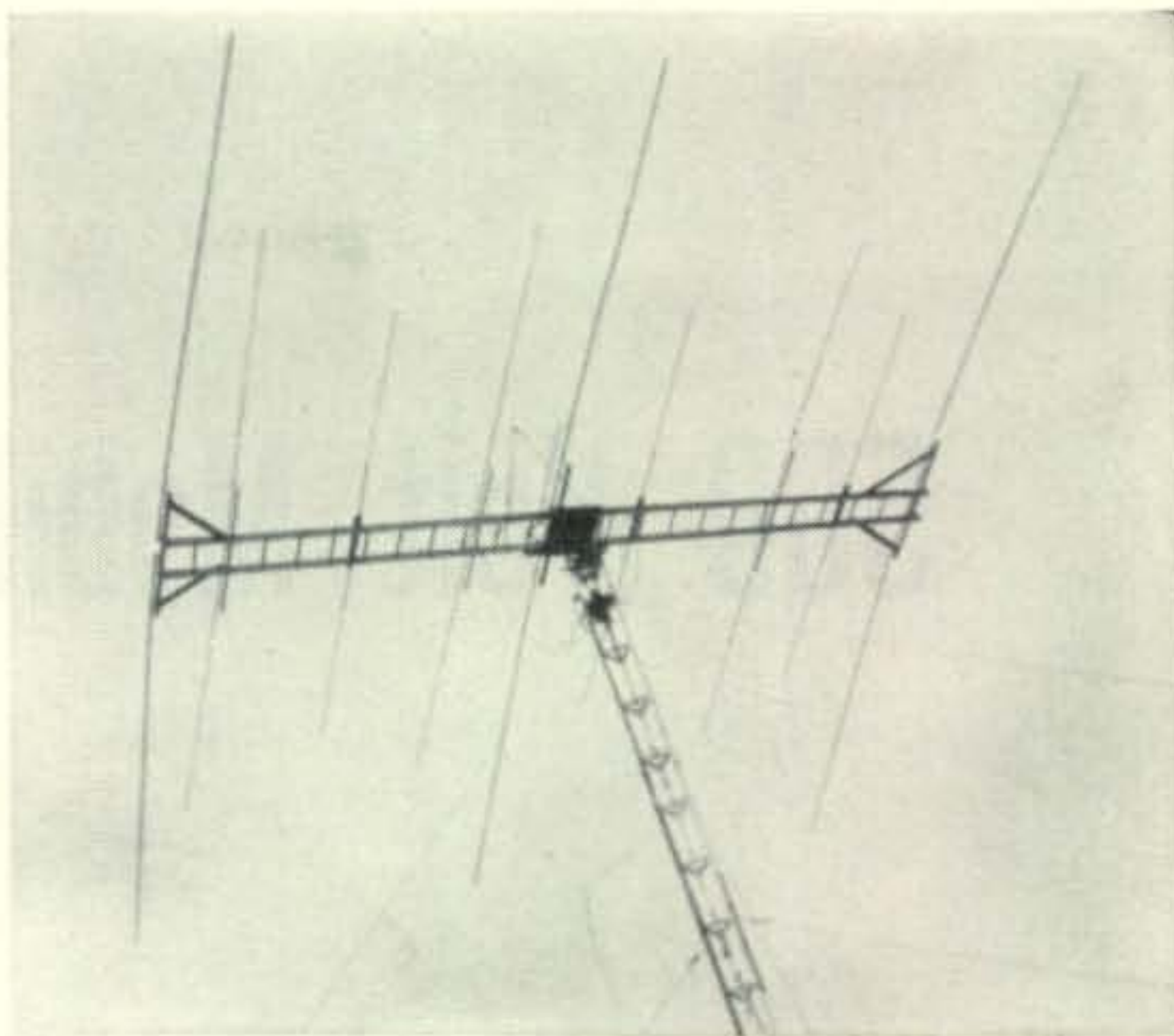

Two views of the new stateside job.

500 Volt Mobile Power Supply

Howard W. Snyder W3LMC

39 Edgemoor Road
Timonium, Md.

The three phase power supply described in CQ, October 1955, by W81WG was too much to power my Elmac AF-67, but a few slight changes were all that was needed to make it ideal. I am still surprised to find so little interest among mobileers in using such power supplies. Maybe they are holding out for the transistor units now becoming available. They, in themselves, are not the complete answer, as the primary source of power is still a necessity. With an ac alternator it is very nice to know that the battery is no longer the limiting factor.

Yes, I know the engine must be running, but it need only idle and you can take your foot from the accelerator. So, I believe the trouble or objection boils down to one thing, parting with the long green. But let's face it—ham radio is not exactly a poor man's hobby. There comes a time when the junk box or club auction will not yield the wanted parts.

The alternators, second hand, are usually incomplete as to pulley size, mounting equipment and too often the rectifiers and regulators are beyond use. But regardless of price, almost everyone will admit to their desirability. Many

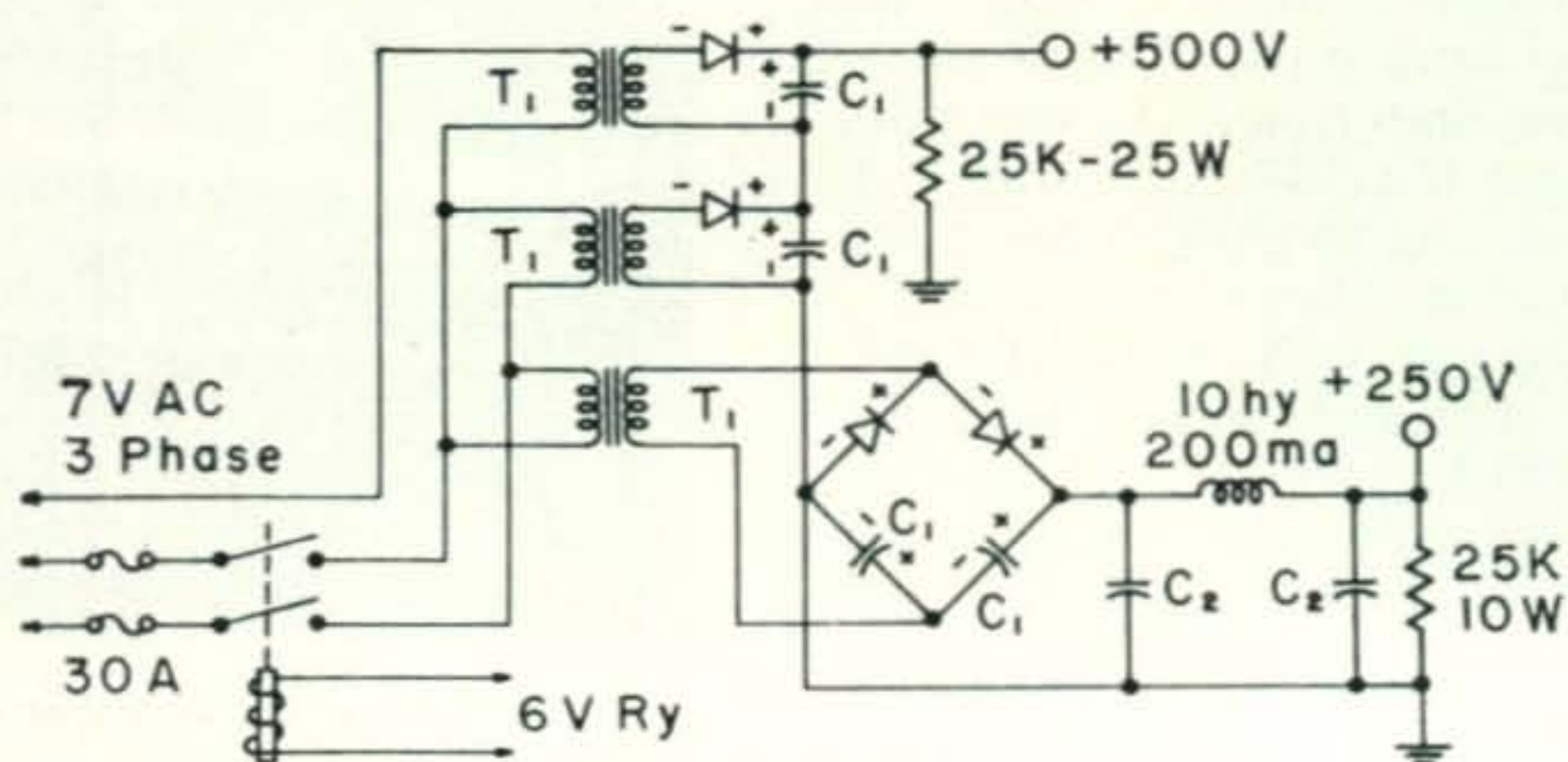

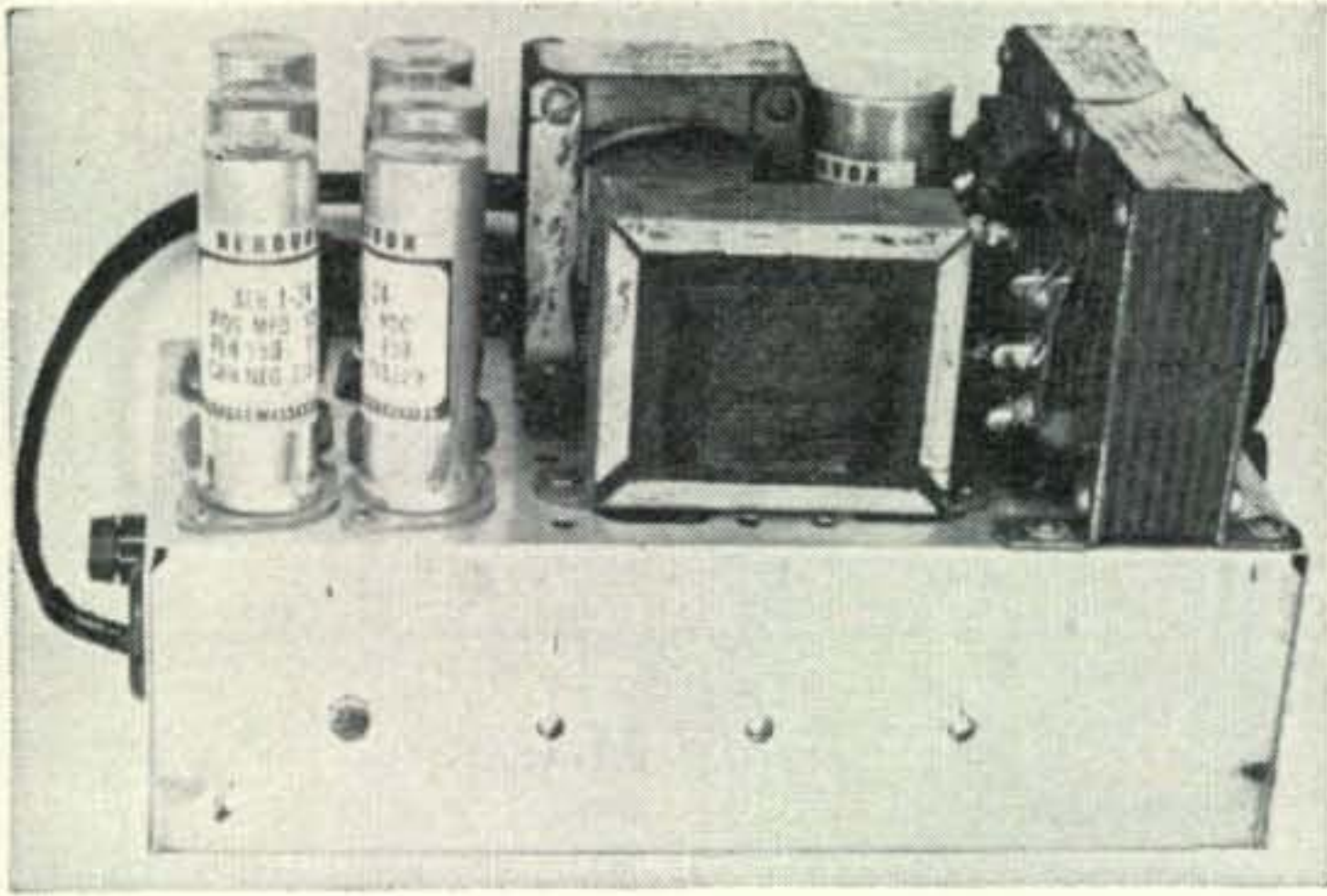

bargains may still be had. As inferred, the alternator must fit the car, so be sure you are able to mount it if you come across one for sale. Naturally, all the proper parts can be obtained through authorized dealers.

This article is not to show all the possible theory or hookups, but to show a supply that works nicely for an Elmac or similar mobile transmitter.

Forget your fears of voltage regulation as you step on the gas. The very thing that causes poor regulation works to your advantage. If efficiency were high, then voltage would soar as engine speed is increased, but due to an increase in eddy losses in the 60 cycle filament transformers, the voltage rises very little from that obtained at idling speed.

The circuit is simply two half wave supplies and a third full wave supply in series. This last supply will create an unbalanced load on the alternator, but is not a serious condition. The transformer used there could stand some experimenting. But regardless of the engineering discrepancies, the supply is smooth, no trace of ripple and plenty husky as an Elmac cannot overload it.

Don't forget to observe correct polarity in connecting the transformers. Be sure to insulate all the condensers from the chassis, except those in the low voltage supply. The cans will be hot, so an insulated cover for them is a good idea. One easy way would be to wrap them with tape. The photograph shows six 150 mfd, 150 volt condensers, but two of them are not used as they are a hold-over from the original hookup using a full wave circuit.

The photographs also show the coaxial antenna relay used in my installation, as well as the dc control cable and connectors.

The selenium rectifiers can be the 400 ma TV variety or 250 ma units in parallel. The 5 x 3 x 10 inch chassis easily contains all the parts, including fuse holders, plugs, relays, etc. As in most power supplies, placement of parts and neatness of wiring is not critical. My Elmac and power supply set in an open framework which straddles the hump on the front floorboard. This method provides easy accessibility and quick removal. ■

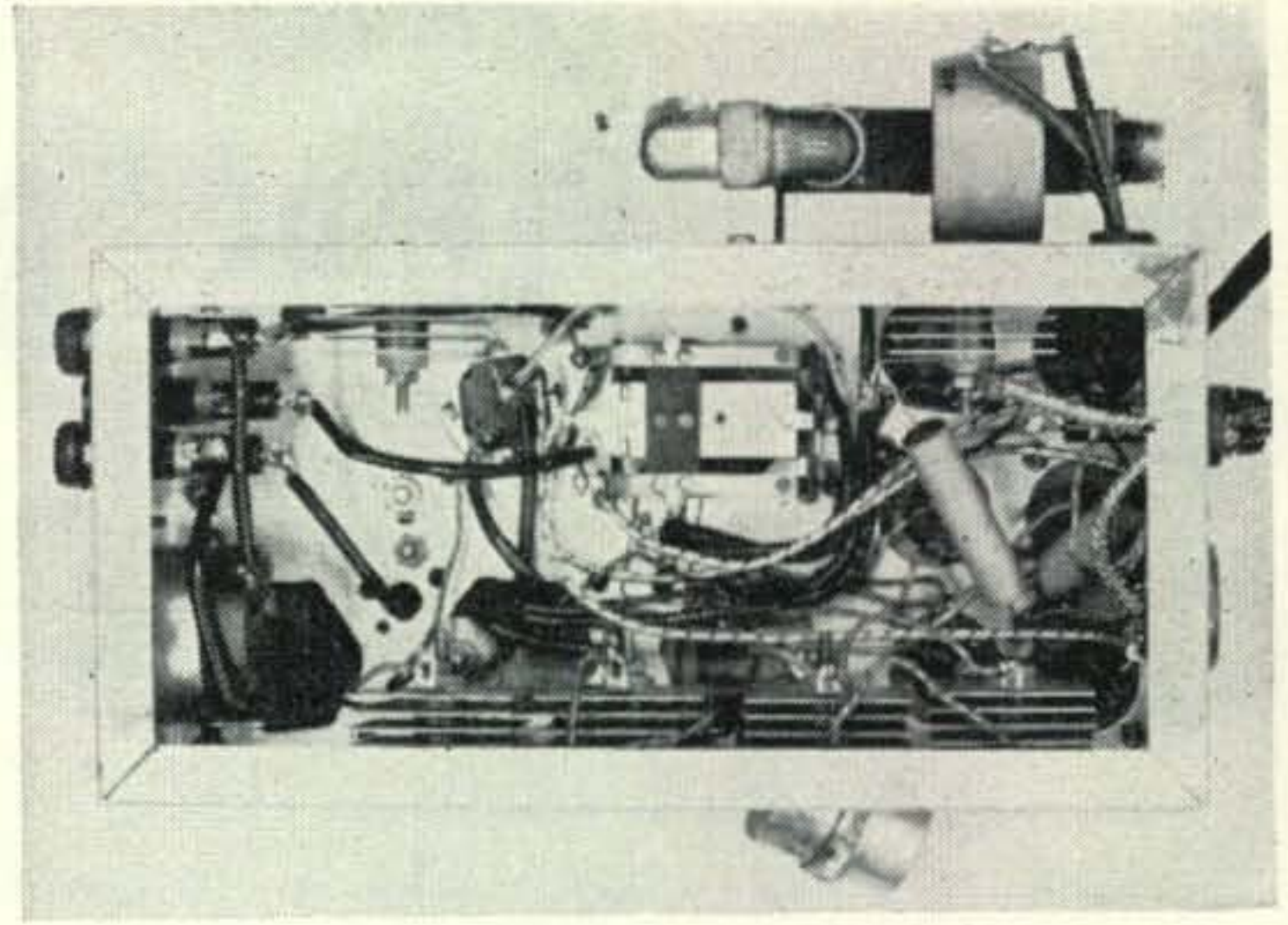

Bottom view of the power supply showing the coaxial antenna relay and a little of the control cable.

Parts List

- T1—Stancor Transformer P-3064 6.3 volts, 8 amperes
- C1—Aerovox AFH-1-24
- C2—Aerovox AFH-2-57
- Selenium rectifiers—Federal 1028 - 250 ma or 1130 - 400 ma
- Choke—10 henry - 200 ma
- Bleeder Resistors—25 k 25 watt
25 k 10 watt
- Chassis—3 x 5 x 10 inch
- Relay—15 ampere contacts

Oops We Goofed

Grounded Grid Kilowatt Sept. p. 38

- Return one side of T2 to one side of T5
- Return one side of T3 to the other side of T5
- Rewire the filament of V1 as shown below.

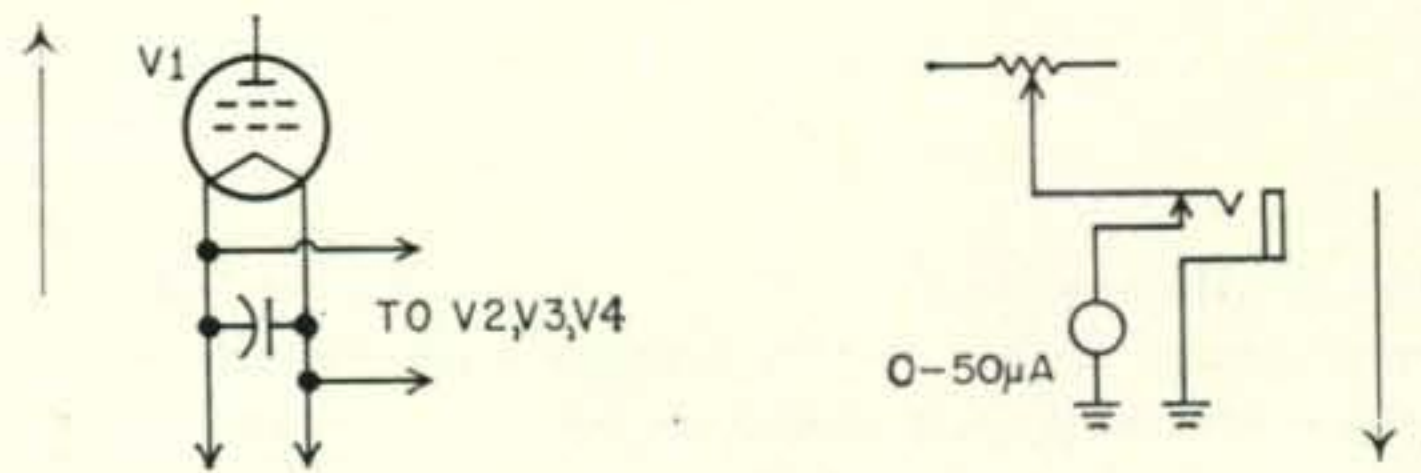

Der Nipper Sept. p. 56

Don can have his complete call WØQFZ and also change the 0-50 millimeter to 0-50 microamperes in fig. 2, p. 57 and move it to the contact shown above.

Grounded Grid Carbon Microphones Sept. p. 30

These amplifiers don't need coils (Honest Injun) please ignore the coil table till we find out where they belong.

MARS BULLETINS

Air Force Mars Eastern Technical Net

Sundays 2-4 PM EDT 3295 KC, 7540 KC, 15,715 KC

Nov. 16—Facts About Quartz Crystals. Mr. Roger A. Sykes and Panel, Bell Telephone Laboratories.

Nov. 23—Double Side Band With The DSB-100. Dr. John Costas, General Electric Company.

Nov. 30—More on Double Side Band and Synchronous Detection. Dr. John Costas and Mr. John Webb, General Electric Company.

Dec. 7—Let's Review Our Physics. Dr. Irving Mirman, Scientist, Rome Air Development Center & Chairman IRE Science Committee, Rome-Utica Section.

Army MARS

Wednesday Evenings 9 PM (New York Time EST) 4030 kc upper sideband.

Nov. 5—"Application of Transistors in SSB Equipment" by Tom Stewart, Engineering Manager, The Hallicrafters Co.

Nov. 12—"Ionospheric Storms and Their Effect on Radio Communications" by Luther C. Kelley, Project Engineer, U.S. Army Signal Radio Propagation Agency.

Nov. 19—"The Engine Scope" by Gene Ecklund, Manager Automotive Equipment Sales, A. B. DuMont Labs.

Nov. 26—"Compatible Single Sideband" by Leonard Kahn, President, Kahn Research Labs.

BASIC ELECTRONICS COURSE TO START ON MARS CHANNEL

On 5 November 1958, First US Army MARS in cooperation with the Fort Monmouth Signal Corps School will present a twenty-six hour course in "Basic Electronics." The lectures will be given each Wednesday evening from 8 to 9 PM (prevailing N.Y.C. time). The broadcast will be on AM on 4030 kc. Seven members of the Ft. Monmouth Signal Corps School Instructor Staff will do the teaching. Fred Dickson, AA2HJU and Lt. Colonel H. M. Russell, AA2ABH, will coordinate the course. Requests for additional information should be sent to MARS Director, First Army, Governors Island, New York 4, N.Y.

Mr. J. Harvey McCoy, W2IYX receive a D-104 microphone with a special honorary award name plate attached in recognition of his service as an Outstanding Radio Amateur from General Curtis E. LeMay. Mr. McCoy has been largely responsible for the excellent Air Force MARS Technical Series of broadcasts.



by **FRANK ANZALONE, W1WY**
14 Sherwood Road, Stamford, Conn.

CONTEST CALENDAR

October	25-26	CQ WW DX Phone
October	25-26	ARAC CW
November	1- 2	ARAC CW
November	8- 9	ARRL SS
November	15-16	ARRL SS
November	22-23	RSGB 21/28 Phone
November	29-30	CQ WW DX CW

CQ WW DX

About the time that most of us receive this issue, the Phone Section of the contest will be past history. We hope the Phone boys had a "ball."

There is still time for the CW gang to make last minute preparations. From the scuttlebut on the air and in the several DX Bulletins around the country, this one should be a real brawl. Look for some record-breaking Club Scores. Known activity from some rare spots during the contest can be expected from LX1KA and LX1RX, KB6BJ, VR2DG, DU7SV and VQ4CC to mention a few. Also look for some 160 meter activity between 0500 and 0800 GMT on each of the two nights. The loss of the 27 mc band to the U S boys should not make much difference in the scores. Those

that can still use that band are free to do so in this year's contest.

A.R.A.C.

This is one for the certificate seekers. Too late to do much about the first week-end but you should be able to participate in the second week-end. (And one week-end should be enough anyway.)

1. Contest period: Saturday, 3:00 PM to Sunday, 7:00 PM EST, on both week-ends.

2. Work only CO7 stations. On CW and in the 20 and 40 meter bands only.

3. CO7 stations will send serial numbers consisting of your RST and the QSO number. Other stations will use the RST and their power as their serial number.

4. A diploma will be awarded to every station that works ten or more CO7 stations. The same station can be worked on two bands and credit will be given for two stations.

5. Send your logs before February 15, 1959, to the Amateur Radio Association of Camaguay, P.O. Box 28, Camaguay, Cuba.

ARRL SS

We were not officially notified about this one,
[Continued on page 193]



Continent winners of the EYMA 1957 Munich contest. Left to right, W3GHS, CN8ME, SM5LL, LU1EF and PY5DI (winner for Brazil). 4X4BX and ZL4CK, the other winners, were not present.

by **BOB ADAMS, W3SW**

P.O. Box 625,
Silver Springs, Md.

sideband
sideband
sideband

SIDEBAND

The past few months have been very productive ones for the DX minded SSB boys, with all of the DX-peditions and new countries appearing. Only a few months ago we were all dreaming of working one hundred countries and now it will not be too long in the future when some one will report two hundred worked. The following have worked over 140 countries on two way SSB: W4IYC, W2JXH, TI2HP, F7AF, VK3AEE, W8PQQ, W4INL, W6UOU, WØQVZ, W8GCN, W3SW, with most of them confirmed.

"Worked One Hundred" certificates have been awarded in the order of listing: W6UOU, W2JXH, F7AF, K6GMA, W3SW, W4IYC, TI2HP, W8QNF, W6ITH, VE3MR, W8GCN, W8EAP, W8YBZ, WØQVZ, WØFUH, W8PQQ, ZL3PJ, K2MGE, W2OQO, W2VZV, W6IAL, K2JFV, W1ADM, TI2RC, W2CFT, KØABH, ZL3IA and W6BAF. All twenty-eight of these stations have submitted 100 or more QSL cards from 100 countries indicating two-way SSB contacts.

Jack, HB9TL reports that he and HB9QR contacted 458 SSB stations on twenty while operating as HB1TL/FL in the Principality of Liechtenstein. A 75A4 receiver, with a 20A and 811A final was used with a trapped ground plane antenna during the three nights of operation. Jack writes that many stations who sent cards did not indicate that the QSO was two-way SSB, and he will send them "AM" cards in reply. He also is having difficulty checking his log to confirm the QSOs as many have used local time instead of GMT. Erwin and Jack hope to make the trip again next year.

One of the most coveted dx-peditions was VQ9GU on Seychelles. We are pleased to show photos of the station and the shack which

Jimmy, VQ4GU used to put a real rare one on SSB. For the information of those who missed Jimmy we are sure it will be very good news to learn that he will return to Seychelles again. Robbie, VQ4ERR will also operate from VQ9 in the later part of next year. He will also operate from VQ1, Zanzibar in November.

Ted Henry's little transmitter turned up at Ceylon and caused many early morning pile-ups on twenty with the call 4S7KD. The transmitter is now on North Borneo from ZC5AL.

Art, ZS6AQQ made a two-day stand at Francistown, Bechuanaland on August 30 and 31 operating as a portable ZS9. The transmitter was a 4-125A running at 50 watts with a 20A and a tri-band Mosley antenna. Art was accompanied by Ben, ZS6ARC who drove the 1100 miles by car over some pretty rough roads. QSL's should go to W4IYC with the



Joe Don

usual self addressed stamped envelopes.

Martin, VE3MR who has difficulty working into the far east, has 126 worked and 110 confirmed. He very kindly sent in the pictures of his dx-pedition to San Andres Island, HKØAI.

From Frank, W6IAL we have just learned that after a long battle with the government officials in Seoul, Korea, Tom, HL9KR has been forbidden to operate SSB any longer. He may operate CW or AM but is further restricted to the hours of 8.00 to midnight Korea time, and on only two frequencies, 14,180 plus or minus 5 Kc. on Am and 14,030 CW. Tom hopes to have this ruling revised soon.

There are many dx-peditions scheduled for operation in some very remote places this Fall and Winter. In order to have the latest information on the times, dates and frequencies etc I recommend that you subscribe to Don Chesser's (W4KVX our DZ Editor) "Ohio Valley DX Bulletin." These Bulletins are published each Monday and the subscription rate of \$6.00 includes first class mailing anywhere in the USA. An extra \$1.50 provides for Air Mail. I have found Don's Bulletin invaluable in keeping up on all the latest DX, either SSB, AM or CW.

As this column is being written, our first WAS SSB Contest has just ended, and from all indications it was very successful. Bill Leonard, W2SKE who proposed the contest said he had enjoyed every minute of it. Bill made 440 contacts in 47 States. He missed Nevada although it is definitely known that there were several SSB stations operating from that State. Several groups traveled to some of the less SSB populated States like New Hampshire, Vermont and Delaware and this sure helped to make the Contest more interesting. Ken, DL4CA just called in to say that he had participated in the Contest and had worked 43 states. He also said that Humberto, TI2HP was working stations like a machine when he last heard him. We hope

[Continued on page 151]



The DXpedition station HB1TL/FL with Jack HB9TL and HB9QR in the background.



Shack of VQ9GU at Seychelles.



Station of VQ9GU with Jimmy, VQ4GU, at the mike.



Ernest—TI2EV



Bob, TI2RC operating, Humberto, TI2HP, logging and Martin, VE3MR QSLing.



RTTY

Byron H. Kretzman, W2JTP

16 Ridge Dr., High Hills,
Huntington Station, N. Y.

W2JTP at Keyboard of W6OWP in Belmont,
California



NOTE: UPPER CASE H MAY BE STOP OR #



Fig. 1 Communications and Weather Keyboards

Autostart is one of the most fascinating phases of RTTY operation. Most commonly in use on 2 and on 6 meters with afsk, autostart is an automatic control system that permits the reception of message traffic in the absence of the station operator. Teletype machines are weirdly started, type out messages, and then shut down—without anyone there throwing a switch. (This can be very disconcerting to a ham's family!)

Briefly, there are two methods of autostart in general use. In one, a time clock is employed to turn on the vhf receiver and terminal unit (TU) at preset times, usually on the hour of only certain hours. If, during the minute or so that the equipment is on, a steady **mark** tone is received, the printer motor starts up and the machine is ready to copy. A steady **space** tone of about one second will stop the printer motor but will not shut down the receiver and TU unless one minute goes by without another steady mark tone being re-

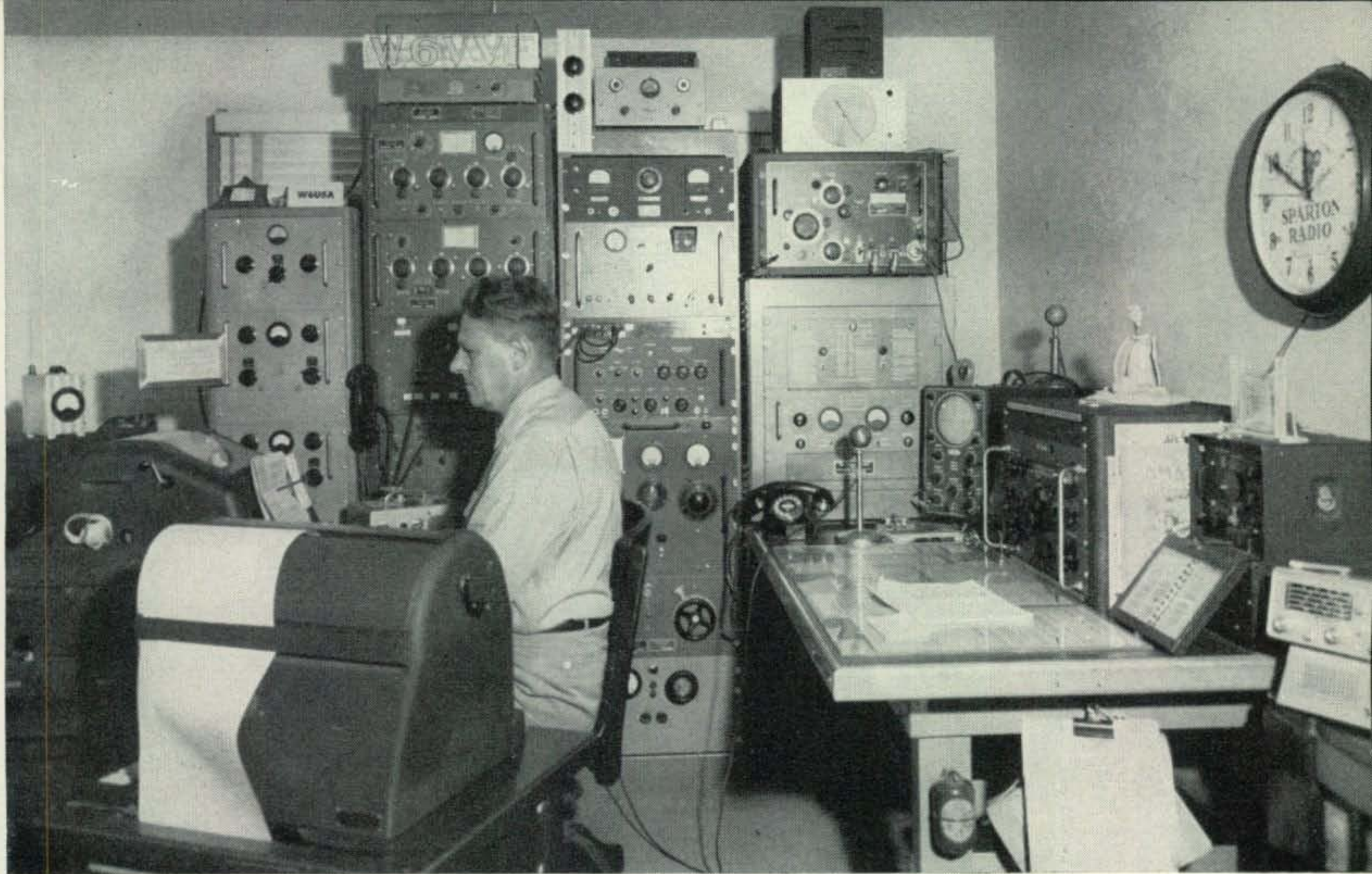

W6VVF, San Francisco, California. NCARTS, Inc., Member Station. The operator William E. (Nick) Nichols. Transmitters: BC-640-B for 2-meter afsk; T-350 for h-f fone-cw and fsk, 20-A with 4-400 amplifier for ssb, Communicator for 2-meters. Receivers: 51-J4 for fsk, Morrow mobile on 115-volts. Converter: CV-31-D/TRA-7 Dual Diversity. Antenna: Twin-Six. Machines: Model 26 page printer, Model 19 with perforator and TD, Model 14 typing reperforator.

ceived. (This permits several stations to be received, one right after the other.)

The other method requires that receiver and TU be left on continuously, with only the machine being controlled. This is a more simple method but the receiver and TU must be designed for continuous 24-hour a day operation. A slight disadvantage might be that machines can be started up, bells rung, etc., in the wee hours of the morning. (There are always comedians!)

Fail-Safe

Whichever method is used, the prime requirement is fail-safe reliability. Machines should start up on any RTTY signal strong enough to print good copy, yet they must *not* start up on any combination of QRN, QRM, or failure of any component. While ordinary hams might be reluctant to leave any of their equipment connected while they are not around, RTTYers should know enough to construct their gear with a generous safety factor and to fuse it intelligently.

Tune in next month and we will describe a much simplified autostart system that is equally applicable to the clock method or to the

continuous monitoring method.

Weather

Figure 1 shows the communications keyboard arrangement of the usual *Teletype* machine as used by RTTYers. Also shown is the weather keyboard and type arrangement as used by government agencies in reporting the weather at airports all over the world. A surprising number of RTTYers, and SWL's, are pilots or do enough flying to be interested in this subject. If you have a general coverage receiver you probably have copied some of these stations, most of whom use 850 cycle shift.

If you are interested in further details on these weather broadcasts, we suggest that you refer to the RTTY columns in the October 1956 CQ and in the February 1957 CQ. Occasionally machines with weather symbols get into ham hands. Should you have one of these machines and would like to sell it, let's hear about it and we will mention it in your RTTY column. If you would like to find one yourself, let us know that, too. In the past, W9GRW has found a few machines with weather symbols, so try asking him, too.

[Continued on page 150]



ham clinic

by **CHARLES J. SCHAUERS, W6QLV**

CQ Magazine, 300 West 43rd St., New York 36, N. Y.

Building your own ham equipment, whether it is merely a simple antenna tuner or a complicated bandswitching transmitter, is fun as well as educational. To those with a penchant for the slide-rule and reference tables, design is even more fun because of the anticipation involved.

Most hams however, are not designers and must depend strongly on construction information contained in articles such as those published in CQ, *RCA's Ham Tips*, *General Electric's Ham Bulletins* . . . QST and various radio handbooks. But we are inclined to think (by the number of letters received) that many amateurs are prone to expect *too much* detail in written form rather than resorting to a little "self-ingenuity."

The majority of questions relative to the construction of a piece of gear are those dealing with part substitution; questions which should have been directed to the authors of the various articles.

"Can I replace L-1 and L-2 in the circuit of the 'keedadleyhopper' on page 18 (of a book or magazine) with *National* coils," is a typical question.

Another: "how about replacing C-5 (.001 mfd.) with an .005 mfd. (that's all I have)? What will the effect be?"

Building a piece of equipment exactly as described in an article is the "safe" way to make certain that it has a fair chance of working. But then, one is still not sure because one may buy a ".005" mfd. condenser and it may actually be closer to .004 or .006 mfd. This small change can be tolerated in most ham circuitry, but if you're working with phasing

circuits in SSB for example, you more than likely *will* have trouble.

Why most hams do not like the "cut and try" method is beyond us, unless time is the important factor.

No ham expects .0001% precision condensers and resistors in construction articles. However, they do expect average parts to do the job because most of them do not have elaborate measuring equipment.

Most ham author-designers will tell you whether or not parts placement is critical and/or if certain substitutions can be made of parts which control the parameters of certain critical circuits. On the other hand, *basic* construction practices are taken for granted by most technical authors.

Templates are nice and efficient but the ham who gets the greatest "kick" out of building is the one who adapts what he has on hand, and makes it "fit" mechanically as well as electrically.

Few articles appear in which changes cannot be made—sometimes thereby boosting operational efficiency as much as 50%. For example, I tried out the mobile converter designed by W5ZCC described in the August '58 issue of QST. I found that by substituting a *Tungsol* 12EZ6 for the 12AF6 rf amplifier and a 12FA6 for the 12AD6 converter, and adding a 20mfd. filter between 12V- and 12V+, the little set worked much better. Incidentally, it works ok on 40 meters too with proper coil substitutions.

Because of part value differences, no author can *guarantee* that his particular design will always work, even if "copied to a T" by anyone

else. Now you can see the wisdom of our editor's disclaimer under the magazine's mast-head!

Here's the *effective* way I have found to build a piece of equipment described in an article: first, study the text and circuits thoroughly to determine if it (the equipment) meets your requirements; second, look over the parts list and make a mental note of what you have on hand (still better, obtain a box and begin your parts collection); third, go to your parts house and obtain the balance of what you need. (I never like to start construction until I have *all* parts.) Fourth, measure, drill and fit your chassis with tube sockets, transformers, coils, switches, variable condensers, etc.; fifth, wire filaments, grid and cathode, plate and power circuits. (I check off each connection made on the diagram with a black pencil.) Sixth, recheck your connections and use a red pencil on the diagram—(merely write over the "Xs" already made); seventh, check operating instructions and adjustments and "fire her up." Simple? Not quite! Then comes (perhaps) hours of finding out why it won't work.

Observed

There are very few mobiles operating in Europe; what with gas costing a dollar or more a gallon, who besides those who drive motor scooters can afford to "call CQ" from a wheeled conveyance?

Questions

Because of the size of this issue of CQ, we're running short on space; so fewer questions this month.

Antenna Tuners

"Can you give me diagrams of an antenna tuner for (a) an end or center fed zepp; (b) a Marconi slightly shorter than an odd number of quarter wavelengths?"

Yes. See figures 1 and 2. (Coil and condenser combination to tune to band.)

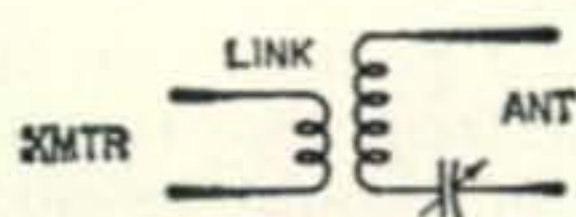

FIG. 1 ZEPP



FIG. 2 MARCONI

UHF

"I want to build a small rf amplifier for 420 mc. What tube do you suggest and where can I find a diagram?"

See ARRL Handbook, current edition page 414 for an amplifier which uses a 6AJ4 tube.

Rectifier Replacement

"In replacing tube rectifiers with the new silicon types are there any special precautions to be taken?"

Yes. Although these rectifiers will operate from a -65° to 150° C. they still must be *well* ventilated and should *never* be mounted on or near high heat producing units, such as transformers, power tubes, etc. Make sure that the units you buy are capable of handling the voltage and current encountered. Above all make *certain* that you observe *polarity*. The instruction sheets are very explicit and if you follow them you can't go wrong.

Tech Information

"What do I do if I do not receive a reply from a manufacturer relative to a piece of his equipment? Surely, a buyer has the right to expect an answer, or doesn't he?"

A number of letters complaining that no replies were received to queries sent to some manufacturers (thank goodness, *no* CQ advertisers) have been sent to **Ham Clinic**. We have "re-queried" certain manufacturers with good results. However, it is suggested that readers who write for information *make certain* that their letters are properly addressed and above all, *courteous!* Although you may have a legitimate complaint, remember—no one has to answer any communication if it is full of abuse and with words not fit for print.

TI

"I live in an apartment house and everytime one of the tenants dials his telephone it raises heck with my receiver, what should I do?"

Call the telephone company. There can be many causes of the trouble. Inadequate grounds often contribute to or cause this trouble. Too, if your antenna is close to *open* (not cable) wire lines there will be induction.

Self Power

"I hear that a receiver has recently been made with transistors requiring no batteries, how is this possible?"

Special energy storage circuits. Rf radiation is received and then is rectified. Stored, it supplies the necessary voltages for operation of associated transistors. For a full article on this, see *Electronics*, page 63, May 9, 1958, Engineering Edition.

Thirty

Next month we'll discuss antenna *selection* and *why* some hams are fooled into believing that an antenna that works for one will work exactly the same for everyone else, regardless of location. Remember: limit your questions *one* to a letter and DO include a self-addressed stamped envelope for quick service.

73, Chuck W6QLV

SURPLUS

by **KENNETH B. GRAYSON, W2HDM**

110-20 71st Ave., Forest Hills 75, N. Y.

Not all surplus equipment is military in origin . . . although we generally consider it to be so. Quite a lot of commercial surplus is around in many forms, from the older types of diathermy machines (not FCC approved) to electric blanket controls. Somewhere in the middle of this maze is that piece of equipment once considered the ultimate. That it is no longer used is due to some development which caused our eyes to look to more modern equipment. Chances are that the old gear still works quite well and could easily be adapted to our present needs. I found just such a gem in the basement of W2UUD, and decided to show just how simple a conversion really can be . . . especially after the BC-603 last month.

The Ten-Eleven Meter Gonset converter was the heart of many a mobile installation of just ten years ago. It went the way of all flesh when the Tri-Band Converter was introduced, but it is still sensitive and reliable, and is sure to provide many more hours of good solid contacts. A lot has happened in just ten years. Single side-band came in, eleven-meters went out and six-meters is getting popular. We decided to put the old Ten-Eleven on Six. The job turned out to be really simple.

The first step is to open the unit. This is done by removing two nuts on the back and sliding cover off. Next remove the two knobs and the bushing nuts holding the front panel on. Slip the front panel off and carefully remove the plastic dial window. Chances are that the case is scratched or dented and needs some work. Trying to fix it with the paint on is a problem. We found it best to strip the paint off completely using a commercial paint solvent and then respray it later after we had cleaned up the cabinet.

The chassis is probably dusty, and some parts may need cleaning or replacing. Use a paint brush to clean the dust out and, if need be, check for those parts which may need a going over. Take off the dial card and make a new one from white cardboard or plastic, leaving room to calibrate the dial. You'll have to re-

move the pointer first, but this is held only by a screw so there is no problem.

You'll have to remove one plate of the rotor of the variable capacitor at the back end (oscillator end) of the set. This is done by removing the assembly screw at the center of the variable condenser shaft and taking one plate off. Reassemble, making sure all of the variable condenser plates are in line (as they were to begin with). The coils will need to have turns removed in order to reach the frequency we want to cover. The range we got was 50 to 53.5 mc which just misses being near the TV station interference. Remove turns from the *rf* and mixer coils so that there are 8 turns remaining, and then spread these turns to cover a length of about one and one-half inches. The oscillator coil is wound on a phenolic form and should have a total of seven turns. Remove turns from the top end of this coil until the seven turns remain. Make sure that the coil is now spread out to about one-half inch and make sure, too, that the tap is left at the two and a half turn location from the chassis end of this coil. The spreading of the coil should be done above the tap. Leave the insulated coils within the *rf* and mixer coils just as they were, and solder all connections, the coils and condensers as they were originally.

The next step is to align the converter. Put the dial we've made onto the chassis and mesh the condenser plates fully by turning the tuning knob shaft until the condenser is closed. Put the pointer on and set it so it points to the left. Using a grid dipper find the frequency to which the coils dip. The oscillator should be about 48.4 mc and the *rf* and mixer should be about 49.9 mc. If this is not so, adjust the trimmer condensers to get the dip. If you still can't get the coils to dip find out at what frequency they do dip at. If the frequency is lower you will have to spread the turns slightly until you get to the right frequency, and if it is higher you will have to squeeze the turns of the coils together slightly until they are on frequency.

Now, having gotten the low end to dip on frequency turn the condenser so it is fully open.

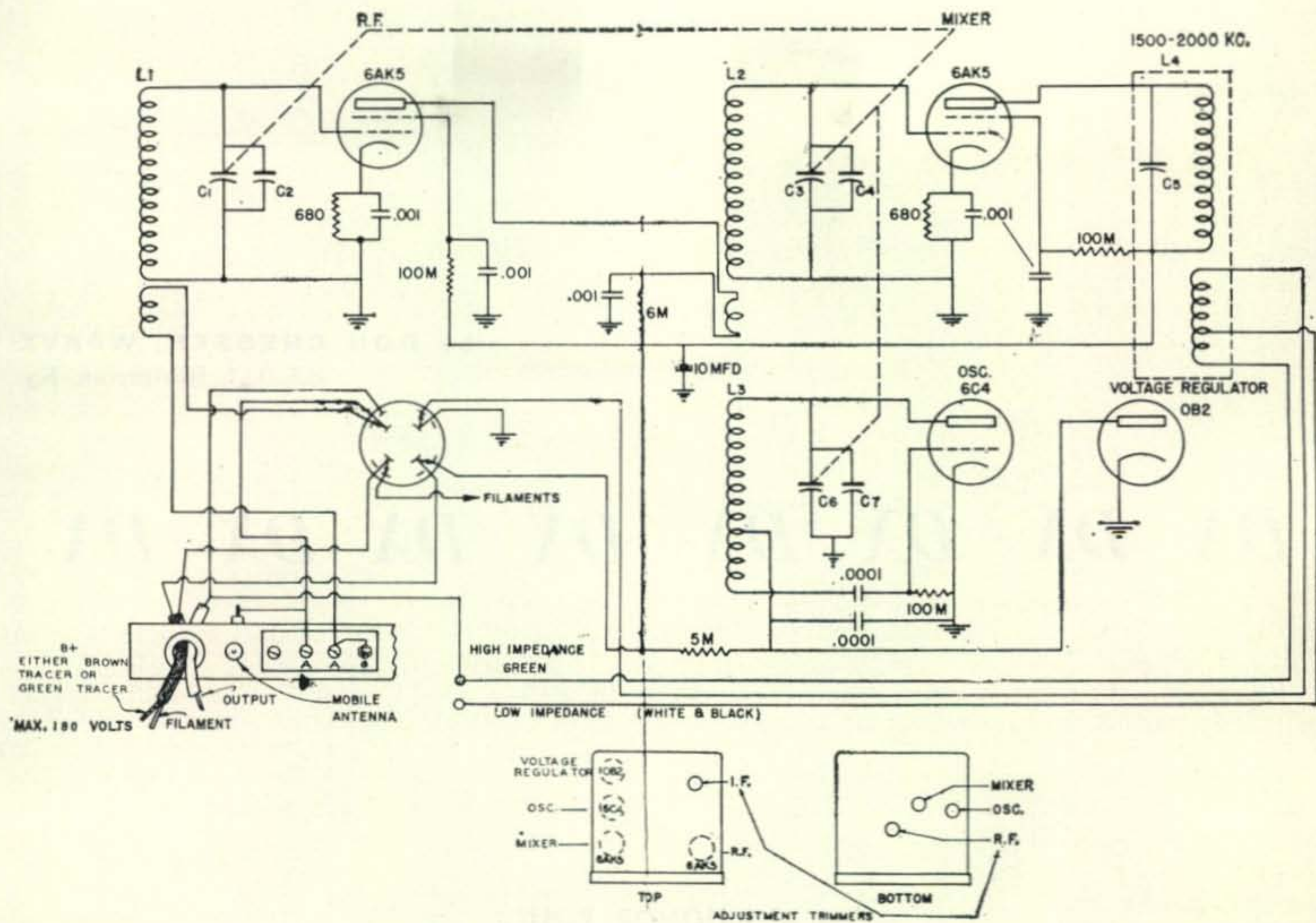

Fig. 1—Circuit of the Gonset 10-11 meter Fixed Mobile Converter.

The pointer should point to the right, and the coils should now dip at about 53.5 mc for the *rf* and mixer, and 52 mc for the oscillator. If this does not occur find out at what frequency the coils do dip at and if it is close (as it should be) adjust the trimmers slightly to bring it in. The *rf* and mixer coils should always be at the same frequency no matter where the dial is set, and the oscillator coil should always be tuned to 1.5 mc lower. By a little effort, we can adjust the coils and condenser to tune quite accurately over the band of 49.9 to 53.5 mc. A little bit of trimmer adjusting and then some coil adjusting will be all that should be necessary. No other circuit changes were necessary.

Calibration of the dial is simple. Although the grid dipper is accurate only for approximate adjustments final calibration should be done using known signals or a signal generator. The trouble with the signal generator is that the average one only goes to about 30 mc so we have to use the second harmonic of 25 mc for 50 mc (25.5 for 51 mc etc.). Mark the dial in pencil where the pointer should be for each frequency mark you want. Remove the dial and ink in the calibration, reassemble the dial and reset the pointer. Check the calibration again and if ok reassemble the unit in its case. Of course for calibration you will have

to apply power and feed the output to a receiver. Don't try to use an AC-DC type receiver as it may cause you to get shocked, and it certainly cannot supply the 150 volts at 20 ma and 6.3v at one half ampere necessary to operate the converter.

The antenna terminal strip in the back was provided for a separate antenna should the installation use twin lead or single wire antenna. For the single wire antenna lead in one terminal A is grounded. For our use we can use the standard coaxial input and disregard this feature. When using a standard whip, the same antenna may be used for broadcast reception. No attempt was made to use a helix. Should any voltage above 180 volts be used (but not more than 300VDC) a 5000 ohm ten-watt resistor should be used in series with the B plus lead to limit current in the voltage regulator. Once installed, peak the output transformer with the receiver tuned to 1500 kc and the converter tuned to a station.

News

We get a lot of mail, as you might expect, from hams all over the world . . . hams with a common problem . . . conversion. We an-
[Continued on page 154]

by **DON CHESSER, W4KVX**
R.F.D. 1, Burlington, Ky.

DX DX DX DX DX DX DX DX

CQ HONOR ROLL

(Awards issued August 15 to September 15, 1958)

WAZ CERTIFICATES ISSUED

#781	Antonio Navatta
#782	H. O. Sills
#783	W. B. Hopkins
#784	J. Reisert
#785	Gerhard Blechert
#786	D. S. Dirden
#787	Charles L. Burgoyne
#788	Loren F. Ashwood
#789	Don C. Palmer
#790	Joseph A. Anderten
#791	Elmer H. Burgman
#792	Pentti Ahola
#793	Martti H. Rautio
#794	Ady Lumpert
#795	Rudolf Timmermans
#796	Emil Hlom
#797	Blanche G. Edwards
#798	Hal Roberts
#799	J. R. Keys
#800	H. D. Sandford
#801	Lauren L. McMaster

LU5AQ
G8QZ
G3FPI
W2HQL
DL9TJ
K6EDE
WILHZ
W9PQA
W0SNL
W2GNQ
W6CTO
OH5NJ
OH3RA
HB9UL
PA0RLF
OKIAEH
W9QLH
K6CWS
ZL3GU
ZL2AI
K2QNG

#802
#803
#804
#805
#806
#807
#808
#809
#810
#811
#812
#813
#814

Everett A. Erickson
Jose Nativilae Silva
Mel Wardell
Dick Feeling
William J. Nolan
A. F. Kuschner
Kenneth F. Gillum
Robert John Boal
Bruce F. Barnard
D. E. C. Lockyer
Jack Coldwell
Cristo Foro Crespi
Wm. H. Barber

WINLM
PYIHX
K4LPW
W5TIZ
W9TQL
W4CRP
WIQJR
G13AXI
ZLIAJU
G3HCL
W4VYP
IISM
VK6DX

ALL PHONE WAZ

=20

Cristo Foro Crespi

IISM

CW WPX

=13

Charles G. Price

W4GXB

If you have recently received an FCC citation for "tail ending" (signing only your call at the end of another's transmission) you are in good company. Quite a number of prominent DXers have found these slips in their mail boxes for violations during DXpedition pile-ups in recent months, most of them originating at monitoring stations in Michigan and Georgia. The rule violated, of course, is that requiring transmissions be complete with call letters of the station called as well as those of the calling station.

It is difficult to understand the FCC's purpose in enforcing this minor rule, when its enforcement serves no good purpose and only results in chaotic conditions for us. Nearly all of us are guilty of "tail ending", for it has

proved to be superb operating practice, resulting in the very minimum of QRM and confusion during contests and DX pile-ups. Since the system is used mostly during those operations when many are calling the same station, there should be little doubt in anyone's mind as to who's calling whom.

This apparently puts a stop to the "DE" system of DX operating instigated by Red, W8EZF, at VP5BH, and later continued with extraordinarily good results at KC4AF. It's the only system we've ever heard that controlled pile-ups, for it permitted us to work so fast they just couldn't develop.

A representative of the FCC, cornered at the Washington National Convention last August, said he knew of no concerted program

by the FCC against this minor infraction of the rules. But rules are rules, he pointed out, and "tail ending" is an infraction.

Speaking of the Washington National Convention, the contest and DX sessions, MC'd by W3EIS and W4 KFC respectively, were judged to be unqualified successes. These two hard-pressed, nerve-wracked individuals turned in flawless performances, although conditions behind the scenes were less than perfect. The movie projector, for example, for presenting the KC4AF 16mm DXpedition film, turned out to be the wrong type. Vic, W4KFC, oozed quantities of nervous perspiration in his efforts to rearrange the DX session in progress, feature by feature, while the city was canvassed for a proper projector. One was found just in time for that part of the program, but then it developed Wayne, W2NSD, scheduled to narrate the film, was in another part of the hotel speaking on the delightful subject, "Sex and Amateur Radio"!

It all ended well, however. Vic handled the situation so smoothly it is doubtful the audience was more than slightly aware that the program had been changed around a bit.

Although it would appear the huge, sprawling Sheraton-Park Hotel, site of this year's convention, should have an ample supply of rooms for conventioners, considerable difficulties were experienced by many, especially at the reservations desk. One such problem was related by Bill Leonard, W2SKE, HH2SKE, etc. While driving down from New York, Bill endeavored to confirm his hotel reservation via ham radio with the aid of his mobile rig. Skip conditions made it necessary for him to relay the confirmation message via a W6 in California to a W3 in Washington, who phoned the hotel. Receipt of the message was dutifully acknowledged back to Bill, who confidently strode up to the reservations desk on his arrival. "Oh yes," remarked the clerk, "this is the reservation that was cancelled by that strange message from California a little while ago."

The highlight of the convention for many DXers occurred at the DX luncheon when W2SKE narrated an epic poem relating the ultimate in DXpeditions—an earth satellite manned by an ardent DXer who became 280 countries in the first few hours of orbit! This poem, a tension builder with a roaring climax, is a masterpiece, but much credit for its tension builder with a roaring climax, is a masterpiece, but much credit for its dramatic presentation goes to W2SKE, who proved his ability as a radio and TV star, presently narrator of the Voice of America world-wide amateur radio programs. If you get a chance to hear this poem, especially as presented by Bill, don't miss it! It, alone, is worth the price of admission.

DX NEWS

(All times noted are GMT)

Further DXpedition rumblings in Zone #7

WPX BOX SCORES

	CW			
W2HMJ	451	W6RLP		276
OK1MB	380	W8IBX		255
W5KC	359	W1EIO		243
W6KG	353	W0BCI		242
W9IU	344	VK4YP		238
W5AFX	312	K2PFC		231
SM5AHK	311	K6SXA		200
W9BPW	310	W4KVV		172
W1BFT	304	W8CSK		170
W2DGW	301	W4KAE		140
LU5AQ	301		Phone	
W8KPL	300	W8WT		340
W4GXB	300	G3DO		315
SM5CCE	299		SSB	
W8LY	294	TI2HP		155
DL1QT	289			

lead off the DX roundup this month with a full-scale assault on Galapagos Islands by Ron, W0AGO, who will sign HC8AGO; Paul W0LUX, HC8LUX; and Vic, W0WGF, HC8WGF; for two to four weeks starting the end of September. Planned and in negotiation for licenses, transportation, customs clearance, etc., for nearly a year, in co-operation with the Quito Radio Club of Ecuador, this ambitious DXpedition hopes to pick up two or four additional operators from the Quito club. Beautifully equipped to operate 10, 15, and 20 meters CW, AM, and SSB, the latter will probably be the mode of transmission favored. Daily skeds will be kept with Quito on 40 meters, although general operation is not planned for this band.

The expedition, called Operation Turtle, will be accompanied by two doctors, one from the University of Michigan and the other from New York University, who will make a survey of the islands for the purpose of locating a clinic there for the treatment of arthritis. The Galapagos Islands' climate is said to be the most perfect in the world. The expedition name, incidentally, is derived from the multitudes of turtles, many of them weighing as much as 500 pounds, which live on the islands.

Still another DXpedition in the zone #7 area, that of Ralph Ladd, W3KA, to Swan Island as KS4AZ, for the period September 26 to October 4, promises activity in a country that has become somewhat rare in recent years. QSL's go to the home QTH of W3KA. Doug, operator of FO8AT, Clipperton Island, is reported to have stopped off in Mexico City on his return to San Diego to inquire into possibilities of an XE4, Socorro Island, license and landing permission for the San Diego DX Club this fall or winter. At this writing we haven't learned the results of his inquiry. Other zone #7 activities: TI2WR, 14010 kc CW, 0300-GMT; TG7AB, 21115 kc CW, 0200; YS1MS, 14320 kc SSB, 0300; YS10, 14085 kc CW, 1930.

There is presently only one station, VP2SH, on St. Vincent, Zone #8, and he operates 7 mc

only, reports W5HJA. He meets a net every Tuesday on 7245 kc (time not known), the net control station of which is KP4USA. Danny Weil, currently at VP2AY, Antigua, plans Dominica, VP2D-, next, probably about the first of October. Reg, W6ITH, is now back at PJ2MC, with no further developments reported in the Anguilla small-pox situation. VP5CB, first SSB station on Grand Turks, will work as many stations as possible, but requests we not break in on their personal QSO's or phone patches. This station is the only Stateside contact for Navy Seabee personnel stationed on the island. Other zone #8 notables: VP2GL, 14025 kc CW, 1045; FG7XC, 14037 kc CW, 1100; VP2AB, 21210 kc AM, 2300; VP2GV, 21223 kc AM, 2100; FG7XF, 14043 kc CW, 0100; VP2AZ, 14309 kc SSB, 0130.

The Trinidad Island, Zone #11, DXpedition by PY1CK (as PYØNA), PY2CK (PYØNB), PY7AN (PYØNC), PY1HQ (PYØND), and PY1BIG (PYØNF), is still on for late October or early November, the exact dates not yet known, writes George, W8BKP, after a long chat with Flavio, PY1CK. After that PY1CK and PY1BIG will go to Fernando de Noronha again for one week to complete Flavio's DXCC from that island. He worked 85 countries from there during his first trip. Flavio is currently engaged in writing QSL's for his previous Trinidad trip, but he finds the chore slow going. He's mailing about 50 a week, with about 600 to go! He asks for patience from the expectant DXers. Fernando de Noronha is currently active in the person of PY7AFN, permanently stationed on that island with PY7SC. Don't let the PY7 prefixes fool you. PY1AQT

[Continued on page 163]

ADDRESS

AP2M—Razak Tenjani, P O Box 4074, Karachi-2, Pakistan
 BV1USB—Area 4, APO #63, San Francisco, California
 CE1DC—Dario Perez Garry, Casilla 255, Copiapo, Chile
 CEØAG—W. E. Douglas, K6BAZ, 8913 Broadway, San Gabriel, California
 CN8FW—B. P. 412, Oujda, French Morocco
 CP1AM—Mac, c/o U S Embassy, La Paz, Bolivia
 CT2AI—Box 29, Ponta Delgada, Azores Island
 DU9JO—Justino E. Ongchua, Cotabato, Mindanao, Philippine I.
 EA8BC—P O Box 8, Laguna, Canary Islands
 EA8CP—Box 215, Santa Cruz de Tenerife, Canary Island
 EA9AP—Box 213, Melilla, Spanish Morocco
 EL1X—Box 18, Harbel, Liberia
 FB8BS—Andre, Box 1619, Tanarive, Madagascar
 FO8AD—Joe Bourne, Ave du Commandant Chesse, Papeete, Tahiti
 FO8AK—George Henderson, Avenue du Cdt. Chesse, Papeete, Tahiti
 FM7MU (ex-FY7YH)—W/K/VE's QSL via W9YSX, Skip Frankie, RFD 6, Box 92, Greenfield, Ind., Direct QTH: Box 61, Fort de France, Martinique
 FPSAR—Via Ed Benkis, W2HTI, Box 385, Halsey Rd., Parsippany, N. J.
 FPSBC—QSL via W2BWQ, Edwin Iriye, 110-14 62nd Dr., Forest Hills 75, N. Y.
 FQ8AJ—Gilbert, P O Box 2023, Brazzaville, Moyen Congo, French Equatorial Africa
 FU8AG—Vincent Vidal, Box 44, Port Vila, New Hebrides
 HA5BI—S; Istvan Biro, Szt. Istvan U. 182, Budapest XXI, Hungary
 HA5DH—S; Oscar Kalmar, Metro U. 18, Budapest XVI, Hungary
 HI8GA—44 Doctor Delgado Street, Ciudad Trujillo, Dominican Republic
 HL9KR—QSL via W6IAL
 HL9KS—SP/2 Wm. Shipp, HQ KMAG, APO 102, San Francisco, California

HP1ME—Manuel, P O Box 493, Panama, Republic of Panama
 HRØAA—QSL via W3YZS, Carl Moore, 112 Palm Ave, Warren, Pa.
 IT1ZND—Stella Polare, 44 Catania, Sicily, Italy
 IS1AUI—Paolo, Via Umbria 15, Cagliari, Sardinia
 JZØDA—Sentani Air Strip, Netherlands New Guinea
 JZØHA—Box 420, Sorong, Netherlands New Guinea
 ex-KA2KS—214 Thelma Drive, San Antonio, Texas
 KA7HH—QSL via John A Moran Jr., W1AHQ, 44 Hillside Ave, Malden, Mass.
 KA9AF—Capt. A. D. Frink, APO #70, San Francisco, California
 KAØIJ—Ted, APO 19, San Francisco, California
 KAØIK—APO 815, c/o PM, San Francisco, California
 KC4USK—For QSO's with opr Don, QSL to Don Edman, c/o Post Office, Solomons, Md.
 W2EPS/KJ6—c/o U S Coast Guard Loran Station, APO 105, San Francisco, California
 KL7FLA—Phil, 4143 Edgewater Dr., Orlando, Florida
 KL7OOT—Box 487, Fairbanks, Alaska
 KP6AN—QSL via W6SGP, George W. Richert, RFD 4, Box 464A, Turlock, Calif.
 Okinawa Amateur Radio Club, APO 331, San Francisco, California
 LU3ZJ—Pola 1354, Buenos Aires, Argentina (His cards will be sent when he returns to Buenos Aires end of this year)
 LZ1AF—Dimitar Petrov, Box 412, Sofia, Bulgaria
 OA4GB—William Dubbs, Apartado 4407, Lima, Peru
 OA4IGY—Minitrack Tracking Station, c/o U S Embassy, Lima, Peru
 OK3AL—Ing. Svejna, Brezno, Slovakia, Czechoslovakia
 OX3WD—Willy Nielsen, Julianehab, Greenland
 OY1J—J. Gerlaldid, Klakksvig, Faeroe Islands
 OY1L—Robert a Lakjuni, a, Gordum Klakksvig, Faeroe Islands
 OY1X—Elias Hansen, Selheyg, Klakksvig, Faeroe Islands
 PY4ZG—Dijalma Nunes Grandi, Rua Tres Ponta, 263, Belo Horizonte, Brazil
 SU1IM—QSL via G. Cole, W9DRS, Homestead 30, Decatur, Ill. (Please include stamped return envelope with your card)
 SVØWA—American Consulate General, APO 223, New York, N. Y.
 TF2WDA—932 AC & W, Box 60, APO 81, New York, N. Y.
 TI2CME—P O Box 2529, San Jose, Costa Rica
 TI2WD—Roy, Box 2412, San Jose, Costa Rica
 VE8MC—Jt. Canadian/US Arctic Weather Station, Mould Bay, N. W. T., Canada
 VK4AL—Everett Brown, c/o Clontarf Beach Post Office, Queensland, Australia
 VK9BS—c/o P O Box 84, Port Moresby, Territory Papua
 VKØKT—QSL via VK2EG
 VP1FL—Box 377, Belize, British Honduras
 VP2AB—QSL to Box 39, Antigua, B. W. I. (not via bureau)
 VP2GL—Art, Box 44, St. Georges, Grenada, B. W. I.
 VP2GV—Grandon Hall, St. Andrews, Grenada, West Indies Federation
 VP2KF—QSL to KV4AA
 VP2LS—Lionel Ellis, P O Box 171, Castries, St. Lucia, B. W. I.
 VP2MR—P O Box 221, Plymouth, Montserrat
 VP5CB—MCB-7, FPO, New York, N. Y.
 VP8CE—Peter Catlow, FIDS, Base J, Fenn Head, via Port Stanley, Falkland Islands
 VP8CY—QSL via G8FC
 VP8DS—Les Hardy, Port Stanley, Falkland Islands
 VP8DW—Tony Hardy, Port Stanley, Falkland Islands
 VQ3CF—QSL via W2CTN, Jack Cummings, 159 Ketcham Ave., Amityville, N. Y., (include stamped return envelope)
 VQ5FS—T. P. Tierney, P O Box 118, Jinia, Uganda
 VR2DE—Dennis, P O Box 225, Nanda Airport, Fiji Islands
 VS1FJ—F/Sgt Frank Johnstone, RAF Changi, Singapore 17
 VS9AS—QSL via RSGB
 VS9MA—QSL via RSGB
 VU2JG—Jalesh C. Ganguli, F148 South Vinay Nagar, New Delhi, India
 WL7CON—Box 487, Fairbanks, Alaska
 XE1ZM—E. J. Rudisuhle, Apdo Postal 26010, Mexico 12, D. F. Mexico
 XW8AI—Box 115, Vientiane, Laos
 YN1JW—Juan, P O Box 389, Managua, Nicaragua
 ZC4RF—c/o RAF, BFPO 53, Nicosia, Cyprus
 ZD7SZ—QSL via W9FJY, RFD #2, Mascoutah, Ill.
 ZD9AF—QSL via SARL, Capetown, Union of South Africa
 ZK1AK—Norm Walding, c/o CAA, Aitutaki, Cook Island
 ZK2AD—Les Hack, Radio Station, Niue Island, Via New Zealand

[Continued on page 163]

Distributor Index

One problem that faces the amateur when he reads about something that interests him is, "Where Do I Get It?" This can be pretty frustrating at times. The handy list on the following pages will tell you where you can buy what you want. We suggest you stick a book mark in this section so you can pull it off the shelf and use it for reference all year 'round.

ALPHABETICAL LIST OF DISTRIBUTORS

- Ack Radio Supply Company 42
3101 Fourth Avenue, So. Birmingham 5, Ala.
- Ack Radio Supply Company of Georgia 43
331 Luckie Street, N. W. Atlanta 13, Georgia
- Adirondack Radio Supply 36
185-191 West Main Street
Amsterdam, New York
- Alco Electronics 50
3 Wolcott Avenue
Lawrence, Mass.
- Alltronics-Howard Co. 89
278 Friend Street
Boston, Massachusetts
- Alltronics-Howard Co. with Shumaker & Evans 90
60 Spring Street
Newport, Rhode Island
- Almo Radio Company 75
1122 French Street
Wilmington, Del.
- Almo Radio Company 76
317 Park Heights Ave.
Salisbury, Md.
- Almo Radio Company 74
4401 Ventnor Avenue
Atlantic City, N. J.
- Almo Radio Company 73
1133 Haddon Avenue
Camden, New Jersey
- Almo Radio Company 77
201 Calhoun Street
Trenton, New Jersey
- Almo Radio Company 78
550 Markely Street
Norristown, Pa.
- Almo Radio Company 70
91 1/2 Arch Street
Philadelphia 7, Pa.
- Almo Radio Company 71
7540 Frankford Avenue
Philadelphia, Pa.
- Almo Radio Company 72
6205 Market Street
Philadelphia, Pa.
- Amateur Electronic Supply 52
3832 West Lisbon
Milwaukee, Wisconsin
- Antrim Marine Radio 65
4022 Woodruff Road
Lafayette Hill, Pa.
- Arrow Electronics Inc. 69
525 Jericho Tpke.
Mineola, L. I., N. Y.
- Arrow Electronics Inc. 68
65 Cortlandt Street
New York 7, New York
- Barry Electronics Corp. 98
512 Broadway
New York 12, New York
- Bond Electronics Inc. 32
42 Cornhill
Boston 8, Mass
- Lew Bonn Company 91
67 South 12th Street
Minneapolis 3, Minn.
- Burghardt Radio Supply 49
Box 746
Watertown, South Dakota
- Burstein-Applebee Company 80
1012-14 McGee Street
Kansas City 6, Missouri
- C & G Radio Supply Co. 92
2502-6 Jefferson Avenue
Tacoma, Washington
- James W. Clary Company 33
1713 Second Avenue,
South
Birmingham, Alabama
- Crabtree's Wholesale Electronics 64
2608 Ross Avenue
Dallas 1, Texas
- Cramer Electronics Inc. 31
811 Boylston Street
Boston 16, Mass.
- Crawford Radio 27
119-121 John Street, N.
Hamilton, Ont., Canada
- Custom Electronics, Inc. 1
1918 S. Brown Street
Dayton 9, Ohio
- Dalton-Hege Radio Supply Co., Inc. 35
912 West Fourth Street
(rear)
Winston-Salem, N. C.
- Dow Radio, Inc. 29
1759 E. Colorado St.
Pasadena, California
- W. H. Edwards Co., Inc. 30
94 Broadway
Providence 3, Rhode Island
- Elmar Electronics 63
140 11th Street
Oakland 7, California
- Electronics Equipment Distributor 8
3686 El Cajon Blvd.
San Diego 4, California
- Electronics-Suppliers 6
2428 Shattuck Avenue
Berkeley, California
- Electronic Supply 62
909 Morningside Drive
Melbourne, Florida
- Electronic Supply 61
61 N. E. 9th Street
Miami 32, Florida
- Evans Radio Inc. 94
Rt. 3A Bow Jct.
Concord, New Hampshire
- Fargo Radio Service Company 54
513 3rd Avenue, North
Fargo, North Dakota
- Gopher Electronics Co. 28
370 Minnesota Street
St. Paul, Minnesota
- Grice Electronics, Inc. 83
300 East Wright St.
Pensacola, Florida
- H & H Electronic Supply, Inc. 26
506-510 Kishwaukee Street
Rockford, Illinois
- Hagerty Radio Supply 16
2926 W. Magnolia
Burbank, California
- Ham 'N Hi-Fi 22
826 N. Main Street
Dayton 5, Ohio
- Harris Radio Corporation 51
289 N. Main Street
Fond du Lac, Wisconsin
- HARRISON "Ham Headquarters, USA" 23
225 Greenwich Street
New York 7, New York
- HARRISON "Ham Headquarters, USA" 24
144-24 Eillside Avenue
Jamaica, Long Island,
N. Y.
- Henry Radio 10
11240 West Olympic Blvd.
Los Angeles 64, California
- Henry Radio 11
Butler, Mo.
- Ken-Els Radio Supply Co. 5
428 Central Avenue
Fort Dodge, Iowa
- Kierulff Electronics Inc. 88
820 W. Olympic Blvd.
Los Angeles 15, Calif.
- Klaus Radio & Electric Co. 38
403 East Lake Street
Peoria, Illinois
- Harold Lund, W8LIM 53
(Field Rep.)
532 East Birch Street
Ironwood, Michigan
- Larry Lynde Electronics W6UG-W6DEP 60
1526 East 4th Street
Long Beach 12, California
- The Mytronic Company 47
2145 Florence Avenue
Cincinnati 6, Ohio
- Nidisco-Cliff, Inc. 56
484 Bergen Blvd.
Ridgefield, New Jersey
- Nidisco-Hack, Inc. 57
55 State Street
Hackensack, New Jersey
- Nidisco Jersey City, Inc. 55
713 Newark Avenue
Jersey City, New Jersey
- Nidisco-Pass, Inc. 58
294 Passaic Street
Passaic, New Jersey
- Nidisco-Trenton, Inc. 59
985 Princeton Avenue
Trenton, New Jersey
- Payette Radio Limited 14
730 St-James St., West
Montreal 3, P. Que.
- Pioneer Electronic Supply Co. 2
Amateur Department
2103 East 21st Street
Cleveland 15, Ohio
- Portland Radio Supply 39
1234 S. W. Stark
Portland 5, Oregon
- Radio Distributing Company, Inc. 15
1212 High Street
South Bend 24, Indiana
- Radio Electric Service Co. of N. J., Inc. 12
513 Cooper Street
Camden 2, New Jersey
- Radio Electric Service Co. 13
452 N. Albany Avenue
Atlantic City, New Jersey
- Radio Electric Service Company 40
5 N. Howard Street
Baltimore 1, Maryland
- Radio Electric Service Company 41
7502 Eastern Avenue
Baltimore 24, Maryland
- Radio Parts of Arizona 87
P. O. Box 6345
214 South 11th Avenue
Phoenix, Arizona
- Radio Parts of Calexico 9
116 2nd Avenue
Calexico, California
- Radio Products Sales Co. 18
1237 16th Street
Denver 2, Colorado
- Radio Shack Corporation 46
230-240 Crown Street
New Haven, Connecticut
- Radio Shack Corporation 44
730 Commonwealth Avenue
Boston, Massachusetts
- Radio Shack Corporation 45
167 Washington Street
Boston, Massachusetts
- Radio Trade Supply Co. 7
1224 Grand Avenue
Des Moines 9, Iowa
- Rogers Radio Company 48
1648-52 Wazee Street
Denver, Colorado
- Satterfield Electronics Inc. 37
1900 South Park Street
Madison, Wisconsin
- Selectronic Supplies Inc. 82
803 So. Adams
Peoria, Illinois
- Selectronic Supplies Inc. 81
3185 Bellevue Rd.
Toledo, Ohio
- Bill Thompson Radio Supply 67
11159-61 Washington Blvd.
Culver City, California
- United Radio Supply, Inc. 19
22 N. W. Ninth Avenue
Portland 9, Oregon
- United Radio Supply, Inc. 20
697 South 12th Street
Salem, Oregon
- United Radio Supply, Inc. 21
974 West Sixth Street
P. O. Box 3266
Eugene, Oregon
- Valley Electronic Supply Co. 3
1302 W. Magnolia Blvd.
Burbank, California
- Valley Electronic Supply Co. 4
17647 Sherman Way
Van Nuys, California
- Valley Engineering Company 85
625 East Main
Farmington, New Mexico
- Valley Engineering Company 84
601 Cedar Street
Los Alamos, New Mexico
- Valley Engineering Company 86
241 West Alameda
Santa Fe, New Mexico
- Valley Radio Distributors 34
518 N. Appleton Street
Appleton, Wisconsin
- Variety Electronics Corp. 79
Bloomfield Ave. at State St.
Bloomfield, New Jersey
- Verl G. Walker Company 17
P. O. Box 1586
205 West Jackson
Medford, Oregon
- Eugene G. Wile 25
218-220 South 11th Street
Philadelphia 7, Penna.
- World Radio Labs Inc. 66
3415 West Broadway
Council Bluffs, Iowa

NUMERICAL LIST OF DISTRIBUTORS

- | | | | | |
|--|--|---|--|---|
| 1 Custom Electronics, Inc.
1918 S. Brown Street
Dayton 9, Ohio | 19 United Radio Supply, Inc.
22 N. W. Ninth Avenue
Portland 9, Oregon | 36 Adirondack Radio Supply
185-191 West Main Street
Amsterdam, New York | 54 Fargo Radio Service Company
513 3rd Avenue, North
Fargo, North Dakota | 75 Almo Radio Company
1122 French Street
Wilmington, Del. |
| 2 Pioneer Electronic Supply Co.
Amateur Department
2103 East 21st Street
Cleveland 15, Ohio | 20 United Radio Supply, Inc.
697 South 12th Street
Salem, Oregon | 37 Satterfield Electronics Inc.
1900 South Park Street
Madison, Wisconsin | 55 Nidisco Jersey City, Inc.
713 Newark Avenue
Jersey City, New Jersey | 76 Almo Radio Company
317 Park Heights Ave.
Salisbury, Md. |
| 3 Valley Electronic Supply Co.
1302 W. Magnolia Blvd.
Burbank, California | 21 United Radio Supply, Inc.
974 West Sixth Street
P. O. Box 3266
Eugene, Oregon | 38 Klaus Radio & Electric Co.
403 East Lake Street
Peoria, Illinois | 56 Nidisco-Cliff, Inc.
484 Bergen Blvd.
Ridgefield, New Jersey | 77 Almo Radio Company
201 Calhoun Street
Trenton, New Jersey |
| 4 Valley Electronic Supply Co.
17647 Sherman Way
Van Nuys, California | 22 Ham 'N Hi-Fi
826 N. Main Street
Dayton 5, Ohio | 39 Portland Radio Supply
1234 S. W. Stark
Portland 5, Oregon | 57 Nidisco-Hack, Inc.
55 State Street
Hackensack, New Jersey | 78 Almo Radio Company
550 Markley Street
Norristown, Pa. |
| 5 Ken-Els Radio Supply Co.
428 Central Avenue
Fort Dodge, Iowa | 23 HARRISON "Ham Headquarters, USA"
225 Greenwich Street
New York 7, New York | 40 Radio Electric Service Company
5 N. Howard Street
Baltimore 1, Maryland | 58 Nidisco-Pass, Inc.
294 Passaic Street
Passaic, New Jersey | 79 Variety Electronics Corp.
Bloomfield Ave. at State St.
Bloomfield, New Jersey |
| 6 Electronics-Suppliers
2428 Shattuck Avenue
Berkeley, California | 24 HARRISON "Ham Headquarters, USA"
144-24 Hillside Avenue
Jamaica, Long Island, N. Y. | 41 Radio Electric Service Company
7502 Eastern Avenue
Baltimore 24, Maryland | 59 Nidisco-Trenton, Inc.
985 Princeton Avenue
Trenton, New Jersey | 80 Burstein-Applebee Company
1012-14 McGee Street
Kansas City 6, Missouri |
| 7 Radio Trade Supply Co.
1224 Grand Avenue
Des Moines 9, Iowa | 25 Eugene G. Wile
218-220 South 11th Street
Philadelphia 7, Penna. | 42 Ack Radio Supply Company
3101 Fourth Avenue, So.
Birmingham 5, Ala. | 60 Larry Lynde Electronics W6UG-W6DEP
1526 East 4th Street
Long Beach 12, California | 81 Selectronic Supplies Inc.
3185 Bellevue Rd.
Toledo, Ohio |
| 8 Electronics Equipment Distributor
3686 El Cajon Blvd.
San Diego 4, California | 26 H & H Electronic Supply, Inc.
560-510 Kishwaukee Street
Rockford, Illinois | 43 Ack Radio Supply Company of Georgia
331 Luckie Street, N. W.
Atlanta 13, Georgia | 61 Electronic Supply
61 N. E. 9th Street
Miami 32, Florida | 82 Selectronic Supplies Inc.
803 So. Adams
Peoria, Illinois |
| 9 Radio Parts of Calexico
116 2nd Avenue
Calexico, California | 27 Crawford Radio
119-121 John Street, N.
Hamilton, Ont., Canada | 44 Radio Shack Corporation
730 Commonwealth Avenue
Boston, Massachusetts | 62 Electronic Supply
909 Morningside Drive
Melbourne, Florida | 83 Grice Electronics, Inc.
300 East Wright St.
Pensacola, Florida |
| 10 Henry Radio
11240 West Olympic Blvd.
Los Angeles 64, California | 28 Gopher Electronics Co.
370 Minnesota Street
St. Paul, Minnesota | 45 Radio Shack Corporation
167 Washington Street
Boston, Massachusetts | 63 Elmar Electronics
140 11th Street
Oakland 7, California | 84 Valley Engineering Company
601 Cedar Street
Los Alamos, New Mexico |
| 11 Henry Radio
Butler, Mo. | 29 Dow Radio, Inc.
1759 E. Colorado St.
Pasadena, California | 46 Radio Shack Corporation
230-240 Crown Street
New Haven, Connecticut | 64 Crabtree's Wholesale Electronics
2608 Ross Avenue
Dallas 1, Texas | 85 Valley Engineering Company
625 East Main
Farmington, New Mexico |
| 12 Radio Electric Service Co. of N. J., Inc.
513 Cooper Street
Camden 2, New Jersey | 30 W. E. Edwards Co., Inc.
94 Broadway
Providence 3, Rhode Island | 47 The Mytronic Company
2145 Florence Avenue
Cincinnati 6 Ohio | 65 Antrim Marine Radio
4022 Woodruff Road
Lafayette Hill, Pa. | 86 Valley Engineering Company
241 West Alameda
Santa Fe, New Mexico |
| 13 Radio Electric Service Co.
452 N. Albany Avenue
Atlantic City, New Jersey | 31 Cramer Electronics Inc.
811 Boylston Street
Boston 16, Mass. | 48 Rogers Radio Company
1648-52 Wazee Street
Denver, Colorado | 66 World Radio Labs Inc.
3415 West Broadway
Council Bluffs, Iowa | 87 Radio Parts of Arizona
P. O. Box 6345
214 South 11th Avenue
Phoenix, Arizona |
| 14 Payette Radio Limited
730 St-James St., West
Montreal 3, P. Que | 32 Bond Electronics Inc.
42 Cornhill
Boston 8, Mass. | 49 Burghardt Radio Supply
Box 746
Watertown, South Dakota | 67 Bill Thompson Radio Supply
11159-61 Washington Blvd.
Culver City, California | 88 Kierulff Electronics Inc.
820 W. Olympic Blvd.
Los Angeles 15, Calif. |
| 15 Radio Distributing Company, Inc.
1212 High Street
South Bend 24, Indiana | 33 James W. Clary Company
1713 Second Avenue, South
Birmingham, Alabama | 50 Alco Electronics
3 Wolcott Avenue
Lawrence, Mass. | 68 Arrow Electronics Inc.
55 Cortlandt Street
New York 7, New York | 89 Alltronics-Howard Co.
278 Friend Street
Boston, Massachusetts |
| 16 Hagerty Radio Supply
2926 W. Magnolia
Burbank, California | 34 Valley Radio Distributors
518 N. Appleton Street
Appleton, Wisconsin | 51 Harris Radio Corporation
289 N. Main Street
Fond du Lac, Wisconsin | 69 Arrow Electronics Inc.
525 Jericho Tpke.
Mineola, L. I., N. Y. | 90 Alltronics-Howard Co. with Shumaker & Evans
60 Spring Street
Newport, Rhode Island |
| 17 Verl G. Walker Company
P. O. Box 1586
205 West Jackson
Medford, Oregon | 35 Dalton-Hege Radio Supply Co., Inc.
912 West Fourth Street (rear)
Winston-Salem, N. C. | 52 Amateur Electronic Supply
3832 West Lisbon
Milwaukee, Wisconsin | 70 Almo Radio Company
913 Arch Street
Philadelphia 7, Pa. | 91 Lew Bonn Company
67 South 12th Street
Minneapolis 3, Minn. |
| 18 Radio Products Sales Co.
1237 16th Street
Denver 2, Colorado | | 53 Harold Lund, W8LIM (Field Rep.)
532 East Birch Street
Ironwood, Michigan | 71 Almo Radio Company
7540 Frankford Avenue
Philadelphia, Pa. | 92 C & G Radio Supply Co.
2502-6 Jefferson Avenue
Tacoma, Washington |
| | | | 72 Almo Radio Company
6205 Market Street
Philadelphia, Pa. | 93 Barry Electronics Corp.
512 Broadway
New York 12, New York |
| | | | 73 Almo Radio Company
1133 Haddon Avenue
Camden, New Jersey | 94 Evans Radio Inc.
Rt. 3A Bow Jet
Concord, New Hampshire |
| | | | 74 Almo Radio Company
4401 Ventnor Avenue
Atlantic City, N. J. | |

ALPHABETICAL LIST OF MANUFACTURERS

KEY NUMBERS INDICATE DISTRIBUTORS HANDLING THEIR PRODUCTS

AMPEREX ELECTRONIC CORP.

230 Duffy Avenue
Hicksville, New York

Electron Tubes

2, 3, 4, 5, 7, 10, 11, 12, 13, 14, 15, 17, 22, 23,
24, 25, 28, 29, 33, 34, 35, 36, 37, 38, 39, 40,
41, 47, 48, 49, 50, 51, 52, 53, 60, 61, 62, 63,
64, 66, 68, 69, 70, 71, 72, 73, 74, 75, 76, 77,
78, 79, 80, 81, 82, 83, 84, 85, 86, 87, 88, 91,
94

ANTENNA SPECIALIST CO.

12435 Euclid Avenue
Cleveland 6, Ohio

Mobile Communications Antennas

1, 2, 10, 11, 12, 13, 16, 19, 20, 21, 22, 23,
24, 25, 26, 29, 31, 32, 33, 34, 35, 36, 37, 38,
42, 43, 47, 48, 51, 52, 53, 55, 56, 57, 58, 59,
61, 62, 64, 68, 69, 70, 71, 72, 73, 74, 75, 76,
77, 78, 81, 82, 87, 92

AUTOMATION ELECTRONICS, INC.

1500 W. Vertugo Avenue
Burbank, California

Mobile Communications Receivers

3, 4, 5, 6, 8, 9, 10, 11, 16, 17, 18, 22, 23, 24,
25, 39, 48, 49, 51, 52, 53, 60, 63, 67, 83, 84,
85, 86, 89, 90, 91

BARKER & WILLIAMSON, INC.

Canal Street & Beaver Dam Rd.
Bristol, Penna.

Transmitter, Amplifiers, Baluns, & Components

1, 2, 3, 4, 5, 6, 7, 8, 9, 10, 11, 12, 13, 14, 15,
16, 17, 18, 19, 20, 21, 22, 23, 24, 25, 26, 27,
28, 29, 30, 31, 32, 33, 34, 35, 36, 37, 38, 39,
40, 41, 42, 43, 44, 45, 46, 47, 48, 49, 51, 52,
53, 54, 55, 56, 57, 58, 59, 60, 61, 62, 63, 64,
66, 67, 68, 69, 70, 71, 72, 73, 74, 75, 76, 77,
78, 79, 80, 81, 82, 83, 84, 85, 86, 87, 88, 89,
90, 91, 92, 93, 94

BASSETT, REX INC.

Ft. Lauderdale, Fla.

Mobile Antennas, Coils and Mounts

2, 3, 4, 5, 8, 9, 10, 11, 14, 19, 20, 21, 22, 23,
24, 25, 27, 29, 31, 32, 36, 37, 38, 42, 43, 44,
45, 46, 48, 49, 51, 52, 53, 54, 60, 61, 62, 63,
65, 67, 87, 89, 90, 92, 94

BLILEY ELECTRIC CO.

Union Station Building
Erie, Penna.

Crystals and Accessories

2, 7, 8, 9, 10, 11, 12, 13, 14, 15, 16, 17, 18,
19, 20, 21, 22, 23, 24, 30, 31, 32, 33, 34, 35,
38, 39, 40, 41, 42, 43, 44, 45, 46, 47, 48, 51,
52, 53, 54, 55, 56, 57, 58, 59, 61, 62, 63, 66,
68, 69, 70, 71, 72, 73, 74, 75, 76, 77, 78, 79,
80, 81, 82, 83, 87, 91, 94

BUD RADIO, INC.

2118 E. 55th Street
Cleveland 3, Ohio

Code Practice Devices, Metal Cabinets and Racks

2, 3, 4, 5, 6, 7, 8, 9, 10, 11, 12, 13, 15, 16,
17, 18, 19, 20, 21, 22, 23, 24, 25, 26, 27, 28,
29, 30, 31, 32, 33, 34, 35, 36, 37, 38, 39, 40,
41, 42, 43, 47, 48, 49, 51, 52, 53, 54, 55, 56,
57, 58, 59, 61, 62, 63, 64, 66, 67, 68, 69,
70, 71, 72, 73, 74, 75, 76, 77, 78, 79, 80, 81,
82, 83, 87, 88, 91, 92, 94

CENTRAL ELECTRONICS, INC.

1247 W. Belmont Avenue
Chicago 13, Illinois

Transmitters, Amplifiers, and Test Equipment

1, 2, 3, 4, 5, 6, 7, 10, 11, 12, 13, 15, 16, 17,
18, 19, 20, 21, 22, 23, 24, 25, 26, 27, 28, 31,
32, 33, 34, 35, 36, 37, 38, 39, 40, 41, 42, 43,
44, 45, 46, 47, 48, 49, 50, 51, 52, 53, 54, 60,
61, 62, 63, 64, 66, 67, 68, 69, 80, 81, 82, 83,
87, 88, 89, 90, 91, 92, 93, 94

CENTRALAB

954K E. Keefe Ave.
Milwaukee 1, Wisconsin

Switches, Components, Transistors—Amplifiers

3, 4, 5, 6, 7, 8, 9, 10, 11, 12, 13, 14, 15, 16, 18, 19, 20, 21, 22, 23, 24, 25, 26, 27, 28, 29, 30, 31, 32, 33, 34, 35, 36, 37, 38, 39, 40, 41, 42, 43, 44, 45, 46, 47, 49, 50, 51, 52, 53, 54, 55, 56, 57, 58, 59, 60, 61, 62, 63, 64, 66, 68, 69, 70, 71, 72, 73, 74, 75, 76, 77, 78, 79, 80, 81, 82, 83, 84, 85, 86, 88, 91, 92, 94

COLLINS RADIO CO.

855 35th Street, N. E.
Cedar Rapids, Iowa

Receivers, Transmitter

1, 2, 3, 4, 5, 7, 10, 11, 12, 13, 15, 18, 22, 23, 24, 29, 34, 35, 36, 37, 38, 39, 42, 43, 49, 51, 52, 53, 60, 61, 62, 63, 64, 66, 81, 82, 83, 87, 91, 92, 94

COLUMBIA PRODUCTS CO.

P. O. Box 5207
Columbia, South Carolina

Mobile Antennas

8, 9, 10, 11, 12, 13, 19, 20, 21, 22, 23, 24, 29, 34, 44, 45, 46, 48, 51, 52, 53, 54, 61, 62, 63, 64, 68, 69, 79, 81, 82, 83, 92, 94

COMMUNICATIONS COMPANY, INC.

300 Greco Avenue
Coral Gables 34, Florida

Aviation Communications Receivers and Transmitters

22, 23, 24, 29, 50, 60, 61, 62, 65

CORNELL-DUBILIER ELECTRONIC CORP.

333 Hamilton Blvd.
S. Plainfield, New Jersey

Rotators, Power Supplies and Components

1, 2, 5, 8, 9, 10, 11, 12, 13, 14, 15, 17, 18, 22, 23, 24, 25, 29, 30, 31, 32, 33, 34, 35, 36, 37, 38, 40, 41, 42, 43, 44, 45, 46, 47, 48, 49, 50, 51, 52, 53, 55, 56, 57, 58, 59, 61, 62, 65, 66, 68, 69, 70, 71, 72, 73, 74, 75, 76, 77, 78, 80, 81, 82, 83, 84, 85, 86, 88, 89, 90, 91, 92, 93, 94

CREATIVE ELECTRONICS, INC.

94 Lincoln Avenue
Stamford, Conn.

Transmitter-converters, Vox, Power Supplies and Test Equipment

12, 13, 19, 20, 21, 22, 23, 24, 26, 29, 37, 40, 41, 42, 43, 48, 50, 51, 52, 53, 64, 68, 69

CUSHMAN PRODUCTS

621 Hayward Street
Manchester, New Hampshire

Antennas and Accessories

12, 13, 22, 23, 24, 27, 29, 30, 36, 48, 50, 51, 52, 53, 55, 56, 57, 58, 59, 60, 61, 62, 67, 87, 94

DAROD ELECTRONICS, INC.

54 West First Street
Mt. Vernon, New York

Phone Patches

7, 12, 13, 22, 23, 24, 31, 32, 48, 50, 51, 52, 53, 55, 56, 57, 58, 59, 60, 61, 62, 66, 67, 68, 69, 87, 93, 94

DOW KEY CO., INC.

Warren, Minn.

Keys, coaxial relays, switches and connectors

1, 2, 3, 4, 5, 6, 7, 8, 9, 10, 11, 12, 13, 15, 16, 17, 18, 19, 20, 21, 22, 23, 24, 25, 26, 27, 28, 29, 31, 32, 33, 34, 35, 36, 37, 38, 39, 40, 41, 42, 43, 47, 48, 49, 50, 51, 52, 53, 54, 55, 56, 57, 58, 59, 60, 61, 62, 63, 64, 66, 67, 68, 69, 70, 71, 72, 73, 74, 75, 76, 77, 78, 79, 80, 81, 82, 83, 84, 85, 86, 87, 91, 92, 94

E-Z WAY TOWERS, INC.

5901 East Broadway
Tampa 5, Florida

Towers

1, 5, 8, 9, 12, 13, 18, 22, 23, 24, 31, 32, 34, 36, 40, 41, 42, 43, 48, 50, 51, 52, 53, 61, 62, 65, 66, 70, 71, 72, 73, 74, 75, 76, 77, 78, 87, 92

EITEL-MCCULLOUGH, INC.

798 San Mateo Avenue
San Bruno, California

Electron Tubes

2, 3, 4, 5, 6, 7, 8, 9, 10, 11, 12, 13, 14, 15, 16, 17, 18, 19, 20, 21, 22, 23, 24, 25, 26, 27, 29, 30, 31, 32, 33, 34, 35, 36, 37, 38, 39, 40, 41, 42, 43, 44, 45, 46, 47, 48, 49, 51, 52, 53, 54, 60, 61, 62, 63, 64, 66, 68, 69, 80, 81, 82, 83, 84, 85, 86, 87, 88, 91, 92, 93, 94

ELDICO ELECTRONICS

72 East 2nd Street
Mineola, New York

Transmitters, Phone Patches, Keyers

1, 2, 3, 4, 5, 7, 8, 9, 10, 11, 16, 17, 18, 19, 20, 21, 22, 23, 24, 26, 34, 35, 36, 37, 38, 39, 40,

41, 42, 43, 44, 45, 46, 47, 48, 49, 50, 51, 52, 53, 60, 61, 62, 63, 64, 66, 67, 70, 71, 72, 73, 74, 75, 76, 77, 78, 79, 80, 81, 82, 83, 87, 92, 94

ELECTRONIC INSTRUMENT CO., INC.

33-00 Northern Blvd.
Long Island City, New York

Transmitters, Test Equipment

1, 2, 3, 4, 5, 6, 7, 8, 10, 12, 14, 15, 16, 17, 18, 19, 20, 21, 22, 23, 25, 26, 28, 29, 30, 31, 32, 33, 34, 35, 36, 37, 38, 39, 42, 43, 44, 45, 46, 47, 49, 51, 52, 53, 54, 55, 56, 57, 58, 59, 60, 61, 62, 63, 64, 66, 68, 69, 70, 71, 72, 73, 74, 75, 76, 77, 78, 79, 80, 81, 82, 83, 84, 85, 86, 87, 88, 91, 92, 94

FREDERICK TOOL & ENGINEERING CORP.

414 Pine Avenue
Frederick, Maryland

Antennas

3, 4, 6, 7, 8, 9, 10, 11, 12, 13, 18, 22, 28, 35, 36, 37, 38, 39, 42, 43, 47, 51, 52, 53, 55, 56, 57, 58, 59, 60, 61, 62, 63, 65, 66, 67, 84, 85, 86, 87, 89, 90, 92, 94

GENERAL ELECTRIC CO.

Electronics Components Div.
Syracuse, New York

Electron Tubes

1, 3, 4, 5, 7, 10, 11, 14, 16, 17, 18, 22, 23, 24, 27, 28, 29, 30, 31, 32, 33, 35, 36, 38, 39, 42, 43, 44, 45, 46, 47, 48, 49, 51, 52, 53, 55, 56, 57, 58, 59, 61, 62, 63, 64, 68, 69, 70, 71, 72, 73, 74, 75, 76, 77, 78, 80, 83, 84, 85, 86, 88, 92, 94

GENERAL ELECTRONICS CORP.

4200 Mobile Rd.
Montgomery, Ala.

Transmitters

8, 9, 10, 11, 22, 23, 24, 35, 42, 43, 47, 48, 50, 60, 63, 83, 93

GLAS-LINE CO.

P. O. Box 2
New York 71, N. Y.

Transmission line, guy line, insulators

1, 15, 22, 23, 24, 36, 38, 47, 48, 51, 52, 53, 54, 61, 62, 63, 67, 92, 93

GLOBE ELECTRONICS, INC. (Formerly WRL)

3415 West Broadway
Council Bluffs, Iowa

Transmitters, Amplifiers, and Test Equipment

1, 2, 3, 4, 5, 7, 8, 9, 10, 11, 14, 15, 19, 20, 21, 22, 23, 24, 26, 28, 29, 31, 32, 33, 35, 36, 37, 38, 39, 42, 43, 44, 45, 46, 47, 48, 49, 50, 51, 52, 53, 54, 61, 62, 63, 64, 66, 67, 68, 69, 70, 71, 72, 73, 74, 75, 76, 77, 78, 80, 81, 82, 87, 92, 94

GONSET CO.

801 S. Main Street
Burbank, California

Receivers, Transmitters, Amplifiers, Antennas and Accessories

1, 2, 3, 4, 5, 6, 7, 8, 9, 10, 11, 12, 13, 14, 15, 16, 17, 18, 19, 20, 21, 22, 23, 24, 25, 26, 27, 28, 29, 30, 31, 32, 33, 34, 35, 36, 37, 38, 39, 40, 41, 42, 43, 44, 45, 46, 47, 48, 49, 50, 51, 52, 53, 54, 55, 56, 57, 58, 59, 60, 61, 62, 63, 64, 65, 66, 67, 68, 69, 70, 71, 72, 73, 74, 75, 76, 77, 78, 79, 80, 81, 82, 83, 87, 88, 89, 90, 91, 92, 93, 94

GREENLEE TOOL CO.

2371 Columbia Ave.
Rockford, Illinois

Hole punching tools

1, 3, 4, 5, 6, 7, 8, 9, 10, 11, 12, 13, 14, 15, 18, 22, 23, 24, 25, 26, 28, 29, 31, 32, 33, 35, 36, 37, 38, 40, 41, 42, 43, 44, 45, 46, 47, 48, 49, 54, 55, 56, 57, 58, 59, 60, 61, 62, 63, 64, 68, 69, 70, 71, 72, 73, 74, 75, 76, 77, 78, 80, 81, 82, 83, 87, 91, 94

HALLICRAFTERS CO.

4401 W. 5th Avenue
Chicago 24, Illinois

Receivers, Transmitters and Amplifiers

1, 2, 3, 4, 5, 6, 7, 8, 9, 10, 11, 12, 13, 14, 15, 16, 17, 18, 19, 20, 21, 22, 23, 24, 26, 27, 28, 29, 30, 31, 32, 33, 34, 35, 36, 37, 38, 39, 40, 41, 42, 43, 44, 45, 46, 47, 48, 49, 51, 52, 53, 54, 55, 56, 57, 58, 59, 60, 61, 62, 63, 64, 66, 67, 68, 69, 70, 71, 72, 73, 74, 75, 76, 77, 78, 79, 80, 81, 82, 83, 84, 85, 86, 87, 88, 89, 90, 91, 92, 94

HAMMARLUND MFG. CO., INC.

460 West 34th Street
New York 1, New York

Receivers and components parts

1, 2, 5, 6, 7, 8, 9, 10, 11, 12, 13, 14, 15, 16, 17, 18, 19, 20, 21, 22, 23, 24, 25, 26, 27, 28, 29, 31, 32, 33, 35, 36, 37, 38, 39, 40, 41, 42, 43, 44, 45, 46, 47, 48, 49, 50, 51, 52, 53, 54, 55, 56, 57, 58, 59, 60, 61, 62, 63, 64, 66, 67, 68, 69, 70, 71, 72, 73, 74, 75, 76, 77, 78, 79,

80, 81, 82, 83, 84, 85, 86, 87, 88, 89, 90, 91, 92, 93, 94

HEXACON ELECTRIC CO.

161 West Clay Street
Roselle Park 9, N. J.

Soldering guns and irons

5, 8, 9, 10, 11, 22, 23, 24, 28, 31, 32, 35, 36, 37, 38, 42, 43, 44, 45, 46, 47, 51, 52, 53, 63, 65, 68, 69, 80, 87, 88, 93, 94

HORNET ANTENNA PRODUCTS CO.

P. O. Box 808
Duncan, Oklahoma

Antennas and accessories

22

HY-GAIN ANTENNA PRODUCTS CO.

1828 North Street
Lincoln, Nebraska

Antennas, rotators, mounts and accessories

1, 2, 3, 4, 5, 7, 8, 9, 10, 11, 14, 15, 17, 18, 19, 20, 21, 22, 23, 24, 26, 27, 28, 29, 30, 33, 34, 35, 36, 37, 38, 39, 40, 41, 42, 43, 44, 45, 46, 47, 48, 49, 50, 51, 52, 53, 54, 55, 56, 57, 58, 59, 60, 61, 62, 63, 64, 66, 67, 68, 69, 70, 71, 72, 73, 74, 75, 76, 77, 78, 80, 81, 82, 83, 84, 85, 86, 87, 91, 92, 94

ILLUMITRONIC ENGINEERING

Sunnyvale, California

Coils, inductors, baluns and transmission lines

1, 2, 3, 4, 5, 7, 8, 9, 10, 11, 12, 13, 15, 16, 17, 18, 19, 20, 21, 22, 23, 24, 25, 26, 27, 28, 29, 31, 32, 33, 34, 35, 36, 37, 38, 39, 47, 48, 49, 50, 51, 52, 53, 54, 60, 61, 62, 63, 64, 66, 67, 68, 69, 80, 81, 82, 87, 91, 92

INTERNATIONAL CRYSTAL MFG. CO., INC.

18 North Lee Street
Oklahoma City 2, Oklahoma

Transmitters, crystals, and accessories, printed circuit amplifiers, test equipment

10, 11, 22, 34, 50, 61, 62, 63, 65

JOHNSON, E. F. CO.

Waseca, Minn.

Transmitters, Amplifiers, Antennas, Rotators and Components

1, 2, 3, 4, 5, 6, 7, 8, 9, 10, 11, 12, 13, 14, 15, 16, 17, 18, 19, 20, 21, 22, 23, 24, 25, 26, 27, 28, 29, 30, 31, 32, 33, 34, 35, 36, 37, 38, 39, 40, 41, 42, 43, 44, 45, 46, 47, 48, 49, 51, 52, 53, 54, 55, 56, 57, 58, 59, 60, 61, 62, 63, 64,

66, 67, 68, 69, 70, 71, 72, 73, 74, 75, 76, 77, 78, 79, 80, 81, 82, 83, 84, 85, 86, 87, 88, 89, 90, 91, 92, 93, 94

L W ELECTRONICS LABS

Route 2
Jackson, Michigan

Transmitters, Converters

2, 5, 18, 22, 26, 38, 48, 51, 52, 53, 61, 62, 63

LAKESHORE INDUSTRIES

Manitowoc, Wisconsin

Transmitter, Amplifiers

1, 2, 5, 8, 9, 10, 11, 18, 19, 20, 21, 22, 23, 24, 34, 35, 36, 37, 39, 42, 43, 47, 48, 49, 51, 52, 53, 55, 56, 57, 58, 59, 60, 61, 62, 63, 64, 65, 66, 67, 68, 69, 83, 87, 92, 94

MARK MOBILE INC.

6416 W. Lincoln Ave.
Morton Grove, Illinois

Mobile Antennas

1, 2, 7, 10, 11, 15, 18, 22, 23, 24, 35, 36, 37, 38, 39, 48, 50, 51, 52, 53, 61, 62, 63, 66, 80, 81, 82, 87, 92, 94

MASTER CRYSTAL LABS

1306 Bond Street
Los Angeles 15, California

Crystals and accessories

8, 9, 10, 11, 16, 22, 39, 48, 51, 52, 53, 55, 56, 57, 58, 59, 60, 63, 67, 92

MASTER MOBILE MOUNTS, INC.

1306 Bond Street
Los Angeles 15, California

Mobile antennas, mounts, and coils, field strength meters, crystals

1, 2, 3, 4, 5, 6, 7, 8, 9, 10, 11, 12, 13, 14, 15, 16, 17, 18, 19, 20, 21, 22, 23, 24, 26, 27, 28, 31, 32, 33, 34, 35, 36, 37, 38, 39, 40, 41, 42, 43, 44, 45, 46, 47, 48, 49, 50, 51, 52, 53, 54, 55, 56, 57, 58, 59, 60, 61, 62, 63, 64, 65, 66, 67, 68, 69, 70, 71, 72, 73, 74, 75, 76, 77, 78, 79, 80, 81, 82, 83, 84, 85, 86, 87, 88, 89, 90, 91, 92, 94

MILLEN MFG. CO., INC. JAMES

150 Exchange Street
Malden 48, Massachusetts

Transmitter, amplifier, power supplies, component parts, test equipment

1, 5, 7, 10, 11, 12, 13, 14, 18, 19, 20, 21, 22, 23, 24, 27, 30, 33, 35, 38, 40, 41, 42, 43, 44,

45, 46, 47, 48, 50, 51, 52, 53, 54, 60, 61, 62,
65, 66, 67, 68, 69, 70, 71, 72, 73, 74, 75, 76,
77, 78, 80, 81, 82, 87, 88, 91, 92, 94

MORROW RADIO MFG. CO.

2794 Market Street
Salem, Oregon

Receivers, Transmitters, Power Supplies

1, 2, 3, 4, 5, 6, 7, 8, 9, 10, 11, 12, 13, 15, 16,
17, 18, 19, 20, 21, 22, 23, 24, 26, 27, 28, 33,
34, 35, 36, 37, 38, 39, 40, 41, 42, 43, 44, 45,
46, 47, 48, 49, 50, 51, 52, 53, 54, 55, 56, 57,
58, 59, 60, 61, 62, 63, 64, 66, 67, 68, 69, 70,
71, 72, 73, 74, 75, 76, 77, 78, 80, 84, 85, 86,
87, 89, 90, 91, 92, 93, 94

MOSLEY ELECTRONICS, INC.

8622 St. Charles Rock Rd.
St. Louis 14, Mo.

Antennas and accessories

1, 2, 3, 4, 5, 6, 7, 8, 9, 10, 11, 12, 13, 14, 15,
16, 17, 18, 19, 20, 21, 22, 23, 24, 26, 28, 29,
30, 31, 32, 33, 34, 35, 36, 37, 38, 39, 40, 41,
42, 43, 44, 45, 46, 47, 48, 49, 50, 51, 52, 53,
54, 55, 56, 57, 58, 59, 60, 61, 62, 63, 64, 66,
67, 68, 69, 70, 71, 72, 73, 74, 75, 76, 77, 78,
79, 80, 81, 82, 83, 84, 85, 86, 87, 89, 90, 91,
92, 94

NATIONAL CO., INC.

61 Sherman Street
Malden, Massachusetts

Receivers, Component Parts

1, 2, 3, 4, 5, 6, 7, 8, 9, 10, 11, 12, 13, 14, 15,
16, 17, 18, 19, 20, 21, 22, 23, 24, 25, 26, 27,
28, 29, 30, 31, 32, 33, 34, 35, 36, 37, 38, 39,
40, 41, 42, 43, 44, 45, 46, 47, 48, 49, 50, 51,
52, 53, 54, 55, 56, 57, 58, 59, 60, 61, 62, 63,
64, 65, 66, 67, 68, 69, 70, 71, 72, 73, 74, 75,
76, 77, 78, 79, 80, 81, 82, 83, 84, 85, 86, 87,
88, 89, 90, 91, 92, 94

P & H ELECTRONICS, INC.

424 Columbia
Lafayette, Indiana

Transmitters, Amplifiers, Test Equipment

2, 5, 10, 11, 22, 23, 24, 26, 29, 35, 37, 48, 51,
52, 53, 60, 61, 62, 63, 66, 81, 82, 87, 94

PALCO ENGINEERING

355 N. Columbia St.
Frankfort, Indiana

Transmitters, Power Supplies

5, 10, 11, 22, 23, 24, 36, 39, 42, 43, 48, 51, 52,
53, 61, 62, 66, 67, 87, 89, 90

PETERSEN RADIO CO.

2800 W. Broadway
Council Bluffs, Iowa

Crystals and Accessories

1, 2, 3, 4, 5, 6, 7, 10, 11, 12, 13, 15, 16, 18, 19,
20, 21, 22, 23, 24, 25, 27, 28, 29, 31, 32, 33,
34, 35, 37, 38, 39, 40, 41, 42, 43, 44, 45, 46,
47, 48, 49, 51, 52, 53, 54, 60, 61, 62, 63, 64,
65, 66, 67, 68, 69, 70, 71, 72, 73, 74, 75, 76,
77, 78, 79, 80, 81, 82, 83, 87, 91, 92, 94

RCA ELECTRON TUBE DIV.

Harrison, New Jersey

Electron Tubes

7, 8, 9, 10, 11, 12, 13, 14, 15, 19, 20, 21, 22,
23, 24, 25, 29, 30, 31, 32, 33, 34, 35, 36, 37,
38, 40, 41, 42, 43, 44, 45, 46, 55, 56, 57, 58,
59, 61, 62, 63, 66, 68, 69, 80, 83, 87, 88, 91

RADIO PUBLICATIONS, INC.

Danbury Rd.
Wilton, Connecticut

Books

1, 2, 5, 7, 12, 13, 14, 19, 20, 21, 22, 23, 24,
30, 33, 34, 35, 36, 37, 39, 40, 41, 42, 43, 47,
48, 50, 51, 52, 53, 55, 56, 57, 58, 59, 60, 61,
62, 63, 64, 65, 66, 67, 68, 69, 80, 81, 82, 83,
87, 92, 94

RAFRED ENTERPRISES

Box 47725 Wagner Station
Los Angeles 47, Calif.

Mobile Antennas

5, 6, 7, 10, 11, 18, 19, 20, 21, 22, 23, 24, 26,
35, 36, 37, 39, 40, 41, 48, 51, 52, 53, 60, 66,
67, 87, 92, 94

REGENCY DIV. OF IDEA, INC.

7900 Pendeton Pike
Indianapolis 26, Indiana

Receivers and Converters

1, 2, 5, 7, 8, 9, 10, 11, 12, 13, 14, 15, 16, 17,
18, 22, 23, 24, 26, 27, 28, 31, 32, 33, 34, 35,
36, 37, 38, 39, 40, 41, 42, 43, 44, 45, 46, 47,
48, 49, 50, 51, 52, 53, 55, 56, 57, 58, 59, 61,
62, 63, 64, 66, 67, 68, 69, 70, 71, 72, 73, 74,
75, 76, 77, 78, 80, 83, 87, 88, 91, 92, 94

RIDER PUBLISHING, INC., JOHN F.

116 W. 14th Street
New York 11, New York

Books

1, 3, 4, 5, 6, 7, 8, 9, 12, 13, 14, 18, 19, 20, 21,
22, 23, 24, 25, 26, 27, 28, 29, 30, 31, 32, 33,

34, 35, 36, 37, 38, 39, 40, 41, 42, 43, 47, 48,
50, 51, 52, 53, 55, 56, 57, 58, 59, 61, 62, 63,
64, 66, 68, 69, 70, 71, 72, 73, 74, 75, 76, 77,
78, 79, 80, 81, 82, 83, 84, 85, 86, 87, 88, 92,
94

ROHN MFG. CO.

116 Limestone
Bellevue, Peoria 5, Ill.

Towers and Accessories

1, 2, 5, 7, 8, 9, 10, 11, 12, 13, 18, 19, 20, 21,
22, 26, 29, 31, 32, 33, 34, 37, 38, 39, 40, 41,
42, 43, 47, 48, 50, 51, 52, 53, 60, 61, 62, 63,
67, 70, 71, 72, 73, 74, 75, 76, 77, 78, 80, 83,
84, 85, 86, 87, 89, 90, 92, 94

SKY-LANE PRODUCTS

5320 Nebraska Avenue
Tampa 3, Florida

Antennas

22, 48

TECHNICAL MATERIEL CORP.

700 Fenimore Rd.
Mamaroneck, New York

Receivers and Transmitters

1, 2, 5, 10, 11, 12, 13, 17, 22, 23, 24, 29, 31,
32, 35, 36, 39, 42, 43, 48, 49, 51, 52, 53, 61,
62, 63, 65, 66, 67, 68, 69, 70, 71, 72, 73, 74,
75, 76, 77, 78, 79, 83, 87, 91, 94

TELEVUE TOWERS, INC.

701 49th Street, So.
St. Petersburg, Florida

Towers and Accessories

1, 10, 11, 12, 13, 22, 23, 24, 36, 50, 51, 52,
53, 61, 62, 67, 81, 82, 89, 90

TAPETONE, INC.

10 Ardlock Pl.
Webster, Mass.

Transmitters and Converters

1, 2, 5, 8, 9, 10, 11, 12, 13, 15, 16, 17, 18, 22,
23, 24, 29, 31, 32, 34, 35, 37, 38, 39, 49, 50,
51, 52, 53, 63, 65, 66, 67, 68, 69, 70, 71, 72,
73, 74, 75, 76, 77, 78, 81, 82, 87, 89, 90, 94

TELECOM, INC.

1019 Admiral
Kansas City, Mo.

Power Supplies

5, 6, 10, 11, 17, 22, 23, 24, 29, 39, 60, 61, 62,
64, 66, 68, 69, 80, 91, 94

TELREX, INC.

Asbury Park 2, N. J.

Antennas, Rotators and Accessories

5, 7, 10, 11, 12, 13, 15, 18, 22, 23, 24, 26, 29,
31, 32, 33, 34, 35, 36, 37, 38, 39, 40, 41, 44,
45, 46, 47, 48, 49, 50, 51, 52, 53, 54, 55, 56,
57, 58, 59, 60, 61, 62, 63, 64, 66, 68, 69, 70,
71, 72, 73, 74, 75, 76, 77, 78, 79, 87, 89, 90,
91, 92, 94

TRIAD TRANSFORMER CORP.

4055 Redwood Avenue
Venice, California

Transformers and Chokes

2, 3, 4, 5, 7, 10, 11, 14, 17, 22, 23, 24, 28, 29,
30, 33, 34, 35, 37, 39, 42, 43, 47, 51, 52, 53,
60, 61, 62, 63, 70, 71, 72, 73, 74, 75, 76, 77,
78, 80, 84, 85, 86, 87, 88, 92, 94

TRI-EX TOWER CORP.

127 E. Inyo Street
Tulare, California

Towers and Accessories

1, 3, 4, 5, 6, 7, 8, 9, 10, 11, 12, 13, 16, 17, 19,
20, 21, 22, 23, 24, 29, 31, 32, 36, 37, 39, 48,
50, 51, 52, 53, 60, 61, 62, 64, 65, 67, 68, 69,
80, 87, 92, 94

VAN NORMAN INDUSTRIES, INC.

Manchester, New Hampshire

Amplifiers and Switches

1, 2, 3, 4, 8, 9, 14, 15, 16, 18, 22, 23, 24, 31,
32, 35, 36, 40, 41, 44, 45, 46, 48, 50, 61, 62,
63, 66, 68, 69, 79, 80, 83, 84, 85, 86, 87, 93,
94

VESTO CO., INC.

20th and Clay Street
No. Kansas City, Mo.

Towers and Accessories

8, 9, 22, 23, 24, 47, 48, 61, 62, 64

VIBROPLEX CO., INC. THE

833 Broadway
New York 3, New York

Keys

1, 2, 3, 4, 5, 6, 7, 8, 9, 10, 11, 12, 13, 14, 15,
16, 18, 19, 20, 21, 22, 23, 24, 28, 29, 30, 31,
32, 33, 35, 36, 37, 38, 39, 40, 41, 42, 43, 44,
45, 46, 47, 48, 49, 50, 51, 52, 53, 54, 55, 56,
57, 58, 59, 60, 61, 62, 63, 64, 66, 67, 68, 69,
79, 80, 81, 82, 83, 87, 89, 90, 91, 92, 94

"AC" Coil for HRO-50T1

Oliver Wilson, VE6WT

3623 Sixth St., S.W.
Calgary, Alberta, Canada

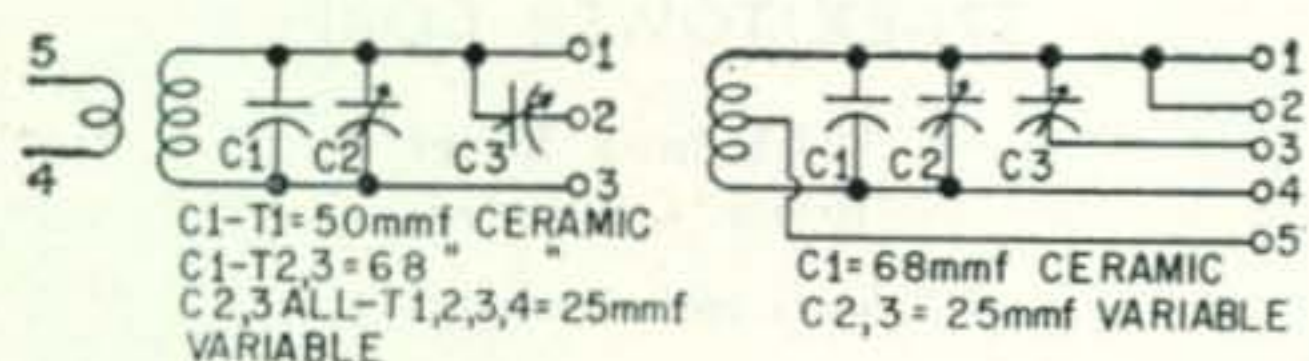

Fig. 1

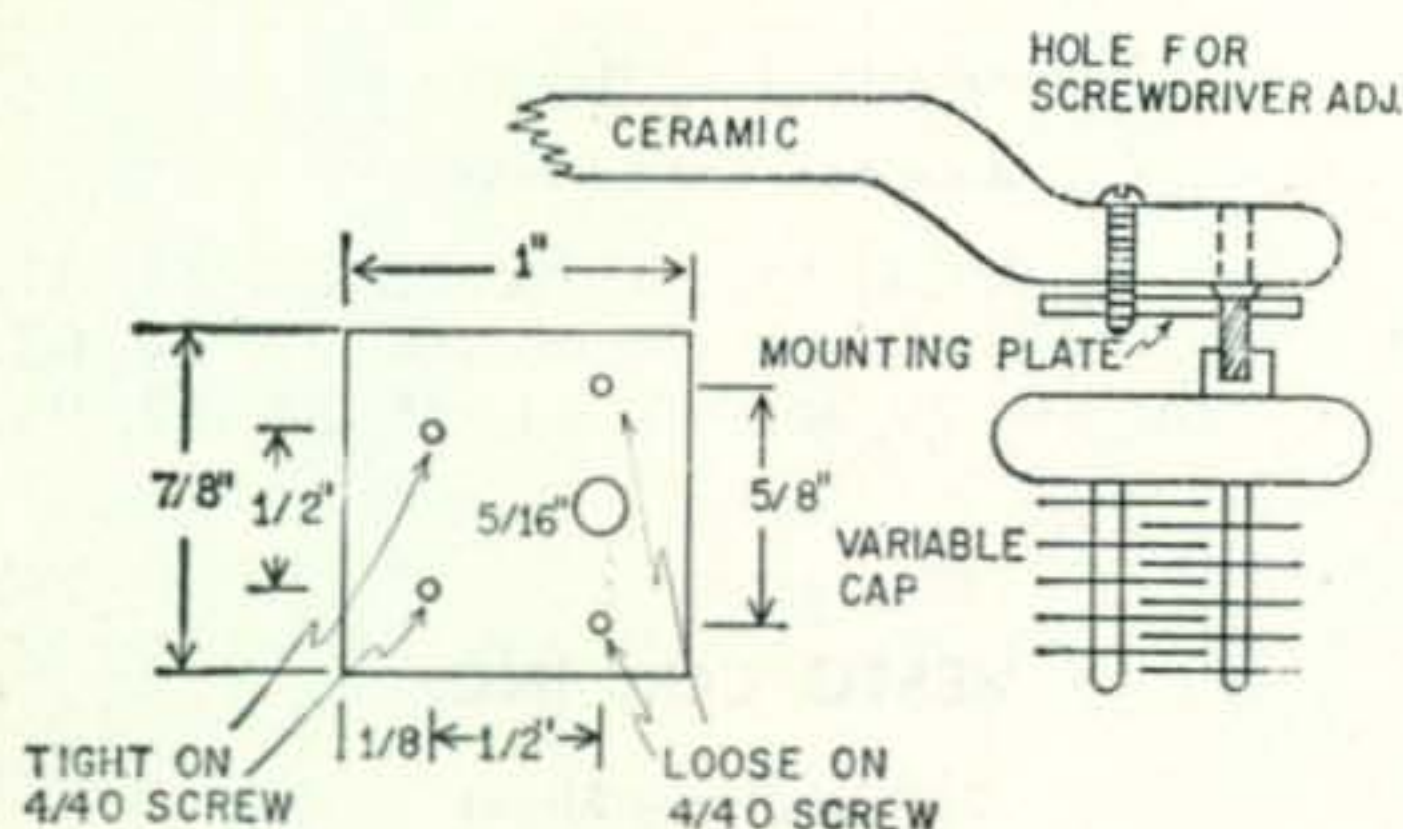

Fig. 2

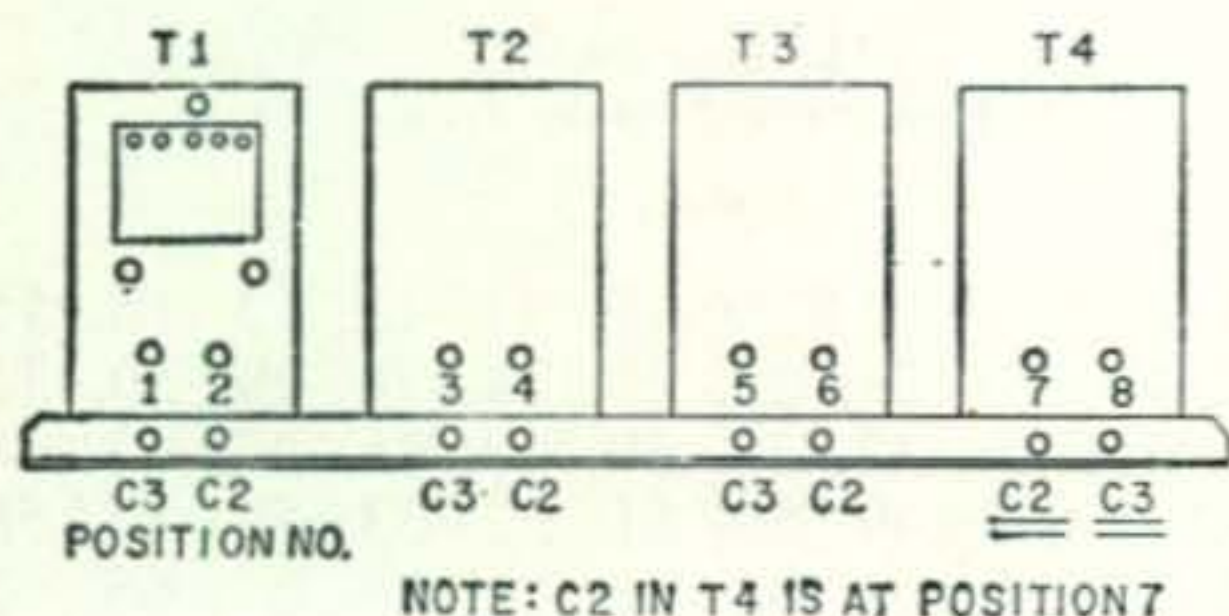

Fig. 3

The "AC" coil for the HRO 50T1 is practically a collector's item and is no longer in production. Here is how to modify the "G" coil to cover the band. If you have no "G" coil, broadcast band coil or any spare coil maybe you can buy one easier than the "AC" coil. Butchering the "G" coil does not affect the saleability of the receiver itself and is no loss unless you happen to be also interested in the aircraft radio range signals.

The "G" coil—like the rest of the set—consists of 4 RF transformers. The cans are held together by the name plate and loosening—not removing—4 screws lets you see its insides. Start with G.4—it's marked—or if not it is the right-hand one when you face the receiver. Loosen the screws and remove it from the name plate. Now take out the 3 screws holding the ceramic slab to the can. Watch for washers between ceramic and can and remember where they were. There are probably none but may be in some cases. This ceramic slab has 2 variable capacitors mounted and a husky oscillator coil—as you would expect—for 650-855 kc. If you are scared and want to replace the "G" coils later, then mark the 3 wires coming from the coil with the number of the terminal to which they are soldered. Remove this coil and the shorted turn which is mounted with it. Wind a coil of 6 turns of #22, formel covered, on a half inch diameter form and space to 3/8 inch. Clear insulation and take a tap at 4th turn. I used the coil forms out of a SCR522 receiver, which I had previously modified, and they will mount in the same place as the original coil by enlarging the mounting hole—in the aluminum bracket—not the ceramic, old boy! Clip out the 100 mmfd ceramic fixed capacitor and replace with a 68 mmfd ceramic. Wiring diagram is shown in fig. 1. Replace this in the can and hope for the best.

Now remove T3 (second from the right as before). Take out coil and discard or save (are you a squirrel?). We now have bad news. There is only one trimmer in this can. Buy 4 of the 25 mmfd variables with screwdriver adjustment and with mounting block about 1/4 inch high—if possible—otherwise the standard 25 mmfd will have to do. Make 4 plates of 1/32" brass (panel out of a 1926 Fada TRF) 7/8 inch by 1 inch and drill as per fig. 2. Use flat head 4/40 screws and fasten plate to the variable. Now run 4/40 screws through holes in ceramic which are there in just the right spots and thread them into the brass plate. I cut the threads with a spare bolt first—broke only one bolt! The second trimmer is now mounted. Install 68 mmfd ceramic as per wiring diagram. Wind coil of 5 1/2 turns #22 on 1/2 inch form as before. Wind coupling coil of 9 turns #26 formel next to it and the whole works will space nicely to 3/8". I wound 6 turns of the #22 and then when soldering in place left the excess sticking out from the side of the coil so it could be bent around to make minor adjustments to the inductance. Remount in can after wiring. Replace washers if there were any.

Follow same plan for T2—the next in line.

The T1 can has no trimmers so you use up the rest of your plates and variables on it. I used the same coils as for T2 and T3 except that I used only four turns of the #26 wire as an antenna link. This T1 has a 50 mmfd

ceramic instead of the 68 mmfd in it.

Replace and align—just like that. Alignment took me 3 days of wondering and experimenting but I didn't have the coils right. When they were, it took only about ten minutes. Radio WLWO and KCBR are just above the 15 meter band. I finally got WLWO and set it at 4 mcs (on the "D" scale) and then trimmed and padded until 3.5 mcs (on the "D" scale) was receiving a 7 mcs (21 mcs) signal from my BC221. Alignment is theoretically done as follows:

Set dial at 4 mcs (21.5) signal source at 21.5 mcs and rotate variable at position 7 to hear signal. Adjust variables at positions 6, 4 and 2 for best S meter reading. Move signal source to 21 mcs. Set dial at 3.5 mcs (21 mcs.) and tune position 8 variable to hear signal. Tune positions 5, 3 and 1 for best S meter reading. Repeat this procedure a couple of times and then try it on the band. You should—if you have the patience, adjust the inductances at 21.3 (3.8 on the dial) for best peak results. I was not so fussy.

Net cost 4 variables \$1.40, screws, wire, etc., 10¢. Labour—first time about one weekend—second time would be about three hours or less. Any coil of the HRO 50 series will do and if it has the whole 8 trimmers mounted so much the better. Position diagram and mounting details for all units are shown in fig. 3. ■

New Amateur Equipment

Transistor Power Supply Kit

Ho, Ho! This isn't what you thought at all. This is a power supply for powering transistors. It supplies you well filtered outputs of 12 volts at 1 amp . . . in series that is 24 volts at 1 amp. The kit is put out by Technical Apparatus Builders and costs \$18.00. They have an elaborate info sheet available if you circle I on page 194.

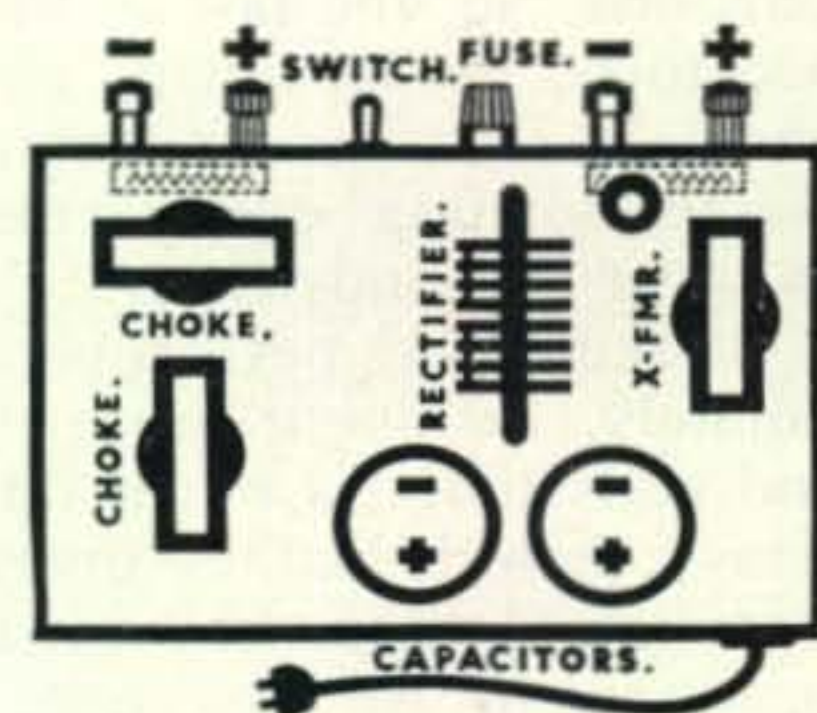

Command Set Power Supply

G & G Radio Supply (NY) has a power supply kit which is specially designed for the Command Set transmitters BC-457, 458, 459, etc. It furnishes 450 volts @ 150 ma for the final, 250 volts @ 50 ma for the oscillator and 24 volts @ 2 amps for the filaments. A supply like this makes for a minimum of conversion of the transmitter and modulator. Want all the details? Circle I on page 194 and we'll have G & G get some literature out to you.

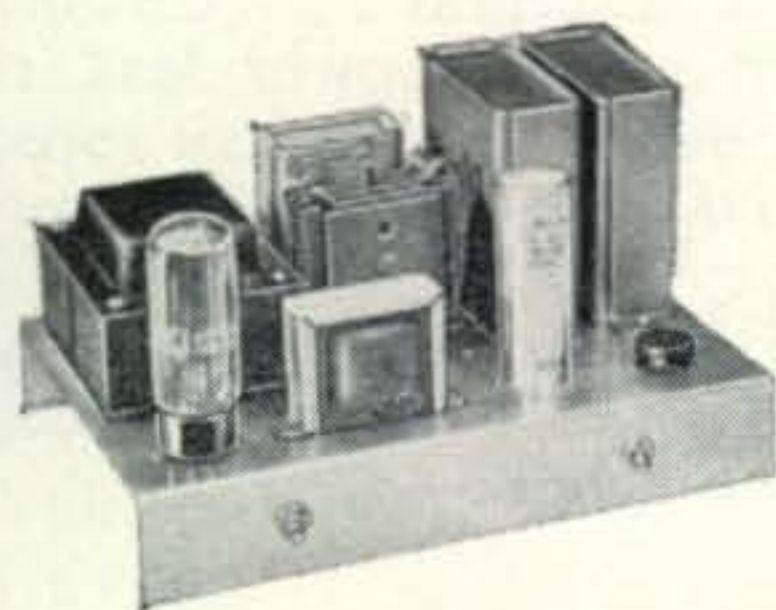

3 BAND BEAMS [from page 103]

ween 1.3 to 1 and 2 to 1. Use of the 27 mc band is not authorized in Japan, and we made no tests there. Front-to-back ratios were in the neighborhood of 20 to 30 db on 14 and 21 mc, and were about 10 db from 28 to 29 mc. Front-to-side ratios were about 50 db on 14 and 21 mc, and about 25 db on 28 mc.

The antenna performed quite well. In many cases we were reported as the loudest KA/JA station on the three bands. Generally, two or three stations were reported as slightly better. However, these stations were running several db more power than our normal 480 watts, and their antennas ranged from three elements at 110 feet to stacked rhombics over salt water. In the 1956 ARRL DX contest, I was on cw for 34 hours and worked 657 stations on the three bands. During the last thirty days of operation in Japan, we worked 102 countries.

One trouble did develop with the antenna. The variables all flashed over because of the high humidity. The variables were replaced with capacitors made of sections of RG/8/U. Tuning was done by first getting s.w.r.'s down to 1 to 1 with variables, inserting slightly more than the estimated required length of RG/8/U, then clipping the coax half an inch at a time until the s.w.r. was again 1 to 1. No further trouble was had. I recommend this system highly to those who haven't been able to keep their gamma capacitors dry. This also eliminates the nuisance of providing enclosures for variables.

Rotators aren't easily available on the Kanto plains so we rigged up a cheap, crude and effective "Armstrong Rotator" using wooden disks, aircraft control cable and pulleys.

Immediately after returning to the States, I received change-of-station orders to North Carolina. So, the last of the W5DWT antennas had to be pulled down. This monstrosity, built on a 30-foot ladder boom, used several elements, loading coils, capacitors, relays, etc., to cover all bands from 7 through 28 mc. When it worked, the performance was fine. Unfortunately, I'd spent more time replacing relays and coils that I'd burnt up because of sticking relays than I had in operating. In the North Carolina climate, which is considerably damper than that of Albuquerque, I could expect even more trouble. Obviously, an interlaced beam with no relays was called for, after my experience with the KA2EC beam.

The first beam planned would have used the 30-foot boom, and would have had four elements on 14 and 21 mc, and five on 28 mc. This was vetoed by the distaff side. More calculation resulted in the beam shown in fig. 2. The 24-foot boom was formed of two magnesium ladders bolted together. This length was

used because it is about optimum for a 14 mc beam, considering gain, swr, and bandwidth. The position of the 14 mc elements was determined by the length of the boom. The other elements were stuck in where they would fit best. Again the earlier formula for 14 and 21 mc was used, with one change. The radiator length was set to $472/F$. The 28 mc elements were calculated so as to resonate the director at 30 mc, the radiator at 28.5 mc, and the reflector at 26.5 mc, to give us wide bandwidth, at some sacrifice in gain. The 14 and 21 mc elements were insulated from the boom and crossarms by some $\frac{1}{2}$ " lucite blocks cut from a sheet obtained on the surplus market. The 28 mc elements were insulated from the boom by 1"x3"x24" oak crossarms. (Oak flooring costs two bits per ten feet.) The elements were insulated from the boom because previous beams which had elements mounted directly on ladder booms had demonstrated that the boom affected element lengths materially.

The beams were checked for tuning on the roof by using a grid-dip meter. Gamma matches were shorted at this time, and all elements appeared to be the correct length. (Radiators resonant in the bands, reflectors below, and directors above.) Then the gammas were tuned. The 14 and 28 mc gammas tuned up normally. However, the 21 mc gamma was abnormally short, and required a very high amount of capacitance to bring the swr down. This gamma was disassembled and rebuilt, but we came up with the same figures. The gammas were set for 1 to 1 swr's on the roof at 14100, 21150, and 28400 kc. When the beam was mounted on a 60-foot tower, the swr's were down to 1 to 1 at 14170, 21200, and 28430 kc. The swr's were below 1.25 to 1 across 14 and 21 mc, and ran about 1.4 to 1 at 28 and 29 mc. At 27 mc, the swr was back down to 1.2 to 1, and at 29.7 mc was 1.5 to 1, and hit a maximum of 1.7 to 1 at 29.4 and 27.6 mc.

Front-to-back ratios are about 20 db across 21 and 14 mc, and varies between 8 and 20 db across the 27 and 28 mc bands. These are normal F/B ratios for beams with similar spacings under average band conditions. Of course, they can be improved upon materially by picking a given angle of signal arrival, or a particular antenna height. For example, this 14 mc beam shows a discrimination in the order of 50 db when our pet power leak is "off the back." Front-to-side ratios on all three beams showed the usual 50 to 60 db discrimination. This, of course, applies to signals directly off the ends of the elements, and may apply only over a range of 5 to 10 degrees

[Continued on page 148]



These gals enjoyed the YL Breakfast held Sunday morning during the West Gulf Division Convention in Oklahoma City, July 25-27, 1958. L. to r., seated: W5EGD, KN5PBE, K5IPG, W5JCY, KN5OPT, K5LKF, K5MBS, W5KGQ. Second row: KNLQX, WØGIC, KN5LAE, W5JAP, K5GMI, K5BNB, KN5QJD, K5COZ, W5WPR, W5DUR, W5MJU, KØGZO, KL7AZI, W1CIE, W5AMI, W5OQT. Top row: W5CCK, W5KEC, K5BNQ, KØLTJ, K5BNH, K5BDL, KN5QAK, W5TSE, K5CPA, K5BLP, W4UDG, W5PWN, W5GPN. Photo by N.G. Morris.

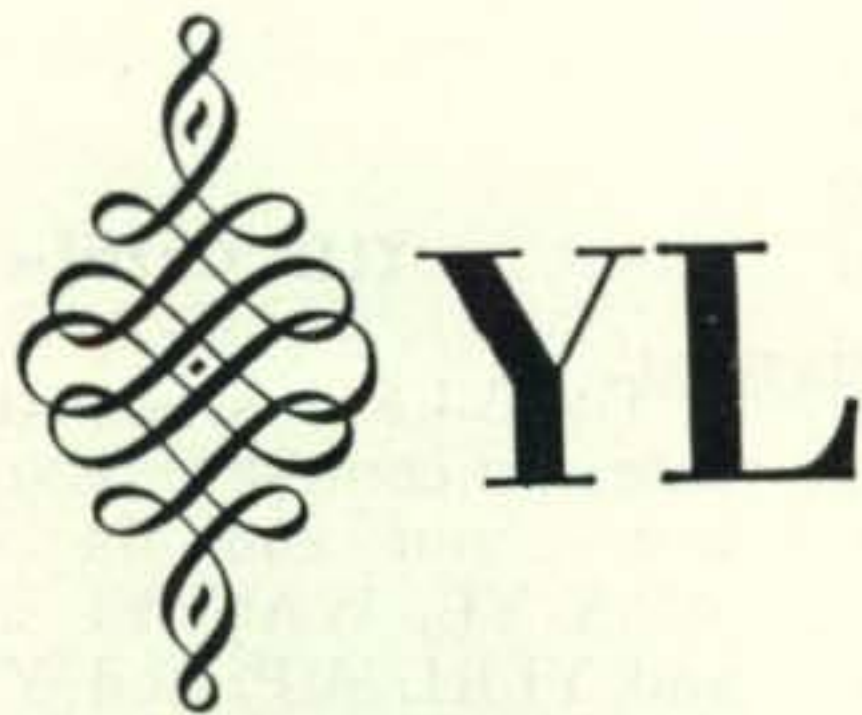

by **LOUISA B. SANDO, W5RZJ**
212 Sombrio Drive, Santa Fe, N. M.

19th YLRL Anniversary Party

Given elsewhere in this column are the rules for YLRL's 19th Anniversary Party. Note the dates: Nov. 12-13 for the phone section; Nov. 19-20 for cw. Two changes of special interest: each section of the contest will be limited to 24 hours (instead of 36 as previously), and there is now an award offered for the highest score turned in by a Novice. All YLs everywhere, whether or not members of YLRL, are invited to participate in this contest. Join the fun, gals—meet old friends and make new ones!

YLRL Officers for 1959

Congratulations to these newly elected officers of the Young Ladies Radio League. They will take over their duties on Jan. 1, 1959.

President: W4BLR, Katherine Anderson, Richmond, Va.

Vice president: W6DXI, Gladys Eastman, Glendale, Calif.

Secretary: K6EXQ, Connie Hauck, Pomona, Calif.

Treasurer: W9YWH, Evelyn Tibbits, Western Springs, Ill.

Publicity chairman: W9RUJ, Mary

Meyer, Brookfield, Wis.

Editor: K6ENK, Wanda Gluck, Fair Oaks, Calif.

District Chairmen: W1ZEN, Onie Woodward; K2JYZ, Lillian Byrne; W3GTC, Carolyn Currens; K4BKT, Sue Cable; K5IMD, Betty Vredenburg; W6MWU, Mary Poe; W7DIC, Bessie Jeans; W8ATB, Esther Stuewe; W9UXL, Lois Zehr; KØJAS, Laura Stegner; KH6BGE, Flo Kumukahi; KL7BHE, Sheila Goodhue; VE6MP, Maude Phillips.

W4BLR, Kay, has served as YLRL's vice president during 1958. Licensed in '53, Kay and her OM, W4BVB, have four jr. ops. She holds CPC-30 and won the '56 YL-OM cw contest. For a photo and other details see this column in CQ for Dec. '57.

W6DXI, Gladys, has been licensed since 1950. Her OM is W6AWI, and their daughter Frances is K6EJE. She has served as D/C for YLRL and as president of Los Angeles YLRC. The "new look" in their shack consists of a Central Electronics 20A SSB exciter which Gladys put together from the kit, a 300-watt final which she helped to assemble, and an SX-100 receiver. W6DXI also works 2 meters. Another new piece of audio frequency electronic gear they are enjoying is a Hammond organ.

K6EXQ, Connie, was licensed as a Novice in 1954 and became a General a year later. She and her OM, K6DQA, use a Viking 500 on 10, 20 and 40. Connie has been NCS of the Hairpin Net for two years, and is a member of the Los Angeles YLRC. She has several certificates from foreign countries and the States, as well as YLCC with 5 stickers, and needs only Nev., Utah and Del. for WAS/YL. She is active in CD work (RACES). Connie has a son 12 and a daughter 10, and has been a den mother and a girl scout leader for two years, as well as active in PTA. Other Ham relatives include W6 YFT, YFF, AQP and K6QPE and they often have 40-meter family roundtables.

W9YWH, Evelyn, was licensed in 1953, the first Ham in her family. Her OM then became W9RYL and now daughter Margot is KN6OWH and son-in-law is KN6OWG. The Tibbits have another grown daughter and Evelyn is an ardent grandmother. Past president of LARKs, active in Quaker work, she likes flowers, sewing and reading. Station gear consists of a Valiant transmitter, SX-100 receiver with a trap antenna for 80, 40, 20, 15, and a vertical for 10 meters.

W9RUJ, Mary has served as P/C during 1958. For photo and write-up, see this column in CQ for Jan. '58.

K6ENK, Wanda, also carries over her job as editor of *YL Harmonics* from 1958. For photo check CQ for Aug. '58. Wanda earned her Novice license in 1954, six months after her OM became K6BNB. She studied with her next door neighbor, Aleta, now K6ENL, and

for the first two years worked cw only. Now she operates 80, 40 and 20 phone and cw and they are working on a 2-meter set-up. K6ENK is ANCS for the MARS net to which she belongs and is in RACES. She is president of the 3C's club and edits their paper. She holds a number of certificates and has 80 DX countries confirmed. There are three jr. ops; the oldest, Linda, is KN6PBG, and the two boys are interested. Wanda also finds time to be active in church affairs.

YLRL membership is growing at a great rate—as of mid-September it totaled 830 YLs, and is still climbing. Any licensed YL is eligible to join; drop your column editor a card for more details.



W6DXI, Gladys Eastman,
YLRL vice president for
1959.

YLRL Certificate Directory

The YLRL is now offering a special certificate and contest Directory. It contains information about and the rules covering YLCC, WAS/YL, WAC/YL and DX/YL certificates and YLRL A.P. and YL/OM contests. Copies are available for 25¢ each from K6HHD, Jan O'Brien, 3417 6th Ave., Sacramento, Calif.

YLRL also has available cuts of the diamond-shaped YLRL insignia for use on QSL cards. They sell for \$1.50, postpaid, and can be obtained from the current treasurer, W6QGX, Harryette.



K6EXQ, Connie Hauck,
secretary of YLRL for
1959.

10th National Convention

Sixty-four YLs registered for the National Convention held in Washington, D.C., Aug. 15-17. Since the convention will be well cov-

ered by W1QON in her column and the YLRL Forum in *YL Harmonics*, we'll hit only a few highlights. In addition to the general convention activities, popular features for the YLs and XYLs were the ladies luncheon, fashion show, SWOOP, silly hat contest, YLRL Forum and tours. The YLRL session was arranged by W3CDQ, Liz, and conducted by W3RXJ, Irene. Speakers included K4LMB, Ethel; W1QON, Eleanor; W4BLR, Kay; W3PVH, Betty, and W4TVT, Claire, conducted the open forum. The mink scarf was won by the XYL of W4DRV. W3BIW, Eleanor, and OM W3BUX won a trip to New York City, and K4RAU, Hester, won a 40' TeleVue crankup tower. Others won prizes at the ladies luncheon and YLRL session.

Those attending: W1 CEW, HOY, QON, YYM; K1HMY; KN1GYY; W2 EEO, LHK, OWL, RUF; K2, AUE, HWM, LUR, MGE, UKQ; WA2AJU; W3 AKB, BIW, CAI, CDQ, CUL, CZT, DHL, GTC, PVH, RXJ, SLS, TSC, URU, UTR, UXU, WML, WRE, ZUF; K3BLG; W4 BAV, BLR, HLF, SGD, TDK, TVT, VCB/3; K4 CZP, GKO, GUD, LMB, QIR, RAU, RBU; W6BIS; K6KUP; W8 SSF, UFZ; K8ARA; W9 GME, RTQ, RUJ; K9DCC; WØ CMV, ZTH; KØ BFS, LYV; CO2WI, KV4BU.

As a result of the convention, on Aug. 21 W3CDQ, Liz, and K4LMB, Ethel, were interviewed on the NBC program Capital Bylines.



W9YWH, Evelyn Tibbits,
YLRL treasurer for 1959.

Work DX?

Don't forget the CQ-sponsored World Wide DX Contest—the phone section is the last weekend in October and cw the last weekend in November. . . . Congrats to these YLs for earning the WAZ DX award—YL number 6 to make WAZ is K6ENL, Aleta Cash, while the 7th YL to achieve the award is ZS1RM, Margery Snyman.

"CQ YL"

Ordered your copy yet? Ham magazines and newsheets all across the country have been carrying news of this first and only book about

the YLs. W2JZK, Editor of G-E HAM NEWS, writes, "Both the XYL and I enjoyed reading 'CQ YL.' It is hard to realize how much the YLs have done for amateur radio until their accomplishments were documented in your book." 18 chapters, 500 photographs, it covers all phases of YL participation in Ham radio. Order from your column editor, W5RZJ (address beginning of column), \$3.50, postpaid, and autographed.

33, Louisa, W5RZJ

YLRL 19th Anniversary Party Rules

- Phone:** Start Nov. 12, 1958 at 12 noon EST. End Nov. 13, 1958 at 12 noon EST.
- Cw:** Start Nov. 19, 1958 at 12 noon, EST. End Nov. 20, 1958 at 12 noon EST.
- Eligibility:** All licensed YL and XYL operators throughout the world are invited to participate. YLRL members are eligible for the cup awards. Non members will receive a certificate. Only YLRL affiliated clubs will be eligible for the club award. Contacts with OMs will not count. The YL/OM contest will be held in the spring of 1959.
- Operation:** All bands may be used. Cross-band operation is not permitted. Only one contact with each station will be counted in each contest.
- Procedure:** Call "CQ YL."
- Exchange:** QSO number, RS or RST report, name of State, U.S. possession, VE district or country. California stations will include the name of their section in the QSO. California is divided into eight (8) sections as follows: Santa Clara Valley, East Bay, San Francisco, Sacramento Valley, San Joaquin Valley, Los Angeles, San Diego and Santa Barbara.
- Scoring:**
- Phone and cw sections will be scored as separate contests.
 - Multiply number of contacts by the number of different States, sections, U.S. possessions, VE districts and countries worked. (Maryland and the District of Columbia count as one state)
 - Contestants running 150 watts input or less at all times may multiply the result of (b) by 1.25 (low power multiplier).
- Logs:** Copies of all logs showing claimed score, must be postmarked not later than Nov. 30, 1958 or they will be disqualified. Send logs directly to the YLRL Vice President, Kay Anderson, W4BLR, 5210 Raleigh Rd., Richmond 23, Va.
- Awards:** Highest phone score—gold cup.
Highest cw score—gold cup.
Highest phone and cw scores in each district, U.S. possession, VE district and country will receive a certificate.
- Club Award:** A gavel will be awarded to the club submitting the highest "average" score. Club secretaries should total the scores of all participating members and arrive at an average score by dividing this total by the number of club members participating. Send this information to the vice president for confirmation.
- Novice Award:** A certificate will be given to the Novice YL with the highest cw score.

LAST MINUTE FORECAST FOR NOVEMBER

November 29th, the first day of the cw contest, may be somewhat disturbed but good short wave propagation conditions are forecast for the remainder of the contest period. A moderate radio storm is forecast for the period November 16-19 and 27-28. Exceptionally good conditions are expected November 4-9. Send a self-addressed stamped envelope direct to W3ASK for a final forecast to be made one week before the cw contest period.

NOVEMBER, 1958

All Times in C. S. T.

MONTH: NOVEMBER, 1958

All Times in E. S. T.

CENTRAL USA TO:

	*6/10 METERS	15 METERS	20 METERS	40/80** METERS
Western & Southern Europe	8A-10A (2)* 6A-9A (3) 9A-2P (4) 2P-6P (2)	6A-8A (3) 8A-11A (2) 11A-2P (4) 2P-5P (3) 5P-8P (2)	11A-3P (3) 3P-8P (4) 8P-11P (3) 11P-11A (2)	5P-12M (3) 7P-11P (1)**
Central & Eastern Europe	6A-8A (2) 8A-11A (3) 11A-1P (2)	5A-8A (3) 8A-11A (2) 11A-1P (3) 1P-3P (2) 3P-5P (1)	6A-12N (1) 12N-8P (2) 8P-11P (3) 11P-6A (2)	6P-12M (1) 8P-11P (1)**
North & West Africa	8A-11A (1)* 7A-10A (2) 10A-12N (3) 12N-4P (2)	5A-11A (2) 11A-3P (3) 3P-8P (2) 8P-10P (1)	5A-7A (2) 7A-1P (1) 1P-6P (3) 6P-1A (2) 1A-5A (1)	6P-1A (2) 9P-12M (1)**
Central & South Africa	10A-1P (1)* 6A-11A (3) 11A-2P (4) 2P-6P (3) 6P-8P (1)	5A-11A (1) 11A-2P (2) 2P-7P (3) 7P-10P (2)	1P-6P (2) 6P-10P (3) 10P-2A (2) 2A-6A (1)	7P-12M (2) 9P-11P (1)**
Near & Middle East	6A-10A (2) 10A-12N (1)	9A-2P (2) 2P-4P (1)	11A-2P (2) 2P-5P (1)	6P-9P (1)
South America, Northern Area	9A-6P (2)* 7A-3P (4) 3P-6P (3) 6P-9P (2)	5A-8A (3) 8A-2P (2) 2P-8P (4) 8P-10P (3) 10P-5A (2)	5A-7A (3) 7A-2P (1) 2P-4P (2) 4P-1A (4) 1A-5A (2)	7P-6A (3) 8P-3A (1)**
Argentina, Chile, etc.	9A-12N (2)* 3P-6P (1)* 6A-3P (3) 3P-7P (4) 7P-9P (2)	6A-2P (2) 2P-8P (3) 8P-12M (2) 12M-6A (1)	5A-8A (3) 8A-3P (1) 3P-10P (3) 10P-5A (2)	7P-4A (2) 8P-3A (1)**
India, Pakistan & Central Asia	7A-9A (1) 8P-9P (1)	7A-10A (2) 5P-9P (2)	6A-11A (2) 5P-9P (2)	Nil
Malaya & Southeast Asia	8A-1P (2) 4P-7P (2)	7A-10A (2) 10A-2P (1) 2P-5P (2) 5P-8P (3) 8P-10P (2)	5A-9A (2) 4P-12M (2)	Nil
Philippine Islands & East Indies	7A-10A (1) 5P-7P (2)	7A-10A (1) 5P-9P (2)	6A-8A (1) 5P-10P (2) 10P-1A (1)	Nil
Japan & Far East	3P-6P (1)* 2P-4P (2) 4P-7P (3) 7P-9P (2)	6A-9A (1) 2P-4P (2) 4P-8P (3) 8P-10P (2)	10A-7P (1) 7P-9P (2) 9P-2A (3) 2A-10A (2)	12M-7A (1)
Australasia	3P-6P (1)* 8A-11A (3) 11A-3P (2) 3P-7P (4) 7P-9P (3)	7A-10A (3) 10A-4P (2) 4P-10P (3) 10P-1A (2)	4P-9P (1) 9P-12M (2) 12M-4A (4) 4A-9A (3)	2A-8A (3) 4A-7A (2)**
Guam & Pacific	4P-6P (1)* 8A-11A (1) 4P-8P (3) 8P-10P (2)	8A-11A (2) 4P-6P (2) 6P-9P (3) 9P-11P (2)	7P-10P (2) 10P-3A (3) 6A-8A (2)	10P-1A (1)
Hawaii	11A-5P (2)* 10A-12N (3) 12N-7P (4) 7P-9P (3)	10A-4P (3) 4P-9P (4) 9P-12M (3) 12M-2A (2)	4P-6P (3) 6P-4A (4) 4A-10A (3) 10A-4P (2)	10P-7A (4) 11P-6A (3)**
Antarctica	7A-9A (1) 6P-10P (1)	6A-9A (2) 9A-2P (1) 2P-10P (3) 10P-12M (2)	3P-7P (1) 7P-9P (2) 9P-3A (3) 3A-8A (2)	12M-3A (2)

NOVEMBER, 1958

All Times in P. S. T.

Western USA TO:

	*6/10 METERS	15 METERS	20 METERS	40/80** METERS
Western & Central Europe	6A-8A (2) 8A-10A (3) 10A-12N (2) 12N-2P (1) 2P-5P (2)	6A-9A (2) 9A-12N (3) 12N-3P (2) 3P-5P (1)	7A-9A (2) 9A-2P (1) 2P-6P (3) 6P-4A (2)	7P-11P (1)
Southern Europe & North Africa	8A-11A (1)* 6A-8A (2) 8A-11A (3) 11A-2P (2)	6A-10A (2) 10A-12N (4) 12N-2P (3) 2P-4P (2)	5A-12N (1) 12N-4P (2) 4P-7P (3) 7P-5A (2)	7P-11P (1)
Central & South Africa	8A-3P (1)* 6A-9A (1) 9A-1P (2) 1P-3P (3) 3P-7P (2)	8A-11A (1) 11A-2P (2) 2P-7P (3) 7P-10P (2)	6A-9A (2) 9A-3P (1) 3P-5P (2) 5P-11P (3) 11P-1A (2)	7P-9P (1)

EASTERN USA TO:

	6/10 METERS	15 METERS	20 METERS	40/80 METERS
Western Europe	9A-11A (2)* 6A-10A (3) 10A-2P (4) 2P-5P (2)	6A-12N (3) 12N-5P (4) 5P-8P (3) 8P-10P (2)	6A-3P (3) 3P-8P (4) 8P-3A (3) 3A-6A (2)	5P-7P (3) 7P-4A (4) 7P-3A (2)**
Central Europe	8A-10A (1)* 6A-8A (2) 8A-11A (3) 11A-2P (2)	5A-10A (2) 10A-1P (3) 1P-4P (2) 4P-6P (1)	12M-5A (1) 5A-7A (3) 7A-11A (2) 11A-6P (3) 6P-12M (2)	5P-7P (2) 7P-1A (3) 9P-11P (1)**
Eastern Europe (USSR)	7A-11A (2)	7A-9A (2) 9A-11A (3) 11A-2P (2)	2P-9P (2) 9P-12M (3) 12M-8A (1)	6P-12M (1)
Scandinavia & North Europe	8A-12N (1)* 6A-8A (2) 8A-12N (3) 12N-2P (2)	5A-8A (2) 8A-2P (3) 2P-4P (2) 4P-6P (1)	3A-7A (2) 7A-11A (1) 11A-3P (3) 3P-6P (2)	5P-9P (1)
Mediterranean West	8A-12N (1)* 6A-8A (2) 8A-12N (4) 12N-2P (3) 2P-5P (2)	5A-11A (3) 11A-2P (4) 2P-4P (3) 4P-7P (2)	3A-8A (3) 8A-2P (2) 2P-7P (4) 7P-11P (3) 11P-3A (2)	6P-3A (3) 9P-2A (2)**
Mediterranean East	8A-10A (1)* 7A-11A (3) 11A-2P (2)	6A-8A (3) 8A-11A (2) 11A-2P (3) 2P-4P (2) 4P-6P (1)	3A-8A (2) 8A-2P (1) 2P-7P (3) 7P-11P (2) 11P-3A (1)	6P-1A (1)
West Africa	8A-11A (1)* 7A-11A (2) 11A-1P (3) 1P-4P (2) 4P-6P (1)	5A-12N (2) 12N-4P (3) 4P-7P (4) 7P-9P (2)	5A-8A (2) 8A-1P (1) 1P-5P (2) 5P-9P (3) 9P-5A (2)	6P-2A (2) 9P-1A (1)**
East Africa	8A-1A (1)* 7A-9A (1) 9A-11A (3) 11A-2P (2)	6A-10A (1) 10A-12N (2) 12N-3P (3) 3P-5P (2)	11A-2P (1) 2P-4P (2) 4P-6P (3) 6P-11P (2) 11P-1A (1)	6P-9P (1)
Central & South Africa	10A-2P (1)* 6A-11A (2) 11A-2P (4) 2P-6P (3) 6P-8P (2)	5A-10A (1) 10A-12N (2) 12N-6P (3) 5P-10P (2)	11A-1P (1) 1P-7P (2) 7P-10P (3) 10P-4A (2) 7A-9A (2)	9P-1A (1)
South America, Northern Area	9A-11A (2)* 2P-6P (1) 7A-3P (4) 3P-6P (3) 6P-8P (2)	5A-8A (3) 8A-1P (2) 1P-7P (4) 7P-9P (3) 9P-12M (2)	5A-7A (3) 7A-1P (1) 1P-3P (2) 3P-1A (4) 1A-5A (2)	7P-6A (3) 9P-4A (1)**
Argentina, Chile, etc.	9A-12N (2)** 3P-6P (1)* 7A-1P (2) 1P-5P (3) 5P-9P (2)	6A-2P (2) 2P-9P (3) 9P-12M (2)	5A-8A (2) 8A-3P (1) 3P-9P (3) 9P-5A (2)	7P-4A (2) 8P-10P (1)** 2A-4A (1)**
India & Pakistan & Central Asia	7A-9A (1) 6P-9P (1)	7A-8A (1) 8A-10A (2) 10A-11A (1) 5P-9P (2)	7A-9A (2) 9A-1P (1) 7P-12M (2)	Nil
Malaya and Southeast Asia	11A-3P (2) 3P-6P (1)	7A-9A (2) 9A-4P (1) 4P-7P (2) 7P-9P (1)	5A-9A (2) 5P-12M (2)	Nil
Philippine Is. & East Indies	7A-10A (1) 5P-7P (2)	7A-10A (1) 5P-9P (2)	6A-8A (1) 5P-8P (1) 8P-2A (2)	Nil
Japan & Far East	4P-7P (3)	6A-9A (2) 4P-6P (2) 6P-8P (3) 8P-10P (2)	5P-8P (1) 8P-1A (2) 1A-8A (3) 8A-10A (2)	2A-8A (1)
Australasia	4P-7P (3)* 9A-12N (2) 12N-5P (1) 5P-8P (3) 8P-11P (2)	9A-12N (2) 12N-5P (1) 5P-10P (3) 10P-1A (2)	12N-9P (1) 9P-1A (2) 1A-8A (3) 8A-12N (2)	4A-8A (2) 5A-7A (1)**
Guam & Pacific	4P-6P (1)* 9A-11A (1) 4P-8P (3)	8A-11A (2) 4P-6P (2) 6P-9P (3) 9P-11P (2)	7P-10P (2) 10P-3A (3) 3A-8A (2)	10P-1A (1)
Hawaii	1P-5P (1)* 12N-2P (2) 2P-6P (4) 6P-9P (3)	11A-5P (2) 5P-9P (4) 9P-10P (3) 10P-1A (2)	11A-1P (2) 1P-5P (1) 5P-7P (2) 7P-10P (4) 10P-3A (3)	12M-7A (3) 1A-6A (2)**

PROPAGATION

by **GEORGE JACOBS, W3ASK**

607 Beacon Road, Silver Spring, Md.

This month's column is devoted to a special forecast for the CW Section of the CQ World-Wide DX Contest which begins at 0200 GMT on November 29th and runs until 0200 GMT December 1.

Providing no sudden radio storms develop during the Contest period (see "last minute forecast") world-wide DX during the daylight and early evening hours are expected to be excellent on 10-meters. Excellent DX propagation conditions are also forecast for the 15-meter band from dawn until well into the

evening hours. *Twenty-meters* is expected to open to one part of the world or another almost around the clock, with the band peaking during the late afternoon and evening hours, and again at sunrise. With the approach of winter, DX propagation conditions improve on 40 and 80-meters. Fairly good openings to many areas of the world are forecast for 40-meters between the hours of early evening and dawn. Some DX on 80-meters should also be possible during the night hours, but signals may be weak and the band noisy. In areas where static levels are low, some DX openings may be possible on 160-meters during the hours of darkness. All in all, conditions this year are expected to be just about as good as they were during the record breaking Contest of last year, with DX conditions best on 10 and 15-meters during the daylight hours and on 20, and to some extent 40-meters, during the night time hours.

Six Meters

While not part of the Contest, it is of interest to note that good world-wide DX is forecast for the 6-meter band during November. The band is expected to open quite regularly on the trans-continental, trans-Atlantic, and trans-Pacific paths, as well as occasionally to South America and Africa. Conditions are expected to be almost as good as last year with excellent possibilities for WAC. Since the present sunspot cycle is believed to be declining in intensity this may be the last year for many years to come that world-wide 6-meter DX may be possible.

Solar Cycle Progress

After dropping slightly for two months in a row, the present solar cycle has surged upwards again to reach a *new record breaking peak* in intensity. The Swiss Federal Solar Observatory reports a monthly sunspot number of 204 centered on July, 1958. This results in a 12-month running smoothed sunspot number of 200 centered on February, 1958. This slightly exceeds the previous record of 199.5 established during November of last year. A smoothed sunspot number of 156 is now forecast for November, 1958.

Good luck during the CW Period of the Contest. Any comments readers of this column may have concerning the accuracy of these forecasts during the Contest periods would be appreciated.

73, George

NOVEMBER, 1958

All Times In P. S. T.

WESTERN USA TO:

	*6/10 METERS	15 METERS	20 METERS	40/80**METERS
South America, Northern Area	8A-5P (1)* 6A-1P (3) 1P-6P (4) 6P-8P (2)	6A-2P (3) 2P-6P (4) 6P-9P (3) 9P-11P (2)	2P-4P (3) 4P-8P (4) 8P-10P (3) 10P-2P (2)	6P-3A (3) 9P-2A (2)**
Argentina, Chile, etc.	9A-2P (1)* 6A-12N (2) 12N-6P (3) 6P-8P (2)	6A-8A (2) 8A-1P (1) 1P-7P (3) 7P-10P (2) 10P-6A (1)	2P-5P (2) 5P-8P (3) 8P-2A (2) 2A-6A (1)	9P-3A (3) 10P-1A (1)**
India, Pakistan & Central Asia	4P-7P (2)	3P-6P (3) 6P-9P (2)	7A-9A (2) 9A-3P (1) 3P-6P (2) 6P-10P (1)	2A-8A (1)
Philippine Is. & East Indies	3P-6P (1)* 8A-10A (2) 2P-7P (3) 7P-9P (1)	8A-2P (3) 2P-6P (1) 6P-12M (2) 12M-4A (1)	8P-11P (1) 11P-6A (2) 6A-9A (3) 9A-11A (2)	4A-8A (1)
Malaya & Southeast Asia	9A-11A (2) 2P-8P (3)	9A-12N (3) 12N-3P (1) 3P-6P (3) 6P-10P (2) 10P-2A (1)	12M-7A (2) 7A-10A (3) 10A-1P (1)	4A-8A (1)
Hong Kong, China & Formosa	3P-5P (1)* 2P-8P (3)	1P-6P (2) 6P-3P (3) 9P-11P (2) 11P-2A (1)	12M-7A (2) 7A-11A (3) 11A-7P (1) 7P-9P (2) 9P-12M (3)	1A-8A (2)
Japan, Okinawa & Far East	3P-5P (2)* 1P-4P (3) 4P-6P (4) 6P-8P (3)	1P-6P (2) 6P-11P (3) 11P-5A (2) 5A-1P (1)	12M-7A (3) 7A-12N (2) 12N-8P (1) 8P-12M (3)	11P-8A (2) 12M-5A (1)**
Australasia	2P-6P (1)* 8A-2P (2) 2P-6P (4) 6P-10P (3) 10P-12M (1)	7A-12N (3) 12N-6P (1) 6P-10P (3) 10P-2A (2)	7A-10A (3) 10A-8P (1) 8P-2A (3) 2A-7A (2)	2A-6A (3) 6A-8A (2) 3A-6A (2)**
Fiji & New Hebrides	2P-6P (1)* 8A-1P (3) 1P-6P (2) 6P-9P (3) 9P-11P (1)	8A-12N (3) 12N-4P (2) 4P-10P (3) 10P-12M (2)	7A-10A (3) 10A-7P (1) 7P-12M (3) 12M-7A (2)	12M-6A (2) 2A-6A (1)**
Guam & Pacific Is.	2P-5P (2)* 12N-2P (2) 2P-6P (3) 6P-9P (2)	8A-12N (2) 12N-2P (3) 2P-6P (2) 6P-12M (3) 12M-8A (2)	7A-12N (3) 12N-7P (1) 7P-11P (3) 11P-7A (2)	12M-8A (3) 2A-7A (2)**
Aleutians & Siberia	2P-4P (2)* 12N-2P (3) 2P-7P (4) 7P-10P (2)	9A-11A (2) 11A-5P (3) 5P-8P (4) 8P-10P (2) 10P-12M (1)	8A-12N (3) 12N-6P (2) 6P-9P (4) 9P-11P (3) 11P-3A (2)	9P-8A (3) 11P-7A (2)**

SYMBOLS FOR NUMBER OF DAYS CIRCUIT PREDICTED TO OPEN:

(1) 1-4 days (2) 5-11 days (3) 12-18 days (4) 19-26 days (5) over 26 days

** Indicates time of possible 80-meter openings.

* Indicates time of possible six-meter openings.

The CQ Propagation Charts are based upon a CW radiated power of 150 watts and are centered on Washington, D. C., St. Louis, Mo., and Sacramento, California. These forecasts are calculated from basic ionospheric data published by the CRPL of the National Bureau of Standards and are valid through December 15, 1958.

VHF

50mc. 144mc. 220mc. 420mc. and above

by **SAM HARRIS, W1FZJ**

P.O. Box 2502, Medfield, Mass.

Now that the contests are over, the antennas all up, six meters open for DX again and two meter aurora back in full swing, I guess it's time to start nagging again. It is not too late to double the size of your antenna for the winter months. Remember: If your antenna hasn't blown down in the last year, it just isn't big enough. If you aren't hearing those weak signals better than your neighbor, it isn't because his receiver is good. It's because yours isn't. The boys who claim that a better noise figure doesn't make the weak signals any easier to read are generally the ones who don't think it's worth the trouble to change that chewing gum feeling to something with low enough loss to let the poor receiver see what the antenna sounds like. A three db pad between your transmitter and your antenna may make your vswr look good, but it sure soaks up those weak ones. For example: if you have a receiver with a three db noise figure (fair on 2 meters) and 100 feet of RG8U, your system will end up with a 6 db noise figure. This is about equivalent to what you might expect with a real poorly front end and a decent feedline. Or about average for two meter equipment a decade (ten years) ago. Now if you decide to shoot the works and put in a 416B pre amp, you might get your receiver noise figure down to 2 db (conservative). With the same feedline your system NF will drop to a resounding 5.0 db. Changing your feedline to something with 1 db loss per hundred feet would drop your system NF to 3.1 db and you could save your 416B for a rainy day. I am not selling feedline, but if you are in the mood to improve your station you ought to look up someone who is.

Parametric Amplifiers

So if you haven't seen it yet you should look through this issue till you find an article on how to build your own parametric amplifier. Don't let the grass grow while you make up your mind. This is the hottest thing since the maser. And this *YOU* can build. One of the fringe benefits of the varactor amplifier is its ability to accept the strong signals without overloading or cross modulation. This means

that while you might not need the improvement in noise figure, on six meters you still can benefit in overall performance with the varactor. In case you are going to ask what happened to the "up converter" I can only say: wait. The people who should know the answers say that the "up converter" is much better than the straight parametric amplifier. Present "up converters" are reminiscent of some of Rube Goldberg's best efforts. (They do work pretty good though.)

Future plans include amplifiers for both 220 and 432 mc. Construction details for the 432 mc amplifier will be completed for next month. When the 432 mc job is done we will take a shot at the "up converter" for use on two meters. (No promises on this one.)

Contest Results

Somewhere around here you will find the results for the August contest. If you didn't get your log in the mail by the 15th of September, you just missed the boat.

Two Letter Technicians

Some time ago reference was made to the fact that W1FY, Ray Stevens, was the only two-letter technician in the country. Boy! Did we make a boo-boo! And did we hear about it! But not from the boys who hold such calls, from their many friends. Because of this fact there are probably a great many two-letter technicians of whom we still know nothing. However, below are a few calls, names and facts concerning the ones of whom we have heard.

First, another W1: W1AU—Ralph Mathewson, Milton, Massachusetts. Ralph got his first license on October 1, 1919, on the first day that the "World War I" ban on "wireless" was lifted, and he drew the call of 1 AP, issued by the Department of Commerce. Due to full time work in radio, Ralph allowed the license to lapse in the mid-twenties. Although not active, Ralph continued his interest in ham radio and last fall applied for a two-letter technician call as he had previously held such a call. On December 16, 1957, Ralph was issued

the call of W1AU and has been active on six meters ever since.

Number two, a K4: K4BZ—E. E. (Al) Young, Miami, Florida. Back in 1928 and '29 Al held the call of W4NM in Miami and he helped to organize the "Miami Amateur Radio Club" and was an officer of same. The club held the first ARRL convention in South Florida. Al drifted away from the "art" and of course lost his call. When he became disabled a few years ago, Al came back to the fold and applied for a two-letter call because of previously holding one. He received the call of K4BZ.

Next in line, #3: W5GL (/6), Ted Lang, Victorville, California. Ted's original call was 5GC and he was located at that time at El Paso, Texas. He doesn't say just when he received this call but does say that after an absence of twenty-eight years from ham radio he again became interested and received the call of W5GL. Ted's home QTH is located on top of an 1100 foot elevation just north of San Antonio, Texas, which puts him about 600 feet above the surrounding terrain. At present he is /6 at George Air Force Base in California.

Next, #4: W. H. Ritter—K6IP, Banning, California. Bill's (?) first station and operator licenses were issued to him in 1916 by the Department of Commerce, Bureau of Navigation, Radio Service, Radio Station #12403, call 9NS. His station was in Kansas City, Kansas, at that time and the closest radio inspector was in Cleveland, Ohio. Bill still has the second operator license issued to him (which is marked "Renewal") dated January 15, 1917, and sent to him by J. F. Dillon, Radio Inspector, Chicago, Illinois. The number on this operator license is 1466.

Not too long ago Al was "re-infected," bought a new hand book and joined the "San Gorgonio Pass Radio Club." He discovered that he couldn't get a Novice license so passed one for Technician and was issued the call of K6IP.

#5: W8RB5 — Al Miller, Olmsted Falls, Ohio. We've been unable to glean any information about Al, but take it for granted that he too had a ticket a lo-ong time ago and was therefore rewarded with a two-letter technician call.

#6: W9BO — Paul Mangus, South Bend, Indiana. After many years of inactivity, Paul took the technician's test and received his old call of W9BO. He was a lucky one. Paul is a member of the transmitter engineering staff of WSBT-TV.

Results of Smokepuff III a la K5IQL

"Operation Smokepuff" is the label given to a series of experiments aimed at bouncing signals off an artificial ionized cloud. The chemicals are carried up into the E-layer region by Aerobee and Nike Cajun rockets and exploded.

Several more or less unsuccessful tests were conducted, with the help of amateurs throughout the Southwest. Finally, after the manufacturers had learned to make the Chemical X, without exploding, a system of beacon signals was worked out; and "Smokepuff III" was scheduled in May.

W7FGG, in Tucson, was selected to beam a signal on 50.010 across the area from the West. W5SFW beamed his signal on 50.400 from the east. Other amateurs listened with calibrated receivers on these frequencies. Jerry, W7FGG, also transmitted on a frequency of 144.010.

The first shot was pulled off at 0240 M.S.T. on May 20. We had receivers monitoring 50 and 144. Immediately upon release of the cloud, the 50 mc signal from W7FGG came booming in S9. It slowly tapered off for more than one minute, when it went down into the noise. From then on for about eight minutes short bursts were copied.

Man had succeeded in bouncing signals off an artificial cloud!

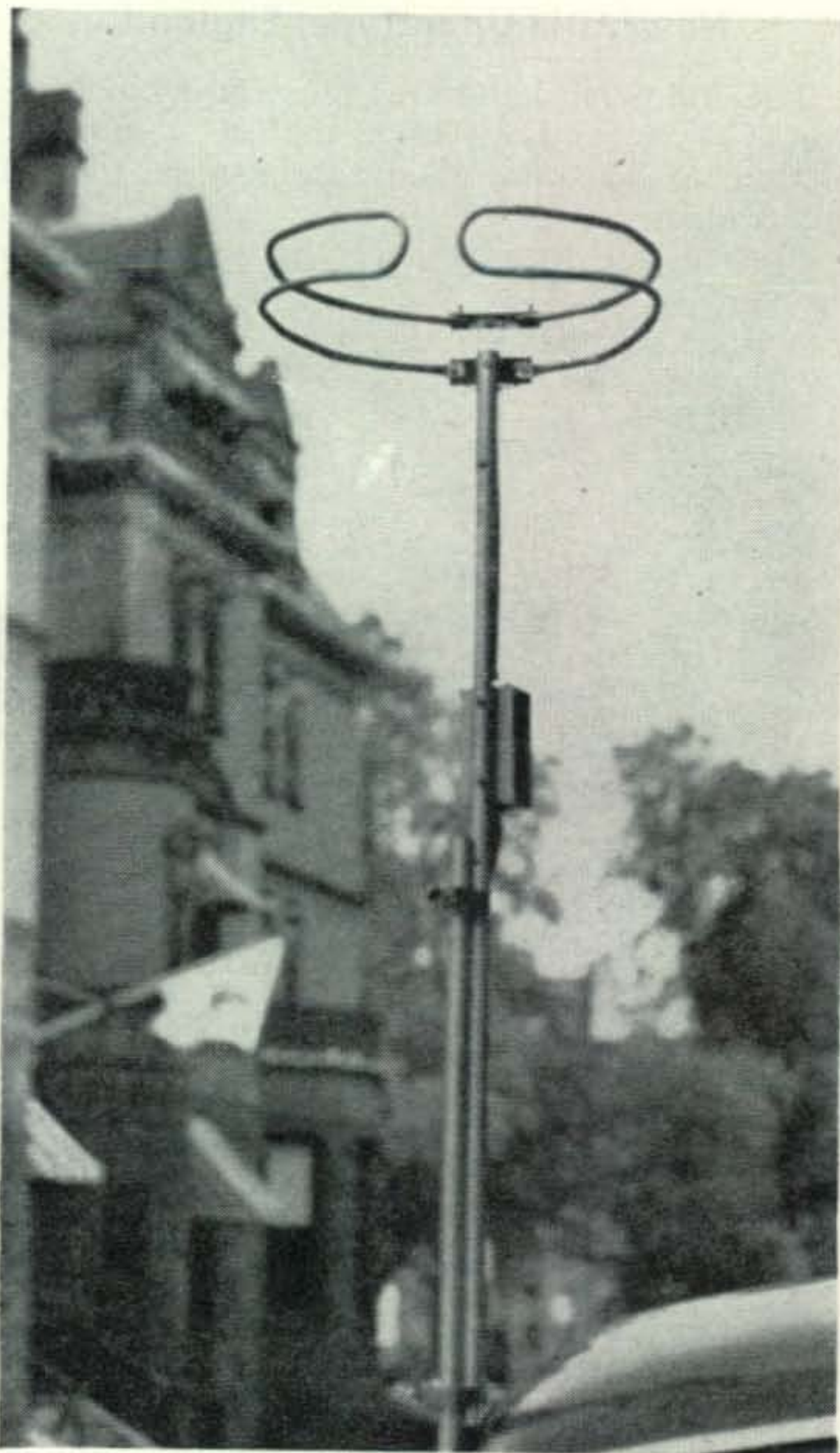

A good photo of Bigelow Green's (W1EHE) home-made "Halo." Have you built yours?

The next shot was scheduled at 0433 on May 21, to catch the sun's rays at the high altitude.

We picked up Jerry's signal on forward scatter as soon as he began transmitting (distance 390 miles). Two short, loud bursts were recorded on this test. One at X plus 85 to 90 seconds, from the rocket itself or a meteorite, and one at X plus 115 to 125 seconds as the cloud was released.

The cloud was released much too high on this test, pointing up the unpredictable performance of the Nike Cajun: and demonstrating our lack of accurate altitude-measuring equipment at heights above 30 miles.

The third shot, at 0434 on May 22, was a calibrating shot. It featured the usual luminescence and spectacular flight, but no ionizing chemical. Its purpose was to learn whether the previous results were due to the chemical. They were.

We again received W7FGG via the scatter route but no bursts were recorded.

Another series of daytime tests are scheduled for September. Beacon stations will transmit on phone for this test.

Newcastle Upon Tyne, England

The following letter was received from Gordon, G4LX, and we hope that it is in print in time to do some good for Gordon and 50 mc contacts.

"Just a line to say that I have a permit to



Lynn, K4KLC, hard at work talking to W1FMK (Vermont) his only New England State.

operate on 52.5 mc until October 31, 1958. Hope the 50 mc band opens up in time for QSO's with the states! 28 mc is just opening up to W/VE, so perhaps by mid-October, we shall find 50 mc open."

"I shall use *CW only* on 52.5 mc, but will look for replies on both phone and CW."

"There is very little 50 mc activity in Europe this summer. Sporadic E openings have been many, and also several aurora openings, but all I've worked have been HB9BZ, HB9QQ and OH2HK (51 mc). I am running skeds with ZE2JV at 1700 GMT daily."

"According to my log, the 50 mc path opened up to my location on October 26, 1957—if propagation conditions repeat this year, there won't be many days for you to work me on 52.5 mc." *Thanks very much for the information Gordon, surely hope we make it on 50 mc this year.—Helen*

Houston is Tops

For some time now we've been receiving requests for C.C.C. both for six meters and for two meters. It suddenly dawned on me the other day that Houston, Texas seemed to be well-represented by requests for the certificate. On checking back into the applications I found that we've received requests from twelve different stations in the state of Texas for the Certificate. Five of these applications were from Houston, Texas, the others from assorted cities in that grand state. Of the five from Houston, four of the requests were from Jack Bayha, K5OQN, who at the present time is the only recipient of FOUR C.C.C. for six meters, (since the middle of March).

Jack (ex-W8BPY) got on six meters on March 15th, 1958 and as he says "I hit it with both barrels, a Gonset III and a five element beam." He has since changed to an eight element beam but is still using that same high power, six watts. Now let's hear the comments about "the high power boys."

All of the contacts were made in Jack's spare time. He works five days a week, from 7:30 to 5:15 as a research engineer with Southwestern Industrial Electronics. Also, his QSL's were listed, sent to us to be checked, and the lists were notarized besides being signed by another licensed amateur.

Congratulations Jack and Houston, for a wonderful job on six meters. Maybe you ought to write an article about "How to get QSL's."

Clubs and Certificates

Speaking of Texas—"The Six Meter Club of San Antonio" was formed last March. This past July it was decided to issue a certificate called "WASA" or "Worked All San Antonio." Anyone wishing to get this certificate (outside Bexar County) must meet the following requirements: 1. Contact must

be made with any five members of the club after July 11, 1958. 2. QSL's from club members should be sent to P.O. Box 82, San Antonio, Texas requesting WASA. There are at the present time about twenty-five club members.

51.30

Another net formed in our own state of Massachusetts is called the "51.30 Club." You guessed it; the idea being to create more interest in the six meter band above 51.0 mc. At the present time there are about twenty members in this group all living in the Framingham, Wellesley, Sudbury and Westboro area. The certificate issued by this group is earned by working ten members of the group at a frequency of 51 mc or above.

Oklahoma

The "Oklahoma Central Six Meter Net" really has a large number of members; more than seventy, and once again—to receive their certificate you must work six members of the net, QSL, and send your list to LEE, Box 7171, Oklahoma City, Oklahoma.

Pennsylvania

The "Society for the Preservation of Amateur Radio's Kindred Spirit" on 50 mc is a new six meter club, located near Pittsburgh, Pennsylvania, whose purpose is to assist and encourage amateurs to make use of six meters. The Club offers free technical advice and assistance to those experiencing difficulties on six. Schematics and full construction information for simple equipment, mobile or fixed, is available free of charge.

The Club uses a calling frequency of 50.2 mc and invites certificate seekers to make use of this frequency in obtaining a "SPARKS" certificate and membership. Crystals for 50.2 mc are also available at nominal rates. For other information write to: SPARKS, C/O Box 300, East Pittsburgh, Pennsylvania.

Phoenix, Arizona George (W7DIQ) gives us some activity news concerning the PVHFRC:

"Recent activities include a transmitter hunt which ended with most participants scratching their heads in front of an innocent looking orange grove. Cries of 'Foul' subsided at a post-mortem gathering at W7DIQ's QTH where tranquilizers in the form of charcoal grilled hamburgers and various and sundry liquid refreshments were served."

"The PVHFRC has at long last succeeded in becoming incorporated, credit goes to those tireless former officers and current members, without whose constant nagging the job would have been dropped. A development made possible by the recently issued club call, K7DAW, is the association with the MARS organization."

"Two meters is not so populous as six meters but with W7VMP and W7RUX poking out kw signals on two meters, Phoenix is well represented." *Thanks for a lot of fine information George, keep it coming.*

Landisville, New Jersey Wallace Cantoni (W2HVW) sends a log of his activity for the past month:

"7/30/58 CO2XZ and K4UDV, 8/1/58 W9PAQ/8 and K8BYA, 8/7/58 K0CAB, 8/8/58 K0LMQ and K0JNH, 8/10/58 W3DHQ/8, 8/22/58 K5AWT/4 and K4LZW, 8/24/58 W0HVW, 8/30/58 K4ETA, 8/31/58 K5EAR. Heard CO2JV but could not raise him on 7/30/58. Used a Gonset III and a three element beam to work the foregoing stations." *Thanks Wally, nice to know what's going on in New Jersey.*

Elkins, West Virginia One of our "8" friends A. E. Minke (K8AXU) sez:

"Just want you to know that I now have 18 states on 2 meters, but I can't seem to work anybody to the south or southeast. I will be operating from my 4000 foot QTH until the weather gets too cold, so tell the boys to look for me when the band is open. Frequency is 144,170 and 144,600." *The boys have been told, hope you have better luck next opening.*

San Antonio, Texas News of openings from Hank (K5HYF):

"The band has been open almost daily to 4's, 6's, 8's, 9's and 0's, with very regular and frequent openings to Phoenix, Arizona. (Written 8/28/58) Quite recently, yours truly, K5HYF and K5MZH worked a real rare one, (or someone has a real rare sense of humor) in the person of HH2PL on July 27, 1958, Pierre in Port Au Prince, Haiti. In the middle of July we also heard, but could not work, that there y! 'Helen', WIHOY, and another y! in Vermont. But they and some other W!s were so darned busy working 4's that they didn't bother looking for some of the Texas boys who need the 1's and 2's for WAS. *Taint so!! I'm always lookin' for the 5's.—Helen.* Among DX worked and confirmed are LU's, VE1's, ZE2JE, SM6BTT, KH6CNI, ZLTDS. The first ZL contact made outside the 6th call area was made between ZL2DS and myself, K5HYF. Also made a cross-band contact with HK7LX in Columbia." *Congratulations Hank, surely sounds like you've been pushing 'em around.*

Lexington, North Carolina From the south and Ron Fritts, (K4OZW) we hear that:

"I have been on the air on six meters for about six weeks, and have worked twenty-three states and three sections of Canada. All call districts except 3's, 6's and 7's have been heard and worked almost every week, and sometimes for several days straight. In addition, several CO's and a couple of Mexican stations have been heard working nearby 4's."

"As for the state as a whole, six meter activity is really booming, with about 35 stations within ground wave distance of each other here in the Piedmont section. Recent formation of the N.C. Six meter Net should cause six meter activity to continue on the increase." *Thanks Ron, and continued good luck with your DX.*



A good inside antenna, according to Harold Itzel (K2CMG) is 'Senor Greg's Sombrero.'

San Francisco 9, California Jack Molinari (K6VXI) inquiries as to where-a-bouts of his C.C.C. for six meters and then continues:

"The rig here is a Gonset Communicator II with a Gonset Linear, WRL vfo, SX-99 with a Filter King Converter and a five element beam. Have worked about 24 states, VE7, KL7, and KH6. Alaska and Hawaii have not QSL'd." *I'm surprsed at Alaska but no one that I know of from this territory has received their Hawaiian QSL.*

"So far the activities have been confined to six, but

hope to be on 220 by the end of the year." *See you on 220, Jack.*

Washington, Pennsylvania Another net, information from Harold McConnell (W3UEM):

"The Penowva Phone Net" standing for Penna., Ohio and West Va., has recently been formed. It is a traffic and emergency net, meeting every Tuesday night at 2000 local time at 50.520. Certificate available by working 1 W.Va. station, 3 Pennsylvania stations and 3 Ohio stations.

73, Sam, W1FZJ

Don't Let These Fool You

Herbert Greenberg, W2EEJ

821 Rutgers Road
Franklin Square, N. Y.

Situation 1

There seems to be a local tuning up, at least there is an unmodulated carrier which is in the band and remains with no identification or break. After waiting quite a while for something to happen, you finally give up with unprintable thoughts about the type of amateur which violates the regulations and is thoughtless enough to blatantly clutter up the airwaves.

Actually, there may be no amateur doing this. You are doing it to yourself, if you have a broadcast receiver on for Conelrad purposes. The harmonics of a superheterodyne's oscillator are of sufficient magnitude to radiate a strong local signal in the immediate vicinity and depending on the fundamental frequency to which it is tuned, may easily create spurious signals in the amateur bands.

This can easily be checked by slightly tuning the BC receiver. If the unidentified signal changes simultaneously, you have identified the culprit. The cure is to monitor another broadcast station whose reception will not cause interference. Don't QRM yourself!

Situation 2

As you settle yourself down for some pleasant uninterrupted operation, you find that the receiver is acting up peculiarly. The S-meter seems to hang at a high level, and no signals can be heard, or at best a very few which you recognize as locals which normally are loud and clear. A loud roaring noise which blankets

all of the bands is killing all reception. You vaguely remember that this has happened before, and when you tried to check the trouble, it suddenly disappeared.

If you remembered precisely, it was raining also the last time it happened. Or perhaps snowing. What you've been experiencing is precipitation static. Sometimes it will start with a few "pops", increasing in tempo, and resembling ignition interference, and it may fade in the same manner. This is a common phenomenon, and treated in some texts, but seemingly little understood by the average amateur.

Usually there is little that can be done. Even grounded antennas don't seem to be able to separate a signal from static and resistors or RF chokes to provide a drain path to ground do not alleviate the condition to any appreciable extent. Changing to an indoor antenna may help, but at the expense of considerable loss of reception capabilities.

This condition is due to small charges of static electricity which each drop or flake contains and which discharges when it contacts the antenna. Enough voltage can build up across an unterminated feedline in the shack to cause discharges. A rhythmic snapping noise was traced to an unused coax fitting which was arcing at regular intervals during a rain, incidentally not a thunderstorm.

While little can be done to relieve the situation, there is no use in condemning the receiver, or starting to trouble shoot a non-existent defect. Remember that "this too will pass". it always has. ■

New Amateur Equipment

New VHF Converter

RME Division of Electro-Voice has a new converter which tunes 6, 2, and $1\frac{1}{4}$ meters. The output is in the 7 mc band. All you have to do is connect your VHF antennas to the input and your station receiver to the output. Tune your receiver to 7 mc and do all further tuning with the VHF-126. Sensitivity is claimed to be excellent. The dial is calibrated in 100 kc divisions. Amateur net is \$239. Circle B on page 194 for data sheet.



New Miniature Millen Line

The James Millen Manufacturing Co. has added to their present line of top quality radio components with a completely new set of dials, knobs, couplings, etc., which are only approximately $\frac{2}{3}$ the size of the regulator units. These should be of great interest to home constructors who are following the present commercial techniques and are miniaturizing their equipment. One of the great setbacks in compact construction has been the extremely restricted selection of small component parts. Circle C on page 194 for a catalog sheet.

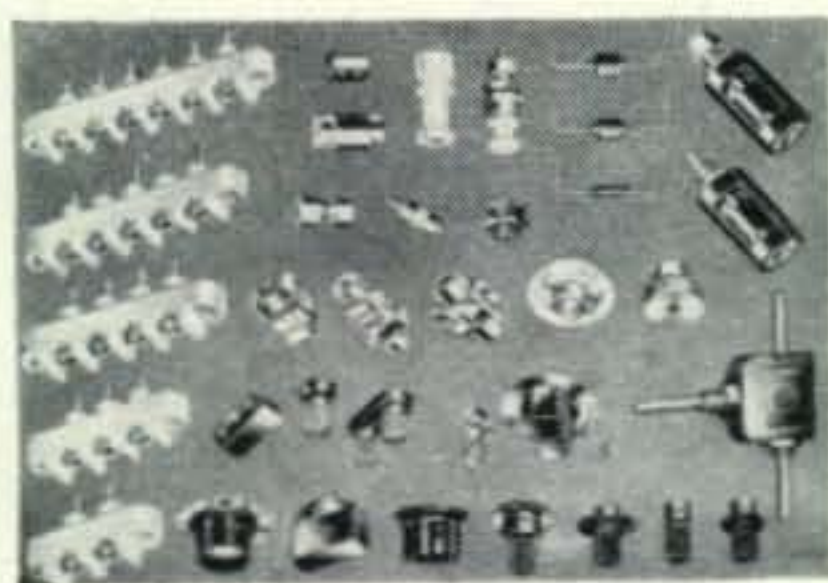

New Heath Kit

The Heath Company has been expanding their ham kit line considerably in the last few months. Their newest addition is a Reflected Power Meter Kit (Model AM-2). This will tell you the SWR from 1:1 up to 6:1 as well as the forward power being transmitted. It will handle well over a kilowatt, will operate from 160 meters through 2 meters, and may be left in the feedline at all times. 50 or 75 ohms input and output impedance. Price \$15.95. Circle E on page 194 for catalog.



Statement of Ownership

STATEMENT REQUIRED BY THE ACT OF AUGUST 24, 1912, AS AMENDED BY THE ACTS OF MARCH 3, 1933, AND JULY 2, 1946 (Title 39, United States Code, Section 233) SHOWING THE OWNERSHIP, MANAGEMENT, AND CIRCULATION OF CQ, published monthly at New York, N. Y. for October 1, 1958.

1. The names and addresses of the publisher, editor and business manager are: Publisher: Sanford R. Cowan, 6 Embassy Court, Great Neck, N.Y.; Editor: Wayne Green, 300 West 43rd St., New York 36, N.Y.; Managing Editor: none; Business Manager, Richard A. Cowan, 6 Embassy Court, Great Neck, N.Y.

2. The owner is: (If owned by a corporation, its name and address must be stated and also immediately thereunder the names and addresses of stockholders owning or holding 1 per cent or more of total amount of stock. If not owned by a corporation, the names and addresses of the individual owners must be given. If owned by a partnership or other unincorporated firm, its name and address as well as that of each individual member must be given.) Cowan Publishing Corp., 300 West 43rd St., New York 36, N.Y.; Sanford R. Cowan, 6 Embassy Court, Great Neck, N.Y.

3. The known bondholders, mortgagees, and other security holders owning or holding 1 per cent or more of total amount of bonds, mortgages, or other securities are: None.

4. Paragraphs 2 and 3 include, in cases where the stockholder or security holder appears upon the books of the company as trustee or in any other fiduciary relation, the name of the person or corporation for whom such trustee is acting; also the statements in the two paragraphs show the affiant's full knowledge and beliefs as to the circumstances and conditions under which stockholders and security holders who do not appear upon the books of the company as trustees, hold stock and securities in a capacity other than that of a bona fide owner.

(Signed) Richard A. Cowan, Business Mgr.

Sworn to and subscribed before me, this 3rd day of September, 1958.

HERBERT PARISER, Notary Public
(commission expires March 30, 1959)

AND **Hy-gain**, Complete Lines Now in Stock!

Meet the Miniature Mini-Tribanders

THE Hy-gain, SMALL SIZE, 3-BAND BEAM (10, 15 & 20),
WITH SINGLE FEED LINE FOR MAXIMUM LEGAL POWER!

Insutraps

These streamline hy-gain traps are small (3" diameter) and light weight. Capacitor dielectric and coil form molded high impact styron. Each designed to take 1 KW AM, 2000 watts P.E.P. (as much as higher priced tribanders; more than 3-times the power handling capabilities of others. No need to limit your present or future power to 300 watts!) Individually factory resonated for maximum frequency accuracy. Completely weather sealed, water proof and airtight (do not breathe) for years of stable operation. Carbon activated polyethylene covers. Guaranteed for the life of the beam. Hi-Q coils well-removed from any metal mean highest efficiency of isolation action.

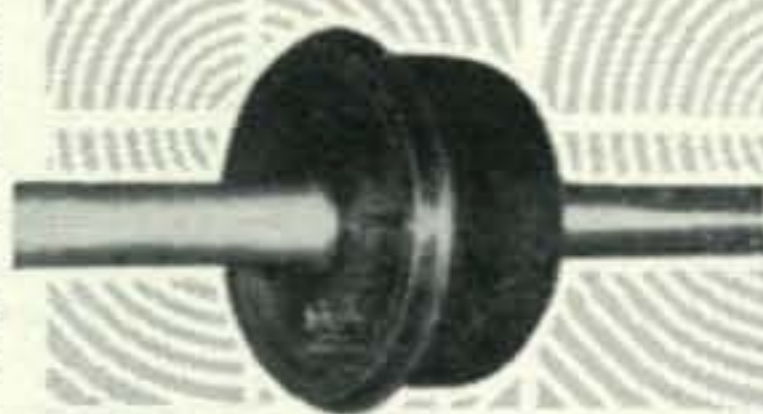

Split Insulated Dipole

Split Insulated Dipole Feed with coaxial choke results in SWR of less than 1½:1 on all bands with exceptional bandwidth. No adjustments needed; simply attach 52 ohm feedline to dipole terminals. Heavy 12 Ga. hot dipped galvanized steel channel and polyethylene insulated U-bolts support hy-gain's driven element.

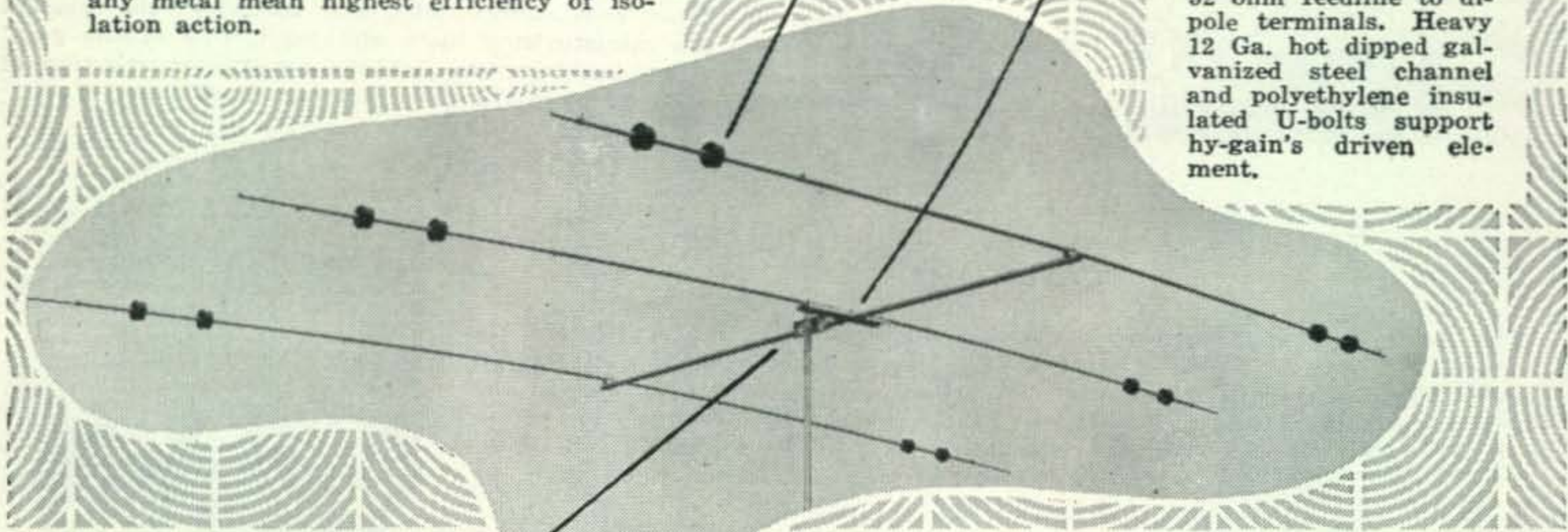

Gain & F/B Ratio:

Hy-Gain's Mini-Tribanders have been carefully tuned for maximum gain and F/B Ratio possible in a reduced size array. Hy-Gain guarantees as much or more gain as any other two and three element split dipole fed 3-Band Beams, regardless of price.

Two-Element Mini-Tribander

Practically a featherweight, the 2-Element Mini-Tribander weighs in at only 33.8 lbs. and is easily one-man installed in the shortest possible time . . . and nearly anywhere, with its turning radius of only 12', 11". Boom length 6'. Longest element 27'.

\$49⁹⁵

Three-Element Mini-Tribander

The 3-Element Mini-Tribander is extremely lightweight, only 39.8 lbs. With a turning radius of 13', 10", this space-saving beam may be installed almost anywhere, yet boasts most of the features of the hy-gain full-sized trap tribanders. Boom length 12'. Longest element 28'.

\$69⁹⁵

Construction

Boom is 1½" dia. by .065" wall thickness, hot dipped galvanized steel. Elements are 6061T6 high strength aluminum alloy. Telescoping sections of 1", ¾", ¾" sizes are used. Heavily plated 10 Ga. steel channels attach all elements to boom and boom/mast with positive grip. High quality, galvanized and iridite treated hardware used throughout.

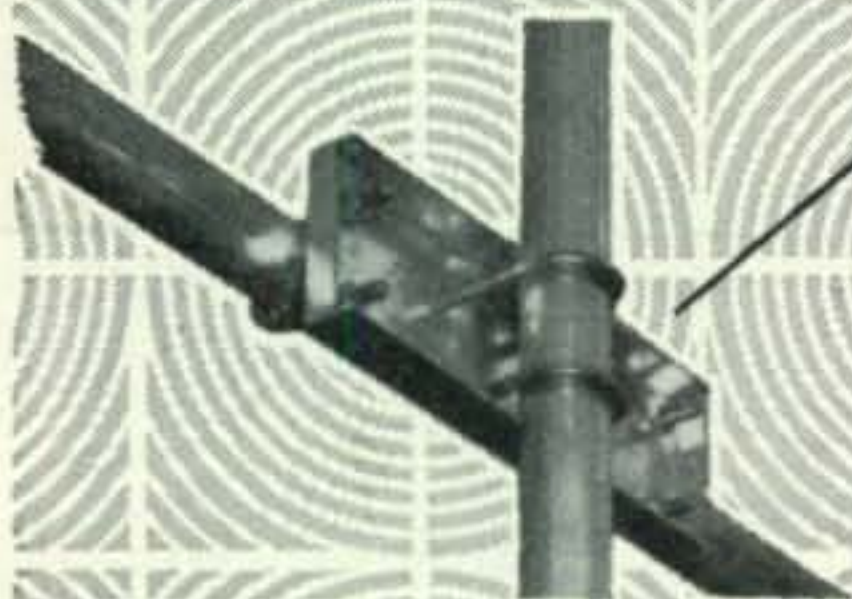

GET THE STORY ON THE COMPLETE HY-GAIN LINE!
10% DOWN • E-Z TERMS • PROMPT SHIPMENT • TOP TRADES
AT

WORLD'S MOST PERSONALIZED ELECTRONIC SUPPLY HOUSE

World Radio LABORATORIES
PH 2 0277

3415 W BROADWAY COUNCIL BLUFFS IOWA

Please send me Free Catalog . . . and complete info on the Hy-Gain line. C-11

NAME: _____

ADDRESS: _____

CITY & STATE: _____



FREE

FREE

For further information, check number 43 on page 194.

"Late National Gear in Stock"

SAYS LEO I. MEYERSON, W0GFQ, WORLD RADIO PRESIDENT

THE GREAT NEW

National NC-303



\$44.90 down
\$2550
per mo.
or \$449
Amateur Net

Here's the time proven features of the fine NC-300 plus the following features. Front panel selector provides instant sideband choice. Retuning or detuning eliminated. "Q" Multiplier. 5-position IF selector (.5kc, SSB-1, SSB-2, 4kc, 8kc). Separate ANL for AM. Separate manually adjusted limiter for CW, DSB and SSB. WWV converter position. Hi-speed 40-1 ratio tuning dial. Fine tuning vernier dial on CW, SSB and DSB. Antenna trimmer. 15 tubes. Sensitivity: 1.5mv. Image rejection 50-80db. Black & grey enamel finish. Shp. wt.: 64 lbs.

and the first, all new,
low-priced shortwave receiver

National NC-60

"Special"

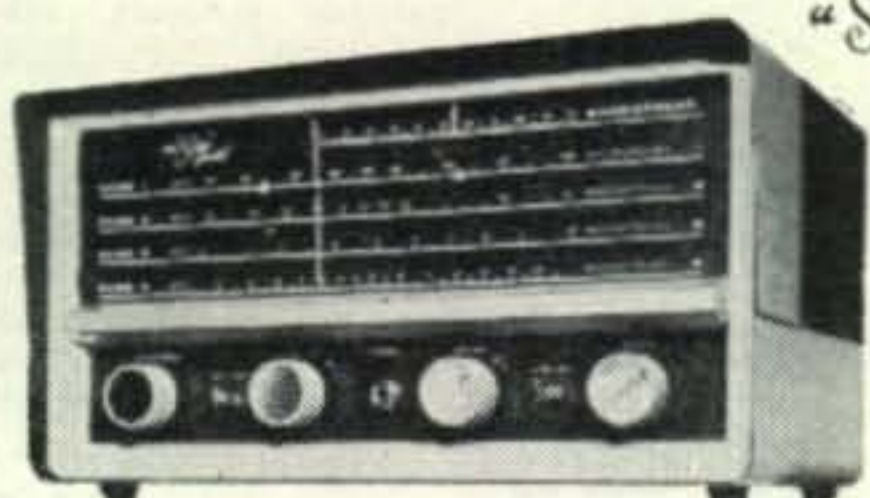

\$6.00 down
\$500
per mo.
or \$59.95
Amateur Net

The NC-60 Special Receiver offers continuous coverage of AM broadcast, Amateur and world-wide shortwave bands. Full electrical bandspread. General coverage 540kc to 3mc in 4 bands. Bandspread knob can be used as vernier on all frequencies. 5 tubes. Built-in speaker. Two-tone grey and black enamel. Shp. wt.: 15 lbs.

We stock the complete National Line:
Send for full information today . . . to
"the World's Largest Distributor of
Amateur Radio Equipment!"



Our size and warehousing facilities allow us to keep in stock continually the National Equipment you want, making "same-day" shipment possible. Yet so many amateurs do business with "the house the hams built", our turn-over is so rapid, you can be assured of Late Serial Numbers, guaranteeing the latest improvements always. Order with confidence! Order from World Radio Laboratories.

PERSONALIZED SERVICE

GUARANTEED SATISFACTION

EASY TERMS

TOP TRADE-INS

PROMPT SHIPMENT

LEADING LINES

Dear Leo: Please send your free 1959 Catalog, information on the National line, and quote your best trade offer on my present

_____ for a new NC-303

NAME: _____

ADDRESS: _____

CITY & STATE: _____

WORLD'S MOST PERSONALIZED RADIO SUPPLY HOUSE



World Radio LABORATORIES

3415 W. BROADWAY, CO. BLUFFS, IA., Phone 2-0277

For further information, check number 44 on page 194.

HARVEY has it! the complete line of

540w AM & CW; 700w max. on DSB or SSB (P.E.P.) Input



Globe King 500C

Completely Bandswitching 10-160M

W/T: \$795.00

Relay-controlled; built-in antenna relay, VFO, commercial type compression circuit. Separate power supply for modulator. Time sequence keying.

350w CW, 275 AM, 450w SSB (P.E.P.) Input

Globe Champion 300A



W/T: \$495.00

Kit: \$399.00

Bandswitching 10-160. Built-in VFO, Pi-Net output, 48-700 ohms, push-to-talk, antenna changeover relay, time sequence keying, compression circuit. Kit with preassembled VFO.

Plate Modulated . . . Globe Scout 680A



W/T: \$119.95

Kit: \$99.95

65w CW
50w AM

Self-contained, bandswitching, 6-80M, with built-in power supply. Pi-Net 10-80M, link-coupled on 6M. High level modulation. Forward Look.

90w CW for 10-160M Globe Chief 90A



W/T: \$74.50

Kit: \$59.95

Forward Look cabinet, bandswitching Xmtr. Built-in power supply, Pi-Net. Provisions for external VFO.

Bandswitching 6 & 2M Xmtr. Globe Hi-Bander



Power Input:
60w CW;
55w AM
on Both
6 & 2M

W/T: \$149.95

Kit: \$129.95

Regulated screen supply. 4-stage RF section allowing straight through operation. Good harmonic and TVI suppression. RF Stages metered. Provisions for mobile use. 52-72 ohm coax output. New duo-band final tank circuit eliminates switching.

100w PEP DSB Input, Suppressed Carrier
40w AM, 50w CW

Sidebender DSB-100



W/T: \$139.95

Kit: \$119.95

Complete transmitter, bandswitching 80-10M. Min. 45db carrier suppression. 3-stage RF section, pi-net; speech clipping. Inverse neg. feedback. Ceramic band and function switches. Narrow bandwidth. Forward Look.

Globe's VOX Model 10

For voice operated control, with extra contacts for auxiliary circuits. Plug in socket at rear of DSB Xmtr. Adaptable for other Xmtrs.

W/T: \$24.95

Kit: \$19.95

QT-10: Accessory for VOX, W/T: \$9.95

VFO 755A

160-10 Meters



W/T: \$59.95

Kit: \$49.95

For 10-160M; output on 40 & 160M. Vernier drive with shock absorbing features. Self-contained, well-filtered power supply with voltage regulation.

VFO 6-2



W/T: \$59.95

Kit: \$49.95

Perfect zero beat. Built-in power supply with voltage regulation. Drives 6 & 2M Xmtrs. Temp. compensated. Ideal for Hi-Bander. Sideband stability.

Model 666 for 6M, w/t only. \$49.95

Power Attenuator PA-1



Use with Xmtrs. up to 70w input; for swamping drive to linear amplifiers. Three power reduction positions. Coax input and output. W/T: \$10.95

Antenna Tuner with VSWR Bridge

Globe Matcher Sr.



W/T: \$79.50

Kit: \$69.50

Shielded Cabinet

For Xmtr. with final RF input up to 600w, 80-10M. Fixed link coupling in output. Coax input, 2-wire balanced output. Monitor SWR between Tuner and Xmtr.

Globe Matcher Jr., AT-3

For input to Xmtr. of 100w CW, 75w fone or less. Substantial harmonic attenuation. Unbalanced output. Self contained.

W/T: \$15.95 Kit: \$11.95

Grounded Grid, Class B or C

Globe Linear LA-1

W/T: \$124.50

Kit: \$99.50



Complete with well-filtered power supply. 200w input AM Class B. 300w DC or 420 PEP input Class B linear SSB or DSB. 300w Class C for CW. Pi-Net 80-10M. 52 ohm Pi-Link coupled on 6M. Extensively TVI-protected.

Versatile Modulator

Plate Modulator UM-1

Modulates RF inputs up to 100w.



W/T: \$49.95

Kit (less tubes): \$32.50

Class A or AB₂ modulator, driver for higher power modulator, PA Amplifier. Matches output impedances 500-20,000 ohms. Carbon or crystal mike usable. Perforated steel cover. \$3.00 extra. Supplies 10-45w audio output. Ideal for use with Chief.

Controlled Carrier Type

Screen Modulator Kit



Ideal for use with Globe Chief. Permits radio-telephone operation at small cost. Self-contained. Connections, instructions, printed circuits, etc. supplied.

Kit: \$11.95

6 Meter Converter

Compact, stable, crystal converter for receivers tuning output frequencies 10-14mc. Cascode RF stage, band-pass coupling, shielded input and output, high sensitivity. Crystal for 10-14mc output supplied.

W/T: \$27.50

Kit: \$19.95

Code Oscillator Kit

Transistor and printed circuit assembly. Code Practice Oscillator. Screw terminal input for key; standard phone tip output jack. Complete with batteries. Kit: \$4.95

Peak Limiting Pre-Amplifier

Speech Booster FCL-1

W/T: \$24.95

Kit: \$15.95



Perfect for Scout, Hi-Bander & other Xmtrs. Clips and filters speech frequencies at pre-set amplitude. Response: 300-3500 cycles. Increases modulation intensity.

★ We're Generous on Trade-Ins
If You Want to Talk SWAPS and
DEALS write . . . or call W2DIO

HARVEY is known the world over, wherever Hams operate, as a reliable source for Ham Equipment. All orders shipped same day received.

For further information, check number 45 on page 194.

Globe Electronics + Hy-gain - now in stock!

Meet the Miniature Mini-Tribanders

THE

Hy-gain

SMALL SIZE, 3-BAND BEAM (10, 15 & 20),

WITH SINGLE FEED LINE FOR MAXIMUM LEGAL POWER!

Insutraps

These streamline hy-gain traps are small (3" diameter) and light weight. Capacitor dielectric and coil form molded high impact styron. Each designed to take 1 KW AM, 2000 watts P.E.P. (as much as higher priced tribanders; more than 3-times the power handling capabilities of others. No need to limit your present or future power to 300 watts!) Individually factory resonated for maximum frequency accuracy. Completely weather sealed, water proof and airtight (do not breathe) for years of stable operation. Carbon activated polyethylene covers. Guaranteed for the life of the beam. Hi-Q coils well-removed from any metal mean highest efficiency of isolation action.

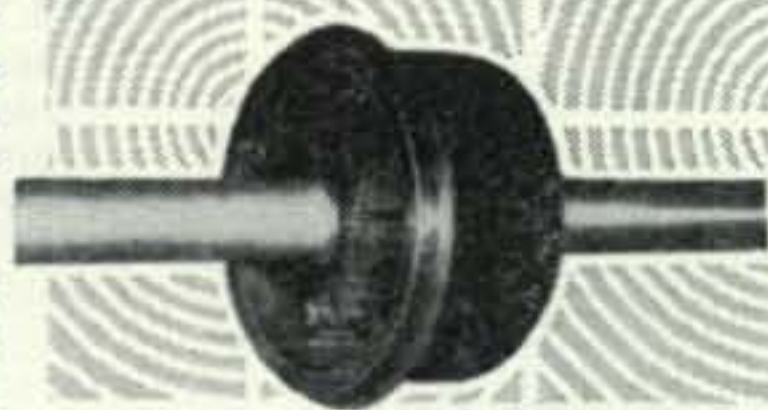

Split Insulated Dipole

Split Insulated Dipole Feed with coaxial choke results in SWR of less than 1½:1 on all bands with exceptional bandwidth. No adjustments needed; simply attach 52 ohm feedline to dipole terminals. Heavy 12 Ga. hot dipped galvanized steel channel and polyethylene insulated U-bolts support hy-gain's driven element.

Gain & F/B Ratio:

Hy-Gain's Mini-Tribanders have been carefully tuned for maximum gain and F/B Ratio possible in a reduced size array. Hy-Gain guarantees as much or more gain as any other two and three element split dipole fed 3-Band Beams, regardless of price.

Two-Element Mini-Tribander

Practically a featherweight, the 2-Element Mini-Tribander weighs in at only 33.8 lbs. and is easily one-man installed in the shortest possible time . . . and nearly anywhere, with its turning radius of only 12' 11". Boom length 6'. Longest element 27'.

Three-Element Mini-Tribander

The 3-Element Mini-Tribander is extremely lightweight, only 39.8 lbs. With a turning radius of 13' 10", this space-saving beam may be installed almost anywhere, yet boasts most of the features of the hy-gain full-sized trap tribanders. Boom length 12'. Longest element 28'.

\$49⁹⁵

\$69⁹⁵

Construction

Boom is 1½" dia. by .065" wall thickness, hot dipped galvanized steel. Elements are 6061T6 high strength aluminum alloy. Telescoping sections of 1", ¾", ¼" sizes are used. Heavily plated 10 Ga. steel channels attach all elements to boom and boom/mast with positive grip. High quality, galvanized and iridite treated hardware used throughout.

HARVEY RADIO COMPANY, INC.

103 WEST 43rd STREET, NEW YORK 36, N. Y. • JUdson 2-1500

For further information, check number 26 on page 194.

November, 1958 • CQ • 145

Dramatic Announcement from TRANSCON

**Sensational New
TRANSISTORIZED
POWER SUPPLIES**

**in Kit Form or
Factory-Wired**

Choose from a line-up of models supplying from 16¼ to 120 Watts continuous duty output. All units are designed for 12-14 VDC BUT can be changed in moments to 6-7 VDC* by substituting two resistors which are supplied with each unit. Complete with mounting brackets.

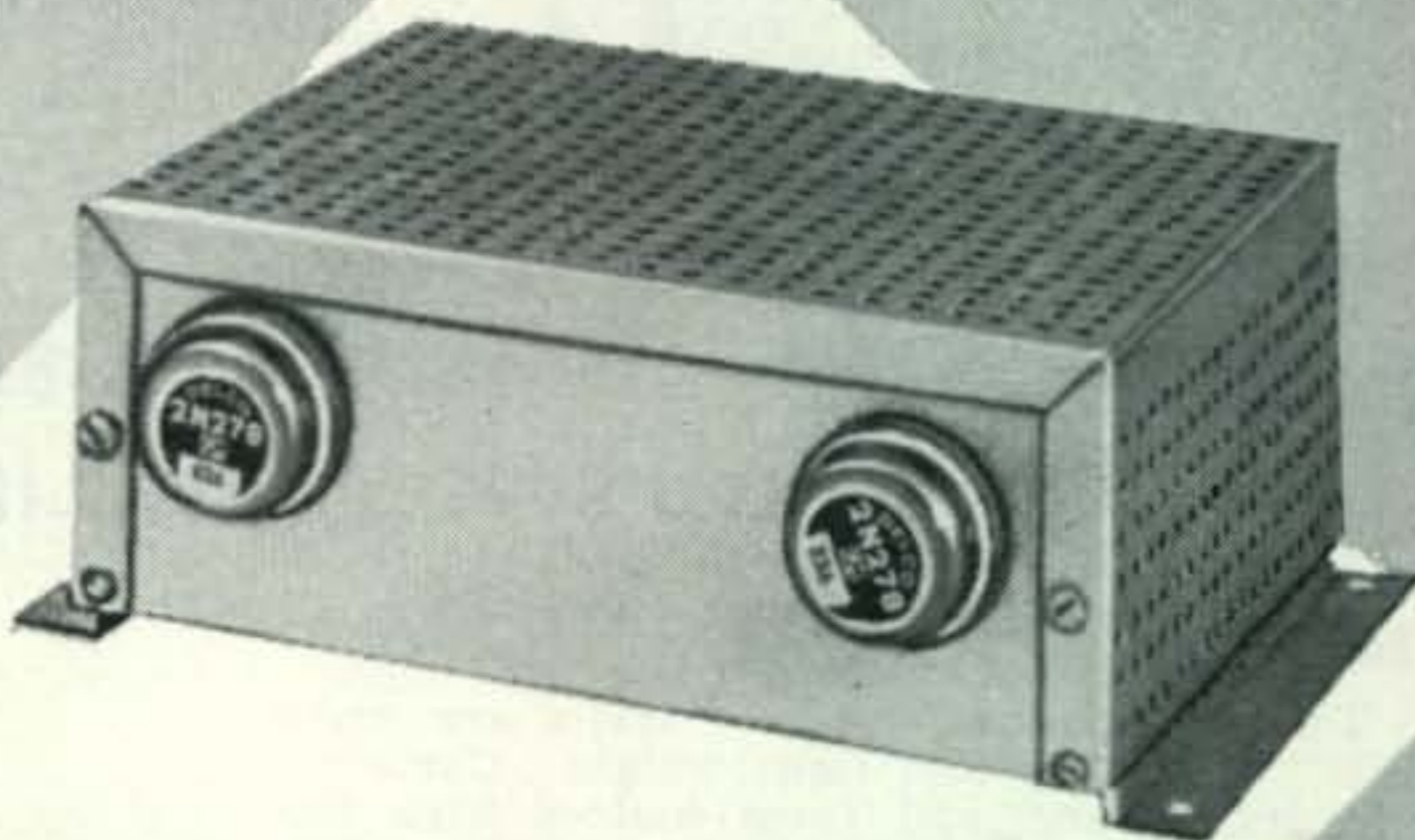

MODEL H600 — CONTINUOUS DUTY OUTPUT: 120 Watts

Single Output 600 VDC @ 200MA
Dual Output { 600 VDC @ 100MA
(Simultaneous) { 300 VDC @ 200MA

Kit, \$59.95 Factory-wired, \$68.95

Size: 2-5/16" High x 5" Wide x 6 7/8" Long (Over Brackets)

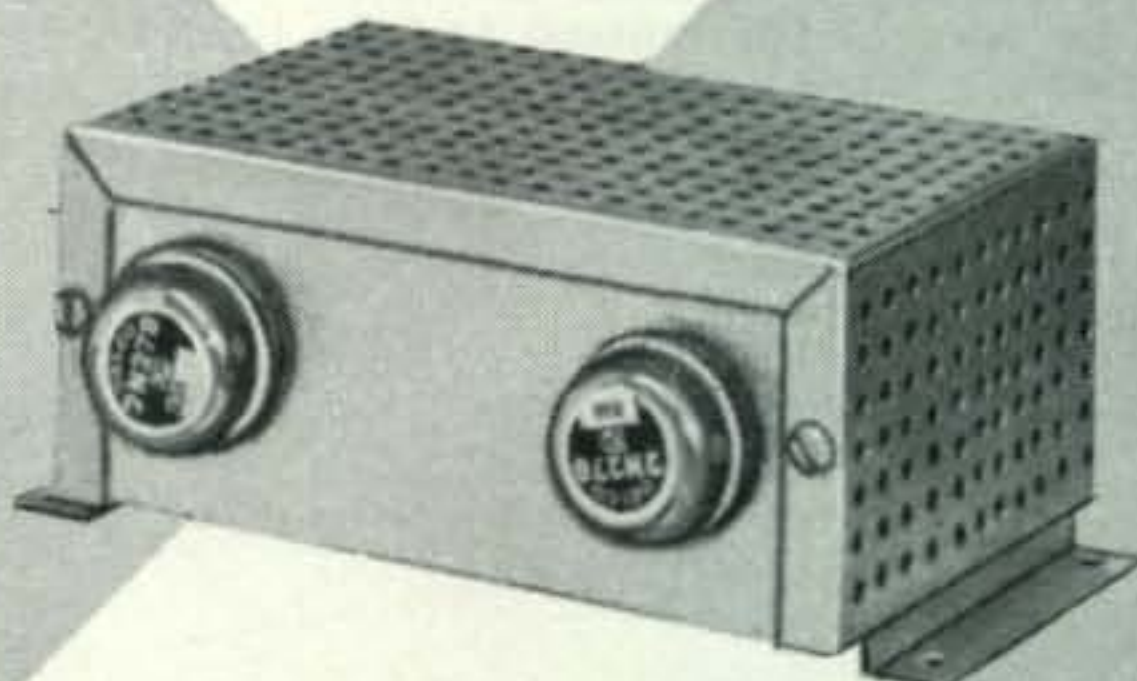

MODEL H-250 — CONTINUOUS DUTY OUTPUT: 16¼ Watts

Single Output 250VDC @ 65 MA
Dual Output { 250VDC @ 32½MA
(Simultaneous) { 125VDC @ 65 MA

Kit, \$33.95 Factory-wired, \$39.95

MODEL H311 — CONTINUOUS DUTY OUTPUT: 30 Watts

Single Output 300VDC @ 100MA
Dual Output { 300VDC @ 50MA
(Simultaneous) { 150VDC @ 100MA

Kit, \$42.95 Factory-wired, \$49.95

MODEL H325 — CONTINUOUS DUTY OUTPUT: 48¾ Watts

Single Output 325 VDC @ 150MA
Dual Output { 325 VDC @ 75MA
(Simultaneous) { 162½ VDC @ 150MA

Kit, \$47.95 Factory-wired, \$55.95

MODEL H375 — CONTINUOUS DUTY OUTPUT: 75 Watts

Single Output 375 VDC @ 200MA
Dual Output { 375 VDC @ 100MA
(Simultaneous) { 187½ VDC @ 200MA

Kit, \$53.95 Factory-wired, \$62.95

All of above models 2-15/16", high x 3" Wide x 6 1/8" Long (Over Brackets)



VOXBOX- A.M. VOICE CONTROL

- Adaptable for any A.M. Rig
- Designed for Crystal or Dynamic Microphone Input
- Controls: Audio Gain, Relay Adjust, Time Delay
- Tubes: 12AX7 Preamp, 12AU7 Relay and Time Control, 1N65 Audio Clipper
- DPDT Relay for XMTR Control
- Operating B-plus Voltages: 150 to 225 VDC
- 6 or 12 Volt AC or DC Operation
- Size: 2 5/8" x 4 1/8" x 4 1/8"

Model H308\$27.50

Model H308A\$33.95

with self-contained power supply

TNS- TWIN NOISE SQUELCH

- Can be Installed Rapidly in Any Car Radio
- Tubes: 6AL5 and 12 AX7
- DC Power Input: 125 to 225 VDC
- Low Current Drain
- Designed for 6 or 12 Volt Auto or Marine Systems
- Size: 2 1/4" x 2 1/4" x 4"

Model H309\$12.95



WRITE TODAY FOR FURTHER INFORMATION:

A.G. RADIO PARTS CO.

939 Township Line, Elkins Park 17, Pa.
17th & Venango, Philadelphia 40, Pa.
628 Schuylkill Avenue, Reading, Pa.

A. G. RADIO PARTS CO.

939 Township Line, Elkins Park 17, Pa.

Gentlemen:

Please send me information about the complete Transcon Line

Name _____

Address _____

City _____ Zone _____ State _____

For further information, check number 21 on page 194.

This is **BIG**

Month —

Signalling the **S**tart of the **BIG**
stampede to **S**witch to **S**ideband!

And **S**mart Hams will **S**ave by
wapping now, while I can
fill give you
Super-allowances for your AM rig!

HARRISON

"HAM HEADQUARTERS, USA" . . . Since 1925

is your Headquarters for even greater

Satisfaction,
ervice, and
avings on all
ideband Equipment.

Specifically, the **S**ensational new *Collins* **S** line



32S-1 TRANSMITTER

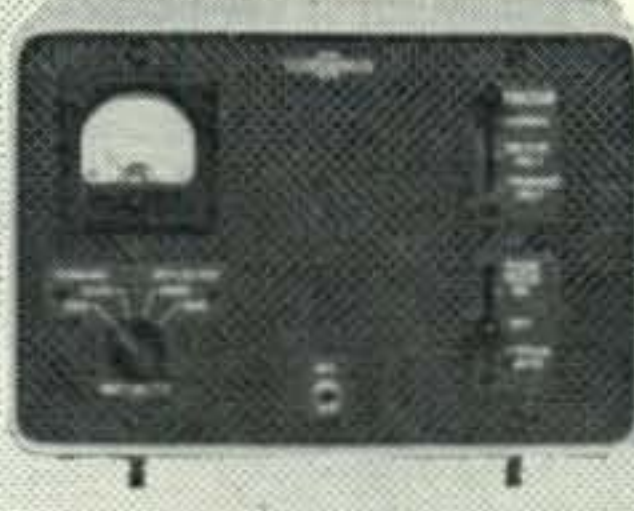

SPEAKER CONSOLE



75S-1 RECEIVER

Come on in, to the World's Greatest Trading Center, to see and to try out this exciting new sideband series! Bring along your old gear, and find out for yourself just how surprisingly little you need, to be enjoying this newest and best equipment!

We're flexible and easy (and pleasant, too) to do business with. Down payment, allowances, installments—all will be individually tailored to suit your convenience and desires. Our largest volume purchasing gives you many important benefits, such as most prompt delivery of the latest, improved production, more value for your money, etc.

I'll be looking for your visit, letter, or phone call—and the mutual pleasure of serving you, OM. TNX

73, Bil Harrison, W2A VA

SAME DAY SHIPMENTS
of all stock items, carefully and safely, to all parts of the world. Mail, phone, and patch orders invited. Enjoy the shopping convenience of a
HARRISON CHARGE ACCOUNT
for regular, or 1/10th per month payments. Ask for simple CA Form, today.

HARRISON
Ham Headquarters Since 1925
225 GREENWICH STREET
NEW YORK 7, N.Y.
PHONE ORDERS - BARCLAY 7-7777
LONG ISLAND - 144-24 Hillside Ave., Jamaica

The world-famous
HARRISON
TRADE-IN CENTER
is the greatest! Come, pick your choice from the hundreds of like-new trade-ins, all money-saving bargain price tagged! Easy terms, trades.

For further information, check number 28 on page 194.

November, 1958 • CQ • 147

now at **Burghardt** RADIO

value-packed **EICO**® HAM GEAR



New

90-WATT CW TRANSMITTER . . #720
KIT \$79.95 WIRED \$119.95

Conservative, highly efficient design plus stability, safety, and excellent parts quality. 80 thru 40, 20, 15, 11, 10 meters (popular operating bands) with one knob band-switching. 6146 final amplifier for full "clean" 90 W input, protected by clamper tube. 6CL6 Colpitts oscillator, 6AQ5 clamper, 6AQ5 buffer-multiplier, GZ34 rectifier. "Novice limit" calibration on meter keeps novice inside FCC-required 75W limit. No shock hazard at key. Wide range, hi-efficiency pi-network matches antennas 50-1000 ohms, minimizes harmonics. EXT plate mod. terminals for AM phone modulation with 65W input. Excellent as basic exciter to drive a power amplifier stage to max. allowable input of 1KW. Very effective TVI suppression. Ingenious new "low silhouette" design for complete shielding and "living room" attractiveness. Conservatively rated parts, copper-plated chassis, ceramic switch insulation. 5" H, 15" W, 9½" D.



NEW UNIVERSAL MODULATOR-DRIVER #730
KIT \$49.95 WIRED \$79.95 Cover E-5 \$4.50

Superb, truly versatile modulator at low cost. Can deliver 50 W of undistorted audio signal for phone operation, more than sufficient to modulate 100% EICO #720 CW Transmitter or any xmitter whose RF amplifier has plate input power of up to 100W. Multi-match output xmfr matches most loads between 500-10,000 ohms. Unique over-modulation indicator permits easy monitoring, no need for plate meter. Lo-level speech clipping & filtering with peak speech freq. range circuitry. Low distortion feedback circuit, premium quality audio power pentodes, indirectly heated rectifier filament. Balance & bias adj. controls. Inputs for xtal or dynamic mikes, phone patch, etc. Excellent deluxe driver for high-power class B modulation. ECC83/12AX7 speech ampl., 6AL5 speech clipper, 6AN8 ampl. driver, 2-EL34/6CA7 power output, EM84 over-mod. indicator, GZ34 rect. Finest quality, conservatively rated parts, copper-plated chassis. 6" H, 14" W, 8" D.

NEW GRID DIP METER #710
KIT \$29.95 WIRED \$49.95 including complete set of coils for full band coverage.



Exceptionally versatile. Basically a VFO with microammeter in grid; determines freq. of other osc. or tuned circuits; sens. control & phone jack facilitate "zero beat" listening. Excellent absorption wave meter. Ham uses: pretuning & neutralizing xmfrs, power indication, locating parasitic osc., antenna adj., correcting TVI, de-bugging with xmitter power off, determining C.L.Q. Servicing uses: alignment of filters, IF's; as sig. or marker gen. Easy to hold & thumb-tune with 1 hand. Continuous 400 kc-250 mc coverage in 7 ranges, pre-wound 0.5% accurate coils. 500 ua meter movement. 6AF4(A) or 6T4 Colpitts osc. Xmfr-operated sel. rect. 2¼" H, 2¼" W, 6¾" L. Satin deep-etched aluminum panel; grey wrinkle steel case.

BURGHARDT RADIO SUPPLY CO., Watertown, S.D.

Please send me:
Send FREE CATALOG #720 Wired Kit \$.....
 #730 Wired Kit check or M.O.
 #710 Wired Kit enclosed.

Name _____
 Address _____
 City _____ Zone _____ State _____ CQ-11

For further information, check number 27 on page 194.

BEAMS [from page 130]

either side of the element ends.

No factual gain figures can be given. I lacked facilities, equipment and time to make such checks. However, this beam seems to hold its own with other three-element beams in this area. In the 1957 ARRL DX contest, I claimed 662 contacts in some 57 hours. My antennas for 80 and 40 were low dipoles, so most of the work was done with the interlaced beam. I'm satisfied—except that I can't work 40 with the beam any more.

One final note may be in order. As a result of my interlaced beams, a number of hams have asked me what I think of them in comparison with the multi-band trap type beams and the multi-band quads. I can't answer the questions, as I haven't used the other antennas. My interlaced beams have started as the result of having a given amount of booms and aluminum tubing and a desire to get increased frequency coverage. For the ham starting from scratch, the other beams might be better, but for those who already have a 14-mc beam, the interlaced beam offers the cheapest way of covering other bands. ■

CONTEST [from page 107]

but even if we do not have reciprocal agreements with ARRL there is no harm in mentioning it here, everybody knows about the SS.

RSGB

This is a 21/28 mc Phone deal only. Activities start at 0700 GMT on Saturday and end at 1900 GMT Sunday. It's the world against the British Isles. Last month's calendar had all the details. Send your logs to the R.S.G.B. Contest Committee, New Ruskin House, Little Russell St., London W.C. 1, England.

Just as I was writing this column I received a call from Bill Leonard, W2SKE, that the CQ WAS SSB contest had just concluded and that it was a tremendous success. Conditions were excellent and there was plenty of activity both in the U S and abroad. Bill himself made 440 contacts and worked all states except one, he missed Nevada. Bob Adams will probably have more to tell you next month in his SSB column.

Remember that contest the Munich gang held last fall? Where the first prize for the winner in each continent was an all expenses paid, 3-day stay in Munich on the occasion of the 800-year Anniversary Festival. We were not kidding. Here's a picture of the boys whooping it up at a local haufbrau. Fritz Hauff, W3GHS, was the North American winner.

Start those logs rolling in fellows, we want your report no matter how large or small. But please don't forget to tabulate your score, it sure saves us a lot of work.

Good luck and 73, Frank, W1WY

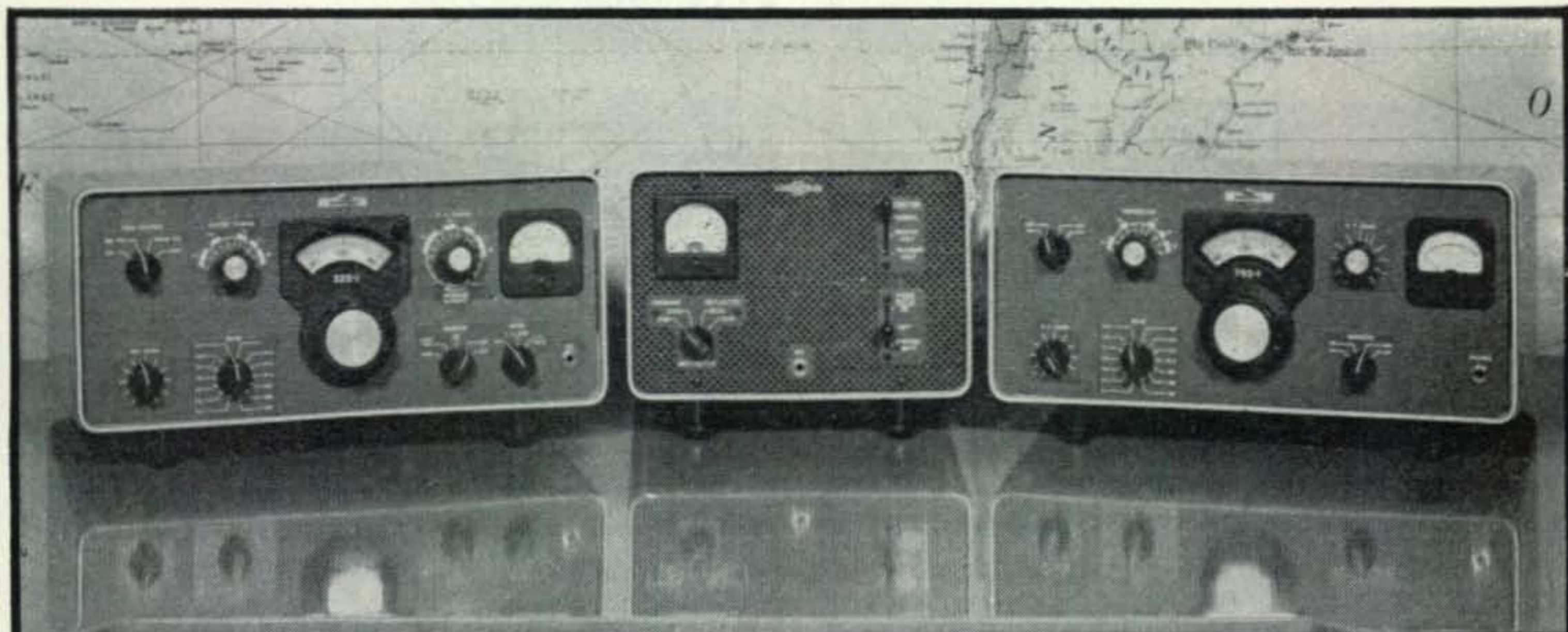

CALL "ACK"

W4ECI IN
BIRMINGHAM
OR
W4RRW IN
ATLANTA

FOR THE BEST DEAL ON *Collins* S/LINE

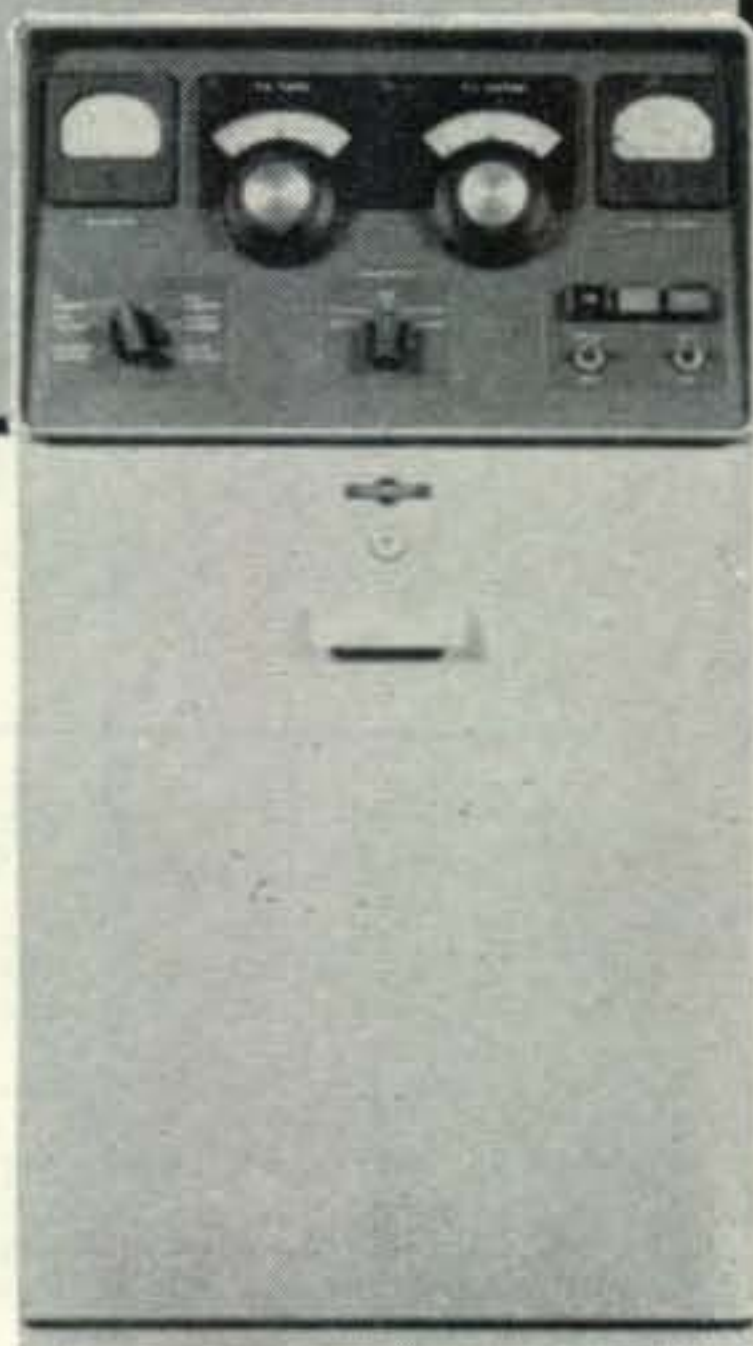

now on display at **ACK RADIO SUPPLY COMPANY**

We're ready to talk Collins S/Line with *you*. In our opinion, this systems-engineered equipment represents the last word in SSB. Offers every operating convenience. Prices are lower, with no sacrifice of quality Collins features. Superior frequency stability and selectivity will increase

your enjoyment of amateur radio to the fullest.

Call, write or stop in and let's talk trade-in allowances, time payment plan or a cash deal. Be the first in your town to get on the air with the Collins S/Line!

P.S. See the Collins 4-page insert in this magazine for all the technical specifications on the new S/Line.

32S-1 Transmitter.....\$590.00	312B-3 Speaker.....\$27.50
75S-1 Receiver.....\$495.00	30S-1 Linear Amplifier
312B-4 Speaker Console.....\$185.00	w/Power Supply (coming soon)

ACK RADIO SUPPLY COMPANY

Wholesale Electronics

3101 Fourth Avenue So.
BIRMINGHAM 5, ALABAMA
Telephone FA 2-0588

331 Luckie St. N. W.
ATLANTA 13, GA.
Telephone JACKson 4-8477

For further information, check number 30 on page 194.

Everybody wants to operate with
the best gear — so it's

COLLINS—eventually
WHY NOT NOW?

Place your order with us today to insure prompt
delivery.

Collins 32S-1	Transmitter	\$ 590.00
Collins 75S-1	Receiver	495.00
Collins 75A-4	Receiver	695.00
Collins KWS-1	Transmitter	2095.00
Collins KWM-1	Transceiver	820.00
Collins 516E-1	12vdc supply	262.00
Collins 516F-1	AC supply	136.00

TIME PAYMENTS UP TO 36 MONTHS

LIBERAL TRADE-IN ALLOWANCE

WILLARD S. WILSON, INC.

403-405 Delaware Avenue

Wilmington, Delaware

Est. 1920 Willard S. Wilson W3DQ

For further information, check number 31 on page 194.



**CHOOSE FROM WISCONSIN'S LARGEST
SELECTION OF USED EQUIPMENT**

KWS-1 \$1390, 32V3 \$420, Pro 310 \$330, B & W 5100B \$340,
L1000 \$350, CE MM-1 \$60, 10B \$120, GC-1 \$39, 600L \$320,
TBS50 \$50, VF-1 \$17, DX-100 \$179, DX-35 \$47, P400GG
\$150, WRL 680 \$75, Chief \$44, QF-1 \$8, PMR6 \$74, PMR-7
\$109, AF-67 \$130, NC-300 \$285, NC-183D \$260, HT-33 \$495,
NC-98 \$109, S40A \$60, S40B \$65, S53A \$59, SX-99 \$105,
SX43 \$105, HQ-129X \$149, HQ-140 \$179, CC5-50 \$27, CC5-
144 \$27, XC-50 \$44, 6 & 2 Meter Transcons Close Out—\$69—
New. Write for complete listing. We feature 10% down, 6%
bank financing, large stock of current new equipment, liberal
trade ins, prompt and friendly service, special attention to
mail orders. Before buying or trading be sure to see us.

AMATEUR ELECTRONIC SUPPLY

3832 W. Lisbon, Milwaukee 8, Wis. • West 3-3262

RECONDITIONED and GUARANTEED. Satisfaction guaran-
teed. Terms financed by us. Hallicrafters S38 \$29.00; S85 \$89.00;
SX99 \$119.00; SX96; SX100; SX101; HQ100 \$139.00;
HQ110 \$189.00; HQ140; HQ150; National NC98 \$99.00; NC125
\$129.00; NC300 \$279.00; HR050T; HR060; NC183D; Globe Scout
\$69.00; Viking II; Ranger; Valiant; Pacemaker; Thunderbolt;
Heath DX35; DX100; Collins 32V; 75A2; 75A3; 75A4; etc.
Many other items. Write for free list. HENRY RADIO,
BUTLER, MO.

RTTY [from page 111]

Hits and Bits

W6NTK in Fresno, Calif., has a Model 15 and a Model 14TD. W6CQK now has a Baldwin electronic organ. QLF? Jack has designed a band-pass input filter using those 88 mhy toroids. W6ITH said he would be on RTTY from VPØRT and FS7RT. W7RIG reports that he has a few bulletins on Models 28, 15, and 14. K6GVG is now /7 in Laramie, Wyoming. New NCARTS, Inc., members are W6GDO and his XYL K6HHD. W6IWA has a terrific signal on 20 at W2JTP.

KR6AF in Okinawa reports that he is ready for RTTY on 14.1 mc with a 3-curtain rhombic pointed at the States. W9KXZ says that HR2FG has been bitten by the bug. W9JKL has a Model 26 which does not unshift on space, so please hit that LTRS key, Gene pleads. (See page 89 in the RTTY Handbook.) W4HKB runs a pair of 6293's in place of the 6146's in his Viking for more power. W7JBF is constructing a tuning fork tone standard.

H. E. Decker, 1 Queens Ct., Huntington 5, West Virginia, has a limited number of manual TM 11-352 on the TG-7-A/B and the TG-37-B, military Model 15's.

Comments

South America is a much needed contact for WAC-RTTY (which nobody, not even WØBP, has as yet), but as of September 1958, only W6CG has a QSL from a QSO some time ago. Personally, I saw many Model 15's in Venezuela not too long ago. Much of the power down there is 60 cps, too. How about it, YV-amigos? Surely, *one* could be borrowed. Si?

The Southern California RTTY Society will sponsor another RTTY SS the first week end of November. The contest will be held over a thirty hour period starting at 6:00 PM EST Friday, October 31, and ending midnight 12:00 EST November 1, 1958. Stations will exchange messages consisting of message number, originating stations call, check or RST report of two or three numbers, ARRL section of originator local time (0000-2400 preferred), date, and band used. Score one point for a message received and acknowledged by RTTY. For final score multiply the total message points by the number of different ARRL sections (see page 6 QST) worked. Two stations may exchange messages again on a different band for added points, but the section multiplier does not increase when the same station is worked on another band. Each foreign country counted by ARRL for DXCC credit is treated as a new section for RTTY multiplier credit. Logs should be mailed to Merrill L. Swan, W6AEE, 372 Warren Way, Arcadia, California.

PS: Help stamp out Dual Identification!
(See Comments, Page 86, August 1958 CQ.)
73, Byron, W2JTP

SIDE BAND [from page 109]

to have some definite reports of some of the leading scorers in next month's column.

We also hope to be able to announce definite dates for our Third World Wide SSB DC Contest. There have been hundreds of requests for another one as soon as we can fit it into the busy calendar.

K8AEC reports 762 messages were handled during August by the SSB Net with an average of 43 per station. For more details on this activity we suggest you contact K8AEC.

Membership in the S.S.B. Amateur Radio Association is growing rapidly according to the official publication, "The Sidebander." Mort, W2KR signed many of the top "Brass" in the Armed Services during the ARRL Convention in Washington. Included in the new members are General LeMay, K4RFA, General Griswold, KØDWC and General Cook, W4FZ. For information on the association contact K2CWQ the President or W2PRB, Secretary.

We welcome PY1AQT, VU2RM, MP4BBW, EA8AC, JT1AA, VP1SD, OK1MB, VS5BY, VQ5FS, and a host of other SSB stations to our ranks.

Starting with the next issue we will endeavor to present some of the new SB equipment now available and to continue to describe other new gear as it is available.

73, Bob, W3SW

4CX1000A [from page 94]

power off. The high voltage negative return to ground is made in the amplifier by the plate current meter. A shunting resistor in the power unit prevents a 'floating' ground if the meter or wiring circuits to it open up. The resistor does not affect the meter accuracy.

Construction

The 10½" x 15½" front panel is ⅛" aluminum, and the chassis are all of #14 gauge aluminum. The over-all depth is 15 inches. The front panel is spaced 3 inches from the front sub-panel and the spacing is made with two ½ inch square x 3" aluminum pieces at the top and a 3" x 15" x ½" chassis at the base. The front sub-panel and the rear panel are identical 10" x 15" x ½" chassis and are spaced apart twelve inches by a pair of ½ inch aluminum angles at the top corners and by a 9 x 12 x 1¼ inch chassis at the bottom. The chassis containing the tube socket and the grid tuning circuit is 6 x 6 inches and is a four sided box with the bottom and the side attaching to the front sub-panel, open.

The baseplate is 12" x 15¼" and covers the bottom of the 9" x 11⅞" chassis and the grid chassis. A three sided cover completes the

COMPLETE
Hy-gain
line in stock in

CANADA

the *Hy-gain* 3-ELEMENT, FULL SIZE

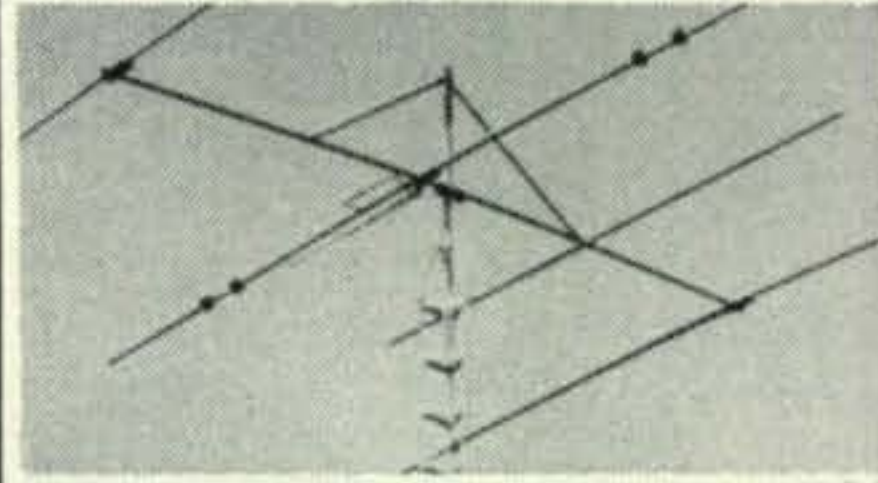

trap
tribander

3 Bands
(10, 15, 20M)
One Feedline

Boom length: 18 ft. Longest element: 32 ft. Full 8 dBS gain and 25 db F/B Ratio. Hot dipped galvanized steel boom for max. strength with lowest wind loading. Designed for easy construction. Full Year Written Guarantee.

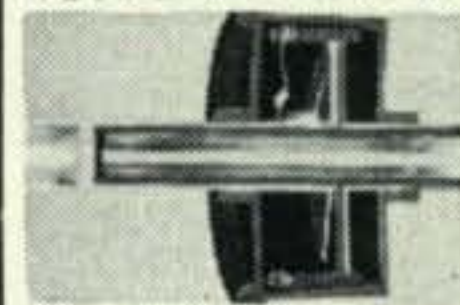

Hi-Q weatherproof 3" dia. Insulators result in minimum element loading and true FULL SIZE performance. Designed to take 1 KW AM, 2000w P.E.P. Individually factory resonated.

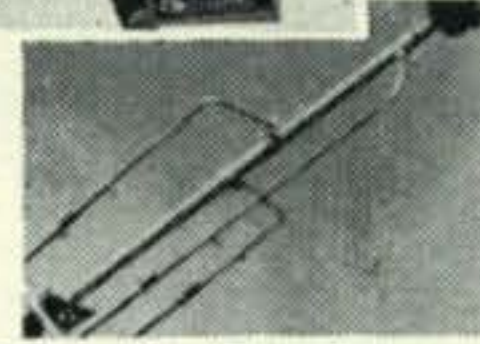

Triaxial Gamma Match System with coaxially formed reactance cancelling capacitor built in, makes possible perfect 1:1 SWR. Factory pre-calibrated, but adjustable for site variations.

Write for Brochure.

Payette Radio Limited

730 St. James St. W.

Ph. UN 6-6681

MONTREAL 3, CANADA

For further information, check number 29 on page 194.

Calling All Hams!



—And everybody else, too!

That's what this lapel pin and tie-bar will do. Because they've each got your call letters engraved on them. Just wait till you've taken these classic beauties out of their gift box and put them on. The heavy silver plating makes your call letters pop right out. They'll be terrific conversation pieces. They're only **\$4.95**

(Money back guaranteed, of course.)

Allow ten days for personalization.

HEWLETT SALES CO.,

1199 E. Broadway, Hewlett, L.I., N.Y.

Gentlemen: Please send my personalized lapel pin and tie bar to: CHECK M.O. ENCLOSED

NAME _____

CALL LETTERS: _____

ADDRESS: _____

CITY _____

ZONE _____

STATE _____

For further information, check number 25 on page 194.

COMPLETE **4u-gain**
line in stock in

FT. WAYNE

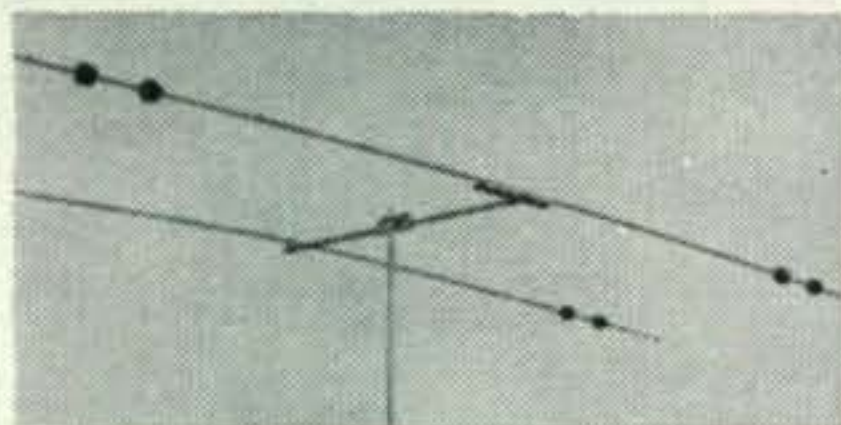

The
4u-gain
2-Element
Mini-Tribander
10, 15 & 20M, with
Single Feedline

Two-Element Mini-Tribander

Practically a featherweight, the 2-Element Mini-Tribander weighs in at only 33.8 lbs. and is easily one-man installed in the shortest possible time . . . and nearly anywhere, with its turning radius of only 12', 11". Boom length 6'. Longest element 27'.

\$49⁹⁵

Special Features

Lightweight, 3" dia. Insu-Traps used, designed to take 1 KW AM, 2000w P.E.P. Individually factory resonated and weatherproofed. Split Insulated Dipole Feed with coax choke results in SWR of less than 1½:1, all bands. Top quality, rugged construction. Designed for easy assembly.

Carefully Tuned for Max. Gain & F/B Ratio

Write for Brochure.

"Hoosierland Ham Headquarters"

WARREN RADIO CO.

1716 S. HARRISON ST.

FT. WAYNE, IND.

Phone Harrison 1232

For further information, check number 33 on page 194.

TELETYPE PRINTERS

Models #14, #15, #19, #26. Telewriter Receiving Converter. Perforators, D.C. Power Supplies. Transmitter-Distributors. Polar Relays.

ALLTRONICS-HOWARD CO.

Box 19, Boston 1, Mass.

(Richmond 2-0048)

EXPORT?

We specialize in the export of
ELECTRONIC EQUIPMENT

ELECTRONICS EXPORT COMPANY, INC.

BOX 1742

RALEIGH, N. C.

U.S.A.

CALL LETTER - decals

Designed For Auto Windshields. 1½ inches high, Gold with Black border. Just 75¢ for one set, 2 sets for \$1.25.

Box RJ, c/o CQ Magazine

300 W. 43 St., N. Y. 36, N. Y.

shielding and acts as a cabinet for the amplifier. A 4½" hole was cut in the top of the cover directly over the 4CX1000A, and a 2½" hole opposite to the blower intake. These cut-outs are covered with perforated metal pieces.

PARTS LIST

- L1, L2, L3—2 Turns #26 plastic covered wire, wound on L6, L7, L8.
- L4, L5—3 Turns #26 plastic covered wire, wound on L9, L10.
- L6—3 Turns #26 enameled wire.
- L7—6 Turns #26 enamelled wire.
- L8—10 Turns #26 enamelled wire.
- L9—½" winding length #26 enamelled wire.
- L10—13/16" winding length #26 enamelled wire.
- Slug tuned coil forms are all ⅜" diameter. (Cambridge Thermionic Co.)
- L11—E. F. Johnson Hi-Q Inductor Type 232-626 (10 microhenries).
- Coil Taps—29mc—1-2/3 Turns, 21.3mc—2-½ Turns
14.28mc—3-1/3 Turns, 7.25mc—7-1/3 Turns,
3.9mc—11-2/3 Turns.
- C1, C3, C16, C17, C18—.002 mfd mica (silver mica type).
- C2—100 mfd variable—E. F. Johnson 100 J12.
- C4, C5, C6, C7—.005 mfd mica (Postage Stamp Size).
- C8, C9, C10—.001 mfd ceramic 5KV—Centralab #859.
- C11, C12—500 mfd 10KV—Centralab TV3-501.
- C13—50-1500 mmfd variable—Cardwell Type P1-8013.
- C14—5 mmfd mica.
- C15—250 mmfd mica.
- C19, C20, C21, C22, C23, C24—.01 mfd disc type ceramic.
- Low Pass Filter—E. F. Johnson #250-20.
- Directional Coupler—E. F. Johnson #250-37.

- R1—100 ohms 20 watts (Ten, 1000 ohm 2 watt resistors in parallel).
- R2—100 ohms 2 watts.
- R3—10K ohms 10 watts.
- R4—4.7K ohms ½ watt.
- R5—10K ohms ½ watt.
- R6—2.2K ohms 2 watts.
- R7—5K ohms potentiometer 2 watts.
- R8—100 ohms ½ watts.
- Note: The 100 K ohm resistors shown with pilot indicators are part of pilot lamp assembly—E. F. Johnson #147-1143.
- J1—Co-ax BNC Receptacle Amphenol type 31-003.
- J2—Co-ax UHF Receptacle Amphenol type 83-1R.
- J3—Two contact microphone Receptacle Amphenol 80-PC2F.
- J4—8 Terminal Receptacle Cinch-Jones P408 LAB.
- P1—Two contact microphone Plug Amphenol 80-MC2M.
- RFC 1—2½ Millihenries 100 ma. National R-100.
- RFC 2—2½ Millihenries 300 ma. National R-300.
- RFC 3—Multiband 800 ma. National R-175A (.225 mH).
- B1—Blower, 60 CFM 115 V 60 cycle motor. Dayton Type 1C939.
- F1—3 Ampere Fuse & Holder.
- M1—0-1 Ampere D.C.
- M2—0-1 Milliampere D.C.
- M3—0-100 Milliampere D.C.
- M4—VSWR Indicator. E. F. Johnson 250-38.
- S1—Wafer switch Single deck 2 pole 6 position, shorting type.
- S2, S3—Toggle switch S.P.S.T. 5 amperes.
- S4—Wafer switch, Single deck, 2 pole 2 position.
- S5—RF deck switch, heavy duty. Single pole 5 position. Communication Products Co Model 86.

The chassis are all fastened together by machine screws. The pi-network coil and capacitors as well as the grid coils, grid bandswitch and grid tuning capacitor are attached to the front sub-panel. Terminal boards on the sub-panel facing the front panel enable the amplifier to be wired separately from the front panel instruments and controls. Connection to the

terminal boards is made from the panel cable. A modern look is provided by the new style open face meters. The front panel and shield cover were painted a black crackle to match the receiver and SB driver which are similarly finished.

The grid to plate feedback capacity of the 4CX1000A is so small (.02 mmfd) that neutralization was found unnecessary. The tube has a very high Gm and was easy to drive. By the same token it is easy for the tube to self oscillate if good design practices are not followed. The component layout should provide minimum rf lead lengths and sufficient by-passing to a common return ground circuit. Mica capacitors of the heavy lead postage stamp size should be used for rf by-passing.

The usual precautions of low plate voltage (about 1000 volts) should be used when making the initial tuneup tests.

The plate voltage should be interlocked with the screen voltage so that the tube never has screen voltage without plate voltage. The screen supply line should also include a 0.25 ampere fuse . . . just in case. Adjust the rf drive and loading for the desired plate and screen current. If there is difficulty obtaining the desired current values, the screen voltage may be varied to obtain it. A "pulser" or an electronic key locked in the DOT position should be used to modulate the rf excitation when making adjustments at full power to prevent excess plate dissipation while the circuit is in off-resonance condition.

Performance

The amplifier performs excellently on all bands. Bandswitching is made simple by a chart listing the input and output capacitor setting of the pi-network for each band. The output meter is a good indicator of resonance, and the grid current meter indicates excessive drive. Modulation is adjusted so that grid current just begins to show on modulation peaks. It has been determined experimentally by the two tone signal input and an oscilloscope that 100% modulation is obtained at this indication of drive.

No flattening of the modulation envelope at 100% modulation was discernible. At 1000 watts indicated power input this linear literally loafs along. The calculated third order harmonic distortion was slightly over three percent, using graphical power output versus grid drive ordinates.

With the amplifier operating at full power input with two tone modulation (using a dummy antenna load) no excessive heating of any of the rf components was noted after a few hours of operation. Perfection in equipment design is never attained, but for the present, this linear amplifier looks like a natural for maximum power SSB operation. ■

now at **ARROW ELECTRONICS**
value-packed **EICO** HAM GEAR



New

90-WATT CW TRANSMITTER . . #720
KIT \$79.95 WIRED \$119.95

Conservative, highly efficient design plus stability, safety, and excellent parts quality. 80 thru 40, 20, 15, 11, 10 meters (popular operating bands) with one knob band-switching. 6146 final amplifier for full "clean" 90 W input, protected by clamper tube. 6CL6 Colpitts oscillator, 6AQ5 clamper, 6AQ5 buffer-multiplier, GZ34 rectifier. "Novice limit" calibration on meter keeps novice inside FCC-required 75W limit. No shock hazard at key. Wide range, high efficiency pi-network matches antennas 50-1000 ohms, minimizes harmonics. EXT plate mod. terminals for AM phone modulation with 65W input. Excellent as basic exciter to drive a power amplifier stage to max. allowable input of 1KW. Very effective TVI suppression. Ingenious new "low silhouette" design for complete shielding and "living room" attractiveness. Conservatively rated parts, copper-plated chassis, ceramic switch insulation. 5" H, 15" W, 9 1/2" D.



NEW UNIVERSAL MODULATOR-DRIVER #730
KIT \$49.95 WIRED \$79.95 Cover E-5 \$4.50

Superb, truly versatile modulator at low cost. Can deliver 50 W of undistorted audio signal for phone operation, more than sufficient to modulate 100% EICO #720 CW Transmitter or any xmitter whose RF amplifier has plate input power of up to 100W. Multi-match output xmfr matches most loads between 500-10,000 ohms. Unique over-modulation indicator permits easy monitoring, no need for plate meter. Low-level speech clipping & filtering with peak speech freq. range circuitry. Low distortion feedback circuit, premium quality audio power pentodes, indirectly heated rectifier filament. Balance & bias adj. controls. Inputs for xtal or dynamic mikes, phone patch, etc. Excellent deluxe driver for high-power class B modulation. ECC83/12AX7 speech ampl., 6AL5 speech clipper, 6AN8 ampl. driver, 2-EL34/6CA7 power output, EM84 over-mod. indicator, GZ34 rect. Finest quality, conservatively rated parts, copper-plated chassis. 6" H, 14" W, 8" D.

NEW GRID DIP METER #710
KIT \$29.95 WIRED \$49.95 including complete set of coils for full band coverage.



Exceptionally versatile. Basically a VFO with microammeter in grid; determines freq. of other osc. or tuned circuits; sens. control & phone jack facilitate "zero beat" listening. Excellent absorption wave meter. Ham uses; retuning & neutralizing xmfrs, power indication, locating parasitic osc., antenna adj., correcting TVI, de-bugging with xmfr power off, determining C.L.Q. Servicing uses: alignment of filters, IF's; as sig. or marker gen. Easy to hold & thumb-tune with 1 hand. Continuous 400 kc-250 mc coverage in 7 ranges, pre-wound 0.5% accurate coils. 500 ua meter movement. 6AF4(A) or 6T4 Colpitts osc. Xmfr-operated sel. rect. 2 1/4" H, 2 1/4" W, 6 1/4" L. Satin deep-etched aluminum panel; grey wrinkle steel case.

Arrow Electronics, Inc. 65 Cortlandt St. New York 7, N. Y. ●

<input type="checkbox"/> Send FREE CATALOG	Please send me:			\$..... check or M.O. enclosed.
	<input type="checkbox"/> #720	<input type="checkbox"/> Wired	<input type="checkbox"/> Kit	
	<input type="checkbox"/> #730	<input type="checkbox"/> Wired	<input type="checkbox"/> Kit	
	<input type="checkbox"/> #710	<input type="checkbox"/> Wired	<input type="checkbox"/> Kit	

Name _____
Address _____
City _____ Zone _____ State _____

For further information, check number 34 on page 194.

COMPLETE

hy-gain

line in stock in

TOLEDO

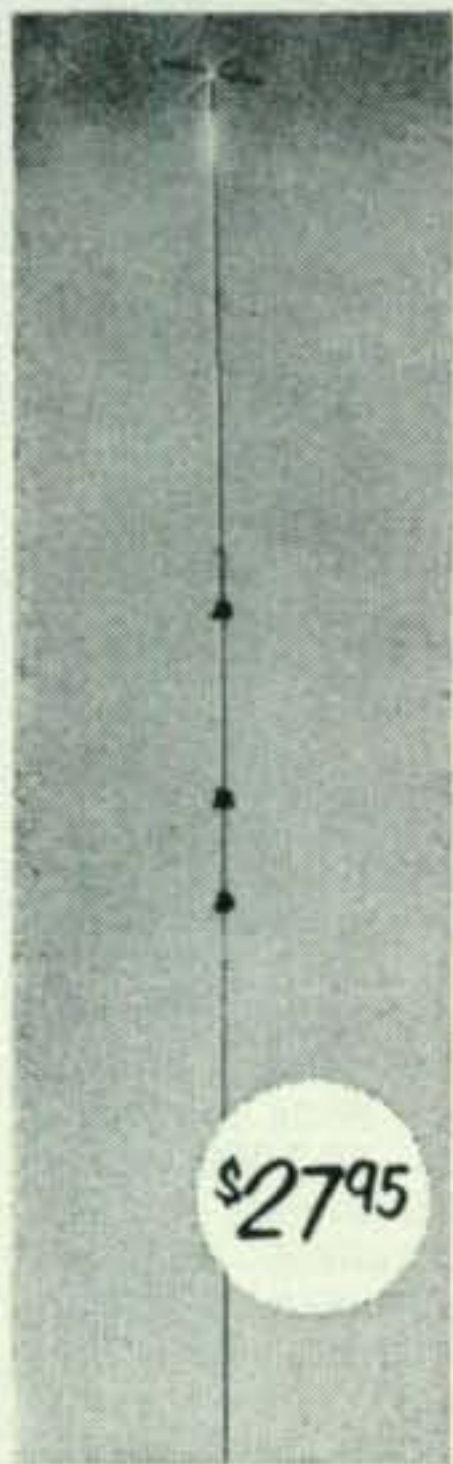

\$27.95

the *hy-gain* 14-AV

TRAP VERTICAL
For 10 thru 40 Meters

Only 21 ft. high, weighing 13 lbs., the 14-AV incorporates Capacity Hat assembly, increasing electrical length of vertical, maintaining high efficiency on 40M. Weatherproof Insu-Traps used, rated to take full max. legal input power. 52 ohm coax feed. Factory pre-tuned; no adjustment necessary. 2:1 SWR maintained over entirety of each band. True 1/4-wave marconi resonance on each band makes possible low angle DX radiation pattern. For automatic coverage of 10, 15, 20 & 40M.

Add 6 Meters: \$4.95
Specially designed decoupling stub adds 6 meter operation with low SWR.

Add 80 Meters: \$2.00
LC-80 loading coil adds 80 meter operation to the 14-AV. Combination mast & radial roof mounting kit, complete with hardware. **\$9.95**

Write for Brochure

"DALE" W8GDE . . . "DICK" K8DTK . . .
"DON" KN8LFC

SELECTRONIC SUPPLIES, INC.

3185 BELLEVUE RD.

TOLEDO, OHIO

PH: GRenwood 4-5477

For further information, check number 35 on page 194.



**TELEWRITER CONVERTER
FOR RECEIVING
RADIO TELETYPE**

To receive amateur or commercial teletyped messages by radio, you need the following equipment: (1) Good communications receiver. (2) A TELEWRITER CONVERTER which plugs into the receiver phone jack. (3) A Polar Relay which plugs into the back of the Telewriter Converter. (4) A small 110 volt, 60 ma, d.c. power supply, to operate the selecting magnet(s) in the teleprinter machine. (5) a teleprinter (teletype) machine, which is an electric typewriter controlled by radio signals. (Used teletype machines are available from \$75 up.) Telewriter Converter \$89.50. Polar Relay \$14.75. For additional information write: Tom, W1AFN.

net(s) in the teleprinter machine, which is an electric typewriter controlled by radio signals. (Used teletype machines are available from \$75 up.) Telewriter Converter \$89.50. Polar Relay \$14.75. For additional information write: Tom, W1AFN.

ALLTRONICS—HOWARD CO.
Box 19, Boston 1, Mass. Tel. Richmond 2-0048

ALL BAND TRAP ANTENNA !



Best for All-Band Receivers
Low S.W. R. 80-40-20-15-10
5" x 1" — 3-ounce Molded
Traps No metal — losses in
field

For ALL Amateur Transmitters
Guaranteed for 300 watts
For Pi-Net or Link-direct
feed Light — Neat — Weather-
proof

Complete as shown with 75 ft. — 72 ohm feedline — 102 ft. copper-weld. Eliminates inefficient multiple antennas. Gets beam results on 20-15-10. No tuners looking troubles or haywire house appearance. Excellent for shortwave listeners. Looks good, works good and lasts. For novice and all class amateurs.

80-40-20-15-10 Complete, assembled\$12.95
40-20-15-10—60 ft. Antenna, assembled\$11.95
20-15-10 Dual Trap, 30 ft. Antenna, assembled\$18.95

SEND ONLY \$3.00 (cash, ck., mo) and pay postman balance COD plus postage on arrival, or send full price for postpaid delivery. Available only from:

WESTERN RADIO • Dept. AC-11 • KEARNEY, NEBRASKA

SURPLUS [from 115]

swer every letter too! But again we are forced to repeat that all letters cannot be answered by return mail in most cases and any requests for air mail returns are out of the question. Most requests are relatively involved and may take weeks to get a final answer to a problem. Tracking down some handbooks or data may even involve getting in touch with several government agencies just to determine what the gear is in the first place. Some conversions requested require heap much engineering. So please, please be patient and we promise to continue with reasonable promptness in answering mail.

Our handbook service seems to be going great guns, with no complaints to date. If you are in need of a handbook, we will request it in your name and you take it from there. For instance C. W. Leinger of 1200 Studio Lane, Deerfield, Illinois is looking for the R114/URC-4 book or even a schematic. K6GUP wants an APN-4 conversion, while W3BMR needs the BL-3 book. A letter from the Southern Tech Radio Club of Chamblee, Georgia asks for operational information on the T-23/ARC-5 for two-meter use. W1DSW has a BC-1306 and even my handbook sources have none so please help. W4BJC got hold of a TS-177 tube tester without a manual.

Ronald Nicholas of 8632 West Boone Street, West Allis 19, Wisconsin and K6JHS both want Mark II, B-19 data. Larry Mindel of 9621 Flower Avenue, Silver Spring, Md. is looking for a complete RAX-2 if he can find one as well as a power supply for a Navy RAK or RAL. K5OGF wants a BC-223-AX handbook while Harvey House, 2022 Bentley Ave. Orlando, Florida wants the BC-652 info.

W3HSL wants ASB data and W9RNL has to set up an SN or SN-1 radar and needs info. W7UVC wants GF-11/RU-16 schematics. The T-69D/AMT-2 radiosonde book is requested by W1SGD. Bill Matson, Box 78, 3961st Recon Tech Sqdn, APO-334, San Francisco needs the ARR-7 handbook. K2LEO wants DAU info.

Bob Walters, 2425 NE Everett, Portland, Oregon needs the DZ-1 and the RT-19/ARC-4 books.

K6CC needs the RMB manual while K5QJR has no way of working on his BC-1333 without a schematic. W1BWB has a six-meter walkie talkie using an MOPA. Known as the BC-222 it uses type 30 and 38 tubes. He is in need of a manual, the various plugs, control box, batteries and an antenna. Maybe someone can help him out.

We found out the TBs is available in Hawaii at EWA Beach TV and Appliances in Aiea, Oahu, T.H. We also have a correction. The little scope converted during the summer to an indicator monitor should have been listed as the ID-116/APG-15.

73 Ken W2HDM

SUPER [from page 91]

Band	Mixer Frequency	Oscillator Frequency
6 meters	50-54 mc	48-52 mc
10 meters	28-29.7 mc	26-27.7 mc
15 meters	21-21.45 mc	19-19.45 mc
20 meters	14-14.35 mc	12-12.35 mc
40 meters	7-7.3 mc	9-9.3 mc
80 meters	3.5-4 mc	5.5-6 mc

TABLE II. Frequencies depend on whether oscillator is above or below mixer frequency, and how much.

Alignment should be done with the receiver in the cabinet, if used, to minimize hand capacity. Small holes in the bottom of the cabinet should be made directly below the trimmer capacitors for easy adjustment.

The i-f stages should be checked because the receiver has been shifted around considerably since the original adjustment. Check by feeding a generator signal to the grid of the first mixer, and realign the 2 mc i-f and the three 85 kc i-f cans. Tune for maximum S-meter reading with minimum signal generator signal output. Starting with six meters, each band is then tuned in this order:

1) Oscillator—some additional juggling of the oscillator may be necessary as outlined previously.

2) Mixer.

3) RF.

Additional oscillator, mixer, and rf coils will be needed if MARS coverage is desired. This one was adjusted to the local 4450 kc MARS net.

Calibrate and make the dial.

Add decals to the front panel to mark the switches. ■

SCRATCHI [from page 116]

Next you getting on and calling seek-you fone patch. It not mattering which signal amchoor "C" are heering, your signal or amchoor "B" signal, on acct. amchoor "B" feeding back his reseever over tellyfone line. When getting amchoor "C" you expaneing things, and telling him to finding amchoor "D" by calling seek-you fone patch local. When "C" finding "D" here what are happening.

You (amchoor "A") speeking into both your mike and into tellyfone. Your sigs going out stereo on your freakwency and on freakwency of amchoor "B". Amchoor "C" reseev-ing freakwency "B" and piping it to amchoor "D" on tellyfone, and amchoor "D" getting freakwency "A" on his reseever direct. Amchoor "D" now getting your sigs stereo.

Of course when you wanting amchoor "B" to transmitting stereo, you having to vicey-versey it, and when you wanting amchoor "C" to heering amchoor "B" on stereo, you having to vicey-vicey-versa it. Are you not thinking this are reel slickey skeme, Hon. Ed?



HAM DESK SET

Your QSL card embedded in a red or black plastic base. Size 6 x 8 x 1/4".

Perpetual, easy-to-read, bronze calendar.

Durable black plastic desk style fountain pen. Hooded point is iridium tipped for years of smooth and dependable service.

Matching black plastic pen holder with full swivel action.

ONLY \$5.75

A welcome addition to any shack.

WARNER PERMANIZ
BOX 947 • MANCHESTER, CONN.

For professional advice on your ham requirements call a communications consultant

ANTRIM MARINE RADIO
Lafayette Hill, Montgomery County, Pa.
Taylor 8-9604

Philadelphia distributor for:
TECHNICAL MATERIAL CORP. • National Company
Complete line of Marine, Aircraft, Ham and Mobile
Communication Equipment

RADIO ZONE MAP
GET YOUR FREE COPY... OF THE UNITED STATES



REQUEST IT WITH YOUR NEXT ORDER OR INQUIRY TO:-

LADD ELECTRONICS
111 No. 41 ST., OMAHA 31, NEBR.



FREE!

OLSON CATALOG
4,872 SQ. IN. OF BARGAINS!

IT'S TRUE! Olson's Catalog has 4,872 sq. inches of Gigantic Bargains at prices that defy comparison—and it's FREE for the asking! Tremendous savings on Name Brand merchandise—Tape Recorders, Hi-Fi's, Radios, Record Changers, Speakers, Amplifiers, Intercoms, Mikes, Kits, Cabinets, Testers, Antennas, Tools—and on and on. You name it, Olson can put it in your hands—and you keep the change. Don't delay, send for your free copy NOW!

MAIL THIS COUPON TO:

OLSON RADIO WAREHOUSE

C-118 FORGE ST., AKRON 8, OHIO

Rush me your FREE Olson Catalog without obligation Today!

Name.....

Address.....

City..... Zone..... State.....

For further information, check number 36 on page 194.

COMPLETE
4u-gain
 line in stock in

RHODE ISLAND

the *4u-gain* 12-AV

TRAP VERTICAL
 For 10 thru 20 Meters

For automatic coverage of the 10, 15 & 20M bands. Insu-Traps isolate the various sections of this vertical, developing $\frac{1}{4}$ -wave resonance on each band. 52 ohm coaxial feed. Less than 2:1 SWR all bands. Overall ht.: 13.5 ft. Wt.: 12 lbs. Factory pre-tuned; no adjustment necessary. True $\frac{1}{4}$ -wave marconi resonance on each band makes poss. low angle DX radiation pattern. Weatherproof traps rated to take full maximum legal input power.

Add 6 Meters: \$4.95

Specially designed decoupling stub adds 6 meter operation with low SWR.

Combination mast and radial roof mount kit, compl. with hardware. \$8.95

\$19⁹⁵

Write for Brochure.

W. H. EDWARDS CO.

94 BROADWAY PROVIDENCE 3, R.I.

Established 1928

Leading Amateur House in Rhode Island!

For further information, check number 37 on page 194.

FREE

GIANT NEW
 1959 B-A CATALOG

A COMPLETE BUYING GUIDE FOR EVERYTHING IN

RADIO TV

ELECTRONICS

BA 1959
 ANNUAL CATALOG 591

SINCE 1927

BURSTEIN-APPLEBEE CO.

180 KING-SIZED PAGES

EVERYTHING IN RADIO TV AND ELECTRONICS

100'S OF NEW ITEMS LISTED HERE FOR 1ST TIME

21 PAGES OF BARGAINS NOT IN ANY OTHER CATALOG

Dept. CQ, 1012 McGee St., Kansas City 6, Mo.

Send Free 1959 B-A Catalog No. 591.

Name.....

Address.....

City..... State.....

SEND FOR IT TODAY

For further information, check number 38 on page 194.

It not taking any extra equipment, and everybuddies having more fun than mouse in bran barrel. Won't it be nice, when heering kids yelling and baby crying in background to knowing what direckshun in background they are? Hon. Ed., you can even telling what side of mouth other amchoor are talking out of!! Yours for more Hon. Progress.

Respectively yours,
 Hashafisti Scratchi

RECORDING SATELLITES [from page 82]

are quite apparent from the continuous chart which might not otherwise be noted when a fast chart speed is used. The two evening passings are approximately the same amplitude and time duration. This indicates that the satellite first passed east of the receiving location and then west of the location. The same holds for the morning passings.

Of particular interest is the amplitude and time duration of the evening passes as compared to the morning passes. The evening passes are shorter in time than the morning passes, indicating that the satellite was on the low side of its orbit and hence its radio line of sight was much shorter. Its time of passing would thus be short. However, since it was lower in the sky, its amplitude would be greater than when it was further from earth as in the morning because of the inverse squared distance law. This is noticeable in the morning passes when the satellite was higher in the sky and hence was "visible" for a longer length of time. But since it was further away, the signal strength was weaker by the factor of "one over the distance squared." The ratio for Sputnik I was about 560 miles (apogee) over 140 miles (perigee), or 4. This means that when the satellite was furthest from the earth, the power received was 1/16 of that when it was closest or it was 12 db weaker. (Power varying with the inverse "square" of distance.)

An item of unusual interest which could be readily noticed by comparing one day with the next was that Sputnik I was appearing about 7 minutes earlier each day. If it passed at 7:22 PM CST one day, the next day it appeared at 7:15 PM CST and about 7 minutes earlier each day. In this manner it was possible to predict a passing by many days and yet have it agree within a fraction of a minute of the time as announced by the Smithsonian Astrophysical Observatory. This is of particular importance to Moonwatch teams who must know when to scan the skies with their "scopes."

The charts also show that the power output

Fig. 5—Circuit for connection of recording meter to receiver.

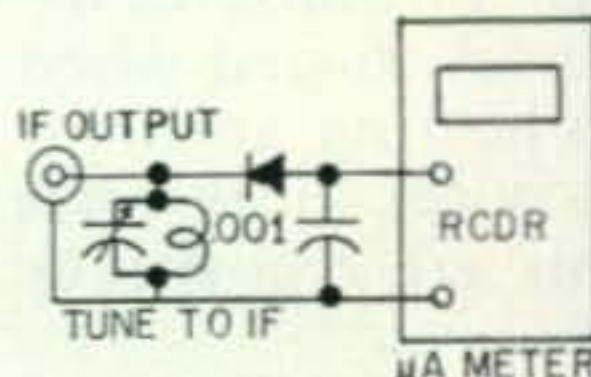

of Sputnik I (about 1 watt) was almost constant until the transmitter went dead. The last passing over Texas was noted on October 25, 1957, with the signal almost as strong as previous passes. On the next pass, the transmitter was dead—there was complete silence, no gradual fade out.

By noting the charts as to when a satellite is again due, it is possible to set an electric timer to turn on an audio recorder before the passing and shut it off after the passing. This can be entirely unattended operation which is especially important if the passing is expected at an hour usually conducive to sleeping!

A slight difference in background or receiver noise can be noted on one day of the chart compared to the other. This is due to the fact that the receiver r-f gain control was turned up on the second day. However, the relative amplitudes for each day are the same. The signals appearing on the chart in the morning and noon hours are due to signals within the pass-band of the receiver coming mainly from the east when the maximum useable frequency (MUF) was above 40 mc.

Perhaps the reader might be able to suggest other uses for slow chart recordings such as these. At any rate, it is an easy and generally unattended manner to keep track of the increasingly interesting and popular earth satellite vehicles—whatever their shape. ■

HQ 170 [from page 79]

entire band-pass to one side or the other from the nominal 60-kc i-f. For AM the bandpass is moved to both sides of the 60 kc i-f in equal amounts. The three stages of 60 kc i-f amplifiers incorporate six high-Q tuned circuits which are capacitively coupled and separately shielded. High C tuned circuits with the addition of ferrite shielding provide long time stability and freedom from external fields. The tuned circuits are staggered in a multiplicity of combinations which are selectable by means of the selectivity and sideband switch selectors.

Final Comments

The days of push-pull Hi-fi Audio circuits (with phone-jacks, no less) to receive Ham stations that are legally limited to 3000 cycles audio (a long way from hi-fi); of General Coverage to help sell to the SWL or the Broadcast band for the XYL; may indeed be a thing of the past on Ham receivers. It is doubtful if anyone will eventually appreciate this trend more than the very Ham who thought he just had to have these features and has struggled with the resultant instability and other undesirable compromises of General Coverage receivers. While it is true that the MARS member (I have been one since 1950) and the 20

[Continued on page 159]

Bob Henry,
WØARA
Butler, Mo.



Ted Henry,
WØUOU
Los Angeles

**WORLD'S
BIGGEST
TRADE-IN**



Write us... get Henry's trade-in offer first... and save money!



HQ-170

HAMMARLUND

Single Sideband at Its Very Best!

Triple conversion **HQ-170** • 20 monthly payment \$17.77. \$35.90 down. CASH PRICE \$359.00. Radio amateur's ideal for modern SSB reception in performance, tuning techniques, dependability. Clock timer \$10 extra.

HENRY HAS THESE HAMMARLUND ITEMS IN STOCK FOR IMMEDIATE SHIPMENT

HQ-110 RECEIVER	\$249.00
HQ-160 RECEIVER	379.00
HQ-100 RECEIVER	189.00
MATCHING SPEAKER	14.95
CLOCK TIMER	10.00

Complete stock of all transmitters, receivers, antennas, rotators, towers, parts, accessories, equipment. Henry has ALL the new equipment first.

PRICES SUBJECT TO CHANGE

TRADE — CASH — TERMS

WRITE, WIRE, PHONE HENRY NOW

Send for
**FREE
Catalog**

**Henry
Radio
Stores**

Butler 1, Missouri Phone 395

11240 West Olympic Los Angeles 64 GRanite 7-6701

For further information, check number 39 on page 194.

IN STOCK AT C and G

Easy Terms • High Trades • Fast Service



Authorized Collins Service

WRITE • WIRE • CALL

Ask for latest free Used-Surplus list

C & G RADIO SERVICE CO

2502 JEFFERSON

TACOMA 2, WASH.

Phone

BR 2-3181

For further information, check number 40 on page 194.

INVEST IN YOURSELF

When are you actually going to start learning something about radio? We've left out all the unnecessary stuff and concentrated on those books that are really top notch for hams. Beginners should have #11-13-23-24. The next step is #21-22-28-32. #16 will help make QSO's a lot more interesting. #1-2-5-25 are important for developing your technical education and giving you a good reference library. #9 will help you get a commercial license.

- | | |
|---|--|
| <p>1 Electronics & Radio Eng. by Terman .. \$13.50
1078 pages. One of the most complete radio textbooks ever printed. All theory but not too heavy on math</p> <p>2 E. E. Handbook by McIlwain
1618 pages. Mostly formulas, tables and circuits. With this, #13 & #32 you will have a complete source of data ..\$10.00</p> <p>3 Cybernetics by Weiner
Pretty heavy going in places, but interesting. Calc all over the place. Basic book on computers.... \$3.50</p> <p>4 Electronics Manual for Radio Engineers
Hundreds of circuit applications and construction articles, really interesting.....\$14.00</p> <p>5 Antennas by Kraus (W8JK) ..\$10.00
The most complete book on antennas in print, but largely design and theory complete with the math</p> <p>7 SOS At Midnight by K6ATX
Adventure novel for the Jr Op. Maybe it'll get him interested in ham radio. Exciting anyway.....\$2.75</p> <p>8 Radio TV Basic Electronics ..\$4.95
This is a good starter book for getting basic theory</p> <p>9 License Q & A Manual
All the dope for getting commercial licenses. \$6.00</p> <p>10 I Libertine by K2ORS
Anybody that hasn't read this novel yet?.....50c</p> <p>11 Radio Handbook by W6SAI
The biggest, best ham handbook ever written. Hundreds of build-its.....\$7.50</p> <p>13 Reference Data, 4th Edition
The IT&T handbook, 1152 pages. Data, data..\$6.00</p> | <p>16 Ham Register by W3VKD
Inside scoop on over 10,000 hams. These are the fellows you hear on the air every day.....\$5.00</p> <p>20 RTTY Handbook by W2JTP
A-Z of ham teletype, supply low, very popular..\$3.00</p> <p>21 VHF Handbook by W6QKI
Covers just about every aspect of VHF.....\$2.95</p> <p>22 Beam Antenna Handbook by W6SAI
Practical, includes both theory and construction..\$2.70</p> <p>23 Novice Handbook by W6TNS
Receiver, transmitter and antenna theory and construction for the Novice and Technician. Terrific....\$2.85</p> <p>24 Better Shortwave Reception by W6SAI
Fine handbook for SWL'ing, long needed.....\$2.85</p> <p>25 Mathematics for Electricians & Radiomen by Cooke—The standard text book in this field..\$5.50</p> <p>26 Surplus Radio Conversion Manual I
BC-221, 342, 312, 348, 412, 645, 946, 1068A, SCR-274, 522. TBY, PE-103, etc.....\$2.50</p> <p>27 Surplus Radio Conversion Manual II
BC-454-459 Xmtr-Rcvrs; APS-13; ARC-5 VHF Xmtr-Rcvrs; BC-357, 946B, 375; TA-12B; ART-13; AVT-112A; GO-9; LM; etc.\$2.50</p> <p>28 Television Interference by Rand
Latest complete dope on licking TVI.....\$1.75</p> <p>29 QSL Album for WAS by Hanover Products
Mount your 48 cards for display.....\$3.50</p> <p>30 Miniature Call Letter License Plate
No Ø available, sorry.....75c</p> <p>32 RCA Radiotron Designers Handbook
1500 pages—fabulous ..\$7.50</p> |
|---|--|

OK fellas, send me postpaid the items circled, and get a move on.

Permission granted to use separate paper if you want.

Put your Name, Call, and Address in the margin, or somewhere. N.Y.C.'ers add 3% Sales Tax.

Radio Bookshop

1379 East 15th St., Brooklyn 30, N. Y.

HQ 170 [from page 157]

mc Sputnik SWL desires coverage of their frequencies, it is also true that these are single channel frequencies and can be obtained very easily on the modern Ham Band Only receiver by adding a very simple one-tube crystal controlled converter between the antenna and input to the receiver. ■

PARAMETRIC [from page 75]

it should be possible to tune the pump oscillator through its frequency range without any signs of instability. Leaving the pump adjustments at this setting the tank tuning should be adjusted for maximum signal gain. If oscillation occurs, the pump coupling should be further decreased until the tank can be tuned through resonance without any signs of instability.

Now: with the receiver tuned to a signal, the pump frequency should be tuned slowly from the low side of $2f$ up. The exact $2f$ frequency can be determined by identifying the lower sideband signal as it tunes through the signal frequency. The curve in figure 5 shows the noise figure as a function of pump frequency. Obviously the pump can be varied several megacycles without appreciably affecting the noise figure of the amplifier. As lower sideband signals are present for all signals in the bandpass of the receiver, it becomes convenient to dump these signals outside the low end of the band. (I hasten to point out that the present state of the art, as far as I am concerned, is not sufficiently advanced for me to say that they couldn't be dumped outside the high end.)

The preliminary adjustments having been made, it is now time to start trimming, pruning and evaluating. Things to keep in mind are: Maximum gain is not necessarily best noise figure or signal to noise ratio. Any measurement of noise figure should be correlated with a signal to noise measurement as well as a gain measurement. In other words, if you can't hear him any better with the amplifier than without, you are not getting the desired results. Wide excursions from the $2f$ frequency can produce increases in noise output sometimes with gain and sometimes without. Depending on your geographical location many spurious signals can be observed by tuning the pump frequency. All of these spurious signals can be explained by using a little arithmetic, some of them might be of sufficient interest to investigate. A pump frequency of $2f$ is not necessarily the best. Investigation shows that comparable results can be obtained with a pump of $3f$, $5f$ and $7f$. Pumping on $4f$ and $6f$ did not appear to produce usable results. Obviously if a $7f$ pump will work, it becomes practical to make a single pump generator for use on

[Continued on page 164]

call

PIONEER

For The Best Deal on Hammarlund



\$189

Automatic
clock timer
\$10 extra

HAMMARLUND HQ-100

General purpose communications receiver continuously tunable from 540 KCS to 30 MCS. Outstanding sensitivity and selectivity. Q-multiplier. Excellent stability. Electrical bandspread. Noise limiter "S" meter. Auto-response.

BEST VALUES IN THE BUSINESS!



\$249

Automatic
clock timer
\$10 extra.

HAMMARLUND HQ-110

Strictly for the amateur. Tunes 6, 10, 15, 20, 40, 80 and 160 meter bands. Q-multiplier. Crystal calibrator. Highly efficient noise limiter. Separate linear detector for SSB and CW. Electrical bandspread. Separate BFO oscillator. Crystal-controlled dual conversion. 12-tube superheterodyne circuit. Auto-response audio system.

SEE, WRITE, WIRE OR CALL

RICK BRAINARD
K8IXN

FRED OHMAN
W8FAT

★ ★ ★ ★ ★

SEND FOR COMPLETE INFORMATION
ON OUR LARGE STOCKS OF
RECONDITIONED EQUIPMENT

PIONEER ELECTRON SUPPLY

2103 EAST 21 ST.

CLEVELAND 3, OHIO

PHONE SUPERIOR 1-5277

For further information, check number 41 on page 194.

November, 1958 • CQ • 159

LORAN APN/4 OSCILLOSCOPE



Easily converted for use on radio-TV service bench.

Completely Assembled

BRAND NEW!

Supplied with 5" Scope, type 5CP1 only.

\$1495

Excellent. Used

Brand New \$19.95

SCR-274 COMMAND EQUIPMENT

ALL COMPLETE WITH TUBES

Type	Description	Used	LIKE NEW
BC-453	Receiver 190-550 KC	\$14.95	\$16.95
BC-454	Receiver 3-6 Mc	9.95	12.95
BC-455	Receiver 6-9 MC	10.95	13.50
BC-450	3-Receiver Control Box	1.49	1.95

110 VOLT AC POWER SUPPLY KIT

For All 274-N and ARC-5 Receivers
Complete with metal case, instructions
Factory wired, tested, ready to operate.....

\$7.95

\$11.50

SPLINED TUNING KNOB for 274-N and ARC-5 RECEIVERS. Fits BC-453, BC-454 and others. Only

49¢

BC-457 TRANSMITTER—4-5.3 Mc. complete with all tubes and crystal. BRAND NEW

\$7.88

BC-458 TRANSMITTER—5.3 to 7 Mc. complete with all tubes and crystal. BRAND NEW

\$7.88

BC-459 TRANSMITTER—7-9.1 Mc. complete with all tubes and crystal. BRAND NEW

\$12.95

ARC-5/T-19 TRANSMITTER—3 to 4 Mc. BRAND NEW complete with all tubes & crystal

\$8.88

BC-456 Modulator USED 3.45 NEW 4.95

BC-451 Transmitter Control Box 1.25 NEW 1.49

POWER SUPPLY KIT For All Command Transmitters

Input: 117 V 60 cycles AC. Outputs: 450 V DC @ 150 Ma., 250 V DC @ 50 Ma., 24 V DC @ 2 Amps. Specially designed for Command Xmitter power requirements, but can be used on other similar equipment. Carefully designed, uses quality components. A really substantial, good-looking unit, very low priced!

\$29.50

BC-645 XMTR RECEIVER

15 Tubes 435 To 500 MC



BRAND NEW

Can be modified for 2-way communication, voice or code, on ham band 420-450 mc, citizens radio 460-470 mc, fixed and mobile 450-460 mc, television experimental 470-500 mc. 15 tubes (tubes alone worth more than sale price!); 4-7F7, 4-7H7, 2-7E6, 2-6F6, 2-955 and 1-WE316A. Now covers 460 to 490 mc. Brand new BC-645 with tubes, less power supply in factory carton.

Shipping weight

\$29.50

PE-101C DYNAMOTOR for BC-645, has 12-24V input (easy to convert for 6V Battery operation)

only **\$7.95**

UHF ANTENNA ASSEMBLY, for BC-645

\$2.45

Complete set of 10 Plugs for BC-645

\$5.50

CONTROL BOX for above

\$2.25

SHOCK MOUNT for above

1.25

CONVERSION BOOKLET, Instructions for most useful surplus rigs

\$2.50

BC-603 FM RECEIVER, 10-channel push button tuning or continuous tuning, 20-28 Mc. Complete with speaker tubes, squelch.

\$10.95

Exc. BRAND NEW

\$14.95

12 or 24 V Dynamotor for above, Excellent.

\$5.50

Used \$4.25. BRAND NEW

AC POWER SUPPLY for BC603, 683. Interchangeable, replaces dynamotor. No revr change except add on-off switch to front panel. Provides 220VDC @ 80 Ma. 24 VAC @ 2 Amps. Complete kit, with easy instructions

\$10.50

SCR-522 2-METER RIG!

Terrific buy! VHF Transmitter-receiver, 100-156 Mc. 4 channels. Xtal-controlled. Amplitude modulated voice. They're going fast! Excellent condition.

SCR-522 Transmitter-Receiver, complete with all 18 tubes, top rack and metal case.

COMBINATION Special **\$33.33**

Receiver only, with all tubes

\$19.50

Transmitter only, with all tubes

\$22.25

Accessories for above available.



BC-442 ANTENNA RELAY

Wonderful Value! Consists of ¼ amp 2" RF Ammeter (antenna current indicator). 0-10 scale. Transmitter-Receiver Switching relay, in aluminum case with associated components. BRAND NEW

\$2.49



ASB-5 'SCOPE INDICATOR

BRAND NEW, including all tubes, together with 5BP1 'Scope Tube. Originally used in Navy Aircraft RADAR equipment. Easily converted for AC operation. VALUE \$250.00!

OUR LOW PRICE **\$15.95**

BC-620 FM TRANSCEIVER, 20-28 Mc BRAND NEW **\$9.95**

PE-120 6-12V Power Supply, with Tubes and Vib. NEW **\$11.95**

Shock Mt. Rack, New **\$2.95**

ARC-5/R28 RECEIVER

2-meter Superhet, 100 to 156 Mc in 4 crystal channels. Complete with 10 tubes.

\$24.45

BRAND NEW

110 V AC Power Supply Kit for above **\$9.75**



ARC-5/T-23 TRANSMITTER

100-150 Mc Includes 2-832A, 2-1625 Tubes,

BRAND NEW **\$19.95**

SPECIAL Limited quantity ARC-5/T23 xmitters.

OFFER! BRAND NEW, less tubes **\$7.95**

Excellent Used, less tubes **\$5.95**

ARC-5 MARINE RECEIVER-TRANSMITTER

Navy Type Comm. Receiver 1.5 to 3 Mc

BRAND NEW with 6 tubes **\$16.95**

Navy Type Comm. Transmitter 2.1-3 Mc

BRAND NEW with 4 tubes and Xtal **\$12.45**

MODULATOR for above, new, with tubes **\$4.95**

Hi-Fi DYNAMIC HEADSET with Cushions

Freq. Range: 40-14,000 CPS. No Distortion.

BRAND NEW **\$7.95**

BC-906 FREQ. METER-SPECIAL



Cavity type, 145 to 235 Mc. BRAND NEW, complete with antenna. Manual incl.

OUR LOW PRICE **\$9.99**

MICROPHONES

Model	Description	Used	BRAND NEW
T-17	Carbon Hand Mike	\$4.95	\$7.45
T-30	Carbon Throat Mike	.39	.79
T-45	Army and Navy Lip Mike		1.33
T-24	Carbon Mike		5.95
TS-9	Headset		3.88
RS-38	Navy Type	2.79	4.95

HEADPHONES

Model	Description	Used	BRAND NEW
HS-23	High Impedance	\$2.25	\$4.75
HS-33	Low Impedance	2.79	4.75
HS-30	Low Imp. (featherwt.)	1.25	1.99
H-16/U	High Imp. (2 units)	3.75	7.95

TELEPHONICS—600 ohm HEADSETS BRAND NEW

PER PAIR **\$3.45**

CD-307A Cords with PL55 plug and JK26 Jack **.99**

Earphone Cushions for above—pair **.50**

MOBILE-MARINE DYNAMOTOR

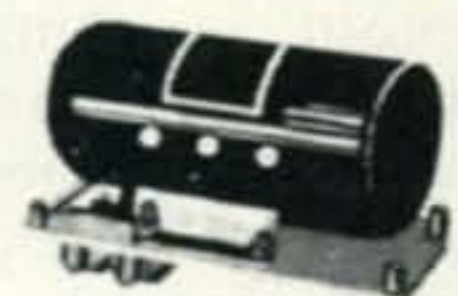

Input 12V DC. Output: 625 V DC @ 225 Ma. for press-to-talk intermittent operation. Shipping weight 14 lbs.

OUR LOW PRICE **\$9.95**

SCHEMATIC DIAGRAMS For any equipment on this page, each **65¢**

Please include 25% Deposit with order—Balance C.O.D. 50¢ HANDLING CHARGE on Orders under \$5.00 MINIMUM. All Shipments F.O.B. Our Warehouse N.Y.C.

G & G Radio Supply Co.

Telephone: CO 7-4605

53 Vesey St., New York 7, N. Y.

For further information, check number 42 on page 194.

★ TEST EQUIPMENT ★

Frequency Meter, BC-221 or LM, with calib. book.....\$ 75.00
 Tube Checker, Hickok 550-X, Dyn. mutl. conduct..... 25.00
 Freq. Meter TS-173/UR, Hi Freq., with calib. book..... 175.00
 Ballantine 300-B VTVM, new—\$95.00..... Used 70.00
 Hickok #610-A FM & TV Signal Generator..... 115.00
 Solar CF Exam-eter Condenser tester, new..... 40.00
 Freq. Meter, TS-127/U, 375-725 MC., new..... 39.00
 Signal Gen., I-208..... 59.00
 RCA Rider chanalalyst..... 49.00

SCOPES 3" & 5"

RCA 155-C, 3 inch..... \$29.00 | Dumont 274, 5 inch.....\$ 55.00
 Dumont 224, 3 inch..... 75.00 | RCA 160, 5 inch..... 45.00
 Elco 425, 5 inch..... 39.00 | Dumont 304-H, 5"..... 175.00
 RCA WO-88A, 5 inch..... 95.00 | Precision Es-520 5"..... 69.00

RECEIVERS

Super-Pro 779 with 115 V.A.C. supply.....\$110.00
 HQ-140-XA with calibrator, like new..... 175.00
 Teletype Rec'r., 11 tubes, Power Sup., less tuning unit... 20.00
 HRO Senior.....\$75.00 & \$95.00 | Hallcrafters SX-27..... 95.00
 National NC-98..... 95.00 | RCA, AVR-20-A1..... 22.00
 Hallcrafters SX-28..... 95.00 | SX-105, 152-173 mc, FM..... 65.00
 RBS-RBM 2-20 mc..... 60.00 | Harvey Wells R-9, S:kr..... 95.00
 B.C.-342, 115 V. P.S..... 69.00 | Heath, with cabinet..... 27.00

TRANSMITTERS

Johnson Ranger.....\$175.00 | Eldico TR-75-TV..... \$45.00
 Lettline Mod. 240..... 45.00 | SSTR-4, cw. w/P.S..... 95.00
 Eldico, SSB-JR..... 45.00 | TBX, Xmitt-Rec..... 25.00
 Heath DX-35..... 45.00 | T-50-M, cw. w/P.S..... 69.00
 B.C.-610 w/sp. Amp..... 295.00 | B.C. 375 w/T.U..... 22.00
 GF-11, & 3 coil sets..... 12.00 | Arc 5 3-4 mc.—Excel... 14.00
 SCR-522, T & R, new..... 39.00 | Arc 5, 5.3-7 mc., New... 8.00

TRANSFORMERS & CHOKES (Cased)

Sola constant voltage 115 V., 1KVA—\$75.00, 3KVA—\$150.00
 600 V.C.T. 60 MA., 5V—2 Amp., 6.3 V.—5 Amp..... 1.95
 Fil. 5 Amp. tapped at 8, 9, 10, 11, 12 V..... 2.95
 2.5 V. 10 Amp. 10KV.....\$ 2.95 | 10HY—250 Ma.....\$ 2.50
 3750-0-3750, 250 Ma..... 19.00 | 8 HY—200 Ma..... 2.25

6.3 V. 5 Amp..... 1.95 | 8 HY—150 Ma..... 2.00
 550-0-550, 220 Ma. plus..... 4.95 | 25 HY—100 Ma..... 2.00
 15 V. CT. 30 Amp..... 7.50 | 15 HY—100 Ma..... 2.00
 6.3 V. 20 Amp..... 2.95 | Dual 9 HY—100 Ma and
 6, 7 or 8V. 10 Amp..... 2.95 | 10 HY—75 Ma..... 2.50
 Sola Constavoltage 115/230 V. 1 KVA, new..... 70.00

DYNAMOTORS

12 V. 3 Amp. 235 V. 75 Ma. cont. or 125 Ma. Int.....\$ 4.95
 Carter 6V, new, 400 V.—375 Ma.—\$18.00, 600 V.—250
 Ma.—\$18.00, 600 V.—170 Ma. \$14.00
 Leece-Neville—6V..... \$39.00 | 12 V..... 69.00
 PE-103, 6 & 12 V..... 24.00 | 12 V. 515/1030 V. at
 12 V., 625 V.—225 Ma. 12.00 | 215/260 Ma..... 14.00

PANEL METER BARGAINS

10 Ma, 15 Ma, 25 Ma, 200 Ma, 500 Ma 2" or 3".....\$2.95
 R.F.—4 Amp. 2".....\$2.95 | 30 Amp. A.C. 2"..... 4.50
 1 Ma. Sp. scale 2"..... 3.75 | 50 Amp. D.C. 2"..... 4.95
 100 Micro A. Sp. Scale 2" 3.95 | 20 Micro Amp. 3"..... 6.50
 1 Ma. Sp. Scale 3"..... 3.95 | 200 Micro Amp. 2"..... 4.50

RELAYS

5000 ohm SPDT Sensitive type relay.....\$4.50
 12 V.D.C. Ceramic ANT. TYPE DPDT & SPST..... 2.50
 6V. D.C. S.P.D.T..... 1.25 | 6V. D.C. 3PDT..... 1.75
 6V. D.C. S.P.S.T..... 100 | 6V. A.C. SPST..... 1.50

MISC.

B.C. 605-D Interphone Amplifier, new.....\$4.50
 Dual 100 mmf. Xmitt. Cond. 1100 V. 350 .gap, boxed..... 7.50
 7-MFD Oil Cond. 1350 V.A.C. good for 4000 V.D.C..... 7.50
 Rotary Inductor 1 KW—\$16.00..... 500 W. 4.75
 200 Mmf. Var. Cond. 6000 V. PK. .16 gap boxed..... 8.50
 Vacuum Cond. 10 KV. 25 MMF—\$3.95..... 50 MMF 4.50
 Vacuum Cond. 32KV 12 MMF—\$4.95..... 50 MMF 5.75
 Prices on the above items are based on fair values—some items
 are new and some are used.

Enclose sufficient money for shipping, excess will be returned.
 25% with C.O.D. orders.

WE BUY — WE TRADE

WANTED—Commercial Receivers, Xmitters, Test Equip.
REPAIR SERVICE—We repair & calibrate the above.

ALGERADIO

ELECTRONICS CO.

236 N. Franklin Street
 Hempstead, N.Y.
 Phone IV 9-0808

For further information, check number 46 on page 194.



NEW 100V EXCITER-TRANSMITTER

NO TUNING (except VFO), uses famous CE BROADBAND system. PRECISION LINEAR VFO—1KC Calibration. Single Knob Bandswitch 80 thru 10. SSB—DSB—AM—PM—CW and FSK. RF Output adjustable 10 to 100 Watts PEP. Meter reads Watts Input, Amps Output and Carrier Suppression. 2" RF Scope. Speech Level and Load Mismatch Indicators. Audio Filter — Inverse Feedback — 50 db Carrier and Sideband Suppression.

IN PRODUCTION SOON..... PRICE \$595.00

SUPERIOR SSB GEAR



MODEL 600L BROADBAND LINEAR

NO TUNING CONTROLS — CE BROADBAND Couplers in HIGH EFFECIENCY CLASS AB² using single 813. Easily driven to 600 Watts PEP Input 160 thru 10 by a 20A or 100V. Built-In HEAVY DUTY POWER SUPPLY — 45 MFD PAPER Capacitor. Meter reads WATTS INPUT, GRID DRIVE, RF AMPS, and SWR. Completely shielded — TVI suppressed — parasitic free. REMEMBER there is LESS than ONE S UNIT difference between the 600L and a 2 KW PEP job.....PRICE \$495.00

MODEL 20A



THESE MULTIPHASE EXCITERS PIONEERED AMATEUR SSB

MODEL 10B — 10 watts PEP. Plug-in coils 160 thru 10 meters. Perfect voice control on SSB—DSB—AM and PM — CW breakin. Carrier and calibrate level controls. 40 DB suppression.
 Wired.....\$179.50 Kit.....\$139.50
MODEL 20A — 20 watts PEP Bandswitched 160 thru 10 meters. SSB—DSB—AM—PM and CW. Magic eye monitors carrier null and peak modulation. Ideal for driving AB¹, AB², and most Class B linears.
 Wired.....\$279.50 Kit.....\$219.50

MODEL 10B



Central Electronics, Inc.

1247 W. Belmont Ave. Chicago 13, Illinois

For further information, check number 47 on page 194.

Sensational NEW COAXIAL BROADBAND BOOSTER WILL INCREASE SENSITIVITY of any RECEIVER..

Regardless of Cost or Class!

- Bring In Signals Heretofore Absent or Unintelligible!
- Improved Reception. Also Increases S.N.R.!
- Voltage, Weight, Size Ideal For Fixed Station or Mobile Service!
- Guaranteed Increased Receiver Sensitivity!



Model DKC - RFB

The DKC-RFB is a broadbanded amplifier, designed, tested and guaranteed to INCREASE RECEIVER SENSITIVITY! Input and output transformers are 50 to 75 ohm impedance matching. Response is obtained without any adjustments. (See response curve graph below). Used with any receiver in 3.5 through 60 mc range enables you to bring in signals heretofore absent or unintelligible. You get more out of your existing antenna.

B+ voltage of 150 to 200 volts
DC. Heater voltage of 6.3 or 12.6.
Weight, less than 6 ounces, Size 1 3/4" x 2".

EACH
10.75

Even greater gain can be enjoyed when DKC - RFB is used with Dow DKC - TRM Antenna Switch.

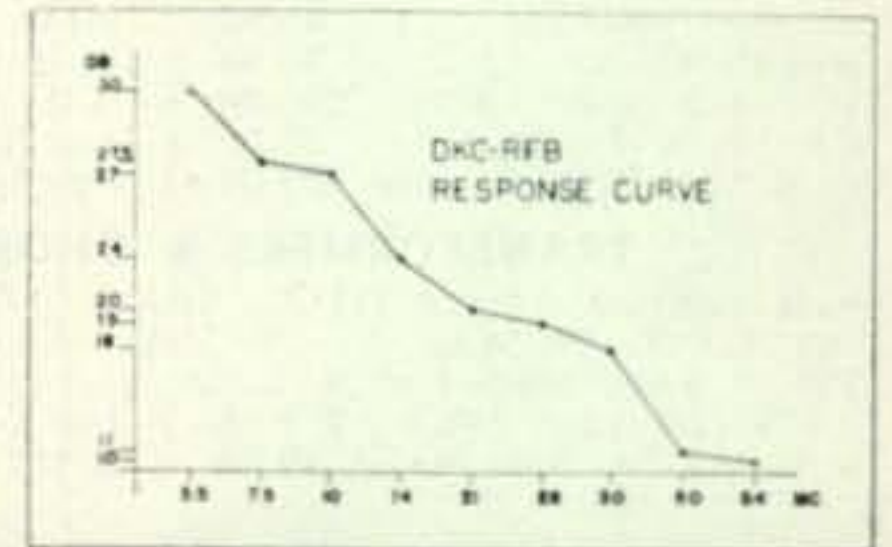

Enjoy Increased Sensitivity, Improved Reception. See Your Electronics Dealer Today or write for Specifications.

Traditional Dow-Key Warranty . . .

DOW-KEY CO. INC.

THIEF RIVER FALLS, MINNESOTA

For further information, check number 48 on page 194.

RECEIVERS

- RAX-1**—Four Band, 4 1/2" Dial, AVC, CW, MCW, Phone Jack, Volume Control. Voltage required: 24 VDC & 200 V 80 MA. With 7 Tubes, less top cover. Good condition. Size: 16" x 7 1/2" x 7 1/2". Unit #1 200 to 1500 KC — Unit #2 1500 to 9000 KC — Unit #3 7000 to 27000 KC — Each Unit.....\$18.95
- R-23/ARC-5 Receiver — 190 to 550 KC.....Used: 14.95
R-26/ARC-5 Receiver — 3 to 6 MC.....Used: 7.95
R-27/ARC-5 Receiver — 6 to 9 MC.....Used: 8.95
R-28/ARC-5 Receiver — 100 to 156 MC.....Used: 14.95
ARB Receiver — 190 to 9050 KC.....Used: 18.95
(For details, send for our Free Catalog!)
- BC-652 Receiver — 2 to 6 MC.....Used: 24.95
BC-312/342 Receiver — 1.5 to 18 MC.....Used: 79.50
BC-733 Rec.—108-110 MC—Used \$9.95—No tubes: 4.95
BC-603 FM Receiver—20 to 28 MC.....New: 14.95
BC-683 FM Receiver—27 to 38 MC.....Used: 24.95
BC-3050 FM Rec.—30 to 50 (10 MC spread).....New: 29.95
BC-1206 Rec.—200 to 400 KC—Used: \$4.95 — New: 9.95



DYNAMOTORS:

- 1000 VDC @ 350 MA. Starting Relay & Filtered. BD-77 —14 V input—Used: \$9.95—New: \$14.95 PE-73—28 V input—Used: \$8.95—New: \$12.95 PL-59 High Voltage Plug: \$1.00—PL-61 L.V. Control Plug: \$1.00
- 300 VDC @ 260 MA & -150 VDC @ 10 MA. Starting Relay, Voltage Regulator, Filtered. PE-98—14 V input—Used: \$12.95—New: \$19.95 PE-94—28 V input—Used: \$4.95—New: \$9.95 Input Plug: \$1.00 Output Plug: \$1.00
- UNIVERSAL PM TYPE—6 Volt 8 A. input; output 12 V 1.8 A. 200 V 80 MA. 12 Volt 4 A. input; output 24 V 1.8 A. 500 V 50 MA. Will operate BC-603/683/3050/ARB from 6 Volts. No. 0515.....New: \$4.95

				NEW	USED
12 VDC	220 VDC	80 MA	DM-34	\$ 4.95	\$ 2.95
12 VDC	625 VDC	225 MA	DM-35	12.95	7.95
12 VDC	375 VDC	150 MA	BD-83	6.95	4.95
12 VDC	540 VDC	450 MA	DA-12	9.95	6.95
12 VDC	425 VDC	163 MA	WE-377	12.95	9.95
12 VDC	225 VDC	100 MA	D-402	8.95	5.95
12 VDC	250 VDC	60 MA	DM-32 12 V	4.95	—
12 VDC	275 VDC	150 MA	DM-64	8.95	—
12 VDC	185 VDC	210 MA	DM-40	4.95	2.95
6 VDC	640 VDC	260 MA	Recond't. by G.E.	12.95	—
6 VDC	420 VDC	260 MA	Recond't. by G.E.	9.95	—
6 VDC	275 VDC	60 MA	DM-9450	6.95	4.95

ADDRESS DEPT. CQ • MINIMUM ORDER \$5.00



WORLD'S FINEST SURPLUS BARGAINS

Send today for your copy of our new FREE CATALOG!

ANTENNA MATCHER—At Left: Variable Inductance Tuner with Calibrated Vernier Lock Dial, 2 1/2"; 0-8 RF Meter mounted on Panel. Size 4 3/8" x 8 1/8"—Used.....\$9.95

AC POWER SUPPLIES & TRANSFORMERS FOR SURPLUS EQUIPMENT:

- Power Supply for BC-603/BC-683 — Used: \$14.95 — Kit: \$10.00
Power Supply & Conversion Kit for ARB..... 10.00
500 VCT 80 MA 24 V 2 A; 5 V 3 A — H-110..... 4.95
500 VCT 80 MA 6.3 V 1 A; 5 V 3 A — H-1000..... 4.95
1200 VCT 200 MA 12.5/2 A; 12.5/2 A; 5 V 3 A — H-108..... 9.95
240 VCT 35 MA 24/9 A; 6.3/6 A; 6.3/3 A — H-113..... 1.75
12.6 V/2 A..... \$1.95 — 24 V/1.5 A..... 1.95
12 V/4 A & 12 V/4 A..... \$4.95 — 16 Volt 35 A..... 14.95

PHONE PATCH TRANS.
No. C-161
\$1.95



RANGE BEAM FILTER
1020 Cycle Acceptance or Rejection, with PL-55 Plug & Cord, two output jacks — New..... \$1.95
Similar to FL-8 — 2 output jacks, less plug and cord..... \$1.50

SIDE BAND LOADING COIL
No. C-114
\$1.95

PHONE PATCH CONVERSION UNIT

REMOTE CONTROL RM-52—Can be used with RM-53 or used as a separate telephone system. Uses 4 flashlight batteries. Also can be used as a direct remote control for radio equipment. Provides bias for Mic. & Sidetone to headset. High or low imp., Mic. & Phone Jacks. Easily converted to Phone Patch—See Oct., '58 CQ—Prices: Used—\$1.95; New— \$2.95

MARS • CD • MARINE

- RECEIVER-TRANSMITTER BC-1306 — 3800 to 6500 KC, Voice 15 Mile, CW 30 Mile, MO or Crystal Control, Crystal Calb. and Net Controls.....Used: \$29.95
PE-237 Power Supply f/BC-1306 — 6/12/ or 24 V.....Used: 14.95
Large Plug to fit BC-1306 or PE-237.....Each: 1.50
SCR-522 RECEIVER-TRANS. — 100 to 156 MC.....Used: 29.95
RT-18/ARC-1 RECEIVER-TRANS. — 100 to 156 MC.....Used: 89.50
BC-1335 FM RECEIVER-TRANS. — 27 to 38 MC.....Used: 24.95
BC-659 FM RECEIVER-TRANS. — 27 to 38 MC.....Used: 14.95
BC-620 FM RECEIVER-TRANS. — 21 to 28 MC.....New: 14.95

PRICES F.O.B. LIMA, OHIO • 25% ON C.O.D. ORDERS

FAIR RADIO SALES

132 SOUTH MAIN ST.
LIMA, OHIO

For further information, check number 49 on page 194.

NOW! AN
IMPROVED

telrex HEAVY DUTY BEAM ROTATOR

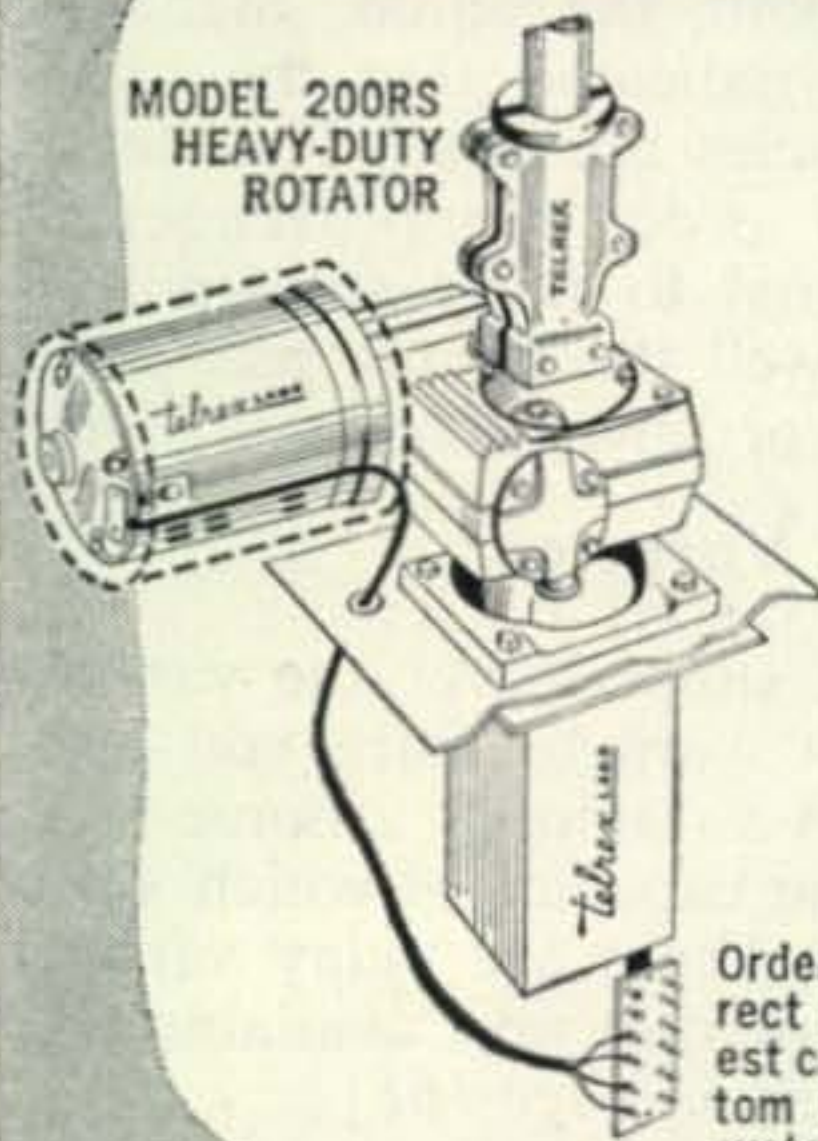

MODEL 200RS
HEAVY-DUTY
ROTATOR

Model 200RS... a Re-designed, Improved Rotator and Direction-control Indicator System to ease installation and reduce control wiring costs

Now! In addition to the superb Boston Gear, double worm and worm gear reducer, tapered bearings and selsyn indication, has been added relays to reduce control wires from 12 to 8 with only two (2) heavy duty wires required. Specifications include 1/6 h.p. S/P 1725, 115-V AC motor reduced to approx 15 rpm at a torque of better than 1200 lbs of torque and with gearing designed to hold better than 6000 inc-pounds of drive back. Specifications which will allow you to rotate and hold large full sized 10, 15 and 20 meter rotaries even thru 120 mph hurricanes! Guaranteed more torque power and reliability per dollar than ever before! Complete 200RS System only \$360.00 f.o.b.

Order today or write direct to Telrex for latest catalog. (Other custom designed rotating systems up to \$8000.)



DIRECTION INDICATOR

ASBURY PARK 22, NEW JERSEY, U.S.A.

PRospect 5-7252

For further information, check number 50 on page 194.

ONLY
\$18.00
plus 10%
Fed. Tax

24-HOUR DIAL ELECTRIC CLOCK

Big 15" illuminated dial for easy reading. Handsome and durable with glass crystal, aluminum case and stainless steel bezel. Ideal as a gift.

SEND CHECK OR MONEY ORDER TO:
SCIENTIFIC INDUSTRIES, Inc.
21 Park Street, Springfield 3, Massachusetts
or write for Free Literature



NEW!

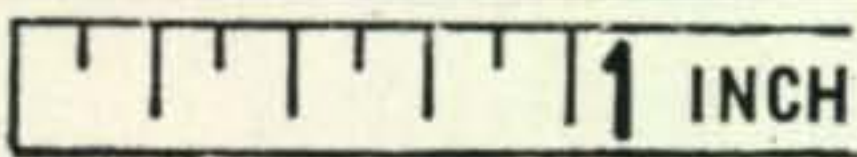

PANEL METERS

Self-shielded

Moving coil



ALCO ELECTRONICS MFG. CO. Lawrence, Mass.

D.C. MICROAMMETERS	
0-300	5.95
0-500	5.75
D.C. MILLIAMMETERS	
0-1	4.95
0-5	4.95
0-10	4.95
0-50	4.95

D.C. VOLTMETERS 1000 Ohms Per Volt	
0-3	4.95
0-10	4.95
0-300	4.95
A.C. Rect. Type—1K Ω per V	
0-15	5.25
0-150	5.25
0-300	5.25

DX [from page 118]

- ZL3DA—W/K/VE's QSL via W6ZEN, Floyd McPherson, 395 Corsicana Dr., Oxnard, California, (include stamped return envelope)
- ZP5AP—Al, Box 512, Asuncion, Paraguay
- W3ZA/3W—QSL to Harry L. Whiting, W2JXH, 765 Park Ave., New York 21, N. Y. (include stamped return envelope)
- 9G1CU—COMCAN, Gifford Camp, Accra, Ghana

reports LA4DD. But LA2JE/P, on Hopen Island (Svalbard), now using a new receiver and planning 21 and 28 mc operation, will be there for another year.

73, Don, W4K VX

WEEKLY DX MAGAZINE

If you would like much faster and more comprehensive DX news coverage and articles than space in this column can permit, we suggest you try "DX", the weekly amateur radio news magazine, edited and published by W4K VX. Annual rates, for a minimum of 40 issues, are \$5 second class mail, \$6 first class, \$7.50 via air mail, to the U.S., Canada, and Mexico, and \$4 a year plus postage to all other countries. Write W4K VX (address at the head of the DX column) for further details or for a free sample copy. ■

is a new one on SSB, now on with 500 watts. Others in zone #11: ZP5MQ, 21200 kc AM, 0230; ZP5AY, 14075 kc CW, 0300; ZP9AY, 14055 kcs CW, 0730.

VQ8AJC says he will remain on Chagos, Zone #39, until the end of this year, when he returns to Mauritius, and then possibly another stint from a DX spot—probably Rodriguez Island. Others in zone #39: FB8CH, 14065 kc CW, 1345; FB8ZZ, 14082 kc CW, 1330; FB8XX, 21081 kc CW, 1045; VQ8AG, 14090 kc CW, 1345.

Sorry, but it appears there will be no Jan Mayen, Zone #40, activity this winter after all,

A HAM'S DREAM COME TRUE!

3 BEAMS FOR THE PRICE OF ONE The SKYLANE Cubical Quad

10-15-20 meters

- ★ 8 db gain on 20.
- ★ 10 db gain on 10 and 15.
- ★ 20 db or better F/B Ratio.
- ★ Pretuned reflector coils.
No adjustment required.
- ★ Cast aluminum alloy end and center spiders
for perfect alignment.
- ★ Minimum wind resistance.
- ★ Turn with a T.V. rotator
wt. 23 lbs.
- ★ No field distortion.

Hams the world over praise the SKYLANE.

Send for free brochure.

Price \$54.95 F.O.B.

SKYLANE PRODUCTS

5320 Nebraska Ave.

Tampa 3, Fla.

For further information, check number 51 on page 194.

Radio
AMATEUR
Call Book Magazine

\$5.00
Foreign \$5.25



Just out!

New edition now available
Be sure and get the latest issue of
the CALLBOOK direct or from your
favorite radio parts dis-
tributor.

Published quarterly
early in March, June,
September and Decem-
ber the CALLBOOK
contains a complete list
of all licensed radio
amateurs throughout
the world.

Single copies \$5.00.
Annual Subscription \$18.00.

RADIO AMATEUR CALL BOOK, INC.
4844 WEST FULLERTON AVENUE
CHICAGO 39, ILLINOIS, U.S.A.

**COMPLETE
ACCURATE
UP TO DATE**

PARAMETRIC [from page 159]

420, 220, 144, and 50 mc.

Noise figures measured at the various pump frequencies were about the same. Signal to noise measurements indicated that the higher order pump frequencies are best. The degree to which the higher order pump frequencies will improve the signal to noise ratio will be determined by how well the circuit gets rid of the so called "idler" or lower side band signal.

The Varactor

If I seem to have slipped over the varactor it is because I didn't want to scare you away before you started. A varactor is a home-made name for a device the capacity of which varies with applied voltage. There are many varactor type devices on the market and available. For
[Continued on page 168]

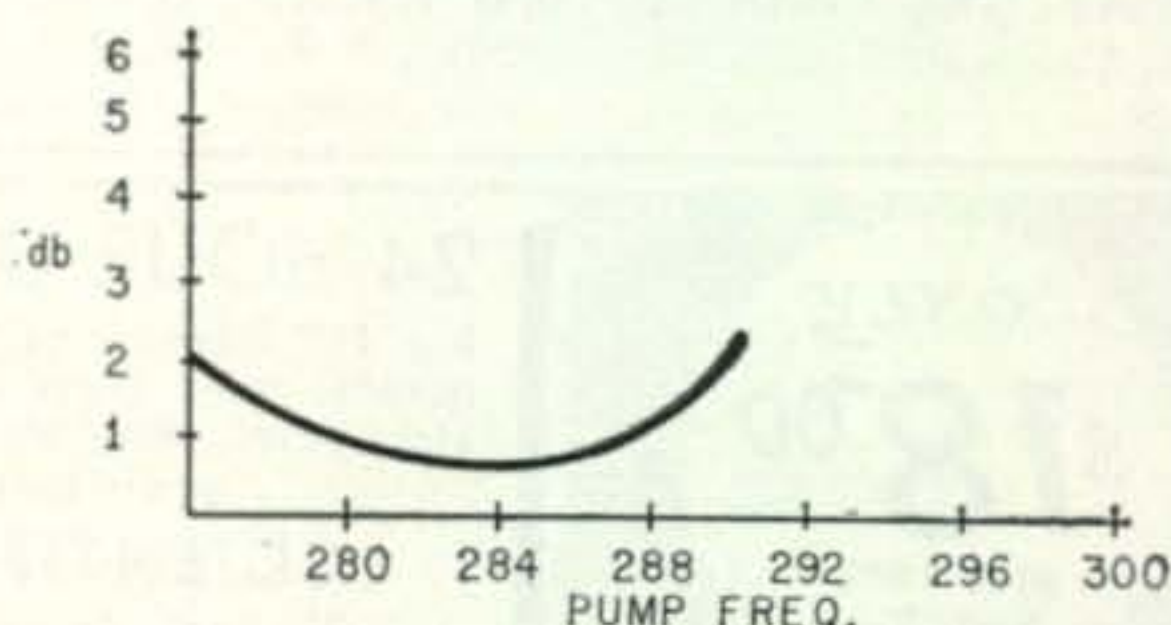

Fig. 5—NF versus Pump frequency for a signal frequency of 144.25 mc.

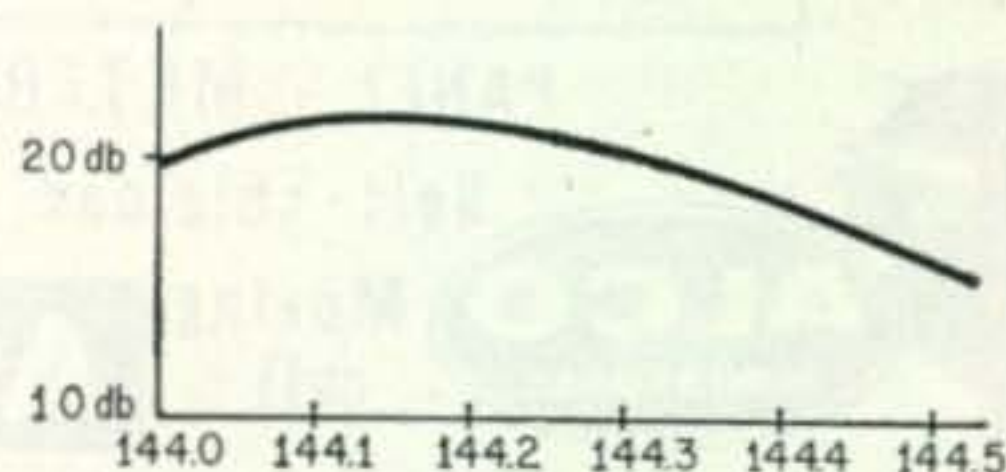

Fig. 6—Gain versus frequency for single tuning of varactor amplifier.

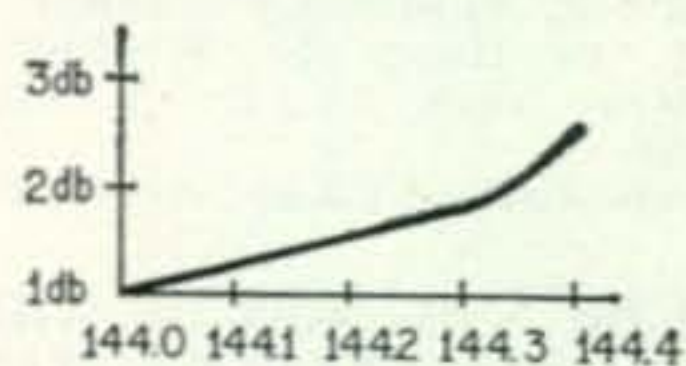

Fig. 7—NF versus frequency or one tuning adjustment of the varactor preamplifier.

PREAMP	NF
6BC4	5 db
417A	2.6 db
416B	1.8 db
MA 450	1.0 db

Fig. 8—NF measured with PRD model 904 noise generator. The preamp is followed by a 144 mc converter with a system NF of 5 db.

**DO YOU HAVE
WHY NOT CURE IT?
WORK DX WITHOUT TVI**

TVI

**Get WIDBM'S BRAND
NEW TVI BOOK AT ONE OF
THE FOLLOWING DEALERS:**

CALIFORNIA:
Burbank: Valley Electronic Supply Co.
Hemet: Gil Severns
Lancaster: Manley's TV Supply Co.
Long Beach: Scott Radio Supply, Inc.
Los Angeles: Henry Radio, Inc.
Zeitlin & Ver Brugge, Booksellers
Oakland: Elmar Electronics
Pasadena: Dow Radio, Inc.
San Diego: Radio Parts Co.
Western Radio and TV Supply Co.
San Francisco: Offenbach and Reimus Co.
San Jose: Frank Quement, Inc.
COLORADO:
Denver: Stacey Technical Book Co., Inc.
CONNECTICUT:
Bridgeport: Kaufman Electronics
Hartford: Hatry of Hartford, Inc.
New Haven: The Radio Shack, Inc.
DISTRICT OF COLUMBIA:
Washington: W. H. Lowdermilk & Co.
ILLINOIS:
Chicago: Newark Electric Co.
Decatur: York Radio and Television
INDIANA:
Indianapolis:
Van Sickle Radio Supply Co.
IOWA:
Council Bluffs:
Globe Electronics (World Radio Lab.)
Des Moines:
Bob & Jack's Store for Hams
Radio Trade Supply Co.
KANSAS:
Wichita: Amateur Radio Equipment Co.
KENTUCKY:
Lexington: Radio Equipment Co.
LOUISIANA:
Monroe: C and O Electronics, Inc.
MAINE:

Portland:
Radio Service Laboratory of NH & Me.
MASSACHUSETTS:
Boston: Campbell & Hall, Inc.
MICHIGAN:
Ann Arbor: Purchase Radio Supply
Saginaw: Morley Bros.
MINNESOTA:
Rochester: Elliott & Hanson
MISSOURI:
Kansas City: DX Radio Co-op.
St. Louis: Van Sickle Radio Co.
Walter Ashe Radio Co.
NEW JERSEY:
Bloomfield: Variety Electronics Corp.
Camden:
Radio Electric Service Co. of N. J.
Mountainside: Federated Purchaser, Inc.
NEW YORK:
Amsterdam: Adirondack Radio Supply
Brooklyn: Radio Bookshop
Mineola, L.I.: Arrow Electronics, Inc.
New York City: Cowan Publishing Corp.
Harrison Radio Corp.
Lafayette Radio
Northport: Bacon Pamphlet Service, Inc.
Riverdale: Kenny's TV Service Co.
OHIO:
Cleveland:
Radio and Electronics Parts Corp.
Columbus: Universal Service
Dayton: Custom Electronics, Inc.
Ham'n Hi-Fi, Inc.
Lima: Rair Radio Sales Co.
Toledo: Selectronics Supplies, Inc.
OREGON:
Portland: United Radio Supply, Inc.
PENNSYLVANIA:
Philadelphia: Philadelphia Book Co.
Pittsburgh: Radio Parts Co., Inc.

RHODE ISLAND:
Providence: W. H. Edwards Co.
Providence College Bookstore
SOUTH DAKOTA:
Watertown:
Burghardt Radio Supply, Inc.
WASHINGTON:
Tacoma: C & G Radio Supply Co.
WISCONSIN:
Fond du Lac: Harris Radio Corp.
Milwaukee: Amateur Electronic Supply
AUSTRALIA:
Melbourne:
Technical Book and Magazine Co.
BRAZIL:
Porto Alegre: Livraria Kosmos Editora—
(Erich Eichner & Cia Ltda.)
Rio De Janeiro: Livraria Kosmos Editora
(Erich Eichner & Cia Ltda.)
Sao Paulo: Livraria Kosmos Editora—
(Erich Eichner & Cia Ltda.)
CANADA:
Calgary, Alberta: Smalley's Radio Ltd.
Hamilton, Ontario: Crawford Radio
Oshawa, Ontario: Henderson's Bookstore
Toronto, Ontario:
Co-operative Book Center of Canada
The T. Eaton Co. Ltd.
DENMARK:
Copenhagen: Intrapress
ENGLAND:
London:
Radio Society of Great Britain
Short Wave Magazine Publication Dept.
GERMANY:
Hamburg: Boysen & Maasch
NORWAY:
Oslo: Johan Grundt Tanum
SWITZERLAND:
Fribourg: Chasset Radio & Television

OR SEND \$1.75 IN U.S.A. or \$2.00 FOREIGN Direct to:

THE NELSON PUBLISHING CO., REDDING RIDGE 1, CONN.

For further information, check number 52 on page 194.

**ASSEMBLE YOUR OWN
WALKIE-TALKIE RADIOPHONES**

General specifications applying to all models:

Highest quality workmanship and materials, silver plated coils, above 50 MC, ceramic capacitors and advanced design assures maximum performance with the longest battery life. Sensitive receivers can detect signals as small as one microvolt and feature automatic volume control and noise clipping. Transmitters use high level amplitude modulation, have a power input of one watt to the R.F. stage and will radiate a signal for 1 to 5 miles (depending on elevation and obstructions) using antennas supplied. Up to 40 miles have been reported by some of our customers when communicating with stations having directional beam antennas. Radiophones can be used singularly to communicate with fixed stations or two or more to communicate with each other providing they are for the same frequency band. Fully portable, no external connections needed. Uses standard radio and flashlight batteries available at your local store. Total weight of completed unit including all accessories is less than 5½ lbs.

Model TC-144. No minimum age requirement. Variable frequency transceiver circuit. Tunes from 144 to 148 mc. Wired, tested and guaranteed electronic chassis complete with two high frequency triodes (3A5) \$7.98
Model TR-144. Similar to above but with independently tuned receiver and transmitter circuits, using 4 high frequency triodes (2-3A5's). Permits receiving frequency to be changed without affecting transmitting frequency..... \$11.98
Model TRX-144-A. Crystal controlled transmitter for maximum stability. Variable frequency receiver with R.F. stage, tunable from 144 to 148 MC and transistorized audio booster stage for extra loud reception. Wired, tested and guaranteed chassis complete with six high frequency triodes, one pentode and transistor meets FCC requirements for general, and novice class amateur licenses, as well as civil defense and other special services \$24.98
Model TRX-50-A. Similar to above, tunes 50 to 54 MC
Model TRX-28-A. Similar to above, tunes 28 to 30 MC
Each \$18.98



for as little as

\$7.98

plus accessories

**NOW 5 MODELS TO
CHOOSE FROM
IMPROVED CIRCUITS
GREATER POWER
TRANSISTORIZED**

The following accessories are required to complete the walkie-talkie as illustrated, in addition to one of the chassis listed at left. Strong 16 gauge 8" x 5" x 3" aluminum case stain etched and anodized with all holes punched for quick assembly. Heavy duty battery holders with phosphor-bronze contacts, battery switch, telephone handset cradle, retractable coiled cord, adjustable shoulder strap, 18" or 24" antenna with loading coil (depending on frequency and necessary hardware. All above accessories for only \$9.98
Western Electric telephone handset with push-to-talk switch \$6.98
Input and output impedance matching transformers for the above handset. Both for \$1.98
Very active quartz transmitting crystal for models TRX-144-A, TRX-50-A and TRX-28-A ground to .01% of your desired frequency and hermetically sealed..... \$3.98
New transistorized power converter completely eliminates "B" batteries. Fits in same space. Pays for itself in the long run. Operates from low cost flashlight cells available everywhere. Complete, ready to operate, only..... \$24.98
How to Order: If your dealer cannot supply you with our products you may order direct from our factory by checking each item desired and ADD 5% of total for postage and insurance. Orders not paid in full will be sent COD for the balance due. COD orders must include \$3.00 deposit. All orders immediately acknowledged.

Dealer inquiries invited.
FREE power output indicator kit with each order over \$20.00.

SPRINGFIELD ENTERPRISES

Box 54-C11, Springfield Gardens 13, N. Y.

For further information, check number 53 on page 194.

CQ Tool Kit

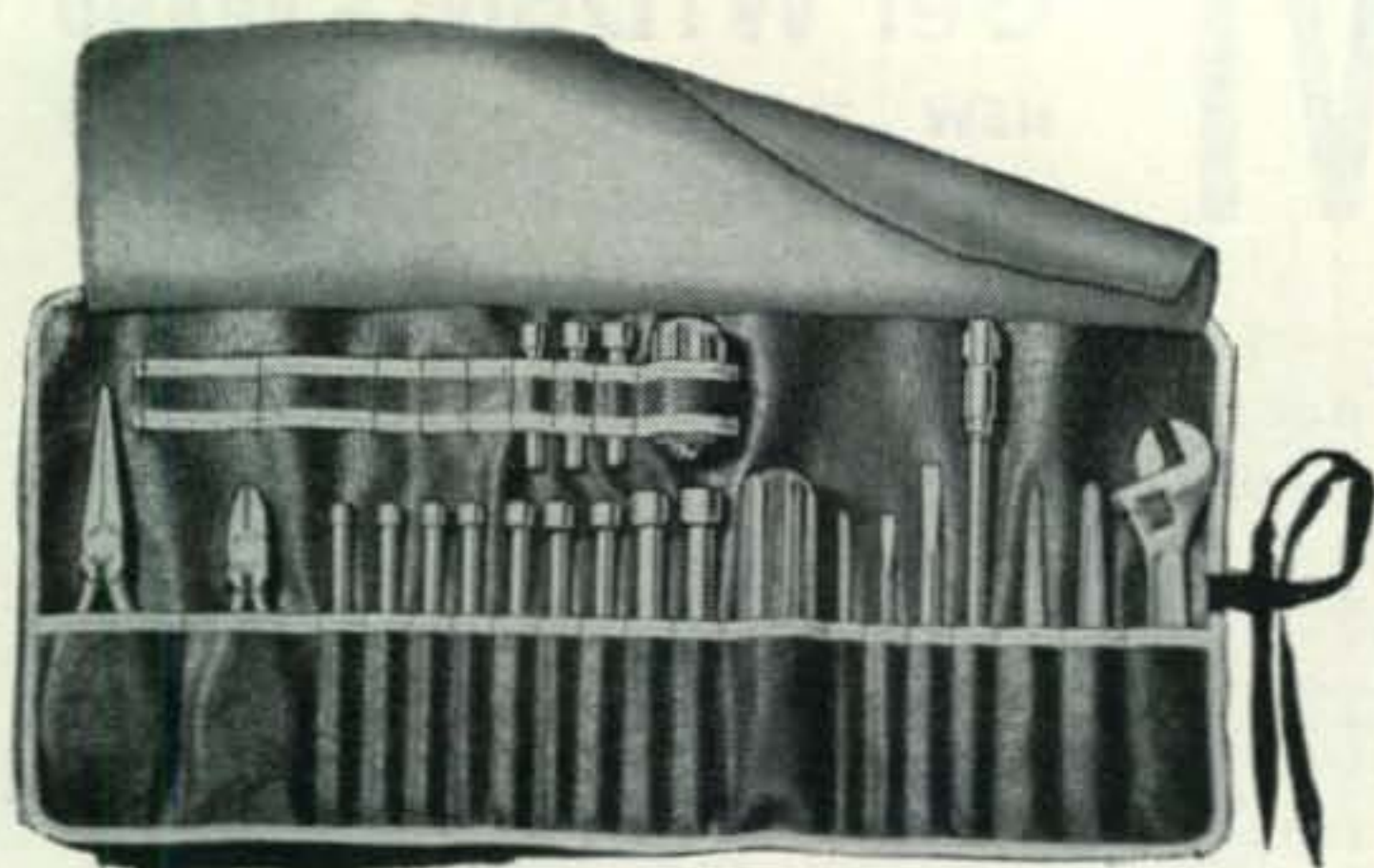

Christmas presents quite a problem every year. "Wotl I give myself this year?" Or perhaps you are hard pressed by the family for your "list." Well, just take a drool at this item. We've been shopping around quite some time now trying to find just the right set of tools for best use around the hamshack. A complete set of tools is pretty expensive, as you know, so we settled on a tool kit which supplies all the tools you need, but, by the use of detachable handles, effects economies both in price and in the physical size of the kit.

Here is what you get in this complete kit: full size long nose pliers and diagonal cutters; a full set of nut drivers (size 6 thru 12-14-16) in the regular size and 8-10-12 in the stubby size; small and medium screwdrivers; Phillips screwdriver; two sizes of reamers, a 6" extension blade for any of the screwdrivers or nutdrivers; a 6" Crescent wrench; a regular and stubby handle and a roll kit with a compartment for each tool. All tools are of the finest grade highly polished Nickel Chrome finish.

Whether you are going to use this kit in the ham shack or take it in the car you will find it the most terrific set of tools you have ever owned.

Price? Ah, there's the catch, as you may have suspected. You send us \$24.00 (lists for \$33.50) and we send you the kit postpaid . . . plus (here is the hooker) a year's subscription or extension of your present subscription to CQ.

Quiz Participants

The Hammond Atlas is still selling hand over fist to prospective quiz contestants who have received their questions to study for the program. Why not join this happy group and invest in this valuable book? It will also come in very handy for locating obscure towns around the world when you are on the air so you can arrange your next travel itinerary to include the hapless fellow who suggested you stop by the next time you are in the neighborhood. \$12.50 and the ever present free year's subscription to good old CQ.

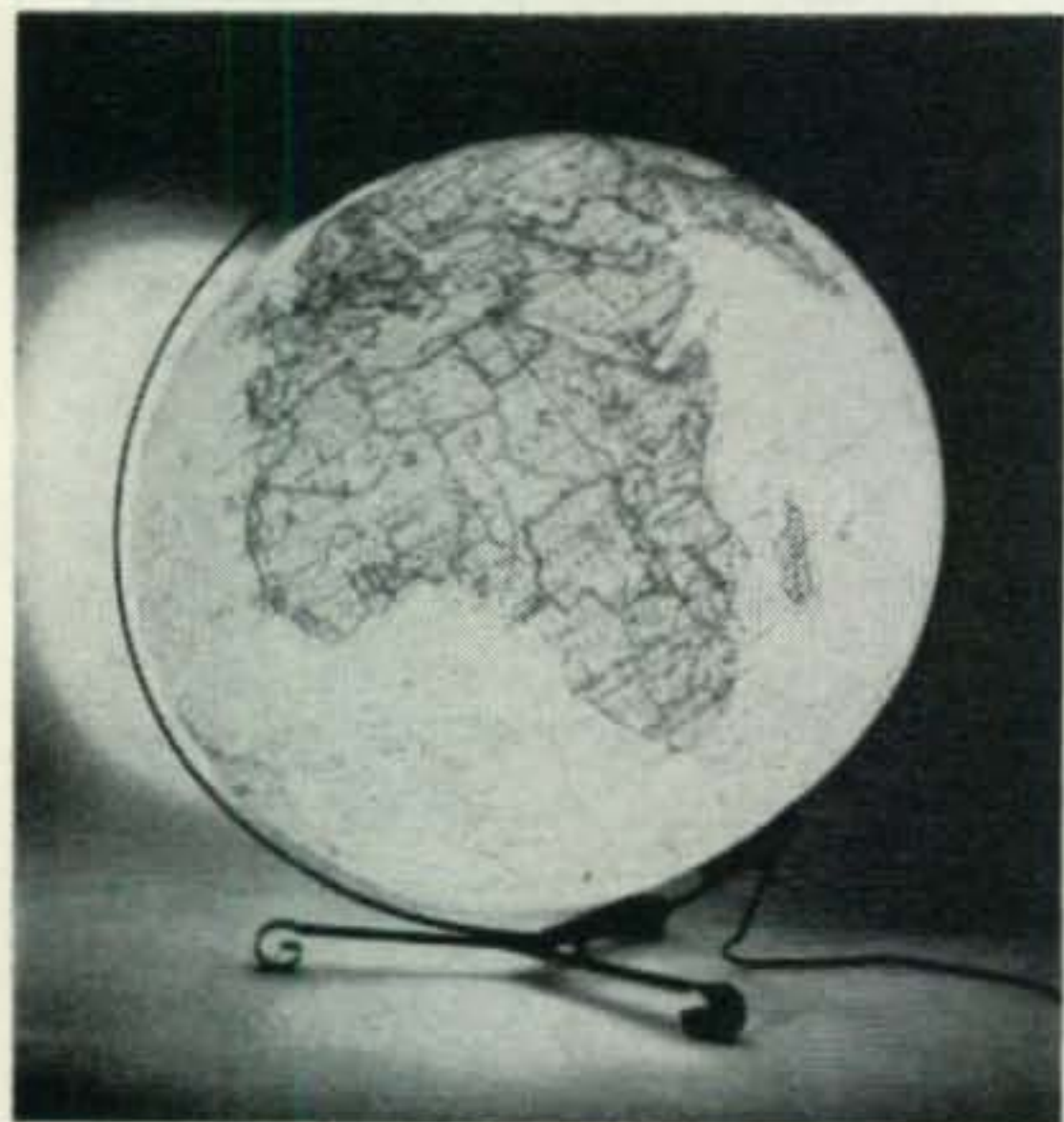
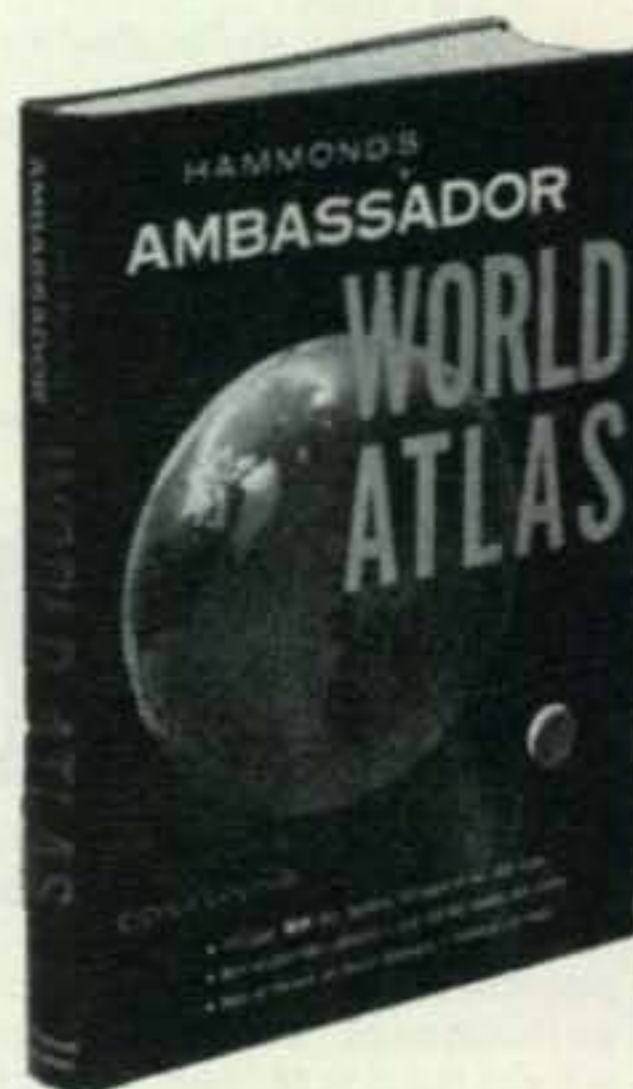

Christmas Presence

Like you should give one of our Lighted Globes away for Xmas and (we'll never squeel on you) keep the free CQ subscription that goes with it for yourself. Or you could give yourself the Globe and not feel quite so guilty about the subscription. You send along \$24.95 to us and let us know where to send the Lighted Globe and subscription. The Globe comes with light bulb, but not lighted. You have to plug it in, see?

Or maybe you want an unlighted globe. Like the plain 18" beautiful Hammond Globe which will be a guaranteed rouser present costs only \$19.95 including our CQ one year sub.

C-11

CQ Magazine SIRS: My check (money order) for \$..... is enclosed. Please send
 300 West 43rd St. the following items to: Tool Kit Atlas
 New York 36, N.Y. Unlighted Globe Lighted Globe

NAME

ADDRESS

CITY ZONE STATE

New York City residents add 3% Sales Tax

BIRD CAGE [from page 34]

serve as a rotating mast. The upper Twin-3 was secured in place on top, again with angle brackets, and the second one allowed to find its position below in accordance with the distance allowed by the length of the quarter-wave matching sections. Once this position was determined, of course, the lower boom was bracketed to the mast.

The phasing and matching lines were of the 600 ohm variety; that is, they were #12 wire spaced 6". The length of each was computed from the formula $246 \text{ over } Fmc$.

Phasing them is simple: merely keep the dipoles in-phase vertically and out-of-phase horizontally. This means "crossing over" both the top and the bottom quarter-wave sections on one side of the entire array. (See fig. 4)

Since a single Twin-3 of this type would be matched with a 600 ohm feedline, two of them would match 300 ohms, since they are in parallel. In 1946, twinlead was used. Today—with Indians on the warpath—coax is a wise idea. 75 ohm RG11/U into a half wave balun would also match 300 ohms.

The vertical spacing of the two Twin-3's left something over four feet of the 4x4 remaining at the bottom, and this was ideal for mounting with the hinges to the anchor-post of a large signboard on the roof of the building. One hinge, of course, was screwed to the bottom of the 4x4, the other just under the bottom Twin-3.

It was finished. Ready to go up.

The rotation was smooth and majestic—if a trifle squeaky.

I moved from there long ago. When I did, I didn't have the nerve to try to take my "Bird-cage" down again. I'd grown older and weaker—and much more cautious. The owner of the building must have taken it down about a year later, though.

Actually, then, the principle of the stacked Twin-3 is an excellent one. While the mechanical construction was a farce, the electrical information contained here is sound, and the antenna is capable of unusual performance. Theoretically, the gain of such an array would fall in the 7 to 8 db range, but, especially at the higher frequencies such as ten meters, its *effective* gain is much better, due to concentration of the signal at the lower radiation angles.

To be effective, the lower Twin-3 should be at least a half-wave above the ground. The entire array, of course, should be as much in the clear as possible.

As Wayne Green said in one of his editorials, you can never tell what to expect from such an antenna. Build it light (by all means!) and get it up in the air. You may trap a few birds, but you'll be happy with the signal you'll put out. ■



**MOSLEY
TRAPMASTER**

Model TA-33
for 10, 15 and 20

**GUARANTEED
FOR A
FULL YEAR**

We want to be
sure you'll be
completely satisfied

Mosley Electronics, Inc.

8622 St. Charles Rock Road • St. Louis 14, Mo.

For further information, check number 54 on page 194.

**MOBILE
POWER
SUPPLY**
MODEL
A12/600/200

\$69.50

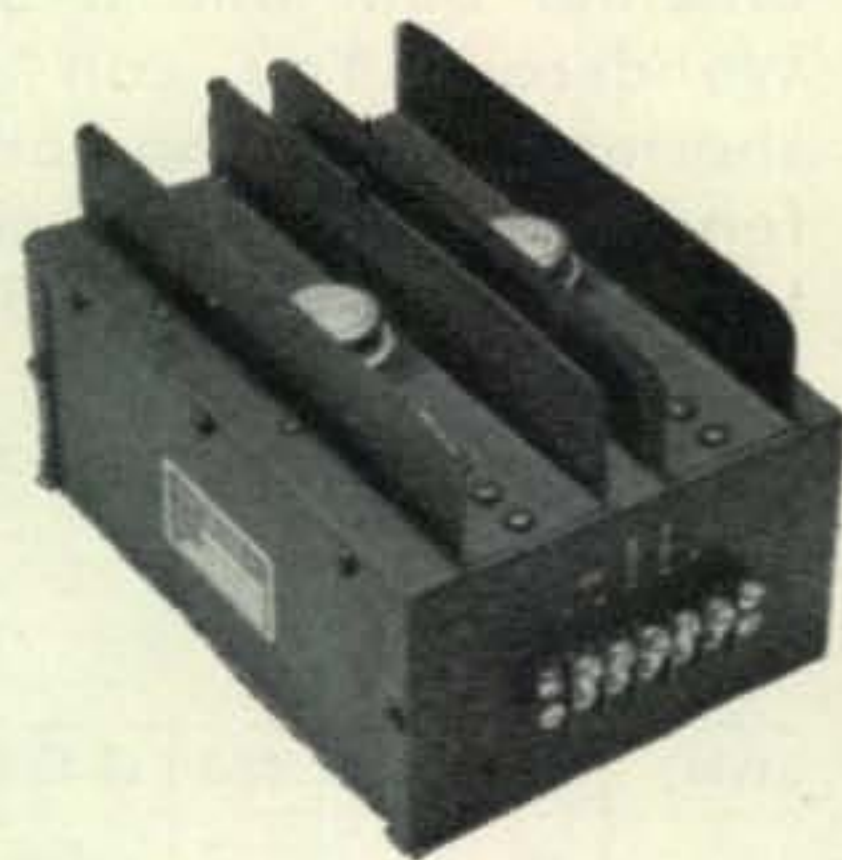

This transistor 12V dc power converter is rated for continuous power of 120 watts at 600 and 300 volts at temperatures up to 105°F without additional cooling.

High efficiency, small size, and light weight, plus freedom from maintenance, conserve your battery and increase the enjoyment of mobile operation.

A companion unit Model A12/300/100, delivering 30 watts at 300 and 150 volts is available at a cost of \$49.50



**ELECTRONICS DIVISION
GLOBE INDUSTRIES, INC.**
525 MAIN STREET
BELLEVILLE, NEW JERSEY

For further information, check number 55 on page 194.

—look for the spiral markings of genuine Shakespeare Wonderods.

better omni-directional radiation

Shakespeare — **WONDEROD**

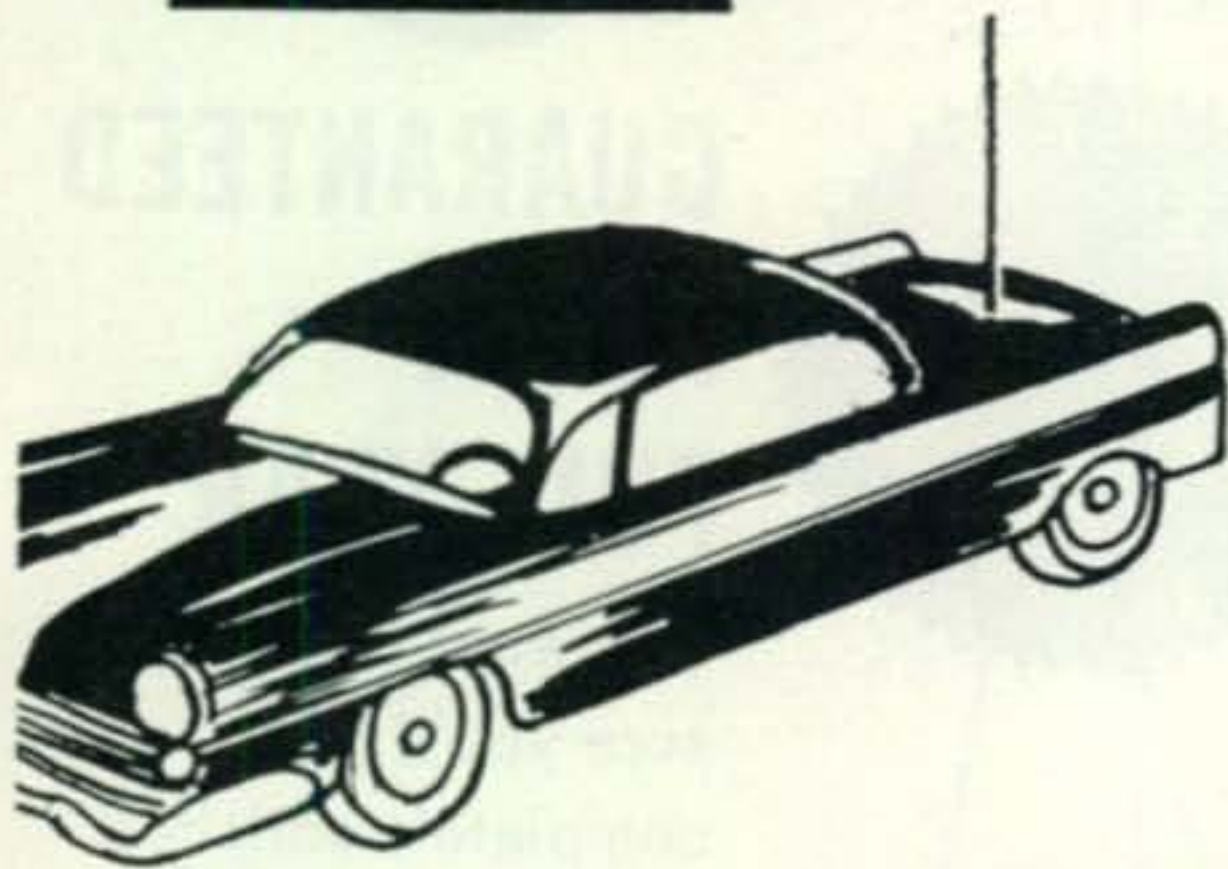

New normal mode helical antennas

Now — an efficient distributed-load antenna built into a Shakespeare Wonderod! You can mount this shortened antenna on trunk or fender . . . where radiation pattern is best. Superior Shakespeare fiberglass construction, using high grade dielectric materials to reduce power loss.

Style	62-1	62-2	62-3	62-4	62-5	62-6	62-7
Band	30-35 mc	35-42 mc	10 meters	15 meters	20 meters	40 meters	80 meters
Approx. Length	4'*	4'*	4'	4'	6'	6'	6'
Price	15.90			18.75			

Special 40 & 80 meter bumper mount antennas in 8' lengths — \$21.

*marked for intermediate frequencies.

Amateur net



COLUMBIA PRODUCTS CO.
Box 5207, Columbia, S. C.

Subsidiary of the Shakespeare Co.

For further information, check number 56 on page 194.

PARAMETRIC [from page 164]

instance, any semiconductor diode exhibits this capacity change to some extent. Some ceramic capacitors do too. If I tell you that there are definite specifications which must be met I will defeat the purpose of the article. Thing to remember is: Anything might work. Usable results were obtained on six meters using a pulsed up IN21 (M.A. of course). Best results obtained so far were with a Microwave Associates M.A.-450. (See fig. 5,6,7,8,). Getting your hands on one of these is difficult at the time of writing but should improve with time. I would say that if you haven't got any results using something else, you aren't ready for a genuine varactor yet. ■

de W2NSD [from page 14]

swatch of red carpet and conducted a briefing for John Huntoon (QST) and myself.

Near as I could figure from everything they said, the story is this: After they had gone to all the trouble to rig up a radar system covering the whole country using the 3000 and 10,000 mc radars some spoilsport asked them what they'd do if the incoming planes were to carry radar jamming gear. The answer to this was simple: use radars on so many different frequencies that no plane could carry that much jamming equipment and still have room left for atom, hydrogen, lithium, or cobalt bombs. This project should be finished in a couple of years or so and we will start finding little (?) buzzing noises around some of our VHF bands. Few of the bands will be entirely filled with radar so we should be able to work in and around them in most areas of the country.

In retrospect we are really rather fortunate in that, if everything works out like the Air Force claims, we should experience little if any QRM in most areas of the country and our UHF's will be safe from any other exploitation.

One other little piece of information leaked out: "Scatter" didn't work out as well as expected. This will probably result in a lot less pressure from commercial and military interests for the expropriation of our six meter band.

73, Wayne.

SPACE [from page 72]

miles per second. With the use of the proposed ion drive, space ships could travel at speeds over 100 miles per second. Thus, logging of exact frequency would have to take into account the direction of movement and the speed of an object, and the frequency change due to doppler shift that this movement caused.

Attenuation of signals with changing distance is another important consideration. An example would be the planet Mars. Its closest

approach to Earth is 38 million miles, and that only once or twice a century. Its furthest distance is over 240 million miles. And of course, there's our space ship whose distance may vary from its jumping off point of a few hundred to perhaps billions of miles. High powered commercial equipment could no doubt maintain contact, but fading with distance change would be a factor to be compensated for in receiving. Time alone will tell what equipment improvement will be necessary before reliable two-way contact will be possible.

Time

One factor, however, that time has very little likelihood of changing, is time itself. Seldom thought of as a nuisance on Earth is the universal physical constant for the velocity of electro-magnetic radiation (186,272 miles per second). But what a nuisance it will be for space travellers. From New York to Capetown, South Africa, via the ionosphere, is approximately 7900 miles. A ten or twenty meter signal makes the round trip in just under 43 thousandths of a second. Moon-to-Earth contacts are not likely to be bothersome, for only 2.55 seconds would pass before one's carrier went off the air and the return signal was at your antenna ready to be received. For Mars the delay for the round-trip would be 6 minutes, 48 seconds at closest approach, and 42 minutes, 5 seconds at its furthest distance. Plenty of time here to fill out the log and address the QSL. A QSO with Pluto would be more like exchanging telegrams, for 10 hours, 58 minutes, 24 seconds would pass before you could even hear an answer to your CQ. Unless someone, someday, finds a way of speeding up radio waves, nothing can be done about this time lag. For long distance space contacts the very nature of ham QSO's will have to change. Any thoughts of the break-in techniques applied today are out of the question.

The foregoing paragraphs have outlined some of the problems that will confront hams when space travel becomes a reality. In an article of this size not all of the difficulties can be dealt with. If they seem insurmountable, it's because we tend to look at them in the light of present day knowledge. But problems have a habit of becoming solved, given enough time and effort. It is with pride that we acknowledge the contributions made by Amateur Radio operators toward the development of the art of radio to its present status. It goes without saying that future hams will make equally important advances, and we will take space-hamming in its stride.

Who will be the first ham to answer a call signing, "This is W8XYZ, operating portable at Base Camp, Earth Expedition One, Syrtis Major, Mars." For that matter, who will be the first ham to make that call? ■

MOSLEY TRAPMASTER
Model TA-33
for 10, 15 and 20

8 DB FORWARD GAIN
over reference dipole

conscientiously measured with the finest, most accurate equipment

Mosley Electronics, Inc.

8622 St. Charles Rock Road • St. Louis 14, Mo.
For further information, check number 54 on page 194.

NOW - faster, easier **ball-bearing drive** **for GREENLEE** **chassis punches**



New GREENLEE Ball-Bearing Drive Nuts and Drive Screws reduce friction and make it easier than ever to cut smooth, accurate holes with GREENLEE No. 730 Round Radio Chassis Punches. The new faster drives are available for all round-type GREENLEE Punches sizes 11/16" through 2-25/32". Operate with ordinary wrench for quick socket openings, etc., in metal, Bakelite, or hard rubber.



GREENLEE TOOL CO.
2371 Columbia Avenue
Rockford, Illinois

For further information, check number 57 on page 194.

NOW LOOK HERE!

BC-221 Frequency Meter

Real Value! QUANTITY IS LIMITED. First come, first served. They are just like new, with original calibration charts. Range: 125-20,000 KX with crystal check points in all ranges. Complete with crystal and tubes.



\$82.50

MODULATED TYPE\$102.50
MODULATED TYPE with AC
Power Supply\$117.50

These Frequency Meters are factory tested, checked for frequency alignment and **GUARANTEED**.

I KW. POWER SUPPLY SPECIAL

Includes: PLATE TRANSFORMER, DUAL 110 V. windings for 110-220 V. 60 cy AC. Secondary: 3750-0-3750 V. @ 275 Ma. 15,000 V. Breakdown Rating. Oil Filled. PLUS 2½ V. @ 10 Amps. Filament Transformer, Oil Filled. Rated at 15 KVA.

BOTH FOR ONLY **\$19.95**

BC-929A SCOPE INDICATOR. BRAND NEW! With all tubes. Exc. for conversion to 3" scope. **PRICE ONLY 14.95**

I-196A SIGNAL GENERATOR. 150-236 Mc. Brand New! With Canvas carrying case. ONLY **\$3.95**

BC-906C FREQUENCY METER. 140-225 Mc. Exc. Condx. Complete. PRICE ONLY **\$9.95**

BC-684 FM XMTR. 27-39.7 Mc. With all tubes, less dynamotor (DM35) Used \$6.95 New **\$15.95**

BC-604 FM XMTR. 20-27.9 Mc. With all tubes, less dynamotor (DM35) BRAND NEW **\$15.95**

SPECIAL! DM35 DYNAMOTORS. INPUT: 12 Volts. OUTPUT: 625 V. @ 225 Ma. Exc. Condx. **\$10.95**

BC-312 RECEIVERS. Complete with RA-20 110 V. AC supply. Used, exc. condx. **\$79.50**

BC-603 RM RCVRS. 20-27.9 Mc. Used, exc. condx. \$10.95 BRAND NEW **\$15.95**

110 V. 60 CY AC SUPPLY for BC683, BC603. Fits into dynamotor compartment. **CONCORD SPECIAL \$10.95**

BC-1335 10 METER FM TRANSCEIVER. 6-12 V. With tubes, used, exc. condx. A real buy at only **\$29.95**

BC-659 FM TRANSCEIVERS. 27-39 Mc. As new condx. With tubes, less P.S. Low price, only **\$10.95**

PE-120 VIBRATOR SUPPLY. Exact unit for BC-659. 6, 12 or 24 V. INPUT. 150 V. 80 Ma. OUTPUT. ALL BRAND NEW. Hurry on this item, only **\$7.95**

ARB RECEIVERS. 190-9050 Kc. See June CQ for conversion article. Less tuning head. Used, clean condx. **\$18.95**

TS-13 HANDSETS. Complete with plugs. Used for BC-659, BC-1335, etc. BRAND NEW \$4.95 USED **\$2.95**

HS-16U 8000 ohm impedance Headset. BRAND NEW, with rubber earpads. Most sensitive Headset. **CONCORD'S special \$4.95**

ARC5/T23. 2 Meter Transmitters. BRAND NEW, CAR-TONED. With ALL tubes. While supply lasts, only **\$19.95**

INCLUDE CHECK OR M.O. WITH ORDER. NO C.O.D.'s
WRITE FOR FREE CATALOG "Q"

CONCORD RADIO CORP.

45 WARREN ST. • NEW YORK 7, N. Y.
Tel. Dlgby 9-1132 Open 9-6 (incl. Sat.)

For further information, check number 58 on page 194.

REMOTE CONTROL [from page 70]

PARTS LISTS

Control Unit

CH1—Triad C-5X, 12H, 75 ma.
CH2—Triad C-1X, 15H, 20 ma.
CH3—UTC H-24 or A-30
C1, 2, 3, 4—1.0 mfd, 400 vdc
C5, 6—0.5 mfd, 400 vdc
J1—Cinch-Jones S-202-B
J2—Cinch-Jones P-202-B
K1, 2 — Potter-Brumfield KA11A, DPDT, 115 vac
K3—Potter-Brumfield SS5D Sensitive relay
M1—Triplet 420PL, 50 microampere meter
MR1—Conant series 500 or Schauer A4M meter rectifier
R1, 2, 3, 4, 8—Mallory M20MPK, 20k, 4 watt
R5—3.3k, 1 watt
R6, 7—10k, 1 watt
S1, 3 — Switchcraft 3037, DPDT, NO
S2—Western Electric 479JR
S4 — Switchcraft 3037L DPDT, NO
SR1, 2, 3—Federal #1159, 4 each set bridge connected
T1—UTC A25 plate to line transformer
T2—WRL XA-761 plate to line and voice coil
T3 — Triad R-9A power transformer
T4 — Triad A-9J input transformer
T5, 6, 7—Triad F-40X 24 v., 1 a., filament transformer
T8—UTC A-10 line to grid transformer
Relay Units
C1—20 mfd, 450 vdc
C2, 3—1.0 mfd, 400 vdc
D1, 2, 3, 4, 5, 6—IN34A crystal diode

K1, 2, 3, 4, 5, 6—Potter-Brumfield SS5D sensitive relays
K7A, 7B, 10A, 10B—Potter-Brumfield KA11A, DPDT, 115 vac
K8 — Advance LE/2C/115VA, DPDT latching relay
K9, 19, 20, 21, 22—Potter-Brumfield PR7AY, DPST, 115 vac
K11, 12—Agastat NE-11, 115 vac
K13—Amperite 115C2, 2 second time delay SPST, NC
K14—Amperite 115NO2, 2 second time delay SPST, NO
K15—Amperite 115 NO30, 30 second time delay SPST, NO
K16 — Potter-Brumfield PR5AY
K17—Coaxial antenna relay with auxiliary contacts
K18—Rotary solenoid, 30° indexing, 120 ohm coil
S1—Mallory 3222J, 2 pole, 2 pos., non-shorting
S3, 4, 5, 6—Switchcraft Littell-switch 201
S7 — Switchcraft 3037L, DPDT, NO
SR1 — Selenium rectifier, 300 ma.
SR2—Federal #1017 selenium rectifier, full-wave bridge 600 ma.
R1, 2—10k, 1 watt
T1, 2 — Filament transformer, 6 v., 1 a.
T3 — Raytheon VR6110 voltage regulating transformer
T4—Filament transformer, 6 v., 3 a.

QRG [from page 32]

Ham bands by any means, and if you are also an SWL just toss in the proper crystal near the SW band and you will have nice check points on 16, 19, 25, 31, or 49 meters. The accuracy is of course very dependent upon the calibration of these crystals, and a surplus crystal should be checked against a reliable frequency meter.

SW1 is used to remove the 10 kc modulation, thereby permitting quicker and easier location of the frequency of the crystal, which otherwise would have to be located by its greater amplitude than the adjacent markers.

Oh yes, actual frequency stability of the unit? Well—build it up and find out. You won't be sorry, that's for sure. A couple of pointers on insuring stability might be in order. Mechanical stability of the case is important since the case

is used for shielding the low frequency oscillator coil, and does affect the inductance of the coil somewhat. And the wave shape of the transistor oscillator might be checked to insure that it is a fair sine wave. Excessive distortion here means the transistor is loading the tuned circuit too heavily, although some distortion or clipping must be present to generate the 10 kc harmonics. The crystal oscillator will actually oscillate on as low as 10 volts, but 67.5 volts was used so the battery voltage dropping off slightly with age wouldn't be a problem. Then too, 1R5's also have a tendency to age a bit, and are really fussy with having the correct filament voltage at all times. In soldering the penlite cells in place, be careful about the hole in the center of the top cap, the manufacturer didn't waste time and money putting the hole there for nothing.

After you've assembled the unit, you will probably find it was just as inexpensive as a home built 100 kc crystal oscillator would have been, and twice as much fun. And no more worry about excursions outside the bands. ■

RULES [from page 53]

market which will provide for the operating ground. This as a wall outlet¹ which will replace the standard type outlet. In addition to the slots for the two parallel power plug blades, it has a U-shaped opening for a ground wire. Attachment caps² and cord sets³ are available for these outlets, although the standard household plugs can still be used with them. Before installing one of these units, it will be necessary to determine whether or not the outlet box is grounded. If your house is wired with conduit or flexible metallic cable, it is probably grounded. If the wiring is open-type, however, it is unlikely to be grounded and you will have to provide an additional wire for the ground. With this type of grounding plug the equipment is automatically grounded whenever the power is available to operate, and additional wires for grounds are unnecessary.

In addition, the National Electrical Code requires that all controls be grounded, transmitters shall be enclosed in a metal frame or grille, and all access doors shall be provided with interlocks which will disconnect all voltages in excess of 350 volts when any access door is opened.

These rules are not stringent. They are all common-sense requirements, and many amateur stations, no doubt, now comply with them. Knowledge of the rules and their existence is, nevertheless, a valuable factor in the presentation of the amateur station as a safe and conforming installation. ■

1 Bryant 5242; Hubbell 5252; General Electric 4060
2 Bryant or Hubbell 5263, 5264, 5266; General Electric 4363-5
3 Pacific Electriccord 1316, 2316

MOSLEY TRAPMASTER

Model TA-33
for 10, 15 and 20



the specially-
designed
Mosley Match...
built-in for
stability, fully
pre-tuned...
does the job!

Mosley Electronics, Inc.

8622 St. Charles Rock Road • St. Louis 14, Mo.

For further information, check number 54 on page 194.

GOV'T SURPLUS BARGAINS

12 VOLT DUAL DYNAMOTOR supply. Output 220 DC 100 mils plus 400 DC 200 mils. TCS Mobile Xlnt	\$ 9.95
SNOOPERSCOPE, British, hand held with self contained 2,000 volt supply, focussing eyepiece.....	New 14.50
RECEIVER BC-455 (6-9.1 mc).....	New 12.75
	Xlnt used \$8.50; Used \$ 6.00
ARC-5 TRANSMITTER T-19 Marine (2.1-3 mc).....	New 10.00
RDO SEARCH RECEIVER 30-1,000 mc w/tuning units	Xlnt 75.00
RBM RECEIVER, long wave & broadcast 200-2000 ke	Xlnt 25.00
SATELLITE RECEIVER BC-733 (108.3-110.3 mc) Xlnt	7.00
ARB RECEIVER control box	New 1.00
CRT-2 spark-gap radio xmtr w/parachute Shipping wgt 60 lbs.	New 6.50
PARABOLIC MIRROR 12", glass, Bausch & Lomb front surface coated (very difficult to procure)	New 12.50
PARABOLIC REFLECTOR aluminum, 17" diameter	New 2.50
U.S. TANK PERISCOPE assembly, see around corners New	2.50
TECH MANUAL for BC 312-342-314-344.....	2.50
TECH MANUAL for BC 1335.....	3.00
TECH MANUAL for Teletype Mod. 14.....	7.50
TECH MANUAL for Teletype Mod. 15.....	7.50
TECH MANUAL for PRC-6 Handle Talkie.....	.25

All material USED unless otherwise noted. All F.O.B. Malden Mass. All radios with all tubes etc. Free schematic with all radios. Eye-popping bargain catalog free.

MESHNA ENTERPRISES

580A LYNN STREET • MALDEN 48, MASS.

For further information, check number 59 on page 194.

NEW BOOKS!

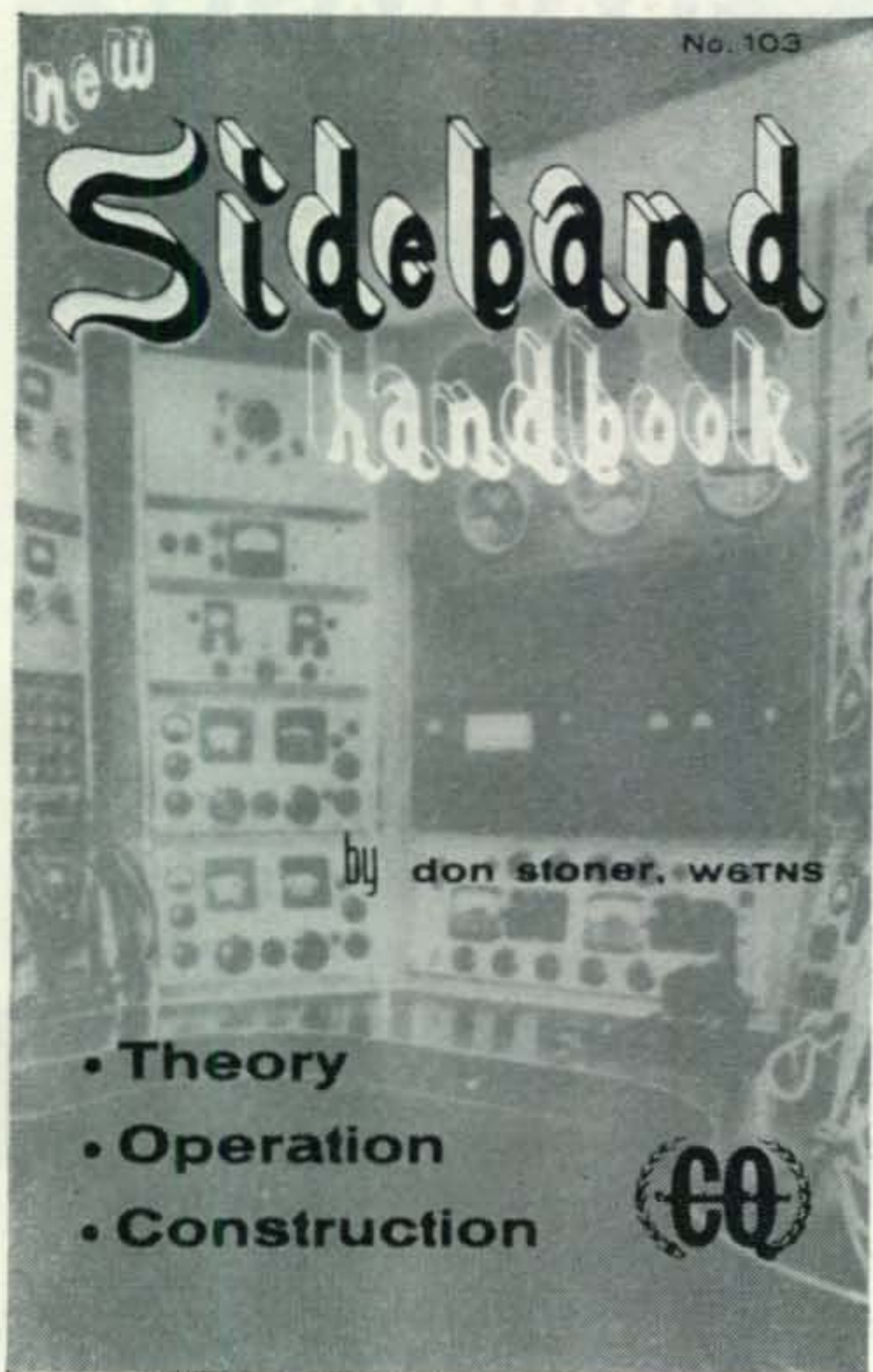

SIDEBAND HANDBOOK

Well, we've done it again. We've got a brand new Sideband Handbook on the presses. Everything in this book is new. All of the dozens of construction articles were written specially for this book. There are absolutely NO reprints of any information that has appeared in CQ or anywhere else. This book is new from cover to cover. Written by Don Stoner, W6TNS, Novice and Semiconductor Editor of CQ as well as author of the best selling Novice & Technician Handbook was almost one full year in the preparation of this terrific volume. This is *not* a technical book. It explains sideband briefly and then spends most of the time on showing you how to get along with it . . . how to keep your rig working right . . . how to know when it isn't . . . and lots of how to build-it stuff, gadgets, receiving adaptors, exciters, amplifiers . . .

The price? Way out of line, only \$3.00 . . . it should be \$7.00.

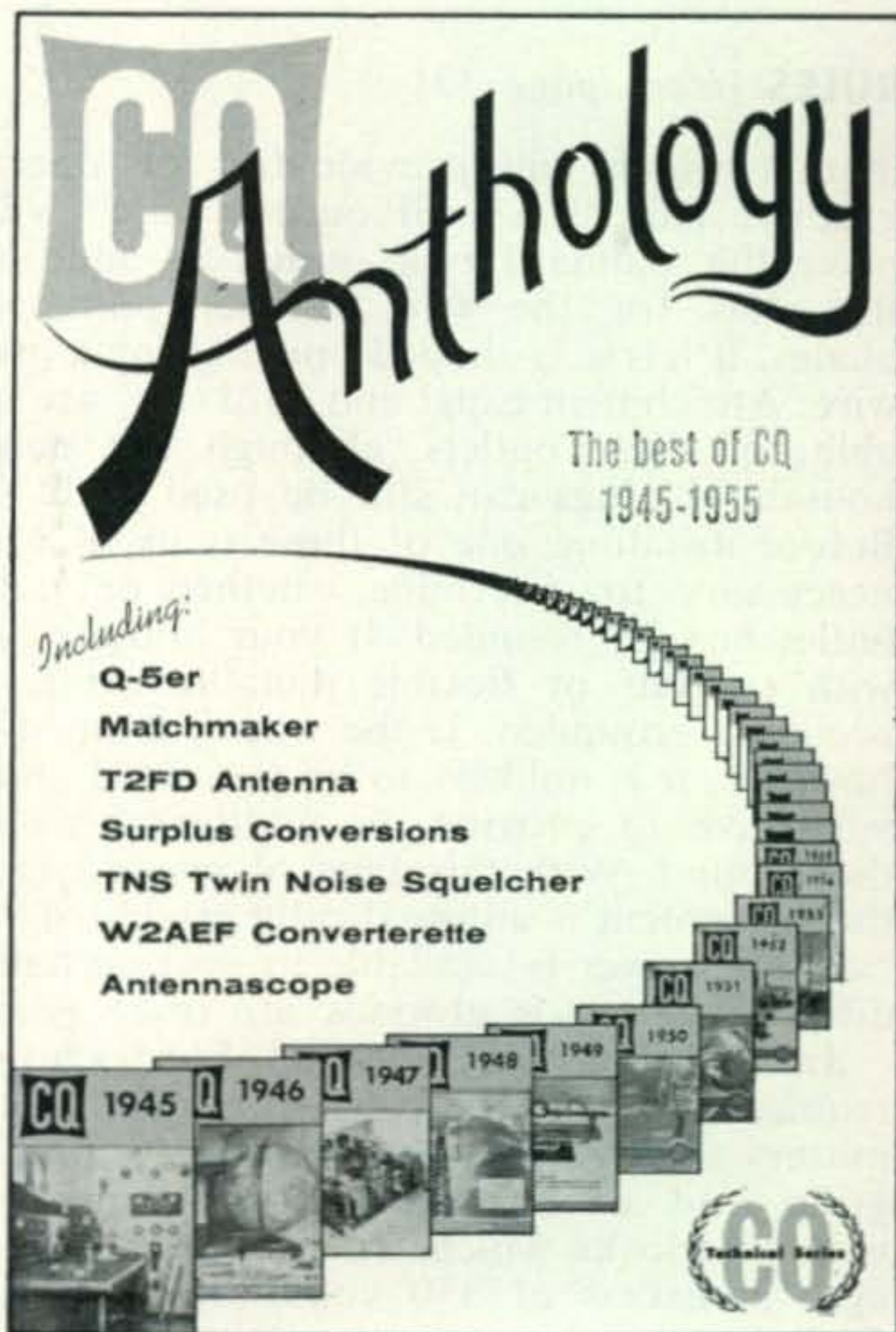

CQ ANTHOLOGY

Down through the years CQ has had the honor of being there first with just about every major discovery in the amateur radio field. Unfortunately most amateurs do not have a good file of back issues of CQ to fall back on when they are interested in building up something or in improving their equipment. So we've looked back through the years 1945-1955 and assembled all in one place the articles that have made a lasting stir. The issues containing most of these articles have long ago been sold out and are unavailable. The price is a paltry \$2.00.

Including:

- Q-5er
- Matchmaker
- T2FD Antenna
- Surplus Conversions
- TNS Twin Noise Squelcher
- W2AEF Converterette
- Antennascope

CQ MAGAZINE BOOK DEPT.

300 West 43rd St.,
New York 36, N. Y.

New Sideband Handbook CQ Anthology

Sirs: I enclose.....Please send the items I have checked above postpaid to:

NAME CALL

ADDRESS

CITY ZONE STATE

N.Y. City residents add 3% Sales Tax

C-11

(see page 54)

The Old Timer

Answers

Please take test *before* reading answers. (ed)

Here are the correct answers:

1. This is definitely TRUE. "Physics," Housman & Slack 3rd Ed. p 350
2. Since there is no scroll work, an amateur license is NOT a federal document and *can* legally be photocopied. See "US Amateur Regulations." 12.25. Answer was FALSE
3. Electrons themselves move slowly but their effect travels at the speed of light. Ref: Any physics book, Ans. FALSE
4. If the electron was accelerating, the statement would be true. See "Federal Handbook" 4th Ed. p 891
5. $\frac{1}{2}$ of 72 = 36 TRUE. Any antenna handbook
6. TRUE
7. TRUE
8. TRUE
9. If the current was changing at a rate of 1 ampere per sec it would be true. See "Physics" H&S p 446
10. This is a stinker. Most people miss this.

$$Q \text{ series} = \frac{WL}{R}$$

$$Q \text{ parallel} = \frac{R}{WL}$$
 Answer FALSE. "Alternating Current Circuits" Kerchner & Corcoran 2nd Ed. p 103
11. Only persons possessing a valid amateur operator's license may *OPERATE* a properly licensed amateur station. See "US Amateur Regulations" § 12.28
12. This is TRUE. See "US Amateur Regulations" § 12.190
13. This will surprise most anyone but, you *CANNOT* legally destroy your own transmitter if you want to. Want proof? See "US Amateur Regulations" § 12.161. Answer FALSE
14. There is no such thing as a "Portable Mobile" etc. The regulations do not possess such a term. Answer FALSE
15. You boys aren't keeping up with the latest jazz. This used to be legally TRUE but no more WHOOPIE!! See "QST" Nov 57 p 69 Docket #12160 Amends section § 12.90 § 12.91 and § 12.93
16. TRUE
17. It is TRUE chilluns. See "Physics" H&S p 539



MOSLEY TRAPMASTER

Model TA-33
for 10, 15 and 20

...but

Now! Not Just Rust-Resistant
FULLY RUST-PROOF!

All metal parts of aluminum, brass or stainless steel— including screws and U-bolts!

Owners of earlier TA-33 models can obtain rust-proofing kits at cost.

Mosley Electronics, Inc.

8622 St. Charles Rock Road • St. Louis 14, Mo.

For further information check number 54 on page 194.

BACK ISSUES FOR SALE

- 1947—Feb. May, Sept., Oct.
- 1948—March, Aug.
- 1949—March, May, Dec.
- 1950—Jan., Mar., July, Oct., Nov.
- 1951—All issues, except May, Nov.
- 1952—All issues, except Jan., Aug.
- 1953—All issues, except May, July, Dec.
- 1954—All issues, except Feb.
- 1955—All issues, except Nov.
- 1956—All issues, except April, July
- 1957—All issues, except Feb. and Nov.
- 1958—All issues

\$1.00 per copy

Except 1958 Issues — 50¢

CQ Magazine

300 West 43rd St., New York 36, N. Y.

NON-METALLIC GUY LINE — PERFECT FLEXIBLE INSULATOR — REVOLUTIONIZES HAM RADIO & TV ANTENNA SYSTEMS

*Non-inductive, non-conducting, non-absorbing
Glas-Line isolates systems from directional
arrays, rhombics, etc.*



The new main insulator of W3UCT. The Glas-Line is between the two egg insulators running to the lower left. The copper link between the center egg insulator and the upper right egg insulator is for the dead-end feeder of a Zepp antenna.



View of an open thimble and eye bolt for coupling the Glas-Line guy wire to a tree.

GLAS-LINE cannot rot, will not shrink, stretch or sag... has high breaking strength of over 500 pounds. Only \$2.89 per 100'. Send 50¢ postage TO GLAS-LINE CO., BOX 2, RIVERDALE 71, N. Y. OR THE FOLLOWING:

Barry Electronics Corp., 512 Broadway, N. Y. 12, N.Y.
Bob & Jack's, 611 Forest Ave., Des Moines 14, Iowa
Consolidated Radio Co., 612 Arch St., Phila. 6, Pa.
Resco Electric Supply Co., 961 E. Sullivan St., Kingsport, Tenn.
Hargis-Austin, Inc., 410 Baylor, Austin, Texas
M. N. Duffy & Co., 2040 Grand River Ave., W. Detroit 26, Mich.
Fargo Radio-TV Service Co., 511-515 3rd Ave., N., Fargo, N. D.
Busacker Electronic Equip. Co., Inc., 1216 W. Clay, Houston 19, Tex.
Scott Radio Supply Co., 266 Alamos Ave., Long Beach 2, Calif.
Electronic Wholesalers, 2345 Sherman Ave., N.W. Washington 1, D.C.
Electronic Supply Co., 61 N.E. 9th St., Miami 32, Fla.
413 New Haven Ave., Melbourne, Fla.
Alaska Radio Supply, 307 Seward St., Box 2538, Juneau, Alaska
Henry Radio, 11240 W. Olympic Blvd., P.O. Box 64398, Los Angeles 64, Cali.

GLAS-LINE

P. O. BOX #2 RIVERDALE 71 NEW YORK

DISTRIBUTOR INQUIRIES INVITED

For further information, check number 60 on page 194.



4X150A Tubes

GUARANTEED NEW, SURPLUS

These are high grade, unused EIMAC and RCA Tubes. Manufactured to meet JAN specs. Net price \$38.95
ONLY \$12.75

H & C SALES, Box 1603, Pittsburgh 30, Pa.

USA MIL TECH MANUALS

AN, TS, UPM, PRC, SCR, R, PE, PH, PW, TG, CF, OA, O, EE, RT, SG, TC, VRC, Etc.

Catalog upon request. Large stock!

JAPAN ELECTRONIC TRADING CO.
CPO Box 1556, Tokyo, Japan



Groth TURN COUNT DIAL

Registers Fractions to 99.9 Turns

OR roller inductances, INDUC-TUNERS, fine tuning gear reducers, vacuum and other multivolt variable condensers. One hole mounting. Handy logging space. Case: 2" x 4". Shaft: 1/4" x 3". TC 2 has 2 1/8" dial—1 5/8" knob. TC 3 has 3" dial—2 5/8" knob. Black bakelite.
TC 2 \$4.20—TC 3 \$4.75—Spinner Handle 75¢ extra
Add 8¢ for Parcel Post

R. W. GROTH MFG. CO.
10009 Franklin Ave. Franklin Pk., Illinois

18. Some of yo'all jus' don't read science fiction. Answer TRUE
19. Were you caught with your pants down on this one? It happens to be TRUE. See "Transmission Lines & Fields" by Johnsen.
20. Tricky!!! 1. RG58/AU is 53.5Ω not 72Ω
2. it says *electrical* length not physical. Answer FALSE. If it said 53.5Ω and physical length it would be true.
21. FALSE
22. F.M. is flat. P.M. has an inherent 6db per octave pre-emphasis. Hence with *complex* audio the signals must be different. See any text on F.M.
23. These are all TRUE. Included to point out the seldom realized advantages of SSB, P.M., and F.M., over A.M. See "Modulation Theory" by H. S. Black.
 1. They're all in parallel kiddo. $48/4 = 12$
 $12/2 = 6$ $6/2 = 3$ Answer 3
 2. This is a dilly. There are *two* answers. Since I is common in series circuit

$$I_1 = \frac{P_1}{E_1} = \frac{10}{E_1}$$

$$I_2 = \frac{E_2}{R_2} = \frac{E_2}{10}$$

$$\therefore \frac{10}{E_1} = \frac{E_2}{10}$$

$$100 = E_1 E_2$$

$$100 = E_1 (25 - E_1)$$

$$100 = 25 E_1 - E_1^2$$

$$E_1^2 - 25 E_1 + 100 = 0$$

$$(E_1 - 20) (E_1 - 5) = 0$$

BUT $E_1 + E_2 = 25V \therefore E_2 = 25 - E_1$

$$E_1 = 20 \quad E_1 = 5$$

$$I_1 = \frac{10}{20} \quad I_1 = \frac{10}{5}$$

$$I = .5 \text{ amp} \quad I_1 = 2 \text{ amp}$$

3. Had you going eh?

$$\frac{x \text{ blips}}{22.5 \text{ sec}} = \frac{x \text{ miles}}{\text{hr}} = \frac{5,280 \text{ ft}}{3600 \text{ sec}}$$

$$1 \text{ blip} = \frac{22.5 \text{ sec} \times 5,280 \text{ ft}}{3600 \text{ sec}} = 330 \text{ ft}$$
4. Lazy "H" remember the early TV rage?
5. As the battery charges the charging current diminishes, therefore the apparent resistance must have increased. Answer R INCREASES
6. Same thing (aren't we devils) Answer I DECREASES
7. This separated the men from the boys. Correct answer is 4.9V. Did you forget that the 6.3vdc flows through 1/2 of primary during 1/225 of a second, but the ac (rms) goes thru a complete cycle in 1/60 of a second? See any commercial mobile power supply schematic such as RCA, Dumont, Link, G.E. etc.
8. Leading by 45° or lagging by 315° any text.
9. (a) lose 63% . . . any text
10. (c) 4 times . . . see any ARRL handbook section on Modulation

Modulation [from page 52]

it both ways, and in the more than two years the system has been in operation, have never received a report other than of "plate modulation" quality.

The simplicity and ease of adjustment of the system, together with a minimum of modification, should recommend it to hams whose main interest is cw.

As to specifications for the choke—almost any old filter choke will do. However, if the inductance is much more than 8 Henrys, bassy modulation will result. Also, the choke should be rated for at least 100 ma., to avoid saturation. ■

TELETHONS [from page 47]

handling paper work, answering the telephone, making coffee and attending to a lot of numerous details. Besides, this will instill them with the spirit of ham radio and co-operation. It will also give them the sense of "belonging" to the organization.

Arrangements with a local bank will solve the handling of money collected by the mobile operators. A choice can be given the mobile operator of turning his collection over to the bank personally, or he may drop it off at the control center. In the latter case, adhere to the following procedure. As each operator arrives, have him place the receipt book and money on a table at which two control center personnel are seated.

While one man double checks the amount of money collected, the other totals the amount as shown on the receipts. When the two totals coincide, the money and receipt book are placed in an envelope and sealed. The mobile operator's name or call is written on the envelope together with the amount contained therein.

One of the men, or two if you wish, is delegated to turn the envelopes and contents in to the bank. It may be wise to have a police escort. Otherwise, ask the telethon sponsors to send a man to pick up the collections. Be sure to obtain a receipt showing the exact amount delivered to him.

Maybe this whole thing seems like a lot of work, but the resulting publicity is worth it. Amateur radio will have been brought to the attention of the general public by television, newspapers and in person by the mobiles. ■

SG-8 [from page 49]

Remove 5600 ohm resistor between TD-1 and G-5, replace it with a 15,000 ohm 1 watt carbon resistor (NS).

Run an insulated lead from G-5 (S) to terminal 3 of 10,000 ohm section of new control (S).



**MOSLEY
TRAPMASTER**

Model TA-33
for 10, 15 and 20

Aluminum Elements AND Boom

STRONG!

No boom braces needed!
No noticeable sag!

Mosley Electronics, Inc.

8622 St. Charles Rock Road • St. Louis 14, Mo.
For further information, check number 54 on page 194.

YOUR mailing strip is IMPORTANT

4- 8C 123 c DEC 60
SUSAN B QUICK-W2SLA
139 BCH 112TH ST
ROCKAWAY PARK N Y

This is a typical mailing strip

Whenever you write to CQ concerning your subscription, change of address, or renewal, cut your mailing strip from the wrapper of your latest copy and attach it to your letter.

This will help us to find your stencil in our files which is the first step in faster, more accurate service to our readers.

CQ Magazine

300 West 43 St., New York 36, N. Y.

BC 603 FM RECEIVER



20-27 mc. Equipped with 10 push buttons for selecting channels. Cont. variable tuning over the entire range. Unit complete with tubes, built-in loud speaker, squelch circuit, head phone jacks, schematic diagram on bottom of case. Approx. weight 34 lbs. For conversion to 6 meters AM or FM see Sept. and Oct. issues of "C Q".

\$12.95
Unused.....

Original 12 Volt Dynamotor for above DM 34. Unused..... **\$4.95**
24 Volt Dyno — Used..... **\$2.95**

BC 604—Companion Transmitter for above 20 to 27 MC FM. Unused..... **\$8.95**

Original 12 Volt input Dynamotor for above—625 VDC C 225MA output. Unused..... **\$10.95**
24 Volt — Used..... **\$4.95**

FT 237—Mounting rack for above Rec. & Transmitter. Unused..... **\$4.95**

BC 659—FM RECEIVER-TRANSMITTER, xtal controlled, two channels, freq. range 27-38.9, 9 mc. 13 tubes, built-in speaker, dual meter for testing filament and plate circuits. F.O.B. West Coast or Chgo. EXC..... **\$6.95**

WHIP ANTENNA—For transmitting and receiving. Monel metal. 8 foot telescopic. BRAND NEW..... **\$1.29**

I-177—TUBE CHECKER. A portable dynamic or mutual trans ductance type. 3" circular meter indicates condition of tube for normal operation. Presence of gas, short circuits between elements and noise, also measures the dynamic mutual conductance. 110 V. AC — 60 Cycle. EXC. **\$16.95**

ARB/RCA—SIX TUBE RECEIVER. All purpose super het receiver covering 195 KC to 9000 KC including weather, lighthouse, aircraft, radio range, broadcast, marine and amateur 160 meter, 80 meter, 75 meter and 40 meter, with tubes, 24 volt dyno. and schematic. EXC. **\$17.95**

Accessories for remote tuning per set..... **\$5.00**
See June 1958 "C Q" for conversion.

\$45.00—HI-FI HEADSET. Uses annular grooved plastic fibre comes with voice coils as in speakers and brand new rubber ear pads to obtain spacing for correct acoustical load. GIVES FINEST MUSIC REPRODUCTIONS! Imp.: 300 Ohms per unit or 600 Ohms when wire series. BRAND NEW..... **\$9.95**

HS-23—Air Force high impedance. 2000 Ohm headphones. Complete with sponge rubber earcups, headband and cord. BRAND NEW..... **\$4.95**

CD-307—Extension Cord for above..... **\$.97**

BC 669—Six Channel Crystal Controlled, 50 Watt Radio Telephone, 1600 to 4500 KC. Ideal for boats or land station, less power supply. Used..... **\$59.50**

METER. 3"—0-5 Ma. 270° Indication—By Pass Shunt and add scale. Excellent condition..... **\$1.25**
Five for **\$5.00**

T-19—3-4 MC XMTR. EXC..... **\$ 5.95**
BC-458—5.37 MC EXC..... **\$ 5.95**
T-23—100-156 MC XMTR. NEW..... **\$13.95**
R-28—100-156 MC RECEIVER. EXC..... **\$15.95**

TA-12 XMTR, 100 Watt. EXC..... **\$19.95**
MP-28 MODULATOR and 28 V. DC Power Supply for above. EXC. **\$14.95**

WRITE FOR LATEST FLYER

R W ELECTRONICS

2430 S. Michigan Ave., Dept. CQ, Chicago 16, Ill.
Phone CALumet 5-1281

Run an insulated lead from TD-1 (S) to terminal 1 of 10,000 ohm section of new control (S).

Replace 150 mmfd. condenser between R-2 and TA-2 (on subchassis) with a .005 mfd. disc ceramic (S).

Replace "AF IN-OUT" knob.

Replace signal generator in cabinet.

These changes should take between 15 and 30 minutes, depending upon your personal working speed. The instructions are valid whether the 1 megohm section of the potentiometer is on the front or the rear.

Operation of the rf section of the signal generator is unchanged by addition of variable percentage modulation; and the external af output functions the same as before. When an external af modulating source is used, available power, for a given source, is very much greater, and variation produced by the "AF IN-OUT" control is now exponential, instead of linear (R^2 instead of R , R being the setting ratio).

When internal modulation is used, normal setting of the "AF IN-OUT" knob will be about 1/3 of the way clockwise from the left stop, and 100 percent modulation will be about 2/3 of full clockwise rotation. For normal servicing use, no other changes are either necessary or desirable.

When the instrument is to be used extensively in tropical environments, or in isolated locations where the line voltage, frequency, and wave form leave much to be desired, operation will be improved, and service life extended by the following changes:

1. Replace all 1/2 watt resistors by 1 watt resistors.
2. Connect a 10 ohm, 2 watt resistor in series with the pilot.
3. Replace the 20-20 md. 150 volt filter capacitor by a 50-50 mfd. filter capacitor.
4. Connect a 50 mfd. 150 volt electrolytic capacitor from TD-1 to ground. ■

SIDEBAND [from page 44]

changed to send us to Kingston and Grand Cayman. We got to Kingston on the 17th, but Sam, VP5RS, had left for the States on a business trip the day before, so were unable to get on from Jamaica. The next morning, we went over to Grand Cayman. Sparky, VP5BH, was at Owen Roberts field waiting for us. (We had been enabled to get on at Cayman through the kind offices of W8SDD who informed us that we'd have to get in touch with Bob, W4OMW, to get permission to operate from Sparky. A quick letter to Bob had gotten the required permission.) Sparky took us down to the Bayview Hotel, where the O.V.A.R.A. gang operated during their celebrated DXpedition last year. The Merrens, who own the hotel, also run another hotel, the Pageant

For further information, check number 61 on page 194.

Beach, and they suggested we take a look at it before we decided on an operating site. After viewing the pool, the beach, and other facilities, we decided that the Pageant Beach was for us. Phil was in Europe on another trip, and Herman wasn't able to come because of sickness in his family. Consequently, Jim and I carried the torch with the help of Sparky. Without the 14-AV, we had to set up dipoles again for 80, 40, and 15, along with a vertical for 20. While the antennas worked all right, again the antenna switching cost us much of the advantage we had in the easy bandchanging of the HT-32. However, we managed to work over six-hundred stations between 1600 on the 18th, and 0900 on the 20th. It was fortunate that we were able to get on when we did, as Cayman lost its separate country status on June 1st. We concentrated on SSB again, but worked a number of cw stations, also. Sparky is a former ship radio operator, and until recently worked as operator for one of the airlines at Owen Roberts. Naturally, his cw operating left nothing to be desired. The O.V.A.R.A. gang had dispensed great numbers of contacts on cw and am last year, and Noel Eaton had given a number of the boys Cayman on am a few weeks before we set up, but there was still a pileup most of the time. This was particularly true on SSB. While we weren't the first station to operate SSB from Cayman, most of the boys still needed it.

Getting away from the ham end of the trip, a few minutes after we got set up, in came the owner of the Cayman Yacht Club, Jim Ford, who is an American from Detroit. A former Navy Commander, he has settled in Cayman, and runs a ship in addition to Yacht Club. After seeing our efforts, he brought over varied refreshments to keep us going. The next day, he took us for tours of the islands in shifts to keep the rig on the air. That night, he threw a dance for us at the club. All this hospitality threatened to disrupt the operating schedule, but Sparky filled in the breach. We managed to get off on the 20th, and got home all right.

The next weekend, we were scheduled for San Juan and Barbados. I had hoped to get to South Caicos again, but the schedule was changed again to send us to Kingston and Barbados. We spent the night of the 23rd in Kingston. Sam still wasn't back from the States, so we left the gear in the plane again. However, Sam should be on SSB soon with a good rig, and everyone who needs Jamaica should be able to get it without having to fight DXpedition QRM. We arrived in Barbados on the evening of May 24th, and blew a tire on landing. It took several hours to make arrangements to get a replacement tire and tube, and we didn't get set up at VP6LT until 2200. We had to stay on 15 that night, as it was too dark to put up the 14-AV. The next morning the vertical was put up, and this let us hit

[continued on page 180]



MOSLEY TRAPMASTER

Model TA-33
for 10, 15 and 20

Ham Net \$99.75
For U.S.A. Only



**BUILT TO
HANDLE
MAXIMUM
LEGAL
POWER —
WITH EASE!**

Mosley Electronics, Inc.

8622 St. Charles Rock Road • St. Louis 14, Mo.
For further information, check number 54 on page 194.

Cut Warm-up Drift on SSB—

End Dampness Failures with

DAMPP-CHASER

CHASSIS DEHUMIDIFYING HEATER®

End leaky condensers — protects Xformers — even in basements. Automatic — never needs attention!

Model 1E 12½" Long, 8 Watts, 117V
Model 3E 18½" Long, 12 Watts, 117V

Two sizes fit any RX, TX or Electronic Equipment. 24" attached cord solders to power SW terminals. Mounting clips and simple instructions included.

Original equipment in Hallicrafters SX-101 and over 12 leading Electronic Organs.

Money back if not satisfied after 30 days trial.
PLUS 5 Year Written Guarantee.

NET \$4.95

POSTPAID

Anywhere in the world.

Airmail order today— we ship tomorrow. State models required. Sorry— No C.O.D.'s. Send \$4.95 each: Check or M.O. to:

DAMPP-CHASER, INC.
P. O. BOX 520
HENDERSONVILLE, N. C.

Over a decade of
quality manufacturing.

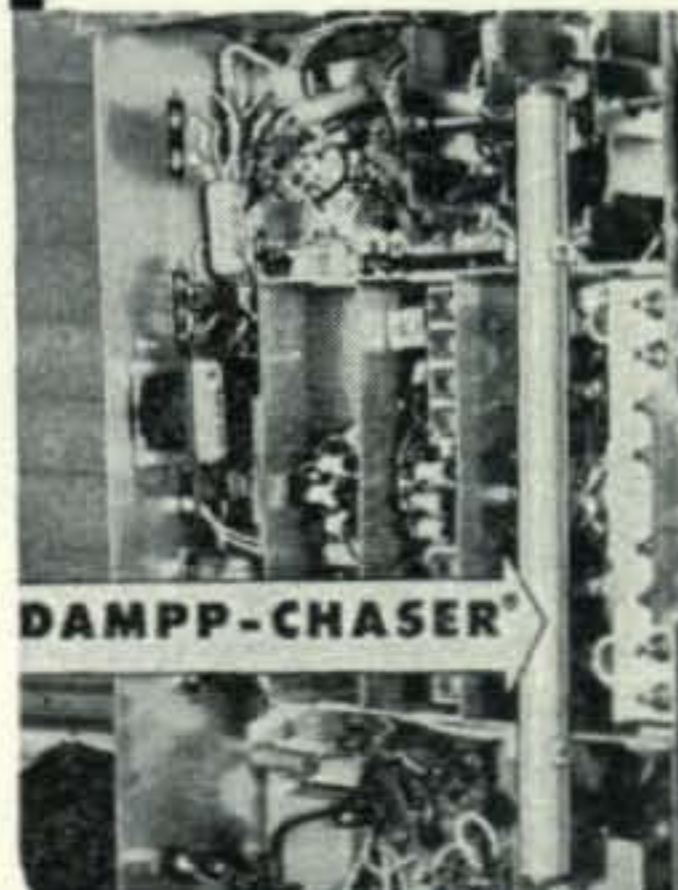

DAMPP-CHASER Jobber Inquiries Invited ▲

For further information, check number 62 on page 194.



How's Your HFK*?

Do you hem and haw when the subject of HI FI comes up, or do you change the subject? Now you can astound your friends with your newly acquired knowledge on the latest in HI FI.

Get a copy of "Care and Repair of HI FI". This nifty volume contains the latest dope on amplifiers, preamplifiers and equalizers plus a buyer's guide of component manufacturers!

Over 150—5½ x 8½" pages of heavily illustrated descriptions covering Hi Fi Audio Components—the greatest publication value in its field today. **Only \$2.50 per copy.**

COWAN PUBLISHING CORP.
Book Division
300 West 43rd St.
New York 36, N. Y.

C-11

I enclose _____ for _____ copies of
Vol. 1 "Care and Repair of HI FI". (Postpaid)

Name _____

Address _____

City _____ Zone _____ State _____

New York City Residents Add 3% Sales Tax

Better Audio-10¢

George Bonadio, W2WLR

320 Winslow St.
Watertown, New York

A small expedient in some ham receivers can give better audio for almost no effort and for only the price of one or two small parts.

Simple inverse feedback on the last audio stage of a receiver will dampen the transient responses of the loudspeaker or headphones. It will also help flatten out the response curve of the mountains and valleys.

A single resistor of between ½ and 1 meg-ohm connected between the audio output plate and the driver stage plate will effect this. The value should be chosen to effect a substantial drop in gain, but not enough to cut the usable gain in CW or SB positions.

If the receiver circuit is not to be tampered with, then a socket to socket jumper, above chassis, with insulation taped around the resistor pigtails can do this fine. The ends are merely wrapped around the proper tube pins upon tube insertions.

If the gain control is on the last grid, then there is another variation which should be used. The connection should be between the last audio grid and plate, including a series blocking condenser of not less than .005 mfd. with the resistor.

One important factor is psychological in that the effects of fatigue from a few predominant audio frequencies reproduced will be lessened. One may listen longer before becoming weary of it. Naturally, readability or copy of voice is slightly enhanced. Friends sound more natural this way, too.

For 10¢ or so, better audio is worth having. Manufacturers please copy.

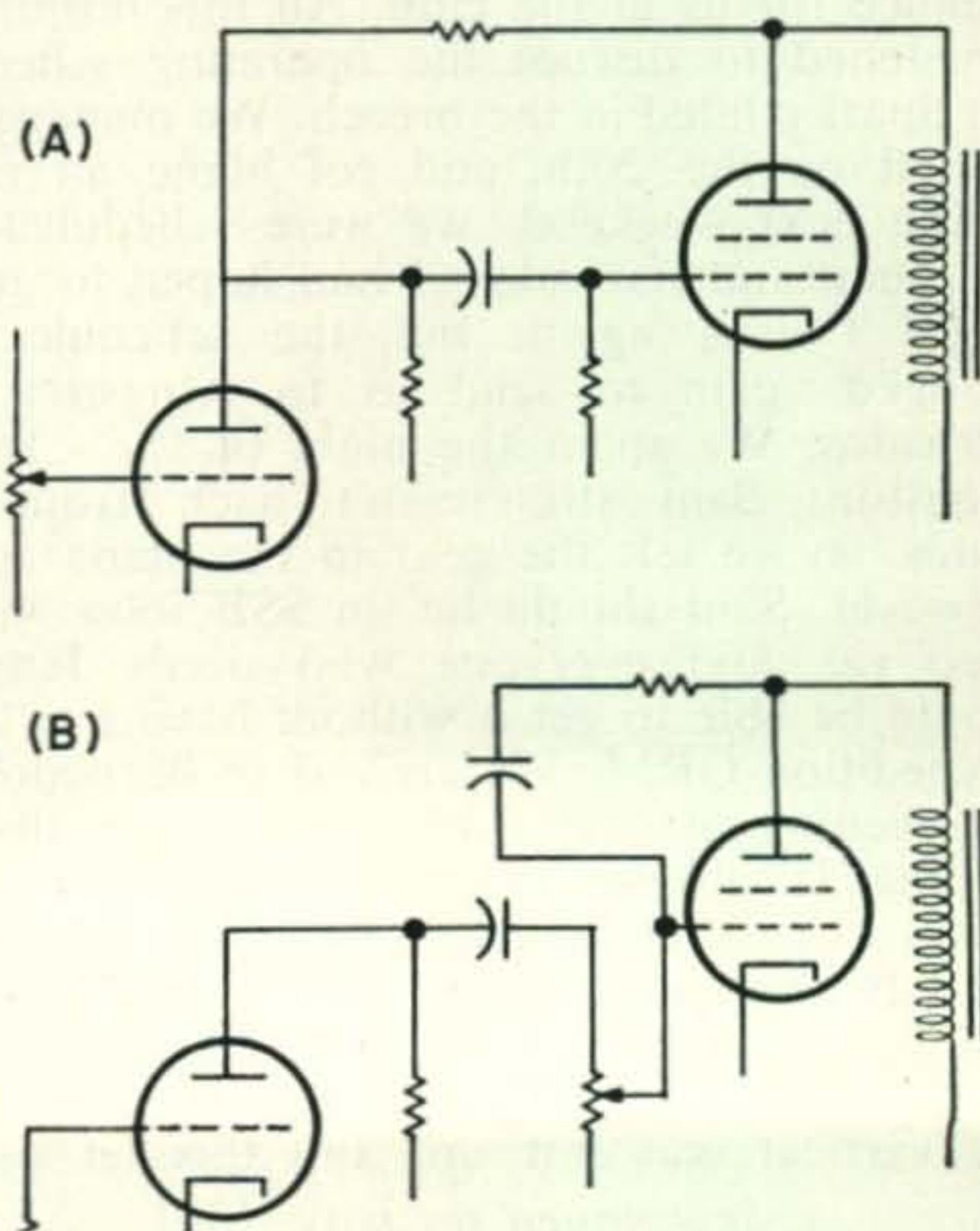

THE HAM SHOP



TVI HANDBOOK

WIDBM's newly written TVI book (no reprints) covers all aspects of curing TVI from both the Ham's viewpoint and that of the TV viewer or the TV serviceman. It includes 2 and 6 meter TVI as well as Industrial, Medical and Utility TVI. Profusely illustrated with diagrams, photos, charts, tables and FCC regulations pertaining to radio and television interference. Price: \$1.75 postpaid, USA, \$2.00 Foreign.

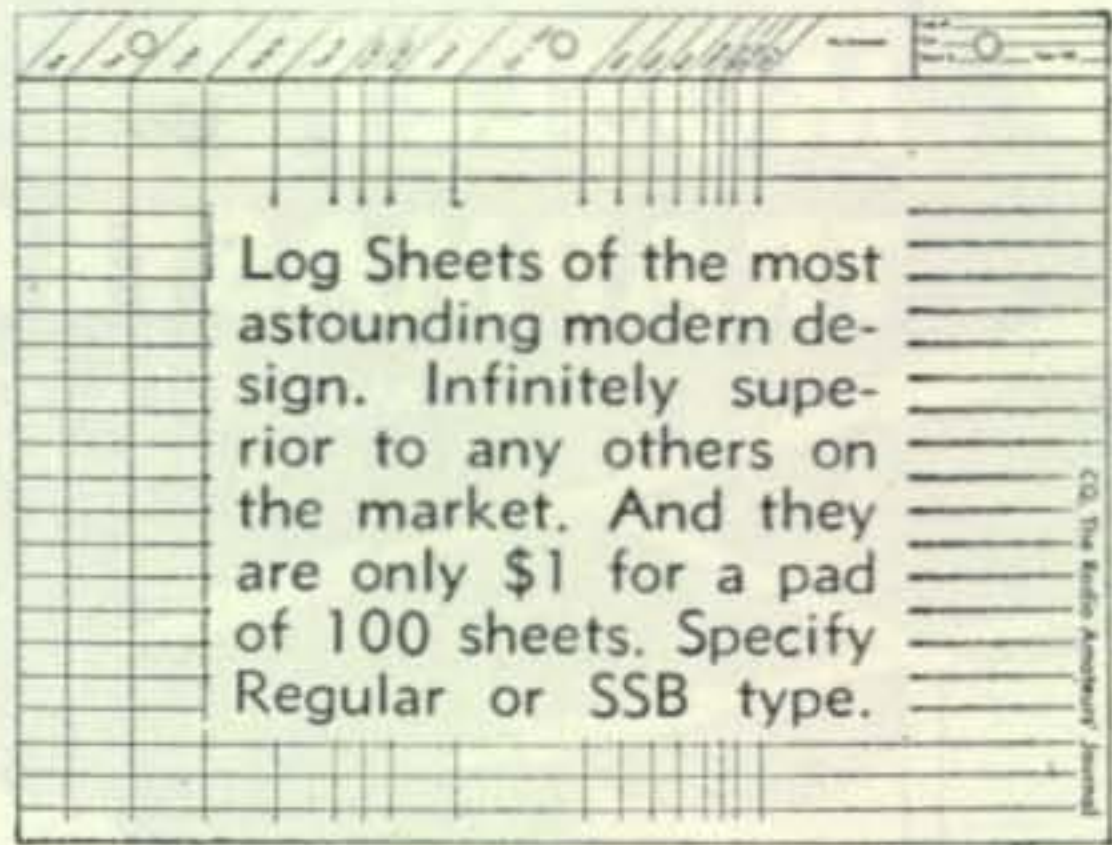

Log Sheets of the most astounding modern design. Infinitely superior to any others on the market. And they are only \$1 for a pad of 100 sheets. Specify Regular or SSB type.

BINDER

There is no other good way to keep your back issues. Make 'em neat. We supply the binder, with the year embossed in gold, not merely a sticker which will come off later. Specify what year you want stamped on your binder. \$3.50 each

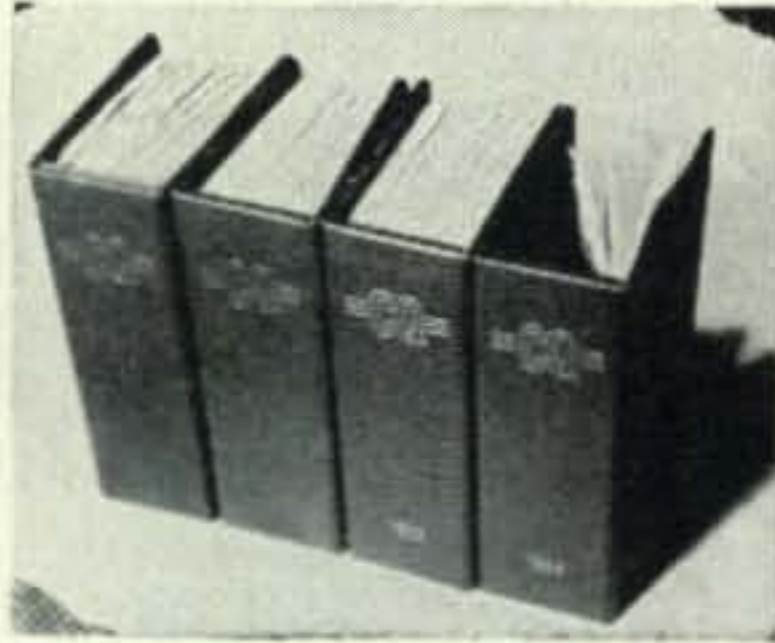

BOUND VOLUME

By far the handiest way to keep your library. Why not go first class? This impressive volume is only \$10.00. We only made a few of them this year, so don't expect to get one later. 1955, 1956 & 1957 still available (circle year wanted). 1958 released Jan. 1st.



MOBILE HANDBOOK

This new Mobile Handbook by Bill Orr, W6SAI, has been getting raves from all of the experienced mobile operators. There is all sorts of information in here that cannot be found anywhere else. This is NOT a collection of reprints. \$2.95 postpaid.

COMMAND SETS

This IS a collection of reprints, containing all of the available information on the conversion of the popular "Command" transmitters and receivers into good ham transmitters and receivers. Invaluable for Novice, Technician, General, Advanced and Extra class operators. 136 fabulous amazing terrific pages for only \$1.50 PPD.



HAM'S INTERPRETER

Now you can talk in broken French, Spanish, Italian, German, Swedish and Finnish. This handy little book gives all the popular ham conversation in seven languages, including letters and numbers. Only \$1.50 postpaid.

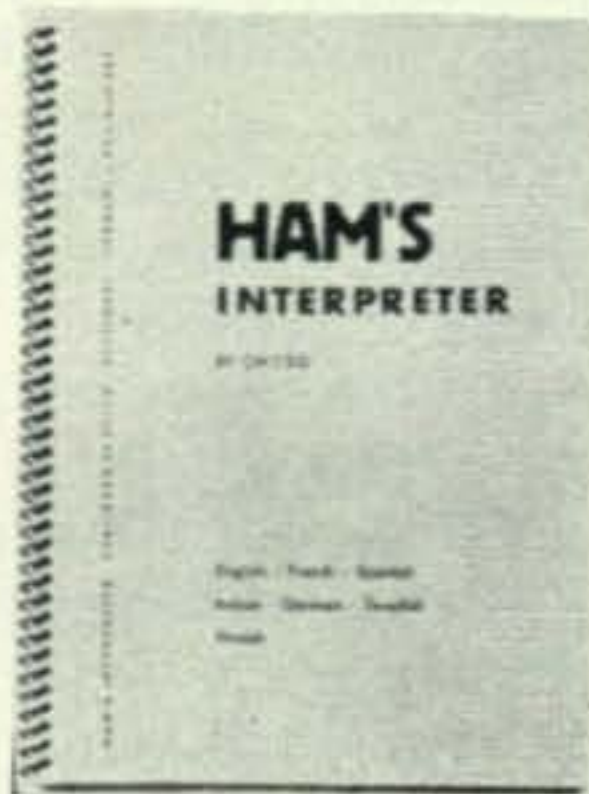

CODE RECORD

Learning code is a snap with this record. Speeds from 3 to 16 WPM, depending upon turntable speed. This 12" LP record has on it all you need to learn the code for both the Novice and General license. \$3.50 each.

CQ Magazine
300 West 43rd St.
New York 36, N.Y.

SIRS: My check (money order) for \$..... is enclosed. Please send the following items to:

TVI Handbook Log Sheets
 Binder—Year Wanted Bound Volume Mobile Handbook
 Command Sets Ham's Interpreter Code Record

NAME

ADDRESS

CITY

ZONE

STATE

New York City residents add 3% Sales Tax

CQ-11

MOSLEY TRAPMASTER

Model TA-33
for 10, 15 and 20

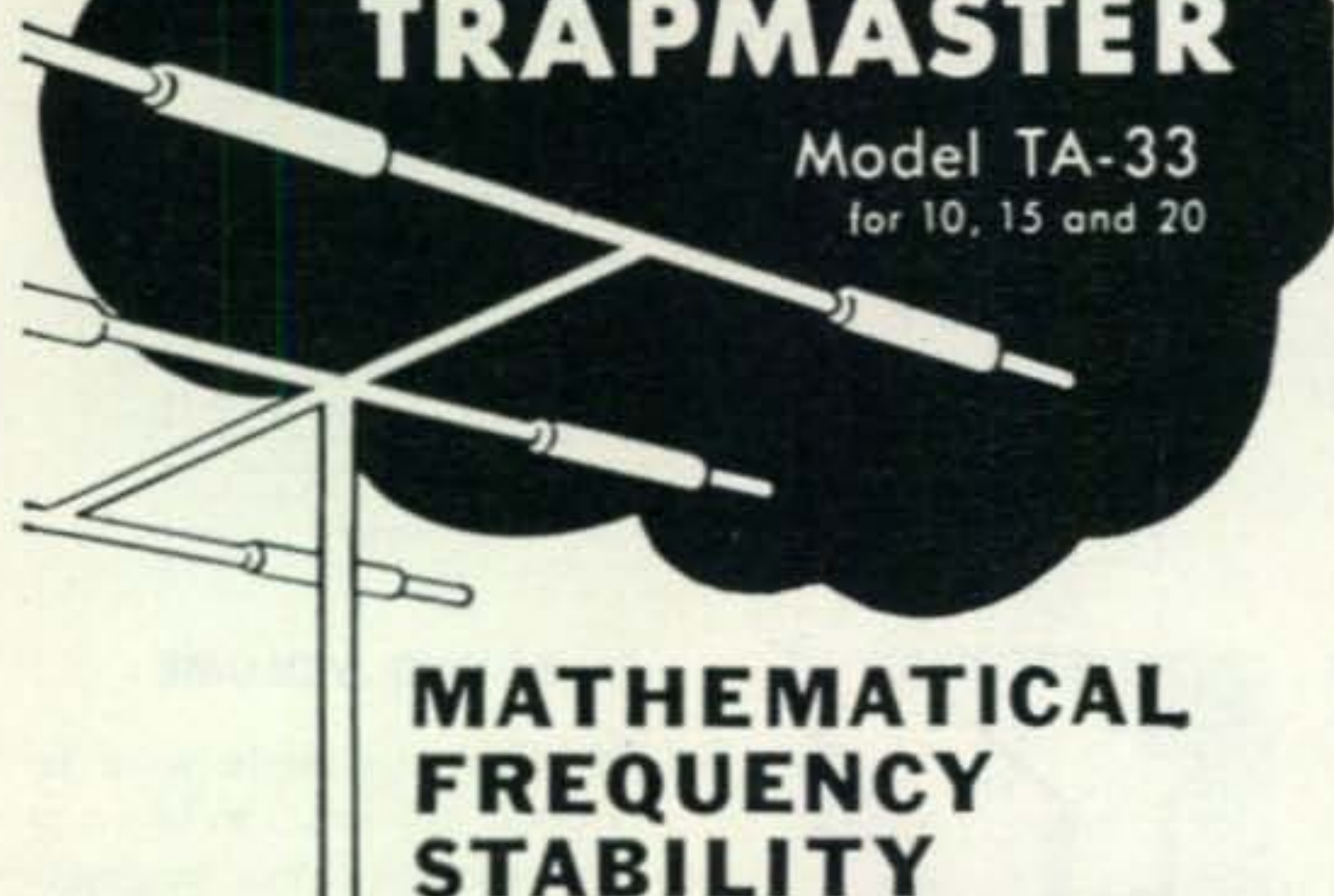

**MATHEMATICAL
FREQUENCY
STABILITY**



Every beam is factory pre-tuned. The especially designed Mosley Traps make any deviation impossible—rain or shine!

Mosley Electronics, Inc.

8622 St. Charles Rock Road • St. Louis 14, Mo.
For further information check number 54 on page 194.

EASY TO INSTALL TELESCOPES

CRANK DOWN TO ADJUST

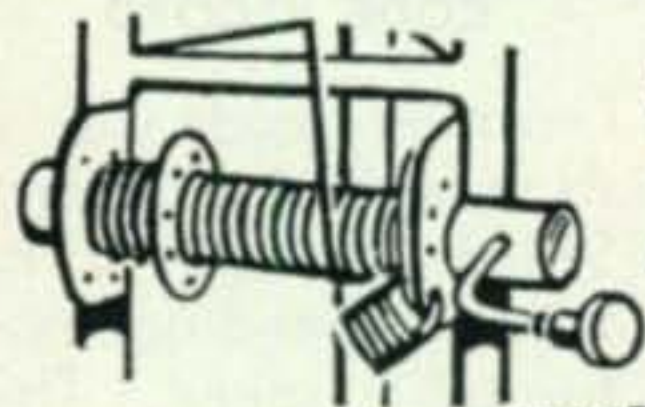

*Spring loaded
ratchet winch
can be padlocked.*

VERSATILE

Used by thousands — Hams, Signal Corps, Civil Defense, Industry, Mobile Units. Made of strong, lightweight 3/4" aircraft type tubular steel.

NEW SECTIONALS
UP TO 400 FT.

GALVANIZED TOWERS AVAILABLE

WRITE FOR FREE BROCHURE

CQ-11

Tele-Vue TOWERS INC.

701-709 49th ST. SO. ST. PETERSBURG, FLORIDA

For further information, check number 63 on page 194.

SIDEBAND [from page 177]

several bands. We packed up the gear again on the 26th, with the exception of the 14-AV. Again, we lost the vertical. This time, Mac, VP6WD, a retired British Army officer, who has been a ham since 1922 in New Zealand, decided he couldn't get along without it. We'd been using the vertical again against a metal roof for a counterpoise with grand results. After waiting at the plane for several hours, we found the tire was in, but the tube was lost somewhere. So, we went back to the hotel, but left the gear in the plane, as Eric and Claude had a large evening planned for me. The next day, we got it out again, and passed out a number of VP6 SSB contacts again. Eric interceded with the local manager of the airline that was getting the tube for us on the 28th, and we managed to get the tube and get out that evening. I don't think we left Barbados as a barren SSB spot, though. Eric is building an SSB rig, and has been offered a commercial rig for two months so that he can put some of the nearby islands that are new countries on SSB. Mac brought an SSB rig out from England with him. It was damaged in shipping, but he expects to have it on the air soon.

Unfortunately, that was my last SSB DXpedition. I'm being transferred to a desk job in Washington, and won't have the golden opportunity to make the trips that has been afforded me through flying for the Navigation School. I only hope that someone else is as fortunate, and is able to get on from some of these countries, as I haven't worked then on SSB, myself.

Naturally, no DXpedition is complete until the QSL situation is handled. We requested that stamped, self-addressed envelopes be sent with each US card. This not only saves us considerable money on postage, but permits us to handle cards in 35% of the time that is required if we have to address and stamp each card. We started the QSL'ing as a joint project, but decided that in order to meet the multi-operator station rules in the DXCC guide, one man should sign them. Since I went on every trip, I handled it, and am responsible for any errors, and have copies of all logs, if anyone still needs a card. Of course, we received a number of cards without envelopes. These have been answered, too—after all others. We received only three cards for which we have no record of contacts, which is an amazingly small percentage, based on my earlier experience as DX. As for the cards used, we decided to save the expense of fancy cards, and have used GE cards when available, and 3 x 5 stock cards when those ran out, handling the printing with a duplicator. This has enabled us to start cards out within a day after our return from the trips. If you have worked us, and have

sent a contribution with your envelope, you have had it returned. We aren't allergic to money, but feel that as we were riding in government aircraft, the acceptance of even an IRC beyond postage cost would be a poor policy.

As for the equipment we took, we were pleased with everything but my exciter. The 75A4 performed perfectly all the way through, and it rode a distance equal to a couple of trips around the world in the back end of transport planes, and had a lot of rough handling on the ground, as well as suffering through widely varying line voltages and currents. We were all greatly impressed by the HT-32. I've been building my own transmitters for 24 years, but I've decided that Mr. Halligan has built a rig better than I can build myself, and that I'd be foolish to try to build my own exciters in the future. It'll be tough going back to my own exciter until I can save up enough pennies to get an HT-32! As for the 14-AV, it worked beautifully for us. It has a low swr, and seems to work as well as a good vertical cut for any single band in its range. It won't put out the signal that a good beam will, of course, but it's a great deal easier to set up than any beam, particularly for applications like ours. If I were going out tomorrow, I'd take along just the equipment we took on the last few trips, and I feel that I'd have to go to a great deal more effort and weight to improve operation materially.

We owe a great vote of thanks to the hams who gave us the opportunity to put their countries on SSB. We probably owe a bit more to their womenfolk who put up with us on these trips, and thank them all. The whole operation has been a lot of fun—and hard work. For me, it has meant giving up all other ham activity for several months. However, we have managed to get several of the SSB boys over the DXCC hump, which was the aim of the trips in the first place. Now, I'll look for new ones.

4 TUBE REGEN [from page 39]

our use. In fact it can be checked with an absorption type grid dipper and will indicate rectified grid current on the meter. A two turn link takes this energy to a similar tuned circuit near the rf stage tube, and it is coupled into the grid of the triode section of the 6U8. This triode section of the 6U8 rf stage acts as a cathode follower to inject 10,494 kc into the cathode of the pentode section.

Conversion is very good. There is plenty of additional gain added to the set on all bands including 14 megacycles and there are not so many spurious signals. The two tuned circuits that bring the 10,494 kc energy from the oscillator tend to reject other harmonics. The set is just as stable on 14 mc now as it was on

MOSLEY TRAPMASTER
Model TA-33
for 10, 15 and 20

114 LBS. WIND LOAD
computed in accordance with sec. TR-116—EIA Standards (formerly RMA)

Mosley Electronics, Inc.

8622 St. Charles Rock Road • St. Louis 14, Mo.
For further information check number 54 on page 194.

BEST towers COST LESS!

Protect your beam and rotor investment by sensibly supporting them with strong, heavy walled, durable STEEL . . . the best cost you less in the long run. Be proud! Own an E-Z WAY . . . a Beauty to Behold!

- Crank up or down—1 minute!
- Tilts over for easy access to beam!
- Brute steel in attractive design!
- 30 types from which to choose!
- No material lost in moving . . . no guys, no concrete!

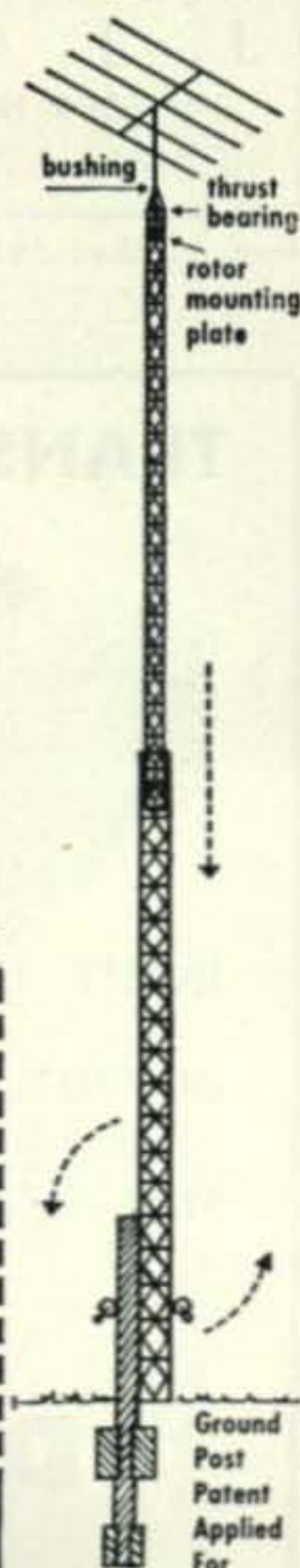
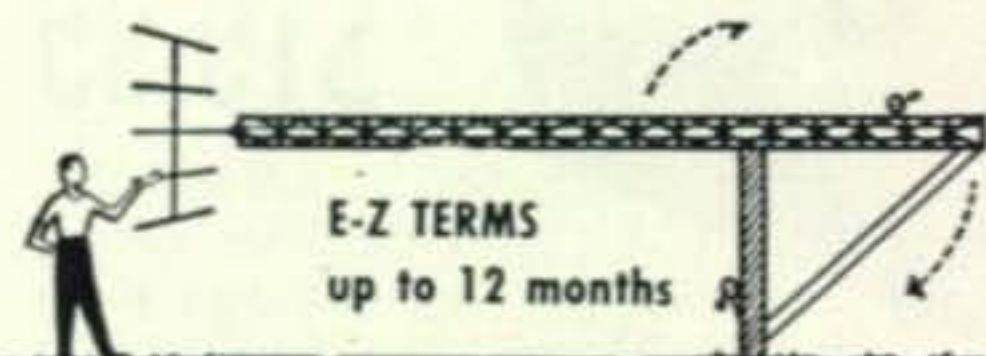

SEND FOR FREE CATALOGUE

Dept. HQ, E-Z Way Towers 11-8-Q
P. O. Box 5491, Tampa, Florida

Send me your FREE catalogue on the following towers:

Broadcast Television
 Ham Radio Two-Way Communication

I am interested in a tower ft. high.
I will use a antenna.
(State type and model)

Type of Rotor
Name
Address
City State

E-Z WAY TOWERS, INC.
P. O. BOX 5491 - TAMPA, FLA.

For further information, check number 64 on page 194.

KEEP CANDEE HANDY!

ART-13 COLLINS TRANSMITTER

Removed from aircraft — so you know it's good — and sold at lowest price EVER! Frequency: 2-18 MC for ham rig. Output 60-100 W. CW or modulated. Crystal calibrated for VFO. Includes dynamotor. Excellent. **\$129.95**

AN/APN-9 LORAN SYSTEM

Used in ships, planes to determine position by radio signals from known xmters. Accurate to within 1% of distance. Complete with tubes. Like new. **\$88.88**

R-435/VRC-2X RECEIVER

For mobile police and fire calls! 30-40 MC, crystal controlled. 24 VDC. Easily converted by replacing vibrapack transformer with 110 VAC transformer. With tubes, less crystals. Used, good. **\$19.95**

MARKET PLACE FOR METERS!

SIMPSON: 1½ inch. Multi-scale panel. 0-1 MA or 0-100 MV. Brand new. \$3.49 3 for \$9.00
ROLLER SMITH: 1¾ inch. DC. amp meter. 0-10 amps. NEW \$3.49 3 for \$9.00
ROLLER SMITH VOLT METER: 3½ inch. 0-20 DC. New \$3.95
MARION ELECTRIC: 2¾ inch checking meter. Hermetically sealed. Ideal for checking tubes, condensers, etc. New \$1.95

I-223 RANGE CALIBRATOR

115 V. 60 cyc. Ideal for power supply and 10 W. amplifier with slight modifications. 61.6 push-pull. Schematic on top cover. New with tubes. **\$9.95**

BC-683 FM RECEIVER

27-38.9 MC. 10 push-buttons for channel selection. Continuous tuning. Squelch circuit. Complete with tubes, speaker (less dynamotor). Brand new. Only. **\$19.95**

BC-603 FM RECEIVER

Same as above except freq. is 20-27.9 MC. Excellent condition. **\$6.95**
12 V. DM-340. DYNAMTR: for above. Excel. \$3.95
110 VAC POWER SUPPLY: for above. Just plug in. No conversion needed. New \$11.95 In Kit Form \$7.95

BC-1335 TRANSCEIVER

Two-channel, crystal controlled. FM. 18 tubes! Output: 1.5 W. For fixed or mobile installation. Range: 5-10 miles. Built-in vibrator type power supply operates from 6 or 12 VDC. New in original carton. **\$29.95**
 In Like New Condition, only \$24.95

DM-35 DYNAMOTOR

Depot re-pack. Like new. With spare brushes. Each **\$9.95**

All items F.O.B., Burbank, California, subject to prior sale. In California add 4%. Minimum order \$3.95.

J. J. CANDEE CO. DEPT. CQ
 509 No. Victory Blvd., Burbank, Calif.
 Phone: Victoria 9-2411

For further information, check number 65 on page 194.

TRANSISTOR MODULATOR KIT

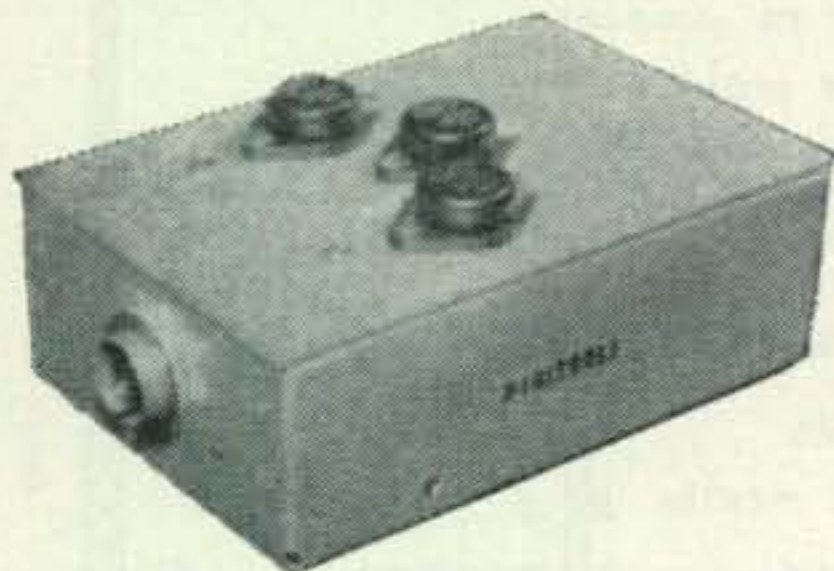

\$19.95

Add 20%
 For Completely
 Wired Unit

INPUT—12 V, 2 Amp, 10 Watts, Carbon Mic.

OUTPUT—10 Watts into 4, 5, and 6,000 Ohm load

SIZE—4" x 6" x 2" Chassis

Write for Details
 of our Complete Line

DIGITROLS

P. O. Box 985
 Baltimore 3, Md.

the other two bands.

At first I thought we might have to use a switch to cut out the 10,494 kc injection when using the rf stage as straight through amplifier on 3.5 and 7 mc. There seems to be nothing gained by this and the injection frequency does not seem to cause harm. The rf stage was mounted on a piece of aluminum about 3 inches square and double decked on the chassis, since we seemed to be running out of chassis space.

For the benefit of those who might be interested in using this device to convert to 21 mc, this was tried. There did not seem to be enough energy on the 10th harmonic of the crystal to give output at 17.5 mc to do the conversion. It might be accomplished by the use of a 17.5 mc crystal, but I have an idea that there is a considerable reduction in gain at 21 mc than that obtained on 14 mc. It appears right now that a successful converter to 21 mc (and 28 mc) is going to need a good rf stage plus a converter stage and several low-loss circuits to do a creditable job.

NOTE

When making the additions to the diagram, several errors were observed. The new schematic is corrected. The errors were:

1. Mixer osc. is a 6K8.
2. Tank condenser of 6K8 triode is 3 mmfd. negative coefficient 750 ppm instead of 750 mmf.
3. Pin 3 of the 6U8 *if* and det. connects to plus 250 through a 47K resistor and not to the filament.
4. The resistor in series with the 10K pot in the same stage is .1 meg. instead of 1 meg.
5. The plate load resistor in the plate (pin 1) of the same stage is 47K instead of 4.7K.
6. The cathode of the 6U8 audio triode is returned to ground instead of the control grid.

For those who might think this little set just a toy, I would like to say that it has been used on all three bands under severe conditions of QRM and weak signal reception, and its performance is comparable to best of receivers, within the frequency and emission coverage for which it is designed.

There is a lot that could be said for simplicity. Ever so often we reach a point in complication that we rebel and go back to simple things, and often leave behind some headaches. I have switched back and forth from the big set to the little set on weak Asian signals on 20 meters and on European signals on 3.5 mc and frankly there is not a lot to choose between the two. The big set has 19 tubes, is as big as a house and weighs a ton. Come to think of it, why should the poor received signal have to excite 19 tubes when it can excite 5 tubes? ■

Special Purchase! — Once In A Lifetime Buy — Special Purchase!

AIR FORCE SIGNAL DATA CONVERTER



MANUFACTURED BY HUGHES AIRCRAFT CO



Side View

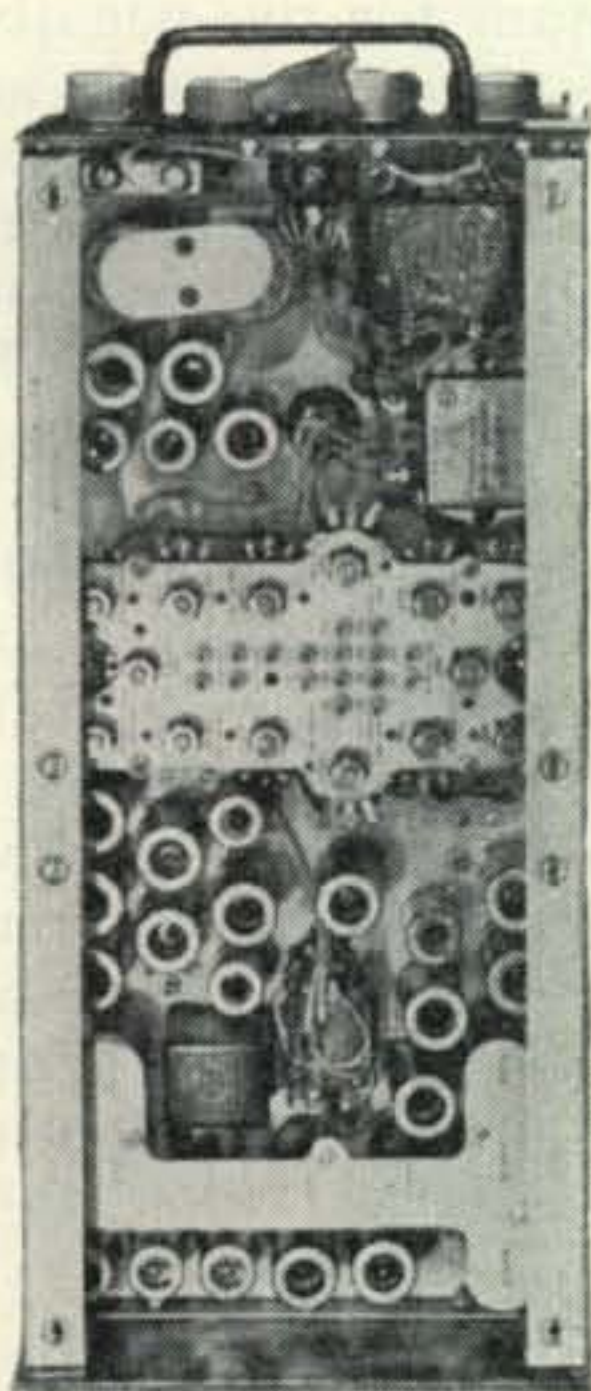

Side View

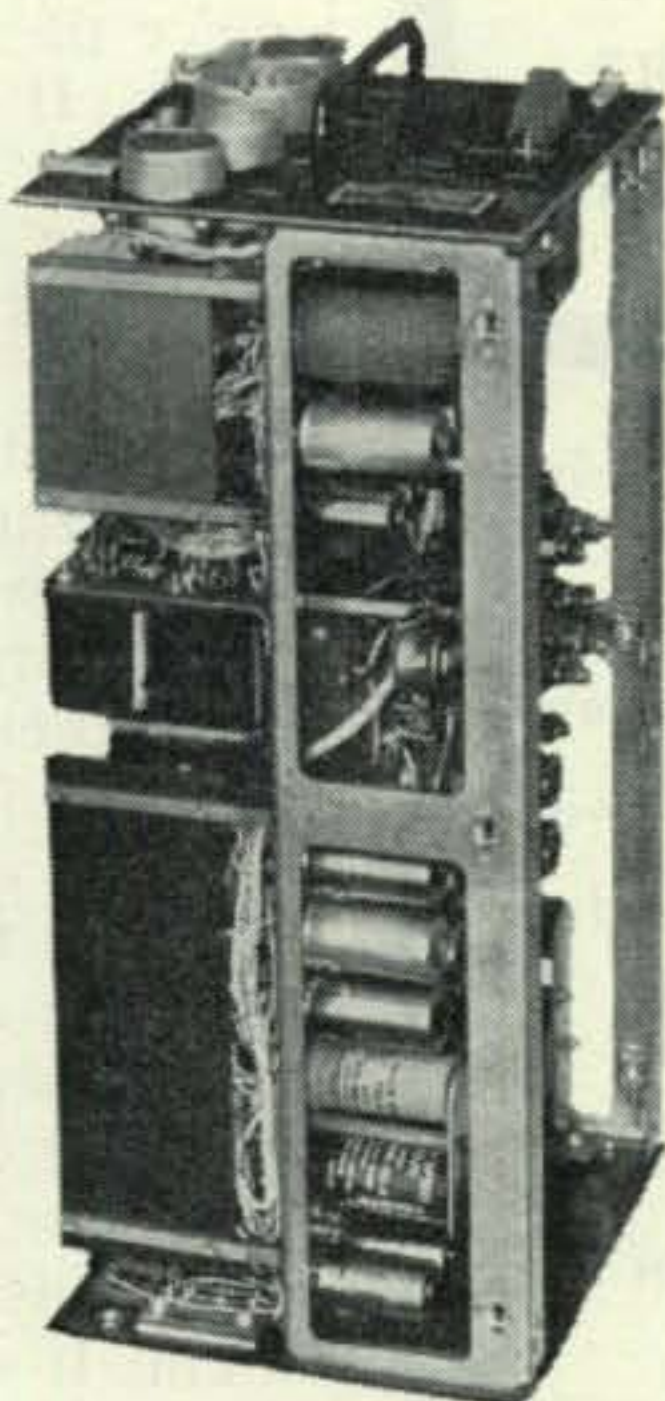

Top View

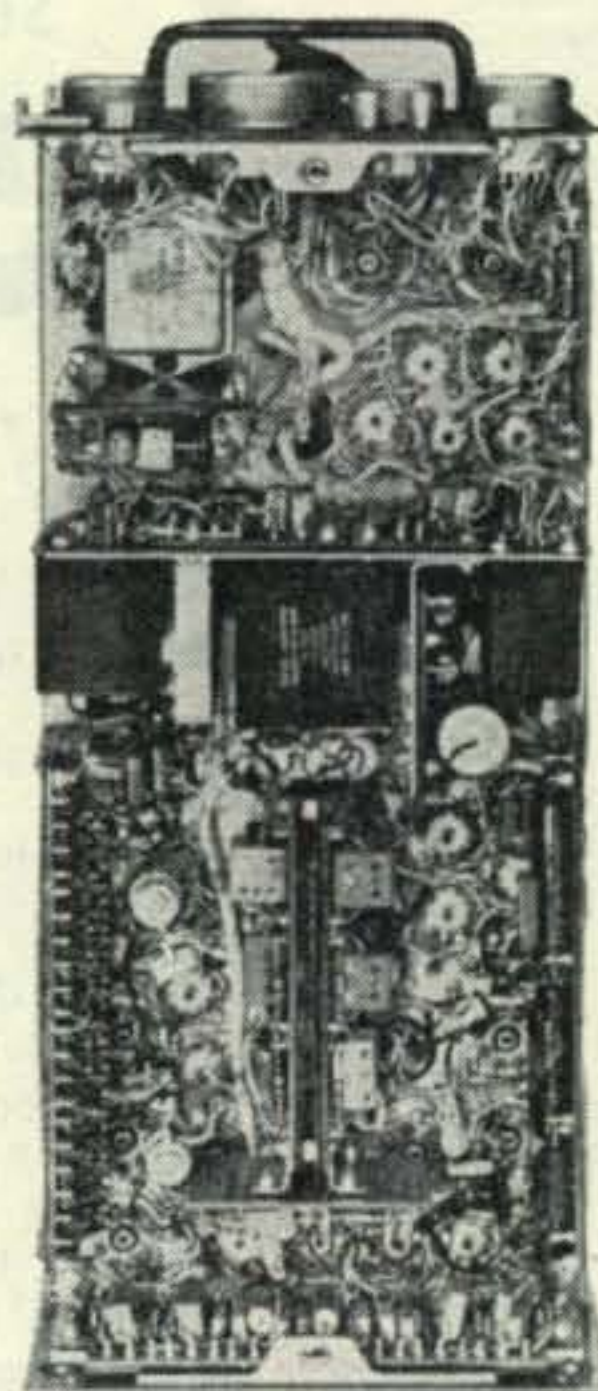

(Photos Shown With Cover Removed)

Price—
ONLY—

\$11.95

(3) for \$30.00

(Tubes alone, worth twice our LOW asking price).

This unit originally cost the Government **\$1362.00.**
There are hundreds of useful parts (tubes, relays, resistors, mica and tubular condensers, sockets and shields, etc., enclosed in an aluminum chassis.— Here is a partial listing of the components:

Tubes

- (7) 12AT7
 - (4) 12AX7
 - (3) 12AU7
 - (5) 6AL5W
 - (2) 5687
 - (3) 6J6
- (Tubes worth: \$24.00.)

Relays

At least 3 Milisec High Speed Mercury Vacuum sealed-Octal Base Relays.

Resistors

Hundreds of 1/2 and 1 Watt Resistors, plus large assortment of Precision Resistors.

Condensers

Large assortment Mica & Tubular and High Voltage Tubular condensers.

Sockets

The finest quality low loss, deluxe ceramic sockets. These are the type that sell for \$1.00 each

Connectors

The latest type with blue inserts. UHF connectors are the new Co-Ax BNC type

Other Parts

(16) NE 2 Neon Bulbs, (2) 400 Cycle Choppers, Band Pass Filters, more than 14 Allen-Bradley Volume Controls with locking washers. Many Elco and Cinch Shields.

All the converters are in excellent, clean condition and the components are in like new condition, ready for immediate use after disassembling. Use the convenient size aluminum chassis for any number of home construction jobs—Mobile transmitter, Exciter, etc. Dimensions: 8" High x 7 1/2" Wide x 18" Deep. Net Weight: 24 lbs.—shipping weight approximately 30 lbs. Shipped only via Railway Express Collect for shipping charges only from warehouse Atlanta, Georgia No C.O.D.'s, remittance in full with order.

BARRY ELECTRONICS CORPORATION

512 BROADWAY, NEW YORK 12, NEW YORK,
DEPT. C-11
WALKER 5-7000

For further information, check number 66 on page 194.



"Mage" Magers
WOOJI, President

A Ham Since 1910

Not The CHEAPEST,
But The BEST!

VESTO'S
Hurricane-Proof*
Self-Supporting
TOWER

A Galvanized Tower that will last a lifetime. Ten sizes to choose from! 22 ft. to 100 ft. Easy Terms Available.

VESTO TOWERS OFFER YOU:

- 4-leg construction for better balance—greater strength
- Safe, steel ladder from ground to platform near top
- Safety platform with metal railing and trap door (optional)

PLUS VESTO'S NEW Geared Crank-Over Antenna Head

Now! Tilt antenna for easy accessibility! Tilts heaviest antennas! Holds in any position!

*NO VESTO TOWER HAS EVER BEEN DAMAGED BY HURRICANE

Easy Payment Plan! Write for complete FREE information

VESTO CO., INC.
20th & Clay St.
North Kansas City, Mo.

For further information, check number 67 on page 194.

GOOD BUYS — ALL NEW

TRANSFORMERS . . . all have 115 volt, 60 cycle primaries
Scope, 2500 v/3 mls & 2.5 v/1.75 a 5 lbs. . . . \$1.95
Scope, 6.3/1.85, 6.3/0.6, 700 ct/30, 525/5, 2.5/1.75, 6.3/0.6, 2 and 3 KV ins, upright shielded 5 lbs. . . . \$3.45
Power, Stancor P-4004, upright double shell, 800 vet/175 mls, 5 v/3 a, 6.3/2.5, 6.3/2.5 and 2.5/1.75 + bias tap. 10 lbs. . . . \$5.95
Power, 790 vet/120 mls, 5/3, 6.3/4.4, 6.3/0.6, HS 10#. . . . \$2.95
Power, 550 vet/240 mls, 5/3, 6.3/11.1, 17/1.2, HS 14#. . . . \$3.45
Filament, 2.5/10, 6.3 ct/5.5, 6.3 ct/1, HS. 13 lbs. . . . \$2.29
Filament, 6.3/22, 6.3 ct/2.4, 6.3/2.25, 6.3 ct/0.6, 9#. . . . \$3.29

CATHODE RAY TUBES 3FP7 . . . \$1.00 ppd 5FP7 . . . \$1.29 ppd
3BP1 . . . \$1.75 5JP2 . . . \$3.45 5GP1/5BP1XXX . . . \$2.45

CHOKES . . . all are potted types, hermetically sealed
10 hy/500 mls, 100 ohm, 2000 v RMS test. 30 lbs. . . . \$6.95
10 hy/150 mls, 160/210 ohm. 5/6 lbs. . . . \$1.69 2/\$2.95
4 hy/60 mls, 412 ohm, 2400 volt test. 1 lb. . . . 59c 2/95c

MISCELLANEOUS VALUES . . . read carefully, some will go fast!
Meter, 0-50 microamp, 2 1/2" round 1 lb. . . . \$4.95
25K ohm, 160 watt bleeder resistor 1 lb. . . . 69c
Full wave xfmr-rect combo for 24 vdc/800 mls 5 lbs. . . . \$2.59
Triple 20/400 octal plug-in electrolytic. 8 oz. . . . 2/95c
1/32 amp Slo-Blo, 3AG fuses. 10/39c Box of 100 for \$2.95
5.3 MC IFs by RCA, double slug tuned. 5 oz. each. . . . 6/95c
455 KC IFs, very nice with schematic 8 oz. . . . 79c
Skirted black knobs with indicator line, 2" 3 oz. . . . 3/95c
TS-13 handset with plugs, complete 3 lbs. . . . \$5.95
BC-610 tuning units 3 lbs. \$3.45 Complete set . . . \$24.95
BC-610 RF coils 2 lbs. . . . \$1.95 Complete set . . . \$10.95
Dynamotor, 6 volt/26 amp input, 600 volts/150 mls intermittent duty cycle 14 lbs. . . . \$6.95
Selsyns, Delco type II-A, C-56701 motor-repeater. . . . 13 lbs. each. . . . natural brass finish . . . \$9.95 2/\$17.95

VACUUM TUBES . . . 701-A . . . \$3.95/pair 3B24 . . . \$4.95/doz.
717-A, 2X2, 1642, 958-A \$2.95/doz 89Y, HY-615 \$19.95/doz

WRITE FOR FREE GOVERNMENT SURPLUS BARGAIN BULLETIN

Send adequate postage with orders We refund any overage
All prices are FOB Sacramento

JOE PALMER
PO BOX 6188 CCC, SACRAMENTO, CALIF.

For further information, check number 68 on page 194.

HEAT SINKS [from page 37]

acid, maybe you can talk a garage out of some battery acid. This stuff runs about 1.260 these days and if you'll mix it with an equal amount of water, you'll be close enough.

We now have the acid in the pot. Toss in a piece of scrap aluminum for the negative electrode. If the XYL was out of town and you used an aluminum pot, then just attach the negative lead to the pan. If you plan to plate a part of a chassis or heat sink, just put it in the pot, clip your positive lead to the part that's outside the solution and let it go. If the pot is aluminum, a small piece of glass in the bottom will keep the thing from shorting out. If you are anodizing the whole piece of aluminum then you'll have to be sure that the wire connection is also aluminum, at least until it gets out of the solution. In the case of washers you can force your aluminum connecting wire into one of the holes or you can leave a tab to be clipped off later. Just remember that where the lead connected there will be no insulation.

As for the power supply, we used a dc supply ordinarily used for bench testing car equipment. It seemed to bubble nicely at around ten to twelve volts and drew four or five amps. The simple system would be to just clip on to the car battery. If it bubbles, it's working, but don't get your nose too close. There will be some fumes and maybe a little splashing as the surface bubbles burst. How long to cook it? Good question. Depends on current density and stuff like that. We've tried all the way from 20 minutes up with good results. Before we learned the hard way that the surface *had* to be smooth we kept trying to improve the anodized surface by keeping a piece cooking for several hours. When we took it out, the anodized surface seemed no thicker, the scarred marks were just as distinct as when we put it in, but the aluminum was considerably thinner. Maybe some authority in the audience can explain that one. (Don't write me, write the editor.) (Don't write the editor either . . . Ed.).

As a good rule of thumb, the surface is anodized when it gets a good milky look. Take it out, wash it off—good. Dry it, *thoroughly*. If your luck has held, you now have a chunk of aluminum with a thin insulating surface. This doesn't mean that you should now take the two needle probes of an ohmmeter and dig in and see. At this point don't louse up your surface. If you're dealing with washers, drill corresponding holes in the chassis where you intend to do your mounting, and carefully de-burr this area where the washer will touch. Your washer has two insulating surfaces, but there's no sense in messing up the spare.

Now, carefully check to see that the base of the transistor, the anodized washers and/or chassis are all clean. Place insulating tubing or spaghetti over the studs or mounting screws

to keep them from contacting the washers or heat sink, and slide the transistor down into place. Place a fibre washer over the mounting stud or screws and tighten it up. Remember that the transistor base needs to make firm contact with the anodized surface.

Now, cross your fingers. Check the resistance between the chassis and the base of the transistor on a high resistance ohmmeter. It should read well up in the megohms. As a typical example, we constructed a transistorized power supply using two 2N278s, mounted on a common thin aluminum washer 2" by 5" and clamped to a 1/4" aluminum panel. Resistance measurements from either transistor base to the panel was greater than 100 megohms. Since the external resistance used across this path will probably not be over a couple of hundred ohms, this seems adequate. Although it's not a factor in this application, the capacity from base to chassis measured at .005 mfd, an indication of the thinness of the anodized surface.

This process is simple and nearly foolproof. Treat the acid with respect, exercise a little care in fabricating the parts to be anodized, get the battery polarity right, and there's little that can go wrong.

At this point it might be well to add a word of reminder. In this procedure we have not *eliminated* the heat problem in germanium transistors. We have, instead, taken steps to transfer as much of the heat out as we can. This does not mean that we can now bolt our heat sink to the exhaust manifold of the family flivver and talk our way to grandma's house. For automotive mounting in the great but hot state of Texas I prefer to have my transistors in the car with me. Under-the-hood mounting may provide good ventilation when the car is in motion, but on a hot summer day the heat radiated off an asphalt highway plus engine heat makes the advantage questionable. A transistor circuit on an adequate heat sink can probably operate inside the car under just about any ambient conditions the operator can stand.

It is undeniably true that the future of the transistor in amateur radio is limited only by the imagination, ingenuity, and stubbornness of the experimenter. Don't hesitate to look for jobs for them, not just in tried applications, but in typical try-it-and-see fashion. The amateur is known for his ability to get more from his equipment than the manufacturer expected. In the early days of the electron tube he found ways to exceed the ratings and get away with it, but he also learned how to get *around* ratings. The transistor is a good case in point. Voltage ratings in transistors, including *transients* must be respected. So must temperature ratings. And yet in today's transistor power supplies we are developing output powers of over a hundred watts, several times what the same transistor could deliver in audio service.



announcing the
Cubex 3-BAND
CUBICAL
QUAD

- EQUALS 3 EL w.s. BEAM
- 8 db GAIN, . . . 24 db FBR
- TV ROTOR HANDLES
- ONLY 16.8' wide - NO STUBS

Dual-band 15-20 \$44.95
Dual-band 10-15 \$34.95
factory prices — f.o.b. arcadia, cal.

— write for brochure 'd' —

CUBEX CO. 3322 TONIA AVENUE
ALTADENA, CALIFORNIA

2, 6, 10 — Meter MOBILE EQUIPMENT

MOTOROLA, R.C.A., G.E., LINK, etc. 30-50 Mc., 152-172 Mc. Used Commercial F.M. Communications Equipment Bought & Sold. Complete two-way sets meeting F.C.C. Licensing Requirements for taxicabs, Police, Fire, etc. **\$169.00** and up.

Motorola F.M. Receivers, Double Conversion **\$55.00** each
Motorola F.M. Transmitters..... **45.00** each

COMMUNICATIONS ASSOCIATES INC.

165 Norfolk Street
Dorchester, Mass.

W2HSU

CALL PLATES—CUSTOM MADE TO YOUR ORDER

Show your Call Letters proudly in a bold new, distinctive style plate. Silver anodized aluminum cast letters—Giant size 3 1/2" high—Three dimensional effect. Permanently mounted on jet black enamelled background. Overall size 4 1/2" x 16". Hang in your shack or mount on your car. Immediate delivery. Only \$5.95 ppd. Satisfaction guaranteed.

CRAFTSMAN, 287 Jay Street, Brooklyn 1, N. Y.
MA 5-3344

FOR THE BIGGEST BATCH . . .

of blockbusting buys in electronics

get our new, free, 32-page

CATALOGUE NO. 117! It's terrific!

ARROW SALES, INC.

Sales-Showrooms:

Western: 7035 Laurel Canyon Blvd., North Hollywood, California.

Central: 2534 S. Michigan Ave., Chicago 16, Ill.
Mailing Address: Box 3007, No. Hollywood, Calif.



RCA OSCILLOSCOPE Model 155C

This scope is a highly efficient conventional 3" oscillograph. Operates from 115VAC-60 cycles. The perfect instrument for service, labs, schools, industry, experimenter. All features of high priced lab scopes available to you at less than the price of a kit.

SIZE: 10"x7 1/8"x14". Weight 23 lbs.

All in perfect operating condition. A complete scope for less than the price of a kit. (We ship by express.)

\$29.95
FOB NY

0-500 MICROAMPS DC METER—Br New—GE—Boxed—	
2 1/2" Rd—Orig. Scale	CQ Special \$1.89
12 VDC DYNA—Br. New—Boxed—7" L x 4" D—400V—180	
Mils Cont.—225 Int.	CQ Special \$8.49
RELAY—Ceramic Base—DI'DT—Hvy Duty Cont.	Special \$1.29
ARC-5 XMTR—3-4 MC—Good	Special \$5.49
ULTRA SENSITIVE MIN. METER—1"—100 U/A Orig.	Scale Special \$3.95
2" SCOPE TUBE #2API—New—Boxed	Special \$1.95

REX

RADIO SUPPLY CO.

88A Cortlandt Street
New York 7, New York

HAMS—HOBBYISTS—DEALERS! Here's a
DEPENDABLE SOURCE of SUPPLY

for RECEIVING TUBES



1-YEAR GUARANTEE

Nationally sold ZALYTRON Tubes are BRAND NEW Quality Tubes, guaranteed to perform as well and as long as tubes much higher priced. Why pay more? Try them once, you'll buy them always. Every tube we ship is covered by our Full Refund Guarantee . . . YOU be the judge! Send today for new Price List "Q".

ZALYTRON

TUBE CORP.
220 West 42nd St.,
New York 36, N. Y.

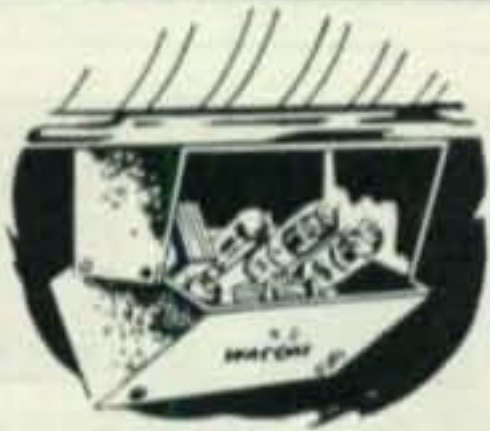

the **WACOM**



6 3/4" wide

4" high

3 3/4" deep

Fixed or Mobile
6-METER TRANSMITTER

For Information Write:

WACO COMMUNICATIONS, INC.
1213 CLAY • WACO, TEXAS

47 RADIO PROJECTS 75¢

Plus "White's Radio Log"



Think of it . . . 47 electronics projects you can build . . . explained with diagrams, photographs and step-by-step instructions, plus "White's Radio Log," a directory listing U.S. and Canadian AM, FM and TV stations by call letters, locations, kilocycles and power and over 1,000 world-wide short-wave stations. Terrific value! Get this 192-page handbook, RADIO-TV EXPERIMENTER, No. 555, at newsstands 75¢; or direct from:

SCIENCE & MECHANICS

450 E. Ohio St., Dept. 792, Chicago 11

FOR THE FINEST IN AMATEUR PHONE PATCHES ITS . . .

KWICKPATCH

The high speed
high quality patch

AM Models \$14.95. Dual
by-brid Sideband models
\$24.95. No switching . . .

No disconnecting . . . Models for single or double connector microphones. See them at your distributor. For literature write to

KWickPatch, P. O. Box 612, Redwood City, California

This is possible by operating the transistor only under conditions of minimum heating. In this service the transistor switches rapidly from one extreme to another. It generates minimum heat during a period of no current flow . . . and then switches rapidly to a condition where it is conducting a large current, but with such a comparatively low internal resistance that I squared R heat generation is at a minimum. So far our main effort in transistor circuit development has been in making them do what tubes or other components once did. This is worthwhile, of course, but the real test of the transistor, and the experimenter, is in new applications.

You may find, as we have, that anodizing is so simple that you'll want to use it for other purposes. Commercial aluminum products are often anodized to give them an extremely hard surface, a condition very desirable in equipment panels. Many commercial aluminum products are anodized and then dyed in color.

There's no reason why you should have any more trouble in this project than we have had. The voltage, current, and acid mixtures used in our work is little more than an intelligent guess. How closely they match with commercial techniques and commercial results is something we have not investigating further, for we got satisfactory results with this system. If you have an easier or better system . . . or have any trouble with this one, let me know. (This time, don't write the editor—write me.)

SATELLITE RECEPTION [from page 33]

becomes almost impossible to read. This is generally true at least part of the time.

2. The beat oscillator also heterodynes against the sideband components produced by the telemetry frequencies. As these frequencies are rather closely spaced to the carrier frequency and each other, the result is the generation of at least two complete sets of spurious frequencies plus the original beat frequency, all of which are continuously changing from doppler shift and/or receiver instability.

If, in addition to this, harmonic distortion is present within the receiver or tape recorder, then to add to the existing woes a second order collection of intermodulation products appear in the output. The result is similar to the "search for a needle in the haystack" with the needle being periodically moved.

Having rather thoroughly covered the dark side of the picture a few positive thoughts on the subject might be appropriate. A few suggestions are given to minimize the difficulties that have arisen from the existing recording procedures.

Receiver tuning procedures may be somewhat different depending upon the type of modulation used in the transmitter. If the be satisfactorily employed even without the use of band separation filters for the various telemetry channels.

transmitter is frequency modulated, the receiver should be centered on the carrier as in standard tuning procedures, either by using the telemetered signal for tuning or, preferably, a stable reference oscillator whose frequency calibration is known accurately.

In the case of the amplitude modulated transmission, two approaches are possible. First, the receiver may be adjusted such that its bandwidth is sufficient to receive both sets of sidebands with little attenuation. An alternate procedure would be to operate the receiver more or less as a single sideband system with a bandpass adequate to accept the carrier frequency plus one set of sidebands with due allowance for doppler shift. In either case, crystal filter operation of the receiver is inadvisable unless the filter rejection peak is well outside the carrier or highest sideband frequency.

If at all possible a crystal reference oscillator is advisable for tuning purposes. No adjustments whatsoever should be made to the receiving equipment during a satellite pass with the possible exception of a quick tuning check during the maximum signal condition if a good reference oscillator is not available. One reason for this is that certain types of data reading equipment, for instance a wave analyzer, may be sensitive to changes in the noise spectrum as caused, for example, by receiver tuning.

In many cases telemetry signals which may not be at all audible may be translated quite readily. If the presence of the carrier is indicated by an increase in the receiver noise, valid telemetering information may be present and recording should be started at this time. Assuming the receiving system is properly adjusted to pass the carrier and sideband components, the audible signal-to-noise ratio is determined by these adjustments. This is not the signal-to-noise ratio, however, as viewed from the standpoint of an individual telemetry channel which is much more narrow than that of the receiving system as a whole. As a result, the signal-to-noise ratio of the individual telemetry channel is improved by a factor equal to the total receiver bandwidth divided by the telemetry filter bandwidth. This improvement factor in itself is adequate to make an apparently useless signal easily readable. In addition, it is not difficult to read at least 20 db. below the noise existing within the filter bandwidth by employing a technique no more complex than an oscilloscope whose vertical input is the telemetered signal and whose horizontal input is an external audio oscillator. The technique, of course, is that of frequency measurement of the sub-carrier oscillator by zero-beating the reference oscillator. The approach is both simple and reliable and has been used in reading many data tapes. This method may

[Continued on page 193]

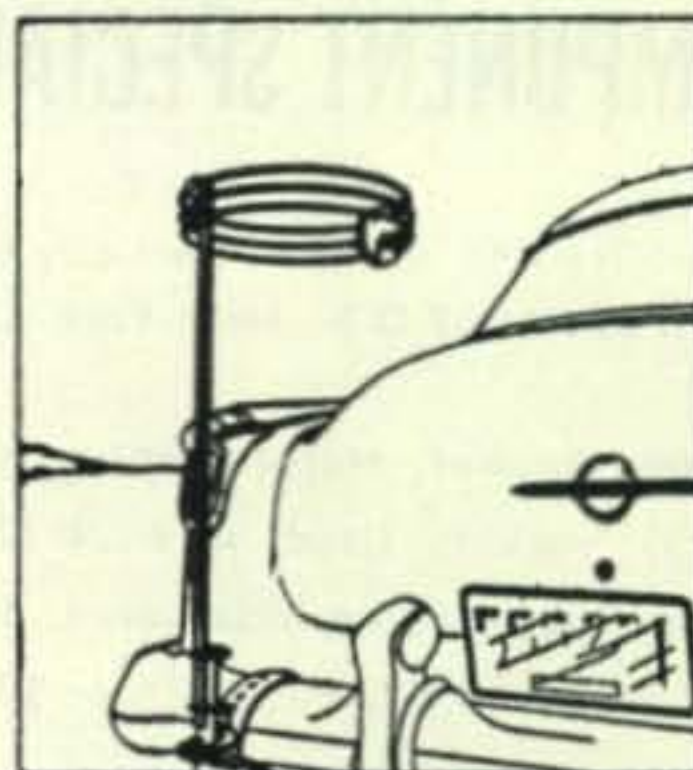

WOW!

Horizontal polarized 6 meter MOBILE antenna.

Reduces flutter . . . swish . . . ignition noise . . . a full sized antenna available with clamp-on bumper mount. Also supplied less mounting accessories.

AVAILABLE NOW.

Write

HI-PAR PRODUCTS CO.
Fitchburg, Mass.



**RADIO AMATEUR
CERAMIC
SPECIALTIES**

ONLY \$2.75

Item #M1. A 22 ounce mug, embossed with colorful amateur figure. (For a "YL" figure, order Item #M3.) Amateur's individual call sign made with one inch black characters. For Christmas delivery please order early.

MILLWOOD STUDIO
Box 223, Rowley, Mass.

EASY TO LEARN CODE

It is easy and pleasant to learn or increase speed the modern way — with an **Instructograph Code Teacher**. Excellent for the beginner or advanced student. A quick, practical and dependable method. Available tapes from beginner's alphabet to typical messages on all subjects. Speed range 5 to 40 WPM. Always ready, no QRM, beats having someone send to you.

ENDORSED BY THOUSANDS!

The **Instructograph Code Teacher** literally takes the place of an operator-instructor and enables anyone to learn and master code without further assistance. Thousands of successful operators have "acquired the code" with the **Instructograph System**. Write today for full particulars and convenient rental plans.



INSTRUCTOGRAPH COMPANY

4711 SHERIDAN RD., CHICAGO 40, ILL.
357 West Manchester Ave., Los Angeles 3, Calif.

A CUSTOMIZED SERVICE FOR THE RADIO AMATEUR

- Custom-Designed Mobile equipment.
- Q-Multipliers built-in your present receiver.
- Custom-Designed VHF-UHF equipment.
- Kit Wiring at a lower cost.
- Expert transmitter repair.
- Complete receiver renovation.
- Custom-Designed VHF SSB equipment.
- Miniature transistorized equipment.

These are just a few of our services.

Write for information.

KALAB ELECTRONICS COMPANY
P.O. Box 8246, Tulsa 15, Okla.

EQUIPMENT & COMPONENT SPECIALS

- **Prop-Pitch Motor**—Medium size—55 lb. unit. Partially converted. Like new condition. \$34.50 F.O.B. New York City.
- **Johnson Air-System Ceramic Socket**, Metal chimney, sub-mounted shielded (122-275) socket. Used with 4-125A, 4-250A, 4-400A, etc. Type tubes. Clean, removed from equipment. Special\$3.50
- **Dolinko & Wilkens 75 MMFD @ 20 KV. Vacuum capacitors.** New—Compact\$5.50 each
- **Dolinko & Wilkens 100 MMFD @ 20 KV. Vacuum capacitors.** New—Compact\$7.50 each

Following items all are in Factory-Sealed Cartons. Latest Serial Nos. We are Authorized Factory Distributors for all the following lines:—

- **Hammarlund Receivers**—HQ-100 Receivers.....Net \$189.00
HQ-110 Receivers.....Net \$249—HQ-160 Receivers.....Net \$379
HQ-170 Receivers.....Net \$359—S-100 Hammarlund Matching Speaker.....Net \$14.95.
- **National Co. Receivers**—NC-60\$59.95
- **Geloso—Ham Receiver**—G-209\$299.50
- **Geloso—Ham XMTR**—G-212/TR\$249.50
- **Vocaline—Citizen's Band Transceivers:**—
Model JRC-400.....\$69.75 each — \$139.50 per pair
Model JRC-425.....\$99.75 each — \$199.50 per pair
- **Barker & Williamson:**—
Model L-1001-A Linear Amplifier\$240.00
- **E. F. Johnson Co.—Ranger—Factory Wired**.....\$329.50
Johnson—Viking Courier—Wired\$289.50
Johnson—Navigator—Kit\$149.50
Johnson—Navigator—Wired\$199.50
Johnson—Viking Valiant—Wired\$439.50
Johnson—Viking Kilowatt.....\$1,595.00 — Desk.....\$132.00

We are factory distributors for Vocaline, Gonset, E. F. Johnson, Eimac, B&W, Hexacon, Adjust-A-Volt, CBS, Hammarlund, National, and Geloso.

Special Trade-ins on E. F. Johnson and Hammarlund Ham Gear!

Continued Next Page

BARRY ELECTRONICS CORP.

512 Broadway, Dept. 11-C, N.Y. 12, N.Y.

Phone: WALKER 5-7000

The Ham Shop

RATES: 25¢ per word per insertion for commercial business organizations.
10¢ per word per insertion for individuals on a non-commercial basis.

MINIMUM CHARGE: \$1.00

FOR SALE

SELL: KWSI, 75A4, Model 15 teletype and altronics terminal unit. Equipment like new and guaranteed. Cost over \$3400. Sacrifice \$2260. Write or call Ralph Barnett, 755 St. Francois Street, Florissant, Missouri.

ATTENTION MOBILEERS!! Leece Neville 6 volt 100 amp. system alternator, regulator and rectifier, \$45.00. Also Leece Neville 12 volt 100 amp. system, alternator, regulator & rectifier \$85.00. Perfect condition. Herbert A. Zimmerman, Jr., 115 Willow St., Brooklyn 1, N.Y. K2PAT, ULster 2-3472.

CALL PLATES: Deluxe 8" x 1 3/4" black phenolic laminate with engraved white letters. Only \$1.00 pp. Polished plexiglass base \$1.00 extra. L. and J. PRODUCTS Co., P. O. Box 122, Downers Grove, Ill.

THIS HALO ANTENNA makes VHF mobile operation worthwhile. Folded dipole elements. 2 meter Model H-144 comes with fitting for standard mounts and 20 feet of coax. Portable Model H-144P mounts directly on your Gonset. Either model only \$13—\$13.50 west of Denver. L. and J. PRODUCTS Co., Box 122, Downers Grove, Illinois.

BARGAINS: Send for list of reconditioned receivers and transmitters with new guarantee. 10% down with up to 24 months to pay. In stock new Collins, Johnson, Hallicrafters, WRL, National, Hammarlund, Gonset, Elmac, Drake, Central Electronics, B&W, Hy-Gain, Mosley, Gotham beams. Shipped on approval. Write Ken, WØZCN, or Glen, WØZKD for your best deal. Ken-Els Radio Supply Co., 428 Central Ave., Fort Dodge, Iowa.

FOR SALE: Schematics, radio or T.V. 59¢. Send make and model number. Call Book \$5.00, Ham register \$5.00, rands T.V.I. \$1.75, 100 QSO file cards \$1.00, DX QSL'S forwarded 2¢ each after membership. Free flyer. "DX radio coop" Box 5938, Kansas City 11, Missouri.

FOR SALE: Schematics for all military-surplus units \$1 each. Dave Rumph Co., P.O. Box 7167, Ft. Worth, Texas.

CRYSTALS GUARANTEED: 2 to 80 meters FT-243. Holders, 3 for \$1.00. SSB crystals FT-241A, 10¢ each. Lists available. Quaker Electronics, 1040 West Main Street, Plymouth, Penna.

TOROIDS: Uncased 88 mhy like new. Dollar each. Five, \$4.00 PP. DaPaul, 101 Starview, San Francisco.

PRESERVE YOUR HAM TICKET, Social Security Card, small photo, passes and anything else of value that is wallet size. We will laminate it in clear plastic, guaranteed for life. Lamination will prevent it from getting torn, soiled or frayed. Send your ticket or anything of value with \$1. in stamps or cash for each item that you want preserved. 24 hour service. Send to Dept. HW, CQ Magazine, 300 West 43rd St., N.Y. 36, N.Y.

FOR SALE: Heathkit AR-3 with cabinet, good condition, one year old, \$35. Graham Peel, VE3EDC, 388 Morse St., Port Arthur, Ontario, Canada.

FOR SALE: BC 221 Freq. Mtr. Excellent condition. \$50.00. K6JFZ, 887 Bridge Road, San Leandro, California.

GLOBE CHIEF "90"—\$35. Joe Wichtowski, W2CUG, 158 Westside Ave., Elmira, N. Y.

LOOK! \$9.95 buys a high quality CW transmitter kit, complete with built-in power supply, and all parts except tubes and xtal. Send for literature. Greenray Industries, M. R., Mechanicsburg, Penna.

FOR SALE: VY gud condition 32V2 XMTR \$325. 75A1 Rcvr. \$225. Package deal \$525. W2/K2 area call Baldwin 3-1122 btwn 7-9 p.m. Need money for college. K2GGC, 2911 Laurel Avenue, Baldwin, L. I., N. Y.

MOBILE HAMS: Stop generation whine—Silence ignition noise, regulator clicks—\$4.25 Postpaid—10 minute installation. Specify frequency. Ignition Kit, 19 Salem St., Cos Cob, Conn.

FOR SALE (Cont'd.)

FOR SALE: Completely built Viking Ranger Xmitter. Brand new. \$175. Hammarlund KQ 110 with clock. Brand new. \$175. Hallicrafter S38D Receiver. \$15. Ameco Code Practice Oscillator with key. \$7.00. Electrovoice Mercury Dynamic Mike. \$10. Herman Richards, W2EPT, 661 East 170 St., Bronx 56, New York.

FOR SALE: 75A4 3&6 K.C. Filters \$4.95. 32V2 Factory TVI Proofed \$350. HT-30 Brand new in sealed carton \$350. Ranger \$150. NC 183D \$295. Phone Patch \$18. Viking Kilowatt with desk \$1185. Mosley VPA 20-3 20 meter shortbeam \$44. Simpson TV FM Signal generator model 479 brand new \$185. Precise oscilloscope model 300 \$89. Communicator III 2 meters \$185. Bell Stereo Amplifier \$125. Stereo tuner \$90. GE 810 \$9. New audio output transformer stancor A-3802 \$8. Eico Signal tracer Model 147 \$19. MORROW MOBILE: Rec MBR5 \$175. Trans MB560A \$165. RVP pur Supply \$25. MLV-50 Tuner \$18. DM-35 \$15. RTS-600 AC Supply & Speaker \$85. Mike N1 \$9. All equipment listed above is in like new condition and guaranteed. Sidney Gogel, W2FUR, 1096 Laux Place, No. Bellmore, Long Island, New York. Laurelton 8-2407, 9-6 P.M. Sunset 5-6976, 6-10 P.M.

FOR SALE: National NC-300 with matching speaker \$300. Johnson Ranger from kit, performs perfectly, \$200. F.O.B. New Orleans in original cartons, with all manuals. No time to operate no mo'. Clint Ritchey, W5OWS, 1817 David Drive, Metairie, Louisiana.

SELL: NC. 125 RCVR. W/S excellent condition, \$95. DB. 23 \$25. AMECO advanced code course \$3; Central Electronics Q Multiplier L/N \$16. Frank Cresswell, K2ONN, 188 Jefferson St., Brooklyn 6, N. Y. HY 7-5812.

FOR SALE: HT-32, \$500; HT-33, \$650; SX-101, \$300. Tel-Rex Tri-Bander \$100. Can be had singly or in any combination. James R. Howerton, M.D. P.O. Box 86, Columbia, North Carolina. Phone 2051.

SELL: Model 224 DuMont Oscilloscope and DuMont type 185 Square Wave Generator both for \$200. Paul Rennard, Moosic, Pa. GLENWOOD 7-3100.

PLATE TRANSFORMER: 1690 KVA Thordarson 15P21, Primary 115/230 volts secondary 1500/200/2500/3000 volts 500 MA DC. \$35.00 cash. You pick up—C. Smiley, 338 Beaufort Ave., Livingston, N. J.

FOR SALE: National Receiver NC-88. 5 12" long playing Novice Code Course. 1 Vibroplex speed key. 1 Segnatone Co. Code Oscillator. 1 Garrard RC-80 Chander with pickering diamond. A AM-FM-S2000 Sherwood Tuner. 1 Sherwood S-100II 36 watt amplifier. Write David Lauer, 1317 Blaine Avenue, Racine, Wisconsin.

FOR SALE: DX-100, \$170; SX-96 with speaker, \$190; SW-54, \$35. All very good condition, FOB my QTH. Larry Langdon, W9MHQ, 201 Broadway, Wilmette, Illinois.

BARGAINS WITH NEW GUARANTEE: Collins 32V-2 \$349.00; Johnson KW and desk \$1,195.00; SX-71 \$159.00; Hallicrafters HT-30 \$349.00; HT-31 \$299.00; HT-4 with speech amplifier & antenna tuner \$695.00; NC-98 \$119.00; NC183D \$319.00; NC-300 \$319.00; DX-35 \$49.50; Eldico SSB-100 \$395.00; 51-SB \$195.00; 51-SB-B \$185.00; Phase-master II \$239.00; Lysco 600 \$69.00; Lysco 600S \$89.00; Gonset Linears (2M) \$99.00; (6M) \$99.00; Globe King 500 \$425.00; Globe King 500A \$455.00; TBS-50 (Hi or Low Z Mike) \$69.50; APS-50 Pow. Supply \$29.50; audio and test equipment, inquire. Trial, terms, write Leo, W0GFQ for best deals. World Radio Laboratories, 3415 West Broadway, Council Bluffs, Iowa.

SELL: New DX-100. Used less than ten hours. First \$200 takes it. Inquiries invited. David Stahl, W8UDX, 110 Yale, Dayton 6, Ohio.

FOR SALE: Collins MBF Transceiver in good condition. Converted to 6 meters. Write for details. Tom Reiter, K0IGM, 1625 Prescott St., Dubuque, Iowa.

FOR SALE: Rochester, N. Y. BC 610D \$200 plus storage costs. W5DCK, 3922 Cambridge, Jackson, Mississippi.

SELL: 32V3 like new \$460 or best offer will deliver reasonable distance. W2BHZ, George Hudson, Route #2, Pine City, New York.

MORE BARRY SPECIALS

- **CL-2 Westinghouse Caesium Tube**—Transmit on a Light Beam—Tube Brand New with Data.....\$7.50
Voltage Regulators, Send for FREE Data!
- **Auto-XMFRS, Step-Down XMFRS**—Voltage Regulators, Isolations—New Lot—Just Arrived—Write.
- **Infra-Red Snoopscope Tube**—With Data Sheet—See In Dark\$4.00 each

WRITE FOR LATEST TUBE CATALOG FREE!

Receiving, transmitting, special purpose tubes, diodes, transistors, etc. We have a large diversified stock at sensible prices.

- **Scintillation Counter, Gramscint Model 1002.** "Ten times more sensitive than a Geiger counter." Self-contained portable Scintillation type Gamma-Ray Detector designed for prospecting, radiation monitoring, etc. Contains a nine-stage photo multiplier tube coupled to Gamma sensitive plastic phosphor which makes this instrument a real buy. Regular Price \$245.00 complete with Trimm headphone, leather strap, batteries, ready-to-operate... Sale Price \$49.95
- **Geloso**—Portable Tape and Stenotape Recorder—Model G-255 SP in Stock—Weights only 7½ lbs.....\$179.95 Net Only 5¾" x 5½" x 9¾".
- **Industrial Johnson** — Johnson #122-244 — New Surplus — Super Jumbo — 4 Pin Socket for 8008, 5C22, and Rectifier, Thyatron Types\$1.00
- **Millen XMTG Socket #33405**—For 803, 4-125A, etc.—Giant 5 Prong Socket—Unused (Reg. \$2.25 Net).....\$1.50
- **New Surplus—Eimac 4-400A Blower Socket**—Designated 4-400A/4000—Unused Surplus w/H'dwre—Can Be Used with 4-125A, 4-250A, and 4-400A—Same as SK-400.....\$7.50 (Surplus Price)—Chimney SK-406—Reg. Stock (Not Surplus) To Match SK-400\$6.00 (Chimney Only)
- **Millen 2" Magnetic Shield with 2½" x 2½" Bezel** with green-tinted face. For 2" C.R. tubes. Made of NICOLOL. Brand new—Millen #80042.....\$2.50
- **Marion 2½" Round Hermetically-Sealed 36-Volt D.C. Voltmeter.** Has expanded 18 to 36-volt scale in Half-volt steps.
Clean, removed from equipment.....\$2.95
- **6 and 12 Volt (operates from either) Input Carter Duo-volt Dynamotors:** Medium Size Unit Puts out 400 Volts @ 375 Ma.\$15.95
Large Size Unit Puts out 620 Volts @ 280 Ma.....\$19.95
All Units are brand new, genuine Carter Dynamotors in original packages.

We are factory distributors for Vocaline, Gonset, E. F. Johnson, Eimac, B&W, Hexacon, Adjust-A-Volt, CBS, Hammarlund, National and Geloso. Trade-ins accepted. All prices F.O.B. N.Y.C. Specify methods of shipment. All merchandise insured and guaranteed for cost of mdse. only.

Open Monday to Saturday—Come in and Browse—We are near Prince St./BMT Station—Spring St./IRT Sta. 1 Flight up—10,000 Sq. feet of values.

BARRY ELECTRONICS CORP.

512 Broadway, Dept. 11-C, N.Y. 12, N.Y.

Phone: WALKER 5-7000

For further information, check number 69 on page 194.

November, 1958 • CQ • 189

Advertising Rates

To fill the many requests for advertising rates that come into our office each month, rate information will be provided periodically in the magazine. For more detailed information interested parties may contact our advertising representatives as listed on the mast head.

	1 Time	3 times	6 times	12 times
1 Page	\$360.00	\$340.00	\$310.00	\$285.00
1/2 Page	190.00	180.00	170.00	155.00
3/8 Page	150.00	140.00	132.50	127.00
1/4 Page	100.00	95.00	90.00	85.00
1/8 Page	51.00	49.50	48.00	46.50
1/16 Page	26.50	25.50	24.50	23.50

Mechanical Requirements

	Width	Depth	Width	Depth
1 Page	5 1/2	8 1/2
1/2 Page	5 1/2	4	2 5/8	8 1/2
3/8 Page	5 1/2	3	2 5/8	6
1/4 Page	5 1/2	2	2 5/8	4
1/8 Page	5 1/2	1	2 5/8	2
1/16 Page	2 5/8	1

Recommended half tone screen—110.

Publication date—25th of preceding month. Last forms close 20th of 2nd preceding month. Proofs furnished only if complete copy and cuts are received on or before closing date.

All advertising is subject to Publisher's approval and acceptance without recourse.

The advertiser agrees to indemnify and protect the publisher from any claims or actions based upon the unauthorized use of any person's name or photograph, or of any sketch, map, words, labels, trademarks, or other copyrighted matter, or based upon libelous statements, in connection with the advertising referred to in this order.

PERFECT CHRISTMAS GIFT

CQ YL

The only book about the YLs. 18 chapters, 500 photographs, covers all phases of YL participation in Ham radio. Autographed copy \$3.50, postpaid. Order from:

LOUISA B. SANDO, W5RZJ

212 Sombrio Dr.

Santa Fe, N. Mex.

COLUMBIA COVERS THE VALLEY!

San Fernando Valley Hams—you're lucky! Columbia Electronics has just opened a brand new branch location at 4900 Lankershim Blvd., North Hollywood, Calif. STOP IN SOON for the best buys in electronics, tools, tubes!

UNUSED SURPLUS

Global Non-Ind. Res. 600 ohms 118 W.....	\$ 1.25
Use 12 paralleled for 50 ohm 1.4 KW Dummy Load (see Sept. ad).....	12 for 12.00
Soldering Iron 6/12 VDC, 10 ft. Cable, Battery Clips and Switch, for Mobile or Field use.....	4.90
Plug-In Trigger Amp. contains 3, CK502AX tubes and Precision Parts.....	.99
UTC #A-10 Transf. Line to Grid. 30-20,000 cys.....	2.90
931A Tubes.....	\$2.90 ea. Special IN28 Diode..... 3.90

ARKAY ELECTRONICS

Ft. George Sta. P.O. Box 23 New York 40, N. Y.

FOR SALE (Cont'd.)

SELL: Collins KW-1, Deluxe AM-CW Kilowatt. Excellent condition \$2,450. Will not ship. Possibly accept in part payment a commercial appearing home brew tetrode kw amplifier and power supplies. Bob Dick, W6OBF, 1633 Mandeville Canyon Rd., Los Angeles 49, Calif. GR 2-3921.

SELL: Viking Valiant factory wired and tested excellent operating condition. Looks like new \$325. W7OOG, Box 367, Great Falls, Montana.

FOR SALE: 75A2 excellent performance \$295 w/speaker. Regency transistor converter \$55. WØBNF, Box 105, Kearney, Nebr.

SELL: Six or 10M Phone transmitter, 100 watts complete with mike, crystal, power supply, TVI'd—New beautiful cabinet \$99.95. Have ten guaranteed 1 yr. Free catalog sheet. KØKJX, L. P. Jackson, 645-B Marshall, St. Louis 19, Missouri.

2-METER STATION: Gonset communicator and Linear Amplifier Civil Defense models, excellent condition. Also VFO-Preamplifier, S-Meter MCW switch and telrex beam. \$300. H. Schwartz, 946 N. Kenilworth, Oak Park, Ill.

PARTS, CRYSTALS, Equipment. Lattice filter crystals all channels, checked, no duds, 25¢. FT-243 crystals all frequencies 3300 to 8600 Kilocycles \$1.00. New 203-A tubes \$1.25. New Westinghouse plate transformers Primary 60 cycle 115 V. Secondary 7500 V. at 100 milliamperes or better. (Don't know the top rating.) Shipping wt. 95 lbs. \$9.95. Brand new ARC-5 5.3 to 7.0 Mc Transmitters \$6.95. Lots of parts. Write for list. Bob Woods, W6KEG, Gilbert 8-3139, 2164 Parkway, El Monte, Calif.

CRYSTALS AIRMAILED: Manufacturer direct to you at only 99¢ each. Custom finished to any frequency between 3500 and 8700 Kilocycles. Novice, net, general, filter, etc. Standard FT-243 holders containing new crystals finished to .01% tolerance or better. Why not have several quality guaranteed crystals at the price of one or two of the others? 1700 to 3499 Kilocycles \$1.75; 8701 to 21,500 Kilocycles \$1.95. Write for additional frequency list and brochure. Crystals since 1933. C-W Crystals, Box 2065-C, El Monte, California.

BUILD YOUR OWN 8-CHANNEL RADIO CONTROL RECEIVER. 8-channel reed unit with transmitter and three receiver circuits \$9.95. Money back guarantee. Described in transistor column, August CQ. Order direct. Dixon Electronics Co., 13444 W. McNichols Rd., Detroit 35, Michigan.

VIKING 11 (factory wired) & matching VEO. A-1 condition. New finals and speech amp. tubes. Best offer takes it. Bill Beckerley, K6RGY, 887-35th Ave., San Francisco 21, Calif.

SELL: Barker & Williamson 5100 transmitter, \$250; Matchbox, \$40; Mon-Key, \$19. Gordon Crowe, 4935 N. Cleveland, Kansas City, Mo.

POCKET SIZED RUBBER STAMP with name, call and QTH \$1.00, also 1,000 gummed address labels 90¢ postpaid U.S.A. R. H. Killion, W6FVO, 6206 Yarmouth Avenue, Reseda, Calif.

COLLINS ART-13 Transmitter, Real clean, perfect condition, cost new \$1200, sell \$95.00. ARC-5 transmitters, BC-457, 4-5.3 mc, BC-458 513-7mc, BC-459 7-9.1 mc \$6.50 each. Two meter transceivers ARC-4, mount, control box, antenna \$25.00. SCR-522, control box, antenna \$25.00. BC-611 Walkie talkies complete \$40.00 each. ARC-5 receivers, BC-453 190-550 kc \$10.00. BC-454 3-6mc \$8.00, BC-455 6-9mc \$8.00. Modulation transformers ART-13, see Aug. '58 radio-TV News for description \$8.50. R.C.A. 500W \$38, UTC S-22 \$18.00, Stancor A3894 \$12.00. Plate transformer, new RCA 115V/60 cycle 2450 V.C.T. at 500 ma \$38.00. Tubes brand new 813's \$7.50, 810's \$8.50, 832A \$4.50, 3E29 (829B) \$6.00, 811A \$3.50, 4-65A \$9.50, 4-125A \$12.50, 250th \$17.50, 304TL \$10, 304th \$9.00, 4E27 \$8.00, 5894 \$10.00, 4X150A \$12.00, 211 \$1.00. Tech manuals, all letters BC-312, BC-221, LM freq meter \$3.50 each. Other manuals, chokes, condensers, transformers. New I-177 army tube tester \$22.50. New batteries for BC-611 \$1.75 pair. All guaranteed C.O.D.'s OK. Bill Slep, W4FHY, Box 178, Ellenton, Florida.

WANTED

WANTED: Receivers, transmitters, testsets, teletype all types military or commercial surplus aviation ground 51R3, 51R2, 17L3-4, 51V1-2-3, ART13, ARN14, BC348, ARN30, ARN6 others advise condition price, WE pay COD RITCO BOX 156 Annandale VA. Jefferson 2-5805.

Satisfaction Guaranteed

All Orders Postpaid

WANTED (Continued)

WANTED: All types of communications receivers, transmitters, test equipment, Teletype printers, URA-8, 75A, 32V, 51J, BC-348, BC-342, BC-221, etc. Cash or trade for NEW Ranger, Valiant, Thunderbolt, HT-32, HQ-160, Gonset Fisher Hi-Fi Bell, etc. Write Tom, W1AFN, Altronics-Howard Co., Box 19, Boston 1, Mass. (Richmond 2-0048, Stores: 278 Friend St., Boston, near North Station; 60 Spring St., Newport, R.I.)

WANTED: BC-610E and Up, BC-614E and Up, BC-939, BC-221. All types of test equipment, PRC, GRC, URD, SCR. Complete sets or parts. We buy all types of electronic surplus. RADALAB, INC., 87-17 124th Street, Richmond Hills 18, N.Y.

NEED THE FOLLOWING BACK ISSUES OF CQ: November 1955, July 1956, February 1957. Will swap a brand new first MOBILE HANDBOOK, or copy of COMMAND SETS, or \$1 in cash for the above three issues. Must be in good condition. Offer limited to first 100 copies. Send to CQ Magazine, 300 W. 43rd St., N. Y. 36, N. Y.

WANTED: Drake Soldering Iron, Model 401 pistol grip. Catalog price. Philip Bridges, 5100 Randolph Rd., Rockville, Maryland.

WANTED: Will pay \$75.00-\$100.00 for used receiver. Write: John Foltz, 19 Glazier Avenue, Covington, Kentucky.

I NEED: a Junction Box J-84 for APS-4 Radar. Plugs too. Frank Keegan, W4MKQ, Box 5, Memphis 1, Tennessee.

CASH PAID FOR TG-7 and Model 15 teletype and parts. Also, BC-610, BC-614, BC-639, ARN-14 and 30, APR-9 and 10, APS 31, ARC-21 and 27, 51R3, 17L3-4, 18S-2-3 etc. and TEST EQPT. We pay freight. AMBER INDUSTRIAL CORP., 75 Varick St., New York 13, New York. CANal 6-7455.

WANTED: All popular Mechanics radio blueprint. Fred Hains, Rural Ave., Lewisburg, Penna.

WANT: RME 50, 4300, 4350. Trade brand new .22 Remington pump. Bausch & Lomb 6+30 binocular, Leica, Busch Pressman. Earl Gowdy, St. Jean Ave., Leominster, Mass.

WANTED: All types Receivers, Transmitters, Test Equipment, especially Collins 51J, 75A, R-388/URR, R-390/URR; BC-221, BC-348, BC-610, etc. Teletype equipment, printers, reperforators, etc. Cash or trade for new amateur receivers, transmitters such as Valiant, Thunderbolt 100V, HT-32, NC-300, SX-101, HQ-170, Fisher Hi-Fi, Bell, Televue Towers, CDR Rotators, etc. Write Tom, W1AFN, Altronics-Howard Co., Box 19, Boston 1, Mass. (Richmond 2-0048). Stores: 278 Friend St., Boston; 60 Spring St., Newport, R. I.

WANTED: Special Purpose Vacuum Tubes; Klystrons, Magnetrons, Power Tubes; Lab Test Equipment: X, S, K, bands, Signal Generator, Slotted Lines; Aircraft communication equipment. We pay top prices fast! REpublic 5-0215. V. & H. Radio-Electronics, 2053 W. Venice Blvd., Los Angeles 6, Calif.

QSL

QSL's SWL's, VHF's, XYL-OM's. (Sample assortment approx. 9 3/4¢.) Covering designing, planning, printing, arranging, mailing, eye-catching, comic, sedate, fabulous. DX-attracting, prototypal, snazzy, unparagoned, cards. Rogers, KØAAB, 737 Lincoln Ave., St. Paul 5, Minn. Also glamorous, pulsating, super-passionate. (Wow!)

QLS's: Samples, dime. Print Shop, Corwith, Iowa.

QSL SAMPLES, Dime, refundable. Roy Gale, Waterford, Conn.

QSL's-SWL's: High quality, reasonable prices. Samples. Bob Teachout, W1FSV, 204 Adams Street, Rutland, Vermont.

QUALITY QSL's. Samples, 10¢ Lee, W5CZA, Box 7171, Oklahoma City, Oklahoma.

QSL's-SWL's: That are different, colored, embossed card stock, and "Kromekote." Samples 10¢. K8AIA, Box 953, Hamilton, Ohio.

KEN-ELS RADIO SUPPLY



\$249

Automatic clock timer \$10 extra

HAMMARLUND HQ-110

Strictly for the amateur. Tunes 6, 10, 15, 20, 40, 80 and 160 meter bands. Q-multiplier. Crystal calibrator. Highly efficient noise limiter. Separate linear detector for SSB and CW. Electrical bandspread. Separate BFO oscillator. Crystal-controlled dual conversion. 12-tube superheterodyne circuit. Auto-response audio system.



\$189

Automatic clock timer \$10 extra.

HAMMARLUND HQ-100

General purpose communications receiver continuously tunable from 540 KCS to 30 MCS. Outstanding sensitivity and selectivity. Q-multiplier. Excellent stability. Electrical bandspread. Noise limiter. "S" meter. Auto-response.



WØZKD—Glen } Fort Dodge
WØZCN—Ken }

428 Central Ave., Fort Dodge, Iowa
Phone: 5-2451

WØCRP—Russ } Cedar Rapids
KØABO—Rog }

67 16th Ave., S. W., Cedar Rapids, Iowa
Phone: EM 4-1172

For further information, check number 70 on page 194.

VALUES GALORE!

RM52 Br. New for Nov. only \$.99

ARC-5 XMTRS

- | | |
|--------------------------|--------|
| BC 696 XMTR — Like New — | \$6.95 |
| 3-4 mcs | |
| BC 458 XMTR — Like New — | \$5.95 |
| 5.3-7 mcs | |
| BC 457 XMTR — Like New — | \$5.95 |
| 4-5.3 mcs | |



All Above Like New With Tubes & Crystals

ALL BAND RECEIVER

190 to 9050 KC

AIRCRAFT • WEATHER • BROADCAST • MARINE
Foreign • Mobile • Amateur—40-75-80 & 160 Meters
NAVY ARB/CRV 46151. Four Band, Six Tube Superhet—
Local and Remote Tuning and Band Change, Illuminated Dial,
Sharp and Broad Tuning, AVC, CW, Provisions for operation of
DU-1 Loop. Complete with Tubes: 1/12SA7, 1/12A6, 4/12SF7;
& 24 Volt Dynamotor. Size: 8" x 7" x 16".
Wt.: 26 lbs. Price—Used.....

\$18.95

MIKES

- | | |
|---|--------|
| Boom mike for headset M6/UR..... | \$3.50 |
| T17 Carbon Hand | \$4.95 |
| RS38 — special | \$1.95 |
| Coil Cords—3 and 4 cond. 7-8 foot | \$.99 |

WALKEY TALKY

- | | |
|--|----------|
| BC611—Fully Checked Out Less Batt..... | \$ 59.95 |
| Matched Pair | \$108.95 |

FIELD PHONE \$9.95

EE8 Ideal for farm, warehouse, garage extension,
etc. Works on 2 flashlight cells. Handset, gener-
ator, ringer, etc., included in sturdy case. Recon-
ditioned, in excellent condition.



TG5—TELEGRAPH SET

- | | |
|---------------------------|--------|
| W/Key & Case..... | \$5.95 |
| J45—Thigh Code Key | \$1.79 |
| J38—w/on off switch..... | \$1.13 |
| J48—Key/Cover W/PL55..... | \$1.95 |



HEADSETS

- | | | | |
|------------------------|--------|------------------------------|--------|
| HS 33 Low input | \$3.95 | Plugs: PL-55 | \$.38 |
| HS 30 Low input | \$1.75 | PL-68 | \$.42 |
| HS 23—8,000 Ohms | \$2.95 | Interphone control | \$.98 |
| H16U—Hi Input | \$2.75 | Hi-Lo Adapter for HS33, etc. | \$.69 |
| H63U—w/Boom Mike | \$6.95 | Coil Cord—3 Con.—15 Ft. | \$.99 |
| Ext. Cord CD307A..... | \$.89 | | |

FIELD TELEPHONE SWITCHBOARD

BD72—Portable telephone switchboard. 12 private lines
with additional 4 lines available. Hand ringing magneto
type using flashlight batteries. Automatic signal, night
light & alarm. Desk type cabinet with folding, adjustable
legs.
Special \$17.95

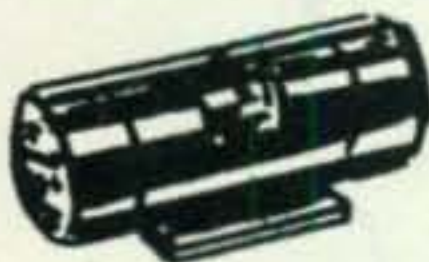

LOWEST PRICES ANYWHERE!

- | | |
|--|--------|
| PE 101 for BC 645 etc. Has 12-24V input
(Easy to convert for 6V Bat. Opr.) only | \$5.95 |
| FL-8 Radio Filter | \$1.49 |

DYNAMOTOR

- | | |
|--|--------|
| DM94 — New — 28V 10.5A,
300V 260MA; 250V 10MA;
4700RPM — Spec. | \$4.95 |
| DM42 — 12 — 14V 46A 7500
RPM 515V, 215MA; 1030V
260MA. using 6V input —
500V at 350MA. Spec. | \$7.49 |

ANTENNAS

- | | |
|--|--------|
| Special — AN 130 Whip —
Brand New, Built-in loading
coil w/screw in base 2PC at-
tached — special | \$.69 |
| AN29C Teles. 14 inch—12 ft.
Spec. \$3.49 Fishpole — 3 ft.
\$3.39, 6 ft. \$3.89, 9 ft. \$1.39,
12 ft. \$2.19, 15 ft. \$2.79, 18 ft.
\$3.89, 24 ft. \$4.69
Free base w/15 ft. or over
TM 210 loading box | \$.75 |

WE ARE SUPPLIERS OF MAINTENANCE PARTS OF
ARMY GROUND EQUIPMENT SEND US YOUR INQUIRIES
SEND FOR FREE BULLETIN, MIN. \$2.50, F.O.B. WHSE,
25% on C.O.D.

East Meadow Surplus Co.

462 Chestnut Lane, Dept. C11
East Meadow, N. Y.

For further information, check number 71 on page 194.

192 • CQ • November, 1958

QSL (Contd.)

QSL's—"Brownie" W3CJI, 3110 Lehigh, Allentown, Pa.
Samples. 10¢ with catalogue, 25¢.

QSL's: Newest designs glossy stock 2 colors, 100 for
\$2.50. Sample brochure free. One week service. Box 671
Hawthorne, California.

QSL's-SWL's. 100—\$2.50. Samples, 10¢. QSO file cards,
\$1.00 per 100. Rusprint. Box 7507, Kansas City 16, Mo.

QSL's: Send something different—High Quality Cards,
samples 10¢. Summerville, K8BYN, RFD 3, Niles, Mich-
igan.

QSL's ? ? ? ? LARGEST variety samples 25¢ (refunded);
CALLBOOKS (latest) \$5.00. Sackers, W8DED, Hol-
land, Michigan. (Religious QSL samples 10¢, "Your
Best Contact" religious booklet free).

QSL's, \$4.65 for 500. Send 4¢ stamp for free brochure.
K9EUF Print, 1839 46th Street, Rock Island, Illinois.

QSLs — Outstanding—Original—Fast service—reasonable
prices. Large assortment samples 10¢. VYS QSLs,
1704 Hale, Ft. Wayne, Indiana.

QSLs, OM-YL, AM-FM-SSB-CW, VHF-UHF, MARS,
CAP, BC-SWBC. Special offer, details, samples 10¢.
Onondaga Press, Box 22, Onondaga, Michigan.

SWAP OR SELL

PE 103 White Elephant? Here is your chance to unload as
I will pay \$10.00 for each PE 103 Dynamotor, unaltered,
complete and with cables, new or used. Send cheapest
transportation and subject to inspection to William C.
Grove, 3402 Forest Drive, Cheyenne, Wyoming.

RADIO MAGAZINES. Buy, sell, trade. Bob Farmer,
Plainview, Texas.

NEED THE FOLLOWING BACK ISSUES OF CQ:
November 1955, July 1956, February 1957. Will swap a
brand new first MOBILE HANDBOOK or copy of COM-
MAND SETS, or \$1 in cash for the above three issues.
Must be in good condition. Offer limited to first 100 copies.
Send to CQ Magazine, 300 W. 43rd St., N. Y. 36, N. Y.

SELL-TRADE: 9 new plate modulators excellent for
following transmitters: Globe Chief, Adventurer, Knight,
Navigator, DX-20, AT-I, \$10-20 each. 8 new transistor
code practice oscillators \$3 each. New supplies:
1100v/300 ma. \$20. 400v/100 ma. \$7. Plate transform-
ers: 1680v. center tap 200 ma. \$8. 1800v/250 ma. center
tap (uncased) \$7. 1800v. center tap 250 ma. \$9. New
60 watt modulation transformer \$8. Stanley Zuchora,
W8QKU, 2748 Meade St., Detroit 12, Michigan.

MISCELLANEOUS

DECORATE YOUR CAR WINDSHIELD WITH YOUR
CALL LETTERS. Attractive 1" letters and numbers avail-
able in gold or black. Complete single set 75¢, two sets
for \$1.25. Include name, call, address and color preference.
Money refunded upon return of unused decals if not satis-
fied. All orders must be prepaid. Send to Box RJ, c/o
CQ Magazine, 300 West 43rd St., N. Y. 36, N. Y.

PRESERVE YOUR HAM TICKET, Social Security Card,
small photo, passes and anything else of value that is
wallet size. We will laminate it in clear plastic, guaran-
teed for life. Lamination will prevent it from getting
torn, soiled or frayed. Send your ticket or anything of
value with \$1 in stamps or cash for each item that you
want preserved. 24 hour service. Send to Dept. HW, CQ
Magazine, 300 West 43rd St., N. Y. 36, N. Y.

W0CVU GOLD CUP given for 100th country verified
Two Way SSB. Airmail your QSL. Don't delay. An-
nouncing winner soon in CQ. Charles Boegel, 1500 Cen-
ter Point Road, N.E., Cedar Rapids, Iowa.

TEST tone record. Your call announced at end. \$2.00.
Expert kit wiring. 20%. Robert E. Brown, W2CCA,
1133 Summit Place, Utica, N. Y.

ALUMINUM from Dick's, plus your ingenuity, will
make you the best beam for less. Write today for list
of tubing, angle, channel, castings, plain and perforated
sheet, and complete beam kits. Dick's, W8IJJ, Cherry
Avenue, Route 1, Tiffin, Ohio.

YOUR BEST CONTACT (spiritual side of ham's life).
Free folder on request. "Rus" Sackers, W8DED, Holland,
Michigan.

SATELLITE RECEP. [from p. 187]

be satisfactorily employed even without the use of band separation filters for the various telemetry channels.

The final data interpretation from both amateur and professional tape recordings is highly dependent upon an accurate knowledge of the time at which the recordings were made. The signal strength at each receiving station varies greatly between various satellite passes as well as during a single pass. It is necessary, therefore, to analyze the data from several stations which may be receiving the signal approximately at the same time. If the recorded time is not known for each station, the data may be incomplete, confusing, or even worthless. In general, this requirement has been recognized by amateurs who have participated in this program.

Various methods of recording time have been used by amateurs. One amateur handled the problem by switching from telemetered data to WWV for both the five minute voice and code announcements with a few seconds break for each one minute mark. This method, while excellent, generally requires the use of a second receiver. An alternate method that should be quite good would be the accurate setting of a clock or watch to WWV before the satellite pass, and voice recording the time for each minute and five minute period. A third possibility would be the recording of time in code by either an accurate 400 cycle oscillator or the 60 cycle AC line. In either case, the start of the minute would be indicated by a five to ten second dash following the code announcement. The use of either an accurate 400 cycle or 60 cycle frequency has the additional merit of providing a check on the exact speed of the recording and reproducing equipment. A worthwhile modification of the above idea would be to continuously record the selected tone at a low level and amplitude key its level for code recording. If possible, the time error should be held to less than one second.

The above information is not meant to discourage the efforts of those who have undertaken measurements of the satellite transmissions but merely to point out possible improvements which might be made in the receiving and recording of data. This laboratory is well aware of the major contributions which the amateur fraternity has made to science. We have the greatest respect for their efforts and results, and fully expect that their contributions to future technology will be equally great.

The author wishes to express his appreciation to Messrs. N. W. Mathews of the Naval Research Laboratory and L. N. Cormier of the National Academy of Sciences for their comments and suggestions on the preparation of this paper.

Can they read you?

now ...
*you can check
your
transmitter's*

Power output
Audio level
Modulation
Distortion
Hum Level
% Modulation
on-the-spot yourself
with the all-new

Nothing
like it
anywhere!
... and
ONLY

\$29⁹⁵

TEST-O-MATIC®

FS-3
**FIELD
STRENGTH
AND
MODU-
LATION
METER**

Operates up to 300 feet from any transmitter and checks your signal strength by both meter and audio level. Ideal for Hams, Police, Planes, CD, and Fleet Operators. Look at all these big features!

- Transistorized
- High Q Tuned Circuit
- Self Powered (Battery)
- Complete with Six Coils for 148 to 2.7 MC
- Retractable Antenna
- Hand Size: 6" x 3 3/4"

Operates on single side band as well.

Write now for complete information
or see your electronic parts distributor

SHELL ELECTRONIC MFG. CORP.

Dept. C-11 1688 Utica Avenue, Brooklyn, New York

Export: RIISE International Corp., 204 E. 38 St., New York, N. Y.
For further information, check number 72 on page 194.

Advertising Index

A. G. Radio Parts Co.	146	Heath Company	4, 5, 6, 7, 8
Ack Radio Company	149	Henry Radio Stores	150, 157
Alco Electronics Mfg. Co.	163	Hewlett Sales Co.	151
Algeradio Electronics Co.	161	Hi-Par Products Co.	187
Allied Radio Corp.	196	Hornet Antenna Products Co.	22
Alltronics-Howard Co.	152, 154	Instructo Graph	187
Amateur Electronic Supply	150	International Crystal Mfg. Co.	12
Antrim Marine Radio	155	Japan Electronic Trading Co.	174
Arkay Electronic Sales Company	190	Johnson, E. F. Co.	Cover 2 and 30
Arrow Electronics, Inc.	153	Kalab Electronics	187
Arrow Sales, Inc.	185	Ken-Els Radio Supply	191
Barker & Williamson, Inc.	23	KwickPatch	186
Barry Electronics Corp.	183, 188, 189	Ladd Electronics	155
Burghardt Radio Supply	148	Lakeshore Industries	18
Burstein-Applebee Co.	156	Master Mobile Mounts, Inc.	29
C & G Radio Supply Co.	158	Meshna Enterprises	171
Candee, J. J. Company	182	Millen, James Mfg. Co., Inc.	2
Central Electronics, Inc.	161	Millwood Studio	187
Cleveland Institute of Radio Electronics	14	Mosley Electronics, Inc.	167, 169, 171, 173, 175, 177, 180, 181
Collins Radio Company	65, 66, 67, 68	National Company, Inc.	Cover 3
Columbia Electronics Sales	190	Nelson Publishing Co.	165
Columbia Products Co.	168	Olson Radio Warehouse	155
Communications Associates	185	Palmer, Joe	184
Communications Company, Inc.	26	Payette Radio, Ltd.	151
Concord Radio Corp.	170	Petersen Radio Co. Inc.	1
Continental Electronics & Sound Co.	20, 21	Pioneer Electron Supply	159
Craftsman	185	RCA Electronic Tube Div.	Cover 4
CQ Back Issues	173	RW Electronics	176
CQ Books	172	Radio Amateur Call Book	164
CQ Ham Shack	179	Radio Bookshop	158
CQ Hi-Fi Book	178	Rex Radio Supply Co.	186
CQ Subscription Ad.	116-117	Science & Mechanics	186
CQ Tool Kit, Atlas & Globe	166	Scientific Industries, Inc.	163
CQ YL Book	166	Selectronics Supplies, Inc.	154
Cubex Company	185	Shell Electronic Mfg. Corp.	193
Dampp-Chaser, Inc.	177	Sky-Lane Products	164
Digitrols	182	Springfield Enterprises	165
Distributor List	119-127	TAB	195
Dow-Key Company, Inc.	162	Technical Material Corp.	19
E-Z Way Towers, Inc.	181	Tele-Vue Towers, Inc.	180
East Meadow Surplus Co.	192	Telrex, Inc.	163
Edwards, W. H. Company	156	Trading Post	150
Eitel-McCollough, Inc.	13	Triad Transformer Corp.	16
Electronic Export Co., Inc.	152	Tri-Ex Tower Corp.	27
Fair Radio Sales	162	United Catalog Publishers	25
G & G Radio Supply Co.	160	Vesto Co., Inc.	184
Glas-Line Company	174	Waco Communications, Inc.	186
Globe Electronics	17	Warner Permaniz	155
Globe Industries, Inc.	167	Warren Radio Co.	152
Gonset Company	24	Western Radio Co.	154
Greenlee Tool Co.	169	Willard S. Wilson	150
Groth, R. W. Mfg. Co.	174	World Radio Labs., Inc.	142, 143
H & C Sales Co.	174	Zalytron Tube Corp.	186
Hallicrafters Company	10, 11		
Hammarlund Mfg. Co.	15		
Harrison Radio Corp.	147		
Harvey Radio Co., Inc.	144, 145		

Reader Service

CQ Magazine, Dept. RS

300 West 43rd Street
New York 36, New York

Reader Service Coupon K

Void after Nov. 25, 1958

Please send me information on your ads in the November 1958 CQ keyed as follows:

1	2	3	4	5	6	7	8	9	10	11	12	13	14	15
16	17	18	19	20	21	22	23	24	25	26	27	28	29	30
31	32	33	34	35	36	37	38	39	40	41	42	43	44	45
46	47	48	49	50	51	52	53	54	55	56	57	58	59	60
61	62	63	64	65	66	67	68	69	70	71	72	73	74	75

A B C D
E F G H
I

Name _____ Call _____ Engineer

(Please Print)

Address _____ Type of work (specify) _____

City _____ Zone _____ State _____

"TAB" THAT'S A BUY

since 1945 custom service!

INSPECTED "TAB" TESTED GUARANTEED

Tubes Wanted

0A2 70	6BZ7 1.25	We Buy & Sell
0A3 85	6C449	4375
0B265	6C569	4549
0C370	6C6 1.08	50L669
0D370	6C8 1.08	RK59 1.39
0Z460	We Trade!	RK60 1.17
1A790	6CB680	HY69 2.20
1B378	6CD6 1.49	7581
1L482	6CF685	HY75 5.00
1R4 5/\$1	6CL6 1.40	8395

We Swap Tubes! What Do/You Have?

IR578	6CG789	4-65A 19.00
IS478	6CG8 1.12	4-125A 29.00
IS568	6CM679	4X150A 38.00
IT485	6CS670	4X250B 41.00
IT595	6CUG 1.29	4-400A 45.00
IU4 6/81	6D699	4E27A 39.00
IU575	6E579	250TL 19.45
IX275	6F4 2.49	307A 2/\$1
2C39A 10.00	6F563	316A 5/\$1
2C46 6.00	6F699	VR92 5/\$1

Send 25¢ for Catalog!

2C43 7.00	6F799	350A 2.45
2C51 2.00	6F8 1.39	350B 1.75
2D2168	6H659	368A 4.59
2E22 1.75	6J4 1.72	371B95
2E24 2.00	6J559	8146 3.90
2E25 3.25	6J659	446A 2/\$1
2E26 2.75	6J799	430TH 13.59
2E30 1.70	6J8 1.39	450TL 13.50
2E35 1.60	6K679	460 11.50
2K25 15.00	6K779	701A 3.95

Wanted Receivers and XMITRS

2K26 39.00	6K899	703A 1.00
2K28 30.00	6L6 1.19	707B 3.50
2V3 2/\$1	6SN772	715C 10.90
2X248	6T898	717A 5/\$1
3A470	6V6GT90	723AB 8.00
3A555	6X549	725A 2.75
3API 3.95	12AT659	801A 5/\$1
3BP1 1.90	12AT789	803 2.00
3C24 2.50	12AU663	804 8.85
3D23 4.00	12AU769	805 4.75

We Buy!

We Sell!

We Trade!

3E29 7.00	12AX779	807 \$1.50
3Q468	12AY7 1.29	80885
3Q586	12B495	809 2.40
4-65 15.00	12BA665	837 1.08
4-125 30.00	12BA799	811 2.70
4-250 31.00	12BD659	812 3.30
4X150 18.00	12BE659	813 8.69
4X250 36.00	12BH679	814 2.35
4X500 37.00	12BH799	815 1.85
5API 2.95	12BY7 1.00	826 2/\$1

Wanted Test Sets and Equipment

5BP1 3.95	12BZ799	828 9.00
5BP4 3.25	12H675	829B 8.00
5CP1 1.95	12J569	832A 6.00
5CP7 9.00	12J769	833A 36.00
5R4 1.00	12J8 1.35	837 2/\$2
5T4 1.25	12K889	866A 1.50
5U459	12SA769	954 10/81
5V489	12SC789	955 3/\$1
5Y365	12SF569	957 3/\$1
5Z389	12SG789	958A 2/\$1

Send 25¢ for Catalog!

5Z4 1.00	12SH789	991 5/\$1
6A7 1.00	12SJ775	1614 2.00
6A899	12SK775	1619 5/\$1
6AB459	12SL779	1620 2.00
6AC779	12SN769	1625 4/81
6AG569	12SQ769	1626 5/81
6AG797	12SR769	1629 4/81
6AK569	15E 1.19	2050 1.25
6AL559	15R 4/81	5517 1.25
6AQ566	FG17 3.49	5608 3.95

We Have It! Just Write!

6AR6 1.95	19T8 1.16	5618 3.25
6AS7 3.49	24G 2.00	5651 1.25
6AT6 2/\$1	25A6 1.19	5654 1.20
6AU679	25A7 2.19	5656 4.25
6B8 1.35	25C581	5663 1.15
6BA659	25L672	5670 1.00
6BE659	25T 4.00	5686 1.75
6BG6 1.49	25Z572	5687 2.25
6BH679	25Z675	5691 4.70
6BJ672	26A7 3.69	5725 1.95

Top \$\$\$ Paid for XM Tubes!

6BK799	FG27 8.28	5732 2.00
6BL7 1.95	HV27 19.39	5736 \$5.00
6BN469	28D789	5749 1.95
6BN6 1.08	FG33 15.00	5750 2.75
6BN7 1.99	EL34 3.49	5751 1.25
6BQ6 1.19	35A569	5814 1.20
6BQ799	35L659	5879 1.20
6BX7 1.11	35T 4.49	5894 \$12.00
6BY5 1.19	35Z589	
6BZ691	RK39 2.99	No See—Write!

"TAB" TERMS: Money Back Gtd. \$2 min. order F.O.B. N.Y.C. Add Shpg. charges or for C.O.D. 25% Dep. Tubes Gtd. via R-Exp. only. Prices shown are subject to change.

111XC Liberty St., N.Y. 6, N.Y., RE 2-6245

"TAB"—THAT'S A BUY!—BARGAINS!!

BC457/1 to 5.3mes as is/good parts... \$1.79
 AN-ARR2/RCVR as is/good parts \$1.59
 RDZ/USN 200-400 Mes Revrs As Is... \$25
 Slim Jim Dynamic Mike Hand or Std \$3.49
 Neck Mike Carbon New 89¢ @, 3/2
 Telescoping 9 to 38" Antenna..... \$1.69, 2/3
 60Mc's/IF-Strip \$5; 30Mc's/As Is... \$3.00
 866A/2 Combo & Fil XFMR/7.5KV Ins 5.98
 Xmtting Mica's .006 @ 2500V. 5 for \$1.00
 Relay 4PDT/3Acts/12 to 24VDC \$1 @, 6/5
 Hvy Dty 115V/60Cy Selsyns. 2 for \$9.00
 Miller 2.5MH/2.5&5Mtr Chokes... 8/\$1.00
 Vibrators 6 or 12VDC \$1.49 @; 4/..... \$5.00
 Blower 24VDC/100CFM \$2.98
 Blower AC/Miniature 6&12VAC \$1.00
 Co-Ax Cnnects PL259A/SO239/40c ea. 6/52
 Battery Charger 6 or 12V/4A \$9.95
 AN Voltmeter 0-30VDC \$2.49 @, 3 for \$6.00
 RF-MTR GE/475 Ma & 5 Amp \$4 @, 2/57
 DC-METER Dejur 800 Ma/3 1/2" \$3 @, 2/55
 DC-METER One Ma/1" Rect \$5 @, 2/58
 RF-MTR Weston 750Ma \$4 @, 2/56
 DC MTR One/Ma/scale No #'s \$2.50
 DC MTR 100Ma/2 1/2" \$3 @, 2/55
 DC MTR 1 Ma/1" Rect. \$5 @, 2/58

TRANSFORMERS all 115V/60cy/10
 6V @ 8A, 5V @ 3A & 1200VCT@200ma \$5
 TPF52/778VCT @ 200ma, 5V @ 3A,
 6.3VCT @ 5A \$4 @ 3 for \$11
 TPF/540VCT @ 30ma/6.3V @ 2A \$2
 TPF61/500VCT @ 70ma & 6.3V @ 4A \$3
 TPF62/550VCT @ 250ma & 6.3VCT @
 2.5A & 12.6V @ 3.5A, & 5V @ 2A \$5
 TFO2/2.5VCT @ 10A/5KV \$4
 TR400R/2x16V @ 1A ea. \$3.45
 TFO5/7.5VCT/12A/15KV KENYON \$9
 TP514 Pri/110, 220, 440V—Secd 880VCT @
 735ma G.E./USN Acq \$90 @, \$9 @ 2/\$15
 TS12 Auto booster 300W/115 to 132V \$3

FILTER & SWINGING CHOKES
 CHI029 CHOKE 8 Hy @ 750ma \$12
 CHI030 CHOKE 6 Hy @ 1.25A \$18
 CHI031 CHOKE 0.6 Hy @ 3.2A \$10
 CHI034 CHOKE 5 Hy @ 500ma \$6
 CHOKE 8 Hy @ 150ma \$2
 UTC/CG40/10 Hy @ 200ma \$3 @ 2/55
 CTC/R88150/8 Hy @ 150ma/80Ω \$3
 CTC/R88250/8 Hy @ 250ma/90Ω \$5
 CTC/R88105/8 Hy @ 105ma/100Ω \$2
 STAN/C2700/2-12 Hy @ 200ma/80Ω \$6
 STAN/C2701/3-12 Hy @ 350ma/80Ω \$10
 KEN/T509/7-22 Hy @ 200ma/140Ω \$8
 KEN/T510/6-10 Hy @ 300ma/125Ω \$9
 CHI011 RCA/10 Hy @ 150ma \$2 @.3/55
 CHI003 UTC/10 Hy @ 125ma \$2
 KEN/3-14 Hy @ 1.1 Amps/5KV \$25

HI-VOLTAGE 2725VDC SELENIUM RECTIFIER

"International Rectifier" Cartridge HiVolt-
 age Selenium one-half wave. Rated
 4500VAC/condensor input. 2725VDC @ 5
 milliamperes; 5" lgth, 9/16" Dia. Similar
 V125HF which sells for \$16.07 each, Jan-
 Spec & W.E. "TAB" Special! \$4.00 each,
 2 for \$7. 8 for \$25.
 Postpaid 48 States, U. S. A.

NEW TPSK2 DC POWER for TRANSISTORS!

Transistors! Filtered Power Supply Kit
 used to power transistor circuits, amplifiers,
 etc. Delivers 12VDC at 2AMPS filtered less
 than 0.5% ripple or 28VDC at
 1A TPSK2 Kit \$18; TPS2W as-
 sembled & wired \$24.
 115VAC Inpt Transformer &
 Full Wave Bridge Rectifier for
 12VDC @ 2AMPS, or REC-
 TRAN KIT RT1K \$4.50
 RT2K Kit 12 or 18VDC at 6
 AMPS \$9.00

2-4-6 & 12 VOLT BATTERY CHARGER KIT 2 TO 4 AMP.

Charges 2-4-6 &
 12 volt batteries.
 Kit BCK-1 \$11.
 Built \$12.75

"IRISH" HI-FI RECORDING TAPE!

1200 Ft.—7" Reel \$1.45 @ Lots
 Money Back Gtd! of 12
 7" REEL, 1200 FOOT Highest Quality
 Precision Coated & slit. "ERIN" Gloss.
 "ERIN" processed constant output. Noise
 Free. Freq. 7 1/2 IPS 40-15 KC Oxide Wnd.
 In. @ \$1.69 ea. 3 for \$5.

Guaranteed Phono Replacement Needles—
 Registered 1 Year Guart'd. by the Mfr.
 Single Diamond \$6; Dual Diamond \$14
 Diamond Sapphire \$8 @ Send Cartridge
 Name and Number.
 Postpaid 48 States, U. S. A.

WE BUY! SELL & TRADE

"TAB" THE BEST KITS!

- KITS! Each "TAB" Kit Contains The Finest Selection**
- Kit 5 Myallex Glass/HF Strips
 - Kit 35 Precision Resistors
 - Kit 10 Switches
 - Kit 75 Resistors 1/2"/1/2W
 - Kit 150 Carbon Resistors
 - Kit 25 Panel Lamps
 - Kit 12 Electrolytic Cond's
 - Kit 15 Volume Controls
 - Kit 56 Tube Sockets
 - Kit 65 Tubular Condensers
 - Kit 500 Lugs & Eyelets
 - Kit 10 Bathing Oil Cond's
 - Kit 5 lbs. Surprise Package
 - Kit 10 Transmitt Mica Cond's
 - Kit Gypsum & Cement
 - Kit 3 Phone/Patch Xfms
 - Kit 3 Searchlights
 - Kit 4 AN/Reflector Lites
 - Kit 6 Insul'd Tuning Tools
 - Kit 3 AN Plugs & cnects
 - Order Ten Kits
 - We Ship Eleven!!!

Order Ten Kits We Ship Eleven!!!

ONE EACH ABOVE 99c

MOBILEERS — NEW IDEAL POWER SOURCE! KIT OR ASSEMBLED

Transistorized "TAB-PAK" Filtered Supply Small in Size! Quiet! Light Wgt. Input 12 to 14VDC (Low Idle Current) Output 450VDC & tap 250VDC @ up to 150MA/65 watts, filtered DC.
"TABPAK" Assembled TR39CB... \$35
"TABPAK" Kit TR39CK... \$30
"TAB HDQTRS FOR TRANSISTOR POWER CONVERTORS PARTS
"TABTRAN" Transistor Transformer 12VDC/Inpt; Output 450VDC & TAP at 225VDC at up to 150MA Output!
"TABTRAN" TR450M3 and data \$14.00

DC AMP	18VAC 14VDC	36VAC 28VDC	72VAC 54VDC	130VAC 100VDC
1/2	\$1.00	\$1.90	\$3.85	\$5.00
1	1.30	2.00	4.90	8.15
2	2.15	3.00	6.25	11.10
3	2.90	4.00	8.60	13.45
6	4.15	8.00	18.75	31.90
10	6.10	12.15	26.30	41.60
12	7.75	14.90	30.95	43.45
20	12.85	24.60	49.90	76.75
24	15.00	29.45	57.50	81.15

New "TABTRAN" Rectifier Xfms
 Sec'd Volts (DUAL) 0-9-15-18- & 0-9-15-18. Series Sec'ds 0-3-6-9-12-15-18-21-24-27-30-33-36 Volts.
 TR4001 @ 1 Amp ea/sec/winding \$4.50
 TR4002 @ 2 Amp ea/sec/winding 6.90
 TR4003 @ 5 Amp ea/sec/winding 8.65
 TR4005 @ 12 Amp ea/sec/wnds 16.70
 TR4006 @ 24 Amp ea/sec/wnds 35.30
 TR4007 @ 50 Amp ea/sec/wnds 57.45
 †Wdngs in Series at Ratings shown: Parallel 2X Current. Voltage output. 0-9-15-18

New Variable VARIAC® Type X-frms SUPERIOR-GR-STACO
 0-132v-1.25A \$7.23
 0-135V/3A 10.63
 Cased 0-135V/7.5A 19.55
 Uncased 135V/7.5A 15.30
 Cased 0-135V/15A 39.10
 Uncased 135V/30A 44.10
 Uncased 270V/12A 44.10
 Uncased 270V/30A 113.00

NEW GTD. 130V/RMS HALF-WAVE RECTIFIERS
 75Ma 49c, 5 for \$2; 100Ma 59c, 6 for \$3
 150Ma 70c, 8 for \$5; 250Ma 79c, 6 for \$4
 300Ma 88c, 5 for \$4; 350Ma \$1.00, 8 for \$7
 400Ma \$1.10, 5 for \$5; 500Ma \$1.35, 5 for \$5
 Postpaid 48 states orders \$10.

New Silicon 500ma./280V RMS/400 P.I.V. 100°C
 Hmt Sealed \$1.50 @ 5 for \$6.50, 40 for \$46
 orders \$10, Postpaid 48 states

Wanted 304TL Tubes & ALL TYPES!!!
 Top \$\$\$ Paid For 304TL Sperry & Raytheon 2K33A, 2K39, 2K41 & 2K42, 2K43. Also EIMAC, GE, RCA, HK, WE, CBS etc!

Wanted—Test-Sets Test Equipment. Send 25¢ for Bonus Catalog!

For further information, check number 73 on page 194.



Incomparably the Best Ham Receiver You Can Build

knight-kit PROFESSIONAL QUALITY AMATEUR RECEIVER KIT

AN ALLIED RADIO PRODUCT

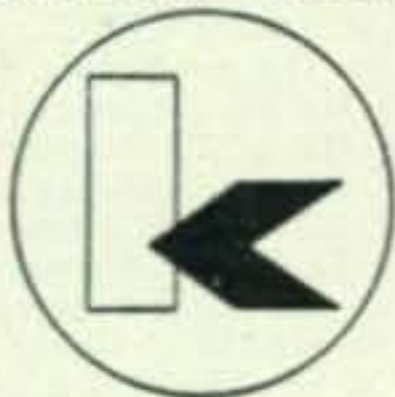

PROFESSIONAL FEATURES AT FAR LESS THAN FACTORY COST

- Printed Circuit Bandswitch
- Printed Circuitry Throughout
- 300 cps to 4.5 kc Selectivity
- Constant Running HFO
- Bandsread on 80-10 Meters
- Tunes 540 kc to 30 mc
- Built-in Q-Multiplier
- 1.5 μ V Sensitivity on SW
- Vernier Dials—No Strings
- Heavy Steel Chassis

Model Y-726

\$104⁵⁰

Only \$10.45
down

The incomparable communications receiver kit value—worthy of the advanced Ham. Has all the features, selectivity and sensitivity of high-priced commercial units. Uses printed circuitry throughout, including the exclusive KNIGHT-KIT printed circuit bandswitch, for easy assembly. Covers 540 kc to 30 mc in 4 ranges; calibrated electrical bandsread on 80-10 meter Ham bands; slug-tuned Hi-Q coils; continuous VR tube-regulated B+ applied to HF oscillator lets you switch from standby to receive with no drift; built-in Q-multiplier peaks desired signal or nulls interference (60 db notch really takes out interference); delayed AVC; built-in noise limiter; provision for crystal calibrator (below). 455 kc I.F. sensitivity: 1.5 microvolts or better for 10 db signal-to-noise ratio, even at 10 meters; 4 μ V on broadcast band. Selectivity: variable from 300 cps to 4.5 kc at 6 db

down. Exalted BFO injection for SSB. Controls: Main tuning, bandsread, bandswitch, BFO pitch, RF gain, AF gain, BFO-MVC-AVC-ANL, OFF-STBY-REC-CAL, ant. trim—plus Q mult. controls: NULL, OFF, PEAK, selectivity, tune. Phone jack on front panel. Both coaxial connector and screw terminal antenna input provided, for 50 to 300 ohm lines. Close tolerance coils reduce alignment time. Cold-rolled 1/16" steel chassis. Handsome metal cabinet, 10 x 10 $\frac{3}{4}$ x 16". With tubes, all parts, wire, solder and instructions. (Less phones, speaker and S-meter.) Shpg. wt., 30 lbs.

Model Y-726. KNIGHT-KIT Amateur Receiver Kit.
Net, only **\$104.50**

Easy Terms: Only \$10.45 Down

Y-728. 4" Speaker in matching metal cabinet for above.
Net, only **\$ 7.50**

Y-727. S-Meter Kit for above **\$10.75**

Y-256. 100 KC Crystal Calibrator Kit **\$10.95**

Free! **452-PAGE 1959
ALLIED CATALOG**

It's packed with the largest selections of station gear at money-saving prices—it's your complete Buying Guide to everything in Electronics. If you haven't a copy, write for it today.

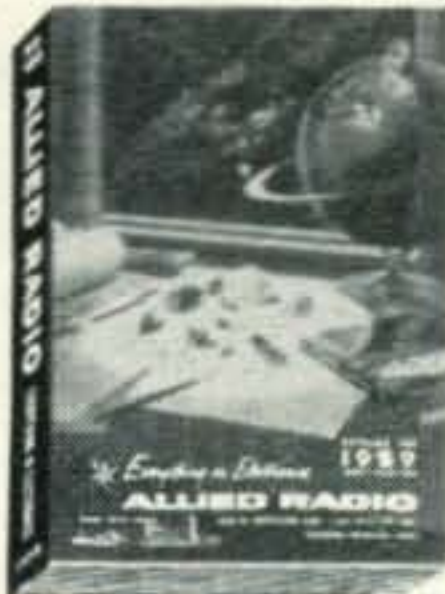

Serving the Amateur for 38 Years

ALLIED RADIO

100 N. Western Ave., Chicago 80, Ill.

For further information, check number 74 on page 194.

ALLIED RADIO

**ALLIED RADIO CORP., Dept. 16-L8
100 N. Western Ave., Chicago 80, Ill.**

Ship me the following:

- Y-726 KNIGHT-KIT RECEIVER KIT
 Y-728 Speaker Y-256 Cal. Kit
 Y-727 S-Meter Kit

\$ _____ enclosed (prices net F.O.B. Chicago)

Name _____

Address _____

City _____ Zone _____ State _____

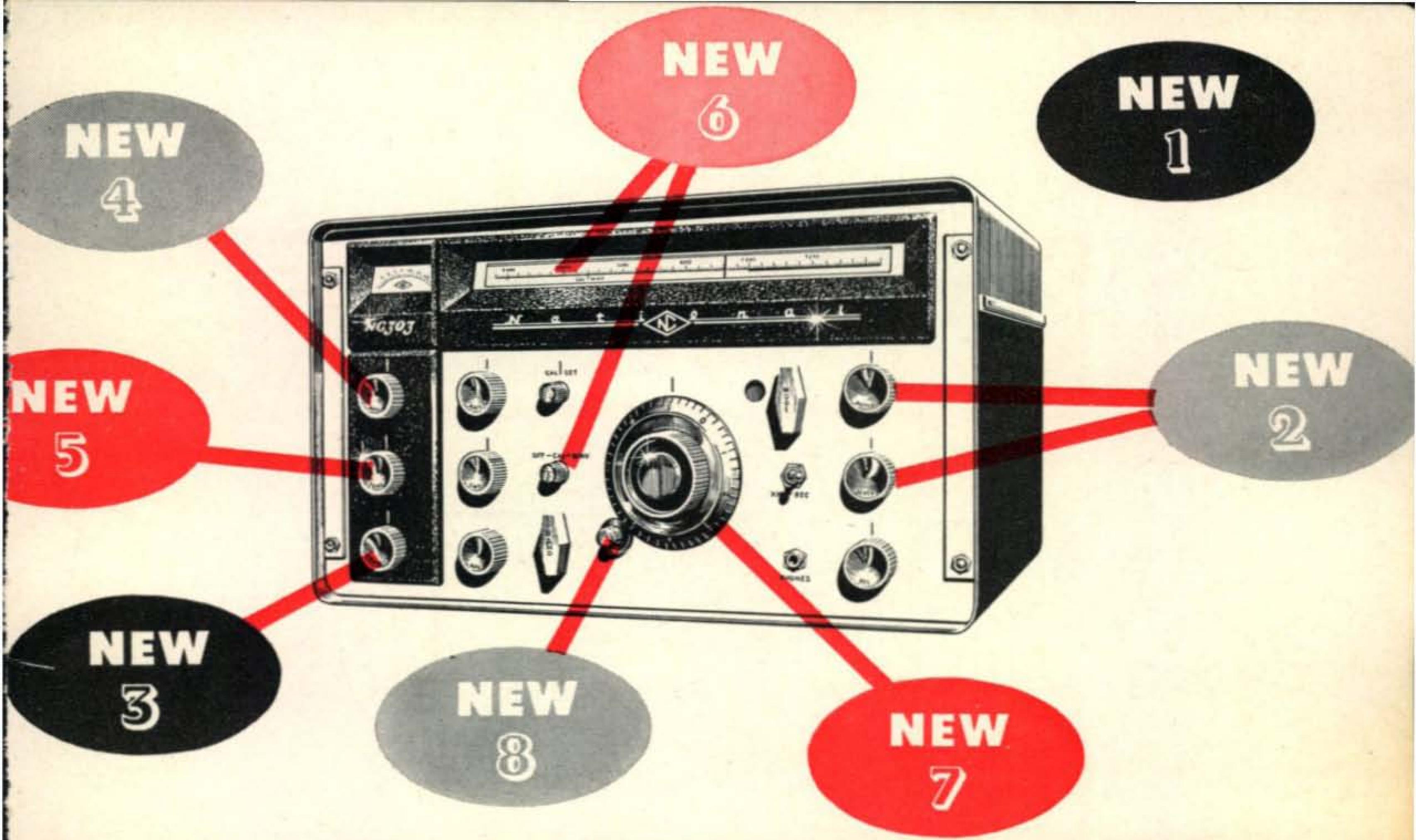

NEW NATIONAL NC-303

- 1 NEW** front panel SSB selector with exclusive, new "IF SHIFT" for instant sideband choice... eliminates retuning or detuning.
- 2 NEW** "Q" Multiplier provides razor-sharp rejection notch (more than 60 db deep). May be tuned continuously across entire receiver passband. Separate notch frequency and notch depth controls.
- 3 NEW** 5-position IF selector provides sharp, SSB-1, SSB-2, medium and broad selectivity. .5 Kc, 2 Kc, 4 Kc and 8 Kc bandwidths provide optimum selectivity for SSB, CW, phone, phone net and VHF plus sideband selection.
- 4 NEW** dual noise limiters. Separate automatic noise limiters for AM. Separate double-ended manual limiter for CW and SSB.
- 5 NEW** tone switch provides for attenuation of highs, lows, or both for maximum readability.
- 6 NEW** exclusive WWV converter provision. No interference with dial calibration or frequency coverage. Accessory calibrator provides one microvolt sensitivity on 10 mc WWV frequency.
- 7 NEW** hi-speed, 40-1 tuning dial with logging scale.
- 8 NEW** fine tuning vernier dial drive provides super-precision for CW and SSB tuning.

ADDITIONAL FEATURES:
 Dual conversion on all bands. Crystal controlled 2nd converter oscillator. Giant, slide-rule dial with ten dial scales covers 160 to 1 1/4 meters, easily readable to 2 kc without interpolation up to 21.5 mc. Exclusive converter provision for 6, 2 and 1 1/4 meters. Separate linear detector for SSB, will not block with RF gain full open. Giant "S" meter. Provision for external control of RF gain automatically during transmitting periods. Muting provision for CW break-in operation. Calibration reset adjustable from front panel. Socket for plug-in crystal and WWV calibrator. Accessory socket for powering converters and future accessories. Fifteen tubes including rectifier. check number 2 on page 194.

Only \$44.99 down*
 Suggested cash price: \$449.00
 (slightly higher west of the Rockies)
 (and outside the U.S.A.)

*Most National Distributors Offer Budget Terms and Trade-In Allowances.

National



NATIONAL COMPANY, INC., MALDEN 48, MASS.

**New
Collins
32S-1
...uses
RCA-6146's**

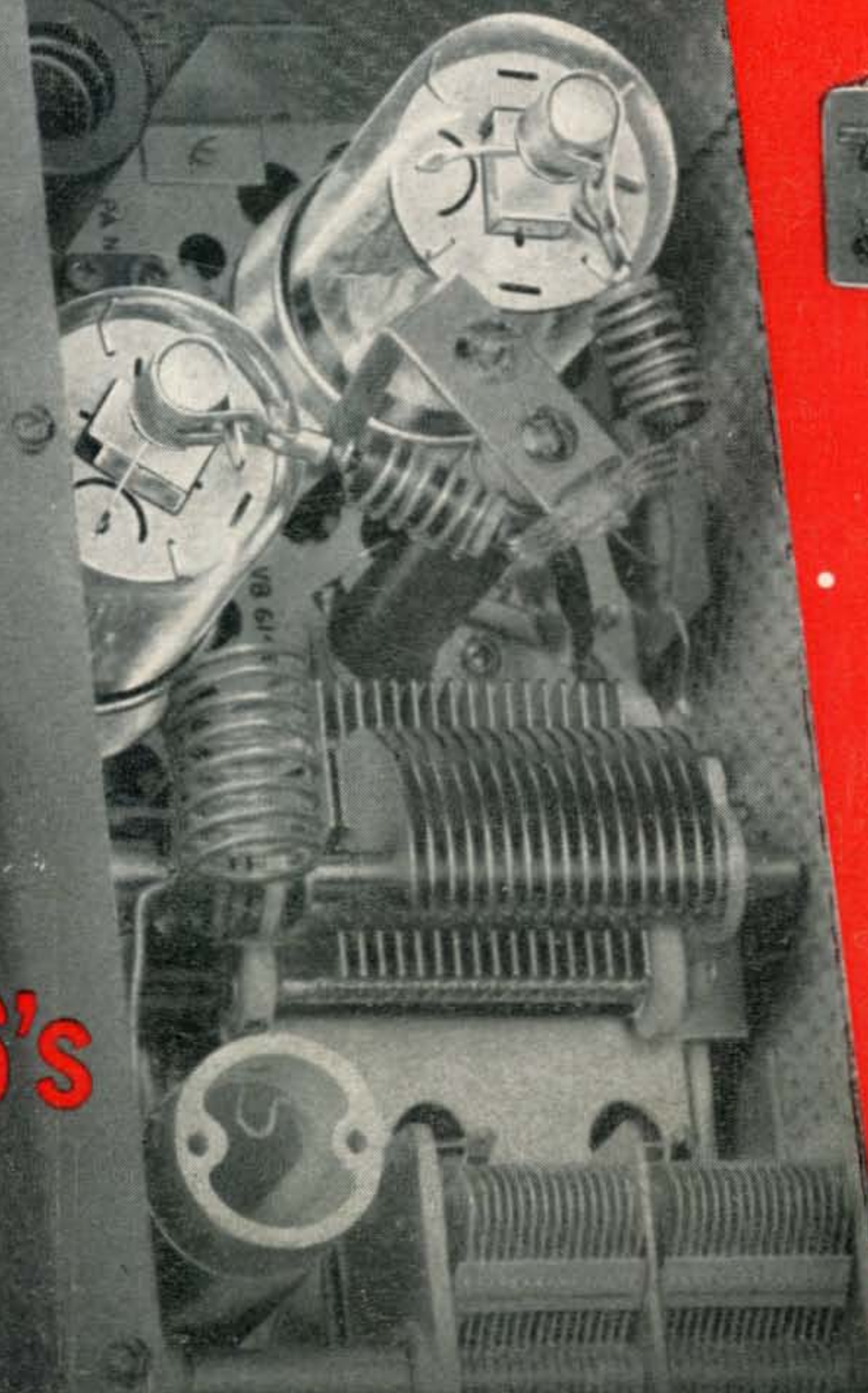

Close-up view of the Collins 32S-1 power amplifier. Two RCA-6146's in parallel deliver the signal punch.



New SSB and CW transmitter for amateurs



RCA-6146
Famous Beam Power Tube
for amateur services

Designed to put out a really potent SSB and CW signal on any band from 10 to 80 meters, the new Collins 32S-1 uses two RCA-6146 beam power tubes in the linear final.

Here are three facts that make the RCA-6146 the overwhelming choice of transmitter designers. (1) This type delivers the required power at relatively low plate voltage. (2) It makes practical the use of fewer stages and

operation with fewer tuning controls. (3) RCA-6146 is a "natural" for compact equipments and bandswitching circuits.

RCA-6146's—as well as the complete line of RCA beam power tubes, triodes, and rectifier tubes—are available through your RCA Industrial Tube Distributor. For technical data on any specific type, write RCA Commercial Engineering, Sect. K-15-M, Harrison, N.J.



RADIO CORPORATION OF AMERICA

® **Electron Tube Division**

Harrison, N. J.