

August 1960

50¢

# CQ

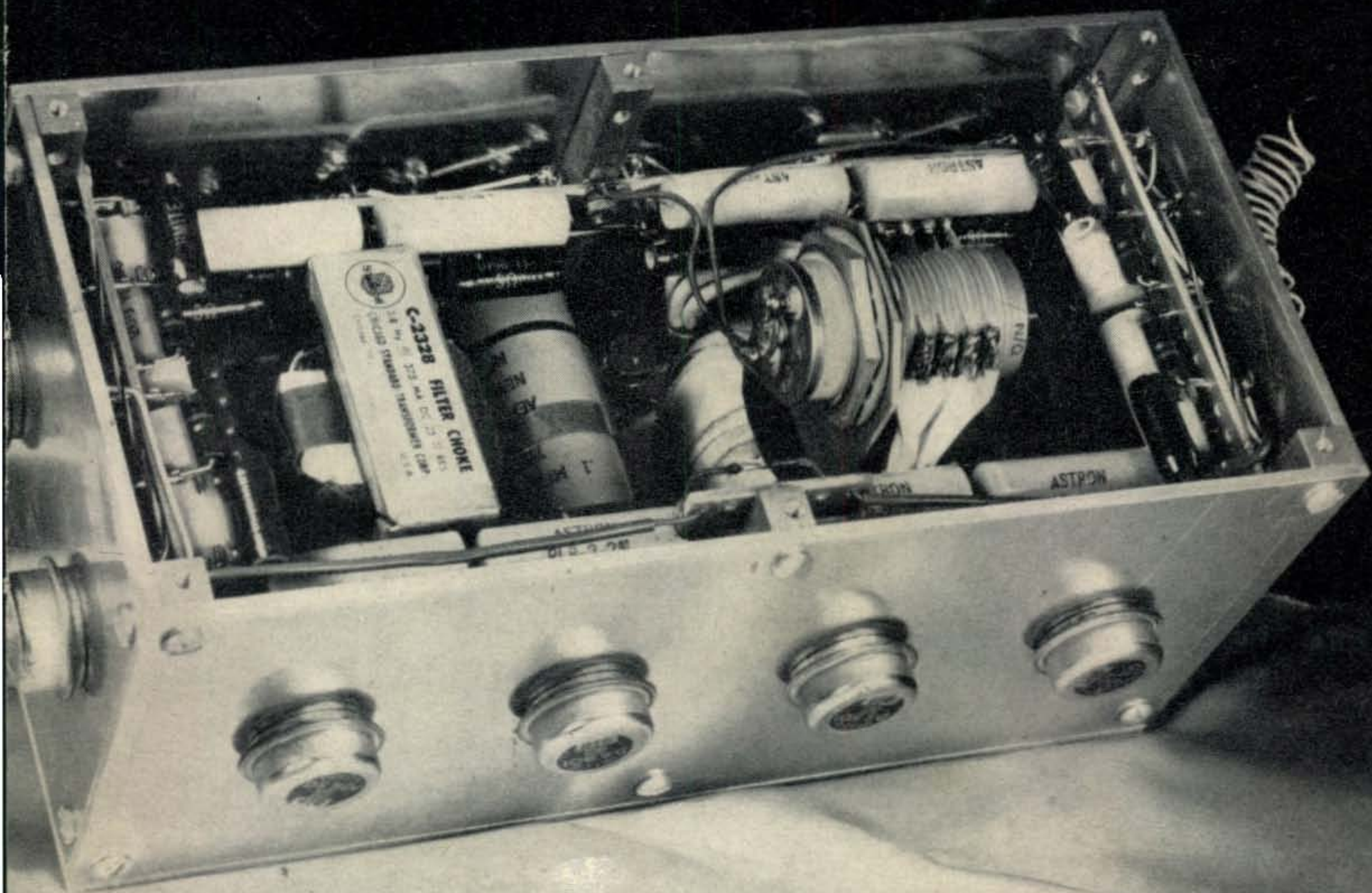

The Radio Amateur's Journal



for hams-on-the-go

## COLLINS SSB STATION IN A SUITCASE

Collins new PM-2 Portable Power Supply teamed with the KWM-2 Transceiver now gives you a complete SSB station weighing less than 45 pounds in its specially designed suitcase.

### PM-2 Portable Power Supply

The PM-2, including its built-in auxiliary speaker, weighs only 13-1/2 pounds.

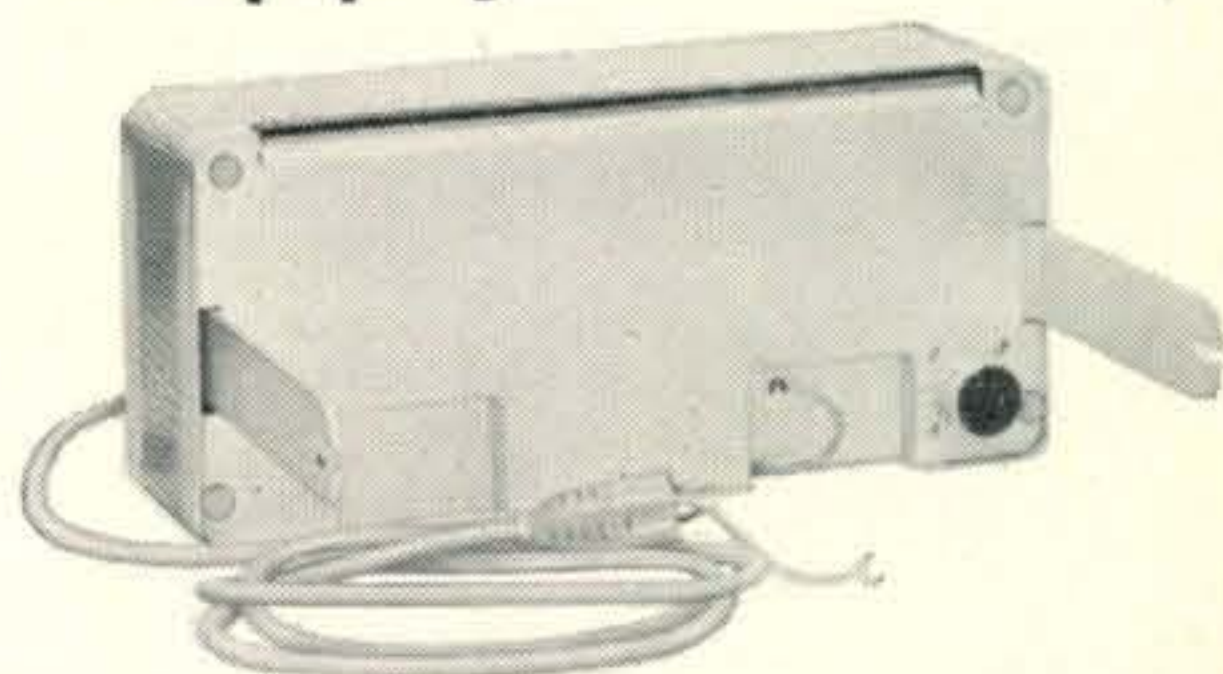
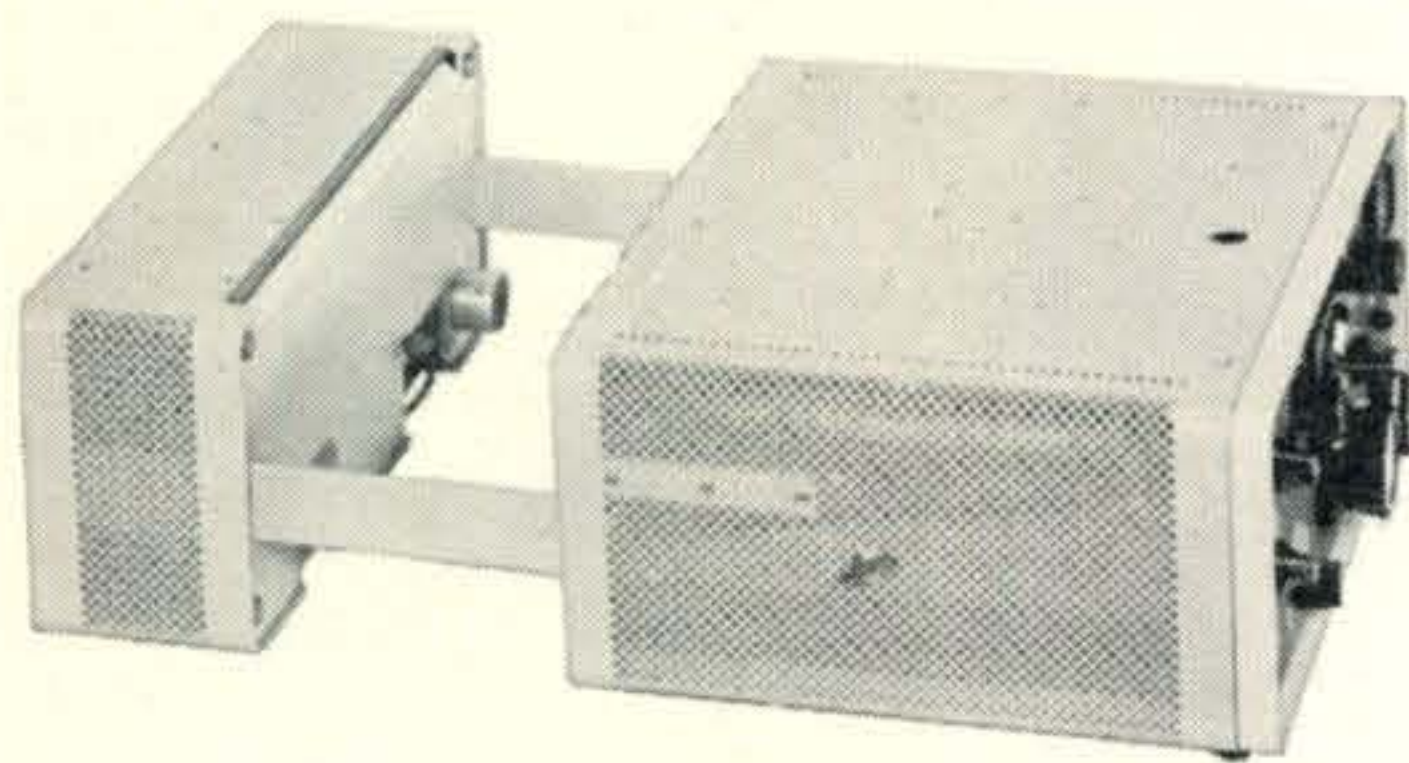

The PM-2 connects directly to the KWM-2; arm-like extensions hold it firmly in place.

Lined with foam plastic, the Samsonite suitcase provides shock-resistant protection for the PM-2, KWM-2 and accessories necessary for a complete SSB station — totaling less than 45 pounds.



*Come to the Western SSB Convention at Santa Barbara, California, Sept. 30 - Oct. 2.  
For registration, write W6ZHH, Box 568, San Pedro, California.*

For further information, check number 1, on page 130.



# ..USE

# PR

## and KNOW WHERE you are!



With PR Crystals in your rig, you can quit worrying about FCC citations, discrepancy notices, and out-of-band signals.

**USE PR'S AND KNOW WHERE YOU ARE!** That goes for old-timer and novice, too. It goes whether you have a big kw rig or a low-powered citizens' band outfit. PR Crystals mean maximum amplifier output, longer distance, clearer reception, minimum drift . . . the sure way to T9X.

Get PR's now, and **KNOW WHERE YOU ARE** . . . right on the kilocycle every time.

**ALL PR CRYSTALS ARE UNCONDITIONALLY GUARANTEED. ORDER FROM YOUR JOBBER.**

### AMATEUR TYPES

#### 40 and 80 Meters, PR Type Z-2

Rugged. Low drift, fundamental oscillators. High activity and power output. Stands up under maximum crystal currents. Stable, long-lasting;  $\pm 500$  cycles. . . . . **\$2.95 Net**

#### 2 and 6 Meters, PR Type Z-9A

Third overtone; multiplies into either 2-meter or 6-meter band; hermetically sealed; calibrated 24000 to 24666, and 25000 to 27000 Kc.,  $\pm 3$  Kc.; .050" pins. . . . . **\$4.95 Net**

#### 6 Meters, PR Type Z-9A

Fifth overtone; for operating directly in 6-meter band; hermetically sealed; calibrated 50 to 54 Mc.,  $\pm 15$  Kc.; .050" pins. . . . . **\$6.95 Net**

#### Type 2XP

Suitable for converters, experimental, etc. Same holder dimensions as Type Z-2.

1600 to 12000 Kc., (Fund.)  $\pm 5$  Kc. . . . . **\$3.45 Net**

12001 to 25000 Kc. (3rd Overtone)  $\pm 10$  Kc. . . . . **\$4.45 Net**



Z-2



Z-9A



2XP



Z-9R



Z-6A

### CITIZENS BAND CLASS "D"

#### Type Z-9R, Transmitter

FCC assigned frequencies in megacycles: 26.965, 26.975, 26.985, 27.005, 27.015, 27.025, 27.035, 27.055, 27.065, 27.075, 27.085, 27.105, 27.115, 27.125, 27.135, 27.155, 27.165, 27.175, 27.185, 27.205, 27.215, 27.225; calibrated to .005%. (Be sure to specify manufacturer of equipment) . . . . . **\$2.95 Net**

### CITIZENS BAND CLASS "D"

#### Type Z-9R, Receiver

Specify I.F. frequency, also whether receiver oscillator is above or below transmitter frequency. Calibrated to .005%. (Be sure to specify manufacturer of equipment.) . . . . . **\$2.95 Net**

#### Type Z-1, MARS and CAP

Official assigned frequencies in the range. Calibrated to .005%. 1600 to 10000 Kc. . . . . **\$3.45 Net**

#### Type Z-6A, Frequency Standard

To determine band-edge. To keep the VFO and receiver properly calibrated. 100 Kc. . . . . **\$6.95 Net**

**PETERSEN RADIO CO., Inc. 2800 W. Broadway**  
**COUNCIL BLUFFS, IOWA**

EXPORT SALES: Royal National Corporation, 250 W. 57th Street, New York 19, N. Y., U. S. A.

For further information, check number 3, on page 130.



# CQ—The Radio Amateur's Journal

August 1960  
vol. 16, no. 8

300 West 43rd Street, New York 36, N. Y.

## Single Sideband Generator Design And Construction

Durward Tucker, W5VU, J. L. Copeland, W5SQT	26
Experimental Timing Code Added To WWV Broadcasts.....	32
Crystal Control For VHF.....Frederick Brown, W6HPH	37
A Transistorized Converter For The 144 MC Band.....J. Specialny, W3HIX	40
"Efficiency" Types Of Amplitude Modulation.....Carl Drumeller, W5EHC	42
The New Concept In Traffic Networks.....R. Erwin, W5JFW	45
1 KW SSB Power Supply For 12 Volt Mobile Operation	
Jo Emmet Jennings, W6EI	48
"The Little Dipper".....Commander Paul Lee, W3JHR	50
A Simple Method Of Determining Transformer Impedances	
Richard Genaille, K4ZGM	51
The Skelton Slot Antenna.....B. Sykes, G2HCG	52
DX-100 VOX.....Lyn Kennedy, K5QWB	54
The Elmac A54 as a Mobile Hybrid.....Albert Allen, W8WA	56
A \$1.00 ZL-Special For Six.....Joe Rolf, K5JOK	59
Voice Of America Amateur Radio Program.....	60
Modifying The Gonset Tri-Bander.....W. P. Clarke, W5DZ	61
50, 144, 220 MC The Easy Way.....Joe Rolf, K5JOK	62
A Tilt-Over Tower For A Dollar A Foot.....Donald Grant, W2DY	64
The Transistorized Tattle-Tale	
Charles Kunde, K9CRD, Donald L. Stoner, W6TNS	66
Rules: 1960 CQ World Wide DX Contest.....	67
CQ Reviews The FCV2 Converter.....	70
CQ Reviews The FSC 250 Frequency Shift Converter.....	71
CQ Reviews The Aircon Converters.....	73
CQ Enters The Space Age.....	94

## DEPARTMENTS

Scratchi	10	Sideband	82	VHF	96
Letters To The Editor	11	Novice	85	YL	98
Announcements	18	Semiconductors	88	Contest Calendar	102
DX	74	Surplus	90	New Amateur Products 104, 116	
Ham Clinic	78	RTTY	92	Correction	108
Units Quiz	81	Propagation	95	Classified	124

### Branch Advertising Offices:

Ted E. Schell, 2700 West 3rd Street,  
Los Angeles 57, Calif. DUmkirk 2-4889.

Charles W. Hoefer, 1664 Emerson Street,  
Palo Alto, Calif. DAvenport 4-2661.

*publisher* S. R. Cowan  
*production manager* Bill Gardner, Jr.  
*circulation manager* Harold Weisner  
*editorial production* Robert Jordan  
*advertising representative* Jack Schneider, WA2FPE  
*advertising representative* Dick Cowan, WA2LRO  
*classified advertising* Kathi Gerace  
*draftsman* Mike Dominguez

CQ—(title registered U. S. Post Office) is published monthly by Cowan Publishing Corporation. Executive and editorial offices at 300 West 43rd Street, New York 36, N. Y. Telephone JUdson 2-4460. Second-class Postage paid at New York, N. Y.

SUBSCRIPTION RATES: U. S. A. and Possessions, APO, FPO, Canada and Mexico; one year \$5.00; two years \$9.00; three years \$13.00. Pan-American and foreign: one year \$6.00; two years \$11.00; three years \$16.00.

FOREIGN SUBSCRIPTIONS: Great Britain: RSGB, New Ruskin House, Little Russell St., London WC 1, England. Australia: Technical Book Co., 297 Swanston St., Melbourne C 1, Victoria, Australia.

Printed in U. S. A. Entire contents copyright 1960 by Cowan Publishing Corporation. CQ does not assume responsibility for unsolicited manuscripts.

Postmaster: Send Form 3579 to CQ, 300 West 43rd Street, New York, N. Y.



# The Stradivarius of electronic keyers



new **HA-1** \$7995  
*T. O. Keyer*

COME TO WESTERN SSB CONVENTION  
AT SANTA BARBARA, CALIF., SEPT. 30-  
OCT. 2ND. FOR REGISTRATION WRITE  
W6ZHH, BOX 568, SAN PEDRO, CALIF.



In every field of human endeavor, there is a group of strong-minded individuals whose goal is perfection. They settle for nothing less in the equipment with which they pursue their hobby or profession.

And inevitably, one manufacturer with similar goals produces a product so strikingly superior that overnight it becomes—like the Stradivarius—not only the ultimate standard of performance but a symbol of perfection.

Whatever your communications experience, if you are among that group who insist on the finest, you will recognize in the new T.O. Keyer a technological stride that will bring you greater personal satisfaction, and clearly advance the art of CW.

## HA-1 ADVANCED FEATURES

- Employs digital techniques. Advanced circuitry assures constant ratio of dot-to-space-to-dash over entire speed range.
- All timing circuits electronic—not affected by relay variations. Dots and dashes are self completing.
- Employs four dual-purpose triodes, two voltage regulators, two neons, three semiconductor diodes. Transformer-operated.
- Plug-in, vacuum-sealed, mercury-wetted relay used only to key transmitter and sidetone signal. Capable of dot speeds up to 100 dots per sec. Life span over 10 billion operations.
- Monitor or sidetone may be heard via built-in speaker, or fed through receiver audio.

**FRONT PANEL:** Function control: off; low speed, hold (key down), high speed. Speed control: calibrated in range 10-30 and 25-65 WPM. Keyjack; neon keying and balance indicator.

**REAR CHASSIS:** D.C. Balance (factory set); Weight (dot duration); Sidetone Level; Head Set Jack; Octal socket for transmitter connections; Aux. Paddle Input; Monitor Tone Output; extra contacts.

The new ideas in communications are born at . . .

For info., check number 4, on page 130.

Export Sales: International Division,  
Raytheon Mfg. Co., Waltham, Mass.  
Canada: Gould Sales Co., Montreal, P. Q.



# hallicrafters

Chicago 24, Ill.

Pat. App. Pend. Copyright 1960 by The Hallicrafters Co.



Designed for



Application

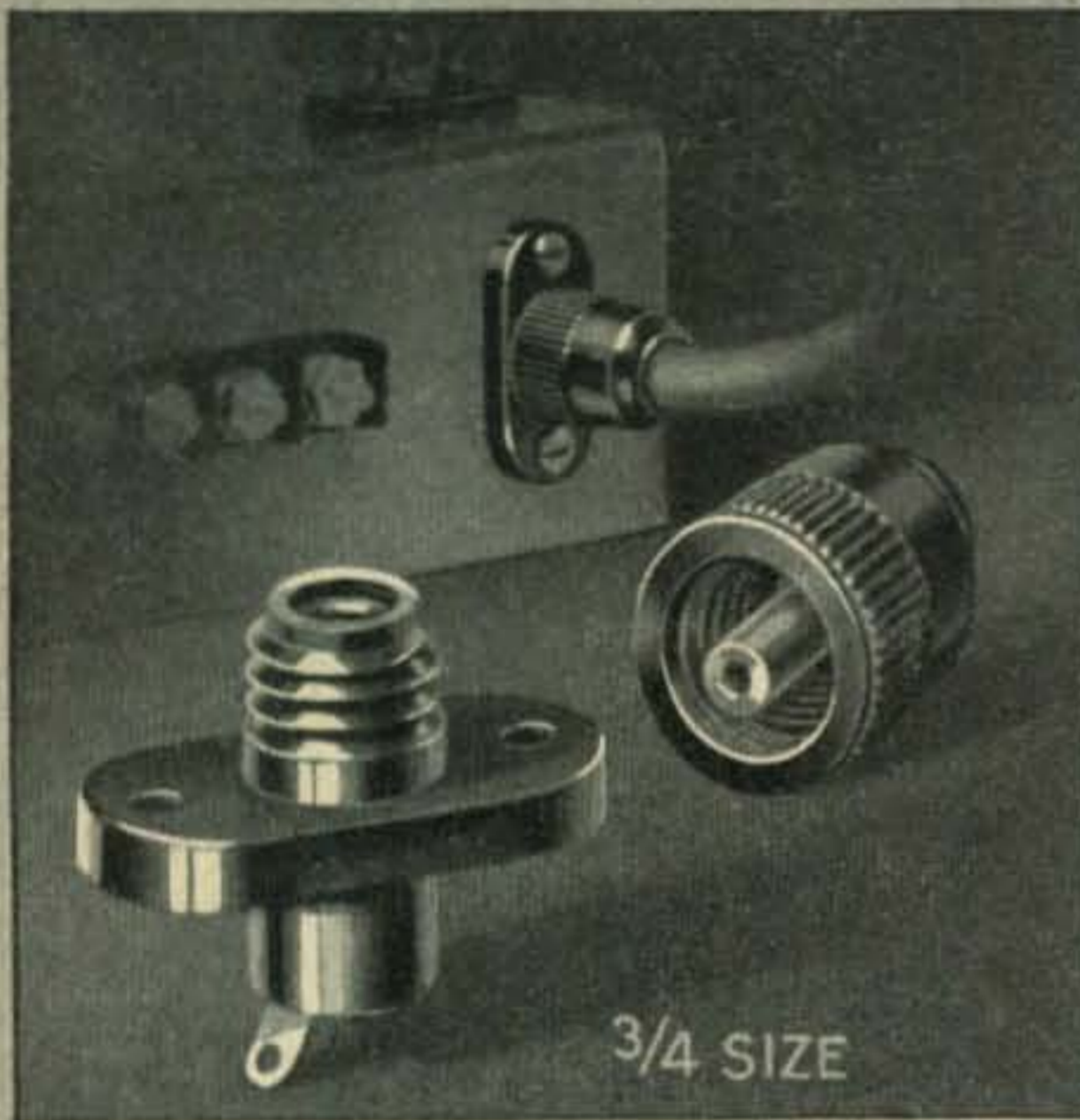

### THE NO. 37001 SAFETY TERMINAL

An old favorite in the line of exclusive Millen "Designed for Application" products. Combination high voltage terminal and thru-bushing. Tapered contact pin fits firmly into conical socket providing large area, low resistance connection. Pin is swivel mounted in cap to prevent twisting of lead wire. Easy to use.  $\frac{1}{4}$ " o.d. insulation high voltage cable fits into opening in cap. Bared conductor passes thru pin for easy soldering to pre-tinned tip of contact plug.

Standard 37001 available in either black or red bakelite. No. 37501 is low loss mica filled yellow bakelite for R.F. applications.

## JAMES MILLEN MFG. CO., INC.

MAIN OFFICE AND FACTORY  
MALDEN  
MASSACHUSETTS



Barry Briskman, K2IEG *managing editor*  
Arnold Trossman, W2DTJ *assistant editor*  
Lee Aurick, W2QEX *technical editor*

*department editors*

Irv Strauber, K2HEA *sideband*  
Dot Strauber, K2MGE

Frank Anzalone, W1WY *contest calendar*  
Urban Le June, Jr., W2DEC *dx*  
Ken Grayson, W2HDM *surplus*  
Sam Harris, W1FZJ *vhf*  
George Jacobs, W3ASK *propagation*  
Byron Kretzman, KØWMR *rtty*  
Marvin Lipton, VE3DQX *club bulletins*  
Louisa Sando, W5RZJ *yl*  
Charles Schavers, W6QLV *ham clinic*  
Don Stoner, W6TNS *novice & semiconductors*

CQ, the Radio Amateurs' Journal is published for active hams by active hams. CQ endeavors to be a true and honest reporter for those interested in the hobby. Suggestions for improvement are welcomed.

Manuscripts submitted to CQ should be typewritten double spaced on 8½ by 11 inch paper with adequate margins on both sides of the typewritten copy. Photographs and drawings should be clear and contain adequate explanations. All manuscripts should be accompanied by an envelope and sufficient postage for its return.

#### CQ CERTIFICATES:

The WPX Award is granted for two-way contact with certain number of amateurs in different prefixes of the world. Full details are contained in the WPX Record Book which is available for 15c from CQ. Application forms are free.

The WAZ Award is granted for contacting all of the amateur zones of the world. Current standings of amateurs working for this award will be found in the DX column. A DX Zone map of the world is available free from CQ. Send stamped envelope.

Special SB Certificates are available from the Sideband Department for operators providing proof of contact (QSL cards) with stations in 50, 75 and 100 countries using two-way sideband. Send cards directly to the SB Editor.

#### TECHNICAL INFORMATION:

CQ's 15-year cumulative index may be obtained free from our circulation department by enclosing a stamped, self addressed envelope (8¢). Most back issues are available at \$1 from us. Check our "Back Issue" ad for details on those not available.

#### THIS MONTH'S COVER:

Jo Emmet Jennings, W6EI has long been a devotee of miniaturization of high power transmitters and power supplies. In this issue, on page 48, he continues to expound on the relative merits of transistors, toroidal transformers and home brew techniques. W6EI has designed a flexible KW supply which you need only trim to fit your needs.

← For further information, check number 5 on page 130.



**A dozen years ago . . .** Conset wrapped VHF into a tidy "package" and "Communicator"—the most widely used, commercially-produced 2-way equipment in amateur VHF history—came into being.



Down through the years, in step with VHF technology advances, Gonset has continued to set the pace with other, improved Communicators—Model II . . . Model III and now . . . again "packaged" for fullest operating flexibility and convenience . . .

# IV

## COMMUNICATOR



New . . . brilliantly new . . . throughout. Handsome, industrial-designer styling provides finger-tip operating convenience—an outer housing with desirable "form factor" which facilitates carrying . . . lends itself to horizontal or vertical mounting. Now . . . for a new decade, an even finer VHF "package", Communicator IV!

#### ADVANCED DESIGN FEATURES . . .

For the receiver . . . latest, frame-grid VHF tubes in front-end for excellent noise figure . . . triple conversion with crystal controlled first conversion—ANL—Squelch.

For the transmitter: 20 watts input . . . broad banded RF driver stages minimize tuning controls. P-P 6BQ5 modulators delivering more than 10 watts of audio, P-t-t-operation . . . high quality ceramic microphone supplied.

For the power supply: 12V DC/117V AC merely by changing cables. Transistorized DC supply eliminates vibrators.

**Highlights:** Frequency range, 143.7 to 148.3 mc. Receiver noise figure, 4 to 5 db. Sensitivity, 0.4  $\mu$ v 10 db S+N/N. Noise figure 4 to 5 db. Receiver tubes: 6ER5 RF 6ER5 1st mix. 6J6 xtl osc. and multiplier. 6AV6 2nd mix. 6C4 tunable osc. 6BE6 3rd conv. 6BA6 1st I-F, 6BA6 2nd I-F, 6AV6 det.—AVC rect, 1st aud amp. 6AL5, ANL, squelch, OB-2 volt. reg.

**Transmitter tubes:** 6360 fin. amp. 12BY7A xtl osc—tripler. 12BY7A, tripler, 12BY7A doub-driver. 7059 speech amp.-phase inv. 2-6BQ5's P-P modulators.

**Dimensions:** 5"H, 9 1/2"W, 13"D. 21.8#

SEE COMMUNICATOR IV AT YOUR GONSET DISTRIBUTOR SOON.



**GONSET**

Division of Young Spring & Wire Corporation  
801 SOUTH MAIN ST., BURBANK, CALIFORNIA

EXPORT SALES: WESTREX CORP., 111 EIGHTH AVE., NEW YORK 11, N.Y.





## W6SAI NOW HEADS EIMAC AMATEUR SERVICES

Here's William I. Orr, W6SAI, new head of Eimac's busy Amateur Service Department. Bill will hold the spot vacated by the retirement of John Reinartz, K6BJ.

If you have a tube application problem or need help, drop Bill a line here at Eimac. He'll be glad to lend a hand with anything from a circuit diagram to expert advice.

And *what* advice! Bill is editor of the internationally distributed "Radio Handbook"

and author of the "Beam Antenna Handbook," "All About Quad Antennas," "VHF Handbook" and other publications. He is also a regular contributor to QST and CQ magazines.

Bill was first licensed as W2HCE in 1934 and has been licensed as W6SAI since 1938. He holds DXCC (260 countries), WAZ and other ham awards. Other famous calls held by him are 3A2AF (Monaco), 7B4QF (Andorra) and FP8AC (St. Pierre and Miquelon).

**EITEL-McCULLOUGH, INC.**  
San Carlos, California



For further information, check number 7, on page 130.



# FROM HEATH ... 9 NEW RADIO AMATEUR KITS



GC-1  
\$99.95  
\$10.00 dn.,  
\$9.00 mo.



## TEN-TRANSISTOR "MOHICAN" GENERAL COVERAGE RECEIVER KIT (GC-1)

An excellent portable or fixed station receiver! Many firsts in receiver design for outstanding performance . . . ten transistor circuit . . . flashlight battery power supply . . . ceramic IF transfilters. The amazing, miniature transfilters used in the GC-1 replace transformer, inductive and capacitive elements used in conventional circuits; offer superior time and temperature stability, never need alignment and provide excellent selectivity. Other features include telescoping 54" whip antenna, flywheel tuning, tuning meter, large slide-rule dial and attractive, rugged steel case in gray and gray-green. Covers 550 kc to 30 mc in five bands. Electrical bandspread on five additional bands cover amateur frequencies from 80 through 10 meters. Operates up to 400 hours on 8 standard size "C" batteries. Sensitivity: is 10 uv, broadcast band; 2 uv, amateur bands for 10 db signal to noise ratio. Selectivity: 3 kc wide at 6 db down. Measures only 6½" x 12" x 10". 20 lbs.

**Heathkit XP-2:** plug-in power supply for 110 VAC operation of GC-1. (optional extra). 2 lbs. \$9.95



HD-20  
\$14.95

## 100 KC CRYSTAL CALIBRATOR KIT (HD-20)

Align or check calibration of your communications gear with this versatile ham aid. Provides marker frequencies every 100 kc between 100 kc and 54 mc. Transistor circuit is battery powered for complete portability. Accuracy is assured by .005% crystal furnished. Measures only 2½" x 4½" x 2⅝". 1 lb.

7 more kits on following pages





# HEATHKIT® . . . WORLD'S FINEST HAM GEAR



**KL-1**  
**\$399<sup>95</sup>**

\$40.00 dn.  
 (Write for time  
 payment details)

## "CHIPPEWA" KILOWATT LINEAR AMPLIFIER KIT (KL-1)

Here is a top-quality kilowatt rig with all the features you've been looking for. Operates at maximum legal power input on all bands between 80 and 10 meters, in SSB, CW or AM linear operation. Premium tubes (4-400A's), forced air cooled with centrifugal blower. Grid neutralized, continuous plate current monitoring, extensive TVI shielding. Features both tuned and swamped grid circuits to accommodate all popular exciters. Operates class ABI for SSB and AM linear service and high efficiency class C for CW service. Convenient panel controls include power switch, tune-operate switch, HV on/off switch, final bandswitch, meter switch, grid bandswitch, grid tuning, mode switch, plate tuning, plate loading and bias adjust. Accessory connectors are provided on the rear apron of the chassis for complete compatibility with all control circuitry in the Heathkit "Apache" Transmitter. Two meters provided; one monitors final plate current; the other indicates switch selected readings of final grid current, screen current, and plate voltages. Send for complete specifications now. 70 lbs.

## A PERFECT COMPANION FOR THE "CHIPPEWA" KILOWATT POWER SUPPLY KIT (KS-1)

Ruggedly constructed for heavy-duty use in medium to high power installations, the KS-1 fills the requirements of a top-notch power supply with economy and safety. Features an oil-filled hermetically sealed plate transformer, "potted" swinging choke input filter and 60-second time delay relay. Line filters minimize RF radiation. Maximum DC power output is 1500 watts. Nominal voltage output, 3000 or 1500 volts. DC current output, average 500 ma, maximum 1000 ma. Control circuitry is arranged to allow remote installation. The KS-1 employs two 866A half-wave mercury vapor rectifiers in a full-wave, single-phase configuration. Power requirements: 115 V, 50/60 cycles, 20 amperes; 230 V, 50/60 cycles, 10 amperes. 105 lbs.

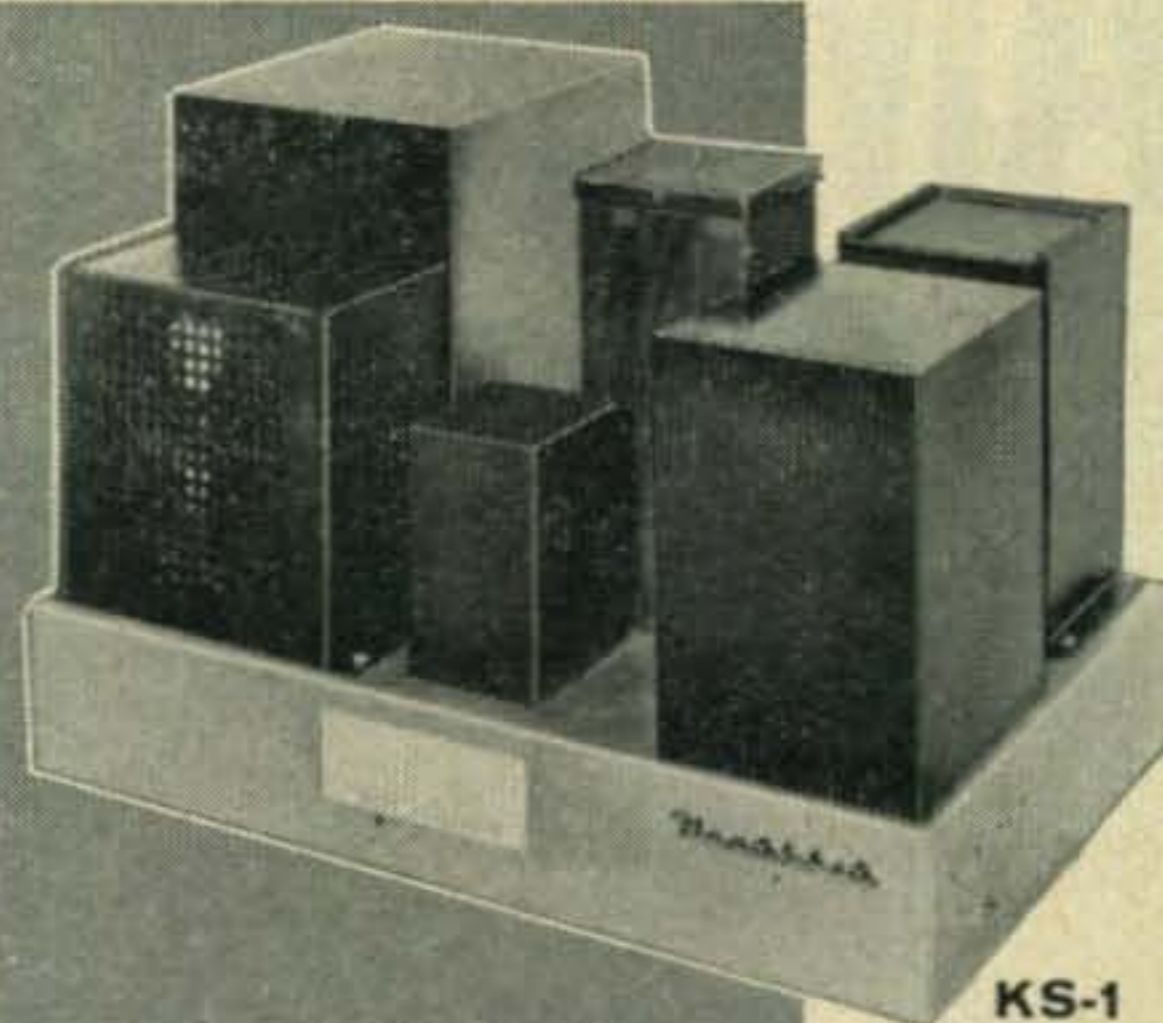

**KS-1**  
**\$169<sup>95</sup>**

\$17.00 dn.,  
 \$15.00 mo.

**XC-6**  
**\$26<sup>95</sup>**

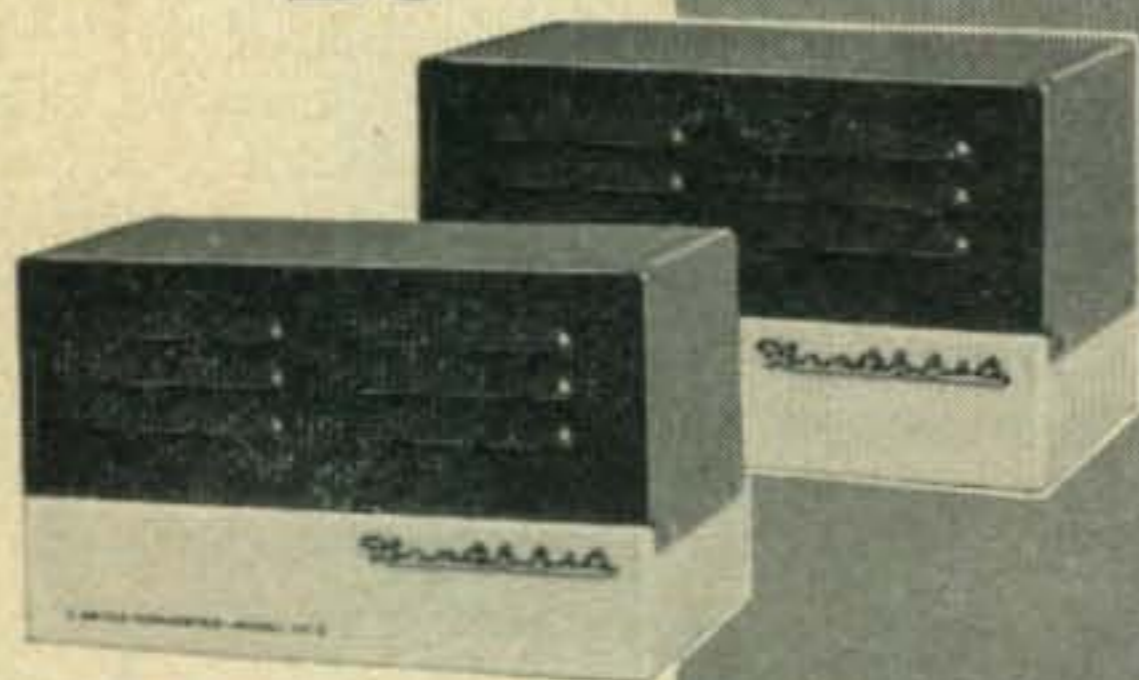

**XC-2**  
**\$36<sup>95</sup>**

## 6-METER CONVERTER KIT (XC-6)

Extends frequency coverage of the Heathkit "Mohawk" and most other general coverage receivers into the 6 meter band. Converts 50-54 mc signals to 22-26 mc. 3-tube circuit provides two RF stages and low-noise triode mixer. Calibration accuracy assured by .005% overtone crystal supplied. Provision for external RF gain control. 6 lbs.

## 2-METER CONVERTER KIT (XC-2)

This top-quality 2-meter converter may be used with receivers tuning any 4 mc segment between the frequencies of 22 and 35 mc when appropriate crystal is used. Converts 144-148 mc signals to 22-26 mc with .005% overtone crystal supplied. High quality parts used throughout. Silver plated chassis and shields. 7 lbs.



# IN KIT FORM TOPS IN TRANSMITTING POWER

## TWO BRAND NEW MODELS HEATHKIT 10 & 6 METER TRANSCEIVER KITS

Complete ham facilities at low cost! The new Heathkit transceivers are combination transmitters designed for crystal control and variable tuned receivers operating on the 6 and 10 meter amateur bands (50 to 54 mc HW-29 and 28 to 29.7 mc for HW-19) in either fixed or mobile installations. Highly sensitive superregenerative receivers pull in signals as low as 1 microvolt; low power output is more than adequate for "local" net operation. Other features include: built-in RF trap on 10 meter version to minimize TVI; adjustable link coupling on 6 meter version; built-in amplifier metering jack and "press-to-talk" switch with "transmit" and "hold" positions. Can be used in ham shack or as compact mobile rigs. Not for Citizen's Band use. Microphone and two power cables included. Handsomely styled in mocha and beige. Less crystal. 10 lbs.

**VIBRATOR POWER SUPPLIES:** VP-1-6 (6 volt), VP-1-12 (12 volt). 4 lbs. Kit; \$8.95 each, wired; \$12.95 each.



HW-19 (10 meter)  
HW-29 (6 meter)  
**\$39.95** each



HD-19  
**\$34.95**

## HYBRID PHONE PATCH KIT (HD-19)

Add the thrill of phone patching to your ham hobbying, while rendering valuable public service during emergencies and in countless other instances. The HD-19 puts a top-flight phone patch in your ham shack at the lowest price anywhere! Features: voice control (VOX) or manual operation; large, easy to read VU meter for continuous monitoring of output to 600 ohm line; specially designed hybrid transformer providing better than 30 db isolation between receiver and transmitter circuit; separate receive and transmit gain controls. Switched circuitry allows VU meter to be used as null depth indicator. Provides effective match for 3 to 16 ohm speaker impedance. 4 lbs.

**ORDER DIRECT BY MAIL OR SEE YOUR HEATHKIT DEALER\***

\*The convenience of Local Heathkit Sales and Service costs but a few dollars more.

## HEATH COMPANY

a subsidiary of  
**DAYSTROM, INCORPORATED**

Benton Harbor 12, Michigan

All prices and specifications subject to change without notice. Please include postage on orders to be shipped parcel post. 20% deposit is required on all C.O.D. orders. All prices are NET F.O.B. Benton Harbor, Mich., and apply to Continental U.S. and Possessions only. Dealer and export prices slightly higher.



### FREE CATALOG!

Describes over 150 easy-to-build electronic kits in HI-FI, Test, Marine, and Ham radio fields. To get yours, fill in this coupon and mail today!

NAME \_\_\_\_\_

ADDRESS \_\_\_\_\_

CITY \_\_\_\_\_ ZONE \_\_\_\_\_ STATE \_\_\_\_\_

ITEM	MODEL	PRICE

For further information, check number 8, on page 130.



**Get This  
Handy  
POCKET  
ELECTRONICS  
DATA GUIDE**

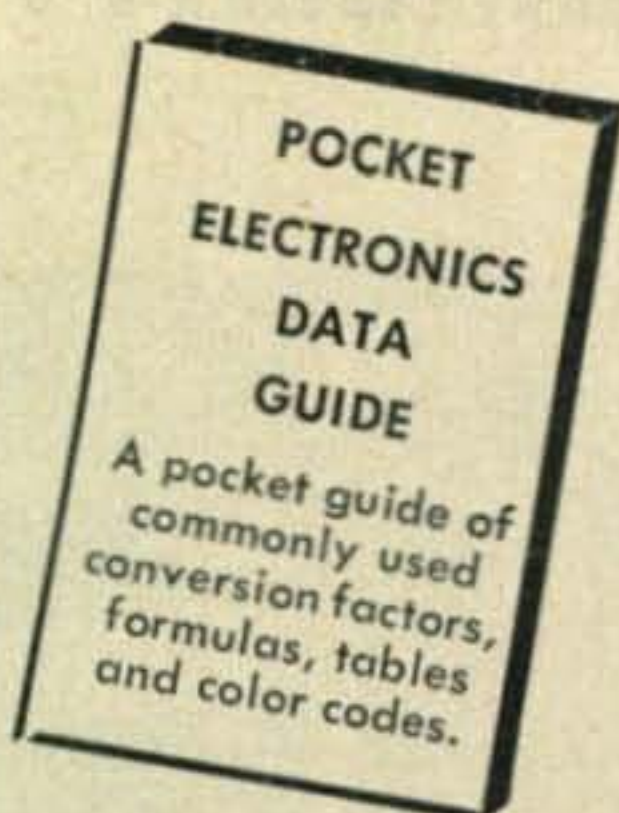

**free**

Puts all the commonly used conversion factors, formulas, tables, and color codes at your fingertips. Yours absolutely free if you mail the coupon below. No further obligation!

**Cleveland Institute Training  
means BETTER JOBS . . .**

**OUR TRAINEES GET JOBS LIKE THIS:**

"Since enrolling with Cleveland Institute I have received my 1st class license, and am now Chief Engineer of Station WAIN. Thanks to the Institute for making this possible." L. M. Owens, Columbia, Ky.

**EMPLOYERS MAKE OFFERS LIKE THESE:**

RCA has positions for technician, field engineers & instructor technicians to install, maintain, & teach military radar, communications, and fire control equipment. Company benefits.

**A Commercial FCC License . . .  
YOUR GUARANTEE OF SUCCESS!**

The Master Course in Electronics will provide you with the mental tools of the electronics technician and prepare you for a 1st Class FCC License (Commercial) with a radar endorsement.

**MONEY-BACK  
GUARANTEE!**



Mail Coupon  
Today and Get  
All 3 Books  
**FREE**



Cleveland Institute of Electronics  
Carl E. Smith, Consulting Engineer, President  
Accredited by the National Home Study Council  
Desk CQ-67, 4900 Euclid Avenue, Cleveland 3, Ohio

Please send Free Booklets prepared to help me get ahead in Electronics and a free copy of your "Pocket Electronics Data Guide." I have had training or experience in Electronics as indicated below:

- |   |   |
|---|---|
| <input type="checkbox"/> Military           | <input type="checkbox"/> Broadcasting       |
| <input type="checkbox"/> Radio-TV Servicing | <input type="checkbox"/> Home experimenting |
| <input type="checkbox"/> Manufacturing      | <input type="checkbox"/> Telephone Company  |
| <input type="checkbox"/> Amateur Radio      | <input type="checkbox"/> Others             |

In what kind of work are you now interested? .....

In what branch of Electronics are you interested? .....

Name ..... Age .....

Address .....

City ..... Zone ..... State .....

CQ 67



Feenix, Ariz.

Deer Hon. Ed:

Rushing right out and seeing if you can buying first-class ICBM in operating condishun. You not having to much time to shopping around, so don't dawdling. Right after you reeding this letter getting busy.

No, Hon. Ed., I not trying to starting Hon. War. No indeedy. Scratchi just coming up with the biggest idea for promoting your Hon. Magazine that you ever heering. In fackly, idea are so big that Scratchi not even wanting any money for it. It are positively stewpendus idea.

Anybuddy in amchoor radio knowing that one big problem all amchoors having are skip. Never can depending on it. Just when settling down to nice QSO old Hon. Heaviside Layer changing height by few miles and QSO going down the drain. Now, if your Hon. Magazine solving this problum, don't you thinking that being pretty big stuffs??

How we doing this? Easy (to geenyus like Scratchi). We just making our own Heaviside-layer by using Hon. Erth Saddlite. For few millyun bux we putting Saddlite in air up high enough so it staying over Hon. Yewnited States. When getting it up there we pushing button and a few acres of aloominum pops out of it, so we having nice big reflecting surface.

We can calling this the Heaviside-layer Amchoor Made Sattlite. Or, for short, the HAM Saddlite. Can't you seeing it now?? On the cuple acres of aloominum are the letters "CQ HAM". That giving you Hon. Magazine a bit of a plug, you not thinking!!

Think what this meening! Amchoors can getting on air, and bouncing signals off the aloominum, having reel 1/c QSO anyplace in country, and never any problums with skip distance changing. Not even sun-spots affecting QSO.

How we paying for it? Hon. Ed., using your imaginayshun. There are 200,000 amchoors in country. We charging each one a measly one hundred bux. That giving us twenny millyun bux.

All amchoors wanting to getting in on this, on acct. then they getting there call letters put in HAM Saddlite Call Book, and they can using picshure of HAM Saddlite on there QSL cards, and not only that, they having call letters engraved in florescent ink on side of saddlite.

[Continued on page 105]



# Letters ... to the Editor

## Contest Calendar

Editor, CQ:

In reference to the so called "Contest Calendar" which seems to take place every-week-end, it's getting to be a nuisance to the regular ham operator.

The hams who have to work during the week, and are home during the week-end are getting so disgusted because the band is cluttered up with QRM due to these contests. It reminds me of a bunch of school boys out on a field day. There are quite a few hams who have mentioned this situation to me, that I decided to write this letter.

I noticed they send their NR-Time etc., but if you ask them to take a message for relay or delivery, they tell you I don't take traffic.

Sometimes I don't think that they could even copy a message and get it straight so it could be delivered.

Frank B. Wilson, K2JCW  
349-55th St.  
Brooklyn 20, N.Y.

## Bush and Lid

Editor, CQ:

For the past several Thursdays, I have had the pleasure of monitoring 14,240 kc on which frequency, the Tango Net meets. This Net consists entirely of licensed YL and XYL operators that are the most sincere group of ladies anyone would wish to talk with. They are excellent operators and most cooperative, which is more than can be said for a number of the male operators.

It is rather difficult to understand why any male operator with plain common sense would deliberately and willfully cause interference when this or any other net meeting was in progress.

During the past three Thursdays when the net was operating, some kind soul deliberately put an unmodulated carrier on the net frequency. Several others would zero in and proceed to call CQ, while others tested on frequency.

This procedure, to my way of thinking—is strictly bush and lid.

In addition, I believe that such antics be reported to the FCC as it is a violation of the radio act. The offenders can be uncovered without too much difficulty.

I have repeatedly heard the net control operators plead and beg for the OM's to allow them to secure the net, but without success. This particular Net is an emergency net and anyone willfully and deliberately causing interference, should be reprimanded by the commission.

In closing, I wish to add, these lady operators are doing a splendid job and are to be commended. It would be appreciated if the male operators would accord these YL and ex-YL operators common courtesy.

Does it pain too much to act like gentlemen?

Louis C. Bremer, W3LE  
Baltimore 14, Md.

## What the H!

Editor, CQ:

Your edition of March, on the 49th page, Carries comment that puts all us G's in a rage, It may be quite true that drop "H's" we do, But these matters are best left unsaid By W's so whacky—no better than Scratchi— Who don't know that Zee should be Zed.

GW3LAD

## New Ham Exams

Editor, CQ:

The most valid purpose of amateur radio today would seem to be in the *education* it offers our citizens. Let's face it, except in unusual cases, the amateur's value as a *communicator* diminishes daily as the commercial and public safety services grow. Whether we are high school freshmen or own two banks, the ultimate investment our government has in us is in the education we have acquired as hams.

But amateur radio, as practiced today is rapidly losing its force as an education medium. Aside from learning to

count money and make an advantageous deal, what does today's typical ham learn when he runs to his local jobber with a fistful of greenbacks, and walks out with a pile of beautifully-constructed but ill-understood ham gear? What motivation exists for any of us when, without even bothering to truly master even the telegraph code, full privileges of at least two excellent VHF bands become completely opened to him. Only a quick and dirty rote memory chore of an hour or two provides him with privileges earned only by diligent intellectual effort in the rest of the world. Amateur radio is not producing educated citizens, as it could and should; this should have been long obvious to everyone.

What's to be done about it? Here are some more suggestions:

1. The License Manual, as it now stands, should be abolished. In its stead should be published a readable, comprehensive manual of the amateur art, and of the amateurs rights and responsibilities. Or, since the present Amateur Handbooks do this, why not abolish this travesty completely?
2. Keep the present code requirement for novices, but reorganize the written novice test completely. As it stands, it is an insult to the intelligence of any high-school freshman. (I deal with these boys every day, officially and otherwise, so this represents fact and not conjecture.) Most of my students agree that the present test almost forces disrespect upon any well-prepared aspirant.
3. Make only the Extra Class license renewable. We need motivation for more extra class hams; here it is with a minimum of administrative effort. (Go ahead and moan, you old duffers! I've had my ticket for twenty-five years, and if I can't pass a reasonable test again, then I better get out of the band and leave room for those who can. The same goes for you.)
4. Organize the rewritten General, Technician, and Extra-class tests in such a manner that a person not intimately familiar with the inside of modern gear cannot pass. This might encourage many to at least look inside of their store-bought gear once in awhile, if not doing some building on their own. (This might require a bit of thought, but a good educational psychologist should be able to devise such a test.)
5. Lower the maximum power limit to 200 watts or less; give the young fellows a chance to compete, DX wise, with the old, established interests.

So amateur radio is a hobby, and such a program would spoil the fun for a lot of people. Perhaps so, but with the modern world as it is, can we justify the assignment of valuable RF spectrum space merely for fun? No, we have our responsibilities as hams, and we'd better darn soon face up to them or we'll lose the whole show. We must justify ourselves in terms of "public interest, convenience, and necessity" also, or we have no legal right to *any* frequencies. And the best way to do this is to become technically-competent, *educated* amateurs.

C. F. Rockey, W9SCH/W9EDC  
Deerfield, Illinois

WWV Again

Editor, CQ:

Recent issues of CQ have carried descriptions of a number of ingenious ways for picking up WWV on a National NC-300. Probably the simplest method of all was suggested by *National* in some of their ad literature which they put out a few years ago. Apparently a great many hams haven't run across this kink. Here it is:

Solder alligator clips to the leads of a 330 mmf mica or ceramic capacitor. Whenever you want to hear WWV, lift the lid of the receiver and clip the capacitor between the stator of the front section of the 300's tuning capacitor and ground. Turn the knob of the antenna trimmer for minimum capacity. The 10 mc signal of WWV will now come in near the top end of the 7 mc band. On my set, the



**The  
SWITCH  
you need  
is carried  
by your**

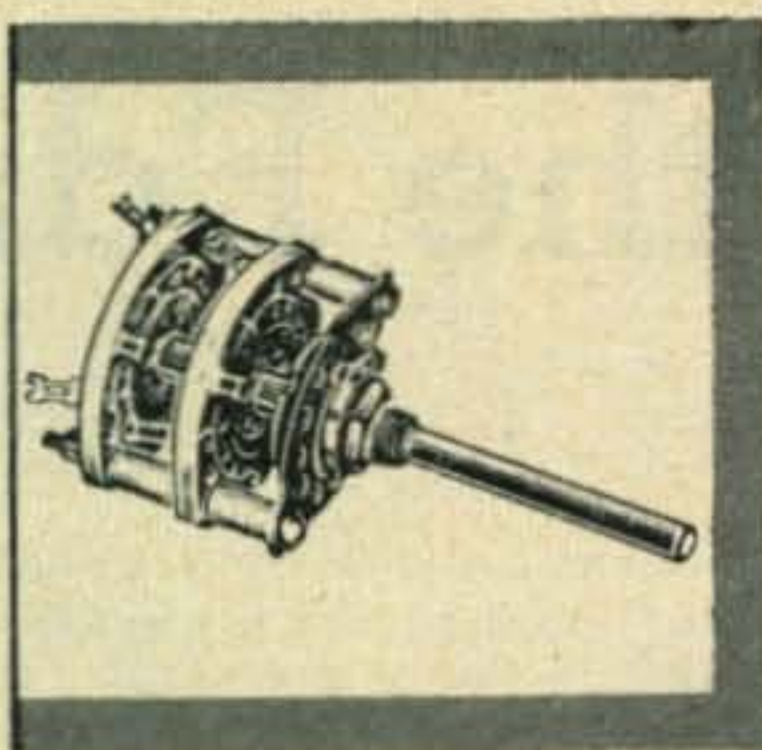

# Centralab

®

## DISTRIBUTOR

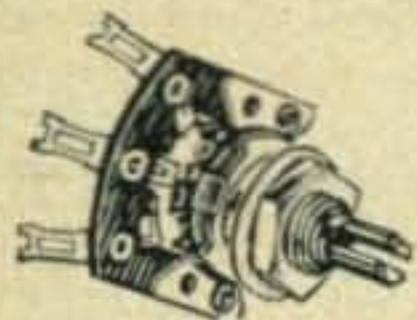
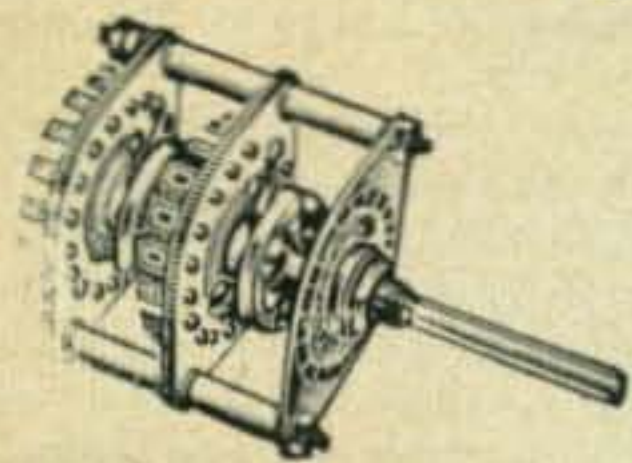
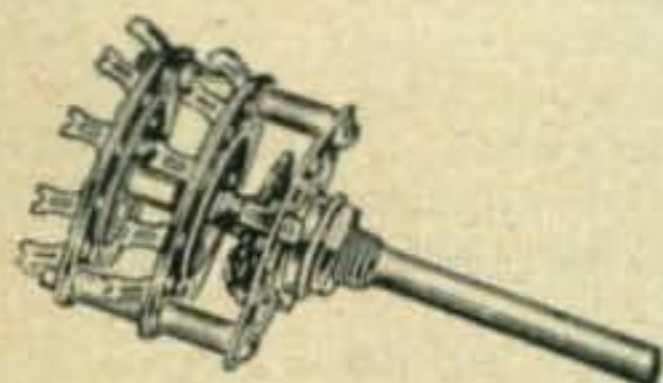
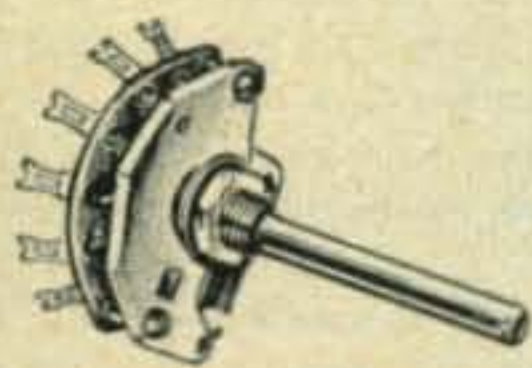
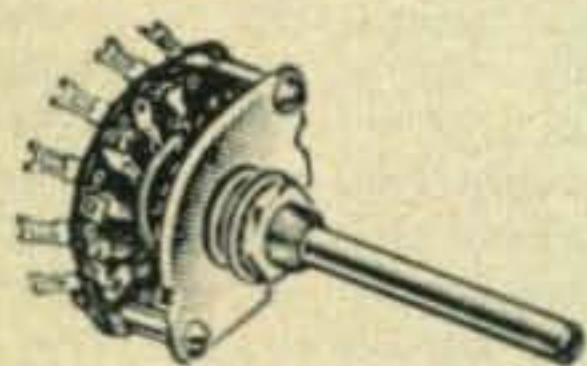
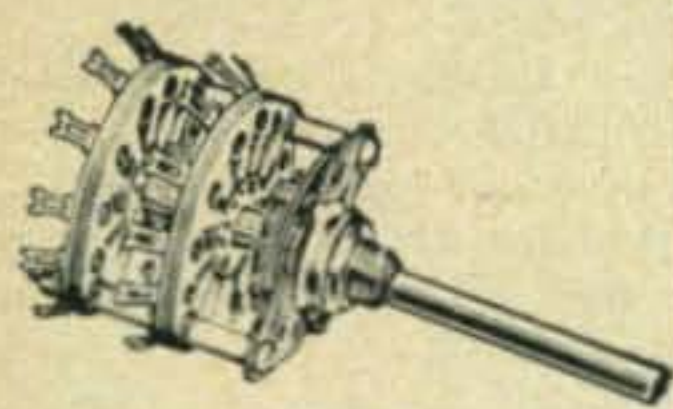

• The extensive CENTRALAB line of high reliability switches includes the unit you need. For ham applications, as well as industrial and military uses, you can depend on CENTRALAB switches. Sub-miniature, miniature, standard and heavy duty; rotary and lever action; ceramic and phenolic—your CENTRALAB distributor has them all. You'll find them listed in CENTRALAB's Catalog 30. If you don't have this catalog, write us or ask your distributor for a free copy.

# Centralab

®

A DIVISION OF GLOBE-UNION, INC.  
954H E. KEEFE AVE. • MILWAUKEE 1, WIS.  
In Canada: 804 Mt. Pleasant Rd., Toronto, Ont.

SWITCHES • CERAMIC CAPACITORS • PACKAGED ELECTRONIC CIRCUITS  
CONTROLS • ENGINEERED CERAMICS • SEMI-CONDUCTOR PRODUCTS

For further information, check number 9, on page 130.

12 • CQ • August, 1960

dial reads 7280 kc. The actual spot will depend on the exact value of the capacitor you use.

Hartland B. Smith, W8VVD  
467 Park Ave., Birmingham, Michigan

### Reciprocation

Editor, CQ:

I noticed with interest the article on reciprocal licensing written by Carole F. Hoover, K9AMD in the March issue of CQ. I know exactly how Bill Allen, K9AKF, feels down there in Venezuela without being able to ham. It happened to me during the first months of my stay in Guatemala in 1958/59.

After applying several times to the Ministerio de Radiodiffusion without success I decided to attack it from a different angle, because the answer I always received was: "We are not able to give you a license as long as there is no agreement for reciprocal licensing existing between Guatemala and Switzerland."

My next step was a letter to the Swiss FCC to ask them if they were interested in such an agreement. The letter which I received was very favorable and a short time afterwards I had my TG9 license. Furthermore I was allowed to pass the telegraphy examination and was one of the very few authorized CW amateurs.

I guess it is worthwhile to make some remarks concerning the unintelligible attitude of the American FCC. It is known that about a half dozen Americans are licensed in Guatemala but what about the Guatemaltecos living in the States?

I recently tried to get Swiss licenses for two of our American engineers who are very active DX'ers. My application failed and I have been informed that the Swiss FCC tried to negotiate with the US FCC but they refused to erect a licensing agreement. The Swiss FCC has certainly done as much as they can, and indicates that Switzerland has, at the present time reciprocal licensing agreements with Germany, Finland, France, Kuwait, Austria, Guatemala, the Netherlands and their colonies.

How about moving those rocks in the U.S.A.?

Peter B. Langenegger, HB9PL ex TG9HB  
Box 35, Geneva 15,  
Switzerland

### ZS7P is Legal

Editor, CQ:

... It would be greatly appreciated if you would inform your readers that ZS7P is a fully licensed station and not a pirate as certain ZS6 amateurs have seen fit to state.

Further, I QSL all cards received one hundred per cent, either direct or via the QSL bureau. In the case of a request for QSL by airmail return, it would be appreciated if the request be covered by currency and not by I.R.C., to clear the postage for airmail.

My station comprises a Gonset GSB-100 transmitter and a National NC-300 receiver, and I am the first resident ZS7 operating SSB.

P. J. Lamont, ZS7P  
P.O. Mhlambanyati  
Swaziland

### Postal Racket

Editor, CQ:

I wonder if the users of I.R.C.'s in the U.S.A. (or anywhere, for that matter) realize that when they pay for a coupon, the recipient can only cash it for stamps of half the face value?

For example, I have received 15¢ coupons to the total face value of 75 cents (U.S.A.), and have only been able to exchange them for stamps to the value of 2 Shillings, 50 cents (East Africa), which, in your coinage, would be 35.713¢, taking the value of the U.S.A. dollar to be 7 Shillings (East African).

It would be much better, and cheaper on the amateurs' pockets, if postage stamp dealers could keep stocks of mint stamps of various countries, and sell them to people who wish to get their QSL cards sent direct from the DX Station.

Ordinary airmail from Kenya to the U.S.A. is Shs. 2/50 (Two point five shillings) or 35.713 cents (U.S.A.)

One last thing: To amateurs in the U.S.A. who may have had hard thoughts about "those XXXX's from XYZ who keep half the I.R.C.'s for themselves, and send the QSL cards at the cheapest rate," may I point out the small print on the face of the 15¢ coupon:

"This coupon is exchangeable in any country of the



# THE BROADBAND TWINS



**THE REVOLUTIONARY NEW 100V  
EXCITER-TRANSMITTER**

NO TUNING (except VFO), uses famous CE BROADBAND system. PRECISION LINEAR VFO—1KC Calibration. Single Knob Bandswitch 80 thru 10. SSB—DSB—AM—PM—CW and FSK. RF Output adjustable 10 to 100 Watts PEP. Meter reads Watts Input, Amps Output and Carrier Suppression. 2" RF Scope. Speech Level and Load Mismatch Indicators. Audio Filter — Inverse Feedback — 50 db Carrier and Sideband Suppression.

AT YOUR DEALERS NOW.....PRICE \$795.00



**FAMOUS MODEL 600L  
BROADBAND LINEAR**

NO TUNING CONTROLS — CE BROADBAND Couplers in HIGH EFFECIENCY CLASS AB<sup>2</sup> using single 813. Easily driven to 600 Watts PEP Input 160 thru 10 by a 20A or 100V. Built-In HEAVY DUTY POWER SUPPLY — 45 MFD PAPER Capacitor. Meter reads WATTS INPUT, GRID DRIVE, RF AMPS, and SWR. Completely shielded — TVI suppressed — parasitic free. REMEMBER there is LESS than ONE S UNIT difference between the 600L and a 2 KW PEP job. ....PRICE \$495.00

**MODEL 20A**



## THESE MULTIPHASE EXCITERS PIONEERED AMATEUR SSB

**MODEL 10B** — 10 watts PEP. Plug-in coils 160 thru 10 meters. Perfect voice control on SSB—DSB—AM and PM — CW breakin; Carrier and calibrate level controls. 40 DB suppression.

Wired.....\$179.50 Kit.....\$139.50

**MODEL 20A** — 20 watts PEP. Bandswitched 160 thru 10 meters. SSB—DSB—AM—PM and CW. Magic eye monitors carrier null and peak modulation. Ideal for driving AB<sup>1</sup>, AB<sup>2</sup>, and most Class B linears.

Wired.....\$279.50 Kit.....\$219.50

**MODEL 10B**



**MODEL GC-1.** Gated Compression Amplifier. Connects between receiver and speaker. Automatically brings all received signals to same level—no blasting. Compensates for receiver AVC deficiencies. Compresses a 40 db increase in level to less than 3 db. Magic Eye continuously monitors compression value. Keep peace with your family and neighbors — buy a GC-1.

KIT....\$49.50 Wired....\$59.50



**MODEL MM-2.** 3" RF analyzer scope for use on SSB—DSB—AM—PM and CW. MONITORS RECEIVED AND TRANSMITTED SIGNALS thru new electronic switching circuits. NO TUNING — BROADBAND response 1MC to 55MC at power levels of 5 watts to 5 KW. SIMPLE CONNECTIONS. Built-in 1KC oscillator for exciter alignment. Plug-in IF adapters available for 450-500 KC, 80 KC and 50 KC.

IF adapter RM-455 or RM-80 or RM-50 .....\$9.95  
MM-2 (less adapter) wired \$149.50  
Kit .....\$119.50



WRITE FOR INFORMATION ON THE COMPLETE MULTIPHASE LINE.

MULTIPHASE  
EQUIPMENT

*Central Electronics, Inc.*

1247 W. Belmont Ave.

Chicago 13, Illinois

A SUBSIDIARY OF ZENITH RADIO CORP.

MULTIPHASE  
THE OVERWHELMING  
CHOICE OF HAMS  
EVERYWHERE

For further information, check number 10, on page 130.



# HOT MOBILE NEWS!

**AIRCON crystal controlled converters which require no external power supplies**



## 4 MODELS NOW AVAILABLE

Size only 5"x3"x3 1/2". Features polarized power plugs. For use with any auto radio, including those where B+ voltage is not available. Can be installed in minutes without breaking into auto radio or ignition system. Models C317 and C318 are also usable in home stations with either b.c. or communications receivers.

Works with any IF range up to 7 mc. merely by changing crystal. Specify IF range when ordering.

#C315	6 METER FOR 12 VDC	\$40.30
#C318	6 METER FOR 12 VDC & 115 VAC	\$49.95
#C316	10 METER FOR 12 VDC	\$40.30
#C317	10 METER FOR 12 VDC & 115 VAC	\$49.95

# TRANSCON TRANSISTORIZED POWER SUPPLIES



3 Models — 12 VDC input, handsomely packaged in 5"x3"x3 1/2" black-anodized drawn aluminum case. Features a built-in master relay which both protects transistors against reversed polarity connection and permit use of low cost (low current) ON-OFF remote switch. Dual voltage outputs.

PS-300 — 300 V @ 100 ma ..... \$60.75

PS-425 — 425 V @ 150 ma ..... \$67.50

PS-600 — 600 V @ 200 ma ..... \$76.50

(6 & 24 VDC input models available on special order.)

Ask your supplier for these TRANSCON UNITS. If he doesn't have them, he can get them for you — or write and give us his name. Literature available.



TRANSCON DIVISION  
**NORTHEAST TELECOMMUNICATIONS, INC.**  
Plantsville, Conn.

For further information, check number 11, on page 130.

Universal Postal Union for a postage stamp or postage stamps representing the amount of postage for an ordinary single rate letter destined for a foreign country."

Sooooo—the answer is for amateurs to find out what the Second Class airmail rates are from the DX country to the U.S.A. — and send *mint* stamps of that country to that value to the DX station concerned!!

A. F. Ward, VQ4FB

## Box Top License

Editor, CQ:

I was comfortably relaxed with one foot perched upon my operating table in the shack when I came across the phrase, Conditional—"send in a boxtop"—license ("Letters" CQ for June, p. 20). This phrase was made by a fellow ham. Boy, it sure made me mad.

What type of ham would make this statement? Is he a person who lives in a little world by himself? If he is, he is not a true ham. Or is it that he just wanted something to gripe about?

I have a Conditional class license which I am very proud of. I worked very hard for it. I must have been lucky, I did not have to send in a boxtop for it.

My first introduction to ham radio came about when I was stationed on Johnston Island. I was in the Air Force at the time. It took me only a short time to decide that I would like to partake in this fascinating hobby.

I studied hard for my license. I thought that I would never bring my code speed up.

If I may, I would like to explain how the test was conducted.

The test paper was placed in front of me. I was plenty shook. I wanted so hard to prove to my instructor that the time that he had spent with me was not in vain. After I had marked my first answers I had to explain my reasoning behind it. This went on throughout the test.

After I had finished the test I was given a lecture in regards to the correct procedures on the air.

Weeks passed and my license finally arrived. I was overjoyed. Now I could get on the air.

My instructor made this remark to me before I made my first contact. "Every time that you send a signal out over the air you are representing me. Don't let me down."

That was seven years ago. To this date I have not let him down.

In the last seven years I have operated CW, AM, and SSB. I have handled many types of traffic as well as phone patches. I have introduced a friend of mine to ham radio, who received his Novice ticket two months ago. I have continually tried to better myself as a ham.

Is it fair to condemn the holders of Conditional and Novice class licenses? Maybe we should put the blame on the "Generals" who were the instructors.

John J. Halser, K9MTM  
2954 N. 28 Street  
Milwaukee, Wisconsin

Editor, CQ:

I feel that, while W5MDN has the best of intentions (CQ for May 1960, p. 20) he is far too prone to make snap decisions, condemn, and give advice and admonitions.

The advertisements to which he so strongly objects, form by far one of the most vital parts of your magazine. It is to the manufacturers that we owe much, if not most, of the sophistication of the technical phase of our hobby. (And when one investigates the insides of a KWM-2, a Cosmophone, or an MSB-1, he cannot help realizing just how technically sophisticated ham radio has become. Consider also what Central Electronics did for sideband.) Through their advertising these manufacturers have built a highly competitive business, a business which requires constant research and improvement, a business which brings the ham all grades of equipment at reasonable prices. Without their advertising, these manufacturers could not move their equipment well enough to maintain their research facilities, not well enough, indeed, for them to be able to afford to consider ham radio as an outlet at all. Not only does advertising acquaint the ham with the various products which are available; it also provides a highly accurate inventory of the technical state of the hobby, and sets before the home constructor many useful ideas.

Let's consider home brew equipment a little more closely. My own case, while not average, is illustrative. I am a senior at Duke University, and my schedule includes morn-



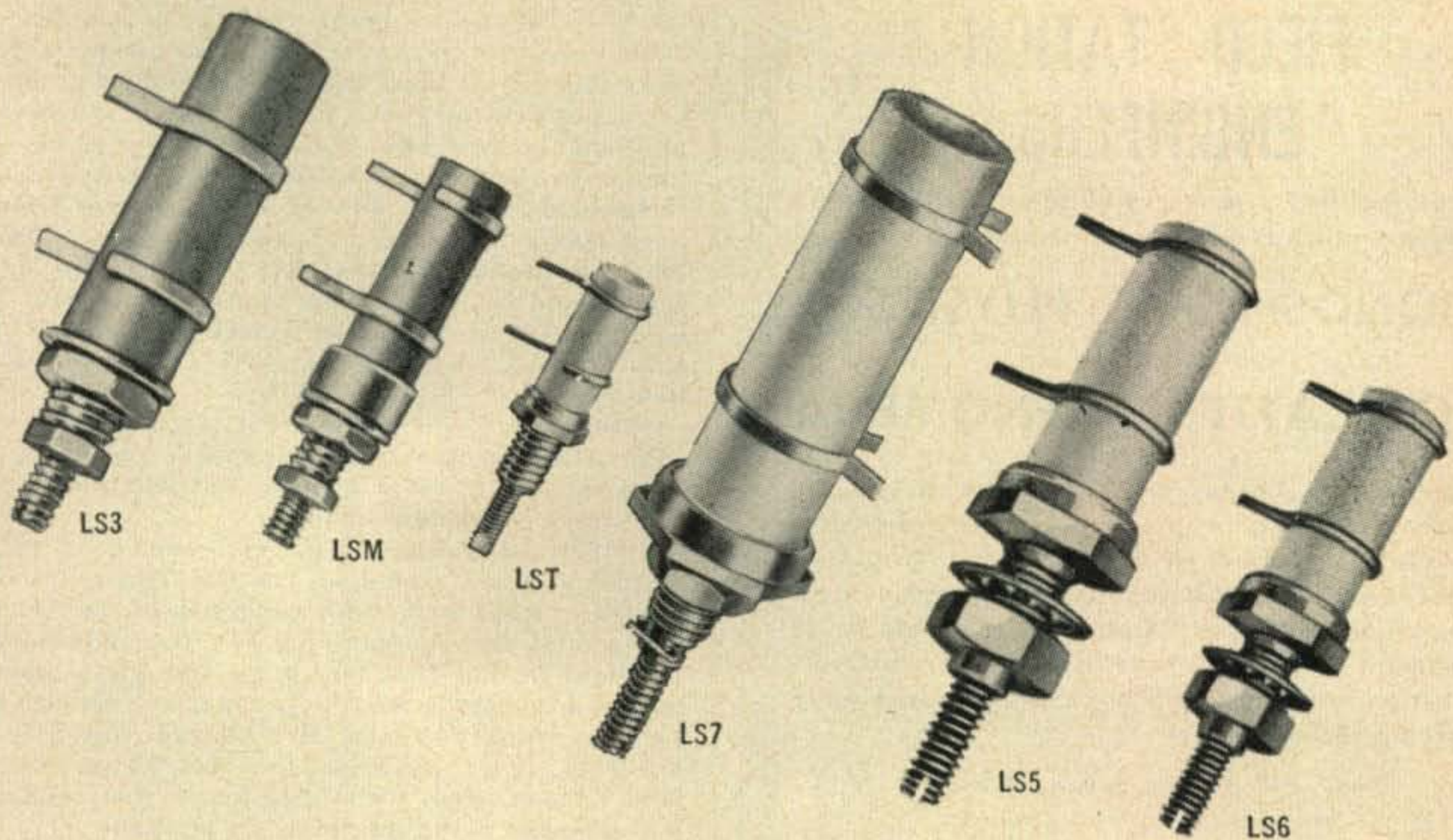

## BUILD LIKE EXPERTS!

### Wind your coils on CAMBION<sup>®</sup> coil forms

Wherever your rig needs coils, *you* need CAMBION coil forms for the real professional performance expert hams are getting from their many different types of home-built equipments. This very successful construction — reported by amateur builders who use CAMBION coil forms like those shown . . . includes:

- **A Solid High-C VFO**, a completely shielded, stable oscillator for new exciters, heterodyne or multiplying type. Coils wound on CAMBION forms serve as tuned circuit components for aid in determining the required frequencies.
- **A BC-453 Command Set**, in which CAMBION coil forms help assure the efficiency provided by this small, low cost unit as the heart of a tunable IF receiver.
- **A Double Sideband Transmitter**, junior size. A CAMBION coil form is used in this RF unit for a suppressed carrier communications system which is of rapidly increasing interest to radio amateurs.

The huge family of CAMBION coil forms, phenolic and ceramic, cover the widest

range of requirements in any type of circuit, RF or IF. New types are designed to solve new problems. Windings can be single layer, close wound or spaced, single or multiple pie. Shielded types give star performance in tight spots. Most CAMBION coil forms are available with Perma-Torq<sup>®</sup> tensioning device, allowing locking of tuning cores while still tunable.

Precision-wind *your* coils on CAMBION precision-made coil forms — for other aids to high performance construction investigate the complete line of CAMBION *guaranteed* components. For performance charts on the LS3 and LSM, and for a helpful folder on CAMBION forms, write direct to Cambridge Thermionic Corporation, 451 Concord Ave., Cambridge 38, Massachusetts.

At your Authorized  
CAMBION Distributors



CAMBRIDGE THERMIONIC CORPORATION  
**CAMBION<sup>®</sup>**

The guaranteed electronic components

For further information, check number 12, on page 130.



# FIELD STATION ENGINEERS

Several qualified engineers will be selected to join in a program which is advancing the state-of-the-art of

## IONOSPHERIC PHYSICS

*and the study of*

## BACKSCATTER PHENOMENA

Background in these areas will be developed through a training program in our Electro-Physics Laboratories, located in Bladensburg, Maryland. Engineers selected will become part of a team extending experiments of the Research and Development Department to the field, in both Domestic and Overseas assignments, and will have ample opportunity to develop technically.

*They will possess a combination of the following requirements:*

- ✓ BSEE, or equivalent consisting of combined civilian or military technical school plus work experience.
- ✓ Presently employed as a Field Engineer or Project Engineer.
- ✓ A good command of some of the following:
  - RADAR, preferably High-Power
  - HF Long-Distance Communications Systems
  - Tropospheric or Ionospheric Scatter Systems
  - Meteor-Burst Communications Systems
  - Propagation Prediction—computation of propagation for long-distance communications
  - Ionospheric Sounder Operations
  - RDF Systems
  - Doppler RADAR Systems
  - Amateur Radio Enthusiast
- ✓ FCC License, 1st or 2nd Class.

They must be willing to accept assignments in areas where dependents are not permitted for periods up to one year. Differential paid for overseas assignments.

Applications Are Also Being Accepted For  
**SENIOR SCIENTISTS  
ENGINEERS (All Levels)  
LABORATORY TECHNICIANS**

*for permanent assignment at our Electro-Physics  
Laboratories in Bladensburg, Maryland.*

Please Send Resume To:

*Professional Employment Dept.*

**ACF ELECTRONICS DIVISION**

**ACF**

**INDUSTRIES, INCORPORATED  
RIVERDALE, MARYLAND**

ing classes, labs until five every afternoon, studying, working twenty hours a week in the library, the various duties and meetings which befall a fraternity member, and about six hours of sleep a night. During the summer, I work as radio counselor in a very fine boys' camp in New Hampshire. I sincerely hope that Mr. Albright will not object too strenuously to my GPR-90 and Viking Navigator! In my opinion, the true ham is the one who uses his equipment, knowledge, and ability to serve the public which owns the frequencies that we borrow; who promotes friendship and good operating procedure; who attempts to promote both his own proficiency and that of his fellow hams in the science and art of radio communications. While home brew equipment is an unequalled source of pride and of technical information, it certainly is not a prerequisite for the true ham.

Most strongly do I agree that a study and knowledge of the science of communications theory and practice is all-to-often lacking in today's hams. But let's put the blame for this where it belongs: upon the F.C.C. for its asinine easy examinations and overly lax enforcement of its own rules and regulations, and upon the Old Timers, who should be the voice, inspiration, and leadership of the Amateur Radio Fraternity, for not carrying out the obligations of their position. Saying that one is an Old Timer should not be the same as saying that he is a purely vegetative organism (which, thank goodness, Mr. Albright and a few like him are not). To a lesser degree, this blame belongs to the newer hams, who, while able to see their obligations, are too spineless to do anything about them.

The two major Amateur Radio periodicals are doing an excellent job, and their watered-down, humorous technical articles reach many persons who would never glance at a serious article.

At risk of closing an idealistic letter with an overly idealistic paragraph, I shall say that Amateur Radio is full of obligations as well as pleasures. Those of us who do not recognize and fulfill these obligations are doing injustices to ourselves, to our fellow hams, and to the public which permits us to use parts of the radio spectrum.

W. H. Fisher, W4EHY/4  
Box 5706 Duke Station  
Duke University  
Durham, North Carolina

Editor, CQ:

Mark me down as another ham who is sick and tired of the fanatical ravings of these individuals who seem to think that the only ham worth issuing a ticket to is the one who has built all, or at least most, of his equipment.

I have not been a ham very long, but I have been one long enough to realize that there are many other interesting and worthy phases of amateur radio besides equipment building (DX, message traffic, high frequency work, etc. etc.).

Don't misunderstand me, I have nothing against a fellow building his own stuff if he wants to, but I violently oppose this idea of cramming this particular field of the hobby down a ham's throat whether he likes it or not—which is what some of these characters have the nerve to suggest.

I have never been accused of being overly bright, but I am intelligent enough to respect the other fellow's interests and not try to force mine on him. After all, it's his hobby as well as mine, and as long as he operates his rig according to F.C.C. regulations and doesn't interfere with other amateurs, his interests are his own.

So what if the ham chooses to just operate his equipment during his "hamming time"? I have seen quite a few trophies and awards given to those who operated their station as a public service (disaster & emergency communications, phone patches for overseas personnel, etc.), but I have never seen one given to a ham just because "he built it himself".

Which proves nothing except that possibly the hams that spend their time operating are contributing as much, maybe more, than those who build!

Besides, as far as I can see, the fact that a person has built his own rig doesn't necessarily prove that he is a genius. If the rig was built from a kit or a plan, all the builder did was follow directions, which may not have taught him a thing as far as fundamentals or theory is concerned. On the other hand, if the builder designed the rig and then built it, he certainly didn't have to go to such

[Continued on page 105]



# IN 1960

as in the  
past 28 years  
B&W will  
continue to  
supply  
amateurs with  
the world's  
finest  
equipment  
and electronic  
components

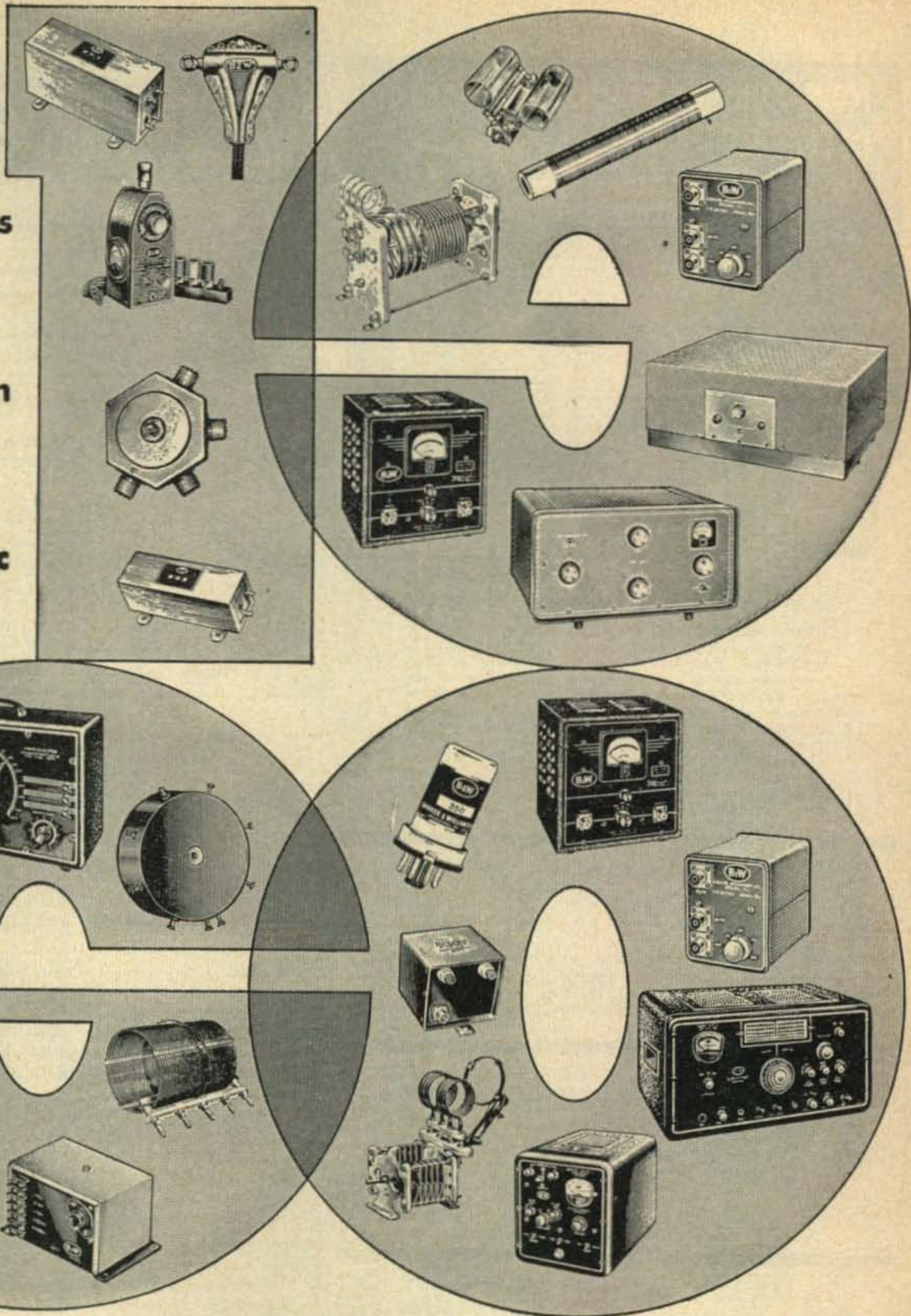

Transmitters-AM-CW-SSB  
Single Sideband Generators  
Dip Meters  
Audio Oscillators  
Distortion Meters  
Linear Detectors

Audio Frequency Meters  
Matchmasters  
Toroidal Coils  
Frequency Multipliers  
Transistorized Power  
Converters & Inverters

Low-Pass & Band Pass Filters  
T-R Switches  
R.F. Filament Chokes  
Transmitting R.F. Plate Chokes  
Audio Phase Shift Networks  
Band Switching Pi-Networks

Cyclometer-type Counters  
Antenna Co-axial Connectors  
Baluns  
Variable Capacitors  
Fixed and Rotary Type Coils  
B&W's famous pioneer line of  
"Air Inductors"

Write for New Catalog

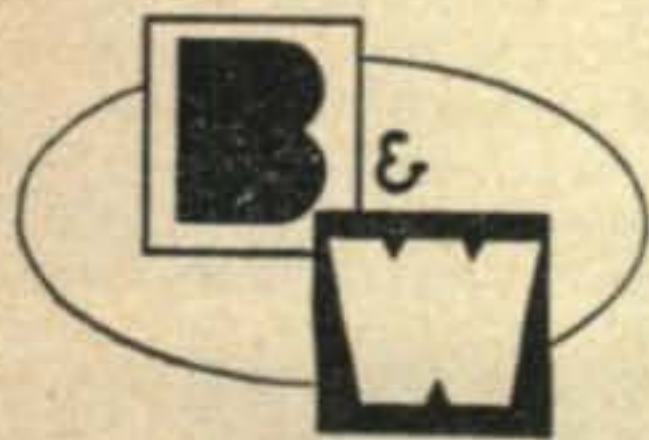

## Barker & Williamson, Inc.

Bristol, Penna.

For further information, check number 13, on page 130.

August, 1960 • CQ • 17



# Now Your BEST BUY in CITIZENS TRANSCEIVERS... **EICO**



- =760 (117 VAC) less bracket: Kit \$59.95. Wired \$89.95
- =761 (117 VAC & 6 VDC): Kit \$69.95. Wired \$99.95
- =762 (117 VAC & 12 VDC): Kit \$69.95. Wired \$99.95

Highly reliable; exemplary electronic, mechanical, industrial design. Powerful 5-watt (as defined by FCC) crystal-controlled transmitter & extremely sensitive, selective superhet receiver with RF stage & noise limiter. Built-in speaker, detachable ceramic mike. Pre-set & sealed crystal oscillator circuit elements. To change channels, just change crystals—no adjustments needed. Built-in variable "pi" network matches most popular antennas. Portable whip & roof antennas available. No exam or special skills needed—any citizen 18 years or older may obtain station license by submitting FCC form, supplied free by EICO.



## 90-WATT CW TRANSMITTER\* #720 Kit \$79.95 Wired \$119.95

\*U.S. Pat. No. D-184,776  
"Top quality" — ELECTRONIC KITS  
GUIDE. Ideal for veteran or novice.  
90W CW, 65W external plate modulation.  
80 through 10 meters.

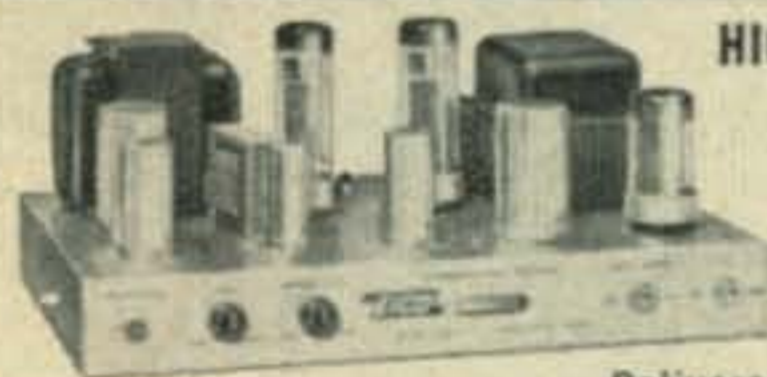

## HIGH LEVEL UNIVERSAL MODULATOR-DRIVER #730 Kit \$49.95 Wired \$79.95

Cover E-5 \$4.50  
Delivers 50W undistorted audio.  
Modulates transmitters having RF inputs up  
to 100W. Unique over-modulation indicator.

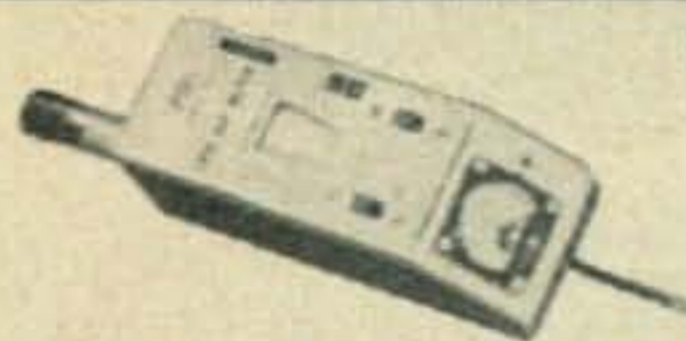

## GRID DIP METER #710 Kit \$29.95 Wired \$49.95

Includes complete set  
of coils for full band  
coverage. Continuous  
coverage 400 kc to 250 mc. 500 ua meter.

**NEW!**



## Code Practice Oscillator #706 Kit \$8.95 Wired \$12.95

Rugged battery-operated transistor oscillator circuit with built-in 3" speaker. Front panel (deep-etched satin aluminum) has flashing light, phone jack, pitch control (500-2000 cps), external key terminals, "temporary" key. Panel switch selects Tone, Light, or both Tone & Light. 6½" h, 3¾" w, 2¾" d.

Compare—judge for yourself—at your neighborhood EICO dealer. Send for FREE catalog on over 70 models of easy-to-build professional test instruments, hi-fi and ham gear. Send for FREE Short Course for Novice License.



Dept. CQ-8, 3300 N. Blvd., L.I.C. I, N.Y.  
Add 5% in the West. ©1960

For further information, check number 14, on page 130.



### National Radiotelegraph Society

The National Radiotelegraph Society, with headquarters in Tulsa, Oklahoma, has been organized to encourage the use of radio-telegraphy by amateurs. It is an independent organization, the sole efforts of which will be directed toward the advancement of the art of radiotelegraphy. The Society now has charter members in every continental U.S. call-district.

The National Radiotelegraph Society operates amateur station K5ZHH regularly on Monday nights. Calling frequency is 7150 kc and all amateur stations are invited to QSO. Mail address of the Society is P.O. Box 2232, Tulsa, Oklahoma.

### Pacific Division ARRL Convention

The Central California Radio Council extends a hearty invitation to all radio amateurs to attend the 1960 Pacific Division ARRL Convention to be held over Labor Day Weekend, September 2-3-4, at the San Mateo County Fairgrounds, San Mateo, California (15 miles south of San Francisco). The host club will be the San Mateo Radio Club.

Top-Notch technical speakers, mobile transmitter hunts, mobile judging contest, golf and bowling tournaments (with trophies to winners), Saturday evening dance (with orchestra), deluxe banquet, conducted tours of electronic plants, Wouff Hong and SWOOP initiations, complete ladies program, equipment displays, and prizes galore (pre-registration prize, Hallicrafters HT-37).

Registration is \$7.50 and pre-registration prize deadline date is August 20. Tickets, motel reservations (if desired) and additional information are available by writing to "ARRL Convention," P.O. Box 751, San Mateo, California.

### R.S.G.B. National Convention

I would like to bring to your notice the fact that the next National Convention of the Radio Society of Great Britain is being held from 15th to 17th September 1960, inclusive, in Cambridge, England.

The theme of the Convention is "The Impact of Fundamental Research upon the Development of Radio Communications Engineering allied to Cambridge the centre of Scientific Research."

Three days of lectures by the Leaders in the University and industrial scientific fields have been arranged, together with visits to places of technical interest, such as the Mullard Radio Observatory, a television relay station and local electronic industries.

The Convention promises to be the best that has ever been held and a warm welcome awaits all those who would care to come and spend a week with us in Cambridge.

Further particulars and reservations may be obtained from: The Secretary, R.S.G.B. Convention Committee, 37 Metcalf Road, Cambridge, England.

### Arctic A.R.C.

The Arctic Amateur Radio Club of Fairbanks, Alaska, will sponsor the 1960 All Alaska Hamfest on August 12, 13, and 14. Housing is being arranged for out of town guests at a nominal cost. All interested amateurs are urged to contact KL7AZJ, Box 735, College, Alaska for reservations, as facilities are limited and will be on a first come basis.

### Northwest DX Get-Together

The 6th Annual Northwest DX Get-Together will be held August 20-21 at the New Washington Hotel in Seattle.

Registration will be \$7.00 prior to August 1, and \$8.50 after that date. A very interesting program is planned including entertainment for the XYLs. Registration forms may be had by writing W7WDM at the above address.

### Hamfesters Radio Club

The Hamfesters Radio Club is holding its 26th Annual Picnic at Santa Fe Park, 9100 South Wolf Road, on Sunday, August 14, 1960. From the East, take Route 4A (Archer Road) to 87th Street in Willow Springs, and turn West following signs to the Park. From the West, take Route 66



# NEW for Mobile...

## autowhip **TM-5**

**for 10 • 15 • 20 • 40 • 80**

A five band mobile antenna with excellent radiating efficiency that changes bands without switches . . . that's the new Autowhip TM-5 by Mosley! Fully automatic electronic switching by means of simple series and parallel resonant trap circuits. These precision made, series-tuned traps improve SWR on the 10-15-20 and 40 meter bands and a parallel network achieves near unity SWR on 80 meters.

All exterior fittings are of stainless steel, brass and weatherproof plastic. The aluminum framed housing has a tough Plastisol cover that is practically unbreakable and will retain its shape through a temperature range of -30° F. to +200° F.

This cover is a neutral ivory color which will blend harmoniously with all vehicles. The Autowhip TM-5 is aerodynamically designed for a minimum of wind resistance.

The Autowhip TM-5 is designed for use with all popular commercial amateur mobile transmitters and transceivers and may be mounted on bumper or standard spring-type base mount, 3/8-24 stud.

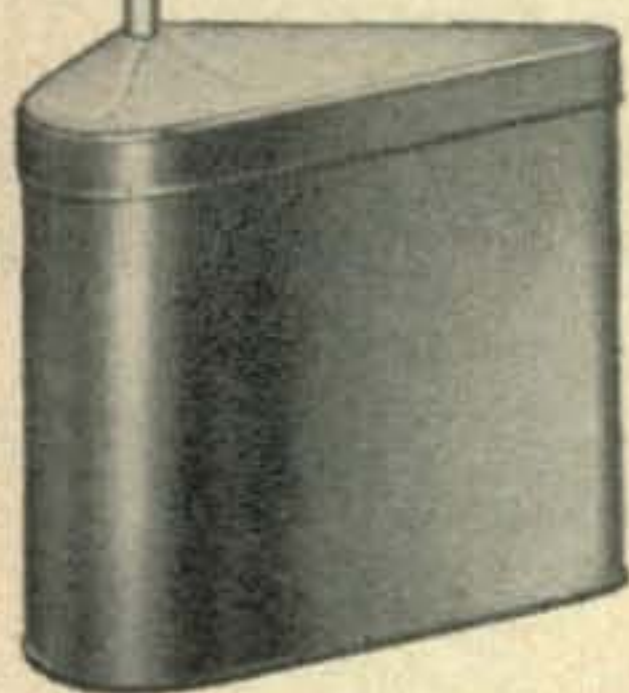

*This antenna offers finest component quality and imaginative engineering at a popular price. Thoroughly field tested, this beautifully designed, band-switching unit is fully guaranteed against defects in material and workmanship for a period of one year.*

Amateur Net \$69.95

**Mosley Electronics, Inc.**

4610 N. LINDBERGH BLVD. BRIDGETON, MISSOURI

WEST COAST BRANCH  
1406-08 South Grand Avenue  
Los Angeles 15, California

INTERNATIONAL DIVISION  
15 Moore Street  
New York 4, New York

For further information, check number 15, on page 130.



## LOW SPECIAL PRICES

for the *BEST*, most easily understood of the current Official U.S. Dept. of Air Force Instruction Manuals—Extremely helpful for on-the-job and at-home reading and learning.

**ANTENNA SYSTEMS, AF Manual 52-19**, 296 pages of the best information ever gathered for any training curriculum. This book is now being used by thousands of Technical Schools and Industrial Training Depts. Govt. List Price \$2.00—**Only \$1.75 per your copy.**

**LEARNER'S GUIDE—ADVANCED CIRCUITS, AF Manual 52-18**, 234 pages of Laboratory Material covering the most frequently used Oscillators, Multivibrator and other Generator Circuits, as well as the Test Equipment necessary for Troubleshooting. Govt. List Price \$2.00—**All for Only \$1.75 per manual.**

**POWER PLANT MAINTENANCE—FOR RECIPROCATING ENGINES, AF Manual 52-12**, 456 pages of Aircraft Engines Training Materials, including 4 and 5-color, exploded-view diagrams, Information necessary to the Ground Crews, Flight Crews and Administration Groups, Covers: Power Plant, Fuel Systems, Ignitions and Controls, Propellers, Mountings and Inspections. Govt. List Price \$3.25—**ONLY \$2.25 per book to you.**

**ENGINE CONDITIONING FOR RECIPROCATING ENGINES, AF Manual 52-9**, 70 pages on final check-outs of Aircraft Engines. Covers: A New Approach To Maintenance, Basic Engine Principles, The Cockpit Check Analysis of Cockpit Check Data, Conditioning of an Engine and the Part of The Flight Crew. Govt. Cat. Price \$1.25—**\$1.00 to you.**

**OPERATION OF AIRBORNE SHORAN, AF Manual 101-6**, 120 pages covering the Basic and Operational Procedures of SHORAN Techniques, what it is and how it operates. Govt. Cat. Price \$2.00—**ONLY \$1.00 ea. to you.**

**SHORAN GROUND STATION OPERATION, AF Manual 102-4**, over 120—8½"x11" pages with over 6 large pull-out schematics. Includes: Introduction To Shoran System, Theory of Operation Of The Shoran Ground Station, Installation and Operational Procedures of the Ground Station. Govt. Price \$2.00—**ONLY \$1.25 each to you.**

## GET THEM NOW WHILE THEY LAST

**COWAN PUBLISHING CORP.**

**BOOK DIVISION**

**300 West 43rd St., New York 36, N.Y.**

N. Y. City Residents add 3% Sales Tax

to 79th Street, then East to Wolf Road. The Park has modern facilities, ample parking, picnic tables, and plenty of shade. There will be Radio Displays, food and refreshments, events and prizes galore. Swap tables available. For advance tickets and information write L. L. Finnan K9EEC, 6411 So. Long Ave., Chicago 38, Illinois.

### Manitoba, Canada

"Manitoba Hamfest," sponsored by the Brandon Amateur Radio Club will be held September 3rd and 4th at Brandon, Manitoba, Canada. Entertainment will be Saturday evening, social get-acquainted get-together at the Forresters Hall. Sunday, will be official opening and Hamfest. A banquet will be held Sunday evening, advanced registration necessary if planning to attend the banquet, the fee being \$5 per couple or \$3 single. For more information contact Fran Haddon, VE4KN at 715-7th St., Brandon, Manitoba, Canada.

### Tri-State A.R. Society

The Tri-State Amateur Radio Society will hold its annual hamfest-picnic on August 28 at Eagles Picnic Grounds, Evansville, Indiana. There will be games, contests and prizes. Refreshments available on the grounds. Bar-B-Que chicken or ribs will be served at noon by advance order only. \$1.25 & 75¢ for children. Mobiles check in on 75, 10, 6 and 2. Advance registration \$2.00 or \$2.50 at the gate. For further information contact Dr. Thomas G. Westfall, W9BKO, 2409 W. Franklin St., Evansville, Ind.

### Erie, Penna.

The Radio Association of Erie, Pa. will hold a Hamfest on September 10, 1960 at the Sportsmen's Athletic Club, Erie, Pa. Registration will be from 10:00 A.M. to 12:00. For reservations contact Dick Millhouse, K3ENE, 1143 E. 40th St., Erie, Pa.

### Florida

The Daytona Beach Amateur Radio Assn., Inc., will hold its annual "gabfest" on September 4th at the Ellinor Village Teen-Age Recreation Bldg. (pavilion), on the corner of Hwy A1A & E. Granada Ave., Ormond Beach, which is about 4 miles north of Daytona Beach. Hospitality House at Ellinor Village from 1200 (noon) EST, Saturday, Sept. 3rd, until ???. Admission free, tickets on prizes 50¢ ea. Hot dogs and drinks will be available on the premises, or bring your own lunch, and plenty of restaurants handy too. Special week-end rates at Ellinor Village, Ormond Beach. W4SDR, Clyde Mashburn, 25 S. Halifax Dr., Daytona Beach is in charge of reservations.

### The Green Valley Radio Club

The Green Valley Radio Club of Alliance, Ohio, announces the Third Annual Dr. Lee DeForest Day Hamfest and Dealer's display to be held on August 21st, 1960, at State Armory Grounds, 1175½ West Vine Street, Alliance, Ohio. Registration—\$1.00. Contact: Harry E. Pownell (W8PXX), 9140 Pontius St., NE Alliance, Ohio.

### North Alabama

The North Alabama Hamfest Association will hold its annual hamfest at Decatur High School, Decatur, Alabama, Sunday, August 21, 1960. For further information contact Paul W. Burks, Secretary, P.O. Box 9, Decatur, Alabama.

### Blue Grass A.R.C.

The Blue Grass Amateur Radio Club of Lexington, Kentucky will hold its traditional hamfest at historic Keeneland Race Track on Sunday, September 11. Lots of prizes, fun for the kids, and an area for swap and shop, plus refreshments at a nominal price, promise a good time at this annual get-together. Transmitters will be in operation on 10, 6 and 2 meters. Registration \$1.00.

Contact Charlie Brown, K4VLR, 2905 Southview Drive, Lexington, Kentucky for any additional information.

### Shenandoah Valley A.R.C.

The Shenandoah Valley Amateur Radio Club will hold its annual banquet and hamfest in Winchester, Va., on Sat. night, Aug. 6th and Sun., Aug. 7th. The banquet will be held on Sat. night at 6:30 P.M., EST, with guest speakers, awards and entertainment by comedian Sammy

[Continued on page 105]



THOUSANDS IN USE ALL OVER THE WORLD

# Hy-gain 6 Meter Beams

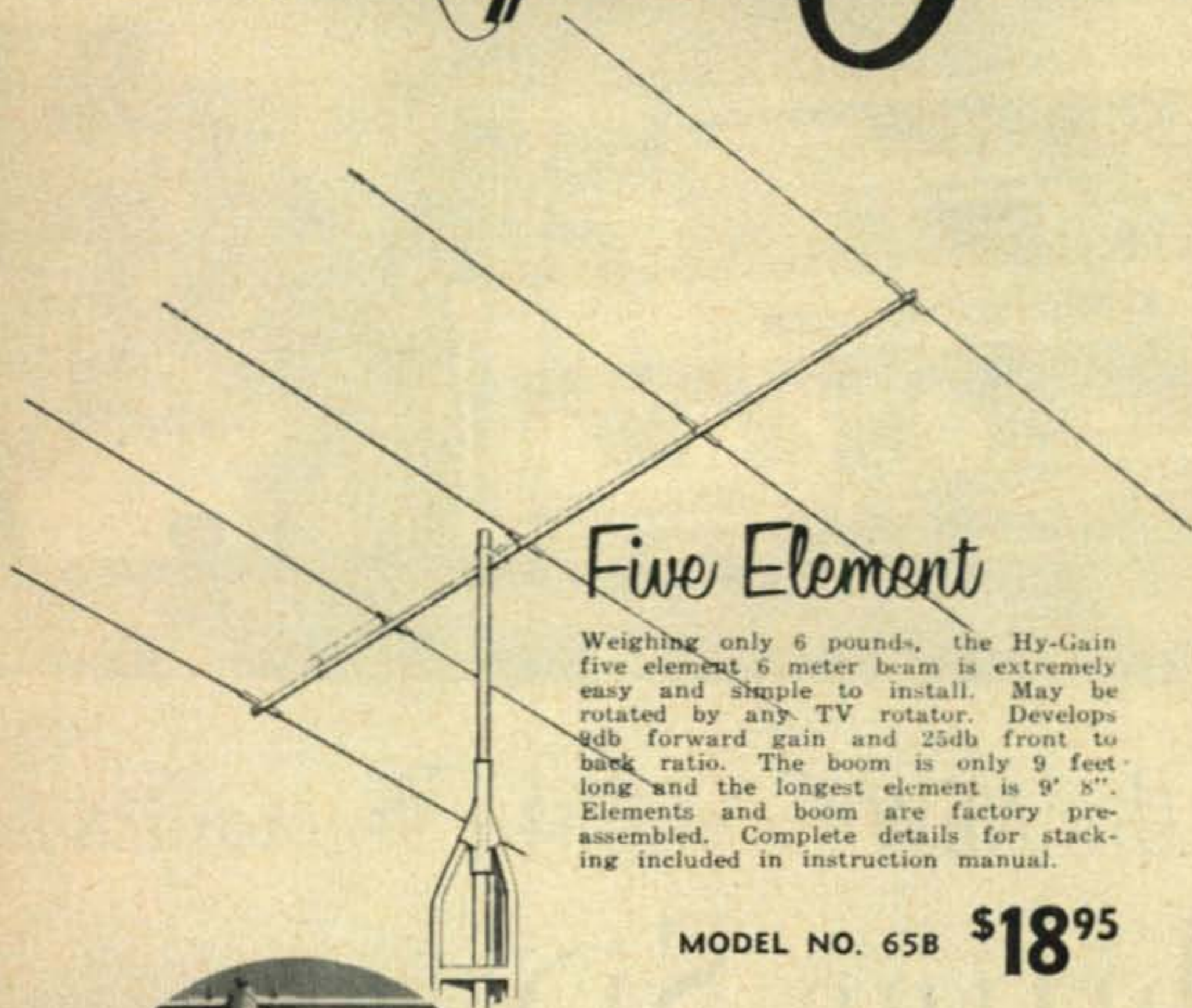

## Five Element

Weighing only 6 pounds, the Hy-Gain five element 6 meter beam is extremely easy and simple to install. May be rotated by any TV rotator. Develops 9db forward gain and 25db front to back ratio. The boom is only 9 feet long and the longest element is 9' 8". Elements and boom are factory pre-assembled. Complete details for stacking included in instruction manual.

MODEL NO. 65B **\$18<sup>95</sup>**

Large 1 1/4" diameter boom and heavywall 7/16" diameter elements constructed of strong, yet light weight heat treated aluminum alloy. All hardware heavily galvanized and iridite treated according to military specifications for maximum weatherability. Positive grip element to boom assembly completely encloses and secures all elements in perfect alignment.

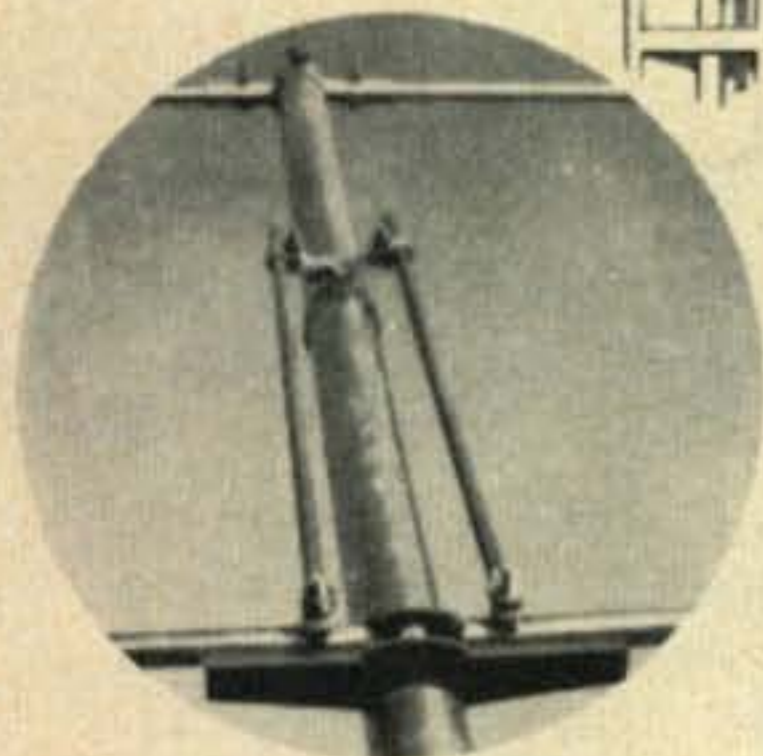

The unique and exclusive new Hy-Gain Beta Match system is completely factory pretuned and adjusted for an SWR of less than 1.5 to 1 into a 52 ohm coaxial transmission line. It is fully adjustable to compensate for installation variables and also maintains excellent band width — VSWR characteristics.

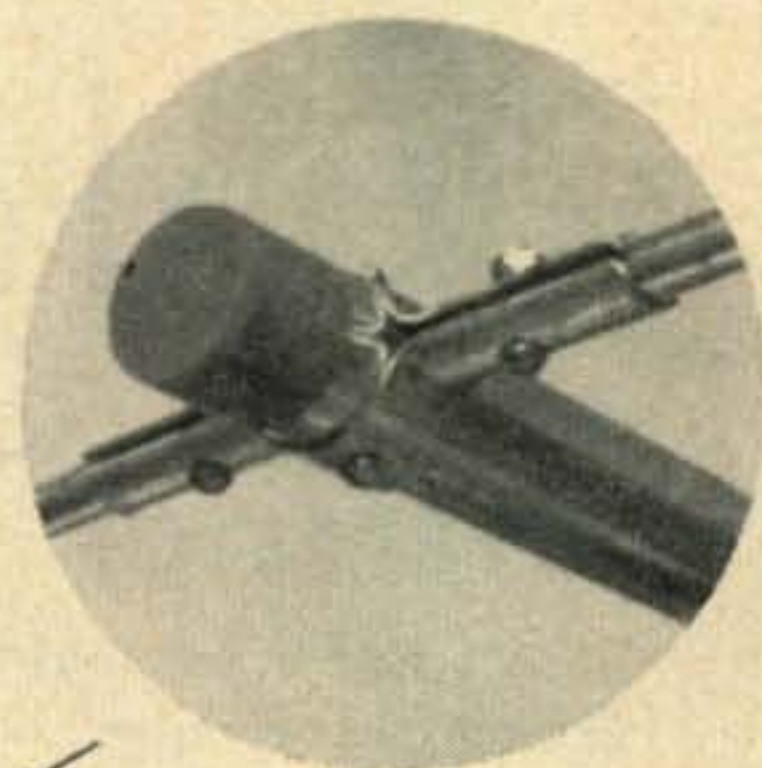

## Eight Element

For producing that big six meter signal, the Hy-Gain 8 element 6 meter beam develops the tremendous forward gain of 12.1db with 25db front to back ratio. Light weight, (only 9 pounds) and still small enough to be rotated by most TV rotators. Overall boom length 18 feet. Longest element 9' 8". Elements and boom are factory pre-assembled and stacking information is included in the instruction manual.

MODEL NO. 68B **\$32<sup>50</sup>**

"The World's Largest Manufacturer of Amateur Communication Antennas"

**Hy-gain**  
antenna products

1135 NO. 22nd ST. • LINCOLN, NEBRASKA

For further information, check number 17, on page 130.



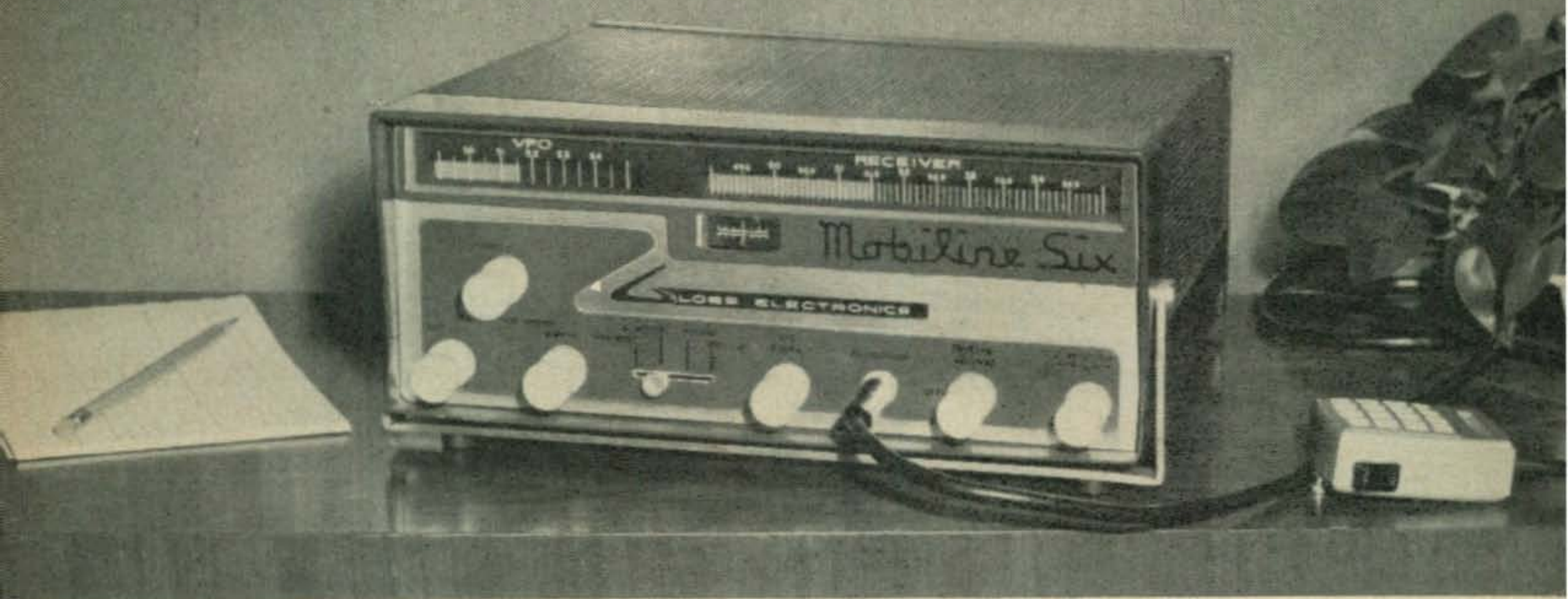

Introducing the NEW Globe  Electronics  
**Mobile Six...**

**6 METER MOBILE OR FIXED STATION TRANSCEIVER  
 CRYSTAL OR VFO CONTROLLED WITH 20 WATTS INPUT**

The smartly styled new Mobile Six is a compact transmitter and receiver combination for equal 6 meter adaptability to a fixed or mobile installation, operating from 115v AC, 12v DC or 6v DC, all with the power supply provided. It weighs only 20 pounds. Sized only 5" x 12", the unit takes little space in either home or car.

The receiver portion utilizes 7 tubes, including an RF stage delivering better than 1 mv sensitivity. A squelch control is also provided in the Mobile Six.

In the transmitter section, the internal VFO is voltage regulated and shock mounted to provide the utmost stability under adverse mounting conditions. The 2E26 amplifier stage is conservatively operated to handle 20 watts input power.

VFO or XTAL control; "S" meter, tuning meter, slide rule dials, VFO spotting and Class B modulation are a few of the other feature highlights. Available September, 1960. \$229.95.

*...and the NEW Citizens Band CB-200 Deluxe and Pocketphone*

**CB-200 DELUXE**

Two-way radio. Five channels. One tunable channel for receiving. Dual conversion. Pi net. \$179.95.



**POCKETPHONE**

Transistorized two-way radio 1<sup>5</sup>/<sub>8</sub>" x 2<sup>3</sup>/<sub>8</sub>" x 6<sup>1</sup>/<sub>4</sub>". 13 ounces. No license required. Range 1/2-1 mile. Rechargeable battery. \$125.00.



**GLOBE ELECTRONICS**

A DIVISION OF TEXTRON ELECTRONICS, INC.  
 22-30 SOUTH 34TH ST. COUNCIL BLUFFS, IA.

For further information, check number 18, on page 130.



# TAKE YOUR PICK!

EVERYONE'S  
A WINNER

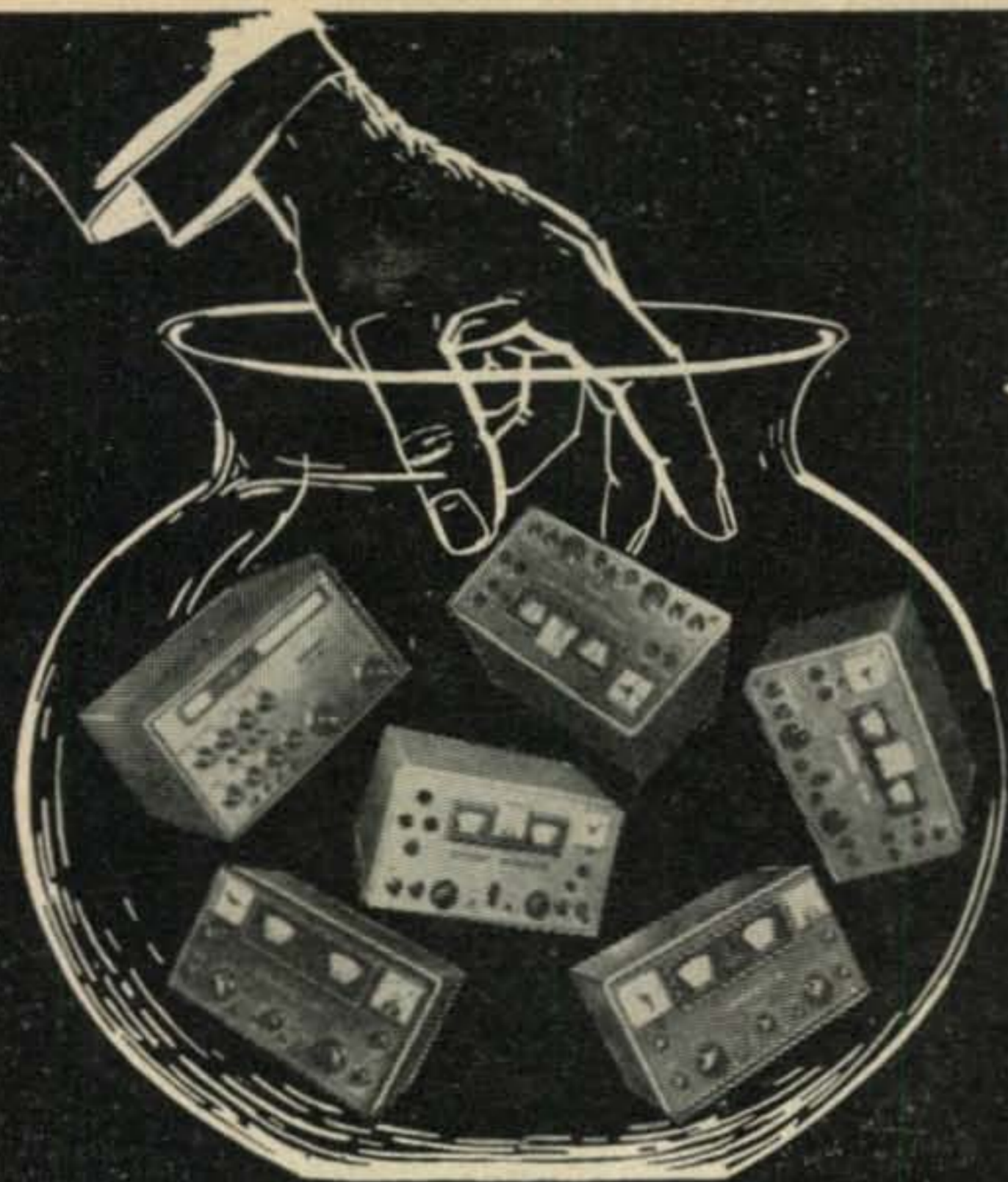

**HX-500**

Advanced design SSB transmitter offering the best features of all.....\$695.00



**HQ-170**

World's most popular SSB amateur bands receiver offering outstanding selectivity .....\$359.00



**HQ-180**

A fine quality general-coverage, SSB receiver offering commercial performance at amateur price .....\$429.00



**HQ-145**

An old favorite (HQ-129) brought up to date with modern engineering concepts \$269.00



**HQ-110**

A low-cost, amateur bands receiver offering operational advantages found in receivers costing far more \$249.00



**HQ-100**

The best buy for a general-coverage, quality communications receiver \$189.00

**READY RIGHT NOW—  
AT YOUR HAMMARLUND DEALER—  
BEST BUYS EVER!**

(Clock-timer \$10 extra)

## HAMMARLUND

MANUFACTURING COMPANY, INC., 460 West 34th Street, New York 1, N.Y.

A DIVISION OF TELECHROME

In Canada: White Radio, Ltd., 41 West Ave., N. Hamilton, Ont.

Export: Rocke International, 13 E. 40th St., N. Y. 16, N. Y.



Established 1910

For further information, check number 19, on page 130.



• "HIGH POWER IN SMALL PACKAGES"

# NEW LINEAR AMPLIFIERS

## from YUBA-DALMOTOR

**NEW**

**NEW**

In constant search for more favorable size and weight ratios, the imaginative engineering at Yuba-Dalmotor has developed two new compact linear amplifiers.

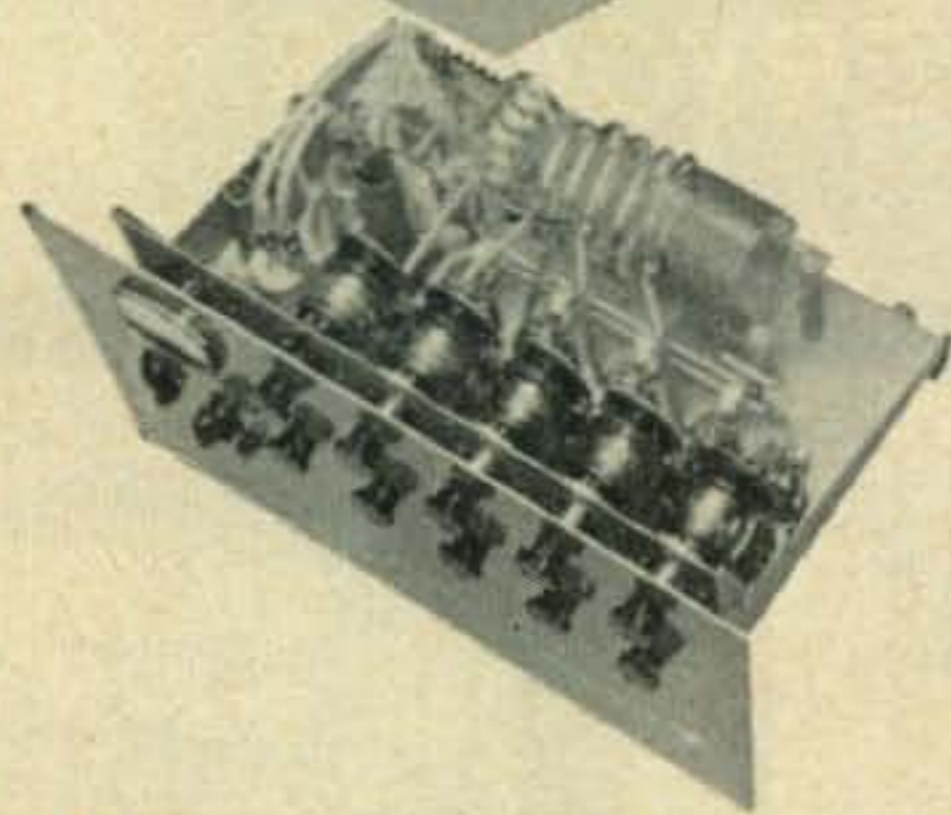

### MODEL DM 4000

#### Complete and Instantaneous Band Switching

For the first time complete and instantaneous band switching with either local or remote control, from 2 to 30 MC, 2 to 5 bands. Unit is capable of 3000 watts PEP input on SSB, also suitable for AM, CW, FM and FSK. Highly efficient and compact through use of Jennings vacuum components, and 3 water-cooled Eimac high power tetrodes in a grounded grid configuration. High degree of linearity attained through use of screen clamping. Adaptable for amateur or commercial service—for portable, fixed station, or portable-mobile use. Available in cabinet or rack mounting.

\*The FCC permits a maximum of one kilowatt average power input for the amateur service. In SSB operation under normal conditions this results in peak envelope power inputs of two times average or more, depending upon individual voice characteristics.

**NEW**

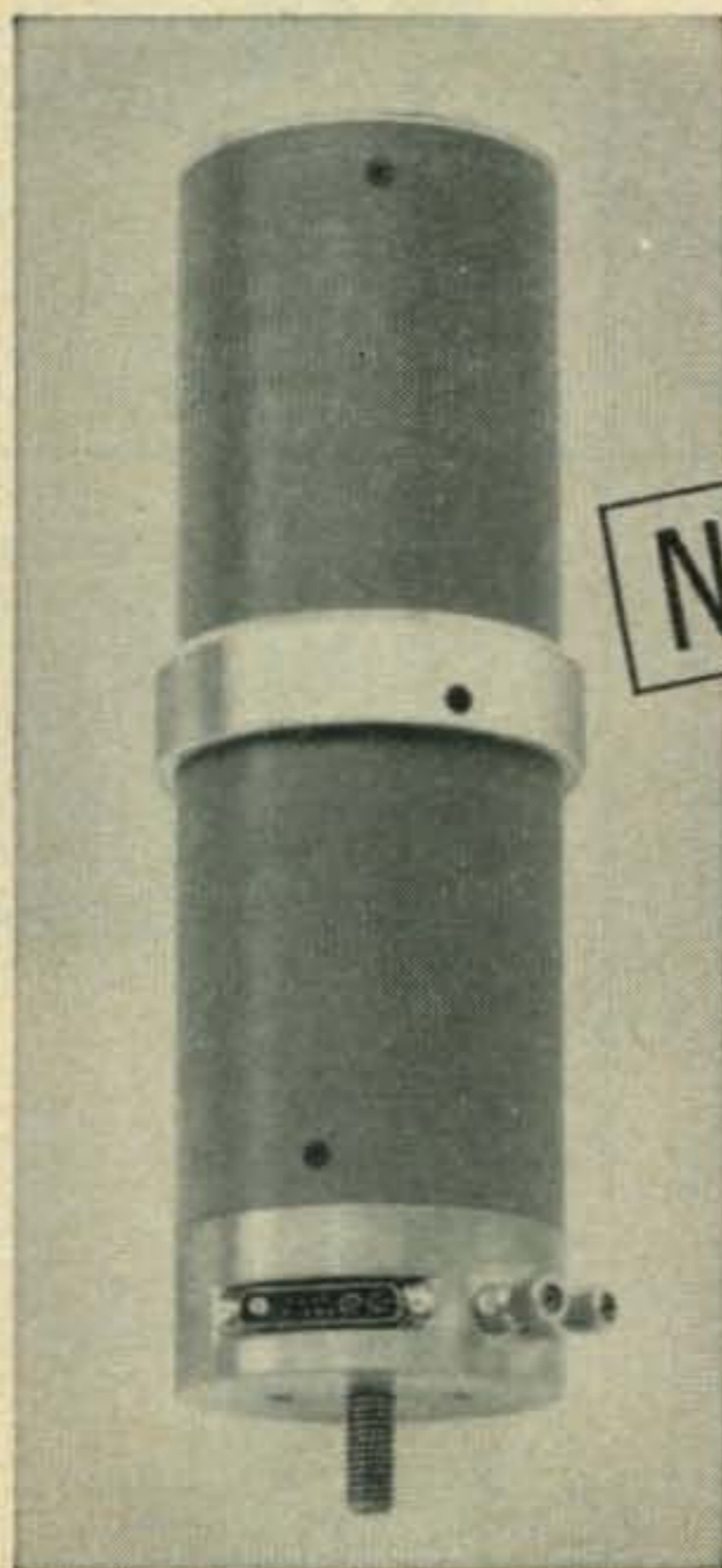

### MODEL DM 1000

#### Specifically for mobile SSB Operation

A completely new design concept in mobile communications—developed for SSB operation. Designed for bumper mounting, this unit puts the RF power directly into a conventional whip antenna. High power Eimac tetrode is used in highly efficient circuit, cooled by small amount of recirculating water. Rated at 1000 watts PEP input with minimum grid drive. Easily interchangeable plug-in units give multi-band operation.

*Two new portable packages to power communications equipment now available from Yuba-Dalmotor: (a) A complete, field power unit with 3-phase, 400 cycle alternator, coupled gasoline engine, coolant and heat exchange components, (b) DC to DC inverter—to provide one KW continuous output from either 12 volt (DMP 1012) or 24 volt (DMP 1024) input.*



**YUBA-DALMOTOR DIVISION**

1375 El Camino Real, Santa Clara, California

**YUBA CONSOLIDATED INDUSTRIES, INC.**

For further information, check number 20, on page 130.



# REAL GAIN

- in a  
**Vehicular  
Antenna!**

Cat. No. 251-509

**2.5 db gain**

**VSWR 1.5:1**

**Bandwidth  $\pm 2\%$**

**Range 144-174 MC**

*Communication Products Company, Inc.*

MARLBORO

NEW JERSEY

Communication Antenna Systems for American Business

→  
5/8λ  
Radiator

←  
17-7 PH  
Spring-  
Tempered  
Stainless  
Steel

1/8λ  
Matching  
Inductor

Insulated  
Mount and  
Cable  
Connector  
Assembly

For further information, check number 21, on page 130.

August, 1960 • CQ • 25



# Single Sideband Generator Design And Construction

Durward J. Tucker, W5VU

6906 Kingsbury Drive  
Dallas, Texas

J. L. Copeland, W5SQT

POB 157  
Wolfe City, Texas

*The authors have long bemoaned the high cost of going sideband and so turn to homebrew. These next six pages describe the general design, construction and adjustment of a phasing type of sideband generator of economical design. The economies of design have in no way compromised the performance of this unit.*

Interest in single sideband continues to grow. Even some of the CW boys, who haven't had an interest in phone work before, have shown an interest. Many amateurs are now on sideband, but there are probably more that *wish* that they were on SSB than there are *actually* on SSB. There is a good logical reason for this. A good SSB transmitter is not exactly easy to come by.

In the first place, the price of a good commercially built transmitter puts them in the dim distant future for all too many hams. It means waiting out a few more dozen QTH payments, after the family bus is paid for, and so on. In the second place, the average single sideband rig isn't exactly the easiest thing in the world to build. This is especially true for the beginner. Last but not least, the price is quite a consideration for many of the "do it yourself" rigs even if you *do* build it yourself.

Both of the authors are old timers who started out back when you either built your gear or did without. In the ensuing years we have had our share of commercial transmitters, but not before we had tried our hand at building and experimenting with any new development of the art. Single sideband was no exception for us; we are still experimenting and building our own.

## Generator Requirements

For some time we have felt that there was a great need for a simplified basic single sideband generator that would get the average ham "off the ground" at a price that he could afford. This meant that the cost should be well under a hundred dollars. It meant that sideband suppression should be at least 30 *db* on *each sideband* and that the *carrier suppression* should be 60 *db* or better. Good design dictated that the frequency of the SSB signal must be chosen such that it will not be *harmonically related* to any of the Ham bands within plus or minus 10% and preferably should be such that it can be heterodyned with a *vfo* so that the sum and difference frequencies will fall in *two* of the amateur bands.

With these thoughts in mind all of the published literature, to our knowledge, was thoroughly reviewed, as well as the data and circuitry of all commercially built rigs. We incorporated a good feature from this one, and a good idea from still another and so on.

Economy dictated the phasing type generator. Since the suppression requirements can be readily met with this type of generator, it was chosen. Thirty *db* sideband suppression is sufficient because most practical Class AB and B final amplifiers that are used with SSB generators have distortion products of 20-35 *db* down from maximum signal and these distortion products appear on the unwanted sideband. The generator's harmonics should be kept at least 10% from edge of the Ham bands because when heterodyning the generator to another frequency it also generates all the harmonics (2nd, 3rd, 4th, 5th, etc.) since any mixer, detector, converter, etc. is also a fair multiplier. These harmonics can be attenuated by circuits tuned to the desired frequency and if the harmonics are removed by as much as 10% from the desired frequency, 50 *db* of suppression can be obtained with two tuned circuits with Q's of 100. By using a balanced modulator (detector, mixer, converter, etc.), the even harmonics can be greatly attenuated if the modulator is well balanced.

Most of us are familiar with the choice of 9 *mc* for the SSB generator frequency. This choice of frequency was made popular by *Central Electronics 10A* and *20A* exciters, which enables the Ham to work two bands (4 *mc* and 14 *mc*) by heterodyning with a 5 *mc* signal. Although this is a good combination to get operation on those two bands it is obviously not the only combination that will give two band operation.

For *vfo* operation a frequency for the SSB generator should be chosen so that the *vfo* frequency shall not be greater than about 8 *mc* since this is approximately the upper frequency limit that a *vfo* can be made stable with a minimum of effort. If a higher frequency *vfo* is



desired it can be readily accomplished by making it a heterodyne type. This, however, requires a crystal oscillator and mixer in addition to a stable low frequency vfo.

Considering the above factors a frequency of 1600 kilocycles was chosen for the SSB generator. It fits the above requirements as follows:

1. Its harmonics are as follows, 3.2 mc 2nd harmonic, 4.8 mc 3rd harmonic, 6.4 mc 4th harmonic, 8 mc 5th harmonic, 9.6 mc 6th harmonic, 11.2 mc 7th harmonic, 12.6 mc 8th harmonic. All harmonics above the 5th are weak and may be disregarded.
2. By mixing a 1600 kilocycle SSB signal with a vfo of from 5.1-5.7 mc we have a frequency sum of 6.700-7.300 mc which covers the 40 meter band and a difference frequency of 3.500-4.100 mc which covers the 80 meter band.

The vfo frequency of 5.1-5.7 mc is low enough so that a stable unit can be readily constructed. This frequency also falls in the range of the popular BC458 transmitter which can be obtained surplus.

Now that 1600 kilocycles has been chosen for the frequency of the SSB generator we have a choice of a number of combination of circuits to gain our objective.

### Phasing Networks

Since the heart of the phasing type generator is its audio phasing network and its rf phasing network we will consider them respectively. There are several audio nets available commercially at reasonable prices. The one chosen here was the B&W 2Q4 since it was the most economical.

For the rf phasing network a passive type was chosen because it requires no adjustment if precision components are used. This basic circuit is shown below in fig. 1.

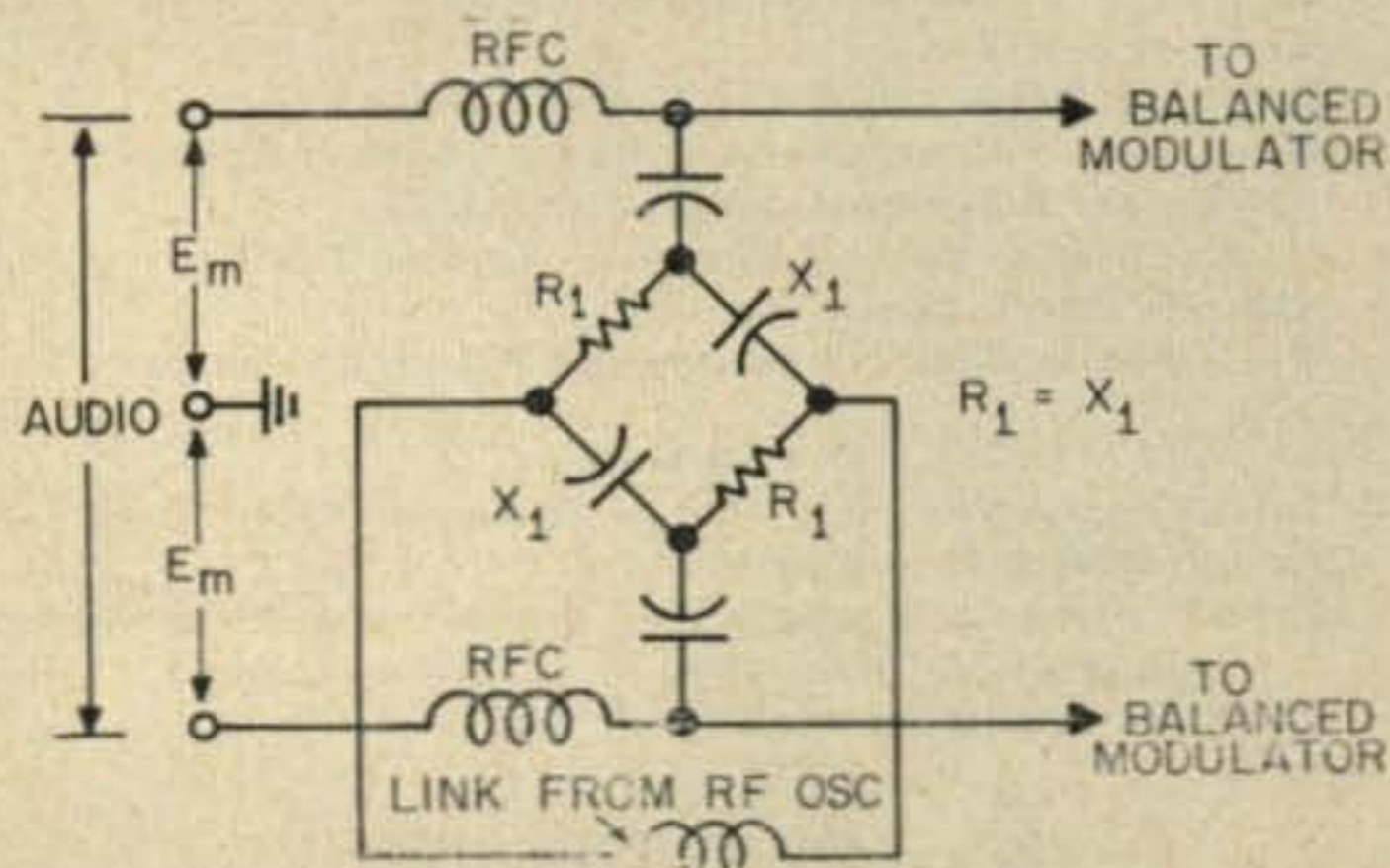

Fig. 1—Basic rf phasing network.

This disposes of the phasing requirements for a good SSB exciter.

### Bandpass Filters

Now consider the audio signal that feeds into the audio phasing network. Since this network

is designed to properly phase signals in the range of 300-3000 cycles per second it becomes obvious that we should feed this network with signals only in that range as near as practical. This will require some sort of bandpass filter system. Some hams attempt to do this by using an audio transformer only. Where the transformer is rated at say 250-2500 cycles per second bandpass. After running curves on quite a few transformers it became evident that this was not the solution desired. This was easily accomplished by using a simple lowpass filter to get rid of the high frequencies and by small values of coupling condensers for the audio stages to get rid of the lower frequencies. The basic filter is shown below in fig. 2.

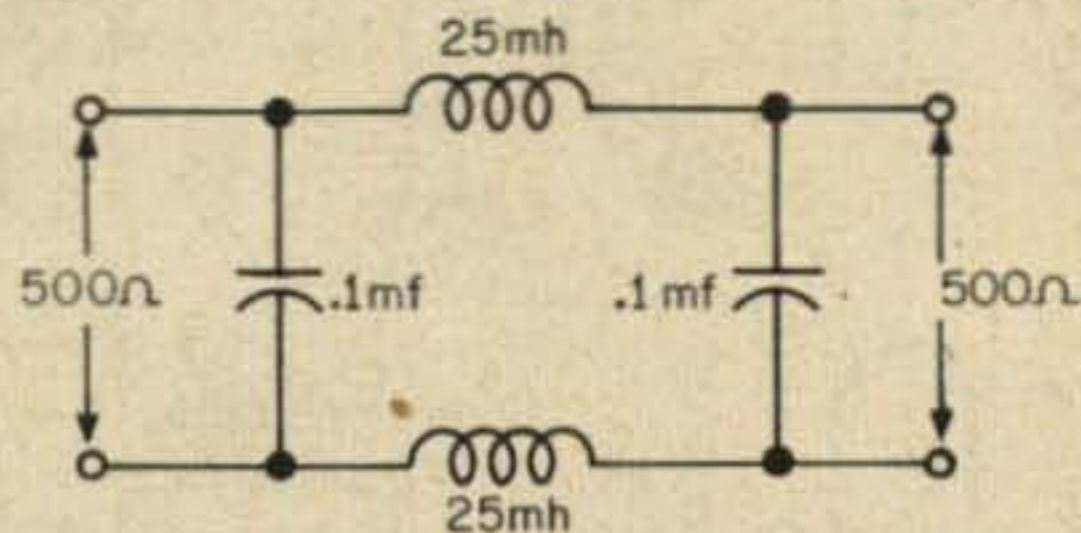

Fig. 2—Lowpass constant K filter.

The input impedance of the B&W 2Q4 phasing net is 500 ohms so that the filter is designed for 500 ohms impedance input and output.

### Balanced Modulator

Now we have the basic design for the following sections; first, an audio filter, second an audio phasing network, third an rf phasing network. Then if we couple all these together properly and feed in audio and rf in their proper sections, we have two audio signals 90° out of phase and two rf signals 90° out of phase. To get modulation it is necessary to feed one each (af and rf) of these signals into a modulator. So now we have to choose a modulator and here we again have several types to choose from. Primarily these may be divided into the solid state type (diode & transistors) and the vacuum tube type (diode, triode, pentode, etc.). Here we choose the solid state diode type modulator in the basic configuration shown below in fig. 3. It is simple and compact.

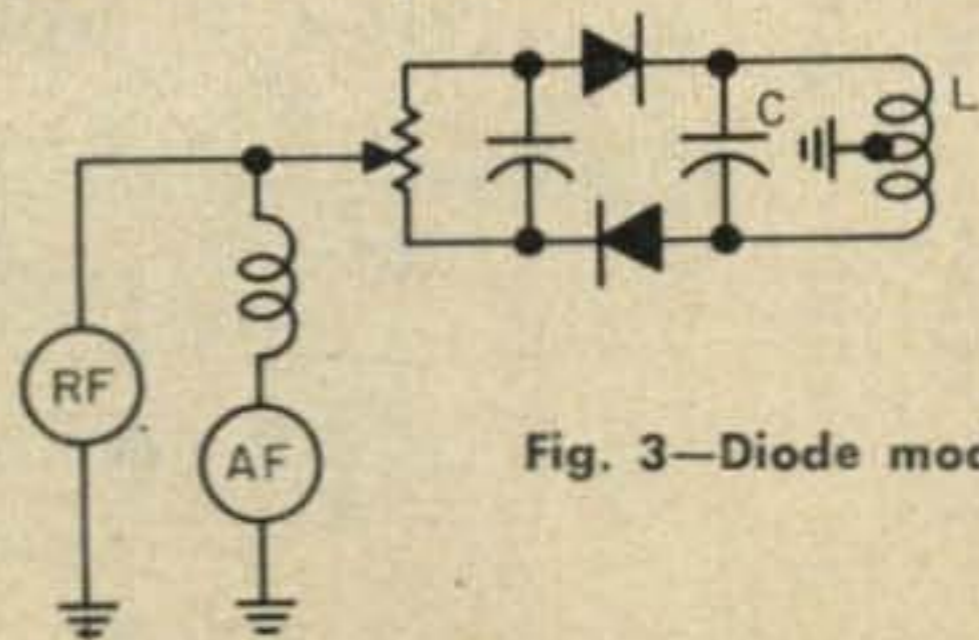

Fig. 3—Diode modulator.

Any type of rectifier will work here, copper oxide, silicon, germanium diode, etc. Type 1N34's were chosen due to price and availability. Choose rectifiers that match within plus or minus 10% of each other in their forward resistance direction (this is the low resistance direction and is about 150-400 ohms for 1N34's). The difference in resistance is compen-



sated for by the potentiometer across the circuit.

The values of L and C in fig. 3 should be such that the resonant frequency is 1600 kilocycles and the loaded Q should be about 10 to 20. Now the carrier balance depends on how well this circuit is balanced so this suggests the use of a bifilar winding for L. Although this is not absolutely necessary, it is good practice and is used here.

Figure 4 shows the basic circuit of the two balanced modulators so phased as to eliminate the carrier and suppress one sideband when fed by audio and rf signals of 90 phase difference and equal amplitudes.

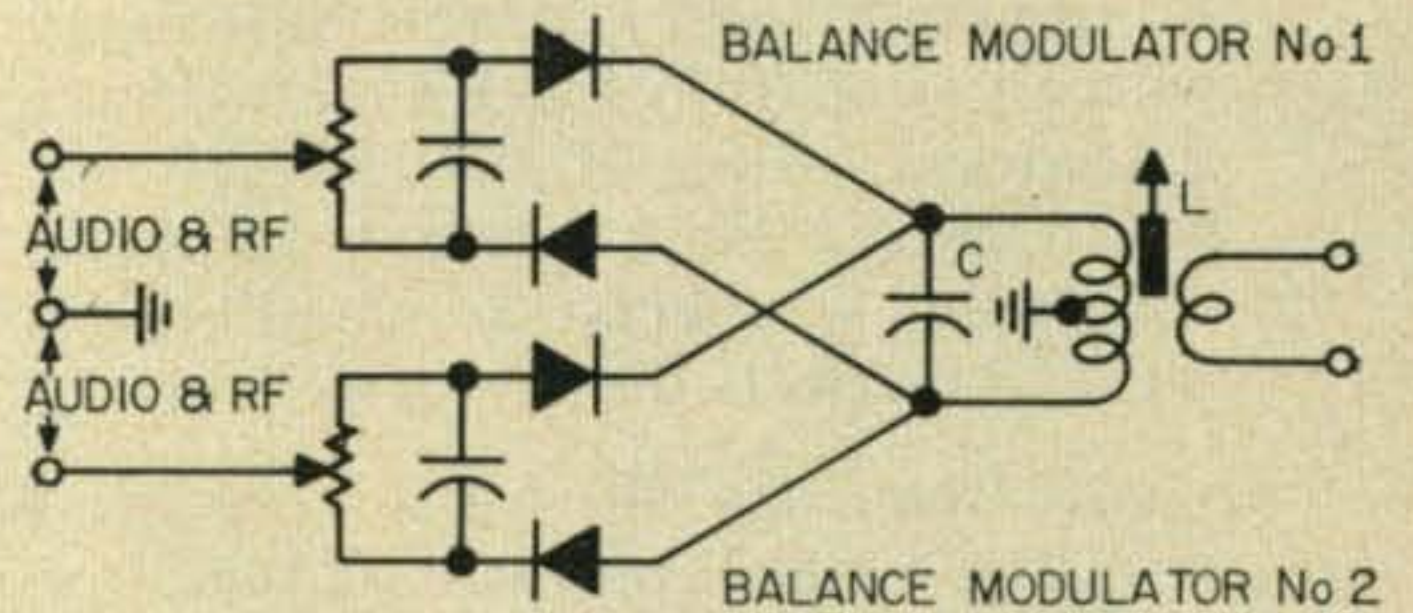

Fig. 4—Basic circuit of two balanced modulators that may be phased to eliminate the carrier and suppress one sideband when properly fed.

Figure 5 shows the complete schematic of these units incorporated into an SSB generator with an output frequency of 1600 kilocycles.

### Construction

It was decided that the SSB generator construction should not be combined with any other construction, such as mixers or amplifiers, or even a power supply. To do this would add other problems and further complicate construction. Keep in mind that one of our objectives was to keep it simple. This also allows for greater flexibility in using this basic SSB generator in connection with various mixers, ampli-

### Parts List

- RFC<sub>1-4-5</sub>—2.5mh Millen J300-2500
- RFC<sub>2-3</sub>—See Text
- R<sub>1</sub>—2 watt Potentiometer 1 meg Linear Taper
- R<sub>2</sub>—2 watt Potentiometer 500 ohms Linear Taper
- R<sub>3</sub>—2 watt Potentiometer 2k Linear Taper
- R<sub>4</sub>-R<sub>5</sub>—2 watt Potentiometer 1k Linear Taper
- SW<sub>1</sub>—D.P.D.T. toggle switch
- T<sub>1</sub>—Stancor A53-C or equivalent 22k to 600 ohms

### Coil Data

- L<sub>1</sub>—53 turns #30 enameled on National XR50 form
- L<sub>2</sub>—3 turns #22 enameled
- L<sub>3</sub>—22 turns #22 enameled, bifilar wound on National XR50 form. (See illustration below)
- L<sub>4</sub>—3 turns #22 enameled

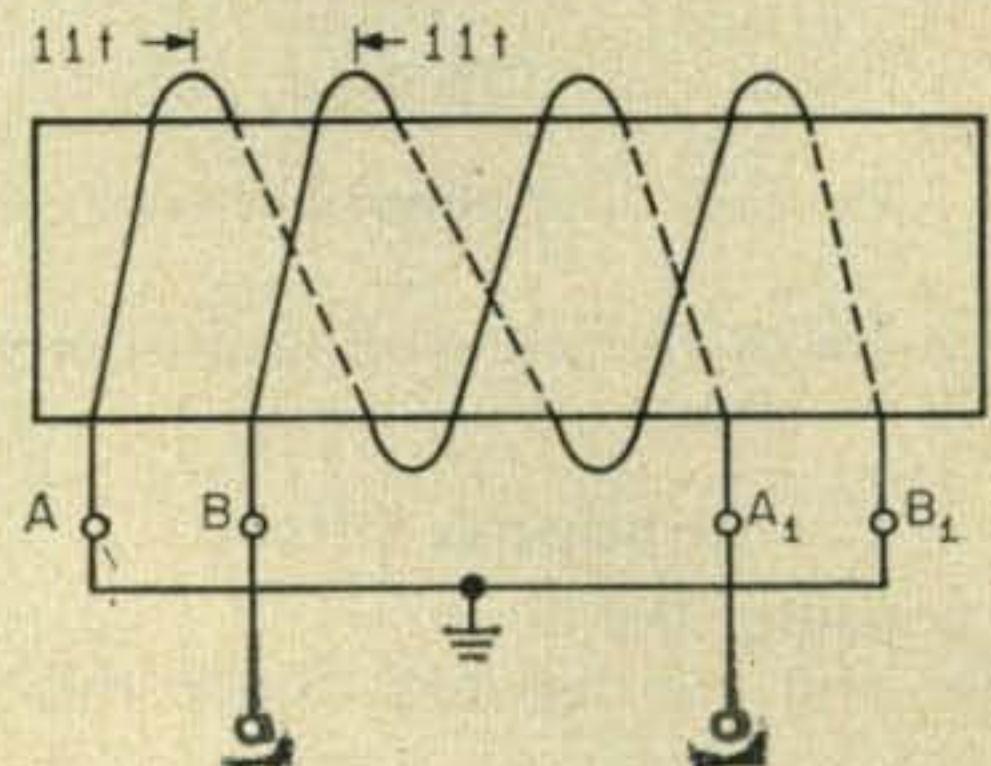

Fig. 5—Complete schematic of the SSB generator.



fiers, and combinations of same as covered later on in this article. The photographs show various views of the completed unit which measures 5" x 7" x 12" and weighs about six pounds including cabinet. The bottom chassis measures 3½" x 9" x 1½" and the upright chassis measures 3½" x 4½" x 2¼".

### Adjustment

To properly adjust this unit you need a receiver that will tune to 1600 kilocycles. It must have AVC, S meter and crystal filter or Q-multiplier. Most all "Communication Type" receivers will meet these requirements and some "Ham band only" receivers will also. In addition to the receiver, you will need a *vtvm* and an audio frequency generator.

The first adjustment is made before assembly of the complete unit. This is the adjustment of the lowpass audio filter inductors. With the inductance and .1 mfd condenser hooked as shown in block diagram, fig. 6, adjust L so that the *vtvm* shows maximum voltage at 3000 cycles per second.

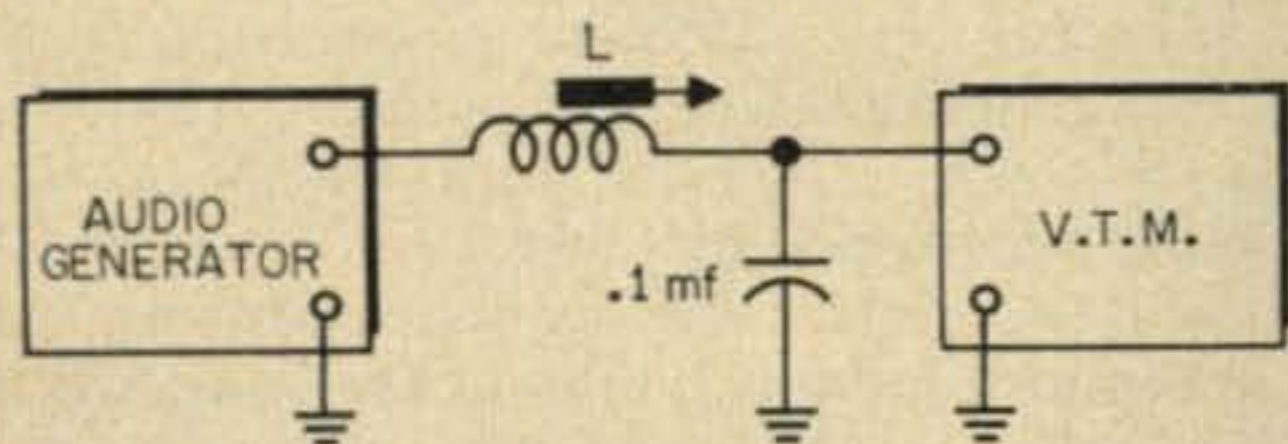

Fig. 6—Test set up used to adjust the inductances in the low pass filter.

*Note:* Any slug tuned coil that can be adjusted to a value of 25 mh can be used here. This adjustment is made for each coil. Two are needed.

The following adjustments are made after the unit is assembled and correct voltages applied. First check the audio amplifier by feeding an audio oscillator into the microphone input at a frequency of about 1500 cycles per second. With low input voltage, check output with a *vtvm* at the input of the audio phasing network. There should be a good signal between this point and ground, two volts or more. Now replace audio generator with microphone. A good sustained tone of Oh-o-o-o-o should show about two volts for a reasonable setting of the audio gain control, say about one o'clock or so. Now, with the potentiometer in the cathode circuit of the cathode follower, set at its center position, a sustained Oh-o-o-o-o into the microphone should show one volt or better from each cathode to ground. This completes the check of the audio section.

Now, with the 1600 kilocycle crystal plugged into the crystal socket, check the oscillator with a *vtvm* across the output link of the oscillator plate coil. Be sure to use an *rf* probe. Tune the plate inductance for oscillation and maximum output voltage. This should be from 2 to 6 volts or more. Now kill the oscillator by turning off the power and then turn power on again being sure that the oscillator takes off each time power

Front view of completed unit showing arrangement of controls with the "on" and "off" switch and audio gain control at the bottom. The two top knobs are the two carrier balancing pots to the input of the balanced modulator. The toggle switch provides for selection of either sideband.

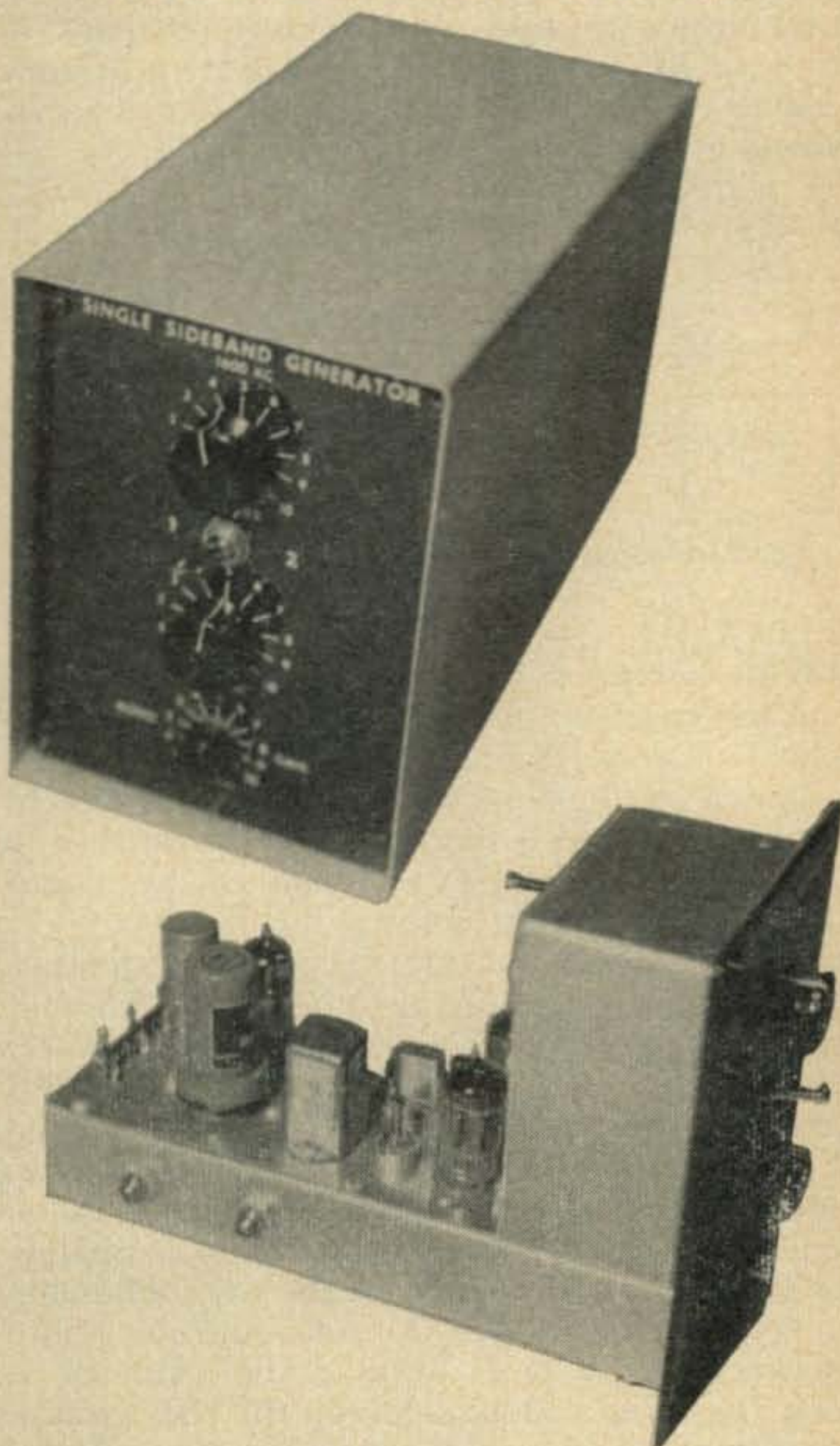

The 500 ohm pot to the input of the phasing network is shown on the side to the rear and the 2000 ohm pot in the cathode follower circuit is along side it. The B&W 2 Q 4 phasing network is shown at the rear of the chassis in the metal tube can. The audio output transformer from the speech amplifier is shown immediately in front. In front of the audio transformer may be seen the tuning slug adjustment screw protruding up from the bottom of the chassis which varies the tuning of the 1600 kc crystal oscillator.

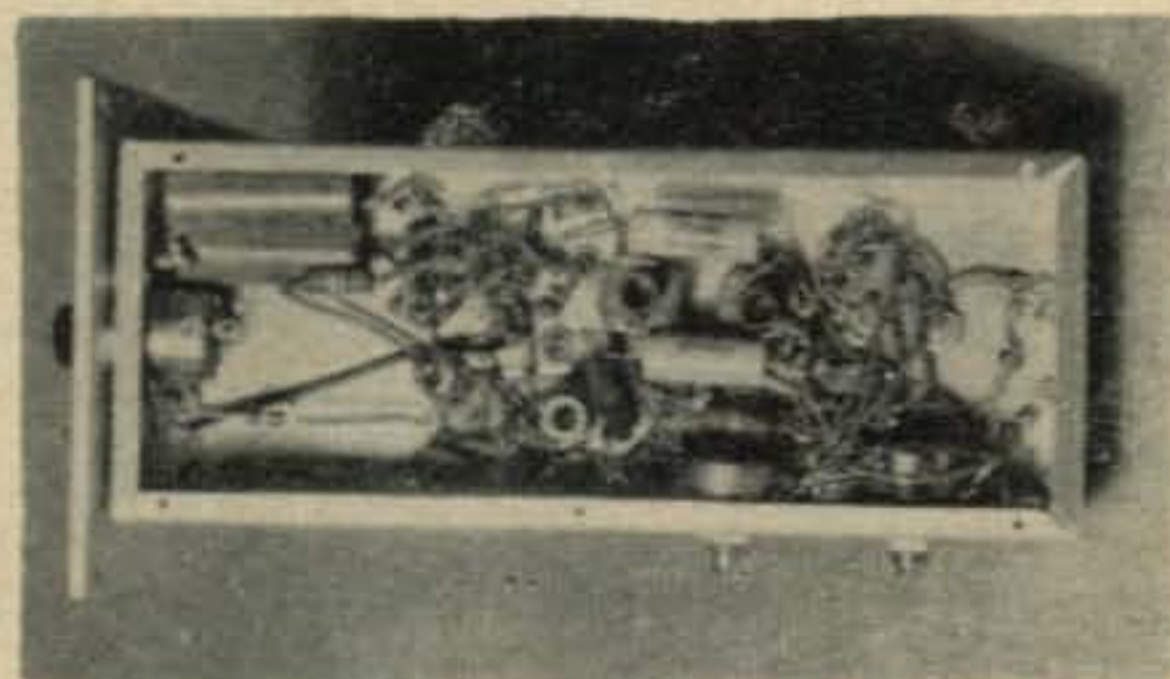

Bottom view of chassis showing general arrangement of parts and wiring.



is turned on and off. A slight adjustment of plate tuning will correct any sluggishness on the part of the oscillator.

Now we can proceed to the use of the receiver for the rest of the alignment. Set up the receiver in the sharp crystal position (or sharp Q multiplier position) as though to receive CW but with *BFO* off and with SSB generator coupled to the receiver through a coax lead as shown in fig. 7.

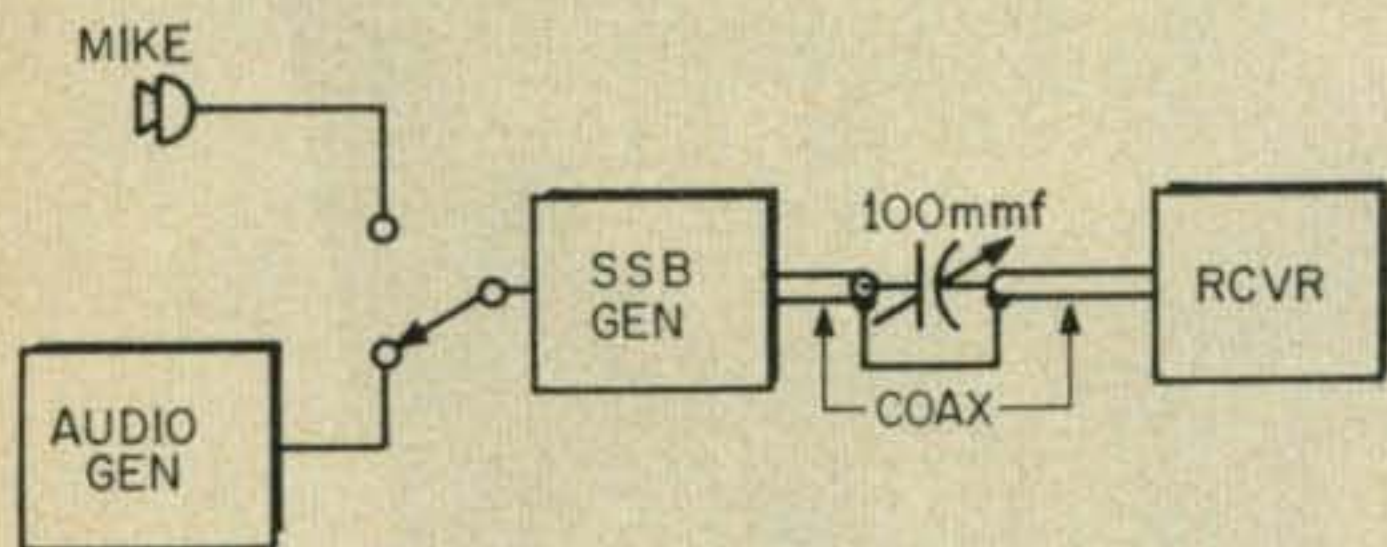

Fig. 7—Block diagram of the test set up used to align the generator.

With balanced modulator pots unbalanced, tune the receiver until 1600 kilocycle signal is indicated on the S meter. Then peak the signal as shown on the S meter by tuning the tank of the diode balanced modulator with the slug in the tank coil. Now you can balance the modulator by alternately setting the balance pots across the diodes of the balanced modulator. Set these for minimum reading of the S meter on the receiver. Since it is possible to get better than 100 *db* of carrier suppression with this system at this frequency, you no doubt will go off the bottom end of the scale of the S meter.

Now with carrier balanced out, feed an audio oscillator signal of low volume (approximately the same as the output from the microphone—it may be necessary to use an audio pad) into the microphone jack. With audio gain set at about 12:00 to 1:00 o'clock on the SSB generator, adjust the frequency of the audio oscillator to about 1500 cycles per second. Now tune the receiver and you will find two signals, one separated from the other about 3 kilocycles. Now flip the sideband switch from one sideband to the other. The chances are that you will not notice much change in S meter reading as you switch from one sideband to the other, probably one or two S units or perhaps less. Now with switch set on one of the sidebands, say sideband #1 and with audio gain control of SSB generator set at say, 1:00 o'clock and condenser C adjusted so that S meter reads S6-S7 with the receiver carefully tuned to frequency, you are ready to adjust for sideband suppression.

### Suppression Adjustment

Assume we have made the above adjustments until we read say, "S" 7 on the receiver. Now retune the receiver until you get the other signal 3 kilocycles away. Tune for maximum S meter reading. This can be more or less than the reading on SSB #1. Then with receiver in this position alternately adjust the 500 ohm pot in the input side of the audio phasing network and the

2000 ohm pot in the cathode follower until the S meter reads, say "S" 3. Now tune the receiver back to the other signal where we began and it will still read about "S" 7 or so. Now throw the sideband switch to Sideband #2. Then the "S" 7 signal should drop sharply. Let us assume for example, "S" 3.5. Then again, adjust pots in the audio phasing net and cathode follower until S meter reads about "S" 2. Then retune back to the other signal and it should read about "S7". Now switch the sideband switch to Sideband #1. The "S" meter should drop to a low reading, say "S" 2.5. Now adjust pots as above for the lowest reading you can obtain which will probably be about "S" 1-2. Now retune the receiver to the other signal which should still be about "S7". Then switch sideband switch back to Sideband #2. It should read "S" 2 or less with receiver in this position. The above readings are typical so we can use them as an example of sideband suppression.

With the receiver in position as above we are listening to Sideband #1 but the SSB generator is putting out its maximum signal on Sideband #2. Therefore, the sideband suppression for the sideband generator when transmitting Sideband #2 is "S" 7—"S" 2 or 5 "S" units or about 30 *db* (on most receiver S meters).

Now if we retune the receiver until we have the maximum signal 3 kilocycles away we are now listening to Sideband #2 and the S meter reads "S" 7; flip the sideband switch to Sideband #1 our S meter now drops to between "S" 1—"S"-2, say S1.5 we are still listening to Sideband #2 but it is down ("S" 7 minus "S" 1.5) 5.5 S units or approximately 33 *db*. Therefore, sideband suppression from Sideband 1 - Sideband 2 is 33 *db*. Note that it is possible to get

equal suppression on both sidebands but not too practical. The above data is typical and is also

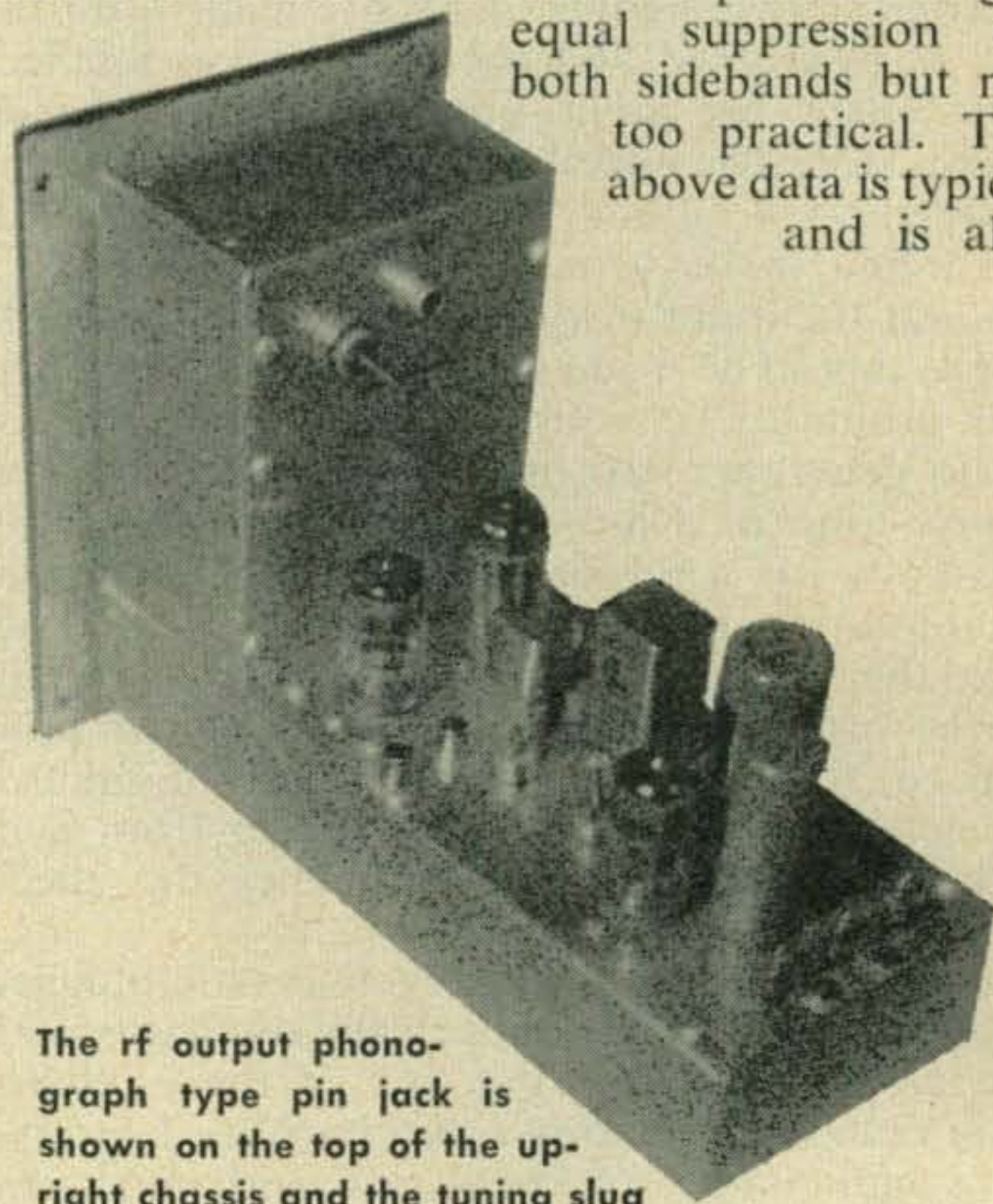

The rf output phono-graph type pin jack is shown on the top of the upright chassis and the tuning slug screw adjustment for the bifilar output coil from the balanced modulator is shown adjacent. The two phonograph type pin jacks shown on the main chassis are mike input, J<sub>1</sub> and vox output, J<sub>2</sub>.



good. Sideband Suppression 1 minus 2 equals minus 33 *db*. Sideband Suppression 2 minus 1 equals minus 30 *db*.

Now if we wish to get more data on our generator we can do so by driving it with varying audio frequencies and obtaining its frequency response. With the generator set up to suppress one sideband and the generator coupled into the receiver as above, feed audio signals of 100, 200, 300, 500, 1000, 1500, 2000, 3000, 5000, 7000 cycles per second into generator each time recording S meter readings while keeping the input constant. A plot of audio frequencies against S meter readings will give an overall audio response curve for the generator. The S meter reading can be converted into *db*.

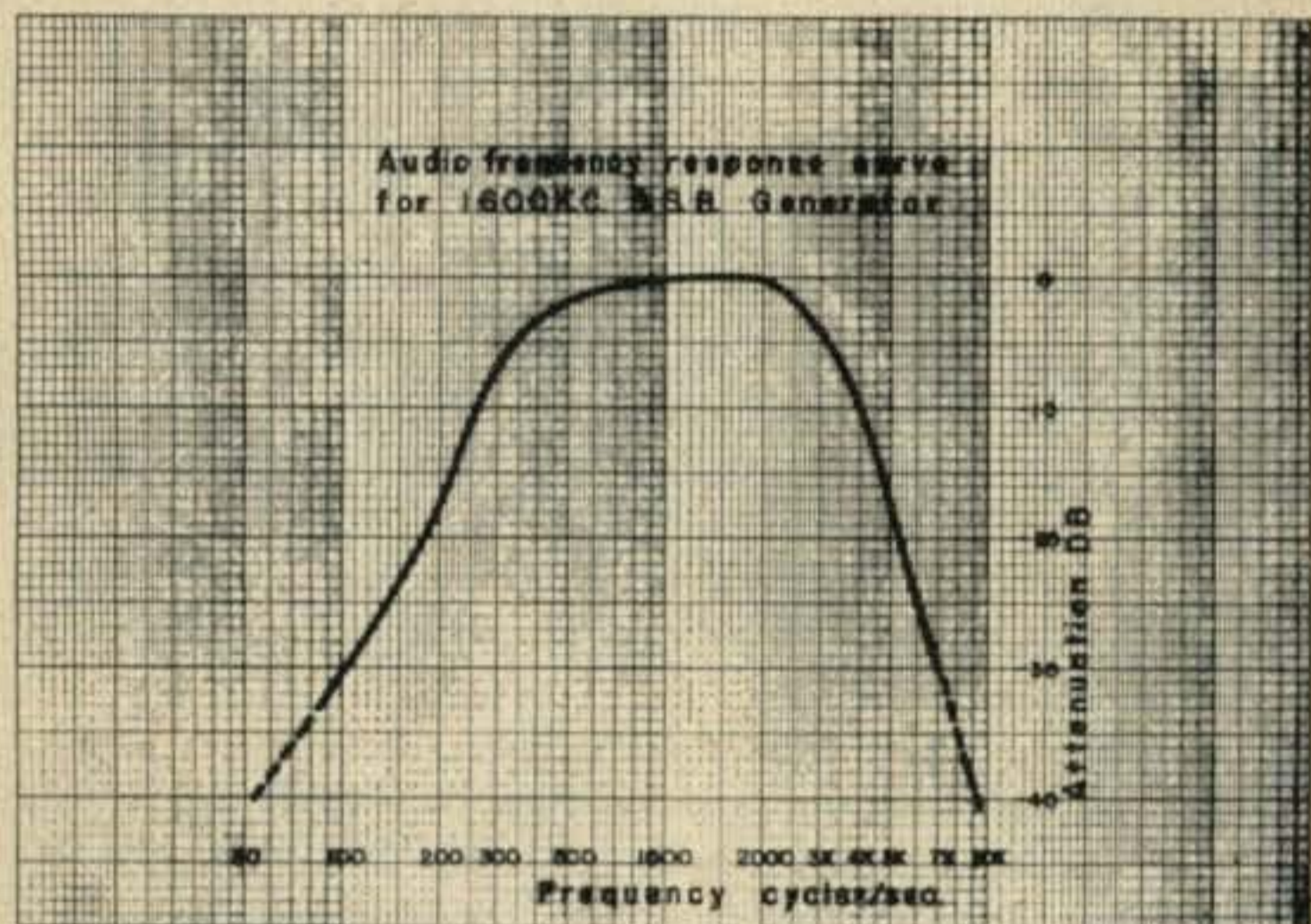

Fig. 8—The audio response curve of the SSB generator described in the article. The text explains how this was plotted.

The audio response curve shown in fig. 8 was run on the generator shown in the schematic and the following additional data was obtained by the methods of adjustments described. The receiver used was a *Collins 75A3*; audio generator, *Heath*; and vacuum tube voltmeter, *Heath*. Sideband suppression; Sideband #1—36 *db*. Sideband suppression Sideband #2—33 *db*. Carrier suppression—126 *db*.

### Hetrodyning to Ham Bands

Now for some suggestions for hetrodyning the SSB signal to the various ham bands. Table 1 shows frequency of *VFO* which will mix with 1600 kilocycle SSB signal to give output on Ham bands with one conversion.

Table 1

160 meters	1600 SSB	VFO 3.4-3.65 mc
80 "	1600 SSB	VFO 5.1-5.7 mc
40 "	1600 SSB	VFO 5.1-5.7 mc
20 "	1600 SSB	VFO 12.4-12.75 mc
15 "	1600 SSB	VFO 19.4-19.85 mc
28.5-29. mc	1600 SSB	VFO 26.9-27.4 mc
29.-29.5 mc	1600 SSB	VFO 27.4-27.9 mc
29.5-29.7 mc	1600 SSB	VFO 27.9-28.1 mc

On 15 and 10 meters it would be best to use a balanced mixer so that the *vfo* would balance out.

The block diagram, fig. 9, shows suggested band switching exciter for all bands by using

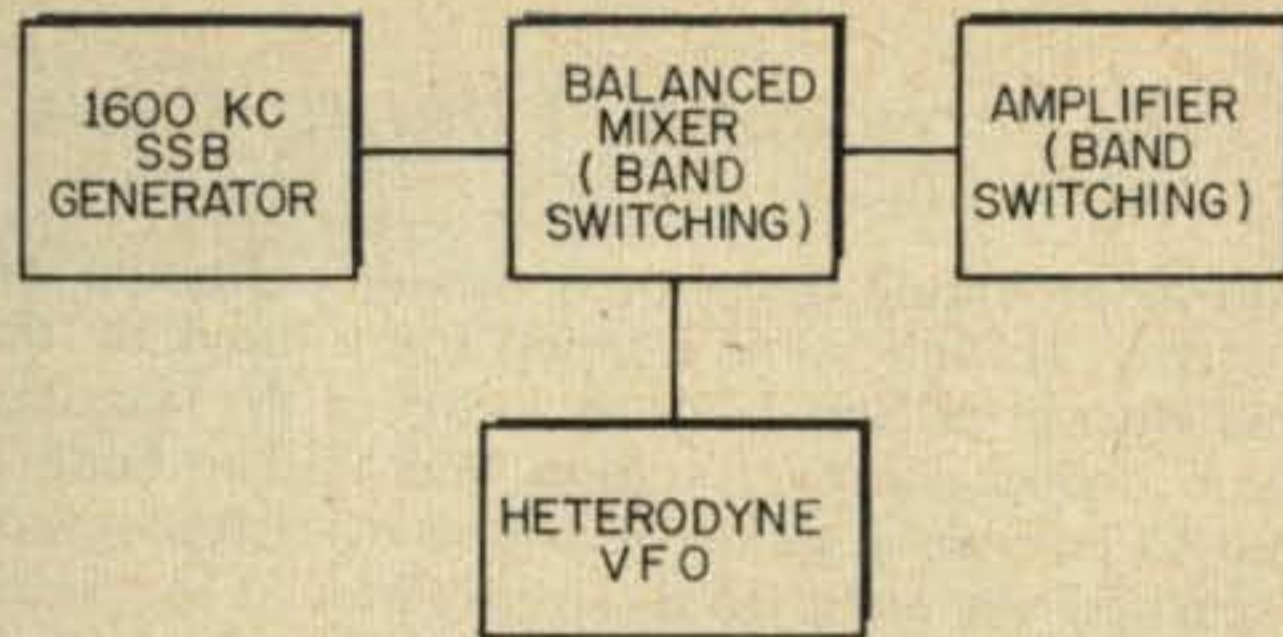

Fig. 9—Block diagram of an all band exciter that may be used with the generator.

external *vfo* and balanced mixer.

For those interested in only the popular 80 and 40 meter phone bands the lineup shown in the block diagram in fig. 10 is suggested.

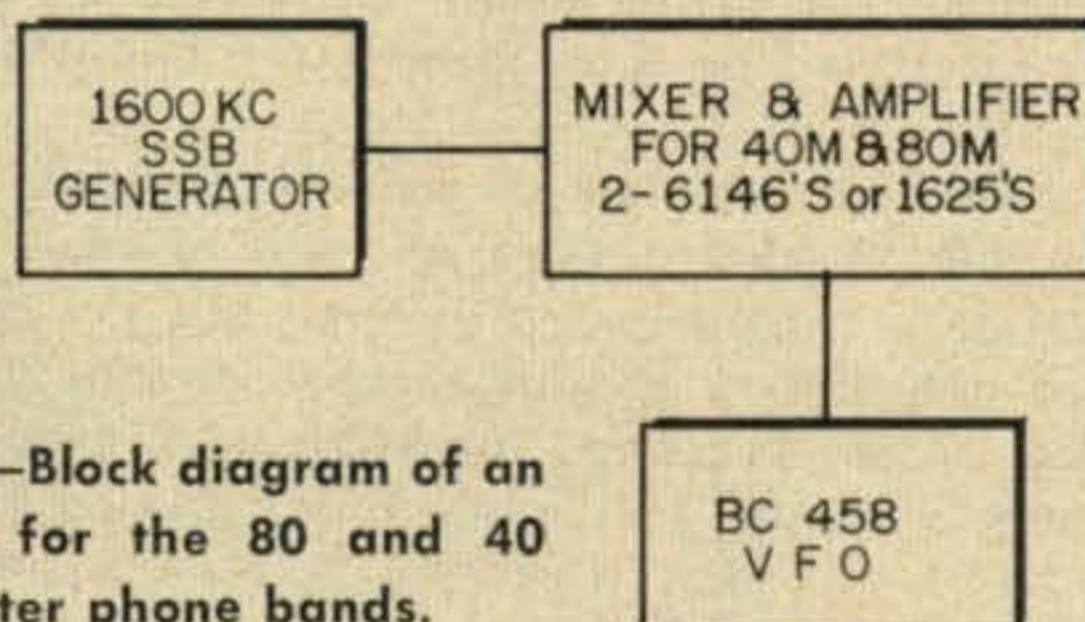

Fig. 10—Block diagram of an exciter for the 80 and 40 meter phone bands.

This combination shown will give an output of 100 watts *PEP* and is relatively easy to build from surplus gear.

An exciter for 40 and 80 complete with built in *VFO*, *VOX*, and power supply is in the making.

### Addenda

When phasing type exciters are used it is sometimes noticed that within a short period of time after the exciter is turned on and the carrier balanced out that the carrier suppression changes. If the carrier suppression is sufficiently great, this will not be noticed and even if it occurs the carrier can be re-nulled after fifteen or twenty minutes and in a well adjusted rig it should give no trouble. The following curve fig. 11 shows this characteristic on the 1600

[Continued on page 129]

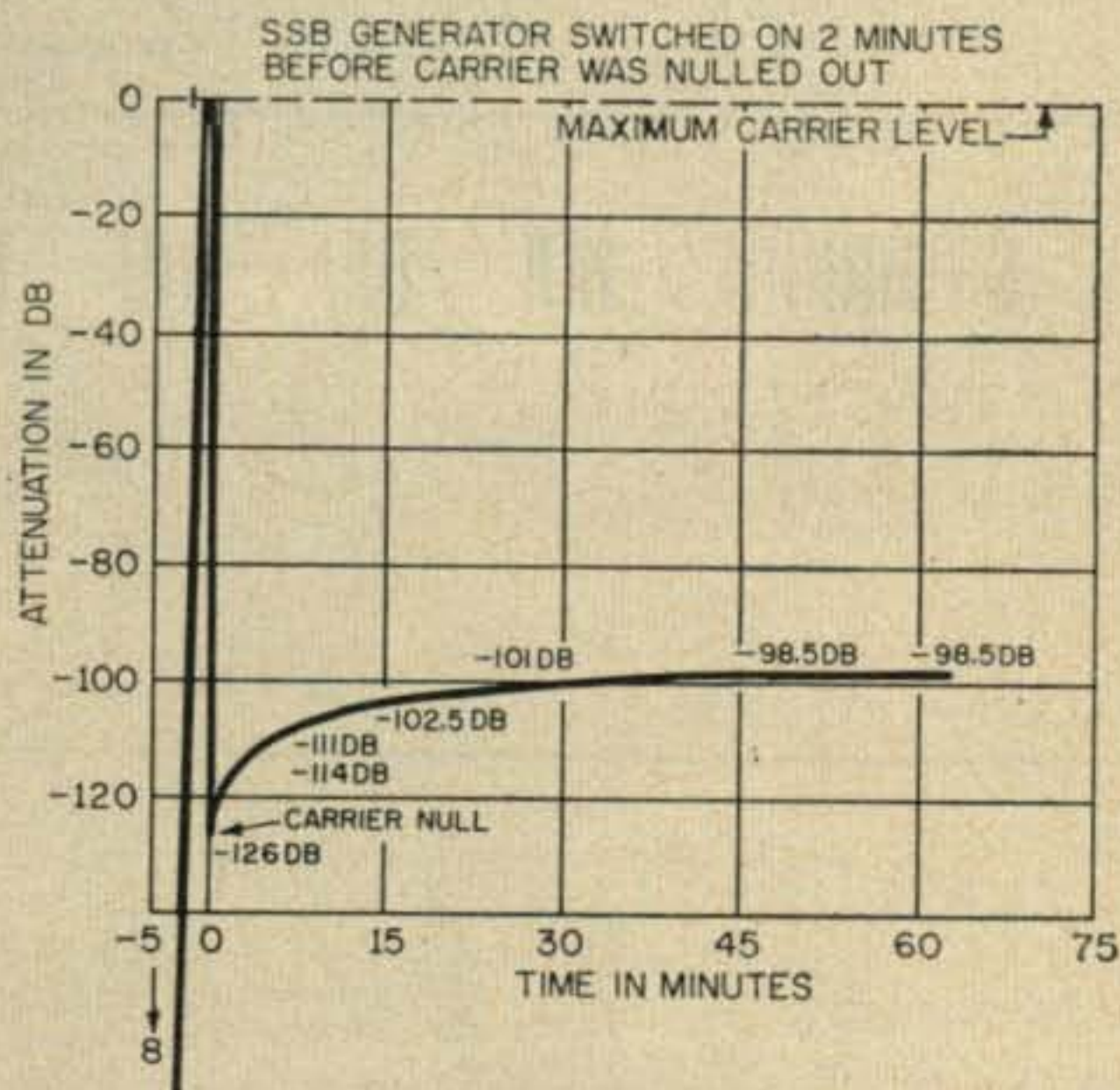

Fig. 11—Carrier suppression drift curve.



## Experimental Timing Code Added To WWV Broadcasts

TO AID in providing a standard timing technique, an experimental code is now being transmitted by the National Bureau of Standards as a part of the standard frequency broadcasts over station WWV. The code is expected to provide a standard timing basis for experiments carried on simultaneously at widely separated locations.

1. WWV is now broadcasting an experimental time code of 36 bits at 100 pps on 2.5, 5, 10, 15, 20, and 25 mc.
2. The code is broadcast for one minute intervals and 10 times per hour (fig. 4.) Except at the beginning of each hour, it immediately follows the standard audio frequencies of 440 cps and 600 cps. The latter frequencies are given alternately as before except the duration is 2 minutes instead of 3 minutes when the code is given.
3. The code contains time of year information (UT) in seconds, minutes, hours, and day of year.
4. The code is binary coded decimal (BCD) consisting of nine binary groups each second in the following order: 2 groups for seconds, 2 groups for minutes, 2 groups for hours and 3 groups for day of year. Code digit weighting is 1-2-4-8 for each BCD group multiplied by 1, 10, or 100 as the case may be.
5. A complete time frame is one second.
6. The least significant binary group and the least significant binary digit in each group occurs first.
7. "On time" occurs at the leading edge of all pulses.
8. The code contains 0.1 second index markers and

a one per second time frame reference marker in addition to the 100/sec clocking rate of the code pulses. The 1000 c/s carrier is synchronized to the code pulses so that millisecond resolution is easily obtained.

9. The 0.1 second index markers consist of "1" pulses preceding each code group except at the beginning of the time frame where it is a "0" pulse.
10. The one second reference marker is made up of five "1" pulses followed by a "0" pulse. The timing frame begins at the leading edge of the "0" pulse.
11. The code is a spaced code format, that is, a binary group (BCD) follows each 0.1 second index marker. The last index marker is followed by an unused four bit group of "0" pulses just preceding the one-second time frame reference marker.
12. The unused four bit group may be used in the future to transmit other types of coded information, such as the last digit of the year, station number, etc.
13. Width coding:  
 "0" pulse, 2 ms wide (2 cycles of 1000 c/s)  
 "1" pulse, 6 ms wide (6 cycles of 1000 c/s)  
 The time code is amplitude modulated on a 1000 c/s carrier. The carrier is coherent with the time code so that the leading edges of the time code pulses coincide with a positive going zero axis crossing of the carrier.
14. The code is illustrated in fig. 1 and is being transmitted on a 1000 c/s carrier as shown in fig. 3. An alternative format which includes the 100/sec index markers as shown in fig. 2 is available from the time generator if desired. Time allotted to the code, on WWV, is shown in fig. 4. ■

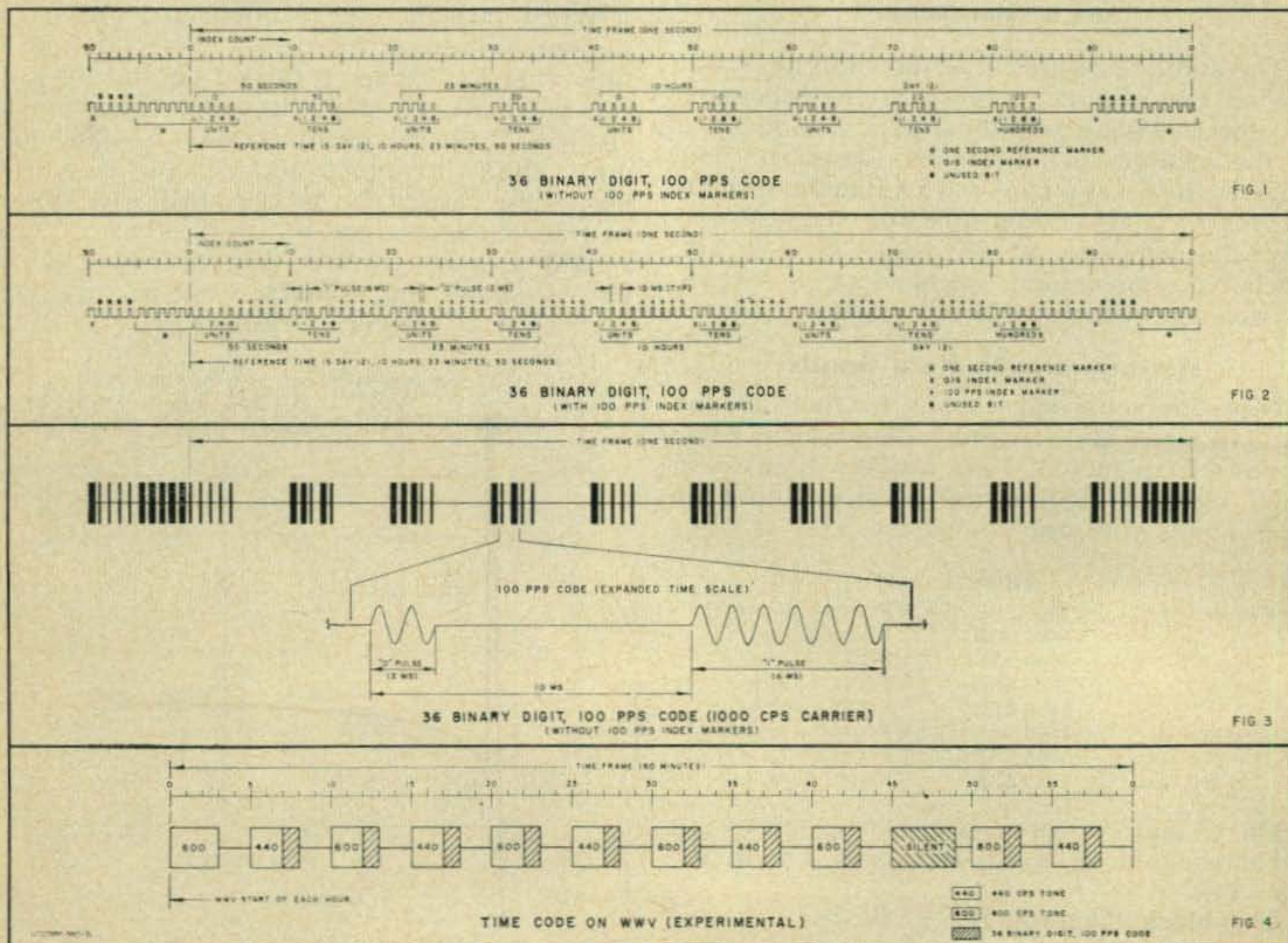



# Viking Amateur Equipment

**your best buy...and here's why!**

Excellent dollar value . . . high trade-in value . . . solid communication power . . . dozens of operating and convenience features—just a few of the many good reasons why Viking transmitters are "1st choice among the nation's amateurs." Visit your authorized Johnson distributor and compare—you'll soon see why dollar-for-dollar a Viking transmitter is your best buy!

**VIKING "KILOWATT" AMPLIFIER** —(Below)—The only transmitter that provides maximum legal power in all modes—SSB, CW, and plate modulated AM. Class C final amplifier operation provides plate circuit efficiencies in excess of 70% with unequalled broadcast-type high level amplitude modulation. Two 4-400A tubes in Class AB<sub>2</sub> easily deliver 2000 watts P.E.P.\* in SSB mode—provides 1000 watts input AM with two push-pull 810 tubes in Class B modulator service. 1000 watts input Class C CW. High efficiency pi-network output circuit will match 50 to 500 ohm antenna loads.

Pedestal contains complete unit. Excitation requirements: 30 watts RF and 10 watts audio for AM; 10 watts peak for SSB. With tubes.

Cat. No. 240-1000 . . . Wired and tested . . . . . Amateur Net \$1595.00

Matching accessory desk top, black and three-drawer pedestal.

Cat. No. 251-101-1 . . . . . FOB Corry, Pa. \$132.00



\*The F.C.C. permits a maximum one kilowatt average power input for the amateur service. In SSB operation under normal conditions this results in peak envelope power inputs of two times average or more, depending upon individual voice characteristics.

**BE SURE TO SEE . . .** the new Viking filter-type sideband transmitter with 60 db sideband suppression—and the new Viking "10-Meter Messenger." For detailed specifications on the new sideband transmitter . . . see your distributor—for information on the "10-Meter Messenger". . . write for Specification Sheet 737.

FIRST CHOICE AMONG  
THE NATION'S  
AMATEURS



*Viking*

**E. F. JOHNSON COMPANY • WASECA, MINNESOTA**



# Viking

**amateur equipment**

**1st choice of amateurs the world over!**

*3 popular transmitters...*



**"ADVENTURER" TRANSMITTER**—Self-contained . . . 50 watts CW input . . . rugged 807 transmitting tube . . . instant bandswitching 80 through 10 meters. Crystal or external VFO control—wide range pi-network output—timed sequence keying. With tubes, less crystals.

Cat. No. 240-181-1 . . . Kit . . . . . Amateur Net \$54.95

**SPEECH AMPLIFIER/SCREEN MODULATOR**—For "Adventurer" phone operation. High gain—use with crystal or dynamic microphones. With tubes.

Cat. No. 250-40 . . . Kit . . . . . Amateur Net \$12.25

**"CHALLENGER" TRANSMITTER**—70 watts phone input 80 through 6; 120 watts CW input 80 through 10 . . . 85 watts CW on 6 meters. Two 6DQ6A final amplifier tubes. Crystal or external VFO control—TVI suppressed—wide range pi-network output. With tubes, less crystals.

Cat. No. 240-182-1 . . . Kit . . . . . Amateur Net \$114.75  
 Cat. No. 240-182-2 . . . Wired . . . . . Amateur Net \$154.75

**"NAVIGATOR" TRANSMITTER/EXCITER**—40 watts CW input . . . also serves as a flexible VFO Exciter. 6146 final amplifier tube—bandswitching 160 through 10 meters. Built-in VFO or crystal control. With tubes, less crystals.

Cat. No. 240-126-1 . . . Kit . . . . . Amateur Net \$149.50  
 Cat. No. 240-126-2 . . . Wired . . . . . Amateur Net \$199.50



**"6N2" TRANSMITTER**

Rated at 150 watts CW and 100 watts phone, this compact VHF transmitter offers instant bandswitching coverage of both 6 and 2 meters! Completely shielded and TVI suppressed—may be used with the Viking I, II, "Ranger", "Valiant" or similar power supply/modulator combinations. Operates by crystal control or external VFO with 8-9 mc. output. Silver-plated balanced tank circuit—series capacitive reactance compensation provides maximum coupling flexibility. With tubes, less crystals, key and microphone.

Cat. No. . . . . Amateur Net  
 240-201-1 . . . Kit . . . . . \$129.50  
 240-201-2 . . . Wired and tested . . . \$169.50



**"COURIER" AMPLIFIER**

Rated a solid 500 watts P.E.P. input with auxiliary SSB exciter as a Class B linear amplifier; 500 watts CW or 200 watts AM linear. Self-contained desktop package—may be driven by the Viking "Navigator", "Ranger" or other unit of comparable output. Continuous coverage 3.5 to 30 mcs. Drive requirements: 5 to 35 watts depending upon mode and frequency desired. Employs two 811A triodes in parallel. Pi-network output will match 40 to 600 ohm loads. TVI suppressed. With tubes and built-in power supply.

Cat. No. 240-352-1 . . . Kit . . . . . Amateur Net \$244.50  
 Cat. No. 240-352-2 . . . Wired and tested . . . . . Amateur Net \$289.50



# 4 feature-packed transmitters...



## "RANGER" TRANSMITTER/EXCITER

This popular 75 watt CW or 65 watt phone transmitter will also serve as an RF/audio exciter for high power equipment. Completely self-contained—instant bandswitching 160 through 10 meters! Operates by extremely stable built-in VFO or crystal control. High gain audio—timed sequence keying—effectively TVI suppressed. Pi-network antenna load matching from 50 to 500 ohms. Final amplifier tube is a 6146. Complete with tubes, less crystals, key and microphone.

<b>Cat. No.</b>	<b>Amateur Net</b>
240-161-1...Kit.....	\$229.50
240-161-2...Wired and tested...	\$329.50



## "VALIANT" TRANSMITTER

Here's power to slice through terrific QRM! 275 watts input CW and SSB (P.E.P. with auxiliary SSB exciter) 200 watts phone. Instant bandswitching 160 through 10 meters—operates by built-in VFO or crystal control. Pi-network output matches antenna loads from 50 to 600 ohms... final amplifier utilizes three 6146 tubes in parallel. TVI suppressed—timed sequence keying—low level audio clipping—built-in low pass audio filter—self-contained power supplies. With tubes, less crystals, key and microphone.

<b>Cat. No.</b>	<b>Amateur Net</b>
240-104-1...Kit.....	\$349.50
240-104-2...Wired and tested...	\$439.50



## "FIVE HUNDRED" TRANSMITTER

Rated a full 600 watts CW—500 watts phone and SSB. (P.E.P. with auxiliary SSB exciter.) Compact RF unit designed for desk-top operation—power supply-modulator unit may be placed anywhere. All exciter stages ganged to VFO tuning—may also be operated by crystal control. Instant bandswitching 80 through 10 meters—TVI suppressed—high gain push-to-talk audio system—low level audio clipping. Final amplifier uses a 4-400A tetrode. Wide range pi-network output. With tubes, less crystals, key and microphone.

<b>Cat. No.</b>	<b>Amateur Net</b>
240-500-1...Kit.....	\$749.50
240-500-2...Wired and tested...	\$949.50

# 3 exciting desk-top linear amplifiers...



## "THUNDERBOLT" AMPLIFIER

The hottest linear amplifier on the market—maximum "talk-power" to smash through QRM! 2000 watts P.E.P.\* input SSB; 1000 watts CW; 800 watts AM linear; in a self-contained desk-top package. Delivers a dominant signal on all amateur bands—continuous coverage 3.5 to 30 mcs—instant bandswitching. May be driven by the Viking "Navigator", "Ranger" or other unit of comparable output. Drive requirements: approx. 10 watts Class AB<sub>2</sub> linear, 20 watts Class C continuous wave. Final amplifier employs two 4-400A tetrodes in parallel, bridge neutralized. With tubes and built-in power supply.

<b>Cat. No. 240-353-1...Kit.....</b>	<b>Amateur Net \$524.50</b>
<b>Cat. No. 240-353-2...Wired and tested.</b>	<b>Amateur Net \$589.50</b>



## "6N2 THUNDERBOLT" AMPLIFIER

This new feature-packed power amplifier is rated at 1200 watts P.E.P.\* input SSB and DSB, Class AB<sub>1</sub>; 1000 watts CW, Class C; and 700 watts input AM linear. Continuous bandswitched coverage on 6 and 2 meters—effectively TVI suppressed—wide range pi-network output. Unique silver-plated Hi-Q coaxial line; silver-plated anode and other external portions of 7034 tubes; silver-plated inductors, capacitors and switch provide outstanding efficiency—losses on 2 meters held to approximately 5%. Drive requirements: approx. 5 watts Class AB<sub>1</sub> linear, 6 watts Class C continuous wave. With tubes and built-in power supply.

<b>Cat. No. 240-362-1...Kit.....</b>	<b>Amateur Net \$524.50</b>
<b>Cat. No. 240-362-2...Wired and tested.</b>	<b>Amateur Net \$589.50</b>

\*The F.C.C. permits a maximum one kilowatt average power input for the amateur service. In SSB operation under normal conditions this results in peak envelope power inputs of two times average or more, depending upon individual voice characteristics.



**FOR 6 AND 2 METERS ...**



240-133-2



250-43

**ANTENNAS, BEAMS AND ROTATORS ...**

137-102



138-420-3



138-112-51

**STATION ACCESSORIES ...**



250-33-2



250-20



250-28



250-30



250-25



250-23-3



250-37



250-38



250-39



250-42-1



250-42-3

The E. F. Johnson Co. reserves the right to change prices or specifications without notice and without incurring obligation.

**"6N2" VFO**—Replaces 8 to 9 mc. crystals in frequency multiplying 6 and 2 meter transmitters. Exceptionally stable. Output range: 7.995 to 9.010 mc. Requires 6.3 VAC at .3 amps and 250 to 300 VDC at 10 ma. With tubes and power cable.

Cat. No. 240-133-1 .. Kit..... Amateur Net \$34.95  
 Cat. No. 240-133-2 .. Wired and tested..... Amateur Net \$54.95

**"6N2" CONVERTER**—Instant front panel switching from normal receiver operation to 6 or 2 meters. Excellent image and I. F. rejection. Available in following ranges: 26 to 30 mcs., 28 to 30 mcs., 14 to 18 mcs., or 30.5 to 24.5 mcs. With tubes. Specify range desired.

Cat. No. 250-43 .. Kits..... Amateur Net \$59.95  
 Cat. No. 250-43 .. Wired..... Amateur Net \$89.95

**PRE-TUNED BEAMS**—Rugged, semi-wide spaced with balun matching sections. High gain—low SWR—excellent front-to-back ratio. 3 elements, boom and balun.

Cat. No. 138-420-3 .. 20 Meters..... Amateur Net \$139.50  
 Cat. No. 138-415-3 .. 15 Meters..... Amateur Net \$110.00  
 Cat. No. 138-410-3 .. 10 Meters..... Amateur Net \$ 79.50

**"ROTOMATIC" ROTATOR**—Supports beam antennas weighing up to 175 pounds. Rotates 1 RPM. Cast aluminum housing—5/16" steel rotating table tilts 90°. With desk-top control box. For coaxial line.

Cat. No. 138-112-51 With limit switches for 370° rotation Amateur Net \$354.00

**"MATCHSTICK"**—Fully automatic, pre-tuned multi-band vertical antenna system. Bandswitching 80 through 10 meters. Remotely motor driven from operating position. Low SWR (less than 2 to 1) all bands. Impedance: 52 ohms. Complete, with 35' mast.

Cat. No. 137-102 .. Pre-tuned..... Amateur Net \$129.50

**VIKING AUDIO AMPLIFIER**—Self-contained 10 watt speech amplifier, with power supply and tubes. Speech clipping and filtering improves performance of your AM transmitter.

Cat. No. 250-33-1 .. Kit..... Amateur Net \$73.50  
 Cat. No. 250-33-2 .. Wired and tested..... Amateur Net \$99.50

**LOW PASS FILTER**—Handles more than 1000 watts RF. 75 db or more attenuation above 54 mc. Wired and pre-tuned.

Cat. No. 250-20 .. 52 Ohms Impedance..... Amateur Net \$14.95  
 Cat. No. 250-35 .. 72 Ohms Impedance..... Amateur Net \$14.95

**CRYSTAL CALIBRATOR**—Provides accurate 100 kc check points to 55 mc. Requires 6.3 volts at .15 amps and 150-300 volts at 2 ma. With tube and crystal.

Cat. No. 250-28 .. Wired and tested..... Amateur Net \$17.95

**"SIGNAL SENTRY"**—Monitors CW or phone signals up to 50 mc., powered by receiver. With tubes.

Cat. No. 250-25 .. Wired and tested..... Amateur Net \$22.00

**"MATCHBOXES"**—Completely integrated antenna matching and switching systems for kilowatt or 275-watt transmitters. Bandswitching 80 through 10 meters. Tunes out large amounts of reactance. No "plug-in" coils or "load-tapping," necessary.

Cat. No. 250-23-3 .. 275 Watts, wired with directional coupler and indicator..... Amateur Net \$86.50  
 250-23 .. 275 Watts, wired less directional coupler and indicator..... \$54.95  
 250-30-3 .. Kilowatt, wired with directional coupler and indicator..... \$149.50  
 250-30 .. Kilowatt, wired less directional coupler and indicator..... \$124.50

**DIRECTIONAL COUPLER AND INDICATOR**—Provides continuous reading of SWR and relative power in transmission line. Coupler may be permanently installed in 52 ohm coaxial line—handles maximum legal power specified by F. C. C. Indicator is a 0-100 microammeter calibrated in SWR and relative power.

Cat. No. 250-37 .. Coupler..... Amateur Net \$11.75  
 Cat. No. 250-38 .. Indicator..... Amateur Net \$25.00

**T-R SWITCH**—Instantaneous break-in on SSB, DSB, CW or AM. Excellent receiver isolation. Gain: 2 db at 30 mcs.; 6 db at 3.5 mcs. Rated 4000 watts peak power. With tube, power supply and provision for RF probe.

Cat. No. 250-39 .. Wired..... Amateur Net \$27.75

**ATTENUATORS**—Provide 6 db attenuation with required power dissipation to enable various units to serve as exciters for Viking "Thunderbolt" linear amplifier.

Cat. No. 250-42-1 .. For Viking "Ranger" or similar..... Amateur Net \$21.50  
 Cat. No. 250-42-3 .. For use with HT-32 or similar unit..... Amateur Net \$21.50

The E. F. Johnson Co. manufactures a complete line of keys and practices. See the entire line at your authorized Johnson Distributor.

FIRST CHOICE AMONG  
 THE NATION'S  
 AMATEURS



Viking



# Crystal Control For VHF

Frederick W. Brown, W6HPH

304 Alosta Drive  
Camarillo, California

*A theoretical discussion and a practical solution to the problem of crystal control on VHF. The shortcomings of the overtone oscillator circuit are avoided in this 2 meter crystal controlled low powered transmitter.*

The principal obstacle to using crystal control in the higher frequency amateur bands is the large number of stages required in the transmitter. If the inexpensive *hf* crystals are used, two or three stages are usually needed just to reach 144 *mc*. The problem facing the designer is to get from the crystal frequency up to the desired *vhf* band with a minimum of tubes and a maximum of output. In the *vhf* and *uhf* region, ordinary doublers and triplers require almost as much drive as they will deliver in output. With a string of such multipliers, the last tube may deliver less power than is supplied to the grid of the first.

The main reasons why frequency multipliers have such poor power gain are: (1) the requirement of large voltage swing at the grid, (2) electron transit time effects at high frequencies, (3) degeneration due to feedback. For high plate

efficiency, we would like a small angle of plate current flow.  $120^\circ$  is a good value for a Class C cally  $100^\circ$ ,  $50^\circ$ , and  $33^\circ$ , the required relative driving powers would be approximately 1.0, 1.97, and 2.95. So the driving power for constant plate circuit efficiency is approximately inversely proportional to the order of multiplication. However, since plate current is flowing only half as often in the doubler, and one third as often in the tripler, we would expect both the output and input powers to have relative magnitudes of 1, amplifier. For a multiplier,  $120^\circ$  at the output frequency means  $60^\circ$  at the input frequency in the case of a doubler, and  $40^\circ$  in the case of a tripler. If the peak value of grid voltage is the same in each case, it can be shown that the relative *rf* driving voltage must have the value of 1.00, 3.73, and 8.3, for the amplifier, doubler, and tripler, respectively. If we take the corresponding angle of grid current flow to be typi-

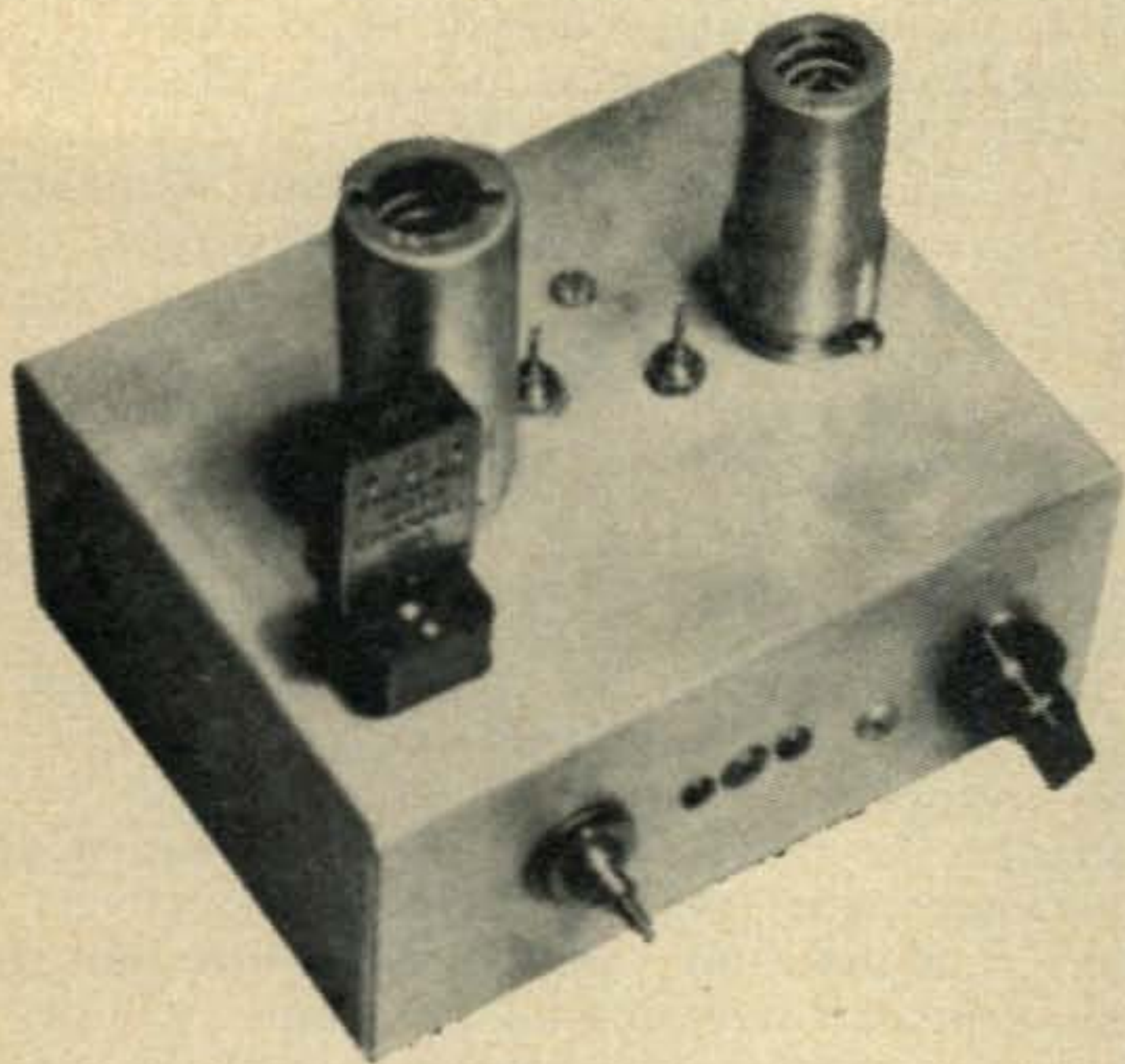

The simple two meter transmitter is built on a standard 2x4x5 inch chassis. At the left on the front is the screwdriver adjustment for  $L_1$  and next to it is  $C_6$ . The knob tunes  $C_{12}$ . The screws for tuning  $L_3$  and  $L_5$  are between the tubes.

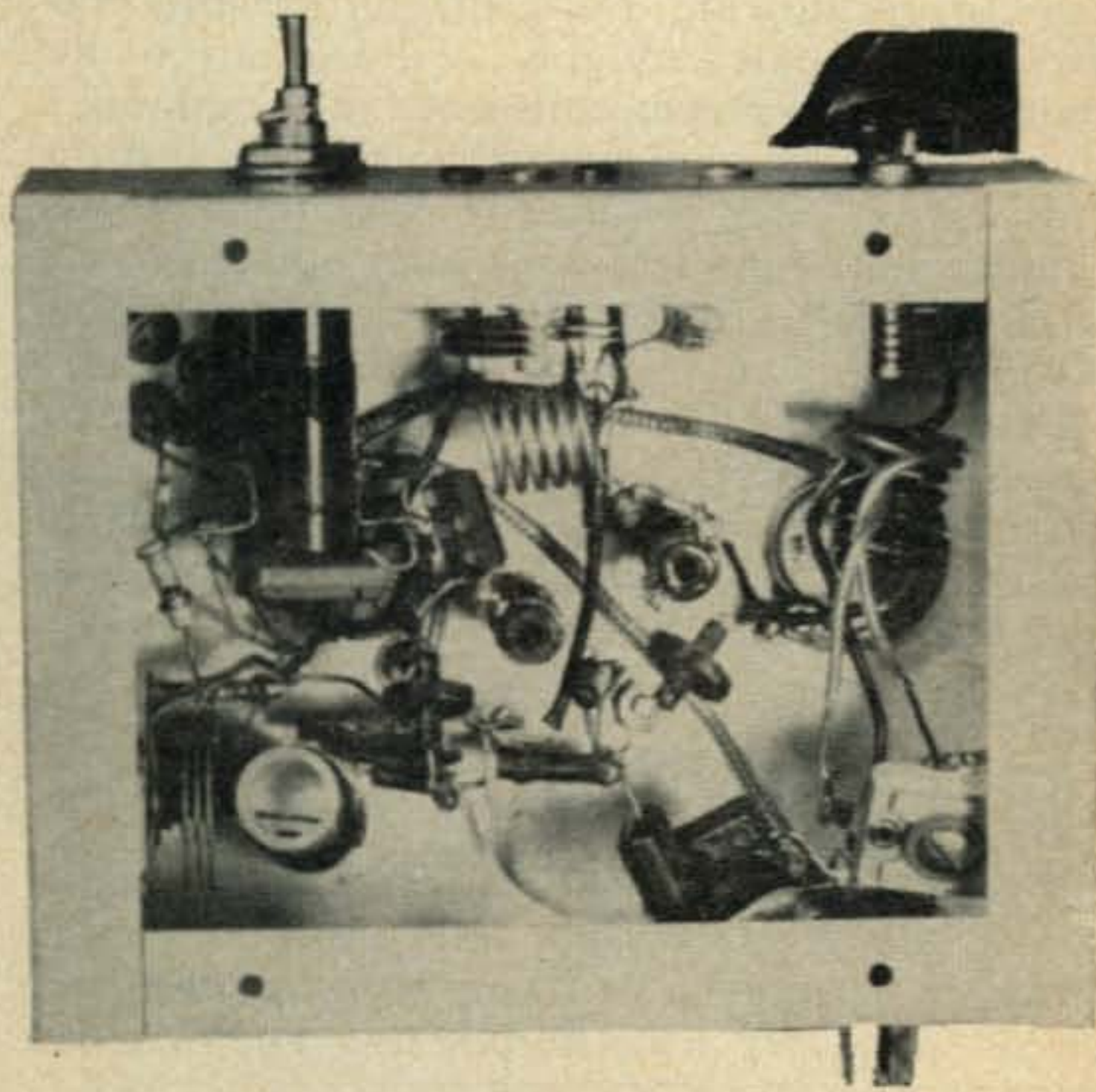

Underside view of the transmitter.  $C_3$  and  $L_2$  are at the lower left and  $C_{13}$  can be seen at the lower right.



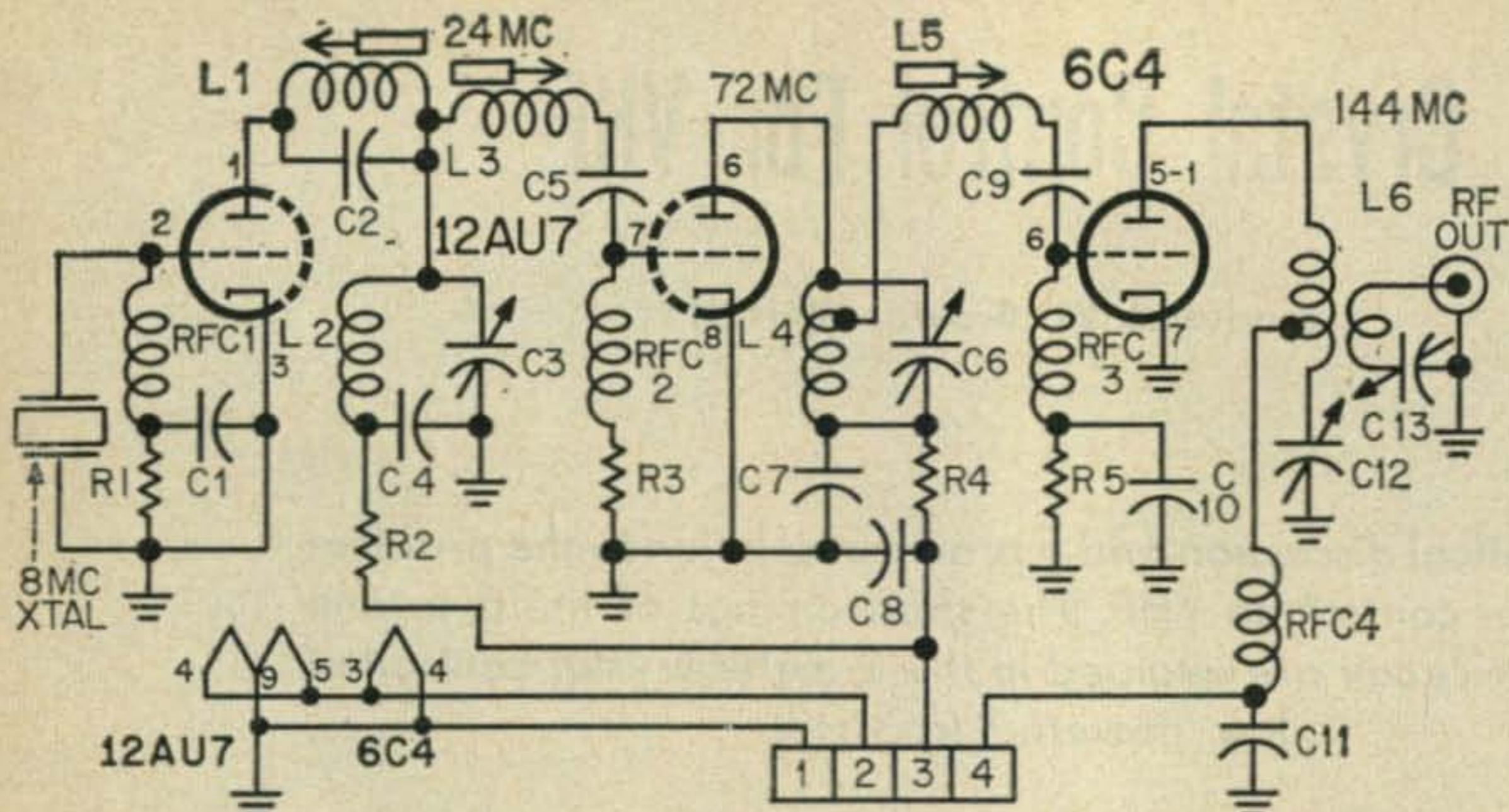

Fig. 1 — Circuit of the low powered 2 meter transmitter. The author used a B+ of 215 volts for all the stages as explained in the text.

C<sub>1</sub>, C<sub>9</sub>, C<sub>10</sub>—39 mmf ceramic  
 C<sub>2</sub>—82 mmf mica  
 C<sub>3</sub>, C<sub>6</sub>, C<sub>12</sub>—25 mmf APC type variable  
 C<sub>4</sub>—.01 disc ceramic  
 C<sub>5</sub>, C<sub>11</sub>—390 mmf mica  
 C<sub>7</sub>, C<sub>8</sub>—.001 mf ceramic  
 C<sub>13</sub>—3-30 mmf mica compression trimmer  
 R<sub>2</sub>, R<sub>4</sub>—680K ½ W  
 R<sub>3</sub>, R<sub>5</sub>—36K ½ W  
 R<sub>1</sub>, R<sub>5</sub>—36K ½ W

#### Coil Data

L<sub>1</sub>—16 turns #28 enameled, close wound on ¼" diameter slug tuned form.  
 L<sub>2</sub>—15 turns #22 enameled, ½" form ¾" long.

L<sub>3</sub>—10 turns #26 enameled, close wound on ¼" diameter slug tuned form.  
 L<sub>4</sub>—6 turns #16 enameled, ⅜" diameter air wound, ½" long. Tap 1½ turns from top.  
 L<sub>5</sub>—7 turns #24 enameled, close wound on ¼" diameter slug tuned form.  
 L<sub>6</sub>—6 turns #16 enameled ⅜" i.d., ⅜" long, tap 1½ turns up from lower end.  
 Link is 2 turns #20 hookup wire wound over lower end.  
 RFC<sub>1</sub>, RFC<sub>2</sub>, RFC<sub>3</sub>—150 uh video peaking coils.  
 RFC<sub>4</sub>—Straight piece of #22 hookup wire, about 1¼" long, running between the tap on L<sub>6</sub> and pin 4 of the power plug which is bypassed by C<sub>11</sub>. This gives better output and greater 72 mc suppression than a vhf rfc.

½, and ⅓. From this simplified analysis, it is seen that the relative power gain will be about 1, ¼, and ⅙ for the case of the amplifier, doubler, and tripler, respectively.

At the higher frequencies, however, transit time and feedback effects reduce the power amplification to still lower values. One effect of electron transit time is to produce a conductive component of input admittance even with no grid current flowing. For a given tube, this conductance increases roughly as the square of the frequency. The power consumed in the conductance goes to heating both the cathode and the grid<sup>1</sup>. In fact, it is possible to operate some frequency multipliers without heater current (after initial warm-up) because of cathode back-heating.

Degenerative effects are caused principally by capacitive feedback between the grid and plate, and by cathode lead inductance. An excellent discussion of degeneration, together with remedies, was given by Robert H. Brown<sup>2</sup>.

### The Circuit

A transmitter circuit that gives 144 mc output from 8 mc crystals using only three triodes is shown in fig. 1. The transmitter was designed primarily for low drain mobile use. The filament

current is only as much as is drawn by a 6J6 and the plate requirements can be supplied by a small vibrapack. The 12AU7 is used as an oscillator and tripler, and the 6C4 is a doubler-final.

Most of the simple two meter transmitters described in the past use overtone oscillator circuits. These circuits have a number of shortcomings: (1) they are critical to adjust, (2) some crystals oscillate only weakly, or not at all, (3) oscillator starting is unreliable. A much better oscillator arrangement originally described by W2CTK<sup>3</sup> is used here. The Keen circuit is easy to adjust and will deliver at least as much third harmonic output as an overtone circuit. In fig. 1, L<sub>1</sub>C<sub>2</sub> are tuned slightly higher than the crystal frequency, and L<sub>2</sub>C<sub>3</sub> to the desired harmonic. If L<sub>2</sub>C<sub>3</sub> is imagined to be shorted out (the impedance is quite low at 8 mc) we have a simple tuned plate oscillator. The third harmonic component in the plate circuit appears across L<sub>2</sub>C<sub>3</sub>.

The purpose of L<sub>3</sub> and L<sub>5</sub> is to neutralize the degenerative feedback from the plate to grid. This arrangement was described by Brown<sup>4</sup>. Inductances L<sub>3</sub> and L<sub>5</sub> resonate to a frequency somewhat higher than L<sub>4</sub> and L<sub>6</sub>, respectively. There is an optimum value of inductance, but it is not critical. Increasing the inductance will decrease the degenerative feedback until the circuit becomes regenerative, and, if increased

<sup>1</sup>W. G. Dow, "Transit-time effects in ultra-high frequency class-C operation", *Proc. I.R.E.*, Vol. 35, pp. 35; January, 1947.

<sup>2</sup>R. H. Brown, "Harmonic-amplifier design", *Proc. I.R.E.*, Vol. 35, pp. 771; August, 1947.

<sup>3</sup>H. S. Keen, "An effective power-type frequency multiplier" *QST*, March, 1932, pp. 22.

I've used that screen grid feed-back idea in Fig. 3 with some success also.

<sup>4</sup>Op. cit., R. H. Brown, Fig. 4C.



further, a point will be reached where the multiplier will oscillate.

### Tuning

To tune up the transmitter, simply adjust  $L_1$ ,  $C_3$  and  $C_6$  for maximum grid current to the 6C4, then tune  $C_{12}$  and  $C_{13}$  for maximum output. Changing crystals usually requires that only  $C_6$  and  $C_{12}$  be readjusted if the frequency is not changed more than  $\pm 1$  mc in the two meter band.

Operating conditions are given in Table I. With only 215 volts for B plus, the tubes are all operating within their conservative CCS receiving tube ratings. Output under these conditions is about one watt as indicated by full brilliance of a #47 dial light. With greater plate voltage, the output will, of course, increase. An effort

Table I

		Plate Ma	Grid Ma
6C4	Doubler	17	1.9
12AU7	Tripler	14	2.3
	Oscillator	13	2.1

Plate voltage was 215 volts for both tubes.

was made to find a more efficient tube for the doubler-final. Only one worked slightly better, and that was the expensive 6AN5.

### Modulation

Modulation can be applied to the 6C4 in the conventional manner. Checking the trapezoidal pattern on the scope, no non-linearity could be noticed at 100% modulation. No fantastic DX has been worked with this transmitter, but on-the-air reports have been gratifying.

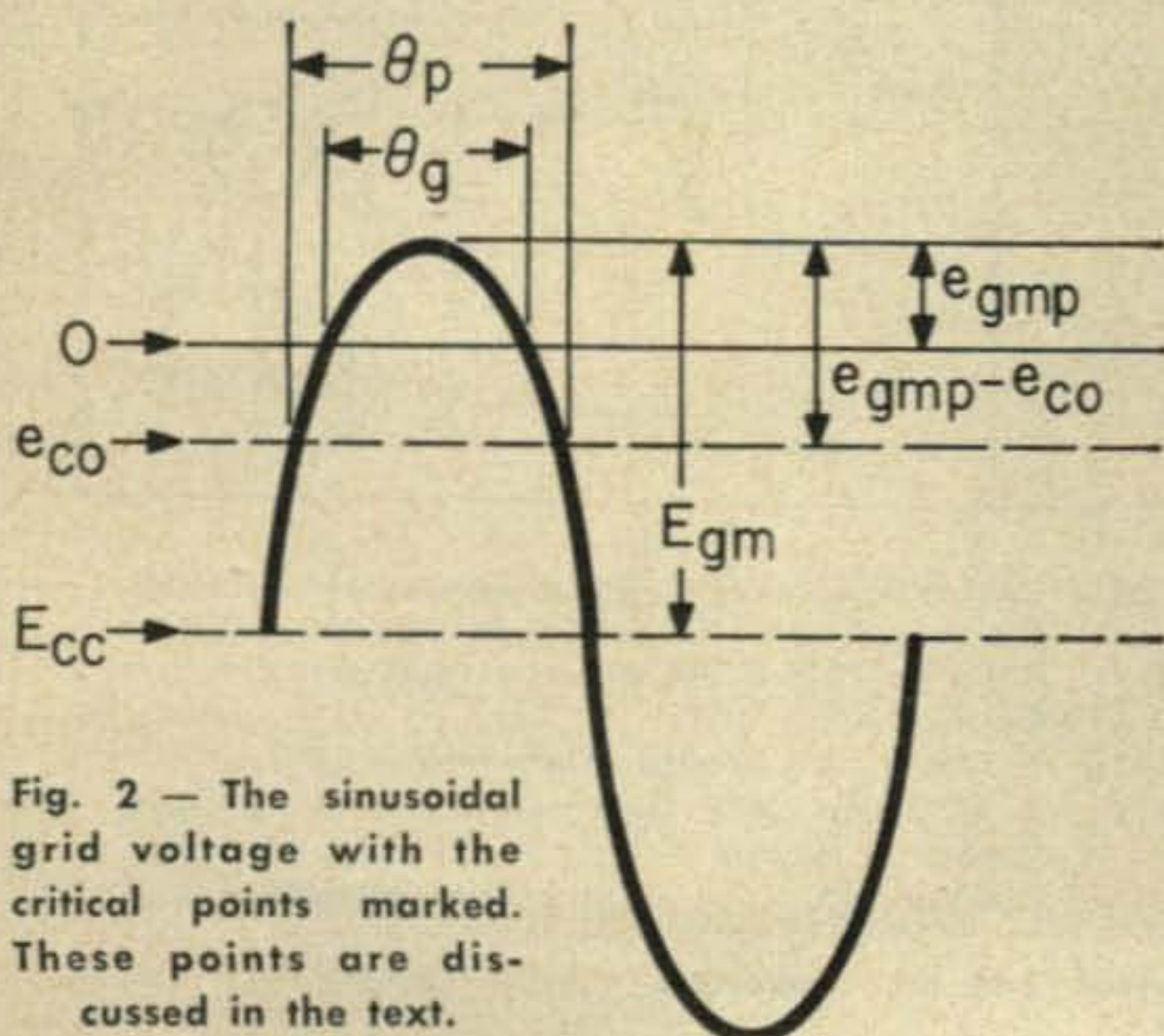

Fig. 2 — The sinusoidal grid voltage with the critical points marked. These points are discussed in the text.

### Appendix

A sinusoidal grid driving voltage is shown in fig. 2. The grid voltage  $e_{co}$  is the value for plate current cut-off, and is assumed constant for simplicity. The voltage  $e_{gmp}$  is the peak positive value of grid voltage. The angle during which plate current flows is  $\theta_p$ . If  $M\theta_p$  ( $M$  being the order of multiplication) and  $e_{gmp}$  have the same values for a multiplier and amplifier, the same plate efficiency can be expected for the two cases. The peak rf voltage,  $E_{gm}$ , needed for drive will be given by

$$E_{gm} = \frac{e_{gmp} - e_{co}}{1 - \sin\left(\frac{\pi - \theta_p}{2}\right)}$$

as can be seen by simple trigonometry. If  $M\theta_p$  is  $120^\circ$  for  $M = 1, 2,$  and  $3$  (amplifier, doubler and tripler),  $\theta_p$  must have the values of  $120^\circ, 60^\circ,$  and  $40^\circ,$  respectively. The relative values of  $E_{gm}$  for constant  $e_{gmp} - e_{co}$  are then seen to be 1.0, 3.73, and 8.3.

The waveform of the grid voltage above zero is a truncated sine wave. The shape is independent of  $\theta_g$  for  $\theta_g < 100^\circ$  to a very close approximation. Let us assume that the grid current depends only upon the grid voltage, and therefore its shape will be independent of  $\theta_g$ . For simplicity assume that the grid pulse has the shape of a rectified sine wave<sup>5</sup>. The grid voltage and current pulse are shown in fig. 3. Integrating the product of this voltage and current over  $\theta$

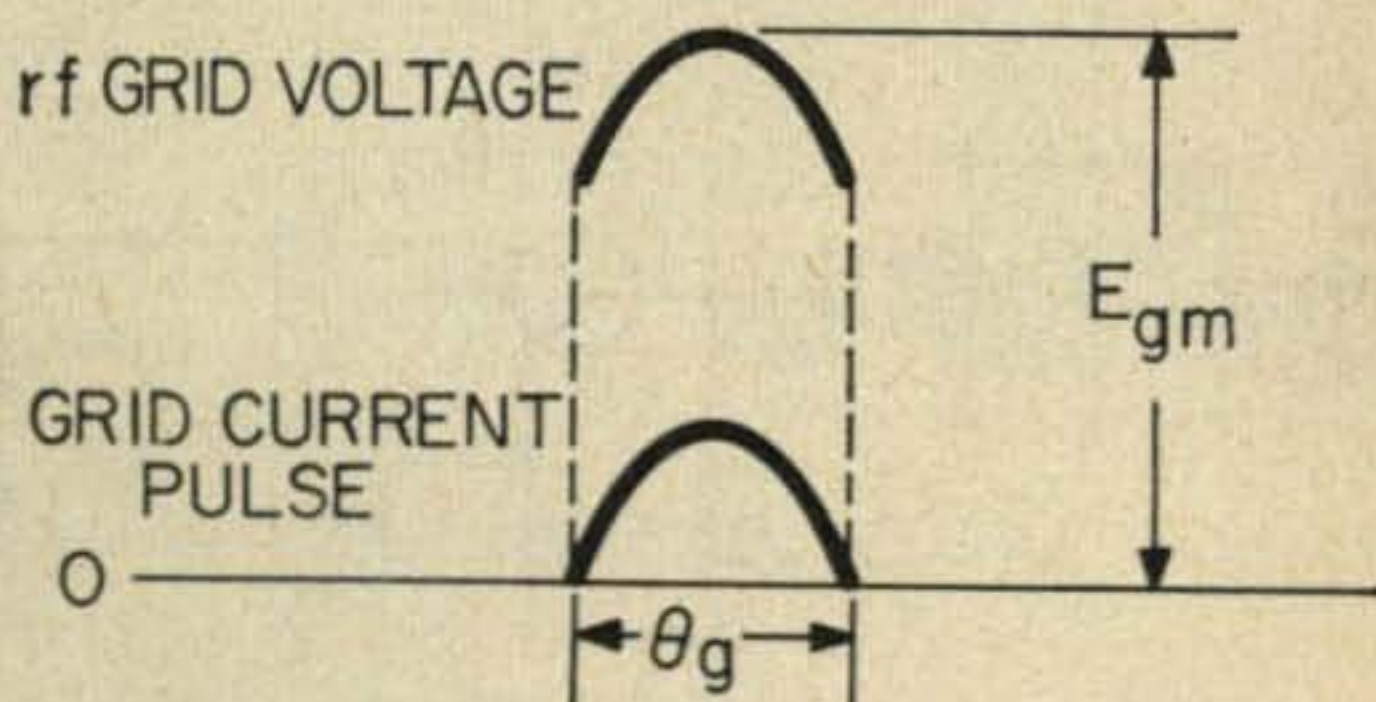

Fig. 3—The grid voltage and its corresponding pulse of grid current.

during the period of grid current flow will give the relative driving power as a function of  $\theta_g$ .

$$\int_{-\frac{\theta_g}{2}}^{\frac{\theta_g}{2}} \cos \theta \cos\left(\frac{\pi}{\theta_g} \theta\right) d\theta = \frac{\cos\left(\frac{\theta_g}{2}\right)}{\frac{\pi}{\theta_g} - 1} + \frac{\cos\left(\frac{\theta_g}{2}\right)}{\frac{\pi}{\theta_g} + 1}$$

This integral has the values of 1.033, .546, and .368, for  $\theta_g = 100^\circ, 50^\circ,$  and  $33^\circ$ . Multiplying by the corresponding values of  $E_{gm}$ , we have the relative driving powers of 1.00, 1.97, and 2.95 for the amplifier, doubler, and tripler. ■

<sup>5</sup>The actual shape of the grid current pulse has little effect on the final answer as can be seen by taking the case of a rectangular pulse of duration  $\theta_g$  and comparing the results with the above.



# A Transistorized Converter For The 144 MC Band

A 144 to 7 mc converter is described which provides excellent results in the 2 meter band. Transistors are used throughout, and the only supply voltage necessary is a 12 volt battery.

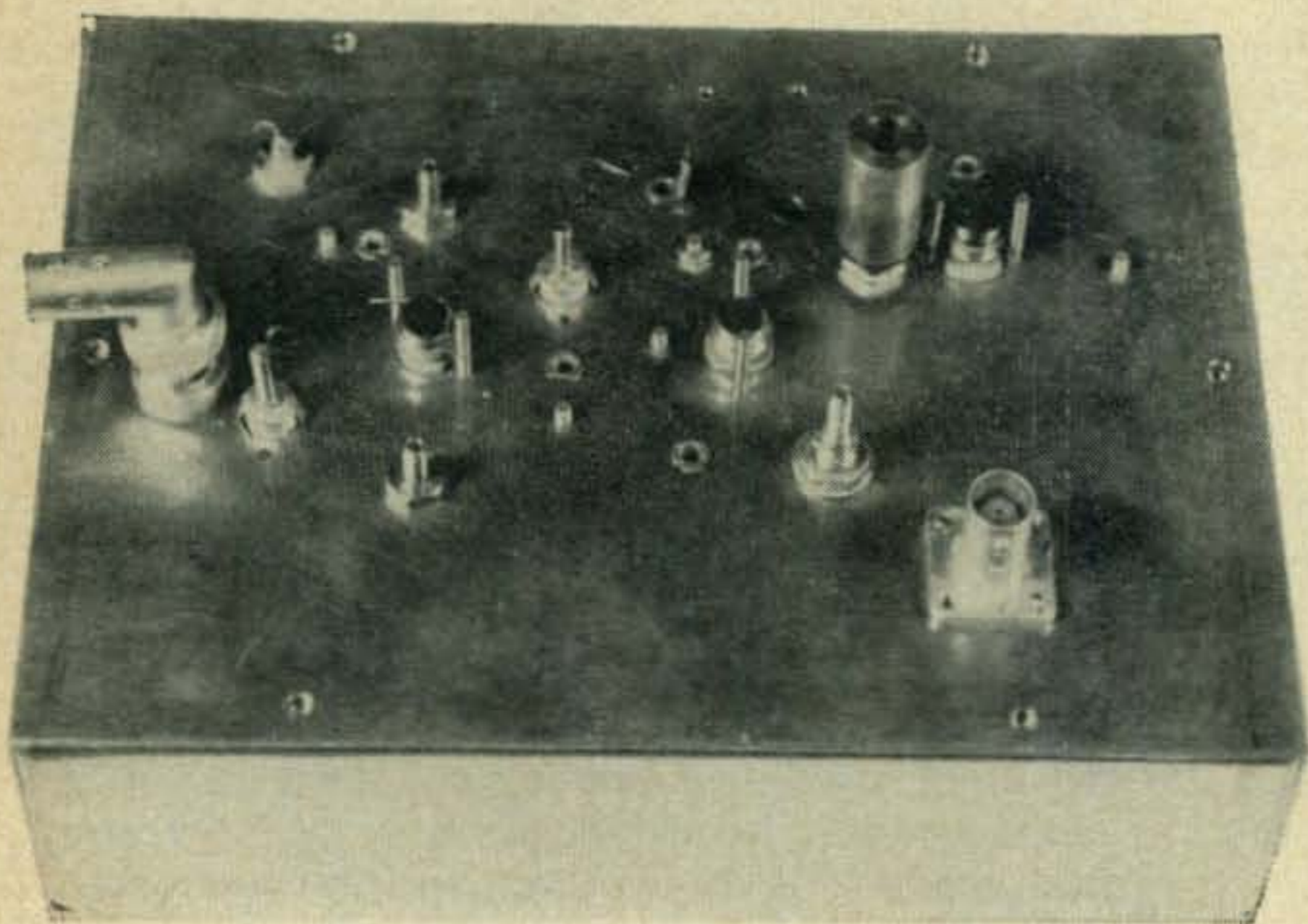

**J. Specialny, W3HIX**  
Philco Corporation  
Lansdale, Penna.

Photograph A

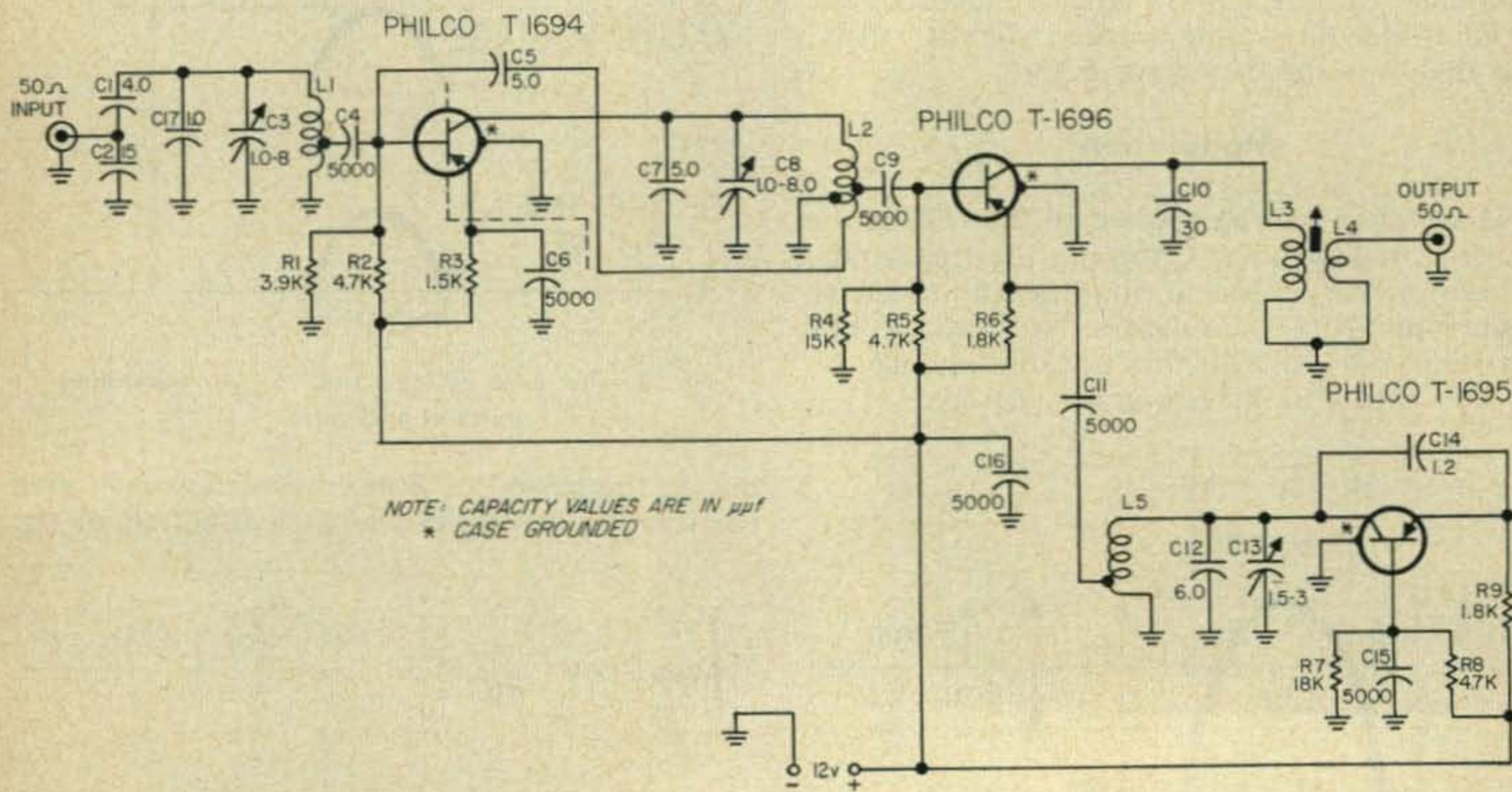

## COIL DATA

- L<sub>1</sub> 4 Turns #18 Bare copper wire 1/4" ID, winding length 1/4"
- Base tap 1 Turn from ground end of L<sub>1</sub>
- L<sub>2</sub> 6 Turns #18 Bare copper wire 1/4" ID, winding length 4/10"
- Ground tap 4 turns from collector end
- Output tap 3/4 turn from ground tap

- L<sub>3</sub> #30 Nyclad closewound to occupy 1/2" of winding space on a 3/8" coil form (Cambion LS-5) (See fig. 2 for construction details) Red Dot Core

- L<sub>4</sub> 5 Turns #30 Nyclad over cold end of L<sub>3</sub>
- L<sub>5</sub> 4 1/2 Turns #18 Bare copper wire 1/4" I.D. spaced to occupy 5/8"
- Emitter tap 1/8 to 1/4 turn from ground end

Fig. 1—Circuit of the transistorized 144 mc converter.



**The circuit** (see fig. 1) is conventional and no difficulty should be experienced in duplicating it. A *Philco* T1694 is employed in the *rf* amplifier stage which is fixed neutralized by capacitor  $C_5$ . Capacitance dividers  $C_1$  and  $C_2$  provide a 50 ohm match to the input circuit. Coil  $L_1$  and capacitor  $C_3$  form the input tuning. The base of the amplifier is tapped on  $L_1$  to match 75 ohms. Coil  $L_2$  and capacitors  $C_7$  and  $C_8$  tune the output of the amplifier. A portion of  $L_2$  together with neutralizing capacitor  $C_5$  form the neutralizing network. The base of the *Philco* T1696 mixer is tapped down on  $L_2$ . The output of the mixer is coupled from the collector by capacitor  $C_{10}$  and output coil  $L_3$  at 7 *mc*. Output winding  $L_4$  provides an output at 50 ohms to permit coupling to the input of a communications receiver.

A *Philco* T1695 is employed as a local oscillator and operates 7 *mc* higher than the signal frequency. Coil  $L_5$  and capacitors  $C_{12}$  and  $C_{13}$  form the tank circuit.

The local oscillator signal is injected into the mixer emitter through capacitor  $C_{11}$  by tapping the oscillator coil  $L_5$ .

### Operation and Results

The *rf* bandpass is about 4 *mc* at the 3 *db* points. A communications receiver capable of tuning the 7 *mc* band should be used as the *if* system. If a mixed tuned converter operation is desired, the tuning range will be limited to about 2 *mc* with the mixer output coil used. The frequency range of 144 to 146 *mc* can be tuned without touching the converter once the local oscillator frequency has been set. The *if* system then tunes from 6 through 8 *mc*.

If continuous tuning of the converter is desired, a vernier dial and a panel can be added to the converter. The communications receiver in this case is operating as a fixed tuned *if* system operating at 7 *mc*.

The power gain at 145 *mc* is about 26 *db* and falls off to 22.5 *db* at 148 *mc*. The noise figure of the particular T1694 used was 6.2 *db* at 200 *mc*. Therefore, the overall noise figure of the

converter should be no greater than 6.0 *db* at 144 *mc*.

Table I indicates the value of collector current flowing in each of the stages.

Table I

	RF Amp.	Mixer	LO	Total (with Bleeder current)
$I_c$	3 <i>ma</i>	1.6 <i>ma</i>	1.2 <i>ma</i>	8.0 <i>ma</i>

### Construction

The accompanying photographs should be helpful in the construction of the converter. The inside view clearly indicates the placement of all of the components.

In photograph A the input connector is located to the left of the chassis and the output connector is located to the right. Note the shaft coupler at the upper right position of the chassis. A vernier dial can be attached to the shaft with a suitable mounting panel to permit calibrated tuning of the converter.

In photograph B, note the partition shield isolating the *rf* amplifier output from its input. The input circuit of the converter is to the left of the chassis.

This converter has been in use at my home location in conjunction with an ARC-4 transmitter with excellent results. No overload protection was employed in the *rf* amplifier stage as it was found unnecessary. Stations from the New England and Washington, D.C. area were heard during the first few nights of listening with signal quality comparable to an equivalent tube type converter.

A stand-by-receiver switch should be located in the positive leg of the 12 volt supply. The coaxial antenna switching relay should be located as near as practical to the input terminals of the converter. ■

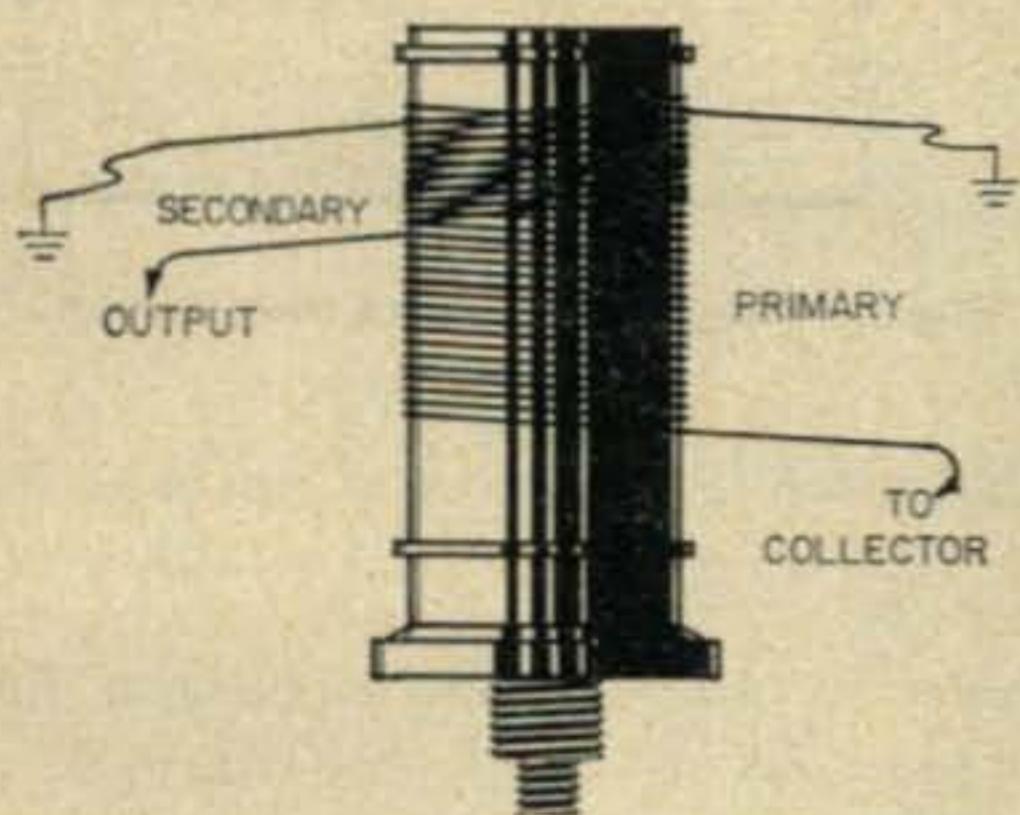
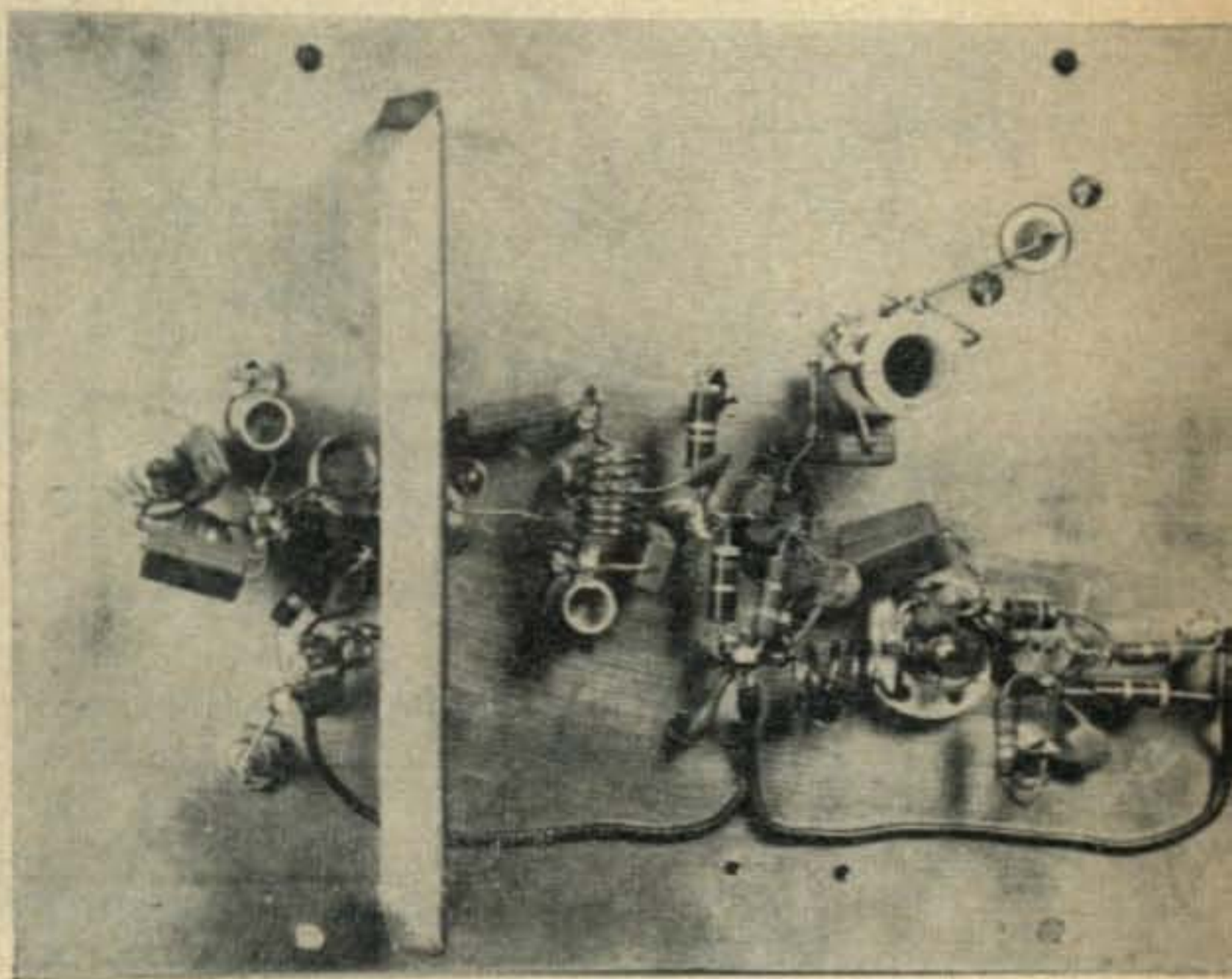

Fig. 2—Construction details for  $L_3$ . Further information is given in the Coil Data in fig. 1. In tuning  $L_3$ , the powdered iron slug is varied so that it meshes only the collector end.

Photograph B





# "Efficiency" Types Of Amplitude Modulation

Carl C. Drumeller, W5EHC

5824 NW 58th St.  
Oklahoma City 12  
Oklahoma

*A theoretical discussion of the merits and demerits of various types of efficiency modulation, or controlled carrier circuits. While no practical applications are given, you can gain an understanding of the principles and methods of an economical modulation system.*

**"Efficiency modulation"** may be defined as any system of amplitude modulation that varies, at an audio frequency, the effectiveness of a constant-amplitude source of radio-frequency energy to deliver that radio-frequency power to a radiating device. It is further distinguished by the fact that the audio-frequency energy utilized in the process does not contribute any power toward the generation of radio-frequency sidebands containing the audio intelligence.

Omitting such specialized applications as transmission-line and out-phase modulators, efficiency modulators may be grouped into the following classifications:

1. Antenna
2. Tank
3. Plate
4. Suppressor grid
5. Screen grid
6. Control grid
7. Cathode

## Antenna Modulation

Figure 1 illustrates a simple form of an antenna modulator. A carbon microphone, which

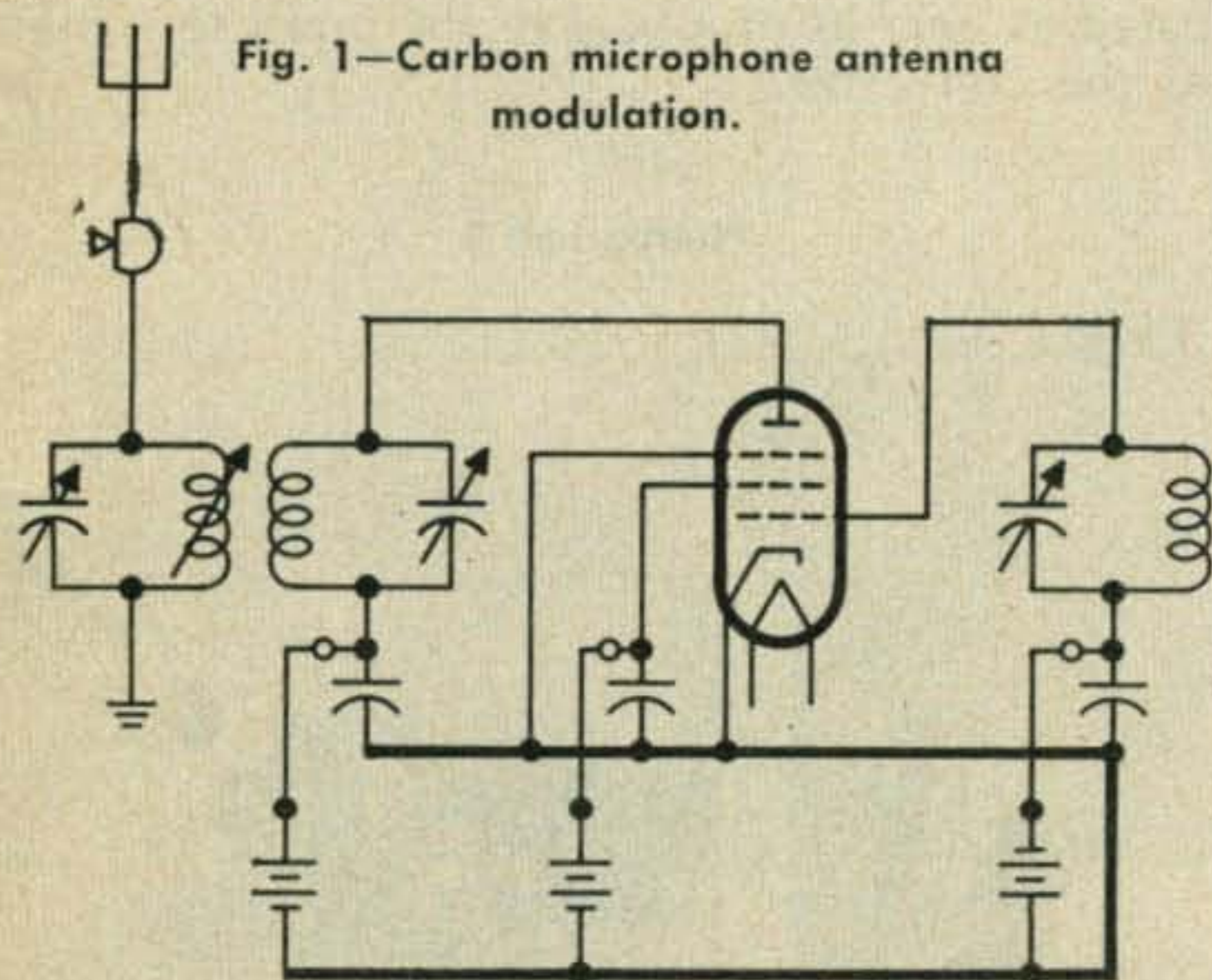

essentially is a variable resistor capable of being varied at audio frequencies by sound waves, is connected in series with the antenna. At rest, it offers a certain amount of resistance to the passage of radio-frequency currents, dissipating a static amount of *rf* power in the form of heat.

Under the influence of voice waves, the amount of dissipated power varies, permitting more (or less) to reach the antenna. It is quite evident that such a system has sharp limits as to power handling capabilities as well as to feasible depth of modulation.

## Magnetic Antenna Modulation

Another, and more practical form is shown in fig. 2. Here the microphone varies the direct current flowing through one winding of a two-winding iron-core choke coil. The fluctuating direct current alters the degree of saturation of the choke's core, thus varying the reactance offered by its second winding to the flow of *rf* current.

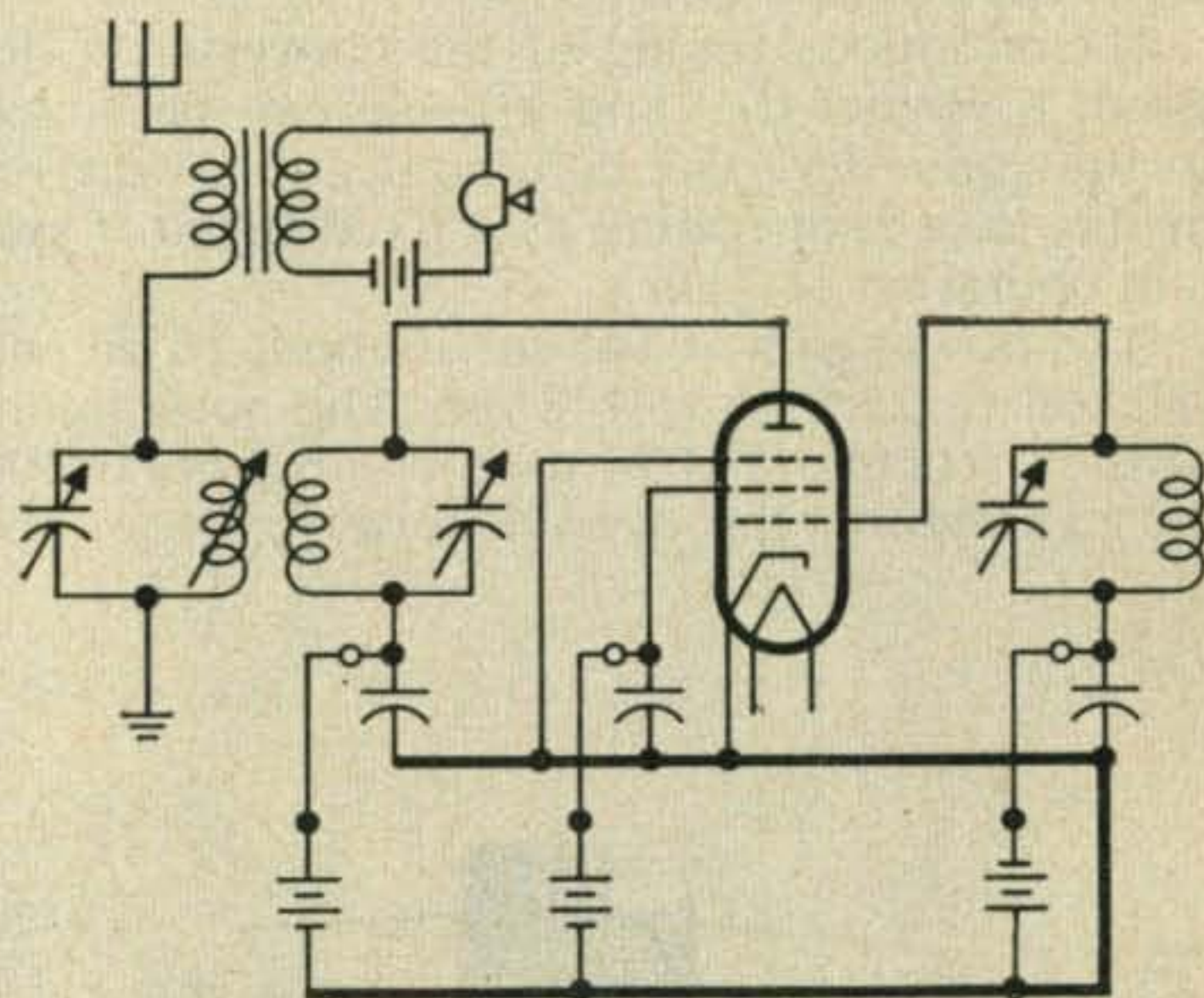

Still another is illustrated in fig. 3, which shows a transistor as the variable-impedance device.

The carbon microphone need not be in the antenna lead, as in fig. 1, but may be coupled to either the plate or the antenna tank circuit. The amount of power absorbed from the tank circuit (and dissipated by the microphone) varies with the voice frequencies. Figure 4 indicates the simple circuitry.



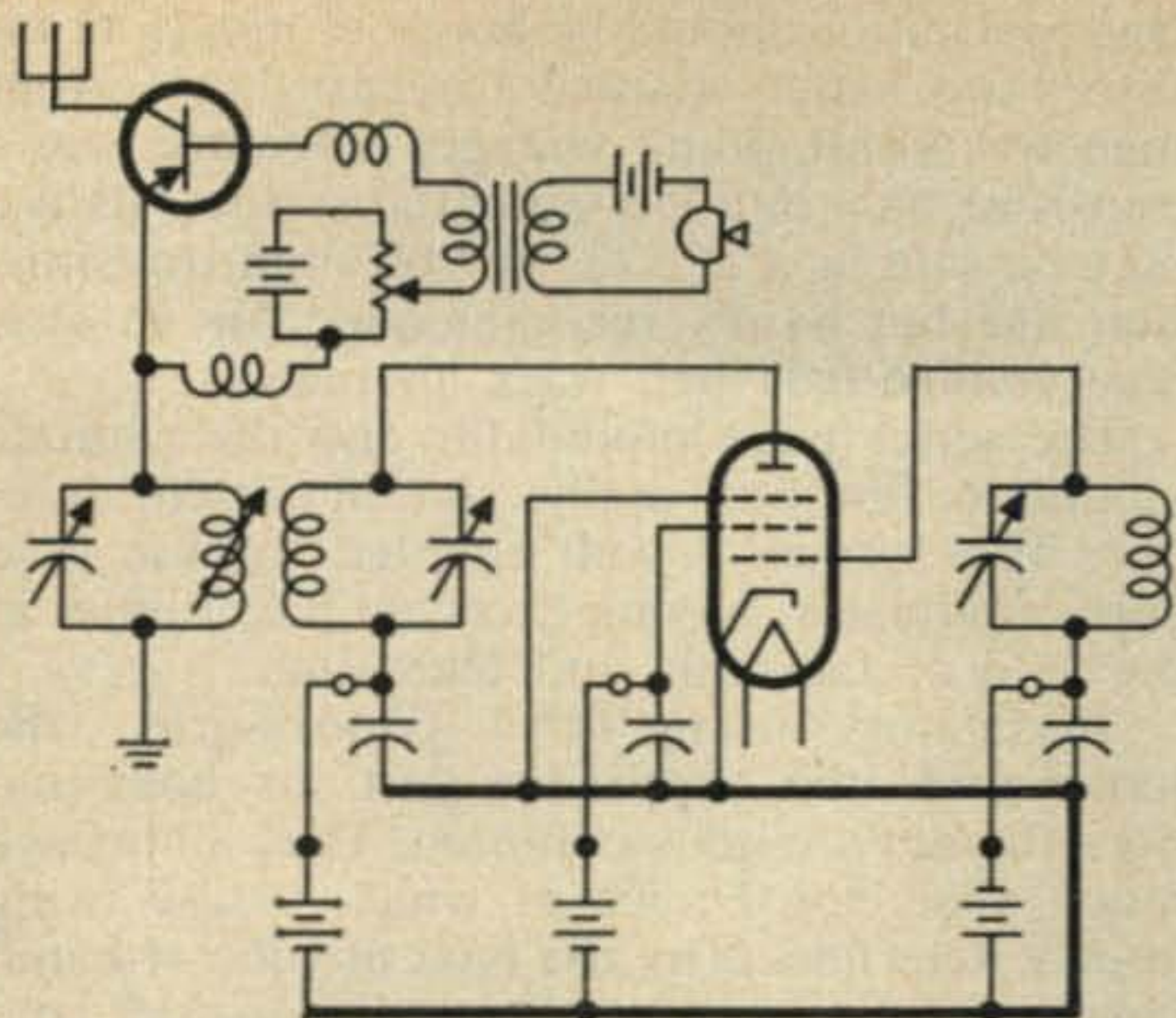

Fig. 3—Transistor antenna modulator. A practical application of this circuit is shown in the Semiconductor Column, December 1959, page 81.

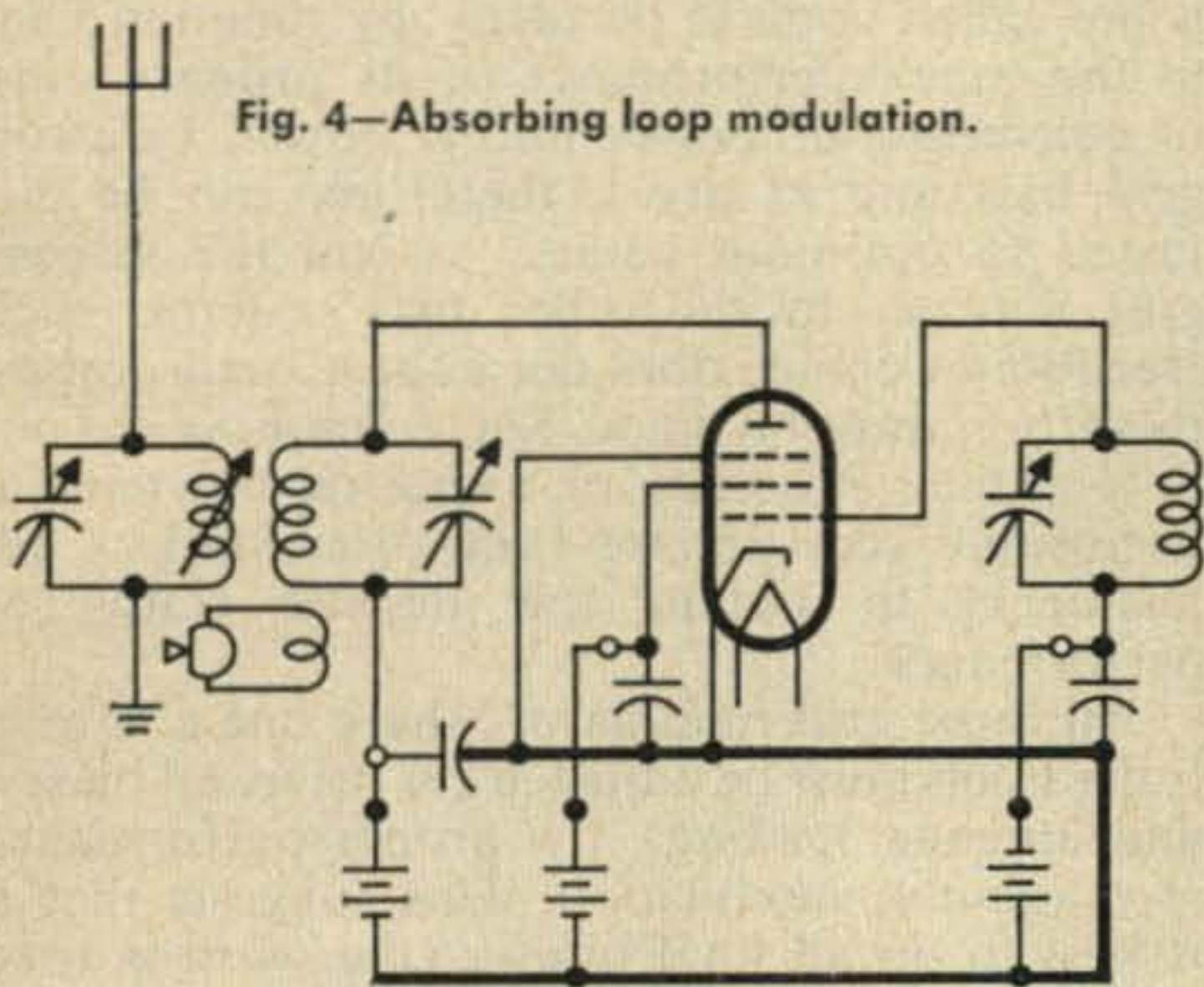

Fig. 4—Absorbing loop modulation.

### Series Plate Modulation

Plate modulation generally is associated with power and not efficiency modulation. There is, however, a form of plate modulation, shown in fig. 5, that is efficiency modulation. A vacuum tube is connected in series with the plate supply source. Its characteristics are such that when biased to true Class A conditions its internal impedance is such as to reduce the plate supply voltage by half. When an audio signal is applied to its grid, the variation in its internal impedance

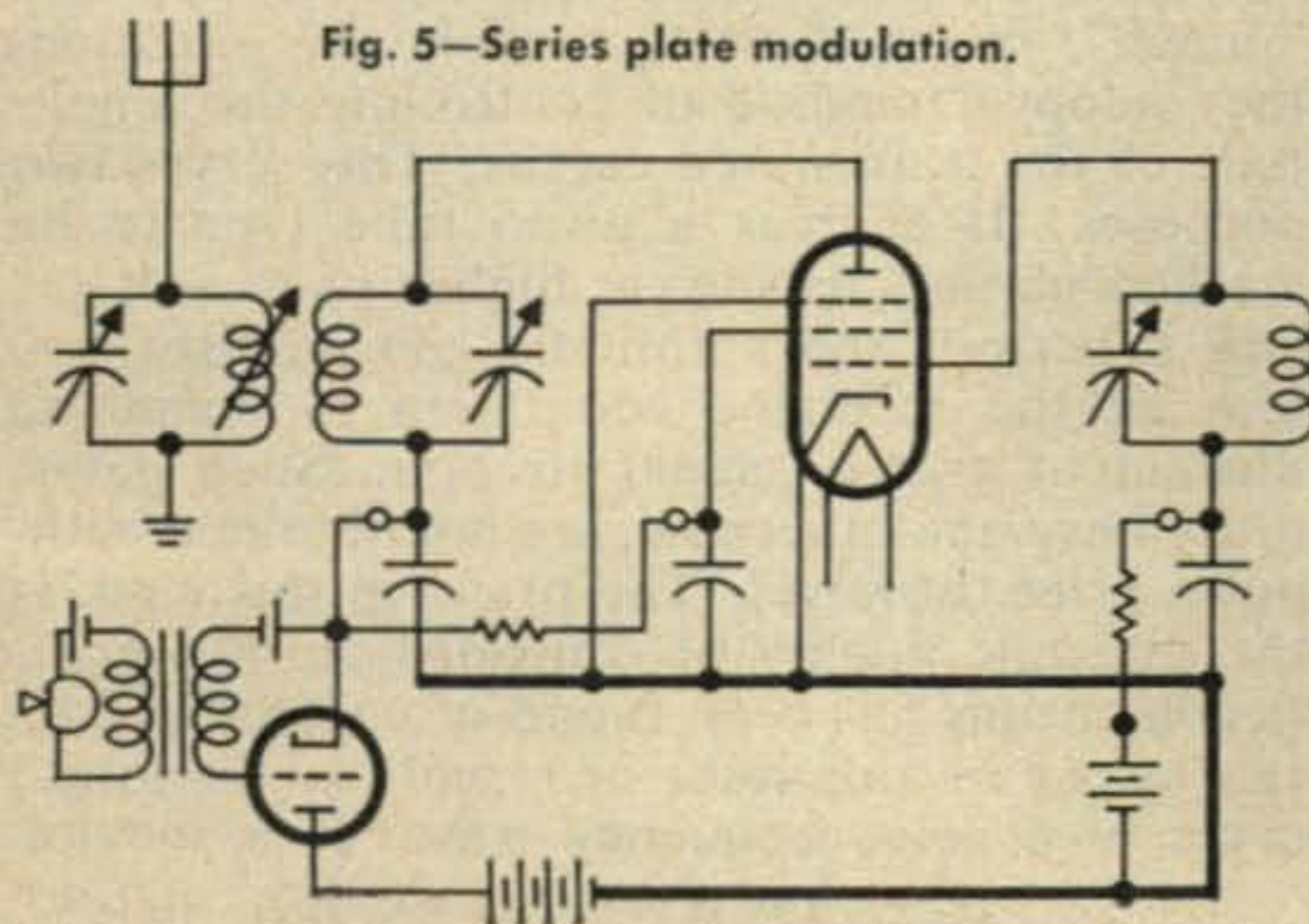

Fig. 5—Series plate modulation.

permits the actual plate voltage applied to the modulated tube to swing between nearly zero to nearly full source value, this producing amplitude modulation.

### Suppressor Modulation

Suppressor-grid modulation, fig. 6, applies an audio-frequency voltage, in series with a *dc* neg-

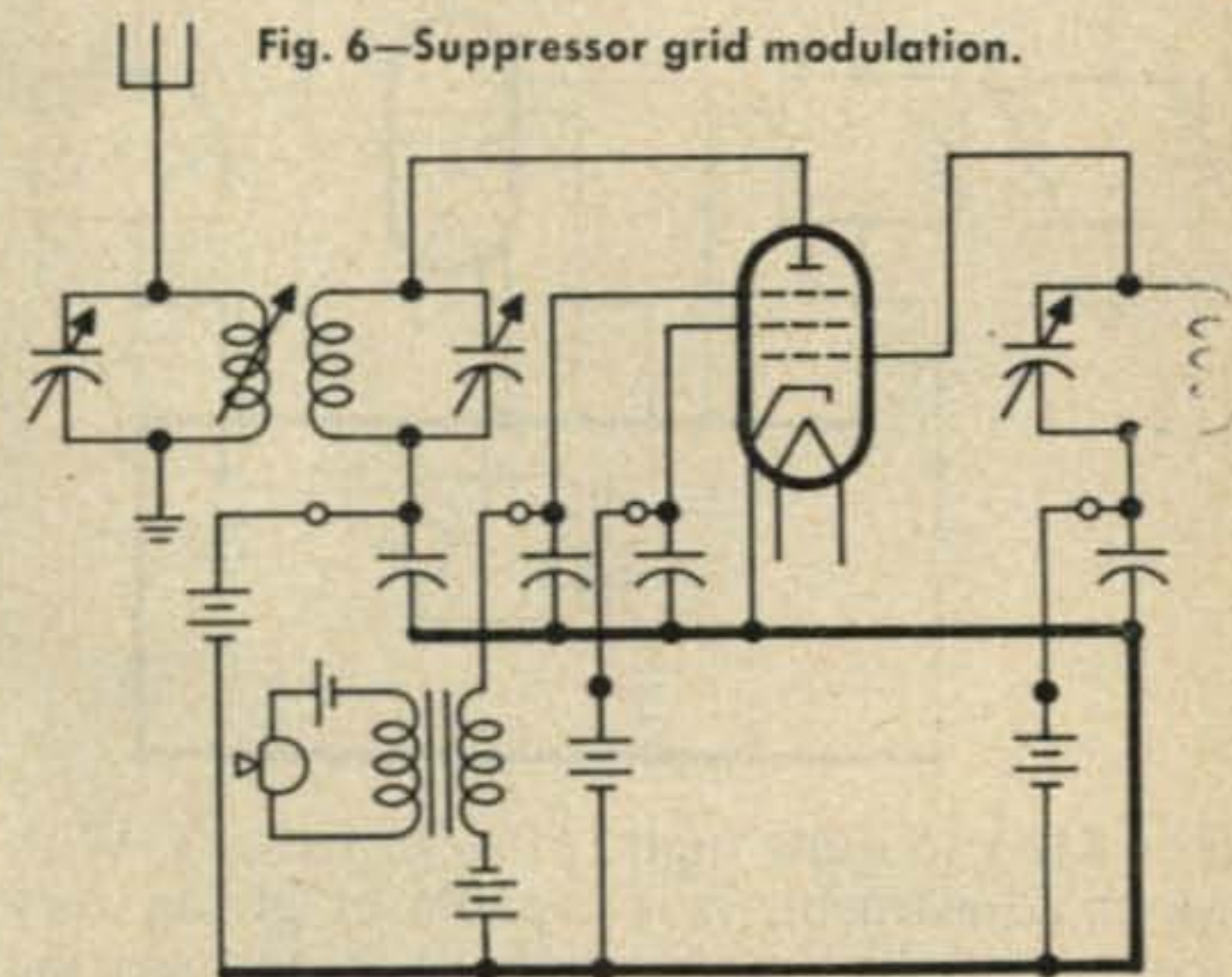

Fig. 6—Suppressor grid modulation.

ative bias, to the suppressor grid of the tube. If the tube has suitable suppressor-grid control characteristics as to permit a high percentage of bias has been set to drop the stage's *rf* output voltage to one-half its maximum value, the applied audio can be used to modulate the tube's output. A high percentage of modulation can be obtained with quite low distortion.

### Screen Modulation

Figure 7 shows positive bias and audio voltage applied in series to the screen grid. Often

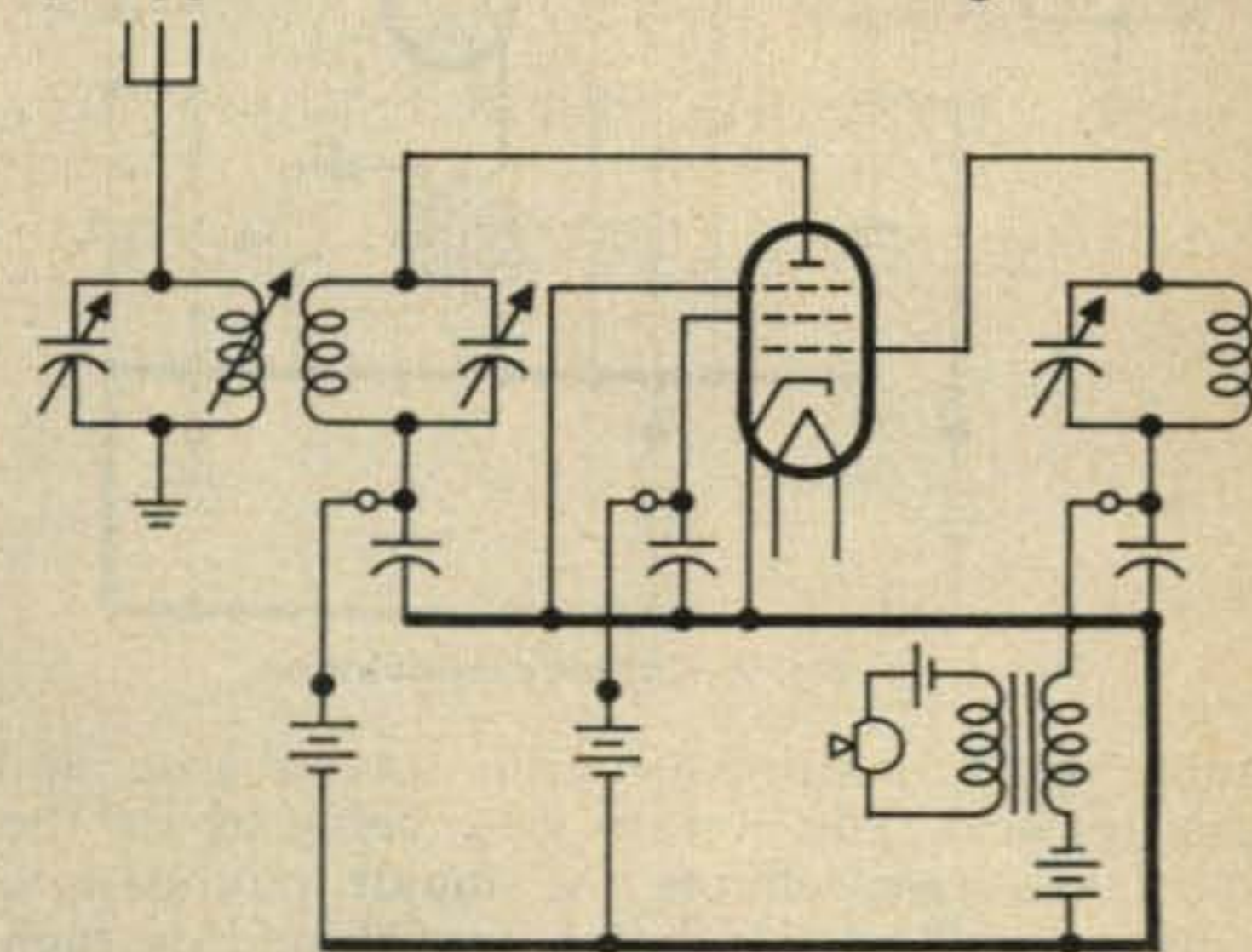

Fig. 7—Screen grid modulation.

this is accomplished in a slightly different manner and called "clamp-tube" modulation; the behavior, however, is identical in either case. Very few tubes have such screen-grid control characteristics as to permit a high percentage of modulation to be accomplished without severe distortion. As in suppressor-grid modulation, the quiescent screen voltage must be approximately half that which would give maximum *rf* output voltage.



## Control-grid Modulation

Control-grid modulation, depicted in fig. 8, has many variations in operating characteristics, ranging all the way from very low efficiency

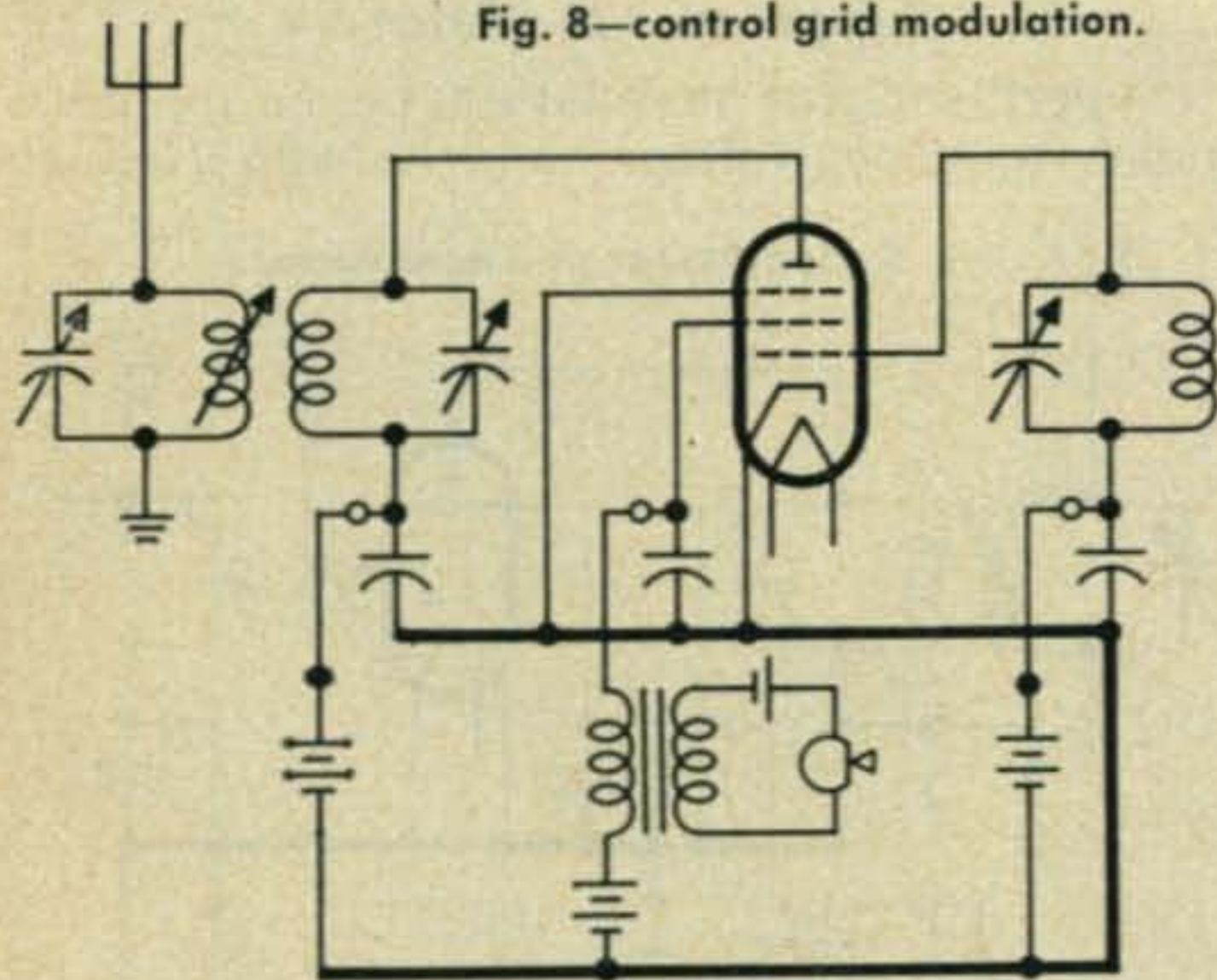

Fig. 8—control grid modulation.

(6 or 8%) to quite high (50% or better). With proper adjustment, it is capable of giving very excellent quality modulation. It is perhaps the most tricky of all to adjust, requiring very precise adjustment of *rf* drive, grid bias, *af* voltage, and plate loading to achieve acceptable quality.

## Cathode Modulation

Cathode modulation, fig. 9, actually involves modulating all the controlling elements of the

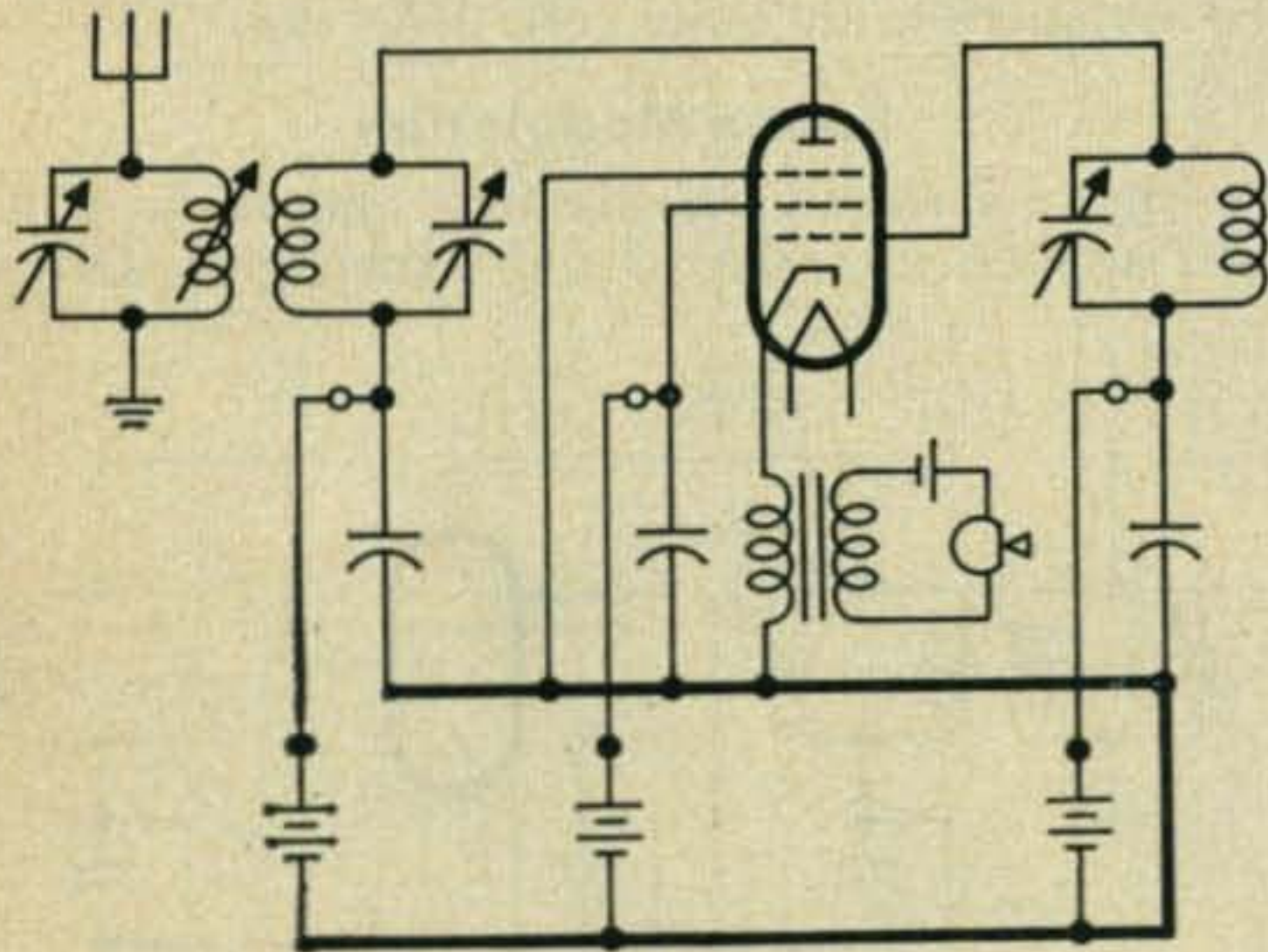

Fig. 9—Cathode modulation.

tube: plate, suppressor grid, screen grid, and control grid. The control grid, being by far the most sensitive, effects the major modulation, with a small portion being contributed by each of the others. Parameters and conditions prerequisite to modulation by control-grid are not compatible with those required for plate modulation; therefore, it is inevitable that distortion must be produced.

## Practical Applications

Antenna and tank modulation, in the simple forms discussed here, have interest only as novelties. One exception, perhaps, is the antenna modulator using a transistor. This has some merit as an attachment to a CW transmitter.

One precaution should be borne in mind: Transistors are better adapted for carrying current than for withstanding voltage; therefore, use a transistor only in a low-potential system. Its use may be safe in a 52, 72, or 300 ohm transmission line but hardly recommended for an end-fed (voltage-fed) half wave antenna.

The series plate modulator and the cathode modulator find little application in current practice. The former is well adapted for use as a pulse modulator, having excellent possibilities in the field of facsimile and television.

Modulators using the control-grid, the screen-grid, the suppressor-grid, or combinations thereof are quite common. They all behave much alike; the choice of which to use being largely determined by the type of tube at hand. Given a tube of proper suppressor-grid control characteristics, suppressor-grid modulation quite possibly has some advantages over the other two types. Normally, the suppressor grid is not called upon to perform any function vital to the tube's performance of its primary duty of converting *dc* power into *rf* power. Control-grid bias and *rf* drive, therefore, can be adjusted to optimum values, as can the screen-grid voltage. In the other two systems, such freedom of choice does not exist. Compromises, therefore, must be made. Such compromises not only reduce efficiency of operation but tend to necessitate very precise (and often tricky) adjustments to obtain the desired status of performance.

All three grid modulators share one common trait: Each must be adjusted (*rf* drive, all biases, and antenna loading) for proper performance at maximum modulation. This suggests that it is best to do all final tuning (the word is used here in its broadest sense) while modulating 100% with a sine wave. If the modulated *rf* envelope, as viewed on an oscilloscope, indicates no distortion under such condition, the operator may be assured of proper performance under normal conditions. If adjustments are made with no (or very little) modulation, it is quite probable that the envelope will flatten on positive-going peaks or hit bottom on negative-going peaks.

Because efficiency modulation devices do not contribute any power toward the generation of *rf* sidebands, many operators feel that they lack "punch". In an effort to remedy this situation, they adopt a method of controlling the amplitude of the transmitted carrier. This serves two purposes: It enables a given tube type to be worked harder, usually at higher plate voltage, and it permits the automatic gain control system on the receiving equipment to create an illusion of greater signal strength. Such gains, illusory and otherwise, are not obtained without a price, however. The price, in this case, is the dynamic fidelity of transmission. No practicable means has been found to enable the carrier to rise in amplitude as rapidly as the initial cycle of a voice-frequency wave. It is inevita-

[Continued on page 128]



# The New Concept In Traffic Networks

Ralph J. Erwin, W5JFW, Trustee  
National Radiotelegraph Society

P. O. Box 2232, Tulsa  
Oklahoma

*Of interest to all CW men as well as enthusiastic traffic handlers is a method of communicating on a twenty four hour basis. Herein is proposed a single National calling frequency which may make this possible.*

**Before we discuss** anything new in the handling of CW traffic, it might be wise to study the aspects of existing traffic systems for a more objective view on the subject.

While networks vary in their specific methods, it can generally be stated that existing CW nets meet at specified times and on specified frequencies, where they then exchange traffic.

Existing networks have basic advantages. They provide the participant with a definite time, frequency and control method for disposing of his traffic. A deeper study of the matter will bring out some of the inherent disadvantages involved in meeting at specified times, on specified frequencies and under conditions which must be 'administered' or 'coordinated.'

## Scheduled Nets

First, consider the circuit which meets weekly. If the net works on Tuesday night, and you happen to receive some traffic on Wednesday (for that net), you have the choice of waiting until your circuit meets again . . . a full week later . . . or joining some other net, or attempting a contact by random CQing.

Perhaps your circuit meets nightly, at a given hour, on a given frequency. In that case, traffic you receive on Wednesday morning has a *possible* outlet that same night but still there is a delay of several hours. So . . . come the appointed hour, you tune your super-het to the net frequency and make the required effort to dispose of your traffic. But . . . what's this? The net has already started. An early bird from Texas is clearing his traffic to a fellow in California, with a Georgia in the side-car. Where does all this leave *you*?

Patience is a virtue. Now's your chance to be virtuous. The Texan now has cleared with California and begins working Georgia. So . . . let's take a trip down to the refrigerator while we're waiting. Hmhmhmhm. That salami looks good,

and a few slices of yesterday's turkey with some mayonnaise and lettuce. One piece of Boston Cream Pie doesn't have a lot of calories — *does it?*

But duty calls! Back to the shack. We still have traffic on hand. And our frequency is still tied up by other people with the same problem. Maybe we could call net control and ask him to take it. But, with Texas and Georgia firmly astride the frequency, we don't dare risk even a sneaky BK.

That salami and turkey combination was *good*. One more trip to the galley won't hurt us. But, for some reason, the XYL hears us pattering down the hall and suspects that we are going forth for a nip of Old Banghead from that fifth on the top shelf of the cabinet.

Back at the shack . . . there's an ominous quiet. Quick, man! The circuit is open. Texas has vacated. Instantly we swing the old bug into action. A quick call to net-control. Hmhmhmhm. No answer. A week later we learn that he was called away from home, just at net time, to fix the main transmitter at the local taxicab headquarters.

But hope is not lost! Suddenly, the heart warming sound of CW chimes in again. CQ CQ CQ. Perhaps net-control is up after all. Yes, the circuit is alive. CQ CQ CQ. Come on, man! Give us your call sign. We have traffic to unload. But, as the minutes tick by, our brief burst of hope fades into the dim realization that one of those rare and elusive butterflies has landed on net frequency. He is Mr. C. Q. Lid, in person. He has a new bug; and what better way of testing it is there than sitting down to a real cool twenty minutes of CQing? Count the minutes. Hold your breath. When this fellow gets off his cloud, he may emit a call sign. At this point, we wish someone had invented a variable-frequency lid-electrocutor.

But our traffic is still on hand . . . staring at us!



It must go! Midnight already. There's only one solution. And we have all the ingredients at hand: envelopes, stamps, and a ball point pen. Quickly the messages are addressed. Now, we'll walk quietly down to the corner mail box, and nobody will ever be the wiser.

"No, Dear! I did *not* sneak out to the Brass Rail—*honest!* I merely went out to mail some radio. . . ." Now, how do you explain to the little lady that sometimes a radiogram can go by mail . . . at midnight.

There we have it, exaggerated but obvious.

### Reasoning

First of all, a circuit which meets only once daily, or weekly, automatically incurs delays of many hours or days in the transfer of traffic. This type of circuit also excludes from its activities those fellows who happen to be unavailable at the particular witching hour involved.

Second, the use of one frequency for the handling of *both* calling and traffic means that the stations standing by are often delayed further in making contact, because of the heavy traffic loading the net during circuit time.

Third, the circuit is often dependent upon a control station which may or may not be present. While a control station may be essential to nets as they now operate, is it really essential that all nets be operated that way? Here we have the question: Is there a better way?

The simple answer is *Yes*. The *National Radiotelegraph Society* now operates an experimental circuit on forty meters . . . a circuit having these advantages:

1. It is not dependent upon any control station, 'administrator,' or 'coordinator' for its operation. Consequently, the presence or absence of any certain station is not the key to the success of the net. It's the *system* that counts!
2. It functions 24 hours a day, seven days a week, without supervision or interruption.
3. It provides for the *simultaneous* exchange of traffic between two, ten, twenty, or a hundred pairs of stations at the same time.
4. It gives the traffic-loaded station an immediate outlet for his outgoing messages. It is the *now* circuit, not the *tomorrow* circuit.
5. Stations exchanging traffic under the *NRS* system do not interfere with other stations wishing to use the circuit for calling and contact purposes.

And what is this system? How does it function? What special equipment is needed and what does it cost? What highly-complicated procedure is used?

The answer is simple. The answer is *simplicity*. No special equipment is needed. Any operator who knows his code and procedure can join the circuit whenever he chooses.

### The Frequency

The entire *NRS* system is based on the single

calling frequency. That frequency is 7150 *kc*, on the border between Novice and General country. *No traffic is handled on 7150 kc.*

Here's the way calls will be handled on 7150 *kc*:

```
CQ CHGO DE W5JFW K
W5JFW DE K9AA C K
K9AA DE W5JFW QSY 7008 KC K
W5JFW DE K9AA R 7008 KC AR
```

Note that both stations transmit the *QSY* frequency, as a double-check. Then, they immediately *vacate* 7150 *kc* and move to the frequency they have selected for the exchange of traffic. Thus, after approximately 30 seconds, 7150 *kc* is again free for other stations to use in making contact.

Though there might be some interference on 7150 *kc* at times, it should be remembered that 7150 *kc* is for *initial* contact only; therefore, perfect conditions on this frequency are not essential. Thus, even if crowded by the accidental drop-in of rag-chewers or foreign broadcast stations, 7150 *kc* can still serve its purpose, so long as two stations can make a simple contact there . . . just long enough to agree on a suitable frequency, *eslewhere* on the band, for the exchange of their traffic.

*National Radiotelegraph Society* has chosen a single calling frequency for the sake of simplicity. The establishment of multiple calling frequencies defeats the purpose of such a system because a multitude of possible frequencies leave the operator little better off than plain random calling.

### The Time

Not only do operators need a frequency, or place, to meet. They also need a time. While 7150 *kc* is intended for use at any and all times, we believe it wise to have certain short and frequent periods during which special attention will be given to the calling frequency. Those times are:

1. Five minutes after each hour.
2. Five minutes after each half hour.

Let us explain how these five minute 'listening' periods work. Suppose you want to make contact with a station in New York. Since the frequency, 7150 *kc*, is already established, the time is the big question. Rather than leave timing to chance, we have set aside the first five minutes of every hour and the first five minutes of every half hour as 'rendezvous time.' Those are the periods during which interested stations should give special attention to 7150 *kc*.

The establishment of contacts between stations is fairly simple. However, the five minute special-period has other distinct advantages. Let us say that you have traffic for Chicago and Tampa. At 1801 you enter the calling frequency and contact a fellow in Chicago. You two then move over to, say, 7005 *kc*, and begin working off the traffic. If you are not finished by 1830, but are *almost* finished, you can ask your Chicago man to *QRX* while you return to 7150 *kc*



and issue a call for Tampa. If Tampa answers, you ask him to move up to 7005 *kc* with you and Chicago, so that he will be on tap the instant you finish your traffic with the Illinois city. There are many variations of this technique, so easily workable that further discussion is not required.

The five minute rendezvous-periods serve not only the traffic station, but also the ham who likes to be of occasional service to home town folks and to other stations. Such amateurs, throughout the country, can monitor 7150 *kc* during the five minute listening periods to see if there is anything for their particular QTH. If not, they can go back to their favorite television program, having missed only the opening commercials. The five minute listening periods have been carefully selected so that they do not interfere with the climax of television programs. The listening periods are frequent enough (twice hourly) to facilitate rapid contact between stations; but they are separated sufficiently to permit the amateur to pursue other interests in the meanwhile.

Here are a few tips on the use of the calling frequency method (7150 *kc*):

1. If you have traffic, make your call brief and make sure that your abbreviations are easily understood. If calling Baltimore, for example:

Bad: CQ BO DE W5CEG

Good: CQ BALTO DE W5CEG

2. In deciding what abbreviations are good, we suggest you use those adopted by the railroads and telegraph company. Our experience has been that local telegraph officials are very cooperative. But we don't recommend that you ask them for a complete list of all their abbreviations at once. Ask for what you need . . . and keep a record of it.
3. If you are available to receive and deliver traffic for a given locality, it is best that you send *nothing* until the stations with traffic on hand have been heard from and have made contact for disposal of their messages. If the band then becomes quiet, if no calls have been issued for your particular locality, and if you still wish to offer your services, use the following type of transmission:  
CQ NRS DE W5ZWT BT TULSA  
BT K  
The above transmission will indicate that you are available to receive and deliver traffic on the *National Radiotelegraph Society* net in the locality you indicate.
4. The calling frequency, 7150 *kc*, can also be used as a convenient means of establishing contact for ordinary rag chews. It is the gathering place for radiotelegraphers, who can make their contacts on 7150 *kc* and then move elsewhere to pound brass.
5. Don't 'chat' on 7150 *kc*. Make your contact and then QSY immediately. Chat elsewhere.

## Concept

The calling frequency idea is not an untried experiment. It is, in fact, the basis of maritime communication throughout the world. Every operator who has been to sea knows that 500 *kc* is 'the frequency.' It is guarded constantly by operators and by auto alarms everywhere on the globe. If a ship needs attention, day or night, all ears are listening for him on 500 *kc*. The seafaring operator knows, too, that all maritime stations, ashore and afloat, will assist him in his efforts to communicate. In the maritime service, certain periods of time are set aside for special attention. Those periods are of three minute duration and begin at 15 and 45 minutes after the hour, every hour of the day and night. Each of these periods is known as an 'International Silent Period' and is observed with special care. We have chosen a similar method of timing because we have seen it work successfully through the years.

Our calling frequency, 7150 *kc*, is not restricted in any way, naturally. All amateur stations are invited to use it in the manner described and to send their comments to us, by radio or by mail. The *National Radiotelegraph Society* operates Amateur Radio K5ZHH in Tulsa and may be addressed at Post Office Box 2232, Tulsa, Oklahoma. ■

## CQ's Propagation Editor Receives Master's Degree

On June 4th, at an impressive ceremony held at College Park, the University of Maryland conferred upon George Jacobs, W3ASK, the degree of Master of Science in Electrical Engineering. As you may have guessed, the title of George's thesis was "Sunspots, and the Solar Influence Upon High Frequency Radio Communications". George received his Bachelor's Degree from Pratt Institute, Brooklyn, in 1949, and he plans to continue his studies towards a PhD. George, an old-timer on the *CQ* staff, has been Propagation Editor since 1951.





# 1 KW SSB Power Supply For 12 Volt

## Mobile Operation

Jo Emmett Jennings, W6EI

970 McLaughlin Ave.  
San Jose, California

*It is not likely that mobile enthusiasts will run out and duplicate this supply. It does, however, effectively illustrate a new design which will undoubtedly foster further thought in power supply circles. Whether mobile or fixed, this Kw plate supply can fit into a shoe box.*

For the past two years we have designed and built a large number of power supplies, generally above the 500 watt rating. There was a great deal to learn from the various results obtained from each supply, especially in regards to miniaturization and efficiency. Several different materials were used for the core of the transformer. Although high grade ferrites worked satisfactorily, and were extremely quiet, they did not give us the desired reduction in space and weight. Winding techniques are simplified when using rectangular cores, but our best designs have utilized .004" strip wound toroids. After completing many of the power supplies and operating them in vehicles, it became evident that the two forms of protection were necessary to insure long, stable operation. The first of course, is not to overload the transistors. They will work beautifully and give long life provided the temperatures are not exceeded. Generally, more power can be obtained from oscillators than described here. However, it was considered wise to make equipment capable of self protection, with a slight sacrifice in maximum power output. Second, transient protection is essential for efficient long life. The circuit operation, described below, is unique and a patent application was made. This explains why it has not been released to the public sooner.

### Discussion Of Basic Oscillator Circuit

If a pushpull inverter is operated with a pair of transistors many circuit variations may be

employed. The basic circuit described here has been used by many firms with success. Two transistors of the types described have a current voltage and wattage limitation, which for the sake of reliability limits the power output for a pair of transistors to approximately 100 watts with 12 volts input. Actually, at 24 volts input one can expect at least 200 and possibly 250 watts output.

Various model transistors are available but the *Delco* DS501 or variations of this model produced reliability. For higher voltages such as 28 volts operation, we used the 2N174 which has a safe voltage capability of 30 volts *dc* input.

Since the continuous output is limited to 100 watts per pair, we have found it possible, for SSB applications, to temporarily exceed these ratings which gives us power capability in excess of those for continuous duty. When only two transistors are used, no real problem exists circuit-wise. As soon as additional transistors are connected in parallel for the purpose of adding increased power output, usually difficulties arise due to (believe it or not), parasitic oscillations as well as circuit unbalance. In some cases, we have been able to isolate two or three in parallel simply by using resistors in series with each base. The best results so far have been obtained when a separate feed-back winding is used for each base. When frequencies are increased at high power, the switching transients become more destructive due to their increased amplitude. Protective devices such as small fixed capacitors from base to ground, give adequate protection

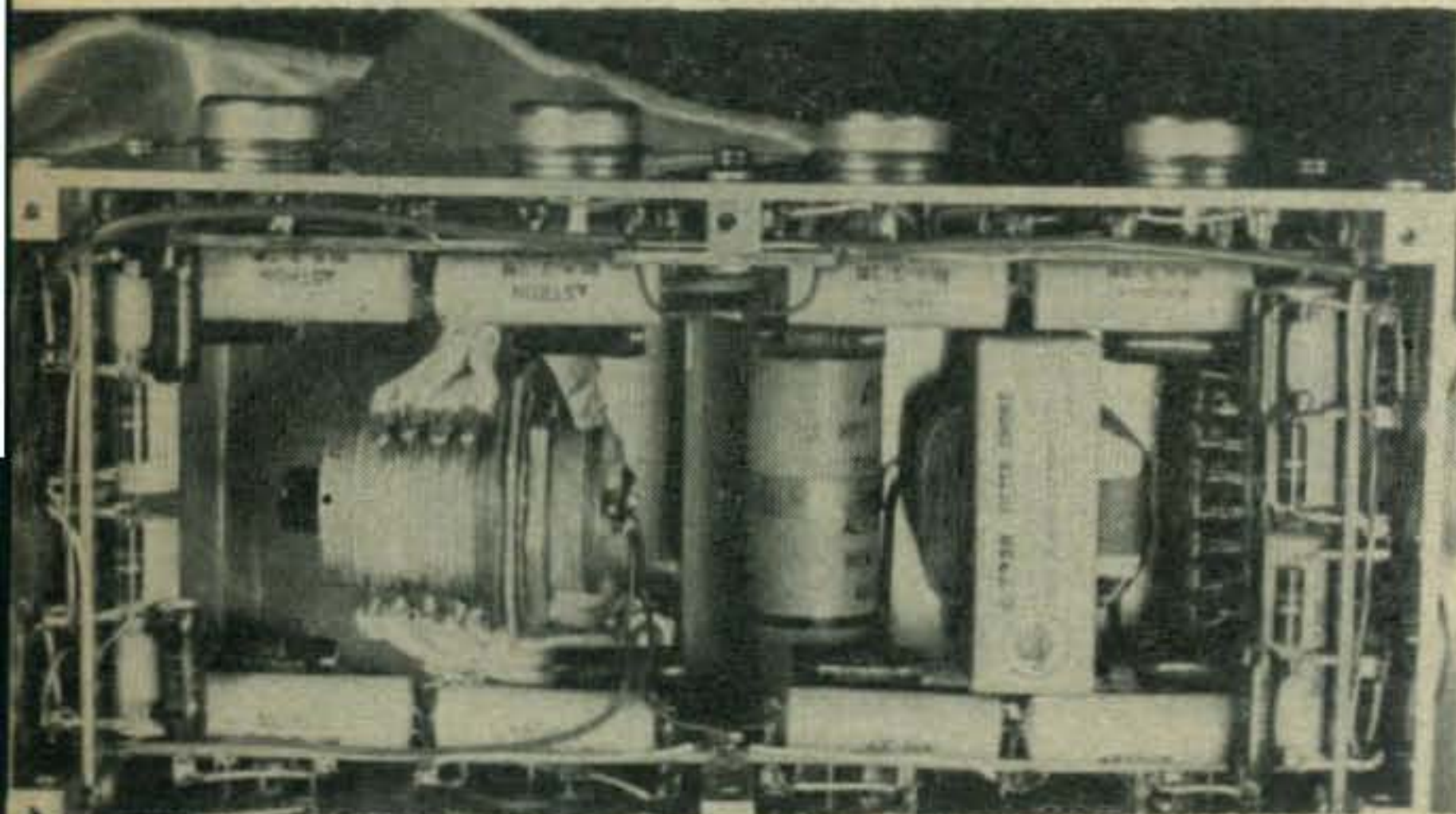

Top view with cover removed showing parts location and sheet metal work. The F6 rectifiers are mounted on an insulated board to the right of the choke. The high power Jennings vacuum switch is mounted above the toroidal transformer and occupies the major portion of the left side of the supply.



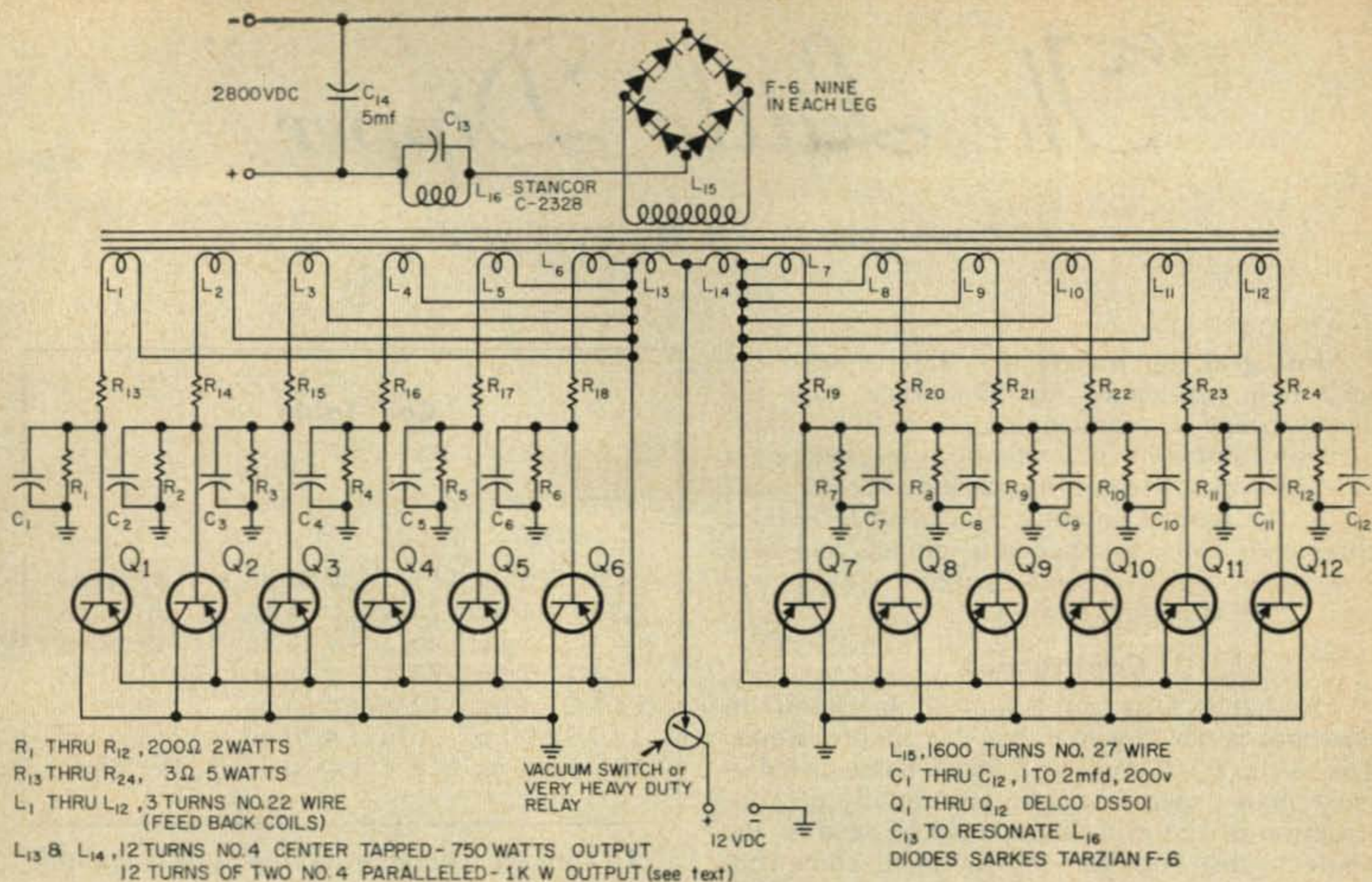

Fig. 1—Schematic of a 1 kw plate supply. The transformer is discussed in the text.

for low power equipment when the rating is at or below the 1 kw level. We have found it necessary to employ 2 mfd capacitors for transient clipping, although Zeners could be used on low power and can more effectively replace other transient suppression methods. Zener diodes are generally omitted due to the cost. In low level power transformers it is possible to wind so as to produce a minimum of transients during normal operations. It is possible, internally or externally, if the circuit is in balance, to produce a very high transient which will destroy a transistor. For that reason we employ transient suppression in one form or another for every circuit from 100 watts up.

### Transformer Design

An interesting point in regard to the primary windings which does not appear evident, but has been proved in practice, is the size of the conductors. Since the inverter basically produces a square wave for each 1/2 cycle, the direct current only flows 1/2 of the time in each winding. Normal experience would dictate that we could keep the conductor size three sizes smaller and still maintain our efficiencies. Unfortunately, this does not work out. If anything, we should make the conductor three sizes larger than the normal amount shown in the handbooks.

An excellent example of this was with the transformer used, the Arnold Engineering #T 6464L-1. This unit has a 1 inch square cross section .004" strip wound core. With a high cur-

rent winding (the primary) of 6 turns on each side of center (2 volts per turn) using #4 glass insulated buss bar or double formvar, we were able to get approximately 750 watts. Simply by paralleling another conductor of the same material, we increased the power output to 1000 watts.

In high efficiency power supplies such as these, the resistance of every circuit is important. Generally speaking, each conductor for the transistor should be as short as possible and preferably of 16 AWG or larger.

### Transformer Construction

When winding toroid transformers, one must remember that the windings must be adequately insulated from ground. We have used *Milar* with excellent results and it must also be remembered that the windings and core must be tight. If they are not, failures will occur at the beginning or at some important time, generally under a heavy power surge. Be sure to secure the windings either by varnish or impregnation with some material to eliminate any movement. The secondary (high voltage) is wound directly over the core which has been insulated. As in all transformers the windings should be as close together as possible and still maintain adequate insulation. In some of the larger toroids we have operated up to 3 volts per turn, which means that a great deal of care must be taken to protect the turns from shorting together as well as the adjacent layers.

[Continued on page 122]



# "The Little Dipper"

Commander Paul H. Lee, USNR, W3JHR

5209 Bangor Drive  
Kensington, Md.

Most grid dip meters that I have seen described in magazines and handbooks have the disadvantage of requiring *ac* power. This limits their usefulness in such situations as checking a beam on top of a tower, or checking out the loading of the mobile antenna. I decided to build a completely self-contained grid dipper, and here it is—*The Little Dipper*—without any power cord "tail" dragging behind.

## Construction

This handy little unit is built in an aluminum box-chassis which is  $8 \times 3 \times 2\frac{3}{4}$  inches in size. This is the *LMB Type 137* Box-Chassis listed in most mail order catalogs. The details of construction of the grid dipper may be seen in the photographs, and may be modified somewhat to suit the parts which the individual builder has available. All components, including the 1.5 volt filament battery and the two *Burgess* Type XX30 45 volt plate supply batteries, are contained in the box. The coils plug into a 5 prong socket in the top of the box. There is plenty of room for everything.

The circuit shown in fig. 1 is quite simple. The only thing to note in the triode connected 1U4 Hartley circuit is that the filament of the tube must, of necessity, be grounded, and the hot ends of the coil go to the plate and grid. This means that the rotor of the tuning capacitor must be insulated from ground, but this is no problem, for the APC-type capacitor that we used came that way.

The Little Dipper "Exposed". For stability, the three batteries are mounted at the bottom. The 1U4 tube shield can be seen just under the RF choke. An odd length of  $2 \times 4$  drilled, and painted makes a neat holder for the coils.

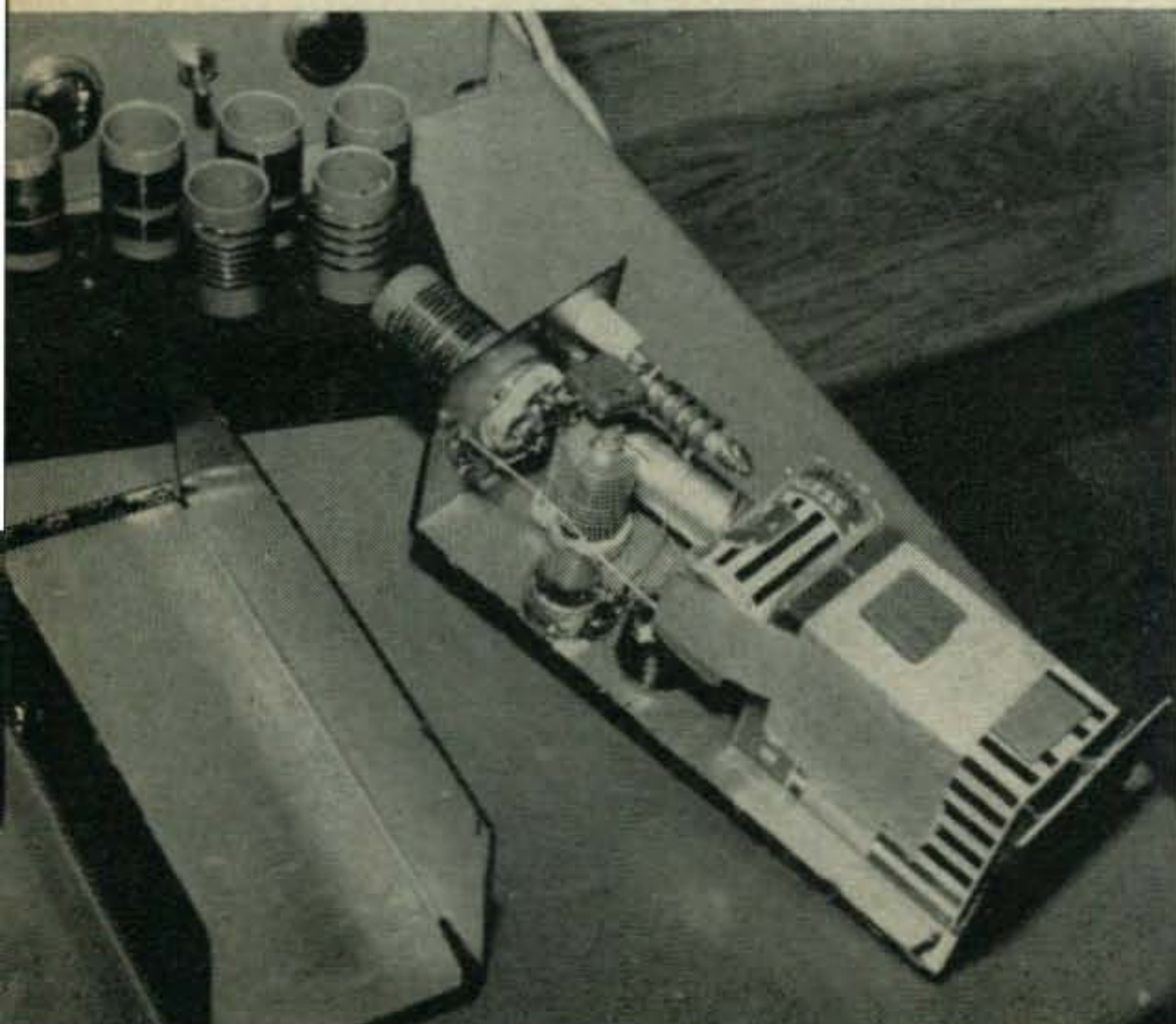

## Coil Table

Frequency	Turns	Wire Size	Tap
1.5- 2.6 mc	115	#36 d.s.c.	45 turns
2.5- 4.4 mc	75	#28 en	30 turns
4.3- 7.5 mc	40	#22 en	15 turns
7.4-12.7 mc	21	#22 en	7 turns
12.5-22.0 mc	12	#20 en	4 turns
21.0-38.0 mc	6 $\frac{3}{4}$	#20 en	3 turns
36.0-65.0 mc	3 $\frac{1}{2}$	#20 en	1 $\frac{1}{2}$ turns

All coils are wound on *Millen* Type No. 45005 5 prong forms, and where necessary the windings are spaced to occupy a winding length of  $1\frac{1}{4}$  inches on the form. The coils were adjusted slightly in number of turns to give the desired frequency ranges, and then were cemented in position with *Duco* cement.

The tube socket for the 1U4 is mounted inside the box on a small aluminum bracket, with the  
[Continued on page 123]

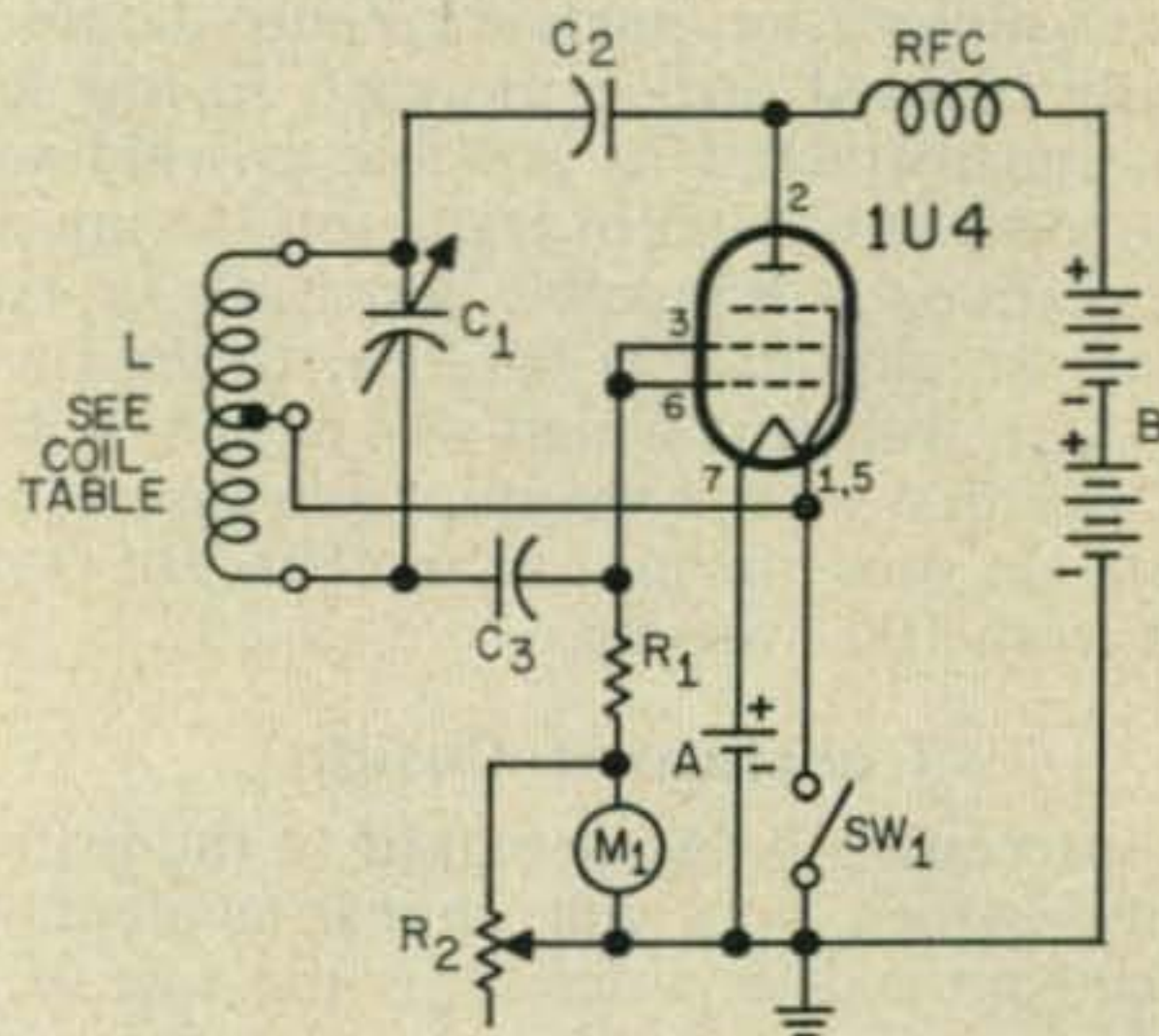

## Parts List

- C<sub>1</sub> 50 mmfd midget APC variable
- C<sub>2</sub> 1500 mmfd 500 volt mica
- C<sub>3</sub> 100 mmfd 500 volt mica
- R<sub>1</sub> 25K  $\times$  W
- R<sub>2</sub> 500 ohm IRC Type Q potentiometer
- M<sub>1</sub> 0-200 micro ampere 1" diameter meter
- RFC 2.5 mh National R-100 rf choke
- SW<sub>1</sub> SPST toggle switch
- A 1.5 volt No. 2 flashlight cell
- B Two Burgess Type XX30 45 volt batteries in series

Fig. 1—Schematic of the "Little Dipper", a one tube battery operated grid dipper, useful from 1.5 to 65.0 megacycles.



# A Simple Method of Determining Transformer Impedances

Richard A. Genaille, K4ZGM

19 Quarterstaff Road  
Winston-Salem, N. C.

There are many times when experimenters and hams have had to fall back upon the junk box as a source to satisfy the need for a particular audio transformer and have come up with an inter-stage audio, line-to-grid, microphone or other transformer for which, due to age or lack of markings, electrical characteristics are not available. This is particularly true in the case of transformers removed from surplus military equipment where one knows the type of transformer that he has removed and not much else. Since impedance matching is usually an important factor in the use of transformers of the audio type, here is a simple method of determining, with a fair degree of accuracy, what the reflected impedances of the primary or secondary windings of an audio type transformer are under normal operating conditions.

## Determining Load

The circuit shown in fig. 1 was used by the author to determine the impedance characteristics of a line-to-grid transformer for which information was not readily available. The author wished to determine what load resistance on grid winding of the transformer would result in an impedance reflection of 500 ohms from the primary or line side of the transformer over the normal voice frequency range. In this case, using the circuit as shown, it was found that a load of 100,000 ohms on the secondary resulted in a fairly constant reflected impedance to the line of 500 ohms over the normal speech range.

The transformer satisfied the author's need and performed very satisfactorily in his equipment.

As shown in fig. 1, the audio source is connected across a voltage divider made up of the primary winding of the transformer and the potentiometer  $R$ . The resistance value of this potentiometer should be close to but somewhat higher than the anticipated impedance value of the transformer winding in the voltage divider. For example, if the transformer under test is a line-to-grid transformer it is safe to assume that the impedance reflected to the line will be under 1000 ohms; therefore, a 1000 ohm potentiometer could be conveniently used at  $R$ . If the transformer under test is a plate-to-voice coil output transformer it is a fairly safe bet that the reflected primary impedance, when the transformer is loaded with a resistance equivalent in value to a voice coil or the voice coil itself, will be between 1000 to 15,000 ohms. In this case a 20,000 ohm potentiometer would work very well. Using a value of  $R$  that is close to the impedance of the winding under test will result in greater ease of adjustment of the potentiometer while performing the check.

## Test Procedure

The procedure for measuring transformer winding impedances is quite simple. The transformer winding which is not in the divider circuit should be terminated with a resistance of suitable value and the winding to be measured should be connected as shown in fig. 1. With a suitable *ac* voltmeter (preferably a *vtvm*) connected between points  $A$  and  $C$ , the output of the audio signal generator should be increased until a useable reading is obtained on the meter. The meter reading of the audio voltage across the transformer winding should be recorded. The meter clip lead should be removed from point  $A$  and connected to point  $B$  and a meter reading taken. If the impedance of the winding under test and the resistance of the potentiometer are exactly the same then the voltage readings taken between points  $A-C$  and  $B-C$  will be equal. Assuming that you are not lucky enough to have this situation exist at the first check, adjust potentiometer  $R$  until the voltage between points  $A-C$  and  $B-C$  are equal. You may have to increase the audio signal generator output to maintain a useable reading on the

[Continued on page 128]

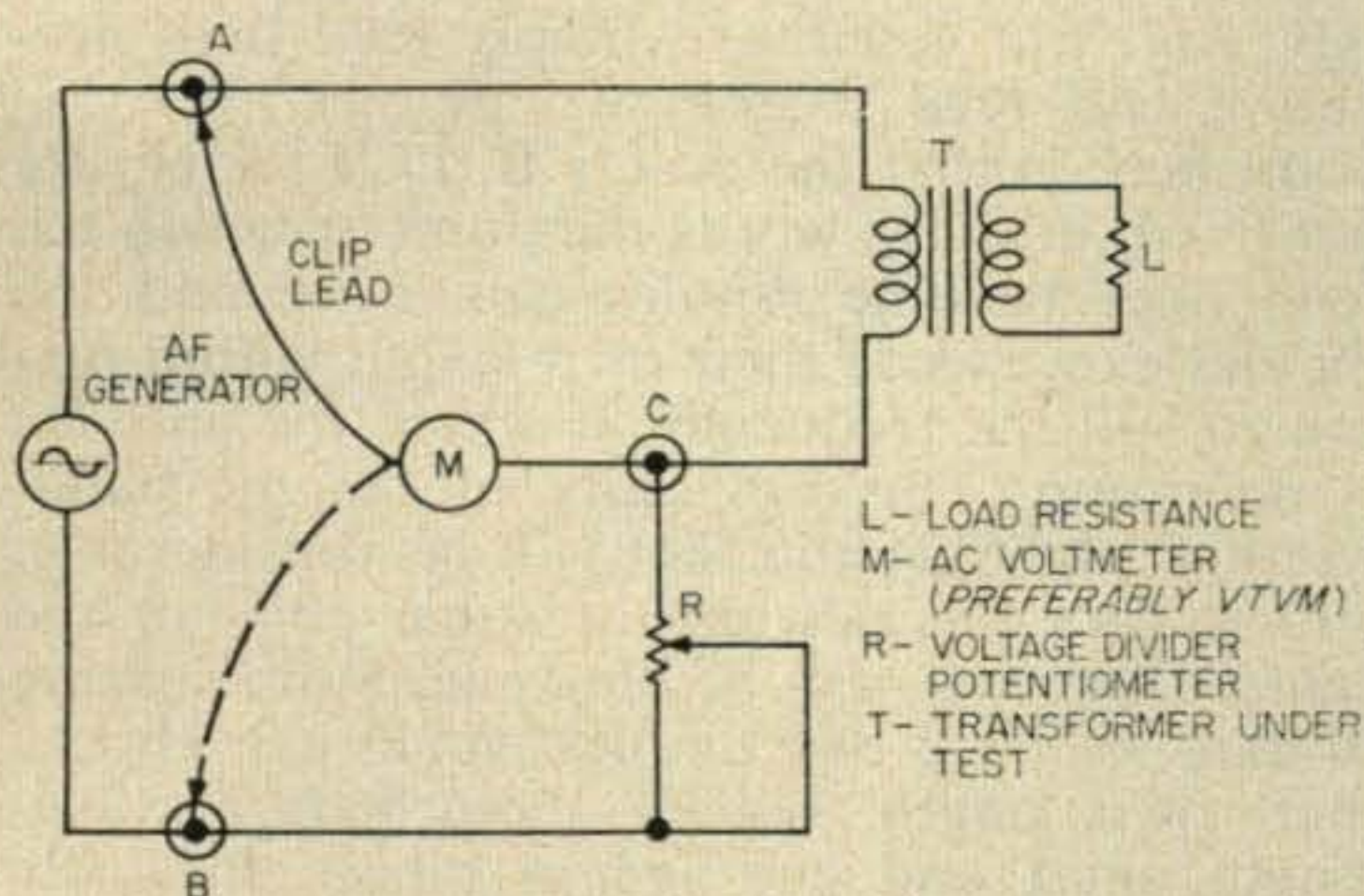

Fig. 1—Schematic of a voltage divider method of determining transformer impedances. See text for a description of  $L$  and  $R$ .



# The Skeleton Slot Antenna

B. Sykes, G2HCG

41 Booth Lane North  
Northampton  
England

The Skeleton Slot was born, as far as is known, some 7 years ago when the writer in an attempt to get a quart out of a pint pot decided to find out just how much metal was necessary around a normal Slot type of Antenna. A standard test set up was organized on 150 mc using as a test radiator a slot cut in a large sheet of 18 gauge metal. By the time the floor was covered in long strips of metal it soon became apparent that the books were correct and at least a quarter wavelength of metal was indeed necessary around the slot. However, when the point was reached where serious loss of efficiency occurred if any more metal was removed from the outside of the sheet, the idea was conceived of removing metal from the inside, i.e. making the slot wider. This immediately produced results and eventually a radiator consisting of  $\frac{3}{4}$ " wide strip some  $\frac{5}{8}$  wavelength long and  $\frac{1}{3}$  this length in width, was found to be giving the same performance as the original narrow slot in a more than cumbersome sheet of metal. The Skeleton Slot had arrived and its characteristics were indeed identical to those of a normal slot; polar diagram, feed impedance and power gain were identical and horizontally polarized waves were radiated from a vertical antenna.

## Basic Theory

The problem to be solved now was why? The infant was born and yelling lustily, but what made it tick? Obviously operation could not be the same as that of a normal slot, normal design procedures had been reversed, and to make the most use of the Skeleton Slot it was essential to know how it worked.

Many tests and measurements were carried out under controlled conditions and a mass of

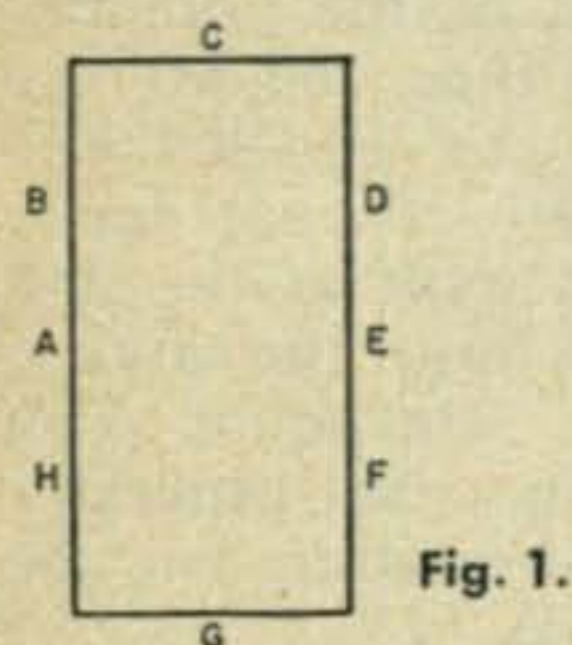

Fig. 1.

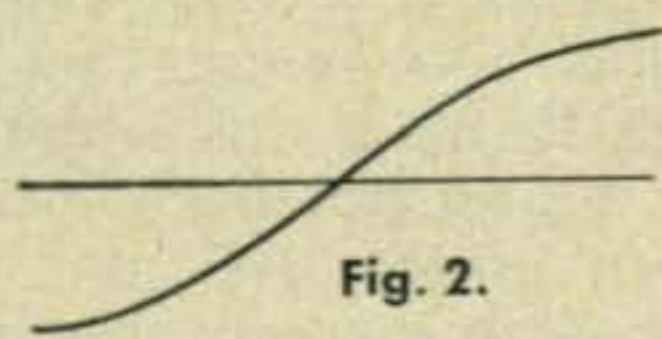

Fig. 2.

experimental data was accumulated together with quite a lot of theories. Much sooner than was anticipated, one of these theories fitted the facts and reference to fig. 1 will make the following simplified explanation clear.

The theory of antennas, dealing as it must with very high frequency alternating current is normally a very complicated mathematical subject and any simplification to bring things down to earth must lead to inaccuracies and approximations, it is hoped that the more knowledgeable readers will forgive the agriculture.

A reasonable idea of what goes on can be very easily realized by ignoring all the *ac* theory and looking at the thing from a *dc* point of view. This can only be achieved however by stopping time and looking at the voltages which appear on the antenna at one particular instant. Assuming therefore that all clocks are stopped and the voltages on the antenna are *dc* we can now measure them with a voltmeter. Figure 1 is a drawing of the Skeleton Slot and starting at one feed point A we find a fairly LOW negative voltage which rises slowly as we move toward B then falls to zero at C and increases positively to D and then gradually falls again to E. The same thing exactly would happen if we moved from A to H-G-F-E. Plotting the voltage from B through C to D in graph form as shown in fig. 2, it is immediately apparent that the waveform is identical to that on a half wave dipole, in fact the sections BCD and HGF are bent half wave dipoles and the sections AB, AH, ED, & EF are simply feed lines providing end feed to the two dipoles. The big point here is that the points B, D, F, & H, are not fixed, in other words the point at which the feed lines become dipoles can move and the dipoles can choose their own length within reason to suit the frequency at which the antenna is operating. This obviously means the bandwidth of the Skeleton Slot will be considerable, and in fact a bandwidth of some 30% of the centre frequency can be obtained. Summarizing to date we have two dipoles which can choose their own length, spaced about half a wavelength apart and end fed in phase. Basically therefore the Skeleton Slot is very similar to a "LAZY H", and has a figure 8 polar diagram in both planes.

The combination of end fed broad band di-



poles is however very interesting when consideration is given to the idea of improving forward gain by adding parasitic elements to produce a stacked yagi. It is well known that the addition of parasitic elements to a centre fed dipole results in a drop in feed impedance necessitating the use of a folded dipole, T Match, Delta Match etc., to raise the feed impedance to a usable value. However the effect of parasitic elements on the feed impedance of an end fed dipole is somewhat different in that there is negligible change in feed resistance but considerable change in reactance. The word reactance starts our clocks again but reactance simply means tuning, which applied to an aerial means length. The addition of parasitic elements to an end fed dipole means that the length of the dipole must therefore be altered but in the Skeleton Slot the dipoles can choose their own length therefore the addition of parasitic elements should have little effect on feed impedance. In practice this is found to be true and it is quite possible to set up a Skeleton Slot with a standing wave ratio of say 1.2:1 and then add reflectors and directors to make it into an 8 over 8 Yagi and still find the standing wave ratio 1.2:1. Anyone who has designed or even tuned up a multi element stacked Yagi will appreciate the simplicity of feed which the Skeleton Slot gives. But this is not all of the picture. A normal centre fed Yagi is quite a sharply tuned system and bandwidths of more than some 3% of centre frequency are not possible without compromise and sacrifice of gain, in addition to which the very sharpness of tuning makes the Yagi sensitive to proximity to nearby objects, icing, rain, etc. The Skeleton Slot fed Yagi on the other hand has considerable broad band properties and a bandwidth of some 8% of centre frequency is easily attainable without compromise in element lengths. This bandwidth is more than adequate to cover the whole of any Amateur band without loss of gain at the edges, in addition to which, proximity to nearby objects, rain, icing, etc., even installation indoors will not affect the properties of the antenna.

### Feed Impedance

The feed point impedance across A and E depends on the size of the Skeleton Slot, the length to diameter ratio of the material used,

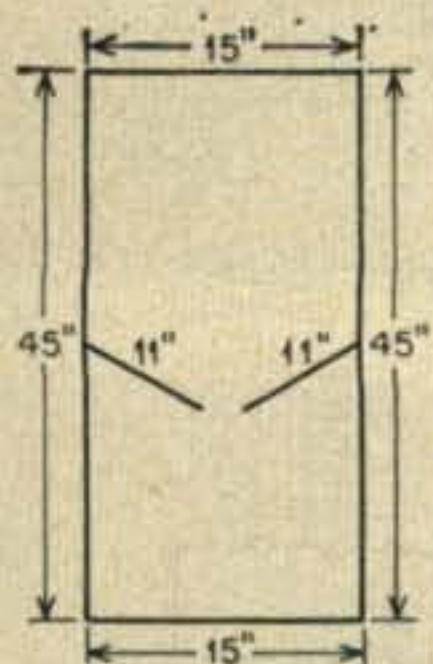

Fig. 3.



Fig. 4.

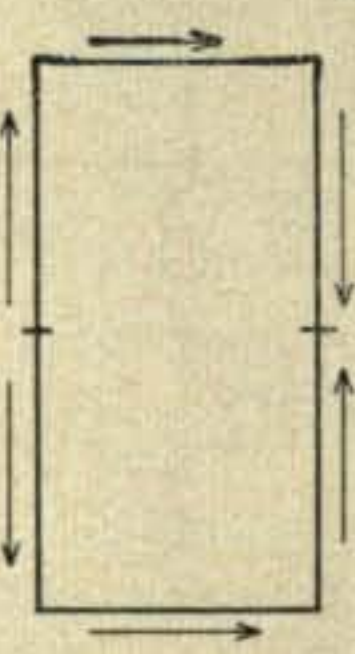

Fig. 5.

and the length to width ratio of the Skeleton Slot. In addition the feed impedance may be varied by the use of DELTA matching sections as shown in fig. 3. The number of variables here produces a sheaf of mathematics as large as this book and it's no good stopping clocks on this one. Figures 3 & 4 show the dimensions of a Skeleton Slot constructed from  $\frac{3}{8}$ " tubing for 2 metres with a feed impedance of 75 ohms at fig. 3 and 210 ohms at fig. 4. The broadband characteristics of the antenna make it reasonably possible to scale these sizes by simple proportion to other frequencies but remember *all* dimensions must be scaled including the size of tubing or rod in construction. Usual lengths and spacings of reflectors and directors may be added to the basic Skeleton Slot with negligible effect on feed impedance.

### Construction

Referring again to the simplified description of the method of operation of the Skeleton Slot we notice that when measuring the voltage around the antenna the voltage at points C & G fig. 1 is zero. There is no point in providing insulation at a point of zero voltage and therefore all metal construction may be used with the Skeleton Slot fixed to metal booms at the centre of the shorter sides and any other elements similarly fixed at their centre to these booms.

### Performance

Since Skeleton Slot consists as it does of two bent dipoles, it may be thought that performance would be considerably inferior to that of two normal dipoles. However this is not so because radiation is a function of current and maximum current occurs at the centre of a dipole—(there can be none at the ends since there is nowhere for it to flow!). The end sections contribute little to the radiation and are only there to make the dipole resonate. In fact the Skeleton Slot has a gain of 3.8 db over a dipole and two stacked dipoles show 4 db, the loss therefore is negligible.

A further thought about the Skeleton Slot may be that there will be considerable radiation from the long sides giving an amount of vertical polarization when the antenna is mounted for horizontal polarization and vice versa. Reference to fig. 5 which shows the current flow in a Skeleton Slot, indicates that while the current flow in the short dipole sections is in the same direction and therefore adds, that in the longer feed sections is in opposition and radiation from these sections is cancelled.

### Use On The Amateur Bands

Skeleton Slot antennas have been used on all bands from 20 meters to 20 cms but in the in-  
[Continued on page 122]



# DX-100 VOX

Lyn R. Kennedy, K5QWB

2705 Whitewood Dr.  
Dallas 33, Texas

*A simple modification to a popular piece of amateur equipment. The addition of a voice operated break in system should improve the operating efficiency of the Heath DX 100.*

**This article is intended** for the experimenter and builder who needs a voice control to complete his station. Although this unit was designed for the DX-100 transmitter, it can be adapted to other types.

After deciding that a voice control would be useful, I looked through back copies of radio magazines for circuits. But these circuits used tubes or special parts which were not available from my junk box. This was to be a very low-cost project.

## Design

Obviously, it would be necessary to design my own. So, I set out to build a voice control to fit these specifications:

- (1) The parts must come from my junk box but be similar to commercially available parts for replacement.
- (2) It should operate, if possible, on both Phone and CW.
- (3) It should connect to the existing push-to-talk circuit.
- (4) It should not distort the excellent audio of the DX-100.

These ideas were also considered:

- (1) Power might come from the transmitter power supply. It operates continuously anyway.
- (2) If the unit could be made small enough, it could be mounted inside the transmitter cabinet.
- (3) Adjustments might be eliminated for simplicity.
- (4) Audio at high level could be supplied by the transmitter pre-amp.

The operation of this control is based on a resistance-capacitance network R4, C1, and RY1 in fig. 1. The resistance of the relay coil plus R3 totals about 10,000 ohms. B plus is supplied to one side of the circuit by the low voltage power supply. When the other side is grounded, the relay operates and the capacitor charges. Removing the ground allows the capacitor to discharge through RY1 delaying its release. Notice that R4 must have enough re-

sistance so that its current is below hold-in current for the relay.

To operate the relay on CW, a ground is provided through R5 and the key. Resistor R5 limits the current through the key and could be eliminated if desired.

On Phone, a 12AU7 is connected between the relay and ground with the plates and cathodes in parallel. The grids are connected in push-pull to the audio driver transformer through isolating resistors. The bias for the 1625's also cuts off the 12AU7. Audio from the driver causes the 12AU7 to conduct twice each cycle which supplies sufficient current for the relay. Obviously, additional rectifiers and capacitors at the grids could improve performance but these were neither available nor absolutely necessary.

## Controls

At this point, I believe that I should justify the lack of controls. Usually a voice control has a gain or sensitivity control and a delay control.

I eliminated the sensitivity control on the basis that it could be preset at a certain modulation percentage which in turn could be controlled by the transmitter gain control. On CW,

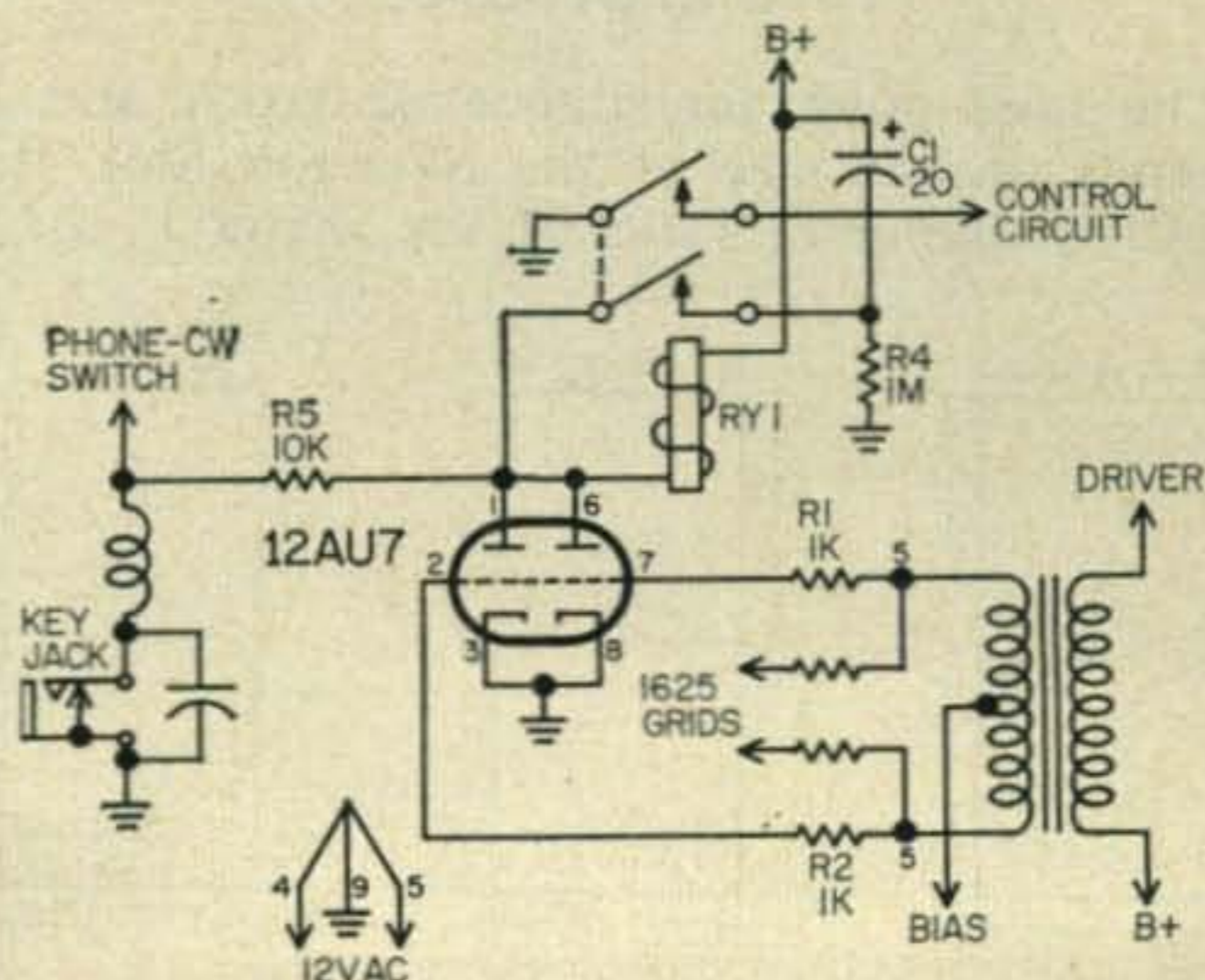

Fig.1—VOX circuit added to the DX-100.



closing the key would activate the relay and no control is needed.

The delay control was not included since it need only hold between words and beyond this time there is a period over which it could vary without bad effects. Besides, I had no place to mount these controls.

### Construction

In considering building the unit, I found that all of the parts could fit under the chassis of the DX-100 in any one of several places. Since the power supply and audio connections would be made just below the 1625's, the unit was mounted on the chassis divider with the tube and relay as shown in the photograph. The mounting for the tube is illustrated in fig. 2 and is placed so the tube is horizontal with the top toward the rear of the chassis.

The relay is mounted by the same screws which hold the tube so the screw holes on these parts should match. The exact location depends on the relay used.

The connections to the transmitter are as follows: The B plus is connected to pin 5 on the low-voltage rectifier socket and the ground may be connected to the ground lug holding the 1625 screen bypass capacitor. The audio connections go to pin 5 on each of the 1625 sockets. This is the junction of the audio driver transformer lead and the 1625 grid resistor. The connection to the key goes to the CW-FONE switch (Pin 9). Notice that this connection must be made between the switch and the key jack or the section of the plate switch which grounds the *rf* stages would also ground the voice control and it would not release. This means that the key must be plugged in and opened for proper Phone operation.

The relay control contacts go to the push-to-talk circuit, if you have one, or may be arranged in any way the builder desires. However, some means should be provided to disconnect the voice control while tuning the transmitter.

The filament of the 12AU7 is connected to 12 volts *ac* on one of the 1625 sockets.

To facilitate construction, wires were connected to the 12AU7 socket before it was placed in position.

There is one unused terminal on one of the

1625 sockets and one on the rectifier socket which may be used for tie points.

The component values shown in the diagrams will probably work on any DX-100 but if adjustments are necessary, C1 controls delay and R3 affects sensitivity. However, adjustment of the relay contacts is preferred for sensitivity since R3 also affects delay.

### Results

After finding a clear spot on 80 meters, I tuned up the transmitter, set the audio gain control, and spoke into the microphone, it worked! So I tried the key. It worked, too! Then I zeroed in on a QSO, hollered "break," and began to realize the operating ease that voice control provided. Quick reports from these stations indicated that the control was working perfectly. Despite the fact that the antenna and push-to-talk relays had to close, no one missed a word I said.

This device is ideal for fast round-table QSO's, but it has two other important advantages. To call "CQ," you simply repeat "CQ" five times, sign twice, and listen a short time for a reply, then repeat. You get the first station to answer which often is DX that would ordinarily be lost under closer stations. None of those long-winded CQ's. Secondly, in answering a station there is no time lost reaching for (or hunting for) the switch. Simply start talking or press the key.

Of course this article would not be complete without mentioning the few disadvantages. There is no anti-trip provided. This can be remedied by wearing the cans, placing the speaker away from the mike (mine is under the table), using a directional mike, or using a mike which is not sensitive beyond several inches. The audio gain control should be turned down while operating CW to prevent audio tripping. At times it may be necessary to override the voice control but this can be accomplished by closing the key.

However, the low cost and simplicity seem to out-weigh these disadvantages. So try it. Lean back in your chair and enjoy having your own voice control. ■

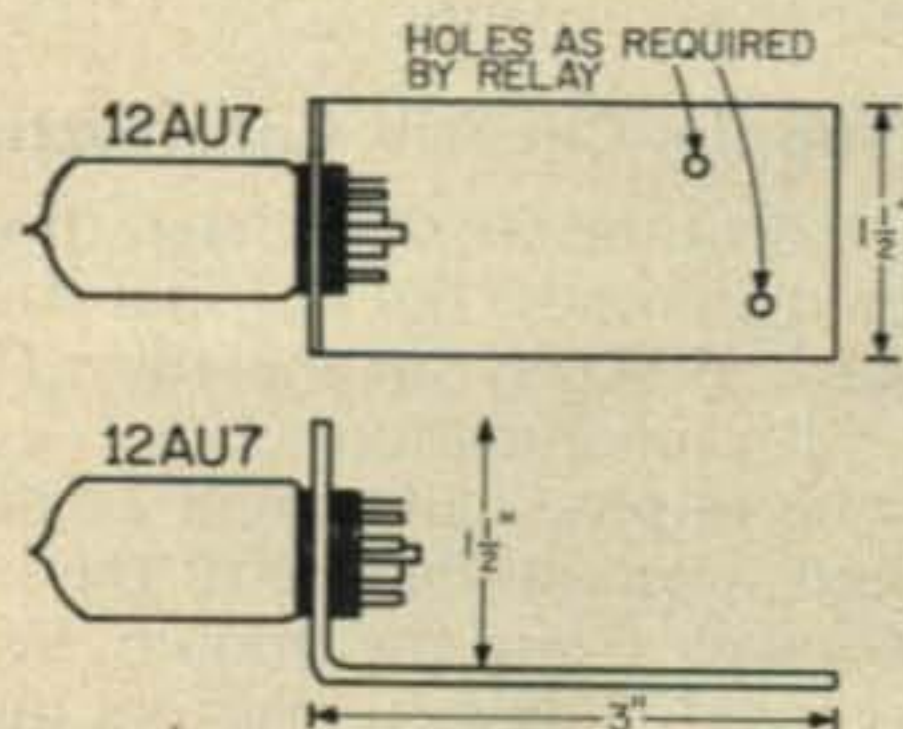
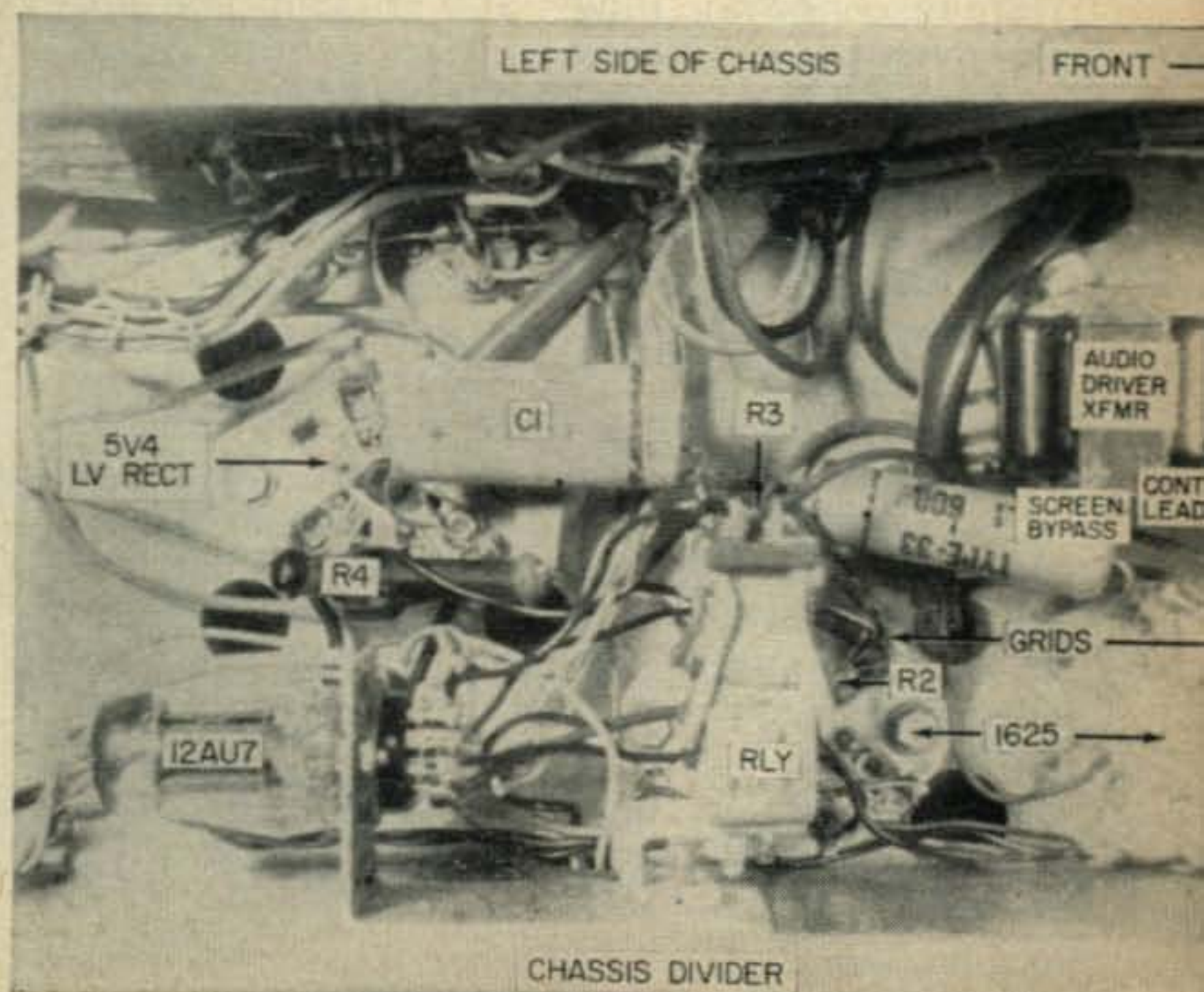
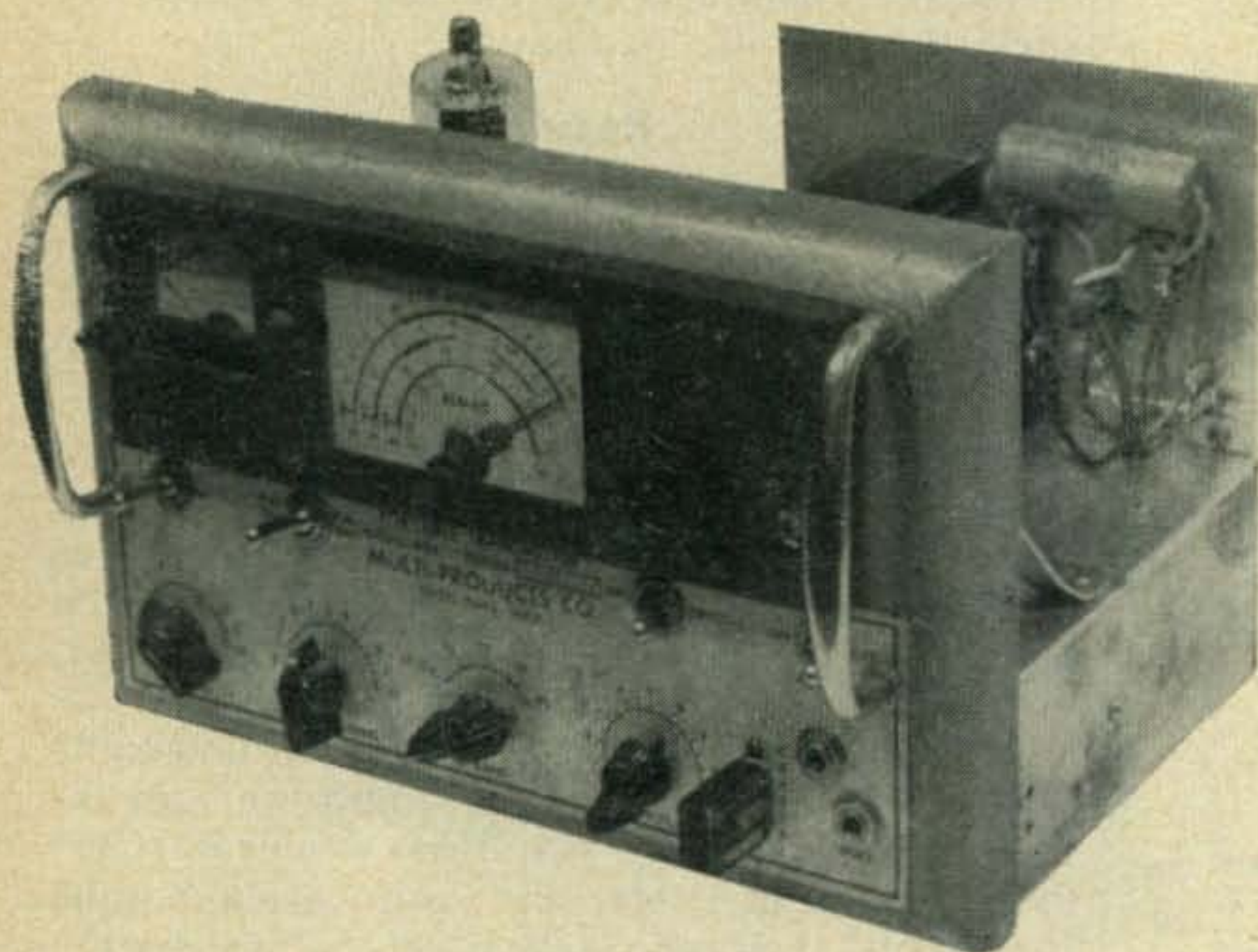

Fig. 2—12AU7 mounting bracket details.





# The Elmac A54 as a Mobile Hybrid



**Albert B. Allen, W8WA**

14908 Northlawn Ave.  
Detroit 38, Michigan

*A transistorized power supply  
and modulator for the AF 54  
Mobile Transmitter.*

During the 40 years that I have been an amateur, active in many phases of its development, I have yet to find any type of operation more interesting than that of Amateur Mobile Communication. While this is especially true during vacation periods and week-end trips, it also is a pleasure during the daily jaunt to and from work, a distance of some 18 miles. However, Mobiling can also be a real pain in the neck and a real headache at times. Not mobile operation as such, but the effects caused by the associated equipment; such as the number of times one runs his battery down by excessive use of the transmitter with insufficient charging rate from the car generator; blowing high-amp fuses on a trip and no more spares; relays sticking while the operator is at work and at the end of the day in a hurry to get home only to find that the battery is absolutely flat; burning up (actually disintegrating) 50 amp relay contacts; salt water getting into contacts and ruining connector plugs; and sticking and arcing dynamotor brushes, only to mention a few.

Such has been some of our experiences. Then one day after the last brush-sticking episode during the extreme cold weather, we were bemoaning our plight to a brother ham who suggested we might overcome some of these problems by the use of a transistor power supply. As a matter of fact, we had been considering just such a thing for some time, but now we really were sold on going ahead with the project. However, before we had barely gotten started, this same ham came up with the brilliant suggestion that we go a little farther and include a transistor modulator. After due consideration we almost decided that this was really the thing to do.

Since we already had our old faithful Elmac A54 installed in the car, we wanted to continue to use it but the high voltage current requirement would be a little more than most transistor supplies readily put out. A pair of 5881 modulators, two speech stages, three *rf* stages plus an 807 final requires somewhat more than 200 mils at 550 or 600 volts. We could compromise and run lower plate voltage at higher current but we were not in the mood to compromise, so—it had to be transistor modulators too.

Furthermore, the combination as described below reduces the battery current drain to between one half and two thirds of that originally required with a dynamotor and tube modulators. And that, of course, means less gasoline consumption.

Delco PNP type 2N278 transistors, now known as DS501, were selected for both applications because of their reliability and their high power output. The power supply transistors with their grounded collectors need no insulation from their heat sync, but those in the modulator must be insulated by means of mica washers which may be obtained from the manufacturer, as can the cooling fins, mentioned later, for use in the power supply.

## Power Supply Chassis Construction

Well, in a short time we completed the power supply designed along the lines of that described by Robert Karl, W8QFH, in the June 1958 issue of *QST*, with modifications. It was essential that the unit be as physically small as possible, in order to find space inside one of the modern automobiles away from the motor heat. As most of you already know, transistors must operate at a moderate temperature, therefore it is



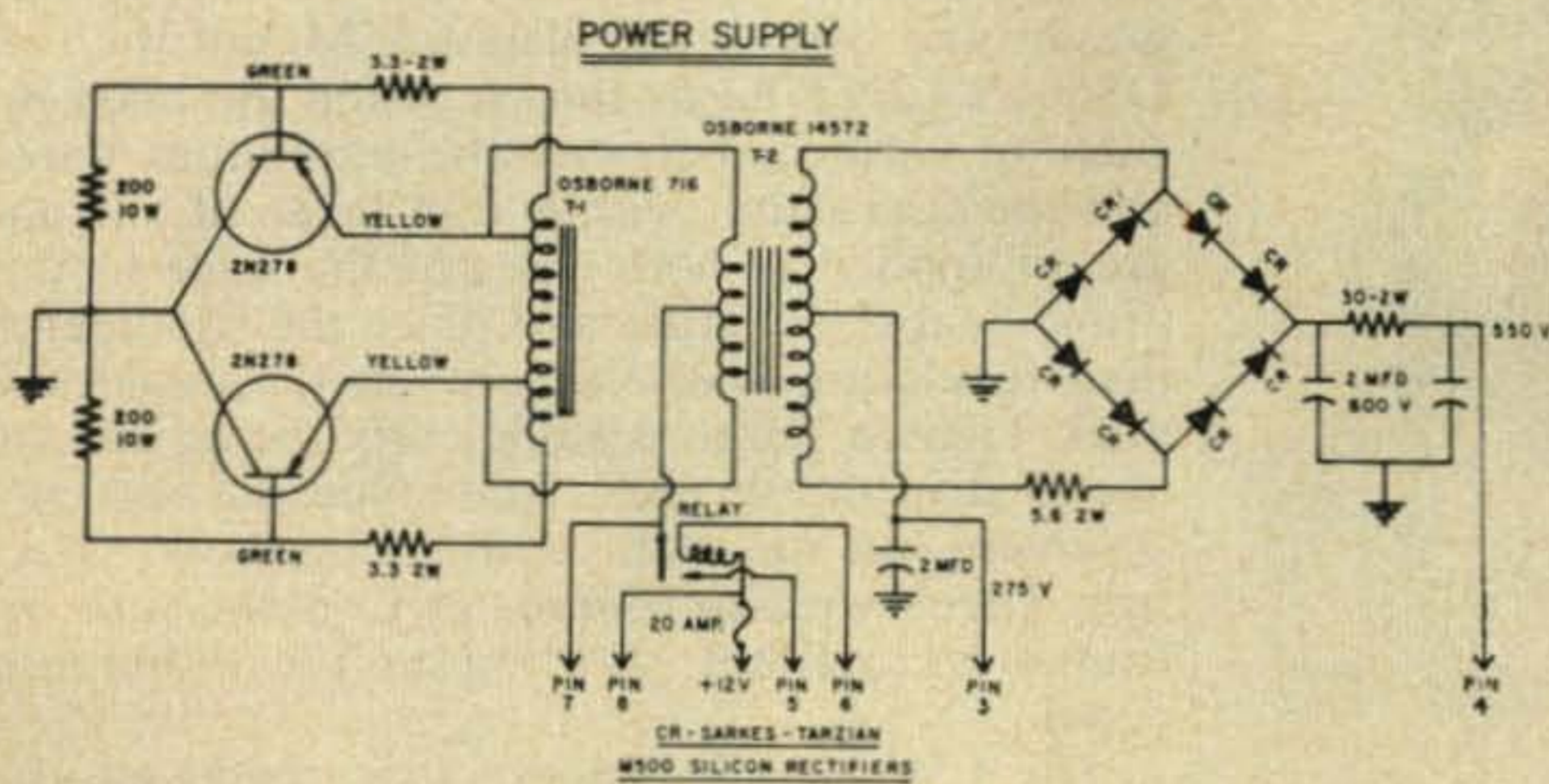
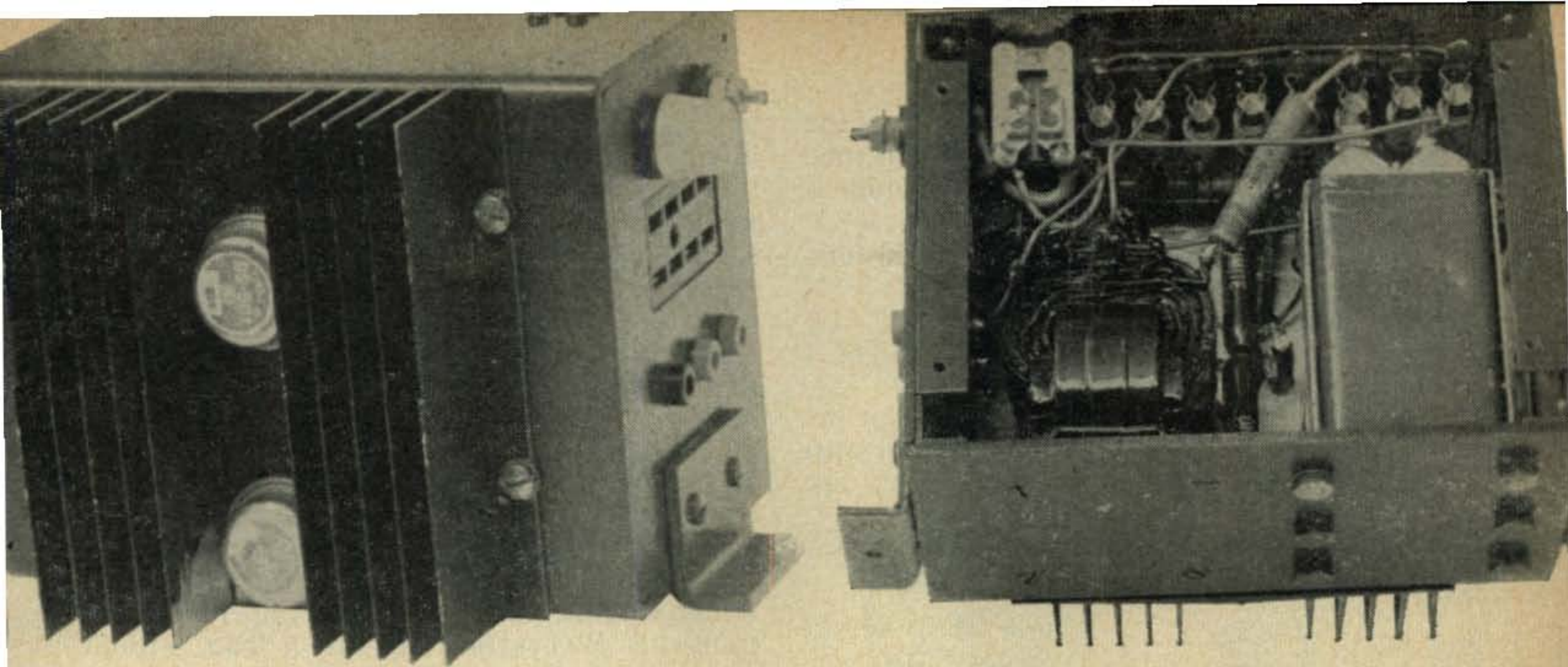

Above—Two views of the transistorized power supply.

Fig. 1—Circuit of the transistorized power supply.

also quite essential that some form of heat dissipation be provided. So to start with, we had to build our own box in which to house the supply since a manufactured box of the size and thickness desired was not available on the market.

We procured a sheet of  $\frac{1}{8}$ " soft aluminum,  $6\frac{1}{2}$ " wide by some 4 feet in length. Out of a portion of this we formed a box approximately  $6\frac{1}{2}$  by  $4\frac{3}{4}$  by  $3\frac{3}{4}$  inches deep. In order to provide further cooling for the power supply transistors we mounted a set of two Delco cooling fins, or heat sinks as they are called, on the outside front. We decided to use the two-transformer-type supply because of the higher efficiency as well as the easier starting of the oscillator or switching circuit and lessening of transient spikes.

### Parts Mounting

The feedback toroid transformer is mounted in the upper left hand corner of the front panel inside the box while below it is the hyper-sil power transformer mounted to the inside bottom of the box. The three filter condensers are bolted to the box bottom while the top inside holds the 8 rectifiers and the relay. The two 200 ohm and the 3.3 ohm resistors are held in place by tie points on the inside front panel and a fuse holder, Jones plug and Hot A post are on the left end.

It will be noted that the despiking network

consisting of R1, C1, CR1 and CR2 of Karl's original circuit has been omitted since it was found that the supply was absolutely free of spikes. Also the original 5.6 ohm resistors in the oscillator circuit were changed to 3.3 ohm values in order to increase the output current and the 2hy choke has been replaced by a 30 ohm resistor. The third 2 mfd capacitor is used to filter the 275 volt output.

After completion, the supply was checked out and found to easily come up to expectations and claims.

### Modulator

Next came part 2 of this noble experiment, the modulator. The circuit selected was that described by R. G. Jordan, W9PUK, and T. A. Prewitt, W9UKT, in the January 1958 issue of *Radio and TV News*. It is simple and straightforward. The only deviation from the original is the output transformer. We used the modulation transformer mentioned in their article but not used in that model.

Then came the how and where to mount the components and still retain the same physical size of our old A54. Inasmuch as the modulator transistors are operating Class B and the idling current (collector current when the mike button is depressed but not speaking) is only 100 ma, it was decided to provide a heat sink. Another piece of the  $\frac{1}{8}$ " aluminum,  $6\frac{1}{2}$ " wide by 7" high plus a 3 by  $3\frac{1}{2}$  inch piece attached



to it at right angles was screwed to the top of the original chassis covering the old modulator tube socket holes. The larger piece of aluminum is bolted to the back of the chassis in a vertical position and on it are mounted the two transistors, resistor R6 and capacitor C3.

First remove from the transmitter the 6L6 or 5881 tube sockets V8 and V9 and the 6C4 speech tube socket, V6, and all associated wiring including that of the 12AU7 except its filament wiring. The V6 hole may be filled with a trim-out plug while those of V8 and V9 are

covered by the small piece of aluminum as described above. Next, remove the old modulation transformer and its primary wiring and mount the new TA17 in its place with the same screws in the same holes.

Replace the PA OFF-ON *spst* switch with a *dpt* switch paralleling all poles (since frequently these switches, even the best of them, don't always make good contact) and bring out a lead from the poles on the OFF side to one end of a new 5000 ohm, 25 watt resistor mounted on the back underside of the chassis in the place of 30 K 10 watt screen dropping resistor. This new 5000 ohm resistor provides a load for the new modulator when operating the transmitter without the final on. It is imperative that transistors always operate into a load. Mount transformers T1 and T2 as shown in the photographs and wire as per diagram. Mount the two DS501's (2N278) as shown, using the mica insulating washers between the aluminum panel and the transistors with a thin layer of silicone grease applied to both sides of the mica to improve heat conduction and place the shouldered fiber insulating washers between the panel and nuts. Tighten the nuts sufficiently, being careful not to strip the threads. Add soldering lugs and a second nut on each of the transistors. Carefully check with an ohmmeter to make sure the transistors are not shorting to the aluminum panel.

The CW jack J3 on the front panel of the A54 was rewired as shown, so that it now may

[continued on page 121]

Rear view of the A54 showing the modulator transistors in the upper left of the mounting plate.

Fig. 2—Circuit of the modified A54.

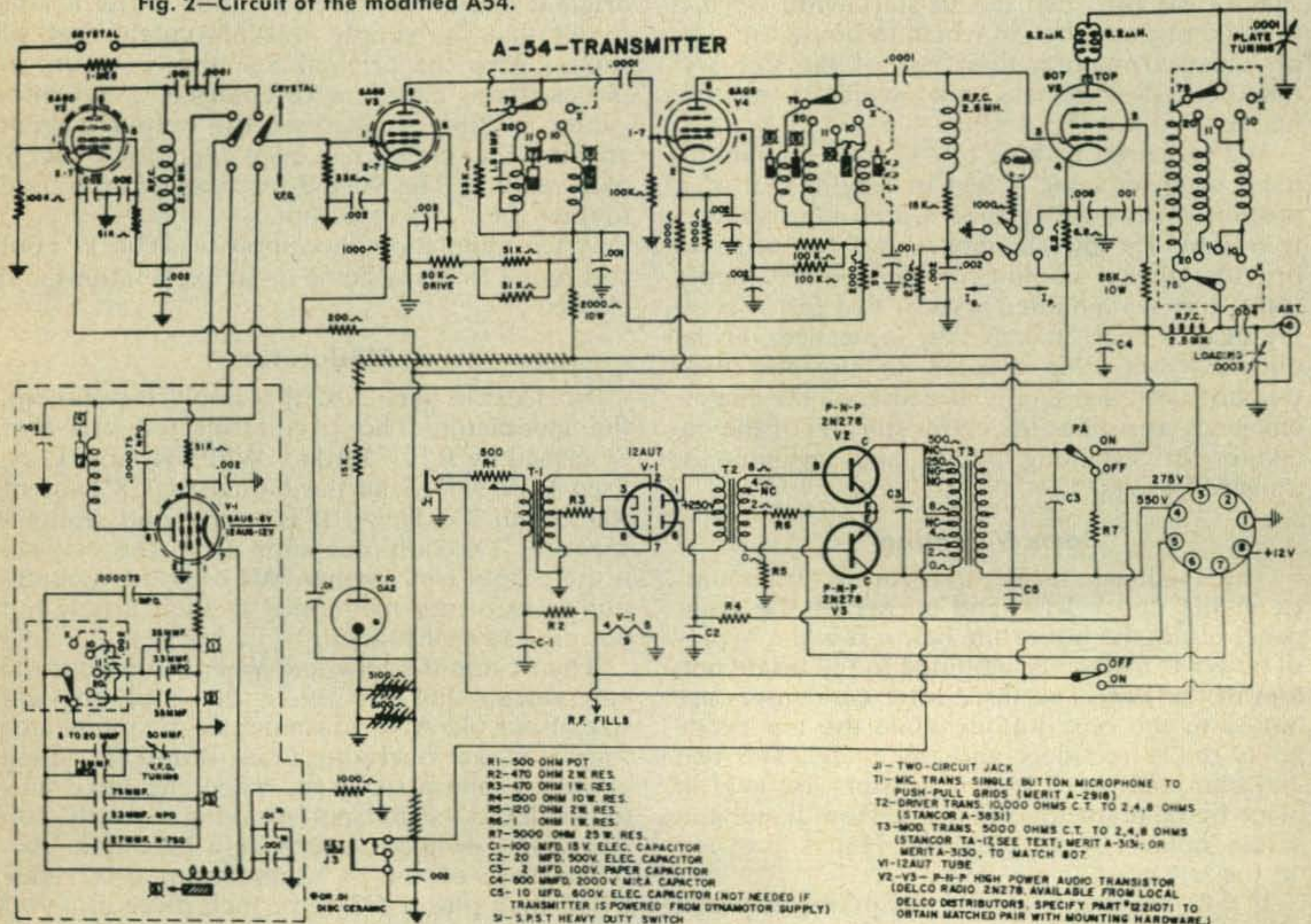



# A \$1.00 ZL-Special For Six

Joe A. Rolf, K5JOK

Box 594  
Jonesboro, Ark.

Some months back, I was informed by a very learned colleague that my tattered, but faithful, six meter dipole was obsolete. This bit of wisdom, and the strong desire to be up to date, prompted much catalogue-paging in search of a beam. Nothing commercial, however, met the prerequisites of low cost and immediate delivery, so a stack of ragged CQ's came from the hall closet for hopeful inspection. Luckily, near the top was the July, 1959, issue with a description of ZL-Specials for 10, 15, and 20.<sup>1</sup>

Since the information given by DL3AO concerning the two lower frequency beams is applicable to six, the reader is referred to his article for particulars. It might be added, though, that the beam's simplicity, bandwidth, and gain make it ideal for six meter usage. The 7 db gain is sufficient to increase ground-wave coverage over a dipole 50%, and the beam's weight and size permits its use in stacked arrays that a light TV rotator can handle. But most interesting, perhaps, is that these advantages can be had for as little as one dollar!

The extreme economy of the author's six meter ZL-Special resulted from altering the construction used by DL3AO. The beam was designed for 50.5 mc and three pieces of 3/4" x 1" x 24" pine, joined with 1 1/4" dime store brackets, formed the framework. A U-Bolt was used for mast mounting. The hardware is worth about a quarter and the lumber needn't be courted, since any respectable ham can beg it from a local lumber company scrap pile.

The elements of 300 ohm twin-lead were wired as shown in fig. 1 and the reflector and radiator taped directly to four thin cane poles with Polyethylene tape. The canes came from a nearby thicket for use in the XYL's bean patch and made fine supports. For those not lucky enough to own a cane thicket, Japanese bamboo or 3/8" dowl rod is available. With

the elements attached, the cane supports were then taped tightly to the framework and a 72 ohm coax feedline connected to the feedpoint. The feedline and phasing element were taped to the framework, also.

Construction time, from start to throwing the switch, was just under an hour and the beam worked beautifully from the start. Good results were obtained with unbalanced coax feedline, but performance was greatly improved by adding the balancing balun shown in fig. 1. A balanced coax, or 75 ohm twin-lead, feedline is recommended for best results. No adverse effects seem to have resulted from taping the elements to their supports. Wet weather losses have hardly been noticed with an antenna input of less than five watts.

Refinements in construction are possible, but the simplicity proves that an effective six meter array is not as hard to come by as one might think. For the cost and construction involved this beam is surprisingly sturdy and efficient. So much so, that it's worth a lot of use before someone comes along and calls it obsolete! ■

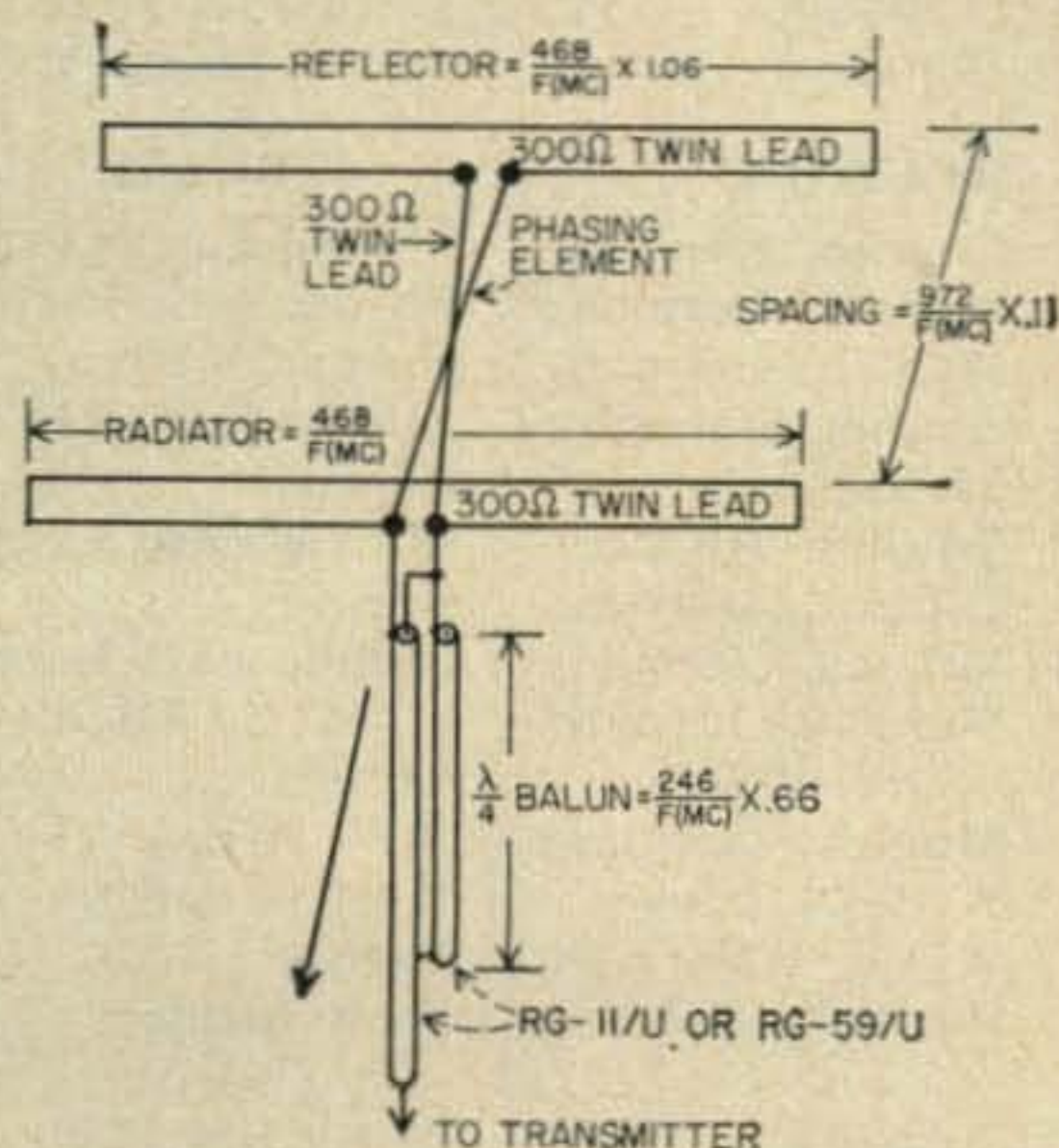

Fig. 1—Wiring of the ZL Special showing balun details. A coax feedline of 72 or 75 ohms may be used.

<sup>1</sup> Schick, R., "A Shortened ZL-Special Beam", CQ July 1959, p. 42



# Voice of America Amateur Radio Program

EVERY week the Voice of America broadcasts the VOA Amateur Radio Programs to all areas of the World at various times throughout the day. The program consists of 15 minutes devoted to the latest gossip on the ham bands, interviews with radio amateurs around the world, propagation forecasts, and discussions of the latest technical news of interest to radio amateurs and shortwave listeners.

The broadcasts, in the English language, are written and voiced by Bill Leonard, W2SKE, one of America's leading news commentators, and a very active radio amateur operator. Gene Kern, W2BAK, produces the program, and propagation forecasts are by Bill Dulin, W4ETT, and George Jacobs, W3ASK with radio amateurs everywhere invited to participate.

The distinctive QSL card of the VOA is available for exchange with listeners of the Ham Show, and W2SKE and the gang are looking forward to receiving QSL cards from radio amateurs and shortwave listeners everywhere. Listeners may forward their QSL cards to: Either of the following addresses.

Bill Leonard Amateur Radio  
Post Office Box #29 or Box 922  
Geneva 12, Switzerland Washington 4, D.C.

The complete world-wide broadcast schedule for the VOA Amateur Radio Program, effective Sunday June 12, 1960 is as follows:

Time (GMT)	Time (EST)		
2115-2130 (Sunday)	4:15-4:30 PM (Sunday)	KC	STATION
		BEAM	
		1259	Courier, Rhodes
		3980	Munich, Germany
		6185	Munich, Germany
		7260	Courier, Rhodes
		9520	Thessaloniki
		9530	Courier, Rhodes
		9620	Tangier, Morocco
		9635	Munich, Germany
		11760	Munich, Germany
		15205	WDSI, USA
		15440	Munich, Germany
		17740	WLWO, USA
		21505	WDSI, USA
		21610	WLWO, USA
		7155	Okinawa
		9545	Okinawa
		9700	Manila
		11800	Manila
		17735	KCBR, USA

KC	STATION	BEAM
17770	KCBR, USA	Far East
21740	KCBR, USA	Far East
	Time (GMT) 2215-2230 (Sunday)	Time (EST) 5:15-5:30 PM (Sunday)
173	Munich, Germany	Europe
1196	Munich, Germany	Europe
1259	Courier, Rhodes	Middle East/S.E. Europe
3980	Munich, Germany	Europe
6185	Munich, Germany	Europe
7260	Courier, Rhodes	Middle East/S.E. Europe
9520	Thessaloniki	Europe
9530	Courier, Rhodes	Middle East/S.E. Europe
9620	Tangier, Morocco	Europe
9635	Munich, Germany	Middle East/ Europe
11875	Tangier, Morocco	Europe
11800	Manila	North East Asia
11895	Philippines	Central East Asia
	0315-0330 (Monday)	10:15-10:30 PM (Sunday)
9530	Munich, Germany	East Africa/Middle East
9615	Tangier, Morocco	Europe
9650	WDSI, USA	Europe
9740	Tangier, Morocco	Europe
11715	Munich, Germany	Europe
11830	WDSI, USA	Europe
11895	Tangier, Morocco	Middle East/South Asia
11920	WLWO, USA	N/W Africa
15250	WLWO, USA	N/W Africa
15270	WDSI, USA	Europe
15320	Tangier, Morocco	Middle East/South Asia
11835	Colombo	South Asia
15130	KCBR, USA	Latin America
17735	KCBR, USA	Latin America
	0415-1430 (Monday)	11:15-11:30 PM (Sunday)
1196	Munich, Germany	Europe
6100	Munich, Germany	Europe
9530	Munich, Germany	E. Africa/Middle East
9615	Tangier, Morocco	Europe
11715	Munich, Germany	Europe
11740	Tangier, Morocco	Europe
11785	Tangier, Morocco	Middle East



# Modifying The Gonset Tri-Bander

W. P. Clarke, W5DZ

Route 2, Box 97  
Waco, Texas

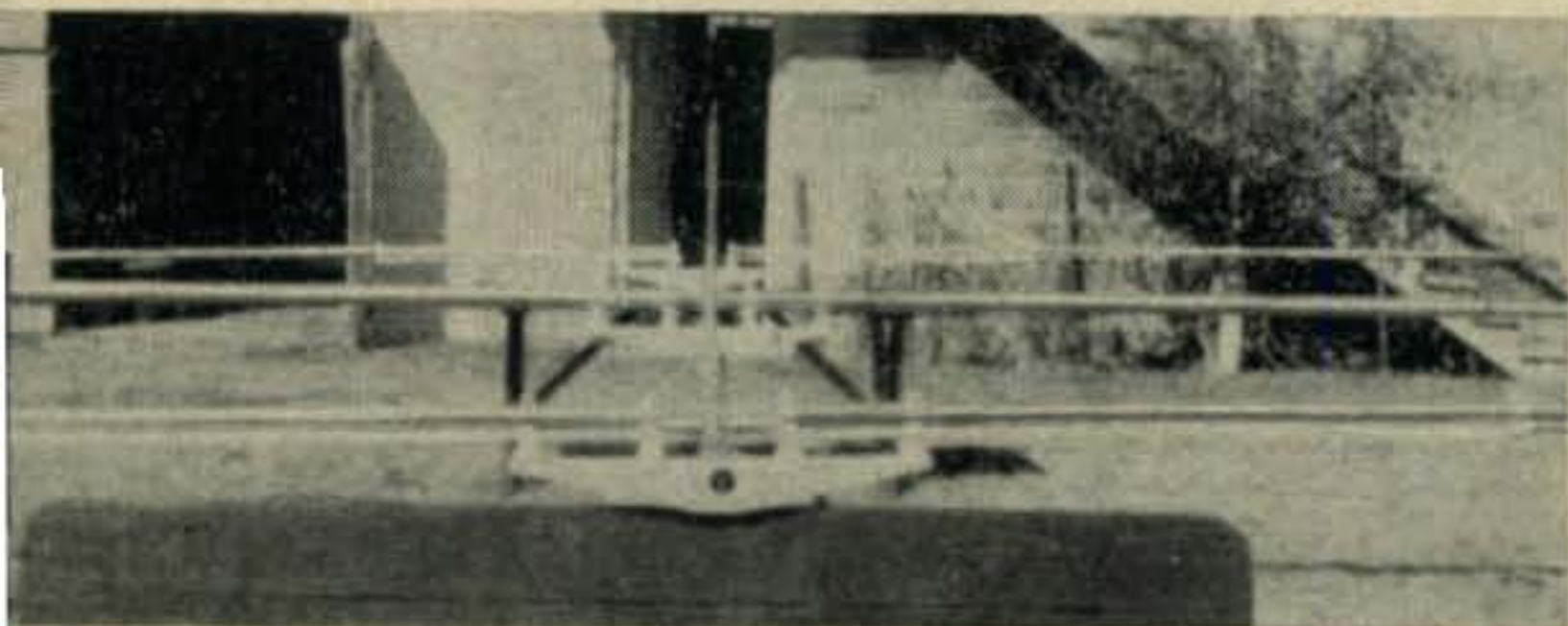

Photograph 1

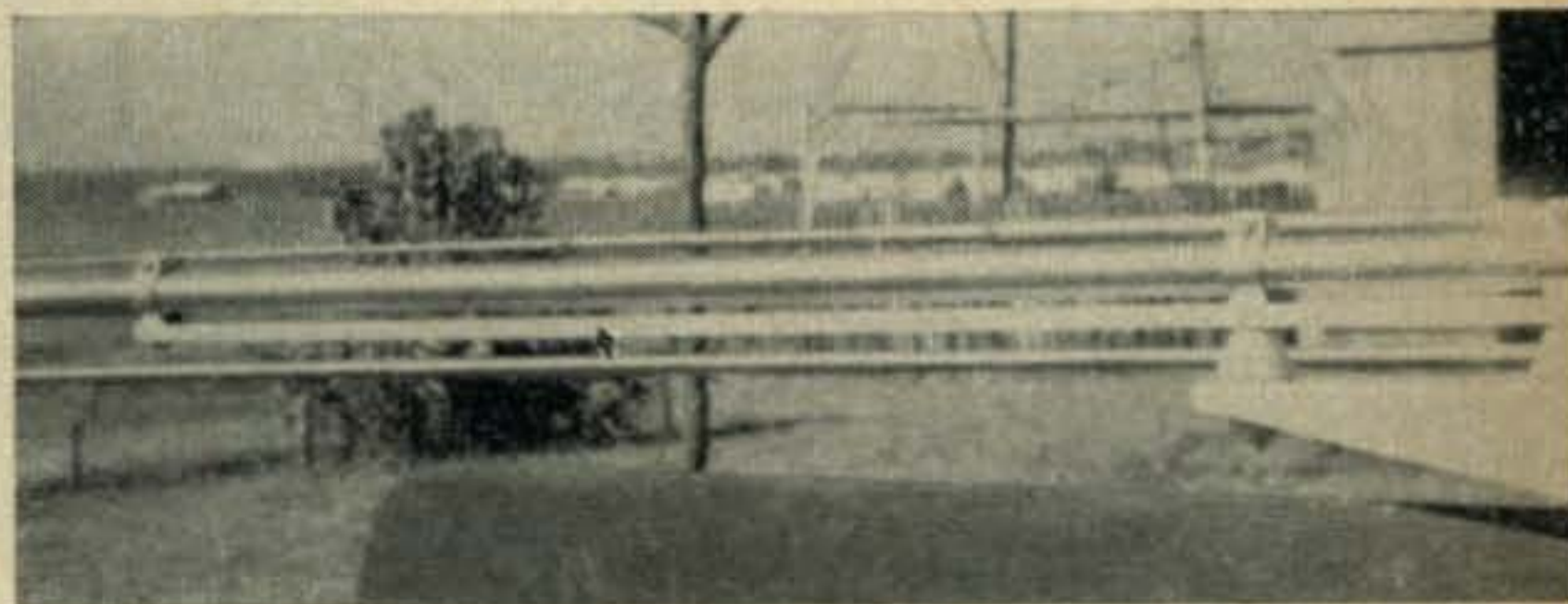

Photograph 2

The Gonset Tri-Bander beam antenna, while producing excellent results and meeting the requirements for a multi-band beam antenna, (without traps), is structurally weak against wind loading, and ice.

The weakness is due to the method of supporting the director and reflector elements, in particular. Each element is supported by two clamps, spaced seven inches apart, and the element tubing collapses at the outer clamp. The manufacturer has made a modification in the clamps in later models, however in areas subject to wind gusts and prevailing winds above normal breezes, the following additional modifications are recommended.

Obtain four pieces of  $\frac{1}{8}$ " channel aluminum stock  $1\frac{1}{4}$ " wide and 30" long. Drill holes at one end, 7" apart and at the other end one hole  $\frac{1}{2}$ " from the end. Refer to fig. 1. Remove elements from antenna and install the aluminum supports as shown in Photos 1 and 2. The base of the clamps will recess snugly in the channel aluminum. Four additional clamps, *Gonset No. 575-004* and four shims *No. 566-037* or suitable substitutes are required for the end clamps.

The addition of the channel aluminum strips will reinforce the elements both horizontally and vertically, and will distribute the strain from the clamps next to the boom.

There was no change in the loading or antenna adjustments.

An additional modification may be made to enable the boom to be tilted to gain access to the end elements. This modification consisted of discarding the rigid center support and hardware furnished by the manufacturer and making a cradle with the boom bolted in two places. Removing one bolt allows the antenna to be tilted over by means of temporary ropes.

Photo 3 illustrates this modification. The stock used was  $\frac{1}{4}$ " iron with a  $1\frac{1}{2}$ " steel tube for the center piece. The tubular bracket supports furnished with the antenna were reversed and serve as additional boom supports in addition to relieving strain on the pivot holes in the boom when it is tilted.

In addition to the reinforcement of the main elements I also reinforced the ten meter director and reflector tubes by inserting  $\frac{5}{8}$  inch dowels

[Continued on page 106]

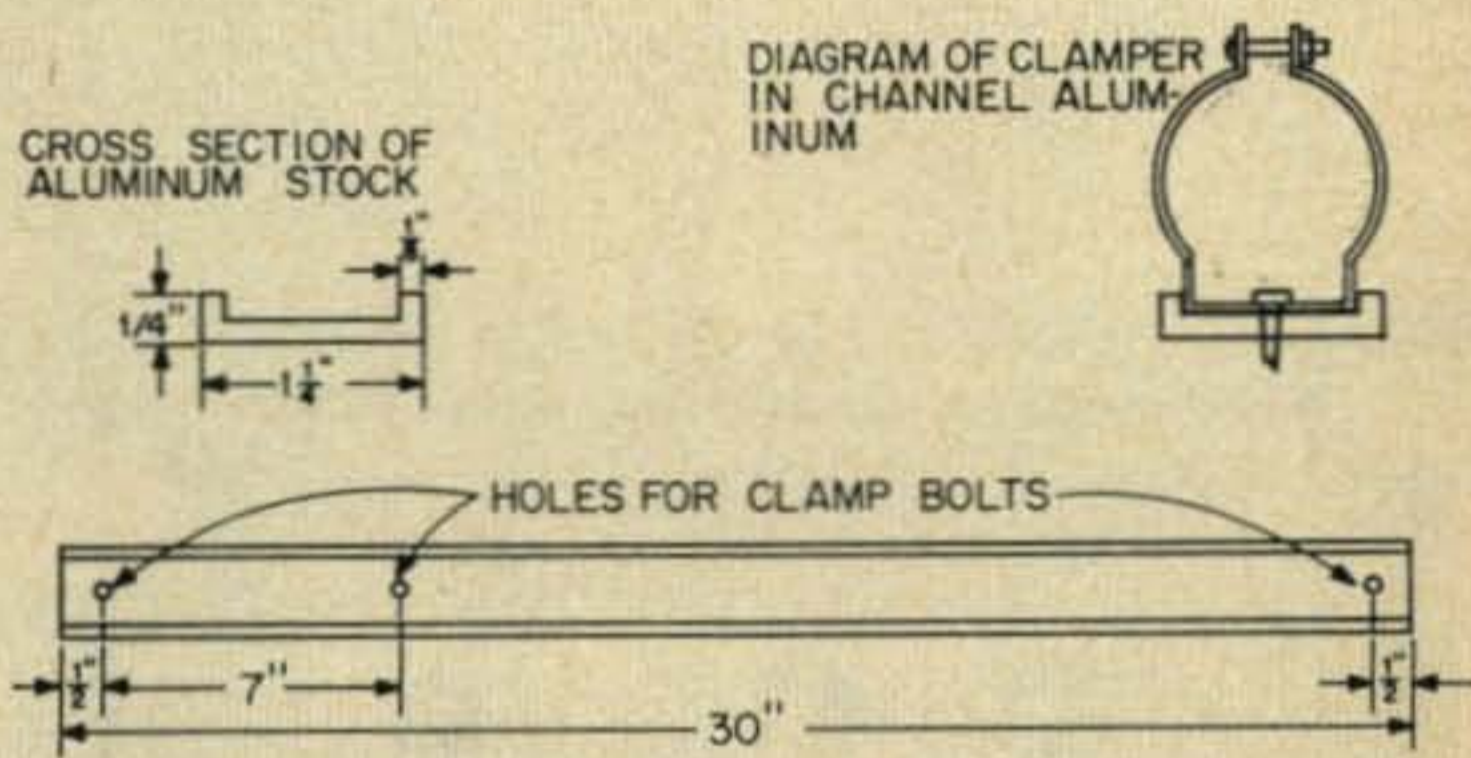
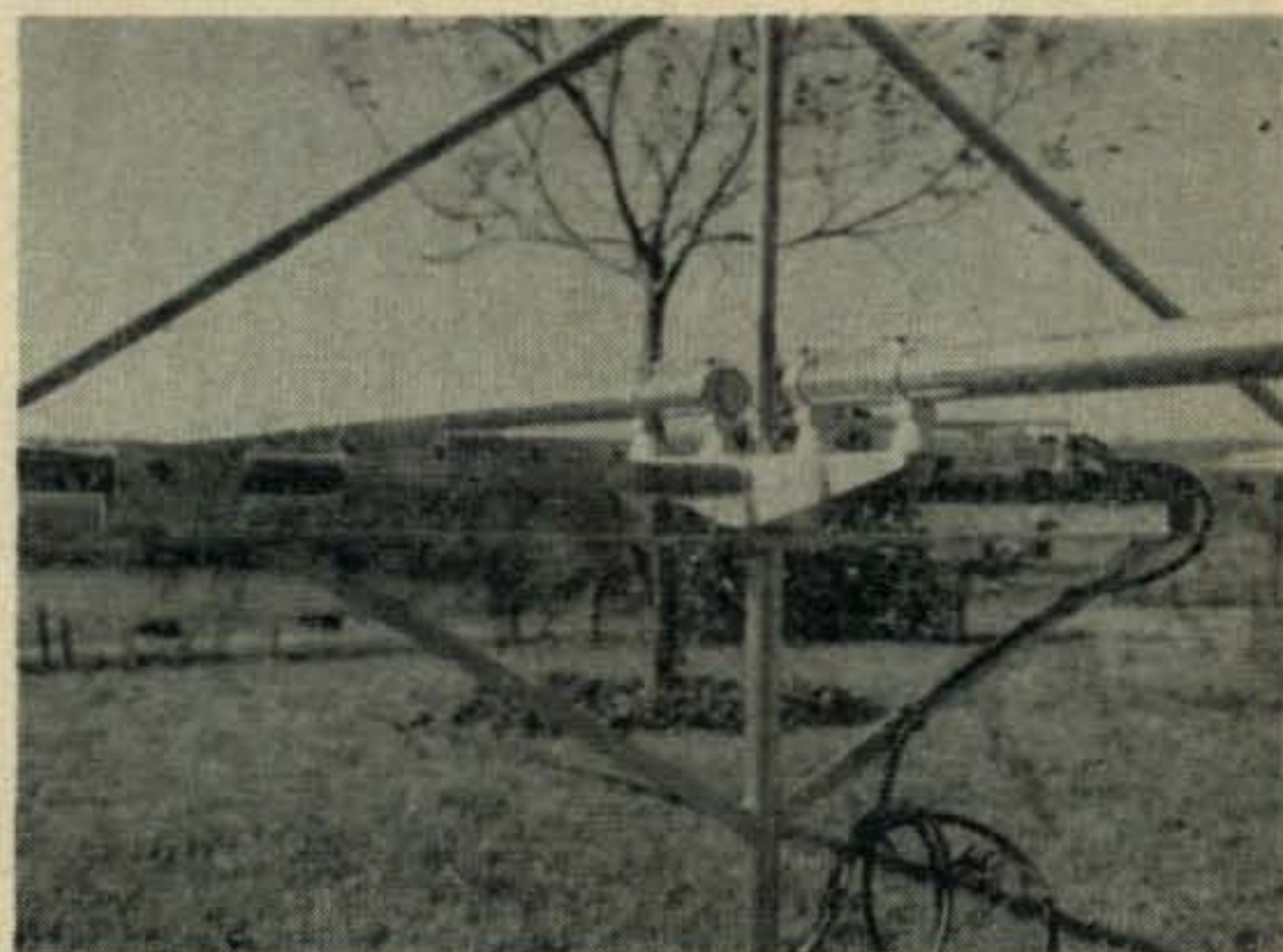
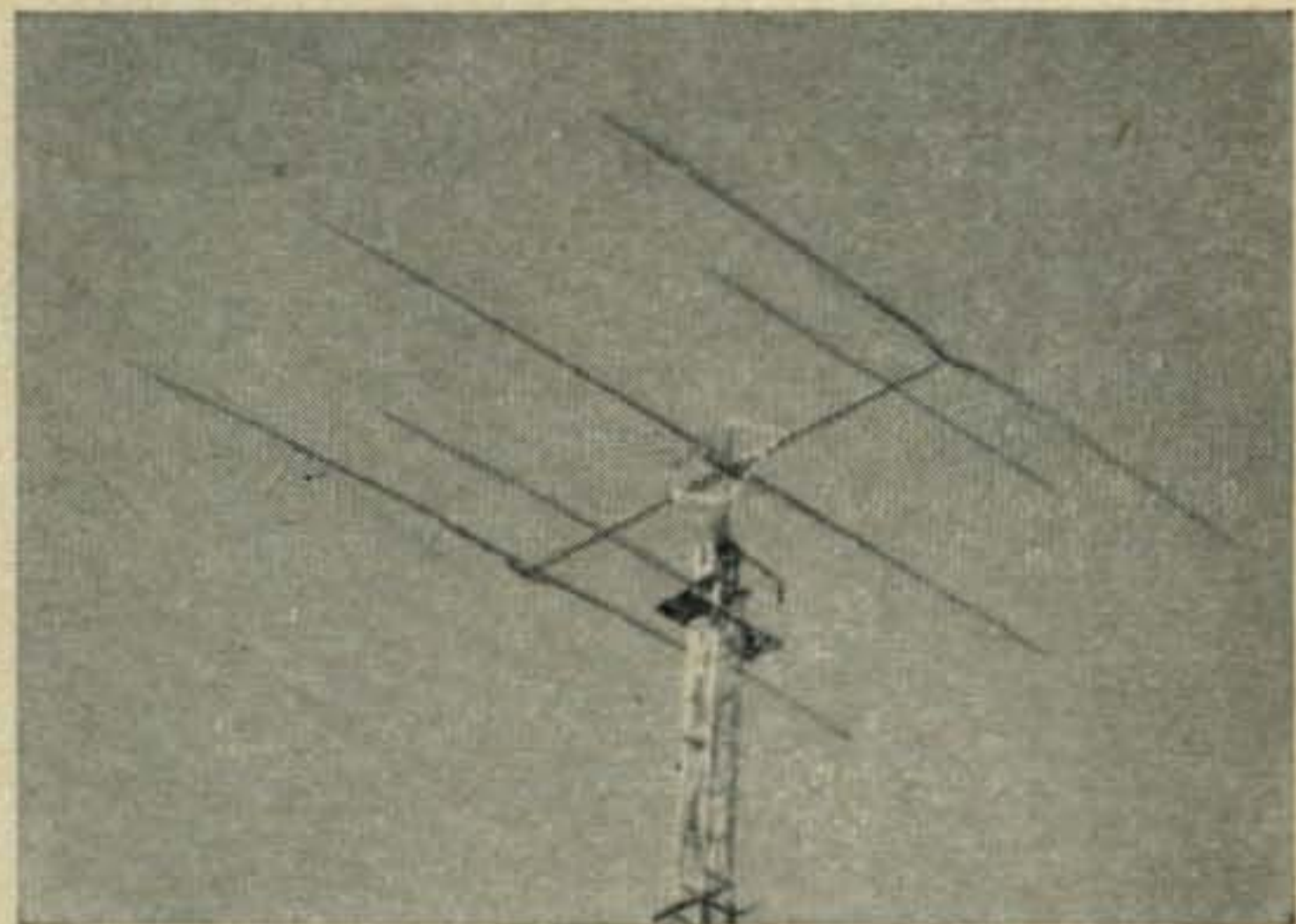

Fig. 1—Measurements of the element support rods.



Photograph 3—View of the boom tilt mechanism.



The modified antenna in place on top of a 55 foot self supporting tower.



# 50, 144, 220 Mc The Easy Way

Joe A. Rolf, K5JOK

Box 594  
Jonesboro, Ark.

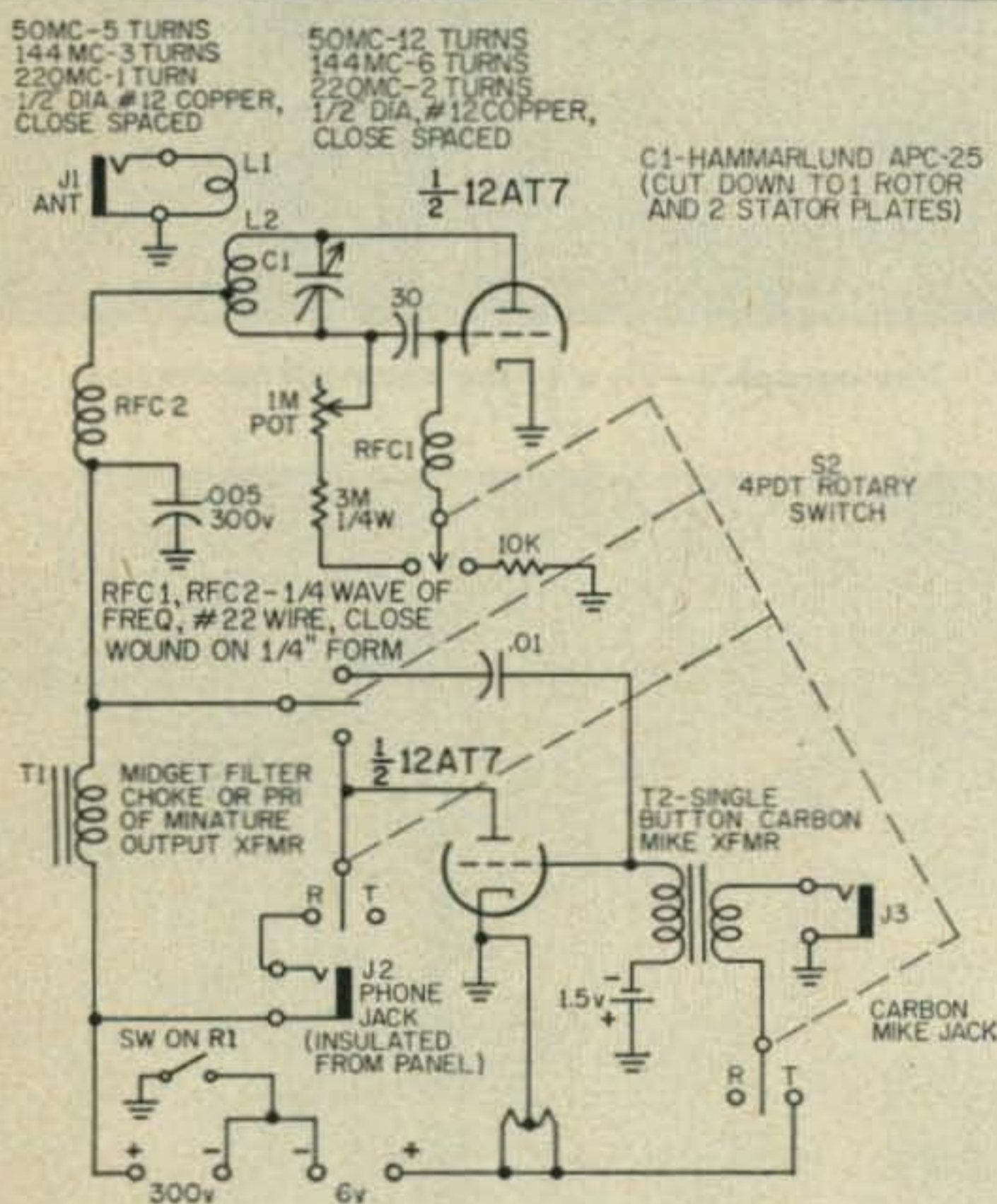
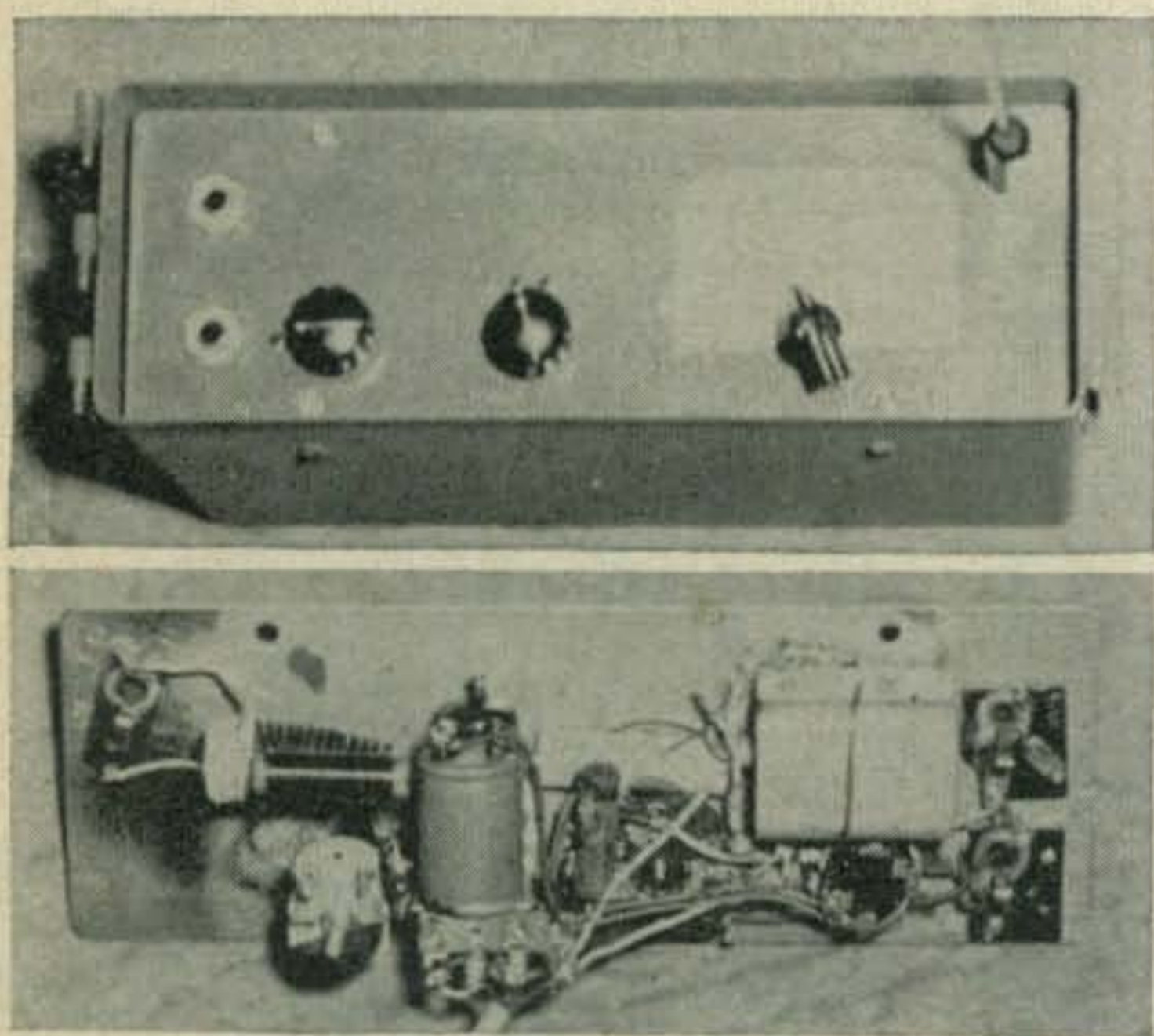

Fig. 1—Circuit of a simple transceiver for 6, 2 and 1 1/4 meters.

When the XYL decided to WAS in record time, two hams to one rig became as maddening as running out of worms when the fish are biting. Until 50 Novice QSLs came, from as many states, the choice operating hours before the 7 AM rush for diapers, pablum, and "beck-fust" were gone . . . maybe forever.

It seemed an ideal time to build the long wanted kilowatt. But sadly—the scrapbox was able to turn up only a gassy 807, and the household financial director, KN5SEL, only two bucks. They may build kilowatts with less in California, but in five-land it's hard to do. Time seemed more ideal for a two or three watt rig.

## Design

A little thought revealed that requirements would be few. The rig would have to use either a 1S4 or a 12AT7, the only tubes on hand. It would have to come largely from the scrapbox. It would have to both transmit and receive. It couldn't be on a Novice band, for reasons of self protection. Because of the low power, it would have to be on a band with local activity.

The 12AT7, some type of transceiver circuit, a handful of parts, and six meters were the final choice. The thing finally became portable; and more finally, battery operated. All that remained was to design and build the rig, house it in something respectable, and fire it up for the local morning ragchews.

A trip to the local Army Surplus Market yielded a 30 cal. ammo tin at an expenditure of just over two-bits. The tin was sturdy, had an attractive removable lid, and was just the size for the small transceiver and batteries. Using aluminum brackets, a metal panel was easily mounted far enough inside the lip of the can so as to allow clearance for dial and knobs with the lid in place. A coat of grey enamel transformed the tin into an inexpensive, but attractive, cabinet.



## Circuit

The circuit was somewhat harder to come by. A first look at the diagram in fig. 1 may even call for some head scratching. What counts is that it works. It's a variation (though hardly an orthodox one) of the popular super-regen circuit. While this circuit is not ideal for six, due to instability, a somewhat rough signal, a little FM'ing and radiation in the receiving position, it is satisfactory for a few watts portable use.

A number of similar circuits have come out in recent years using a single tube with grid modulation, or a multi-tube, plate modulated, circuit. A common disadvantage to both has been the use of low voltage tubes, making only a watt or a fraction of a watt input possible. The low efficiency of grid modulation is a chief disadvantage in the single tube circuits, while the multi-tube types are usually bulky and require a special transformer or two. The circuit shown compromises these disadvantages.

With a 12AT7, 300 volts can be applied to the plates with an input of about 3 watts to the oscillator. The tube also allows for a more compact construction of the multi-tube circuit and the need for a transceiver transformer is overcome by the use of Heising Modulation. The result is increased output, simplification of construction, and improved modulation.

One may well question the advisability of a Lantern Battery to power the 12AT7 filaments and carbon mike. Current drain is considerably more than tubes of the 1.5 volt class, but not so much as to seriously shorten the average life of the battery which is switched out of the mike circuit when receiving. Stability with 300 volts on the plates is good, but 300 volts worth of battery is expensive. A Burgess U200, or Eveready 493, is employed while the rig is used in the field; a simple fullwave voltage doubler while in the shack. This arrangement, facilitated by common power connections, permits intermittent use of the somewhat expensive battery. Actually anything from 90 volts up can be used, but with reduced input.

## Operation

The method of coupling the detector to the *af* amplifier and the regeneration control are the main irregular features of the circuit. While in the detect position, T1 serves as plate load for the detector and is coupled to the mike transformer secondary and *af* grid by C4. The impedance of the T2 secondary is sufficient for ample output. In the transmit position T1 becomes the *af* amplifier load and C4 is switched out of the grid circuit. The phones are also switched out in this position, just as the carbon mike is switched out while receiving. Six volts on the carbon mike results in very little distortion, despite the low bias on the modulator.

The rig modulates with a good "wallop" to the signal.

Regeneration is controlled by R1 in series with R2, varying the grid leak from 3 to 4 megohms. This control may be omitted entirely, if desired, by using a 4 meg grid leak and adjusting the antenna coupling to a point where the detector will barely regenerate across the band. Regeneration control is desirable, however, in permitting the use of several different antennas with no coupling changes, and in multiband operation.

Regeneration control with the grid leak method may be considered impractical, but insertion in the plate would result in additional switching, or reduced voltage while transmitting. Since regeneration is dependent upon the grid blocking, the grid leak, and plate blocking values, along with tube characteristics and antenna coupling, any one of these constants can be changed to control regeneration. The trick in making the grid leak control work is in adjusting the antenna coupling to a point where the control permits regeneration at about half scale. R1 can be returned directly to the B+ terminal of the battery, if desired.

## Construction

Construction of the unit is non-critical. The tube and modulation choke are mounted on an aluminum bracket. Other components are mounted dish fashion. The tank capacitor is mounted on spacers and coupled to the dial with an insulated shaft to avoid hand capacity. A phone jack is used for antenna terminal. A whip constructed of welding rod and soldered to a phone plug permits quick connection in the field. With the whip, some hand capacity may be evident due to the nearness of the tuning dial to the antenna jack. This can be minimized by varying the antenna coupling slightly.

Using the whip, the unit puts out a healthy signal. With 90 volts on the 12AT7 plates, Q5 reports were possible at four miles. With 300 volts the distance and signal strength increased. All reporting stations were using horizontally polarized systems. The unit can be connected to a coax vertical or a beam to increase range. Reports on modulation have included a noticeable FM'ing, but not so much as to prohibit reception with a superhet. The unit puts out a broad signal and it is advisable not to get too near the band edges.

On six, the unit can be adjusted to tune from about 50.1 to 54 mc. It can also be operated on 144 mc and 220 mc with suitable coils, plates, chokes, and antennas. The unit regenerates on these bands, but local inactivity has not permitted actual QSO's. Working ranges, however, should be comparable to those experienced on six.

Not every ham will have to build the rig  
[Continued on page 106]



# A Tilt-over Tower for a Dollar a Foot

Donald A. Grant, W2DY

5 Fir Tree Lane  
Huntington Station, L. I., N. Y.

There's no doubt about it! A ham who put up his first tower in 1924 can surely get mighty sick of climbing the thing. He also wearies of buying extra cases of beer for antenna raising parties, devoted to maneuvering the monsters with gin poles, scissor levers, and just plain slave labor! Not only that, but figure it out, boys; even though the OM was a young kid when the first tower went up, it isn't difficult to compute that he should, according to all the laws of common sense and energy, deteriorate with the years, and no longer be climbing at all! Combine all the above factors with the fact that at our station, we are not happy unless the antenna is worked on in some way at least once a week, and you will see that something had to be done.

One thing would have been to take stock in one of the mast-aluminum companies. This, however, would have left less cash with which to placate the long suffering but tolerant XYL, and also much less for actual equipment. It didn't take much cogitation to decide the only immediately practical solution was to build a wood, lattice-work, tilt-over tower.

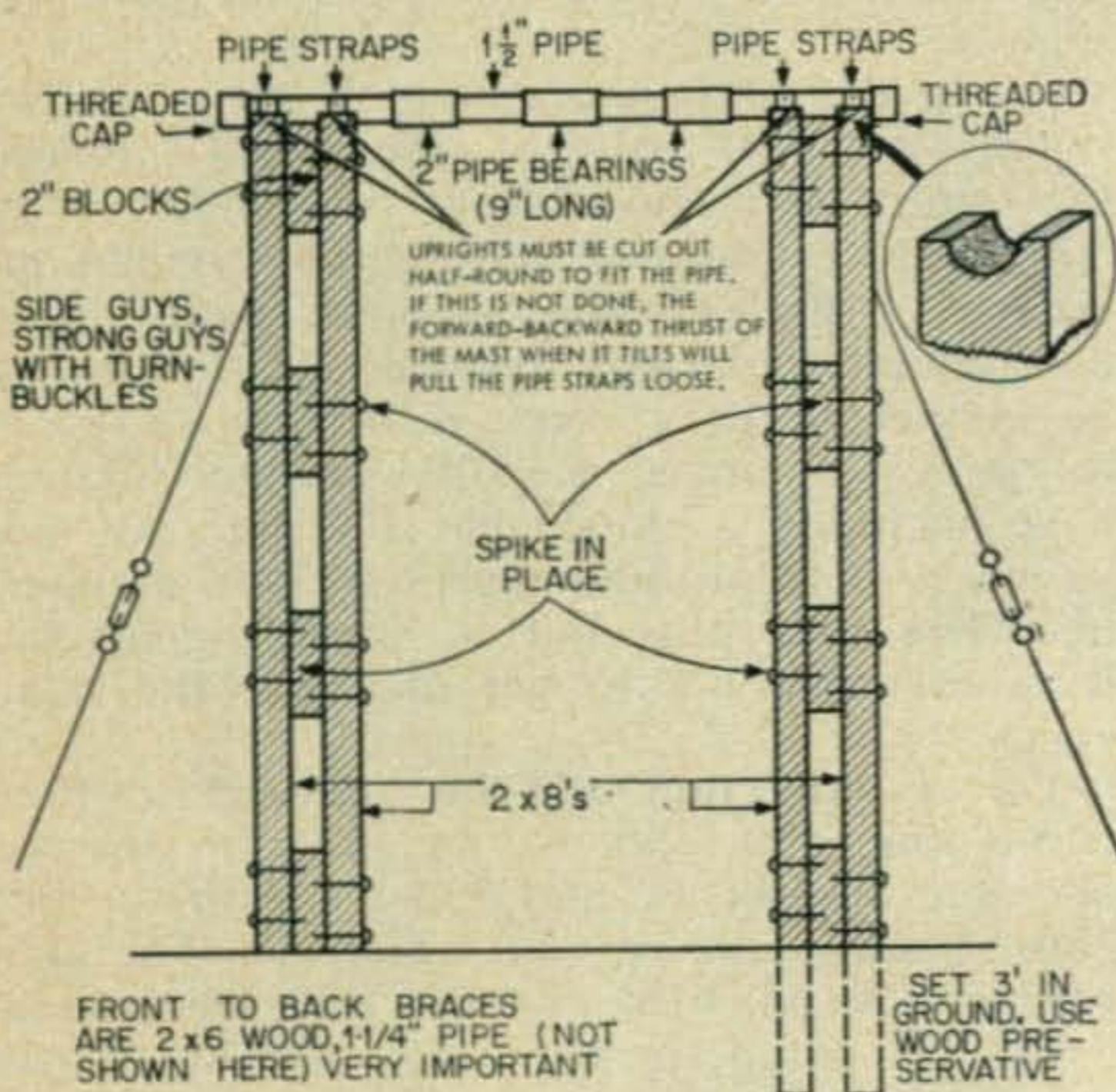

Fig. 1—Details of crib construction. Guy wires are used for side support while 2x4 or pipe braces (not shown) are used for front to back support.

## Tower Construction

So many articles have appeared describing how to make a wood lattice tower, that full details will not be presented in this effort. Its main purpose is to describe the tilt-over arrangement. However, build the tower itself carefully and sturdily. The tilt-over arrangement itself is strong, simple and virtually fool-proof. This will not prevent the tower, from collapsing, if it is carelessly constructed.

This is a 32 foot tower. Use 8 knot-free Fir "two by two's". Each leg of the tower is made by putting two of the members together, then overlapping with a 4 foot length of the same material. Use two quarter inch stove bolts, with both flat and lock washers on either side of the joint. The heads of the bolts should be toward the outside of the tower when complete. The tower is 4 feet square at the bottom, and about one foot square at the top. The bottom is made larger than usual so it will be virtually self-supporting when complete. I use two side guys for safety, just so my adjoining neighbors will sleep more soundly during the windy season.

Use "one by two" redwood (if available) or pine "furring strip" material for the cross-pieces and diagonals. Also use "no. 8" galvanized nails—4 at each joint. Paint all wood pieces before assembling! This may sound crazy if you have never tried to paint a lattice tower after it was finished. Use two coats of aluminum. You will never be sorry you took time to give it the second coat (except while

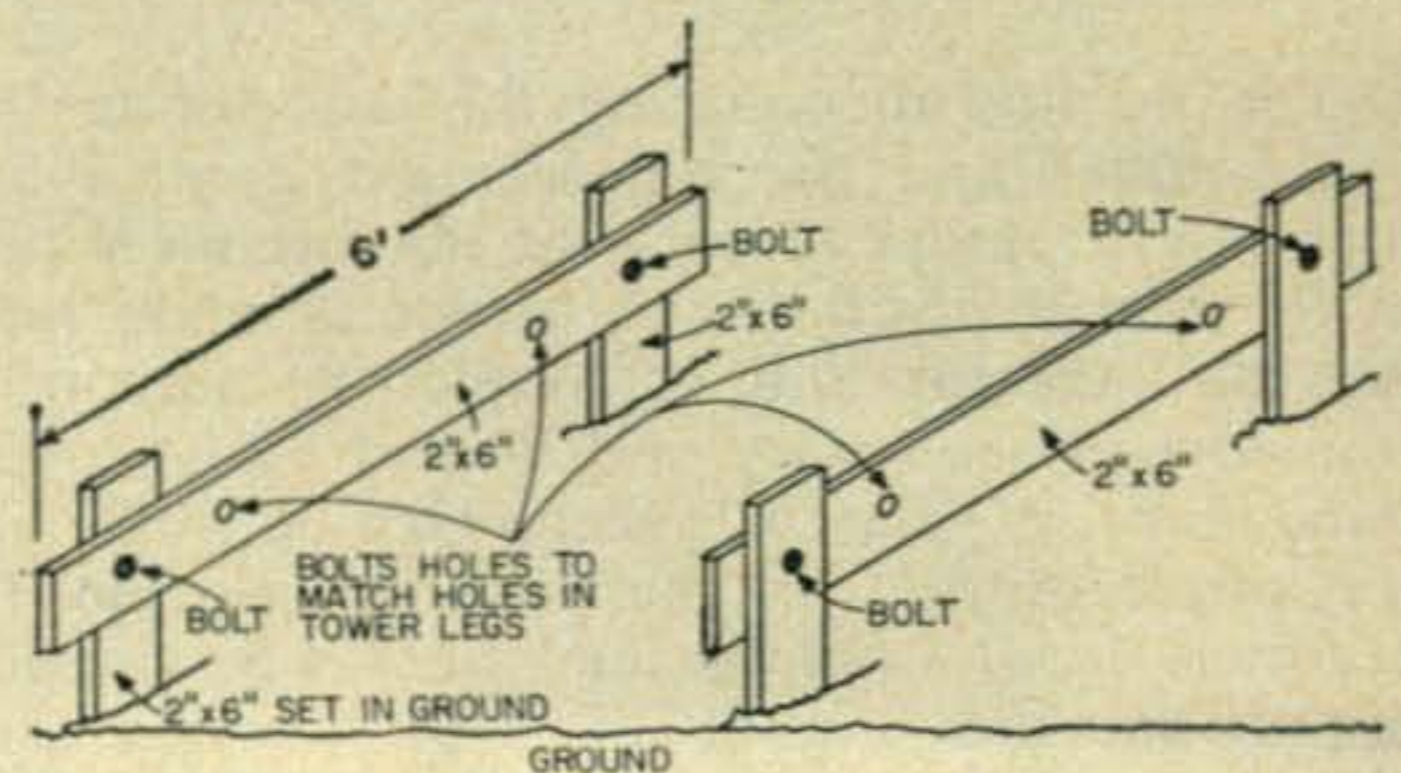

Fig. 2—Details of tower base. When the antenna is in place it may serve to remove the weight from the pivot hinge.



you are doing it!). Do not try to save time or wood by placing cross braces too far apart. They should not be farther apart than 3 feet for the bottom half of the tower, and not more than 2 feet apart on the top half.

Fit a pipe flange large enough to pass 1¼ inch pipe in a wood platform at the top of the tower. This serves as one bearing. Cut two "two by fours" approximately the right length to go across the tower *diagonally* about two-fifths of the way down, and three-quarters of the way down, respectively. Notch the ends to fit against the longerons of the tower. At the exact middle of each two by four, bore (with an expansion bit) a hole 1⅞ inches in diameter. These diagonals serve the dual purpose of greatly strengthening the tower, and as bearings for the 1¼ inch pipe which extends from 6 feet above the tower to within four feet of the ground. A rotator of your own choosing can be mounted near ground level. One important point: one pipe joint must be made. (Be sure to pin this joint!). This joint comes just *above* the bottom bearing. When this joint has been made, the coupling, which of course must be above the bearing, serves to keep the pipe from dropping down. After the two by four diagonals are nailed in place, auxiliary wood braces from the two by fours to the longerons should also be nailed in.

If you are going to put a heavy beam instead of a quad on the tower, we recommend the pipe extend above the top by only a couple of feet. The quad is lighter, and you can gain

height if you are using a quad, by letting the pipe extend farther above the tower.

### Tilt-Over

Details of the tilt-over arrangement are shown in the diagram. Build *two* crib structures from a total length of 60 feet of "two by eight" lumber. This does not include the blocks or shims placed between the side pieces of two by eight. When you finish, you should have two structures 15 feet long, and very strong. Set these in the ground 3 feet. Tamp the ground around the structures well. They should be spaced 5 feet. Run two by four or pipe braces back from these uprights, and bolt these to heavy angles driven in the ground. Side guys should be made of very heavy guy wire using turnbuckles and secure ground anchors. This structure must hold the entire weight (about 300 pounds) of the tower when it tilts over. Be sure it is strongly built.

Place a 5'6" length of 1½ inch pipe across the tops of the crib structure. The ends should be threaded 3 inches. Before this pipe is fastened in place, slip 3 pieces of 2 inch pipe 9 inches long over it. These will be fastened to a ¾" marine plywood panel, which is located on the front of the tower, with large "U" bolts. These short pieces of pipe act as bearings around the longer pipe, and allow the tower to move freely.

[Continued  
on page 106]

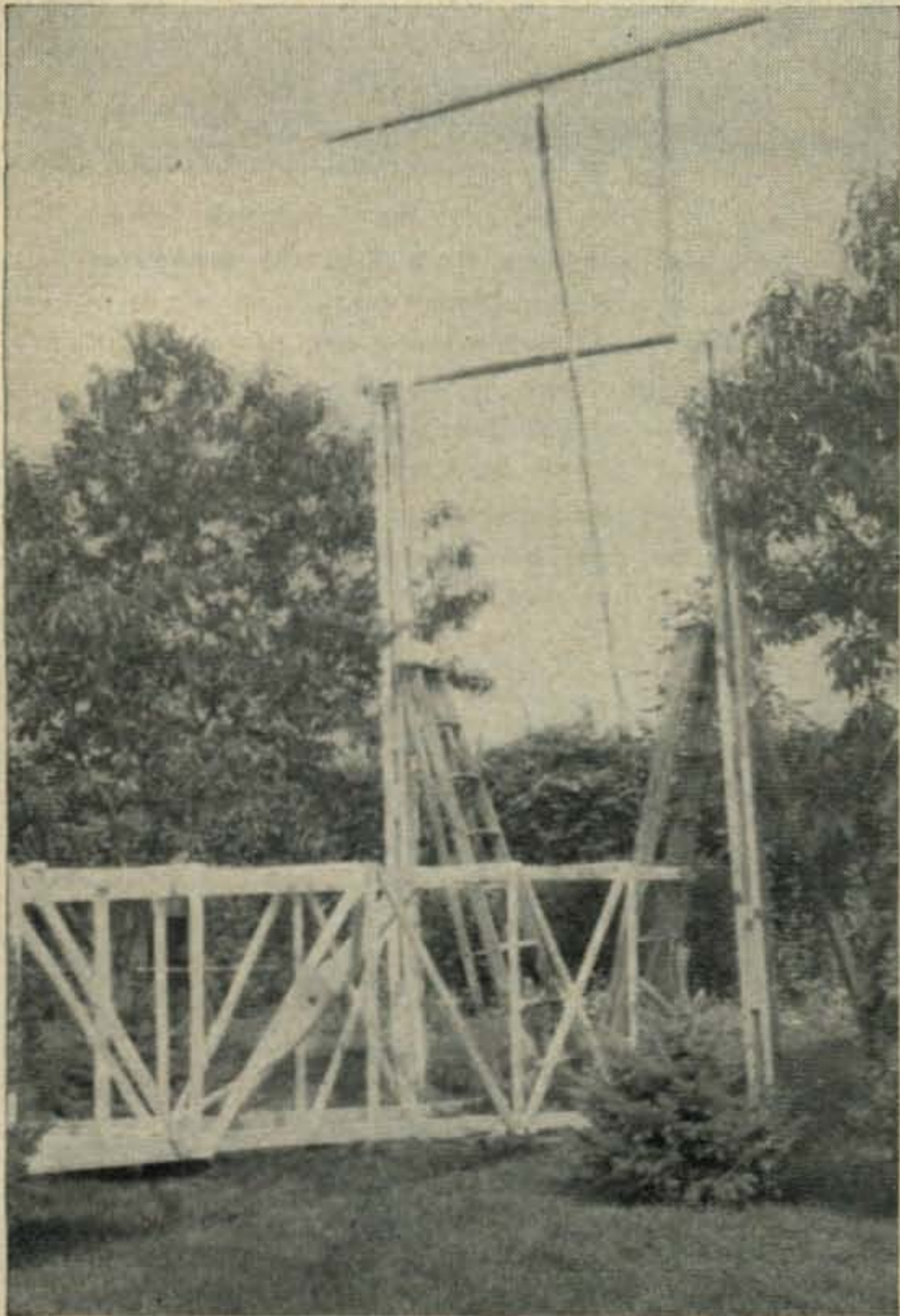

Left—View of the temporary boom used to move the tower in position.

Right—View of the completed tower. Note the marine plywood hinge plate. Tower bottom is loaded with concrete to provide a counterbalance.

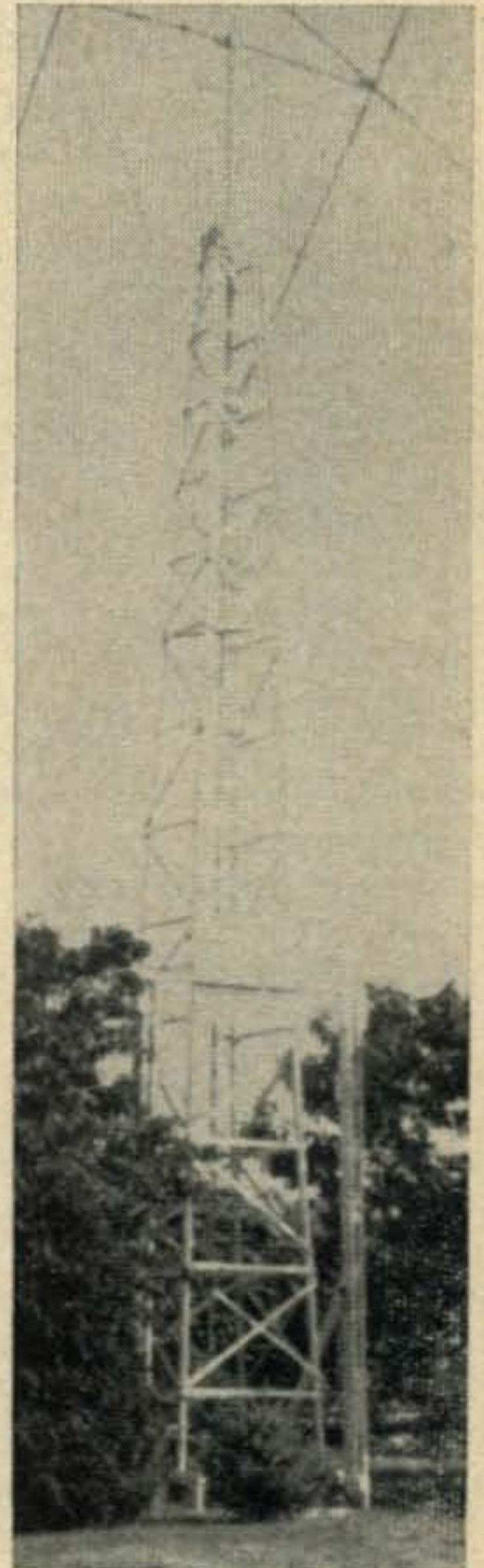



# The Transistorized Tattle-Tale

Charles Kunde, K9CRD

Roselle, Illinois

and

Donald L. Stoner, W6TNS

Ontario, California

The Conelrad regulations are still with us, and radio amateurs both young and old are required to comply. The unit to be described is a simple, low-cost project, that makes it fun to abide by the rulings.

For simplicity the unit does not illuminate a lamp, sound a buzzer, or blow up the final if the radio station goes off the air. It may be left playing quietly in the background and will "sound off" when the 1 kc Conelrad tone is broadcast.

## Operation

The "Transistorized Tattle-Tale" is simply a combination crystal set and transistor amplifier. Because of the properties of transistors, the detection and amplification is accomplished in the same transistor. Coils L1 and L2, along with capacitors C2 and C3, form a resonant circuit that is selective enough to separate stations that are very close in frequency. Coil L3 matches the tuned circuit impedance to that of the transistor base.

The transistor, Q1, is operated with no bias and therefore draws little or no current. When a station is tuned in, the positive *rf* cycles cause the transistor to conduct, while the negative half cycles drive it further into the cut-off region. Thus, in the collector circuit, a rectified *rf* envelope appears. Capacitor C4 removes the or detected *rf* envelope appears. Capacitor C4 removes the *rf* component, leaving only the audio which amounts to changes in current through the speaker impedance matching transformer, T1.

When the speaker cord is pulled out, it disconnects the collector from the batteries and there is no current drain. The battery will last for many months. A sensitive relay could also be used in place of the speaker. It, in turn, can be used to operate lights or warning bells. The coil resistance of this relay should be between 5K and 10K. The battery should be jacked up to 15 volts.

You may have noticed that there is no volume control on the set. Actually the volume

can be excessive on local stations, but it is reduced simply by tuning one of the capacitors off the frequency.

[Continued on Page 106]

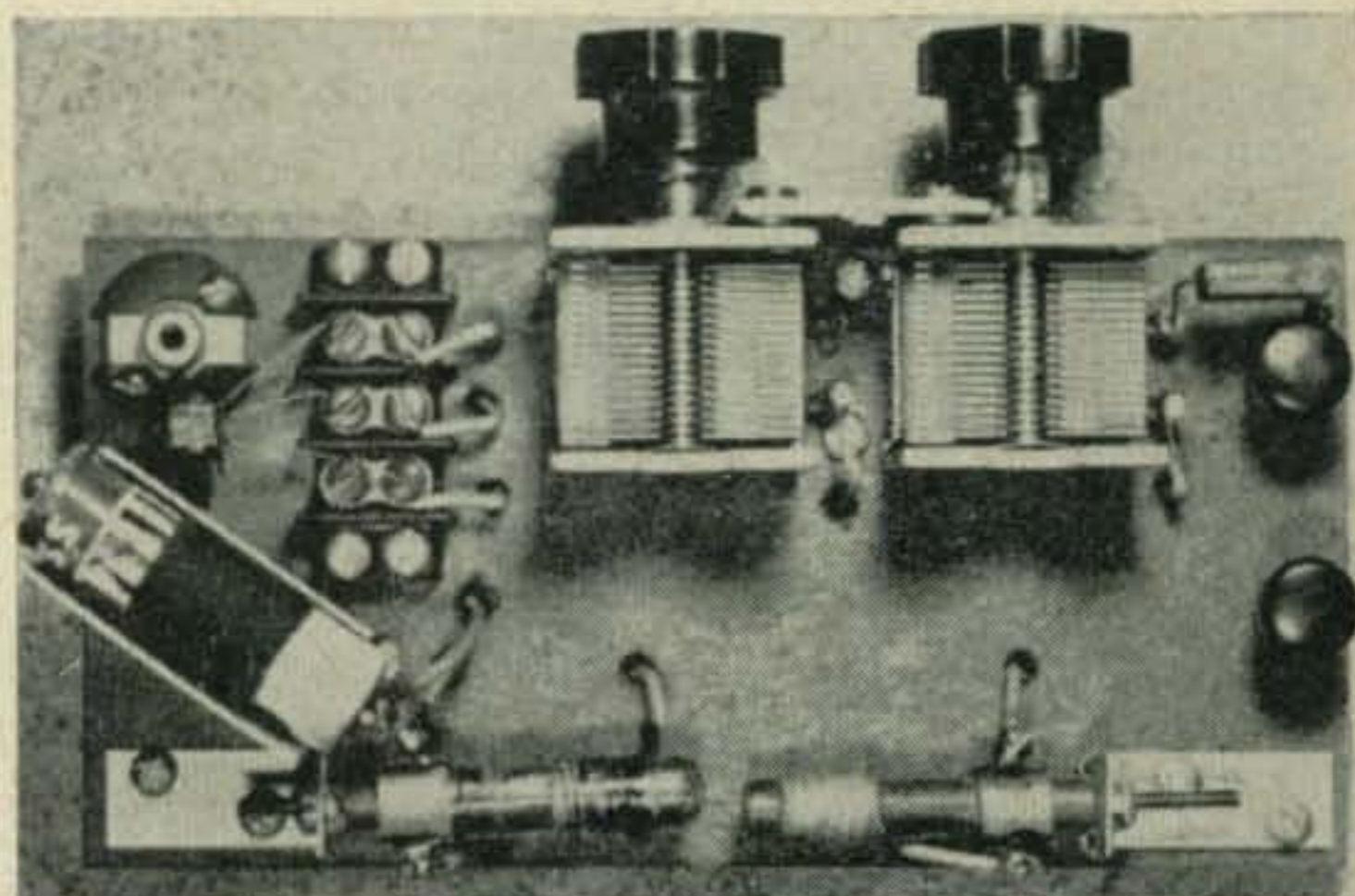

Layout and wiring view of the Transistor Tattle-Tale Conelrad receiver. Note that the transistor is secured to a Kulka block type terminal strip. Posts for antenna and ground are at the right, while the speaker line is near the transistor. The coils should be mounted as shown, back-to-back, near the rear of the chassis. If a metal chassis used, bend the coil brackets so the coils clear the chassis by one inch or more. (Photo by Ray Welch, K9ISQ)

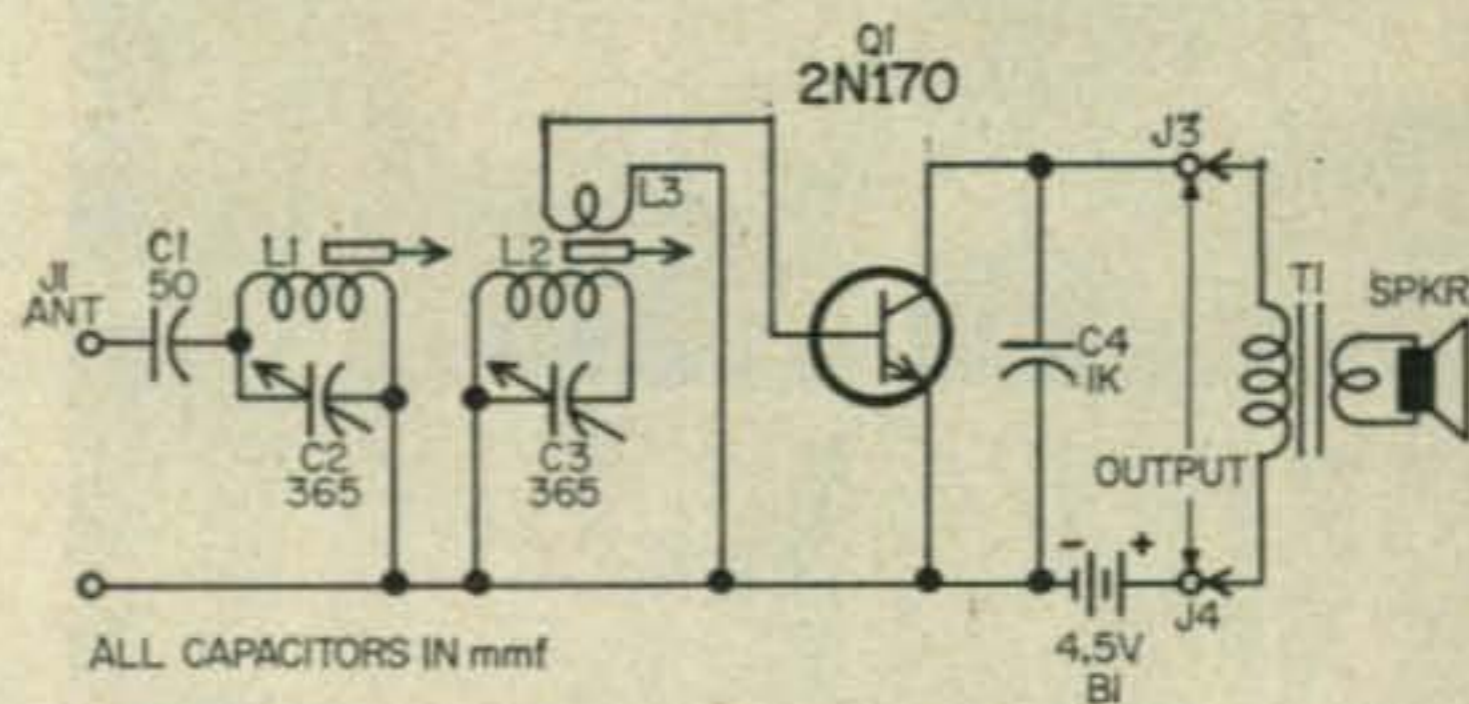

- C<sub>2</sub>, C<sub>3</sub>—365 mmfd. tuning capacitors (J. W. Miller #21111)
- L<sub>1</sub>, L<sub>2</sub>—Ferrite "Loopsticks" (Miller #6300)
- L<sub>3</sub>—20 turns, #28 enam. wire wound over L<sub>2</sub>.
- T<sub>1</sub>—Transistor collector to speaker matching transformer, 10,000 to 4 ohms (Triad TY-62X or equiv.)

Fig. 1—Schematic of the Transistorized Tattle Tale Conelrad radio receiver.



# RULES: 1960 CQ WORLD WIDE DX CONTEST

- I. CONTEST PERIOD:**  
Phone Section: 0200 GMT October 29 to 0200 GMT October 31.  
CW Section: 0200 GMT November 26 to 0200 GMT November 28.
- II. BANDS:**  
The contest activity will be in the 1.8, 3.5, 7., 14., 21., and 28. mc amateur bands.
- III. TYPE OF COMPETITION:**  
1. Phone Section. (a) Single Operator. (b) Multi-operator, single transmitter. (c) Multi-operator, multi-transmitter.  
2. CW Section. (a) Single Operator. (b) Multi-operator, single transmitter. (c) Multi-operator, multi-transmitter.  
3. Inter-Club. (DX Clubs affiliated to a National body.)
- IV. EQUIPMENT:**  
There is no limit to the number of transmitters and receivers allowed and competitors may use the maximum power permitted under the terms of their license.
- V. SERIAL NUMBERS:**  
1. Phone stations will exchange serial numbers consisting of 4 numerals, the first 2 being the RS report and the last 2 their own Zone number.  
2. CW stations will exchange serial numbers consisting of 5 numerals, the first 3 being the RST report and the last 2 their own Zone number.  
3. Stations in Zones 1 thru 9 will prefix their Zone number with Zero. (01 and etc.)
- VI. POINTS:**  
1. Contacts between stations on different continents will count 3 points.  
2. Contacts between stations on the same continent, but not in the same country, will count 1 point.  
3. Contacts between stations in the same country will be permitted for the purpose of obtaining a Zone and/or Country multiplier but no QSO points are credited.  
4. Only one contact with the same station is permitted per band.
- VII. MULTIPLIER:**  
Two types of multipliers will be used.  
1. A multiplier of 1 for each Zone contacted on each band.  
2. A multiplier of 1 for each Country worked on each band.
- VIII. SCORING:**  
1. The score of each Single Band is the sum of the Zone and Country multiplier for that band, multiplied by the total contact points on that band.  
2. The total All Band score is the sum of the Zone and Country multipliers of all bands, multiplied by the sum of the contact points on all bands.  
3. Those sending in logs for a Single Band are eligible for a Single Band award only. If a log is sent in for more than one band, indicate which band is to be judged, otherwise it will be judged as an All Band entry.  
4. A station is not eligible for more than one award.  
5. Single operator contestants must show a minimum of 12 hours of operating time to be eligible for an award. If a contestant operates more than one band and wishes to be judged for a specific single band, he must show a minimum of 12 hours on that band.  
6. Multi-operator stations must show a minimum of 24 hours of operating time to be eligible for an award.  
7. Multi-operator stations will only be judged on the basis of an All Band score.
- IX. ZONES and COUNTRIES:**  
The CQ Zone map and the ARRL and WAE country lists will be used as standards. The continental boundaries used for WAC will also be recognized. Should any question arise as to the positive location of a station, the official definition will be final.
- X. AWARDS:**  
Certificates will be awarded in each section as follows:  
1. To the highest scoring Single Operator station on each Single Band in the following areas:  
a. Each call area of the United States, Canada and Australia.  
b. All other countries.  
2. To the station having the highest All Band score (more than one band) in



## WORLD-WIDE DX CONTEST LOG

CALL W2JB COUNTRY U. S. A. PHONE  CW   
 LOG FOR 14 MC BAND CALL LETTERS OF OTHER OPERATORS \_\_\_\_\_ NR. OPERATORS 1  
(Use separate log for each band)

DATE (GMT)	TIME (GMT)	STATION	SERIAL NUMBERS		FILL IN ONLY WHEN QSO IS A MULTIPLIER		POINTS (1 or 2)
			SENT	RECEIVED	WAR ZONE NO.	NAME OF COUNTRY	
Nov. 26	0210	W2BO	56905	55905	5	USA	-
"	15	KE2FA	59905	58906	6	Mexico	1
"	20	W6RW	59905	57903	3		-
"	25	CE2CO	58905	58913	13	Uruguay	3
"	0310	KV4AA	59905	59908	8	Virgin Is	1
"	15	KH6DLP	57905	56931	31	Hawaii	3
"	30	CE3AG	57905	57912	12	Chile	3
"	1200	W4KFC	56905	55904	4		-
"	05	VE3API	55905	55904		Canada	1
"	15	4S7WP	55905	55922	22	Ceylon	3
"	30	JA1AA	55905	44925	25	Japan	3
"	2200	QW3ZV	59905	56914	14	Wales	3
"	10	F9RS	57905	56914		France	3
"	15	DL7AA	57905	56914		Germany	3
"		DJ3JZ	57905	56914			3
"		4ARE	56905	55920	20	Israel	3
"			57905	56915	15	Czechoslovakia	3
"			56905	55915		Finland	3
TOTAL NUMBER ZONES, COUNTRIES, POINTS:					13	15	39

All Band Entry  Phone  Station Call Letters W1GYE  
 Single Band Entry  CW  Number of Operators 1

## CQ WORLD-WIDE DX CONTEST

Band	QSO'S	Zone Multipliers	Country Multipliers	Points	Score	Band
1.8 MC	2	2	2	1	4	1.8
3.5 MC	10	5	4	18	162	3.5
7 MC	15	6	10	33	528	7
14 MC	18	7	13	45	900	14
21 MC	20	10	12	60	1320	21
47-MC						<del>37</del>
28 MC	30	12	18	80	2400	28
<b>TOTAL</b>	<b>95</b>	<b>42</b>	<b>59</b>	<b>237</b>	<b>23,937</b>	<b>All Bands</b>

INSTRUCTIONS: To determine All Band score, total each column stations are permitted to operate on more than one band. If you wish judged.

Transmitter Description and Power \_\_\_\_\_

I hereby certify that I have read and understand the rules of the contest and agree to operate my transmitter within the limitations of the contest.

*Andrew Malashuk*  
 Andrew Malashuk W1GYE  
 Name Call

40 Crane Road, N.  
 Street and Number

Stamford, Conn. U.S.A.  
 City Country

Logs must be postmarked not later than December 1, 1960 for Phone section and January 15, 1961 for CW section.

Submit logs to: CQ Magazine, 300 West 43rd St., New York 36, N.Y. Att: Contest Comm.



the following areas:

- a. Each call area of the United States, Canada and Australia.
  - b. All other countries.
3. Awards to multi-operator stations will only be made in the #2 ruling.

#### XI. SPECIAL AWARDS:

In addition the following special awards will be made:

1. A cup will be awarded to the highest scoring Single Operator, on a Single Band, Phone Station in the world. (*Donated by W6AM*)
2. A cup will be awarded to the highest scoring Single Operator on a Single Band, CW Station in the world. (*Donated by W7KVU*)
3. A cup will be awarded to the highest scoring Single Operator, All Band, Phone Station in the world (*Donated by W2SKE*)
4. A cup will be awarded to the highest scoring Single Operator, All Band, CW Station in the world. (*Donated by W9IOP*)
5. A cup will be awarded to the highest scoring Multi-operator, All Band, Phone Station in the world. (*Donated by K2AAA*)
6. A cup will be awarded to the highest scoring Multi-operator, All Band, CW Station in the world. (*Donated by K2GL*)
7. A plaque will be awarded to the affiliated DX Club (not a national body) submitting the highest aggregate score of the scores submitted by its members. (*Donated by CQ*)
  - a. For a club to enter, an officer of the club must submit a list of its participating members and their scores.
  - b. This list may include scores of single operator and multi-operator stations; both phone and CW.
  - c. Stations that are members of a competing club therefore must indicate this fact on their report forms.
8. At the request of the donors, previous winners are not eligible for the 1960 awards. In other words the trophy cannot be won more than once by the same station. This does not apply to the plaque.
9. Also such special or additional awards as the Committee shall choose to make. In countries or sections where the returns justify second and third place certificates will be awarded.

#### XII. DISQUALIFICATION:

Violation of the rules and regulations pertaining to amateur radio in the country of the contestant or the rules of this contest

will be deemed sufficient cause for disqualification.

#### XIII. LOG INSTRUCTIONS:

1. In keeping a log, fill in Zone number and Country, **ONLY FIRST TIME** it is contacted.
2. Use a separate sheet for each band and a tally sheet or report form.
3. Keep all times in **GMT**.
4. All contestants are expected to compute their scores. Logs should be checked for contact duplications and proper point credit before they are submitted.
5. Make sure name and address is clearly noted on each log. Print or type.
6. Each contestant must sign a pledge that all rules and regulations have been observed and that the report is a true one. Note sample contest report form.
7. If official log forms are not available, use a duplicate form as indicated. The size is 8½" x 11" with 52 contacts to the page.
8. Copies of the Zone map, log sheets and report forms are available from CQ, address listed below. Send a self-addressed envelope, large size. Include sufficient postage, in the case of overseas stations IRC coupons are acceptable. Make sure to indicate how many sheets are needed.

#### XIV. RULE CHANGES:

1. Note Par. VIII #7 and Par. X #3. The Committee feels justified in making this change. It does not require the efforts of more than one operator to cover a Single Band during a contest period. Especially now that the active time of the higher frequency bands is becoming shorter. Therefore there will no longer be Single Band awards for multi-operator stations.
2. In the multi-operator division, (b) single transmitter and (c) multi-transmitter under Par. III. The separation as made last year will be retained. Therefore it is important that multi-operator stations indicate under what classification they are operating.

#### XV. DEADLINE:

All logs must be postmarked **NO LATER** than December 1, 1960 for the Phone section and January 15, 1961 for the CW section. In rare isolated places the deadline will be made more flexible. Send logs directly to:

**CQ Magazine**  
300 West 43rd St.,  
New York 36, N. Y.  
Att: Contest Committee

(Please inform your local association of this contest)



# The FCV-2 Converter

Lee Aurick, W2QEX

Technical Editor, CQ

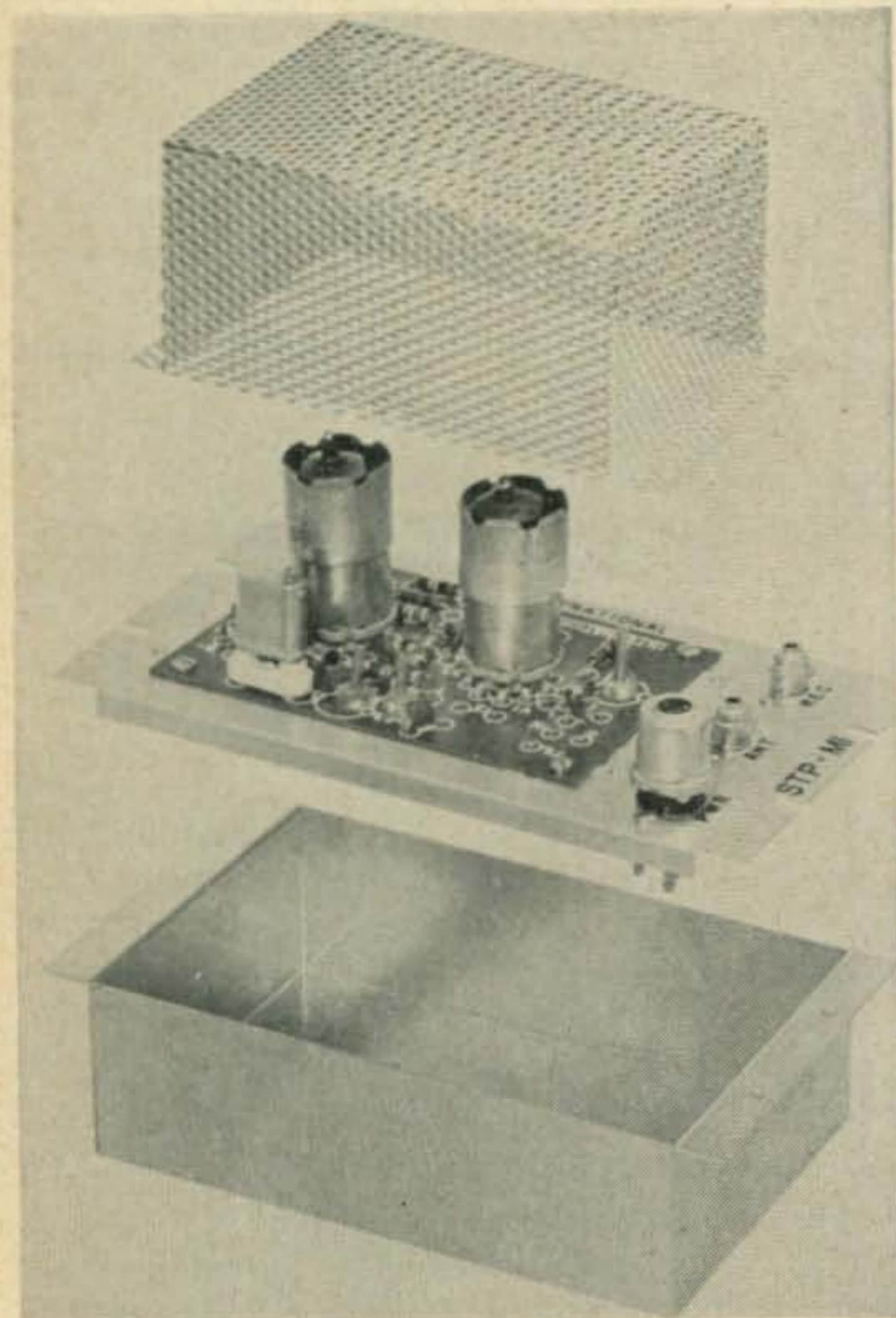

FCV-2 converter and STP-M1 shielded mounting chassis.

This popular converter by International Crystal Co. is available in two models; for either 6 or 2 meters.

For more than six months a 2 meter unit has been under examination and daily use by your reviewer. The conditions under which it has been used haven't been exactly conducive to prolonging the life of the unit, but no failures have been experienced and it is still performing as well as ever.

Considerable operating has been done on 2 meter CW where it was necessary to use the converter and receiver for monitoring since a separate monitor was not available for this purpose. Despite the fact that the converter is beside the transmitter, and nearer to it than the receiver, no overloading, saturation or arcing have been observed.

For a time, the converter was operated into a 28 mc superregen. It did a fine job, limited only by the inadequacies of this "if strip," and helped stimulate some thinking about a very compact 2, 6, and 10 meter portable receiving lash-up

Either model may be obtained assembled or in kit form for just about any *if* up to 30 mc. Standard frequencies are 600 to 4600 kc, and 7 to 11 mc. Other frequencies may be ordered specially. Each unit features a sensitivity capability of 1/2 microvolt or better. Crystal frequency of course depends upon the *if* desired.

Easy assembly from either kit is made possible by a printed circuit board. In addition, part numbers are clearly marked on one side to facilitate mounting, and to remove any possibility of error. The correct part is simply inserted in the proper holes, soldered, and leads clipped. It's an easy one-evening job.

A 6BQ7 cascode pre-amplifier, and a 6U8 mixer/oscillator provide essentially four-tube operation. The FCV-2 requires 250 volts *dc* maximum at 26 to 30 *ma*, and 6.3 volts *ac* at .85 amperes. The converter may be used on 12 volts for mobile operation by using a 7 1/2 ohm, 10 watt resistor in series with the filament lead. It measures 3 x 4 1/2 x 2 7/8 inches and weighs in at 4 ounces.

A completely shielded, but well ventilated mounting chassis, STP-M1, is also available. It no doubt is largely responsible for a complete lack of feed-through of stations operating on the *if*, 28-30 mc, and no images throughout the 2 meter band.

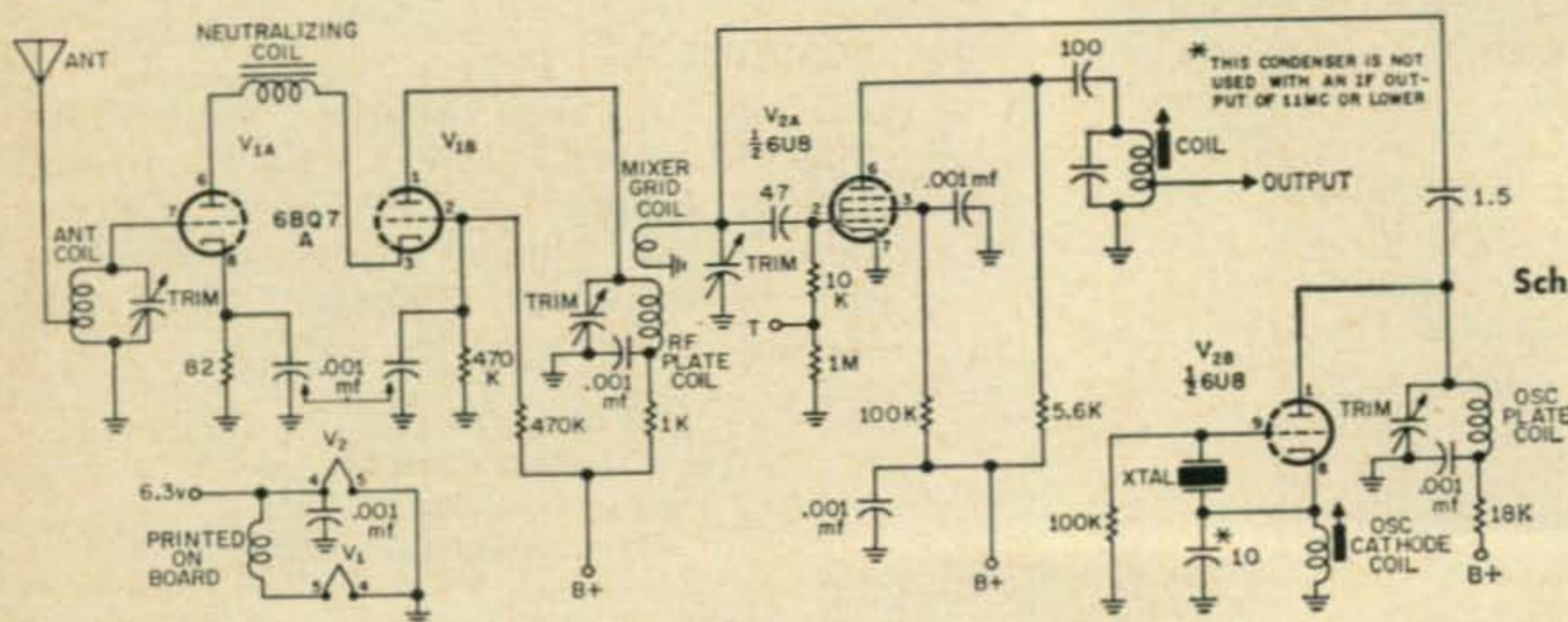

Schematic of FCV-2 converter.



# The FSC-250 Frequency Shift Converter

Byron Kretzman, KØWMR, RTTY Editor, CQ

Amateur frequency shift radioteletype (RTTY) was first permitted on our *hf* bands February 20, 1953. Since that time extremely few converters, or terminal units (TU's), within the financial means of the average ham have appeared on the market. Some surplus converters have appeared but invariably have been of the *if* type, designed to work from some strange intermediate frequency of a military receiver. In addition, these surplus units sometimes weigh several hundred pounds. It should be kept in mind, too, that when operated intelligently the *audio* type of TU has proved more satisfactory in our crowded ham band operation than the *if* type.

The *Electrocom* Model FSC-250 is a completely self-contained audio type of TU. It is fed from the audio output of a receiver and it directly operates the receiving selector magnets of a teleprinter machine. No external *dc* power supply is necessary for the machine. This TU is built on a standard 3½ inch relay rack panel and the chassis extends 10½ inches behind the panel. A built in 2 inch oscilloscope is provided as a receiver tuning indicator and as a monitor.

Channel filters are plug in, and are normally supplied for 850 cycle shift and are for the standard *mark* tone of 2125 cycles and the standard *space* tone of 2975 cycles. Other filters are available for reception of other values of shift, 170 cycles for example. A socket also permits the plugging in of an optional input filter. A band pass input filter is not required for the

operation of the converter but it will give improved performance when the FSC-250 is used with the less complex communications receivers. When a receiver having a 1.5 *kc* mechanical filter *if* is used, a notch filter centered on 2550 cycles is available for use with the standard 850 cycle shift channel filters. Use of the notch filter will tend to prevent strong signals between the *mark* and *space* from messing up copy. The accompanying block diagram, fig. 1, shows how the incoming audio tones are filtered and separated. The response curves of the 850 cycle shift channel filters are shown in fig. 2.

### Autostart

An extraordinary feature of the FSC-250 is built in autostart. This feature enables the attended or unattended control of the printer motor by the received radio signal. Of course, standard operating procedure is a must, whether you are on 80 meters with FSK or on 2 with AFSK. This means sending a steady *space* for two or three seconds just before you turn it over to the other fellow (before dual identification, too) and a steady *mark* for about the same length of time before you begin hitting the keyboard.<sup>1</sup>

<sup>1</sup>Kretzman, B. *RTTY Handbook* pp. 58 and 89 give details of RTTY procedures and autostart.

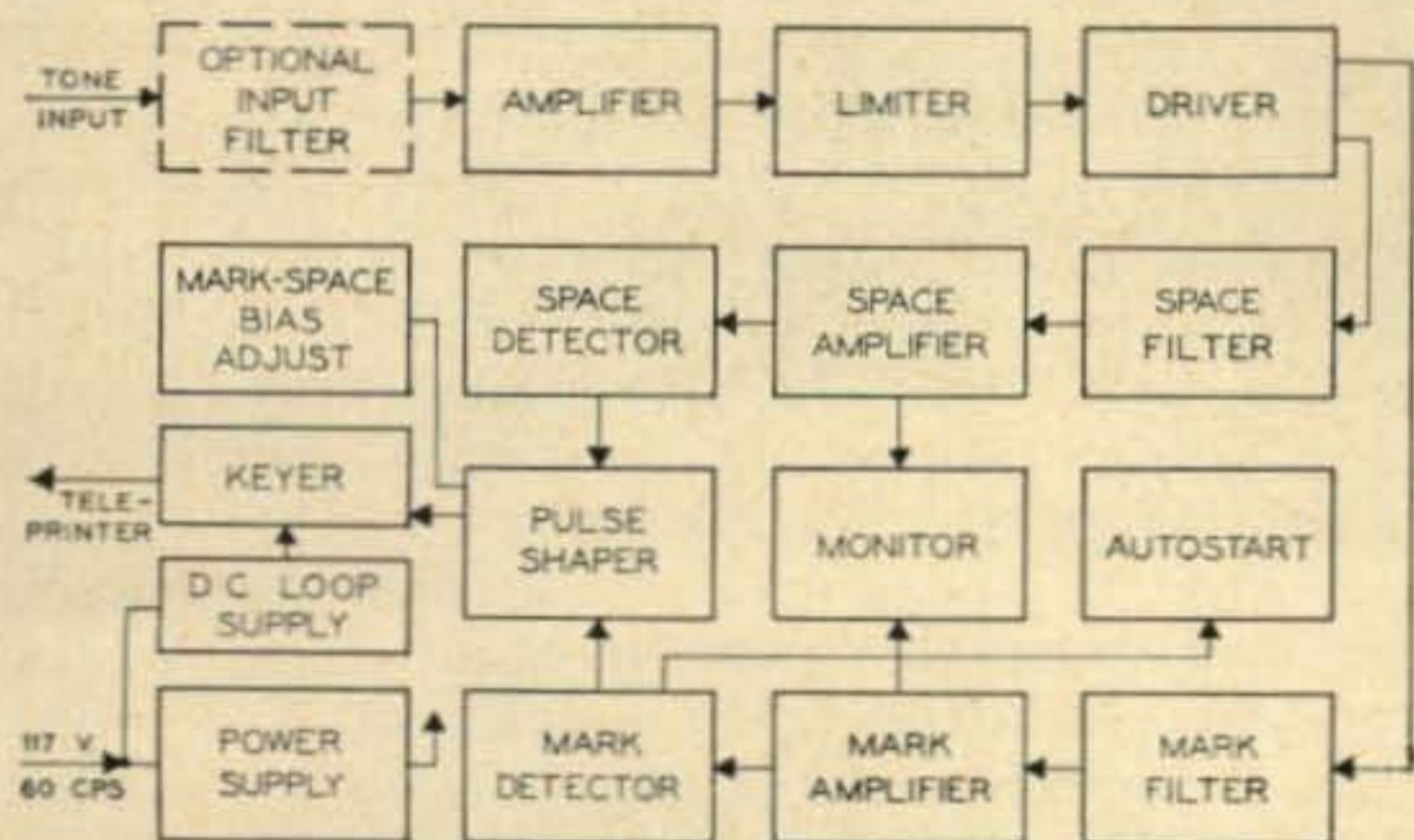

Fig. 1—Block Diagram, Model FSC-250 Frequency Shift Converter.

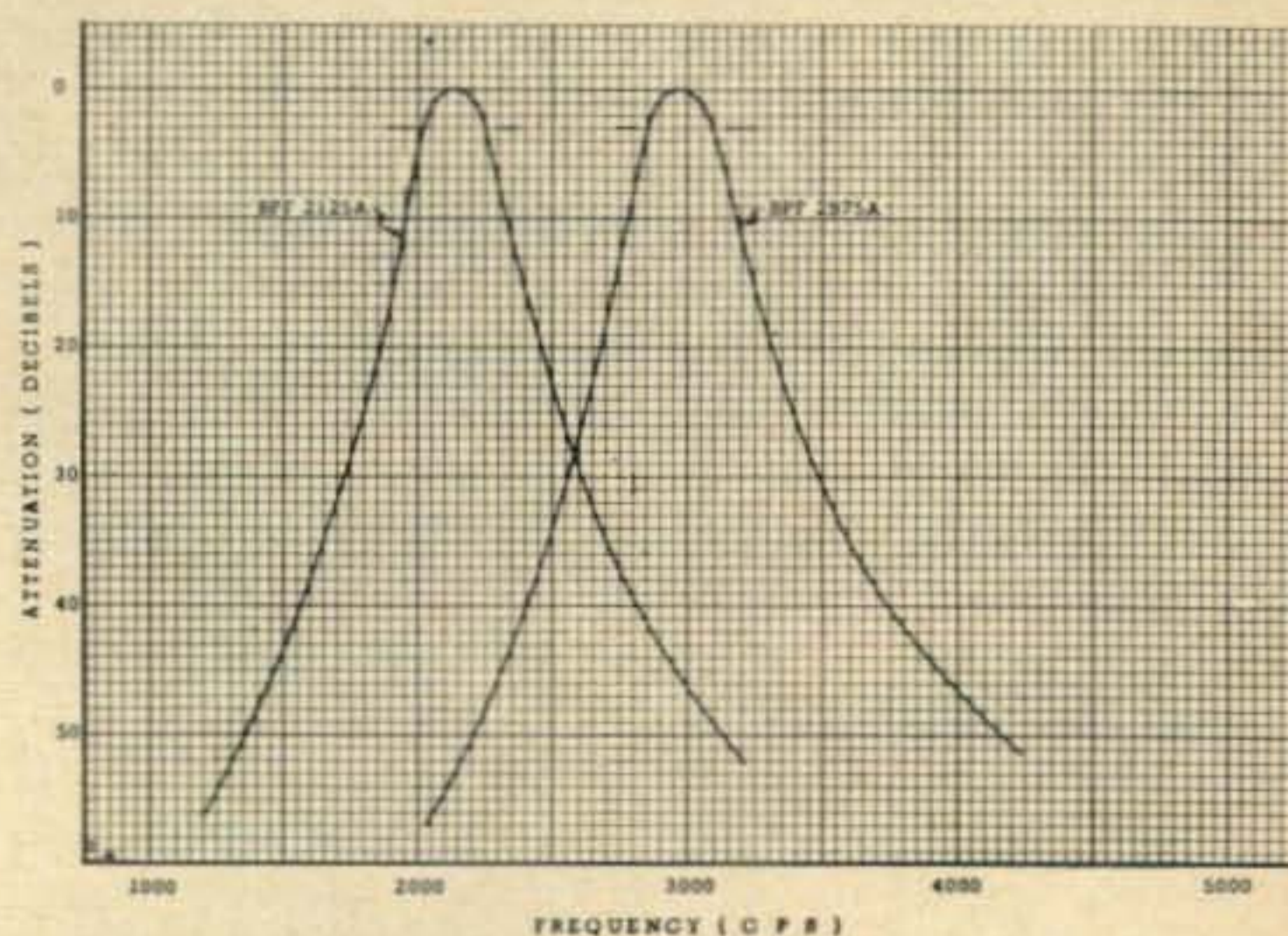
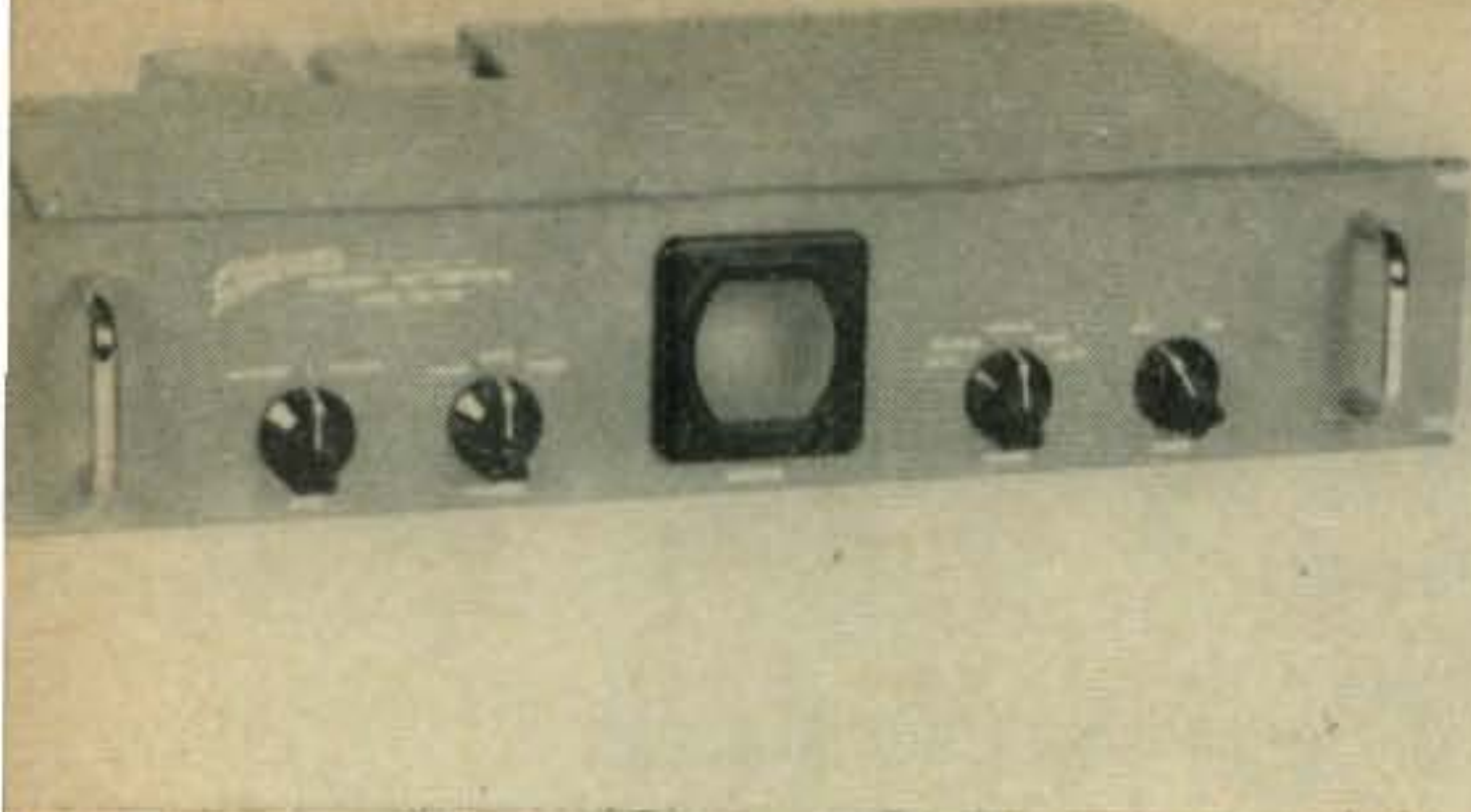
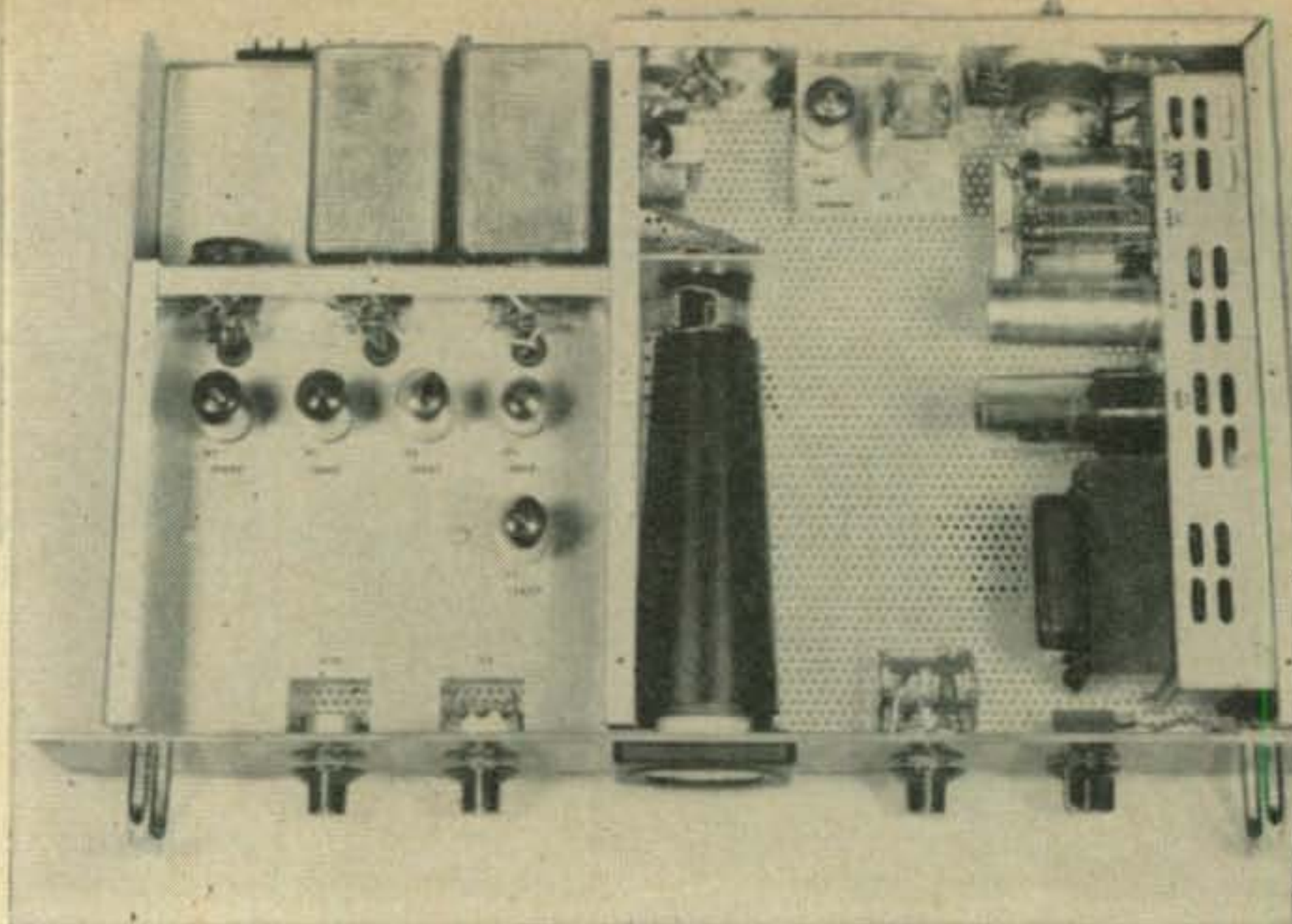

Fig. 2—Response Curves, 850 cycle Shift Channel Filters.





Top—Electrocom Model FSC-250 Frequency Shift Converter. Controls from l to r.; Bias, Channel, Monitor Scope, Keying Selector, and Power Switch. Right—Inside the FSC-250 Converter. The entire unit is constructed on a 3½" rack panel. Power supply components are to the right. Plug-in band pass filters can be seen at the upper left.



### Operation

A look at the front panel of the FSC-250 discloses that there are only four panel controls, which will give you some idea of how simple it is to operate. The MONITOR scope bezel is centered on the panel. Its display, for a properly tuned in and shifted RTTY signal, is the familiar cross, with the *mark* as a vertical line and the *space* as the horizontal line.

Starting from the left, the BIAS control adjusts the TU for best copy. In other words, if the received signal has, say, marking bias, it can be compensated for by turning this control towards SPACING. The adjustment of this control is not critical. The next control is a three position CHANNEL switch. It allows you to make copy from either MARK or SPACE instead of BOTH when QRM rears its ugly head. Just to the right of the scope is the KEYING function switch which controls the keying of the selector magnets in the machine. NORMAL, of course, means what it says. REVERSE permits making copy when the transmitted signal is upside down, and LOCAL supplies a continuous marking current to the local loop. If your keyboard is connected in series you can then use this function to make printer copy or to punch tape.

The MARK position of the KEYING switch locks the local loop in a marking condition during no signal or dual identification periods. It also shuts off the machine motor, if so connected. A one second *mark* signal then starts things up. This is "attended" autostart operation.

The operation of the TU when the KEYING switch is in the AUTO position is similar to that when it is in the MARK position except that the local loop is open and the scope is blanked to prevent burning a spot in the center as the result of long no signal periods. This position is used in "unattended" autostart operation. As in the MARK position, a one second *mark* signal starts up the machine motor, energizes the local loop, and makes the machine ready to copy. A one second *space* signal by the transmitting station shuts things down again. (These are minimum time lengths. It is suggested that two or three second signals be used to assure positive operation.)

### Testing

We gave this TU a very thorough workout in the midwest. It was used at several different stations, on different bands, by different operators, with different receivers, and with different machines. Unfortunately we don't have enough space in *CQ* to give each operator's comments and impressions, so we will try to boil all of our information down to give you an unbiased report.

Hooking up this TU at different stations was very simple. Where a 600 ohm output was not available on a particular receiver we merely hooked it across, in series with a 560 ohm resistor, the voice coil speaker terminals. There is more than enough sensitivity so the gain control on the receiver could be run way down to where the tones won't bother the XYL.

The *dc* output current was easily adjusted, by a pot on the back of the chassis, to either a 20 *ma* or a 60 *ma* local loop current for the machine. *Electrocom* has very thoughtfully provided a screw on cover for this adjustment to keep out unauthorized screwdrivers.

Control of the machine motor was obtained by connecting a pair of wires across the usual motor control *ac* switch found on the machine table. Or, we disconnected the table switch and completely controlled the machine's motor by the KEYING switch on the panel of the TU.

The scope presentation was found to be not just an aid for tuning the associated receiver but was found essential in analyzing the received signal when the printed copy was full of errors. With a little experience it became pretty obvious who was short on shift, or when propagation was causing multipath reception to foul up the copy. Some of the fellows using the FSC-250 would rather have had the phase shift type of scope presentation<sup>2</sup> but that was considered a matter of personal preference.

When the station being received was really short on shift it became very handy to throw the CHANNEL switch over ON MARK and make copy that way. This little feature proved to be very handy when QRM, intentional and otherwise,

[Continued on page 106]

<sup>2</sup>Kretzman, B. *op. cit.* p. 65.





## The Aircor 6 and 10 Meter Converters

Lee Aurick, W2QEX  
Technical Editor, CQ

These high performance, crystal controlled converters by Northeast Telecommunications Inc. are fairly new to the amateur scene. All told, there are six different units; three for six meters, and three for ten meters.

They are all distinguished by the fact that normal B+ voltage is not required. Plate and filament voltages are derived directly from the battery source which may be either 6 volts or 12 volts. The use of "hybrid-type" tubes eliminates the need for a high voltage supply. The chart below shows the various models available.

MODEL	OPERATING VOLTAGE	BAND
C-314	6-DC	6
C-315	12-DC	6
C-316	12-DC	10
C-317	12-DC/115-AC	10
C-318	12-DC/115-AC	6
C-319	6-DC	10

All units are identical in circuitry and components, except for the obvious tank differences between the 6 and 10 meter units.

These converters should appear extremely attractive to prospective mobile operators since it is unnecessary to open the auto broadcast receiver, or even remove it from the car. The connection of a short, 50 ohm coax jumper from

the converter output to the input of the auto receiver is the only alteration made to the normal broadcast set-up. It only remains to connect the mobile antenna to the converter, the red lead to the positive side of the battery at any convenient point in the auto electrical system, and the black lead to the negative side. It makes no difference which side of the battery is grounded in your particular auto; for the converter is completely isolated from ground.

Operation of the slide switch on the front of the converter will turn the unit OFF, and connect the mobile antenna to the broadcast receiver for normal BC use.

Models C317 and C318 incorporate a small power supply to permit operation on 115 volts *ac*, as well as 12 volts *dc*. In these models, all that is required to change from one operating voltage to the other is the use of the proper power cable. Both units come equipped with *ac* and *dc* power cables.

The 6 volt *dc* models are identical, except that two penlite cells are added in series with the oscillator plate supply to boost this voltage to a more effective 9 volts *dc*. Current drain in this circuit is only about 2 *ma* and battery life-expectancy should approach shelf life.

The 10 meter converters, as normally sup-  
[Continued on page 108]

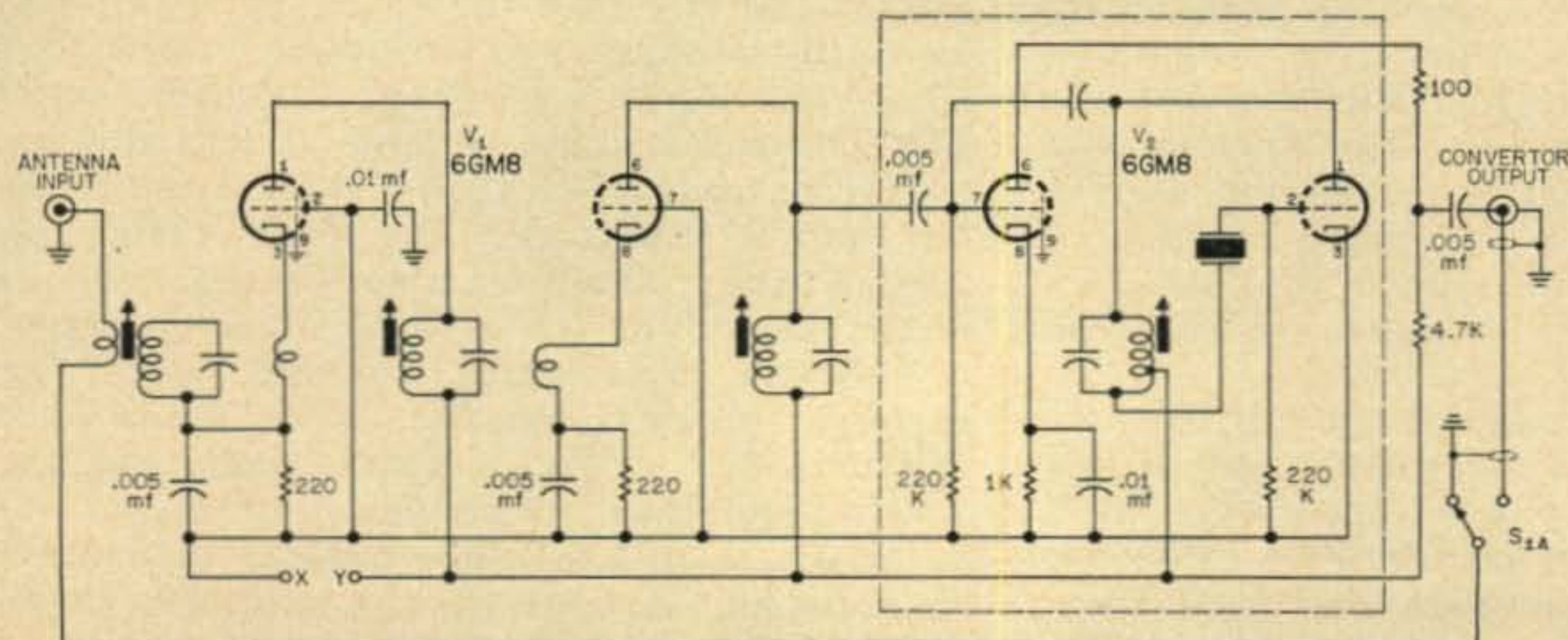

Fig. 1—Schematic of the Aircor converters. All models use the same circuit.









The rig of the very popular 151DKL on the left and 151DKL in the driver's seat on the right.  
(Tnx W2DEO)

most of the fellows who have the most to lose are all for this idea. They want everything on an equal basis.

The following letter was received by W2OKM from 5A5TR, who is ex YA1IW:—

“Dear Bob:—I was extremely sorry to hear I'd kept you waiting so long and, as you say, there are probably quite a few others who are in the same boat.

I've been in a rather undecided condition since leaving YA, driving across Pakistan, I ran, and then back to Afghanistan. From there to VU, SU, and then over here to accept a job in 5A.

I'm at present on a Geophysical exploration group located for the present time about 550 KM E, of Tripoli. (Halfway between Tripoli and Benghazi. Operating SSB and mainly 20

from 2200 GMT to sometimes 0500 or 0600 GMT.)

Best of luck Bob, hope to say hello one of these days from 5A or? Oh, by the way, might be an FF7 in the future on SSB with a KWM-1 that I now have with me.

“Cal” Moss, 5A5TR.

#### Who, Where and What

**AC3 SIKKIM**—AC3NC has been heard on 14310 kc CW around 14-17 GMT, also on phone on the same frequency.

**CR1Ø Timor**—Rumor has it that MP4BCC is now CR1ØAD and is active on 21, 225 kc AM around 1000 GMT. Can anyone confirm this?

**FB8 Comores**—We are sorry to hear that FB8GP has passed away. (Tnx WGDXC)

**FG7 Guadeloupe** — Correction of earlier



On the left the shack of FA3LX and on the right FA3LX and family on a Sunday outing. (Tnx K2UKQ)





Following a recent audience with Pope John XXXIII, Bill Halligan, W9AC (center) takes a turn operating HV1CN. At the left is Domenico Petti, I1CNS licensee of HV1CN and at the right is Loris Castaldi, I1CL. The racks at the rear are part of "Radio Vatican."



Vance ZL2AX and his home brew 813 transmitter and Eddystone receiver. Someone has been using his call on CW lately and since Vance operates no CW, cards, of course, cannot be sent. (Tnx W5SU) Bill, KA2RA, and his very neat station in Tokyo. Bill is trying to make WAS before he goes to SVØ land next year.



George, VK5RX, who is the VK5 QSL manager, returning from the post office with a batch of smiles for the VK5 boys. (Tnx K2UKO)

column, ex XW8AI is not FG7XG; he is FG7XF. FG7XG is Roger Reynier and W3GJY is his QSL manager. (Tnx W3GJY)

**FP8 St. Pierre**—W2EQS will return to FP8 again this year during the first two weeks in August. All bands 160 through 10 will be used.

**FR7 Reunion Island**—FR7ZD is active on 14240 *kc* phone and 14060 CW around 19-20 GMT. A new one, FR7ZE, is using 600 watts and a ground plane on 14 *mc*. (Tnx DXer)

**KJ6 Johnston Island**—Look for KJ6BV on 14240 to 14265 *kc*, mostly on weekends. (Tnx WGDXC)

**PX andora**—ON4RC is going to PX for five days in August: phone only (Tnx K2UKQ)

**SVØ Crete**—The following are active from Crete:—

SVØWT on 14 *mc* SSB and 21 *mc* fone, best time is 22-23 GMT on 14305 *kc*.

SVØWZ on 14 *mc* CW around 20-23 GMT.

SVØWI on 7 *mc* CW around 23 GMT.

**VR1 Gilbert Islands**—A new one has appeared from this spot. He is VR1E and has been heard on 28.230 *kc* phone around 0100 GMT.

**VR3 Christmas and Fanning Islands**—VR3V, Don, uses 30 watts on 10 15/20 CW, he is G3MKG;

VR3W, Ron, vy QRV 14 *mc* fone. QSL direct:

VR3X, Roy, 14 *mc* CW, he is G3JHI;

VR3Z, 14 *mc* CW, around 07-09 GMT. (Tnx DXer)

**ZC5 North Borneo**—VS1BK plans more operations as ZC5BK in the near future. (Tnx DXer)

**ZD6 Nyasaland**—ZE3JO and ZE3JJ will be operating from ZD6 for two weeks during the latter part of August or early September, using CW, fone and SSB, if a rig can be obtained. ZE3JO will be remembered for his work as VQ1JO, VQ3JO and VQ4JO.

**ZL4 Campbell Island**—ZL4JF has been active around 0430 to 0530 GMT on 14120 fone although he is *vfo*. He will be there until the end of November.

**7G1 Republic de Guinee**—7G1A is active on 14050 *kc* CW around 20-22 GMT and 17-19 GMT on 14310 SSB. QSL via OK1PD.

#### QTH's

The following is a reasonably up-to-date list of QSL managers:—





Here are three more of W8OCT's masterpieces:  
 "Great balls of rf look at that radiation;" W3KT.



"He was running 1 amp at 4,000 volts when they walked in." W9IOP, W2JDR.



"No! not another phoney." W3RTB, W3BSF.



Bill, KA2RA, and his very neat station in Tokyo. Bill is trying to make WAS before he goes to SVØ land next year.

W3ZA/EP via W2JXH  
 HCCC8 via W8MXS  
 HB9FC/VQ8 via VE7ZM  
 OQ5IE via K2MGE  
 TF2WEG via K6VQQ  
 VKØIT via VK3KB  
 VP2KH via W2CTN  
 VP6BY via VE6BY  
 VS5BY via W6ZEN  
 ZD2JKO via W4MCM  
 3A2BB via G3IEW  
 VU2RM via W3KVQ  
 HKØAI via W9WHM  
 ZM6AS via ZL2ANB  
 CR4AH via W2CTN  
 FK8AT via W2CTN  
 FM7WU via W2CTN  
 JT1AB via OK1KX  
 KW6CU,CP via W2CTN  
 SUIMS via W6QNA  
 VK9GK via W2CTN  
 VQ3HH via W2CTN  
 VQ6LQ via K6KII  
 VS4JT via K6GMA  
 ZE1JV via KØDQI  
 ZS7M via W2CTN  
 ZD1AW via W3KVQ  
 4S7YL via KH6BPF  
 OQØRL via ON4RA  
 TF2WEN via K5QBG  
 BV1USE via W9HCR  
 HP1AO via K4ASU  
 HB9FC/MM via K1AJQ  
 OQ5RL via W8FTD  
 TF5TP via W2MUM  
 VP2AR via W3KVQ  
 VP2ML via K4SXO  
 VP7BI via W4ISH  
 YN4AB via K4ASU  
 ZK1BS via W7ZAS  
 3A2AV via I1ZBS  
 VS9MB via K2QXG  
 FM7WN/WQ via F8IE  
 7G1A via OK1PD  
 CR4AV via W2CTN  
 FK8AW via W2CTN

F08AX via WA6DFH  
 JZØHA via W2CTN  
 KC6AT via W3AFM  
 OAKK via WSHWM  
 VK2FR via W2CTN  
 VK9NT via W2CTN  
 VQ3CF via W2CTN  
 ZB2I via W2CTN  
 ZS3B via WØVXO  
 VR3Y via G3EMY  
 FG7XC via W3DJY  
 LA3SG/P via VE7ZM  
 HB9QP/CR8 via W4IYC  
 ZS7P via W6UND  
 VKØPN via VK4PM  
 FD8AMS via W6KUT  
 KW6DA/KM6 via KM6BI  
 OX3DL via W2CTN  
 TG9TI via W9YSQ  
 VP2DX via W8VDJ  
 VP5ME via W5TGV  
 VP7NT via W2TQR  
 W5FZB/KG6 via W5ADZ  
 ZL5AA via ZL2DX  
 VS6AZ via K6GMA  
 SVØWT via K2RYP  
 CN8JF via W8UWT  
 CR4AX via W2CTN  
 FM7WP via W2CTN  
 FY7YF via W2FXA  
 JZØDA via W2CTN  
 VK9BW via W2CTN  
 VQ4AQ via W2CTN  
 VQ2EW via W2CTN  
 VS4BA via W5UX  
 ZD2DCP via W2CTN  
 3A2AE via G3ATU  
 F08AC via W4KWC  
 ZK1AK via W3GJY  
 TA3GI via VE7ZM  
 XZ2SY via W4ANE  
 VU2ANI via W8PQQ  
 VQ6GM via ISWL  
 OY3PF via OZ Bureau

73, Urb, W2DEC





# ham clinic

CHARLES J. SCHAUERS, F7FE/W6QLV

CQ Magazine, 300 West 43rd St., New York 36, N. Y.

## International Friendship

If you have read HAM CLINIC consistently during the past three years, you have seen many references made to the *need* for cultivating genuine friendship between the peoples of the various countries of the world. It has been pointed out that no better medium exists than amateur radio for the exchange of ideas because it is a *direct* (person to person) method of communication.

This columnist introduced the signal abbreviation "72" (Peace and Friendship in Freedom) some months ago for the purpose of accentuating the role that ham radio plays in bringing people of all walks of life—in every country of the world, closer together, thus contributing to world peace.

Although "72" is used more often on CW than on phone, it has really caught hold throughout the world's ham fraternity.

An International abbreviation, "72" was not meant to be used between hams at home—and its meaning is quite clear.

When an American ham sends "72" over the airways to a ham in another country, he in effect says: "I am an American who wants *peace* along with millions of my other countrymen. Friends cannot be enemies, so I want your *friendship*. Because I respect the dignity of man and value my American *freedom* I can do no less than wish for you and your fellow countrymen the *best* of everything."

So let us hams in America use "72" in a sincere manner and do as much as we can toward *International Friendship and Peace*.

## Observation

CW, AM and SSB are today's prominent ham communication modes. FM has practically disappeared.

Like many hams I enjoy talking with CW at 40 words per minute or more and I also use AM and SSB. But I am not going to make some "off-the-cuff" predictions (as some people have done) that AM and CW are doomed and will, within a short span of time give way to SSB as the exclusive ham communications medium. (Remember when color TV made its debut, and how "it was going to be the *only* TV people would accept?")

There is little doubt that SSB has a number of advantages over AM, but it will be a very long while yet before it becomes the "exclusive" ham communications mode. Who is there to say that another better method may not "pop up" that will antiquate SSB? Electronic miracles are happening every day.

If you have decided (as many hams have—that SSB is the *only* medium for you, then you should join the SSBARA (Single Sideband Amateur Radio Association). This organization is devoted to furthering the progress of SSB and numbers among its ranks some of the world's most ardent hams including me. Contact our SSB Column Editors for full information.

I like SSB communication and think it is tops for voice communication but I can get through on CW when I cannot on SSB. To me, the ham who can use all three modes (CW, SSB and AM) is a well-rounded ham and prepared to communicate under all circumstances. By confining himself to only one mode he denies himself the advantages of more contacts with more hams.

Observed: more hams are using SSB every day, but there are too many who are forgetting CW and AM. The argument that SSB enables more stations to operate in less frequency space is a valid one, but let us not forget that CW occupies even *less* of our spectrum. Even if every ham in the United States of America can afford to switch over to SSB, there are many hams in other countries of the world who cannot—at least not yet. So in our haste to enjoy ham voice communications at its (present) best (SSB) let us not forget those who are not as fortunate as we, and who still desire to talk to us via AM and CW.

## Questions

"In referring to the ICAO-NATO phonetic alphabet, you say, 'A is *alpha*'; should it not be ALFA?"

For English speaking people "alpha" is acceptable in English print. For non-English speaking people, "alfa" is used and spelled this way in the original version because it is itself phoneticized.

**CB-1 Squelch**—"Can you give me a simple



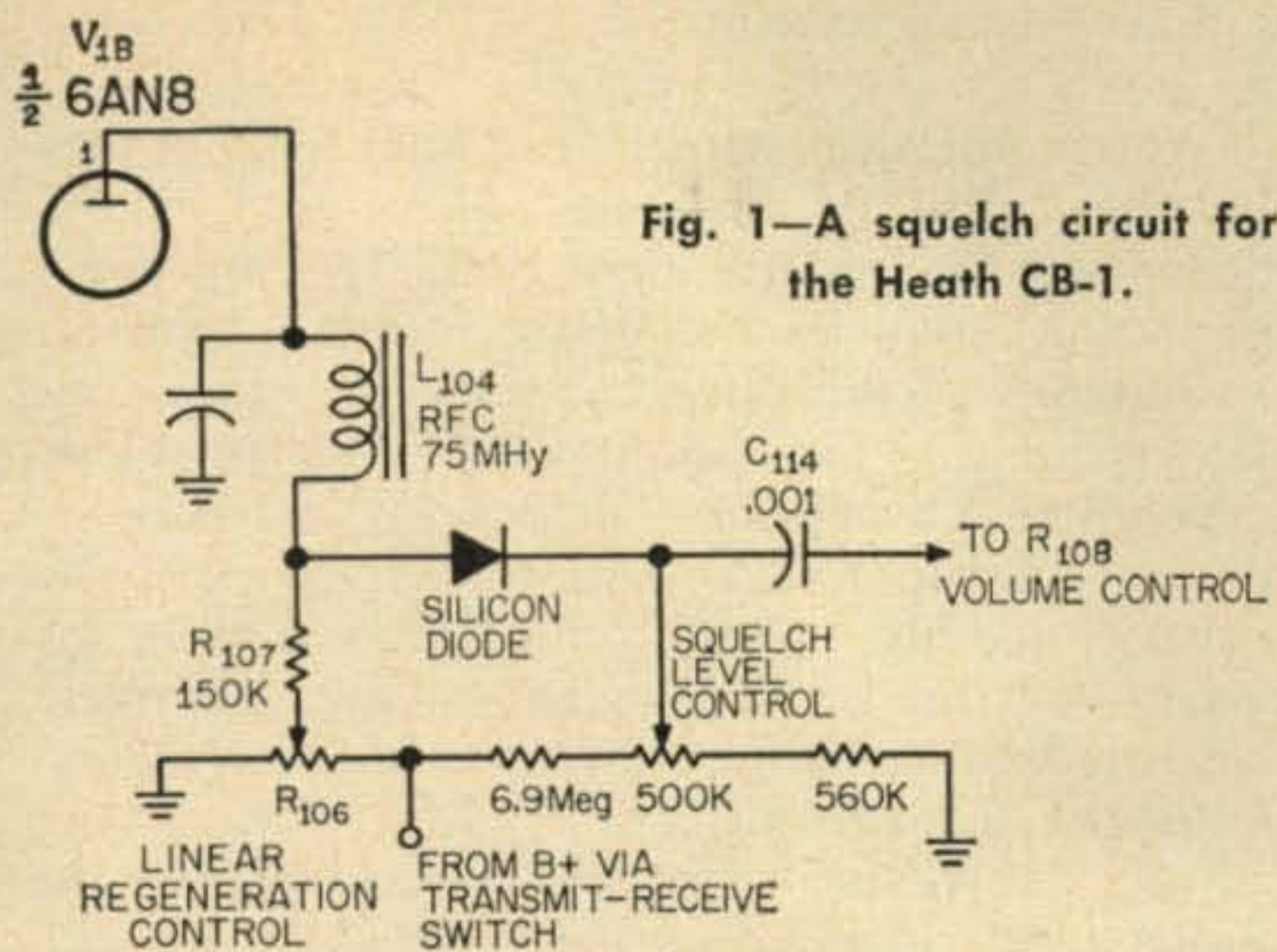

Fig. 1—A squelch circuit for the Heath CB-1.

diagram for a squelch for use with my Heath CB-1?"

Thanks to Doc Lamb, WØPHD, see fig. 1. The silicon diode may be any good diode with a high front to back resistance ratio. Doc used an unmarked Japanese diode. For best results some experimentation may be necessary with various diodes. The Raytheon 1N537 looks like a good bet, as does the CBS 1N67. Further, if there is too much unbalancing of the squelch control when the regeneration control setting is varied, you might try picking up the voltage for the level control at a lower B+ point.

**Lightning and Mobile**—"It seems to me that the tall vertical antenna used by many mobile hams can attract lightning as well as those mounted on a backyard pole. What do you say, and what's the suggested protection?"

Lightning can strike anything during a storm and this includes mobile antennas. However, I have not yet heard of a mobile antenna being struck. I advocate removing the antenna during an electrical storm.

**DX-40 Fuse**—"I bought a second-hand DX40 and I find that it is not fused. Is it worthwhile to install one?"

Certainly. Use a *fused plug* on the end of the set's cord. The plug sells for 33¢ and can be obtained from *Allied Radio*. The plug catalog number, 52N648.

**Antenna Lead**—"I have about 200 feet of shielded wire which appears to be about size #18. Can I use this to connect up my doublet?"

No. For one thing, it will not match the doublet's 72 ohm impedance. Secondly, shielded wire is not coaxial cable. Lastly but not least, the shielded wire's capacity per foot is much, much higher than coax. (Remember too, that because the shield is not uniformly spaced over the wire you'll have "uneven" capacitive distribution)

**TV Noise**—"During damp or wet weather I can hear a popping coming from inside my TV cabinet—I can also hear this popping in my ham receiver. I've tried grounding the TV set better but this makes little difference. What's arcing or sparking?"

High voltage corona. Redressing your CR tube's high voltage leads and using some anti-corona spray like *General Cement's #47*, will

no doubt alleviate the trouble. My advice to you is to call in a good TV serviceman for the job.

**Q Multiplier Adjustment**—"Maybe my head is full of rocks but isn't a Q multiplier supposed to act like a good sharp crystal filter when it is operating? Also, what makes the darn thing squeal when its external controls are manipulated to a certain position?"

Most Q multipliers installed in commercial ham receivers provide for internal adjustment. The adjusting control is usually set just below the threshold of oscillation (as in the NC303). In most cases you will not find the Q multiplier causing a "ringing" effect as you do when phasing a crystal filter. The exterior Q multiplier controls must be *carefully* adjusted in vernier steps for proper nulling or notching action. A squeal indicates improper *internal* adjustment.

**MT-1 Crystal Oscillator**—"Any modifications relative to adding a crystal to the Heath MT-1 for operation on MARS, CAP etc.? I don't want anything that is complicated or hard to install."

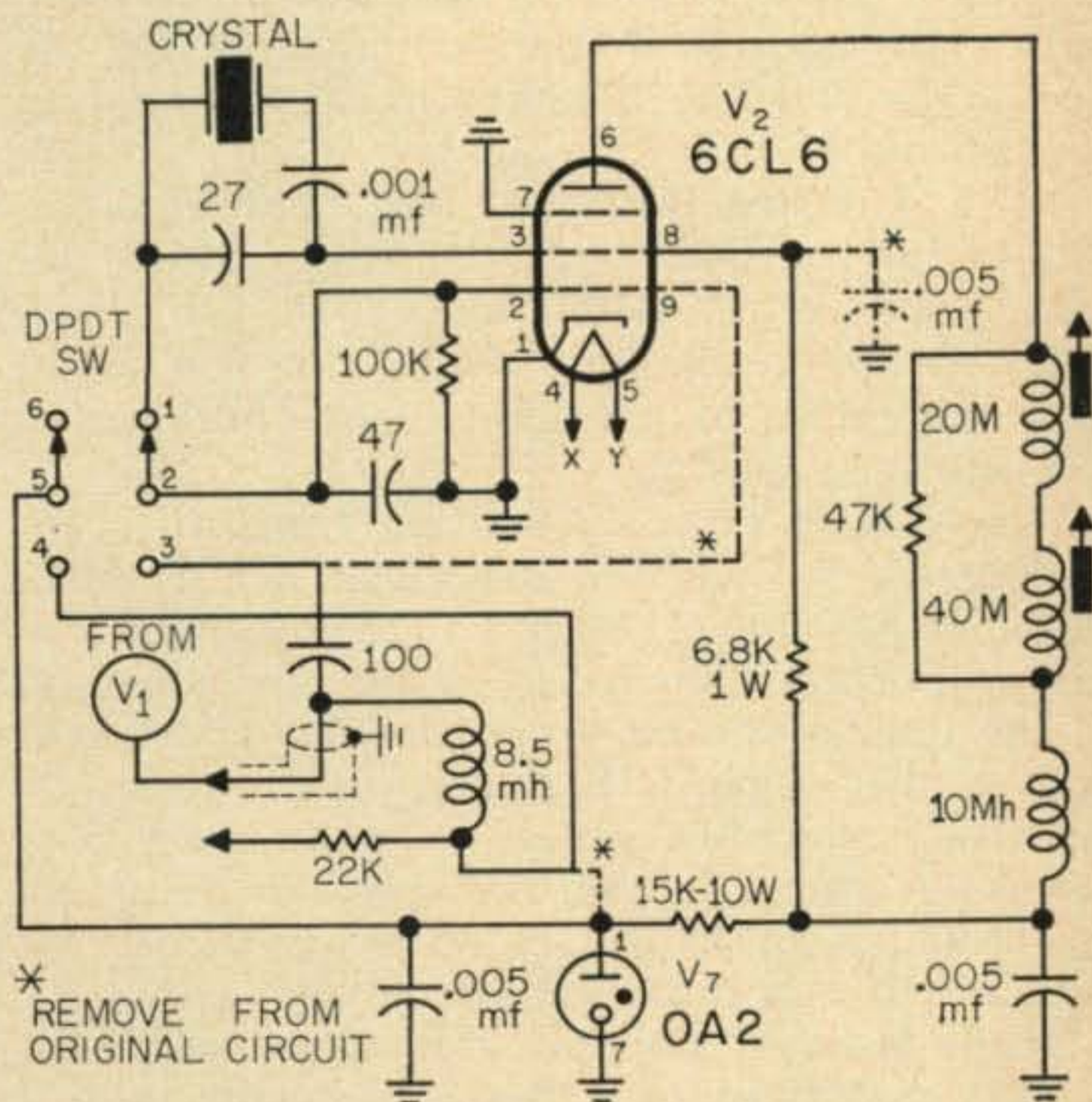

Fig. 2—Circuit modification to permit crystal controlled operation of the Heath MT-1.

Thanks to K3HHE, Walter M. Kessler, see fig. 2 for his suggested modifications. Only 5 small parts are required for the very worthwhile addition and original calibration of the set's *vfo* is undisturbed.

**Trap**—"How about a trap to cut down the spurious signal response on 21 mc? I seem to be receiving a number of commercial stations on this band that I never received before."

Before you consider a trap, check the receiver alignment. If the alignment is okeh, then try a National R60-4 coil in parallel with an 8-50 mmf Erie 557 N-750 capacitor and place the combination in series with your antenna. This works fine on an NC300 or NC303 and will provide up to 80 db of unwanted signal suppression between 12 and 35 mc. Remember that commercial stations are using high power these



days and do often leak through on the best receivers. Incidentally, the trap just described must be retuned for each band or removed for the band on which no interference is experienced.

**Dial**—"I'm planning on building a four band receiver. Can you suggest a good multi-scale dial to me costing under \$10.00?"

Yes. Try the *Millen* Type 10035. It sells for about \$7.50. The *National* Type ACN for about the same price is also a good one.

**Drill Noise**—"My electric drill really raises heck with our TV and BC sets. How can I get rid of the noise?"

First, try a couple of .1 mf capacitors in series across the input terminals to the drill, the center of these two capacitors is grounded to the drill frame. If you can add a third wire ground to the drill frame, all the better. If this does not get rid of your noise then try a brute force filter. The ARRL Handbook contains the info on making one.

**SB-10 Owners Note**—The *Heath Co.* now has published a flyer on all SB-10 changes. Send them a self-addressed stamped envelope for the info. (Most of the changes have appeared in this column.)

**VFO Construction**—"I am contemplating building a transistorized *vfo* using info I obtained out of the May-June 1956 *GE Ham News*. Do you have any special tips you might have obtained in designing and building a transistorized *vfo*?"

I have built three *vfos* using transistors, including the 3.5 *mc vfo* described in *GE Ham News*. If possible, I suggest that you try to obtain a ribbed coil form and as the wire is wound on the coil, it should be pre-heated under tension. I also suggest that mercury batteries be used for power; but above all, make every connection as *sturdy* as you possibly can. I suggest that you try an RCA 2N247 transistor as the oscillator if you build the GE 3.5 *mc vfo*.

**Scope Hum**—"I obtained a surplus scope for \$15.00 and thought I had a bargain until I worked it over and then tried to use it. All the controls seem to work okeh along with the vertical and horizontal amplifiers, but I must have slipped up somewhere because the straight horizontal line I am supposed to get is all one 'jagged mess'. I figured that this must be power supply hum so I added more capacity and even changed some of the original condensers without success. How about a little assistance?"

I'll bet 10-1 that your set has *no* CR tube anti-magnetic shield. Take a good close look at just the CR tube spot and you'll no doubt find it distorted. Mu-metal shields are not inexpensive, especially for the larger tubes. A shielded transformer does not always "guarantee" that your CR tube will not be modulated by circulating electromagnetic fields.

**Tank Arc-over**—"I built up a little AM rig using a 6146 in the final modulated by a pair of 6L6s. I use link output coupling. If I load the 6146 up to full rating and modulate it the

final tank condenser arcs over. What's the cause and cure?"

Overmodulation with a low final load is usually the cause of arc-over. However, a condenser not having sufficient plate spacing (voltage rating) may be the cause. Suggest you try a condenser of the same capacity with twice the plate spacing. This should solve your problem.

**Antenna Absorption**—"I recently installed an all-band dipole which runs under my tri-band beam. Since its installation, I notice that my transmitter final control settings have changed. Can this be due to the new antenna or a defect within the transmitter?"

Both. However, I am inclined to blame the dipole a bit. Depending on how close the antennas are to each other, there can be some "mutual impedance effect," and of course some absorption too. Why not take one end of the dipole down and swing the antenna out of the road of the beam and check the difference? I'll bet if your transmitting uses a pi-final you will find some "effect."

**Dust**—"I built up a nice little set using a bakelite panel but it seems to collect dust better than our vacuum cleaner. What can I use to keep the panel dust-free?"

Try an anti-static cloth that is sold very widely for cleaning phono records. Anyone else have another suggestion?

**GD—I**—"I am a victim of garage door interference, or perhaps I should say that my neighbor down the block is. For when I go on 10 meters I open his garage door. The neighbor found out through the serviceman he called that I was the cause of his woe. Well, to make a long story short, my father has told me to keep off the air until I can figure out how to keep from interfering with other people's garage doors that are electronically operated. What can I do?"

You did not say if the interference occurred on only one or a group of frequencies. If it is a single frequency caused interference you no doubt can make up a filter for 10 meters. But if your signal is saturating the opening device (receiver) then you may have a larger problem. Also you did not say what frequency the garage opening device operates on. Give HAM CLINIC more detailed information and we'll try to help. In the meantime, anyone run into the same problem? What cure was found effective?

### Non-Technical Problems

"About a year ago I moved into a new neighborhood. I installed a long wire antenna between my house and an existing power pole about 200 feet away. Nothing was said about this antenna installation until a few days ago. I was told in no uncertain terms to pull it down immediately or they (the power company) would do it for me. Because I pay electric bills I feel I have a right to use that power pole. Am I right?"

No, you are stone-dead wrong. A good ham *never* uses a power or telephone pole for his antenna installation. This is *dangerous* elec-



trically as well as legally. Put up your *own* pole or tower and stay away from utility poles.

**Tax**—"Is equipment that I use both in my ham hobby *and* for CD, Red Cross and other community type communications a 'granted operations deduction' for my income tax?"

No, unfortunately it is not.

**DX-peditions**—"How do I go about getting on a DX-pedition?"

The best way I know of is to place an ad in the various ham mags (especially CQ) offering your services. Be sure to give full particulars of your status (age, available equipment, money etc.) to those who write you and DO DEMAND that they do likewise. Be careful that all deals you make are in writing and witnessed. If you do not, you may end up paying bills that you never heard of. If you are under 21 years of age you more than likely will need parental consent. DX-peditions are fun but they do cost money whether you go it alone or with a group.

**Re-dress**—"I bought a receiver from \_\_\_\_\_ Company and it has not worked properly since I picked it up. I took it back once and their 'experts' checked it over and said nothing was wrong. I tried again and nearly got thrown out of the store. Now what do I do?"

Write the manufacturer a detailed letter and ask him. If you do not receive satisfaction let HAM CLINIC know. If the set is a second-hand one the manufacturer is in no position to help you. If the store still refuses to help you, take up the matter with the local Better Business Bureau. They can definitely be of assistance.

**PHONETIC STORY**—Congratulations to E. G. White, GW3LAD, of Cardiff, Wales for winning \$25.00 for the best entry. He has my personal check. Runner-up, Louis Anderson, W7UZE/Ø New England, N. D. receives a copy of Don Stoner's Single Sideband Handbook.

### Thirty

In May, I was privileged to participate in a meeting of the Spanish-American Radio Club at Madrid and was given honorary membership. I was impressed with the business-like and friendly way that the amateurs of America and Spain got together. Let us hope that operating reciprocity will result from the efforts of this very fine group.

Again, you are reminded that HAM CLINIC exists to help you, the practicing ham wherever you may be. Although our batting average is quite high we cannot answer all questions received; but we do try to do our best. If we do not have the answer you are honestly told so.

The opinions and statements are the writer's (unless indicated otherwise) and do not reflect the active or passive indorsement of the publisher or any agency—governmental or civilian.

Send in your technical tips and help out your fellow hams—HAM CLINIC will be proud to publish them.

72 (Internationally) and 73 and 75, Chuck

## How's Your Units Knowledge?

**Just as very short** and long distances are measured off in inches, feet and miles various quantities in radio and electronics have units of measurement. Are you familiar with all of them? Sure, you know some of the most frequently used ones, but how about those you do not use every day?

After the word listed in the column at the left write in the quantity's unit of measure in the space provided at the right. After you have finished, check your answers with those on page 118. A score of twenty or better gives you a units rating of excellent.

- |  |           |
|--|-----------|
| 1. Voltage   | 1. _____  |
| 2. Current   | 2. _____  |
| 3. Power   | 3. _____  |
| 4. Resistance                                      | 4. _____  |
| 5. Impedance                                       | 5. _____  |
| 6. Capacitance                                     | 6. _____  |
| 7. Inductance                                      | 7. _____  |
| 8. Frequency                                       | 8. _____  |
| 9. Conductance                                     | 9. _____  |
| 10. Wavelength                                     | 10. _____ |
| 11. R. F. Field strength                           | 11. _____ |
| 12. Electrical quantity                            | 12. _____ |
| 13. Power, current, voltage ratio                  | 13. _____ |
| 14. Light and very short wavelengths               | 14. _____ |
| 15. Magnetic induction                             | 15. _____ |
| 16. Magnetic intensity                             | 16. _____ |
| 17. Magnetic reluctance (opposition)               | 17. _____ |
| 18. Magnetomotive force                            | 18. _____ |
| 19. Audio frequency power level                    | 19. _____ |
| 20. Reactance                                      | 20. _____ |
| 21. Speed of rotation (as applied to motors, etc.) | 21. _____ |
| 22. Admittance ( <i>ac</i> circuit conductance)    | 22. _____ |
| 23. Tape speed (as applied to tape recorders)      | 23. _____ |
| 24. Electromagnetic flux                           | 24. _____ |
| 25. Sound pressure                                 | 25. _____ |



sideband  
sideband  
sideband

# SIDEBAND

Irv and Dorothy Strauber, K2HEA/K2MGE

12 Elm Street, Lynbrook, New York

## SSB DX HONOR ROLL

TI2HP	210	HB9TL	151
TI2RC	207	4X4DK	150
W6UOU	207	ON4DM	150
W8EAP	200	W7VEU	150
W4IYC	199	PY4TK	150
VQ4ERR	197	W2VZV	150
W8PQQ	195	W8YIN	148
W2JXH	190	K2FW	147
W6PXH	188	K2HEA	145
W6BAF	180	K6LGF	143
WØQVZ	176	W5RHW	140
K2MGE	171	W5KFT	138
W6RKP	169	W1GR	137
TG9AD	166	VE3ES	136
ZL3IA	165	W7DLR	135
W6WNE	164	KØCTL	135
VK3AHO	160	W5IYU	134
K6GMA	160	W1OOS	130
WØCVU	158	K6ZXW	130
K9EAB	158	W9QNO	129
MP4BBW	157	W4OPM	129
W2TP	157	K6LMS	129
WØFUH	156	W3VSU	127
W3MAC	152	W2FXN	121
HB9IE	152	W6VUW	118

## SSB "Worked All States" Contest Sept. 10-11, 1960

The Second Annual SSB "Worked All States" Contest will start at 1500 GMT, Saturday, Sept. 10, 1960 and end at 2100 GMT, Sunday, Sept. 11, 1960. This year, the contest is being sponsored by the Single Sideband Amateur Radio Association. The rules have been formulated by Bill Leonard, W2SKE, world famous ham and top contest winner. The rules are different from those of last year, so please read carefully.



Jan, K9KKR, of Aurora, Ill., was the third gal to earn the "Worked 100" Award on SSB. Jan, who sounds just as charming as she looks, is a school-teacher and the daughter of "Carp," W9TLF.

1. The primary object of this contest is to work as many SSB stations in as many of the 50 states as possible via two-way SSB within the prescribed time.

2. Any amateur on SSB is eligible to compete, but special additional prizes will be awarded to the top 3 scorers among the members of the SSBARA.

3. The contest has been arranged to allow operators to compete for the full contest period and still get some sleep. The contest is 30 hours long but a *participant must not operate for more than 24 hours*. The six hours of non-operation



Mahmud, SU1MS, operator of the first Egyptian SSB station, is now continuing his radio engineering studies in Germany.

*must be consecutive*; at the beginning, end, or any six hours during the middle of the contest and must be reflected in the contest log. In other words, contestants may select their rest period. They may, of course, operate *less* than the maximum of 24 hours. *Logs not indicating a 6 hour silence period will be disqualified.*

4. Only one transmitter may be operated from any one station at any time.

5. Serial Exchange: The following information must be exchanged and acknowledged during each QSO: Report, Time in GMT, Name of the Operator at the mike, and State.

### Sample Log

W2SKE		Bill New York			
Sent	GMT	Received	GMT		Band
5-8	1546	W3NJR	5-9 1547	Al, Md.	40
5-8	1549	W6YY	5-9 1549	John, Cal.	40
5-6	1552	W9THK	5-8 1552	Bill, Ill.	20
5-9	1555	W6YY	5-9 1555	John, Cal.	20

Score: Stations (4) × States (3) = 12



6. Scoring: Count ONE point for each station worked, regardless of that station's location. Final score is total number of stations worked, multiplied by the number of states worked (a maximum multiplier of 50).

A station may be worked once on the higher bands (10, 15, or 20) and may also be worked *once again on either of the lower bands* (40 or 80), or vice versa. However, no additional multipliers can be made by working the same state twice on two bands. Bands from 10 through 80 may be used.

7. Foreign Participation: The contest represents a good opportunity for stations outside the U.S. to fill out their WAS Award, and DX Sidebanders are invited to participate. A special award will be made for the leading scorer outside the W/K area.



Arch, W4AFZ, at his "dream console" in Maysville, Ky.

8. Logs: Logs must be postmarked no later than Nov. 15, 1960, and must be signed by the licensee of the station and by all operators. Logs should be sent to:

SSBARA WAS Contest  
12 Elm Street  
Lynbrook, New York

9. Awards: Special "Worked All States" QSL Albums will be awarded to any amateur working all 50 states during the contest period. (Note: in the 1959 WAS Contest, no amateur worked all the states.) If no participant works 50 states during the contest period, albums will be awarded to the top ten scorers.

A special Grand Prize will be awarded to the highest scoring contestant . . . A Lifetime Membership in The SSBARA.

An engraved trophy will be awarded at the 1961 Sideband Dinner in New York to the highest scoring SSBARA member. (Specify on your log if you are a member.)

Participants in last year's WAS Contest will confirm that it was a most enjoyable event and we hope you'll all not only join in this year's contest but will also pass along the news to your sideband friends.

#### SSB Honor Roll and Certificates

We'd like to remind you that, in order to keep your call on the SSB DX Honor Roll (you must bring your total up to date at least *once in every three months*). If we do not hear from you within



Ham radio has lost one of its most active and colorful members with the untimely passing of Edward A. Stanley, W4DQZ, of Tampa, Florida on June 10, 1960.

Long active in the field of amateur radio, both as a distributor and as an ardent DXer, Ed gained international fame during the past year as Editor of *The Yasme News*. Reflecting his extensive background in the newspaper field, the publication was his impetus for traveling all over the country meeting fellow hams. A native of Kentucky, Ed was the epitome of a true son of the South—soft-spoken, charming, with a quick smile and ready wit. He will be missed by all who knew him.

To his wife and family, we extend the sympathy of hams all over the world.

that time, your call will be removed to make way for other stations who are actively in the DX race.

A "Worked 175" certificate goes to W6BAF and a "Worked 150" certificate to MP4BBW with our congratulations. Moving up the ladder this month with "Worked 125" stickers to add to their certificates are W5IYU, W4OPM, MP4B-BW and W5KFT. Joining the circle of stations that have confirmed 100 SSB contacts are K2LGS, ZL3AB, W6HYG, VE1NH, W6VUW, WØUUV, W2YBO, K6MLS, K9KKR, W2NUT, VE6TF, W6GT, W7EOI, W1ICW, W4ANE, ZS5DW, W6YMV, W1AOL, W2BLP, SM6SA, VE2KW, W3LMA, and I1AMU. A new entrant in the race is W8JIN, who received his "Worked 75" certificate.

Our congratulations to Bill, ZS5DW; Goran, SM6SA; and Al, I1AMU, who are the first Sidebanders in their respective countries to earn these awards.

#### Johnson "Viking Invader"

From the E. F. Johnson Co., comes news of a new filter type transmitter with a really unusual feature that is bound to make news. Called the *Viking Invader*, it is a complete transmitter/exciter with 200 watts input PEP, 200 watts CW and 90 watts input AM. At any time after the



purchase of the *Invader*, according to John, WØAGD, Service Supervisor, a few minutes with a screwdriver and wrench is all that it takes to add the Hi-Power Conversion to the transmitter and you have a 2kw PEP rig in a desk top unit the size of a receiver. The final uses a pair of 4-400A's; the power supply is stored in any handy place under the desk. The complete unit may be purchased as the *Viking Invader 2000*, to save yourself an extra trip to your favorite distributor. Technically, it covers all bands from 80 through 10 meters without extra crystals; has a pi-network output circuit and provides for continuous metering of power output. Claimed is, unwanted sideband and carrier suppression of 60 db or better; spurious frequencies are down 55 db or better and distortion products better than 35 db down.

### SSB Around The World

Talk about rare calls—how about "AR1PC" which belonged to Marty, EL1C, when he was in Syria in 1947? . . . Claude, FF8AK, delighted us with a surprise visit in early June during his brief stay in New York. He is now in Paris on a four month vacation but left some QSL cards with us for those who were negligent in confirming their contacts with him. If you still lack an FF8AK card, send the pertinent information to us (with SASE and date and time in GMT, please) and we'll get Claude's log check through the mail. He will be returning to Dakar but will probably operate under a different prefix. . . . Alfred, DJ4WN, has a dog named Whiskey and a cat named Nancy after the phonetics in his call. . . . Ted, VQ9TED, is leaving Mombassa about August 19 to visit the Seychelles and possibly also the Aldabras. . . . When Ray, SVØWK, returns to the States in September, it will be with a new addition to the family. . . . And again in the Stork Department, congratulations to Peter, HB9IE and Philippe, F2PA, and their wives. Both couples recently became parents of baby girls. . . . Send QSLs for the 9G1CX DXpeditions to Bob Scully, W2FXN, Box 35, Oaklyn, 6, New Jersey. Both Bob and Harold, W6BAF (who handles the cards for FB8CJ and VQ2AB), emphasize the need for SASE and GMT notations. . . . Floyd, VR6AC, is expected to return to Pitcairn Island from his Los Angeles visit with SSB equipment and a good antenna. . . . Charlie, TI3CS, a newcomer to ham radio, recently joined the SSB fraternity. . . . Listen for Art, VE1EG/Ø and XYL, Joy, KØIKL, who were planning a

trip to Prince Edward Island the last two weeks in July. Their object is to dispense beaucoup contacts for the WAVE Award which requires contacts with all the VE Districts on 2 different bands each. . . . Bill, PZ1AX, was heard 5-9 on 7204, contacting SSBers from East to West Coast around 0100 GMT. . . . Heartiest congratulations to Jock, ZL2GX, who won the big race for 300 countries confirmed via Phone and CW. . . . Many thanks to Ian, MP4BBW, who passed along the following DX tidbits: Rundy, W3ZA, etc. will operate from Aden as VS9ARF, July 3-6; Bryan, MP4QAO, should be heard on various dates, operating portable from Yemen; VU2NR hopes to take in the Laccadives sometime between November and February. Ian also wrote that "judging by the level of sideband activity, it is now possible to work 100 SSB countries in 100 days!" But he did not mention if the time limit included week-ends. . . . Al, W8PQQ, has sent Colin, AP2CR, a cable and plug assembly for use with a battery-powered dc supply. It is expected that Colin will visit East Pakistan to put another country on the SSB DX list. . . . Thanks to Cliff, K9EAB, who has forwarded the necessary crystals, SP5HS should now be on SSB. . . . 17 year old Peter, OE7ZH, puts out a beautiful signal with his homebrew 85 watts.

### Band Hopping

Mary, W9RUJ, who is one of our top notch XYL ops, was an SWL for 15 years before getting her license and then did so all on her own since her OM was not and still is not a ham. . . . Dave, W2PCX, who is studying International law at New York University, keeps his language proficiency up to date by CQing and conversing in any one of six languages: Spanish, French, Italian, Portuguese, Russian, and English. . . . Mary, WA6HKJ/5, is the guiding light behind all those SSB get-togethers at Keesler AF Base in Mississippi. . . . His many friends will be delighted to learn that Ray, W6MLZ, is under consideration as an F.C.C. Commissioner. . . . K5BAK has had to change his handle from "Paw" to "Grandpaw" since the arrival of granddaughter "Tootles". . . . And congratulations to Dick, KV4AA, whose daughter, Sandy, presented him with his sixth grandchild recently. . . . It was very heartening to chat with Bill, K8JLD, and learn that he had left a good job in industry to return to his first love, education. Bill is now studying at Michigan State University for his Master's Degree in Public School Administration. With more people like Bill, we need not worry about our children's educational future. Bill, incidentally, is the son of Stu, W2ZE. . . .

We hope you're all having a fine Summer and will be listening for you in SSB WAS Contest on Sept. 10-11.

73, Irv and Dorothy

## CQ Serenade



**A**MATEUR radio now has its own song! Music written by Maurice Durieux, VE2QS, of 1310 Elizabeth St., St. Laurent, Montreal 9, Quebec, words by VE2BR and F9KT, this song, on the Q-S-O label is bound to become a big hit.

VE3BR who wrote the English words and F9KT the French, collaborated with Maurice to make this an all ham, song writer team.

Two 45 R.P.M. records are available each featuring a vocal and orchestral side.

Sheet Music, too, has been printed with the cover cartooning the composer in his shack.

As for VE2QS he was last heard muttering: "I wonder who could write a Spanish lyric?" ■



VE2QS at his shack in Montreal holding a copy of "CQ Serenade." VE2BR looks on approvingly while a copy of the sheet music hangs on the wall.





# Novice

The operation of most radio equipment requires that a steady voltage be applied to the vacuum tubes. If this is not done, their operation will fluctuate with the alternations of the power line. The direct current for this purpose may be obtained from batteries if the total amount of power required is small.

The most common source of power is alternating current from the power lines. This energy must be *rectified* if it is to be used in vacuum tube circuits. Vacuum tubes, which are capable of rectifying very large amounts of power, can supply *dc* to even the most powerful amateur transmitters.

By definition, a rectifier is a device which is used to convert alternating current into direct current. A few of the devices which perform this rectifying function are vacuum tubes, metallic rectifiers, crystal rectifiers and mechanical rectifiers. Of these, vacuum tubes are by far the most important in amateur radio, although extensive use of silicon and germanium rectifiers is increasing their popularity.

**Half-Wave Rectifier** In a diode rectifier, electrons are attracted to the plate when it is more positive than the cathode. When the plate becomes negative, electrons are repelled by it and no current can flow in the tube. Therefore a single diode may be used as a *half-wave* rectifier since current can flow in the tube during only the half cycle when the plate is positive.

Figure 1 shows a simple half-way rectifier circuit. An alternating voltage (supplied by a transformer from the *ac* power line) is applied across the diode and load resistor.

When the applied voltage is positive, the plate of the diode is more positive than the cathode. Electrons therefore, flow from cathode to anode,

through the *ac* source, up the load resistor, and back to the tube.

At the beginning of the positive half-cycle, a few electrons are attracted to the plate. As the plate of the diode becomes more positive, the electron flow increases until the maximum value of the positive half-cycle is reached. As the voltage decreases, the electron flow also decreases until at zero voltage conduction ceases entirely. No electron current can flow during the negative half-cycle. Thus the flow of electrons produces a positive pulse of voltage across the load resistance.

Since the electron flow in the load resistor is always in one direction, we say the alternating current has been changed into a *pulsating direct current*. The waveform of the current in the load is also shown in fig. 1. A current flows during the positive half-cycle only. This is why the circuit is called a half-wave rectifier.

**Filters** The output voltage of this circuit is not suitable for delivering *dc* to most vacuum tubes because of the pulsating output voltage. These variations in the direct current are known as *ripple* voltage. Ripple may be thought of as an alternating voltage on top of the direct voltage. For our purposes the ripple voltage must be reduced to a low percent of the *dc* output voltage. A device for eliminating ripple is called a *filter*.

A filter consists of capacitors connected in parallel, and inductors connected in series, with the load. A capacitor opposes any change in voltage across its terminals (across the load) by storing up energy in its electrostatic field whenever the voltage tends to rise, and converting the stored energy back into voltage whenever the load voltage tends to decrease.

An inductor, commonly called a *filter choke*, opposes a change in current through it (through the load) by storing up energy in its electromagnetic field when the current tends to increase and by taking energy from the magnetic field to maintain the flow when the voltage tends to decrease. Another way of looking at the action of a filter circuit is to consider that the capacitor forms an easy path to ground for the ripple voltage and offers a difficult obstacle to the *dc*. The choke, on the other hand, offers an easy path to the *dc* but places a road block in the way of the ripple. Either way you look at it, it leads to the conclusion that there is a reduction of the amplitude of the ripple voltage, without seriously affecting the *dc* voltage.

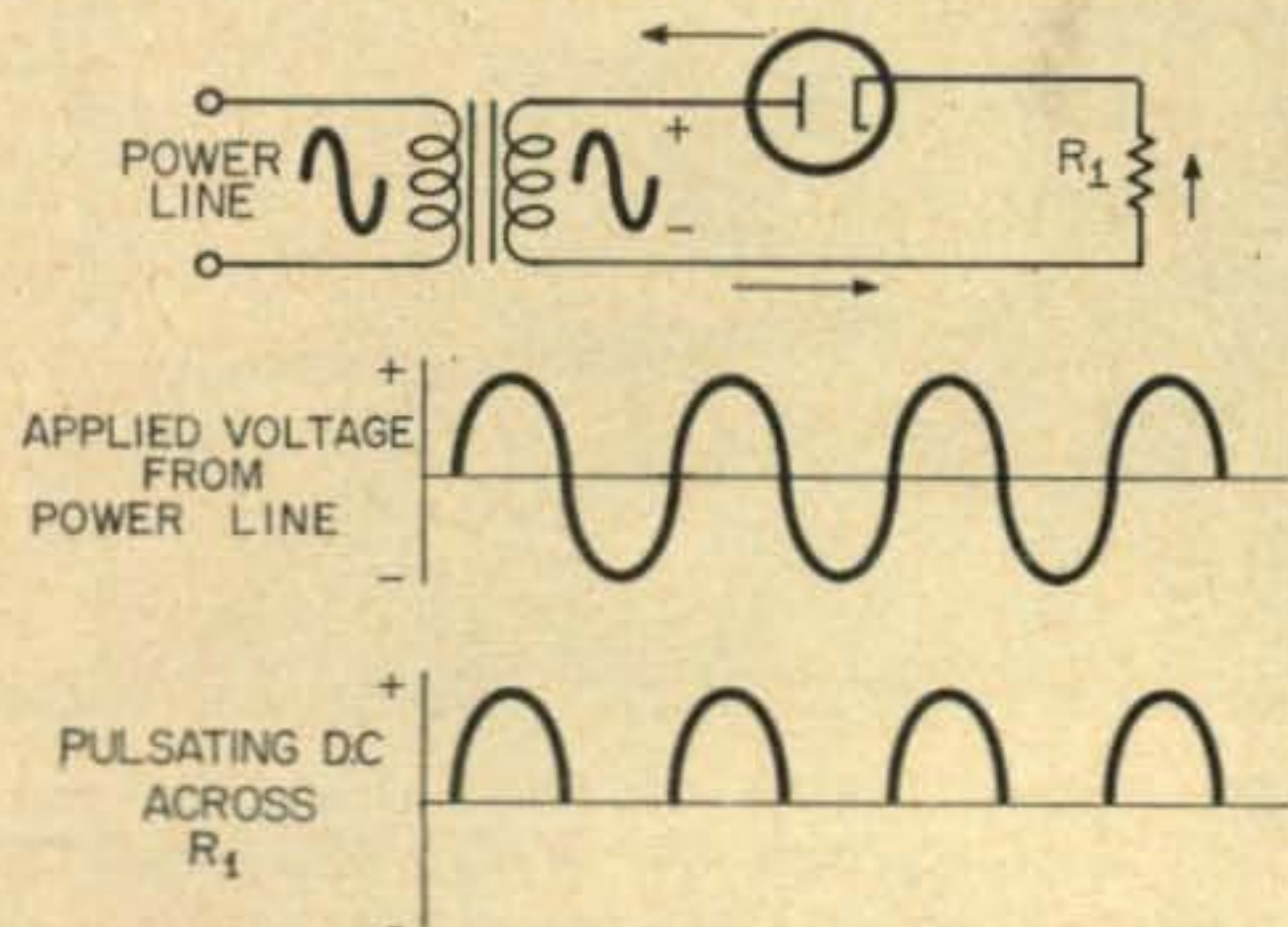

Fig. 1—A simple half-wave rectifier circuit



Next month we will discuss the full wave rectifier and some of the systems used to filter out the ripple voltage.

### Directory

Every so often I receive requests for information on specific certificates which Novices and amateurs in general can earn. Requests are usually directed to horse's mouth, so to speak, the Certificate Seekers Directory. Cliff Evan, K6BX, Box 385, Bonita, California, has taken over the work of Bill Clark, W3RPG, on this publication. Cliff has prepared the largest issue yet, listing more than 350 awards! The cost of this directory is \$3.50, which includes a year's revision issued quarterly. For more information of The Directory of Certificates and Awards, "The Award Hunter's Bible," drop a line to Cliff at the above address.

### Who's DX?

P.f.c. Mark E. Lawyer, RA13630115, Co. C, 2nd Med. Tk Bn, 13th Cav., APO 39, New York, N. Y., writes to tell us that The Armored Radio Sports Club, DL4YU, is still working Novices on the 40 and 15 meter bands with their BC-610, DX-40, HQ-110 and SX-100. Their antennas consist of quads for 10 and 15, plus dipoles for 80, 40, and 20. Mark says the club will arrange skeds, and all letters will be answered.

Don Kirkman, WA6ENG/JA1, 500 Shimi Ochiai 1-Chome, Shinjuku-ku, Tokyo, Japan, writes to advise the following Novice stations they were heard in Japan: April 2, 1040-1050 GMT: WV6GEZ, IEO/KL7, KXW. April 4, 0836-0847 GMT: WH6DPS, WV6IEO/KL7, KN7KHT (?). April 5, 0835-0840 GMT: WV6KSG, LCW. April 30, 1000-1122 GMT: KN3KTW/KL7, WH6DRB, WV6IEO/KL7, KBH, WL7DJU. April 31, 1146 GMT: WV6-KTS.

A quick trip south takes us to the QTH of Bill Stevenson, VK3AWS, 11a Maud Street, Ormond S.E. 14, Victoria, Australia. He reports working the following stations on 15 meters during May: KN3KAY/5, KN4UXC, KN5YVQ, ZFI, ZRO, WV6FFV, GNC, GWM, HAE, HNW, IDC, LCK, KN7IVU, JTN, KNØWGY. In addition, Bill writes: "The Novices have been trying a new stunt on me, Don. I work station A. Then Novice A asks me to listen for his friend Novice B. I do so. It turns out that Novice B is visiting Novice A and is using A's rig. B does not give me a report, nor receive one. *A and B both expect a QSL!* I just don't fall for this one. Why should B get a QSL after A has done all the donkey work? If A had a dozen mates in the shack with him, and they sent me an 'R', would each expect a card? An easy way to 'work' DX! I know I wouldn't value a card obtained under such circumstances." I wonder where they learned this trick, Bill? Could be from some of the "broad minded" DX club stations who have been doing this for years. Sometimes we set a poor example!



Meet KN4TKQ, of Rockwood, Tenn., who is building a Quad for 15 meters to boost his WAS of 28/24. He will sked anyone needing Tenn., and would like skeds with Maine, Vermont, R. I., Md., and Del.



Bob (?), KN7LVI, Prosser, Washington has been on for a week now, and worked 10 states, with 4 confirmed. Can you handle that "bug" already, Bob?



John J. Riley, KN8TNE, Glen Dale, W. Va., built this neat operating desk out of two nite-stands. In John's first 10 days of operation, he piled up a WAS of 26/16.





Its the same 'round the world. Swedish Novices Kurt Aadhammar, SM6-3059, and Johan Berlund, SM6-E53, of Trollhatten, Sweden, are shown using the NC-57 and BC set while studying for their licenses.



Buster Johnson, KN4QZZ, 315 Charlotte Avenue, Rock Hill, South Carolina has had his ticket since December and hopes to swing the General this summer. Bus only works 40, but has picked off 25 states so far.



Introducing Russel Appleyard, WV2MHY, 16 Coolidge St., Larchmont, New York, who received his license on May 19 of this year. Russ should be on with a DX-20 and S-38 by this time, and hopes to have his General ticket by the end of the year.

Michael Giddings, 5, Tennyson Rd., Matlow Hill, High Wycombe, Aucks, England, is an SWL but very interested in ham radio and would like to correspond with a Novice about his age, 18.

### Help Wanted

The following persons have written requesting help with their code and theory for the Novice license. Can you give them a hand?

W2—Allen J. Schwartz, 551, Third St., Albany 6, N. Y.

W4—Grey Pash, 111 West Wind Trail, Bardstown, Ky. F18-3780

W9—Paul Mayer, RR1, Box 395, Michigan City, Indiana TR2-4756

Henry A. Maier, 600 Romaine, Racine, Wisconsin

### Letters

Sherman Stanley, Jr., WV6IRN, 2412—29 St., Sacramento 17, Calif., leads off this month. Sherm is knocking 'em dead with a DX-40 running 75 watts and an SX-111 hooked to a folded dipole. So far he has a WAS of 34/32 and DXCC of 3. He hopes to improve the score with a new Apache and a three element beam.

Jerry Bouvier, KN1LPA, 1280 Old River Dr., Manville, R. I., represents his rare state on 15 meters, with a S-77A and three element beam. His DX includes EA5, GM3, G3, KL7, KP4, OH3, SM3, VO2 and CR5 (yum-yum—ed.)

Bob (KN8RZN), and Betty (KN8SQO) of P.O. Box 32, Grover Hill, Ohio, are husband and wife in a ham family. They work 80 and 40, with preference for the latter band. The WAS stands at 38/32 and Bob mentions that he would like skeds with Utah, Idaho, and N. Mexico.

Dale Clark, 3319 Constance Circle, Alameda, Calif., recently earned his general ticket and is active on 6 meters, both phone and CW, in addition to his work on 40 with the Globe Chief Delux and SX-101A.

Jack Carr, KN8RHZ, 2467 McMichen, Cincinnati 14, Ohio, has his WAS up to 38/35 plus a WH6 and WP4, with his DX-20, S-38E feeding a 15 meter dipole and 40 meter Zepp. Jack would like skeds with Idaho, Nevada, Maine, and Alaska.

Ross Huston, KN4WIS, 2053 N. Bay Rd., Miami Beach, 40, Fla., is 13 and has had his license a little better than a month. So far he has racked up a WAS of 38, along with VE2, KZ5, WP4, VP3, and KR6, with his HQ-100, Globe Chief and 15 meter beam.

Phil Griffin (K4??), 386 2nd St., Atlantic Beach, Fla., offers to help hams in the Jacksonville area (Phone CH 9-5313) and will sked for any reason. Phil runs a DX40 and NC-303 on the various bands.

We're a little long on pictures, and short on letters, this month, so for now—

73, Don, W6TNS





# semiconductors

One of the reasons I enjoy telling you about semiconductors is to "plug you in" on some of the bargains which come along occasionally.

You may recall, about a year ago, a note in this column requesting contributions from engineers for a handbook of semiconductor circuits. This book was recently completed and is now available from the Government Printing Office. To say that it is quite a bargain would probably be the understatement of the year.

The title of the new book is *A Handbook of Selected Semiconductor Circuits*. The manual was prepared by Transistor Applications, Inc., under Navy contract NObsr 73231 for the Bureau of Ships. The catalog number is Navships 93484.

The purpose of the handbook is to provide the transistor circuit engineer with a reference of reliable, well-designed examples of contemporary circuits. To make the handbook valuable, even after the circuits become obsolete, a design philosophy is included in each section. It is stressed that the book is *not* a collection of preferred circuits but rather a group exemplifying good design and reliability. In other words, it is a "state of the art" manual, containing building blocks rather than complete systems.

The handbook is divided into 10 parts which include direct coupled amplifiers, low frequency amplifiers, high frequency amplifiers, oscillators, switching circuits, logic circuits, *ac* to *dc* power supplies, power converters, and small signal non-

linear circuits (modulators, demodulators, etc.). The first part contains a list of preferred transistors as listed in MIL-STD 701A, and a complete list of abbreviations and symbols used in transistor work.

I have extracted several circuits which will be of interest to amateurs for their suitability in ham gear. The first, shown in fig. 1, is a 450 *kc* crystal oscillator suitable for use in transistor receivers and transmitters as *bfo* or carrier generator. The circuit was contributed by R. L. Steele of Motorola, Inc. The circuit is a modified Colpitts with more capacity between base and emitter than between emitter and ground to effect an impedance transformation. The frequency of the crystal can be rubbered slightly by adjustment of  $L_1$ . An interesting feature of the circuit is the load is in series with the collector which provides a high degree of isolation when the source impedance is high and the capacity low. The circuit will operate with potentials between 5 and 30 volts over a temperature range of  $-40$  to plus  $140^\circ\text{F}$ . War surplus FT-241 crystals work well in this circuit.

The frequency of operation can be raised to 9 *mc*. for high frequency crystal filters by making the following substitutions:  $L_1 = 2-6.5 \mu\text{h}$ ,  $C_1$  eliminate,  $C_2 = 470 \text{ mmf}$ ,  $C_4 = 100 \text{ mmf}$ ,  $L_2 = 1 \text{ mh}$ ,  $C_6 = 68 \text{ mmf}$ ,  $L_3 = 4-12 \pi\text{h}$ .  $Q_1 = 2\text{N}384$  and load  $Z = E:8 \text{ 2.2K}$ .

Another oscillator circuit is the one shown in fig. 2 (contributed by John Silver of James Knight Company), and is useful as a 100 *kc* frequency standard. The crystal unit is placed in series with the feedback connection from the capacitively tapped tuned collector circuit to the

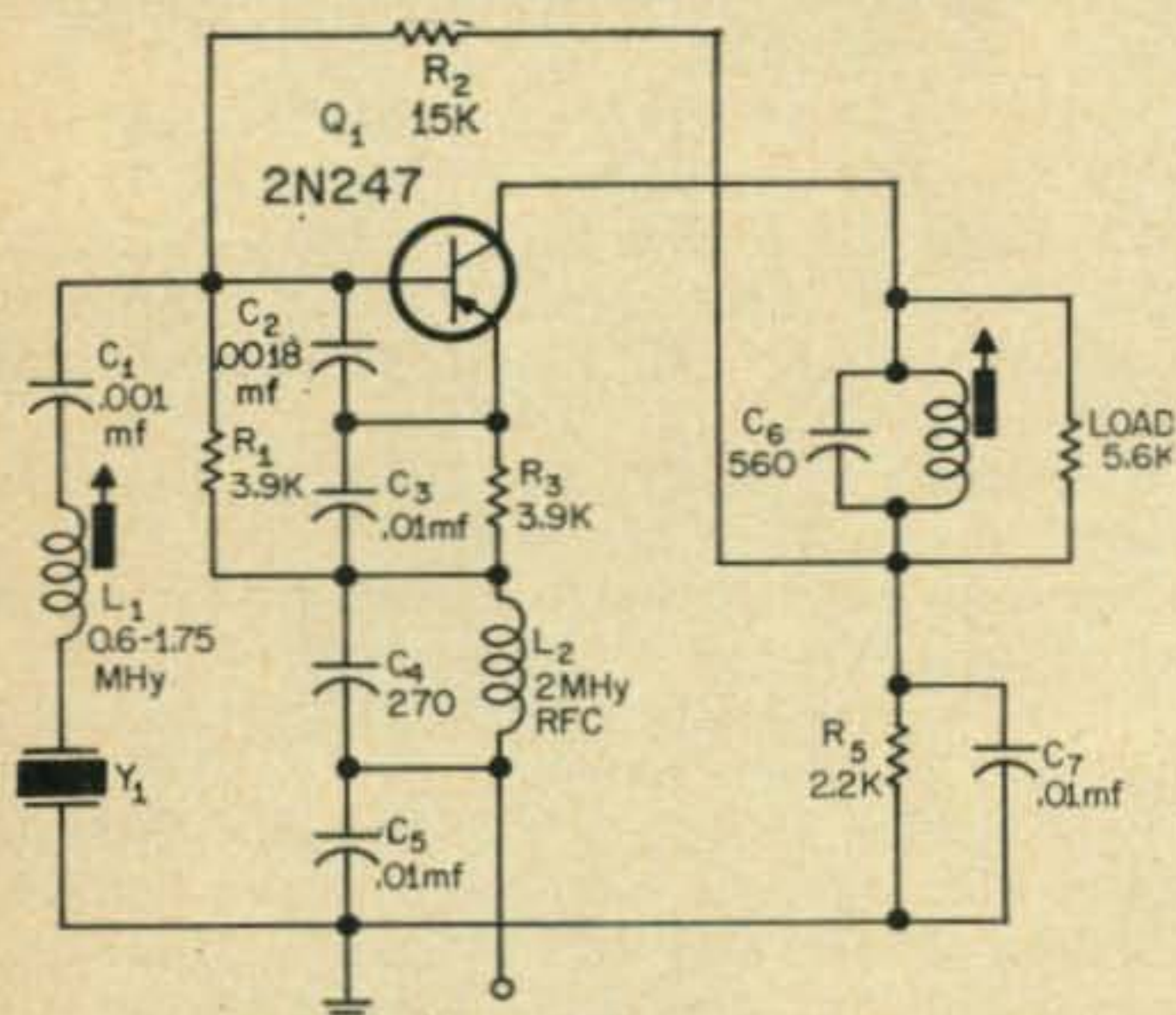

Fig. 1—A 450 *kc* crystal oscillator suitable for use in transistor receivers as a *bfo* or in a transmitter as a carrier generator.

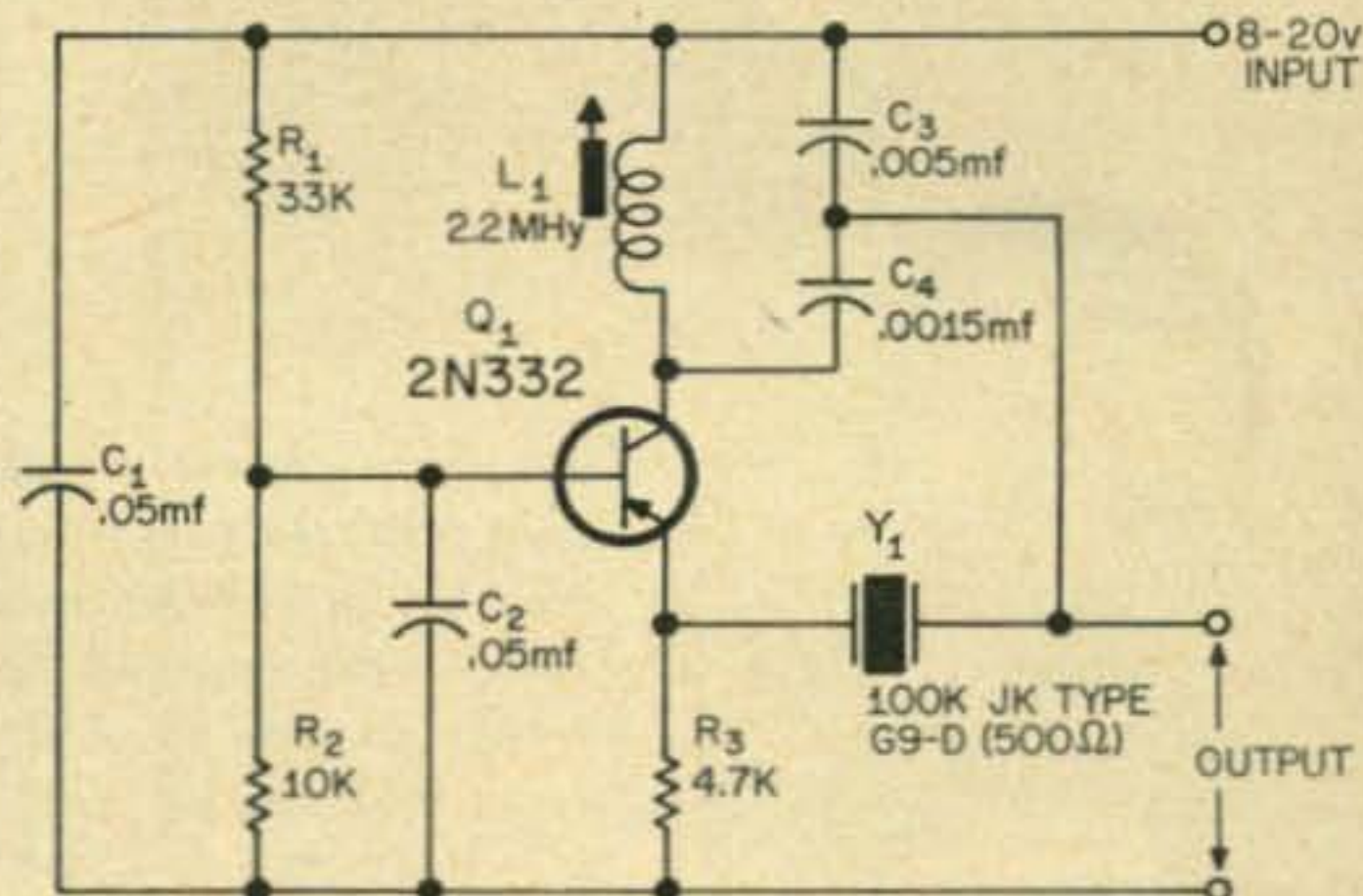

Fig. 2—Circuit useful as a 100 *kc* frequency standard.



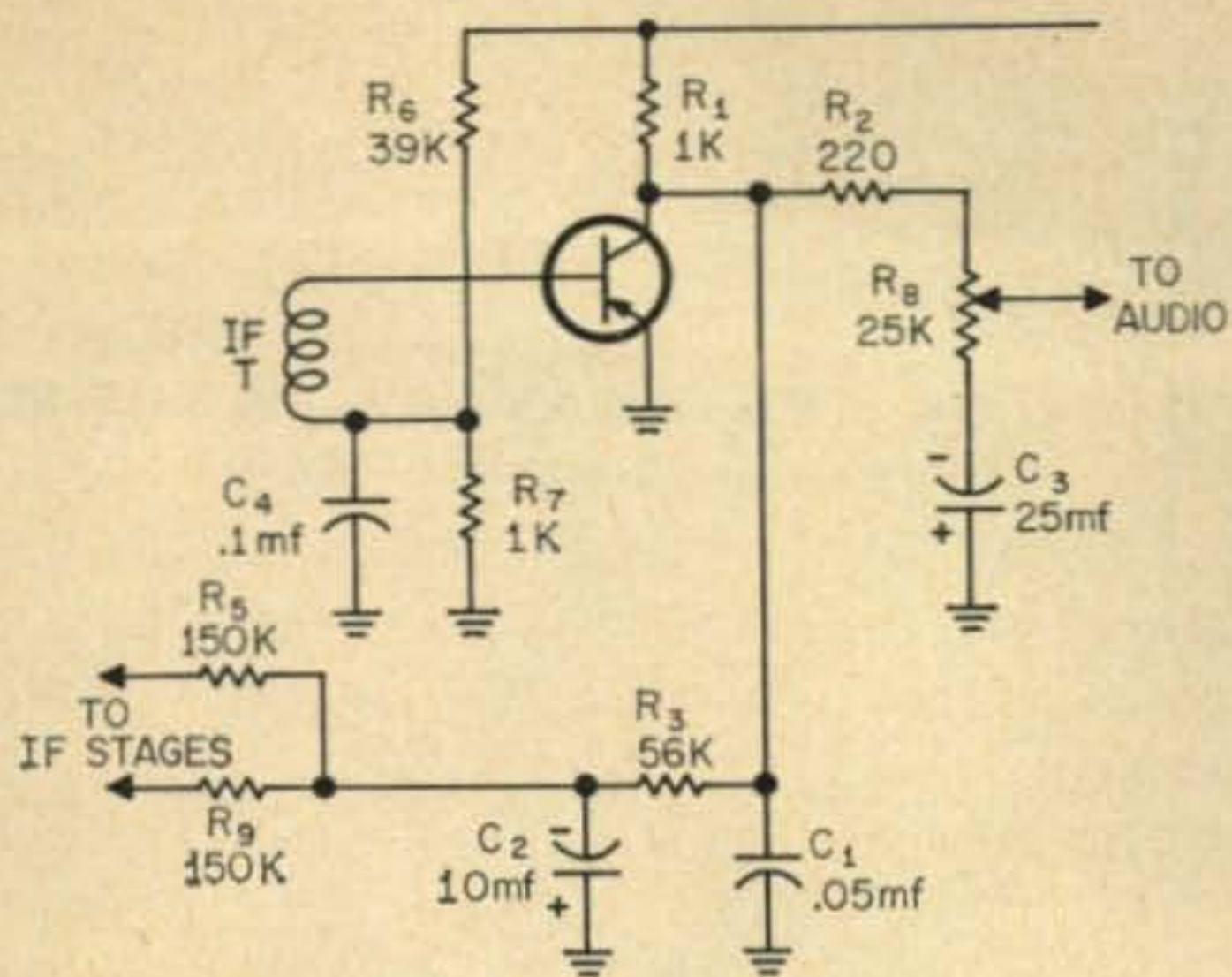

Fig. 3—Detector circuit designed by W. E. Sheehan and J. H. Ivers of Raytheon Mfg. Co. Operation is explained in the text.

emitter. The use of a tuned collector circuit prevents oscillation at a spurious crystal frequency. Although a silicon transistor is used, almost any type should work due to the low frequency of operation.

A second detector with *agc* is the contribution of W. E. Sheehan and J. H. Ivers of Raytheon Mfg. Co. This circuit would be useful in amateur communications receivers where strong *agc* action is required. The detector operates class B and provides about 10 *db* of gain as well as a stable source of *agc* voltage. The emitter is grounded and, in the absence of signal, the base is given a slight negative bias so that the emitter-base diode is just at the point of conduction. The circuit will conduct on negative half cycles and the resulting collector current produces, after filtering by C<sub>1</sub>, an audio voltage across the 1K collector load resistor. As the signal strength increases, the collector voltage will drop, thereby reducing the bias to the *if* amplifier stages. For amateur applications, I would like to inject that a 0-1 *ma* meter connected in series with the collector load will provide a relative indication of signal strength, since the collector current increases with the strength of the incoming signal.

The handbook also contains an impressive section on transistor power converters. In addition to presenting a group of circuits, an elaborate section on the theory and design considerations is given. One example of the circuitry is the design shown in fig. 4 (submitted by Delco), intended to supply 250 volts at 200 *ma* from a 6 volt source. The circuit employs the common collector configuration so that the transistors may be bolted directly to the heat sink without insulating washers. The bias network, R<sub>1</sub> and R<sub>2</sub>, provides for easy starting. The *dc* output voltage is obtained through a bridge rectifier and capacitive filter. The diode should have a rating of at least 300 *piv* or better yet, 400 volts. The capacitor reduces the ripple to less than 1%. Although a toroid core is specified in the circuit, a Chicago DCT-2 (with full wave rectification) should make an excellent substitution.

There are many more circuits which I would

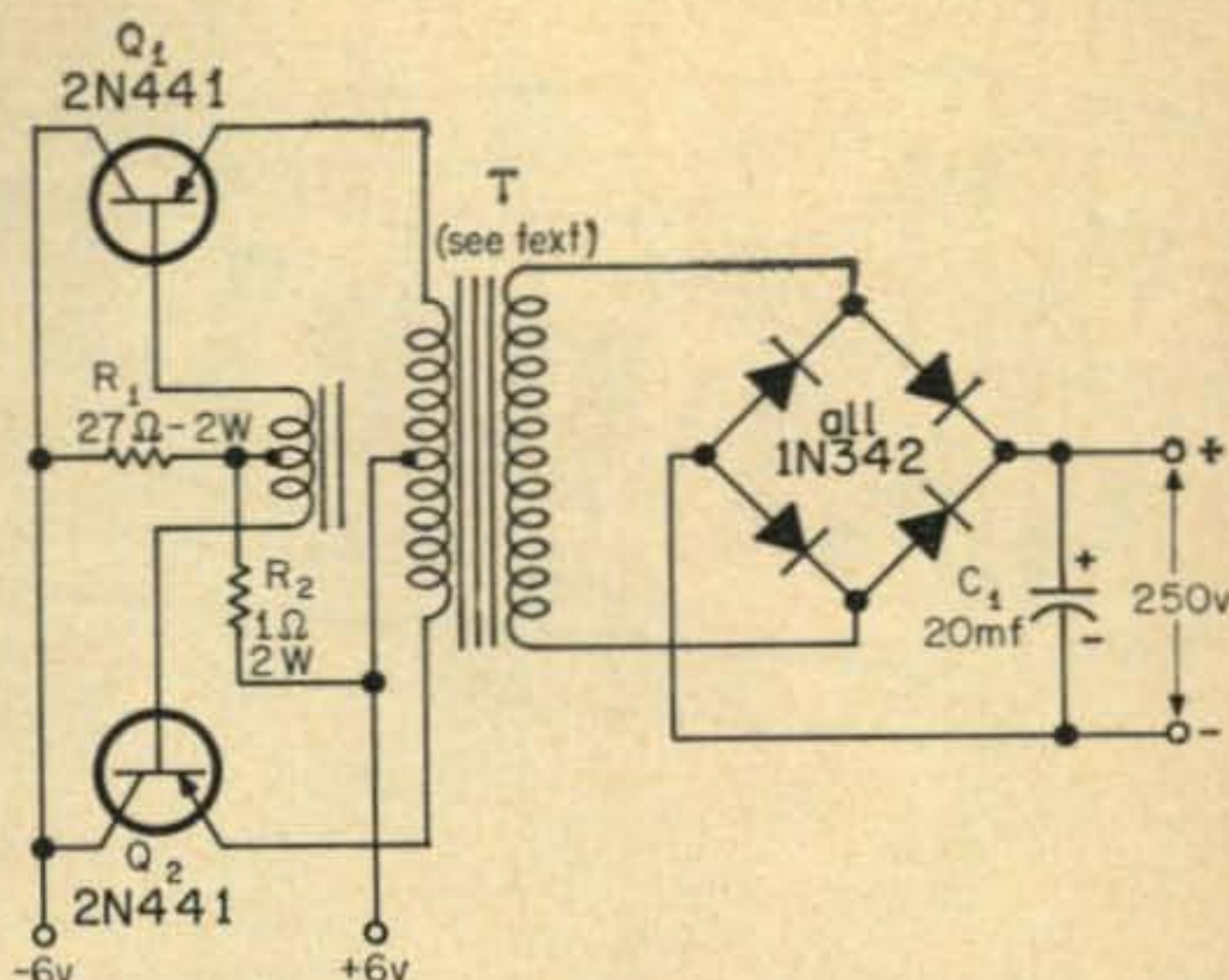

Fig. 4—Power supply circuit submitted by Delco intended to supply 250 volts at 200 *ma* for a 6 volt source.

like to present, but of course, space will not permit this. You can obtain a copy of this wonderful manual by writing the U.S. Government Printing Office, Washington 25, D. C. The cost is \$2.75.

### Semiconductor News

*Arnold Magnetics Corp.*, 6050 W. Jefferson Blvd., Los Angeles 16, Calif., is marketing transistorized static inverters for 400 cycle *ac* power generation from 28 volt sources.

*CBS Electronics*, 900 Chelmsford St., Lowell, Mass., is selling a new group of diffused silicon diodes grouped for fast recovery and high conductance for airborne and industrial computers.

*General Electric* is making available a new series of silicon rectifiers using the hard solder process. This technique is said to greatly reduce failure due to thermal fatigue. The group, available with positive or negative studs, is in the 2 to 8 ampere, 50 to 600 *piv* range.

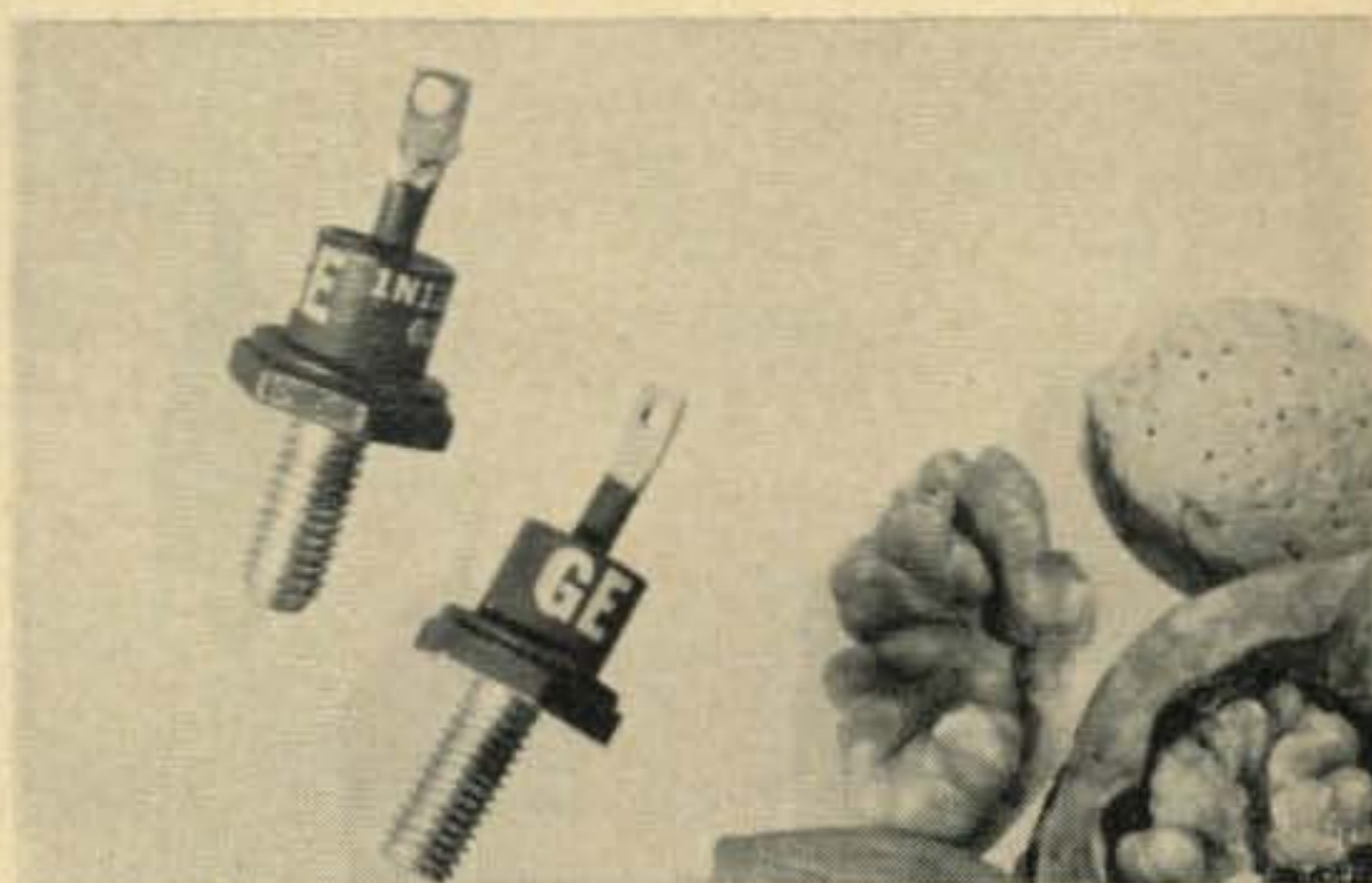

General Electric's new group of 16 medium current silicon rectifiers feature a high temperature hard solder design for maximum thermal fatigue-free operation.

*Pacific Semiconductors*, Culver City, California, makers of exotic semiconductor devices have just announced a series of very high voltage rectifiers. The new types, 1N3052 through 3061 are rated at 12,000 volts to 30,000 volts and are  
[continued on page 118]





by **KEN GRAYSON, W2HDM**  
 Care of CQ 300 West 43rd Street,  
 N. Y. C. 36, N. Y.

We recently returned from training duty with the Navy (learning all about the stuff that will some day be surplus) and found a stack of mail that will take a long time to answer. One letter in particular was extremely sad. Seems that Meshna's warehouse in Boston burnt down and with a great loss to John Meshna and we surplus hounds as well. Maybe something good will come out of it anyway, for in the next batch of mail was a letter from John telling about a good buy he made on a British surplus plug in unit that can be made into a fine six meter converter with very little effort. I immediately contacted K2VBI who had one a few years ago and got the scoop on it. Turns out that it is a three tube, tunable converter with an output frequency of 7.5 mc. The input is 50 to 65 mc, and it has a fine 20 to 1 vernier, which is also an illuminated dial. I don't know the exact price, but it seems worth what ever they charge, and Meshna is usually quite reasonable.

Upon opening the converter it was immediately obvious that it would be necessary to remove the two locking pins at the rear of the chassis. This is accomplished by simply removing the cotter pins holding the washer in place at the rear and sliding them out. You will see that the power plug is a Jones type, and since many combinations of hood assemblies can be obtained

see your parts distributor for the best type for your installation. Power and the output signal (7.5 mc) are obtained on the power plug. The input rf connector is a typical British type and very difficult to obtain in this country. However it can be easily changed to a standard coax of the UHF type (SO-239).

The antenna trimmer has a great effect in peaking up a signal and should be used for that final adjustment. The front panel could be removed and trimmed down so as to be a little neater. You will have to really search to find out how to remove the dial lamp, so we will save you a lot of effort by saying that you just pull the pointer assembly straight up and the bulb will be visible. The bulb is a typical European type and can be purchased at some Volkswagen dealers.

The power requirements are 6.3 volts at about an ampere and between 100 and 300 volts depending upon what you have handy. Plate current is not more than 20 milliamperes. No attempt was made to spread out the six meter band as there is plenty of bandspread as it is now. If there is a desire to increase the bandspread, this can be done by careful pulling of plates on the variables (one plate per section at a time) and retrimming the trimmers. Some additional capacity will probably be necessary

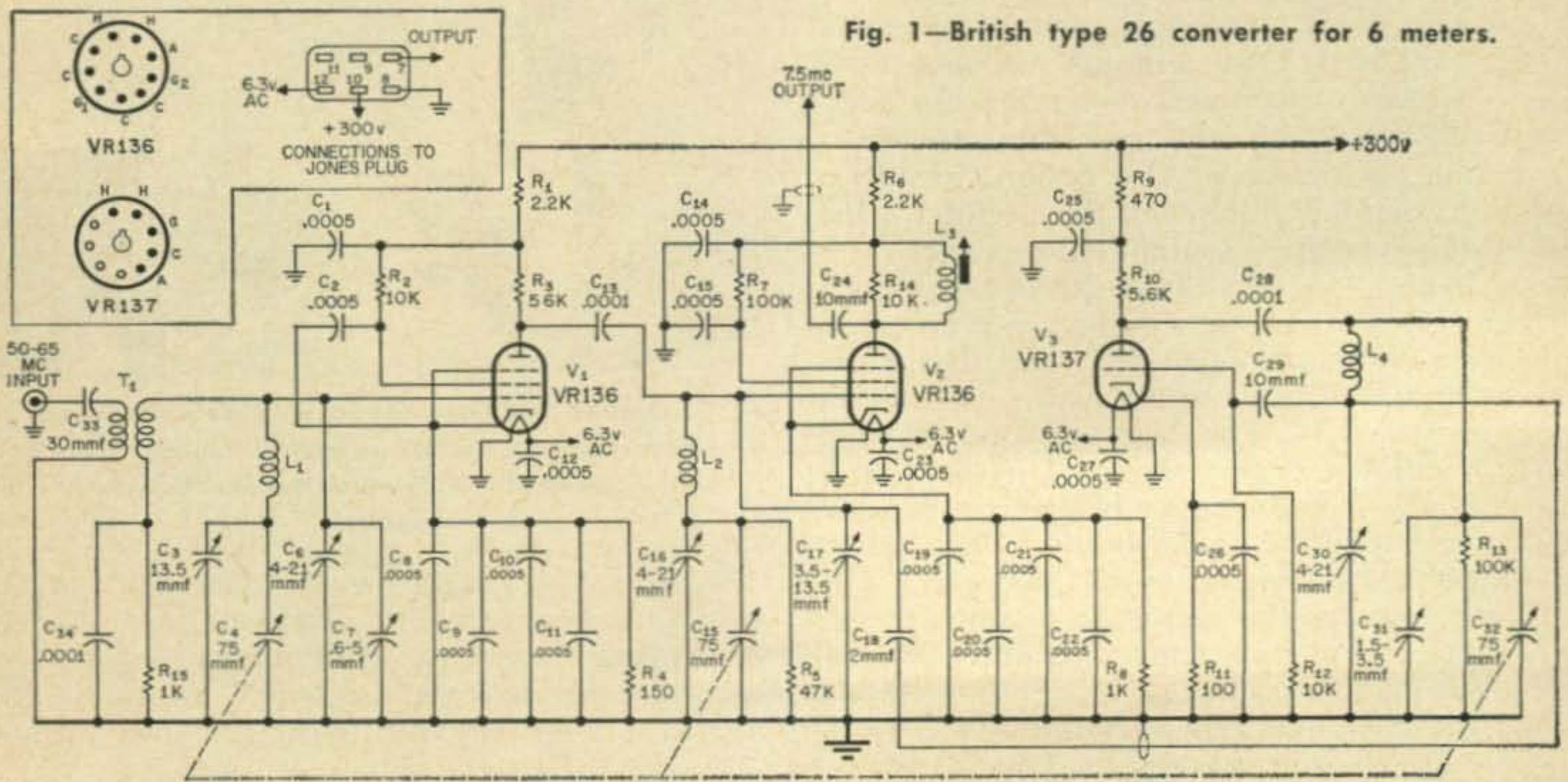

Fig. 1—British type 26 converter for 6 meters.



(about 10 mmf) across each section. Use a good signal generator or a grid dipper when doing this and don't rush.

### Corrections to the ARR-2 Conversions

We have had some mail indicating that there has been difficulty in trying to duplicate the oscillator addition to the ARR-2 receiver. We finally reworked the receiver oscillator to a circuit shown in fig. 2. The main problem with the original conversion was the mechanical configuration of the coil assembly, one side of which was anchored to ground. We got around this nicely, as you can see, and made a decent 220 mc receiver out of it. See August 1959 CQ for the original conversion.

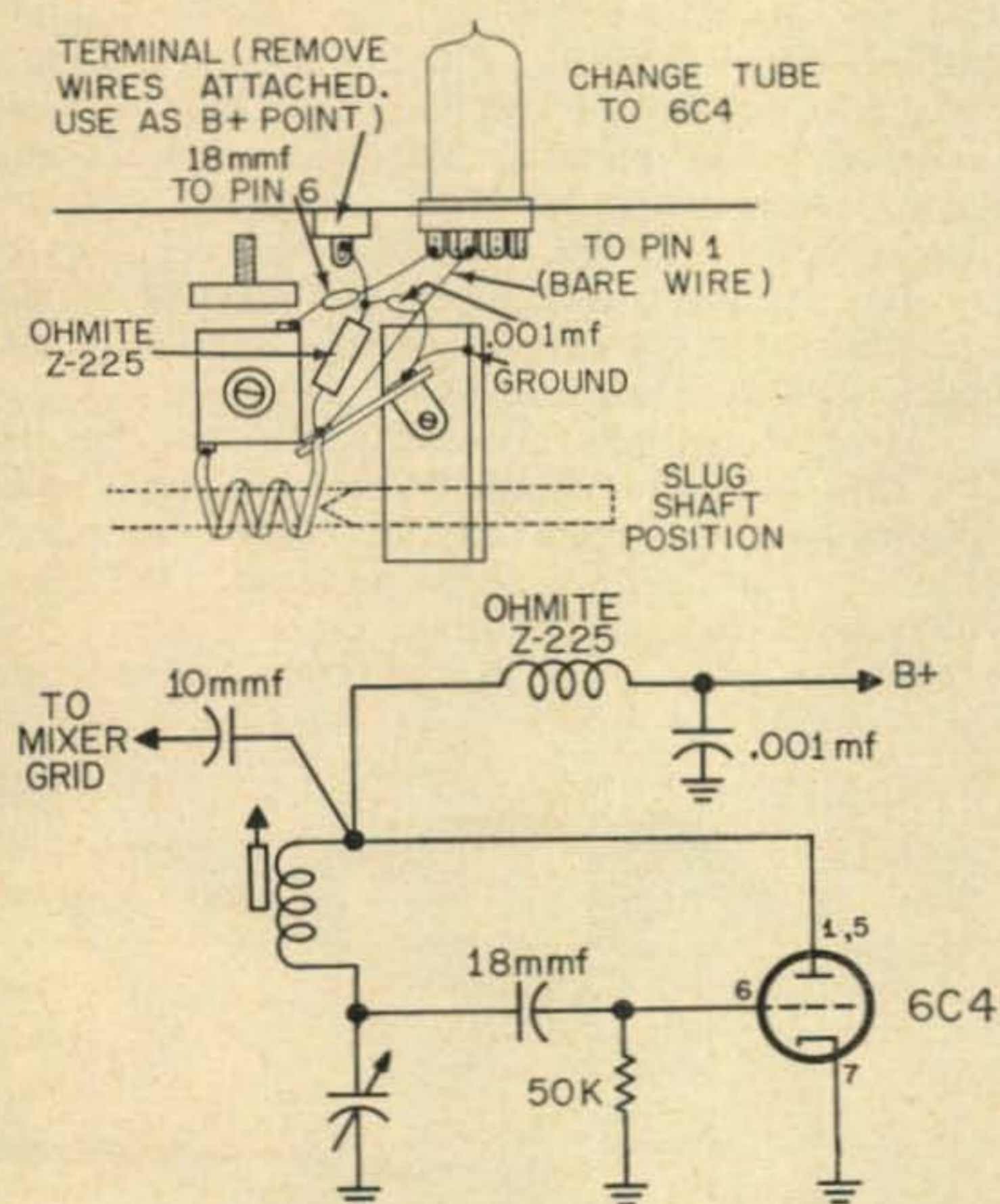

Fig. 2—Revised ARR2 oscillator schematic and pictorial.

The ARR-2, in case you forgot, is a combination TRF-Superhet. The carrier is modulated (in the original system) with a second carrier about 1 mc in frequency. This second carrier was also modulated, but by audio. The *trf* portion of the receiver picked up the signal, demodulated it and passed the 1 mc signal and its modulation to a conventional superhet for further detection. The superhet was preset to any of six different frequency channels, depending upon the sub-carrier used. The superhet alone should make a good rear end for a mobile converter.

### Future Conversions

Next month in this column we will modify the 220 mc transmitter currently available from many surplus outlets, including Barry. This little gem is complete except that it has a tone modulator. A simple rewiring job makes a fine twenty watt rig. We will also discuss the mobile ten meter converter for under five bucks that Meshna

has plus a few other goodies from here and there. The BC-604 and 684 should be complete by the November issue and will be a fine 15 and 10 meter rig putting out about fifty watts.

### Mail

This month we are making a special request for ourselves. In an attempt to tabulate all commercial sources of surplus electronic equipment for future reference, any dealers reading this are requested to send a *postcard* with their complete name and address as well as those particular types of surplus in which they specialize.

John McNutt K5KOS, Morris, Oklahoma wants a schematic for the **Canadian AR6 (Ref No. 10D-428)** made by **RCA of Canada**. J. Botwinick, 30-47 83rd Street, Jackson Heights 70, N.Y. needs any information on the **Model 260 wire recorder** made by **Pierce Wire Recorder Corp.** Brother Omer, St. Xavier High School, 118 West Broadway, Louisville, Kentucky is in need of a manual on the **R-237/VRC** receiver. Harry A. Smith, 800 Gerry Drive, Kenner, La. wants schematics or conversions on the **T-51-A/ARQ-8**. Don Roberts, 3085 N. 19th Ave. #123, Phoenix, Arizona would like a manual for the **BC-433F** series of receivers.

Richard Davis, 2121 Terrace Way, Santa Rosa, California has an **IP-67/APA-81** and requires a schematic of this equipment to convert it. C. L. Rodgers, 427 E. 18th Street, Marysville, California requests a manual on the **AN/CRC-3** and a possible conversion to 80 meters AM. Rollin J. Robb, Route 4-11 Vincennes, Indiana asks for the service manual on the **T-4/FRC**. Cliff Chadwick, 2450 Teller, Denver, Colorado is still looking for the **GP-7** schematic or handbook. R. R. La Brenz, 940 W. Hampton Rd. Essexville, Michigan would like a manual for a **BC-669C** and a **PE-110C**.

Herbert Guckel, 42-14 Saull Street, Flushing 55, New York needs a manual on the **BC-1031** panoramic adapter. Paul Girdner, 3324 Euclid Ave., Ft. Wayne, Indiana could use a **TBS** manual for a transmitter conversion.

Z. D. Maciekowich, Director of Education, Maryland Penitentiary, 954 Forrest Street, Baltimore 2, Maryland asks about a manual on the **BC-669**. Winfield E. Davis, 702 Murray Avenue, Merchantville 10, N.J. has an **RDR** Navy receiver and needs a manual for it. This part of the **MAR** equipment. Charles E. Hanner, 232 Taft Avenue, Syracuse 6, N.Y. wants to contact anyone with a conversion for the **AXT-1 TV** transmitter. Willard Walker, Maria's Trailer Court, Hefeford, Arizona needs conversion information on the **BC-AR-229/230**. Edwin Robertson's Grocery and Market, Bonita, Louisiana needs a manual on the **SO-6** Radar Power supply. W. D. Thompson, 4525 Robinwood Drive, Waco, Texas wants a handbook on the **R332/ARR-31** equipment. John Olson Jr., 115 West Magnolia Ave., Savannah, Georgia needs a tech manual on the **R-111/APR-5**. B. E. Martin, 6012 Rogers Drive, Shawnee, Kansas has a

[Continued on page 119]



# RTTY

Byron H. Kretzman, KØWMR

108 W. Teresa Drive  
West St. Paul, Minn.

In the June column we began our basic course in radioteletype fundamentals for the newcomer to this most fascinating phase of amateur radio. In case you didn't know, RTTY is truly the last frontier of amateur radio, where hams still build their own specialized gear; where commercialism is at a minimum. This last frontier, by the way, is where so many old timers find a home when ordinary interest in other operation becomes jaded.

Last month we gave some machine theory and outlined the method of operating RTTY on *vhf*. This month we would like to give you a general run-down on the various "page printer" types of machines as found in amateur RTTY stations. Although some RTTYers, W9UE and K2AAA for example, have *Klienschmidt* machines and swear by 'em, most of the machines in ham hands are made by the *Teletype Corporation*, so we will confine our descriptions to their models.

## Page Printers

The *Model 12* was the first machine hams got their hands on. Sure, it sounded like a cement mixer, and many a ham found himself in hot water with the XYL, but it sure was a rugged machine. The *Model 12* utilizes type bars like a typewriter and a motor, not always the desirable synchronous type, is the source of mechanical printing power. The keyboard, on a separate

plug-in base, contains another motor which is just used to drive the sending and receiving distributors. Unlike later models, this machine has six electromagnets, requiring 300 *ma* pulses, which are supplied by the receiving distributor. A seventh magnet (start) is used for unlatching the distributor cam. A polar relay is required for operation, too. As you can easily imagine, all this high current contacting is a great source of clicks and hash to be picked up by any radio receiver in the vicinity. Shielding all wires and using filters helps but does not cure. Separate vacuum tube keyers for each magnet are required. As the result, most operation of *Model 12's* has been on *vhf* where less difficulty is experienced as compared to *hf* operation.

Most *Model 12's* have been retired to the cellar now that more modern, and less noisy, machines have become available. Hams with hardy families should be able to pick up a 12 these days with little cash outlay.

The *Model 26* is probably the most com-



Model 26 Page Printer with Keyboard.

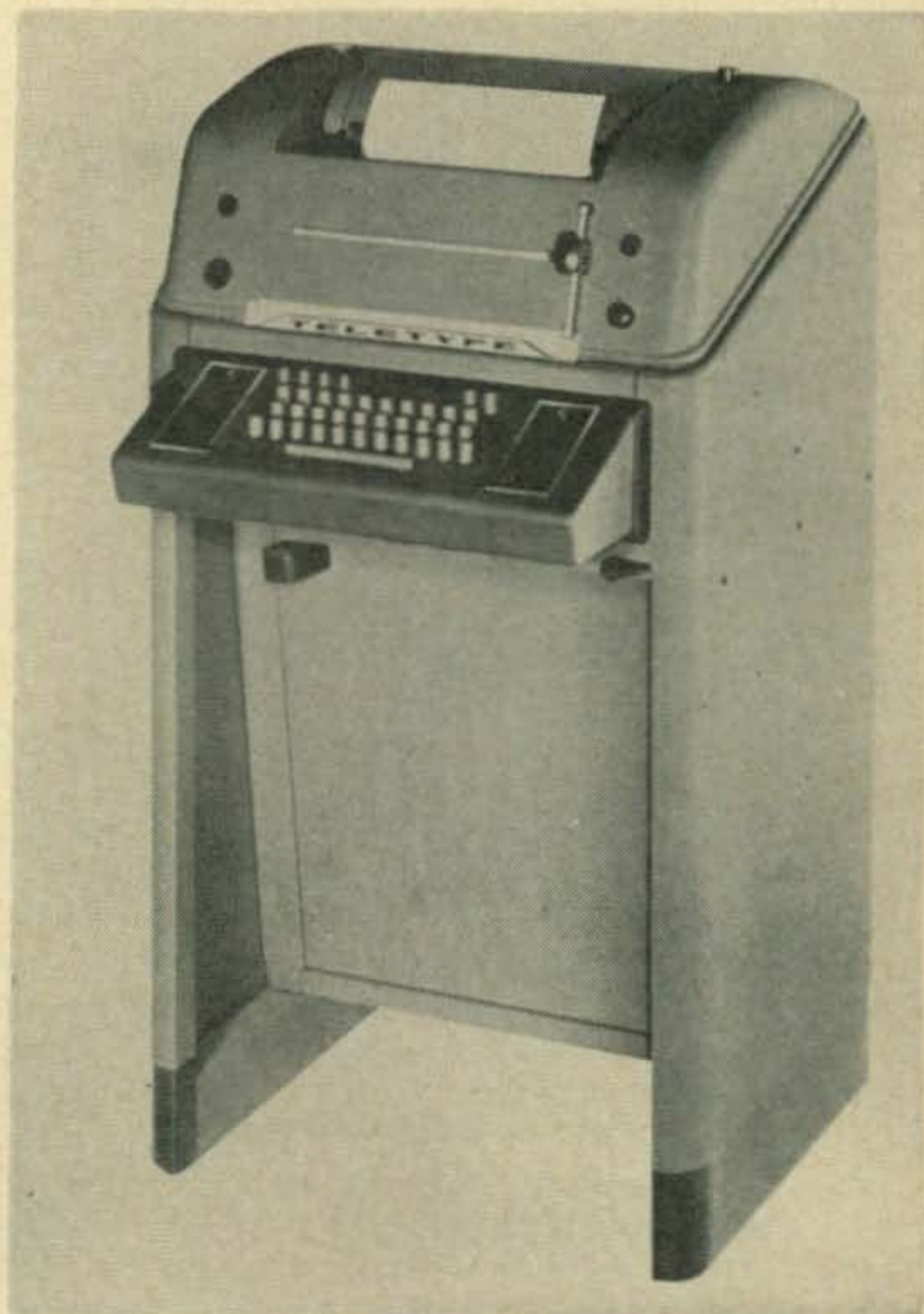

Model 28 Keyboard Sending and Page Receiving Teletypewriter.



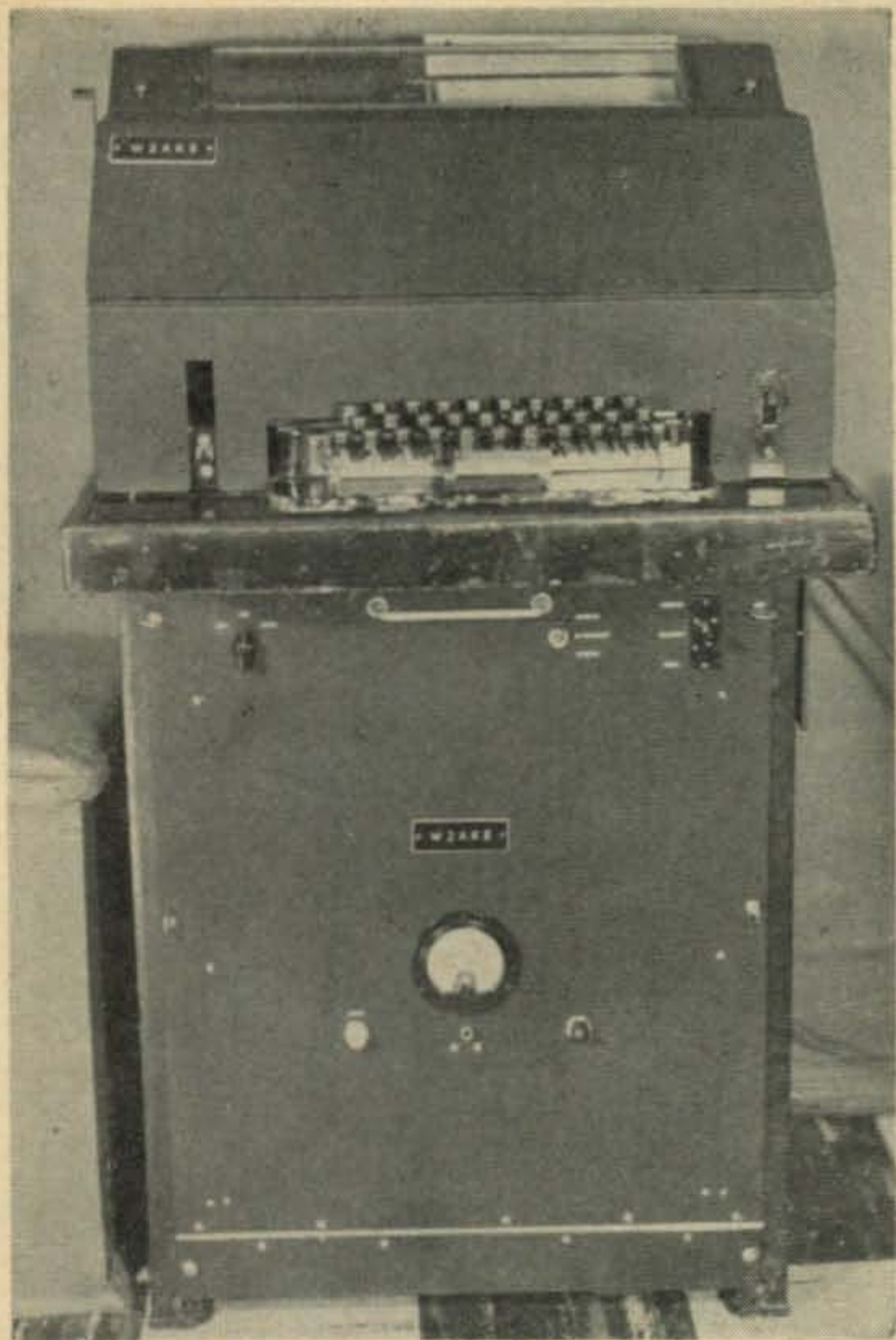

**Model 12 Page Printer with Keyboard (with converter built into table).**

monly used. Although a page printer like the 12, this machine has no type bars but has a type wheel like a children's typewriter. Small movable type pallets are carried by this type wheel and are individually hit forward for typing by a hammer or striker arm as the paper carriage moves back and forth. The type wheel rises for each character to permit the completed typing to be more easily observed. Unlike the Model 12, the 26 is a "single magnet" machine which makes it real easy to get noise free operation. Mechanical noise is real low, too, which is fine business from the XYL's point of view. This machine has been replaced, fortunately for us, by most of the wire services because it is good for 60-speed operation only. Also, many 26's are becoming available now on a second-hand basis as the older RTTYer acquires the newer Model 15.

*The Model 15* (Signal Corps TG-7A or TG-7B) is similar to the 26 in the respect that it is also a single magnet machine; however, the paper platen is stationary while type bars in a carriage moves from left to right while printing. This model is larger and more rugged than the 26, and it is capable of 75-speed operation. Fortunately, again, the 15's getting to the hams are essentially all 60-speed machines. More and more of the 15's are becoming available as the wire companies install the latest higher speed 28's.

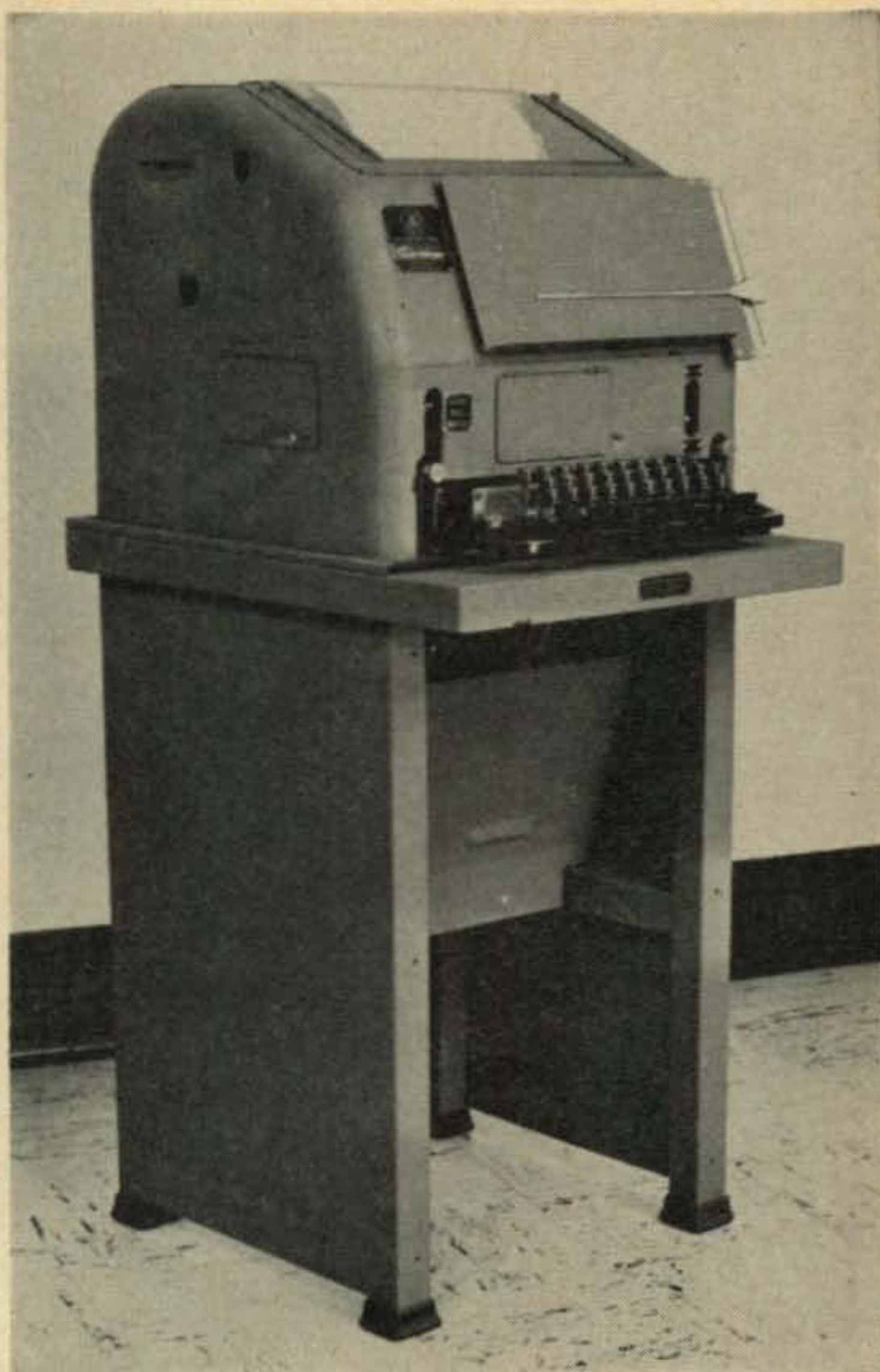

**Model 15 Keyboard-Send and Receive Teletype.**

*The Model 28* is the latest and the most modern machine, designed for 60, 75, and 100-speed operation. Of course, this machine is in current production and in extensive use so not too many get into ham hands. A "stunt box" enables many switching functions to be performed by the reception of certain sequences of characters. This feature is not found on the older machines. The 28, by the way, has no type basket or type wheel, but has its movable type pallets in a rectangular type block which moves back and forth across the paper.

The preceding description of page printers has been necessarily brief in order to give an over-all picture of the various *Teletype* page printer machines in general use today. In a subsequent column we will give you detailed circuit information, invaluable in the unraveling of the mysteries of your own newly acquired mechanical monster. In the very next column, though, we will give you the same kind of general run-down on the various pieces of tape equipment used in the more sophisticated RTTY stations.

#### **Equipment Procurement**

It behooves us right now to say a few words about how you go about the business of obtaining a machine. First of all, do **NOT** contact your local telephone company or the *Teletype Corporation* directly. These people cannot, and *must not*, be bothered by individual requests or



deals for machines. When obsolete (to them) machines are to be disposed of, they prefer to do it through established channels. These are the legitimate incorporated societies of active RTTYers. Now, some machines, such as the TG-7's, used by the military find their way into the surplus market, but these are relatively few and are priced comparatively high.

When the time comes that you no longer can stand being of the "unwashed multitude," and you just *have* to get a machine, go to the nearest *active* RTTYer in your area. He will not only acquaint you with the legitimate incorporated RTTY societies who procure machines but he will undoubtedly know where those second-hand machines are for sale in your own area. (Beware of that "national" unincorporated society with "headquarters" in the New York vicinity. It is a one man operation which has nicked many a newcomer with "windfalls" and "package" deals.)

If you don't know of any RTTYer near you, we suggest that you obtain the *RTTY Call Book* published by the RTTY Society, Inc., of Southern California. The price is \$1. Incidentally, they also put out a mighty fine monthly bulletin, *RTTY*, for \$2.75 a year. Their QTH is 372 West Warren Way, Arcadia, California.

#### The R.S.G.B. and RTTY

"There appears to be some misapprehension in certain quarters regarding the attitude of the R.S.G.B. towards RTTY. The position is that here in the United Kingdom there is a small but flourishing group interested in this method of communication—The British Amateur Radio Teleprinter Group—which works in close collaboration with the R.S.G.B. Indeed, the Honorary Secretary of the Group, Dr. A. C. Gee (G2UK), has prepared a paper on the technical standards for Amateur Radio Teleprinter operation which will be submitted to a conference of Region I, I.A.R.U. Societies at Folkestone, England, in June 1960. The paper has been produced at the request, of the R.S.G.B.

Despite the difficulties, interest in RTTY is growing in the U.K. Suitable equipment is not

easy to come by but small quantities do become available from time to time, at prices which amateurs can afford. Such equipment is quickly snapped up.

I should be glad if you would let your readers know that, far from wishing to discourage interest in RTTY, as has apparently been suggested in some quarters, the R.S.G.B. hopes that many more British amateurs will experiment with this branch of Amateur Radio."

(signed) John Clarricoats, G6CL  
General Secretary

#### 20 Meters

W4MJI located at the Signal Training Center at Fort Gordon, Georgia, is operated by the Signal Training Center Radio Club. Operators Ken W4MIY, Cas K4KDO, Mel W4PMJ, and Will W4OEB usually hang out "just above 14,100" between 1400 and 2200 hours. They are interested in making skeds with other RTTY stations.

OA5G in San Juan Bay (Lima) Peru was heard working WØTUO just *below* 14,100 June 10th at 2220 CDT. Also heard just below 14,100 was W3CRO, the machine expert of Springfield, Pennsylvania; and KØJHG of Wayne, Nebraska, a YL newcomer by the name of Joan.

#### Comments

At the risk of sounding like "The Old Man," we have noticed that many an RTTYer these days is omitting the use of standard keyboard operating procedure when starting, and in particular, when ending a transmission. We realize it's just sloppy operating rather than intentional discourtesy when an RTTY transmission is ended in the middle of a line or at the end of a line, when the switchover to code identification is made. It's good practice, too, at the end of *every* line to hit the following keys in this sequence: CAR RET, LINE FEED, and LTRS. The object here is to prevent over-printing on the other fellows' machine in case some functions are missed. Very few of us, actually, have automatic carriage return and line feed, so give the other fellow a break, huh?

73, Byron, W2JTP, KØWMR

## CQ Enters The Space Age

With Explorers, Pioneers and Sputniks criss-crossing outer space, the space age is truly here. Heralding this marvelous new age, and in recognition of its great importance to amateur radio, next month *CQ* inaugurates a Space Communications column. Devoted to those aspects of space communications that are of interest to amateur radio and those in which radio amateurs can actively participate, the new column will appear monthly thereafter.

Slated for early columns are discussion of such topics as *Project Echo*, a space communications project which may make it possible for radio amateurs to communicate around-the-world with space-reflected *vhf* signals; *Projects Smokepuff* and *Shotput*, attempts to produce a man-made ionosphere which may be utilized by radio amateurs; and a discussion of amateur radio's first successful attempt at "bouncing" signals off of an earth satellite. The new column will be conducted by an Editor well-known professionally in the field of communication, and to *CQ* readers. . . . George Jacobs, W3ASK. Space communications offers new horizons and challenges to amateur radio, don't miss the inaugural column in next month's *CQ*. ■





# PROPAGATION

## CQ SHORT-SKIP PROPAGATION CHART

AUGUST-SEPTEMBER, 1960

BAND (METERS)	DISTANCE - MILES			
	50-250	250-750	750-1300	1300-2300
10	****	7A-12M (0-1)*	7A-12M (1-2)*	7A-4P (2-1)* 4P-8P (2-2)* 8P-12M (2-1)*
15	****	6A-4P (0-2)* 4P-12M (0-2)* 12M-6A (0-1)*	6A-4P (2-3)* 4P-7P (2-3)* 7P-12M (2-2)* 12M-6A (1-1)*	7A-4P (3-3) 4P-8P (3-4) 8P-12M (2-2)* 12M-7A (1-1)*
20	****	6A-10A (1-3)* 10A-3P (1-4)* 3P-8P (1-3)* 8P-6A (1-2)*	6A-10A (2-5) 10A-3P (4-5) 3P-8P (2-5) 8P-10P (2-4) 10P-6A (2-2)*	6A-10A (5-4) 10A-4P (5-3) 4P-8P (5-5) 8P-10P (4-5) 10P-6A (2-2)
40	7A-9A (2-4) 9A-8P (4-5) 8P-11P (2-3) 11P-7A (1-2)*	7A-9A (4-3) 9A-7P (3-3) 7P-3A (3-4) 3A-7A (2-4)	7A-9A (2-2) 9A-3P (2-1) 5P-7P (2-2) 7P-5A (4-4) 5A-7A (4-3)	5A-8A (3-1) 8A-5P (1-0) 5P-7P (2-1) 7P-5A (4-4)
80	5A-9A (3-5) 9A-4P (5-4) 4P-7P (5-3) 7P-9P (5-4) 9P-5A (5-5)	5A-7A (5-2) 7A-7P (3-1) 7P-10P (4-2) 10P-5A (5-5)	5A-7A (2-1) 7A-6P (1-0) 6P-10P (2-1) 10P-3A (5-4) 3A-5A (5-3)	5A-7A (1-0) 7A-5P (0-0) 5P-8P (1-1) 8P-3A (4-3) 3A-5A (3-2)
160	5P-7P (1-0) 7P-9P (2-2) 9P-5A (5-5) 5A-7A (2-2) 7A-9A (1-0)	8P-10P (2-1) 10P-2A (5-3) 2A-5A (5-1) 5A-7A (2-0)	8P-10P (1-1) 10P-2A (3-2) 2A-4A (1-1)	8P-10P (1-0) 10P-2A (2-2) 2A-4A (1-1)

\*Predominantly Sporadic-E type opening

ALL TIMES SHOWN IN PROPAGATION CHART ARE GIVEN IN LOCAL STANDARD TIME

### HAWAII

(TIME GIVEN IN HAWAIIAN STANDARD TIME)\*

TO:	10 Meters	15 Meters	20 Meters	40/80**Meters
Eastern USA	1P-5P (1)	6A-8A (2) 8A-11A (1) 11A-1P (2) 1P-5P (2) 5P-7P (2)	1P-3P (1) 3P-6P (2) 6P-9P (4) 9P-11P (3) 11P-2A (2) 2A-5A (3) 5A-7A (2) 7A-10A (1)	6P-8P (1) 8P-1A (3) 8P-12M (2)**
Central USA	2P-7P (1)	7A-1P (2) 1P-5P (3) 5P-7P (2)	9A-1P (1) 1P-3P (2) 3P-6P (3) 6P-9P (5) 9P-12M (3) 12M-3A (2) 3A-6A (3) 6A-9A (2)	6P-8P (1) 8P-1A (4) 1A-3A (2) 10P-1A (2)**
Western USA	11A-2P (2) 2P-4P (1)	8A-10A (2) 10A-2P (4) 2P-5P (3) 5P-7P (2)	6A-8A (4) 8A-3P (3) 3P-7P (5) 7P-9P (4) 9P-11P (3) 11P-6A (2)	6P-8P (2) 8P-4A (4) 4A-6A (2) 8P-4A (3)**

\*Hawaiian Standard Time is equal to:

Eastern Standard Time minus five hours;  
Central Standard Time minus four hours;  
Mountain Standard Time minus three hours;  
Pacific Standard Time minus two hours.

### ALASKA

(TIME GIVEN IN ALASKAN STANDARD TIME)\*

TO:	10 Meters	15 Meters	20 Meters	40/80**Meters
Eastern USA	NIL	3P-6P (1)	3P-6P (1) 6P-8P (2) 8P-10P (1)	NIL
Central USA	NIL	4P-8P (1)	6P-7P (1) 7P-9P (2) 9P-11P (1)	9P-3A (1)
Western USA	NIL	5P-8P (1)	6A-10A (2) 10A-4P (2) 4P-6P (3) 6P-8P (4) 8P-12M (1)	10P-4A (2)

\*There are four different time zones in Alaska. The Chart is based on Standard Time in the zone from Skagway to 141 degrees West Longitude. Time in this zone is equal to:

Eastern Standard Time minus four hours;  
Central Standard Time minus three hours;  
Mountain Standard Time minus two hours;  
Pacific Standard Time minus one hour.

### SHORT-SKIP FORECAST INDICES

Circuit Forecast To Open:

- (0) Less than 3 days a month during forecast period.
- (1) Between 3 and 8 days a month during forecast period.
- (2) Between 9 and 14 days a month during forecast period.
- (3) Between 15 and 20 days a month during forecast period.
- (4) Between 21 and 25 days a month during forecast period.
- (5) On more than 25 days a month during forecast period.

Where two indices are shown within a parenthesis the first applies to the forecast for the shorter distance range, the second to the forecast for the longer distance.

A - A.M. P - P.M. N - Noon M - Midnight

The CQ Short-Skip Propagation Charts are based upon a CW effective radiated power of 75 watts from a half-wave dipole antenna, a half-wave above ground. The Charts are valid through September 30, 1960. These forecasts are based upon basic propagation data published by the Central Radio Propagation Laboratory of the National Bureau of Standards, Boulder, Colorado.

## General Forecast

Typical summertime shortwave radio propagation conditions are expected to continue through the month of August. Fifteen meters is forecast as the band that should produce the best DX openings during the hours of daylight, with conditions peaking during the late afternoon and early evening hours. Except for some north-south path openings, very little DX is expected for 10 meters. During darkness and the early morning hours, 20 meters is expected to be the best band for DX openings, with openings to some areas of the world also predicted for 40 meters during the hours of darkness. Seasonally high static levels are expected to hamper DX openings on both 80 and 160 meters during August. A complete forecast for specific circuits to all areas of the world was included in the July-August DX Propagation Charts appearing in last month's column.

This month's column contains Short-Skip Propagation Charts for August and September. A considerable amount of Sporadic-E propagation is forecast for August and early September, and this is expected to result in numerous short-skip openings on 10, 15 and 20 meters. During the hours of darkness, 40 meters is forecast as the best band for short-skip openings, with fairly good short-skip conditions also predicted for 80 meters.

## Solar Cycle

The sunspot cycle continues to *decline* at an increasingly rapid pace. The Zurich Observatory reports a monthly mean sunspot number of 120 for May, 1960. This results in a 12 month running smoothed sunspot number of 136 centered on November, 1959. A smoothed sunspot number of 112 is predicted for August, 1960.

## Last Minute Forecast

Probability Indices	Above Normal Conditions (Aug. 9-12)	Normal Conditions (Aug. 1-8, 13-17, 20-23, 29-31)	Slightly Disturbed (Aug. 18-19, 27, 28)	Moderately Disturbed (Aug. 24-26)
1	C	D-E	E	E
2	B	C-D	E	E
3	A	B-C	D	E
4	A	A	C	D
5	A	A	B	C

[Continued on page 101]



# VHF

50mc. 144mc. 220mc. 420mc. and above

Sam Harris, W1FZJ

P. O. Box 334, Medfield, Mass.

## Project Moonbounce

The Rhododendron Swamp V.H.F. Society has finally gotten the 1296 mc Moonbounce project on the air. Vital statistics for those interested in listening for our signals are as follows:

1. Frequency of transmitter is 1295.999 mc.
2. Power input to the antenna is 350 watts.
3. Antenna gain is 35 db (18 foot parabolic dish).
4. Transmissions start 9 hours after moonrise G.M.T.
5. Transmissions end 13 hours after moonrise G.M.T.
6. Transmissions consist of 2.5 second pulses with 2.5 second pauses. Identification is made every 10 minutes in CW. A different code word is transmitted each night.
7. Reception of signals should be QSLed pronto. Phone number of R.S.V.H.F.S. is Fleetwood 9-2254, Medfield, Mass. (P.O. Box 334).

In case you are wondering how good your equipment must be to hear our signals, consider the following: Return echoes received on an 18' parabolic antenna with 0.5 db feed line loss and a 200° receiver front end average 8 to 16 db above the noise level. This means that with a four foot parabolic you should receive a signal that is from 0 to 3 db above the noise, assuming

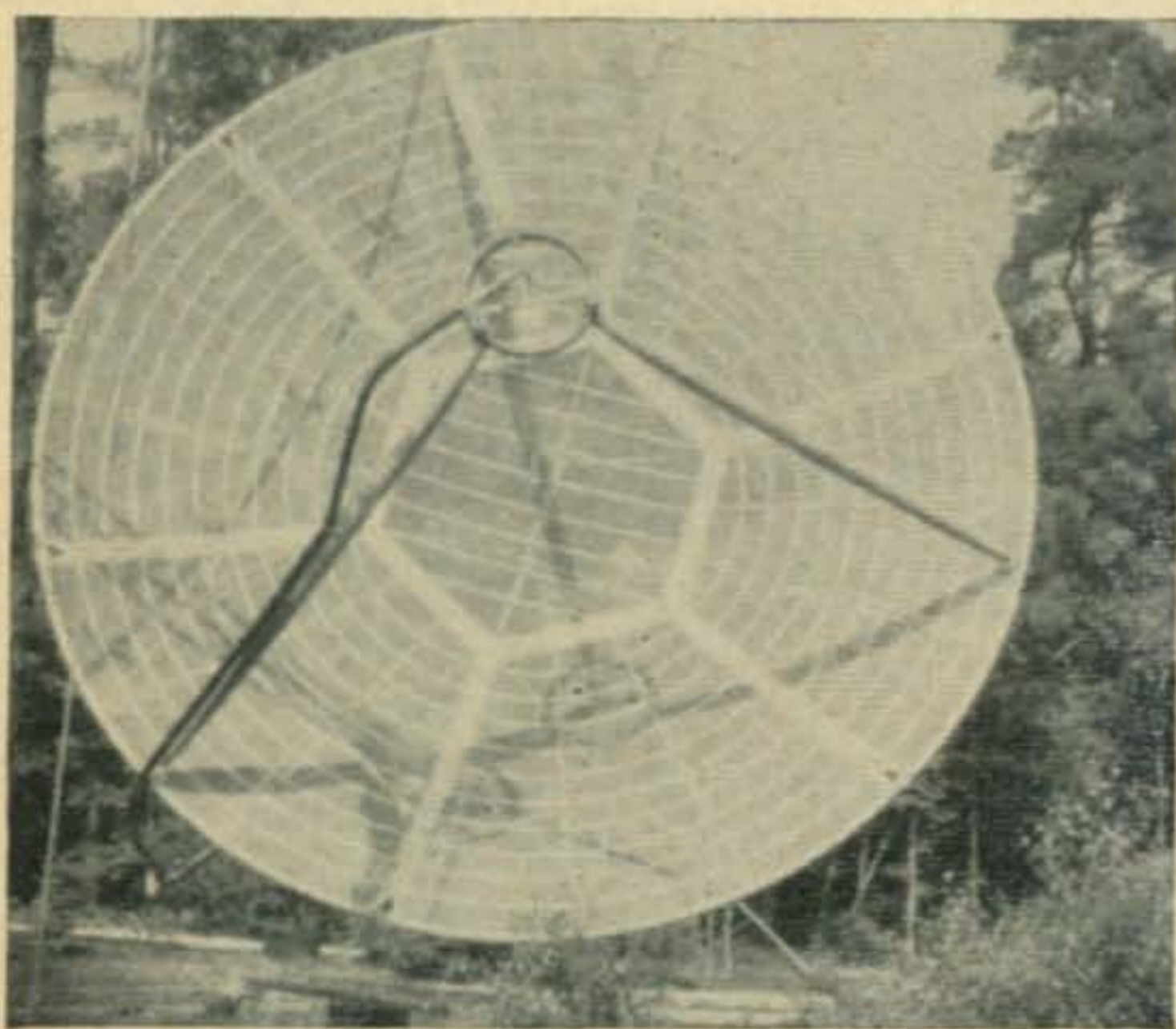

18' parabolic reflector in use at the R.S.V.H.F.S. for 1296 mc Moonbounce project.

a parametric preamp with a useable 1.5 to 2 db noise figure, and no more than 0.5 db total feed line loss.

Parabolic antenna gain (as given by the Andrews parabolic antenna system Computer) for a four foot dish is 22 db. Eight foot dish is 28 db, ten foot dish is 30 db, twelve foot dish is 31.2 db. Obviously, the beamwidth of the antenna becomes sharper as the gain increases and as a result more care must be taken in aiming the larger systems. The four foot parabola must be pointed at the moon within about eight degrees. An eight footer with forty degrees, a twelve footer within 2.5 degrees, etc. Aiming accuracy of the 18 foot parabola at the R.S.V.-H.F.S. is one degree.



Members of the Sudbury Radio Club (rear) and the R.S.V.H.F.S. (front) moving the Klystron power supply used on the 1296 mc Moonbounce project.

A parabolic reflector is a convenient method of getting gain but it should not be considered as the only practical way. A four foot parabola, for instance, only gives about 55 per cent as much gain as the equivalent area in half wave spaced dipoles in front of a flat reflector. The prime advantages of the parabolic reflector are independence of frequency and simplicity of feed. For small antennas the home constructor might well consider an array of square corners.

Antenna arrays with gains in excess of 2.5 db however, become extremely difficult to adjust and the construction of a parabolic reflector with a dimensional accuracy of one inch over a 6' diameter begins to look easier.



## Schedules

Schedules with interested parties can be arranged by addressing the R.S.V.H.F.S., P.O. Box 334, Medfield, Mass. Liaison communication is available on any amateur band. Please include a list of equipment in use, such as antenna size, aiming accuracy, receiver temperature (or noise figure), band width, etc. A copy of *The Nautical Almanac* for the year 1960 is essential. This tome is available from the Superintendent of Documents, Washington, D.C., for \$2.00, or at most book stores and libraries. (In London from Her Majesty's Stationery Office.) Instructions for using the almanac are included.



Moving the Klystron body coil and blower assembly into the remote control shack at the R.S.V.H.F.S. 1296 mc Moonbounce site. Front are Fred Collins (W1FRR) and Gordon Pettengill (W1OUN). Rear are lend-lease members from the Sudbury Radio Club.

## Clubs—Nets

The newly formed VHF Club in the Detroit, Michigan, area, recently held a VHF contest to spur activity and interest in this field. The top thirteen scores and the lowest score collected prizes donated by various concerns in the area.

Members of the "Michigan 6 Meter Club" number one hundred and fifty members, so can be sure of a good contest even without "an opening".

### Rhode Island State 6 Meter Net

Announcing a new traffic net for Rhode Island: The Rhode Island State 6 Meter Net on 50.6 daily at 1930. Complete coverage for Rhode Island and nearby Massachusetts and Connecticut.

Net control stations are K1GRC and W1TXL. An open invitation is extended to all six meter hams to join in and have fun.

### 6 Meter Emergency Net—Ft. Worth

The 6 Meter Emergency Net of Fort Worth, Texas, met at Lake Worth on the last Sunday in May for the purpose of holding a business meeting and picnic. The following officers were elected: Elmer Shoaf, K5MTK for secretary; Jack Waddell, K5PMX for Net Manager; Jack

## Liars Club Net Certificate

IF U AIN'T A LIAR SIX METERS CHANCES R. U AIN'T A MEMBER

UNDER CONDITIONS SET FORTH BELOW AND UPON AN UNSIGNED I. O. U. FOR ANY DAMAGE TO HAM PROPERTY OR RADIO GEAR HE CAN'T ALIBI HIS WAY OUT OF; THE LIARS CLUB NET CERTIFICATE-AT-LARGE IS ISSUED TO:

AND IT AUTHORIZES, IDENTIFYING FLYING SAUCERS, PICKING NIGHT WALKERS, TELLING AT LEAST ONE SOUND PROOF LIE PER MEETING, BEING ABLE TO RUN AN OUTBOARD MOTOR AND LIKE MICE AND ALL SUCH PETS AND BEING ABLE TO BOTHER AT LEAST ONE NEIGHBOR WITH TENNESSEE VALLEY INDIANS EACH EVENING. IT FURTHER AUTHORIZES THE HOLDER TO PROMOTE GEAR FOR ONE ANOTHER AND LIE ABOUT ANY SUBJECT THAT MAY ARISE, TO HAM COMPANIONS. IN ACCORDANCE WITH THESE LAWS TO PROTECT ALL MEMBERS THIS CERTIFICATE CERTIFIES THAT YOU ARE A PROFESSIONAL LIAR AND HAVE WORKED FOUR MEMBERS OF THE LIARS CLUB NET AND HAVE TOLD AT LEAST FOUR LIES.



KIDER	PRESIDENT	W1GKI	TREASURER IN CHARGE OF PROMOTIONS
K1HDM	CHIEF PROMOTER	W1JAT	ALIBI EXPERT
K1BBG	IDENTIFICATION EXPERT	K1DTR	SECRETARY

Certificate No. \_\_\_\_\_

A "different" certificate issued in Western Massachusetts by the "Liars Club Net".

Murray, K5ZPE as Net Control; Sam Baker, K5VUF as 1st Assistant; Jay Pickle, K5BBG as 2nd Assistant; Billie Baker, K5ZIF as 3rd Assistant. Ann Baker, K5VUM, was appointed entertainment chairman for the net.

## Mail

**Coventry—Warwicks—England** "A few words about my modest *vhf* and *uhf* activities. Was licensed in September, 1956, and have operated *vhf* almost exclusively. I am active on 144 mc and 435 mc, running 90 watts on 2 and 80 watts on 435 mc. The PA in both transmitters is a Mullard QQVO6/40A Twin Tetrode which is a very popular tube for *vhf* in this country and is the equivalent of your 5894 tube. My converter uses 6J6 PP *rf* stage, 6J6 PP Mixer, CC chain into 3 stage neutralized Cascode amplifier at 26 to 30 mc."

"The 70 cms converter is GL 446A *rf* into xtl mixer, CC chain into 3 stage neutralized cascode amplifier at 26 to 30 mc."

"Aerial for 2 meters is only a 6 element stack, Bi-directional, fed with 300 ohm ribbon, gain about 10 db over dipole, but it seems to do a reasonable job. Aerial on 70 cm is 16 element colinear stack; both aerials are at 36'."

"Have worked the following countries on 144 mc: G, GW, GM, GC, GI, GD, EI, OZ, DL, F, ON, PA. Best DX was an F station worked in the south of France, 750 miles. Have also heard HB9, SM, OH, I1, and LX."

"I also have a Gonset Communicator III which is used for portable and mobile work"

"Plenty of aurora contacts on 2 meters these days in G Land, probably due to the high power allowed to certain stations. 500 watts, CW, only; one frequency only. No QSYing."

"GM is being worked fairly regularly by the London boys, 500 miles away over mountainous territory, however, my 90 watts do not seem to be good enough."

"No big tropo openings in G Land for seven months, but we are all listening and hoping."

"Would like to correspond with *vhf*'ers in W land about my own age group (34) and meet

[Continued on page 120]



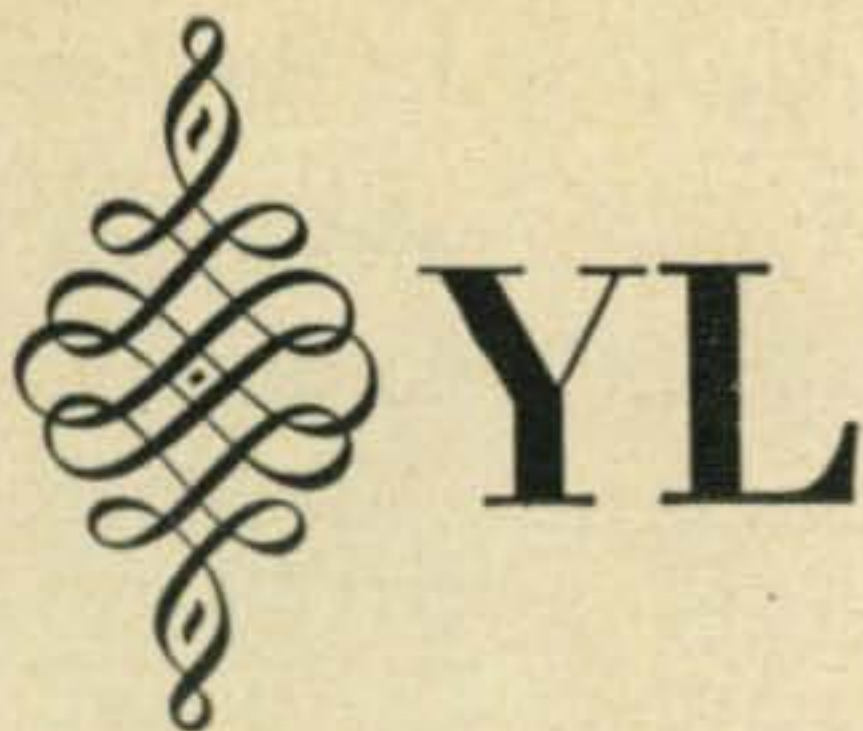

by **Louisa B. Sando, W5RZJ**  
212 Sombrio Drive, Santa Fe, N.M.

This month's column is by **Carole Hoover, K9AMD** as I am on vacation. See you in September.  
33, Louisa, W5RZJ

## "Club" Your Women

**Miss Carole F. Hoover, K9AMD**

401 East Wood Street  
Hillsboro, Illinois

**Is your radio club boring?** Would you rather watch an old movie on television than sit through another dull meeting and hear Tom Brown tell for the umpteenth time how he worked all states and Africa on 75 meter phone using only twenty watts? If you're grimly nodding "yes," then it's about time something was done to pep up those gruesome gatherings before they completely die out. This is really a simple thing to do with a little help. Just call on the original spicer of life; add the missing element—the never-to-be underestimated "woman's touch."

Now wait a minute! I know what you're thinking: that would be like burning down the barn to get rid of the rats! You're not about to let a bunch of chattering females invade your last stronghold with their lace curtains, dainty doilies, and disgusting rules about feet on furniture, ashes on the floor, and what time to go home. Women really aren't as impossible as you men think, and just to prove you're whistling on the wrong corner, let me tell you about our local club where hams and ma'ams meet and like it.

When I stuck my curly head in the door of the club shack for the first time, I drew as much attention as Sputnik I. It was strictly a man's meeting. Even after I was formally introduced as the first YL of the area, I felt as conspicuous as a purple people eater. Parliamentary procedure that evening seemed strained; the president "hemmed and hawed," and I was all set to head for the hills until a couple of friendly fellows drifted over to say that at least *they* were sure glad to have some

different "scenery," and they hoped I would come back.

I did go back, but next month at meeting time I rallied a force of willing XYLs and together we advanced to the shack armed with a coffee pot. Instead of a password, we took a big sack of doughnuts, and the scheme worked. From that day on, the club hasn't been the same, but I'll wager no one is shedding tears. Going on the old adage that the "way to a man's heart is through his stomach," we girls whipped a meet-and-eat plan into action which has probably done more than anything else to double and triple club turn-out. A steaming cup of coffee goes hand in "fist" with Field Days, DX contests, and ham radio in general, so two or three of us reach for a percolator as automatically as for our purses when we head for a meeting.

It's surprising how quickly an enthusiastic core of XYLs and YLs will grow. We welcome gals with and without licenses and find that many times all a lagging wife needs is some of that "if she can do it, so can I" spirit to get a ticket. One OM told me proudly, "I've been trying to get Diane interested in radio for years, but nothing worked. It wasn't until she saw you and the other girls having such a picnic that she changed her mind."

The red carpet is out, too, for the women who don't seem to give a hang about code but enjoy sitting in on the good times with their husbands. While she's sitting, she may be soaking up valuable information. As rare as a house without a TV antenna is the XYL who knows her hi-pass filters and when to recommend



them if she hears a neighbor in the grocery store saying something like "I just wish those awful hams would quit ruining television when I'm trying to watch Evelyn, Girl Skin Diver, or the Constable of East Manchester County."

### **Togetherness**

Since amateur radio is such a friendly-one-big-happy-family hobby, hams will go for get-togethers which include their "best girls" and children after the initial ice-breaking. Even our club dues are scaled to encourage family participation: a licensed ham pays \$5.00 per year; a sympathetic XYL or waiting-for-ticket associate member kicks in just \$2.50, and our thrifty group plan features a \$4.00 charge for the second ham in a family, \$3.00 for the third, etc.

During the warm summer weather we may have a family picnic at the park for one meeting, a barbecue in the country for another, or perhaps a hidden transmitter hunt followed by a wiener roast. We hold card parties, dances, "Dutch Treat" restaurant dinners where everybody pays his own bill, and progressive suppers with one course served at each ham's shack.

Naturally, all the troublesome date picking and ironing out of details is done by a committee of XYLs. In the winter meetings held at one another's homes keep us out of a rut and gives husband ham a good chance to show off his new final and wall full of QSL cards. His wife can exhibit her new bedroom suite and African violets if she wants to, and she's unusual if she doesn't welcome the opportunity to turn out a big batch of cookies, a devil's food cake, or some other delicious goody since there are plenty around to share the calories. We found that by teaming up and taking turn about, no one has to stand all the expense. Paper cups, coffee, and napkins can always come from the hat-passing fund.

### **Chefs Too**

On Field Day, none of our fellows have to wheedle permission to stay away from home all night. Their XYLs don camping togs, too, and pitch right in keeping coffee cups brimming, insect repellent handy, and the kids from underfoot. Meals are served buffet style, potluck, or pitch-in, whichever you call it. After several hours of battling QRM, or interference, a table heaped with dishes of fried chicken, baked beans, potato salad, and a dozen kinds of cake and pie looks mighty good. Last summer one fellow looked up from his loaded plate and said happily, "This sure beats those stag Field Days with sack lunches and dried-out sandwiches."

Irene, the only YL but third ham in her family, volunteered to serve bacon and eggs at 6 am from a portable grill right at the campsite to every hardy soul who operated through the night. She lived up to her promise and fed a hoard of hungry hams, too! I'll bet anyone suggesting that "a woman's place is in the

[Continued on page 101]



A "Bake Sale" brings in money to the club.



The gals are handy with key or coffee.

The fellows turn the mike over to the girls.





?  
 WHY  
 DO  
 THINGS  
 THE  
 HARD  
 WAY  
 ?

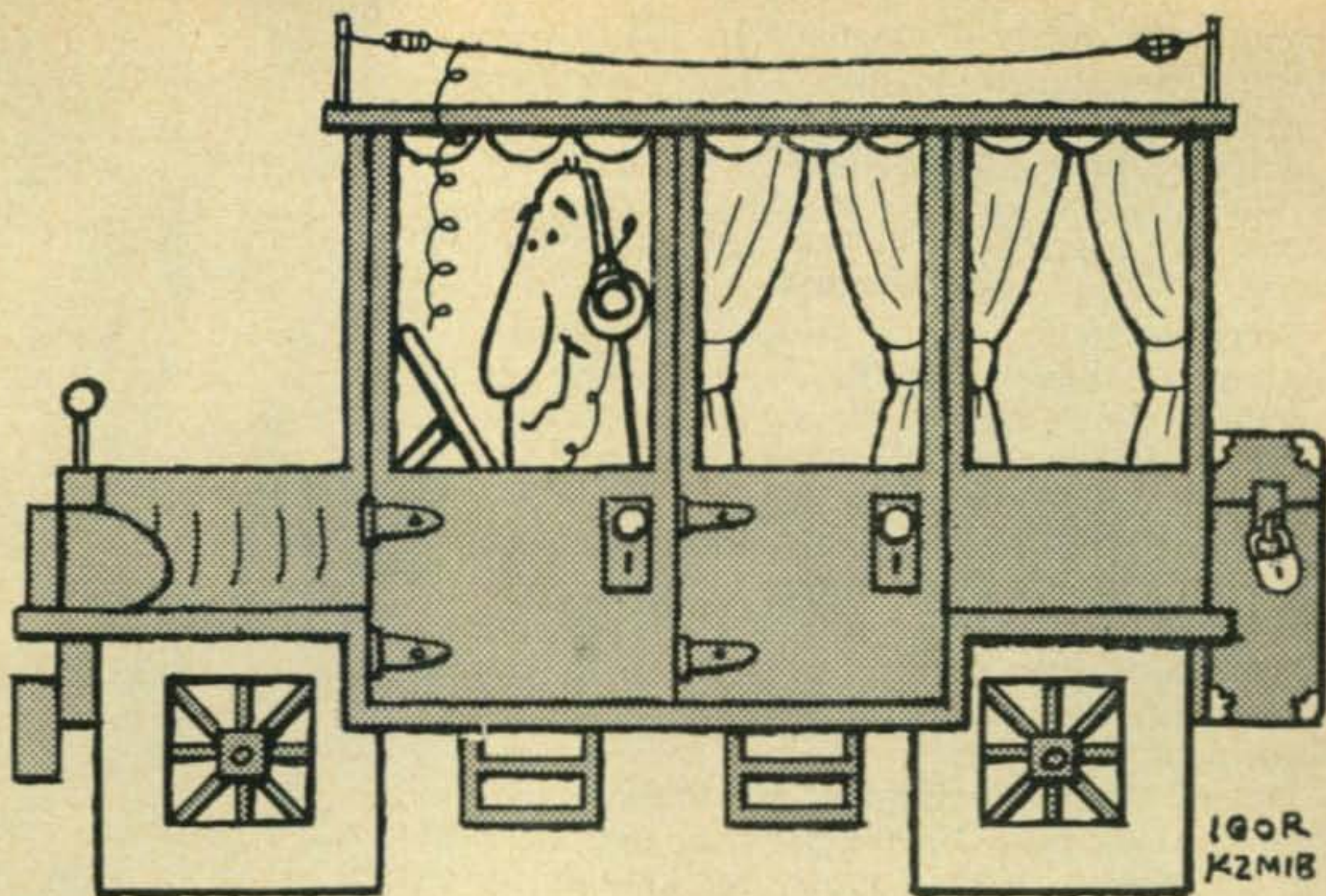

Well, we know that there's always someone in a crowd who likes to do things the hard way. That's human nature. The same desire to learn by experience often leads to fantastic discoveries, so who are we to criticise.

One thing we do know, however, is that ham radio can and should be loads of fun. And here experimenting is a part of the hobby—an important element that's made hamming appeal to almost a 1/2 million Americans.

But experimenting must only go so far. It's a wise man who knows how to learn from the ground work that's already been laid by others. That's where *CQ* fits into the picture.

*CQ* is, and always has been, a magazine for active hams, produced by the efforts of active hams. It's the one monthly publication that serves your specific needs most closely, because there's a department for every phase of hamming activity.

So don't be fooled by the fact that *CQ* is an independent publication. We know that if you compare it to other ham magazines, you'll find that *CQ* offers you more of the information you want about your hobby. More construction articles, more columns, more meaty info. How about it? Is your *CQ* subscription up to date?

**CQ Magazine**  
 300 West 43rd St.  
 New York 36, N.Y.

**One year, \$5      Two years, \$9      Three years, \$13**  
 in U.S. Possessions, APO & FPO, Canada & Mexico

C8

Enclosed is \$

for a ..... year  new  renewal subscription to *CQ*, to be

Name ..... Call .....

Address .....

City ..... Zone ..... State .....

Pan-America and all other foreign: 1 yr. \$6; 2 yrs. \$11; 3 yrs. \$16.



home" would have been tarred and feathered on the spot.

But don't get the idea that feminine talent blossoms only over a mixing bowl. Not by any means! For one thing, YL phone operators are always in demand. There seems to be something magic about hearing a soft, melodious "CQ Field Day" on a receiver that makes a fellow in a tent or car, on a hill or knee-deep in clover, forget he can hardly hold his unshaven head up. Why, one of our sultry voiced XYLs got as many as six answers to one CQ and kept a log keeper busy sorting out signal reports.

Admittedly, the radio club offers some jobs that women just simply enjoy more than men, so we shouldn't feel too noble about doing them. Take paperwork, for instance. I get a bang out of sending publicity releases to the newspapers and also seeing that monthly notices and bulletins reach each member. Bobbie, a pert XYL with a flare for journalism, does a dandy job of editing "Ham Hash," our club newspaper. Everybody reports their new equipment, choice DX contacts, mobile activity, or anything else that might be news. She also prints columns by volunteer correspondents and

### Finances

For every wife who overdraws the bank account, there are three who can stretch the grocery budget a mile; and this priceless skill can certainly be used on the club piggy bank. Rather than raise individual dues to buy a generator last winter, our men bravely launched an exhausting house-to-house soliciting campaign. Sure, they came up with \$15.30, but it took that and more to treat two embarrassing cases of dogbite. Next came a wastepaper drive which went on for five frosty Saturdays. This effort netted a disappointing five dollar bill and the junk man's remark that he would probably be stuck with the bundles for months. When all hope of reaching our goal seemed gone, we girls put our pony-tails and poodle cuts together at an emergency pinochle party. We talked of having a benefit chili supper, rummage sale, white elephant auction—anything to make money. Then we hit on the idea of a bake sale. XYLs, and YLs donated cakes, pies, cookies, and home-canned foods; notices in papers and posters in store windows brought lots of hungry people to the sale. Were we ever bubbling with pride when we announced our fifty dollar success at the next club meeting. The treasurer leafed through the bills and then boomed, "Well, maybe you gals can't raise antennas, but you sure can raise money!"

Following a triumph such as the bake sale, we have to guard against a "take over" impulse that could shrink a thriving club to a sewing circle in a matter of weeks. If the American male is declining, he's not doing it in our radio club—the fellows run the show, and we all like it that way. We girls have given up ideas about painting the nicotine brown shack walls a baby

pink, putting ruffled curtains at the windows, and working petit-point bottoms for the old cane chairs. And we overlook those tangled wires behind the transmitter although we know they would look much nicer tied with pretty bows and ribbons. We do manage to empty wastebaskets, sweep up, and sneak off with a "girlie" calendar now and then, but it's done undercover.

In closing, if any of you girls have been lucky enough to wangle an invitation to a radio club, let me pass along a little sisterly wisdom. For the first few meetings, take a back seat; then, later, when you get into the swing of things, keep the following tips in mind—the fellows will never be sorry they invited you.

DO spread joy with your coffee pot and cookie sheet. Start right away and do it often.

DON'T let the club's social whirl get in a rut; plan a variety of family activities the men will really enjoy.

DO join the OM on Field Day whether he's on a mountaintop or in a weedpatch. Pack the kids, a picnic basket, and your most tried-and-true good-sport smile.

DO what comes naturally—volunteer for some of the pencil-pushing, program planning, and date-picking that the fellows despise.

DO show that women are good for more than running up charge accounts and wrecking paychecks. Use your special skills for money raising and other club projects that men start but can't finish.

And for heaven's sake, don't try to take over! Let the fellows wear the radio club trousers. Remember it's their club, and, besides, we might as well admit those trousers fit'em better anyway. ■

---

### PROPAGATION [from page 95]

- A—Excellent circuit, strong steady signals.
- B—Good circuit, moderately strong signals, little fading and noise.
- C—Fair circuit, weak to moderately strong signals, noticeable noise and fading.
- D—Poor circuit, weak signals, considerable fading and high noise level.
- E—Circuit out.

The above Chart is an experimental forecast attempting to relate day-to-day propagation conditions with the band openings predicted in the DX and Short-Skip Propagation Charts. For example, an opening rated in the Charts with a Probability Index of (2) is expected to be moderately strong (quality rating B) on August 9-12; generally weak on August 1-8, 13-17, 20-23, 29-31 (quality rating C-D), and out entirely on August 18-19, 24-26 and 27-28 (quality rating E). Since this type of forecast is very experimental in nature, the Editor of this column solicits reader's comments concerning the presentation of the Chart, and its accuracy or lack of it.

73, George, W3ASK



# CONTEST CALENDAR

by Frank Anzalone, WIWY

14 Sherwood Road, Stamford, Conn.

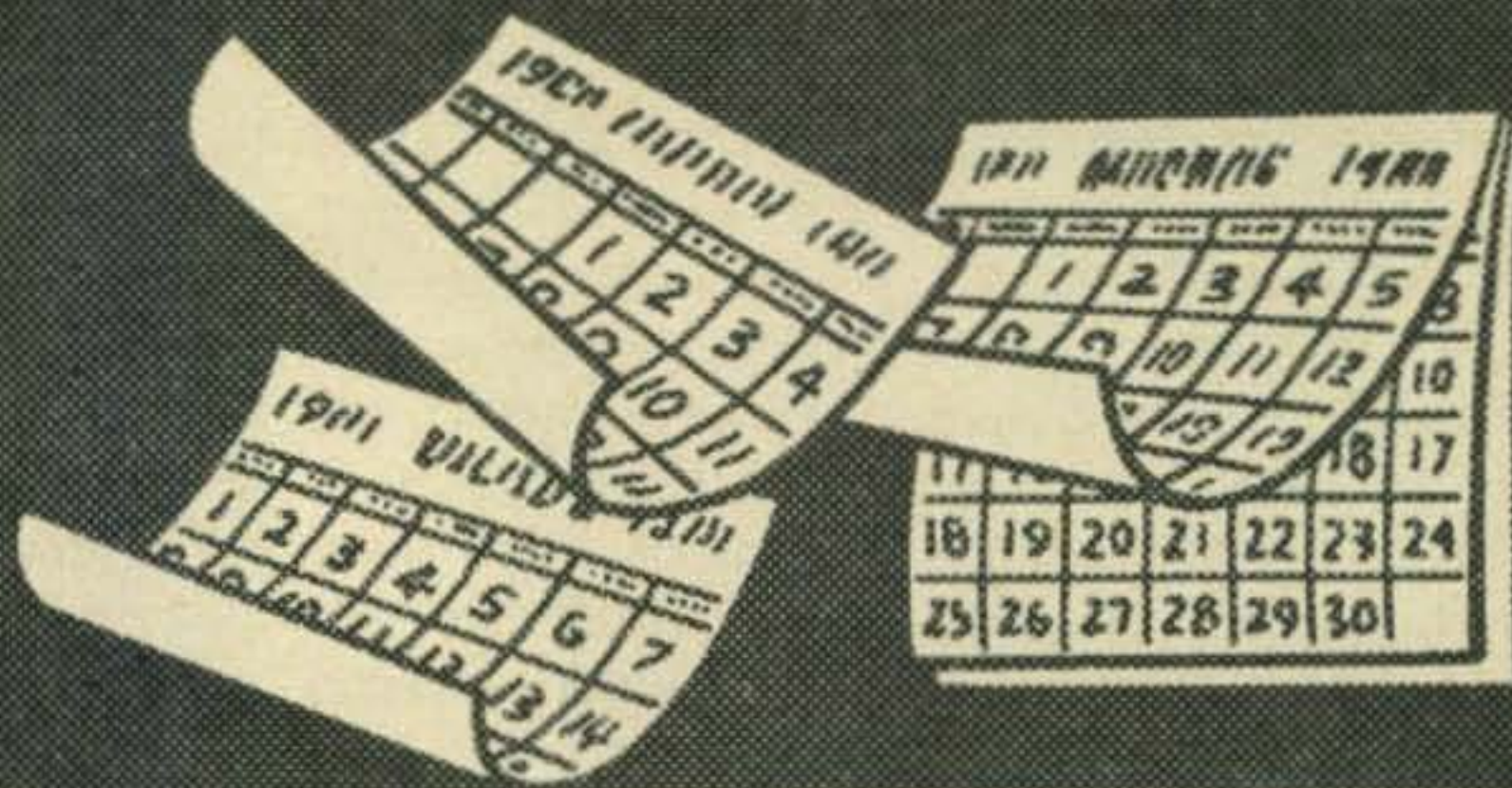

August	27-28	— JARL DX
September	3- 4	— LABRE CW
September	10-11	— LABRE Phone
September	10-11	— SSBARA WAS
September	10-11	— Peruano CW
September	17-18	— Peruano Phone
September	17-18	— S A C CW
September	24-25	— S A C Phone
September	24-25	— MARC VE/W
October	1- 2	— VK/ZL Phone
October	8- 9	— VK/ZL CW
October	22-23	— Boy Scouts
October	29-31	— CQ WW DX Phone
November	12-13	— ARRL SS
November	19-20	— ARRL SS
November	26-28	— CQ WW DX CW
December	3- 4	— RSGB 21/28 Phone

## JARL DX

Starts: 10.00 GMT Saturday, August 27th.  
Ends: 16.00 GMT Sunday, August 28th.

This is a new one with full coverage of the rules in last month's Calendar.

Logs go to: The J.A.R.L. Contest Committee, P.O. Box 377, Tokyo Central, Japan.

## LABRE

### CW

Starts: 00.01 GMT Saturday, September 3rd  
Ends: 24.00 GMT Sunday, September 4th.

### Phone

Starts: 00.01 GMT Saturday, September 10th.  
Ends: 24.00 GMT Sunday, September 11th.

Bands: All bands, 3.5 thru 50 mc. No cross-band or CW to Phone contacts permitted.

Serial Numbers: The usual 5 and 6 figures, the signal report plus a progressive three digit number starting with 001.

Points: (a) Between stations in the same country, 0 points; but permitted for purpose of obtaining a multiplier.

(b) Between stations of different countries outside the American area, 1 point.

(c) Between stations of different countries in the American area, 2 points. (See WAA country list.)

(d) Between stations in the American area and all other countries, 3 points.

Multiplier: Two types of multiplier will be used.

(a) A multiplier of 1 for each American area country worked on each band.

(b) A multiplier of 1 for each Brazilian district worked on each band. (PY1-PY9)

Awards: 1st and 2nd place certificates to the top scorers in each country and each Brazilian call district. (Why not each USA call area?) Awards will be made for each Single Band and for Multi-band (3 or more bands)

Scoring: A Single Band score is the contact points on that band multiplied by the sum of American area countries and Brazilian call districts worked on that band.

The Multi-band score is the total contact points on all bands multiplied by the sum of the multipliers, American and Brazilian, on all bands.

Single Band entries are eligible for single band awards only. However, Multi-band entries are eligible for Multi-band awards as well as single band awards.

Mail your logs to: The LABRE Contest Commission, Caixa Postal 2353, Rio de Janeiro, Brazil.

## SSBARA

Starts: 15.00 GMT Saturday, September 10th.  
Ends: 21.00 GMT Sunday, September 11th.

This is a WAS contest put on by the Side-Banders. There is a time limit in the operating time so you had better check K2HEA/K2MGE's Sideband column for the details. It was found necessary to move to the above date because the Hudson Amateur Radio Council is holding its convention in New York on the previously announced date. The LABRE was late in announcing its dates, hence the conflict.

## Peruano

### CW

Starts: 12.00 EST Saturday, September 10th.  
Ends: 24.00 EST Sunday, September 11th.

### Phone

Starts: 12.00 EST Saturday, September 17th.  
Ends: 24.00 EST Sunday, September 18th.

This year's contest is in celebration of the Radio Club Peruano's 30th anniversary. The rules were given in full in last month's Calendar.

Logs must be mailed within 20 days of end of contest to: The Radio Club Peruano, Att: Pres. Commission Concurso, Casilla 538, Lima, Peru.



## S A C

### CW

Starts: 15.00 GMT Saturday, September 17th.

Ends: 18.00 GMT Sunday, September 18th.

### Phone

Starts: 15.00 GMT Saturday, September 24th.

Ends: 18.00 GMT Sunday, September 25th

This is the second Scandinavian Activity Contest and this year it is sponsored by the Swedish Radio Amateur League.

It's the Scandinavians working the world. For contest purposes the following prefixes will be considered: LA, LA/p, OH, OHØ, OX, OY, OZ and SM/SL.

Serial Numbers: The usual 5 and 6 figures, the signal report plus a progressive contact number starting with 001.

Points: One point for each completed QSO.

Multiplier: Maximum of 8 per band. Note list of prefixes above. (LA/p counts only one even though there may be more than one country.)

Final Score: The total QSO points multiplied by the sum of multipliers from all bands.

Classes: Single operator and multi-operator. Club stations are classified as multi-operator even though they are operated by only one operator. One or more bands may be used at the same time but the exchange number must progress in chronological order.

Certificates: Will be awarded to the two highest scoring stations in each country and U.S. call area. Additional awards will be considered depending on the number of returns from active areas.

Logs: It is not necessary to use a separate log for each band but a summary sheet listing the score on each band is requested. Also include all other information that is pertinent to the contest not forgetting to sign the usual declaration.

Mail your log not later than October 15th to: The SSA, Att: Contest Committee, Stockholm 4, Sweden.

## MARC VE/W

No word from the boys up north as yet but this contest is usually held the last week-end in September. There is an anticipated change in the rules for this year's affair. We hope to have all the details in the next issue which will still be in time for the contest.

## VK/ZL

### Phone

Starts: 10.00 GMT Saturday, October 1st.

Ends: 10.00 GMT Sunday, October 2nd.

### CW

Starts: 10.00 GMT Saturday, October 8th.

Ends: 10.00 GMT Sunday, October 9th.

This year's contest is sponsored by the New Zealand group. Last month's Calendar gave the rules in detail. Your logs go to the N.Z.A.R.T. Contest Committee, P.O. Box 489, Wellington, New Zealand.

## Boy Scouts

This is not a contest and there will be no awards. The event has been organized for the sole purpose of promoting contacts between Scouts of different countries.

Any radio amateur with a past or present association with the Scout movement or operating on behalf of a Scout unit, should take part in this event. It will give invaluable training to the boys who take part.

Use Phone or CW and call "CQ Jamboree." Why not contact your local Boy Scout unit and give the boys a hand.

Activities start at 00.00 GMT Saturday, October 22nd and ends 24 hours later, 00.00 GMT Sunday, October 23rd.

## CQ WW DX

See Page 67 in this issue for all the details.

## ARRL SS

It's a little early yet, even the boys in the know at West Hartford haven't given the details on this one.

## R S G B

This is a Phone contest to promote activity on the higher frequency bands. With diminishing signals on those bands, this contest serves a useful purpose. More information at a later date.

That's about it for this time.

73 for now, Frank, W1WY

## Ham Hints

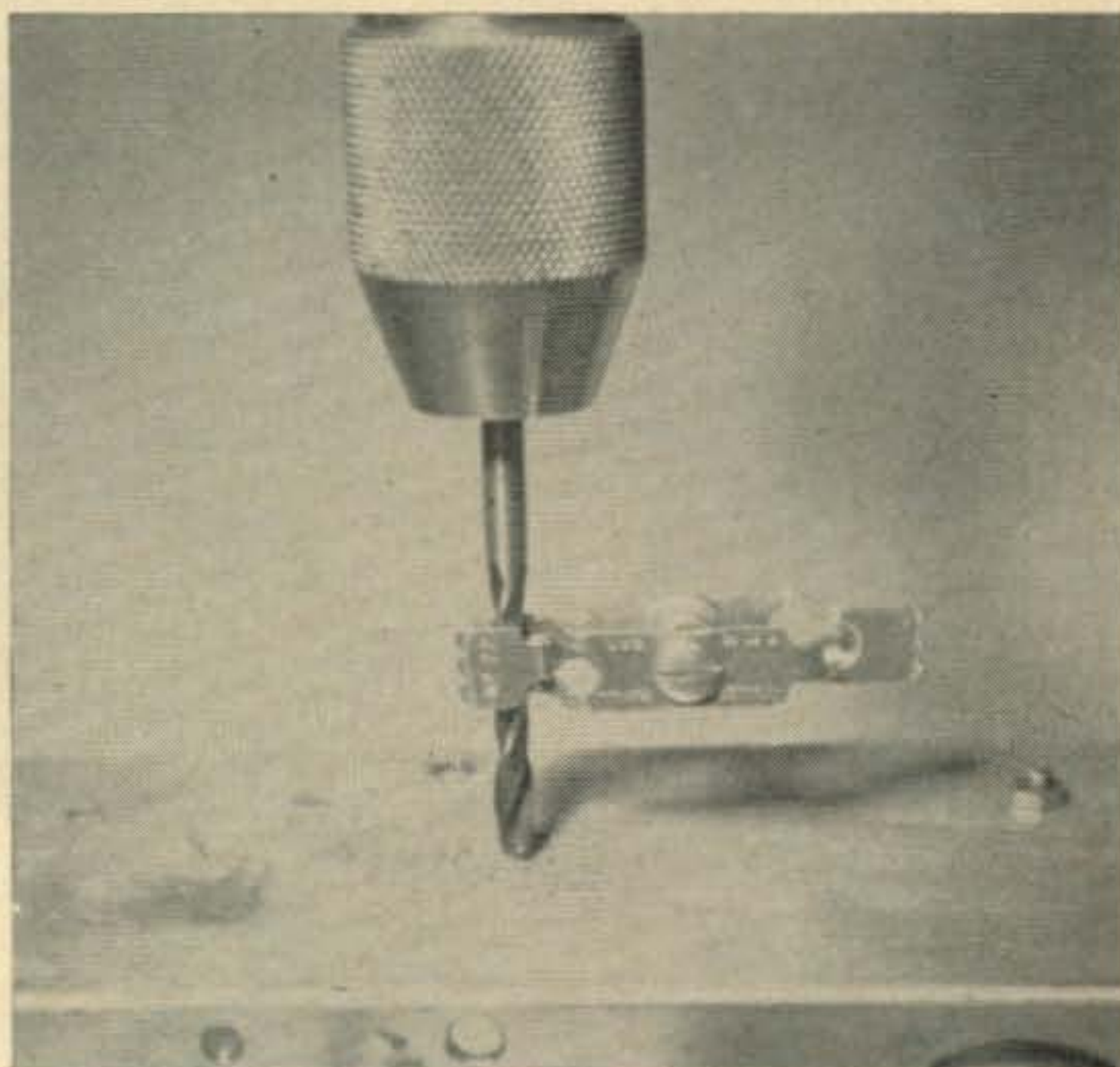

### Clip Is Ready-To-Use Drill Stop

Need a drill stop in a hurry? A test clip makes a good one. A dual-clip like the one shown (Mueller #22) will fit drill sizes up to 1/2". Clips with strong springs can be used on electric drills without any danger of centrifugal force throwing them off. Clips make good stops because they are always handy and ready to be put to use.



## New Amateur Equipment

### Panel Mounting Oscilloscopes

Two new miniature oscilloscopes have been announced by James Millen Mfg. Co., Inc. These units designated 90912-R and 90913 feature a new rectangular 3UP1 or 3UP7, and 3XP1, 3XP2, 3XP7 and 3XP11 cathode ray tube respectively. The 90912-R takes up a panel space of only 3"×5" and the 90913 uses 3"×6" to mount. Both the vertical and horizontal deflection sources as well as heater power and accelerating potential are taken from the equipment in which the oscilloscope is mounted. Frequency response is good through the *vhf* bands, however, no amplifiers are supplied with the oscilloscopes.

Accelerating voltage required is 750 to 2500 volts *dc*, and heater voltage is 6.3 volts *ac* at 0.6 amperes.

The 90912-R features screen size of 2½"×1⅞" and the 90913 is 3"×1½", 3⅜" diagonal. Front panel controls are; INTENSITY, FOCUS, VERTICAL and HORIZONTAL centering. For more information circle A on page 130.

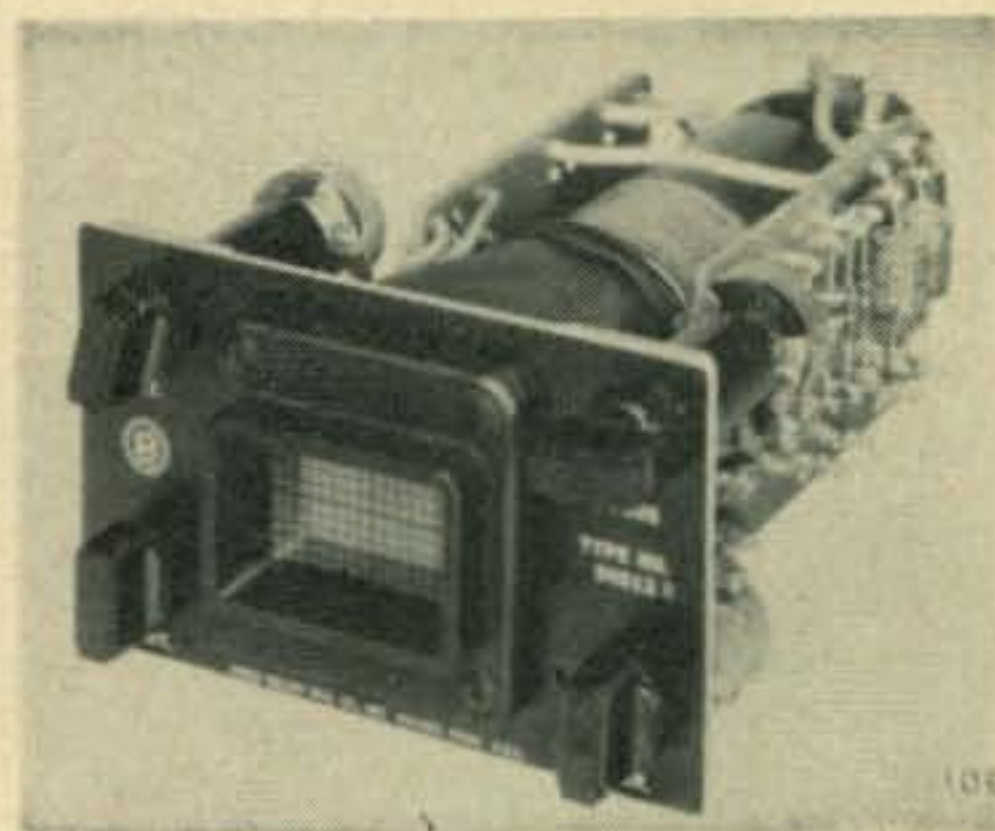

### 2 Meter Converter

American Electronics Co. (Ameco) of 178 Herricks Road, Mineola, N. Y. have announced a new two meter crystal controlled converter. It can be bought wired and tested or in kit form. A companion power supply can also be purchased which mates with the converter. The tube lineup is a 6ES8 low noise, cascode, first *rf* amplifier, 6U8 second *rf* amplifier and mixer, and a 6J6 oscillator-multiplier. The manufacturer claims spurious and image rejection to be down 70 *db*, and the *if* rejection better than 100 *db*. Noise figure is better than 4 *db*.

The unit comes in an attractive plated copper chassis and measures 2"×2½"×5". The *if* frequency must be specified when ordering, although only a few minor changes are required to change the *if* frequency. Power requirements are 100 to 150 volts *dc* at 16 *ma* and 6.3 volts *ac* at 0.85 amperes. More information may be obtained by circling B on page 130.

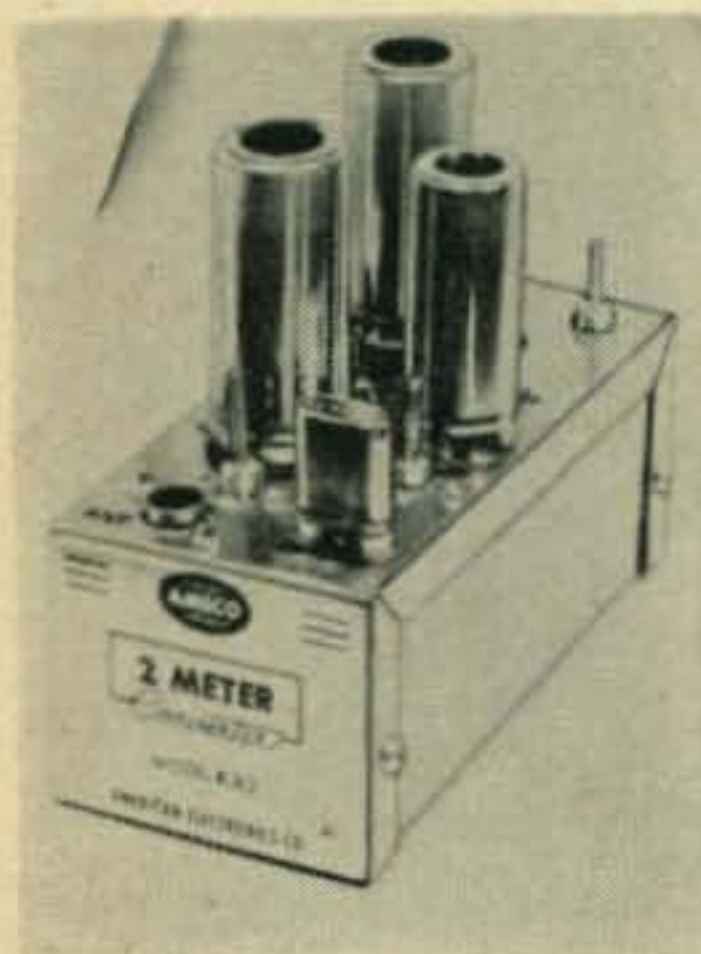

### Crystal Checker and Stable RF Source

Seco Manufacturing Co. of 5015 Penn Ave. South, Minneapolis, Minnesota has introduced a portable transistorized checker and low power signal source, able to accept FT-243 and HC-6/U crystals as low as 100 kc. The "Model 500" can either check crystal activity or be used as a highly stable crystal oscillator.

A self-contained audio oscillator can modulate the *rf* signal or an audio generator or modulator can be used externally. A unique feature provides visual indication of relative field strength and modulation. The unit is powered by a single 1.5 volt "C" battery and comes complete with a 15 foot pick up cable. Circle C on page 130 for more information.



### Free Circular Slide Rule

General Industrial Co. has started production on a handy Circular Slide Rule for engineers and for other plant and office executives.

Operation of the rule is simple and the results are accurate. To multiply, divide and find proportions is easy and exceptionally fast with this convenient circular rule. Complete easy-to-follow instructions will be included with each slide rule.

For your *free* Circular Slide Rule write on your *business letterhead* to General Industrial Co., 1788J Montrose Ave., Chicago 13, Illinois and be sure to mention the name of *CQ*. To those of our readers who do not qualify as an engineer or other business executive to receive a free slide rule General Industrial Co., will be pleased to send one for 50¢.





## ANNOUNCEMENTS [from page 20]

Ross, TV and stage star. Tickets will be \$2.50 and sold only in advance.

On Sunday, Aug. 7th, the hamfest will be held at the Winchester National Guard Armory with games, prizes, displays, swap tables and MARS Rep. Registration for hamfest will be \$1.00 at the door.

For banquet tickets and further information please write to: Shenandoah Valley Amateur Radio Club, P.O. Box 139, Winchester, Virginia.

### Wyoming, Idaho, Montana, Utah

August 5-6-7—WIMU Hamfest, Big Springs, Idaho. Events of interest to OMs, YLs and XYLs. Cabins and good camp grounds available. For more information contact Helen M. Maillet, W7GGV, Secy., WIMU Hamfest 1960, Route #1 South, Pocatello, Idaho.

### Texas A.R.C.

The Central Texas Amateur Radio Club of Waco, Texas has scheduled their annual hamfest for Sunday the 4th of September 1960. The location has been changed from the Cameron Park Club House to the Waco Syran Association Club House.

The activities will begin about 1030 and continue until late afternoon. A pre-registration prize is offered for all interested in early registration. Further information may be obtained by contacting the CTARC at P.O. Box 1032, Waco, Texas.

### Pittsburgh, Pa.

The annual hamfest of the South Hills Brass Pounders and Modulators Radio Club of Pittsburgh, Pa. will be held on Sunday, August 7, 1960 at the Museum Building, South Park Fair Grounds, South Park, Pittsburgh, Pa.

Pre-Registration \$1.50. For more information contact Anthony P. Trnosky, W3ZQC, 4503 Mollenauer Street, Bethel Park, Pa.

### Sara Sevilla Change

As a result of a recent meeting between K1ECT, EA7JH, EA7DK and EA7ID... we wish to change the conditions for awarding of the SARA SEVILLA certificate.

Following are the more compatible conditions for the award:

1. Zones 14, 15 and 33.....15 QSO's with 15 EA7 stations.
2. Rest of the world.....10 QSO's with 10 EA7 stations.
3. No listening stations eligible.
4. No QSL's needed. Just send a copy of station log to "SARA Sevilla", Apartado 394, Sevilla, España.

The certificate committee thought these conditions more reasonable after viewing activity since 1 April.

### Codfish Certificate

The Argentinia Amateur Radio Club, U. S. Naval Station, Argentinia, Newfoundland is sponsoring its Codfish Certificate. The AARC will award the certificate to Amateur Stations that acquire a ten point score by contacting Argentinia Stations. One point for each station worked, two points if a phone patch is included.

When eligible, requests should be addressed to the Secretary, AARC Box 73, Navy 103, c/o F.P.O. New York, N.Y. The Codfish Net meets the first, third and fourth Tuesday of each month, 7 P.M. EDST at 29.4 mc.

## LETTERS [from page 16]

extremes to show he was qualified for a ticket... his conversation and conduct on the air would have reflected his knowledge and experience far more than mere construction could ever do.

In short, build equipment or follow any other phase of the hobby you like, but for Pete's sake, *let the other fellow do the same!*

Another well meaning pest is the ham who has had his ticket 20 years or so and has by this time accumulated a great deal of technical know how.

He understandably but unreasonably feels that all new hams are a bunch of ignorant buffoons that shouldn't be

allowed to operate their receivers, let alone their transmitters. So consequently he loudly cries that the exams should be made tougher and further recommends that the Novices be kicked off the air.

Of course the newcomer makes mistakes, but they are new at the game, which somewhat excuses them... but there is no excusing some of the old timers unhelpful attitudes and critical comments.

Many of the new amateurs are fellows long out of school who may work hard all day and then try to study theory and code by night, some even go to night school or take correspondence courses to make the grade.

To these individuals (whose only prior radio experience may have been operating their B.C. receiver or TV set) the present exams seem mighty tough. To expect these fellows to absorb the 20 years accumulated knowledge of the old timer in a few months spare time is like expecting a first grader to recite the Declaration of Independence on his first week of school.

I, for one, would like to go on the record as favoring leaving the exam requirements just the way they are. If any of you older hams run across an inexperienced or uninformed ham, instead of criticizing his shaky procedure try helping him out, he will probably appreciate it. Who knows, maybe in the process you can talk him into building some of his equipment.

Gary Davidson, WA6KDK  
Rt. 1, Box 304  
Manteca, California

## SCRATCHI [from page 10]

Need more money? Selling space to your Hon. Advertisers. We can putting tape playback in saddlite and small xmitter to broadcasting commercials. Like say, a fifteen-second ad on STICKY resistors. I can heering it now: "Buy STICKY RESISTORS—no soddering—just lick 'em and stick 'em in." Or: "Want a deal that's a steal—buy your radio equipment from Mad-Man McGillicuddy."

That will bring in at least another cupple of millyun bux. Advertisers breeking in your Hon. Door to buying space on that tape in the saddlite.

And how about your Hon. Magazine. Certainly you not going to letting this opportunity going by without investing some of you own bux!! I can putting you down for another cupple millyun bux, can't I?

Now, if you still needing more money (how much are a first-class saddlite costing these days) are having another brane-storm. We can selling tickets to the Big Blast-off. We can letting the Hon. Reporters in free, so getting dubble-page picture in Life Magazine, but we can charging everybuddy else at least fifty bux to getting in on ground floor of Hon. Lawnching.

Now, if you still needing more money, having another grate idea. Any commercial communi-cayshun company what wanting to bouncing signal off HAM Saddlite are having to pay you money. No money, no bouncy. Are not yet figuring out how can making them pay, but that are minor detale you can working out.

Okey?? Time are flitting by, Hon. Ed., so getting moving fast. One thing first, howsumever. I not telling you what part Scratchi are wanting to play in this skeme. You not gessing yet, Hon. Ed?? Scratchi are the man that are pushing that button—five, four, three, two, one—ZOWIE!!!

Respectively yours,  
Hashafisti Scratchi



## TILT OVER TOWER [from page 65]

Since the panel is placed with its center only 12 feet from the bottom of the tower, it will not be counterbalanced unless about 100 pounds of weights are placed on the bottom of the tower. I used large rocks fastened in place on a platform with metal straps. However, a better job can be done with small concrete slabs or posts bolted to the bottom back of the tower. The exact amount of weight will be determined by the weight of the antenna structure.

To place the tower in position, build a temporary boom above the crib structure. (This can be seen in one of the photographs.) Place the tower on the ground with its *large* end near the front of the crib, and the large panel on the ground. Lift the large end with block and tackle until it will just catch on the cross pipe. Be sure the longerons are caught enough so it will not drop off. Now "horse" the tower back until pre-drilled holes in the plywood panel come flush with the 3 short pipe bearings on the cross pipe. Fasten in place with large "U" clamps. Be sure to use metal plates on the nut side of the plywood panel.

When the mast has been put this far in place, the block and tackle can be shifted to the "front bottom" of the tower behind the crib structure, and the tower lifted, more or less easily, into place. The degree of ease will be determined by how much initial counterbalancing weight was fastened to the bottom.

### Base Support

Obviously, some sort of base support for the tower must be made ready before it is swung into place the first time. Figure 2 shows details of the structure used at W2DY. Small bolts should be in place at the bottom of the longerons of the tower, ready to engage pre-measured holes in the base structure. After the tower is in place, much weight may be taken off the panel by driving shims under the 4 legs of the tower.

The entire cost of this tower was approximately 30 dollars. The cost if labor were a factor would, of course, be much more. Building such a structure *is* a chore. However, every time it is tilted over (don't try it in a high wind, because of side sway!), this OM is more than repaid for the time and labor involved. After the initial raising, it is strictly a one-man job. ■

---

## 50, 144, 220 MC [from page 63]

to stay on the air, but many will find use for a rig in the "walkie talkie" class, or end up with an occasional loose Saturday afternoon. The unit suggests a number of uses. It can be employed for a portable or standby rig for local work, or just as easily be bolted

into a car for mobile work. K5RAG has been using an identical unit for mobile work for several months with good results. The *bc* antenna can be used on six and two meters. Conceivably, the unit could be miniaturized to the confines of a mini-box and a surplus handset used in place of mike and headphones. The unit is also a quick way to get on the 144 mc and 220 mc bands for initial local activity. In fact, the XYL already has a plot brewing for a Novice Two Meter rig to work with the unit! ■

---

## GONSET TRIBANDER [from page 61]

24 inches long in the ends that attach to the boom clamps. Without this reinforcing the tubes vibrate in the wind, crystalize and drop off. The outside ends of these tubes were closed up with wooden plugs also. ■

---

## TATTLE TALE [from page 66]

### Construction

Depending on the wealth of your junk box, perhaps you will only need to purchase the transistor (99 cents) or the loopsticks (also about one dollar).

The layout is clearly shown in the photograph. The unit is constructed on a piece of masonite. Circuit wiring is on the underside of the "chassis." The dimensions of the masonite plate are 3" x 6", but this can be increased or decreased as the layout is not critical. The coils should be mounted as shown, as they provide optimum coupling and selectivity. If placed in a case, mount the antenna and ground binding posts outside and the phono plug so a cord can be quickly attached. The "U" shaped holder for the batteries is a piece of metal from a tobacco or food can, and it is bolted to the masonite. A three point terminal strip, with screw lugs, makes an ideal socket for the transistor. It can be easily changed for experiments or even used as a transistor tester!

### Conclusion

This device will easily pull in local stations with speaker volume, using only a small antenna twelve feet up and ten to twenty feet long. If used for broadcast band DX'ing, the speaker can be replaced with a pair of 2,000 ohm magnetic headphones. ■

---

## FSC-250 [from page 72]

parked on either the *mark* or *space* frequency. We just picked the clearest channel and made copy like the little men weren't even there!

To summarize, all who used this converter found it very easy to hook up and to operate. It is amazingly light in weight (14 pounds), and those familiar with modern construction practices of commercial equipment pronounced its



The Ham from Harvey says:

**YOUR FIST IS "LETTER-PERFECT"**

with the **HALLICRAFTERS**

**'T0' Electronic Keyer**

Remember when tape was considered the only means of perfect code transmission? Not any more! With the Hallicrafters 'T0' Electronic Keyer, your fist takes on all the crisp intelligibility of tape. Every character is letter-perfect. You'll clear up your transmission backlog in no time, and collect compliments on the clarity of your sending.

### The 'T0' Electronic Keyer

forms dits, dahs, and spaces **electronically**, at any speed from 10 to 65 wpm. Employing digital computer circuitry, it opens and closes the circuit in perfect rhythm, regardless of what the operator does. Holding the key closed will result in a stream of dits or dahs, all properly spaced and perfectly formed.

If you should deviate from the pre-set speed of the Keyer, a dual neon indicator on the front panel flashes a warning. Pre-set speed remains constant regardless of temperature or line voltage variations.

The 'T0' Keyer installs in an instant. Just connect it to your transmitter's key terminals, and plug in the Keyer's AC line.

Match your 'T0' Electronic Keyer with the **VIBROPLEX**

### **VIBRO-KEYER**

*for a perfectly matched sending team!*

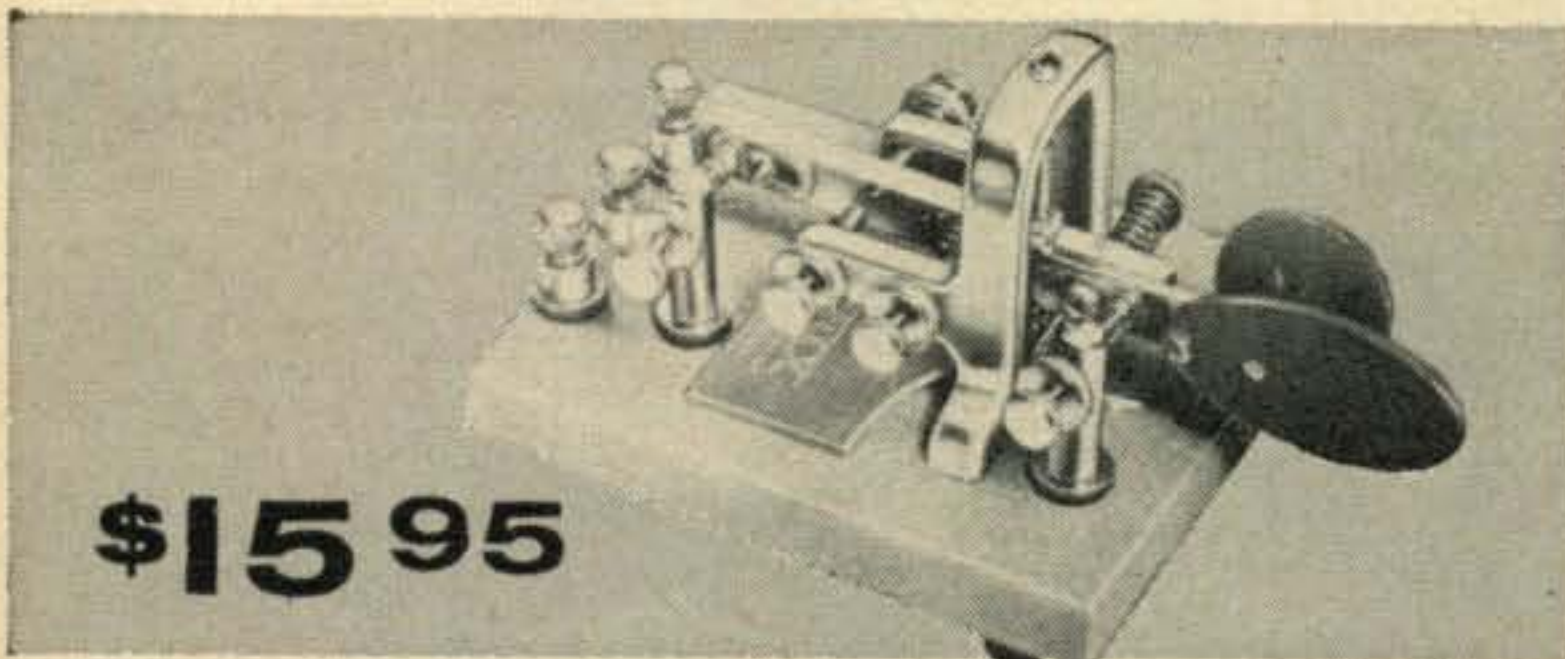

Oversize contacts are mounted on a sturdy main frame and compound lever. Bearing movement minimizes friction and wear... lets you send for hours without developing a "glass arm". Accurate adjustment settings tailor the VIBRO-KEYER to your individual fist. Smooth, red paddles and heavy beige base make the VIBRO-KEYER an attractive addition to your rig. Base dimensions: 3 1/2" x 4 1/2" with skid proof feet.

The place to buy Hallicrafters and Vibroplex is

**HARVEY**



...known the world over as the most reliable source of ham equipment. For the best deal, contact The Ham From Harvey: W2D10

**HARVEY RADIO CO., INC.**

103 West 43rd Street, New York 36, New York • JUDSON 2-1500

For further information, check number 24, on page 130.

August, 1960 • CQ • 107



Model HA-1

**\$79.95**

in 7" x 7" x 5" two-tone gray finish metal cabinet





## CITIZEN BAND CLASS "D" CRYSTALS

All 22 Frequencies in Stock

3rd overtone, .005% tolerance—to meet all F C C requirements. Hermetically sealed HC6/U holders. 1/2" pin spacing—.050 pins. (.093 pins available, add 15¢ per crystal).

**\$2.95  
EACH**

The following Class "D" Citizen Band frequencies in stock (frequencies listed in megacycles): 26.965, 26.975, 26.985, 27.005, 27.015, 27.025, 27.035, 27.055, 27.065, 27.075, 27.085, 27.105, 27.115, 27.125, 27.135, 27.155, 27.165, 27.175, 27.185, 27.205, 27.215, 27.225.

Matched crystal sets for Globe, Gonset, Citi-Fone and Hallcrafters Units . . . \$5.90 per set. Specify equipment make.

### RADIO CONTROL CRYSTALS IN HC6/U HOLDERS

Specify frequency, 1/2" pin spacing . . . pin diameter .05 (.093 pin diameter, add 15¢) . . . \$2.95 ea.

### FUNDAMENTAL FREQ. SEALED CRYSTALS

in HC6/U holders  
From 1400 KC to 4000 KC .005% Tolerance . . . \$4.95 ea.  
From 4000 KC to 15,000 KC any frequency  
.005% Tolerance . . . \$3.50 ea.

### SEALED OVERTONE CRYSTALS

Supplied in metal HC6/U holders  
Pin spacing .486, diameter .050  
15 to 30 MC .005 Tolerance . . . \$3.85 ea.  
30 to 45 MC .005 Tolerance . . . \$4.10 ea.  
45 to 60 MC .005 Tolerance . . . \$4.50 ea.

## QUARTZ CRYSTALS FOR EVERY SERVICE

All crystals made from Grade "A" imported quartz—ground and etched to exact frequencies. Unconditionally guaranteed! Supplied in:

FT-243 holders Pin spacing 1/2" Pin diameter .093	MC-7 holders Pin spacing 3/4" Pin diameter .125
DC-34 holders Pin spacing 3/4" Pin diameter .156	FT-171 holders Pin spacing 3/4" Banana pins



### MADE TO ORDER CRYSTALS

1001 KC to 2600 KC:	
.01% tolerance . . . . .	\$2.00 ea.
.005% tolerance . . . . .	\$2.75 ea.
2601 KC to 9000 KC:	
.005% tolerance . . . . .	\$2.50 ea.
9001 KC to 11,000 KC:	
.005% tolerance . . . . .	\$3.00 ea.
Specify holder wanted	

### Amateur, Novice, Technician Band Crystals

.01% Tolerance . . . \$1.50 ea.—80 meters (3701-3749 KC), 40 meters (7152-7198 KC), 15 meters (7034-7082 KC), 6 meters (8335-8650 KC) within 1 KC  
FT-241 Lattice Crystals in all frequencies from 370 KC to 540 KC (all except 455 KC and 500 KC) . . . 50¢ ea.  
Pin spacing 1/2" Pin diameter .093  
Matched pairs ± 15 cycles \$2.50 per pair  
200 KC Crystals, \$2.00 ea.; 455 KC Crystals, \$1.50 ea.; 500 KC Crystals, \$1.50 ea.; 100 KC Frequency Standard Crystals in HC6/U holders \$4.50 ea.; Socket for FT-243 crystal 15¢ ea.; Dual socket for FT-243 crystals, 15¢ ea.; Sockets for MC-7 and FT-171 crystals 25¢ ea.; Ceramic socket for HC6/U crystals 20¢ ea.  
Write for new free catalog #860 complete with oscillator circuits

ASK YOUR PARTS DEALER FOR TEXAS CRYSTALS  
See big red display . . . if he doesn't stock them, send us his name and order direct from our Florida factory.

### RUSH YOUR ORDER TO OUR NEW PLANT

Use coupon below for 1st Class shipment.

## TEXAS CRYSTALS

Dept. C-80, 1000 CRYSTAL DRIVE, FORT MYERS, FLORIDA  
For extra fast service, Phone WE 6-2100

ATTACH THIS COUPON TO YOUR ORDER FOR SHIPMENT VIA  
1ST CLASS MAIL AT NO EXTRA COST

TERMS: All items subject to prior sale and change of price without notice. All crystal orders must be accompanied by check, cash or M.O. with **PAYMENT IN FULL**. No COD's. Add 5¢ per crystal for postage and handling. Dept. C-80

For further information, check number 23, on page 130.

mechanical design excellent. While no part failed during our tests, all components are readily accessible should a replacement be necessary. The plug in feature of the channel filters as well as the input filter is a guarantee against future obsolescence should present day standards or regulations change.

The Model FSC-250 was designed by Burt Jaffee, K9BRL, of *Electrocom Industries*, 1105 North Ironwood Drive, South Bend, Indiana. ■

## AIRCON CONVERTER [from page 73]

plied, work into an *if* of 540 to 1600 *kc*, and will receive the range 28.350 to 29.350 *mc*.

The 6 meter converters are likewise normally supplied to work into a broadcast receiver as an *if*, and will receive 50 to 51 *mc*.

If you intend using the converter in mobile operation in conjunction with your auto receiver and would like a different one-megacycle segment, you may specify the segment desired when ordering.

Other *if*'s up to 7 *mc* may be specified, and here, of course, when used with a general coverage receiver, the entire 6 or 10 meter band may be covered.

Test of a 6 meter unit during the June VHF Contest indicated good selectivity and sensitivity into an auto receiver, with signals easily separated on the very crowded segment between 50 to 51 *mc*. No images or "birdies" were detected. The Aircon converters use two stages of grounded grid *rf* amplification. A triode oscillator, utilizing third-mode crystals, supplies the injection voltage to the triode mixer.

A sensitivity of 1 microvolt or less, and Image-rejection and Feed-through of better than -50 *db* are claimed. Selectivity, of course, depends upon the receiver used as the tunable *if*.

## CORRECTION

We apologize for the omission of the last 7 answers of the Antenna Quiz which appeared on page 22 of *CQ*, July, 1960. The last 7 answers appear below.

14. No. Current will increase by only 0.4.
15. Yes. Electrical ground is nearly always some feet *below* the earth's surface.
16. Not if harmonics are the trouble. Harmonics radiate best off the ends of the elements.
17. No. Generally loads better on the *hf* side of resonance. An antenna that draws extremely well generally has a high *swr*!
18. Yes. It is three half waves on 15, resistive, and about 100 ohms which is quite a fair match to 75 ohm feeder.
19. No. The radiation resistance will be only 8 ohms, the antenna will be very reactive, and the *swr* prohibitive.
20. No. The impedance is only 35-40 ohms. Even with a lump of muckite so poor that the leakage was 1000 ohms there would be no noticeable loss of power.



FOR A LIMITED TIME FROM THE HOUSE THE HAMS BUILT . . .

# FREE CALIBRATOR WHEN YOU PURCHASE\* NATIONAL'S SMART



Leo I. Meyerson,  
WØGFQ, says:

Whether you would take advantage of this National NC-109 offer, or are looking for anything in the field of amateur radio, your best bet is a guaranteed deal with World Radio, "the world's largest distributor of amateur radio equipment." Personalized service with 23 hams here to serve you, as well as

## NC-109 Receiver

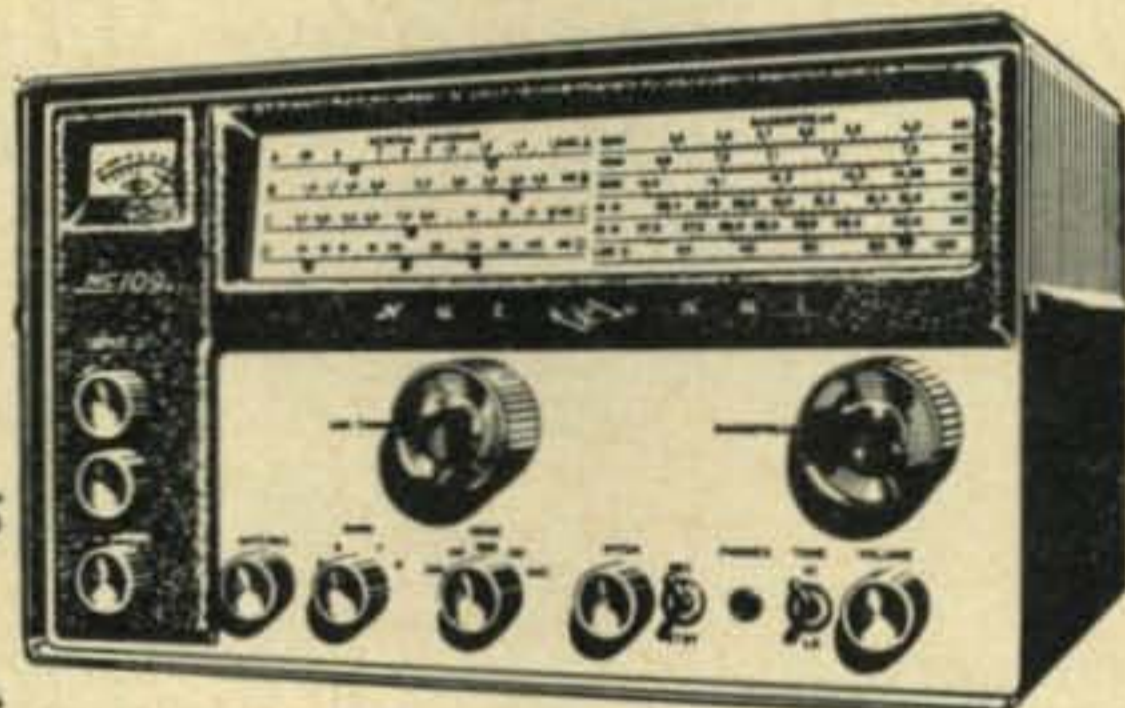

AMATEUR NET: \$169.95

**\$17<sup>00</sup>** down **\$10<sup>00</sup>** per mo.

A general coverage receiver with the exclusive "Microtome" crystal filter, separate product detector for CW and SSB reception. Covers 540 kc to 40 mc in four bands including Broadcast Band, AM, CW, DSB or SSB. Calibrated bandspread for the 10-80M amateur bands. Large 12" indirectly lighted Lucite slide rule dial. Adequate overall selectivity with eleven miniature tubes including rectifier and voltage regulator. Has accessory socket for external adapters and accessories. Gang-tuned RF amplifier stage, two IF and two AF stages. Separate antenna trimmer and tone control on front panel. Has ceramic oscillator coil forms and is temperature compensated for exceptional stability. Automatic noise limiter. Size 16 13/16" x 10 x 10 3/4". Speaker at \$17.50 additional.

### Highest Trades . . .

are keynotes in the WRL operation. Let us make an offer on your present equipment when you purchase new. Often the trade value is enough to cover the entire down payment. Then pay only small monthly payments for up to as long as two years. Top offers are made possible by the fast turn-over in . . .

### Reconditioned Equipment . . .

carefully serviced by 5 able technicians. This merchandise leaves that department in straight-factory operating condition. Below are just a few of the current bargains selected from stocks of more than 1000 pieces. Save up to 50%.

*Order Today . . . on Easy Terms*

### FREE CALIBRATOR\* WITH THE

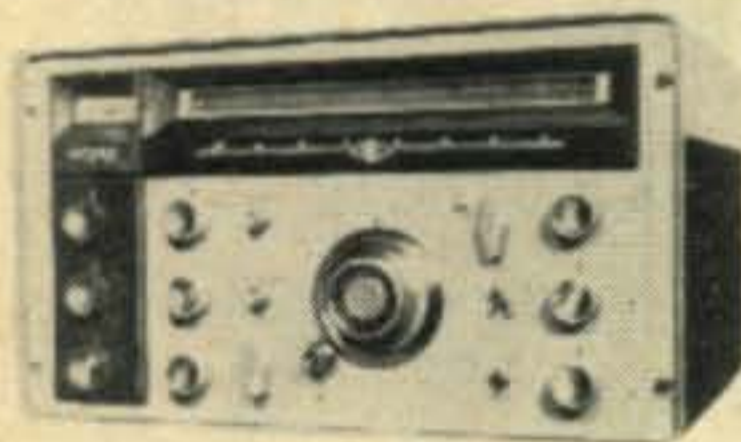

### National NC-303

Receiver for DSB, SSB, CW  
Fone, Fone Net and VHF

\$449.00 **\$449<sup>00</sup>** **\$25<sup>50</sup>**  
down per mo.

## FREE 1960 CATALOG

200 page Catalog with thousands of ham bargains. Send for yours today:

\*without trade-ins



Collins 32V3 Xmtr.	\$399.00
Globe Scout 680 Xmtr.	69.95
Gonset G50 Transceiver	229.00
Hallicrafters SX96 Receiver	137.50
Hammarlund HQ110 Receiver	180.00
Johnson Ranger	195.00

Send for Latest FREE List Today!

# WRL

## WORLD RADIO LABORATORIES

C-8

3415 W. BROADWAY • PHONE 32 8-1851 • COUNCIL BLUFFS, IOWA

Leo: Please send:  FREE Catalog,  Reconditioned Equipment Lists,  Info on the complete National Line. Enclosed is my down payment for a NC-109.  With no trade-in. Send my FREE NC-109XCU Calibrator.  I want to order the NC-109 and trade in my

Model \_\_\_\_\_

NAME: \_\_\_\_\_ CALL \_\_\_\_\_

ADDRESS: \_\_\_\_\_ CITY & STATE: \_\_\_\_\_

For further information, check number 23, on page 130.



**IT'S SO EASY TO OWN A HORNET TRIBANDER -- AND YOU JUST COULDN'T BE BETTER SATISFIED**

**MODEL TB-500** AS SHOWN  
**CASH PRICE** LESS MAST  
**49.95**

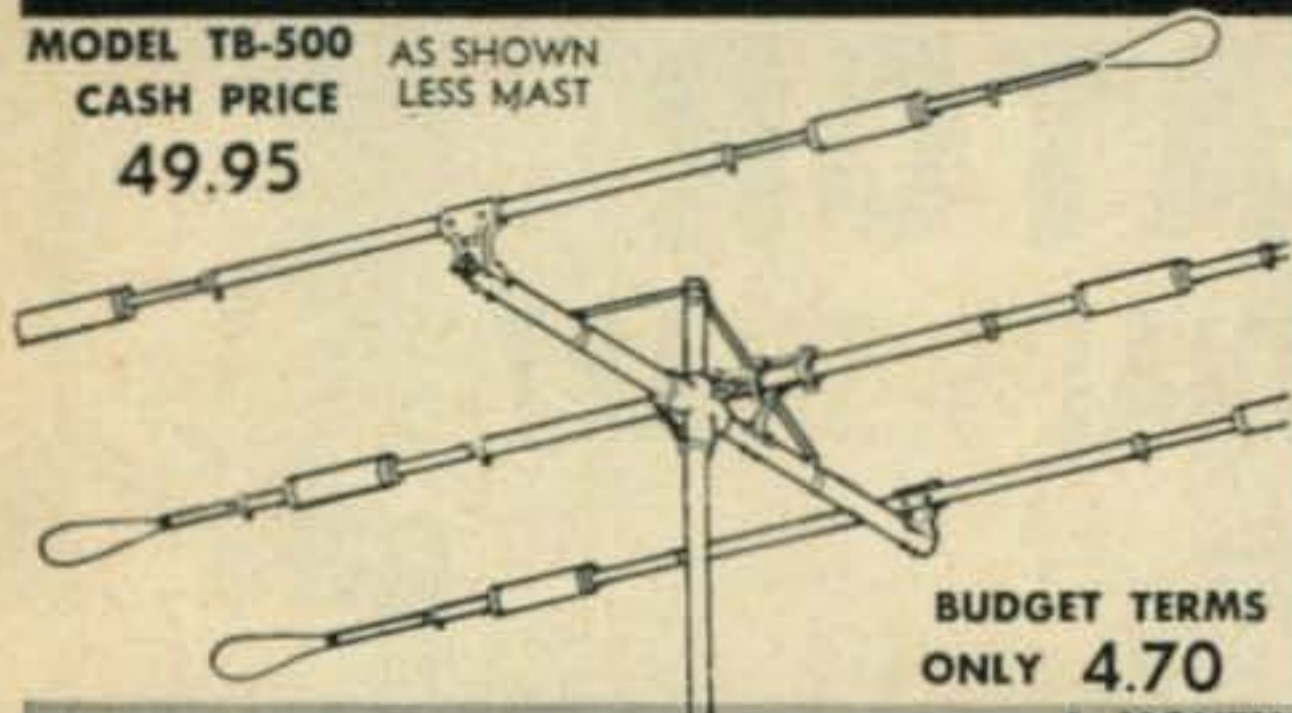

**BUDGET TERMS**  
**ONLY 4.70**

**A MONTH**

- ★ 3 BANDS — 10-15-20 METERS
- ★ TOP PERFORMANCE ON ALL 3 BANDS
- ★ ELEMENTS — 6061-T6 HEAT-TREATED SEAMLESS ALUMINUM TUBING ★ ALL BRIGHT HARDWARE
- ★ HEAVY GALVANIZED STEEL BOOMS
- ★ CARPET-BEATER ELEMENT TIPS GREATLY INCREASE BAND WIDTH, FEATURING EXCLUSIVE RIVETLESS CONSTRUCTION; WILL NOT SHAKE LOOSE

- ★ SPECIAL CUSTOM FITTINGS OF CAST ALUMINUM ALLOY
- ★ EXCLUSIVE WEATHER-SEALED FREQUENCY-DIVIDER SECTIONS — STURDY; FREQUENCY STABLE; LIGHTWEIGHT; NEAT APPEARANCE; EXTERNALLY ADJUSTABLE
- ★ COMPLETELY PRETUNED AND VERY EASY TO INSTALL
- ★ NEAT APPEARANCE; STREAMLINED AND STRONG
- ★ SINGLE 52 OHM COAX. FEEDLINE
- ★ TURN WITH TV ROTATOR

**HEAVY-DUTY MODEL TB-600**  
**CASH PRICE**  
**59.75**

AS SHOWN  
 LESS MAST

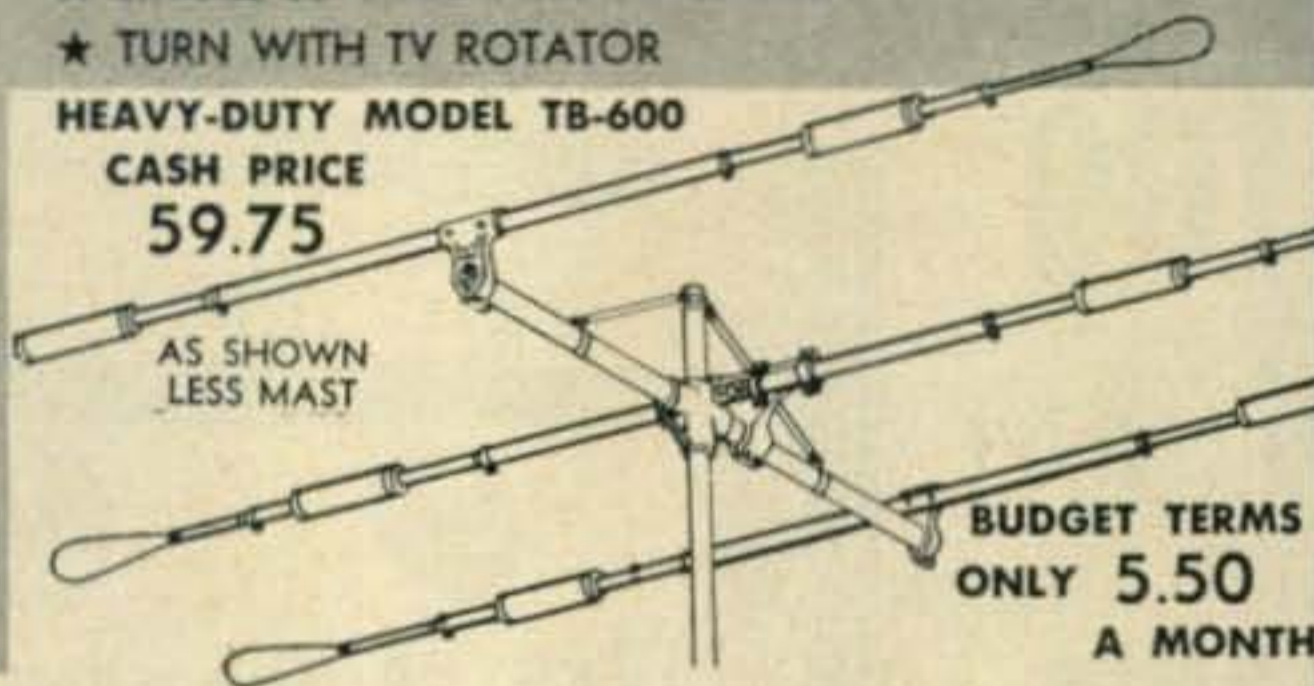

**BUDGET TERMS**  
**ONLY 5.50**  
**A MONTH**

**TRY BEFORE YOU BUY**

Shipped on approval for **FREE 10 day trial**. No obligation to buy

**EASY TO BUY IF YOU'RE SATISFIED!**

Pay in small monthly payments

THESE EXTREMELY LOW PRICES ARE MADE POSSIBLE ONLY BECAUSE YOU ARE BUYING DIRECT FROM THE MANUFACTURER.

**GUARANTEED FOR ONE FULL YEAR**  
**ORDER DIRECT FROM HORNET ... AND SAVE \$\$**

Notice: Effective September 1, 1960, prices will be slightly higher on all models due to increased manufacturing cost.

**HEAVY-DUTY MODEL TB-3 — CASH PRICE \$79.75**  
**BUDGET TERMS, ONLY \$7.45 A MONTH**  
**DELUXE MODEL TB-3B WITH ADJUST-A-GAM® FEED SYSTEM**  
**CASH PRICE \$99.75; BUDGET TERMS ONLY \$9.30 A MONTH**  
**COMPLETE FOLDED DIPOLES FOR ALL BANDS** \*pat. pend.

**MAIL COUPON NOW—NO MONEY REQUIRED WITH ORDER**

**HORNET ANTENNA PRODUCTS CO.**  
**P. O. BOX 808 • DUNCAN, OKLA.**

**MY CALL LETTERS ARE \_\_\_\_\_**

Please Rush the Model \_\_\_\_\_ HORNET TRIBANDER for a 10-Day FREE TRIAL. If Fully Satisfied, I Agree to Pay as Checked Below. If Not Satisfied, I Agree to Return the Boom Prepaid within 10 Days without Further Obligation. ALL PRICES F.O.B. FACTORY

- I Will Pay Cash Within 10 Days, if Fully Satisfied.
- I Will Pay  \$4.70  \$5.50 Within 10 Days and  \$4.70  \$5.50 per Month for 11 Months.

Name \_\_\_\_\_  
 Address \_\_\_\_\_  
 City \_\_\_\_\_ State \_\_\_\_\_

**ABSOLUTELY NO RISK ON YOUR PART**

WRITE FOR **FREE ILLUSTRATED CATALOG**



\*Pat. Pending.

**P. O. BOX 808 • DUNCAN, OKLA.**

For further information, check number 26, on page 130.

**NEW**

**MULTI-ELMAC**

**PMR-8**  
*Mobile or Fixed Station*  
**RECEIVER**

**COMPANION UNIT TO THE AF-68 TRANS-CITER**



**PRICE \$189.50**

- ✓ 7 BANDS INCLUDING 6 METERS!
- ✓ IMPROVED SELECTIVITY
- ✓ EXCELLENT SIGNAL TO NOISE RATIO
- ✓ CALIBRATED BFO WITH UPPER AND LOWER SIDEBAND SELECTION
- Illuminated slide-rule dial
- Built-in noise limiter
- Dual conversion, crystal controlled
- Adjustable antenna trimmer
- Antenna input for 50-75 ohm coax cable
- Cabinet finished in charcoal grey
- Size 4 1/2" high, 7" wide, 9 1/2" deep

Power supply available for 6-12 Volts D.C. or 115 Volts A.C.

**MULTI-PRODUCTS COMPANY**  
 21470 COOLIDGE HWY. • OAK PARK 37, MICH. • JORDAN 6-2377

For further information, check number 27, on page 130.



**"CALL ME  
for  
Personal Service"**

**"CALL ME  
for  
Personal Service"**

Bob Henry  
WØARA  
Butler, Mo.  
ORchard 9-3127



**ON**

Ted Henry  
W6UOU  
Los Angeles  
GRanite 7-6701



**WORLD'S  
BEST TERMS**

**Because we finance  
our own terms...**

- Only 6% a year finance cost
- 20 months or longer to pay
- Only 10% down (or your trade-in as down payment)
- No finance charges if paid within 90 days
- Reduced charges if paid off ahead of time
- You get more flexibility of financing in the future (such as re-financing) because we handle our own financing

**Collins  
S/LINE**



**A-1 Reconditioned  
Apparatus**

Nearly all makes and models. Big savings!  
Ten day trial—90 day warranty. 90 day full  
trade back on new apparatus. Write for  
bulletin.

KWM-2 Transceiver .....	\$1095.00
32S-1 Transmitter .....	666.00
516F-2 AC Power Supply .....	115.00
516E-1 12 V DC Power Supply .....	262.00
75S-1 Receiver .....	495.00
312B-3 Speaker .....	27.50
312B-4 Speaker Console .....	185.00
F455Q-05 Mechanical Filter .....	50.00
30S-1 Linear Amplifier .....	1556.00

Write, phone or visit either store today!  
Inquiries & orders from military men  
and others outside USA wanted.

Butler 1, Missouri  
ORchard 9-3127



**Henry Radio Stores**

11240 West Olympic Blvd.  
Los Angeles 64 Ph. GRanite 7-6701



**BIG  
TRADE-INS**

**World's Largest Distributors of Short Wave Receivers**

For further information, check number 28, on page 130.



# CUSTOM STYLED GIFTS



## The Finest in Ham Jewelry

A complete line of personalized jewelry handsomely engraved with your call letters, name or initials. All items available in choice of gold plate or silver plate. Mark appropriate box on coupon. Sandblast finish insures long wear.

Money Clip....\$3.50\*    Tie Bar.....\$2.50\*  
 Cuff Links..... 3.50\*    Tie Tack..... 2.50\*  
 Buckle..... 3.50\*    Lapel Pin..... 2.50\*

### Match Books

Personalized with your call letters, name or initials. 50 books of matches attractively packed in a reusable clear plastic drum. Attractive Gold, Silver, Green, Red metallic colors and White letters.

\$2.95 postpaid.

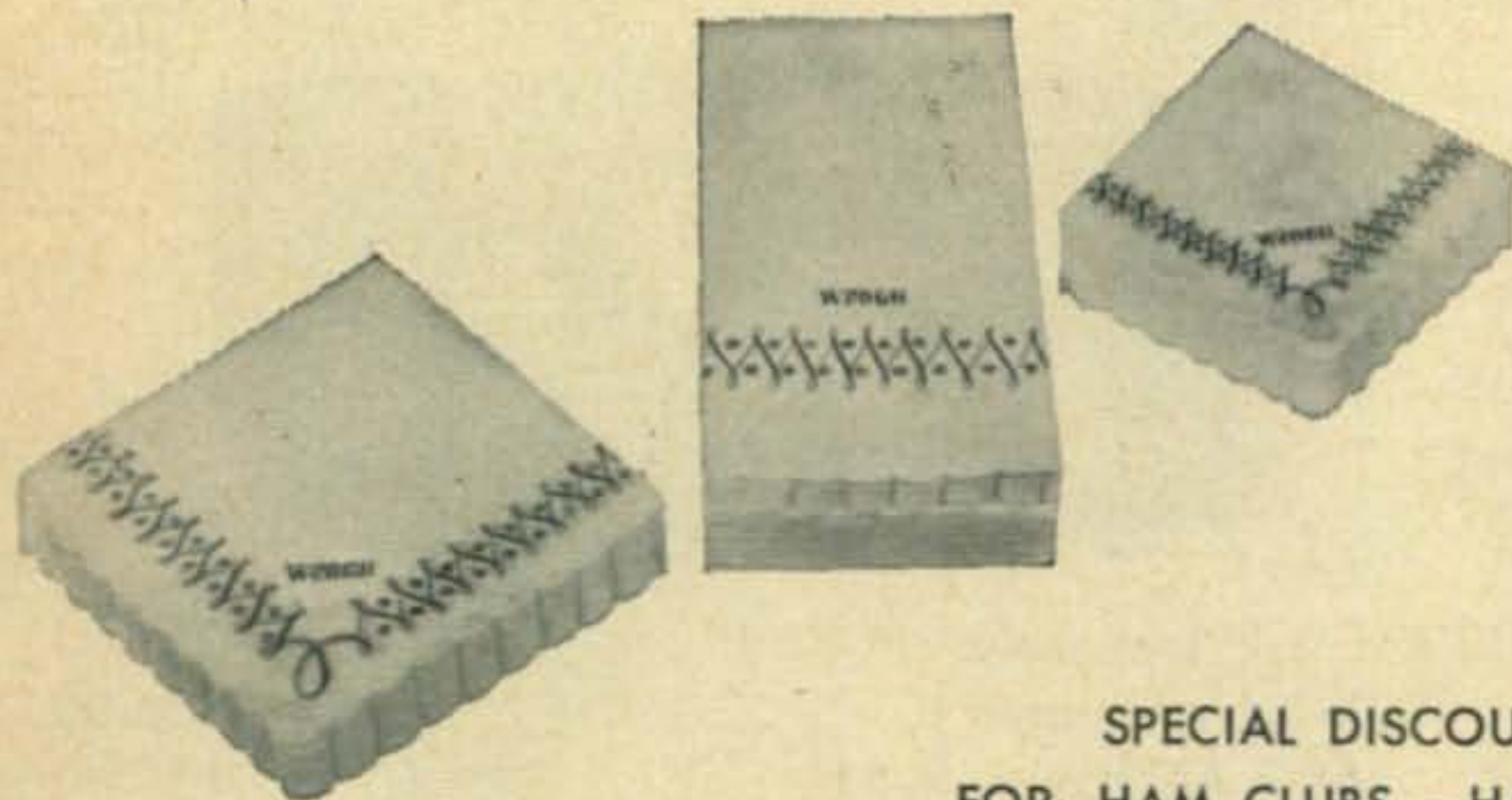
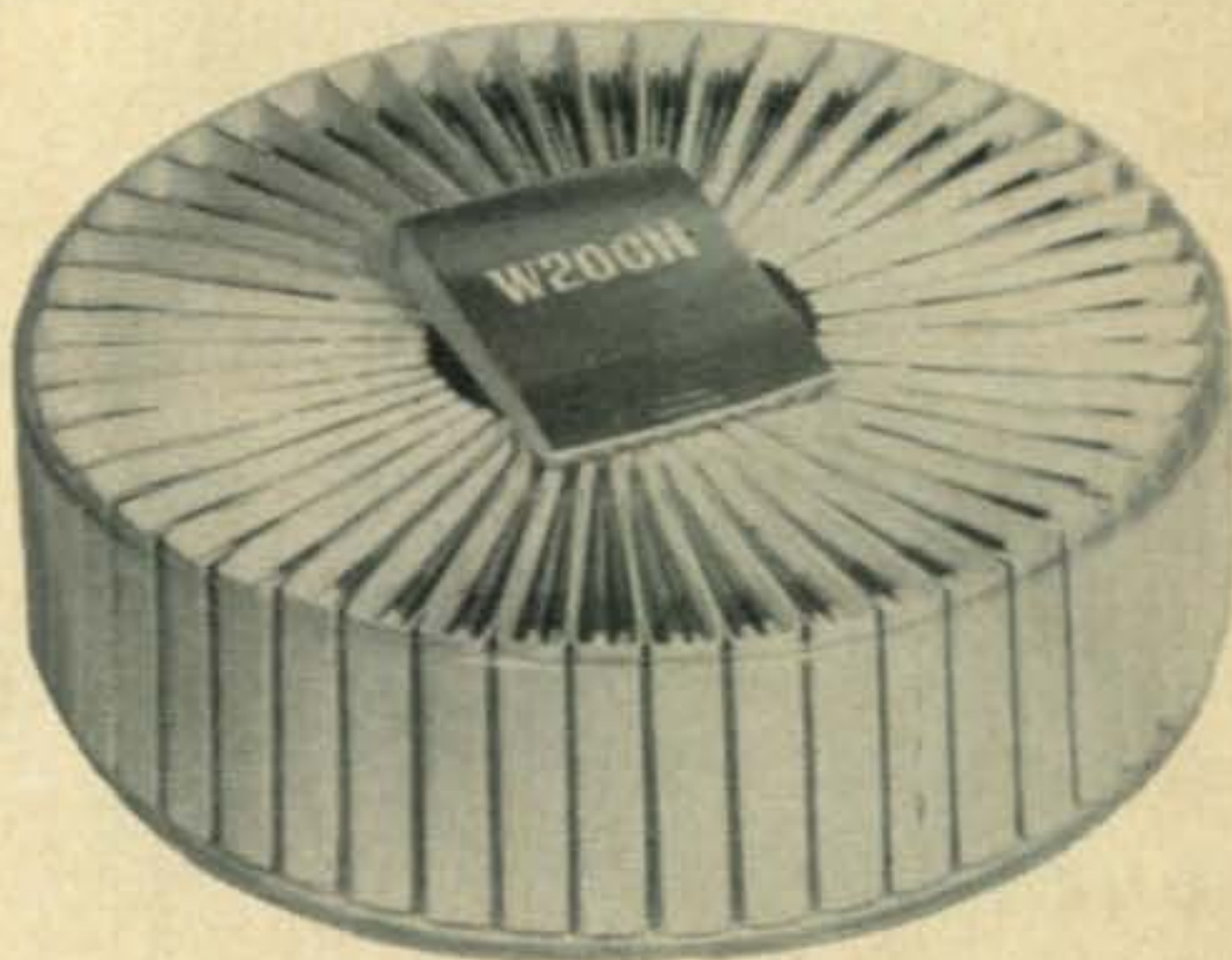

### Hostess Set

50 each, beverage and luncheon napkins and guest towels. Personalized with your call letters, name or initials. Attractive Gold and Silver scroll border design, gift boxed.

\$4.95 postpaid.

SPECIAL DISCOUNTS ON QUANTITY ORDERS  
 FOR: HAM CLUBS — HAMFEST PRIZES — MANUFACTURERS  
 WRITE FOR FULL DETAILS, SPECIFYING YOUR PARTICULAR NEED

\*Add 10% Federal Excise Tax to all jewelry.

Hewlett Sales Co.		CQ 8	
Box 600CQ		SIRS: My check (money order) for \$..... is enclosed. Please send	
300 West 43rd St.		Money Clip	G <input type="checkbox"/> S <input type="checkbox"/>
New York 36, N.Y.		Buckle	G <input type="checkbox"/> S <input type="checkbox"/>
		Tie Tack	G <input type="checkbox"/> S <input type="checkbox"/>
		Cuff Links	G <input type="checkbox"/> S <input type="checkbox"/>
		Tie Bar	G <input type="checkbox"/> S <input type="checkbox"/>
		Lapel Pin	G <input type="checkbox"/> S <input type="checkbox"/>
		Match Books	Gold <input type="checkbox"/> Silver <input type="checkbox"/> Green <input type="checkbox"/> Red <input type="checkbox"/> Hostess Set <input type="checkbox"/>
NAME or INITIALS.....		CALL.....	
ADDRESS.....			
CITY.....		ZONE..... STATE.....	
Add 10% Federal Excise Tax to all jewelry.		New York City residents add 3% Sales Tax.	



# BRAND NEW!



**NEVER  
BEFORE A  
HAM MAP  
LIKE THIS!**

**SO BIG!  
SO BEAUTIFUL!  
SO ACCURATE!  
SO FACT FILLED!  
SO UP-TO-DATE!**

**KNOW THE ZONES FOR WAZ • KNOW  
THE CONTINENTS FOR WAC • KNOW  
THE COUNTRIES FOR DX-CC • ETC. • ETC.**

We are proud to announce the publication of the long-awaited **AMATEUR RADIO WORLD-WIDE DX & ZONE MAP.**

This new map is complete, accurate and up to the minute with information that every amateur needs.

It contains:

- Every prefix, including the newest additions and latest changes, printed in red, right in, or next to, the Country or Island, for accurate identification.
- The most authentic Zone Boundaries, including the **ANTARCTIC CONTINENT for the FIRST TIME ANYWHERE!**
- Great circle beam bearings for East, Mid-West and Western United States.

Attractively printed on heavy vellum map paper in four colors for easy location of Zones and Prefixes.

Size 36 by 42 inches for easy, no squint reading from operating position.

Price only **\$3.00** postage paid in the U.S.A. and possessions.



**GET  
YOURS  
NOW!**

**COWAN PUBLISHING CORP.**

Map Division  
300 West 43rd Street  
New York 36, N. Y.

C-8

**SIRS:** My check (money order) for \$\_\_\_\_\_ is enclosed.

Please send \_\_\_\_\_ maps to:

(Additional name, or names, enclosed on separate paper.)

Name \_\_\_\_\_

Address \_\_\_\_\_

City \_\_\_\_\_ Zone \_\_\_\_\_ State \_\_\_\_\_

New York City residents add 3% Sales Tax



# THE CQ HAM MART



## 19" GLOBE

Here is a chance to preserve your breath for posterity! This beautiful World Globe, made by Hammond, is a must for every hamshack. Plain for \$19.95 or lighted for \$24.95. The first 10,000 people who jump at this bargain will get a year of CQ at no extra charge.

## ATLAS

What! You don't know where Nicobar Island is? Incredible! And with the CQ deal on the Hammond Atlas so reasonable too. This is a reference book that will get good usage around your house if you have any kids. 7 lbs. of colored maps and a gazetteer for only \$12.50... and you get a year of CQ.

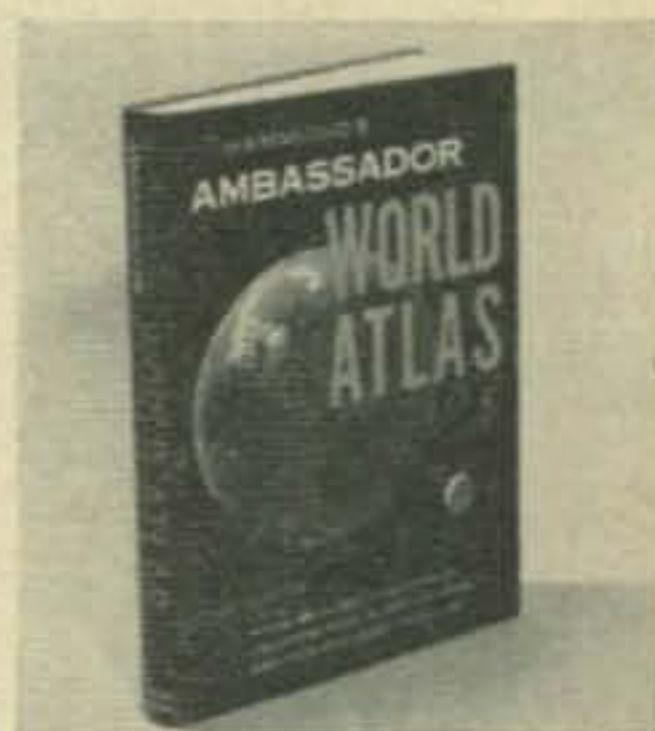

## COMMAND SETS

This IS a collection of reprints, containing all of the available information on the conversion of the popular "Command" transmitters and receivers into good ham transmitters and receivers. Invaluable for Novice, Technician, General, Advanced and Extra class operators. 136 fabulous, amazing terrific pages for only \$1.50 postpaid.



## MOBILE HANDBOOK

Anyone who tries to go mobile without getting this book should register for a sanity hearing. Bill Orr, W6SAI has put everything you need to know in this book. Build-its by the dozen... solutions to ignition problems, keeping the battery charged, noise... only \$2.95 postpaid.



## CODE RECORD

Learning code is a snap with this record. Speeds from 3 to 16 WPM, depending upon turntable speed. This 12" LP record has on it all you need to learn the code for both the Novice and General License. \$3.50 each.



Log Sheets of the most astounding modern design. Infinitely superior to any others on the market. And they are only \$1 for a pad of 100 sheets. Specify Regular or SSB type.

## HAM'S INTERPRETER

Now you can talk in broken French, Spanish, Italian, German, Swedish and Finnish. This handy little book gives all the popular ham conversation in seven languages, including letters and numbers. Only \$1.50 postpaid.



## TVI HANDBOOK

W1DBM's newly written TVI book (2nd edition) covers all aspects of curing TVI from both the Ham's viewpoint and that of the TV viewer or the TV serviceman. It includes 2- and 6-meter TVI as well as Citizen's Band, Industrial, Medical and Utility TVI. Profusely illustrated with diagrams, photos, charts, tables and FCC regulations pertaining to radio and television interference. Price \$1.75 postpaid. USA, \$2.00 Foreign.



## BINDER

There is no other good way to keep your back issues. Make 'em neat. We supply the binder, with the year embossed in gold, not merely a sticker which will come off later. Specify what year you want stamped on your binder. \$3.50 each.

## BOUND VOLUME

By far the handiest way to keep your library. Why not go first-class? This impressive volume is only \$10.00. We only made a few of them this year, so don't expect to get one later.







### CQ ANTHOLOGY

Most amateurs do not have a good file of back issues of CQ. So we've looked back through the years 1945-52 and assembled all in one place the articles that have made a lasting stir. The issues containing most of these articles have long ago been sold out. The price is a paltry \$2.00.

### ALL ABOUT MISSILES & SATELLITES

Here's a book, written in down-to-earth language, which answers questions on missile maintenance, fire control, flight control tracking, testing, fuels, payload and many other achievements in rocketry and space for both scientific and military applications. Also, featuring the most up-to-date "Directory of 38 Most Popular Missiles and Their Photos," (supplied by Department of Defense) as well as a "Glossary of Missile Terms." \$1.50 per copy.

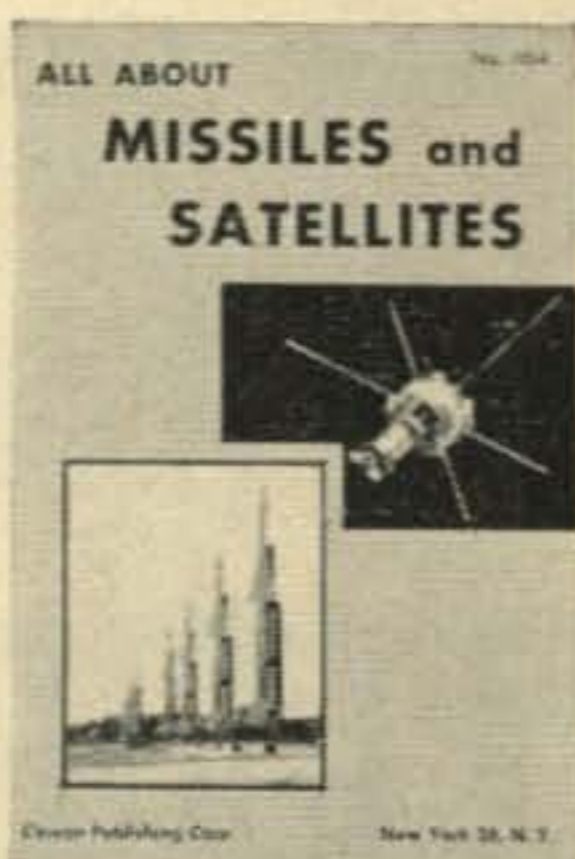

### HI-FI BOOK

This nifty volume contains the latest dope on amplifiers, preamplifiers and equalizers plus a buyer's guide of component manufacturers! Over 150 — 5½" x 8½" pages of heavily illustrated descriptions covering Hi Fi Audio Components—the greatest publication value in its field today. Only \$2.50 per copy.



### SIDEBAND HANDBOOK

Written by Don Stoner, W6TNS, was almost one full year in the preparation of this terrific volume. This is not a technical book. It explains sideband, showing you how to get along with it... how to keep your rig working right... how to know when it isn't... and lots of how to build-it stuff, gadgets, receiving adaptors, exciters, amplifiers. Price, only \$3.00.

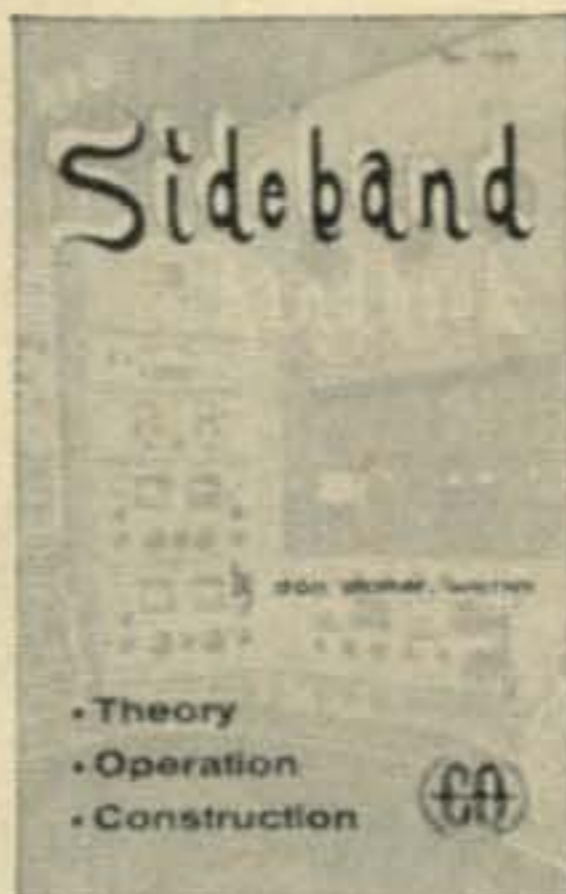

**COWAN PUBLISHING CORP. CQ 8**  
**Book Division**  
**300 West 43rd Street**  
**New York 36, N. Y.**

LIGHTED GLOBE .....	\$24.95	<input type="checkbox"/>
UNLIGHTED GLOBE .....	19.95	<input type="checkbox"/>
ATLAS .....	12.50	<input type="checkbox"/>
COMMAND SETS .....	1.50	<input type="checkbox"/>
MOBILE HANDBOOK .....	2.95	<input type="checkbox"/>
CODE RECORD .....	3.50	<input type="checkbox"/>
REGULAR LOG SHEETS (100).....	1.00	<input type="checkbox"/>
SSB LOG SHEETS (100) .....	1.00	<input type="checkbox"/>
HAM'S INTERPRETER .....	1.50	<input type="checkbox"/>
TVI HANDBOOK .....	1.75	<input type="checkbox"/>
BINDER—YEAR WANTED .....	3.50	<input type="checkbox"/>
BOUND VOLUME .....	10.00	<input type="checkbox"/>
CQ ANTHOLOGY .....	2.00	<input type="checkbox"/>
MISSILES & SATELLITES .....	1.50	<input type="checkbox"/>
HI-FI BOOK .....	2.50	<input type="checkbox"/>
SIDEBAND HANDBOOK .....	3.00	<input type="checkbox"/>
CQ LICENSE GUIDE .....	2.50	<input type="checkbox"/>
SURPLUS SCHEMATICS HANDBOOK....	2.50	<input type="checkbox"/>

SIRS: My check (money order) for \$\_\_\_\_\_ is enclosed. Please send the following items to:

Name \_\_\_\_\_

Address \_\_\_\_\_

City \_\_\_\_\_ Zone \_\_\_\_\_ State \_\_\_\_\_

New York City Residents Add 3% Sales Tax

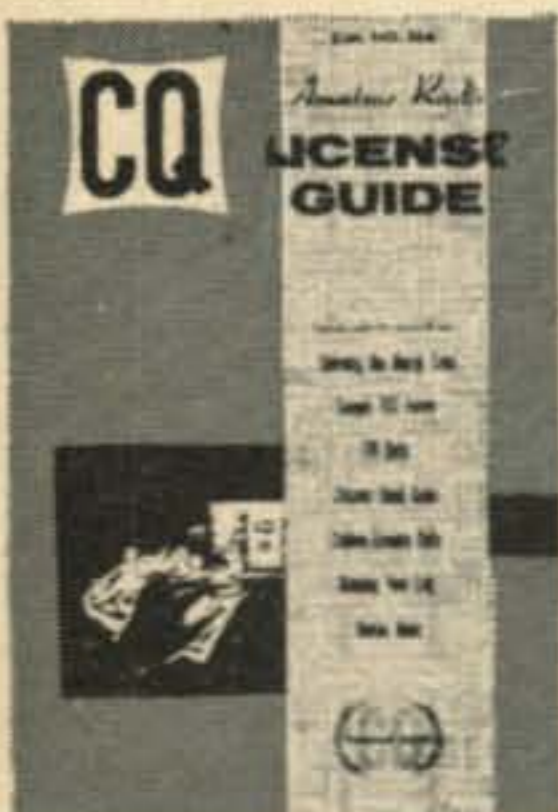

212 pages of everything the Amateur must have to get his license and progress toward the general class ticket. Plus many additional pages of vital information for the ham operator. All this for only \$2.50.

This is a book literally loaded with schematics for all the currently popular pieces of surplus gear. Most amateurs are well aware of the problems encountered in purchasing seemingly inexpensive surplus units, only to find that no schematic diagram is available. Trying to figure out the circuitry cold turkey can be many times more difficult than the most involved puzzle, and purchasing a single instruction book can run as high as \$3.50. Why knock yourself out when you can have a book with complete coverage on hand in your library? All this for only \$2.50.

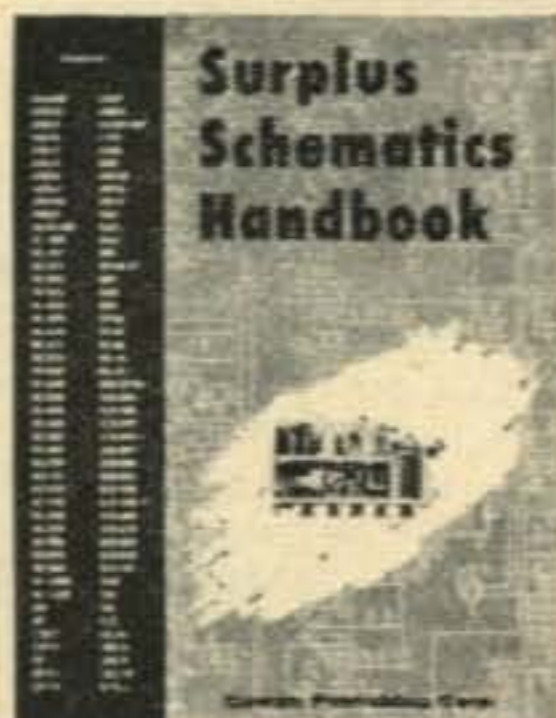



# BOARD OF THE MONTH



"TATTLE TALE" - Conelrad receiver, uses one 2N170 on 5" X 3" board - Price \$1.50 Ea.

## OUR LATEST

50 Mc Transistor Converter  
Amperex OC 170 OC, 171 Transistors.  
On 1 7/8 X 3 1/4 Epoxy Glass Board,  
Price With P.C. Coil Forms... \$3.50

Send for **FREE** list of  
more than ~~20~~ 35 models

# IRVING ELECTRONICS CO.

417 DWYER · SAN ANTONIO 4, TEXAS · POST OFFICE BOX 9222

For further information, check number 30, on page 130.

## Model M-100 NEW SELF CONTAINED UNIVERSAL SERIES GATE AM MODULATOR

BECAUSE OF THE BIG DEMAND:

**NOW AVAILABLE IN A KIT FORM !!**

EASILY ADAPTABLE TO MOST COMMERCIAL CW TRANSMITTERS  
AN IDEAL MODULATOR FOR THE HOMEBREW TRANSMITTER



- Modulates any beam tetrode or pentode amplifier up to 1 KW
- Extremely economical and efficient method of modulation
- No sacrifice in CW power capacity
- Amazingly small: only 6"x 7 1/2"x 5 1/2"
- Two years complete guarantee

Find out for yourself why the M-100 is your best ham investment per dollar:  
**10 DAYS TRIAL, MONEY BACK GUARANTEE**

Kit .....\$29.95 Net

Wired and tested..... 39.95 Net

Write for complete technical information. Send check or money order to:

## ELECTROTONE LABORATORIES

2717 North Ashland Avenue  
Chicago 14, Illinois

For further information, check number 31, on page 130.

## New Amateur Products

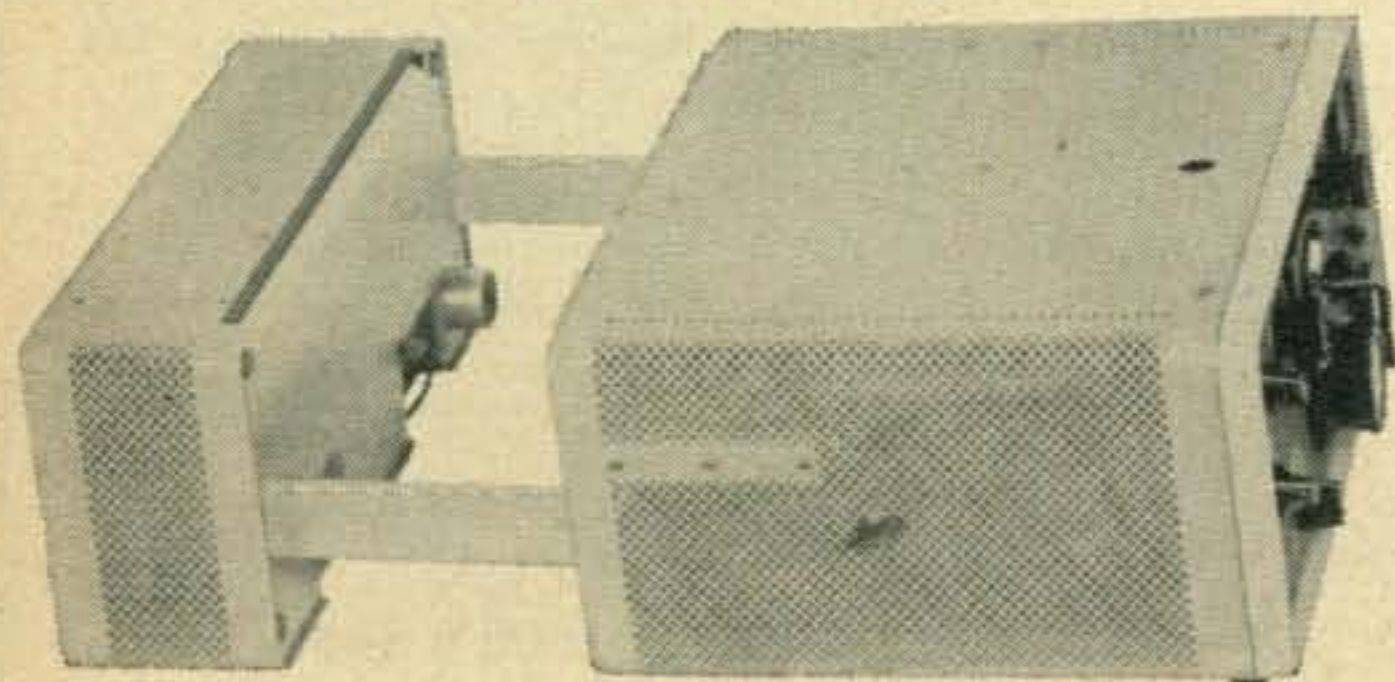

## Collins Carrying Case and Power Supply For The KWM-2

Collins Radio has just announced a new carrying case and companion power supply for the KWM-2. Weighing only 13 1/2 pounds, including a built-in auxiliary speaker, the Collins PM-2 Portable Power Supply operates from either 115 volts ac or 220 volts ac at 50-400 cps. It provides all voltages necessary for Collins' KWM-2 SSB transceiver. The power supply slips directly onto the back of the KWM-2 as shown in the photo.

A Samsonite Ultralite suitcase, lined with shock resistant polyurethane foam plastic, provides a protective carrying case for the power supply, transceiver and accessories. The complete station weighs less than 45 pounds.

Size of the PM-2 is 14 3/4" W, 7 3/4" H, 4" D. Height and width are same dimensions as the KWM-2 and the suitcase dimensions are; 21" W, 21 1/4" H, 8 3/4" D. Circle D on page 130 for more information.





# TWO-WAY RADIO

*communications equipment*

## VHF-FM FOR:

MOBILE  
AIRCRAFT  
MARINE  
MOTORCYCLE  
PORTABLE  
BASE

## VHF-AM FOR:

AIRPORT VEHICLES  
GROUND STATIONS  
POINT-TO-POINT

## VHF

ANTENNAS  
REMOTE CONTROLS  
ACCESSORIES



## COMCO'S ALL NEW

# "580 FLEETCOM"

## VHF-FM MOBILE RADIO

The new "580" is compact, light weight, has high performance, and features an original concept in Mobile equipment packaging by combining the control head, speaker, and transistorized power supply in one small easily mounted case assembly.

### FEATURES

★ **HIGH PERFORMANCE** . . . meets "split channel" technical requirements, all FCC and FCDA requirements.

★ **FULL POWER OUTPUT** . . . 35 Watts in 25-50 Mcs. 25 Watts in 144-174 Mcs.

★ **BUILT-IN RELIABILITY** . . . Preproduction Models field tested in 5 states and 3 foreign countries before starting production.

★ **SMALL AND LIGHT WEIGHT** . . . Chassis in case 13" x 9<sup>5</sup>/<sub>16</sub>" x 5<sup>1</sup>/<sub>2</sub>". Control-power Supply-Speaker case 5" x 5" x 3<sup>3</sup>/<sub>16</sub>". Complete Mobile installations 24 lbs.

★ **EASY TO INSTALL** . . . "Two-unit" package so small most installations are under dash.

★ **LOW COST** . . . Complete mobile package

**\$398** f.o.b. factory

★ **EFFICIENT** . . . Transistor power supply gives high efficiency. Total standby drain 5.25 amp.

★ **INTERCHANGEABLE CHASSIS** . . . Mobile transmitter-receiver chassis instantly interchangeable with base stations in simplex systems.

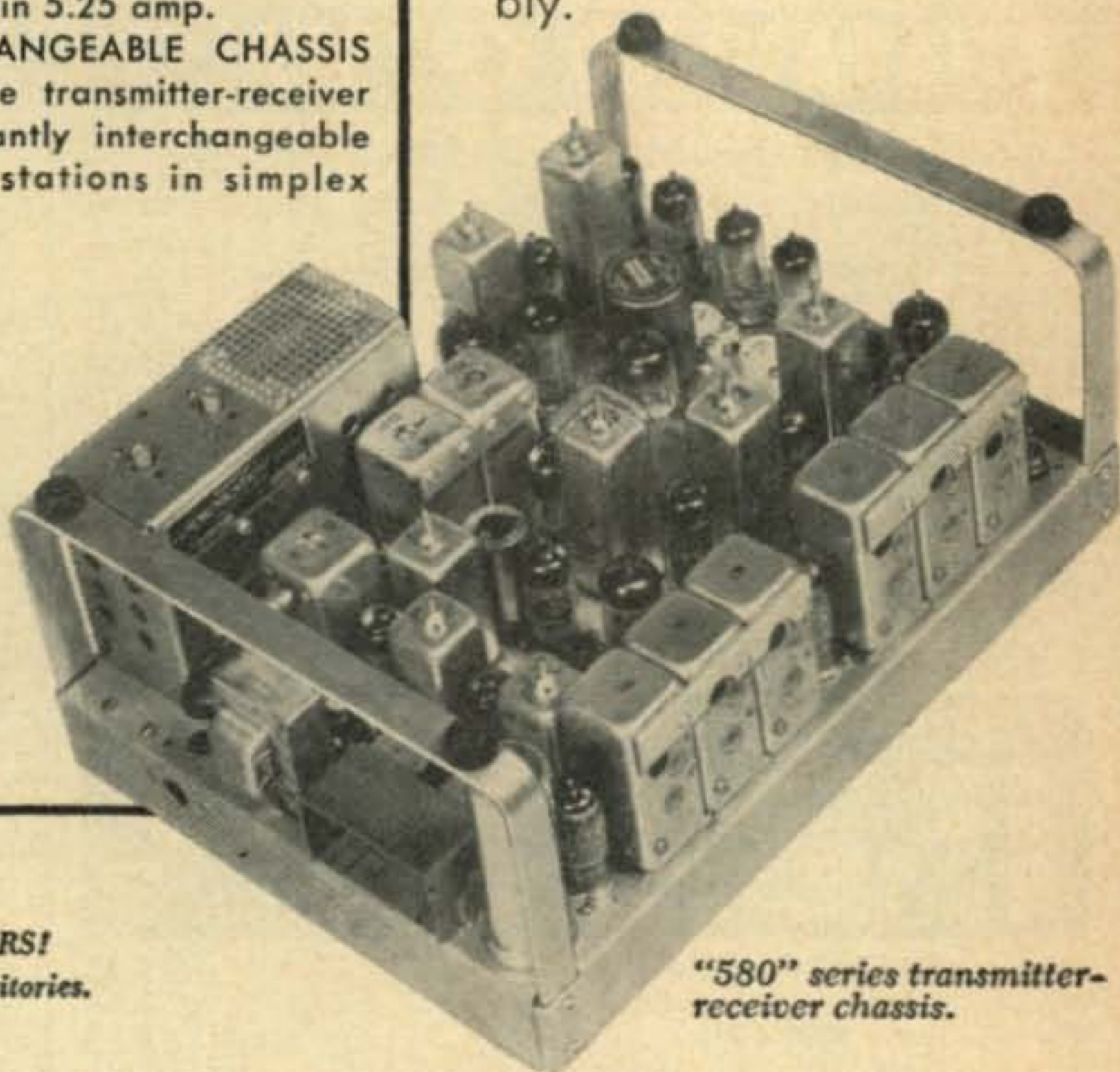

"580" series transmitter-receiver chassis.

**ATTENTION DEALERS!**  
Write for available territories.

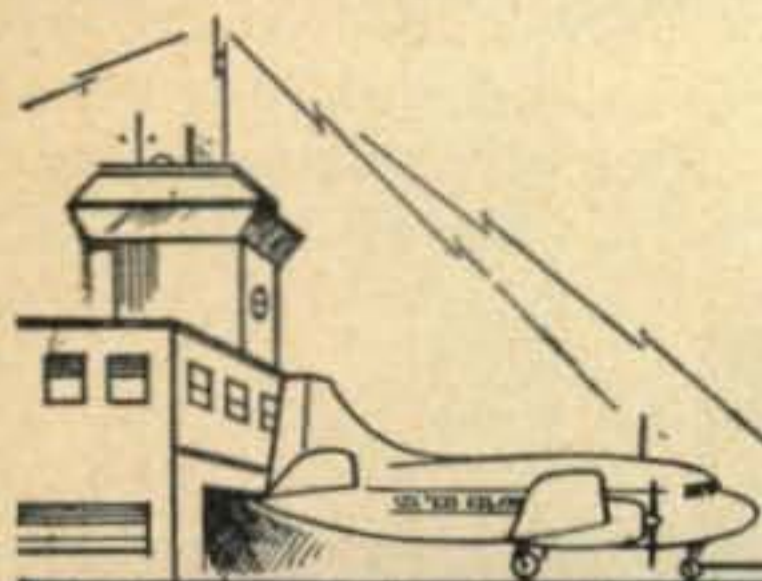

DESIGNERS AND MANUFACTURERS OF

RADIO COMMUNICATIONS EQUIPMENT

# COMMUNICATIONS COMPANY, Inc.

FOUNDED 1938

CORAL GABLES, MIAMI 34, FLORIDA

For further information, check number 46, on page 130.





a Ham Tower anyone  
can afford—

### THE LEADER-40

Here is a sturdy, low cost, quality tower that is ideal for novice or technician. The same E-Z WAY standard of quality found in our higher priced towers has been incorporated into the LEADER-40. Cranks up to 40' - down to 20'. Equipped with winch and safety rest. Will support 2M, 6M, or Quad unguyed. Mast extra.

Sold by  
Top Flight Distributors  
▶ Write for catalog CL 40

**E-Z WAY TOWERS, INC.**  
P. O. BOX 5491 - TAMPA, FLA.

For further information, check number 32, on page 130.

## GUARANTEED CRYSTALS!

**BUY NOW AND SAVE!!**

ALL MARINE FREQ.-FT-243, DC-34 Holders. Tol. .005	\$2.00
POLICE, C.A.P., CD, MARS. Tol. .01%	\$1.60
CITIZENS BAND—11 METERS—.005% TOL.	
26.965 to 27.225 MC, 3rd Over. Herm. Seal. or FT-243	\$2.50
13.4825 to 13.6125 MC, 2nd Harm. Herm. Seal. or FT-243	\$2.50
6741.25 to 6806.25 Kc, 4th Harm. FT-243 only	\$2.00

**SPECIAL!**  
**STOCK CRYSTALS**

FT-243 Holders 4035 KC to 8650 KC  
in steps of 25 KC's  
DC-34 Holders 1690 KC to 4440 KC  
steps of 10 KC

SEND FOR FREE CATALOG

**50¢**  
ea.

### NOVICE BAND FT-243 Fund.

80 Met. 3701-3748—Steps of 1 KC. FT-243  
40 Met. 7150-7198—Steps of 1 KC. FT-243  
Dbl. to 40 Met. 3576-3599. Steps of 1 KC. FT-243  
15 Met. 5276-5312—7034-7083 Steps of 1 KC. FT-243

**86¢**  
ea.

FT-243—2 Meters (Steps of 1 KC)	\$ .93
FT-243—6 Meters (Steps of 1 KC)	\$ .93
FT-243—From 3000-4000	\$ .93
FT-243—From 1005-2999 (Steps of 5 KC)	\$2.39
FT-241 SSB Low Freq. Xtals 370 to 540 KC (Steps of 1.852 and 1.388)	\$ .49
FT-241 SSB Matched Pairs	\$1.95

Open Friday Evenings until 9 P.M.

Include 5c per crystal for postage (U. S. Only) Calif. add 4% Tax. No. C.O.D.'S. Prices subject to change. Ind. 2nd choice; substitution may be necessary. Min. Order \$2.50.

"The House of Crystals"

**U. S. CRYSTALS, Inc.**  
1342 S. La Brea Ave. Los Angeles 19, Cal.

For further information, check number 33, on page 130.

118 • CQ • August, 1960

## Answers To Quiz on Page 81

1. Volt.
2. Ampere.
3. Watt.
4. Ohm.
5. Ohm.
6. Farad (micro-farad and micromicro-farad in most common use).
7. Henry.
8. Cycle.
9. Mho (ohm, unit of resistance spelled backwards).
10. Meter.
11. Microvolt per meter.
12. Coulomb.
13. Decibel.
14. Angstrom.
15. Gauss.
16. Oersted.
17. Rel.
18. Gilbert, ampere-turn.
19. Volume unit.
20. Ohm.
21. Revolution per minute (rpm).
22. Mho.
23. Inches per second.
24. Maxwell.
25. Dyne per square centimeter.

## SEMICONDUCTORS [from page 89]

of the wire-in coaxial configuration. They are one-half inch in diameter and four to eight inches long, depending on type.

The latest issue of *Philco Small Signals* describes their new tunnel diodes designed for frequencies of 1500 mc and up. A pilot line is making diodes of 1 ma peak, with a max. tolerance of  $\pm 2.5\%$ . The Philco tunnel diode is packaged in a TO-18 case.

RCA, Sommerville, N. J., has just reduced price on some of their silicon rectifiers up to 45%. If you use types 1N 444B, 445B, 537B, 538, 539, 540, 547, or 1095, or plan on using them, check the new prices. Also new from RCA is their "do-it-yourself" micromodule laboratory kit. In addition to a stock of basic micromodule parts, the kit includes a curing oven, vacuum dust collector, a 10 to 20 power "stereo-zoom" microscope, a parts cabinet, heat sink, encapsulation mold, and a variety of other support element. The unit is available for less than \$8,000!

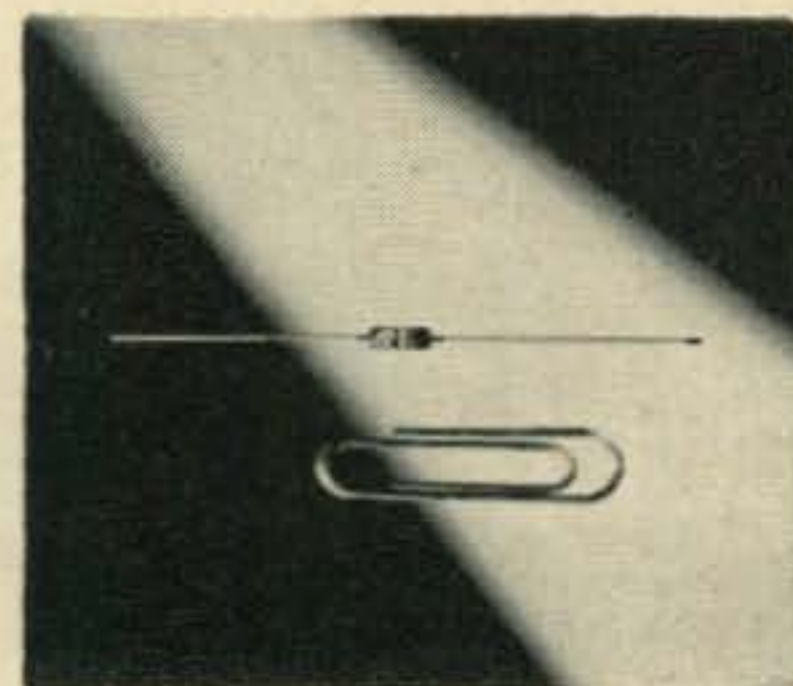

The new Rheem general purpose silicon diode is useful in amateur applications where stability is required. The price is attractive to experimenters.



Rheem Semiconductor Corporation, 350 Ellis St., Mountain View, California, has just announced a new all-purpose silicon diode, type 1N661A. At 200 volts the 1N66A features a maximum reverse leakage of 0.025  $\mu$ a! The new diode will meet the test specifications for a number of general purpose and computer silicon diodes. They are priced at \$2.74 in 100 quantity.

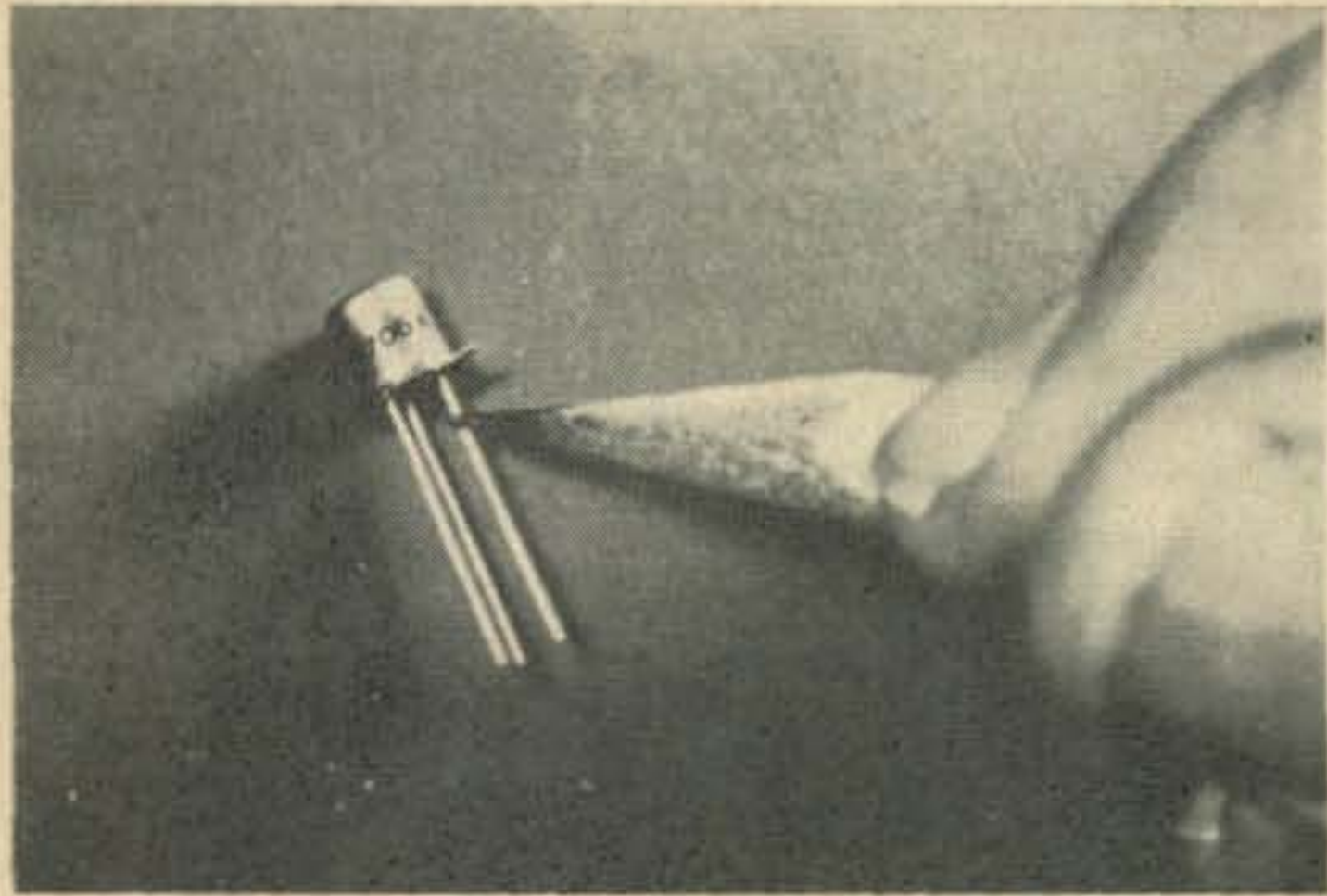

Close-up view of the new Texas Instruments 2N706A ultra high speed switching transistor.

Texas Instruments, Box 312, Dallas 21, Texas, have just announced the industry's fastest silicon mesa switcher, the 2N706A. It is an NPN silicon mesa ultra high speed switch and has a guaranteed turn-on time of 40 nanoseconds and turn-off time of 75 nanoseconds! That's about how long it takes the light from this page to reach your eyes!

Wells Electronics Company, 1701 S. Main St., South Bend 23, Indiana, is marketing a new group of encapsulated diode assemblies where environmental conditions make this desirable.  
73, Don, W6TNS

#### SURPLUS [from page 91]

URC-4 and needs data to convert it to two meters. Marvin Fricklas, 27 Melane Avenue, Audrey Gardens, Riverhead, Long Island, N.Y. needs a manual on the URC-11.

Howard S. Robb, Bird Island, Minnesota. R. M. Baldwin, 409 Kaelin Dr. Louisville 7, Ky. wants conversion info on a BC-222. Harold G. Crisp, 309 1/2 So. First St., Aberdeen, S.D. needs a power supply and manual for a Navy LM-14 frequency meter. Steve Phillips, 3019 Blair Avenue, Ashtabula, Ohio needs info on a power supply for a WCH sonar set. Larry Kistler, 726 W. Galena, Freeport, Delaware needs a circuit diagram for a Royal Canadian AF transmitter-receiver REF-10D/4713. T. P. Hall, 8928 Wakefield, Panorama City, California needs a conversion for the BC-669. Ralph E. Moote, 15848 Bramell, Detroit 23, Mich. needs manuals on the ID-102/CPN scope, R-111/APR-5, T-9/APQ-2, TS-1/ARR-1 and R-1/ARR-1. Morris Siegel, 8569 Pringle Dr., Cincinnati 31, Ohio needs a conversion of the BC-923 to a converter. Tom Reid, Box 203, Canal Fulton Ohio wants a conversion of the BC-654 to ac and ham bands. Bill

## GOOD BUYS — ALL NEW

Extraordinary values await you in government surplus components. Our specialty is components; we have many of those hard to find items that you just won't see advertised elsewhere in surplus materials. Don't buy anything until you have our "Bargain Bulletin"; write for it today, it's free. New material is available to you for mere nickels and dimes on the dollar value. Here are some typical values:

**RELAYS**, all are beautifully constructed to govt specs.  
13 VAC coil, DPDT + SPDT, 10 amps, ceramic.....1# \$2.89  
12 VDC, 64 $\Omega$  coil, DPDT, 20 a + SPST, 6 a. cer.....1# \$1.89  
Differential, 2-9000 $\Omega$  coils, 2-SPDT sect, 2 a.....1# \$3.39  
115 VAC coil, DPDT at 5 amps, hermetic seal.....3/4# \$1.95  
Min. DPDT, 3800 $\Omega$  coil, 1 amp cont, 28 VDC.....1/2# 89c

**AUDIO TRANSFORMERS**, a few typical values, many more.  
5 w output, 5K $\Omega$ :15 $\Omega$ ,  $\pm$  1/2 db 16-18,000 cps, per pr 3# \$2.22  
Line match, 15K $\Omega$  to 600 $\Omega$ , 50-10,000 cps, pot.....1 1/2# 69c  
25 w output, 8,000 $\Omega$  et, 15/125/250 $\Omega$ , potted.....4# \$1.95  
Line to v c, Thord. 2-16 $\Omega$  v c to 500 $\Omega$  line.....2# \$1.39

**PLATE & FILAMENT POWER TRANSFORMERS**, 115 volt, 60 cycle.  
720 vet/135 mils, 5/3 and 6.3/3, potted.....12# \$3.79  
490 vet/130 mils, 5/2, 6.3/3, potted.....9# \$3.19  
800 et/175, 80 v tap, 5/3, 6.3/2.5, 6.3/2.5.....9# \$4.44  
600 vet/350 mils, 12.6 v/11 amps, potted.....18# \$4.29  
Auto, 115 to 230 volts, 90 watts, potted.....7# \$2.29  
HV scope, 4500 volts/5 mils, 10 KV RMS ins.....10# \$1.95

**FILAMENT TRANSFORMERS**, 115 volt unless otherwise shown.  
5 vet/30 amps, 215/230 pri., 15 KV ins., Chi.....20# \$6.45  
6.3/0.6 potted, uses only 3 sq in chassis areal.....1 1/2# 79c  
6.3/27 amps, four windings, 3 amps are et.....9# \$3.29

**MISCELLANEOUS VALUES**, all are outstanding.  
CW "Dream Filter", bandwidth 200 cps down 20 db.....4# \$6.95  
Oil cond., 15 mfd/330 VAC, HV ceramic terms.....3# \$2.29  
BC-610 40 meter coils, C-390-A, three for.....1# \$1.79  
3AP1 cathode ray tubes.....2# \$1.45  
3C24 triodes, Lewis and Kauffman, a pair.....2# \$5.55

and hundreds of other equal values appearing in the "Bargain Bulletin". Write for yours today!

Send adequate postage with orders. We refund any overage. All prices are FOB Sacramento, \$3.00 minimum order please.

**JOE PALMER**

PO BOX 6188 CCC, SACRAMENTO, CALIF.

For further information, check number 34, on page 130.

## QUICKLY CUT HOLES in metal, plastics, hard rubber...



### GREENLEE CHASSIS PUNCHES

Make smooth, accurate openings in 1 1/2 minutes or less... for sockets, plugs, controls, meters, panel lights, etc. Easy to use... simply turn with wrench.

Many sizes and models.

Write for literature.

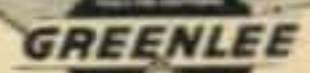

GREENLEE TOOL CO., 1915 Columbia Ave., Rockford Illinois  
For further information, check number 35, on page 130.



## NEW IN ALL RESPECTS!

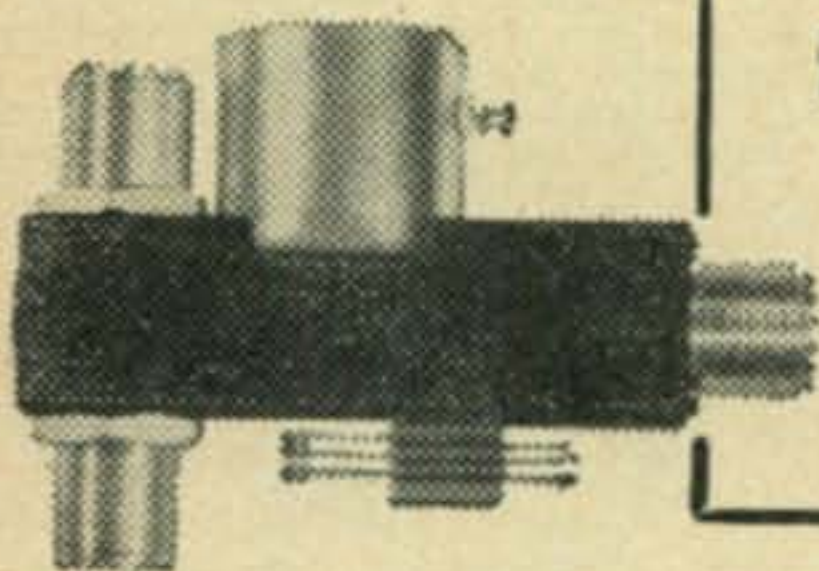

EPOXY RESIN  
USED IN  
DK60  
SERIES

## COAXIAL RELAYS

For quieter operation and resistance against moisture, all coils are encapsulated in an epoxy resin. Add to this; low VSWR—less than 1.15 at 500 mc.—low losses—high contact pressures—patented receiver protecting connector (optional)—bifurcated DFDT external contacts (optional)—and many other mechanical and electrical features, all of which are found in the NEW Dow DK60 series. \$10.90 to \$14.20.

### OTHER FINE DOW-KEY PRODUCTS:

DK60-T2-Transfer two or more antennas—1KW capacity—price (with standard U.H.F. connectors) \$10.90 to \$12.65.

T/R switches—3 models—self powered and non self-powered. Also available for special COMMERCIAL frequencies up to 250 mc. Engineering inquiries solicited, regular models \$12.50 and \$27.75.

We invite inquiries for coaxial relays using types 'N' 'C' 'HN' 'BNC' and 'UHF' connectors.

Catalog sheets available from any of our 700 dealers and distributors in U.S. and Canada or from the main office.

**DOW-KEY CO. INC.**  
THIEF RIVER FALLS, MINNESOTA

For further information, check number 36, on page 130.

## • HAM-SWAP •

The New service for the Radio Amateur

Buy, sell, swap your equipment NOW in its pages! Published twice monthly—national circulation. \$1 ad free with \$1 year's subscription. Send \$1 to . . . . .

HAM-SWAP, Inc., 35-D East Wacker Drive, Chicago 1, Ill.

## "HOW TO MAKE MONEY IN Mobile Radio Maintenance"

AUTHORITATIVE GUIDEBOOK  
ABOUT THE BOOM IN TWO-WAY MOBILE-RADIO:  
GIVES FACTS, FIGURES, PAY RATES,  
WRITE TODAY!

FREE

LAMPKIN LABORATORIES, INC. Electronic Div. BRADENTON, FLA.

### OPPORTUNITY

**WANTED**—Imaginative, Industrious young man to research and develop new ideas in Electronic and Allied Fields. Syndicate will provide Capital—Guaranteed minimum salary—Future Incentives and Guidance. Give detailed background, previous experience, references and recent photo in first letter to C. M. Tierney, 612 3rd Ave. South, Fort Dodge, Iowa.

## BC-603 CONVERSION

BC-603 Conversion article (Sept. & Oct., 1958 CQ)  
Reprints available at 50¢ per set.

CQ Magazine, Book Div.,  
300 W. 43 St.  
New York 36, N. Y.

Keiser, 44 Ovington Avenue, Highland Park, New Jersey has a need for a *tech* manual on the ABA-1 equipment.

Don Guptill, 17 Park St., Ct. Medford, Mass. wants a conversion for the ID-6/APS-4.

73, Ken, W2HDM

### VHF [from page 97]

any visiting amateurs to my area from across the pond. Also am desperate for Gonset III schematic and 12AV7 or 12AZ7 valve. Will exchange anyone for magazines or other tubes. Have full measurements on Skeleton Slot Yagi Aerial if anyone wants info on these, 6 over 6, gain 14db over dipole." *The fore-going is from Ray Bastin, G3LHA, who writes a most informative letter. Thanks Ray, and do it more often.*

**St. Johns, Newfoundland** "Enjoy your VHF column every month. I am assigned to the tropospheric scatter systems, otherwise known as 'Pole Vault', that runs from St. Johns, Newfoundland, to about as far north as the dew line. We operate from 750 to 1000 mc and the stations range from 100 to 150 miles. We use a parabolic antenna 60 foot in diameter and run 10 kw."

"Since the system was installed in 1954 we have been on the air 99.9% of the time. I used to work 6 meters from Mt. Nebo, Oregon, but as there is no 6 meter activity up I am now on 15 meters." *Thanks for all the dope Smitty, and why don't you look up VOIAE. He dropped into the New England area the other night, via 6 meters. Above info from K7DNK/VO.*

**Auburn, Alabama** For a change of climate we read a letter from "Butch" (W4HTP).

"Present plans call for me to operate W4HTP/4 from Mt. Mitchell, North Carolina, during June, July and August. I expect to operate 144 mc (kw by July), some 50 mc with possibility of 200 and 420 if ambition holds up."

"Operation will be from WMIT FM transmitter site on Clingman's Peak, about 100 feet below the highest place in the eastern U.S. (6684 feet). I am looking forward to some real exciting DX most likely as QRS CW on low end of band." *Good luck, Butch, hope it turns out as exciting as it sounds.*

**Woodbridge, Virginia** Excerpts from a three pager received from Lynn Sholar, K4UKQ:

"Flash—Worked LU2KE, LU1KJ and LU4DKN on April 23rd at 2100 EST. Worked LU4DOZ on May 7th at 1000 EST and heard him again at 1330. LU's were heard in Sudbury, Ontario by VE3CJN at noon on the 7th of May." *Quite a flash!*

"The station set-up here consists of a 4X250 on 6, running 250 input on CW, 160 on 'phone. We key the screen of the exciter, Globe 6-2 vfo. Antenna is an 8 element Hi-Gain on a 40 foot pole. On 220 we run a 4X250 at about 150 w input, haven't figured out yet how to key it.



Antenna is Telrex Spiralray, 29 elements, 26' boom (keeps the neighbors talking)." *Wish we could reprint the entire letter Lynn, very interesting.*

**Plainfield, New Jersey** Billy Hudzik (no call, age 13) sez: "Since I've gotten the *vhf* bug, I'd like to inform you of my VHF-SWL activities. I SWL at W2SMF's shack using an HQ-110 and a 4 element 6 meter beam. Since listening is confined to the early evening hours we do not hear the late openings."

"The first band opening I have to report was on May 15th when Florida, Missouri, Georgia, Illinois, Pennsylvania, New York, West Virginia, Ohio, Arkansas and Canadian stations were logged in a two-hour period."

"The second band opening was on May 19th when Florida, Virginia, Arkansas and Georgia were logged in about a half-hour period."

"A total of 15 states have been heard and logged and 4 confirmed. Right now I'm waiting for my SX-110 to arrive so I can bone up on CW and get the novice license." *Keep with it Billy, and we'll soon be hearing you on the air too. Billy would like to hear from vhfers his age.*  
73, Sam, W1FZJ

#### A54 HYBRID [from page 58]

be used to measure modulator collector current by plugging in a portable O-5 ammeter. Note . . . this is an ammeter, NOT a milliammeter.

A 500 ohm screwdriver adjustable pot is mounted near the right hand end of the front panel as a semi-fixed gain control in series with the microphone. Once set it needs no further adjustment.

It should also be noted that the 25,000 ohm dropping resistor which fed the 12AU6 *vfo* and 6AG5 crystal oscillator tube has been replaced with a 15,000 ohm unit and the 275 volt supply, which is brought in on pin 3 of the power plug is used instead of the original 550 volts. The 25K voltage dropping resistor also has been changed to 15K. All wiring shown in hatched lines has been removed.

#### Testing

After completion and thorough checking the new wiring, connect the A supply only, *remove the 12AU7 tube*, plug a 500 *ma* meter in the measuring Jack J3 and note the reading which should be between 100 and 250 *ma*. Should the reading be higher than the maximum, turn off immediately and recheck the wiring. If the reading is lower, adjust R5 for proper current.

Reinsert the 12AU7 in its socket, throw the PA switch in the OFF position, putting the 5000 ohm load across the modulation transformer secondary and fire up the transmitter with high voltage applied. With an *ac* voltmeter across the load resistor a reading of between 350 and 400 volts should be obtained when speaking into the microphone. The collector current as read on the O-5 ammeter will be

## G4ZU 20/40 M. BIRD CAGE

"G4ZU PAT." ANOTHER "G4ZU FIRST"

REVOLUTION-  
ARY DESIGN

LOW SWR

LOW LOSS  
ELEMENTS

9" TURNING  
RADIUS

COMPLETE  
WITH MAST

COAX OR  
BALANCED  
FEED



HIGH F/B  
RATIO

EASILY TUNED

LOW WIND  
RESISTANCE

LOW ANGLE  
RADIATION

NOT A KIT

GAMMA "T"  
MATCH OR  
COAX FEED

FOR THE FIRST TIME "EVERYONE" CAN ERECT A  
20/40 METER BEAM \$94.50

10/15 and 20 Super Coax Minibeam. Extremely  
effective—light 16#. No Traps, No Coils, Hi Gain—  
Broad Banded, Pretuned, Low SWR.....\$89.50

Rohn 50' tilt over tower, strong.....\$186.60  
Rohn 50' no guy tower, sturdy.....\$100.65  
34' telescoping tilt over mast .....\$ 49.50  
Just three of 1000 bargains

Distributors for Andrew commercial antennas and apparatus.

Be It Wave Guides or Dipoles. Get Our Quotation  
Before Deciding.

IMMEDIATE DELIVERY — NO WAITING  
EXPORTS ORDERS HANDLED PROMPTLY  
TERMS AVAILABLE

HOUSE of ANTENNAS  
MASTER SERVICE COMPANY

1155 East 82nd  
Chicago 19, Ill.  
Tel. SO 8-9282

For further information, check number 38, on page 130.

World's best reconditioned equipment. Shipped on approval. Trades. Terms financed by us. Central 20A \$159.00; Collins 75A-1 \$229.00, 75A-2 \$299.00, 32V-3 \$349.00, 75S-1 \$399.00, 32S-1 \$449.00, KWM-1 \$549.00; Drake 1-A \$199.00; Elmac PRM-7 \$119.00, AF-67 \$129.00; Globe Chief \$39.00, Globe Scout \$59.00; Hallicrafters S-76 \$99.00, SX-99 \$109.00, SX-100 \$199.00, SX-101 \$279.00, HT-32 \$429.00, HT-32A \$499.00, HT-33A \$575.00; Hammarlund HQ-100 \$129.00, HQ-129X \$149.00, HQ-110 \$189.00, HQ-150 \$219.00, HQ-170 \$289.00, HQ-160 \$289.00; Heath DX-35 \$49.00, DX-40 \$65.00; SB-10 \$89.00, DX-100 \$179.00, RX-1 \$199.00, Apache \$239.00; Johnson Adventurer \$39.00, Viking II \$179.00, Valiant \$279.00; National NC-173 \$99.00, NC-183 \$149.00, NC-300 \$229.00, HRO-60 \$349.00.

Many other items. List free.

Henry Radio Company, Butler, Mo.

#### "GUARANTEED USED EQUIPMENT"

B&W 5100B \$395.00; 5100 \$300; 5100 W/518B \$425.00; Collins 32V3 \$425.00; 32V2 \$350.00; 75A2 \$325.00; 75A4 \$650.00; Hallicrafters HT-31 \$199.95; HT-32 \$550.00; Johnson Viking I \$119.95; Viking II \$219.95; Pacemaker \$299.95; Courier \$179.95; National NC-300 \$289.95; HRO-60 \$425.00.

LIBERAL TRADES . . . . . TIME PAYMENTS  
"WRITE FOR LATEST USED EQUIPMENT LIST"  
Evans Radio, Inc. P.O. Box 312 Concord, N. H.

#### HAM SHACK NOVELTY

Authentic-looking, two-color gag certificate claiming tongue-in-check ownership of an acre on the Moon's surface. Ideal humorous gift or conversation piece for shack, bar, den or office. With gold seal and name and call inscribed only \$1.00 cash. Six for \$5.00. Send check or M.O. only to—

BOX DXG, 1738—201 St., Bayside 60, N. Y.

#### PERFECT GIFT FOR YL OR OM

CQ YL

The only book about the YLs. 18 chapters, 500 photographs, covers all phases of YL participation in Ham radio. Autographed copy \$3.00, postpaid. Order from:

LOUISA B. SANDO, W5RZJ  
212 Sombrio Dr. Santa Fe, N. Mex.



### BC-603 FM RECEIVER

20 TO 27.9 MC. Exc. Used..... **\$14.95**  
**BRAND NEW** ..... **\$16.95**



10 Channel, pushbutton tuning or continuous tuning. Complete with speaker, tubes, squelch.

12 or 24V Dynamotor for Above  
Exc. Used \$4.25..... Brand New \$5.50

**BC-604 TRANSMITTER** — Companion for BC-603 above.  
With all tubes. **BRAND NEW**.....\$10.95 Used.....\$4.95

### SPECIAL! BC-603 FM RCVR CONVERTED FOR ANY FREQUENCY FROM 30 TO 50 MC!

Checked out, perfect working condition, ready for operation. Specify Frequency desired (between 30-50 Mc) when ordering. **BRAND NEW**..... **\$27.50**

**AC POWER SUPPLY FOR BC603, 683**  
Interchangeable, replaces dynamotor. Has On-Off Switch. NO RECVR. CHANGE NEEDED. Provides 220 VDC @ 80 Ma. 24VAC @ 2 Amps.....\$10.49  
Complete 240-page Technical Manual for BC-603, 604.....\$3.15

### SCR-274 COMMAND EQUIPMENT

#### ALL COMPLETE WITH TUBES

Type	Description	Excel. Used	Like NEW
BC-453	Receiver 190-550 KC	\$12.95	\$14.95
BC-454	Receiver 3-6 Mc	9.45	12.45
BC-455	Receiver 6-9.1 Mc	9.95	12.50

110 Volt AC Power Supply Kit, for all 274-N and ARC-5 Receivers. Complete with metal case, instructions.....\$7.95  
Factory wired, tested, ready to operate.....\$11.50

**SPLINED TUNING KNOB** for 274-N and ARC-5 RECEIVERS. Fits BC-453, BC-454 and others. Only **49c**

**BC-457 TRANSMITTER**—4-5.3 Mc. complete with all tubes and crystal. Exc. Used \$5.95 **BRAND NEW**..... **\$7.85**

**BC-458 TRANSMITTER**—5.3 to 7 Mc. Complete with all tubes and crystal. Exc. Used \$6.95 **BRAND NEW**..... **\$9.75**

**BC-459 TRANSMITTER**, 7-9.1 Mc. Complete with all tubes and crystal. Like New \$12.50 **BRAND NEW**..... **\$13.95**

**BC-456 Modulator**..... USED 3.45 NEW 5.95  
**ALL ACCESSORIES AVAILABLE FOR ABOVE**

### BC-929 3-INCH SCOPE

Low cost station monitor and/or bench scope. Has Horiz., focus, sweep, intensity controls. Tubes: 7 tubes and 3BPI CR Tube. Req. 115V 400 cy. and 24VDC. Complete with tubes, exc. used..... **\$9.95**  
**BRAND NEW**.....\$12.95  
Conversion instructions for 110 V 60 cyc AC 65c



### EE-8 FIELD PHONES

Talk as far as 17 miles! Ideal for home, farm, field. Each phone complete with ringer. Exc. Cond. Our price, each phone..... **\$12.95**

### RADIOSONDE TRANSMITTER

Complete with tubes and antenna. New.....\$1.69

**HI-FI HEADPHONES**, dynamic, 40-14000 cps. Deluxe quality with soft earcushions, made by RCA, orig. value \$85.00 **\$7.95**  
our price, exc. used

**BC-652A RECEIVER**. Hot special! 2 to 6 Mc AM revr., 2-band, complete with all tubes, 200 Kc Xtal Calibrators and 12V Dynamotor. Wonderful for 80-meter Ham band. Provides for CW, MVC, AVC. Speaker Jack, two headphone jacks. **\$22.50**  
Shpg. wt. 50 lbs. Like New

### BC-659 TRANSMITTER & RECEIVER

27 to 38.9 Mc. F.M. Two preselected channels crystal controlled. 5 watts. Complete with speaker, tubes. Used..... **\$10.95**

Less tubes, exc. used.....\$5.95  
Antenna for BC-659. Telescoping 20" to 8 ft. ....\$2.95

**BC-620 FM TRANSCEIVER**—21-28 Mc. **\$9.95**  
With all tubes, like new

### MOBILE-MARINE DYNAMOTOR

Model DM35—Input 12V DC. Output: 625 V DC @ 225 Ma. for press-to-talk intermittent operation. Shpg. wt. 14 lbs. **\$8.45**  
**OUR LOW PRICE. BRAND NEW**

### BC-906 FREQ. METER — SPECIAL

Cavity type, 145 to 235 Mc. **BRAND NEW**, complete with antenna. Manual included. **OUR LOW PRICE**.....\$10.88

Please include 25% Deposit with order—Balance C.O.D., or Remittance in Full. 50c Handling Charges on all orders under \$5.00. All shipments F.O.B. Our Warehouse, N.Y.C. All Merchandise subject to Prior Sale and Price Change.

# G & G

## Radio Supply Co.

Telephone: CO 7-4605

53 Vesey St., New York 7, N. Y.

For further information, check number 39, on page 130.

about 4 amps on peaks.

Punch two 1½" holes in the back of the transmitter cabinet so that the transistors will protrude with ample clearance when the chassis is in place.

Now you are ready to reinstall the rig in the family jalopy and enjoy many hours of care-free operation with a minimum of drain on the battery.

To date all of our contacts indicate that the modulation is more effective than that which we had heretofore. This no doubt is due to restricting both the lower and higher audio frequencies and is accomplished through judicious choice of component value. ■

### SKELETON SLOT [from page 53]

terests of practical size the greatest use may be made of the Skeleton Slot between 6 meters and ¾ meters. The ten meter band is just possible and a Four over Four Skeleton Slot has been used by the writer on ten, but it is an astonishing edifice although may be the astonishing results justify it. G2HSN used a single Skeleton Slot on 20 once with wonderful results, but brother the size of it! Above the ¾ meter band parabolic reflectors and corner reflectors are a simpler proposition. We are left then with 6, 2 & ¾ meters for the real use of the Skeleton Slot and there it really comes into its own, measured gains of 20 db over a dipole are quite easy to obtain with two eight over eights stacked two wavelengths between centres and if a broader radiation pattern is required similar gain figures can be achieved with the "Billboard" type of array made up of four Skeleton Slots with reflectors only.

Matching the Skeleton Slot, as previously stated, is rather awkward if a standing wave ratio of less than 1.1:1 is required but the antenna has such broadband characteristics that a Skeleton Slot anywhere near the required frequency will always give less than 2:1 standing wave ratio and straightforward simple proportion from the dimensions given will produce results. ■

### KW POWER SUPPLY [from page 49]

The diagram shows the circuitry as well as the general requirements for these transformers. Without a toroid winder, it will take approximately 24 hours to wind a transformer. If the core cross-section is reduced to ½ square inch, twice as many turns will be required as shown. It is obvious that the larger cores are the simplest to handle.

### Switching and Power Requirements

In the case of the switches we recommend the use of several contacts in parallel, each of which can carry load currents. This is done for two reasons; first of all, it is possible to loose up to 50% of the available power in the switch, and



second, if the switch has bounce, there is a possibility of destroying the transistors, rectifiers, or both. This latter point has not been generally understood in the electronic industry for failures of certain silicon diode applications.

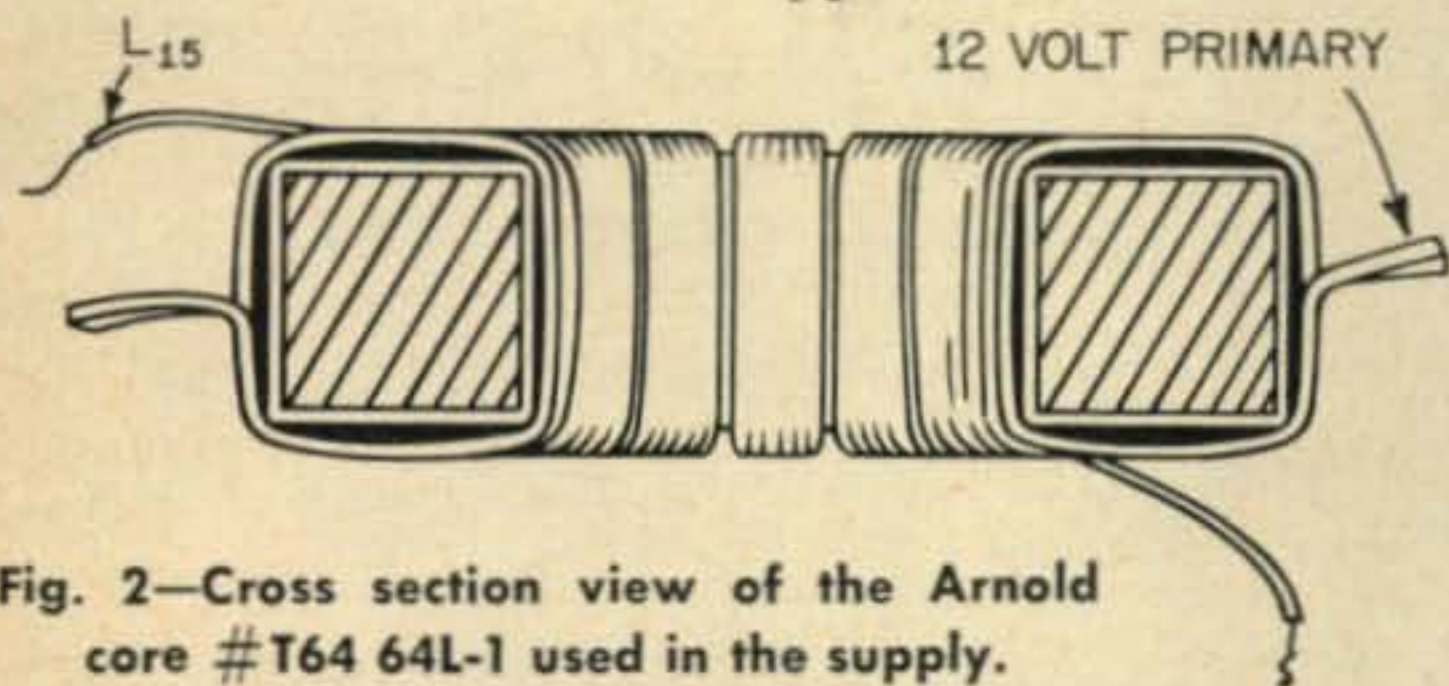
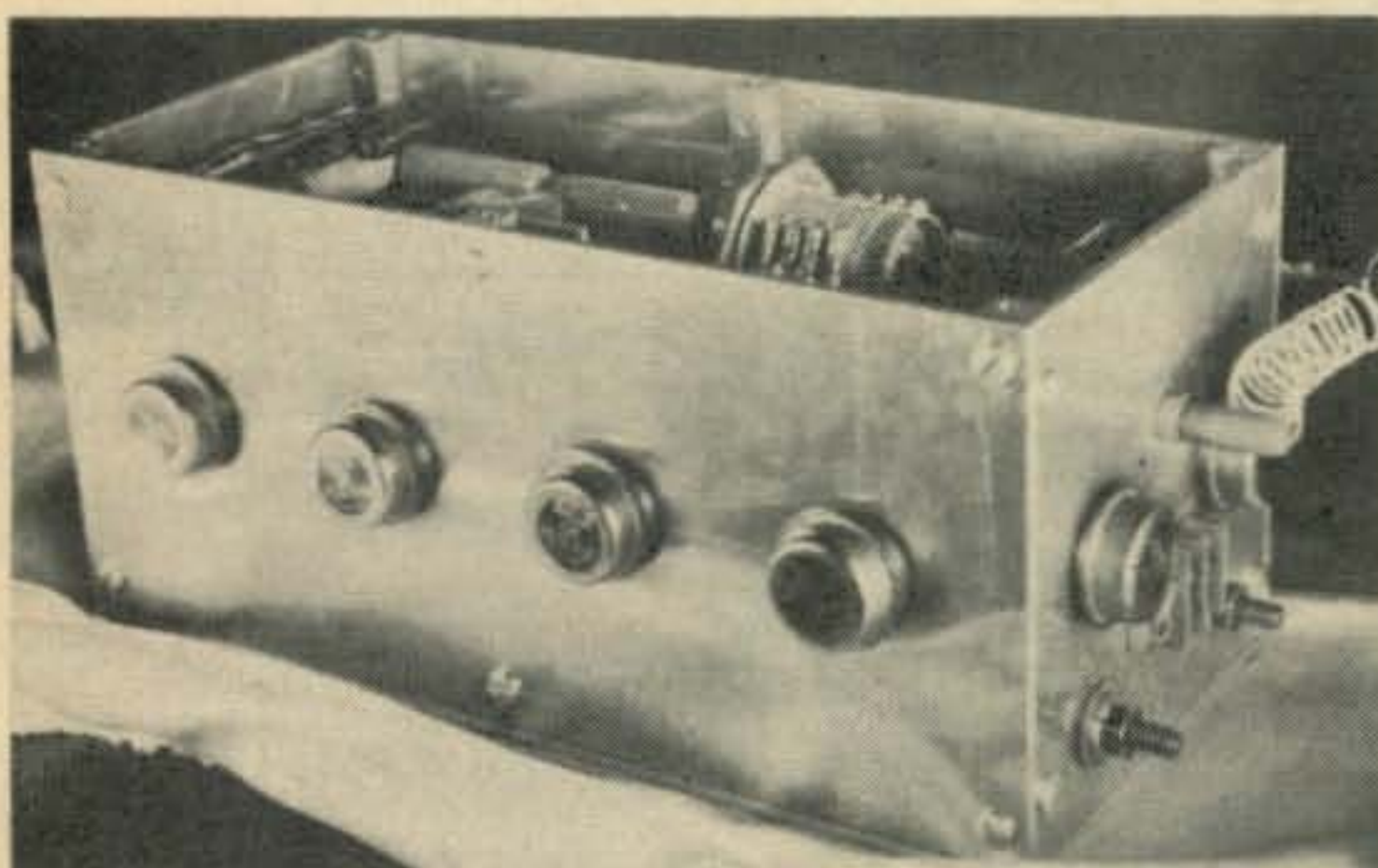

Fig. 2—Cross section view of the Arnold core #T64 64L-1 used in the supply.



Three quarter view of the transistorized power supply. The  $\frac{1}{4} \times 20$  studs are the battery connections. The two terminal Jones strip is to the input voltage of the vacuum switch and the coiled wire is plugged into the high voltage output jack.

For a 1 kw supply, the normal requirement is 12.5 volts *dc* at 100 amperes. In SSB applications the average power amounts to approximately 25% for the talk power. This drops the effective input current to approximately 25 amperes and the battery does not have to stand the excessive load continuously. We have been able to operate by using low current drain exciters and receivers to drive high power amplifiers, simply by adding an additional storage battery to the vehicle. The extra battery lowers the overall resistance of the system and supplies the necessary power required for peak output. ■

#### GRID DIPPER [from page 50]

tube upside down, to give short tuned circuit leads. The 1U4 has a suppressor grid which is internally connected to the filament, but this does not seem to make any difference, as it oscillates violently in its triode connection in the Hartley circuit.

The meter is one of the miniature 200 micro-ampere, 1 inch variety, which made an appearance in surplus recently. Meters of a similar size and type may be obtained from *Lafayette Radio*, New York City. The meter screws into the hole in the panel. It is shunted by a 500 ohm variable resistor, which controls meter deflection. On the

[Continued on page 128]

## GET BETTER RANGE

FROM YOUR CB TRANSCEIVERS  
WITH ANTENNAS

### M-52

Fiberglass mobile antenna with continuously loaded whip. 4' whip sealed in white plastic covering to prevent shorting. Patented rocker support fits in  $\frac{15}{16}$ " to  $1\frac{1}{4}$ " hole. Furnished with 5' of RG-58/U cable and PL-259 connector.

**\$9.95**

### M-49

Center loaded antenna provides excellent horizontal pattern and eliminates fading when changing direction. Not necessary to trim or clip whip to tune. Sealed loading coil. Low VSWR. Chrome plated tube and stainless whip, 60" extended, 43" collapsed. Patented rocker support fits in  $\frac{15}{16}$ " to  $1\frac{1}{4}$ " hole. Furnished with 5' of RG-58/U cable with coax fittings on both ends.

**\$9.96**

Just two of over 200 popular Antenna Specialists models available at your local distributor.



the  
antenna specialists co.

12439 Euclid Ave. • Cleveland 6, Ohio  
Sweetbriar 1-7878

For further information, check number 40, on page 130.

## BACK ISSUES FOR SALE \$1.00 per copy

- 1950—Jan., July, Oct., Nov.
- 1951—All issues, except Nov.
- 1952—All issues, except Aug.
- 1953—All issues, except May, July, Dec.
- 1954—All issues, except Feb.
- 1955—All issues, except Nov.
- 1956—All issues, except April, July
- 1957—All issues, except Feb. and Nov.
- 1958—All issues, except July, Sept., Oct.
- 1959—All issues except Jan.
- 1960—All Issues, except May of the  
Current Year, 50¢ Per Copy.

BC-603 Conversion article (Sept. & Oct., 1958 CQ)  
Reprints available at 50¢ per set.

**CQ Magazine**  
300 West 43rd St., New York 36, N. Y.



# AUGUST FEATURES

- Factory Authorized Distributor for: Adjust-A-Volt, B & W, Central Electronics, Drake, Glas-Line, Hammarlund, E. F. Johnson, National Co., T. M. C. Vibroplex, Sonotone. Tubes: National Electronics, Westinghouse.
- Prop-Pitch Motor. Rotates the heaviest Ham or Comm'l Rotary Beam. Weight 80 lbs. via economical motor freight. Unconverted \$35.00. Converted ..... \$44.00. FOB, Georgia
- Mobile Transmitter. Uses 5618 crystal oscillator into CBS 5516 amplifier. Modern design. Only 7 lbs. net wt. including built-in 6 Volt vibrator pwr supply. Enc. in aluminum cabinet. Furnished w/crystal that doubles near 10 meter band. Requires slight & easy modification for 10 meter operation. A real beauty. New with tubes..... \$13.95
- Jaeger Clock Movements  $\pm$ HA0553B. Operates on 1.5 VDC. All you need are hands and dial plate. \$1.00 each (10/\$8.00)
- Type 83-1R Coax Receptacle. ....30c each (100/\$2.00)
- Xmtg Socket, 5 Prong. Mycalex for tube types 4-125A, 4-250, 4-400, 803, etc. ....90c
- New! 701-A Tube Socket ( $\frac{3}{4}$  lb.).....\$2.50
- B & W Model 400 Distortion Meter. Very good condition .....\$125.00
- The Whole Wide World . . . or USA in third dimension. Beautiful, colored plastic relief maps. Self-framed. Ideal for Den or Shack. Conversation piece. Educational. 28 $\frac{1}{2}$ " x 18 $\frac{1}{2}$ " only 9.95 42" x 60" (Brochure available). \$49.95
- Plate Transformer. Pri.: 117 V. @ 60 CPS. Sec.: 2700-0-2700 Volts @ 400 Ma. Open frame construction. 36 lbs. net weight. Order Stock No. TP-5001 (2738)..... \$30.00
- Modulation Transformer. 850 Watts Audio (2 K.W.R.F.) Pri: 10 K Ohms. Sec.: 3750 and 7500 Ohms. Orig. wood box. .... \$44.50
- Plate Transformer. Pri: 117 V. 50/60 CPS. Sec: 1250-0-1250 @ 25c Ma. (C.T. grounded). Fil.  $\pm$ 1: 2 $\frac{1}{2}$  V. @ 10 A. Fil.  $\pm$ 2: 6.3 V. @ 8 A. Weight: 20 lbs. Stock  $\pm$ T-1006. \$9.00 Same as above but Dual primary 117 V. or 234 V. 50/60 CPS. Order Stock  $\pm$ T-1007.....\$10.50
- VHF Transmitter type BC-640-B. 100 to 156 Mcs. Completely enclosed in 6 foot relay racks. Operates from standard 115 or 230 VAC. Final uses pair of 3C24/24G. Unused orig. crate w/book. Write for details!
- Pilot-Lite Ass'y. White removable  $\frac{3}{4}$ " Diam. Jewel. Bayonet type lite. (lite not furnished). Stock  $\pm$ 14-114. ....35c
- Transformer Special. Pri: 115 V 60 CPS. Sec: 800 VCT @ 250 Ma. 6.5 VCT @ 7.5 Amps. 5.1 VCT @ 4.0 Amps. Herm. sld. 16 lbs. ....\$4.50
- Choke. 10 Hy. @ 500 Ma.—Herm. sld.—100 Ohms DC res. 6 $\frac{1}{2}$ " x 6 $\frac{1}{4}$ " x 5 $\frac{1}{4}$ ". 25 lbs. ....\$4.50

TREMENDOUS TUBE INVENTORY. FIRST-QUALITY—SENSIBLE PRICES. SAVE 50% and more on your tube purchasing. Make your electronic tube dollar go twice as far. Send for Free Tube Catalog.

## BARRY ELECTRONICS CORPORATION

512 BROADWAY, NEW YORK 12, NEW YORK  
(NEAR SPRING ST.), DEPT. C-8  
Telephone: WALKER 5-7000

# The Ham Shop

RATES: 25¢ per word per insertion for commercial business organizations.  
10¢ per word per insertion for individuals on a non-commercial basis. Full payment must accompany order.

**MINIMUM CHARGE \$1.00**

CLOSING DATE: 20th of the 2nd month preceding date of issue.

MAIL: Your typewritten copy with full remittance should be sent to CQ Magazine, 300 West 43rd Street, New York 36, N. Y.  
Attention: Classified Ad Dept.

NOTE: The products and services advertised in this section are not guaranteed by the publisher of CQ. Telephone orders not accepted.

## FOR SALE

deedeeN neM laeR: Due to over 3 years of preparation, a staff of about 25 people is now being organized to delve into all phases of Radio Astronomy, Propagation and Moon Bounce. The experiments are to be conducted in a chosen isolated area, and supported by the staff members. If you are a single male, and feel like expressing yourself, then do not hesitate to mail your qualifications to Radiometric Research, 4711 E. 56 St., Maywood, California.

ONE THIN DIME brings 50 page eye-popping war surplus electronics catalog. Fabulous bargains. Meshna, Malden 48, Mass.

RADIO & TV TUBES at Manufacturer's prices! 100% Guaranteed! Brand New! No re-brands or pulls! United Radio, Box 1000-a, Newark, N. J.

GREAT SURPLUS VALUES!! BC-603 Receiver New \$17.00—R-26/ARC5 Rec 3-6 mc New \$12.95, used exc \$7.95—R-27/ARC5 Rec 6-9 mc New \$12.95, used exc \$7.95—BC-659 Transceiver with PE-120 \$19.95—T-47/ART-13 Transmitters \$39.00—BC603 AC-Supply \$9.95—Synchrosopes Model TS-34/AP \$49.00—Sound-Powered Dynamic Phones Pr. \$4.75—Rec. Microwave R-111/APR-5 \$39.00—Collins CF1 82-Q for Q-5'er compl. w/tubes & instructions \$5.95—Collins Mod. Xformer 100 watt 811-PP to 813 final \$3.95—RA-62-C Power Supply AC for SCR-522 VHF 110/60 eye. New \$59.50—Kits only for above \$17.00—Ground-plane VHF antennas 30-200 MC New \$9.95—Hi-Mu Electronics. 137 Hamilton St., New Haven, Conn. Store hours 10-5. Sat. 9-12.

CHICAGOLAND AMATEURS! Factory Authorized service for Hallicrafters, Hammarlund, Globe, Service all Amateur equipment to factory standards. Heights Electronics, Inc., 1145 Halsted St., Chicago Heights, Ill. Skyline 5-4056.

EIMAC 4X150A tubes, NEW, fully guaranteed, interchangeable with 7034 and 4X250B. Large stock, \$4.00 each 2/7.00. H & C Sales, 1705 Lafayette, Mattoon, Illinois.

RECEIVER BUILDERS SPECIAL! Kit of four IF Transformer Assemblies, CW Oscillator Assembly, and Crystal Filter Assembly with crystal, for famous BC-348R receiver \$10.00. Postpaid in USA. No COD. Electroncraft, Box 399, Mt. Kisco, N. Y.

TOROIDS: Uncased 88 mhy like new. Dollar each. Five \$4.00 PP. DePaul, 101 Starview, San Francisco.

COLLINS 51J-2 \$495. 51J-3 \$675. Both reconditioned. PMO Oscillator \$245. 75A-1 \$259., 75A-2 \$295., 32V-3 \$325., HRO-7R \$95., HQ-145X \$155., HQ-110 \$149. Valiant \$319., Ranger \$198. Gonset III 2m \$209. Panadapter \$89., R-390A/URR, R-274 \$245. NC-183D \$199. Tom W1AFN, Alltronics-Howard Co. Box 19, Boston 1, Mass. (Richmond 2-0048)

PRESERVE YOUR HAM TICKET, Social Security Card, small photo, passes and anything else of value that is wallet-size. We will laminate it in clear plastic, guaranteed for life. Lamination will prevent it from getting torn, soiled or frayed. Send your ticket or anything of value with \$1 in stamps or cash for each item that you want preserved. 24-hour service. Send to C. Lee Co., P.O. Box 395, Times Square Station, New York 36, N. Y.



**ANTENNA TROUBLES?** Watch Laurel & Hardy erect a roof antenna amid hilarious antics Kraus and Yagi never dreamed of. Low front to back ratio, but loads of laffs for all ages... especially the Jr. Ops. 200 ft, 8mm film, \$5.50 postpaid; send check or M. O. (no cash or COD) to JAGFILMS, 1737-201 St., Bayside 60, N. Y.

**CALL LETTERS** may be applied to any surface. 2" sets 60¢, 3" set 80¢. Send to C. Lee Co., P. O. Box 395, Times Square Station, New York 36, N. Y.

**SELL:** Motorola FMT30D12 Volt Mobile Transmitters 30-44 MC \$12.50 each. Villers, Box One, Steubenville, Ohio.

**For Sale:** TV Cameras, Teletype, Panadaptors, Transmitting Tubes, Transistors, single side band gear. Write for list. Spera Electronic, 37-10 33 Street, L.I.C., N. Y. Stillwell 6-2199.

**BARGAINS:** Returning to College: DX100 (prof. wired and push to talk) \$145; SX71 with speaker only \$105; Astatic T-3 mike with G stand \$20; Write K2PDG, 41D Oakwood Manor, Woodbury, N. J.

**SELL** complete station all in excellent condition. 75A4 with speaker, Phasemaster 2B, D-104 Mike, Johnson Match Box, RME Clipper, DB23A, B & W 650 Matchmaster, B & W 380B T/R Switch, Bud FCC 90 Crystal Calibrator, B & W 550 Switch, Sonar Phone Patch, Mosely TA33 Beam, plus Coax Cable, Tubes, etc. Best offer over \$750 takes all. Al Spiewak K2CKZ, 1150 Broadway, New York 1, New York.

**RECONDITIONED! TERMS! FULL GUARANTEE!** Collins 75A-1 \$245.00; Elmac PMR-6 (6V) \$69.00; Hallicrafters S-40A \$64.50; Hallicrafters SX-71 \$135.00; Hammarlund HQ-100 \$125.00; Harvey Wells R-9 \$85.00; National HRO-60T w/coils \$345.00; National NC-98 \$95.00; National NC-183D \$234.50; National NC-300 \$209.00; TMC GPR-90 \$355.00; B&W 51-SB \$159.00; B&W 51-SB-B \$149.00; CE 600L \$299.00; Collins KWS-1 \$999.00; Collins 32V-3 \$399.00; Eldico SSB-100F \$495.00; Scout 65-B \$65.00; Globe DSB-100 \$74.50; Globe Champ 300-A \$349.00; Gonset 6M Comm. III \$199.00; Hallicrafters HT-32 \$435.00; Hallicrafters HT-33 \$390.00; Heath SB-10 \$75.00; Johnson Pacemaker \$295.00; Viking KW \$895.00. Leo, WØGFQ, Box 919, Council Bluffs, Iowa—World Radio Laboratories.

Hallicrafters S-40B recvr. very good condition, best offer takes it. Fred Zon-Frilli, 736 Fairmont Ave., Chatham, N. J.

New "Apache," SB-10, \$295. Gonset "Commander," VFO, Gen-E-Motor, \$75. Morrow 3BR-5, \$23. Radiart "Vipower" #6/12DC6, \$25. QF-1, \$4.50. K7DAI, 219 South Hillcrest, Yakima, Washington.

Selling out, KWM2, AC Power Supply, Mike, \$935.00, Mosley TA 33 Beam, CDR Ham M Rotator, 200 feet RG8U, 200 feet Rotator Cable \$140.00—Sam J. Rhoades, Jr., W5RVX, 4616 South Columbia, Tulsa, Oklahoma, Phone Riverside 2-7772.

Central Electronics 20A, BC458 VFO, QT-I, and manual. Recently re-aligned \$200. W3WUW, 638 Wyoming Ave., Wyoming, Penna.

**SELL:** National 300 Receiver, used only 6 hours. Like New mint condition \$210, Prefer local buyer, but will ship. Peter Feely, W2BAO, 1035 Old Post Road, Mamaroneck, N. Y.

**SELL:** Complete Station now in use. Johnson Ranger, HQ170 Revr. Cubical Quad. Many Extras. K2PDD, N.Y.C. FI 7-8673.

**EXTENSIVE COLLECTION:** gear, components, RTTY, books and back issue magazines (singles and sets). Send stamped self-addressed envelope for list. W4NYF, 405 NW 30 Terr., Ft. Lauderdale, Fla.

**FOR SALE:** Tickets to The One and Only—Syracuse VHF Roundup, October 8, 1960. Write K2TXG, 317 Clover Ridge Dr., Syracuse 6, N. Y.

Columbus, Ohio area, receivers, transmitters repaired. W8VWX, AM 2-2550.

200 back issues CQ, QST. 1930-1960. \$20.00. Shipping Collect. WØDVN, Box 5938, K.C. 11, Missouri.

**FOR SALE:** Viking Valiant, Reluctant to part with. Best offer over \$250. Joe Fuhr, W3FHZ, 33 Hilltop Rd., Levittown, Pa.

**COLLINS KWS-1** Transmitter \$1200.00, **COLLINS 75A-4** Receiver with speaker \$575.00, **TELREX** Heavy duty rotator with controls \$125.00, **TELREX** Medium duty rotator with control \$80.00. R. E. Macomber W3CZE, P. O. Box #68, North Beach, MD.

- **Swinging Choke.** 2.3 to 5.5 Hys. @ 850/100 Ma. 15 Ohms DC resistance. 6 KV insulation. 40 lbs. .... \$7.50
- **Choke.** 3.2 Hy. @ 550 Ma. 21.2 Ohms DC resistance. 14 lbs. Packed two to a case—wt. 28 lbs. .... \$3.00
- **CG-442 UTC Jobber-Boxed Power & Bias Xfmr.** Pri: 115 VACT @ 50/60 CPS. Sec: 435/365-0-365/435 @ 125 Ma. 125-0-125 @ 25 Ma. Filaments: 5 V. @ 3 A., 5 V. @ 2 A., 6.3 VCT @ 3 A., 2.5 VCT @ 5 A. With instruction sheet. Herm. sld. 11½ lbs. (Reg. \$21.00 Net). .... \$4.50
- **Altec Lansing Hi-Fi Output Xfmr.** Herm. sld. Pri: 3300 Ohms C. T. Sec: 500 Ohms Tapped @ 250 Ohms. 5" x 4¼" x 4¼". 13 lbs. (\$20.00 value). .... \$2.50

**IN STOCK. WRITE FOR BEST DEAL ON FOLLOWING.**

- **CENTRAL ELECTRONICS**—Model 100 V—SSB Xmr.
- **DRAKE**—Model 1A and Model 2A—SSB Receivers.
- **HAMMARLUND**—HQ-145-C, HQ-180-C, SP600-JX.
- **JOHNSON CHALLENGER (KIT), COURIER (WIRED), AUDIO AMPLIFIER CAT. #250-33.**

- **NATIONAL CO.** NC-60 Receiver..... \$49.95
- **MEASUREMENTS MODEL 80** Sig. Gen. (2 to 400 Mcs)..... \$350.00
- **GONSET G-50** 6 Meter Communicator..... \$299.00
- **B&W Model 850-A** Turret ..... \$35.00
- **B&W Model 600** Grid Dip Oscillator..... \$45.72
- **B&W Model 650** Matchmaster..... \$47.50
- **B&W Model 800** RF Plate Choke. .... \$ 3.75
- **B&W Model TT-120W** Toroid Xfmr..... \$15.25
- **Citizens Band Model TR800** Transceiver..... \$65.00
- **Ward 10** Meter & Citizens Band Whip W/Base & Spring. .... \$12.00
- **Ling Model 2050** (420 to 450 Mcs) TV Xmr. .... \$1,495.00
- **Hewlett Packard 623B** Test Set..... \$1,100.00
- **Hewlett Packard 405AR** Automatic D.C. Digital Voltmeter. .... \$750.00
- **Sylvania Model 402** Synchroscope. .... \$299.50
- **Dumont 303/303A** Scope..... \$399.00

**KEEP AHEAD OF THE CROWD ON VALUES.**

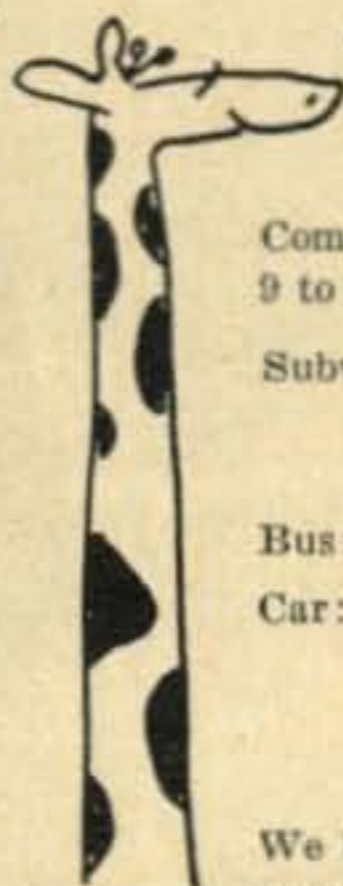

**WRITE FOR CATALOG ON TUBES AND EQUIPMENT . . . FREE.**

Come in and browse. We are open Mon. to Fri. 9 to 6. Sat.: 10 to 2 P.M.

Subways: **BMT:** (Broadway local) to Prince St. Station—walk 1 block to Spring St.  
**IRT:** Lexington (local) to Spring St.

Bus: Broadway #6 Bus to Spring St.

Car: We are 4 blocks North (uptown of Canal St.) Parking allowed on Broadway Sat., Mon. thru Fri. parking at 501 & 557 B'way.

Minimum Order \$5.00.

We buy surplus inventories. Send us list of good commercial equipment and unused tubes.

**BARRY ELECTRONICS CORPORATION**

**512 BROADWAY, NEW YORK 12, NEW YORK**

(NEAR SPRING ST.), DEPT. C-8

**Telephone: WALKER 5-7000**

For further information, check number 41, on page 130.



## TWO-WAY COMMUNICATION CRYSTALS



**UNCONDITIONALLY  
GUARANTEED**

**FAST — 24 HOUR SERVICE**

American specializes in two-way communications. Frequency correlation data for G.E., Motorola, R.C.A., Collins, Lear, Narco, Hallierafter, Link, Gonset, Aerotron, Heath, Bendix, Johnson, Globe, U.S. Gov't, and many other companies.

FREQUENCY RANGE	CALIBRATION TOLERANCE	PRICE
2501 KC to 9999 KC	.002%	\$3.00
15 MC to 32 MC	.0025%	\$3.00
32 MC to 50 MC	.0025%	\$4.00
10 MC to 17 MC	.002%	\$4.00
2001 KC to 2500 KC	.002%	\$4.00
50 MC to 60 MC	.0025%	\$6.00
1000 KC to 2000 KC	.002%	\$7.50

Write for quantity discounts—

**AMERICAN CRYSTAL CO.**

P. O. Box 2366

Kansas City 42, Mo.

### BLITZ-BUG COAXIAL CABLE

Lightning Arrester  
Model # LAC-1  
Pat. No. 2,922,913

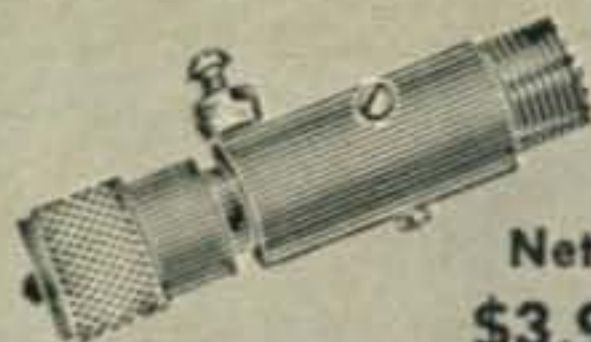

Net  
**\$3.95**

**CUSHCRAFT**

621 HAYWARD ST.  
MANCHESTER, N. H.

## Now! AVAILABLE

The Most Complete Catalog on

AMATEUR  
COMMUNICATION  
SYSTEMS

*Ever  
Printed!*

With important  
reference and  
technical  
information.



Send for Yours Today

**hy-gain** antenna products

1135 NO. 22nd ST.  
LINCOLN, NEBRASKA

Please send FREE Catalog to:

NAME: \_\_\_\_\_

ADDRESS: \_\_\_\_\_

CITY & STATE: \_\_\_\_\_

For further information, check number 42, on page 130.

126 • CQ • August, 1960

## FOR SALE (Cont'd.)

Latest out: Directory listing over 350 Award Certificates; includes quarterly Revision Service. Write Clif Evans, K6BX.

Technical book bargains, all in excellent condition. "Short-wave Wireless Communication" by Ladner & Stoner, 5th Ed. \$4.75. "VHF Techniques" by Radio Res. Lab. 2 Vol. \$8.50. "Higher Math. for Eng. & Phys." by Sokolnikoff, \$4. "Engineering Math." by Sohon, \$3.25. "Handbook of Industrial Electronics Ckts" by Markus & Zeluff, \$4.75. "Airglow and the Aurora," Pergamon Press, \$10. "Solar Eclipses and the Ionosphere," Pergamon Press, \$10. "Advanced Mech. of Materials" by Seely, \$3. "Inorganic Qual. Anal." by Fales & Kenny, \$2. All for \$40 postpaid. George Jacobs, W3ASK, 11307 Clara Street, Silver Spring, Md.

Collins 32V3. One of the cleanest and best working units in existence. Kept in factory fresh condition. A real buy at \$450. Will ship. Have gone S.S.B. W2PVK, 416 Barry Rd., Rochester, N. Y.

Portable typewriter, \$15; Professional belt-driven turntable, synchronous motor, with B-J arm, \$20. "Ted" Hein, 418 Gregory, Rockford, Illinois.

FOR SALE: Carter dynamotors 6V in 500V/200MA \$12.50, 12V in 600V/300MA \$19.50. Mobile Xmtr beautifully built Fisher Research 80, 40 & 20, 4 channel & VFO 807 Mod, 616's complete w/carter dyn pack 6V \$95.00, 12V \$135.00. W5BUL, 17 Boca Chica Blvd., Brownsville, Texas

HAMS Profit Through Investment Knowledge, your copyright pocket guide to security for your family now available from author post paid \$1.00. Send order to James H. Stover, 1209 Linda Vista Rd., Madison, Wisconsin.

"The VHF Amateur"—At last a magazine for VHF'ers! Don't miss a single issue! Send \$2.00 for year or \$1.00 for six big issues... 67 Russell, Rahway, N. J.

Something new and useful for \$1. Flexible holster for soldering gun; fits all types; facilitates work bench storage; easily mounted and no more burned fingers or tabletops. Postpaid, money back guarantee. George Jacobs, W3ASK, 11307 Clara Street, Silver Spring, Md.

LISTEN TO the Radiotrician Digest; Southern Calif. every Friday 7 PM, 860 kc.

## WANTED

WANTED: Teletype printers, perforators, reperforators, transmitter-distributors, test equipment: Model #14, #15, #19, #26, #28, GRC, TT, TGC, GGC, etc. All types Collins receivers, 51J, R-388, R-390, 75A, etc. Cash, or trade for NEW amateur equipment. Write Tom, W1AFN, Alltronics-Howard Co., Box 19, Boston 1, Mass. (Richmond 2-0048).

WANTED: TELETYPE TG-7 and Model 15 and parts, printers and reperforators, etc.; COMM'NS and REC'V'RS AND XMTRS, e.g. BC-610-E, -I, BC-399A, Collins 51J, 17L3, -4; R-388 and R-390/URR; 18S-2, -3; ARN-14 and -30; APR-9, -10, ARC-21, 27, etc.; APS-31, -33, and TEST EQP'T, with TS- or 1-prefix. We pay freight. AMBER INDUSTRIAL CORP., 75 Varick St., N. Y. 13, N. Y.

WANTED: Military and Commercial laboratory test and measuring equipment. Electronicraft, Box 399, Mount Kisco, N. Y.

ANY TUBES commercial test equipment, broadcasting equipment, any quantity. Diamond, 749 W. End Avenue, New York City.

WANTED: 300 Ft. RG17A/U or RG14A/U Low Loss 52 OHM Coax. 1.2-1.5 KW Modulation XFMR. K3CJY, 1208 Linden, Cheswick, Pa.

Need several burned out, shorted or damaged variacs. W8QKU, 2748 Meade St., Detroit 12, Mich.

WILL BUY: Tubes, Diodes, Transistors, Military or Commercial Lab-Grade Test Equipment, Components. All types. Top prices paid. Write us detailed description c/o Bob Sanett, W6REX, V & H RADIO & ELECTRONICS, 2053 Venice Blvd., Los Angeles 6, Calif.

Wanted to buy 1955 Ford auto radio. Will pay cash or trade radio tubes and parts. George Jacobs, W3ASK, 11307 Clara Street, Silver Spring, Md.

## QSL

QSL's: Samples, dime. Print Shop, Corwith, Iowa.



QSL's-SWL's: That are different colored, embossed card stock, and "Kromekote." Samples 10¢. K8AIA, Box 953, Hamilton, Ohio.

QSL's-10 useable samples 10¢. Back issues CQ, QST, 75¢. Co-op, Box 5938 Kansas City 11, Missouri.

QSL's. Samples 15¢. Sims, 3227 Missouri Ave., St. Louis 18, Mo.

GLOSSY 3-color QSL cards 100-\$4.50. Free sampler. Rutgers Vari-Typing Service, 7 Fairfield Road, New Brunswick, N. J.

QSL's-SWL's: 100 2-color glossy \$3.00; 100 QSO file cards \$1.00; Sample 10¢. Rusprint, Box 7507, Kansas City 16, Missouri.

QSL's, SWL's, XYL-OM's. (Sample assortment approximately 9 3/4¢). Covering designing, planning, printing, arranging, mailing, eye-catching, comic, sedate, fantabulous, DX-attracting, prototypal, snazzy, unparagoned cards, (Wow!) Rogers KØAAB, 737 Lincoln Avenue, St. Paul 5, Minnesota.

QSL Printing Co., Box 12351, Houston 17, Texas.

QSL'S. Samples Free. Phillips, W7HRG, 1708 Bridge Street, The Dalles, Oregon.

QSL's-SWL's, samples 10¢. Malgo Press, 1937 Glendale Avenue, Toledo 14, Ohio.

QSLs four colors glossy stock forty design send \$5 for 200 and get surprise of your life. 48 hour service satisfaction guaranteed. Constantine Press, Bladensburg, Md.

QSL's-"Brownie" W3CJI, 3110 Lehigh, Allentown, Pa. Samples, 10¢, with catalogue, 25¢.

Picture QSL Cards of your shack, rig, home; made from your photograph. 1000 \$12.00. Raum's 4154 Fifth Street, Philadelphia 40.

QSLs, SWLs: Glossy 2-color \$2.00 per 100. Free sample. "Hal" K8KXS, 3571 Kirchling Rd., Hamilton, Ohio.

QSL's?? SWL's?? Largest variety samples 25¢ (refundable). CALLBOOKS (latest) \$5.00. Religious QSL samples 10¢. Sackers, W8DED, Holland, Michigan.

C. FRITZ quality QSL's, new location, P.O. Box 1684, Scottsdale, Arizona. Samples 25¢ deductible. Get our card-of-the-month deal, a 30 day special from Arizona.

QSL's, SWL's \$1.75 per 100 and up. Nicholas & Son Printery, Post Office Box 11184, Phoenix, Arizona.

BEAUTIFUL QSL's . . . Dime . . . Filmcrafters. Martins Ferry, Ohio.

### MISCELLANEOUS

THE ANNUAL PEORIA HAMFEST will be held at Exposition Gardens Youth Building, Sept. 18, 1960. Advance registration \$1.00. At the gate \$1.50. Contact Larry Pearsall, W9FDY, 2224 Herold, Peoria, Illinois.

Hamfesters Radio Club announces its 26th Annual Picnic on Sunday, August 14, 1960, at Santa Fe Park, near Chicago. See July Announcements column or write K9EEC.

### GRID DIPPER [from page 123]

lower frequency bands the grid current tends to be higher than on the higher frequency bands.

The dial is a piece of white cardboard cemented to the box with the frequency calibrations drawn in by hand in india ink. The dipper is calibrated against the station receiver. After calibration, the dial may be sprayed with clear lacquer to protect it. The box is painted flat black.

The batteries are taped together, and are held snugly in place when the box is assembled. When not in use, the dipper stands on its end as seen in the photographs. A wooden block with holes

## THE NEW P & H LA-400-C 800 WATTS PEP SSB LINEAR AMPLIFIER



**NOW 800 WATTS PEP  
FOR ONLY \$164.95  
THE "BEST BUY" YET**

NEW modern styling! NEW high efficiency 3 element band-switching pi net. Puts more power into any antenna or load from 50-70 ohms. For SSB, DSB, Linear AM, PM, CW and FSK. All bands 80-10 meters. May be driven to 800 WATTS PEP SSB with popular 100 watt SSB exciters. Uses four modified 1625's in grounded grid. On customers order, will be furnished with 837's. (note: 1625's and 837's are not directly interchangeable, since sockets are different.) Typical P&H Low Z untuned input. TVI suppressed. Parasitic Free. Meter reads grid drive, plate current, RF amps output. Heavy duty power supply using 816's. NEW modernistic grey cabinet measures approx. 9" x 15" x 10 1/2". Panel is recessed. WANT TO SAVE MONEY? BUY IT IN KIT FORM. It's a breeze to assemble and wire. BEFORE YOU BUY — SEE THE NEW LA-400-C AT YOUR DEALERS.

LA-400-C Kit complete with tubes.....\$164.95  
LA-400-C Wired and Tested.....\$219.95

**P & H ELECTRONICS INC.**  
424 Columbia Lafayette, Ind

For further information, check number 43, on page 130.

**"SURE HOPE THE CHAIN HOLDS"**

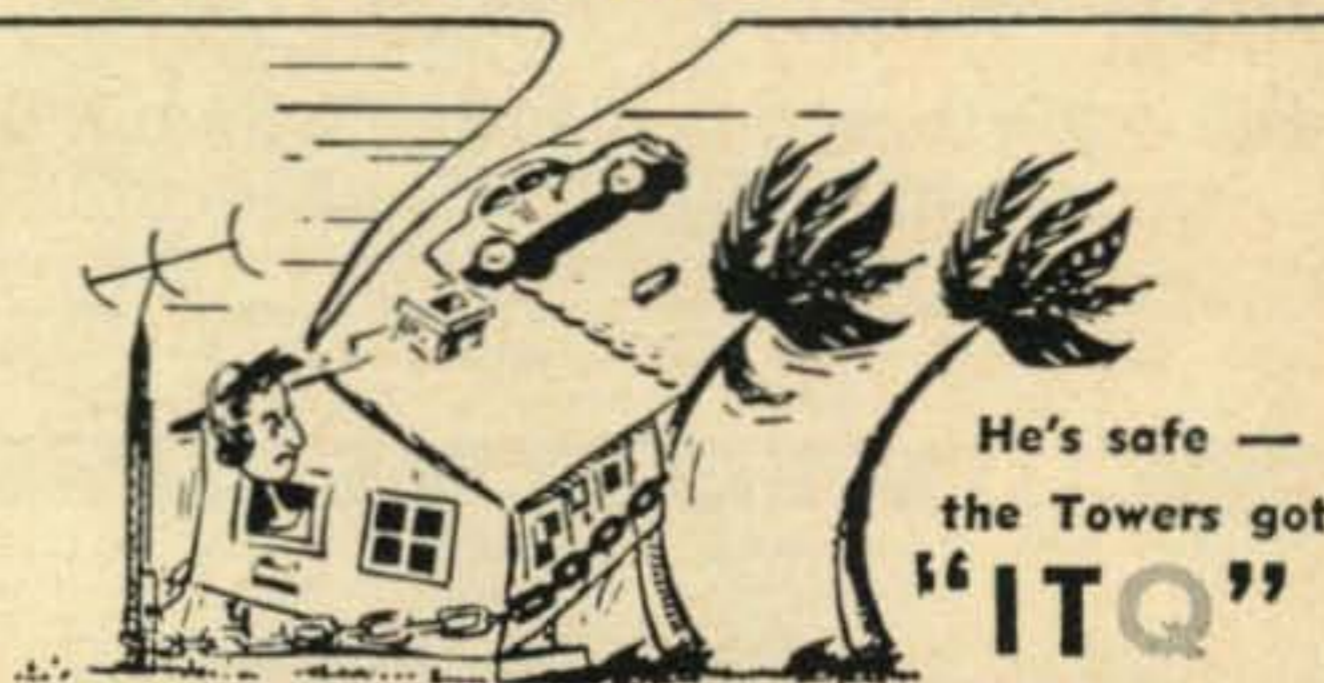

**E-Z WAY TOWERS, INC.**  
P. O. BOX 5491 - TAMPA, FLA.



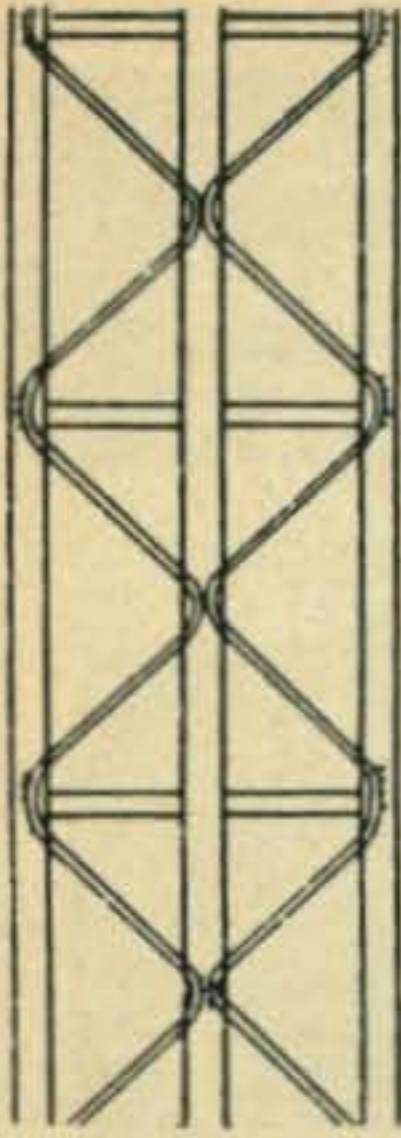

**IF YOUR TOWER AIN'T GOT  
DIAGONAL BRACING**

*It Ain't Got*

**\* ITQ**

INERT TORSIONAL QUALITY

"Diagonal bracing resists twisting caused by constant starting and stopping of large rotary beams. Also twisting of tower caused by gusty winds . . . All E-Z Way Towers got "IT Q".

Write for free literature!  
**E-Z Way Towers**  
P. O. Box 5491 Tampa, Florida

drilled in the top in appropriate locations holds the plug-in coils neatly, in readiness for use. With a flick of the switch the dipper is in operation, ready to give you an assistant indication of the resonant frequency of that tank circuit, parasitic loop, or antenna element. ■

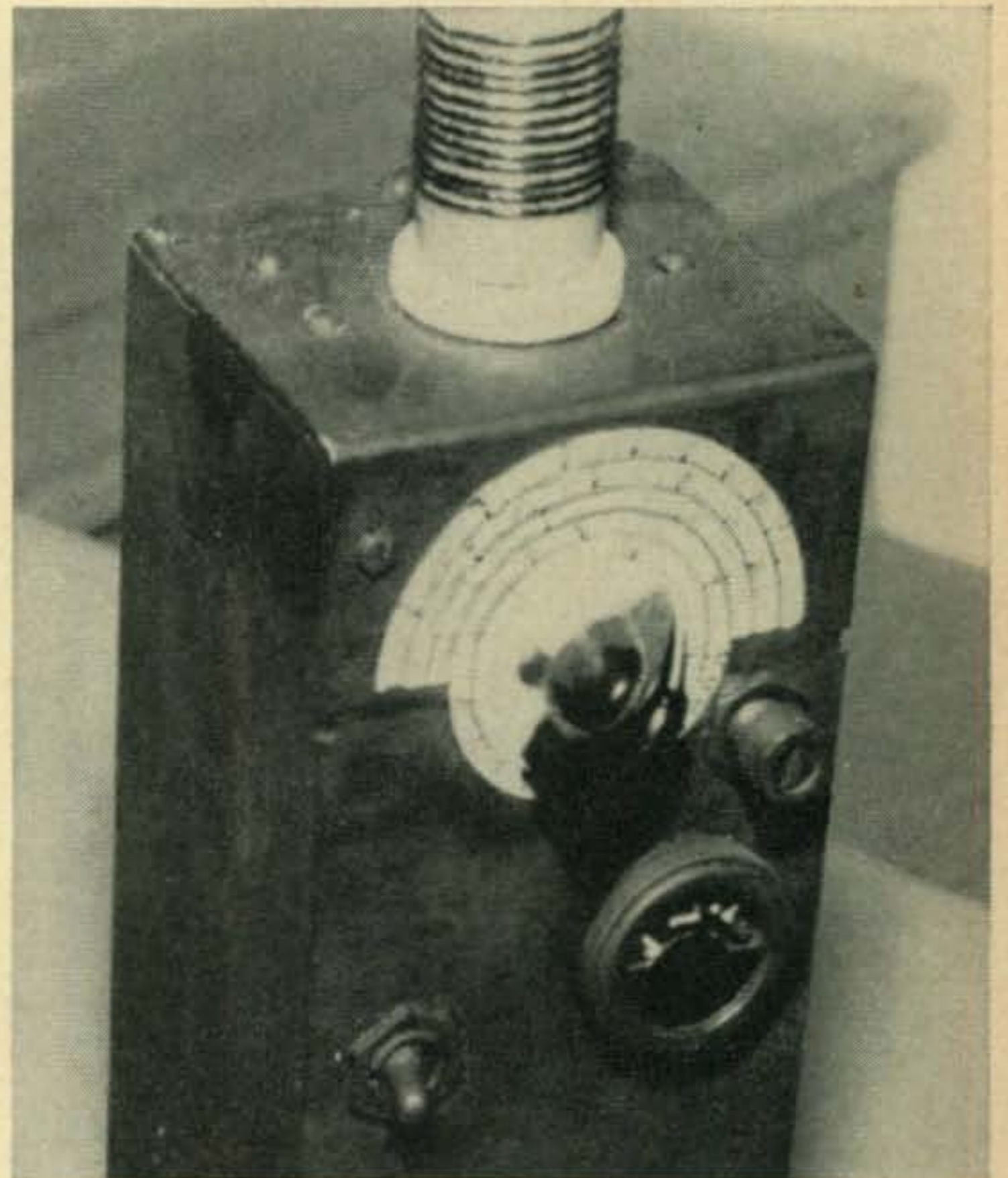

Details of the front panel showing control layout. The small knob above the meter is  $R_2$  meter adjust.

**VIBRO-KEYER**



**Only \$15.95**

The Vibroplex Company has a boon for those amateurs that need the mechanical end of an electronic keyer. The

Vibro-Keyer is constructed in line with the high-quality workmanship for which Vibroplex has long been famous. The unit has large, non-corroding contacts, heavy beige colored base, colorful red finger and thumb pieces, and smooth, easy operating trunion lever. It is adjustable to any amateur's taste. Only \$15.95.

THE VIBROPLEX CO., INC., 833 Broadway, N. Y. 3, N. Y.

**ARE YOU MOVING?**

If you expect to move, and IF you know your new address now, and IF you don't want to miss any issue of CQ here are three things you can do right now!

1. Tear your name and address label off the wrapper of this issue and paste it in this box right over these words, or make a complete and accurate copy of your old address label.
2. Print your name and NEW post office address in the lines below:

(Name)

(Number and street—or Route)

(City)

(Zone)

(State)

3. Cut out this whole box and mail it to: CQ Magazine, 300 W. 43 St., New York 36, N. Y.

**FREE**



**Full year's subscription to RADIO SHACK'S  
Sensational ELECTRONICS CATALOGS**

Send coupon at once! See world's largest and best line of electronic equipment. Stereo, hi-fi, ham radio, tapes—over 100,000 items for pro or amateur—all at money-saving prices. 15-day no-risk home trial on any item.

**MAIL COUPON NOW!**

Radio Shack Corp., 730 Commonwealth Ave., Boston 17, Mass. Dept. 60-H21  
Without further request, send latest catalog plus every new issue for one full year—all FREE and POSTPAID.

Name \_\_\_\_\_

Address \_\_\_\_\_

Post Office \_\_\_\_\_

or City \_\_\_\_\_

Zone \_\_\_\_\_

State \_\_\_\_\_

**IMPEDANCE [from page 47]**

meter. When you have equalized the two voltage readings by adjustment of the potentiometer, then the impedance of the transformer winding should be the same as the resistance of the potentiometer,  $R$ . Disconnect the audio signal generator from the circuit and disconnect the meter clip lead. Using an ohmmeter, read the resistance value of potentiometer  $R$  by connecting the ohmmeter between points  $B$  and  $C$ . This resistance reading is approximately equal to the reflected impedance of the transformer winding under test.

The voltage divider method of determining audio transformer input and output impedances has been around for some time and is not original with the author. It has, however, been overlooked by many experimenters and hams. Try it the next time you have any doubt about the electrical characteristics of some of your junk box audio transformers. You may be able to save yourself some money as well as a needless trip to the parts supply house. ■

**MODULATION [from page 40]**

ble, therefore, that there is distortion at the start of each sound. In addition, the *agc* systems of most receivers, while bravely trying to follow



the wild gyrations of the carrier, add grunting and gulping effects to the voice. Small wonder, then, that controlled-carrier systems sometimes are referred to as "pig-pen" modulators.

This article does not attempt to list in detail the advantages and the disadvantages of each of the various types of efficiency modulation. Each has its own merit . . . and lack of merit. Perhaps the kindest thing that can be said about any form of efficiency modulation is that it offers a means of converting a continuous-wave radiotelegraph transmitter into a radiotelephone transmitter at a minimum cost, with a minimum number of additional parts, and with a minimum amount of additional power requirements

## SIDEBAND GENERATOR [from page 31]

kilocycle generator described.

Two minutes after turning on the exciter, the carrier was nulled down to a minus 126 db below the maximum carrier level as indicated on a 75A3 Collins receiver. This level was set at S2. 5. Observations on carrier level were then taken at intervals of several minutes for a period of one hour. The curve in fig. 11 shows this data plotted in db below maximum carrier level against time. You will note that the curve indicates that the carrier level at the end of one hour is still down a minus 98.5 db. Therefore, if the carrier in this exciter was nulled out as soon as it was turned on, no further null adjustment would be required. Note that within ten minutes after the exciter was turned on that most of the carrier amplitude drift has taken place and only about one S unit or 6 db increase occurs in the next 50 minutes. This curve suggests that the correct procedure for operation would be to turn the exciter on and let it warm up for a period of about ten minutes then null out the carrier and proceed with station operation. This is customary procedure among most sideband operators since it takes ten to fifteen minutes for a vfo to stabilize and it must be a very good vfo at that to stabilize in that period of time. It is also worth noting that at the end of say, a period of ten to thirty minutes that if you so desire you might re-null the carrier to get the full one hundred db or better carrier suppression then at the end of the operating period when the set is turned off one should be able to come back a day or so later or even longer and be able to turn on the exciter and to have practically maximum carrier suppression after a period of ten or fifteen minutes without any adjustment of the carrier pots whatsoever. The carrier drift that we speak of is caused by the heating effect of the current flowing through the rectifier and the associated potentiometers. Most other sideband generators, both phasing and filter, that the authors are familiar with have carrier suppression in the order of from 40 to 60 db which is certainly adequate in practice.

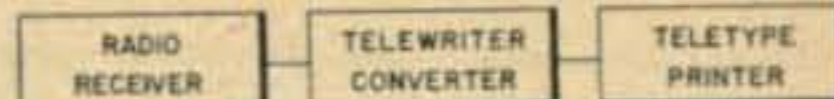

## Telewriter Converter for receiving Radio Teletype

To receive amateur or commercial teletyped messages by radio, you need only the following equipment: 1. Communications receiver. 2. TELEWRITER CONVERTER, which converts radio signals into d.c. pulses, and is connected to the speaker terminals of your receiver. 3. Teletype printer, which is an electric typewriter designed to be controlled by an

electromagnet. Teletype machines are obtainable from us at \$75. and up. TELEWRITER CONVERTER complete with polar relay and selector magnet power supply, \$155. For additional information write Tom, WIAFN.

**ALLTRONICS-HOWARD CO.** Box 19, Boston 1, Mass.  
Tel. Richmond 2-0048

2, 6, 10 - Meter

## MOBILE EQUIPMENT

MOTOROLA, R.C.A., G.E., LINK, etc. 30-50 Mc., 152-172 Mc. Used Commercial F.M. Communications Equipment Bought & Sold. Complete two-way sets meeting F.C.C. Licensing Requirements for taxicabs, Police, Fire, etc. \$169.00 and up.

Motorola F.M. Receivers, Double Conversion ..... \$55.00 each  
Motorola F.M. Transmitters..... 45.00 each

## COMMUNICATIONS ASSOCIATES INC.

21-27 Batchelder Street  
Boston 19, Mass.

## EASY TO LEARN CODE

It is easy and pleasant to learn or increase speed the modern way—with an Instructograph Code Teacher. Excellent for the beginner or advanced student. A quick, practical and dependable method. Available tapes from beginner's alphabet to typical messages on all subjects. Speed range 5 to 40 WPM. Always ready, no QRM, beats having someone send to you.



### ENDORSED BY THOUSANDS!

The Instructograph Code Teacher literally takes the place of an operator-instructor and enables anyone to learn and master code without further assistance. Thousands of successful operators have "acquired the code" with the Instructograph System. Write today for full particulars and convenient rental plans.

## INSTRUCTOGRAPH COMPANY

4711 SHERIDAN RD., CHICAGO 40, ILL.  
4700 Crenshaw Blvd., Los Angeles 43, Calif.

## ALL BAND TRAP ANTENNA!



Reduces interference and Noise on All Makes Short Wave Receivers. Makes World Wide Reception Stronger, Clearer on All Bands!

For ALL Amateur Transmitters. Guaranteed for 500 Watts Power for Pi-Net or Link Direct Feed. Light, Neat, Weatherproof

Complete as shown total length 102 ft. with 87 ft. of 72 ohm balanced feedline, HI-impact molded resonant traps. (Wt. 3 oz. 1" x 5" long). You just tune to desired band for beamlike results. Excellent for ALL world-wide short-wave receivers and amateur transmitters. For NOVICE AND ALL CLASS AMATEURS! NO EXTRA TUNERS OR GADGETS NEEDED! Eliminates 5 separate antennas with excellent performance guaranteed. Use as Inverted V for all band power gain. NO HAYWIRE HOUSE APPEARANCE! EASY INSTALLATION!

80-40-20-15-10 meter bands. Complete..... \$14.95  
40-20-15-10 meter bands. 54-ft. ant. (best for w-w swl's).... 13.95  
20-15-10 meter bands. Dual Trap. 24-ft. antenna..... 19.95

SEND ONLY \$3.00 (cash, ck., mo) and pay postman balance COD plus postage on arrival or send full price for postpaid delivery.

Available only from:

WESTERN RADIO • Dept. AC-8 • Kearney, Nebraska



## ADVERTISING INDEX

**TWO 3" GALVANOMETERS**—Test Leads, Multiplier Switch in hinged carrying case.—G.E. Servo Test-meter. BRAND NEW ..... \$ 9.95

**X-BAND POWER LEVEL TEST SET, TS-36/AP.** BRAND NEW, in original packing, with accessories. Measures 10 to 30 dbm. 8700-9500 mc. (Acq. cost \$477.00) ONLY ..... \$14.95

**METER**—3"—0-5 Ma. 270° indication. By-Pass Shunt and add scale. Excellent condition ..... \$ 1.29  
5 for ..... \$ 5.00

**TELEGRAPH KEY**—J 47. New ..... \$ 1.29

**ART-13 TRANSMITTER** with tubes and meters.... \$29.95

Send M.O. or check with order  
Write for Bulletins

### R W ELECTRONICS

2430 S. MICHIGAN AVE., DEPT. CQ  
Chicago 16, Ill. Phone: CALumet 5-1281

**A**  
**Lightning Rod**  
To Protect  
**your Home**  
Plus "ITQ"

Write for FREE BROCHURE



**E-Z WAY TOWERS, INC.**  
P. O. BOX 5491 - TAMPA, FLA.

### READER SERVICE

#### CQ Magazine, Dept. RS

300 WEST 43rd STREET  
New York 36, N. Y.

Coupon H

Void after

Aug. 25, 1960

Please send me information on your ads in the August 1960 CQ keyed as follows:

1	2	3	4	5	6	7	8	9	10	A
11	12	13	14	15	16	17	18	19	20	B
21	22	23	24	25	26	27	28	29	30	C
31	32	33	34	35	36	37	38	39	40	D
41	42	43	44	45	46	47	48	49	50	
51	52	53	54	55	56	57	58	59	60	

NAME \_\_\_\_\_

(Please Print)

Call \_\_\_\_\_ Engineer

Type of work (specify) \_\_\_\_\_

ADDRESS \_\_\_\_\_

CITY \_\_\_\_\_

ZONE \_\_\_\_\_ STATE \_\_\_\_\_

ACF Industries, Inc. ....	16
Allied Radio Corp. ....	132
Alltronics-Howard Company .....	129
American Crystal Company .....	126
Antenna Specialists Co., The .....	123
Barker & Williamson, Inc. ....	17
Barry Electronics Corp. ....	124, 125
Cambridge Thermionic Corp. ....	15
Centralab .....	12
Central Electronics, Inc. ....	13
Cleveland Institute of Electronics .....	10
Collins Radio Company .....	Cover II
Communications Associates, Inc. ....	129
Communications Company, Inc. ....	117
Communications Products Co., Inc. ....	25
Cush Craft .....	126
CQ's BC-603 Conversion Data .....	120
CQ Back Issues for Sale .....	123
CQ's Classified Ad Section .....	124
CQ Government Book Division .....	20
CQ Ham Mart .....	114, 115
CQ Subscription Ad .....	100
CQ YL Book .....	121
CQ Worldwide DX Zone Map .....	113
Dow-Key Company, Inc. ....	120
E-Z Way Towers, Inc. ....	118, 127, 128, 130
EICO .....	18
Eitel-McCullough, Inc. ....	6
Electro-Tone Laboratories .....	116
Evans Radio .....	121
G & G Radio Supply Company .....	122
Globe Electronics .....	22
Gonset Company .....	5
Greenlee Tool Co. ....	119
Hallcrafters Company .....	3
Hammarlund Mfg. Co., Inc. ....	23
Ham-Swap, Inc. ....	120
Harvey Radio Co., Inc. ....	107
Heath Company .....	7, 8, 9,
Henry Radio Stores .....	111, 121
Hewlett Sales Company .....	112
Hornet Antenna Products Co. ....	110
House of Antennas .....	121
Hy-Gain Antenna Products .....	21, 126
Instructograph Company .....	129
Irving Electronic Co. ....	116
Johnson, E. F. Company .....	33, 34, 35, 36
Lampkin Laboratories, Inc. ....	120
Millen, James Mfg. Co., Inc. ....	4
Mosley Electronics, Inc. ....	19
Multi-Products Company .....	110
National Radio Company, Inc. ....	Cover III
Northeast Telecommunications, Inc. ....	14
P & H Electronics .....	127
Palmer, Joe .....	119
Petersen Radio Co., Inc. ....	1
RCA Electron Tube Division .....	Cover IV
RW Electronics .....	130
Radio Shack Corp. ....	128
TAB .....	131
Texas Crystals .....	108
Tierney, C. M. ....	120
U.S. Crystals, Inc. ....	118
Vibroplex Co., Inc., The .....	128
Western Radio Company .....	129
World Radio Laboratories, Inc. ....	109
Yuba Consolidated Industries, Inc. ....	24



"TAB" FOR THE BEST KITS!

KITS! Each "TAB" Kit Contains The Finest Selection!!!!

- Kit 1 Adj Wire Stripper & Cut
- Kit 2 Bakelite Panels 6x12"
- Kit 3 5 pes Wrench Set
- Kit 4 8 pes Nut Driver Set
- Kit 5 Gain Xtal Mike
- Kit 6 ea Phonoplugs & Jacks
- Kit 7 25 ft Lo-Cap 2 Cond M-Cable
- Kit 8 25 ft RG59U Coax Cable
- Kit 9 15 ft RG11U Coax Cable
- Kit 10 pair SO239 & PL59
- Kit 11 Binding Posts Asstd
- Kit 12 Phone Jacks Asstd
- Kit 13 Phone Plugs Asstd
- Kit 14 Long Nose Plier
- Kit 15 Side Cutter Plier
- Kit 16 Xmttr Variables
- Kit 17 5 of 2mfd @ 600wvdc/oil

99c

ONE EACH ABOVE KIT ONLY

- Kit 1 AN Plugs & ennctrs
- Kit 2 Sub-Min Tubes
- Kit 3 Standoff Insulators
- Kit 4 Power Resistors
- Kit 5 Mica Condensers
- Kit 6 Crystal Diodes
- Kit 7 200ft Hook Up Wire
- Kit 8 4 Rolls, 50ft/ea. Asstd. Color
- Kit 9 Fuses, assorted types
- Kit 10 Ceramic Condensers
- Kit 11 FT243 Xtal Holders
- Kit 12 Microswitches
- Kit 13 Wheat Lamps
- Kit 14 Transistor Xtmrs
- Kit 15 Xtal Osc-Blanks
- Kit 16 Asstd Rectifiers
- Kit 17 Alligator Clips Asstd
- Kit 18 UG/Connectors
- Kit 19 100 Self-Tap Screws

- Kit 1 Mycalex Glass/HF Strips
- Kit 2 Precision Resistors
- Kit 3 10 Switches
- Kit 4 Resistors 1/2 1/2W
- Kit 5 Carbon Resistors
- Kit 6 Panel Lamps
- Kit 7 Electrolytic Cond's
- Kit 8 Volume Controls
- Kit 9 56 Tube Sockets
- Kit 10 Tubular Condensers
- Kit 11 Lugs & Eyelets
- Kit 12 Bathub Oil Cond's
- Kit 13 lbs. Surprise Package
- Kit 14 Transmit Mica Cond's
- Kit 15 Glyptal & Cement
- Kit 16 3 Phone/Patch Xtmrs
- Kit 17 Searchlights
- Kit 18 AN/Reflector Lites
- Kit 19 6 Insldd Tuning Tools

Order Ten Kits We Ship Eleven!!!

**NEW "SILICON 750 Ma RECTIFIERS WORKING VOLTS RMS-ACV INPUT!**

Order 10 or More 750Ma deduct 10%

rms/piv	rms/piv	rms/piv	rms/piv
35/50 19c	70/100 29c	140/200 34c	210/300 43c
280/400 50c	350/500 62c	420/600 80c	490/700 95c
560/800 \$1.05	630/900 \$1.25	700/1000 \$1.70	770/1100 \$2.00

Use in Bridge or C.T. up to 1 Amp DC  
 \*Derate 20% for Capacitive input  
 "TAB" Special General Purpose Silicons  
 400 PIV @ 300Ma 39¢ @, 25 for \$8.00  
 General Purpose & Replacement  
 \*Silicon 400PIV at 250 Ma Rectifiers  
 Hi-Temp 106°C at 252V/RMS, Special 2 for \$1.25 for \$10.  
**EXPORTERS-OEM-DISTRIBUTORS**  
 Write for Data & Qty Prices  
 Silicon Orders \$20 shppd prpaid U.S.A.

**SELENIUM F.W. BRIDGE RECTIFIERS**

DC AMP	18VAC 14VDC	36VAC 28VDC	72VAC 54VDC	130VAC 100VDC
1/2	\$1.00	\$1.90	\$3.85	\$5.00
1	1.30	2.00	4.90	8.15
2	2.15	3.00	6.25	11.10
3	2.90	4.00	8.60	13.45
6	4.15	8.00	18.75	31.90
10	6.10	12.15	26.30	41.60
12	7.75	14.90	30.95	43.45
20	12.85	24.60		
24	15.00	29.45		

New "TABTRAN" Rectifier Xfmrs  
 Sec'd Volts (DUAL) 0-9-15-18-& 0-9-15-18-16. Series Sec'ds 0-3-6-9-12-15-18-21-24-27-30-33-36 Volts.

Write for Rectifier Catalog  
 TR4001 @ 1 Amp ea/sec/winding \$5.15  
 TR4002 @ 2 Amp ea/sec/winding \$7.15  
 TR4003 @ 5 Amp ea/sec/winding .90  
 †Wndgs in Series at Ratings shown: Parallel 2X Current. Voltage output. 0-9-15-18

**RECTIFIERS 130V/RMS HALF-WAVE**

75Ma 49c, 5 for \$2; 100Ma 59c, 6 for \$3  
 150Ma 70c, 8 for \$5; 250Ma 79c, 6 for \$4  
 300Ma 88c, 5 for \$4; 350Ma \$1.00, 8 for \$7  
 400Ma \$1.10, 5 for \$5; 500Ma \$1.35, 5 for \$5  
 This Item P.Pd. 48 states orders \$10.

**WE BUY! SELL & TRADE**  
 Send 25¢ for Bonus Catalog!

**"TAB" THAT'S A BUY**



"TAB" Tubes Tested, Inspected, Boxed  
 Six Months Guaranteed! No Rejects!  
**GOVT & MFGRS Surplus! New & Used**

0A2 ..... .70	6BZ7 ..... 1.25	We Buy & Sell
0A3 ..... .80	6C4 ..... .45	43 ..... .75
0B2 ..... .65	6C5 ..... .69	45 ..... .49
0C3 ..... .70	6C6 ..... 1.08	50L6 ..... .69
0D3 ..... .50	6C8 ..... 1.08	RK59 ..... 1.39
0Z4 ..... .60	We Trade!	RK60 ..... 1.17
1A7 ..... .90	6CB6 ..... .89	HY69 ..... 2.20
1B3 ..... .78	6CD6 ..... 1.49	75 ..... .81
1L4 ..... .81	6CF6 ..... .85	HY75 ..... 5.00
1R4 ..... 5/\$1	6CL6 ..... 1.40	83V ..... .95
<b>We Swap Tubes! What Do/You Have?</b>		
1R5 ..... .78	6CB6 ..... .89	4PR60A ..... 37.50
1S4 ..... .78	6CG8 ..... 1.12	4-125A ..... 27.50
1S5 ..... .68	6CM6 ..... .79	4X150G ..... 15.00
1T4 ..... .85	6CS6 ..... .70	4X250B ..... 41.00
1T5 ..... .95	6CU6 ..... 1.29	4-400A ..... 41.75
1U4 ..... 6/\$1	6D6 ..... .99	4E27A ..... 39.00
1U5 ..... .75	6E5 ..... .79	250TL ..... 19.45
1X2 ..... .99	6F4 ..... 2.49	307A ..... 2/\$1
2C39A ..... 9.00	6F5 ..... .63	316A ..... 5/\$1
2C40 ..... 5.50	6F6 ..... .99	VR92 ..... 5/\$1
<b>Send 25¢ for Catalog!</b>		
2C43 ..... 6.50	6F7 ..... .99	388A ..... 3/\$1
2C51 ..... 2.00	6F8 ..... 1.39	350A ..... 2.45
2D21 ..... .65	6H6 ..... .59	350B ..... 1.75
2E22 ..... 1.75	6J4 ..... 1.72	371B ..... .95
2E24 ..... 1.90	6J5 ..... .59	3I46 ..... 3.90
2E25 ..... 2.50	6J6 ..... .59	416B ..... 16.00
2E26 ..... 2.75	6J7 ..... .99	450TH ..... 43.00
2E30 ..... 1.70	6J8 ..... 1.39	450TL ..... 43.00
2E35 ..... 1.60	6K6 ..... .59	460 ..... 11.50
2K25 ..... 9.75	6K7 ..... .79	703A ..... 2.00
<b>All Tubes Stocked at Low Prices!</b>		
2K26 ..... 34.00	6K8 ..... .99	707B ..... 3.50
2K28 ..... 30.00	6L6 ..... 1.19	715C ..... 10.90
2V3 ..... 2/\$1	6SN7 ..... .72	717A ..... 5/\$1
2X2 ..... .48	6T8 ..... .98	723AB ..... 5.00
3A4 ..... .70	6V6GT ..... .90	725A ..... 2.75
3A5 ..... 1.00	6X5 ..... .49	803 ..... 3.50
3AP1 ..... 5.95	12AT6 ..... .59	804 ..... 8.85
3BP1 ..... 3.99	12AT7 ..... .89	805 ..... 6.00
3C24 ..... 3.50	12AU6 ..... .63	
3D23 ..... 3.95	12AU7 ..... .69	
<b>We Buy! We Sell! We Trade!</b>		
3E29 ..... 6.00	12AX7 ..... .79	807 ..... 1.10
3Q4 ..... .68	12AY7 ..... 1.29	5/\$5, 10/\$12
3Q5 ..... .86	12B4 ..... .95	
4-65A ..... 13.50	12BA6 ..... .65	811 ..... 3.45
4-125A ..... 27.50	12BA7 ..... .99	811A ..... 4.41
4-250A ..... 34.00	12BD6 ..... .59	812 ..... 3.30
4X150A ..... 7.00	12BE6 ..... .59	813 ..... 8.00
4X250 ..... 36.00	12BH6 ..... .79	815 ..... 1.75
4X500 ..... 37.00	12BH7 ..... .99	826 ..... .59
5AP1 ..... 2.95	12BY7 ..... 1.00	
<b>Wanted Test Sets and Equipment</b>		
5BP1 ..... 5.02	12BZ7 ..... .99	828 ..... 9.00
5BP4 ..... 5.00	12H6 ..... .75	829B ..... 8.00
5CP1 ..... 4.99	12J5 ..... .69	832A ..... 6.00
5CP7 ..... 9.00	12J7 ..... .69	833A ..... 36.00
5R4 ..... 1.00	12J8 ..... 1.35	837 ..... 2/\$2
5T4 ..... .90	12K8 ..... .89	866A ..... 2.45
5U4 ..... .99	12SA7 ..... .89	954 ..... 10/\$1
5V4 ..... .89	12SC7 ..... .89	955 ..... 3/\$1
5Y3 ..... .60	12SF5 ..... .69	957 ..... 3/\$1
5Z3 ..... .89	12SG7 ..... .89	958A ..... 2/\$1
<b>Send 25¢ for Catalog!</b>		
15GP22 ..... 89.00	12SH7 ..... .89	991 ..... 5/\$1
6A7 ..... 1.00	12SJ7 ..... .75	1614 ..... 2.75
6A8 ..... .99	12SK7 ..... .75	1619 ..... 5/\$1
6AB4 ..... .59	12SL7 ..... .79	1620 ..... 2.00
6AC7 ..... .72	12SN7 ..... .69	1625 ..... 5/\$1
6AG5 ..... .65	12SQ7 ..... .69	1626 ..... 5/\$1
6AG7 ..... .75	12SR7 ..... .69	1629 ..... 4/\$1
6AK5 ..... .69	15E ..... 1.19	2050 ..... 1.25
6AL5 ..... .59	15R ..... 4/\$1	5517 ..... 1.25
6AQ5 ..... .66	FG17 ..... 3.49	5608 ..... 3.95
<b>Top \$\$\$ Paid for 304TL tubes</b>		
6AR6 ..... 1.95	19T8 ..... 1.16	5618 ..... 3.25
6AS7 ..... 3.49	24G ..... 3.50	5651 ..... 1.35
6AT6 ..... 2/\$1	25A6 ..... 1.19	5654 ..... 1.20
6AU6 ..... .79	25A7 ..... 2.19	5656 ..... 4.25
6B8 ..... 1.35	25C5 ..... .81	5663 ..... 1.15
6BA6 ..... .59	25L6 ..... .72	5670 ..... .90
6BE6 ..... .59	25T ..... 4.00	5686 ..... 1.75
6BG6 ..... 1.49	25Z5 ..... .72	5687 ..... 1.15
6BH6 ..... .79	25Z6 ..... .75	5691 ..... 4.70
6BJ6 ..... .72	26A7 ..... 3.69	5725 ..... 1.95
<b>Top \$\$\$ Paid for XMTTR Tubes!</b>		
6BK7 ..... .99	FG27 ..... 8.28	5732 ..... 2.00
6BL7 ..... 1.35	HV27 ..... 19.39	5736 ..... 85.00
6BN4 ..... .69	28D7 ..... .89	5749 ..... 1.95
6BN6 ..... 1.08	FG33 ..... 15.00	5750 ..... 2.75
6BN7 ..... 1.99	EL34 ..... 3.49	5751 ..... 1.25
6BQ6 ..... 1.19	35A5 ..... .69	5814 ..... 1.20
6BQ7 ..... .99	35L6 ..... .59	5879 ..... 1.20
6BX7 ..... 1.11	35T ..... 4.49	5894 ..... \$12.00
6BY5 ..... 1.19	35Z5 ..... .89	
6BZ6 ..... .91	RK39 ..... 2.99	No See-Write!

**"TAB" GUARANTEED XTALS!**

HAM BAND 80 or 40Mtrs ..... \$1 @  
 NOVICE BAND ..... \$1 @  
 CITIZENS BAND ..... \$3 @  
 Include 1st, 2nd, 3rd & 4th choice!  
 On XTALS!  
 \*Postpaid 48 States XTALS Only

**DC POWER SUPPLIES for TRANSISTORS!**

New low-cost filtered 0.5% Ripple Power Supply. Same as specified in Transistor Manual G.E. Ideal for Powering transistor circuits, small in size!

12VDC at 150Ma-  
 T12V150M ..... \$ 8

25VDC at 150Ma-  
 T25V150M ..... \$10

40VDC at 1 Amp-  
 T40V1A ..... \$19



**NEW POWER CONVERTER**

12VDC to 500VDC  
 up to 200MA  
 100 Watts; Tap at 250VDC  
 Type C1250E \$35

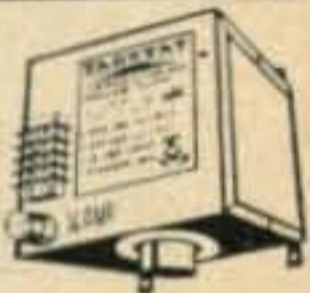

Hi efficiency, low ripple, low idle current-Silicon rectifiers! Toroidal HiEff! Magnetal tape wound transformer, fused & short circuit proof, small in size! Quiet! Light weight! C1250EE built, ready to go. Conservatively Rated. Delco Transistors Heavy Copper-Heatsink.

**12VDC to 250VDC up to 150MA**

Type C1225A \$30

**PROTECT THAT METER "TABISTOR" LOW LEVEL VOLTAGE REGULATING DIODES**

TG150 1V@100Ma 50¢, 5 for \$2  
 TM2K 2V@2000Ma 90¢ @, 3 for \$2

**SELENIUM**

**PHOTOCELL-**

**"SUNTAB" R**

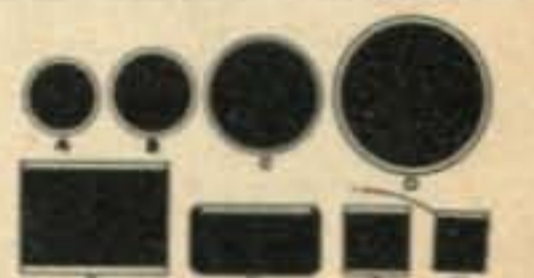

5AP ROUND 1 1/2" Dia.-250ua ..... \$1.00  
 10AP ROUND 1 1/2" Dia.-360ua ..... \$1.75  
 15AP ROUND 2" Dia.-750ua ..... \$3.00  
 2BP RECT 3/4 x 7/16-75ua ..... .70  
 5BP RECT 1-7/16 x 7/8-200ua ..... \$1.35  
 10BP RECT 1-11/16 x 7/8-360ua ..... \$1.80  
 KIT ALL SIX ONE EACH ..... \$7.00

ORDER OYSTERS TEN OR MORE  
 DEDUCT 20%  
 THIS ITEM SHIPPED POSTPAID  
 ORDERS \$5 UP.

**"TAB"-THAT'S A BUY!-BARGAINS!!**

AN-ARR2/RCVR less tubes A-1 endtn \$1.95  
 RDZ/USN 200-400 Mes Revrs As Is \$25  
 G.E./YRS-1 Side Band Selector ..... \$45  
 829B Socket 85¢, 2/\$1.50, 813 Socket \$1  
 4x150 Ceramic/LOKTA ..... 2 for \$1.00  
 W.E. 416B Hlgain-HiMu ..... \$4

If U Don't See It Write!

**"VACDAC" SILICON TUBE REPLACEMENTS**

WITH BUILT IN RF SURGE & SERIES BALANCING PROTECTION

TYPE	VRMS/PIV	AMPS	PRICE
ST866	5000/10400	0.3	\$20.00
ST816	5000/7000	0.3	\$16.00
ST5R4	1900/2800	0.5	\$15.00
ST5U4	1120/1800	0.6	\$ 8.00



**HDQTRS. TRANSISTORS & ACCESSORIES**

2N441/\$3; 2N442/\$4.50; 2N277/\$4; 2N278/\$5; 2N155/\$1.39; 2N176/\$1.80; 2N177/\$1; 2N178/\$1.75; 2N247/\$1.50; 2N255/\$1.20; 2N270/.95; 2N274/\$1.25; 2N408/.80; 2N554/\$1.20; 2N578/\$1.80; 2N579/\$2.20.

DIAMOND BASED MICA MTG KIT ..... \$30  
 DELCO ROUND BASED MICA MTG KIT ..... \$30  
 DELCO FINNED POWER HEAT SINK ..... \$75

**Leece Neville Charger Systems "SILTAB" Silicon Rectifier Replacement Non-Aging Hermetically Sealed FOR 6 or 12VDC @ 100A, Type YJ9 \$24**

NEW BATTERY CHARGER !!!  
 FOR 2V OR 4V OR 6V OR 12 VOLT BATTERIES. TRICKLE & FULL CHARGE up to 4 AMP

Charges 2-4-6 & 12 volt batteries.

Built BCK-1 ..... \$13.50



Send 25¢ for Catalog

Wanted 304TL Tubes & ALL TYPES!!!

**"TAB"**

TERMS: Min Order \$3-25% with order F.O.B. New York. Ten day guarantee, price of mdse. only. Our 15th year. Prices shown are subject to change.

111CL Liberty St., N. Y. 6, N. Y. RE 2-6245

For further information, check number 44, on page 130.



you get the best deal

at **ALLIED** ...

the best place to get your

**hallicrafters**

HIGHEST TRADES

BEST TERMS

15-Day Trial Privilege  
90-Day Warranty



**HT-32A TRANSMITTER  
EXCITER**  
Stock No. 94 SZ 807  
\$695.00



**SX-101A RECEIVER**  
Stock No. 77 SZ 769  
\$399.50



**HT-33A LINEAR  
AMPLIFIER**  
Stock No. 92 SZ 348-2  
\$795.00



**HT-37 TRANSMITTER**  
Stock No. 77 SU 838  
\$450.00

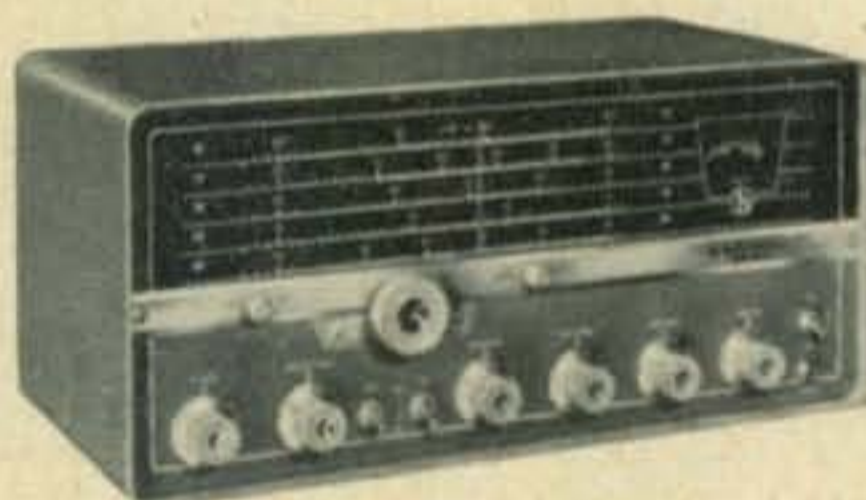

**SX-111 RECEIVER**  
Stock No. 77 SX 896  
\$249.50



**HA-1 T. O. KEYER**  
Stock No. 77 S 327  
\$79.95

**ONLY \$2 DOWN**

on orders up to  
\$50; only \$5  
down on orders  
up to \$200; only  
\$10 down over  
\$200. Up to 24  
months to pay!

**FOR THAT BEST DEAL** on the new equipment you want, write to Jim Sommerville, W9WHF, % Allied, or stop in at our Ham Shack and meet Joe Huffman, W9BHD, Joe Gizzi, W9HLA, Jack Schneider, W8CZE...

**HAM-TO-HAM HELP**—Our staff of 35 Hams will go all-out to give you the help you want, whether you write or call in or visit us in person. You'll like the friendly attention and interest you get *all-ways* at Allied.

order from

**ALLIED RADIO**

100 N. WESTERN AVE., CHICAGO 80, ILL.

For further information, check number 45, on page 130.



# NC 270

Your National Distributor  
September 15



Photographed in true color

## THE "COSMIC BLUE" NATIONAL'S NEW HAMBAND RECEIVER

This newest and finest precision double conversion amateur receiver with 6 meter coverage, brings you an ease of sideband tuning previously available only in the most expensive equipment. The NC-270 features an exclusive "Ferrite Filter" for instant upper-lower SSB selection, and a degree of selectivity to conquer even the toughest AM and CW signal conditions. The solid  $\frac{1}{8}$ " steel panel, ceramic coil forms, double-spaced tuning gang, and full ventilation cabinet combine to give mechanical and thermal stability that will surprise even the most critical operator. Even the color of the NC-270 is outstandingly different, National's new duo-tone "Cosmic Blue." Write for detailed specifications.

**Only \$24.99 down\***

Suggested cash price: \$249.95. NTS-3 Matching Speaker: \$19.95 (slightly higher west of the Rockies and outside the U.S.A.). \*Most National distributors offer budget terms and trade-in allowances.

**NATIONAL RADIO COMPANY, INC.**



A WHOLLY OWNED SUBSIDIARY OF NATIONAL CO., INC.

MELROSE 76, MASS.

Export: AD AURIEMA, INC., 85 Broad St., New York, N. Y.

Canada: CANADIAN MARCONI CO., 830 Bayview Ave., Toronto 17, Ont.

"FERRITE FILTER" PATENT PENDING

SPECIFICATIONS SUBJECT TO CHANGE WITHOUT NOTICE

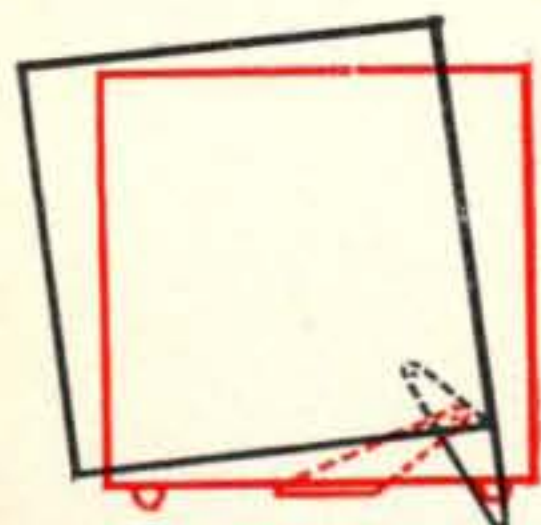

And National Radio's patented "Flip Foot" makes operating the NC-270 so easy.



# OUTER-SPACE

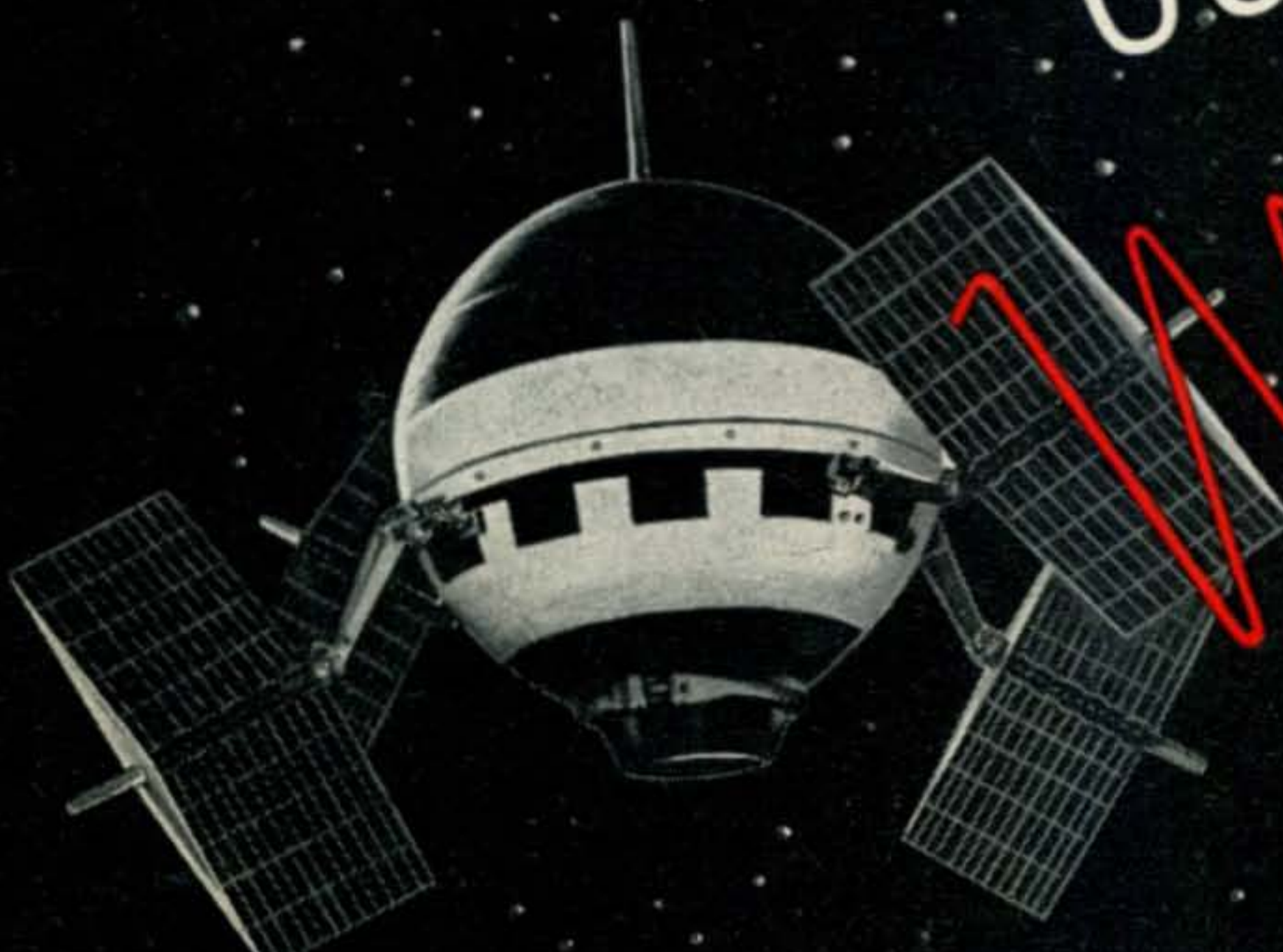

# DX



**...with RCA POWER TUBES**

Already so deep in space that it staggers a dx man's imagination, Pioneer V—the paddlewheel sun satellite—is keeping skeds with earth millions of miles away. Two RCA Cermolox Power Tubes (precision aligned grids with ceramic-metal construction) “deliver the goods” in the 150-watt rig aboard Pioneer V. Back on earth, RCA high-power Cermolox Power Tubes develop the 10-kw triggering pulses that are expected to keep contact with the satellite until it is 50 million miles from home.

Planetary communication, although somewhat outside the realm of DXCC, is another major example demonstrating the ability of RCA Tubes to deliver the power wherever it's needed—from watts to megawatts! Meanwhile, for amateur applications back in the earthbound ham shack, there's a comprehensive line of RCA Power Tubes to meet every transmitter need. See your RCA Industrial Tube Distributor for the types you want.

**RCA Electron Tube Division, Harrison, N. J.**



The Most Trusted Name in Electronics  
RADIO CORPORATION OF AMERICA