

September 1960

50¢

CQ



Massachusetts to California Contact
Established, 1,296mc. -Via Moon.

The Radio Amateur's Journal

Come to the Western SSB Convention at Santa Barbara, California, Sept. 30-Oct. 2.
For registration, write W6ZHH, Box 568, San Pedro, California.

Two hamshacks One Transceiver

For further information,
check number 1 on page 126.

At home or on the highway you get single sideband and CW fixed station performance with this mobile Collins KWM-2 Transceiver. It covers all amateur bands from 3.4 to 29.7 mc. Visit your Collins Distributor and try the KWM-2 for use in your ham shack at home or the one on wheels.

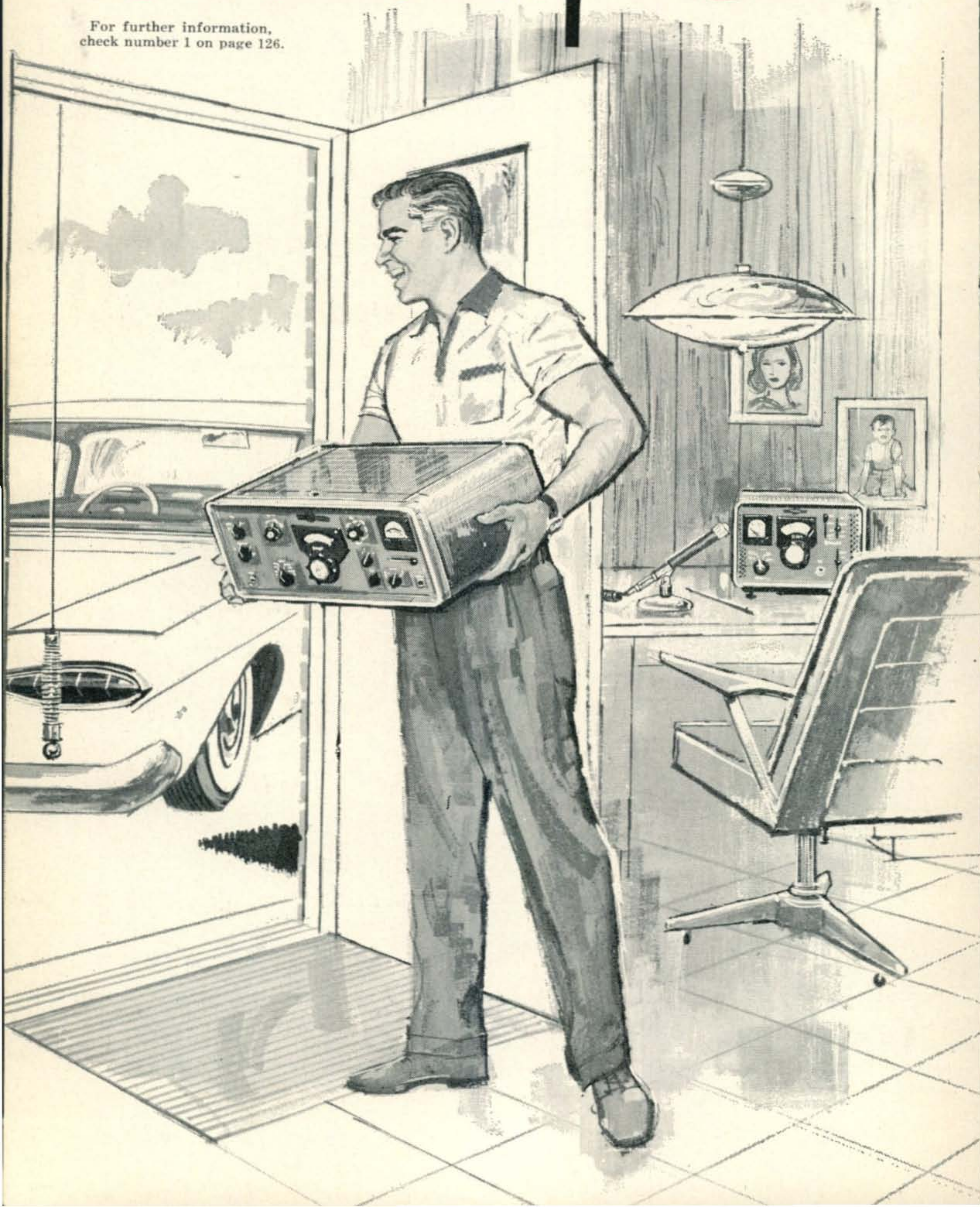

It pays to insist on

PR crystals

STANDARD OF EXCELLENCE SINCE 1934

AMATEUR TYPES

40 and 80 Meters, PR Type Z-2

Rugged. Low drift, fundamental oscillators. High activity and power output. Stands up under maximum crystal currents. Stable, long-lasting; ± 500 cycles.....**\$2.95 Net**

Third Overtone, PR Type Z-9A

Hermetically sealed; calibrated 24,000 to 24,666 and 25,000 to 27,000 Kc., ± 3 Kc.; .050" pins.....**\$4.95 Net**

6 Meters, PR Type Z-9A

Fifth overtone; for operating directly in 6-meter band; hermetically sealed; calibrated 50 to 54 Mc., ± 15 Kc.; .050" pins.
\$6.95 Net

CITIZENS BAND CLASS "D" Type Z-9R, Transmitter

FCC assigned frequencies in megacycles: 26.965, 26.975, 26.985, 27.005, 27.015, 27.025, 27.035, 27.055, 27.065, 27.075, 27.085, 27.105, 27.115, 27.125, 27.135, 27.155, 27.165, 27.175, 27.185, 27.205, 27.215, 27.225; calibrated to .005%. (Be sure to specify manufacturer of equipment).....**\$2.95 Net**

CITIZENS BAND CLASS "D" Type Z-9R, Receiver

Specify I.F. frequency, also whether receiver oscillator is above or below transmitter frequency. Calibrated to .005%. (Be sure to specify manufacturer of equipment.)
\$2.95 Net

Type Z-9R, Radio Control

FCC assigned frequencies in megacycles: 26.995, 27.045, 27.095, 27.145, 27.195, 27.255; calibrated to .005%. (Be sure to specify manufacturer of equipment).....**\$2.95 Net**

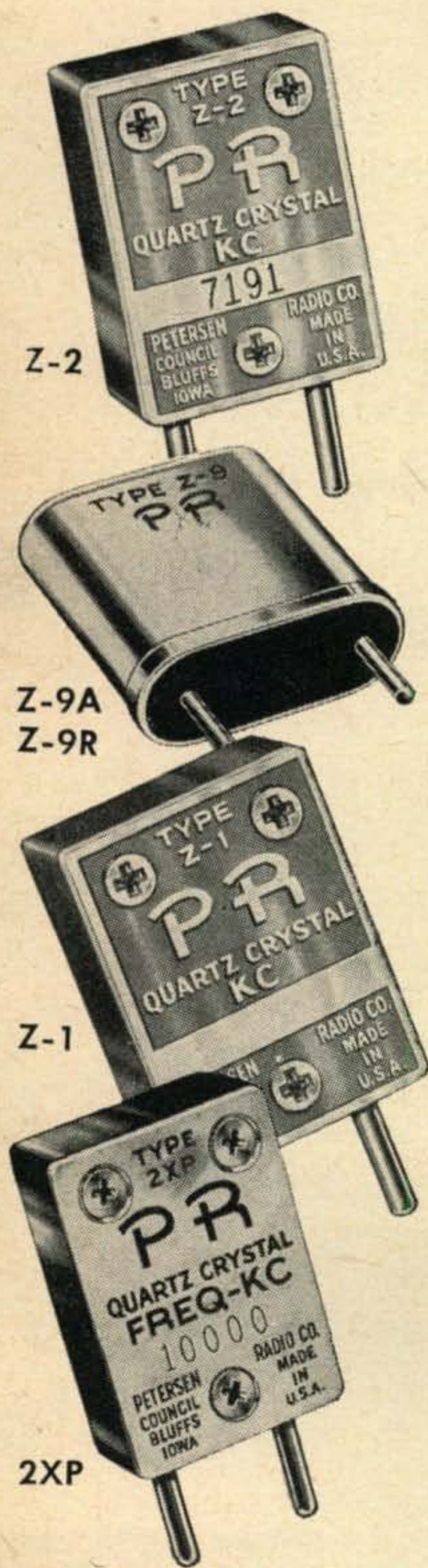

Type 2XP

Suitable for converters, experimental, etc. Same holder dimensions as Type Z-2.

1600 to 12000 Kc., (Fund.) ± 5 Kc.....**\$3.45 Net**

12001 to 25000 Kc. (3rd Overtone) ± 10 Kc.....**\$4.45 Net**

ALL PR CRYSTALS ARE UNCONDITIONALLY GUARANTEED.
ORDER FROM YOUR JOBBER.

COMMERCIAL TYPES

Commercial Crystals available from 100 Kc. to 70 Mc. Prices on request.

Type Z-1, MARS and CAP

Official assigned frequencies in the range. Calibrated to .005%. 1600 to 10000 Kc.....**\$3.45 Net**

Type Z 1, TV Marker

Channels 2 thru 13.....**\$6.45 Net**

4.5 Mc. Intercarrier,
.01% **\$2.95 Net**

5.0 Mc. Signal Generator,
.01% **\$2.95 Net**

10.7 Mc. FM, IF,
.01% **\$2.95 Net**

Type Z-6A, Frequency Standard

To determine band edge. To keep the VFO and receiver properly calibrated.

100 Kc. ... **\$6.95 Net**



PETERSEN RADIO CO., Inc. 2800 W. Broadway
COUNCIL BLUFFS, IOWA

EXPORT SALES: Royal National Corporation, 250 W. 57th Street, New York 19, N. Y., U. S. A.

For further information, check number 4 on page 126.

CQ—The Radio Amateur's Journal

September 1960
vol. 16, no. 9

300 West 43rd Street, New York 36, N. Y.

Big Brother Linear	Cmdr. Paul Lee, W3JHR	32
A 1625 Grounded Grid Linear	David Bell, W8GUE	36
Building The Heathkit Seneca	John Wilhelm, K2OZW	41
Selectivity With A Bandpass Filter	R. E. Hollenbach, W5KZU	44
A Reactance Amplifier For 432 MC	Frederick Brown, W6HPH	46
DX And The Novice	Tima Popovich, YU1FR	48
Automatic Keyboard Switching	Charles Teeters, K2DHE	51
A Two-Tone Generator	Richard Burns, W9NVC/W9OBU	52
Moisture Problems In The Ham Shack		
	D. C. McCoy, W8DG, Lloyd Root, W8HB	54
A Control Central For The HT-32/SX-101 "Combo"		
	William I. Orr, W6SAI/3A2AF	58
Lone Voice On Tobago	Jack Lambert, G3TA ex VP4WD	60
Earth—Moon—Earth QSO		78

DEPARTMENTS

<i>Amateur Legal Notes</i>	24	<i>Ham Headlines</i>	20	<i>RTTY</i>	88
<i>Announcements</i>	16	<i>Letters To The Editor</i>	10	<i>Space Communications</i>	68
<i>Classified</i>	118	<i>New Amateur Products</i>		<i>Sideband</i>	85
<i>Contest Calendar</i>	91	<i>Novice</i>		<i>Surplus</i>	82
<i>Correction</i>	35	<i>Propagation</i>	74	<i>VHF</i>	79
<i>DX</i>	62			<i>YL</i>	70
<i>Ham Clinic</i>	66				

Branch Advertising Offices:

William A. Ayres, The William A. Ayres Co.,
233 Sansome Street, San Francisco 4, Calif.
YUkon 6-2981

Fred Frisenfeldt, The William A. Ayres Co.,
1709 West 8th Street, Los Angeles 5, Calif.
HUBbard 3-2777

publisher S. R. Cowan
production manager Bill Gardner, Jr.
circulation manager Harold Weisner, WA2OBR
editorial production Robert Jordan
advertising representative Jack Schneider, WA2FPE
advertising representative Dick Cowan, WA2LRO
classified advertising Kathi Gerace
draftsman Mike Dominguez

CQ—(title registered U. S. Post Office) is published monthly by Cowan Publishing Corporation. Executive and editorial offices at 300 West 43rd Street, New York 36, N. Y. Telephone JUdson 2-4460. Second-class Postage paid at New York, N. Y.

SUBSCRIPTION RATES: U. S. A. and Possessions, APO, FPO, Canada and Mexico; one year \$5.00; two years \$9.00; three years \$13.00. Pan-American and foreign: one year \$6.00; two years \$11.00; three years \$16.00.

FOREIGN SUBSCRIPTIONS: Great Britain: RSGB, New Ruskin House, Little Russell St., London WC 1, England. Australia: Technical Book Co., 297 Swanston St., Melbourne C 1, Victoria, Australia.

Printed in U. S. A. Entire contents copyright 1960 by Cowan Publishing Corporation. CQ does not assume responsibility for unsolicited manuscripts.

Postmaster: Send Form 3579 to CQ, 300 West 43rd Street, New York, N. Y.

HVICN GOES SINGLE SIDEBAND



On the 15th of May, 1960, SSB-AM-CW transmission was inaugurated from HVICN, Vatican Radio, VATICAN CITY. Domenico Petti, Custodian and official operator, is shown with Bill, W9AC, and Loris, 11CL, at the recently completed station. Equipment is Hallicrafters SX-101A Receiver; HT-32A Transmitter, HT-33A Kilowatt Amplifier; HA-1 Electronic Keyer; and R-47 Speaker. Domenico operates on 20, 15 and 10 meters.

Export Sales: International Division, Raytheon Mfg. Co., Waltham, Mass. Canada: Gould Sales Co., Montreal, P.Q.

hallicrafters  **company**

Chicago, Illinois, U.S.A.

For further information, check number 5 on page 126.

Designed for



Application



90672

The No. 90672 ANTENNA BRIDGE

The Millen 90672 Antenna Bridge is an accurate and sensitive bridge for measuring impedances in the range of 5 to 500 ohms at radio frequencies up to 200 mc. It is entirely different in basic design from previous devices offered for this type service inasmuch as it employs no variable resistors of any sort. The variable element is an especially designed differential variable capacitor capable of high accuracy and permanency of calibration over a wide range of frequencies. A grid dip meter such as the Millen 90651 may be used as the source of RF signal. The bridge may be used to measure antenna radiation resistance, antenna resonance, transmission line impedance, standing wave ratio, receiver input impedance and many other radio frequency impedances. By means of the antenna bridge, an antenna matching unit may be adjusted so as to provide the minimum standing wave ratio on the radiation system at all frequencies.

**JAMES MILLEN
MFG. CO., INC.**

MAIN OFFICE AND FACTORY
**MALDEN
MASSACHUSETTS**



Barry Briskman, K2IEG	<i>managing editor</i>
Arnold Trossman, W2DTJ	<i>assistant editor</i>
Lee Aurick, W2QEX	<i>technical editor</i>
<i>department editors</i>	
Frank Anzalone, W1WY	<i>contest calendar</i>
Ken Grayson, W2HDM	<i>surplus</i>
Sam Harris, W1FZJ	<i>vhf</i>
George Jacobs, W3ASK	<i>propagation</i>
Byron Kretzman, KØWMR	<i>rtty</i>
Urban Le June, Jr., W2DEC	<i>dx</i>
Marvin Lipton, VE3DQX	<i>ham headlines</i>
Louisa Sando, W5RZJ	<i>yl</i>
Charles Schavers, W6QLV	<i>ham clinic</i>
Don Stoner, W6TNS	<i>novice & semiconductors</i>
Irv Strauber, K2HEA	<i>sideband</i>
Dot Strauber, K2MGE	

CQ, the Radio Amateurs' Journal is published for active hams by active hams. CQ endeavors to be a true and honest reporter for those interested in the hobby. Suggestions for improvement are welcomed.

Manuscripts submitted to CQ should be typewritten double spaced on 8½ by 11 inch paper with adequate margins on both sides of the typewritten copy. Photographs and drawings should be clear and contain adequate explanations. All manuscripts should be accompanied by an envelope and sufficient postage for its return.

CQ CERTIFICATES:

The WPX Award is granted for two-way contact with certain number of amateurs in different prefixes of the world. Full details are contained in the WPX Record Book which is available for 15¢ from CQ. Application forms are free.

The WAZ Award is granted for contacting all of the amateur zones of the world. Current standings of amateurs awarded WAZ will be found in the DX column. A DX Zone map of the world is available free from CQ. Send stamped envelope.

Special SB Certificates are available from the Sideband Department for operators providing proof of contact (QSL cards) with stations in 50, 75 and 100 countries using two-way sideband. Send cards directly to the SB Editor.

TECHNICAL INFORMATION:

CQ's 15-year cumulative index may be obtained free from our circulation department by enclosing a stamped, self addressed envelope (8¢). Most back issues are available at \$1 from us. Check our "Back Issue" ad for details on those not available.

THIS MONTH'S COVER:

The installation at the Eimac Radio Club in San Carlos, California that completed two-way communication via moon bounce, on 1296, with the Rhododendron Swamp VHF Society in Medfield, Mass. See the story on page 78.

← For further information, check number 6 on page 126.

GONSET G-76

FULL-FEATURED

AM TRANSCEIVER

For 6-band operation...

Now... a powerful 100 watt AM transmitter and a sensitive, dual-conversion receiver, a handsome 6-band combo.—integrated—working perfectly together—within a handsome modern housing designed to be just right in size and shape for easy installation in your car.

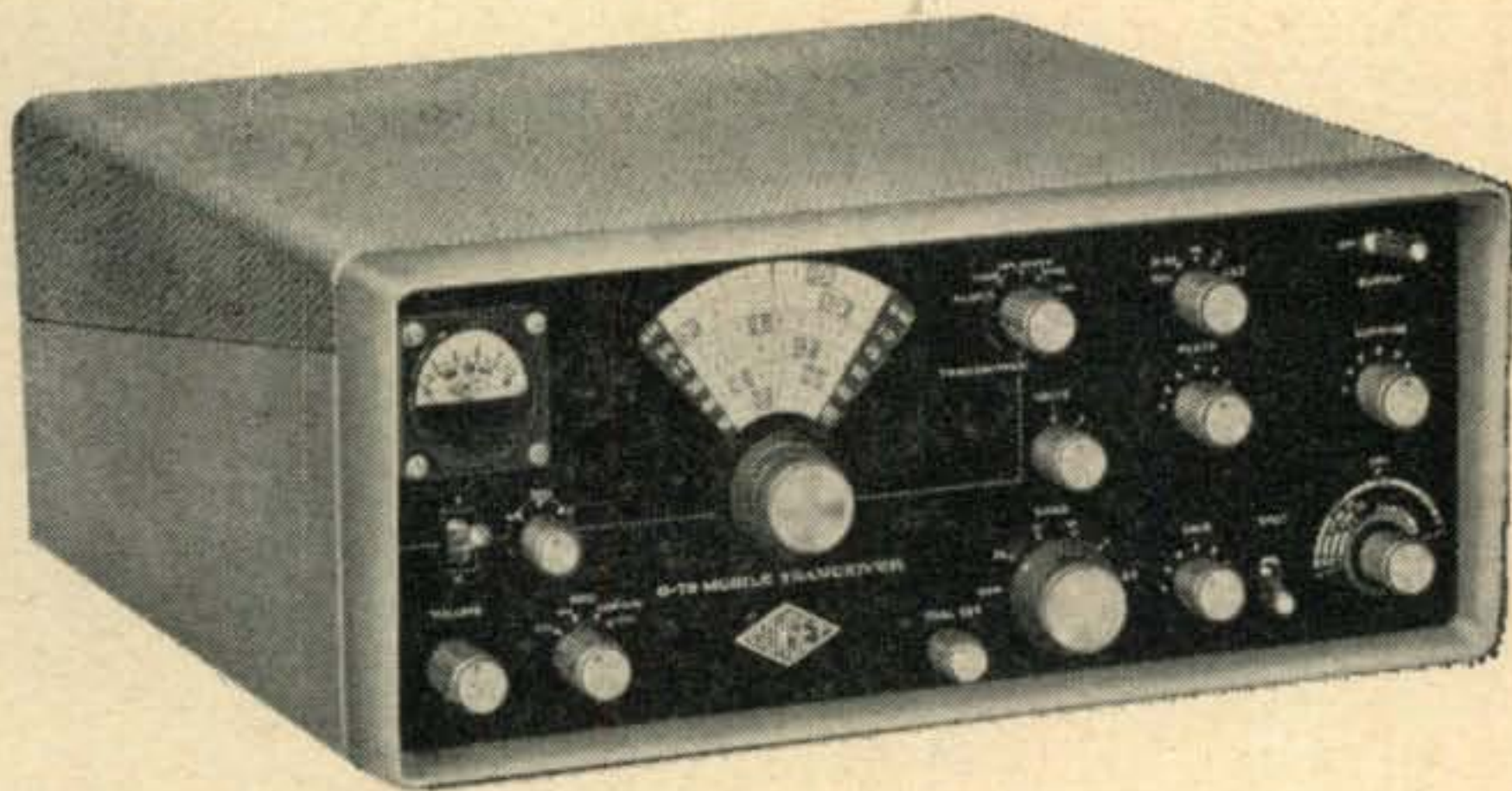

Your mobile operation will be more enjoyable with G-76! First, excellent 2-way communication on any of 6 amateur bands—80, 40, 20, 15, 10 and 6 meters! Performance has of course been the foremost design objective but flexibility and operating convenience has not been overlooked. Receiver tuning dial... "S" meter... any element that occasionally requires a quick glance while driving, is fully visible. And because the entire front panel is only 5" high and 12½" wide, every control—including transmitter VFO and Band switch—is conveniently at the driver's fingertips.

Those important "extras" have not been overlooked either. For example: Spotting switch of VFO to "zero in" station being received—Hi-Lo power switch for tune up—Switch to cut transmitter filaments when not needed—Crystal calibrator provisions for receiver with panel In- Out switch.

Use G-76 both in your car and home station. Simple to do. Transistorized 12 volt DC supply remains in car; 117V AC supply with speaker is optionally available for home use.

POWER SUPPLIES

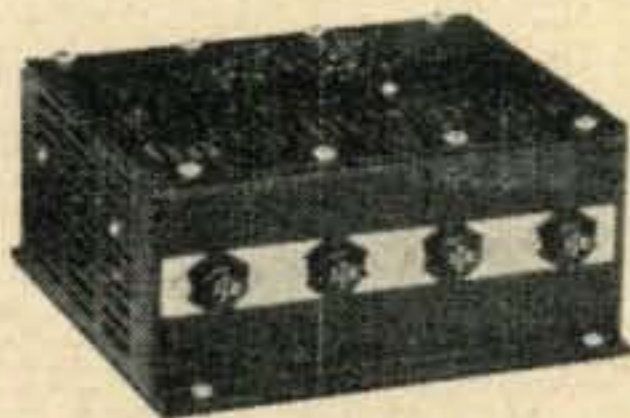

G-76 Power Supply, transistorized—for 12 VDC.

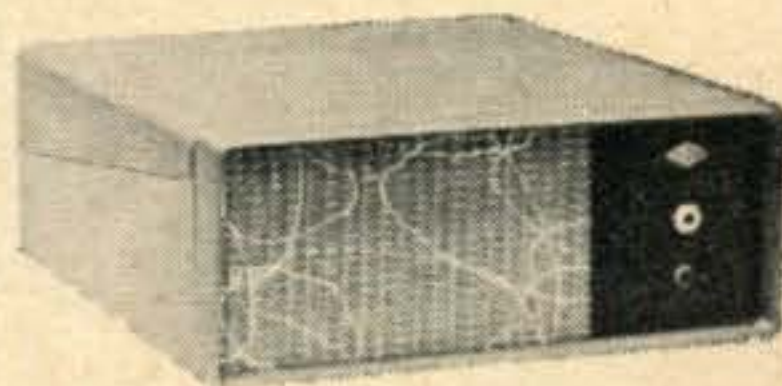

G-76 Power Supply and External Speaker unit—For 115VAC.

HIGHLIGHTS:

Receiver is dual conversion, 1st IF at 2065 kc; 2nd IF at 262 kc. Features includes BFO for SSB and CW reception, and ANL. Unit has excellent selectivity and sensitivity. Transmitter and receiver oscillators temperature compensated. Transmitter has stable VFO for all bands except 50 mc.* Crystal-control is optional. Power input of transmitter is 100 watts AM phone, 120 watts CW. Final tube is 6DQ5 operating into pinetwork output. Control is push-to-talk, or T-R switch on panel. Meter facilitates tuning. Dimensions: 12½"W, 5"H, 10½"D.

* Crystal-control

Further information, check number 7 on page 126.



GONSET

Division of Young Spring & Wire Corporation
801 SOUTH MAIN ST., BURBANK, CALIFORNIA

EXPORT SALES: WESTREX CORP., 111 EIGHTH AVE., NEW YORK 11, N.Y.

NOW — A 400-WATT BEAM PENTODE DIRECTLY INTERCHANGEABLE WITH THE 4-400A!

The advantages of Penta's exclusive vane-type suppressor beam pentode design are now available to the majority of 4-400A users. Simply plug the new PL-175A into the socket, retune slightly, and enjoy increased efficiency and lower distortion. The PL-175A, an improved version of the PL-175, requires no change in operating voltages when substituted for the 4-400A, and will deliver substantially more output in most applications.

Most tank circuits designed for the 4-400A will easily accommodate the slightly higher input and output capacitances of the PL-175A. The lower grid-plate capacitance reduces neutralizing problems.

The chart below shows the actual measured 14-Mc. power output performance of the PL-4-400A and PL-175A when operated in the same amplifier, which was adjusted for maximum output from each tube at maximum rated plate current, with identical plate, screen-grid, and control-grid voltages.

Other PL-175A advantages include a sturdy, solid, one-piece plate cap and seal with no set-screws or separate parts to loosen or fall off, and an electrode geometry which puts an end to annoying negative screen-grid current.

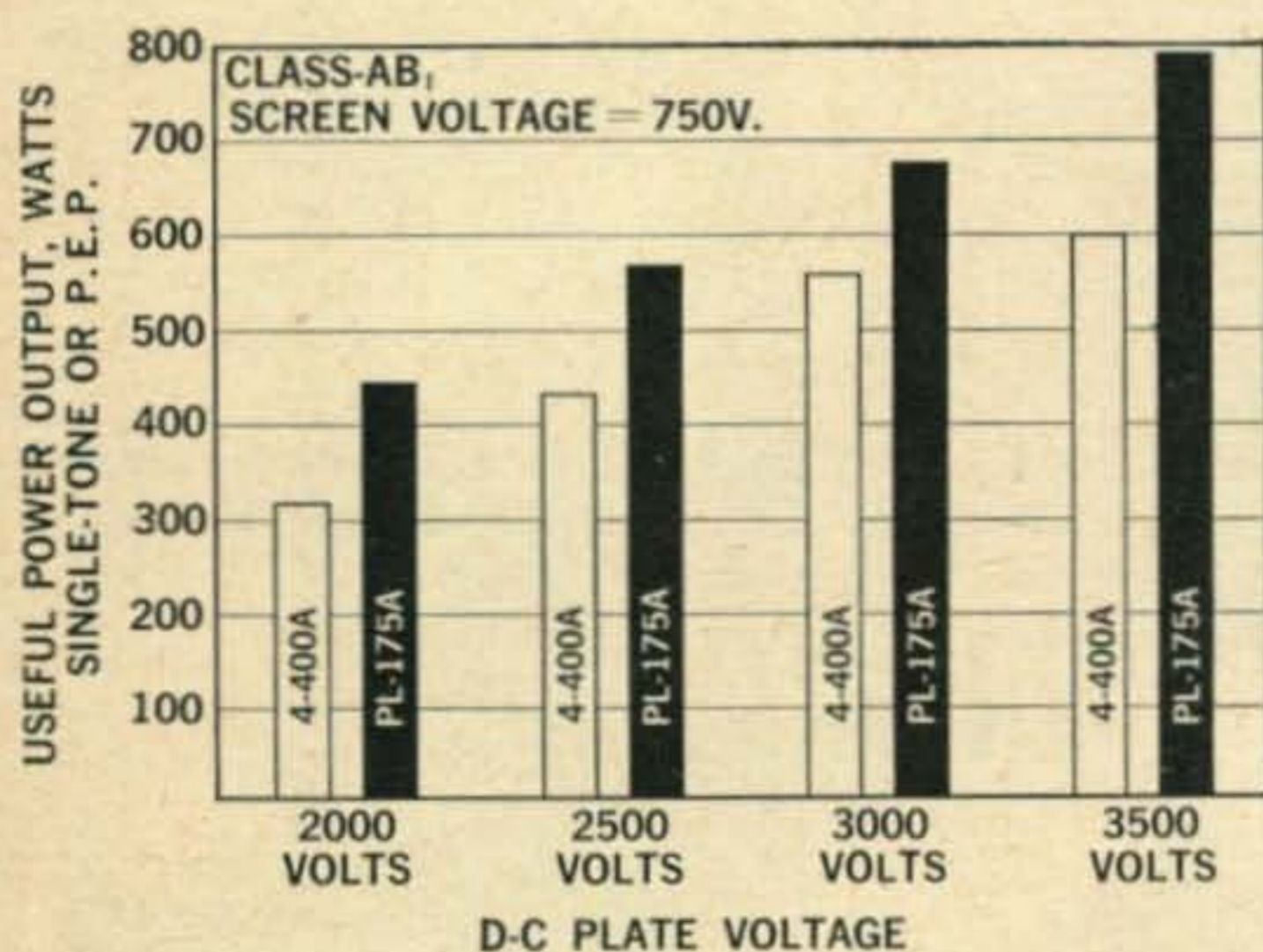

PL-175A

CHARACTERISTICS AND RATINGS

	PL-4-400A	PL-175A
Filament Voltage	5.0	5.0 volts
Filament Current	14.5	14.5 amperes
Direct Interelectrode Capacitance		
Input	12.5	15.1 mmfd
Output	4.5	9.8 mmfd
Grid-Plate	0.12	0.06 mmfd
Screen-Grid Amplification Factor	4.9	4.5
Maximum Plate Voltage	4000	4000 volts
Maximum Plate Current	350	350 ma
Maximum Plate Dissipation	400	400 watts

For complete details write for the PL-175A data sheet. Also, ask for your copy of "Transmitting Tubes for Linear Amplifier Service," a nine-page bulletin which shows in detail how and why Penta's pentodes out-perform conventional tetrodes.



PENTA LABORATORIES, INC.

312 North Nopal St., Santa Barbara, California

TRADE MARK REG. U. S. PAT. OFF.

For further information, check number 8 on page 126.

FROM HEATH ... 9 NEW RADIO AMATEUR KITS



GC-1
\$99.95
\$10.00 dn.,
\$9.00 mo.



TEN-TRANSISTOR "MOHICAN" GENERAL COVERAGE RECEIVER KIT (GC-1)

An excellent portable or fixed station receiver! Many firsts in receiver design for outstanding performance . . . ten transistor circuit . . . flashlight battery power supply . . . ceramic IF transfilters. The amazing, miniature transfilters used in the GC-1 replace transformer, inductive and capacitive elements used in conventional circuits; offer superior time and temperature stability, never need alignment and provide excellent selectivity. Other features include telescoping 54" whip antenna, flywheel tuning, tuning meter, large slide-rule dial and attractive, rugged steel case in gray and gray-green. Covers 550 kc to 30 mc in five bands. Electrical bandspread on five additional bands cover amateur frequencies from 80 through 10 meters. Operates up to 400 hours on 8 standard size "C" batteries. Sensitivity: is 10 uv, broadcast band; 2 uv, amateur bands for 10 db signal to noise ratio. Selectivity: 3 kc wide at 6 db down. Measures only 6½" x 12" x 10". 20 lbs.

Heathkit XP-2: plug-in power supply for 110 VAC operation of GC-1. (optional extra). 2 lbs. \$9.95



HD-20
\$14.95

100 KC CRYSTAL CALIBRATOR KIT (HD-20)

Align or check calibration of your communications gear with this versatile ham aid. Provides marker frequencies every 100 kc between 100 kc and 54 mc. Transistor circuit is battery powered for complete portability. Accuracy is assured by .005% crystal furnished. Measures only 2½" x 4½" x 2⅝". 1 lb.

7 more kits on following pages



HEATHKIT® . . . WORLD'S FINEST HAM GEAR



KL-1
\$399⁹⁵

\$40.00 dn.
 (Write for time
 payment details)

"CHIPPEWA" KILOWATT LINEAR AMPLIFIER KIT (KL-1)

Here is a top-quality kilowatt rig with all the features you've been looking for. Operates at maximum legal power input on all bands between 80 and 10 meters, in SSB, CW or AM linear operation. Premium tubes (4-400A's), forced air cooled with centrifugal blower. Grid neutralized, continuous plate current monitoring, extensive TVI shielding. Features both tuned and swamped grid circuits to accommodate all popular exciters. Operates class ABI for SSB and AM linear service and high efficiency class C for CW service. Convenient panel controls include power switch, tune-operate switch, HV on/off switch, final bandswitch, meter switch, grid bandswitch, grid tuning, mode switch, plate tuning, plate loading and bias adjust. Accessory connectors are provided on the rear apron of the chassis for complete compatibility with all control circuitry in the Heathkit "Apache" Transmitter. Two meters provided; one monitors final plate current; the other indicates switch selected readings of final grid current, screen current, and plate voltages. Send for complete specifications now. 70 lbs.

A PERFECT COMPANION FOR THE "CHIPPEWA" KILOWATT POWER SUPPLY KIT (KS-1)

Ruggedly constructed for heavy-duty use in medium to high power installations, the KS-1 fills the requirements of a top-notch power supply with economy and safety. Features an oil-filled hermetically sealed plate transformer, "potted" swinging choke input filter and 60-second time delay relay. Line filters minimize RF radiation. Maximum DC power output is 1500 watts. Nominal voltage output, 3000 or 1500 volts. DC current output, average 500 ma, maximum 1000 ma. Control circuitry is arranged to allow remote installation. The KS-1 employs two 866A half-wave mercury vapor rectifiers in a full-wave, single-phase configuration. Power requirements: 115 V, 50/60 cycles, 20 amperes; 230 V, 50/60 cycles, 10 amperes. 105 lbs.

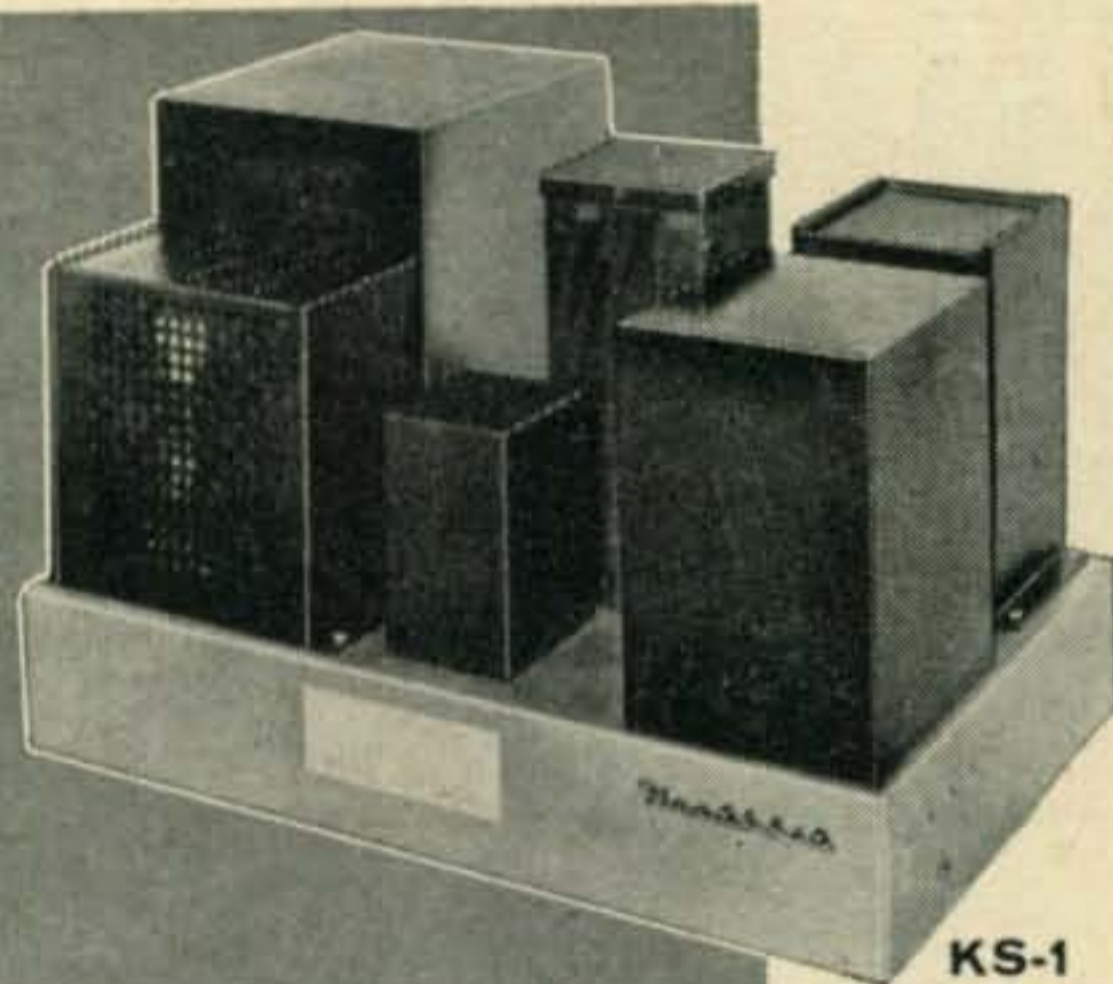

KS-1
\$169⁹⁵

\$17.00 dn.,
 \$15.00 mo.

XC-6
\$26⁹⁵



XC-2
\$36⁹⁵

6-METER CONVERTER KIT (XC-6)

Extends frequency coverage of the Heathkit "Mohawk" and most other general coverage receivers into the 6 meter band. Converts 50-54 mc signals to 22-26 mc. 3-tube circuit provides two RF stages and low-noise triode mixer. Calibration accuracy assured by .005% overtone crystal supplied. Provision for external RF gain control. 6 lbs.

2-METER CONVERTER KIT (XC-2)

This top-quality 2-meter converter may be used with receivers tuning any 4 mc segment between the frequencies of 22 and 35 mc when appropriate crystal is used. Converts 144-148 mc signals to 22-26 mc with .005% overtone crystal supplied. High quality parts used throughout. Silver plated chassis and shields. 7 lbs.

IN KIT FORM TOPS IN TRANSMITTING POWER

TWO BRAND NEW MODELS HEATHKIT 10 & 6 METER TRANSCEIVER KITS

Complete ham facilities at low cost! The new Heathkit transceivers are combination transmitters designed for crystal control and variable tuned receivers operating on the 6 and 10 meter amateur bands (50 to 54 mc HW-29 and 28 to 29.7 mc for HW-19) in either fixed or mobile installations. Highly sensitive superregenerative receivers pull in signals as low as 1 microvolt; low power output is more than adequate for "local" net operation. Other features include: built-in RF trap on 10 meter version to minimize TVI; adjustable link coupling on 6 meter version; built-in amplifier metering jack and "press-to-talk" switch with "transmit" and "hold" positions. Can be used in ham shack or as compact mobile rigs. Not for Citizen's Band use. Microphone and two power cables included. Handsomely styled in mocha and beige. Less crystal. 10 lbs.

VIBRATOR POWER SUPPLIES: VP-1-6 (6 volt), VP-1-12 (12 volt). 4 lbs. Kit; \$8.95 each, wired; \$12.95 each.



HW-19 (10 meter)
HW-29 (6 meter)
\$39.95 each



HD-19
\$34.95

HYBRID PHONE PATCH KIT (HD-19)

Add the thrill of phone patching to your ham hobbying, while rendering valuable public service during emergencies and in countless other instances. The HD-19 puts a top-flight phone patch in your ham shack at the lowest price anywhere! Features: voice control (VOX) or manual operation; large, easy to read VU meter for continuous monitoring of output to 600 ohm line; specially designed hybrid transformer providing better than 30 db isolation between receiver and transmitter circuit; separate receive and transmit gain controls. Switched circuitry allows VU meter to be used as null depth indicator. Provides effective match for 3 to 16 ohm speaker impedance. 4 lbs.

ORDER DIRECT BY MAIL OR SEE YOUR HEATHKIT DEALER*

*The convenience of Local Heathkit Sales and Service costs but a few dollars more.

HEATH COMPANY

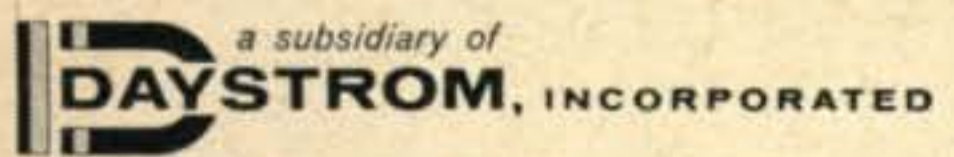

Benton Harbor 12, Michigan

All prices and specifications subject to change without notice. Please include postage on orders to be shipped parcel post. 20% deposit is required on all C.O.D. orders. All prices are NET F.O.B. Benton Harbor, Mich., and apply to Continental U.S. and Possessions only. Dealer and export prices slightly higher.



FREE CATALOG!

Describes over 150 easy-to-build electronic kits in HI-FI, Test, Marine, and Ham radio fields. To get yours, fill in this coupon and mail today!

ITEM	MODEL	PRICE

NAME _____

ADDRESS _____

CITY _____ ZONE _____ STATE _____

For further information, check number 9 on page 126.

How To Pass FCC COMMERCIAL RADIO OPERATOR License Exams

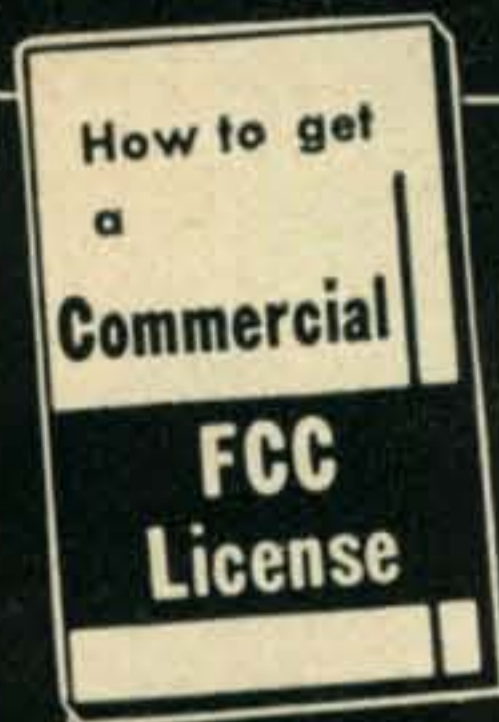

Free . . .
Tells where to apply and take FCC examinations, location of examining office, scope of knowledge required, approved way to prepare for FCC examinations, positive method of checking your knowledge before taking the examination.

GET YOUR FCC TICKET IN A MINIMUM OF TIME!

Get this Amazing Booklet FREE



TELLS HOW . . .

1. Tells how thousands of brand-new, better paying radio-TV-electronics jobs are now open to FCC License Holders.
2. Tells how we guarantee to train and coach you until you get your FCC License.
3. Tells how our amazing Job-Finding Service helps you get the better paying job our training prepares you to hold.

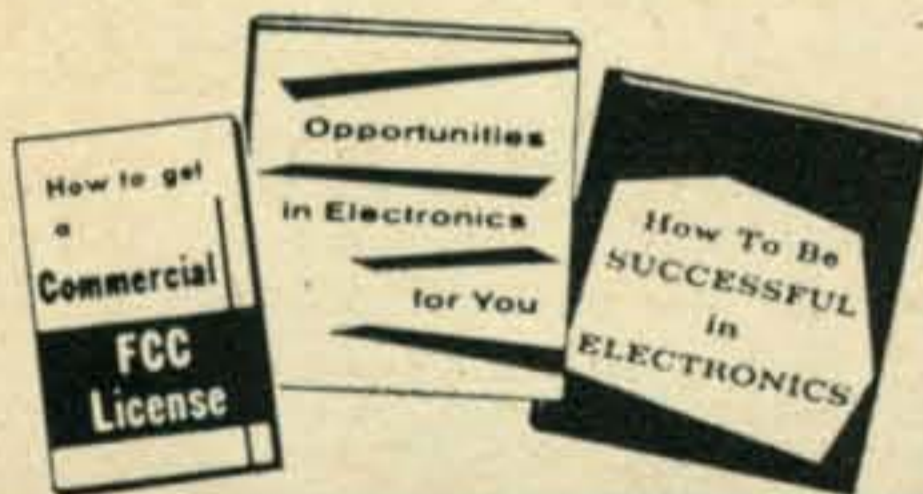

GET ALL 3 FREE!

MAIL COUPON NOW!

CLEVELAND INSTITUTE OF ELECTRONICS
Desk CQ-68, 4900 Euclid Bldg., Cleveland 3, Ohio.
(Address to Desk No. to avoid delay)

I want to know how I can get my FCC ticket in a minimum of time. Send me your FREE booklet, "How to Pass FCC License Examinations" (does not cover exams for Amateur License), as well as amazing new booklet, "Successful Electronics Training."

Name Age

Address

City Zone..... State.....

FOR PROMPT RESULTS SEND AIR MAIL

CQ-68

Letters to the Editor



Money In Thy Purse

Editor, CQ:

The request for a QSL for a contact on this continent, is a sign of immaturity.

They send you a card and you are a louse if you don't do the same. Furthermore, those who do QSL haven't a brain in their head! For instance, after a QSO, you get a card from the guy, who has spent both money and time and postage, laboriously filling in such information as time of QSO, date, frequency, his rig, what receiver he has, what antenna he uses, how glad he is to have made contact, etc., etc. Then, because he has written on the card, (with information other than the address) he pays extra postage. All this information was given during the QSO, why spend time and money repeating by mail?

As far back as the year 1927, with probably a dozen QSO's daily, this business of filling out cards in this manner, got me down, and so I got the job down to nothing but the address.

This type of QSL called for one cent in those days. My present QSL now costs me two cents. The QSL cards come in and I simply address a return card. The cost of over 45,000 cards in 41 years on the air, has cost me, in postage over \$1000.

So, you guys who still spend time writing information you have already given (I keep a log you know) and pay extra postage, keep doing it, but Shakespeare did say: "Put Money In Thy Purse."

M. J. Caveney, VE3GG
29 Byng Avenue

Willowdale, Ontario, Canada

Date, time, frequency, emission and report are required on QSL cards to substantiate any claim made for awards.-Ed.

20 Meter SSB

Editor, CQ:

Your comments in the editorial article in the April CQ on the extension of the United States phone section of the 20 meter band are of particular interest to me in view of the fact that I am the only SSB operator active from the Federation of Malaya at present, with the result that I am a little rather hard pressed at times. My opinions on the points raised by you are as follows:

1. I have had no difficulty in working DX stations (other than United States amateurs) since the band was extended. This is no doubt partly due to the fact that at this location when I am beaming into Europe, Australia, South America, etc., few United States amateurs can hear me.
2. When I am working into the United States it is only on rare occasions that I have had any difficulty from QRM although my power is less than 200 watts PEP. It is really much easier for me to maintain a clear channel into the States now that I work the W's on the same frequency, as prior to the extension it was quite a common occurrence for a KA or a KR to move on to "my frequency" say 14,320 while he was working someone below 14,300.
3. The reason why there are so few VS1/9M2's on Twenty AM is largely due to the "lack of thought" of the KR6 high powered Club Station operators who were active during 1955-58. When those "professional" operators

WHAT'S
NEW?

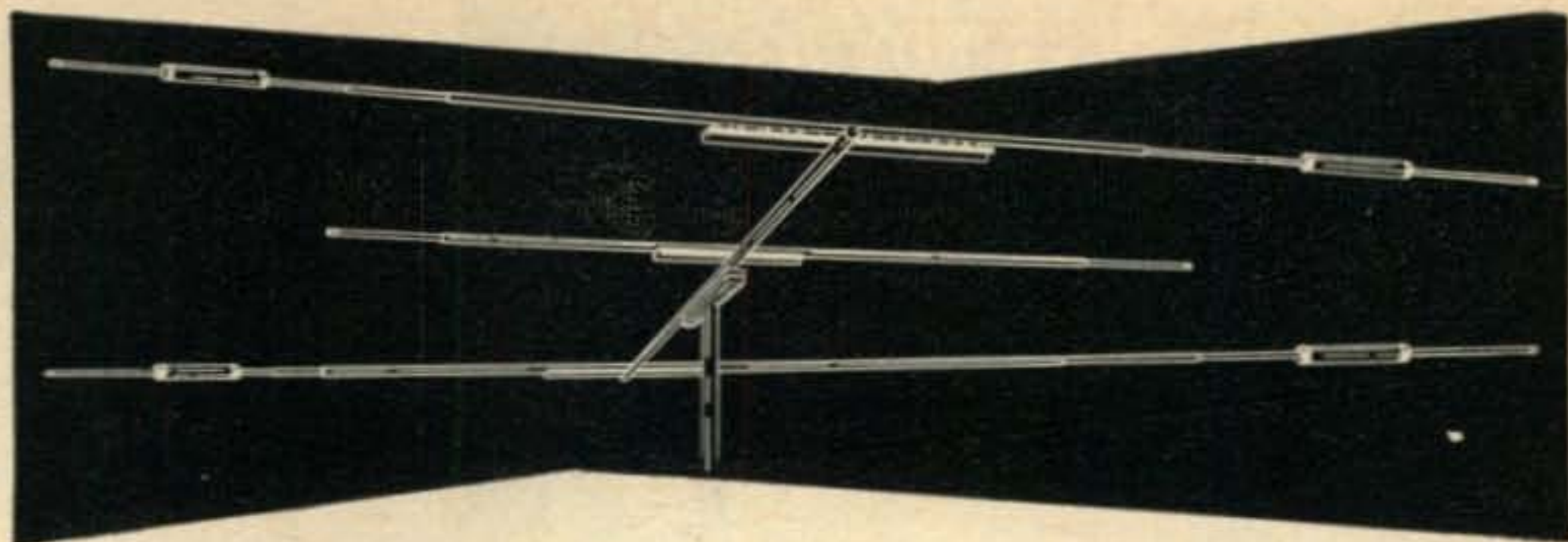

THE BIG SIGNAL BEAM FOR 20 & 40 METERS

BUILT FOR OPERATION AT MAXIMUM LEGAL AMATEUR POWER
EXCLUSIVE DESIGN AND CONSTRUCTION FEATURES

FREQUENCY STABILITY IN ALL WEATHER

FULLY RUST AND CORROSION PROOF—GUARANTEED!

For those radio amateurs who will not accept less than the finest . . .

Mosley Electronics, Incorporated proudly announces a new model for 20 and 40 meter operation.

An extraordinary antenna, the Mosley TA-20-40 offers performance to satisfy the perfectionist.

Frequency selection is accomplished by means of exclusive design, high impedance parallel-resonant "trap-circuits". Automatic band selection is achieved by a simple phasing network. This system permits fewer elements with a consequent reduction in weight and wind load - the result of research by the excellent engineering staff of growing Mosley Electronics, Incorporated.

You want contacts . . . this is THE ANTENNA!

Model TA-20-40 complete with tilting head and illustrated instruction booklet.

Amateur Net \$337.50

See your nearest amateur equipment dealer or write for literature describing the newest member of the Mosley TrapMaster antenna family.

THE

TA-20-40

MOSLEY ELECTRONICS, INC.

WEST COAST BRANCH
1406-08 South Grand Avenue
Los Angeles 15, California

INTERNATIONAL DIVISION
15 Moore Street
New York 4, New York

MAIN OFFICE
4610 N. Lindbergh Boulevard
Bridgeton, Missouri

For further information, check number 10 on page 126.

September, 1960 • CQ • 11

Now Your BEST BUY in CITIZENS TRANSCEIVERS... **EICO**



#760 (117 VAC) less bracket: Kit \$59.95. Wired \$89.95
 #761 (117 VAC & 6 VDC): Kit \$69.95. Wired \$99.95
 #762 (117 VAC & 12 VDC): Kit \$69.95. Wired \$99.95

Highly reliable; exemplary electronic, mechanical, industrial design. Powerful 5-watt (as defined by FCC) crystal-controlled transmitter & extremely sensitive, selective superhet receiver with RF stage & noise limiter. Built-in speaker, detachable ceramic mike. Pre-set & sealed crystal oscillator circuit elements. To change channels, just change crystals—no adjustments needed. Built-in variable "pi" network matches most popular antennas. Portable whip & roof antennas available. No exam or special skills needed—any citizen 18 years or older may obtain station license by submitting FCC form, supplied free by EICO.



**90-WATT CW
TRANSMITTER* #720**
 Kit \$79.95
 Wired \$119.95

*U.S. Pat. No. D-184,776
 "Top quality" — ELECTRONIC KITS
 GUIDE. Ideal for veteran or novice.
 90W CW, 65W external plate modulation.
 80 through 10 meters.



**HIGH LEVEL UNIVERSAL
MODULATOR-DRIVER
#730**
 Kit \$49.95
 Wired \$79.95

Cover E-5 \$4.50
 Delivers 50W undistorted audio.
 Modulates transmitters having RF inputs up
 to 100W. Unique over-modulation indicator.

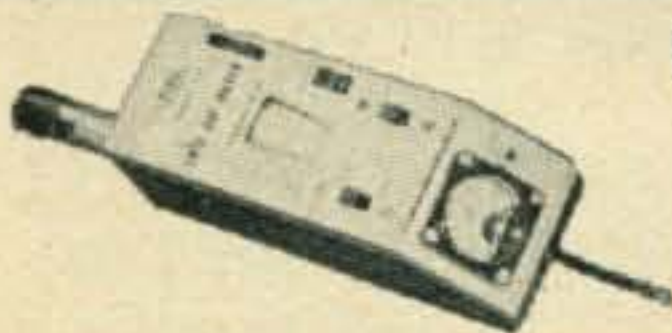

GRID DIP METER #710
 Kit \$29.95
 Wired \$49.95

Includes complete set
 of coils for full band
 coverage. Continuous
 coverage 400 kc to 250 mc. 500 ua meter.

NEW!



Code Practice Oscillator #706
 Kit \$8.95 Wired \$12.95

Rugged battery-operated transistor oscillator circuit with built-in 3" speaker. Front panel (deep-etched satin aluminum) has flashing light, phone jack, pitch control (500-2000 cps), external key terminals, "temporary" key. Panel switch selects Tone, Light, or both Tone & Light. 6 1/2" h, 3 3/4" w, 2 3/4" d.

Compare—judge for yourself—at your neighborhood EICO dealer. Send for FREE catalog on over 70 models of easy-to-build professional test instruments, hi-fi and ham gear. Send for FREE Short Course for Novice License.



Dept. CQ-8, 3300 N. Blvd., L.I.C. I, N.Y.
 Add 5% in the West. ©1960

For further information, check number 11 on page 126.

were asked by a Stateside Station to QSY a few kc's due to QRM, they seldom, if ever, checked their own frequency before moving, with the result that we were forced to fifteen meters.

4. The unpleasant part of it is that I am in contact with a weak station (for instance S3/4) and before I have finished some high powered W6 calls me and blasts my ear drums (I use phones at night when the family is asleep).
5. Recently I was asked to move by a KX6 while working a VKØ as apparently I was causing the KX6 interference while he was endeavouring to work phone patch traffic into the States. I QSY'd extra couple of kc's on to his frequency and suggested that if he wanted to have a clear channel for phone patch traffic he should move on to a MARS frequency. This comment of mine was naturally not appreciated. He seemed to think he had the right of way. My conclusion was that the operator concerned was not a real amateur but a professional operating a Military Club Station.

I would like to suggest that an agreement should be reached between all the amateur organizations through the International Amateur Radio Union on perhaps the following points:

- A. The maximum power to be used on 10, 15 and 20 meter DX bands should be restricted to 250 watts input on AM with 500 PEP on sideband.
- B. That CW should be restricted to the lower portion of each band i.e. from 14,000 to 14,100 on the 20 meter band.
- C. That all traffic handling by semi-commercial stations, i.e. Military Stations should be transferred to Military channels.

If the above could be agreed, then it would not really matter to us amateurs as to what part of the bands the United States licensees work. Few of us really object to the extension; what we do object to is the high power permitted in the United States and the commercializing of the amateur bands by traffic handling by U.S. Licensees.

S.A. Faulkner, 9M2DB
 Editor of "The Malayan Radio Amateur"

Hospital-ity

Editor, CQ:

Since the second world war there has been a steady increase in the number of internships and residency positions occupied in our hospitals by foreign doctors. The present figure is about 25% nationally but in many hospitals is close to 100%. These doctors come for training from all parts of South America, the Philippines, and some from Europe. They stay for up to three years.

Because of the length of time they remain in this country and the distance involved, many have no opportunity to return home for several years. Their situation is parallel to that of our armed forces in overseas bases.

At Christ Hospital in Jersey City, New Jersey, with which I am affiliated, most of the house staff comes from one area—the Philippine Islands. These young women doctors live and work at the hospital. I am seeking anyone in the area who would be interested in handling occasional messages directly from them or through me to a net or other willing channel with the philosophy of "Adopt a Hospital" or of adopting a group of likeable young doctors who will soon return to their homelands as ambassadors of goodwill for us and for amateur radio.

It takes two weeks for them to send and receive a letter. Perhaps we could cheer them up by shortening this time considerably. I spend a few hours a week, about midnight, on 20 and 40 meter CW. Thank you very much.

Morris Soled, M.D., W2NXS
 135 Belmont Ave.
 Jersey City 4, N. J.

Agreement

Editor, CQ:

Re: Letters for June 1960 CQ, I am in complete agreement with Mr. Crump. I believe 150 watts is more than adequate and would surely clear up the bands, especially when 2 kw P.E.P. signals move on to the a.m. portion of the band.

In fact I say let's do away with P.E.P. that's just another

DEFINITION:

"A Vertical Is an Antenna Which Radiates Equally POOR in All Directions!"

This is a statement rarely heard since the Fall of 1957. In that year Hy-Gain Antenna Products introduced for the first time a series of highly efficient multiband vertical antennas of which there are now more than 25,000 in use the world over.

But this time-worn gag received its death blow six months ago with the introduction of the Hy-Gain hy-Tower — a completely self-supporting, TRAPLESS multiband vertical for use on the 10, 15, 20, 40 and 80 meter bands. This was the first practical antenna configuration covering all popular amateur bands and requiring only two square feet of ground space. It could be installed easily by a 2-man team and required no guy lines for its overall height of 50 ft. Users were amazed at the high efficiency, low angle radiation using only a simple ground rod system at the base of the tower.

Today the hy-Tower is in use throughout the world. Below is a partial list of users in every US Call Area.

K1AKC
 W1JHR
 W1MAE
 K2IEG
 K3DML
 K3EMA
 W4CV
 W4LHS
 K4VKA
 KN4WVK
 K5JBD
 K5MRQ
 K5OAJ
 K5QHZ
 K5TCM

K5ZHB
 K5ZPS
 W6AEE
 K6AQP
 W6DRZ
 WV6HBD
 K6HIJ/Ø
 K6HJN
 WA6JKY
 W6PLG
 W7HCJ
 K7GCO
 K7MSL
 W8DUS
 W9GLM

K9QPX
 KN9SZY
 K9UBW
 W9YZO
 WØAHU
 KNØAOX
 KØDOM
 WØLTE
 KØOBX
 WØQAN
 KØSCG
 WØUSE
 KØVQH
 KØVVS
 KL7CZM

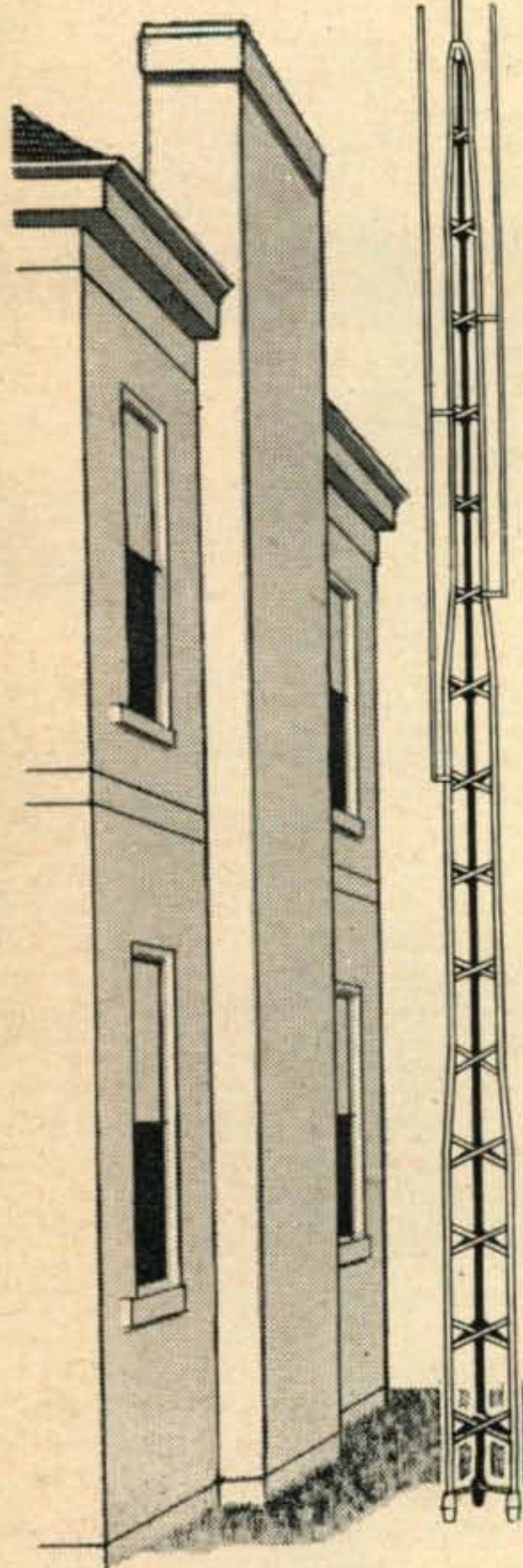

LISTEN FOR THEIR BIG SIGNALS.

Don't Ask Us! Ask Them!

Illustrated engineering report and descriptive literature describing the unique operation of the hy-Tower is now available at your favorite jobber's.

hy-gain antenna products

1135 No. 22nd St.

Lincoln, Nebr.

For further information, check number 12 on page 126.

**IMPROVE
SPEECH
INTELLIGIBILITY
AND
CUT
THROUGH
QRM**

SHURE

Ten-Four



list price
\$48.50

**MODEL NO. 405T
controlled magnetic microphone
with transistor amplifier**

All the advantages of controlled magnetic microphone construction—ability to withstand hard usage and extremes of climate and weather conditions—are yours in this sturdy, reliable microphone. The Ten-Four 405T has a flat frequency response characteristic (200 to 4000 cps), controlled to provide maximum speech efficiency.

It is ideally suited for SSB-AM transmission. Fits naturally and comfortably in the palm of the hand . . . takes up minimum space in mobile or fixed-station equipment. Equipped with heavy-duty push-to-talk switch.

Shure Brothers, Incorporated
222 Hartrey Ave., Evanston, Ill.

**MICROPHONES, HIGH FIDELITY AND
ELECTRONIC COMPONENTS**

For further information, check number 13 on page 126.

way of getting around the legal regulations.

T/Sgt. D. R. Schweitzer
CMR 2, Box 6911, 3392 S.S.
Keesler A.F.B., Miss.

Editor, CQ:

Regarding power, CQ for June, I have seen what the European stations can do with 50 watts of power. They use efficient antennas, they run clean rigs, and they come in here with some very nice signals. I have worked guys in the states, in some cases right in the same city, where a guy with 65 watts had a better signal than a guy with 500 watts. Almost all European countries have a power limit from 50 to 150 watts and yet these stations work the states and all over the world on both phone and c.w.

I am happy to see that the stateside magazines are continuing to point out the reasons why the DX stations sometimes act the way they do. I know if the stateside boys are working a station, they do not like to have someone break-in during the contact, or to keep calling when they are trying to read the other station. Yet stateside operators will do the same thing trying to get the choice DX they want. I am not claiming to be an angel, I have also done this several times when I was in the states—but one soon learns. I hope that I am able to work as many of the guys as I can, but I am now getting ready to come home (in about 5 months) and at that time as far as I know the station on Crete will become inactive for a while.

James M. Crump, III, K2RYP/SVØWY
Chief Operator, SVØWT
Crete

S.S.B. License

Editor, CQ:

. . . To give some meaning to the Extra class license why not make it mandatory to have this license to operate s.s.b. A new test might be devised by FCC for the Extra class license, one composed of about 50% s.s.b. material. I believe this would solve the problems quite adequately.

Grant Jung, KØSFX
800 Cedar Street
Charles City, Iowa

Finish Reciprocation

Editor, CQ:

You may be interested to know that I am the first American ever issued an OH call and that K2RKN who has just returned to the States was the second American licensed in Finland. My call is OH2XZ and Bob's OH2QZ. Any W/K can receive permission to operate in Finland by writing to the SRAL and waiting for the processing which may be a couple of months or more. With all the talk of reciprocal licensing it's nice to know that Finland, one of our firmest friends, has done their part. Please extend an invitation to anyone visiting Finland to call on me and I will arrange for them to meet the Finnish Hams, who are a fine group of very enthusiastic amateurs.

Nick Lassiter, OH2XZ
The Foreign Service of the
United States of America
Helsinki, Finland

Safety First

Editor, CQ:

After reading the July CQ concerning all the various antenna projects, I thought a grim footnote was in order.

About a year ago (Labor Day to be exact), I had the honor of helping a fellow ham install a beam antenna. It seems he wanted it located atop a 50' pine tree. Because he was "chicken" and I was fearless (at the moment at least) I was elected to climb said tree to remove its top. I asked about a safety belt and luckily for me Hal had one which I donned and up I went (I would have gone up in any case). As much as I hate to admit this—10 minutes later I fainted (yah fainted) and for 15 minutes until the fire department arrived my life depended on that almost forgotten safety belt (we live in a *very* rural area).

Thanks to that moldy old belt I'm not a Silent Key but still able to cause QRM and TVI with the best of you. So if you're fed up with the TVI and QRM do your antenna work without a safety belt and do us all a favor—but, your kids will miss you!

Ken Smith, K1ICM
P.O. Box 22
Charlton City, Mass.

On the air tonight



HAMMARLUND HX-500 TRANSMITTER

Tonight, and every night to come, more and more Hammarlund HX-500 SSB transmitters will be operating and serving as the topic of conversation. This new transmitter is rapidly setting the standards by which all other transmitters will be judged.

Loaded with new features, designed to provide the finest performance, and built to the fine traditions of Hammarlund craftsmanship, the HX-500 is your best buy in the fine transmitter field...

Write today for complete details... **\$695⁰⁰** amateur net.



Established 1910

HAMMARLUND

A DIVISION OF
TELECHROME

HAMMARLUND MANUFACTURING COMPANY, INC., 460 W. 34th ST., N. Y. 1, N. Y.

Export: Rocke International, 13 E. 40th St., N. Y. 16, N. Y. Canada: White Radio, Ltd., 41 West Ave. N., Hamilton, Can.

For further information, check number 14 on page 126.

September, 1960 • CQ • 15

CDR

"HAM-M" ROTOR

install in any type of tower

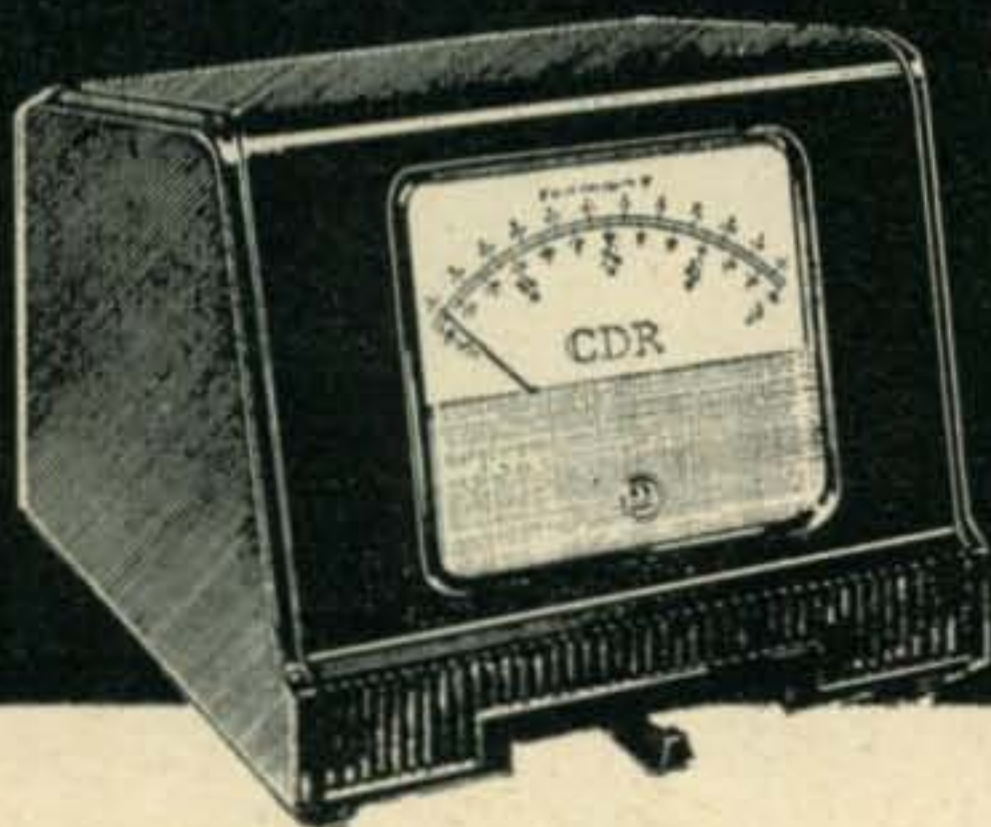
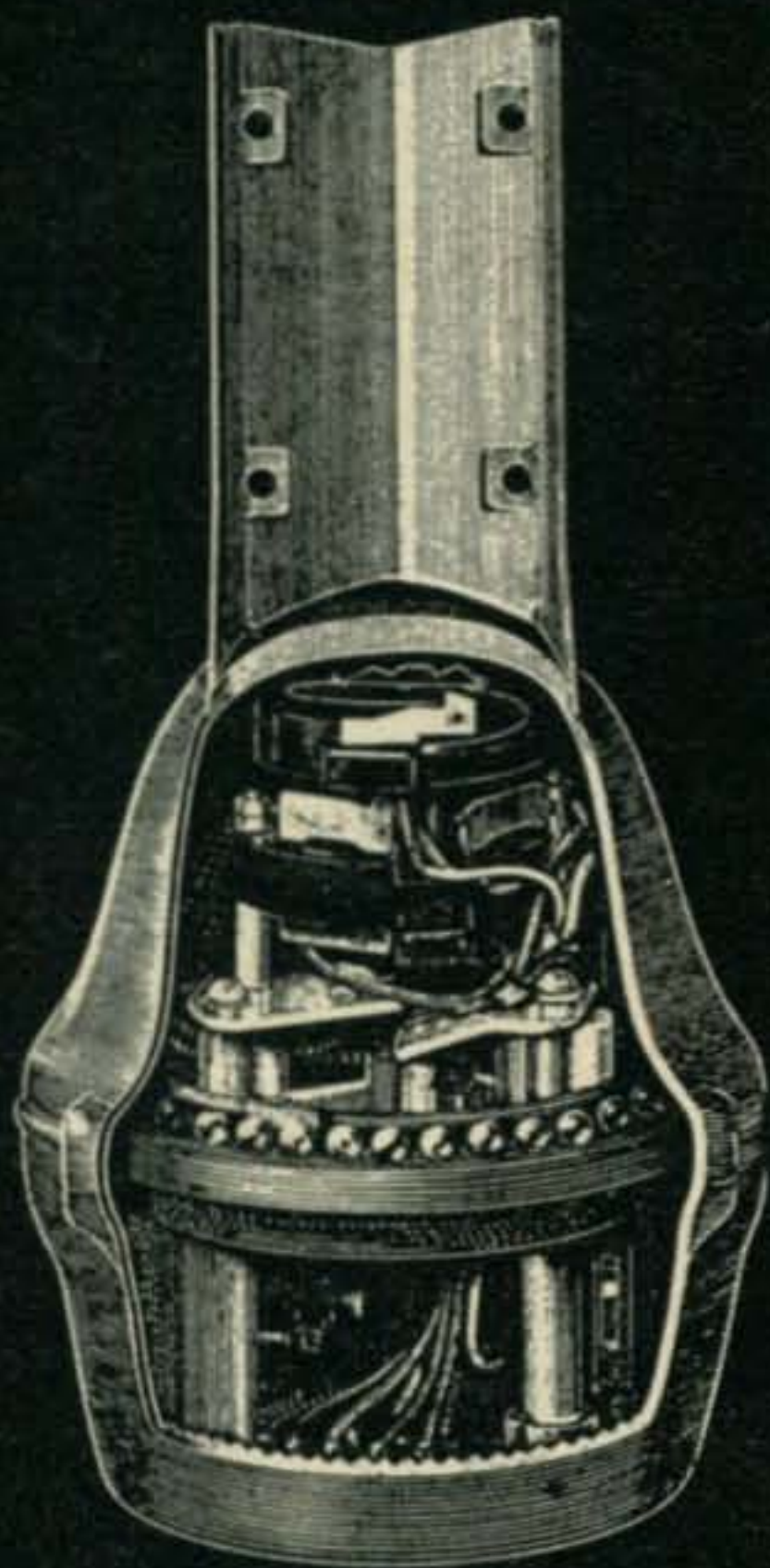

COMPLETE PACKAGED SYSTEM. Nothing else to buy. Can be installed atop any tower, and inside most towers in 30 minutes. Also available: North Center meter scale kit, plate for internal mounts, anti-meter flutter kit. **EXTREMELY RUGGED.** Extra heavy-duty. Thousands now in use, rotating every conceivable antenna combination. Wind-proof, ice-proof, moisture-proof! Won't drift! Provides 3500 in.-lbs. resistance to lateral thrust! Will replace any existing rotor installation and give superior performance. At your distributor. Only \$119.50.

CDR HAM ROTOR

Cornell-Dubilier Electric Corp., South Plainfield, N. J.
The Radiart Corporation, Indianapolis, Ind.



For further information, check number 15 on page 126.

Lightning Protection

Editor, CQ:

The article in the July issue of CQ on Lightning Protection by W6SAI was most interesting and will no doubt be closely adhered to by many hams anxious to circumvent lightning disaster in their radio shacks.

I do believe that #6 is the minimum size wire recommended for adequate protection for such service. This has been borne out by the work of the GE Lightning Research Lab projects since about 1936. They have demonstrated that smaller sizes simply evaporated under current surges simulating lightning hits.

The Lab made some revealing tests on the tower at KOA, Denver around this time. Their Surge Crest Ammeter links were installed on the four legs of the tower at the safety gap and on the *rf* lead connection to the tower. After a direct hit on the tower the links, measured in the lab, indicated a total peak current of 86,000 amperes. Damage: 5 turns of 7/8" copper tube 30" dia in the antenna lead direct to ground were crushed flat between support bars as if by a giant vise. The *shorted* antenna ammeter and external shunt were ruined. There were numerous bad burns on the ball/horn gaps and the *rf* circuit components.

If you expect static drain devices to protect your equipment from a direct lightning hit or from the induction from a near miss—you could become one of the few who may learn differently in the sad school of experience. That flashing neon lamp or sputter of static across a receiver input gap conveys the message that you should have already shut down the station and grounded the antenna. May I be quite explicit in stating that a 30 amp knife switch is *not* sufficient? A husky 1" blade knife switch is the thing. The oldtimers will remember the Navy and Commercial station grounding switch practices and present day hams would do well to follow this example.

Harold G. Austin, WØPI, Ex TF2WBR
200 Wisconsin Ave. N.W.
Washington 7, D.C.



Great Lakes Division Convention

The ARRL Great Lakes Division Convention, sponsored by the Cleveland Amateur Radio Convention Committee, will be held on October 7 and 8 at The Manger Hotel, East 13th Street and Chester Avenue, in Cleveland. On the evening of the 7th group suppers and several hospitality shows are scheduled. At 2400 there will be a *Royal Order of Wouff Hong* ceremony and initiation. The main portion of the convention will start at 1000 and continue throughout the day on the 8th. Technical talks, a DX Session, an afternoon tea for the ladies and an ARRL Session are included on the agenda. The Convention will terminate with an evening banquet in The Grand Ball Room.

Registration is \$2.00 per person and banquet tickets are \$5.00. Hotel rooms may be reserved by writing the Hotel Manger. For Convention registration and banquet tickets write The Cleveland Amateur Radio Convention Committee, P.O. Box 5167, Cleveland 1, Ohio. Preregistrants will qualify for special prizes.

Greater Cincinnati A.R.A.

Annual 23rd Stag Hamfest on Sunday, September 25, sponsored by the Greater Cincinnati Amateur Radio Association. The location is Stricker's Grove on Compton Road, East of Hamilton Avenue, in Mt. Healthy, Ohio. Registration \$2.50 at the gate, which provides you with hot dogs all day long, coffee and donuts until noon, beer and pop served all day, and full picnic dinner and supper (all you can eat) rain or shine. Main prizes include Hammarlund HX-500, SSB rig, and Hallicrafters SX-111 SSB Receiver. For further information, contact, Paul R. Wolf, W8IVE, 1329 Coolidge Ave., Cincinnati 30.

Blue Grass A.R.C.

The Blue Grass Amateur Radio Club of Lexington, Kentucky will hold its traditional hamfest at historic Keene-

FIGHTS STORMS

NEW!

**Base Station
STORMMASTER[®]
Unity-Gain Antenna**

Cat. No. 175-509 STORMMASTER is designed for service in areas where maximum physical strength and/or resistance to precipitation static is required. This design results in a reduction of precipitation static interference in the order of 20 db.

SPECIFICATIONS

- Frequency range 30-50 Mc
- Nominal input impedance 50 ohms
- Maximum power input 500 watts
- VSWR 1.5:1
- Bandwidth $\pm 1\%$
- Rated wind velocity 100 MPH with $\frac{1}{2}$ " of ice
- Weight 80 lbs. at 30 Mc



Communication Products Company, Inc.
MARLBORO NEW JERSEY

Communication Antenna Systems for American Business

For further information, check number 16 on page 126.

September, 1960 • CQ • 17

NEIL TRANSMITTERS

Sound Better



NEIL Beta 60 watt Transmitter • 6 or 10 Meters

In a true 50 to 60 watt phone transmitter, the audio system must provide 25 to 30 watts output or the signal will suffer.

Two 6CZ5, 6AQ5, or 6BQ5 tubes simply cannot do it. That's why NEIL uses FOUR 6BQ5's in the Beta modulator.

All NEIL transmitters sound better because:

- they do NOT use carrier controlled modulation, nor choke modulation, nor single tube modulators
- the modulator tubes ARE capable of 100% modulation
- the final is extremely stable so that it CAN be 100% plate and screen modulated

To top it off, a NEIL transmitter will amaze you with its ease of tuning.

- no screwdriver tuning
- tunes in seconds with front panel controls
- no long complicated initial tune-up or QSY
- no overtone oscillator circuits
- uses inexpensive low frequency crystals
- complete with tuning meters; no meter switching or calculation involved.

Check the values: NEIL transmitters tune easier (all controls on front panel, no screwdriver tuning), and sound better (because they are fully modulated using the best type of modulating system with the finest audio circuitry).

For use in FIXED STATION or MOBILE OPERATION without any modification.

TRANSMITTER PRICES • 6 OR 10 METERS

BETA transmitter, 60 watts. Requires 600v at 100ma, 300v at 200ma.

Wired \$125.00
Kit 98.00

ALPHA transmitter, 20 watts. Requires 300v at 200ma.

Wired \$78.50
Kit 58.50

Power Supply for fixed station use, wired 39.95

MOBILEER transmitter, 20 watts. With built-in mobile power supply for 12 volt operation.

Wired \$159.00
Kit 134.00

All transmitters only 3 inches high.

Please specify band and filament voltage desired.

SEE YOUR DEALER, OR ORDER FROM

THE NEIL COMPANY
1336 Calkins Rd.
PITTSFORD, N. Y.
• BAKER 5-6170 •

For further information, check number 17 on page 126.

land Race Track on Sunday, September 11. Lots of prizes, fun for the kids, and an area for swap and shop, plus refreshments at a nominal price promise a good time at this annual get together. Transmitters will be in operation on 10, 6 and 2 meters. Registration \$1.00.

Contact Charlie Brown, K4VLR, 2905 Southview Drive, Lexington, Kentucky for any additional information.

Post Office Net

The California Post Office Net is open to membership employees of the Postal service, active or retired who hold current amateur radio license issued by the FCC. The regional net is the center of operation for the 15 postal regions covering the 50 states and all Pacific possessions. The net started operations on April 18, 1960. For more information you may contact K6SAJ, at the Calif. Post Office Net, P.O. Box 301, Central Valley, California.

W9 DXCC Gathering

The annual W9 DXCC meeting will be held Sept. 17, 1960 beginning at 1:00 PM C.D.T. at the Tropical Room of the Sheraton Hotel in Chicago, Ill.

Only Church Ham Station?

The members of Grace Methodist Church, Carolina and Barton Streets in El Paso, Texas, would like to know if their's is the only church-owned amateur radio station.

W5AYV (Able Young and Vigorous) was started by the pastor, Reverend De L. Hinckley (with Ross, K5UCH—ex K4HKD as trustee) because, in the pastor's words: "We wish to introduce our young people to the fields of communications and electronics, so important in the space age; and to teach them civic responsibility through participation in local civil emergency communications groups. Then too, a church owned and operated station has an indirect effect in the field of Christian evangelism. It is a subtle reminder that God speaks in all languages—including Morse Code."

Unlike most ham stations though, church-owned W5AYV is more interested in GIVING QSL's, than in receiving them. It's attractive card bears the prominent advice: "Go To Church Or Synagogue This Week".

Metro Worked Ontario Counties Contest

H. Lee Foster is now coordinator of the Worked Ontario Counties Contest being conducted by Metro Amateur Radio Club of Toronto, Ontario.

All enquiries regarding regulations and any cards submitted in connection with the contest should be forwarded to, H. Lee Foster, 42 Ann Dale Drive, Willowdale, Ont., Canada.

Ohio Hamfest

The Findlay Radio Club, W8FT, will hold its annual hamfest on Sunday, Sept. 11, at Findlay Riverside Park. Families welcome. Ham equipment and ladies' handicraft swap and shop. Two main door prizes, each an Elmac AF-68 multi-band mobile transmitter. Many other prizes. Mobile talk-in on 3812 kc. Advance registration is \$1.00 per family or \$1.50 at the park. Tickets and information from Paul A. Chapin, W8KII, RFD 5, Findlay, Ohio.

Motorola Tech Manual

Motorola consumer Products Inc. of 4545 W. Augusta Blvd., Chicago 51, Ill. have issued a pamphlet entitled "A Guide To Noise Free Car Radio Installation." The eight-page pamphlet is a soft covered manual suitable for mounting in a loose leaf binder. It covers all aspects of noise generation in automobiles and suitable cures. Price is 50¢ and the Motorola part no. is 68P543953.

Five Towns Radio Club

The Five Towns Radio Club (Hewlett, Woodmere, Cedarhurst, Lawrence and Inwood, N. Y.) are sponsoring a Certificate obtainable by confirming contacts with five members of the club. No cards, no charge! Address Auguste Schwab Jr., K2LGS, 560 Woodmere Blvd., Woodmere, L. I., N. Y. Club members are: W2ANF, BFN, DAH, FEI, GPE, GXR, JNN, KFM, KRP, MNR, OGA, SAP, K2ADV, BHU, CDN, CFF, CTK, DIL, EWD, GCP, HMH, IHS, KPO, KQG, KXJ, LDF, LGS, OTO, QEY, QZU, RNY, SFA, STT, TAP, TXD, VBJ, VIX, VNP, WA2ARO, AZE, BEI, CQY, DCM, DEL, DMW, HTI, WV2BWX, CLL, CLM, FUZ, GGR, HAP, IFU, IJ, JEW.

ANTENNAS
SINCE
1921

Communication and TV Antennas
telrex LABORATORIES

ASBURY PARK 25, NEW JERSEY, U.S.A

DESIGNERS AND MANUFACTURERS OF
COMMERCIAL SERVICE "BEAMED-POWER" ARRAYS

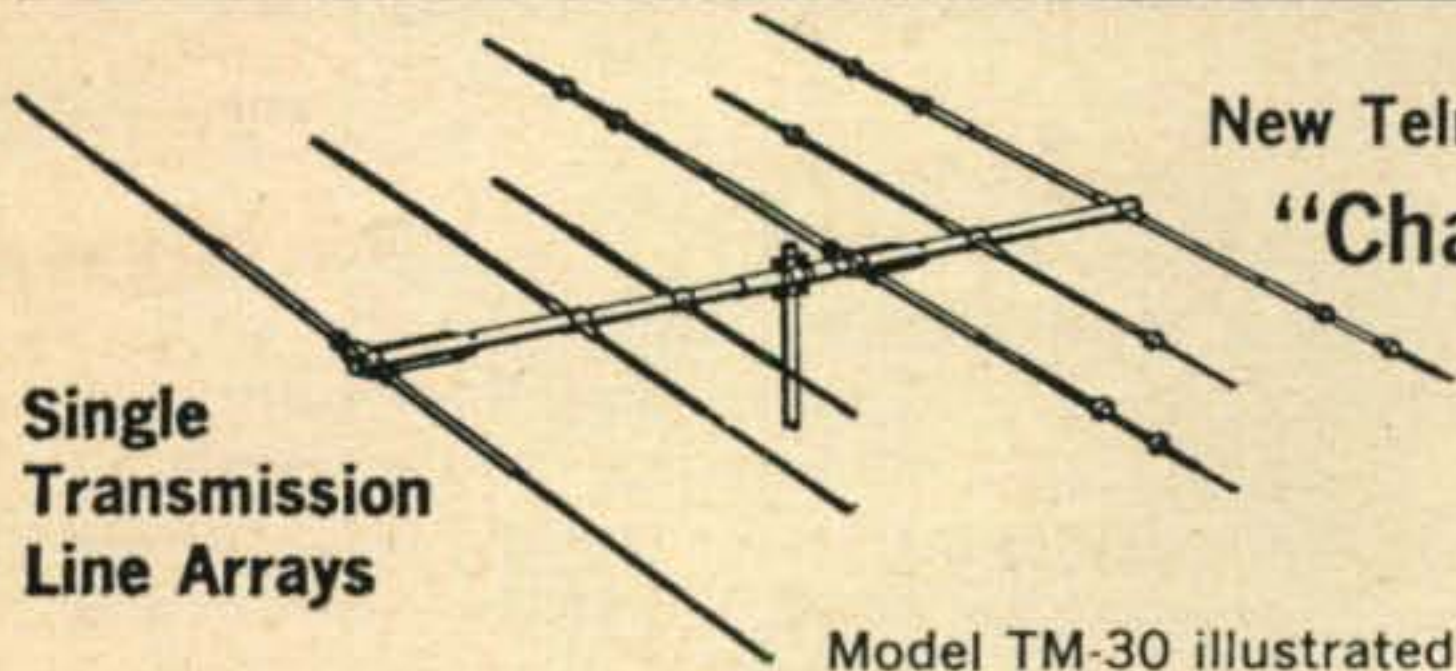

Single
Transmission
Line Arrays

Model TM-30 illustrated

26 pounds of educated aluminum—Telrex "Tri-Band" is World Renowned for performance, excellence and value.

New Telrex
"Challenger"

Model TC-88
"Tri-Band"
\$99.75

- Model TC-99 \$159.50
- Model TM-30 \$328.00
- Model DP-3 \$38.50
(10-15-20 Meter Dipole)
- Model DP-4 \$175.00
(10-15-20-40 Meter Dipole)

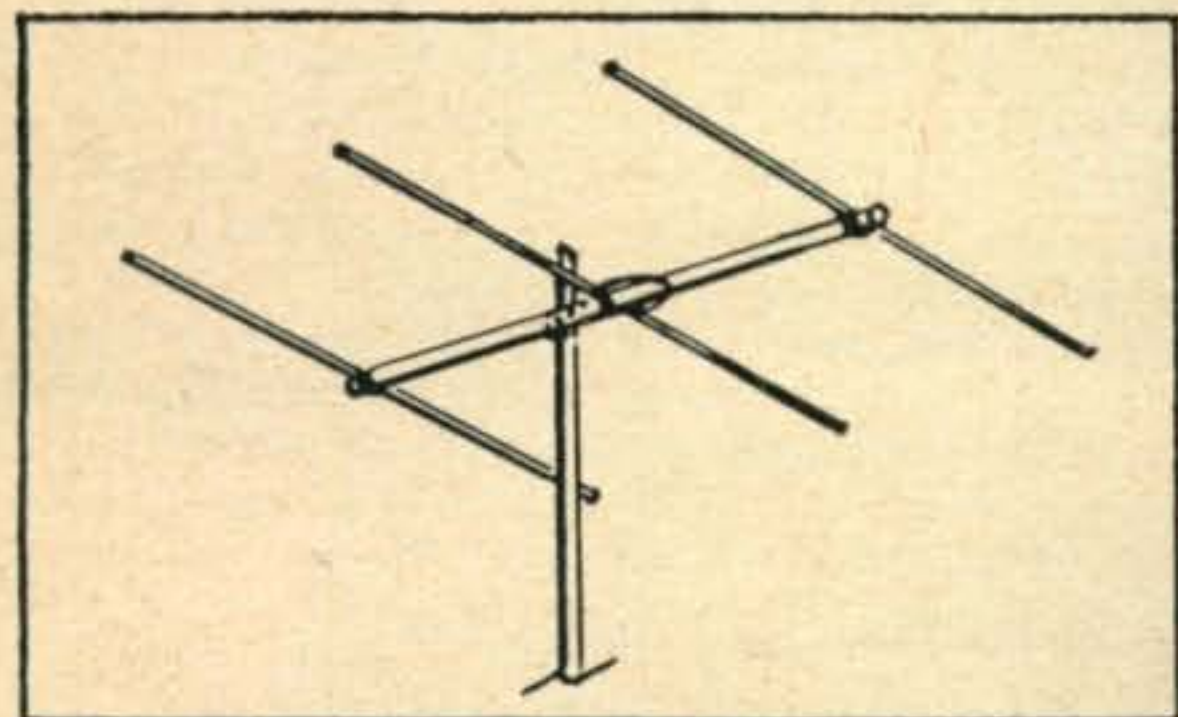

Model 2M-3C \$6.95

2 Meter Arrays

Telrex offers 12 models in the 2-meter band. Prices range from \$6.95 to \$115.00.

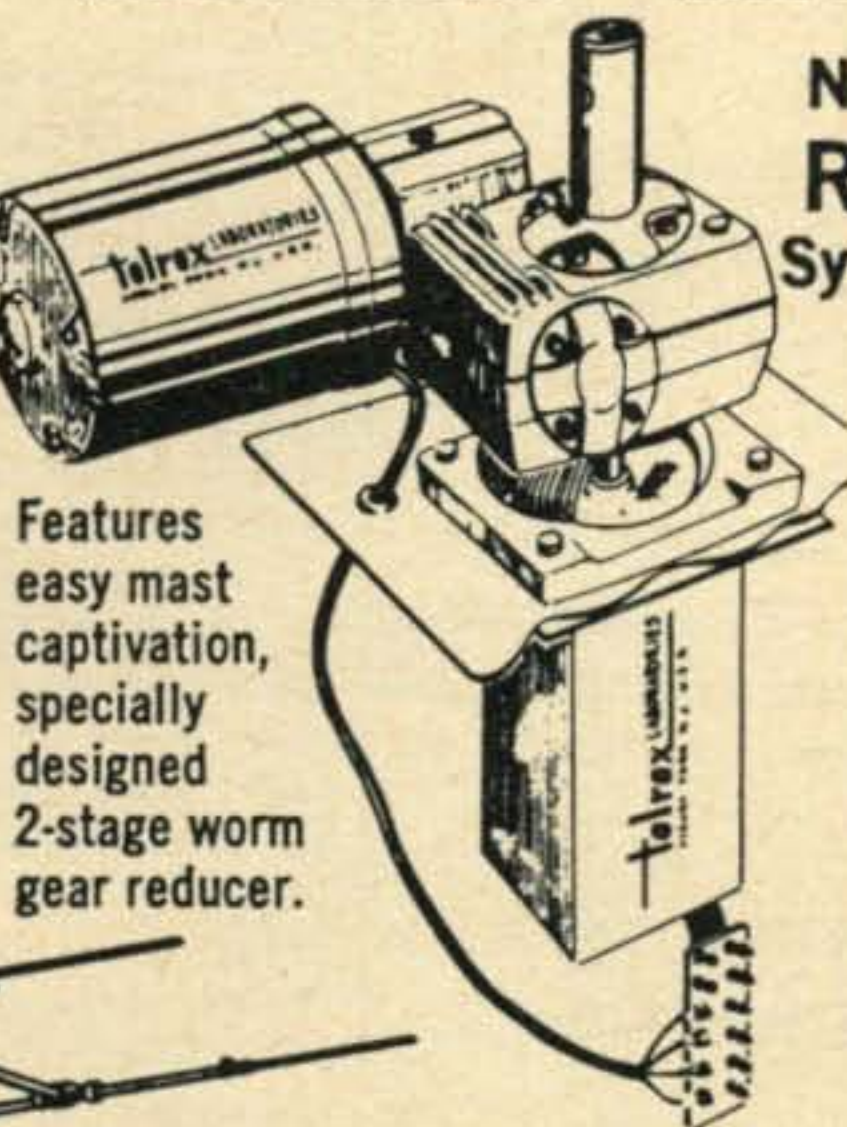

Features easy mast captivation, specially designed 2-stage worm gear reducer.

New Telrex
ROTATOR/INDICATOR
System Model 175-RIS \$198.50

Designed to out-perform and outlast any other beam rotator in its class. Will hold and rotate beams in winds up to 110 mph. Control Housing is Telrex quality thru-out. Black japanned aluminum housing. Tri-colored azimuth rose and reciprocal readings. Has sel-syn indication and limit of rotation circuitry.



Also available—Extra Heavy Duty Rotator Models

New Telrex
"CHRISTMAS TREE"
3-Band System

By far the most powerful and practical 3-element "Tri-band"® System . . . guaranteeing no compromise, 3-band performance and reliability—rain or shine! "Balun" feed and optimum antenna design assures . . . maximum gain, and impedance bandwidth, plus pattern symmetry with minimum TVI, BCI and harmonic radiation qualities not possible with so-called "Tri-banders".

World's Finest, Most Practical Communication System Featuring "Beamed-Power" and "Balanced-Pattern"

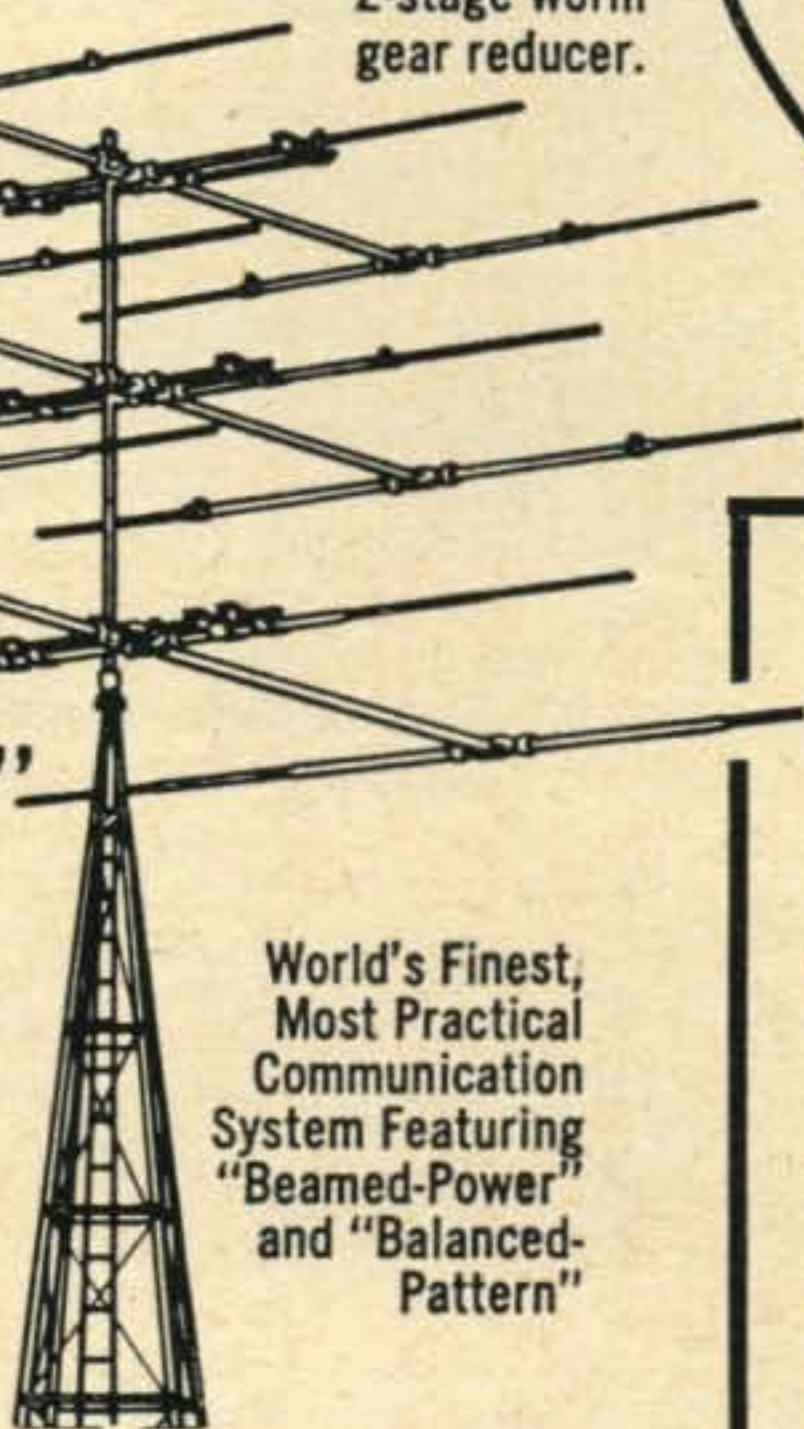

New Telrex
"SPIRALRAY"

\$19.50

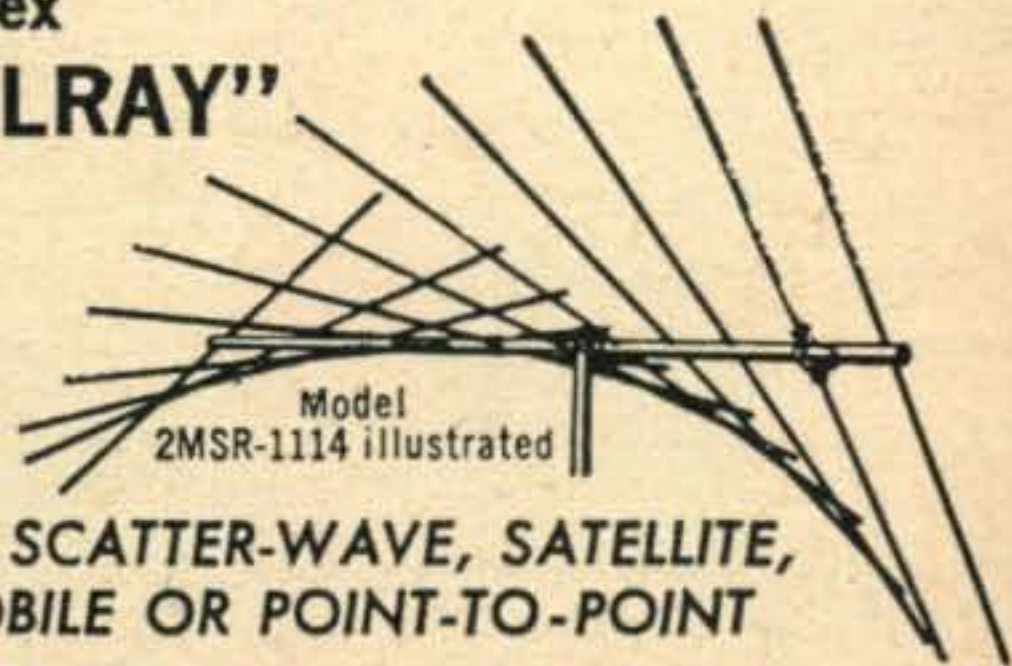

Model 2MSR-1114 illustrated

FOR SCATTER-WAVE, SATELLITE,
MOBILE OR POINT-TO-POINT

Extremely high-gain, high signal-to-noise, practically no fade, all radiation planes — horizontal, vertical or oblique! 50, 108 and 144 megacycle models available.

All prices FOB Asbury Park, New Jersey, subject to change without notice

For further information, check number 18 on page 126.

LET GEORGE DO IT!



Instead of singing our own praises, we're going to let George Bonadio do it. George Bonadio — W2WLR — of 373 East Avenue, Watertown, New York is a recent purchaser of a Turner 250. Here's the letter he wrote to The Turner Microphone Company.

Gentlemen:

Here are some comments on my new Turner 250 Hi-Z Dynamic mike. I copied these direct quotations out of my logbook:

'broadcast quality' 'smooth as can be'
'best quality I've ever heard from you'
'sounds beautiful' 'sounds just like you'
'very good' 'very normal — kinda refreshing'
'you've got very good audio'
'excellent' 'beautiful audio'
'nice signal, nice tone' 'modulation sounds
real fine. I appreciate one that does.'

I've left on the whole 20 feet of mike cord so I can roam as far as the bed or the back porch and operate.

I'm a gadgeteer myself, but can't figure out a happier set of switching controls than those on the 250 mike-stand. It's very handy. My compliments for a job well done.

Sincerely,
George Bonadio, W2WLR (160-10)

P.S. I wish everybody I worked on phone used one.

THE TURNER 250, FOR "BROADCAST QUALITY"

More versatile, convenient and easy to operate than any other amateur microphone. Has exclusive 3-way switching arrangement. Wired to operate both relay and mike circuits at a touch.



For more information write:



THE TURNER MICROPHONE COMPANY

925 17th Street N.E.,
Cedar Rapids, Iowa

For further information, check number 19 on page 126.

ham headlines

MARVIN D. LIPTON, VE3DQX
311 ROSEMARY ROAD
TORONTO 10, ONTARIO,
CANADA

Marvin Lipton VE3DQX, conductor of the CQ Club Bulletin column, which may be familiar to many readers, is again reading and editing the hundreds of club newspapers and periodicals throughout the country. We resume this column under the new title of HAM HEADLINES so that all our readers may benefit from the many interesting and topical items which would otherwise go unnoticed.

U.S. Hams Aid In Canadian Rescue

(Florida Skip, AP)

"Ham Radio help save 5 soldiers," was the headline in the *Miami News*. A Scranton, Pa., radio operator related how he helped rescue five U.S. soldiers lost in Manitoba, Canada, 1500 miles away, while sitting before his short wave radio.

Stanley Wojewdoski said he was operating the US Army Signal Corps' short wave radio station when he heard the soldiers trying in vain to call Churchill, on Hudson Bay.

Wojewdoski said he cut in and called Fort Churchill. He then relayed instructions to the soldiers to build a signal fire.

Two hours later Fort Churchill reported the soldiers had been rescued by helicopter, Wojewdoski said.

Young Hams Make News

(QLF, Lookport, N.Y.)

Two teenage amateurs say that they bounced code signals off ionized trails left by satellites and achieved two-way communication between their homes.

Massachusetts Institute of Technology making public an account of the experiment, called it probably the world's first successful two-way communication with the aid of artificial satellites.

The experiment was reported by Rafael Soifer of New York City, an MIT freshman, and Perry I. Klein, Bethesda, Md., who will enter MIT next fall. Both are 17 years old.

The young hams made use of a principle known as the Kraus effect. In 1957, Prof. John D. Kraus of Ohio State University, found that a fast moving body like a satellite leaves a wake of ionization in the ionosphere that may spread out 100 miles behind it.

The two students made their tests in the early morning of February 6, 1960. Further study is being given to the achievement at MIT.

Japanese Hams

(Metropolitan Ham News, Detroit, Mich.)

About 40,000 persons are preparing either to open stations or to qualify as hams the Japan Amateur Radio League says. Under the radio wave law passed in November, 1958, graduates of junior high schools and blind persons may take the state examinations. Formerly, only graduates of senior high schools could do so.

Under the old law, state examinations required a high standard of technique, almost equal to that of professional radio operators. The first state examination under the new law was held last April, with 15,000 applicants. Of these, 7800 persons passed the examinations, including 50 blind persons and 300 women.

Japanese hams began to attract attention when they successfully carried out emergency communications during floods in southern Japan in 1953 and in 1957. When a 1958 typhoon damaged communications in Kyushu, Japan's southernmost island, 50 amateur radio stations took over press and Red Cross communications. In the 1957 flood in

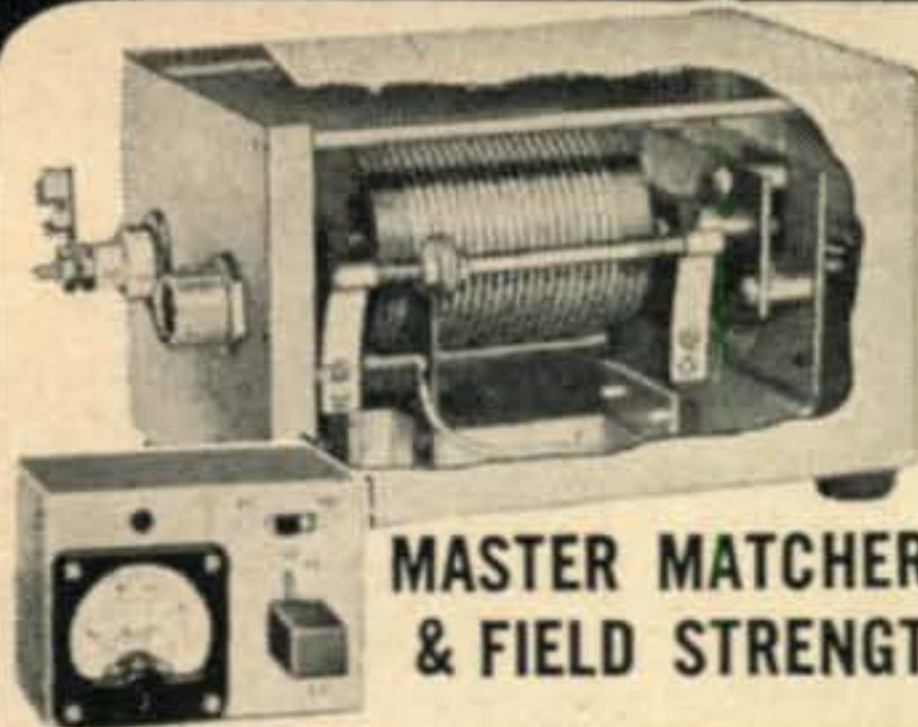

MASTER MATCHER & FIELD STRENGTH METER

6 or 12
volt models

Complete
\$24.95

Automatically
tunes entire
band by re-
mote control.



ULTRA-HI-"Q" COILS FOR 80, 40, 20, & 15 METERS

Your
Choice

\$5.25
ea.

The coil with the highest "Q" ever obtained. Tested and found to have a "Q" of well over 515. Use with 36" base sect. 60" whip. 3" Dia.

NEW! SLIM-JIM ALL-BAND BASE LOADING ANTENNA COIL

96" WHIP

FOR 10, 11,
15, 20, 40, 80
METERS

SIZE 1 3/8" x 19"

Positive action,
just slide whip
in or out to
loading point
and lock nut
into position.

NO.
B-1080

\$17.95

MULTI-BAND ANTENNA COILS

New Plug-in type coils, designed to operate with std. 3' base and 5' whip.



NO. 999
10-15-20 MET

NO. 900
10-15-20-40-75

NO. SSB-156
40 & 75 M.

• Rigidly tested & engineered—found to have "Q" of 525 • Handles 500 Watts input
• Operates into a 52-ohm cable • Positive contact—noise-free, trouble-free operation
• Weathersealed • Factory pre-tuned—no adjustments needed. **YOUR CHOICE EA \$14.95**

FIBRE-GLAS WHIPS

The Feather-
Weight Antenna
with Spring-Steel
Strength!

Completely
weather proof,
breakproof ant-
enna with
special flexibil-
ity that prevents
accidental short-
ing-out against
overhead ob-
structions which
can cause loss of
signal, serious
damage to equip-
ment.

FG-60 60" \$4.95
FG-72 72" \$4.95
FG-84 84" \$5.15
FG-96 96" \$5.25
FG-103 103" \$6.95

Leaders in the Design and Manufacturing of Communication Equipment & Antennas FOR LAND, SEA AND AIR

MONOPOLE ANTENNA

Folded radiating
element for in-
stallation requir-
ing a ground
plane configura-
tion and a wider
useful range.

11 Met. . \$24.50
10 Met. . 24.50
6 Met. . 16.95
2 Met. . 14.95

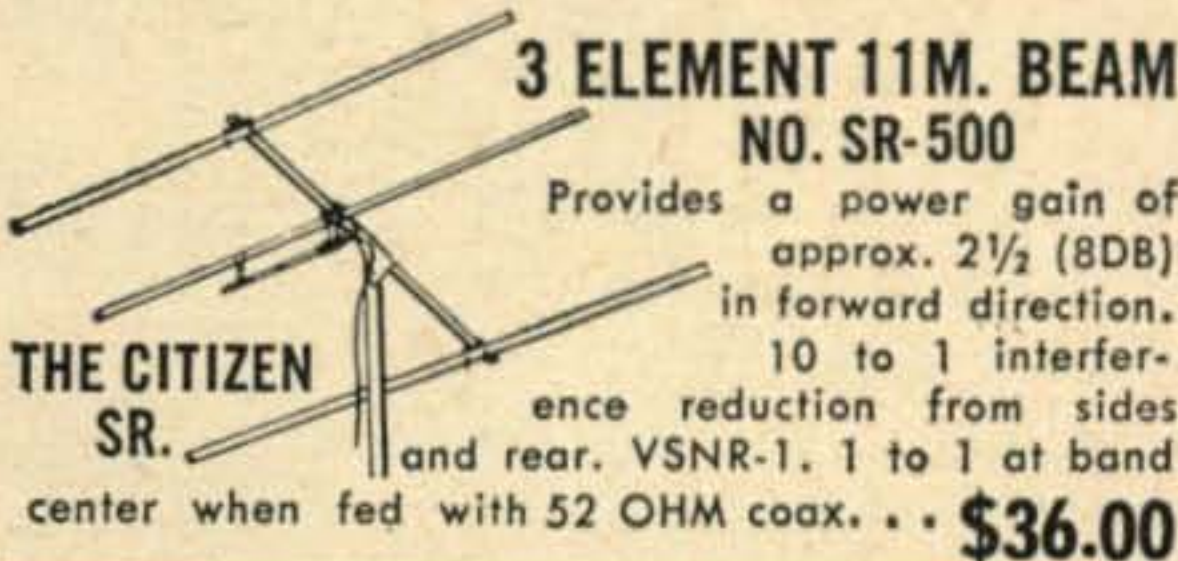

3 ELEMENT 11M. BEAM NO. SR-500

Provides a power gain of
approx. 2 1/2 (8DB)
in forward direction.

THE CITIZEN
SR.

10 to 1 interfer-
ence reduction from sides
and rear. VSNR-1. 1 to 1 at band
center when fed with 52 OHM coax. . . **\$36.00**

MOUNTS

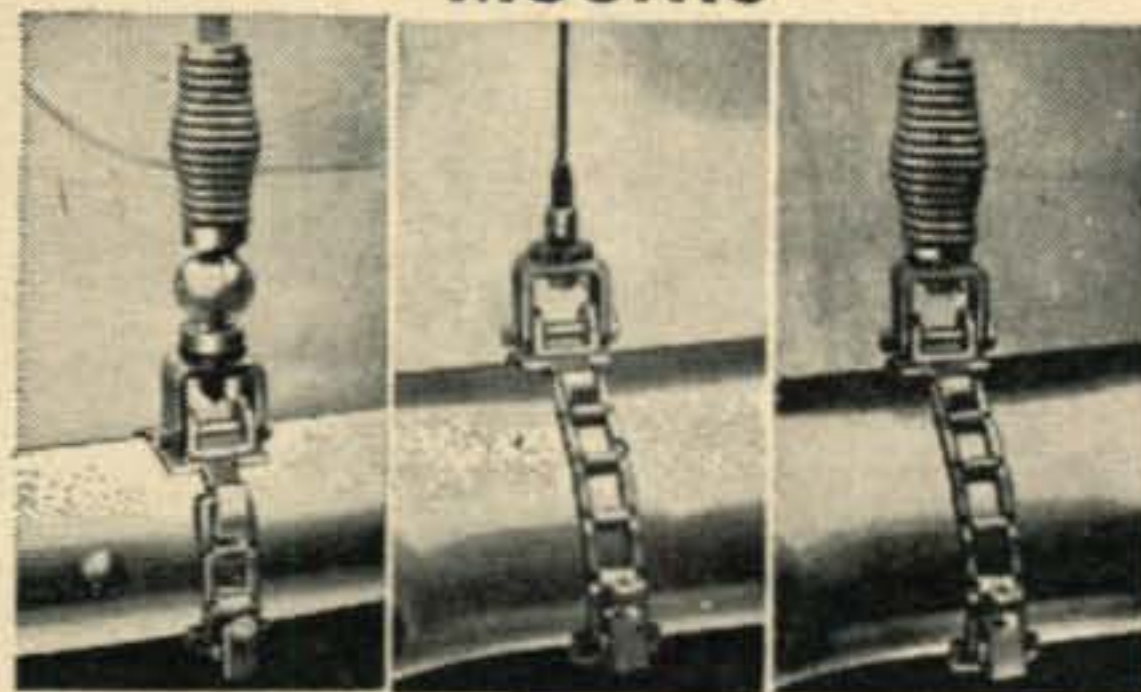

No.444 \$17.80 No.445 \$7.95 No.446 \$13.45
Adjustable to any bumper. No holes to drill.

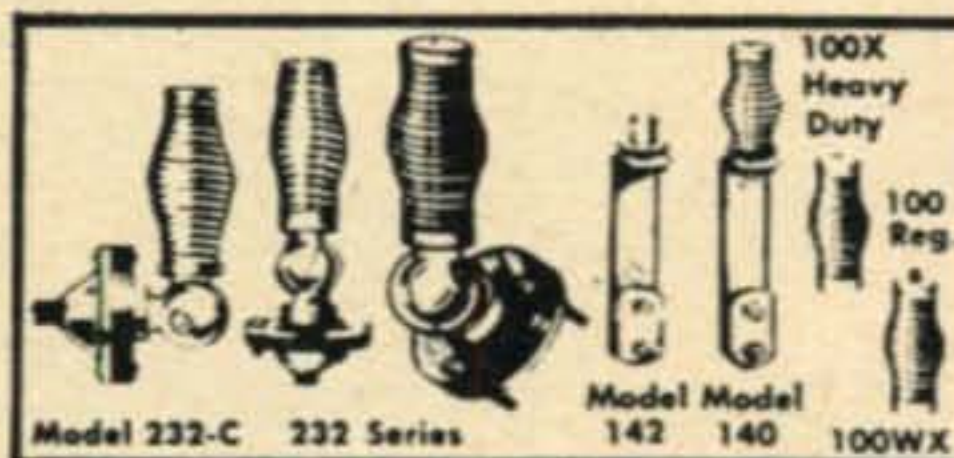

Model 232-C 232 Series 142 140 100WX

MASTER-MAGIC WAND

New easy-to-install, sin-
gle band, top-loaded
plastic covered fiber
glass antenna provides
maximum performance
at the most useful ra-
diation frequencies.

10 Met.- 5 Ft. L. \$8.95
11 Met.- 5 Ft. L. 8.95
11 Met.-35 In. L. 8.95
11 Met.-45 In. L. 8.95
15 Met.- 5 Ft. L. 8.95
20 Met.- 5 Ft. L. 8.95
40 Met.- 6 Ft. L. 9.95
80 Met.- 6 Ft. L. 9.95

SKYMASTER COAX ANTENNA

Gets your signal
through where others
fail. Concentrates
signals at the lowest
angle, provides
omni-directional pat-
tern for best cover-
age. Matches RG
59/U Cable. SM-700
11 Met. . . \$17.95
10 Met. . . 17.95
6 Met. . . 15.95
2 Met. . . 10.95



MOUNT

Smaller version of
Master Mobile Mounts,
less spring. Swivels,
mounts in all positions.
3/8"-24 thread for
Magic Wand, and all
Master Antennas.

No. J-11 **\$2.95**

11M. CITIZEN BAND ANTENNA

40" base loaded
S.S. whip antenna.
Fitted with a 1/4"
dia. brass slug for
all-purpose
mounts. Low
standing-wave ra-
tio on most of
band when fed
with a 52 ohm
coax.

8B-27 **\$12.95**

CITIZEN BAND ANTENNA

26.960-27.225
MC

VSWR under 1.5:1
at resonance. Com-
plete with 50' RG
58/U Cable. Swivel
type antenna
base for flat or
peaked roof
installation.

GP 27-11
\$34.50

WRITE FOR FREE
CATALOG

All products are for Universal Use-Mobile, Home,
Marine, C.A.P., Civil Defense, Emergency, etc.



Master Mobile Mounts, Inc.

4125 W. JEFFERSON BLVD. • LOS ANGELES 16, CALIF.

AT LEADING
RADIO JOBBERS
EVERYWHERE

For further information, check number 39 on page 126.

FIELD STATION ENGINEERS

Several qualified engineers will be selected to join in a program which is advancing the state-of-the-art of

IONOSPHERIC PHYSICS *and the study of* BACKSCATTER PHENOMENA

Background in these areas will be developed through a training program in our Electro-Physics Laboratories, located in Bladensburg, Maryland. Engineers selected will become part of a team extending experiments of the Research and Development Department to the field, in both Domestic and Overseas assignments, and will have ample opportunity to develop technically.

They will possess a combination of the following requirements:

- ✓ BSEE, or equivalent consisting of combined civilian or military technical school plus work experience.
- ✓ Presently employed as a Field Engineer or Project Engineer.
- ✓ A good command of some of the following:
 - RADAR, preferably High-Power
 - HF Long-Distance Communications Systems
 - Tropospheric or Ionospheric Scatter Systems
 - Meteor-Burst Communications Systems
 - Propagation Prediction—computation of propagation for long-distance communications
 - Ionospheric Sounder Operations
 - RDF Systems
 - Doppler RADAR Systems
 - Amateur Radio Enthusiast
- ✓ FCC License, 1st or 2nd Class.

They must be willing to accept assignments in areas where dependents are not permitted for periods up to one year. Differential paid for overseas assignments.

Applications Are Also Being Accepted For
SENIOR SCIENTISTS
ENGINEERS (All Levels)
LABORATORY TECHNICIANS

*for permanent assignment at our Electro-Physics
Laboratories in Bladensburg, Maryland.*

Please Send Resume To:

Professional Employment Dept.

ACF ELECTRONICS DIVISION
ACF INDUSTRIES
INCORPORATED

RIVERDALE, MARYLAND

Isahaya, Kyushu hams took over communications.

Two Bootleggers Apprehended

(Metro Modulator, Toronto, Ont.)

Radio Station WMEW is off the air. Its presidents, William Mortimer and Edward W. Wolfrum are among the unemployed.

William and Edward are 14 years old.

Their daily 5PM to 8PM operation on 650 Kilocycles, with a signal that reached out half a mile, got put off the air by the Federal Communications Commission.

A newspaper story about WMEW, made from \$25 worth of radio parts and some junk from sympathetic adult radio bugs, was read by a FCC official. WMEW had to go, he said, because it did not have a license and was using the same frequency as a station down in Tennessee.

Altimeter Has New Use

(Roundtable, Denver, Col.)

After the kind of winter this area has had, a recent announcement by scientists at the U.S. Army will come as no surprise to Colorado hams. They tell us that radio waves will penetrate solid ice.

What led them to bring up the subject is the fantastic story of a pilot who was approaching the Army's Camp Century in Greenland in a blinding blizzard. He was understandably shocked when he saw the figure of a man standing in front of him. He cut his engines, in spite of the fact that his radio altimeter registered 2000 feet, and found that he had unknowingly landed on the Camp Century airstrip.

Several incidents of this type—some with more tragic results—have led to the realization that radio altimeters are unable to be used accurately in Polar regions because their beams will penetrate glacial ice and reflect only when they strike the earth shelf beneath.

But the radio altimeter will still be used in Arctic Regions—in another capacity. Because of its ability to penetrate ice it will replace much more costly devices for measuring the thickness of ice in studies of Polar areas. The idea had never occurred to anyone before the pilot landed his plane without knowing it.

Beware Of Korea

(Pearl (M) News, Guam)

As we all know there have been many bootleggers in Korea. At the present time there are only six authorized stations and these are all club stations. Each station is authorized to operate but one assigned frequency for fone and one for CW per 14, 21 and 28 Mc. band. The other day I heard an irrate op moaning because the HL station wouldn't move from "his" frequency. As these poor boys only have one frequency per band, let us do the moving.

'Fraternity Dollars' For Chile

(The Sidebander, Lynbrook, N.Y.)

The amateurs of Ecuador have organized a campaign, now in progress, to help the earthquake stricken people of Chile through donations known as 'Fraternity Dollars'. Amateurs are being requested to send their dollars to "Radio Club, P.O. Box 1366, Cuenca, Ecuador." Cheques should be made out to the Red Cross of Chile or simply Red Cross. Joe, HC6KA/HC1 announced that periodic listings of contributors would be made over the air. We urge our members to participate in this worthwhile campaign to further the cause of friendship and good will through amateur radio. Send your 'fraternity dollars' today.

Announcement

Editors of amateur radio club publications are invited to send a monthly copy of their papers to the editor of this department to be considered for inclusion herein. To help editors acquire suitable copy for their journals through exchange with other editors, I have prepared a directory of amateur radio publications. For 25¢ you can have your paper registered and you automatically qualify for a copy of the directory. Direct any inquiries to me at the QTH at the column head.

THIS BEAM THINKS IT'S A PIPELINE

THE NEW MODEL TB 1000-4 10-15-20 Meter Antenna

- Famous Hornet Quality
- Rated at Maximum Legal Power
- Four Elements On Each Band

Model TB 1000-4 Cash Price, Only \$119.50

YOU WILL THINK SO TOO!

The four triband elements, in operation on each band make the difference —

A Powerful four element punch!

NOW AT YOUR DEALERS!

World famous Hornet antennas are now available from dealers. See your dealer today for the model of your choice, or order direct from Hornet.

THE NEW MODEL TB 750

This husky antenna replaces Hornet's famous Model TB 600, and is now rated at 750 watts AM or SSB.

Model TB 750 Cash Price, Only \$69.95

THE NEW MODEL TB 1000 offers top performance in three element design.

- Famous Hornet Quality
- Rated at maximum legal power

Model TB 1000 Cash Price,
Only \$89.75

ALL MODELS . . .

- Are Pre-tuned and Easy to Install
- Have Custom Fittings of Cast Aluminum
- Use a Single 52 ohm Coaxial Transmission Line
- Have completely weather-sealed Frequency-Dividers*
- Have Elements of 6061-T6 Aluminum

All Prices F.O.B. Dealers Store or Factory

Model TB-500
Cash Price
Only \$59.75

WRITE FOR
FREE
ILLUSTRATED
CATALOG

THE BEAM WITH A STING

HORNET
Antenna Products Co.

P.O. BOX 808 • DUNCAN, OKLA.

MAIL YOUR ORDER TODAY — 10 DAYS FREE TRIAL

HORNET ANTENNA PRODUCTS CO.
P.O. Box 808, Duncan, Okla.

- Please ship one Model _____ Hornet tribander. Cash price in full is inclosed.
- I wish to purchase one Model _____ Hornet tribander, and would like to use your time-payment plan.

NAME _____ My Call Letters Are _____

ADDRESS _____

CITY _____ STATE _____

ABSOLUTELY NO RISK ON YOUR PART

For further information, check number 22 on page 126.

TELEX[®]

SUPERIORITY IN SOUND

FIDELITY... FOR HAMS WITH A LIKING FOR LIGHTNESS

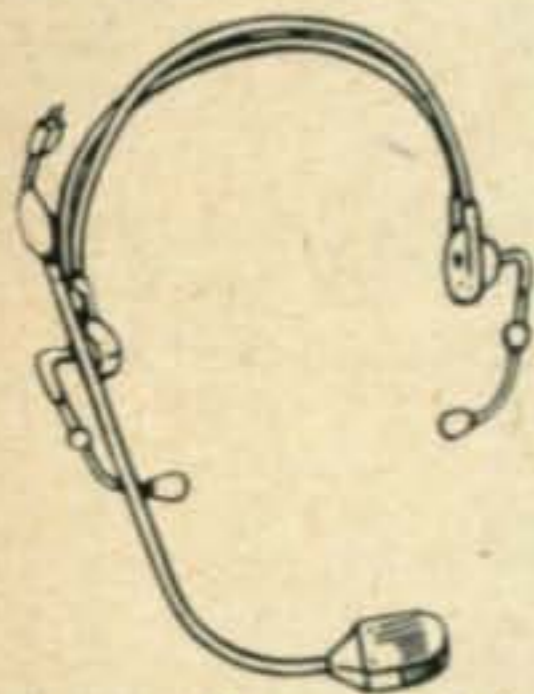

LIGHT...

Boom Mike Headset—Light 4 oz. parallel connected receivers transmit sound directly to ears through adjustable tone arms. Rubber or plastic tips block background noise without pressure, allowing continuous communication under the most difficult conditions. Available with a wide choice of

general or special purpose microphones. Mike boom, angled for best pickup, has 360° swivel. Ideal headset for mobile use. Impedance: 500 ohms. Frequency response: 50 to 5000 cps. Sensitivity: 114 db above .0002 dynes per sq. cm. for 1 milliwatt input.



LIGHTER...

Twinset—FAA approved, the 1.6 oz. Twinset is standard on airlines; fits any amateur, experimental or commercial installation. The lightest twin magnetic receiver headset ever made! Sound is piped through adjustable tone arm. Ear-

tips block out background without touching ears. Standard 5' cord and phone plug or optional cord with volume control. Frequency response: 50 to 5000 cps. Sensitivity: 101 db above .0002 dynes per sq. cm. for 10 microwatts input.



STILL LIGHTER...

Monoset—Under-chin 1.1 oz. set features removable eartips, optional volume controls. Durable aluminum construction, Monoset has 5' cord and standard plug. Frequency response: 100 to 5000 cps. Sensitivity: 88 db above .0002

dynes per sq. cm. for 10 microwatts input.

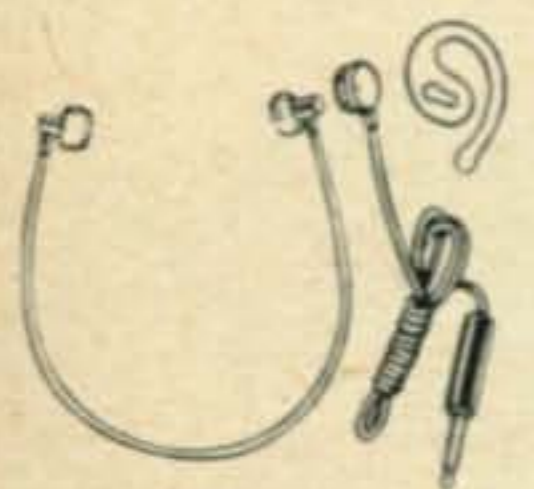

LIGHTEST...

Tele-Fi—True dimensional sound and 30% better understanding with this 1/2 oz. set because of a 1 millisecond delay in sound reaching ear opposite receiver. Replaceable ear tips. Change from headset to accessory earset in seconds. Standard phone plug and 5' cord included. Tele-Fi chin band usable with all TELEX transistor receivers. Frequency response: 50 to 5000 cps. Sensitivity: Comfortable at 1 milliwatt.

See your jobber today for superior quality communications accessories... by TELEX! Or, write for information to:

TELEX

Communications Accessories Division

Dept. CA-307, Telex Park, St. Paul 1, Minnesota

For further information, check number 23 on page 126.

24 • CQ • September, 1960

Amateur Radio

Legal Notes

Maurice J. Hindin, W6EUV

6565 Wilshire Boulevard
Los Angeles 38, Calif.

One of the State Supreme Court cases involving amateur radio activity which is most frequently cited by lawyers is a case known as the Appeal of Lord. This case was decided finally in the Supreme Court of Pennsylvania.

The case developed as follows: Mr. George Lord was an amateur radio operator who lived in the Borough of Munhall, Pennsylvania. He desired to erect a 32 foot mast in the backyard of his home to support a beam antenna. He was advised that it was necessary for him to secure a building permit before he could erect the mast. He thereupon applied to the appropriate authorities for a building permit. In due course, the permit was denied. After exhausting his procedural remedies before the Board of Adjustment, Mr. Lord instituted a law suit in the Court of Common Pleas to compel the issuance to him of a building permit. The case was tried before the Court of Common Pleas, and resulted in a victory for Mr. Lord. The Court ordered a building permit to be issued to him.

The city authorities then appealed the judgment of the Court of Common Pleas. The appeal was heard by the Superior Court. After hearing the arguments presented on the appeal, the Superior Court entered a judgment reversing the judgment of the Court of Common Pleas and upheld the ruling of the Board of Adjustment in denying Mr. Lord's application for a building permit.

Mr. Lord thereupon filed an appeal in the Supreme Court of the State of Pennsylvania. The Supreme Court, after a full hearing, reversed the judgment of the Superior Court and reinstated the Order of the Court of Common Pleas which had ordered the granting of the building permit to Mr. Lord.

This case has been frequently cited because the Supreme Court of the State of Pennsylvania reviewed, at some length, the history of zoning laws. Since amateurs are frequently involved in legal problems involving zoning laws, reference to the case of the Appeal of Lord may be helpful.

[Continued on page 114]



CRYSTALS

AMATEUR TYPES

H43 or H73 low drift fundamental oscillator crystals. Will withstand high drive conditions.

1800 to 3000 kc ± 2 kc	\$2.95
3000 to 9000 kc ± 5 kc	2.95
9000 to 15000 kc ± 10 kc	3.95

Type H173 plated, high stability oscillator crystals.

1800 to 3000 kc ± 2 kc	\$4.95
3000 to 9000 kc ± 5 kc	4.95
9000 to 21 mc ± 10 kc	4.95
21 mc to 40 mc ± 15 kc	4.95
40 mc to 54 mc ± 25 kc	5.95
54 mc to 75 mc ± 100 kc	7.95

Special close tolerance crystals for the amateur.

H43 or H73 1800 kc to 18 mc	\$4.80
H173 1800 kc to 75 mc	7.95

MARINE CRYSTALS

Type H-4 or H-7 marine tolerance high drive crystals.

Frequency range 2 mc to 7 mc \$4.95

AIRCRAFT CRYSTALS

All types available. State holder size, pin dimensions, and spacing, equipment model and manufacturer, crystal frequency and channel frequency. If receiver, specify IF frequency.

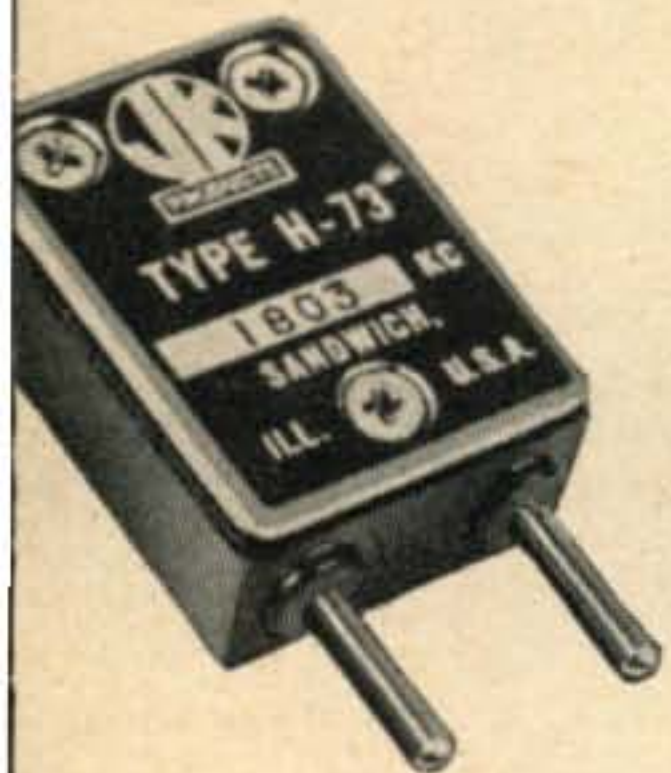

H-73 or H-7 (FT-243).
Pin Dia. .090". Pin Spacing .500".

H-43 or H-4 (HC-1/U).
Pin Dia. .125". Pin Spacing .750".

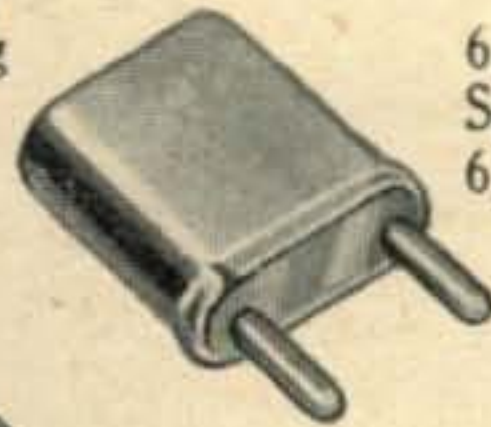
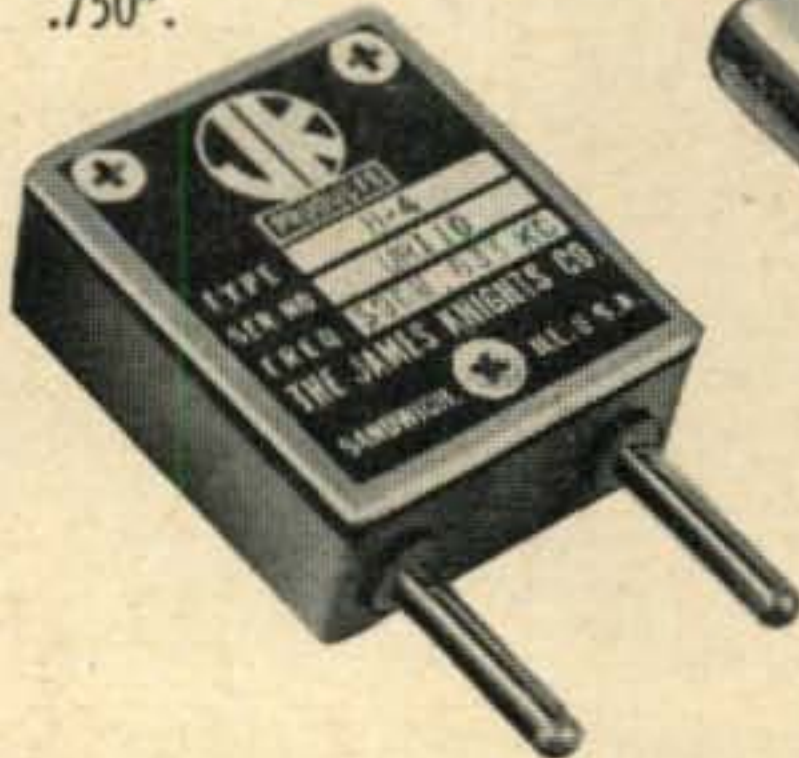

H-173 or H-17 (HC-6/U). Pin Dia. .050". Pin Spacing .486". H-17W (HC-6/U) With Wire Leads.



H-17TL (HC-13/U). Pin Dia. .090". Pin Spacing .468".



H-3 (HC-18/U). Pin Dia. .039". Pin Spacing .192".

CITIZENS BAND

Standard Transmitter Crystals. Type H-17 (HC-6/U) mmfd load, .005% tolerance. Crystal on any FCC channel frequency..... \$2.00

Standard Receiver Crystals. Type H-17 (HC-6/U), mmfd load. Crystal 455 KC lower than FCC channel frequency. $\pm .005\%$ tolerance..... \$2.00

Special Transmitter Crystals. Type H-17 (HC-6/U), 3 with pins, or H3W (HC-18/U) with wire leads. Any practical load, crystal on $\frac{1}{2}$ or $\frac{1}{3}$ FCC channel frequency. Give holder, load, frequency, and make of equipment. Also includes control frequencies of 26.995, 27.045, 27.095, 27.145, 27.195, and 27.255 MC. $\pm .005\%$ tolerance..... \$2.95

Special Receiver Crystals. Same holders and loads as special transmitters crystals but crystal frequency for IF other than 455 KC lower than channel frequency. Give holder, crystal frequency, load, IF frequency, and make of equipment. $\pm .005\%$ tolerance..... \$2.95

MARS AND CAP

Type H-7 available on assigned frequencies. Calibrated to $\pm .005\%$.

Frequency Range 2 mc to 10 mc \$4.80

TV & MARKER CRYSTALS

Calibrated $\pm .005\%$	
Type H7, 3 mc to 18 mc	\$4.80
Type H17, 4 mc to 30 mc	7.95
Type H17, 3579.545 kc	4.80
Type H173, 1000 kc	7.95
Type H17TL, 100 kc	6.95

All prices postage paid. Send cash, check, or M.O. No COD's. Distributor inquiries invited.

For further information, check number 24 on page 126.

THE JAMES KNIGHTS COMPANY
Sandwich, Illinois



WHERE TIME AND DEPENDABILITY COUNT IN COMMUNICATIONS . . .

INTERNATIONAL'S *ONE DAY CRYSTAL PROCESSING
SERVICE AVAILABLE WORLD WIDE

AMATEURS • EXPERIMENTERS • COMMERCIAL

AMATEUR CRYSTALS (FA-5, FA-9 spot frequencies 1000 KC to 137 MC .01% Tolerance.

Wire mounted, plated crystals for use by amateurs and experimenters, where tolerances of .01% are permissible and wide-range temperatures are not encountered.

Designed to operate into a load capacitance of 32 mmf on the fundamental between 1000 KC and 15 MC. Designed to operate anti-resonance on 3rd overtone modes into grid circuit without additional capacitance load. Fifth overtone crystals and seventh overtone crystals are designed to operate at series resonance. (Write for recommended circuits.)

Custom made COMMERCIAL CRYSTALS 70 KC to 100 MC

Wire mounted, plated crystals, for use in commercial equipment (Type F-6) where close tolerances must be observed. All units are calibrated for the specific load presented by equipment.

Circuit: As specified by customer. Crystals are available for all major two-way equipment and in most cases the necessary correlation data is on file.

Prices on request.

How To Order: For fastest service, our crystals are sold direct, Terms F.O.B. Oklahoma City.

**One Day Processing . . . Orders for less than five crystals will be processed and shipped in one day. Orders received on Monday through Thursday will be shipped the day following. Orders received on Friday will be shipped the following Monday.*

Now IN ONLY MINUTES **CONVERT YOUR CAR RADIO**
 FOR SHORT WAVE RECEPTION WITH A **MOBILETTE**



International's NEW all transistor, Crystal Controlled Converter.

- Easy to Install. • Works on 6 or 12 volts without change.
- Power connector plugs into cigarette lighter socket. (No external power supply needed.)

Designed by International for Amateurs, Citizens Licensees, Short Wave Listeners, Hobbyist.

Available in Seven frequency ranges covering the Amateur bands, 75 through 10 meters, the Citizens band, and WWV National Bureau of Standards Time Broadcasts.

Three simple steps to install (1) Remove antenna lead from car radio and plug into input of Mobilette. (2) Plug jumper wire from Mobilette into antenna connection of car radio. (3) Plug power connector into cigarette lighter socket. Mobilette normally wired for negative ground battery system. When ordering positive ground, add Suffix "P" to catalog number.

International Mobilettes cover these short wave bands.

Catalog No.	Frequency	Catalog No.	Frequency
630 - 105.....	75 meters (Amateur)	630 - 102.....	15 meters (Amateur)
630 - 104.....	40 meters (Amateur)	630 - 101.....	11 meters (Citizens)
630 - 106.....	10 MC (WWV Time)	630 - 100.....	10 meters (Amateur)
630 - 103.....	20 meters (Amateur)		28.5 - 29.5 MC

Available soon for 6 and 2 meters at slightly higher price.

INTERNATIONAL
CRYSTAL MANUFACTURING CO., INC.

18 NORTH LEE • OKLAHOMA CITY, OKLA.



Complete, ready to
 plug in and operate
 only \$19.95

Order direct from International. Terms F. O. B. Okla. City. Include postage. Shipping weight 2 lbs.

Send for **FREE** Catalog covering International's complete line of Crystals and Equipment.

For further information, check number 25 on page 126.

SSB

A totally new concept in transmitter design — FILTER-TYPE

TRANSMITTER / EXCITER / AMPLIFIER



“INVADER”

*A superbly engineered SSB Transmitter/Exciter
... add hi-power conversion for 2000 watts P. E. P.
(twice average DC) input SSB!*

Here is the most versatile . . . most advanced SSB Transmitter/Exciter/Amplifier package ever designed for the amateur service! Excitingly different—from exclusive filter-type circuitry to distinctive front panel and cabinet design—the Viking “Invader” and the “Invader-2000” offer flexibility and performance for a lifetime of operating pleasure.

“HI-POWER CONVERSION”



“INVADER-2000”



Vikima

INVADER •

INVADER-2000



FILTER-TYPE SIDEBAND—Exclusive high frequency bandpass filter gives you more than 60 db of unwanted sideband and carrier suppression! Select upper or lower sideband instantly with front panel "mode" switch.

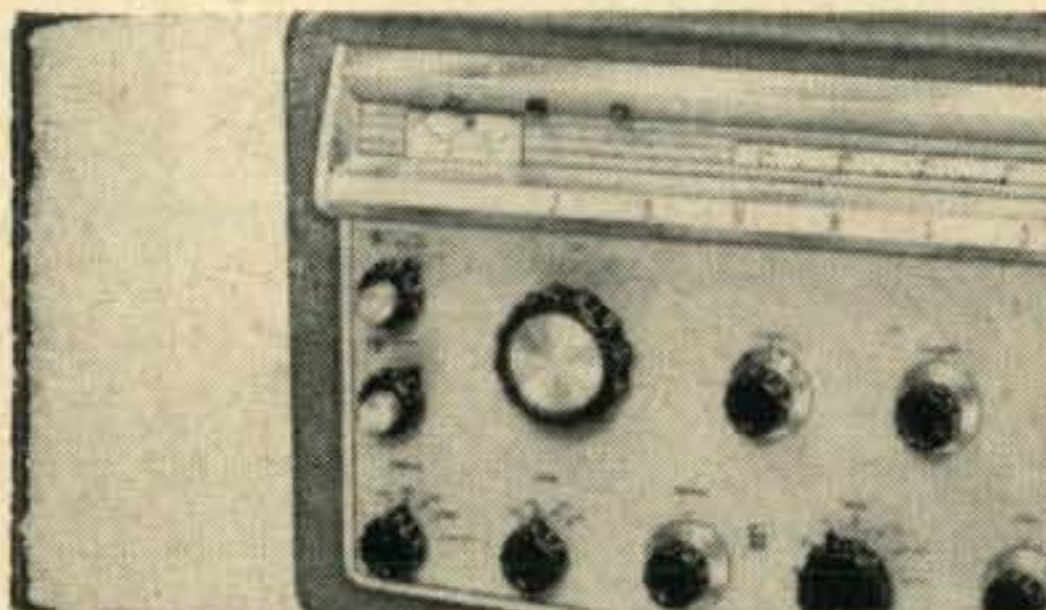

SIMPLIFIED OPERATION—Unique design and circuitry make the "Invader" and the "Invader-2000" extremely easy to tune and operate! Tune for maximum on the meter and you're ready to go—just a few front panel controls give complete flexibility!

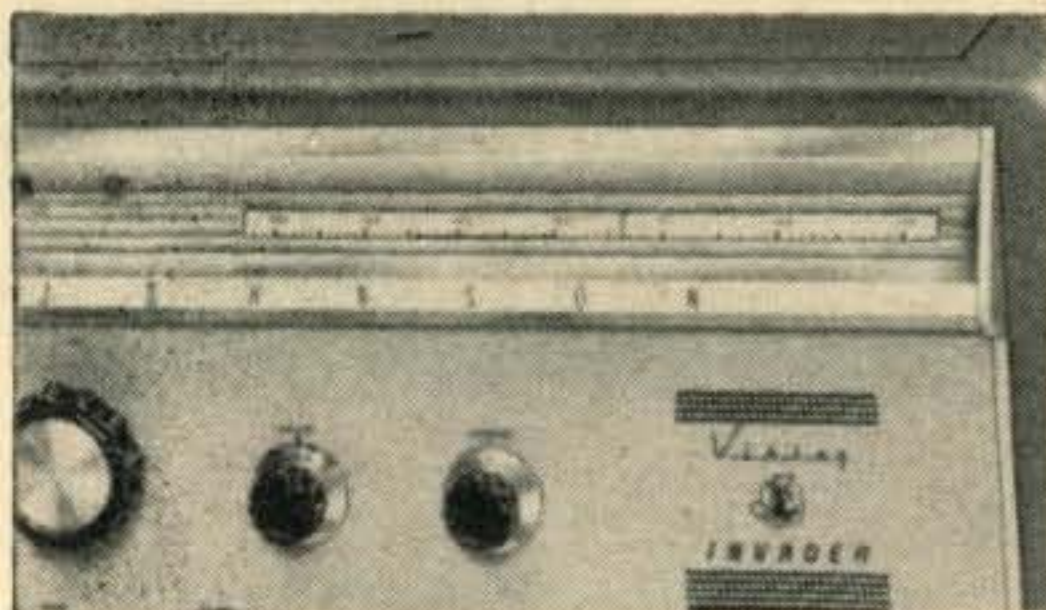

FREQUENCY CONTROL—Instant bandswitching coverage of the full 80, 40, 20, 15 and 10 meter bands... no extra crystals or retuning required. Highly stable, built-in VFO is differentially compensated and factory adjusted for maximum stability—exclusive "keep warm" heater element keeps VFO at operating temperature even with equipment turned off... NO WARM-UP DRIFT!



Write today for your free 8-page "Invader" brochure—complete with detailed specifications and photographs!

Here's the transmitter with the sharp, penetrating signal you've been waiting for—plus more exclusive operating and convenience features than any other Transmitter/Exciter on the market today! The "Invader" offers instant bandswitching, full bandspread coverage 80 through 10 meters—no extra crystals to buy—no retuning necessary! Rated a solid 200 watts CW and SSB input; 90 watts input on AM! Final amplifier utilizes a pair of 6146's in parallel, bridge neutralized. Unwanted sideband and carrier suppression is 60 db or better! Exclusive RF controlled audio AGC and ALC (limiter type) provide greater average speech power—high gain push-to-talk audio system has plenty of reserve gain for either crystal or dynamic microphones. VOX and anti-trip circuits are extremely smooth in operation—built-in anti-trip matching transformer—adjustable VOX time delay circuit. Mixer-type shaped keying is crisp, sharp—click and chirp free. Single knob wide range pi-network output circuit. Fully TVI suppressed. Blocking and operating bias provide noise-free T-R switch operation. Heavy duty power supply is completely self-contained. The "Invader" may also be used as an exciter for the Viking "Courier", "Thunderbolt", or the Viking "Kilowatt". Dimensions: 11 $\frac{5}{8}$ " high x 21" wide x 17 $\frac{1}{2}$ " deep. Compact, heavy duty power supply with swinging choke circuitry gives excellent voltage regulation—supplies all necessary high and low voltages. Power Requirements: 325 watts, 105-125 V AC 2-wire, 50-60 cycle.

Cat. No. 240-302-2 . . . Viking "Invader" wired and tested with tubes, crystals, less key and microphone.

Amateur Net \$619.50

VIKING "INVADER" HI-POWER CONVERSION—Take the features and performance of your Viking "Invader" . . . add the power and flexibility of the unique Viking "Hi-Power Conversion" system . . . and you're "on the air" with the "Invader-2000"—a solid 2000 watts P.E.P. (twice average DC) input* SSB, 1000 watts CW and 800 watts input on AM! Completely wired and tested—includes power supply, new front overlay panel, extra knobs, additional meter, necessary tubes—everything you need to convert your "Invader" into the power-packed "Invader-2000". All you need is a small wrench and a screwdriver—no soldering necessary—complete the entire conversion in just one evening!

Cat. No. 240-303-2 . . . Hi-Power Conversion, complete . . . **Amateur Net \$619.50**

Available completely factory wired and assembled, the "Invader-2000" offers all of the fine features of the "Invader" plus the added power and flexibility of an integral linear amplifier and remote controlled power supply. Here's desk-top operating convenience unsurpassed by any other high power transmitter . . . 2000 watts P.E.P. (twice average DC) input on SSB, 1000 watts CW, and 800 watts AM input! Final amplifier employs two rugged, high efficiency, low replacement cost Type PL-175A pentode tubes in parallel, bridge neutralized . . . features a ganged tank assembly that provides exceptionally uniform "Q". RF stages are cut off automatically on stand-by and key-up—wide range output circuit (40 to 600 ohms adjustable) will match virtually any antenna system. Push-pull fan assembly draws air through the chassis, effectively cooling components as well as filament and plate seals for extended tube life. Heavy duty, multi-section power supply uses 866A High Voltage Rectifiers. Screen supply employs a 5U4GA rectifier and uses heavy bleeder and high filter capacity for excellent dynamic screen voltage regulation in Class AB₂ operation. An OC2 bias regulator provides regulated bias for the two PL-175A final amplifier tubes. Dimensions: 11 $\frac{5}{8}$ " high x 21" wide x 17 $\frac{1}{2}$ " deep. Power Supply: 11 $\frac{1}{4}$ " high x 19 $\frac{3}{4}$ " wide x 14 $\frac{1}{2}$ " deep. Power Requirements: 1600 watts, 105-125 V AC 2-wire; or 210-250 V AC 3-wire, 50-60 cycle.

Cat. No. 240-304-2 . . . Viking "Invader-2000" wired and tested with remote power supply, tubes, crystals, less key and microphone.

Amateur Net \$1229.00

FIRST CHOICE AMONG
THE NATION'S
AMATEURS



Viking

ANTICIPATED DELIVERY—LATE FALL

E. F. JOHNSON COMPANY • WASECA, MINNESOTA



"RANGER" TRANSMITTER/EXCITER

This popular, superbly engineered transmitter also serves as an RF/audio exciter for high power equipment. 75 watts CW or 65 watts phone input. Built-in VFO or crystal control—instant bandswitching 160 through 10. 6146 final amplifier. Wide range pi-network coupling system will match antenna loads from 50 to 500 ohms—tunes out large amounts of reactance. Timed sequence keying. TVI suppressed. With tubes, less crystals.

Cat. No.	Amateur Net
240-161-1..Kit.....	\$229.50
240-161-2..Wired and tested...	\$329.50

No matter what you expect from a transmitter...

"VALIANT" TRANSMITTER

Here's effective power, wide flexibility, and many unique operating features combined in a compact desk-top transmitter! 275 watts input CW and SSB (P. E. P. with auxiliary SSB exciter) and 200 watts phone. Bandswitching 160 through 10. Built-in VFO or crystal control. Final amplifier utilizes three 6146 tubes in parallel—wide range pi-network output. With tubes, less crystals.

Cat. No.	Amateur Net
240-104-1..Kit.....	\$349.50
240-104-2..Wired and tested...	\$439.50



"FIVE HUNDRED" TRANSMITTER

More than one-half kilowatt of power plus outstanding operating convenience! 600 watts CW input ... 500 watts phone and SSB (P.E.P. with auxiliary SSB exciter)—instant bandswitching 80 through 10 meters! All exciter stages ganged to VFO tuning. High gain push-to-talk audio system. Built-in VFO or crystal control—VFO is temperature compensated, highly stable. Wide range pi-network output. Low level audio clipping—effectively TVI suppressed. With tubes, less crystals.

Cat. No.	Amateur Net
240-500-1..Kit.....	\$749.50
240-500-2..Wired.....	\$949.50

The world at your finger tips!



VIKING "KILOWATT" AMPLIFIER

This exciting unit is the only power amplifier available which will deliver full 2000 watts SSB* input, and 1000 watt CW and plate modulated AM! Class C final amplifier operation provides plate circuit efficiencies in excess of 70%. Continuous coverage 3.5 to 30 mcs. Excitation requirements: 30 watts RF and 10 watts audio for AM; 10 watts peak for SSB.

Cat. No. Amateur Net
 240-1000... Wired and Tested . \$1595.00
 251-101-1... Matching desk top, back and 3
 drawer pedestal, FOB Corry, Pa... \$132.00

**The FCC permits a maximum of one kilowatt average power input for the amateur service. In SSB operation under normal conditions this results in peak envelope power inputs of two times average or more, depending upon individual voice characteristics.*

you'll get more with a **VIKING!**

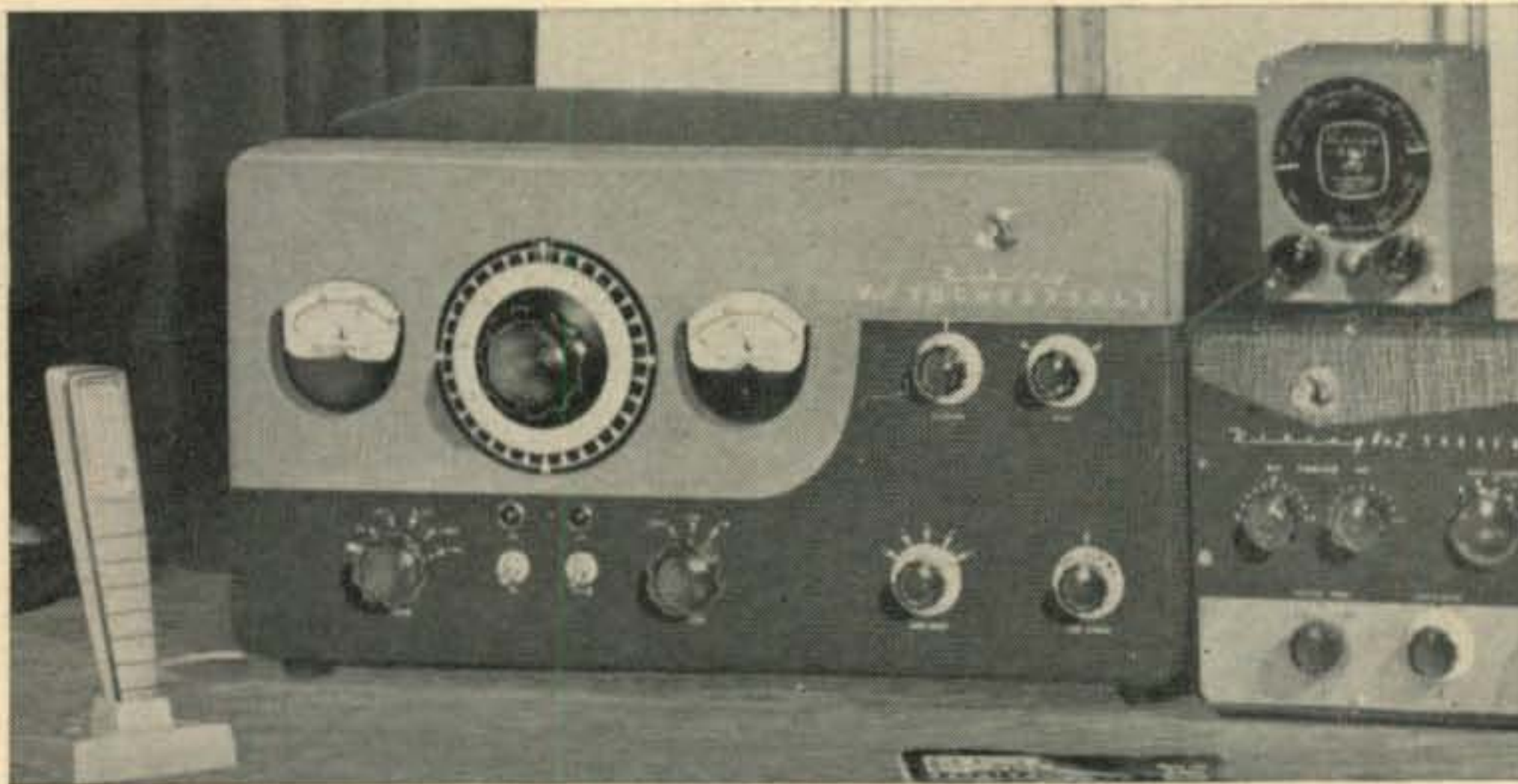

"6N2" THUNDERBOLT POWER AMPLIFIER

Rated at a solid 1200 watts P.E.P.* input SSB and DSB, Class AB₁; 1000 watts CW input, Class C; and 700 watts input AM linear, Class AB₁—with continuous bandswitched coverage on 6 and 2 meters. Wide range pi network output—effectively TVI suppressed—outstanding efficiency! Drive requirements: 5 watts in Class AB₁ linear, or 6 watts Class C continuous wave. Completely self-contained. With tubes.

Cat. No. Amateur Net
 240-362-1... Kit..... \$524.50
 240-362-2... Wired..... 589.50

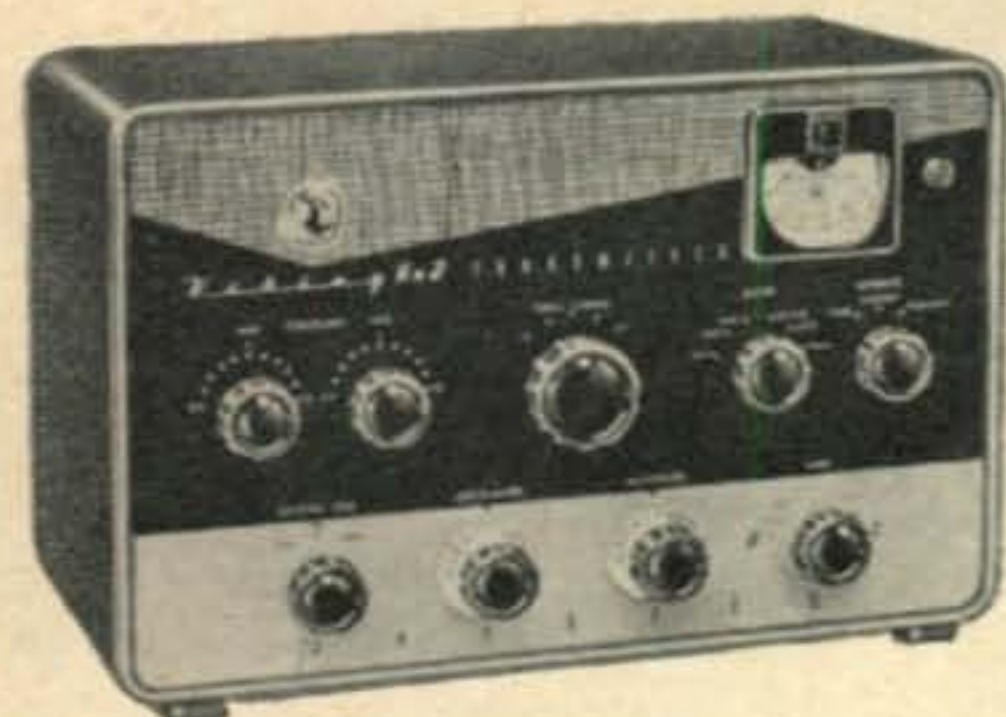

"6N2" TRANSMITTER

A compact VHF transmitter with instant bandswitching coverage of both 6 and 2 meters. Power input: 150 watts CW; 100 watts AM phone. Completely shielded and TVI suppressed. External VFO or crystal control—may be used with Viking "Ranger," Viking I, "Valiant," or similar power supply-modulator combinations. With tubes, less crystals.

Cat. No. Amateur Net
 240-201-1... Kit..... \$129.50
 240-201-2... Wired..... 169.60

New Catalog

Your complete guide to amateur radios' most popular equipment. Includes details and schematics on all Johnson transmitters and amplifiers, as well as specifications on the complete line of station accessories, keys and practice sets, and antennas. Write for your free copy today!



FIRST CHOICE AMONG
 THE NATION'S
 AMATEURS



Viking

E. F. JOHNSON COMPANY • WASECA, MINNESOTA

For further information, check number 26 on page 126.

BIG BROTHER LINEAR

Here is a high power linear which, if you can procure a tube, will undoubtedly catch your fancy. Other than the home brew socket, construction is straight forward with no frills or fancy stuff.

The November, 1959 issue of *CQ*¹ carried my article describing a linear amplifier using a pair of 5D23/RK-65's in parallel in a grounded grid circuit. This article brought many inquiries from those interested in grounded grid operation of high-power linear amplifiers, so I decided to try other tube types in such a circuit, and to write about my experiences for your benefit.

Tube Characteristics

My first step was to contact tube manufacturers for information on grounded grid operation of several types of tetrodes in the zero-bias triode connection. I corresponded with the Applications Engineering Department of *Eimac*

¹Lee, P. H., "Grounded Grid RK-65's Here, Fellows", *CQ*, Nov. 1959, p. 40

regarding operation of their 4-400A, 4-1000A, and other tetrodes in this mode. I had in mind building a new linear using a pair of 4-400A's or a single 4-1000A. They very helpfully gave me complete operating data and characteristic curves for operation of these types in the grounded grid zero-bias mode. It was evident from this data, that using the 4-400A in this mode would buy me nothing at all. Due to the very light grid dissipation rating of the 4-400A high peak envelope powers are impossible to achieve without tube damage. This drawback can be overcome, of course, by providing *dc* grid and screen voltages, and grounding these grids for *rf* with bypass capacitors. However to me, this nullifies what is one of the big advantages of this mode of operation, namely, the

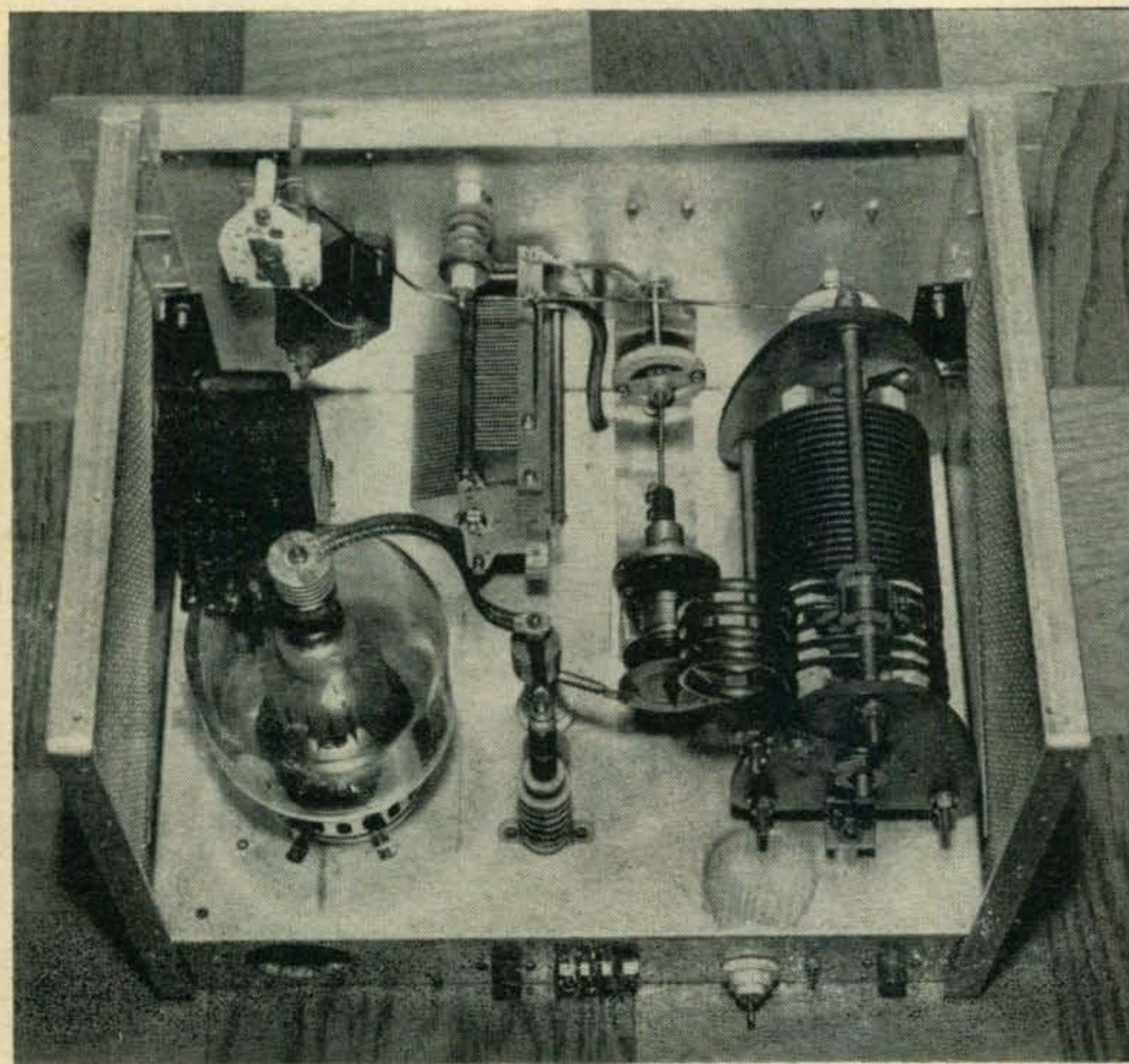

Rear view of the amplifier with cover removed showing parts layout. Since this picture was taken the *rf* choke has been changed and a parasitic suppressor has been installed. The large mica capacitor mounted on the front panel is the extra capacitor required to tune 80 meters. Antenna loading capacitor and plate capacitor can be seen grounded together with a wide strip of copper running along the chassis and front panel. On the edge of chassis l. to r. hole for the forced air cooling, *rf* input, 110 volts ac input, + B and *rf* output.

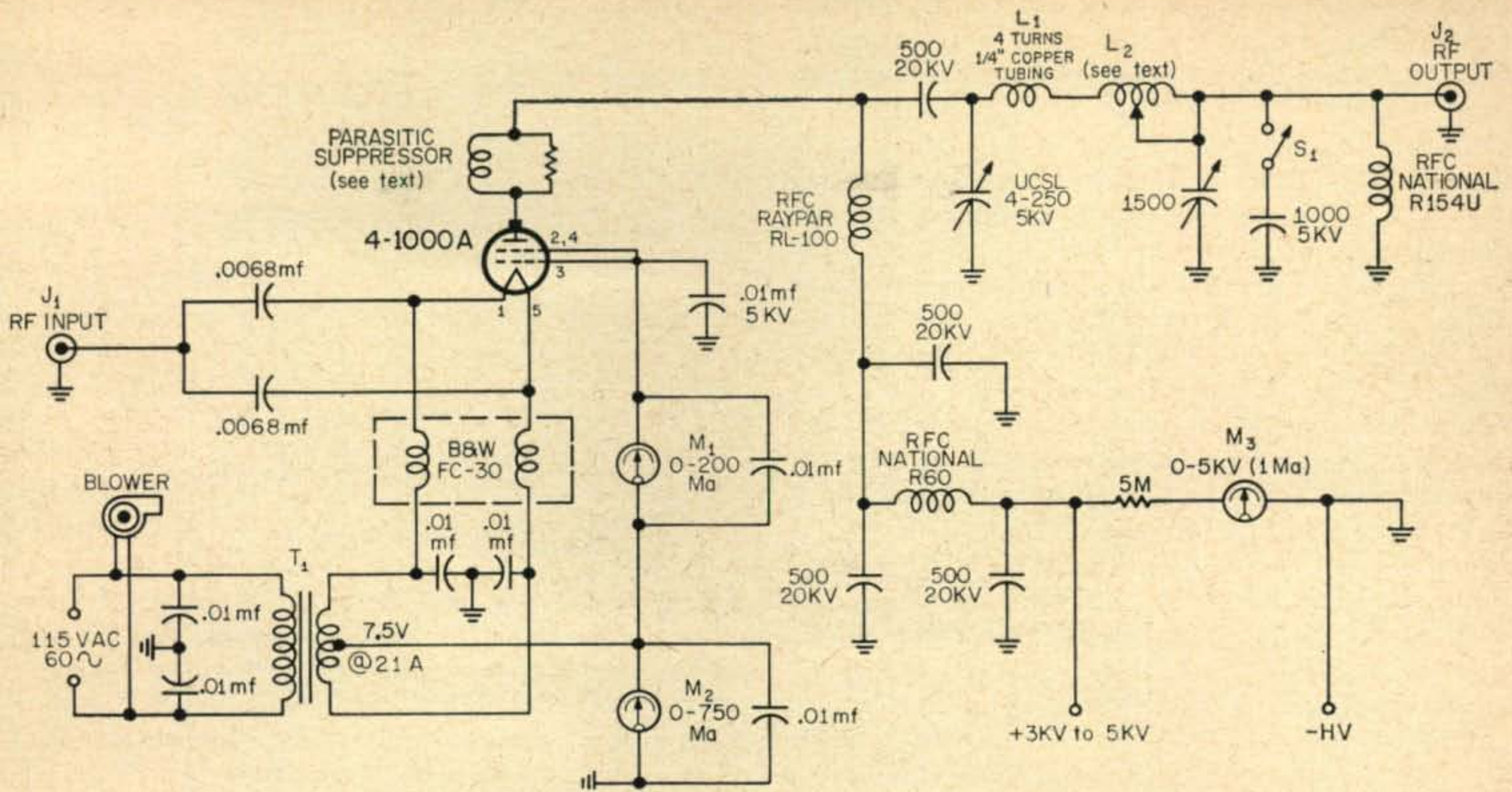

Fig. 1—Schematic of a grounded grid 4-1000A kilowatt amplifier. Drive required is in the neighborhood of 100 watts.

absence of grid and screen voltage supplies.

The same limitation imposed by grid dissipation applies to other types such as the PL-172, Amperex 6079, 4-250A, 4CX1000A, 4CX-300A, 4X250, 4X150, etc. The only Eimac tetra-ode in the power class of interest which has sufficient grid dissipation rating for grounded grid zero-bias operation is the 4-1000A. The Raytheon 5D23/RK-65 and the 6D22 also have heavy grid structures and are designed for this mode of operation. However, the idea of using a single 4-1000A to provide plenty of reserve peak power capability greatly appealed to me, so I designed and built this "Big Brother" to the first linear described in the November issue.

4-1000A

The operating data given me by Eimac on the 4-1000A showed that it could be driven with ease by my existing exciter with nominal 100 watts output. The extra driving power required in this mode of operation is not wasted, but goes through to the antenna as useful power output. Also, at plate voltages in the order of 3000 to 5000 volts, this tube has a high peak envelope power capability, which is very desirable to prevent flattening when running at a kilowatt average power input on voice.

The 4-1000A is expensive when purchased new, costing \$132. Even as surplus they sell for \$75 to \$90. However, there are sources from which these tubes can be "liberated" in used condition, but with plenty of life left for amateur voice operation. The RCA Types TT-10AL and TT-25AL low band *vhf* TV broadcast transmitters each use a pair of them. They are also used in such military transmitters such as the AN/FRT-18, AN/FRT-25, and AN/FRT-51. They have been mentioned in the "HamAds"

and over the air. The amateur who really wants one should have no trouble finding it.

Construction

The construction of this amplifier was very easy. I started with a clean $17 \times 15 \times 3$ inch chassis, and a new $12\frac{1}{4} \times 19$ inch panel. I used the same general physical arrangement and salvaged most of the components from the previous linear.

I made my own socket for the 4-1000A,² using a heavy fiberglass plate for a base, and fabricating the clamps from copper strap. A sketch showing details of the clamp and its mounting to the base is shown in Fig. 2. This socket, plus five clamps, is mounted below the chassis at such a distance that the base of the tube rests on top of the chassis. The socket hole is 3 inches in diameter and provides clearance for the base pins and for air holes in the tube base. The metal shell of the tube base is grounded to the chassis by means of four spring clips. There are 16 holes drilled $\frac{3}{8}$ inch in a $4\frac{1}{2}$ inch circle around the socket hole. The chassis is pressurized by a small blower providing about 50 cfm of air. The air flow divides fairly evenly between the holes in the tube base and the 16 vent holes, providing adequate cooling for the base seals as well as bulb. This cooling is adequate for intermittent voice operation, but if one were running this tube at full power on CW or AM use of a glass chimney would be necessary. In the rear of the chassis there is a 2 inch diameter hole for the air intake from the blower.

The 4-1000A requires 7.5 volts at 21 amperes for its filament. I had the 5 volt 30 ampere trans-

²The tube manufacturer recommends using their SK-500 air system socket and SK-506 glass chimney with the 4-1000A.

former from the old linear on hand, and rewind it using two number 12 enamelled wires in parallel to give the 21 amperes capacity. The only other source of this type of transformer is Chicago-Standard who make one in the Stancor line, (P-6457) and one in the Chicago line (F-725). No other manufacturer makes a 7.5 volt transformer of sufficient current rating. However, these two are readily available from distributors or from mail-order houses.

The amplifier may be seen in the photographs. The arrangement of parts is clean and neat, with plenty of air space around the tube, and clearance around the plate *rf* choke. Since the photos were taken, I have substituted a RayPar RL-100 *rf* choke for the National R-175-A shown. The latter developed two hot spots where the insulation began to char, near top and bottom. There has been no trouble experienced with the RayPar choke.

The schematic is shown in fig. 1. The filament is fed through a B & W FC-30 filament choke. *RF* drive is applied to the filament through a center-tapped arrangement of .0068 mf 5000 volt mica capacitors. The filament leads at the cold end of the choke are bypassed to ground with two .01 mf 1000 volt micas. The grid pin and two screen pins of the tube are tied together by copper straps on the bottom of the socket, and are bypassed to ground by a .01 mf 5000 volt mica capacitor right at the grid pin. The *dc* grid return goes to the filament center-tap through the 0-200 *ma* meter, and the 0-750 *ma* plate current meter is placed in the filament return to ground. This keeps grid current out of the plate current meter, thus giving true plate current reading.

Parasitic Suppressor

The plate circuit is the familiar pi-network with shunt feed of plate voltage. The plate blocking capacitor and the bypass at the cold end of the choke are of the 500 mmf 20 kv ceramic variety. Experience has shown that micas do not last long here. Since the photos were taken, I have added a parasitic suppressor in the plate lead, to eliminate a *vhf* parasitic that appeared when I first applied plate voltage. This suppressor consists of a 10 ohm 30 watt Global resistor, about 4½ inches long and ¾ inches in diameter, with a three turn coil of number 10 wire wound around it. In fact, this suppressor is the plate lead, extending from blocking capacitor to tube cap. Global resistors are available from Workman TV Products, Sarasota, Florida. I first tried an Ohmite R-300 suppressor in this position, but it overheated on 21 *mc* and opened up one night with a flash of flame!

Rotary Inductor

The plate coil is a large rotary inductor with ⅛ by ¼ inch ribbon, with a "trolley wheel" which rides along and progressively shorts turns. The E. F. Johnson type 226-1 is a substitute. The input tuning capacitor is a Jennings UCSL 4-250 mmf 5 kv vacuum variable. The

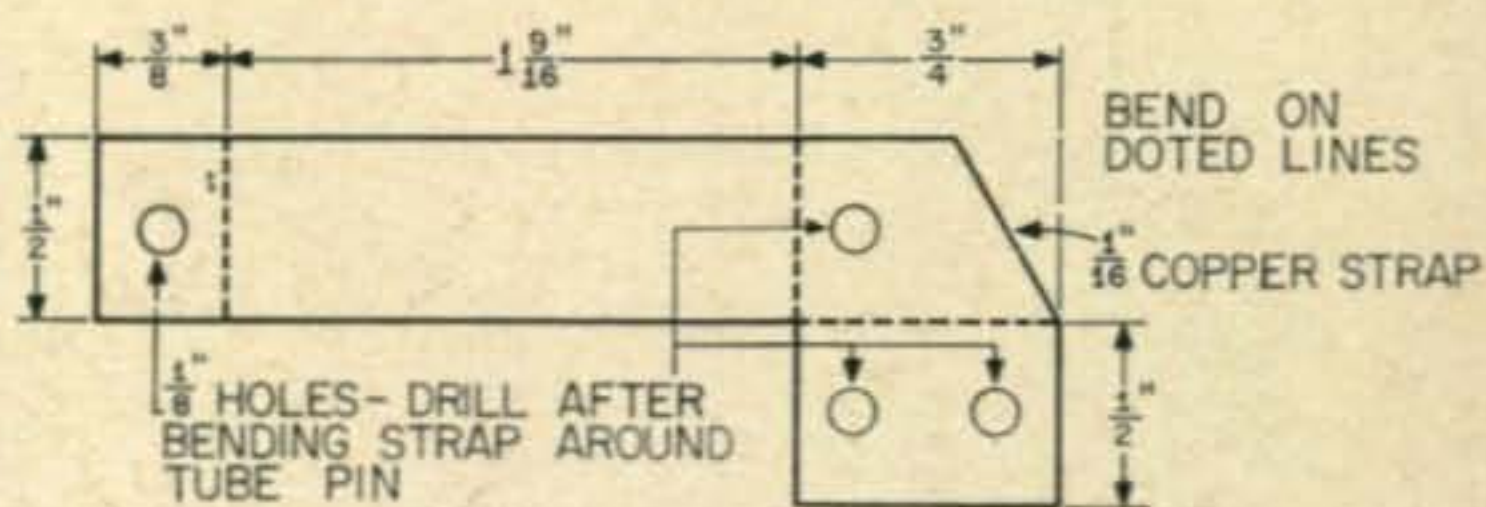
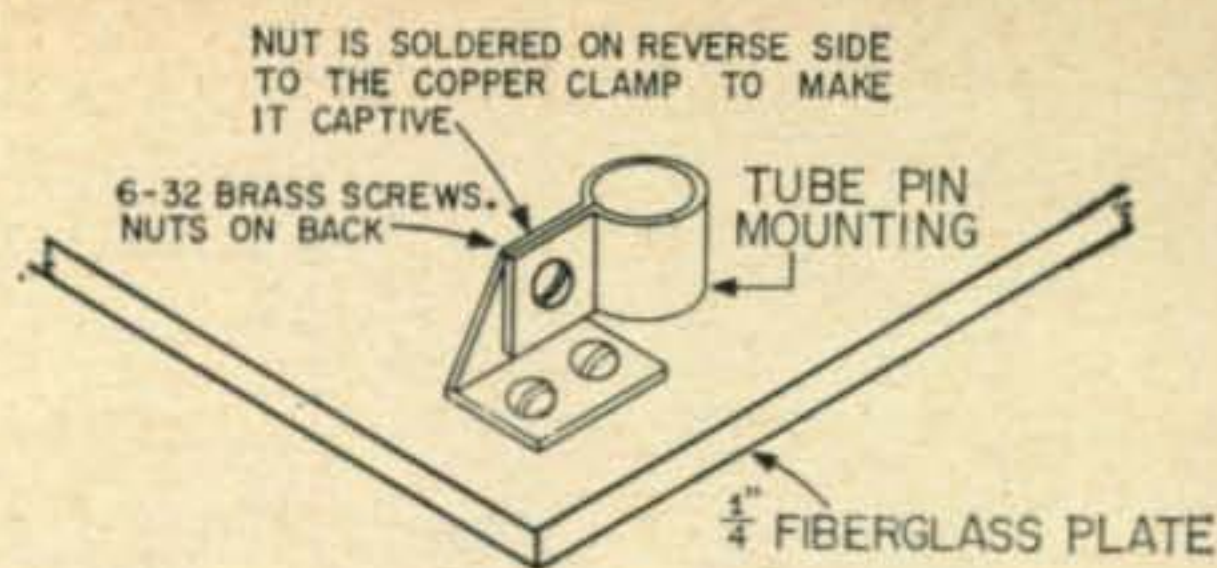
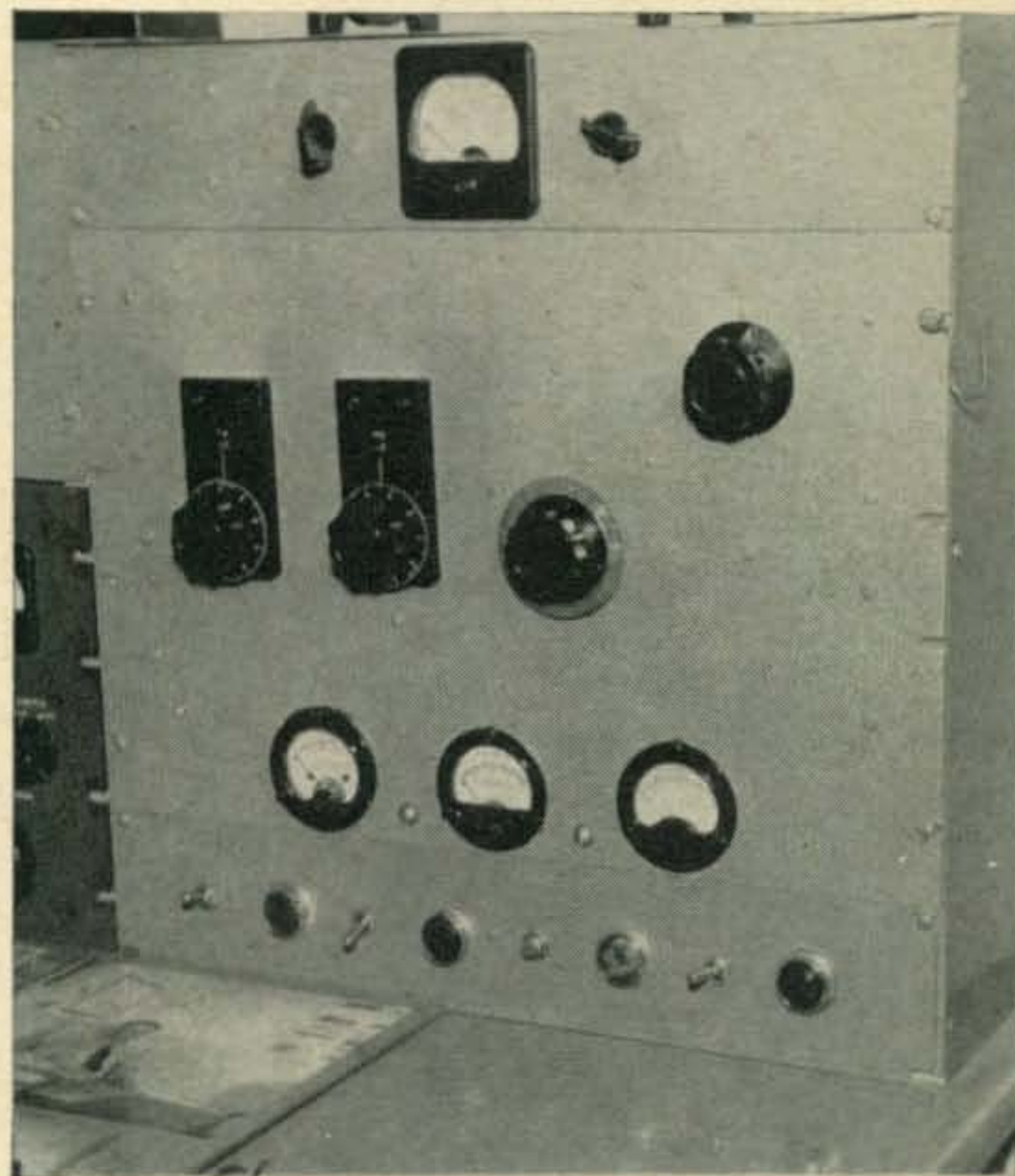

Fig. 2—Drawing illustrating the fabrication of the pin connectors of the 4-1000A. After the copper has been cut and bent it should be formed tight around the pins of the 4-1000A and the nut, together with a solder lug should be securely soldered, preferably with silver solder.



On top of the kw linear sits a swr bridge and below are the switches, circuit breakers and associated pilot lights. The turns counter on the left of the 19 inch panel tunes inductance L^2 while the other controls the vacuum variable plate capacitor. The larger skirted knob twiddles the Cardwell 8013, antenna loading capacitor while the smaller knob is used to switch in extra capacity for 80 meters.

output capacitor is a Cardwell PL-8013, 1500 mmf variable. A 2 inch wide copper strap provides a low impedance ground bus between the ground side of the vacuum variable and the panel mounting of the loading capacitor. No reliance is placed on panel-to-chassis contact for carrying the heavy tank current.

A small auxiliary tank coil of 4 turns of ¼ inch copper tube, 1½ inches in diameter, is

used in the hot lead from the rotary coil. This reduces the effect of the distributed capacity of the large rotary coil to ground which would otherwise appear across the input capacitor of the pi-network. The end of the rotary coil with the shorted turns is also used as the output end, placing the distributed capacity of all the shorted turns across the output capacitor to ground, where it has no harmful effect. These precautions in design permit increased efficiency on 21 and 28 *mc*.

The tuning dials are the R. W. Groth Co. type TC-2, which are very fine for this multi-turn application. They do not require cutting large viewing windows in the panel. Flexible insulated couplings are used between the dials and the rotary inductor and vacuum capacitor to prevent stray *rf* current paths via the shafts.

An additional output capacitor is used only on 3.9 *mc* to obtain full loading. This is a Sangamo type F2-521, which is switched in by means of a surplus heavy ceramic switch. An ordinary small mica capacitor will not work here, as it cannot carry the current.

The *rf* input and output jacks are type SO-239. The output lead from the 1500 mmf capacitor to the jack is made of RG-8/U with the plastic jacket stripped off. The braid of this lead is grounded to the chassis at several points. The R-154-U choke provides an emergency *dc* return to ground in case of plate blocking capacitor failure. The *dc* grid return lead, the plate high voltage lead and several other leads below the chassis are made of RG-8/U stripped coaxial line, for shielding purposes. The *vhf* harmonic choke in the high voltage plate lead is a National R-60, which is bypassed by a pair of 500 mmf 20 *kv* ceramic capacitors. I used micas here but one of them "blew" so I replaced both with ceramics.

The bottom of the chassis is covered by a plate, and the cracks at the edges are sealed by Scotch drafting tape, to prevent air leakage. The complete unit is enclosed in a shield made from perforated aluminum, which is mounted on a frame of 3/4 inch angle. The only *rf* exits are through the filtered leads and the coaxial line. An external low-pass filter is used in the coaxial output lead. The amplifier is mounted in a desk-top console as seen in the photos. Thus the amplifier is doubly shielded, as is the exciter at the other end of the console.

Testing

In the case of single sideband voice operation, the FCC gives us a "break" and states that the input power to the stage or stages delivering power to the antenna must not exceed 1 *kw* as indicated by maximum *meter swing* on meters having a time constant not over 0.25 seconds. Of course the actual instantaneous peaks exceed a kilowatt. With full carrier injection in the exciter, this 4-1000A is capable of a maximum plate current of 650 *ma* at 5000 volts! Combined grid and screen current is 140 *ma*. Input to the 6146 driver is 150 watts. Needless to say,

tests of this sort must be done with a dummy load. On voice, I hold the maximum plate current meter swing down to 180 *ma*, giving me 900 watts *indicated* input. Adding in the *indicated* input of 60 watts from the 6146, as I must do in grounded grid operation, I have a maximum *indicated* input of 960 watts on voice. Waveform observations on a panoramic analyzer show absolutely no flattening under these conditions. The actual instantaneous peak power developed will depend on the characteristics of the operator's voice waveform. In my case, actual peaks go to about 2.5 *kw* under the above conditions. These operating conditions conform very closely to those predicted by Eimac.

Again I repeat that testing should be done with a dummy antenna. This amplifier should never be put on the air with full carrier injected. When on rare occasions, I use CW, the power is reduced by dropping the plate voltage, or by holding down the carrier injection at the exciter.



Operating position at W3JHR. To the left of the BC-221 is the exciter and to the right of the Collins 51J receiver is the linear amplifier.

Bragging

It is wonderful to have a linear capable of handling a kilowatt indicated power input on voice, with sufficient reserve power to carry instantaneous peaks without flattening. The 4-1000A is so rugged that there isn't much one can do to harm it, and it shows only a dull red color at full power. The tuning and operation of the grounded grid circuit is so simple and fool-proof that it is a pleasure to use. This "Big Brother Linear" puts out a beautiful signal. Good luck to you in building yours! Inquiries from readers are invited.

The author gratefully acknowledges the fine cooperation of Eitel-McCullough, Inc., which helped make this amplifier and this article possible. ■

Correction

We apologize for the error which occurred in the August issue of *CQ* concerning the article, "Efficiency" Types Of Amplitude Modulation. The drawing of fig. 7 and 8, on page 43 and 44 were inadvertently reversed.

A 1625 Grounded Grid Linear Amplifier

David L. Bell, W8GUE

WNED-TV
Hotel Lafayette
Buffalo 3, N.Y.

By utilizing an ARC-5 chassis and providing a little elbow grease, W8GUE has come up with a rather good looking 200 watt amplifier which matches the very popular Central Electronics sideband equipment.

The 1625 grounded grid linear amplifier described here is the result of a slim pocketbook and a desire to have something in the shack that wasn't "factory made." A pair of 1625's in grounded grid certainly isn't revolutionary, but it is a conversation piece.

The 1625 GG matches the Central 20A and its companion *vfo* and has the same front panel dimensions as the *vfo*. In addition to a matching attractiveness and commercial appearance, the big plus for this linear is its low cost. Mine cost about \$55.00. Though inexpensive, this is in no sense a junk box rig.

General

The 1625 GG is capable of around 200 watts *dc* input on all bands with 20 watts drive. Two circuits are metered, the final plate current and the relative power output. A three position meter switch in the power output meter allows the meter to read *swr* when used with an external bridge. The linear is built in an old ARC-5 transmitter chassis. If you don't have an ARC-5 you should be able to "borrow" one from a friend.

Components

Before you start collecting parts, you should take a close look at the available space. The power transformer can be no larger than 5 by 4 $\frac{1}{4}$ by 5 $\frac{3}{4}$ inches high and should be rated at 500 to 600 *vac*, 200 *ma*. The transformer I used has a printed rating of 600 volts at 90 *ma*. Since it is a surplus transformer (for what it's worth, it's a Raytheon U 3508A) I thought it might be conservatively rated so I tested it. I drew 300 *ma* from it for 40 minutes. It was hot, but not too hot, so I decided it would suffice. Surplus transformers are often underrated, but not always. The power supply electrolytics are 100 mf, 450 *vdc* each. Both capacity and voltage ratings are already near minimum values for

this circuit, so don't compromise and use smaller ones. Also, don't use surplus electrolytics, buy new ones. The surplus jobs I had developed high voltage arcing.

The plate tuning condenser is a Johnson 150-E30, 14 to 154 mmf. I used the Johnson because I had one and because it was an ideal base for mounting the pi coil. An ARC-5 condenser or the large variable from BC-375E Tuning Unit 5A should work just as well. Any of these condensers has more than adequate spacing.

The three gang antenna tuning condenser is approximately 350 mmf per section. The condenser I bought is too old to reveal a manufacturer but measures 3 $\frac{3}{8}$ long, 2 $\frac{1}{2}$ high, 2 $\frac{3}{8}$ wide with the plates extended to their widest point. Using the Johnson plate tuning condenser, the width of the antenna condenser, plates extended, can be no more than 2 $\frac{3}{8}$ inches. As long as none of these dimensions are exceeded, everything will fit on the chassis.

Points of Reference

Just to be sure I'm getting through to you I proffer the following definitions: When I say "right" or "to the right", this assumes front panel toward you whether the rig is upside-down or right-side-up. "Up" or "top" always means toward the ceiling of the room, again whether the rig is up-side-down or right-side-up. With this settled you should be able to place your parts exactly where I placed mine, assuming you want to.

Construction

Actually, the first step is *destruction*. Completely strip an ARC-5 transmitter, leaving only the tube sockets and feed-through insulators. Cut a square hole in the front panel above the chassis leaving a $\frac{5}{8}$ lip around the edges. This hole is handy for getting fingers into tight spots and the panel frame that remains is used for

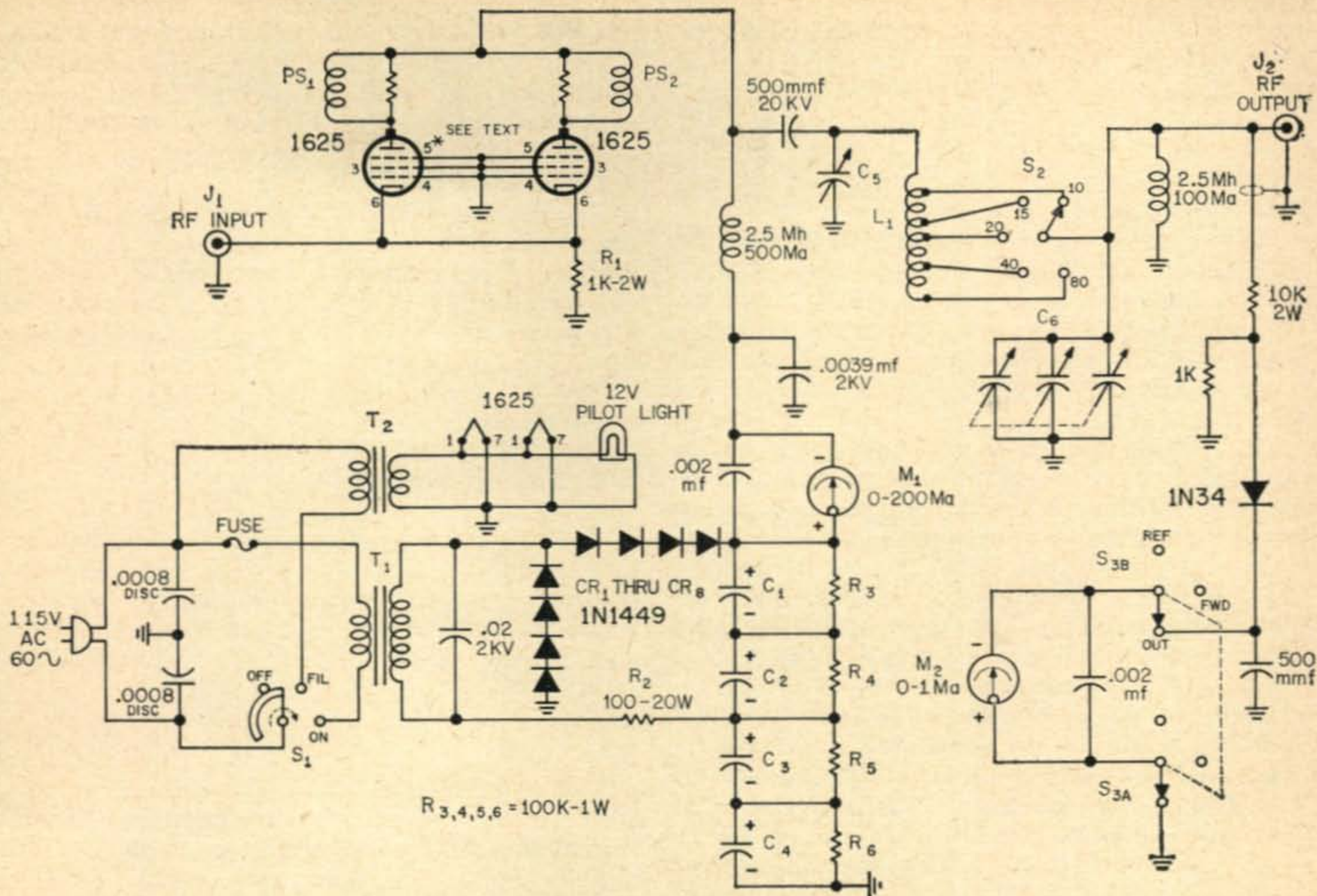

Fig. 1—The circuit of the 1625 grounded grid linear amplifier.

Parts List

T₁—Plate Transformer: 600 volts ac @ 200 ma
 T₂—Fil Transformer 12.6 volts, 1 amp.
 C₁, C₂, C₃, C₄—100 mf, 450 volt, electrolytic, Aerovox PRS series or equivalent
 C₅—150 mmf variable, Johnson 150E30 or equivalent
 C₆—3 section, 365 mmf per section, Miller 2113 or equivalent

L₁—see text
 S₁—1 pole, 3 pos. progressively shortening miniature rotary
 S₂—1 pole, 5 pos. steatite
 S₃—2 pole, 3 pos. miniature rotary
 PS₁, PS₂—Parasitic suppressors, 8 turns enamel wire on 47 ohm 1 w resistors

mounting the meters, bandswitch bracket, etc. Drill $\frac{3}{16}$ " ventilation holes about $\frac{1}{4}$ inch apart through the chassis around each tube socket. Do not drill holes in that portion of the chassis between the two sockets. Cut two $1\frac{1}{2}$ inch holes in each side of the chassis (as seen in photographs) centered 2 and 9 inches from the front panel. These are under-chassis ventilation holes. Matching holes will be cut in the cabinet.

Power Supply

The power supply is a standard voltage doubler circuit using four 1N1449's in each leg. These silicon diodes are rated at 280 volts *rms*, 400 *piv* at 100 degrees Centigrade. Eight of these will set you back \$10.00 from TAB. Any silicon diode with this rating or higher will work, of course. With four in series, each leg of this supply will handle 1120 volts *dc* for a total of 2240 volts *dc* for the entire supply.

With my 600 volt transformer, the output voltage is 1450 under static plate current load of 40 *ma*, and drops less than 50 volts under full



Front view of the transmitter before the front panel was assembled. The pilot light can be seen mounted between the meters.

load. Don't use a transformer with secondary voltage higher than 600 volts *ac* or you'll end up with an embarrassing amount of voltage.

Two sets of 100 mf electrolytics in series total 50 mf, 900 volts *dc* in each leg of the supply. Remember, these are near minimum values; don't compromise.

R_2 is a 100 ohm, 20 watt surge current limiting resistor. R_3 through R_6 are 100K, 1 watt voltage equalization resistors. These resistors are mounted about $\frac{1}{4}$ inch away from the capacitors to allow air passage. Wire used in the power supply high voltage circuit is 3 kv insulated test lead wire.

The .02 mf condenser is a hash filter and is mounted directly across the transformer secondary. The silicon rectifiers are plugged into standard fuse clips that are mounted in four rows on a piece of polystyrene 5 by $2\frac{3}{4}$ by $\frac{1}{4}$ inches. The left front fuse clip is grounded, thus the high voltage emerges at the right front fuse clip where a 3 kv insulated wire takes it to the closest

Side view of the transmitter showing component layout. S_2 , the bandswitch can be seen slanted directly in front of the tank coil. It is switched from the front panel by a flexible shaft and right angle drive. Plate and antenna tuning capacitors are mounted on standoff insulators to match the height of the Central 20A and 458 VFO.

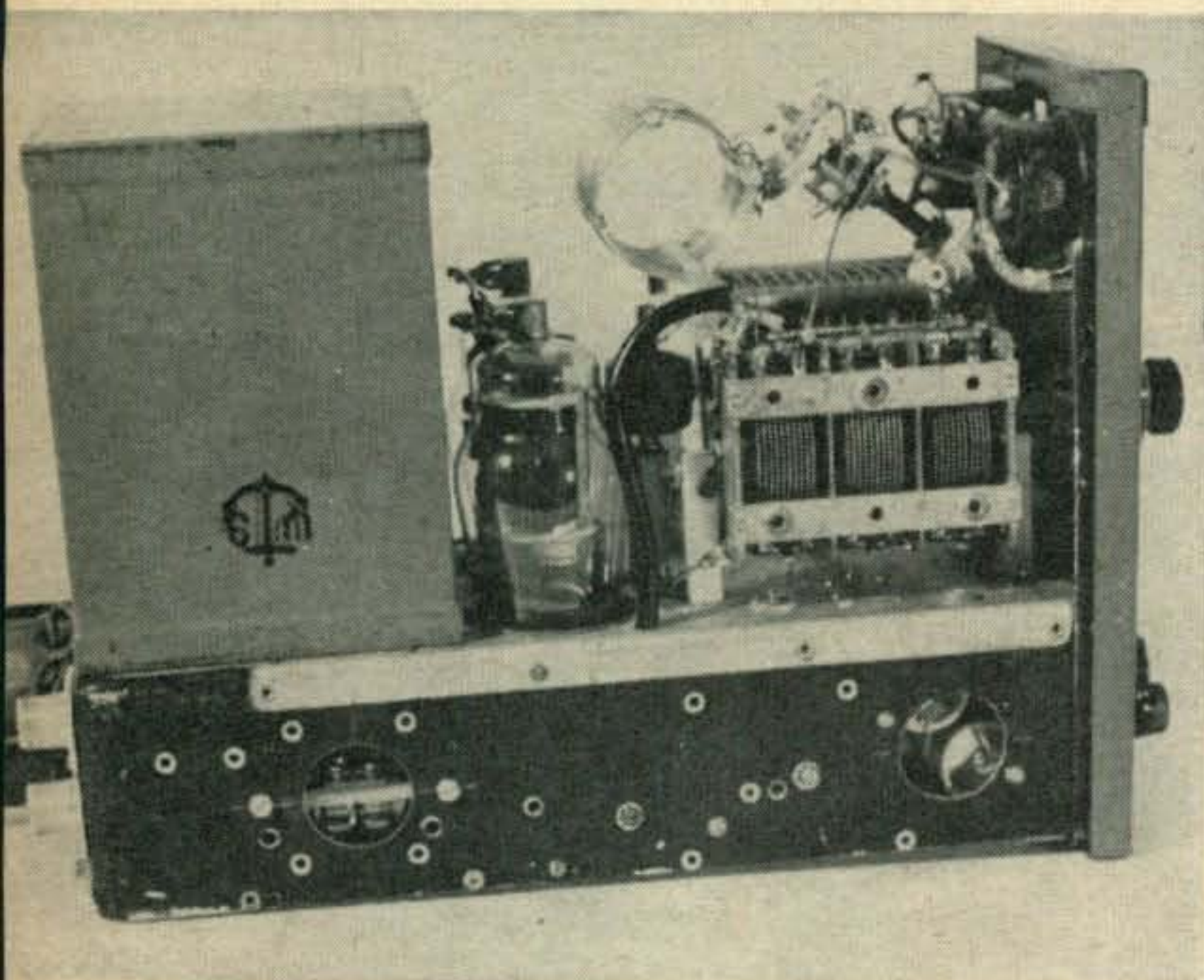

Bottom view of the linear amplifier using a stripped down ARC-5 chassis. Filament transformer, fuse holder, input and output receptacles are mounted on the rear skirt. A piece of sheet plexiglass holds the fuse clips which mount the 1N1449 silicon rectifiers. Capacitors C_1 through C_4 take up the majority of space in the front of the chassis.

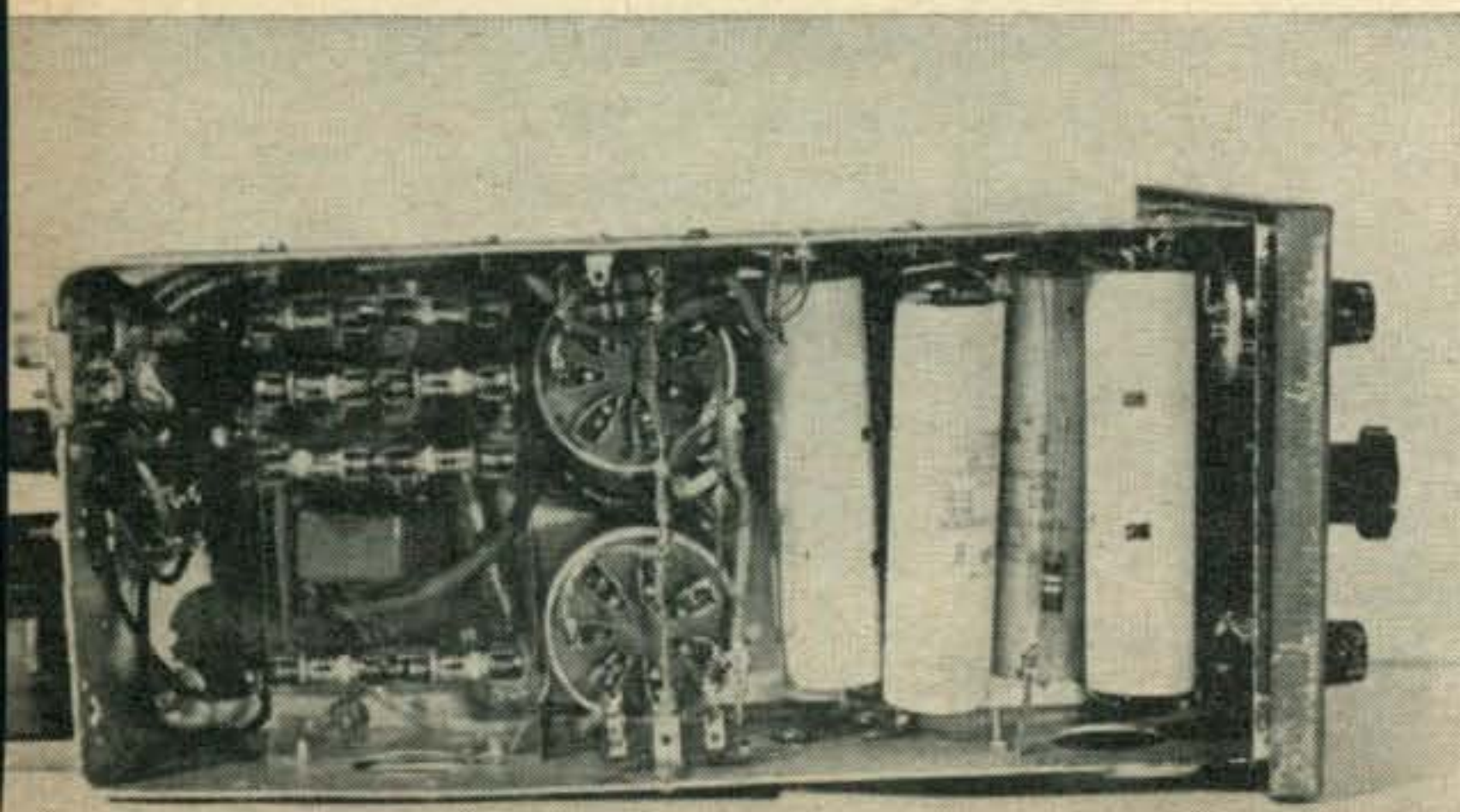

lug of a two lug terminal board mounted directly above the right hand tube socket. The positive side of the high voltage condenser bank is also connected to this point. From the front terminal on this board a 3 kv insulated wire connects to the feed-through insulator just in front of the two tube sockets and is by-passed to ground with the .0039 mf condenser at that point. The plate current is read between the two lugs of this high voltage terminal board. If your plate meter is less than 0-200 *ma*, this is a good place for the shunt.

The *ac* power switch is a single pole, three position, progressively shorting rotary mounted on the right front corner of the front panel as viewed from beneath the chassis. All control wiring is done with shielded wire.

The two front condensers are the low voltage pair, and the two closest to the tubes are the high voltage pair. They are mounted on insulated single terminal solder lugs extending from the walls of the chassis.

The RF Section

Under the chassis, the input and output coax connectors are mounted on the right rear apron. I used RG-59/U (73 ohm) coax since I use dipoles. Each coax connector is fitted with a shield hood (Amphenol UG 177/U) to isolate input and output circuits.

A heavy ground wire (braid) is run through pins 1 and 5 of each tube socket and is soldered to a ground lug mounted beside pin 1 of the left socket and pin 5 of the right socket. This same wire is grounded to the chassis between the two sockets. Pins 3 and 4 are connected to pin 5 of each socket with braid. The shield of the input coax is connected to the ground wire between the sockets.

The cathodes, pin 6, are connected together with heavy solid wire. The center conductor of the input coax is soldered to the center of this wire. R_1 is also soldered to this point and grounded between the tube sockets.

The only other *rf* circuitry below the chassis is the power output meter rectifier assembly. The resistors, condenser, and 1N34 are attached to a 4 lug terminal board which is mounted between the chassis and the meter switch. The *rf* for this circuit comes through the front feed-through insulator on the ARC-5 chassis and is carried to the assembly through shielded wire.

Above the chassis, the plate condenser is mounted to the right on $\frac{3}{4}$ inch stand-offs. These stand-offs raise the condenser shaft to 5 inches from the bottom of the panel to match the knob height of the 20A. The three gang antenna condenser is mounted to the left on stand-offs to raise the shaft to 5 inches. If the condensers are mounted on insulated stand-offs, the frame of each condenser should be grounded directly to the chassis. The output is taken from the stator terminal at the top rear of the output condenser. A wire is run from a bottom stator terminal of the output condenser to the front

chassis feed-through insulator for the *rf* meter circuit previously described.

The plate choke is mounted on a 1 inch stand-off behind and between the tube sockets, and the 500 mmf, 20 kv condenser is mounted on a 1½ inch stand-off directly in front of the tube sockets.

Output Tank

The pi network coil is 13½ turns #14 wire, 1¾ inches long (B&W Miniductor No. 3022), and 10 turns #20 wire, 5/8 inches long (B&W No. 3023). The coil is 1¾ inches in diameter. It is mounted with polystyrene cement to a plexiglass strip fastened to the rear of the Johnson input variable with the stator bolts. If some other plate capacitor is used, it shouldn't be difficult to figure another way to mount the coil. The wide spaced (high frequency) half of the coil faces the right, with this end of the coil connected to the right rear stator bolt of the tuning condenser.

With the coil temporarily in position, taps are made from right to left as follows: 10 meters, 2¼ turns; 15 meters, 3 turns; 20 meters, 6¼ turns; 40 meters, 12¼ turns; closer spaced coil attached at 13½ turns; 80 meters, 23¼ turns from the right hand end of the entire coil.

The BANDSWITCH control knob is mounted between the ON-OFF and METER switches in the lower center of the front panel. These three switch shafts are 1⅜ inches from the panel bottom. The band switch right angle drive, mounted to the ARC-5 lower front panel, allows a shaft to extend vertically through the chassis to a height approximately 3/8 inch above the chassis. A Johnson 3 inch flexible coupling connects this shaft to the band switch which is mounted at a 45 degree angle from the front panel on a 2 inch long, specially made bracket. (My bracket was made from a mounting leg of a 200 watt resistor. Heavy aluminum or sheet metal should do.) The flexible coupling is mounted so that the bottom insulator is below the tuning condenser and the top insulator is above the condensers.

The band switch is a single pole, 5 position steatite Centralab 2501. The switch shaft is cut to 3/4 inch to allow the flexible coupling insulator to clear the condensers.

The right angle drive used was taken from an uncommon piece of surplus gear. It is ideal for this job because it is small. If you don't have a right angle drive in your junk box, Millen A 012 should just fit.

Both 1½ inch diameter meters are mounted at the top of the original ARC-5 front panel and read through 5/16 by 1/8 inch slots cut in the new front panel. The bulb is mounted on the bandswitch bracket and lights the meters indirectly but very adequately. Shielded wire is used for all above chassis meter wiring. The plate meter wires must be 2 kv insulated as well as shielded. The small condenser across the posts of each meter equalizes any *rf* that may be present there.

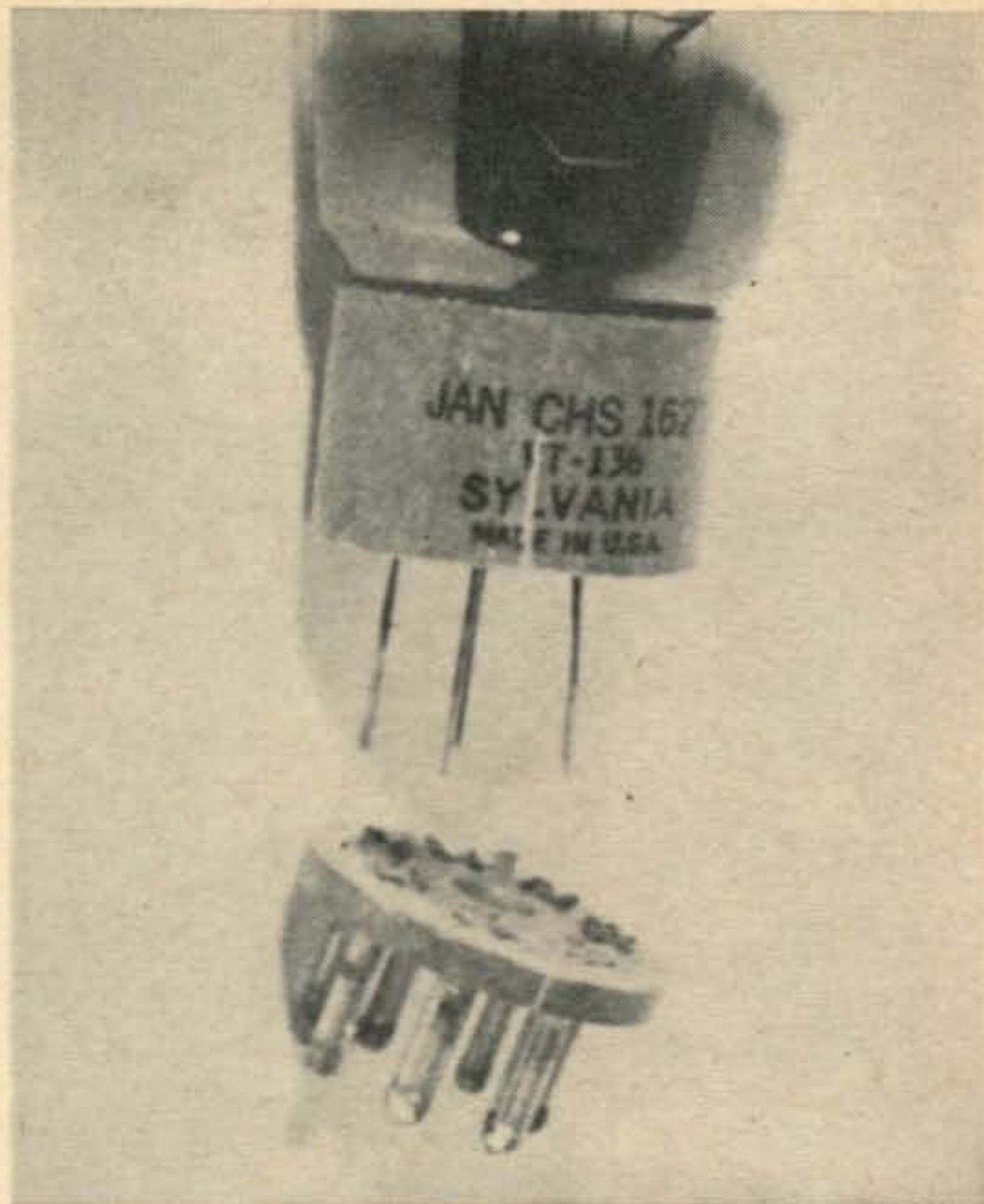

Modifications of the 1625 is explained in the text. This photo illustrates the position at which the base should be sawed off. The scratch mark, made for reference is visible on the attached, as well as the separated part of the tube base.



Front panel layout and enclosure design of the 1625 grounded grid amplifier. Vent holes in the bottom of the shield enclosure match with holes drilled in the ARC-5 chassis. Forward and Reflected positions of the meter switch are used with an external bridge.



The completed unit sits to the left of the Central 20A and 458 VFO. Neat job huh?

Tube Modification

This is not the first application of 1625's in grounded grid, but they are rarely used.¹ The reason for this neglect is simple. 1625's require modification for grounded grid use because the cathode is internally connected to the beam forming plates. Without modification the input signal appears on the beam forming plates as well as on the cathode, causing instability. Therefore, the beam forming plates must be grounded separately. There are three manufacturers who obligingly joined the beam forming plates and the cathode at the tube base instead of inside the envelope; Sylvania, Tung-Sol and National Union.

I know of two methods of modification, the hard way and the easy way. As far as I know there is no Army way. The hard way has been described elsewhere.^{2,3} The easy way is as follows⁴: First, scratch a vertical line on the tube base to be used later as a key. Using a hacksaw, cut a shallow slot around the circumference of the tube base about 3/16 inch from the bottom. Then saw through this slot exposing the interior of the tube base. Do not break the fine wires running from the envelope to the pins. After sawing, the pin end of the base should be connected to the envelope only by the element connecting wires.

Next heat two (or more if possible) of the pins at their tips, and a slight amount of pressure should free the pin section from the rest of the tube. Try to avoid bending the wires coming out of the envelope. With the pin base off, you will see two wires soldered together which formerly ran to pin 6, the cathode. Separate the two wires. Looking at the envelope from the bottom, the wire of this pair closest to the outer edge of the tube is the beam plate lead and should be repositioned to fit in pin 5, previously unoccupied. The cathode wire enters the envelope close to the center and should be positioned to re-enter pin 6.

If you didn't bend the wires it should be a simple matter to match the key you scratched on the base and re-insert the wires in their proper holes. A touch of solder to each pin and the base is back on. Polystyrene cement does a fair job of holding the base sections together. With a little practice it shouldn't take more than 15 minutes to modify each tube. The modification is easier to do than to explain. At 20 cents each, 1625's are undoubtedly the world's best bargain in transmitting tubes.

Tune Up

Nothing could be simpler than tuning this

¹P & H Electronics' LA 400 uses four 1625's in grounded grid.

²Hoover, E. L., and Peck, R. L., "A 200-Watt Grounded Grid Linear Amplifier", *QST*, June 1955, p. 21.

³Morgan, C. A., "Modifying 1625's and 807's for Linear Amplifier Use", *CQ*, February 1960, p. 53.

⁴The easiest way is to order the 1625's completely modified from P & H Electronics, 424 Columbia, Lafayette, Indiana, price, \$3.75 each.

linear. With the meter switch in the POWER OUTPUT position, dummy load attached, antenna condenser at minimum capacity, and the band switch to the desired band, apply plate voltage. Static (no signal) plate current should be around 40 *ma*. Insert a small amount of carrier or tone from your exciter until the plate current meter reads around 60 *ma*. Dip the final. Adjust the loading condenser for maximum output, re-dip the final. Continue this process until you get a reasonably small dip and that's it. Voice peaks should kick the plate meter around 100 to 120 *ma* for about 160 to 195 *dc* watts input, including fed-through exciter power.

After you get used to tuning the rig, you'll find that the simplest tune-up method is to insert very little carrier and peak the output meter by careful adjustment of both plate and antenna condensers. This method eliminates the necessity of having the 1625's draw high plate current during tune-up and assures you maximum output.

The Trimmings

My XYL had decided before I got a design together for this rig that it was going to have a commercial appearance, with deluxe case, decals, etc. The case consists of four separate pieces: Front panel, rear panel, a "U" shaped plate that serves as bottom and about 1/3 of each side, and an inverted "U" perforated metal plate or screening that fits over the top and 2/3 of each side. The two "U"s and the back plate are soldered or bolted together.

The dimensions of the 1625 GG case are 8 3/4 high by 5 9/16 wide by 12 inches deep. The front panel is 5 11/16 by 8 7/8 with a 1/2 inch lip. The only necessity in case design is that you provide adequate ventilation both above and below the chassis. The top plate must be perforated or screened. You can't get too much ventilation.

Incidentally, all metal work was done at a local sheet metal shop. Total cost for materials, metal work, paint and decals was \$6.50. The XYL picked up that tab.

The Central Deluxe vfo case would fit around the linear, but it is inadequately ventilated for this purpose and it costs about \$10.00.

Odds And Ends

One of the optional features of this rig is the OUTPUT meter switch. Even if you already have an *swr* bridge this switch might come in handy. You could, for instance, meter the grid current on one of the positions.

As it happens, my *swr* bridge will work with a 0-1 *ma* meter. If your bridge requires a more sensitive meter, you will have to shunt that meter to 0-1 *ma* for use with the output power circuit diagrammed here.

The front panel is held to the transmitter by the line switch and meter switch nuts. The cabinet is held to the transmitter with screws through the cabinet sides into four of the nuts that previously held the cover of the ARC-5 in position.

[Continued on page 125]

Building The Heathkit "Seneca"



John F. Wilhelm, K2OZW

474 Walton Road
Maplewood, New Jersey

A high-class performer, compact, complete, and with single-control bandswitching for 6 and 2 meters—that's the new Heathkit "Seneca". Everything is in one sturdy and handsome cabinet—all power supplies, modulator, and *rf* units including *vfo* for both bands

The use of controlled-carrier modulation had me skeptical until on-the-air tests were made. Now I am a staunch convert to this simple yet effective system. Reports from other hams have ranged from "really didn't know that you were using controlled carrier" to "that's the best controlled carrier I've ever heard". All contacts have reported the modulation to be excellent in quality. Of course a few fellows reported "thought you must be mobile the way my S-meter is swinging".

The components used in the Seneca are of high quality. The multipurpose transformer and the power choke are *heavy*—the power supplies are husky and built to deliver without strain the 120 watts and 95 watts input respectively on 6- and 2-meter phone. On 6 the Seneca will run at 140 watts CW input and on 2 at 110 watts CW input.

The construction of the Seneca is not a weekend project. It required roughly 60 hours of spare time and an additional 6 hours for calibration and cabling to get it on the air.

As experienced *vhf* men will agree, there's a lot of difference between 50 *mc* and 144 *mc* as far as design, construction, and operation of a transmitter are concerned. Heath has done a remarkably good job here of combining the two bands in one transmitter. The Seneca has *rf* sections that are compact, utilize short leads, and

at the same time are within the ability of the moderately experienced kit builder to assemble. I do not recommend this kit as a first project unless someone with experience provides guidance during the construction. Although most of the instructions are clear, there are places where the manual bogs down in ambiguity and incomplete directions. I found, however, that the rough spots are not insurmountable if you follow the plentiful schematics and pictorials as well as the instructions.

Assembly

In the Seneca, Heath makes extensive use of sub-assembly type construction. This practice not only isolates and "seals" the various *rf* units, but makes the job more interesting by providing completed units every few construction hours. The *vfo* is wired first and is the most compact of the assemblies. Care here in construction will pay off later in excellence of performance.

Other sub-assemblies include the oscillator-multiplier unit, driver unit, and final amplifier assembly.

All coils are pre-wound and calibrated. If you are careful not to squeeze or bend the air-wound coils, the calibration of the Seneca should fall into place easily. I did not have to adjust a single air-wound coil. I will admit that the assembly of the 6-meter tank coil in the center of the 2-meter tuned lines and fastening all this to stand off insulators made me wish that I had 6 hands, but I made it ok.

After the sub-assemblies are complete the main-chassis wiring is started. No trouble was experienced here. In fact, after the tight work

of the *rf* units this comes as a real breather. The band-switch in the driver cage comes pre-wired with the final grid coils and the plate lead for the 2E26 in place. Pre-wiring of these very critical parts is especially helpful.

The 6146's are neutralized by means of stubs which are moved near to or away from the tubes to accomplish neutralization. The perspective drawings showing the mounting of these stubs are not as clear as they should be. However, by observing symmetry in mounting each set of stubs the correct arrangement will result.

The accessory socket on the rear of the chassis involves some close-spaced soldering of components, but Heath has worked out an assembly sequence which is almost fool-proof.

The single-control bandswitching employed in the Seneca involves an interesting mechanical-linkage system. The exploded views for assembly are clear, but I advise studying *Pictorial 20* before placing the linkage system on the various shafts to be controlled.

Assembly of the *vfo* to the front dial drive plate is a job which should be undertaken when wide awake and only after thoroughly understanding the instructions. Then, after having sweated through this process, comes the real toughie—stringing the dial cord! This is where they separate the men from the boys. It's tough and its rough. So what if the cord slips the first few times. You just start over; but success at last and with it comes that inner glow of a job well done. Needless to say, the best location for these two operations is a soundproof room.

My next trouble came when the spring which holds the *vfo* dial cord in tension insisted on getting hung up on a protruding shaft! However, by judicious juggling, the *vfo* pointer was made to cover the entire dial scale.

Heath has simplified the final inter-unit wiring by supplying a pre-assembled harness. This saves an enormous amount of time and adds to the professional appearance of the kit.

Top view of the Heath Seneca. Power supply components including power transformer, rectifiers, voltage regulator and clamp tube are mounted at the upper left. Below the power transformer are the crystal sockets and 6AN8 crystal oscillator, buffer. The v.f.o. sub chassis is located on the right, under the high voltage filter choke. The 6146 tank and two meter tuned lines are mounted inside the perforated cage.

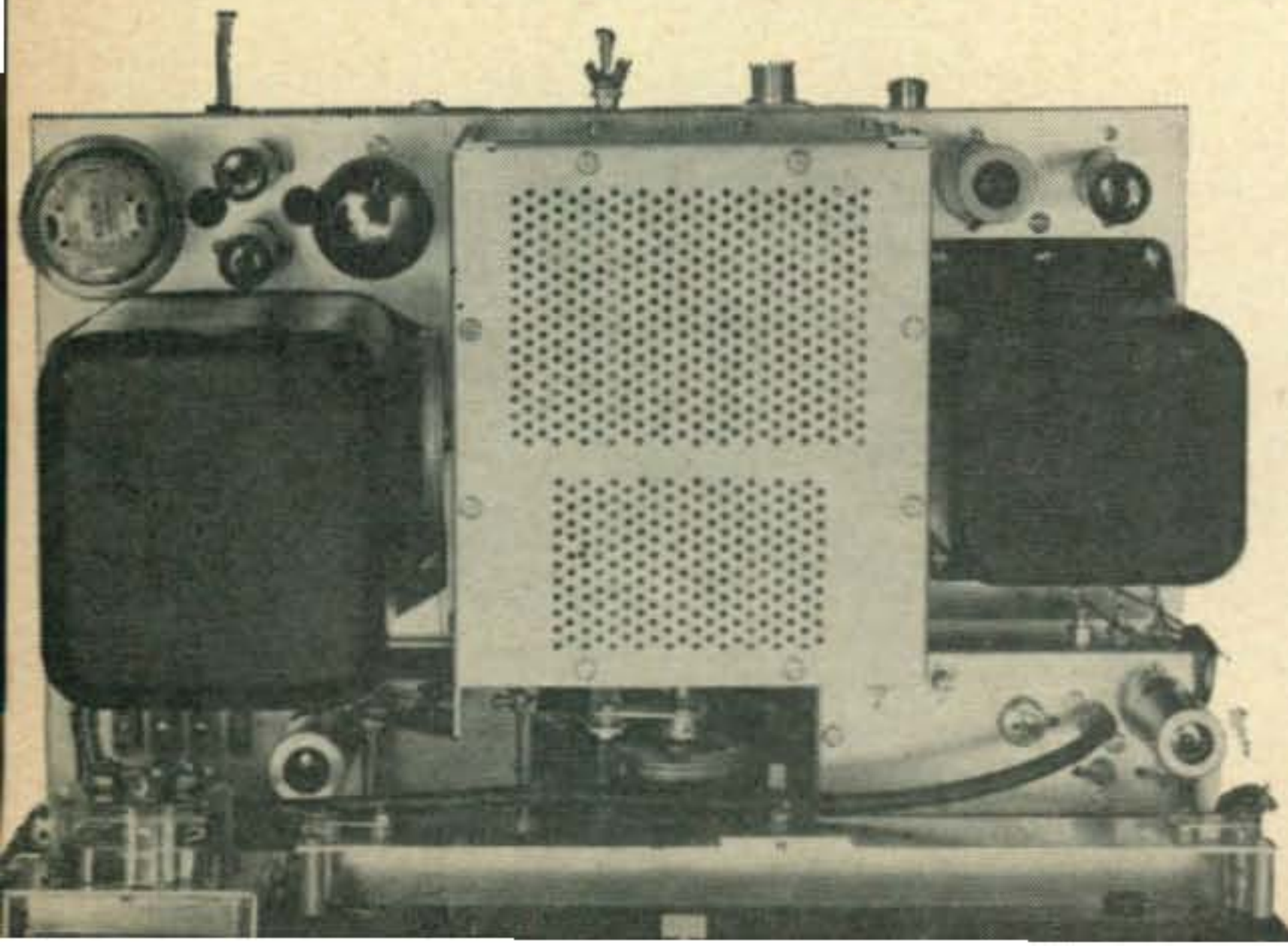

A word to the wise: be sure the function switch and the meter switch are installed correctly. While the pictorials are clear, the instructions are somewhat ambiguous. By reading ahead in the manual to the knob-placement section there will be no trouble with these items. (I managed to get both switches in backwards the first try.)

The remainder of the wiring should progress without any major problems.

Preliminary Checks

By all means check, as Heath suggests, for possible short circuits before applying power. A little time spent here will prevent burned out parts and will really get the rig operational *sooner*.

Adjustments

Most important adjustment is the neutralization of the final-6146's. I used a Heath Grid Dip Oscillator GD-1B during the neutralization. The instructions are very good and the resulting degree of neutralization was excellent. If you don't have a grid dip oscillator or wave meter, beg, borrow, or buy one, but DO neutralize the final! The remaining adjustments are clearly described. If care is used in assembly, no real problems should be encountered.

Calibration of VFO

If you can calibrate the *vfo* with the aid of a frequency standard such as the surplus LM or BC series, by all means do so. One day I hope to go through the *vfo* calibration using this method. Instead I employed the alternate method of calibration against crystals. The final result was quite good, but I am more wary of the band edges than I would like to be.

The *vfo* is a great convenience for all but the Novice who must operate crystal controlled. The Novice will find the switch-selection of four crystals a big help in dodging QRM.

Bottom view showing cable harness and general layout of components. The ceramic wafer switch at the upper right is the emission switch and is nestled between the bandswitch on the right and plate tuning on the left. Below the shielded crystal oscillator compartment are the high voltage filter capacitors. Above the speech amplifier tubes at the bottom right is the low voltage power supply filter choke.

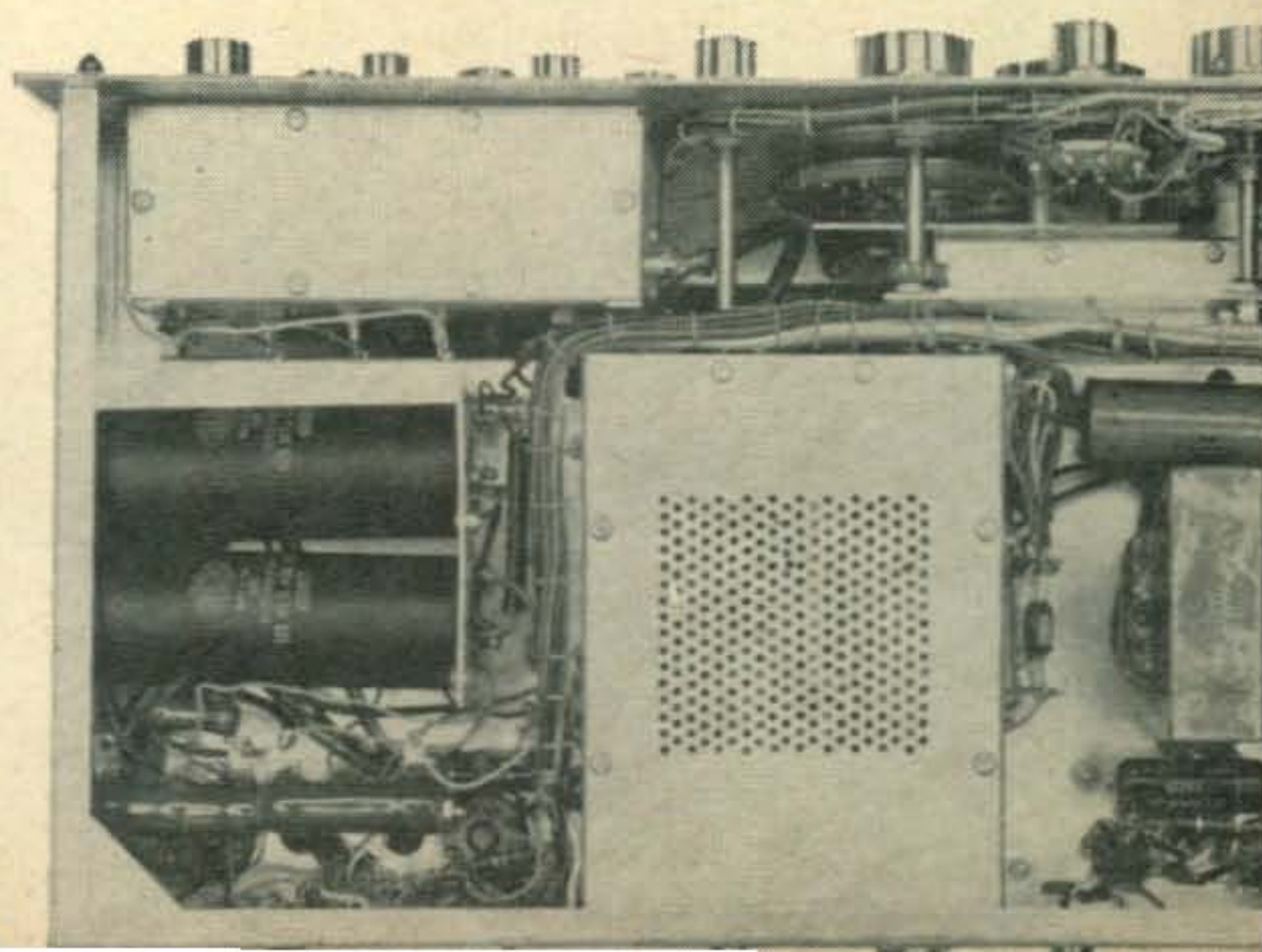

Operation

Actual operation of the Seneca is quite simple. All important currents are metered as is the final plate voltage. The multi-purpose meter and the *vfo* dial are well lighted and are easy to read. Connections for microphone, antenna, as well as the key jack and the accessory socket are located on the rear of the chassis. Therefore, there are no wires interfering with the control knobs.

The spotting switch allows for "zeroing" in with *vfo* without putting the final on the air. All controls are clearly labeled and in cases where important, directions of rotation are indicated. The large *vfo* knob gives a feel of rugged, yet fine control.

Output is designed for unbalanced coax line, but Heath supplies instructions for those wishing to feed a balanced 300-ohm transmission line.

While harmonic rejection of the link coupling circuit is good, the use of low pass filters is strongly recommended, especially when operating on 6 meters. I feed the output into a Telrex 3 element beam on 2 meters and to a Gotham 4 element beam on 6 meters.

Circuits

The *vfo* is a self contained unit located away from all heat-generating units of the transmitter except the 6AU6 in the *vfo*—and this tube is located on the outside of the *vfo* box. The 6AU6 operates as a Clapp oscillator in the frequency ranges 8.000 to 8.222 *mc* (for 2 meter band coverage) and 8.333 to 9.000 *mc* (for 6 meter band coverage). Heath has taken extreme care to provide a reasonably stable, drift free *vfo*—no mean task for the bands covered—and comes out with flying colors. Results are quite satisfactory and drift is held to a very low value. The *vfo* is bandswitched by the linkage mechanism when the single band-switch control is rotated.

The crystal oscillator-buffer employs the pentode section of a 6AN8 tube. This part of the two unit tube operates in a tuned plate circuit, the oscillating circuit being equivalent to a

grounded-plate Colpitts. As mentioned previously, switch selection of four crystals is provided. The crystals may be for either or both bands. The output of the pentode section of the 6AN8 is tuned from 24 to 27 *mc*.

The triode section of the 6AN8 operates as a doubler to 6 meters and as a tripler for 2 meters.

The driver tube for the 6146's is a 2E26 which operates straight through on 6 and doubles to 2 meters. For CW operation, cathode keying of this stage is employed.

The two type 6146 tubes operate push pull in the final amplifier stage which operates *straight through* on both 2 and 6 meters. Protection to the final is provided by the use of a 6AQ5 as clamp tube. This tube serves to drop the screen-grid voltage if the excitation is removed from the 6146's.

On 2 meters the plate circuit is a shorted quarter wave section of transmission line. For 6 meters a conventional split tank coil is used. Loading of antenna on both bands is accomplished by a coil and hairpin loop combination.

The modulator consists of two tubes, a 12AX7 and a 6DE7. High-impedance microphone input is provided, but the lack of a gain control will seem odd at first. The operation is simple. With modulation the screen grid voltage of the 6146's is varied giving the controlled-carrier effect. In a typical set up, the no-modulation plate current runs about 50 milliamperes with speech peaks pushing this to about 200 mils. Best operation comes with practice and results when continuous talking rather than large voice spacings is employed. This will seem logical when one realizes that the carrier output increases with the percentage of modulation employed. You can literally talk yourself into the "S meter" reading you get from the other guy!

The Seneca is a *vhf* "powerhouse" in but 16 $\frac{5}{8}$ " x 10" of desk space (it's 10 $\frac{1}{8}$ " high). I feel that this rig should appeal to any ham interested in extending his operating activities into the 6 and 2 meter bands. Overall I found the Seneca top notch in both appearance and operation. Reports from all contacts have been very gratifying. ■

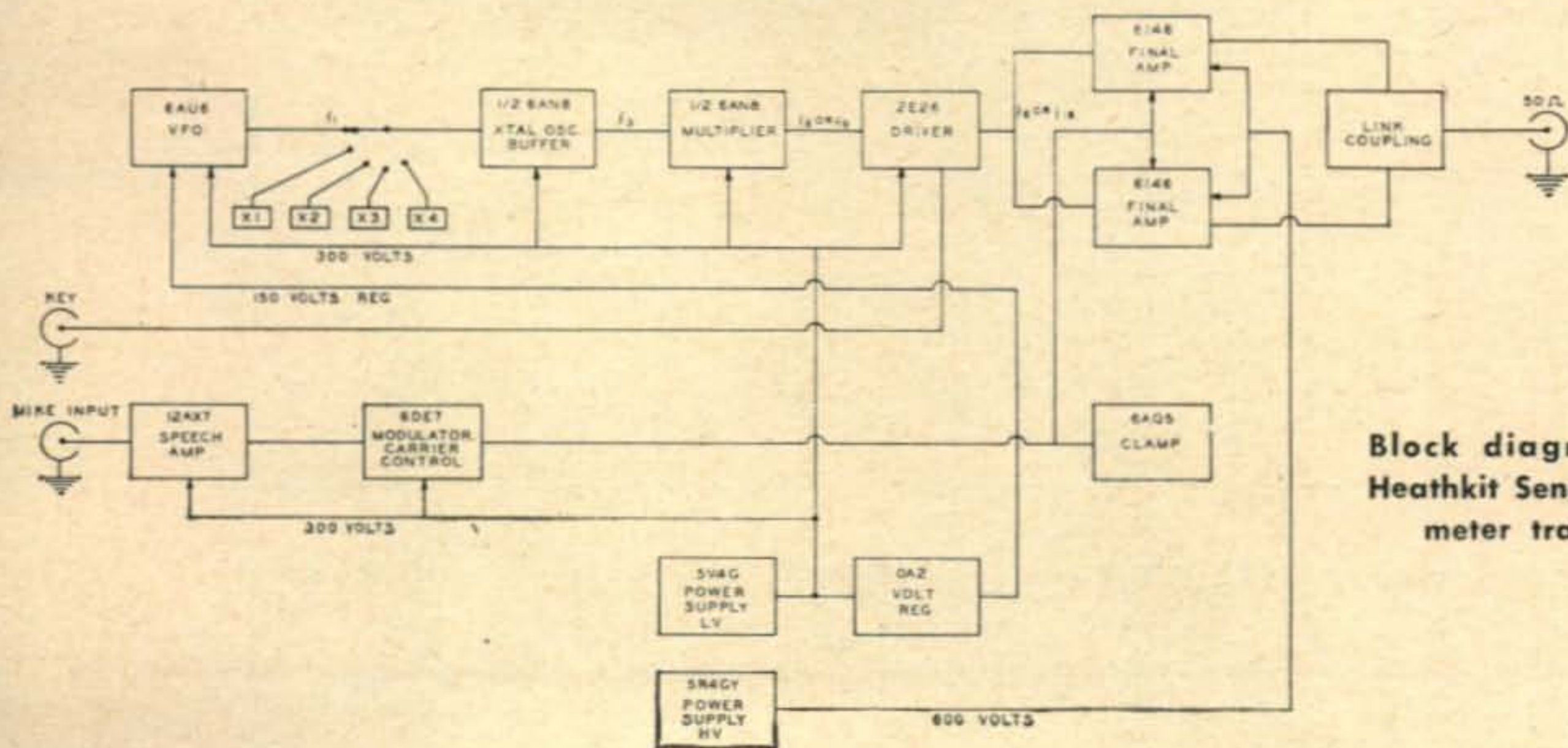

Block diagram of the Heathkit Seneca 6 and 2 meter transmitter.

Selectivity With a Band-Pass Filter

R. E. Hollenbach, W5KZU

3711 Veranda Rd. N. E.
Albuquerque, New Mexico

There has probably been a time in the life of every ham when he craved just a little bit more selectivity out of that old receiver. Perhaps this longing has occurred to you on one of those weekend pile-ups, in a DX Contest, or during a plain old ragchew. This fundamental desire coupled with the fact that I am hard of hearing and have trouble separating different tones, convinced me that something had to be done to improve CW copy on my HQ-129X. Having used both Q multiplier and Q 5er with varying degrees of success, I decided that the next contrivance to be tried here would have to be simple—no knobs to be adjusted on every signal. A simple audio filter tied to the receiver output seemed to be the best possibility. Several articles have appeared in recent years dealing with a surplus band-pass filter but neither appealed to me for reasons indicated later. There have also been articles using selective audio amplifiers. It seems to me that the ideal filter would have minimum loss, a sharp response curve and require no external power. The last requirement excluded any amplifier arrangement.

Surplus FL-8

My first attempt to fulfill these criteria was with one of the surplus FL-8 filters. For those who are not familiar with this unit, the FL-8 is a range filter used by the Air Force to monitor radio range beacon signals. It is a band-pass filter with a nominal pass frequency of 1000 cycles. While the filter works reasonably well there is an insertion loss of approximately 12 db that cannot be overcome without the use of

some sort of amplifier. Ford uses amplifiers in the "SAF-4"¹ to make up for this loss. *The Radio Engineers' Handbook*, by F. E. Terman, tells us that in order to keep losses at a minimum the inductances used in a filter should have a Q of 15 or higher. Keeping this fact in mind, I began experimenting with a variety of toroids having a Q much higher than the minimum requirement. Using good toroids in the filter circuits described by F. E. Terman, one can easily construct a filter having more desirable characteristics than the FL-8 and without the 12 db loss. Several circuits were tried but the one described here seemed to give optimum performance with a minimum of parts. I have no doubt that a better unit could be devised around a more elaborate circuit.

Circuit Description

The complete unit consists of a reverse wired output transformer that is used to raise the low impedance output of the receiver to a more useful value; a single section T filter, and a simple audio clipper. In order to realize maximum energy transfer, the input side of T_1 should be the same impedance as the output of the receiver. Several output impedances were tried for T_1 , but the 1000 ohm value gave minimum loading at resonance. The components listed here were calculated to give a pass frequency of 925 ± 50 cycles. There is an insertion loss of 2.5 db at resonance. If desired, other constants may be used for different pass frequencies. When altering for different frequen-

¹Ford, G.C., "SAF-4 The C.W. Man's QRM Eliminator," *CQ*, Nov. 1957, p. 60.

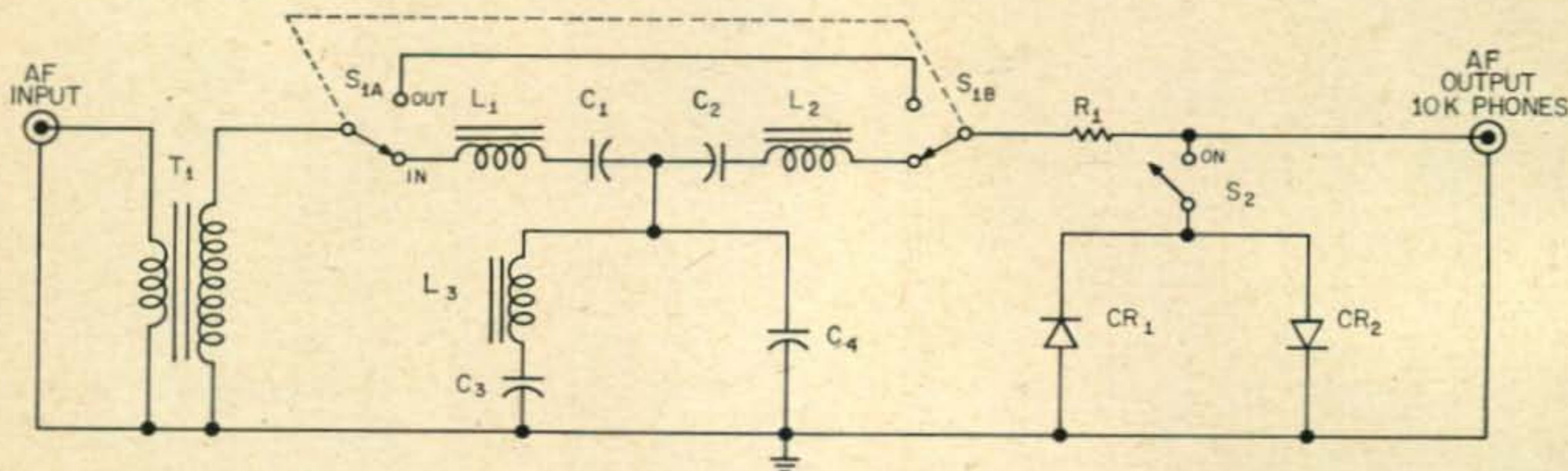

Fig. 1—Schematic of the filter. This unit has an insertion loss of approximately 2.5 db.

C_1, C_2 —.0027 mf, 200 v.
 C_3 —.3 mf, 200 v.
 C_4 —.16 mf, 200 v.

CR_1, CR_2 —65 ma selenium
 L_1, L_2 —12 Hy toroid, UTC
HQB-10

L_3 —0.3 Hy toroid, UTC
HQA-9
 R_1 —2.2 K $\frac{1}{2}$ w.

T_1 —plate to voice coil.
UTC R-58

cies just remember L_1 and L_2 should be of equal value and C_1 and C_2 should also be of equal value. The series circuits $L_1 C_1$ and $L_2 C_2$ should each be resonant for the desired frequency. Likewise, the parallel circuit of L_3, C_3 and C_4 should be resonant at this same frequency. The series circuit of $L_3 C_3$ determines the low frequency dip in the response curve. If different output impedances are desired the various values of inductance and capacitance will have to be recalculated by formula. Two 65 ma Selenium rectifiers and a 1/2 watt carbon resistor are used in a clipper circuit that works quite well without the use of bias cells. The clipper exhibits some clamping effect even on low level signals, with wave-form distortion starting at 4 volts peak to peak. Maximum output from the clipper is only 6 volts pp even with a 40 volt pp signal applied to the filter input. Two toggle switches are used to insert or omit either filter or clipper. The construction can be noted from the photographs. Since these are audio frequencies no special precautions need be observed. The "minibox" was home constructed with aluminum sheet salvaged from old broadcast transcriptions. Chassis dimensions are 5 1/4 by 2 by 3 inches.

Frequency Response

Figure 2 shows the response curve of the filter. If a curve such as this does not mean much to you, let's illustrate it another way. Suppose you are copying a nice 900 cycle beat note from station A when station B comes on at a slightly higher frequency giving a 500 cycle QRM note and then station C comes on at a still

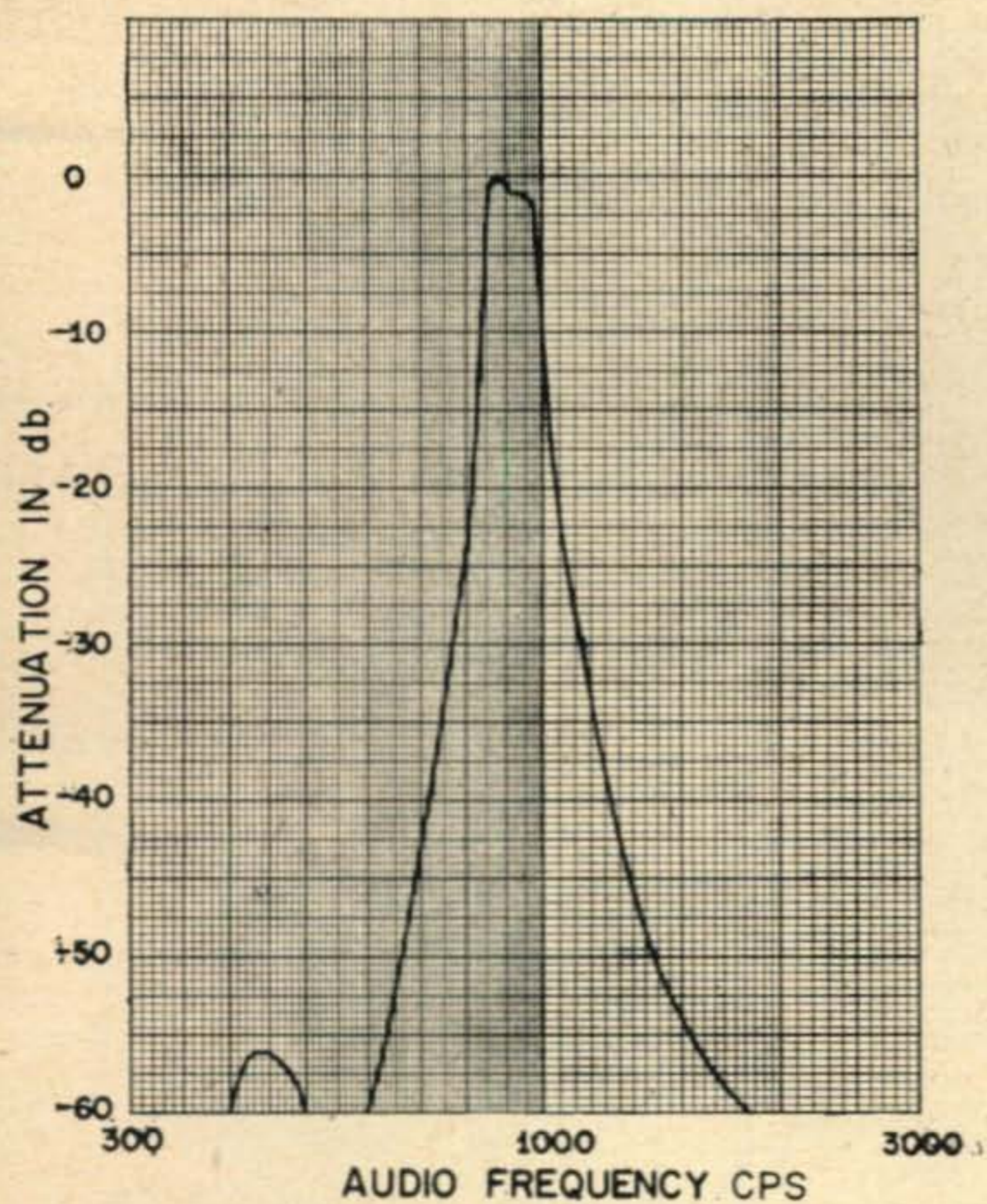
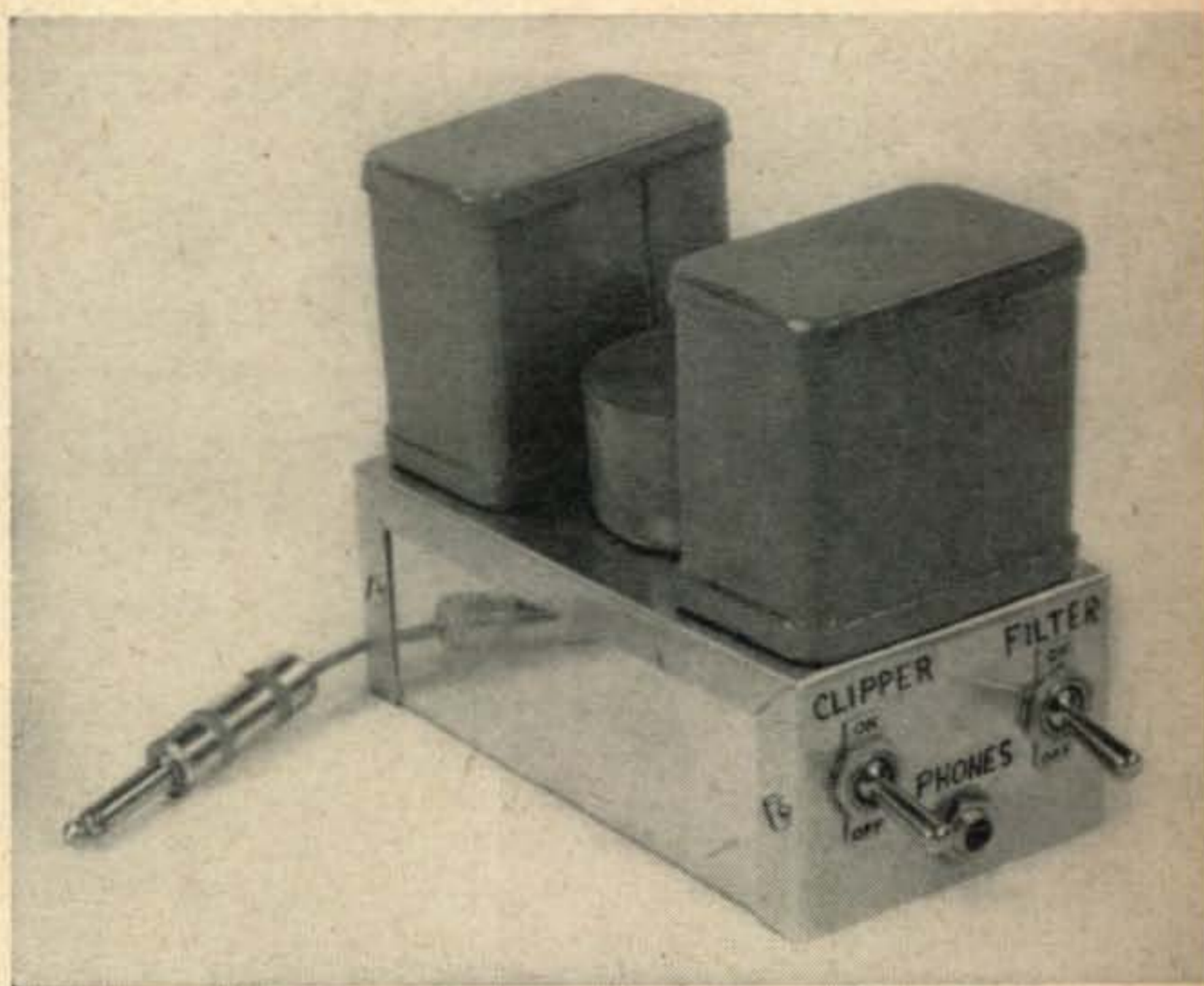

Fig. 2—Response curve of the audio filter. At -6db the bandwidth is approximately 165 cps.

higher frequency adding a 2000 cycle note. Now you have the desired signal from station A mixed with the undesired notes from stations B and C. Simply switch in the filter and B and C seem to disappear. Disappear is really not a true word here since stations B and C are still there, but now you will have to retune to find them.

Disadvantages?

The only drawback noticed in several months of use at this QTH is that receiver and transmitter drift show up as never before. Also my
[Continued on page 124]



Side view of the band pass filter. L_2 is mounted above the toggle switches and L_1 is mounted at the rear of the chassis. The 0.3 Hy Toroid, L_3 sits in the middle of both inductors.

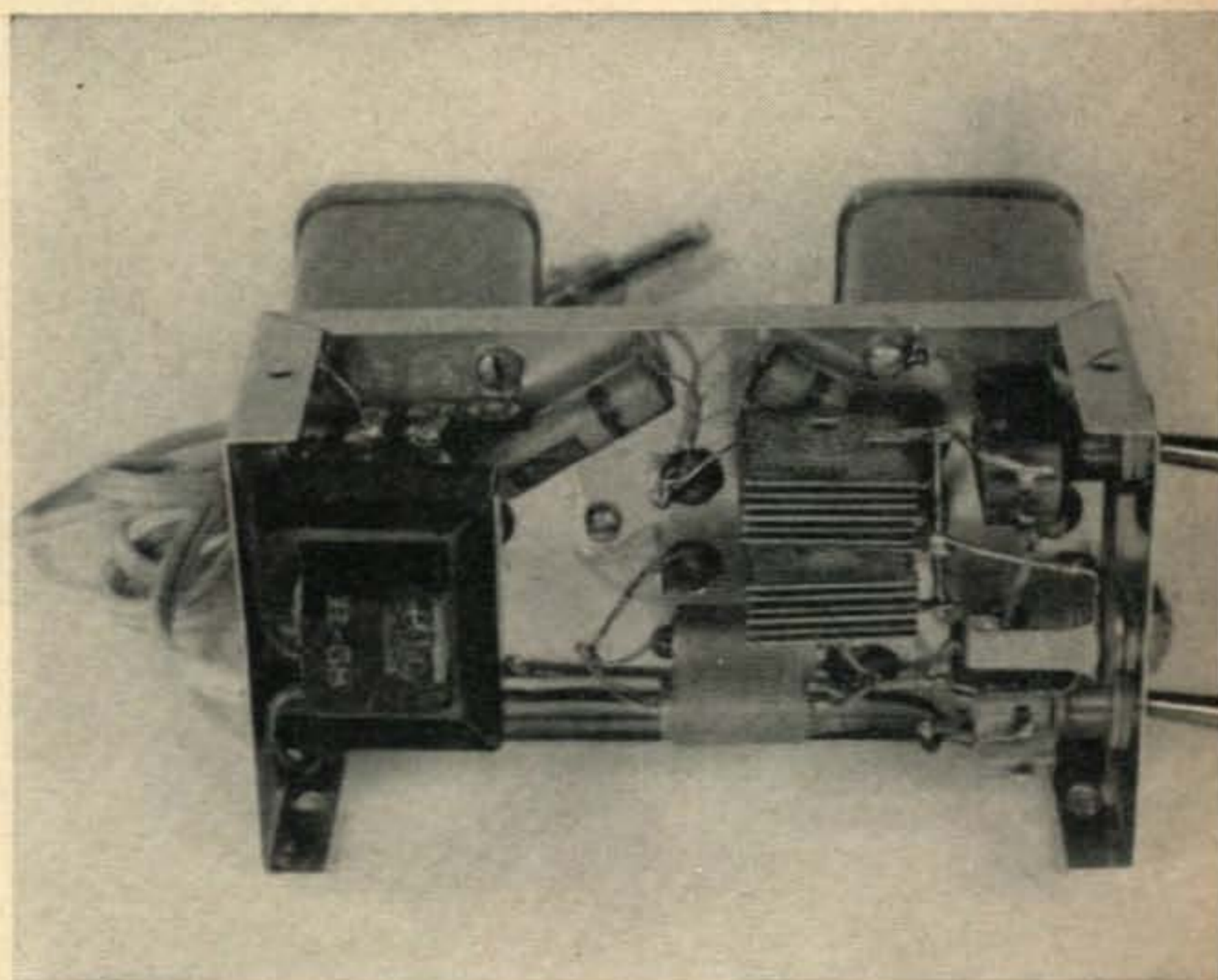

Under chassis view of the filter built on a home made 5 1/4 x 2 x 3 inch aluminum chassis. T_1 is mounted on the left skirt and the selenium rectifiers CR_1 and CR_2 can be seen behind the toggle switches.

A Reactance Amplifier For 432 MC

Frederick W. Brown, W6HPH

304 Alosta Drive
Camarillo, Calif

A low noise one and a quarter meter parametric amplifier employing an inexpensive varactor element.

The reactance amplifier offers an inexpensive solution to the low-noise, *uhf* receiver problem. In fact, at 432 *mc* and above, it is possible to achieve a lower noise figure with the reactance amplifier than with any tube now on the market. This article describes one such amplifier, which may not be the "last word", but is easy to construct and gives performance that will surpass even the very best tube amplifiers.

The requirements for a regenerative two-tank type of reactance amplifier are: (1) A reactive element that has high *Q*, low noise, and that can be varied in reactance at a microwave rate. This element is usually provided by a semi-conductor diode that is back biased to form a voltage dependent capacitance. (2) A "pump" source to vary the reactance. Only a fraction of a watt of power is normally required, but the frequency should be at least twice that of the signal. The pump oscillator should be tunable and have good amplitude and frequency stability. A voltage regulated plate supply is very desirable. (3) A high *Q* tank circuit resonant at both the signal and idler frequencies. The idler frequency is the difference between the pump and signal frequencies.

Circuit Details

A semi-schematic diagram is given in fig. 1.

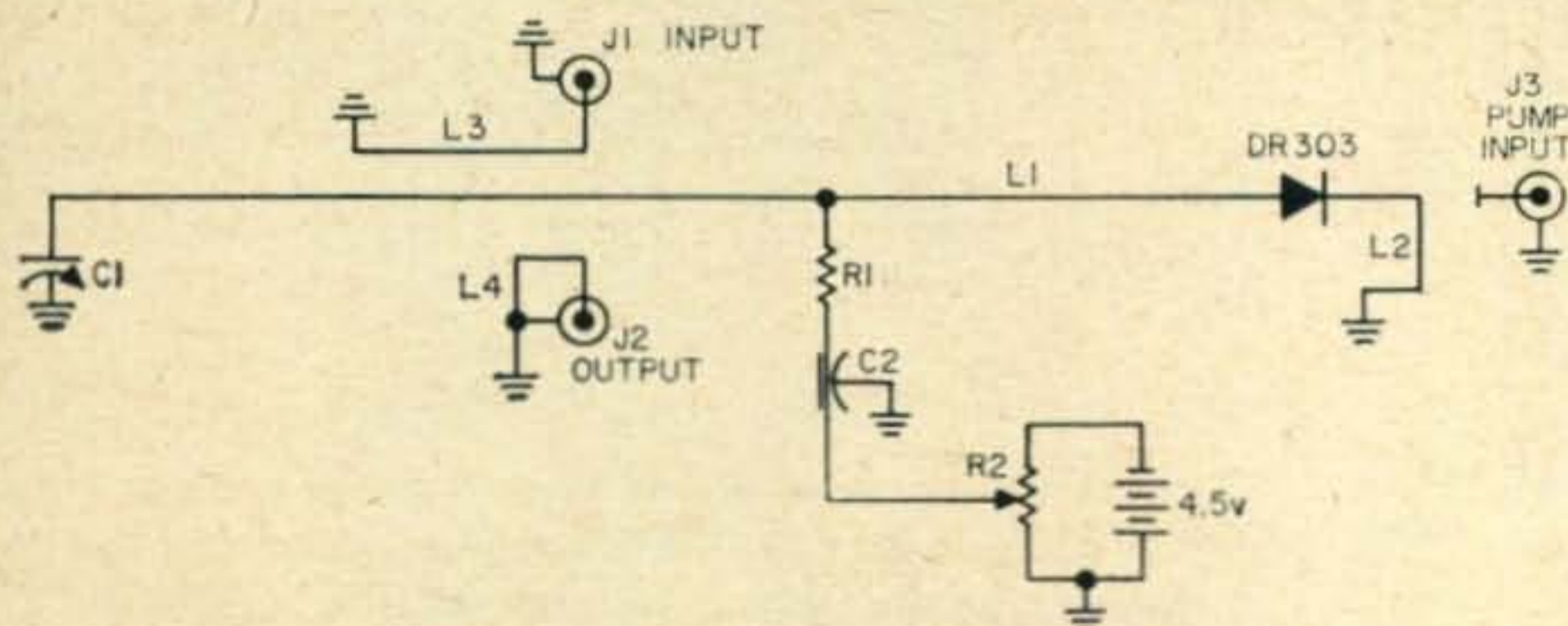

C₁—5 mmf miniature Johnson 5M11
C₂—500 mmf feed through by-pass
J₁, J₂—BNC female coax connector
J₃—Type N female coax connector
L₁—Copper strip 3/8" wide, 9" long
L₂—See text
L₃—1 1/8" x 3/16" # 18 wire
L₄—1/4" x 1/4" # 18 wire
R₁—1 meg 1/2 watt
R₂—2.5 meg pot.

Fig. 1—Circuit of the 1/4 meter parametric amplifier.

An inexpensive (\$1.12) DR303 made by the *General Instrument Corp.* is used for the "varactor" element. L₁ is a trough line resonant in the 1/2 wave mode at 432 *mc* and in the 3/2 wave mode at the idler frequency. Pump power is coupled into L₂, which is approximately resonant at the pump frequency. Input and output coupling is provided by L₃ and L₄, respectively. The output link, L₄, is made very small to avoid coupling noise from the converter back into the amplifier, which would degrade the overall noise figure.

The drawings of fig. 2 give the necessary dimensions for constructing the amplifier. The entire unit can be made of flashing copper, and no special tools are required. In soldering the diode to L₁ and L₂, be sure to have at least 1/4 inch of lead length to avoid heat damage.

Pump Oscillators

There are quite a few possibilities for a pump oscillator on the surplus market.¹ All of these oscillators use either a lighthouse or pencil tube. The local oscillator in the currently available APX-6 looks like a good possibility. Another

¹Jones, F. C., "432 MC Parametric Amplifiers", *CQ*, August, 1959, p. 30.

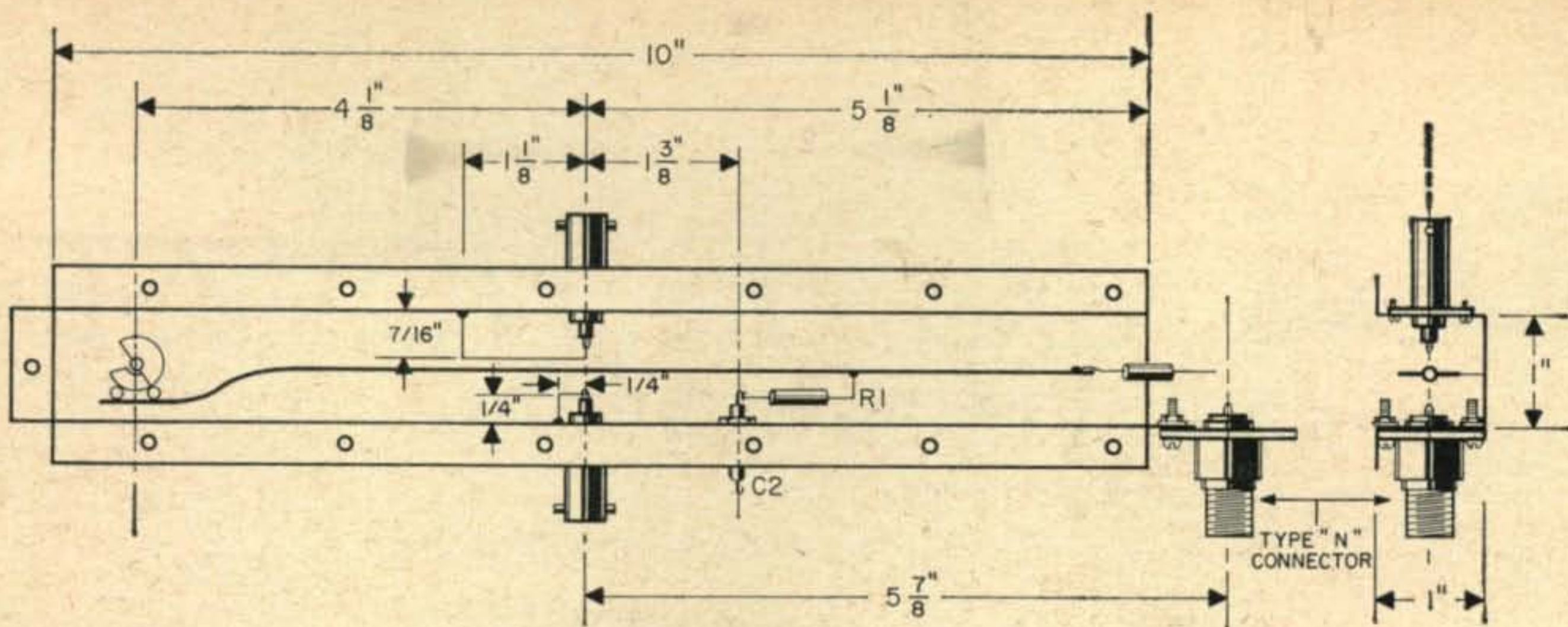

Fig. 2—Construction details of the 1/4 meter parametric amplifier.

likely candidate is the 1600 *mc* Radiosonde oscillator. The pump I use is the local oscillator from an L band radar receiver (TPS-1B). Using a 446A, it tunes from about 1000 to about 1500 *mc*. Plate voltage is regulated by a VR150.

The pump output terminates in a type "N" fitting which is fastened to a copper tab on the end of the trough line. The very small capacity between the soldering lug on the N fitting and L_2 provides enough coupling, separation is about $\frac{3}{8}$ inch. If enough coupling is not provided in this manner, a short piece of wire may be soldered to the N fitting and brought into the vicinity of L_2 . Pump injection can be controlled by bending back or forward, the tab on which the coax fitting is mounted.

Bateman and Bain² point out that a high pump frequency is desirable, at the same time a pump frequency that is an integral multiple of the signal frequency should be avoided. For this particular trough line, $\frac{3}{2}$ wave resonance happened to be 886 *mc*, requiring the pump to be at 1318 *mc*. If a higher frequency pump is available, it should be possible to operate the line at $\frac{5}{2}$ wave resonance, or even higher for the idler frequency. This should give a slightly lower noise figure.

Tune Up

Tune up procedure is as follows: Connect the amplifier between the antenna and 432 *mc* converter. Supply a strong signal to the antenna. This can be provided by a local station, or a signal generator loosely coupled to the transmission line. With about 2 volts of bias on the diode, tune C1 for maximum S meter reading. Now, disconnect the lead running between C2 and the bias pot and measure the voltage at C2 with a *vtm*. Adjust the pump oscillator coupling to give about 2.0 volts and reconnect the bias control pot. Next, tune the pump throughout its range, a point should be found where the S meter reading increases. Having found this point, alternately repeak C1 and the pump tuning while gradually decreasing the bias. The bias control acts as a fine adjustment on the regen-

eration, and should be set at a point that brings up the receiver noise at least 10 db. Too much regeneration will cause the amplifier to oscillate; this being characterized by a very strong unstable signal, tunable by C1. As with any regenerative device, bandwidth will decrease with increasing regeneration, 3 db bandwidth being only about 100 kc under normal operation. The bandwidth between points where the noise figure drops 3 db will be considerably greater, however.

No absolute noise figure measurements have been made, but the amplifier is a good 7 db better than the 6J4 rf stage formerly used at this station. Signals that were previously buried in the noise are brought up to Q5. ■

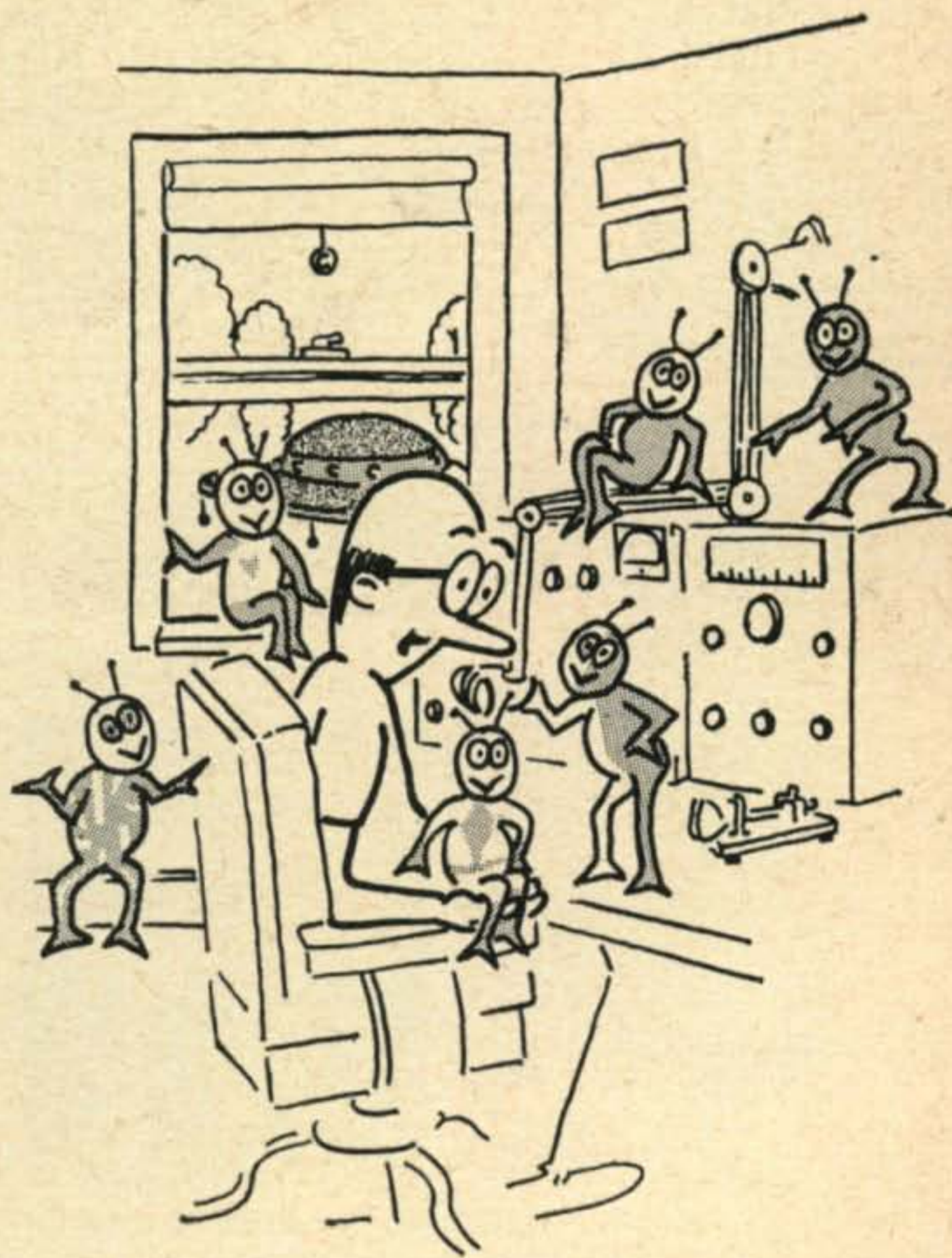

Well, Fred, I finally made a contact on one and a quarter meters.

² Bateman and Bain, "New Thresholds in VHF and UHF Reception" QST, March, 1959.

DX and the NOVICE

Tima Popovich, YU1FR

Bratstva 95
Ban. Novo Selo, Yugoslavia

Between the lines of this article lies a message for both Novice and Pro. The theme has been printed before and will undoubtedly be printed again. We are sure though, that the few hints suggested here will considerably boost your DX score.



Tima Popovic YU1FR at his receiving position.



Next to the home brew tape recorder sits a 10 tube and 6 tube superhet. With this simple setup Tima has worked hundreds of Novices. Is your card part of his wall paper?

It was a disagreeably cool autumn evening in early October 1956 when I worked my first Novice station. One of those exasperating evenings when you suddenly feel the band may cave in on a good DX opening. Although the band was unsettled, I had high hopes that a rare piece of DX would roll in.

To a certain degree these hopes materialized when I worked VQ5BK. He was not exactly what I would call rare, but it did mean a new country for me.

The next call, which came from W1HAG wasn't particularly exciting, not because I have any disregard for W/K stations, (in fact I work them by the hundreds on occasion and with great pleasure) but merely because the call came at, what seemed to me an inopportune time. However, my disappointment turned to delight when I realized that the operator on the other end was a YL by the name of Sandra. Call it what you like, I perked up immediately and in no uncertain terms was trying to ascertain whether or not Sandra was really a YL's name (these DX names are always confusing, Hi).

By the time I was assured that Sandra was a YL my chances to work any genuine DX dropped considerably. But who cared; compared to working a YL rare DX was like *taking candy from a baby*.

Under such circumstances I didn't devote too much attention to KNØCXJ my first Novice contact. We kept this QSO short and conventional due to some annoying bit of flutter.

As it became obvious that nothing more was to be expected of the 15 meter band that night, I switched to 20 meters and worked W/K stations exclusively for the rest of the evening. Included were two W7's from Washington, a

state I have never confirmed, before or after the war, despite the fact that QSLs were always solemnly promised many times.

I wasn't trying too hard for WAS and it occurred to me, as it has to many, that working them is much easier than getting the cards. It was then that I remembered the KNØ I had worked the night before.

The Barrier

"Why not concentrate on Novices and work them en masse"? No doubt they would be pleased to work DX (and I certainly was DX for them). Being comparatively less blasé than the average old timer, I should have no trouble getting my cards for WAS.

The idea seemed quite ingenious to me and I was soon hard at work. I filled the band with CQ WN/KN calls and tried to answer every Novice station I could hear. There were an impressive number of stations on the air, but all my operating techniques were fruitless.

I must emphasize here that I was not the only one with the same idea. Probably, for the same reasons, ZS, OQ5, FA, CN8, and VQs as well as many European stations were also calling Novices. But a strange barrier seemed to exist between them and us. The boys seemed to be deaf to any signals outside their own hemisphere, or to be more exact, their own borders. There were some exceptions of course, but in general a Novice who worked DX was a rarity.

It was not too long before I realized that the ever elusive WAS was still going to be a tough nut to crack, particularly so, because of the poor QSLing habit of the old timers, and on the other hand the total lack of receptivity of the Novices, on whom I was so keenly concentrating my efforts.

At first I was at a complete loss for an answer to this mysterious problem. I couldn't figure out why the Novices were constantly ignoring DX, many of which were doing their best to attract some attention. I began to keep a keen eye open on the band, and closely followed the context of the traffic on the Novice frequencies I soon made some interesting discoveries!

First of all Novices had the peculiar notion that DX was a rather formidable venture. Secondly, the psychological barriers inflicted on the Novice, (ie; crystal controlled, low power, crowded bands etc,) prevented him from realizing the possibilities of a DX band. Thus, his thoughts couldn't be further from DX.

Let us presume, for instance, that a CQ DX call from a Novice in New York is answered by a California station. The operator is thoroughly convinced he is working DX, and if the answering station happens to be his first W6, the more thrilling for him. Nevertheless he doesn't realize that his tiny 75 watts is being heard in foreign lands as well. Many times I have heard Novices say: "My best DX is California," or "Oregon," or "... Nevada."

In my opinion, lack of self confidence prevents the Novice from realizing that his signals are getting out beyond his borders. Hence he only listens to strong signals and works other Novices.

Considering the above comments, I suggest that the Novice listen more attentively to the weaker signals, especially around his own frequency. In order to become a skillful operator, learning to read a weak signal is of prime importance. Remember the old adage, "You can't work 'em if you don't hear 'em."

Alerting the Clan

In an effort to alert these pacifists, I began to think of some way of informing them that they were being heard overseas. It seemed to me that the best way to solve this problem was to carefully log every Novice station I was able to hear and then submit this list to a widely read ham magazine for periodical publication. This is what I have done for the past 38 months. With the cordial assistance of the Novice Editor for CQ, my listings were added to the "Calls Heard" report in his monthly column.

These reports really electrified the fellows. Soon after the appearance of the first calls in print, I became swamped with mail. The fellows were writing enthusiastic letters with thrilling accounts of their DX expectations. Here are some of the comments: "Boy my sigs are really going and doing things..." (KN2HAT) "Just about fell out of my chair when I saw my call in CQ..." (KN8EZQ) "Glad to know I am being heard in Europe. I've no DX but will try now..." (WN1LJO). "Never knew I was getting out..." (KN2UWY) "Your list of Novices being heard abroad is about the most read part of CQ. It is quite a thrill when a Novice finds his call among your listings. Since I wrote to you I've done a bit of DX with my little rig. Truthfully, you were the spark that started me looking for DX" (WN2PSZ).

"I was not interested in DX until I saw my call in your column. Then two weeks later I worked a G3, so the bug really bit..." (KN3AUT).

"After being advised that my signals had been heard in your country by a local amateur operator, and that all the information was listed in the May CQ, I could hardly believe it..." (WN7FYW). "...It was a surprise to know that my signals were being received in your country. My rig at that time was running 50 watts to an indoor folded dipole..." (KNØIEW).

Needless to say I was just as thrilled as they were with the results of these published reports. My original idea was proven correct. The Novice, like everyone else, is highly interested in working DX. The only thing they needed was someone to arouse their interest, and show that the possibility of working DX is always there, if

patience and interest are shown.

Novice Peculiarities

After dealing with the Novice for over three years I would like to comment on a few peculiarities which occur steadily on the Novice bands. These peculiarities are no fault of the operator, but result because of the lack of self-confidence and proper supervision of the unskilled amateur.

Long Calls

One of the most widely spread misconceptions among the Novices is the belief that a call has to be a long one to be effective. Endless CQs are heard quite frequently on the Novice frequencies. To me, this is one of the most nerve racking routines on the air. Try to imagine something like this: You're trying to identify a Novice who is calling CQ. There are quite a few stations close by, some strong, some weak. A few European phone stations are also on the frequency, increasing the QRM tremendously. While using every control on your receiver to keep him audible, he endlessly continues with his CQs. When he does decide to sign his call, he does it only once, though he never forgets to repeat DE several times. When his call is signed it is usually ten words per minute faster than the CQs and of course it becomes garbled and unreadable. It may sound unbelievable but I had occasion to hear a Novice calling CQ 228 times without signing his call more than once. I must say that I didn't start counting his CQs until I realized that he was one of these individuals that doesn't give up easily. I don't know how he felt after that ordeal, not receiving a reply, but for me it was sheer exhaustion and boredom.

Much the same happens when a Novice *calls* a station; endless calls without an inkling of who he is. Finally he's lost in the QRM or simply abandoned in boredom. It has been said countless times that a simple short call is the most effective. Consider the situation when your CQ is answered by more than one station. If by chance all the stations answering are of equal strength the one signing first will probably receive the reply. This is particularly true when DX work is concerned.

DE-AR-KN Misuse

Another peculiarity which seems to be magnified considerably by the Novice clan is the incessant rectification of one's slips of the key. For example: a chap is sending a series of fifteen to twenty CQs and on the twenty-first CQ he slips at the "Q," stops instantly and beats out a string of dots and resends the "Q" correctly. This is perfectly legitimate according to all operating practices, but we should, for clarity, eliminate this type of transmission and assume that the fellow on the other end knew that a "Q" was forthcoming. Another type of mistake which leads to confusion, is the misuse of DE and AR. DE is considered to be the telegraphic equivalent of "this is" or "from." It should, under no cir-

cumstances be used every time one signs his call letters.

Then, one can often hear something like this: "CQ CQ . . . CQ DE WV2XYZ DE WV2XZY DE WV2XYZ . . . AR KN." This sort of call is very likely to remain unanswered. For the fellow rapidly exploring a crowded band, this call may be extremely confusing. First, because of the abusive use of the letters DE, a false impression may arise indicating that a specific station is being called. Secondly, the use of AR may create the impression that a station is being called. The use of AR should be confined to calling a specific station only. Finally, the use of KN signifies that you want a specific station to transmit and all others should keep out. The sending of these letters at the closing of a CQ may lead a ham who has heard only the last part of the transmission to an erroneous conclusion that you are in QSO with someone and don't want anyone else to break in. Obviously, the fellow is going to stay out when he hears KN, though he may have been disposed to answer the call.

Some Suggestions

There are many more examples of poor operating practices which I could go into, however I doubt if that is the best way of straightening things out. It might be better, perhaps, to set up a few simple rules to be observed in order to do a proper job, rather than just cite examples of wrong procedures. Here is what I suggest: 1. Never send a CQ before you listen on your own frequency! There may be a DX station right there calling *you*. In fact, one night I heard an OQ5 calling CQ WN/KN while at least five Novices were on the same frequency calling CQ DX. 2. Don't call CQ more than four or five times without signing your call. Limit calls to a reasonable length. Too long a call is boring to the listener and also creates unnecessary QRM. 3. When you finish calling CQ, be sure to listen on your own frequency first. DX almost always zeros the stations they work. 4. When you answer a CQ, make your calls as short as possible. Nothing prevents you from repeating your call if you don't hear the station come back. 5. Never repeat the letters DE. Everyone who has ever touched a key knows that the only thing between a CQ and a call sign is DE. 6. Do not send your call more than four or five times when calling a station. It may create the impression that you are the one being called instead of the one who is doing the calling. 7. Simply use K after CQ and at the end of each transmission during a QSO; AR after a call to a specific station before contact has been established, and KN at the end of each transmission during a QSO, when you don't want other stations to break in.

Conclusions

No claims are made that the application of
[Continued on page 124]

AUTOMATIC KEYBOARD SWITCHING

Charles R. Teeters, K2DHE

1314 Birch Avenue
Asbury Park, N. J.

CW has break-in, phone has push to talk, SSB has voice control, and radio teletype has problems. Signing by CW, critical receiver tuning, and restrictions against AØ emission remove some of the operating pleasure from a teletype QSO. Two of the nicest operating systems are the voice control of SSB and the break in of CW. To make my teletype operation more convenient I have combined parts of each system to provide automatic transmit-receive switching, operated by the keyboard typing. All manual switching is eliminated and it is necessary only to use the key to sign, and the keyboard for teletype. With this arrangement teletype QSO's take on the aspects of a land line half-duplex circuit.

Keyboard Characteristics

Automatic switching controlled by the teletype keyboard is different from voice control or break in due to the characteristics of the keyboard. The keyboard is electrically similar to an inverted telegraph key, in that the contacts are normally closed. Typing on the keyboard causes various openings and closings of the contacts with a return to the closed condition between each character typed. The requirements for automatic switching then are to turn the transmitter on instantaneously with the opening of the keyboard contacts and remain on even though the contacts reclose. But if the contacts remain closed for several seconds, the transmitter should turn off.

These requirements can be obtained with an R-C circuit using a high resistance for charge and a low resistance for discharge. A diode vacuum tube has a high reverse resistance and a low forward resistance which works nicely. One additional tube used as a *dc* amplifier to operate the transmit receive relay completes the circuit.

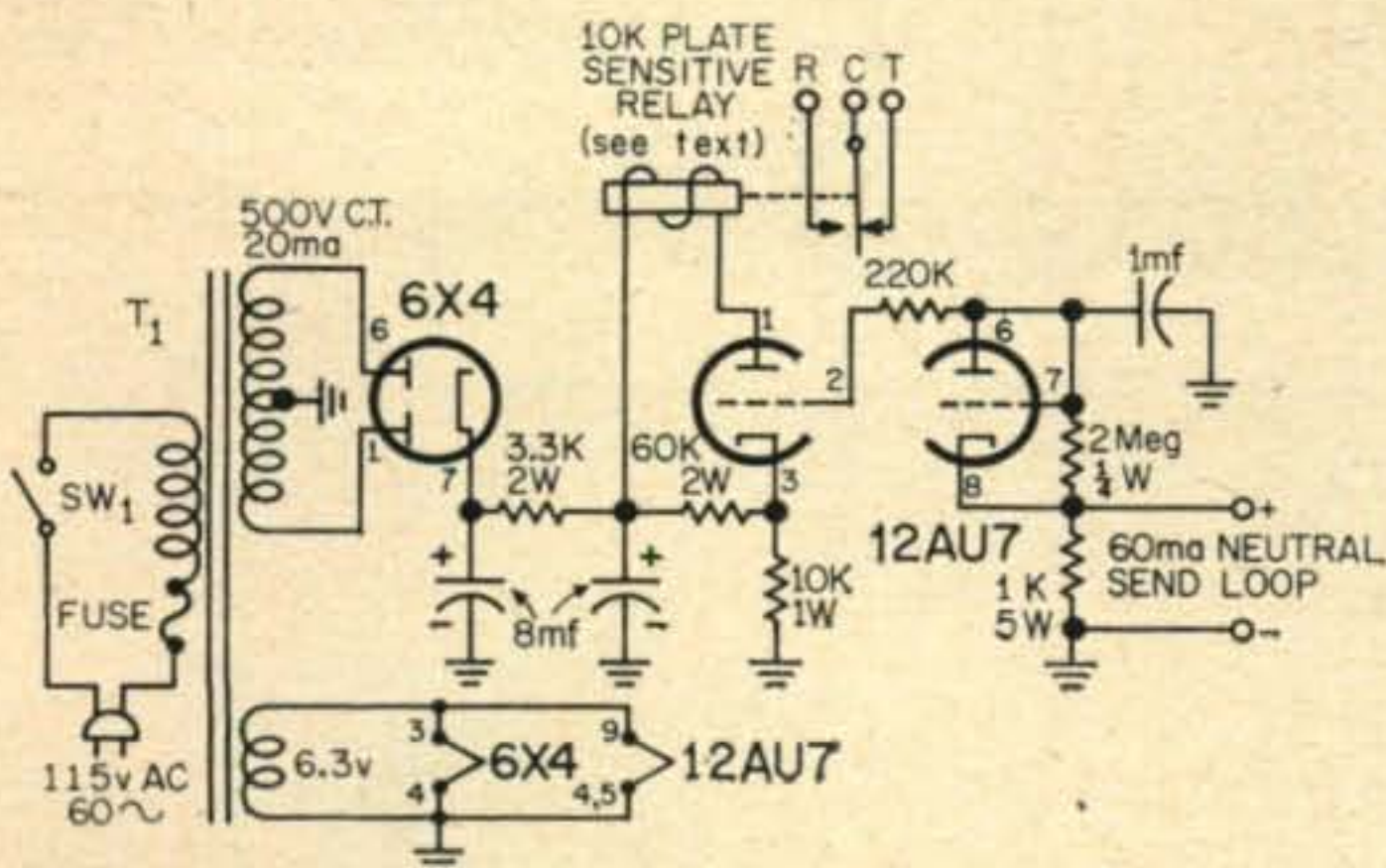

Fig. 1—Diagram of an Automatic Keyboard Switch. Resistors are 1/2 watt unless otherwise specified.

Theory

The schematic diagram of the complete keyboard switch is shown in fig. 1. When the contacts are closed the marking current of 60 *ma* through the 1000 ohm resistor produces a positive 60 volts at the cathode of the diode connected section of the 12AU7. The positive cathode keeps the diode nonconducting, and charges the 1 mf capacitor through the 2 megohm resistor. The positive voltage on the capacitor is applied to the grid of the triode and causes the tube to conduct holding the plate relay closed in the receive condition. When the keyboard of the teletypewriter is operated it will open the loop circuit for at least 22 milliseconds regardless of what key is depressed. Opening the loop removes the source of positive 60 volts at the cathode of the diode, but the plate will retain a positive potential due to the charge on the capacitor. This causes the diode to conduct, and this discharges the capacitor which makes the grid of the triode section of the tube zero volts. The fixed positive voltage on the cathode of the triode cuts off the plate current, opening the relay, which turns on the transmitter. This action occurs within 3 milliseconds of the initial operation of the keyboard. Random typing will not allow time for the 1 mf capacitor to build up a charge through the 2 megohm resistor. When the typing is stopped for about two seconds, the capacitor will have time to charge and will apply a positive voltage to the triode grid. The triode will then conduct and pull the relay to the receive condition. The result is that the transmitter will turn on whenever a key on the keyboard is operated and remain on for two seconds after the last character typed.

Plate Relay and Construction

There are no particularly critical parts in the switch and it can be constructed in any convenient form. A BC-357 marker beacon receiver will provide a suitable relay for the plate circuit,

[continued on page 123]

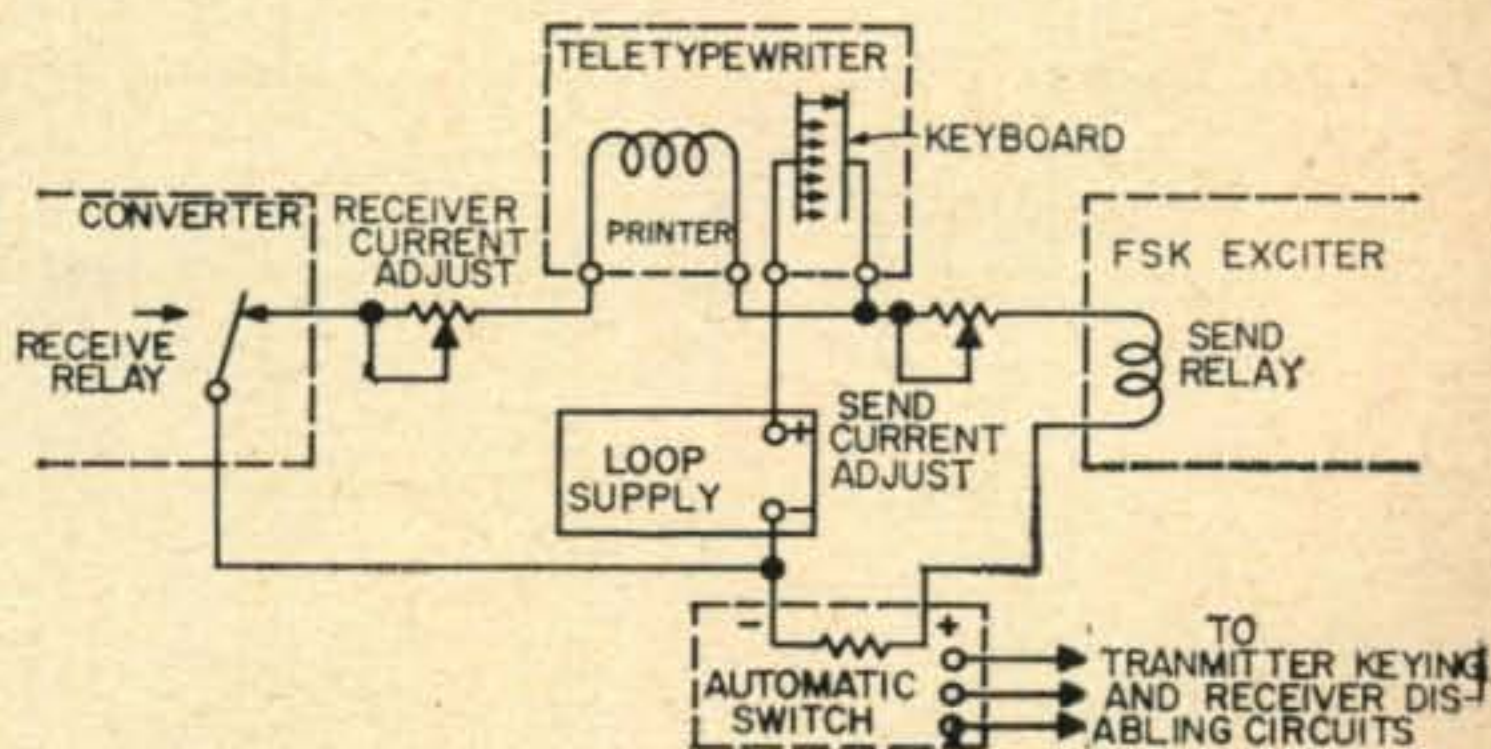

Fig. 2—Block diagram demonstrating a loop arrangement for printing local copy while sending.

A Two-Tone Generator

Richard F. Burns, W9NVC/W9OBU

Hallicrafters, Research and Development Lab.
4401 West Fifth Avenue
Chicago 24, Illinois

Accessories are always a welcome sight in the hams shack especially if they can be used to good advantage and do not take up much room. Herein is described a single tube two-tone test generator and employment techniques.

With the advent of single sideband, linear amplifiers have become almost as common in amateur transmitters as in receivers. Since an improperly adjusted linear amplifier can be responsible for as much splatter, TVI, and distortion in an SSB transmitter as over-modulation can cause in an *a.m.* rig, the linear amplifiers in an SSB transmitter must be adjusted for proper operation before putting the transmitter on the air. One simple but delicate test used extensively to check the linearity of SSB transmitter amplifiers is the "two-tone test".

In the two-tone test, the SSB transmitter is modulated with two audio tones having approximately equal amplitudes and frequencies which fall within the audio passband of the transmitter. The resulting *rf* signal is then examined by means of some sort of spectrum analyzer or an oscilloscope. Nonlinearity is evidenced by the appearance of spurious signals, i.e., distortion products, in case the spectrum analyzer is used or distortion of the "two-tone" pattern in case the scope is used.

This article describes a simple, compact, *ac* operated two-tone generator which produces signals having excellent waveforms and having the proper frequencies and amplitudes to produce a good two-tone pattern on a scope when

used in making tests on most SSB transmitters.

Circuit Description

The two sections of a 12AX7 are used as phase-shift oscillators utilizing four-section phase-shift networks.¹ Output from each oscillator is taken from the un-bypassed cathode resistors. Relative output signal levels are controlled by the balance potentiometer, R_9 , which permits f_1 alone, f_2 alone, or any combination of f_1 and f_2 to be selected. Generator output is set by the output potentiometer, R_{10} . The generator is designed to work into the usual high impedance transmitter microphone input circuit. The power supply utilizes an instrument-type power transformer and silicon rectifiers in a conventional voltage-doubler circuit.

Construction And Test Of The Generator

The generator was built into a small metal box; the tube, transformer, and phase-shift networks being mounted inside on an "L-bracket". A JAN-lock type tube shield was used to hold the tube in place. The phase-shift networks were mounted on terminal strips near the tube. Placement of components is not critical provided the

¹E. L. Ginzton and L. M. Hollingsworth, "Phase-Shift Oscillators," *Proc. IRE*, Feb., 1941.

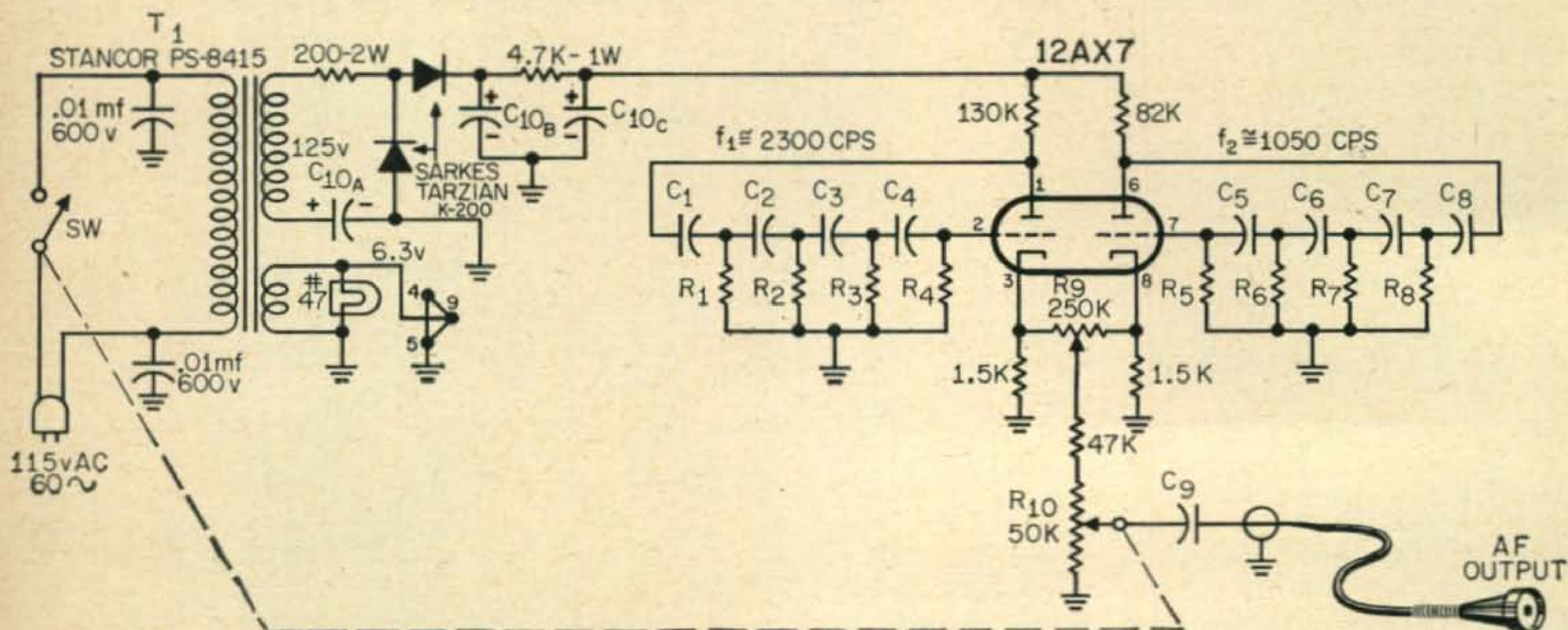

Fig. 1—Circuit of the Two-Tone generator.

usual precautions of isolating the *ac* supply as far as possible from the grid and output circuits are observed. Before using the generator for tests, the waveform of each oscillator signal should be checked for distortion. This may be done by means of an oscilloscope in several ways. The simplest is to observe the waveform on a scope and then compare it with that produced by a good signal generator. The second, which is somewhat more delicate (*it is difficult to detect distortion by observing the scope trace of a sine wave*) requires the signal to be fed into the scope's vertical and horizontal amplifiers, a simple phase-shift network being inserted in the horizontal input lead. The scope amplifiers are then adjusted to produce something which looks like an ellipse. If the waveform is not perfectly sinusoidal, the ellipse will appear unsymmetric, e.g., there may be a sharp corner on one end. The proper appearance of the scope trace can be observed, as before, by comparison with the trace produced by substituting a good signal generator for the oscillator under test. In the event that the "good" signal generator produces a kinky trace, the scope amplifiers may be overloaded and the input levels must be reduced. Waveform distortion in the generator, if observed, may be reduced by increasing the value of the cathode resistor of the oscillator in question. Waveforms having less than 1% total distortion may be obtained from the oscillators in this generator.

Using The Two-Tone Generator

To test an SSB transmitter for linearity using the two-tone generator and an oscilloscope, the transmitter is first adjusted to produce rated output into a dummy load and the output signal is monitored by means of an oscilloscope as shown in fig. 2. The two-tone generator balance control is then adjusted until the familiar two-tone

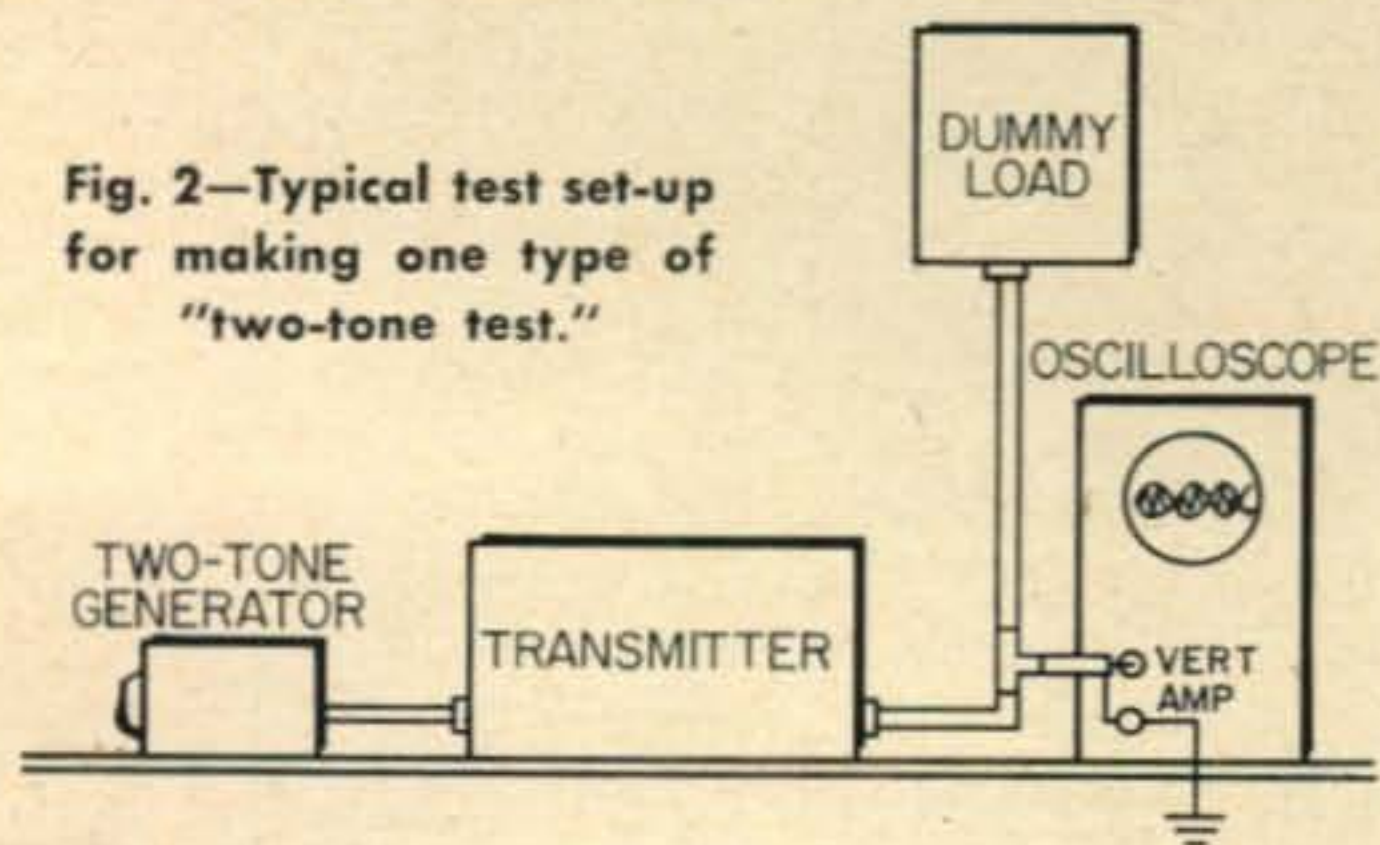

Fig. 2—Typical test set-up for making one type of "two-tone test."

Parts List

- R₁, R₂, R₃ and R₄—180K, ¼ watt
- R₅, R₆, R₇ and R₈—150K, ¼ watt
- R₉—2 watt potentiometer, 250K
- R₁₀—2 watt potentiometer, 50K with AC switch
- C₁, C₂, C₃ and C₄—260 mmfd mica, 300 DCWV, 2% capacitance tolerance, DM-15 or equivalent
- C₅, C₆, C₇ and C₈—500 mmfd mica, 300 DCWV, 2% capacitance tolerance, DM-15 or equivalent
- C₉—.1 mfd 50 DCWV, miniature disc ceramic, Sprague TG-P10
- C₁₀ A, B, C—16 x 16 x 16 mfd electrolytic, 450 DCWV, Cornell Dubilier BBRT 16T45

pattern shown in fig. 3 is obtained. The control will be near mid-position. Distortion of the two-tone pattern, if observed, indicates that amplifier adjustments should be made, assuming, of course, that no malfunctions exist in other parts of the transmitter circuitry.

If the transmitter audio level control is set too low, a false indication of trouble may be observed when making the two-tone test. Many SSB transmitters run the first audio tube wide open in order to have sufficient voltage to operate the voice control circuitry, the audio level control being in the second stage. If this is the case, a low setting of the transmitter audio level control will require a relatively high output level from the two-tone generator to modulate the transmitter to rated output. The high audio level may overload the first audio tube causing severe distortion which may mask much of what happens subsequently in the transmitter. This trouble may be avoided, of course, by setting the

[Continued on page 122]

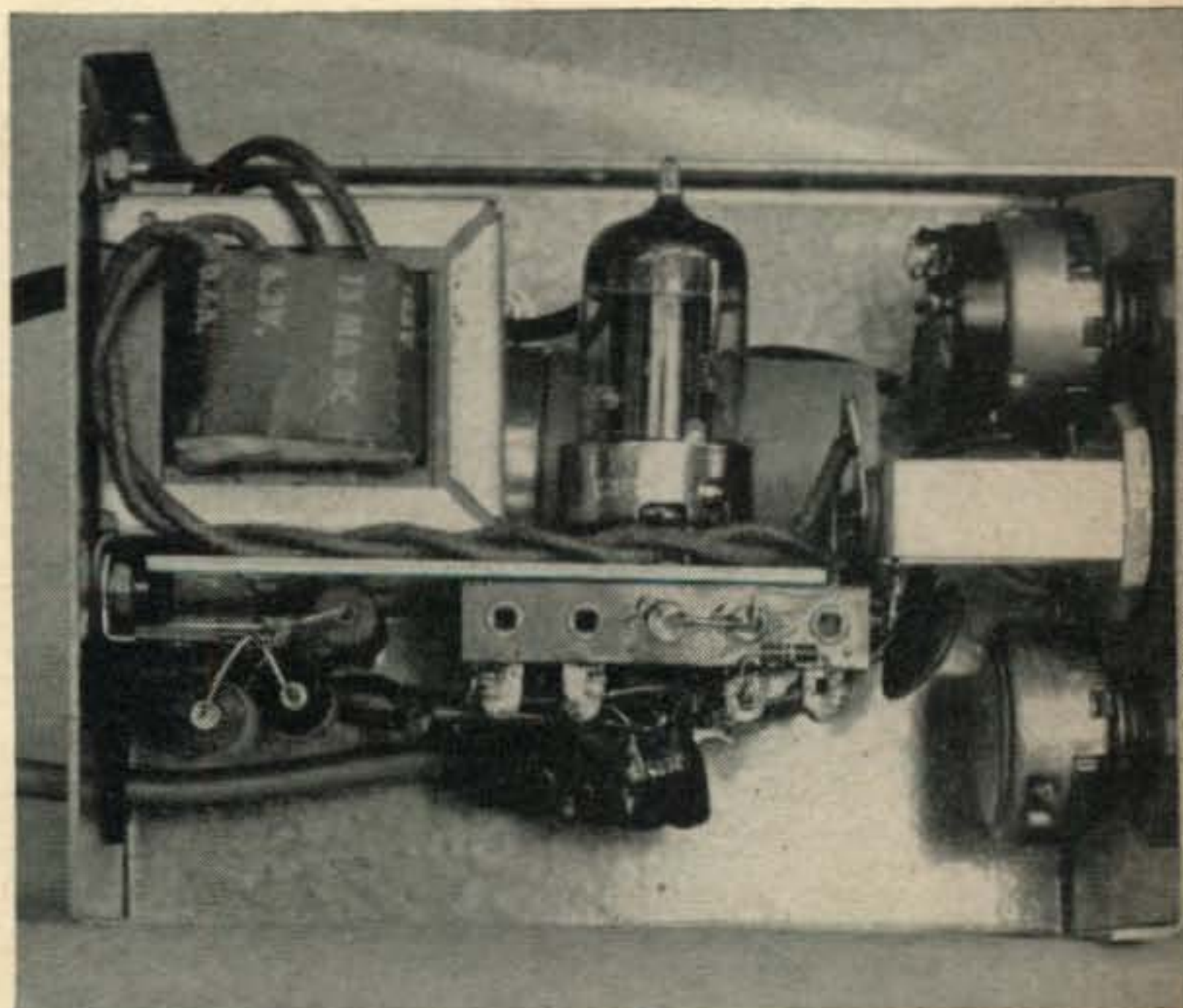

Bottom view of the two tone test generator. Power transformer, filter capacitor and tube are mounted on top of the vertical plate. Output potentiometer R₁₀ is mounted at the top and R₉ the balance control is at the bottom.

Bottom view of the vertical bracket showing parts location. The audio output can be seen coupled through C₉ to a piece of shielded mike cable.

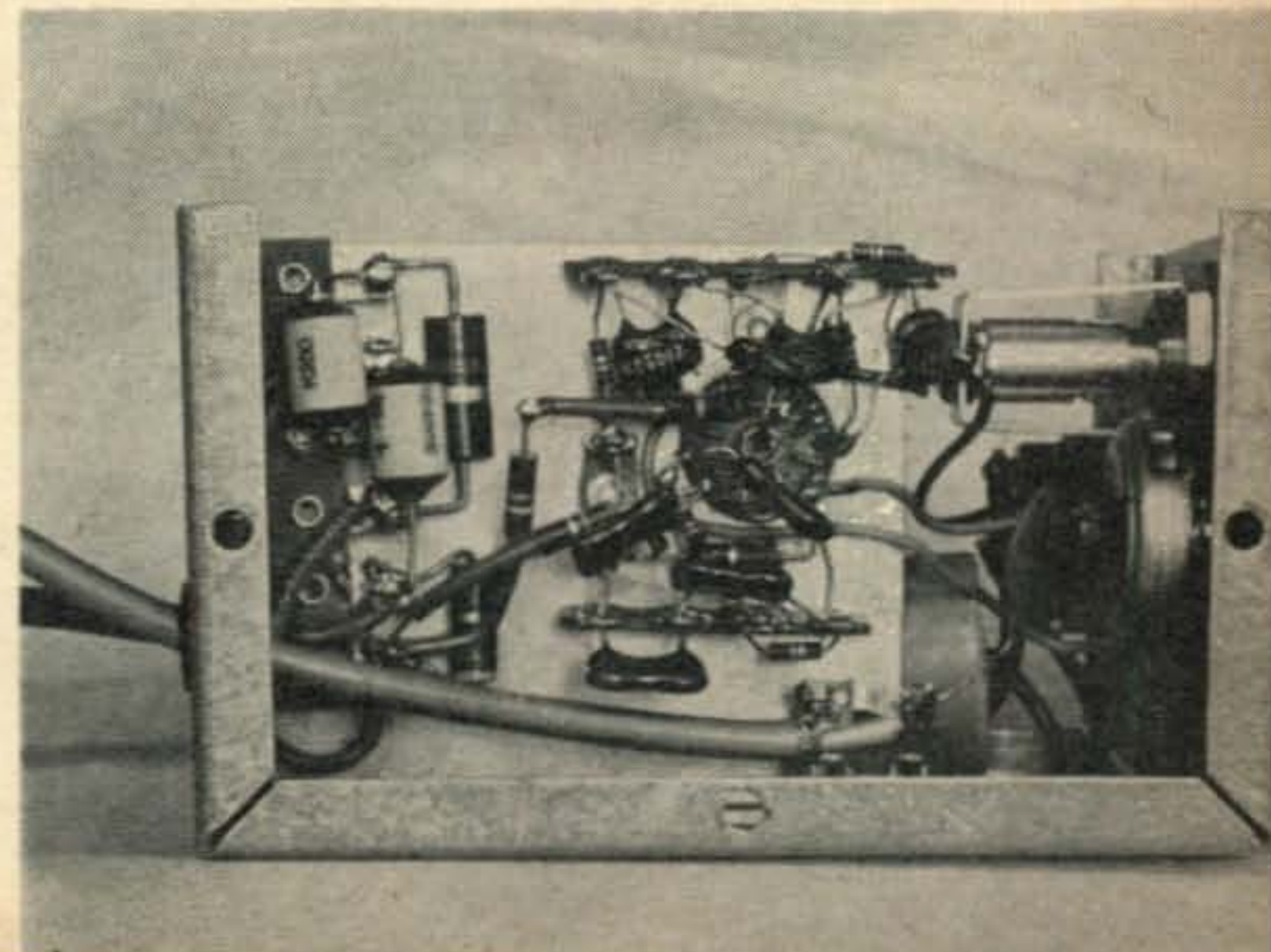

Moisture Problems In The Ham Shack

D. C. McCoy†, W8DG and Lloyd Root‡, W8HB

Here is a first hand account of experiments conducted by two men well versed in moisture and humidity problems. The conclusions derived from these experiments have a direct relationship to the ham shack since here may lie the clue to breakdowns resulting from "unknown" causes.

In the course of our long careers in Amateur Radio (W8DG 53 years and W8HB 34 years) the shack has been located in every room in the house except the bathroom, usually to the displeasure and discomfort of the XYL. The garage, basement, attic and a separate shack out in the back yard, locations preferred by the XYL, have also been victims of our hobby. When located in certain areas, the effect of atmospheric moisture on electronic and other equipment can be serious and expensive. Tools and other metal items such as spare parts, etc. are also victims. Wire in some types of resistors will corrode, then break, often opening the resistors with expensive after results. Some insulating materials will break down due to absorption of moisture. Mold and fungus will form on books, papers, leather, cloth, and some types of insulating materials. Cardboard cartons will become unglued and collapse.

The National Bureau of Standards Technical News Bulletin, July, 1957, page 111, says: "Wherever metals are used, corrosion presents its threat to economy and efficiency. Although much has already been done to control its damaging effects, corrosion is still estimated to cost this country more than five billion dollars annually."

Ways and means of correcting the situation exist. Discussion of these and their application to the ham shack are the purpose of this paper. We will first discuss the fundamentals involved and then outline the application of these fundamentals to the shack. Types of equipment suitable for correction of the moisture problem will also be discussed.

Fundamentals

Water vapor is one of the constituents of our atmosphere. Oxygen, nitrogen, carbon dioxide, and other gases make up the rest. Water vapor, about which we are now concerned, is not visible under normal conditions, only becoming so under certain special conditions. On warm humid days we are uncomfortable due partially to high water vapor content of the air. Even though we do not see it, we are aware of its exist-

tence. The amount of water vapor that the air will hold is related to the air temperature. The warmer the air, the more water vapor it will hold—thus, in summer, we are often uncomfortable not only because of the high temperature, but have still more discomfort due to the high moisture content (humidity) of the air. The definite relation between air temperature and its water vapor content is given in the Psychrometric Chart, copy of which can be found in engineering handbooks. Study of it will give a good understanding of why these moisture problems exist and the fundamentals of how they can be corrected. The following brief generalities explain what is involved.

Dew Point

When air holds all the water vapor it can absorb *at a given temperature* it is said to be "saturated." The relative humidity of saturated air is 100%. If the temperature of the air drops, some of this water vapor is released in the form of liquid; and we become visually aware of it as fog, rain, snow, hail, or condensation. The temperature at which this release of moisture takes place as known as the "Dew Point."

Even though the air temperature does not drop, we can still release moisture from the surrounding air when we place cold objects in it, such as a glass of ice water, cold water pipes, or any object whose temperature is below the dew point. Water in the air will condense on the cold object, and it will "sweat." This happens to radio components and tools. When they are below the dew point due to conditions in the shack, then water condenses on them. Trouble follows in the form of rusting or corrosion, or more serious, break down of insulation and electrical failure of some component.

Vapor Pressure

Another difficulty due to water vapor is caused by vapor pressure differentials. The water vapor in the air has a "vapor pressure" which also varies directly with the temperature. Many materials which seem impervious to liquid water are penetrated by water vapor when a differential in vapor pressure exists between water vapor on the two sides of the material. The water vapor will pass from the area of high vapor pressure to that of low vapor pressure until equilibrium is established.

†Consulting Engineer, 7546 Normandy Lane, Dayton 59, Ohio. Consultant on Controlled Humidity Storage for the United States Air Force.

‡Director of Research, The George Behm & Sons Company, 24 McDonough Street, Dayton, Ohio.

Some impregnated and waxed papers are not moisture vapor proof. When these compose the insulation between windings of a transformer, and the metal of the core and/or the windings are cold in relation to the surrounding atmosphere, water vapor will pass through the insulation, and condense on windings causing breakdown of the insulation between windings and failure of the transformer.

Hygroscopic Materials

Moisture can also create problems with materials which are hygroscopic in nature. Webster defines hygroscopic as "attracting or absorbing moisture from the air." Certain materials have this property. In fact calcium chloride, which will be mentioned later, is an excellent example and, therefore, is used as a drying agent because it will absorb moisture from the air. The collapse of cardboard cartons is doubtless due to the hygroscopic nature of some glues used in making them and to the hygroscopic nature of the paper of which they are composed.

Methods of Correction

Two fundamental ways for correcting these conditions are:

1. Raise and maintain the temperature of the tools, parts, and equipment above the air "Dew Point."
2. Reduce the moisture content of the atmosphere in the space where the tools, parts, and equipment are located to a point where it will not reach the "Dew Point" of any equipment, water pipes, etc. located therein, or so that there will be such a low moisture content present in the air that there is little moisture for hygroscopic materials to absorb.

Both of these solutions cost money. Initial investment in equipment may vary from a moderate to a considerable sum, but may not be much more than the price of a high power plate or modulation transformer at today's prices. If books, cloth, leather (some of which may not be replaceable) and some types of insulated wire are involved, prevention of mold and fungus growth may well be worth the investment and operating cost. It thus becomes a matter of where you want to spend your money, for protection or for replacement, assuming the latter is possible.

Solution No. 1 is simple and effective for radio equipment which is self-contained in a fairly well enclosed cabinet. Depending on the size of the cabinet, one or more properly placed small electric light bulbs, or better yet, a strip heater of reasonable wattage may be installed in the bottom of the cabinet. Since hot air rises, placing the bulbs or heater in the bottom is essential to dissipate the heat by convection throughout the inside of the cabinet and thus warm up the various components by the circulating warmed air. In this manner the equipment is heated and kept above the "Dew Point," and condensation will not occur. With some receivers

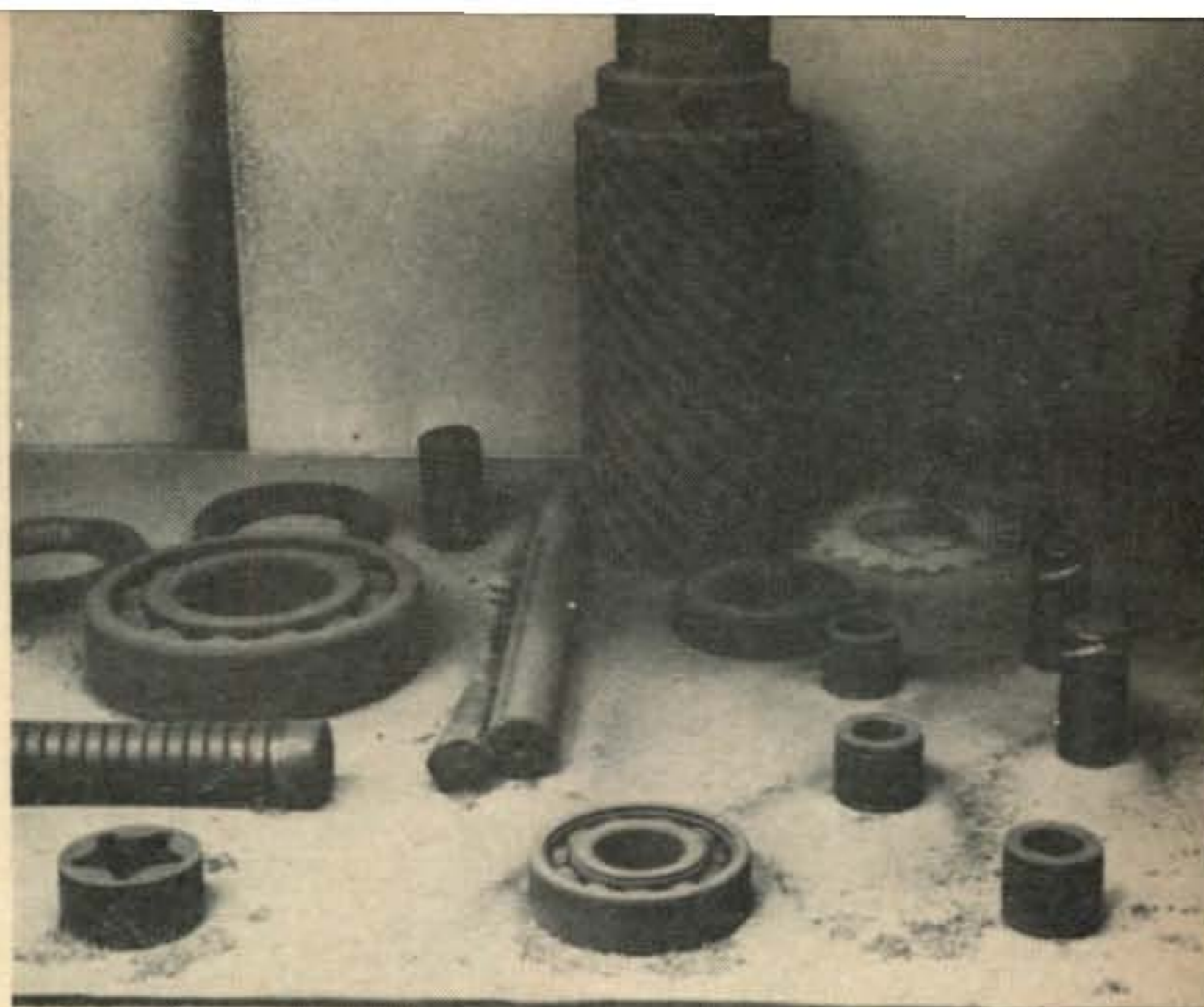
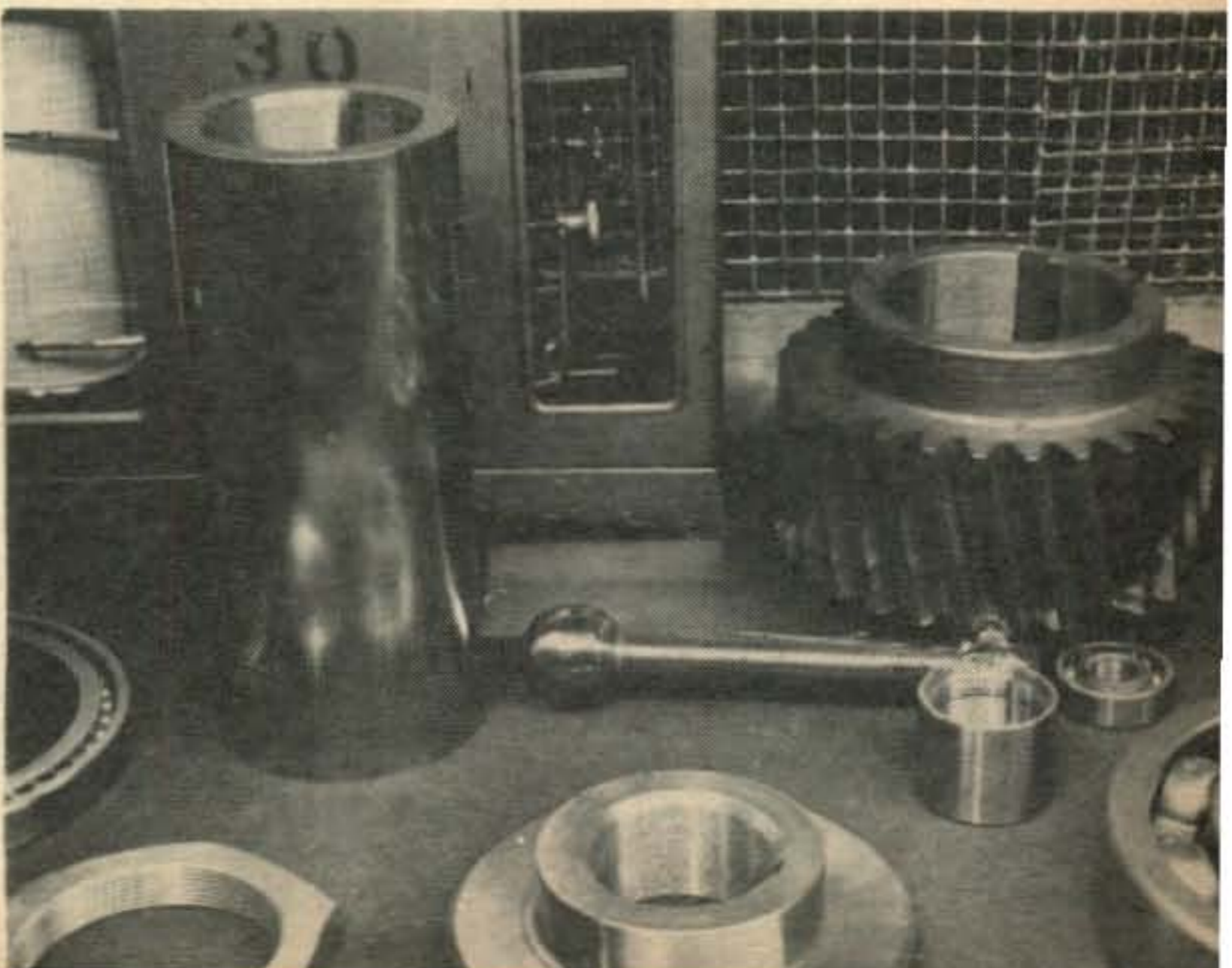

Fig. 1—Specimens exposed to outdoor air continuously. Steel specimens have a complete covering of fine grained rust.



Fig. 2—Specimens exposed to 70 to 80% relative humidity continuously. Steel specimens show localized pitting and encrusted rusting. Organic specimens (not shown) were mildewed.

Fig. 3—Specimens exposed to 38 to 40% relative humidity, in "Controlled Humidity Storage" warehouse. These remain bright, unruined, uncorroded. Organic specimens (not shown) were free of rot or mildew.



or transmitters tube filaments can be left burning when equipment is not in use and will often supply enough heat to do the trick.

Strip heaters¹ especially designed for this service are available. These may be obtained in convenient lengths varying from 12" to 36" with current requirements of 8 to 25 watts and cost in the neighborhood of \$6 to \$8. They are easy and simple to install. It is advisable to use the longest heater which can be installed in the bottom of the piece of equipment so that the distribution of heat will be as uniform as possible over the cross sectional area (plan view) of the equipment and thereby get maximum distribution of heat by way of the convected air. A heating unit with low surface temperature, with its area well distributed, is far more effective than a spot heater of higher temperature. Spot heating by a concentrated type of heater unit or a single lamp may not be effective and may also cause overheating of parts nearest to the spot heater.

Solution No. 2 is very effective and is becoming more widely used in various types of commercial applications where protection of equipment from the ravages of atmospheric moisture are required. The fundamental principle behind this method is to reduce the air moisture content in the space to a point where objects in it cannot reach the dew point, or where absorption of moisture due to hygroscopic action is reduced to a minimum.

This method has been used by the Navy in "moth balling" many of their vessels since World War II to protect them from atmospheric moisture. It has also been used most successfully to protect warehouse stocks of critical materials subject to corrosion or other types of deterioration due to moisture, with substantial savings on individual piece packaging and reduced losses due to moisture caused corrosion. If optimum protection is desired, a sizeable amount of money may be spent for this type of equipment with a good return on the investment and operating expense being more often than not obtainable.

For optimum protection by this method the space where it is to be used must be modified so that it is possible to maintain the moisture content of the air in that space at 40% relative humidity or lower. For best results it may be necessary to moisture vapor proof the boundary areas of the space. However, for the ham shack reasonably good results can be obtained as will be demonstrated later by the use of simple and relatively inexpensive equipment and somewhat higher humidity.

Figures 1, 2, and 3 record tests made at the U.S. Naval Supply Depot, Mechanicsburg, Pa. These show specimens which have been subjected to about nine years continuous exposure to various types of atmospheres as noted on each figure. Photographs were taken in 1955. As of March, 1959 the Depot reports no material

change in the condition of the specimens. These photographs were supplied by courtesy of the Depot and the U.S. Navy Bureau of Yards and Docks.

Test Cases

Many ham shacks and shops are located in basements. This is perhaps one of the easiest locations to experience summer moisture problems. In the summer months when the furnace is not in operation the moisture content of the basement air gets very high. This is first due to moisture migrating through open spaces into the basement from the outside atmosphere, the lower temperature of the basement with relation to outside and infiltration of moisture from the ground surrounding the basement walls and under the floor (unless steps have been taken to moisture vapor proof the walls and floors). Other sources of moisture also can be encountered.

Laundry activities in basements, especially dryers which are not vented to the outside, can create very disagreeable moisture problems for the ham shack the year round.

In a moderate size basement the ordinary household dehumidifier, which can be obtained from a number of sources today for under \$100.00, will do a quite satisfactory job for amateur radio purposes as illustrated by the following test data obtained by W8HB.

Dehumidifier

"A FRIGIDAIRE dehumidifier manufactured in 1948 was purchased on June 25th, and placed in immediate operation in my basement. Basement space was approximately 6000 cubic feet and occupied by usual clothes washer, ironer, stationary tubs, etc., in addition to which I had a small workshop with bench lathe, drill press, jig saw, many small tools and radio test equipment including stocks of metal rods and sheet and the usual "trivia" incident to a small research lab.

Prior to the dehumidifier installation sling psychrometer readings showed relative humidities (RH) of upwards of 90% and more with cold water pipes dripping, mold growth on books, cloth, leather and insulated wire, glued paper boxes falling apart and severe rusting of tools and all machinery. Since the dehumidifier installation none of the above effects are observed. Normal practice is to watch the gradual climb of the RH in the basement until about the middle of June when it reaches about 75%, then turn on the unit and let it run continuously until it is no longer needed around the first of September. Power consumption of the unit is 160 watts, thus it costs about \$3.50 per month to operate (at 3¢/kwh).

While in operation the unit removed from 0.3 to 0.4 lbs. of water per hour from the basement air whose RH was always kept below 64% regardless of what the outside humidity was. Typical results were those obtained during the second summer of operation as noted below.

¹"Dampp Chaser," 1440 Ridgewood Boulevard, Hendersonville, North Carolina.

RH in the basement was checked daily and the unit turned on at noon June 14, 1949 when sling psychrometer tests showed the basement RH to have climbed to 74%.

Date	Relative Humidity (%)	
	Outside	Basement
June 4, 1949	43	59
June 13	91	70
June 14	73	74 (unit turned on)
June 15	86	66
June 16	raining	69
June 21	56	61
June 23	39	55
June 24	47	53
June 25	75	64
June 28	53	64
June 29	62	64

In general, basement RH's would slowly lag the outside RH's, rising as the outside rose and falling when the outside fell.

At the present location the basement space is about 6300 cubic feet and the unit is doing an excellent job although no data has been taken.

It will be seen from Lloyd's data that even though the household dehumidifier does not do the optimum job of maintaining 40% RH in the basement, the results obtained have been quite satisfactory from the amateur standpoint.

The basement location is by no means the only place where moisture difficulties can be experienced by the amateur. Equipment installed in garages and ham shacks located separate from the house and not heated in winter, or heated only when occupied, can also be a serious source of difficulty.

To cite personal experience, for many years my transmitting equipment was located in an unheated garage and operated remotely by relays from the living room. The shop, tools, stock of spare parts and usual "trivia" were also located in the garage. Nearly every winter there would be failures of bleeder resistors, voltage dropping resistors, electrolytic condensers, and transformers along with considerable rusting and corrosion of tools, spares and "trivia."

Weather Factors

A little serious thought on why this occurred reveals the following: In the Dayton area (and elsewhere) we often have quite changeable winter weather. For several days or a week the temperature will fall to near or well below freezing. Then this period of low temperature will be followed by a period of very warm and humid weather. When not in use continuously, the mass of the metal, in transformers in particular, will reach atmospheric temperature during the cold spells and not warm up very fast when followed by a period of warmer and humid

weather, or when operated only for short periods of time. It was not uncommon to see transformers with moisture condensation on their casings and, of course, the same thing was occurring on the insides if they were not sealed or "potted" types. When the equipment was used, breakdowns would occur due to this condensation. In the case of resistors, particularly those with variable taps where the wire was exposed, moisture would condense on this wire, it would corrode, and the resistor would open up. Cement coated resistors would shed the cement protection exposing the resistance wire followed by wire corrosion and then failure. In the case of electrolytic condensers, these apparently would freeze when the temperature got low enough and then short out when put back into service. It was necessary to completely eliminate all electrolytic condensers from the remotely controlled equipment until the space was continuously heated in the winter.

After a few years of this aggravation, it was decided to turn the garage into a ham shack and shop, abandon remote control, build a new garage, and heat the new shack in winter. Since this has been done, there have been no failures.

The remotely located shack, even if heated only when occupied, will act in the same manner. Temperatures of components will drop with drop in atmospheric temperature, then warm up slowly only when temperature rises or when used, making them subject to condensation just as in my old garage. One obvious answer is to keep the shack heated at all times.

Corrective Methods

Two other ways of correcting moisture problems in the unheated shack and the basement are available: one by chemical means and the other by use of mechanical dehumidifiers. The chemical, calcium chloride (CaCl_2) as noted before is hygroscopic, that is, it has a great affinity for water. This can be spread out in troughs or pans in an area to be protected and air circulated by a fan over the calcium chloride. In small spaces a fan may not be necessary. It will remove moisture from the air and dry out the air. In doing so the solid calcium chloride goes into solution and must be replaced from time to time by fresh dry calcium chloride. Calcium chloride of suitable grade is available in 25 and 100 pound bags from local building supply houses and department stores. Two bulletins—*Air Drying with Calcium Chloride* and *It Is Easy to Reduce Humidity—How to Build Your Own Dehumidifier*—are available from the Calcium Chloride Institute, 909 Ring Building, Washington 6, D.C.

The second method using mechanical dehumidifiers is very satisfactory and can provide exact moisture control when this is required. This type of equipment has been successfully applied in spaces equivalent to the average amateur radio shack up to spaces of several million

[Continued on page 117]

A "Control Central" for the HT-32/SX-101 "Combo"

William I. Orr, W6SAI/3A2AF

No doubt about it! The HT-32 and SX-101 make a nifty sideband combination. They look good and work good. However, I'll bet a gassy 304-TL that a lot of owners have fallen into the same trap that I did when I first unpacked the boxes and happily took the new, glistening transmitter and receiver out of their protective wrappings . . .

It was in Monaco. I was sitting on the floor of the Hotel Siecle surrounded by mountains of empty packing crates, excelsior, corrugated boxes, packing slips, and various components that would soon make 3A2AF a reality rather than an exotic call buried in the back pages of the *Callbook*. Receiver, transmitter, microphone, antenna relay, coaxial cables, wires, solder: all the miscellany needed to get on the air was at hand. All that was required was a rapid fusing of the components into a working station! Although I knew better, the DX-fever had me in its grip and I took the easy way out. The HT-32 and SX-101 were hurriedly placed atop the bureau, coaxial cables were draped across the room, wires were run here and there at shin-tripping height, and the complete lash-up (I use the word advisedly) was hay-wired into the electric razor socket above the shaving mirror. In the record time of fifteen minutes 3A2AF was on the air!

Entering the hotel the next morning for a session of DX I was horrified to meet the

French cleaning maid coming downstairs armed with a broom, dustpan, coils of wire, my precious antenna relay, and assorted frazzled lengths of coaxial line. There ensued a painful scene wherein I explained that the rat's nest she was clasping to her bosom was not *trash* to be thrown out, *au contraire* it was the vital interconnecting links and control wiring of the radio equipment! With a snort of disbelief she thrust the wad of tangled cables into my hands with a veiled warning that anything found on the floor of the room (with the possible exception of shoes) would be instantly incinerated in the roaring furnace shortly after her morning room cleaning chores!

I had to ruefully admit she was right. It was a pretty sad pile of trash to inflict upon such fine equipment. A little thought could consolidate the whole mess into one neat, compact control box that could be tucked unobtrusively behind the equipment. *This* would be project number one, I vowed silently to myself as I trudged up the stairs; cables, relay, and coaxial lines dangling and bouncing behind me on the stone steps.

* * *

This handy Control Central was used in primitive form at 3A2AF and has since been rebuilt for use at W6SAI. It is highly recommended to other fortunate owners of the HT-32/SX-101 "combo." This little control box is mounted to the back of the HT-32 (Hallicrafters very conveniently supplies a generous number of ventilation slots in the back of the equip-

Parts List

- P-1—11 prong plug (Cinch-Jones #11-PB, with cap #16-F).
 - P-2—8 prong plug (Cinch-Jones #8-PB, with cap #16-F).
 - P-4, P-5—Coaxial plug PL-259A with adapter UG-175/U (Amphenol).
 - S-1—Coaxial receptacle, SO-239 (Amphenol).
 - S-2—Dual insulated binding posts (Millen #37222 with insulating plates #37202).
 - TP-1—Lug terminal strip, 6 terminals (Cinch-Jones #55A).
 - RY-1—D.P.D.T. antenna relay, 115-volt ac coil (Potter & Brumfield KT-11A).
 - 1—Aluminum box (see text). (L.M.B. #138).
- Cable length as follows: (measured from outside of box)
- RG-58/U to receiver (P-5): 3'6"
 - RG-58/U to transmitter (P-4): 0'10"
 - 3-wire cable to receiver (P-2 & P-3): 3'6"
 - 5-wire cable to transmitter (P-1): 0'6"

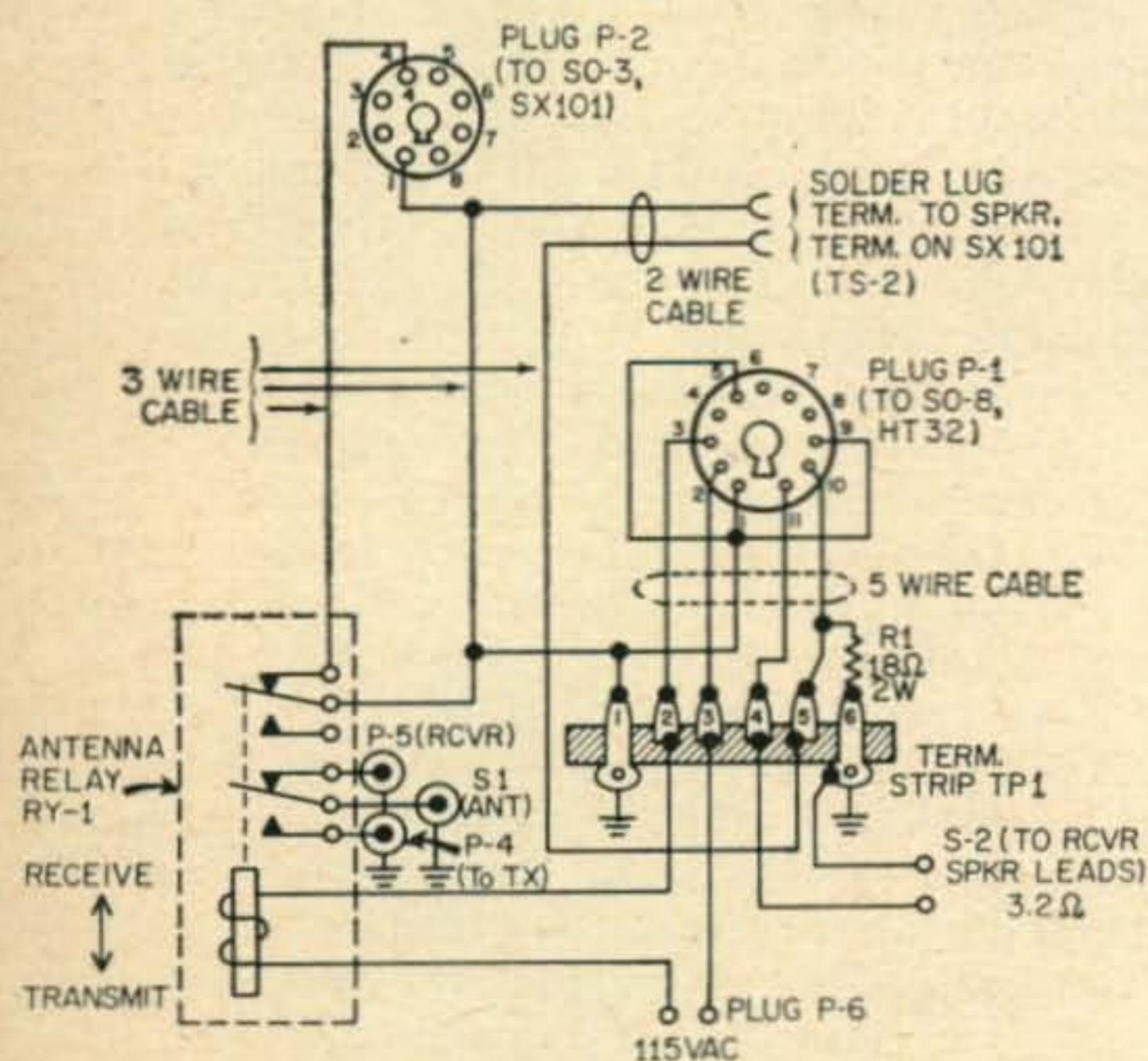

Fig. 1—Schematic of the control central.

ment cabinet that simplifies things), a few plugs are quickly inserted in receptacles in the HT-32 and SX-101, the coaxial transmission line is plugged into the Control Central and—*presto!*—you are in business with complete voice control (VOX) operation. Simple, neat, and fool proof, the Control Central requires no equipment modification and can be connected or disconnected in seconds, making the separate receiver and transmitter into a unified station, completely voice controlled. Best of all, tangled "hay-wire" is abolished, much to the delight of the OM (or XYL) who has to dust, maintain, or operate the equipment!

The Control Central

The complete circuit of the Control Central is shown in fig. 1. To the casual observer it resembles nothing but a collection of plugs, receptacles, and a relay. And that's all it is! Its simple duty in life is to correlate the standby functions of the receiver, transmitter, speaker, and antenna relay with the transmitter VOX circuits. Let's examine the circuit more closely. Plug P-1 is an eleven pin plug that is inserted in receptacle SO-8 (see instruction book) on the rear of the HT-32 chassis. The vital circuits of the VOX relay in the transmitter are brought to this receptacle. Available at SO-8 are relay contacts which control the primary circuit of the antenna relay (pins 2 and 3), VOX control leads to the receiver (pins 9 and 10), and VOX control leads to the loud speaker (pins 1 and 11). Also found at SO-8 are auxiliary key terminals (pins 8 and 9), and bias voltages (pins 6 and 7).

Plug P-1 brings these various circuits into the Control Central and reroutes them to where they will do the most good. The VOX relay in the HT-32 operates antenna relay RY-1A in the Control Central which in turn controls the standby circuit in the receiver. Other antenna relay contacts (RY-1B) break the receiver speaker circuit. Connections are made from the relay to the receiver via the auxiliary accessory socket SO-3 mounted on the rear apron of the receiver as well as the speaker terminal strip, TS-2. The antenna receptacle for the coaxial

transmission line (S-1) is mounted on the Control Central and short lengths of light, flexible RG-58/U coaxial line are run to the antenna receptacle on the HT-32 and the SX-101. Antenna switching between receiver and transmitter is accomplished by relay contacts RY-1A. The receiver standby circuit is actuated by relay contacts RY-1B. The latter contacts are connected across the receiver standby switch (S-9A) mounted on the right side of the SX-101 panel. When the Control Central is used S-9A is left in the "Standby" or open position.

Swamping resistor R-1 (18 ohms, 2 watts) is located in the Control Central. Its purpose is to prevent switching transients from damaging the audio output circuits of the receiver. It has no effect on audio volume or clarity.

Finally, *ac* power for actuating the antenna relay is obtained from 115 volt plug P-6. Operation of the antenna relay from a *dc* source was contemplated but the compact *ac* relay used for antenna switchover purposes has proven to be unusually quiet so no substitution has been made.

Construction of the Control Central

The Control Central is built within an aluminum box measuring 6 $\frac{1}{4}$ "x3 $\frac{1}{2}$ "x2 $\frac{1}{8}$ " in size. The box is two sections, held together by two 6-32 machine screws. The portion of the box having the tapped screw holes is bolted to the rear of the HT-32 cabinet. The various plugs and the antenna relay are mounted on the other half of the box. By removing the two machine screws the "whole shootin' works" may easily be removed from the HT-32, leaving the other half of the box firmly attached to the transmitter.

To prevent the Control Central from degenerating into the hay-wire installation which it is designed to eliminate, a large six terminal phenolic tie point strip (TP-1) is mounted in the box and all cables and wires are terminated at this strip. Figure 2 will give you a general layout of the interior of the box. Antenna receptacle S-1 and speaker terminal strip S-2 are mounted on the rear wall of the box. The coaxial cables to the receiver antenna receptacle and transmitter antenna receptacle pass through

[Continued on page 116]

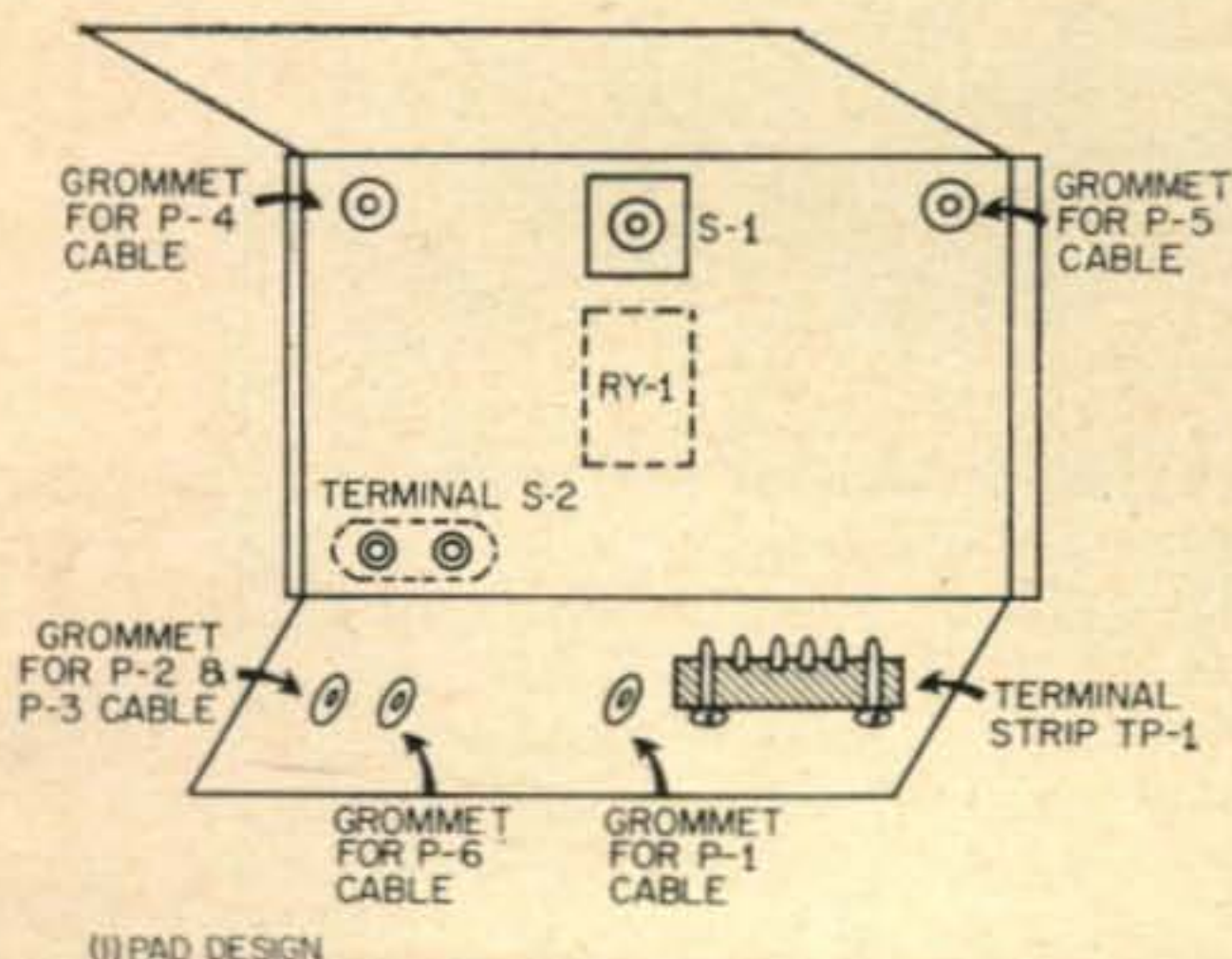

Fig. 2—Interior view of Control Central showing placement of major components.

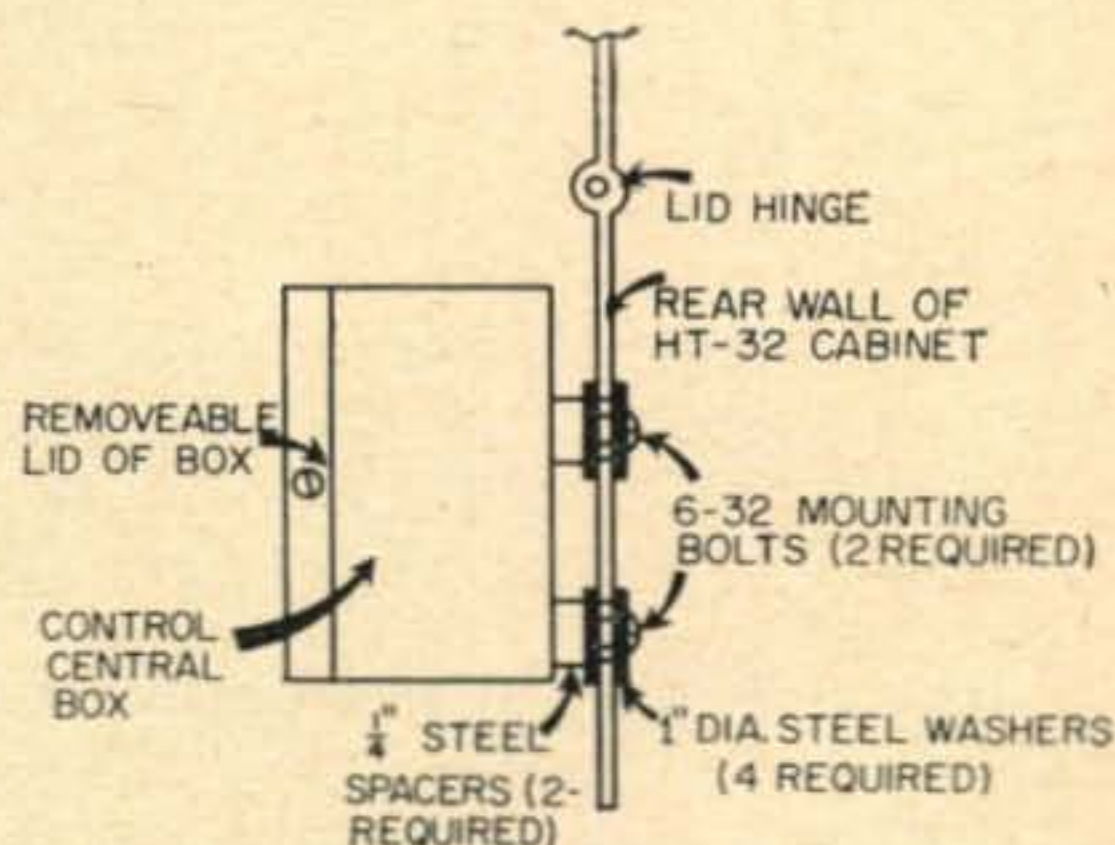

Fig. 3—Method of mounting Control Central to rear wall of HT-32 transmitter cabinet.

Lone Voice on TOBAGO.



PHOTO COURTESY OF ALEC MILLS, WALT DISNEY PRODUCTIONS LTD., PALL MALL, LONDON.

Jack Lambert, G3TA at the operating position of VP4WD. The rig consisted of an EL 33/6L6 with an input of 25 watts. Receiver was a 4 tube superhet and the antenna was a half wave dipole. Jack was rock bound on 7011, 7025, 14022 and 14050 kc. The equipment sitting on top of the transmitter is not essential to the operation of the rig — but it helps!

Jack Lambert, G3TA, ex VP4WD

327, Parkway
Iver Heath
Buckinghamshire, England

The first amateur station on Tobago was made possible by the fact that Walt Disney Production Ltd. (England) decided to shoot a film, "The Swiss Family Robinson", on the Island.

I was lucky enough to be one of the members of the main shooting unit, flying out via the Azores in August 1959. I'd heard that life on the island was not exactly hectic, and that we would be there for approximately 17 to 20

weeks, so I decided that a spot of "hamming" would keep me happy.

Through the willing co-operation of G3AAE, and G3YF I was able to get a loan of a complete B2 outfit. This consisted of a compact portable low power transmitter, receiver and power pack. The transmitter was a two stage crystal controlled oscillator and the power amplifier ran 25 to 30 watts input. The receiver was a 4 tube unit and the power pack was adaptable from

90 to 240 volts, 50/60 cycles *ac* with alternative operation from six volt batteries.

The Call

On arrival in Tobago I went about getting a license from the authorities in Trinidad. This took three weeks in all but it eventually arrived, granting me full facilities plus the special call sign I'd requested—VP4WD (Walt Disney).

At the hotel "Robinson Crusoe" the site for my antenna was not too good, being surrounded on two sides by 35 foot power pylons, and on the third open side by an array of phone cables.

My first temporary aerial consisted of about 40 feet of PVC lighting flex slung up on a rose bush at the far end, 8 feet high. With this I worked quite a few W's and an HA5 on 7 *mc* on the first evening. This antenna resulted in my first QSO with England, an old friend, G5JL on the second evening.

Better Aerial

On my first free week end, I managed to obtain locally, two 30 foot bamboo poles. With a 14 *mc* dipole strung up between these, signal reports from the states perked up quite a bit. I also strung up a 67 foot Hertz at a lower level for 7 *mc*. Owing to changing conditions, however, 40 meters was only used on a few occasions. I found that the high level of QRM from the States was too much for the 4 valve superhet receiver to cope with. The dipole, however, worked quite a number of stations in Europe, including LZ, OZ, SP, DL/DJ and also PY, LU, etc.

QSY 100 yards

Towards the middle of December, I had to move my station to a house (belonging to the Hotel) about 100 yards south. This QTH proved to be very fine business, as it was situated on a small hillock about 50 feet high, looking out to the open sea. It possessed quite a large garden, so two slightly longer bamboo poles 35' to 37' were erected and another 14 *mc* dipole was put up.

Reports from the states went up by two "S" points from most districts with the same results from Europe. During the last few weeks of operation the best DX results in the log were hooked, including a couple of JA1's and HZ1-AB. On the final breakdown of the log after my return to G-land I found that the total number of QSO's made was approximately 520, 350 of these with all districts in the USA, with 38 states confirmed and 41 worked. W7 proved to be the most elusive as I only had 5 QSO's from that area. Looking back on my stay in Tobago, I reckon I could have easily doubled the number of contacts if I'd had a better receiver and more spare time to operate.

Both Don of *DX Magazine* and Sandy of the *West Gulf DX Bulletin*, made attempts to obtain the loan of a receiver for me, but were unfortunately unsuccessful. I also contacted a famous firm in the States for a loan of equipment for

VP4WD, but they were not interested. I wrote the ARRL with a request for separate country status for Tobago but this was turned down. The explanation given was that, as Trinidad was the administrator for the island, and the fact it was only 20 miles away from Trinidad, separate status could not be granted. This seems hardly fair, when comparing G, GM, GW, GD, GI, etc. when exactly the same conditions apply, in fact GM, GW, and G all border each other and are joined to each other under the same administration!

Local Co-operation

To round this off, I would like to express my appreciation for the co-operation given me by the manager of the Electric Supply Commission in Tobago.

I experienced severe electrical interference during December for close to three weeks. To track down the source of the trouble, he, at various times, switched the two ice plant factories in the area out of service and also a complete street lighting circuit equipped with sodium vapor lamps; a stock and feeding farm, plus two electrically equipped pumping stations. Furthermore, he put on a crew to check all the pylon connections and step down transformers in the vicinity of the "Hotel Robinson Crusoe". The trouble was eventually traced to sea-salt corrosion on one of these transformers, and VP4WD was in business again!

QSL cards

On the question of QSL cards, please note that I still have a large number to come in from the States. If these operators will forward their cards via the RSGB, I will be very happy to QSL. I believe that a number of cards have been sent to the VP4 bureau. Despite the fact that I have forwarded self addressed stamped

[Continued on page 124]

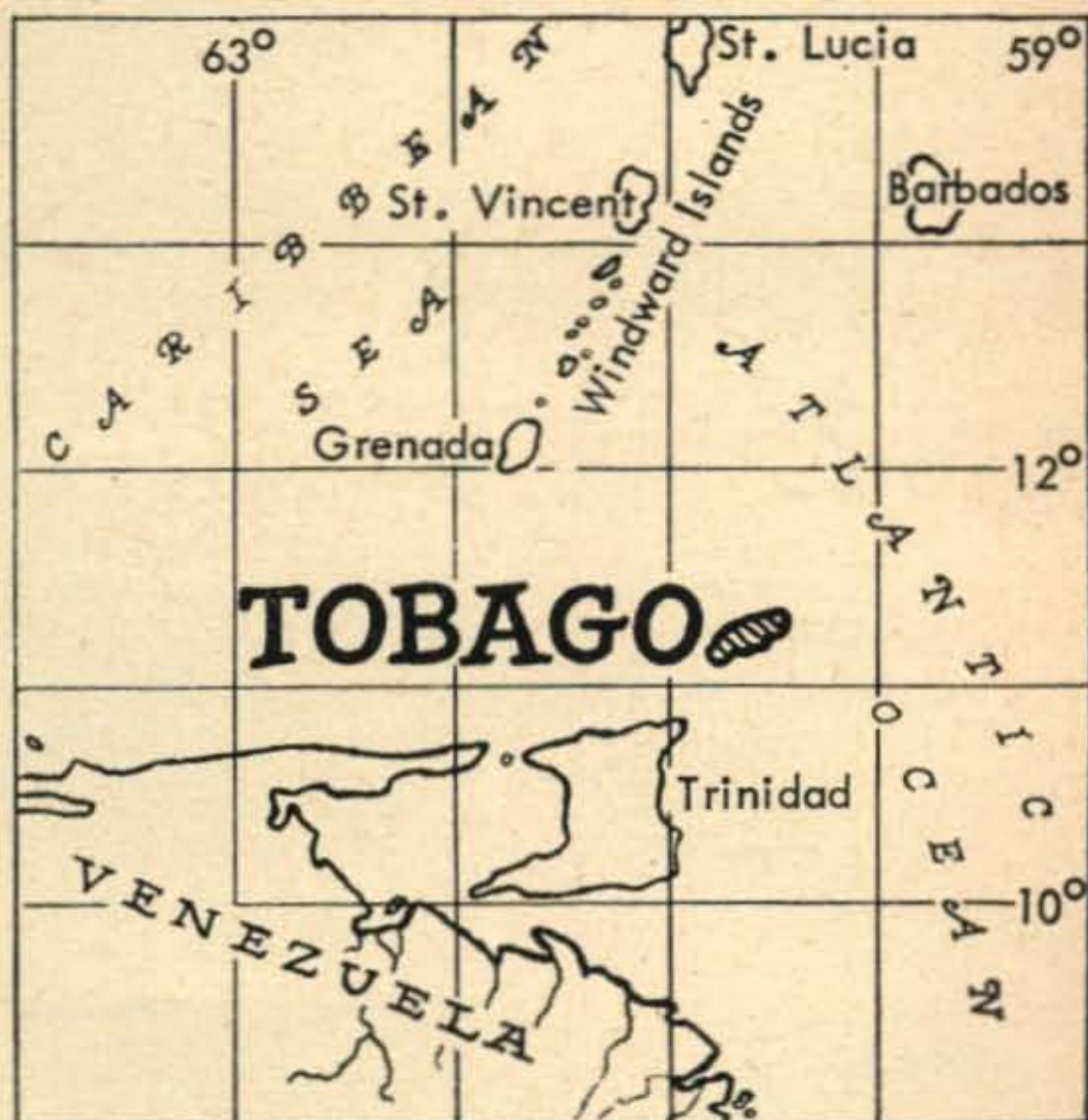

Position of Tobago with relation to the South American Coast and related islands in the Caribbean.

Urban Le Jeune, Jr., W2DEC

416 North 15th St., Kenilworth, N. J.

The following certificates were issued between June 11, 1960 and July 10th, 1960:—

the sticker applies:—

WAZ		
1379	JAØAC	Hidetaka Wada
1380	OK1AW	Alois Weirauch
1381	OK2NN	Josef Strachota
1382	OK1MG	Antonin Kriz
1383	K2PKT	Harold Jamieson
1384	W1LQ	Frederick H. Black
1385	WØTJ	William M. Atkins
1386	K8IKB	Dan Redman
1387	W2BHU	A. Ziehm, Jr.
1388	W8DSZ	Harold C. Bitler
1389	W4BFR	Bruce E. Montgomery
1390	WA6AMZ	William R. Barnes
1391	3V8AB	Jean Marcille
1392	ZL3IS	Gil A. Soanes
1393	K4CLT	Dale Green
1394	ZE3JO	Mal Geddes
1395	W8LY	Michael A. Bakos
1396	W2KJZ	Edward H. Joseph

1.8 mc	50 prefixes
3.5 mc	200 prefixes
7 mc	300 prefixes
14 mc	300 prefixes
21 mc	300 prefixes
28 mc	300 prefixes
50 mc	50 prefixes

All cards must be of the same mode as the original certificate and must also date after 1st January, 1957.

The sticker application should, if possible, be made on the forms which are provided for this purpose. The forms are available for a self-addressed stamped envelope from either the DX editor or the New York office.

Confirmations for the continent stickers may be on any combination of bands as long as the mode is the same as the original certificate. If cards have already been accredited, it is not necessary to send cards, only a list of prefixes in the desired continent, as the list will be checked against the master file. PLEASE list the prefixes in alphabetical order. Band stickers will, however, require that the cards be sent. If you are applying for WPX and anticipate applying for a band sticker, please make note of it and a record will be kept which will eliminate the necessity of sending in cards when applying for the band stickers.

STICKER APPLICATION AS WELL AS ALL CORRESPONDENCE AND CARDS FOR WAZ AND WPX. SHOULD BE SENT DIRECTLY TO THE DX EDITOR AT THE ADDRESS SHOWN AT THE HEAD OF THIS COLUMN.

I would like to thank Jerry Andrew, W1-7959 for his untiring efforts in helping to prepare the continent lists. Without his efforts, it would have been an almost impossible task. Tnx Jerry.

Letters

The following letter was received from Eric ST2AR.

"Just a few lines concerning the recent SSB operation from this station for your records. The visit of Rudy W3ZA to Khartoum enabled him to bring his KWM-1 and we were on for eight days straight, from June 22nd to 30th. In order to put out the best possible signal, I hurriedly erected a two band single element quad for 14 and 21 mc. This proved very effective indeed. We each spent as much time on the air as our respective work permitted but conditions generally were very poor indeed, especially to the west coast of the States, there being only one brief opening to W6/7 land. Our

All-Phone WAZ		
61	ZS6Q	Harry A. Chenik
62	KH6OR	Fred L. Mason

CW WPX		
127	W1NHJ	Shailer A. Herrick, Jr.
128	W6UNP	Daniel E. Earhart
129	W1EIO	Harland K. Goodwin

SSB WPX		
32	K2JXY	George J. Skivington, Jr.
33	WITYQ	Victor L. Crawford

WPX Honor Roll					
CW WPX					
W2HMJ	560	W9UXO	414	W9DYG	367
W6KG	517	W8LY	413	W4AZK	365
W5KC	483	W2PTD	411	W9QGR	361
K6CQM	455	W4OPM	411	SM5AJU	359
W1NLM	455	W6WO	409	VE3DIF	357
W8KPL	453	W9YSX	408	DL7CS	356
W2EQS	443	W5AFX	407	KL7MF	356
OK1MB	428	W8JIN	403	W5OLG	356
W1EQ	427	W2MUM	400	K9AGB	354
K5LIA	426	W3OCU	383	W5AWT	353
W8PQQ	418	K4JVE	377	WØPGI	353
K6SXA	415	WØQYE	377	HB9TT	351
W3BQA	415	K2UKQ	369	W5DA	351

Phone WPX					
W8WT	495	PAØHBO	363	W8PQQ	327
G3DO	448	PY2CK	354	W5ERY	315
CT1PK	431	5A5TO	353	W9YSQ	308

SSB WPX					
MP4BBW	257	TI2HP	231	K9EAB	204
W8PQQ	250	HB9TL	221	K2MGE	203
W1GR	245	W3MAC	212	W4OPM	183

Starting immediately, the following additional stickers are available for holders of WPX certificates; continent stickers requiring proof of contact from the number of prefixes shown below:

North America	126 prefixes
South America	88 prefixes
Europe	116 prefixes
Africa	72 prefixes
Asia	68 prefixes
Oceania	51 prefixes

Band stickers require proof from the number of prefixes shown below on the band for which



KA7AX/W6UUX Bob, DU1GF George, and JA6AV Inami San. The occasion of the international ham get together was the arrival of George DU1GF at Fukuoka, Japan. The location of this photo is the Asahi Broadcasting Company, of which Mr. Inami, JA6AV is the Chief Broadcast Engineer. The operation position of KA7AX. Equipment shown is as follows. Millen R9'er, SX36, SX73, Collins 51J3, Viking Valiant and Viking 6N2.



Jock, ZL2GX world renown DX operator, contest operator, and lion tamer. From the look on Jock's face he must have just snagged a new one. (Tnx W2LPE and SWL Jimmy Hart)



My good friend, Dimiter, LZ1AF, as seen through the eyes of his XYL Margarita. Because of his 90% operation at nite he has earned the title of "Night Owl." The rig is a BC348 and a home brew transmitter.



The home and field day operating position of OK2UD. Fanda has some very attractive wall paper. (Tnx K2UKQ).

apologies, but we worked just about everything that we heard. Our final country score was 68 for the eight days. I am hoping to be on SSB permanently before long, so am looking forward to completing the century on SSB.

Stateside, Canadian and 4X4 stations were asked to QSL via W2JXH and others direct to this QTH. All cards are answered immediately. Usual IRC's and SASE please. We hope that this little operation was enjoyed by the gang as much as we enjoyed performing it,

73's

Eric ST2AR"

Eric's QTH is Sudan Airways,
P.O. Box 253
Khartoum, Sudan, Africa

The following is an open letter to all DXers received from ET2US/K8SNA.

"Dear OM: I wish that there was some way through which we could have an eyeball QSO, but since that is impossible at present, I have decided to write and tell you my problems.

I have been trying to get permission to take a DXpedition and I am sure that you would be interested in seeing me go to 4W1 land. I am aware of the fact that this country has been turned down to many of the other fellows, but I still have hopes of being able to get into 4W1 land somehow.

I am trying my best on this end, but I am sure that if I could get a typewritten letter from you fellow hams, that this would have a great influence on the commander, when I present my request to him. So what I would like to have, is a letter from as many hams as possible, and I am almost certain that I will be able to get some sort of a 4W1 QSL for each of you fellows.

I am hoping that each of you will take the time to do this for me, and in turn you will pass the information on to your friends and see how many letters I can get together here.

Remember, there is nothing definite but I am sure that if I can get enough backing from you fellows, I will be able to come up with something.

Hoping to hear from you soon, I am;

Sincerely Yours
ET2US/K8SNA
Mark F. Slabaugh
4th USASA OPNS Co.
APO 843 Box 404
New York, New York"

Jimmy, LA6CF, who is operating /MM on the M/S Bonneville these days, advises us of his schedule and operating frequencies. He promises all a QSL.

Aug 30th	Arrive Seattle
Sept 5th	Arrive Vancouver
Sept. 17th	Arrive Portland
Sept 22nd	Depart San Francisco
Sept 24th	Depart Los Angeles
Oct 12th	Arrive Manila
Oct 21st	Arrive Hong Kong
Oct 26th	Arrive Singapore

Operating frequencies

CW	3.510	Phone	3.800
	7.020		7.050 7.100
	14.080		14.150 14.195
	21.125		21.200
	28.050		28.300 28.600

On c.w. usually listen 5 kc higher up, if nothing else is mentioned in calls. As usual, very heavy QRM from all stations calling, pse give short calls, mine is ok once, yours twice, mostly QRV on 14.080 in case of QRM on frequencies, I will QSY down 1-5 kc.

QSL's—QSL cards will be sent 100% as soon as I get them back from the printer, meanwhile I will QSL all with old QSL marked /MM, if an IRC is received.

2 IRC's for air mail.

Post addresses as follows;

From few days before leaving Hong Kong to Overseas Shipping Co.

P.O. Box 128

Terminal Island, Calif.

After arrival USA send to

Overseas Shipping Co.

310 Sansome St.

San Francisco, Calif.

From departure USA till a few days before last departure from Hong Kong send to

The Bank Line China Ltd.

Hong Kong

Address all letters and cards to

LA6CF/MM Jimmy

Radio Officer

M/S Bonneville

New Countries

As we all know, things have been changing very rapidly in Africa and several new countries have been born. It seems like a new prefix is popping up almost every day. First, we had Guinea and FF8AC/GN and 7GIA doing a very good job on that one. Then along came FF7 and FF4. More recently, we have OQ5 changing to 9Q5 and now I5 has changed to 6O2 (that's 6O2, not six hundred and two) and VQ6 has changed to 6O1. I even hear talk that someone has worked a 12AT7. But seriously, it would behoove one to work as many of these as possible. In the past, the country status has not been changed unless boundaries changed, as in the case of Ghana. However, at this stage of the game, it is very difficult to tell exactly what has happened or what will happen. It would seem that the boundaries have changed in the case of FF4 and FF7 and possibly 9Q5 and 9U5. If things keep changing at the rate they have been, we should have at least 400 countries by the end of the year; that is, if the band will only stay open long enough for us to work some of these fellows.

While on the subject of new countries, it looks as though Marcus Island, which was visited by KG6ICD, as described later, will definitely be a new one and that Baja Nuevo, from which Danny's operation as HKØAA, has a good change, if there is no US claim on the island.

Who What Where

AC3—Sikkim—W3GJY worked a station signing AC3PN who gave his name as Joe and his QTH as Gangtok, Sikkim on 14.080 at 0340 GMT. He said to QSL via VU2JP. Does anyone have any additional information on this one?

AC3—AC5 and East Pakistan—If all follows schedule, Glen, 9N1GW, will be in these places in Sept. Questionable at present is AC5. Glen has a KWM1 with DX adapter and will have a two element Hy-Gain beam. Frequencies as follows; SSB, 14190, with alternates 14348, 21405, c.w. on 14040 and 21040. QSL to W7PHO with a SASE.

AP—East Pakistan—AP2CR hopes to be active from East Pakistan during the late summer or early fall using a KWM1 (Tnx WGDXC).

JY—Jordan—A station signing JY1ZA has been worked on 21 mc c.w. by F9RS and others. He given his name as Sid and QTH as Box 25, Amman.

VK8—Northern Territory—All stations operating in Northern Territory will, in the future, use the VK8 prefix. VK8TF who is ex-VKØTF is now active on 14080 and 14100 c.w. using 20 watts. This is a very good catch for the Worked All VK certificate. (Tnx WGDXC).

VU2—Andaman and Nicobar Islands—Al, W8-PQQ, informs us that all VU2ANI cards have been forwarded. He received only the cards not the logs, so if you did not receive a card write to VU2AK c/o ARSI and he will check the logs.

VU—Laccadive Islands—Most of the gang that made the very successful VU2ANI trip are planning to go to the Laccadives in December or January. Will keep you posted. (Tnx VU2AK).

3V8—Tunisia—Sid, who you will remember as XW8AH, is now operating as W8UTQ/3V8 and may be reached at Sydney, Wagoner, c/o American Embassy, Tunis, Tunisia (Tnx W8-PQQ).

KG6—Marcus Island—Thanks to the FEARL and KA2GI for the following account of the KG6ICD trip:—

"The Marcus DXpedition was possible through the efforts of KA2's LT, AA, AL and LP. Our thanks to these KA's plus others in 6000th Support Wing, 56th WRS, 6102nd OPRON, and 1954th AACSRON.

Anyway, after 3 weeks of preparation, the crew, consisting of KA2ZZ-Dave-(W7YBI), KA2GI-Earl-(W7OCD), KA2MK-Max-(W2-VRP), Tom-K6EQX and Bob-(W5EWM) departed on 18 June, 1960. The call KG6ICD and operating frequencies, (all American phone band) had been assigned.

Equipment consisted of HT-32A, ELMAC AF67, 32V1, 2 51J's, 2 R390's, 1 SP600 and 10, 15 & 20 homebrew Ant's by KA2GI.

Operation started at approximately 0840 on 18 June and continued until 0400 27 June with poor band conditions throughout our stay. Over 80 countries and about 2500 contacts were logged, however, and the operation was considered successful.

The JMA crew at Marcus (37 strong) treated us like kings. None of the crew expected the comforts of the white sheets on the beds in a freshly painted building. Incidentally, the power was 200 volts but two variacs (one 50 and one 30 amp) were immediately produced by JMA and all went well.

Most of the operation was on 20 SSB and CW, however AM, SSB and CW contacts were made on 15 during sporadic openings and two AM contacts (one each with a VK6 and a W6) were logged on 10.

It was a real enjoyable trip and I hope to return (in retired status) for some operation during January 1961. Of course this will depend on the space available, transportation on MATS and approval, but it's possible. At least a group of KA's should make the trip and operation should include at least 50% CW from 3 separate locations on the island. I'll keep in contact with KA2LP and KA2AA and get the plans and equipment ready early if it is possible."

W7PHO is the QSL Manager for the expedition. Pse SASE.

New England DXCC Meeting

The following is the schedule of the Tenth Annual New England DXCC meeting.

Date: Saturday, October 1, 1960.

Time: 5:00 P.M. *Bill Loeffler, W1PFA*, will present an illustrated lecture about his experiences while operating as FP8BH at St. Pierre and Miquellon Islands.

Pete Card, W1WDD, will present slides showing views in foreign countries he has visited. This presentation will immediately precede the FP8BH talk.

6:30 P.M. *Cocktail Hour*—Liquid refreshment on an individual basis at the "cash" bar.

7:30 P.M. Dinner.

QSL's: W1GKK is being given a list of all the W1 DXCC members, and your cards can be picked up in person at the meeting.

Place: *Motel 128 on Route 128 at Route 1 South (Exit 57) Dedham, Mass.* Easy to reach by auto from all directions.

Cost: \$5.00 per person for *Roast Beef Dinner*, including gratuity. It would be appreciated if you would mail your check as early as possible so that we can inform the Motel 128 management at least four days in advance of the meeting, that is by Tuesday, September 27, the number of expected dinner reservations for Saturday, October 1, 1960.

Remember the deadline date for your reservation.

Make checks payable to your DXCC chairman:

Philip Baldwin, W1ZW
c/o WHDH

50 Morrissey Blvd., Boston 25, Mass.
There will be no tickets sent out. Upon

[Continued on page 98]



ham clinic

CHARLES J. SCHAUERS, F7FE/W6QLV

CQ Magazine, 300 West 43rd St., New York 36, N. Y.

The Incredible Increductor¹

Most hams are now familiar with the silicon capacitor whose capacitance is determined by the applied *dc voltage*. Smaller than a regular transistor, this tiny device can replace manually operated variable condensers one hundred times larger. Now we come to a component whose inductance can be varied by changing the magnitude of a *dc current*. It too is a small device and is comparable in size with some of the smallest audio transformers . . . especially the types used in some of the smaller radio receivers.

The controllable inductor described here is manufactured by the *CGS Laboratories, Inc.* of Wilton, Conn. and is called the *Increductor*.

In one simple form a controllable inductor consists of two toroidal windings on a ferrite core. (See fig. 1.) The winding which is to be controlled and used as a variable inductor in the active circuit is called the "signal winding." The second winding which is aptly named the "control winding" is used to control the inductance of the signal winding. All that is necessary to change the signal inductance is to pass current through the control winding. This direct current creates a magnetic flux in the ring core and thereby changes its incremental permeability. Because the signal winding is on the same core, its inductance is proportional to the incremental inductance and will change accordingly. This simple device forms a useful controllable inductor. It has obvious advantages in sweep circuits. For example, by passing an appropriate sawtooth current through the control winding of the inductor, the oscillator can be made to sweep recurrently over a relatively wide range of frequencies. You can readily see then that it can be used for panoramic work.

¹CGS Trademark

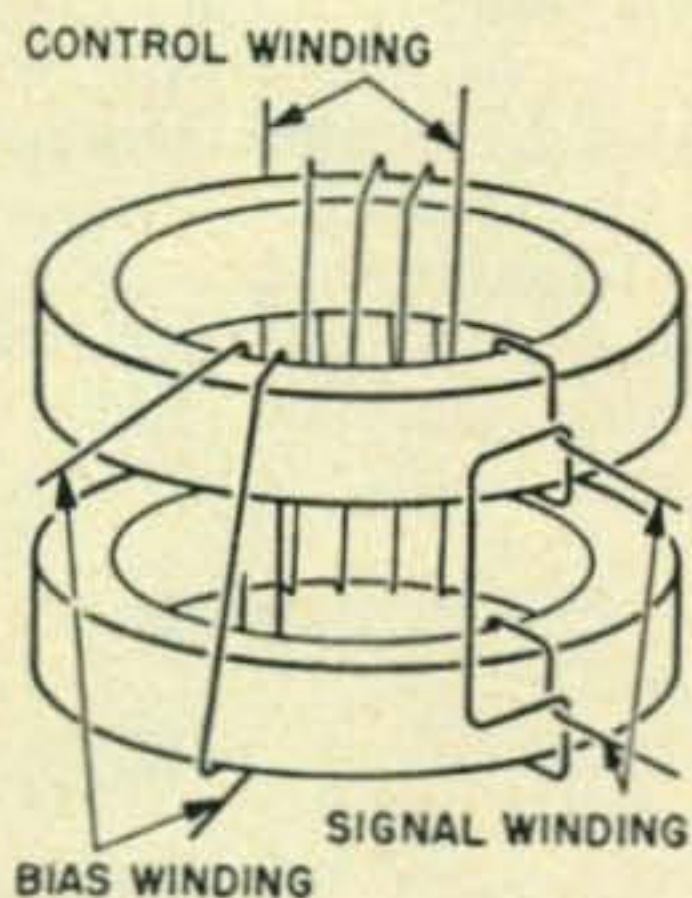

Fig. 1—Simple variable inductor—current controlled.

Sometimes a third winding (called a "bias winding") is added to the Increductor which acts as a secondary control winding and may be used to set a primary level around which the inductance is varied. It is also used in dual control arrangements where both the control and bias windings may perform independent control functions. The control or bias windings are not the only way to introduce *dc* fields in the material on which the signal winding is wound, for it is quite useful sometimes to obtain this control field from a permanent magnet.

"Inductance change ratio" (the measure of how much change of signal inductance can be effected by going from near zero control current to the saturated state of the core) is a very important concept when considering the Increductor. The change ratio generally refers to the ratio of some starting inductance which will be large as compared to the saturated inductance, which in general, will be small.

Practical units have been constructed having starting signal inductances from 0.01 mhs to 10 hys and have been usable from *dc* to 500 *mc*.

The largest inductance ranges (400:1) are obtained with units useful at audio frequencies. Core material and stray parameter limitations control the available inductance range which is decreased with an increase of frequency.

Standard units now in production give inductance ranges of 3:1 around 300 *mc*; and laboratory units have been made which have a 4:1 inductance range around 400 *mc* (the latter

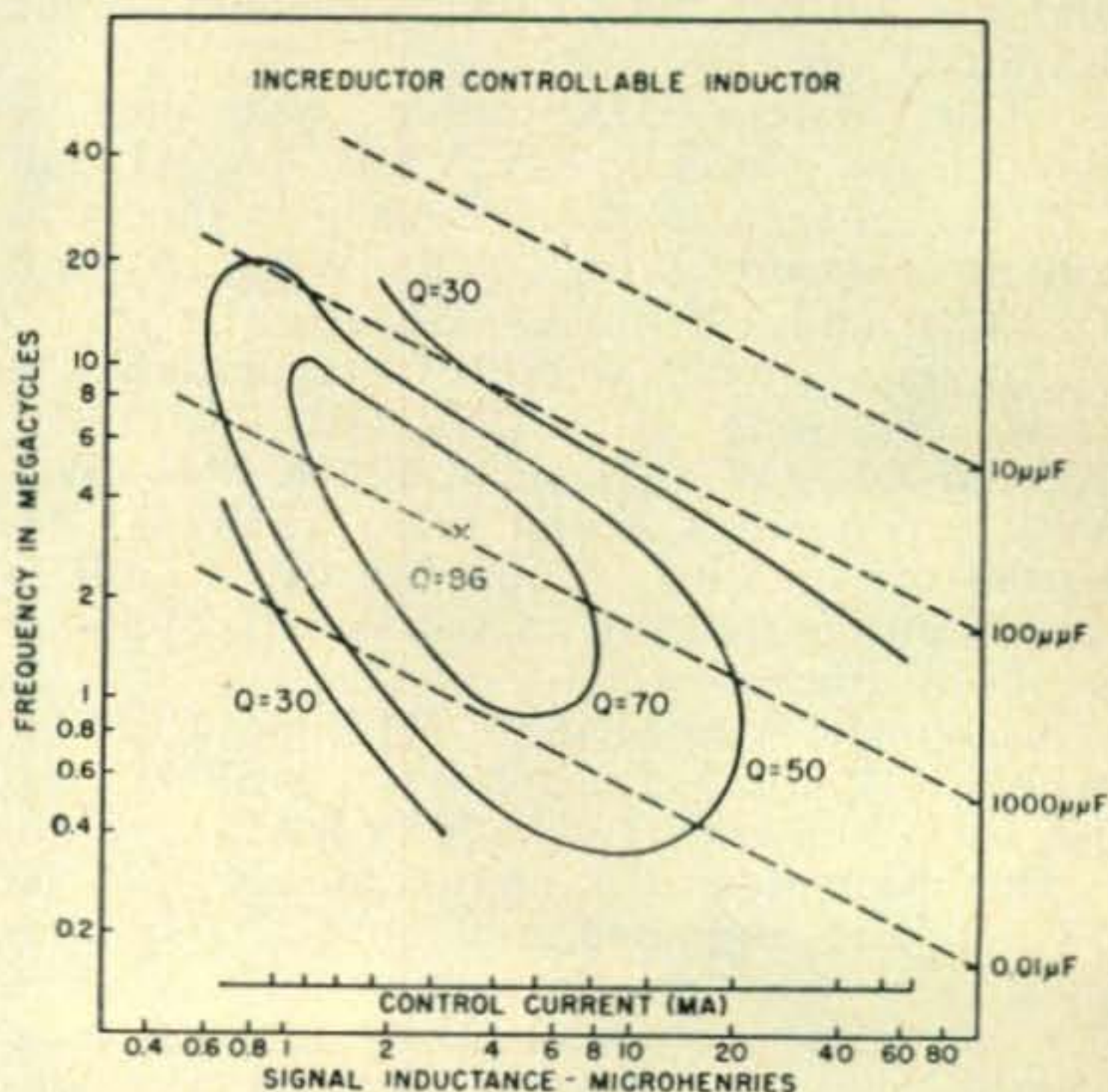

Fig. 2—Q map.

requiring a vacuum tube and circuitry integrally associated with the inductor).

Another important signal parameter is the "starting Q" which will be near 80 to 120 at low audio frequencies and tends to rise to 250 as the frequency increases. At 400 *mc* it drops to around 5 to 10.

Q is not simply a function of starting frequency but will also vary as both or either signal inductance or applied frequency vary. Q is a function of the core material, its state of saturation and the usual factors affecting it.

With small signals, the Q of a controllable inductor must be regarded as a function of two variables: frequency and signal inductance (or control current). With large signals, it is possible that signal amplitude will affect Q. Plots of the surface formed by Q in inductance-frequency space are called "Q maps." Refer to fig. 2 for CGS Laboratories' Q map.

At very low frequencies, because the series copper losses predominate, Q will usually drop as frequency of operation increases—by increasing control current. At fairly high frequencies (above 80 *mc*) core losses predominate. The effect of these losses is to make Q rise with frequency and increasing control current. A typical variation of Q with frequency in the 100 to 150 *mc* range will be from 25 at 100 *mc* to 130 at 150 *mc*.

Control power is no problem, varying from 1/100 to 10 watts. Because the Increductor is a current sensitive device, it must be driven from a constant current source; in practice, 10 and 150 mils are required for full range. Typical control winding resistances are 100 to 1500 ohms.

Whenever control inductance becomes a problem, it can be reduced by decreasing the number of turns and thereby increasing the control current required. Control inductances have varied from less than 100 millihenries to 100 henries.

Typical change in inductance with temperature is from .01% to 2% per degree Centigrade. The characteristics are uniform in controllable inductors of the same type.

Because the signal winding is usually balanced with respect to the control winding (to reduce coupling), a -40 *db* "decoupling" is not uncommon and units have been built with coupling that is below a -60 *db*.

Manufactured today are units which can handle 100 watts at 150 *mc*.

Depending upon the nature of the signal winding, distributed capacitance varies from over 60 mmf at audio frequencies to less than 1 mmf for units useful at *vhf*.

Short response times can be obtained by reducing the number of turns on the control winding. This reduces the control inductance and increases the control current required. Response speeds measured in microseconds have been obtained with the Increductor.

Although hysteresis and temperature problems may arise, either effect can be minimized

by the selection of a suitable operating point, and by using special closed loop circuitry (as recommended by the manufacturer).

The applications of the Increductor are numerous. In ham work they can be used in panoramic receiver circuitry; antenna switching; sweep generators etc. Actually, their use is governed only by the imagination of the amateur radio designer.

The two Increductors in which I think the ham would be most interested are the types 6XBK4 and the 6XBK5 which sell for \$13.60 and \$14.10 respectively. These units have a suggested operating frequency range of 3.7 to 216 *mc* (4 band) and 3.0 to 209 *mc* (5 band). The BK4 has a frequency change ratio range (frequency change ratio²) governed by the available sweep; the BK5 has a range of 3 to 16 *mc*.

My deepest thanks to the CGS Laboratories for making their descriptive material on the Increductor available for column publication. Those of you who are interested in learning more about it are invited to write to the manufacturer directly. He will be glad to give you more information.

Observation

The International Ham-Hop Club (IHHC) is certainly a wonderful organization and I am of the very firm opinion that it deserves more publicity and MORE members. This organization has done (and is doing) more for international good-will than any other club I know of.

What is the IHHC? Well, let me tell you.

The IHHC with its headquarters in Kent, England ("Brent House" 17 Ethel Road—Broadstairs) is devoted to the sponsoring of friendship between radio enthusiasts of every nation, creed and color. It is the organization that manages to hurdle the "money barrier" which keeps so many hams from traveling.

Here is the way it works: say you live in New York and want to visit Mexico City for a couple of days. You have enough money for travel but not enough for lodging and board. Through the IHHC, arrangements can be made for an "exchange" visit . . . with another ham member. Other than your transportation and personal items your stay costs you nothing.

When your Mexican ham friend visits you, the same arrangements prevail. Of course now, any arrangements you wish to make privately are perfectly okeh. Usually, a ham has accommodations for one or two people.

The IHHC has different classes of membership, i.e., *members*: who offer overnight hospitality to visiting members of the club; *associate members*: who invite radio amateurs to visit their stations (the associate membership is *free*); *family exchange*: visits arranged between members' families to their mutual convenience; *friendship links*: between radio clubs sponsored by the IHHC. The *Ham-Hop News* is the Club's official journal and costs 5/ per annum (about 70¢).

[Continued on page 93]

Space Communications

GEORGE JACOBS, W3ASK

11307 CLARA STREET
SILVER SPRING, MARYLAND

Blast Off

With Explorers, Pioneers and Sputniks crisscrossing outer space, the space age is truly here. Heralding this marvelous new age, and in recognition of its great importance to the future of amateur radio, CQ inaugurates this Space Communications column. Devoted to those aspects of space communications that are of practical interest to amateur radio and those in which radio amateurs can actively participate, this new column will appear monthly. Featured in this column will be discussions on the latest developments in the field of space communications, so that radio amateurs can keep abreast of events in this fast moving new field which opens new horizons and technical challenges to amateur radio. It is also intended that this column serve both as a point of coordination and as a clearing house for radio amateur participation in many of this country's space communication projects planned for the not-too-distant future. Indeed, because of the tremendous scope of these proj-

ects, officials of the National Aeronautics and Space Agency have already notified the Editor of this column that they are counting on the volunteer participation of radio amateurs to augment the scientific observations that they are planning on a contractual basis. The NASA is the government agency in charge of this country's non-military space program.

The great distances involved in space communications, and the generally weak signal levels, demand the utmost in transmission and reception equipment and techniques. Space communication circuitry that has practical utilization or application to amateur radio will also be a topic of discussion in this column. In substance, it is intended that this column serve as a focal point and as a forum for radio amateurs interested in the field of space communications. Readers of this column are invited, in fact urged, to participate in the column by submitting comments, suggestions, questions, observations and newsworthy items concerning space communications directly to W3ASK, the column Editor.

Fig. 1—Close up view of the Project Echo sphere container. The inflatable plastic balloon is folded inside. Balloon inflation will take place at an altitude of about 1000 miles. The visible antenna belongs to a beacon transmitter in the third stage of the carrier rocket. Official NASA Photo.



Amateur Role

Since its early days, nearly sixty years ago, amateur radio has played a very important role in pioneering advances in the field of radio communications, and space communications is no exception. Long before the first Sputnik, radio amateurs established contact using the earth's natural satellite, the moon, as a passive reflector of 2 meter radio signals. This was the epic achievement of W4AO, W3GKP and W3LCK on January 23rd 1953. In 1957, and in subsequent years, dozens of radio amateurs in the southwestern part of the United States have participated actively in "Operations Smoke-Puff". By means of special chemicals released from rockets, this project has on several occasions successfully created an artificial ionosphere of a temporary nature over localized regions of the earth's upper atmosphere.

Within minutes after the announcement of the successful launching of the first earth satellite during the fall of 1957, thousands of radio amateurs in this country tuned in the history-making "beeps" on 20 and 40 megacycles. Much of the observational data collected by radio amateurs from the first Sputnik, and subsequent earth satellites, have played a very important role in radio wave propagation and other areas of scientific research. More recently

(during early March, 1960), amateur radio made the headlines in newspapers all over the United States when two teen-age hams, K2QBW and K3JTE, successfully communicated for the first time by means of a radio signal reflected from an earth satellite, thus making "satellite scatter" communications a reality. Many of these events will be reported upon in greater detail subsequently in this column, and this is only the beginning. One of the more immediate and practical applications of earth satellites is their utilization for improving global communications, and in this, amateur radio has a direct interest since hams *are* global communicators. Use of satellites for communication systems could make possible in the not-too-distant future the means for providing very much needed spectrum space to help fill the rapidly growing world communication needs. Space communications could transform the *vhf* and *uhf* regions of the radio spectrum from their present line of sight use to unlimited global use, possessing greater efficiency for world wide communications than the *hf* region of the radio spectrum which is presently used for this purpose. This would have at least a two fold advantage for amateur radio; it would relieve the present congestion in the *hf* region thereby decreasing the possibility that some future International Radio Conference might consider re-allocating to other radio services some of the *hf* spectrum presently allocated to Amateur Radio, and it opens new and unlimited DX possibilities for the *vhf* and *uhf* amateur bands. Space communication systems and their impact upon amateur radio will be discussed in greater detail subsequently in this column. The Editor considers it appropriate, however, that in this initial column, at least one of the space communication systems planned for early implementation be discussed at least briefly.

Project Echo

Two classes of space communication systems are presently being considered by NASA; passive and active. *Passive* systems will consist of satellites designed to scatter or reflect radio signals in a manner similar to ionospheric reflection, but much more efficient. *Active* systems will consist of satellites carrying transmitting equipment aboard, so that signals received from the ground can be amplified and re-transmitted from the satellite. Considering the present state of space technology, the passive space communication system is considered by NASA as showing the greatest promise for initial achievement. NASA is currently developing such a system under the code name of *Project Echo*. The system makes use of a 100 foot diameter reflecting sphere which will be rocketed 1000 miles into the earth's atmosphere in a circular orbit (see fig. 1 and 2). The satellite is made of .0005 inch thick Mylar plastic and is coated with vapor-deposited aluminum to provide radio wave reflectivity of at least 98% up to frequencies of

[Continued on page 100]

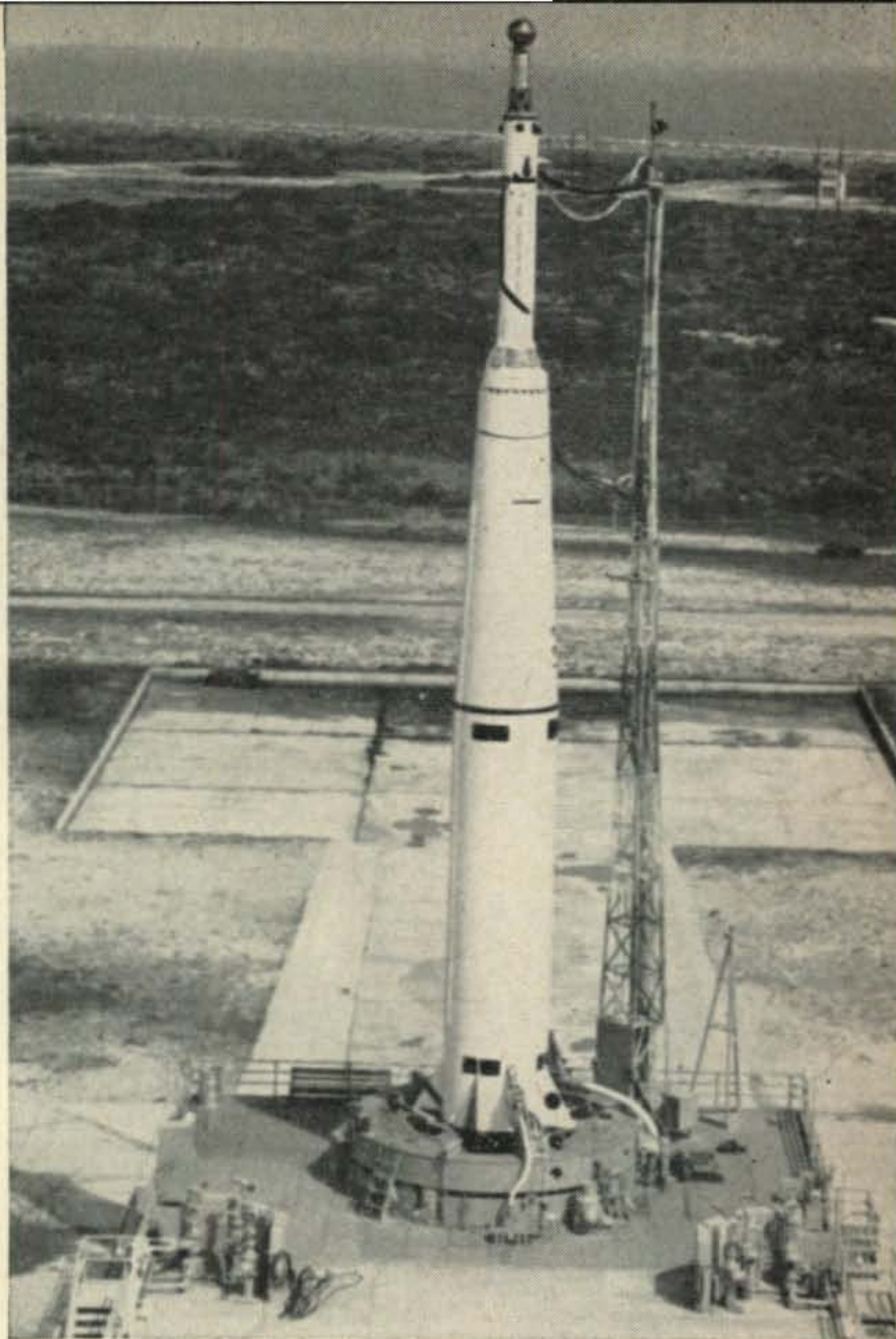

Fig. 2—Project Echo sphere container atop a Delta launch vehicle on the pad at Cape Canaveral, Fla. The next attempt for launching the 100 foot radio wave reflecting sphere is planned for the late fall of 1960 or early 1961. Official NASA Photo.

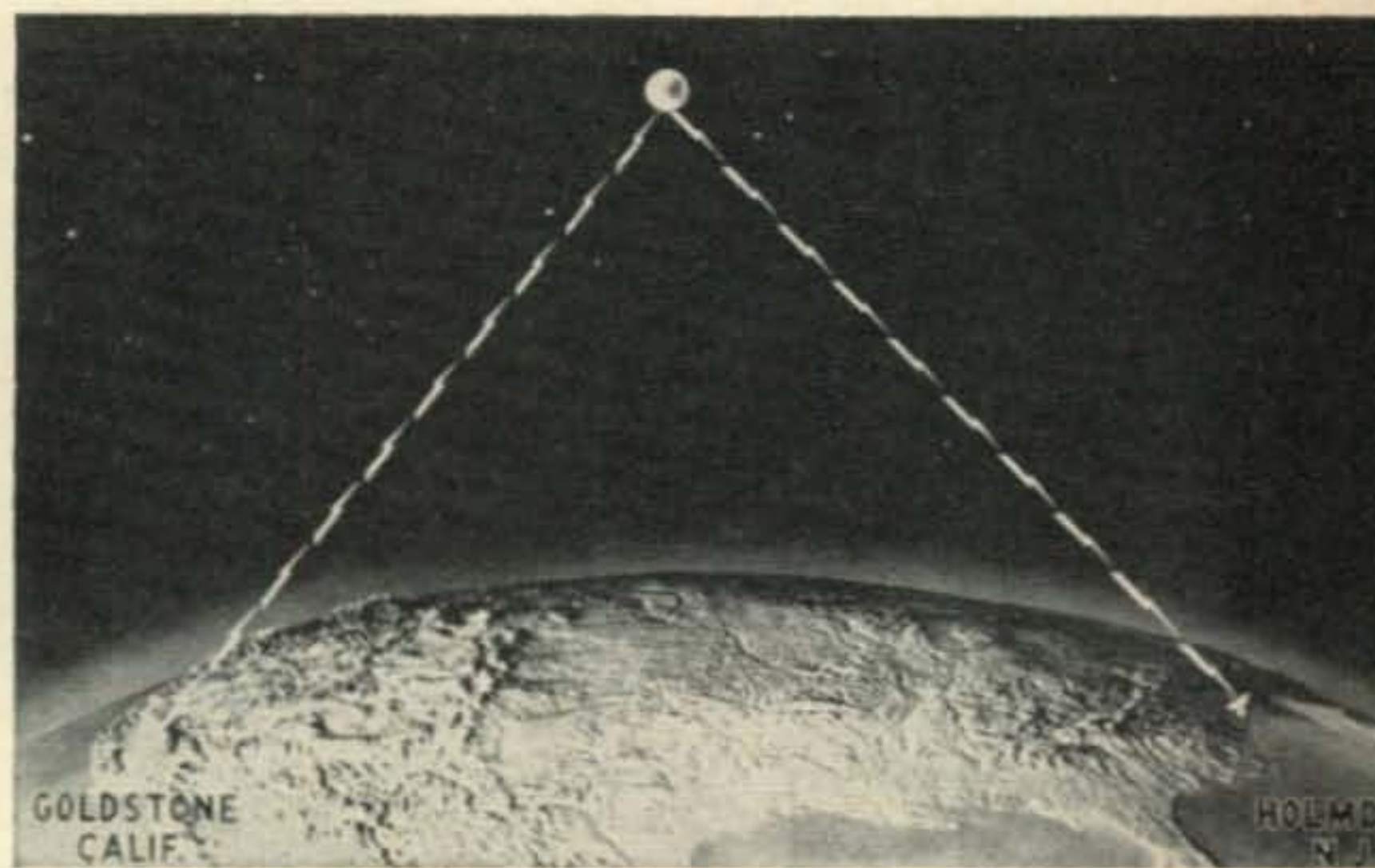

Fig. 3—When the Project Echo sphere successfully orbits, it will be used for communications between the east and west coasts of the United States by means of signal reflection from the surface of the satellite. Frequencies used will be 960 and 2390 megacycles. Official NASA Photo.



YLRL presidents, l. to r., K4LMB, ex-W7FWB, founder and first president, 1939-40 and 1940-41; W1FTJ, 1943-44 and 1950-51; W6CEE, 1954-55; W3PVH, 1957; W6DXI, 1960. W5IWL photo.



Members of WRONE who served on convention committees. L. to r., front: WISVN, K1ADY, WIZEN, K1IZT, K1EKO. Standing: W1VOS, W1RLQ, W1UKR, W1SCS, W1CEW, K1IJV, W1HOY. W4HWR photo.



by Louisa B. Sando, W5RZJ
212 Sombrie Drive, Santa Fe, N.M.

3rd International YLRL Convention Cambridge, Massachusetts June 17-19, 1960

From California and Florida, from Wisconsin and Texas, plus a dozen other States, the YLs gathered at the Hotel Commander in Cambridge, Mass., on June 17-19, 1960, for the 3rd International YLRL Convention, sponsored by WRONE, the Women Radio Operators of New England. Over ninety YLs attended, with every call area except the 7th represented, and with DX in the person of OH5SM, Carola.

Events got under way on Friday morning with the WRONE gals (and some helpful Oms) setting up the convention station in the Hospitality Rooms. The special call W1YL was issued for the convention and for the two weeks prior to it, during which time it was used by WIZEN, K1IZT and W1HOY.

W1CEW, Mary, and K1ADY, also Mary, set up Ye Olde WRONE Gift Shoppe in the Hospitality Rooms and had many lovely items for the gals to choose from. Also on display were club albums and scrapbooks. Here and in the hotel lobby the YLs gathered throughout the day, amid hugs, kisses (and more formal greetings) as friend greeted friend, and new acquaintances were made. Excitement ran high, especially when Onie, WIZEN, displayed the now famous bedspread incorporating embroidered replicas of all the certificates offered by YL clubs (two received too late to go into the spread were made into a pillow), and the lace afghan made by Onie. Each one of us longed to win one or the other.

YLRL FORUM

On Saturday morning with registration completed and the OMs on their way for an all day

tour, the YLs gathered in the George Washington Ballroom for the YLRL Forum. Here the bedspread and afghan were on display, on one wall a replica of the WRONE gal—with the acorn head and beret, mascot of the New England YLs—and on the head table the "girl-on-the-globe," YLRL's symbol. On the head table, too, and on each of the other tables were interesting figurines mounted on styrofoam depicting scenes from each of the New England States and many others as well. As Onie told us at the luncheon, these were made by WIZJS, Dee. Delightful tiny figures, they were complete to miniature walkie-talkie rigs.

The entire stage was covered with prizes, all of them donated by individuals, YL clubs, manufacturers and retailers. Prize chairmen WIHOY, Helen, and WISVN, Millie, had collected nearly \$1800.00 worth of prizes!

WIHOY, Helen, welcomed the YLs attending. W6DXI, Gladys, president of YLRL, conducted the business session and introduced W5EGD/3, Lillian, vice president of YLRL. Gladys reported that YLRL is now incorporated, that the War Bonds were cashed and the money placed in a permanent savings account, and that KØGZO, Virginia, is now the custodian of YLRL supplies. She brought up the possibility of a custodian for the YL-OM Contest, instead of its being handled by the vice president, and also suggested a YLRL VHF contest in the spring.

Onie, WIZEN, co-chairman with WISVN, Millie, of the convention, read messages from K6ENK, Wanda, editor of YL Harmonics, from former president W7NJS, Beth, and from W9RTH and the YLs of WHOOT. Onie thanked YLRL for advancing \$100 to the convention committee, but reported happily that they had been able to return the money to YLRL's treasury as their bedspread-afghan project had financed convention expenses, beyond the registration fees paid.

W5EGD/3 reported on YLRL contests and suggested that the Anniversary Party be held in October rather than November.

Following the coffee break the meeting was open to general discussion and covered such things as reporting for YL Harmonics, and the advisability of YLRL holding its conventions by itself or in conjunction with ARRL. W9RUJ, Mary, announced there will be a great grandmothers' certificate available, as well as the grandmothers'.

Luncheon

At 1 p.m. we returned to the Ballroom for the luncheon, for which WIHOY was MC. In addition to the decorations already mentioned, at each place there was a favor—diamond shaped earrings in blue enamel on copper with YLRL inscription. These were made by WIZEN and K1IZT, Blanche. Ceramic ashtrays inscribed with the convention date, etc. and made by K2DKL, Bonnie, and K1ICW, Mary, were presented by Onie to K4LMB,

YLRL THIRD INTERNATIONAL	
W 1 Y L	
Radio.....	Remarks:
QSO of June.....1960	
at.....EDSJ	
U.....Mo.....	
R.....S.....J.....	Operator.....
CAMBRIDGE, MASS.	COMMANDER HOTEL

QSL for W1YL, special call issued for station operated at convention hotel.



Father Dan Linehan, W1BWK, speaker for the banquet. YLRL's "girl-on-the-globe" on table. K9QGR photo.



At the registration desk, Hotel Commander lobby, l. to r., K2DPN, W2EEO, W5TOW/2, K5MRU (ex-KZ5DG). K9QGR photo.



W1ZR, Edith Rotch, 85-year young YL, is greeted by convention co-chairman, W1ZEN, and W6DXI (in background). W4HWR photo.



YLRL's 1960 president, W6DXI (left), and vice president, W5EGD/3, confer during luncheon. W4HWR photo.

W6DXI, W5EGD, W1HOY, W1QON, and W5RZJ and to the members of the WRONE convention committees. Onie also had orchid corsages for K4LMB, Ethel, founder of YLRL; for W6DXI, W5EGD/3, and for members of the committees, the gift of the WRONE club. Onie gave a report on the convention planning and activities and received a standing ovation from all present.

Speakers were then introduced—your column editor, W5RZJ, who reported on "CQ YL" (the book was undertaken at the request of the YLs attending the 1st YLRL International Convention in 1955), proposed that we think about establishing a permanent YLRL headquarters with part-time-paid secretary, and recommended that YLRL continue to hold its conventions by itself.

W1QON, Eleanor, brought greetings as YL editor of *QST*; OH5SM, Carola, brought greetings from Finland; and W4HWR/2, Hilda, just back from Japan, told of operating as JA2HA. K4LMB, Ethel (now Mrs. W3CN), who as W7FWB founded YLRL in 1939, congratulated YLRL on having "come of age" and reached its 21st birthday. Ethel also proposed a compromise on the conventions; she suggested the YLRL conventions be held in the same city, or area, and within the week preceeding the ARRL ones, so both YL and OM would have more incentive to attend. Ethel also introduced her mother, Nell, who after many years of exposure to Ham radio studied for her license and is now KN4VHM.

W1FTJ, Dot, and W1FOF, Cookie, were introduced as first-year members of YLRL, while W1HUH, Sister Emeliana, and W1ZR, Edith, were applauded for being long-time YLs. Edith

[Continued on page 77]



W1HUH, left, a Ham since 1933, attended convention with a companion. W4HWR photo.



Operating W1YL in the hospitality rooms, W6CEE and W6QGX with W1ZEN kibitzing. K9QGR photo.



Convention co-chairman W1SVN holds the ticket stubs while W3GTC draws the lucky numbers for WIHOY to announce following the banquet. W5IWL photo.



DX at the International Convention was represented by ex-JA2HA (W4HWR/2); OH5SM; and Paula Bloemen and OM, operators of PAØULA, who are awaiting W calls. As JA2HA, Hilda was one of the few foreign YLs to operate with her own call in Japan. OH5SM, Carole Tigerstedt, flew from Finland for the convention, licensed in '58, her OM is OH5NW and her brother-in-law, who has been studying in the U.S., is OH5NQ. W5IWL photo.



Southwesterners K5BNQ from Oklahoma and W5RZJ of New Mexico, wearing "fiesta" dresses at convention. W5IWL photo.



W1SVN with model of W1YL, WRONE's acorn gal in background. K9QGR photo.



W6DXI addressing the YLs at the YLRL Forum; bedspread in background. W4HWR photo.



W6YLs pictured at the Sunday picnic at QTH of WIHOY-W1FZJ at Medfield, I. to r. W6's CEE, DXI, QGX, UHA. K9QGR photo.

SEPTEMBER - OCTOBER, 1960

TIME ZONE: EST

EASTERN USA TO:

	10 METERS	15 METERS	20 METERS	40/80* METERS
Western Europe	8 A - 11A (1) 11A - 2 P (2) 2 P - 4 P (1)	7 A - 12N (2) 12N - 4 P (3) 4 P - 6 P (2) 6 P - 8 P (1)	5 A - 8 A (2) 8 A - 12N (1) 12N - 3 P (2) 3 P - 6 P (4) 6 P - 9 P (3) 9 P - 11P (2) 11P - 5 A (1)	6 P - 8 P (2) 8 P - 12M (3) 12M - 2 A (2) 10P - 1 A (2)*
Eastern Europe	10A - 1 P (1)	7 A - 1 P (2) 1 P - 4 P (1)	4 P - 8 P (1) 8 P - 11P (2) 11P - 2 A (1)	8 P - 11P (1)
North Africa	8 A - 12N (2) 12N - 2 P (3) 2 P - 3 P (2) 3 P - 4 P (1)	6 A - 12N (2) 12N - 3 P (3) 3 P - 5 P (2) 5 P - 8 P (1)	5 A - 7 A (2) 7 A - 12N (1) 12N - 4 P (2) 4 P - 9 P (4) 9 P - 11P (3) 11P - 1 A (2) 1 A - 5 A (1)	7 P - 12M (2) 9 P - 11P (1)*
South Africa	8 A - 10A (1) 10A - 1 P (2) 1 P - 3 P (3) 3 P - 5 P (2) 5 P - 6 P (1)	6 A - 11A (1) 11A - 3 P (2) 3 P - 5 P (3) 5 P - 7 P (2) 7 P - 8 P (1)	2 P - 5 P (1) 5 P - 7 P (2) 7 P - 9 P (3) 9 P - 1 A (2) 1 A - 7 A (1)	9 P - 12M (2) 10P - 12M (1)*
Eastern Mediterranean	8 A - 11A (1) 11A - 1 P (2) 1 P - 3 P (1)	7 A - 10A (1) 10A - 1 P (2) 1 P - 2 P (3) 2 P - 3 P (2) 3 P - 5 P (1)	1 P - 3 P (1) 3 P - 5 P (2) 5 P - 8 P (3) 8 P - 12M (2) 12M - 2 A (1)	7 P - 11P (1)
Central Asia	9 A - 12N (1) 6 P - 8 P (1)	9 A - 12N (2) 12N - 6 P (1) 6 P - 8 P (2) 8 P - 9 P (1)	7 A - 9 A (2) 9 A - 6 P (1) 6 P - 9 P (2) 9 P - 1 A (1)	6 P - 9 P (1) 5 A - 7 A (1)
Southeast Asia	2 P - 7 P (1)	10A - 11A (1) 11A - 1 P (2) 1 P - 5 P (1) 5 P - 8 P (2) 8 P - 9 P (1)	7 A - 9 A (2) 9 A - 12N (1) 5 P - 8 P (1)	NIL
Far East	5 P - 7 P (2) 7 P - 8 P (1)	8 A - 10A (1) 4 P - 6 P (1) 6 P - 8 P (3) 8 P - 9 P (2) 9 P - 10P (1)	1 A - 7 A (1) 7 A - 9 A (3) 9 A - 11A (1) 7 P - 11P (1) 11P - 1 A (2)	NIL
Pacific Islands	1 P - 5 P (2) 5 P - 7 P (3) 7 P - 8 P (2) 8 P - 9 P (1)	8 A - 1 P (2) 1 P - 4 P (1) 4 P - 7 P (2) 7 P - 9 P (3) 9 P - 11P (2) 11P - 1 A (1)	5 P - 8 P (1) 8 P - 10P (2) 10P - 1 A (4) 1 A - 4 A (3) 4 A - 7 A (2) 7 A - 9 A (3) 9 A - 11A (2) 11A - 1 P (1)	12M - 2 A (2) 2 A - 6 A (3) 6 A - 8 A (2) 2 A - 6 A (2)*
Australia	4 P - 8 P (2) 8 P - 10P (1)	9 A - 11A (2) 11A - 5 P (1) 5 P - 8 P (2) 8 P - 10P (3) 10P - 12M (2) 12M - 2 A (1)	9 P - 11P (1) 11P - 1 A (2) 1 A - 4 A (3) 4 A - 7 A (2) 7 A - 9 A (3) 9 A - 10A (2) 10A - 12N (1)	3 A - 6 A (2) 6 A - 8 A (1) 5 A - 7 A (1)*
New Zealand	8 A - 10A (1) 1 P - 4 P (2) 4 P - 6 P (3) 6 P - 8 P (2) 8 P - 10P (1)	12N - 5 P (1) 5 P - 7 P (2) 7 P - 9 P (3) 9 P - 12M (2) 12M - 4 A (1) 8 A - 10A (3)	7 P - 9 P (1) 9 P - 11P (2) 11P - 4 A (4) 4 A - 7 A (2) 7 A - 9 A (3) 9 A - 10A (2) 10A - 12N (1)	2 A - 6 A (3) 6 A - 8 A (1) 3 A - 6 A (2)*
South America	7 A - 9 A (2) 9 A - 2 P (3) 2 P - 6 P (4) 6 P - 8 P (2) 8 P - 11P (1)	6 A - 8 A (3) 8 A - 2 P (2) 2 P - 4 P (3) 4 P - 8 P (4) 8 P - 11P (3) 11P - 2 A (2) 2 A - 6 A (1)	2 P - 5 P (2) 5 P - 7 P (3) 7 P - 1 A (4) 1 A - 3 A (3) 3 A - 5 A (2) 5 A - 7 A (3) 7 A - 9 A (2) 9 A - 2 P (1)	6 P - 8 P (1) 8 P - 3 A (3) 3 A - 5 A (1) 9 P - 3 A (2)*
McMurdo Sound	2 P - 4 P (1) 4 P - 6 P (2) 6 P - 7 P (1)	3 P - 5 P (1) 5 P - 7 P (2) 7 P - 8 P (3) 8 P - 9 P (2) 9 P - 10P (1)	3 P - 6 P (1) 6 P - 8 P (2) 8 P - 11P (3) 11P - 3 A (2) 3 A - 7 A (1)	12M - 3 A (1)

TIME ZONES: CST & MST

CENTRAL USA TO:

	10 METERS	15 METERS	20 METERS	40/80* METERS
Western Europe	9 A - 12N (1) 12N - 1 P (2) 1 P - 3 P (1)	7 A - 12N (2) 12N - 2 P (3) 2 P - 4 P (2) 4 P - 6 P (1)	12N - 3 P (1) 3 P - 5 P (2) 5 P - 8 P (3) 8 P - 12M (2) 12M - 8 A (1)	8 P - 10P (1) 10P - 1 A (2) 1 A - 2 A (1) 10P - 1 A (1)*
Eastern Europe	9 A - 11A (1)	8 A - 11A (2) 11A - 1 P (1)	1 P - 4 P (1) 4 P - 6 P (2) 6 P - 10P (1) 10P - 12M (2) 12M - 8 A (1)	8 P - 1 A (1)
North Africa	8 A - 12N (1) 12N - 2 P (2) 2 P - 3 P (1)	6 A - 12N (2) 12N - 2 P (3) 2 P - 4 P (2) 4 P - 6 P (1)	5 A - 11A (1) 11A - 2 P (2) 2 P - 7 P (3) 7 P - 12M (2) 12M - 2 A (1)	7 P - 12M (2) 9 P - 11P (1)*
Central Africa	8 A - 10A (1) 10A - 1 P (2) 1 P - 3 P (3) 3 P - 5 P (2) 5 P - 6 P (1)	6 A - 11A (1) 11A - 2 P (2) 2 P - 6 P (3) 6 P - 8 P (2) 8 P - 10P (1)	1 P - 4 P (1) 4 P - 6 P (2) 6 P - 10P (3) 10P - 1 A (2) 1 A - 7 A (1)	8 P - 10P (2) 9 P - 10P (1)*
Eastern Mediterranean	10A - 12N (1)	7 A - 9 A (1) 9 A - 12N (2) 12N - 2 P (1)	1 P - 5 P (1) 5 P - 10P (2) 10P - 12M (1)	7 P - 11P (1)

Central Asia	8 A - 11A (1) 7 P - 9 P (1)	8 A - 12N (2) 12N - 6 P (1) 6 P - 9 P (2) 9 P - 10P (1)	7 A - 9 A (2) 9 A - 7 P (1) 7 P - 9 P (2) 9 P - 11P (1)	7 P - 8 P (1) 5 A - 7 A (1)
Southeast Asia	1 P - 5 P (1) 5 P - 7 P (2) 7 P - 9 P (1)	9 A - 12N (2) 12N - 7 P (1) 7 P - 9 P (2) 9 P - 11P (1)	7 A - 9 A (2) 9 A - 12N (1) 10P - 1 A (1)	NIL
Far East	3 P - 4 P (1) 4 P - 7 P (2) 7 P - 8 P (1)	7 A - 9 A (1) 2 P - 4 P (1) 4 P - 5 P (2) 5 P - 8 P (3) 8 P - 10P (2) 10P - 12M (1)	10P - 7 A (1) 7 A - 9 A (2) 9 A - 1 P (1)	5 A - 7 A (1)
Pacific Islands	12N - 5 P (2) 5 P - 7 P (3) 7 P - 8 P (2) 8 P - 9 P (1)	7 A - 1 P (2) 1 P - 4 P (1) 4 P - 6 P (2) 6 P - 8 P (3) 8 P - 10P (2) 10P - 12M (1)	4 P - 6 P (1) 6 P - 8 P (2) 8 P - 3 A (4) 3 A - 5 A (3) 5 A - 7 A (2) 7 A - 9 A (3) 9 A - 11A (2) 11A - 1 P (1)	12M - 7 A (3) 7 A - 9 A (2) 1 A - 7 A (2)*
Australia	8 A - 10A (1) 2 P - 3 P (2) 3 P - 7 P (3) 7 P - 8 P (2) 8 P - 9 P (1)	8 A - 11A (2) 11A - 4 P (1) 4 P - 8 P (2) 8 P - 10P (3) 10P - 11P (2) 11P - 1 A (1)	8 P - 10P (1) 10P - 12M (2) 12M - 4 A (3) 4 A - 7 A (2) 7 A - 9 A (3) 9 A - 11A (2) 11A - 1 P (1)	3 A - 8 A (2) 4 A - 6 A (1)*
New Zealand	11A - 1 P (1) 1 P - 2 P (2) 2 P - 7 P (3) 7 P - 8 P (2) 8 P - 9 P (1)	12N - 5 P (1) 5 P - 7 P (2) 7 P - 10P (3) 10P - 3 A (2) 3 A - 7 A (1) 7 A - 9 A (2)	6 P - 8 P (1) 8 P - 10P (2) 10P - 4 A (4) 4 A - 9 A (3) 9 A - 10A (2) 10A - 12N (1)	1 A - 7 A (3) 7 A - 8 A (1) 2 A - 6 A (2)*
South America	7 A - 9 A (2) 9 A - 2 P (3) 2 P - 6 P (4) 6 P - 9 P (2) 9 P - 1 A (1)	6 A - 8 A (3) 8 A - 2 P (2) 2 P - 4 P (3) 4 P - 8 P (4) 8 P - 12M (3) 12M - 3 A (2) 3 A - 6 A (1)	2 P - 4 P (2) 4 P - 7 P (3) 7 P - 2 A (4) 2 A - 7 A (3) 7 A - 9 A (2) 9 A - 2 P (1)	7 P - 9 P (1) 9 P - 3 A (3) 3 A - 5 A (1) 8 P - 3 A (2)*
McMurdo Sound	10A - 12N (1) 12N - 3 P (2) 3 P - 6 P (3) 6 P - 7 P (2) 7 P - 8 P (1)	10A - 4 P (1) 4 P - 6 P (2) 6 P - 9 P (3) 9 P - 10P (2) 10P - 12M (1)	4 P - 6 P (1) 6 P - 8 P (2) 8 P - 11P (3) 11P - 4 A (2) 4 A - 6 A (1)	2 A - 6 A (1)

TIME ZONE: PST

WESTERN USA TO:

	10 METERS	15 METERS	20 METERS	40/80* METERS
Western Europe	8 A - 10A (1) 10A - 11A (2) 11A - 12N (1)	7 A - 8 A (1) 8 A - 11A (2) 11A - 1 P (1)	5 A - 7 A (2) 7 A - 12N (1) 12N - 5 P (2) 5 P - 9 P (1) 9 P - 11P (2) 11P - 5 A (1)	7 P - 11P (1) 8 P - 9 P (1)*
Eastern Europe	8 A - 11A (1)	6 A - 8 A (1) 8 A - 9 A (2) 9 A - 11A (1)	5 A - 7 A (2) 7 A - 12N (1) 12N - 3 P (2) 3 P - 9 P (1) 9 P - 11P (2) 11P - 5 A (1)	7 P - 11P (1)
North Africa	8 A - 10A (1) 10A - 12N (2) 12N - 2 P (1)	6 A - 9 A (2) 9 A - 12N (3) 12N - 2 P (2)	6 A - 10A (1) 10A - 2 P (2) 2 P - 5 P (3) 5 P - 7 P (2) 7 P - 12M (1)	6 P - 10P (2) 8 P - 9 P (1)*
South Africa	7 A - 10A (2) 10A - 1 P (3) 1 P - 3 P (2) 3 P - 4 P (1)	5 A - 8 A (1) 8 A - 11A (2) 11A - 3 P (3) 3 P - 4 P (2) 4 P - 6 P (1)	11A - 1 P (1) 1 P - 3 P (2) 3 P - 5 P (3) 5 P - 9 P (2) 9 P - 11P (3) 11P - 12M (2) 12M - 2 A (1)	7 P - 10P (2) 8 P - 10P (1)*
Eastern Mediterranean	8 A - 11A (1)	7 A - 8 A (1) 8 A - 10A (2) 10A - 11A (1)	6 A - 9 A (2) 9 A - 7 P (1) 7 P - 9 P (2) 9 P - 11P (1)	NIL
Central Asia	8 A - 12N (1) 5 P - 7 P (2)	8 A - 10A (2) 10A - 12N (1) 12N - 5 P (1) 5 P - 7 P (2) 7 P - 9 P (1)	6 A - 8 A (2) 8 A - 12N (1) 10P - 12M (1)	NIL
Southeast Asia	10A - 12N (2) 12N - 4 P (1) 4 P - 6 P (2) 6 P - 8 P (1)	8 A - 9 A (2) 9 A - 11A (3) 11A - 1 P (2) 1 P - 5 P (1) 5 P - 9 P (2) 9 P - 11P (1)	1 A - 7 A (1) 7 A - 10A (2) 10A - 12N (1) 10P - 11P (1) 11P - 1 A (2)	3 A - 5 A (2) 5 A - 6 A (1) 3 A - 5 A (1)*
McMurdo Sound	10A - 12N (1) 12N - 3 P (2) 3 P - 5 P (3) 5 P - 7 P (2) 7 P - 8 P (1)	8 A - 10A (2) 10A - 3 P (1) 3 P - 6 P (2) 6 P - 8 P (3) 8 P - 10P (2) 10P - 12M (1)	4 P - 6 P (1) 6 P - 8 P (2) 8 P - 12M (3) 12M - 2 A (2) 2 A - 4 A (1)	12M - 6 A (1)
Far East	1 P - 3 P (2) 3 P - 6 P (3) 6 P - 7 P (2) 7 P - 8 P (1)	8 A - 12N (1) 12N - 2 P (3) 2 P - 5 P (2) 5 P - 7 P (4) 7 P - 8 P (3) 8 P - 9 P (2) 9 P - 10P (1)	7 A - 8 A (2) 8 A - 9 A (4) 9 A - 11A (3) 11A - 12N (2) 12N - 6 P (1) 6 P - 9 P (2) 9 P - 11P (3) 11P - 1 A (2) 1 A - 3 A (1)	2 A - 6 A (3) 6 A - 8 A (1) 3 A - 6 A (2)*



PROPAGATION

George Jacobs, W3ASK
11307 Clara St., Silver Springs, Md.

General Forecast

This month's column contains DX Propagation Charts for September and October, 1960.

September is a month of changing shortwave radio propagation conditions. During the early part of the month conditions are generally quite similar to those observed during the summer months, but towards the end of the month typical "wintertime" propagation conditions begin to become evident. Winter propagation conditions, which prevail through February, are characterized by *higher* usable frequencies during the daytime hours and *lower* usable frequencies during the hours of darkness, as compared to summertime conditions. During September, therefore, a sharp *increase* in daytime 10 and 15 meter openings are expected, but 20 meter openings during the hours of darkness are expected to *decrease*. Static levels and ionospheric absorption begin to decrease during September,

and will continue to decrease during the winter months. This is expected to result in generally improved propagation conditions on 40, 80 and 160 meters, especially during the hours of darkness. Sporadic-E type short-skip openings are expected to decrease sharply during September, while the occurrence of auroral activity usually peaks during the month.

During late September, and continuing through October, there is generally a considerable improvement in propagation conditions on long circuits between the northern and southern hemispheres (for example, between the USA and Australia). This improvement is forecast for all amateur bands between 10 and 160 meters.

Sunspot Cycle Progress

The Zurich Solar Observatory reports a monthly mean sunspot number of 109 for June, 1960. This result in a 12 month smoothed sun-

Pacific Islands	9 A - 2 P (2)	7 A - 9 A (2)	4 P - 6 P (1)	10P - 6 A (3)
	3 P - 7 P (3)	9 A - 11A (3)	6 P - 8 P (2)	12M - 5 A (2)*
	7 P - 8 P (2)	11A - 4 P (2)	8 P - 3 A (4)	
	8 P - 10 P (1)	4 P - 6 P (3)	3 A - 4 A (3)	
	6 P - 10P (4)	4 A - 6 A (2)		
	10P - 12M (3)	6 A - 8 A (4)		
	12M - 1 A (2)	8 A - 9 A (3)		
	1 A - 3 A (1)	9 A - 10A (2)		
		10A - 12N (1)		
Australia	7A - 9 A (1)	7 A - 9 A (2)	7 P - 9 P (1)	2 A - 7 A (3)
	12N - 4 P (2)	9 A - 12N (1)	9 P - 11P (2)	3 A - 5 A (2)*
	4 P - 6 P (4)	12N - 6 P (2)	11P - 2 A (4)	
	6 P - 8 P (2)	6 P - 9 P (3)	2 A - 7 A (2)	
8 P - 9 P (1)	9 P - 11 P (2)	7 A - 9 A (2)		
	11P - 2 A (1)	9 A - 10A (2)		
		10A - 12N (1)		
New Zealand	10A - 3 P (3)	7 A - 9 A (1)	5 P - 7 P (1)	12M - 6 A (3)
	3 P - 6 P (4)	9 A - 12N (2)	7 P - 9 P (2)	1 A - 5 A (2)*
	6 P - 8 P (3)	12N - 4 P (1)	9 P - 3 A (4)	
	8 P - 10P (2)	4 P - 7 P (2)	3 A - 7 A (3)	
10P - 11P (1)	7 P - 10P (4)	7 A - 9 A (2)		
	10P - 1 A (2)	9 A - 11A (1)		
	1 A - 3 A (1)			
South America	5 A - 7 A (2)	5 A - 7 A (3)	2 P - 4 P (2)	7 P - 8 P (1)
	7 A - 12N (3)	7 A - 12N (2)	4 P - 6 P (3)	8 P - 1 A (3)
	12N - 4 P (4)	12N - 3 P (3)	6 P - 12M (4)	1 A - 2 A (1)
	4 P - 7 P (2)	3 P - 7 P (4)	12M - 5 A (3)	8 P - 12M (2)*
7 P - 12M (1)	7 P - 9 P (3)	5 A - 7 A (2)		
	9 P - 1 A (2)	7 A - 2 P (1)		
	1 A - 5 A (1)			

FORECAST INDICES

Circuits forecast to open:

- (1) Less than 7 days during each month of forecast period.
- (2) Between 8 and 13 days during each month of forecast period.
- (3) Between 14 and 22 days during each month of forecast period.
- (4) On more than 22 days during each month of forecast period.

See "Last Minute Forecast" in text for the relationship between the Forecast Indices and the day-to-day propagation conditions expected during the month.

* Indicates expected times for 80 meter openings. On nights when atmospheric noise conditions are exceptionally quiet, 160 meter openings are likely to occur during these same periods.

A - A. M. P - P. M. N - Noon M - Midnight

The CQ DX Propagation Charts are based upon a CW effective radiated power of 150 watts at radiation angles less than thirty degrees, and are centered on the Eastern, Central and Western areas of the USA. The DX Charts are valid through October, 1960. See the May issue of CQ for further details concerning the use of these Charts. These forecasts are based upon basic ionospheric data published by the Central Radio Propagation Laboratory of the National Bureau of Standards, Boulder, Colorado.



W3ASK, CQ's Propagation Editor, at his last winter's QTH in the Swiss mountain town of Zermatt. With George are his YL Jr. Ops Michele (age 11) and Joy (age 7).

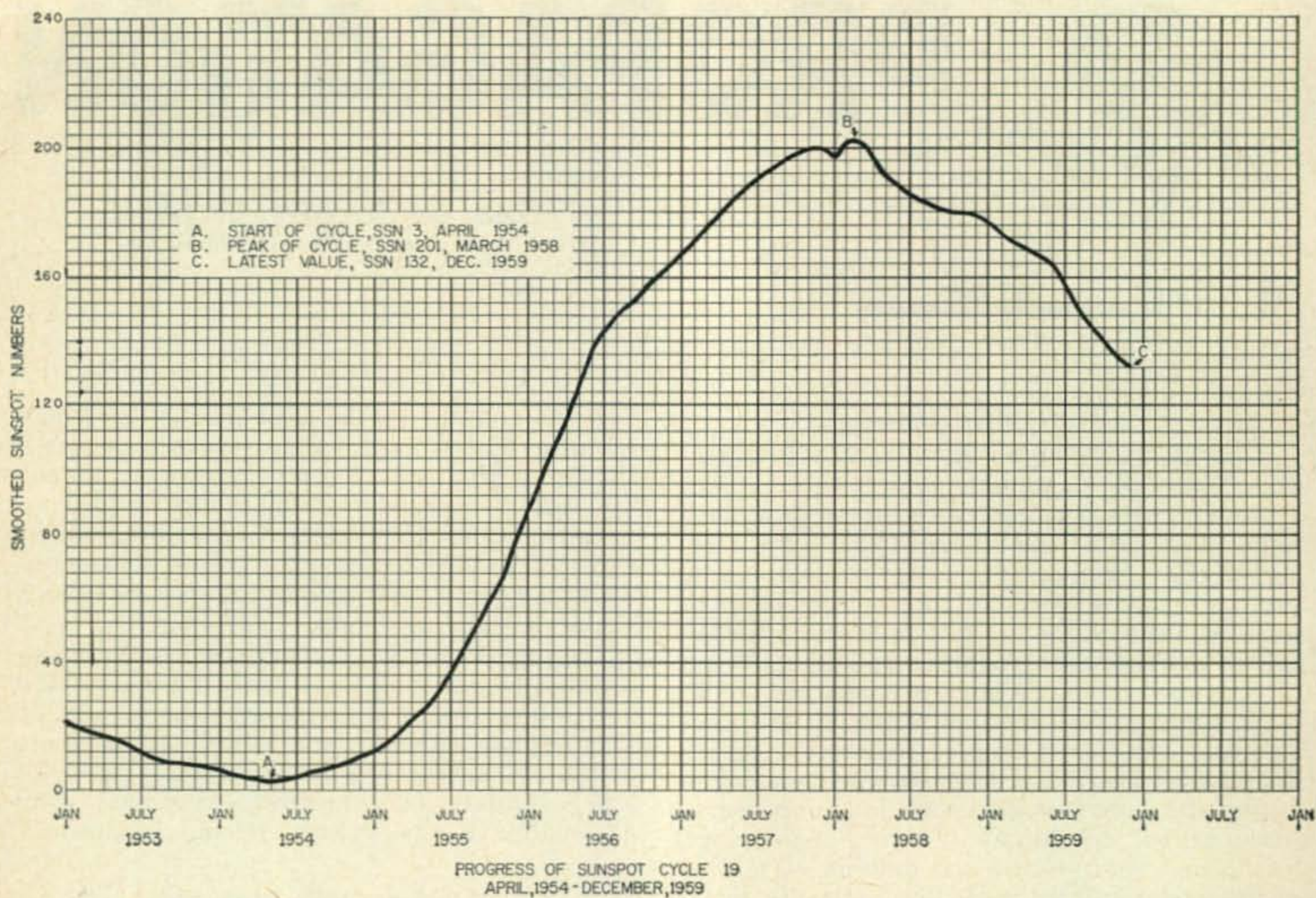

Fig. 1—Graphic presentation of the Sunspot Cycle progress listed in Table 1.

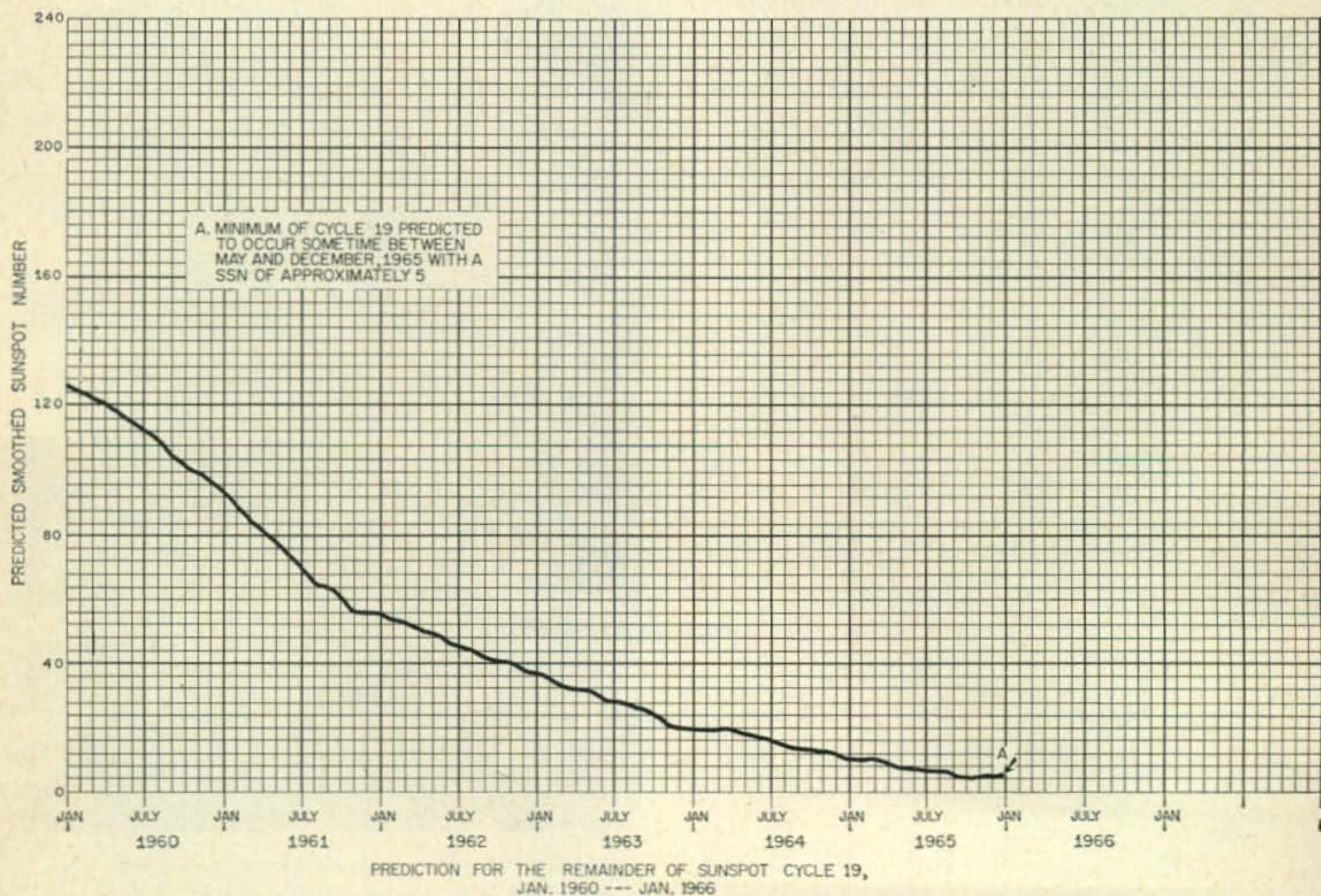

Fig. 2—Graphic presentation of the predicted behavior of the remainder of Sunspot Cycle 19 listed in Table 2.

spot number of 132 centered on December, 1959. This month's CQ propagation forecast is based upon a predicted smoothed sunspot number of 106 centered on September, 1960.

The present sunspot cycle, cycle number 19, continues to decline from the record breaking peak established during March, 1958. Figure 1 and Table 1 depict the course of cycle 19 since its beginning in April, 1954. CQ's prediction for the remainder of the cycle, based on extensive research conducted by the editor of this column, is shown in fig. 2 and Table 2. *Solar activity is expected to decline continuously until the minimum of the present cycle is reached sometime during the latter half of 1965.* With this decline in solar activity there is expected to occur a related decline in general shortwave radio propagation conditions. The influence of the declining solar cycle on propagation conditions for the various amateur bands will be discussed in greater detail in a special article being prepared for publication in CQ later this year.

TABLE 1

Observed smoothed sunspot numbers for Sunspot Cycle 19 April 1954- December 1959

	1954	1955	1956	1957	1958	1959
Jan.	6	14	89	170	199	179
Feb.	5	16	99	172	201	177
March	4	20	109	174	201	175
April	3	23	119	181	197	169
May	4	29	127	186	191	165
June	4	35	137	188	187	161
July	5	40	146	191	185	156
Aug.	7	47	150	194	185	151
Sept.	8	56	152	197	184	146
Oct.	8	64	156	200	182	140
Nov.	10	73	160	201	181	136
Dec.	12	81	164	200	181	132

TABLE 2

CQ's smoothed sunspot number prediction for the remainder of Cycle 19.

	1960	1961	1962	1963	1964	1965
Jan.	127	94	57	38	21	11
Feb.	124	91	56	37	21	10
March	122	87	55	35	20	9
April	120	83	53	34	19	8
May	118	80	50	33	18	8
June	115	75	48	31	17	7
July	112	71	46	29	16	6
Aug.	109	66	44	27	15	6
Sept.	106	64	43	25	14	5*
Oct.	103	61	42	24	13	5*
Nov.	99	59	41	23	12	5*
Dec.	97	58	39	22	11	5*

*Absolute minimum expected to occur sometime during this period

Last Minute Forecast

The Forecast Indices for the month of September, shown in the Propagation Charts by parentheses following the times of openings, are expected to be related to day-to-day propagation conditions in the following manner:

Forecast Indices	Above Normal	Normal	Below Normal	Disturbed
	Sept. 2-5, 8-10	Sept. 6-7, 11-17, 22-23, 27, 30	Sept. 1, 28-29	Sept. 18-21, 24, 26
(1)	C	D-E	E	E
(2)	B	C-D	E	E
(3)	A	B-C	D-E	E
(4)	A	A	B-C	D
(5)*	A	A	B	C

Where:

- A - Excellent circuit, strong steady signals.
- B - Good circuit, moderately strong signals, some fading and noise.
- C - Fair circuit, moderately strong to weak signals, moderate fading and noise.
- D - Poor circuit, weak signals, considerable fading and very high noise level.
- E - Circuit out.

*Applies to Short-Skip Propagation Charts appearing in last month's column.

73, George, W3ASK

YL [from page 73]

is 85 years young and still active in Ham radio!

YLS seated at each table then introduced themselves. The total registration included: W1's RLQ, UKR, ZEN, ITW, YPH, FTJ, CEW, QON, VOS, ICV, ZJS, EYS, HGM, GSF, SCS, SVN, LES, ZEJ, HOY, FOF, HUH, UZR, KDY, ZR, HBW, TUD, DQF, COL; K1s JGP, EKO, ADY, IIF, CDC, IZT, DTR, HXX, ION, JOE, LCI, AEY, JNM, HF, GCU, DZZ; W2EEO; K2's DKL, TGZ, DPN, GTJ, JYZ, IGA; W3's PVH, TNP, GTC; K3's DKN, LFZ, EDO; W4's HWR/2, BAV, HRC, ERX; K4's CTF, LMB; KN4VHM; W5's EGD/3, TOW/2, RZJ; K5's NJW, MRU, BNQ, ZZJ, ZZK; W6's, CEE, DXI, QGX, UHA; W8RIR; K8MZT; W9's RUJ, YWH, GME; K9QGR; OH5SM; ex-PAØULA, and several others not licensed. Of the above YLS, only these four have attended

all three of the YLRL Conventions: W3PVH, Betty; W6CEE, Vada; W6QGX, Harryette, and W5RZJ.

Completing the afternoon activities, prizes were awarded to OH5SM as the YL coming the greatest distance—she flew from Finland. (K5MRU, Grace, and her OM also flew to the convention, in their own plane, from Texas.) Another prize went to W6QGX, Harryette, for traveling the greatest distance mobile. She and W6DXI drove all the way from California and kept daily skeds with home via a rig especially installed for the trip. (KØBTV, Kay, also mobile all the way from Colorado, to attend Nat'l Bu. Standards meetings as well as the YLRL convention.) Later a prize was awarded to K5BNQ, Doris, as the YL present who had

[Continued on page 90]

Earth-Moon-Earth QSO

The first amateur radio moon-bounce two-way microwave communication took place July 17, between two distant points. This contact marks an important milestone in the development of amateur radio. The historic contact was between the members of the Eimac Radio Club in San Carlos, California and Sam Harris, Rhododendron Swamp VHF Society, Medfield, Mass., VHF Editor for *CQ*.

After months of personal effort by the radio amateurs concerned with this project, signals were transmitted in both directions on 1296 mc. The equipment was then refined and the first successful two-way communication was made Thursday morning, July 21st between 7:30 and 8:00 AM, PDT. The first transmission was from West (W6HB) to East (W1BU); the pattern was then reversed and the first amateur coast-to-coast communication via the moon completed. At each end of the circuit, a 1000 watt klystron was used in the transmitter and a very sensitive Microwave Associates MA2-1000 parametric amplifier in the receiver.

This successful reception and transmission using the moon as a signal reflector will stimulate efforts to improve amateur-built equipment for further moon bounce communications. The only other moon bounce communications equipment in existence is military or experimental in nature; the principal installation is the Naval link between Washington and Hawaii which employs a huge 85' antenna and special equipment not available to amateurs.

Once more the amateur radio operator has blazed a trail of progress through his constant desire to experiment with radio as a hobby.

The members of the Eimac Radio Club, San Carlos, California, who participated in the moon bounce circuit are: Bill Orr, W6SAI, Menlo

Park; Hank Brown, W6HB, Menlo Park; Bill Eitel, W6UF, Woodside; Ray Rinaudo, W6KEV, San Mateo; Bob Morwood, K6GJF, Redwood City; Bob Sutherland, W6UOV, San Mateo; Hugh MacDonald, W6CDT, Millbrae; George Badger, W6RXW, Menlo Park; Allan Beer, K6GSO, San Carlos; Al Clark, W6MUC, Los Altos; Mike Krivohlavek, K6AXN, San Leandro; Charlie Anderson, W6IVZ, San Carlos.

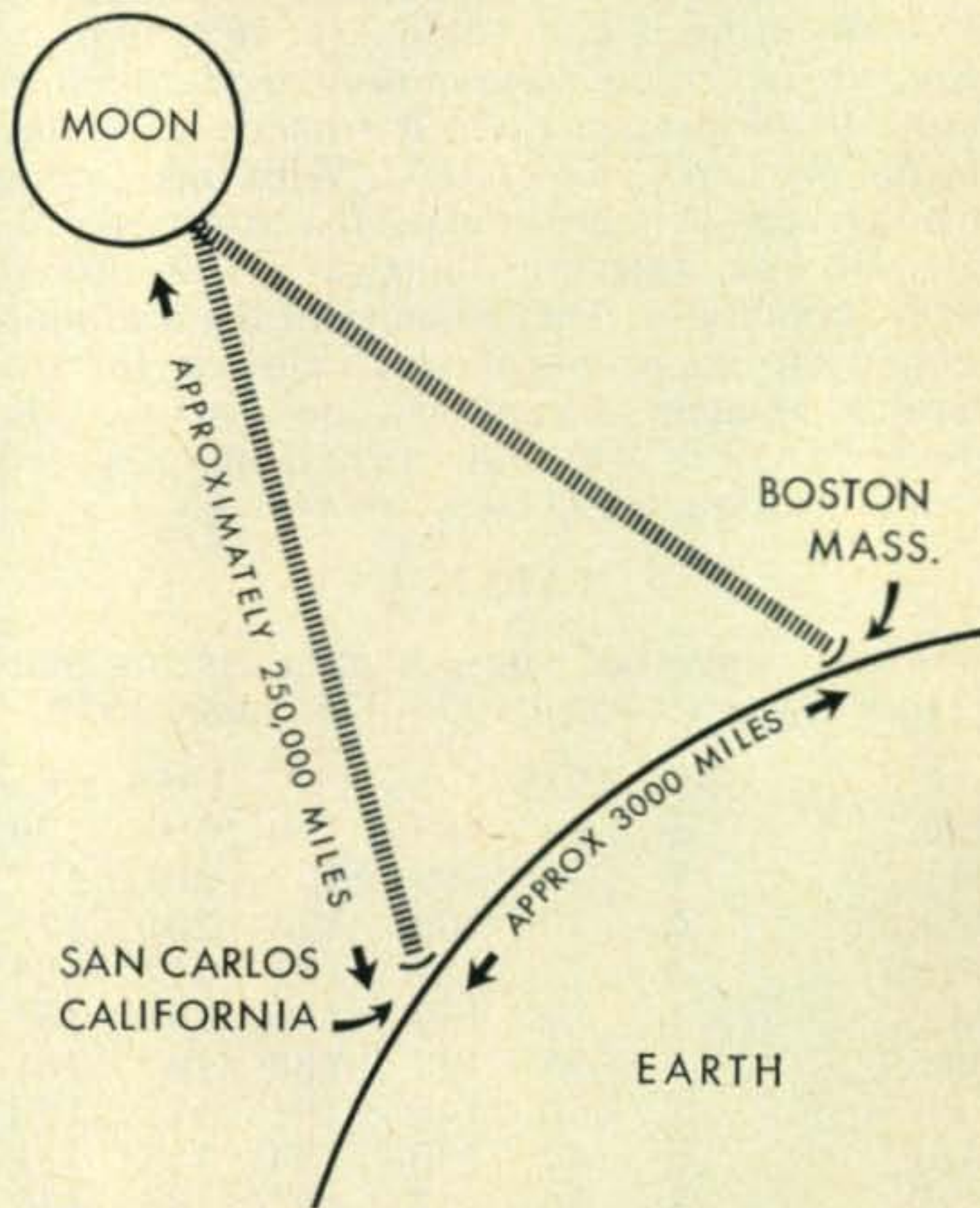

Path of the 1296 mc signal of W1FZJ-W6HB. The moon characteristics are: Mean distance from earth, 238,000 miles; Diameter, 2,160 miles; Radar cross section, 10^{12} square meters.

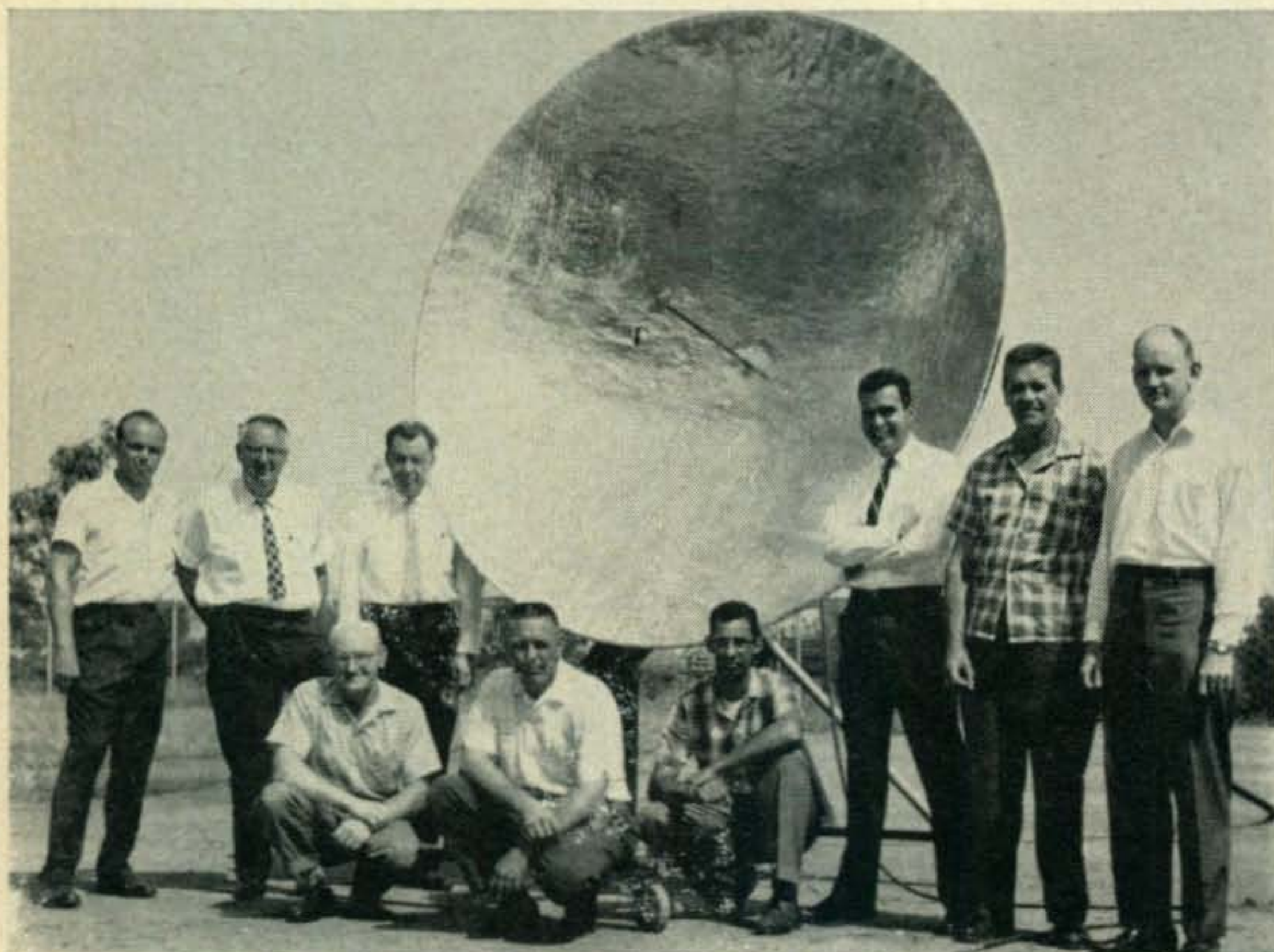

Standing from l. to r.; Robert Sutherland, W6UOV, O. H. Brown, W6HB; Bill Eitel, W6UF; George Badger, W6RXW; Al Clark, W6MUC; Bob Morwood, K6GJF; sitting Ray Rinaudo, W6KEV; Charles Anderson, W6IVZ; and Allen Beer, K6GSO.

VHF

50mc. 144mc. 220mc. 420mc. and above

Sam Harris, W1FZJ

P. O. Box 334, Medfield, Mass.

1296 Moonbounce

As mentioned last month we have the R.S.-V.H.F.S. project on the air. Innumerable nights of keeping the moon warm have given us a big light bill and lots of echoes. We can get returns almost at will. Tracking system works 90% of the time; receiver and transmitter are 100% reliable. Maintenance time on the equipment averages three hours a day, operating time about two hours.

We no longer keep the nightly (when moon is up) schedules but will keep individual schedules with any interested parties.

So far the only signals received other than our own were some fairly good steady carriers and a few isolated letters and calls from either W6HB, 6UF or K6GSM in San Bruno, California. Got one 1FZJ and one W1FZJ plus the calls above, out of a half hour of tape. Maybe by the time you read this we will have made a two way contact. See opposite page.

In case you think you have to be a millionaire to operate a moon bounce project, take a look at what ol' Jack (W8LIO) is building in the miserable photograph he sent.

Jack plans a twenty foot by seventeen foot parabola of a cylinder. Gain should be around 34 db. Total cost under \$100.00 plus lots of blood and sweat. Should be done by reading time. Drop him a line at Dorset, Ohio, and give moral support.

220 mc

About twelve years have been used up since old Gordon (W1OUN) favored the "VHF News" with an article on converting the ARC-5/T23 for use on 220 mc. Gordon's conversion was a success then and needs no improving now. I personally have converted four T23s following his directions, with results as predicted. It is interesting to note his comments on 220 mc activity twelve years ago.

220 mc The Easy Way

With equipment techniques for two meters reaching a point of saturation, and activity on that band settling down to a DX competition, many experimentally inclined amateurs are turning towards exploring the bands above two meters. Several articles have appeared in other publications on obtaining crystal controlled output on the 220 mc band, but perhaps the simplest method lies in converting a piece of surplus gear that many hams are using already on the two meter band.

This versatile transmitter, called the ARC-5/T23, contains four sets of coils, each set pretuned to any desired frequency in the normal range of the unit. Thus, operation on the remaining channels is not harmed by altering any given set of coils. By removing the coil forms from the turrets, the coils become very easy to work on, and the whole conversion should not

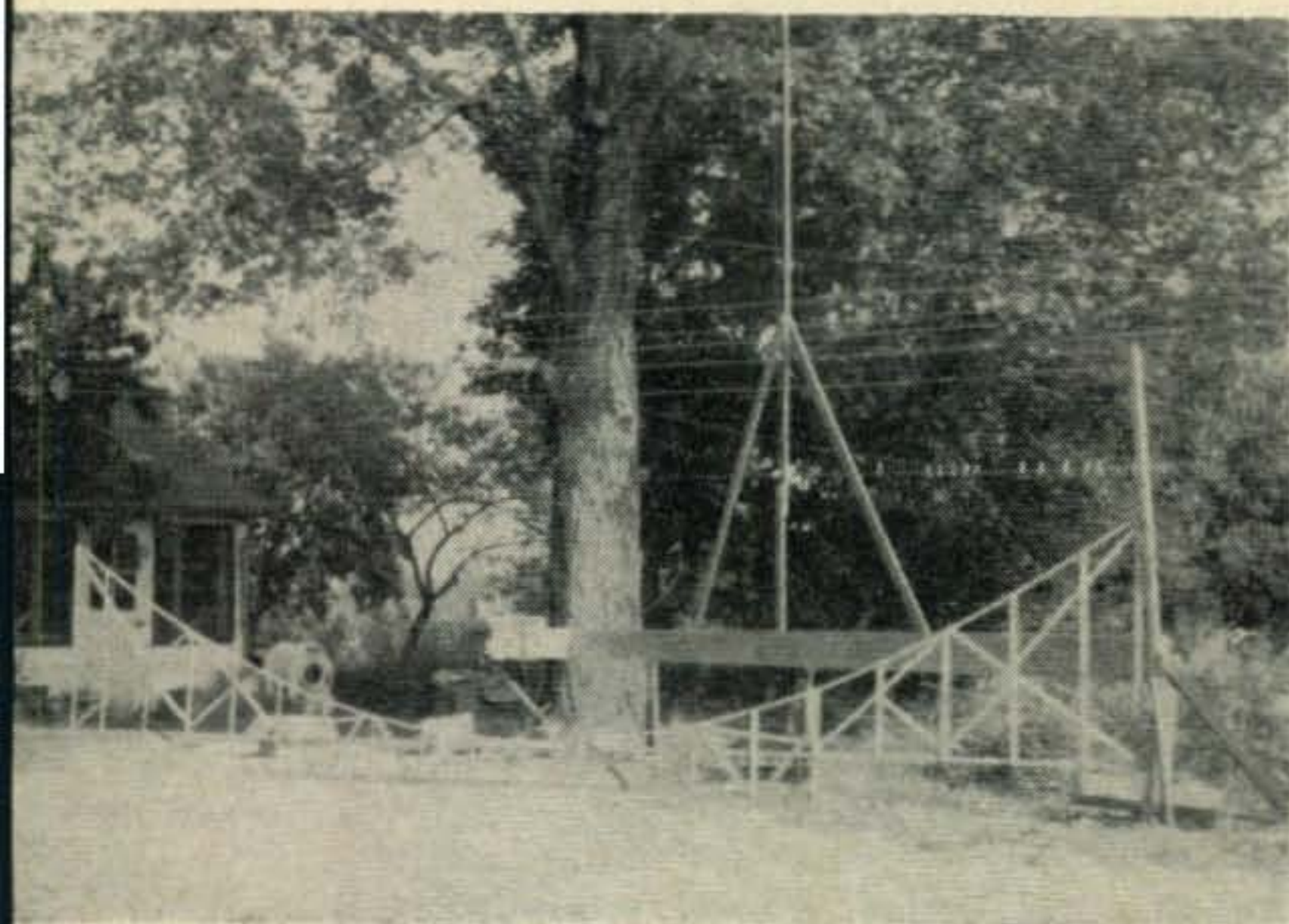

Measuring curve of parabola at W8LIO.



First completed section of parabola

take much over an hour. Channel D was selected by the author because it was easy to remember the various channel frequencies as running from low to high in alphabetical order.

Turns data are given in Table I; these turns are for the same size wire that was supplied on Channel D.

In the new arrangement, the total multiplication is 27 times. Crystals in the range 8148 to 8333 kilocycles should be used.

The final tank is made by removing the regular ceramic coil form and soldering a hairpin loop, two inches long by one inch wide, directly to the two studs making connection to the plate pins of the 832-A. Across these two studs, a 3-30 mica trimmer capacitor, compression type, is mounted.

Care should be taken so that there is sufficient clearance for the turret to rotate freely. The antenna coupling loop is another hairpin, roughly an inch in diameter, mounted parallel to the plate tank.

Plate voltage should be removed from the final during preliminary tune-up of the driver stages. The only caution to be observed is to make sure that the third crystal harmonic is obtained at turret No. 2; this will be the resonance position obtained with the slug screwed furthest out. (A neon bulb will be helpful at this point, as well as the regular grid current metering provided in the ARC-5.)

The addition of two, small, 2 mmf capacitors in parallel with two 3 mmf coupling capacitors supplied in the grid circuit of the final 832 as well as changing the grid leaks of the various stages, was helpful in obtaining the proper drive. A final grid current of 2 ma, under load, was obtained with approximately 400 volts on all stages. R.f. output should be approximately 10 watts under these conditions.

TABLE I

COIL	TRT	TRNS	XTALHARM.
#1 1625 P	2	14	3rd
#2 1625 P	3A	5	9th
#1 832A G	3B	8	9th
#1 832A P	4	2	27th
#2 832A P	5	1*	27th

*See text.

TABLE II

Oscillator grid leak:	82,000 ohms.
#2 1625 grid leak:	50,000 ohms.
#1 832A grid leak:	100,00 ohms, per grid.
#2 832A grid leak:	unchanged.

Proposal for 144 mc

After consulting with W2CXY, K2GQI and W2TTM, I would like to propose the following calling and listening sequences when propagation conditions indicate the possibility of E_s on 144 mc:

STATION	Transmit	Listen
West of Miss. River	1st, 3rd and 5th minutes of each $\frac{1}{4}$ hr., beginning on the hour.	2nd, 4th and 6th minutes of each $\frac{1}{4}$ hr., beginning on the hour.
East of Miss. River	2nd, 4th and 6th min., etc.	1st, 3rd and 5th min., etc.

As reported by W4LTU and others, it appears that a likely time for 144 mc E_s is when 50mc stations at midpoint of the 144 mc path are experiencing close-in E_s contacts. W2ORI watches f.m. broadcast band (88 - 108 mc) for E_s as an indication of possible 144 mc openings. It seems probable that a number of 144 E_s openings go unnoticed because of lack of systematic calling and listening, and perhaps the foregoing proposal will correct this situation.

Here is a list of some western stations who will probably be available for these schedules, particularly on week-ends:

W5VWU—Albuquerque, N. M.	144.169
K7HKD—Cheyenne, Wyo.	.195
W7JRG—Billings, Mont.	.010
W7QDJ—Clearfield, Utah	.025
WØAZT—Denver, Colorado	.062
WØIC—Denver, "	.103
WØENC—Rapid City, So. Dak.	.187
WØMOX—Boulder, Colorado	.059

The foregoing proposal was made by Claude M. Maer, Jr., WØIC, and sounds like a good one to us.

Clubs, Nets and Mail

The membership of the Phoenix VHF Radio Club has altered the requirements in regards to obtaining a QSO certificate in consideration of the passing of the peak of the sunspot cycle. Effective June 15, 1960, those stations outside of the continental limits of the USA (including Alaska and Hawaii) may obtain the certificate following five contacts with active Phoenix VHF Radio Club members confirmed by QSL. The requirements for the original forty eight States remains at 10 confirmed contacts.

In view of the revised requirements, a certificate has been awarded to LU3DCA, having acquired his 5 contacts, and in special recognition of his outstanding work in the v.h.f. spectrum. This is the first such certificate issued to a South American Station and the second to a foreign country. XE1PG, Mexico City, previously qualified under the original ten contact requirement.

The Mt. Airy VHF Radio Club is changing their 220 net frequency to 221.4 mc. Over the past year they have had a high of fifteen stations call in on one night and on another occasion had six states call in.

The 220 net is one of three nets sponsored by the club on Monday nights.

50.2 mc at 20.00 144.2 mc at 2100
221.4 mc at 2215

All nets are informal and anyone is invited to call in.

Milan, Italy—Marie (I1ER) sends a bit of information concerning contest contacts in Europe.

"On May 7th and 8th ran a VHF Contest here and I was astonished to contact three portable stations, namely F9UY, F2PP and HB1OF. High groups of mountains, (Alps) more than 12,000 feet, obstructed these paths and it appears hard to establish if these QSOs were due to ionospheric or tropospheric scattering, or to a diffraction by the so called 'knife edge' effects from tops of mountains, especially for the path from IIER-HB1OF.

"The stations F9UY and HB1OF were heard most of the time of the contest period, and I QSOed both again on Sunday PM when signals were heard S9 plus here. *Many thanks, Mario. Just one more of the many problems (?) still to be answered on a v.h.f. band.*

New London, Connecticut—Another interesting report from Carl Milner (W1FVY/K1JSG):

"We hope to have KL7FLC back in operation at T-3 about the first of August. We will then probably stay in operation well into October. *Anyone hear 'em yet?*

"I expect to leave Seattle, bound for T-3 about the 18th of July. Now that the summer melt is in progress, the air strips have melted out and the only way to get there is by "Ice Breaker."

"We will be in operation on 2, 6, 10, 15, 20, 40 and 80 meters as time permits. On 2 and 6 meters we will have the 6N2 Thunderbolt KW in operation a large portion of the time. We will also operate our KWM-1 on 10, 15, or 20 meters into our TA33 for communication back to our home station, W1RQU at the Laboratory in New London. The Viking II will be used evenings on 75 for local Alaska contacts.

"Our frequency on six meters will have to be raised slightly so that we can operate on both phone and c.w. We will probably operate on 50.16 or 50.4 mc. We hope to get both our 5 element Mosley beams stacked this trip as the weather will be more suitable for antenna work than it was this winter.

"There is a possibility that Bob, W1IJD, may be unable to make the trip this time, in which case he will be holding down the fort at W1RQU this time.

"The best time for trying to hear KL7FLC will be at plus to minus one hour from solar midnight at the stateside location. Reports of reception should be forwarded to E. Tilton at ARRL. *Honestly Carl, we'd be interested too!*

Gurdon, Arkansas—Report from Jay (W5-JWL), avid two meter man, concerning the June 18th opening.

"I believe you have me with 21 states on two meters—so here is the dope: 8/30/58-Georgia-W4FWH-#22, 1/3/59-Conn.-W1REZ-MS #23, 8/13/59-Pennsylvania-W3TDF-MS #24, 9/13-59-Nebraska-WØEMS-#25, 6/18/60-West Virginia-#26, and last on 6/18/60-New York-W2RXG-#27.

"All afternoon of the 18th of June, the TV spectrum was full-house on all channels. Called and listened frequently during afternoon looking NE, N, NW, but only heard a faint carrier

on .130 a time or two. Finally about 2214 CST heard W8WNM and then the fun began. Worked the following W8's-QVK, TYY, SDJ, SFG, BLN, KAY, LOG, plus K8AXU, W9IFA, W9MEA, W3RUE, W3ER, W3GKP, W3SGA and W2RXG. Locally we were hearing W5AJG, W4HHK, W4RFR, W5KTD and other La. and Okla. stations. Certainly did enjoy this opening as we had managed to miss several good ones the past year or two.

"I now have a pair of 4X250B's in the final running limit on c.w. and am still using 416B pre-amp, 417A converter into 75A1 and 23' 13 element long yagi. Expecting to have a Boehme keyer going by the August Meteor showers.

Dallas, Texas—Same opening as seen by Leroy May (W5AJG).

"Following is a report of a nice opening for us on 144 mc down here in Dallas. This 144 mc opening (and 220 mc) occurred, starting at about 1000 PM, CST, and lasted until about 3:00 a.m. This was Saturday night and Sunday morning, June 18th and 19th. The following states were heard or worked on 144 mc: Kentucky, Maryland, Pennsylvania, West Virginia, Illinois, Ohio, Tennessee, Kansas, Missouri, Oklahoma and Texas.

"The following stations were worked from W5AJG: W8KAY, W3RUE, K8AXU, W9IFA, W3SGA, W4LTU, W3GKP, W4HJQ, W8LOF, W8SFG, K9SGD, W4HHK.

"Stations logged but not worked were: K8ABU, K8COJ, W8TOJ, W8BLN, KØQCS.

"W2SMX called W5AJG by telephone and played back the signals on the land line. Was not able to hear W2SMX however at Dallas for some reason.

"During the QSO with K8AXU, he transmitted on 220 mc. Signals were immediately received on this band by W5AJG and retransmitted back to K8AXU on 144 mc. Then W5AJG got his transmitter on 220 mc and two way was established with K8AXU. This is a good haul for 220 mc for overland distance.

"K8AXU was still coming in on Sunday morning as late as 6:30 a.m., CST.

REVISED BOX STANDING FOR W5AJG

Three new states picked up, Penn, W. Va., My-Ind.

144 mc-States worked-29	Call areas 9
220 mc-States worked- 3	Call areas-2

Wewoka, Oklahoma—A bit of 432 mc news from Merlin Berrie (W5HTZ).

"Have worked W4HHK twice this month (June) for the first Oklahoma-Tennessee contact on 432 mc. Signals were very good. The first contact was at 0552 on June 19th and the second at 2119 on June 20th.

"I have a 4X150 running straight through for final. Am using a parametric amplifier ahead of my converter, and am using a MA-HU diode in a circuit drawn by Microwave Associates. *Real good to hear from some using a par-amp, not many as yet but the number is up.*

73, Sam, W1FZJ



by **KEN GRAYSON, W2HDM**

Care of CQ 300 West 43rd Street,
N. Y. C. 36, N. Y.

With the advent of the citizens band licenses, we have been completely swamped helping the class "D" licensee get surplus equipment into operation. So much attention has been given by this department to this purpose, that some letters have literally taken months to answer. While in some aspects, the problem is similar to amateur problems, in approximate frequency and power levels of equipment, the citizens band is strictly speaking a commercial band and definitely not amateur in both scope and concept. By devoting much time to the commercial problem we are neglecting the amateur, something we cannot afford to do. Strictly speaking (and the FCC is strict about this), operation of a transmitter, such as is necessary in the conversion of surplus, requires a commercial license. While we have one, which, when properly used, enables the editor to properly and legally convert equipment to this or any other band, within the specifications established, most readers do not. As a matter of fact, most readers in attempting to convert surplus have very little electronic education, or so the letters we receive seem to indicate. No slur is intended, since we must all start somewhere, and we must walk before we run, and crawl before we walk. However, it seems that the conversion of surplus to this end is best left alone. Chances are it is cheaper to buy a kit than build from surplus, considering all of the problems and expenses that you'll run into. THEREFORE, we find it necessary to refuse any conversion assistance requested on any equipment of a non-amateur nature. This includes queries regarding conversions to marine, aircraft, citizens band and mobile applications. We are sorry that we must decline this service, but the responsibility is with the Ham and it is the Ham who must be serviced.

Barry's Two Meter Gem

When we saw the little rig shown in fig. 1,

we didn't quite believe it cost only twenty dollars. We took a look at it and saw that it was beautifully built and had a lot of features that would make it worthwhile converting. As a matter of fact, the conversion came with it and we had nothing to do but a bit of reporting. This device is apparently a telemetering transmitter operating in the 240 *mc* band. It is tone modulated with a twenty watt final amplifier.

The first part of the conversion is to modify the rig to two meters. This is easily accomplished by following the changes shown in fig. 2. This shows the oscillator and modulator and should be wired using the original oscillator tube (6201 is the military number for a 12AT7). L_1 is changed to a coil of 18 turns of number 28 enamel wound on an XR-91 coil form. This should resonate at 24 *mc* and it acts as a tripler coil for the 8 *mc* crystal. The remainder of the coils are changed, but the circuit otherwise remains the same. L_3 becomes 4 turns of number 16 enamel wound on a $\frac{3}{4}$ inch form, spaced to resonate at 72 *mc*. L_4 is identical to L_3 . L_2 is not used. L_5 and L_6 are each made of two turns of number 16 wire (enamel) wound on a $\frac{1}{2}$ inch diameter form, spaced for tuning at 144 *mc*. L_6 is center-tapped. The coil sets, L_3 , L_4 and L_5 , L_6 are tightly coupled to each other, as they were in the original equipment. L_7 is 6 turns of number 16 enamel wound on a $\frac{3}{8}$ inch diameter form, spaced one wire diameter, and center tapped. L_8 is two turns of number 16 enamel wound on a $\frac{3}{8}$ inch diameter form, and spaced one wire diameter. This coil is located at the center tap of L_7 (insulated from L_7 , of course). The Z-235 Ohmite RFC in the plate circuit of the 6360 should be changed to an Ohmite Z-144.

The original circuit was tone modulated by means of the screen-grid modulator tone-generator combination. Remove the motor and tone oscillator circuit and rewire as the circuit shows. There should be sufficient space within the unit for the modulator. The modulator we show uses

Fig. 1—The telemeter transmitter before the 2 meter conversion.

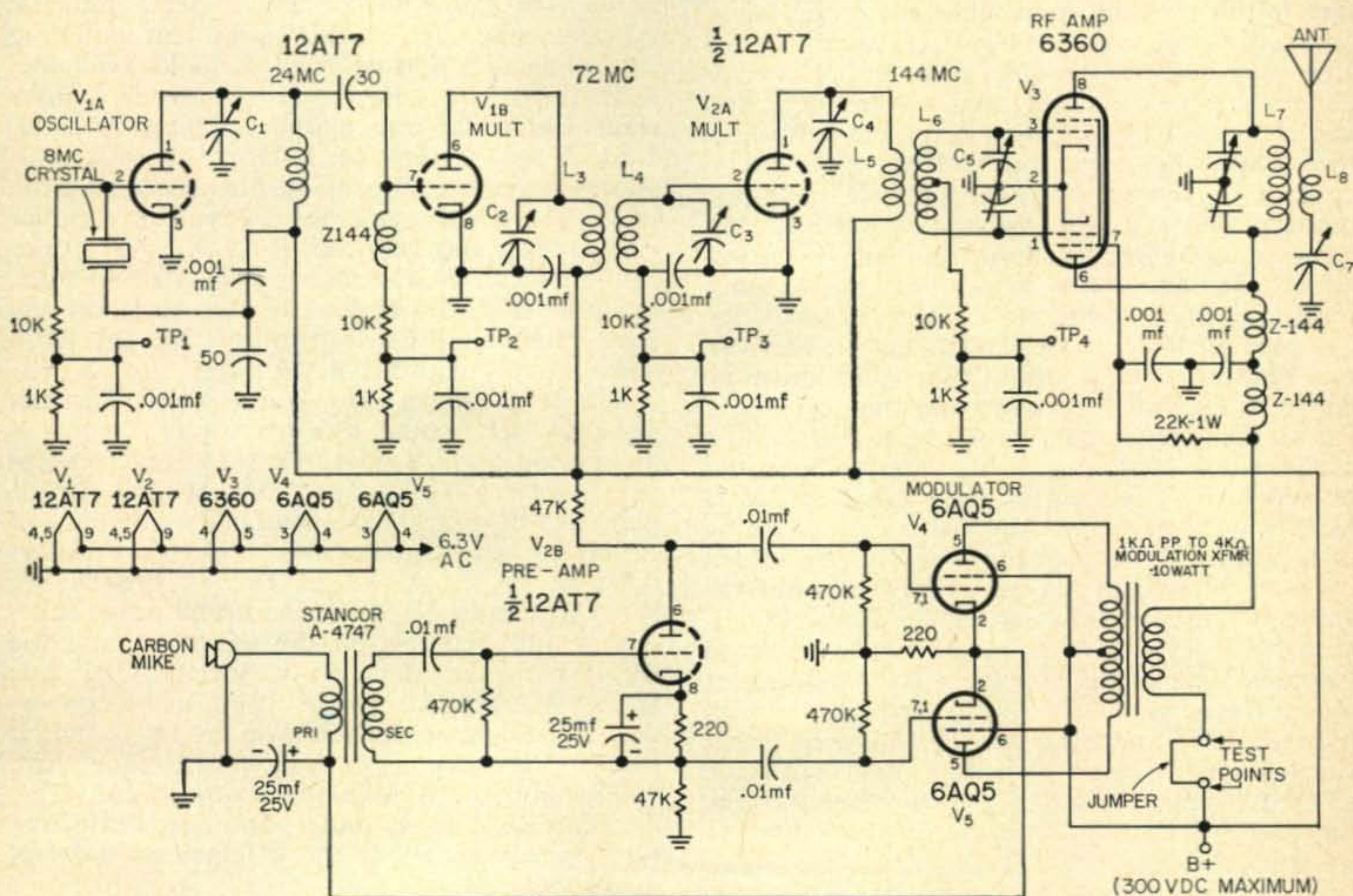
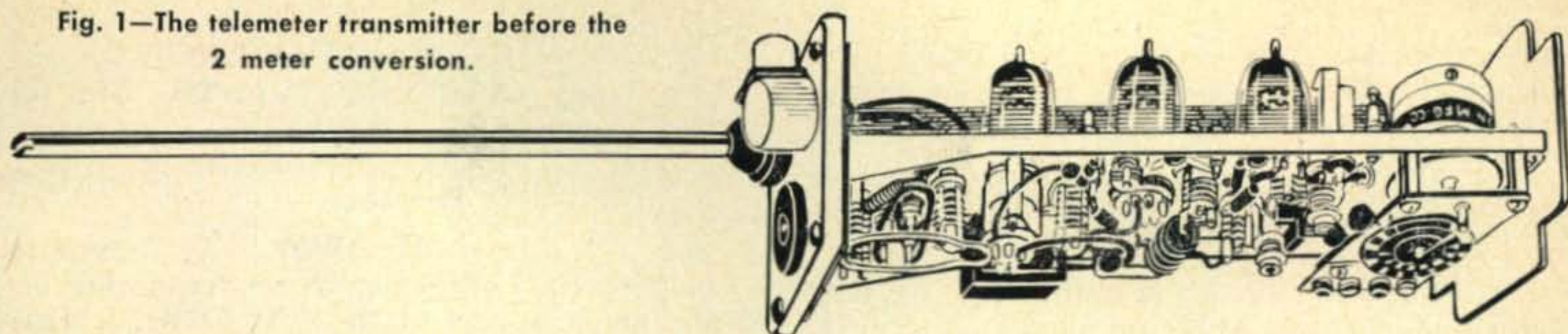

Fig. 2—The telemeter transmitter converted to 2 meters including a modulator.

tubes, and is quite conventional. Any desire to go mobile with this unit, and it should definitely be considered, since this is just right for mobile use, should make use of a transistor modulator, such as shown in the ARRL Handbook and the instruction book which Triad Transformers issues covering their 10 watt mobile modulator transformer TY-65Z. Tuning up the transmitter is no different than any other type. A 5 milliamper meter is used in the driver and doubler stages, while the final stage uses a 100 milliamper meter. Test points are provided for the 5 ma meter, but some method of getting into the final circuit plate lead should be provided, such as a set of test points with a jumper, (or an insulated closed circuit phone jack) as shown in the converted schematic.

Always tune a transmitter for maximum or rated grid drive, and minimum plate current. Increase the final plate current by adding some loading to the circuit (by C7 in the case of this unit) and then readjusting the plate current for a dip. This is done several times until the rated plate current is flowing. No change should be

seen in the final grid current, since the unit should be pretty well neutralized. Any grid current change would indicate a condition of improper neutralization.

While we had originally intended to present the R-257/U amplifier as a conversion this month, there just isn't enough room to do the job. This unit, which we got from Meshna, up in Malden Mass, is a fine little instrument, about 2" x 2" x 6" which can be converted to any frequency band from 25 to 50 mc as a crystal controlled converter. Meshna has worked out a pretty fine conversion and can supply this unit for about four and a quarter plus postage, I am told. Next month we will have room for a general bit of info on this conversion, for those who already have this receiver amplifier.

Next month we will also have a 3 inch oscilloscope conversion to a modulation monitor. This is the ID-11/APS-4 and the AM-5A/APS-5 scope indicator and amplifier. Rex Radio has this for all of four-fifty plus postage and it as a useful gadget in any shack, especially at that price. They also have a beautiful ground plane antenna for

six meters (new in boxes) for seven bucks plus postage for twenty pounds. It comes complete with clamps ready to attach on a mast, roof or what have you.

Mail

Just as a reminder to the uninitiated, we will publish your name, QTH and handbook request free in this column upon request. Certain stipulations must be imposed however, regarding the free plug, namely that no commercial use, or dealers in books may be listed. No responsibility can be assumed by CQ and that once published, the deal is between you and the people you contact. Likewise, we will publish bona-fide requests for assistance wherever possible, but again no commercial application will be honored. It takes about two months, at best, to get a request in the column and no degree of urgency can possibly speed it up. Just today we received two registered mail notices that will require ye editor to take off time and go to the post office, yet no possible problem could be that urgent or even serious. More than likely the problem could be solved by checking in back issues, which is exactly what happened the last time mail came in registered. The problem was already solved by a conversion of several years back, but because the sender didn't check his index (available from CQ for free yet) he wasted much valuable time of his and ours. As a method of aiding the newcomer we went through the back issues of QST and compiled the following list of surplus conversions which they published since 1945. Chances are we may have missed a few, but they will certainly aid the surplus hound in his work.

QST Surplus Conversions

BC-348	Jan 47	BC-221 as	
BC-645	Feb 47	Af Gen	Feb 50
BC-221 as a		BC-221 Cali-	
VFO	Mar 47	bration	Mar 50
Wilcox F-3	Apr 48	Q-5er	Feb 51
APS-13 on		PE-103A	Apr 51
420 mc	May 48	BC-221 Band-	
SCR-522 on		spread	Aug. 53
10	May 48	ARC-5 RCVR	
Q-5er for		6-10M	
BC-348	Jun 48	Conv.	Sept 53
ARC-5 Xmtr		ARC-5 Xmtr as	
Modulator	Jun 48	Het VFO	Nov 53
BC-788 on		BC-610 for	
420 mc	Jul 48	SSB	Nov 55
BC-610 Exciter		BC-454	Jan 59
units	Jul 48	BC-454	
PE-103A	Aug 48	(80-6)	May 59
HRO		ARC-5 RCVR	
(updating)	Feb 49	Triple	
ARC-5 Xmtr		Conv.	Aug 59
to 14 mc	Apr 49	ARC-5 Rcvr as	
SCR-522 Im-		tunable IF	Sept 59
provements	Apr 49	ARC-5 Xmtr	
ARC-5 Xmtrs		Xtal Contr	Nov 59
as Exciters	Jan 50		

BC-454 on
Two Bands Jan 60

T-23/ARC-5
"2M-SSB" May 60

Requests

Alec W. Brown, W6BWM, 131 Yosemite Ave., Madera, California, writes requesting information on a unit of the AN/ARR-27. This is the AM-259/ARR-27. Please send him any info you may have on this equipment including any schematics and instruction books available. B. E. Martin, 6012 Rogers Dr., Shawnee, Kansas wants conversion information for the R-1/ARR-1 for 2 or 6 meters. M. J. Douglas, 1401 Amador, Concord, California wants manuals for the BC-6405, RE-47 and RA2A power supplies (ART-13), and for the R-65/APN-9 Loran equipment. C. W. Davidson, 43 E. Yale Avenue, Orlando, Florida, is looking for data on the RR-6 receiver, RT-6 transmitter, and the RP-6 power supply with the RA-6 filter.

Clarke Redfield, 31 Grand View Terrace, Tenafly, N.J. would like to beg or borrow a manual on the KY-65A/ARA-26 Keyer equipment. Jeffrey Goldman, 5809 Midhill Street, Bethesda 14, Maryland would like a manual and conversion data on the BC-1000 to six meters AM. R. W. Rose, VK2AQR, 17 Brooks St., West Wallsend, N. S. W., Australia needs schematics and manuals on the BC-929A and the BC-184A indicators. Wray Sheen, 3501 Lee Street, Waukegan, Illinois would like a conversion, schematic or any books on the TS-16/APN. Philip Greenway, 2712 Caldwell Avenue, Apt. 8, Birmingham 5, Alabama wants to convert a T-14C/TRC-1 to six meters and needs information, especially about the original crystal frequencies.

Cliff Chadwick, 2450 Teller Street, Denver 15 Colorado is still looking for the data on the VRC-8, 9 & 10 as well as a BC-779 manual. Capt. Joseph E. Cooke, Hq. 1st BG 30th Inf., APO 36, New York, N. Y. is in dire need of any info in the case of an oscillator made by ESPEY, model 101, particularly with respect to the two lamps used therein.

Harry W. McGaughy, 303 W. Bay Drive, Olympia, Washington would like to get a manual on the TS-306/ARW test set. John Eigenbrode, 207 W. King St., Waynesboro, Pa. is seeking the R-1/ARR-1 and BC-AS-229 receiver and transmitter and would like to have manuals for them. Ernest H. Lorenson, Hillsdale, N. Y. needs a manual for the BC-639A and RA-42A power supply.

Raymond Robertson DL5BL, CO D 32nd Sig BN, APO-175, N.Y., N. Y. needs manuals on the BC-610E/BC-614E equipments, the BC-924, 0-165 and PE-120-A. Hilton Hoover Jr., Highway 51, Ponchatoula, La., wants to acquire info on the R-320-/FRC receiver. Joseph J. Lewalski, 1367 Perkiomen Ave., Reading Penna. is looking for conversion information for the ABD and ABK equipment test set to 2 meter operation.

73, Ken, W2HDM

sideband
sideband
sideband

SIDEBAND

Irv and Dorothy Strauber, K2HEA/K2MGE

12 Elm Street, Lynbrook, New York

SSB DX HONOR ROLL

TI2RC	212	ON4DM	150
TI2HP	210	W8YIN	148
W6UOU	207	K2FW	147
W8EAP	200	W1OOS	147
W8PQQ	200	K2HEA	146
VQ4ERR	200	K6LGF	143
W4IYC	199	W5KFT	138
W2JXH	190	VE3ES	136
W6PXH	190	W7DLR	135
PY4TK	186	KØCTL	135
W6RKP	181	W4OPM	129
W6BAF	180	W3VSU	127
WØQVZ	176	XE1AE	125
K2MGE	175	W2FXN	121
K9EAB	175	W6VUW	120
TG9AD	172	W1DCE	118
W6WNE	168	W6UPP	118
W2TP	159	W2MAF	117
MP4BBW	159	W4UWC	112
W2LV	159	W1JSS	110
WØCVU	158	W4ANE	110
W3MAC	152	W2ATJ	109
K6ZXW	151	ZS5DW	108
W5IYU	150	K8RTW	108
4X4DK	150	W7EOI	107

FLASH NEWS! Stop the presses, Mr. Editor! We just received the last two cards from Robby, VQ4ERR, qualifying him as the first station in Africa and the first station out of the Americas to win the "Worked 200 Countries" on sideband Certificate. Probably no one was more eager than Robby to earn this award. As he worked each new country during the past weeks, he extracted promises from the DX operators that their QSL cards would be sent directly to us via Air Mail. And the promises were kept; Robby's total on his file card mounted one by one! Finally, the magic number of 200 was reached just as this column was being put in the envelope that would take it to the magazine. Robby, it is with mutual pride in your achievement that we award you Certificate #6!

Al Hix, W8PQQ, entered the charmed circle of top SSB DX men by submitting the additional cards entitling him to Certificate #5 For "Worked 200 Countries." Many are trying but thus far few have succeeded in getting this award so each new station deserves a special bow for finally making the grade. Congratulations to you, Al, and keep up the good work.

Moving closer to the top this month with "Worked 175" stickers were PY4TK, K2MGE, K9EAB, and W6RKP. K6ZXW, W2LV, and W5IYU earned the "Worked 150" stickers while XE1AE was the only station to receive the "Worked 125" sticker. Swelling the list of stations receiving "Worked 100" Certificates were

W9YHE, K4YUX, DL4GX, VE3BWY, XE1SN, K2QXG, K8RTW, and W2LV, while K8CFU entered the DX race on SSB with a "Worked 50" Certificate.

Don't forget to send us a large stamped, self-addressed envelope for SSB DX awards regulations and convenient forms for listing your confirmations.

SSB WAS Contest Sept. 10-11

Draw a big red circle on your calendar for the exciting SSB Worked All States Contest which will open up the Fall operating season.

The contest starts at 1500 GMT, Sat., Sept. 10 and ends at 2100 GMT, Sun., Sept. 11. Full details appeared in the August issue in this column. If you missed them, send us a large envelope (stamped with 14¢ for airmail, 8¢ surface mail) and we'll rush the rules to you. Briefly, the object of the Contest is to work as many stations in as many of the 50 states as possible in 24 out of the 30 hours. We've been lining up the rare states so this weekend of Sept. 10-11 should provide you with the opportunity to get WAS on SSB in record time!

Keep It Clean!

Tuning across the 40 and 75 meter bands is apt to uncover some of the most bizarre and brazen deliberate interference ever heard in amateur radio. There is the "mystery" operator who appears regularly on the low end of 40 meter phone on weekends, using fake calls, whistling, playing music, and displaying other wanton evidence of disregarding regulations. Another major offender is the chap on the low end of 75 who sets himself on a well occupied frequency and proceeds to call stations who are not even on the band, let alone on the frequency—he never makes a contact—just sits there all evening passing derogatory remarks while *pretending* to call other operators.

The long suffering legitimate operators on these bands, probably not wishing to be considered "trouble makers" have done little else than complain to each other. Now you know and we know that complaining among yourselves is going to get you nowhere. Nor is it of any use to bury your heads in the sand like ostriches and pretend that this interference doesn't exist, in the vain hope that it will disappear if you don't call attention to it. These "bandits" are not only interfering with the enjoyment of

the hobby by legitimate operators but are also exhibiting disgraceful disregard for the rules and regulations by which the rest of us abide.

The only authority able to cope effectively with this problem is the FCC. It is up to each one of us to either write to our local FCC office and file a complaint against these interlopers who have no more right on the bands than does a drunken driver on a busy highway, or, better still, request the FCC to give you the phone number of the nearest monitoring station so that it may be instantaneously alerted to the appearance of these characters. Protect your rights as an amateur—fulfill your duty as an amateur—keep amateur radio clean!

Filters vs Phase Shift

We have been asked numbers of times about the relative merits of the filter system versus the phase shift system of generating single sideband signals; perhaps a discussion is in order. Both systems are good and will perform well if properly designed and adjusted, and, more important, properly operated.

The filter system uses a band pass filter; i.e., crystal, L-C or mechanical, having sufficient selectivity to pass one sideband and reject the other. Filters of this type are normally constructed for relatively low frequencies, but crystal filter research has produced workable filters at 5 megacycles.

The output of the carrier generator is combined with the audio output of a speech amplifier in a balanced modulator. The upper and lower sidebands appear in the output but the carrier is suppressed by introducing the audio in push pull and the *rf* drive in parallel and connecting the output of the tubes in push pull. The balanced modulators may also be connected with the *rf* drive and the audio inputs in push-pull and the output in parallel. There is no output from the balanced modulators with no audio signal; the signal from one tube is balanced or cancelled in the output by the signal from the other tube. With applied push-pull audio, the modulating voltages are of opposite polarity and one tube will conduct more than the other. In any modulation or mixing process, sum and difference frequencies will be generated. These frequencies are the sidebands, upper and lower, and will appear in the output of the balanced modulators. The amount of carrier suppression depends upon the matching of the two tubes and the circuits. At least 30 *db* of carrier suppression is possible without further filtering but since it is desirable to suppress the carrier at least 40 *db*, a selective filter is used for further carrier suppression.

The band pass filter follows the balanced modulator stage and will pass the selected sideband and suppress the other. The single sideband, still at the generated frequency, is then passed through a series of mixers and selective amplifiers until the signal is heterodyned to the desired output frequency. The attenuation of undesired mixer products arising in frequency

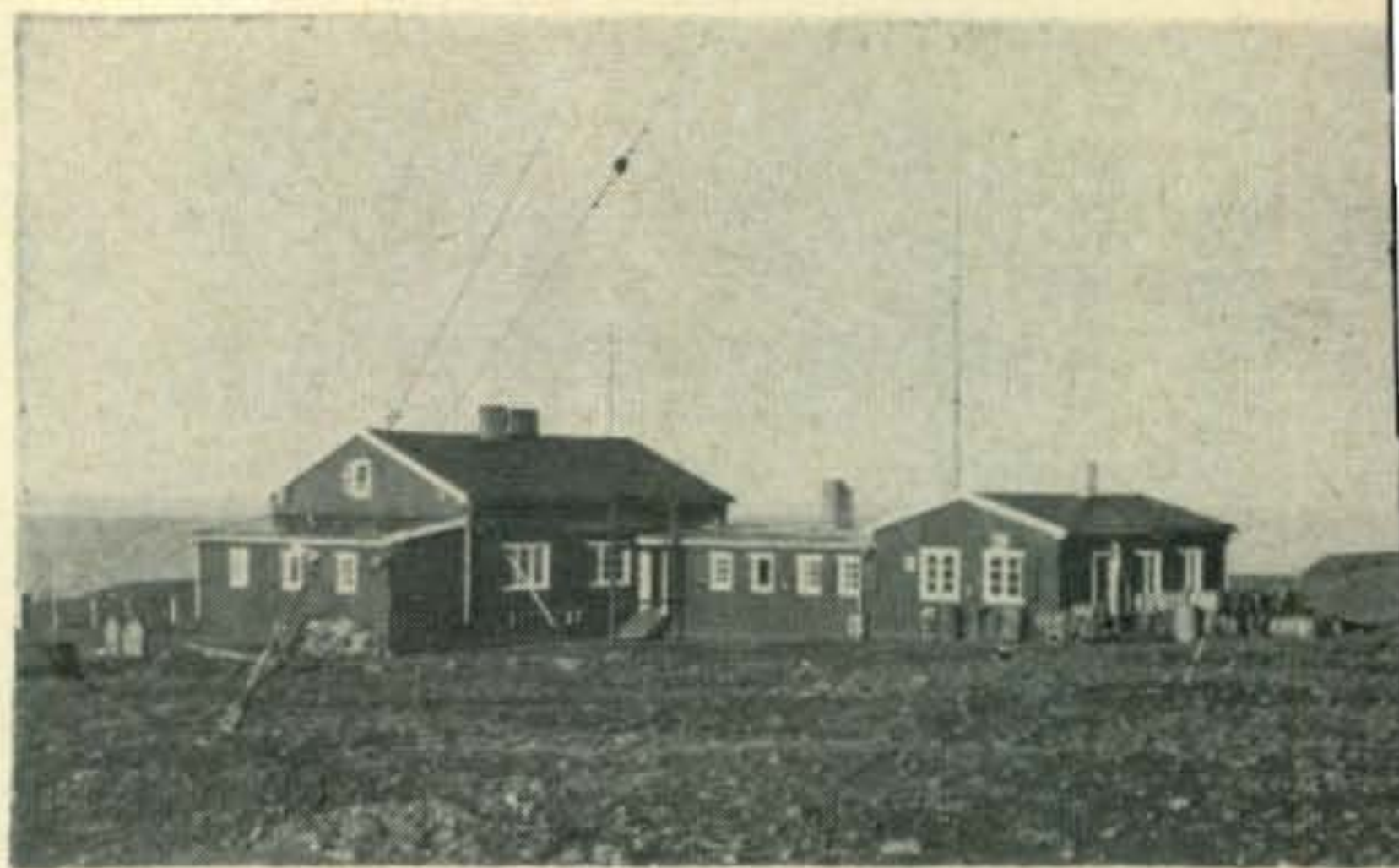

The main buildings and antennas used by Kjell during his operation from LA3SG/P (Photo courtesy of VE7ZM)



Doc, W5RHW (left) obviously is not lonesome anymore, not when he has such fine company as Bruce, W2GBX/5 (center) and John, ZE4JN, who has been cementing many friendships during his tour of the States.



Luis, XE1SN, who, in only 10 months on SSB, has made the DX Honor Roll. In addition to hamming, Luis' interests include boating, swimming and horseback riding.



Guy, W4HVU, ex-DL4GX and IIEZZ/M1, who worked over 100 countries with a barefoot KWM-1.



Two of the key men on 40 meter SSB are Jack, W2CD, (left) and Doc, W2ZF. Anytime a rare station comes on 40 meters, you'll hear Jack maintaining order on the frequency with his powerful signal.



No wonder George, K2JXY, (left) is paying such rapt attention to Vic, WITYQ . . . Vic was the first American to operate from the Vatican station, HV1CN.



Jim, KØSGY, (left), Collins' popular representative, who usually adds "Mobile" after his call, seems most pleased to be stationary while chatting with Glenn, K9USB, who is the proud possessor of 2 DX QSLs and Glenn doesn't even chase DX!

conversions is minimized by well adjusted balanced modulators and selective amplifiers.

The principles of single sideband generation by the phase shift method involves two separate simultaneous modulation processes and the combining of modulation products. The audio signal is split into two components that are identical except for a phase difference of 90 degrees. The output of the *rf* oscillator is also split into two components having a phase difference of 90 degrees. The *rf* oscillator may be at the desired output frequency or at some other selected frequency for later mixing to the output frequency. One *rf* and one audio component are combined in each of two separate balanced modulators. The carrier is suppressed in the modulators and the relative phases of the sidebands are such that one sideband is balanced out by the phase difference and the other sideband is accentuated by the phase addition. The output of the balanced modulator is usually fed to a linear stage for amplification at a modest power level.

Sideband selection is accomplished in the filter system by switching the frequency of the carrier generator; in the phase shift system, by switching the phase shift to the balanced modulators.

We have touched briefly on but one facet of single sideband. If we have generated some interest and desire to learn more about the techniques of sideband, we suggest reading the Sideband Handbook by Don Stoner, W6TNS, in the *CQ* Technical Series. It contains detailed, easy to understand, circuit descriptions and theory and circuits for exciters and linear amplifiers.

SSB Around The World

Fernando, CT3AV, is a new station on sideband . . . double sideband . . . forty watts to a long wire antenna
[Continued on page 104]

RTTY

Byron H. Kretzman, KØWMR

108 W. Teresa Drive
West St. Paul, Minn.

As you can imagine, a good percentage of our mail is from the newcomers to RTTY, or from the fellows just getting interested in this fascinating facet of amateur radio. They, naturally, ask for basic, down-to-earth, information since so little dope is available from sources other than *CQ*, which, by the way, has had an RTTY column since 1955.

The result was the start, in the June 1960 issue, of a series of columns describing the methods and machines used on the amateur bands. (Right now I can hear the question, "Where?" This we answered before in detail, but briefly, look around 3620, 7240, 14,100, and 21,090 *kc* for frequency-shift-keying.)

Last month we gave you a general run-down on the various "page printer" types of machines used in amateur radio stations. Of course there are other machines which we didn't describe, but it is suggested that the newcomer stay away from all but those described for two rea-

sons: First of all, the machines described are familiar (except possibly the Model 12) to active RTTYers and local machine repairmen, and secondly, replacement parts are more easily obtained for those machines listed.

Tape and Traffic

More and more traffic nets are adopting RTTY and tape transmission these days. MARS nets have used RTTY and tape for years. The main reasons are speed, simplification, and accuracy. Taped messages can be perforated directly (mechanically) with a keyboard "perforator" or indirectly (electrically) with a "reperforator," even from an RTTY signal being received. No matter how slow the typist, each character is punched in the tape right after the preceding character. Messages can be spliced together and then put on the air by running them through the tape transmitter-distributor, one right after the other, at the automatic constant speed of **60 words-per-minute**.

Complicated? Heck no. A traffic handling RTTY station has, in addition to the usual page printer with keyboard, the tape transmitter-distributor (TD), and a perforator, or more likely a reperforator. Since a "local loop" within the shack is a simple series circuit, it is very easy to set up a switching or patching arrangement to get the desired machine connected to the proper radio equipment. More about this in a subsequent issue.

Teletype Tape

This month we will give you the same general run-down on the various kinds of tape equipment. But, before we get into that, perhaps we should explain just what we mean by "tape." Punched tape, as usually used on land line and RTTY circuits is about 11/16" wide. Figure 1 shows exactly the way this tape is perforated in accordance with the *Teletype* signal code. The third column, "Signals in Loop Circuit," is an actual graph of the current variations in a neutral circuit plotted against time. Remember, that when no character is being sent, the last "stop" pulse runs into and becomes part of the resting loop current.

Looking at the perforated tape, you will notice the smaller feed holes between the 2nd and 3rd selecting pulse holes. These feed holes engage a sprocket in the tape transmitter which moves the tape along from character to character. In addition, there are five sensing pins in the transmitter which feel for the selecting pulse holes. When a hole is encountered, the sensing pin drops through and closes a contact, thereby transmitting a *mark* pulse (through the associ-

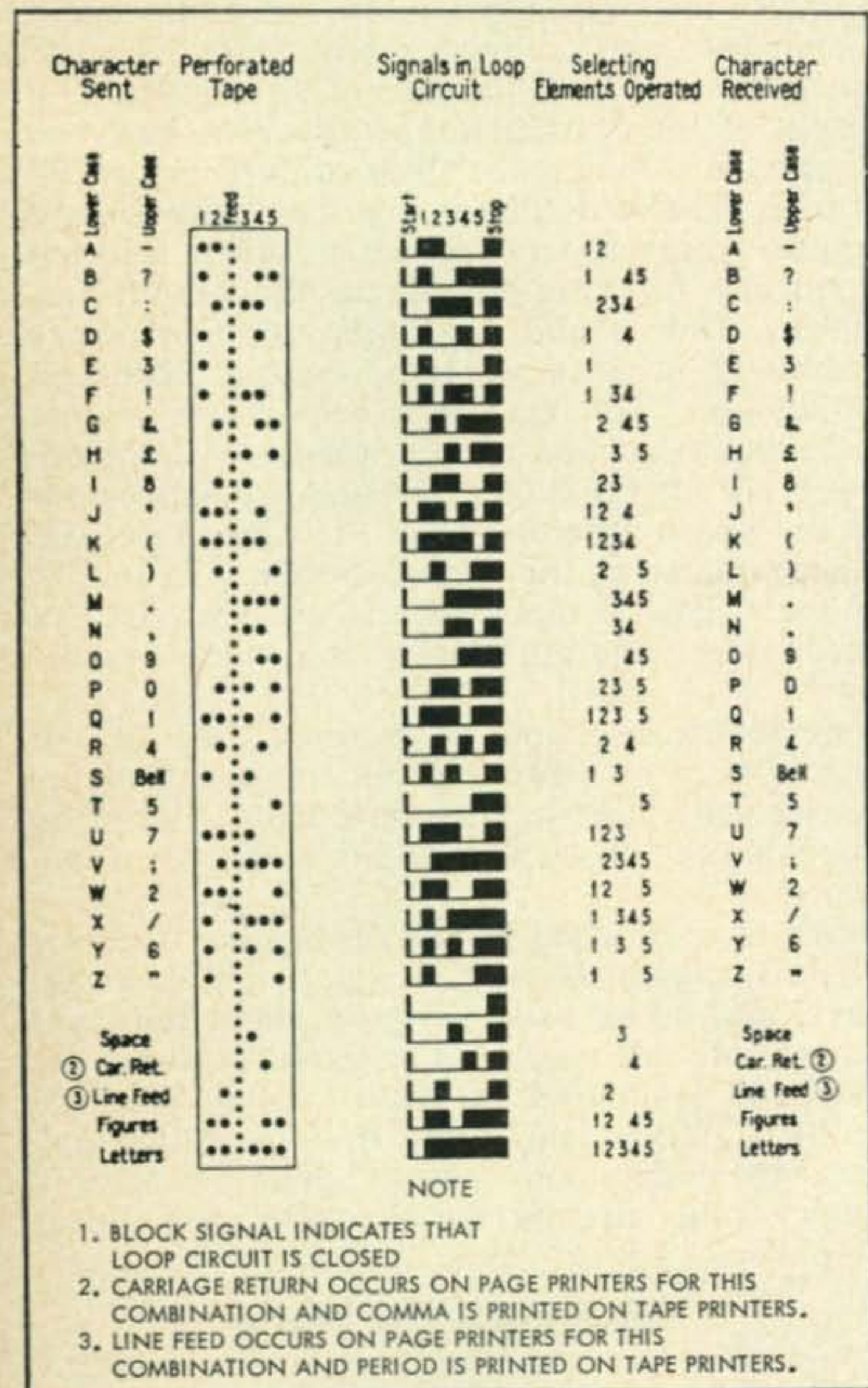

Fig. 1—Teletype Code

ated distributor) in the proper sequence and at the correct speed.

The upper case character for "H" shown as the *Pound* symbol in fig. 1 is usually found only in the old model 12 or in old *Western Union* machines. The newer machines have the "H" key marked STOP for the upper case. The reason for this is that some machines used on wire line circuits use that function, with a special mechanism, to stop the *ac* motor.

Tape Equipment

The *Model 19*, shown in the photo, is a set or table of equipment designed for the expeditious preparation of tapes. A *Model 15 Page Printer* is mounted on a special base that permits the keyboard to operate the perforator, immediately to the left of the 15. The standard 11/16" tape is punched clear through and the message punched is not printed on the tape. The dial on the right counts characters punched and a light behind it warns that the end of the line is being approached. This is handy when punching tape without the 15 page printer being switched in. To the left of the perforator is mounted a *Model 14 Transmitter-Distributor (TD)*.

The *Model 28 ASR*, shown in the photo, is the latest current production tape set which replaces the *Model 19*. This set does all the 19 did and much more besides. It can be supplied to punch tape clear through, like the 19, or it can be supplied to punch "chadless" tape and print the message right on the tape as it is being punched. Needless to say, very few of the *Model 28 ASR's* are in ham hands.

The *Model 14 Typing Reperforator* with keyboard is shown in the accompanying photo. (It is sometimes supplied without keyboard.) This machine has a receiver selecting and typing mechanism with type bars similar to the *Model 15 Page Printer*. This model 14 prints right on the tape at the same time that it is being perforated, but six characters behind. "Chadless" perforating permits printed and perforated characters to occupy the same part of the tape as the punchings (chads) are not completely severed but form lids attached to the leading edges. The keyboard, electrically separate from the receiving circuit, can be used independently if desired. A warning light is provided to indicate the approach of the end of a line so it is not necessary for the operator to peer at the tape as it is being punched. (This light is not supplied when this model has no keyboard.)

The *Model 14 Tape Printer*, also with or without keyboard, looks like the *Model 14 Typing Reperforator* except that a narrow tape, about 3/8" wide, is used. The message is printed on the tape, which of course does not get perforated. Wire companies used this machine to print incoming messages on this narrow tape, which was gummed. The tape was then cut up, moistened, and pasted directly on telegram forms for delivery. This machine is sometimes called a "strip printer."



Model 19 Tape Equipment



Model 28-ASR Tape Equipment



Model 14 Typing Reperforator

The Model 14 Reperforator, not pictured, is a black box with rounded corners about a foot square. This unit, operated electrically, punches the wide (11/16") tape clear through. It does not print the message on the tape. When its circuit is connected through the local loop to the receiving converter (TU), a message tape can be prepared by the distant RTTY station being received. If it is desired to punch a tape for a message originated or corrected, the keyboard of the station's page printer must be patched or switched into the same local loop as this unit.

Other Tape Equipment

Disregarding modern *Kleinschmidt* equipment, which unfortunately is far too scarce, most of the remaining tape gear kicking around on the market is surplus *Western Union* equipment. This *WU* equipment was designed to run at 61-speed, slightly faster than the standard 60-speed. While *WU* tape transmitters can be copied during solid signal conditions, with a little range adjustment, it certainly doesn't make it easy for the fellow on the receiving end.

Most commonly found is the *WU* 1-A Tape Head or transmitter. This is a sensing unit alone, requiring a separate sending distributor. Furthermore, it is set up for tape perforated only on a *WU* perforator, meaning that the feed holes are not exactly in line with the selecting pulse holes as they are in *Teletype* tape. Many of these 1-A units have been modified with no little effort and are being used with the transmitting distributor of a page printer.

The *WU* Model 21-A "midget" tape printer prints the received message on narrow tape like the Model 14 Tape Printer; however, the 21-A has no internal receiving distributor or motor like the 14, nor is there any provision for a keyboard. These units were operated in banks from a large common master distributor. Almost none of these units are in use today, even in RTTY stations.

The *WU* Model 401-A is a narrow tape strip printer like the 21-A. It is a bit more usable, although it has no keyboard, as it contains its own motor and receiving distributor. The 401-A utilizes a type wheel with the characters molded in rubber, like a rubber stamp. The ink, by the way, is very indelible. As other *WU* gear of this vintage, it is designed to operate at 61-speed; and, strangely, a 70 *ma* loop current.

So, from all of the above you can conclude that the safest thing to do is to stick to the *Teletype* models when buying tape gear. Beware of "windfalls" and other special "package" deals offering tape gear of vague description.

WØBP

The Boyd Phelps Memorial Station received the long-awaited station license, with those famous call letters, late in June. The trustee of the station is Harold T'Kach, WØLFI. Since the story first appeared in *CQ*, (page 75, June, 1960) we have received many letters asking when the Sunday "BeeP-casts" will be resumed.

Well, at the time of this writing (July) the equipment is almost ready. A low power rig (BC-610) is in limited operation but firing-up of the big, high power, multichannel *Marconi* rig still awaits the repair of an underground 3 phase power cable. We hope, soon, to have a special story with pictures on this active memorial to the man who did so much for RTTY. Watch for it.

On the Bands

Summer net activity on 80 slowed down quite a bit, naturally, but should pick up rapidly now that fall is approaching. The midwest RATS-Nest Net, largely informal during the summer, still had 6 or more check-ins on the average. WØAUS is NCS and WØJHS is alternate. K9BHD in Hoopston, Illinois, is an RTTY bulletin station, also on 80 with tape gear.

On 20, just about all the activity seems to be between 14,090 and 14,100 *kc* now. VE7TF near Vancouver was heard running a pair of 813's. He is using a W2JAV TU with his NC303 and Model 26. Jim was heard working W5BGP. Other old stand-bys heard regularly are, WØAJL, W3CRO, WØFMK, K6DSQ, and W8DU.

73, Byron, W2JTP, KØWMR

YL [from page 77]

earned the greatest number of YL certificates. Many of us were lucky as OH5SM drew the numbers and some 40 non-radio prizes were distributed. Big luncheon prize was the SX-111 receiver and this was won by W1YPH, Leona.

Banquet

At 7 p.m. we returned to the Ballroom, this time many of the YLs accompanied by their OMs. The YL Club of Hawaii had sent, by plane, a number of beautiful leis and these Hilda, ex-JA2HA, was asked to present to the YLs at the head table, with the customary kiss on each cheek. And present them she did—the lei went on each YL, but the cheek kisses she gave to those gals OMs!

Favors at the banquet included for the YL's little wooden pins made with acorn cups and tiny hemlock cones, and for the OMs Air Dux tie clasps.

After a delicious roast beef dinner, W1HOY introduced the guest speaker, Father Dan Linehan, W1HWK, Director of Weston Observatory, who presented his scientific travels to Antarctica with colored slides and from a "Ham's Eye View." A chaplain (Priest), geophysicist and Ham, he blended the three aspects of his career into a terrific presentation that brought a standing ovation at the finish.

Bedspread Drawing

Another great moment had arrived—time for drawing for the souvenir bedspread. And guess who won it—an OM—W1NUP. We wonder
[Continued on page 102]

CONTEST CALENDAR

by Frank Anzalone, WIWY
14 Sherwood Road, Stamford, Conn.

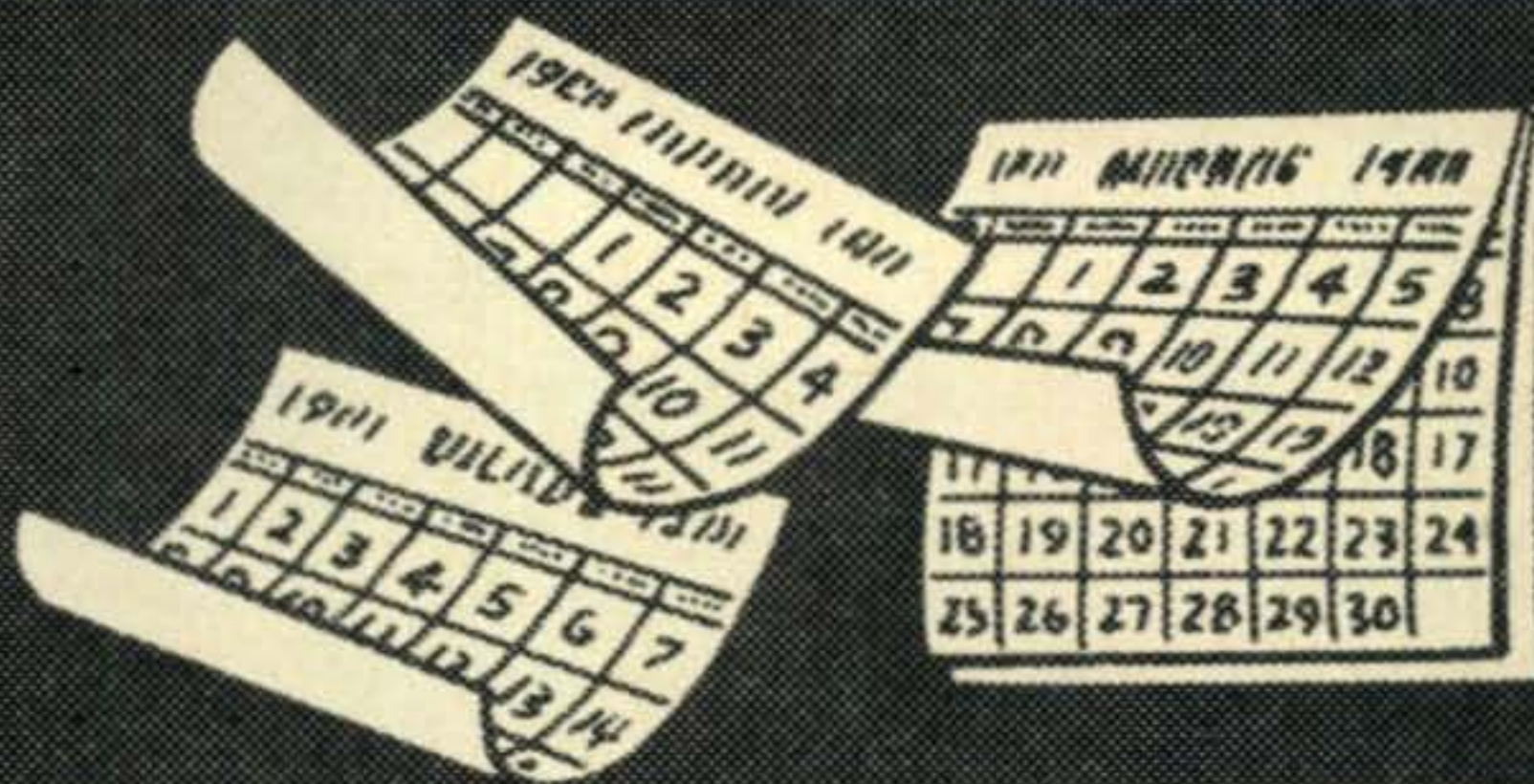

August	27-28	JARL DX
September	3-4	LABRE CW
September	10-11	LABRE Phone
September	10-11	SSBARA WAS
September	10-11	Peruano CW
September	17-18	Peruano Phone
September	17-18	S A C CW
September	24-25	S A C Phone
September	24-25	MARC VE/W
October	1-2	VK/ZL Phone
October	8-9	VK/ZL CW
October	22-23	Boy Scouts
October	29-31	CQ WW DX Phone
November	12-13	ARRL SS
November	19-20	ARRL SS
November	26-28	CQ WW DX CW
December	3-4	RSGB 21/28 Phone

JARL DX

Starts: 10.00 GMT Saturday, August 27th.
Ends: 16.00 GMT Sunday, August 28th.

This is a new contest for c.w. stations only. The rules were fully covered in the July Calendar.

Your log should show in this order: Date, time (GMT), station, serial number sent and received, country (underline each new multiplier) and points.

It is also requested that a summary sheet be included showing the scoring on each band and your name and address in BLOCK LETTERS. Don't forget to sign the customary declaration.

Be careful not to contact stations on the ban list. For your convenience following is a list of Asian countries.

Sikkim, Tibet, Bhutan, Pakistan, Formosa, China, Manchuria, Goa, Macau, Korea, Siam, Saudi Arabia, Japan (Japanese nationals only), Mongolia, Jordan, Bonin and Volcano Is., Ryukyu Is., Bahrein I., Kuwait, Qatar, Trucial Oman, Lebanon, Turkey (Asian Part), Asiatic Russian S.F.S.R., Wrangel I., Uzbek, Tadzhik, Kazakh, Kirghiz, Singapore, Malaya, Hong Kong, Sultanate of Oman, Aden, Maldive Is., India, Laccadive Is., Andaman and Nicobar Is., Burma, Afghanistan, Syria, Cyprus, Palestine, Laos, Ceylon, Yemen, Israel, Iraq, Iran.

BAN LIST

Cambodia, Viet Nam.

Your logs must be postmarked no later than September 30th and sent to: The J.A.R.L. Contest Committee, P.O. Box 377, Tokyo Central, Japan.

LABRE

CW

Starts: 00.01 GMT Saturday, September 3rd.
Ends: 24.00 GMT Sunday, September 4th.

Phone

Starts: 00.01 GMT Saturday, September 10th.
24.00 GMT Sunday, September 11th.

The LABRE contest is a world wide affair and not a one way pipeline to Brazil. Therefore it would be advisable to study the rules in last month's Calendar. Note, especially, the point and multiplier scoring.

This year, a cup will also be awarded to the highest scorer in each continent, providing the winner shows a minimum score of over a 1,000 points.

Mail your logs to: The LABRE Contest Commission, Caixa Postal 2353, Rio de Janeiro, Brazil.

SSBARA WAS

Starts: 15.00 GMT Saturday, September 10th.
Ends: 21.00 GMT Sunday, September 11th.

The Side-Banders once again are sponsoring this WAS contest. The format of the contest gave us the impression that the rules favor the US stations; however, operation is open to foreign stations too. Operation is limited to 24 hours out of the 30 hour contest period. Better check K2HEA/K2MGE's Sideband column.

Your logs go to: The SSBARA WAS Contest, 12 Elm Street, Lynbrook, L.I., N.Y.

Peruano

CW

Starts: 12.00 EST Saturday, September 10th.
Ends: 24.00 EST Sunday, September 11th.

Phone

Starts: 12.00 EST Saturday, September 17th.
Ends: 24.00 EST Sunday, September 18th.

Keep in mind that this is a Pan American contest and therefore operation is confined to the North and South America areas. Also note the additional multiplier this year for operating on more than one band.

Check the July Calendar for a rundown on the rules.

Logs must be mailed, within 20 days after the end of the contest, to: The Radio Club Peruano, Att: Pres. Comission Concurso, Casilla 538, Lima, Peru.

S A C

CW

Starts: 15.00 GMT Saturday, September 17th.
Ends: 18.00 GMT Sunday, September 18th.

Phone

Starts: 15.00 GMT Saturday, September 24th.
Ends: 18.00 GMT Sunday, September 25th.

This year's Scandinavian Activity Contest is sponsored by the Swedish Radio Amateur League.

It's the Scandinavians working the world. For contest purposes the following prefixes will be considered: LA, LA/p, OH, OHØ, OX, OY, OZ and SM/SL.

Over 600 logs were received in last year's contest, this in spite of very poor conditions. This, therefore, should prove to be a very popular week end.

Last month's Calendar had all the rules which are same as they were for the original contest last year.

Your logs must be mailed no later than October 15th to: Karl O. Friden, SM7ID, SSA Contest Mgr., Box 2005, Kristianstad 2, Sweden.

MARC VE/W

Starts: 18.00 EST Saturday, September 24th.
Ends: 24.00 EST Saturday, September 25th.

This is strictly a Canadian/US party extending over a 30 hour period. However, you are limited to 20 hours of operation only. Therefore it is necessary to show times on and off in your log. MESSAGE—Example: W1WY de VE2BB Nr 1 RST 579 Que. Your number, of course, progresses with each contact. POINTS—Each completed contact counts 2 points. The same station can be worked once on each band, phone and again on c.w. MULTIPLIER—For US stations. (a) Number of VE sections worked, multiplied by 7.22. (b) Power multiplier of 2 if input is less than 30 watts, 1.5 if input is 30 to 100 watts and 1. for over 100 watts. (c) Additional multiplier of 2.5 for all W/K stations. SCORING—Example for W/K stations: Contact points \times VE sections worked \times 7.22 \times power multiplier \times 2.5 for final score. The 7.22 multiplier is the ration of VE districts (9) to the ARRL section (65) and the 2.5 multiplier is the ratio of logs received in past contests. This is used to equalize the scoring be-

tween US and Canadian stations. Note—There are 9 VE districts. VE1 thru VE8 plus VO. Therefore your maximum multiplier is 9. (Not for each band)

You are expected to score your own log and check for duplicate contacts. Include a summary sheet giving all the essential information: Call, ARRL section, number of operating hours, power used and scoring. Sign the usual declaration that all rules have been observed. There were a few disqualifications last year so follow the rules closely.

Send your logs, not later than October 12th, to: Gordon H. Webster, VE2BB, 69 Pine Beach Blvd., Dorval, Quebec, Canada.

VK/ZL

Phone

Starts: 10.00 GMT Saturday, October 1st.
Ends: 10.00 GMT Sunday, October 2nd.

CW

Starts: 10.00 GMT Saturday, October 8th.
Ends: 10.00 GMT Sunday, October 9th.

Since this year's contest is sponsored by the New Zealand group, the rules follow a different pattern than they did last year. The July Calendar gave the rules in detail.

Your logs go to: The N.Z.A.R.T. Contest Committee, P.O. Box 489, Wellington, New Zealand.

Boy Scouts

As explained last month, this is not a contest but an event to promote contacts between Scouts of different countries. If you have or ever have had any association with the Scout movement why don't you contact your local Scout unit and give the boys a hand?

Activities start at 00.00 GMT Saturday October 22nd and end 24 hours later on Sunday October 23rd.

CQ WW DX

Phone

Starts: 02.00 GMT Saturday, October 29th.
Ends: 02.00 GMT Monday, October 31st.

CW

Starts: 02.00 GMT Saturday, November 26th.
Ends: 02.00 GMT Monday, November 28th.

The rules are same as in previous years except for scoring of multi-operator stations as noted in Par. VIII #7 and Par. X #3 in the rules published in the August 1960 issue of CQ.

It is strongly recommended that you get your request for log sheets and report forms in early.

A LARGE self-addressed envelope and sufficient postage is a must with each request. Of course IRC's are acceptable in lieu of stamps. Bear in mind however that it must have the postmark of a foreign country, otherwise its value is 4¢.

[Continued on page 108]

[from page 67]

Being a non-profit organization, dues are low. The entrance fee is 2/6d (about 35¢). Group dues are 10/ or about \$1.40.

You can readily see what a club of this nature can do. Those countries which limit the amount of money that can be taken out make it difficult for their citizens to travel. The IHHC overcomes this barrier by making it possible to exchange hospitality and to reduce trip expenses to the very bare minimum. Another thing, when you belong to the IHHC you are never a stranger!

Observed: international friendship and peace are not obtainable through wishful thinking—we all must work “at it.” Although ham radio is the direct link and does much for a better understanding between peoples than any other like medium, person-to-person visits (after radio contact) serve to cement our “on-the-air friendships” and to better understand each other. World peace not only depends on what our leaders do but also on what we (a country’s little citizens) do. Look into the advantages of belonging to the IHHC—you’ll be glad you did!!

Questions

Real Old Sets—“Where can I obtain diagrams for a real old Atwater Kent radio set? I also have an old Crosby. Surely there must be some place a person can obtain information.”

Try Supreme Publications, 1760 Balsam Road, Highland Park, Ill. A schematic for a set sells for 40¢. You can obtain a manual covering early day receivers (1926 to 1938) for \$2.50. Hope you find what you are looking for. I know many hams like you have these old sets and are sentimentally attached to them.

Open Transmission Line—“How can I determine whether or not my transmission line (coax) becomes disconnected from my beam which is mounted on a very high (100 foot) tower?”

Merely by checking your final loading control. Another way is by using a grid dip meter. In most cases you will find that your antenna won’t load as it did before. If you’re using a pi network you’ll find that your final loading control setting for a particular band will be way off—for even a partial load.

Constant Heater Supply—“I’d like a constant current heater supply for a tube checker I am building. How do I do it?”

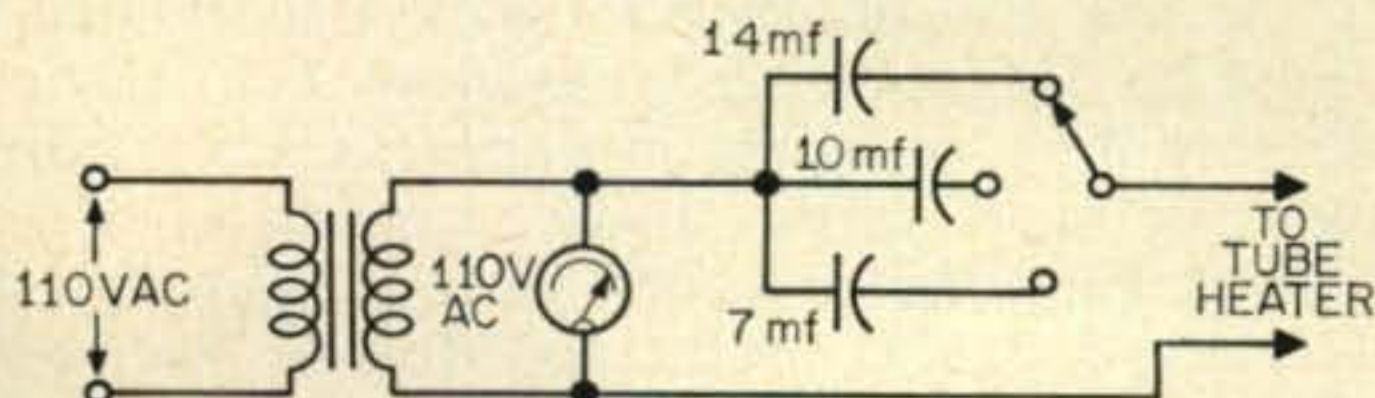

Fig. 3—Low voltage constant current supply.

Why not try *Heath's* scheme. See fig. 3. For 300, 450 and 600 ma positions, 7.1, 10.7 or 14.3 mf are switched in. Because the voltage drop across the tube is small in comparison to the voltage drop across the capacitor, the impedance of the capacitor will be the current determining

element in the series circuit and will in effect, be a very efficient current regulating unit.

LW-51 and LW-51 Deluxe (6 Meters) Improvement—“I have an LW-51 6 meter transmitter that has worked okeh until recently. I am experiencing audio feedback and my average modulation percentage does not seem to be correct. I also get a little distortion and ringing. What can I do?”

The *LW Electronic Lab.* is very cooperative. On query they suggest that you do the following: on socket #3, 6U8A speech amp, bend pin #1 lug away from the socket. Bend pin #2 lug toward the center of socket. Then route blue lead from pin #1 close to socket #4, the 6CZ5. The green lead on pin #2 should be close to socket #3. Then add a 10 mmf ceramic capacitor from socket #3, pin #2 to pin #6. Add a 1.0 meg resistor from socket #3, pin #3 to ground between tie points #3 and 4 (from 6U8A screen to ground). Your trouble will disappear. Incidentally, this is a fine 6 meter transmitter and well worth the money you paid for it. Thank you LW! Those of you who have these nice little sets are invited to write to the company for the two parts (resistor and capacitor) and a change sheet. (Be sure to give serial number of set.)

6 Meter Diagram—The simple 6 meter rig referred to in the July column seems to have invited more inquiries than I was prepared for, resulting in a shortage of diagrams. I’ll print the diagram in the October issue—it will be easier for you and for me. My mimeographed supply is exhausted, so please do not write for a diagram.

Dual Mike Connection—“I like to use both a carbon and crystal mike for the mobile-fixed transmitter. How can I do it?”

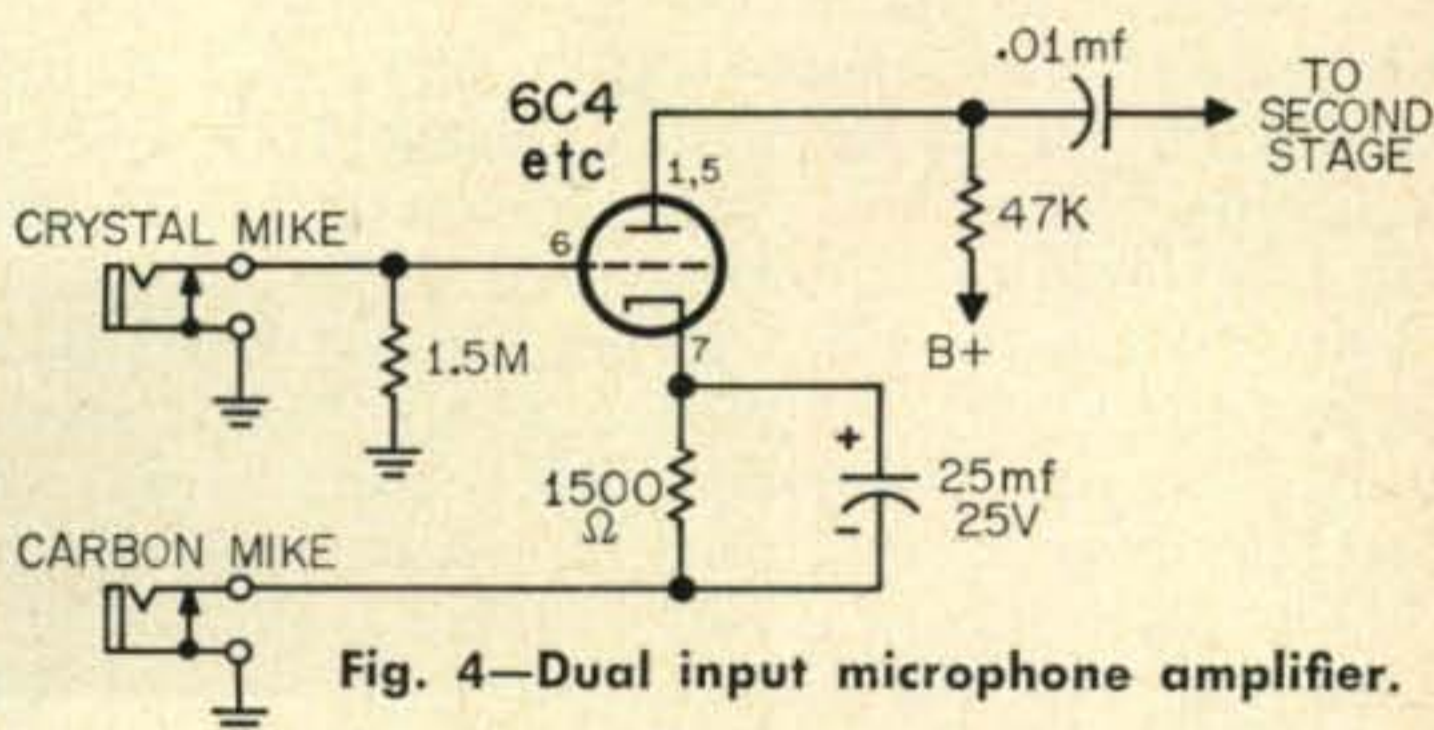

Fig. 4—Dual input microphone amplifier.

See fig. 4. Leaving a crystal mike in a closed car in the heat of summer is not a good idea; heat does not affect a carbon mike.

Ignition Noise—“Where can I get some ‘down-to-earth’ information on ignition noise suppression?”

See the ARRL Radio Handbook or read my article in the REF (French amateur mag) if you can read French—May 1960 issue. I also suggest that you drop a line to the Electric Auto-Lite Company, Toledo 1, Ohio and ask for their bulletin, “Suppressed Ignition for Two-Way Radio Installations.” It is free and covers the subject without verbosity.

Transistor Curve Tracer—“I have a scope and

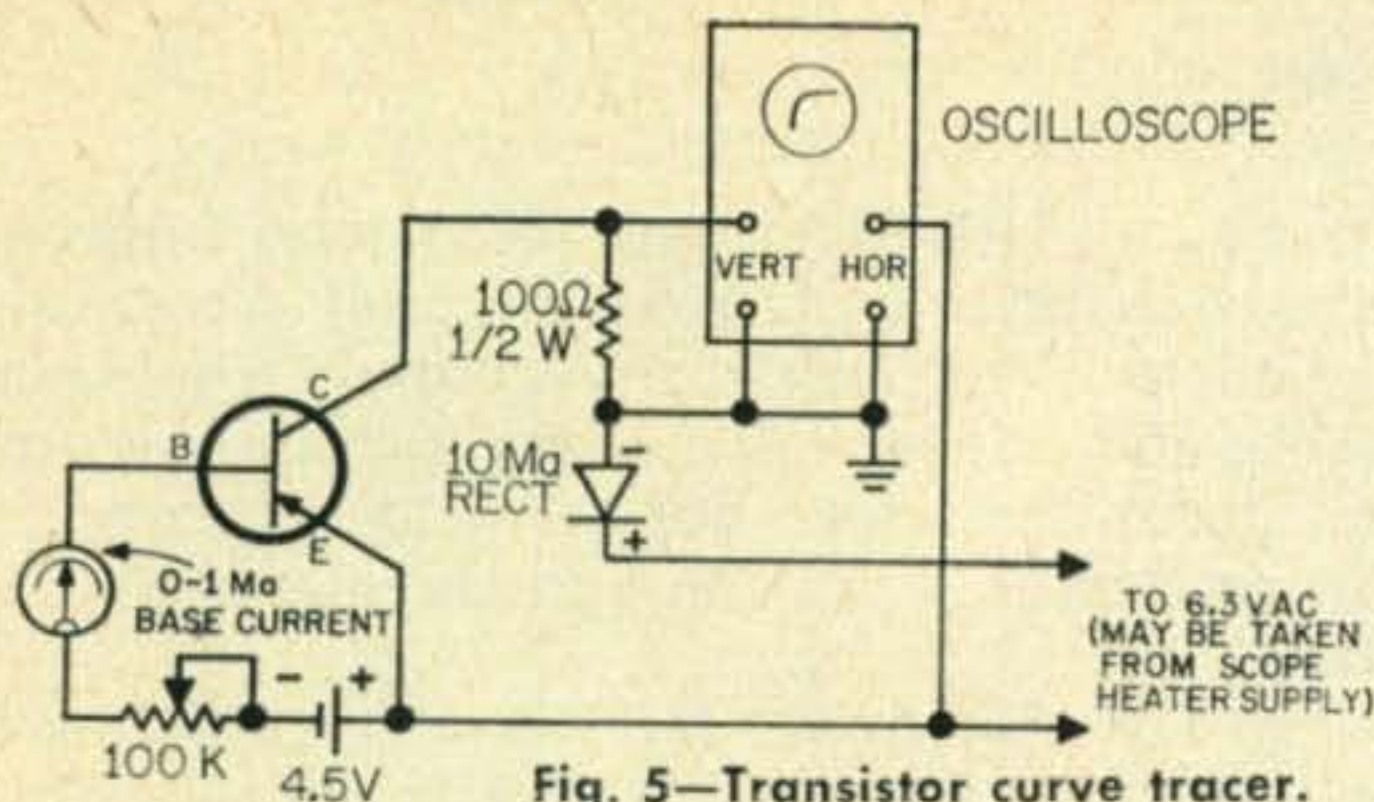

Fig. 5—Transistor curve tracer.

know how to use it. But I'd like some information on connecting it up so that I can read a transistor characteristic curve. Any ideas?

Well good for you! Sure, see fig. 5. The operation of this circuit is simple. Vary R1 to establish the desired bias and desired curve on the scope. Read on the scope: instantaneous collector voltage (length of horizontal line); collector current (height of vertical line). By testing a number of the *same* transistors you can easily pick out the best.

Higher AC Voltage—"I live in an area where the voltage hovers around 100 volts. I find that the receiver I have works better when there is at least 110 volts available. How can I get this extra voltage without resorting to expensive auto transformers etc.?"

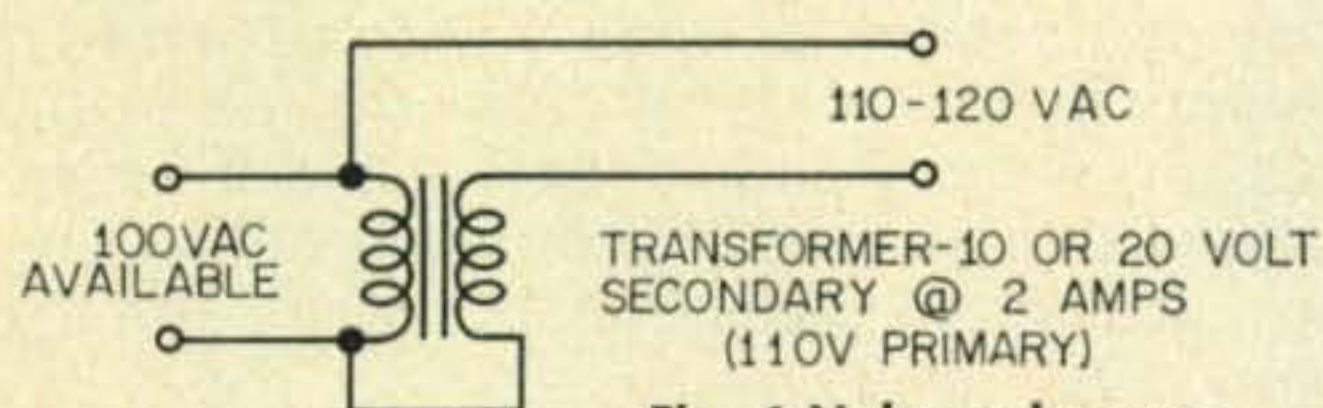

Fig. 6 Voltage booster

See fig. 6. Use a good sturdy 10 or 20 volt (at least 2 amps secondary) filament transformer and connect as shown.

Lightning Protection—"Bill Orr scared the 'pants' off me in his article in the July CQ on lightning protection. I use a beam and coax and am in a so-called lightning area. What can I do?"

My advice to you is to get a good 'Blitz Bug' from *Cush Craft*. Only costs \$3.95 and when installed properly (outside the house) gives you just about the surest protection you can get (outside of disconnecting your transmission line and dropping it on the ground). One thing that Bill forgot to mention is that lightning DOES take the path of least resistance, but YOU have to provide the path. In any event, if you go on vacation during the "lightning months" DO disconnect your transmission line from all equipment and make sure it is grounded.

Hum in Phone Patches—My hat is off to Harvey R. Pierce, WØOPA for his nice article on hum in phone patches printed in the June 1960 *Philmont Mobile Radio Club paper*. It was re-printed from the "Ground Wave." If you are interested let HAM CLINIC know.

KWM-1 Spurious Outputs—"I have a fairly 'old' (1958) KWM-1 and I have noted a spurious output. What can I do?"

First, write to *Collins Radio* for their Service

Bulletin No. 1 dated Sept. 9, 1958. The spurious output you mention is caused by the third harmonic of the variable frequency oscillator beating with the output frequency in the first transmit mixer. The cross-over point is 14,286 kc. This spurious output is caused by the output of driver, V2, getting into the first transmit mixer, V6, due to poor grounding of the shield can for L8. It may be eliminated by the addition of five ground clips around the edges of the L8 shield can. In the event that the spurious output is less than 40 db below the key down output power, Collins recommends the following modification: 1. Remove the L8 shield can. 2. Install five ground clips around the edge of the can and replace in its original location. Make certain that all can mounting nuts are tight. The 5 clips for this job sell for \$.02 each and are available from Collins as part number 220 1323 00 and are called "clips, grounding."

Note to ALL hams

Most manufacturers of repute send service modification changes to buyers of their equipment. In keeping with the *ham spirit* don't you think it would be nice for the original buyer to pass on the changes as they are received to the individual second buyer? I do. If the second buyer receives them, then he should pass them on to the third buyer. All that it costs is a 4¢ stamp. This is thoughtfulness at its best. If you sell your set (or trade it) to a "going" dealer, he should advise you (or the factory) who the second or third buyer is. This is only fair. It is terrible to have a set around which could be made better if the modifications were known. This is a MAJOR SELLING POINT and should not be forgotten by those who handle second or third-hand ham equipment.

More on Modification

"How come most manufacturers do not incorporate modifications in their equipment which have been discovered and made by highly efficient technical hams? It seems to me that they are not taking advantage of 'field know-how'. What do you think?"

If the average ham equipment manufacturer made all the changes suggested by hams he would go broke. They do however, make *some* suggested changes which are very worthwhile. Furthermore, the average manufacturer thrives on concrete criticism, and welcomes it. But remember this: the cost of any ham gear is controlled—it must be. Engineering know-how, field testing, assembly line organization, parts, advertising, usual overhead administrative costs and so on, all enter into the price of your transmitter-receiver etc. Labor is not cheap. Most of the modifications suggested by users are not practically *sound*; and to try them all out in the laboratory is nearly impossible. So what does the manufacturer do? He tries to come up with the best that the state of the art will permit . . . with price a major consideration. Now that *minification* is becoming an electronic byword and more attention

[Continued on page 100]

“Zero-five-seven...you are fifty feet above glide path... increase your rate of descent... you are now on course, on glide path...over touchdown point...take over visually for landing and contact tower.”

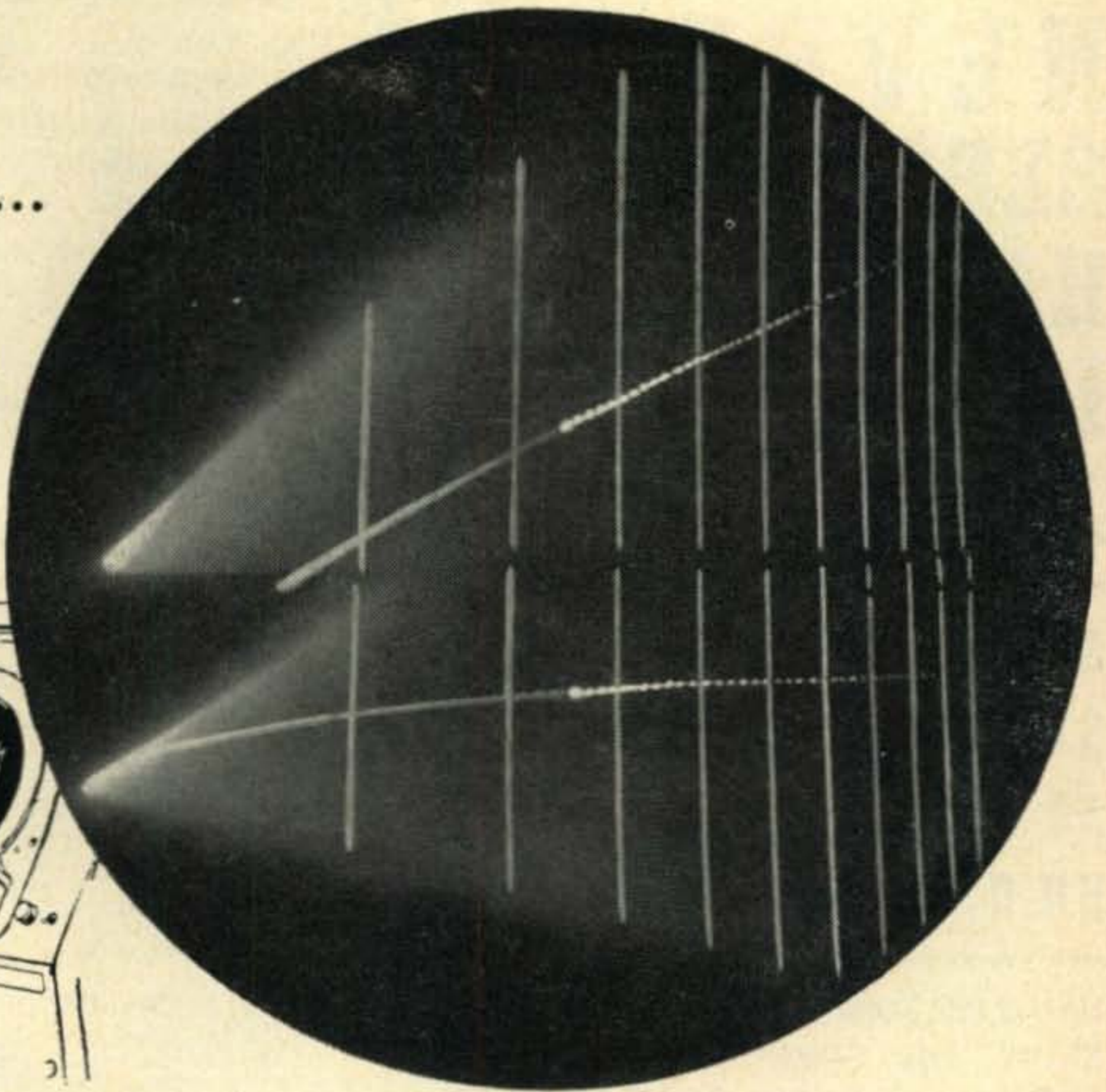

YOU MAY HANDLE A SITUATION LIKE THIS... *If you measure up to the Aerospace Team*

The man in command of this situation is an Air Force Ground Control Approach Radar Technician. And those “blips” on the glide paths of his radar screen represent an aircraft coming down blind through bad weather. This is the kind of man whose dependable skill and calm judgement make him a key member of the Aerospace Team...he is the kind of man who can meet the qualifications of the U. S. Air Force.

Are you that man? As a trained and ex-

perienced Air Force technician, you will have an opportunity to build a career for yourself in the Aerospace Age—the age of air and space travel. Such a career offers you valuable training and education, steady advancement and an assured future.

If you are the kind of young man who could learn to handle situations of increasing responsibilities, we of the Air Force would like to talk to you. If you are interested, just clip and mail this coupon.

U.S. AIR FORCE

There's a place for tomorrow's leaders on the Aerospace Team

PASTE COUPON ON POSTCARD AND MAIL TO:

Airman Information, Dept. MC09, Box 7608, Washington 4, D. C.

Please send me more information on my opportunities in the U.S. Air Force. I am between the ages of 17-34 and reside in U.S.A. or possessions.

Name _____

Address _____

City _____ Zone _____ County _____ State _____

**NEVER
BEFORE A
HAM MAP
LIKE THIS!**

**SO BIG!
SO BEAUTIFUL!
SO ACCURATE!
SO FACT FILLED!
SO UP-TO-DATE!**

**KNOW THE ZONES FOR WAZ
KNOW THE CONTINENTS
FOR WAC • KNOW THE
COUNTRIES FOR DX-CC
ETC. • ETC. • ETC.**

• NOW ON SALE • BRAND NEW •

We are proud to announce the publication of the long-awaited **AMATEUR RADIO WORLD-WIDE DX & ZONE MAP.**

This new map is complete, accurate and up to the minute with information that every amateur needs.

It contains:

Every prefix, including the newest additions and latest changes, printed in red, right in, or next to, the Country or Island, for accurate identification.

The most authentic Zone Boundaries, including the **ANTARCTIC CONTINENT for the FIRST TIME ANYWHERE!**

Great circle beam bearings for East, Mid-West and Western United States.

Attractively printed on heavy vellum map paper in four colors for easy location of Zones and Prefixes.

Size 36x42 inches for easy, no squint reading from operating position.

Price only **\$3.00** postage paid in the U.S.A. and possessions.

COWAN PUBLISHING CORP.

C-9

Map Division
300 West 43rd Street
New York 36, N. Y.

SIRS: My check (money order) for \$_____ is enclosed.

Please send _____ maps to:

(Additional name, or names, enclosed on separate paper.)

Name _____

Address _____

City _____ Zone _____ State _____

New York City residents add 3% Sales Tax

E. S. P. (extra-sensory perception)

For many years scientists all over the world have been delving into this mysterious subject. Many remarkable reports have been investigated and confirmed and there is little doubt that mental telepathy is a proven fact. The gang up here is an up-to-date bunch, and like most hams, are interested in all kinds of scientific phenomena. And since E. S. P. is practically related to Ham Radio . . . being another form of communication . . . we decided to give it a try.

So if you feel a little tingle while you're reading this, it's only us up here at the office transmitting a telepathic message. We hope you read it 5 by 9!!

CQ Magazine
300 West 43rd St.
New York 36, N.Y.

One year, \$5 Two years, \$9 Three years, \$13
in U.S. Possessions, APO & FPO, Canada & Mexico

C9

Enclosed is \$..... for a..... year new renewal subscription to CQ, to be sent to:

Name..... Call.....

Address.....

City..... Zone..... State.....

Pan-America and all other foreign: 1 yr. \$6; 2 yrs. \$11; 3 yrs. \$16.

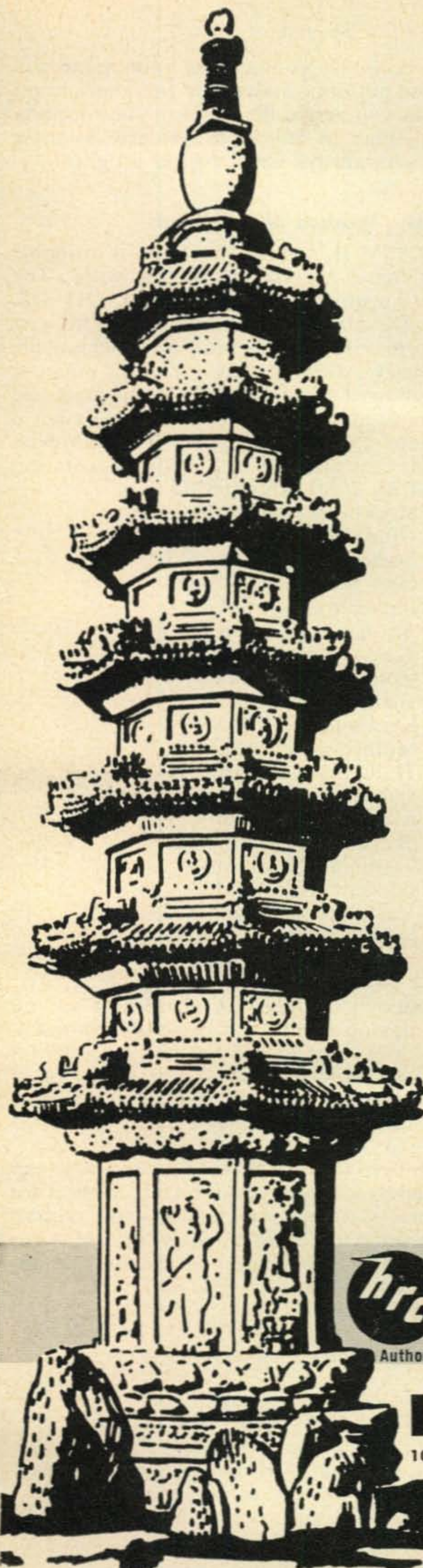

Wherever you are...

Harvey and RCA are ready to serve you

At any point on the globe, from Durban to Dawson, from Bremen to Buna Buna, Harvey Radio's 33 years of service and reliability is with *all hams—regardless of location.*

At Harvey's, all orders for ham equipment are personally supervised and handled in all phases by hams. W2DIO and his ham associates devote immediate attention to your order. Your instructions—in any language—are followed meticulously. The items called for are drawn from Harvey's large up-to-date inventory and are carefully rechecked against your order. Harvey's rapid turnover is your assurance that only the very latest models are shipped.

Upon your instructions, Harvey's will open the original factory sealed cartons and give the equipment complete inspection and checkout. And there is no charge for this extra service, for Harvey's policy is "satisfaction always guaranteed."

Intimate daily working knowledge with overseas shipping requirements enables Harvey to provide the proper protective packaging and crating as well as all necessary forms and paperwork.

Hams around the world know that Harvey means confidence and RCA means dependability. Always ready to discuss your ham problems, always ready to supply your exact requirements—Harvey talks the language of hams—wherever they are.

WE'RE GENEROUS ON TRADE-INS. IF YOU WANT TO TALK SWAPS OR DEALS, WRITE OR CALL W2D10. MAIL ORDERS SHIPPED SAME DAY AS RECEIVED.



Authorized Distributor

Harvey Radio carries a complete stock of RCA tubes for every power tube requirement.

Partners in Dependable Global Service

HARVEY RADIO CO., INC.

103 WEST 43rd STREET NEW YORK 36, N. Y. • JUdson 2-1500



For further information, check number 29 on page 126.

Mr. Distributor:

**Have you received the
advance promotion on
the November 1960
Annual issue. This issue
will contain a Special
Distributor Section. This
will be your issue so be
certain you return the
coupon below.**

CQ Magazine
300 W. 43rd Street
New York 36, N. Y.

Sirs:

I want to know more about the November 1960 Annual Special Distributor Section. Send me your colorful brochure with all the details.

Name _____

Address _____

City _____ Zone _____ State _____

DX [from page 65]

receipt of your check, your name will be put on a master list and checked off as you arrive the night of the meeting.

Plan to attend, if you can, as these boys always have a good program.

WASM II Worked all SM lands

The WASM II, awarded by SSA, is available to all amateurs everywhere in the world. The class A is for amateurs located in LA, OH, OZ, and SM. The class B is for amateurs in the rest of the world. All contacts must have been made since January 1st, 1953. Any one of the amateur bands is allowed and contacts to be made in c.w. or phone or any combination of both. Sweden is divided into 25 different "Lan". The abbreviation of the lans are

- A City of Stockholm SM5
- B Stockholms lan SM5
- C Uppsala lan SM5
- D Sodermanlands lan SM5
- E Ostergetlands lan SM5
- F Jenkeping's lan SM7
- G Kronobergs lan SM7
- H Kalnar lan SM7
- I Gotlands lan SM1
- K Blekinge lan SM7
- L Kristianstads lan SM7
- M Malmehus lan SM7
- N Hallands lan SM6
- O Goteborgs och Bohus lan SM6
- P Alvsborgs lan SM6
- R Skaraborgs lan SM6
- S Varmlands lan SM4
- X Gavlebergs lan SM3
- Y Vasternorrlands lan SM3
- Z Jamtlands lan SM3
- AC Vasterbottens lan SM2
- BD Norrbottens lan SM2

Amateurs in the class A area must submit proof of having established two-way communication with each of the 25 lan on two different bands (50 QSL's). Amateurs in the class B area must submit proof of having established two-way communication with each of the 25 lan (25 QSL's).

Application for the WASM II must be accompanied by all the requested QSL cards, a list of claimed stations and 5 IRC's or unused stamps from your own country of the same value. Address all applications and confirmations to SSA Contest Manager SM7ID

Karl O. Friden
Box 2005
Kristianstad 2 Sweden

Certificates

Most of you know of the very fine directory of certificates that was put out by W3RPG. Unfortunately, Bill had to give it up because of changing QTH's but it is now being handled in grand style by Clif, K6BX. If you are the least bit interested in certificates, you should have a

**"CALL ME
for
Personal Service"**

**"CALL ME
for
Personal Service"**

Bob Henry
WØARA
Butler, Mo.
ORchard 9-3127



ON

Ted Henry
W6UOU
Los Angeles
GRanite 7-6701



**WORLD'S
BEST TERMS**

**Because we finance
our own terms...**

- Only 6% a year finance cost
- 20 months or longer to pay
- Only 10% down (or your trade-in as down payment)
- No finance charges if paid within 90 days
- Reduced charges if paid off ahead of time
- You get more flexibility of financing in the future (such as re-financing) because we handle our own financing

**Collins
S/LINE**



**A-1 Reconditioned
Apparatus**

Nearly all makes and models. Big savings!
Ten day trial—90 day warranty. 90 day full
trade back on new apparatus. Write for
bulletin.

KWM-2 Transceiver	\$1150.00
32S-1 Transmitter	666.00
516F-2 AC Power Supply	115.00
516E-1 12 V DC Power Supply	270.00
75S-1 Receiver	520.00
312B-3 Speaker	29.00
312B-4 Speaker Console	195.00
30S-1 Linear Amplifier	1556.00

*Write, phone or visit either store today!
Inquiries & orders from military men
and others outside USA wanted.*

Butler 1, Missouri
ORchard 9-3127

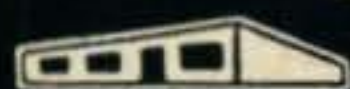

Henry Radio Stores

11240 West Olympic Blvd.



Los Angeles 64 Ph. GRanite 7-6701

BIG

TRADE-INS

World's Largest Distributors of Short Wave Receivers

For further information, check number 30 on page 126.

**DOW-KEY
DKC-TRP
COAXIAL
ELECTRONIC
TR SWITCH**



WITH
**Built-in
Power
Supply**

Designed to operate in 1.8 to 30 mc. range. NO EXTERNAL D. C. POWER NEEDED! Just plug into any regular 120 v. A. C. outlet. About 15 watts power required.

FEATURES INCLUDE: Rated maximum legal amateur power. Low VSWR. Cast aluminum construction makes DKC-TRP TVI proof. Switch allows break-in operation with single antenna system. Type N connectors available at slight additional cost.

FACTORY WARRANTY! **DKC-TRP** **\$27.75**
 . . . Each

See your Electronic Dealer.

DOW-KEY CO. INC.
THIEF RIVER FALLS, MINNESOTA

For further information, check number 31 on page 126.

SHIPSHAPE SHACK

No more screwing and unscrewing connections, no more dangling, sloppy leads when you have B&W multi-position coaxial switches.

Model 550A conveniently selects any one of five transmitters, antennas, exciters, receivers or other r-f equipment. Model 551A is a two-pole, two-position unit for switching equipment such as r-f power amplifiers in or out of a circuit. Both switches can be used with 52 or 75 ohm lines.

See these efficient, reasonably-priced switches at your B&W dealer, or write us for information.

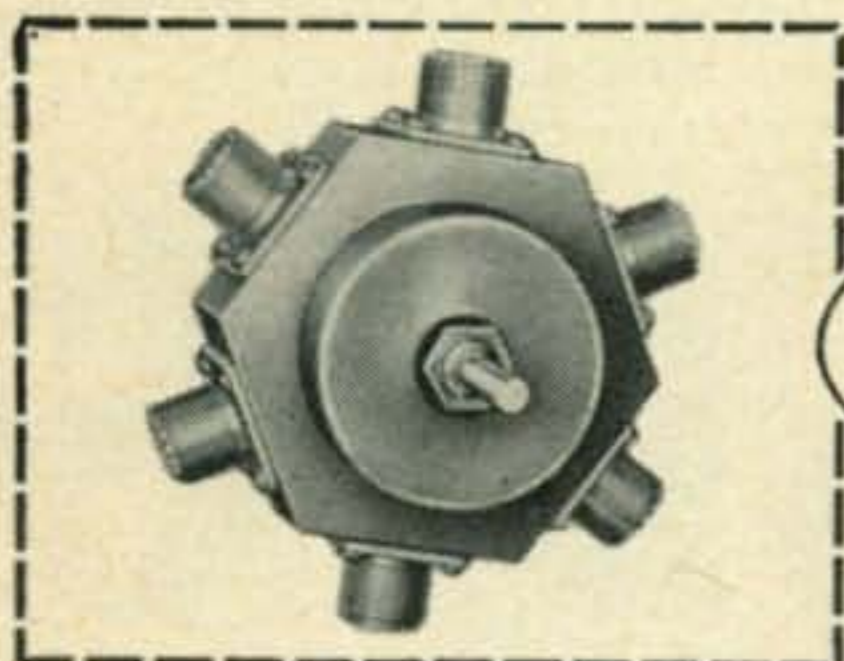

550A—PRICE \$8.25



551A—PRICE \$7.95

Barker & Williamson, Inc.

Bristol, Pennsylvania

For further information, check number 32 on page 126.

100 • CQ • September, 1960

copy of this very informative directory at your operating position. Over 350 awards from over 50 countries are listed.

For more information, drop Clif a line. His QTH is:

Clif Evans
Box 385
Bonita, Calif.

The Certificate Hunters Club, CHC, was founded by Clif Evans, K6BX to encourage Amateur operation achievements and their due recognition as exemplified by possession of

[Continued on page 112]

HAM CLINIC [from page 94]

is being given the mechanical engineering aspects of electronic manufacture, watch competition increase! One of these days in the not too distant future you will be able to carry a *complete* 200 watt station in something like a brief case!

Ham Clinic Award

For the best technical twist (tip) received during the year, HAM CLINIC will award a hand-carved (in wood) "little doc" (the symbol appearing at the head of the column). The front base plate will be engraved with the winner's name and call and possibly be awarded at either a hamfest or convention. This award signifies that the recipient is truly interested in helping out brother hams and has contributed in a special way to the art of amateur radio. How about trying for it? The simplest tech tip may win. Send yours in today!

Thirty

The mail being received by HAM CLINIC is so heavy that it is quite impracticable to answer it quickly. So have patience please.

Fall is approaching and with it the "ham season" . . . make sure your guy-wires are tight—for this month then, 73 and 75 to my fellow American hams and 72 to my friends overseas!

Chuck

SPACE [from page 69]

4,000 megacycles. The first attempt at launching a Project Echo satellite failed earlier this year, but other attempts are planned for the late fall of this year or early in 1961. According to press-time information furnished by NASA, the initial Project Echo satellite will be launched from Cape Canaveral, Florida, in a northeasterly direction with an inclination of 50 degrees to the equator. Launching time will be selected so that the first passes of the aluminum coated sphere will occur over continental United States during the twilight hours. This will permit optical as well as radio tracking since the sphere will have the brightness of a zero magnitude star, about as bright as Vega. Initial information on the satellite will be obtained by means of a beacon transmitter on the third stage of the rocket,

RADIO SHACK'S



"CARLOAD BUYING"

MEANS

- **BEST BUYS**

Radio Shack carries the complete line of Hallicrafter's receivers and transmitters for their amateur radio customers.

- **BEST TRADES**

Radio Shack's tremendous volume allows us to give the "Biggest Trades" in the electronic equipment industry.

- **BEST TERMS**

Radio Shack's Easy Budget Plan lets you spread your cost over 18 to 24 months, with low payments of \$2 to \$24 monthly.

Choice of The Following:

Cat. No.	Model	Type	Down Payment	Monthly	Amount
45DX313	S-38E	Receiver	\$ 2.00	\$ 5.00	\$ 59.95
45DX325	SX-111	Receiver	10.00	11.50	249.95
45DX349	HT-37	Transmitter	10.00	21.00	450.00
45DX322	S-107	Receiver	5.00	5.00	94.95
45DX323	S-108	Receiver	5.00	7.00	129.95
45DX324	SX-110	Receiver	5.00	7.50	159.95

GIANT TRADES!

Use your old equipment as down payment.

NOW 4 STORES
RADIO SHACK

167 Washington St., Boston 8, Mass.

730 Commonwealth Avenue, Boston 17, Mass.

230 Crown St., New Haven 10, Conn.

29 High Ridge Road,
Stamford, Conn.

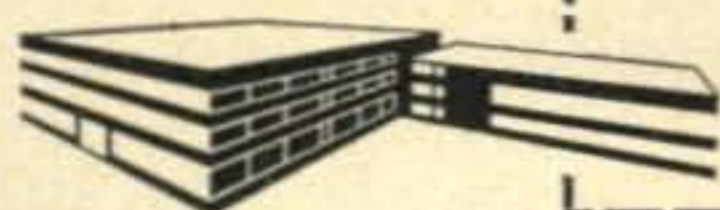

RADIO SHACK CORPORATION, Dept. 9C

730 Commonwealth Avenue, Boston 17, Mass.

Please "QUOTE BIG" on my model _____
I would like to trade-in toward

Send

Name _____

Address _____

City _____ Zone _____ State _____

Check

M.O.

C.O.D

For further information, check number 33 on page 126.

September, 1960 • CQ • 101

EDDYSTONE

GEARED SLOW MOTION DRIVE
For Amateur Radio & Communications
RECEIVERS & TRANSMITTERS

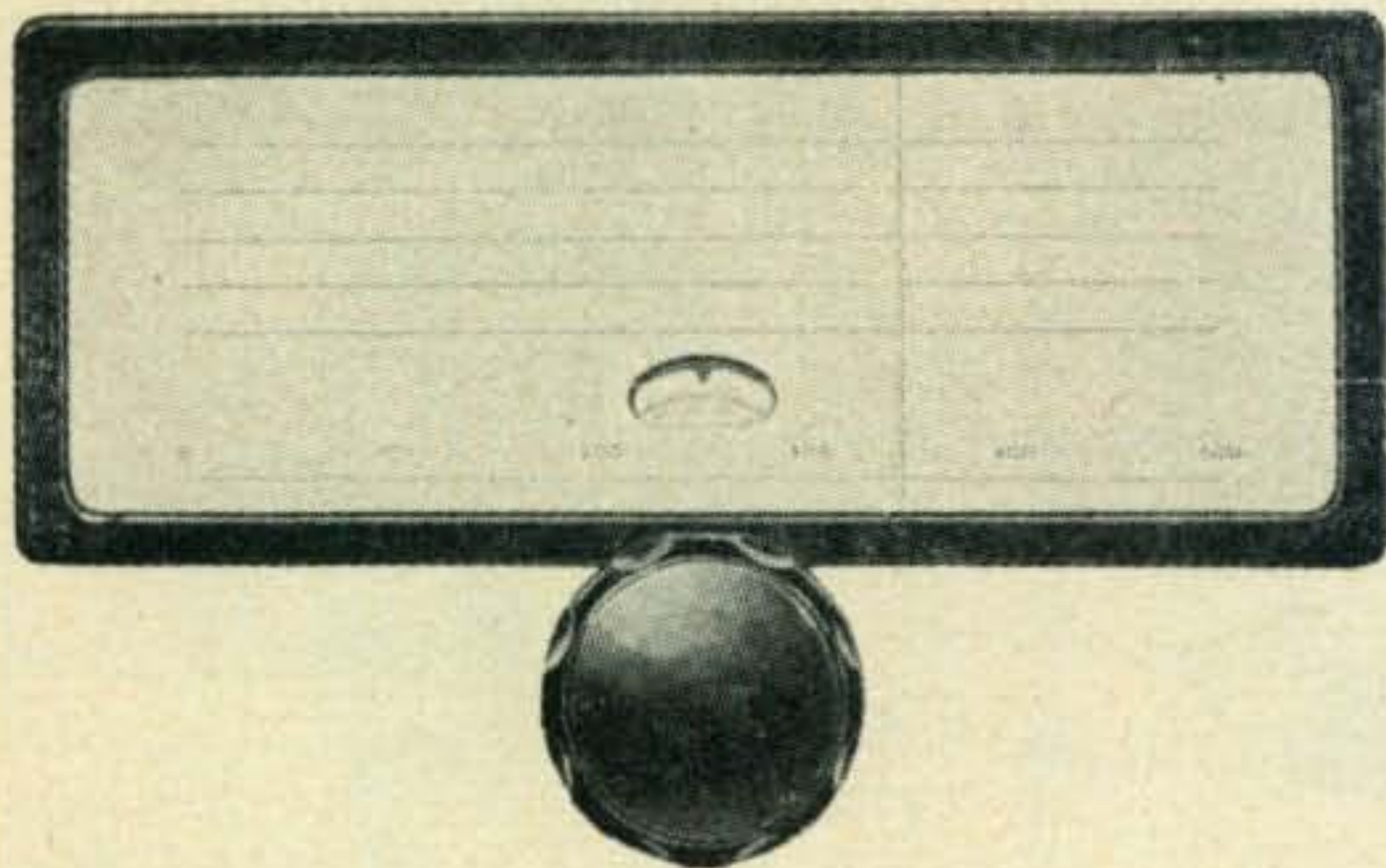

A high grade assembly, flywheel loaded, manufactured to fine tolerances, provides a smooth positive drive with a reduction ratio of 110:1. The vernier with its 100 divisions rotates 5 times for one pointer traverse, giving 500 divisions with positive reset readings and no backlash. A cam adjustment on the vernier assures correct zero setting. A spring loaded jockey arm maintains tension of the pointer drive. Overall dimensions $9\frac{3}{16}'' \times 5\frac{3}{4}''$.

PRICE \$15.00 NET
Postpaid

Manufactured by
Stratton & Co., Ltd. (Eddystone)

DISTRIBUTED BY
Birmingham, England
BRITISH RADIO ELECTRONICS, LTD.

1833 JEFFERSON PLACE, N.W.

WASHINGTON 6, D. C.

For further information, check number 34 on page 126.

BACK ISSUES FOR SALE \$1.00 per copy

- 1950—Jan., July, Oct., Nov.
- 1951—All issues, except Nov.
- 1952—All issues, except Aug.
- 1953—All issues, except May, July, Dec.
- 1954—All issues, except Feb.
- 1955—All issues, except Nov.
- 1956—All issues, except April, July
- 1957—All issues, except Feb. and Nov.
- 1958—All issues, except July, Sept., Oct.
- 1959—All issues except Jan.
- 1960—All issues, 50¢ Per Copy

BC-603 Conversion article (Sept. & Oct., 1958 CQ)
Reprints available at 50¢ per set.

CQ Magazine
300 West 43rd St., New York 36, N. Y.

operating on a frequency of 108 megacycles. It is planned to have two other beacon transmitters within the sphere itself, operating on frequencies of 107.94 and 107.97 megacycles. Once the satellite has been successfully placed into orbit, it is intended that two way communications be established between the east and west coasts of the United States by means of signals reflected from the satellite. Two different frequencies will be used in this experiment (see fig. 3), 960 megacycles for east-west transmission and 2390 megacycles for west-east transmission. The west coast transmitting and receiving site will be located at Goldstone, Calif., and operated by NASA. On the east coast, the transmitting and receiving site will be located at the Bell Telephone Laboratory at Holmdel, N.J. The transmitting power on both frequencies will be 10 KW, and highly directional antennas will be used. The orbital period of the satellite will be about 120 minutes. It is expected to pass over every portion of the United States except Alaska, enabling many independent researchers in the communications field (including radio amateurs) to make use of the large sphere for propagation experiments. The maximum time of mutual visibility between the east and west coasts for any one pass will be about 16 minutes.

Project Echo is NASA's first step in a long range investigation of the application of artificial earth satellites to global communications. Such satellites may one day be used as passive relays for transmissions of signals, voice and television to all parts of the world.

In closing this inaugural column on Space Communications, the Editor again wants to emphasize reader participation, and comments, suggestions, observations, questions and newsworthy items are requested.

73, George W3ASK

YL [from page 90]

how long it will be before a YL talks him out of it. . . . Lucky ticket for the afghan was owned by K1HUI, Frances. The other big prize, a Tapetone 345 receiver, was won by W6UHA's mother, Marie Emmons. She was much pleased for she is a faithful SWL. Dozens of other radio prizes were distributed before the evening was over.

Picnic

The banquet might have meant *finis* to the convention. Instead, the WRONE gals brought us "back to earth" gently and most pleasantly with a picnic, on Sunday, at the QTH of W1HOY-W1FZJ, Helen and Sam. A fabulous place, deep in the woods of the countryside, it has a spacious log cabin home with a lovely swimming pool in the yard. And to the rear was W1FZJ's amazing arrays for *uhf* (Sam is VHF editor for CQ), plus on the opposite side a high tower loaded with beams.

How the gals did it after all the other conven-



FREE!

LAFAYETTE RADIO'S 324-PAGE 1961 CATALOG

America's "Electronics Shopping Center"

40 years of servicing the Amateur

HERE IT IS — the biggest, best and most comprehensive catalog you can ask for. Immediate delivery at the lowest, money-saving prices.

• Amateur Equipment • Radio and TV Parts and Tubes • Mobile and Fixed Station Equipment • Stereo Hi-Fi Equipment • PA Systems • Industrial Supplies • EXCLUSIVE LAFAYETTE KITS

SATISFACTION GUARANTEED OR MONEY REFUNDED

EASY PAY PLAN—the simplest, and quickest way to get what you want when you want it. As little as \$2 down . . . up to 24 months to pay.

Mail the coupon today for your FREE copy

NEW! LAFAYETTE HE-15A CLASS D CITIZENS BAND SUPERHETERODYNE TRANSCEIVER



Completely
Wired
57.50
5.00 Down

- For Industry, Farming, Business, Pleasure
- 5 Crystal Controlled Transmitting Positions
- Tuneable Receiver Over Full 23 Channel Band
- Complete with Transmitting Crystal for Channel 9
- Planetary Vernier Tuning
- Full-Wave Variable Noise Limiter
- High Output Crystal Microphone
- 5-Prong Microphone Jack for Easy Relay Addition

No examination or technical knowledge required—any citizen 18 years or older is eligible for a license. Simply fill out enclosed FCC application. HE-15A size: 10 $\frac{3}{4}$ "x6 $\frac{7}{8}$ "x5 $\frac{7}{8}$ ". Shpg. wt., 11 lbs.

HE-15A Wired and Tested (less antenna) 5.00 Down Net 57.50
HE-19 Whip Antenna Net 3.95
HE-16 Power Supply for 12 Volts Net 10.95
HE-18 Power Supply for 6 Volts Net 10.95

LAFAYETTE PROFESSIONAL QUALITY COMMUNICATIONS RECEIVER— ENGINEERED FOR THE AMATEUR



KT-200
in Kit Form
64.50
5.00 Down

- Superhet Circuit Utilizing 8 Tubes and Rectifier Tube
- Built-in "S" Meter with Adjustment Control
- Band Spread 80 to 10 Meters
- Covers 455kc to 31 mc
- Variable BFO and RF Gain Controls
- Switchable AVC and Automatic Noise Limiter

HE-10
wired
and tested
79.95
5.00 Down

The Communications Receiver that meets every amateur need — available in easy-to-assemble kit form or factory wired and tested. Signal to noise ratio is 10 db at 3.5 MC with 1.25 microvolt signal. Selectivity is -60 db at 10kc, image reflection is -40 db at 3 MC. 7 $\frac{7}{8}$ "x15"x9". Shpg. wt., 22 lbs.

LAFAYETTE RADIO

Please include shipping charges with order

165-08 LIBERTY AVENUE, JAMAICA 33, N. Y. • OTHER LOCATIONS

NEW YORK, N. Y.
100 6th Avenue

NEWARK, N. J.
24 Central Avenue

BRONX, N. Y.
542 E. Fordham Rd.

PARAMUS, N. J.
182 Route 17

BOSTON, MASS.
110 Federal Street

PLAINFIELD, N. J.
139 W. 2nd Street



CUT OUT
AND PASTE
ON POST
CARD



Lafayette Radio Dept. CI-6
P.O. Box 190 Jamaica 31, N. Y.

Send me the FREE 324-Page
1961 Catalog No. 610

Name _____
Address _____
City _____ Zone _____ State _____

For further information, check number 36 on page 126.

HERE NOW!

For mobile and home station operation . . .

NEW TRANSCON 6 or 10



A COMPLETE 17½ WATT XMTR WITH STABLE VFO AND CRYSTAL CONVERTER ALL IN ONE SMALL PACKAGE

INCLUDING POWER SUPPLY for 12 VDC and 115 VAC operation

OTHER FEATURES TO THRILL YOU

- Pi network
- "Power on" indicator
- VFO bandswitch for practical band width
- Simple one knob loading
- Audio gain from front panel
- Crystal, dynamic or carbon mike into panel
- Switch for zero beat
- Neon tuning lamp
- Xtal socket on front panel
- Converter installs without breaking into broadcast receiver
- Converter has 2 stage grounded grid RF amplifier with xtal controlled triode osc.
- Mounting brackets included

Only 6½" x 4¾" x 8"

All this for only **\$179⁹⁵**

Don't delay — get your TRANSCON and be on the air in a few minutes. It's the easiest and the BEST way to go mobile.

ARROW ELECTRONICS, INC.

65 CORTLANDT ST., NEW YORK 7, N. Y. • Dlgby 9-3790
525 JERICHO TURNPIKE, MINEOLA, N. Y. • Pioneer 6-8686

Canadians: available from

ELECTRONIC TUBE CO. 464 MCGILL ST., MONTREAL 1, P. Q.

For further information, check number 37 on page 160.

104 • CQ • September, 1960

tion activities we'll never know, but with Helen and K1EKO, Edith, in charge, they provided a sumptuous spread for well over a hundred hungry people. Swimming, ragchewing and enjoying a beautiful New England day filled the rest of Sunday.

To give credit where due, in addition to convention committee members mentioned above, W1RLQ, Chata, served as business manager; W1SCS, Ruthe, planned program; W1VOS, Marge, headed publicity; W1UKR, Eunice, and K1IJV, Jean, handled reservations. To each on the convention committees, and to all of the other YLs and OMs who made the 3rd International YLRL Convention the tremendous success that it was, the grateful thanks from all of us who were privileged to attend.

During this convention it was recommended that the next YLRL convention be held in 1964, to celebrate YLRL's 25th anniversary. No doubt YLRL officers will be glad to receive bids from any YL clubs wishing to sponsor it. *CU in Cambridge* could well now become *CU in 1964!*

Anyone wishing copies of photographs credited to K9QGR, contact Hazel Cain at DeWitt, Ill.

Prior to the convention, on June 6th, the WRONE YLs were featured on a TV program. Called "Dateline Boston," it was viewed by many over WHDH-TV that evening.

YLRL "Howdy Days"

"Howdy Days", a get-acquainted fun party for licensed YLs, will be held Wed.-Fri., Sept. 28-30, 1960. Here are the rules:

1. Score will be based on licensed YL contacts only.
2. All bands and all modes of emission may be used.
3. Only one contact for a station may be claimed.
4. Contacts on nets not permitted.
5. No multipliers.
6. Contest opens 12 noon EST, Sept. 28 and closes 12 noon EST Sept. 30, 1960.
7. Scoring—two points for YLRL member; one point for non-member YL.
8. Logs not required. Submit list stating date, time, call, name, QTH, YLRL member or not.
9. Awards—Top YLRL member score—choice of YLRL pin or stationery. Top non-member score—one year paid membership in YLRL.
10. Score sheets must be received by YLRL vice president by Oct. 15, 1960. Mail as soon as possible after contest to W5EGD/3, Lillian Beebe, 923 Kent Ave., Baltimore 28, Maryland (be sure to include Zone number).

21st YLRL Anniversary Party

Put these dates on your calendar now for YLRL's 21st Anniversary contest: October 19-20 and November 2-3, 1960. More details and the rules in the next issue of *CQ*.

33, Louisa, W5RZJ

SB [from page 89]

—from Madeira Island. His stateside QSL manager is W3KVQ . . . Bert, I1TBU, in Bolzano, pushes through a potent signal in the early morning hours with his 150 watt home-brew exciter to a 3 element beam . . . Don, KØTAJ, kindly informs us that anyone needing a card from Bert, ZS3ES, may write to Bert c/o F. P. Turville, 42 Devon Avenue, Westmount, Montreal, Canada. And not noted in last month's column was the fact that ZS3AD

CUSTOM STYLED GIFTS

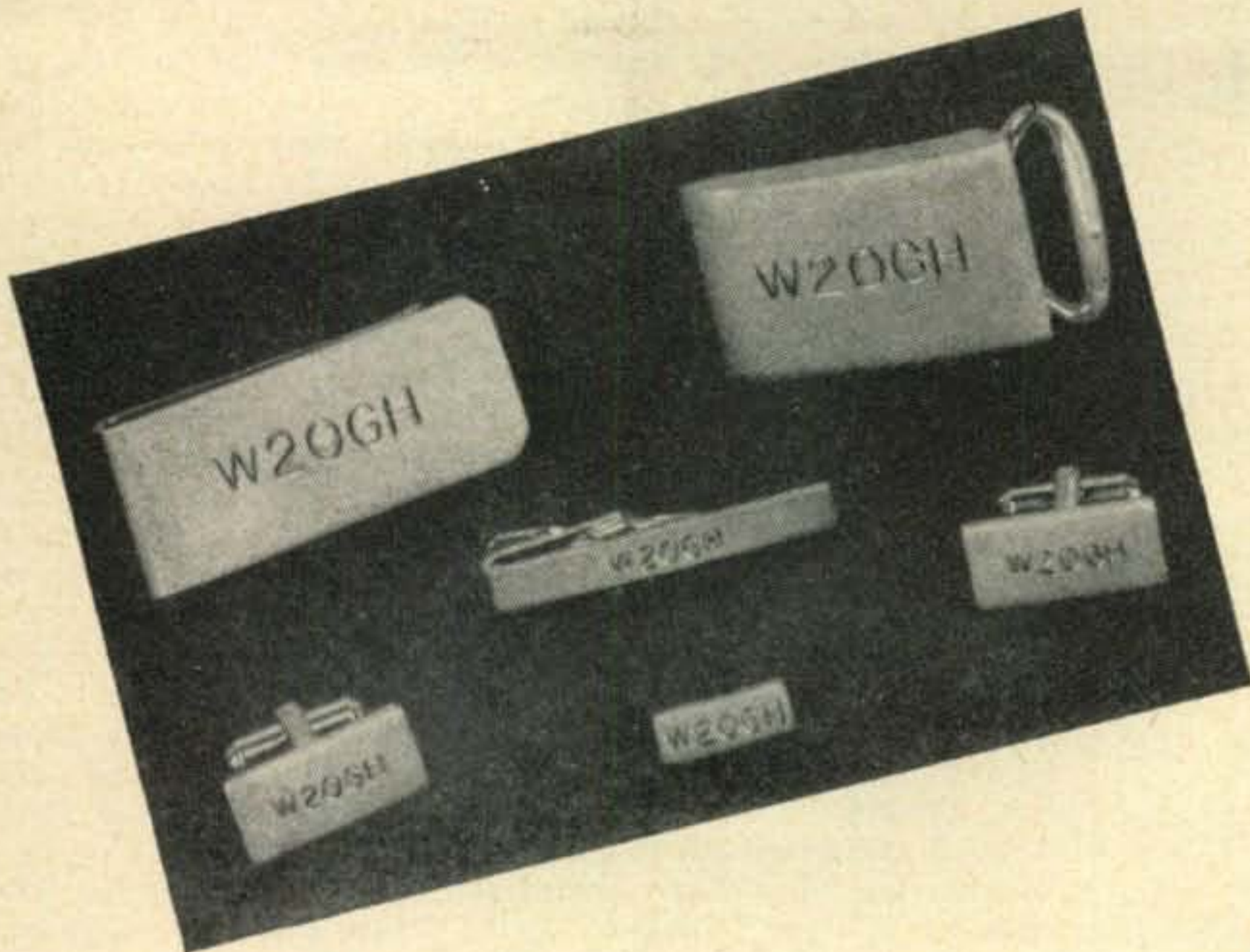

The Finest in Ham Jewelry

A complete line of personalized jewelry handsomely engraved with your call letters, name or initials. All items available in choice of gold plate or silver plate. Mark appropriate box on coupon. Sandblast finish insures long wear.

Money Clip....\$3.50* Tie Bar.....\$2.50*
 Cuff Links..... 3.50* Tie Tack..... 2.50*
 Buckle..... 3.50* Lapel Pin..... 2.50*

Match Books

Personalized with your call letters, name or initials. 50 books of matches attractively packed in a reusable clear plastic drum. Attractive Gold, Silver, Green, Red metallic colors and White letters.

\$2.95 postpaid.

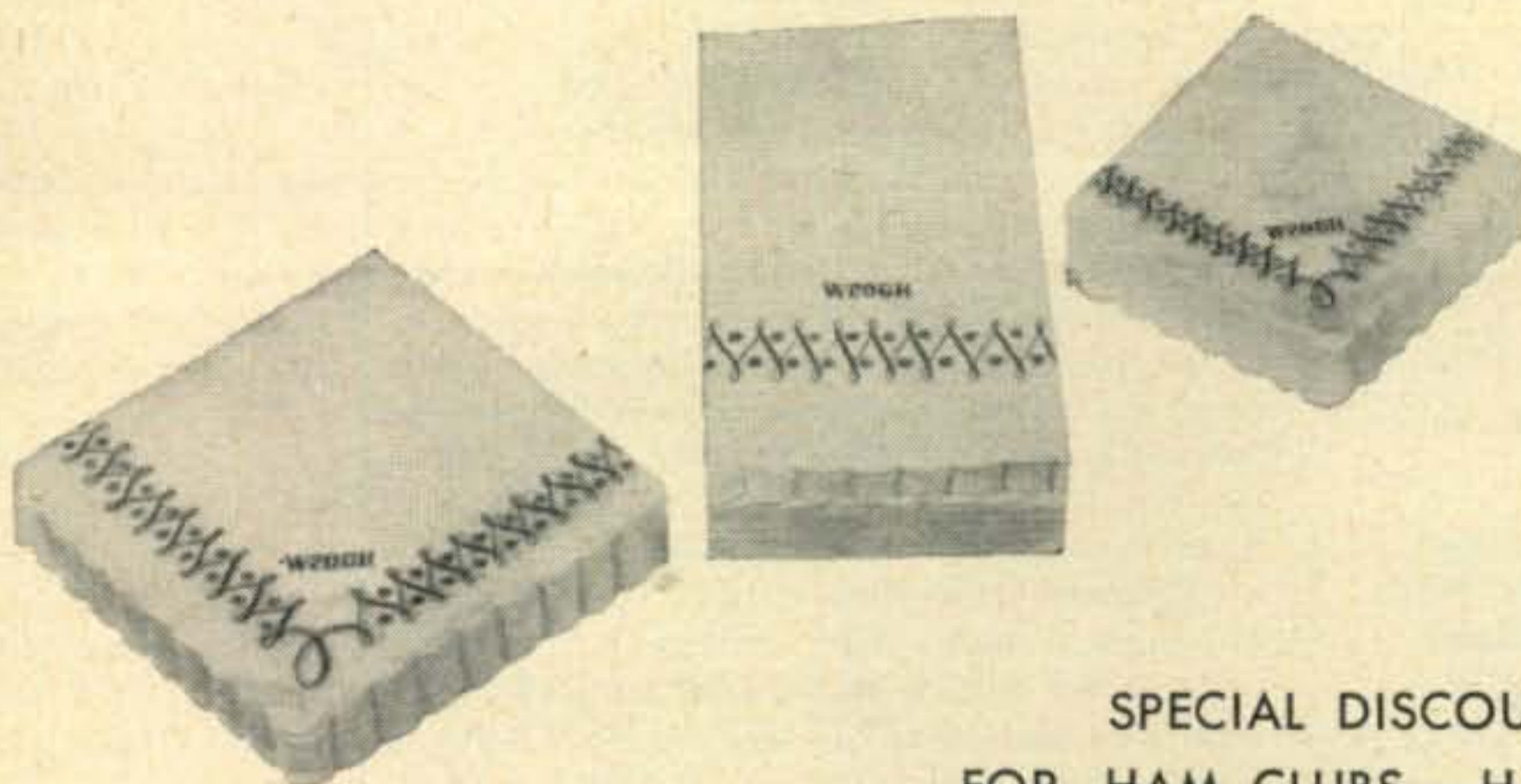
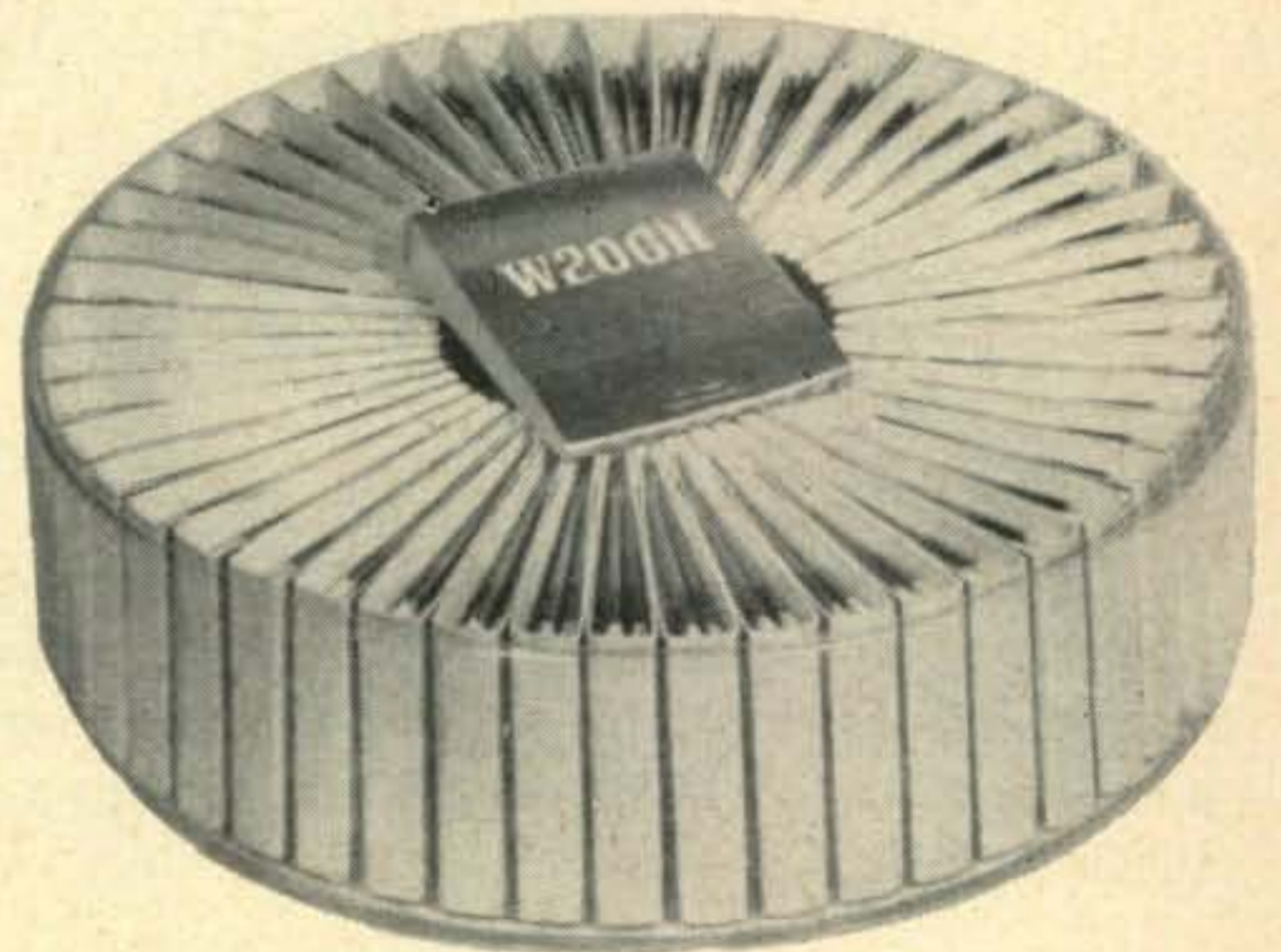

Hostess Set

50 each, beverage and luncheon napkins and guest towels. Personalized with your call letters, name or initials. Attractive Gold and Silver scroll border design, gift boxed.
 \$4.95 postpaid.

SPECIAL DISCOUNTS ON QUANTITY ORDERS
 FOR: HAM CLUBS — HAMFEST PRIZES — MANUFACTURERS
 WRITE FOR FULL DETAILS, SPECIFYING YOUR PARTICULAR NEED

* Add 10% Federal Excise Tax to all jewelry.

Hewlett Sales Co.
 Box 600CQ
 300 West 43rd St.
 New York 36, N.Y.

CQ 9

SIRS: My check (money order) for \$..... is enclosed. Please send

Money Clip G S Buckle G S Tie Tack G S
 Cuff Links G S Tie Bar G S Lapel Pin G S
 Match Books Gold Silver Green Red Hostess Set

NAME or INITIALS.....CALL.....

ADDRESS.....

CITY.....ZONE.....STATE.....

Add 10% Federal Excise Tax to all jewelry.

New York City residents add 3% Sales Tax.

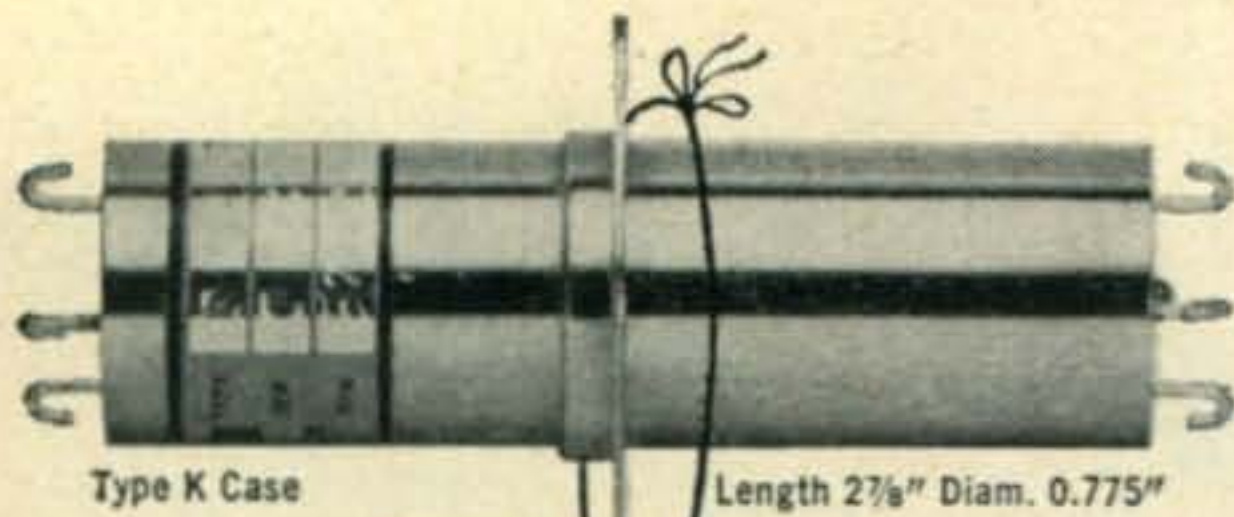

**SPECIAL
OFFER!**

**BUILD OR CONVERT TO SSB
WITH ECONOMICAL
HIGH QUALITY COLLINS
455 KC MECHANICAL FILTER**

JUST \$26.50 will get you started. Collins 2.1, 3.1 or 4.0 kc bandwidth Mechanical Filters with center frequencies of 455 kc are available...in discontinued models...at this low price (up to 50% below regular prices)...in three different case styles...as long as the supply lasts.

Excellent in your receiver IF section for flat-topped, steep-skirted selectivity. The filters can also be used in the exciter for straightforward sideband generation without touchy phasing systems.

With each filter, Collins provides easy-to-understand application notes, and specifies the points 20 db down the selectivity curve so you can easily obtain crystals for proper carrier and sideband suppression.

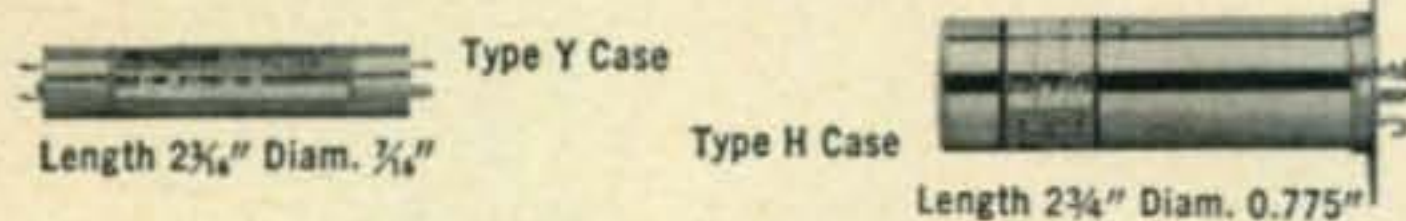

USE COUPON TODAY!

Please send me, prepaid, the following Mechanical Filters at \$26.50 each.

QUANTITY	BANDWIDTH	CASE STYLE
_____	2.1°	K___H___
_____	3.1	K only
_____	4.0	Y only

Limited stock may require us to substitute case styles.

Will you still accept filter? Yes _____ No _____

Enclosed is my check or money order for \$ _____
(no cash, please!)

NAME _____ CALL _____

ADDRESS _____

CITY _____ ZONE _____ STATE _____



COLLINS RADIO COMPANY
2700 WEST OLIVE AVENUE
BURBANK, CALIFORNIA

For further information, check number 38 on page 126.

who took over Bert's rig is a charming XYL named Joy Bryant . . . More good news re the distaff side: Thanks to Dave, YN1TAT, another Nicaraguan station (and probably the prettiest) is now on SSB. Mibbs, YN1MW, set her new KWM-2A on a desk, turned her library into a shack, and by now is probably a regular on the bands . . . Al, W8PQQ, heaved a sigh of relief after the last of the VU2ANI cards was inserted in its envelope. Cards for which no envelopes were received were sent via the Bureaus . . . Harry, VE3CIO, and XYL, Paula, spent a most enjoyable vacation week in Costa Rica with old friends, Hans, TI2IO, XYL, Hansi, and the rest of the TI group . . . Bill, VE7ZM, who is now acting as MC for ZL4JF (on AM, darn it), sent along the photo of LA3-SG/P's shack and antennae set-up on Jan Mayen. Kjell left Jan Mayen in June and is now back in Finland . . . Giedrius, UP2CG, delighted Doc, W2YBO, with an unexpected reply to Doc's CQ, but maybe the pileup was too much for Gied because he has not been heard too often. However, in anticipation of more contacts with Lithuania, Gied's QTH is PO Box 17, Shoulay . . . Sid, W8UTQ/3V8, will be in Tunisia for about a year, satisfying, we hope, all the requests for an exchange of signal reports . . . Jo, CR6CA, needs about 8 more cards for YLCC. How about it, gals? Incidentally, Jo should be operating shortly from Sao Thome . . . All cards for Rudy's operation from VS9AZ should go via the RSGP . . . Chus, CO7AA, prefers ragchewing and the cultivation of friendships to DX chasing. His son is now living in White Plains, New York, so Chus is always on the lookout for Westchester County contacts . . . John, F7AC, with NATO in Fountainbleu, is ex-W7GQH from Cheyenne, Wyo . . . As we have mentioned before, keep your ears open for Rudy—he now has permission to operate as FL8ZA and will put that call on the air in the late Fall of this year . . . Bob, ON4VD, may join the first Belgian scientific expedition to the Antarctic as its radio operator. The amateur call will be OR4—the first time that prefix has been used. If Bob does not go to Antarctica, listen for him operating from Luxembourg on Sept. 10-11 during the WAS Contest . . . Had a most interesting chat with Cal and George at 5A5TR. They are part of a 16 man team concerned with geophysical exploration for oil in the desert. Cal is ex-YA1IW (why weren't you on SSB then, Cal?) while George, a Scotsman, is becoming so fascinated by SSB that it probably won't be long before George has his own license . . . Father Bill, OA7Q, has returned to Cuzco, Peru, loaded down with most of the radio equipment he sought to maintain communications with his widespread parish. Bill hopes to be assigned special frequencies by the Peruvian government in order to keep in touch with his fourteen priests working among the natives . . . Except for visits with Bruno, HB9FU, and Jean, HB9J, Bob, TG9AD, had a real vacation from hamming during his two-month's holiday in Europe. Bob wrote that he didn't even see many ham antennas except for two very prominent beams atop old palaces on the Grand Canal in Venice!! . . . Ted, VQ9TED, who has been most active on SSB with a KWM-1 Maritime Mobile, has embarked on a sentimental journey, enhanced by his recently acquired amateur license. Ted was an enthusiastic SWL for many years before getting his call last year. Recently he decided to make an eight month's tour by sea, revisiting scenes of his early youth. And what better way to share his joy with his many new friends on the air than to take along his rig and provide contacts from some new rare spots? So Ted's itinerary will include The Seychelles, The Aldabras, The Amaranthes and Chagos Archipelago from August to December. He will then return to the Seychelles for the Christmas holidays and will embark again on January 3 for Pakistan and Kashmir and India after which he will re-visit the islands on his return trip home. We extend our best wishes to Ted for a wonderful journey and look forward to sharing his experiences through radio.

Band Hopping

Tom, ex-HL9KR, is now at Fort Gordon, Ga., operating from the shack of W4MJI . . . All his many friends will be happy to learn that Ray, W4BJ, has recuperated nicely from his operation in July . . . Al, K1IXG, will detour to Mexico in the Fall on his way to a dental convention in Los Angeles . . . A chap rang our bell, stood there without saying a word, spoke one sentence and immediately identified himself. Yes, it was our friend, Eloy, W1DBN/4,

WE HAVE THE EXCITING
NEW GLOBE ELECTRONICS'

Mobiline Six...

20 WATTS INPUT; VFO OR
CRYSTAL CONTROLLED

A smartly styled, compact transmitter and receiver combination for equal 6 meter adaptability to fixed or mobile installation. Operates 115V AC, 12V DC or 6V DC, with power supply included. Weight: 20 lbs. Size: 5"x12½"x12¼".

Receiver utilizes 7 tubes with RF stage, delivering better than 1 mv sensitivity. Squelch control provided.

Transmitter features voltage regulated and shock mounted VFO for utmost stability under adverse conditions. 2E26 amplifier stage is conservatively operated to handle 20 watts input.

VFO or XTAL control; "S" meter, tuning meter, slide rule dials, VFO spotting, Class B Modulation are other feature highlights. \$229.95.



6 METER MOBILE OR FIXED STATION TRANSCEIVER

For further information, check number 20 on page 126.

September, 1960 • CQ • 107



the Globe Chief Deluxe

Globe's quality, compact and self-contained bandswitching 10-80M transmitter for 90 watts CW (75 watts for novice). Cathode or bias keying. Built-in power supply. New Pi-Net. Plug-in for external accessories.

Wired: \$79⁹⁵ Kit: \$59⁹⁵

the Globe Scout Deluxe

NOW RELAY CONTROLLED CIRCULATORY

Versatile 90w CW, 75w AM Xmtr., bandswitching 80-6M. Straight thru operation. Pi-Net matches 50-300 ohms 80-10M; 50-75 ohms link coupled on 6M. High level plate modulation. Plug-in VFO or crystal. Shielded & filtered.

Wired only: \$159⁹⁵



STOP IN OR WRITE FOR INFORMATION ON THE ENTIRE GLOBE ELECTRONICS LINE

PIONEER ELECTRONICS

2103 EAST 21ST STREET • CLEVELAND, OHIO • PHONE SUPERIOR 1-5277

PROMPT SHIPMENTS • EASY CREDIT • HIGH TRADES • LOW DOWN PAYMENT



G4ZU

"G4ZU PAT."

Save In September Sale

Save—Save—Save More than you can in a bank
You choose your own Combination

Choose Either G4ZU Antenna

G4ZU 20/40 Meter Birdcage—the fifteen pound dandy with 9 ft. turning radius—Now with improved cylindrical stubbing and center masts. Gains 9.6 db on 20, F/B over 25, SWR virtually 1:1 on 20—40 Meter results slightly less.....\$94.50

G4ZU 10/15 and 20 Super Coax Mini-beam (Not Miniature). 16 pounds total weight. 13'6" turning radius. Furnished as part of the beam, the Bi Nodal coupler, radar engineered for broadbanding and increased gain.....\$89.50

NO COILS • NO TRAPS IN EITHER

Choose Any Rohn Tower

All from the Famous 25G line with 1 1/4 inch side rails made of heavy duty steel tubing for strength and long life—Hot Dip Galvanized. All towers furnished with top section, house bracket and standard sections.

30'\$ 64.15 40'\$ 82.40
50'\$100.65 60'\$118.90

These are heavy duty towers—Not TV specials. For the fastidious the 50' Tilt over Tower—King of them all 50'.....\$186.60
(can be furnished in 60' and 70')

Instructions

Chose your G4ZU beam—add the cost of any tower and take off 10% (YOUR SAVING). Other items available.

AR22 Rotators\$32.75
RG8 Cable (not surplus) per 100 ft.\$12.35

Cables—Connectors—Switches—We have them.

Buy your antenna system at one place—don't shop.

**CREDIT AVAILABLE
IMMEDIATE SHIPMENT**

HOUSE of ANTENNAS

1155 East 82nd
Chicago 19, Ill.
Tel. SO 8-9282

For further information, check number 40 on page 126.

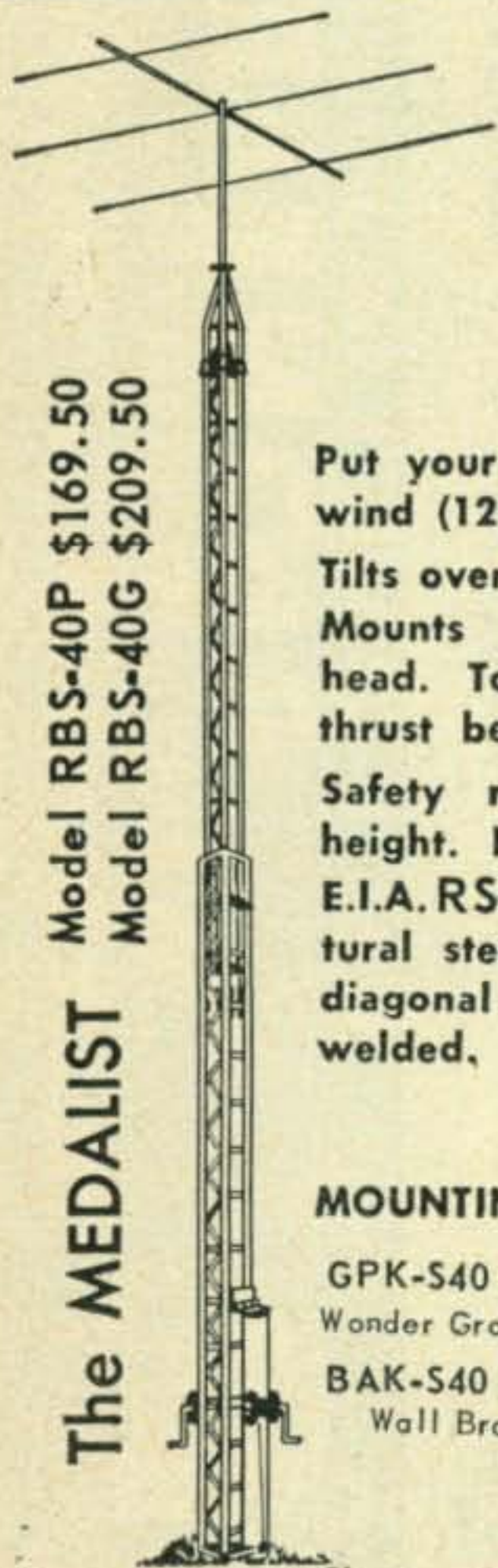

STURDY E-Z WAY TOWERS

Put your Tribander at 41' in 70 mph wind (125 mph cranked down to 24').

Tilts over for E-Z access to array.

Mounts Ham-M Rotor inside tower head. Top radial bushing - vertical thrust bearing.

Safety rest locks tower at desired height. No weight on cables.

E.I.A. RS-222 specs. Heavy wall structural steel tube legs, solid steel rod diagonal & horizontal bracing — arc welded, Sold by Top Flight Distributors
Everywhere!

MOUNTING KITS:

GPK-S40 \$75.00
Wonder Ground Post
BAK-S40 \$10.50
Wall Bracket



Write for Catalog 22-1

P.O. BOX 5767 TAMPA 5, FLORIDA

For further information, check number 59 on page 126.

who dropped in to say hello and you can bet that, after four years of hearing Eloy from various parts of the world, it was a great pleasure to meet him personally at last . . . Paul, KØTAD, and XYL Marian, W4MCB/Ø, found the TVI problem too rough in their trailer court so regrettably have decided to forego hamming for the next year until a new location eliminates their problem. They will be missed on the air . . . Ken, W8SS, was finally pushed into SSB by KH6KH when the Blatts repaid a visit Ken had made to them in Honolulu. Ken lives near and is interested in the Henry Ford Museum in Dearborn, Mich., and invites any hams visiting the Museum to drop in and say hello to him. Ken's Motor City Radio Club was invited to make the Museum its Headquarters so now they have a club house with a swimming pool, showers, gymnasium, ballroom, banquet hall, class rooms, and projection rooms, etc. Ken asks, "Who said there was no Santa Claus?" . . . Sybil, K5MRR, again taught in the "Summer Enrichment Program" in the Waco, Texas school system. She had 14 students each, in two classes, learning amateur radio with practical demonstrations via a KWM-1 right from the classroom . . . When Don, K6GJZ, comes right back with your name, don't attribute it to a prodigious memory. Don's card file is 52 inches long with cards for each contact listing names, locations, dates, and other pertinent information. Don is a retired TV distributor who left Seattle for Santa Barbara and is now happily dividing his time between SSB, photography, and gardening . . . Al, WA2BKT, feels he is the only station who can legitimately claim a "ground wave" contact. Al was working a WØ with his mobile when his attention was directed to the fact that his antenna spring mounting had broken. He was making the contact and getting a good report with the antenna dragging on the ground!!

While the weather is still warm and you have the opportunity, here's a gentle reminder to clean up and tune up antennas, feedlines, towers and rotors. Prepare now to enjoy the operating season ahead.

73, Irv and Dorothy

CONTEST CALENDAR [from page 92]

Five log sheets will go for 1 ounce.

If you get your request in early it can be mailed 3rd class at a great saving. The rates for printed matter are 3¢ for the first 2 ounces and 1 1/2¢ for each additional ounce. That means that 10 sheets will go for only 3 cents.

The savings on foreign mail is even greater, 4¢ for the first 2 ounces and 2¢ for each additional 2 ounces. However plenty of time must be allowed for this mail classification, especially for distant countries. It's advisable that you consult your postmaster before you request this type of service.

So don't wait until the last week before the contest and then expect us to mail them by Air Mail for a single IRC.

ARRL SS

There's plenty of time to prepare for the "Silly Symphonies" marathon. No doubt QST will make the announcement next month.

R S G B

Although confined to 28 and 21 mc only, this Phone contest has become quite popular. It might be tough diggins this year but the boys of the British Isles will provide the activity so give it a try. Details next month.

Things should be starting to hum about the time you receive this issue. Have fun.

73 for now, Frank, W1WY



... symbol of
RAD-TEL
FIRST QUALITY

INSIST ON RAD-TEL FOR EVERY
 TELEVISION AND RADIO TUBE NEED

Super-Special!
KIT OF 100
Bi-Pass
CONDENSERS
 Over 50%
 Are 600V
 at LESS
 THAN 4¢ each
 Goodall
 Semi-Molded
 Paper and MYLAR
 Made up of approx.
 16-200V, 20-400V
 and 64-600V.
 Values .001 to 1 mf

\$3.95

Up To 75% Off on BRAND NEW TUBES

GUARANTEED ONE FULL YEAR! You Can Rely On Rad-Tel's Speedy One Day Service!

Not Used — Not Pulled Out Of Old Sets • Each Tube Individually and Attractively Boxed!

Qty.	Type	Price	Qty.	Type	Price	Qty.	Type	Price	Qty.	Type	Price	Qty.	Type	Price	Qty.	Type	Price
—	0Z4M	.79	—	4BZ7	.96	—	6AV6	.40	—	6DE6	.58	—	12AE6	.43	—	12CR6	.54
—	1AX2	.62	—	4CS6	.61	—	6AW8	.89	—	6DG6	.59	—	12AF3	.73	—	12CU5	.58
—	1B3GT	.79	—	4DE6	.62	—	6AX4	.65	—	6DQ6	1.10	—	12AF6	.49	—	12CU6	1.06
—	1DN5	.55	—	4DK6	.60	—	6AX7	.64	—	6DT5	.66	—	12AJ6	.46	—	12CX6	.54
—	1G3	.73	—	4DT6	.55	—	6BA6	.49	—	6DT6	.53	—	12AL5	.45	—	12DB5	.69
—	1J3	.73	—	5AM8	.79	—	6BC5	.54	—	6EU8	.79	—	12AL8	.95	—	12DE8	.75
—	1K3	.73	—	5AN8	.86	—	6BC7	.94	—	6EA8	.79	—	12AQ5	.52	—	12DL8	.85
—	1L6	1.05	—	5AQ5	.52	—	6BC8	.97	—	6H6GT	.58	—	12AT6	.43	—	12DM7	.67
—	1LN5	.59	—	5AT8	.80	—	6BD6	.58	—	6J5GT	.51	—	12AT7	.76	—	12DQ6	1.04
—	1R5	.62	—	5BK7A	.82	—	6BE6	.55	—	6J6	.67	—	12AU6	.50	—	12DS7	.79
—	1S5	.51	—	5BQ7	.97	—	6BF6	.44	—	6K6	.63	—	12AU7	.60	—	12DZ6	.56
—	1T4	.58	—	5BR8	.79	—	6BG6	1.66	—	6S4	.48	—	12AV5	.97	—	12EL6	.50
—	1U4	.57	—	5CG8	.76	—	6BH6	.65	—	6SA7GT	.76	—	12AV6	.41	—	12EG6	.54
—	1U5	.50	—	5CL8	.76	—	6BH8	.87	—	6SK7	.74	—	12AV7	.75	—	12EZ6	.53
—	1X2B	.82	—	5EA8	.80	—	6BJ6	.62	—	6SL7	.80	—	12AX4	.67	—	12F5	.66
—	2AF4	.96	—	5EU8	.80	—	6BK7	.85	—	6SN7	.65	—	12AX7	.63	—	12F8	.66
—	3AL5	.42	—	5J6	.68	—	6BL7	1.00	—	6SQ7	.73	—	12AZ7	.86	—	12FM6	.45
—	3AU6	.51	—	5T8	.81	—	6BN4	.57	—	6T4	.99	—	12B4	.63	—	12K5	.65
—	3AV6	.41	—	5U4	.60	—	6BN6	.74	—	6U8	.78	—	12BA6	.50	—	12SA7M	.86
—	3BA6	.51	—	5U8	.81	—	6BQ5	.65	—	6V6GT	.54	—	12BD6	.50	—	12SK7GT	.74
—	3BC5	.54	—	5V6	.56	—	6BQ6GT	1.05	—	6W4	.57	—	12BE6	.53	—	12SN7	.67
—	3BE6	.52	—	5X8	.78	—	6BQ7	.95	—	6W6	.69	—	12BF6	.44	—	12SQ7M	.73
—	3BN6	.76	—	5Y3	.46	—	6BR8	.78	—	6X4	.39	—	12BH7	.73	—	12U7	.62
—	3BU8	.78	—	6AB4	.46	—	6BU8	.70	—	6X5GT	.53	—	12BL6	.56	—	12V6GT	.53
—	3BY6	.55	—	6AC7	.96	—	6BY6	.54	—	6X8	.77	—	12BQ6	1.06	—	12W6	.69
—	3BZ6	.55	—	6AF3	.73	—	6BZ6	.54	—	7AU7	.61	—	12BY7	.74	—	12X4	.38
—	3CB6	.54	—	6AF4	.97	—	6BZ7	.97	—	7A8	.68	—	12BZ7	.75	—	17AX4	.67
—	3CF6	.60	—	6AG5	.65	—	6C4	.43	—	7B6	.69	—	12C5	.56	—	17BQ6	1.09
—	3CS6	.52	—	6AH6	.99	—	6CB6	.54	—	7Y4	.69	—	12CA5	.59	—	17C5	.58
—	3CY5	.71	—	6AK5	.95	—	6CD6	1.42	—	8AU8	.83	—	12CN5	.56	—	17CA5	.62
—	3DK6	.60	—	6AL5	.47	—	6CF6	.64	—	8AW8	.93	—			—		
—	3DT6	.50	—	6AM8	.78	—	6CG7	.60	—	8BQ5	.60	—			—		
—	3Q5	.80	—	6AN4	.95	—	6CG8	.77	—	8CG7	.62	—			—		
—	3S4	.61	—	6AN8	.85	—	6CM7	.66	—	8CM7	.68	—			—		
—	3V4	.58	—	6AQ5	.50	—	6CN7	.65	—	8CN7	.97	—			—		
—	4BC5	.56	—	6AR5	.55	—	6CR6	.51	—	8CX8	.93	—			—		
—	4BC8	.96	—	6AS5	.60	—	6CS6	.57	—	8EB8	.94	—			—		
—	4BN6	.75	—	6AT6	.43	—	6CU5	.58	—	10DA7	.71	—			—		
—	4BQ7	.96	—	6AT8	.79	—	6CU6	1.08	—	11CY7	.75	—			—		
—	4BS8	.98	—	6AU4	.82	—	6CY5	.70	—	12A4	.60	—			—		
—	4BU8	.71	—	6AU6	.50	—	6CY7	.71	—	12AB5	.55	—			—		
—	4BZ6	.58	—	6AU7	.61	—	6DA4	.68	—	12AC6	.49	—			—		
			—	6AU8	.87	—	6DB5	.69	—	12AD6	.57	—			—		

Use This As Your Mail Order Form

Name.....

Address.....

City.....

State.....

PLEASE PRINT PLAINLY

Experimenters! Hams! Rad-Tel Saves You Money On All Your Equipment Needs!

SEND FOR FREE TROUBLE SHOOTER GUIDE AND NEW TUBE & PARTS CATALOG.

RAD-TEL TUBE CO. 55 Chambers St
 Newark 5, N. J.
 CQ-960

TERMS: 25% deposit must accompany all orders — balance C. O. D. Not Affiliated With
 \$1 HANDLING CHARGE FOR ORDERS UNDER \$5. Subject to prior sale. Any Other Mail
 Please add postage. No C. O. D.'s outside continental U. S. A. Order Tube Co.

For further information, check number 41 on page 126.

THE CQ HAM MART



19" GLOBE

Here is a chance to preserve your breath for posterity! This beautiful World Globe, made by Hammond, is a must for every hamshack. Plain for \$19.95 or lighted for \$24.95. The first 10,000 people who jump at this bargain will get a year of CQ at no extra charge.

ATLAS

What! You don't know where Nicobar Island is? Incredible! And with the CQ deal on the Hammond Atlas so reasonable too. This is a reference book that will get good usage around your house if you have any kids. 7 lbs. of colored maps and a gazetteer for only \$12.50... and you get a year of CQ.

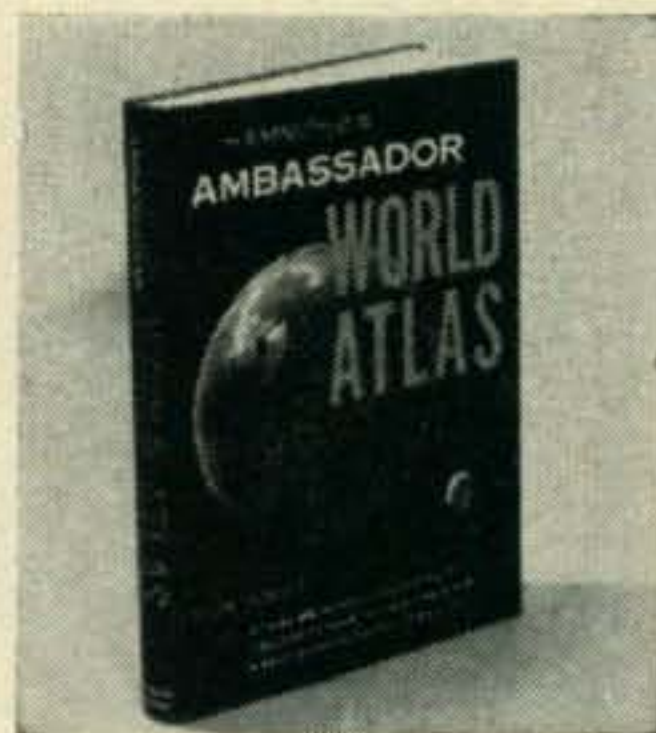

COMMAND SETS

This IS a collection of reprints, containing all of the available information on the conversion of the popular "Command" transmitters and receivers into good ham transmitters and receivers. Invaluable for Novice, Technician, General, Advanced and Extra class operators. 136 fabulous, amazing terrific pages for only \$1.50 postpaid.



MOBILE HANDBOOK

Anyone who tries to go mobile without getting this book should register for a sanity hearing. Bill Orr, W6SAI has put everything you need to know in this book. Build-its by the dozen... solutions to ignition problems, keeping the battery charged, noise... only \$2.95 postpaid.

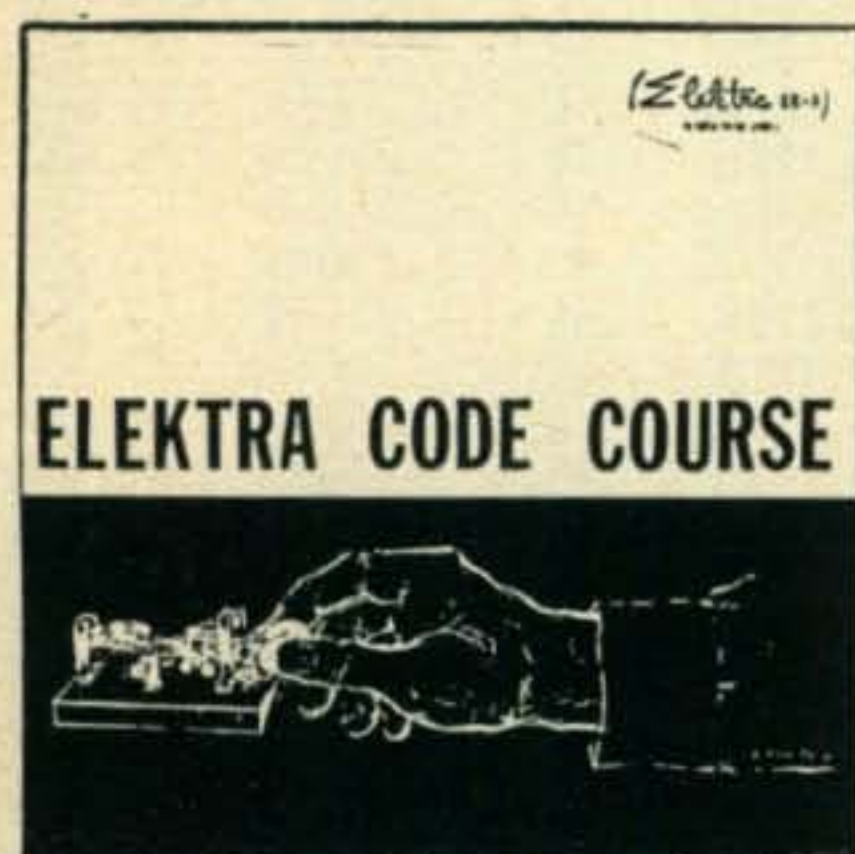

CODE RECORD

Learning code is a snap with this record. Speeds from 3 to 16 WPM, depending upon turntable speed. This 12" LP record has on it all you need to learn the code for both the Novice and General License. \$3.50 each.



Log Sheets of the most astounding modern design. Infinitely superior to any others on the market. And they are only \$1 for a pad of 100 sheets. Specify Regular or SSB type.

HAM'S INTERPRETER

Now you can talk in broken French, Spanish, Italian, German, Swedish and Finnish. This handy little book gives all the popular ham conversation in seven languages, including letters and numbers. Only \$1.50 postpaid.

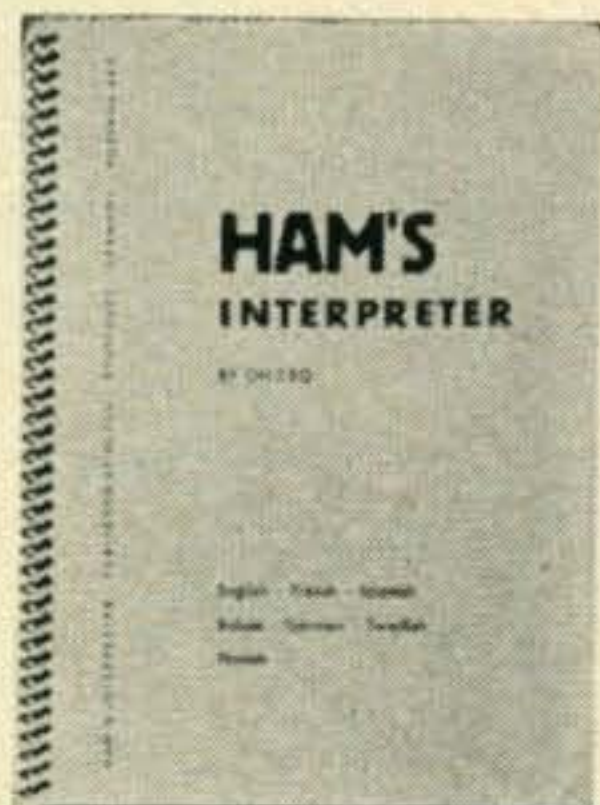

TVI HANDBOOK

W1DBM's newly written TVI book (2nd edition) covers all aspects of curing TVI from both the Ham's viewpoint and that of the TV viewer or the TV serviceman. It includes 2- and 6-meter TVI as well as Citizen's Band, Industrial, Medical and Utility TVI. Profusely illustrated with diagrams, photos, charts, tables and FCC regulations pertaining to radio and television interference. Price \$1.75 postpaid, USA, \$2.00 Foreign.



BINDER

There is no other good way to keep your back issues. Make 'em neat. We supply the binder, with the year embossed in gold, not merely a sticker which will come off later. Specify what year you want stamped on your binder. \$3.50 each.



BOUND VOLUME

By far the handiest way to keep your library. Why not go first-class? This impressive volume is only \$10.00. We only made a few of them this year, so Don't expect to get one later.





CQ ANTHOLOGY

Most amateurs do not have a good file of back issues of CQ. So we've looked back through the years 1945-52 and assembled all in one place the articles that have made a lasting stir. The issues containing most of these articles have long ago been sold out. The price is a paltry \$2.00.

HI-FI BOOK

This nifty volume contains the latest dope on amplifiers, preamplifiers and equalizers plus a buyer's guide of component manufacturers! Over 150 — 5½" x 8½" pages of heavily illustrated descriptions covering Hi Fi Audio Components—the greatest publication value in its field today. Only \$2.50 per copy.



SIDEBAND HANDBOOK

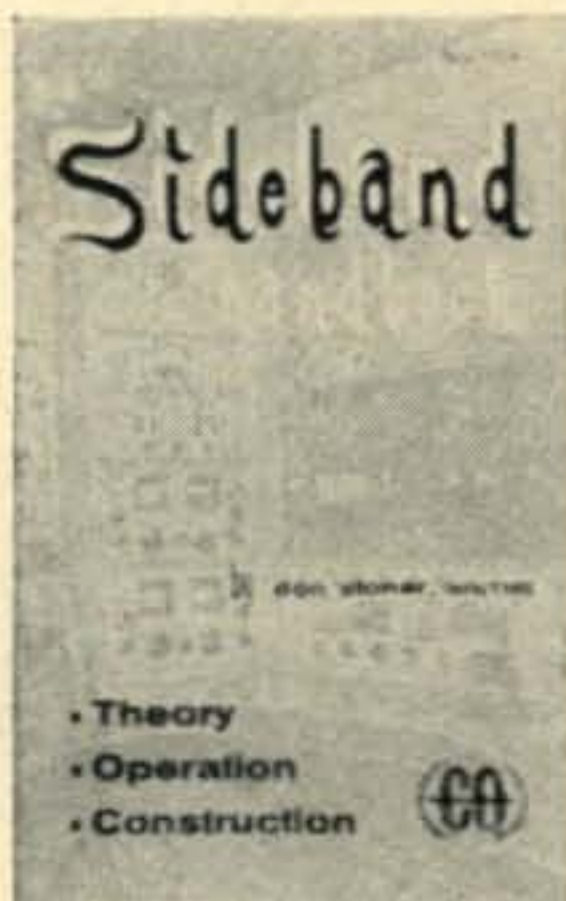

Written by Don Stoner, W6TNS, was almost one full year in the preparation of this terrific volume. This is not a technical book. It explains sideband, showing you how to get along with it... how to keep your rig working right... how to know when it isn't... and lots of how to build-it stuff, gadgets, receiving adaptors, exciters, amplifiers. Price, only \$3.00.

ALL ABOUT MISSILES & SATELLITES

Here's a book, written in down-to-earth language, which answers questions on missile maintenance, fire control, flight control tracking, testing, fuels, payload and many other achievements in rocketry and space for both scientific and military applications. Also, featuring the most up-to-date "Directory of 38 Most Popular Missiles and Their Photos," (supplied by Department of Defense) as well as a "Glossary of Missile Terms." \$1.50 per copy.

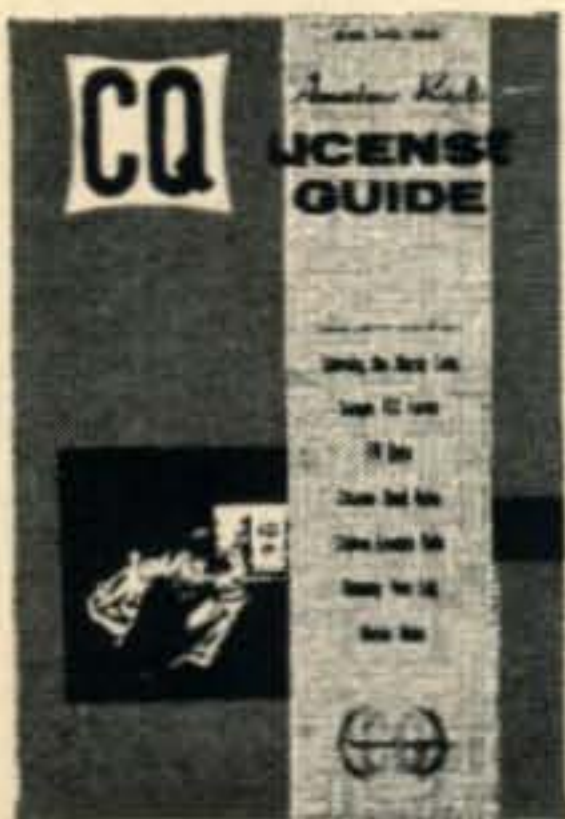
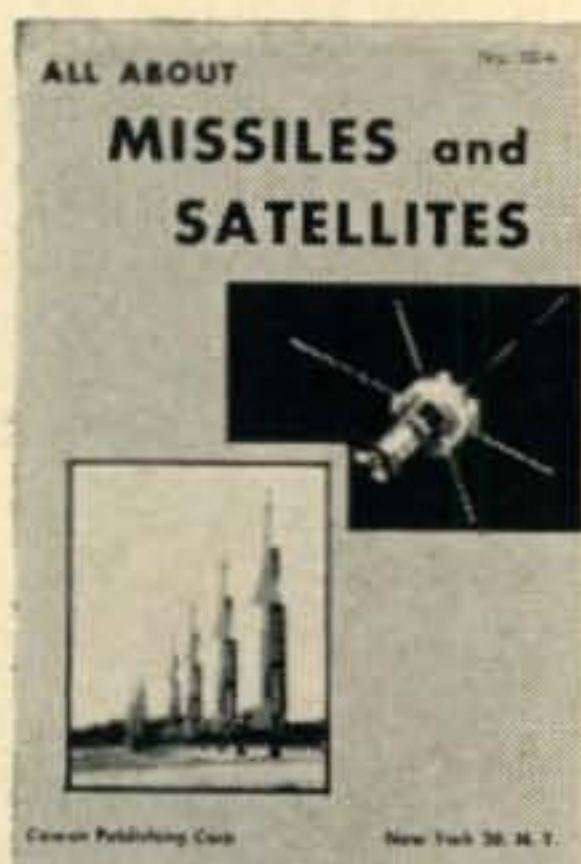

212 pages of everything the Amateur must have to get his license and progress toward the general class ticket. Plus many additional pages of vital information for the ham operator. All this for only \$2.50.

This is a book literally loaded with schematics for all the currently popular pieces of surplus gear. Most amateurs are well aware of the problems encountered in purchasing seemingly inexpensive surplus units, only to find that no schematic diagram is available. Trying to figure out the circuitry cold turkey can be many times more difficult than the most involved puzzle, and purchasing a single instruction book can run as high as \$3.50. Why knock yourself out when you can have a book with complete coverage on hand in your library? All this for only \$2.50.



COWAN PUBLISHING CORP. CQ 9
Book Division
300 West 43rd Street
New York 36, N. Y.

LIGHTED GLOBE	\$24.95	<input type="checkbox"/>
UNLIGHTED GLOBE	19.95	<input type="checkbox"/>
ATLAS	12.50	<input type="checkbox"/>
COMMAND SETS	1.50	<input type="checkbox"/>
MOBILE HANDBOOK	2.95	<input type="checkbox"/>
CODE RECORD	3.50	<input type="checkbox"/>
REGULAR LOG SHEETS (100).....	1.00	<input type="checkbox"/>
SSB LOG SHEETS (100)	1.00	<input type="checkbox"/>
HAM'S INTERPRETER	1.50	<input type="checkbox"/>
TVI HANDBOOK	1.75	<input type="checkbox"/>
BINDER—YEAR WANTED	3.50	<input type="checkbox"/>
BOUND VOLUME	10.00	<input type="checkbox"/>
CQ ANTHOLOGY	2.00	<input type="checkbox"/>
MISSILES & SATELLITES	1.50	<input type="checkbox"/>
HI-FI BOOK	2.50	<input type="checkbox"/>
SIDEBAND HANDBOOK	3.00	<input type="checkbox"/>
CQ LICENSE GUIDE	2.50	<input type="checkbox"/>
SURPLUS SCHEMATICS HANDBOOK....	2.50	<input type="checkbox"/>

SIRS: My check (money order) for \$_____ is enclosed. Please send the following items to:

Name _____

Address _____

City _____ Zone _____ State _____

New York City Residents Add 3% Sales Tax

DX [from page 100]

award certificates.

Likewise, the club will bring together many of the world's top DXers and award holders who are making Amateur history with their accomplishments.

The basic membership certificate, the most beautiful of all the certificates, attests that the member has Amateur awards totaling 25 or more. The certificate approximately 11" x 14", with gold border and background, handsomely printed, has space for five gold seals each overprinted with club seal and with different colored ribbons attesting endorsements for holding awards from all six continents, awards from 25 or more countries, 50 or more awards, and the supreme 100 or more awards. The CHC certificate is "The Award of All the Awards."

The basic membership certificate will be issued by the club secretary upon receipt of proper communication of application containing a listing of 25 or more acceptable awards held; such listing to give complete award identification showing issue date and serial number if any, properly signed by the applicant and witnessed by two other licensed Amateurs or a Notary Public, providing further that all awards listed meet requirements of CHC rules.

Application: Send application, list, own QSL card and \$1 U.S. or 12 IRC's to Club Secretary, Clif Evans, K6BX, Box 385, Bonita, Calif. The \$1 is for life membership, membership certificate and cost of all future endorsement seals. For future endorsements send certified list under same conditions together with SASE in U.S. or 1 IRC for foreign postage.

QTH's

I would like to thank G8KS, W9ZRG, K4LRA, W9YSQ, W3GJY, W1BAN, K2SBW, W6KG, K6EC, K2TDI, KH6BXU, W1WY, The DXer, WGDXC, OVARA, WVARA, NCDXC, SCDXC, FEARL(M) and Yasme newsletter for the help with the QTH's.

Under W2DEC goofs again, add that ex XW8AI is not FG7XG he is FG7XF. Also had W9ZRG as QSL manager of VP2AR, taint so. W9ZRG did handle cards for VS1KM but he is now back in U.K. Try him at John Dart, 11 Garfield Rd., Paignton, South Devon, England.

The following from Les, G8KS: "I am QSL manager for Ronald Pinder VP8EG, Signy Island, South Orkneys. As there are only two boats or so a year it is not advisable to send cards direct. When conditions permit I maintain a weekly schedule with Ron during which he passes details of QSO's he has had since the last schedule, so keeping the log book up to date, I have confirmed all cards received from those who have worked him."

For W2AYN/EP take your pick of the two QTH's both of which are from his QSL.

Commander B. F. Borsody
Khiaban Sepand 46

Teheran, Iran

Or

Commander B. F. Borsody USNR
USOM Iran
APO 205
c/o PM New York, New York

Jerry, K4SXO is going QRT and moving to W5 land but Jerry K4LRA is going to continue as QSL manager for VP2KW, VP2ML, VP2SL, and VP2KD, K4LRA's QTH is P.O. Box 85, Kendall, Florida.

Cards for CP5EL are now being handled by Charlie Perham, W1BAN, Box 64, Woodstack, Conn. CP5EL has over 500 cards already made out that cannot leave Bolivia because of a postal strike.

CE0AD Operator Nelson Radio Estacion De La Fuerza,
Aerea De Chile, Chile
FG7XG, FG7XC via W3GJY
FO8AU via W3GJY
HC1KA Box 1332 Quito, Ecuador
HH2OT Box 1027 Port-au-Prince, Haiti
HR1DL Box 451 Tegucigalpa, Honduras
HP1SB Box 3080 Panama City, Republic of Panama
HC2CS Cesar Solano PO Box 1007 Quayaquil, Ecuador or
via W1CV
IT1ACA Giuseppe de Luca 18 via Generale Di Giorgio
Palermo Sicily, Italy
IT1BXX Franco Lamantia 58 via Serradifalco Palermo
Sicily, Italy
FQ8HO via K6EC 3803 Liggett Drive San Diego 6 Calif.
GI3ATH Ft/L Harry Pain Officers Mess, RAF Bishop
Court, County Down, Northern Ireland.
KJ6BV APO 105 San Francisco
ST2AR (SSB only) via W2JXH
VS9AZ (SSB only) via W2JXH
KA2GL Navy 3835 Box FPO San Francisco, Calif.
TG5HC via K5GOT
TG9FI PO Box 115 Guatemala City, Guatemala
TG80W PO Box 852 Guatemala City, Guatemala
VK8TF ex VK0TF Ted Fuller PO Box 41 Darwin N.T.
Australia
VE0NK 1149 Goldstream, Victoria, B.C. Canada
TI5AX c/o Sala Apdo XX San Jose Costa Rica
TG9RK Box 70 Guatemala City, Guatemala
JT1KAA Box 639 Ulan Bator, Mongolia
VQ4HX Box 14301 Nairobi, Kenya
VQ6GM Box 164 Berbera, British Somaliland
VR1D via ZL2GX
UA9KOG Box 44 Novosibirsk, Siberia, U.S.S.R.
YV4AKU Box 2224 Caracas, Venezuela
XE1GGU Juarez 127 Toluca, Mexico
ZK1AR Airport, Aitutaki Island, Cook Islands, S. Pacific
ZK1AK via W3GJY
ZS3DM Box 1601 Windhiek, Southwest Africa.
4S7GE Pallepola via Matale, Ceylon
9N1MM Box 50 Khatmandu, Nepal

We were very sorry to hear of the passing of Red Reece W8EZF who was one of the operators of the VP5BH and KC4AF expeditions and who invented the DE system of break-in style QSO's.

Do you realize that the CQ world wide DX contest begins next month? What have you done to be ready for it? If you're not ready you had better get on the stick quick and get ready to have the time of your life. See W1WY's column for the complete details but make sure you give the contest a fling.

Well I guess that's about it for this month. I'd really appreciate all information or pictures of a DX nature that you could part with for a short time. Pictures will, of course, be returned.

CU next month, 73 es DX Urb W2DEC

CREATIVE ABILITY AT MOSLEY



This interesting new catalog describing performance-proven Mosley antennas for a wide variety of commercial and industrial applications is yours for the asking!

In addition to the antennas shown in this fact-filled catalog, Mosley Electronics, Inc. produces a wide variety of multi-frequency Yagis and Verticals as well as other single frequency configurations to meet specific requirements.

You are cordially invited to submit your antenna problems to our creative engineering staff. Prompt evaluations and proposals will be made along with price quotations and delivery commitments.

Drop us a note on your letterhead today . . .

Mosley Electronics Inc. BRIDGETON, MISSOURI

For further information, check number 42 on page 126.

Radio Shack 1961
Guide to Electronic Buying

Rush Coupon for Your

FREE

full year's subscription to Radio Shack's Famous Electronics Catalogs

Receive giant Electronics Buying Guide and all new issues for a year! See newest and best in electronics at money-saving prices! Over 100,000 items for "pro" or amateur.

SAVE UP TO 50% ON TYPICAL VALUES LIKE THESE

Realistic 2-speed
TAPE RECORDER
—compare at ~~\$99.95~~
only **\$49.50**

CODE PRACTICE SET
complete with key, buzzer only **\$1.79**

Realistic fully wired
STEREO AMPLIFIER
only **\$9.95**

MAIL COUPON TODAY!

RADIO SHACK CORP. Dept. 60J21
730 Commonwealth Ave., Boston 17, Massachusetts

Without obligation, please send me FREE and POSTPAID, your latest giant Electronics Catalog plus every new issue for one full year.

Name _____

Address _____

Post Office or City _____ Zone _____ State _____

If coupon is clipped, write **RADIO SHACK CORP.** Dept. 60J21
730 Commonwealth Ave., Boston 17, Massachusetts

For further information, check number 43 on page 126.

SOLAR SYSTEM VI 6 METER TRANSCEIVER

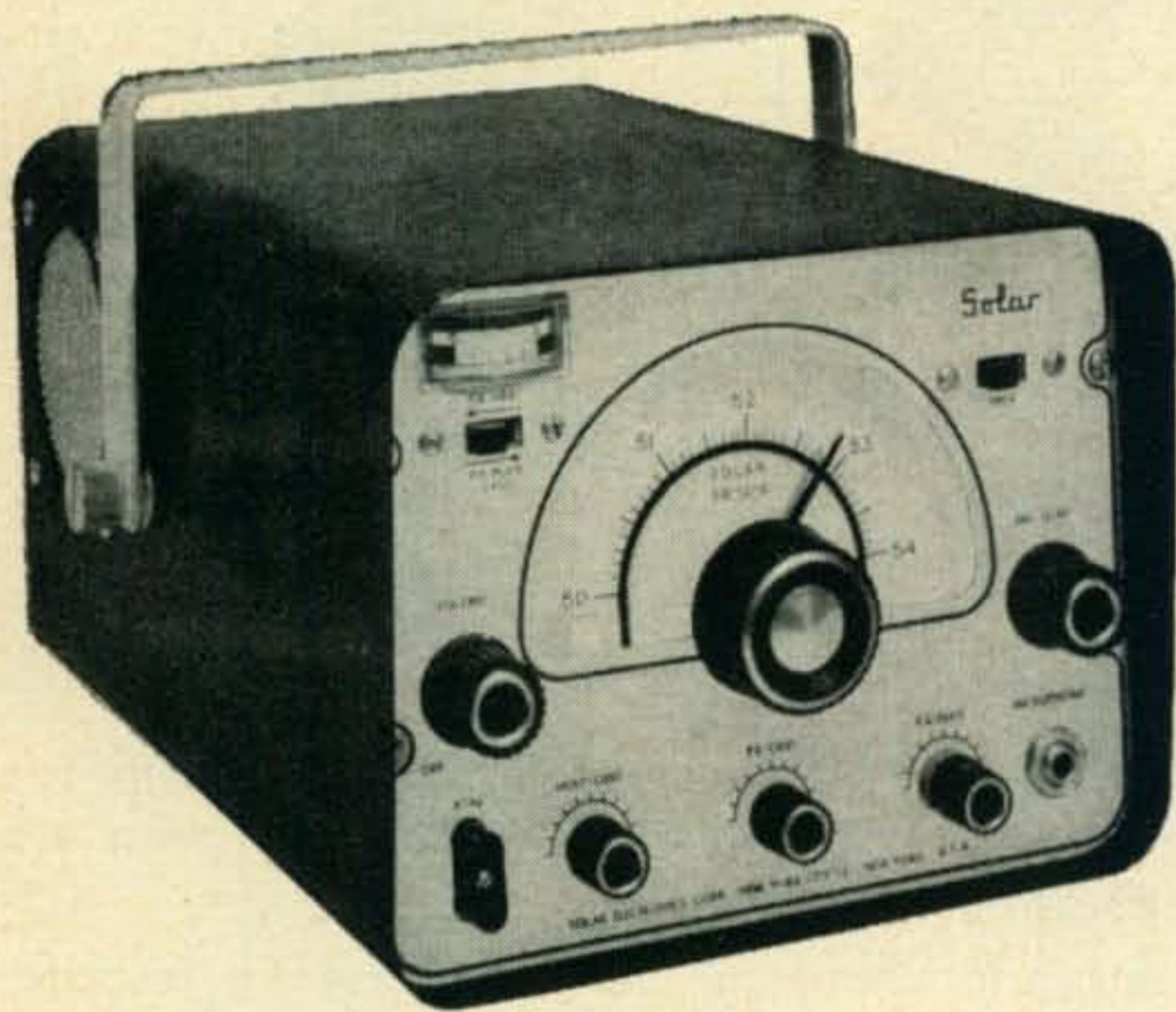

TRANSMITTER 12 watts input to 5763 final • All transmitter controls are on the front panel • Both plate and grid of final are metered • Push-to-talk operation • Uses a crystal, ceramic or carbon microphone • Uses popular low cost 8 mc crystals • Provision for a VFO 35-75 ohm output, can be used with car whip • Spotting switch to check your frequency.

RECEIVER Better than 1/2 microvolt sensitivity • Built-in noise limiter • Double-conversion superhet for selectivity and no in band images • I.F.'s of 3 mc and 455 kc • Vernier dial for fine tuning (6:1).

FEATURES Power input: 6 vdc, 12 vdc, or 115 vac • Power supply built right in...no separate mounting, no separate costs • Weighs only 15 pounds...great for trips, vacations • 8" x 6" x 12", fits anywhere • Chassis easily removed for service, nothing hidden • Military type construction for ruggedness • High quality components used throughout • Carrying handle/mounting bracket (for car, boat, or plane) • Removable mounting feet for installation anywhere.

\$189.50 SOLAR ELECTRONICS

149 WOOSTER STREET, NEW YORK 12, NEW YORK

Send for literature giving full details. Representative Inquiries Invited.

For further information, check number 60 on page 126.

NEW



T-R SWITCH



MODEL 381

...with selectable bandswitching

This compact electronic T-R switch (4 3/4" x 4" x 4 1/2") does a big job in automatic break-in operation on CW-SSB-AM-DSB. Bandswitch covers 80 through 10 meter bands. Integral power supply. For commercial applications, it will handle more than 1KW AM phone and up to 5KW SSB. "Fail-safe" design automatically keeps transmitter connected to antenna when unit is not energized. Matches 52-75 ohm coaxial lines.

This is the switch you've been looking for. See it at your local dealer, or write the factory direct.

Price: \$60.00

Barker & Williamson, Inc.

Bristol, Pennsylvania

For further information, check number 44 on page 126.

AMATEUR RADIO LEGAL NOTES

[from page 24]

The Supreme Court, in reviewing the history of zoning laws, pointed out that, historically, owners of real property have enjoyed the right to use their property as they see fit provided that such use does not (1) violate laws of a State or the Federal Government; (2) create a nuisance; (3) violate a covenant or deed restriction; (4) violate valid zoning ordinances.

Zoning ordinances, on the other hand, have been upheld by the Courts if they are reasonably necessary for the preservation of health, safety, morals or the general welfare of the community. On the other hand, zoning ordinances have been held invalid where they have been found by the Courts to be unjustly discriminatory, arbitrary, unreasonable or confiscatory. It can readily be seen that whether a particular zoning law is valid or not may depend upon a number of variable circumstances. Very often the only way in which the validity of a zoning ordinance can be tested is by court proceedings.

The courage and determination of amateurs who have been willing to risk the dangers of litigation have done much to clarify the applicability of zoning ordinances as they are applied to amateur radio activities.

For anyone interested in reading or referring to the Appeal of Lord case, it is officially cited as 368 Pa. 121, 81 A. 2nd 533.

EVANS HAM SHACK OFFERS FREE COUNSEL TO THE BEGINNER!

Never hesitate! Our job is to counsel as well as sell. As Northern New England's largest distributor we'll help you select new or reconditioned equipment. Our sales are backed by our engineering department — no need to return equipment to factory for repairs. Come to us, we will meet your purpose as well as your purse.

- Service to hams by hams
- Good trade-ins and liberal time payments.
- Engineering Department

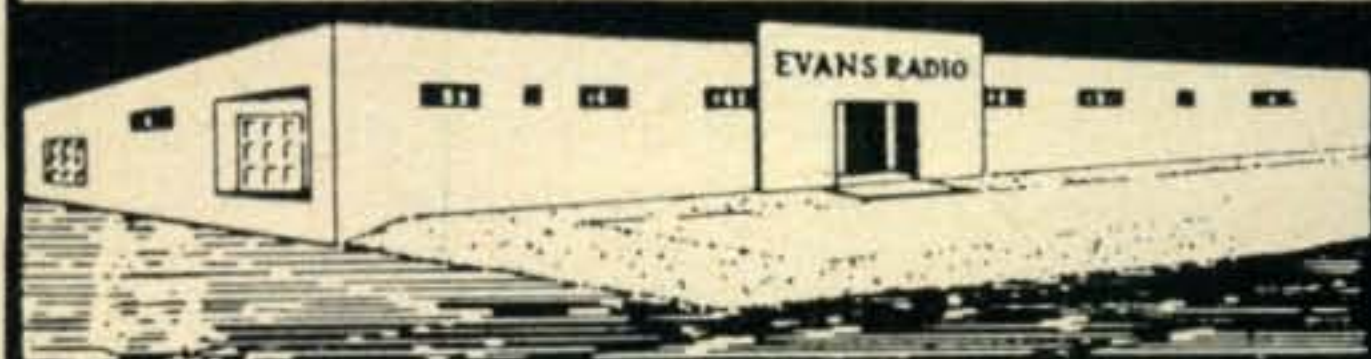

Evans RADIO

P.O. BOX 312 • CONCORD, N. H.

For further information, check number 45 on page 126.

NEW! Auto-Mate K5/50 Electronic Keyer Kit,



Now, you can assemble this latest type ELECTRONIC **\$39.00** KEYER at moderate cost . . . in a few hours.

Kit includes sturdy 3-part, commercially finished, cabinet, (HOOD, CHASSIS, PANEL) with all sockets riveted on chassis, ready to be wired. All parts to complete the keyer are included, except the tubes. A mercury-wetted contact relay is included. PANEL ITEMS: Slow/Fast Control: Mark/Space Control: High/Low Range Switch, (5-17 WPM) (15-50 WPM): AC Switch with HOLD, (Key Closed), and Neon Indicator. REAR chassis connections include 2-conductor side-tone output jack for Hi-Z speaker or headphones and 3-conductor jack for a key lever. 115 volts a.c. power supply with silicon diodes. Detailed wiring and operating instructions are in the kit.

TUBES—(NOT SUPPLIED) 4—5963 or 12AU7, 1—0A2, 1—OB2, 1—NE51, 1—NE2. Size 5½" H, 4⅛" W, 8½" D. Weight 5 pounds. Color, Green.

At your dealer, or direct from Ben, W9UE. Direct shipments in the U.S.A. are postpaid. Return the K 5/50 Kit immediately for a prompt refund, if you are not delighted with it.

Ben Woodruff, Dept. C, 6140 N. Harding, Chicago 45, Ill.

For further information, check number 46 on page 126.

NEW Especially Designed for Single Side Band! HIGH VOLTAGE POWER SUPPLY DELIVERS 3500 or 4200 VOLTS DC AT 500 MILS

The high-voltage power supply you've been waiting for! All the power you'll ever need—even for that Alaskan Kilowatt! Especially designed for single side band by one of the leading manufacturers of precision electronic equipment since 1947...No transients due to poor dynamic regulation...No chokes. Write for complete descriptive literature.

MODEL 65A — 4.2 KV — \$365.00

MODEL 65B — 3.5 KV — \$335.00

Send check or money order only—no C.O.D.'s

Amateur Division

TIC Tel-Instrument ELECTRONICS CORP.

728 GARDEN ST., CARLSTADT, N. J.

Specifications:

INPUT: 115, 208, 230 V. AC; 50-60 cps; single phase

OUTPUT: Model 65A—4200 V. DC @ 500 mils, cont. duty
Model 65B—3500 V. DC @ 500 mils, cont. duty
(350, 750 or 1050 V. screen voltages)

REGULATION: 15%, no load to full load

WEIGHT: Model 65A—150 lbs. net
Model 65B—130 lbs. net

RIPPLE: Nom. 1% at full load
SIZE: 17"x17"x8½" high

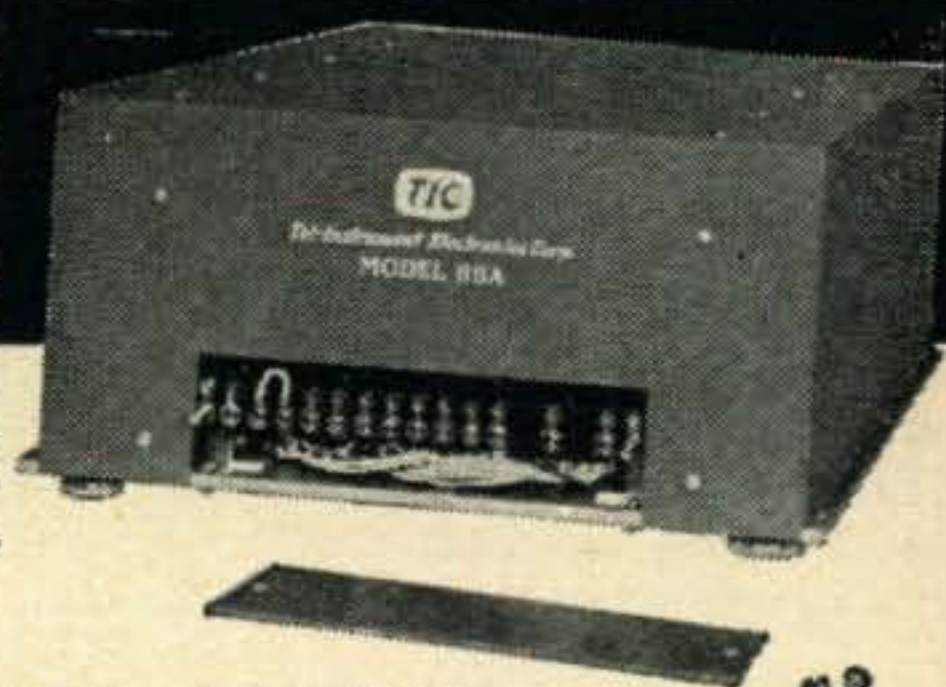

For further information, check number 47 on page 126.

LET'S GO COLLINS' BILING!

(THIS IS MOBILE AT IT'S BEST)

Let us equip your car with a Collins KWM-2. Later on this fall, buy the 110 V power supply and move your KWM-2 indoor.

We offer fast delivery, complete stocks, liberal trades and easy budget terms.

Try C & G today, 6 stores for better service to the West, Hawaii and Alaska.



C AND G ELECTRONICS CO.

SEATTLE 1, WASH. TACOMA 2, WASH. BREMERTON, WASH. OLYMPIA, WASH. CENTRALIA, WASH. ABERDEEN, WASH.
2221 3RD AVE. 2502 JEFFERSON AVE. 1301 PACIFIC AVE. 318 NO. CAPITOL WAY 217 SO. TOWER 510 WEST WISHKAH

For further information, check number 48 on page 126.

TAPETONE'S NEW
WTC-432,
3/4 METER,
LOW-NOISE
CRYSTAL
MIXER
CONVERTER



**NEWEST
CONVERTER
ON THE MARKET . . .**

This advanced design approach, seldom used by amateurs but widely used in commercial UHF receivers, achieves outstanding performance. It consists of a double-tuned cavity preselector, followed by a crystal mixer and low-noise IF preamplifier.

SPECIFICATIONS:

NOISE FIGURE: 6.0 DB
GAIN: 20 DB
IMAGE REJECTION: GREATER THAN 50 DB
IF REJECTION: GREATER THAN 80 DB
TUBE COMPLIMENT: 1N21E, 6BC4, 6BC4,
12AT7, 6AK5

STANDARD MODELS AVAILABLE:

WTC-432 IF OUTPUT FREQUENCY 50-54 MC.
WTC-432A IF OUTPUT FREQUENCY 51-55 MC.
WTC-432N IF OUTPUT FREQUENCY 30.5-34.5 MC.
WTC-432C IF OUTPUT FREQUENCY 28-32 MC.

PRICE \$119.50 (ANY MODEL)

ALSO AVAILABLE: WTC-1296, PRICE \$134.50

TAPETONE, INC. 10 ARDLOCK PLACE,
WEBSTER, MASS.

For further information, check number 49 on page 126.

**Cush
Craft**

- 2 Meter with mast
Model # AM-2M \$8.70
- 2 Meter stacked
COMPLETE
Model # AM-22
- 6 Meter with mast
Model # AM-6M
\$12.50
- DUAL HALO with
mast. Mod. # AM-26
\$17.45



HALOS
NEW
PORTABLE 3 El.
6 meter beam.
(50" x 4" folded)
Model No. A50-3P
\$10.95

CUSHCRAFT 621 HAYWARD ST.
MANCHESTER, N. H.

BC-603 CONVERSION

BC-603 Conversion article (Sept. & Oct., 1958 CQ)
Reprints available at 50¢ per set.

CQ Magazine, Book Div.,
300 W. 43 St.
New York 36, N. Y.

HAM SHACK NOVELTY

Authentic-looking, two-color gag certificate claiming tongue-in-cheek ownership of an acre on the Moon's surface. Ideal humorous gift or conversation piece for shack, bar, den or office. With gold seal and name and call inscribed only \$1.00 cash. Six for \$5.00. Send check or M.O. only to—

BOX DXG, 1738—201 St., Bayside 60, N. Y.

HT 32/SX101 [from page 59]

rubber grommets mounted in the top corners of the rear wall of the Control Central. Four rubber grommets are mounted along the lower side of the box and cables for the transmitter control plug (P-1), 115-volt line cord (P-6), and receiver control plug (P-2) pass through these grommets.

Within the box the antenna relay RY-1 is centered on the rear wall and the phenolic tie point strip TP-1 is bolted to the lower wall of the box as shown in the drawing.

Wiring the Control Central

Cut the cables to the lengths suggested in the parts list. Strip the wires at the ends of the cables and tin the leads. The wires that extend into the plug pins should be stripped and tinned a sufficient length to pass through the pins as the soldered connection is made at the tip of the pin. Slide the plug caps on the cables before connections are made. The two wires designated P-3 to the 3.2 ohm speaker terminals of the SX-101 receiver (TS-2 on the rear of the receiver) are brought out of the cable hole of plug P-2. Splice extra lengths of wire to the cable sufficient to reach from P-2 to the speaker terminals (about four inches). Pass the free ends of all cables through the rubber grommets into the Control Central and wire to the respective tie points on strip TP-1. Wire resistor R-1 between terminals #5 and #6 of TP-1 at this time.

The last step is to prepare the two coaxial cables running to the receiver and transmitter. Coaxial type PL-259A plugs with UG-175/U reduction adapters are used for the small RG-58/U coaxial line, to make a neat and efficient mechanical termination for the cables. The coaxial lines are passed through rubber grommets to the interior of the Control Central. The shields are firmly bolted to the metal box and the center conductors are attached to the fixed contacts of relay segment RY-1A. A short, flexible lead connects the moveable arm of RY-1A to the center pin of coaxial receptacle S-1.

When the wiring is complete, trace it out to make sure that you have made no mistakes. To check relay operation temporarily short pin #3 to pin #2 on plug P-1 and insert plug P-6 in the light socket. Relay RY-1 should close and then open as soon as the short between the pins of P-1 is removed.

Installation of the Control Central

Look at the rear of the HT-32 cabinet. Notice the ventilation slots. You may bolt the Control Central to the cabinet without drilling holes if you make use of these slots (fig. 3). Drill four holes in the mounting half of the Control Central box that will line up with four of the ventilation slots. Place the box low enough on the cabinet so that it does not interfere with the

hinged lid, and position it clear of the receptacles on the rear apron of the transmitter. Center the box so that its edges line up with sockets SO-2 and SO-9 on the HT-32, and so that the top edge of the box is about 1/4" below the cabinet hinge. Mark the position of the ventilation slots on the box with a pencil, working from the inside of the transmitter cabinet. Drill the box and bolt it to the cabinet as shown in the illustration. The box is spaced away from the cabinet in order not to hinder the flow of cool air into the transmitter. Finally, identify P-4, P-5, and S-1 with tape labels.

Station Operation

After the Control Central is mounted in position, place the plugs in the proper receptacles, affix the speaker leads to terminal strip S-2 and attach your antenna transmission line to coaxial receptacle S-1. Place the "standby-receive" switch on the receiver in the "standby" position and you are ready for VOX operation.

Receiver and transmitter tuning adjustments are made as described in the instruction manuals. Upon speaking into the microphone the VOX circuit actuates the relay changeover system, switching the antenna from receiver to transmitter, and muting the receiver. The operator is free to concentrate fully upon the QSO, leaving equipment operation in the trusty hands of the Control Central. ■

MOISTURE [from page 57]

cubic feet. The simple household dehumidifier² may be obtained for prices well under \$100 with operating costs comparable to those quoted by Lloyd above.

The household dehumidifier consists of a simple refrigeration system. A compressor is attached to a cooling coil, a drain pan is placed under the cooling coil and a refrigerant condenser and fan are included. The fan circulates the room air over the cooling coil which is cooled by the compressor. The moisture laden air gives off part of its moisture to the cooling coil. This moisture is transferred to the drain pan which can be connected to a permanent drain or emptied from time to time. The cooled dehydrated air then passes over the condenser, is slightly warmed, and returns to the room. The only disadvantages to this type of equipment are, at room temperatures about 70° the cooling coil is likely to freeze and clog up with ice cutting off the air circulation, and the emptying of the drain pan will require practically daily attention in many areas.

[Continued on page 122]

²Makers of Household Dehumidifiers—Coolerator Division, Albion, Michigan; Ebco Manufacturing Company, Columbus 13, Ohio; Emerson Electric Manufacturing Company, St. Louis 21, Missouri; Fedders-Quigan Corporation, Maspeth 78, New York; Gibson Refrigerator Company, Greenville, Michigan; Kelvinator Division, American Motors Corporation, Detroit 32, Michigan; Westinghouse Electric Corporation, Springfield, Massachusetts; and Whirlpool Corporation, St. Joseph, Michigan.

GOOD BUYS — ALL NEW

Extraordinary values await you in government surplus components. Our specialty is components; we have many of those hard to find items that you just won't see advertised elsewhere in surplus materials. Don't buy anything until you have our "Bargain Bulletin"; write for it today, it's free. New material is available to you for mere nickels and dimes on the dollar value. Here are some typical values:

RELAYS, all are beautifully constructed to govt specs.
 13 VAC coil, DPDT + SPDT, 10 amps, ceramic.....1# \$2.89
 12 VDC, 64Ω coil, DPDT, 20 a + SPST, 6 a, cer.....1# \$1.89
 Differential, 2-9000Ω coils, 2-SPDT sect, 2 a.....1# \$3.39
 115 VAC coil, DPDT at 5 amps, hermetic seal.....1/2# \$1.95
 Min. DPDT, 3800Ω coil, 1 amp cont, 28 VDC.....1/2# 89c

AUDIO TRANSFORMERS, a few typical values, many more.
 5 w output, 5KΩ:15Ω, ±1/2 db 16-18,000 cps, per pr...3# \$2.22
 Line match, 15KΩ to 600Ω, 50-10,000 cps, pot.....1 1/2# 69c
 25 w output, 8,000Ω ct, 15/125/250Ω, potted.....4# \$1.95
 Line to v c, Thord. 2-16Ω v c to 500Ω line.....2# \$1.39

PLATE & FILAMENT POWER TRANSFORMERS, 115 volt, 60 cycle.
 720 vet/135 mils, 5/3 and 6.3/3, potted.....12# \$3.79
 490 vet/130 mils, 5/2, 6.3/3, potted.....9# \$3.19
 800 ct/175, 80 v tap, 5/3, 6.3/2.5, 6.3/2.5.....9# \$4.44
 600 vet/350 mils, 12.6 v/11 amps, potted.....18# \$4.29
 Auto, 115 to 230 volts, 90 watts, potted.....7# \$2.29
 HV scope, 4500 volts/5 mils, 10 KV RMS ins.....10# \$1.95

FILAMENT TRANSFORMERS, 115 volt unless otherwise shown.
 5 vet/30 amps, 215/230 pri., 15 KV ins., Chi.....20# \$6.45
 6.3/0.6 potted, uses only 3 sq in chassis areal.....1 1/2# 79c
 6.3/27 amps, four windings, 3 amps are ct.....9# \$3.29

MISCELLANEOUS VALUES, all are outstanding.
 CW "Dream Filter", bandwidth 200 cps down 20 db...4# \$6.95
 Oil cond., 15 mfd/330 VAC, HV ceramic terms.....3# \$2.29
 BC-610 40 meter coils, C-390-A, three for.....1# \$1.79
 3AP1 cathode ray tubes2# \$1.45
 3C24 triodes, Lewis and Kauffman, a pair.....2# \$5.55

and hundreds of other equal values appearing in the "Bargain Bulletin". Write for yours today!

Send adequate postage with orders. We refund any overage. All prices are FOB Sacramento. \$3.00 minimum order please.

JOE PALMER

PO BOX 6188 CCC, SACRAMENTO, CALIF.

For further information, check number 50 on page 126.

NEW 2-WAY RADIO TEST SET ...



Combination Crystal Checker,
RF Signal and Field Strength Meter

Perfect "assist" instrument for all types of crystal controlled fixed and mobile installations! Checks crystal activity—indicates output—use for final amplifier tuning—generates signal for adjusting squelch or peaking. With 15' cable for remote use. **MODEL 500.....\$29.95 NET**

See your distributor, or write to:



SECO ELECTRONICS INC.

5015 Penn Ave. So., Minneapolis 19, Minn.



VIBRO-KEYER

Only \$15.95

The Vibroplex Company has a boon for those amateurs that need the mechanical end of an electronic keyer. The Vibro-Keyer is constructed in line with the high-quality workmanship for which Vibroplex has long been famous. The unit has large, non-corroding contacts, heavy beige colored base, colorful red finger and thumb pieces, and smooth, easy operating trunion lever. It is adjustable to any amateur's taste. Only \$15.95.

THE VIBROPLEX CO., INC., 833 Broadway, N. Y. 3, N. Y.

SEPTEMBER BARGAINS

- Marion TS-15A/AP Gauss Meter. 1200 to 9600 Gauss w/probe & case. 9 lbs. New.\$99.00
- Hickok 539A Tube Tester.\$115.00
- Gonset Communicator III. 6 Meters. 115 VAC/12 VDC.\$150.00
- Dumont Model 248 Lab 'Scope w/pwr supply.\$395.00
- BC-640B VHF mtr (100 to 156 Mcs.) Unused. Orig. crates. Write for details.\$395.00

Extra discounts offered on trade-ins towards purchase of new Hammarlund Receivers and Speakers. Applies to: HQ100C, HQ110C, HQ145C and Speakers S-100 and S-200.

- Prop Pitch Motor. Rotates heaviest Ham or Comm'l Rotary Beam. 80 lbs. via economical motor frt. Unconverted \$35.00. Converted. FOB, Ga.\$44.00
- Choke. 10 Hy. @ 500 Ma. Herm. sld. 100 Ohms DC res. 6½" x 6¾" x 5¼". 25 lbs.\$4.50
- Swinging Choke. 2.3 to 5.5 Hys. @ 850/100 Ma. 15 Ohms DC resis. 6 KV insul. 40 lbs.\$7.50
- Choke. 3.2 Hy. @ 550 Ma. 21.2 Ohms DC resis. 14 lbs. Pckd 2 to a case 28 lbs.each \$3.00
- CG-442 UTC Jobber-Boxed Power & Bias Xfmr. Pri: 115 VAC @ 50/60 CPS. Sec: 435/365-0-365/435 @ 125 Ma. 125-0-125 @ 25 Ma. Filaments: 5 V. @ 3A. 5 V. @ 2A. 6.3 VCT @ 3 A. 2.5 VCT @ 5 A. With instruction sheet. Herm. sld. 11½ lbs. (Reg. \$21.00 Net).\$4.50
- Altec Lansing Hi-Fi Output Xfmr. Herm. sld. Pri: 3300 Ohms C.T. Sec: 500 Ohms Tapped @ 250 Ohms. 5" x 4¼" x 4¼". 13 lbs. (\$20.00 value).\$2.50
- Transformer Special. Pri: 115 V 60 CPs. Sec: 800 VCT @ 250 Ma. 6.5 VCT @ 7.5 Amps. 5.1 VCT @ 4.0 Amps. Herm. sld. 16 lbs.\$4.50
- Modulation Transformer. 850 Watts Audio (2 K.W.R.F.) Pri: 10K Ohms. Sec: 3750 and 7500 Ohms. Orig. wood box.\$44.00
- Mobile Transmitter. Uses 5618 crystal oscillator into CBS 5516 amplifier. Modern design. Only 7 lbs. net wt. including built-in 6 Volt vibrator pwr supply. Enc. in aluminum cabinet. Furnished w/crystal that doubles near 10 meter band. Requires slight & easy modification for 10 meter operation. A real beauty. New with tubes.\$13.95
- Xmtg Socket. 5 Prong. Mycalex for tube type 4-125A, 4-250, 4-400, 803, etc.90¢
- New! 701-A Tube Socket. (¾ lb.)\$2.50
- Maps. USA or World. Self-framed. Raised plastic. You can feel mountains, etc. 28½" x 18" \$9.95. 42" x 60" \$49.95 Specify USA or World.

KEEP AHEAD OF THE CROWD ON VALUES.

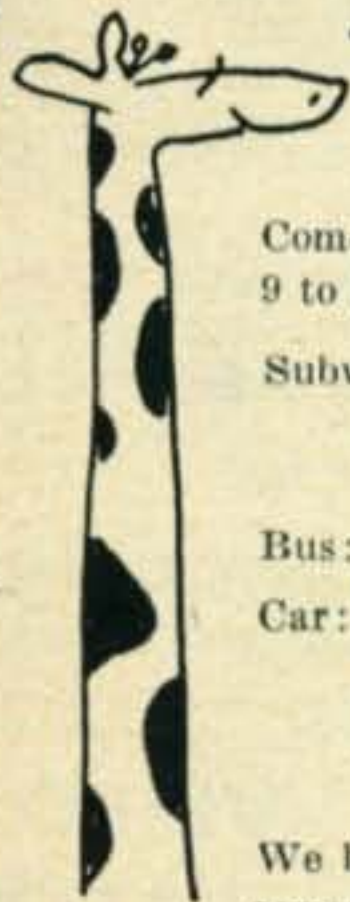

WRITE FOR CATALOG ON TUBES AND EQUIPMENT . . . FREE.

Come in and browse. We are open Mon. to Fri. 9 to 6. Sat.: 10 to 2 P.M.

Subways: BMT: (Broadway local) to Princee St. Station—walk 1 block to Spring St.
IRT: Lexington (local) to Spring St.

Bus: Broadway #6 Bus to Spring St.

Car: We are 4 blocks North (uptown of Canal St.) Parking allowed on Broadway Sat., Mon. thru Fri. parking at 501 & 557 B'way.

Minimum Order \$5.00.

We buy surplus inventories. Send us list of good commercial equipment and unused tubes.

BARRY ELECTRONICS

CORPORATION

512 BROADWAY, NEW YORK 12, NEW YORK

(NEAR SPRING ST.), DEPT. C9

Telephone: WAlker 5-7000

Classified Ads

RATES: 25¢ per word per insertion for commercial business organizations.

10¢ per word per insertion for individuals on a non-commercial basis. Full payment must accompany order.

MINIMUM CHARGE \$1.00

CLOSING DATE: 20th of the 2nd month preceding date of issue.

MAIL: Your typewritten copy with full remittance should be sent to CQ Magazine, 300 West 43rd Street, New York 36, N. Y.
Attention: Classified Ad Dept.

NOTE: The products and services advertised in this section are not guaranteed by the publisher of CQ. Telephone orders not accepted.

FOR SALE

GREAT SURPLUS VALUES!! BC-603 Receiver New \$17.00—R-26/ARC5 Rec 3-6 mc New \$12.95, used exc. \$7.95—R-27/ARC5 Rec 6-9 mc New \$12.95, used exc \$7.95—BC-659 Transceiver with PE-120 \$19.95—T-47/ART-13 Transmitters \$39.00—BC603 AC-Supply \$9.95—Synchrosopes Model TS-34/AP \$49.00—Sound-Powered Dynamic Phones Pr. \$4.75—Rec. Microwave R-111/APR-5 \$39.00—Collins CF1 82-Q for Q-5'er compl. w/tubes & instructions \$5.95—Collins Mod. Xformer 100 Watt 811-PP to 813 final \$3.95—RA-62-C Power Supply AC for SCR-522 VHF 110/60 cyc. New \$59.50—Kits only for above \$17.00—Ground-plane VHF antennas 30-200 MC New \$9.95—Hi-Mu Electronics, 137 Hamilton St., New Haven, Conn. Store hours 10-5. Sat. 9-12.

EIMAC 4X150A tubes, NEW, fully guaranteed, interchangeable with 7034 and 4X250B. Large stock, \$4.00 each 2/7.00. H & C Sales, 1705 Lafayette, Mattoon, Illinois.

TOROIDS: Uncased 88 mhy like new. Dollar each. Five \$4.00 PP. DePaul, 309 South Ashton, Millbrae, Calif.

COLLINS 51J-2 \$495. 51J-3 \$675. Both reconditioned. PMO Oscillator \$245. 75A-1 \$259., 75A-2 \$295., 32V-3 \$325., HRO-7R \$95., HQ-145X \$155., HQ-110 149. Valiant \$319., Ranger \$198. Gonset III 2m \$209. Panadapter \$89., R-390A/URR, R-274 \$245. NC-183D \$199. Tom W1AFN, Alltronics-Howard Co. Box 19, Boston 1, Mass. (Richmond 2-0048)

PRESERVE YOUR HAM TICKET, Social Security Card, small photo, passes and anything else of value that is wallet-size. We will laminate it in clear plastic, guaranteed for life. Lamination will prevent it from getting torn, soiled or frayed. Send your ticket or anything of value with \$1 in stamps or cash for each item that you want preserved. 24-hour service. Send to C. Lee Co., P.O. Box 395, Times Square Station, New York 36, N.Y.

ANTENNA TROUBLES? Watch Laurel & Hardy erect a roof antenna amid hilarious antics Kraus and Yagi never dreamed of. Low front to back ratio, but loads of laffs for all ages . . . especially the Jr. Ops. 200 ft. 8 mm film, \$5.50 postpaid; send check or M.O. (no cash or COD) to JAGFILMS, 1737-201 St., Bayside 60, N.Y.

CALL LETTERS may be applied to any surface. 2" sets 60¢, 3" set 80¢. Send to C. Lee Co., P.O. Box 395, Times Square Station, New York 36, N.Y.

Technical book bargains, all in excellent condition. "Short-wave Wireless Communication" by Ladner & Stoner, 5th Ed. \$4.75. "VHF Techniques" by Radio Res. Lab. 2 Vol. \$8.50. "Higher Math. for Eng. & Phys." by Sokolnikoff, \$4. "Engineering Math." by Sohn, \$3.25. "Handbook of Industrial Electronics Ckts" by Markus & Zeluff, \$4.75. "Airglow and the Aurora," Pergamon Press, \$10. "Solar Eclipses and the Ionosphere," Pergamon Press, \$10. "Advanced Mech. of Materials" by Seely, \$3. "Inorganic Qual. Anal." by Fales & Kenny, \$2. All for \$40 postpaid. George Jacobs 11307 Clara St., Silver Spring, Md.

Read the HAM TRADER. Filled 100% with classified ads selling ham equipment. Sample copy 20¢. \$1.00 for 6 issues. The HAM EXCHANGE, Box 147, Franklin Square, N.Y.

For further information, check number 51 on page 126.

Something new and useful for \$1. Flexible holster for soldering gun; fits all types; facilitates work bench storage; easily mounted and no more burned fingers or tabletops. Postpaid, money back guarantee. George Jacobs, 11307 Clara St., Silver Spring, Md.

FOR SALE: Tickets to The One and Only—Syracuse VHF Roundup, October 8, 1960. Write K2TXG, 317 Clover Ridge Dr., Syracuse 6, N. Y.

ONE THIN DIME brings 50 page eye-popping war surplus electronics catalog. Fabulous bargains. Meshna, Malden 48, Mass.

For Sale: TV Cameras, Teletype, Panadaptors, Transmitting Tubes, Transistors, SSB gear. Write for list. Spera Electronics, 37-10 33 Street, L.I.C., N.Y. STillwell 6-2199.

FOR SALE: Collins KWM-2 with a.c. supply, 4-400 G.G. 1 Kw. bandswitching final. Excellent cond. \$1,000.00. W4-NKZ Leo G. Birgenheier, P.O. Box 205, Ph. BALL 9-2181, 2109 Long Avenue, Port St. Joe, Florida.

SELL: Grounded Grid Linear built from article in March 1960 issue of CQ complete with tubes, less power supply, \$40. Also a 4-1000A tube, a few hrs. on it, best offer. H. J. Hoover, K4PIJ, 1126 Elizabeth St., Eau Gallie, Florida.

VALIANT—\$325, GPR-90 Receiver, \$375; D104 mike and stand, \$23; Monitone \$10; Vibroplex, \$15, Miscellaneous. No shipping, K6EVY, 11898 Edgewood Circle, Garden Grove, California. LEhigh 9-4921.

FOR SALE: Factory reconditioned AF67 xmtr, PMR7 rcvr, Elmac 6-12 volt power supply, all band antenna assembly, fibreglass whip, master matcher, center loading coil, field strength meter, E.V. dynamic mike, cables, rack, sundries. All for \$275.00. Also NC 200 with matching speaker for \$80.00. K1GGP—Maurice Finer, 379 Central Ave., Milton, Mass.

Super-Six plus Mobilceiver. Mobile xmtr, VFO, dynamotor, multiband antenna. All Johnson. 6/12V except power 6V. Excellent. Cost \$425. Sacrifice \$195. W4OIT, 15445 S. W. 88th Ave, Miami, Florida.

FOR SALE: DX-100. Excellent. Johnson Lo-Pass filter. Mike no stand. Metered antenna change over relay. \$150 M. O. SFC Thomas North, Co. B, 93rd Sig. Bn. Ft. Huachuca, Arizona.

COLLINS 516E-1 power supply used eight days \$200 pre-paid. K5KTX.

FOR SALE: NC-183D complete with speaker and phones. Excellent condition. \$200. Also C. E. Mod. B slicer complete with AP-1 adapter and AP-3 cable. Excellent. \$50. Will pack. G. O. Ellison, Route 2, Box 365, Montrose, Colorado.

COLLINS KWM-2 and "S" line IN STOCK at—Purchase Radio Supply, 327 E. Hoover Ave., Ann Arbor, Mich. Ph. NO 8-8696.

6L6 TRANSMITTER: ARRL design, 4 tubes, w/pwr supply. Ideal novice rig. \$20. K1EHQ, Box 733, New Canaan 1, Connecticut.

SELL: Viking II and VFO; HQ 129X and speaker; coax relay. All in excellent condition. George Kimeldorf, 214-15 82nd Avenue, Queens Village, N.Y. SPruce 6-9060.

ALUMINUM for every ham need. Write to Dick's, 62 Cherry Avenue, Tiffin, Ohio, for list of tubing, angle, channel, castings, plain and perforated sheet, and complete beam kits.

HEATH AR3 good condition \$18. Globe 6 mtr. converter factory wired like new \$12. NEW VO6 100kc-50mc test oscillator w/tube/4.3 mc crystal \$3. BC 1033 rcvr. w/tubes/sensitive relay \$3. K0MJM, 5024 Michigan, Kansas City 30, Mo.

CE20A link coupling, QT-1, Bandhopper VFO, 100W GG amplifier \$250. Globe Scout 65B with 10 Novice Crystals \$55. WA2FSD, 11 Burbury Lane, Great Neck, N.Y. HU 2-2737, Siegel.

BARGAIN PRICES ON GLOBE GEAR: New DSB-100 double sidebander wired & tested, \$109.95. New VHF-62 6 & 2 meter AM rig wired & tested, \$129.95. New 680A Scout, 6 to 80 AM wired and tested, \$89.95. New PB-1 Scout power booster, wired & tested, \$16.95. New 666 6 meter VFO, \$39.95. New VOX-10 voice control and QT-10 anti-trip, \$27.95. Used DSB-100 double sidebander just like new, \$99.95. Used VHF-62 6 & 2 meter AM rig another like new, \$109.95. Used LA-1 linear amp, \$99.95. Used 680A Scout, \$79.95. Used 680 Scout, \$69.95. Used 6 & 2 meter VFO \$44.95. Used 666 6 meter VFO, \$34.95. Used Voice relay, \$15.95. Used Universal modulator, \$34.95. And many more. Send for list. We buy ham gear for cash. H & H Electronic Supply, Inc., 506-510 Kishwaukee Street, Rockford, Illinois.

CHALLENGING CAREER OPPORTUNITIES for CREATIVE ENGINEER

Transistor Circuit Engineers
SSB Engineers
Transmitter Design Engineer
Receiver Design Engineer
Antenna Design Engineer
Filter and Network Design Engineer
Components Design Engineer
Test Equipment Design Engineers
Communications Technicians

With a company of long standings, leadership and communications. Write or call collect, The Chief Engineer.

Barker & Williamson, Inc.

BRISTOL, PENNSYLVANIA

Phone STillwell 8-5581

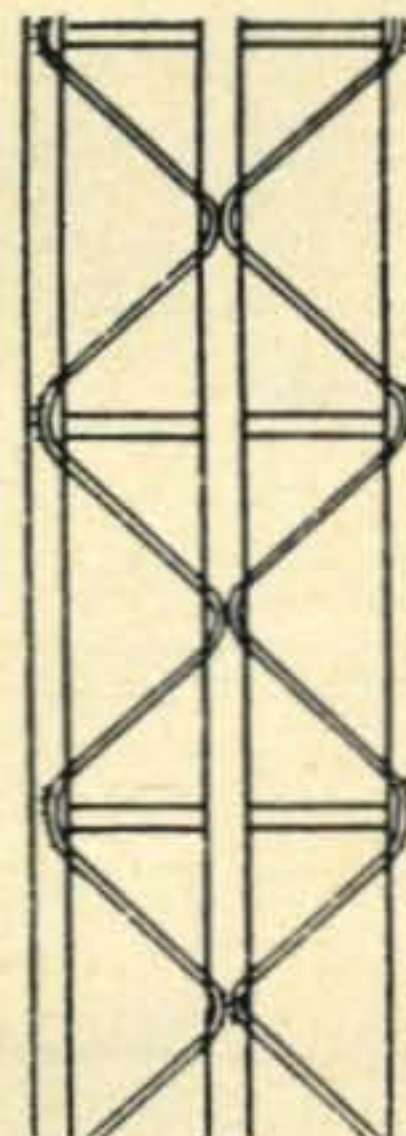

IF YOUR TOWER AIN'T GOT
DIAGONAL BRACING
It Ain't Got

* **ITQ**

INERT TORSIONAL QUALITY
"Diagonal bracing resists twisting caused by constant starting and stopping of large rotary beams. Also twisting of tower caused by gusty winds . . . All E-Z Way Towers got "IT Q".

Write for free literature!
E-Z Way Towers
P. O. Box 5491 Tampa, Florida

• HAM-SWAP •

The New service for the Radio Amateur

Buy, sell, swap your equipment NOW in its pages! Published twice monthly—national circulation. \$1 ad free with \$1 year's subscription. Send \$1 to

HAM-SWAP, Inc., 35-D East Wacker Drive, Chicago 1, Ill.

"HOW TO MAKE MONEY IN Mobile Radio Maintenance"

AUTHORITATIVE GUIDEBOOK
ABOUT THE BOOM IN TWO-WAY MOBILE-RADIO:
GIVES FACTS, FIGURES, PAY RATES.
WRITE TODAY!

FREE

LAMPKIN LABORATORIES, INC. Electronic Div. BRADENTON, FLA.

FAMOUS BC-645 TRANSCEIVER

15 Tubes 435 to 500 MC

Can be modified for 2-way communication, voice or code, on ham band 420-450 mc. citizens radio 460-470 mc. fixed and mobile 450-460 mc. television experimental 470-500 mc. 15 tubes (tubes alone worth more than sale price!); 4-7F7, 4-7H7, 2-7E6, 2-6F6, 2-955 and 1-WE-316A. Now covers 460 to 490 mc. Brand new BC-645 with tubes, less power supply in factory carton.

\$19.50

BRAND NEW

Shipping weight 25 lbs. **SPECIAL!**
 PE-101C Dynamotor, 12/24V input \$7.95
 UHF Antenna Assembly 2.45
 Complete Set of 10 Plugs 5.50
 Control Box 2.25

SPECIAL "PACKAGE" OFFER:

BC-645 Transceiver, Dynamotor and all accessories above. COMPLETE, BRAND NEW, While Stocks Last **\$29.50**

BC-603 FM RECEIVER

20 TO 27.9 MC. Exc. Used..... **\$14.95**

BRAND NEW **\$16.95**

10 Channel, pushbutton tuning or continuous tuning. Complete with speaker, tubes, squelch.



12 or 24V Dynamotor for Above
 Exc. Used \$4.25..... Brand New \$5.50

BC-604 TRANSMITTER — Companion for BC-603 above.
 With all tubes. BRAND NEW..... \$10.95 Used..... \$4.95

SPECIAL! BC-603 FM RCVR CONVERTED FOR ANY FREQUENCY FROM 30 TO 50 MC!

Checked out, perfect working condition, ready for operation. Specify Frequency desired (between 30-50 Mc) when ordering. BRAND NEW..... **\$27.50**

AC POWER SUPPLY FOR BC603, 683
 Interchangeable, replaces dynamotor. Has On-Off Switch. NO RECVR. CHANGE NEEDED. Provides 220 VDC @ 80 Ma. 24VAC @ 2 Amps..... \$10.49
 Complete 240-page Technical Manual for BC-603, 604..... \$3.15

SCR-274 COMMAND EQUIPMENT

ALL COMPLETE WITH TUBES

Type	Description	Excel. Used	Like NEW
BC-453 Receiver	190-550 KC	\$12.95	\$14.95
BC-454 Receiver	3-6 Mc	9.45	12.45
BC-455 Receiver	6-9.1 Mc	9.95	12.50

110 Volt AC Power Supply Kit, for all 274-N and ARC-5 Receivers. Complete with metal case, instructions **\$7.95**
 Factory wired, tested, ready to operate..... \$11.50

SPLINED TUNING KNOB for 274-N and ARC-5 RECEIVERS. Fits BC-453, BC-454 and others. Only **49c**

BC-457 TRANSMITTER—4-5.3 Mc. complete with all tubes and crystal. Exc. Used \$5.95 BRAND NEW..... **\$8.95**

BC-458 TRANSMITTER—5.3 to 7 Mc. Complete with all tubes and crystal. Exc. Used \$6.95 BRAND NEW..... **\$9.75**

BC-459 TRANSMITTER, 7-9.1 Mc. Complete with all tubes and crystal. Like New \$12.50 BRAND NEW..... **\$13.95**

BC-456 Modulator USED 3.45 NEW 5.95
 ALL ACCESSORIES AVAILABLE FOR ABOVE

5-TUBE AMPLIFIER

HOT SPECIAL! Uses 2-6SN7, 2-6H6, 1-6X5. BRAND NEW Only **\$2.95**

DYNAMOTOR ASSEMBLY

Very fine unit, made by Collins Radio. Consists of TWO Dynamotors mounted on filter base.

	INPUT	OUTPUT
Dynamotor #1	12V DC @ 3.8A	220 VDC @ 100 Ma.
Dynamotor #2	12V DC @ 9.9A	400 VDC @ 180 Ma.

BRAND NEW in original packing; shpg. wt. 29 lbs. **\$10.95**
 OUR LOW PRICE only

MOBILE-MARINE DYNAMOTOR

Model DM35—Input 12V DC. Output: 625 V DC @ 225 Ma. for press-to-talk intermittent operation. Shpg. wt. 14 lbs. **\$8.45**
 OUR LOW PRICE, BRAND NEW

Please include 25% Deposit with order—Balance C.O.D., or Remittance in Full. 50c Handling Charges on all orders under \$5.00. All shipments F.O.B. Our Warehouse, N.Y.C. All Merchandise subject to Prior Sale and Price Change.

G & G

Radio Supply Co.

Telephone: CO 7-4605

53 Vesey St., New York 7, N. Y.

For further information, check number 53 on page 126.

FOR SALE (cont'd)

RECONDITIONED! TERMS! GUARANTEE! Collins 32V3 \$399.00; KWM-1 \$595.00; KWS1 \$999.00; 75A4 \$499.00; Central Electronics 10B \$109.00; 600L \$299.00; B-W 5100 \$245.00; Gonset 500W linear \$149.00; Communicator III-6 \$199.00; Hallicrafter SX71 \$135.00; SX88 \$349.00; SX96 \$137.00; SX101 \$235.00; HT32 \$435.00; HT33 \$429.00; SR34AC \$249.00; Hammarlund HQ 110 \$180.00; HQ 100 \$125.00; HQ 140X \$165.00; Heath DX103 \$189.00; SB-10 \$75.00; Apache \$265.00; Johnson Viking II \$169.00; Pace-maker \$295.00; KW final \$890.00; National HRO60T \$345.00; NC98 \$95.00; NC183D \$234.00; NC 300 \$209.00; Regency ATC1 \$49.50; TMC GPR-90 \$355.00; Globe 680 \$69.95; Chief \$42.50; DSB-100 \$74.50; 300A \$349.00; 500 \$375.00; 755 \$37.00; Leo, WØGFQ, Box 919, Council Bluffs, Iowa—World Radio Laboratories.

COLLINS 75A-4, mint condition, #1891, 3.2 kc filter, handbook, original carton, \$550; BC-221-T, original calibration book, manual, unmodified, good condition, \$30 FOB. Jerry Felch, W5AZF, 2809 Caribbean, Mesquite, Texas.

LICK TVI problems with a really effective low-pass filter. Passes 1.8 to 5.2 Mc., sharp cut-off below channel 2. Handles KW. Money-back guarantee. Specify impedance. Send \$5.25 (\$6.75 for coax connectors) to Electronic Engineering, Box 213, Reading, Mass.

FREE AD. Sell your excess equipment through the HAM EXCHANGE Ad is free. Pay only 10% of advertising price if you make a sale. If no sale, no advertising fee. The HAM EXCHANGE, Box 147, Franklin Square, N. Y.

SELLING OUT, A 20 YEAR ACCUMULATION. NEW TUBES, SEVERAL OF EACH, BOXED, GUARANTEED, 4-250A \$25.00, 4-65 \$8.00, 4X150A \$6.00, 3E29 \$2.50, 3B28 \$3.00, 3B29 \$2.00, 807 \$1.00, 807W \$2.00, 1625 50¢, 6AG7 75¢, 12A6 40¢, 4-1000A \$60.00, 813 \$6.00, 1616-5R4-816-6L6 \$1.00, 837 829B-811-814-866 \$2.00, 100th \$5.00, 150 panel meters 3½ and 2½"—all types, \$3.00 each, S-77 receiver, outstanding condition \$55.00, R-28 and 7.0-9.1 Mc Xmitter—\$9.00 each, 100 assorted FT-243 crystals—5 to 9 Mc \$10.00, 7120 Kc Xtals 20¢ each \$15.00/100, over 150 desirable surplus tech manuals, a ton of transformers, and hundreds of other desirable hard to get parts, new and used, all at bargain prices. All FOB, write me your needs—all letters answered promptly. Everything must go. Paul Hancock, W4OWZ, 545 West 66th St., Jacksonville, Florida.

SELL: KWS-1 with 4X250 Bs, perfect. \$1050, Telrex 15 M full size, sealed package. \$65., Roberts 4 track stereo tape recorder \$400., amplifier speaker \$20., Fisher PR-66 stereo preamp \$15., Fisher 101 R Stereo tuner with cab. \$200., Bell 3030 stereo amp. \$100., Concertone stereo professional tape recorder. \$750 . . . all like new. Lame, 1219 Yardley Rd., Morrisville, Penna.

WANTED

WANTED: Military and Commercial laboratory test and measuring equipment. Electronicraft, Box 399, Mount Kisco, N.Y.

WANTED: TELETYPE TG-7 and Model 15 and parts, printers and reperforators, etc.; COMM'NS and REC'V'RS AND XMTRS, e.g. BC-610-E, -I, BC-399A, Collins 51J, 17L3, -4; R-388 and R-390/URR; 18S-2, -3; ARN-14 and -30; APR-9, -10, ARC-21, 27, etc.; APS-31, -33, and TEST EQP'T, with TS- or 1-prefix. We pay freight. AMBER INDUSTRIAL CORP., 75 Varick St., N.Y. 13, N.Y.

WANTED: Teletype printers, perforators, reperforators, transmitter-distributors, test equipment: Model #14, #15, #19, #26, #28, GRC, TT, TGC, GGC, etc. All types Collins receivers, 51J, R-388, R-390, 75A, etc. Cash, or trade for NEW amateur equipment. Write Tom, W1AFN, Alltronics-Howard Co., Box 19, Boston 1, Mass. (R1chmond 2-0048). Wanted to buy 1955 Ford auto radio. Will pay cash or trade radio tubes and parts.

WANTED: Collins Filters, F455B-08, F455C-08 & F455C-31, also Collins 51J RX, state model. Condition & price in first letter. W7IYW, 3116 S. E. 39th Ave., Portland 2, Oregon. WANTED TO BUY: UX-201 or UX-201A tubes good condition. Quote price. Reply, Joe Ganzel, Motorola Inc. 4545 W. Augusta, Chicago, Ill.

QSL

QSL's: Samples, dime. Print Shop, Corwith, Iowa.

QSL's-SWL's: That are different colored, embossed card stock, and "Kromekote." Samples 10¢. K8AIA, Box 953, Hamilton, Ohio.

QSL's—10 useable samples 10¢. Back issues CQ, QST, 75¢. Co-op, Box 5938 Kansas City 11, Missouri.

BEAUTIFUL QSL's . . . Dime . . . Filmerafters. Martins Ferry, Ohio.

QSL's?? Largest variety samples 25¢ (refundable). CALL-BOOKS \$5.00. Religious QSL samples 10¢. Sackers, W8DED, Holland, Michigan.

C. FRITZ quality QSL's, new location. P.O. Box 1684, Scottsdale, Arizona. Samples 25¢ deductible. Get our card-of-the-month deal, a 30 day special from Arizona.

QSL'S. Samples Free. Phillips, W7HRG, 1708 Bridge Street, The Dalles, Oregon.

QSL's-SWL's, samples 10¢. Malgo Press, 1937 Glendale Avenue, Toledo 14, Ohio.

QSLs four colors glossy stock forty design send \$5 for 200 and get surprise of your life. 48 hour service satisfaction guaranteed, Constantine Press, Bladensburg, Md.

QSL's—"Brownie" W3CJI, 3110 Lehigh, Allentown, Pa. Samples, 10¢, with catalogue, 25¢.

GLOSSY 3-color QLS cards 100—\$4.50. Free sampler. Rutgers Vari-Typing Service, 7 Fairfield Road, New Brunswick, N.J.

QSL's-SWL's: 100 2-color glossy \$3.00; 100 QSO file cards \$1.00; Sample 10¢. Rusprint, Box 7507, Kansas City 16, Missouri.

QSL's, SWL's, XYL-OM's. (Sample assortment approximately 9 3/4¢). Covering designing, planning, printing, arranging, mailing, eye-catching, comic, sedate, fantabulous, DX-attracting, prototypal, snazzy, unparagoned cards, (Wow!) Rogers KØAAB, 737 Lincoln Avenue, St. Paul 5, Minnesota.

QUALITY QSLs at reasonable prices, \$2.00 per 100. Samples 25¢ (deductible). K4ICH Press, 3506 Van Winkle Cir. Chattanooga, Tenn.

QSL CARDS: 6 designs, 2 for mobile operators. All are new and original designs. Printed in 2 colors on glossy cards. 100 cards \$2.75. Sample brochure and card Nickel. Williams Printing, P.O. Box 2597, Van Nuys, Calif.

QSL Cards printed. 24 hours service, send dime for samples.

QSL Printing Co., Box 12351, Houston 17, Texas.

SWAP OR SELL

ANY TUBES commercial test equipment, broadcasting equipment, any quantity. Trade ham equipment for photography equipment. Inquire, Diamond, 749 W. End Avenue, New York City.

HAVE G.E. 12V transistor supply, 150 watt. Want Johnson KW matchbox, SWR meter, Baluns 50 Kc Q-Multiplier 829/3E29, &/or money. Kent, 7230 N. Clark, Chicago, Ill.

SWAP Johnson Valiant, perfect condition need mobile gear or SSB excitor or what have you? All letters answered. K2QWG R. C. Miller, Hillcrest Road, Plainfield, New Jersey.

MISCELLANEOUS

dedeeN neM laeR: Due to over 3 years of preparation, a staff of about 25 people is now being organized to delve into all phases of Radio Astronomy, Propagation and Moon Bounce. The experiments are to be conducted in a chosen isolated area, and supported by the staff members. If you are a single male, and feel like expressing yourself, then do not hesitate to mail your qualifications to Radiometric Research, Box 315, Mercury, Nevada.

HOME-STUDY REVIEW for FCC Commercial phone exams. Fast, inexpensive, and highly effective. Free literature. Wallace Cook, (C9), Box 10634, Jackson 9, Miss.

WATCH FOR THE
1960 ANNUAL
Special Distributor Section

THE NEW P & H LA-400-C 800 WATTS PEP SSB LINEAR AMPLIFIER



**NOW 800 WATTS PEP
FOR ONLY \$164.95
THE "BEST BUY" YET**

NEW modern styling! NEW high efficiency 3 element band-switching pi net. Puts more power into any antenna or load from 50-70 ohms. For SSB, DSB, Linear AM, PM, CW and FSK. All bands 80-10 meters. May be driven to 800 WATTS PEP SSB with popular 100 watt SSB exciters. Uses four modified 1625's in grounded grid. On customers order, will be furnished with 837's. (note: 1625's and 837's are not directly interchangeable, since sockets are different.) Typical P&H Low Z untuned input. TVI suppressed. Parasitic Free. Meter reads grid drive, plate current, RF amps output. Heavy duty power supply using 816's. NEW modernistic grey cabinet measures approx. 9" x 15" x 10 1/2". Panel is recessed. WANT TO SAVE MONEY? BUY IT IN KIT FORM. It's a breeze to assemble and wire. BEFORE YOU BUY — SEE THE NEW LA-400-C AT YOUR DEALERS.

LA-400-C Kit complete with tubes.....\$164.95

LA-400-C Wired and Tested.....\$219.95

P & H ELECTRONICS INC.
424 Columbia Lafayette, Ind

For further information, check number 54 on page 126.

ALL BAND TRAP ANTENNA!



Reduces interference and Noise on All Makes Short Wave Receivers. Makes World Wide Reception Stronger, Clearer on All Bands!

For ALL Amateur Transmitters. Guaranteed for 500 Watts Power for Pi-Net or Link Direct Feed. Light, Neat, Weatherproof

Complete as shown total length 102 ft. with 87 ft. of 72 ohm balanced feedline, Hi-impact molded resonant traps. (Wt. 3 oz. 1" x 5" long). You just tune to desired band for beamlike results. Excellent for ALL world-wide short-wave receivers and amateur transmitters. For NOVICE AND ALL CLASS AMATEURS! NO EXTRA TUNERS OR GADGETS NEEDED! Eliminates 5 separate antennas with excellent performance guaranteed. Use as Inverted V for all band power gain. NO HAYWIRE HOUSE APPEARANCE! EASY INSTALLATION!

80-40-20-15-10 meter bands. Complete.....\$14.95

40-20-15-10 meter bands. 54-ft. ant. (best for w-w swl's).... 13.95

20-15-10 meter bands. Dual Trap. 24-ft. antenna..... 19.95

SEND ONLY \$3.00 (cash, ck., mo) and pay postman balance COD plus postage on arrival or send full price for postpaid delivery.

Available only from:

WESTERN RADIO • Dept. AC-9 • Kearney, Nebraska

NON-METALLIC GUY LINE — PERFECT FLEXIBLE INSULATOR — REVOLUTIONIZES HAM RADIO & TV ANTENNA SYSTEMS

Non-inductive, non-conducting, non-absorbing Glas-Line isolates systems from directional arrays, rhombics, etc.



The new main insulator of W3UCT. The Glas-Line is between the two egg insulators running to the lower left. The copper link between the center egg insulator and the upper right egg insulator is for the dead-end feeder of a Zepp antenna.



View of an open thimble and eye bolt for coupling the Glas-Line guy wire to a tree. GLAS-LINE cannot rot, will not shrink, stretch or sag... has high breaking strength of over 500 pounds with proper use.

100' SPOOL \$3⁷⁵ Plus 50¢ for postage & handling
600' REELS \$17⁸⁴ Plus \$1.00 for postage & handling

'SUPER' GLAS-LINE

with 1,000 lb. TENSILE STRENGTH with proper use.

100' SPOOL \$6⁹⁵ Plus \$1.00 for postage & handling
600' REELS \$34⁷⁵ Plus \$2.00 for postage & handling

Announcing New "G-3 50X GLAS-LINE CABLE" with 2,500 lb. TENSILE STRENGTH with proper use.

100' SPOOL \$13⁹⁰ Plus \$1.50 for postage & handling
600' REELS \$69⁵⁰ Plus \$3.00 for postage & handling

Send check or M.O. No C.O.D.'s please.
DEALER & DISTRIBUTOR INQUIRIES INVITED.

THE GLAS-LINE CO.

2751 NOSTRAND AVE., DEPT. 1, B'KLYN 10, N. Y. • CL 2-9851

For further information, check number 55 on page 126

TWO 3" GALVANOMETERS—Test Leads, Multiplier Switch in hinged carrying case.—G.E. Servo Test-meter. BRAND NEW \$ 9.95

X-BAND POWER LEVEL TEST SET, TS-36/AP. BRAND NEW, in original packing, with accessories. Measures 10 to 30 dbm. 8700-9500 mc. (Acq. cost \$477.00) ONLY \$14.95

METER—3"—0-5 Ma. 270° indication. By-Pass Switch and add scale. Excellent condition \$ 1.29
5 for \$ 5.00

TELEGRAPH KEY—J 47. New \$ 1.29

ART-13 TRANSMITTER with tubes and meters..... \$29.95

Send M.O. or check with order
Write for Bulletins

R W ELECTRONICS

2430 S. MICHIGAN AVE., DEPT. CQ
Chicago 16, Ill. Phone: CALumet 5-1281

World's best reconditioned equipment. Shipped on approval. Trades. Terms financed by us. Central 20A \$159.00; Collins 75A-1 \$229.00, 75A-2 \$299.00, 32V-3 \$349.00, 758-1 \$399.00, 328-1 \$449.00, KWM-1 \$549.00; Drake 1-A \$199.00; Elmac PRM-7 \$119.00, AF-67 \$129.00; Globe Chief \$39.00, Globe Scout \$59.00; Hallcrafters S-76 \$99.00, SX-99 \$109.00, SX-100 \$199.00, SX-101 \$279.00, HT-32 \$429.00, HT-32A \$499.00, HT-33A \$575.00; Hammarlund HQ-100 \$129.00, HQ-129X \$149.00, HQ-110 \$189.00, HQ-150 \$219.00, HQ-170 \$289.00, HQ-160 \$289.00; Heath DX-35 \$49.00, DX-40 \$65.00; SB-10 \$89.00, DX-100 \$179.00, RX-1 \$199.00, Apache \$239.00; Johnson Adventurer \$39.00, Viking II \$179.00, Valliant \$279.00; National NC-173 \$99.00, NC-300 \$209.00, HRO-60 \$349.00.

Many others. List free.
Henry Radio Company, Butler, Mo.

The larger commercial regenerating³ type units will cost more depending on the space requirements. For those who desire optimum control the various mechanical units can be arranged for automatic control by reasonably priced humidistats and thus become as automatic and reliable in operation as the household refrigerator.

The regenerating type operate as follows: a dehydrating agent (desiccant) is used in connection with blowers continuously re-circulating the air in the conditioned space through the desiccant. By means of suitable controls, when these desiccants have absorbed so much water that they are no longer effective, the wet desiccant is switched from the circulating air stream, and a fresh dry desiccant switched into the circulating room air. The dry desiccant continues to maintain proper moisture conditions in the space. The saturated desiccant is then heated and outside air circulated through it. The heat and outside air drive the absorbed moisture out of the saturated desiccant and discharge it to the outside air, reconditioning this lot of desiccant for a switch at a later date back into the dehydrating cycle, while the other saturated desiccant is then regenerated for future use.

For those amateurs who have been having some of the difficulties outlined in this paper the use of the methods outlined herein is recommended for consideration. ■

³Makers of Commercial Dehumidifying Equipment—Surface Combustion Company, Toledo 1, Ohio; Bryant Heater Company, Cleveland 10, Ohio; Cargocaire Engineering Corporation, New York 7, New York; Pittsburgh Lectrodryer Corporation, Pittsburgh 30, Pennsylvania; Desomatic Products, Inc., Falls Church, Virginia; Walton Laboratories, Inc., Irvington 11, New Jersey; and Dryomatic Corporation, Alexandria, Virginia.

TWO TONE GEN. [from page 53]

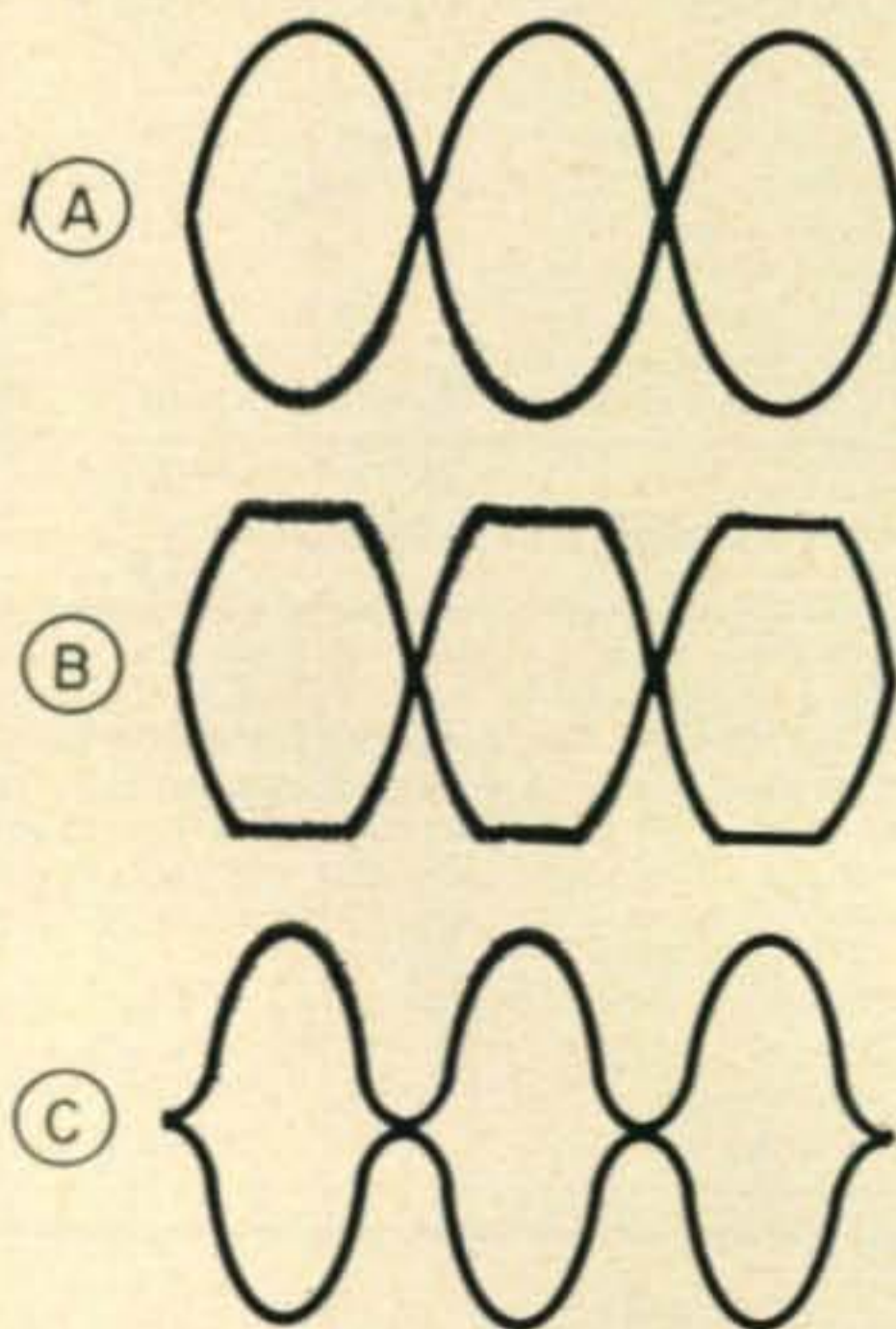

Fig. 3—Typical two-tone patterns: A. Correct amplifier operation; B. Peak flattening possibly due to over drive or poor regulation; C. Poor cross-over characteristics probably due to incorrect grid bias.

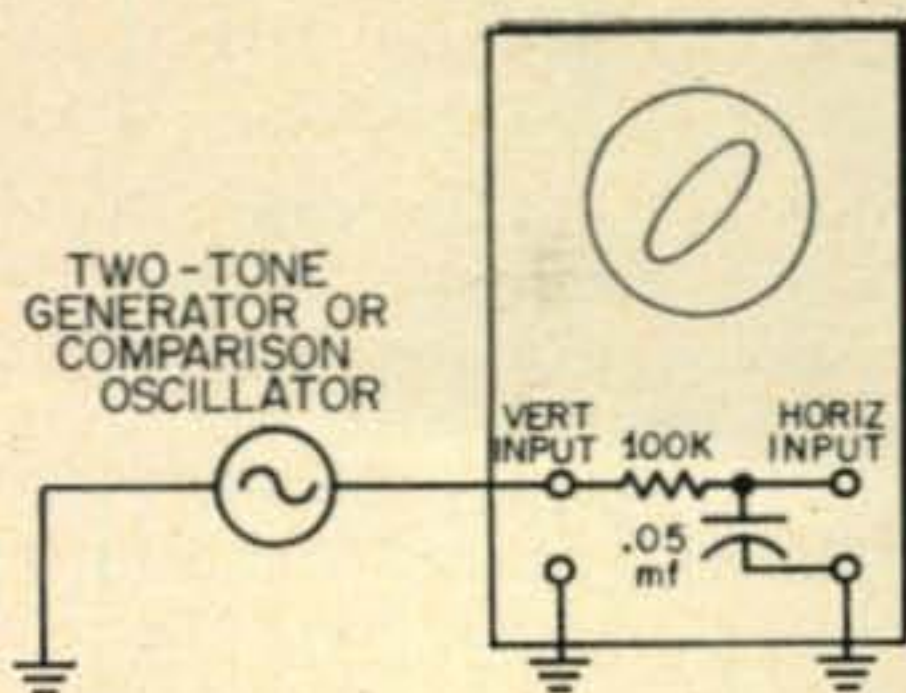

Fig. 4—Test set-up used for testing oscillator waveform. The phase-shift network in the horizontal input of the scope makes it possible to obtain an ellipse-like trace which is somewhat easier to interpret than the sinewave trace obtained when the internal sweep is used.

transmitter audio level control near maximum and using the two-tone generator output level control to adjust the transmitter power output.

My thanks to Lloyd Boesch, W9VKJ, who was responsible for the chassis design and wiring layout. ■

KEYBOARD [from page 51]

and also is a good cabinet and chassis for the construction of the unit. Since the negative side of the power supply is connected directly to one of the loop terminals it is desirable to float all of the ground connections shown above the case to prevent a possible short in the external loop circuit. The hold in time of the switch can be adjusted by changing the value of the 1 mf capacitor. Decreasing the value will decrease the hold in time. The pull in time is also affected by the change but is unimportant as long as it is less than 5 milliseconds. Current drain from the power supply is 8 ma with the 250 volt supply. The unit will work satisfactorily with plate voltages reduced to 150 volts. If the unit is built into existing equipment and uses the same power supply make sure that the grounded loop will not affect the operation of the external loop circuit.

Precautions

The only precaution in installing the switch is to make sure the received teletype signal can not key the send loop. If this happens the transmitter will turn on and off intermittently. Since it is desirable to print local copy while sending, a suggested loop arrangement is shown in fig. 2. The keyboard keys both the send loop and the printer, while the receive relay keys only the printer. With this arrangement it is necessary to lock the receive relay on mark while transmitting. This can be done with the receive contact on the switch relay.

Many other arrangements and methods of installation are possible and can be tailored to the individual installation. The switch is also useful in an AFSK system to provide automatic switching between voice and tone transmission. ■

ROHN "fold-over" TOWERS*

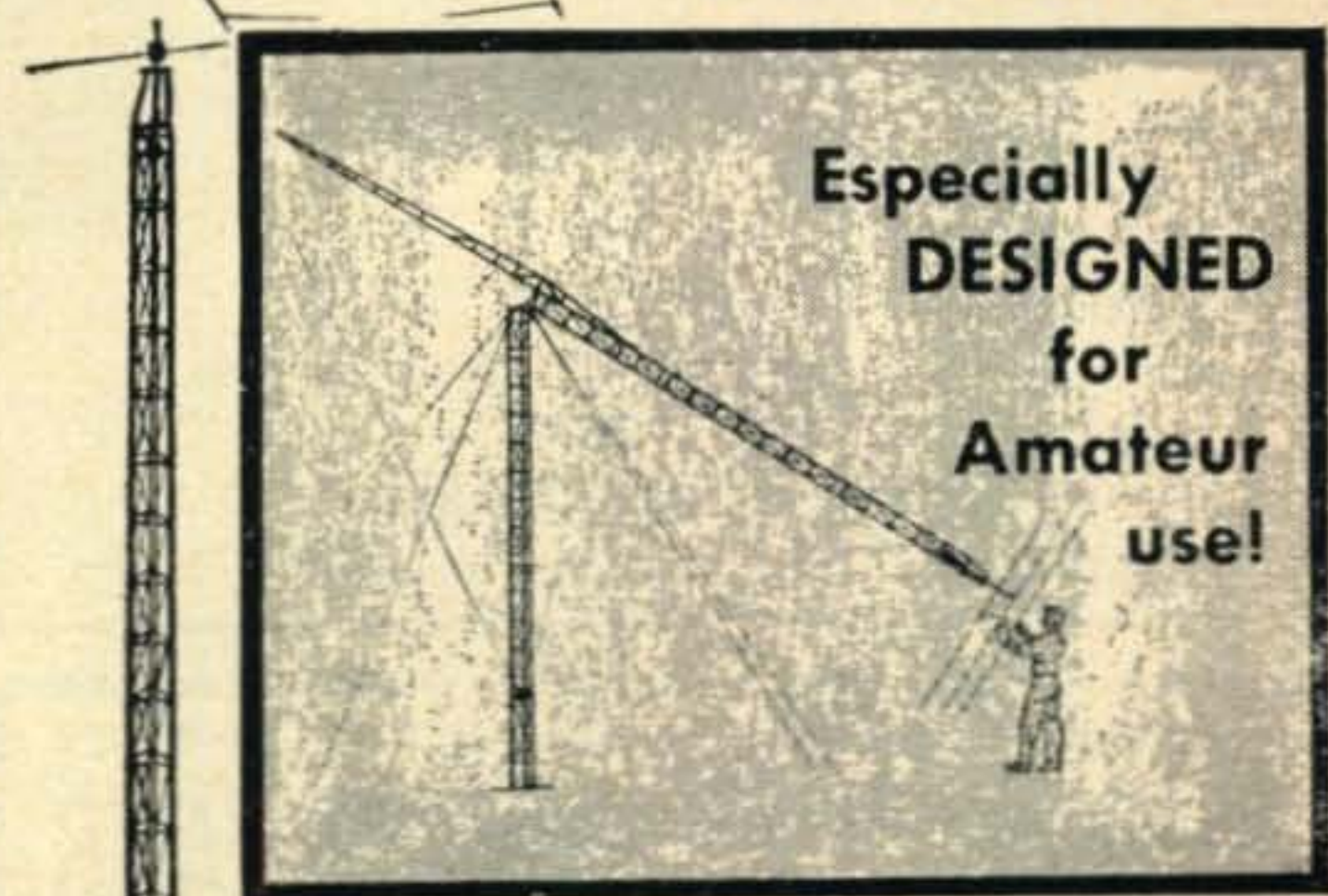

first IN DESIGN foremost IN SALES

ROHN "fold-over" towers are ESPECIALLY made for amateur use. They are the most practical tower in design because they allow you to work ON THE GROUND for antenna maintenance and servicing. You'll quickly agree that this is a most wonderful feature for an amateur tower. In addition, these towers are made and designed for true, heavy duty use. They are structurally sturdy for use up to 70 feet and in enough sizes for all types and sizes of amateur antennae. This means that they can easily handle your requirements. They have unexcelled workmanship. They are hot-dipped galvanized after fabrication which means you have no problem of maintenance. They come as a complete package with all materials and accessories included. Add all these wonderful features together and you see why they're the most demanded tower today! Priced from \$186.

FREE literature and near source of supply gladly sent. Be Sure you investigate ROHN towers before buying!

*Patent—2,875,865

ROHN Manufacturing Company

116 Limestone, Bellevue • Peoria, Illinois

"World's largest exclusive manufacturer of TV-Communication towers"

For further information, check number 56 on page 126.

EASY TO LEARN CODE

It is easy and pleasant to learn or increase speed the modern way—with an Instructograph Code Teacher. Excellent for the beginner or advanced student. A quick, practical and dependable method. Available tapes from beginner's alphabet to typical messages on all subjects. Speed range 5 to 40 WPM. Always ready, no QRM, beats having someone send to you.

ENDORSED BY THOUSANDS!

The Instructograph Code Teacher literally takes the place of an operator-instructor and enables anyone to learn and master code without further assistance. Thousands of successful operators have "acquired the code" with the Instructograph System. Write today for full particulars and convenient rental plans.



INSTRUCTOGRAPH COMPANY

4711 SHERIDAN RD., CHICAGO 40, ILL.
4700 Crenshaw Blvd., Los Angeles 43, Calif.

SKYLANE QUAD

- Single Feed Line.
- Aluminum Alloy End—Center Spiders.
- Very Low SWR—Low Q—Broad Tuning.
- High F/B Ratio and High Gain.
- No Stubs to Tune.
- Everything Cut to Fit—Assemble and Use.
- Pre-Tuned Reflector Coils.
- High "Area" Factor.
- 10-15-20 Meters.
- Aluminum Boom With Hardwood Insert.
- No Misalignment of Quads.

Write for Free Brochure.

Price \$59.95

SKYLANE PRODUCTS

405 Bon Air

Tampa 10, Florida

OVER 1000 SOLD THE 1st MONTH! NOT ONE RETURNED!

RADIO - TV PARTS BY THE POUND in JUMBO PAKS

500-1000 PCS PER POUND! MONEY-BACK GUARANTEE!

ONE POUND OF	WORTH	\$3 ⁰⁰	per pound
<input type="checkbox"/> Precision Resistors	\$100, NOW		
<input type="checkbox"/> Disc Condensers	\$ 50, NOW		
<input type="checkbox"/> Ceramic Condensers	\$ 85, NOW		
<input type="checkbox"/> Discs & Ceramics	\$ 75, NOW		
<input type="checkbox"/> Discs, Ceramics, Precisions	\$ 70, NOW		
<input type="checkbox"/> Carbon Resistors	\$ 60, NOW		
<input type="checkbox"/> "Tiny" Paper Cond'n's	\$ 60, NOW		

16-Ton's of mfr's over-runs **BUY 4** pick **5th**
Pre-packed to save you money **the 5th** FREE

FREE!
GIANT BARGAIN
CATALOG
Write for Yours

LEKTRON

241C Everett Av.
Chelsea 50, Mass.

"SURE HOPE THE CHAIN HOLDS"

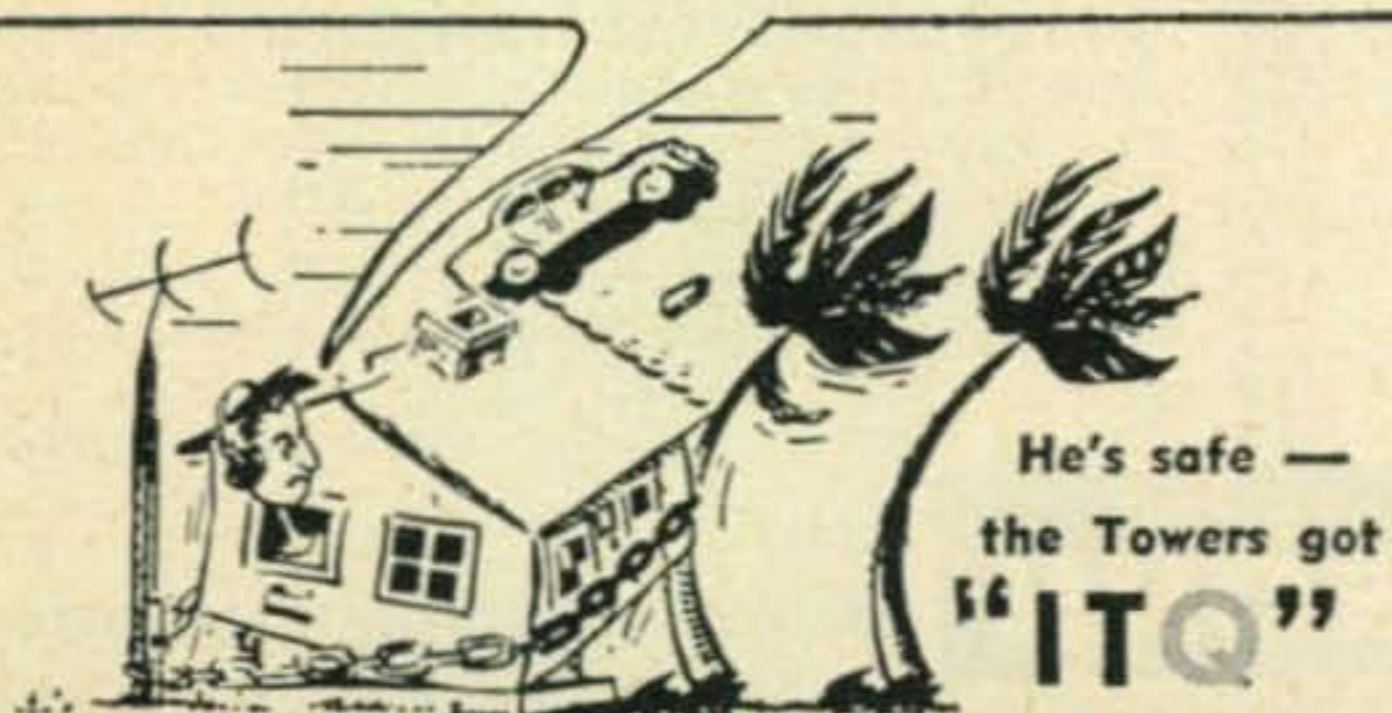

E-Z WAY TOWERS, INC.
P. O. BOX 5491 - TAMPA, FLA.



Groth TURN COUNT DIAL

Registers Fractions to 99.9 Turns
FOR roller inductances, INDUC-
TUNERS, fine tuning gear reduc-
ers, vacuum and other multiturn
variable condensers. One hole mounting. Handy
logging space. Case: 2" x 4". Shaft: 1/4" x 3". TC 2
has 2 1/8" dial—1 5/8" knob. TC 3 has 3" dial—2 1/2"
knob. Black bakelite.

TC 2 \$4.20—TC 3 \$4.75—Spinner Handle 75c extra
Add 12c for Parcel Post

R. W. GROTH MFG. CO.

10009 Franklin Ave. Franklin Pk., Illinois

Did You Get Your
CQ World Wide DX
Zone Map Yet

(See page 96)

NOVICE DX [from page 50]

these suggestions will transform a Novice into a skillful DX-man overnight. In fact the restrictions of crystal control greatly hinders the Novice licensee. Coupled with the tremendously crowded bands, working DX isn't the simplest of chores. However, I feel confident that everyone, if really determined, should be able to work a bit of DX within a couple of weeks. So let's give it a go fellows! You may be surprised with the results, and I still may get that very elusive WAS. ■

BANDPASS FILTER [from page 45]

receiver tuning rate proved to be too severe. This was overcome by the use of a surplus National planetary drive mounted externally on the bandspread dial. It is possible to use the *bfo* pitch control for fine tuning. Incidentally, when using the filter it is quite easy to copy a CW signal through the foreign phone stations that are prevalent on 40. This simple device has greatly enhanced CW operating for the author. For selectivity it will out perform either *Q* multiplier or *Q* 5er. Try it—see if you don't agree. ■

TOBAGO [from page 61]

envelopes to VP4, no cards have been received from this source. I suggest therefore, that duplicate cards should be sent either directly to me or via the RSGB.

VP4TAQ

There is one resident ham on the island. Mr. Cecil O'Brien, VP4TAQ of the Fort Wireless Station on Tobago. He is not active, and has never been from Tobago. I think it would be a good idea if some of the gang were to write to him. He has very limited spare time and although he is building a medium power transmitter for the high frequency bands, he is not at all sure when he will be active.

Radio components are in short supply on Tobago as I soon discovered when I needed new electrolytics for my power pack; so some help in this direction would no doubt be greatly appreciated by "TAQ".

I sure enjoyed installing and operating VP4-WD and would like to thank all the W's for the enjoyable contacts I had with them.

Most W's were very co-operative in getting clear of the channel after a QSO, and fairly patient in awaiting their turn in the pile-ups that built up on the frequency.

For the record, the station was opened on September 6th, 1959 and finally closed on January 14, 1960. The first QSO was with W2KQT on 7 mc and the last QSO on 14 mc with WØJXT at 2217 hours on January 14th, 1960.

The Island

As a matter of general interest the climate on Tobago is ideal for vacations; averaging about 80-86°, with cool Atlantic breezes during morning and evening. But the humidity is high at times reaching 80/90 percent early mornings and decreasing to 50/60 percent later in the day. Radio gear suffers accordingly as I found out!! Nevertheless the island is, so far, an unspoiled paradise. (As Princess Margaret & Anthony Jones discovered recently.) So fellows, if you want to combine a good vacation with a spot of DX, why not get some light weight gear sent down and follow it up smartly, and put Tobago back on the Amateur radio map. Who will be the first, to be the SECOND Lone Voice on Tobago?

Late flash. Had an air letter from VE6BY a couple of weeks back to say he'd paid a short visit to the island whilst in vacation and that VP4TAQ had apparently not made any further progress with his rig since I left in January. G6XL also stayed there for a few days in mid-February, but to date I've had no report from him regarding TAQ's activity either.

Do think the reason for his continued non-appearance is possibly due to the fact that he has a large family of growing boys? Seven in all ranging from 18 months to 12 years of age. Hi!! I myself have sent off several letters to him over the months past but no reply so far. Maybe Disney will wave his magic wand and stage another film epic over there. If he does so and I get the opportunity to go, you can bet that VP4WD will be back with a far stronger voice than before. ■

1625 LINEAR [from page 40]

The nameplate, if you want to go as hog-wild as I did, is available from Neutron Nameplate, 22960 Lorain Ave., Fairview Park 26, Ohio.

After the panel is painted and decals are added, 5 or 6 coats of plastic spray will insure the appearance in the knob twisting days to come. Be careful with the spray, too much at once will wither the decals. Incidentally, Central Electronics cannot supply paint to match the 20A, and even if they could it probably wouldn't match. They inform me that each batch of panels they get from their jobber is a slightly different color.

On The Air

At the time of writing the 1625 GG has been used about 1000 hours, including one 17 hour endurance stretch. Due to antenna limitations at this QTH the majority of operation has been on 40 and 15 meters, but all bands have been tried with success. Of the several hundred amateurs I've talked to since completing the linear, none has had any complaints regarding signal quality and many have praised it.

This rig has proved to me that 200 watts is more than sufficient power for a sideband linear regardless of band. The electric bill hasn't gone up noticeably, all of my QSOs have been 100 per-cent (well, almost all), and the XYL is happy. What more could you want?

My thanks to Jack, W8LIO, for his kind indulgence, help, and usual enthusiasm. Thanks also to Brad, K3LRV, and Dave, K3ACT, for checking this commentary. ■

TWO-WAY COMMUNICATION CRYSTALS

UNCONDITIONALLY
GUARANTEED

FAST — 24 HOUR SERVICE

American specializes in two-way communications. Frequency correlation data for G.E., Motorola, R.C.A., Collins, Lear, Narco, Hallcraft, Link, Gonset, Aerotron, Heath, Bendix, Johnson, Globe, U.S. Gov't. and many other companies.



FREQUENCY RANGE	CALIBRATION TOLERANCE	PRICE
2501 KC to 9999 KC	.002%	\$3.00
15 MC to 32 MC	.0025%	\$3.00
32 MC to 50 MC	.0025%	\$4.00
10 MC to 17 MC Fund	.002%	\$4.00
2001 KC to 2500 KC	.002%	\$4.00
50 MC to 60 MC	.0025%	\$6.00
1000 KC to 2000 KC	.002%	\$7.50

Write for quantity discounts—

AMERICAN CRYSTAL CO.

P. O. Box 2366

Kansas City 42, Mo.



Towers

For Hams
For Research at Schools
For Geodetic Survey
For Wind Measurement,
For Antenna Testing
For Government Research

SEND FOR
ILLUSTRATED FOLDER



Tower

AND COMMUNICATION COMPANY

SULLIVAN, ILLINOIS

WANTED: A career in mathematics. Holder of BS in math, working on Masters Degree, desires position where he can put his knowledge of mathematics, including advanced differential and integral calculus, theory of probability, statistical analysis, theory of complex variables, etc. to good use in a forward looking company. High education honors, still higher potential. Contact

Larry Bernstein,
457 Schenectady Ave., Brooklyn 3, N.Y. • PR 4-7512

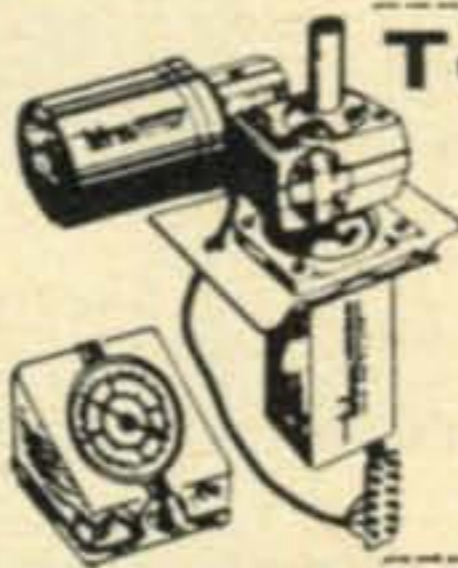

Telrex 175 RIS — the

- ★ 2 Stage Boston Gear Reducer
- ★ 1/12 HP. Motor
- ★ Selsyn Indicator

\$198⁵⁰

finest
low cost
rotator
on the
market!

TELREX LABORATORIES
ASBURY PARK 40, N. J., U. S. A.

ADVERTISING INDEX

TELETYPEWRITER EQUIPMENT

Model #14, 15, 19, 26 & 28 Teletype machines, Telewriter Receiving Converter and others. Collins 51J, R388, R390A general coverage receivers. For general information & equipment list write:

Tom WIAFN, ALLTRONICS-HOWARD CO.
Box 19, Boston 1, Mass. Richmond 2-0048

OPPORTUNITY

WANTED—Imaginative, Industrious young man to research and develop new ideas in Electronic and Allied Fields. Syndicate will provide Capital—Guaranteed minimum salary—Future Incentives and Guidance. Give detailed background, previous experience, references and recent photo in first letter to C. M. Tierney, 612 3rd Ave. South, Fort Dodge, Iowa.

New! Telrex "Spiralray"

Extremely high-gain, high signal-to-noise, practically no fade, all radiation planes—horizontal, vertical or oblique! Ideal for scatter-wave, satellite, mobile or point to point work! 50, 108 and 144 megacycle models available

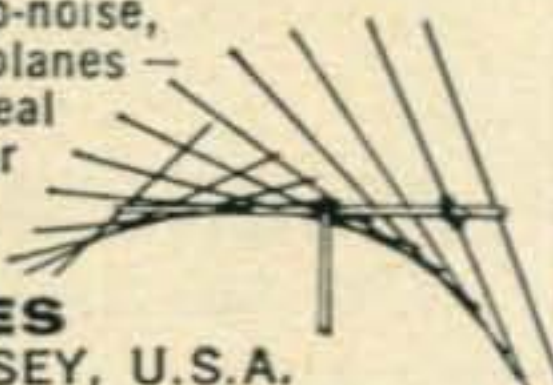

TELREX LABORATORIES
ASBURY PARK 40, NEW JERSEY, U.S.A.

PERFECT GIFT FOR YL OR OM

CQ YL

The only book about the YLs. 18 chapters, 500 photographs, covers all phases of YL participation in Ham radio. Autographed copy \$3.00, postpaid. Order from:

LOUISA B. SANDO, W5RZJ
212 Sombrio Dr. Santa Fe, N. Mex.

READER SERVICE

CQ Magazine, Dept. RS

300 WEST 43rd STREET
New York 36, N. Y.

Coupon J
Void after
Sept. 25, 1960

▲
Please send me information on your ads in the Sept. 1960 CQ keyed as follows:

1	2	3	4	5	6	7	8	9	10
11	12	13	14	15	16	17	18	19	20
21	22	23	24	25	26	27	28	29	30
31	32	33	34	35	36	37	38	39	40
41	42	43	44	45	46	47	48	49	50
51	52	53	54	55	56	57	58	59	60

NAME _____

(Please Print)

Call _____ Engineer

Type of work (specify) _____

ADDRESS _____

CITY _____

ZONE _____ STATE _____

ACF Industries, Inc.	22
Allied Radio Corp.	128
Alltronics-Howard Co.	126
American Crystals Co.	125
Arrow Electronics, Inc.	104
Barker & Williamson, Inc.	100, 114, 119
Barry Electronics, Corp.	118
Bernstein	125
C & G Radio Supply Co.	115
Cleveland Institute of Electronics	10
Collins Radio Co.	Cover II
Collins Radio Co., Western Div.	106
Communications Products Co., Inc.	17
Cornell-Dubilier Electric Corp.	16
Cush Craft	116
CQ's BC-603 Conversion Data	116
CQ's Classified Ads	118
CQ Ham Mart	110, 111
CQ November Announcement	98
CQ Subscription Ad	96
CQ YL Book	126
CQ Worldwide DX Zone Map	96
Dow-Key Company, Inc.	100
E-Z Way Towers, Inc.	108, 119, 124
Eddystone-British Radio Elect., Lab.	102
EICO	12
Evans Radio	115
G & G Radio Supply Co.	120
Glas-Line Co.	122
Globe Electronics	107
Gonset Co.	5
Groth, R. W. Mfg. Co.	124
Hallcrafters Co.	3
Hammarlund Mfg. Co., Inc.	15
Ham-Swap, Inc.	119
Harvey Radio Co., Inc.	97
Heath Co.	7, 8, 9
Henry Radio Stores	99, 122
Hewlett Sales Co.	105
Hornet Antenna Products Co.	23
House of Antennas	108
Hy-Gain Antenna Products	13
Instructograph Co.	123
International Crystal Co.	26, 27
James Knights Co., The	25
Johnson, E. F. Co.	28, 29, 30, 31
KTV Towers & Communication Co.	125
Lafayette Radio	103
Lampkin Laboratories, Inc.	119
Lextron, Inc.	124
Master Mobile Mounts, Inc.	21
Millen, James Mfg. Co., Inc.	4
Mosley Electronics, Inc.	11, 113
National Radio Co., Inc.	Cover III
Neil Co.	18
P & H Electronics	121
Palmer, Joe	117
Penta Laboratories, Inc.	6
Petersen Radio Co., Inc.	1
RCA Electron Tube Division	Cover VI
RW Electronics	122
Radio Shack Corp.	101, 113
Rad-Tel Electronics	109
Rohn Mfg. Co.	123
Seco Electronics Inc.	117
Shure Brothers	14
Skylane Products Inc.	124
Solar Electronics	114
TAB	127
Tapetone, Inc.	116
Telex Inc.	24
Tel Instrument Electronics	115
Telrex, Inc.	19, 125, 126
Tierney, C. M.	126
Turner Microphone Co.	20
U.S. Air Force	95
Vibroplex Co., Inc.	117
Western Radio Co.	121
Woodruff, Ben	115
World Radio Labs., Inc.	Covers IV, V

"TAB" FOR THE BEST KITS!

KITS! Each "TAB" Kit Contains The Finest Selection!!!

- Kit 5 Mycalex Glass/HF Strips
- Kit 35 Precision Resistors
- Kit 10 Switches
- Kit 75 Resistors 1/2/1/2W
- Kit 150 Carbon Resistors
- Kit 25 Panel Lamps
- Kit 12 Electrolytic Cond's
- Kit 15 Volume Controls
- Kit 56 Tube Sockets
- Kit 65 Tubular Condensers
- Kit 500 Lugs & Eyelets
- Kit 10 Bath Tub Oil Cond's
- Kit 5 lbs. Surprise Package
- Kit 10 Transmit Mica Cond's
- Kit 8 Xtal Osc-Blanks
- Kit 4 Xtal Rectifiers
- Kit 3 Phone/Patch Xfms
- Kit 3 Searchlights
- Kit 4 AN/Reflector Lites
- Kit 6 Insult Tuning Tools

NEW POWER CONVERTER
12VDC to 500VDC
up to 200MA
100 Watts; Tap at 250VDC
Type C1250E \$35



Hi efficiency, low ripple, low idle current-Silicon rectifiers! Toroidal HiEN! Mag-metal tape wound transformer, fused & short circuit proof, small in size! Quiet! Light weight! C1250EE built, ready to go. Conservatively Rated. Delco Transistors Heavy Copper-Heatsink.

12VDC to 250VDC up to 150MA
Type C1225A \$30

"TAB" GUARANTEED XTALS!
HAM BAND 80 or 40Mtrs \$1@
NOVICE BAND \$1@
CITIZENS BAND \$3@
Include 1st, 2nd, 3rd & 4th choice!
On XTALS!
*Postpaid 48 States XTALS Only

DC POWER SUPPLIES for TRANSISTORS!

- New low-cost filtered 0.5% Ripple Power Supply. Same as specified in Transistor Manual G.E. Ideal for Powering transistor circuits, small in size!
- 12VDC at 150Ma-T12V150M \$ 8
 - 25VDC at 150Ma-T25V150M \$10
 - 40VDC at 1 Amp-T40V1A \$19



NEW BATTERY CHARGER!!!
FOR 2V OR 4V OR 6V OR 12 VOLT BATTERIES. TRICKLE & FULL CHARGE up to 4 AMP

- Charges 2-4-6 & 12 volt batteries.
- Built BCK-1 \$13.50



"TAB"—THAT'S A BUY!—BARGAINS!!
AN-ARR2/RCVR less tubes A-1 endtn \$1.95
RDZ/USN 200-400 Mes Rvrs As Is \$25
G.E./YRS-1 Side Band Selector..... \$45
829B Socket 85¢, 2/\$1.50, 813 Socket \$1
4x150 Ceramic/LOKTAL..... 2 for \$1.00
W.E. 416B Hlgain—HIMU \$4

Leece Neville Charger Systems
"SILTAB" Silicon Rectifier Replacement
Non-Aging Hermetically Sealed
FOR 6 or 12VDC @ 100A, Type YJ9 \$24
If U Don't See It Write!



"TAB" THAT'S A BUY

"TAB" Tubes Tested, Inspected, Boxed

Six Months Guaranteed! No Rejects!

GOVT & MFGRS Surplus New & Used

0A2	.70	6BZ7	1.25	We Buy & Sell	
0A3	.80	6C4	.45	43	.75
0B2	.65	6C5	.69	45	.49
0C3	.70	6C6	1.08	50L6	.69
0D3	.50	6C8	1.08	RK59	1.39
0Z4	.60	<i>We Trade!</i>		RK60	1.17
1A7	.90	6CB6	.89	HY69	2.20
1B3	.78	6CD6	1.49	75	.81
1L4	.82	6CF6	.85	HY75	5.00
1R4	5/\$1	6CL6	1.40	83V	.95

We Swap Tubes! What Do/You Have?

1R5	.78	6CB6	.89	4PR60A	37.50
1S4	.78	6CG8	1.12	4-125A	27.50
1S5	.68	6CM6	.79	4X150G	15.00
1T4	.82	6CS6	.70	4X250B	41.00
1T5	.95	6CU6	1.29	4-400A	41.75
1U4	6/\$1	6D6	.99	4E27A	39.00
1U5	.75	6E5	.79	250TL	19.45
1X2	.99	6F4	2.49	307A	2/\$1
2C39A	9.00	6F5	.63	316A	5/\$1
2C40	5.50	6F6	.99	VR92	5/\$1

Send 25¢ for Catalog!

2C43	6.50	6F7	.99	388A	3/\$1
2C51	2.00	6F8	1.39	350A	2.45
2D21	.65	6H6	.59	350B	1.75
2E22	1.75	6J4	1.72	371B	.95
2E24	1.90	6J5	.59	3146	3.90
2E25	2.50	6J6	.59	416B	16.00
2E26	2.75	6J7	.99	450TH	43.00
2E30	1.70	6J8	1.39	450TL	43.00
2E35	1.60	6K6	.59	460	11.50
2K25	9.75	6K7	.79		

All Tubes Stocked at Low Prices!

2K26	34.00	6K8	.99	703A	2.00
2K28	30.00	6L6	1.19	707B	3.50
2V3	2/\$1	6SN7	.72	715C	10.90
2X2	.48	6T8	.98	717A	5/\$1
3A4	.70	6V6GT	.90	723AB	5.00
3A5	1.00	6X5	.49	725A	2.75
3API	5.95	12AT6	.59	803	3.50
3BPI	3.99	12AT7	.89	804	8.85
3C24	3.50	12AU6	.63	805	6.00
3D23	3.95	12AU7	.69		

We Buy! We Sell! We Trade!

3E29	6.00	12AX7	.79	807	1.10
3Q4	.68	12AY7	1.29	5/\$5, 10/\$12	
3Q5	.86	12B4	.95		
4-65A	13.50	12BA6	.65	811	3.45
4-125A	27.50	12BA7	.99	811A	4.41
4-250A	34.00	12BD6	.59	812	3.30
4X150A	7.00	12BE6	.59	813	8.00
4X250	36.00	12BH6	.79	815	1.75
4X500	37.00	12BH7	.99	826	.50
5API	2.95	12BY7	1.00		

Wanted Test Sets and Equipment

5BP1	5.02	12BZ7	.99	828	9.00
5BP4	5.00	12H6	.75	829B	8.00
5CP1	4.99	12J5	.69	832A	6.00
5CP7	9.00	12J7	.69	833A	36.00
5R4	1.00	12J8	1.35	837	2/\$2
5T4	.90	12K8	.89	866A	2.45
5U4	.99	12SA7	.69	954	10/\$1
5V4	.89	12SC7	.89	955	3/\$1
5Y3	.60	12SF5	.69	957	3/\$1
5Z3	.89	12SG7	.89	958A	2/\$1

Send 25¢ for Catalog!

15GP22	89.00	12SH7	.89	991	5/\$1
6A7	1.00	12SJ7	.75	1614	2.75
6A8	.99	12SK7	.75	1619	5/\$1
6AB4	.59	12SL7	.79	1620	2.00
6AC7	.72	12SN7	.69	1625	5/\$1
6AG5	.65	12SQ7	.69	1626	5/\$1
6AG7	.75	12SR7	.69	1629	4/\$1
6AK5	.69	15E	1.19	2050	1.25
6AL5	.59	15R	4/\$1	5517	1.25
6AQ5	.66	FG17	3.49	5608	3.95

Top \$\$\$ Paid for 304TL tube.

6AR6	1.95	19T8	1.16	5618	3.25
6AS7	3.49	24G	3.50	5651	1.35
6AT6	2/\$1	25A6	1.19	5654	1.20
6AU6	.79	25A7	2.19	5656	4.25
6B8	1.35	25C5	.81	5663	1.15
6BA6	.59	25L6	.72	5670	.90
6BE6	.59	25T	4.00	5686	1.75
6BG6	1.49	25Z5	.72	5687	1.15
6BH6	.79	25Z6	.75	5691	4.70
6BJ6	.72	26A7	3.69	5725	1.95

Top \$\$\$ Paid for XMTTR Tubes!

6BK7	.99	FG27	8.28	5732	2.00
6BL7	1.35	HV27	19.39	5736	85.00
6BN4	.69	28D7	.89	5749	1.95
6BN6	1.08	FG33	15.00	5750	2.75
6BN7	1.99	EL34	3.49	5751	1.25
6BQ6	1.19	35A5	.69	5814	1.20
6BQ7	.99	35L6	.59	5879	1.20
6BX7	1.11	35T	4.49	5894	\$12.00
6BY5	1.19	35Z5	.89		
6BZ6	.91	RK39	2.99		

"TAB" TERMS: Min Order \$3—25%
with order F.O.B. New York.
Ten day guarantee, price of
mdse. only. Our 15th year.
Prices shown are subject to change.

111CM Liberty St., N. Y. 6, N. Y. RE 2-6245

99c

ONE EACH ABOVE KIT ONLY

Order Ten Kits We Ship Eleven!!!

NEW "SILICON 750 Ma RECTIFIERS WORKING VOLTS RMS—ACV INPUT!

Order 10 or More 750Ma deduct 10%

rms/piv	rms/piv	rms/piv	rms/piv
35/50	70/100	140/200	210/300
19¢	29¢	34¢	43¢
rms/piv	rms/piv	rms/piv	rms/piv
280/400	350/500	420/600	490/700
50¢	62¢	80¢	95¢
rms/piv	rms/piv	rms/piv	rms/piv
560/800	630/900	700/1000	770/1100
\$1.05	\$1.25	\$1.70	\$2.00

Use in Bridge or C.T. up to 1 Amp DC

*Derate 20% for Capacitive input

"TAB" Special General Purpose Silicons

400 PIV @ 300Ma 39¢ @ .25 for \$8.00

General Purpose & Replacement

*Silicon 400PIV at 250 Ma Rectifiers

Hi-Temp 106°C at 252V/RMS. Special 2 for \$1.25 for \$10.

EXPORTERS-OEM-DISTRIBUTORS

Write for Data & Qty Prices

Silicon Orders \$20 shppd prpaid U.S.A.

PROTECT THAT METER "TABISTOR"

LOW LEVEL VOLTAGE

REGULATING DIODES

TG150 1V@100Ma 50¢, 5 for \$2

TM2K 2V@2000Ma 90¢ @. 3 for \$2

SELENIUM

PHOTOCELL—

"SUNTAB"®

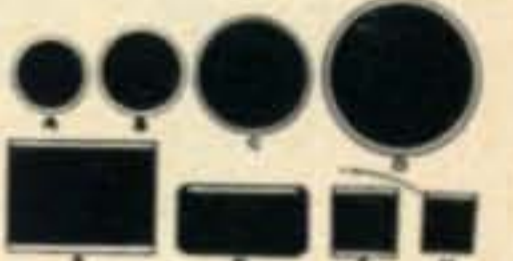

- 5AP ROUND 1 1/2" Dia.—250ua..... \$1.00
 - 10AP ROUND 1 1/2" Dia.—360ua..... \$1.75
 - 15AP ROUND 2" Dia.—750ua..... \$3.00
 - 2BP RECT 3/4 x 7/16—75ua..... .70
 - 5BP RECT 1-7/16 x 3/8—200ua..... \$1.35
 - 10BP RECT 1-11/16 x 3/8—360ua..... \$1.80
 - KIT ALL SIX ONE EACH \$7.00
- ORDER QTY'S TEN OR MORE
DEDUCT 20%
THIS ITEM SHIPPED POSTPAID
ORDERS \$5 UP.

SELENIUM F.W. BRIDGE RECTIFIERS

DC AMP	18VAC 14VDC	36VAC 28VDC	72VAC 54VDC	130VAC 100VDC
1/2	\$1.00	\$1.90	\$3.85	\$5.00
1	1.30	2.00	4.90	8.15
2	2.15	3.00	6.25	11.10
3	2.90	4.00	8.60	13.45
6	4.15	8.00	18.75	31.90
10	6.10	12.15	26.30	41.60
12	7.75	14.90	30.95	43.45
20	12.85	24.60		
24	15.00	29.45		

New "TABTRAN" Rectifier Xfms

Sen'd Volts (DUAL†) 0-9-15-18-&-0-9-15-18. Series Sec'ds 0-3-6-9-12-15-18-21-24-27-30-33-36 Volts.

Write for Rectifier Catalog

TR4001 @ 1 Amp† ea/sec/winding \$5.15

TR4002 @ 2 Amp† ea/sec/winding \$7.15

TR4003 @ 5 Amp† ea/sec/winding \$9.90

†Wndgs in Series at Ratings shown: Parallel 2X Current. Voltage output. 0-9-15-18

RECTIFIERS 130V/RMS HALF-WAVE

75Ma 49¢, 5 for \$2; 100Ma 59¢, 6 for \$3
150Ma 70¢, 8 for \$5; 250Ma 79¢, 6 for \$4
300Ma 88¢, 5 for \$4; 350Ma \$1.00, 8 for \$7
400Ma \$1.10, 5 for \$5; 500Ma \$1.35, 5 for \$5
This Item P.Pd. 48 states orders \$10.

WE BUY! SELL & TRADE

Send 25¢ for Bonus Catalog!

"VACDAC"® SILICON TUBE

REPLACEMENTS

WITH BUILT IN RF SURGE & SERIES BALANCING PROTECTION

TYPE VRMS/PIV AMPS PRICE

ST866 5000/10400 0.3 \$20.00

ST816 5000/7000 0.3 \$16.00

ST5R4 1900/2800 0.5 \$15.00

ST5U4 1120/1600 0.6 \$ 8.00

HDQTRS. TRANSISTORS & ACCESSORIES

2N441/\$3; 2N442/\$4.50; 2N277/\$4; 2N278/\$5;

2N155/\$1.39; 2N176/\$1.80; 2N177/\$1;

2N178/\$1.75; 2N247/\$1.50; 2N255/\$1.20;

2N270/.95; 2N274/\$1.25; 2N408/.80;

2N554/\$1.20; 2N578/\$1.80; 2N579/\$2.20.

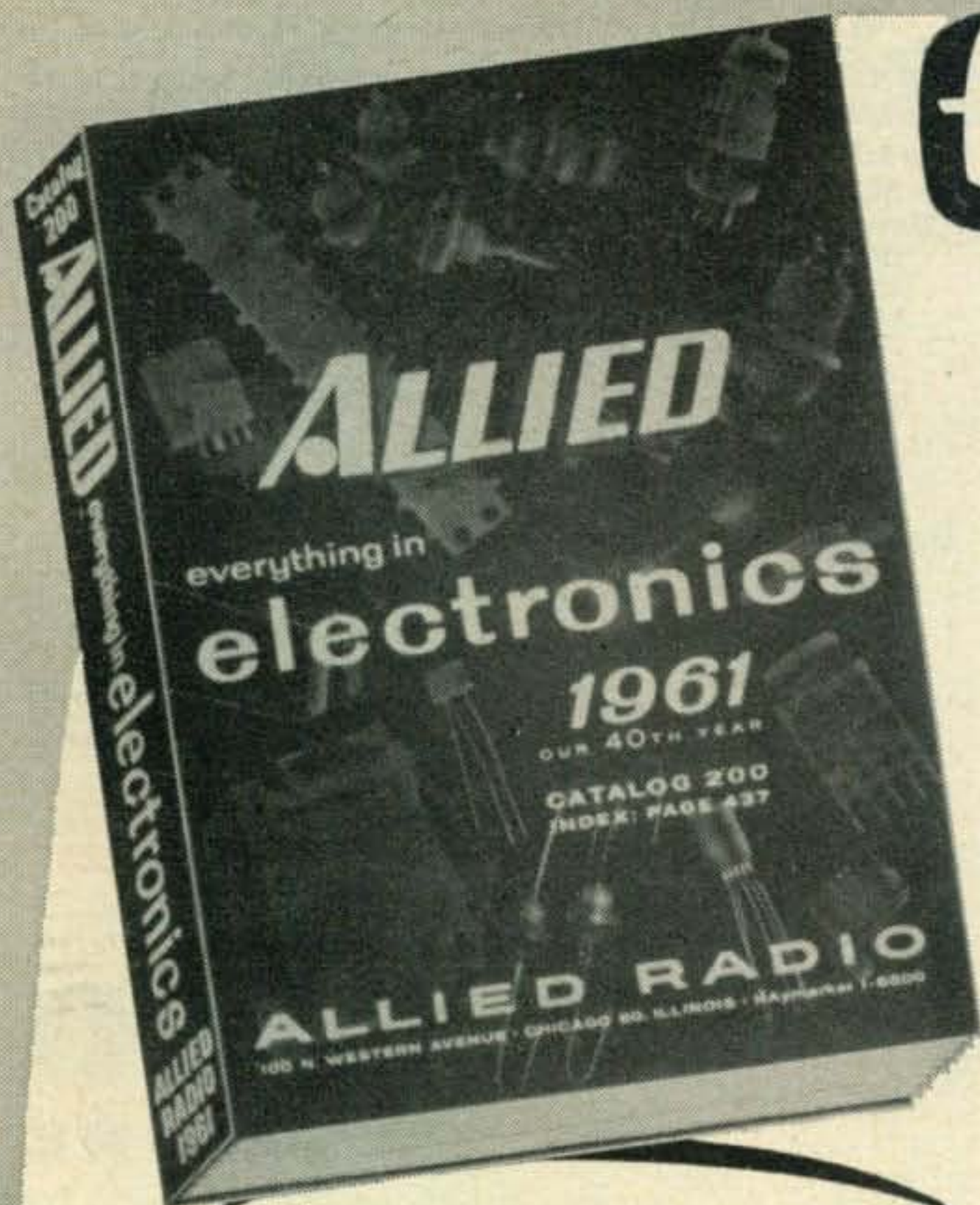

free

send for the

ALLIED

VALUE-PACKED 1961 ELECTRONICS CATALOG

444 PAGES • MOST COMPLETE

.....

Everything IN ELECTRONICS FOR THE AMATEUR

Write for the 1961 ALLIED Catalog—the most widely used electronic supply source for Amateurs. You'll want it handy always—to fill all your station equipment needs—to supply you with *everything* in electronics at lowest, money-saving prices. Features the largest and latest selection of:

- Ham Receivers
- Ham Transmitters
- Station Supplies
- Electron Tubes
- Semiconductors
- Test Instruments, Meters
- Knight-Kit® Equipment
- Everything in Stereo Hi-Fi
- Recorders & Accessories
- Everything in Electronic Parts, Tools & Tech Books

For *everything* in electronics, get the 444-page 1961 ALLIED Catalog now!

ALLIED RADIO
serving the Amateur for over 40 years

get every buying advantage:

FOR THAT BEST DEAL on the new equipment you want, write or call Jim Sommerville, W9WHF, c/o ALLIED or stop in at our Ham Shack and meet Joe Huffman, W9BHD; Joe Gizzi, W9HLA; Jack Schneider, W8CZE...

HAM-TO-HAM HELP—Our staff of 35 Hams will go all-out to give you the help you want, whether you write, call or visit us in person. You'll like the friendly attention and interest you get *all-ways* at ALLIED.

ONLY \$2 DOWN
on orders up to \$50; only \$5 down on orders up to \$200; only \$10 down over \$200. Up to 24 months to pay!

**one order to Allied
fills the whole bill**
Save time, effort and money; fill *all* your electronic supply needs from your 1961 Allied Catalog.



send for
**FREE
CATALOG**

ALLIED RADIO, Dept. 16-J
100 N. Western Ave., Chicago 80, Ill.

Send me the FREE 1961 ALLIED Catalog

Name _____

Address _____

City _____ Zone _____ State _____

For further information, check number 58 on page 126

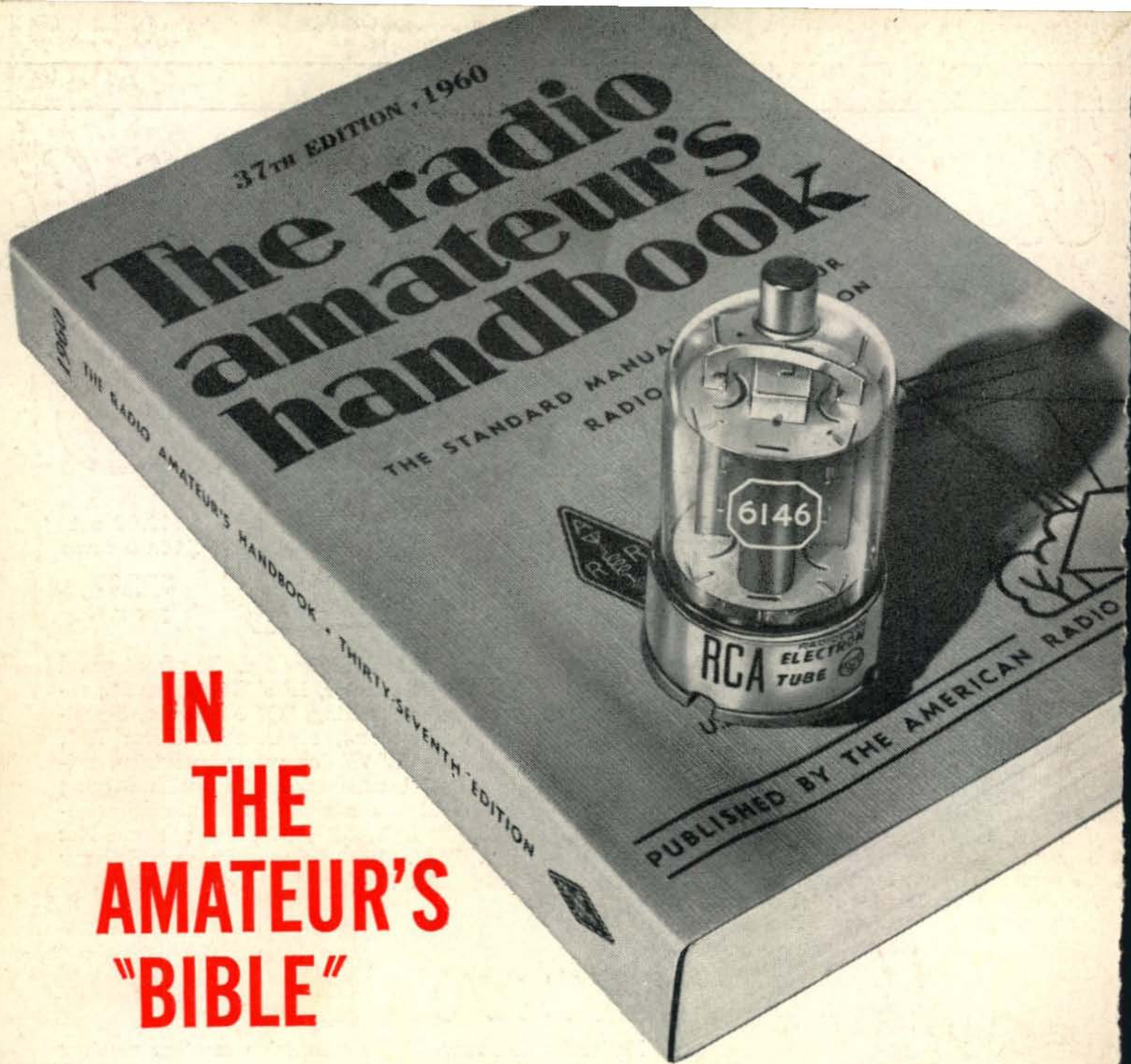

IN THE AMATEUR'S "BIBLE"

...beam power dominates

Over 70% of all the transmitting tube types featured in the HF, VHF, Mobile, and Modulator circuits of the Radio Amateur Handbook are high-perveance beam power types. As the originator of this famous power tube design, RCA is proud to see beam power tubes specified by the Amateur "Fraternity".

Why all this interest in high-perveance beam power tubes?

Take a look at a modern beam power rig. Note the lower-power driver...the minimum number of stages...control simplification...lower plate-voltage ratings...lower voltage-rated (and less expensive) circuit components. Then add it up, and you'll see why RCA Beam Power Tubes are the answer when you're looking for more "transmitter watts" for your dollar.

You can get RCA Beam Power Tubes at RCA Industrial Tube Distributors everywhere. For free technical information on specific RCA Beam Power Tubes listed here, write RCA Commercial Engineering, Section I-15-M Harrison, New Jersey.

Popular RCA Beam Power Tubes for the Amateur
(listed in order of plate input ratings) *

Type	Max. DC Plate Input (watts)	Max. DC Plate volts	Max. Freq. at Max. Ratings Mc.	Max. at Red. Ratio M
5763§ (6417)	17	350	50	17
2E26 (6893)	40	600	125	17
807 (1625) #	75	750	60	12
6524 (6850)	85+	600	100	47
6146 (6883)	90	750	60	17
829-B†	120+	750	200	25
7270 (7271)	315	1350	60	17
813	500	2250	30	12
7094	500	1500	60	17
7034/4X105A	500	2000	150	50

* Class C—CW † Twin-unit type, total per

() 12.6-volt or 13.5-volt heater-version

† Tapped heater for either 6.3 or 12.6-volt operation

§ 6.0-volt heater type # Has different base from type

RCA Electron Tube Division, Harrison, N. J.



The Most Trusted Name in Electronics
RADIO CORPORATION OF AMERICA

Celebrating 25 Years of Service

NC 400



\$895.00 net
\$89.50 down
\$45.00
per mo.

A modern, multi-purpose general coverage receiver. Tuning range — 540 kc to 31mc in 7 bands, dual conversion all bands above 7mc. Self-contained, manually tuned or crystal controlled. Synthesizer techniques possible for extreme frequency stability . . . Bandsread, 0-100 logging scale, 80 through 10 meter bands. 4, 8 and 16kc bandwidth positions provided with 6 tuned circuits. Separate heterodyne detector. Separate crystal controlled beat oscillator. HF oscillator has 5 crystal sockets for fixed channel operation, selectable from front panel.

NC 303



\$449.00 net
\$44.90 down
\$22.00
per mo.

Dozens of top features including front panel DSB, SSB selector, IF shift eliminating returning or detuning, "Q" Multiplier, 5-position IF selector, separate ANL for AM, exclusive WWV converter provision, hi-speed 40-1 ratio tuning dial with logging scale, antenna trimmer and optimum selectivity for SSB, DSB, CW, Phone, Phone Net and VHF. 15 tube receiver with 1.5 mv sensitivity. Black and grey enamel finish.



NC-270

National's fine new double conversion amateur receiver with 6 meter coverage with special ease in sideband tuning. For more details, examine National's inside back cover adjacent to this section.

NC-60

A handsome continuous coverage receiver for AM, Amateur and short wave bands. Full electrical bandsread on all frequencies, 540kc to 30mc in 4 bands. Easy-to-read dial with police, civil defense, marine, aircraft, amateur and foreign short wave clearly marked. 5 tubes. 50-300 ohms antenna input. Built-in speaker. Two-tone grey and black enamel.

\$59.95 net
\$6.00 down
\$6.00
per mo.

NC-109

General coverage receiver with exclusive "Microtome" crystal filter, separate product detector for CW and SSB. Covers 540 kc to 40mc in 4 bands. Includes Broadcast, AM, CW, DSB, or SSB. Calibrated bandsread for 10-80 Meters. 12" slide rule dial, indirectly lighted. 11 miniature tubes including rectifier and voltage regulator. Accessory socket for external adapters and accessories. Gang-tuned RF amplifier stage, two IF and two AF stages. Separate antenna trimmer and tone control on front panel. Temperature compensated for exceptional stability. ANL. Speaker, \$17.50 additional.

\$169.95 net \$12.00
\$17.00 down per mo.

HRO-60

Dual conversion on all frequencies above 7 mc. High frequency oscillator and first mixer have current regulated filament circuits. Features include edge-lighted direct frequency reading scale, three IF stages at 456kc, plus one IF stage at 2010kc on all frequencies above 7 mc. Built-in power supply. Sensitivity 1 mv or better for 6 db signal/noise ratio. Provision for crystal calibrator unit operation from front panel. S-meter amplifier. 17 tubes plus voltage regulator. Matching speaker, \$19.95.

\$745.00 net
\$74.50 down
\$34.00
per mo.

SAVINGS UP on Recondit

WRL's huge Recondit carries more than 1000 turnover of nearly 500 you buy from WRL's re assured that your gear repaired, aligned and te team at WRL. In sho as if it came directly fr great demand and subs be prepared each month

WRL Service to the Ham Fraternity!

AN ANNIVERSARY MESSAGE

"During 1961, our Silver Anniversary Year, WRL is proud to pledge the continuation of the policy which over the past 25 years has made World Radio Laboratories *"the house the hams built!"*

Whatever the Amateur requires in quality merchandise, personalized service and qualified assistance, you will find first at World Radio.

Our Reconditioning Department and its staff of trained technicians will continue to offer the finest of used gear at tremendous savings yet with guaranteed factory-new operation. Our new liberal time-payment plan, maximum trade-in allowances and personalized sales service will continue to become the copied standard of the ham industry.

On behalf of World Radio's 23 hams, as well as our entire staff I say "Thank You" for your part in making WRL *"the world's largest distributor of amateur radio equipment."*

Leo I. Meyerson



Leo I. Meyerson, WØGFQ
President,
WORLD RADIO LABORATORIES



CELEBRATING

25

YEARS OF SERVICE



Over 200 Pages of excellent bargains for the novice, the technician and the advanced amateur. Fully illustrated. Includes the complete service story on World Radio.

Send for your FREE copy now!

**UP TO 50% at WRL
on Reconditioned Equipment**

Reconditioned Equipment Department items continually in stock, with new pieces each month. Whenever reconditioned department, you are guaranteed. Each item has been thoroughly checked, tested by the five-man technician department, this equipment will operate like new from the factory line. With the frequent turnover, new lists must be prepared. Send for your free lists today.

**SILVER
ANNIVERSARY CATALOG**

WRL WORLD RADIO LABORATORIES
3415 WEST BROADWAY • PHONE 328-1851 C-9
COUNCIL BLUFFS, IOWA

LEO: PLEASE SEND: FREE CATALOG LATEST RECONDITIONED EQUIPMENT LISTS, AND COMPLETE INFO ON THE NATIONAL LINE.

NAME: _____

ADDRESS: _____

CITY & STATE: _____

For further information,
Check No. 2 on page 126.

NC 270

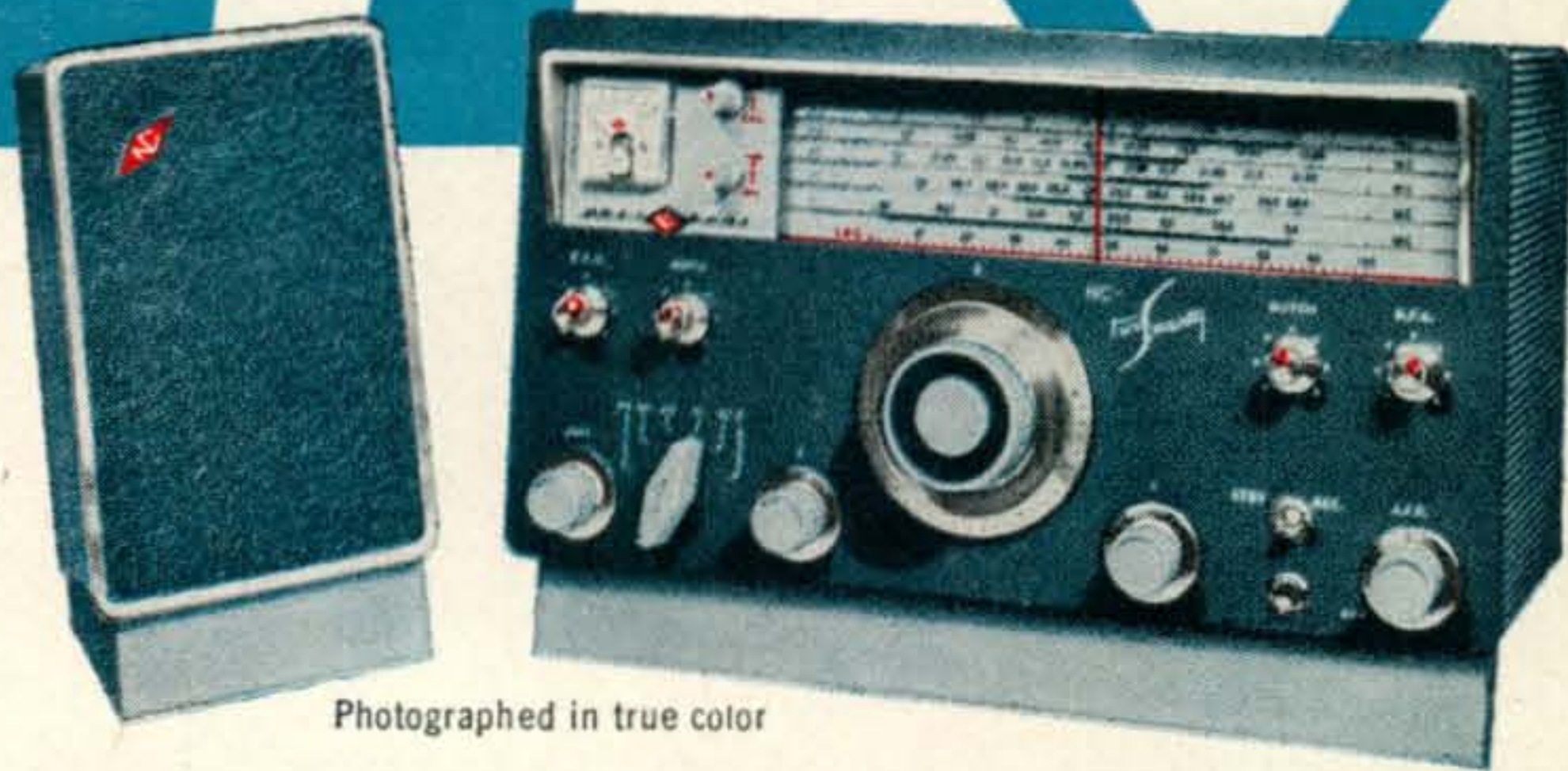

Photographed in true color

THE "COSMIC BLUE" NATIONAL'S NEW HAMBAND RECEIVER

This newest and finest precision double conversion amateur receiver with 6 meter coverage, brings you an ease of sideband tuning previously available only in the most expensive equipment. The NC-270 features an exclusive "Ferrite Filter" for instant upper-lower SSB selection, and a degree of selectivity to conquer even the toughest AM and CW signal conditions. The solid $\frac{1}{8}$ " steel panel, ceramic coil forms, double-spaced tuning gang, and full ventilation cabinet combine to give mechanical and thermal stability that will surprise even the most critical operator. Even the color of the NC-270 is outstandingly different, National's new duo-tone "Cosmic Blue." Write for detailed specifications.

Only \$24.99 down*

Suggested cash price: \$249.95. NTS-3 Matching Speaker: \$19.95 (slightly higher west of the Rockies and outside the U.S.A.). *Most National distributors offer budget terms and trade-in allowances.

NATIONAL RADIO COMPANY, INC.



A WHOLLY OWNED SUBSIDIARY OF NATIONAL CO., INC.

MELROSE 76, MASS.

Export: AD AURIEMA, INC., 85 Broad St., New York, N. Y.

Canada: CANADIAN MARCONI CO., 830 Bayview Ave., Toronto 17, Ont.

"FERRITE FILTER" PATENT PENDING

SPECIFICATIONS SUBJECT TO CHANGE WITHOUT NOTICE

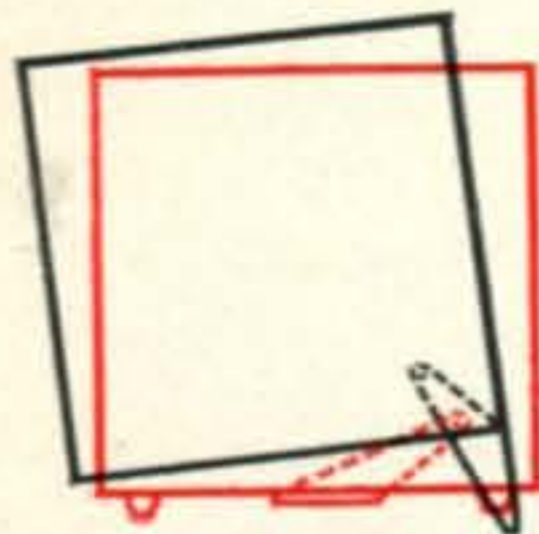

And National Radio's patented "Flip Foot" makes operating the NC-270 so easy.