

February 1961

# CQ

**CQ**  
**160 Meter**  
**C.W. Test**  
**Feb. 24-26**

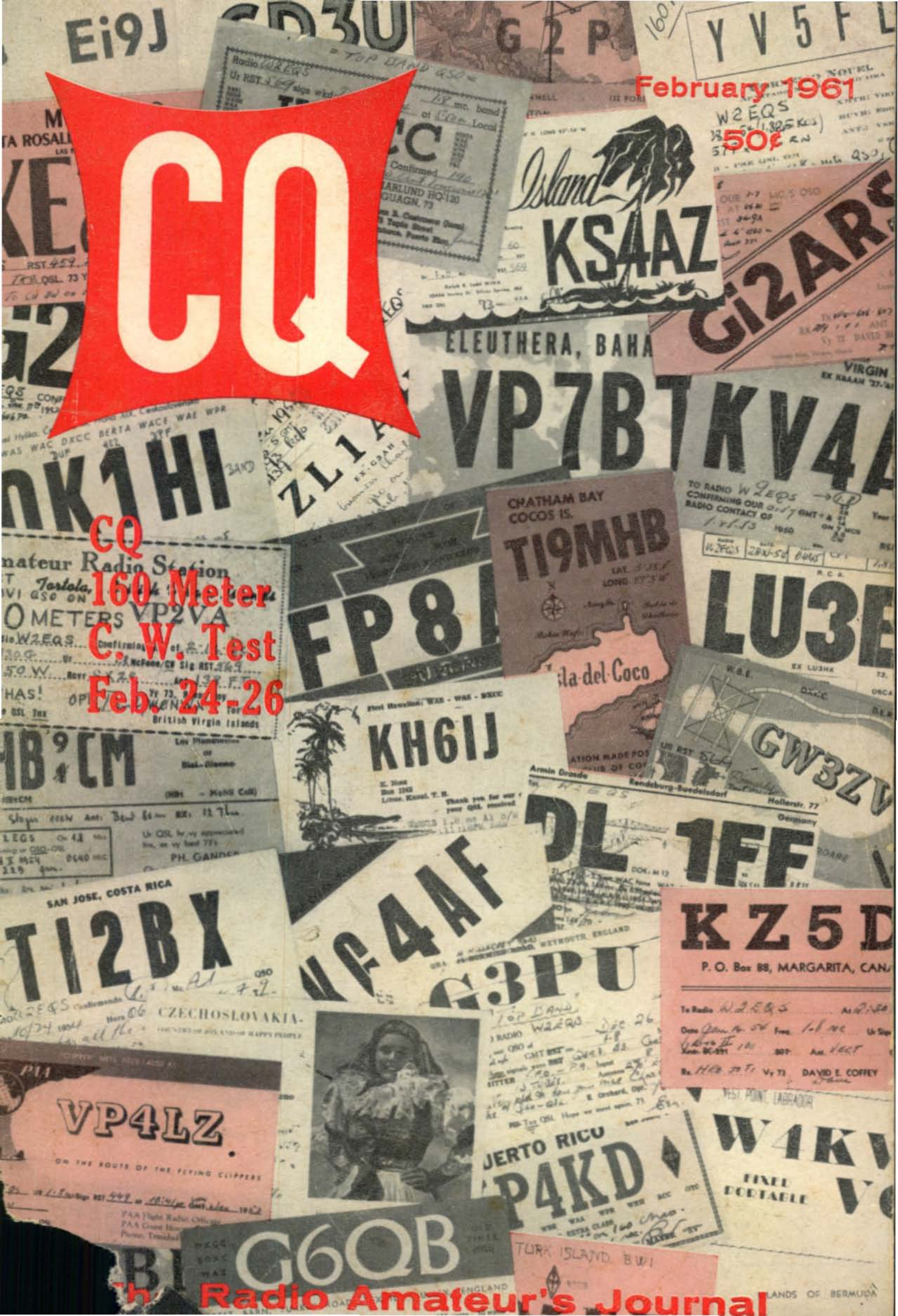

Amateur Radio Station  
Tortola, British Virgin Islands  
160 METERS  
W2EQS  
RST 459  
PH. GANDER

CHATHAM BAY  
COCOS IS.  
T19MHB  
LAT. 3°52' S  
LONG. 173° W  
Island del-Coco

San Jose, Costa Rica  
T12BX  
CZECHOSLOVAKIA  
THE LAND OF JOY AND OF HAPPY PEOPLE



JERTO RICU  
PAKD  
TURK ISLAND, BVI

KZ5D  
P. O. Box 88, MARGARITA, CANA  
To Radio W2EQS  
Date Jan 14 58  
Name DAVID E. COFFEY

G6QB  
ENGLAND

W4KV  
FINEE  
PORTABLE  
LANDS OF BERMUDA



# NOW ONLY COLLINS GIVES YOU A SIX-MONTH WARRANTY ON AMATEUR EQUIPMENT



The unexcelled performance of the S/Line and KWM-2 allows Collins to offer you, effective February 1, 1961, the most generous warranty in amateur radio. Visit your Collins Distributor and find out how easy it is to own the finest in amateur radio--Collins.



CREATIVE LEADER IN COMMUNICATION  
COLLINS RADIO COMPANY • CEDAR RAPIDS • DALLAS • BURBANK



# HIGH ADVENTURE FOR PR CRYSTALS

When Agena, the world's first polar orbit satellite, was launched from Vandenberg Air Force Base, California, in the Air Force Discoverer program, it was a great triumph for the Air Force Ballistic Missile Division and Lockheed Missiles and Space Division. Even greater triumph was the **FIRST CAPSULE** from space, recovered near Hawaii, after being ejected from the orbiting Agena satellite on its 17th trip around the earth.

The 300-pound capsule, separated from the satellite and de-orbited by retro-rockets, was tracked in its progress back to earth, by radio signals (telemetry) received on recovery planes and ships.



Petersen Radio Co., is proud that PR Crystals are making an important contribution to the Lockheed/Air Force Satellite Program. In this field where split-second timing, precision and dependability are vital to success, PRs are being used in circuits in the various tracking stations. These stations perform many functions during the orbital life of the satellite, including the recovery sequence of the re-entry body.

Here the Agena Satellite, 19 feet long, takes off on its long journey into orbit. — Photograph courtesy of Lockheed Missiles and Space Division.

**PR** Crystals

Since 1934

USE **PR** AND KNOW WHERE YOU ARE

PETERSEN RADIO COMPANY, INC.  
2800 W. BROADWAY • COUNCIL BLUFFS, IOWA

EXPORT SALES: Royal National Corporation, 250 W. 57th Street, New York 19, N. Y., U. S. A.

For further information, check number 3 on page 126.

← For Further information, check number 1 on page 126.

February, 1961 • CQ • 1



ASK THE MAN WHO OWNS ONE...



AND LISTEN TO THE DIFFERENCE!

# HAMMARLUND HX-500 SSB TRANSMITTER

- ★ SSB, DSB, CW, FM, FSK for RTTY plus 40 cps identification keyed shift.
- ★ Carrier suppression 50 db or better.
- ★ Unwanted sideband suppression 50 db or better.
- ★ 3rd and 5th order distortion down 30 db or better.
- ★ Spurious frequencies down 50 db or better.
- ★ 80, 40, 20, 15 and 10 meter bands.
- ★ Tuning accuracy better than 200 cps.
- ★ AND POWER THAT COUNTS—OUTPUT POWER OF 100 Watts P.E.P.; 100 watts CW; 25 watts AM; 100 watts FM; 100 watts FSK.

See it at your dealer, or—write for complete technical details...

It doesn't take long to *hear* the superiority of the HX-500 SSB Transmitter as any owner will tell you. He'll tell you about the true TALK-POWER first—resulting from the restricted speech range... then he'll get into the details about operational features such as separate dial scales for each band, the fact that all crystals are included at no extra cost, and all about the built-in antenna changeover relay. Most of all, he'll brag about the solid contacts he's made with his HX-500. In fact, if you don't change the subject, you'll never get away from him.

amateur net **\$695<sup>00</sup>**



Established 1910

# HAMMARLUND

MANUFACTURING COMPANY, INC.,  
an affiliate of Telechrome  
460 West 34th Street, New York 1, N.Y.

For further information, check number 4 on page 126.





# The Radio Amateur's Journal

## EDITORIAL STAFF

EDITOR

A. S. TROSSMAN, W2DTJ

ASSISTANT EDITOR

RICHARD A. ROSS, K2MGA

TECHNICAL EDITORS

LELAND W. AURICK, W2QEX

IRVING TEPPER

## CONTRIBUTING EDITORS

CONTEST CALENDAR

FRANK ANZALONE, W1WY

V.H.F.

ROBERT BROWN, K2ZSQ

PROPAGATION

SPACE COMMUNICATIONS

GEORGE JACOBS, W3ASK

RTTY

BRYON KRETZMAN, K0WMR

DX

URB LE JEUNE, W2DEC

YL

LOUISA B. SANDO, W5RZJ

HAM CLINIC

C. J. SCHAUERS, W6QLV

NOVICE

SEMICONDUCTORS

DONALD L. STONER, W6TNS

SIDEBAND

DOT STRAUER, K2MGE

IRVING STRAUER, K2HEA

## BUSINESS STAFF

PUBLISHER

S. R. COWAN

ADVERTISING REPRESENTATIVES

JACK SCHNEIDER, WA2FPE

DICK COWAN, WA2LRO

CIRCULATION MANAGER

HAROLD WEISNER, WA2OBR

PRODUCTION MANAGER

CHARLES W. GARDNER, JR.

## OFFICES

300 West 43rd Street

New York 36, N. Y.

Telephone, JUDSON 2-4460

WEST COAST REPRESENTATIVES

WILLIAM A. AYRES

The William A. Ayres Co.

233 Sansome Street

San Francisco 4, California

YUKON 6-2481

FRED FRISENFELDT

The William A. Ayres Co.

1709 West 8th Street

Los Angeles 17, California

HUBBARD 3-2777

CQ—(Title registered U.S. Post Office) is published monthly by Cowan Publishing Company. Second class postage paid at Garden City, New York and New York, N. Y. Subscription Rates: U.S.A. and Possessions, APO, FPO, Canada and Mexico; one year \$5.00; two years \$9.00; three years \$13.00. Pan-American and foreign, one year \$6.00; two years \$11.00; three years \$16.00. Printed in the U.S.A. Entire contents copyright 1961 by Cowan Publishing Corp. CQ does not assume responsibility for unsolicited manuscripts. Postmaster; send Form 3579 to CQ, 300 W. 43rd St., N. Y. 36, N. Y.

VOL. 17, No. 2

FEBRUARY 1961

## TABLE OF CONTENTS

The Guywire Pyramid.....	G. H. Pieteron, ex-PAØGE	26
The Gentleman's V.F.O.....	Ed Marriner, W6BLZ	30
Sawtooth Sweep For Modulation-Monitor Scope .....	Vernon Trexler, W5IUR	34
Utilizing Small Pin Crystals.....	Antonio Gelineau, W4LEQ	35
The Diode Switch .....	Donald L. Stoner, W6TNS Lester A. Earnshaw, ZL1AAX	36
Voltage Variable Silicon Capacitors .....	Stephen E. Silverman, W1ZPT	40
Inexpensive Screen-Grid Modulation .....	Frank Seier, K2MYC	43
Understanding Very-High-Frequency Antennas, Part II .....	Stanley Leinwoll	44
An Electronic Control System.....	William T. Long, W9UZQ	49
The In-Between Power Supply.....	Herbert Greenberg, W2EEJ	52
Know Those British Calls.....	Pat Hawker, G3VA	53
CQ Reviews: The Hallicrafters SX-111.....		54
CQ Reviews: The Knight T-400.....		56

## DEPARTMENTS

Announcements .....	12	QSL Contest .....	20
Contest Calendar .....	64	RTTY .....	96
DX .....	59	Semiconductors .....	70
Ham Clinic .....	66	Sideband .....	80
Ham Shop .....	122	Space Communications .....	85
Letters To The Editor .....	12	Surplus .....	101
New Amateur Products .....	58	VHF .....	88
Novice .....	75	YL .....	99
Propagation .....	72	Zero Bias .....	7



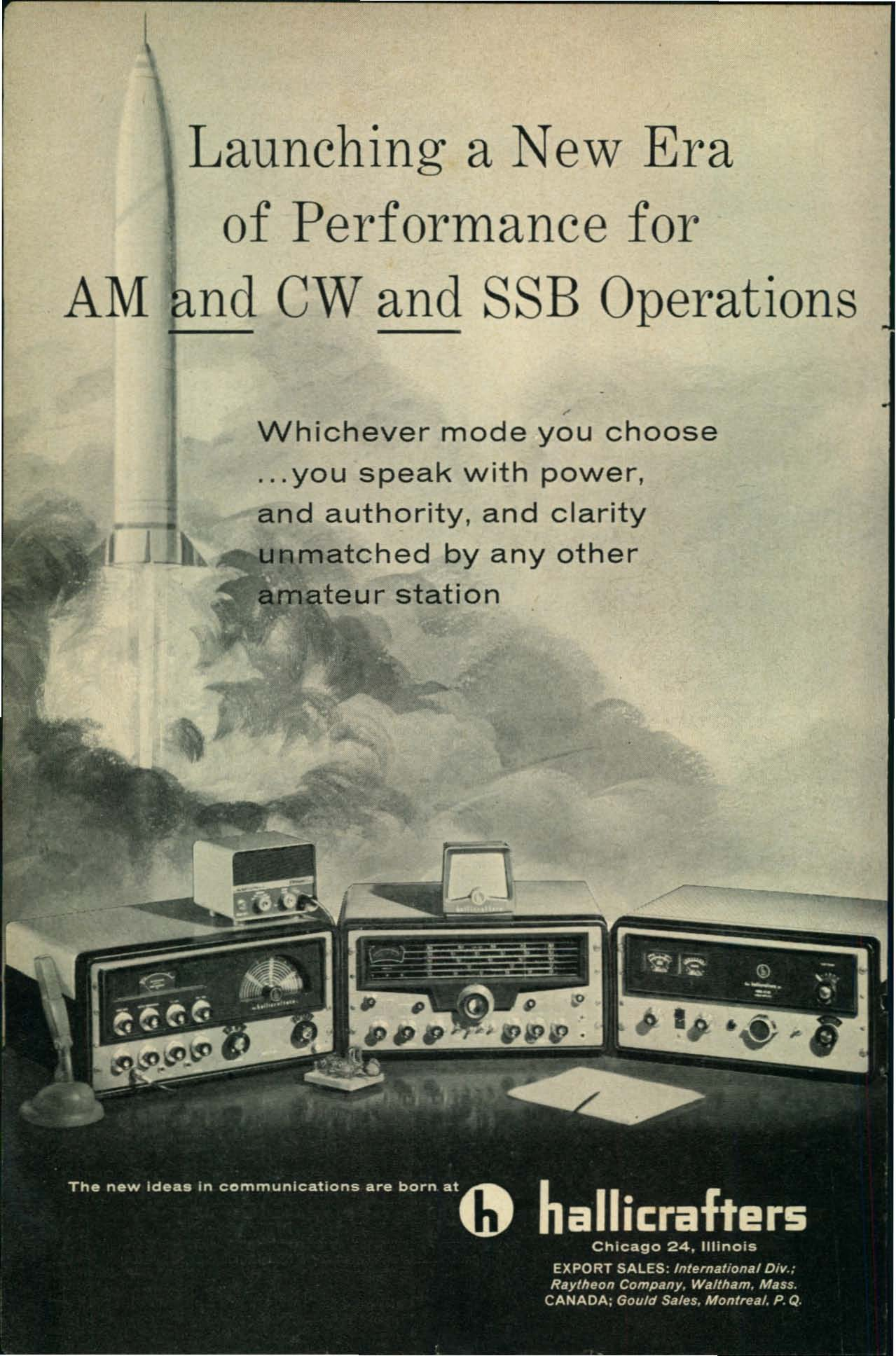

Launching a New Era  
of Performance for  
AM and CW and SSB Operations

Whichever mode you choose  
...you speak with power,  
and authority, and clarity  
unmatched by any other  
amateur station

The new ideas in communications are born at



**hallicrafters**

Chicago 24, Illinois

EXPORT SALES: *International Div.;*  
*Raytheon Company, Waltham, Mass.*  
CANADA; *Gould Sales, Montreal, P. Q.*



## World's cleanest signal, and three big new features!



**HT-32B Transmitter:** Now — Hallcrafters' famous "32" offers a major innovation in SSB generation, the *beam-switching modulator*, with greater carrier suppression stability than ever before. All other time-proven features of previous models *plus* C.T.O. direct reading in kc. and complete 10-meter coverage make the HT-32B the outstanding choice of experienced amateurs.

**FEATURES:** Beam-deflection, high level sideband modulator for low-noise, high-stability signal, Hallcrafters' exclusive 5.0 mc. quartz crystal filter with sideband rejection of *50 db. or more*; C.T.O. direct reading in kilocycles to *within 1 kc.*; 10-meter coverage in four band-switched segments (calibration accuracy same as lower bands); 144 watts plate input (P.E.P. two-tone). Five band output (80, 40, 20, 15, 10 meters). All modes of transmission—CW, AM, S.S.B. Unwanted sideband down 50 db. or more. Both sidebands transmitted on A.M. Precision gear driven C.T.O. Exclusive Hallicrafters patented sideband selection. Logarithmic meter for accurately tuning and carrier level adjustment. Ideal CW keying and break-in operation, Push To Talk and full voice control system built in. Keying circuit brought out for teletype keyer.

**FRONT PANEL CONTROLS, FUNCTIONS AND CONNECTIONS:** Operation — power off, standby, Mox., Cal., Vox.—P.T.T. Audio level 0-10 R.F. level 0-10. Final tuning 80, 40, 20, 15, 10 meters. Function—Upper sideband, lower sideband, DSB, CW. Meter compression. Calibration level 0-10. Driver tuning 0-5. Band selector—80, 40, 20, 15, 10 meters. High stability, gear driven V.F.O. Micro-phone Key, and Headphone monitor jacks.

**TUBES AND FUNCTIONS:** 2-6146 Power output amplifier. 6CB6 Variable frequency oscillator. 12BY7 R.F. driver. 6AH6 2nd Mixer. 6AH6 3rd Mixer. 6AB4 Crystal oscillator. 12AX7 Voice control. Audio Amp. 12AU7 Audio Amp. and Carrier oscillator. 7360 Modulator. 12AT7 Sideband selecting oscillator. 6AH6 1st Mixer. 6AH6 4.95 Mc. Amp. 6AU6 9 Mc. 5R4GY HV Rectifier. 5V4G LV Rectifier. OA2 Voltage Regulator.

**REAR CHASSIS:** Co-ax antenna connector. FSK jack A.C. accessory outlet. Line fuse. Control connector ground stud AC power line cord. Cabinet 20" wide, 10½" high, and 17" deep. Approximate shipping weight 86 lbs. (Conforms to F.C.D.A. specifications.)

## Big signal—effortless performance!



**HT-33B Linear Amplifier:** Beautifully engineered with extra-heavy-duty components, the HT-33B is *conservatively rated* at the maximum legal limit. You are guaranteed one of the big signals on the band, plus the effortless performance that means so much to efficiency and long life. (Conforms to F.C.D.A. specifications.)

**FREQUENCY COVERAGE:** Complete coverage of amateur bands; 80, 40, 20, 15, 10 meters.

**FEATURES:** Rated *conservatively* at the maximum legal input. Third and fifth order distortion products down in excess of 30 db. Built-in r.f. output meter greatly simplifies tune-up. All important circuits metered. Maximum harmonic suppression obtained through pi-network. Variable output loading. Protection of power supply assured by circuit breaker. HT-33B is a perfect match to Hallicrafters' famous HT-32 in size, appearance and drive requirements.

**CIRCUIT DETAILS:** This power amplifier utilizes a PL-172A high efficiency pentode operating in class AB1. The tube is grid-driven across a non-inductive resistor, thus assuring the maximum stability under

all possible conditions. Band switching is accomplished by one knob which selects the proper inductance value for each band. The output circuit is a pi-network with an adjustable output capacitor, accommodating loads from 40 to 80 ohms. 2 panel meters are provided: one is circuit switched to measure Grid current, screen current, plate voltage and R.F. output voltage. A second meter continuously monitors cathode current of the PL-172A.

**TUBES:** (1) PL-172A high power pentode; (2) 3B28 rectifiers; (6) OA2 screen regulators.

**FRONT PANEL CONTROLS:** Meter selector; Filament switch; High Voltage switch; Bias adjustment; Band switch; Plate tuning; Plate loading.

**PHYSICAL DATA:** Gray and black steel cabinet (matches HT-32) with brushed chrome knob trim. Size: 8¾" x 19" (relay rack panel). Shipping wt. approx. 130 lbs.

**REAR CHASSIS:** Co-ax input; co-ax output; filament and bias fuse; cutoff bias relay terminals; screen fuse; ground terminal.

## Rugged as a boxer... sensitive as an artist!



**SX-101A Receiver:** Today's heavy-weight champion, with technical features way ahead of its time.

**FEATURES:** Complete coverage of 80, 40, 20, 15, 10 meter bands *plus* a 2 and 6 meter conv. band; Dual scale S-meter functions with AVC off. Special 10 Mc. position for WWV. Dual conversion. Exclusive Hallicrafters' upper-lower sideband selection. Tee-notch filter. Full gear drive from tuning knob to gang condensers. 40:1 tuning knob ratio. 100 kc. evacuated marker crystal. Five steps of selectivity from 500 cycles to 5000 cycles. Direct coupled series noise limiter for improved noise reduction. Sensitivity—one microvolt or less on all amateur bands. 52 ohm antenna input. Antenna trimmer. Relay rack panel. Double spaced gang condenser.

**FRONT PANEL CONTROLS:** Main tuning knob.

Pointer reset, antenna trimmer, tee-notch frequency, tee-notch depth, sensitivity, band selector, volume, selectivity, BFO, response — (upper-lower-sideband AM-CW). AVC on/off, AVC fast/slow, ANL Cal. Rec./standby.

**TUBES AND FUNCTIONS:** 6DC6, R.F. amplifier—6BY6, 1st converter—12BY7A, high frequency oscillator—6BA6, 1650 kc. i.f. amplifier—12AT7, dual crystal controlled 2nd conversion oscillator—6BA6, 2nd converter—6DC6 50.75 kc. i.f. amplifier—6BJ7, AM detector, A.N.L., A.V.C.—6BY6 SSB/CW detector—6SC7 1st audio amplifier & B.F.O.—6K6, audio power output—6BA6, S-meter amplifier—6AU6, 100 kc. crystal oscillator—OA2, voltage regulator—5Y3, rectifier.

**PHYSICAL DATA:** 20" wide, 10½" high and 16" deep—Panel size 8¾" x 19"—weight approximately 74 lbs. (Conforms to F.C.D.A. specifications.)

For further information, check number 5 on page 126.



*Central Electronics*

Famous for

**DYNAMIC  
PUNCH**



ANNOUNCES  
THE NEW  
**200V**  
BROAD-BAND  
Exciter-Transmitter



**NEW FEATURES IN THE 200V**

Amateur net. . . . \$795

- NEW! Silicon rectifier power supply. Better regulation. Less heat. Higher voltage. 200 watts PEP input on SSB.
- NEW! Frame grid (6EH7-6EJ7) mixers. Extremely high gain. Less heat. Unwanted mixer products down in excess of 50 DB.
- NEW! Temperature compensated crystal oscillator circuits for extreme, long term stability.
- NEW! Increased mike pre-amplifier gain. Compensates for weak voices or low output microphones.
- NEW! Smooth as silk two speed tuning knob with 5 KC per turn vernier tuning ratio.

**PLUS  
THESE  
ORIGINAL  
FEATURES**

- COMPLETELY BROAD-BANDED. You tune only the VFO. Inherently matches output impedances of 50-72 ohms.
- COMPLETE BAND COVERAGE. ALL of the 80-40-20-15-10 meter bands, plus generous overlap and position for extra band.
- INPUT 175 watts on CW, FSK and PM. 100 watts on AM.
- "TAILORED" audio filter-Audio limiter.
- ADJUSTABLE POWER OUTPUT control. 2" MONITORING SCOPE.
- CALIBRATION ACCURACY better than 1 KC.
- UNWANTED SIDEBAND SUPPRESSION 50 DB.
- CARRIER SUPPRESSION at least 50 DB.
- HARMONICS down in excess of 50 DB.
- Third order DISTORTION PRODUCTS down in excess of 40 DB.
- EASIER TO OPERATE THAN EVER! Choice of USB-LSB-AM-PM CW-FSK at the flip of a switch. Perfected VOX, PTT, CW breakin 4 ways to key.

THERE IS  
NOTHING  
FINER THAN  
THE  
**200V**

Available soon - write for literature.

*Central Electronics, Inc.*

1247 W. Belmont Ave.

Chicago 13, Illinois

A subsidiary of Zenith Radio Corp.



For further information, check number 6 on page 126.



# ZERO BIAS

**I**F you haven't taken a good look at this month's cover, we suggest you flip over right now and take a good squint at a delightful assortment of "Top Band" cards. Charlie O'Brien, W2EQS, was good enough to lend us his precious set of 160 meter wallpaper, so that we may prime the pump for a little more one-sixty activity coming up later this month.

Despite the short notice given to the 160 meter 'test last year, the turn-out was quite impressive and we hope that the fellows who weren't aware of the event last year will make their presence known in 1961.

The contest is strictly c.w. and you'll find the rules posted under CONTEST CALENDAR in the January issue as well as on page 64 of this issue.

For some reason, 160 meter activity has never quite blossomed here in the U.S. as much as it has in Europe. A few pioneers here, notably W1BB, W9PNE and others, have stirred 160 meter activity by arranging schedules and watching propagation activities very carefully. W1BB also issues his 160 meter *Newsletter* which keeps the Top Banders well informed on current activity.

Keep the last week-end of February open for a real slam-bang affair on 160.

Because operation on 160 meters is shared with the Loran radio navigation system, we reprint the regulations governing the use of 160 meters for the United States and its possessions from the Communications Act of 1934.

SEC. 12.111, (4) Amateur operation shall be limited to the following areas, to the indicated frequency bands within each such area, and to the indicated maximum plate power

input to the tube or tubes supplying energy to the antenna during day and night hours, respectively, on such frequencies:

Area	Authorized Bands, Kc.	D.C. Plate Input Power in Watts	
		Day	Night
Minnesota, Iowa, Wisconsin, Michigan, Pennsylvania, Maryland, Delaware, and states to the north of these including the District of Columbia	1800-1825	500	200
North Dakota, South Dakota, Nebraska, Colorado, New Mexico, and states to the west of these states (except State of Washington)	1975-2000	500	200
State of Washington	1975-2000	200	50
Oklahoma, Kansas, Missouri, Arkansas, Illinois, Indiana, Kentucky, Tennessee, Ohio, West Virginia, Virginia, North Carolina, South Carolina, Texas (West of 99°W or North of 32°N)	1800-1825	200	50
Hawaiian Islands	1975-2000	500	200
Texas (East of 99°W and South of 32°N), Louisiana, Mississippi, Alabama, Georgia, Florida, Puerto Rico, Virgin Islands, Alaska, Guam and other Territories and Possessions of the U.S. not listed above.	None	No Operation	No Operation

## Propagation

Stanley Leinwoll and George Jacobs, W3ASK, both well versed on Ionospheric Propagation Conditions have put their Sunspots together and come up with a three part article entitled "Sunspot Cycle 19; The Declining Years" which will begin in the April issue of *CQ*. Those of you who remember George's excellent predictions of Cycle 19, back in 1956 will find this series even more enlightening as world-wide communications conditions diminish in the next few years.



The

# BIG STICK

## -in Communication Antenna Systems

Cat. No. 200-509

**STATIONMASTER®**

**Collinear Gain Antenna**

is designed to meet the ever increasing need for high antenna gain in minimum space and at lowest cost.

### SPECIFICATIONS

- Frequency Range . . . . . 144-174 Mc and 220-225 Mc
- Omnidirectional Gain . . . . . 5.8 db
- Maximum power input . . . . . 500 watts
- Nominal input impedance . . . . . 50 ohms
- Bandwidth . . . . .  $\pm 0.3\%$
- VSWR . . . . . 1.5:1
- Rated wind velocity . . . . . 100 MPH
- Weight . . . . . 30 lbs.
- Element housing length . . . . . 19'

Communication Antenna Systems for American Business



*Communication Products Company, Inc.*  
MARLBORO NEW JERSEY



# Heathkit® Amateur Gear — tops in quality and economy

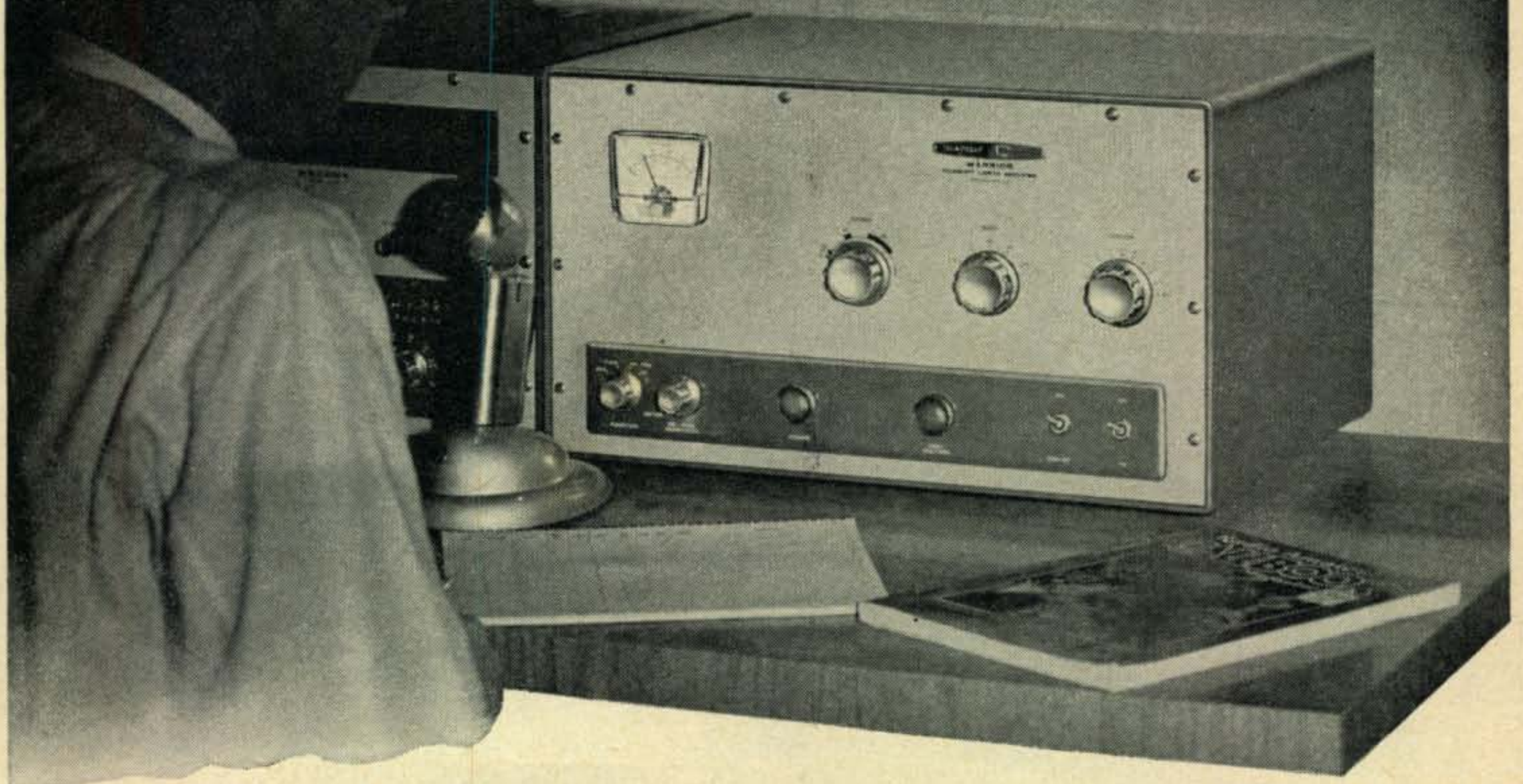

**HERE'S A NEW HEATHKIT GROUNDED GRID KW LINEAR AT A  
RECORD-SMASHING LOW PRICE . . . JUST \$229<sup>95</sup>**

The new Heathkit "Warrior" is a completely self-contained, desk-top kilowatt linear, loaded with special features, at half the cost of comparable units! Compare feature for feature, quality component for quality component, you'll find no shortcuts . . . only the finest watt-per-dollar value in a linear amplifier on the amateur market today!

**Maximum power input:** SSB—1000 watts P.E.P., CW—1000 watts, AM—400 watts (500 watts using carrier controlled modulation), RTTY—650 watts. **Driving power required:** 50 to 75 watts—depending on frequency. **Output circuit:** Variable pi-network (50 to 75 ohms). **Input circuit:** Broad banded—requires no tuning. **Input impedance:** Approx. 70 ohms. **Band coverage:** 80, 40, 20, 15, 10 meters. **Panel metering:** Switch-selected, grid current, plate current, high voltage and relative power output for ease of loading. **Tube complement:** 4-811A, 2-866A. **Size:** 19½" W x 11½" H x 16" D.



This inside view shows the neat circuit layout and husky components that emphasize quality. Note the internal shielding of plate circuit for maximum protection against TVI.

## CHECK THESE FEATURES . . .

- Completely self-contained . . .* HV, Fil. and Bias supplies built in.
- Versatile . . .* May be driven by any 50 to 125 watt transmitter or exciter—no matching or swamping network required.
- Efficient . . .* Stable grounded grid circuitry allows most driving power to appear in output for up to 70% efficiency.
- Oil-filled capacitor . . .* And 5-50 henry swinging-choke provide the excellent dynamic regulation required for high peak power output with low distortion.
- Inexpensive tubes . . .* 4 paralleled 811A's and 2-866A's, forced-air cooled by silent built-in fan.
- Design . . .* Special low-capacity filament transformer—requires less driving power—eliminates broad band filament RF choke.
- Exclusive . . .* Internal RF shielding of plate circuit for maximum TVI suppression.
- Interlocked switching . . .* prevents accidental application of HV before switching on filament and bias.
- Neutralized . . .* For the last word in stability in conjunction with grounded-grid operation.
- Rugged construction . . .* 16 gauge steel chassis—½" aluminum front panel—welded one-piece cabinet.
- Easily assembled . . .* Average time 8 hours.
- Model HA-10 . . . 100 lbs. . . \$23 dn., \$20 mo. . . . . \$229.95**

**HEATHKIT® by DAYSTROM**

**HEATH COMPANY** Benton Harbor, Michigan





Model DX-60 **\$82<sup>95</sup>**

- Built-in low pass filter
- Neutralized 6146 final amplifier
- Grid block keying
- Handsome low profile styling

*more features, better performance in this new Heathkit transmitter*

**PHONE AND CW TRANSMITTER KIT (DX-60)**

Smart modern styling . . . clean, rugged construction . . . and conservatively rated components all add up to ease of assembly, trouble-free operation and fine performance in the new DX-60 Transmitter. Offering far more than any other unit in its price and power class the DX-60 features a built-in *low pass filter* for harmonic suppression, *neutralized final* for high stability, *grid block keying* for excellent keying characteristics and easy access to crystal sockets on the rear chassis apron. A front panel switch selects any of four crystal positions or external VFO. Modulator and power supply are *built in*. *Single knob bandswitching* for 80 through 10 meters and the *pi-network output* provide complete operating convenience. A tune-operate switch provides protection during tuneup and a *separate drive control* allows adjustment of drive level without detuning driver. *Panel meter* shows final grid or plate current. A fine kit for the beginner as well as general class amateur, the DX-60 may be run at reduced power for novice operation. Operates CW or AM phone with crystal or VFO control. Power input is *90 watts peak*, carrier controlled phone or CW. Construction of the DX-60 is a breeze, with its clean circuit layout, pre-cut and cabled *wiring harness* and the complete, informative instructions furnished. The handsomely-styled finished unit measures only 13<sup>3</sup>/<sub>4</sub>" W x 11<sup>1</sup>/<sub>2</sub>" D x 6<sup>1</sup>/<sub>2</sub>" H. 29 lbs.

Model DX-60 . . . \$8.30 dn., \$8 mo. . . . . **\$82.95**

**you get twice as much for your budget**



Model HW-20 **\$199<sup>95</sup>**

- Tracked VFO & Exciter Stages for single knob tuning
- 10-watt RF output to antenna—6360 final
- Built-in low pass filter
- Built-in 3-way power supply for 117 VAC, 6 VDC, 12 VDC
- Push-to-talk ceramic element microphone

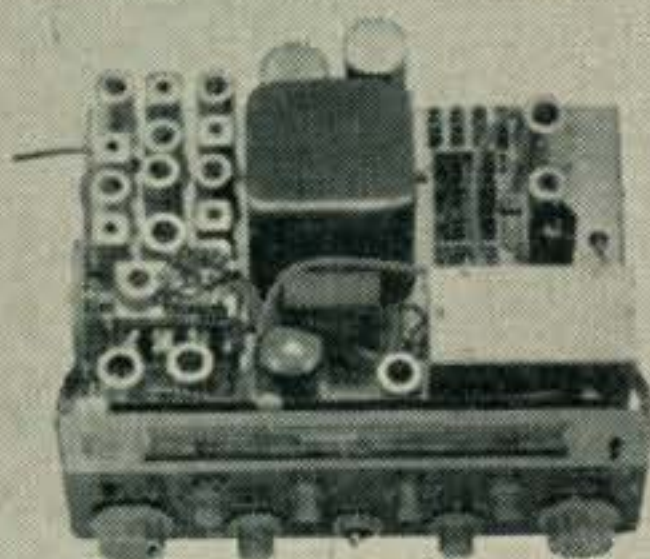

*new transceivers for 6 & 2 meter nomads*

**VHF TRANSCEIVER KITS (HW-10 & HW-20)**

"Mobile" or "Fixed", the new "Shawnee" 6-meter or "Pawnee" 2-meter transceivers bring you unprecedented performance, for each is a complete AM & CW Transmitter/Receiver combination with features unmatched at this price . . . just connect an antenna and you are in business! Transmitters feature a *built-in VFO* with all frequency determining components mounted on a "heat sink" plate for temperature stability and *four* switch-selected crystal positions for novice, CAP, MARS or net operation. VFO and all exciter stages are tracked for convenient *single knob tuning* over any 500 kc band segment (greater excursions require simple re-peaking of final). A VFO "spotting" switch is provided to "zero in" signals with transmitter off-the-air. The 6360 dual-tetrode final RF amplifier provides 10 watts of power *output* to the antenna and a built-in *low pass filter* is incorporated to suppress harmonics and other spurious radiation. The *dual-purpose modulator* provides a full 10 watts of audio for high level plate modulation of the final RF amplifier or 15 watts of audio for paging or public address use, selectable with push-pull switch. Superheterodyne receivers feature double conversion with first oscillator crystal-controlled. All oscillators are voltage regulated for stability. A large slide-rule dial and vernier tuning provide more than ample bandspread for both receiver and VFO. RF gain, BFO, ANL, Squelch, AVC on/off and transmitter controls are front panel mounted. *Tuning meter* is automatically switched to read signal strength or relative power output. Units come complete with built-in speaker, heavy duty AC & DC power cables, primary fused relay, adjustable mounting bracket and push-to-talk ceramic element microphone with coil cord & mounting clip. 6" H x 12" W x 10" D. 34 lbs. each.

Model HW-20 (2 meters) . . . \$20 dn., \$17 mo. . . . . **\$199.95**  
Expected Shipping Date Feb. 25.

Model HW-10 (6 meters) Coming Soon.



Model  
HW-29A  
\$44<sup>95</sup>



Attn. HW-29 owners: Convert your "Sixer" to the new improved "A" model with this easy-to-install conversion kit. Allows use of 8 mc crystal for maximum stability.

Model HWM-29-1 1 lb. \$4.95

*lowest cost transceivers on the air*

- Operate from low-frequency crystals for greater stability
- Push-to-talk Transmit/Receive switch
- Variable receiver tuning
- Built-In AC power supply—easy conversion to mobile operation, using accessory vibrator power supply

**2, 6 & 10 METER TRANSCEIVER KITS (HW-30, 29A, 19)**

These three outstanding transceiver models bring you top performance at the lowest prices offered in complete amateur facilities. Each model has a crystal controlled transmitter and tunable, superregenerative receiver with RF preamplifier. Receivers pull in signals as low as 1 uv and the 5 watt transmitters are ideal for emergency work or "local" net operation. Features include push-to-talk transmit/receive switch, metering jack, ceramic element microphone, and two power cables. Less crystal. 10 lbs. each.

Model HW-19 (10 meter)...\$4 dn., \$5 mo.....**\$39.95**  
 Model HW-29A (6 meter)...\$4.50 dn., \$5 mo.....**\$44.95**  
 Model HW-30 (2 meter)...\$4.50 dn., \$5 mo.....**\$44.95**

# with Heathkit® Amateur Gear

## FREE CATALOG

Lists over 200 kits. Send for your free copy today!



### MONEY BACK GUARANTEE

Heath Company unconditionally guarantees that each Heathkit product, whether assembled by our factory or assembled by the purchaser in accordance with our easy-to-understand instruction manual, must meet our published specifications for performance or your purchase price will be cheerfully refunded.

ORDER DIRECT BY MAIL OR SEE YOUR HEATHKIT DEALER



**HEATH COMPANY**  
Benton Harbor 12, Michigan

### ORDERING INSTRUCTIONS

Fill out the order blank below. Include charges for parcel post according to weights shown. Express orders shipped delivery charges collect. All prices F.O.B. Benton Harbor, Mich. A 20% deposit is required on all C.O.D. orders. Prices subject to change without notice.

Please send the following HEATHKITS:

ITEM	MODEL NO.	PRICE

Ship via ( ) Parcel Post ( ) Express ( ) COD ( ) Best Way

( ) SEND MY FREE COPY OF YOUR COMPLETE CATALOG

Name \_\_\_\_\_

Address \_\_\_\_\_

City \_\_\_\_\_ Zone \_\_\_\_\_ State \_\_\_\_\_

Dealer and export prices slightly higher.

For further information, check number 7 on page 126.



Designed for



Application

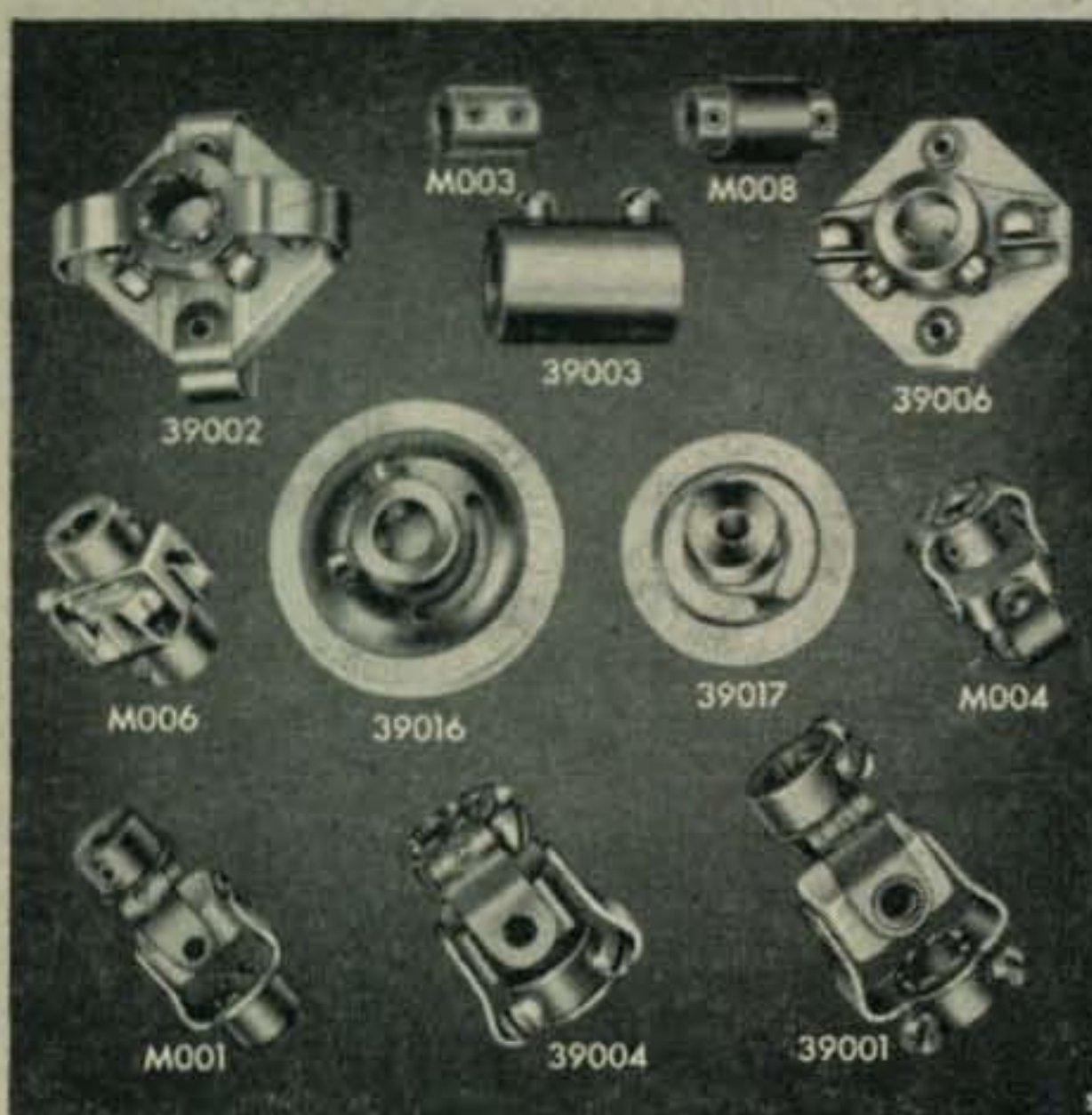

### COUPLINGS

Illustrated are a few of the stock miniature and standard Millen couplings. Flexible or solid—insulated or non-insulated—normal or high torque. Also available with inverted hubs to reduce length.

**JAMES MILLEN  
MFG. CO., INC.**

MAIN OFFICE AND FACTORY  
**MALDEN  
MASSACHUSETTS**



## Letters . . . . to the Editor



### Once And For All . . .

Editor, CQ:

I am writing in reference to the letter of Mr. Berner, VP4TAM, in your December issue, concerning the "Lone Voice on Tobago" article by Mr. Jack Lambert, VP4WD/G3TA. Mr. Lambert is to be commended on his courteous reply to the criticism from VP4TAM. However, for the further constructive enlightenment of Mr. Berner and others concerned, it is essential that the views of CQ readers and those who actually worked VP4WD be presented to settle the matter once and for all.

Being a CQ reader and an avid DX chaser of several years, I feel that I express the view of the majority of DX'ers when I say that we are not only very grateful to Jack for using the few free hours he had on Tobago to give hundreds of us a new country, but also for the excellent and interesting account of his trip he rendered in the September CQ. Had it not been for VP4WD, VP4 would have undoubtedly been more like my 270th country rather than my 170th . . . this feeling is echoed by hundreds of other recipients of VP4WD QSL cards.

Despite the alleged purpose of VP4TAM's letter, e.g. to inform your readers that some station was rumored to have operated from Tobago and hence the "Lone Voice" article was presumably an exaggerated farce, the real motive behind the letter should be apparent to most of us. It is simply a childish attempt of cover-up personal indignance because "TAM's" "territory" was "invaded."

Because Jack Lambert had the initiative to put Tobago on the radio-map for a large number of fellow amateurs, and then to report details of this venture in CQ—none of which Mr. Berner nor his colleagues have had the ambition to do . . . and because he confirmed all of these contacts 100%, a courtesy VP4's are notably lax about . . . then he must suffer the 'slings and arrows' of an immature and unjust criticism.

If VP4TAM & Co. wish to continue "Piling up contacts" by rag-chewing among themselves and evading W/K QSO's and QSL's, certainly this is their prerogative—but between the pages of a major amateur radio publication is no place for 'TAM', or anyone else to give vent to jealous personal arrogance, especially against someone who has made a grand contribution toward making our hobby a little more enjoyable.

Whit Cotten, W4CXQ  
1670 Powhatan Avenue, Petersburg, Virginia

### Novice Pamphlet

Editor, CQ:

Hoorah for K9MYZ who wrote the fb article on Novices in the November issue. I'm sure that he expressed the opinion of many Novices. It is too bad that we must be stereotyped as poor operators just because we have a "N" in our call. Some Novices are just as good operators as some generals and some are better. Of course, nobody is perfect. What I can't figure out, who is to be the judge of good procedure.

I recently received a pamphlet about bad Novice habits. In this it mentioned that we shouldn't use punctuation except for DAH-DIT-DIT-DIT-DAH. If we aren't supposed to use periods, commas, and question marks what are there characters for? The pamphlet said that the older operators wouldn't recognize the punctuation. Maybe they are just too lazy to learn or relearn these characters. Is it possible that the Novices are right for once?

Phil Bauer, KN8VKK  
139 Washington Avenue, Clyde, Ohio

← For further information, check number 8, on page 126



get

**SHURE**

quality &  
dependability  
in a completely  
equipped  
SSB MICROPHONE  
for less than  
\$30

- Complete With Grip-To-Talk Switch, Desk Stand, 2-Conductor Shielded Cable.
- Eliminates Need For Audio Filters—Sharp Cutoff Below 300, Above 3000 cps.
- Superb Intelligibility, Extraordinarily Rugged, Choice of 2 Models.
- Trouble-Free Controlled-Magnetic Design, Output -52.5 db (100,000 ohm impedance).

MODEL 440SL—ONLY \$28.50\* Complete with stand, grip-to-talk switch, 7 ft. highest quality 2 conductor shielded cable. Cable connector equivalent to Amphenol MC3M plug.

MODEL 440—ONLY \$15.00\* Low cost, same performance characteristics as 440SL. 7 ft. single conductor (shielded), less stand, switch, connector.

*\*Amateur Net Prices*



SHURE BROTHERS, INC.  
222 Hartrey Avenue  
Evanston, Illinois

MICROPHONES, HIGH FIDELITY  
AND ELECTRONIC COMPONENTS

For further information, check number 9 on page 126.



**Get This  
Handy  
POCKET  
ELECTRONICS  
DATA GUIDE**

**free**

Puts all the commonly used conversion factors, formulas, tables, and color codes at your fingertips. Yours absolutely free if you mail the coupon below. No further obligation!

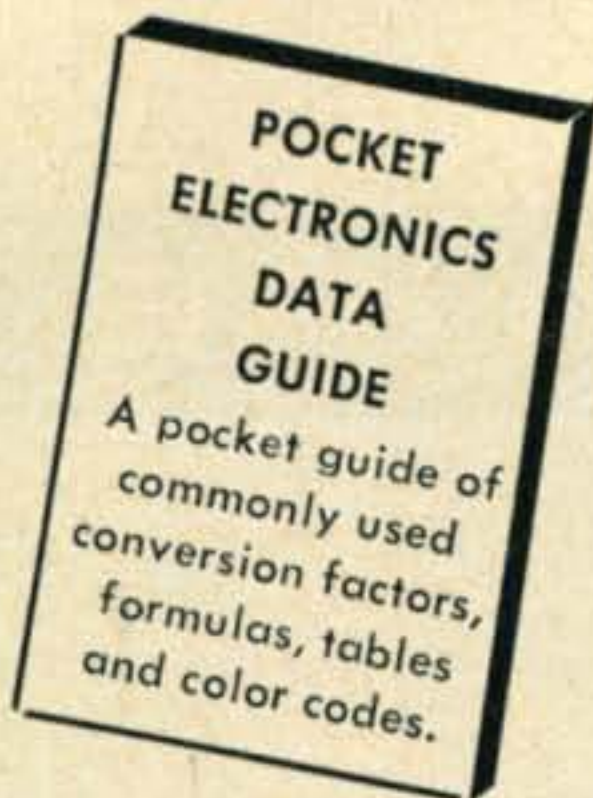

**Cleveland Institute Training  
means BETTER JOBS . . .**

**OUR TRAINEES GET JOBS LIKE THIS:**

"Since enrolling with Cleveland Institute I have received my 1st class license, and am now Chief Engineer of Station WAIN. Thanks to the Institute for making this possible." L. M. Owens, Columbia, Ky.

**EMPLOYERS MAKE OFFERS LIKE THESE:**

RCA has positions for technician, field engineers & instructor technicians to install, maintain, & teach military radar, communications, and fire control equipment. Company benefits.

**A Commercial FCC License . . .  
YOUR GUARANTEE OF SUCCESS!**

The Master Course in Electronics will provide you with the mental tools of the electronics technician and prepare you for a 1st Class FCC License (Commercial) with a radar endorsement.

**MONEY-BACK  
GUARANTEE!**



Mail Coupon  
Today and Get  
All 3 Books  
**FREE**



Cleveland Institute of Electronics  
Carl E. Smith, Consulting Engineer, President  
Accredited by the National Home Study Council  
Desk CQ-73, 4900 Euclid Avenue, Cleveland 3, Ohio

Please send Free Booklets prepared to help me get ahead in Electronics and a free copy of your "Pocket Electronics Data Guide." I have had training or experience in Electronics as indicated below:

- |   |   |
|---|---|
| <input type="checkbox"/> Military           | <input type="checkbox"/> Broadcasting       |
| <input type="checkbox"/> Radio-TV Servicing | <input type="checkbox"/> Home experimenting |
| <input type="checkbox"/> Manufacturing      | <input type="checkbox"/> Telephone Company  |
| <input type="checkbox"/> Amateur Radio      | <input type="checkbox"/> Others             |

In what kind of work are you now interested?.....

In what branch of Electronics are you interested?.....

Name..... Age.....

Address.....

City..... Zone..... State.....

CQ 73

**I Say Again!**

Editor, CQ:

It was with great interest that I read the account of the Echo Satellite facsimile mail experiment (in SPACE COMMUNICATIONS for January 1961). While the transmission from the Post Office Department in Washington to the Post Office in Newark was successful, it seems that the transmission was so attenuated by the time it reached CQ that a portion of the message was obliterated.

The part of the message that did not get through is . . . "The first facsimile mail experiment using satellites was managed for the Post Office Department by Adler Electronics, Inc. of New Rochelle, New York."

I hope that we can increase our transmitter power so that future Adler messages are clearly recognizable to all reception points.

Emanuel Strunin  
Director, Advertising &  
Public Relations  
Adler Electronics, Inc.  
New Rochelle, New York

**Normal People**

Editor, CQ:

Have just noted the letter of W9FB (Letters, Oct. 1960) in which he suggests contests be held only on 160 meters, leaving the "regular bands" to normal people and normal activities.

Since when is 160 meters not one of the "regular bands"? I got my start in hamming, reading the mail on 160 which the Central Illinois Radio Club used for a "local" rag-chew net. My biggest incentive to get a general class license is to get on 160 in addition to 6 and 2. What does that make me, some kind of a nut?

Equipment for 160 is inexpensive and the band offers some interesting operation. Why fight the unholy QRM of 75 phone when you can talk to the same guy on 160 leaving the heterodyne-jobber, wholly to the "normal people?"

Just to soothe W9FB's feathers you can put me on record with him on contests other than those such as Field Day, which can demonstrate the amateurs ability to serve his community in an emergency (and demonstrates to a lot of hams that field operation is tougher than he thinks).

Jack L. Boyce, WA2MDX, ex-K9IUK

**Conditional License**

Editor, CQ:

After reading a letter in CQ for October 1960, re: "Box Top" licenses, I was really indignant! I cannot imagine any member of the Ham fraternity taking such a view. What gives these fellows the right to be smug, narrow and biased toward anyone holding a conditional license?

I was forced to take the Conditional exam as I work six days each week, and also live 90 miles from the nearest FCC Regional Office. I studied and burned the midnight oil many weeks before I felt I was ready. Having held a General ticket back in 1923, in the old spark days, this did not come easy! I took the test one evening before a very competent and conscientious amateur. I expected no favors, and I certainly received none.

No one could be prouder, when I was notified by the FCC that I had passed. I fail to see any stigma attached to holding a Conditional License. The FCC certainly does not feel this way. I feel that I am every bit as good a ham as anyone else on the air, and I resent all the implications voiced by a few condemning some of us who hold the Conditional License. Surely there must be more important problems in ham radio to occupy our thoughts than quibbling about what type of license a fellow ham holds!

Dick Burghoffer, K7WD  
2006 Iron Street  
Bellingham, Washington



# Gonset does it again!

## Communicator IV for 220 mcs!

# 220 mc.



Now... another  
important "first" .. this time the  
first complete commercially-produced  
"package" operating on the amateur 220 megacycle band!

Here is no micro-power peanut whistle! An input power of 20 watts—**substantial** for VHF—capable of a man-sized signal. "Big ears" also—real ability to copy the weak ones—a sensitive, triple conversion receiver with a very good noise figure. This is 2-way equipment of the highest quality built for effective **communications** on an amateur band with great potential ... "one-and-a-quarter-meters" ... 220-225 megacycles.

This new model features a triple-conversion receiver which is continuously tunable over the frequency range of 219.7 to 225.3 mcs. In order to comply with OCDM requirements, additional provision is made for spot frequency reception on one crystal controlled frequency. Receiver sensitivity is 1 microvolt for 10 db signal-plus-noise to noise ratio. Noise figure of 3-5 db is exceptional for equipment of this general type.

Transmitter is crystal controlled, offers choice of six frequencies. (Required crystals are within the range of 8.148 to 8.333 mcs.) Power input to PA is 20 watts (power output approximately 10 watts), amplitude modulated by P-P 6BQ5's operating in Class AB-1. High-level speech clipping and audio shaping are incorporated.

All the many convenient features for fixed and mobile operation incorporated in the 2-meter Communicator IV are retained. The same, easily-carried, highly compact housing, the built-in 2-way power supply for 117V AC and 12V DC—the latter with transistorized power supply. A flexible, snap-back handle on one face of the housing facilitates carrying. Available universal bracket kit allows simple under-dash vehicular mounting.

Communicator IV-220.... #3351 ..... 394<sup>50</sup>  
(Less microphone, crystals.)

### CIVIL DEFENSE KIT

Communicator IV-220 will meet OCDM requirements and will qualify for matching funds when supplied with #3361 CD kit. Latter consists of yellow-color canvas carrying case, telescoping antenna, C-D decal and crystal certificate.

For further information, check number 10 on page 126.

**GONSET**

**GONSET**

Division of Young Spring & Wire Corporation  
801 SOUTH MAIN ST., BURBANK, CALIFORNIA

EXPORT SALES: WESTREX CORP., 111 EIGHTH AVE., NEW YORK 11, N.Y.



The  
**SWITCH**  
 you need  
 is carried  
 by your

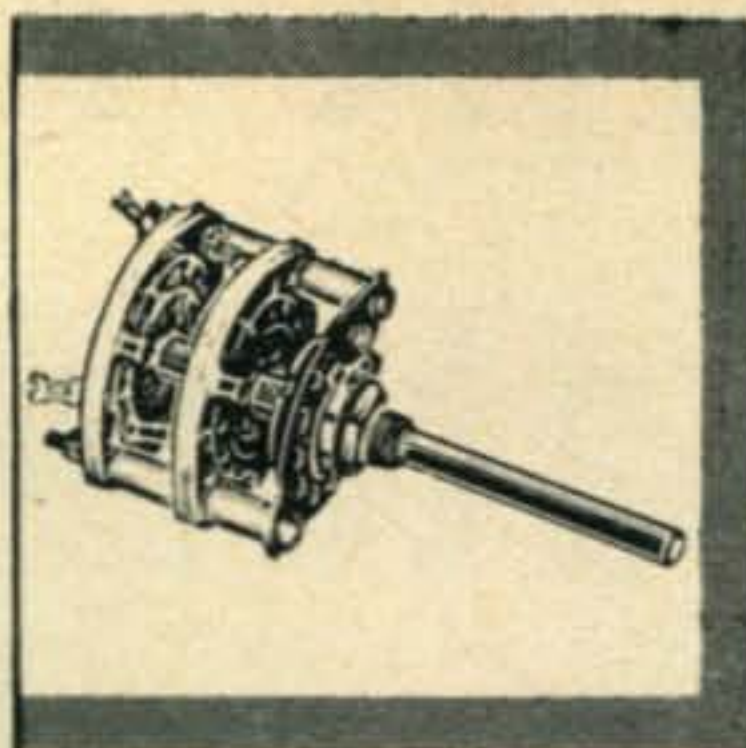

**Centralab**  
CR  
**DISTRIBUTOR**

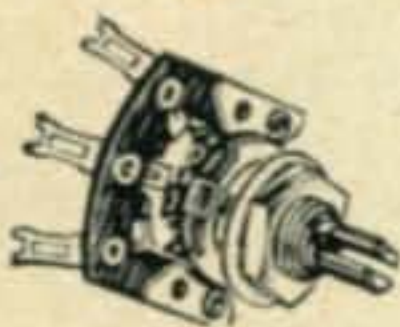
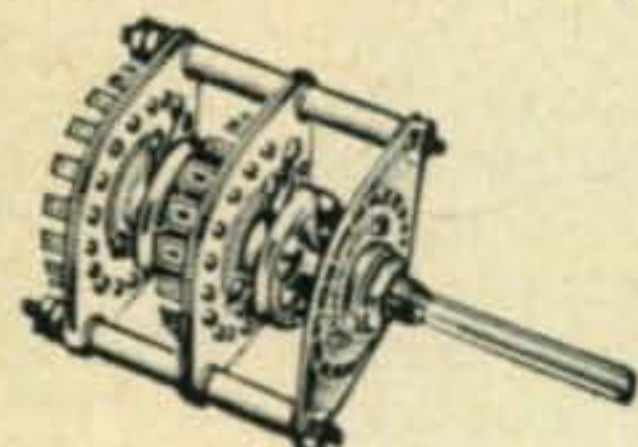
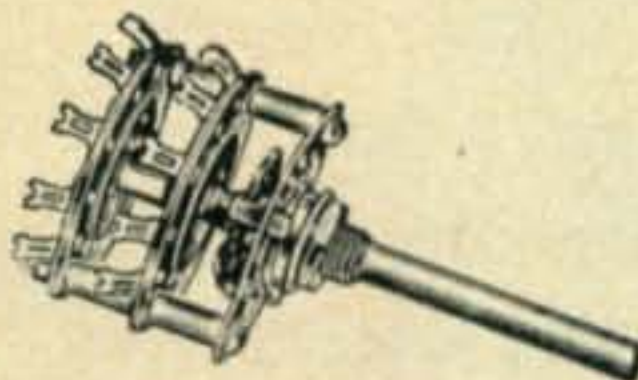
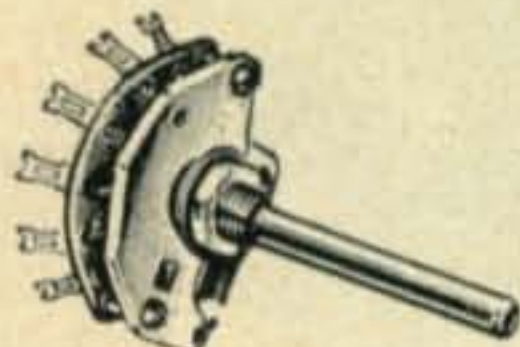
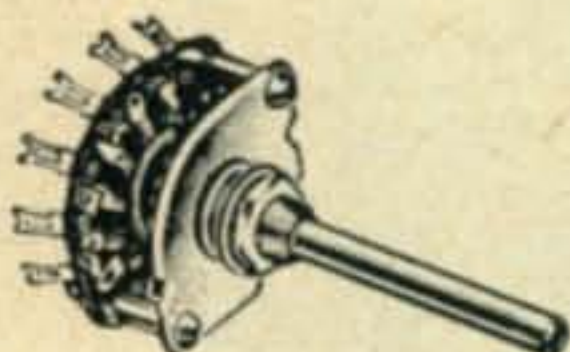
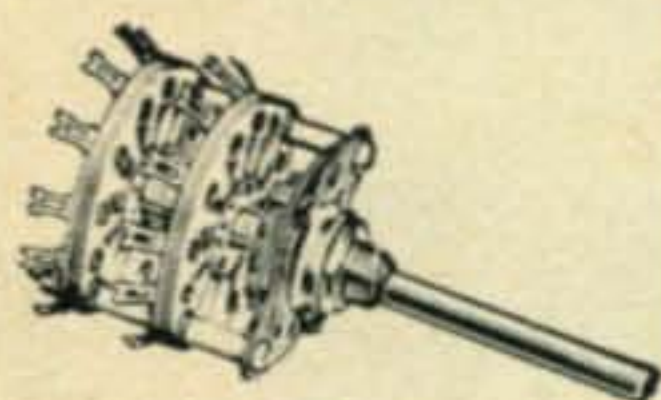

• The extensive CENTRALAB line of high reliability switches includes the unit you need. For ham applications, as well as industrial and military uses, you can depend on CENTRALAB switches. Sub-miniature, miniature, standard and heavy duty; rotary and lever action; ceramic and phenolic—your CENTRALAB distributor has them all. You'll find them listed in CENTRALAB's Catalog 30. If you don't have this catalog, write us or ask your distributor for a free copy.

**Centralab**  
CR

A DIVISION OF GLOBE-UNION, INC.  
 954B E. KEEFE AVE. • MILWAUKEE 1, WIS.  
 In Canada: 804 Mt. Pleasant Rd., Toronto, Ont.

SWITCHES • CERAMIC CAPACITORS • PACKAGED ELECTRONIC CIRCUITS  
 CONTROLS • ENGINEERED CERAMICS • SEMI-CONDUCTOR PRODUCTS

For further information, check number 11 on page 126.



**Propagation Test**

On or about February 1, 1961, transmissions on 32.700 mc, 39.200 mc, 48.500 mc, 74.500 mc and 87.400 mc, will originate from Salisbury Southern Rhodesia. Purpose of transmission is to study the Transequatorial Propagation (TEP) Mode. Although monitoring equipment is being deployed at a number of North African and European sites, interested amateurs and short wave listeners particularly in the European-African area are urged to participate and report on their findings.

Around-the-clock operation is planned on a programmed basis. Emission will be of a pulsed tone (2 Kc. sine wave) with the carrier present at all times to permit measurements of signal strength. The dwell time on each frequency will be 12 minutes with the first and last minute devoted to identifying call and time marker. The sequencing will be as follows:

Frequency	Time	
32.700 Mc	0000-0001	Time Marker & Identification
	0001-0011	Pulsed Tone
	0011-0012	Identification
39.200 Mc	0012-0013	Time Marker & Identification
	0013-0023	Pulsed Tone
	0023-0024	Identification
48.500 Mc	0024-0025	Time Marker & Identification
	0025-0035	Pulsed Tone
	0035-0036	Identification
74.500 Mc	0036-0037	Time Marker & Identification
	0037-0047	Pulsed Tone
	0047-0048	Identification
87.400 Mc	0048-0049	Time Marker & Identification
	0049-0059	Pulsed Tone
	0059-0060	Identification

The above schedule will be repeated hourly. The transmitters will have a radiated power of several hundred watts, and tentative plans call for continued transmission for approximately 6 months.

Those interested in participating are asked to contact Dr. P. H. Licastro, c/o HRB-Singer Inc., Science Park, State College, Pa.

**East Coast V.h.f. Society Inc.**

The East Coast V.h.f. Society Inc. will again entertain its members and many friends at their 3rd Annual Dinner and Hamfest to be held Saturday, February 25th at Neptune's Inn, located near River Edge, N. J. on Route 4, starting at 7:00 P.M.

Tickets are priced at \$5.00 per person and are available from any member of the society, or by writing: Roy King, K2BNQ, 55 Woodland Avenue, Montvale, New Jersey.

Ticket deadline is Sunday, February 12th and no tickets will be sold at the door. Requests from other radio clubs for specific groupings will receive special attention, if such orders are received early by K2BNQ. Requests of this nature can be honored only for blocks of five (5) or more tickets. Motel accommodations are available nearby for out-of-town visitors.

The Society, well known in amateur radio circles for its hospitality, once again extends a warm invitation to young and old alike with a hearty "See You At River Edge."



*Quality · Performance · Styling*



*Globe Scout Deluxe*

## The most outstanding low-cost AM transmitter available today

The new Globe Scout Deluxe (Model SD-75A) is the very latest in a bandswitching 6-80M transmitter for 90wCW, 75w phone input power with relay controlled circuitry. Final amplifier works straight through on ALL bands. Has panel control for antenna loading on all bands, built-in high level plate modulator, pi-net output on 10-80M—tuned link on 6M, matching into low impedance beams. When changing frequency on 6M, link can be tuned from front panel. Three-gang (1300 mmfd) loading capacitor provides continuous adjustment 10-80 M plus harmonic and TVI—suppression. Built-in power supply for 115 VAC, high quality choke input for best regulation. Tube lineup: 6146 Final, 6CL6 Buffer, 6CL6 Oscillator, 6U8 Speech Amplifier/Driver, 6AQ5 Clamp Tube, 7027A Modulator and 5R4GYB Rectifier. Extensive TVI precautions including separate shielding of final amplifier and meter. Convenient rotary switches. Newly designed cabinet features modern "low look." Attractive etched-aluminum panel trimmed in black. 15 $\frac{1}{4}$  x 6 $\frac{1}{4}$  x 11 $\frac{1}{4}$ .

Most Distributors Offer Terms of 10%  
Down Payment and 18 Month Pay Plans. Wired **\$159<sup>95</sup>**



**GLOBE VFO 755A** CALIBRATED  
10 M—160 M  
The Globe VFO 755A comes complete with well-filtered power supply with voltage regulation. Output on 40 and 160M. Vernier Drive, 13:1 tuning ratio. Approx. 50 RF volts output. Temperature compensated for utmost stability for AM and CW.

Wired, \$59.95  
Kit, \$49.95



**GLOBE FCL-1** SPEECH BOOSTER  
Globe's FCL-1 Speech Booster is a peak limiting audio preamplifier. Increases modulation intensity for most penetrating audio. Includes harmonic suppression. Adapts to most transmitters.

Wired, \$24.95  
Kit, \$15.95



See your local distributor or write direct to

**GLOBE ELECTRONICS**

A DIVISION OF TEXTRON ELECTRONICS, INC.  
22-30 SOUTH 34TH ST. COUNCIL BLUFFS, IA.

For further information, check number 12 on page 126.



# FIELD STATION ENGINEERS

Several qualified engineers will be selected to join in a program which is advancing the state-of-the-art of

## IONOSPHERIC PHYSICS *and the study of* BACKSCATTER PHENOMENA

Background in these areas will be developed through a training program in our Electro-Physics Laboratories, located in Bladensburg, Maryland. Engineers selected will become part of a team extending experiments of the Research and Development Department to the field, in both Domestic and Overseas assignments, and will have ample opportunity to develop technically.

*They will possess a combination of the following requirements:*

- ✓ BSEE, or equivalent consisting of combined civilian or military technical school plus work experience.
- ✓ Presently employed as a Field Engineer or Project Engineer.
- ✓ A good command of some of the following:
  - RADAR, preferably High-Power
  - HF Long-Distance Communications Systems
  - Tropospheric or Ionospheric Scatter Systems
  - Meteor-Burst Communications Systems
  - Propagation Prediction—computation of propagation for long-distance communications
  - Ionospheric Sounder Operations
  - RDF Systems
  - Doppler RADAR Systems
  - Amateur Radio Enthusiast
- ✓ FCC License, 1st or 2nd Class.

They must be willing to accept assignments in areas where dependents are not permitted for periods up to one year. Differential paid for overseas assignments.

Applications Are Also Being Accepted For  
**SENIOR SCIENTISTS  
ENGINEERS (All Levels)  
ELECTRONIC TECHNICIANS**

*for permanent assignment at our Electro-Physics  
Laboratories in Bladensburg, Maryland.*

Please Send Resume To:

*Professional Employment Dept.*

ACF ELECTRONICS DIVISION  
**ACF INDUSTRIES**

INCORPORATED

RIVERDALE, MARYLAND

## Radio-Weather Pamphlet

The Mobile Oil Company, Marine Retail Department at 150 East 42nd Street, New York 17, N. Y. has just published their 1961 edition of *Radio-Weather*. This pamphlet may be obtained free and is of valuable information for the radio-boatman. Three editions are available for the Pacific Coast; Great Lakes, Gulf Coast, and Inland Rivers; and for the East Coast.

## The Colvin Award

Famed DXer Lt. Col. Lloyd Colvin, KL7KG is now offering a certificate to those who may have worked Lloyd from his previous stations. The rules are as follows:

1. For working different land-based stations, licensed to the same operator (or his immediate family) under one of the following conditions:
  - a) Stations located in 3 different continents.
  - or b) Stations located in 4 different countries.
  - or c) Stations located in 5 different U.S. States or combinations of U.S. States and countries other than U.S.A.
2. Stickers available for re-qualifying. Contacts must be with stations licensed to different operator than previous award.
3. Award is free. Return postage appreciated.
4. Mail QSLs to KL7KG, P.O. Box 373, Fort Richardson, Alaska.

Previous calls held by Lloyd were, W2USA, K2CC, W4KE, K4WAB, W6AHI, W6ANS, W6IPF, W6KFD, W6KG, W6TG, W7KG, W7YA, DL4ZB, DL4ZBD, DL4ZC, FA8JD, J2AHI, J2USA, JA2KG, JA2US.

## Hospital-Radio Link

A radio amateur network linking 30 Veterans Administration hospitals was opened by Dr. William S. Middleton, the VA Chief Medical Director.

The first message was broadcast by Dr. Middleton from the Brooklyn, N. Y., VA hospital station WA2MAH to Dr. Joseph B. Bounds, manager of the Roanoke, Va. VA Hospital, at station K4UCD.

The 30 VA hospitals and their stations, licensed by the FCC are: Albany, N.Y., K2CWX; Batavia, N.Y., WA2LRA; Bath, N.Y., WA2MAA; Bay Pines, Fla., K4RKY; Beckley, W. Va., K8VLF; Biloxi, Miss., W5BBX; Brooklyn, N.Y., WA2MAH; Buffalo, N.Y., K2YCU; Cleveland, O., K8UZW; Clinton, Iowa, K0WXP; Fort Howard, Md., K3GXP; Hines, Ill., K9WFN; Hot Springs, S.D., W0BSC; Iowa City, Iowa, K0ZPF; Jefferson Barracks, Mo., W0AYB; Lake City, Fla., W4RMX; Little Rock, Ark., W5BAF; Long Beach, Calif., WA6NWL; Minneapolis, Minn., W0BLV; Rutland Heights, Mass., K1BRN; Roanoke, Va., K4UCD; Spokane, Wash., W7NZZ; Temple, Tex., K5BLW; Togus, Me., K1MDM; Topeka, Kan., W0AYC; Tucson, Ariz., W7PYL; Tuscaloosa, Ala., W4RWZ; Walla Walla, Wash., K7NFX; Wood, Wisc., K9ZEA, and Northport, Long Island, N.Y., W4LDW/2.

## Ft. Lauderdale Auction

Broward Amateur Radio Club will hold its fifth annual Auctionfest March 11, in Ft. Lauderdale, Florida at the Armory at S.W. 4th Avenue and S.W. 24th Street. Doors open at 8 A.M. Auctioning starts at 10, with a break for free lunch at noon. This is Florida's most popular auction event. W4NYF is handling all the incidentals. Contact him at 405 N.W. 30 Ter., Ft. Lauderdale, Fla.

## Lawton-Ft. Sill A.R.C.

The Lawton-Ft. Sill Amateur Radio Club is holding its annual founders Day Hamfest at the Armory in Lawton, Oklahoma on the 12th of February 1961. Further information may be secured by writing to The Lawton-Ft. Sill Amateur Radio Club, Box 892, Lawton, Oklahoma.



from **EICO**® ... a completely new

# CITIZENS BAND TRANSCEIVER

that meets  
FCC regulations\*

\*EICO premounts, prewires, pretunes, and seals the ENTIRE transmitter oscillator circuit to conform with FCC regulations (Section 19.71 subdivision d). EICO thus gives you the transceiver in kit form that you can build and put on the air without the supervision of a Commercial Radio-Telephone Licensee!

#760:  
117 VAC  
Kit  
**\$59.95**  
Wired  
**\$89.95**



#761: 117 VAC & 6 VDC  
#762: 117 VAC & 12 VDC  
incl. mtg. bracket (Pat. Pend.)

Kit  
**\$69.95**  
Wired  
**\$99.95**

designed  
by Hams...  
for Hams...

to the highest  
Ham standards

Highly sensitive, selective SUPERHET (not regenerative) receiver with 5½ dual function tubes and RF stage. Continuous tuning over all 23 bands. Exclusive Super-Hush® noise limiter. AVC. 3"x5" PM speaker. Detachable ceramic mike. 5 Watt xtal-controlled transmitter. Variable "pi" network matches most popular antennas. 12-position Posi-Lock® mounting bracket. 7 tubes and 1 xtal (extra xtals available). Covers up to 20 miles. License available to any citizen over 18 — no exams or special skills required; application form supplied free. Antennas optional.

Additional crystals \$3.95 each.

Most EICO distributors offer budget terms.



**NEW! 60-WATT CW TRANSMITTER #723**  
Kit \$49.95      Wired \$79.95  
Ideal for novice or advanced ham needing low-power, stand-by rig. 60W CW, 50W external plate modulation. 80 through 10 meters.



**COLOR & MONO DC-5MC LAB & TV 5" OSCILLOSCOPE #460**  
Kit \$79.95      Wired \$129.50  
**5" PUSH-PULL OSCILLOSCOPE #425**  
Kit \$44.95      Wired \$79.95



**90-WATT CW TRANSMITTER\* #720**  
Kit \$79.95      Wired \$119.95  
\*U. S. Pat. No. D-184,776  
"Top quality" — ELECTRONIC KITS GUIDE. Ideal for veteran or novice. 90W CW, 65W external plate modulation. 80 through 10 meters.



**PEAK-TO-PEAK VTVM #232 & \*UNI-PROBE®**  
Kit \$29.95      Wired \$49.95  
\*U. S. Pat. No. 2,790,051  
**VACUUM TUBE VOLTMETER #221**  
Kit \$25.95      Wired \$39.95



**HIGH-LEVEL UNIVERSAL MODULATOR-DRIVER #730**  
Kit \$49.95      Wired \$79.95  
Delivers 50W undistorted audio. Modulates transmitters having RF inputs up to 100W. Unique over-modulation indicator. Cover E-5 \$4.50.



**RF SIGNAL GENERATOR #324 (150kc-435mc)**  
Kit \$26.95      Wired \$39.95  
**TV-FM SWEEP GENERATOR & MARKER #368**  
Kit \$69.95      Wired \$119.95



**GRID DIP METER #710**  
Kit \$29.95      Wired \$49.95  
Includes complete set of coils for full band coverage. Continuous coverage 400 kc to 250 mc. 500 ua meter.



**DYNAMIC CONDUCTANCE TUBE & TRANSISTOR TESTER #666**  
Kit \$69.95      Wired \$109.95  
**TUBE TESTER #625**  
Kit \$34.95      Wired \$49.95

**EICO**®

33-00 Northern Blvd.,  
Long Island City 1, N. Y.

EICO, 33-00 N. Blvd., L.I.C. 1, N.Y. Show me how to save 50% on 72 models of top-quality:  Ham Gear  Test Instruments  Hi-Fi  Send free Short Course for Novice License. Send free catalog and name of neighborhood EICO distributor. Send 36-page Stereo - Hi-Fi Guidebook: 25¢ enclosed for postage & handling

Name..... CQ-2  
Address.....  
City..... Zone..... State.....

Add 5% in the West.

ENGINEERS: Excellent career opportunities in creative electronics design. Write to the Chief Engineer. For further information, check number 14 on page 126.



# MAKE SURE YOUR STATION-ON-THE-GO— GOES FIRST CLASS

THE TURNER **350's**  
magnificent mobile  
microphones for  
moderate money

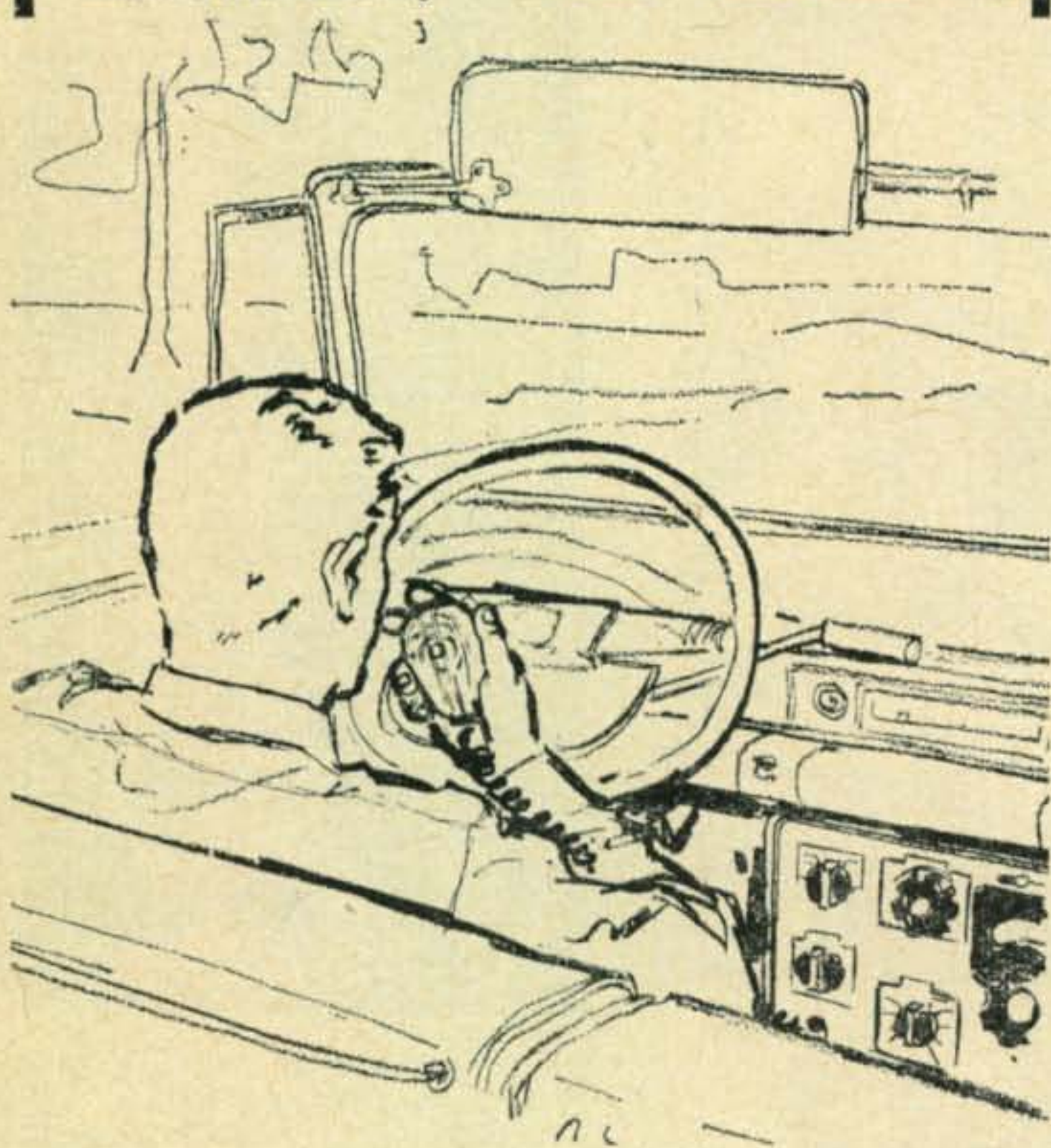

This reasonably priced, hand-held microphone is the perfect mike for amateur mobile rigs. Its price range fits the typical amateur's budget but its performance is strictly professional. Prices for the three microphones in the 350 series range from \$16.80 through \$19.00. All models are wired for relay operation, and feature extra-tough plastic case; hanger button and standard dash bracket for easy mounting; 11" retractable, five-foot extended Koiled Kord; and handy, momentary on-off switch. The 350's also excel as citizen's band and paging microphones.

TYPE	350X crystal	350C ceramic	350R carbon
RESPONSE	60-8,500	80-7,000	200-4,000
OUTPUT	-48 db	-54 db	-38 db
LIST PRICE	\$16.80	\$16.80	\$19.00

For complete specifications write:

**THE TURNER MICROPHONE COMPANY**  
909 17th St. NE, Cedar Rapids, Iowa

For further information, check number 15 on page 126.

## QSL contest

The winner this month is Manfred Rosenow, HK1JF with a three color card on "Kromekote" stock. Manfred is obviously a chess player as illustrated by the board and chessmen. A three colored ribbon is attached to the card and covers the words "Are you a chess player? Play us over r.f.!"

A years subscription is extended to Manfred.



### Runners Up

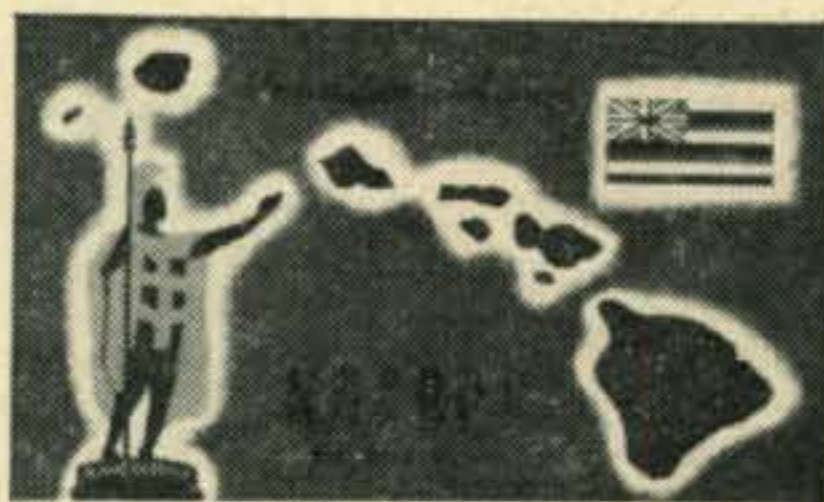



# PENTA PL-175A BEAM PENTODES SELECTED FOR OUTSTANDING NEW "INVADER 2000" TRANSMITTER!

In designing the new "Invader 2000" single-sideband transmitter, the E. F. Johnson Company chose a pair of Penta Laboratories PL-175A beam pentodes for the final amplifier. The 400-watt PL-175A was a logical choice, because it employs Penta's exclusive, patented "vane" suppressor grid, which causes it to deliver more useful output than similarly-rated conventional screen-grid tubes.

If your present transmitter uses conventional 250-watt or 400-watt tetrodes, chances are that you, too, can enjoy the many advantages of Penta's newest tube. Most tank circuits have sufficient tuning range to accommodate the slightly higher input and output capacitances of the PL-175A, and slight retuning is usually all that's necessary to put you on the air with increased power output.

The PL-175A has other advantages, too—such as the lower grid-plate capacitance which reduces neutralizing problems, a complete lack of annoying negative screen-grid current, and a sturdy, solid, one-piece plate cap and seal which has no set-screws or separate parts to loosen or fall off.

Follow the lead of the E. F. Johnson Company's knowledgeable engineers, and get the best for your transmitter—the new Penta PL-175A beam pentode.

## PENTA LABORATORIES, INC.

312 North Nopal Street, Santa Barbara, California

### CHARACTERISTICS AND RATINGS

Filament Voltage	5.0	volts
Filament Current	14.5	amperes
Direct Interelectrode Capacitances		
Input	15.1	$\mu\mu\text{fd}$
Output	9.8	$\mu\mu\text{fd}$
Grid-Plate	0.06	$\mu\mu\text{fd}$
Maximum Plate Voltage	4000	volts
Maximum Plate Current	350	ma
Maximum Screen Voltage	1000	volts
Maximum Plate Dissipation	400	watts

For complete details write for the PL-175A data sheet. Also, ask for your copy of "Transmitting Tubes for Linear Amplifier Service," a nine-page bulletin which shows in detail how and why Penta's pentodes out-perform conventional tetrodes.

TRADE MARK REG. U.S. PAT. OFF.

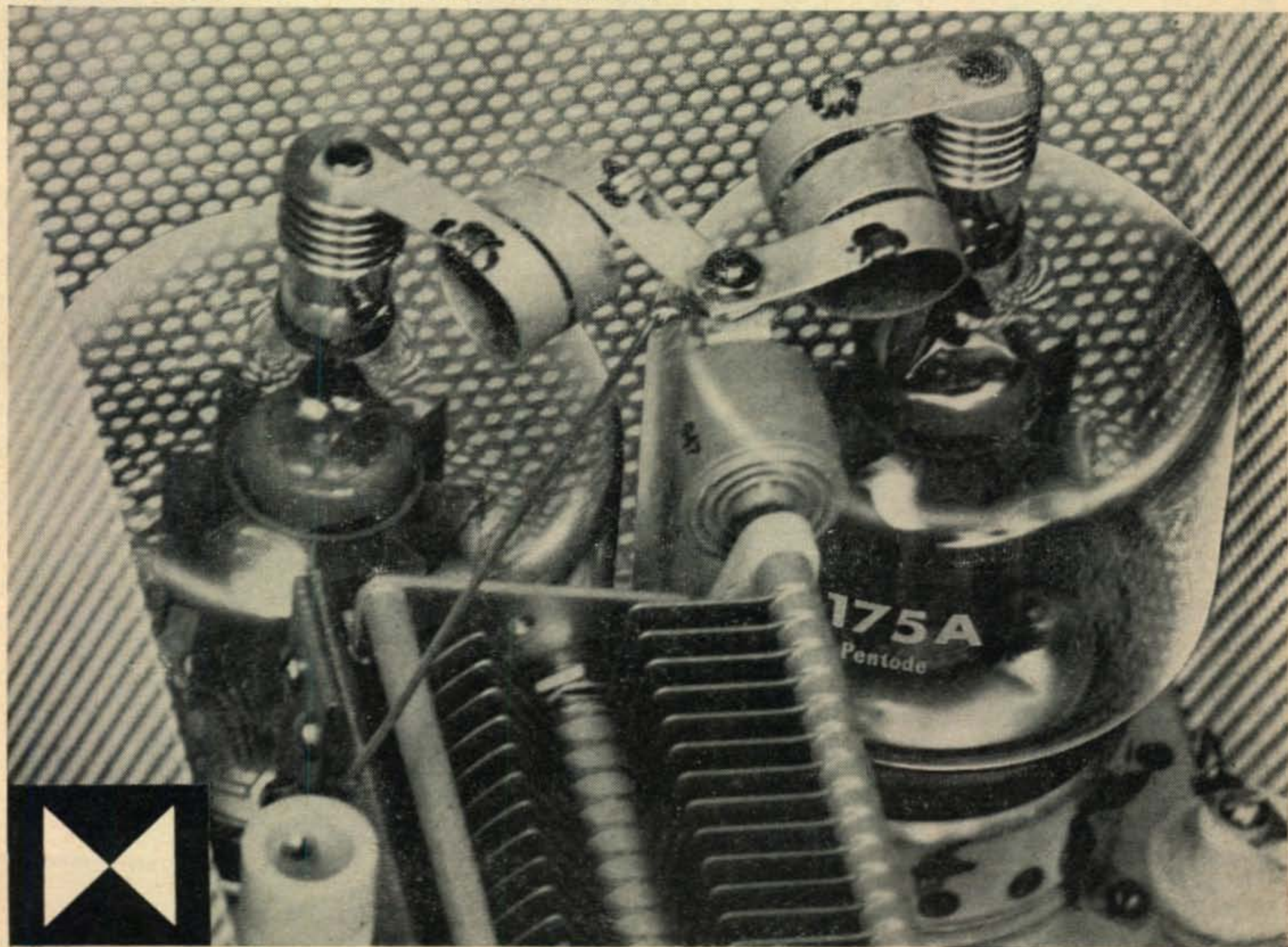
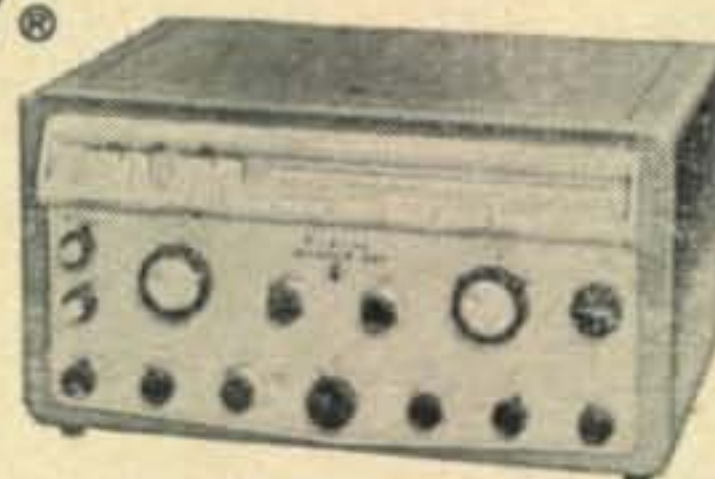

For further information, check number 16 on page 126.



**VHF**  
**NOW**  
**AVAILABLE!**

# MOBILETTE 61



MOBILETTE 61, International's new improved all transistor, crystal controlled converter provides a "quick and easy" way to convert your car radio for short wave reception. MOBILETTE 61 units cover a specific band of frequencies providing a ONE MEGACYCLE tuning range. Mobilette units are miniature size and quickly interchangeable.

Check these all New features . . . New and improved circuit for increased gain . . . New internal jumper for positive and negative grounds . . . New RF amplifier, mixer/oscillator . . . New separate input for broadcast and short wave antennas . . . Mounting bracket for under dash installation.

MOBILETTE 61 is available in a wide choice of frequencies covering the Amateur bands 75 through 6 meters, Citizens band, Civil Air Patrol low band frequencies, WWV time and frequency standards. Any frequency in the range 2 MC to 50 MC available on special order.\*



CIVIL AIR PATROL

AMATEURS

CITIZEN LICENCEES

# ...with improved circuit for mobile short wave reception

Write for International's complete catalog of precision radio crystals, and quality electronic equipment—yours for the asking.

**INTERNATIONAL  
CRYSTAL MANUFACTURING CO., INC.**

18 NORTH LEE • OKLAHOMA CITY, OKLA.

Designed for 12 vdc, MOBILETTE 61 will operate on 6 vdc at reduced output. Power connector plugs into cigarette lighter socket.

Mobilette 61 units cover these short wave frequencies.

Catalog No.	Frequency
630 - 110	6 meters (Amateur) 50 - 51 MC
630 - 111	10 meters (Amateur) 28.5 - 29.5 MC
630 - 112	11 meters (Citizens) 26.9 - 27.3 MC
630 - 113	15 meters (Amateur) 21 - 21.6 MC
630 - 114	20 meters (Amateur) 14 - 14.4 MC
	15 MC (WWV)
630 - 115	40 meters (Amateur) 7 - 7.4 MC
630 - 116	75 meters (Amateur) 3.8 - 4.0 MC
630 - 117	10 MC (WWV)
630 - 118	CAP (Low Band)
630 - 119	Special Frequencies 2 MC - 50 MC

### MOBILETTE 61 VHF

VHF frequencies for Aircraft, 108-135 mc; Amateur and Civil Air Patrol, 144-148 mc; Two-Way Communications, 150-170 mc. Special VHF transistors in both RF amplifier and mixer circuits.

Complete .....\$49.50

Cat. No.	
630 - 120	VHF Special 100 to 170 mc
630 - 121	VHF Special 54 to 100 mc

See the Mobilette 61 at your dealer today!

**Complete, ready to plug in and operate . . . . only \$22.95**

*\*Special frequencies 2 MC - 50 MC.....only \$25.95*

For further information, check number 17 on page 126.



Pick your  
features and  
power from  
the popular

# Viking TRANSMITTER LINE



"ADVENTURER"



"CHALLENGER"



"NAVIGATOR"



"6N2"



10-METER  
"MESSENGER"

### "ADVENTURER" TRANSMITTER

Self-contained . . . 50 watts CW input . . . rugged 807 transmitting tube . . . instant bandswitching 80 through 10 meters. Crystal or external VFO control—wide range pi-network output—timed sequence keying. With tubes, less crystals.

Cat. No. 240-181-1 . . . Kit . . . . . Amateur Net \$54.95

### "CHALLENGER" TRANSMITTER

70 watts phone input 80 through 6; 120 watts CW input 80 through 10 . . . 85 watts CW on 6 meters. Two 6DQ6A final amplifier tubes. Crystal or external VFO control—TVI suppressed—wide range pi-network output. With tubes, less crystals.

Cat. No. 240-182-1 . . . Kit . . . . . Amateur Net \$114.75

Cat. No. 240-182-2 . . . Wired . . . . . Amateur Net \$154.75

### "NAVIGATOR" TRANSMITTER/EXCITER

40 watts CW input . . . also serves as a flexible VFO Exciter. 6146 final amplifier tube—bandswitching 160 through 10 meters. Built-in VFO or crystal control. With tubes, less crystals.

Cat. No. 240-126-1 . . . Kit . . . . . Amateur Net \$149.50

Cat. No. 240-126-2 . . . Wired . . . . . Amateur Net \$199.50

### "6N2" TRANSMITTER

Rated 150 watts CW and 100 watts phone—offers instant bandswitching coverage of both 6 and 2 meters. Fully TVI suppressed—may be used with the Viking I, II, "Ranger", "Valiant" or similar power supply/modulator combinations. Operates by crystal control or external VFO with 8-9 mc. output. With tubes, less crystals.

Cat. No. 240-201-1 . . . Kit . . . . . Amateur Net \$129.50

Cat. No. 240-201-2 . . . Wired . . . . . Amateur Net \$169.50

### 10-METER "MESSENGER" TRANSCEIVER

Complete 10-tube (including rectifier) crystal-controlled transceiver. 10 watts input—pre-tuned for 29.4 to 29.7 mcs—covers any 5 frequencies within a 300 kc segment of 10-meter band. Excellent receiver sensitivity and selectivity. ANL, AVC, and positive-acting Squelch. With tubes, push-to-talk microphone, and crystals for national calling and emergency frequency (29,640 kc).

Cat. No. 242-201 . . . 115 V only . . . . . Amateur Net \$129.75

Cat. No. 242-202 . . . 115 V and 6 V . . . . . Amateur Net \$139.75

Cat. No. 242-203 . . . 115 V and 12 V . . . . . Amateur Net \$139.75



### "RANGER" TRANSMITTER/EXCITER

This popular 75 watt CW or 65 watt phone transmitter will also serve as an RF/audio exciter for high power equipment. Completely self-contained—instant bandswitching 160 through 10 meters! Operates by built-in VFO or crystal control. High gain audio—timed sequence keying TVI suppressed. Pi-network antenna load matching from 50 to 500 ohms. With tubes, less crystals.

Cat. No. . . . . Amateur Net

240-161-1 . . . Kit . . . . . \$229.50

240-161-2 . . . Wired and tested . . . \$329.50



### "VALIANT" TRANSMITTER

275 watts input CW and SSB (P.E.P. with auxiliary SSB exciter) 200 watts phone. Instant bandswitching 160 through 10 meters—built-in VFO or crystal control. Pi-network output matches antenna loads from 50 to 600 ohms. TVI suppressed—timed sequence keying—built-in low pass audio filter—self-contained power supplies. With tubes, less crystals.

Cat. No. . . . . Amateur Net

240-104-1 . . . Kit . . . . . \$349.50

240-104-2 . . . Wired and tested . . . \$439.50



### "FIVE HUNDRED" TRANSMITTER

Full 600 watts CW—500 watts phone and SSB. (P.E.P. with auxiliary SSB exciter.) Compact RF unit designed for desk-top operation. All exciter stages ganged to VFO tuning—may also be operated by crystal control. Instant bandswitching 80 through 10 meters—TVI suppressed—high gain push-to-talk audio system. Wide range pi-network output. With tubes, less crystals.

Cat. No. . . . . Amateur Net

240-500-1 . . . Kit . . . . . \$749.50

240-500-2 . . . Wired and tested . . . \$949.50



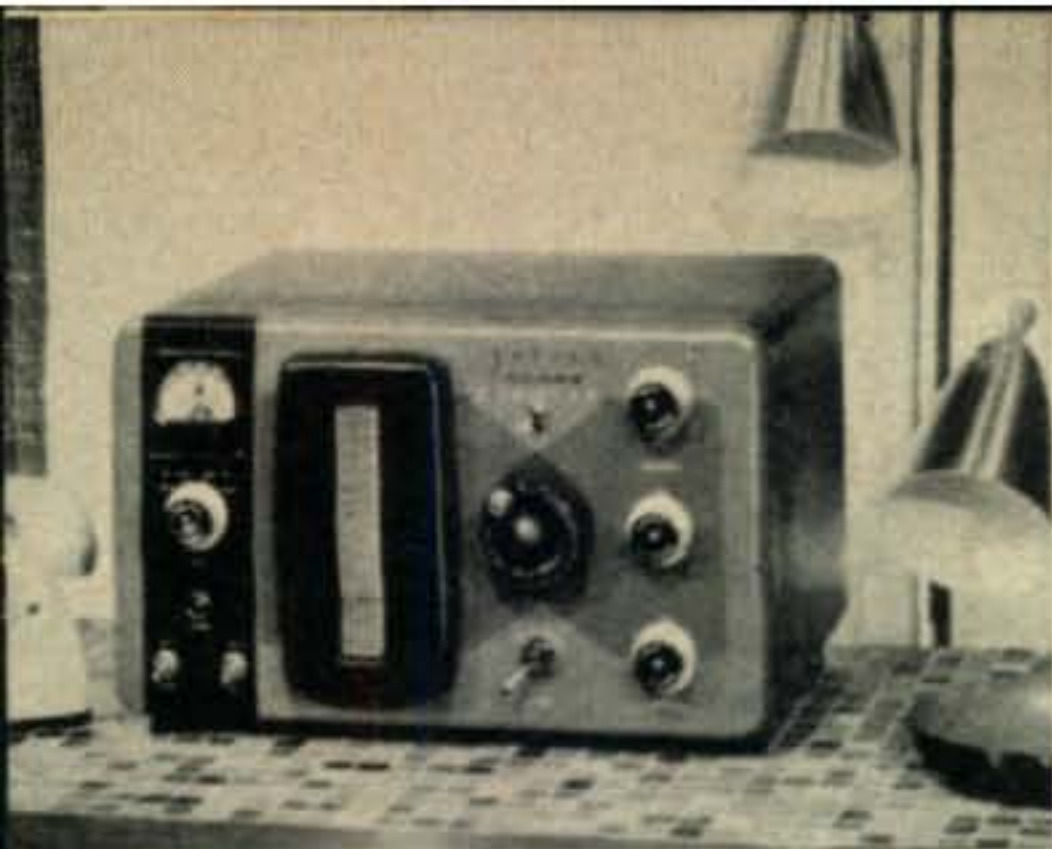

**"COURIER" AMPLIFIER**

Rated a solid 500 watts P.E.P. input with auxiliary SSB exciter as a Class B linear amplifier; 500 watts CW or 200 watts AM linear. Self-contained desk-top package—continuous coverage 3.5 to 30 mcs. Drive requirements: 5 to 35 watts depending on mode and frequency desired. TVI suppressed. With tubes and built-in power supply.

Cat. No. **Amateur Net**  
 240-352-2..Wired and tested...\$289.50

**"THUNDERBOLT" AMPLIFIER**

The hottest linear amplifier on the market—2000 watts P.E.P. (twice average DC) input SSB; 1000 watts CW; 800 watts AM linear. Continuous coverage 3.5 to 30 mcs.—instant bandswitching. Drive requirements; approx. 10 watts Class AB<sub>2</sub> linear, 20 watts Class C continuous wave. With tubes and built-in power supply.

Cat. No. **Amateur Net**  
 240-353-1...Kit.....\$524.50  
 240-353-2..Wired and tested...\$589.50

**"6N2 THUNDERBOLT" AMPLIFIER**

1200 watts (twice average DC) input SSB and DSB, Class AB<sub>1</sub>; 1000 watts CW, Class C; and 700 watts input AM linear. Continuous band-switched coverage on 6 and 2 meters. TVI suppressed. Drive requirements: approx. 5 watts Class AB<sub>1</sub> linear, 6 watts Class C CW. With tubes and built-in power supply.

Cat. No. **Amateur Net**  
 240-362-1...Kit.....\$524.50  
 240-362-2..Wired and tested...\$589.50

*The world at your fingertips!*

**VIKING "KILOWATT" AMPLIFIER**

The only transmitter that provides maximum legal power in all modes—SSB, CW, and plate modulated AM. Two 4-400A tubes in Class AB<sub>2</sub> easily deliver 2000 watts P.E.P. (twice average DC) in SSB mode—1000 watts input AM with two push-pull 810 tubes in Class B modulator service—1000 watts input Class C CW. High efficiency pi-network output circuit. Excitation requirements: 30 watts RF and 10 watts audio for AM; 10 watts peak for SSB. Pedestal contains complete unit. With tubes.

Cat. No. 240-1000..Wired and tested.....**Amateur Net \$1595.00**  
 Matching desk-top and three-drawer pedestal.  
 Cat. No. 251-101-1.....**FOB Corry, Pa. \$132.00**



*The very finest SSB equipment you can buy!*



**INVADER**

The transmitter you've been waiting for—with more exclusive features than any other Transmitter/Exciter on the market today! Instant band-switching 80 through 10 meters—no extra crystals to buy—no retuning necessary. Rated 200 watts CW and SSB input; 90 watts input on AM. Unwanted sideband and carrier suppression is 60 db or better! Wide range pi-network output circuit. Fully TVI suppressed. Self-contained heavy-duty power supply. Wired and tested with tubes and crystals.

Cat. No. **Amateur Net**  
 240-302-2.....\$619.50

**INVADER-2000**

Here are all of the fine features of the "Invader", plus the added power and flexibility of an integral linear amplifier and remote controlled power supply. Rated a solid 2000 watts P.E.P. (twice average DC) input on SSB; 1000 watts CW; and 800 watts input AM! Wide range output circuit (40 to 600 ohms adjustable). Final amplifier provides exceptionally uniform "Q". Exclusive "push-pull" cooling system. Heavy-duty multi-section power supply. Wired and tested with power supply, tubes and crystals.

Cat. No. **Amateur Net**  
 240-304-2.....\$1229.00

**HI-POWER CONVERSION**

Take the features and performance of your "Invader"... add the power and flexibility of this unique Viking "Hi-Power Conversion" system... and you're "on the air" with the "Invader-2000"—a solid 2000 watts P.E.P. (twice average DC) input SSB, 1000 watts CW and 800 watts input AM. Completely wired and tested—includes *everything* you need—no soldering necessary—complete the entire conversion in one evening!

Cat. No. 240-303-2..Hi-Power Conversion, complete.....**Amateur Net \$619.50**



*Free Catalog*

Write for your free copy of our newest amateur equipment catalog—complete specifications, illustrations and schematics on Viking amateur equipment.



**E. F. JOHNSON COMPANY**

WASECA • MINNESOTA

For further information, check number 18 on page 126.



# The Guywire Pyramid

G. H. Pieteron, ex-PAØGE

c/o Denison Research Foundation  
Powell, Ohio

*Space has always been an amateur's headache especially when it comes to erecting antennas for 160 and 80 meters. Described here is a full-wave, tuneable 80 meter antenna which occupies an area only 42 feet square.*

**T**HERE'S no doubt about it: The best antenna for 80 is a horizontal half-wave dipole at a height of a quarter wavelength. This means in practical terms, a 125 feet line some 60 feet up in the air. In spite of the vastness of this country but few of us can afford this ideal. It not only requires a piece of real estate just a bit larger than the average lot but also two fair sized masts or towers. Anything less than that is a compromise between practicability and efficiency.

## Compromise

All right, so we settle for a little less. We use a trap dipole that may just fit the length of our lot. We get by with two 24 foot poles, or we run a line from the top of our beam tower sloping down to the highest point we can find at the other end. Or we think up any odd shaped concoction resonating on 80, as long as it stays within the limits of the available space and height. And we get out all right, particularly when our rig is of the full gallon variety.

Do we realize, however, what this compromise is costing us? We are wasting a lot of precious r.f. energy in a very inefficient radiating system. In the first place is the antenna so close to ground that its terminal impedance is down to 30 ohms or less. But the handbooks tell us that the impedance of a half-wave dipole is 73 ohms, so how could we go wrong with our 75 ohm coax cable? Well, we just happened to overlook the fact that the 73 ohm figure is only correct for an antenna in free space or at certain heights above ground, the lowest of which is a quarter wavelength. This amounts to some 60 feet for the 80 meter band. The result is a substantial mismatch on our 75 ohm cable and thus increased line losses.

Then, the close proximity to ground means increased ground losses and less upward reflection. In addition overhead power and telephone lines, probably at about the height of our antenna and, to make matters even worse often parallel to it, sip up a goodly portion of the radiated r.f. juice. In doing so we aggravate our TVI, HiFiI and similar I sores by running the stuff right into our neighbors' homes.

Last but not least; our antenna is essentially a

one frequency device. We may operate it over a couple of hundred kc without running into an objectionable s.w.r. but it is a fact that an antenna designed for say 3900 kc is quite a bit off resonance at 3550 kc. And the phone man who hops from around 3900 to 3290 in order to fulfill his MARS commitments is really in a spot. Again the result is a decrease in radiation efficiency.

The author had never given these problems much thought until he came to live in the States. During his 25 years of licensed hamming in PAØ land he built and used many 80 meter antennas that approached the ideal. The higher suburban homes over there, at least two floors plus an attic topped by a high pointed roof, didn't need much in the way of a mast on top of them to provide tie points at a desirable height. The near non-existence of overhead power and telephone lines created an ideal low-loss environment for antennas.

While serving my five year term as a resident alien, which may ultimately lead to U.S. Citizenship and a ham ticket, I am "grounded". That's not much fun for an oldtimer but it has one big advantage; plenty of time otherwise spent on just "being on the air" is now available for the study of specific ham problems and can be devoted to some creative thinking and experimentation in this field.

Immediate incentive for an attack on the 80 meter antenna problem were the complaints of a fellow ham living on a rather small lot, almost fenced in by overhead power and telephone lines. No matter what antennas he tried he just did not seem to get out satisfactorily on 80. And to complicate his problems, he prefers phone work and is also a MARS member so that he has to hop from the high end of the band to lower-than-the-low end.

An additional stimulant was the consideration that 80 is gaining in importance and will continue to gain during the coming years. While old Mr. Sun is gradually losing his freckles, conditions on the DX bands deteriorate and the maximum useable frequency is approaching our low frequency bands. This may bring us quite a bit of DX on 80 provided we have an antenna capable of doing the job. The Guywire Pyramid may well be it.



## Research And Development

In his search for a solution to the aforementioned problems the author was inspired by an existing antenna type that has a number of desirable features: the inverted V-shaped dipole. A good article on this antenna appeared in *QST*.<sup>1</sup> The inverted V requires only one pole and occupies less space than a horizontal dipole but the distance between anchor posts is still some 100 feet.

Although the Guywire Pyramid is closely related to the inverted V as will be shown later its development and operation can probably be best explained by starting out with an antenna we are all familiar with: the folded dipole. This antenna is illustrated in fig. 1A. The arrows indicate the direction of the r.f. currents during one half cycle and the dots are placed at the "hot ends" or high voltage points of the antenna.

By pulling the wires of the folded dipole apart we can form a rectangle with sides  $1/3$  and  $1/6$  wavelength long, as shown in fig. 1B. Next, by squeezing the centers of the long sides together and giving the system a half-turn twist at the intersection we form the skeleton bowtie of fig. 1C. Finally by bending this bowtie at the intersection, until the intersecting lines form angles of  $90^\circ$ , we arrive at fig. 1D, a pyramid with a square base, measuring  $1/6 \times 1/6$  wavelength.

This pyramid shaped antenna has some interesting properties. Its terminal impedance, depending on the height above ground, ranges from 60 to 100 ohms. Radiation is mainly off the slanting wires. As can be concluded from the current distribution, the horizontal sections carry comparatively small currents that are equal in magnitude and opposite in direction so that the fields tend to cancel. Radiation from the horizontal sections is therefore negligible. At high angles with respect to ground, the antenna is substantially omni-radiant; at lower angles radiation is strongest in the direction A-B, weakest in the direction C-D, as indicated in fig. 1D. Because the radiating wires are angled their coupling with overhead power and telephone lines is much less than is the case with horizontal antennas.

The  $Q$  of the Pyramid is lower than that of a single wire inverted V. With other full wave loop systems, such as the Quad element, the Pyramid shares the characteristic of having no "end-effect". As a result the total wire length approaches the natural wavelength, provided the high voltage ends (in this case the horizontal sections) are sufficiently remote from ground and other objects. The area occupied by this full-wave antenna is extremely small and only one mast is required. Because of its shape the antenna may double as guywire system for its supporting pole. Thus it was christened the Guywire Pyramid.

By observing fig. 1D the relationship with the inverted V dipole will be obvious. In fact, the Pyramid can be defined as consisting of two shortened inverted V's, placed at right angles and connected in series. With the inverted V, the Pyramid shares

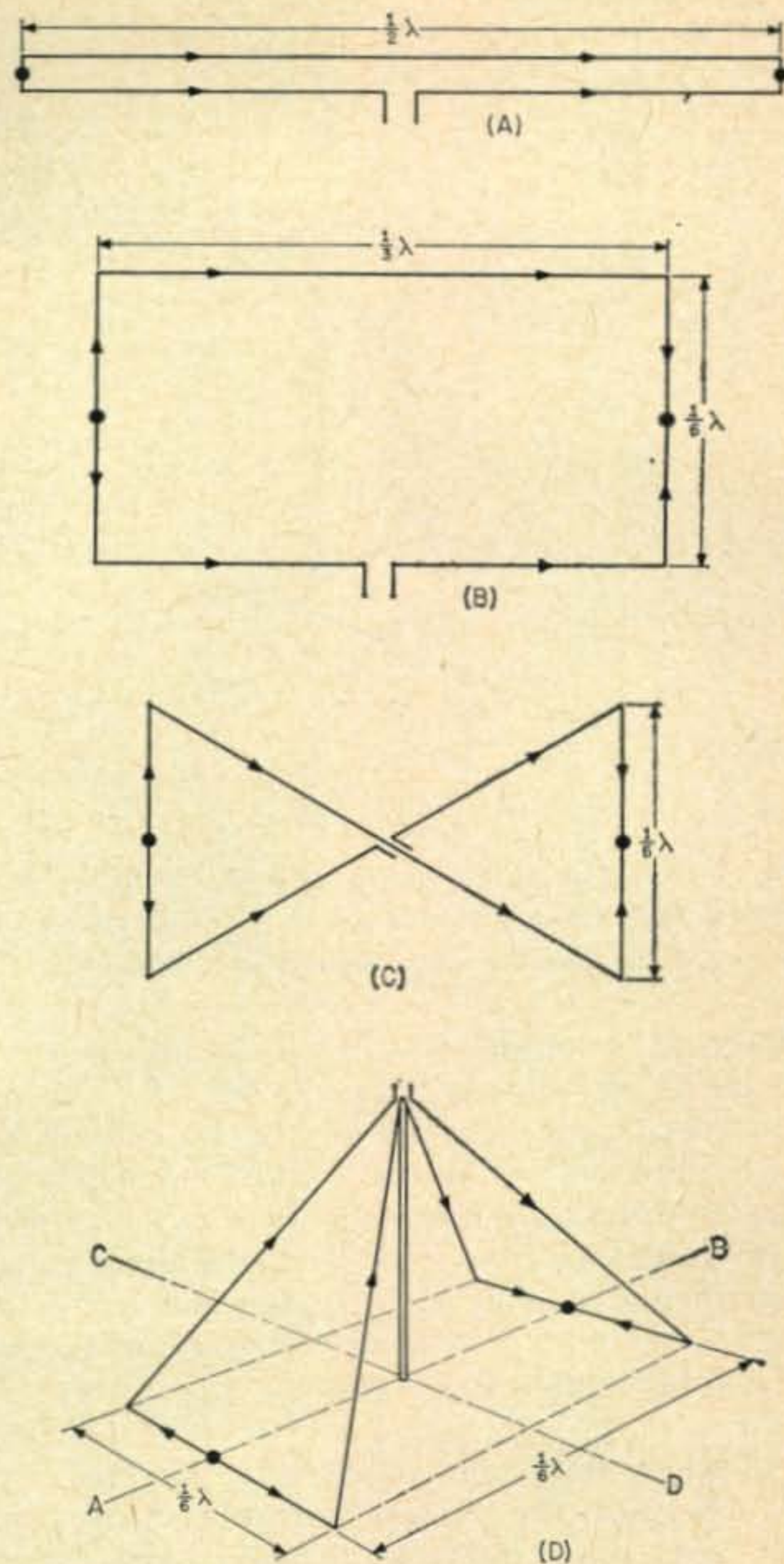

Fig. 1—Evolution from the folded dipole (A) via the rectangular loop (B) and the skeleton bowtie (C) to the Pyramid (D). Arrows indicate current flow and the dots indicate the high voltage points. The similarity between this antenna and the inverted V may be seen from (D).

the advantage of having its terminals at the top of the pole, offering a convenient support for the feedline.

A quick calculation shows that such an antenna for 4 mc would occupy an area of not more than  $42 \times 42$  feet and that the height would be about 40 feet, assuming that the horizontal sections are 10 feet above ground. As accidental touching of the "hot ends" of a fired-up antenna cannot be considered to be conducive to longevity the horizontal sections of the Pyramid should be at least 10 feet high above ground.

### Tuning

Figure 2A shows, schematically, how the resonant frequency of such an antenna can be reduced. Single wire stubs connected to the "ends" do the trick. The fact that these ends, i.e. the centers of the horizontal sections of the Pyramid, are easily accessible enables us to build in a tuning feature.

<sup>1</sup>Glanzer, K., "The Inverted-V-Shaped Dipole", *QST*, Aug. 1960, page 18.



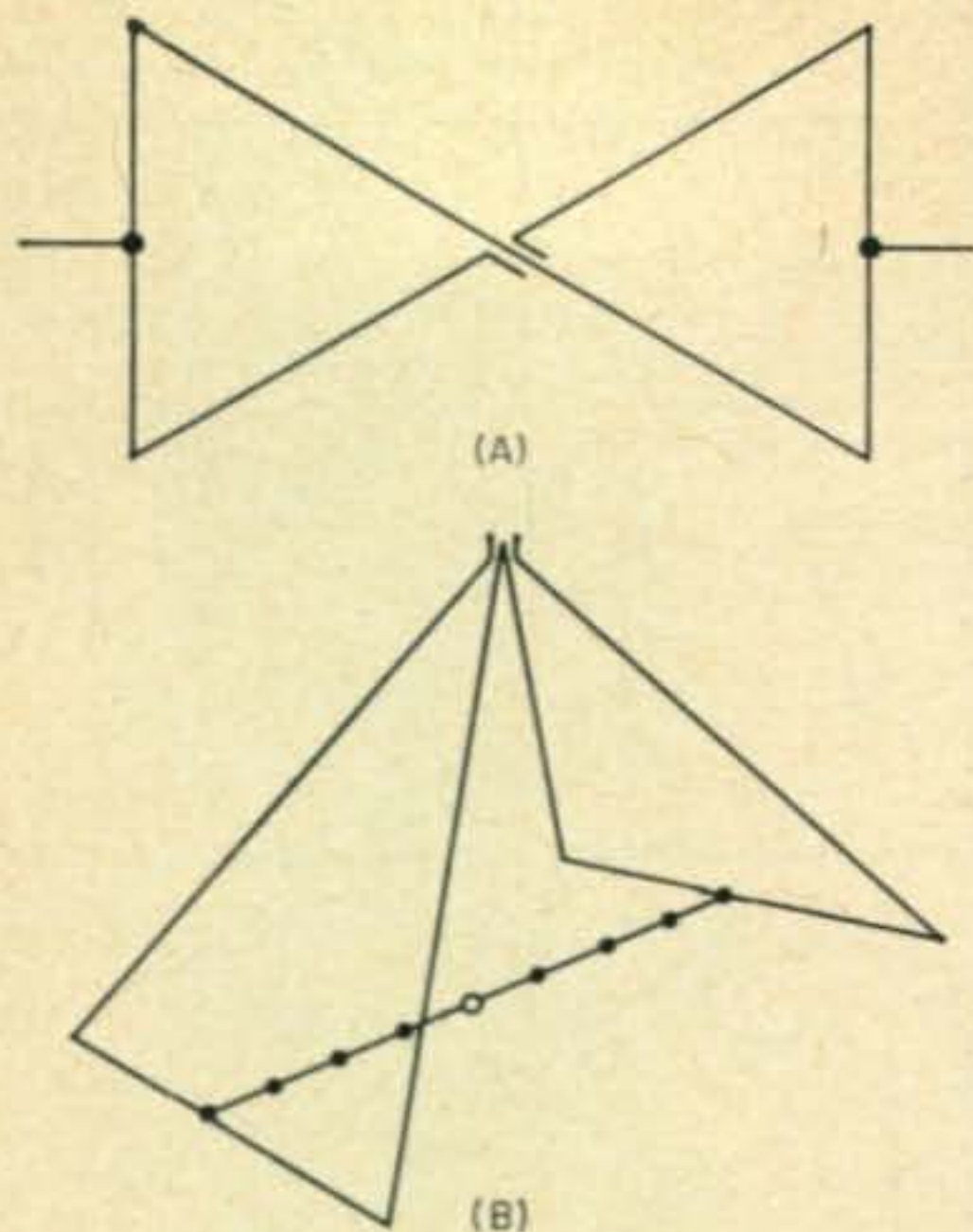

Fig. 2—Addition of the tuning stubs (A) on each end lowers the resonant frequency. A tuning stub line, shown in (B), permits adjustment to spot frequencies.

A practical solution, offering as many spot frequencies as we want is shown in fig. 2B. The line interconnecting the centers of the horizontal sections is broken by insulators at predetermined points. By simultaneously shorting out one or more sets of insulators from each end, the antenna can be lengthened step by step. In this manner a frequency range with a ratio of 1.2 to 1 can be covered. On 80 meters this would be from 4.0 to 3.3 mc.

The stubs not only reduce the resonant frequency but also the terminal impedance. Measurements have shown that over the full range, the impedance will vary from around 90 ohms at the highest frequency to around 50 ohms at the lowest. The fone man might therefore prefer a 75 ohm feedline whereas a 53 ohm line would suit the bug artist better. The all around operator had better flip a coin and live with some mismatch at one end of the band or the other. This slight mismatch is more than made up for by the fact that the antenna is resonant at our operating frequency.

### Construction Details

There is little sense in trying to give a clear cut recipe for the construction of an antenna of this type. Your site may call for some modification in the shape. If a pyramid with a 50 x 30 feet base would fit your lot better, by all means go ahead. And try to keep the horizontal sections at the short sides in this case. The shape and the environment will influence the resonant frequency as well as the impedance. So will the height. The only way to arrive at the correct dimensions is by measuring the frequency. This is not difficult. A grid dipper, the cut-and-try method and a little ingenuity is all there is to it.

The following should therefore merely be seen as an example plus some practical hints. There are some minimum requirements such as the height of the pole and the height of the horizontal sections. The higher the whole system is, the better the effi-

ciency, with a minimum of 40 feet for the top, and for reasons mentioned earlier, a minimum of 10 feet for the horizontal sections. These sections should also be kept away as far as possible from high fences, overhead power lines and other conductors.

Assuming that a tower or pole of at least 40 foot height is already available at the center of a 42 x 42 feet area the bill of goods really does not amount to much:

Two lengths of 125 ft antenna wire (for a target frequency of 3900 kc).

Eight antenna insulators.

One coax receptacle mounted on a plexiglass plate.

One coax cable 83 ft long (75 or 53 ohms, make up your mind and take your pick).

Four ten foot poles with braces (this item might be deleted).

Some guywire (plastic clothline with nylon core is just fine).

The first step is to survey the area and determine which are the best sides for the horizontal sections, keeping in mind that the more they are in the clear the better. At the same time try to determine if there are any existing poles, fence posts or walls that may be utilized as tie points for the corners of the Pyramid. Otherwise we'll have to place the ten foot poles as shown in fig. 3A or, if more space is available, four anchor stakes as pictured in fig. 3B.

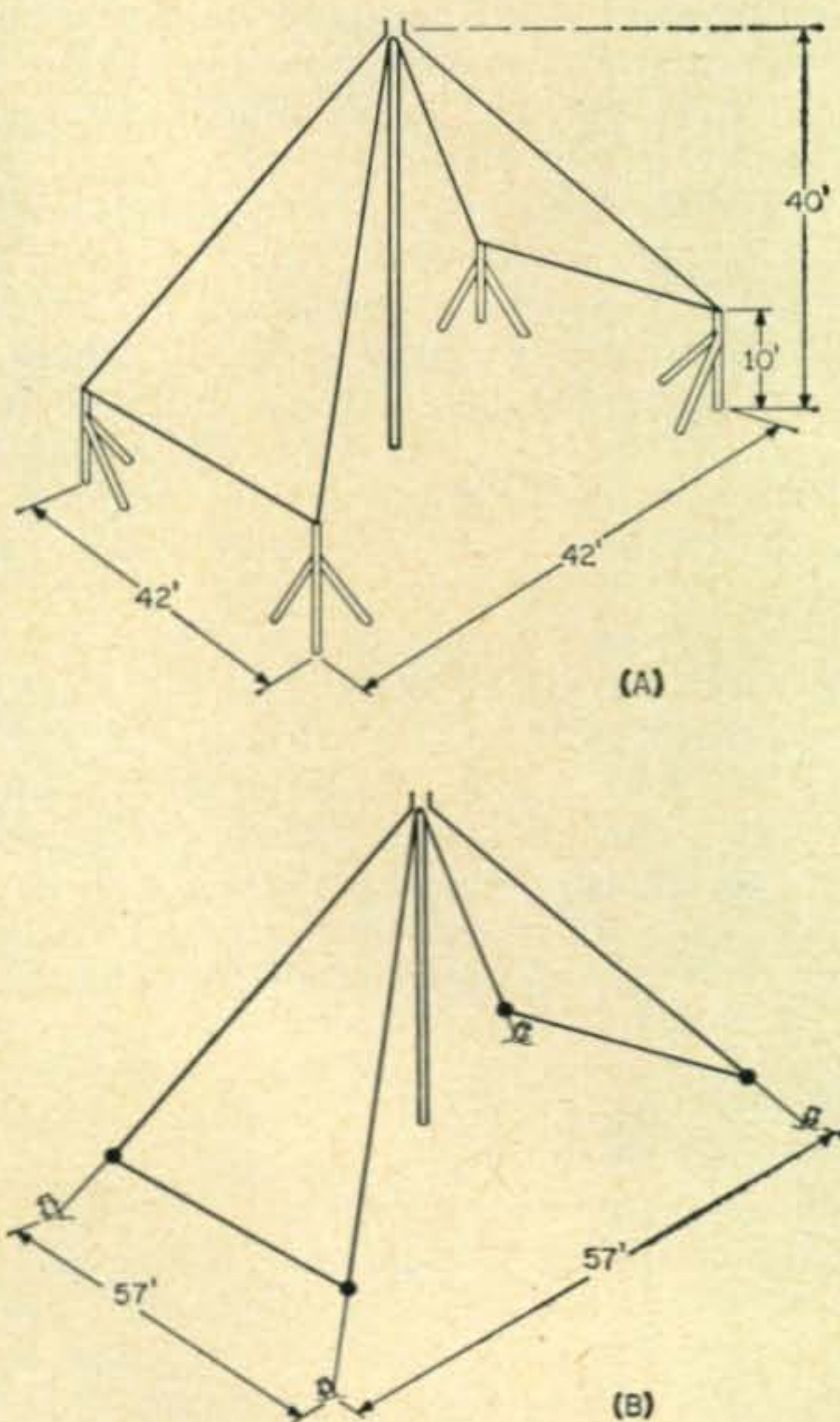

Fig. 3—Two alternate methods of anchoring the corners of the Pyramid. Method (A) would be more suitable for a small lot.



We next roll out the antenna wires in U-loops with the ends near the center pole and their bases in the directions where we planned the horizontal sections. Then we string two insulators on each leg of the loops, securing them in place with a couple of twists at 1 and 42 ft from the ends. Now we are ready to complete the top construction as shown in fig. 4. One set of wires is interconnected, the other set goes to the coax receptacle. Picking the right ends now will avoid a lot of headaches later on.

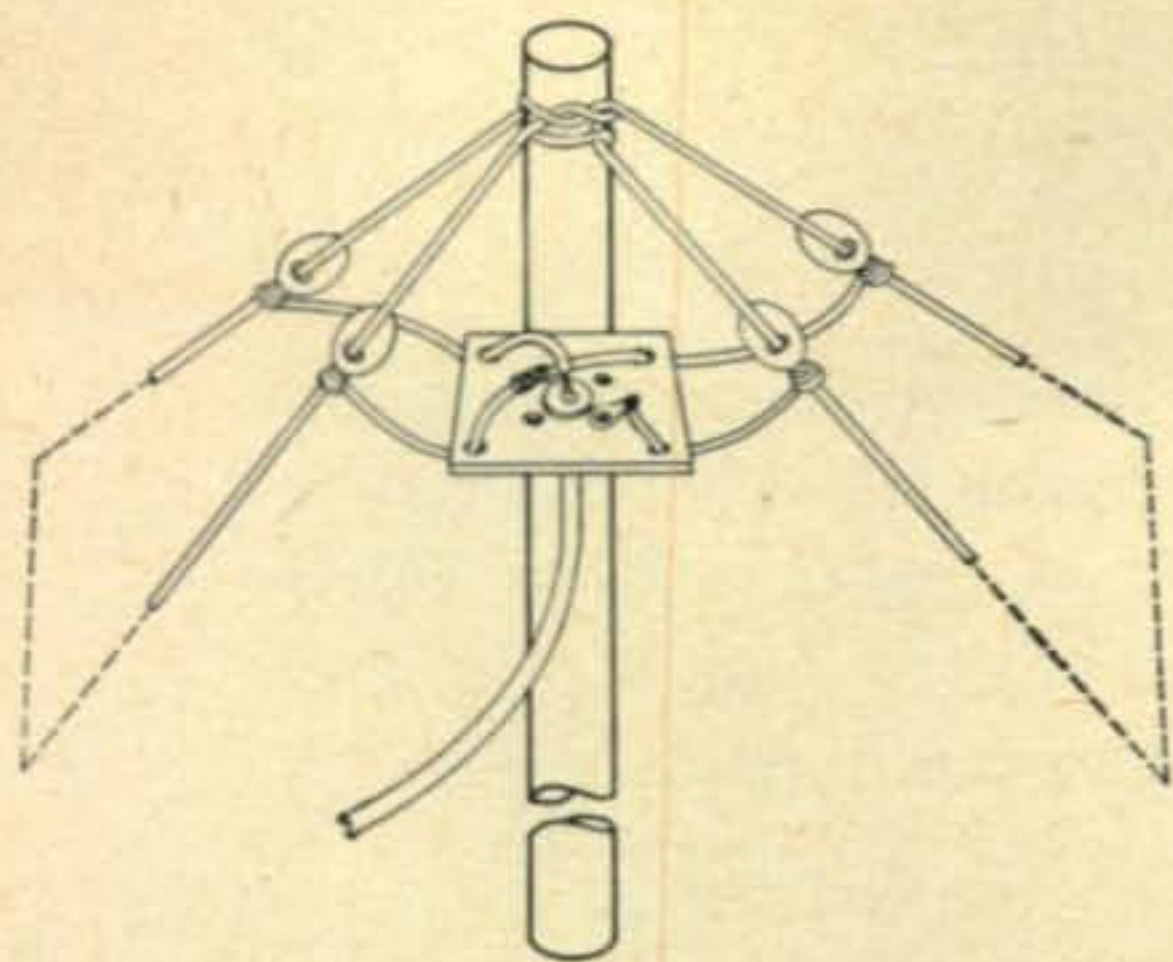

Fig. 4—Construction details of the Pyramid peak.

The way in which the top will be brought to the proper height and tied to the mast or tower depends on your facilities and is left to your ingenuity. To prevent the wires from becoming a tangled mess, the corner insulators should be tied to the corner posts with generous lengths of guyline before hoisting the top section in place. Make sure the antenna wires do not touch the mast or other antennas. Complete the construction by stretching the guylines and hooking on the coax cable.

Now check the resonant frequency with a grid dipper coupled to a coil of a few turns at the end of the coax cable. If the frequency is lower than 3900 kc we simply shorten the horizontal sections by cutting out a piece of each. A rule of thumb is 1½ feet per 50 kc. Too high a frequency can be corrected with single wire stubs connected to the centers of the horizontal sections, using the same rule of thumb. If we own an impedance bridge we may check the terminal impedance which should be in the range of 70 to 100 ohms. It can be measured at the end of the 83 foot coax cable which is a half-wave length at 3900 kc.

As the antenna is a symmetrical device the perfectionist might prefer a 1:1 ratio balun instead of the single coax cable described here.

As an extra we may throw in the spot frequency tuner, consisting of a line connecting the centers of the horizontal sections. For spot frequencies around 3900, 3700, 3500 and 3300 kc this line is broken by insulators at zero, 6, 13 and 21 feet from each end. Short tail ends, as shown in fig. 5, with

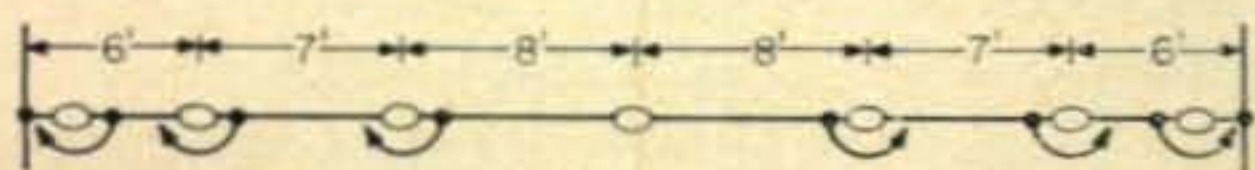

Fig. 5—A tuning stub line for 3900, 3700, 3500, and 3300 kc.

heavy duty alligator clips complete the job. If going outdoors on a wintry night to tune the antenna is considered incompatible with the American way of life, the real gadgeteer might come up with a remote control switching device for the stubs.

### Combination With Other Antennas

The problems encountered on 80 also pertain to 40, be it on a lesser degree. The Pyramid resonates on its second harmonic, but shows some undesirable characteristics. The horizontal sections will act as radiators and the terminal impedance will be very low. A workable solution is paralleling the Pyramid with an inverted V as shown schematically in fig. 6. To minimize interaction between

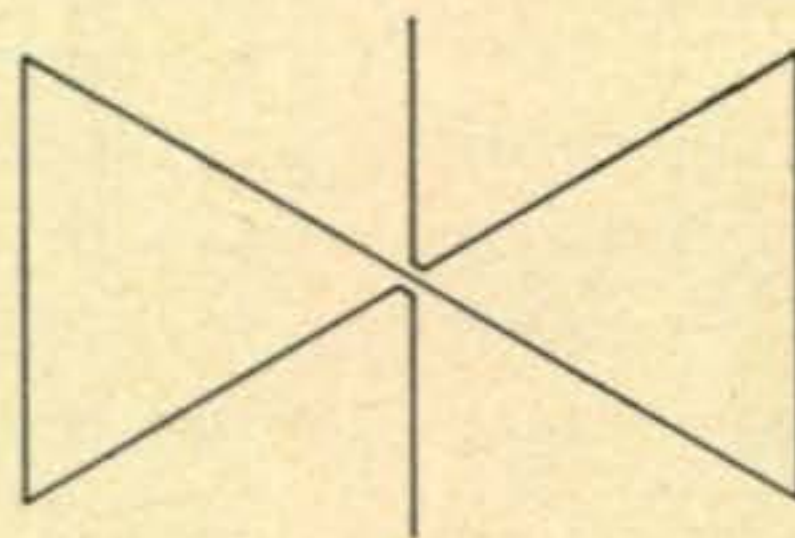

Fig. 6—A combined Pyramid and inverted V.

the two antennas the inverted V should run parallel to the horizontal sections of the Pyramid. Also, when operating the V, the Pyramid should be tuned to its highest frequency so that its second harmonic is well above 7 mc.

In constructing an inverted V for 40 the same procedure should be followed as described for the Pyramid, i.e. start out with 36 foot wires each side of the terminal, measure the resonant frequency and then readjust the length of the wires.

The terminal impedance of the inverted V is around 50 ohms, so that a 53 ohm coax line would be a good compromise for this antenna combination.

Combination with antennas for other bands is of course possible. During my experiments, successful results were obtained with a 4½ wavelength long inverted V for 20.

The added antenna might influence the resonant frequency of the Pyramid. It is advisable to run a check on that and readjust the wire length of the Pyramid if necessary.

### Results

The Pyramid has been in use at W8QEF for over six months. Invariably reports ranged from "edging over" to several S points better than a 30 foot high trap dipole at the same location. Only local stations in a direction through the "open" sides of the Pyramid reported slightly weaker signals.

During Field Day 1960 the Columbus Amateur Radio Association used a combination 75 meter Pyramid and 40 meter inverted V, resulting in a greater number of 75 phone contacts than on any previous Field Day. In this instance the Pyramid served as guywire system for a 40 ft steel mast that was topped by a 10 meter ground plane.

[Continued on page 121]



# The Gentleman's V.F.O.

OR

## How to key a Command Set and Stay Popular

Ed Marriner, W6BLZ

528 Colima Street  
La Jolla, California

By combining a vacuum tube keyer, time sequence keying and that often troublesome oscillator from the BC-458, the author has come up with a rather simple and good looking rig. A new front panel dresses up the unit, but even with it, the price of this exciter can be kept to a minimum.

**T**HE Command sets have always been notoriously bad actors when it comes to keying. Clicks, chirps, and drift are common, unless steps are taken to eliminate them. The conversion to be described, although quite extensive, can turn the inexpensive and easily obtainable ARC-5 transmitters into some of the best sounding exciters and transmitters on the air. This conversion may be the solution to the problem for many fellows desiring a stable and clean keying c.w. rig, although unable to afford one of the better commercial rigs.

### Description of the Exciter

The foundation of this unit is the BC-458 transmitter covering 5.3 to 7.0 mc, which is usually available locally for about \$10. Others of the ARC-5 series may be used with appropriate changes in the oscillator circuit. The completed transmitter consists of the original v.f.o. unit, (a 6J5 replacing the 1626), a 6AC7 driver-multiplier and a single 807 final amplifier-multiplier.

The v.f.o. is altered to give 7 mc output by readjusting the trimmer capacitor and coil slug in the oscillator coil enclosure. For 40 and 15 meter output, the 6AC7 functions as an untuned straight-through amplifier with  $RFC_1$  as a plate load, while on 20 and 10 meters it doubles from 7 to 14 mc,  $L_4$  and  $C_{12}$  being switched in by  $S_1$ . The 807 final operates straight-through on 40 and 20 meters, triples on 15 meters and doubles on 10 meters. Although this is not the most efficient system, bear in mind that the conversion is designed primarily to provide a low power exciter for a power amplifier and its use as an output device is only incidental.

Capacitor  $C_3$  (shown dotted, in fig. 1) represents the stray capacity of the  $L_4$  winding. A grid dip oscillator may be used to determine

Front view of the converted Command Transmitter, complete with new front panel and repainted v.f.o. dial, calibrated for 20 meters. The pilot light is not shown on the circuit diagram. Capacitor  $C_4$  (next to the antenna jack) is calibrated for 20 meters, for quick tune-up. Below  $C_4$  is the link coupling control. Above the pilot light is bandswitch  $S_3$ . At the lower left is switch  $S_2$  and at the lower right is the v.f.o. tuning capacitor,  $C_2$ .

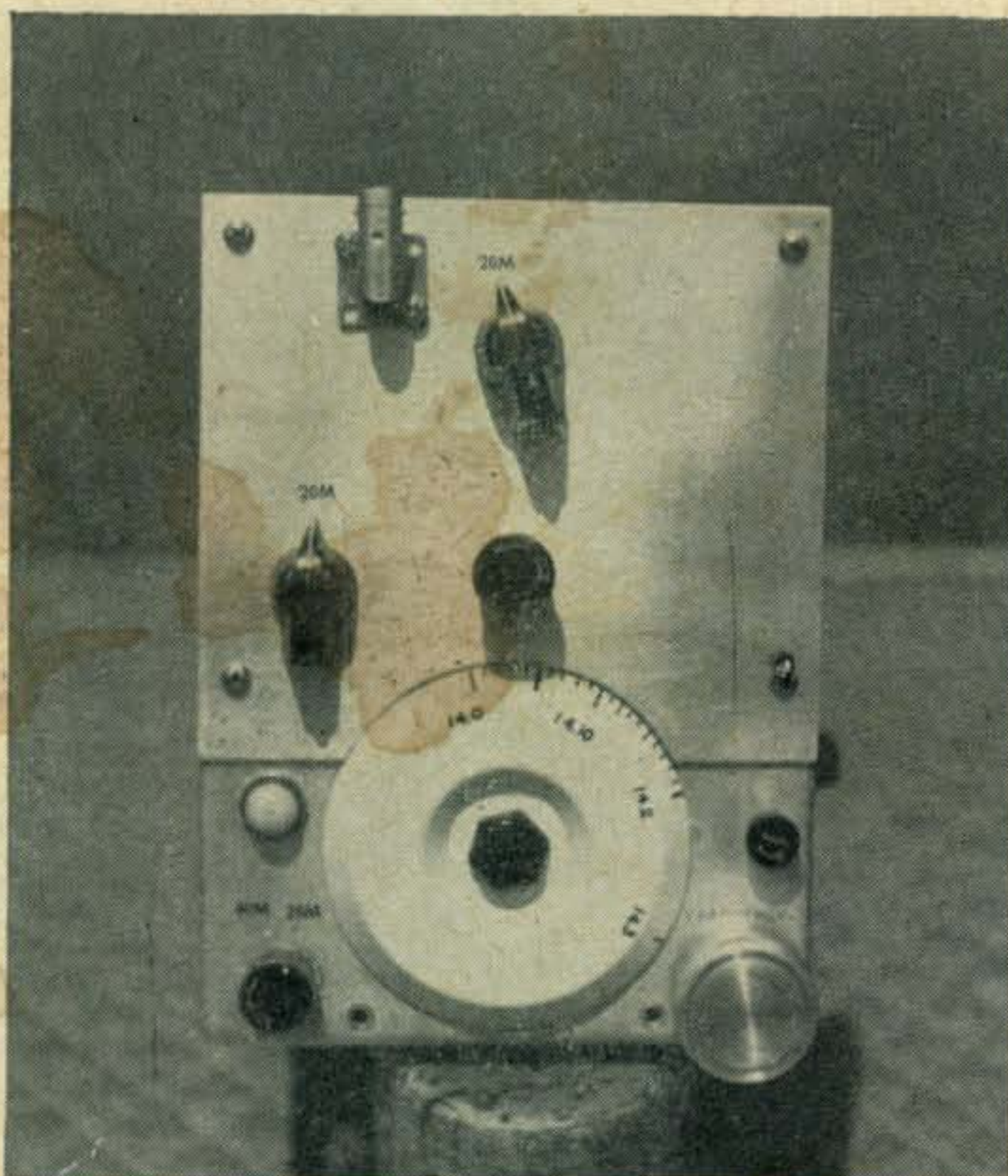







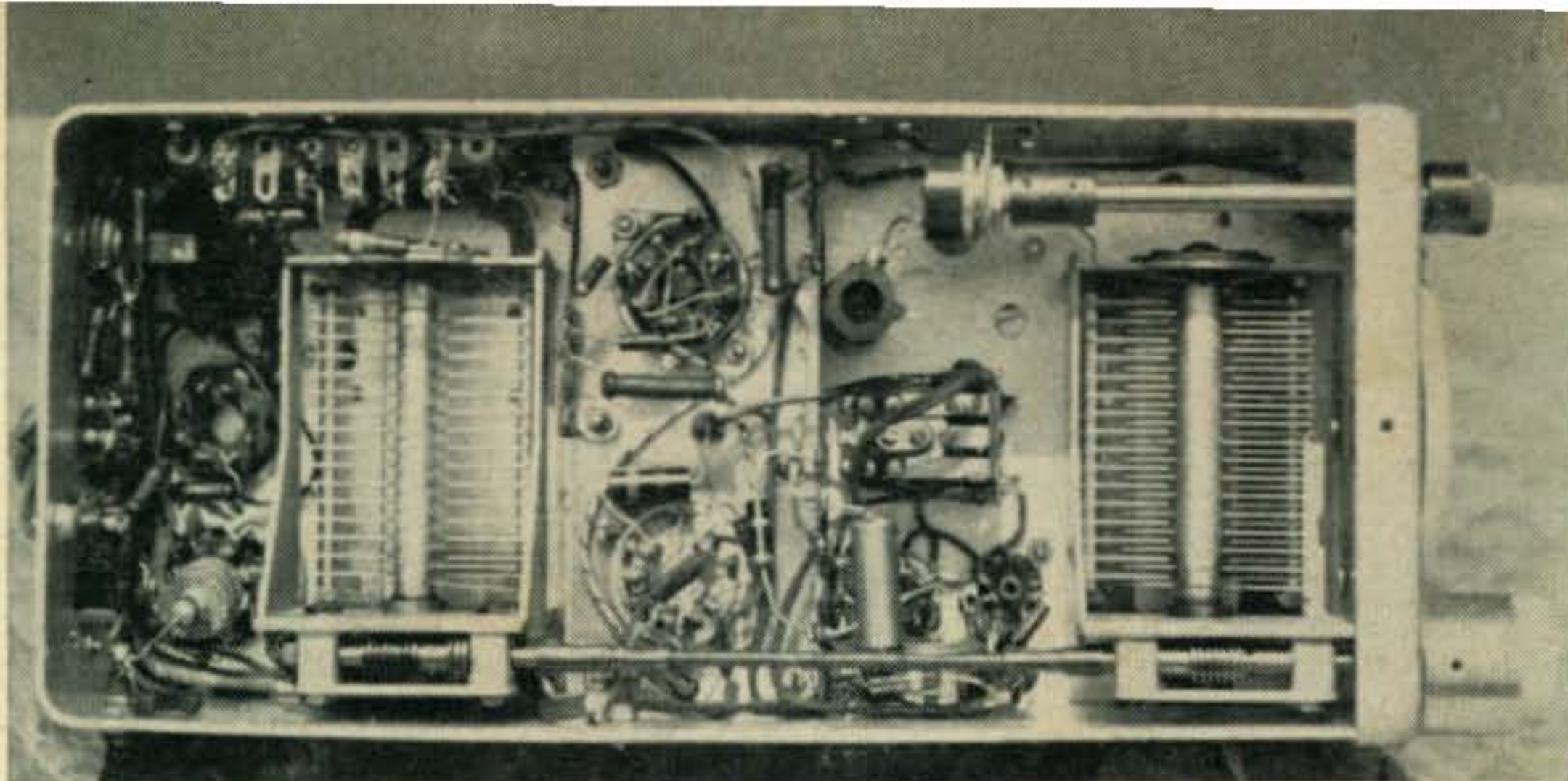

Under-chassis view of the converted BC-458. Only three plates remain in the variable capacitor at the left. The variable capacitor on the right is not used except to mount the v.f.o. dial mechanism. Key jack, power plug and auxiliary contacts for receiver muting are mounted on the rear apron. The 12AX7 and 0A2 regulator are mounted below the relay. Switch  $S_2$  is controlled by the knob at the upper right.

### Preparation of the ARC-5 Chassis

The ARC-5 chassis must be stripped of all original circuitry except the oscillator, before actual re-construction begins. The 1625 sockets and supports are removed and merely replaced with an aluminum plate punched to accommodate the 6BX7 and 807 sockets. The plate is sub-mounted below the chassis on 1" metal spacers to provide clearance for the 807 final above chassis. The 6AC7 mounts in the socket formerly occupied by the magic eye tube on the rear deck.

Of the three original variable capacitors, only one is used in the converted unit. This capacitor,  $C_2$  the oscillator tuning capacitor, is connected to the dial mechanism through a second capacitor which is used only to provide mechanical coupling to the dial.

All controls and dial locks are removed from the front panel with the following exceptions: v.f.o. frequency control, its associated dial lock and the v.f.o. dial. A new partial front panel is cut as shown in the photograph or, if desired, a complete panel may be used for the sake of improved appearance.

With the roller coil removed, the gear mechanism driving the variable antenna coupling link can be removed and replaced with a shaft extending directly through the new front panel. This link coupling control will then be centered on the panel. A single section, 4 position ceramic rotary switch is mounted on an L bracket and positioned so as to have the shaft protrude through the original coupling control hole. Plate tuning capacitor  $C_1$  is mounted above the link coupling control while r.f. output connector  $J_2$  (UG-1098/U) is to the left.

Sockets for  $V_5$  and the 0A2 regulator are then mounted in line, in front of the 807 socket.

Below the chassis, switch  $S_2$  is mounted on another L bracket on the left wall of the chassis while its associated inductor,  $L_4$ , wound on a National XR-50 form, is located to the rear. Relay  $K_1$  is centered between  $L_4$  and  $V_5$ . On the rear apron, the ARC-5 power plug may be replaced with a standard male power connector. Key jack  $J_3$  and receiver muting connector  $P_2$

are mounted, as shown in the photo, on either side of the power connector. The chassis is now ready for wiring.

### Wiring

Wiring of the unit is straight-forward and no difficulty should be encountered if normal good wiring practices are followed. It should be noted, however, that the cathode of the 807 *must* be well bypassed or the final may not cut-off properly under key-up conditions.

Notice that the terminals of the v.f.o. coil compartment are numbered from 1 through 8 from the rear. Not all the terminals are necessary in the finished unit so no connections should be made to terminals 1, 6 or 7.

For the sake of TVI reduction, all power plug connections are bypassed with .001 mmf discs before leaving the chassis and all filaments should be bypassed at the tube sockets with .005 mmf discs to minimize any oscillator instability.

### Adjustment

The oscillator must first be made to operate in the 7 mc region. To accomplish this and to provide more bandspread, all rotor plates, except the last three, are removed from the oscillator tuning capacitor. This will leave two complete rotor plates and one notched plate, the purpose of which is to provide a fine tracking adjustment and therefore permit nearly linear dial calibration.

With voltages applied and a calibrated receiver tuned to 7.0 mc, adjust  $C_1$  and  $L_2$  (both accessible at the top of the v.f.o. coil can) until the oscillator signal is heard. These adjustments are made with the oscillator tuning capacitor in the low frequency or fully meshed position. Some juggling of the  $C_1$  and  $L_2$  settings may be necessary to achieve the desired bandspread and calibration. A dial coverage of 500 kc is good if 10 meter operation is contemplated.

Inductor  $L_4$  and capacitor  $C_3$  may be tuned to approximately 14 mc with a grid dip meter, while final tank  $L_5C_4$  should also be checked for resonance at their proper frequencies (7, 14, 21 or 28 mc, depending upon the position of



Top view showing tube placement and parts location. At the left, the 6J5 appears in the foreground with the 6AC7 to the rear. The 6BX7 keyer tube is installed in the hole previously occupied by the 1625. Both the 12AX7 and the 0A2 are hidden by the tank inductor,  $L_5$ .

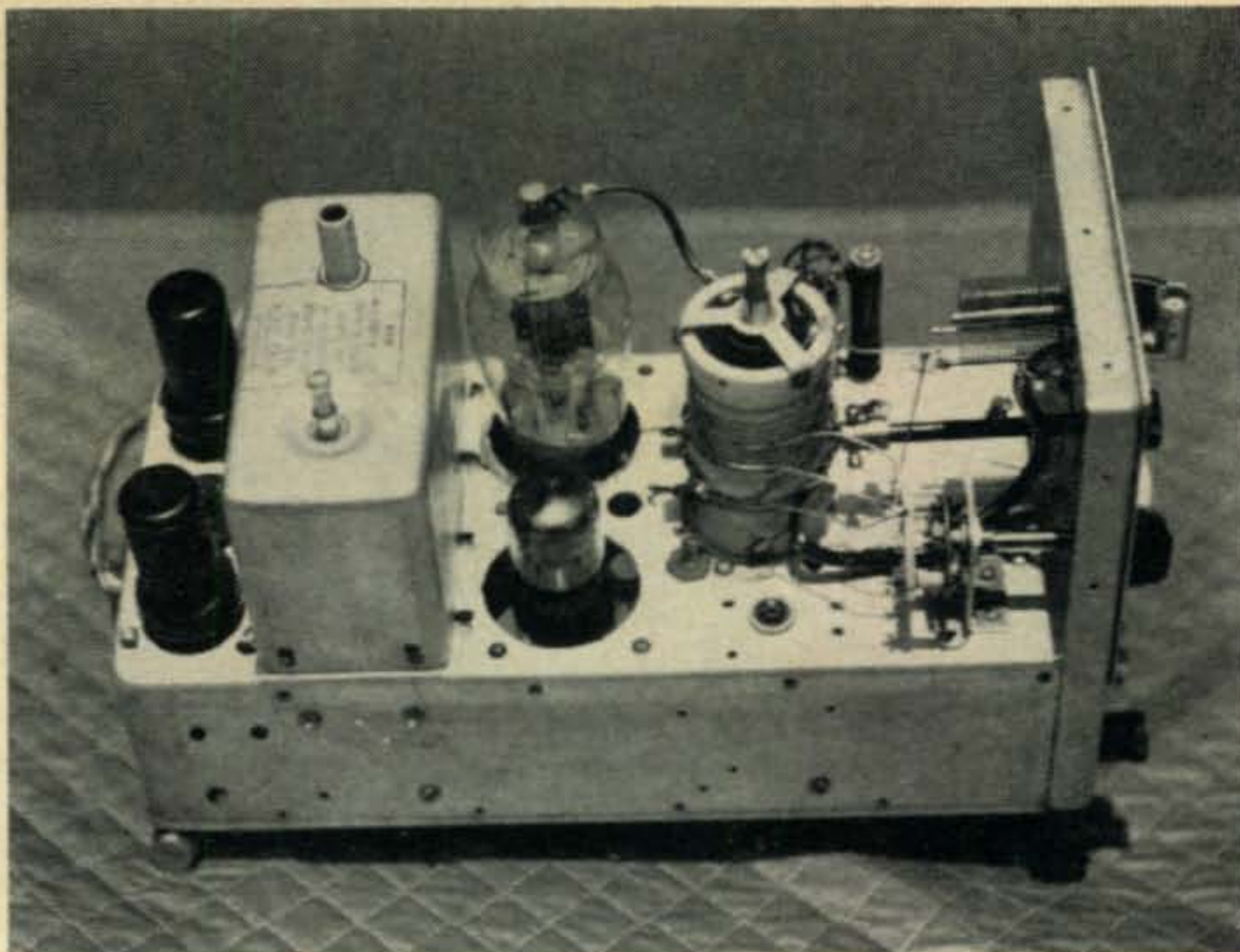

$S_3$ . With voltages applied, and relay  $K_1$  held closed, the exciter may be tuned up in a conventional manner if the 807 cathode is temporarily grounded through a 0-100 milliammeter. The keyer may now be adjusted. With the transmitter in operation, (this time with the keyer functioning) adjust the value of  $C_5$  slightly, until the keying is soft and pleasing. Relay  $K_1$  should close when the key is depressed and  $R_1$  should be adjusted to give the desired release time. Should it be impossible to get a delay from the relay,  $C_6$  may be adjusted to about 1 mf and if this too fails, the voltage at the junction of  $R_2$  and  $R_3$  should be checked. This voltage should be between 7 and 20 volts and may be varied by varying the values of  $R_3$  and  $R_4$ .

The release delay should be adjustable from zero to several seconds throughout the range of  $R_1$ .

### Operation

Tuneup and operation are simple and straightforward as described above. The receiver muting system, however, deserves mention. Many commercial receivers have provision for an external r.f. gain control, to be switched in to reduce the r.f. gain to a tolerable level on transmit. This feature is easily added to most receivers simply by inserting a terminal strip in series with the ground side of the r.f. gain control. In receive,  $R_5$  is shorted out by relay  $K_1$ , thus providing full r.f. gain to the receiver. During transmit,  $R_5$  is unshorted and inserted in series with the receiver r.f. gain control, thus limiting the gain to a reasonable value. Resistor  $R_5$  should be set to give a comfortable monitoring level during transmit. A third set of contacts on  $K_1$  may be used to operate an antenna relay if an electronic T-R switch is not used.

### Variations

Should it be desired to operate the converted unit as a transmitter, increased plate voltage may be applied to the 807. Some changes will have to be made, however, because of the sub-

sequent increase in plate current. The 6BX7 keyer tube is adequate only for plate currents up to about 80 ma. If higher power operation is contemplated, the heavier current carrying capacity 6AS7 should be substituted. Higher grid voltage will be needed for the 6AS7 since it cuts off at about—200 volts as compared to—60 volts for the 6BX7. Resistors  $R_6$  and  $R_7$  will not be needed with the 6AS7 since their purpose is only to suppress oscillations in the 6BX7.

Some sharp eyed readers will probably note that the 6X4 bias rectifier is operated above its rated filament-cathode voltage. No trouble has been encountered, though, (a 33K resistor taking up the voltage surges) but if the builder is the cautious type, the 6X4 may be replaced with a 5Y3 (using a separate 5 volt transformer winding) or better still, a silicon diode.

So there you have it. Simple? Well, maybe not; but very worthwhile. Good luck and best of keying! ■



"And the neighbors awarded me this one."



# Sawtooth Sweep For Modulation Monitor Scope

Vernon Trexler, W5IUR

2459A 45th

Los Alamos, New Mexico

*The deflection sensitivity of the small scope is such that large sweep voltage are required. This then requires a sweep oscillator and amplifier. The author suggests a circuit using a single thyratron that will provide linear sweep at 30 cycles with up to 450 volts peak to peak output.*

Many amateurs have constructed small monitor scopes that have a 60 cycle sine wave sweep for the horizontal. For observations of a.m. signals this system leaves much to be desired. The results are poor for s.s.b. These scopes can be greatly improved if a sawtooth waveform of about 30 cycles is applied to the horizontal sweep.

Investigating the requirements for such a sweep, I found that at least two tubes and sometimes more were used for generation and amplification of the sawtooth sweep. Not wanting to go to such extremes, I decided that one tube could do the job very well.

## Oscillator Circuit

A circuit was evolved that used a thyratron which is a gaseous tube that is either in a non-conducting or a full-conducting state, with a grid to control the action. The circuit is shown in fig. 1. This tube is used as a switch across a capacitor to discharge it for return portion of the sweep (short portion of the sawtooth), and a resistor in series with the capacitor to charge

the capacitor from the voltage source to generate the long portion of the sweep.

The sweep frequency is determined by the plate resistor and the capacitor to ground and the 2500 ohm potentiometer in the cathode circuit. The power supply voltage must be at least 500 volts to generate a good wave form. The chart given shows what current drain to expect at a given input voltage and the output amplitude to expect for a given voltage input.

The amplitude necessary for a particular scope will determine the minimum input voltage. To find this amplitude, consult the tube tables which give the necessary d.c. voltage for deflection of your scope along with its acceleration voltage. This d.c. voltage is directly proportional to the peak to peak voltage of the sawtooth waveform. For instance a 2AP1A with 500 volts acceleration requires a d.c. deflection voltage of 115 volts d.c. per inch, so the tube would require 230 volts for full deflection. You would need at least 230 volts of peak to peak sawtooth waveform which, as shown in the table, would require about 850 volts input to the thyratron at an operating current of 2 ma and a maximum current of 2.96 ma.

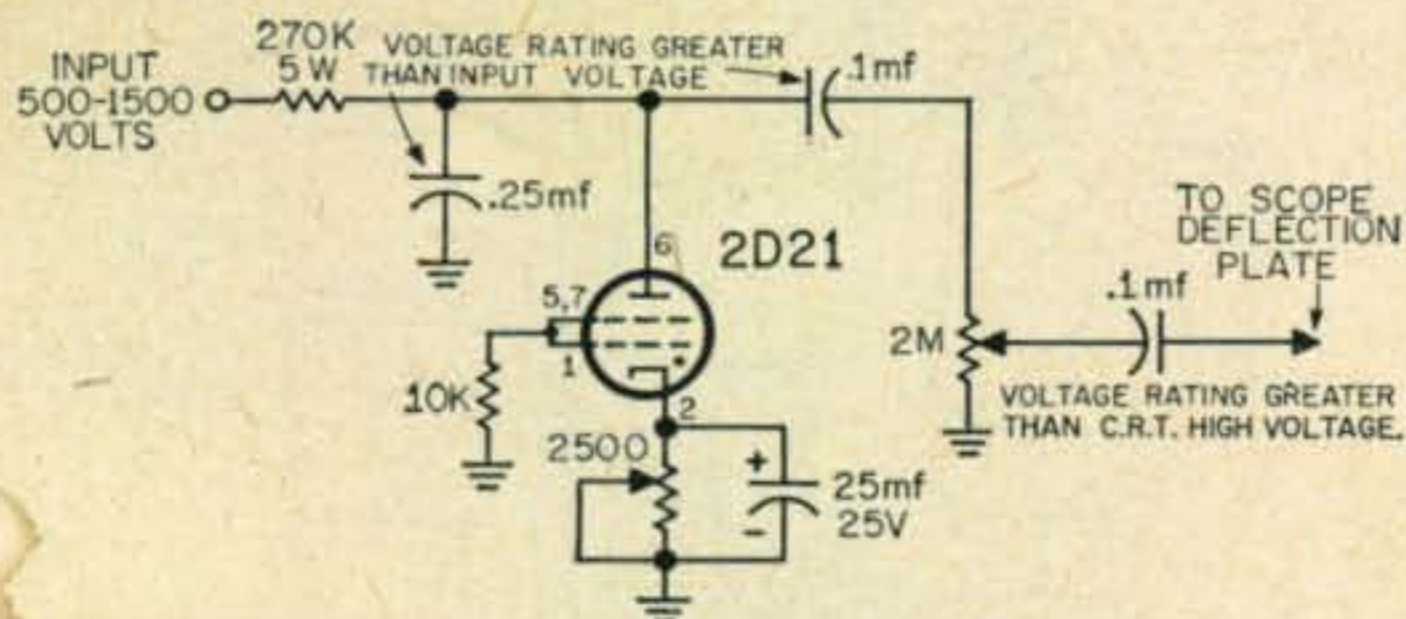

Fig. 1—A thirty cycle thyratron sawtooth generator circuit.

Voltage In	Peak to Peak Voltage Output	Operating Current—Ma.	Max. Current—Ma.
500	150	1.2	1.85
800	250	2	2.96
1000	320	2	3.7
1200	400	2.8	4.5
1500	450	3.6	5.6



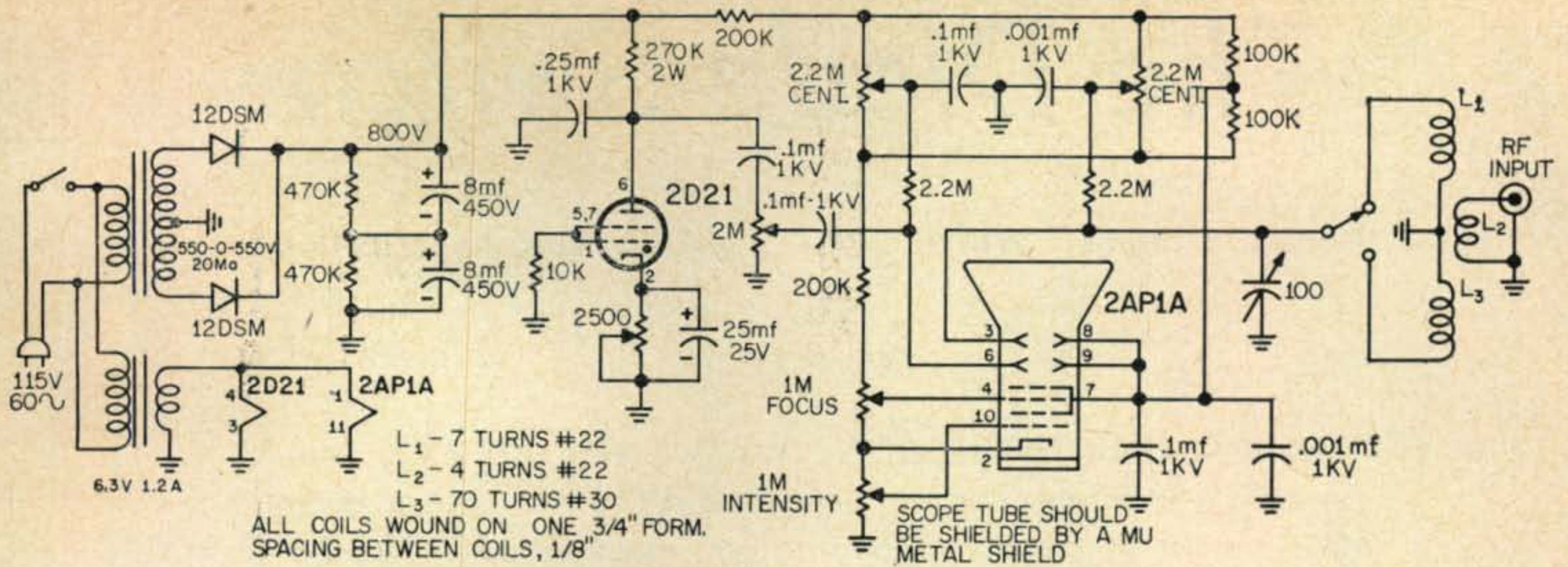

Fig. 2—An a.m. s.s.b. modulation monitor employing the thyatron sweep circuit.

If you desire to build a complete monitoring scope a good circuit is shown in fig. 2.

### Coupling Capacitors

If you modify your old scope, be sure the coupling and bypass capacitors are large enough to pass the 30 cycle sawtooth or else you will have a distorted waveform.

The coupling capacitors to the scope should have a voltage rating equal to the acceleration voltage of the scope. The capacitor from plate of the 2D21 to ground must have a voltage rating equal to the power supply voltage applied to the 2D21. The coupling capacitor to the potentiometer from the 2D21 should have this same voltage rating.

### Adjustment and Operation

To adjust the sawtooth to 30 cycles, a 60 cycle voltage of variable amplitude can be temporarily injected into the vertical plates of the scope and the amplitude adjusted to give a reasonable deflection on the face of the tube. The 2500 ohm pot is then adjusted for a two cycle sweep across the face of the tube.

In operation the horizontal sweep is set to just cover the face of the tube. Normally the cathode resistor would be attached to a resistor to the B+ when using a thyatron, however in this case the cathode bypass capacitor holds a charge from one waveform to the next. ■

## Utilizing Small Pin Crystals

Antonio Gelineau, W4LEQ

425 Falcon Avenue  
Miami Springs 66, Florida

Many amateurs have acquired, through various means, crystals mounted in sealed containers with small diameter pin connectors (International Z-9)

How to insert them in the standard crystal or octal sockets has often been a problem. It is especially so when you own commercial equipment which you would rather not modify. It would seem more logical to modify the crystal holder.

One method of modifying the crystal is to attach pins from a discarded octal socket as shown in the photograph. Clean the crystal pins and tin them

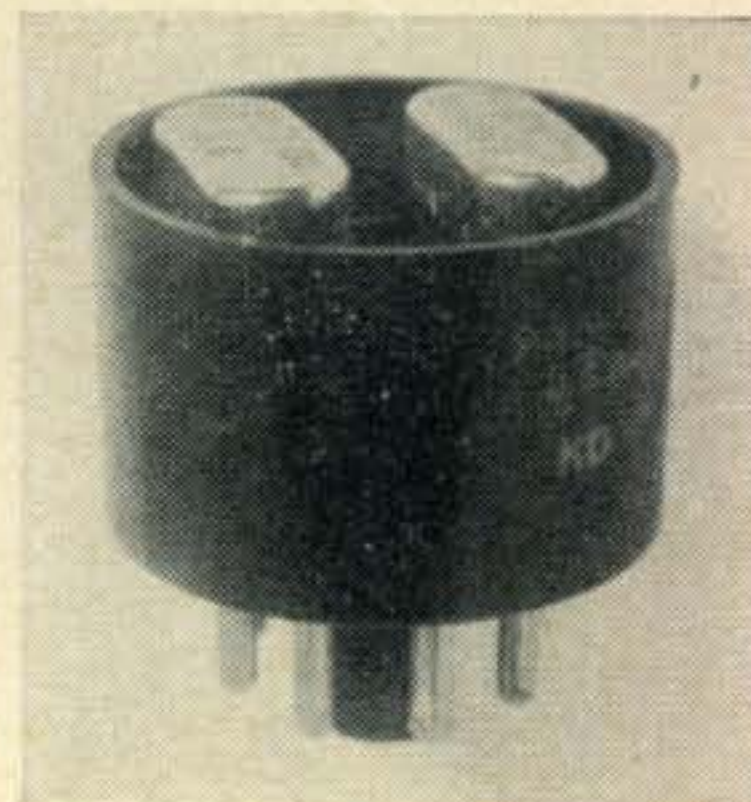

Pair mounting of hermetically sealed crystals to fit standard octal sockets.

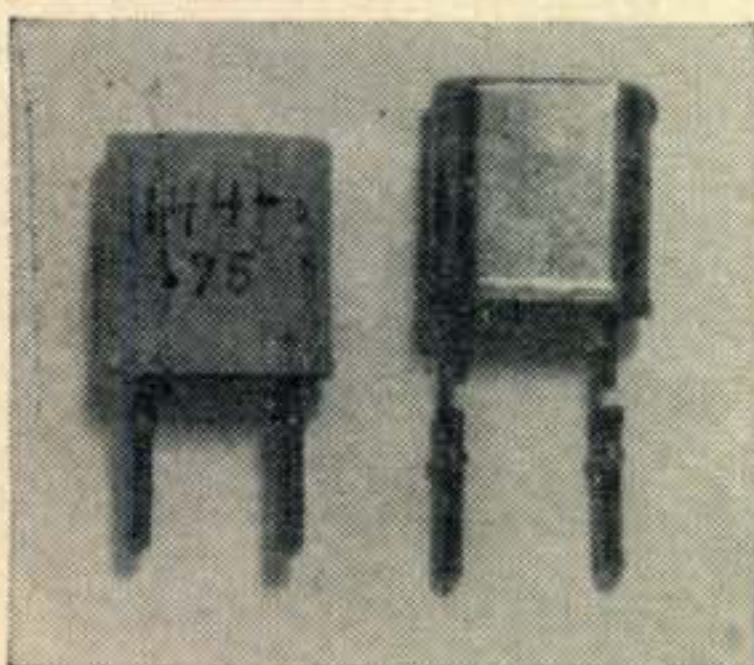

Modifying small pin crystal holders for use in standard crystal sockets.

quickly without overheating them. Mount the tube pins and solder them.

A second method of modifying the crystals is "Pair Mounting" as shown in the photograph. The crystals' pins must be bent slightly in order to align them with the proper tube base pins and then are pressed into position.

Several pairs may be similarly mounted for net frequencies, step frequencies and so on. ■



# The Diode Switch

Donald L. Stoner, W6TNS

P.O. Box 137  
Ontario, California

L. A. Earnshaw, ZL1AAX

P.O. Box 51  
Warkworth, New Zealand

*The techniques described by W6TNS and ZL1AAX should be of great interest to all amateurs. Why not adapt proven diode switching circuits to amateur applications? The basic principles and techniques are provided herein by the authors.*

The technique to be described is one which should be of vital interest to amateurs and experimenters, particularly the "roll your own" artists.

Diode switching systems are widely used in electronic circuits. Probably the most noteworthy application is the computer. Television stations also use the diode for reliable and transient-free switching of video signals.

Few hams are interested in these aspects of the electronics industry but we believe you will be quite amazed to learn how semiconductors may be applied to signal switching in amateur communications equipment.

## A Switch With No Moving Parts

From semiconductor theory, we know that a diode biased in the forward direction becomes a conductor. As such, it may be used to conduct current from one point to another. What happens, though, when an a.c. signal is impressed on the current? When the diode is conducting, an a.c. signal may be passed in either direction through the diode, just as if it were a piece of solid wire. As long as the alternating voltage does not exceed the bias applied to the diode, the a.c. will not be rectified.

If the same diode is reverse biased, it becomes an insulator and can no longer be used as a conductor. Thus, the diode has two states; (a) it will pass a current (a.c. or d.c.) and (b) it will stop current flow (a.c. or d.c.). The diode is therefore a switch which may be operated in the ON position or the OFF position simply by changing the bias from forward to reverse.

It still takes a switch, you say. Certainly, but consider this—Let's say you want to switch a transceiver from one function to the other. How many contacts does it take? It varies, of course, but a unit as complicated as the KWM-1 takes approximately 20 switch sections. By using diodes, everyone of these circuits could be

switched with only one single pole, double throw contact! Even more important, the possibility of trouble due to dirty contacts is reduced by a factor of 20 to 1.

The diode switch may be remotely operated at any distance. Diode switches may take over a number of operations presently the prerogative of the relay, and in many cases do a better job of it. Having no moving parts, the diode switch lends itself to use in places where access is difficult or in situations where relays would be affected by dirt and dust.

It should be pointed out that diode switches may have a number of disadvantages. A diode that has a low forward resistance may exhibit a large capacity when reverse biased (off condition). This capacity will allow leak-through of signal. By the same token, a diode of very low internal capacity may have a large forward resistance and limited current handling capacity.

## A Practical SPST Switch

Consider the circuit, fig. 1. Here we have a diode connecting an antenna to our receiver. When the switch is at (a), the diode is biased forward and the signal from the antenna is allowed to reach the receiver. When the switch is moved to (b), the diode is reverse biased and will no longer conduct. Excessive d.c. through the diode is avoided by the resistors  $R_1$  and  $R_2$ , which also prevent the signal from being

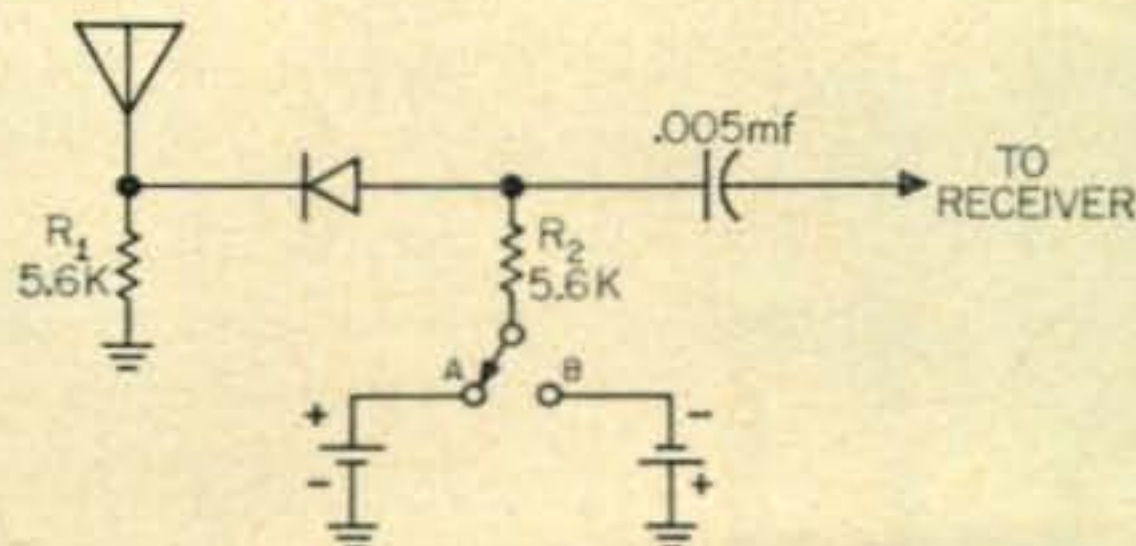

Fig. 1—Any diode may be used as a switch. It is on when the switch arm is at (A) and at (B) it is off.



grounded through the bias supply. The voltage across the diode will be small; less than 0.5 volts with the average receiving-type diode.

Various diodes were tried in this circuit and some worked better than others. In some cases it was necessary to parallel two diodes to lower the forward resistance to a point where the signal was not attenuated.

### Push-Pull Switch

Leakthrough of reverse biased diodes may be overcome by using a push-pull switch configuration as shown in fig. 2. This is a video switcher,

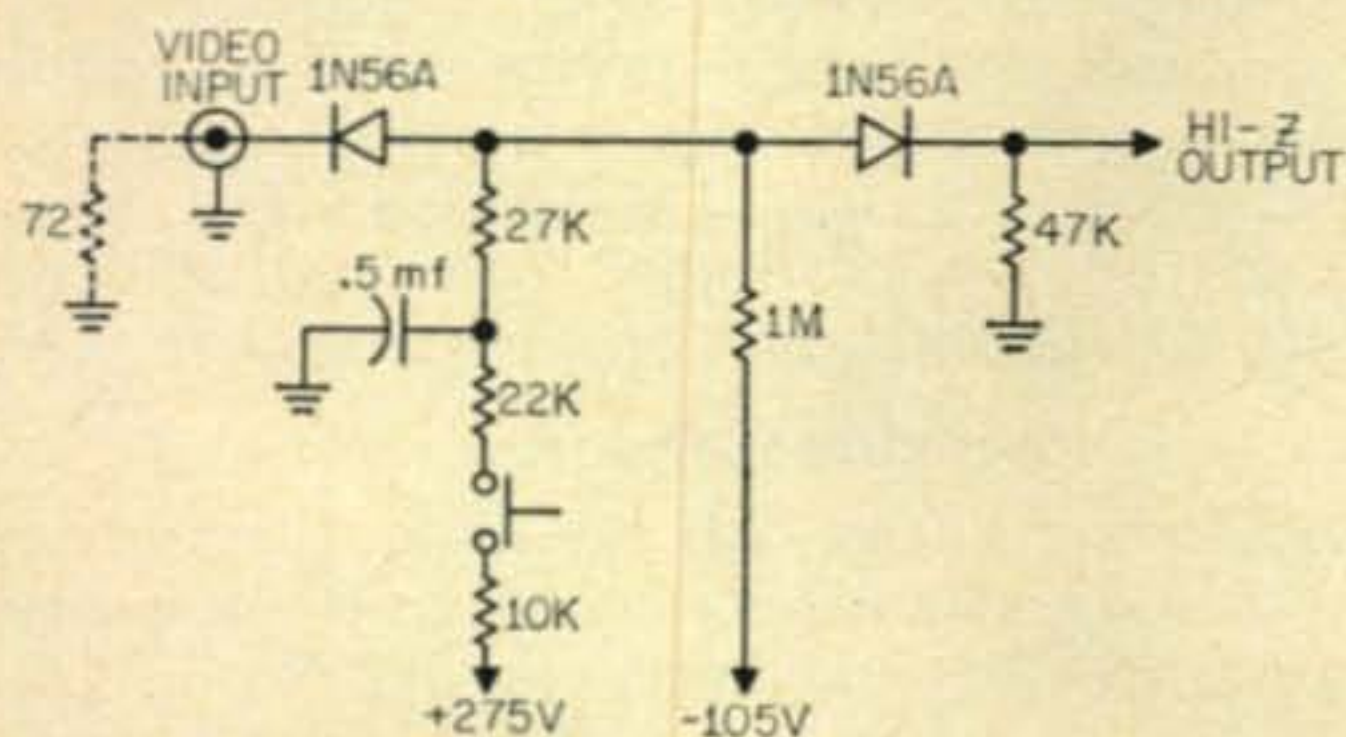

Fig. 2—Two back-to-back diodes will reduce the feedthrough capacity.

commonly used in television stations. Here, two diodes are connected anode-to-anode. When the push button is open, the minus 105 volt supply biases both diodes in the reverse direction, providing complete isolation between the 72 ohm input and hi Z output. Depressing the button applies the positive bias supply to the diodes through current limiting resistors. Since this voltage is higher, and the series resistors smaller, the positive bias voltage prevails and the diodes conduct heavily, passing the signal.

### A Practical SPDT Switch

Diode switch sections may be ganged to one switch if required. Figure 3 shows the circuit of a practical s.p.d.t. switch. This system may be used to remotely select one of two receiving antennas.

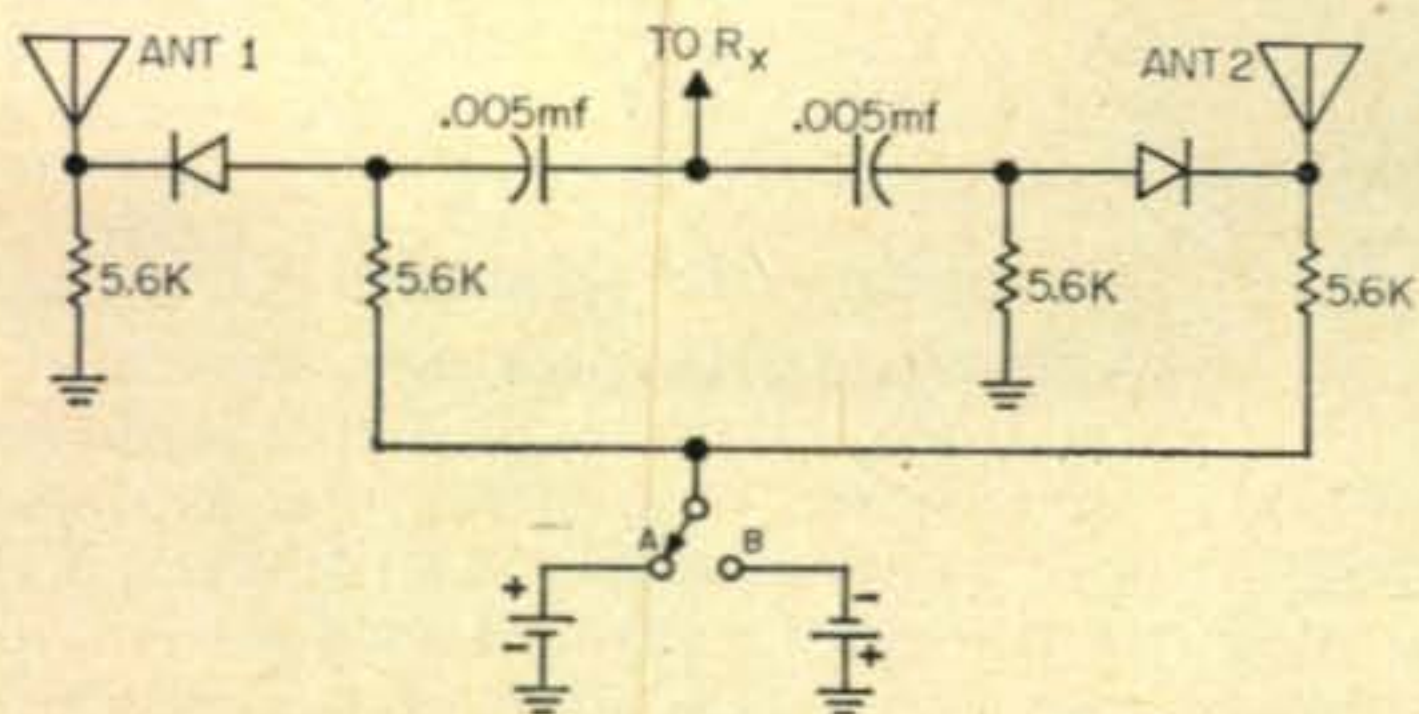

Fig. 3—A SPDT diode switch. Diode sections may be ganged together giving any desired combination of switching.

### Switching High Power

When the signal voltage being switched is very small, even a tiny d.c. bias may be large in comparison. In fig. 3, for example, there is little danger of the signal being rectified. A fraction of a volt of forward bias will still be greater in

amplitude than the signal being received. An analysis is made of the situation when larger power is handled by the diode switch, such as when a diode is connected between an amateur transmitter and an antenna.

In fig. 4, resistance  $R_d$  represents the d.c. resistance of the diode and  $R_L$  is the resistance of the load. If the diode resistance is low and the load resistance is high, the voltage drop across  $R_d$  will be small and the drop across  $R_L$  high. The current that flows through  $R_d$  will also flow through  $R_L$ . Thus it is desirable to keep  $R_d$  very small, for the power consumed by this resistance is wasted power. As the signal voltage drop across  $R_d$  is low, the forward bias voltage may also be low. These points are well worth remembering because they explain some of the reasons why the diode switch may not be satisfactory in certain applications.

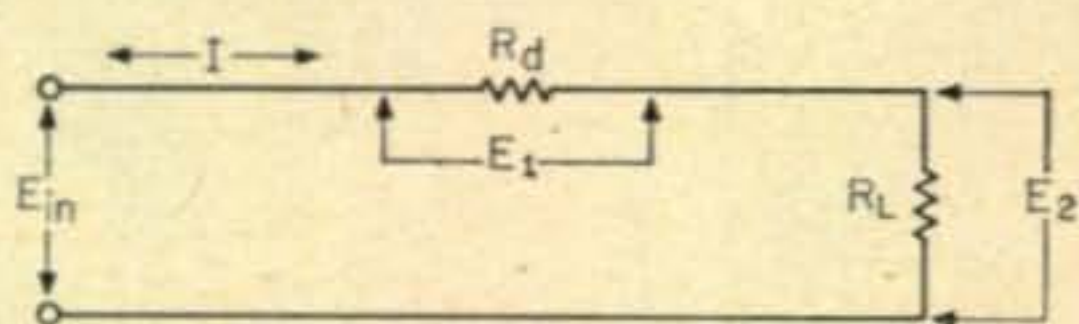

Fig. 4—An equivalent circuit showing that when the diode resistance is low, and the load resistance high, the voltage across  $R_d$  is small

### Solid-State Antenna Relay

A number of amateurs have at one time or another used an electronic TR switch. Almost an equal number have thrown them in the trash can and have gone back to the antenna relay. Why? Let's discuss electronic TR switches and find out.

One type of TR switch leaves the antenna connected to the transmitter tank circuit through an isolating tube and a small coupling capacitor. This is an excellent type of TR switch, but has two serious faults. The tank coil must be tuned to the same band as the receiver (and who doesn't want to scan the other bands?). Even more important, the final generates noises which are fed into the receiver, effectively masking weak signals.

A less desirable TR switch leaves the antenna connected to the transmitter. The receiver is connected to the transmission line through an isolating tube which biases itself off during transmit periods. This TR switch has the following faults: (a) the transmitter tank circuit "sucks-out" the signal from the receiver, causing up to 20 db of signal loss. Even an amplifier will not make up this loss for the signal to noise ratio has been degraded. As before, the final noise is fed directly to the receiver. The many other systems using neon tubes, spark gaps, etc. do not warrant discussion for they are more effective as TVI generators than they are as TR switches!

It may be argued that the disadvantages of the two systems may be overcome by juggling transmission line lengths and biasing off the final amplifier. The authors concede the point without firing a shot, but hasten to point out a system which is superior to any!



If, in the second system discussed, we broke the lead to the transmitter during *receive* periods, it would be possible to overcome all the objections listed. The tank circuit would no longer be able to "suck-out" signal and the final would not be able to feed noise to the receiver.

A practical, working circuit, is shown in fig. 5. In the experimental unit constructed, an RCA silicon power diode (type 1N1763) was used as the switch. This does not imply that these diodes are optimum (higher current types would be superior, as we shall point out later) but they were handy and were pressed into service.

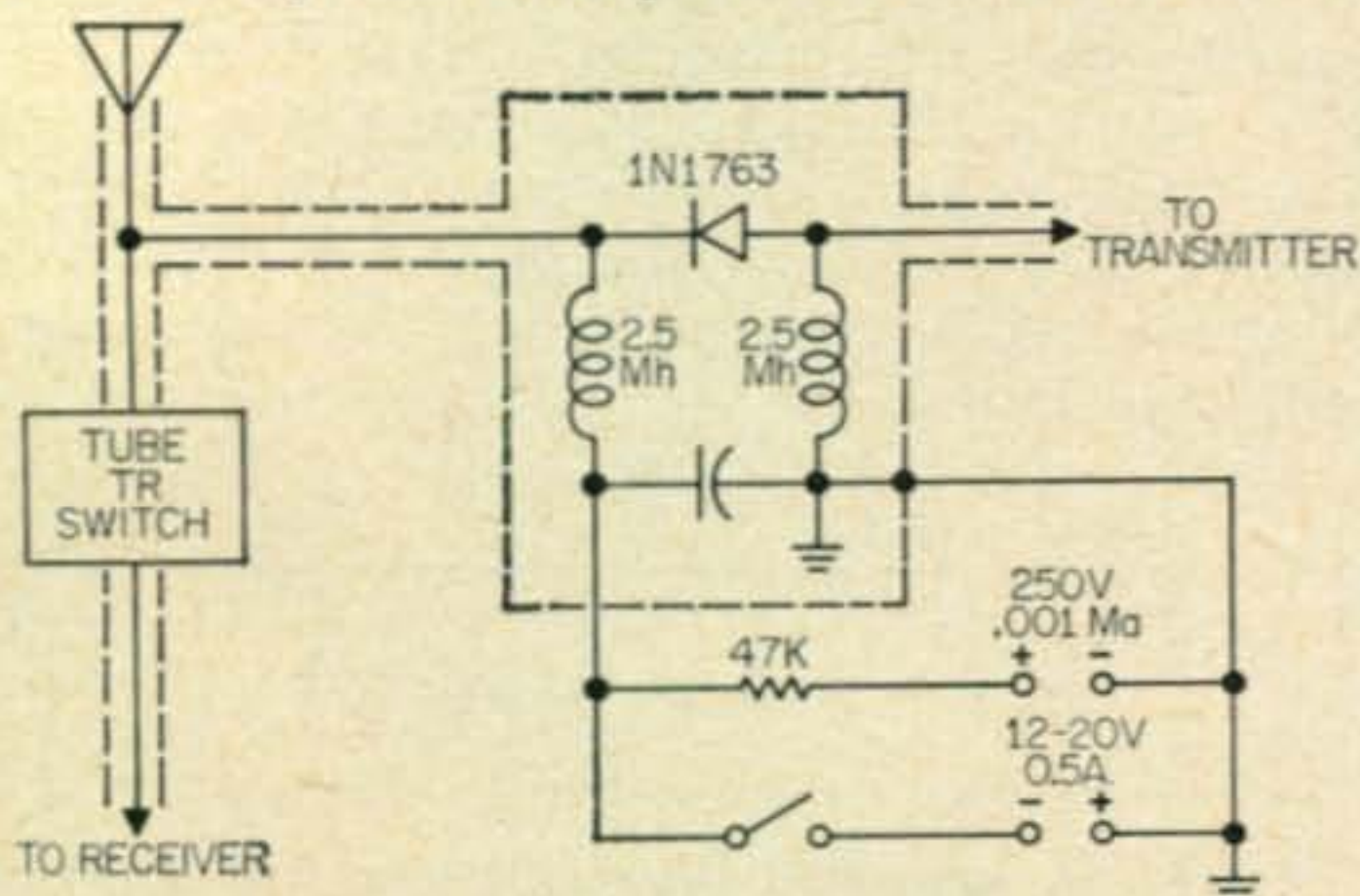

Fig. 5—A power diode may be used to make or break the connection from the antenna to the transmitter to prevent "suck-out."

The reader will immediately assume that a diode connected between the transmitter and antenna will rectify the *rf* antenna current. Disspell this thought from your mind, for this is definitely *not the case*. As long as the antenna current does not exceed the bias current, the diode acts like a piece of copper wire! The 1N1763 has a current rating of one half ampere and the antenna current was kept below this figure.

On transmit there was no evidence whatever to suggest that the diode was in the circuit! On receive there was no "suck-out" and no final noise fed to the receiver.

During this experiment the transmission line impedance was about 200 ohms. A later experiment used three 1N1763's (in parallel) in conjunction with a 72 ohm transmission line. Bias from the original mechanical relay power supply was fed through two 2.5 *mh* r.f. chokes, each having a resistance of 30 ohms. The forward current was set to a little under one half ampere for the diodes. On receive, a reverse bias is fed from the exciter power supply through a 47K resistor. This bias is left connected at all times and is simply overcome by the forward bias on transmit. The high reverse bias potential used (250 volts), is necessary to reduce the high capacity of the diode. Most diodes have a high junction capacity when the reverse bias voltage is low. This effect is exploited in the variable capacity diode which uses a variable reverse bias to vary the capacity and thus control the frequency of a tuned circuit.

If you duplicate these experiments, remember that provision must be made to prevent the bias

from being shorted by the antenna, coupler, etc. If the antenna is a complete d.c. circuit, it will be necessary to install a coupling capacitor between the diode switch and the antenna, or between the switch and the transmitter. If a pi-coupler is used, it may be satisfactory to lift the r.f. choke across the output. Such chokes are sometimes used in the pi output as a safety measure. A capacitor, if used, must have a very large capacity. Remember that even a .01 *mf* capacitor has 6 ohms reactance at 3.5 *mc*. Six ohms, when compared to an antenna impedance of 72, is 1/12th! One twelfth of the power output of the rig would be dissipated in the capacitor!

Because the diode impedance is low, and the antenna impedance high by comparison, very little power is dissipated in the diode. The voltage drop is small even though the voltage might be quite high at the output of the transmitter.

### Switching the Receiver

Referring to fig. 4, if the diode  $R_d$  is reverse biased its resistance is very high. If the resistor  $R_L$  represents the receiver,  $R_L$  will be low in comparison. Therefore most of the voltage applied to the circuit will be across  $R_d$ . Thus  $R_d$  would have to have very high inverse ratings. On receive,  $R_d$  will need to be very small so that the received signal is not attenuated in the diode.

The above facts have so far prevented successful operation of a fully "diodized" TR switch. It will be appreciated that any diode switch connecting the common transmitter-receiver antenna to the receiver must withstand the whole of the r.f. voltage present in the line to the antenna. Such diodes are no doubt made, but they certainly were not available at the time of the experiments. The ordinary biased off triode was used to connect or disconnect the antenna from the receiver.

### Linearity

No accurate checks on linearity have been made. Various reports from listening stations have given a clean bill of health. Linearity should be excellent for the voltage current curve of a silicon diode is very straight once the knee at the bottom is overcome. The r.f. current should therefore be kept a little below the bias current.

### Television Interference

By now everyone is probably wondering "What about the TVI generated by the diode switch?" There is no known reason to suppose that the diode switch will create TVI unless it is grossly overloaded. Once again we hasten to point out that the diode is not used as a rectifier, but as a *switch*.

### Standing Waves

By causing high currents and voltages, standing waves may ruin a good diode. If  $R_L$ , in fig. 4, is allowed to drop to a very low figure, the voltage built up across  $R_d$  might well exceed the bias. Before duplicating the circuits and experiments, the reader is cautioned to check and/or adjust the transmission line to insure that it is flat.



## Future Uses

The authors believe that this article will stimulate an entirely new train of thought and experimentation in amateur ranks. The possibilities of applying this technique are limitless!

As an example, let's say that Sam Ham is building a transistor SSB transceiver, and wants to duplex the filter on receive and transmit. The problem sets up like this: On receive, the i.f. mixer must feed the filter, but on transmit the filter should be switched over to the balanced modulator and carrier generator. The "easiest" solution would be to install a relay capable of handling r.f. energy (low capacity about \$5.00) to switch the filter connections. Of course, Sam could do it the "hard way", as shown in fig. 6, with a couple of 50 cent diodes.

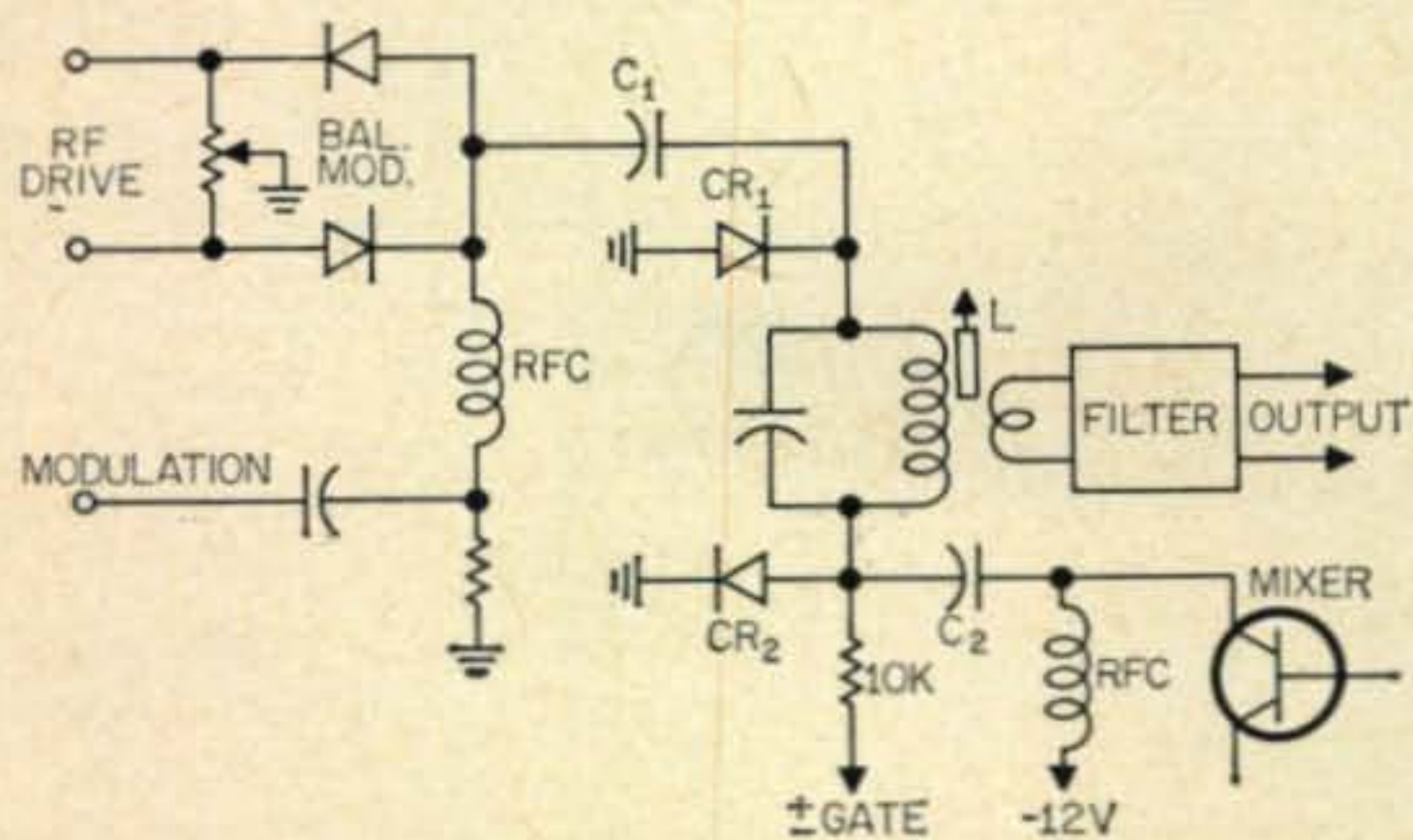

Fig. 6—A diode signal switcher for transistor circuits. Two diodes allow an ssb filter to be duplexed on receive and transmit. A similar system would be used at the output of the i.f. strip.

Does it work? It sure does, and here's how. On receive, a negative voltage is applied to the gate terminal, and to the switch diodes through a 10K isolating resistor. The negative potential on the

cathode of  $CR_2$  "cuts it off" and greatly reduces the junction capacity (about 10 mmf.). At the same time a negative voltage is applied to the cathode of  $CR_1$ , causing it to conduct. (It is the same as a positive voltage on the anode). In effect we have shorted to ground the top end of coil  $L$ , and opened the bottom end. This allows signal from the mixer transistor to appear across the coil and be coupled to the filter. From this point it goes to the remainder of the i.f. strip.

On transmit, the conditions reverse by applying a positive voltage to the gate. This causes  $CR_2$  to conduct and  $CR_1$  to cease conduction. In effect we have now shorted the bottom end of the coil and opened the path to the balance modulator. This allows the d.s.b. energy to pass through the filter, thereby creating an s.s.b. signal.

Coil  $L$  would be resonated approximately 20% higher than the filter frequency by the associated capacitor, and the reverse capacity of either switch diode. Capacitor  $C_1$  would be used to bring the tuned circuit into resonance on transmit, while  $C_2$  would serve the same function when receiving. These two capacitors, by the way, also serve to match the impedances of the balanced modulator and mixer to the tuned circuit. The link on coil  $L$  would be determined by the filter impedance, and normally would be positioned at the center of the coil. This would provide equal filter coupling on receive and transmit, but not equal drive. Juggling the position of the link will provide a means of balancing the two signals.

Naturally a similar system could be used at the output of the i.f. amplifier to effect signal circuit switching. By now the reader will no doubt agree that the possibilities for using diode switch circuits in amateur equipment are infinite. Give it a whirl in your next home brew project. ■

## Amateur Radio Tour of Europe



Hugh Tinley, WØGHK has organized a Radio Amateur Tour of Europe, in cooperation with the British Overseas Airways Corporation which is due to leave New York City, Saturday evening April 22, 1961 via BOAC Comet. The first stop will be London, where they will begin a three week tour of the European continent. Besides stopping off at the BBC and MSF in England, the tour will move on to Paris, Berne, Heidelberg, Brussels and many more places of interest. This should be a great opportunity to see the amateurs whom you never thought you would meet. Hugh will be glad to fill in all the incidentals and supply you with a colorful brochure which explains the entire trip. Price: \$1065.00 Complete . . . Hugh can be reached at 6741 North 35th Street, Omaha, Nebraska.



# Voltage Variable Silicon Capacitors

Stephen E. Silverman\*, W1ZPT

Johns Hopkins University  
Alumni Memorial Res. Box 2254  
Baltimore 18, Md.

The following article presents a discussion of the fundamentals of voltage variable silicon capacitors and their application in remotely tuned mobile and fixed station v.f.o.'s.

IN MANY mobile stations, space limitations require that the transmitter and its associated components be mounted in the luggage compartment of the automobile. This necessitates the use of a remote control system operated from the instrument panel. Cables to control the filaments, high voltage, and antenna relay can be easily wired and installed from the instrument panel to the luggage compartment.

Successful operating, especially in a relatively low-powered mobile station, requires the use of a variable frequency oscillator, so that the station being called can be answered on his own frequency. If the mobile transmitter is to have a v.f.o., it must be remotely tuned from the driver's seat. This article will explain how voltage variable silicon capacitors can be applied to v.f.o. use in solving remote control frequency problems.<sup>1,2</sup>

## Clapp Oscillator

The most popular v.f.o. circuit used in amateur applications is the Clapp oscillator (series tuned Colpitts)<sup>3</sup> shown in fig. 1. Capacitors  $C_1$  and  $C_2$  act as the feedback voltage divider capacitances as well as the frequency determining capacitance. The frequency is varied by  $C_3$  which varies the resonant frequency of the tank circuit consisting of  $L_1$ ,  $C_1$ ,  $C_2$  and  $C_3$ . The advantage of this circuit lies in the swamping that  $C_1$  and  $C_2$  provide between the tuned circuit and the tube capacities, which are apt to be very unstable as the tube heats up.

\*The project described here, under the title "Research in the Application of Voltage Variable Silicon Capacitors," was entered in the Rhode Island Schools' Science Fair by the author where it won first grant. It was then selected to represent the State of Rhode Island at the National Science Fair-International at Indianapolis in May 1960. The project won a fourth grant at the N.S.F.-I.

<sup>1</sup> Kretzman, B., "A Remote Control 80 Meter VFO for RTTY", *CQ*, June 1960, page 63.

<sup>2</sup> Miller, C. E., "A Transistorized Aural-Visual Field Strength Meter", *CQ*, December 1960, page 45.

<sup>3</sup> Popovich, T., "High Stability VFOs of Recent Design", *CQ*, December 1960, page 40.

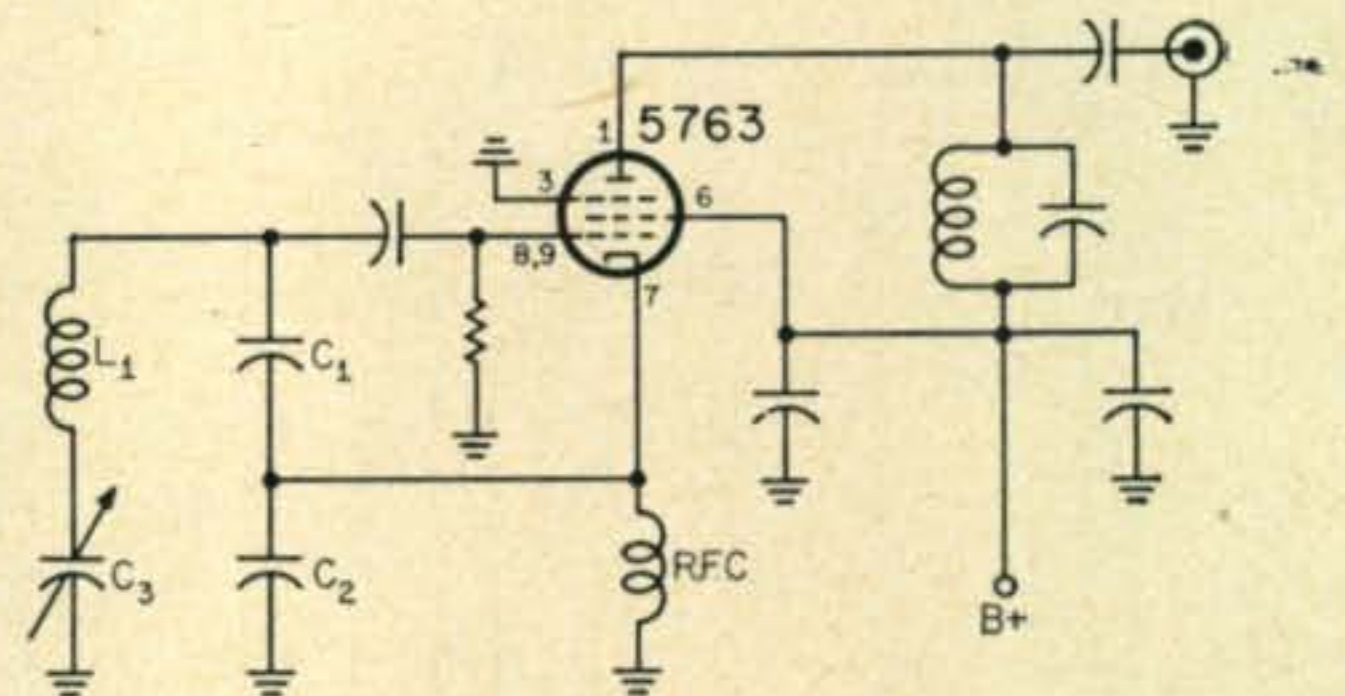

Fig. 1—Diagram of the conventional Clapp oscillator circuit commonly used in amateur applications.

To tune the Clapp oscillator by remote control, a piece of RG-22/U *Twinax* cable was connected between the tuned circuit including  $C_1$  and  $C_2$  and the oscillator tube elements. Since the leads to the tube are relatively low impedance, there is little attenuation in the cable, but the complex capacities that exist within the cable introduce all sorts of problems. See fig. 2. The capacitance between the inner con-

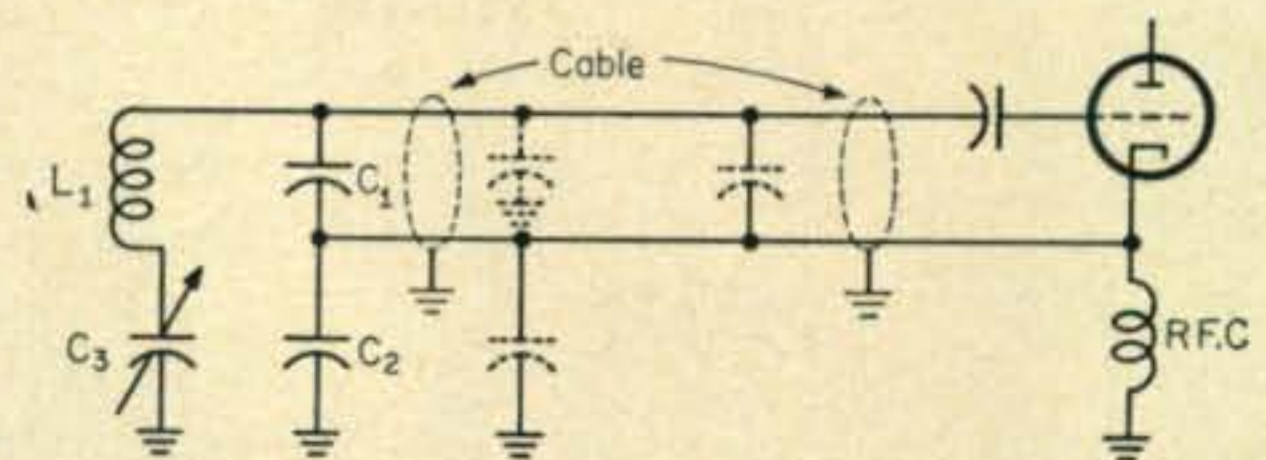

Fig. 2—Schematic representation of the miscellaneous capacitors introduced by the addition of RG-22/U *Twinax* for remote control of the Clapp oscillator.

ductors of a fifteen foot length of RG-22/U is several hundred mmf, and the capacitance between each conductor and the shield (ground) is more than 300 mmf. To compensate for this,  $C_1$  and  $C_2$  must be changed. This in itself is impractical because different installations would require different lengths of cable. The capacitance of the cable is rather unstable due to its motion in relation to the car body and temperature effects.



## Operation

At this point the qualities of the voltage variable silicon capacitor were investigated. The voltage variable silicon capacitor is a very simple device that will change its capacitance with a change in applied voltage. The principle of operation is as follows:

Two pieces of silicon are treated with impurities and joined together. One piece of the silicon has an excess of electrons (N region), while the other piece has a deficiency of electrons (P region). If a positive voltage is applied to the P region, and a negative voltage is applied to the N region, current will flow through the junction. If the silicon junction is reverse biased, *i.e.*, negative voltage to P region and positive voltage to N region, a depletion region with a neutral charge will occur at the center of the junction. This depletion region appears to the external circuit as a dielectric between two conducting regions—the definition of a capacitor. Since the width of the depletion region depends on the applied voltage across the junction, the capacitance varies with the applied voltage. This is the basis of the voltage variable silicon capacitor.

## Applications in the Clapp Oscillator

I wrote to several semiconductor manufacturers for information pertaining to the application of silicon capacitors to the Clapp oscillator. The silicon capacitors used were Hughes number HC-7001. They had a minimum capacitance of 6 mmf at 130 v.d.c. and a maximum capacitance of 88 mmf at 0.1 v.d.c. The  $Q$  was 360 at 5 mc and maximum voltage. Since the capacity between two plates varies with the square of the distance between them, the capacitance of the junction is equal to:

$$C = \frac{K}{\sqrt{V}}$$

where:

$C$  is capacitance

$V$  is bias voltage

$K$  is constant

$K$  for the HC-7001 is 70.

The  $C/V$  curve is, of course, exponential.

The Clapp oscillator requires only a 10 mmf change in capacitance to cover the band of 3500 kc to 3750 kc. Since the HC-7001 covers from 6 to 88

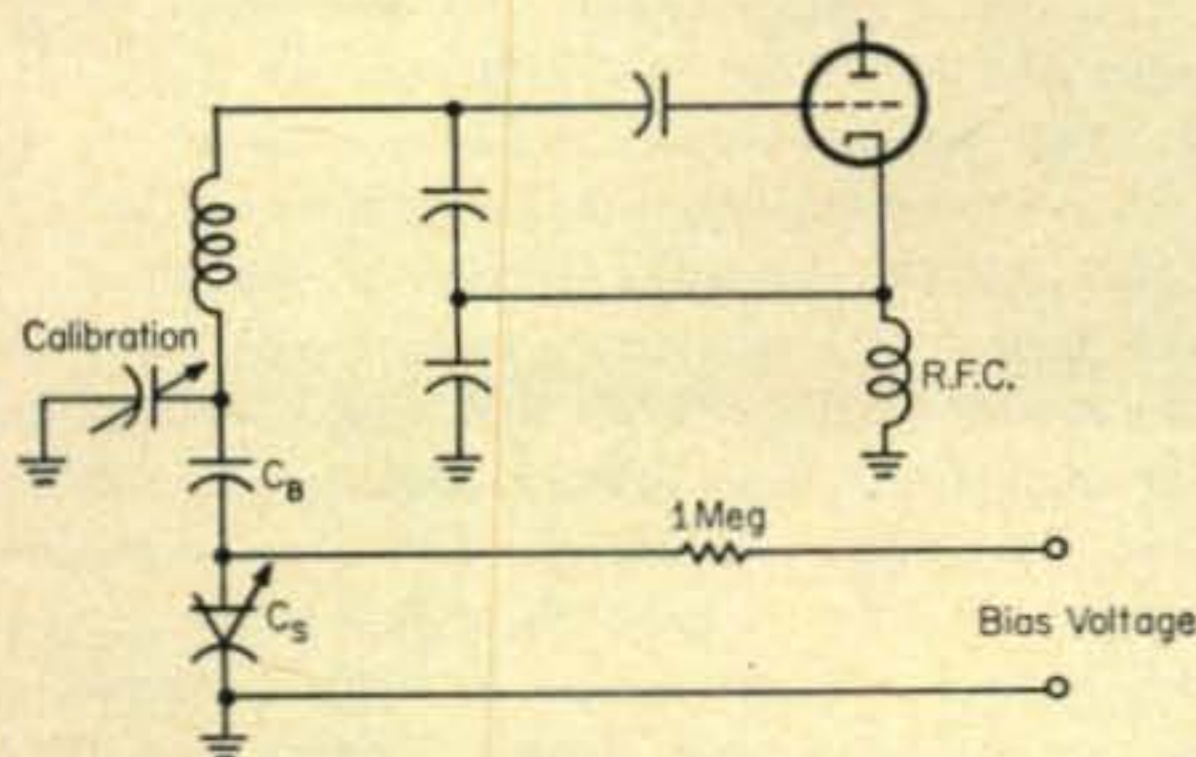

Fig. 3—The Clapp oscillator modified for use with a voltage variable silicon capacitor for remote d.c. tuning.

mmf, there are an infinite number of 10 mmf ranges that can cover the required frequency range. An examination of the  $C/V$  curve will reveal that a large voltage change results in a very small change in the lower portion of the curve. In the upper region, a very small voltage results in a very large change in capacitance; therefore, the higher voltage would result in excellent stability due to the low  $\Delta C/\Delta V$  in the lower region of the curve.

A blocking capacitor,  $C_b$ , is required between the silicon capacitor and the oscillator tank to block the d.c. bias voltage as shown in fig. 3. This capacitor, if a high quality silvered mica unit, can effectively increase the  $Q$  of  $C_s$ , the silicon capacitor. If the  $Q$  of one capacitor is much greater than the  $Q$  of the other in series the net  $Q$  formula is:

$$Q_t = \frac{C_1 + C_2}{C_2} Q_1$$

where:

$Q_t$  is net  $Q$

$Q_1$  is  $Q$  of  $C_1$

$C_1$  is capacity of  $C_1$

$C_2$  is capacity of  $C_2$

In order to be able to calibrate the dial of the v.f.o. linearly, I made many graphs plotting the degree of pot rotation against voltage variation so that the  $C/V$  curve would result in a straight line. All this work proved to be unnecessary because if two capacitors are in parallel, as is the case, and if the fixed capacitor is at least four times the value of the other, the frequency variation controlled by the small variable capacitor is nearly linear.

## Calibration

In order to evaluate the advantage of the silicon capacitor v.f.o., I first constructed a conventional Clapp oscillator. It was constructed to the highest standards, using heavy machined brass to mount the main tuning capacitor and #12 wire for all critical wiring. The oscillator keyed well and was very stable.

I developed a very accurate method for making stability measurements. The v.f.o. was tuned to zero beat with a 100 kc crystal oscillator. The human ear and limitations in the receiver audio system do not permit accurate zero beat to within 35 c.p.s. As the two frequencies approached equality, beat notes of several c.p.s. were produced. These beats can be seen on the receiver's S-meter as pulses. The needle fluctuates at the difference in frequency between the two oscillators; thus, measurements down to  $\frac{1}{4}$  c.p.s. at 3.5 mc can be made. This is 78.5 parts per billion.

It seemed simple enough to substitute a silicon capacitor in place of the air capacitor in the v.f.o. The modified circuit is shown in fig. 3.

The function of the 1 meg resistor is twofold. First, it isolates the silicon capacitor from the low impedance d.c. bias supply. Since the silicon capacitor only draws about 0.5 microamperes, the resistor has little effect on the voltage. Second, it protects the silicon capacitor from current surges.



## High C Colpitts

Obviously the silicon capacitor would have to be used in a different oscillator circuit. After careful examination, the High-C Colpitts oscillator was chosen. This oscillator is similar to the Clapp oscillator with one exception; the frequency is varied by a variable capacitor  $C_3$ , in parallel with the tank coil,  $L_1$ . See fig. 4.

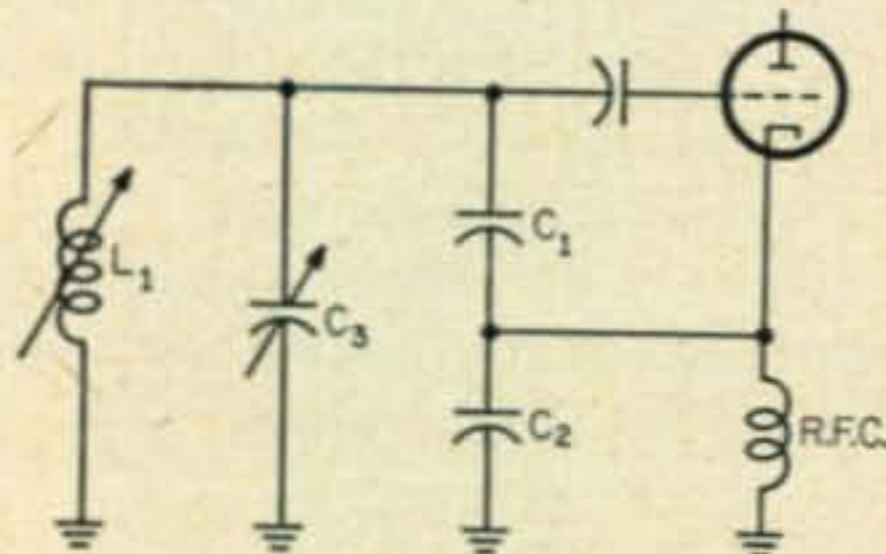

Fig. 4—The high C parallel tuned Colpitts oscillator suitable for remote tuning by use of a voltage variable silicon capacitor.

It is advantageous to use silicon capacitors in the High-C Colpitts oscillator because the capacitance required to cover the band is approximately 100 mmf. Slight variations in capacity caused by voltage fluctuations on the silicon capacitor have very little effect on the frequency.

I connected the silicon capacitor to the tank along with the blocking capacitor and the isolating resistor. The modified Colpitts oscillator circuit is shown in figure 5. After a short warm-up, the oscillator was tuned in on the receiver. The note was as pure as a crystal note. Extensive stability tests indicated a short term stability of 1 c.p.s. in 30 seconds and a long term stability of 50 c.p.s. or 14 p.p.m. in two hours.

The bias voltage on the silicon capacitor had to be kept above the a.c. voltage on the tank or the output would be clipped as the tank voltage dipped below the bias voltage.

The voltage source was two 45 volt B batteries connected in series. This source was chosen over a regulated power supply because of the extreme

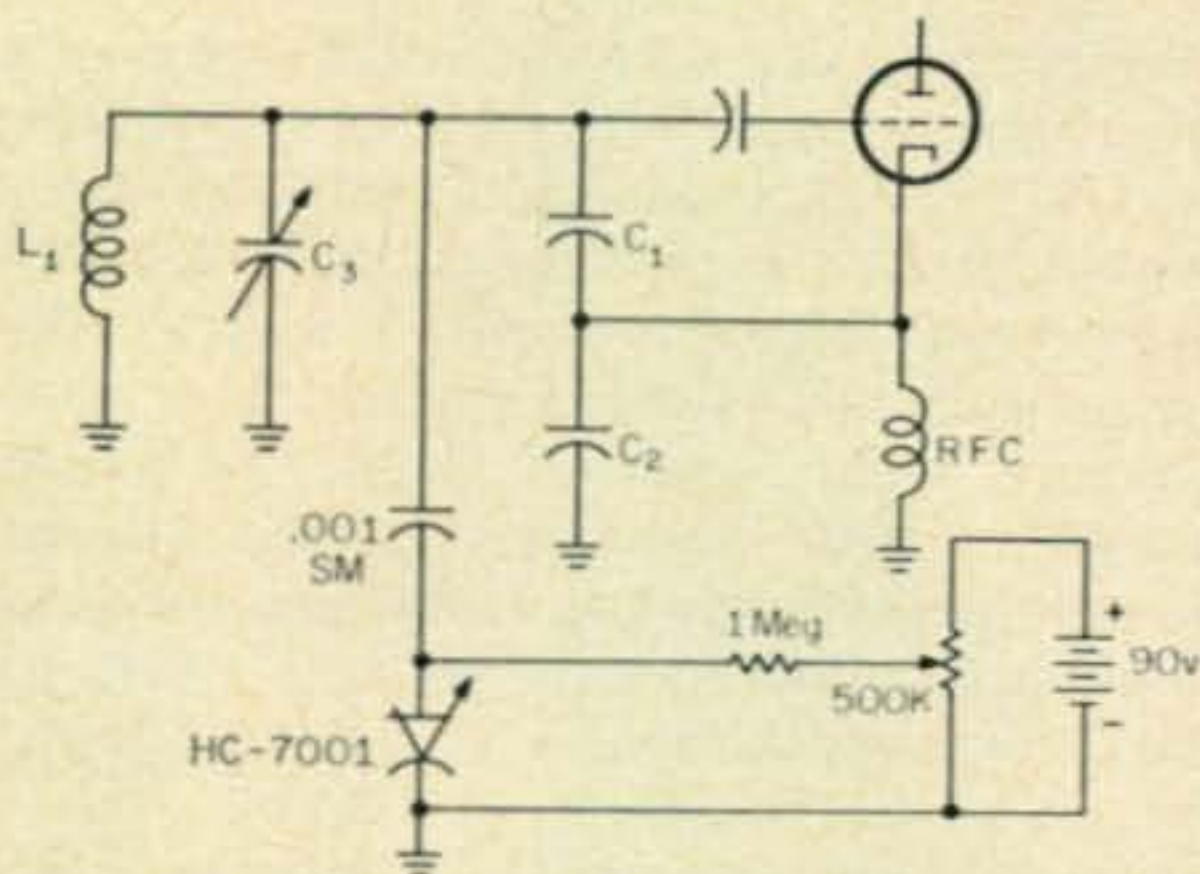

Fig. 5—Silicon capacitor control circuit applied to the parallel tuned Colpitts oscillator

## Results

As soon as I warmed up the oscillator and applied bias to the capacitor, my troubles began. The oscillator signal, when found, was anything but a pure continuous wave. Frequency modulation was so bad

that the signal occupied over 5 kc. Every possible source of the f.m. was investigated. The bias voltage was steady. The plate voltage on the 5763 was well regulated. The trouble was finally traced to the silicon capacitor itself. The a.c. voltage on the tank was being rectified by the diode (silicon capacitor) and this varying voltage was biasing the capacitor in addition to the d.c. control bias. To reduce this a.c. voltage, the .001 mmf silvered mica blocking capacitor,  $C_b$ , was replaced with a 50 mmf variable air. When the variable capacitor was tuned to 2.5 mmf, minimum capacity, the f.m. stopped. This small value in series with the silicon capacitor resulted in such a small capacitance change that at least five banks of silicon capacitors would be needed to cover 100 kc. After three months of experimentation, the Clapp oscillator was scrapped. stability of the battery voltage. The voltage was varied by a 500 K potentiometer connected as a voltage divider. A fifteen foot length of cable does not effect the stability of the oscillator at all. Apparently the d.c. leads to the control potentiometer could be extended for thousands of feet without any effect on the oscillator. The use of voltage variable silicon capacitors has thus solved the remote tuning problem. ■



A dramatic half-hour radio documentary, taped during the first six weeks of the American hospital ship *HOPE*'s training and teaching mission to Indonesia, has been distributed to all a.m. and f.m. stations throughout the country as a public service by the Ex-Cell-O Corporation of Detroit.

The documentary covers the launching of the good ship *HOPE* at San Francisco on September 22, 1960 the shake-down cruise to Hawaii, the arrival and the reception in Jakarta, Indonesia.

Narrated by veteran newscaster Jim Vinall of WJR, Detroit, the disc captures the excitement and the promise of the *HOPE*'s first weeks with on-the-spot sounds and interviews. Especially effective are scenes where the American medical crew practice their rudimentary Indonesian at first haltingly, and then, after gentle prompting from their Indonesian teachers, with more and more confidence and pride. Particularly gratifying to American contributors to *HOPE* will be the Indonesian voices stating their gratitude for this teaching hospital.



# Inexpensive Screen-Grid Modulation

Frank Seier, K2MYC

748 Oriole Avenue  
West Hempstead, N. Y.

*Do you have a small audio amplifier floating around the shack? Here is a brief discussion and practical application for low power audio equipment to modulate your rig.*

Do prohibitive prices of plate modulation systems perish all your thoughts of operating phone? Are you looking for a modulation system which is easy to adjust and inexpensive to install? Must the system contain a minimum of components and be easily incorporated into the existing transmitter? These questions can be answered with the circuit of fig. 1. This circuit is basically an impedance matching system which permits the connection of any audio amplifier to the transmitter enabling the amplifier to function as a modulator.

This method of modulating the transmitter has met with gratifying results. Many a station was surprised upon enlightenment of the mode of modulation, which at first was believed to be plate modulation. The modulator may be any convenient audio amplifier such as a radio, television, phonograph, or hi-fi amplifier.

## Components

Only a few parts are required for this system: a variable resistor, a capacitor, and a small audio output transformer. The values of the parts are not critical and may be obtained from any scrap-box. If parts must be purchased new the cost will be approximately \$3.50. With these few parts to install in the transmitter alterations are easily made without disturbing the existing cir-

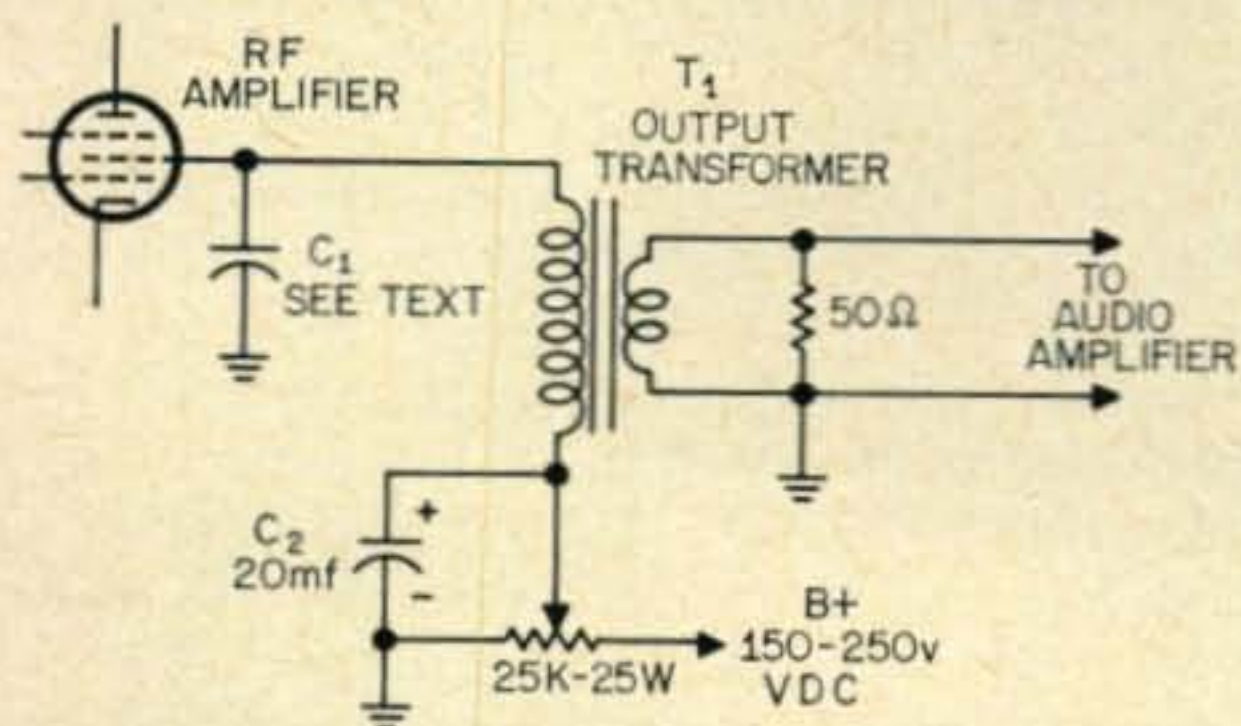

Fig. 1—Diagram of the screen grid modulator. T<sub>1</sub> is a small audio output transformer, primary 5000-10,000 ohms, secondary, 4-8 ohms Stancor No. A3879.

cuitry, or a crowding of the chassis as some modifications require.

## Amplifier Requirements

The only demand made of the audio amplifier is that it must deliver the necessary audio power; this will vary with the ratings of the final *rf* amplifier. A couple of watts of audio is plenty to modulate a pair of 807's. An amplifier that contains a microphone or phono jack is custom made to suit our needs, but it is an easy task to install a jack if one is not already present on the unit.

The only modification that will be performed on the amplifier itself will be to disconnect the speaker, or the installation of a toggle switch on the unit so that you may, at will, change the amplifier from a modulator to its original function at the flick of a switch. More on this feature later.

## Circuit Description and Design

The ability to use a household amplifier as a modulator, without extensive modifications, is the result of using a second audio output transformer in reverse. An audio output transformer has two windings, a high impedance primary and a low impedance secondary. For an efficient transfer of power to occur the impedance of the generator and the load should be equal. When this condition is true, the circuit is said to be matched. The low impedance output from

[Continued on page 120]

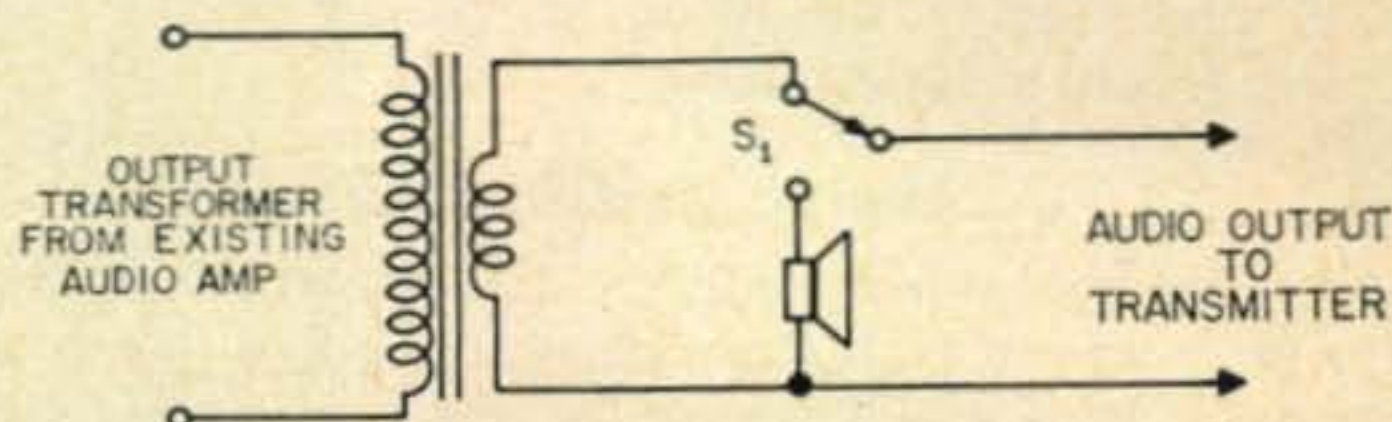

Fig. 2—Method of obtaining audio output without disturbing audio amplifier. S<sub>1</sub> is a single pole double throw switch which allows the audio to be switched from the existing speaker to the transmitter.



# Understanding Very-High-Frequency Antennas

## Part II\*

Stanley Leinwoll

33 Cranston Road  
Franklin Park, New Jersey

**I**N OUR introductory article we spoke only in terms of a thin wire antenna having a uniform cross section and which was centered at its design frequency. As soon as we operate an antenna away from its design, or center frequency, its characteristics begin to change. For example; as the frequency, center-fed to a simple half-wave thin wire antenna is varied from its design frequency, the broadside response of the antenna begins to fall off significantly. At first, the main lobe splits into several lobes, and finally, at approximately the fourth harmonic, becomes nil.

It has been found that the characteristics of an antenna operating off resonance (its center frequency) can be altered considerably by changing the configuration, or shape, of the antenna.

We find that the bandwidth over which an antenna will operate satisfactorily, depends on the thickness of the conductor as well as its uniformity. Generally speaking, the thicker the antenna elements, the broader will be its bandwidth.

Another interesting change takes place as the antenna diameter is varied: as the diameter of an antenna increases, the antenna will generally hold its broadside lobe over a wider range of frequencies.

Because the center-fed half wave dipole has certain shortcomings, a series of half-wave antennas has been developed, in an attempt to prevent these shortcomings. These antennas, through modifications in configuration, are able to achieve greater bandwidth and uniformity of broadside response than the simple half-wave dipole. One of the more important of these is the folded dipole.

### The Folded Dipole

This antenna is simply a half-wave center-fed dipole whose ends have been connected to a parallel rod of equal length. If the diameter of the rod is the same as the diameter of the dipole elements, then equal currents will flow in both conductors. Since the total power developed in

the folded dipole is equal to that developed in a standard half-wave dipole, the terminal impedance of the folded dipole will be greater than that of the conventional dipole. It can be shown that the impedance at the terminals of a folded dipole antenna is equal to the number of conductors comprising the antenna, *squared*, times the impedance at the terminals of a conventional dipole.

Thus, the impedance of a two conductor folded dipole is:

$$(2)^2 \times 72 = 288 \text{ ohms.}$$

This is one of the advantages of the two conductor folded dipole; that it can be fed with a conventional 300 ohm transmission line without any other matching arrangement.

When the two conductors have different diameters, equal currents no longer flow, and the current values now depend on the spacing between elements as well as the ratio of conductor diameters.

The folded dipole performs consistently well over a wide range of frequencies, but does not perform satisfactorily at frequencies which are even multiples of the fundamental frequency. At even multiples of the fundamental the folded section appears to be simply a continuation of the transmission line.

### Coaxial Antenna

One of the most common half-wave antennas used in v.h.f. work is the coaxial, or "sleeve" antenna, shown in fig. 1. Essentially, it is a vertical dipole, consisting of a rod and a tube. Feeding is accomplished by a flexible, coaxial seventy ohm transmission line which runs up through the hollow lower radiating element, or "skirt."

The inner conductor of the transmission line is connected at the bottom of the upper radiating element, or "whip." The outer conductor of the line is connected to the upper portion of the "skirt."

Since the impedance of the line is the same as the impedance of the antenna at the feed points, the transmission line is non-resonant.

Because the transmission line is shielded by the skirt, relatively little current is induced on

\*Part I of this series appeared in *CQ* for January 1961.



Fig. 1—Coaxial or sleeve antenna. The inner conductor of the transmission line is connected to the whip. The outer conductor is connected to the skirt. The whip and skirt are separated by an insulating ring.

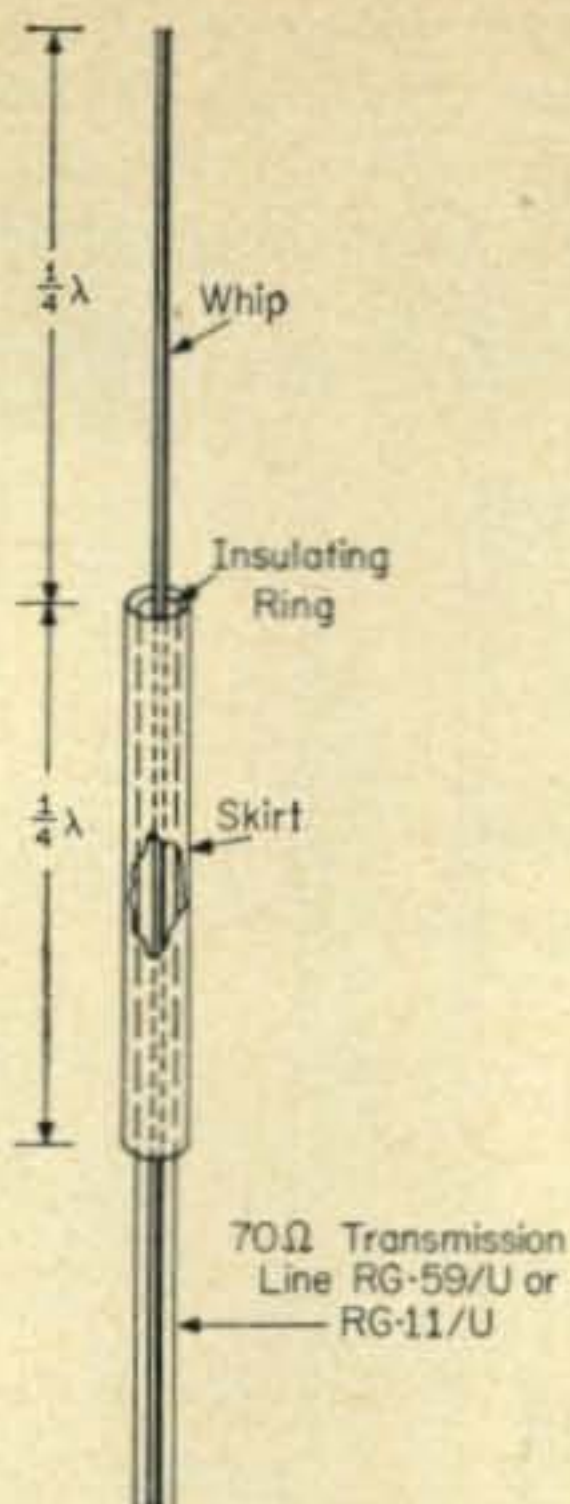

the outer coaxial line. As a result, high angle radiation is minimized, making the antenna, which has an omnidirectional horizontal radiation pattern suitable for v.h.f.

### Driven and Parasitic Arrays

Although the basic principles of antenna operation and design are similar over an extremely wide range of frequencies, certain requirements in the v.h.f. range necessitate the use of specific techniques unique to the range of frequencies above 50 megacycles.

Since the physical dimensions of an antenna element designed for operation at or beyond 6 meters are small compared to the dimensions of an element operating in the h.f. range, it becomes practical to erect an antenna system with significantly more gain and directivity over a simple half-wave dipole.

This is an extremely important consideration. A high gain antenna system gives the advantage of high effective radiated power in a given direction, thus considerably extending the coverage area of a station operating at a given frequency. A directional array offers the added

advantages of protecting other nearby stations operating in the same range as well as reducing pickup of unwanted signals or noise coming from other directions.

The multi-element array presents one of the most common methods of obtaining increased gain and directivity from an antenna. The array is a combination of dipole antennas oriented in such a way as to produce a given type of radiation pattern.

The antenna element can either be directly connected to the transmission line, in which case it is a *driven* element, or it can be electromagnetically coupled to a driven element, in which case it is a *parasitic* element.

If all the elements in an antenna system are driven, it is called a *driven* or *connected* array.

### Parasitic Arrays

A considerable increase in an antenna's ability to radiate energy in certain directions can be obtained by using one or more parallel resonant rods in close proximity to a standard half-wave dipole.

These rods are called "parasites" and are not physically connected to the antenna circuit. Figure 2b shows a standard antenna with a parasitic element behind it.

The parasite is electromagnetically coupled to the antenna, referred to as the driven element. A current is induced in the parasite and it radiates additional energy.

The radiation pattern of a parasitic array is generally uni-directional. When the parasitic element is in front of the driven element and in the direction of maximum radiation it is called a *director*. When the direction of maximum radiation is from the parasite, through the driven element, it is called a *reflector*.

Whether a parasite acts as a director or a reflector depends on the spacing between elements as well as the length of the parasitic element. In general, a parasite will act as a director when it is shorter than the driven element, and as a reflector when it is longer. (figs. 2b and d)

Both the spacing of elements as well as the dimensions of the parasitic elements are critical in determining whether the parasite will in-

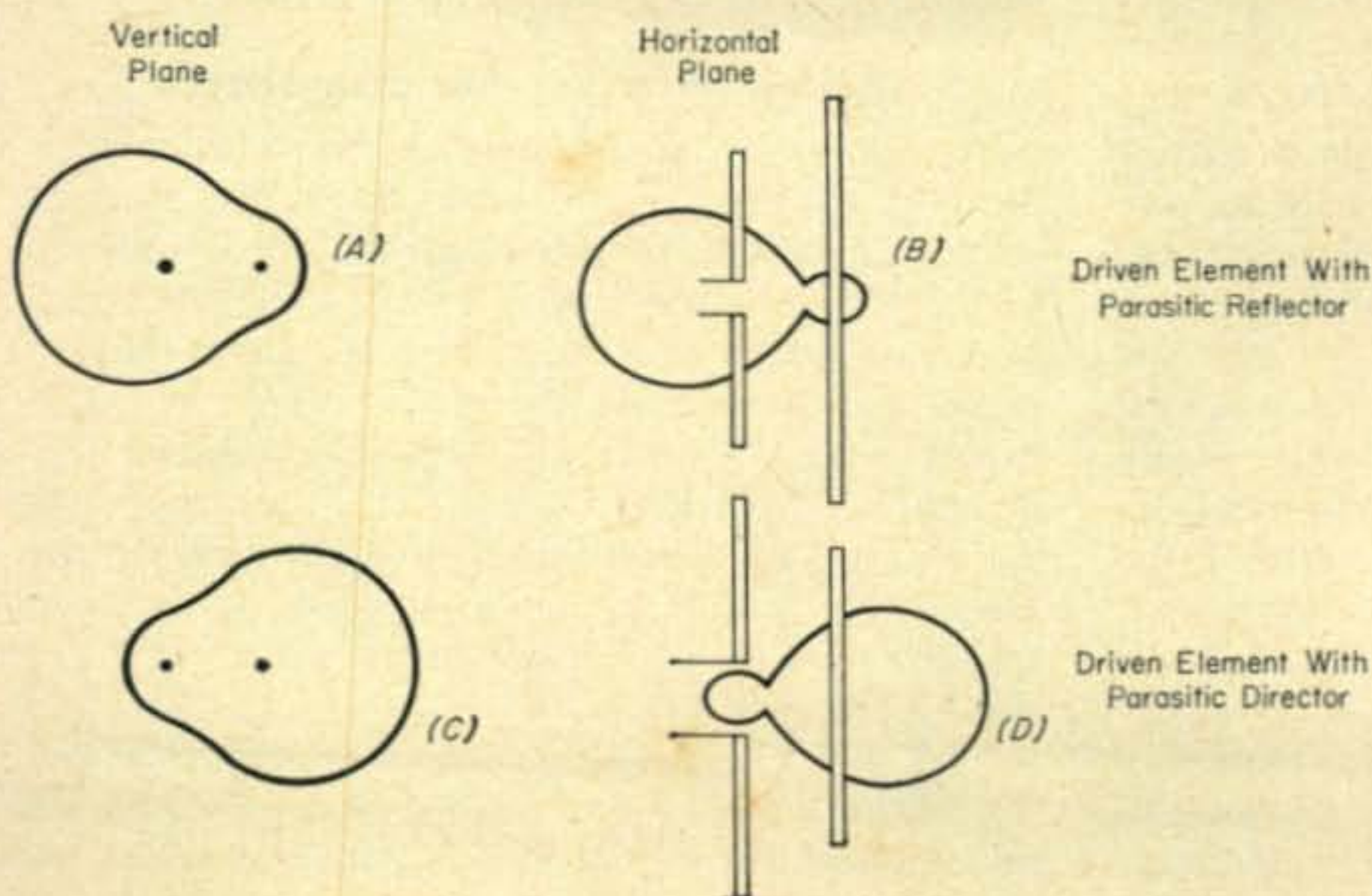

Fig. 2—Parasitic element antennas with horizontal and vertical directional response patterns. Patterns for the longer parasitic reflector and the shorter director are shown.



crease radiation in a given direction, decrease it, or not affect it at all. As a result, optimum lengths and spacing can only be obtained at a single frequency, and satisfactory performance is therefore possible only over a relatively narrow band of frequencies.

In most cases, the compactness of parasitic antennas far outweighs this advantage, and size for size there is no other antenna which gives comparable gain and directivity than the parasitic array. It is extremely difficult to predict the exact dimensions of a parasitic array at a specific frequency, and it is not unusual for field tests of a particular first model to show a need for adjustments of up to 2 per cent in the length of a parasitic element.

The table below gives typical element lengths of parasitic arrays operating on 52, 146 and 222.5 mc, respectively. Lengths are in feet.

Element	52 mc	146 mc	222.5 mc
R = Reflector	9.3	3.3	2.2
D = Driven Element	8.9	3.1	2.1
D <sub>1</sub> = First Director	8.5	3.0	2.0
D <sub>2</sub> = Second Director	8.3	2.9	1.9

The impedance at the terminals of the driven element depends on two electric actions: one of these is the magnitude of the voltage induced in the parasite, the other the phase of the induced voltage. Both of these actions depend on the distance between the driven element and the parasite, as well as the length of the parasite.

The directional patterns obtained with a single parasitic element depends upon the same actions, and are therefore also a function of spacing and parasite length. Generally, two element parasitic arrays are adjusted either for optimum gain or front-to-back ratio. The front-to-back ratio, generally expressed in *db*, is the ratio of energy radiated in the principal direction, to that radiated in the opposite direction.

The patterns shown in fig. 2 are typical of those obtained with 2 element parasitic arrays.

In general, gain of the order of 5 db, and front-to-back ratios of up to 17 db are obtainable with proper adjustment of the elements.

### Three Element Parasitic Arrays

When two parasitic elements are used with a driven element it is conventional to operate one of these as a director and one as a reflector. This system, often referred to as a beam antenna, can give a gain in the order of 8 db, or a front-to-back ratio of as much as 20 db. Such a system is highly frequency sensitive. With spacing of the order of 0.1 to 0.15 wavelengths between elements, a useful frequency bandwidth of the order of 2% is obtained.

### Yagi Antennas

Yagi antennas are the most compact high gain antennas known. They consist of a driven element, a reflector, and one or more directors.

Figure 3 shows a frequently used Yagi arrangement consisting of one reflector and three directors. As is the case with most parasitic arrays, frequency response is severely limited.

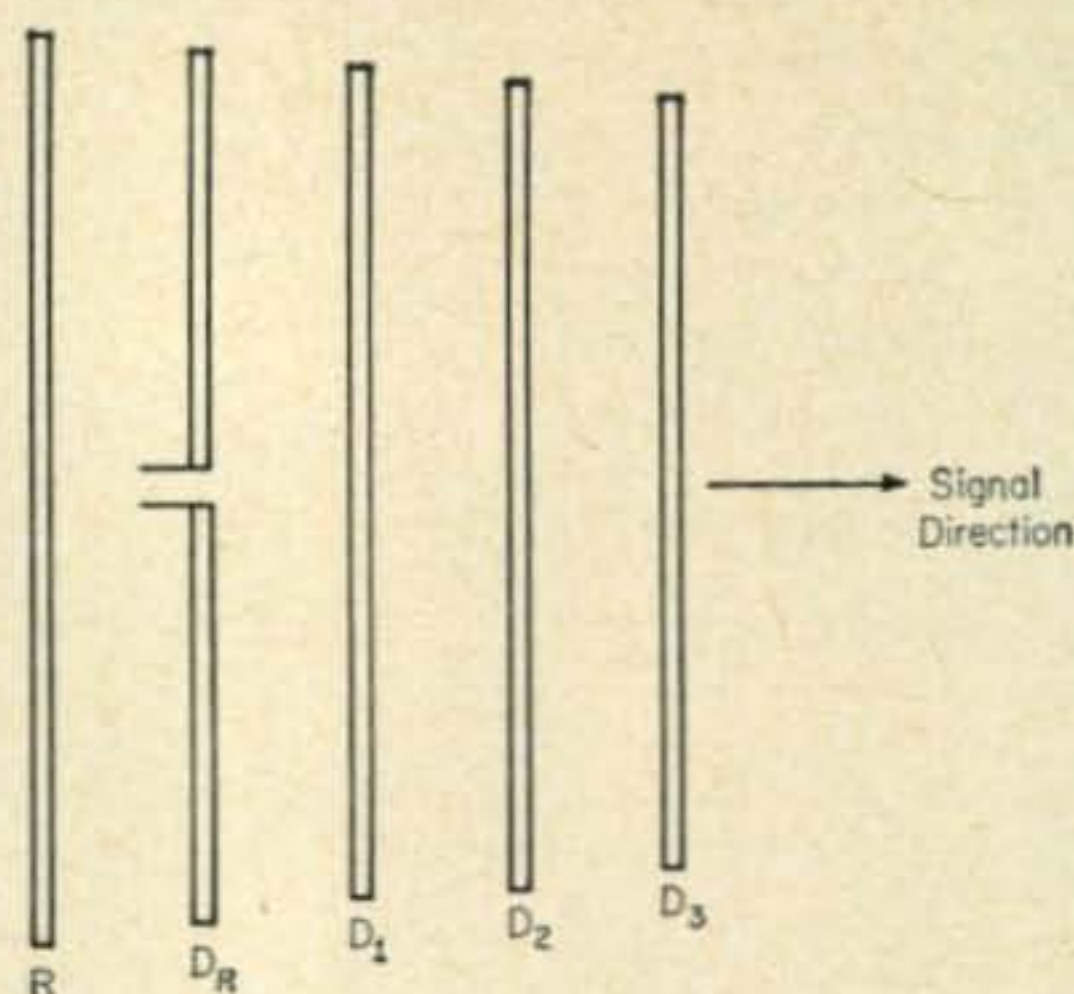

Fig. 3—One type of Yagi array having a reflector and three directors.

Since an antenna element designed for 2 meter operation is approximately one meter in length, it is possible to use multi-element arrays having more than four parasites. In such an array, the directors are usually all the same length for highest gain, although tapering the directors gives higher front-to-back ratios and widens the bandwidth over which the system is effective.

### Stacking

Since element dimensions at v.h.f. are relatively small, it is practical to stack Yagi arrays vertically. Generally, a spacing of approximately a half-wave length is used, with a gain of up to 3 db over a single array being possible.

Where limited space is a problem, it is possible to use stacked parasitic arrays for operation on two different bands. Generally, such an arrangement is most practical for operation on 6 and 10 meters. The antennas, mounted on a common tower, can be rotated simultaneously. A separation between arrays of 2 to 3 meters (6 to 9 feet) is important to minimize interaction. If it is absolutely essential, closer spacing is possible, but there is a corresponding loss in effectiveness.

### Driven Arrays—Fundamentals

As we know, a driven element is connected directly to the transmission line. An antenna system in which all the elements are connected to the transmission line is called a driven array.

Arrays are often described by the types of elements which make them up (driven or parasitic), and by their radiation patterns (bi-directional or unidirectional). Still another useful method of describing arrays is based on the manner in which the elements are placed and the direction of the major lobes with respect to these elements.

The term **broadside** array, for example, describes an antenna system in which the direction of maximum radiation is perpendicular, or



broadside, to the plane containing the elements. In general the term is confined to antenna systems in which all the elements are parallel to each other, and lie in one plane.

A **collinear** array is one in which all the elements lie in one straight line. The direction of propagation is perpendicular to the array.

An **end-fire** array is one in which maximum radiation occurs off the end of the array, in a plane containing the array.

The radiation pattern that an array produces depends, as in the case of the parasitic array, on the distance between elements. In addition, however, the phase relationship among currents fed to each of the elements is also of prime importance.

One method of adjusting phase relationships between driven elements is by use of sections of transmission line, called stubs. This is shown in fig. 4. In part (a), two collinear half-wave elements have been connected directly to form a

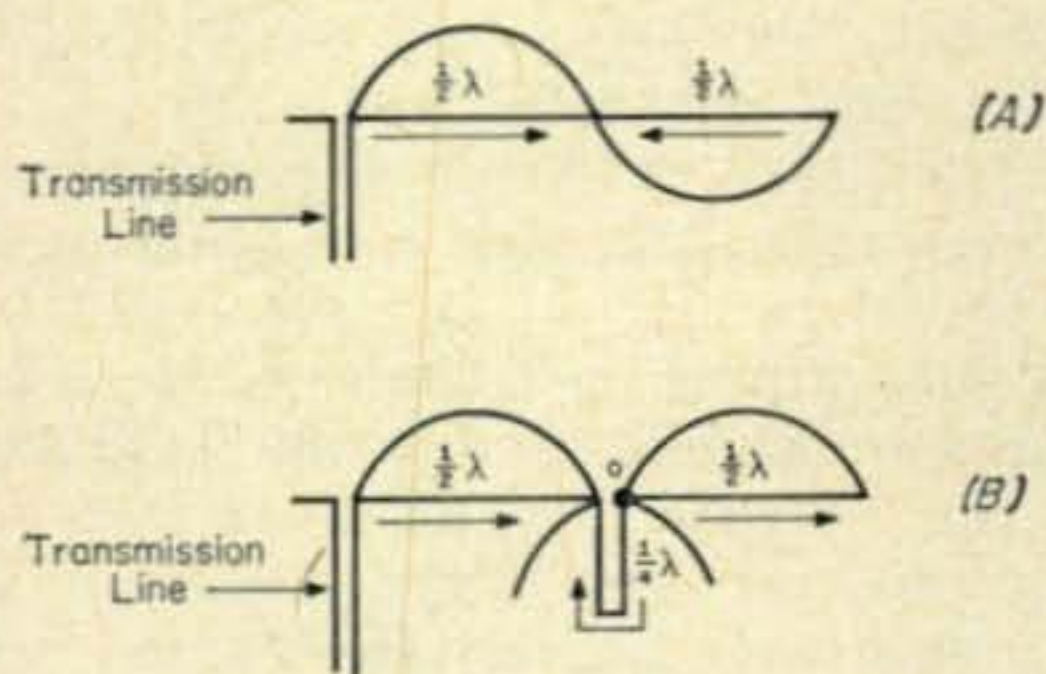

Fig. 4—Phase relationships between two adjacent half wave elements. By use of stubs, phase relationship can be adjusted.

single full-wave antenna. It can be seen that the current in one half-wave section is  $180^\circ$  out of phase with the current in the second. This is an undesirable condition and can be reversed by inserting a quarter wave stub, as in (b). The current travels down one half of the stub and up the other half, a total distance of half a wavelength. By the time it enters the second element (shown at 0), it is in phase with the current flowing in the first element. In the stub itself, the currents produced are equal and opposite. As a result, the fields cancel and no radiation occurs from the stub.

Since the overall power loss is lower in driven arrays than in systems containing parasites, the driven array is generally used when high power transmission as well as high directivity are required. In parasitic arrays, insufficient coupling between the driven element and the parasites often results in energy losses not usually occurring in driven arrays.

Feeding the driven elements also present special problems. In a four element driven array, for example, the current in each element must be in phase with the current in all the other elements. If this is not the case, undesired cancellations and reinforcements may occur, with the result that gain, beam width, and directivity may be seriously affected.

**Collinear Arrays.** Figure 4(b) shows a method of connecting two half wave antenna elements by means of a stub. The radiation pattern of such a system can be represented by two lobes in opposite directions, and similar to the pattern produced by a single half-wave dipole. The radiation pattern of the collinear array, however, tends to be sharper, or more directive along the lines of maximum radiation. Thus, by reducing beam width, the gain is increased.

Addition of more elements heightens this effect, and also adds several insignificant minor lobes. Figure 5 shows a method of using four

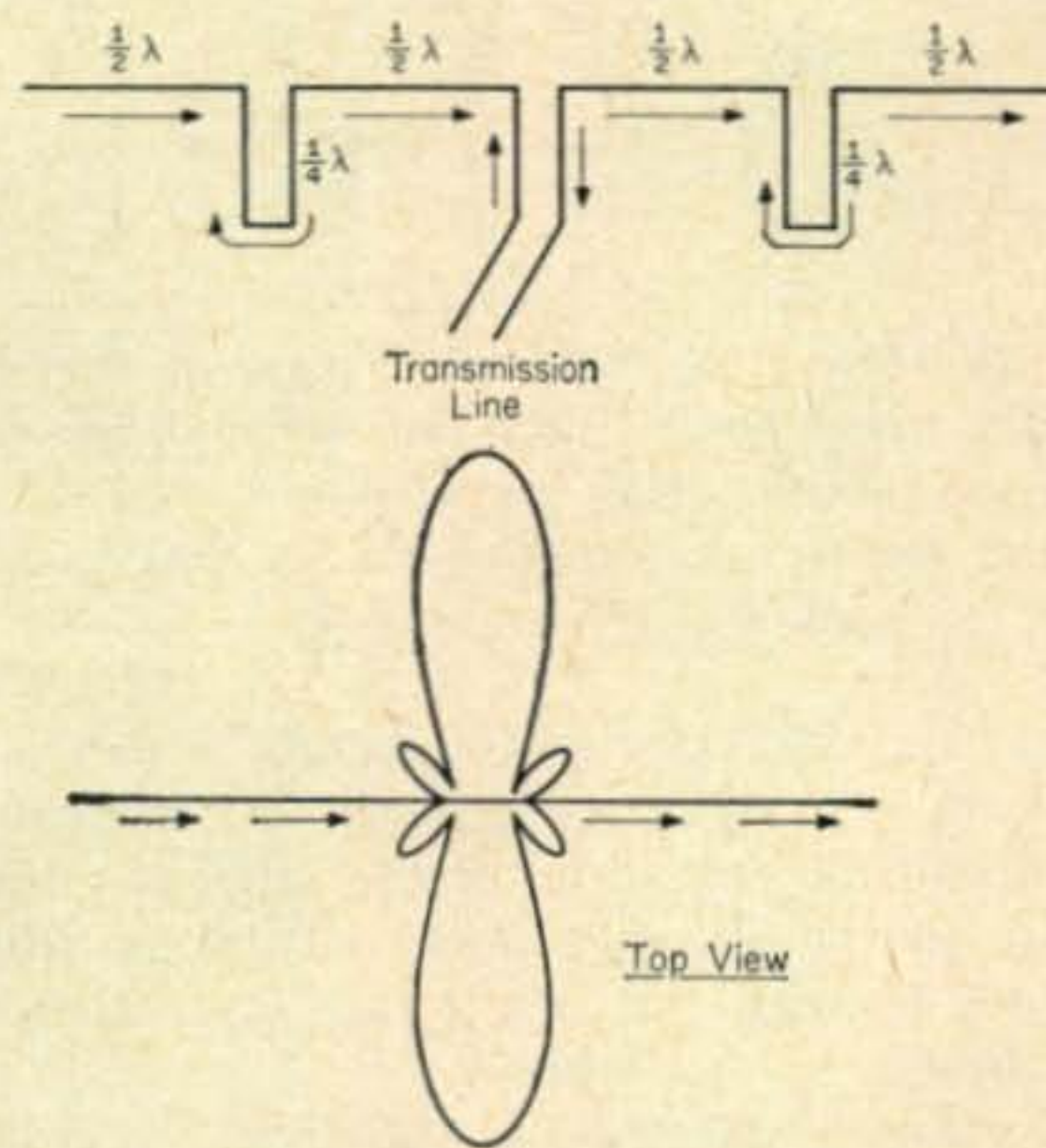

Fig. 5—Four stub-connected collinear elements and the radiation pattern they produce.

collinear elements, and the radiation pattern such an array produces.

**Broadside Arrays.** Figure 6(a) shows a two element broadside array, connected in parallel

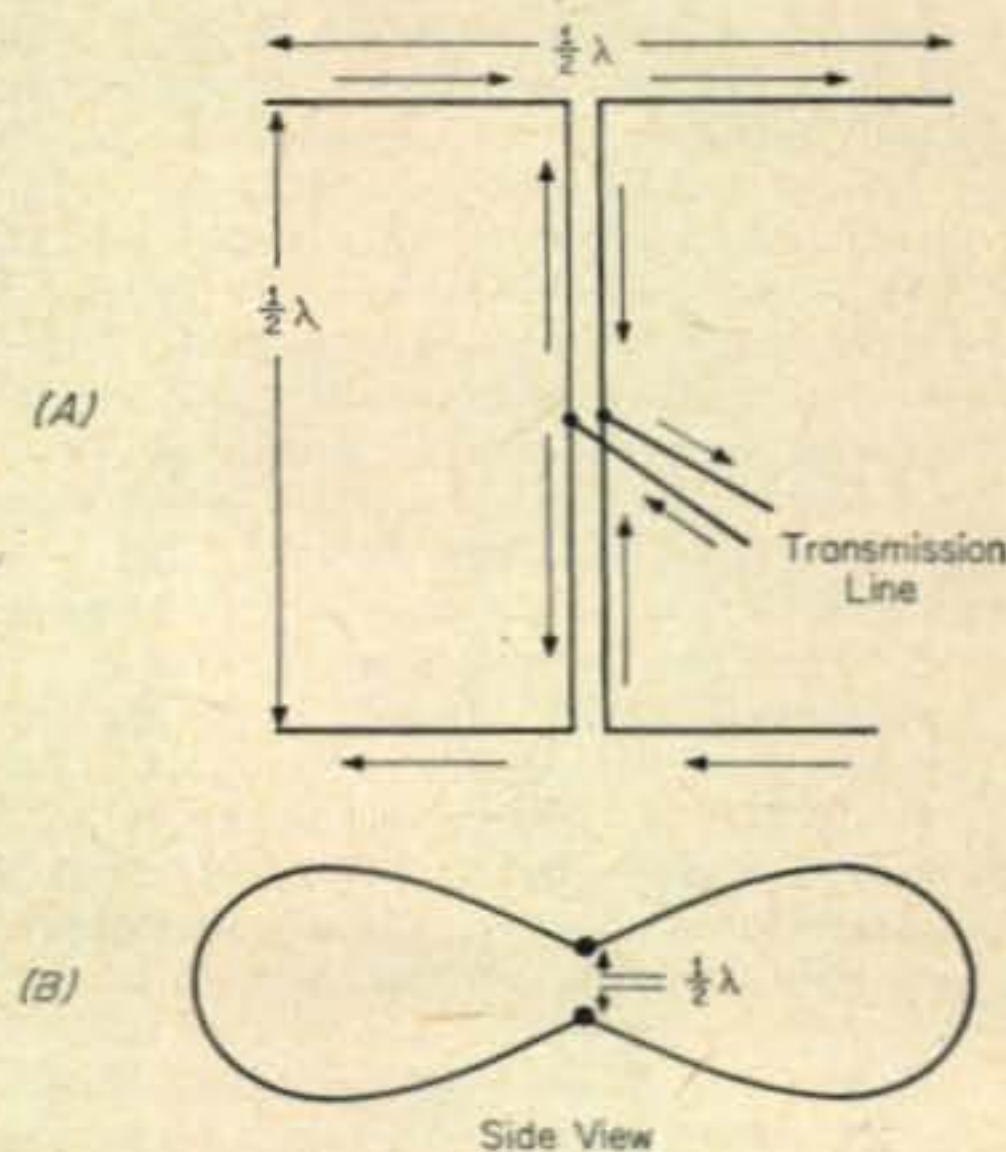

Fig. 6—Two element broadside array and its resultant vertical radiation pattern.

and fed at its center points. Figure 6(b) shows an end view of this array, and its radiation pattern. Since the currents are in phase, energy radiated by each antenna reinforces the other in the broadside direction.



In the plane containing the two elements, however, there is a cancelling effect. This occurs because the elements are a half-wavelength apart, and when the energy from one antenna has travelled to the other one, there is a phase difference of  $180^\circ$ , resulting in cancellation.

**End-Fire Arrays.** Figure 7(a) shows the radiation pattern for a pair of half wave elements

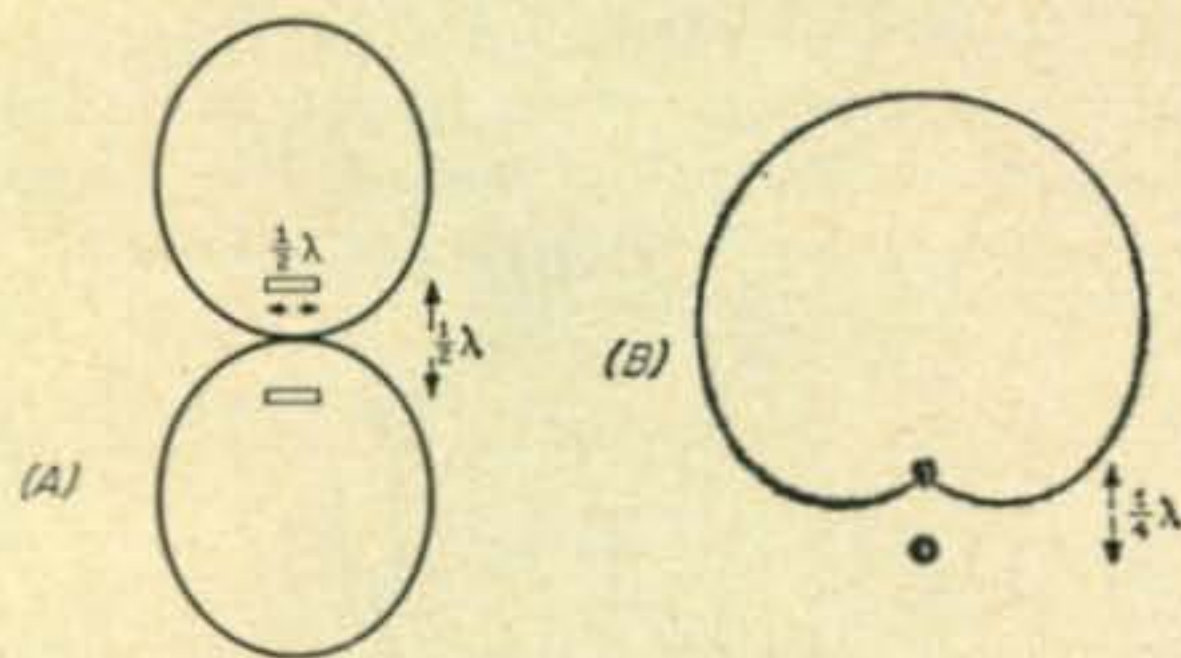

Fig. 7—End-fire array patterns. Figure (a) shows the bidirectional pattern obtained with half wave spacing and feeding  $180^\circ$  out of phase. With  $90^\circ$  feed and quarter wave spacing the unidirectional pattern of (b) is obtained.

which are fed  $180^\circ$  out of phase and which are a half-wave apart. This is exactly the opposite of the broadside situation. Radiation travelling broadside to the end fire array is always  $180^\circ$  out of phase, with the result that cancellation in this direction is complete.

In the plane of the array as shown in fig. 7(a), on the other hand, radiation from one antenna starts out  $180^\circ$  out of phase with radiation from the second. But since the antennas are separated by half a wavelength, radiation ar-

rives in phase, causing reinforcement at antenna two. This end-fire array produces a bi-directional pattern. A unidirectional pattern can be obtained by spacing the elements one-quarter wavelength apart and feeding them  $90^\circ$  out of phase, as shown in fig. 7(b).

It can be seen that gain and directivity of end-fire arrays depend on the relative phase of currents flowing in the elements, as well as the spacing between them.

Since spacing between elements of a broadside array runs in the vicinity of a half-wavelength or more, and since all broadside elements are co-planar, and parallel, certain serious limitations in constructing such arrays face the amateur. Although there are no theoretical limits to the number of broadside elements in an array, v.h.f. antennas used by amateurs seldom have more than four elements.

Similarly, unidirectional end-fire arrays are seldom used by amateurs in any band, since such arrays require that the driven elements be fed approximately  $90^\circ$  out of phase, and difficult adjustment problems arise.

As a result, most unidirectional arrays in use by amateurs are of the Yagi type parasitic systems discussed earlier.

In our final article on Understanding V.H.F. Antennas, we plan to go into more detail about some of the driven arrays, particularly as they pertain to amateur operation. In addition, several antennas used exclusively in the v.h.f. range and above, such as screen and parabolic reflectors will be discussed in terms of the amateur. ■

[To be continued]

## Changes in WWV/WWVH Standard Broadcasts

ON January 1, 1961, at 0000 UT, the National Bureau of Standards retarded the time signals broadcast from radio stations WWV and WWVH by 5 milliseconds<sup>1</sup>, and at the same time resumed broadcasting on WWV a special timing code<sup>2</sup> which gives the day, hour, minute, and second (UT) coded in binary form. The 5-millisecond retardation brought the time signals of WWV/WWVH into closer agreement with other standardized frequency broadcasting stations throughout the world. The pulse timing code, tried out on an experimental basis for several months during 1960, has now been returned to the air on a permanent basis.

The United Kingdom and the United States began coordinating their Time and Frequency transmissions early in 1960. This coordination is the result of an agreement announced by Dr. James H. Wakelin, Jr., Assistant Secretary of the Navy (Research and Development), Dr. Allen V. Astin, Director of the U. S. National Bureau of Standards, and in the United Kingdom by the Astronomer Royal, Royal Greenwich Observatory, and the Director of the National Physical Laboratory.

Coordination was begun to help provide a more uniform system of time and frequency transmissions throughout the world, needed in the solution of many scientific and technical problems in such fields as radio communications, geodesy, and the tracking of artificial satellites.

Participating in the project are the Royal Greenwich Observatory, the National Physical Laboratory, and

<sup>1</sup> "National standards of Time and frequency in the United States," *Proc. IRE*, 48, 105-106, January 1960.

<sup>2</sup> "Experimental Timing Code Added to WWV Broadcasts", *NBS Technical News Bulletin*, 44, No. 7, p. 114, July 1960; *CQ*, August 1960, p. 32.

the Post Office Engineering Department in the United Kingdom, and, in the United States, the U. S. Naval Observatory, the Naval Research Laboratory, and the National Bureau of Standards. This program follows previous cooperative efforts of these agencies to achieve uniformity and simplification in procedures.

The transmitting stations which are included in the coordination plan are GBR and MSF at Rugby, England; NBA, Canal Zone; WWV, Beltsville, Maryland; and WWVH, Hawaii.

Although the signals emitted by all these stations are kept on as uniform a basis as is feasible, occasional corrections are necessary. The last previous time adjustment for WWV/WWVH, a retardation of 20 milliseconds, was made on December 16, 1959. It is expected that such adjustments in the time signals will be made as infrequently as possible and preferably at the beginning of each calendar year when necessary. The time signals are locked to the broadcast frequency.

In 1961 it is planned to maintain the frequency stable to 1 part in  $10^{10}$  and at the same offset value as before, i.e., -150 parts in  $10^{10}$  with reference to the United States Frequency Standard.<sup>3</sup>

The timing code provides a standardized timing basis for use when scientific observations are made simultaneously at widely separated locations. It can be used, for example, where signals telemetered from a satellite are recorded along with these pulse-coded time signals; subsequent analysis of the data is then aided by having unambiguous time markers accurate to a thousandth of a second. Astronomical observations may also benefit by the increased timing potential provided by the pulse-coded signals. ■

<sup>3</sup> "Atomic Frequency Standards," *NBS Technical News Bulletin*, 45, No. 1, p. 8, Jan. 1961.



# AN ELECTRONIC CONTROL SYSTEM

William T. Long, W9UZQ

3213 N. Bolton Ave.  
Indianapolis 18, Indiana

*The author describes an integrated system for controlling receiving and transmitting functions. Break-in is provided by W9TRG's T-R switch. Other functions such as audio tone monitoring, 100 kc crystal calibrator and a visual modulation indicator were added to increase usefulness and flexibility.*

As a result of reading many CQ<sup>1,2</sup> construction articles, I have combined several of the miscellaneous pieces of equipment into one unit. This piece of equipment has the following features:

1. T. R. Switch
2. Negative Peak Modulation Indicator
3. 100 kc calibration oscillator
4. C.w. audio tone oscillator
5. Receiver muting for break-in c.w.
6. Common power supply

This system has no ON-OFF switch, and power is supplied from a receptacle on the rear of my receiver. The other four functions are controlled from the front of the unit and may be selected at will.

## T.R. Switch

Carl Heisinger, W9TRG, described an electronic method of operating a receiver and transmitter from a single antenna without the use of conventional coaxial relays or switches. The unit is tuned r.f. amplifier providing its own cutoff bias when a signal of transmitting amplitude is applied to its input. Its major advantages over other types of T.R. switches are lack of insertion loss and improved spurious and harmonic rejection.

The heart of this unit is W9TRG's T. R. switch. Three changes were made to adapt it to this purpose. The 0.5  $\mu$ h r.f. choke, RFC<sub>2</sub>, was changed to 2.5  $m$ h to increase sensitivity on the lower frequency bands. Tube V<sub>3</sub> was changed from a 12AU7 to a 12AX7. Although the 12AU7 works well in the T. R. switch, it does not have enough gain to operate as a B+ switch for the audio tone generator. The cutoff bias circuit in the T.R. switch now gets its r.f. power from the cathode of V<sub>2a</sub> instead of the plate. This alteration was necessary

to provide enough bias for receiver muting on 21 and 28  $mc$  with low power. On higher powered rigs other than mine (over 100 watts) it may work well with the previous plate connection.

## Crystal Calibration

The 100 kc oscillator, V<sub>1</sub>, is coupled to the receiver antenna input through C<sub>1</sub>. Although C<sub>1</sub> is a Centralab type 822 EN ceramic trimmer, any gimmick will do, since coupling is not critical. Strong harmonics to 30  $mc$  are easily obtained from this oscillator.

## Receiver Muting

Tube, V<sub>4</sub> supplies cutoff bias for V<sub>3b</sub> to operate the relaxation audio tone oscillator. Switch, S<sub>1</sub> is a d.p.s.t. toggle switch to turn on B+ to the audio tone oscillator and muting bias to the receiver first audio stage. When phone is used, another switch at the rear of R<sub>1</sub>, (S<sub>1</sub>), permits operation with muting bias only.

Receiver muting is accomplished by biasing the receiver first audio stage beyond cutoff. Bias for this purpose is obtained from the T. R. switch cutoff bias circuit. A 2 mf electrolytic capacitor and 7 megohm potentiometer, R<sub>2</sub>, controls receiver recovery time while preventing clicks when the rig is keyed. This potentiometer, R<sub>2</sub>, is a rear panel control since one setting will suffice for all bands if input power to the transmitter is not changed over too-wide a range. A voltage divider is provided at the input to the receiver first audio stage (fig. 2) to isolate the audio from hum pickup by the load from the control unit. All three leads are shielded wire and grounded at both receiver and control unit. A satisfactory compromise between hum pickup and adequate receiver muting resulted in the values shown in fig. 2.

When S<sub>1</sub> is in VFO TUNE position, the receiver r.f. gain control must be reduced for direct monitoring of the transmitted signal.

<sup>1</sup> Campbell, J. W. Jr., "Negative Peak Indicator," CQ, June, 1955, p. 13.

<sup>2</sup> Heisinger, C., "A Practical T.R. Switch," CQ, October, 1955, p. 43.



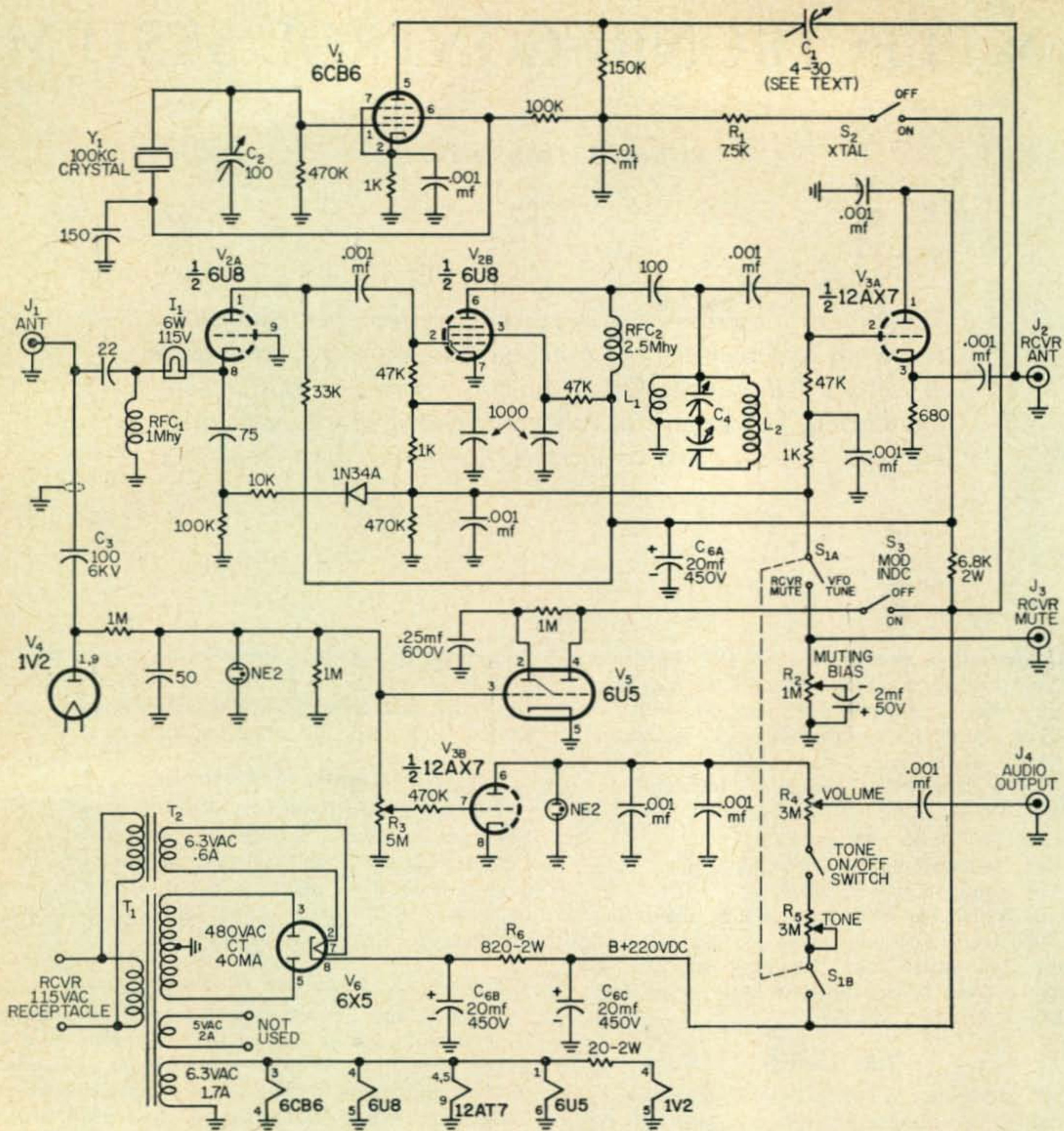

Fig. 1—Schematic of an "Electronic Control System" which includes a 100 kc crystal calibrator, T-R switch, modulation indicator, receiver muting, c.w. audio tone oscillator and a common power supply. All resistors are 1/2 watt and all capacitors are disc ceramic unless otherwise specified.

### Audio Oscillator

The audio note is generated by the NE2, .001 mf capacitor and  $R_5$  in the plate of  $V_{3b}$ . The oscillator is controlled by the bias on  $V_{3b}$ . When  $V_{3b}$  is biased, the plate voltage rises to a level sufficient to ignite the NE2 causing the circuit to act as a relaxation oscillator, the frequency being determined by the .001 mf capacitor across the NE2 and  $R_5$ . When the bias is removed from  $V_{3b}$ , the tube conducts heavily dropping the plate voltage below the firing point for the NE2 resulting in no output.

The grid bias is obtained from the 1V2,  $V_4$ , when r.f. is applied to its plate. A 5 megohm potentiometer,  $R_3$ , controls the bias on  $V_{3b}$  and  $R_4$ , a 3 megohm potentiometer controls the output to the receiver audio. The output is fed to the screen grid of the audio amplifier. When fed to the control grid

too much hum and output was experienced. The proper connection point will vary with each receiver and should be determined experimentally.

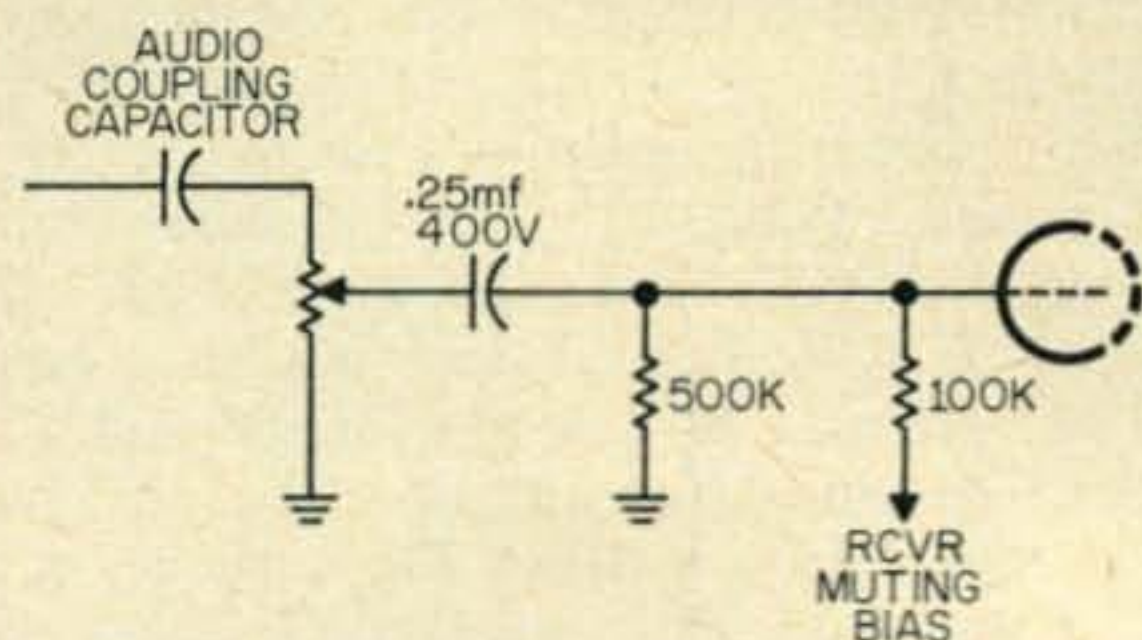

Fig. 2—Muting bias voltage divider in receiver. This also provides isolation for hum as described in the text.





Front view of the control unit showing control location and function.

### Negative Peak Indicator

John Campbell's article in *CQ* June 1955 describes a negative peak modulation indicator using a 1V2 rectifier and 6E5 electron eye indicator. Negative peak clipping is indicated when the eye opens and the eye is held in this condition for a short time by an RC circuit of 1 megohm and .25 ufd capacitor. The 6E5 may also serve as a tuning aid.

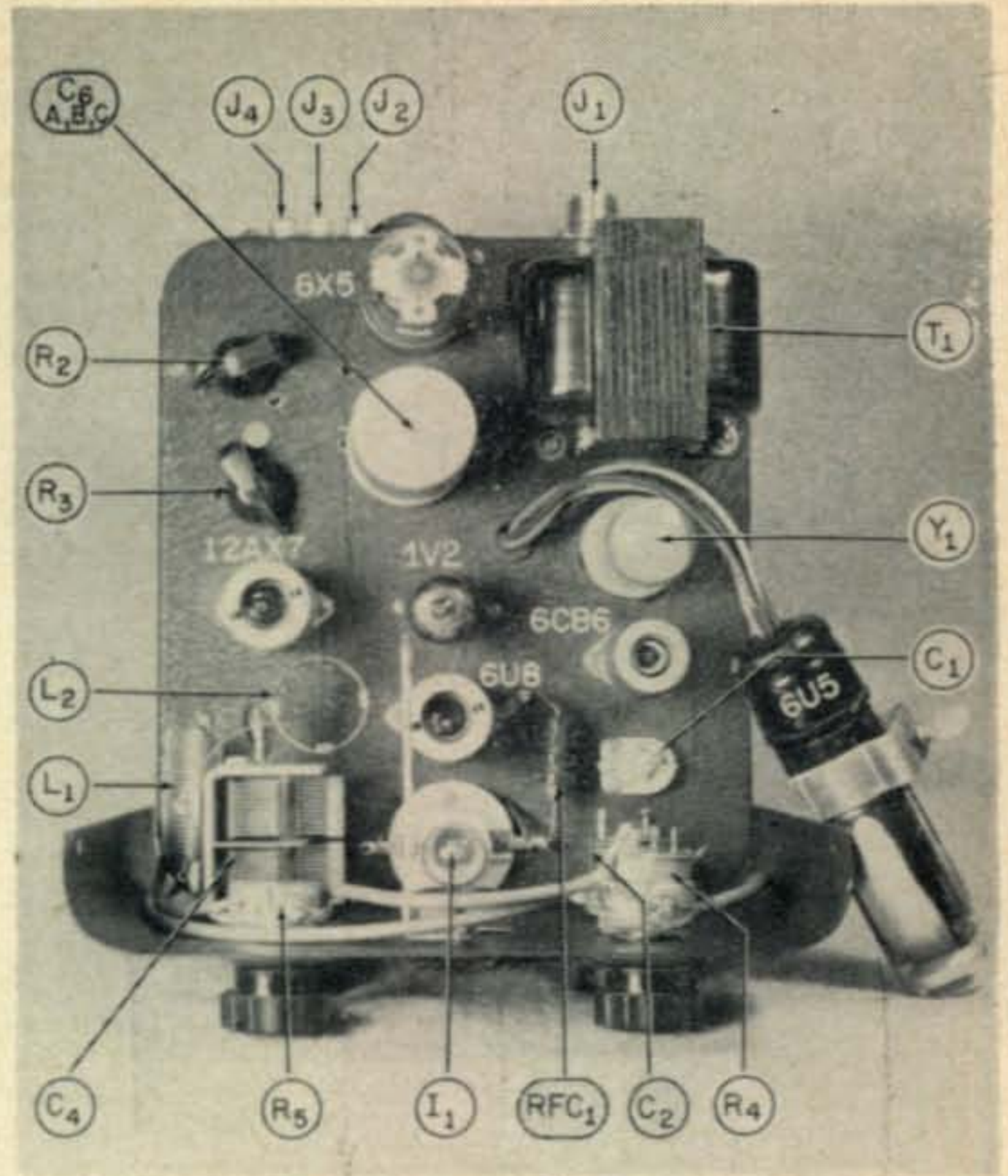

Top view showing component layout and identification.

### Results

The absence of clicking relays and smooth break-in operation with a c.w. monitor should make electronic station control attractive to both DX hounds and ordinary brass pounders. Requests for a cease fire of station operation are now seldom heard at my location. ■

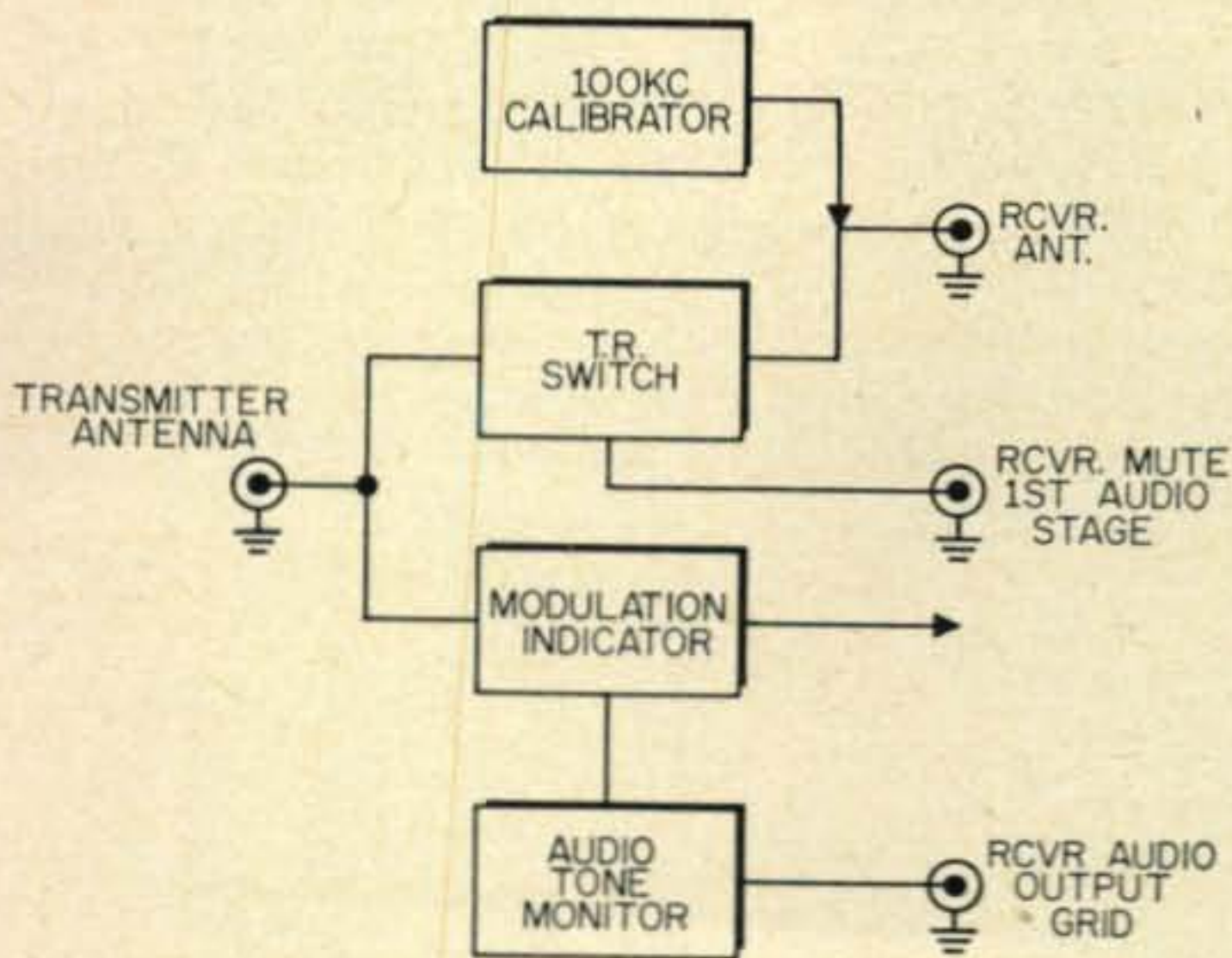
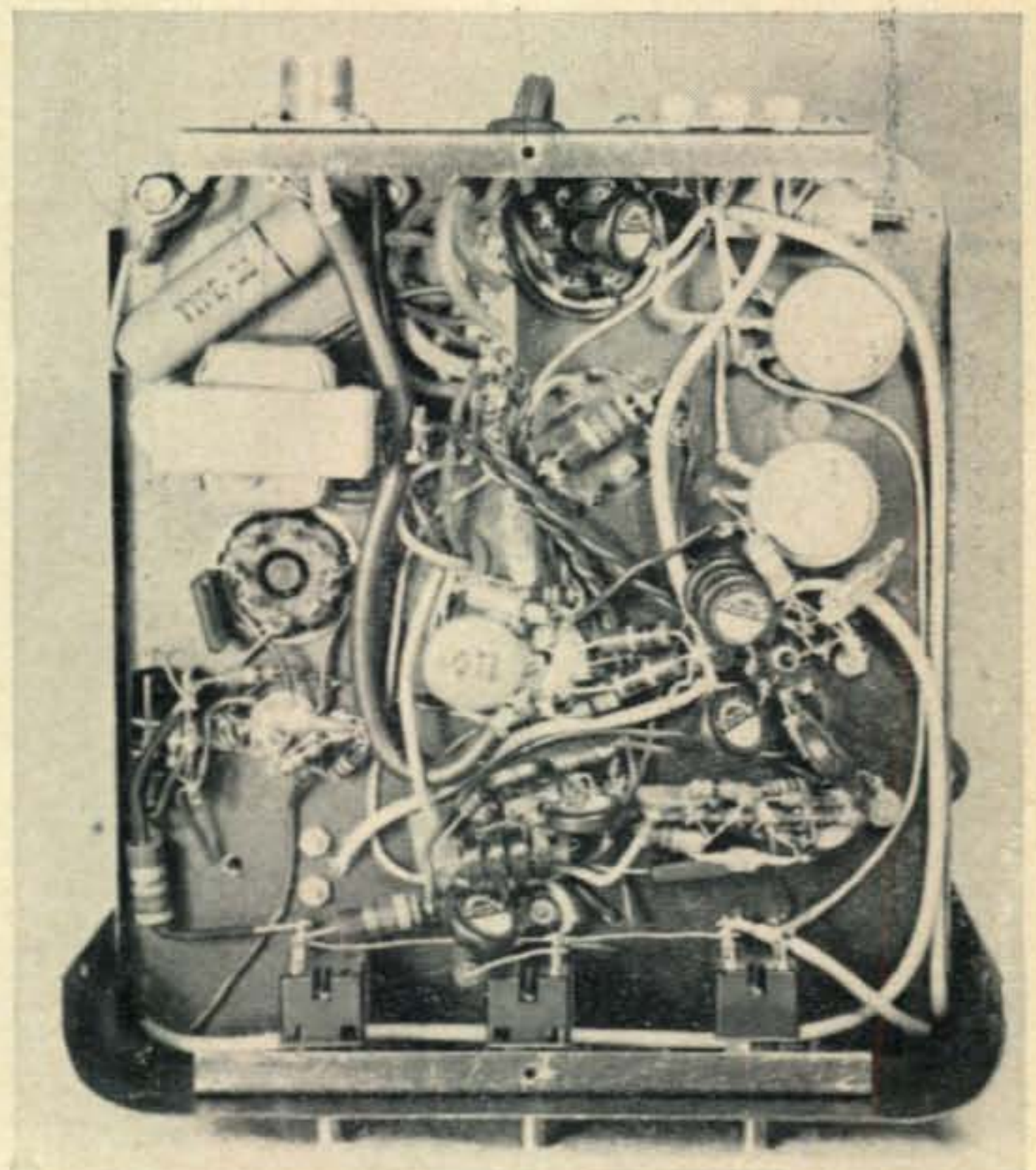

Fig. 3—Block diagram of the "Electronic Control" unit.

### Construction

The original unit is housed in a Bud cabinet which is no longer available, however a Bud C973 cabinet which is one inch lower and has a hinged lid will make a more convenient unit. Transformer,  $T_1$  has been adapted from the junk box, but ratings are given in fig. 1. A separate filament transformer powers the 6X5 filament to prevent overloading of  $T_1$  filament winding. Any other transformer or combination may be used provided they equal or exceed the ratings given.



Bottom view. Transformer  $T_2$  is in the upper left corner. One NE2 is located above the 1V2 socket (center) and the other NE2 above the 12AX7 socket on the left (below  $R_3$ ).



# The In-Between Power Supply

Herbert Greenberg, W2EEJ

821 Rutgers Road  
Franklin Square  
New York

*The author presents a low cost power supply circuit that provides 500 to 800 volts using two surplus or TV receiver power transformers. The transformers need not be identical.*

There is little or no difficulty and only moderate expense involved in the construction of a standard vacuum tube plate supply operating in the region of 250 to 350 volts, widely used for the majority of receivers, converters, v.f.o.s, and excitors. However, when a supply of 500 to 800 volts is required, expenses for components increase drastically. The cost of a very high voltage supply can be reconciled as these must be of good quality or volumes of expensive smoke will result.

The need for the middle ranges of voltage is widespread. Many popular transmitting tube types require these voltages. Relatively inexpensive linear amplifiers and class C finals with modulators are in this class. Also surplus transmitters of the popular ARC-5 series, the Bendix TA-12, TCS and TBX, and others are powered with these voltages.

The power supply circuit presented is not new, but the availability of used television power transformers and surplus transformers with dual plate windings make it of practical use for the average amateur. Additionally, with several filament voltages available, the powering of surplus gear with 12 or 24 volt heater requirements is facilitated.

Connecting the plates of the rectifiers in parallel results in doubling the current handling capabilities of the rectifiers. The 5R4 type, rated at 175 milliamperes per section, will thus handle up to 350 milliamperes. As two tubes are required, this is not a clear gain. Do not attempt substitution of rectifiers with any having lower inverse breakdown voltage rating as the peak inverse voltage of the more commonly used rectifiers will be exceeded.

## Transformer Phasing

The secondaries must be properly phased or no high voltage will be developed. By experimentally connecting the leads to the rectifier plates or filaments and checking for output, the proper phasing can be established. If no output voltage is present, reverse the connections to either the plates or the rectifier filaments.

Other components, salvaged from old television sets can be used. The chokes used in the power supply of the older sets, while not having much inductance, is low in resistance and high in current handling capacity. The filter capacitors can be used with higher voltage supplies by series connecting with balancing resistors to equalize the distributed voltages.

[Continued on page 102]

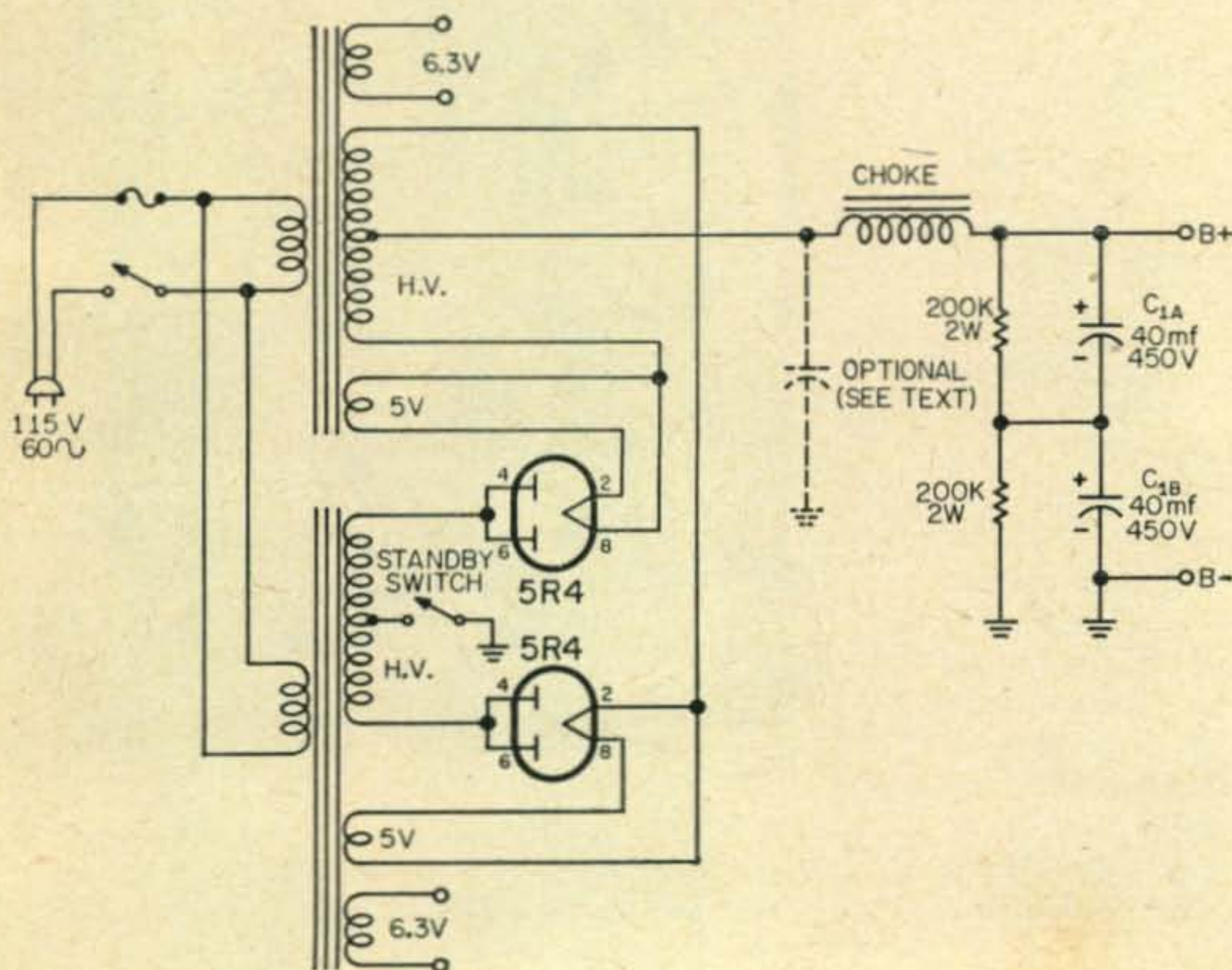

Fig. 1—Power supply circuit that permits the combining of dissimilar power transformers. Transformer windings must be phased for correct operation.



# Know Those British Calls

Pat Hawker, G3VA

37 Dovercourt Road,  
London, S.E.22, England

*G3VA, well known British Amateur, has consented to explain the simple, yet generally unknown method of call allocations in Great Britain*

**G4XX DE KNIABC MNI TKS OM FER FB QSO ES NW PSE PSE QSL FER NEW G CALL AREA.** . . . With so many American amateurs gleefully cutting their first DX teeth on contacts with British amateurs, messages such as the above daily find their way across the Atlantic. But it takes a dyed-in-the-wool DX man to know that the G4 may have, as his neighbor a G2, G3, G5, G6 or a G8 station. But if a G call means nothing so far as the location goes, can it tell you anything about the fellow at the other end? Yes, the call gives you a useful clue as to how long he has been on the air.

## Experimental Station

The very first British amateur calls—assigned before World War I—were just three letters, one of which was always "X" to show it was an "experimental" station. But none of these calls were ever heard in the States (25 miles was good DX then) and they were cancelled for all time at the outbreak of the European war in August 1914—though quite a few of these real old-timers are still active with modern calls. It was almost six years later, in mid-1920, before any amateurs could operate legally again in Britain. But when licences were reissued, the brand new calls consisted of a number ("2" at first, soon followed by "5" and "6") and two letters. It was not until after the Washington Radio Conference of 1928 that the international prefix G was officially added, although for some years, either G or EG was used for Transatlantic work, often in the form of an "intermediate." For example, 1AA 1AA NU-EG 2NM 2NM meant that British 2NM was calling North American 1AA.

Up to 1936, the three numbers 2, 5 and 6 with two letters were sufficient for all British transmitting licences, particularly as the same calls were often reissued several times. But with the growing number of British hams, new blocks of calls were needed and were created by using first G8, then G3 and finally G4. Before the G4 block had been exhausted, all amateur radio was suspended by the outbreak of World War II in September, 1939.

These pre-war two letter calls were reissued in 1946, but the General Post Office (which is responsible for all British amateur radio li-

cences), decided that new licences should have three instead of two letters following the number. The first number chosen was 3 and since then all new licences have been issued in sequence from G3AAA onwards, except for a few cases where out-of-sequence calls have been especially requested, for example to fit the call to the operator's initials.

## "Artificial Aerial"

There is one other block of calls worth mentioning. Before World War II, special non-radiating permits known as "artificial aerial" licences were issued in Britain as a preliminary to the full licence. These A.A. licences, as they were called, allowed the owner to install and test a rig on a dummy antenna but not to use a radiating antenna. Calls were assigned, consisting of the number 2 and three letters. After World War II no more of these licences were issued but pre-war holders who qualified for the full licence by passing the British Morse test of 12 w.p.m., were permitted to retain their old calls.

The list below shows the approximate date of issue of all British calls:

G2AA — G2ZZ	1920 to 1939
G3AA — G3ZZ	1937 to 1938
G4AA — G4ZZ	1938 to 1939
G5AA — G5ZZ	1921 to 1939
G6AA — G6ZZ	1921 to 1939
G8AA — G8ZZ	1936 to 1937
G2AAA — G2HZZ	Pre-war "A. A." permits, reissued 1946 onwards
G3AAA — G3AZZ	1946
G3BAA — G3BZZ	1946 to 1947
G3CAA — G3CZZ	1947
G3DAA — G3DZZ	1947 to 1948
G3EAA — G3EZZ	1948
G3FAA — G3FZZ	1949
G3GAA — G3GZZ	1950
G3HAA — G3HZZ	1950 to 1951
G3IAA — G3IZZ	1951 to 1952
G3JAA — G3JZZ	1952 to 1954
G3KAA — G3KZZ	1954 to 1956
G3LAA — G3LZZ	1956 to 1957
G3MAA — G3MZZ	1957 to 1958
G3NAA — G3NZZ	1958 to 1960
G3OAA	1960

[Continued on page 103]



## The Hallicrafters SX-111

Adolph Suchy, W2KHE

109-35 213 St.  
Bellerose, L. I., N. Y.

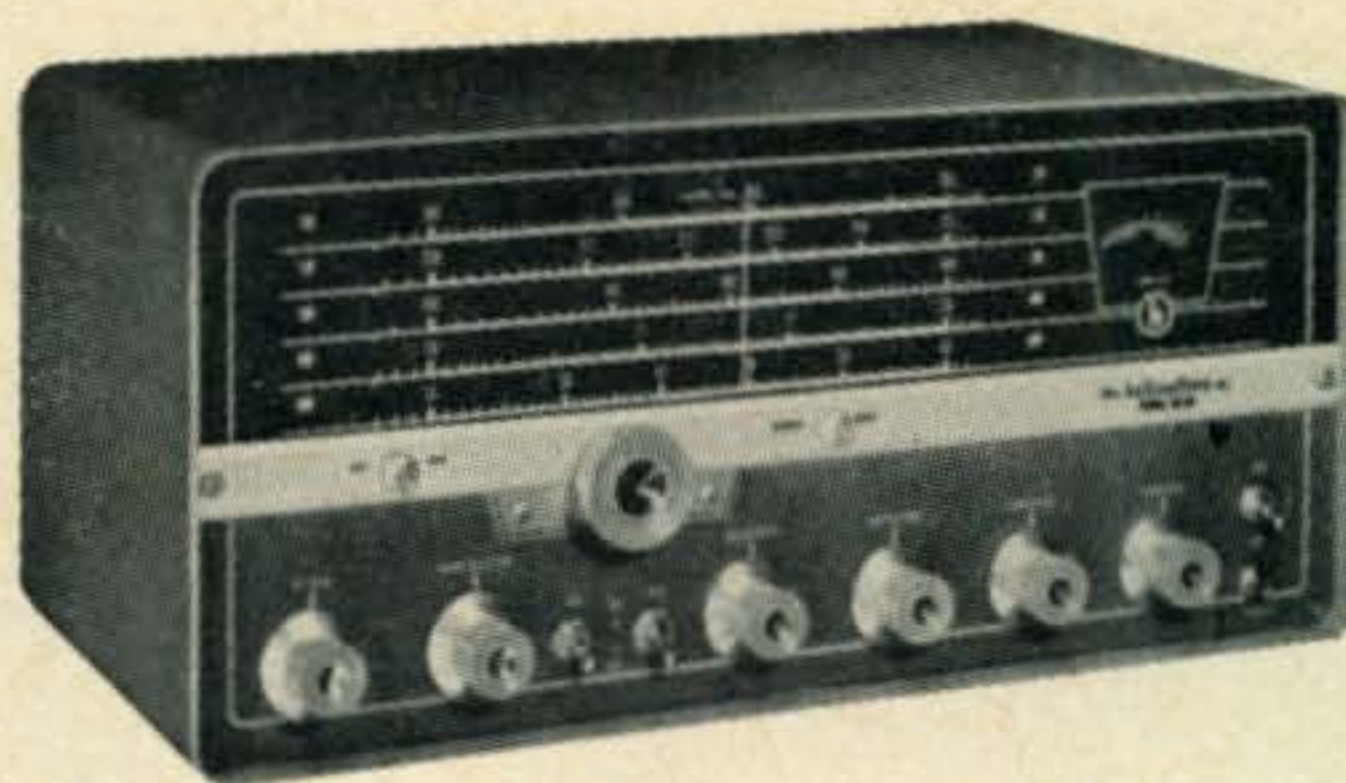

As a fitting companion to the HT37 or as a new receiver in its own right, Hallicrafter's SX111 has much to offer to the ham interested in a new receiver. After operating it side by side with the HT37 and admiring its neat and trim appearance, its sterling performance left little to be desired.

Electrically, the SX111 resembles closely the series of receivers that started with the SX100 and famous SX101. Its dual conversion on all bands offers excellent selectivity the control of which will be described later. Stability proved more than adequate except for hams who occasionally check this feature by throwing the receiver out of the third floor window. Sensitivity-wise, the published specification of "less than 1 microvolt for a 10 db signal to noise ratio" proved to be a gross understatement. The inclusion of low noise converter and *rf* type tubes has given the SX111 maximum sensitivity and high signal-to-noise ratio on even the weakest of signals. In its price range it is one of the few receivers that includes rejection tuning, crystal calibrator with a WWV position on the dial, noise limiting and a dial of such proportions that 20/20 vision is not an absolute necessity to tune it.

### Block Diagram

The block diagram, fig. 1, will give a birds eye view of the "works". The *rf* amplifier,  $V_1$ , contributes substantially to the high signal-to-noise ratio mentioned before. Its sensitivity is controlled by the *rf* gain control which also controls the sensitivity of the 50 *kc* *if* amplifier. The first mixer  $V_2$ , uses a 6BY6, noted for its ability to give high conversion gain with a minimum of noise. This is heterodyned by an old reliable 6C4 oscillator. The performance of this oscillator is all-important in determining the over all stability of the receiver. Great care was taken in the design of this part of the circuitry. While it is the conventional Hartley oscillator, ceramic coil forms, reinforced switch sections (mechanically) and placement of the oscillator in a portion of the chassis where the effects of heat are minimized all contribute to the electrical and mechanical stability which made the performance of the SX111 outstanding.

The second mixer which converts the 1650 *kc* output of the first mixer to 50.75 *kc*, uses crystals for the conversion oscillators thus contributing even more to stability. Upper and lower sideband selection is obtained by switching in the desired portion of a 12AT7 crystal oscillator. One section of the 12AT7 is controlled by a 1600 *kc* crystal for lower sideband reception and the other has a 1700 *kc* crystal for upper sideband reception. While on the subject of stability, the plate voltage of the *bfo*, crystal calibrator, 1st conversion oscillator and the screen voltage of the 1st mixer and 1650 *kc* *if* amplifier are all regulated with an 0A2 voltage regulator tube.

The selectivity of the receiver is controlled in the plate circuit of  $V_{201}$ , the second mixer. Figure 2 shows the equivalent circuit for the type

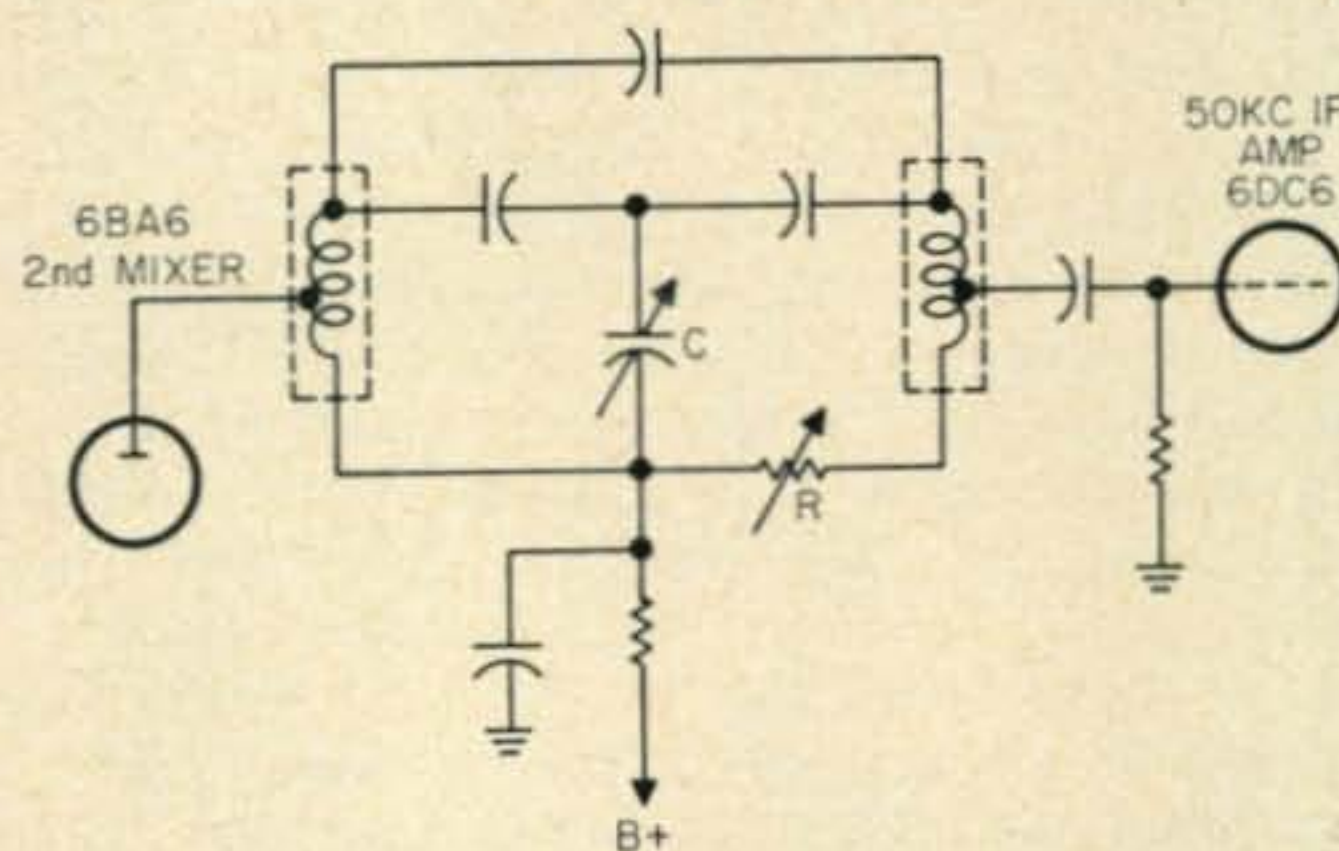

Fig. 2—Equivalent circuit of the *i.f.* coupling system used in the SX-111 circuit Q is controlled by resistor R.

of coupling used in the 50.75 *kc* *if* system. By careful shielding of the *if* coils, inductive coupling is avoided and signal transfer occurs only through capacitance and resistance. The capacitor C controls the coupling between the coils and resistance R controls the "Q" of the circuit. By selection of proper values of C and R the bandwidth response of this *if* amplifier can be reliably controlled.

A similar circuit couples the output of the 50 *kc* *if* amplifier to the diode detector,  $V_{5B}$ . With switches controlling the amount of capacitance and resistance introduced into these circuits, the *if* amplifier selectivity is controlled to give band-



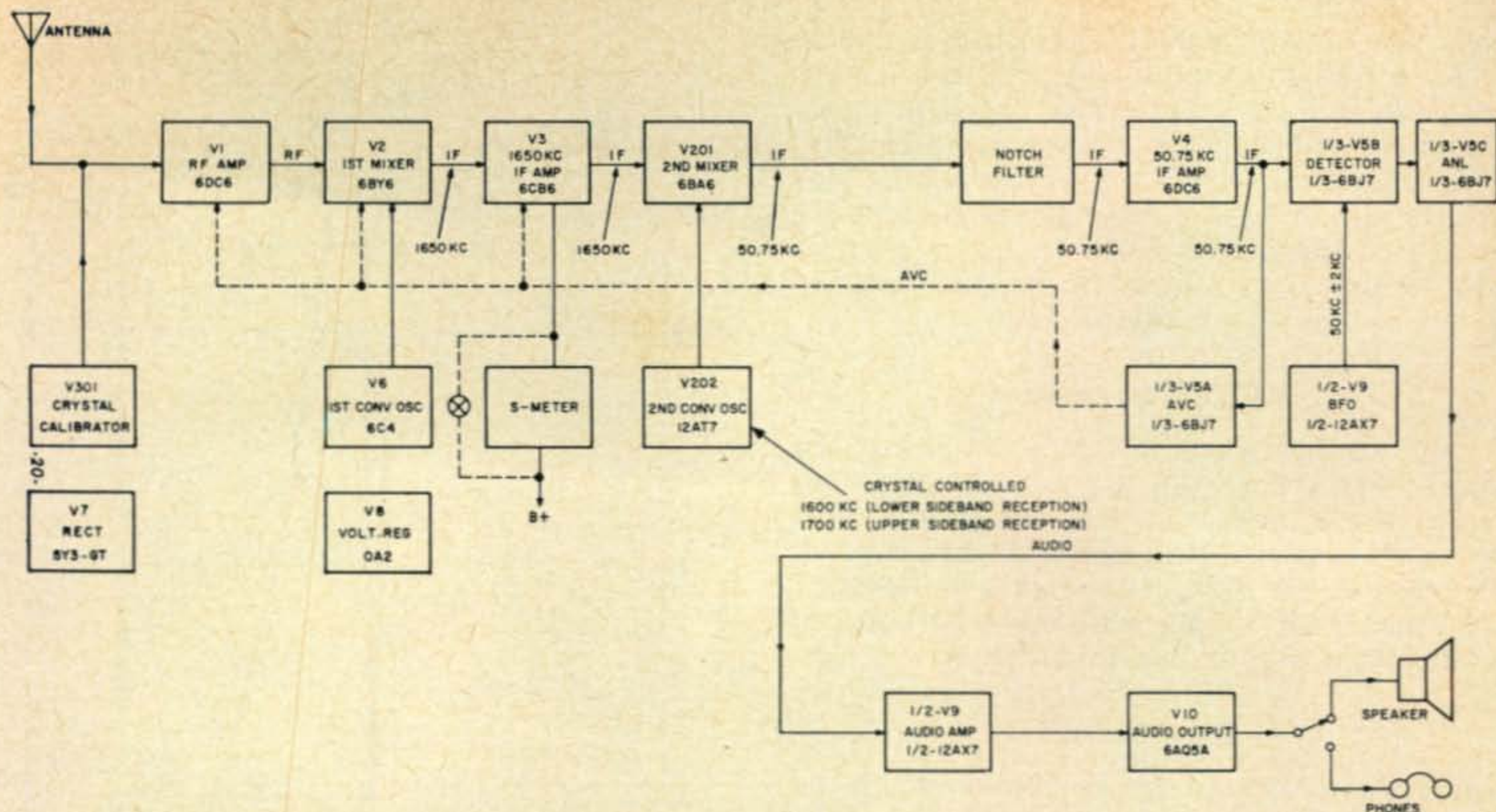

Fig. 1—Block diagram of the new SX-111 receiver. The newer SX-111 Mark I incorporates a product detector located between V<sub>4</sub> and V<sub>5</sub> in the block diagram.

widths of 5 kc, 3 kc, 2 kc, 1 kc and 0.5 kc. Figure 3 shows the *if* response curves for the different positions of the selectivity switch. During operation it was quite evident that the 0.5 kc was excellent for c.w. operation and that the 2 or 3 kc position was usable on s.s.b. while the 5 kc position was best for a.m. phone.

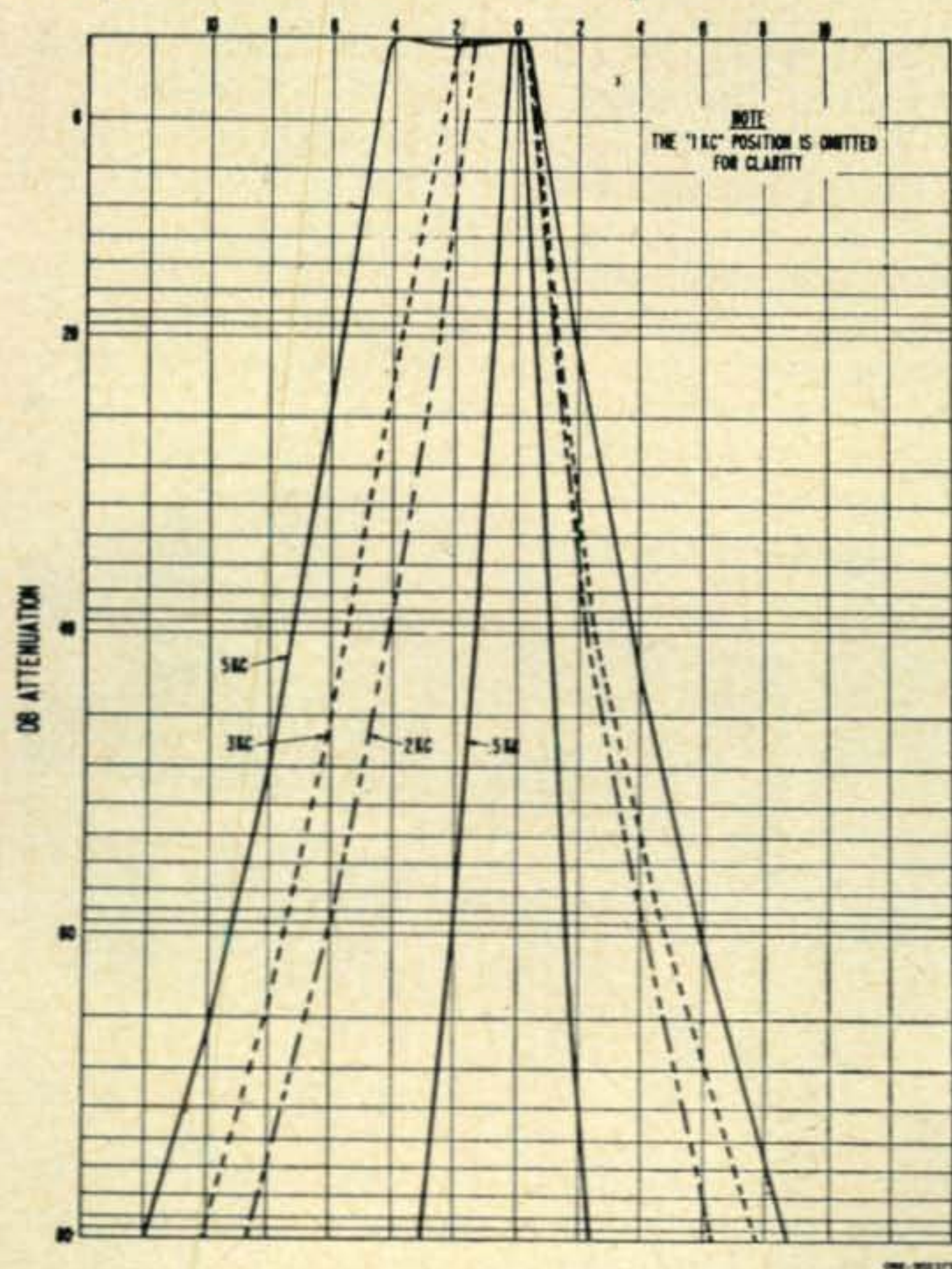

Fig. 3—Diagram illustrating the selectivity of the SX-111 in the various positions of the selectivity switch. Note that the "1 kc" position is eliminated for clarity.

### Notch Filter

One cannot operate in the crowded ham bands of today without the aid of some type of rejection tuning in the receiver. The notch filter incorporated in the SX111 proved to be extremely effective in eliminating heterodynes from adjacent a.m. and c.w. stations. However, while one can eliminate the heterodyne caused by an adjacent carrier, if that carrier is modulated, the "monkey chatter" will still persist. Frequently, the monkey chatter can be minimized by increasing the selectivity and a QSO that was originally impossible to carry on is made entirely possible. The notch filter is diagrammed in fig. 4. The effectiveness of this notch filter is many times greater than that of a

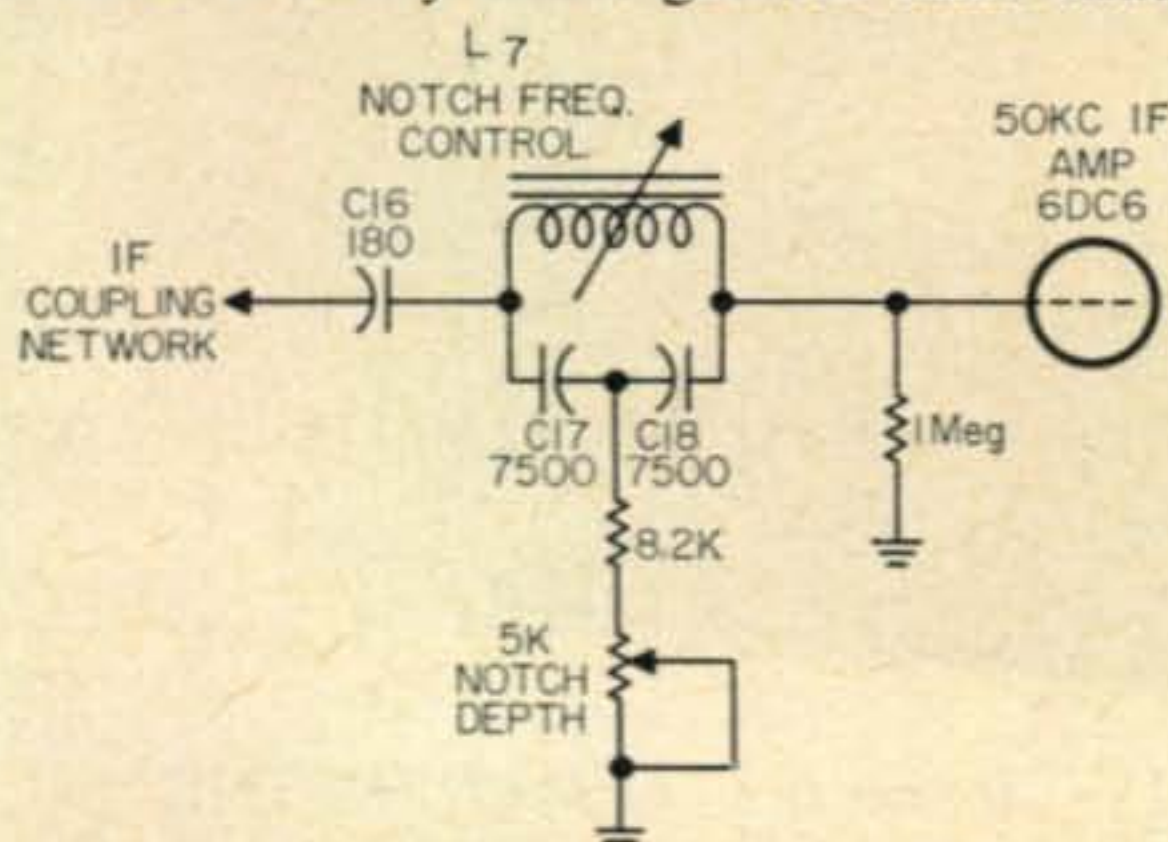

Fig. 4—Diagram of the notch-filter in the SX-111. The notch frequency is controlled by inductor L<sub>7</sub>, while the notch depth is controlled by the 5K potentiometer.

crystal filter. Furthermore, the notch as illustrated in fig. 5 can be moved across the entire *if* pass band of the receiver by tuning the notch filter inductance. Therefore, it is possible to tune out an offending heterodyne unless this heterodyne is rich in harmonics or is modu-



lated. One feature of this circuit which demands attention is that care must be exercised in tuning the notch frequency control so as not to notch out the desired signal. The notch depth control, a 5K ohm variable resistor is preset at the factory for a minimum of 50 db attenuation at the notch frequency. The notch frequency control must be tuned very slowly or else the notching feature will go by unnoticed.

### Product Detector

Later models of the SX-111, designated the SX-111 Mark I, include a product detector for improved c.w. and s.s.b. reception. Located between i.f. amplifier  $V_4$  and  $V_5$ , the 6BY6 product detector,  $V_{11}$ , is capacity coupled to the b.f.o.,  $V_9$ . Easier s.s.b. tuning with less distortion can be attributed to this simple addition.

### Conclusion

In outward appearance, height and width the SX111 is the same size as the HT37 and its finish, knobs and general decor makes this pair a matching set with considerable eye appeal. The output of SX111 can be coupled to a voice coil directly or through a 500 ohm output to a line. The headphones are plugged in series with the 3.2 ohm output which effectively silences the speaker if the impedance of the phones is fairly high. Headphones of almost any impedance will give satisfactory results in this circuit.

On the rear apron of the chassis a "mute" terminal which when ungrounded effectively silences the receiver by placing a high bias on the *rf* and *if* amplifiers. The receiver may then be effectively muted either by the antenna relay auxiliary contacts or by the relay in the s.s.b. exciter thus making for effective voice control.

The *avc* section of the 6BJ7 tube provided excellent *avc* action with fast attack for s.s.b. work.

All in all, for the beginner or seasoned opera-

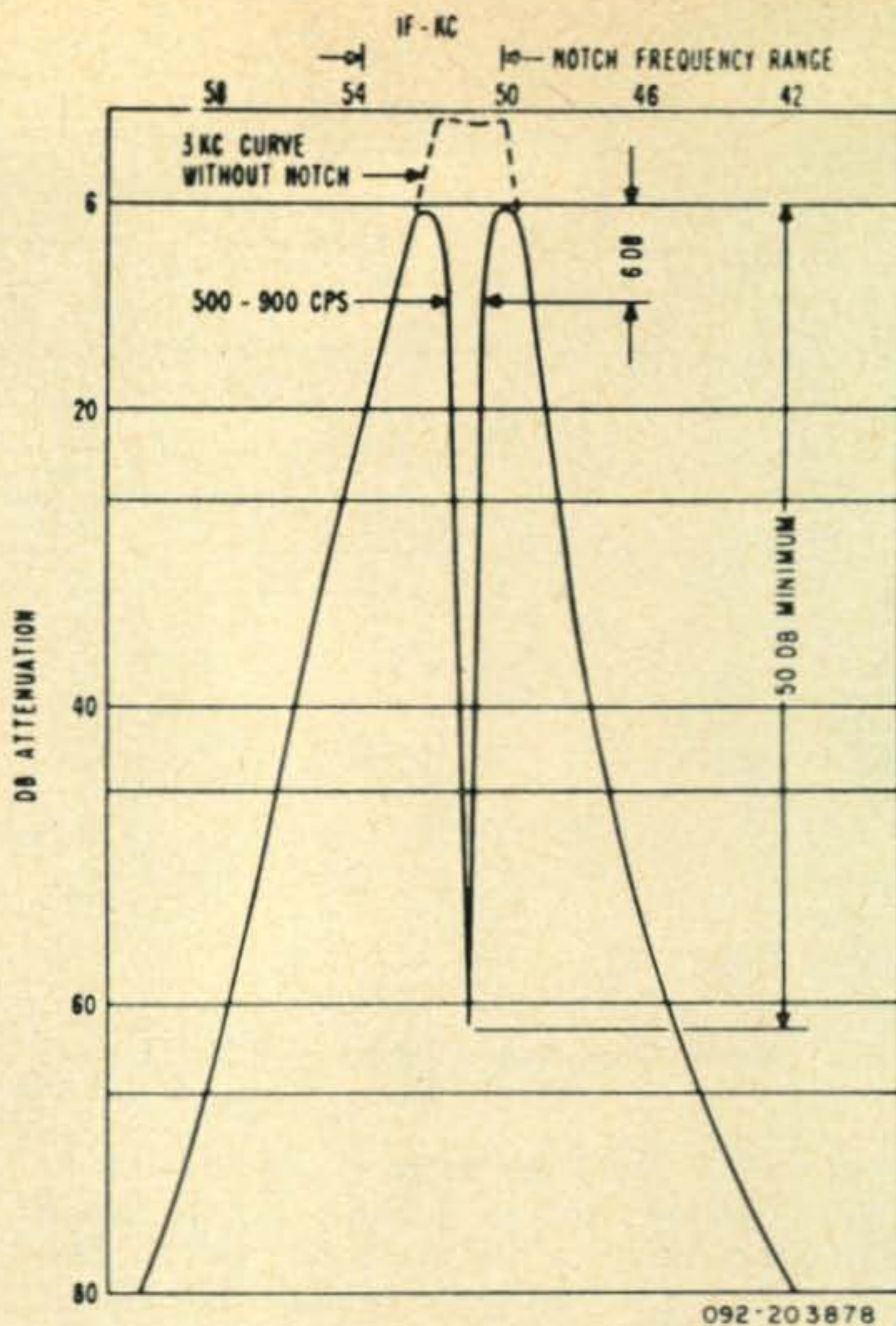

Fig. 5—Graph illustrating notch frequency and depth with relation to the 3 kc selectivity curve.

tor, the SX111 is a fine receiver which will satisfy even the most precise of operators. For s.s.b. it was compared with several other receivers of approximately the same price range and not found wanting in any respect. In fact it compared with receivers selling for fifty or a hundred dollars more and all of the features mentioned here were not incorporated in all of these more expensive jobs. ■

### CQ Reviews:

## The Knight T-400

Donald L. Stoner, W6TNS

P.O. Box 137,  
Ontario, California



Elbowing my way through the mobs at the 1960 WESCON show in Los Angeles, I was suddenly confronted by an insurmountable obstacle. The aisle was completely blocked by a great blob of humanity milling around the Allied display. By kneeling my way to the counter, I found the object that attracted the interest of this group of

people. It was not a quadra-beam memory oscilloscope, or anything of the sort, but the new Knight-Kit T-400 Amateur Transmitter.

By spreading a rumor about the redhead attending booth 1410, I was able to clear enough room to get a close look at the T-400. Here's what I found. . . .



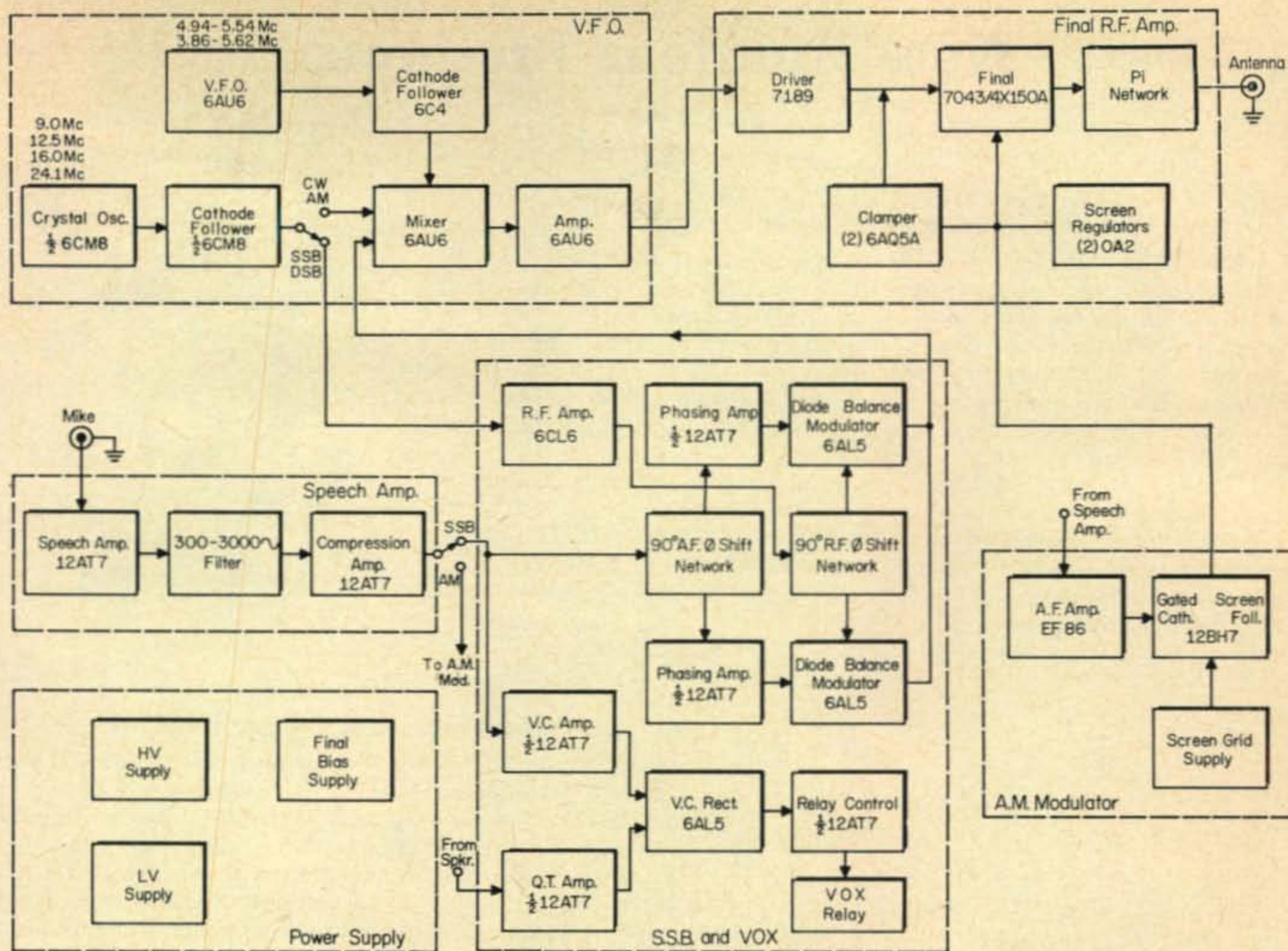

Fig. 1—Block diagram of the new Knight T-400 transmitter with all accessory units. The basic v.f.o., exciter, final amplifier and power supply are standard, while accessory a.m., s.s.b., scope and speech amplifier units are also available.

### Technical

The Knight-Kit T-400 is a very unusual transmitter. It would appear that Allied tried to please everyone and succeeded admirably. To avoid the old saw about the kitchen sink, let's just say it has just about every feature a ham could ask for. The basic package is a c.w. transmitter. A v.f.o.-exciter section drives a class C power amplifier to 400 watts on all bands from 80 through 10 meters. Unlike most transmitters in this power class, the package also contains the power supply.

One of the attractive features of the T-400 is the modular construction. By using this technique it is possible to interchange subassemblies to provide just about every combination the builder desires. A block diagram of the transmitter is shown in fig. 1.

### VFO-Exciter

The v.f.o. is the heart of the transmitter and is worthy of special mention. The 4" X 14" slide-rule dial is pleasing to the eye and very easy to interpret. The v.f.o. is a heterodyne type which operates on 5.0- 5.5 mc for 80, 40, and 20, and 3.9- 5.6 mc for the 15 and 10 meter bands. On 80 and 20 the v.f.o. is mixed with the signal from a 9.0 mc crystal oscillator, producing an output between 3.5 and 4.0 mcs on 80 and 14.0 and 14.5 mc on 20 meters. On the 40 meter band a 12.5 mc crystal is switched into the oscillator and this beats with the v.f.o. to produce a signal between 7.0 and 7.5 mc. On 15 the new v.f.o. frequency beats

with a 16.0 mc crystal to produce an output between 19.9 and 21.6 mc. A 24.1 mc crystal is used on 10 meters and when combined with the v.f.o. provides a sum signal between 28.0 and 29.7 mc. Actually a generous "overcoverage" is provided at each end of the dial, but round numbers have been used here to simplify the explanation.

Both oscillators (fixed and variable) drive cathode followers to obtain maximum stability and isolation. The outputs of the followers are combined in a mixer stage, which in turn drives an amplifier-buffer operating class A. The output of the v.f.o.-exciter subassembly drives the final on a.m., c.w., and as we shall see, on s.s.b. also.

**Final**—The r.f. drive from the exciter section is set with an excitation control. The driver tube, a premium type 7189, delivers r.f. to the 7034/4X150A final amplifier. It coasts along at less than the CCS ratings with 1600 volts on the plate. They say the high speed blower isn't there to cool the tube but to keep icicles off the cooling fins. However this sounds like it might be an exaggeration. The pi-network is able to match transmission lines between 30 and 600 ohms. Parallel-connected clamp tubes provide complete protection for the final. The grid, screen and plate are metered. The meter may also be switched to read relative r.f. output to assist in loading the antenna. It cannot read actual watts because this depends on the output impedance.

[Continued on page 103]



# New Amateur Products

## Electronic Keyer

**B**EN Woodruff, W9UE, of 6140 North Harding Avenue, Chicago 45, Ill. recently presented his Auto-Mate, K 5/50 Electronic Keyer Kit which should nicely fill the bill for a low cost, high performance keyer.

The chassis for the keyer comes completely punched with tube sockets and terminal strips already mounted. Keyer speed is controlled by means of the large center control. Speeds from 5 to 17 w.p.m. and 15 to 50 w.p.m. may be selected by switching the RANGE control from low to high. Side tone output and associated volume control as well as a jack for the key lever are provided at the rear. For convenience, all circuits are brought out to a 9 pin socket also located at the rear. Located on the a.c. ON-OFF switch is a HOLD control for tuning up. A MARK-SPACE control adjusts the ratio of dot to dash. The keyer comes attractively packaged with an etched green panel and measures 5½" high × 4¼" wide × 8½" deep. Weight is 5 pounds.

Tubes (not included) are 4-12AU7s, 1-0A2, and 1-0B2. For more information circle A on page 126.



## Hammarlund Noise Limiter

**T**HE Hammarlund Manufacturing Company at 460 West 39th Street, New York 1, N. Y., has come to the aid of HQ-170 and HQ-180 owners residing in high impulse-noise areas, with the presentation of their new Lamb-type i.f. noise limiter. The modification kit, consisting of a plug in i.f. adaptor, noise limiter sub-chassis and a replacement dual noise control potentiometer with hardware, is easily installed in all HQ-170 and HQ-180 receivers in about 15 minutes. No front panel "butchering" is necessary, since the old noise limiter control is removed and merely replaced by the new dual concentric control, thus, not only retaining panel appearance but also the original audio peak clipper type noise limiter. Installation involves only seven soldered connections and the results achieved on ignition noise and other impulse noise are truly startling. For complete details circle B on page 126.

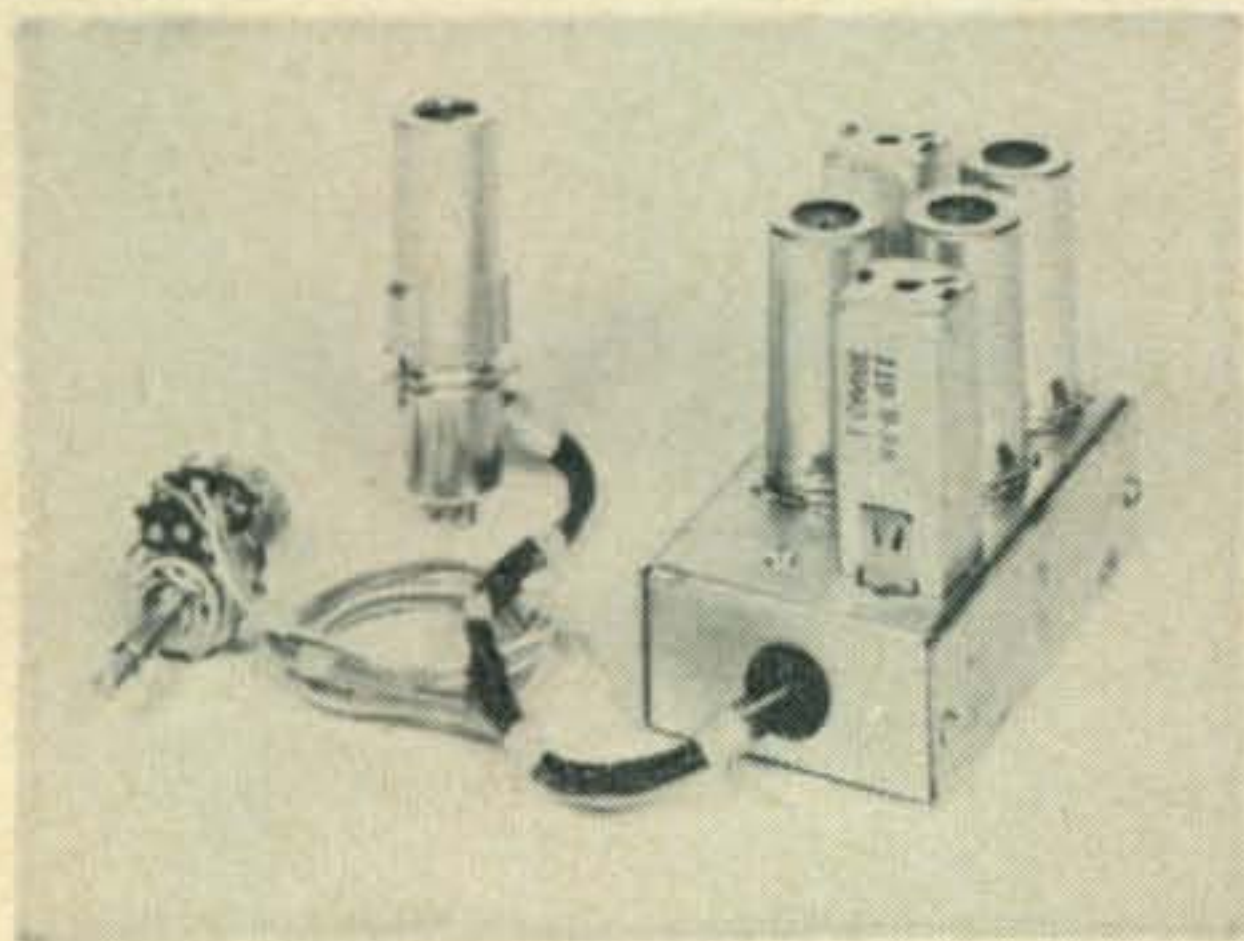

## Compact New Transmitter

**E**ICO of 33-00 Northern Boulevard, Long Island City, New York recently announced a new 60 watt c.w. transmitter designated the Model 723. The compact unit, measuring 6" high, 8½" wide and 9" deep, has a self contained power supply and a modulator/accessory socket for modulator input, antenna relay, v.f.o. power take-off and emergency power input. Effective TVI suppression is achieved through extensive filtering, by-passing and shielding. One knob bandswitching from 80 through 10 meters, a one knob OFF-STANDBY-TUNE-TRANSMIT switch and a panel meter switchable between final grid and final plate combine to make operation quick and easy. For more information circle C on page 126.



## BNC Type Coax Switches

**B**ARKER and Williamson Inc. of Bristol, Pa., has announced two new coaxial switches designed for use with the BNC or UG-88/U type connectors. The Model 560 is a single pole, 5 position switch while the Model 561 is a double pole, two position unit designed for rapidly cutting equipment such as s.w.r. bridges, linear amplifiers and converters in and out of series connection in coaxial lines. Both are designed for 52 or 75 ohm coaxial lines. Maximum crosstalk is better than -48 db at 30 mc. The switches, which are rated at 380 volts r.m.s., measure 4 inches across the terminals and are 3⅞ inches deep including shaft. For further information circle D on page 126.

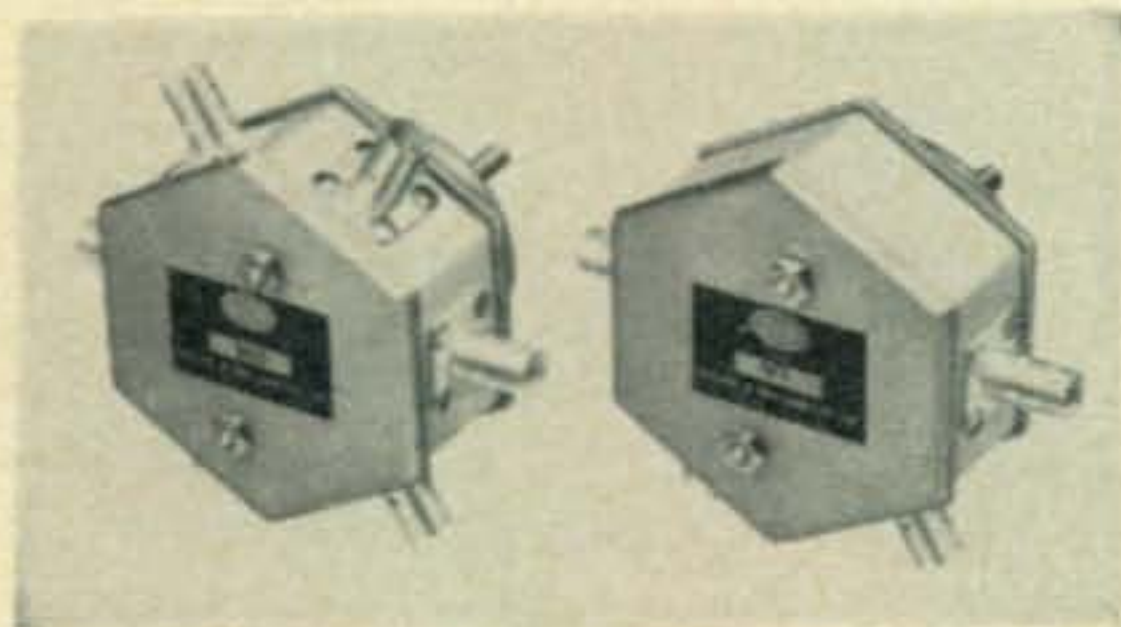



# DX DX DX DX DX DX DX DX

URBAN LE JEUNE, JR., W2DEC

BOX 35, HAZLET, NEW JERSEY

The following certificates were issued between November 15th, 1960 and December 10th, 1960:

WAZ		
1459	W7STC	L. A. Killpack
1460	SM5DW	Rolf Andersson
1461	SM5BZ	Jan E. Bjork
1462	DJ2KS	H. U. Widdel
1463	G3ID	A. E. Tupman
1464	DJ1VS	Dr. Hermann Edelmann
1465	LU8BAJ	Carlos E. Trench
1466	K6OYD	Robert R. Cava
1467	W6CBE	Ronald A. Panton
1468	W6FWQ	Roy Gould
1469	KØWQI	Paul McKnight
1470	W7CWE	Laird M. Wise
1471	K5KES	Wayne Casson

CW WPX		
148	WA2DIG	Victor C. Ulrich
149	K4GSS	Roger M. Lindley
150	W9SFR	Steve Hritsko

PHONE WPX		
22	EI3R	Tim A. Hurley

SSB WPX		
42	GW3DUR	Noel N. Lapper
43	W2YBO	William L. Heeve, M. D.
44	UA3CR	Leonid Labutin
45	K1IXG	Dr. Alvin Liftig

DL1QT	328	WØGUV	305
WØSNL	327	K5JZY	304
LU8EN	326	K6RTK	304
DL3RK	324	OK1AEH	304
W6UNP	322	SM5CCE	304
EA4CR	318	W1BFT	304
G3EYN	318	W1EIO	304
LA6CF	318	W1FZ	304
SM7EH	318	W6NWI	304
DJ1VS	316	W6RLP	304
W2GT	316	K8IKB	303
VK6WT	316	OK3EA	303
F9MS	315	W7ABO	303
PAØVB	315	W8UMR	303
PAØVO	315	W9VIN	303
W2BYP	315	VE3HB	303
W1NHJ	314	K2CPR	302
W1IUU	313	K9CLO	302
SM5WI	312	OK1KKJ	302
SM5AHK	311	W3DBX	302
W5BRR	311	WØDMA	302
W8RQ	311	JA2JW	301
W9WIO	311	LU5AQ	301
OH3TH	310	OK1CX	301
PAØLY	310	W2DGW	301
SM7TQ	310	W4HYW	301
W3GHD	310	W4IMI	301
W9BPW	310	W8IBX	301
W9UX	310	W8TTN	301
W3AYD	309	ZL4CK	301
DJ3BB	308	DL9KP	300
SM5AHJ	308	G2GM	300
SM5BCE	308	K4KOY	300
WØAUB	308	K9KDI	300
DU7SV	307	PY4AO	300
W9YNB	307	SM2BCS	300
K4IEX	306	SM5BPJ	300
OK3DG	306	SP6FZ	300
UA9DN	306	VE3CIO	300
W2SAW	306	W1HWH	300
W8RSW	306	W2FXA	300
K4HXF	305	W3BCY	300
VE3BWY	305	W3LMA	300
W2TP	305	W3SOH	300
WA2DIG	305	W7TPE	300
W5AZB	305	W4GXB	300

## WPX HONOR ROLL

### CW WPX

W2HMJ	569	W2MUM	400
W8KPL	520	W9SFR	397
W6KG	517	K2UKQ	394
K6CQM	500	K4JVE	377
W5KC	492	WØQYE	377
W1NLM	491	W5BUK	369
W9YSX	482	W9DYG	367
W2EQS	464	W4AZK	365
W1EQ	455	W9QGR	361
K6SXA	435	SM5AJU	359
W4OPM	434	K2ZKU	357
K9EAB	432	UC2AA	357
K5LIA	428	VE3DIF	357
OK1MB	428	WØMCX	357
W3BQA	426	DL7CS	356
WØPGI	420	KL7MF	356
W2HO	419	W5OLG	356
W8PQQ	418	W2GVZ	355
W9UXO	414	K4GSS	353
W8LY	413	W5AWT	353
W2PTD	411	W9WCE	352
K9AGB	409	HB9TT	351
W6WO	409	W5DA	351
W5AFX	407	K2PFC	350
W3OCU	405	VK3KB	350
W2NUT	403	W1IJB	349
W8JIN	403	W9IU	344
PY4OD	402	IT1AGA	330
W5LGG	401	W6YY	330

### PHONE WPX

W8WT	500	W3AYD	314
G3DO	462	I1CBZ	312
CT1PK	430	W3DJZ	306
W9YSQ	382	ZP5CF	306
W9WHM	367	DL3TJ	305
FAØHBO	363	SM3BIZ	304
W9UZC	356	F8PI	302
PY2CK	354	FY1NC	302
5A5TO	353	EI3R	302
W8PQQ	327	W9PQA	301
W5ERY	315	VE1ADE	300

### SSB WPX

TI2HP	313	HB9TL	221
MP4BBW	300	WØCVU	221
K9EAB	275	DL4AS	208
K2MGE	263	W3VSU	200
W4OPM	257	ÆE1AE	197
W8PQQ	250	K2HEA	181
W1GR	246	W6BAF	170
W3MAC	225	W8BKO	166



UA3CR	165	W2VZV	153
W2JXY	165	K2JFV	152
VE3MR	164	VE3BWY	152
VE3BKL	163	W5RHW	152
YV5FK	162	W6VUV	152
TG9AD	160	W8JXY	152
W8YIN	157	W8YBZ	152
K1IXG	155	K2TDI	151
W1TYQ	155	W2BLP	151
W2YBO	155	W2GNQ	151
GW2DUR	154	W9YHE	151
K2QXG	153	W0FUH	151
W2OTZ	153	K6HZZ	150
W2TP	153	W5DA	150
		W6TNS	150

**Handy Guide to the new African Countries**

Country	Prefix	Stations Known To Be There
British Cameroons	ZD	ZD2KHK, ZD2KHP, ZD2KHR, ZD2GWS (?)
Togoland	FD4	FD4BD
Ivory Coast	FF4	FF4AA thru FF4AH Inclusive, FF4AK
Mali	FF8	FF8BQ
Senegal	FF8	All FF8's except above
Volta	FF	None
Dahomey	FF	None
Niger	FF	None
Mauritania	FF7	FF7AB through FF7AG
Chad	FQ8	FQ8AT, FQ8HA, FQ8HB, FQ8HO, FQ8HW, FQ8HL, FQ8HI
Central African Rep.	FQ8	FQ8AK, FQ8AP, FQ8HT, FQ8HN
Gabon	FQ8	FQ8AH, FQ8AL
Congo	FQ8	All Other FQ8's.

(Tnx NEDXA)

**The West Gulf DX Club**

This will be the first of a series of articles on well known DX Clubs, and I can think of no better starting place than the well-known West Gulf DX Club.

The West Gulf DX Club was founded by a group of well-known W5 DXers upon a suggestion by Jim Price, W5FXN, at the West Gulf Division Annual Convention held in Austin, Texas back in 1951. During the years it has grown and expanded until today it is respected and known throughout the far corners of the earth. Among its well-known foreign members, you will find MP4BBW, ZL2GX, ZS6Q, G3KZI, CE3AG, CR6BX, DJ1BZ, DL7AA, HB9J, KV4AA, KZ5WZ, PY2CK, ST2AR, TG9AD, VE2WW, VK5AB, XE1AE, and

9N1GW. Stateside members reside in every call area and more than 41 states, including KH6CD in Hawaii.

The club has a constitution which ably lays out its objectives, which are to promote and protect the interest of those radio amateurs engaged in two-way communication with foreign and remote areas through the dissemination of pertinent information and data, and improvement of the skills, techniques and procedures of its members.



The club QSL card, which has the same background as the Ranger and Membership certificates, are available to members.

The West Gulf DX Club is a non-profit organization financed from membership dues payable annually. The Officers, Executive Committee and Editors serve without any remuneration except the reward of fostering the spirit of furthering this never ending enchanting game of DX. The Executive Committee sets up policy and approves any capital expenditure of club funds, other than the ordinary expenses of publishing and mailing. Officers and the Executive Committee are elected annually at the yearly convention of the West Gulf Division of the ARRL. The Officers consist of a President, Vice President and Secretary-Treasurer. The Executive Committee consists of these elected Officers, the Editor and two members elected at large from the general membership attending the annual meeting.

During the years, the following persons have served the Club as President:

1951-1952	.....	No President
1952-1953	.....	Robert W. Wagner, W5KUC
1953-1954	.....	Robert W. Wagner, W5KUC

The WGDXC executive committee in the usual order W5OLG, W5KC, W5CEW, W5VLI, W5CE, K5OSH, and W5PM with the money.





1954-1955 ..... Jack T. Moore, W5ALA  
 1955-1956 ..... Jack T. Moore, W5ALA  
 1956-1957 ..... Bradfield A. Beard, W5ADZ  
 1957-1958 ..... Vincent L. Rosso, W5KC  
 1958-1959 ..... Allen F. Wingate, W5CEW  
 1959-1960 ..... Durward J. Tucker, W5VU

The present administration consists of Durward J. Tucker, W5VU, President; George Welch, W5CE, Vice President; and Jack Swanson, W5PM, Secretary-Treasurer. These officials and the immediate past president, Al Wingate, W5CEW and Bob Stark, W5OLG, R. W. Van Kirk, Jr., K5OSH, and the Editors, Clay Fry, Jr., W5GNG and Vernon G. Parker, W5KBU make up the Executive Committee.

Membership in the club is open to all amateurs evidencing a sincere interest in the ethical pursuit of DX activities. Annual dues are \$6.00 domestic and \$12.00 foreign. This includes the Club *Bulletin*. To those amateurs who desire their weekly *Bulletin* air mail, the annual dues are \$7.50.

forecast, club business and reports and general remarks are also included.

To foreign amateurs, the West Gulf DX Club offers an opportunity for them to become a Ranger and receive a handsome DX Ranger certificate. To become a Ranger and receive the certificate, the foreign DX station must work twenty-five or more members of the West Gulf DX Club and QSL each of these QSOs. He then must send a certified copy of his log (no cards) to the Secretary. It is then turned over to the Ranger Activities Manager, Lyman M. Edwards, W5FJ, who checks the logs and if found in order, the Ranger Title assigned, viz Two Gun Pete, Lone Wolf George, Sure Shot Mike, the certificate prepared and forwarded to the recipient. However, the recipient does not automatically become a member of the West Gulf DX Club. Over 327 Rangers have been awarded through the years. The first five awards went to CE3DZ, OY3IGO, VK1BS, VS2EB and EL2X and the latest foreign DXer to receive the award was 4S7YL.

If you would like to join the West Gulf DX Club, send your annual dues to the Club Secretary, Jack Swanson, W5PM, 9015 Linkmeadow, Houston, Texas. You will be welcomed.



This is the much sought after WGDXC's Ranger certificate.

The *Bulletin* is published at least weekly, barring unforeseen limitations and its name is the *DX Bulletin*. The bulletin publication consists of DX news and headline flashes, reported DX activities, fone and c.w., as well as s.s.b. Questions asked by members, suggestions by members, QSL information, radio propagation

### ZD6 DXpedition

My thanks to Ivan Wood, ZD3JJ, for the following account of his recent ZD6 DXpedition.

"In August, 1959 on returning from a DXpedition to Nyasaland by car, Mal (ZE3JO) and I decided that never again would we make such a journey by road. However, being hams and not wanting to charter an air-freighter, September 1960 found us loading, TX, RX, and what-have-you into the 1954 ZE3JJ 10 h. p. car of popular breed.

"From Salisbury (our home QTH) the nearest (and, in fact, the *only*) town in Nyasaland is Blantyre/Limbe, some 400 miles to the northeast, where our good friend Norman Kloka, ZD6NJ, is living.

"Norman had very kindly asked Mal and myself to ZD6 for another DXpedition, so with the opportunity of operating from an exotic

This is where the big s.s.b. signals W5CVU emanate from. The tower is 60 ft. high with Telrex beams on top.







ZE3JJ, in longs and ZE3JO, in shorts, at the start of their trip.

land, instead of from everyday ZE, we decided to treat the road with the contempt it so richly deserves, and one Sunday morning, the two of us climbed aboard the car en route for the ZE/CR7 border. The first 100 miles out from Salisbury is on a 'strip' road (two parallel strips of tar spaced for car tracks) at the end of which is a small village named Mtoko. This town, boasts of a hotel and petrol pump, where liquids essential for motoring are available.

"Beyond Mtoko, the road degenerates into a 60 mile stretch of corrugated gravel and 'spring breaker' surface, after which one arrives, somewhat dazed, at the border, and enters Portuguese East Africa, where the road immediately improves (slightly). Another 90 miles of hot, hard driving, through low-lying country, brings one to the 400 year old town of Tete, on the south bank of the Zambesi River, and in the Portuguese Province of Mozambique.

"Tete is a small town, usually hot, but pleasant, and it was here that we spent the night at a hotel overlooking one of Africa's great rivers.

"Early next morning, we were on the jetty, and after a short ferry trip on a pontoon, were on the north bank of the Zambesi. Another 90 miles of bouncing over rocks and we entered Nyasaland at a remote border post, picturesquely situated amongst hills. An inspection of the car at the small hotel where we lunched revealed a radiator leakage but the insertion of a small amount of mealie-meal (similar to porridge) into the water system cured this undesirable feature, and a few hours later, after 60 miles of undulating and serpentine road, we arrived in the twin town of Blantyre/Limbe. These two places are controlled by one municipal organization, and almost merge into each other.

"Norman (ZD6NJ) and his charming wife, Joan, made us really feel at home, and within a few hours we were on the air with our suffix of '/ZD6.' It soon became apparent that our best chance to make contacts was mainly by using c.w. on 14 and 21 mc from 1400 to 2200 GMT, and taking advantage of a short opening on 14 mc in the early mornings. Various at-



ZE3JJ inspecting the ZD6 border marker.

tempts were made to put two rigs on the air simultaneously, but experience showed that best results were obtained by working 'shifts' on one rig—which, with the similarity of call signs must have been confusing to DX stations. In nine days of operation, we totalled just over 750 contacts, mainly with the U. S. A., but each scoring approximately 50 countries.

"The TX was 3JO's Panda Cub, the RX being 3JJ's Eddystone 888. ZD6NJ's Mosley 3-band beam completed a functional rig. We had tried to borrow a small s.s.b. rig from overseas, but had no news about this prior to our departure.

"As the bands were almost dead for many hours each day, we had an opportunity of visiting Zomba—a village which is the official capital of Nyasaland—where the 1959 DXpedition was sited, and on another day, we visited Mlanje, a village at the foot of a towering 10,000 ft. mountain. From Mlanje, we crossed the Portuguese border for a few hours, and partook of an excellent luncheon in Continental style before returning to Limbe for the evening DX session.

"On our last evening in Limbe, we had planned to make an all out effort to bring the total score as high as possible. However, a three-hour power failure started just as the bands were opening, so we were forestalled in this endeavor.



SM5AQV, Abe, and Rolf, SM5DW who need no introduction to the DX gang, are shown in Rolf's shack. Congratulations on your WAZ, Rolf.



"The return trip to Salisbury was made in one day. When re-entering ZE, we found that border formalities are not conducted after 6 P.M. . . . However, 3JO in his inimitable and highly effective manner negotiated the red tape, and we slept at home in Salisbury that night.

"Once again, we have pledged 'never again by road.'  
ZE3JJ"

### Bits and Pieces

**AC5 Bhutan:** AC5PN has been active on 14,065 around 1230 GMT on occasion. He has been worked by W2AIW and W3CRA, among others.

**CT2 Azores:** CT2AH should be on s.s.b. with a new 20A exciter by the time you read this. (Tnx WGDXC)

**EP Iran:** SM5OK is now on as EP5OK, his QTH is Ake Alseus, c/o Diawild Trading Co., Ltd., Soraye Omid, Teheran, Iran—Fran, W2-AYN/EP is also EP2AY, EP5X and EQ2AT. (Tnx DXer)

**FQ8 Tschad:** Both FQ8HL and FQ8HI are located in Fort Lami, Tschad Republic and active on 21 mc fone around 14-18 GMT. FQ8HL is located at Box 449 and FQ8HI at Box 235. (Tnx DXer).

**MP4Q Qatar:** W2CTN, Jack, has received a letter from ex-JZØDA who is now located in Qatar/Persian Gulf and he is QRX for his ticket.



Joe, VU2JA, at the operating position and his XYL outside their home in Bangalore. Joe is 65 years young. (tnx W2LNB)



This neat station belong to Tom KG4AK. (tnx K2UKQ)

**VQ8 Mauritius:** VQ8BC will soon be using the W6UOU portable s.s.b. transmitter.

**VU2 Laccadives:** VU2NR and company will operate soon from this spot using the call VU2NRM.

**XW8 Laos:** Please note that Laos is again on the ban list.

**YA Afghanistan:** YA1BW should be getting back to Afghanistan about this time, after a vacation in Germany, during which time he acquired an XYL. He will be active as follows: Friday, Saturday and Sunday at 1700 GMT on 14,080 kc and also Sundays at 1330 GMT on 21,075. All QSL's via DL8AX. (Tnx WGDXC)

**ZD8 Ascension Island:** "Am on ZD8 for a while and its a long haul back to Florida. Unfortunately I am unable to obtain permission to operate here. It's a shame. Have check with the British Cable and Wireless people. There are no British hams on this island at present. Do a little listening from time to time. Have heard lots of W6 stations—very loud.

"Very interesting job here but place itself is miserable—a desert island. Wouldn't I like to get permission to get on for even a couple of weeks.

73, John K4LJV, ex T19MHB, W6MHB, VP7BT"

[Continued on page 105]

Raja, VU2RA, and his two jr. ops. Raja is on the lookout for Nev., Utah, Wyo., S. Dak., and N. Mex. to complete is WAS. (tnx W2LNB)





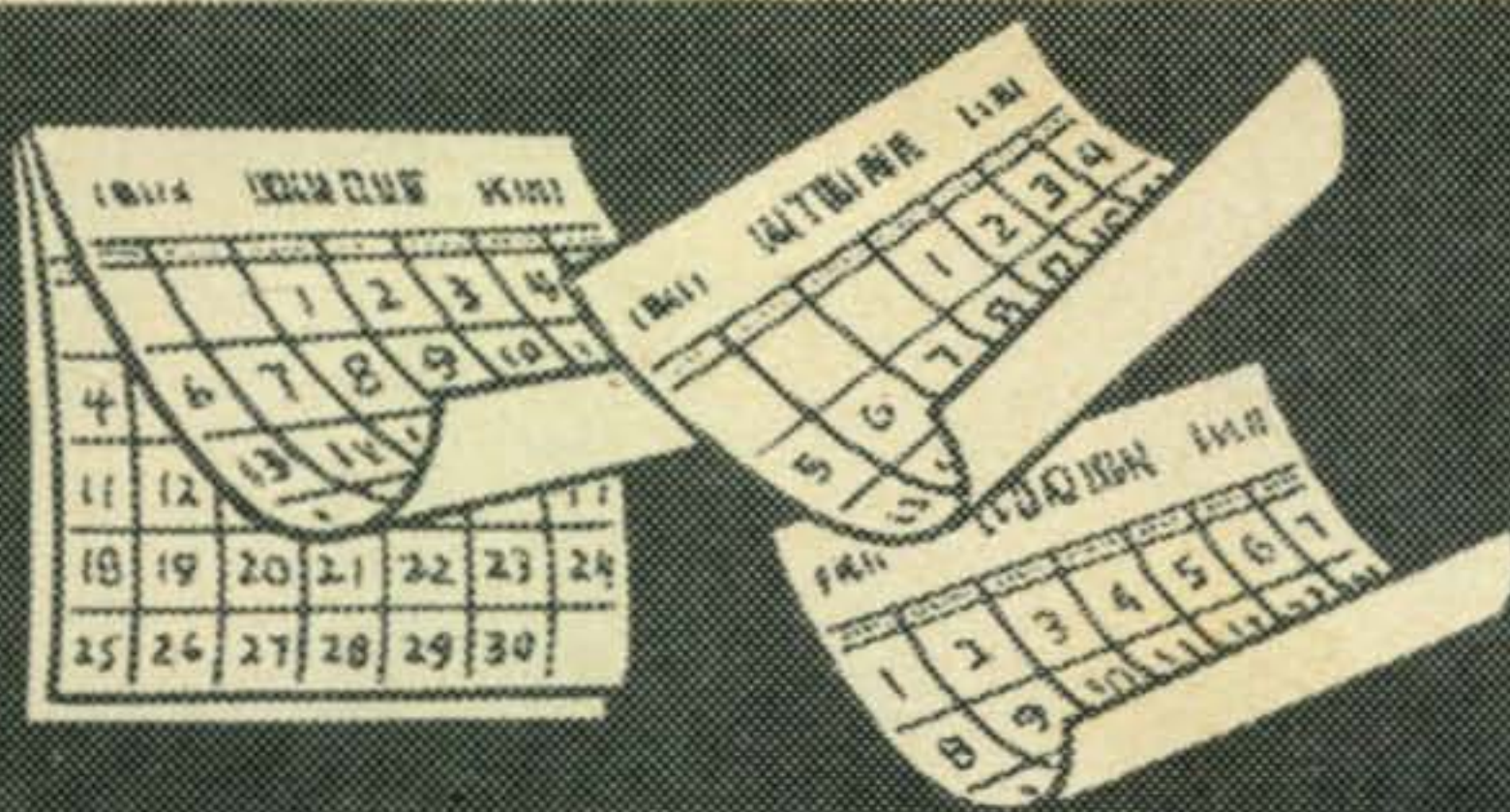

# CONTEST CALENDAR

by Frank Anzalone, W1WY

14 Sherwood Road, Stamford, Conn.

## CALENDAR OF EVENTS

January	28—29	CQ WW DX S.S.B.
January	28—29	Kansas QSO Party
February	3—5	ARRL DX Phone
February	10—12	QCWA QSO Party
February	17—19	ARRL DX C.W.
February	24—26	CQ 160 C.W.
February	25—26	YL/OM Phone
February	25—26	CQ W.W. V.H.F.
February	25—26	REF C.W.
March	3—5	ARRL DX Phone
March	11—12	BERU
March	11—12	YL/OM C.W.
March	17—19	ARRL DX C.W.
April	15—16	REF Phone

### CQ WW S.S.B.

Starts: 1500 GMT Saturday, January 28th  
Ends: 2100 GMT Sunday, January 29th

A last minute reminder for you s.s.b. addicts who want to get in-on-an exciting week-end. See Dorothy's and Irv's S.S.B. Column for November.

Remember, your logs *don't* go to CQ but to the World Wide ssb Contest Committee, 12 Elm Street, Lynbrook, N. Y.

### Kansas

Starts: 1400 GMT Saturday, January 28th  
Ends: 2359 GMT Sunday, January 29th

There are quite a few details to this Party so check last month's CALENDAR if you are interested.

There are two other worthwhile awards from Kansas for the 1961 calendar year, also covered in January's CALENDAR.

Your logs go to the Kansas Centennial QSO Party Committee, 414 Avenue C, Wichita, Kans.

### ARRL DX

Phone: February 3-5 and March 3-5  
C.W.: February 17-19 and March 17-19

Starts: 2400 GMT Friday  
Ends: 2400 GMT Sunday

On each week-end as per above schedule. Phone and c.w. are separate contests. DX stations will be working W, K, VE, VO, KH6 and KL7s and use RS and RST reports plus their power to make up their serial number. USA and Canadian stations naturally will have the world at their beck-and-call and make up a serial number of the RS or RST report plus the abbreviated name of their State or Province.

Each completed QSO counts 3 points and it is permitted to work the same station on each additional band. The multiplier for DX stations is the total call areas (not States) worked on each band. (21 per band). For W/Ks and VE/VOs its the number of countries per band. *Final Score* is the number of QSO points times the multiplier.

Your logs go to—"What the heck am I doing?" Check QST or write the boys up at West Hartford if I have confused you.

### CQ 160 C.W.

Starts: 2100 EST Friday, February 24th  
Ends: 0900 EST Sunday, February 26th

The annual CQ 160 Meter C.W. Contest is going to be a permanent fixture. If you want to hear a normally inactive c.w. band suddenly come to life, listen to the Top Band the last week-end in February.

The rules are quite simple. Contacts between stations within the US and Canada count 2 points and 5 points with a foreign station. A multiplier of 1 for each State, Canadian Province or foreign country worked. *Final Score*, total points times the multiplier. Last month's CALENDAR covered it thoroughly.

Logs go to CQ, att: 160 Contest, 300 West 43rd Street, New York 36, N. Y. The deadline is March 15th.

### QCWA

Starts: 1800 PST Friday, February 10th  
Ends: 1800 PST Sunday, February 12th

The second week-end in February has been chosen for the Annual QCWA QSO Party and this year is sponsored by the Southern California boys. Use both Phone and c.w. and see





## 1959 CQ World Wide DX Contest Trophies

CQ Plaque—Won by The German DX Team; Bill Leonard, W2SKE Cup—Won by Yair Ben-Nissim, 4X4GB, world high, All Band score on phone. Don Wallace, W6AM Cup—Won by Oscar Acosta, CE3DY, world high Single Band score on 21 mc phone. Don Merten, K2AAA Cup—Won by Station HZ1AB, world high All Band Phone score in the Multi-operator single transmitter division. Larry LeKashman, W9IOP Cup—Won by Josef Plazak, 7G1A, world high All Band score on c.w. John D. Ryan, W7KVU Cup—Won by Luis Desmaras, CE3AG, world high Single Band score on 14 mc c.w. Barry Briskman, K2IEG Cup—Won by Station W1BIH, world high All Band c.w. score in the Multi-operator single transmitter division. "Buzz" Reeves, K2GL Cup—Won by Station DJ3JZ, world high All Band c.w. score in the Multi-operator, multi-transmitter division.

how many members you can contact. A list of frequencies to use was published in last month's CALENDAR.

There is a Trophy and a tri-band beam for the Top Man.

Ted Lowe, K6FH would appreciate it if you sent your logs to him at 425 West Almond Street, Compton 3, Calif.

### REF C.W.

Starts: 1400 GMT Saturday, February 25th.  
Ends: 2200 GMT Sunday, February 26th.

### Phone

Starts: 1400 GMT Saturday, April 15th.  
Ends: 2200 GMT Sunday, April 16th.

The REF boys have added a multiplier to their contest scoring this year. Rules are quite simple.

1. Serial number, the usual RS or RST report plus a progressive three digit number starting with 001.

2. Each QSO with a French or French possession station counts one point.

3. A multiplier of one for each French department or country (DUF list) worked on each band.

4. *Final Score*—Total QSO points times the total multiplier. Your logs got to the R.E.F. Contest Committee, Boite Postale 42-01, Paris RP, France.

[Continued on page 119]

## CQ WW DX C.W. Contest Claimed Scores

All Band			
KW6DG	412,594	W1BIH	197,224
W3GRF	401,544	K6CTV	184,338
W8JIN	368,068	OK3EA	141,900
SVØWI	341,850	KA2JL	135,660
W2EQS	272,076	ZC4CT	66,661
W2BXA	270,216	FR7ZD	52,644
28 Mc.			
W3LSG	39,440	K2HWL	25,406
W5LGG	30,294	W1OJR	22,010
21 Mc.			
W2WZ	60,610	W9YSX	46,233
W2CYS	59,148	W3TLN	34,943
W3MFJ	58,330	HB9DX	20,500
WIWY	50,654		
14 Mc.			
K6EIV	99,912	W4LVV	46,690
W3JTC	75,752	W5KC	33,250
W1GYE	46,852	HK1HV	32,172
7 Mc.			
K2DGT	96,820	W6PQW	20,923
W4DHZ	41,850	JA8FC	14,135
Multi-Opr.			
W6GHM	400,425		





# ham clinic

CHARLES J. SCHAUERS, F7FE/W6QLV

C.Q. Magazine, 300 West 43rd St., New York 36, N. Y.

## Some Advice for the Beginner

Those of us who have been active hams for many years, realize that it is not easy for the newcomer to ham radio to learn the code, electronic and radio theory; and finally after obtaining his license, to choose *wisely* the equipment he will need to put his station on the air.

We receive many letters from beginners seeking information and we try (within our time limitations), to answer all questions as completely as we can. However, more often than not, we recommend ARRL publications, the *CQ License Guide* (Cowan—\$2.50) and other good books written by experienced amateurs.

Anyone who has *mastered* the code will tell you that the learning processes must be coordinated and that *practice* is the by-word. Like touch typing, code is learned through repetition. Regardless of what some modern teachers advocate, there are few shortcuts to acquiring a comfortable (15 words per minute) speed.

Before settling down to really learn the code, the beginner should first study the alphabet and numerals to "see" how the *sound* equivalents are made. He should never, never try to memorize the code by using the "dot-dash" visual system. For example, the letter A is DI-DAH *not* "dot-dash."

I have taught hundreds of students to send and receive code. Those who persisted in learning the alphabet by sight had to be retrained before they could acquire any acceptable speed. Those who learned the *sound* equivalents had it easy.

Each letter should be thought of in terms of sound and there should be no attempt to learn the code by word or object association.

When one adds a new word to his vocabulary, he usually hears its whole sound first; and with the exception of some duplicate word sounds (such as: sew, so; right, write; to, too; etc.), he will recognize the new word by sound when he hears it. When he reads the word, he will not break it down into individual letters, but will unconsciously break it down into sound.

Each letter and numeral of the code must be learned by sound—*not* by dot and dash composition. DA-DI-DI-DIT is always the letter B, not 6, D or TS. When the dah and dits are made properly, the letter B sound like the letter B and *nothing* else.

What stumps most beginners when first starting out to learn the code are the slight changes in letter composition. An added dit or dah will change the overall sound of any character. But the way to overcome the confusion that results from trying to distinguish between "nearly-the-same" letters is to continually practice those you know *best* . . . *not* those that confuse you. This negative approach really does work. For it has been demonstrated that the more you concentrate on the confusing letters or numerals, the longer it will take you to learn them. By mixing them up with the letters you know best at infrequent intervals, you will find that all of a sudden they are not difficult to remember.

Although I learned to send and receive by myself, the best approach for the beginner is to enlist the aid of an experienced ham who really knows and likes the code.

If the instructor knows what he is doing he will always send *faster* than 8 words per minute (wpm) when he begins instruction. For contrary to what some young hams think, a letter or numeral sent at 10 wpm will sound the same at 35 wpm *if* it has been learned properly in the first place! (The length of letter components and spacing are the only things that change—*not* the overall sound.)

After the beginner has been taught to use the hand key, he should practice sending to himself by varying his sending speed. This will enable him to recognize each letter and each numeral by *whole* sound.

I have found that the average person can learn two characters per day well. At the end of two weeks, the beginner can usually start concentrating on copying whole words.

Copying behind (putting down a letter or two while listening to other letters coming) requires special practice and concentration. When I copy



50 wpm on the typewriter, I usually do copy as many as 5 words behind. Only after you have reached the 15 wpm mark should you try to learn copying behind. It can be done at lesser speeds but I do not recommend it.

When you have reached the good solid copying speed of 8 wpm, you should then begin to copy code from your radio receiver. But do not copy the ham who is sending at 5 wpm; try to pick up a signal whose speed is just a little faster than you can comfortably copy by printing the characters.

The printing system usually taught in military communications schools should be used. This is the system that enables you to form each letter or figure so that your pencil will be at the right when it finishes a character. The system is sometimes called the "short-hand sweep" because there is little lost motion and very little "back-tracking" when a character is formed.

As your speed picks up do not be surprised that you find yourself copying whole words by the whole word sound. Words such as: the, this, are, for, station, Q signals etc., will begin to come through the phones and loudspeaker as whole sounds. With practice, longer words will be received by whole sound. Why? Because you have trained your brain to solidify each word by a very rapid sweep of each letter.

Do not worry about letters or words missed in your practice sessions, but concentrate on the next letter and whole word or group.

Another thing, do *not* practice plain language exclusively—mix up the English word equivalents with 5 letter code groups, i.e., KMZXC RADIO YUKRK MAKE CVBHM etc. This will get you out of the habit most beginners acquire by trying to anticipate the next word in English sentences. When your speed is around 25 wpm you will be putting down many words whose sequence has been anticipated because of the subject matter.

Anyone can learn the code if they approach its learning with sufficient interest and patience. It is something that requires practice and more practice. If you look on it as learning a new language (which in reality it is), your learning task will be much easier.

### Equipment Selection

"I've got \$300.00 saved. What do you suggest in the way of a receiver and transmitter for my first station?" is a typical question received by HAM CLINIC.

What advice should be given the beginner who asks such a question? Should he be told to buy second hand equipment, kits or to concentrate on "good" usable surplus?

Well, there is little doubt in anyone's mind that the newcomer wants the best equipment he can get for his money. He surely does not want gear that he cannot use when he operates under a General or higher class license.

To those of us who have much experience in the construction, trading and buying of equipment over the years, the answer to the question

presents no major problem.

Providing the beginner with \$300.00 has at least \$15.00 coming in each month, we would suggest that he use the money he has for a down payment on good kit or manufactured equipment. We would also suggest that he consider building his first transmitter. But we know, regardless of what we suggest he more than likely already has his mind made up and only wants the advice we give to fortify his own convictions.

However, the beginner who does not have \$300.00 is in somewhat of a different and more difficult position. The answer for him is not easy. In this case, we suggest that he first try to obtain the best receiver that he can buy—new, second-hand or surplus. Then we would tell him to install the receiver and a good doublet antenna. His start will be good and realistic and will enable him to listen to other hams and to find out what they are using and how they operate.

Where money is a major consideration, we would suggest a small transmitter like a DX-40, EICO 720 or Knight T-50. As time goes on he can trade, re-trade and/or buy other equipment.

I have known some hams who started with only \$45.00 and surplus command set equipment. Of course, the modifications were work (and fun) but these hams learned something about set construction in the process.

The ham who starts right off with a mammoth "store bought" station is missing a lot of fun.

We still maintain that the fine kits put out by Allied Radio, Heath, Johnson, EICO, Hallcrafters, Globe, Lafayette and others, *do* enable those who want to, to learn a good deal about set construction and design.

Contrary to what some "hot-shot" ham engineers say, relative to learning "nothing" when putting a kit together, let *us* say that the ham who takes the time to analyze a kit diagram (perhaps with some experienced technical help), the mechanical layout of parts, and who carefully reads and assimilates the technical descriptive information contained in nearly all kit instruction books, will learn *more* than the guy who merely buys a piece of ready-made equipment and follows tuning instructions.

The kit builder will know something about trouble-shooting his set when he is finished putting it together. And like the guy who constructs equipment from articles in *CQ* and the various handbooks, will have a very good insight of circuit analysis.

Hams who have built their own gear and who now buy the finished products are fortunate because they have accumulated some *very* necessary experience.

Manufactured equipment has the edge over kit equipment only because many hams do not own or have access to good test equipment. But if a ham does have good reliable test equipment or can borrow it, his results can be just as good or in some cases better than that experienced with manufactured equipment.



Some hams are not mechanically inclined and do not like working with tools. For them, the manufactured article is the answer to their needs.

Beginners should have no qualms about requesting help from those of us who are already established in the hobby of ham radio. We should be sure to give them the best advice we can. By so doing, we can save the newcomer a lot of heartaches and (sometimes) a big drain on his pocketbook.

Newcomers should be warned not to buy surplus equipment with which they are not familiar or for which there are no modification instructions for ham use.

HAM CLINIC advises those hams-to-be who have equipment purchases in mind to contact the reputable ham dealers who advertise in *CQ*. Through them and their experienced ham salesmen, they will not only receive good purchasing advice but encouragement as well. Certainly, dealers are in the business of selling ham gear to make a living, but not at the expense of some unwary, inexperienced novice.

Yet, sometimes the newcomer is "taken" by an unscrupulous "dealer" or two, but these instances are few and far between (thank goodness!)

One last bit of advice to the beginner; if you feel that you have not been given a fair deal on equipment you have purchased, and your efforts through management have not produced results to your satisfaction, let HAM CLINIC know. Our correspondence with local Better Business Bureaus has been very successful in the past.

Good luck newcomer, we hope you get up that code speed, receive your license and are soon on the air! We are for you!

### Observation

Ham mobiling is a lot of fun, but there are some very thoughtless fixed station operators using high power to contact local mobileers who "louse it up" for mobileers operating some miles away.

When a fixed station operator is in contact with local mobiles he should cut his power! Surely this is only common courtesy to other mobile hams in roundtable operating out of the range of the mobiles that the fixed station is contacting.

For example: why should a station in San Francisco be using a kw to contact mobiles in Oakland and at the same time knock out a mobile net in Los Angeles? It just does not make good operating sense.

**Observed:** some hams do not consider the air rights of others.

**Recommended:** use only the power necessary to make your contacts solid—local or DX. (This is covered by an FCC regulation.)

### Questions

**DX-100 Modifications** "Where can I obtain some modification information on the DX-100?"

See *CQ* for August, October and December

1956. Suggest you also write the Heath Co. for the latest info.

**European Tubes (again)** "Please give me the equivalent American types for these European tubes: D152, B309, ECC91, EL90, ECF82."

In order: 6AL5, 12AT7, 6J6, 6AQ5 and 6U8.

**Modulation Monitor** "How about a circuit for a direct reading modulation monitor?"

Suggest that you see page 4 of *Western Radio Amateur* for June 1960. K6AI has an article in this issue describing a fine little instrument which incorporates two meters—one for carrier level and one for a direct modulation percentage measurement. This is the best one I have seen (outside of a scope setup).

**Mike Cable** "Is 72 ohm coax cable okay for use as a mike cable?"

Yes, but it's a little stiff, don't you think?

**Transformer Rating** "Will it make much difference if I use a 250 ma transformer instead of a 125 ma unit suggested in a construction article?"

Only to your pocketbook.

**TVI (Yet)** "I live in a part of South America where it is very difficult to obtain a good short ground for my equipment, consequently I have TVI trouble. I am on the top floor of an apartment building and the ground around the building is full of rocks. What can you suggest?"

Very little. Even if you had a good outside ground, unless you used a very large copper cable for the long run, you more than likely would still have trouble. A counterpoise would do little good. I assume that you have tried using the plumbing pipes in the building for your ground. Before you blame the ground too much for your TVI, I would suggest that you get a copy of Rand's *TVI Handbook* and check the section on TVI-proofing your home-made transmitter. Anyone have any other suggestions for our South American friend?

**F.M.** "What happened to f.m. on the ham-bands? Some years ago it was the 'rage,' now one seldom hears it."

F.M. is not entirely dead. The new Russian hams use it, but it is *not* narrow-band! I believe one can attribute the lack of f.m. to the lack of f.m. receiving equipment. It is hard to tune in on a regular receiver. But f.m. does have its advantages over a.m. and s.s.b. It is by no means dead in the commercial communications world—in fact, it is the dominant mode in taxi, police and fire service.

**Transistorized Keyer** "Please, a diagram of a transistorized keyer."

Where you been? Better get with it! The big November 1960 Annual issue of *CQ* (\$1.00 on the newsstands or from *CQ*—if any are left), contains a terrific article by K2LGY on the keyer you seek. I cannot suggest anything better.

**TV Tech Info** "My folks have been after me to fix their TV set. I do not know too much about TV but am willing to try (with a little assist from you). The set is a Motorola with the chassis number TX-564. The picture tube is full



of streaks and flashes. I checked the h.v. rectifier etc., and everything seems to check out okay. How about a tip or two?"

**HAM CLINIC** does *not* give advice on commercial TV servicing and does not encourage hams to do their own TV servicing. Suggest (if you persist in trying to repair the set) that you first get the service data on it from the Howard W. Sams Co., 2201 East 46th St., Indianapolis 6, Ind. Write them for prices. Your local distributor may be able to help you with the Sam's data too.

**Head Cleaner** "Is lighter fluid okay to clean the head on my tape recorder?"

No. Some lighter fluids contain a trace of oil. I'd suggest that you use *G-C Mag-Netik* recording head cleaner. This stuff won't hurt the head and cleans quickly and surely.

**Transistor Regulator** "How is a transistor used to regulate a low d.c. voltage?"

See the diagram in figure 1. No values are given because you did not state the voltages available and desired.

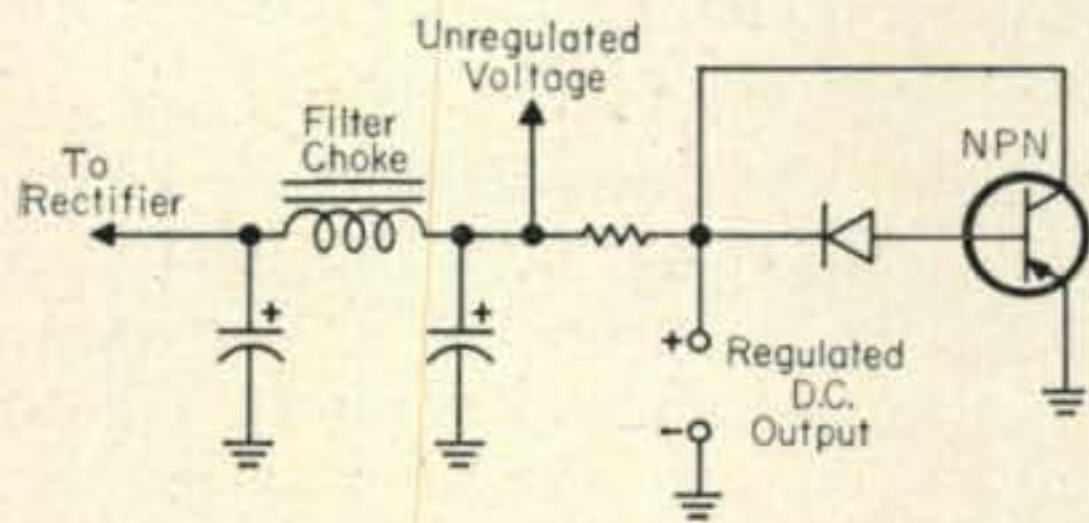

Fig. 1—One method of regulating low d.c. voltages at low currents using a transistor and a reverse connected diode.

### Non-Technical Department

**MARS** "Tell me, what are the real advantages of belonging to MARS (Military Affiliate Radio System)?"

For a good answer to this question, see the November 1960 issue of *QST* and General Cooke's enlightening article on MARS.

Through MARS, the Department of Defense recognizes the capabilities of the radio amateur in being able to contribute to public service. If you cannot get along without the hobby of ham radio in peace or disaster, look into MARS membership. I recommend it to every ham who is serious about the hobby.

**CB Transmitter Adjustment** "Can an extra class licensee adjust the circuitry in a C.B. transmitter which normally requires a commercial ticket holder such as the 2nd class radiotelephone?"

No he cannot. Only commercially licensed operators 2nd phone or higher can actually do any on-the-air tuning on C.B. rigs.

**Ham Correspondence Course** "How is it that some enterprising hams do not get together and form a ham radio correspondence school? It seems to me that this would be a good thing. Can you think of any large drawbacks to such a venture?"

Any educational venture costs money. I pre-

sume that the correspondence school would also teach code via machine and correct lessons, etc. Yes, I think it might not be a bad idea. At least the ham-to-be would be guided step-by-step toward his license. This venture would be a "natural" for some of the large companies who sell kit equipment. What about it? Who's game?

### Thirty

We have never received a letter complaining of **HAM CLINIC's** service per se and his bothers us a little. After all, we are sure that we have not pleased *every* ham who wrote in. Perhaps it is recognized by the majority of fellow hams that answering hundreds of letters each month and getting this column out is no easy task. As we have said before, we do make mistakes and have never tried to pass ourselves off as the hottest of ham hotshots. Yes, we are sometimes stumped and admit it; but not until we have tried every informational source at our disposal.

Our files bulge with technical information gathered over the years and we can still count on some very experienced hams actively working in the technical field to assist in helping you.

If our answer seems a little slow in coming, please be patient; we try to do our best within the time available to us, and so far we have let no one down.

73 and 75 and to hams internationally, a big 72.

Chuck



Assistant Secretary of the Navy, The Honorable Richard Jackson, is shown presenting the Navy Department's Walter S. Gifford, Jr. Trophy to Commander Blake V. Blakely, USNR, Commanding Officer of U. S. Naval Reserve Naval Security Group Division 11-2(S), Los Angeles, California, while amateur members of his unit stand by in smiling appreciation. The Gifford Trophy is awarded annually by the Navy Department to the outstanding Naval Reserve Naval Security Group Division in the nation. Naval Reservists are (left to right) Paul Hinkston W6RPZ, Bob Hartley K6MRR, Jerry Fradin K6TUH, Commander Blakely W6NSK and Assistant SecNav Jackson, Marvin Collins W6OQI, Ted Fisher WA6FQT, and Del Devins W6UDX





by DONALD L. STONER, W6TNS  
P.O. Box 137, Ontario, Calif.

## semiconductors

The feature item last month, as most of the regular readers know, was a transistorized two meter station. It occurred to me that the inexpensive transistors used in this station would also make an excellent six meter set-up because of their high alpha cutoff frequency (in excess of 500 megacycles).

The same Philco "T" series of Micro Alloy Diffused-base Transistors (MADT's) are used in the six meter units, in fact, the same device numbers are used as in their two meter counterpart. This permits the amateur to construct both stations and use them by switching transistors to the desired unit. The parametric diode is not used in the six meter converter since doubling is not required and 43 mc overtone crystals are commonly available.

By employing an overtone crystal in the transmitter, one transistor could be eliminated, since the doubler circuit would not be required. However, let's look at economics. We only need one crystal frequency in the converter for a given i.f. range, so an overtone is a good investment to eliminate a \$3.00 transistor.

However, amateurs want to QSY their transmitter frequency. Overtone crystals (at approximately \$4.00 each) can get to be a pretty expensive deal when several frequencies are desired. The design idea in this transmitter was to employ an extra doubling transistor to permit the use of 8.3 mc surplus "rocks" are available at approximately 25 cents each. The oscillator circuit is about the slickest one I have ever used. It does not require a feedback tap on the coil and will work even with sluggish crystals. More about this later.

### Converter

The converter (fig. 1) is an adaption of the Meyer circuit, modified for 12 volt operation, and uses higher alpha transistors. Signals appearing at the antenna connection are link coupled to  $L_1$ , which is resonated with an 8 mmf capacitor. The r.f. amplifier, a T-1832 ( $f_{max} = 1300$  mc), is connected in the common base configuration to eliminate the need for neutralization. Bias is provided by a divider consisting of  $R_2$  and  $R_3$ , and the stage is sta-

Fig. 1—Six meter converter schematic.

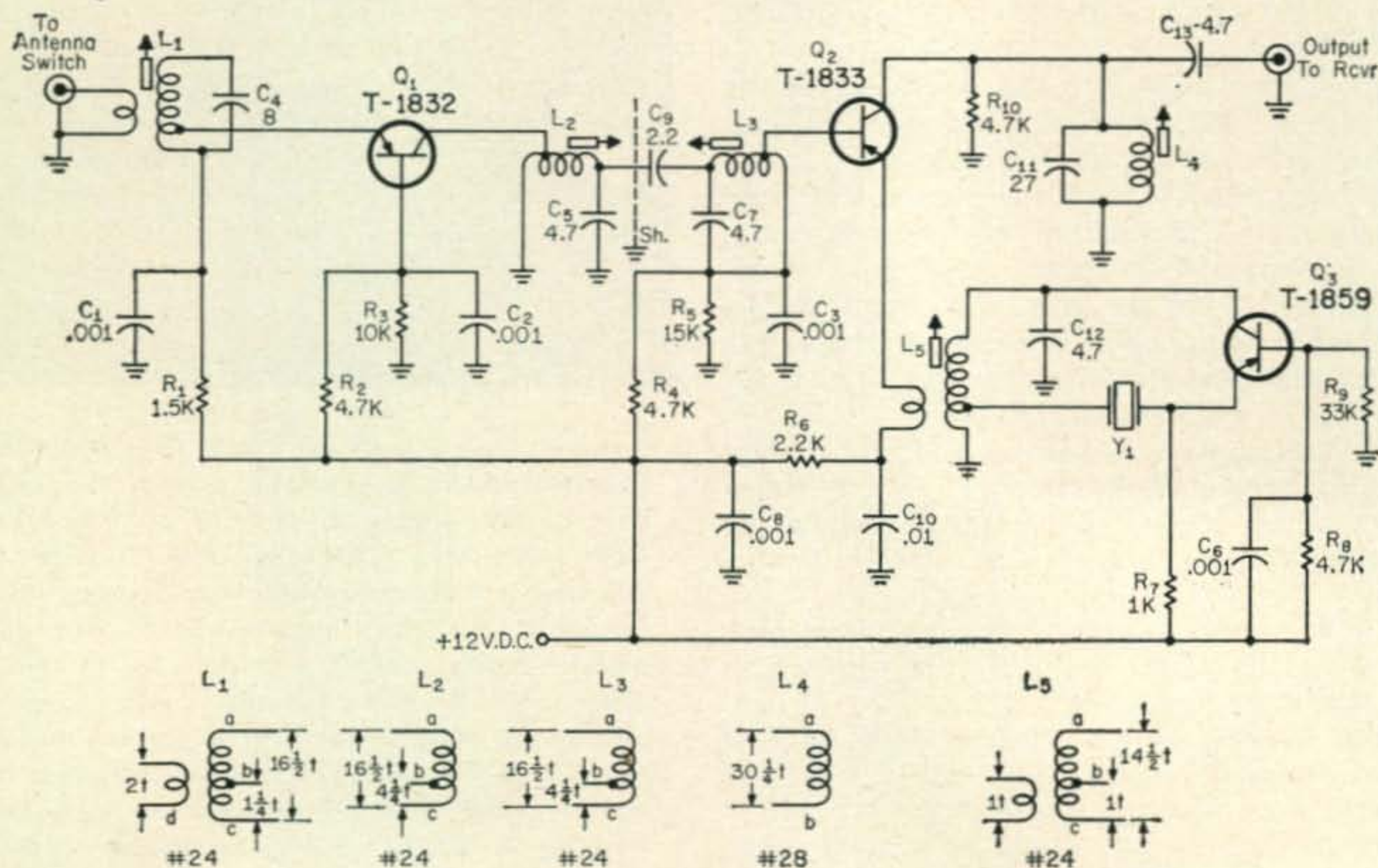

$L_1, L_5$ —All coils wound on  $\frac{1}{4}$ " diameter slug tuned forms. Turns data in diagram

$Y_1$ —43 mc third overtone crystal for 7—11 mc i.f. (International FA-9)



bilized by  $R_1$ , a 1.5K resistor.

One of the problems which arise in compact converters is the reception of spurious frequencies, such as television picture and sound signals. This is usually caused by poor selectivity which permits the unwanted signals to reach the mixer and be heterodyned to the i.f. This effect is minimized by using a bandpass coupler between the r.f. and mixer stages. The amplified signals from the r.f. stage are connected to only part of the collector coil,  $L_2$ . This minimizes the loading on the coil and provides a high operating "Q." The signals are "top-coupled" to a second interstage coil,  $L_3$ . These two coils provide the typical "double hump" selectivity curve. The tuning of the slugs determines the position of the "humps" while the coupling capacitor,  $C_9$ , regulates the "hole" in the middle. Rejection outside six meters is excellent and "birdies" are reduced to a minimum.

The mixer, a T1833, is driven from a low impedance tap on coil  $L_3$ , and is connected in the common emitter configuration. The oscillator voltage is impressed on the emitter through a coupling link on coil  $L_5$ . The difference signal between the incoming frequency (50 mc) and the oscillator (43 mc) appears across coil  $L_4$  at 7 mc. Signals received near 51 mc will, of course, appear on the receiver at 8 mc. Capacitor  $C_{11}$  resonates  $L_4$  at the i.f., while resistor  $R_{11}$  broadbands the coil to provide constant gain over the i.f. range. The signal is coupled to the receiver through  $C_{13}$ , a 4.7 mmf disc. The mixer stage is biased by resistors  $R_4$  and  $R_5$ , while  $R_6$  provides the necessary stabilization. Note that the resistor values are higher than in the r.f. stage because the mixer operates near the cutoff knee to provide the proper mixing action.

The oscillator operates in the common base mode and feedback occurs between collector and emitter. The impedance at each end of the 43 mc crystal is low and no capacity neutralization is required. Resistors  $R_8$  and  $R_9$  provide forward bias. In addition to stabilizing the stage,  $R_7$  is a load for the emitter r.f. signal. If the crystal seems to be sluggish, it may be necessary to move the crystal tap one turn

towards the hot end of  $L_5$ . Don't change the bias values for they have been optimized for maximum stability. The link on  $L_5$  controls the injection voltage to the mixer.

### The Transmitter

The transistors in the six meter transmitter were found to operate with higher efficiencies in the common emitter configuration, as shown in fig. 2.

The oscillator transistor ( $Q_1$ ) is a T-1858, normally used in 45 mc i.f. amplifier circuits. Note that the emitter is not completely bypassed, that is, the reactance of  $C_2$  (56 mmf) is rather high at 25 mc. This permits signals appearing in the collector to be coupled to the emitter through the transistor capacity. Since the emitter is not completely bypassed, some of this energy is passed back to the collector by the majority carriers. Thus a feedback loop is created. Since it is in phase, oscillation occurs. The 8.3 mc crystal appears to be a low impedance at the third overtone frequency (25 mc), thus permitting the stage to amplify and oscillate. The tuning of the oscillator stage is the smoothest of any tried by the author. As the slug is run in the coil the output will continue to increase until the point is reached where the phase shifts are incorrect for oscillation. At this point the oscillator "plops" out of oscillation. Backing off on the slug approximately one-quarter turn provides stable operation. There is no tendency for spurious oscillation and the circuit will not oscillate when the crystal is removed. In this stage resistors  $R_1$  and  $R_2$  provide bias and  $R_3$  prevents the transistor from drawing excessive current.

The 24 mc oscillations from  $Q_1$  are used to drive a doubler-buffer stage,  $Q_2$ , another T-1858. The negative r.f. alternations cause the base-emitter junction to conduct and current flows through  $R_4$ , thereby providing bias for the stage which operates in deep Class C. The rapid switching of this transistor, at a 25 mc rate, generates large quantities of harmonics. Every second pulse causes the collector coil to ring, which provides a strong second harmonic content across  $L_2$ .

[Continued on page 106]

Fig. 2—Six meter transmitter circuit. Coils  $L_1$ ,  $L_2$  and  $L_3$  are wound on  $\frac{1}{4}$ " slug tuned forms.

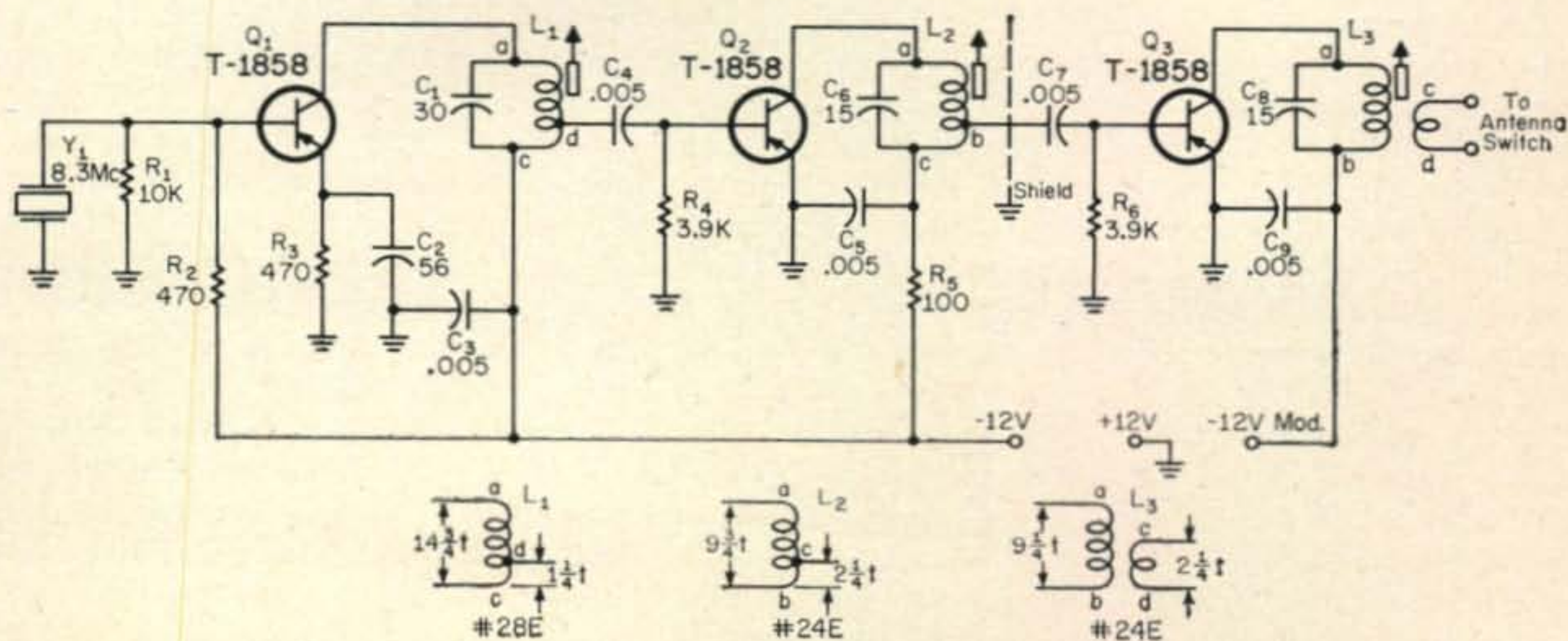



# PROPAGATION

**George Jacobs, W3ASK**  
11307 Clara St., Silver Spring, Md.



## LAST MINUTE FORECAST

The forecast indices for the month of February, shown in the Propagation Charts following the predicted times of openings, are expected to be related to day-to-day propagation conditions in the following manner:

Forecast Indices	Above Normal Feb. 2-4	Normal	Below Normal	Disturbed Feb. 14-17, 20-21
		Feb. 1, 5-6, 9, 12-13, 18-19, 22-28	Feb. 7, 8, 10-11	
(1)	C	D-E	E	E
(2)	B	C-D	E	E
(3)	A	B-C	D-E	E
(4)	A	A	B-C	C-D

Where:

- A—Excellent circuit with strong steady signals.
- B—Good circuit, moderately strong signals, with some fading and noise.
- C—Fair circuit, signals fluctuating between moderately strong and weak, with moderate fading and noise.
- D—Poor circuit, signals weak, with considerable fading and very high noise level.
- E—Circuit not possible.

## General Conditions

Fewer 10 meter openings are expected during February, and conditions on 15 meters are expected to remain about the same as they were during the earlier winter months. During the daylight hours, 15 meters is expected to be the best band for long distance propagation. Fairly good DX openings to most areas of the world should also be possible on 20 meters from dawn through the early evening hours.

During the hours of darkness 40 meters is expected to be the best band for long distance propagation, with 80 meters a close follow-up to some areas of the world. During periods of exceptionally low static levels 160 meter openings may also be possible to some areas of the world.

DX Propagation Charts for the month of February, showing band openings from the United States to all major world areas, appears in last month's column.

The Charts in this month's column are for short-skip circuits between distances of 50 and

2300 miles, and for paths between the mainland and Alaska and Hawaii. For short-skip openings less than 750 miles, 40 meters should be best during the daylight hours and 80 meters during the hours of darkness. For longer openings, up to 1300 miles, the optimum band during the daylight hours is expected to be 20 meters, with 40 meters optimum during the hours of darkness. Fifteen meters is forecast as optimum during the daylight hours for band openings up to 2300 miles, with 20 meters best during the early evening hours, and 40 meters optimum during the later evening and early morning hours.

## Record Radio Storms

November, 1960 was one of the poorest months for shortwave radio conditions in nearly six years. Radio storms disrupted long distance communications during nineteen days of the month.

Figure 1 shows the daily quality ratings for trans-Atlantic circuits during November as determined by the Central Radio Propagation Laboratory of the National Bureau of Standards. The ratings are based on the following scale:

- \* (1) Conditions useless
- \* (2) Conditions very poor
- \* (3) Conditions poor
- \* (4) Conditions poor to fair
- (5) Conditions fair
- (6) Conditions fair to good
- (7) Conditions good
- (8) Conditions very good
- (9) Conditions excellent

\* Indicates radio storm conditions

Also plotted in Figure 1 are the highest values of maximum usable frequency recorded each day during November on the circuit between Eastern U.S.A. and Western Europe. The highest frequency recorded during the month was 40 mc. This occurred during a brief period of good conditions on November 10th. During the rest of the month, however, the maximum frequency rose above 29 mc (ten meter band openings) on only 16 days.

The poor conditions during November reached a climax on November 13, when one of the severest radio storms ever recorded took place. CRPL rated the day "useless," and a radio blackout existed to almost all areas of the world.



**CQ SHORT-SKIP PROPAGATION CHART**

FEBRUARY-MARCH, 1961

LOCAL STANDARD TIME

Band (Meters)	50-250 Miles	250-750 Miles	750-1300 Miles	1300-2300 Miles
10	NIL	NIL	8 A - 10A (0-1) 10A - 3 P (0-2) 3 P - 6 P (0-1)	8 A - 10A (1-2) 10A - 3 P (2-4) 3 P - 6 P (1-3) 6 P - 8 P (0-1)
15	NIL	9 A - 4 P (0-1)	7 A - 9 A (0-1) 9 A - 4 P (1-4) 4 P - 6 P (0-3) 6 P - 8 P (0-1)	7 A - 9 A (1-2) 9 A - 4 P (4) 4 P - 6 P (3-4) 6 P - 8 P (1-3) 8 P - 10P (0-1)
20	12N - 4 P (0-1)	7 A - 9 A (0-1) 9 A - 12N (0-3) 12N - 4 P (1-4) 4 P - 7 P (0-3) 7 P - 9 P (0-1)	7 A - 9 A (1-3) 9 A - 12N (3-4) 12N - 4 P (4) 4 P - 7 P (3-4) 7 P - 9 P (1-3) 9 P - 11P (0-2) 11P - 7 A (0-1)	7 A - 9 A (3-4) 9 A - 4 P (4-3) 4 P - 7 P (4) 7 P - 9 P (3-4) 9 P - 11P (2-3) 11P - 7 A (1-2)
40	8 A - 10A (2-3) 10A - 5 P (4) 5 P - 8 P (2-3) 8 P - 1 A (1-2) 1 A - 8 A (0-1)	8 A - 10A (3) 10A - 5 P (4-3) 5 P - 8 P (3-4) 8 P - 1 A (2-4) 1 A - 8 A (1-2)	8 A - 10A (3-2) 10A - 4 P (3-1) 4 P - 6 P (3-2) 6 P - 1 A (4) 1 A - 8 A (2-3)	7 A - 10A (2-0) 10A - 3 P (1-0) 3 P - 6 P (2-1) 6 P - 1 A (4) 1 A - 7 A (3-2)
80	8 A - 10A (4) 10A - 3 P (4-2) 3 P - 9 P (4) 9 P - 6 A (1-2) 6 A - 8 A (2-3)	8 A - 10A (4-2) 10A - 3 P (2-0) 3 P - 6 P (4-2) 6 P - 9 P (4-3) 9 P - 6 A (2-4) 6 A - 8 A (3)	8 A - 10A (2-0) 10A - 3 P (0) 3 P - 6 P (2-0) 6 P - 9 P (3-2) 9 P - 5 A (4) 5 A - 8 A (3-1)	8 A - 6 P (0) 6 P - 8 P (2-1) 8 P - 3 A (4-3) 3 A - 6 A (4-2) 6 A - 8 A (1-0)
160	6 A - 7 A (4-3) 7 A - 9 A (3-1) 9 A - 5 P (2-0) 5 P - 7 P (4-2) 7 P - 6 A (4)	6 A - 7 A (3-2) 7 A - 9 A (1-0) 9 A - 5 P (0) 5 P - 7 P (2-0) 7 P - 9 P (4-2) 9 P - 6 A (4-3)	6 A - 7 A (2-0) 7 A - 7 P (0) 7 P - 9 P (2) 9 P - 3 A (3) 3 A - 6 A (3-1)	6 A - 7 P (0) 7 P - 9 P (2-0) 9 P - 3 A (3-2) 3 A - 6 A (1-0)

**ALASKA**

OPENINGS IN ALASKAN STANDARD TIME \*\*\*

TO	10 Meters	15 Meters	20 Meters	40/80* Meters
<b>Eastern USA</b>	8 A - 10 A (1) 10A - 2 P (2) 2 P - 4 P (1)	7 A - 9 A (1) 9 A - 11A (2) 11A - 2 P (3) 2 P - 4 P (2) 4 P - 5 P (1)	6 A - 1 P (1) 1 P - 3 P (2) 3 P - 5 P (3) 5 P - 6 P (2) 6 P - 7 P (1)	9 P - 4 A (1)
<b>Central USA</b>	10A - 1 P (1) 1 P - 3 P (2) 3 P - 4 P (1)	8 A - 10A (1) 10A - 12N (2) 12N - 3 P (3) 3 P - 4 P (2) 4 P - 5 P (1)	6 A - 3 P (1) 3 P - 4 P (2) 4 P - 6 P (3) 6 P - 7 P (2) 7 P - 8 P (1)	10P - 5 A (1)
<b>Western USA</b>	10A - 12N (1) 12N - 3 P (2) 3 P - 4 P (1)	8 A - 10A (1) 10A - 12N (2) 12N - 4 P (3) 4 P - 6 P (2) 6 P - 7 P (1)	6 A - 9 A (1) 9 A - 11A (3) 11A - 3 P (2) 3 P - 6 P (3) 6 P - 8 P (2) 8 P - 11P (1)	9 P - 6 P (1) 10P - 5 A (1)*

\*\*\*There are four different time zones in Alaska. This chart is based on standard time in the zone from Skagway to 141 degrees west longitude. Time in this zone is equivalent to:

Eastern Standard Time minus four hours;  
Central Standard Time minus three hours;  
Mountain Standard Time minus two hours;  
Pacific Standard Time minus one hour.

**HAWAII**

OPENINGS IN HAWAIIAN STANDARD TIME \*\*

TO	10 Meters	15 Meters	20 Meters	40/80* Meters
<b>Eastern USA</b>	7 A - 9 A (1) 9 A - 12N (2) 12N - 2 P (3) 2 P - 4 P (1)	7 A - 12N (2) 12N - 2 P (3) 2 P - 3 P (4) 3 P - 4 P (3) 4 P - 5 P (2) 5 P - 6 P (1)	6 A - 12N (1) 12N - 3 P (2) 3 P - 5 P (4) 5 P - 8 P (3) 8 P - 1 A (2) 1 A - 3 A (1)	5 P - 7 P (1) 7 P - 12M (3) 12M - 2 A (2) 2 A - 3 A (1) 8 P - 2 A (2)*
<b>Central USA</b>	7 A - 8 A (1) 8 A - 9 A (2) 9 A - 2 P (4) 2 P - 4 P (3) 4 P - 6 P (1)	6 A - 8 A (2) 8 A - 1 P (3) 1 P - 4 P (4) 4 P - 6 P (2) 6 P - 7 P (1)	6 A - 8 A (3) 8 A - 2 P (2) 2 P - 5 P (4) 5 P - 7 P (3) 7 P - 9 P (2) 9 P - 6 A (1)	6 P - 8 P (2) 8 P - 3 A (4) 3 A - 5 A (2) 8 P - 2 A (2)*
<b>Western USA</b>	7 A - 9 A (2) 9 A - 1 P (4) 1 P - 3 P (3) 3 P - 4 P (2) 4 P - 5 P (1)	6 A - 8 A (2) 8 A - 3 P (4) 3 P - 5 P (3) 5 P - 6 P (2) 6 P - 8 P (1)	6 A - 8 A (2) 8 A - 5 P (4) 5 P - 7 P (3) 7 P - 9 P (2) 9 P - 6 A (1)	6 P - 8 P (2) 8 P - 2 A (4) 2 A - 4 A (3) 4 A - 6 A (2) 8 P - 4 A (3)* 4 A - 6 A (2)*

\*\*Hawaiian Standard Time is equivalent to:

Eastern Standard Time minus five hours;  
Central Standard Time minus four hours;  
Mountain Standard Time minus three hours;  
Pacific Standard Time minus two hours.

**FORECAST INDICES**

Circuits Forecast To Open:

- (1) Less than 7 days during each month of forecast period,
- (2) Between 8 and 13 days during each month of forecast period,
- (3) Between 14 and 22 days during each month of forecast period,
- (4) For more than 22 days during each month of forecast period.

Where two forecast indices are shown within a parenthesis the first applies to the forecast for the shorter distance range, and the second to the forecast for the longer distance.

A - A. M. P. - P. M. N - Noon M - Midnight

See "Last Minute Forecast" in text for the relationship between the Forecast Indices and the day-to-day propagation conditions expected during the month of February, 1961.

\*Indicates times for expected 80-meter openings from Alaska and Hawaii to other areas of the United States. On nights when atmospheric noise conditions are exceptionally quiet, 160-meter openings are likely to occur during these same periods.

The CQ Short-Skip Propagation Charts are based upon a CW effective radiated power of 75 watts from a half-wave dipole antenna, a half-wave above ground. The Charts are valid through March 31, 1961. These forecasts are based upon basic propagation data published by the Central Radio Propagation Laboratory of the National Bureau of Standards, Boulder, Colorado.

**Solar Flare**

On November 12, one day before the big storm broke, an intense flare on the surface of the sun was recorded at several solar observatories throughout the world. This flare set off a remarkable series of terrestrial events.

The solar eruption which accompanied the flare ejected great masses of X-ray radiation and electrically charged particles of energy into the earth's atmosphere. The first bombardment of solar radiation, travelling with the speed of light, penetrated the lower layers of the ionosphere (about 50 miles above the earth's surface) at 1325 GMT. The saturated condition which resulted, caused abnormally high absorption in the radio reflecting layers. All skywave propagated radio signals in the sunlit part of the world, up to at least 30 mc, were completely absorbed, and a total blackout took place.

The blackout began to lift at 1345 GMT, and by 1430 GMT conditions returned to normal on most circuits, at least temporarily. The sudden ionospheric disturbance had lasted for just over one hour.

Simultaneously with the initial X-ray bombardment which caused the sudden ionospheric disturbance (disturbances of this type are generally called SID's), there was a great increase in the cosmic ray intensities measured on the earth's surface, and by several satellites in orbit in the earth's atmosphere at the time.

**Ionospheric Storm**

At about the same time, ionospheric measuring stations in the far northern region of the earth began noting instabilities in the ionosphere. Within a few hours after the solar flare took place, the ionosphere in the northern regions became completely unstable, and was no longer capable of reflecting high frequency radio signals. This instability spread southward at a very rapid rate. By 1730 GMT trans-Atlantic radio reception began to become erratic.



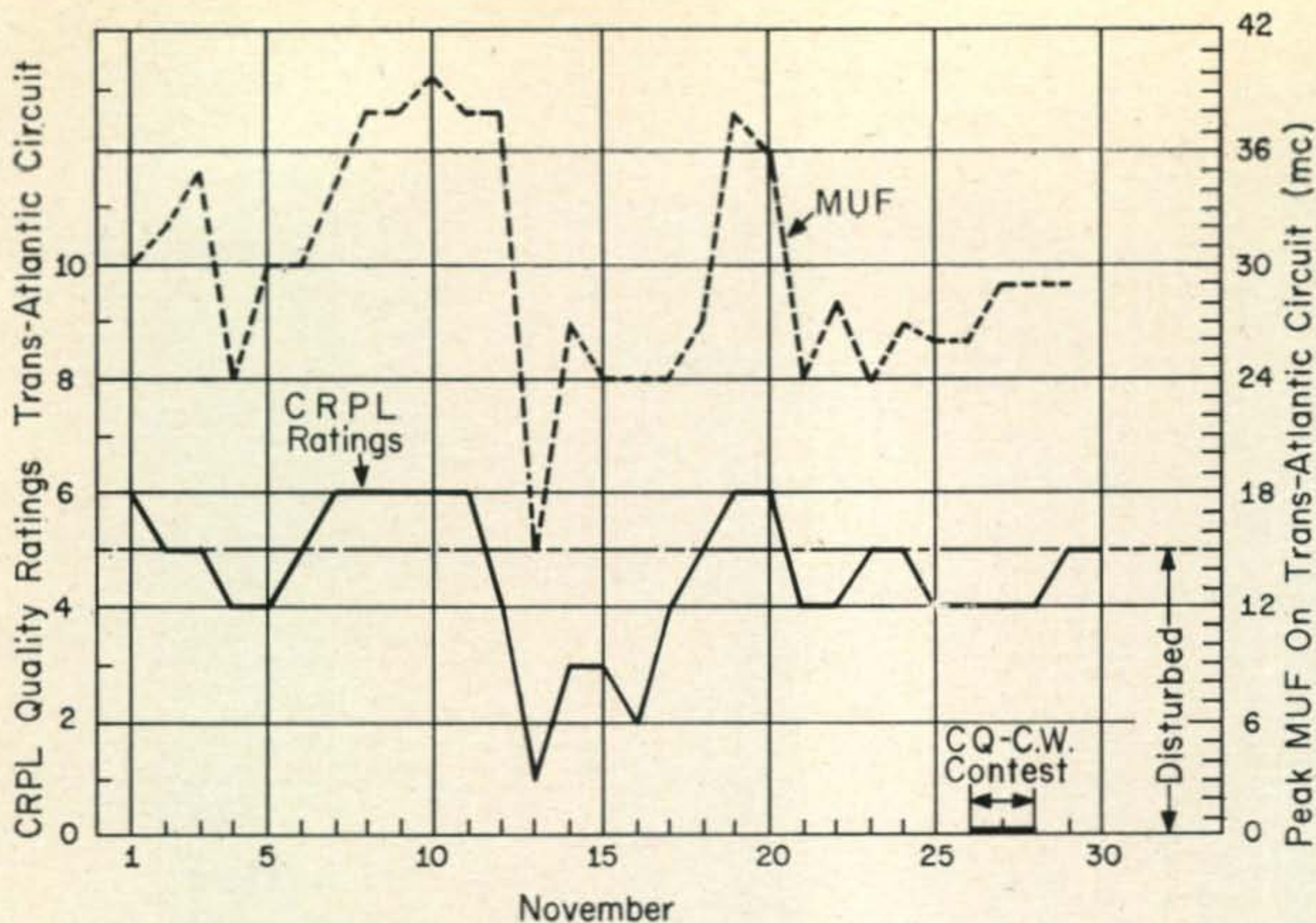

Fig. 1—Daily propagation conditions during November, 1960 and peak MUF's observed on Trans-Atlantic circuits.

Conditions continued to deteriorate rapidly, and by 1800 GMT trans-Atlantic radio circuits were very weak and badly distorted by flutter fading. By 1930 GMT a very severe ionospheric storm was in progress, and most high frequency radio circuits in the mid and high latitudes were very poor.

Strong blasts of electrically charged particles of energy, originating from the solar flare, penetrated the earth's atmosphere on Nov. 13.

The particles took a day longer reaching the earth than did the X-ray radiation because being heavier, their velocity was greatly reduced. The heavy absorption caused by the particles, and the general instability of the ionosphere, resulted in "useless" high frequency radio conditions for nearly 24 hours. CRPL gave a rating of 1 to conditions on Nov. 13.

The severity of the storm continued until November 16, when it started to abate. The ionosphere recovered completely by November 19, the storm having lasted nearly seven days.

### Red Aurora

Besides the one hour SID on November 12, and the subsequent ionospheric storm which lasted a week, other unusual terrestrial effects were noted. During the evening hours of November 12 a red aurora lit up the northern sky and was seen as far south as Los Angeles. Red auroral displays are quite rare, and are seldom seen so far south. Intense Sporadic-E clouds also formed in the ionosphere during this period, permitting unusual 6 and 2 meter v.h.f. openings over distances up to about 1300 miles. These v.h.f. openings occurred during the time when the high frequency bands were almost completely useless.

The flow of solar particles into the earth's atmosphere, in addition to upsetting conditions in the ionosphere, also caused violent fluctuations in the earth's magnetic field. During the peak of the storm, and for several days thereafter, magnetic compasses were pointing in the wrong direction by several degrees.

Solar flares, of the type that occurred November 12, develop suddenly and without much warning. At the present state of the art solar flares cannot be predicted much in advance with any degree of accuracy. To give an idea of the suddenness with which the November 12 flare developed, on November 9 CRPL forecast fair-to-good conditions (rating of 6) for the entire week of November 10-16. The *CQ* "Last Minute Forecast" in the November column called for "above normal" conditions from November 12 through 15!

### Contest Critique

The c.w. section of *CQ*'s DX contest was held from 0200 GMT November 26 to 0200 GMT November 28. The "Last Minute Forecast" given in November's column called for "below normal conditions" during the entire contest period. *CQ* hit this forecast pretty much on the nose.

A moderate ionospheric disturbance in progress on November 26, continued through the 27th. The storm deteriorated to severe during the final hours of the contest. CRPL rated trans-Atlantic circuits as generally poor-to-fair for both days, while circuits to other parts of the world were not much better than fair.

Despite the disturbance, most of the high frequency bands did open for DX, even if only

[Continued on page 119]





by **DONALD L. STONER, W6TNS**

P.O. Box 137, Ontario, Calif.

# Novice

For some time I have wanted to tell you about traffic nets and how to become an active participant. However, I am probably the least qualified person in the fraternity for the job—HI. During my WN6TNS days I was too busy mastering the code to join a net and handle traffic.

Realizing my limitations, I called on Sam VanWyck, K7BWV, Box 187, Lapwai, Idaho, who is manager of the Northwest Slow Speed Net, which meets on 3700 kc at 2100 PST Monday through Saturday. The NSN exists primarily to train c.w. traffic operators in net procedure and message handling. All net members are encouraged to use the net and new members are cordially welcomed. Sam graciously complied with my request for information by sending a copy of a manual of standard procedure which is issued to new members after a few check-ins. Let's look at a standard message and see how it is handled.

*Message Form*—A typical message might be transmitted to or from the net as follows:

(Preamble) NR I K7XXX CK 10 BIGTOWN  
WASH 2100 MAY 5 BT

(Address) MR JOHN DOE  
133 45 ST  
LITTLETOWN CALIF  
FONE ADAMS 98765 BT

(Text) LETTER RECEIVED X  
ANSWER ON THE WAY X BEST  
REGARDS BT

(Signature) JACK FROST AR N

Breaking the message form down, with the preamble, we find the message number. This is assigned by the station originating the message and stays with it, without change, by any other station. Next is the call of the station originating the message. The check (CK) may be sent without the abbreviation CK before it and serves as a guide to the number of words in the text. Note that punctuation, numbers and words each count as one in the check count. Following the check is the location of the station or origin. The time the message was filed is shown in 24 hour time and is given in the zone standard of the filing station. When the time of filing has no significance to the text or importance to the addressee, it may be eliminated from the preamble. Finally, the date of

which the message was filed with the originating station is listed. The break sign BT separates the preamble from the address.

The address is self-explanatory. The main thing to watch, is that you send it clearly and receive it correctly. It's mighty embarrassing to call someone up and try to deliver a message from a person they never heard of.

The text is the "meat" of the message. The letter X represents a period. Regular code punctuation is never used except in rare cases such as the fraction bar (/). Ordinarily, all punctuation is spelled out or, preferably, eliminated. A question is followed by the word QUERY and this is counted as one in the check, as is the X. Salutations such as 73, love, and so on are also part of the text. The end of the text is shown by the BT.

The last part of the message is the signature. This is merely the name or names of the person(s) sending the message. While not common practice, the signature may include the address of the sender in case it is not known to the addressee and a reply is expected. The final procedure symbol (AR) tells the receiving station that you are at the end of the message, the N tells him that you have no further messages for him. Should you have more messages for him, you would end the number remaining in place of the N. For example, if you sent AR 2 it would mean the end of the message and you have two more to send. Follow the message with the break-in symbol BK, make sure he has received the message, and away you go again.

*Fills*—Probably one of the most discouraging things in traffic handling occurs when the beginner misses part of the message and has to get a "fill." The two methods, in common use on amateur traffic circuits, of asking for a fill use these common symbols:

IMI	Interrogation or?	BN	Between
AA	All After	WA	Word After
AB	All Before	WB	Word Before

Referring to the sample message earlier, suppose you missed the word RECEIVED. You could ask the sending station for it by sending WA LETTER, or WB X ANSWER. To get a fill of more than one word, or when other methods might be ambiguous due to the nature of the text, suppose you missed the words between



ANSWER and BEST. You could then send: ? BN ANSWER I I BEST BK. The two I's represent the blank space in your text and serve to indicate to the sending station that this is the portion needing the fill. The sending station would reply: ANSWER ON THE WAY X BEST BK. Should you miss part of the preamble, just ask CK? or TIME FILED? BK, etc. The same procedure holds for the address and signature.

If you are in doubt about any part of the message, ask for a fill or a confirmation. A confirmation is merely a request by the receiving station that a doubtful part be repeated or checked by the sender. Let's suppose that you copied the phone number just as a lightning crash sounded in your phones. You think you received it but wish to be sure. You can ask: CFM FONE ADAMS 98765 BK. The sending station would then reply: CFM (I confirm that) or, should you be in error, repeat the correct number.

*Listing Traffic With The NCS*—If you have traffic for the net there is a standard procedure to be followed in telling the NCS (net control station) all about it. Each station on the roll is asked if he or she has anything to send (QN1 QTC?). The station replies QRU if nothing or QTC 1 XXX (one message for XXX, the destination city or next higher net that would handle it).

*Clearing the Traffic*—When the NCS is ready for you to send your message or when he wants you to take one from another station, he will use the symbols QNK (transmit messages for ..... to ..... ) or QNR (Answer ..... and ..... receive traffic). Suppose you, K7XX, have listed two messages for RN7 (another net) with the NCS, K7NCS. He wants you to send them to K7XYZ, the RN7 liaison station. A typical exchange would be: K7XXX DE K7NCS QNK 2 RN7 K7XYZ K. You would then call as follows: R K7XYZ DE K7XXX QRV? K. He replies: K7XXX de K7XYZ QRV K, and away you go with your messages. When you have sent both messages he will QSL (confirm) and turn it back to you. You then give him a quick thanks and call the NCS telling him that you are now clear and standing by.

*Delivery of Messages*—The goal of any traffic net is the delivery of the message from the sender to the addressee, in addition to training good traffic handlers. All the good procedure in the world is worthless, if the message is not delivered. If you are the closest station to the destination of a message, take it. If you can't phone it in, you can always mail it. It costs only four cents but if you are not willing to spend that much once in a while, you shouldn't be taking time to learn traffic handling. Also you will be surprised how many people will send a stamp along with a letter of thanks. It is a good idea to order a pad or two of ARRL message blanks for your mail deliveries. They are neat in appearance, have appropriate spaces for all

vital information and have an explanation of the traffic system so that the addressee will know what it is all about.

*Fixed Text Message*—The ARRL has devised a set of code numbers representing text which can be used to expedite traffic during peak load periods (holidays etc.). The ARRL list of fixed text messages is found at the back of all ARRL *Log Books*. By using a number to represent a common phrase, a great saving of time can be realized. A sample message with fixed text can be illustrated by the following:

103 K7XXX ARL 5 ALAMO ARIZ 2100

MAY 15 BT

JOHN BROWN

1234 56 ST

OMAHA NEBR BT

ARL TWO X ARL THREE BT

SUSIE AR

Note that the numbers are spelled out as they should be in all messages. Of course delivery to the addressee must be in plain text or it wouldn't make much sense. The message just sent reads: COMING HOME AS SOON AS POSSIBLE X AM PERFECTLY ALL RIGHT X DONT WORRY.

If you, Joe Newnovice, would like to participate in a net, here's how to go about it. First listen to the net for a few nights to see how they operate and to familiarize yourself with their methods. After the roll call, the Net Control Station will listen for late checking and new members. If the net operates near the edge of a Novice band segment, members will tune the Novice band for calling stations. Joe Newnovice, WN6TNS, would call in like this: K7-NCS DE WN6TNS QNI QRU LOS ANGELES BK. Since the NCS has probably not worked you before it is a good idea to give your QTH or the nearest recognizable large town, so NCS can determine if he has any traffic for your area. Since you are not operating on the net frequency (or assuming you are not) it is permissible to repeat your break-in (as above) over several times until you are recognized. If you are operating on the net frequency send your break-in *once* (as above) and then listen to see if you have been recognized. If not, there is probably a stronger station on frequency blotting you out. Wait until he has cleared with NCS and follow in closely behind with your break-in.

*Net Manners*—One of the greatest assets the net can have is a well-mannered, helpful crew. There are many factors not under the control of the NCS which combine to make his job a tough one. Not the least among these are the terrible three QRM, QRN, and QSB. Add to those, several thoughtless or careless net members and you have a situation that will reduce even the most competent NCS to near insanity. The basic rules of good net manners are few and simple.

1. Do not transmit unless you have been asked to do so by the NCS. Resist the impulse to hit that key, even if you think he needs help.







He uses the gear on all the regular Novice bands and has separate dipoles for each band.

Dick is a member of ARRL, the Boy Scouts of America Emergency Service Radio, the Boy's Life Radio Club and numerous short wave groups. Dick goes to the Mt. Horeb public high school, is in the sophomore class, is a member of the Science Club, and actively participates in sports.

Dick has it made now, and is well on the way to his General ticket. His only problem is the theory, which he doesn't get too well. Dick says he can always use help on that order of business! On the subject of QSL's, KN9APW says "I file all cards received in alphabetical order according to the call) and am proud to say that I have QSL'ed every QSO. To date I have received only 80 QSL cards compared to the 190 that I have sent out. This is very angering and makes a kid wonder sometimes!" And all I can add to that is it makes an ole timer wonder sometimes too, Dick.

### Mail

An interesting letter comes from Shin-ichi Hanaki, JA1CJU, 2169, 3-chome, Setagaya, Setagaya-Ku, Tokyo, Japan. Shin-ichi is very interested in Novice stations and listens for them around 7175 kc. He has tried to contact them, but always in vain. One of the reasons is the low power of his transmitter, but more important, most Novices do not realize the Japanese c.w. band is 7.0 to 7.1 mc. They cannot operate as high as the Novices do. If you would like to work the JA stations, get up early in the morning and call CQ JA, then listen below 7100 kc. The chances are excellent that you will hook one. OM JA1CJU sends along the following list of Novice stations heard in Tokyo between October 59 and 1960; on the 40 meter band: KN4PNM/KL7, WH6BKE, DID, DHG, DNF, DNO, DRB, DRT, DSD, DUA, DLU, DUX, DWT, DWX, NKN, WV6DBD, HCP, HUU, HXT, HXV, IEO/KL7, IJN, IJT, JAJ, JQP, KDO, KEA, KJZ, KLF, KSG (or KSO), KYK, LBB, LBD, LCP, LIY, LNM, LSQ, LUG, MAR, MAZ, MBQ, MBN, MDC, MDL, MDR, MEK, MLI, MMX, NAN, NBF, NEX, NJG, KN7DYR, JWE, KCQ, KWL, LES, LHF, LKH, LPK, LPM, LSO, LUM, LUV,



Bob Williams, KN4UFE, 151 Wallace Rd., Memphis, Tenn. sends out this home made photographic QSL. He cut up one of the "\$1.00 per 100" cards to make it up. Bob has 42 states confirmed, plus WP4 and several VE's.

MJQ, MLD, WL7DIK, DJN, DQF, DRW, WV-7DMO. I have S Reports for the stations listed above, and if you will send a s.a.s.e. or postal card I will fill it out to confirm reception of your station.

Our friend from England, F. Allan Heridge, GG3IDG, 95 Ramsden Rd., London, S.W. 12, writes to report that the station calling WV-6KOJ (Nov. CQ, page 124) was not G3IGD, but Allan G3IDG. Allan called the WV6 when he was MM also. Allan reports hearing and calling the following stations from his QTH in London, during the period between March and November 1960, on the 15 meter band: KN1-MEE, MVN/1, NNA, OEX, OPJ, PSK, WV-2GXB, GXG, JTN, KAJ, LJY (twice), LNC, LTK, LYH, MZP, NAW, OOF, KN3JWJ, KDP, KTY, LAU, LJH, KN4QCO, TBB, UHM/4, VFY, WIP, WZM, ZTL, WV6KOJ, KOJ/MM, KN8RNN, WL7DJN, WP4ATR/-KP4. Allan also comments that he needs cards from the following stations: KN1MTZ/1, KN1NOE, KN4JSY. Allan continues, "Ask the boys not to write requesting skeds, get them to fill in their cards accurately and finally, please tell them to listen more. Seventy-five watts will work wonders, especially with a beam or even a dipole. I run only 55 watts to a very inefficient bent, longwire and I find no trouble in getting over."

Bill Watts, ET2, USN, Lorac Team #3, c/o



Speaking of home-made QSL's, how's this one from Hank Leopold, KN9BCH, 7158 S. Constance Ave., Chicago 49, Ill.? Hank says this photo proves he is the most comfortable ham in Chicago, and usually reports 599 "armchair copy!"



FPO, New York, N. Y. write to advise many Novices that they have been heard in VP9 land, on the lower frequencies. One November 13, 1960, between 0040 and 0412 on 80 meters: KN1NYY, WV2LIU, MYU, NHZ, NIL, NIP, KN3LQF, NLC, NLM, NPK, QPY, KN4BYA, CWW, NNA, NQM, VWM, WHW, WWK, YGC, YSQ/4, YTD, ZEN, ZIN, ZVI, KN5-DHE, DXY, KN8SVH, TWL, UIW, Between 0412 and 0445 on 40 meters: KN4BXJ, DKK, NKB, QZB/4, WKE, WQM, YCZ, YMU, YSN, KN5AEE, BDX, DYX, EGG, ESI, FNF, WV6-JPS, (only 6 heard), KN8WVG (the only 8), KN0AAT, BQI, NAS, ZIL. November 14, 1960, between 0600 and 0220 GMT, on 80 meters: KN1PKI, PWB, WV2KIH, MPQ, OCX, KN3-LEF, LZL, NAS KN4ILG, VAT, ZMM, KN5-AHD, KN8AMW, SAK, TCM, VPF, VQX, VVL, KN9VYD. On 15 meters, between 2120 and 2200 GMT: KN10KJ, WV2KSC, NMW, KN3NII, KN4NII, QIZ, YMU, ZVS, KN5EJA, FRI, ZFG, KN9AGH, KN0BVE, WCC. November 16, 0745 to 1300 GMT on 40 meters: KN1-OLP, WV2LLU, OBC, KN3LTN, NFO, MYV, KN4RIJ, WLW, WMY, WNW, VRI, YSN, YXJ, ZDL, KN5EEI, FLJ, FSM, YSD, WV6KST, KXN, LEY, LKZ, NDI/6, NET, OIG, UVI, WGP, KN7LNE, KN8TDW, TLX, TOG, UHB, VZP, KN0ZNH, ZXQ/9, KN9VVU, ZAW, WH6DAL. Many thanks for the fine report Bill.

Dan Dolan, K5SDY/G, 55 Cromwell Rd., Weeting nr. Brandon, Norfolk, England, writes to say that the regs have him off the air but he does lots of listening. On December 4, 1960, Dan heard WV2NAX, KN3KLD, LBV, KN4-BLT, WQS, NJ, WV6MCL/4, KN8RXY, all on the 15 meter band. Dan s.w.l.'s the Novices he hears so drop a line to him if your call is listed.

Last, but not least, a comprehensive report from Tima Popovic, YU1RS 357, Banat Novo Selo, Yugoslavia, of stations heard on 15 meters, between September 12 and November 9, 1960. Tima reports hearing the following signals: September 12, 1914 to 1920 GMT: KN4-WVK, KN8TDR, Sept. 18, 2016, 2038 GMT: KN1OLZ, WV2JFH, JZE, KEK, LUD, MPY, WP4AVW, KN4VFN, KN5BWE, KN0BAD. September 28, between 1910 and 2012 GMT: KN1KSG, MQW, NBW, NOT, OFN, OXB, WV2JLP, KKK, KXX, MOB, NPR, TWW, KN3MKL/3, MNJ, MNP, KN4AUX, QLZ, TSJ, TTA, VVT, WTT, KN5OMK, KN9-KXX, ZFI. October 21, 1540—1903 GMT: KN1MNP, OBR, OPQ, WV2NAF, NAY, NXZ, KN3LAD, MUI, NFT, KN4AGL, DHD, PKR, QYS, KN5FWN, KN7MST, KN8RQO, RWY, UVU, VAY, VCF, VKF, KN9ZAD, ZCR, YDU, N0YCS. November 9, 1749- 1802 GMT: November 9, 1749 to 1802 GMT: KN1OFN, KN4YXT, KN9-UHF/KP4.

Let's hope the column this month stimulates interest in net activities. If your net is interested in active Novice participation, drop a line to W6TNS for inclusion under this heading.

Don Fitzgerald, KN7LML, 16 S. Roosevelt St., Boise, Idaho and Dave Combes, KN7NQJ, 1205 McKinney Rd., also in Boise, are planning a Novice ragchew net about January 10 which will operate around 7178 kc.

### Novice Assistance

Ed Grey, K9SLM, Evergreen Park, Route 64, Sycamore, Illinois, writes to say that the Kishwaukee Radio Club is starting a class to assist persons in obtaining their Novice class licenses. They hope to start the first session in January. The radio club meets on the second Monday of each month, at the DeKalb High School, DeKalb, Illinois at 8 P.M. For more information drop a line to Ed at the above address.

### Letters

Leading off this month is Levi Davis, K4TNQ, 920 Kelly Street, Montgomery 8, Alabama. Levi constructed the rig described in the October 1960 NOVICE column, but used an 807 and 6AG7 with an 800 volt power supply to obtain 70 watts output. K4TNQ suggest that I describe a simple modulator so that Novices can convert their c.w. rigs to phone when the "big one" arrives. Your wish is my command, OM, it should be ready in a month or two.

John Pete Billon, WV6MWG, 4040 Via Opata, Palos Verdes Estates, Calif., has been slugging away since July and has piled up several hundred juicy contacts, including choice DX such as L, CX, F8, DJ3, VK, G, CR5, HB9, KR6, YV5, DU7, UA1 and LU7. John suggests that Novices are too prone to call CQ before spending at least a half-hour listening to band conditions. He further suggests tuning to the phone portion of the band and finding out who the "big boys" are working- HI.

Joe Millen, KN0BQI, 3224A Nebraska Avenue, St. Louis 18, Missouri, got started a little late (he is 31- HI) but is making up for lost time with a WAS of 29/29 on 40 meters with a Knight-Kit T-50 and HQ-145, lashed up to a vertical. Joe usually fires up after 0300 GMT on week nites and will sked anyone needing Missouri for he gets a kick out of being a "first." Also BQI needs the Western and New England States, plus a very elusive Colorado.

Jeff Kadet, K1MOD, 501 Greendale, Needham 92, Mass., finally shed the "N" and is now active on all bands with his Adventurer and SX-100. DX takes the place of local contacts now, and Jeff has 30 countries but the WAS is still hung at 47/47. Jeff will still sked anyone needing Mass., and would like Ark., Del., and Utah, to polish off the WAS.

Frank Leppa, KN0ZXE, 233 East Willow St., Duluth 11, Minn., has solved the "X" and "Z" phonetics by tagging himself KN0Zany Xylophone Enthusiast. Frank really digs c.w. and has piled up 405 contact in 191 days of operation, which brought him to a WAS of 43/42 plus VE's and a KG1, with his Elmac A-54H and Knight R-100 tied up to a three-element

[Continued on page 114]



# SIDEBAND

Irv and Dorothy Strauber, K2HEA/K2MGE

12 Elm Street, Lynbrook, New York

## SSB DX HONOR ROLL

TI2HP	221	K4TJL	152
W6UOU	218	W5KFT	151
W4IYC	214	K8RTW	151
VQ4ERR	212	W5RHW	150
W8PQQ	206	K9CTL	150
W6PXH	200	K2HEA	150
PY4TK	198	W2YBO	135
W7VEU	191	W6VUW	134
W9QVZ	190	W6YMV	130
K2MGE	189	W2MAF	127
HB9TL	186	W8ACT	125
VK3AHO	185	W2NUT	125
W6WNE	183	K6MLS	125
W6RKP	181	K2TDI	124
K9EAB	181	W6UPP	122
TG9AD	176	W2ATJ	121
MP4BBW	174	W7DLR	121
W2LV	174	W4UWC	119
W9CVU	170	W1JSS	118
W5IYU	169	ZL3AB	117
W3MAC	165	K1IXG	115
W2FXN	161	W9CYL	115
K2FW	160	W3GHD	113
W1OOS	155	YV5AFF	103
W4OPM	153	W8JIN	103

### W6PXH Earns "200 Certificate"!

Cy Kahn, W6PXH, entered the charmed circle by submitting confirmation of contacts with 200 countries on two-way sideband and received Certificate #8 as evidence of this outstanding achievement. If you check back, you'll see that the first "200 Certificate" was awarded back in March, 1960 and to date only eight sidebanders have qualified, making this award probably one of the most difficult to attain; so W6PXH is to be warmly congratulated on his successful efforts. Cy was licensed in



1917 as 2CY and later had the calls 2CGX and W2FPT. In 1938, he moved to California and received his present call. Until 1940, Cy was also a different kind of "ham"—actor, vaudevillian, ballad singer, comedian, and musician. He retired from the stage to devote his time to writing for motion pictures until 1947 when he joined Ted Henry, W6UOU, as General Manager of Henry Radio Los Angeles. Cy's XYL is a charming Scotswoman named "Inky" and the Kahn's family consists of a daughter, son-in-law and six grandchildren! According to those who know him best (and who could be closer, than Meredith, W6WNE, whose persistence pried the above information out of Cy), W6PXH is witty, unassuming and a great guy! (We know he's unassuming because it took a California visit by Jan, K9KKR, to provide us with the photograph of Cy and Meredith which we are pleased to include in this month's issue. Otherwise, we'd probably never get a picture from W6PXH himself!) Cy, we salute you and look forward to a contact with you ourselves!

Other recipients of S.S.B. DX awards this month include the following stations: the "Worked 50" Certificate was sent to K9KWK, K5KTX, and XE1CV who also submitted sufficient confirmations to receive the "Worked 75" Certificate. "Worked 75" Certificates are also now hanging in the shacks of DL1IN, K9MGF, W6DLY, and EI8P who is the first station in Ireland to earn a CQ S.S.B. award. Nice going, Joe!

Leo, UA3CR, covered himself with glory by being the first sidebander in the USSR to earn one of CQ's awards when he submitted sufficient confirmations for the "Worked 100" Certificate. Other sidebanders to whom the "Worked 100" was sent this month are W4IFN, W1ORV, W2BQM, K9CRS, W1FZ, and G3DO. An addition in the form of the "Worked 125" sticker was made to their certificates by W2HXG, W8ACT, K6MLS, and W2MAF while K8RTW added another one in the form of a "Worked 150" sticker. Keep up the good work, fellows—you're doing great!

Cy Kahn, newest member of the charmed "Worked 200" circle, with Meredith, W6WNE, whose DX activity should soon gain her entry into this top-notch group of sideband DXers. (Photo courtesy of K9KKR)



If you wonder why we keep repeating the requirements for these certificates, you ought to see our mail. Cards without listings; listings with just prefixes and no calls or countries; little scraps of paper that get lost in our files—yes, guess we had better repeat again. To qualify for these awards, send us a listing of your confirmations, verified by another ham, for the "Worked 50," "Worked 75" Certificates and the "Worked 125," "Worked 150," "Worked 175," "Worked 225" etc. stickers. The cards themselves plus listings must be submitted for the "Worked 100" and "Worked 200" Certificates. All clear?

### Bryan, W5KFT, Winner Of WAS Contest



Bryan Edwards, Jr., W5KFT, Winner of the WAS Contest.

Bryan Edwards, Jr., W5KFT, of Lubbock, Texas, took top honors with the highest score in the SSBARA WAS Contest held on Sept. 10-11, 1960. Bryan worked all 50 states and 476 contacts for the winning score of 23,800 points. As his award, Bryan has received a Lifetime Membership in the SSBARA.

The top scoring SSBARA member was Bill Leonard, W2SKE, who worked 49 states and 473 contacts for a total of 23,177 points. Bill will be presented with a trophy at the 10th Annual Sideband Dinner on March 21, 1961.

The top scoring sidebander outside the W/K area was Carlos de Leon, Jr., XE1CV, who worked 47 states and 320 contacts. This was quite an achievement in view of the nature of the contest and Carlos has received a special award to commemorate his victory.

Handy WAS QSL Albums, courtesy of Bill, W2SKE, were sent to the following stations for working 50 states: Bryan, W5KFT; Dave, K5MDX; Cliff, K9EAB; Al, W6ONP; Wallace, K4TJL; Scotty, K9PPX; and John, KØLUX.

Congratulations to you all on this fine display of good operating.

Here are the scores as finally tabulated, (First column indicates number of contacts made; second column indicates number of states worked; third column indicates total score):

W5KFT	476	50	23,800	K2LGN	215	44	9,460
W2SKE	473	49	23,177	K1EJO	215	43	9,245
K5MDX	460	50	23,000	KL7AZN	219	42	9,198
K9EAB	370	50	18,500	K2MGE	198	46	9,108
W2HLL	394	46	18,124	W3CJI	188	48	9,024
KH6DLD	380	44	16,720	KØTGF	200	39	7,800
W6ONP	334	50	16,700	K6RAU	182	41	7,462
XE1CV	320	47	15,040	W4MAM	174	41	7,134
WØNFA	298	49	14,602	W6LKE	165	43	7,095
W8TWA/8	292	46	13,432	K5TKY	181	39	7,059
K4TJL	248	50	12,400	W4LY/7	183	38	6,954
W7LEV	288	41	11,808	KØLUX	137	50	6,850
W9YRU	252	46	11,638	K9PNV	158	42	6,636
K9MBR	242	47	11,374	W2GBX/5	137	47	6,439
WØFUH	236	46	10,856	K2HEA	130	47	6,110
K4LPW	234	46	10,764	W4DS	141	42	5,922
W5EXZ	215	47	10,105	W5RIT	146	40	5,840
K9PPX	202	50	10,100	W9ATU	128	43	5,504
				W5BFW	130	40	5,200

Thanks to the following stations, who scored less than 5,000 points, for their participation in the WAS Contest and for submitting their logs: K5YAA, KØRGM, KØPLY, K6HMA, VE1SN, WØKCG, YV5AFF, CN8HX, W1WY, K5YTO, W1ORV, W9MG, K4GIUA, W9CJO, VE3ES, K6LTO, W3AEC, KØJGF, KL7MF, W2HKY, K2HWF, K2OFD, W7PT, K1KPS, K1NBN, W2ATM, W8TTN, W6OMR, K8LEF, K1LLF, W5GGS, K8GPD, W2QKJ, W2CVW, W8FQS, W2IWC/9, W3LUC, W1PVF/4, and W6EJA.

### W8YIN Trophy

In our December column, we announced the Mickey Unger Memorial Trophy to be awarded to the highest scoring station using under 175 watts during the Sideband DX Contest January 28-29. Unfortunately, we did not clarify a most important point and the real reason for the award. Since the great majority of the sidebanders overseas are limited to 175 watts, this award would have no real meaning but to the low powered W/K stations who are battling their higher powered brothers a high score is really an achievement to be rewarded. So, low powered W/K contest operators, the Mickey Unger Award is for you!!! Mickey, W8YIN, was a great believer in the theory that it was the operator, not the power, that won contests and it is hoped that this award will encourage the low powered operator to enter this competition.

### Right Under Our Noses

Here's another letter from one of our DX sideband brethren—Bryan Bisley, MP4BDA, MP4MAB, etc.—presenting his opinion of current 20 meter operations:

"Dear Editors:

"I have, over the past couple of years, travelled around Europe and the Middle East putting various countries on s.s.b. for the first time. Originally, it was comparatively easy to work W/K stations by sitting on a channel above 14,300 kc and listening for W/K's below the frequency.



"Then came the blow—the top 50 kc of 14 mc were thrown open to the Stateside stations. Since this time, it has been virtually impossible to work into the U.S.A. at all, as the band is full of W/K s.s.b. stations ragchewing interstate and phonepatching.

"I fully appreciate that there are almost 250,000 amateur stations in the U.S. and that it is only a minority of these stations who are interested in DXing or long-distance ragchewing but, even so, is it really fair to operate in such a way as to spoil 14 mc for all other users of the band outside the States?

"I know that, to the average U.S. operator on 14 mc a.m. or s.s.b., the extra 50 kc was a boon not to be given up under any circumstances, so my solution to the problem is as follows: allow W/K stations using A3 and A3a to operate from 14,150 to 14,300 kc instead of 14,200 to 14,350. This would leave the band divided as 14,000-14,100, c.w.; 14,100-14,150, non-U.S.A. A3 (these stations could also operate above 14,150 as their comparative low power would not cause too much QRM in the States); 14,150-14,200, U.S.A. A3; 14,200-14,300, U.S.A. A3a; and 14,300-14,350, non-U.S.A. A3a.

"In this manner, the s.s.b. band of 100 kc width would still be available for U.S. amateurs to do as they please in; and the rest of the world could operate in the top 50 kc as before, not only hearing each other, but being heard virtually QRM-free in the U.S.A.

"Perhaps someone could persuade ARRL to petition the FCC to make this change as I am convinced that it is the only answer.

"It has been very frustrating on recent DXpeditions I have made to very rare spots to sit up all night trying to work the U.S. and getting only a handful of QSO's, whereas, during the day, one can work the rest of the world in pile-ups at one a minute.

"In the meantime, there must be a very large number of W/K stations still needing MP4Q, MP4T, MP4M, VS9O, 4W1, ZB2, YI, EI5 and DJØ on s.s.b., whereas most of the rest of the world's DXers have worked me from nearly all of the above-mentioned countries and prefixes. I was on, boys—right under that Illinois-New York ragchew and that chap in Texas (or wherever it may be), talking to his friend over the phone patch . . . !

73, Bryan A. Bisley, MP4BDA, MP4MAB, MP4QAO, MP4TAE, EI5AI, G3OFI"

### Worked 100 and 200 Certificates

All stations must submit QSL cards clearly marked 2-Way S.S.B., together with an alphabetized list and sufficient return postage for these certificates and your cards.

### Worked 50 and 75 Certificates Stickers for 125, 150, 175 etc. Countries

All stations must submit an alphabetized listing of confirmed 2-Way S.S.B. contacts verified and attested to by another ham. No cards need be submitted. Include letter postage.

### African Stations

Send lists and/or cards to ZS6AMV, A. J. Louw, 52 Wargrave Ave., Auckland Park, Johannesburg, Tvl, South Africa from the following call areas: All ZS's, ZE, VQ2, ZD6, CR6 and CR7.

All sideband stations in the other African call areas requesting certificates, send cards and/or lists to Awards Manager, R.S.E.A., QSL Bureau, Box 30077, Nairobi, Kenya.

### United Kingdom and Ireland

Contact R. F. Stevens, G2BVN, 51 Pettits Lane, Romford, Essex, England for verifications of your cards and/or list.

### Others

Direct to the Sideband Editors, 12 Elm St., Lynbrook, L.I., N.Y. Cards and/or verified list.

We print Bryan's letter in its entirety because, not only has he devoted a great deal of thought to its contents, but also because we imagine that it reflects the thinking of many of our DX sidebanders. As Bryan mentions, only a minority of W/K sidebanders admit to being interested in DX; however it seems to us that when a new country appears on sideband, every one and his brother suddenly finds newly-awakened interest in DXing as evidenced by the tremendous pile-ups. The seasoned DXer knows enough of the procedure to try to preserve a little order in working the rare one whereas it's the fellow who "wasn't interested in DX" who calls and calls and calls even while a contact has already been established with another station on frequency.

We didn't think it possible either but, thanks to Buck, W4TO, here's a photo of Gus, W4BPD sitting still! Gus has just returned from his four months' DXpedition to such rare spots as 3A2, M1, 6O1, FL8, and MP4 among others.





However, be that-as-it-may and as interesting as Bryan's solution of the problem may seem, it seems quite unlikely that the FCC will prove itself amenable to considering a change in operating on the 20 meter band. It is highly erroneous for the DX stations to believe that not much thought was given to this opening of the 50 kc for W/K operation. This move was debated and considered for several years before the step was taken and we must assume that it was done to preserve the greatest amount of the 20 meter band for amateur operation.

With the band closing up during this low in the sun spot cycle, it is up to us to make the most of any opportunities that may arise to contact the DX stations. It is obvious that any previous suggestions to provide some clear operating space for the lower-powered DX stations have gone unheeded. Therefore, there seems to be only one further workable solution; that is, for the DX s.s.b. stations to operate in the region of 14,100-14,150 kc, eliminating the W/K QRM on their frequencies and listening for the W/K DXers between 14,275 and 14,300. Naturally this would make us forego one of the advantages of s.s.b.—enjoying roundtables on one's own frequency and being able to break in for a contact, but it stands to reason that, if the DX stations cannot break through the American QRM, they must carve out a niche for themselves in another part of the band.



Henry, W2MAF, shown with his fine station in Jackson Heights, New York. Despite a very busy schedule, Henry manages to get on 20 meter sideband at every opportunity.

### Primer For New Sidebanders

Bob, W8BKO; Jim, K8RCQ; and Ye Editors are collaborating on a manual to be called *A Primer for New Sidebanders*, designed to acquaint new sidebanders (and old) with proper techniques for sideband operation and the answers to many questions that arise when joining the sideband fraternity. Many of our newer sidebanders are also brand new hams and practices that we sometimes take for granted are learned by them only after many weeks of operation by the trial and error method. If you have any hints or suggestions that you would

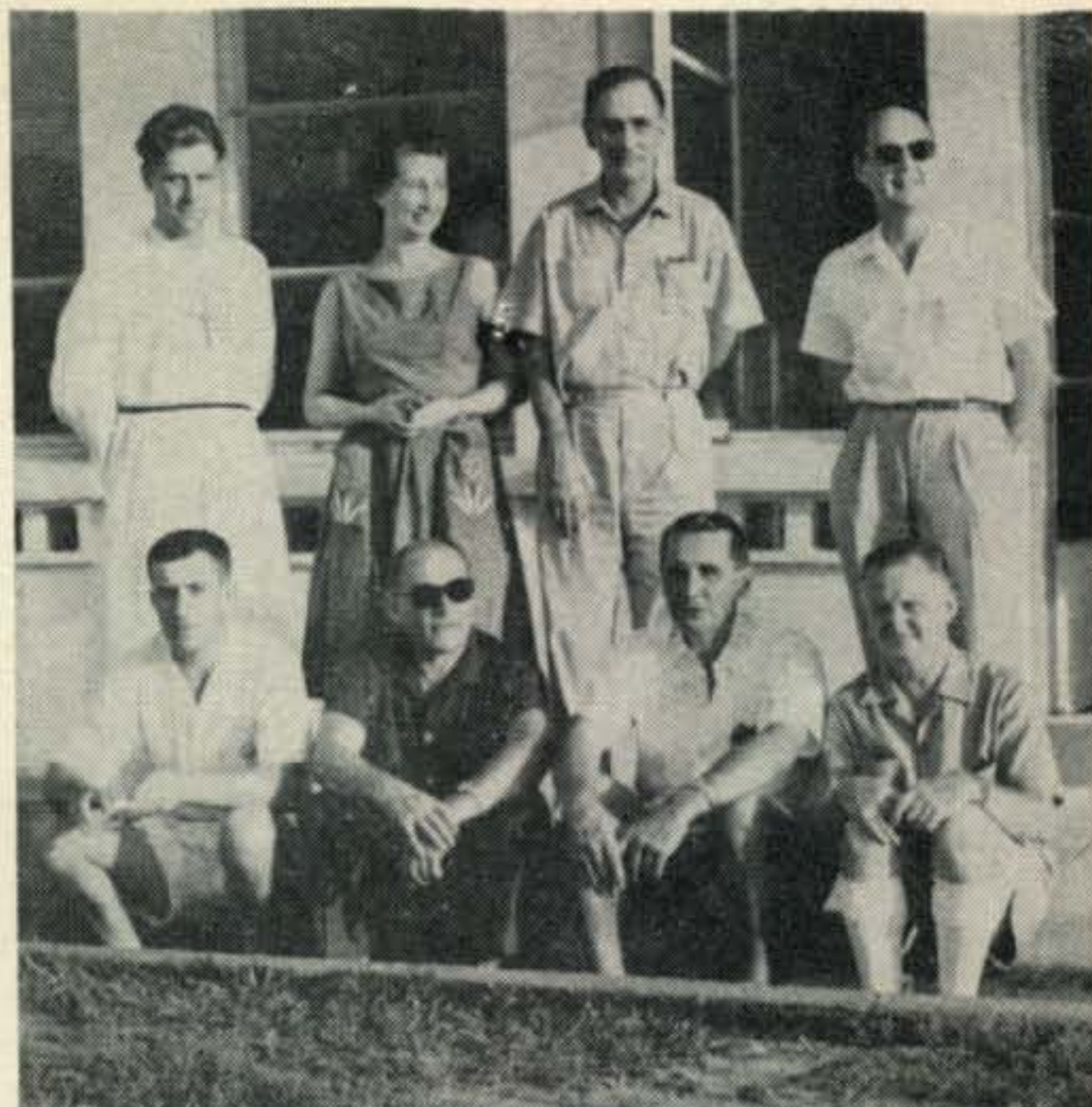

Here's a group of ex-OQ5 operators including two of the most popular sidebanders; seated, left to right, OQ5JY, OQ5KW, OQ5MA, and OQ5EL; standing, left to right, Bro. Franciscus, Jane, OQ5IE, (first OQ5 to earn the "Worked 100" Certificate), OQ5PS, and Jane's OM Paul, OQ5GU.

like to see included in this manual, please drop a note to the **SIDEBAND** Editors at the above address.

### A Visit To Hallicrafters

We don't often have the opportunity to watch ham gear being put together, commercial kind, that is! Business called us to Chicago and having some extra time before our 707 left for home, we paid a visit to the Hallicrafter plant to watch them put together some of the gear that has been putting some pretty sideband signals on the air. A whirlybird dropped us at Midway where Fritz Franke picked us up for a tour of the company's factories. We watched assembly lines producing the Lowrey Electronic Organ, amateur receivers and transmitters and components for military equipments. One thing that impressed us was the care with which every piece of ham equipment was assembled and tested. We saw some of the new projects that are being prepared for the hams in 1961 and it promises to be a real exciting year.

Did they find the \$200,000 receiver, Fritz?

### "Ex 'G' Net" Formed

Reg, W3HQO, has asked us to tell you about the formation of a new net called the "Ex 'G' Net" comprising all American and Canadian amateurs born in the British Isles. The Net meets every Sunday on 21,445 kc at 2100 GMT. A lovely certificate is available to W/K stations for working 6 W/K and 2 VE members of the Net. Cards should be sent to K5QWZ with s.a.s.e. for return of your cards and the certificate will be mailed to you. All "G" and British Isles stations (GM, GW, etc.) need 4 Stateside and 2 VE contacts. Their QSLs should



go to G8KS with s.a.s.e. and K5QWZ will forward the certificate direct.

Charter members of the "Ex 'G' Net" include W3HQO, WA2EVH, W1QNC, W0OYP, K0YYW, K6CKM, K6PAK, W6UBU, WA6GLF, WA6HOH, K5QWZ, VE3CWB/6, VE3DZQ/6, VE3BPV, VE3ENH, VE3CDM, VE3CWY, VE3AYE, and VO1EX.

### Radio Amateur Tour of Europe April 22-May 10, 1961

Just when we thought we had come up with an original idea—a ham excursion to Europe—along comes a pamphlet in the mail from Hugh Tinley, K0GHK, with a complete plan already set to go. Hugh's Ham Tour will leave from New York City on April 22 and jet to London where many interesting activities have been planned until April 27. Next stop is Paris, then Basle, Lucerne, Heidelberg, Cologne, Brussels, Eindhoven, Amsterdam, and back to New York City. At each city in Europe, Hugh has gone to great lengths to insure that members of the Tour see all the sights of interest as well as meet many well known European hams and visit spots of particular interest to hams. Write immediately to Hugh Tinley, K0GHK, 4820 Dodge St., Omaha 2, Nebraska and ask for complete details of the Radio Amateur Tour of Europe.

### Sideband Around The World

Thanks to Nick, W4MXL, QSL manager for EA8BA, we learn that Bud is manager at the Project Mercury Site in the Canary Islands and that Bud and Dino, W2WST, will be operating their GSB-100 from there until June or so. By now, they probably have replaced their folded dipole with a beam . . . Conditions were quite poor during Rudy and Gus' visit to MP4T and so we missed them, but here's hoping that Rudy makes a return visit and that

It's not often that such an illustrious group of hams can be photographed all together but we did it! Shown here, left to right, Fritz, W4DK; Frank, W5KW; Cheever, W8LJ, and Lou, W2CLD. (Photo by K2HEA)



Yes, there really is an "Eloy" and here he is—Eloy, W1DGN/4, DL4LE, whose sideband activity has made him a great favorite all over the world.

(Photo by K2HEA)

Gus is safely home by now . . . Peter, ZS-7P, was looking forward to putting out a stronger signal through the use of a tri-band beam; we hope it went up easily . . . Send your QSLs for the Laccadives DXpedition to Cal, W4ANE; don't forget the s.a.s.e. . . . It's good to know that Gied, UP2CG, is back on s.s.b. (even though we didn't get him) but our calls attracted the attention of Enn, UR2AR and his friend, Arvo, UR2KAA and the three of us had a fine ragchew . . . Gus, I1KL, is a new station on sideband, putting out a fine signal from Rome with his homebuilt rig to a long wire . . . What a disappointment to learn that the Argonaut was not put to extensive use in the shack of VQ8AD. He used it for about one month but the pile-ups got too much for him and last we heard, Ted Henry's famous little rig is travelling again . . . Keep your ears open for FK8AU and UO5PK who should be active on s.s.b. . . . As far as we know, the S.S. *Hope* operates only/-MM so don't get too wrought up about those exotic calls you've been hearing . . . Hope that Gamboa, CT2AH, is now fully recovered from the illness that put him in the hospital the day after his s.s.b. rig arrived; after waiting so long to join us on sideband, Gamboa must have been sorely disappointed . . . A most welcome addition is Dr. Lee, 9M2GA, who has been putting through a good signal about 1230 GMT and is adept at handling the pileups . . . Bill, VK3-AHO, suggests that W/K stations listen for Australia from 3790-3800 kc on lower sideband at 1100-1200 GMT. Bill has worked several W's and also several ZS stations on 40 and 80 meters . . . Another good time to work VKs on 20 is 2130 GMT. We've had regular chats with VK3SK and VK3HG at that time, each with S9 signals . . . Chuck, F7FE, has returned to the States and will be operating out of Washington, D.C. while Ted and Frankie, EL2AD/EL2AB,

[Continued on page 116]



# Space Communications

GEORGE JACOBS, W3ASK

11307 CLARA STREET  
SILVER SPRING, MARYLAND

## Project OSCAR Progress Report

December's column carried the story of Project OSCAR, a proposed program for orbiting a communications satellite designed, built and tested entirely by radio amateurs.

Judging by the response, Project OSCAR seems to have fired the interest of radio amateurs throughout the world. Fred Hicks, W6EJU, President of the OSCAR program, enthusiastically reports that more and more radio amateurs are joining the project, and that the entire program is proceeding on schedule.

The following are among the several large radio clubs in the San Francisco area that are presently carrying out the major part of the OSCAR program:

Lockheed Amateur Radio Club  
South Peninsula Amateur Radio Club  
Philco Amateur Radio Club  
Ampex Amateur Radio Club  
Eimac Amateur Radio Club, (of Moon-bounce fame)  
Foothills Amateur Radio Society, Inc.

Many members of these clubs are working professionally in the satellite field and have played very important roles in the Discoverer series of shots and in the recent success of the Courier active communications satellite.

Fred Hicks further reports that the physical completion of the OSCAR payload is progressing rapidly. Plenty of electronic equipment is on hand and a mock-up prototype of the satellite has been completed.

The beacon transmitter that will be placed in the proposed three pound canister satellite is under construction. It is now hoped to get as much as 100 milliwatts output from the sub-miniature, transistorized transmitter.

According to present plans, the prototype satellite canister, containing the beacon transmitter, is expected to be sent aloft for flight testing in a low altitude balloon sometime during the spring months. The completed satellite is expected to be ready for space launching by late summer or early fall.

## OSCAR Package

The Project OSCAR program is much broader than just the design and construction of the satellite and its radio equipment and associated hardware. So that the project will not be a financial or manpower drain on an eventual launcher, it is being prepared as a complete "package" from start to finish.

The package, while consisting of mounting hardware, container, OSCAR satellite, separation mechanism, beacon transmitter, etc., will also include plans for a radio amateur tracking network and a comprehensive data collection and analysis program. Reception of the satellite's beacon transmitter should provide a source of valuable scientific data concerning radio wave propagation. Amateurs throughout the world (preferably through the organized participation of radio clubs) will be asked to report reception of the satellite, and it is planned to have these reports (which will probably number in the thousands) evaluated for scientific data by other groups of radio amateurs having experience in this sort of work.

Project OSCAR is intended to be a radio amateur effort from beginning to end.

## World-Wide Participation

If Project OSCAR is to succeed it certainly must be a national program, and better yet, international. The scope and importance of the program demands participation by radio amateurs everywhere.

Tracking the proposed satellite, and the collection and analysis of scientific data from OSCAR's beacon transmitter, offer the opportunity for radio amateurs throughout the world to participate actively in this program.

So that Project OSCAR will be truly representative of amateur radio, Articles of Association have been drawn up formally, in order that radio clubs throughout the country, and overseas, may join in the program. It is planned to administer the OSCAR project through a Board of Directors, with the Directors elected by participating radio clubs.

Until the Project OSCAR Association gets rolling, Fred Hicks, W6EJU is acting as President. Fred reports that the busiest man on the present Board of Directors is Secretary, M. C. Towns, Jr., K6LFH, who has the task of handling all mail and correspondence. The least-worked Director, according to W6EJU, is Treasurer Bernie Barrick (W6OON). Though Project OSCAR has money in the bank, Bernie hasn't had to write any checks as yet. Everytime a problem develops, some radio amateur seems to turn up who is an expert in the particular field, and solves it.

## Project OSCAR Association

The following are the Articles of Association for Project OSCAR. Amateur radio clubs de-





Recently Tom Kelly, W3AEC, had the opportunity of combining two of his hobbies—space communications and philately. Shown left is a special cover Tom obtained on the first day of issue for the 4¢ stamp honoring the ECHO communications satellite. The cover is signed by Dr. T. Keith Glennan, Administrator of the National Aeronautics and Space Administration, and by Leonard Jaffe, K3NVS, who is in charge of NASA's communication satellite program, of which ECHO was a project.

siring to participate in the OSCAR program should contact the Association directly at the address given in Article Five.

*Article One:* That the group of Amateur Radio Operators who formed the OSCAR Committee, hereby establish themselves as an unincorporated Association of Amateurs open to membership under the conditions set forth in Article Three of the By-Laws of this Association.

*Article Two:* That the name of this Association is: THE PROJECT OSCAR ASSOCIATION.

*Article Three:* That the objects and purposes for which this Association was formed are:

- a) To inaugurate active participation by Radio Amateurs in the Field of Space Communications.
- b) To stimulate and expand the Amateurs capability to augment our space exploration program.
- c) To provide Amateur Radio Satellite equipment and assist in its integration with available Space Vehicles for orbital placement.
- d) To compile and publish technical and other information towards securing the maximum utilization of such Amateur equipment.

*Article Four:* That this Association in the exercise of its powers does not contemplate pecuniary gain or profit or the distribution

of gains, profits or dividends to the members thereof.

*Article Five:* That the mailing address of the Association, now registered with the United States Post Office Department as, PROJECT OSCAR, SUNNYVALE, CALIFORNIA, actually is Post Office Box 183 of that City and State.

*Article Six:* a) That the number of persons who shall constitute the Board of Directors and who shall act in the capacity of Directors of this Association, shall not be less than seven nor more than eleven.

b) The names and addresses of the persons who shall act as the Board of Directors for the Association until the selection of their successors are:

- F. H. Hicks  
13173 Montrose Street, Saratoga, Calif.
- M. C. Towns, Jr.  
764 Corlista Drive, San Jose 28, Calif.
- B. B. Barrick  
12179 Hilltop Drive, Los Altos Hills, Calif.
- M. K. Caston  
2871 Stevenson Street, Sunnyvale, Calif.
- S. Benson  
1498 Samedia Street, Sunnyvale, Calif.
- N. K. Marshall  
25671 Moody Road, Los Altos Hills, Calif.
- R. Hill

*Article Seven:* That this Association be controlled by its Active members who have met



the requirements provided in the By-Laws, with equal voting rights and privileges.

*Article Eight:* These Articles of Association may be amended in whole or in part by a majority vote of the Board of Directors and by the vote or written consent of members representing at least 10 percent of the voting power.

IN WITNESS WHEREOF, we the duly authorized President and Secretary of the Project OSCAR Association have executed these Articles of Association this 18th day of October, 1960.

(signed) F. H. Hicks, President

(signed) M. C. Towns, Jr., Secretary

### Project OSCAR Launching

The only part of the Project OSCAR effort that can't be radio amateur is, of course, the launching. At the time of writing (mid-December) this is the only phase of the program that cannot be reported upon optimistically.

In order that OSCAR not be a financial burden on an eventual launcher, it is hoped that the radio amateur satellite can be sent into orbit piggy-back, using the same vehicle as some other existing, or planned space program. While arrangements for launching have not as yet been successfully worked out, high-level discussions on this subject are continuing.

### Amateur Rocketeer Progress Report

The story of young Michael Beltran, amateur rocket builder, was carried in November's column.

Although not a radio amateur himself, Michael Beltran is working on a project which requires the participation of radio amateurs if it is to be completely successful. Michael is building a rocket of his own design which he hopes to launch to an altitude of about 50 miles. In the nose of the rocket will be a chemical contaminant bomb containing either cesium or potassium with a sodium dope. When released at maximum altitude, Michael expects the chemicals to form an ionized region from which radio amateurs could reflect v.h.f. signals over distances of several hundred miles.

The following letter received from Michael during mid-December contains a status report on this intriguing project:

Michael R. Beltran  
1133 East 35th Street  
Brooklyn 10, N.Y.  
'phone DE-8-3312

Mr. George Jacobs, W3ASK  
Space Communications Editor, CQ  
11307 Clara Street  
Silver Spring, Md.

Dear Mr. Jacobs:

In accordance with our telephone conversation, I am writing you about the current progress of my rocket project.

The difference in the project now, from what I had planned earlier this year (1960) is that the rocket to carry the chemical contaminant bomb will be a two-stage solid propellant rocket capable of attaining 300,000 feet with a 10 pound payload. The total take-off weight would be 55 pounds and the rocket would be 4.5

inches in diameter and 7 feet long. Even though the rocket is much smaller than the one I was going to build originally, you will note that it carries the same weight to a higher altitude. This is possible because of the higher performance propellant which I am now able to fabricate.

I have spent the last month building a strand burner which is used to determine the linear burning rate of rocket propellant. This week-end I finally got the burner working and from the tests I was able to run, I am now sure of the new propellant.

The next step will be small static tests of the propellant in the motors which I should be able to complete in the next 1-2 months. For thrust measurement I am using strain-gages, a bridge circuit, an amplifier, and a galvanometer recorder.

After these tests, I am setting up a full scale rocket bay at Grumman's Peconic Bay Plant on Long Island, N.Y. You could mention in your column that I need electrical equipment which I could use for static testing: strain gages, or lead cells, bridge circuits, amplifiers, galvanometer recorders and recording paper, wiring and cable, pressure transducers, and temperature measuring equipment. It will take many static tests before we are ready to go, however I would rather see all the bugs removed on the ground than have a mis-launch.

As I told you over the phone, Dr. S. F. Singer of the Dept. of Physics, University of Maryland, will help me with the chemical contaminant and tracking equipment. The U.S. Rubber Co. has also arranged to supply me with some of the ingredients I need for fabricating the solid propellant.

I would like to thank you and the readers of CQ for cooperating in this project. I am looking forward to having a successful shot in the near future.

Sincerely,

(signed) Michael R. Beltran

### Amateur Participation

Radio amateurs who might be able to assist Michael Beltran with the equipment he needs for static testing his rocket should get in touch with him directly. His address appears on the heading of the letter reproduced above.

While Michael doesn't expect to fire his rocket until later this year, he would like to prepare a roster of radio amateurs who could participate in the ionospheric experiments he plans. The rocket will be launched from a government rocket range located either in Virginia or Florida. Amateurs living in the East Coast area, from approximately New York to Key West, and who would like to participate in bouncing 20, 15, 10, 6 and 2 meter signals off the man-made ionized region Michael hopes to create, should send their names, addresses, calls and a description of their stations directly to Michael. From these volunteer stations, a roster will be prepared so that Michael can get in touch immediately with radio amateur participants as soon as a date for firing can be established. Latest information concerning this project will, of course, also appear in this column from time-to-time.

While not as glamorous as Project OSCAR, here is another significant space communications project which requires radio amateur participation if it is to be completely successful. By participating in Project OSCAR, and projects of this sort, amateur radio can gain additional stature in the eyes of the world, and our hobby will have again made a lasting contribution to advancing the state of the communications art.

73, George, W3ASK



# VHF

50mc. 144mc. 220mc. 420mc. and above

BOB BROWN, K2ZSQ  
67 RUSSELL AVENUE  
RAHWAY, NEW JERSEY

As you know, this is the month we've all been waiting for! Our CQ W.W. V.H.F. Contest starts this coming February 25th and promises to be the best yet! If you missed the details of the contest, check last month's column for all the dope. We'll be looking for you!

Our mapping system program (see page 100, November CQ) is slowly gaining momentum and will be under way very shortly—but we need your help. We are having some maps made up to send out to volunteers and they will undoubtedly be on their way by the time this is in print. Write us *now* if you'd like to participate. Give us a run-down of your equipment, time you can spend monitoring 6 meters, and geographical location. You will receive a prompt reply and further details.

"JB" Goetsch, KØRTF, provides us with a good start through his recent letter and map. To quote, "Regarding the Sporadic-E mapping system, I thought everybody kept maps to

track that elusive "E-cloud." I know my system works and has helped me to bring in states that I otherwise might have missed. To explain (theoretically it's probably wrong) I assume that the cloud is located one-half the distance from me to the station I hear. Now following this further, if the station I can hear is working a station (which I usually can't hear) in another area, then why can't I work across "this E-cloud?" Perhaps looking at the map might explain my little system better. For example, I, monitoring the 6 meter band, hear W5XX calling "CQ skip." This alerts me to the presence of a band opening . . . Now I already have Texas (or I would be calling him by now) so I listen. I hear other 5's calling Ø's . . . jotting down the calls, I check them in the callbook—at both ends—and plot the skip on a glass-covered map on my desk. Then I hear K5XX calling and talking to W7XX in Billings, Montana . . . after

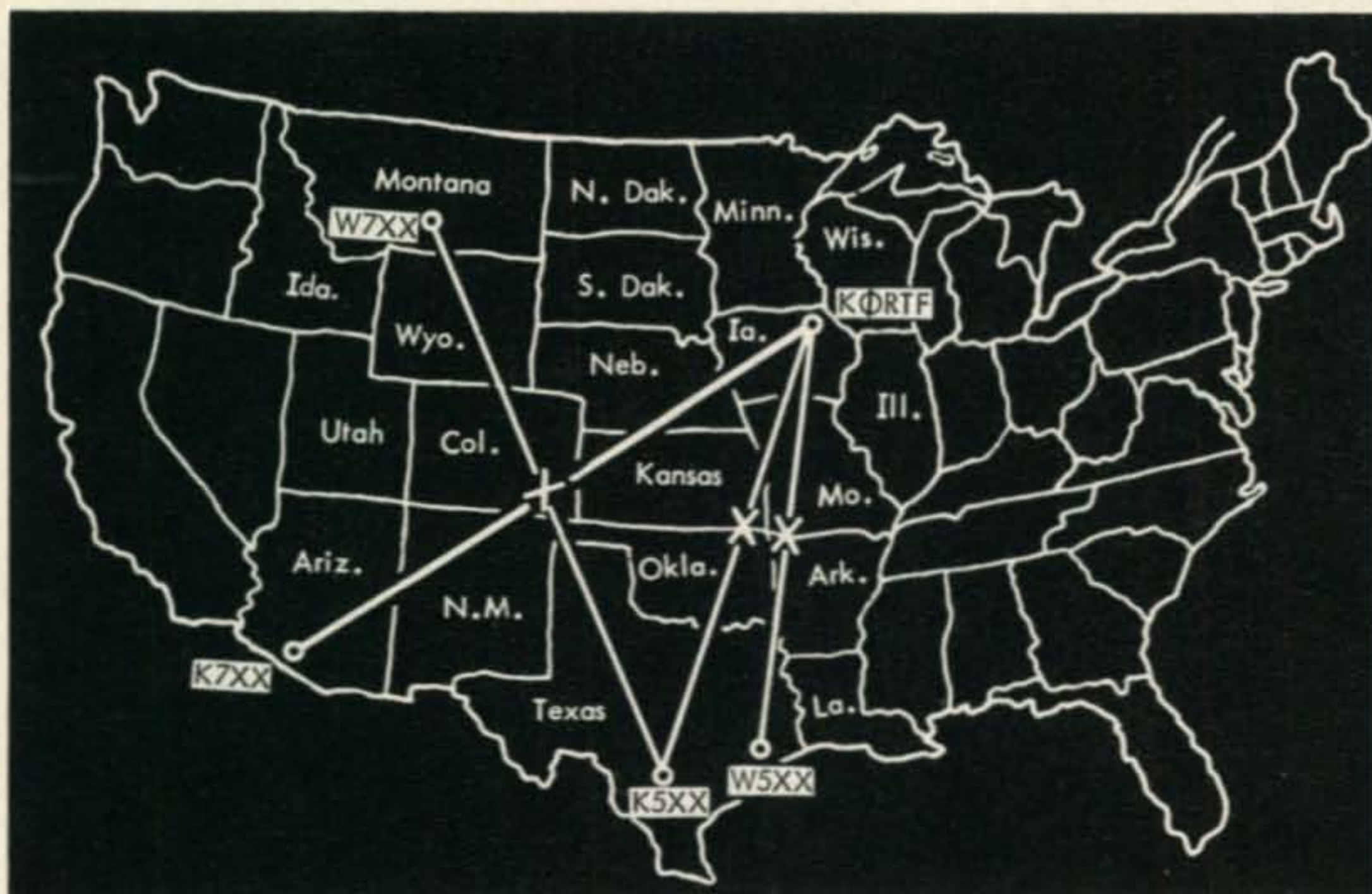

KØRTF's sample map of U.S. showing how he determines center of skip and makes use of it. Example: KØRTF hears K5XX and W5XX. He draws connecting lines from his station to them, marking with an "X" center of skip. Then he hears K5XX talking to

W7XX (who he can't hear). He does the same thing between K5XX and W7XX. Now that he has determined a working location of the cloud, he points his beam *between* (where the "X" is) K5XX and W7XX—and presto! KØRTF works Arizona (K7XX)!



checking, aha—around goes the beam . . . Not to Montana, but pointed directly across the mid-point of their skip route. Now is the time to call "CQ" and see who I can wake up and chase out of the woodwork. K7XX hears my call and I have a new state.

"Questions? Well, sure . . . It doesn't always work or perhaps your signal ends up in the middle of the ocean to be heard only by mystery submarines, but quite often it does produce! Plus the fact that by hearing only two stations working two other stations, you come up with four center skip marks!"

Well, there you have it. "JB" certainly has a point, as his views are really not "new"—they've been used over and over again. But to rubber stamp this as a proven fact would be foolish. Many have expressed their opinions that the location of the ionized cloud is not the mid-point but rather a constantly changing phenomena. This may well be. We'd like to hear from you, with your ideas on the subject.



Here's the new Towers Of Power Award. For details see text.

### Certificates and Awards

**The Towers of Power:** This certificate is awarded by the Towers of Power group in California. A real snazzy looking piece of wallpaper, the award is given to anyone operating less than 10 watts at 51.6 mc and contacting a member of the club. The ones to look for are: K6VNT,

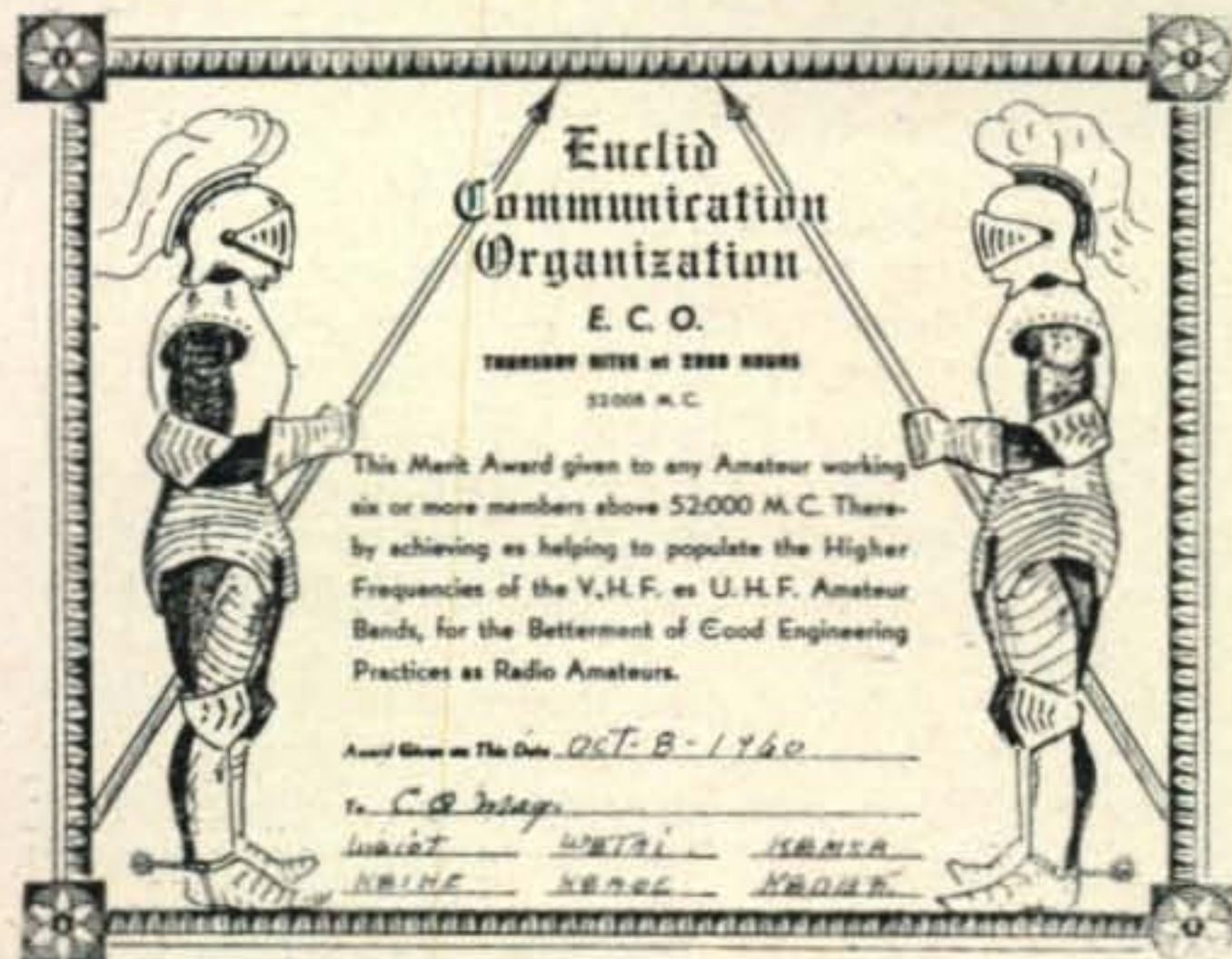

This unusual certificate is issued by a group in Ohio. See text.

WA6KUY, WA6ARM, K6UGT, WA6KWY, WA6DZU, WA6MIK, K6SQJ, WA6GAG, and WA6NRX.

**Euclid Communication Organization:** Here's a certificate open to anyone contacting six or more members above 52 mc. A few of the boys you might contact out Ohio way are: W8IOT, W8TAI, K8MSR, K8IHE, K8AOE, and K8DBF.



The Delaware V.H.F.-U.H.F. Award. Nice, eh? See text.

**VHF-UHF Certificate:** This is available for issuance from the Delaware Six Meter Emergency Net. All interested applicants must: 1.) If less than 75 air miles from Dover, Delaware, contact and QSL with at least ten net members. If more than 75 air miles from Dover, contact and QSL with at least five net members. 2.) Send a log extract listing date, time, frequency, and name of each station contacted and QSL'd with to John D. Cordray, K3AXW, 1416 Oak Hill Drive, Wilmington 5, Delaware. *Do not send confirmations with the applications*, as the stations listed have to have the applicant's QSL card before the certificate can be issued. A spot check can be made locally. (All participating Delaware stations QSL 100%.)

There is no charge for this certificate.

Any contacts on or after January 1, 1960, may be counted. The contacts may be on any single band or any mixture of bands, 50 mc and up. A Delaware station will count as only one contact, even though the station may be contacted a second time on a different band.

The Delaware Six Meter Emergency Net meets every Tuesday evening, 2100 EST on 50.4 mc. Net contacts may be counted, but specify upon checking in, that Certificate Contacts are being sought.

All net members are running respectable power and are quite active, so no difficulty should be encountered in making the required contacts.

Stations to be on the look-out for are: W3ASD, K3AXW, K3AZH, K3BAU, W3CGV, K3CNH, W3CNI, K3CPJ, K3DEA, K3EBB, K3GIM, W3HHW, K3JEX, W3JNL, K3KEO, W3KOI, K3KRH, W3LZN, K3MPZ, W3UDR, W3WHZ, AND W3ZVX. (Thanks to K3AXW for this info.)



## Man of the Month

This article will be a regular in this column every month, featuring one v.h.f. man recommended by one of our readers. To qualify, one doesn't have to be a propagational expert or avid DX man, but rather a station with something just a bit "out of the ordinary." Operating skill, especially, should be taken into consideration. This month Dave Heller, K3HNP, advised us of...

**Dave Green, WA2MWU**, of Tenafly, New Jersey. WA2MWU has become one of the regulars from the New York City area heard around Philadelphia. To quote K3HNP, "Nothing remarkable there—all he needed was a bit of power, a good beam and receiver, plus a goodly amount of operating know-how."

"Dave is using a Heath Sixer and a 5 element beam. Nothing else. He is a good operator, as was demonstrated when he accepted serious traffic for me and was able to reach me rapidly with an unexpected urgent reply."

"Dave is fourteen."

"This is an outstanding instance of a younger ham working out with minimal equipment. Dave has earned whatever encouragement and assistance we can give him. He has an excellent signal and would certainly appreciate any semi-DX calls. His frequency is 50.316 mc."

Many thanks, Dave, for the information on WA2MWU. As a sidelight, K3HNP collects call letter license plates and would appreciate hearing from any prospective donors.

Let's hear from *you* next month!

## "Auroral Beacon"—GB3VHF

The RSGB with the cooperation of the BBC inaugurated on Sunday December 11, a beacon transmitter operating from Wrotham, Kent on 144.5 megacycles using a directional antenna beamed *north*. Continuous wave is radiated with pulses of 55 seconds duration identified as GB3-VHF every 5 minutes.

The Radio Society of Great Britain v.h.f. "Auroral Beacon" transmission on 144.5 mc using the call-signal GB3VHF was restored to service during the week of December 4th. Its transmission schedule is 0630 to 0830, 1200 to 1400 and 1830 to 2400 GMT and is intended to enable radio amateurs to detect the presence of auroral reflections.

G2AHL just told me that the power radiated is 50 watts into an 8 element yagi atop the 180 ft. BBC tower which is about 700 ft. above sea level—via George Jacobs, W3ASK.

## South American V.H.F. Report

Our regular South American reporter, Michael Cyzsch, LU3DCA, of Buenos Aires, Argentina, comes through for us again this month with a detailed report of activities down his way...

"Certainly one of the most interesting byproducts of our 6 meter work is the observation and recognition of the various kinds of propagation phenomena. Everyone of us, especially in the South and Central American area, who has been in the game for several years now, accumulated a large and valuable experience and knows what he can expect at any time of the year and at a certain hour of the day, trying to figure out, in every case, what type of propagation he may be facing at that moment."

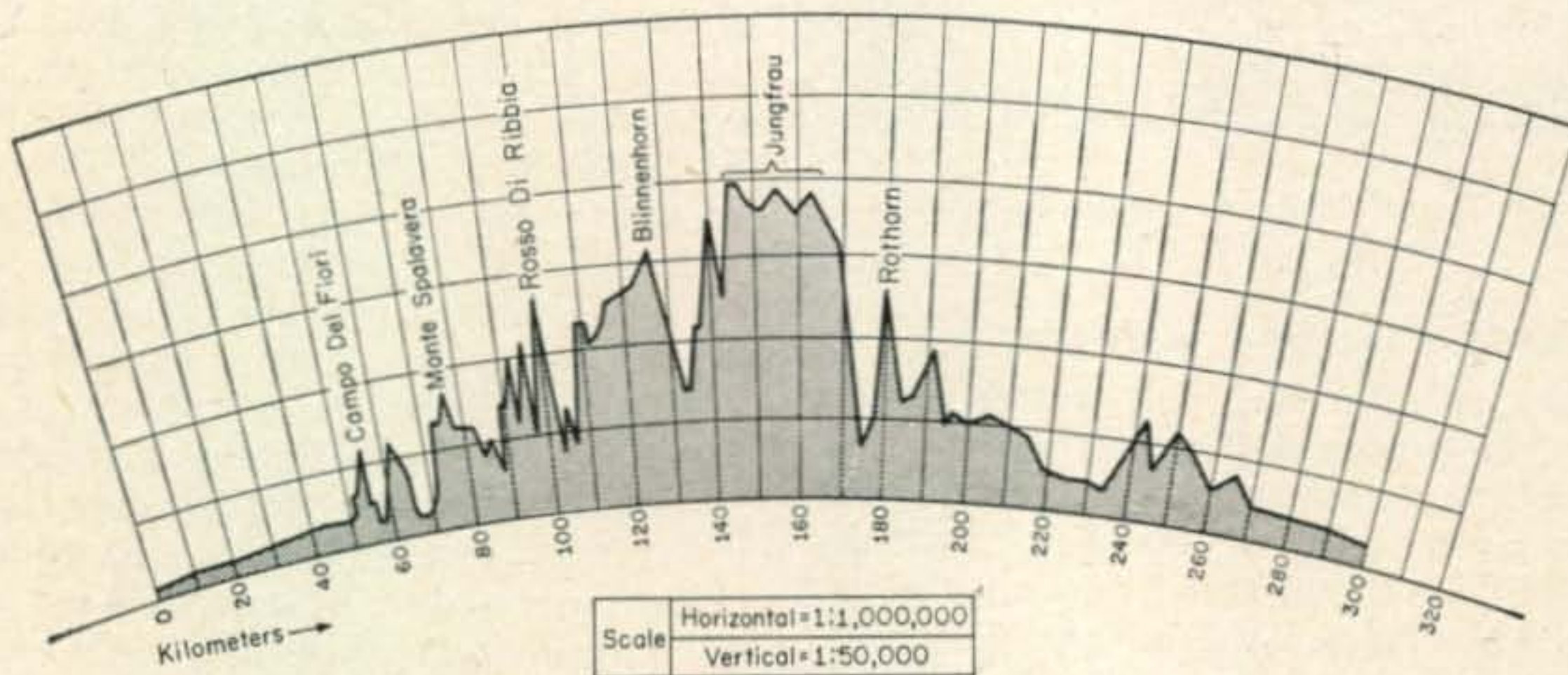

Mario, I1ER, sent along this profile of a path between I1ER and F3AR. Scale, horizontally, is 1:1'000. Vertically, 1:50.

## I1ER—F3AR on 144 Mc.

A call familiar to regular readers of this column is our faithful contributor, Mario Santangeli, I1ER, of Milan, Italy. Mario sent along a profile of an interesting v.h.f. path of a QSO which runs continuously with F3AR and I1ER on 144 mc. This course between Milan and Bel-fort runs through mountains which reach 12,000 feet in height!

Mario is now studying this phenomena to check the "knife effect." Mario's address is Dr. Ing. Mario Santangeli, I1ER, Via Raffaello Sanzio, 32, Milan, Italy. He'd like to hear from others interested in this type of work.

"The fading characteristics of the signals heard are perhaps the most important factors which may permit this identification, and among others are the distance involved, the predictions of CRPL and so on. Sometimes in the past it seemed to us that this identification was a fairly simple matter, but now I think the more experience you have, less will be the probability to give an explanation to all the observations made."

"There is, for example, the case of TE propagation: we used to think about this in terms of flutter fading signals in the late afternoon, especially on the north-south path. But what do you say after hearing stations which come in with this characteristic flutter fading but just aren't on the other side of the equator, not even the magnetic equator? Or if you hear a signal with the above mentioned flutter,



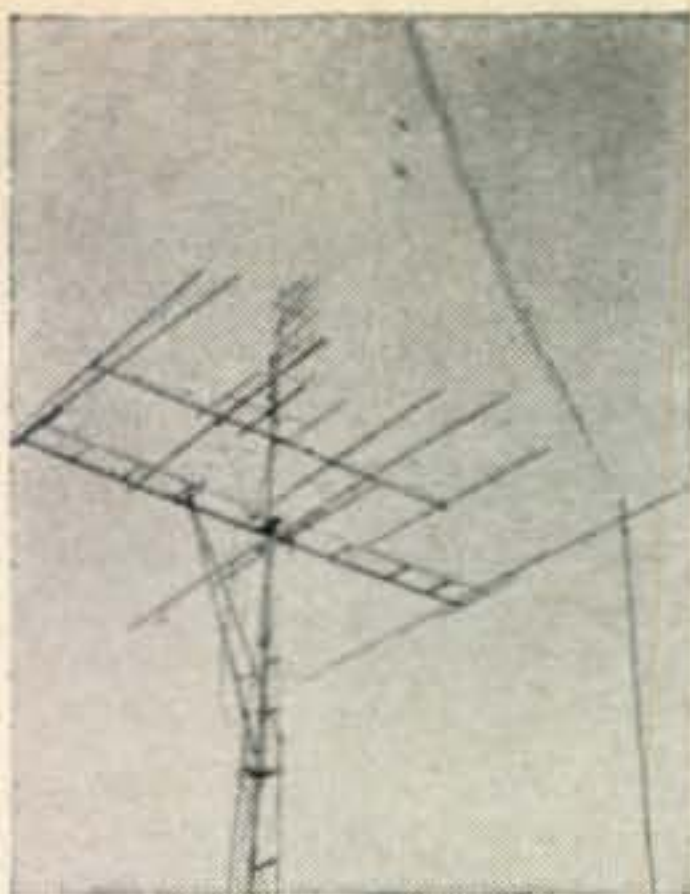

LU7AT's "christmas tree" with antennas for 28, 50, 144 and 432 mc (shown here in reverse, top to bottom).

and two hours later this same signal stabilized completely and sounds like a local fellow two blocks away? This same story in reverse was also observed many times.

"It is therefore impossible, at the present state of the art, to explain satisfactorily all the propagational phenomena that makes 6 meter work so interesting, but this is no reason for us not to fully enjoy all these wonderful DX possibilities offered on 50 mc.

"And that is just what we've been doing! **DX:** Some kind on every day during the 4 weeks from October 17 to November 18, and the list of countries contacted from Buenos Aires is quite impressive: Brasil, Puerto Rico, Martinique, Venezuela, U.S.A., Panama, Mexico, Aruba, Ecuador and Hawaii. Many other countries in Central America and in the Pacific area could have been contacted if there would have been activity by amateurs: the band was observed to be open many times from these areas and commercial stations were coming in with unbelievable strength just outside of the band, but after every "CQ" call only the monotone background noise was striking the antenna when the converter was tuned above the imaginary "barrier" at 50.0 mc.

"But not everything was disappointment, of course; we also had a lot of wonderful contacts with our many friends in the above mentioned countries, and the highlight of the month was the appearance of HP1RJ on the band, the first station ever heard from the republic of Panama.



LU2EW, the first to use s.s.b. on 6 and 2 meters in Argentina. Apparently no shortage of gear in this shack!

"It was during the afternoon of November 4; the band had been open to the north since noontime and many commercial signals from Central America were heard for several hours, but still no amateurs. At 2225 GMT at last, KP4AFA showed up with an S-8 signal and I had a short contact with this fellow, and after signing, I heard another station calling but it was too late to copy the call letters. So a local

friend, LU2DHP, had the first chance to work this new country, and my opportunity came just behind and shortly before the propagation faded out. As we learned from José, this was his first day on the air. I happened to be his third station contacted on 6 meters and his transmitter was a Heathkit Seneca, feeding a 40 meter windom antenna. Nevertheless, he was putting a very fine signal into Buenos Aires, another proof that just everything works on 6 over this path.

"Conditions to the United States were not too good in the period covered by this report, and only twice was it possible to manage a QSO with a W station. The first opportunity came on October 31, the date of a fair disturbance (forecast in *CQ*). At 2300 GMT I met John, K5ZEG, of Houston, Texas, but unfortunately this was the only W/K coming in. Fifty minutes later I answered a call from Ron, K9KVV/KH6, and again no other KH6 was on the air to span this real long distance hop.

"The second time we heard from some friends up your way was just a few days ago, on November 16. One WA6 was worked at 2005 GMT, and after a pause of 40 minutes, several W5's from Texas came in with good signals. I was lucky enough to work four new friends. K4HJB from Alabama was also heard but his signal faded out before a QSO could be made.

"Conditions to Brasil and Puerto Rico were sometimes extremely good. For example: I had a 3 hour QSO between LU4DOZ and KP4AAN during the late evening hours of October 30; this was not an isolated case of nice propagation but rather the rule. The PY7's were also favored by these regular conditions, and night after night we chatted with PY7AEE, PY7ADI and PY7AFP. On the other hand, they not only worked into LU-land, but also some KP4's, W's and PZ1AE, and on November 12, FF8AP was heard by PY7AEE, although a contact could not be made.

"And mentioning Africa, I can complete the story by telling you now about a letter received from EL4A. Ken says he is ready now to operate on 6 with a Johnson Viking 6N2. It will be very interesting to see if we can really contact him, although it may already be a little late in the season. Anyway, we will be trying to make it.

"Closing this month's report, I wish all of you a very happy new year, and hope you will have the most fun on the v.h.f.'s in 1961."



You may recognize some of the equipment in LU-7AT's shack. Transmitter for 6 and 2 is mounted in the right hand wall.

### Hamfests

**February 25:** Here we go again! Just a reminder to check last month's announcement of the East Coast V.H.F. Society's Dinner and Hamfest for further



16 element phased array  
for 432 mc at LU9AT.

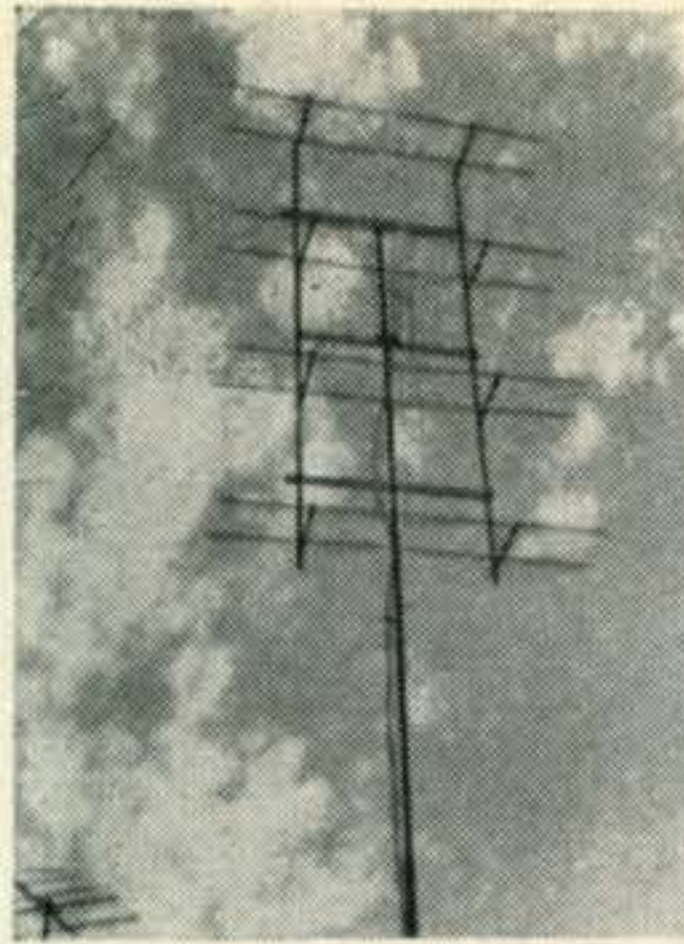

details. And don't forget that no tickets will be sold after Sunday, February 12th! Order yours now, by writing me (and enclosing \$5.00) c/o Dinner and Hamfest, 67 Russell Avenue. And if I can tear myself away from our fabulous V.H.F. Contest, I'll be there. Be looking for you! **April 22:** Another reminder . . . this time check the Announcements (at the beginning of each CQ) for the Tampa Bay V.H.F. Association's big Annual Hamvention to be held in Tampa, Florida. **July 22, 23:** This one admittedly is quite a way off yet, but the advance publicity is certainly warranted! Dave Forster, VE6FF, from Lethbridge, Alberta, Canada, sends word of the Glacier Waterton 27th Annual International Peace Park Hamfest. There promises to be a special session for the v.h.f. boys in this next BIG hamfest to be held in Waterton Park in Canada which adjoins the Glacier Park on the U.S. side. Last year they had an exceptionally large crowd of v.h.f. men in attendance and this year it will be better yet. Flip the pages on your calendar and circle July 22 and 23—Do it now before you forget!

### W4LTU, Antennas and DX

Walt Bain, W4LTU, and another *Auto-Call* report . . .

"With the ever-increasing use of long yagis on the ham bands it is of interest to consider what measurements the professionals have made and how much they agree with some of the gain figures one hears bandied about on the air. Simone, in France, has made measurements on yagis up to 80 wavelengths long which yielded 29 db gain. Others have made similar careful measurements on yagis of various lengths and, to sum it all up, it appears that the maximum gain that may be obtained is 10 times the boom length in wavelengths. This of course assumes that element spacing and length are optimum. To reduce this relation to some useful numbers, the following table (converted to gain over a dipole in decibels) gives the maximum gain that may be expected.

Boom length in wavelengths	Gain in db over dipole
1	8 db
2	11 db
3	13 db
4	14 db
5	15 db
10	18 db
20	21 db

"It is apparent that these gain figures are in some disagreement with what is usually claimed. Applying the above relation to the widely used 23½ foot 2 meter yagi, one finds an unexpected gain of 13.5

db over a dipole, rather than the 16.1 db that it advertised. The reason for this is that when the measured beamwidth is used to determine the gain, you are assuming that all the power radiated is in the main lobe. That is, you neglect that which is lost in sidelobes or in ohmic losses. Sidelobes generally run 10 to 12 db below the level of the main lobe, which does not seem too serious until we consider that there are quite a few of them and the lost power begins to add up. Assume we have four major sidelobes, one each side of the main lobe and one above and below it. If each is 10 db below the level of the mainlobe then four together account for 0.4 of our total power, or our mainlobe is down by 2 db from what might be expected from it, considering only its beamwidth. The solution is that antenna gain should be measured by actual comparison of field strength with that of a dipole at the same height. This gives us a measure of our actual realized gain which is what we are interested in.

"Before everyone switches to phased arrays in place of yagis, it might be well to indicate that figures on gain for phased arrays have been somewhat exaggerated also. As a general rule of thumb, it is found that the power gain of a phased array over a dipole is approximately equal to the number of elements. That is, a 16 element array has a gain of 16, or 12 db, a 32 element array has a gain of 15 db, a 64 element array a gain of 18 db, etc. So having added our two-cents worth to the antenna arguments, let's move on.

"There is little to report in the 2 meter propagation department, largely due to your correspondent being out of town much of the time. Nevertheless, there was some aurora on October 25 that saw several W8's coming through and one W9. After the aurora of October 6 reported last month, are we asking for more?

"K3KPT (ex-W8SRW), Pittsburgh, mentioned that he now has a Nuvistor preamp going on 144 mc. He is most enthusiastic about it and reports a 2.8 db noise figure with a minimum of adjustment. This is as low as anything he has measured previously. (2.8 db may not sound low, compared with some of the fantastic numbers one hears quoted but which can't be reproduced. We'll get up on the noise-figure soapbox some other issue.) Hope to have reports on the Geminids shower of December 10-14th soon."

### KL7AUV/KL7—Spenard

Yes, that's right . . . Jack Reich, KL7AUV, and his charming wife Margie, KL7BLL, have moved to Spenard, Alaska. This may account for a slight lag in Jack's reports . . .



Here's KL7AUV's new home with some of the local gang on the roof helping out yagi-wise.





KL7AUV working on antenna erection at Spenard, Alaska.

"Am enclosing a few pictures of our new Stump Farm, which is about 8 miles southwest of Anchorage City Center, and about 2 miles south of the Anchorage International Airport. Since the pictures, the ground has been all leveled off and we are pretty well snuggled up for the winter. We are living in the basement, and won't start on the inside of the upstairs until Spring. Only antenna up so far is 2 meters for local RACES (35 stations), but hope to get the 15 and 6 meter antennas up soon—possibly this weekend. Weather holding pretty good (letter dated early November—Ed.)—only a couple of inches of snow on the ground, and, although it hit 12 degrees early the other morning, it has been averaging about 25 to 28 degrees the past three or four weeks.

"On the news side, I just verified yesterday that Bob Mellen and the crew at KL7FLC heard the Big Delta TVOR on 109.2 mc back on September 7th. Big Delta is the town where Ft. Greeley is located, about 300 miles northeast of Anchorage. The TVOR is operated by the Army and should have a power of about 50 watts. Hearing that thing clear out Northwest of Pt. Barrow is quite unusual, but just makes me surer that a 2 meter DX here in the state could be real interesting . . .

"Hope to get the 6 meter stuff back on soon anyway, and keep on with my activity. At least I should at last be able to hear something in the 0400-1000 GMT time period for a change. Sure has hurt my feelings to hear KG1FN/KL7FLC working the States and not being able to hear a "cotton-picking" thing through Channel 2's lower sideband. The 8 miles might cure it, though. Will keep you posted."

### Arkansas Activity

Jake Lowman, K5EZI, sends along a very interesting report on Arkansas, v.h.f.-wise . . .

"In working the various v.h.f. bands, we often hear this plaintive cry, "Why don't you guys in Arkansas get some activity on 6, 2, or 1 1/4?" As the lawyers say, I wish to refute this plea. We in Arkansas have activity plus on 6 and 2 and the beginnings of activity on 220 mc and 432 mc.

"Down in our area (central Arkansas) the v.h.f. activity is very ably stirred by the Arkansas V.H.F. Club and its associated nets, and the Central Arkansas Emergency Net and its Associated Club.

"The Arkansas V.H.F. Club had its beginnings in the old "Wonder State Net" established way back in 1956. Active resident President is Ike Roland, K5GOW, of Malvern. The club net on six covers from Forest City to Conway and from Searcy to

Texarkana, with relay coverage of the entire state. At present the net numbers 36 members on 6 and 9 meters on 2 meters. The "check in" percentage is about 67% on six and 50% on two.

"The Central Arkansas Emergency Net covers Pulaski County and the counties that touch it on 6 and 75 meters. At present (only from the v.h.f. angle) we have 26 mobile units on narrow-band f.m., with almost complete coverage of the area manned from 6 base stations. The net has assisted news media and civil officers in several instances, since its birth in 1959. The "check in" percentage on this net is about 75%, which is darned good!

"The following is a list of nets operating v.h.f. in our area and the frequencies to tune when you're in Arkansas . . .

Net	Frequency	Night	Time	Net Control Stations
Ark. V.H.F. Net (50 mc)	51 mc	Tues.	2000	K5OZE and K5EZI
Cen. Ark. Emg. Net	50.25 & 51 mc	Thurs.	2000	K5CQP and W5TIE
Ark. V.H.F. Net (144 mc)	145.05 mc	Thurs.	2100	W5TIE and K5EZI

"In addition to the above, we have two MARS (Air Force) Nets operating in the area on 6 meters. The 51.0 mc frequency in Arkansas is almost constantly monitored from 1700 'til 2300 as is the n.b.-f.m. frequency at 50.25 through the day from 0730 'til 1700 and later. The 145.05 mc frequency on two meters is sampled hourly (on the hour) from 2000 'til 2300.

"The Arkansas V.H.F. Club is setting the spring of 1961 as the target date for net operation on 220 mc and on 432 mc. Several of the fellows have gear that will operate on these frequencies now and will polish it up and check it out during the winter.

"So, fellows, please don't, in a weak moment pick up your mike and say, "Hey, Jake, why don't you fellows in Arkansas get in the game . . . Don't you know v.h.f. is fun?!"—Because, OM, we're in it up to our XYL's necks—if you don't believe it, just ask mine. I've simply got to get that gal out of my shack if it takes an ax!!!"

### Pacific Northwest and Canada

The first contribution for this section comes from . . .

Don Smith, K7HNI, of Bellingham, Washington, writes, "Just a note to let you know that this area is still active on the v.h.f. bands. You might mention in your column that being as most of the stations in the Puget Sound area, Seattle, Mt. Vernon, Bellingham, and the British Columbia area have crystals for 145.8 mc it is being set up as the area calling frequency.

"Two meters hasn't been as active the last few months as it was last year at this time but we have hopes of seeing some of the old timers back on.

"Six meters is coming slowly, mainly in the area north of Seattle because of Channel 2 in Vancouver, B.C., but there are a few daring souls planning to eventually go on 6.

"There is some talk of trying 432 mc but, as this is somewhat a mountainous area, results may not be as hoped for.

"A note to those planning v.h.f. in this area is that the majority of the stations are horizontally polarized with the exception of the f.m. mobile net frequencies.

"VE7BBA just finished a 416B preamp and K7EEK and myself are building 5894 finals. Keep up the good work and I'll keep buying CQ. See you at Contest time with a full log!"



L. M. Dakin, VE1UG, of Saint John, Canada, sends in a brief on 144 mc stations . . . "A list of 2 meter stations on the air in Saint John for the last two years: VE1QS, VE1QG, VE1UG, VE1IW, VE1IZ, VE1XN, VE1EE—All working around 145.89 mc. Lower in frequency are VE1CL, VE1MA, and VE1AAR."

George Elliott, VE2LI, of Montreal, Quebec, Canada, writes . . . "I am active on 144.221 mc with 500 watts to a pair of 4CX250B's and a 6 over 6 stacked yagis. Am looking for QSO's on aurora with Delaware, West Virginia, and Indiana. (George's QTH is 5225 MacDonald Avenue, for you boys who'd like skeds—Ed.)

"I'm interested in 432 mc, if only authorities would grant permission for 500 watts or so. Final note—Also need shower skeds on 2 meters with anyone who wants a VE2 sked."

Bill Loftus, VE4TL, Winnipeg, Manitoba, Canada, emits with . . . "We here in Winnipeg have a very interested group on the v.h.f. bands at the moment, particularly on 6 meters and we are planning on moving to 2 meters this winter and very likely will make an excursion up to the higher bands very soon.

"This group is bonded together by the desire to learn more about the v.h.f. spectrum and while we are members of one or another local ham clubs, we have formed a group, not a club as yet, known as the Winnipeg V.H.F. Group."

### Wide-Band F.M. Nets

One hears quite a bit about these wide band f.m. nets nowadays—and for good reason! Used commercial gear is rapidly becoming available to the fraternity for this type of operation and we expect that the number of hams using f.m. will increase ten fold during the next several years. Many of these will be in areas where there is presently no f.m. activity, and as a consequence they will have the problem of picking a frequency.

As mentioned briefly last month, the Lynchburg (Virginia) Amateur Radio Club headed by such able v.h.f. men as W4DYE, W4KDH, K4ZAD, and many more, have painstakingly compiled a directory of fixed-frequency wide band frequency modulation nets. This directory is a *must* for reading material for every v.h.f. man in the country, especially those contemplating f.m. activity.

In abbreviated form, we'll try to cover some of the essentials of this directory. For further details, revisions, etc., we advise writing to Tom McKee, K4ZAD, 508 Oakridge Blvd., Lynchburg, Virginia

### WIDE-BAND F.M. NETS

Frequency	Location	No. of Stations	Liaison
52.525 Mc.	Old Greenwich, Conn.	—	—
	Greater Chicago, Ill.	6	W9QBH
	Angola, Indiana	15	K1CMT/9
	Elkhardt, Indiana	3	K9DOF
	Fort Wayne, Indiana	20	W9PRO
	Huntington, Indiana	5	W9INV
	Indianapolis, Indiana	25	W9KYU
	Cedar Rapids, Iowa	—	—
	Lafayette, Indiana	10	W9KRE
	Battle Creek, Mich.	—	K8GOQ
	Benton Harbor, Mich.	5	K8JMA
	Kalamazoo, Mich.	16	K8AFJ
	Greater St. Louis, Mo.	3	W0PYS
	Kenton, Ohio	2	K8ANT
	Salt Lake City, Utah	—	—
	Lynchburg, Virginia	6	W4DYE
	Richmond, Virginia	8	W4DXC
	Catawissa, Pennsylvania	4	W3MYV
52.530 Mc.	Cleveland, Ohio	7	W8AZO
52.580 Mc.	Syracuse, New York	7	K2KZL
	Troy, New York	14	W2KLZ

	Providence, R.I.	4	—
	Lynchburg, Virginia	3	W4DYE
52.640 Mc.	Kalamazoo, Mich.	—	K8AFJ
	Angola, Indiana	—	K1CMT/9
53.000 Mc.	San Antonio, Texas	9	W5LVE
53.098 Mc.	Portland, Oregon	2	W7VS
	Seattle, Washington	2	W7FNO
53.290 Mc.	Olympia, Washington	63	W7UVH
53.440 Mc.	Onondaga County, N.Y.	12	K2JIM
53.480 Mc.	Auburn, N.Y.	—	K2AJV
53.560 Mc.	Milwaukee, Wisconsin	8	—
53.600 Mc.	Louisville, Kentucky	20	W4BAZ
	Dupage County, Ill.	—	—
	Onondaga County, N.Y.	8	K2JIM
53.620 Mc.	State of Ohio	—	W8ITR
53.640 Mc.	Minneapolis, Minn.	50	K0GTT
53.720 Mc.	Portland, Oregon	2	W7VS
53.740 Mc.	Milwaukee, Wisconsin	8	—
53.75 Mc.	Syracuse, N.Y.	7	K2KZL
	Troy, N.Y.	14	W2KLZ
144.70 Mc.	Seattle, Washington	—	W7FNO
145.17 Mc.	Portland, Oregon	14	W7VS
145.20 Mc.	State of Ohio	—	—
	San Antonio, Texas	—	W5LVE
	Longmont, Colorado	—	—
	Baltimore, Maryland	—	—
	Detroit, Mich.	—	—
	Cleveland, Ohio	—	W8ITR
145.26 Mc.	Lynchburg, Virginia	43	W4DYE
	Syracuse, N.Y.	20	W2AMY
	Columbus, Ohio	35	W8OQT
	Worthington, Ohio	—	W8RSY
	Westerville, Ohio	—	—
	Washington, D.C.	—	W4ZAW
	Norfolk, Virginia	—	KN4WKI
	Amhearst, Virginia	—	W4MXH
	Roanoke, Virginia	—	K4ZAD or K4UMK
	Cleveland, Ohio	50	W8BUQ
	Detroit, Michigan	—	—
	Ottawa County, Ohio	—	—
145.32 Mc.	Baltimore, Maryland	—	—
145.35 Mc.	Birmingham, Alabama	—	—
	Milwaukee, Wisconsin	12	—
145.38 Mc.	Toledo, Ohio	—	W8DPE
145.44 Mc.	Boise, Idaho	50	W7OL
145.50 Mc.	Memphis, Tennessee	—	—
145.53 Mc.	Milwaukee, Wisconsin	12	—
145.59 Mc.	Utica, New York	15	W2SSL
145.68 Mc.	Lynchburg, Virginia	43	W4DYE
	Amhearst, Virginia	—	W4MXH
	Roanoke, Virginia	—	K4ZAD or K4UMK
146.76 Mc.	Seattle, Washington	110	W7YKA
	Boise, Idaho	—	—
	Coquille, Oregon	—	—
	Los Angeles, Calif.	—	—
	San Diego, Calif.	—	—
146.82 Mc.	Seattle, Washington	—	W7FNO
146.88 Mc.	Seattle, Washington	—	W7FNO
146.90 Mc.	Quincy, Ill.	—	K9KCY
	Toledo, Ohio	6	K8DPE
146.94 Mc.	Chicago, Ill.	—	K9OJV
	Ann Arundel Co; Md.	10	W3NAE
	Seattle, Washington	—	W7FNO
	Milwaukee, Wisconsin	8	—
146.97 Mc.	Chicago, Ill.	3	K9OJV
	Dallas, Texas	—	K5MYG
146.98 Mc.	Roanoke, Virginia	5	K4UMK
147.00 Mc.	Milwaukee, Wisc.	6	—
147.06 Mc.	Chicago, Ill.	—	K9OJV
147.18 Mc.	Chicago, Ill.	—	K9OJV
	Pittsburgh, Pa.	48	W3UGV
	Milwaukee, Wisc.	8	—
147.24 Mc.	Chicago Suburbs	—	K9OJV
	Cleveland, Ohio	—	W8ITR
	St. Louis, Mo.	—	—
147.30 Mc.	Chicago, Ill.	—	K9OJV
	Northwestern Ind.	100	W9EHZ
	Central Indiana	100	K9KRE
	Louisville, Ky	30	W4BAZ
	Detroit, Mich.	—	—
	Columbus, Ohio	1	W8RSY
	St. Louis, Mo.	—	—



	Cleveland, Ohio	3	W8GMS
	Anne Arundel Co; Md.	3	W3NAE
	Appleton, Wisc.	—	—
	Champaign, Ill.	—	—
147.40 Mc.	Chicago, Ill.	6	K9OJV
147.50 Mc.	Chicago, Ill.	100	W9LLZ
147.60 Mc.	Chicago, Ill.	—	K9OJV
	Portsmouth, Va.	5	K4STE
147.70 Mc.	Chicago, Ill.	12	K9OJV

Although this list may seem rather extensive, it is by no means complete—but rather an aid to promote the selection of frequencies already in use when establishing a new network of stations using used commercial equipment. As more details are available, and space permits, we'll make present more information covering this timely subject.

As a final note, Tom, K4ZAD, adds that if you'll send him a stamped, self-addressed envelope, he will send the more complete copies as long as they hold out, and then will put them on the list to receive issue number III to be printed in May.



W3BWU's impressive layout at his Pittsburgh, Pennsylvania QTH.

### Mailbag

**Pittsburgh, Pennsylvania:** Ed Lips, W3BWU, writes us a very informative letter . . .

"Results with the equipment shown in the enclosed photo on 50 mc to date include 44 states, 12 countries (CO, CT1, EI, HC, KP4, LU, SM, VE, W, XE, ZE and ZS3), on four continents. All confirmed with the exception of XE1GE.

"Ground wave has been of prime interest because by that mode communications can be made at almost any time to somewhere. So far I have worked over to Rhode Island, down to North Carolina, out to Cincinnati and up to Michigan on extended ground wave. I heard Burt, K1NQB, in New Hampshire three evenings this past summer.

"Since last January, a Sunday morning group known as the Five State Roundup has met on 50.4 mc at 8:00 EST. We have W8IWT, Ohio, K3BOB, Maryland, K8KZR, West Virginia, K4VWH, Virginia, W3UFR and W3BWU, Pennsylvania. Visitors are recognized only after the regulars have had a go-around. It has been surprising how regular communications can be maintained over this mountainous path. The operators out in the flat country should check their maps to see what mountains we must cross.

"The Greater Pittsburgh V.H.F. Society issues the P6MNA—Pittsburgh 6 Meter Net Award—to anyone contacting and QSL'ing six or more member stations. A list of the stations, date of contact and statement they have been QSL'd should be addressed to me: Ed Lipps, W3BWU, 3302 Hazelhurst Avenue, Pittsburgh, Pa." *A very interesting letter,*

*Ed, and we'll be in there trying for that P6MNA certificate! Maybe we'll hook up on Sunday mornings at 8:00 EST, eh?*

**Brooklyn, New York:** Bill Pasternak, WA2HVK, writes . . .

"Enclosed is a photo of the turnout that we had at our last "Bunny Hunt" held on Sunday, November 13. It was sponsored by the combined Kings County 6 Meter Traffic and Emergency Net and the 6 Meter Brooklyn AREC, RACES, CD Net.

"The Bunny Car was Alex Rizzo, WA2AIZ, and he was found by Bob Leefe, K2EVR. We had a total of 6 mobiles plus the Bunny Car.



Kings County 6 Meter Traffic and Emergency Net and the Brooklyn AREC, RACES, CD net participants in their monthly "Bunny Hunt." K2EVR was the winner.

### Chatter

George KØITF, is now using W1ET at Dartmouth College, Hanover, N. H. He played it smart—brought all his v.h.f.-u.h.f. equipment along with him. . . . Fred Mason, K2TCS, is another traveling collegiate—at Villanova University. Fred went home at Christmas time and fetched the 'ole Communicator and is back on. . . . Boy! More people are moving this month! Next on the list is Don Cutright, K8QHZ/5, now all set up and ready to partake in our Sporadic-E Project from his new Dallas QTH. . . . That big storm took K2ZBX's antenna farm down, but John's almost got the thing back up—all set for next month's big winds. . . . K2UCY is busy conducting code classes on 145.8 mc. . . . Here's an on-the-air swap session! Wednesday nights the Columbia University station, W2AEE, has their "program" on 145.35. Take a listen. . . . Guy, K2EFB, rates congratulations for his recent v.h.f. DXpedition to Hog Back Mountain, Vermont. . . . The GARNET meets on 145.53 in the northern New Jersey area with a real fine crew headed by Bob, K2JNJ, and Eileen, K2-AGJ (who publishes a real fine net bulletin in addition to the job of secretary to the net club). . . . Skeds, Skeds, Skeds—W1QKA wants 'em for 432 mc work-way up thar in New Hampshire. He's running 32 elements on 144 mc, 32 elements on 432 mc, and a 60 degree "horn" on 1296 mc! Write W1QKA at 48 Learned Street, Nashua, New Hampshire, if you know of an East Coast supplier of preformed finger stock for 2C39B tubes, also. . . . "JB", KØRTF, sends in some late notes on a good skip opening into North Dakota and Montana at 0130 to 0300 December 6. Heard WØGNS, K7CML, W7BUT and others putting in real fine signals. W7LHK, Joe, and his 385 foot long wire (!) was, as usual, doing a fine job on 50 mc.

### Thirty

As you've no doubt noticed, CQ's v.h.f. Column is expanding more every month. This is all due to your cooperation as contributors in an effort to cover each month of v.h.f. work more extensively for a better, more comprehensive report on activities. It is indeed a real pleasure to work with such a receptive and enthusiastic fraternity as is our v.h.f. group. Our heart-felt thanks for such a wonderful welcome to the staff at CQ. 73, Bob, K2ZSQ



# RTTY

Byron H. Kretzman, KØWMR

108 W. Teresa Drive  
West St. Paul, Minn.

In the mail, from the "unwashed multitude," as 'ole BeeP used to call 'em, we invariably get two comments: (1) RTTY is too expensive, and (2) RTTY is too complicated. We have answered (1) before; but briefly, a machine can be bought through a legally incorporated radioteletype society for \$55 to \$90, and also from some reputable individuals for about the same price. The parts needed to modify a transmitter v.f.o. can be bought, new, for less than \$3, and the parts needed to build a simple

five selecting pulses, which may be either a *mark* or a *space*, a start pulse which is always a *space*, and a stop pulse which is always a *mark*. (For 60-speed the selecting pulses and the start pulse are 22ms and the stop pulse is 31ms for a total of 163ms per character.) The start and stop pulses, of course, are for synchronization. It is the particular combination of the five selecting pulses that determines which character is printed.

Figure 1 shows as ideally squared pulses the

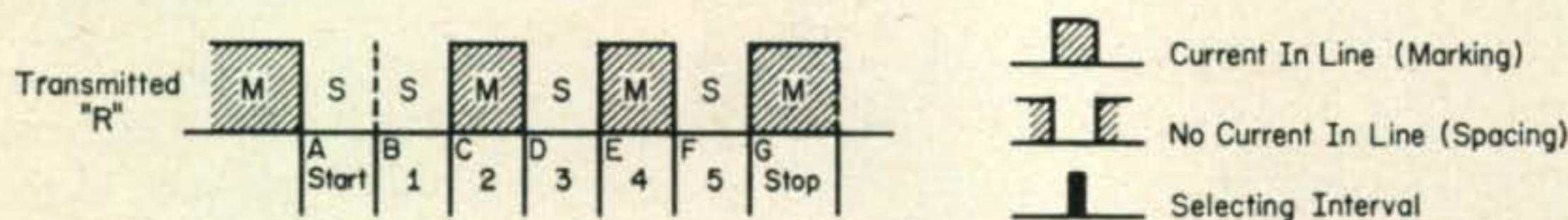

Fig. 1 Transmission of the letter "R."

converter or terminal unit (TU) to attach to your receiver need not cost more than \$25. Of course, old timers with well stocked junk boxes seldom need spend anything, except for the machine.

Now, if you have been following the RTTY column since the June 1960 issue you know that comment (2) is a fallacy. You don't have to be an expert telephone company Teletype repairman to be able to hook up and to operate a machine on the ham bands. And, you don't have to be a radio engineer to be able to build and adjust a converter. Sure, you can buy an excellent converter<sup>1</sup>, for about the price of a good communications receiver, but you will learn a lot more about how this RTTY business works if you sit down and build one from scratch, doing all the necessary tuning and adjusting yourself. If you do, you will be much better equipped to fight the battle on the bands. Take my word for it, too; you will get much more satisfaction out of actual operation if you do.

## Signal Requirements

In order to better understand how a radioteletype converter works, you should first understand the basic fundamentals of how a machine functions. By this we mean that you should understand the signal requirements of the receiving portion of the machine. Looking at it simply, the receiving mechanism must respond to a code of *marks* and *spaces* with a certain sequence for each character. As we mentioned before<sup>2</sup>, each character is made up of

combination sent to print the letter "R." Note that there are *mark-to-space* transitions at points C, E, and G. Another letter, "Y" for example, might require a transition at point "B," but in any combination there can be only two, four, or six transitions. It is important that these transitions occur so that there is no possibility of interference to either the selecting operations or to the synchronization (starting and stopping) of the receiving mechanism. Now, the *Teletype* receiving mechanism has been cleverly designed to require only 20 per cent of each selecting interval to set up a character. This is only 4.4-ms. Figure 2 shows this in the form of black blocks. Setting the selecting blocks squarely in the middle of each selecting pulse puts the transitions as far as possible from the selecting intervals, thereby setting the receiving mechanism for minimum error. This procedure is called "orientation" and is accomplished by mechanically rotating the receiving mechanism in an arc.

From the above it is apparent that a machine can theoretically tolerate a maximum signal distortion of about 40 per cent. By signal distortion we mean a shift in time or position of the transitions. It doesn't take much imagination to see that intermittent displacement of the transitions, called "fortuitous distortion," takes place over a radio circuit, especially when multipath exists. The job of the radioteletype converter then is to battle not only the signal distortion caused by propagation effects, but to battle further displacement of transitions by QRM, QRN, and noise when the radio signal is weak. As you can see, the theoretical 40 per cent margin soon vanishes, and our TU must make every effort to approach the providing of

<sup>1</sup> Kretzman, "CQ Tests the FSC-250 on RTTY," Aug. '60 CQ, page 71.

<sup>2</sup> RTTY Column, Fig. 1, CQ, Sept. '60, page 88.



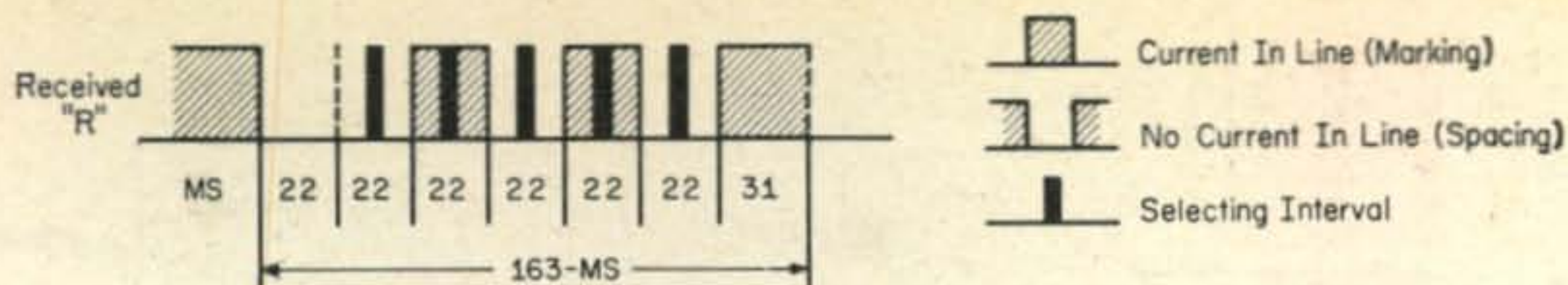

Fig. 2 Reception of the letter "R."

the middle 20 per cent of the original pulses sent, at the very least.

The signal finally sent to the machine is in the form of direct current pulses for *marks* and an absence of current for the *spaces*. This is the old familiar neutral telegraph circuit. Our radioteletype converter must therefore supply these pulses at either 20ma or at 60ma, depending upon the requirement of the selector magnets of the machine, or it must operate a relay which is used to key a local loop powered with a 115-volt d.c. supply with enough external resistance to limit the selector magnet current to the required value on *mark*.

### Converters in General

Radioteletype converters or TU's fall into two general classes, the i.f. type and the audio type. This classification describes their input arrangement. The output of a converter may be in the form of an electronic vacuum tube keyer designed to directly key the selector magnets of a machine, or it may be designed to operate a polar relay whose contacts key a local loop containing the selector magnets of a teleprinter machine.

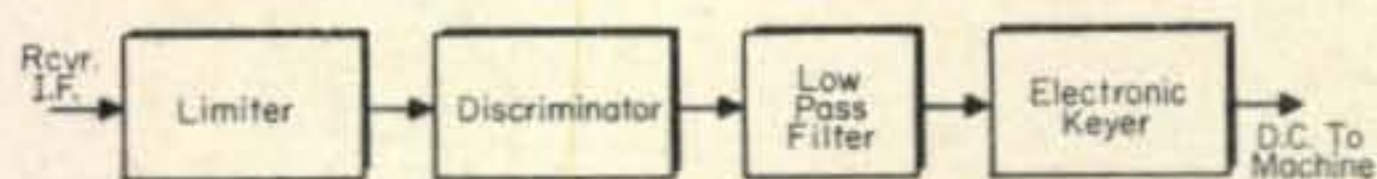

Fig. 3 I. F. converter block diagram.

Figure 3 shows the block diagram of an i.f. type of TU. This kind of circuit contains the basic elements of an f.m. receiving system, namely the limiter and the discriminator. Looking at it as the receiving part of an f.m. system, you can consider it designed to accept a carrier frequency modulated by a 22.8 cycle square wave with a deviation of plus or minus 425 cycles, giving a deviation ratio of about 20. The limiter removes all amplitude variations and provides a signal to the discriminator that varies only in frequency. The discriminator then converts this frequency variation to the 22.8 cycle amplitude variation of the voltage

across the discriminator load resistors. This variation in voltage might be used to simply control a push-pull d.c. amplifier with a polar relay in its plate circuit, or the 22.8 cycles may be a.c. coupled to an electronic keyer with appropriate clipping and filtering. When applied to a communications receiver this type of conversion requires that all necessary selectivity and interference rejection be obtained with the receiver's i.f. system. Like any f.m. system, it is subject to capture by an interfering signal greater in strength than the desired signal.

Figure 4 shows the block diagram of an audio type of TU. Notice the similarity to the i.f. type of converter described above. Amateur practice has been to design the *mark* filter for 2125 cycles and the *space* for 2975 cycles to accept the standard shift of 850 cycles. These filters, actually part of the discriminator circuit, can be designed either to provide a linear discriminator response, or they may be designed as flat-topped filters with steep sides.<sup>3</sup> The latter approach is erroneous when a limiter is used *ahead* of the filters because the rejection in the "notch" is not complete, as shown by W4EHU.<sup>4</sup> The output circuit here, as with the i.f. type of TU, is a matter of choice.

Figure 5 shows the block diagram of another audio type of TU. In this TU the filters are ahead of the detectors. Sometimes separate *mark* and *space* limiters are used between the filters and the detectors. The combiner is actually a form of discriminator, and it is usually followed by clipping and filtering before the 22.8 cycle signal is fed to the keyer tube.<sup>5</sup> The simple polar relay output is seldom used with this arrangement because of the post-detection clipping desired, and unless there is some special local loop requirement for the isolated contacts of the polar relay.

It will be observed that all of the TU block

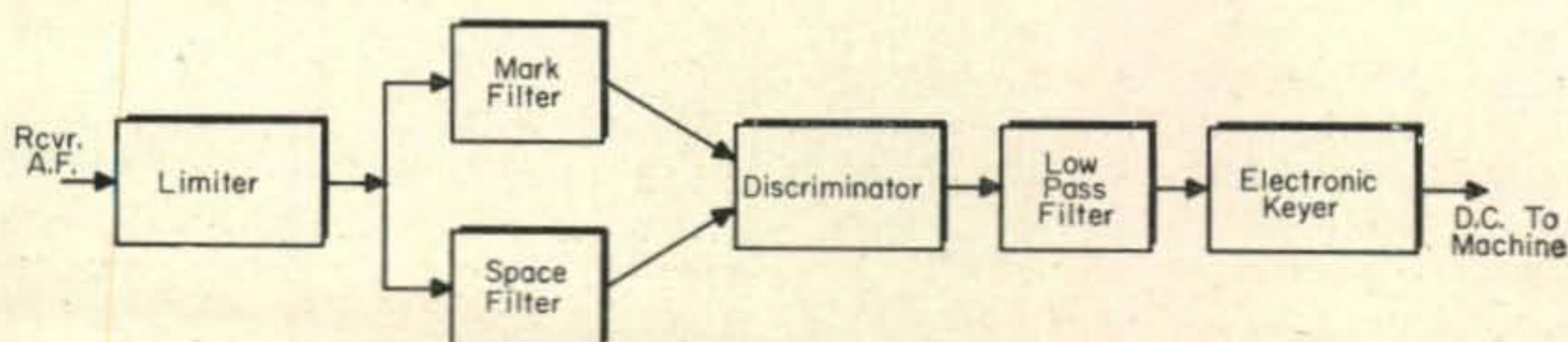

Fig. 4 A. F. FM converter block diagram.

<sup>3</sup>Weitbrecht, "Band-Pass Filters," *RTTY*, Jan. '57, page 3.

<sup>4</sup>Wiggins, "Interference Characteristics of FSK Systems," *RTTY*, Nov. '60, page 3.

<sup>5</sup>Gates, "This is a Terminal Unit," *RTTY*, Oct. '54, page 3.



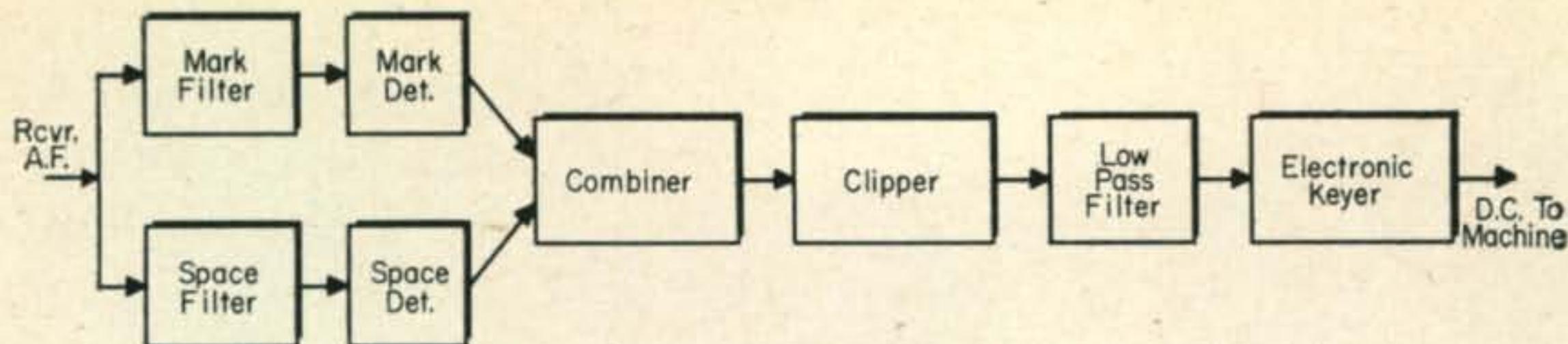

Fig. 5 A. F. filter converter block diagram.

diagrams shown contain a block labeled, LOW PASS FILTER. In its simplest form this might consist of the by-pass capacitors across the discriminator load and/or use of the polar relay; however, and *L-C* low pass filter designed for a 70 to 80 cycle cut off frequency will reduce the adverse effects of beat frequency interference, impulse noise, etc., which are really felt when you are working with weak radio signals. W4EHU also points out logically that an f.m. audio type of converter can be considerably improved by the use of a "comb" filter tuned to the *mark* and *space* frequencies and installed *ahead* of the limiter to reduce the effective noise bandwidth to improve the signal to noise ratio.<sup>6</sup>

To summarize the preceding discussion, on the basis of the basic requirement that only 20% of the selecting pulse is needed, we can design and built a very simple audio discriminator type of TU that will perform perfectly on v.h.f. when AFSK is used and which will perform reasonably well when used on h.f. with a good communications receiver. If we are only interested in h.f. operation the i.f. type of TU might be easier to build.<sup>7</sup> A little more complex, the filter type of TU with post-detection limiting should make a more effective unit when working with marginal signals. In respect to the choice of d.c. or a.c. coupling out of the detector, the d.c. coupling and the use of a polar relay certainly simplifies circuitry, but accurate tuning-in of the FSK signal is required to avoid bias distortion of the output signal pulses. The use of a.c. coupling might make tuning less critical and it does permit the added circuit refinements of post-detection limiting, or clipping, axis restorer, *mark* hold, etc. It is highly recommended that anyone who desires to build a TU with a.c. coupling read the article, "TU Engineering," by K8GWZ which appeared on page 44 of the March 1959 issue of *CQ*.

### Antique Tape Printer

The accompanying photograph is that of an antique tape printer with keyboard which bears the *Teletype* trade mark which, incidentally, was registered August 11, 1925 by a predecessor company, the Morkrum-Kleinschmidt Corporation, and was used as early as October 1921 by another predecessor company, the Morkrum Company, according to Mr. E. Rob-

inson of the Teletype Corporation in Chicago. W4NZY, the present owner, informs us that a photo of this type of machine appeared in a 1923 issue of the *Literary Digest*. All of which indicates fairly well the age of this machine.

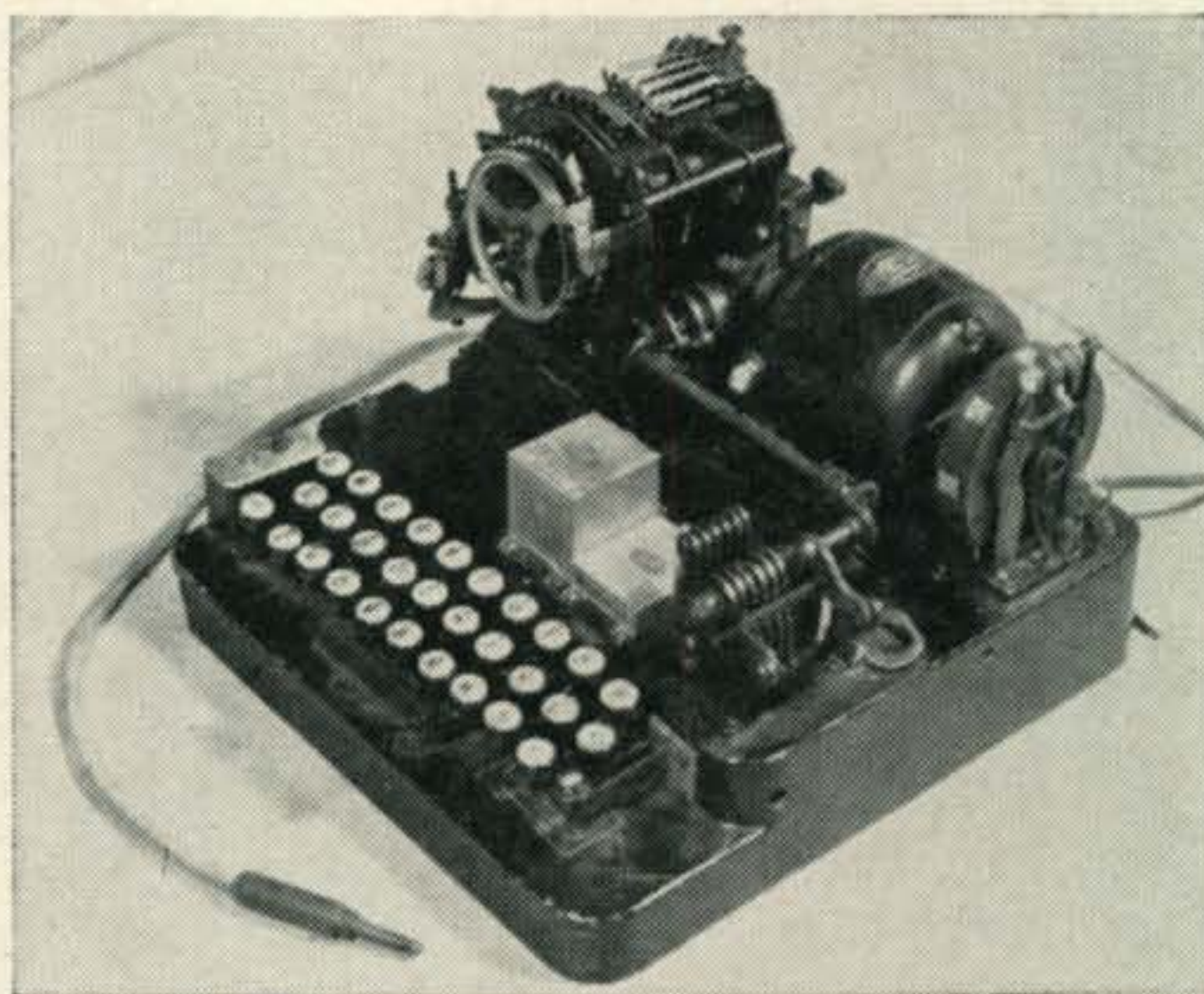

An antique tape printer

The machine pictured prints on narrow tape, not in the machine when photographed, by means of a type wheel inked from a felt roller which made contact with the type wheel as the wheel rotated. The motor is for 12 volts d.c., and the speed was regulated by the governor assembly visible in the photo. The strobe marks on the wheel suggests that an aperture-type of tuning fork, similar to that used today with the TG-7B military version of the Model 15, was used to set the speed. The metal cased capacitors just behind the keyboard were made by the now absent but then well known Tobe-Deutschman Corporation.

### Letter from Cleveland, Ohio

"This is to inform you of the latest RTTY activity here in the Cleveland, Ohio, area. I am pleased to write you of the formation of NOTS, the Northern Ohio Teleprinter Society. Our first meeting was held recently, with a great deal of interest, and a very good number of active and interested amateurs participating in teleprinter operation. We had a number of persons from as far away as 40 miles from Cleveland come to this meeting. We were all most surprised to see the good turn-out with the very little publicity that was given prior to the meeting. It was decided to hold future gather-

[Continued on page 117]

<sup>6</sup>RTTY Column, *CQ*, April '59, page 70.

<sup>7</sup>RTTY Column, *CQ*, April '58, page 61.





by Louisa B. Sando, W5RZJ  
212 Sombrio Drive, Santa Fe, N.M.

### Rules 12th Annual YL-OM Contest

- Phone:** Starts Sat., Feb. 25, 1961, 1:00 p.m. EST. Ends Sun., Feb. 26, 1961, 12 midnight EST.
- CW:** Starts Sat., Mar. 11, 1961, 1:00 p.m. ESTS. Ends Sun., Mar. 12, 1961, 12 midnight EST.
- Eligibility:** All licensed OM, YL and XYL operators throughout the world are invited to participate.
- Operation:** All bands may be used. Cross-band operation is not permitted.
- Procedure:** OMs call "CQ YL." YLs call "CQ OM."
- Exchange:** QSO number; RS or RST report; name of state, U.S. possession, VE district, or country.
- Scoring:**
- Phone and CW sections will be scored as separate contests.
  - One point is earned for each station worked, YL to OM, or OM to YL. A station may be contacted no more than once in each section of the contest for credit.
  - Multiply the number of QSOs by the number of different states, U.S. possessions, VE districts and countries worked. Maryland and the District of Columbia count as one state.
  - Contestants running 150 watts input or less at all times may multiply the result of item "C" by 1.25 (low-power multiplier).
- Logs:** Copies of all Phone and CW logs, showing claimed scores, must be postmarked not later than March 31, 1961, and received no later than April 15, 1961, or they will be disqualified. Please file separate logs for each mode of operation. Send logs directly to "Onie" Woodward, W1ZEN, Vice President YLRL, 14 Emmett St., Marlboro, Mass.
- Awards:** 1st place Phone: YL Cup, OM Cup  
1st place CW: YL Cup, OM Cup  
The winner of the Phone cup also is eligible for the CW cup. Certificates will be awarded to high place CW and Phone winners in each district, U.S. possession, and country.

### TYLRUN's 6th Anniversary

Members of the Texas YL Round-Up Net celebrated the 6th anniversary of the net with a party at San Antonio on Nov. 5, 1960, with the ALAMO YLs as hostesses. These 35 YLs were present for the luncheon and business meeting: K5's YTN, BJU, YIT, IRB, GYZ, LSO, MIZ, LIU, IHF, MBS, MTS, BJV, MJW, OPT, POD, CRH, RJJ, PIO, YIB, ALF, PFF, BNQ, BWM, OPV, YCE, MXO, UTO; W5's FBM, WXT, RYX, ERH, DIV, KQG.

Games were played at the get-together Friday night. K5BNQ was the first to find her call letters out of a handful of alphabet noodles and K5BWM won the prize for pinning, blindfolded, the ALAMO to the closest spot on the map of Texas. K5LIU won the embroidered tablecloth made by the ALAMO YLs. It had the TYLRUN symbol in the center with all charter members' call letters around it. Each corner had designs representing the WHO, WHOOT, GAYLARK and ALAMO club certificates. The remaining area was covered with over 140 calls of TYLRUN members.

At the business meeting the following were elected: Pres., W5JCY, Bertha; V.P., K5IMF, Betty; sec.-treas., W5ERH, Betty, and P/C, W5ZPD, Cindy. K5SOT received a trophy as TYLRUN's most faithful check-in. Permanent certificate custodian for TYLRUN is K5GBX, Bernell Johnson, 1822 S.W. 3rd, Grand Prairie, Tex. She will have a supply of up-to-date directories which can be had for 25¢. TYLRUN also is to have a regular newsletter and its editor is W5LGY, Helen. The GABS from Brownfield invited the group to their city for the 1961 TYLRUN party.

On Nov. 17 TYLRUN checked in member No. 150, and at present there are about 85 active members.

### W6 YL Convention

The all-California YL Convention for 1961 is set for May 12-14 at the El Cortez Hotel in San Diego. The San Diego YLRC is hosting this year's get-together with W6VSL, Barbara, as chairman. K6UTO, Betty, is handling registrations. There will be special prizes, side trips, luncheon and banquet with entertainment, and for the OMs a no host luncheon and trip to the NEL or some electronic firm. More details as plans develop.

### With the Clubs

New officers for WHO at Ft. Worth for 1961: Pres., K5CRH, Marie; V.P., W5ETH, Betty; secy, K5LQK, Dottie; treas., K5VLW, Lillian.

Custodian for the Mermaid Certificate, offered by BAYLARC, is K6ZCR, Claire Hoge-weide, 537 Valverde Dr., South San Francisco, Calif. The certificate requires 6 contacts with



BAYLARC members. Endorsements will be issued for each additional six previously unreported BAYLARC contacts. Here is a listing of BAYLARC member calls: W6's PCN, QYL, BDE, JKC, HDV, DXI, ALL, SH, WIU, PCA, USE, GQZ; K6's AIU, CUV, QCL, ZCR, HIW, UDT, EEE, SZT, ZKH, LPH, RMC, JHA, DEN, RCM; WA6's GQC, DPN, HDE, ALK, JGR, BQV, IIB, AFZ, AFG, HSQ, JCS, FLW, DQZ, NEL, FBX; WV6's NOW, HSF, LIZ. BAYLARC YLs have three nets in operation—the Mermaid Net, Sat. 1000 on 3850, W6QYL NCS; BAYLARC 6M net, Mon. 2000 on 50.56 mc, WA6ALK, ANCS; the Finger Tip net on Tues. 1400 on 7.020 mc c.w., K6ZCR net mgr.

New officers for 1961 for the Rhode Island YL Club: Pres., K1DWH, Florence; V.P., WIJHY, Frances; secy, W1ZOK, Norma; treas., W1CEW, Mary.

Officers for the Georgia Peach YL Club are: Pres., K4LVE, Gladys; V.P., K4DNL, Olivia; secy, K4LIU, Marita; treas., K4BDZ, Martha. The Peaches have 40 members and now welcome YLs of neighboring states as honorary members. When a Georgia YL resident moves she still retains her membership as long as she holds a license. Honorary Peaches, those who are not and have not been residents of Georgia, can count as ½ point toward the Peach certificate, while regular members count a full point. 10 points are needed for the certificate. K4DNL is custodian; QSLs are required. For each additional 5 points a gold sticker is available. The Georgia Peach YL Net still meets on Thurs. 0900 EST on 7260 with K4ZZS, Marguerite, as NCS.

### K4LVE

President of the Georgia Peaches, K4LVE, Gladys Biggs, is serving her second term in office. Gladys has quite a story that starts with her becoming W5EDD in 1934 and, eight children later, when the youngest started school, she became K4LVE. Her OM Terry, W4ETD, gave the "lowdown" on Gladys' early entry into Hamming and we'll quote him: "In the spring of 1934 Gladys got so tired of my having transformer cores, wires, tools, etc., in every room of the house that she threatened to have me locked up. Now you know that's no way to treat an innocent Ham. So I ups and tells her that the kitchen range just has to go. So when she got hungry enough, she told me to bring back the range and she would get her ticket in self defense. Which she did. I was in the Army and on maneuvers a great deal of the time, so she got her ticket in order to talk to me while I was away. I'd take her small rig with me and she would use my big rig. During my career in the Service she was called upon to relocate frequently and she just could not have a rig on the air very much. But she stayed on until WW II when I was sent overseas, leaving her with six youngsters and the household burdens to manage."



K4LVE, Gladys Biggs, president of the Georgia Peaches, first went on the air in 1934 as W5EDD.

When Terry went back on the air at Valdosta, Ga., Gladys renewed her interest and took over his Viking II when he got a KW 1. She enjoys handling traffic and received the BPL Medalion last year, all of her traffic handled on phone. Currently W4ETD/K4LVE are operating portable at Ocala, Fla., and she meets the Fla. Mid-day Phone net and the Dixie Early Bird net. She now uses a Viking 500 given her by her OM for their wedding anniversary, a 75A2 receiver and a Mosley Tri-band vertical antenna. She belongs to Air Force MARS, Floridora, Ga. Peaches and Grandmothers Club (11 grandchildren at present). She also holds OPS and OBS appointments. Terry was MARS Director for 14th AF at the time the numbered Air Forces were disbanded, at which time the Biggs family moved to Fla. where they are for the most part retired—and enjoying Ham radio.

### Here and There

In our listing of YLRL officers in the November issue we unintentionally omitted three of the positions—Advertising Mgr., W6QYL, Martha Edwards; Property Custodian, KØGZO, Virginia Bush, and Publicity Chairman, K4TGA, Alice Ginsberg. Sorry gals—we know each and every one who takes on a job for YLRL finds it a big one with our present large membership.

Congrats again to K2UKQ, Kay Gaynor. From K6BX we learn that with all the OMs seeking No. 1 "Hunt The Hunters" award, a YL, K2UKQ, was the first one to win it for working 25 members of the Certificate Hunters' Club. Kay is a CHC'er; is the only YL to hold WPX on c.w. with 425 confirmed, and her DXCC standing is 209/196.

[Continued on page 120]





by **KEN GRAYSON, W2HDM**  
Care of CQ 300 West 43rd Street,  
N. Y. C. 36, N. Y.

This will probably come as a surprise to the readers of *CQ* but next month is to be the last SURPLUS column. This was prompted by the dwindling stocks of unconverted surplus and the time necessary to devote to the more sophisticated surplus which is reaching the market. In other words, we can't provide the necessary coverage on a monthly basis when the conversions take several months to do properly. Instead of a column, *CQ* will publish articles as they are received and they will certainly continue to keep an eye out for good conversions. We will continue to provide conversions as they crop up with the exception that we will no longer answer mail relating to surplus. In three years this department has answered almost six thousand letters. Not all were answered as promptly as we would have liked, but they were answered and to the best of our ability. We have honestly tried to report on surplus and while we have made a few mistakes, we were always humble enough (we hope) to "own up to them," and make the corrections. We hope that we have made friends with many and possibly stepped on a toe or two in the process, but we are sorry and apologize where appropriate.

Surplus is a big business. It is by far the supplier of the largest percentage of components and equipments for most shacks. Bargains galore abound in surplus stores throughout the country and careful buyers can obtain equipments they wouldn't have dreamed existed.

We came across a couple such gems. At Barry Electronics (see his ad this issue) we found a couple of units which abound in tubes and nice clean parts. One unit has over thirty late-type tubes and sockets for sixteen bucks while the other has over forty tubes and sells for about twenty bucks. Sure, the thing was made for 400 cycle operation, but it was worth many times that price in parts, like the tubes. I'll bet the cabinets were worth more than that new.

We came across another terrific gem the other day at a new place in New York City under the name of Amber Industrial. They have an AN/ART-7 which sells for about twenty-five dollars. This was originally a jammer for the ten meter band, and with very little effort will make a terrific ten or six meter linear. Add a power supply and a few parts to complete the

job. With a pair of 35TG's in the final you can get 90 watts out at 600 volts on the plate. Put 2000 volts on it and you have a 200 watt linear . . . not bad, and fully metered too.

It's these little gems that we run into in surplus that makes the hobby worth while. Looking back over the years we can see that surplus has changed over the year. The BC-375 is hardly heard of anymore and the BC-312,348 receivers seem to be outmoded (actually they are still one of the best buys on the market for about \$50.00). V.H.F. has replaced h.f. and m.f. communications from the surplus point of view, except that the ARC-5's are still coming through the horn of plenty. The only cheap microwave equipment is still being put together with surplus, and transistors are slowly taking the place of the dynamotor.

We have been writing the column in *CQ* for over three years, and we find the biggest amazement that we have had is the average ham is no longer self-reliant as he used to be. He no longer dopes out the problem with his friends, but is more reliant upon a column for an answer even if it takes a couple of months to get the answer. With very few exceptions, I can't think of an answer that I have had to give in a technical manner that couldn't have been answered by opening a copy of the *ARRL Handbook*. Since this column is to be terminated, I want to point this out. One practical example is a noise limiter. A good ten percent of all technical correspondence deals with the use of a noise limiter in a particular piece of equipment, yet the noise limiter in *ARRL Handbook* works well in almost any equipment. This is what we are up against and we regret the lack of industriousness on the part of the average reader.

Many letters have a humorous side to them too. We recently received a letter from a west coast ham who wanted us to convert a surplus radar set to an oven to cook his TV dinners. Several hundred amateurs requested answers to urgent problems . . . without including their return address and in some cases they didn't even include their names.

But now we are closing shop we wish to clear up as much business as possible; so here go the answers, in a sort of rambling style, to many problems that have been of interest.



The BC-620 and 659 do not require the internal battery, when converted to a.m. . . . the AN/UNS-1 sound ranging equipment is an audio device that incorporates squelch, and should have possibilities as a fine phone patch, since it has two audio channels . . . Hickock Electrical Instrument Co., 10514 Dupont Avenue, Cleveland 8, Ohio, has a dollar book called *Tube Data for Tube Tester 510X-530-530X* which contains data for testers similar to the I-177 . . . when converting from f.m. to a.m. in a transmitter it is necessary to either short the mike input or better yet, remove the reactance tube circuit completely . . . that the only big changes in 400 c.p.s. equipment is the power supply and relays. This means transformers, chokes and filter capacitors . . . the 12A6 is similar to the 6V6 or 6F6 except for filament voltages . . . the ARC-5 receivers often come with i.f. transformers that have variable coupling and the selectivity is adjustable on these models . . . the v.h.f. ARC-5 receiver can be made tunable by adding a feedback capacitor of about 100 mmf in the last crystal multiplier stage, from plate to grid . . . the ARC-5 transmitters can be used for checking crystal frequencies by using the unknown crystal in place of the standard, and looking for the eye tube to indicate frequency, as you tune the transmitter v.f.o. . . . the TDZ transmitter is great for two meters and requires no conversion for 16 mc crystals and only a slight oscillator change from t.p.t.g. to Tri-tet for 8 mc rocks. It will run almost 90 watts output a.m. from 110 volts as supplied . . . a dynamotor will operate on half its input voltage. It will give half the output, but will require a little longer to start and is almost as efficient.

### Requests for Manuals

Norman E. Troutt, 1501 Woodland Street, Beatrice, Nebraska needs information on the BC-923, especially the i.f. frequency and the conversion and schematic to six meters. Don Oker, 504 Canterbury Road, Bay Village, Ohio is in need of information on the R-19/TRC-1 for tunable operation. George Muise, 272 Hollis Street, Framingham, Mass. is looking for info on the TBW transmitter. George Lehmkuhl, 509 West 2nd St., Waconia, Minnesota, wants a manual for the BC-624 and

625 (SCR-522), and for the TS-170/ARN-5. F. E. Schrafft, Box 38, Old Lyme, Conn. needs the AN/APN-1 manual. John Skinner, 27 Draper St., Woolcott, N.Y. wants information regarding a CML-model BB-27 broad band converter. Mike Kuehl, 1418 N. Stevens St., Rhinelander, Wis. wants a manual for the BC-604. Frank Kobulnecky, 143 Pike Street, Weirton, West Virginia, wants a manual on the BN equipment. Caryl P. Baldwin, Star Route, Gray, Maine wants a manual on the Link f.m. equipment model 1498.

Ed Lake, a Scoutmaster, has need of assistance regarding a BC-1066 for use with a station run for a group of handicapped boys. Contact him at Troop 146 BSA, 1930 Ottawa Beach Road, Holland, Michigan. Joe Bronson 15397 Cruse, Detroit 27, Michigan wants a manual on the UPM-1 radar test-set. Ray Smith, 8834 North 2nd Way, Phoenix, Arizona wants any available data on the ARC-1 equipment. Owen Densmore, Georgia Tech. Box 3655, Atlanta, Georgia needs a book on the TBX-8 equipment. Dr. Verne Goerger, 471 West Hidalgo Ave., Raymondville, Texas wants information on the conversion and use of a Navy MAW transmitter receiver unit.

Warren Farris, 1961 S. Woodland, Amarillo, Texas wants data on the TU/FRC the TCS-13 and the BC-1287-A equipments. George Lahr, W4LQY, 925 Samar Rd., Cocoa Beach, Fla. has a T-22/ARC-5 and a BC-AS-230 without manuals, and could use them. G. J. Gustke, 4901 Outlook, Mission, Kansas wants a manual for the ART-13. Ed Leftwich, 3447 Wisteria Drive, San Diego 6, California wants any data on the GF-11 equipment. Paul A. Plante, VE3ORP, P.O. Box 987, Cochrane, Ontario, Canada needs manuals for the RCAF model AR-6R ef 10D/1428 and power supply 2A/CAN 1720 for No. 19 MK III and Model SC 1277A. Gerald Mitchell, Hankinson, N.D. wants conversion data on the ARC-1 transceiver. Philip Ruehl, Stout State College, Menomonie, Wisc. needs conversion and alignment info on the BC-499 equipment.

Reeve Strock K4AW, 132 Rutledge Drive, Hendersonville, N.C. wants the instruction manual on the TS-28/UPN synchroscope. Gene Atwood, 7702 LeBerthon, Tuunga, Calif. wants conversion data on the RDR transceiver. Alan Binns, 27 Dene Road, Cottingham, Yorkshire, England, wants an operating manual or schematic of the BC-699-C and the RM-21 with PE-110A power supply. Dick Haskin, 154 N. McKinley Place, Monrovia, California wants info on converting the ARC-3 to continuous tuning and the TDZ for general use. Stephen Collins, VE6ADI 15036, 85 Avenue, Edmonton, Alberta, Canada, wants info on the AM-293B/UPX Video amplifier. John Crosby, 176 Cloud Street, Jonesboro, Georgia wants a schematic for the R-148/ARC-5X. Charles Mishmash, Jr., 1008 S. Santa Fe, Pueblo, Colorado wants conversion dope on the GF-11. A. Reglington, 17 Wavell Drive, Pietermaritzburg, Union of South Africa wants a manual or any data on the BC-1031A panadapter.

73, Ken, W2HDM

## POWER SUPPLY [from page 52]

### Voltage Output

The circuit shown has performed very satisfactorily as a supply for the final of a single sideband exciter. To increase the available voltage, a one microfarad capacitor, with suitable high voltage breakdown rating, was added to the input of the filter. Choke input will yield a lower voltage but will exhibit better regulation. If used for pulsed service with an s.s.b. linear, some capacity can be used on the input side of the filter at the expense of good regulation.

For higher voltage applications of 2000 to 3000 volts, the same circuit, with either 1616 vacuum or standard mercury vapor rectifiers and a couple of medium voltage transformers with 1200 to 1700 volts either side of center tap, will result in a supply without the need of

a very high voltage plate transformer. Separate filament transformers are needed, and if separate primary switches are provided for the plate transformers, one may be turned off and a lower voltage for tune up or reduced power operation will be available. Mercury vapor rectifiers must be warmed to operating temperature for at least one full minute before high voltage is applied. Use of 1616, 3B25, or similar tubes obviate the need of this precaution.

Standard safety precautions should be observed. Well insulated wire, dressed neatly, with no voltage present at any point where operator contact might be made, is a worthwhile practice. Fusing is also a good practice, being economically worthwhile in the event of trouble or overload. The standby switch must be heavy enough to handle the open circuit voltage as well as the closed circuit current load. ■



### Power Supply

The power section utilizes silicon rectifiers for low heat generation and compact construction. This sub-section delivers 1600 volts to the final and 300-500 volts to the exciter and accessory units. A half-power switch is included to aid in tuning up the transmitter.

### Accessory Sections

Although the basic transmitter handles only the c.w. mode, you can adapt it to operate a.m. or s.s.b. simply by plugging in the appropriate accessory module.

**SSB Section**—Sooner or later the c.w. operator will want to get on s.s.b. to snag the new countries, and the T-400 will be ready for him. The s.s.b. module, which can be seen in the lower left-hand corner of the transmitter photo, is a phasing exciter. When the transmitter is switched to s.s.b., the final is connected for linear operation in class  $AB_1$ . At the same time the crystal oscillator in the exciter section is switched from the mixer to the is formed using fundamental phasing on 9.0, 12.5,

sideband module. Here the single sideband signal compression amplifier (not to be confused with a speech clipper) which serves to raise the average audio level with a minimum of distortion. The output of this module drives either the audio phase-shift network in the s.s.b. module, or the audio amplifier in the a.m. modulator subassembly.

**Monitor Scope**—Want to see how good your signal is? You can incorporate a three-inch monitor scope module (upper left in the photo) which will display trapezoid patterns when operating on a.m. and s.s.b. With the instructions given the scope can be used to align the s.s.b. generator and tune the transmitter.

**AM Modulator**—For a.m. operation, a plug-in gated screen controlled-carrier modulator may also be installed. This unit uses a low-noise EF-86 driving a 12BH7 screen control cathode follower. The circuit provides as near 100% modulation as you can obtain from plate modulators, but at much less cost. The amount of carrier control is adjustable and can be set to avoid pumping the *avc* at the other fellow's receiver, yet retain a good deal of "talk power" (fig. 2).

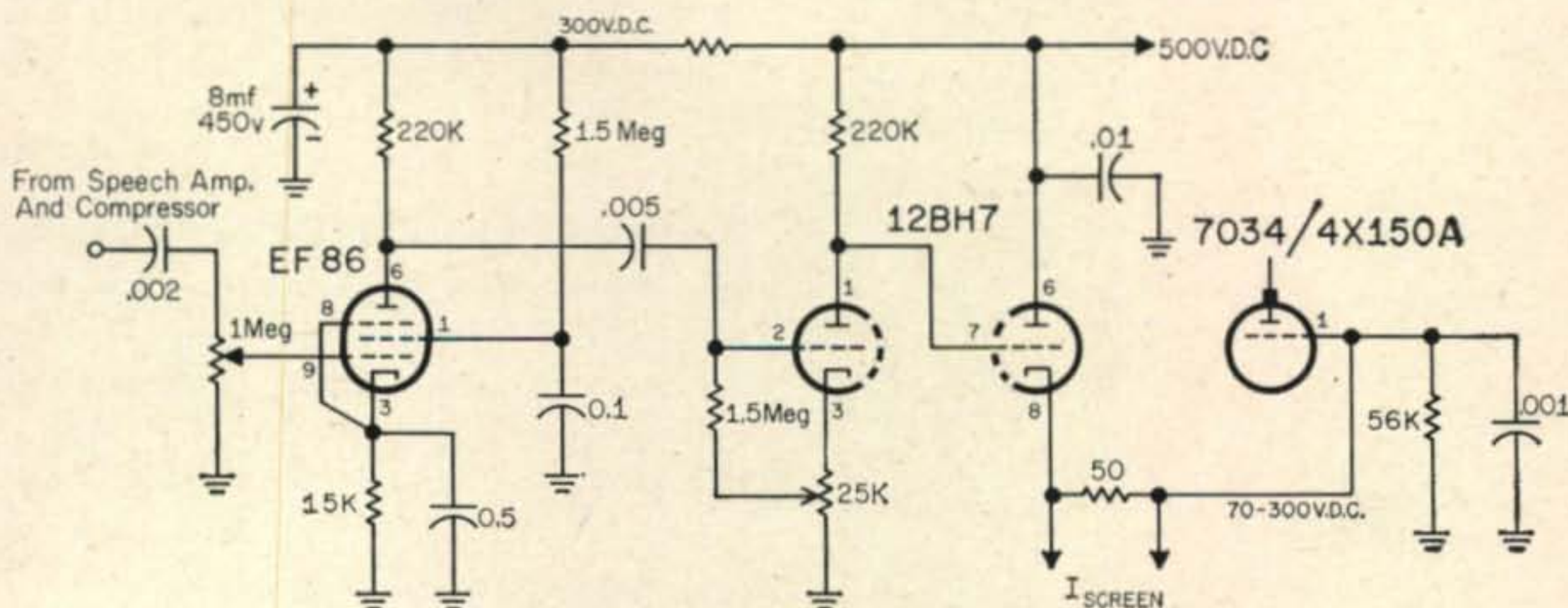

Fig. 2—Schematic of the gated screen controlled carrier modulator used in the T-400 transmitter.

16.0 or 24.1 *mc*, depending on which band is in use. The properly shaped signal is re-inserted at the mixer, in the exciter subassembly. The s.s.b. module also includes a voice operated relay and an anti-trip circuit.

**Speech Amplifier**—The speech amplifier module contains a preamplified driving a 300-3,000 cycle band-pass audio filter. This is followed by a

### Conclusion

Due to the interest created by the prototype model of the T-400, the author predicts we shall soon hear many of these versatile transmitters on the air. If you would like more information on the unit, you can obtain a free four-page folder on the T-400 by sending a request to Allied Radio, 100 N. Western Avenue, Chicago 80, Illinois.

## BRITISH CALLS [from page 53]

### Interchangeability

One useful feature of British procedure is that all calls for United Kingdom stations, including GC, GD, GI, GM and GW prefixes, are issued from the same block without duplication. This means that a G amateur does not need to change his call should, for example, he wish to operate from Scotland, but simply uses the GM prefix instead of G. Also helpful in avoiding mix-ups is that, nowadays, the same call is never reissued to other operators, except in special circumstances such as where a son is given a call once held by his father.

### Portable Calls

To indicate portable operation, the home call is used followed by /P, while the use of /A ("alternative address") shows that the station is being operated from a building other than the regular one. /M indicates mobile operation and requires a special permit of which almost 1000 are in force, while should you ever hear a G station signing /T switch on your TV set as this indicates an amateur television transmission: but as operation is confined to 420 *mc* and above, it's unlikely many will be heard or viewed State-side! ■





## The Radio Amateur's BOOKSHELF

Here is a selection of basic books that belong in every hamshack. Use coupon below to order; money refunded if not completely satisfied.

### 1. RADIO OPERATING QUESTIONS AND ANSWERS

Prepare to pass license examinations quickly and easily with this reliable question and answer book. By J. Hornung, M.I.T., and A. McKenzie, McGraw-Hill Book Co. 12th Ed., 571 pp., 142 illus., over 1900 answers. \$6.25

### 2. ELECTRONIC COMMUNICATION

Fundamental theory and practice for modern electronic communication—a basic "how-to" guide to operation, maintenance, professional and amateur license examinations. By R. Shrader, Oakland Junior College. 936 pp., 771 charts, graphs, tables, and illus., \$13.00

### 3. BASIC ELECTRONICS

This easy-to-read book covers everything from basic electricity to tubes and transistors. Helps you learn electronics from A-to-Z at home! By B. Grob, RCA Institutes, Inc. 524 pp., 376 illus., \$9.25

### 4. APPLICATION OF ELECTRONICS

This big guidebook gives you the electronic know-how that helps you perform better, faster technical work. By B. Grob, RCA Institutes, Inc.; and M. Kiver. 618 pp., 495 illus., \$10.00

### 5. BASIC MATHEMATICS FOR ELECTRONICS

Gives you a sound mathematical background needed for working in today's electrical and electronics fields. By N. Cooke, Cooke Engineering Co. 2nd Ed., 679 pp., 373 illus., \$10.75

### 6. ELECTRONICS AND NUCLEONICS DICTIONARY

An illustrated dictionary giving up-to-date definitions, abbreviations, and synonyms for over 13,000 terms used in television, radio, radar, industrial electronics, medical electronics, avionics, space electronics, nuclear science, and nuclear engineering. By N. Cooke, Cooke Engineering Co.; and J. Markus, McGraw-Hill Book Co. Over 13,000 terms, 452 illus. and diagrams, \$12.00

### 7. TWO-WAY RADIO

This book clearly explains how to install, service, and maintain two-way radio sets for top efficiency. By A. Lytel, Avco Manufacturing Co. 281 pp., 283 illus., \$9.50

### 8. ELEMENTS OF ELECTRONICS

Gives you, without the use of difficult mathematics, all the basic theory you must have to go on to advanced work in radio, television, radar, sonar, or industrial control. By H. Hickey, Chief Electronics Technician, USN; and W. Villines, Jr., Lt., USN. 549 pp., 482 illus., \$8.75

### 9. RADIO ENGINEERING HANDBOOK

Solve your radio engineering problems more quickly, easily, and accurately with the reliable data and practice in this modern handbook. Edited by K. Henney, McGraw-Hill Book Company. 5th Ed., 1775 pp., over 1500 illus., \$25.00

### 10. TRANSISTORS IN RADIO, TELEVISION, AND ELECTRONICS

Provides a simplified summing up of facts about transistors and transistor circuits—how they are designed and work, and their use and maintenance. By M. Kiver, 2nd Ed., 423 pp., 337 illus., \$7.95

### 11. RADIO ENGINEERS' HANDBOOK

Represents an organized and substantially complete interpretation of the engineering literature of radio that has appeared in English. By F. Terman, Stanford University. 1019 pp., 869 illus., 84 tables, \$14.00

**SEND CHECK OR MONEY ORDER TO:**  
CQ, BOOK DEPT.  
300 West 43rd St., N. Y. 36, N. Y.

Send me book(s) whose numbers I have circled below, for which I enclose check or money order in full payment.

1 2 3 4 5 6 7 8 9 10 11

(PRINT)

Name .....

Address .....

City ..... Zone ..... State .....

Money refunded if not completely satisfied C-2



DX [from page 63]

(You're not the only one who wishes he could get permission to operate-Ed) (Tnx NCDXC)

**3W Cambodia—HR10S**, Ocie, will soon start working at the U.S. Embassy in Phnompenh and will try to get a license from there. (Tnx DXer)

**ZC4—Cyprus**. The following letter to K6CQM from ZC4AK should help to explain the present situation in Cyprus.

"I am no expert on the complex politics of this unhappy island but here is the info you ask for...."

"On the 16th of August (2200 GMT on 15th August) the British Crown Colony of Cyprus ceased to exist and authority and sovereignty over most of the island was vested in the new Independent Republic of Cyprus. (Capital—Nicosia, President—Archbishop Makarios) which is now a member of the United Nations.

"However, two military bases, of total area, 99 square miles were retained by the British Government under the Sovereignty of H. M. Queen. These comprise the Akrotiri Base Area, near the town of Limassol, where I am located, and the Dhekelia Base Area, near the town of Larnaca. These are *not* held on a lease, as is KG4, but are domains of the British Crown *in perpetuity*. Akrotiri is located about 50 miles from Dhekelia, with territory of the Republic of Cyprus intervening.

"The complete information is to be found in the treaty of Establishment of the Cyprus Government, in the British Act of Parliament which set up the Republic and in British newspapers of July 8th, 1960.

"I agree, there does seem to be a precedent for new country status for the Base Areas based on KG4, but this is complicated by the fact that the two areas are separated by Republican Territory so that it might be possible to create *two* new countries. The Republic also might have claim to new status, as I noticed that when Ghana became independent new status was granted by ARRL.

"Certain administrative functions of the base areas have been delegated to the Republic. These include the issue of driving and wireless licenses, and explains why hams in both parts of the island still sign ZC4.

"The following are among the most active hams in the island.

*Republic:* ZC4IP, ZC4WR, ZC4JB, ZC4CP, ZC4AB and ZC4KV.

*Akrotiri Base Area:* ZC4AK, ZC4SC.

*Dhekelia Base Area:* C4GT, ZC4PC, ZC4SS and ZC4SJ.

"One thing is sure; more Cyprus hams do not wish to change country status—we are quite nicely rare enough as it is!"

73 es DX, Urb

NEW ADVANCED DESIGN  
**Hy-gain**  
FOR  
2 AND 6 METERS



Available  
at 5 Stores  
Boston, Brookline,  
Hartford, New Haven  
and Stamford.

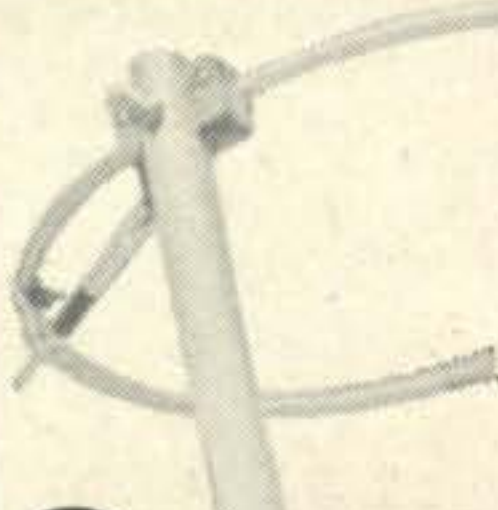

**2 METERS**  
MODEL HH-2  
CAT. NO. 29DX790 **\$5<sup>95</sup>**

The 2 Meter Halo. Only 14 inches in diameter and weighing less than one pound, the Hy-Gain 2 meter Halo is extremely small and light weight. It is constructed of heavy wall, half inch diameter, heat treated alloy aluminum tubing. Molded high impact cyclocac plastic bracket attaches Halo to any one inch mast. Perfect match to 52 ohm coax cable is made possible through the use of Hy-Gain's exclusive gammamaxial gamma match system. No external matching sections required. Completely factory pretuned, the 2 meter halo is adjustable over the entire 2 meter band and provides up to 15 db gain over vertical whips when working other stations using horizontally polarized antennas. It may be stacked for an additional 3 db gain. Stacking kit complete with all hardware and matching sections. (Order 2 Model HH-2 Halos) Model HHS-2 ham net \$3.00.

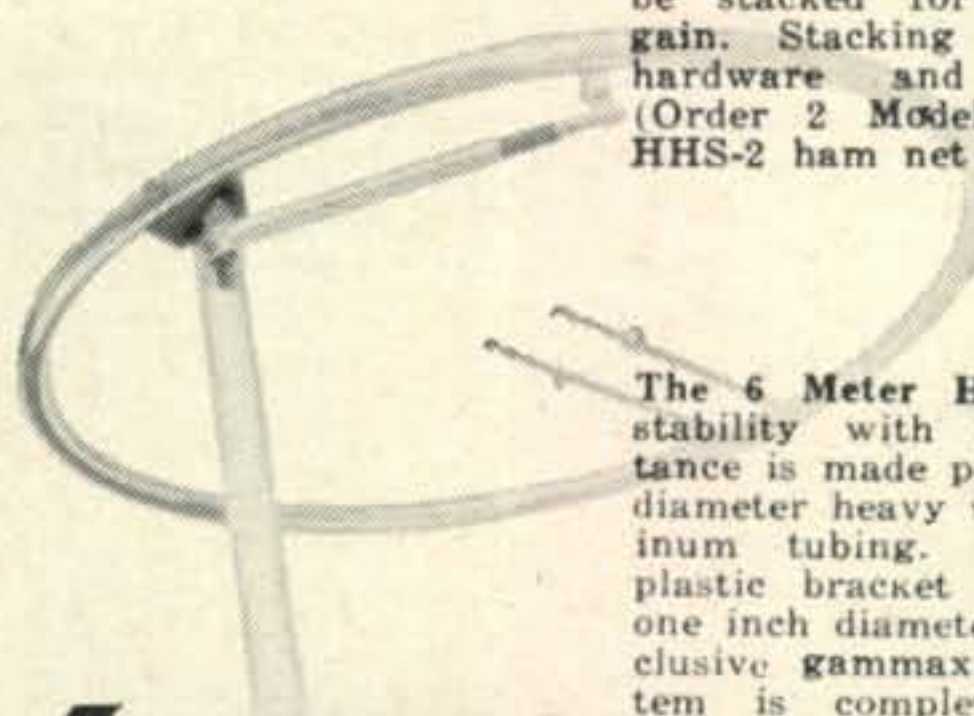

**6 METERS**  
MODEL HH-6  
CAT. NO. 29DX789 **\$12<sup>95</sup>**

The 6 Meter Halo. High mechanical stability with minimum wind resistance is made possible by the one inch diameter heavy wall heat treated aluminum tubing. High impact cyclocac plastic bracket attaches Halo to any one inch diameter mast. Hy-Gain's exclusive gammamaxial gamma match system is completely factory pretuned and provides a perfect match to 52 ohm coaxial cable. No external matching sections required. Exclusive new Hy-Gain Stub Tuning system is used to resonate Halo quickly and easily on any frequency on the 6 meter band. Its use eliminates weather problems and obsoletes difficult to adjust capacitor tuning assemblies.

The Model HM. Heavy duty, five foot telescoping aluminum mounting mast complete with threaded stud for any standard mobile mount. May be used with either 6 meter or 2 meter Hy-Gain Halo stacked or single.

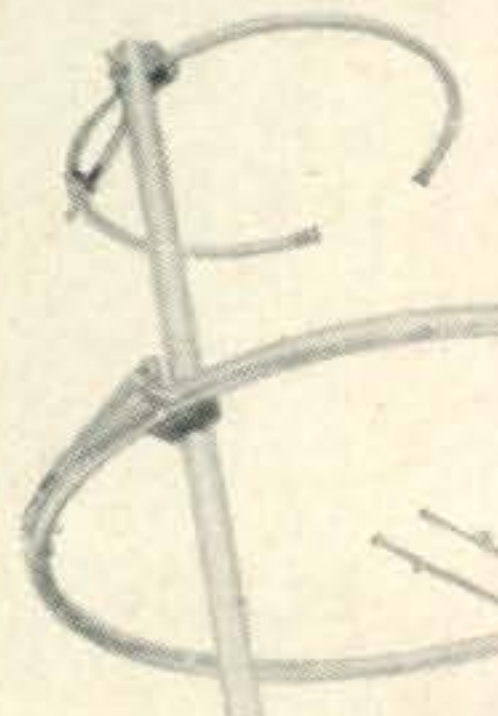

MODEL HM  
CAT. NO. 29DX795 **\$4<sup>95</sup>**

The 2 and 6 Meter Halo. Unique Hy-Gain development permits combination of both 6 and 2 meter Halos to form a high efficiency duo-bander Halo for operating either band with a single coaxial feedline and low SWR. Order both Model HH-2 and Model HH-6. Supplied with simplified instructions for quick and easy assembly.

**\$18<sup>85</sup>** **2 & 6 METERS**  
CAT. NO. 29DX799 **HH-2 & HH-6**

**RADIO SHACK CORPORATION** Dept. 2c  
730 Commonwealth Avenue, Boston 17, Mass.  
Please send me the following items:  
Order No. \_\_\_\_\_ Price \_\_\_\_\_  
Send Free  Radio Shack Catalog  Hy-Gain Catalog  
Name \_\_\_\_\_  
Address \_\_\_\_\_  
City \_\_\_\_\_ Zone \_\_\_\_\_ State \_\_\_\_\_  
 Check  Money Order  C.O.D.



# The World's Most Popular ANTENNAS . . . NOW

Over **21,683**\* in Use!

The exciting new hy-gain Slim-Trap (only 1 1/4" in diameter) is the world's smallest, lightest weight trap assembly. Its high efficiency coil and capacitor circuit is wound on and completely imbedded in the new, low-loss, polypropylene plastic. It is unconditionally guaranteed to be completely impervious to all weather conditions. Power rating: 1000w AM, 2 KW (PEP).

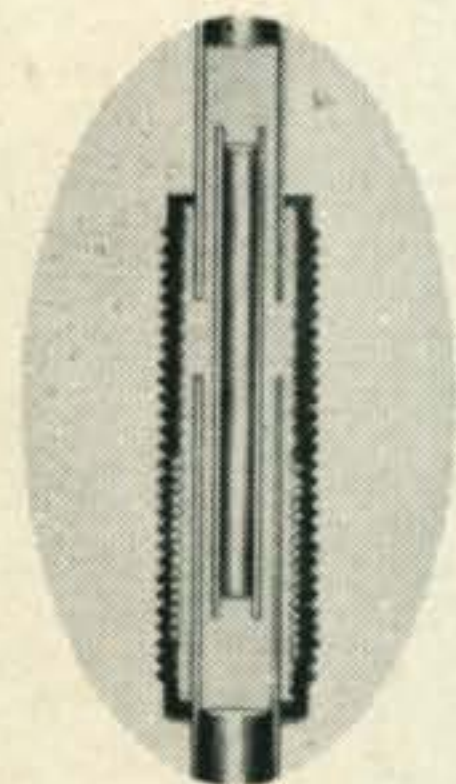

The Self-Supporting Hy-Gain Multiband Trap Verticals are completely factory pre-tuned with no further adjustment necessary, maintaining an SWR of 2:1 or less across the entirety of each band. 52 ohm coax feed line. True 1/4-wave marconi resonance on each band makes possible low angle DX radiation pattern. All top grade construction throughout. May be mounted on rooftops or directly on the ground.

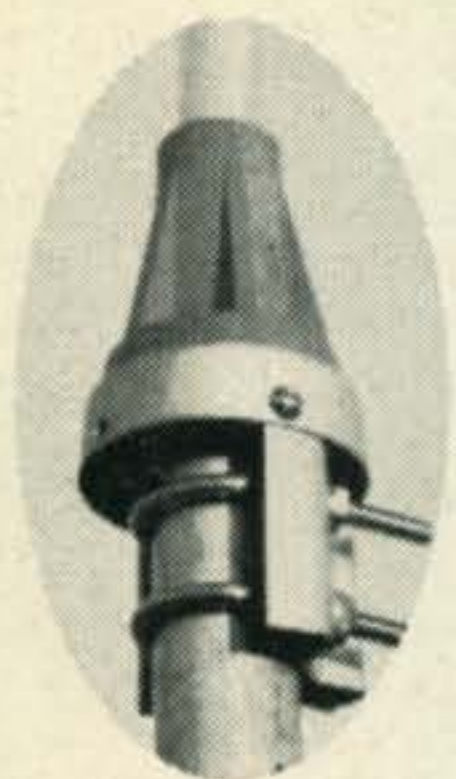

Ribbed cicolac base insulator makes these hy-gain verticals completely self-supporting. Heavy ten-gauge formed steel mounting bracket is adjustable for various sizes of masts. Weatherproof internal coaxial fittings supplied.

Model LC-80 Loading Coil (\$7.95) adds 80M operation to the 14-AVS Vertical. Decoupling Stub (\$4.95) adds 6M operation to both models 12 and 14 AVS.

**\$21<sup>95</sup>**

## 12 AVS VERTICAL

For 10, 15 and 20 Meters; 13.5 ft. high, 9 lbs.

**\$27<sup>95</sup>**

## 14 AVS VERTICAL

For 10-40 meters; 21 ft. high, 11 lbs. Includes Capacity Hat.

For quick and easy assembly on rooftop, the combination mast and radial roof mounting kit, complete, for either Vertical. 12-AVS kit: \$8.95. 14-AVS kit: \$9.95.

\*as of Jan. 1, 1961

THE **Lew Bonn** co.

Distributors of  
Nationally-Known Amateur Equipment  
Dept. C2, 1211 LaSalle, Minneapolis 3, Minn.  
Write to Bob, WØVVL

For further information, check number 13 on page 126.

106 • CQ • February, 1961

## SEMICONDUCTORS [from page 83]

The 50 mc signal from  $L_2$  drives the amplifier transistor which is biased in the same manner as the frequency doubler. However, the tank circuit of this stage ( $L_3$ ) is also tuned to 50 mc. The amplifier,  $Q_3$ , receives its collector voltage through the modulation transformer. The audio power causes the collector voltage to increase and decrease, thereby amplitude modulating the stage. R.f. output from  $Q_3$  is coupled to the antenna switching system.

### Modulator

The modulator used in the six meter station is identical to the one featured last month for two meters, and there is no need to dwell further on it. The switching circuit likewise, is identical. The converter requires 12 volts with a negative ground, while the transmitter requires the same voltage with a positive ground.

### Adjustments

The converter is extremely simple to adjust. First, determine that the oscillator is operating properly. Adjust coil  $L_5$  for the maximum change across resistor  $R_7$ , consistent with stable oscillator operation. Next feed in a source of six meter energy and peak coils  $L_1$ ,  $L_2$ ,  $L_3$ , and  $L_4$  for maximum signal in the desired portion of the band. If the builder desires to cover only the bottom megacycle of the band,  $C_9$  can be replaced with a gimmick, consisting of two pieces of plastic insulated wire. Twisting the wires together will increase the capacity. If the entire four mc of the band are desired, increase the value of  $C_9$  to 4.7 mmf. The number of turns and the position of the link on  $L_1$  can be adjusted for the best noise figure, if desired.

The transmitter is simplicity itself. Peak coil  $L_1$  for the maximum collector current in  $Q_2$ , consistent with stable oscillator operation. This can be checked by switching the oscillator on and off to see if it comes on each time. Next, peak coil  $L_2$  for the maximum collector current in the  $Q_3$  stage. Peak coil  $L_3$  for the maximum signal as indicated by a grid dip meter. Resonance of  $L_3$  will not be accompanied by the "dip" characteristic of tube transmitters. The collector current will increase in proportion to the load, however.

### On The Subject of Nickel Cadmium Cells

Ni-Cad represent a good investment for the amateur and experimenter for they can be used over-and-over simply by recharging the cell. A ham-rep for the Sonotone Corporation sent in an interesting application note on recharging such cells, a point which confuses many. Although the safe charging rate is stamped on each Sonotone cell, the following "rule-of-thumb" system can be used on any Ni-Cad battery.

To fully charge a cell, 140 percent of the rated ampere hour must put back into the cell. A voltage of 1.4 volts per cell is required for

[Continued on page 110]



# ★ WANTED ★

## LAFAYETTE

## "VOYAGER"



HE-25

**6 to 80 meter  
TRANSMITTER  
by AMATEURS  
EVERYWHERE**

for

- ★ SINGLE KNOB BANDSWITCHING 80 THROUGH 6 METER
- ★ 120 WATTS CW INPUT 80-10 METERS  
90 WATTS ON 6 METERS  
75 WATTS PHONE 80-10 METERS
- ★ PI-NETWORK OUTPUT -40-600 OHMS
- ★ "STRAIGHT THROUGH" OPERATION EVEN ON 6 METERS
- ★ SHAPED KEYING - ELIMINATES CHIRPS AND CLICKS
- ★ OUTSTANDING TVI SUPPRESSION
- ★ HIGH GAIN CLAMP TUBE MODULATION (UP TO 100%)
- ★ TUBE LINEUP-6AU6 Oscillator, 6DQ6A Buffer, 2-6DQ6A-Final Amplifier, 12AX7-Cascaded High Gain Speech Amplifier, 6AQ5-Clamper & Modulator, 5U4GB Rectifier

**REWARD!** OUTSTANDING PERFORMANCE AND UNMATCHED VERSATILITY AT A SENSATIONAL LOW PRICE

HE-25 "VOYAGER" TRANSMITTER Completely wired and tested with tubes, less crystal, key, and microphone.

5.00 Down

# 109<sup>50</sup>

**LAFAYETTE RADIO**  
165-08 LIBERTY AVENUE, JAMAICA 33, N. Y.

OTHER LOCATIONS

<b>NEW YORK, N. Y.</b> 100 6th Avenue	<b>NEWARK, N. J.</b> 24 Central Avenue	<b>BRONX, N. Y.</b> 542 E. Fordham Rd.
<b>PARAMUS, N. J.</b> 182 Route 17	<b>BOSTON, MASS.</b> 110 Federal Street	<b>PLAINFIELD, N. J.</b> 139 W. 2nd Street



★★★★★★★★★★★★★★★★★★★★  
Lafayette Radio, Dept. CB-1  
P.O. Box 190  
Jamaica 31, New York



Send me the FREE Lafayette 324 page 1961 catalog 610

Name .....

Address .....

City..... Zone..... State.....

For further information, check number 21 on page 126.



# THE CQ HAM MART



## 19" GLOBE

Here is a chance to preserve your breath for posterity! This beautiful World Globe, made by Hammond, is a must for every hamshack. Plain for \$19.95 or lighted for \$24.95. The first 10,000 people who jump at this bargain will get a year of CQ at no extra charge.

## ATLAS

What! You don't know where Nicobar Island is? Incredible! And with the CQ deal on the Hammond Atlas so reasonable too. This is a reference book that will get good usage around your house if you have any kids. 7 lbs. of colored maps and a gazetteer for only \$12.50... and you get a year of CQ.

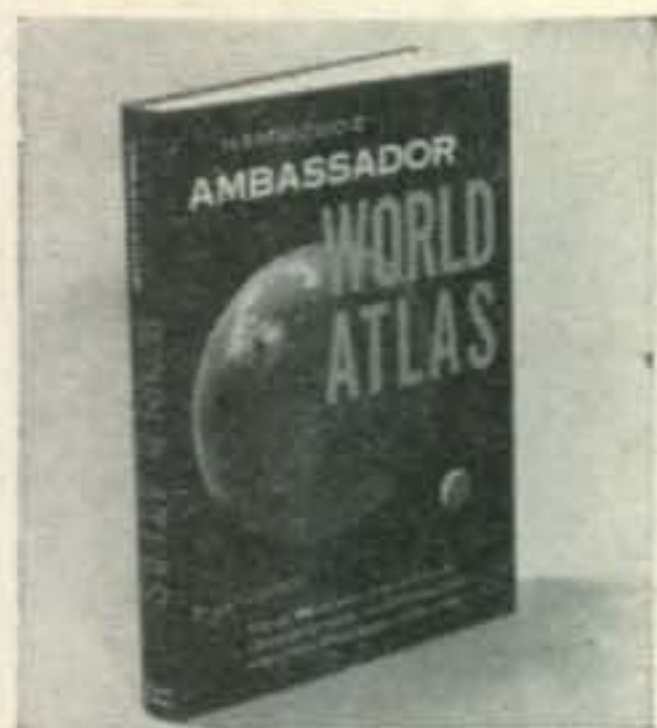

## COMMAND SETS

This IS a collection of reprints, containing all of the available information on the conversion of the popular "Command" transmitters and receivers into good ham transmitters and receivers. Invaluable for Novice, Technician, General, Advanced and Extra class operators. 136 fabulous, amazing terrific pages for only \$1.50 postpaid.



## MOBILE HANDBOOK

Anyone who tries to go mobile without getting this book should register for a sanity hearing. Bill Orr, W6SAI has put everything you need to know in this book. Build-its by the dozen... solutions to ignition problems, keeping the battery charged, noise... only \$2.95 postpaid.



## CODE RECORD

Learning code is a snap with this record. Speeds from 3 to 16 WPM, depending upon turntable speed. This 12" LP record has on it all you need to learn the code for both the Novice and General License. \$3.50 each.

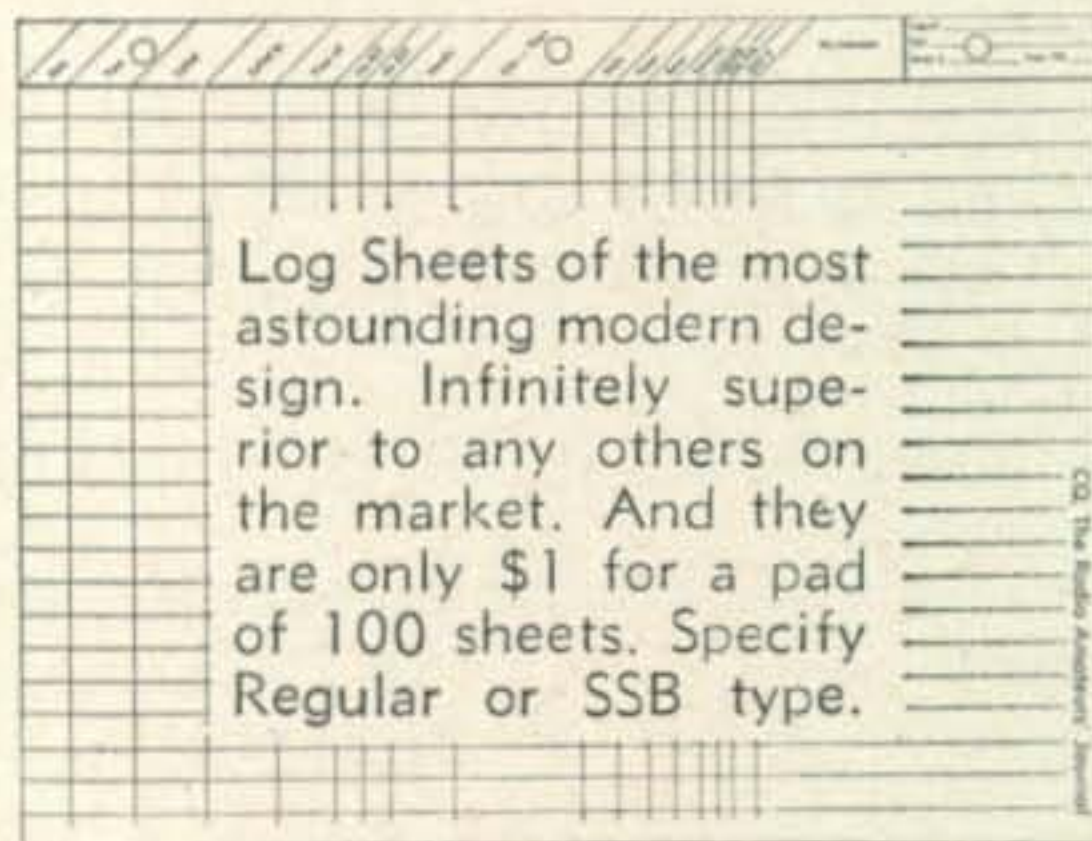

Log Sheets of the most astounding modern design. Infinitely superior to any others on the market. And they are only \$1 for a pad of 100 sheets. Specify Regular or SSB type.

## HAM'S INTERPRETER

Now you can talk in broken French, Spanish, Italian, German, Swedish and Finnish. This handy little book gives all the popular ham conversation in seven languages, including letters and numbers. Only \$1.50 postpaid.



## TVI HANDBOOK

W1DBM's newly written TVI book (2nd edition) covers all aspects of curing TVI from both the Ham's viewpoint and that of the TV viewer or the TV serviceman. It includes 2- and 6-meter TVI as well as Citizen's Band, Industrial, Medical and Utility TVI. Profusely illustrated with diagrams, photos, charts, tables and FCC regulations pertaining to radio and television interference. Price \$1.75 postpaid, USA, \$2.00 Foreign.



## BINDER

There is no other good way to keep your back issues. Make 'em neat. We supply the binder, with the year embossed in gold, not merely a sticker which will come off later. Specify what year you want stamped on your binder. \$3.50 each.

## BOUND VOLUME

By far the handiest way to keep your library. Why not go first-class? This impressive volume is only \$10.00. We only made a few of them this year, so Don't expect to get one later.







### CQ ANTHOLOGY

Most amateurs do not have a good file of back issues of CQ. So we've looked back through the years 1945-52 and assembled all in one place the articles that have made a lasting stir. The issues containing most of these articles have long ago been sold out. The price is a paltry \$2.00.

### DX ZONE MAP

Brand New! Amateur Radio World-Wide DX & Zone Map complete, accurate and up to the minute with Prefix, Zone Boundaries, Great Circle beam bearings. 4 Colors, 36 by 42 inches on heavy vellum map paper. Mailed in heavy cardboard mailing tube. Only \$3.00.

### ALL ABOUT MISSILES & SATELLITES

Here's a book, written in down-to-earth language, which answers questions on missile maintenance, fire control, flight control tracking, testing, fuels, payload and many other achievements in rocketry and space for both scientific and military applications. Also, featuring the most up-to-date "Directory of 38 Most Popular Missiles and Their Photos," (supplied by Department of Defense) as well as a "Glossary of Missile Terms." \$1.50 per copy.

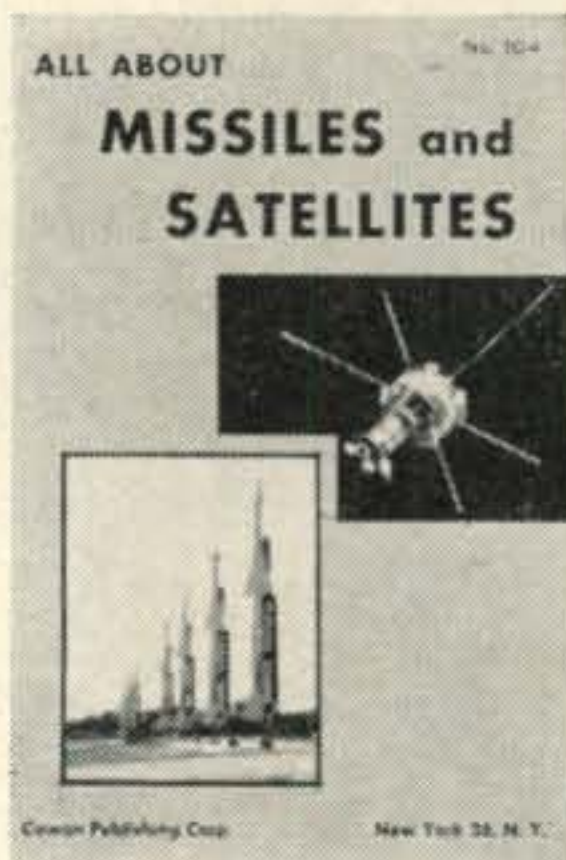

### HI-FI BOOK

This nifty volume contains the latest dope on amplifiers, preamplifiers and equalizers plus a buyer's guide of component manufacturers! Over 150 — 5½" x 8½" pages of heavily illustrated descriptions covering Hi Fi Audio Components—the greatest publication value in its field today. Only \$2.50 per copy.



### SIDEBAND HANDBOOK

Written by Don Stoner, W6TNS, was almost one full year in the preparation of this terrific volume. This is not a technical book. It explains sideband, showing you how to get along with it... how to keep your rig working right... how to know when it isn't... and lots of how to build-it stuff, gadgets, receiving adaptors, excitors, amplifiers. Price, only \$3.00.

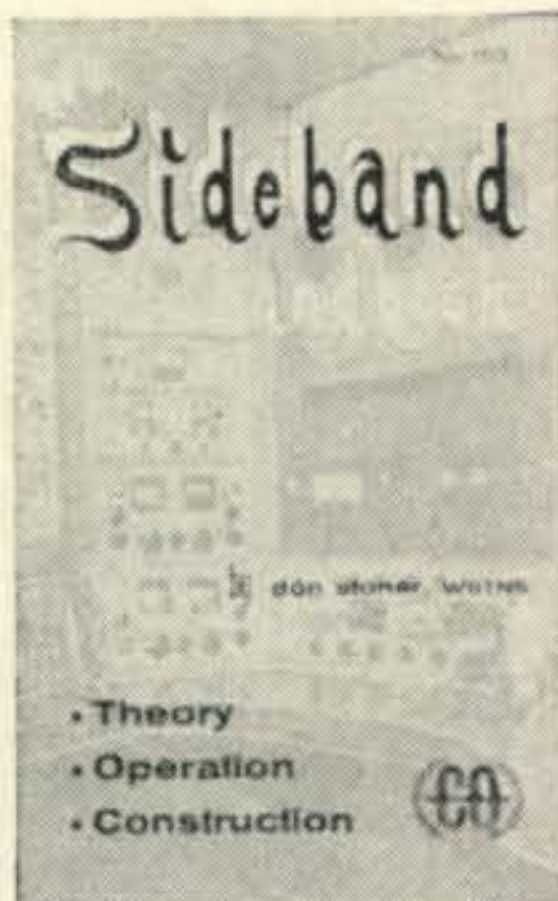

**COWAN PUBLISHING CORP. CQ-2**  
**Book Division**  
**300 West 43rd Street**  
**New York 36, N. Y.**

- LIGHTED GLOBE ..... \$24.95
- UNLIGHTED GLOBE ..... 19.95
- ATLAS ..... 12.50
- COMMAND SETS ..... 1.50
- MOBILE HANDBOOK ..... 2.95
- CODE RECORD ..... 3.50
- REGULAR LOG SHEETS (100) ..... 1.00
- SSB LOG SHEETS (100) ..... 1.00
- HAM'S INTERPRETER ..... 1.50
- TVI HANDBOOK ..... 1.75
- BINDER—YEAR WANTED ..... 3.50
- BOUND VOLUME ..... 10.00
- CQ ANTHOLOGY ..... 2.00
- MISSILES & SATELLITES ..... 1.50
- HI-FI BOOK ..... 2.50
- SIDEBAND HANDBOOK ..... 3.00
- CQ LICENSE GUIDE ..... 2.50
- SURPLUS SCHEMATICS HANDBOOK ..... 2.50
- DX ZONE MAP ..... 3.00

SIRS: My check (money order) for \$\_\_\_\_\_ is enclosed. Please send the following items to:

Name \_\_\_\_\_

Address \_\_\_\_\_

City \_\_\_\_\_ Zone \_\_\_\_\_ State \_\_\_\_\_

New York City Residents Add 3% Sales Tax

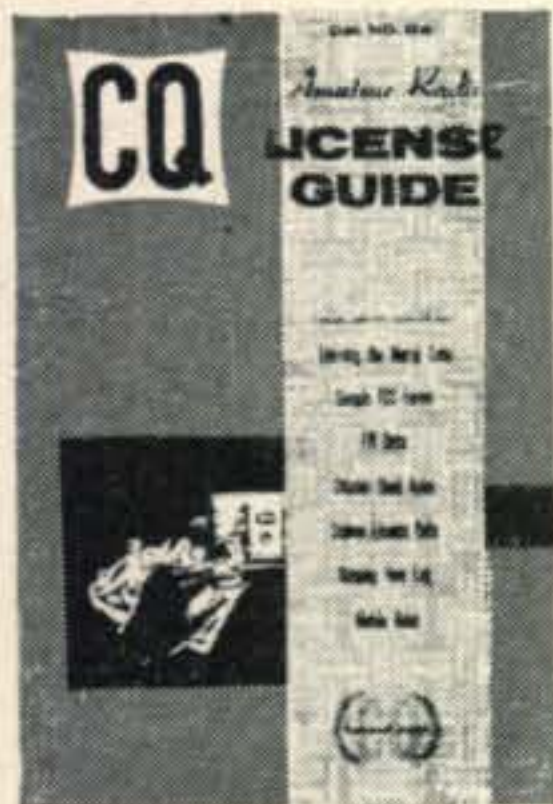

### CQ LICENSE GUIDE

212 pages of everything the Amateur must have to get his license and progress toward the general class ticket. Plus many additional pages of vital information for the ham operator. All this for only \$2.50.

### SURPLUS SCHEMATICS HANDBOOK

This is a book literally loaded with schematics for all the currently popular pieces of surplus gear. Most amateurs are well aware of the problems encountered in purchasing seemingly inexpensive surplus units, only to find that no schematic diagram is available. Trying to figure out the circuitry cold turkey can be many times more difficult than the most involved puzzle, and purchasing a single instruction book can run as high as \$3.50. Why knock yourself out when you can have a book with complete coverage on hand in your library? All this for only \$2.50.







# CITIZEN BAND CLASS "D" CRYSTALS

All 22 Frequencies in Stock

3rd overtone, .005% tolerance—to meet all F C C requirements. Hermetically sealed HC6/U holders, 1/2" pin spacing—.050 pins. (.093 pins available, add 15¢ per crystal).

**\$2.95 EACH**

The following Class "D" Citizen Band frequencies in stock (frequencies listed in megacycles): 26.965, 26.975, 26.985, 27.005, 27.015, 27.025, 27.035, 27.055, 27.065, 27.075, 27.085, 27.105, 27.115, 27.125, 27.135, 27.155, 27.165, 27.175, 27.185, 27.205, 27.215, 27.225.

Matched crystal sets for Globe, Gosnet, Citi-Fone and Hallcrafters Units . . . \$5.90 per set. Specify equipment make.

## RADIO CONTROL CRYSTALS IN HC6/U HOLDERS

Specify frequency, 1/2" pin spacing . . . pin diameter .05 (.093 pin diameter, add 15c) . . . \$2.95 ea.

### FUNDAMENTAL FREQ. SEALED CRYSTALS

in HC6/U holders  
From 1400 KC to 4000 KC .005% Tolerance . . . \$4.95 ea.  
From 4000 KC to 15,000 KC any frequency .005% Tolerance . . . \$3.50 ea.

### SEALED OVERTONE CRYSTALS

Supplied in metal HC6/U holders  
Pin spacing .486, diameter .050  
15 to 30 MC .005 Tolerance . . . \$3.85 ea.  
30 to 45 MC .005 Tolerance . . . \$4.10 ea.  
45 to 60 MC .005 Tolerance . . . \$4.50 ea.



## QUARTZ CRYSTALS FOR EVERY SERVICE

All crystals made from Grade "A" imported quartz—ground and etched to exact frequencies. Unconditionally guaranteed! Supplied in:

FT-243 holders Pin spacing 1/2" Pin diameter .093	MC-7 holders Pin spacing 3/4" Pin diameter .125
DC-34 holders Pin spacing 3/4" Pin diameter .156	FT-171 holders Pin spacing 3/4" Banana pins

<b>MADE TO ORDER CRYSTALS</b>	Specify holder wanted
1001 KC to 2600 KC:	
.01% tolerance . . . . .	\$2.00 ea.
.005% tolerance . . . . .	\$2.75 ea.
2601 KC to 9000 KC:	
.005% tolerance . . . . .	\$2.50 ea.
.005% tolerance . . . . .	\$3.00 ea.

### Amateur, Novice, Technician Band Crystals

.01% Tolerance . . . \$1.50 ea.—80 meters (3701-3749 KC), 40 meters (7152-7198 KC), 15 meters (7034-7082 KC), 6 meters (8335-8650 KC) within 1 KC  
FT-241 Lattice Crystals in all frequencies from 370 KC to 540 KC (all except 455 KC and 500 KC) . . . 50¢ ea.  
Pin spacing 1/2" Pin diameter .093  
Matched pairs ± 15 cycles \$2.50 per pair  
200 KC Crystals, \$2.00 ea.; 455 KC Crystals, \$1.50 ea.; 500 KC Crystals, \$1.50 ea.; 100 KC Frequency Standard Crystals in HC6/U holders \$4.50 ea.; Socket for FT-243 crystal 15¢ ea.; Dual socket for FT-243 crystals, 15¢ ea.; Sockets for MC-7 and FT-171 crystals 25¢ ea.; Ceramic socket for HC6/U crystals 20¢ ea.  
Write for new free catalog #860 complete with oscillator circuits

**ASK YOUR PARTS DEALER FOR TEXAS CRYSTALS**  
See big red display . . . if he doesn't stock them, send us his name and order direct from our Florida factory.

**NOW!** Engineering samples and small quantities for prototypes now made either at Chicago or Ft. Myers Plant. 24 Hour Service!  
IN CHICAGO, PHONE GLadstone 3-3555

### RUSH YOUR ORDER TO OUR NEW PLANT

Use coupon below for 1st Class shipment.

## TEXAS CRYSTALS

Dept. C-21, 1000 CRYSTAL DRIVE, FORT MYERS, FLORIDA  
For extra fast service, Phone WE 6-2100

**ATTACH THIS COUPON TO YOUR ORDER FOR SHIPMENT VIA 1ST CLASS MAIL AT NO EXTRA COST**

**TERMS:** All items subject to prior sale and change of price without notice. All crystal orders must be accompanied by check, cash or M.O. with **PAYMENT IN FULL.** No COD's. Dept. C-21

For further information, check number 22 on page 126.

## SEMICONDUCTORS [from page 106]

the unit to accept a charge. Any number of cells can be charged in series but only the larger cells are recommended for parallel charging. The current must be held within a safe rate by a current limiting resistor.

To figure the charging voltage required, multiply the number of cells in series by 1.4 times 3, or 4.2 volts per cell. This voltage figure is what the charger should deliver with no load. To calculate the resistance of the current limiter, we must know the voltage drop across it. This is determined by deducting the number of cells times 1.4 volts to arrive at the voltage drop across the limiting resistor. Then by Ohm's Law ( $R=E/I$ ) limiting resistor value.

As an example let's say we want to charge eight Sonotone 1/2D cells, which require a 40 ma charging current. We would multiply the eight cells by 1.4 times 3, arriving at 33.6 volts. The eight cells would require 11.2 volts so the resistor would have to drop the other 22.4 volts. Ohm's Law provides the answer; a resistance value of 560 ohms. The wattage value of the limiting resistor is found by Ohm's Law again. As an example, it would be  $W$  equals 22.4 times 0.040 or 0.8961 watts. Thus a 1-watt resistor would be adequate.

If you would like more information on the Sonotone line, drop a card or letter to Texas Electronics Komponenten Ko., (TEKKO) Box 6567, Dallas 19, Texas. They will be happy to send catalog sheets and charger bulletin free of charge.

## Semiconductor News

CBS Electronics, Danvers, Mass. is now marketing a micro-alloy transistor type 2N393. The device is used in direct coupled logic circuits, and is supplied in the TO-24 package (usually associated with surface barrier transistors).

Have you been confused by replacing transistors in the tiny Japanese transistor portable radios? It would appear that quite a few have, for Electronic Transistors Corp., 9226 Hudson Blvd., North Bergen, New Jersey, is producing a line of transistor for replacement purposes, in these radios. To further simplify the job, ETCO will supply interested persons with a complete interchangeability chart along with a price list for the new types. Drop 'em a line at the above address.

Although it's not free, the new General Electric Transistor manual is one of the finest works on the subject published. The latest, edition five, has been expanded and now include tunnel diode theory including switching circuits, amplifiers, in addition to servo amplifiers, test circuits, silicon controlled rectifiers and many other items. GE points out that this amazing book has been translated into Japanese, Spanish, Portuguese and Turkish. One-half million copies of the manual have been published to date, permitting the low price of \$1.00 each. See your local GE distributor.



**"CALL ME  
for  
Personal Service"**

**"CALL ME  
for  
Personal Service"**

Bob Henry  
WØARA  
Butler, Mo.  
ORchard 9-3127



**ON**

Ted Henry  
W6UOU  
Los Angeles  
GRanite 7-6701



**WORLD'S  
BEST TERMS**

**Because we finance  
our own terms...**

- Only 6% a year finance cost
- 20 months or longer to pay
- Only 10% down (or your trade-in as down payment)
- No finance charges if paid within 90 days
- Reduced charges if paid off ahead of time
- You get more flexibility of financing in the future (such as re-financing) because we handle our own financing

**Collins  
S/LINE**



**A-1 Reconditioned  
Apparatus**

Nearly all makes and models. Big savings!  
Ten day trial—90 day warranty. 90 day full  
trade back on new apparatus. Write for  
bulletin.

KWM-2 Transceiver .....	\$1150.00
32S-1 Transmitter .....	666.00
516F-2 AC Power Supply .....	115.00
516E-1 12 V DC Power Supply .....	270.00
75S-1 Receiver .....	520.00
312B-3 Speaker .....	29.00
312B-4 Speaker Console .....	195.00
30S-1 Linear Amplifier .....	1556.00

Write, phone or visit either store today!  
Inquiries & orders from military men  
and others outside USA wanted.

Butler 1, Missouri  
ORchard 9-3127

**Henry Radio Stores**

11240 West Olympic Blvd.  
Los Angeles 64 Ph. GRanite 7-6701

**BIG  
TRADE-INS**

**World's Largest Distributors of Short Wave Receivers**

For further information, check number 23 on page 126.



# Why don't you **Talk** WITH **Westinghouse** about **FIELD ENGINEERING**



Deskbound? Investigate the field engineering opportunities at Westinghouse-Baltimore. Advance your career while participating in an exciting global operation. Westinghouse Field Engineers receive intensive training on the latest electronic developments . . . and utilize that training in providing engineering liaison for Westinghouse at a myriad of interesting locations . . . assisting and instructing others in the operation and maintenance of Missile Guidance, Airborne Radar and Fire Control, Heavy Ground Radar, Microwave Communications, Shipborne Radar, and many other advanced military electronic programs. An engineering degree or equivalent is required. Those accepted will receive liberal fringe benefits and a salary commensurate with experience.

Send resume to: Mr. J. F. Caldwell, Dept. 355

## Westinghouse



### BALTIMORE

P. O. BOX 746 Baltimore 3, Maryland  
AIR ARM • ELECTRONICS • ORDNANCE

General Transistor, 65 Gouverneur St., Newark 4, New Jersey, have generated several application notes and catalog sheets of interest to amateurs and experimenters. Their bulletins on diode coupling and clamp circuits (vol. 10, nos. 3 and 4) are most interesting. Their catalog of germanium devices contains a wealth of information, too. GT is also producing a new line of 10 watt voltage regulator diodes with sharp knees and extremely low dynamic impedances. The silicon types 1N1801, 1N2044 through 1N2049, and 1N1351 through 1N1362 are currently available.

The latest issue of SPAN, published by Hoffman Corp., 1001 Arden Drive, El Monte, Calif., contains an interesting discussion of voltage regulator diode surge ratings and a technical description and applications for the new Hoffman Uni-Tunnel Diode. By the way, a tunnel diode ten meter transmitter circuit is reproduced in fig. 3, for the benefit of experimenters, courtesy of SPAN.

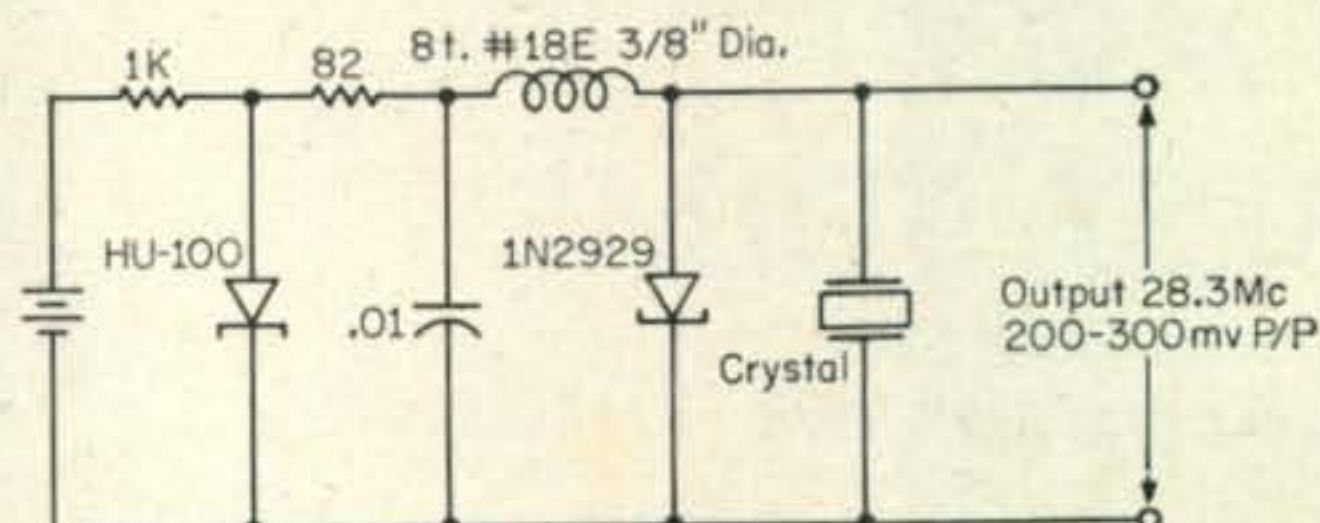

Fig. 3—Tunnel diode transmitter for 10 meters.

International Rectifier Corporation, El Segundo, Calif., has just announced a new series of compact 5 to 50 ampere silicon rectifier stacks for "close-quarter" circuitry. The devices are available in 50 to 500 p.i.v. ratings.

A new material forms company, Kollstand Semiconductor Elements, Inc., Golden, Colorado, is supplying high volume production of Czochralski and float zone single crystal slices, dice and special silicon and germanium forms.

Minneapolis-Honeywell, Minneapolis, Minnesota, has just announced a new line of medium power transistors, types 2N539, 2N540, 2N1658 and 2N1659. In addition to data sheets, applications notes on voltage regulator and audio amplifiers (AN1C and AN2A) are available along with their short form catalog.



Pacific Semiconductor, Hawthorne, Calif., long the leader in high frequency-high power transistor, has done it again with their new PT530. This amazing device, of the silicon triple diffused mesa type, is described as a medium power v.h.f. communications transistor. The new unit is characterized by a power output of five watts at 30 mc, with a power gain of 10 db minimum at 28 volts  $E_c$ . The PT530 delivers useful oscillator power to 200 mc. The physical structure of the transistor is an n.p.n.n. configuration. The line emitter, dual base contacts, and low collector region resistance result in a device optimized for v.h.f. power operation. In the manufacturing process an exclusive etch-rinse sequence assures contaminant-free silicon surfaces. Absorbed gas-





**HERE IT  
IS AT  
HARVEY**

# THE COLLINS KWM-2 TRANSCEIVER

Distinctive modern styling and easy mobility make the lightweight KWM-2 an attractive unit for the **CAR**  **BOAT**  **AIRPLANE**  or fixed station.

Featuring operation on all bands between 3.4 mc and 30 mc on either voice or CW, the KWM-2 has the quality and performance of the time-proven KWM-1 and famous Collins S/Line.

Filter type SSB generation and crystal-controlled double conversion also are features of the KWM-2, in addition to VOX and speaker anti-trip circuits. ALC keeps the signal adjusted to its rated PEP resulting in an increased average talk power.

The KWM-2 is easily moved between mobile and fixed station installations. For mobile use, the transceiver slides into the mount and the power, antenna, selector and car radio speaker plugs connect automatically. These same four connectors are used in a fixed station installation.

The KWM-2 mobile transceiver transmits on SSB or CW with a nominal output of 100 watts for complete coverage on all amateur bands. Any of fourteen 200 kc segments of the 3.4-30.0 mc frequency range may be utilized except the 5.0-6.5 mc range on transmitting. Other frequencies (such as MARS) outside the amateur bands may be obtained by inserting the proper crystals.

**PRICE — \$1150.00**

Type/Description	Net Price
516E-1 DC Power Supply .....	\$270.00
351D-2 Mobile Mount .....	\$120.00
351E-4 Mounting Tray .....	\$15.00
516F-2 AC Power Supply .....	\$115.00
312-B5 Speaker Console .....	\$350.00
30S-1 Linear Amplifier .....	\$1556.00
136B-2 Noise Blanker .....	\$124.00

*For complete versatility in either fixed station or mobile use, Harvey has a full line of Collins accessories for the KWM-2.*



**HARVEY**

Estab. 1927

**RADIO CO., INC.**

103 West 43rd Street, New York 36, N. Y. **JU 2-1500**

HARVEY is known the world over, as a reliable source for Ham Equipment. All orders shipped same day received. If you want to talk SWAPS and DEALS write or call **W2DIO**.

For further information, check number 24 on page 126.



# GUARANTEED CRYSTALS!

**BUY NOW AND SAVE!!**

ALL MARINE FREQ.-FT-243, DC-34 Holders. Tol. .005.....	\$2.00
POLICE, C.A.P., CD, MARS. Tol. .01%.....	\$1.60
CITIZENS BAND—11 METERS—.005% TOL.	
26.965 to 27.225 MC, 3rd Over. Herm. Seal. or FT-243.....	\$2.50
13.4825 to 13.6125 MC, 2nd Harm. Herm. Seal. or FT-243.....	\$2.50
6741.25 to 6806.25 Kc, 4th Harm. FT-243 only.....	\$2.00

**SPECIAL!  
STOCK CRYSTALS**

FT-243 Holders 5700 KC to 8650 KC  
in steps of 25 KC's  
DC-34 Holders 1690 KC to 4440 KC  
steps of 10 KC

SEND FOR FREE CATALOG

**50¢  
ea.**

**NOVICE BAND FT-243 Fund.**

80 Met. 3701-3748—Steps of 1 KC. FT-243  
40 Met. 7150-7198—Steps of 1 KC. FT-243  
Dbl. to 40 Met. 3576-3599. Steps of 1 KC. FT-243  
15 Met. 5276-5312—7034-7083 Steps of 1 KC. FT-243

**86¢  
ea.**

FT-243—2 Meters (Steps of 1 KC) .....	\$ .93
FT-243—6 Meters (Steps of 1 KC) .....	\$ .93
FT-243—From 3000-4000 .....	\$ .93
FT-243—From 1005-2999 (Steps of 5 KC) .....	\$2.39
FT-241 SSB Low Freq. Xtals 370 to 540 KC (Steps of 1.852 and 1.388) .....	\$ .49
FT-241 SSB Matched Pairs .....	\$1.95

Open Friday Evenings until 9 P.M.

Include 5c per crystal for postage (U. S. Only) Calif. add 4% Tax. No. C.O.D.'S. Prices subject to change. Ind. 2nd choice; substitution may be necessary. Min. Order \$2.50.

"The House of Crystals"

**U. S. CRYSTALS, Inc.**  
1342 S. La Brea Ave. Los Angeles 19, Cal.

For further information, check number 25 on page 126.

## For Perfect Code

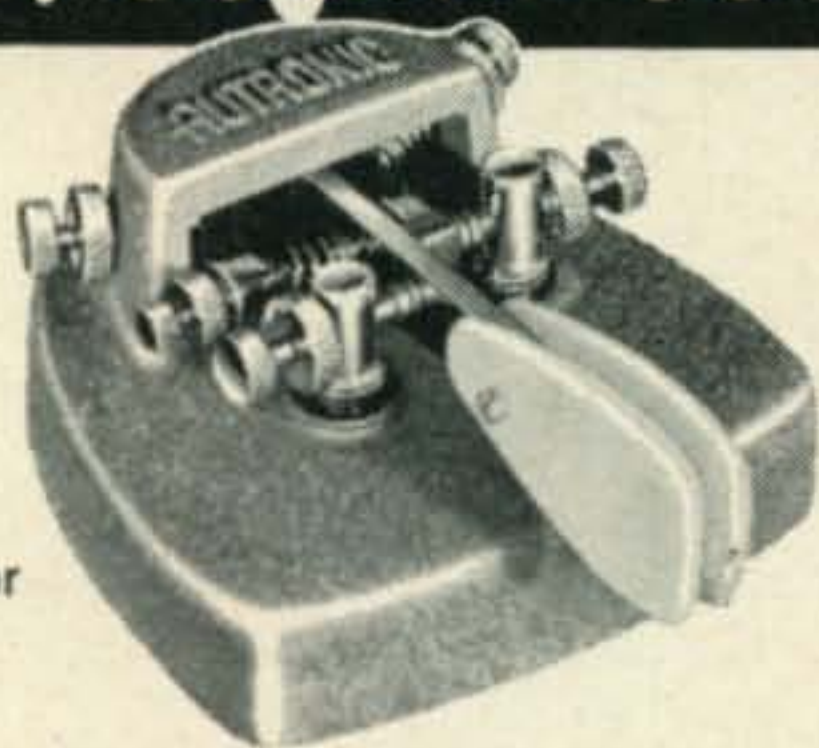

\*Approved for Gov't tests

**AUTRONIC KEY**—For better, faster CW. Easy to use. Velvet touch. Heavy silver alloy contacts. Fully adjustable. Superior quality to last a lifetime. Contact bounce eliminated regardless of lever movement or keying pressure. Properly weighted base will not walk. Attractive and streamlined...3" x 3½". Can be used with any electronic keyer.



**AUTRONIC KEYSER**—For better DX. All transistorized with improved digital circuitry...no relays or tubes. Compact and lightweight for portability. (7" x 5" x 2")

Can be used automatic or semi-automatic. Precisely proportions each dot, dash, and space...all self completing. Makes the novice sound like a pro, and takes out all the work for the OT. Superior readability...makes CW a real pleasure. Instantly variable speed from 6 to 45 wpm. Self contained speaker for monitoring or code practice. Use vertically or horizontally in any type of fixed or mobile station.

**ELECTROPHYSICS CORP.**  
2500 West Coast Highway  
Newport Beach, California

See your dealer or write direct for info and prices.

For further information, check number 39 on page 126.

eous contaminants are eliminated by a high temperature vacuum bakeout immediately prior to sealing the package. Slightly anticlimatic is news of PSI's improved 2N697 switching transistor. The new type, a 2N1837 has half the  $C_e$  voltage drop of the earlier type, nearly three times the small signal beta, and half the collector capacity and leakage current.

RCA, Somerville, N. J., has announced a new type of transistor for the hi-fi industry. The device is described as a "drift-field" power type which incorporates special processing techniques. The transistor is a PNP germanium type and can be used in both Class A and B audio amplifiers. An alloyed emitter, diffused collector and graded base manufacturing technique is used.

Sylvania Electric, Woburn, Mass., has introduced a new series of PNP germanium transistors for audio, servo, and motor control applications. The series, types 2N1372 to 2N1381 are very competitively priced; for example the popular 2N1380 is 50 cents in quantities of 100.

For another month, 73, de Don, W6TNS

### NOVICE [from page 79]

home brew beam. Frank is a member of the Arrowhead Radio Amateurs, in Duluth.

Dwight E. Cochran, KN9ZLA, 3517 Franklin St., Highland, Indiana, "haunts" the 80 meter band, and has extracted a WAS of 26/22 from it with his rock crusher. "Pepper," as he is known to his friends, suggests that if you want to get out on 80, get up about 0500 CST with the chickens.

William Christy, 112 Atlantic Avenue, New Kensington, Penna., (see photo) goes by the call of KN3MRH and is active on 40 with a Lysco 600 and National HRO-M receiver. Bill was just elected secretary of the Allegheny Kiski Amateur Radio Assoc. for 1961.

Dennis L. Brager, KN9ZYU, RFD #2, Box #2, Mount Horeb, Illinois is a friend of our



Bill Christy, KN3MRH, looks like he just hooked a new one!



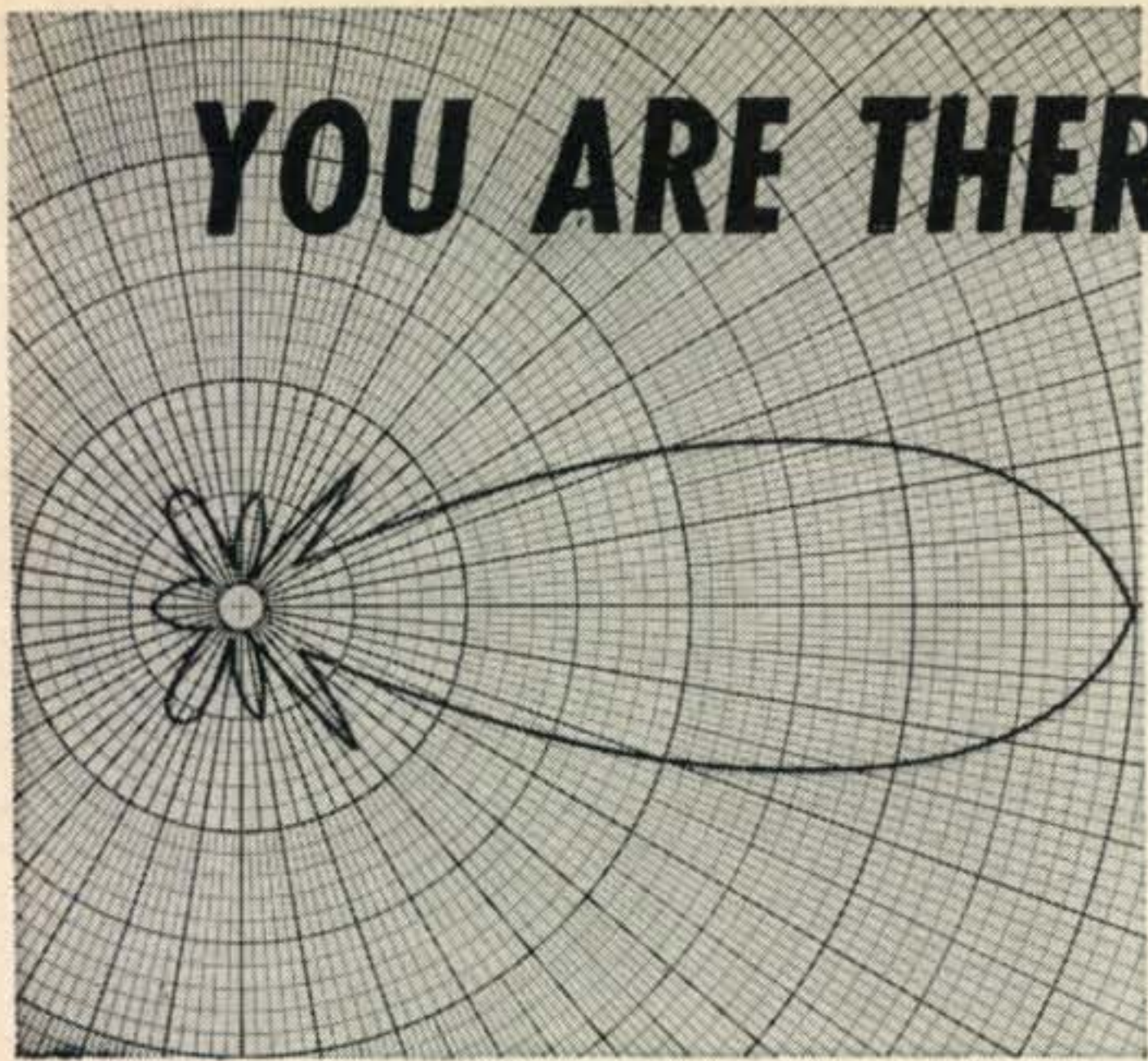

**YOU ARE THERE!**

**with telrex**

—“the-performance-line”—  
with a “MATERIAL” difference!

Send for (or, at your distributor), PL 77 Technical Specifications and Performance Bulletin describing 106 Antennas from 3/4 through 80 meters including “BALUN”—FED ROTATABLE DIPOLES, MONO, DUO, TRI, 4-BAND AND “SPIRALRAY” ANTENNAS, ROTATOR/INDICATOR SYSTEMS, TOWERS, BROAD-BAND “BALUNS,” ACCESSORIES AND “NICE-TO-HAVE-AROUND-YOUR-SHACK” INFO.

For TOP-MAN-ON-THE-FREQUENCY results...

Install a Telrex antenna...dollar for dollar better in every way! Antenna systems from \$6.95 to \$12,000.00

ANTENNAS Communication and TV Antennas  
SINCE 1921 **telrex** LABORATORIES  
ASBURY PARK 42, NEW JERSEY, U.S.A.

For further information, check number 26 on page 126.

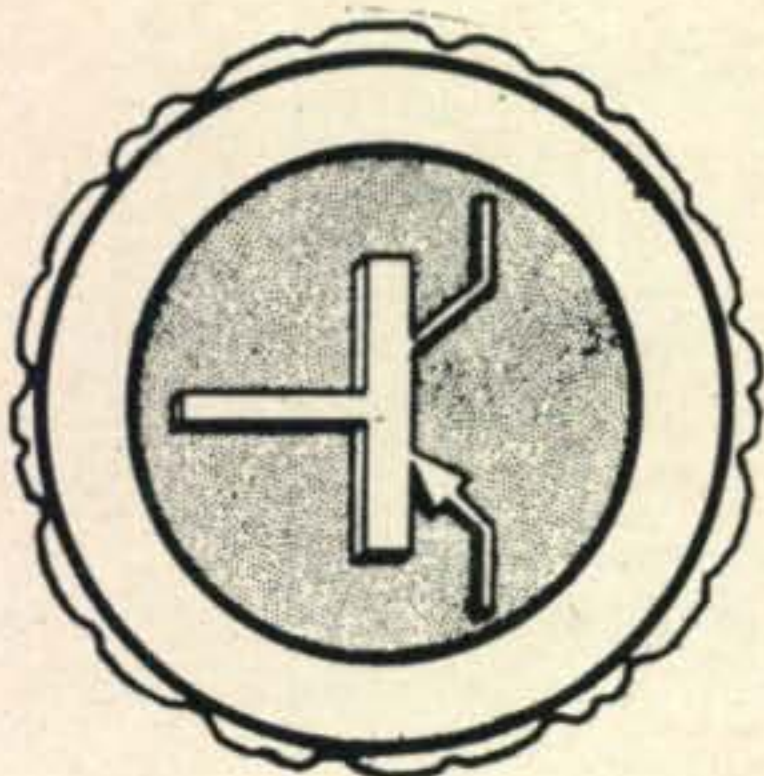

**STONER  
ELECTRONIC  
SALES  
CO.**

**TRANSISTORIZED SIX METER STATION**

Converter Epoxy Circuit Board and PC Coils .....	\$ 3.50
Converter Transistors and parametric diode .....	\$10.00
Transmitter Epoxy Circuit Board and PC Coils .....	\$ 3.50
Transmitter Transistor Set .....	\$ 9.00
Mini-Modulator Circuit Board (XXXP) .....	\$ 1.00
Mini-Modulator Transistor Set .....	\$ 2.00
Modulation Transformer .....	\$ 1.65
Complete Set, With Instructions, Postage Paid .....	\$29.95

STONER ELECTRONIC SALES CO., Box 7388, Alta Loma California

For further information, check number 27 on page 126.

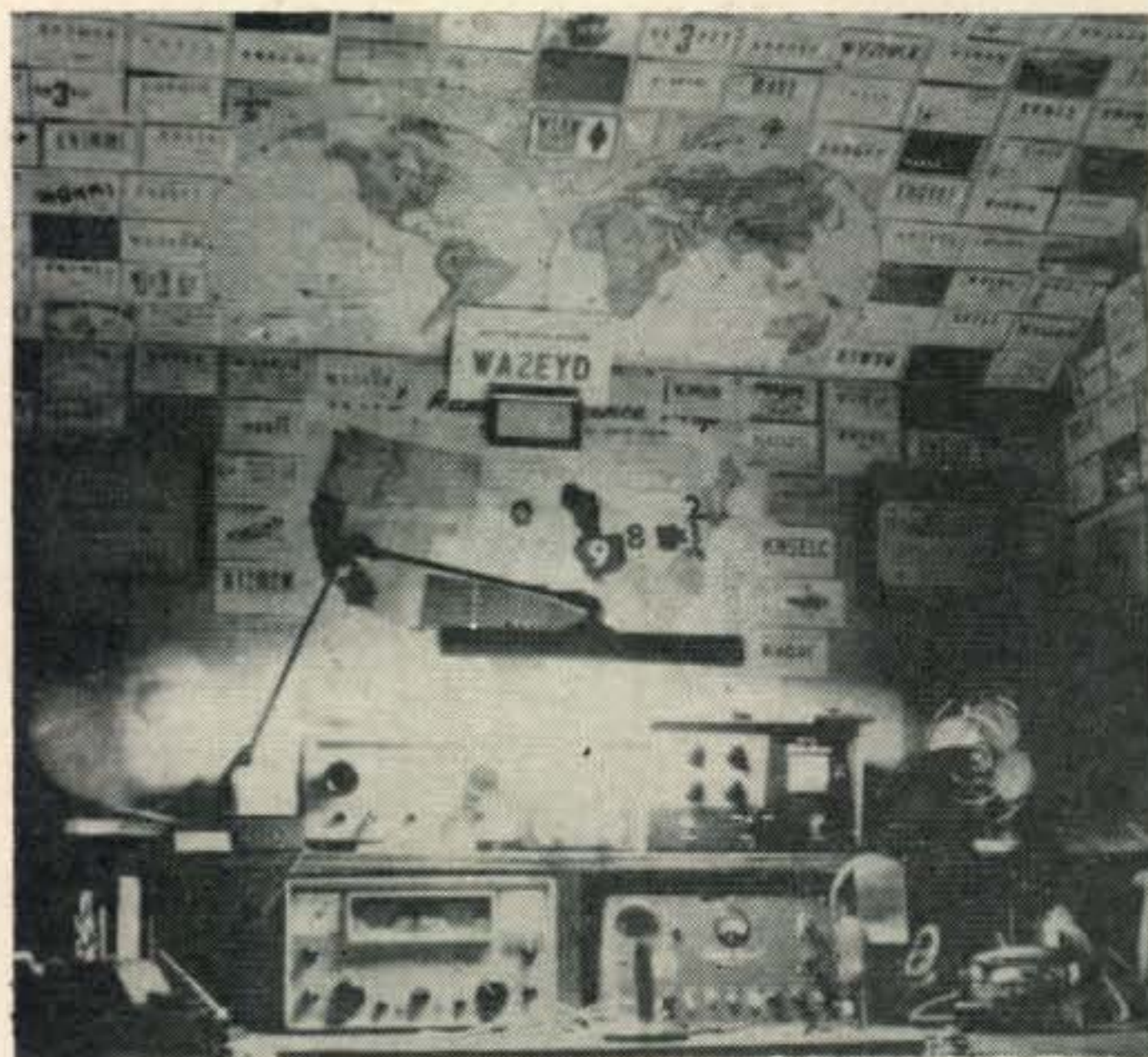

Pete Crosby, WA2EYD, has so much “wall paper,” he has to extend it to the ceiling! Not shown is Pete’s all-band trap antenna.

featured Novice for this month. Dennis got his ticket around the 1st of September 60, and has worked 30/26 so far, with a Globe Scout 680-A, pulling 'em in with an HQ-100C, tickeling dipoles on 80 and his favorite band, 40.

Pete Crosby, WA2EYD, 108 Waverly St., Cattaraugus, New York, only recently graduated from the Novice ranks, but is still one at heart. Pete says “One Saturday during August '57, at the tender age of 17, I ran across a magazine called CQ, from that moment on, my life was to take on a strange new hobby. I must admit that most of the first copy was a complete mystery to me. I even had trouble understanding the ads!” Early in '58 Pete got his start from the “Help Wanted” section of the column and received call letters K2TVA. Pete’s WAS stands at 45/44 and DX is now 4/4. You can see his lash-up in the photo.

That empties the folder marked “Novice” for another month. Until 30 more

73, de Don, W6TNS



**SAVE 20%  
BUY DIRECT**

**You can now buy this  
VOXBOX at BIG SAVINGS**



A voice-controlled relay device for voice-operated "break-in" with any voice modulated rig either fixed or mobile. Gives you tremendous advantage in contest operating, traffic handling, telephone type conversation and "two hands on the wheel" mobiling.

~~\$35.70~~

Buy direct for only

**\$28.56**

Send 25% deposit, balance C.O.D. plus postage or send payment in full, unit shipped postpaid.



TRANSCON DIVISION  
**NORTHEAST TELECOMMUNICATIONS, INC.**

Danbury, Conn.

**CATALOG ON REQUEST**

Available from franchised dealers at slightly higher cost.

For further information, check number 28 on page 126.

## GOOD BUYS — ALL NEW

Extraordinary values await you in government surplus components. Our specialty is components; we have many of those hard to find items that you just won't see advertised elsewhere in surplus materials. Don't buy anything until you have our "Bargain Bulletin"; write for it today, it's free. New material is available to you for mere nickels and dimes on the dollar value. Here are some typical values:

**RELAYS**, all are beautifully constructed to govt specs.  
13 VAC coil, DPDT + SPDT, 10 amps, ceramic.....1# \$2.89  
12 VDC, 64Ω coil, DPDT, 20 a + SPST, 6 a, cer.....1# \$1.89  
Differential, 2-9000Ω coils, 2-SPDT sect, 2 a.....1# \$3.39  
115 VAC coil, DPDT at 5 amps, hermetic seal.....3/4# \$1.95  
Min. DPDT, 3800Ω coil, 1 amp cont, 28 VDC.....1/2# 89c

**AUDIO TRANSFORMERS**, a few typical values, many more.  
5 w output, 5KΩ:15Ω, ±1/2 db 16-18,000 cps, per pr 3# \$2.22  
Line match, 15KΩ to 600Ω, 50-10,000 cps, pot.....1 1/2# 69c  
25 w output, 8,000Ω ct, 15/125/250Ω, potted.....4# \$1.95  
Line to v c, Thord. 2-16Ω v c to 500Ω line.....2# \$1.39

**PLATE & FILAMENT POWER TRANSFORMERS**, 115 volt, 60 cycle.  
720 vet/135 mils, 5/3 and 6.3/3, potted.....12# \$3.79  
490 vet/130 mils, 5/2, 6.3/3, potted.....9# \$3.19  
800 ct/175, 80 v tap, 5/3, 6.3/2.5, 6.3/2.5.....9# \$4.44  
600 vet/350 mils, 12.6 v/11 amps, potted.....18# \$4.29  
Auto, 115 to 230 volts, 90 watts, potted.....7# \$2.29  
HV scope, 4500 volts/5 mils, 10 KV RMS ins. 10# \$1.95

**FILAMENT TRANSFORMERS**, 115 volt unless otherwise shown.  
5 vet/30 amps, 215/230 pri., 15 KV ins., Chi.....20# \$6.45  
6.3/0.6 potted, uses only 3 sq in chassis areal.....1 1/2# 79c  
6.3/27 amps, four windings, 3 amps are ct.....9# \$3.29

**MISCELLANEOUS VALUES**, all are outstanding.  
CW "Dream Filter", bandwidth 200 cps down 20 db 4# \$6.95  
Oil cond., 15 mfd/330 VAC, HV ceramic terms.....3# \$2.29  
BC-610 40 meter coils, C-390-A, three for.....1# \$1.79  
3AP1 cathode ray tubes.....2# \$1.45  
3C24 triodes, Lewis and Kauffman, a pair.....2# \$5.55

and hundreds of other equal values appearing in the "Bargain Bulletin". Write for yours today!

Send adequate postage with orders. We refund any overage. All prices are FOB Sacramento. \$3.00 minimum order please.

**JOE PALMER**  
PO BOX 6188 CCC, SACRAMENTO, CALIF.

For further information, check number 29 on page 126.

## SIDEBAND [from page 84]

will be returning in March . . . For those sidebanders who do not yet have Antarctica confirmed due to the mail situation, here's good news: Mac, K2QXG, may handle the cards for VK2BK who's headed for the South Pole where he'll use the call VKØVK and Mac guarantees fast confirmations . . . Southwest Africa is again represented on s.s.b., this time by the station of Matty, ZS3BC . . . Haven't heard Uda, ex-W2-UD, operating from Peru as yet but we heard he was expecting his OA call shortly . . . Jo, CR-6CA, answered all his San Thome contacts with a CR5CA card—good confirmation no matter what call he was using when you worked him . . . Although the 10 meter band has been far from lively, Frank, EI4J, has been doing a fine job satisfying the 28 mc. DXers with good contacts from Ireland . . . Everyone please keep your fingers crossed that band conditions during the weekend of January 28-29 are good. Need we remind you that that is the weekend of the CQ S.S.B. DX Contest and we hope you will all participate?

## Band Hopping

We ran into Bill, K8NDE, who measures 5 feet 24 inches. Yup, it's no misprint! Bill played basketball for Dayton a few years back and is in insurance now . . . Didn't think it was possible but Jack, K2JDV, who spends most of his time mobiling, has his KWM-1 in a T-Bird . . . KP4EE, Carl, operates at the Catholic University in Ponce. Hailing from Baltimore, Carl has been busy putting up building after building for the University but manages to find some time now and again to chat with his friends . . . Had the pleasure of being contact number two for Bob, W8CUZ. Welcome to s.s.b. . . . We'd like to thank Roger, W3NQM, and Abe, W9-PMZ, for their help at 2 A.M. in checking out our new KWM-2. It's nice to know that we can be heard barefoot among the higher powered stations . . . There's a guy on the West Coast masquerading under the title of "Doc." The call is WA6AXB and he runs a GSB-100—but don't ask for a house call! Ask him when you run across him on the air . . . Spent a very pleasant hour with B.J., W4LMB, discussing the state of the world. Don't know what rig he was using but the conversation was fascinating . . . Mary, K5SPD/1, is scouring the country looking for another section for the Tylon tower she and OM Chuck, K5OEA/1 have up in Groton, Conn. . . . Mary told us that W1RQU is the call for the new sideband station at the Underwater Sound Lab in New London, Conn. . . . Guess you've all heard that wonderful signal put out by Pat, K1ALL/8 but did you know that Pat is ex-DL4ABC who made so many friends on sideband when he was operating from Germany? . . . Bob, W1KSK, uses an 8 foot center loaded whip on his car and puts out such a terrific mobile signal that he's worked 15 countries . . .



Congratulations to Bob, K5KDN, and Grace, K5YTT who had a baby girl in November . . . Had a most interesting chat with Perry, K9DMG, who is a power engineer for a famous distillery near Peoria. Perry was very patient in explaining the various facets of his work and it made most fascinating listening . . . K4NAA is Net Control Station for the Intercontinental Net which meets every Tuesday and Thursday on 14,330 at 1200 GMT . . . Nick, W0IIC, is a rugged individualist and prefers taking his chances in pile-ups calling DX stations but we couldn't help but admire the fine work done on behalf of FF8CW by John, W2ESZ and his cohorts, W0AGO, W5ASX, W6DIX, W4AXE, K9LIH. Through their cooperation, many W/K stations had the opportunity to work FF8CW in an orderly and concise fashion. Nice going, fellows! . . . Phil, W4MUI, is ex-W2IGK, who has retired to Miami after serving many years with the New York City Fire Dept. . . . Joe, W4OPM, is now QSL manager for VP6WD while Nick, W4MXL, is performing the same service for EA8BA . . . A very hearty welcome to Mary, K8TGP, of Taylor, Mich. whose first s.s.b. contact we were privileged to be the day she got her general license in the mail. Mary is a R.N. with quite a busy schedule but we hope she finds plenty of time to get on sideband . . . Norm, W4SN, is one of the few American Morse experts who's also a ham. So far, he's found only 12 others on the air who are also American Morse experts . . .

That's all for this month. We'd like to ask you again to send us news and photographs so that we can make the column representative of sidebanders everywhere.

73, Irv and Dorothy

### RTTY [from page 98]

ings on a very informal basis, as a combination social and technical group. Meetings are to be held one per month, notice to interested persons by postal card, and over the air on local nets.

"In addition to the formation of an RTTY group, we also have instigated, and have in operation, a weekly RTTY net on 10 meters: 29200 kc FSK, at about 8:30 p.m. Wednesday evenings. This net follows the AREC Weather Net (Phone), on 29160 kc. Since many of the RTTY stations also check into the weather net, they are on tap for RTTY operation. Five or more stations check in on a regular basis. Any of the local teleprinter stations are welcome to check into this net.

"Recently RTTY was used for the first time in a public service connection with our operation in the Cleveland Muscular Dystrophy Drive. RTTY was used for a line between the headquarters to the West Side net control station who then relayed the data to 10 meter mobile stations via 'phone. In the past the custom was to use voice as the link, but it was demonstrated that teleprinter is much more accurate

## AMAZING NEW VIBROPLEX

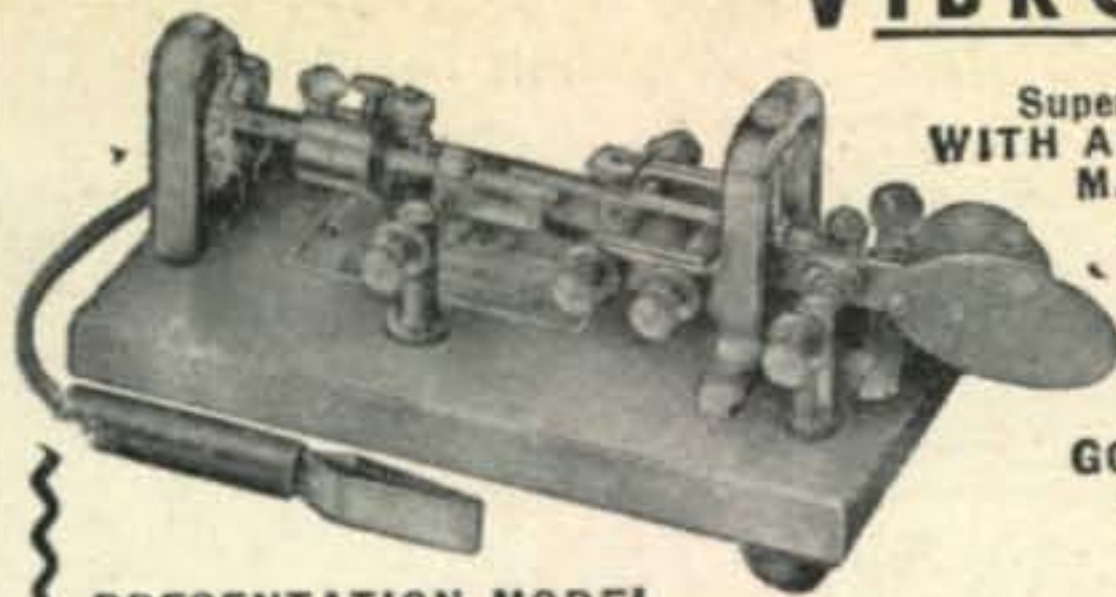

Super DeLuxe  
WITH ADJUSTABLE  
MAIN SPRING  
AND OTHER  
GREAT  
FEATURES

24-K  
GOLD-PLATED  
BASE TOP

### PRESENTATION MODEL

\$29.95

Vibroplex presents the first really speed control key. An adjustable main spring permits operator to send slower or faster as desired. No more muddy signals . . . no sacrifice of signal quality. Suits any hand or any style of sending. Free of arm tension. Sends easily as pressing a button. Praised by operators and beginners alike. Try this new Vibroplex key! You'll be delighted. Other new popular Vibroplex keys from \$15.95 up. At your dealer or

THE VIBROPLEX CO., INC. 833 Broadway, N. Y. 3, N. Y.

## ALL BAND TRAP ANTENNA!



Reduces interference and Noise on All Makes Short Wave Receivers. Makes World Wide Reception Stronger, Clearer on All Bands!

For ALL Amateur Transmitters. Guaranteed for 500 Watts Power for Pi-Net or Link Direct Feed. Light, Neat, Weatherproof

Complete as shown total length 102 ft. with 87 ft. of 72 ohm balanced feedline, HI-impact molded resonant traps. (Wt. 3 oz. 1" x 5" long). You just tune to desired band for beamlike results. Excellent for ALL world-wide short-wave receivers and amateur transmitters. For NOVICE AND ALL CLASS AMATEURS! NO EXTRA TUNERS OR GADGETS NEEDED! Eliminates 5 separate antennas with excellent performance guaranteed. Use as Inverted V for all band power gain. NO HAYWIRE HOUSE APPEARANCE! EASY INSTALLATION!

80-40-20-15-10 meter bands. Complete . . . \$14.95  
40-20-15-10 meter bands. 54-ft. ant. (best for w-w swl's) . . . 13.95  
20-15-10 meter bands. Dual Trap. 24-ft. antenna . . . 19.95

SEND ONLY \$3.00 (cash, ck., mo) and pay postman balance COD plus postage on arrival or send full price for postpaid delivery.

Available only from:

WESTERN RADIO • Dept. AC-2 • Kearney, Nebraska

## FREE ELECTRONICS APTITUDE TEST



Prove to yourself that you are qualified to learn 2-way FM radio servicing. All you need to know is basic electronics to begin studying for a rewarding career in this rapidly growing field.

Two-way radio technicians are desperately needed now to fill the many full and part time job opportunities in service shops throughout the country. The 38 lesson Motorola Training Institute home study course trains you to be a qualified 2-way FM radio technician in as little as 6 to 8 months. You learn up-to-date trouble-shooting and servicing techniques, system analysis and circuitry, plus all the vital material on transistors and new transistorized equipment.

Step ahead to greater earnings, a better future by learning 2-way FM radio servicing. Send for your FREE Motorola Training Institute electronics test today. No obligation and no salesman will call.



### MOTOROLA TRAINING INSTITUTE

4501 Augusta Blvd., Dept. A-164, Chicago 51, Illinois

Please send me your FREE electronics test, plus details on the Motorola Training Institute home study course. (please print)

NAME \_\_\_\_\_

ADDRESS \_\_\_\_\_

CITY \_\_\_\_\_ ZONE \_\_\_\_\_ STATE \_\_\_\_\_



Send for **FREE** list of more than 40 models.

KITS  
MAILED POSTPAID  
ANYWHERE IN U.S.A.

Let's "kit" Together  
Use **YOUR** Parts & **PAPPY'S** wiring

Kits Consist Of Etched Circuit Board, Schematic, Parts List, Assembly Instructions And Any Necessary Tube Or T.R. Sockets

**IRVING ELECTRONICS CO.**  
POST OFFICE BOX 9222 SAN ANTONIO, TEXAS

New Colorado Ham Directory—January 1961—Now available for \$1.00 from the Denver Radio Club—C/O Tillie Curington—KØRGU, 2067 Brentwood St., Denver 15, Colorado.

**BC-603 CONVERSION**

BC-603 Conversion article (Sept. & Oct., 1958 CQ) Reprints available at 50¢ per set.

**CQ Magazine, Book Div.,**  
300 W. 43 St.  
New York 36, N. Y.

**HAM SHACK NOVELTY**

Authentic-looking, two-color gag certificate claiming tongue-in-cheek ownership of an acre on the Moon's surface. Ideal humorous gift or conversation piece for shack, bar, den or office. (See Pg. 119, Jan. '61, CQ.) With gold seal and name and call inscribed only \$1.00 cash. Six for \$5.00. Send check or M.O. only to—

**BOX DXG, 1738—201 St., Bayside 60, N. Y.**

**FREE Famous Electronics CATALOGS** from **RADIO SHACK**

Mail coupon now—get free catalogs for 12 full months!

- See the world's biggest and best line of electronic equipment at savings up to 50%
- Hi-Fi, Ham Radio, Stereo, Transistors, Kits and Parts
- Easiest terms—low as \$2 down
- Your satisfaction guaranteed

**RADIO SHACK CORPORATION** Dept. 61B21  
730 Commonwealth Avenue, Boston 17, Massachusetts  
Please send me Radio Shack's famous electronics catalogs for the next 12 months—all FREE and POSTPAID.

Name \_\_\_\_\_  
Address \_\_\_\_\_  
City \_\_\_\_\_ Zone \_\_\_\_\_ State \_\_\_\_\_

and satisfactory for this operation. Only one half the complete link was RTTY, so that we might find the problems involved. Finding none at all, it was decided that in future work both the east and the west sides, as well as the Police Department, will be serviced with RTTY for links. Operation of RTTY was on 6 meter AFSK. No problems were encountered with the equipment or the entire operation. The impression on the general public was most satisfactory, and has indicated that the amateur can and does have the ability to provide advanced efficient communications via printer.

"Activity and interest has come up greatly since my first letter. Cleveland is now moving forward with RTTY, and I am sure the future will hold many additional firsts for RTTY in this area. We have the usual problems of obtaining good working equipment for the interested amateurs, but all available sources are being checked, and so far we are all hoping for the best. Most of the fellows are in need of working printers such as the Model 26, and the Model 15. Some of the advanced boys are looking for tape gear, re-perfs and so on, but it looks like tape gear is at a premium for the present. I myself picked up some Kleinschmidt equipment and am most pleased with it. I passed some of my older Teletype equipment to the newer hams in RTTY. I would like to find some tape gear myself, but at a price that's reasonable. Well, no doubt you have heard this song before, so shed a tear, and I'll be dropping you a line from time to time to let you know of our activity here."

73, Al Panzer W8ZEP

*Thanks a million, Al. Cleveland is really on the map!*

**Comments**

Since we began, with the June '60 RTTY column, the technical discussion of RTTY for the newcomer our mail has increased quite a bit, for which we thank you. The consensus of opinion is that this pattern for the column is greatly appreciated. We could get "long-haired" and present a mathematical analysis of the pulse problems of RTTY, but we feel we can better serve you, the newcomer, by presenting the basic fundamentals in a more simple form. If you have the normal inquisitive mind of the dyed-in-the-wool RTTYer, you will dig further, using the references given and by looking elsewhere on your own, Terman for example. Lots of luck, and don't forget to send us a picture of *your* RTTY shack!

73, Byron, KØWMR

**VHF AMATEUR**

Printed Exclusively for the VHF man

6, 2, 220 and 432 plus extra features on 1296 mc! Page after page of construction items, propagation reports, DX, news, and loads of pictures. Only \$2.00 a year for the **ONLY** VHF Magazine! Send your \$2.00 to . . .

**THE VHF AMATEUR**  
67 Russell Avenue, Rahway, N. J.



**PROP.** [from page 74]

briefly. Conditions during the 1960 c.w. contest were much poorer than during previous years, and this will, no doubt, reflect in much lower total scores.

**Solar Cycle**

The Zurich Observatory reports a monthly mean sunspot number of 87 for November, 1960. This results in a 12-month smoothed sunspot number of 115 centered on May, 1960. A smoothed sunspot number of 92 is predicted for February, 1961, as the present solar cycle continues to decrease.

An announcement has been received from the Swiss Broadcasting Service giving the latest schedule for sunspot number broadcasts. These broadcasts, given on the 4th of each month, contain the latest sunspot information as well as a forecast of solar activity for the following six months. The broadcasts are beamed to North America on the following frequencies:

6165 kc, 9535 kc, and 11865 kc, at the following times:

- 8:35 p.m. and 11:20 p.m. EST
- 7:35 p.m. and 10:20 p.m. CST
- 6:35 p.m. and 9:20 p.m. MST
- 5:35 p.m. and 8:20 p.m. PST

A comprehensive special report dealing with the declining solar cycle and its probable influence on propagation conditions in the amateur bands during the next five years, is scheduled to begin in April's CQ. The report will consist of three parts, with subsequent parts appearing in May and June.

73, George, W3ASK

**CALENDAR** [from page 65]

**YLRL YL/OM**

**Phone**

Starts: 1300 EST Saturday, February 25th  
Ends: 2400 EST Sunday, February 26th

**C.W.**

Starts: 1300 EST Saturday, March 11th  
Ends: 2400 EST Sunday, March 12th

See Louisa's YL Column in this issue for all the details.

**Editor's Note**

No word from the USKA or VERON, even after second requests. So I have nothing on their activities usually held in March and April. Maybe that's why their contests are never a big success.

Altho conditions were not at their best for the c.w. week-end, they were much improved over the phone contest. There was plenty of activity and some of the claimed scores listed should give you an idea how your efforts stack up against some of the other boys.

73 for now, Frank, W1WY

**EASY TO LEARN CODE**

It is easy and pleasant to learn or increase speed the modern way—with an Instructograph Code Teacher. Excellent for the beginner or advanced student. A quick, practical and dependable method. Available tapes from beginner's alphabet to typical messages on all subjects. Speed range 5 to 40 WPM. Always ready, no QRM, beats having someone send to you.



**ENDORSED BY THOUSANDS!**

The Instructograph Code Teacher literally takes the place of an operator-instructor and enables anyone to learn and master code without further assistance. Thousands of successful operators have "acquired the code" with the Instructograph System. Write today for full particulars and convenient rental plans.

**INSTRUCTOGRAPH COMPANY**

4711 SHERIDAN RD., CHICAGO 40, ILL.  
4700 Crenshaw Blvd., Los Angeles 43, Calif.

LOWEST PRICED ELECTRONIC ASSORTMENTS IN AMERICA!

**RADIO - TV PARTS JUMBO PAKS**  
BY THE POUND in **JUMBO PAKS**

- |  |   |
|--|---|
| <input type="checkbox"/> ONE POUND PRECISION RESISTORS WORTH \$100 | <input type="checkbox"/> ONE POUND Discs, Ceramics, PRECISIONS WORTH \$70 |
| <input type="checkbox"/> ONE POUND DISCS & CERAMICS WORTH \$75     | <input type="checkbox"/> ONE POUND CERAMIC CONDENSERS WORTH \$85          |
| <input type="checkbox"/> ONE POUND DISC CONDENSERS WORTH \$50      | <input type="checkbox"/> BUY 4 PAKS for \$11.00                           |

500-1000 PCS. PER POUND!  
**\$3.00**  
Clip out & mail per pound  
MONEY-BACK GUARANTEE!

Free catalog Write! **LEKTRON** HOW TO ORDER: Include check or M.O. with sufficient postage; excess returned. C.O.D. orders, 25% down; rated, net 30 days. INCLUDE 241C Everett Ave., Chelsea 50, Mass. POSTAL ZONE in address.

"TIME AT A GLANCE" G.M.T.

**24-HOUR NUMERAL CLOCK**

#100-24H<sup>1/4</sup>  
**\$15** Plus Applicable Taxes

Walnut or ebony plastic case. H 4", W 7<sup>3/4</sup>", D 4". Wt. 3 lbs. 110V 60 cy. AC. Guaranteed 1 year.



At Your Dealer ... or WRITE to

**PENNWOOD NUMECHRON CO.**  
7249 FRANKSTOWN AVE. PITTSBURGH 8, PA.

**R W BARGAINS!**

- BC-603 FM Receiver 20-27.9 Mc Complete. New .....\$17.95
- BC-603 plus 6 spare tubes .....\$19.95
- DM-34 Dynamotor 12v. New .....\$ 2.95
- BC-604 FM Transmitter 20-27.9 Mc Complete with spare tubes. New .....\$ 6.95
- DM-35 Dynamotor 12v. New .....\$ 7.95
- FT-237 Rack for BC-603 & BC-604 New .....\$ 2.95
- Antenna Mount with four mast sections. New .....\$ 2.95
- Manual TM11-600 for BC-603 & BC-604 .....\$ 2.00

Send Money Order or Check with order.

Write for Flyer—LOADS OF BARGAINS!

**R W ELECTRONICS**

2430 S. MICHIGAN AVENUE • DEPT. CQ  
Phone: CALumet 5-1281 CHICAGO 16, ILL.



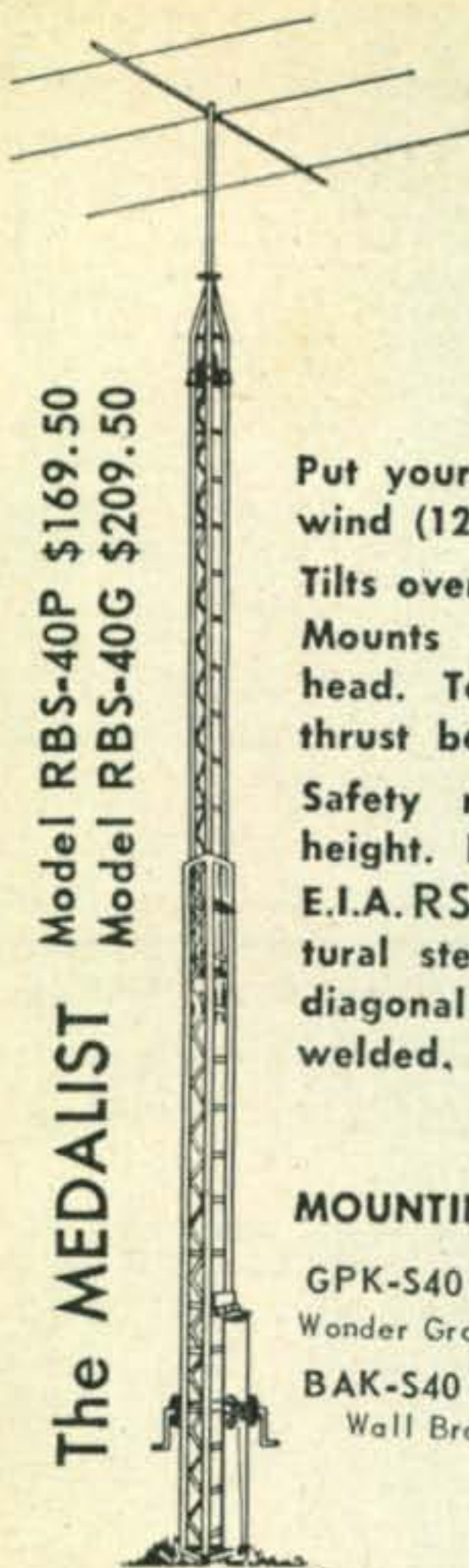

Model RBS-40P \$169.50  
Model RBS-40G \$209.50

The MEDALIST

# STURDY E-Z WAY TOWERS

Put your Tribander at 41' in 70 mph wind (125 mph cranked down to 24').

Tilts over for E-Z access to array.  
Mounts Ham-M Rotor inside tower head. Top radial bushing - vertical thrust bearing.

Safety rest locks tower at desired height. No weight on cables.

E.I.A. RS-222 specs. Heavy wall structural steel tube legs, solid steel rod diagonal & horizontal bracing — arc welded. Sold by Top Flight Distributors Everywhere!

### MOUNTING KITS:

GPK-S40 \$75.00  
Wonder Ground Post  
BAK-S40 \$10.50  
Wall Bracket



Write for Catalog 22-1

P.O. BOX 5767 TAMPA 5, FLORIDA

For further information, check number 30 on page 126.

## HAM LICENSE COURSES

Resident Classes—3 Evenings a Week. Thorough preparation in Code and Theory. Qualifies for NOVICE CLASS in 4 Weeks and for General Class in 2 Months.

Dept. C, DELEHANTY INSTITUTE

117 East 11 St., N.Y. 3—Phone GR 3-6900

FOR THE FINEST IN AMATEUR PHONE PATCHES ITS...

# KWICKPATCH

The high speed  
high quality patch  
AM Models \$14.95. Dual  
hy-brid Sideband models  
\$24.95. No switching...

No disconnecting... Models for single or double connector microphones. See them at your distributor. For literature write to

KWickPatch, P. O. Box 612, Redwood City, California

# VAN SICKLE Radio Supply Co.

BEST PLACE TO BUY HAM GEAR!  
New and used bargains, big trades  
4131 N. Keystone Ave., Indianapolis 5, Ind.

## "HOW TO MAKE MONEY IN Mobile Radio Maintenance"

AUTHORITATIVE GUIDEBOOK  
ABOUT THE BOOM IN TWO-WAY MOBILE-RADIO:  
GIVES FACTS, FIGURES, PAY RATES.  
WRITE TODAY!

FREE



LAMPKIN LABORATORIES, INC. Electronic Div. BRADENTON, FLA.

YL [from page 100]

The Camellia Capital Chirps have reduced the price of their much talked about Cook Book. This is the one made up by Hams, for Hams with favorite recipes from Hams around the world. Originally priced at \$1.75, you can now get this book for only \$1, postpaid. Order from K6HHD, Jan O'Brien, 6606 5th St., Rio Linda, Calif.

33, Louisa, W5RZJ

SAWTOOTH [from page 43]

the audio amplifier will not provide the proper match to the high impedance screen-grid circuit of the transmitter. To obtain this match, we must increase the output impedance of the audio amplifier until it equals the impedance of the screen-grid. We can accomplish this by replacing the output transformer with a modulation transformer of the proper impedance. To do this, however, would defeat our objective, which is to use the existing amplifier without altering its internal circuitry or original function.

We can, however, accomplish these requirements if we use the circuit of fig. 1. The high impedance winding of an audio output transformer is connected in series with the screen-grid lead. The impedance of the screen-grid circuit is now equal to, or nearly equal to that of the transformer. We therefore have solved the requirement of a proper match between the transformer and the screen circuit. This is true because the low output impedance of the audio amplifier is equal to the low impedance primary winding of the audio output transformer.

### Power Requirements

With the impedance matching requirements solved, we may now concentrate on the amount of power the audio amplifier must supply to the transmitter. This value is found to be approximately one-fourth the *dc* input to the screen-grid under CW operation. With the values of screen current and screen voltage known, it is a simple matter to compute the audio power that will be required. A couple of watts of audio will provide ample power for most transmitting tubes. Incidentally, if the audio amplifier has power to spare it is desirable to include a loading resistor across the output; this produces better regulation over the audio cycle.

In choosing a transformer, you need not be critical. Any transformer within the ratings indicated in fig. 1 will suffice. It is to your advantage if the transformer you choose happens to have a tapped winding, as you may vary the turns ratio to obtain the most desirable impedance match.

### Screen Grid By-Pass

At this point it is wise to check the capacitance of the screen grid by-pass located at the



screen-grid terminal of the *rf* amplifier. If the capacitance is greater than .005 mf, replace it with one of this value. If the capacitance is found to be less, no changes are necessary.

The next step is to obtain the B+ for the voltage divider. This voltage may be obtained from a separate supply, or from the low voltage supply contained within the transmitter.

The switching circuit that was mentioned earlier as shown in fig. 2. This circuit will appeal to those who use their television or radio as the modulator. In one position it's a modulator for the transmitter, in the second position the unit functions normally.

### Adjustment and Operation

Place a dummy load across the transmitter output, turn on the power and tune up the rig. If the plate current is greater than one-half its original value before the modification, the slider on R<sub>1</sub> must be adjusted for reduced screen voltage. If the plate current is less than one-half the original plate current value the slider must be advanced until a reading of one-half the original plate current is obtained. Make all adjustments with the slider resistor with the power off! The bands may be crowded but we would certainly miss hearing your voice; *exercise caution.*

### Precautions

If you are using an *ac-dc* audio amplifier make certain that the chassis is at ground potential by observing the polarity of the linecord. The polarity of the unit may be checked by holding one lead of a small neon bulb by the fingers and touching the other lead to the suspected chassis. If the neon bulb glows, reverse the plug in the wall outlet. With all precautions accounted for, connect the audio amplifier and the transmitter together thus completing the "operation."

Button up the transmitter and attach the microphone to the audio amplifier. Switch on the transmitter and amplifier. Tune up using heavy plate loading, advance the gain on the audio amplifier until occasional kicks of plate current are seen on the meter. These kicks of plate current are voice peaks and indicate that the transmitter is modulated. ■

### GUY WIRE [from page 29]

While the Guywire Pyramid does not pretend to be the best radiator for 80 it certainly has proven to be one of the best compromises between practicability and efficiency. The built in spot frequency tuner renders it a versatility that could only be matched by the old fashioned center-fed Zepp. Its additional low angle radiation might contribute to good DX results.

### Acknowledgment

I wish to express my appreciation for the cooperation of Lee Campbell, K8GVO who furnished the incentive and of Skipper Knowles, W8QEF who made her station, yard and time available for the many experiments. Thanks also to Dan Umberger, W8ZCQ, CARA Field Day Chairman 1960 for taking a chance with the Guywire Pyramid during Field Day. ■



## RADIOTELEPHONE LICENSE MANUAL \$5.75

Helps you prepare for all U.S.A. commercial radiotelephone operator's license exams. Gives the basis for a sound understanding of every pertinent subject. Complete study-guide questions and answers in one volume.

**RADIO HANDBOOK** — largest ever published. The comprehensive reference source on radio. Gives simplified theory . . . latest design data . . . more "How-to-Build" data than any book in field . . . . . **\$8.50**

**WORLD'S RADIO TUBES** (Brans' Radio Tubes Vade Mecum). World's most authoritative tube book . . . . . **\$6.00**

**WORLD'S EQUIVALENT TUBES** (Brans' Equivalent Tubes Vade Mecum). Over 32,900 comparisons . . . . . **\$6.00**

**SURPLUS RADIO CONVERSION MANUALS**  
Practical conversions of most popular surplus equipment, in 3 volumes. Send stamped envelope for list of contents . . . . . **\$3.00 each**

at your distributor, or add 10% on orders to



**EDITORS and ENGINEERS, Ltd.**  
Summerland 3, California

Bookstores: order from Baker & Taylor, Hillside, N.J.  
For further information, check number 31 on page 126.

## VHF Colinear Arrays

### FEATURES

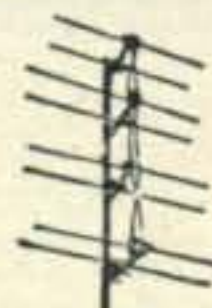

- LIGHT WEIGHT
- MECHANICALLY BALANCED
- HIGH FORWARD GAIN
- HIGH FRONT TO BACK RATIO
- LARGE CAPTURE AREA

32 AND 64  
ELEMENT  
STACKING  
KITS  
AVAILABLE

430 MC. 16 Element \$ 9.85  
220 MC. 16 Element \$12.95  
144 MC. 16 Element \$16.00

See your distributor or write for  
FREE CATALOG

**CUSHCRAFT** 621 HAYWARD ST.  
MANCHESTER N. H.



# QUICKLY CUT HOLES

in metal, plastics,  
hard rubber...

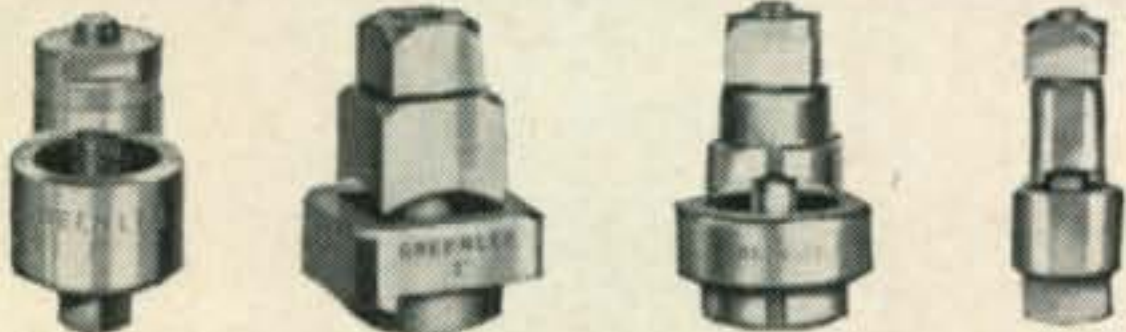

## GREENLEE CHASSIS PUNCHES

Make smooth, accurate openings in  
1½ minutes or less . . . for sockets,  
plugs, controls, meters, panel  
lights, etc. Easy to use . . .  
simply turn with wrench.  
Many sizes and models.  
Write for literature.



GREENLEE TOOL CO., 1915 Columbia Ave., Rockford Illinois  
For further information, check number 32 on page 126.

# FREE

## GIANT 1961 204 PAGE CATALOG

BA

1961

ANNUAL CATALOG #11

Guarantee

SINCE 1927

A Complete Buying Guide for Everything in

# RADIO TV ELECTRONICS

**BURSTEIN-APPLEBEE CO.**

Dept CQ, 1012 McGee St., Kansas City 6, Mo.

Send Free 1961 B-A Catalog No. 611

Name .....

Address .....

City..... State.....

SAVE UP TO  
50% ON B-A  
SELECTED  
KITS

HI-FI AND  
STEREO  
SYSTEMS &  
COMPONENTS

TOP VALUES  
IN POWER  
AND HAND  
TOOLS

30 PAGES  
OF BARGAINS  
NOT IN ANY  
OTHER CATALOG

For further information, check number 33 on page 126.

# Ham Shop

RATES: 25¢ per word per insertion for commercial  
business organizations.  
10¢ per word per insertion for individuals on  
a non-commercial basis. Full payment must  
accompany order.

**MINIMUM CHARGE \$1.00**

CLOSING DATE: 20th of the 2nd month preceding  
date of issue.

MAIL: Your typewritten copy with full remittance  
should be sent to CQ Magazine, 300 West 43rd  
Street, New York 36, N. Y.  
Attention: Classified Ad Dept.

NOTE: The products and services advertised in this  
section are not guaranteed by the publisher of  
CQ. Telephone orders not accepted.

For Sale: TV Cameras, Teletype, Panadaptors, Transmit-  
ting Tubes, Transistors, SSB gear. Write for list. Spera  
Electronics, 37-10 33 Street, L.I.C., N.Y. STillwell 6-2199.

PRESERVE YOUR HAM TICKET, Social Security Card,  
small photo, passes and anything else of value that is wallet-  
size. We will laminate it in clear plastic, guaranteed for  
life. Lamination will prevent it from getting torn, soiled  
or frayed. Send your ticket or anything of value with \$1 in  
stamps or cash for each item that you want preserved.  
24-hour service. Send to C. Lee P. O. Box 395, Times Square  
Station, New York 36, N.Y.

CALL LETTERS may be applied to any surface. 2" sets  
60¢, 3" set 80¢. Send to C. Lee, P.O. Box 395, Times  
Square Station, New York 36, N.Y.

ONE THIN DIME brings 50 page eye-popping war surplus  
electronics catalog. Fabulous bargains. Meshna, Malden  
48, Mass.

TOROIDS: Uncased 88 mhy like new. Dollar each. Five  
\$4.00 PP. DePaul, 309 South Ashton, Millbrae, Calif.

BEGINNERS: Code bothering you? Now learned in one  
hour. New Method. Quick approach towards your ham  
ticket. Used in Armed Services, Ham Radio, Scouting.  
Ketchum's One Hour Code Course \$1.00 postpaid. MONEY  
BACK GUARANTEED—O. Ketchum, 10125 Flora Vista,  
Bellflower, California.

COLLINS 51J \$495. 51J-3 \$675. Both reconditioned.  
HRO-60, \$325. HQ-160, \$275. Teletype printers & receiving  
converters. Valiant \$319., Ranger \$198. Panadapter \$75.,  
R-390A/URR, DX-100, \$125., HC-10, \$75. Tom W1AFN,  
Alltronics-Howard Co., Box 19, Boston 1, Mass. (Richmond  
2-0048).

FREE! 1961 catalogs for newest, best electronic bargains  
available. Stereo, hi-fi, ham radio, 1000 other items, Alco  
Electronics, Lawrence 5, Mass.

WANTED: Teletype printers, perforators, reperforators,  
transmitter-distributors, test equipment: Model #14, #15,  
#19, #26, #28, GRC, TT, TGC, GGC, etc. All types Collins  
receivers, 51J, R-388, R-390, 75A, etc. Cash, or trade for  
NEW amateur equipment. Write Tom, W1AFN, Alltronics-  
Howard Co., Box 19, Boston 1, Mass. (Richmond 2-0048).

ANY TUBES commercial test equipment, broadcasting  
equipment, and quantity. Diamond 749 W. End Avenue,  
New York City.

WANTED: Military and Commercial laboratory test and  
measuring equipment. Electronicraft, Box 399, Mount  
Kisco, N.Y.

WANTED: TELETYPE TG-7 and Model 15 and parts,  
printers and reperforators, etc.; COMM'NS REC'V'RS  
AND XMTRS, e.g. BC-610-E, -I, BC-399A, Collins 51J,  
17L3, -4; R-388 and R-390/URR; 18S-2, -3; ARN-14 and  
-30; APR-9, -10, ARC-21, 27, etc.; APS-31, -33, and TEST  
EQP'T, with TS- or 1-prefix. We pay freight. AMBER  
INDUSTRIAL CORP., 75 Varick St., N.Y. 13, N.Y.

"The VHF Amateur"—At last a magazine for VHF'ers!  
Don't miss a single issue! Send \$2.00 for year or \$1.00 for  
six big issues . . . 67 Russell, Rahway, N. J.



Interrogation: Applications are now being accepted for Election into our Research and Administration staff. The function of the organization is non-profit in nature, and will work under contributions and grants. The purpose of the organization is Research in Extra-Terrestrial phenomena; i.e. Radio Astronomy, Propagation, Scatter, etc. If you are seriously interested and would like more information write: Radiometric Research, Ltd., P.O. Box 4335-Annex, Las Vegas, Nevada.

XXXP Copper laminate. 1 side (6" x 4 1/2") 45¢., (9" x 12") \$1.50. Etchant — 4 oz., 35¢ — 8 oz. 60¢ plus postage, balance refunded with your order. Glover's Electronics, 7822 Croydon Avenue, Los Angeles 45, Calif.

FOR COLLINS in Detroit area it's Michigan Ham Headquarters. Also large selection of tradeins on display. M. N. Duffy Ham & Electronics, 2040 Grand River, Detroit 26, Michigan. WO 3-2270.

CASH for surplus tech manuals — W4FXQ, Box 2513, Norfolk, Va.

ATTENTION Mobileers! Leece-Neville 6 volt 100 amp system, \$50; 12 volt 50 amp system \$50; 12 volt 60 amp system \$60; 12 volt 100 amp system \$100. Guaranteed no ex-police car units. Herbert A. Zimmermann, Jr. K2PAT, 115 Willow St., Brooklyn 1, N.Y. Tel. Dickens 2-9121 or Jackson 2-2857.

WANTED: World War I French L-3 Amplifier, Mu-Rad receivers and R.F. Transformers for electrical test. Buy, borrow, trade. Also UV206, UV208 tubes. Grote Reber, Research-Cottrell, Bound Brook, New Jersey.

QSL's, SWL's, XYL-OM's. (Sample assortment approximately 9 3/4¢). Covering designing, planning, printing, arranging, mailing, eye-catching, comic, sedate, fantabulous, DX-attracting, prototypal, snazzy, unparagoned cards. (Wow!) Rogers KØAAB, 737 Lincoln Avenue, St. Paul 5, Minnesota.

QSL's-SWL's: That are different colored, embossed card stock, and "Kromekote." Samples 10¢. K8AIA, Box 953, Hamilton, Ohio.

QSL's—"Brownie" W3CJI, 3110 Lehigh, Allentown, Pa. Samples, 10¢, with catalogue, 25¢.

QSL's-SWL's: 100 2-color glossy \$3.00; 100 QSO file cards \$1.00; Sample 10¢. Rusprint, Box 7507, Kansas City 16, Missouri.

QSL's four colors glossy stock forty design send \$5 for 200 and get surprise of your life. 48 hour service satisfaction guaranteed. Constantine Press, Bladensburg, Md.

QSL's. Samples 15¢. Sims, 3227 Missouri Ave., St. Louis 18, Mo.

GLOSSY 3-color QLS cards 100—\$4.50. Free sampler. Rutgers Vari-Typing Service, 7 Fairfield Road, New Brunswick, N. J.

QSL's: Samples, dime. Print Shop, Corwith, Iowa.

QSL's - \$1.75 per 100 postpaid U.S. only. Glossy, red and green. All orders mailed within 10 days. Free sample. Hobby Print Shop, Umatilla, Florida.

SWL's, QSL's Nicholas & Son Printery, P.O. Box 1184, Phoenix, Arizona. Samples 5¢.

TRI-COLOR QSL's \$3.50, Dime. Filmcrafters, Martins Ferry, Ohio.

C. Fritz for better QSL's! Samples 10¢. P.O. Box 1684, Scottsdale, Arizona.

PHOTO-QSL's, free samples, A&D Studios, 2030 S. Prairie; Pueblo, Colorado.

QSL's you'll like. Samples 10¢. Dupli-Press, 1367 Gary Street, Merritt Island, Fla.

QSL's-SWL's, samples 10¢. Malgo Press, 1937 Glendale Avenue, Toledo 14, Ohio.

Religious QSL Cards. (with bible verses). Samples 10¢. Sackers, W8DED, Holland, Michigan.

QSLs?? Finest, largest variety samples 25¢. (refundable). Callbooks: American calls \$5.00, Foreign \$3.00. Sackers, W8DED, Holland, Michigan.

QSL's—Photographic and regular. Samples 10¢. Dick W8VXX, Rt. 1, Gladwin, Michigan.

## SPECIALS

Central Electronics 100 V Xmtr. \$795.00 Ppd.

RCA Precision 500 KC Crystal Oscillator. Accuracy ±0.0012%. Herm-sld case. Plugs in 7 pin min. socket. W/xtal 5840 tube & schematic. \$3.75 Ppd.

Revolutionary new 12" globe for you . . . the first full-color raised relief globe ever produced.

\$24.95 Ppd.

UTC VM-2 Vari-Match Modulation Xfmr. Hdl's any pwr tubes to modulate a 40 to 120 Watt Class C stage.

Orig. UTC cartons; w/complete info. sheet. Wt: 10 lbs packed

\$5.95

MOSLEY BEAMS IN STOCK!

NATIONAL NC270 IN STOCK!

Come in and browse. We are open Mon. to Fri. 9 to 6. Sat.: 10 to 2 P.M.

Subways: BMT: (Broadway local) to Prince St. Station—walk 1 block to Spring St.

IRT: Lexington (local) to Spring St.

Bus: Broadway #6 Bus to Spring St.

Car: We are 4 blocks North (uptown of Canal St.) Parking allowed on Broadway Sat., Mon. thru Fri. parking at 501 & 557 B'way.

Barry's "Greensheet" Values\*  
are out of this World

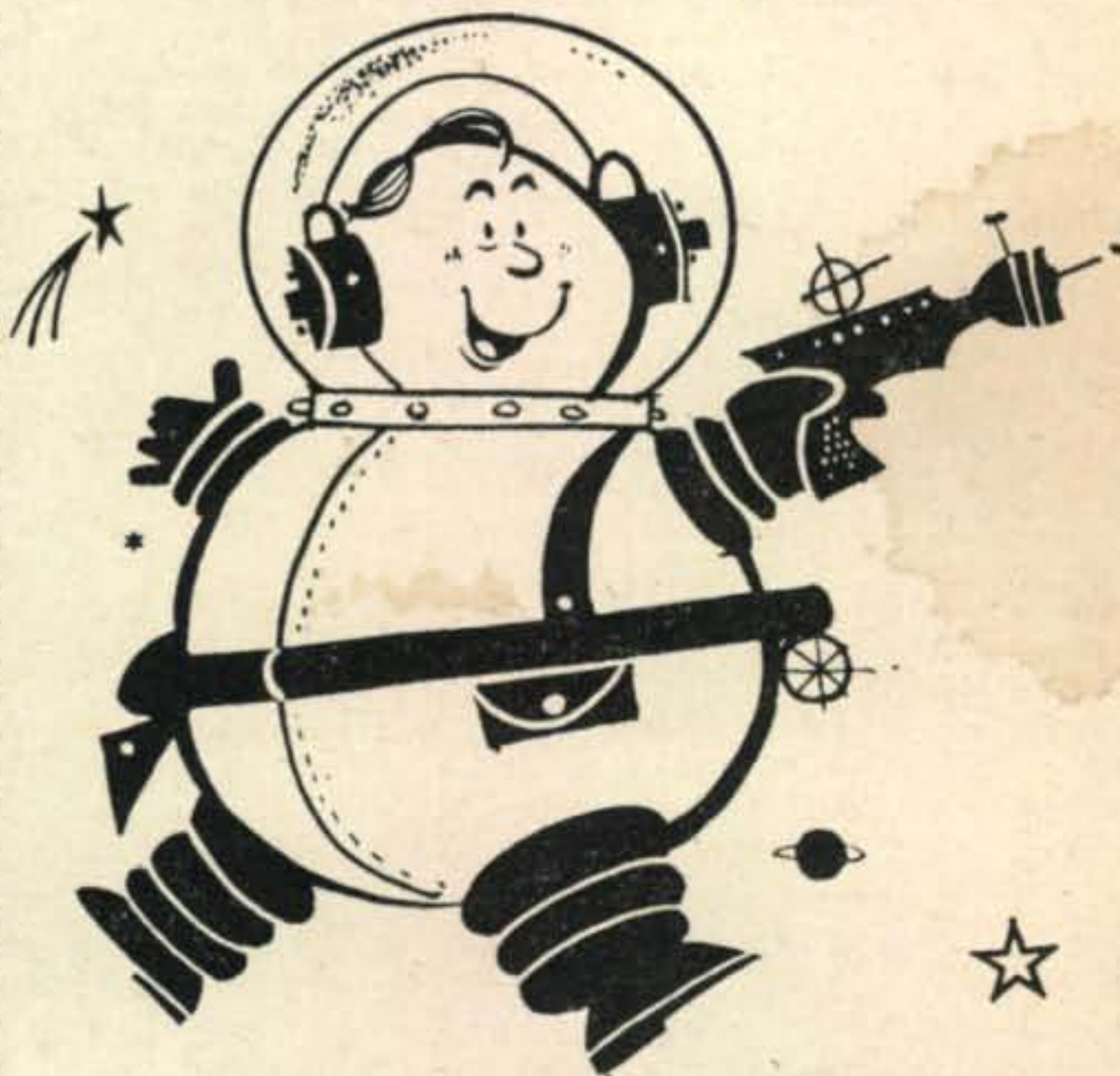

### NEW 1961 CATALOG

★ A complete catalog of specialized HAM GEAR, Electronic TUBES and COMPONENTS . . . featuring Barry Electronics savings to HAMS, Servicemen and Experimenters.

We have hundreds of Buys. First Quality at Sensible Prices. Buy with confidence.

Prove these values to yourself! Complete and mail the coupon below for your copy of the \*Greensheet.

We'll also purchase your equipment and unused tubes. Send details:

BARRY ELECTRONICS CORP.

512 Broadway, New York 12, N. Y. Dept. C-2

Please send me a copy of the new 1961 \*Greensheet and add my name to your mailing list. (C-2)

Name ..... Title

Company .....

Address .....

City ..... State

For further information, check number 34 on page 126.



USE A  
**P & H AUDIO COMPRESSOR**



**FOR MINIMUM DISTORTION  
MAXIMUM TALK POWER**

100% MODULATION—WITHOUT DISTORTION is practically impossible to attain with most ham rigs. NOW—Thanks to P&H—you can have your cake and eat it too!

Simply connect a P&H MODEL AFC-1 or AFC-2 between the mike and the mike input of any SSB, DSB, AM, PM or FM transmitter—Set the transmitter audio gain control for 100% modulation and FORGET IT! From a WHISPER to a SHOUT—the compressor output level NEVER VARIES MORE THAN 6DB. May also be used on PA systems to maintain high audio output without blasting.

NOT A CLIPPING DEVICE! This is an AVC type compressor, like broadcast stations use. Operation is instantaneous, with no pumping effect. Built-in audio filters and SEPARATE HIGH and LOW IMPEDANCE CIRCUITS.

HIGH IMPEDANCE threshold is set at -52 DB and will provide up to 50 DB of compression with negligible distortion. LOW IMPEDANCE threshold is set at -25 DB, and will provide up to 40 DB of compression when used between the speaker and the audio output of a receiver; resulting in excellent AVC action from receivers with poor RF AVC characteristics.

MODEL AFC-1 (3" x 3" x 5") requires an external power source (often available from transmitter or receiver) and contains a 90-3500 cycle bandpass audio filter.

MODEL AFC-2 (5" x 5" x 7") has a built-in power supply and a switch controlled BROAD-MEDIUM-SHARP audio filter.

MODEL AFC-2CW is identical to the AFC-2 except for much sharper audio filters. It is intended for use with filter type exciters and for CW reception when used in the speaker line of receivers.

MODEL AFC-1 With tubes (less power supply).....\$32.95  
MODEL AFC-2 or AFC-2CW Complete .....\$54.95

**P & H ELECTRONICS INC.**  
424 Columbia Lafayette, Ind.

For further information, check number 35 on page 126.

2, 6, 10 — Meter

**MOBILE EQUIPMENT**

MOTOROLA, R.C.A., G.E., LINK, etc. 30-50 Mc., 152-172 Mc. Used Commercial F.M. Communications Equipment Bought & Sold. Complete two-way sets meeting F.C.C. Licensing Requirements for taxicabs, Police, Fire, etc. \$169.00 and up.

Motorola F.M. Receivers, Double Conversion .....\$55.00 each  
Motorola F.M. Transmitters..... 45.00 each

**COMMUNICATIONS ASSOCIATES INC.**  
21-27 Batchelder Street  
Boston 19, Mass.

QSLs. Large selection styles including photos. Lowest prices. Fast service. Samples dime. Ray K7HLR, 679 Borah, Twin Falls, Idaho.

QSL Cards printed. Send dime for samples. QSL Printing Co., 4319 Wuthering Heights, Houston 45, Texas.

Rubber stamp QSL's with postcard size stamps. Your name, address permanently set in rubber, reproducing perfect QSL's. Available with above information on one stamp, stock information on another or both on one stamp at the same \$6.25 price. 3¢ postage your cost per QSL. No high priced cards . . . you print your own on postcards saving @ 3¢ per card. Send for free sample now to Jim W0AYW, Willstamp, 1102 N. State, Brookfield, Mo.

TRADE—Ham Radio—Citizens Band equipment for Hi-Fi equip. or vice-versa. Amateur Radio Exchange, Div. of Audio Exchange, 153-21 Hillside Avenue, Jamaica 32, New York. AX 7-7577.

2-watt transmit. SX 28 Revr. Contact after 7:00 p.m. K2KLY, Herbert Rosenzweig, 901 Avenue H, Brooklyn. GE 4-2803.

A-1 reconditioned equipment. On approval. Trades. Terms. Hallicrafters S-40B \$69.00, SX-99 \$109.00, SX-100 \$199.00, HT-37, S-85, SX-110, SX-111, SX-101A, HT-32, HT-32A, HT-33A; Collins 75A-1, 75A-2, 75A-3, 75A-4, KWM-1, 32S-1, 75S-1, KWS-1; Central 20A \$159.00; Elmac PMR-6 \$69.00, AF-67 \$109.00; Gonset G-66B, G-77A, G-50, GSB-100, GSB-01; Hammarlund HQ-100 \$129.00, HQ-110 \$179.00, HQ-129X, HQ-140X, HQ-140XA, HQ-150, HQ-160, HQ-170, HQ-180; Johnson Adventurer \$33.00, 6N2 \$99.00, Viking II \$179.00, Ranger \$179.00; National NC-98 \$99.00, HRO-50T \$99.00, NC-300, HRO-60, NC-183D, NC-303; Heath, Globe, RME, other items. List free. Henry Radio, Butler, Missouri.

WANTED: Collins mechanical filter adapter 353E-1 or 354A-1. Filters F500B-14, F500B-31, F500B-60. Also Crosby 67B Sideband adapter. VE3VG, 47 Parkwood Ave., Toronto 7, Ont., Canada.

ATTENTION MOBILES—50 watt General Electric 30-50 Mc two-way FM equipment. Easily converts to six or ten meters. 12V operation. Write Electronic Specialty, Box 3095C, Hayward, California.

POWER supply for sale. 2500vdc at 1000 ma. W0OMH, 2632 Victoria, Wichita, Kansas.

FOR SALE: Complete 500w SSB station. GSB-100, HQ-170, Factory-wired Viking Courier. All equipment 18 mos. old, \$800. Will demonstrate. Philip Margulies, K2GYY, 9 Pine Court, Westfield, N. J.

Viking II and VFO for sale. Factory wired. Excellent condition. W2EC, 169 Buckingham Road, West Hempstead, L. I., N. Y.

Vacation and ham at the same time. Ideal location. Ocean-front apartments. Just bring transmitter, beam already up. Write Ocean House, 4053 South Surf Road, Hollywood, Florida.

Collins 75S1, 32S1, 516F2, plus speaker. Like new. In original cartons. Used less than 50 hrs. \$1000.00. W9IPB 1712 Crescent Dr., Pekin, Ill.

FIRM SALE: clean Ranger \$159, DX-100 \$139, 6N2 \$90. F.O.B. W6DZM, 1929 King, Santa Rosa, Calif.

Sacrifice—Viking 6N2 mint condition \$80. NC-303 like new \$290. MM-1 \$54. 100 Watt all band AM-CW plate modulated transmitter \$62. Will ship any of above. Howard Fruchter, WA2DCM, 589 Barnard Avenue, Woodmere, L. I., N. Y.

SELL: Mobile rig, Johnson Viking Mobile, VFO, Elmac PMR-7, power supplies, mounts, relays, etc. \$200. Write W0PSJ, Box 503, Grand Island, Nebraska.

75A-1 and 32V-1 completely TVI'd. DMHZ Mike and push-to-talk stand. Like new condition \$450.00. G. M. Crook, 8364 Remmet Avenue, Canoga Park, California, Diamond 8-3169.

FOR SALE: Hallicrafters SX-100 receiver perfect condition, used very little, \$175.00. Vernon Pettingill, Park Ave., Wool Rich, Pa. Phone Porter 9-6135.

CITIZENS BAND: Pair Heath CB-1 transceivers plus a 12v power supply, \$75. Orvill Maben, Garner, Iowa.

WANTED: RAL with power supply. Also double button mike. Sensitive scintillator also desired. Send details. W6QV, 4532 Paulhan Ave., Los Angeles 41, Calif.



F/W Ranger, \$179; SX-99, \$99. Both in excellent condition. Edward Miller, Box 144, Calistoga, California.

With "DIP-A-CAP" and your Grid Dip Meter, range 1.7 to 85mc, measure capacity 3.0 to 7000 micromicrofarads easily and quickly. \$3.50 each. E. M. Shook, W5IT, 227 West Woodin Blvd., Dallas 24, Texas.

Gonset 101 amplifier for sale. Asking \$350. Excellent condition. Cash and carry only, no shipping. Larry Frank, WA2IAF, 698 West End Ave., N. Y. C. UN 5-9820.

BARGAINS in new and used surplus beams, rotators, transmitters, etc. Send self-addressed envelope for complete lists and prices to W1OZ, 42 Sun Hill Lane, Newton Center, Mass. Phone LA 7-2641.

First certified check or money order for \$350.00 takes spotless Viking Valiant, Matchbox, Low Pass Filter, mike w/stand. W9RTB, 1551 Ohio Ave., Whiting, Indiana.

FOR SALE: NC-98 w/QF1 \$98. TCS13 new w/ACPS \$60. TCS12 Complete w/ACPS and receiver \$75. BC342-N XInt. \$55. Manuals for all. Want Harvey-Wells T-90 and APS-90. Also APR-1 receiver. Cash or trade. Al Johnson, 67 West 10th St., Hialeah, Fla.

Viking Ranger and Heath DX-40. Priced Low. Gerst-2674 W 25th St., Cleveland 13, Ohio.

WANTED: 75S-1 and 32S-2 with 516F-2. Will swap, practically new, in perfect condition Linhof Supertechnika IIIIE 4 x 5, #58218 with Apo-Lanthar 4.5/150 mm; Angulon 6.8/90 mm; Telomar 5.5/360 mm; optical multifocus viewfinder; 120 film pack adapter; 4 filters; 1 polaroid lens; sunshade; heavy duty tripod; carrying case, etc. KH6DBJ, 216 Halemaumau Street, Honolulu 16, Haw., Tel. 33405.

Ranger for Sale: First \$165 takes it. Dennis Royal, 852 E. Aurora, Des Moines, Iowa.

WANTED: Lampkin 105B & 205A in good shape. We buy all types of 2-way equipment. Let us bid on your used equipment today. M. J. Curley, 408 Forest Ave., Staten Island 1, N. Y. GI 2-8942.

WANTED—CQ volumes 1, 2, 3, 4, 5, all issues. Best offer accepted. Correspond with C. Lee, P.O. Box 395, Times Square Stn., New York 36, N. Y.

AUCTIONFEST—Broward Amateur Radio Club's fifth annual auction and get-together, Saturday, Mar. 11, Armory, S. W. 4th Ave. & 24th St., Ft. Lauderdale, Fla. Doors open 8 a.m., auction at 10, free lunch at noon.

We buy for cash as well as sell and trade on good used ham gear. Send for our bargain list. H&H Electronic Supply, 506 Kishwaukee St., Rockford, Illinois.

Amazing low prices on radio gear and parts. FREE LIST. Martin Brothers, 1420 South 10 1/2 St., Springfield, Illinois.

FOR SALE: QST 1929—Dec. 1959. Best offer, all or none. S-38E \$55. Heathkit xtal mike \$15. Channel Master 8 transistor radio \$59, RA62-C rectifier \$35. Novice band xtals \$5, set Lionel trains with equip. \$250, will trade or buy Hy Gain 3-element Thunder Bird Ant. Thomas Lesler, 25 North Market, Elizabethville, Pa., Phone EN 2-8314.

MOBILE—RME MC55 6v-12v Converter—Stancor ST203A transmitter with wencharger dynamotor power supply. Transmitter converter to 75M-12v—Also Eicor dynamotor input 5.7v output 600v. Best offer or trade for anything of like value. K5HDH, Box 1881 Harlingen, Texas.

100V in factory sealed crate. Never opened. Just received. Need cash, \$750.00. MM-2 used very little with adapter for rec. \$100.00. K9CNG, phone 320, Vandalia, Ill.

RECONDITIONED! Terms! Full guarantee! Dynamotors 200ma. 400v. 12V new \$5.95; Carbon Mobile Mic. PTT cc \$6.00; 24 hr. clocks 15" face \$6.95; Heath Comanche \$119.00 slicer \$7.50; HRO-1 \$169.50; HQ 129X \$139.50; 140X \$179.59; Super Pro 400X \$199.50; NC-173 \$129.50; 109 \$129.00; 240D ws \$139.95; 300 \$229.00; 57 \$49.95; 20-A \$179.50; MM-1 \$79.50; Model B slicer \$39.95; Viking II \$209.00; Navigator \$129.95; Valiant \$325.00; Adventurer \$29.95; RME 4300 \$149.00; DSB 100 \$109.00; Globe King 500A \$395.00; Chief 90 \$49.95; 90 \$49.95; 90A Kit \$39.95; Scout 680A \$79.00; KWM-1 WPS new \$695.00; 75A4 \$595.00; S40 \$79.00; SX71 \$139.00; 99 \$99.00; 32V II \$350.00; Gonset 6 meter linear \$89.95; Comm III 2 meter \$239.95; Lakeshore Band hopper \$79.95; Lysco 600 \$59.00; Harvey Wells TBS 50D \$49.95; James C 1450 \$39.95; PMR 6 \$79.95; 7 \$99.95; Knight World Wide receiver w/S-meter \$69.50. Ken, WØZCN, Harold WØZVB, Ken-Els Radio, 428 Central Avenue, Fort Dodge, Iowa.

## NON-METALLIC GUY LINE — PERFECT FLEXIBLE INSULATOR — REVOLUTIONIZES HAM RADIO & TV ANTENNA SYSTEMS

Non-inductive, non-conducting, non-absorbing Glas-Line isolates systems from directional arrays, rhombics, etc.

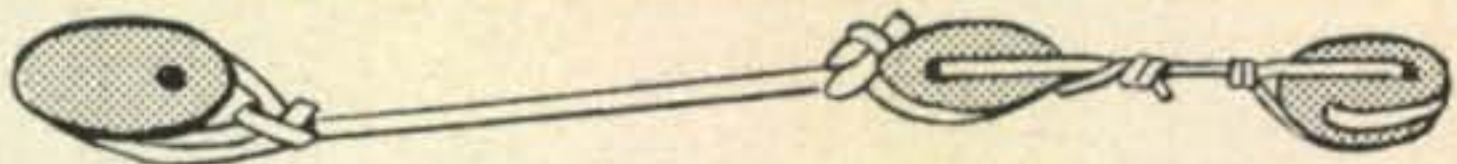

The new main insulator of W3UCT. The Glas-Line is between the two egg insulators running to the lower left. The copper link between the center egg insulator and the upper right egg insulator is for the dead-end feeder of a Zepp antenna.



View of an open thimble and eye bolt for coupling the Glas-Line guy wire to a tree. GLAS-LINE cannot rot, will not shrink, stretch or sag . . . has high breaking strength of over 500 pounds with proper use.

100' SPOOL \$3<sup>75</sup> Plus 50¢ for postage & handling  
600' REELS \$17<sup>84</sup> Plus \$1.00 for postage & handling

'SUPER' GLAS-LINE with 1,000 lb. TENSILE STRENGTH with proper use.  
100' SPOOL \$6<sup>95</sup> Plus \$1.00 for postage & handling  
600' REELS \$34<sup>75</sup> Plus \$2.00 for postage & handling

Announcing New "G-3 50X GLAS-LINE CABLE" with 2,500 lb. TENSILE STRENGTH with proper use.  
100' SPOOL \$13<sup>90</sup> Plus \$1.50 for postage & handling  
600' REELS \$69<sup>50</sup> Plus \$3.00 for postage & handling

Send check or M.O. No C.O.D.'s please. DEALER & DISTRIBUTOR INQUIRIES INVITED.

# THE GLAS-LINE CO.

2751 NOSTRAND AVE., DEPT. 1, B'KLYN 10, N. Y. • CL 2-9851

For further information, check number 36 on page 126.

## ANTENNA - ITUS? \*

Friend, are you suffering from Antenna-itus? Have you noticed these symptoms lately?

1. Fewer and fewer answers to CQ's
2. DX QSO's rare
3. Clobbered by the "Big Boys"
4. DX Bands always dead

If so, you need a G4ZU antenna system. Let our antenna doctors prescribe from our stock of antennas for all bands, rotators, towers, cable, masts, SWR meters, etc. We carry a complete stock of all popular brands including the ever popular G4ZU 10, 15 and 20 meter Minibeam (Only \$89.50), the powerful 20-40 meter G4ZU Birdcage (Only \$87.25), and matching mast for the Birdcage (just \$7.25 with antenna).

And Now, for a Limited time only, we are offering . . .

### FREE, FREE, FREE

the Foreign Edition of The Radio Amateurs Call Book with every purchase totaling \$25.00 or more. Offer begins February 1st. Don't Miss Out!!

\*(An illness common to many amateur stations)

Get our prices before you buy

We export anywhere

## HOUSE OF ANTENNAS

1155 East 82nd Street, Chicago 19, Illinois  
Tel. SO. 8-9282



# ADVERTISING INDEX

## Are You TRADING?

Let me make you a trade-in offer on your used amateur equipment. All name-brand merchandise—late serial numbers assured. Quick delivery.



WRITE TODAY! Bill W9ZSO-KØIUH

### COMMUNICATIONS EQUIPMENT CO.

518 State St., LaCrosse, Wis.  
Phone 4-7373

## Nate's SPECIAL of the MONTH! BC-604 50W. FM TRANSMITTER

20-28 Mc. COMPLETE WITH ALL TUBES, spare tubes and COMPLETE SET of 80 crystals in slide-in drawer INCLUDING the hard-to-get SSB crystals and one 500 Kc. calibrating crystal! Shipping weight: approx. 100 lbs. BRAND NEW IN ORIGINAL CASE. **\$9.95**  
Each

(FOB Gardena, Calif. SEND CASH WITH ORDER.  
No COD. Calif. residents add 40¢ tax.)

ALSO IN STOCK: BC-603 Receivers, DM-35 Dynamotors, Headsets, Mikes, raft of other parts and equipment!  
SEND FOR FREE BARGAIN FLYER!

**NATE BECKERMAN & ASSOCIATES, Dept. C**  
1703 West 135th St. Gardena, California  
Phone: FAculy 1-2318

## READER SERVICE

### CQ Magazine, Dept. RS

300 WEST 43rd STREET  
New York 36, N. Y.

Coupon B  
Void after  
Feb. 25, 1961

Please send me more information on your ads in the Feb. 1961 CQ keyed as follows:

1	2	3	4	5	6	7	8	9	10	A
11	12	13	14	15	16	17	18	19	20	
21	22	23	24	25	26	27	28	29	30	B
31	32	33	34	35	36	37	38	39	40	C
41	42	43	44	45	46	47	48	49	50	
51	52	53	54	55	56	57	58	59	60	D

NAME \_\_\_\_\_

(Please Print)

Call \_\_\_\_\_ Engineer

Type of work (specify) \_\_\_\_\_

ADDRESS \_\_\_\_\_

CITY \_\_\_\_\_

ZONE \_\_\_\_\_ STATE \_\_\_\_\_

ACF Industries, Inc. ....	18
Allied Radio Corporation .....	128
Barry Electronics Corporation .....	123
Beckerman, Nate & Assocs. ....	126
Bonn, Lew .....	106
Burstein-Applebee Company .....	122
Centralab .....	16
Central Electronics Incorporated .....	6
Cleveland Institute of Electronics .....	14
Collins Radio Company .....	Cover II
Communications Associates, Incorporated .....	124
Communications Equipment Company .....	126
Communication Products Company, Inc. ....	8
Cush Craft .....	121
CQ's Classified Ads .....	122
CQ Ham Mart .....	108, 109
Delehanty Institute .....	120
Denver Radio Club .....	118
E-Z Way Towers, Incorporated .....	120
Editors & Engineers Limited .....	121
EICO .....	19
Electrophysics Corporation .....	114
Glas-Line Company .....	125
Globe Electronics (WRL) .....	17
Gonset Company .....	15
Greenlee Tool Company .....	122
Hallcrafters Company .....	4, 5
Hammarlund Manufacturing Company .....	2
Harvey Radio Company, Incorporated .....	113
Heath Company .....	9, 10, 11
Henry Radio Stores .....	111
The House of Antennas .....	125
Instructograph Company .....	119
International Crystal Manufacturing Co. ....	22, 23
Irving Electronic Company .....	118
Johnson, E. F. Company .....	24, 25
KwickPatch .....	120
Lafayette Radio .....	107
Lampkin Laboratories, Incorporated .....	120
Lektron, Incorporated .....	119
Millen, James Manufacturing Co., Inc. ....	12
Motorola Training Inst. ....	117
National Radio Company, Incorporated .....	Cover III
Northeast Telecommunications, Inc. ....	116
P & H Electronics .....	124
Palmer, Joe .....	116
Pennwood Numechron Company .....	119
Penta Laboratories, Inc. ....	21
Petersen Radio Company, Incorporated .....	1
RCA (TUBE DIVISION) .....	Cover IV
RW Electronics .....	119
Radio Amateur's Book Shelf, The .....	104
Radio Shack Corporation .....	105, 118
Shure Brothers, Incorporated .....	13
Stoner Electronic Sales Co. ....	115
TAB .....	127
Telrex, Incorporated .....	115
Texas Crystals .....	110
Turner Microphone Company .....	20
U.S. Crystals, Inc. ....	114
Van Sickle Radio Supply Co. ....	120
Vibroplex Company, Incorporated .....	117
Western-Radio Company .....	117
Westinghouse Electric Corp. ....	112



**"TAB" FOR THE BEST KITS!**

**KITS! Each "TAB" Kit Contains The Finest Selection!!!**

- Kit 100 Self-Tap Screws
  - Kit 4 Selenium "Suncells"
  - Kit Adj Wire Stripper & Cut
  - Kit 5 pcs Wrench Set
  - Kit 8 pcs Nut Driver Set
  - Kit Hi Gain Xtal Mike
  - Kit 6 ea Phonoplugs & Jacks
  - Kit 25 ft Lo-Cap Mike Cable
  - Kit 20 ft RG59U Coax Cable
  - Kit 15 ft RG11U Coax Cable
  - Kit 2 pair SO239 & PL59
  - Kit 12 Binding Posts Asstd
  - Kit 5 Phone Jacks Asstd
  - Kit 3 Phone Plugs Asstd
  - Kit Long Nose Plier
  - Kit Side Cutter Plier
  - Kit 2 Xmttr Variables
- Kit 5 Mylex Glass/HF Strips
  - Kit 35 Precision Resistors
  - Kit 10 Switches
  - Kit 75 Resistors 1/2 1/2W
  - Kit 150 Carbon Resistors
  - Kit 12 Electrolytic Cond's
  - Kit 15 Volume Controls
  - Kit 56 Tube Sockets
  - Kit 65 Tubular Condensers
  - Kit 500 Lugs & Eyelets
  - Kit 10 Bathing Oil Cond's
  - Kit 5 lbs. Surprise Package
  - Kit 10 Transmit Mica Cond's
  - Kit Glyptal & Cement
  - Kit 3 Phone/Patch Xfmrs
  - Kit 4 AN/Reflector Lites
  - Kit 6 Insid Tuning Tools
  - Kit 4 "Suncells" Asstd.
- Kit 5 AN Plugs & cncntrs
  - Kit 5 Sub-Min Tubes
  - Kit 40 Standoff Insulators
  - Kit 35 Power Resistors
  - Kit 75 Mica Condensers
  - Kit 8 Crystal Diodes
  - Kit 200ft Hook Up Wire
  - 4 Rolls, 50ft/ea. Asstd. Color
  - Kit 100 Ceramic Condensers
  - Kit 5 FT243 Xtal Holders
  - Kit 5 Microswitches
  - Kit 10 Wheat Lamps
  - Kit 3 Transistor Xtmrs
  - Kit 8 Xtal Osc-Blanks
  - Kit 4 Asstd Rectifiers
  - Kit 12 Alligator Clips Asd
  - Kit 5 UG/Connectors

**99c**

**ONE EACH ABOVE KIT ONLY**

**Order Ten Kits We Ship Eleven!!!**

**"TAB" THAT'S A BUY**



**"TAB" Tubes Tested, Inspected, Boxed**

Six Months (Guaranteed! No Rejects!)

**GOVT & MFGRS Surplus! New & Used**

0A2	.89	6BZ7	1.25	We Buy & Sell	
0A3	.80	6C4	.45	43	.75
0B2	.65	6C5	.69	45	.49
0C3	.70	6C6	1.08	50L6	.69
0D3	.50	6C8	1.08	RK59	1.39
0Z4	.79	<i>We Trade!</i>		RK60	1.17
1A7	.90	6CB6	.89	HY69	2.20
1B3	.99	6CD6	1.49	75	.81
1L4	.82	6CF6	.85	HY75	5.00
1R4	5/\$1	6CL6	1.40	83V	.95

*We Swap Tubes! What Do/You Have?*

1R5	.78	6CB6	.89	4PR60A	37.50
1S4	.78	6CG8	1.12	4-125A	27.50
1S5	.68	6CM6	.79	4X150G	15.00
1T4	.85	6CS6	.70	4X250B	41.00
1T5	.95	6CU6	1.29	4-400A	41.75
1U4	6/\$1	6D6	.99	4E27A	39.00
1U5	.75	6E5	.79	250TL	19.45
1X2	.99	6F4	2.49	307A	2/\$1
2C39A	Q	6F5	.63	316A	5/\$1
2C40	5.50	6F6	.99	VR92	5/\$1

*Send 25¢ for Catalog!*

2C43	6.50	6F7	.99	388A	3/\$1
2C51	2.00	6F8	1.39	350A	2.45
2D21	.65	6H6	.59	350B	1.75
2E22	1.75	6J4	1.72	371B	.95
2E24	1.90	6J5	.59	6146	3.90
2E25	2.50	6J6	.59	416B	16.00
2E26	2.75	6J7	.99	450TH	43.00
2E30	Q	6J8	1.39	450TL	43.00
2E35	1.60	6K6	.59	460	11.50
2K25	9.75	6K7	.79	703A	Q

*All Tubes Stocked at Low Prices!*

2K26	34.00	6K8	.99	707B	3.50
2K28	30.00	6L6	1.19	715C	10.90
2V3	2/\$1	6SN7	.72	717A	5/\$1
2X2	.48	6T8	.98	723AB	5.00
3A4	.70	6V6GT	.90	725A	2.75
3A5	1.00	6X5	.49	803	3.50
3AP1	5.95	12AT6	.59	804	8.85
3BP1	3.99	12AT7	.89	805	6.00
3C24	3.50	12AU6	.63		
3D23	3.95	12AU7	.69		

<i>We Buy!</i>	<i>We Sell!</i>	<i>We Trade!</i>			
3E29	6.00	12AX7	.79	807	1.10
3Q4	.68	12AY7	1.29	5/\$5, 10/\$12	
3Q5	.86	12B4	.95	811	3.45
4-65A	13.50	12BA6	.85	811A	4.41
4-125A	27.50	12BA7	.99	812	3.30
4-250A	34.00	12BD6	.59	813	8.00
4X150A	Q	12BE6	.59	815	1.75
4X250	36.00	12BH6	.79	826	.99
4X500	37.00	12BH7	.99	828	9.00
5AP1	2.95	12BY7	1.00	829B	8.00

*Wanted Test Sots and Equipment*

5BP1	7.95	12BZ7	.99	991	5/\$1
5BP4	7.95	12H6	.75	1614	2.75
5CP1	4.99	12J5	.69	1619	5/\$1
5CP7	9.00	12J7	.69	1620	2.00
5R4	1.00	12J8	1.35	1625	3/\$1
5T4	.90	12K8	.89	1626	5/\$1
5U4	.99	12SA7	.69	1629	4/\$1
5V4	.89	12SC7	.89	2050	1.25
5Y4	.60	12SF5	.69	5517	1.25
5Z3	.89	12SG7	.89	5608	3.95

*Send 25¢ for Catalog!*

15GP22	89.00	12SH7	.89	991	5/\$1
6A7	1.00	12SJ7	.75	1614	2.75
6A8	.99	12SK7	.75	1619	5/\$1
6AB4	.59	12SL7	.79	1620	2.00
6AC7	.72	12SN7	.69	1625	3/\$1
6AG5	.65	12SQ7	.69	1626	5/\$1
6AG7	.75	12SR7	.69	1629	4/\$1
6AK5	.69	15E	1.19	2050	1.25
6AL5	.59	15R	4/\$1	5517	1.25
6AQ5	.66	FG17	Q	5608	3.95

*Top \$\$\$ Paid for 304TL, 726B Tubes*

6AR6	1.95	19T8	1.16	5618	3.25
6AS7	3.49	24G	3.50	5651	1.35
6AT6	2/\$1	25A6	1.19	5654	1.20
6AU6	.79	25A7	2.19	5656	4.25
6B8	1.35	25C5	.81	5663	1.15
6BA6	.59	25L6	.72	5670	.90
6BE6	.59	25T	4.00	5686	1.75
6BG6	1.49	25Z5	.72	5687	1.15
6BH6	.79	25Z6	.75	5691	4.70
6BJ6	.72	26A7	3.69	5725	1.95

*Top \$\$\$ Paid for XMTTR Tubes!*

6BK7	.99	FG27	8.28	5732	2.00
6BL7	1.35	HV27	19.39	5736	85.00
6BN4	.69	28D7	.89	5749	1.95
6BN6	1.08	FG33	15.00	5750	2.75
6BN7	1.99	EL34	3.49	5751	1.25
6BQ6	1.19	35A5	.69	5814	1.20
6BQ7	.99	35L6	.59	5879	1.20
6BX7	1.11	35T	4.49	5894	\$12.00
6BY5	1.19	35Z5	1.25		
6BZ6	.91	RK39	2.99		

**"TAB" TERMS: Min Order \$3-25%**  
with order F.O.B. New York.  
Ten day guarantee, price of  
mdse. only. Our 15th year.  
Prices shown are subject to change.

**111CB Liberty St., N. Y. 6, N. Y. RE 2-6245**

For further information, check number 37 on page 126.

**NEW POWER CONVERTER**  
12VDC to 500VDC  
up to 200MA  
100 Watts; Tap at 250VDC  
\*Type C1250E \$35



Hi efficiency, low ripple, low idle current-Silicon rectifiers! Toroidal HiEff! (Mu-Metal) tape wound transformer, fused & short circuit proof, small in size! Quiet! Light weight! C1250EE built, ready to go. Conservatively Rated. Delco Transistors \*Heavy Duty Finned Delco Heatsinks.

**TYPE C650E FOR 6VDC INPUT \$35**  
Hi efficiency, low ripple, low idle current-Silicon rectifiers! Toroidal HiEff! (Mu-Metal) tape wound transformer, fused & short circuit proof, small in size! Quiet! Light weight! C650E built, ready to go. Conservatively rated. Delco Transistors Heavy Duty Finned Delco Heatsinks.

**12VDC to 250VDC up to 150MA**  
Type C1225E \$30  
**C625E for 6VDC input \$30**  
**TOROID TRANSFORMER FOR TRANSISTOR POWER SUPPLY APPLICATION**  
T6-500E/6VDC Impt, 500VDC & Tap, Max 200Ma \$15. T12-500E/12VDC Impt, 500VDC & Tap, Max 200Ma \$15. T6-250E/6VDC Impt, 250VDC, Max 150Ma \$14. T12-250E/12VDC Impt, 250VDC, Max 150Ma \$14.

**Send 25¢ for Catalog**  
**Leece Neville Charger Systems**  
**"SILTAB" Silicon Rectifier Replacement**  
**Non-Aging Hermetically Sealed**  
FOR 6 or 12VDC @ 100A, Type YJ9 \$24



**NEW \*SILICON 750 Ma TOP HATS!**  
Orders Silicons \$10 or more Postpaid

17.5/25 rms/piv 14c	35/50 rms/piv 19c	70/100 rms/piv 29c	140/200 rms/piv 34c
210/300 rms/piv 43c	280/400 rms/piv 55c	350/500 rms/piv 70c	420/600 rms/piv \$1.00
490/700 rms/piv \$1.25	560/800 rms/piv \$1.05	630/900 rms/piv \$1.25	700/1000 rms/piv \$1.70

Use in Bridge or C.T. up to 1 Amp DC  
"TAB" Special General Purpose Silicons  
400 PIV @ 300Ma. 2 for \$1, 20/\$7.  
\*Derate 20% for Capacitive input

**HDQTRS. TRANSISTORS & ACCESSORIES**  
2N441/\$2.80; 2N442/\$4; 2N277/\$4; 2N278/\$5; 2N155/\$1.39; 2N176/\$1.80; 2N177/\$1; 2N178/\$1.75; 2N247/\$1.50; 2N255/\$1.20; 2N270/.95; 2N274/\$1.25; 2N408/.80; 2N554/\$1.20; 2N578/\$1.80; 2N579/\$2.20.  
**DIAMOND BASED MICA MTG KIT**...30  
**DELCO ROUND BASED MICA KIT**...30  
**DELCO POWER HEAT SINK 80 sq."** \$1.00

**"VACDAC"® SILICON TUBE REPLACEMENTS**  
WITH BUILT IN RF SURGE & SERIES BALANCING PROTECTION  
**TYPE VRMS/PIV AMPS PRICE**  
ST866 5000/10400 0.3 \$20.00  
ST816 5000/7000 0.3 \$16.00  
ST5R4 1900/2800 0.5 \$15.00  
ST5U4 1120/1600 0.6 \$ 8.00

**SELENIUM F.W. BRIDGE RECTIFIERS**

DC AMP	18VAC 14VDC	36VAC 28VDC	72VAC 54VDC	130VAC 100VDC	One Year Gtd!	
					1/2	1
1	\$1.00	\$1.90	\$3.85	\$5.00		
2	1.30	2.00	4.90	8.15		
3	2.15	3.00	6.25	11.10		
6	2.90	4.00	8.60	13.45		
10	4.15	8.00	18.75	31.90		
12	6.10	12.15	26.30	41.60		
20	7.75	14.90	30.95	43.45		
24	12.85	24.60				
	15.00	29.45				

**NEW BATTERY CHARGER BC6-12V**  
FOR 6V OR 12 VOLT BATTERIES,  
TRICKLE & FULL CHARGE up to 4 AMP  
Charges 6 & 12 volt batteries.  
Built BC6-12V .....\$10.00

Wanted 304TL Tubes & ALL TYPES!!!



**!!! TUBE SPECIAL !!!**  
4X1500 - Removed from Govt. equipment. Tested. \$3 ea., 2 for \$5. Filament Xfmr \$2. First come, first served.

**TOP HAT SILICON DIODE EXPERIMENTERS KIT.** USE AS STABIS-TORS, ZENER DIODES & METER PROTECTION DIODES, CLIPPER & RECTIFIER DIODES! A \$10 VALUE, 8 for \$1.

**"TAB"-THAT'S A BUY!-BARGAINS!!**  
IRISH/MYLAR Tape 2400 ft.....3/\$12  
CONDNR Oil/W.E. 2mfd@600WVDC 6/\$1  
SNOOPERSCOPE TUBE 2".....\$5@. 2/\$9  
MINI-FAN 6 or 12VAC/60 Cys \$2 @ 3/\$5  
NEW PRINT CKT-PANEL, 11x12x.062" \$2  
IRISH TAPE 1200' HiQlty, .....3 for \$5

BANDPASS 60 or 90 or 150 Cys...each \$2  
1N34A 45c@. 15/\$5; 1N35 \$1; 1N38 70c@;  
XTAL OVEN-115V&Thermostat .....\$2  
Blower 24VDC/100CFM .....\$3.98  
Blower AC/Miniature 6&12VAC .....\$1.00  
Xmitting Mica's .006 @ 2500V, 5 for \$1.00

Miller 2.5MH/2.5&5Mtr Chokes ...8/\$1.00  
Vibrators 6 or 12VDC \$1.49@; 4/.....\$5.00  
New Variacs/or equiv 0-135V/7.5A \$15.30  
New Variacs/or equiv 0-135V/3 Amp \$10.65  
New Variacs/or equiv 0-132V/1.25A \$7.25

RF-MTG GE/475 Ma & 5 Amp \$4@. 2/\$7  
DC-METER Dejur 800 Ma/3 1/2" \$3@. 2/\$5  
DC-METER One Ma/4" Rd. \$5@. 2/\$8  
RF-HTR Weston 750Ma/TC...\$4@. 2/\$6  
DC MTR 100Ma/2 1/2".....\$3@. 2/\$5

AN-ARR2/RCVR less tubes A-1 cndtn \$1.95  
829B Socket 85c, 183 Socket.....\$1  
4x150 Ceramic/LORTAL.....2 for \$1.00

**SELENIUM RECTIFIERS 130/RMS HALF WAVE**  
75Ma 49c, 5 for \$2; 100Ma 59c, 6 for \$3  
150Ma 70c, 8 for \$5; 250Ma 79c, 6 for \$4  
300Ma 88c, 5 for \$4; 350Ma \$1.00, 8 for \$7  
500Ma \$1.35, 5 for \$5  
This Item P.Pd. 48 states orders \$10.

**WE BUY! SELL & TRADE**  
Send 25¢ for Bonus Catalog!



only at **ALLIED**

**greatest 6-meter value ever!**

Join the VHF fun  
with **ALLIED's** own  
**LINCOLN**  
**6-METER**  
**TRANSCEIVER**  
MODEL L-2754



**SUPER-VALUE**  
**COMPLETE 6-METER STATION**

FOR ONLY **\$59<sup>95</sup>**

only \$5 down

- ✓ Tunable Superhet Receiver Covers Entire Band
- ✓ Built-In Adjustable Noise Limiter
- ✓ Front-Panel Crystal Socket
- ✓ 7 Watts Input—6CX8 Final Amplifier

Get in on the 6-meter fun with this outstanding Allied special! It's *complete*—all set to go, with built-in 115-volt AC power supply, 50.2-mc crystal and crystal mike—tops in value for 6-meter mobile, fixed station, or both. Just connect an antenna and you're on the air! Superhet receiver section covers 50-54 mc with vernier tuning; includes adjustable noise limiter. Transmitter section uses a 6CX8 final at 7 watts input; has built-in TVI filter; fully tunable output network matches any 30-100 ohm

antenna; uses 3rd-overtone crystals which plug into front-panel socket. With neon modulation indicator. Tube line-up: 6U8A RF amp/mixer; 6U8A osc/IF; 6AL5 det/ANL; 6CX8 xtal osc/RF output; 12AX5 AF/mike amp; 6V6GT AF output/modulator. Attractive, compact cabinet measures 5½ x 16¼ x 6¾". Shpg. wt., 11 lbs.

- 78 SZ 195 S. Only \$5 Down. NET..... \$59.95
- 12-Volt Power Supply. 2¾ x 5¾ x 4¾". 4 lbs.
- 78 S 163. NET..... \$10.95
- 6-Volt Power Supply. 2¾ x 5¾ x 4¾". 4 lbs.
- 78 S 164. NET..... \$10.95

**make ALLIED your Ham Headquarters!**

- Get our famous "King-Size" trades—they're highest!
- Only \$2 down on orders up to \$50; only \$5 up to \$200!
- Enjoy top service and real "ham-to-ham" help!

**Flash! Ham Shack Open Sundays**

We're open at 100 N. Western Ave. on Sundays from 11:00 a.m. to 5:00 p.m.—so we're at your service seven days a week...

**if you haven't this Catalog, send for it**



order from

**ALLIED RADIO**

ALLIED RADIO, Dept. 16-B1  
100 N. Western Ave., Chicago 80, Ill.

Ship me the following:

- 78 SZ 195S Lincoln 6-Meter Transceiver
  - 78 S 163 12-Volt Power Supply
  - 78 S 164 6-Volt Power Supply
- \$.....enclosed

**BIG VHF Savings**

Send Free 1961 Allied Catalog

Name \_\_\_\_\_  
PLEASE PRINT

Address \_\_\_\_\_

City \_\_\_\_\_ Zone \_\_\_\_\_ State \_\_\_\_\_

For further information, check number 38 on page 126.



# NATIONAL'S NC-303 HIGHEST MECHANICAL STABILITY LOWEST THERMAL DRIFT MAXIMUM SSB/AM/CW VERSATILITY

Three decisive reasons why National's NC-303 outperforms all other receivers in its price class:

**HIGHEST MECHANICAL STABILITY**—solid chassis and component construction, pre-loaded double-spaced tuning gang and positive detent bandswitch assure stability under extremes of shock and vibration.

**LOWEST THERMAL DRIFT**—National's exclusive "high-zero" temperature compensation, carefully engineered oscillator circuitry and ceramic coil forms provide thermal stability unequalled by competitive receivers.

**MAXIMUM SSB/AM/CW VERSATILITY.** For The SSB User: "IF Shift" selectable sideband / SSB noise limiter / Product detector / Fast attack, slow decay AVC / "Q" multiplier with separate depth control. For The AM Man: 3.5 Kc phone bandwidth / 8.0 Kc bandwidth for net or VHF operation / Automatic AM noise limiter / Tone control / AM AVC. For The CW User: 500 cycle CW selectivity / "Peaking" audio filter / External CW muting for break-in. For Everyone: 1 microvolt sensitivity / "X" band and 12" dial scales for VHF converters / Accessory socket / 2 Kc dial calibration and vernier tuning control.

**Only \$44.99 down\***

Suggested cash price: \$449.00 (slightly higher west of the Rockies and outside the U.S.A.). \*Most National distributors offer budget terms and trade-in allowances.

**NATIONAL RADIO COMPANY, INC.**

A WHOLLY OWNED SUBSIDIARY OF NATIONAL CO., INC.



MELROSE 76, MASS.

Export: AD AURIEMA, INC., 85 Broad St., New York, N. Y. In Canada: CANADIAN MARCONI CO., 830 Bayview Ave., Toronto 17, Ont.

SPECIFICATIONS SUBJECT TO CHANGE WITHOUT NOTICE

For further information, check number 2 on page 126.





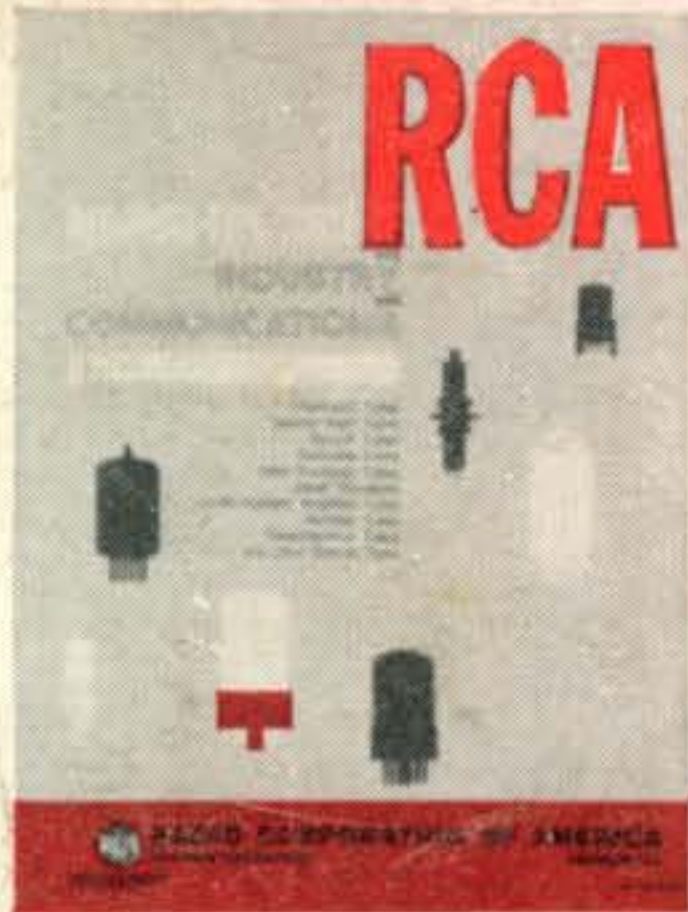
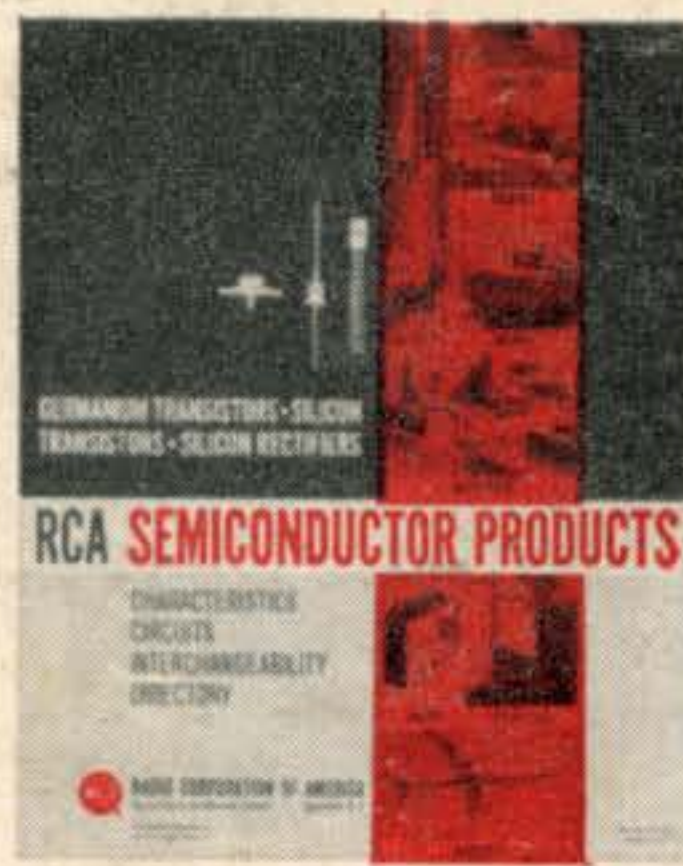
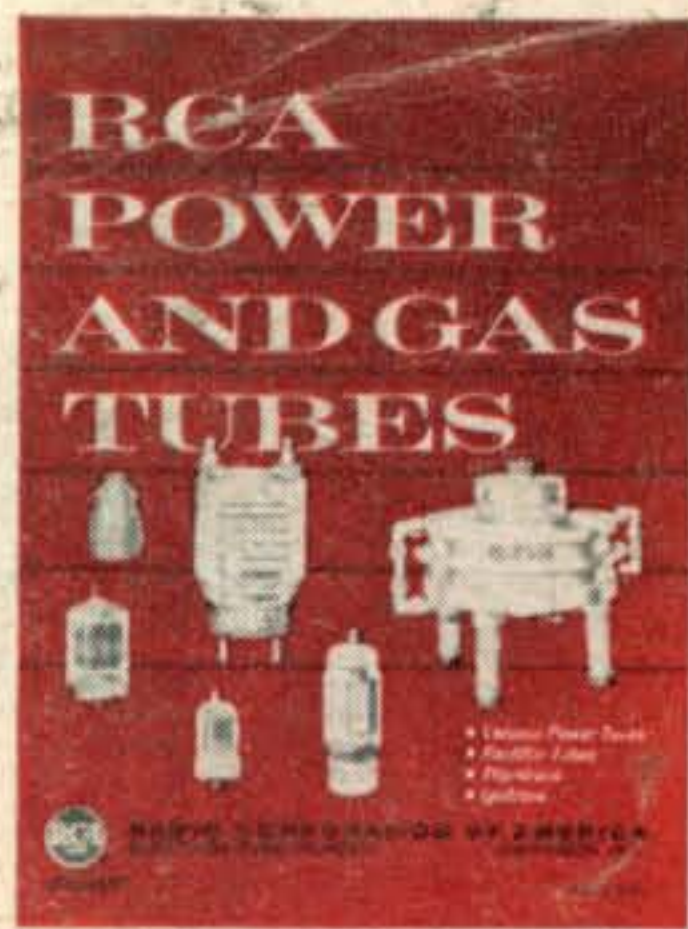
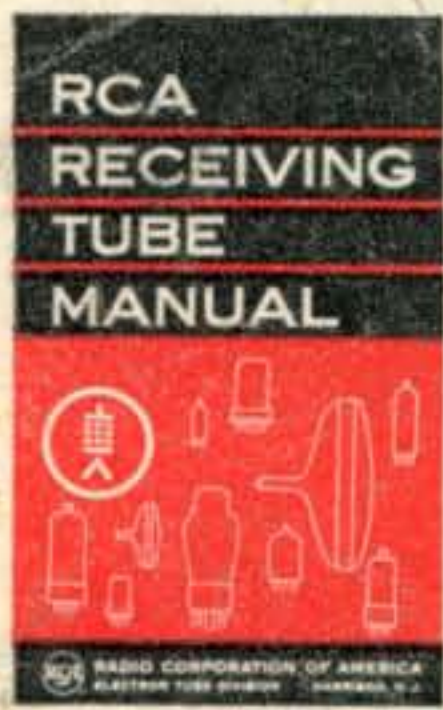

Amateur  
Radio's Most  
Comprehensive  
Technical  
References  
on...

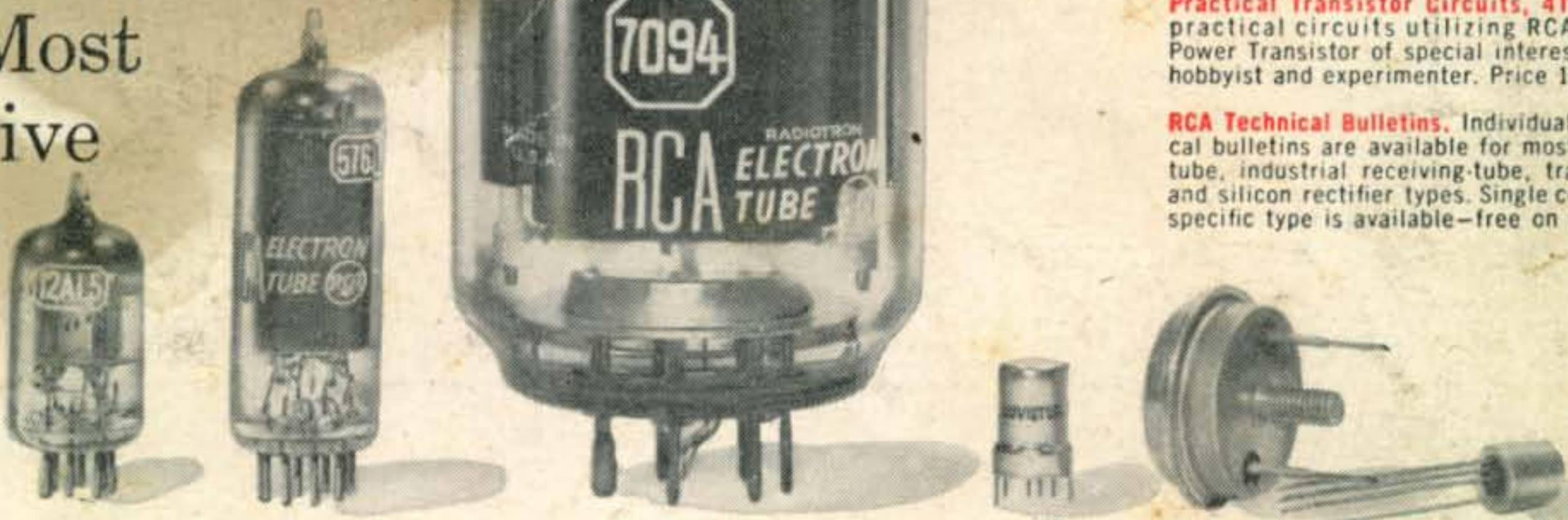

**POWER TUBES • RECEIVING TUBES • SEMICONDUCTOR DEVICES...** What's the best power tube for my final? Which tube combination will do the most for my receiver design? Which is the right transistor for my portable rig? You can get the answers to questions like these from the RCA publications pictured on this page.

Here, in easy-to-understand form, is a storehouse of technical facts you will want to know about hundreds of RCA tubes and transistors. In these publications you will find operating conditions, quick-reference charts, pages of circuits—application hints, installation tips, characteristics curves, all sorts of technical aids.

For copies of these authoritative ham-shack references, check the list above and contact your RCA Tube Distributor. Or remit payment with your order—direct to Commercial Engineering, Section A-37-M, RCA Electron Tube Division, Harrison, N. J.

**RCA Transmitting Tube Manual, TT-4.** Covers power types having up to 4 Kw plate input and associated rectifier types. 175 pages of data, theory, application, circuit diagrams. Price \$1.00.

**RCA Power and Gas Tubes, PG101D.** Illustrated 32 page booklet giving technical data in quick-reference form on 175 different types including RCA vacuum power tubes, rectifier tubes, thyratrons, and nitrons. Price 30 cents.

**RCA Receiving-Type Tubes for Industry and Communication, RIT-104B.** 32 pages technical information on premium tube types—low-microphonic amplifier tubes, glow-discharge tubes, pencil tubes, small thyratrons, and many others. Price 30 cents.

**RCA Receiving Tube Manual, RCA-20.** Revised, expanded, and brought up to date contains 432 pages of technical data on more than 760 receiving types and 170 picture-tube types. Features tube theory, circuits, resistance-coupled amplifier charts, curves, and socket diagrams. Price \$1.00.

**RCA Semiconductor Products, SCD-108D.** 108 pages packed full of technical data on RCA transistors and silicon rectifiers, plus circuits. Price 30 cents.

**RCA Receiving Tubes and Picture Tubes, 1275-J.** 48 pages of technical data on more than 900 receiving tubes and picture tubes. Price 35 cents.

**Transistor Fundamentals and Applications, 4T37.** Discusses transistor theory, applications, and servicing techniques. Price 50 cents.

**Practical Transistor Circuits, 4T64A.** 16 pages of practical circuits utilizing RCA-2N36 Power Transistor of special interest to the hobbyist and experimenter. Price 15 cents.

**RCA Technical Bulletins.** Individual technical bulletins are available for most power tube, industrial receiving-tube, transistor and silicon rectifier types. Single copy for specific type is available—free on request.



The Most Trusted Name in Electronics  
RADIO CORPORATION OF AMERICA