

March 1961

50¢



CQ



PROJECT OSCAR

The Radio Amateur's Journal

Two hamshacks One Transceiver

At home or on the highway you get single sideband and CW fixed station performance with this mobile Collins KWM-2 Transceiver. It covers all amateur bands from 3.4 to 29.7 mc. Visit your Collins Distributor and try the KWM-2 for use in your ham shack at home or the one on wheels.

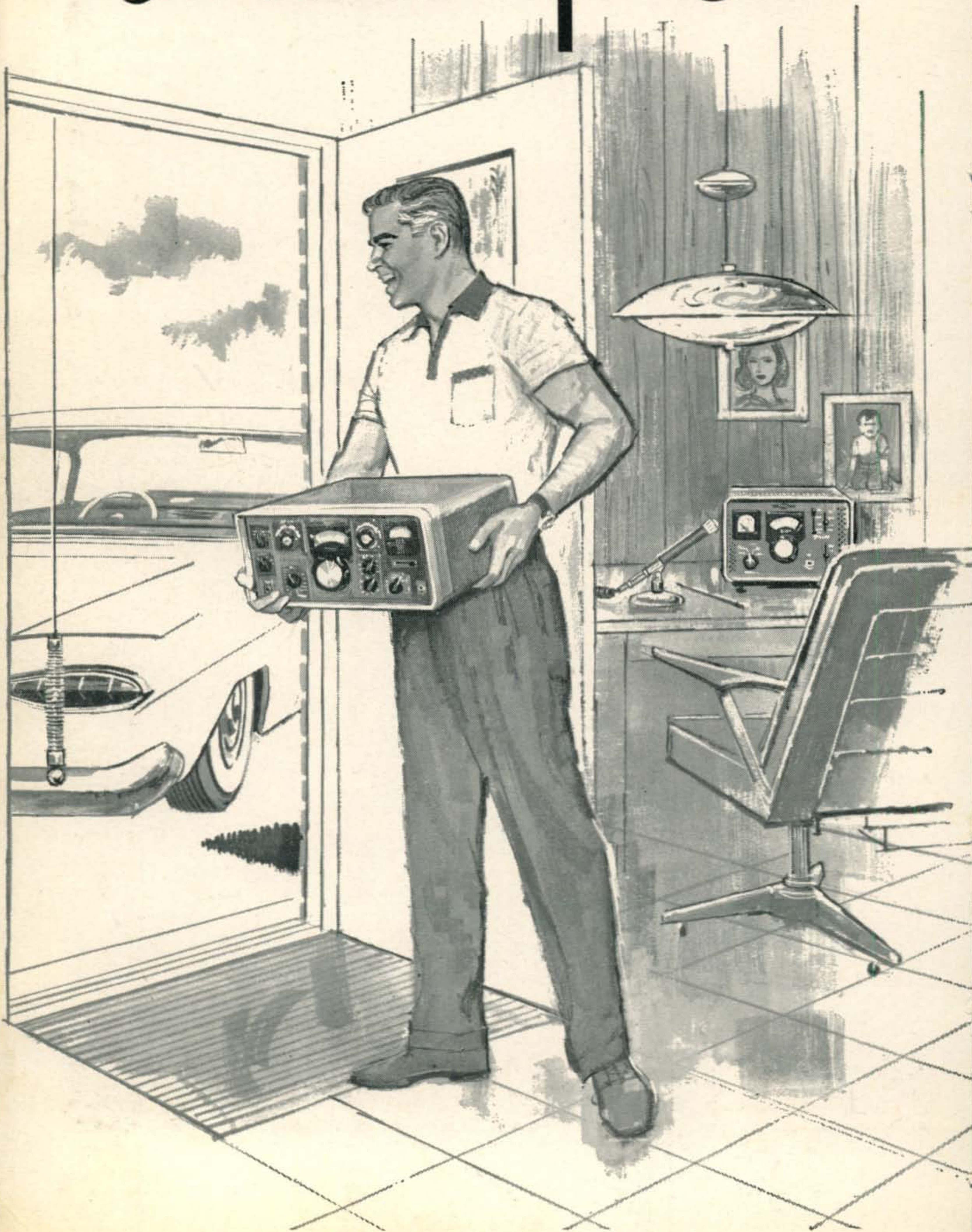

It pays to insist on

PR crystals

STANDARD OF EXCELLENCE SINCE 1934

AMATEUR TYPES

Fundamental, PR Type Z-2

Frequency Ranges in Kcs.: 3,500 to 4,000 (80M); 7,000 to 7,425 (40M); 8,000 to 8,222 (2M); 8,334 to 9,000 (6M).

Rugged. Low drift, fundamental oscillators. High activity and power output. Stands up under maximum crystal currents. Stable, long-lasting; ± 500 cycles.....**\$2.95 Net**

Third Overtone, PR Type Z-9A

Hermetically sealed; calibrated 24,000 to 24,666 and 25,000 to 27,000 Kc., ± 3 Kc.; .050" pins.....**\$4.95 Net**

6 Meters, PR Type Z-9A

Fifth overtone; for operating directly in 6-meter band; hermetically sealed; calibrated 50 to 54 Mc., ± 15 Kc.; .050" pins.
\$6.95 Net

CITIZENS BAND CLASS "D"

Type Z-9R, Transmitter

FCC assigned frequencies in megacycles: 26.965, 26.975, 26.985, 27.005, 27.015, 27.025, 27.035, 27.055, 27.065, 27.075, 27.085, 27.105, 27.115, 27.125, 27.135, 27.155, 27.165, 27.175, 27.185, 27.205, 27.215, 27.225; calibrated to .005%. (Be sure to specify manufacturer of equipment).....**\$2.95 Net**

CITIZENS BAND CLASS "D"

Type Z-9R, Receiver

Specify I.F. frequency, also whether receiver oscillator is above or below transmitter frequency. Calibrated to .005%. (Be sure to specify manufacturer of equipment.)
\$2.95 Net

Type Z-9R, Radio Control

FCC assigned frequencies in megacycles: 26.995, 27.045, 27.095, 27.145, 27.195, 27.255; calibrated to .005%. (Be sure to specify manufacturer of equipment).....**\$2.95 Net**

COMMERCIAL TYPES

Commercial Crystals available from 100 Kc. to 70 Mc. Prices on request.

Type Z-1, MARS and CAP

Official assigned frequencies in the range. Calibrated to .005%. 1600 to 10000 Kc.....**\$3.45 Net**

Type Z1, TV Marker

Channels 2 thru 13.....**\$6.45 Net**

4.5 Mc. Inter-carrier,

.01% **\$2.95 Net**

5.0 Mc. Signal Generator,

.01% **\$2.95 Net**

10.7 Mc. FM, IF,

.01% **\$2.95 Net**

Type Z-6A, Frequency Standard

To determine band edge. To keep the VFO and receiver properly calibrated.

100 Kc. ... **\$6.95 Net**



Z-6A



Z-2



Z-9A

Z-9R

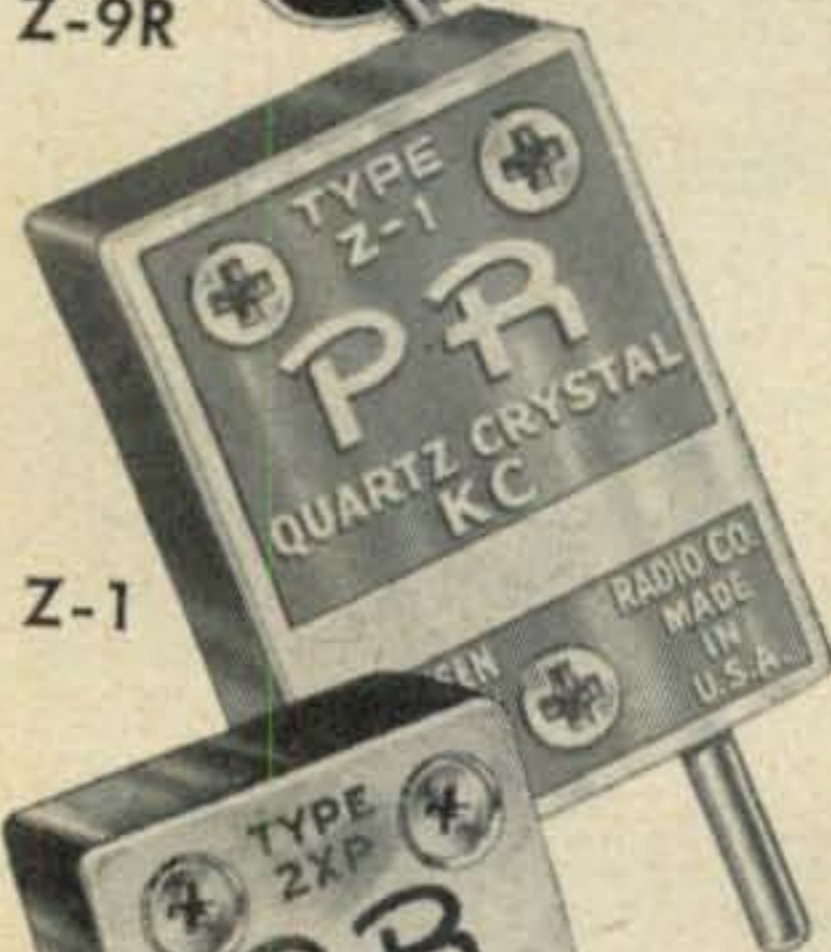

Z-1



2XP

Type 2XP

Suitable for converters, experimental, etc. Same holder dimensions as Type Z-2.

1600 to 12000 Kc., (Fund.) ± 5 Kc.....**\$3.45 Net**

12001 to 25000 Kc. (3rd Overtone) ± 10 Kc.....**\$4.45 Net**

ALL PR CRYSTALS ARE UNCONDITIONALLY GUARANTEED.
ORDER FROM YOUR JOBBER.

PETERSEN RADIO CO., Inc. 2800 W. Broadway
COUNCIL BLUFFS, IOWA

EXPORT SALES: Royal National Corporation, 250 W. 57th Street, New York 19, N. Y., U. S. A.

For further information, check number 3, on page 126

Very Hot News . . . from hallicrafters

Two great new kits... a complete, high-performance AM/CW station, from the world's most experienced designers of short wave equipment

HALLIKITS, we call them—a completely new concept of kit engineering that brings to your workshop, for the first time, these two outstanding advantages:

First, the unparalleled design experience of Hallicrafters' communications labora-

tories; and *second*, production-line proof of "Constructability" before you buy.

Have a wonderful time! Save a bundle of money! End up with a station the most experienced amateur would be proud to call his own.



HT-40 TRANSMITTER, \$79.95

A perfect match for the handsome SX-140, both in quality and appearance. Hallicrafters' transmitter leadership is evident in every precision-engineered feature of this crystal-controlled 75-watt beauty—features as important to old-timers as they are to novices.

- **FEATURES:** You get excellent CW performance as well as AM. Full band switching, 80 through 6 meters. Enjoy easy tune-up and crisp, clean styling that has efficient operation as well as appearance in mind. Unit is fully metered, TVI filtered.
- **SPECIFICATIONS:** Maximum D.C. power input: 75 watts. Power output in excess of 35 watts CW, 30 watts peak AM phone. (Slightly less on 6 meters.) Frequency bands: 80, 40, 20, 15, 10 and 6 meters.
- **TUBES AND FUNCTIONS:** 6DQ5 power output; 6CX8 crystal oscillator and driver; 12AX7 speech amplifier; 6DE7 modulator; silicon high voltage rectifiers.
- **FRONT PANEL:** Function (AC off, tune, standby, AM, CW); Band Selector (80, 40, 20, 15, 10, 6); Drive control; Plate tuning, plate loading, Crystal-V.F.O.; Grid Current; Meter; AC indicator light; RF output.
- **REAR CHASSIS:** Microphone gain; antenna co-ax connector; remote control terminals; AC power cord.



SX-140 RECEIVER, \$94.95

Doesn't it make sense to team up your skill with the experience of a company who has designed and built more high-performance receivers than any other in the world? Especially when the result is the *lowest-priced amateur band receiver available?*

- **FEATURES:** You get complete coverage of all amateur bands 80 through 6 meters, with extremely high sensitivity and sharp selectivity. Unit has RF stage; S-meter; antenna trimmer; and XTAL calibrator. Tuning ratio is 25 to 1.
- **CONTROLS:** Tuning; Antenna Trimmer; Cal. Reset; Function (AC off, standby, AM, CW-SSB); Band Selector; Cal. on/off; RF Gain; Auto. Noise Limiter on/off; Selectivity/BFO; Audio Gain; phone jack; S-meter Adj.
- **TUBES AND FUNCTIONS:** 6AZ8 tuned RF amplifier and crystal calibrator; 6U8 oscillator and mixer; 6BA6 1650 kc. IF amplifier and BFO; 6T8A 2nd detector, A.V.C., ANL and 1st audio; 6AW8A audio power amplifier and S-meter amplifier; (2) silicon high voltage rectifiers.

P.S. Both units are available fully wired, and tested. SX-140, \$109.95. HT-40, \$99.95.

halli-kits from  hallicrafters

Chicago 24, Illinois

See you in
New York at
the SSB Dinner,
March 21st,
Statler-Hilton
Hotel

For further information, check number 4, on page 126

... where the new ideas in communications are born!

Export Sales: International Div., Raytheon Co., Waltham, Mass. Canada: Gould Sales Co., Montreal, P.Q.



The Radio Amateur's Journal

EDITORIAL STAFF

EDITOR

A. S. TROSSMAN, W2DTJ

ASSISTANT EDITOR

RICHARD A. ROSS, K2MGA

TECHNICAL EDITORS

LELAND W. AURICK, W2QEX

IRVING TEPPER

CONTRIBUTING EDITORS

CONTEST CALENDAR

FRANK ANZALONE, W1WY

V.H.F.

ROBERT BROWN, K2ZSQ

PROPAGATION

SPACE COMMUNICATIONS

GEORGE JACOBS, W3ASK

RTTY

BRYON KRETZMAN, K0WMR

DX

URB LE JEUNE, W2DEC

YL

LOUISA B. SANDO, W5RZJ

HAM CLINIC

C. J. SCHAUERS, W6QLV

NOVICE

SEMICONDUCTORS

DONALD L. STONER, W6TNS

SIDEBAND

DOT STRAUBER, K2MGE

IRVING STRAUBER, K2HEA

BUSINESS STAFF

PUBLISHER

S. R. COWAN

ADVERTISING REPRESENTATIVES

JACK SCHNEIDER, WA2FPE

DICK COWAN, WA2LRO

CIRCULATION MANAGER

HAROLD WEISNER, WA2OBR

PRODUCTION MANAGER

CARY L. COWAN

OFFICES

300 West 43rd Street

New York 36, N. Y.

Telephone, JUDSON 2-4460

WEST COAST REPRESENTATIVES

WILLIAM A. AYRES

The William A. Ayres Co.

233 Sansome Street

San Francisco 4, California

YUKON 6-2481

FRED FRISENFELDT

The William A. Ayres Co.

1709 West 8th Street

Los Angeles 17, California

HUBBARD 3-2777

CQ—(Title registered U.S. Post Office) is published monthly by Cowan Publishing Corp. Second class postage paid at Garden City, New York and New York City. Subscription Rates: U.S.A. and Possessions, APO, FPO, Canada and Mexico: one year \$5.00; two years \$9.00; three years \$13.00. Pan-American and foreign, one year \$6.00; two years \$11.00; three years \$16.00. Printed in the U.S.A. Entire contents copyright 1961 by Cowan Publishing Corp. CQ does not assume responsibility for unsolicited manuscripts. Postmaster: send Form 3579 to CQ, 300 W. 43rd St., N. Y. 36, N. Y.

VOL. 17, No. 3

MARCH 1961

TABLE OF CONTENTS

The "All Around," A Versatile 10 Meter Portable Rig <i>William H. Kennedy, W3ZFJ</i>	26
A 1500 Watt Dummy Load <i>Ken "Judge" Glanzer, K7GCO</i>	30
Diode Gate Keying..... <i>Glen Benskin, K6ARQ</i>	33
Mobile Selectivity..... <i>Nat Gold, K1MIA</i>	35
The Heath DX-100B, 1961 Version <i>William I. Orr, W6SAI</i>	36
Understanding Very-High-Frequency Antennas, Conclusion..... <i>Stanley Leinwoll</i>	41
One Man's Family of Antennas..... <i>Vic Clark, W4KFC</i>	45
Modulation, Audio Power and Readability..... <i>Carl C. Drumeller, W5EHC</i>	50
The Significance of S.W.R. Measurements..... <i>Don M. Wherry, W6EUM</i>	51
CQ Reviews: The Heath Twoer..... <i>Lee Aurick, W2QEX</i>	52
CQ Reviews: The Auto-Mate Keyer.... <i>Lee Aurick, W2QEX</i>	53
Amateur Radio Legal Notes..... <i>Maurice Hindin, W6EUV</i>	54
French Amateurs Honor W6QLV.....	55

DEPARTMENTS

Announcements	16	QSL Contest	18
Contest Calendar	61	RTTY	90
DX	56	Semiconductors	88
Ham Clinic	66	Sideband	74
Ham Shop	120	Space Communications	79
Letters To The Editor	12	Surplus	96
New Amateur Products.....	69, 98	VHF	83
Novice	70	YL	93
Propagation	63	Zero Bias	7



High power for Outstanding Performance teamed with reduced power for local contacts

Globe King 500C

Outperforms any transmitter in its price and wattage range. A completely bandswitching 10-160M transmitter for 540wAM & CW; 700w maximum on SSB (PEP), with 15-20W external exciter. Includes built-in antenna relay, built-in VFO, separate power supply for modulator. Commercial type compression circuit. Grid block keying for signal clarity. Pi-Net matches most antennas 52-300 ohms. Optional crystal operation. Many other top features including push-to-talk, phone patch input. Gray color cabinet 30 x 22 x 14³/₄" especially designed for TVI suppression.

Wired, \$895.00

GLOBE VFO-755A

Comes complete with well-filtered power supply with voltage regulation. Output on 40 and 160M. Vernier Drive, 13:1 tuning ratio. Approx. 50 RF volts output. Temperature compensated for utmost stability for AM and CW. Calibrated 10M-160M.

Wired, \$59.95

Most Distributors Offer Terms of 10% Down and 18 Months Pay Plans

Globe Scout Deluxe

The very latest in a bandswitching 6-80M transmitter for 90wCW, 75w phone input power with relay controlled circuitry. Final amplifier works straight through on ALL bands. Has panel control for antenna loading on all bands, built-in high level plate modulator, pi-net output on 10-80M—tuned link on 6M, matching into low impedance beams. Built-in power supply for 115 VAC. Extensive TVI precautions. Convenient rotary switches. Modern "low-look" cabinet. 15¹/₄ x 6¹/₄ x 11¹/₄. Wired, \$159.95

OTHER QUALITY GLOBE ACCESSORIES

GLOBE FCL-1 SPEECH BOOSTER

Globe's FCL-1 Speech Booster is a peak limiting audio pre-amplifier. Increases modulation intensity for most penetrating audio. Includes harmonic suppression. Adapts to most transmitters.

Wired, \$24.95
Kit, \$15.95

6 METER CONVERTERS 6 PMC SERIES

Crystal controlled. Jumper for 6 or 12 volt filaments.

6 PMC-1 (I.F. 10-14 mc.)

6 PMC-2 (I.F. 600-1600 kc.)

Wired, \$29.95
Kit, \$21.95



See your local distributor or write direct to

GLOBE ELECTRONICS

A DIVISION OF TEXTRON ELECTRONICS, INC.
22-30 SOUTH 34TH ST. COUNCIL BLUFFS, IA.

For further information, check number 5, on page 126



in the stew as to what to do?

**GO SSB
RIGHT NOW...**

Join the fast-growing group of SSB-ers right now! No point in delaying because sooner or later you'll be one yourself. And the right way to get started is to get yourself some of that outstanding Hammarlund SSB gear. Transmitter and receivers are designed to make SSB easy...

WITH HAMMARLUND ALL THE WAY!



HX-500 TRANSMITTER

A superb SSB transmitter of super talk-power. Pumps out the clearest, sharpest, cleanest signal. The best in SSB, DSB, CW, FM, FSK for RTTY plus 40 cps identification keyed shift. Incorporates every operational feature and more than any transmitter in its price range. **\$695.00**



HQ-180 RECEIVER

Here's professional performance at amateur price. Provides outstanding SSB performance over a continuous tuning range of 540 kc to 30 mc. Triple-conversion 18-tube superheterodyne receiver with bandspread calibration for 80, 40, 20, 15 and 10 meter amateur bands. **\$429.00**

HQ-170 RECEIVER

The most-wanted ham-band receiver in the industry! Triple-conversion 17-tube superheterodyne with a selection of tuning modes that permits you to slice that incoming signal anyway you wish. Full dial coverage of 6, 10, 15, 20, 40, 80 and 160 meter amateur bands.

\$359.00



WRITE FOR COMPLETE DETAILS ON HAMMARLUND SSB EQUIPMENT ...

HAMMARLUND
MANUFACTURING COMPANY, INC.,
an affiliate of Telechrome
460 West 34th Street, New York 1, N.Y.

Established 1910

REMEMBER THE 10th ANNUAL SSB DINNER, MARCH 21

For further information, check number 6, on page 126



CONQUERS SPACE!



The Famous STATIONMASTER Base Station Antenna



Cat. No. 200-509 Specifications

- Frequency Range 144-174 Mc
- Omnidirectional Gain 5.8 db
- Maximum power input 500 watts
- Nominal input impedance 50 ohms
- Bandwidth \pm 0.3%
- VSWR 1.5:1
- Rated wind velocity 100 MPH
- Weight 30 lbs.
- Element housing length 19'

Communication Products Company, Inc.

Communication Antenna Systems for American Business

MARLBORO • NEW JERSEY • U.S.A.

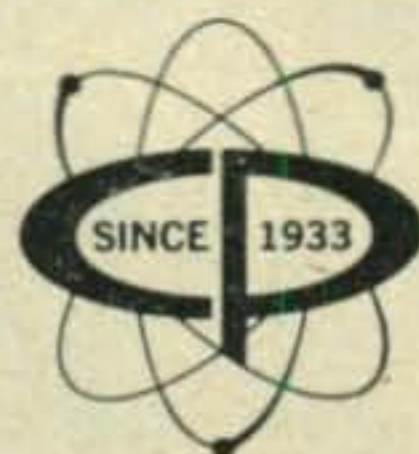
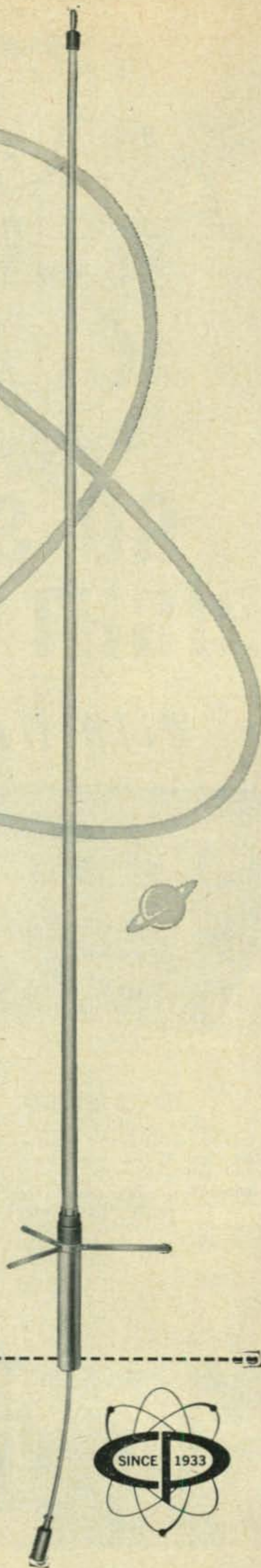

ZERO BIAS

EVERY once in a while (not often mind you), an item of amateur interest makes its way into our local newspapers. Usually, most of these anecdotes relate to amateur activities performed during a time of flood, hurricane or other mercy missions. Occasionally the public gets a glimpse of amateur radio when the local gang brews up a hamfest and the "cub" reporter arrives to relate to the public what he saw. Other than a local TVI complaint or a sharp-eyed motorist who spots a "peculiar" license plate, the public generally hasn't the remotest idea of what amateur radio is all about. Any traffic man can attest to the fact that when a message is delivered via the land-line, many people are completely ignorant of the service amateur radio plays in the field of communications.

As Project OSCAR^{1,2} nears reality, there is an excellent chance that the public will, with great interest, become aware of the role played by amateur radio.

A small group of amateurs in Sunnyvale California, working on their own time, are formulating an idea which will put into orbit, a satellite transmitting in the amateur bands. When OSCAR is put into orbit, the data usually recovered by sophisticated tracking stations will be recovered by none other than radio amateurs. This feat in itself will make the amount of data recovered by "Discoverer" and "Explorer" look like a drop in the bucket. With the possibility of thousands of tracking stations submitting data to a central agency, this project may become one of the most successful launchings ever made.

We can see amateur radio reaping great prestige from this type of project, but, we feel that we must make it clear that to rush into a plan of this kind for glory alone, is walking the wrong road.

Right now the Project OSCAR committee, headed by Fred Hicks, W6EJU, the Chairman, is seeking reactions from interested amateurs who may offer some ideas for the project.

Team work is certainly the main theme for this undertaking and we hope that the cooperation which should be forthcoming is properly solicited.

Speaking of team work, we are very pleased to report that John Chambers, W6NLZ and Ralph Thomas, KH6UK have jointly received the highly coveted Edison Radio Amateur Award, sponsored by the General Electric Company.

This year marks a highlight in the long line of Edison award winners, for this is the first time the award has been granted to two men *and* for a scientific achievement. V.h.f. enthusiasts will recall that KH6UK/W6NLZ set their record of 2,540 miles on two meters in 1957; the same distance on 220 mc in 1959 and a one-way record of 2,540 miles on 432 mc in 1960.

Special citations were awarded to Harry Phillips, W7CKV; Don Johnson, W6QIE; Frank Ireland, K4UUO; Al Parker, W4BAW; Cesare Cavadini, W6GYH; and Ed Van Deusen, W3ECP. A special commendation went to Mario Lagos, CE7BC who handled over 3,700 messages during the Chilian earthquake last summer.

We congratulate the recipients of this year's Edison Award and also the judges, for rendering an excellent decision.

¹SPACE COMMUNICATIONS, CQ, Dec. 1960, p. 76.

²Stoner, D. L., "Project Oscar," QST, Feb. 1961, p. 56.

It's The

GREATEST!

the
All
New

40

Meter SIGNAL MASTER

by **Mosley**

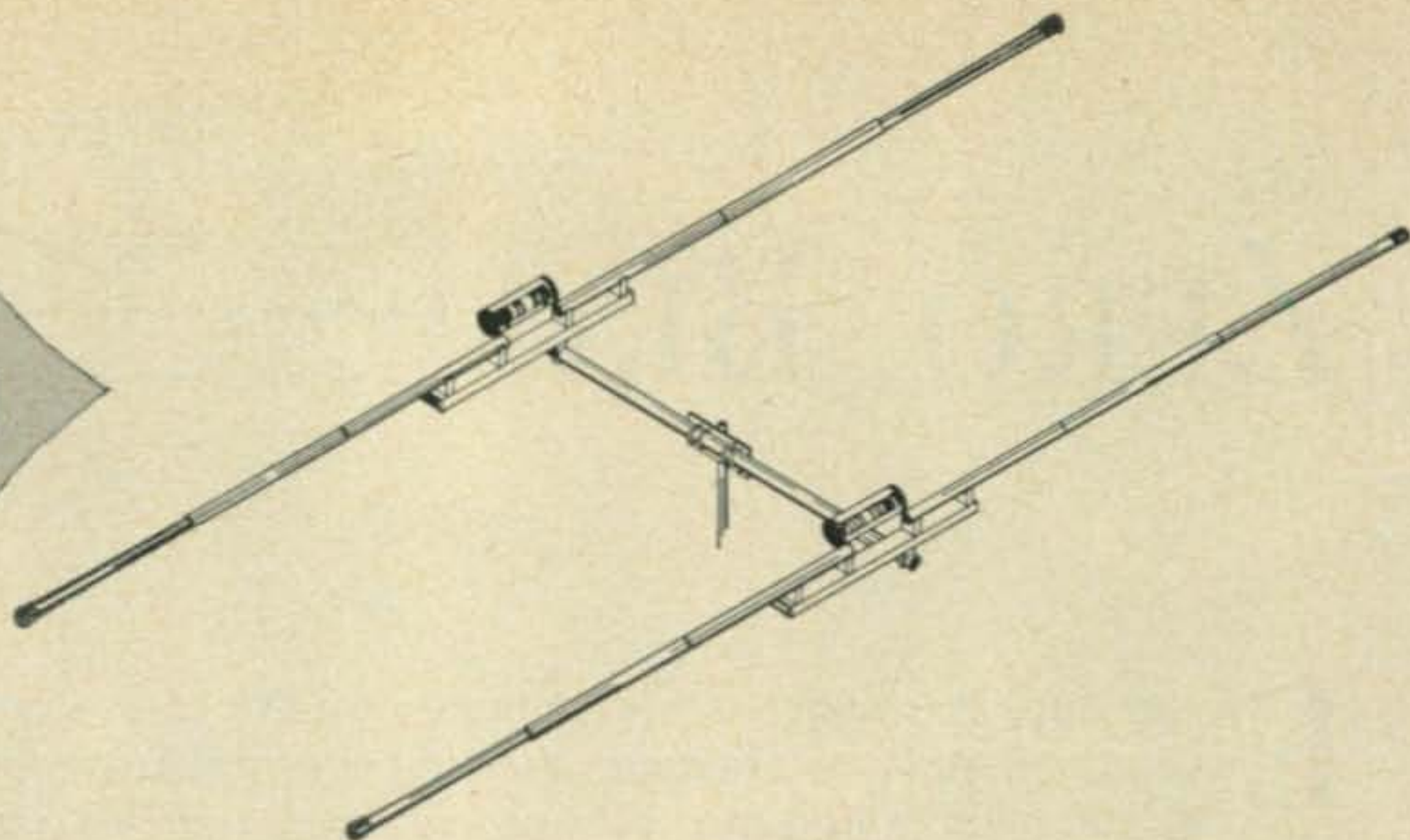

Model S-402 Features . . .

- Excellent Forward Gain and F/B Ratio!
- Efficient Link Coupled Feed!
- 100% Rust Proof!
- Heavy-wall 6061-T6 Aluminum Boom and Elements!
- 2 Elements for True Beam Performance!

"Forty" is the *hot* band now and the all new Mosley Signal Master Beam is the antenna to give your signal real authority! This rugged beauty is designed and engineered to provide the performance you need whether you are DX hunting or relaxing in a pleasant rag-chewing session.

You'll want a Mosley Signal Master Beam . . . see it at your favorite Ham Equipment Dealer's store!

Amateur Net, \$124.50

Mosley Electronics, Inc.

4610 North Lindbergh Blvd. — Bridgeton, Missouri

For further information, check number 1 on page 126.

Tenth Annual SSB Dinner
March 21, 1961
Hotel Statler-Hilton, New York City

Heathkit® Amateur Gear — tops in quality and economy



**HERE'S A NEW HEATHKIT GROUNDED GRID KW LINEAR AT A
RECORD-SMASHING LOW PRICE . . . JUST \$229⁹⁵**

The new Heathkit "Warrior" is a completely self-contained, desk-top kilowatt linear, loaded with special features, at half the cost of comparable units! Compare feature for feature, quality component for quality component, you'll find no shortcuts . . . only the finest watt-per-dollar value in a linear amplifier on the amateur market today!

Maximum power input: SSB—1000 watts P.E.P., CW—1000 watts, AM—400 watts (500 watts using carrier controlled modulation), RTTY—650 watts. **Driving power required:** 50 to 75 watts—depending on frequency. **Output circuit:** Variable pi-network (50 to 75 ohms). **Input circuit:** Broad banded—requires no tuning. **Input impedance:** Approx. 70 ohms. **Band coverage:** 80, 40, 20, 15, 10 meters. **Panel metering:** Switch-selected, grid current, plate current, high voltage and relative power output for ease of loading. **Tube complement:** 4-811A, 2-866A. **Size:** 19½" W x 11½" H x 16" D.



This inside view shows the neat circuit layout and husky components that emphasize quality. Note the internal shielding of plate circuit for maximum protection against TVI.

CHECK THESE FEATURES . . .

Completely self-contained . . . HV, Fil. and Bias supplies built in. *Versatile . . .* May be driven by any 50 to 125 watt transmitter or exciter—no matching or swamping network required.

Efficient . . . Stable grounded grid circuitry allows most driving power to appear in output for up to 70% efficiency.

Oil-filled capacitor . . . And 5-50 henry swinging-choke provide the excellent dynamic regulation required for high peak power output with low distortion.

Inexpensive tubes . . . 4 paralleled 811A's and 2-866A's, forced-air cooled by silent built-in fan.

Design . . . Special low-capacity filament transformer—requires less driving power—eliminates broad band filament RF choke.

Exclusive . . . Internal RF shielding of plate circuit for maximum TVI suppression.

Interlocked switching . . . prevents accidental application of HV before switching on filament and bias.

Neutralized . . . For the last word in stability in conjunction with grounded-grid operation.

Rugged construction . . . 16 gauge steel chassis—1/8" aluminum front panel—welded one-piece cabinet.

Easily assembled . . . Average time 8 hours.

Model HA-10 . . . 100 lbs. . . \$23 dn., \$20 mo. \$229.95

HEATHKIT® by **DAYSTROM**

HEATH COMPANY Benton Harbor, Michigan



Model DX-60 **\$82⁹⁵**

- Built-in low pass filter
- Neutralized 6146 final amplifier
- Grid block keying
- Handsome low profile styling

more features, better performance in this new Heathkit transmitter

PHONE AND CW TRANSMITTER KIT (DX-60)

Smart modern styling . . . clean, rugged construction . . . and conservatively rated components all add up to ease of assembly, trouble-free operation and fine performance in the new DX-60 Transmitter. Offering far more than any other unit in its price and power class the DX-60 features a built-in *low pass filter* for harmonic suppression, *neutralized final* for high stability, *grid block keying* for excellent keying characteristics and easy access to crystal sockets on the rear chassis apron. A front panel switch selects any of four crystal positions or external VFO. Modulator and power supply are *built in*. *Single knob bandswitching* for 80 through 10 meters and the *pi-network output* provide complete operating convenience. A tune-operate switch provides protection during tuneup and a *separate drive control* allows adjustment of drive level without detuning driver. *Panel meter* shows final grid or plate current. A fine kit for the beginner as well as general class amateur, the DX-60 may be run at reduced power for novice operation. Operates CW or AM phone with crystal or VFO control. Power input is *90 watts peak*, carrier controlled phone or CW. Construction of the DX-60 is a breeze, with its clean circuit layout, precut and cabled *wiring harness* and the complete, informative instructions furnished. The handsomely-styled finished unit measures only 13³/₄" W x 11¹/₂" D x 6¹/₂" H. 29 lbs.

Model DX-60 . . . \$8.30 dn., \$8 mo. **\$82.95**

you get twice as much for your budget



Model HW-20 **\$199⁹⁵**

- Tracked VFO & Exciter Stages for single knob tuning
- 10-watt RF output to antenna—6360 final
- Built-in low pass filter
- Built-in 3-way power supply for 117 VAC, 6 VDC, 12 VDC
- Push-to-talk ceramic element microphone

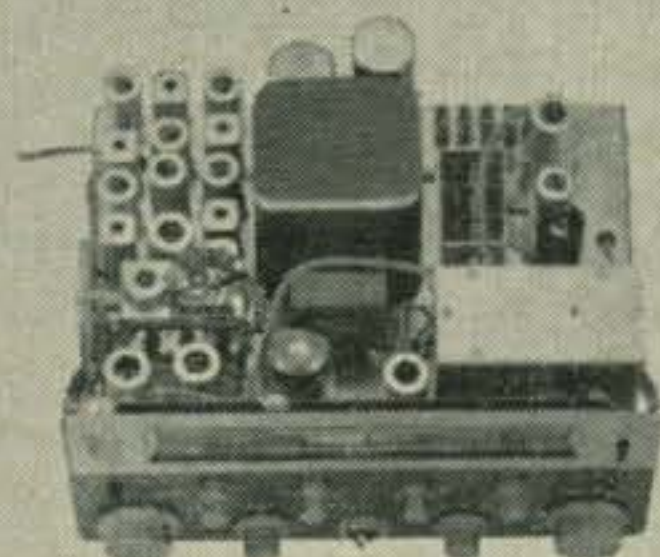

new transceivers for 6 & 2 meter nomads

VHF TRANSCEIVER KITS (HW-10 & HW-20)

"Mobile" or "Fixed", the new "Shawnee" 6-meter or "Pawnee" 2-meter transceivers bring you unprecedented performance, for each is a complete AM & CW Transmitter/Receiver combination with features unmatched at this price . . . just connect an antenna and you are in business! Transmitters feature a *built-in VFO* with all frequency determining components mounted on a "heat sink" plate for temperature stability and *four* switch-selected crystal positions for novice, CAP, MARS or net operation. VFO and all exciter stages are tracked for convenient *single knob tuning* over any 500 kc band segment (greater excursions require simple re-peaking of final). A VFO "spotting" switch is provided to "zero in" signals with transmitter off-the-air. The 6360 dual-tetrode final RF amplifier provides 10 watts of power *output* to the antenna and a built-in *low pass filter* is incorporated to suppress harmonics and other spurious radiation. The *dual-purpose modulator* provides a full 10 watts of audio for high level plate modulation of the final RF amplifier or 15 watts of audio for paging or public address use, selectable with push-pull switch. Superheterodyne receivers feature double conversion with first oscillator crystal-controlled. All oscillators are voltage regulated for stability. A large slide-rule dial and vernier tuning provide more than ample bandspread for both receiver and VFO. RF gain, BFO, ANL, Squelch, AVC on/off and transmitter controls are front panel mounted. *Tuning meter* is automatically switched to read signal strength or relative power output. Units come complete with built-in speaker, heavy duty AC & DC power cables, primary fused relay, adjustable mounting bracket and push-to-talk ceramic element microphone with coil cord & mounting clip. 6" H x 12" W x 10" D. 34 lbs. each.

Model HW-20 (2 meters) . . . \$20 dn., \$17 mo. . . . **\$199.95**
Expected Shipping Date Feb. 25.

Model HW-10 (6 meters) Coming Soon.

Model
HW-29A
\$44⁹⁵



Attn. HW-29 owners: Convert your "Sixer" to the new improved "A" model with this easy-to-install conversion kit. Allows use of 8 mc crystal for maximum stability.

Model HWM-29-1 1 lb. \$4.95

lowest cost transceivers on the air

- Operate from low-frequency crystals for greater stability
- Push-to-talk Transmit/Receive switch
- Variable receiver tuning
- Built-In AC power supply—easy conversion to mobile operation, using accessory vibrator power supply

2, 6 & 10 METER TRANSCEIVER KITS (HW-30, 29A, 19)

These three outstanding transceiver models bring you top performance at the lowest prices offered in complete amateur facilities. Each model has a crystal controlled transmitter and tunable, superregenerative receiver with RF preamplifier. Receivers pull in signals as low as 1 uv and the 5 watt transmitters are ideal for emergency work or "local" net operation. Features include push-to-talk transmit/receive switch, metering jack, ceramic element microphone, and two power cables. Less crystal. 10 lbs. each.

Model HW-19 (10 meter)...\$4 dn., \$5 mo.....**\$39.95**
 Model HW-29A (6 meter)...\$4.50 dn., \$5 mo.....**\$44.95**
 Model HW-30 (2 meter)...\$4.50 dn., \$5 mo.....**\$44.95**

with Heathkit® Amateur Gear

FREE CATALOG

Lists over 200 kits. Send for your free copy today!



MONEY BACK GUARANTEE

Heath Company unconditionally guarantees that each Heathkit product, whether assembled by our factory or assembled by the purchaser in accordance with our easy-to-understand instruction manual, must meet our published specifications for performance or your purchase price will be cheerfully refunded.

ORDER DIRECT BY MAIL OR SEE YOUR HEATHKIT DEALER



HEATH COMPANY
Benton Harbor 12, Michigan

ORDERING INSTRUCTIONS

Fill out the order blank below. Include charges for parcel post according to weights shown. Express orders shipped delivery charges collect. All prices F.O.B. Benton Harbor, Mich. A 20% deposit is required on all C.O.D. orders. Prices subject to change without notice.

Please send the following HEATHKITS:

ITEM	MODEL NO.	PRICE

Ship via () Parcel Post () Express () COD () Best Way
 () SEND MY FREE COPY OF YOUR COMPLETE CATALOG

Name _____

Address _____

City _____ Zone _____ State _____

Dealer and export prices slightly higher.

For further information, check number 8, on page 126

Designed for



Application

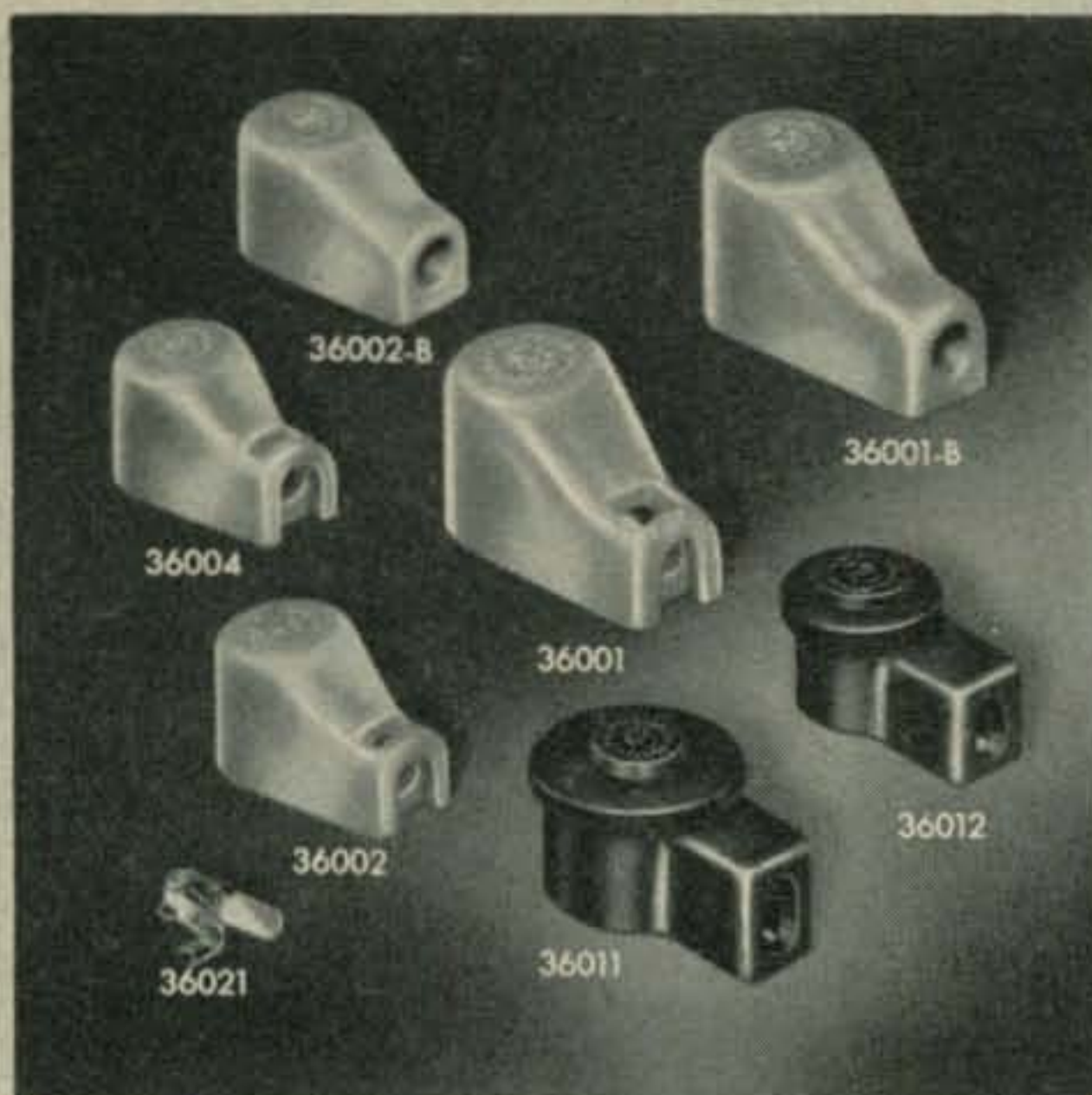

PLATE AND GRID CAPS

Illustrated are the stock military and standard ceramic Millen plate and grid caps and the snap lock caps for mobile and industrial applications requiring tighter than normal grip. Standard plate caps have phosphor bronze clips; military plate caps have beryllium copper clips.

**JAMES MILLEN
MFG. CO., INC.**

MAIN OFFICE AND FACTORY
**MALDEN
MASSACHUSETTS**



Letters..... to the Editor



G.C. vs H.B.

Editor, CQ:

I have read with interest Mr. Tepper's article in January issue of CQ titled "General Coverage versus Ham Band". The subject certainly is timely and Mr. Tepper has done a good job.

I would like to point out that our 2-A receiver has all the advantages of "Ham Band" only plus the capability of selecting any in between frequencies merely by inserting appropriate crystals. The Collins "S" line also has this feature, but each crystal covers only a 200 kc band compared to 600 kc for each crystal in our 2-A.

This type of reception is the equivalent of the use of crystal controlled converters with a tunable low frequency receiver. All the converter circuits are built into the 2-A and require only the plugging in of a crystal to make them operate on any frequency from 3.5 to 30 mc.

An additional feature of this design is the fact that any changes in ham band allocations cannot make our 2-A obsolete.

R. L. Drake, President
R. L. Drake Company
540 Richard St.
Miamisburg, Ohio

TVI??

Editor, CQ:

Recently I received a letter from the FCC indicating that I was causing TVI in a community in Connecticut. Under my present operating conditions, I considered this to be impossible and wrote the FCC explaining why. Since then I have not heard from the Regional Office (Boston, Mass.).

The reasons I gave the FCC were: One (1) 90 watts input to a Siemens RS 1003, driven with a Geloso v.f.o., on a 10 meter three element beam (all home brew). Also a built in Modulation scope and BC-221 freq. meter. Two (2) I checked my entire frequency range and found I have an s.w.r. of 1-1.2 on the 10 meter beam; 1-1.3 on 15 & 20 meters (doublet antenna); 1-1.2 on 80 meters (doublet antenna). Three (3) no TVI or BCI in my own home. Four (4) Extensive TVI and BCI shielding. Five (5) grounding better than minimum requirements. Six (6) (Here is the KICKER), I received my license from the FCC as a Conditional class license, while stationed in Germany and have not been in the Continental United States since the license was issued. I have been using my German Call (DL4OE) or (DL5DE) only. I do sometimes tell other op's that my home call is K1OHY.

Although TVI from Germany is possible it is entirely improbable with the rig as described above.

It is apparent that someone checked the *Call Book* and found me there and decided to use my call while I was away.

I suggest that the FCC require all hams that intend to operate outside of the CONUS (Continental US) to register with the local FCC office indicating where they will operate from, for how long, and what bands or band they will be using. Then if a complaint is received, the FCC can check and know immediately if the man is in the CONUS and if he isn't, start monitoring for the bootlegger without wasting time writing a letter that will be forwarded half way around the world before they find out they have the wrong man. This would save a lot of writing and help nab the bootlegger a lot faster.

Norman E. Brooks, DL4OE/K1OHY
Headquarters, 34th Sig. Bn. Corp.
APO 154, N.Y., N.Y.

← For further information, check number 9, on page 126

SSB COMBO



Gonset continues to offer you big SSB values!

First, GSB-100, SSB transmitter/exciter... then GSB-101, the powerful 1000 watt P.E.P. linear amplifier. Now... to complete the SSB combo... *G-63 a communications receiver of exceptional value!*

G-63, modern in every respect, has many operating features usually found only in receivers priced substantially higher. Example: Sensitivity less than 1 microvolt for 6 db signal-plus-noise/noise ratio. And... *a 6 meter band that is really "live."*

For SSB reception... compare G-63 with other receivers in the same price Bracket. G-63 is stable, has low-drift HF and BF oscillators. There are two second detectors: Product type for better SSB/CW reception and diode type for AM. Full vision drum dial spreads each amateur band fully for easy tuning—vernier tuning knob has flywheel for smooth operation. This modern receiver covers six amateur bands—80, 40, 20, 15, 10 and 6 meters.

Other features: Double conversion—peaking-type "Q" multiplier gives adjustable band widths down to 100 cycles for CW. Bandpass I-F circuitry provides desirable steep-shoulder selectivity for AM and SSB reception. Also... "S" meter... AVC... Automatic noise limiter... plug-in crystal calibrator is available as an accessory.

G-63 communications receiver 239⁵⁰

GSB-100, 100 WATT P.E.P. SSB TRANSMITTER/EXCITER.. 499.50

GSB-101, 1000 WATT P.E.P. SSB LINEAR AMPLIFIER..... 459.50

For further information, check number 10, on page 126



GONSET

Division of Young Spring & Wire Corporation
801 SOUTH MAIN ST., BURBANK, CALIFORNIA

EXPORT SALES: WESTREX CORP., 111 EIGHTH AVE., NEW YORK 11, N.Y.

The Turner '254'

THE MICROPHONE DESIGNED FOR THE HAM



Versatile, easy to operate—the new Turner 254 gives hams a dependable desk type crystal mike that's engineered for all amateur communications. It operates by a touch-bar on-off switch and lever-lock on-off switch. Output level—48 db. Response level 60 — 8,000 cps. Smart grey hammertone finish. One-piece die cast construction gives years of rugged service. And it's priced for every ham budget — only \$14.10 net. See your Turner dealer right away, and get on the air with the new Turner 254.

THE TURNER MICROPHONE COMPANY

925 17th Street N.E., Cedar Rapids, Iowa

For further information, check number 12, on page 126

14 • CQ • March, 1961

Wobbulator®

Editor, CQ:

In your January issue of CQ we noted an article entitled "A Wobbulator for Filter Alignment." We wish to advise you that the term "Wobbulator" is a trademark belonging to this Corporation. If this word is used in the future, we would appreciate your giving recognition to our company.

George J. Hartman
Secretary & Treasurer
Canoga Electronics Corp.
15330 Oxnard St.
Van Nuys, Calif.

More, More, More!

Editor, CQ:

I have read with much interest the many letters and comments that have been made regarding reciprocal license agreements. This is of more than passing interest to me. I have lived in a foreign country where my United States license was of no value. The big problem, is of course, our country's refusal to license foreign amateurs.

I do not feel that the original law as written was meant to exclude foreign amateurs. I realize that the FCC must operate under this law, and that they have no choice in the matter. However, in view of the Canadian agreement, it would seem that the FCC does have some leeway in the matter if they choose to use it.

Notwithstanding this, there is another approach. It is in this approach that I feel that CQ could play a large and major part in helping to solve this problem.

We live in a democratic representative country. If the people do not like a law, or visa versa, it is within their power, through representation to change the statutes of this country. When the hams of this country wanted call letter license plates for their cars, they went through representatives of their local State governments, and have been very successful. There is no reason why the reciprocal license problem cannot be solved in the same way.

If all, or a major portion, of the amateurs would contact their Congressional Representatives and Senators in the proper manner, stating their valid reasons and desires, then Congress could change this law to permit the solution of this problem. It is well known that our Congress responds to the wishes of their people, provided reasonable numbers express their sentiments.

I suggest therefore, the CQ start a campaign to alert its readers of this possibility. This should urge all amateurs to write the proper people in Congress in the proper manner, and giving proper reasons and information. If the hams respond in a body, I predict an early solution. I feel that having the law changed is the only solution to this problem.

I think CQ can render a valuable service to amateurs by giving publicity to this approach, and urging this individual action on the part of the many thousands of amateurs in this country.

Alden H. Davis, W5DPI
P.O. Box 831
Borger, Texas

Signal Reports

Editor, CQ:

I write to try to get your backing to initiate a new method of report which has some real meaning. The report system that I have used since 1918 is now and always has been meaningless. I am quite sure you will have to agree when proper thought is given to the subject. My proposal is as follows:

1. The operator first tunes the band and decides which signal is the strongest signal he can find on the band, such as S9 + 20 db.

2. He then proceeds to work a station and gives him a report as follows: "Your signal here is S9 + 5, S9 + 20." This then means that with the receiver-antenna, and receiving conditions existing at that time, the station being worked is S9 + 5 db on a band that S9 +

[Continued on page 108]

INTERNATIONAL 1961 CATALOG

FREE



Your
BUYING GUIDE FOR
PRECISION RADIO CRYSTALS
AND QUALITY ELECTRONIC EQUIPMENT.

- COMMERCIAL CRYSTALS • AMATEUR AND
CITIZENS BAND CRYSTALS • AUTO
RADIO CONVERTERS • OSCILLATORS • FREQUENCY
ALIGNMENT EQUIPMENT • TRANSMITTERS
- MODULATORS • POWER SUPPLIES
- TRANSISTOR SUBASSEMBLIES • CITIZENS
BAND TRANSCEIVERS • CITIZENS
BAND ANTENNAS/ACCESSORIES

Specialists in precision radio crystals, Citizens 2-Way radio equipment, and quality electronic products.

INTERNATIONAL
CRYSTAL MANUFACTURING CO., INC.

18 NORTH LEE • OKLAHOMA CITY, OKLA.

AMATEURS —

Complete data on International's all transistor subassemblies; 6 and 2 meter transmitting and receiving gear; crystal controlled converters for 75, 40, 20, 15 and 10 meters.

CITIZEN LICENSEES —

International transceivers, accessories and antennas for dependable 2-Way radio communication. See International's kit for constructing your own Citizens transceiver.

EXPERIMENTERS —

Printed circuit oscillators, RF converters, IF units, audio units, transistor subassemblies, crystals and crystal ovens.

Mail today for your **FREE** Catalog!

International Crystal Mfg. Co., Inc.
18 North Lee, Oklahoma City, Okla.
Send Free 1961 International Catalog

Name _____

Address _____

City _____ Zone _____ State _____

For further information, check number 11, on page 126

How To Get an FCC License (Commercial)



**GET
ALL 3
FREE!**

Just Mail Coupon

YOUR GUARANTEE:

Completion of the Master Course (both Sections) will prepare you for a First Class Commercial Radio Telephone license with a Radar Endorsement. Should you fail to pass the FCC examination for this license after successfully completing the Master Course, you will receive a full refund of all tuition payments. This guarantee is valid for the entire period of your enrollment agreement.

Cleveland Institute Announces an EXCLUSIVE Technician Training Program

in Computers, Servo Mechanisms, Magnetic Amplifiers and others

Other advanced fields covered include Basic Math, A.C. Circuit Analysis, Pulse Circuitry, Color TV, Radar, Advanced Measuring Techniques, Industrial Electronics, Instrumentation, Automation, Radio Telemetry. Send for information today.

Get This Handy POCKET

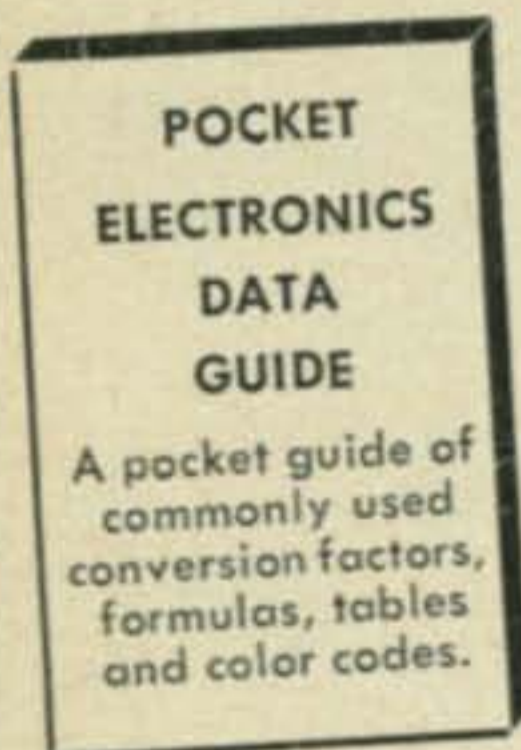

ELECTRONICS DATA GUIDE **free**

Puts all the commonly used conversion factors, formulas, tables, and color codes at your fingertips. Yours absolutely free if you mail the coupon today.

Mail Coupon TODAY!

CLEVELAND INSTITUTE OF ELECTRONICS
Desk CQ-74, 4900 Euclid Ave., Cleveland 3, Ohio

Please send FREE Career Information Material prepared to help me get ahead in Electronics.

Name..... Age.....

Address.....

City..... Zone..... State.....

FOR PROMPT RESULTS SEND AIR MAIL

CQ 74



Tenth Annual S.S.B. Dinner

The S.S.B. Amateur Radio Association will sponsor the Tenth Annual S.S.B. Dinner and Hamfest on Tuesday March 21st at the Hotel Statler-Hilton, 33rd St. and 7th Avenue, N.Y.C. All amateurs and their friends are invited. Held during the week of the I.R.E. Convention, this dinner attracts many outstanding radio amateurs and communications men from all parts of the world. Emphasis will be placed on a large social gathering featuring good food, good fellowship and professional entertainment. There will be no formal speeches.

Equipment displays open at 10 A.M. and the dinner starts at 7:30 P.M. William B. Williams, noted radio personality, will be master of ceremonies. Tickets purchased in advance are \$10 each and \$11 at the door.

Send checks for reservations to SSBARA, care of Mike Le Vine, WA2BLH, 33 Allen Road, Rockville Centre, L.I., N.Y.

New Publication

Standard Frequencies and Time Signals from NBS Stations WWV and WWVH, a National Bureau of Standards Miscellaneous Publication 236, issued December 1, 1960, 5 pages, 10 cents is available from the Superintendent of Documents, U.S. Government Printing Office, Washington 25, D.C.

This publication describes the six technical services broadcast by National Bureau of Standards radio stations WWV and WWVH. These widely used services include: 1, standard radio frequencies; 2, standard audio frequencies; 3, standard time intervals; 4, standard musical pitch; 5, time signals; and 6, radio propagation forecasts.

Other domestic and foreign standard frequency and radio time signal broadcasts are tabulated in this publication, and stations operating outside the exclusive bands, and other time signal broadcasts are given. Foreign remittances must be in U.S. exchange and should include an additional one-fourth of the publication price to cover mailing costs.

Alaska Mars Party

The Alaskan Air Force MARS party will be held on the 10th of March at 1900 hours at the non-commissioned officers club at Elmendorf AFB, Alaska. All Air Force MARS members and their immediate families are cordially invited to attend. There will be a drawing for some very fine gifts. Dancing to the music of the Elmendorf AFB combo will follow the dinner. Anyone planning on attending should contact, D. L. Lindblom, 1383R/Vista Rd. Anchorage Alaska Phone BR 60392, for further information and reservations. Reservations must be in by 5 March 1961.

DARC Deutschlandtriffer 1961

The Dortmund gang, (DL2, 4 and 5) have joined together and announce what is expected to be one of the largest gatherings in Europe. Filling three days, May 19, 20 and 21 the hamfest will conduct tours of the local scenery as well as amateur events. Included will be discussion groups on v.h.f., DX, s.s.b., a mobile d.f. contest and many more items. Some of the events require pre-registration, so that everyone is urged to sign-up as soon as possible. Details should include the number of persons, accommodation requirements and whether or not you intend to participate in the events. Mail all inquiries to DARC Tagungsbüro Dortmund, Borsgrasse 68, or Russ Lawson, DL4BS, P. O. Box 3049 Darmstadt. Russ' picture, by the way, can be found in CQ for January 1961 on page 61.

[Continued on page 106]

get

SHURE

quality &
dependability
in a completely
equipped
SSB MICROPHONE
for less than
\$30

- Complete With Grip-To-Talk Switch, Desk Stand, 2-Conductor Shielded Cable.
- Eliminates Need For Audio Filters—Sharp Cutoff Below 300, Above 3000 cps.
- Superb Intelligibility, Extraordinarily Rugged, Choice of 2 Models.
- Trouble-Free Controlled-Magnetic Design, Output -52.5 db (100,000 ohm impedance).

MODEL 440SL—ONLY \$28.50* Complete with stand, grip-to-talk switch, 7 ft. highest quality 2 conductor shielded cable. Cable connector equivalent to Amphenol MC3M plug.

MODEL 440—ONLY \$15.00* Low cost, same performance characteristics as 440SL. 7 ft. single conductor (shielded), less stand, switch, connector.

**Amateur Net Prices*

SHURE BROTHERS, INC.
222 Hartrey Avenue
Evanston, Illinois

MICROPHONES, HIGH FIDELITY
AND ELECTRONIC COMPONENTS

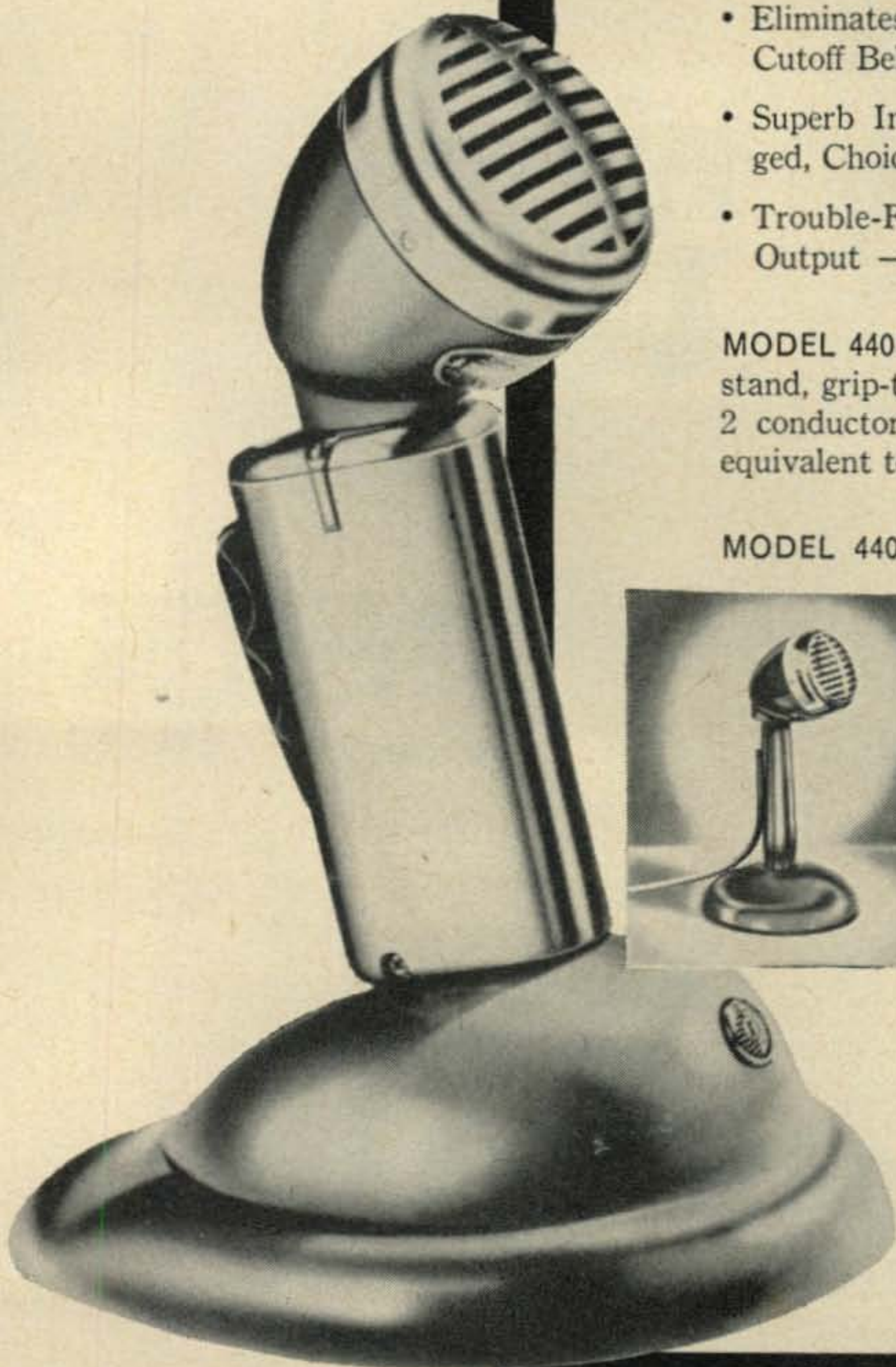

Why don't you **Talk**
 WITH
Westinghouse
 about **FIELD ENGINEERING**



Deskbound? Investigate the field engineering opportunities at Westinghouse-Baltimore. Advance your career while participating in an exciting global operation. Westinghouse Field Engineers receive intensive training on the latest electronic developments . . . and utilize that training in providing engineering liaison for Westinghouse at a myriad of interesting locations . . . assisting and instructing others in the operation and maintenance of Missile Guidance, Airborne Radar and Fire Control, Heavy Ground Radar, Microwave Communications, Shipborne Radar, and many other advanced military electronic programs. An engineering degree or equivalent is required. Those accepted will receive liberal fringe benefits and a salary commensurate with experience.

Send resume to: Mr. J. F. Caldwell, Dept. 355

Westinghouse



BALTIMORE

P.O. BOX 746 Baltimore 3, Maryland
 AIR ARM • ELECTRONICS • ORDNANCE

QSL contest



A free subscription this month goes to K1QAJ who has submitted a rather interesting card with data displayed in the form of controls on an SX-110. The card is done in black and grey and the call is in red.

Runners Up



YOU ARE THERE!

with **telrex**

—“the-performance-line”—
with a “MATERIAL” difference!

Send for (or, at your distributor), PL 77 Technical Specifications and Performance Bulletin describing 106 Antennas from 3/4 through 80 meters including “BALUN”—FED ROTATABLE DIPOLES, MONO, DUO, TRI, 4-BAND AND “SPIRALRAY” ANTENNAS, ROTATOR/INDICATOR SYSTEMS, TOWERS, BROAD-BAND “BALUNS,” ACCESSORIES AND “NICE-TO-HAVE-AROUND-YOUR-SHACK” INFO.

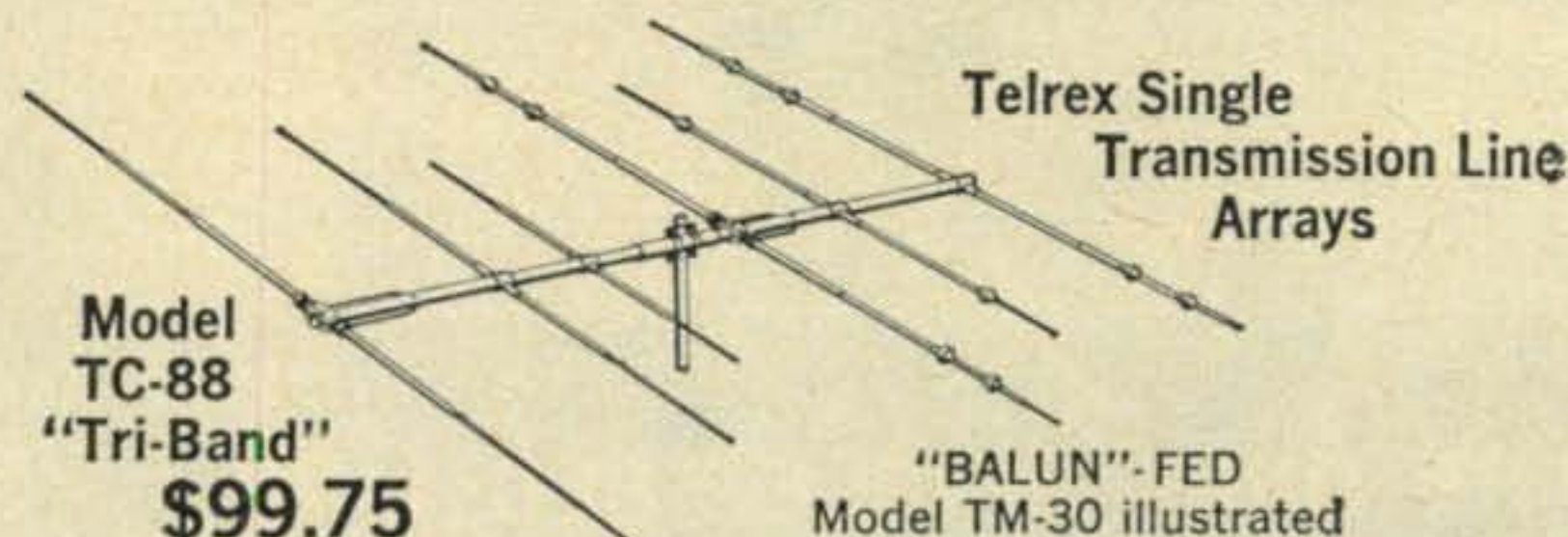
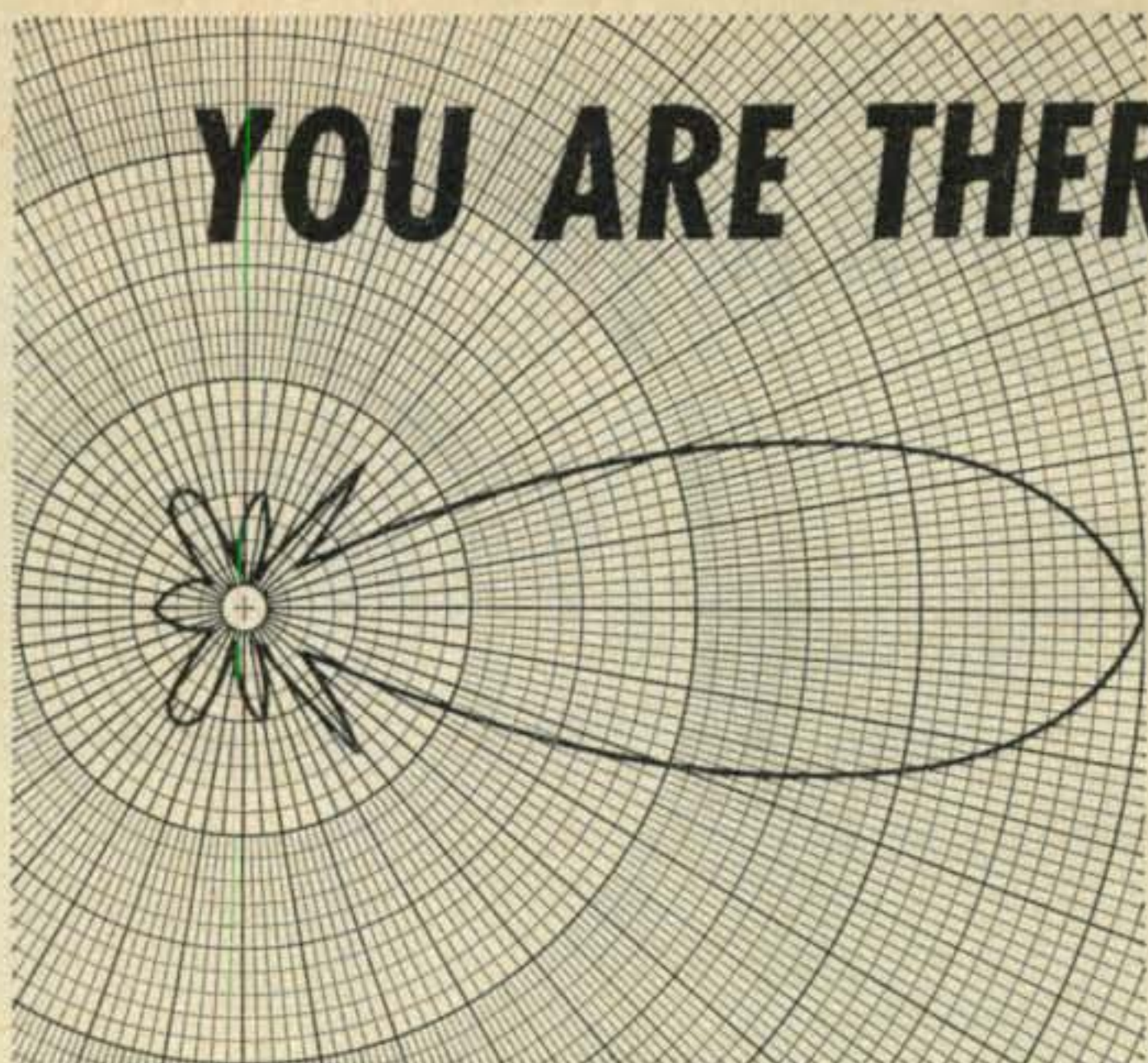

TC-88- thirty pounds of educated aluminum—
World Renowned for performance, excellence and value. Also—

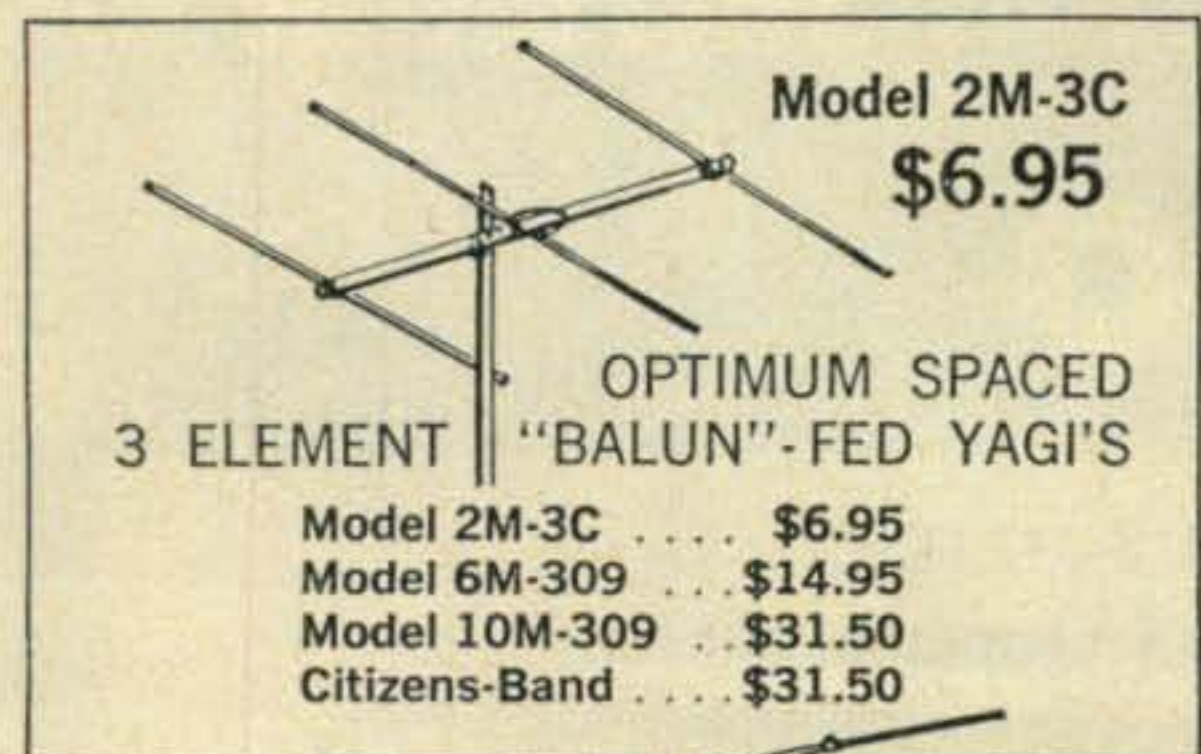

Model TC-99 . . . \$159.50
Model TM-30 . . . \$328.00
Model DP-3 . . . \$38.50
(10-15-20 Meter Dipole)
Model DP-4 . . . \$195.00
(10-15-20-40 Meter Dipole)

TELREX ADVANCED DESIGN GROUND—PLANE

THE VERY BEST GROUND-PLANES MONEY CAN BUY!

CGP-2M . . .	\$8.50	MODEL CGP-2M \$8.50
CGP-6M . . .	\$11.75	
CGP-1011M	\$19.95	
CGP-15M . .	\$37.95	
CGP-20M . .	\$88.00	

Telrex Model 175-RIS ROTATOR/INDICATOR System \$198.50

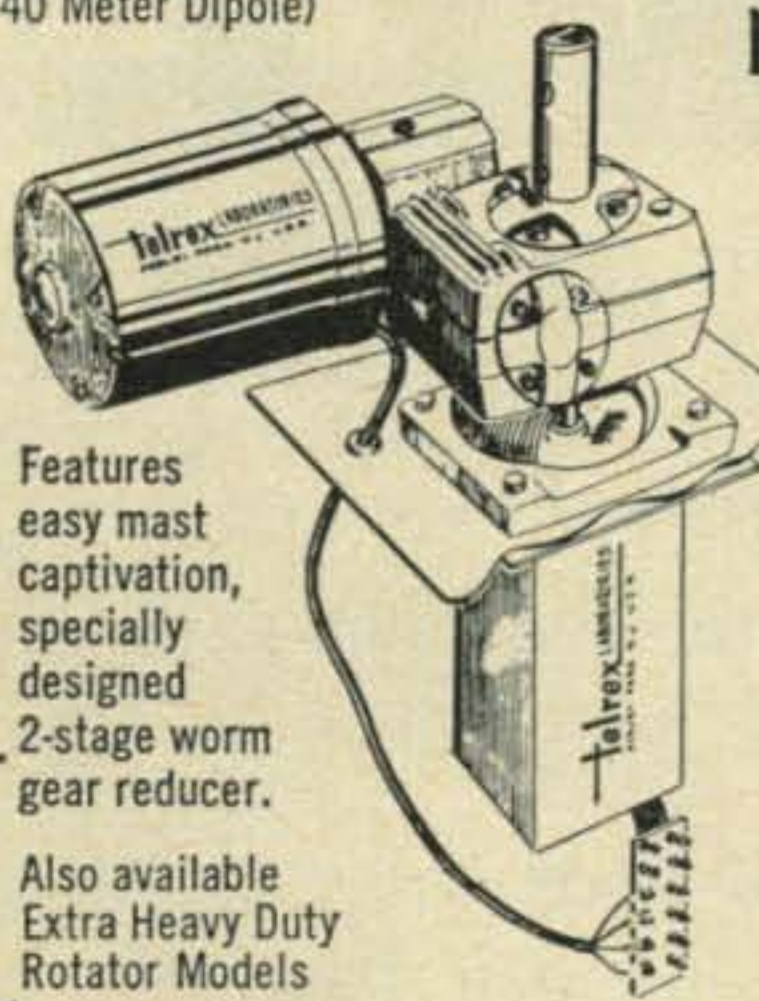

Features easy mast captivation, specially designed 2-stage worm gear reducer.

Also available Extra Heavy Duty Rotator Models

Designed to out-perform and out-last and other beam rotator in its class. Will hold and rotate beams in winds up to 110 mph. Control Housing is Telrex quality thru-out. Black japanned aluminum housing. Tri-colored azimuth rose and reciprocal readings. Has selsyn indication and limit of rotation circuitry.

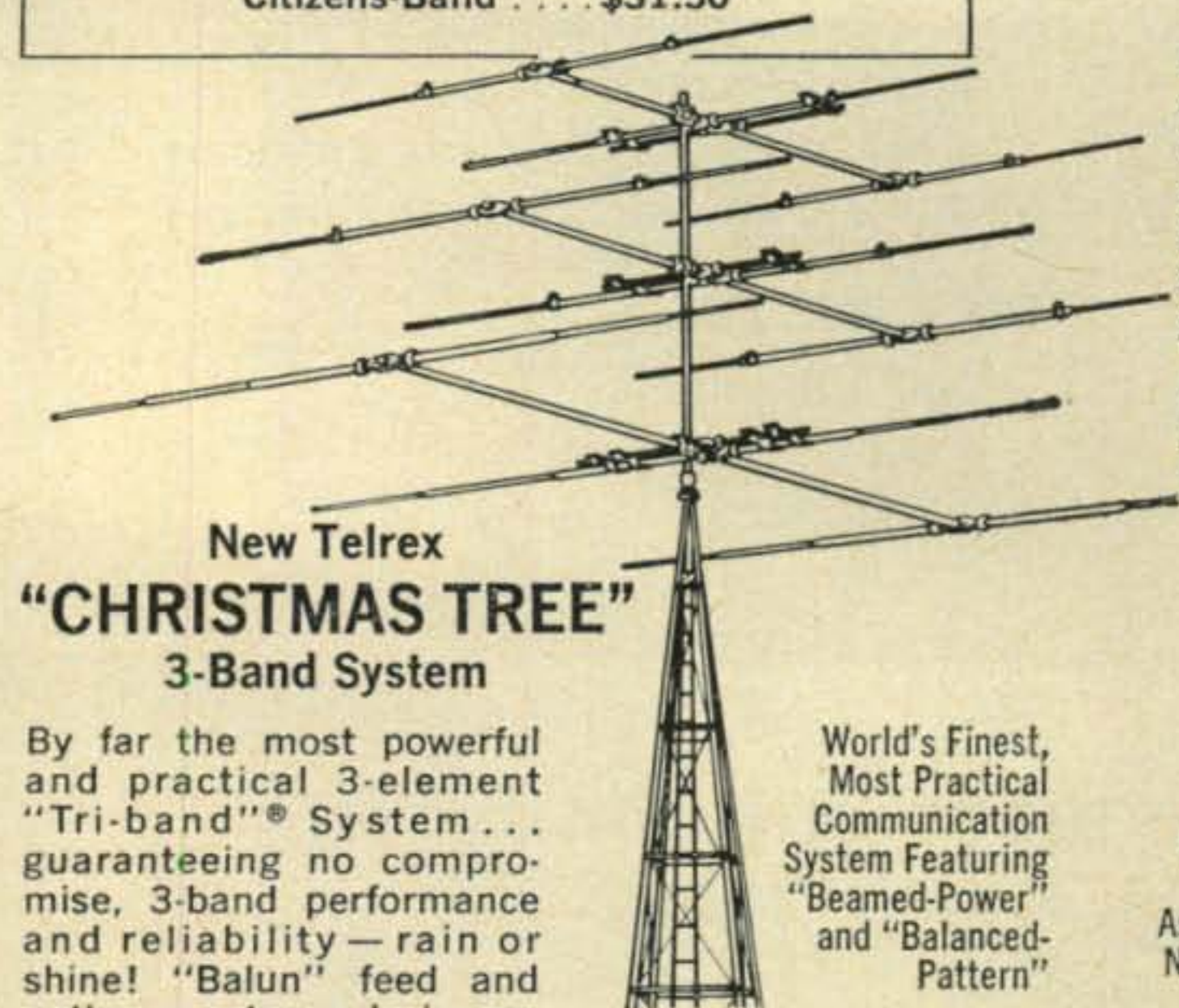

By far the most powerful and practical 3-element “Tri-band”® System . . . guaranteeing no compromise, 3-band performance and reliability—rain or shine! “Balun” feed and optimum antenna design assures . . . maximum gain, and impedance bandwidth, plus pattern symmetry with minimum TVI, BCI and harmonic radiation qualities not possible with single transmission line “Tri-banders”.

World's Finest, Most Practical Communication System Featuring “Beamed-Power” and “Balanced-Pattern”

All prices FOB
Asbury Park, New Jersey, subject to change without notice.

“SPIRALRAY”

Model 2MSR-1114 illustrated

\$19.50

FOR SCATTER-WAVE, SATELLITE, MOBILE OR POINT-TO-POINT

Extremely high-gain, high signal-to-noise, practically no fade, all radiation planes—horizontal, vertical or oblique! 9 models available on 3/4, 1 1/4, 2 and 6 meters.

For TOP-MAN-ON-THE-FREQUENCY results . . . Install a Telrex antenna . . . dollar for dollar better in every way! Antenna systems from \$6.95 to \$688.00

ANTENNAS SINCE 1921

telrex LABORATORIES

Communication and TV Antennas
ASBURY PARK 40, NEW JERSEY, U.S.A.

For further information, check number 13, on page 126

NOW! TWO ANTENNAS TWO ANTENNAS IN ONE*

*another **FIRST** from **FINCO**

Patent Re 24,413
Other patents pending
6 & 2 Meter
Model No. A-62
Amateur Net. A-62 \$33.00
Stacking Kit AS-62 \$2.19

Introducing..... THE ONLY SINGLE FEED LINE
6 & 2 METER COMBINATION ANTENNA
from **FINCO**[®]

- Heavy Duty Square Aluminum Boom, 10 Ft. Long
- All Elements Are Sleeve Reinforced And Completely Pre-assembled With "Snap-out" Lock-Tite Brackets
- Boom Suspension Rods Are Supplied Completely Pre-assembled, Ready To Be Snapped Into Upper End Of Mast

ON 2 METERS

- 18 Elements
- 1 - Folded Dipole Plus Special Phasing Stub
- 1 - 3 Element Collinear Reflector
- 4 - 3 Element Collinear Directors

ON 6 METERS

- Full 4 Elements
- 1 - Folded Dipole
- 1 - Reflector
- 2 - Directors

OTHER ANTENNAS for the DISCERNING AMATEUR

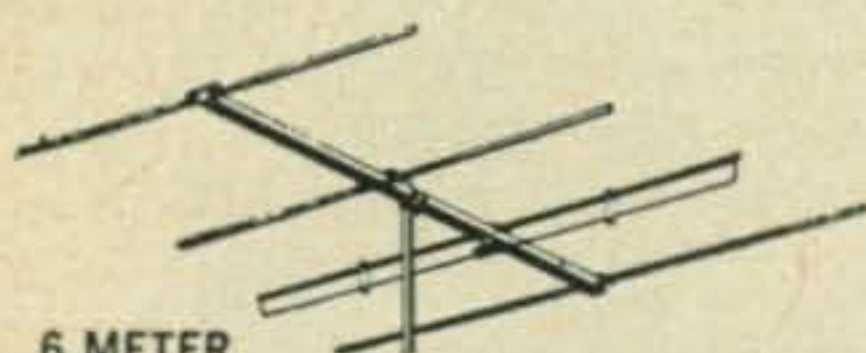

6 METER
4 ELEMENT
AMATEUR NET
A6-4 \$17.16
STACKING KIT
AS-6 \$2.19

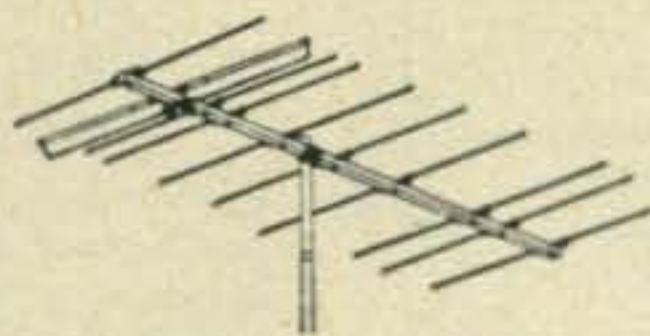

2 METER
10 ELEMENT
AMATEUR NET
A2-10 \$11.88
STACKING KIT
AS-2 \$1.83

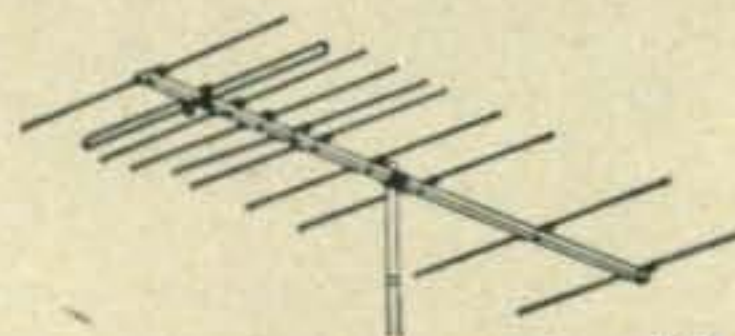

1 1/4 METER
10 ELEMENT
AMATEUR NET
A1 1/4-10 \$11.88
STACKING KIT
AS-1 1/4 \$1.26

See your **FINCO**[®] distributor

or write direct to

THE FINNEY COMPANY • DEPT. 19, 34 W. INTERSTATE ST., BEDFORD, OHIO

For further information, check number 14, on page 126

Central Electronics

Famous for

**DYNAMIC
PUNCH**



ANNOUNCES
THE NEW
200V
BROAD-BAND
Exciter-Transmitter



NEW FEATURES IN THE 200V

Amateur net... **\$795**

NEW! Silicon rectifier power supply. Better regulation. Less heat.
Higher voltage. 200 watts PEP input on SSB.

NEW! Frame grid (6EH7-6EJ7) mixers. Extremely high gain Less
heat. Unwanted mixer products down in excess of 50 DB.

NEW! Temperature compensated crystal oscillator circuits for ex-
treme, long term stability.

NEW! Increased mike pre-amplifier gain. Compensates for weak
voices or low output microphones.

NEW! Smooth as silk two speed tuning knob with 5 KC per turn
vernier tuning ratio.

**PLUS
THESE
ORIGINAL
FEATURES**

COMPLETELY BROAD-BANDED. You tune only the VFO. Inher-
ently matches output impedances of 50-72 ohms.

COMPLETE BAND COVERAGE. ALL of the 80-40-20-15-10 meter
bands, plus generous overlap and position for extra band.

INPUT 175 watts on CW, FSK and PM. 100 watts on AM.

"TAILORED" audio filter-Audio limiter.

ADJUSTABLE POWER OUTPUT control. 2" MONITORING SCOPE.

CALIBRATION ACCURACY better than 1 KC.

UNWANTED SIDEBAND SUPPRESSION 50 DB.

CARRIER SUPPRESSION at least 50 DB.

HARMONICS down in excess of 50 DB.

Third order DISTORTION PRODUCTS down in excess of
40 DB.

EASIER TO OPERATE THAN EVER! Choice of USB-LSB-AM-PM
CW-FSK at the flip of a switch. Perfected VOX, PTT, CW breakin
4 ways to key.

THERE IS
NOTHING
FINER THAN
THE
200V

Available soon - write for literature.

Central Electronics, Inc.

1247 W. Belmont Ave.

Chicago 13, Illinois

A subsidiary of Zenith Radio Corp.



For further information, check number 15, on page 126

March, 1961 • CQ • 21

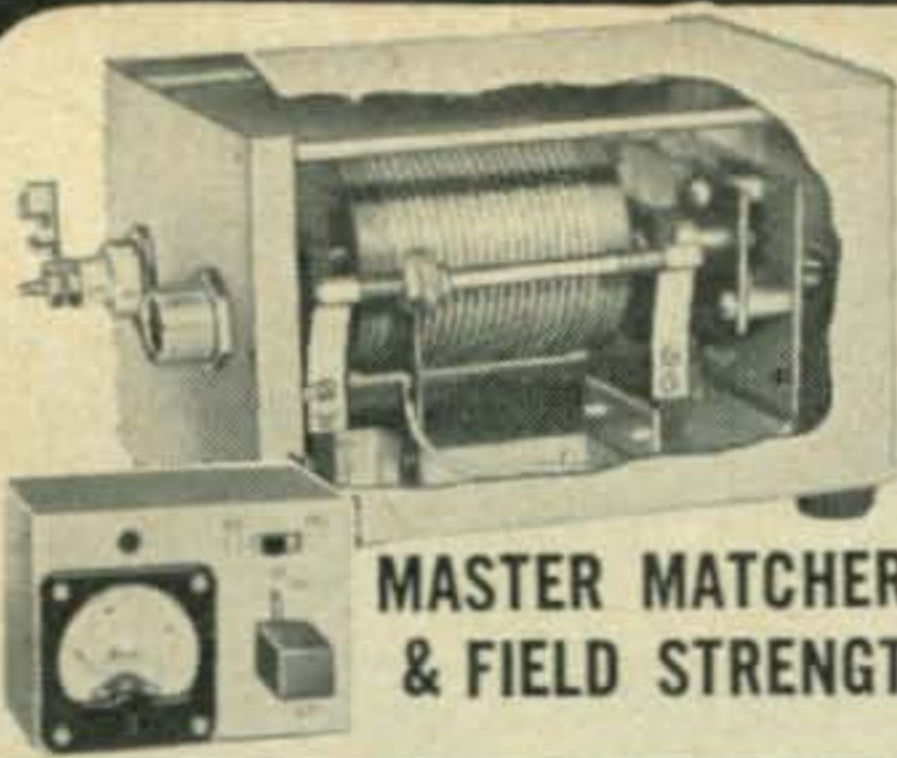

MASTER MATCHER & FIELD STRENGTH METER

6 or 12
volt models

Complete
\$24.95

Automatically
tunes entire
band by re-
mote control.



ULTRA-HI-"Q" COILS FOR 80, 40, 20, & 15 METERS

Your
Choice
\$5²⁵
ea.

The coil with the highest "Q" ever obtained. Tested and found to have a "Q" of well over 515. Use with 36" base sect. 60" whip. 3" Dia.

NEW! SLIM-JIM ALL-BAND BASE LOADING ANTENNA COIL

96" WHIP

FOR 10, 11,
15, 20, 40, 80
METERS

SIZE 1 3/8" x 19"

Positive action,
just slide whip
in or out to
loading point
and lock nut
into position.

NO.
B-1080
\$17.95

MULTI-BAND ANTENNA COILS

New Plug-in type coils, designed to operate with std. 3' base and 5' whip.

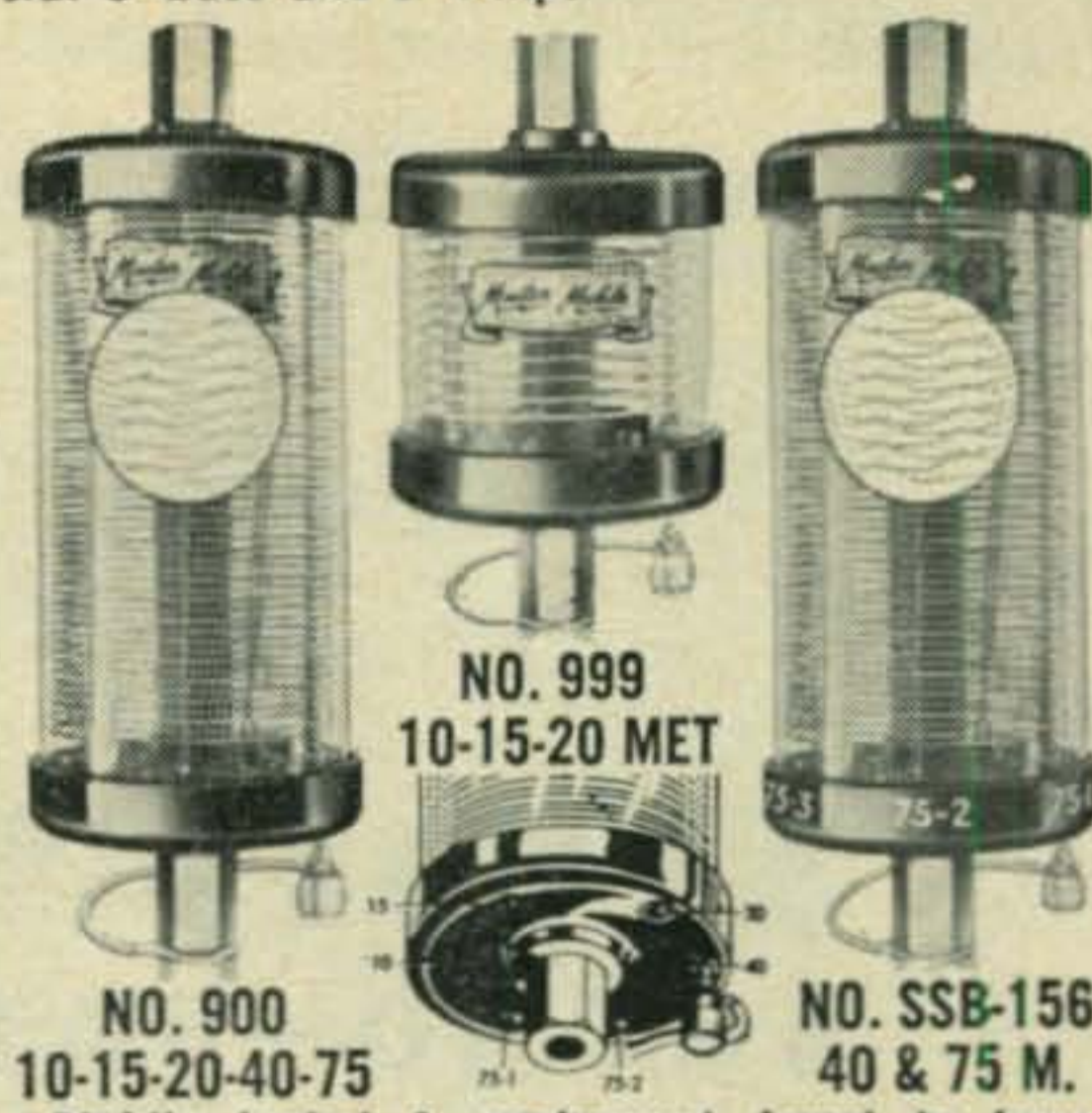

NO. 900
10-15-20-40-75

NO. 999
10-15-20 MET

NO. SSB-156
40 & 75 M.

• Rigidly tested & engineered—found to have "Q" of 525 • Handles 500 Watts input
• Operates into a 52-ohm cable • Positive contact—noise-free, trouble-free operation
• Weathersealed • Factory pre-tuned—no adjustments needed. **YOUR CHOICE EA \$14.95**

FIBRE-GLAS WHIPS

The Feather-Weight Antenna with Spring-Steel Strength!

Completely weather proof, breakproof antenna with special flexibility that prevents accidental shorting-out against overhead obstructions which can cause loss of signal, serious damage to equipment.

FG-60 60" \$4.95
FG-72 72" \$4.95
FG-84 84" \$5.15
FG-96 96" \$5.25
FG-103 103" \$6.95

Leaders in the Design and Manufacturing of Communication Equipment & Antennas FOR LAND, SEA AND AIR

MONOPOLE ANTENNA

Folded radiating element for installation requiring a ground plane configuration and a wider useful range.

11 Met. . \$24.50
10 Met. . 24.50
6 Met. . 16.95
2 Met. . 14.95

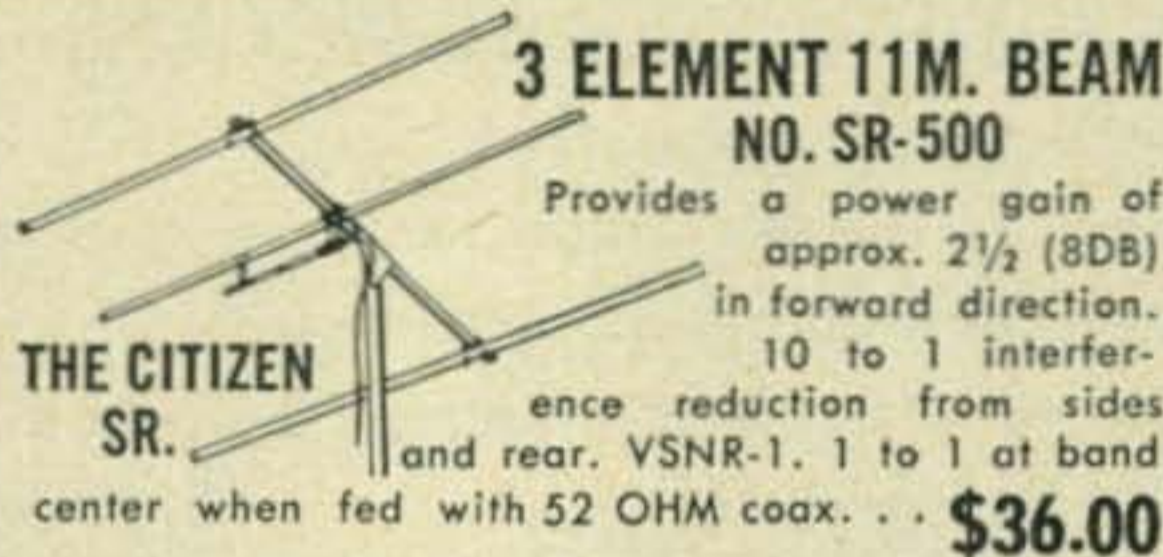

3 ELEMENT 11M. BEAM NO. SR-500

Provides a power gain of approx. 2 1/2 (8DB) in forward direction. 10 to 1 interference reduction from sides and rear. VSNR-1. 1 to 1 at band center when fed with 52 OHM coax. . .

\$36.00

MOUNTS

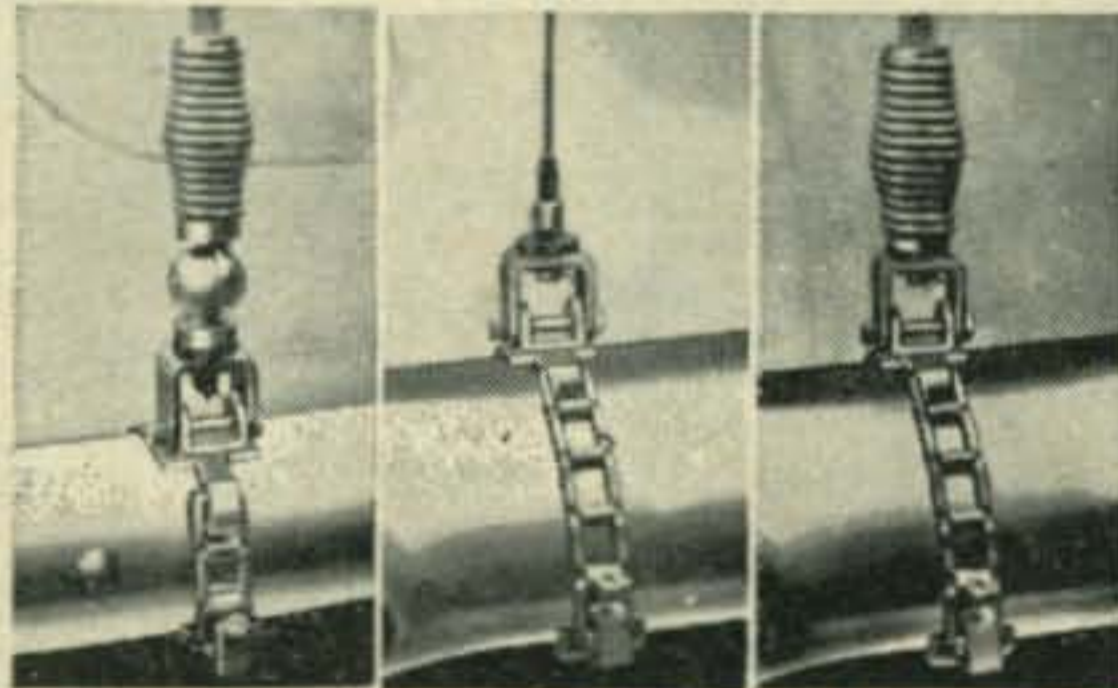

No.444 \$17.80 No.445 \$7.95 No.446 \$13.45
Adjustable to any bumper. No holes to drill.

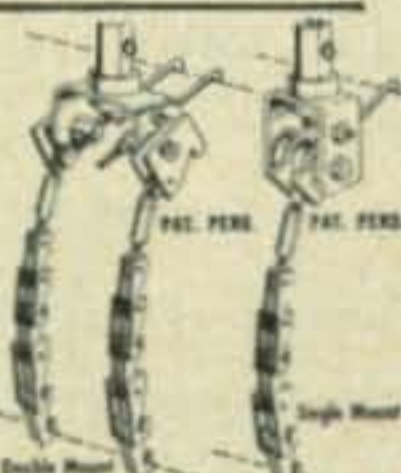

UNIVERSAL MOUNTS

Heavy-duty communications antenna mounts. Either mount can be attached through openings as small as 3/16". Receptacle for spring or whip with phenolic insulators. 3/8"-24-thread.

MM530 Deluxe Dbl. SS. \$21.95
MM531 Deluxe Sgl. SS. 11.95
MM520 Dbl. St-Cad. Pl. 7.95
MM519 Sgl. St-Cad. Pl. 4.95

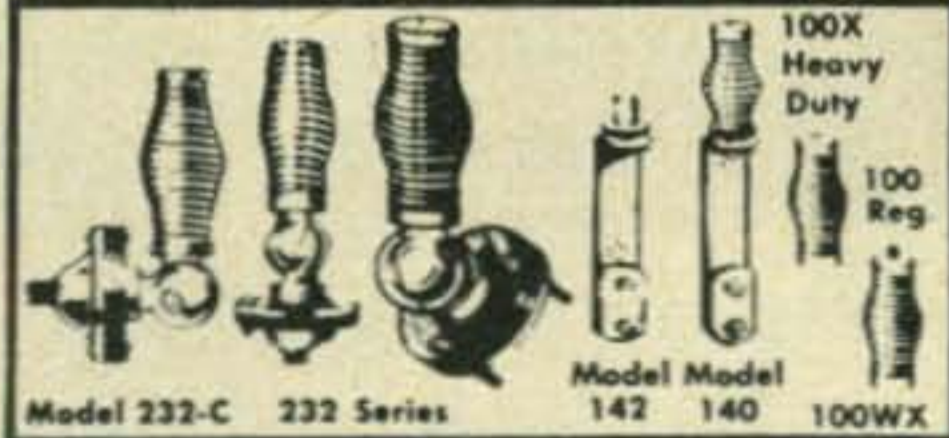

Model 232-C 232 Series 142 140 100WX
100X Heavy Duty 100 Reg

MASTER-MAGIC WAND

New easy-to-install, single band, top-loaded plastic covered fiber glass antenna provides maximum performance at the most useful radiation frequencies.

10 Met.- 5 Ft. L. \$8.95
11 Met.- 5 Ft. L. 8.95
11 Met.-35 In. L. 8.95
11 Met.-45 In. L. 8.95
15 Met.- 5 Ft. L. 8.95
20 Met.- 5 Ft. L. 8.95
40 Met.- 6 Ft. L. 9.95
80 Met.- 6 Ft. L. 9.95

SKYMASTER COAX ANTENNA

Gets your signal through where others fail. Concentrates signals at the lowest angle, provides omni-directional pattern for best coverage. Matches RG 59/U Cable. SM-700

11 Met. . . \$17.95
10 Met. . . 17.95
6 Met. . . 15.95
2 Met. . . 10.95



MOUNT

Smaller version of Master Mobile Mounts, less spring. Swivels, mounts in all positions. 3/8"-24 thread for Magic Wand, and all Master Antennas.

No. J-11 **\$2.95**

11M. CITIZEN BAND ANTENNA

40" base loaded S.S. whip antenna. Fitted with a 1/4" dia. brass slug for all-purpose mounts. Low standing-wave ratio on most of band when fed with a 52 ohm coax.

8B-27 **\$12.95**

WRITE FOR FREE
CATALOG

All products are for Universal Use-Mobile, Home,
Marine, C.A.P., Civil Defense, Emergency, etc.



Master Mobile Mounts, Inc.

4125 W. JEFFERSON BLVD. • LOS ANGELES 16, CALIF.

AT LEADING
RADIO JOBBERS
EVERYWHERE

For further information, check number 16, on page 126

from **EICO**® ... a completely new

CITIZENS BAND TRANSCEIVER

that meets
FCC regulations*

*EICO premounts, prewires, pretunes, and seals the ENTIRE transmitter oscillator circuit to conform with FCC regulations (Section 19.71 subdivision d). EICO thus gives you the transceiver in kit form that you can build and put on the air without the supervision of a Commercial Radio-Telephone Licensee!

designed
by Hams...
for Hams...

to the highest
Ham standards

Highly sensitive, selective SUPERHET (not regenerative) receiver with 5½ dual function tubes and RF stage. Continuous tuning over all 23 bands. Exclusive Super-Hush® noise limiter. AVC. 3" x 5" PM speaker. Detachable ceramic mike. 5 Watt xtal-controlled transmitter. Variable "pi" network matches most popular antennas. 12-position Posi-Lock® mounting bracket. 7 tubes and 1 xtal (extra xtals available). Covers up to 20 miles. License available to any citizen over 18 — no exams or special skills required; application form supplied free. Antennas optional.

Additional crystals \$3.95 each.

Most EICO distributors offer budget terms.

#760:
117 VAC
Kit
\$59.95
Wired
\$89.95

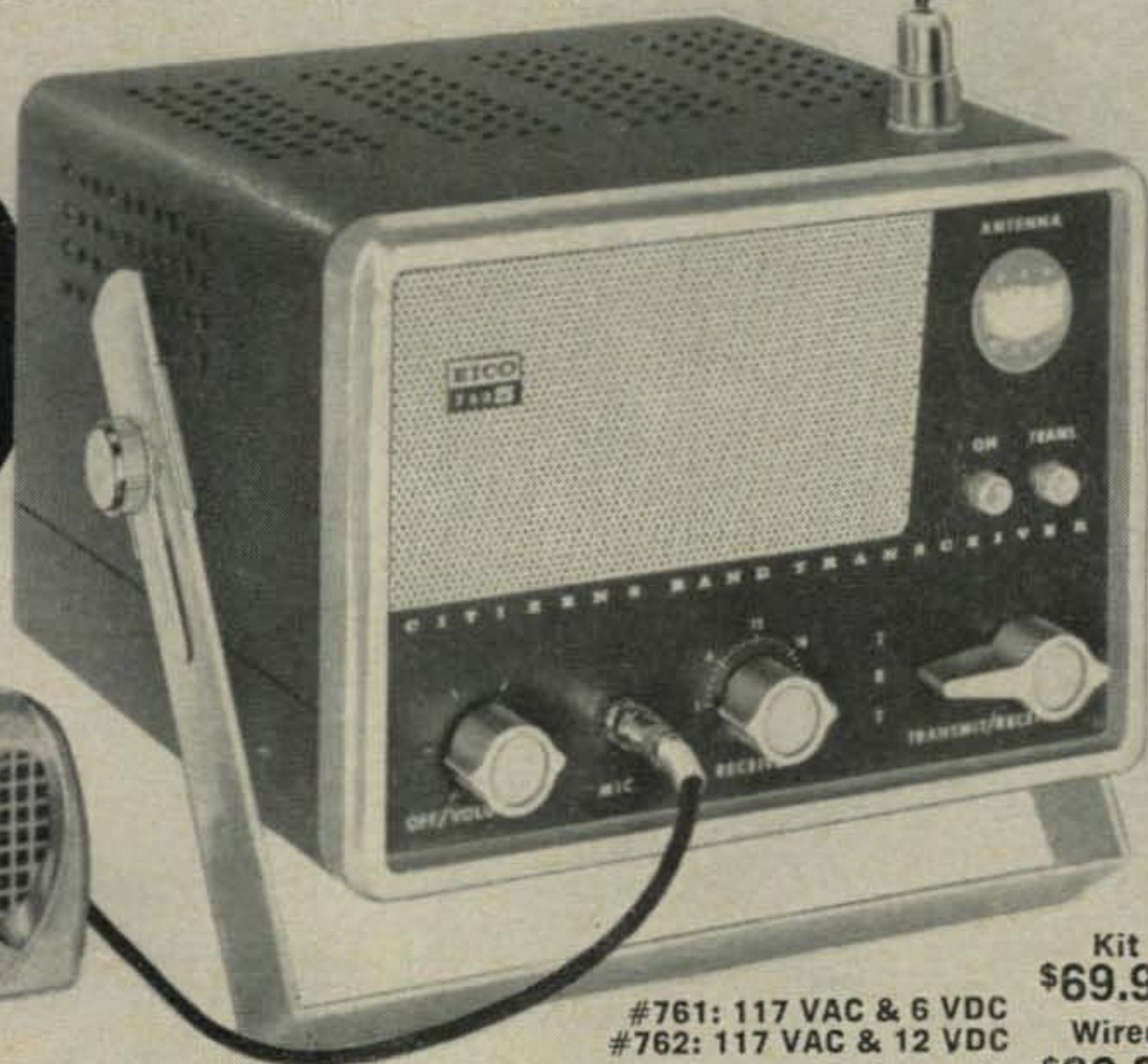

Kit **\$69.95**
Wired **\$99.95**
#761: 117 VAC & 6 VDC
#762: 117 VAC & 12 VDC
incl. mtg. bracket (Pat. Pend.)



NEW! 60-WATT CW TRANSMITTER #723
Kit \$49.95 Wired \$79.95
Ideal for novice or advanced ham needing low-power, stand-by rig. 60W CW, 50W external plate modulation. 80 through 10 meters.



COLOR & MONO DC-5MC LAB & TV 5" OSCILLOSCOPE #460
Kit \$79.95 Wired \$129.50
5" PUSH-PULL OSCILLOSCOPE #425
Kit \$44.95 Wired \$79.95



90-WATT CW TRANSMITTER* #720
Kit \$79.95 Wired \$119.95
*U. S. Pat. No. D-184,776
"Top quality" — ELECTRONIC KITS GUIDE. Ideal for veteran or novice. 90W CW, 65W external plate modulation. 80 through 10 meters.



PEAK-TO-PEAK VTVM #232 & *UNI-PROBE®
Kit \$29.95 Wired \$49.95
*U. S. Pat. No. 2,790,051
VACUUM TUBE VOLTMETER #221
Kit \$25.95 Wired \$39.95



HIGH-LEVEL UNIVERSAL MODULATOR-DRIVER #730
Kit \$49.95 Wired \$79.95
Delivers 50W undistorted audio. Modulates transmitters having RF inputs up to 100W. Unique over-modulation indicator. Cover E-5 \$4.50.



RF SIGNAL GENERATOR #324 (150kc-435mc)
Kit \$26.95 Wired \$39.95
TV-FM SWEEP GENERATOR & MARKER #368
Kit \$69.95 Wired \$119.95

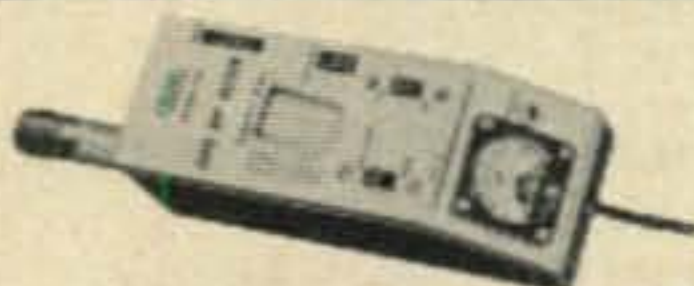

GRID DIP METER #710
Kit \$29.95 Wired \$49.95
Includes complete set of coils for full band coverage. Continuous coverage 400 kc to 250 mc. 500 ua meter.



DYNAMIC CONDUCTANCE TUBE & TRANSISTOR TESTER #666
Kit \$69.95 Wired \$109.95
TUBE TESTER #625
Kit \$34.95 Wired \$49.95

EICO®

33-00 Northern Blvd.,
Long Island City 1, N. Y.

EICO, 33-00 N. Blvd., L.I.C. 1, N.Y. Show me how to save 50% on 72 models of top-quality: Ham Gear Test Instruments Hi-Fi Send free Short Course for Novice License. Send free catalog and name of neighborhood EICO distributor. Send 36-page Stereo - Hi-Fi Guidebook: 25¢ enclosed for postage & handling

Name..... CQ-3
Address.....
City..... Zone..... State.....

Add 5% in the West.

ENGINEERS: Excellent career opportunities in creative electronics design. Write to the Chief Engineer.

For further information, check number 17, on page 126

Pick your
features and
power from
the popular

Viking TRANSMITTER LINE



"ADVENTURER"



"CHALLENGER"



"NAVIGATOR"



"6N2"



10-METER
"MESSENGER"

"ADVENTURER" TRANSMITTER

Self-contained . . . 50 watts CW input . . . rugged 807 transmitting tube . . . instant bandswitching 80 through 10 meters. Crystal or external VFO control—wide range pi-network output—timed sequence keying. With tubes, less crystals.

Cat. No. 240-181-1 . . . Kit Amateur Net \$54.95

"CHALLENGER" TRANSMITTER

70 watts phone input 80 through 6; 120 watts CW input 80 through 10 . . . 85 watts CW on 6 meters. Two 6DQ6A final amplifier tubes. Crystal or external VFO control—TVI suppressed—wide range pi-network output. With tubes, less crystals.

Cat. No. 240-182-1 . . . Kit Amateur Net \$114.75

Cat. No. 240-182-2 . . . Wired Amateur Net \$154.75

"NAVIGATOR" TRANSMITTER/EXCITER

40 watts CW input . . . also serves as a flexible VFO Exciter. 6146 final amplifier tube—bandswitching 160 through 10 meters. Built-in VFO or crystal control. With tubes, less crystals.

Cat. No. 240-126-1 . . . Kit Amateur Net \$149.50

Cat. No. 240-126-2 . . . Wired Amateur Net \$199.50

"6N2" TRANSMITTER

Rated 150 watts CW and 100 watts phone—offers instant bandswitching coverage of both 6 and 2 meters. Fully TVI suppressed—may be used with the Viking I, II, "Ranger", "Valiant" or similar power supply/modulator combinations. Operates by crystal control or external VFO with 8-9 mc. output. With tubes, less crystals.

Cat. No. 240-201-1 . . . Kit Amateur Net \$129.50

Cat. No. 240-201-2 . . . Wired Amateur Net \$169.50

10-METER "MESSENGER" TRANSCEIVER

Complete 10-tube (including rectifier) crystal-controlled transceiver. 10 watts input—pre-tuned for 29.4 to 29.7 mcs—covers any 5 frequencies within a 300 kc segment of 10-meter band. Excellent receiver sensitivity and selectivity. ANL, AVC, and positive-acting Squelch. With tubes, push-to-talk microphone, and crystals for national calling and emergency frequency (29,640 kc).

Cat. No. 242-201 . . . 115 V only Amateur Net \$129.75

Cat. No. 242-202 . . . 115 V and 6 V Amateur Net \$139.75

Cat. No. 242-203 . . . 115 V and 12 V Amateur Net \$139.75



"RANGER" TRANSMITTER/EXCITER

This popular 75 watt CW or 65 watt phone transmitter will also serve as an RF/audio exciter for high power equipment. Completely self-contained—instant bandswitching 160 through 10 meters! Operates by built-in VFO or crystal control. High gain audio—timed sequence keying TVI suppressed. Pi-network antenna load matching from 50 to 500 ohms. With tubes, less crystals.

Cat. No. 240-161-1 . . . Kit Amateur Net \$229.50
240-161-2 . . . Wired and tested . . . \$329.50



"VALIANT" TRANSMITTER

275 watts input CW and SSB (P.E.P. with auxiliary SSB exciter) 200 watts phone. Instant bandswitching 160 through 10 meters—built-in VFO or crystal control. Pi-network output matches antenna loads from 50 to 600 ohms. TVI suppressed—timed sequence keying—built-in low pass audio filter—self-contained power supplies. With tubes, less crystals.

Cat. No. 240-104-1 . . . Kit Amateur Net \$349.50
240-104-2 . . . Wired and tested . . . \$439.50



"FIVE HUNDRED" TRANSMITTER

Full 600 watts CW—500 watts phone and SSB. (P.E.P. with auxiliary SSB exciter.) Compact RF unit designed for desk-top operation. All exciter stages ganged to VFO tuning—may also be operated by crystal control. Instant bandswitching 80 through 10 meters—TVI suppressed—high gain push-to-talk audio system. Wide range pi-network output. With tubes, less crystals.

Cat. No. 240-500-1 . . . Kit Amateur Net \$749.50
240-500-2 . . . Wired and tested . . . \$949.50

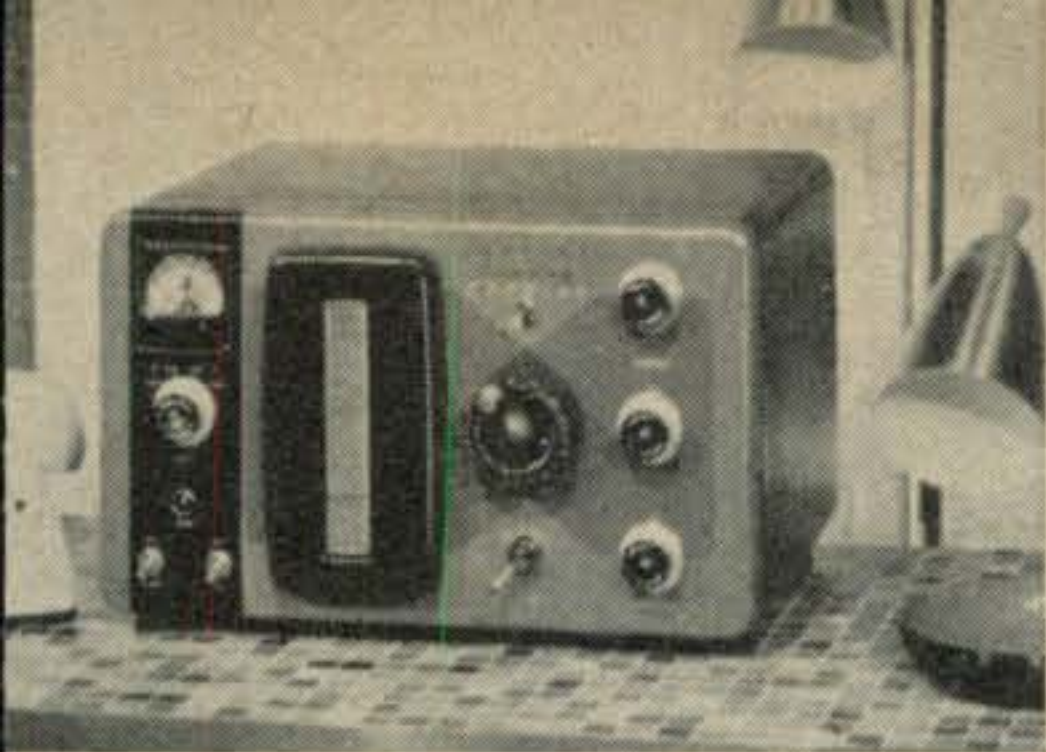

"COURIER" AMPLIFIER

Rated a solid 500 watts P.E.P. input with auxiliary SSB exciter as a Class B linear amplifier; 500 watts CW or 200 watts AM linear. Self-contained desk-top package—continuous coverage 3.5 to 30 mcs. Drive requirements: 5 to 35 watts depending on mode and frequency desired. TVI suppressed. With tubes and built-in power supply.

Cat. No. **Amateur Net**
 240-352-2..Wired and tested...\$289.50



"THUNDERBOLT" AMPLIFIER

The hottest linear amplifier on the market—2000 watts P.E.P. (twice average DC) input SSB; 1000 watts CW; 800 watts AM linear. Continuous coverage 3.5 to 30 mcs.—instant bandswitching. Drive requirements; approx. 10 watts Class AB₂ linear, 20 watts Class C continuous wave. With tubes and built-in power supply.

Cat. No. **Amateur Net**
 240-353-1..Kit.....\$524.50
 240-353-2..Wired and tested...\$589.50



"6N2 THUNDERBOLT" AMPLIFIER

1200 watts (twice average DC) input SSB and DSB, Class AB₁; 1000 watts CW, Class C; and 700 watts input AM linear. Continuous band-switched coverage on 6 and 2 meters. TVI suppressed. Drive requirements; approx. 5 watts Class AB₁ linear, 6 watts Class C CW. With tubes and built-in power supply.

Cat. No. **Amateur Net**
 240-362-1..Kit.....\$524.50
 240-362-2..Wired and tested...\$589.50

The world at your fingertips!

VIKING "KILOWATT" AMPLIFIER

The only transmitter that provides maximum legal power in all modes—SSB, CW, and plate modulated AM. Two 4-400A tubes in Class AB₂ easily deliver 2000 watts P.E.P. (twice average DC) in SSB mode—1000 watts input AM with two push-pull 810 tubes in Class B modulator service—1000 watts input Class C CW. High efficiency pi-network output circuit. Excitation requirements: 30 watts RF and 10 watts audio for AM; 10 watts peak for SSB. Pedestal contains complete unit. With tubes.

Cat. No. 240-1000..Wired and tested.....**Amateur Net \$1595.00**

Matching desk-top and three-drawer pedestal.

Cat. No. 251-101-1.....**FOB Corry, Pa. \$132.00**



The very finest SSB equipment you can buy!

Filter Type Sideband—Highly Stable Operation and Unusually Sharp Response!



INVADER

The transmitter you've been waiting for—with more exclusive features than any other Transmitter/Exciter on the market today! Instant band-switching 80 through 10 meters—no extra crystals to buy—no retuning necessary. Rated 200 watts CW and SSB input; 90 watts input on AM. Unwanted sideband and carrier suppression is 60 db or better! Wide range pi-network output circuit. Fully TVI suppressed. Self-contained heavy-duty power supply. Wired and tested with tubes and crystals.

Cat. No. **Amateur Net**
 240-302-2.....\$619.50

INVADER-2000

Here are all of the fine features of the "Invader", plus the added power and flexibility of an integral linear amplifier and remote controlled power supply. Rated a solid 2000 watts P.E.P. (twice average DC) input on SSB; 1000 watts CW; and 800 watts input AM! Wide range output circuit (40 to 600 ohms adjustable). Final amplifier provides exceptionally uniform "Q". Exclusive "push-pull" cooling system. Heavy-duty multi-section power supply. Wired and tested with power supply, tubes and crystals.

Cat. No. **Amateur Net**
 240-304-2.....\$1229.00



HI-POWER CONVERSION

Take the features and performance of your "Invader" . . . add the power and flexibility of this unique Viking "Hi-Power Conversion" system . . . and you're "on the air" with the "Invader-2000"—a solid 2000 watts P.E.P. (twice average DC) input SSB, 1000 watts CW and 800 watts input AM. Completely wired and tested—includes *everything* you need—no soldering necessary—complete the entire conversion in one evening!

Cat. No. 240-303-2..Hi-Power Conversion, complete.....**Amateur Net \$619.50**

Free Catalog

Write for your free copy of our newest amateur equipment catalog—complete specifications, illustrations and schematics on Viking amateur equipment.



E. F. JOHNSON COMPANY

WASECA • MINNESOTA

For further information, check number 18 on page 126.

The "ALL AROUND"

A Versatile 10 Meter Portable Rig

William H. Kennedy, W3ZFJ

RD #2 Box 67A
Export, Pennsylvania

The need often arises for a lightweight and versatile station able to do a respectable job in widely varying situations. The unit described here, meets these requirements with a 30-40 watt 10 meter a.m. transmitter and small superregenerative receiver. In addition, a system of jumper "programming" plugs allows the use of any portion of the unit independently.

I HAVE, for some time, felt the need for a 10 meter portable rig that could be used anywhere and anytime. The rig described here has proved to be one of the most valuable pieces of equipment in my shack. Before going into the details of the circuitry I would like to give you some idea as to the versatility of the "All Around."

The unit runs 30-40 watts input with high level modulation. The r.f. and the audio may be used independently and simultaneously to provide drive for a higher power final and modulator which is being done at the present time. The power supply may also be used independently or with the modulator for another r.f. section, 2 meters for example. The transmitter may be used for mobile operation on either 6 volts or 12 volts. A superregenerative receiver is included for portable use. Muting voltages, speaker, and antenna switching are available for use with a regular station receiver. This switching, or programing if you will, is done very

simply with three Jones plugs and appropriate jumpers. The details of this programing will unfold as we describe the individual circuits.

Circuit Description

The v.f.o. is a standard Clapp oscillator operating on 7 mc. The frequency determining components are mounted in a 2 $\frac{3}{4}$ " \times 2 $\frac{1}{8}$ " \times 1 $\frac{5}{8}$ " Minibox on the front panel with coax cable connecting the tank circuit to the tube. An external v.f.o. may be used at a fixed location if better calibration is desired than that obtained with the 0-100 division dial used here.

The 6J6 twin doubler should be familiar to CQ readers interested in mobile operation¹. It is W6WYA's 28-9 driver. Be sure to use ceramic sockets, short leads, and coil forms similar to the National XR-50, for this circuit. Any compromise will result in inadequate grid drive to the final.

¹J. R. Smith, "The 28-9" CQ, May 1952, p. 47.

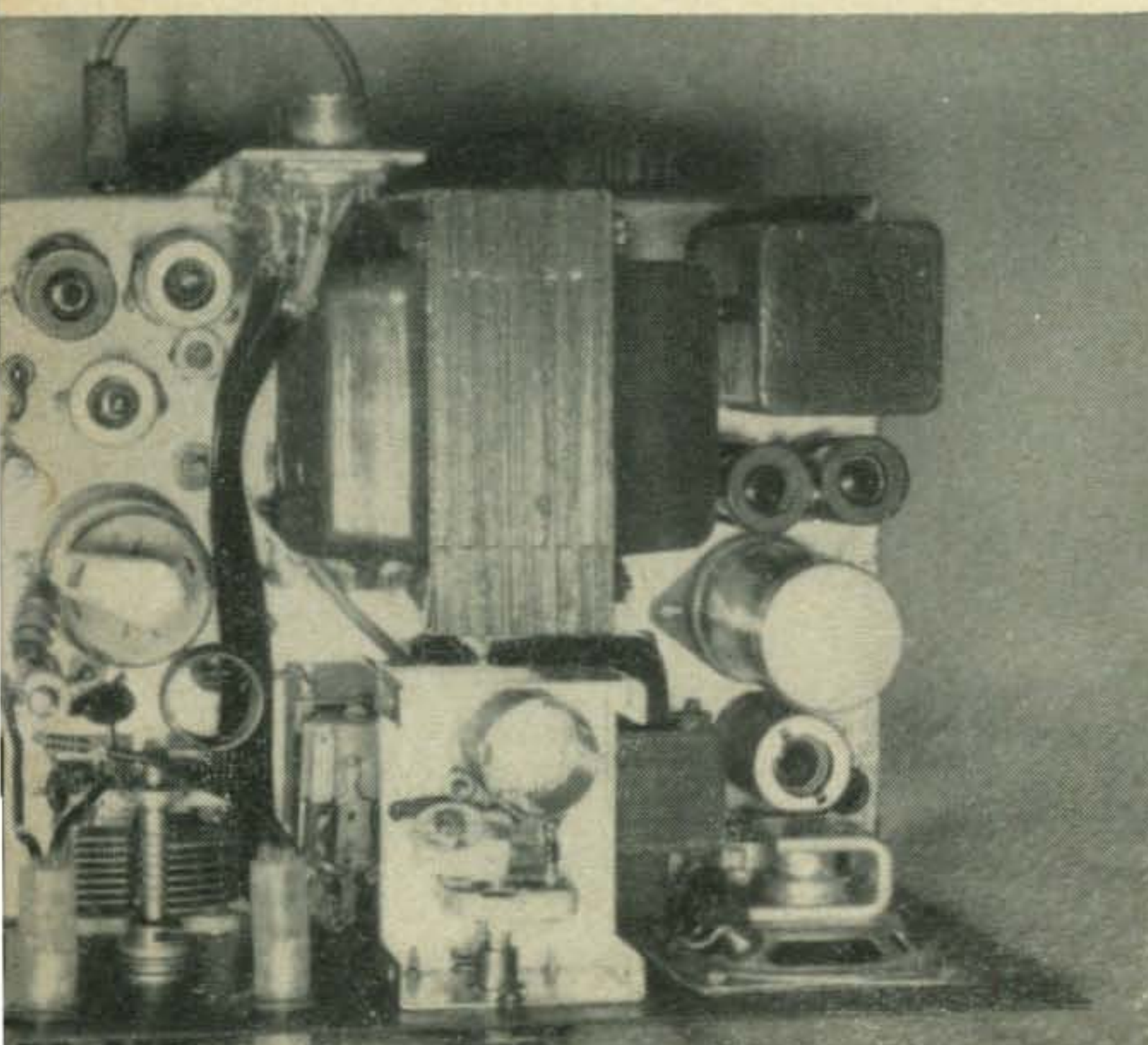

Top view of the "All Around" showing v.f.o. components mounted in a small minibox. R.f. components on the left consist of the plate tuning capacitor mounted on the front panel, with the antenna loading capacitor mounted below it, out of sight. Behind the 6146 is the 6J6, 6AH6 and 0B2 voltage regulator. The large transformer behind the v.f.o. is the power transformer, T₄.

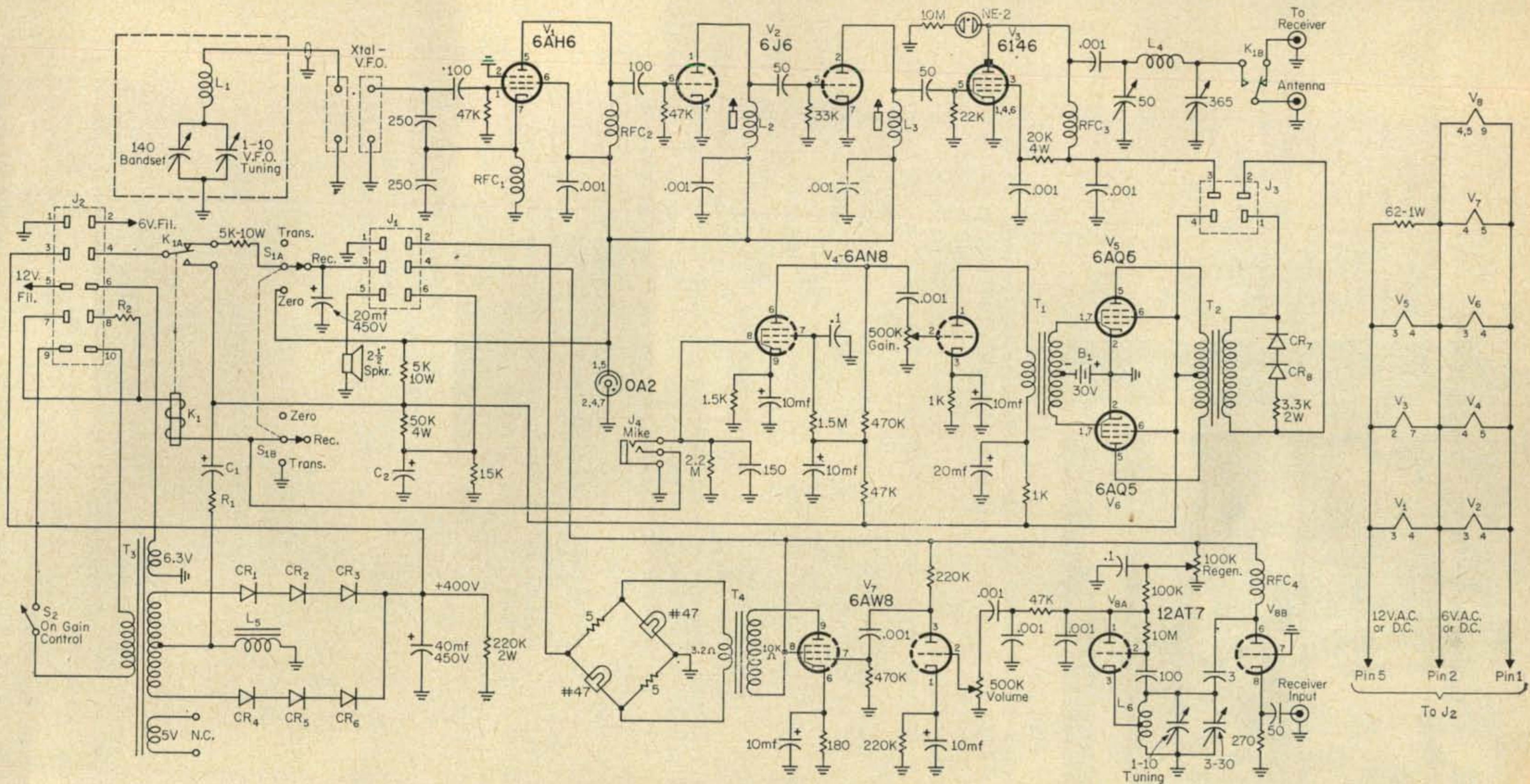
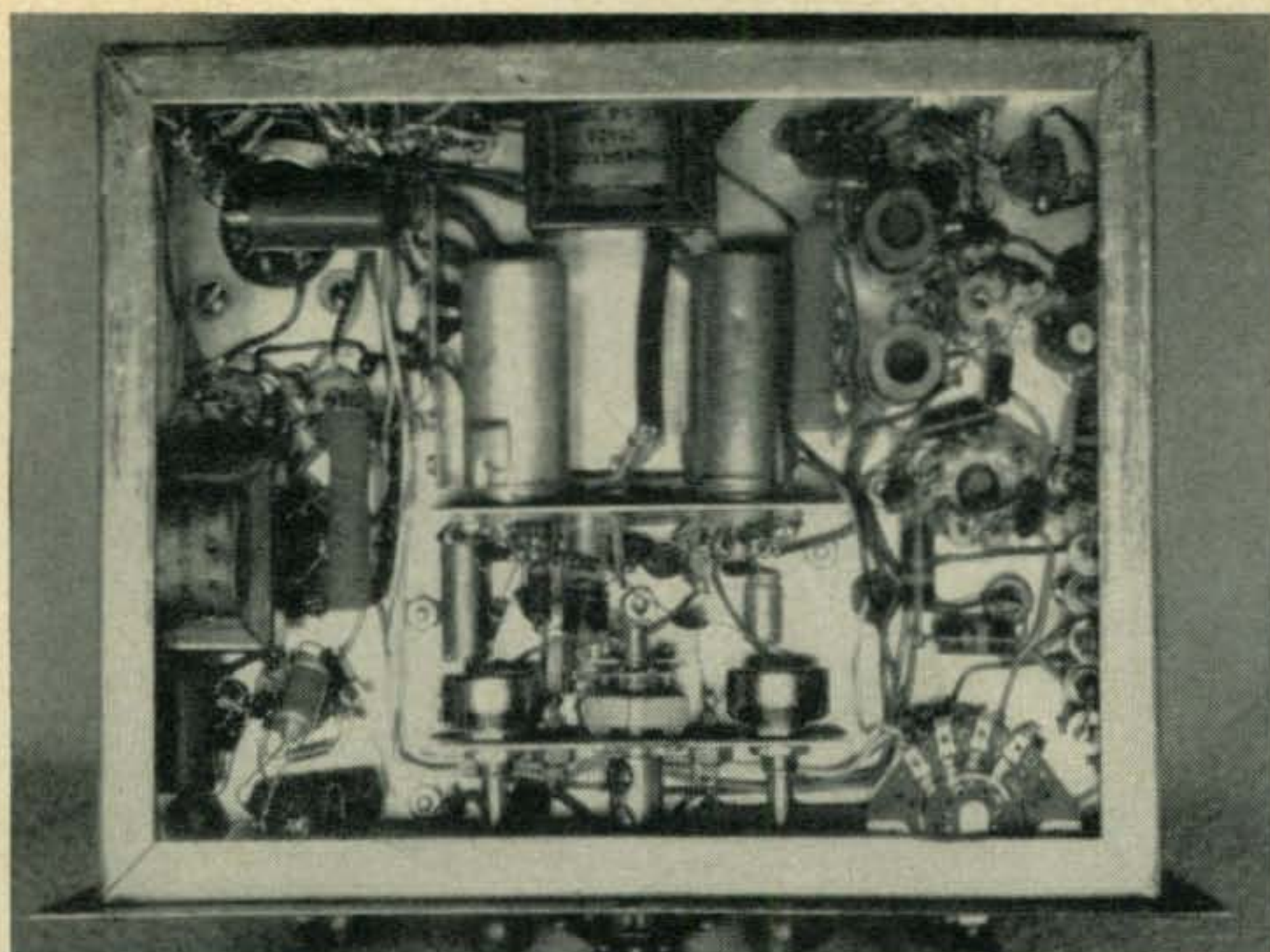

Fig. 1—Complete schematic of the "All Around" portable 10 meter station.

L₁—30 turns B & W 3016
 L₂—28 turns #24 Enamel on XR-50 form
 L₃—13 turns #18 Enamel on XR-50 form
 L₄—9 turns of B & W 3010
 L₅—150 ma filter choke
 L₆—9 turns #20 Enameled on 3/8" diameter polystyrene rod, tapped 2 turns from ground end.
 RFC_{1, 2}—2.5 mh r.f. chokes
 RFC₃—Ohmite Z-28 r.f. choke

RFC₄—75 turns #30 enameled on 1 megohm
 1 watt resistor
 B₁—30v hearing aid type battery
 T₁—3:1 Interstage transformer, Stancor A-53-C
 T₂—Modulation transformer, Stancor A-3845
 T₃—750 volts c.t. @ 150 ma, Stancor PC-8411
 T₄—Output transformer, Stancor A-3822
 CR₁ to 8—Westinghouse 320-K, 500 ma diodes
 J₁—6 pr female plug, Jones #S306 AB

J₂—10 pr male plug, Jones #P310 AB
 J₃—4 pr female plug, Jones #S304 AB
 K₁—Relay 6 VAC, d.p.d.t., Guardian 200 series,
 S₁—2P3T lever switch, Centralab 1454
 R₁—100 ohms 10W
 R₂—10 ohms 10W
 C₁—40 mf, 450 volts
 C₂—50 mf, 50 volts



Under-chassis view of the ten meter transmitter-receiver. The receiver components are mounted on two angle brackets. The tubes and tuning controls are so arranged that the shortest possible leads are obtained.

The r.f. amplifier is a 6146 with tank circuit values designed to match a 50 ohm load. The neon indicator, also familiar to *CQ* readers, is used in lieu of a meter. This method requires a meter for initial tune up but with a little practice the loading and dip of the final may be set very easily with the neon bulb.

The plate choke used here is home brew. It is wound with about 100 turns of #30 enameled wire on a 1/2" x 2" ceramic standoff. An Ohmite Z-28 could be substituted, however, with no sacrifice in performance.

The modulator consists of push-pull 6AQ5s. The modulation transformer used in this unit is from a surplus ARC-4, two meter transceiver. It is not a perfect match, however there is a very good reason why I used it. I just happened to have one! A Stancor A-3845 could be substituted and would provide a better match.

The 6AN8 driver and speech amplifier was designed with a crystal mike for fixed operation. If, however, mobile operation is the primary objective, a carbon mike would be more desirable. With the appropriate circuit changes as shown in fig. 2, a carbon mike may be used.

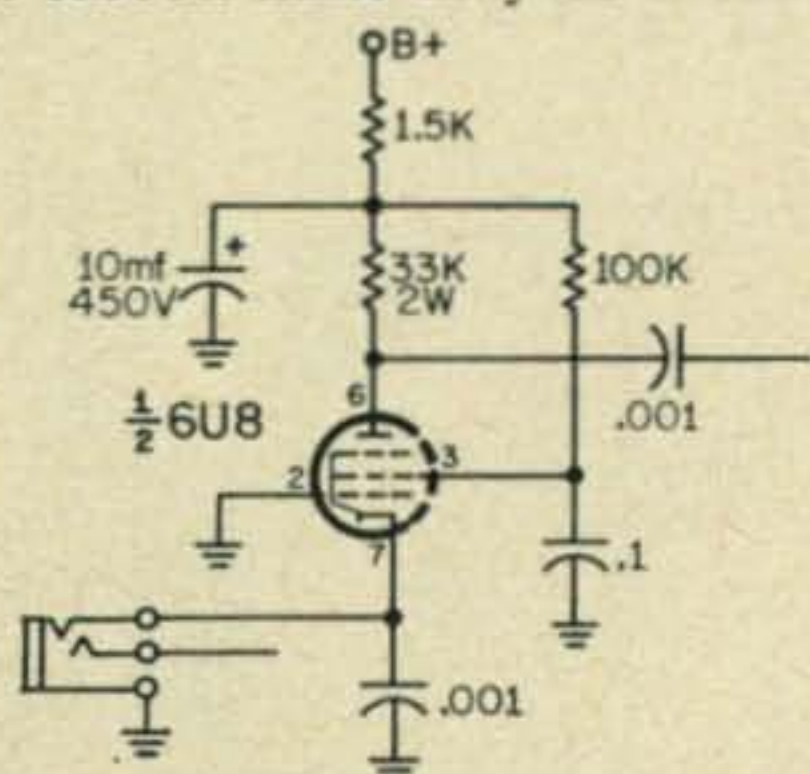

Fig. 2—Schematic illustrating the changes necessary in the speech amplifier circuit of the "All Around" for use with carbon microphones. The original 6AN8 is replaced with a 6U8 with appropriate changes in pin connections in both sections.

Power Supply

The power supply, is a full-wave type utilizing silicon rectifiers. A 5U4 could be substituted,

however, two main considerations prompted the use of these diodes. The primary reason was the virtual elimination of heat from the rectifiers, very necessary in this small enclosure. The second reason was the increased voltage output (about 30 volts) with the resulting improvement in voltage regulation under modulation.

A rather unique play of voltages is used in the power supply. Initially the unit used a pi-filter in its conventional form, however, in receive position, since the receiver presents a very light load, the voltages approached 500, which exceeded the filter capacitor ratings. By removing the input filter capacitor the voltage dropped to a safe value of 350 volts but this in turn dropped below 300 volts in the transmit position. The input filter capacitor had to be replaced during transmit. This was accomplished by putting the filter choke in the negative lead and tying the filter capacitor C_1 to the B plus relay. The voltage now rests at 400 volts in transmit. The series resistor R_1 reduces the initial surge to prevent pitting the relay contacts.

Referring to the schematic of the power supply in fig. 1, you will note the power switching is done through J_2 with the various jumper plugs shown in fig. 3. Receptacle J_2 is used when voltages are taken from the internal supply, or voltages are applied for mobile operation. The leads

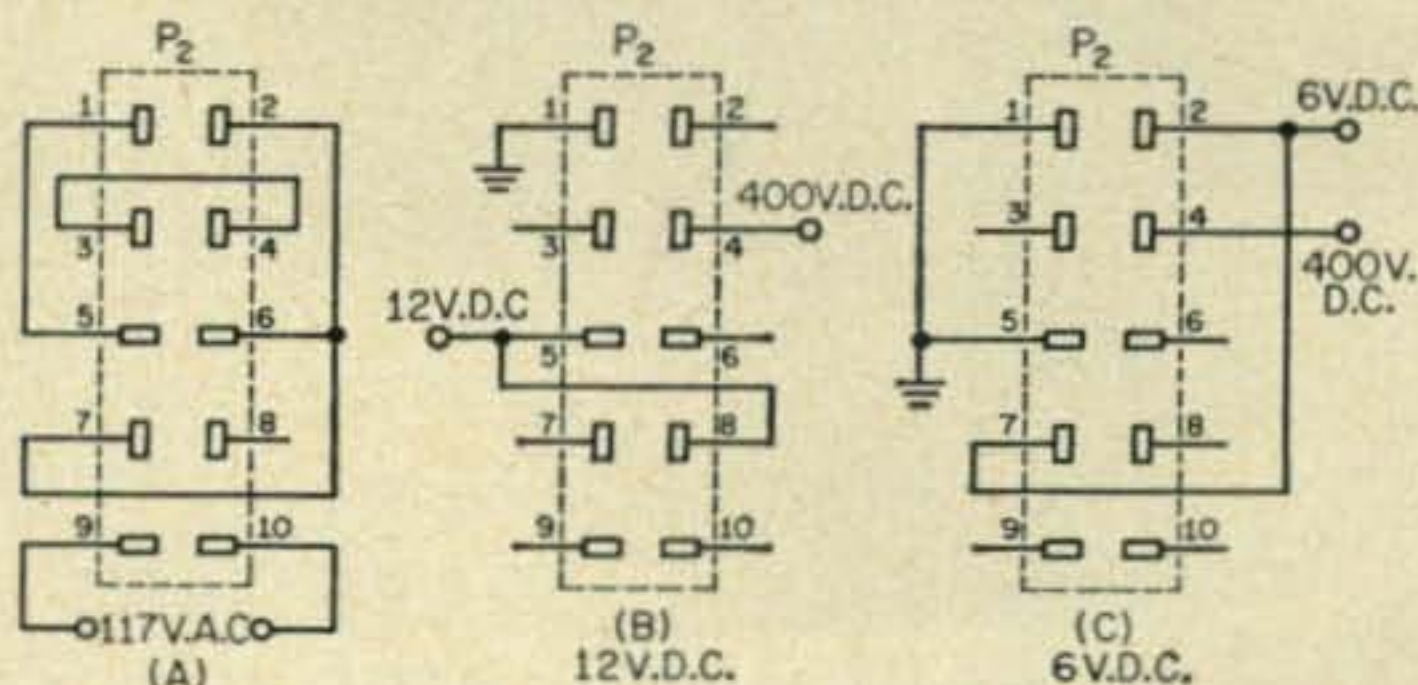
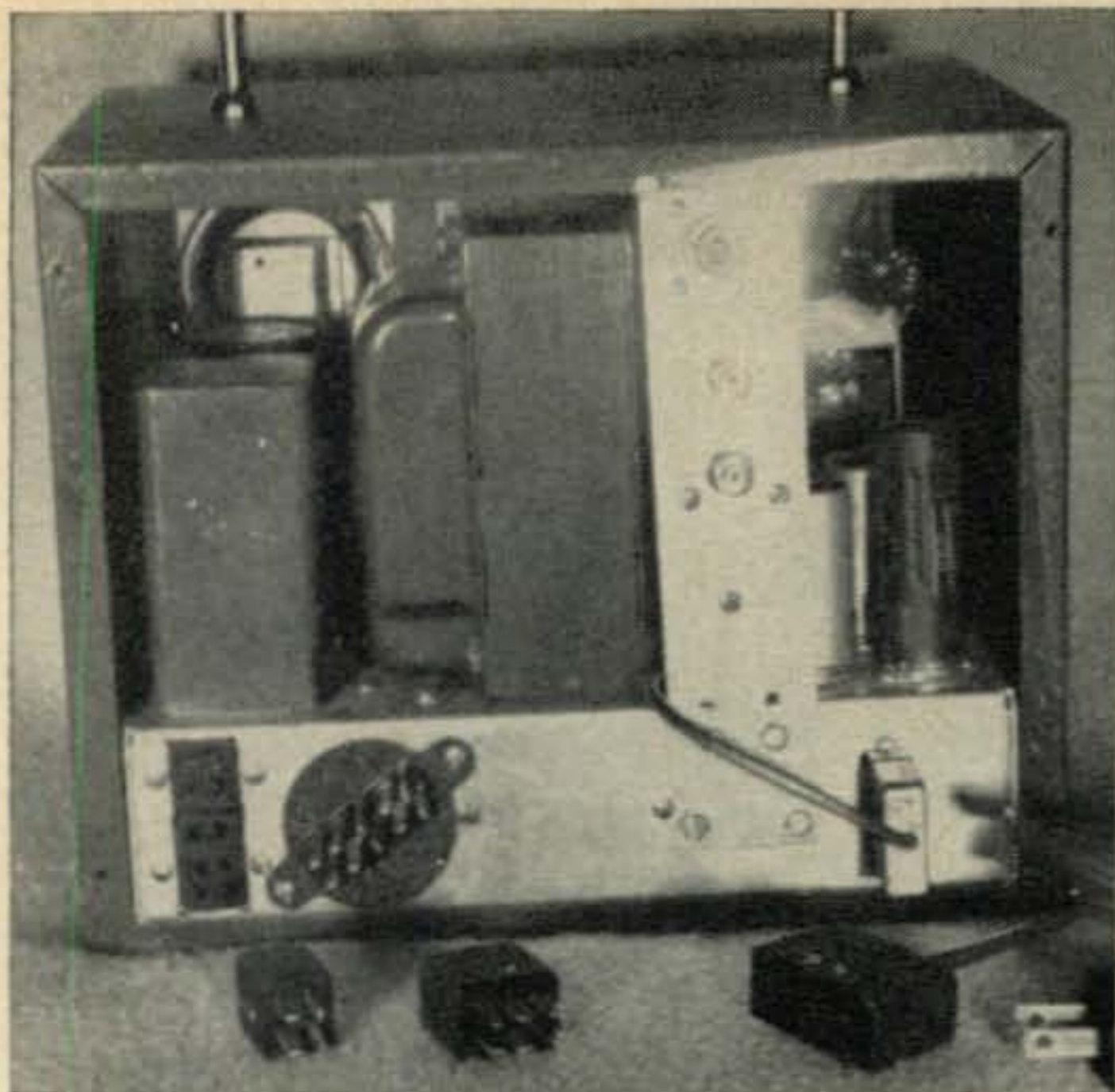

Fig. 3—Jumper plug P_2 connections for various methods of operation. (A)—Plug for the use of self contained a.c. power supply. (B)—Plug for 12 volt external filament supply and separate high voltage source and (C)—Plug for 6 volt filament supply with external high voltage supply.



Rear view shows the "programming" plug arrangement on the left. On the right of the chassis is the v.f.o. plug made from an old surplus crystal holder. The vertical bracket contains the three antenna connectors.

from internal antenna and B+ relay is also brought to J_2 so that resistor R_2 may be inserted in series with the coil for 12 volt operation.

When the unit was first put into operation, the fixed station receiver (75A-4) appeared to be returning to "on" before the transmitter was fully off, due to the use of both a switch and relay for RECEIVE-TRANSMIT switching. This caused a very short but disturbing feedback screech. This was corrected by installing capacitor C_2 across the muting voltage. This provided sufficient delay.

Receiver Switching

The superregenerative receiver B+ and the receiver audio output are passed through J_1 and

may be disconnected, enabling a regular station receiver to be used. Pin 6 of J_1 provides 25 volts on transmit for receivers requiring a muting voltage (75A-4) or this voltage may be applied to a 10K plate relay to provide switch muting. The speaker in the unit is connected to pin 5 and may also be used with another receiver. The +200V at pin 3 of J_1 may be used to supply power to a converter for higher frequencies. I have used this voltage applied to the internal receiver and simultaneously with a 2 meter converter and used the internal superregenerative receiver as the tuneable i.f. Figure 4 shows the necessary jumper and cable connections.

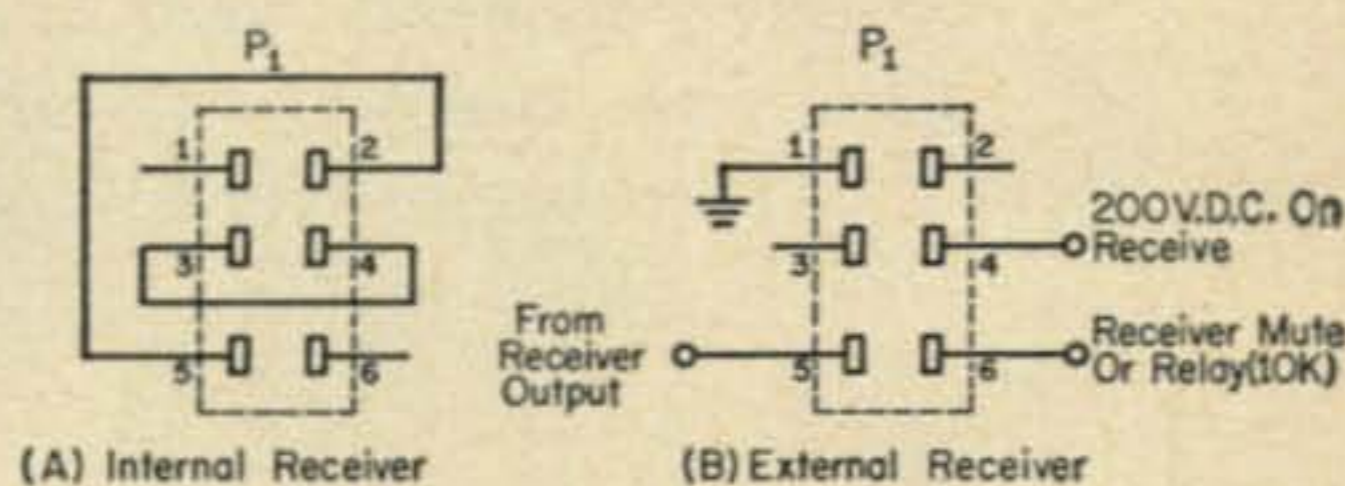

Fig. 4—Plug P_1 connections for selection of either the internal or an external receiver.

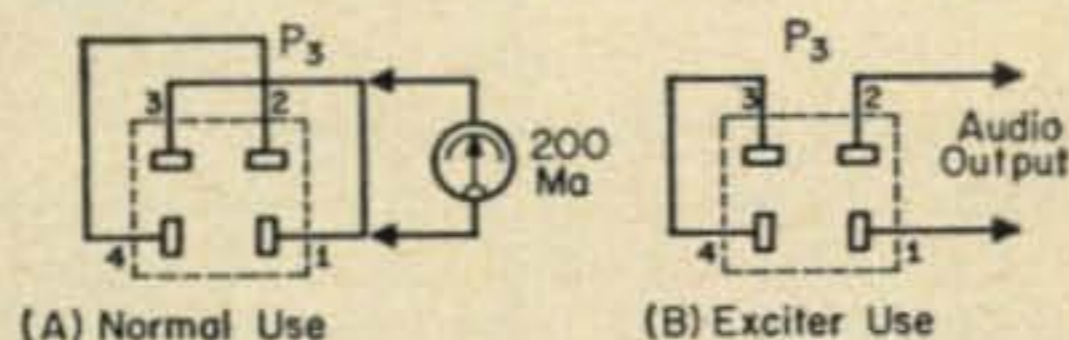

Fig. 5—Plug P_3 connections for selecting internal or external modulator as well as for allowing use of the "All Around" to drive a high power amplifier and modulator.

Transmitter

A 4 prong Jones socket is used for J_3 to disconnect the final from the modulator. The r.f. may be disconnected altogether and the power supply and modulator used with a separate r.f. section, again 2 meters! By the way, this rig is a
(Continued on page 114)

Front panel layout of the "All Around," a ten meter transmitter-receiver featuring a 6146 as an r.f. amplifier with a pi-network output and a two-tube superregenerative receiver. Provision is made for operation from 6 and 12 volts d.c. or 110 volts a.c. By means of suitable jumpered plugs the regular station receiver may be interconnected in place of the superregen, and the audio and r.f. portions of the unit may be tapped for use with other equipment. Receiver controls are grouped around the bottom center of the cabinet. The lever switch at the lower left is the TRANSMIT-RECEIVE-ZERO control.



A 1500 Watt Dummy Load

Ken "Judge" Glanzer, K7GCO

202 S. 124th
Seattle 88, Washington

With the ever increasing popularity of s.s.b., a high power dummy load for final amplifier testing is a must. Here is a simple and inexpensive 50 ohm load that fills the bill. The resistive elements have been advertised in CQ from time to time. They are 600 ohm units rated at 125 watts. Twelve are used in parallel to provide 50 ohms at 1500 watts.

A dummy load is not quite complete without some method of indicating power. W7JNC's original design used a built in r.f. voltmeter. R.f. ammeters are used in this model because of their availability and simplicity. The ammeters were converted to a plug-in type to accommodate different power levels. The terminal posts of different meters are often the same distance apart so different range meters may be used. Banana jacks are screwed into the r.f. ammeter rear terminals which have been drilled and tapped for 6-32 screws as shown in fig. 1.

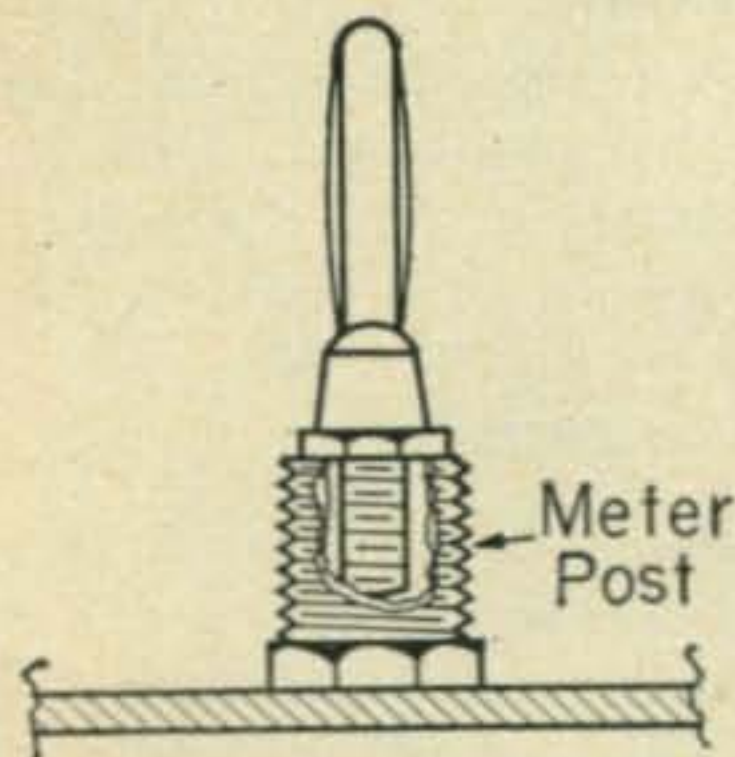

Fig. 1—Detail of banana jack attached to the meter terminal. Jacks are available, drilled for a 6-32 screw.

Mounting The Resistors

The resistors are mounted on two 10⁵/₈ inch lengths of "T" angle aluminum obtained from a local surplus house. Actually a strip about 1 inch wide and 1/8" thick would work just as well and be easier to obtain.

The two brackets, 10⁵/₈ inches long, are drilled as shown in fig. 2. The large fuse clips (available from Mil E Supply at 10¢ each) are mounted with twelve 10-32 or 10-24 × 3/8" bolts as illustrated in the photographs. The entire unit will be mounted on the four standoff insulators.

Laying Out The Sheet Metal

The load is housed in a shielded cabinet made of Reynolds Do-It-Yourself 1/2" angle (two 6 foot lengths required) and perforated aluminum (one square yard required) available at most hardware stores. The perforated aluminum may be cut with shears and the angle with a hand saw. The pattern for cutting the perforated sheet is shown in fig. 3. It is important that this pattern be followed precisely.

Two edges of the perforated sheet are solid (finished) and the template measurements should start from one of these edges. All the dashed lines are "bends" and should fall out on the large holes as it is very easy to bend there. The solid lines on the template are cutting lines. These should, where possible, fall out between the small and large holes so that a straight edge results. It is advisable to use masking tape on the sheet so that accurate measurements may be marked off. Be sure to remove the thin coat of oil from the aluminum so that the tape will adhere.

Fig. 2—Layout of holes for mounting the resistors on the 1/4" thick "T" angle. Two such pieces are required.

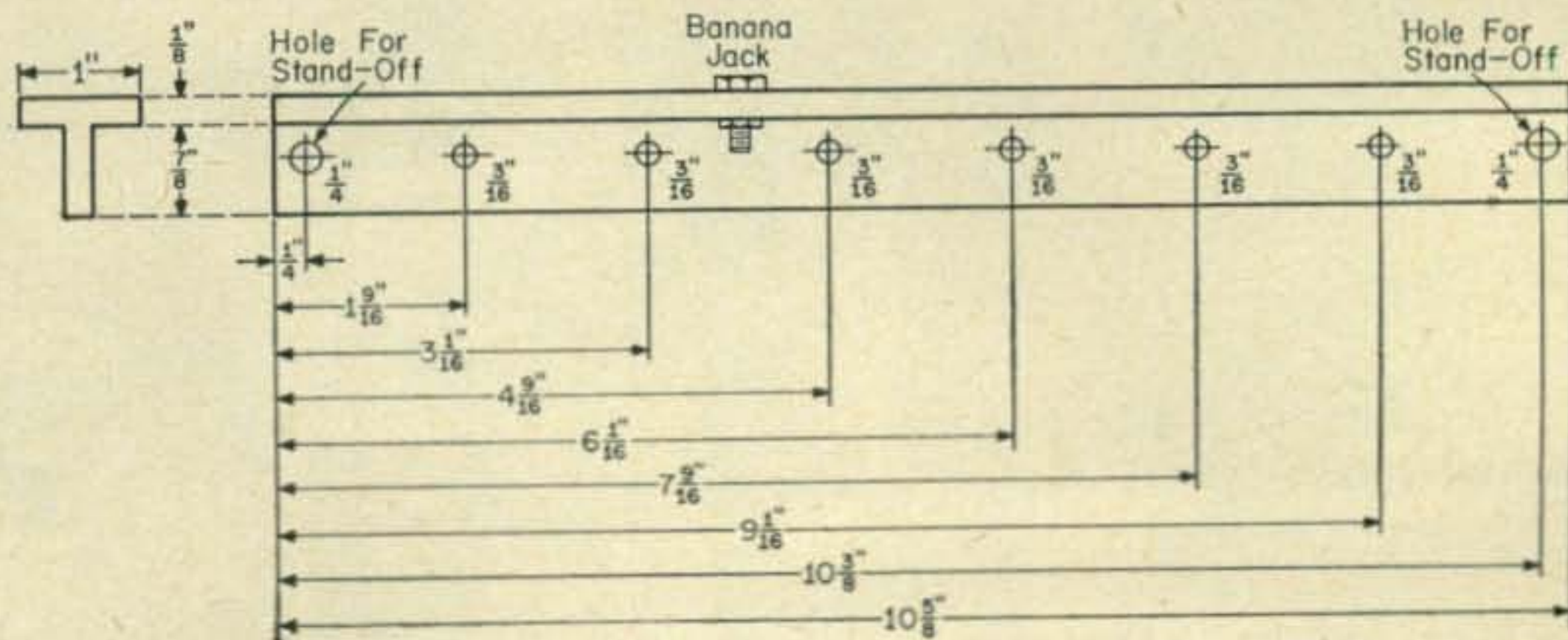

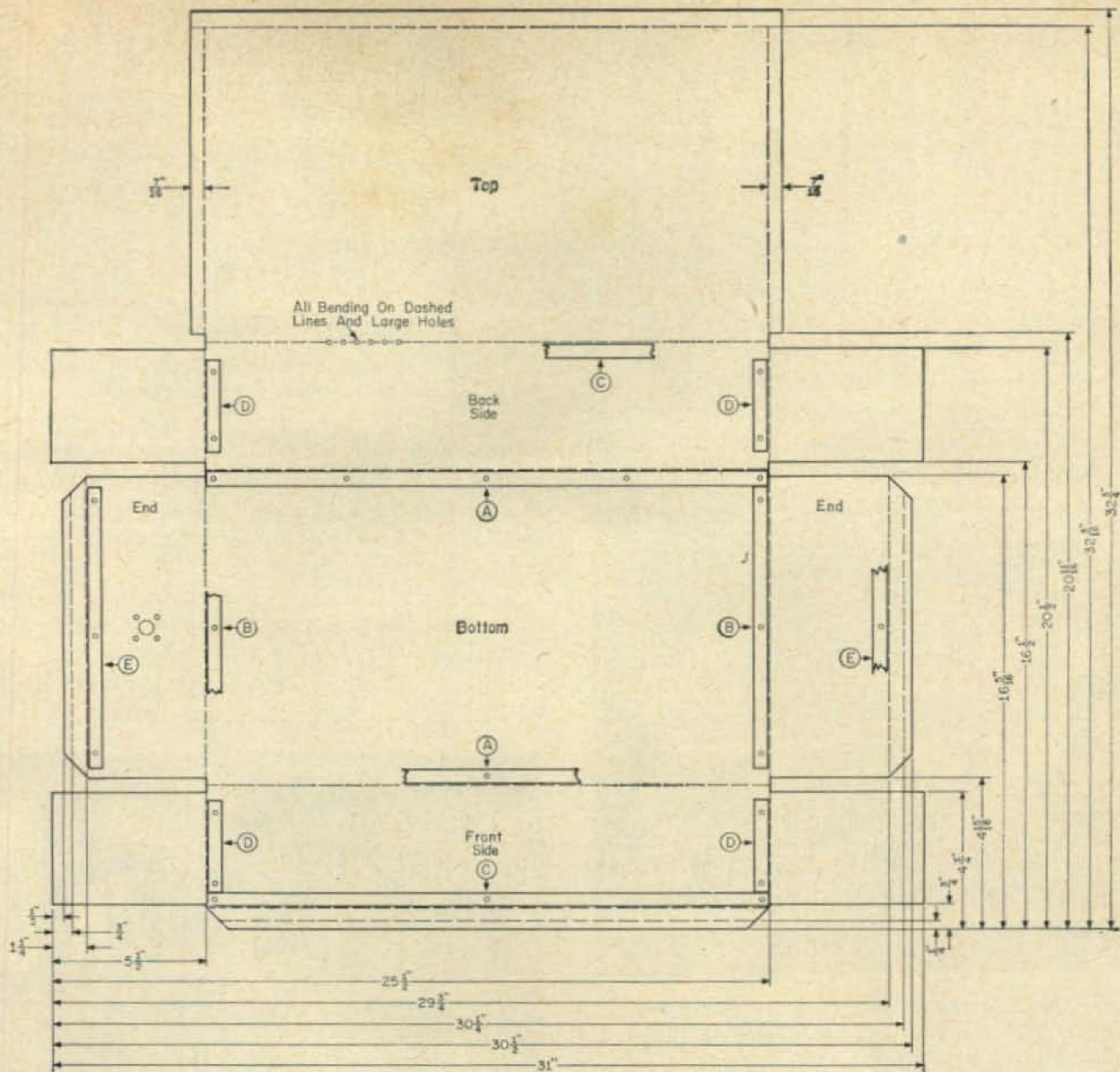
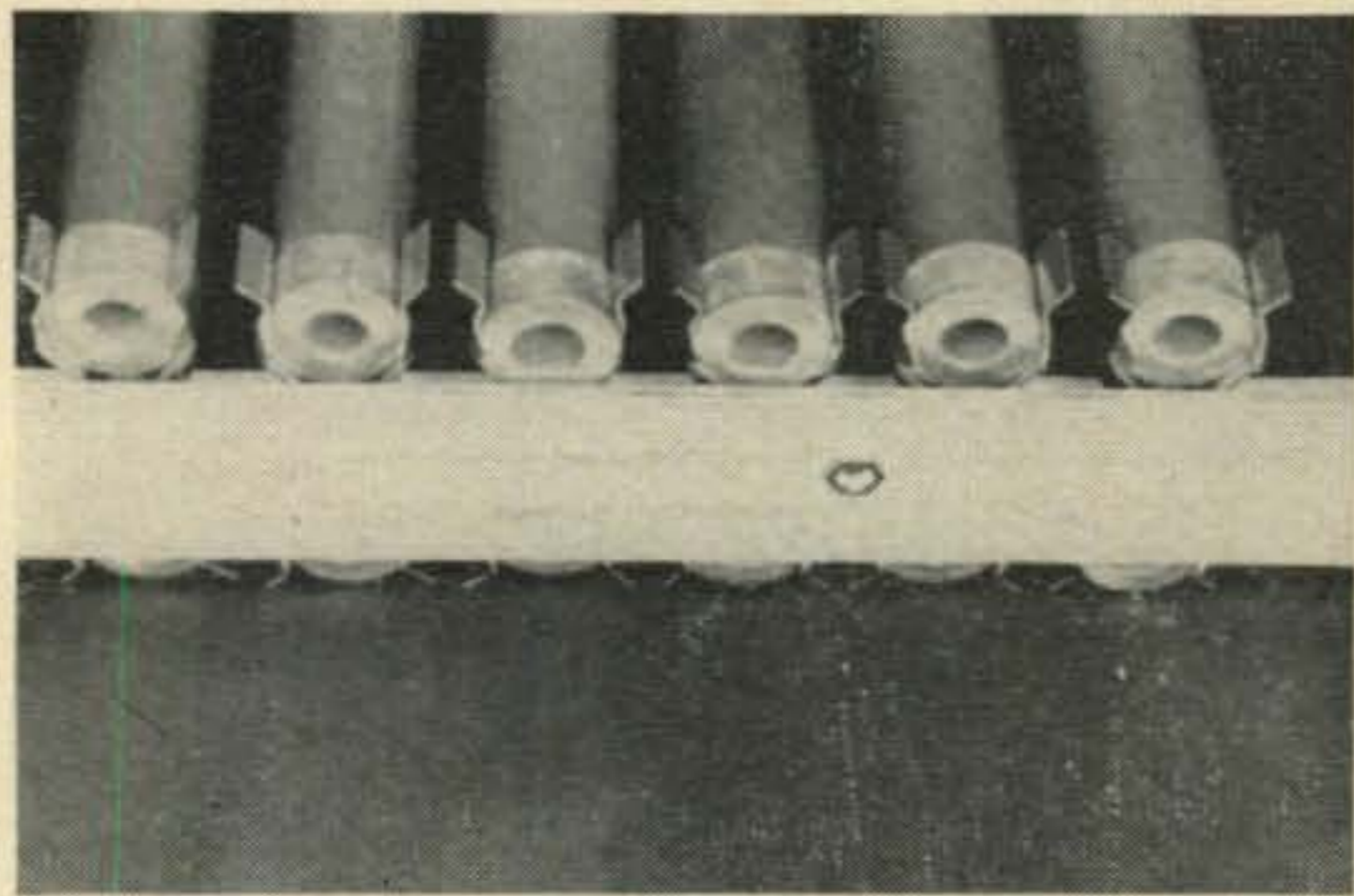

Fig. 3—Template for cutting perforated aluminum sheet to be folded into cage for the resistors.

Framing The Case Bottom

The 20" × 1/2" × 1/2" angle is first mounted on the bottom section (lengths A in fig. 3). The procedure to use is to hold the angle stock in place under the perforated aluminum and, using a scribe, mark off a hole to be drilled with a 7/64" drill bit. It is then tapped for a 6-32 screw. Mount the angle with one 6-32 × 1/4" screw to hold it in place. Mark



End view of the globars mounted on the Tee angle. Banana jack for meter can be seen mounted between two globars.

off a second point at the other end and drill and tap it also. A total of 5 mounting holes are drilled in the 20 inch lengths. Mount the second 20 inch length in the same manner.

Sheet metal screws may be used instead of 6-32 screws but great care must be taken not to strip the aluminum as the aluminum angles are soft.

The two 10 1/2" strips may then be mounted to form the base.

When fitting the angle, the edges should be positioned so that it is slightly off center of the large holes. This will permit the perforated aluminum to bend on the center of the large holes. Some practice using the scrap sheets will quickly give you an idea of the correct mounting position.

The edges of the 20 inch lengths should end at the center of the large holes. If they do not, file accordingly.

The two 10 1/2" lengths (marked B in fig. 3) may now be mounted.

Mounting The Load

Place the load with the attached 2" insulators on the bottom section. The edges of the cone insulators should set snug against the vertical portion of the angle. If no r.f. ammeters are to be used the load

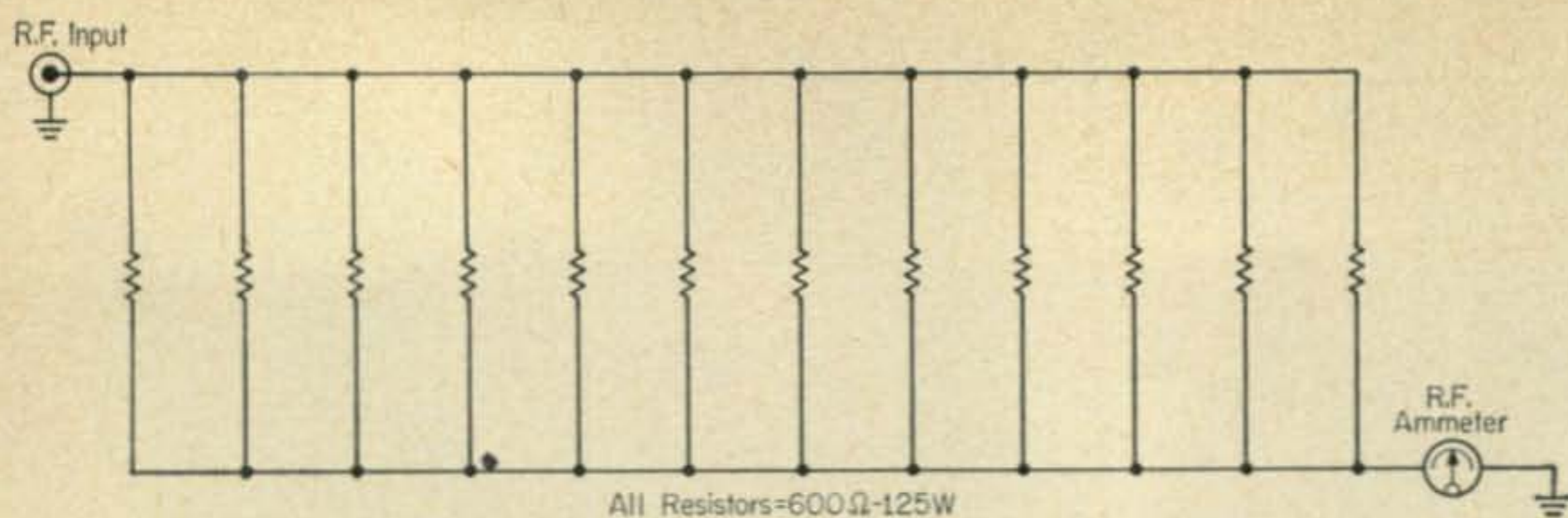
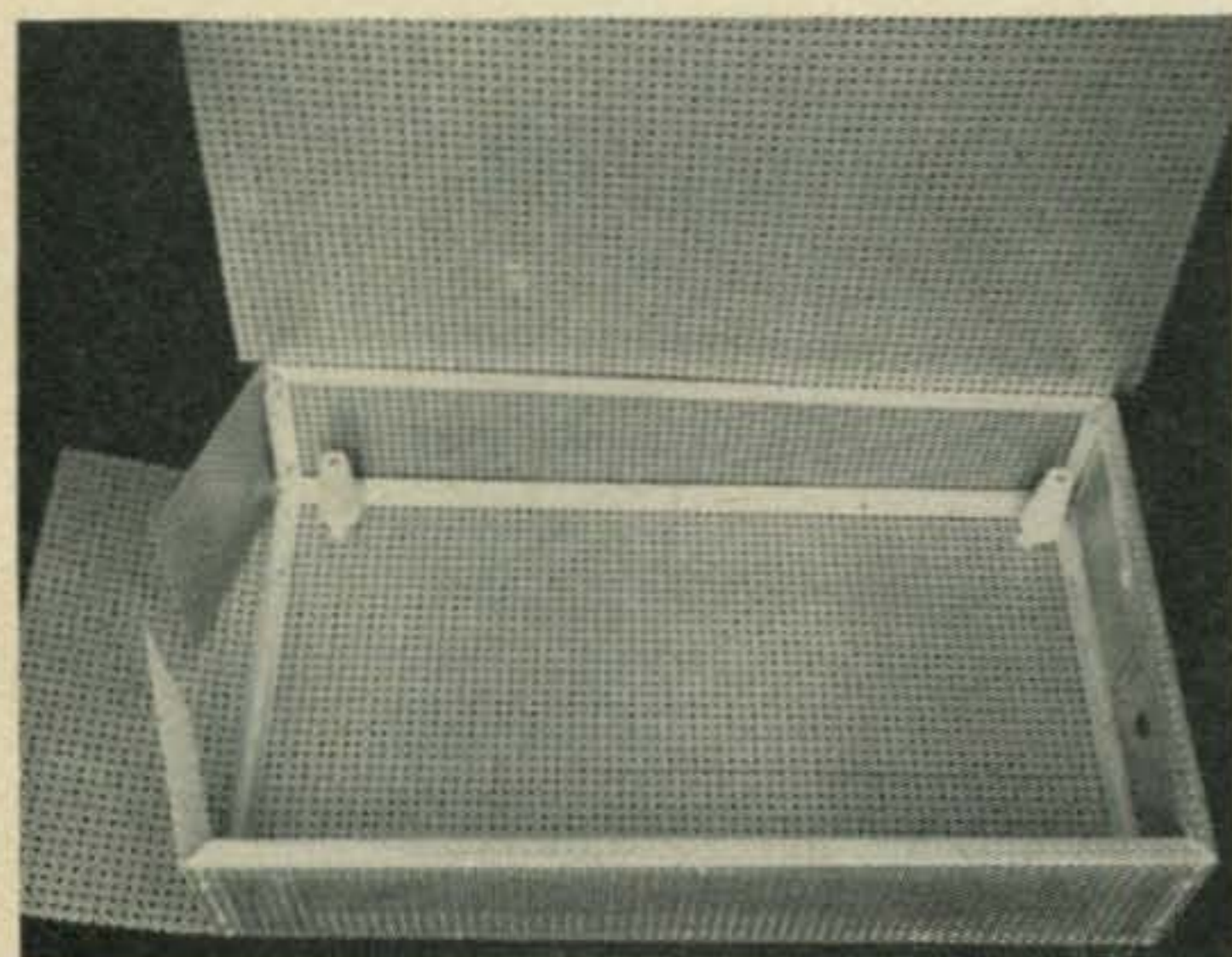

Fig. 4—Simple circuit of the 1500 watt dummy load using inexpensive high power, non-inductive resistors, available surplus.

is mounted flush with the end of the case and only two standoffs are used. If the ammeters are used, the load is mounted $\frac{1}{4}$ " from the end in which the ammeter is to be set. When the load is in position mark off the insulator mounting holes and ream or drill them for the mounting screws.



Partially completed case. Note shims under the cone insulators. The standoff insulators and the load are positioned before the sides are bent up. Note how the edges are folded over the angle on the right.

Since only $\frac{1}{3}$ of the standoff base is resting on the bracket, shims must be formed to provide a more solid footing. The shims are formed from two 1" lengths of angle cut down the center. Quarter inch holes are drilled close to the edges of the four pieces and they are placed under each insulator as shown in the photographs.

Remove the load but leave the insulators attached to the base.

Completed load ready to be buttoned up.

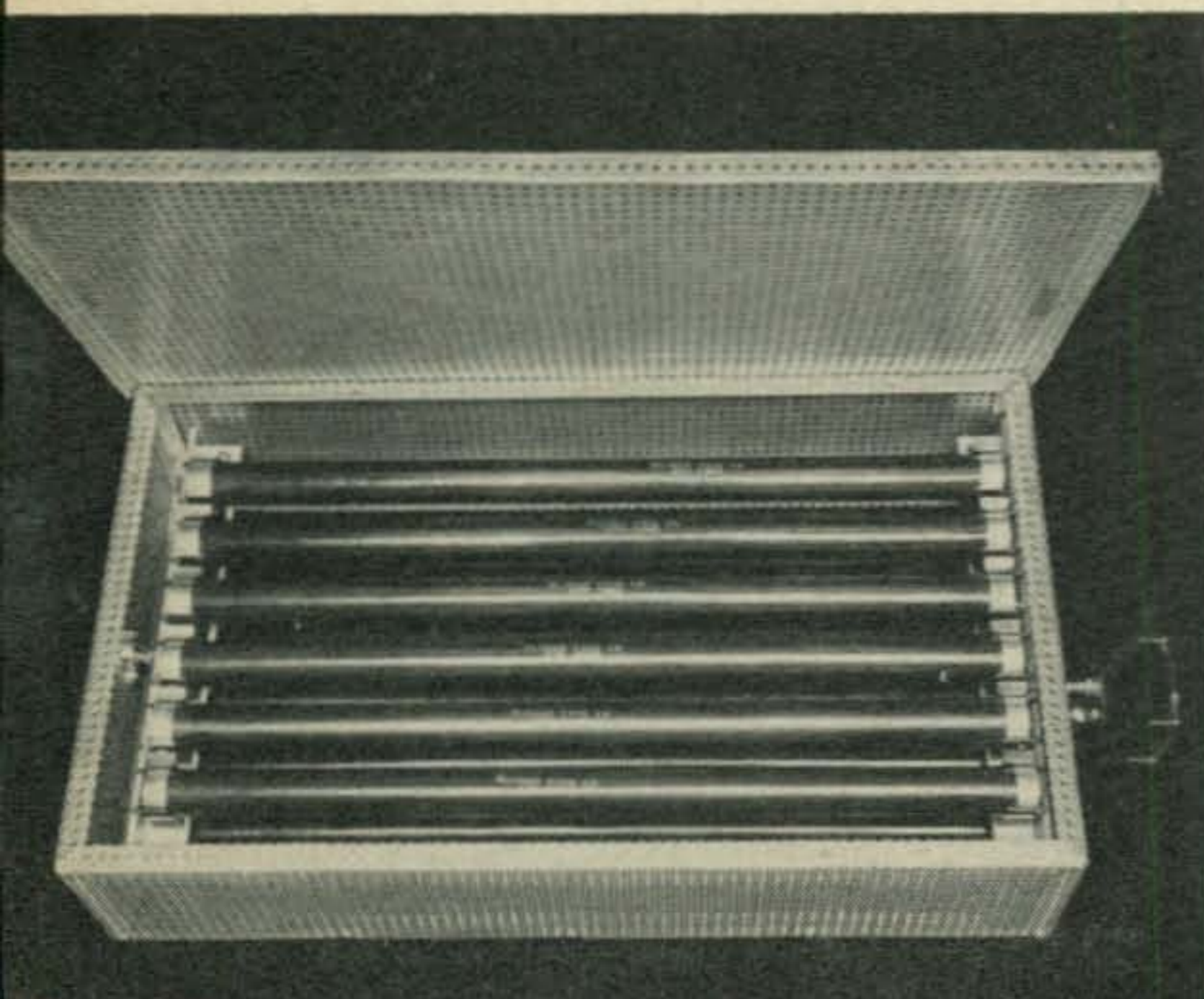

Framing The Case Sides and Top

The 20" length of stock angle for the top of the front and back sides (C) are mounted next. Now bend the sides up at right angles and mount the vertical side pieces (D) which are about $3\frac{1}{4}$ " long.

It is now possible to fold the four end flaps in and mount the top end pieces (E). The two end flaps may now be folded up and the whole end section bolted together.

The extra aluminum is bent around the angle so that when the bolts are removed the angle remains stationary. This is necessary, as these bolts must be removed and then reinserted through the cover when it is bent bent down and formed.

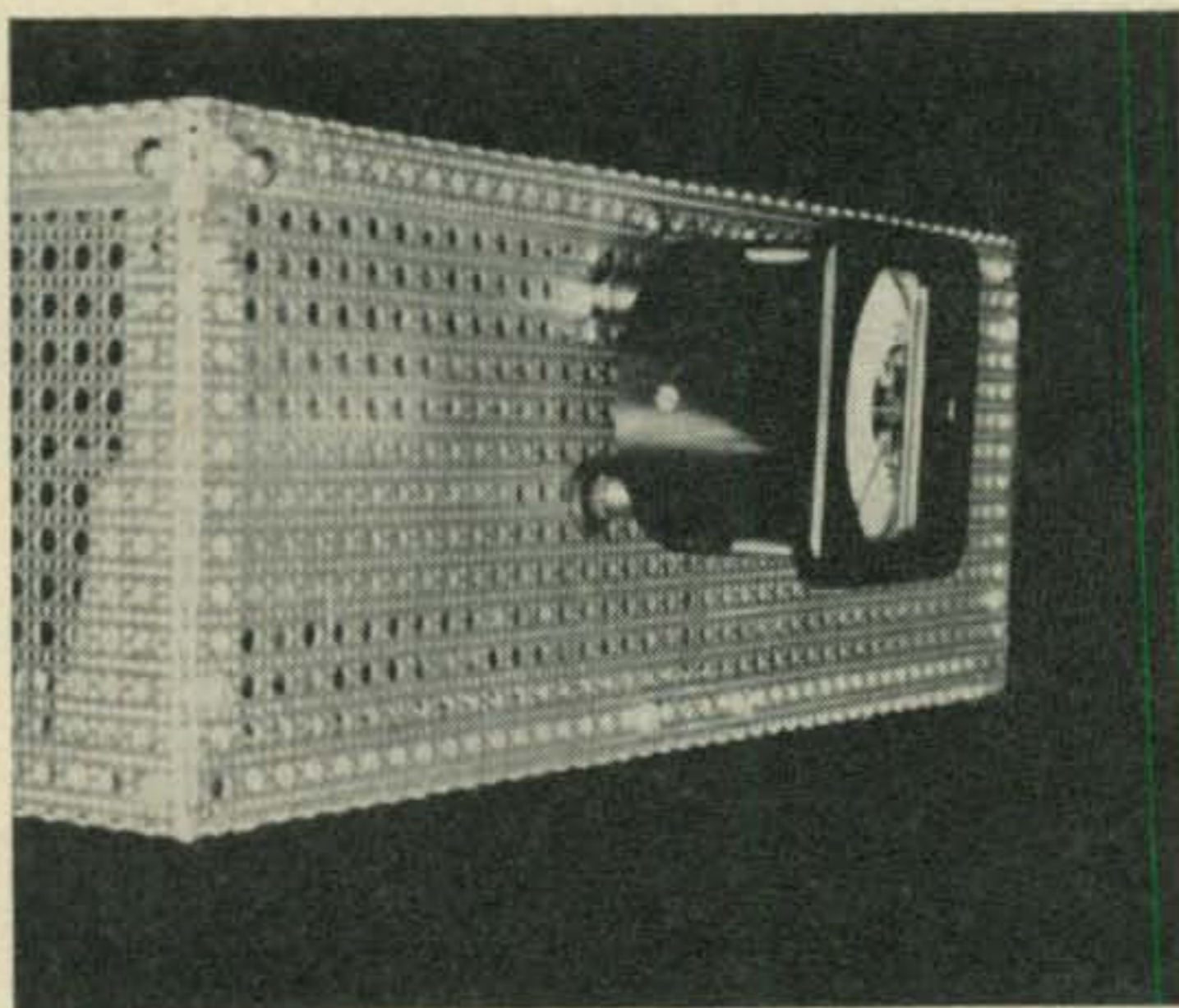

Note how r.f. ammeter is mounted. Grommet prevents jack from shorting to the case.

Mounting The Meter and Connector

The position of the ground return banana jack mounted on the case is determined by the location of the jack on the "T" angle. First ream out a hole in front of the jack on the "T" angle and install a rubber grommet. Partially insert the r.f. ammeter and mark the hole location for the banana jack in the case. Ream out the hole for the banana jack and mount it.

If a flat $1" \times \frac{1}{8}"$ strip, as mentioned previously, was used to mount the resistors a banana jack may be fastened to a piece of angle $\frac{1}{2}"$ wide.

Mount an SO-239 coaxial connector on the end opposite the meter before permanently mounting the load. Connect the center of the coaxial connector to the load with short piece of $\frac{3}{8}"$ copper strap connected under one of the fuse clip mounts. ■

Diode Gate Keying

Glen Benskin, K6ARQ

18233 Rancho Street
Tarzana, California

In his efforts to eliminate chirps, clicks and backwave in transmitter keying circuits the author has developed a fresh approach, diode gate keying.

Diode Gate Keying Circuit

HAVING fought the battle of chirps, clicks, and backwaves in transmitter keying circuits, with conventional oscillator keying, amplifier keying, differential keying, and combinations thereof, it was felt that a fresh approach to the problems of keying might be worthy of consideration. The keying circuit to be described was developed from a desire to eliminate some of the apparent disadvantages of these standard keying methods.

It was felt that the necessity of keying two or more tubes (as often as not, one of the keyed tubes being the oscillator) to obtain sufficient signal suppression to avoid backwave during the key-up interval, provides an interesting field for improvement. At frequencies normally used for a v.f.o., the grid-to-plate capacitance of vacuum tubes provides an a.c. path for the signal even though the tube is cut off. Although the very small grid-to-plate capacities listed in the tube specifications appear very attractive at first glance, by the time tube socket capacity, plus stray and wiring capacities have been included, some of the appeal is lost. Approximately twenty decibels of suppression is about all that can be expected per keyed stage.

It seemed logical to assume that if this capacity could be reduced, a considerable improvement in backwave suppression would result without keying the oscillator tube. If, at the same time, the keying circuit could be designed to minimize loading of the oscillator, the chirp problem would be eliminated automatically. That would leave only the problem of key clicks to contend with. With these objectives in mind, a brain-storming period was begun. Several ideas were considered and then discarded before deciding that a diode gating scheme held some promise. It was decided that vacuum tube diodes would solve little if anything. Silicon junction diodes with typical shunt capacitances of four to ten mmf didn't appear to be much better. However, germanium point contact diodes, which have typical shunt capacitances in the range of one-half to one mmf are especially suitable for this type of switching operation.

Although the 1N277 diode was used in this circuit, there is no reason why any one of the many other germanium point contact diodes readily available on the market at reasonable prices could not do the job just as well. The 1N67A, 1N68A, 1N89, 1N90, 1N95, 1N96, 1N97, 1N98, 1N99, 1N100, and 1N116 are all available at prices varying from thirty-nine cents to slightly over one dollar.

Diode Keying Circuit

The basic keying circuit is illustrated in fig. 1. Assuming that the resistance values have been properly chosen in the voltage dividers, it can be seen from the figure that when the switch is open CR_1 is reverse-biased and CR_2 is forward-biased. An a.c. signal applied to the input of this circuit meets with the high impedance of the reverse-biased diode CR_1 , which greatly attenuates this signal as measured at the common connection of CR_1 and CR_2 . In addition, this attenuated signal sees the low impedance path to ground provided by the forward-biased diode CR_2 , and the capacitor C_3 , which further attenuates the signal. Consequently, the output is virtually zero.

When the switch is closed (again assuming that the resistance values were properly chosen) CR_1 becomes forward-biased and CR_2 becomes

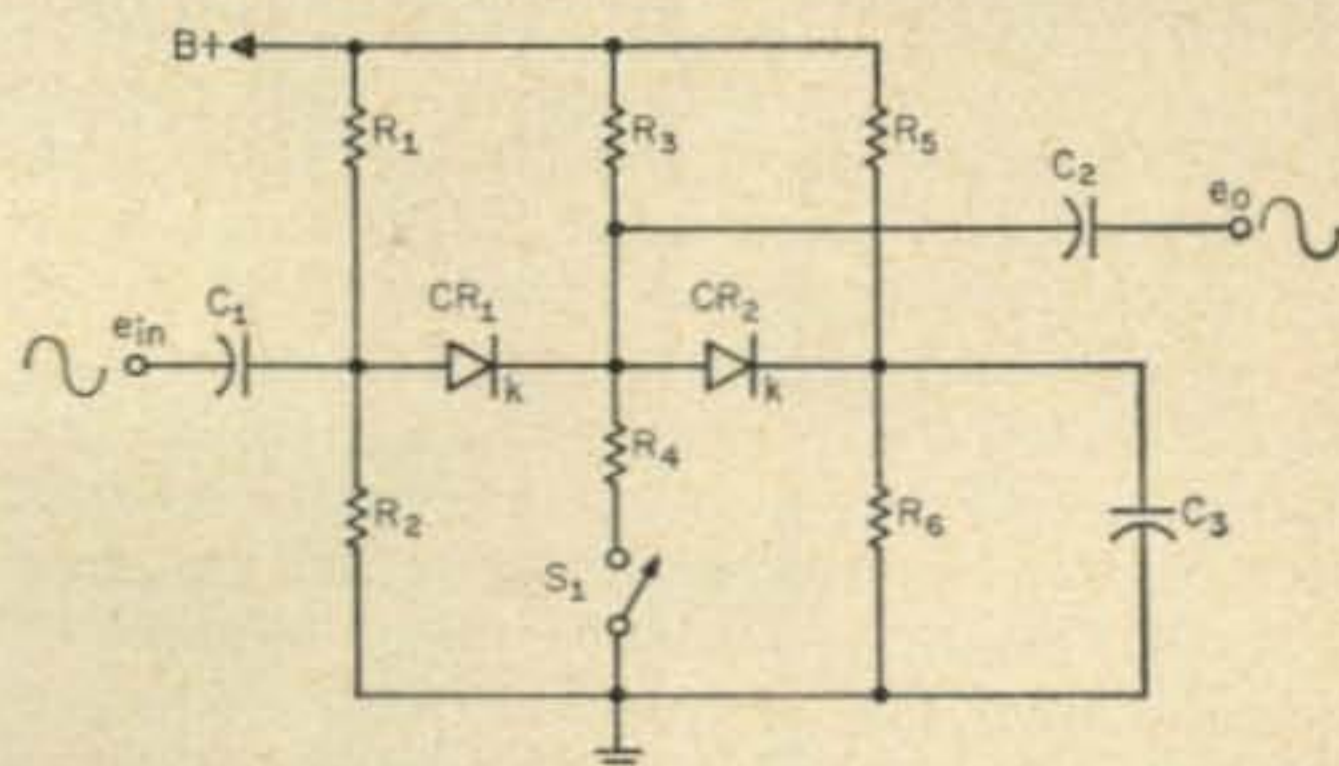

Fig. 1—Basic diode keying circuit. When CR_1 is forward biased and CR_2 back biased the input signal will appear at the output. Reverse the biasing with S_1 and the output will disappear.

reverse-biased. Now the a.c. signal applied to the input of the circuit sees a low impedance path between input and output and a high impedance path to ground. That's all there is to it, assuming that it will work.

Working Circuit

Figure 2 is a schematic diagram of a Clapp oscillator designed to operate over the frequency range of 6.65 to 7.5 megacycles followed by a cathode follower to minimize loading on the oscillator when the circuit is keyed. The other half of this twin-triode tube is used for keying, in place of the switch used in fig. 1, to remove high voltage from the key. The maximum voltage which appears at the key is sixteen volts and the maximum current which is handled by the key is about eight milliamperes.

volts peak-to-peak for the key-down condition, and 0.1 volt peak-to-peak for the key-up condition. This represents a signal suppression of slightly over forty-four decibels. If this slight leakage signal during the key-up interval should prove annoying, its effect can be eliminated by applying negative bias slightly in excess of cut-off to the following stage.

Construction

Dashed lines have been used in fig. 2 to indicate separation of circuit components into compartments. This probably represents the minimum amount of shielding which would be effective. Better shielding would increase the backwave suppression, especially if the diodes of the gating circuit were separately compartmented.

It should be pointed out that the resistance

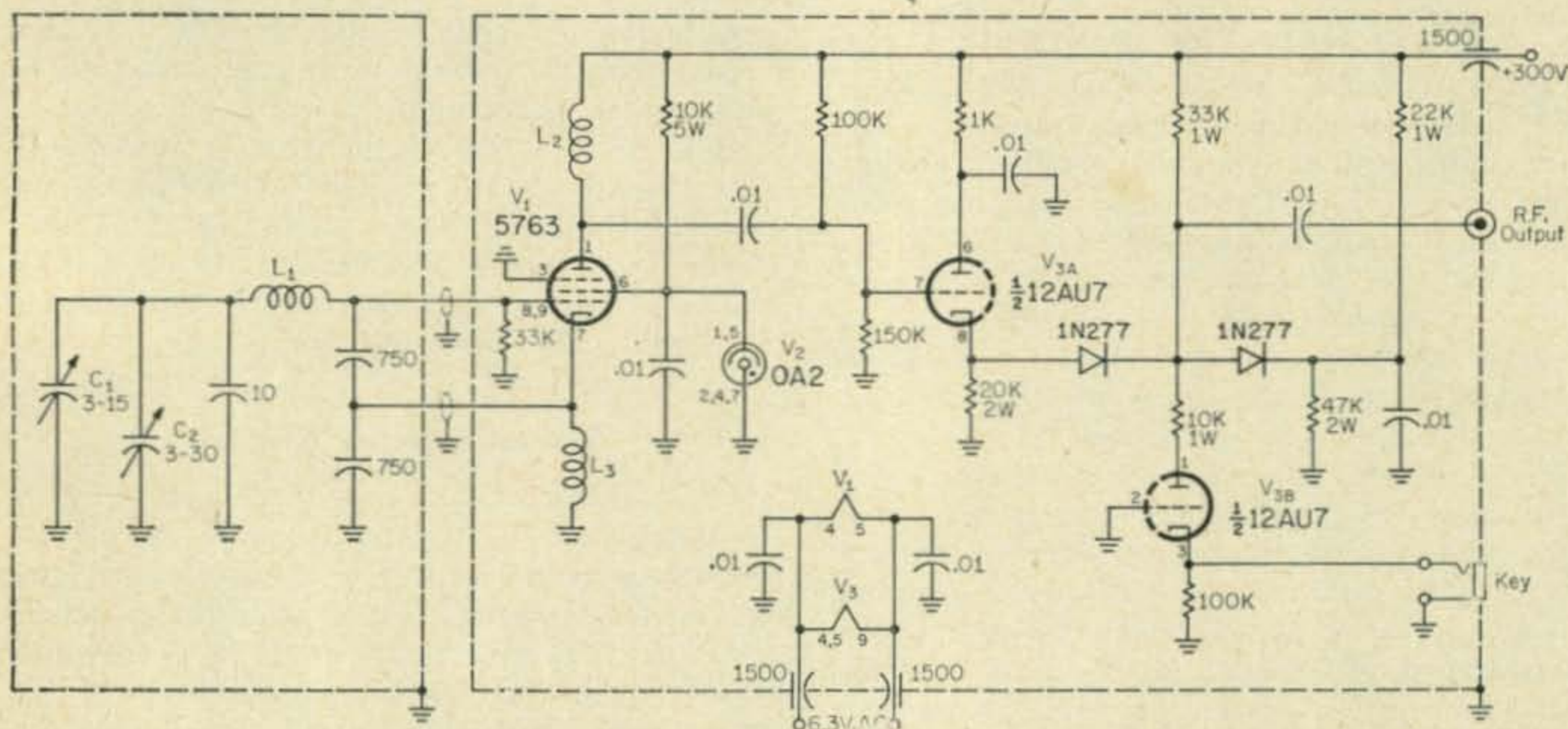

C₁—V.f.o. tuning, Bud LC 1641, 3-15 mmf.
C₂—Bandset, Johnson 20M11, 2.7-19.6 mmf

L₁—32 t B&W Miniductor #3019
L₂, L₃—R.F.C. 2.5 mh @ 75 ma.

Fig. 2—A combined oscillator and keyer circuit. The oscillator, V₁, is a Clapp circuit operating from 6.65 to 7.5 mc. A cathode follower, V_{3A}, minimizes the loading on the oscillator and V_{3B} is the keying tube and acts as does S₁ in fig. 1. All circuits must be thoroughly shielded as shown and improved isolation may be had by separating CR₁ and CR₂ by shielding.

Frequency Shift and Drift

A breadboard model of this circuit was monitored for several hours using a Tektronix oscilloscope (model 535) and a Beckman/Berkeley counter (model 7370) to determine frequency drift versus time, and frequency shift due to keying. Consequently it was possible to monitor the frequency to seven significant figures. At intervals, during the period of monitoring of frequency drift, the circuit was keyed to determine the frequency shift. None was observable. The frequency drift from turn-on time to five minutes after turn-on was approximately four hundred cycles per second, and after thirty minutes of warm-up time had elapsed the total frequency drift over a period of four hours measured out at less than six hundred cycles per second. Thus the long term stability was measured to be less than one hundred parts per million. The output signal measured with 33K loading was sixteen

values chosen for the voltage divider networks were selected to provide operation of the gating circuit compatible with the signal amplitude expected from a 5763 Clapp oscillator. If an oscillator with greater output were to be substituted, it might become necessary to alter these values to insure adequate reverse biasing of the diodes. However, care should be taken to ensure that the reverse voltage ratings of the diodes to be used are not exceeded. The 1N277 is capable of withstanding 125 volts reverse bias, but some of the types previously mentioned are rated as low as 60 volts. A simpler solution might be to reduce the signal amplitude with a divider which would also lighten the loading on the oscillator.

An effort was made to use the pentode section of a 6U8A in place of the 5763 oscillator and the triode section in place of the first half of the 12AU7 for the cathode follower, but difficulty was encountered. Signal suppression for the

[Continued on page 114]

Mobile Selectivity

Nat Gold, K1MIA

308 La Grange Street
Newton, Mass.

A simple outboard filter that may be connected between a converter and broadcast receiver to improve the selectivity.

AFTER a very short period of mobile operation on the 75 meter band, it was very obvious to me that the selectivity of an auto receiver was incapable of coping with the bedlam that is normal on this band. I began looking for ways to increase the selectivity of the tuneable converter-auto receiver combination. Since I dislike tearing into a receiver, I concentrated on devices that could be connected between the 1430 kc output of the converter and the input of the auto receiver.

Q Multipliers

My first attempt consisted of the well known Q multiplier modified to operate at 1430 kc. This resulted in some improvement, but had the following disadvantages:

1. The Q multiplier was very unstable when set for maximum selectivity, even with regulated B+.
2. It would not give a flat bandpass with steep skirts.
3. The ringing characteristics of the Q multiplier stretched out the pulses from ignition noise, reducing the effectiveness of the limiter.

Crystal Filters

When I became disgusted with the instability of the Q multiplier I decided to build a crystal filter for 1430 kc. Not having a balanced transformer for this frequency, it was necessary to devise a crystal filter that did not require a balanced input. The circuit for this filter is shown in fig. 1. Conventional crystal filter circuits use a push pull transformer and a balancing capacitor to balance out the effect of the capacitance of the

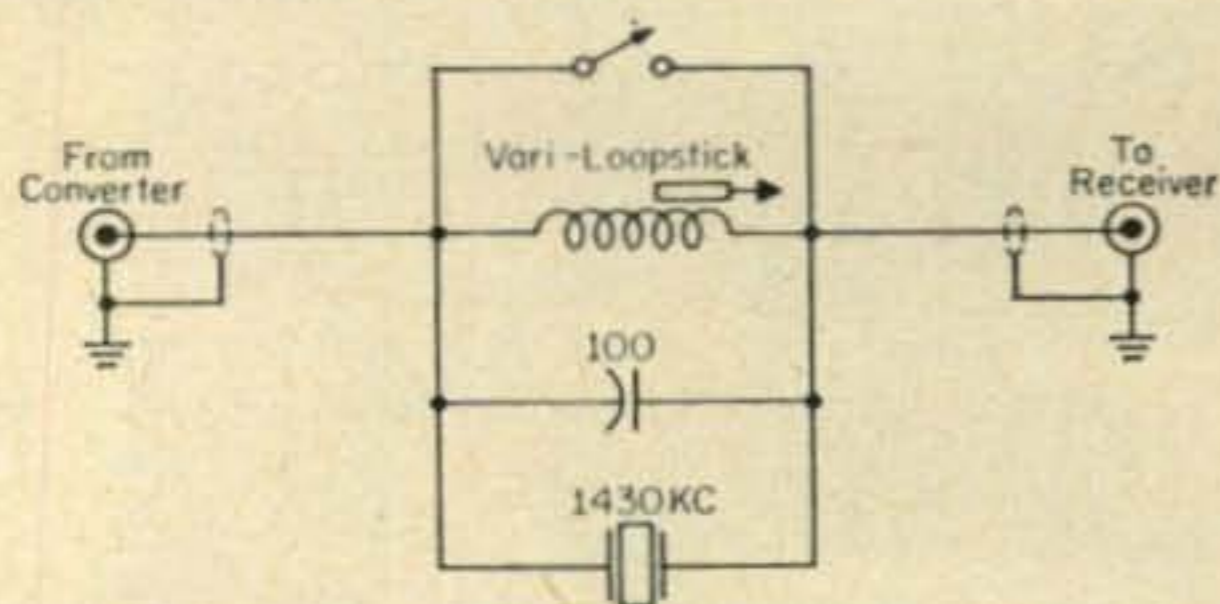

Fig. 1—Circuit of the first crystal filter tried. The circuit had to be discarded because it was too sharp for phone work. By changing the coil and crystal to 455 kc components this circuit can be used to sharpen the bandwidth of an inexpensive receiver for c.w. work.

crystal holder. In this circuit, the capacitance of the crystal holder becomes part of a parallel tuned trap centered on the crystal frequency. The series resonance of the crystal effectively short circuits the trap for a very narrow band of frequencies. This filter also passes frequencies that are far removed from the crystal frequency, but the selectivity characteristics of any receiver are adequate to take care of this.

The crystal filter did not have the first disadvantage of the Q multiplier, instability, but it did have the other two disadvantages. In addition, the selectivity was a little too sharp for good phone reception. This circuit may be used in a low priced receiver with a 455 kc. crystal and a different coil for sharp c.w. selectivity without using a special i.f. transformer. In this case, the filter should go between the secondary of the first i.f. transformer and the grid of the first i.f. tube. The selectivity will be much too sharp for phone reception but ideal for c.w.

Half Lattice Filter

My third attempt at mobile selectivity was the half lattice crystal filter shown in fig. 2. The core for the coil came from a permeability tuned 455 kc i.f. can. One of the ferrite tuning slugs was

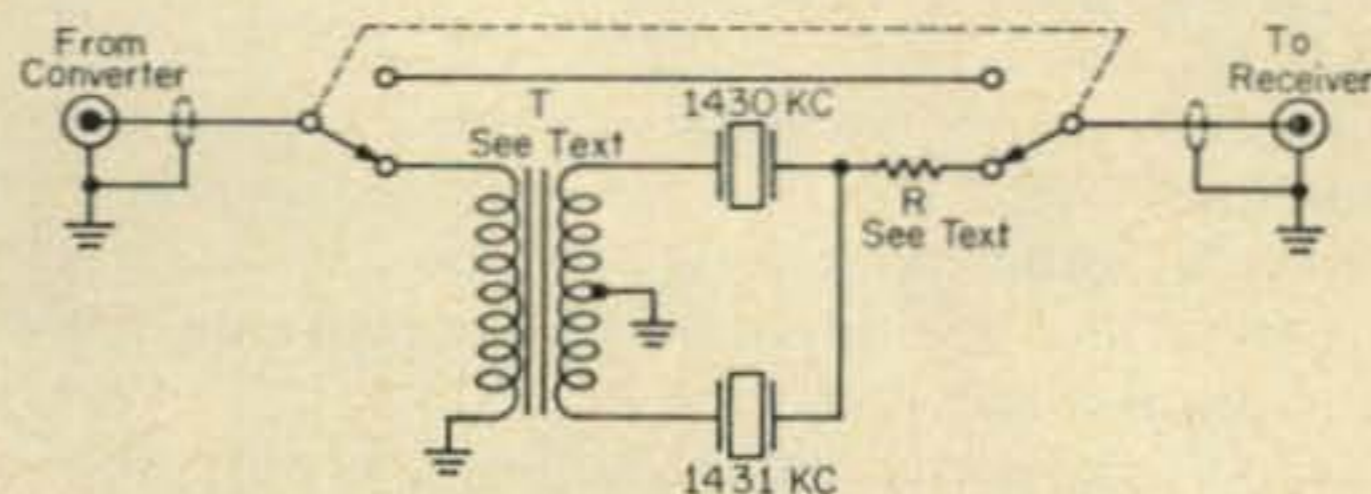

Fig. 2—The circuit of the half lattice crystal filter that was used. The transformer is made from a 455 kc K-Tran i.f. as explained in the text and the value of R must be determined experimentally as directed.

used as a cup core. A disk was cut from the other tuning slug and was glued over the open end of the first core after the coils were in place. The coils were made of wire taken from the i.f. can coils.

The secondary consists of 50 bifilar wound turns (100 turns total). The primary consists of 100 turns wound directly over the secondary. The coils may be wound on an ordinary drinking straw and then slipped into the core. This cup core coil gives close coupling comparable to a toroid core coil, and is much easier to obtain. It acts as an untuned r.f. transformer.

[Continued on page 110]

The Heath DX-100B, 1961 Version

William I. Orr*, W6SAI

This 1961 conversion improves the operation of the DX-100 on 160 meters, increases the stability of the 6146 amplifier stage and reduces TVI-producing harmonics generated in the exciter circuits. The changes are simple to make, inexpensive to do, and result in smoother, TVI-free operation, particularly on 15 and 10 meters. Each conversion may be done independent of the others, so you can do all of them, or just the one that fits your particular operating need.

THERE'S no doubt about it! The Heath DX-100 and the DX-100B are mighty popular pieces of ham radio equipment! You'll hear plenty of them on the air, and if you are the owner of either version of a DX-100, you will be interested in this article describing some simple circuit changes that makes the transmitter even better than before!

Improved 160 Meter Operation

The plate tank circuit of the parallel 6146 amplifier stage can be easily modified for improved 160 meter operation. The problem to be solved on this band is to match the r.f. plate load impedance of the amplifier stage (approximately 2000 ohms) to the impedance of a typical 160 meter antenna system. Ideally, the antenna should have an input impedance of 52 ohms in order to match the popular RG-8/U feedline and the input impedance of the DX-100 transmitter.

One-sixty meter antennas, however, are stubborn "critters" and usually exhibit disgustingly low values of input impedance, running all the way from 50 ohms or so, down to one or two ohms. In general, the lower the input impedance of the antenna, the more difficult it is to match it to the plate circuit of the transmitter, and the greater are the losses in the matching network.

In addition, there are circuit requirements that specify certain values of inductance and capacity in the plate circuit of the amplifier for proper harmonic suppression and proper operation. As is, the DX-100 is skating on pretty thin ice on 160 meters, and the tank circuit is certainly not optimized for best results. In fact, operational tests on 160 showed the DX-100 to be extremely cranky and proper loading could not be achieved when operating with several

types of common antennas. Some casual slide-rule work, and pencil scratching confirmed the notion that theoretical optimum tank circuit conditions could not be met, merely because there was not enough room in the transmitter cabinet for the extra capacitors needed to properly resonate the circuit. A bit more figuring showed that nearly optimum conditions could be achieved by removing sufficient turns from the 160 meter amplifier plate coil so as to establish resonance at the low end of the chosen 160 meter band segment with the plate tuning capacitor 95% meshed. At the same time, extra loading capacitance must be added to the pi-network output circuit to permit matching antenna loads in the region of 30-50 ohms. For loads of lower impedance (short Marconi antennas, etc.) additional extra capacitance must be added to the circuit, external to the transmitter. Here is how this modification is accomplished:

- 1—The 160-meter auxiliary plate coil (part No. 40-59) is removed from beneath the center section of the DX-100. The outer wire of the coil is then unsoldered and five turns are unwound from the coil. The wire is cut at this point, tinned and resoldered to the terminal. The coil is returned to its original position. The amplifier plate circuit will now resonate at 1950 kc with the tuning capacitor 95% meshed. (If operation is desired in the 1800 kc portion of the band, it is not necessary to remove any turns from the coil and it is left untouched as this portion of the modification is unnecessary.)
- 2—The next step is to connect a 1200 mmf, 500 volt mica capacitor in parallel with the 1260 mmf three section variable antenna loading capacitor. This will provide sufficient extra capacitance to load most medium impedance antennas. The capacitor may be mounted under the chassis between the "cold" end of

*Manager, Amateur Service Department
Eitel-McCullough, Inc., San Carlos, California

the 160 meter coil and ground (fig. 1). The capacitor is automatically switched out of the circuit when the 160 meter band is not in use. When extremely low impedance antennas are used, a second identical loading capacitor may be placed across the terminals of the coaxial antenna receptacle.

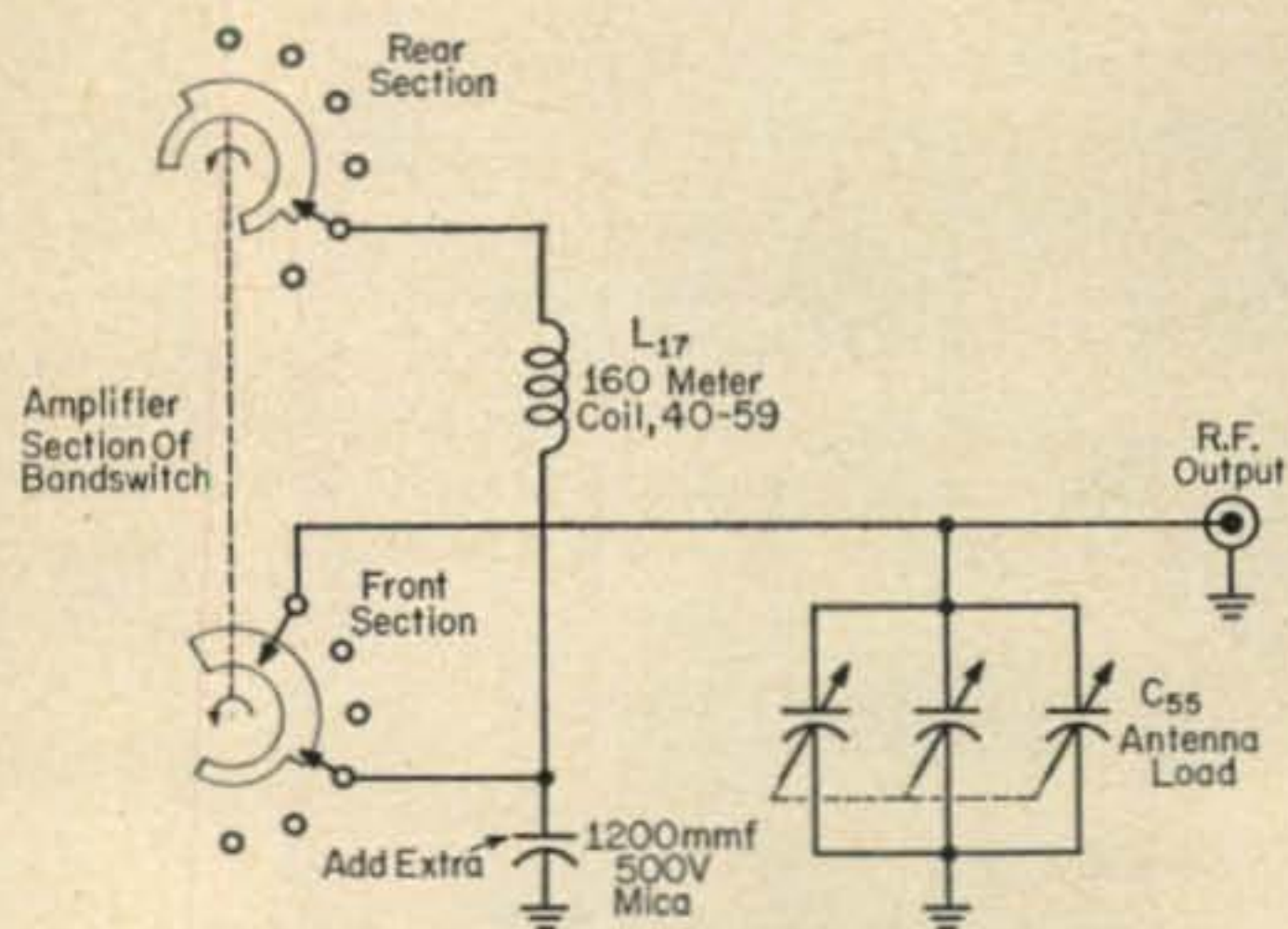

Fig. 1—A one-sixty loading capacitor may be mounted between the "cold" terminal of the 160 meter coil (terminal nearest 6146 sockets) and the ground bus of the variable loading capacitor. Refer to page 2 of the DX-100 manual for the complete schematic.

Improved Power Amplifier Stability

The 6146 is a high efficiency, high gain tube that will perform well in the v.h.f. region. Accordingly, it will oscillate with vigor if the circuit design is such that unwanted v.h.f. resonant loops appear in the grid, plate, or cathode leads circuits. True, the DX-100B amplifier stage has plenty of ground terminal points around the tube sockets, but some of the grounding leads are quite long, and others run to the socket grounding ears, whose grounding efficiency is questionable in the v.h.f. region.

It is possible to improve this situation by removing the small amplifier sub-chassis and replacing all ground leads with ultra-short, low impedance ground connections. This is easy to do, provided you don't lose all your marbles getting the sub-chassis out of the transmitter! Here's how you go about this task:

- 1—You'll have to remove the 160 meter coil, and loosen the bolts holding the band-switch to the vertical portion of the amplifier sub-chassis. Detach the filament and bias leads, the B plus lead and the wire-wound resistors, the excitation lead and the B plus lead above the sub-chassis, and remove the 6146 tubes from the sockets. You are now ready to remove the sub-chassis.
- 2—Believe it or not, this can be done! Once the 160 meter coil is out of the way, and the long 6-32 bolts and spacers are removed, you'll find that by twisting and turning the sub-chassis, it will mysteriously lift out of its niche. Amateurs who are adept at removing olives from bottles will have no trouble with this chore.

- 3—With the sub-chassis on your work bench, you must now remove all the various ground wires roaming about the sub-chassis. To do a ship-shape job, strip the underside right down to the components and clean the socket terminals of excess solder. Be careful not to injure the fine wires of the grid r.f. choke.

The first step is to securely solder the two 6146 socket retainer rings to the sub-chassis. You will note that the rings actually contact the sub-chassis at the two ends which are affixed by the mounting bolts. The retainer ring, in effect, is a one-turn loop mounted parallel to the sub-chassis at two points. The inductance of the halves of the loop will be in series with any ground connection made to the loop. As soon as you solder a wire to the grounding "ears" of the socket, you are automatically placing this unwanted loop in series with your ground terminal. Since we want to use the "ears" as ground terminals, we must eliminate the loop.

- 4—The socket retainer ring can be soldered directly to the plated sub-chassis with the aid of a large, clean soldering iron. Use plenty of heat and rosin core solder. Allow the solder to flow into the seam between the socket ring and the sub-chassis. It is not necessary to make a perfect seam all around the ring, spot soldering beneath the grounding "ears" will do the job. I found that three spots of solder on each side of the socket ring did the job in fine fashion. The loop is now effectively shorted to the sub-chassis.
- 5—The next step is to ground all the socket pins that should be grounded. These pin numbers are: (on the socket nearest the grid choke) 1, 2, 4, 6, and 8. On the socket furthest from the choke, ground these pins: 1, 4, 6, 7, and 8. Note that the grounded filament pins are reversed on each socket. Grounded pins should be bent down flush against the ceramic material of the socket. A few of the grounded pins will touch the grounding ears and should be soldered directly to them. Other pins will miss the ears, and will not quite reach the grounding ring. A *short*, heavy piece of bare copper wire may be soldered from the pin to the ring. It should be made as short as possible. When you have completed this task, the grounded socket pins are *really* grounded!
- 6—Each "hot" filament pin is now bypassed to ground by means of a .01 mf ceramic capacitor mounted directly between pin and socket. Cut the capacitor leads as short as possible so the capacitor is jammed between the socket pin and the mounting ring. Finally connect these "hot" pins in parallel with a short piece of insulated wire running from socket to socket.
- 7—The screen terminals (pin 3) of each socket are now treated in the same fashion as the filament pins. Bypass each screen pin on each socket to ground with a .001 mf, one kv ceramic disc capacitor. Use as little lead length on each capacitor as is possible, without permitting the capacitor to short out against the

chassis or the socket. Connect the screen terminals in parallel with a short length of insulated wire.

- 8—The grid wiring can be completed now. Run a piece of #14 solid tinned wire through a free hole of each #5 socket pin and over to the terminal of the grid choke nearest the

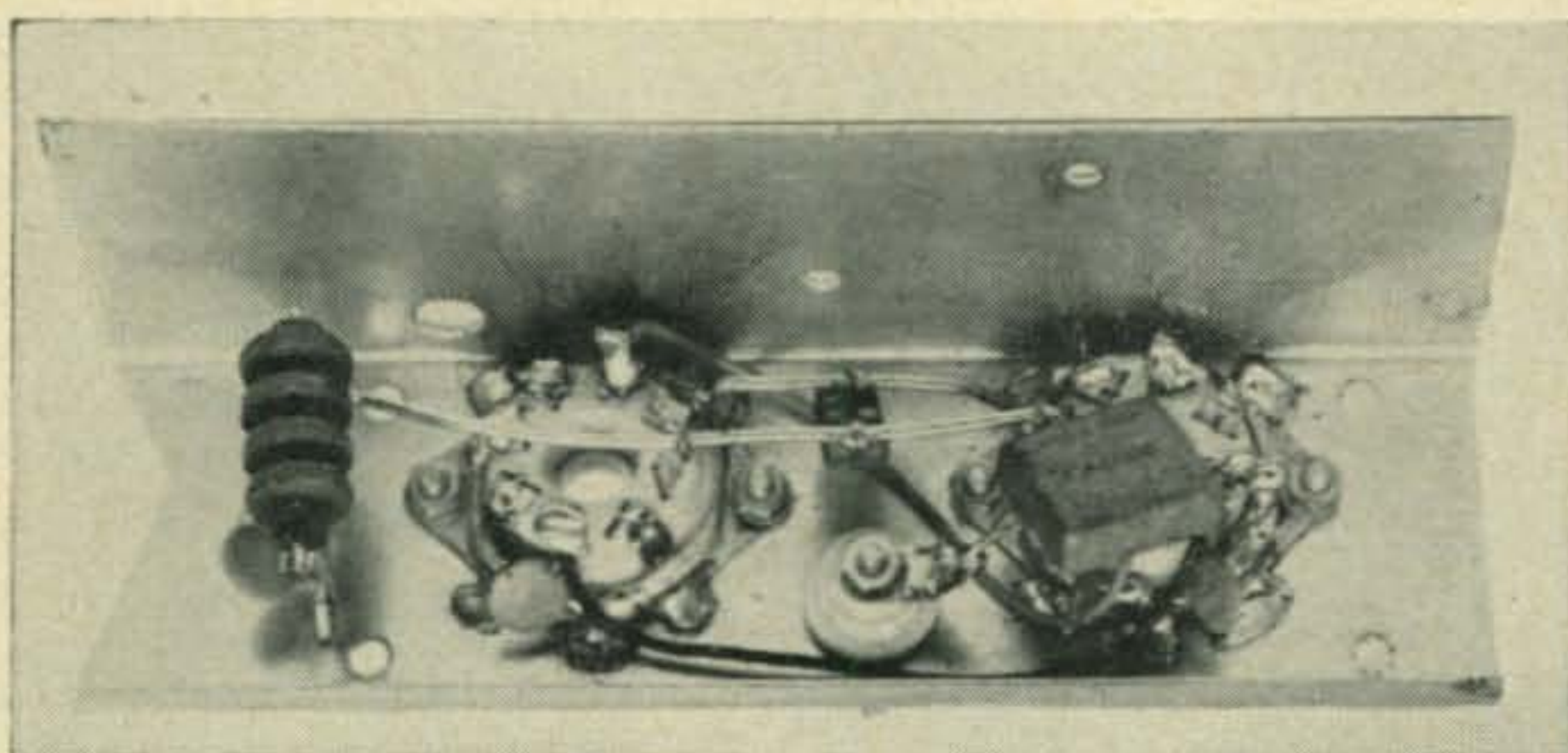

large sub-chassis flange (see illustration). Next, connect the small 47 mmf mica padding capacitor from the grid circuit to ground. An easy way to do this is to run a second length of tinned wire from one socket ground to the other, parallel with and below the grid wire. The mica capacitor can be connected between these two wires at their midpoint.

- 9—The B plus bypass capacitor is affixed between the ceramic feed-through terminal and a ground pin of one of the sockets as shown in the illustration. Check all your wiring as shown in fig. 2 and you are ready to place the sub-chassis back in the DX-100.

- 1—Remove the transmitter from the cabinet and remove the 6146 tubes from the sockets.
2—Observe the partial schematic of fig. 3. This illustrates the modified pi-network coupling arrangement between the 5763 buffer stage and the final power amplifier grid circuit. The proper phase-shift is developed across

The .001 mf, 2 kv plate blocking capacitor is moved from the top of the chassis and relocated under the chassis. It may be seen at the right, connected between the B plus feedthrough insulator and a ground pin of the 6146 socket.

the buffer coil so that a small value of capacitance placed between the plate of the 5763 and the plates of the 6146's will suffice to neutralize the amplifier stage.

- 3—A convenient termination for this capacitor (which will take the form of a short length of solid wire) is the free, rear stator terminal of the buffer tuning capacitor (see fig. 4). The wire is soldered to the terminal and will pass through a hole drilled in the shield plate between the two stages.
4—Drill the shield plate as shown in the diagram. This operation can be done from the rear of the transmitter, making sure that the drill

Fig. 2—Pictorial representation of the sub-chassis wiring at the 6146 sockets.

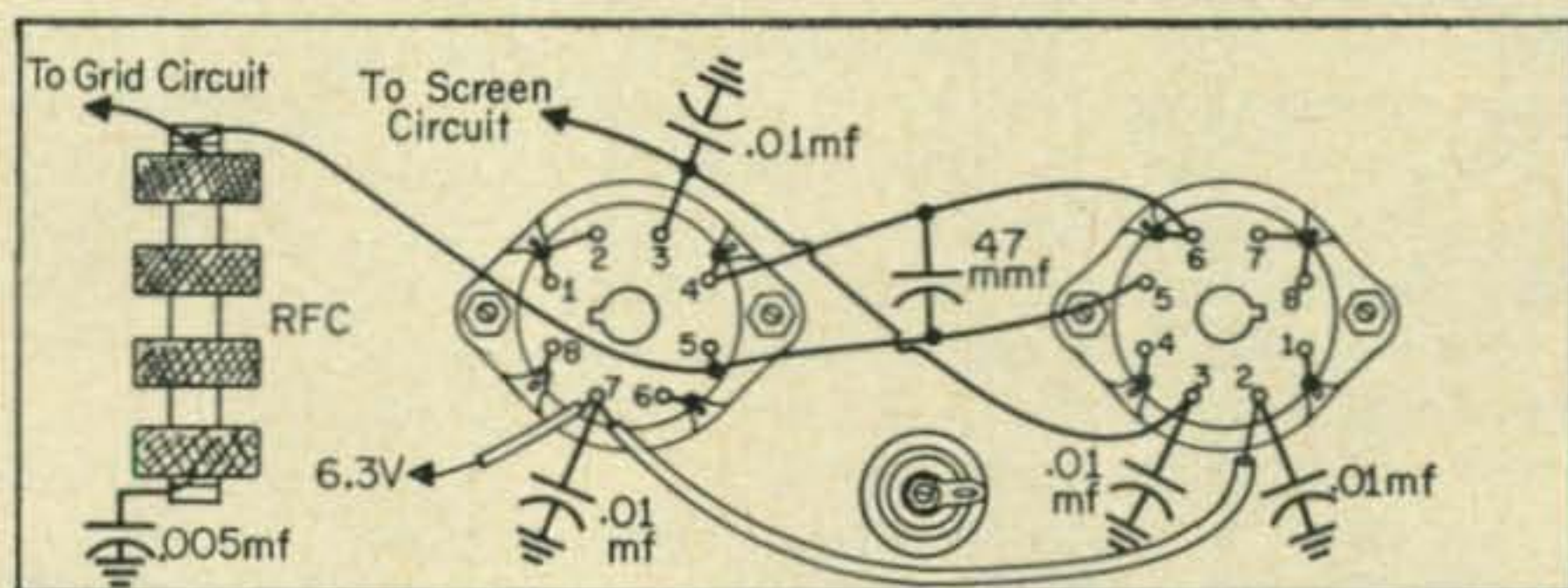

This is like trying to get a number eight foot into a number four shoe. The ladies do it every day, so you should be able to do it too! It can be done, so don't despair! Once the sub-chassis is back in position, bolt it firmly in place, and reconnect the filament and bias leads, the B plus lead to the wire-wound resistors, the excitation lead, and the B plus lead above the chassis. Check all wiring, and if O.K., your modification is complete. Plug the 6146's back in the sockets, and you are ready to tune up and go on the air.

Neutralizing the Power Amplifier Stage

It is a smart idea to neutralize the 6146 amplifier stage if operation is contemplated on 10 and 15 meters. Transmitter tuning is greatly simplified, the excitation level is increased, grid current is stabilized, and overall operation is smoother. The following steps are a modification of the original neutralization process developed by Lloyd Jones, W6DOB. This is how you do it:

chips do not spread throughout the equipment. Insert a rubber insulating grommet in the hole.

- 5—Clip a piece of #12 tinned copper wire about 2¾ inches long, pass it through the grommet from the rear of the transmitter and solder the end firmly to the stator terminal of the buffer tuning capacitor. Replace the 6146 tubes in their sockets.
6—As a starter, bend the wire so that it points directly at the plate choke of the amplifier stage. Center the wire in the grommet so that it does not touch the walls. You are now ready to neutralize the transmitter.
7—Turn on the transmitter; tune and load it in a normal fashion on either the 10 or 15 meter band. Observe when you detune the AMPLIFIER TUNING capacitor either side of resonance the grid current of the 6146 stage swoops wildly up and down. With plate tuning capacitor one side of resonance, the grid current is abnormally low; on the other side of reso-

Fig. 3 — Diagram illustrating the neutralizing circuit for the final amplifier of the DX-100.

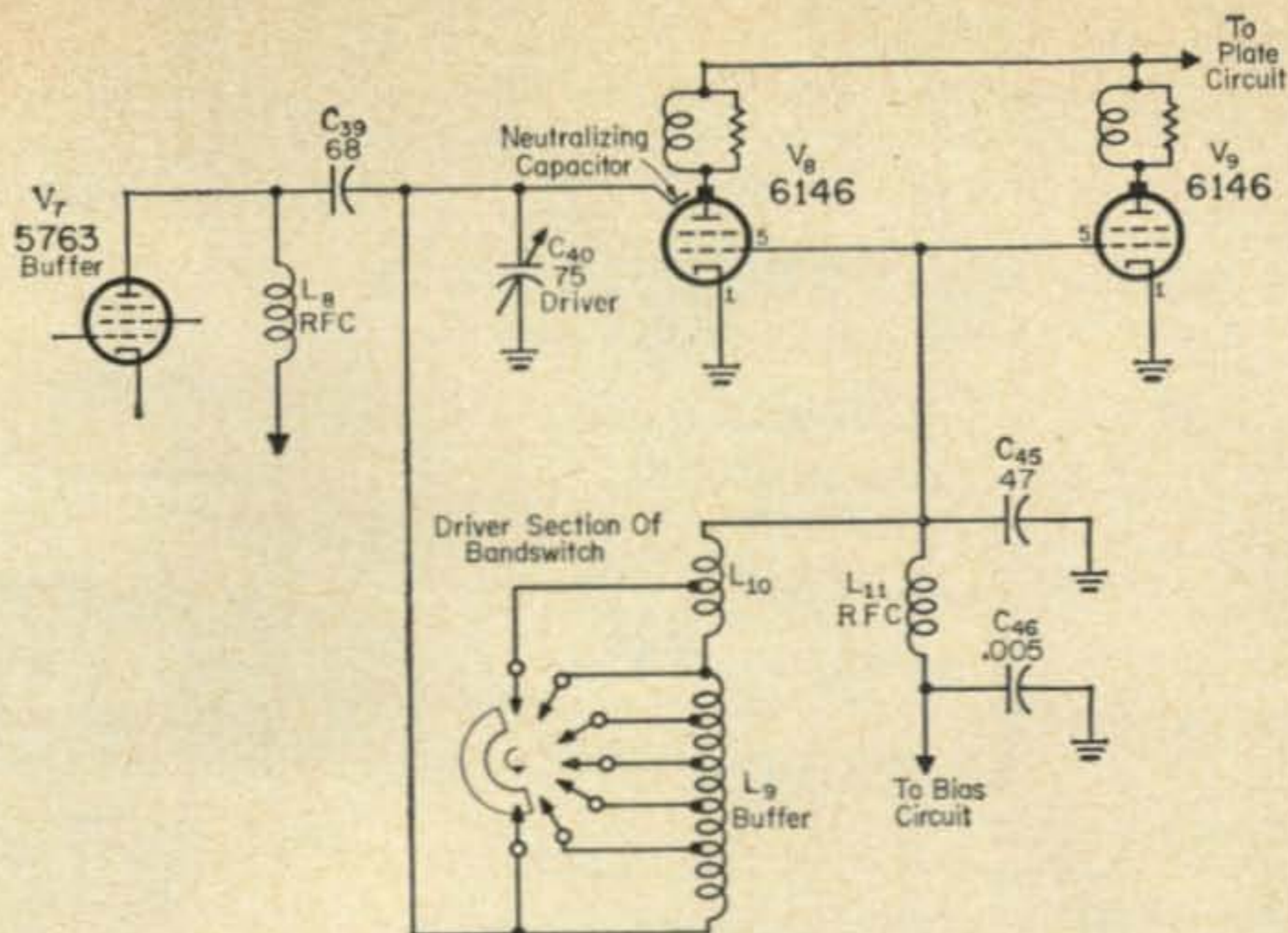

nance it is abnormally high. Make this test quickly, as you can damage the 6146s by running them out of resonance for any great period of time. You need only detune the circuit a very small amount. Practice doing this with the meter switch set in the PLATE CURRENT position. See how far you have to detune the capacitor to bring the plate current up to 250 ma. Switch to GRID CURRENT indication on the multi-meter. Now you are ready to neutralize. Do not detune the plate current a greater amount than 250 ma, and only detune long enough to observe the action of the grid current.

mistake, however, of assuming that the buffer coil is "cold." The buffer plate supply is taken from the low voltage power supply, so there is still r.f. voltage in the buffer coil, plus a hundred or so volts of negative bias. Adjust the position of the neutralizing wire with a wooden rod or insulated screwdriver and play safe!

- 9—Once you have found the proper point for the position of the neutralizing wire you can forget it until you change 6146's. It may then be necessary to touch up the neutralization a bit for the new tube.

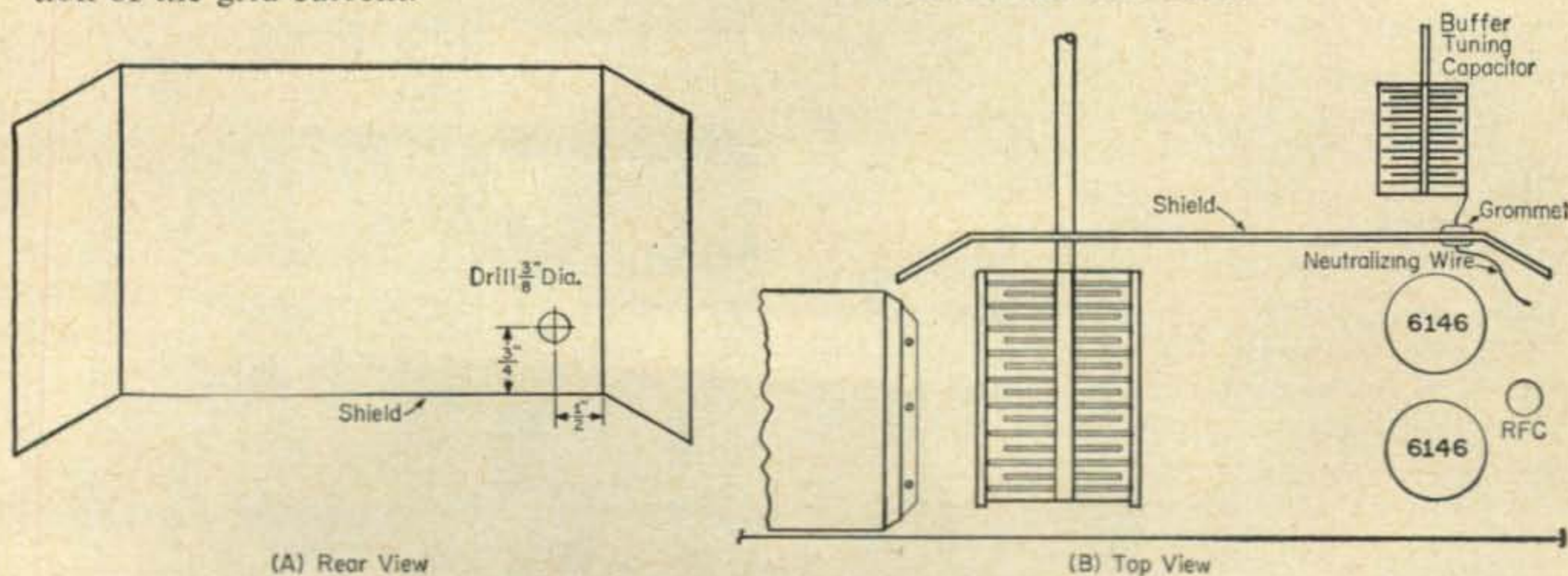

Fig. 4-A: Location of the hole in the interstage shield which permits the neutralizing lead to perform its function. Insert a rubber grommet in the $\frac{3}{8}$ " hole. B: Solder neutralizing wire to the stator of the buffer tuning capacitor. See text for adjustment.

- 8—You should now adjust the position of the neutralizing wire so that the grid current remains reasonably constant when you detune the final amplifier plate circuit from resonance. It may rise and drop slowly during the detuning operation, but the wild swoops and swings of the meter can be "ironed out" by proper adjustment of the wire in relation to the envelope of the nearest 6146. You'll find that the wire will probably take the position shown in the illustration. **IMPORTANT!** Make sure that you turn off the high voltage between adjustments! This will let the 6146's cool off a bit between trials. *Don't* make the

A Simple De-TVI Measure for the DX-100

The DX-100 transmitters show a wee bit of TVI when operated on 10 and 15 meters in an area of low television signal strength. You'll notice, too, that when you go on c.w., the TVI increases manyfold. In fact, if you have nearby TV viewers, operation of the DX-100 on 10 meter c.w. is almost equivalent to committing hari-kiri!

The sudden increase in TVI when c.w. operation is attempted provides the clue to this trouble. The key jack is "hot" with harmonics and r.f. that is easily radiated by the key leads. A

few bypass capacitors, placed at strategic spots will easily cure this difficulty! You will need three .01 mf, 600 volt disc ceramic capacitors for the job. Let's go to work.

- 1—Remove the DX-100 from the cabinet and up-end it. Notice the key jack is connected, via an air-wound r.f. choke to a terminal of

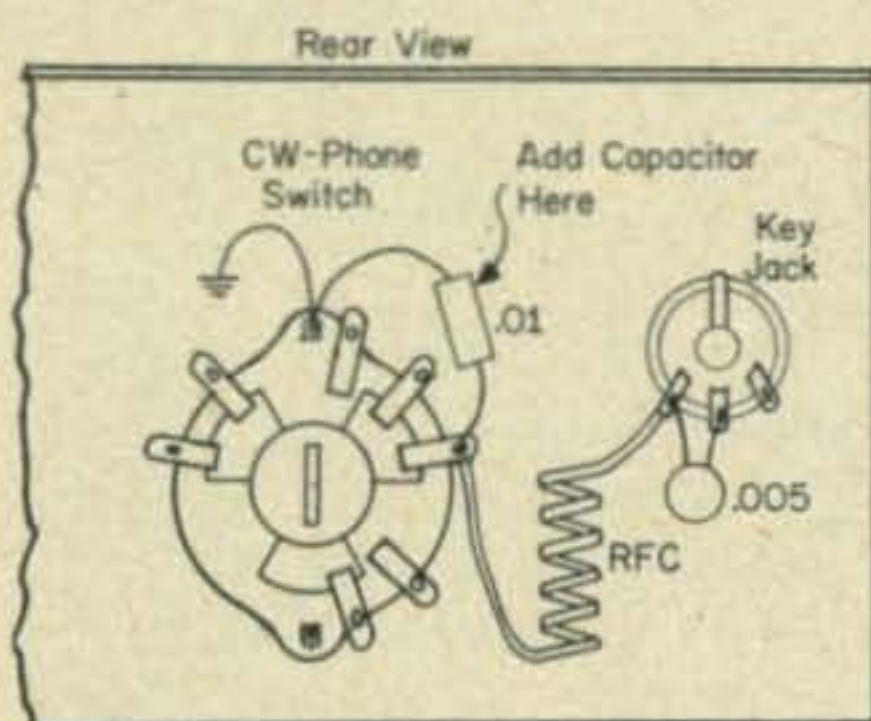

Fig. 5—Anti-TVI capacitor is placed between the arm (#9) of the PHONE-C.W. switch and ground. Refer to pictorial drawing #2 in the DX-100 instruction manual.

the C.W. FONE transfer switch (see fig. 5). The key jack end of this choke is bypassed with a disc ceramic, but the switch end of the choke has no capacitor to ground. This is where you place one of the three .01 mf capacitors. Cut the capacitor leads short and connect it between the switch terminal holding the choke and one of the stud bolts (ground) of the switch.

- 2—The remaining two capacitors will be placed inside the v.f.o. cabinet. Remove the bolts holding the U-shaped shield of the v.f.o. box, and lift the shield clear of the v.f.o. This will expose the v.f.o. wiring, and the terminal strips at the bottom of the v.f.o. enclosure. The capacitors will be placed on these terminal strips.
- 3—The "hot" leads to be bypassed are the ones from the cathode (blue) and plate circuit (red) of the 6AU6 oscillator tube. Clip the leads of the capacitors to the proper length, slip short sections of insulating "spaghetti" over the leads and solder the capacitors be-

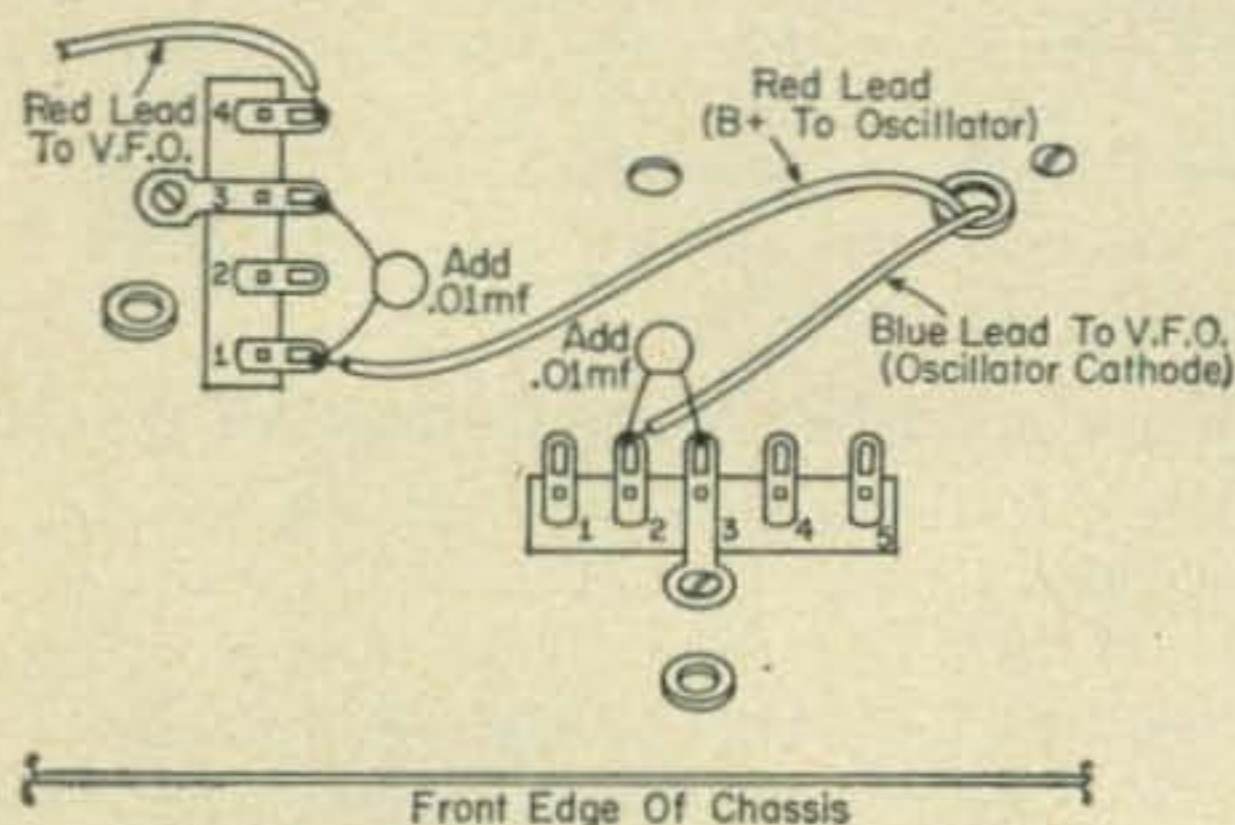

Fig. 6—Another anti-TVI measure is the installation of a .01 mf capacitor between lugs 2 and 3 of the 5 lug terminal strip located in the v.f.o. compartment, and another .01 mf capacitor between lugs 1 and 3 of the 4 lug terminal strip. Make sure the capacitors leads do not short to adjacent lugs or other wires.

tween the proper terminals and the ground lug located at one end of the strips (fig. 6). Finally, replace the U-shaped shield over the oscillator. This completes the modification.

A Final Word

Properly operated, the 6146 tubes in the DX-100 will last a long time, even though they are operated at maximum input. A few words of friendly advice, however, are not out of order.

- 1—Hold the grid current below four milliamperes at all times. During the c.w. operation, be sure to watch grid current when the high voltage switch is turned off. The buffer stage continues to operate, supplying excitation to the final amplifier, and grid current can soar to excessive values when the amplifier stage is not operating. If the key is open when the plate switch is off, the exciter stages are disabled and no grid current flows. However, with no key plugged in the equipment, the self-shorting key jack permits the exciter to operate even when the high voltage is turned off. If you are a phone man, take care to monitor grid current when the PHONE C.W. switch is in the c.w. position and no key is in the jack.
- 2—Keep your resonant plate current to 200 milliamperes on phone and 220 milliamperes on c.w. for maximum tube life. Make sure you are in resonance at all times. ■

Ham Hints

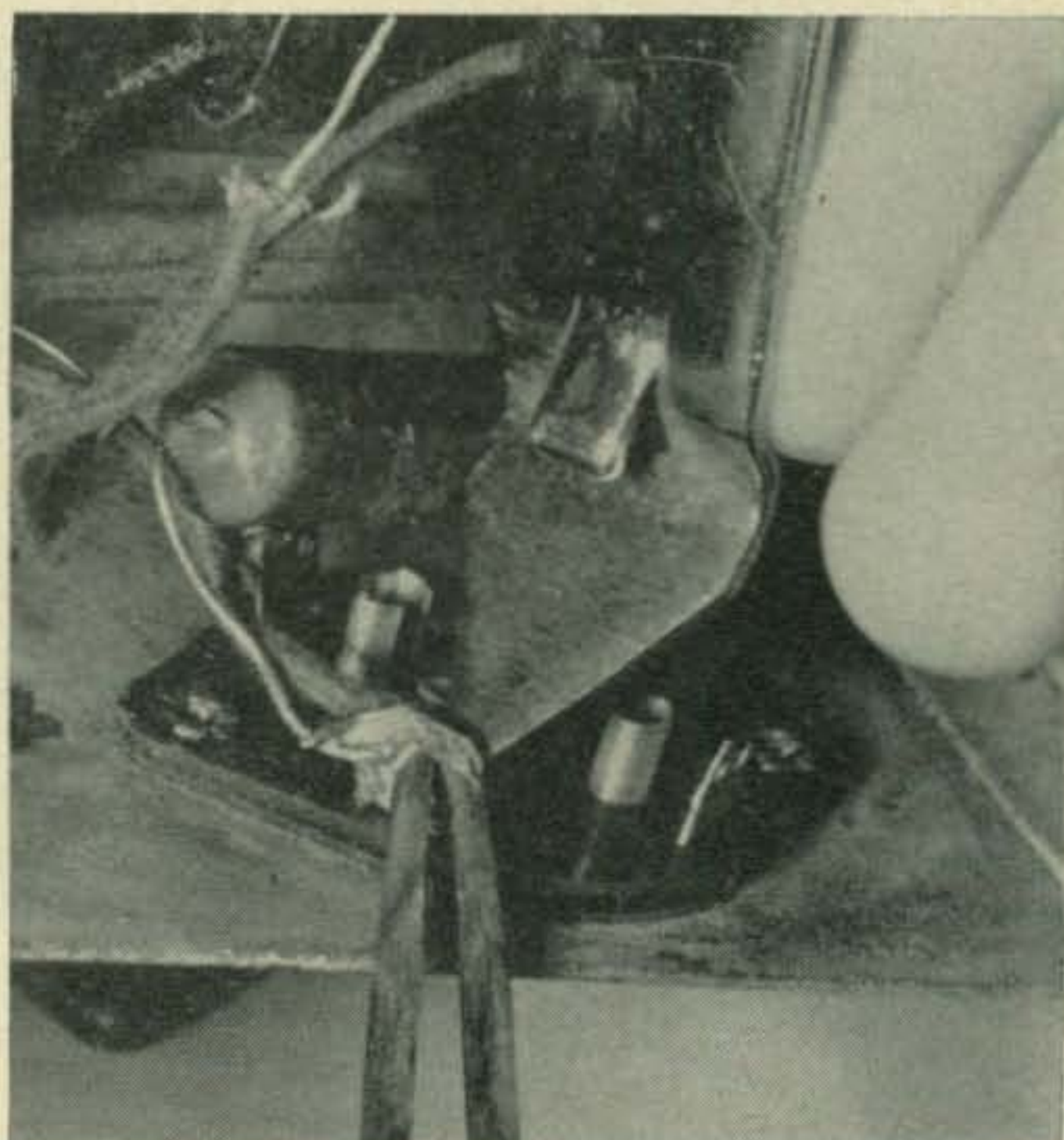

Eye Opener For Solder Lugs

Ever try to thread a wire through the eye of a soldering lug only to find that the eye was clogged with solder? Next time, melt the solder with an iron and poke the clogged eye open with the sharp point of a puncture type can opener. File the point just a little sharper to get it to fit the smallest size eye.

Understanding Very-High-Frequency Antennas

Part III, Conclusion*

Stanley Leinwoll

33 Cranston Road
Franklin Park, New Jersey

A HIGHLY directional radiation pattern similar to the beam effects obtainable with a Yagi-type array of elements can be achieved by use of a metallic reflector in conjunction with a single dipole.

The size, shape, and composition of the reflector may vary considerably, depending on the materials available, antenna requirements, etc. Because the size of a dipole element operating in the high frequency range is relatively large, sheet reflectors are never used for short wave antennas. However, since they can be easily and economically built for operation in the v.h.f. bands, their use in these ranges is quite common.

The simplest type of reflector is the flat sheet mounted in back of a single driven dipole element, as shown in fig. 1a. The gain obtainable with such a system is of the order of 7 db. This gain figure can be increased by bending the flat sheet to form a cylindrical parabolic section, as shown in fig. 1b. The dipole element is located at the focal point of the parabola.

The purpose of the reflector is to intercept radiation energy and re-radiate it in a more desirable direction, similar to the way a mirror

*Parts I and II of this series appeared in the January and February issues respectively.

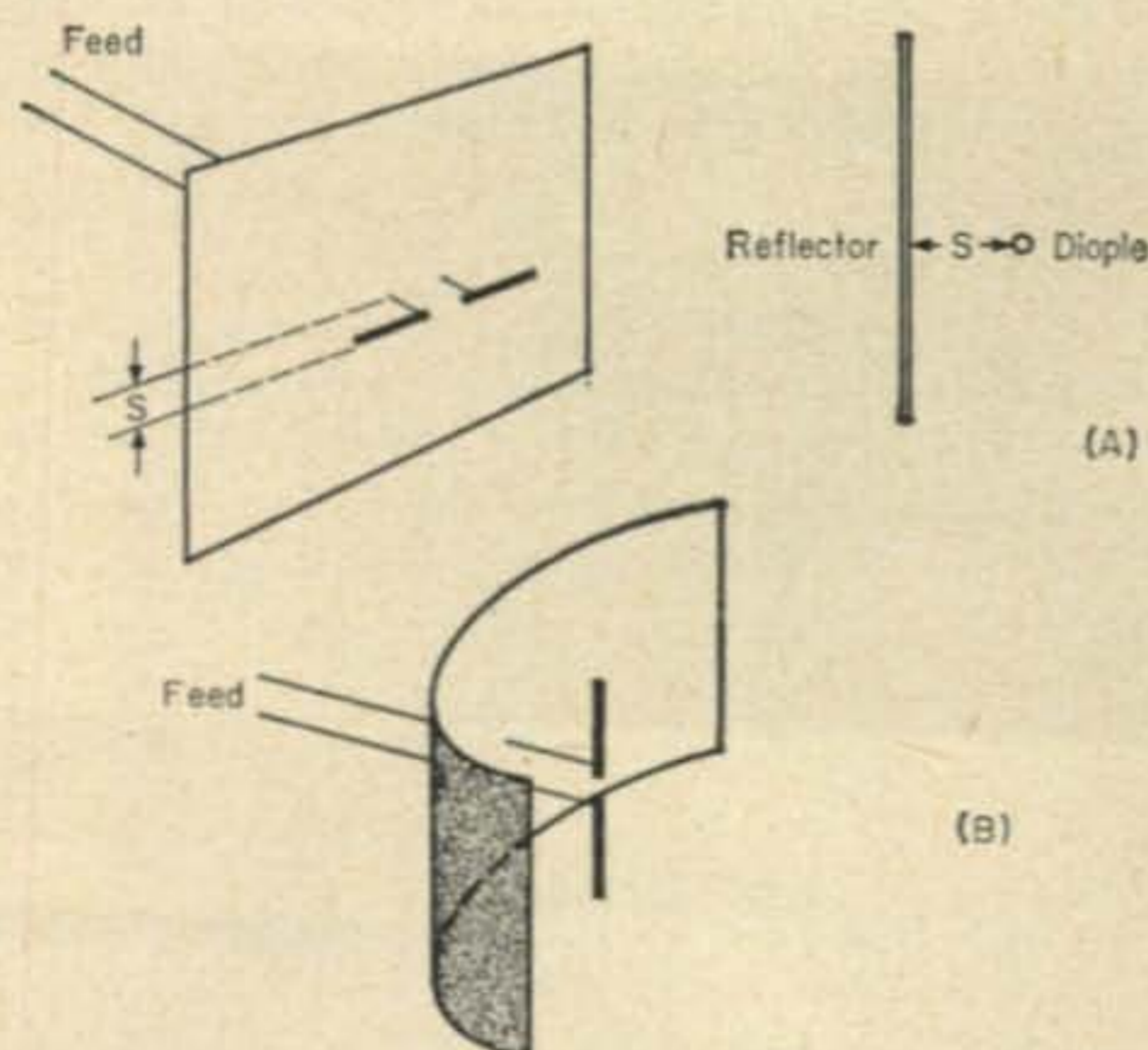

Fig. 1—Two typical reflector type antennas. In (a), the ordinary flat sheet reflector is shown, while in (b), bending the sheet to form a parabolic section produces a cylindrical parabola.

intercepts and re-radiates light.

Perhaps the simplest and most practical of the reflector type antennas is the corner reflector, shown in fig. 2. This antenna is highly directive in the plane perpendicular to the plane contain-

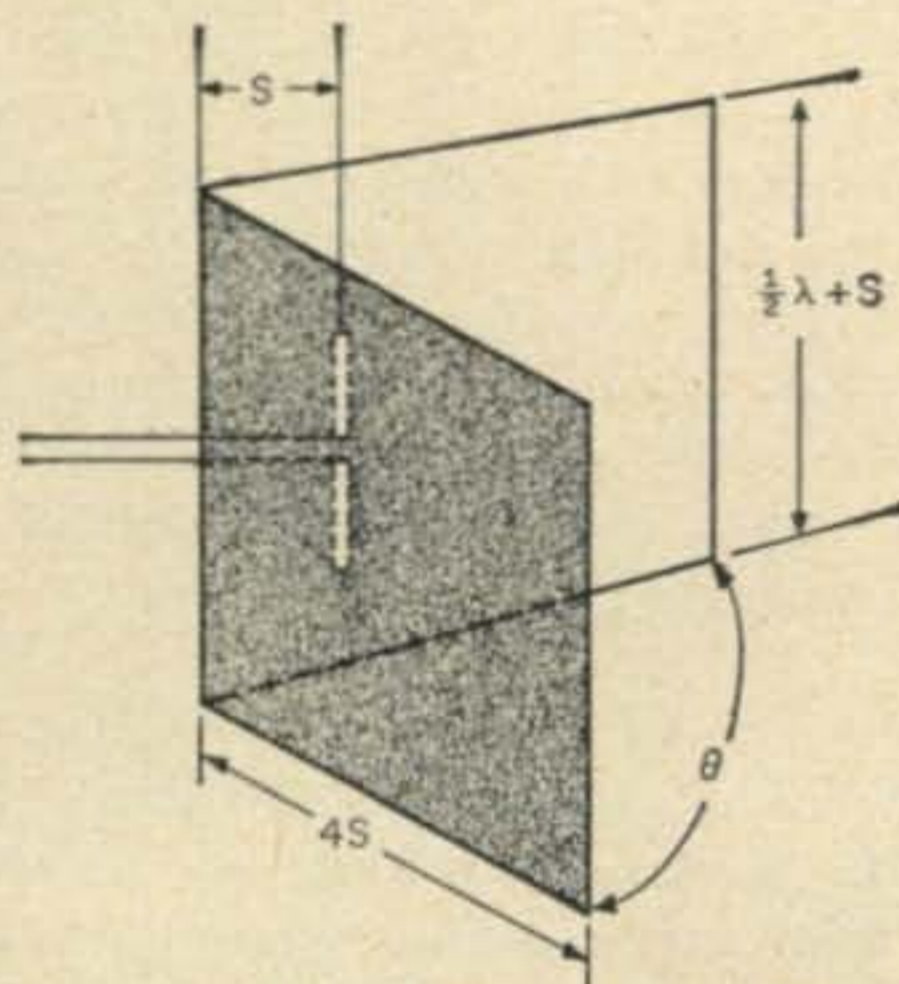

Fig. 2—Corner reflector. The relationships between the measurements shown are discussed in the text.

ing the dipole element, and running through the center of the reflector. It consists of two flat sheets forming an angle ranging anywhere from 45 to 90 degrees. The dipole element lies in the plane bisecting the angle formed by the sheets, and is parallel to the line of intersection of the sheets.

The corner reflector can give extremely high directivity, as well as a gain ranging from approximately 9 to 13 db, depending on the distance between the dipole element and the reflector apex, the angle of the reflector sheets, and the material making up the reflector.

The table below gives values of gain and radiation resistance for typical spacings and apex angles most commonly found in corner reflector-type antennas.

Apex Angle	Spacing in Wavelengths		
	0.4	0.5	0.6
45°	13.5 db 7 ohms	13.5 db 18 ohms	13.5 db 40 ohms
60°	11.9 db 25 ohms	11.8 db 60 ohms	11.5 db 100 ohms
90°	9.5 db 80 ohms	9.5 db 130 ohms	9.0 db 165 ohms

The corner reflector antenna can be centered by bringing the transmission line in along a line bisecting the apex angle of the reflector, and running it in perpendicular to the dipole element.

Maximum directivity and gain can be achieved by making the dimensions of the reflector large enough in terms of the wavelength. In fig. 2, for example, the side h should be $\lambda/2 + s$, and the length l should be $4s$.

The material making up the reflector can be either solid or a screen or grid type arrangement, consisting of chicken wire or parallel rods. Whatever the material used, the spacing between wires should, at most, be 0.15 wavelength but preferably smaller.

Spacing dimensions are important because the way in which energy is reflected will depend on the smoothness of the reflector. The word smoothness is defined as the ratio between the size of the irregularities in the reflecting surface and the wavelength of the incident energy. If the spacing between wires is any greater than 0.15 wavelength, considerable scattering will occur, resulting in a significant decrease in the efficiency of radiated energy.

The use of a screen or grid for the reflector offers the advantage of a much lighter reflector than would be the case if a solid reflecting surface were used. In addition, this type of surface offers considerably less resistance to wind than a solid.

The above table shows that as the apex angle of the reflector is increased, gain increases. Practically speaking, however, 45° is about the smallest apex angle usable without making the dimensions of the reflector prohibitive. This is so because as the apex angle is decreased, the distance s must be increased to keep resistance losses down. Since the side length of the reflector depends on s , the greater this becomes the greater the side length.

The corner reflector can be mounted so that the dipole element is either horizontal or vertical. Where horizontal polarization is required, the orientation of the reflector is such as to give maximum directivity in the vertical plane, and vice-versa.

The Paraboloid or "Dish" Antenna

A refinement over the cylindrical parabola, or the corner reflector can be achieved by placing a dipole element at the focal point of a reflector which has been shaped in the form of a rotational parabola, or "dish" as shown in fig. 3.

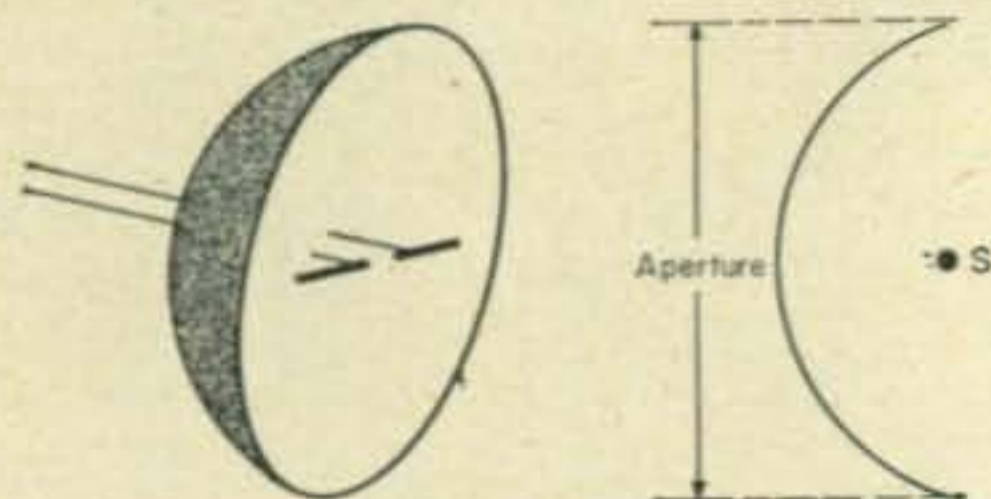

Fig. 3—Rotational parabola or "dish."

Such an arrangement, which can be mounted either horizontally or vertically, provides considerably higher gain, as well as directivity, in both the horizontal and vertical planes, than the other types of reflector antenna.

Theoretically, an isotropic radiator placed at the focus of a paraboloid whose dimensions are large in terms of the wavelength would convert spherical waves to a plane wave on reflection.

This theoretical situation can only be approached in actual practice since the dipole is not an isotropic radiator, and the inside of the dish is not uniformly illuminated. As a result, the beam is elliptical rather than circular, and somewhat broader than would theoretically be expected.

Design of a dish antenna is often highly complex, and in order to obtain optimum gain and directivity in some instances, the dipole element, because it is not an isotropic radiator, must sometimes be located somewhat removed from the mathematical focus of the paraboloid.

Long Wire Antennas

Long wire antennas consist of single wires, longer than one-half wavelength, in which the current in adjacent half wave sections is 180° out of phase.

As a result of these phase differences, there is no longer a null off the ends of the antenna, and considerable radiation occurs in the direction of the long wire.

In addition, the fields produced in individual half wave sections combine to produce radiation in a direction that is broadside to the long wire. Consequently, the resulting lobes of maximum radiation are neither in the direction of the long wire, nor perpendicular to it, but instead at some acute angle with respect to the wire. The angle depends on the length of the wire in terms of a wavelength at the operating frequency.

We have already pointed out that the electrical and physical length of an antenna are not the same, depending on its dimensions, and on end-effect. A convenient method of determining the length, in feet, of a single wavelength, for any given frequency, in megacycles, is:

$$L(\text{ft.}) = \frac{492(H - 0.05)}{f(\text{mc})}$$

where H is the number of half waves on the antenna. For example, for a length of two full wavelengths, H would be four. For a frequency of 144 mc, the length in feet would be equal to:

$$L(\text{ft.}) = \frac{492(4 - 0.05)}{144}$$

$$L = \frac{492 \times 3.95}{144} = 13.5 \text{ feet}$$

As the antenna length is increased, the lobe of maximum radiation decreases in width. As the lobe narrows, more and more energy is concentrated in a smaller sector, and power gain increases. An antenna length of four wavelengths,

for example, results in a power gain of approximately two. Doubling this length increases the power gain to 4.3.

Increasing antenna length also brings the lobes of maximum radiation closer to the direction of the antenna wire. The angle between the wire and a line running through the center of the lobe is the angle of maximum radiation. At an antenna length of two wavelengths, for example, this angle is 36 degrees. At four wavelengths it is 25 degrees, and at eight wavelengths, 25 degrees.

The presence of the ground under an antenna modifies its radiation pattern, depending on the distance, in wavelengths, between the antenna and the ground.

V Antenna

The V antenna consists of two long (in terms of wavelength) wires, arranged to form a V, and fed at its apex with currents of opposite polarity. Figure 4a shows a V antenna and indicates the

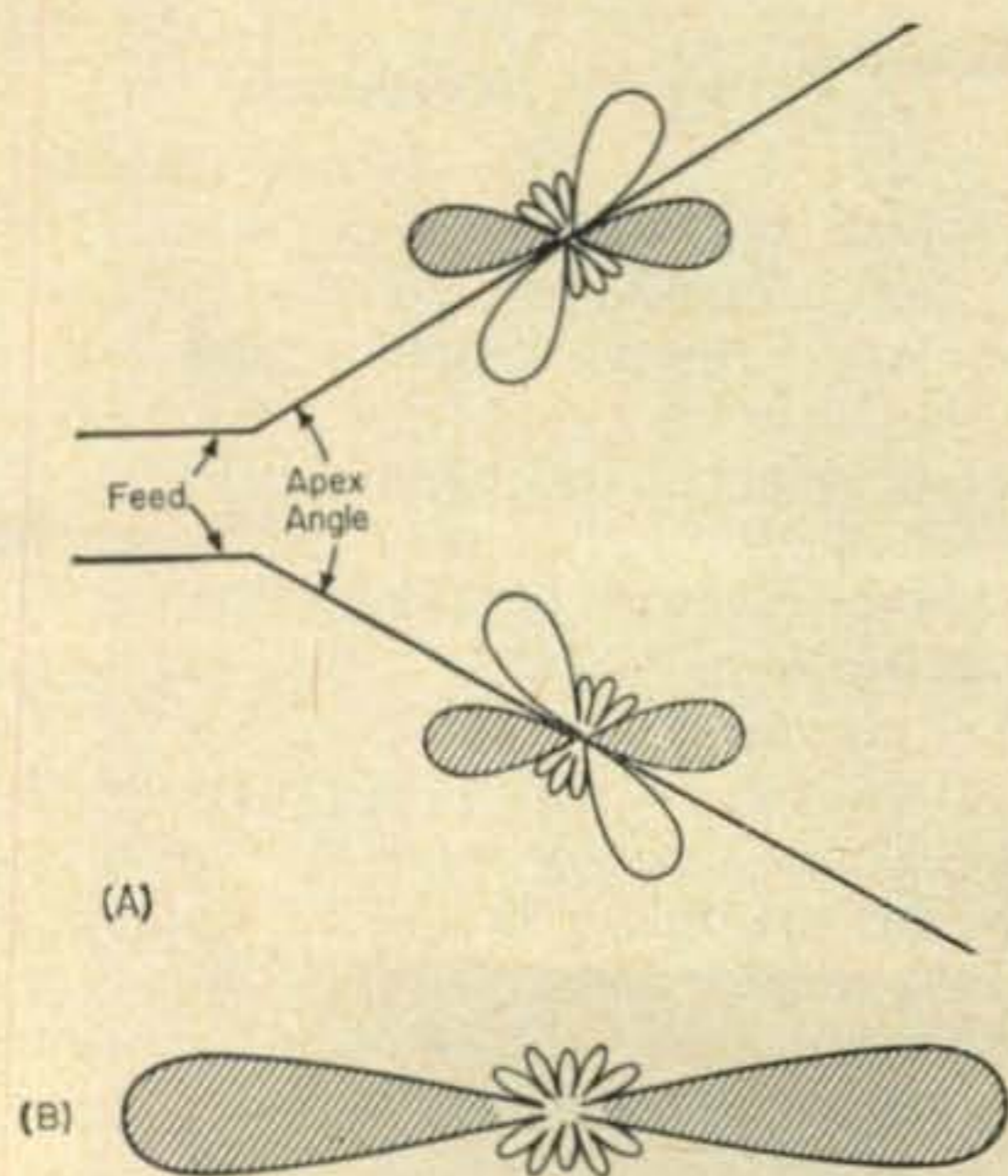

Fig. 4—V antenna patterns. The individual patterns in (a) combine with the shaded lobes adding and the others cancelling, to produce the pattern in (b). Pattern (b) is bi-directional and has a higher gain than the individual patterns of the long wires in (a).

major lobes in each wire. These combine in such a way as to produce maximum radiation along a line bisecting the apex angle of the V, as shown in fig. 4b.

As in the case of the single long wire, the greater the antenna length, the greater the gain and directivity. Since the radiation from two wires combines to form a single pattern, the gain of the V antenna is approximately twice that of a single wire antenna. For a leg length of two wavelengths, for example, a power gain of close to three is achieved. At four wavelengths, there is a power gain of five.

At a particular wavelength, the optimum apex angle of the V antenna can be determined by taking twice the angle of maximum radiation when a single wire at the same wavelength is used.

As leg length is varied, the optimum apex angle changes, as shown in the table below:

Leg Length (λ)	Optimum Apex Angle
1	90°
2	70°
3	58°
4	50°
6	40°
8	35°
10	33°

The optimum vertical angle of radiation depends on the length of the antenna legs as well as its height above ground.

Increasing either leg length, or height above ground will generally lower the optimum vertical angle.

For an antenna height above ground of $\frac{1}{2}\lambda$, the optimum vertical angle of radiation for a V-type antenna varies from 31° at one wavelength long, to 20° at 4 wavelengths, and 13° at ten wavelengths.

Unidirectional V

The V antenna can be made unidirectional by connecting non-inductive resistors of about 500 ohms between the far end of each leg of the V and ground, as shown in fig. 5. Since the resistors

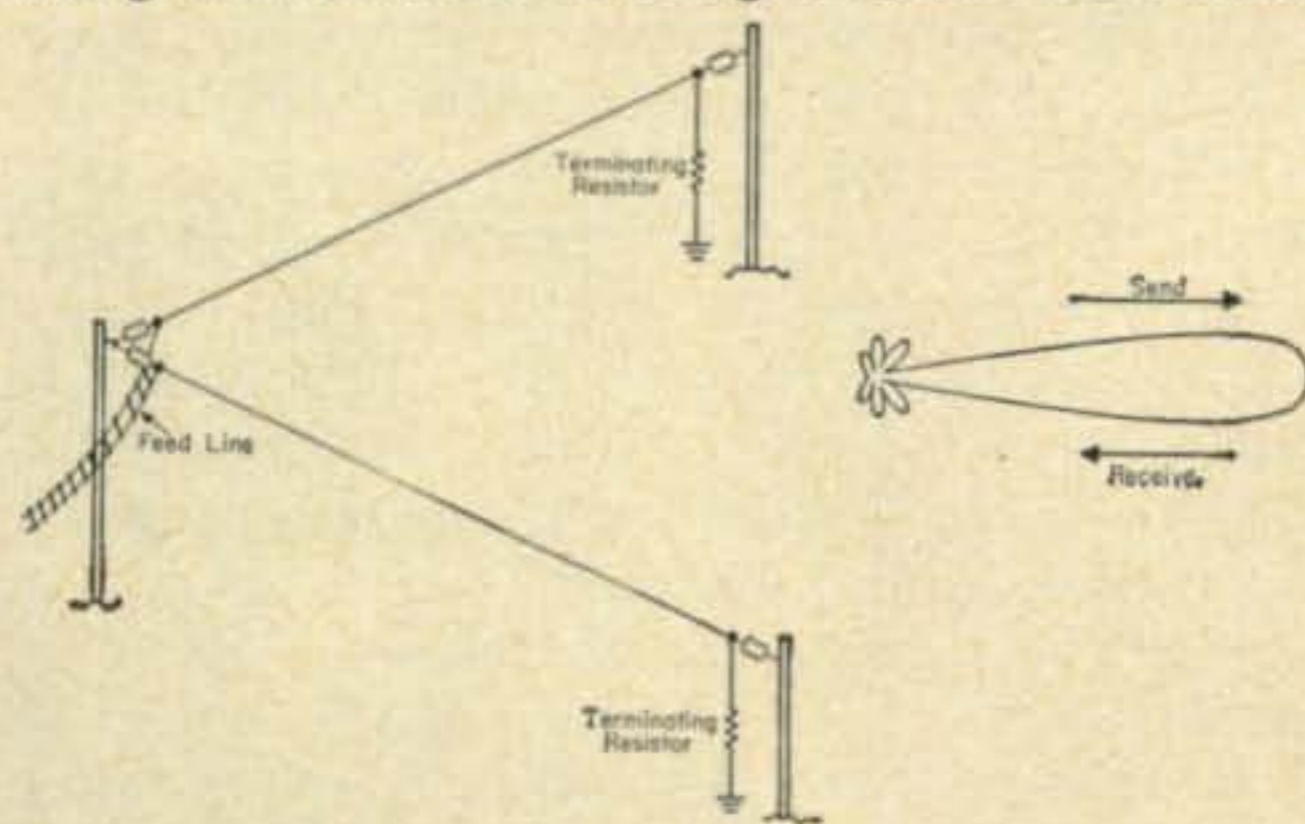

Fig. 5—The unidirectional V antenna, showing terminating resistors and the radiation pattern produced by this type antenna.

must be able to dissipate about $\frac{1}{3}$ of the power applied to the antenna, they must go to a good ground.

In the case of a terminated V, the leg lengths need no longer be multiples of a half-wavelength, since no standing waves now exist on the antenna. The maximum radiation in a terminated V occurs in the direction of the resistors, toward the mouth of the V antenna, with radiation in the opposite direction being largely suppressed.

Power gains approximately twice those obtained by the non-terminated antenna, can be obtained by use of terminating resistors.

Rhombic Antenna

The rhombic antenna, shown in fig. 6, represents the highest development of the long wire antenna. As in the case of the terminated V, the rhombic antenna radiates best at some angle to the plane containing the antenna, and in the di-

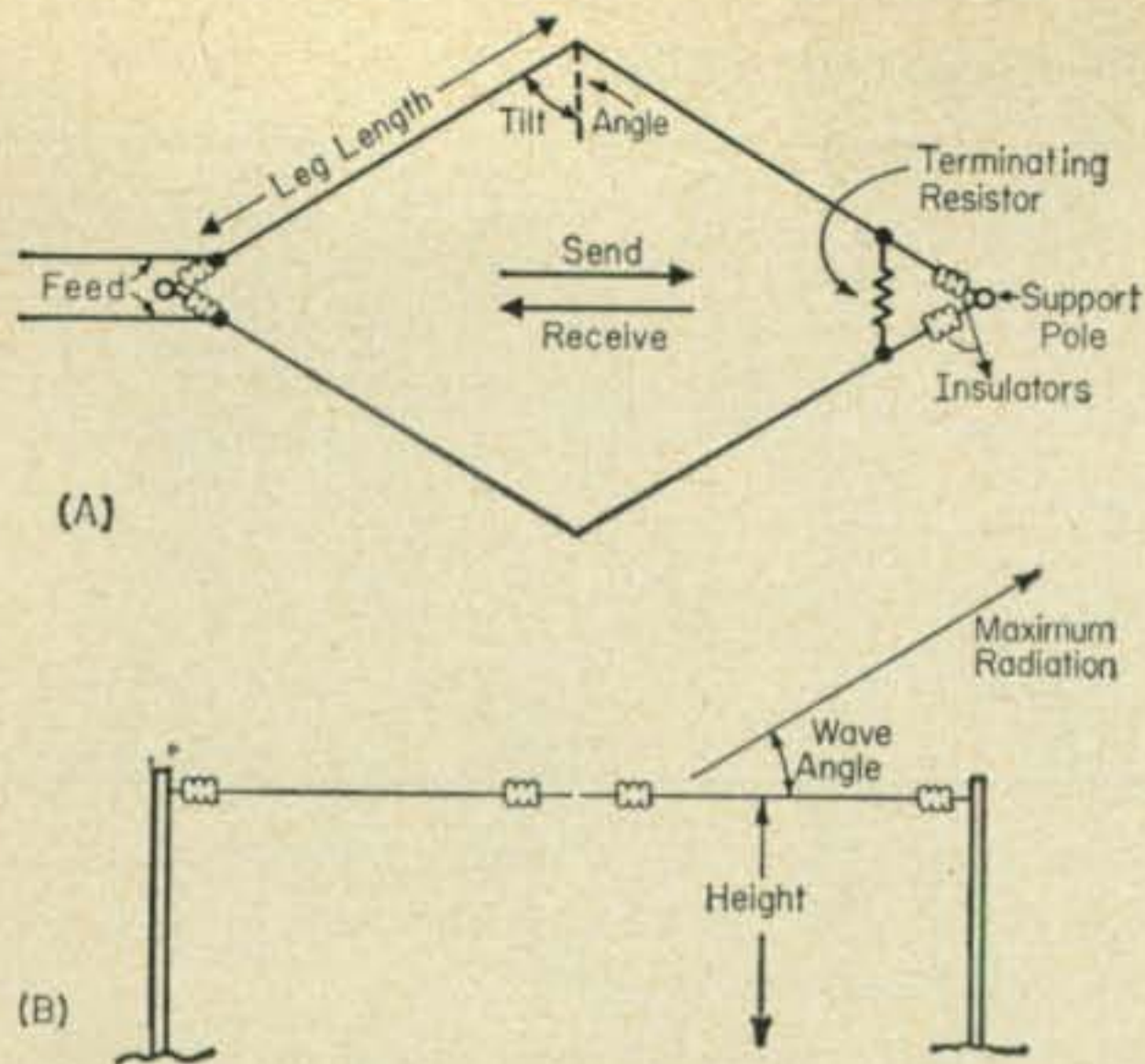

Fig. 6—The ultimate in long wire antennas, the terminated rhombic, showing wave and tilt angles in side and top views.

rection of the terminating resistor. The angle between the optimum vertical angle of radiation and the plane containing the antenna is called the wave angle. The tilt angle is one half the angle made by the two adjacent legs of the antenna.

One of the chief advantages of the rhombic antenna is its broad frequency characteristics, making it non-critical in so far as operation and adjustment are concerned. Although there are some changes in gain, directivity, and characteristic impedance that occur as the frequency is changed, the changes are generally small, with a frequency range of as much as 4 to 1 being obtainable with excellent results. This makes it possible to operate a rhombic over more than one v.h.f. band. For example, operation on 10 and 6 meters, with good results in both bands, is possible. The rhombic lends itself even better to operation in the 6 and 2 meter bands, since an almost perfect 3 to 1 harmonic relationship exists between bands.

The chief disadvantage of the rhombic antenna is its size, with a fairly large site being required. If each leg is made only one or two wavelengths long at the lowest operating frequency, for example, then an antenna operating on 6 meters would be a minimum of 30 to 35 feet long. Since the high gain and directivity obtainable with rhombic antennas would require leg lengths up to 10 or 12 wavelengths long, it can be seen that in general fairly large sites are required.

Most rhombics are built with the legs parallel to the ground. Adjacent sides of the antenna are fed with currents of opposite polarity producing horizontally polarized radiation as shown in fig. 7a, which combine as shown in fig. 7b.

As leg lengths are increased, gain increases, while horizontal beam width and the optimum vertical angle decrease.

The gain of a rhombic is considerably greater than of any other long wire system, with power gains varying from approximately 2.5 at one wavelength, to 11.2 at four wavelengths, and 22.4 at eight wavelengths.

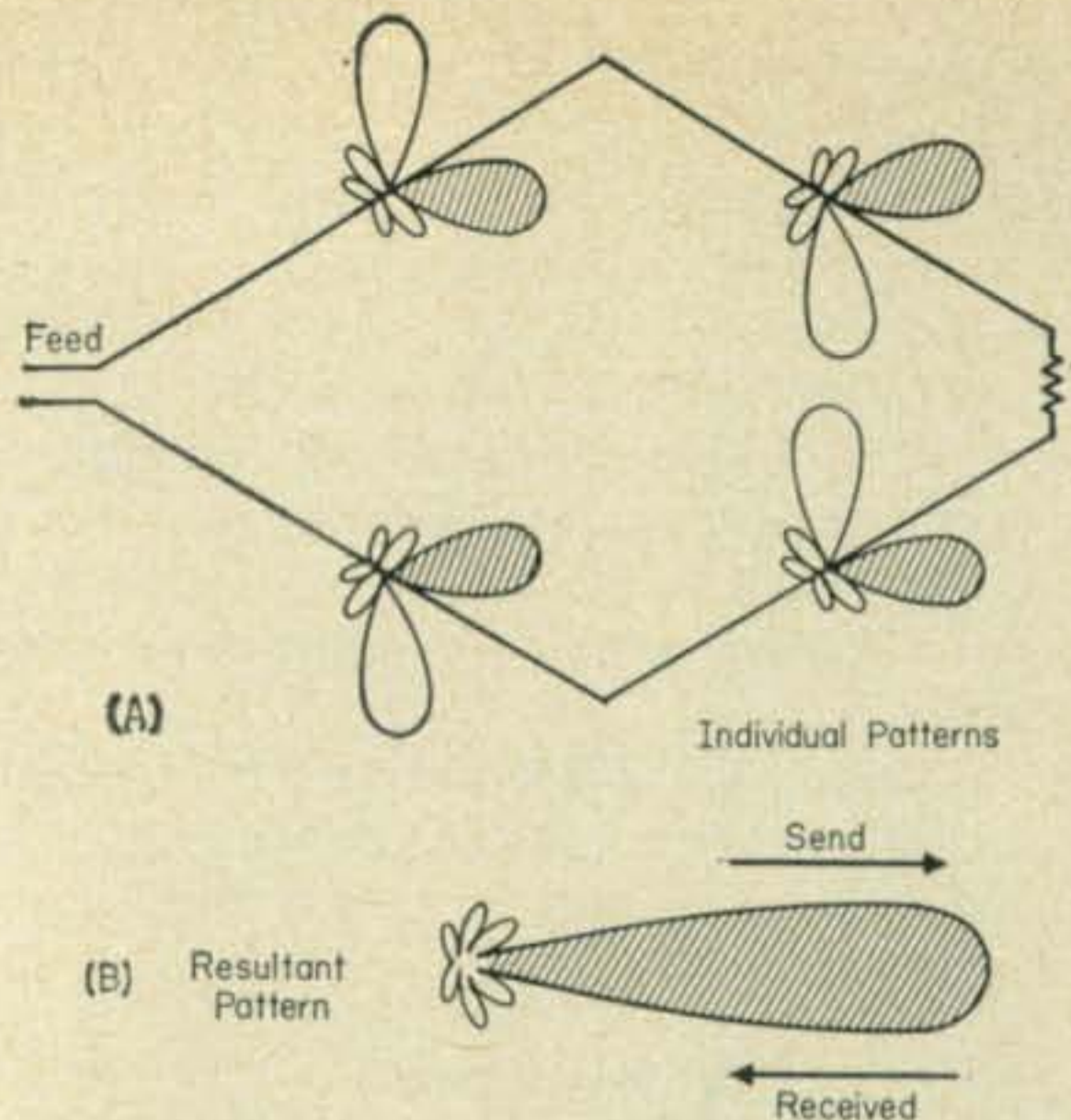

Fig. 7—Individual radiation patterns of a terminated rhombic antenna. The unshaded patterns cancel while the shaded patterns combine to produce the resultant shown in (b).

Using TV Antennas

Since the range of frequencies in the TV bands coincides closely with the amateur v.h.f. bands, a great many commercially available TV antennas can be used in amateur work with little or no modification.

A beam antenna, for example, designed for channel 2 operation (57.5 mc) can be used without any modification, although lengthening the elements by approximately 10% will improve its performance.

Similarly, there are available other Yagi and corner-reflector type TV antennas which can be adapted for use on 50, 144, and 220 mc.

As with all such antenna systems however, the range of frequencies over which such an antenna can operate efficiently is quite limited. ■

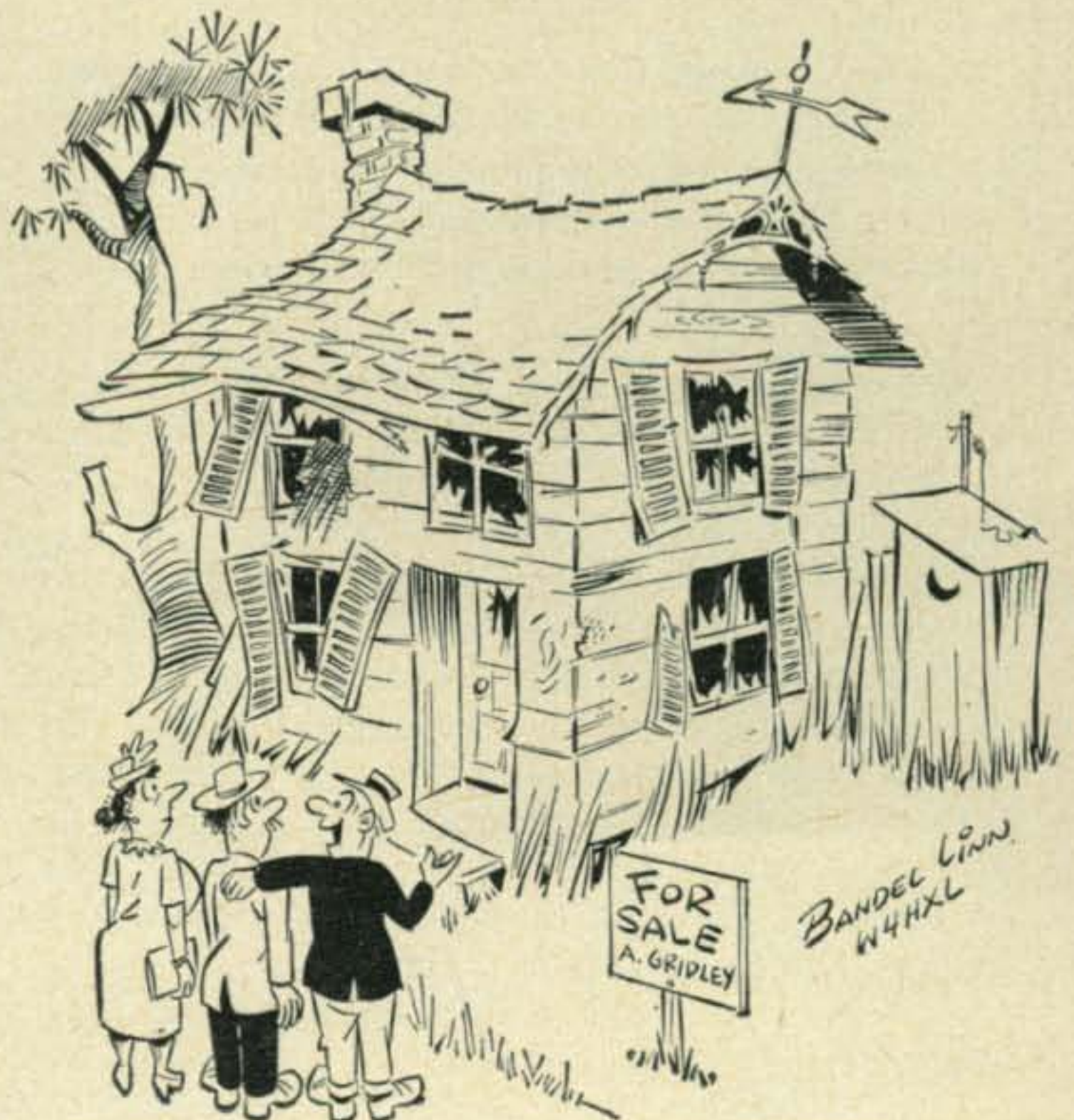

"—and another thing—it's a perfect location for antennas!"

ONE MAN'S FAMILY

Of Antennas

by Vic Clark, W4KFC

RFD1, Clifton, Virginia

QTH, HR, OM, is on a hill in the country!"

Lives there a ham with soul so dead, that he hasn't yearned for a spot meeting that description?

The classic hypothesis of a rural hilltop with "a clear shot in all directions," materializes for all too few of us, as the vision fades before the more practical aspects of life . . . earning a living, raising a crop of harmonics and attempting to conform, in general, to the accepted patterns of society . . . (often difficult enough for the species infected with the ham virus!)

So, except for the fortunate hams who are foresighted enough to be born and raised in the boon-docks, most of us are to be found pursuing our hobby in an unfriendly environment of power lines, TV birdie-factories and zoning restrictions. It is worthy of more than just a passing note, therefore, when one of the clan casts off the traditional fetters and transforms the reverie into reality.

Meet Len Chertok, W3GRF, a Washington, D. C. amateur, who dreamed of a lofty ham sanctuary far from the city, and then proceeded to create one from a comparative wilderness. His remarkable station is the product of tremendous fixity of purpose, careful planning and hard work. It would seem to establish a high water mark for what one ham can achieve in assembling an effective DX factory—starting with only an idea.

Brief Biography

Len, by way of further introduction, was first licensed at the age of 15 and operated his completely home-built station from the family residence in a Philadelphia three-story row-house during the years

from 1936 through 1940. Antenna possibilities in this congested district were limited to a few bent wires threaded through housetop clotheslines and broadcast receiving antennas. From such an unfavorable ham location, Len managed a pre-war WAS and WAC, rounding up 56 countries—a fairly impressive total for those days. In September, 1940, he enlisted in the U.S. Army Signal Corps.

The notion of the "ham shack on the hill" persisted with Len through the war years, during which he saw service in the Pacific theater of operations, visiting spots such as VK9, JZØ, DU, KR6 and JA. Code-handling and technical proficiencies derived from his earlier hamming days qualified Len for a communications billet with the AACCS, and he held down one end of many a hot c.w. inter-island circuit.

Emerging from the war intact and as a Master Sergeant, Len went to work as a civilian operator at the Signal Corps communications center in the Pentagon at Washington, D. C. Here, with co-workers W3JTC (later SVØWP), W9NWX (later WØNWX, VP7NG, FO8AJ, etc.) and others, Len helped to organize the now widely-known Potomac Valley Radio Club of Washington; D. C. and environs. (Len has subsequently served terms as president, activities manager, secretary and treasurer of the club.)

Len's first postwar operation was under the call W4KXN from an Alexandria, Virginia, apartment, and later as W3GRF from his sister's home in suburban D. C. He established W3GRF as one of the country's outstanding DX and contest stations during this period.

In 1950, Len transferred to his present job as a



An important ingredient for good DX . . . a driveway, half a mile long!

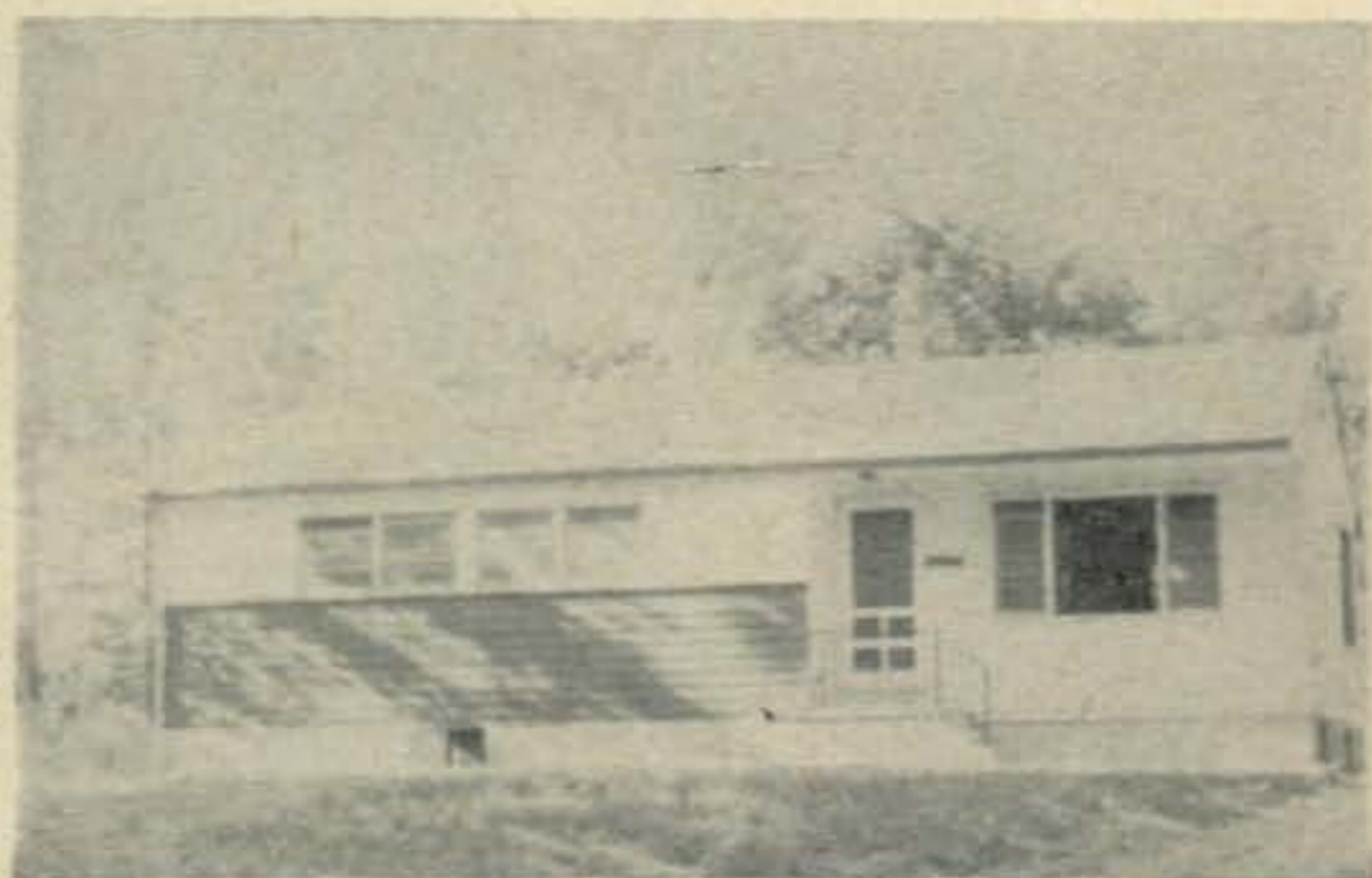

Front view of the "shack" at W3GRF.

All photographs by M. H. Baller, Washington, D. C.

civilian Communications Specialist at the AACCS Overseas Communications Center at Andrews Air Force Base, near Washington.

A Hill is a Hill is a Hill

The desire for a rural hilltop QTH persisted and, early in 1954, routine sorties into the Maryland countryside became a weekend feature on Len's agenda. Armed with road and topographic maps and a fistful of real estate listings, Len scoured the hinterlands for "The Hill." The rest of us in the club followed Len's bucolic frolic with a mixture of admiration, skepticism and, knowing Len's penchant for follow-through, more than a little anticipation.

Finally, we learned, he had found It! Fifteen acres, including a hill, which, he said, dominated the surrounding terrain. He made the down payment to clinch the deal, then announced his good fortune to the rest of the membership.

"Great!!" we reacted, but what kind of a building did the deal include? No building at all, we learned . . . this could come later. Hmm-m, OK . . . but were there clearings to accommodate the Vee's and Rhombics? Hardly . . . the place was thickly wooded, with fifty- and sixty-foot pines, poplars and oak standing shoulder to shoulder over the entire hill!

Anyway, the location seemed strategic—a scant eight miles from the District line and only five miles from GRF's place of work at Andrews Air Force Base. Convenience of access was one significant redeeming feature, we all agreed. "Now, how do you get there to look the place over?" we inquired. We-ell, you don't, exactly, we learned; the hilltop is a good half-mile from the nearest road, and it would be necessary to cross a substantial creek and plough, shanks mare, uphill through a thousand yards of brambles and underbrush . . . there to peer

about among the trees only to see . . . more trees!

To shorten a long story, no one made it. We accepted Len's assurances that it was *the QTH*, but, appalled by the magnitude of the task ahead, we all began to have misgivings concerning the ultimate success of the venture.

Well, we heard from Len once in a while after that . . . his appearance at club meetings were less frequent, and W3GRF all but disappeared from the air. As the weeks rolled by, reports of progress began to trickle in. Len couldn't make the meeting, we would hear, because he had a date with a bulldozer . . . or he was building a culvert to carry the embryo access road over the creek.

The culvert didn't work; heavy rains converted the tranquil creek into a destructive force and the roadway was washed away on two occasions. Thereupon, Len, undaunted, abandoned the culvert scheme and contracted for a thirty-foot timber bridge. Then the rest of the road went in—a half mile of it through the woods and all the way up the hill. Next came the power company, and after some negotiation, a special line was installed requiring nine widely-spaced poles . . . and terminating in a brand new 15 kva pole pot near the prospective homesite.

Len, meanwhile, had purchased a chain saw and—working every night after leaving the job and all day Saturdays and Sundays—the trees began to fall, permitting sunlight to reach the ground in steadily-growing patches. It was back-breaking work, but our city boy thrived on it and was soon sporting an enviable tan and a set of bulging muscles.

As funds permitted, Len would have a bulldozer in to help with the clearing of underbrush and to push the felled timber into huge piles for burning. Mostly, though, it was Len, chipping away with the chainsaw . . . summer and winter, in solitude on the hilltop . . . Gutzon Borglum was no more dedicated

The operating position at W3GRF—separate finals for every band.

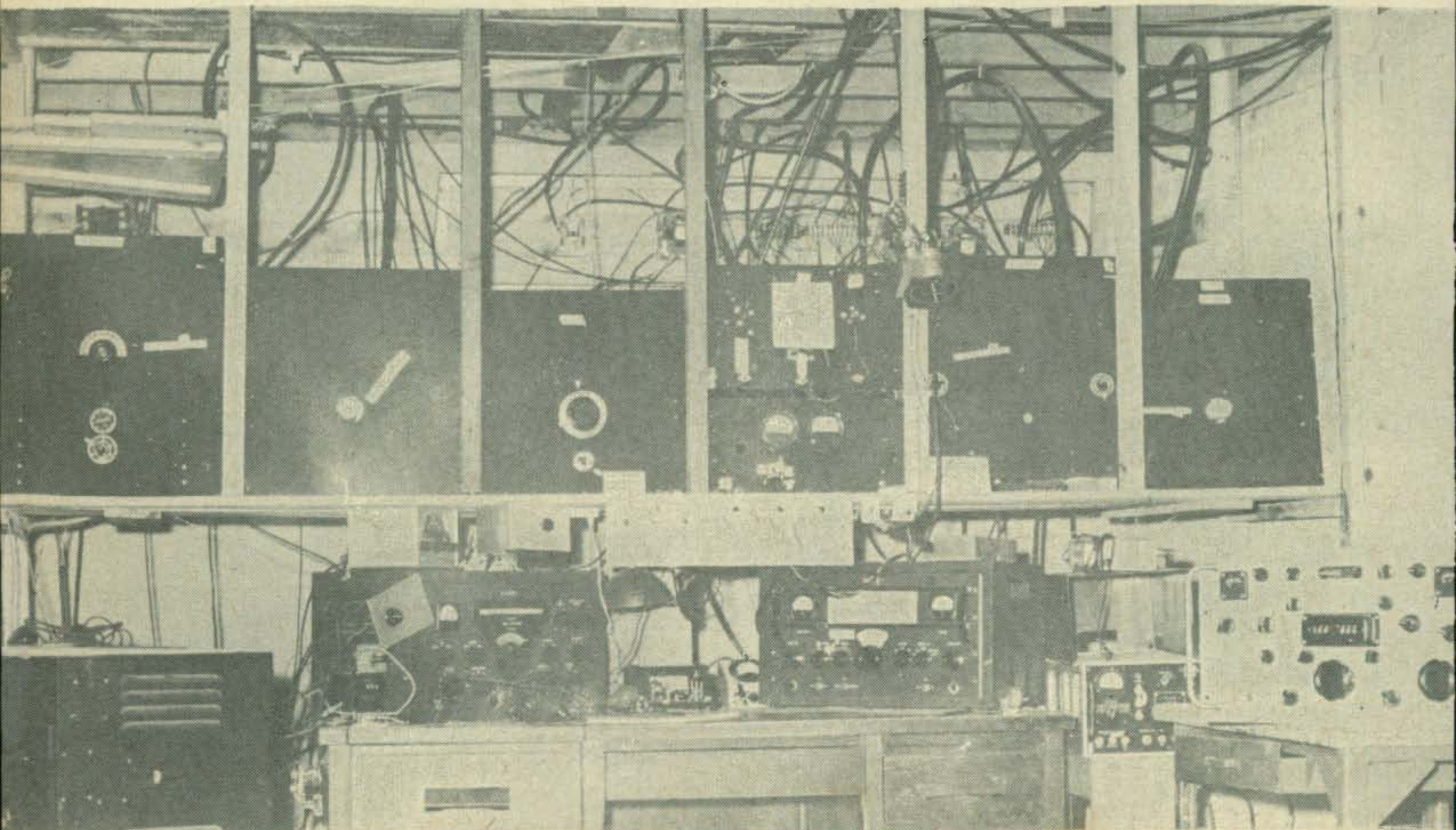

or purposeful in his attack on Rushmore.

Len's unbachelor-like activities were, in fact, regarded with some concern by his family and friends alike. Some found it difficult to understand why he would squander his money on rural acreage and a house, when he could be investing it sensibly in cars, clothes and riotous living. But Len, the man with a plan, paid little heed to the critics.

With completion of the access road, the visitor-index rose sharply, and Len began to realize dividends on past favors to others (and few were the PVRC members who hadn't at one time been ably assisted by W3GRF in carrying out their own antenna construction projects!). Many of those who showed up were motivated largely by idle curiosity . . . these, too, were promptly pressed into service by resourceful Len, who laid in a supply of extra axes and shovels with which his "guests" might entertain themselves.

On Field Day, 1955, W3EIS/3, a one-transmitter, two-man entry, made the first radio contacts from Len's hilltop—operating from a tent in the center of a 100-by-100-foot clearing, with dipoles hanging from trees rimming the opening. The future home of W3GRF was confirmed as a very promising QTH, indeed; thirty watts, from batteries, produced a (then-record) score of 493 contacts to lead all one-transmitter entries in the event.

Hard to Believe

The success of any homesteading effort, we should explain for the benefit of you city-dwellers, depends heavily upon the availability of a suitable source of water. Before proceeding into the construction of the house, therefore, Len contacted a local well-digging outfit and arranged to have the job done. Well digging, for the uninitiated, is a somewhat speculative proposition wherein the well digger (or driller, as the case may be) gets reimbursed for his effort—but this does not necessarily produce water in the desired quantities. So it was in Len's case. A hole was dug some thirty feet into GRF's hilltop with negative results; a second attempt some distance away was no more successful. At three dollars per foot, Len's financial resources were dwindling rapidly. Even Len's indomitable enthusiasm waned somewhat; contemplating this distressing turn of events, he said to the well digger: "What do you suggest? I can't afford to have many more dry ones dug!" "Well," said the contractor,

mopping his brow, "you may think it's silly, but I know a fellow who claims to be able to locate underground streams by using a divining rod . . . I can't hardly believe it myself, but I've seen him produce results more than once. He charges ten bucks and makes no guarantees, but you're in a spot . . . and it might work."

It should be noted here that Len is a hard-headed realist, devoid of superstitions and holding no brief for witchcraft in any form. His decision, therefore, is indicative of his desperation at this juncture, for, with a sigh of resignation, he replied: "OK, call him over . . . I've gone this far, I can't quit now!"

A short time later, the advertised rhabdomantist put in his appearance at the GRF estate, complete with a forked stick and an air of self-assurance. His performance commenced to an audience consisting of the well-digging contractor, his two assistants and Len, the latter conscience-stricken at his role as sponsor of the ritual . . . and wondering, guiltily, what he would say if a friend should drive up unexpectedly!

The fellow held the stick in front of him and walked slowly forward . . . suddenly the stick dipped down; he recrossed the point several times with the same result . . . whereupon he scratched an "X" in the dirt, and took off along a parallel path. The diggers watched, bug-eyed. Len, writhing inwardly, looked on without enthusiasm. The ceremony continued for perhaps fifteen or twenty minutes, by which time two well-defined rows of X's had been marked on the ground; then the chap turned to the group and said: "Dig here, I think this is a good spot."

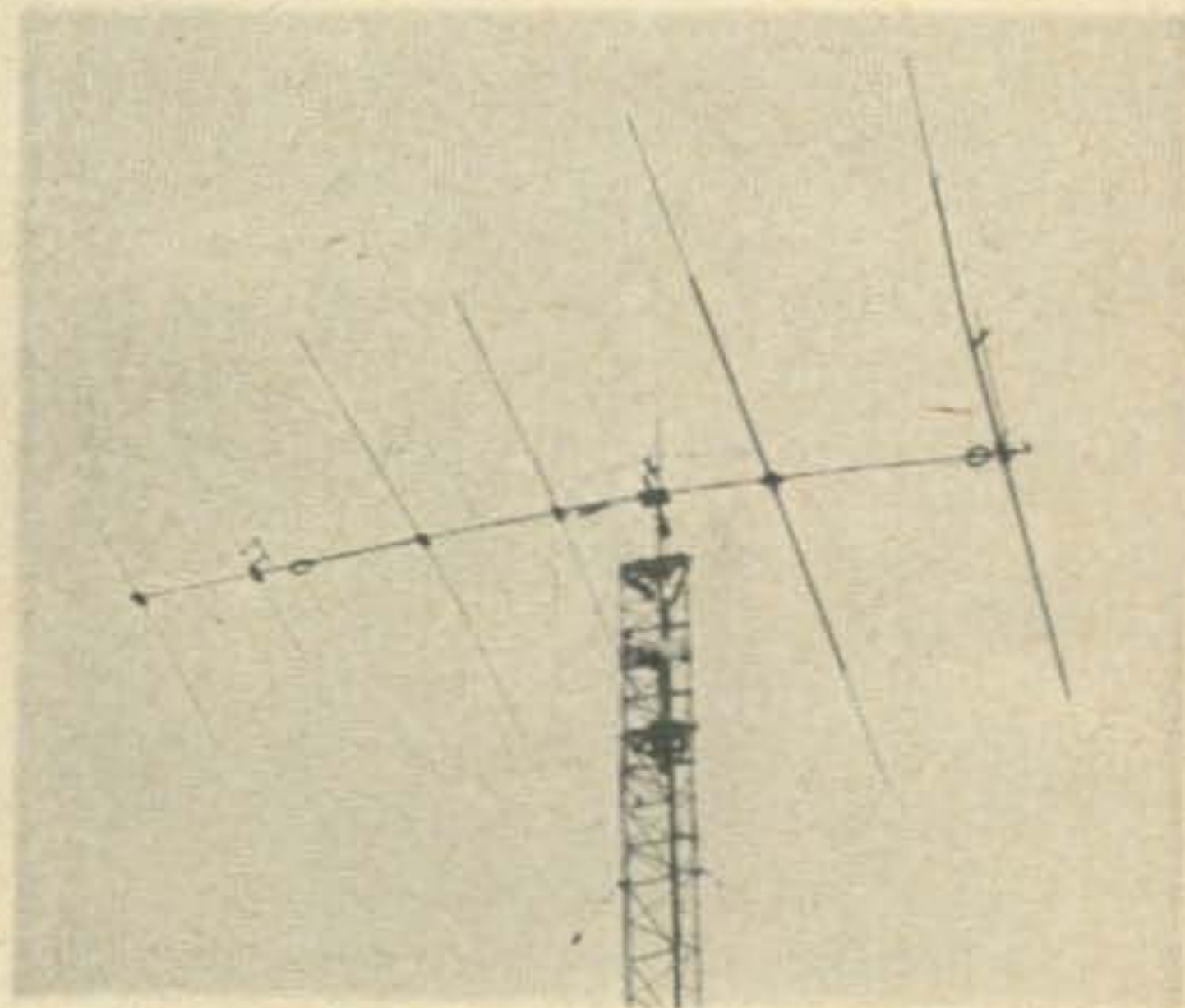

Three band beam for 10, 15 and 20 meters, on 70-foot mast.

Len, describing his feelings at this point, says that he had become somewhat impressed with the diviner's confident manner, but felt certain his ten dollars would have to be chalked up to "experience" and whatever comfort could be derived from the knowledge that he had tried *everything*. The spot which the man selected was not far removed from the two previous dry holes, so there was little basis for expecting better results. Len paid the man and he left; the digging resumed.



Len Chertok and his musical saw.

The results? You guessed it! Len's well stands right where the mystic with the twig said "dig!" It has produced an ample flow of cool, clear water right through severe droughts. With a gesture of resignation, Len simply says: "I just don't understand it, but there it is!"

Construction Underway

In the spring of 1956 the site for the house had been cleared and leveled, and Len contracted for a three-bedroom rambler with a full 25 by 42 foot basement. The building proceeded rapidly and Len, meanwhile, set about to erect suitable towers for his dream beams. By this time, nearly three acres had been cleared, including a central clearing for the house and three tower sites, and four 50-foot-wide swaths through the woods in various directions for the long wire Vee's. When Len moved into his new home in the late summer of that year, three towers loomed above the trees. These included a 100 foot Vesto self-supporting tower and two guyed towers, one a 100 footer and the other 90 feet in height.

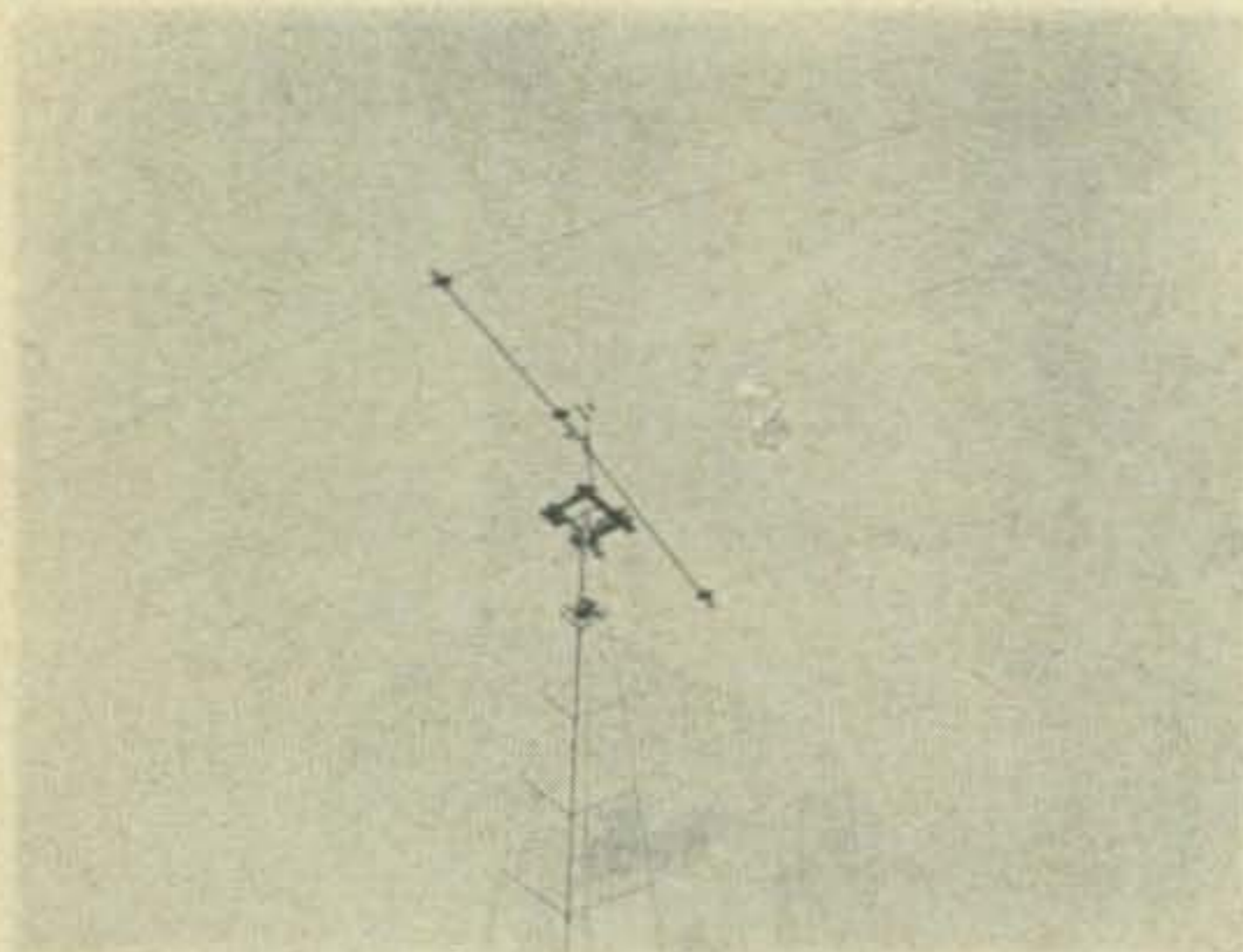

A full-sized forty meter beam, 100 feet above the ground.

By the advent of the 1956 contest season, an impressive set of antennas had been installed and W3GRF boomed forth with real authority on the DX bands. Len turned in the third high national score in the CQ DX Contest that year, and followed it up with a fourth high national score in the 1957 ARRL DX Test.

Into Each Life . . .

Life at the Chertok Estate has never been dull. On one well remembered occasion, Len, working with an electric drill at the sixty foot level on one of his guyed towers, found himself providing a direct circuit to the well grounded tower for the 115 volt line current; the drill had shorted internally! Frozen solidly to the tower and unable to release his grip on either the drill or the tower, Len shouted for help to W6HOH/3, who was assisting from the ground below. Fortunately, HOH reacted swiftly, dashed over and pulled the plug, thereby releasing Len from a very serious predicament. A much chastened Chertok has established use of rubber gloves and an isolation transformer as S.O.P. for future use of electrical appliances on the GRF towers.

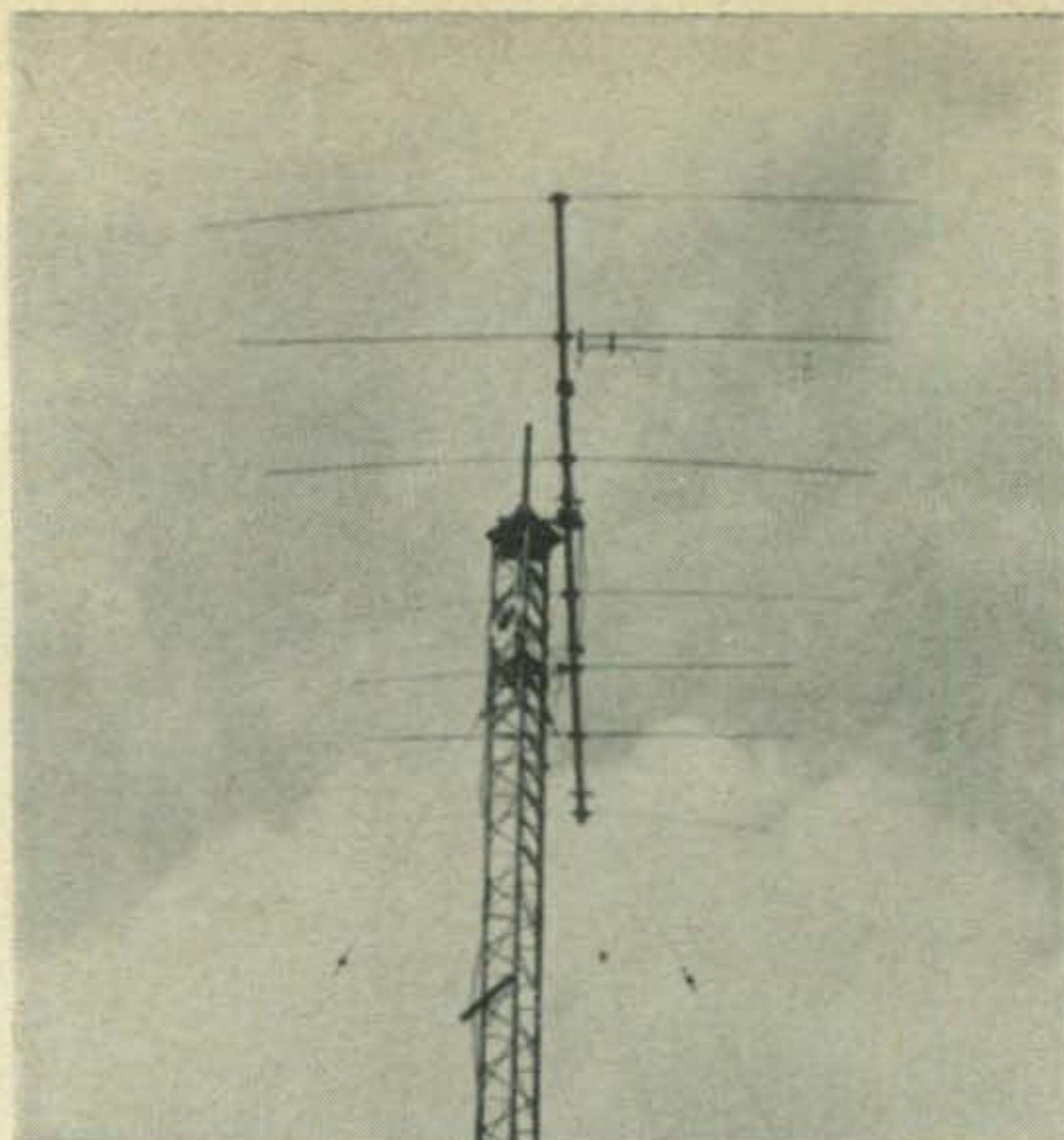

Dual 10-15 meter beam, 125 feet straight up!

Then there was the time when Len, removing a few trees standing close to vital guy wires, felled a forty-foot pine which went over in exactly the opposite direction from that intended. Before Len's horrified gaze, the errant tree deposited itself across a guy wire from his 90 foot tower; the tower promptly buckled and fell into a pile of twisted metal, topped off with the wreckage of two four-element beams (10 over 15 meters). The entire catastrophe required an estimated ten seconds from the time the tree started to tip until the pile of tangled metal stopped bouncing. Reporting the disaster on the club's two meter net that evening, Len wryly observed, "This has not been one of my better days."

A few months later the calamity was repeated when a bulldozer, clearing land near one of the guy anchors for the 100-footer, backed into the guy wire . . . and down came 100 feet of steel tower and a four-element wide-spaced twenty meter beam! A lesser spirit than Len's would have turned to stamp collecting or, possibly, drink. Not Len, however, who began planning for bigger and better towers even while the rubble was being cleared away!

UR 599

Today the monument to Len's persistence and courage stands near completion:

The 100 foot Vesto tower supports a *full-sized* three element forty meter rotary . . . the reflector is 73 feet long! A 100 foot guyed tower is topped off with a five element twenty meter beam employing a 45 foot boom. An in-line beam with three ten meter elements arranged in front of four fifteen meter elements perches atop a 125 foot guyed tower, while a diminutive 70 footer near the house carries a three band in-line beam which combines a total of six elements for ten, fifteen and twenty meter operation. All of the rotaries were constructed in the basement on long winter evenings. A single section 8JK, suspended about ninety feet above the ground, is oriented for Europe and New Zealand

80 meter DXing. A 270 foot long wire for 80 and 160 completes the present antenna set-up.

Len's hamshack now occupies one end of the large basement room, with the remainder devoted to equipment storage and an outsized workbench. Separate home-built finals are available for each band from ten through one-sixty, and these are driven by a Collins 32V3. Look at this firepower:

160 Meters	single 4-65A, 200 watts
80 Meters	p.p. 810's, 1 kw
40 Meters	p.p. 833's, 1 kw
20 Meters	p.p. 833's, 1 kw
15 Meters	p.p. 450TL's, 1 kw
10 Meters	p.p. 833's, 1 kw

"One kw, hah!" you say? Len has documentation. Smack in the middle of the 1958 CQ DX contest, the FCC wheeled up to confirm the point, as they did in many places on that fateful day. It cost Len a vital hour of contest time, but he can point with pride to a rig that is U.S. Government Inspected.

A further note or two on the rig: It is almost completely unshielded and its configuration (see photo) conveys a bit of nostalgia from the pre-TVI days. Len's nearest neighbors are a good half mile away and any harmonics radiated directly by the finals peter out before they reach the sensitive ears of a TV set. "After all," points out Len, "if I stopped to shield and beautify the rig, where would I get the time to do all the other things that need attention around here?" A single power supply is used for the final amplifiers, and all transmitter and antenna combinations are available for use from the operating position at the flip of a switch. A seldom-used modulator is available, which functions with any final; it employs a pair of 833's, lighted only once or twice a year when some of the gang show up to put W3GRF on for one of the phone DX contests. Needless to comment, Len's first love is c.w.

Feed lines to the various antennas consist for the most part of RG-17/U cable, suspended from messenger cables between poles erected for the purpose. The longest feedline measures about 325 feet.

Receiver

A trusty Collins 75A-2, with an 800 cycle mechanical filter and augmented by a DB-33 preselector, carries the receiving burden.

As for the house . . . it's looking better every day. Recent improvements include wall-to-wall carpeting and fancy drapes. A hi-fi set and ample collection of big band jazz records serves to liven the rustic environment. Lacking the assistance of an XYL, Len hires a cleaning lady to drop by and set things in order once a week, and (excepting the workshop end of the basement) the appearance of the place belies its role as a bachelor's abode.

Tourist Attraction

Len's once-inaccessible wooded hilltop is now a Mecca for Washington area hamdom; visitors come and go on various errands ranging from sightseeing to soliciting Len's assistance and advice on antenna construction projects or other ham-oriented undertakings. The Potomac Valley Radio Club has held summer meetings there and, during June, 1959, the

W3GRF establishment was the scene of the annual joint meeting between the Frankford Radio Club of Philadelphia and the PVRC. On that occasion, Len's thirty-foot bridge supported a Greyhound bus laden with forty-five beefy linemen from Frankford's first team!

W3GRF is always activated for the operating contests; if Len himself is not at the key, one or more of the local gang takes the helm to enjoy a memorable operating experience. W6HOH/3 piloted the station to a top U.S. score in the 1959 European W.A.E. contest, for example. Len himself achieved one of his major goals in the 1959 CQ DX contest, by topping all U.S. entries with a 388,010-point score. (See June, '60 CQ, page 36). His sights now are set on a national first place in the ARRL C.W. DX Test. He almost made it in 1960 . . . and the smart money says it's W3GRF in '61!

Other Activities

Not all of Len's efforts go into development of his homestead and contest operation. He has managed to edge his country count up to 275 or so, occupies an active role in PVRC affairs and presides as anchor man on the club's two meter net. He maintains a lively interest in political and rulemaking activities affecting ham radio. Len will be remembered by several hundred DXer's as the master of ceremonies for the DX luncheon at the National ARRL Convention held in Washington, D. C., in 1958, under sponsorship of the Foundation for Amateur Radio, Inc. He now serves as secretary for the F.A.R., an organization with representation from nineteen Washington-Baltimore area radio clubs. No social slouch, Len rarely misses out on weekend dancing dates . . . except, of course, during the contest season!

Len has built a better hamshack, and the world, so to speak, is beating a path to his door. His spectacular demonstration of what can be done along these lines, and his enthusiasm on the subject has motivated a number of his fellow PVRC members to "take to the hills." While none of them, to date, has attempted a raw pioneering effort to match Len's, the shift from the suburbs into rustic areas has proven equally beneficial for all . . . W3MSK, W3PZW, W4YHD, W4KFC and W3MSR, to mention a few, have followed suit and established new and more favorable antenna sites for themselves. Others now are combing the hinterlands around Washington, D. C. with a calculating eye.

Now that the skywires are all in place and working well, Len's homesteading efforts are mainly directed toward further clearing of underbrush, leveling of the terrain, stump removal and planting of grass. His aerie proved to be atop a deposit of almost solid bank gravel, a useful road-building component, for which he has already received an attractive offer. But Len's reaction to this is in character: "Why should I sell? I'd just have to go out and do this all over again!"

Next time you're sightseeing in Washington, D.C., be sure to include, along with your visits to Mount Vernon, the Lincoln Memorial and the Smithsonian, a sidetrip to W3GRF . . . it'll put you in a hill-hunting mood ■

Modulation, Audio Power and Readability

Carl C. Drumeller, W5EHC
5824 N. W. 58 St.
Oklahoma City 12, Oklahoma

FOR years electronic technicians have been urged to adjust radiotelephone transmitters so that the average percentage of modulation ran as near to 100% as feasible and still avoid over-modulation. This doctrine has become so firmly ingrained that it is accepted without question. The tendency has been to push ever closer to the full limit and even spill over beyond the legal limit in an effort to enhance the readability of the received signal.

Aural Perception vs. Modulation

Perhaps it would be well to examine carefully the relationships between audio power output of a modulator, modulation percentage, and aural perception levels. With this relationship established, the way will be clear to consider the subject in more detail.

It has been established that the human sense of hearing can detect a change of audio level of one decibel. This, however, is under carefully controlled, idealized conditions. Under ordinary circumstances, a change of two decibels in the level of a tone can be detected in a quiet room. Under conditions of moderate noise a three decibel difference in tone level can be distinguished. With voice signals, however, it is doubtful that a three decibel change could be detected in the presence of any masking noise. A four decibel change could be noticed through faint noise, a six decibel change through moderate noise, such as the normal background noise of a radio receiver. From this, then, it may be assumed that a six decibel change is the minimum that may be readily noted under normal radio reception conditions.

For an example, let's consider a radiotelephone transmitter with a d.c. power plate input to the final amplifier of 100 watts. To modulate it 100% by a pure tone would require 50 watts of audio-frequency power at the secondary of the modulation transformer. This requirement is computed by the formula

$$P_1 = 0.5 (m)^2 P_2$$

where: m = the modulation index (1 for 100%)

P_1 = the audio power from the modulator

P_2 = the d.c. plate input

If it is desired to find the modulation index, the formula is rearranged to read

$$m = \sqrt{\frac{P_1}{0.5 P_2}}$$

With these facts at hand, let's consider next the relationship of audio-frequency power and decibels. With the formula

$$\text{Decibels} = \frac{\text{Audio power for 100 \% modulation}}{\text{Audio power for less modulation}}$$

one can establish exact values.

We're ready now to investigate the relationships. Let's first see what happens if we drop the level two decibels, which would be too small an increment to detect in a voice circuit.

$$2 = 10 \log \frac{50 \text{ watts}}{P}$$

$$0.2 = \log \frac{50}{P}$$

$$1.58 = \frac{50}{P}$$

$$P = 31.6 \text{ watts}$$

To determine the modulation percentage at this level, we drop figures into the previously given formula.

$$m = \sqrt{\frac{31.6}{0.5 \times 100}}$$

$$m = 79.5$$

This tells us that no listener can detect the difference between 100% and 80% modulation in a radiotelephone being modulated by voice.

Repeating the process for three decibels, we find the modulation percentage to be 70.7%; for four decibels, 63%; for six decibels, 50%. It will be recalled that a three decibel drop in voice signal level probably could not be detected by a listening test. A four decibel drop could be noted only if the noise level were quite low, but a six decibel drop would give a positive indication of lower audibility.

These audibility relationships would hold true only if the receiving equipment were not equipped with a noise limiter circuit. Almost all noise limiters work on a principle of limiting the response on higher percentages of modulation. Many commercial receivers start this limiting process at as low as 30% modulation. When such a system of noise limiting is used, it becomes increasingly difficult to distinguish between 100% voice modulation and, say, 70% modulation.

Conclusion

These facts all add up to this: If a transmitter drops from 100% modulation to 70% no one will ever know the difference; therefore it is not worth the risk of over-modulation to crowd a transmitter close to the 100% mark. ■

The Significance Of S. W. R. Measurements

Don M. Wherry, W6EUM

2121 Grand View Drive
Camarillo, California

A definition and review of S. W. R. and how it affects your transmissions.

We frequently hear such statements as, "I have been working all day and I can't get my *swr* below 1.5 to 1." Let's see just what this means in terms of losses, but first let's define *swr*. This term can be simply stated as, "the ratio of maximum current, or voltage, to the minimum current, or voltage, along a transmission line." This definition can be expressed as

$$SWR = \frac{Z_r}{Z_o}$$

where Z_r is the impedance of the load (pure resistance) and Z_o is the impedance of the line. The right hand factor, Z_r over Z_o can be inverted, if necessary, to allow the larger figure to appear in the numerator, thus allowing the answer to always be larger than one.

The answer you get will then be the number of times larger the current, or voltage, is at the maximum point in the line over the current, or voltage, at the minimum point.

Going back to the original statement, let's examine the situation. From a set of curves showing attenuation data for common types of transmission lines, which we can find in almost any text book or handbook, including the ARRL *Handbook*, we find that 100 feet of RG-8/U cable has a loss of 0.4 *db* when operating flat at 7 *mc*. Now, since the rule of the thumb definition for *db* is "one *db* change in volume is the minimum change which can be detected by the human ear" this shows that it would take approximately 250 feet of RG-8/U at 7 *mc* to introduce enough loss to be detectable at the receiving end, this, if the line is flat.

As our original statement expressed an *swr* of 1.5 to 1, let's see how that effects the total losses in the line. Again going to published tables we find that the *additional* loss per 100 feet of line at 7 *mc* is too low to be measurable for a *swr* of 1.5 to 1. An *swr* of 2 to 1 shows an additional loss of 0.1 *db* per 100 feet which when added to the original line loss of 0.4 *db* gives a 0.5 *db* loss per 100 feet. It would take therefore, approximately 200 feet of line at an *swr* of 2 to 1 to have a detectable loss in volume at the receiving end. Looking at it from the *swr* aspect

only, it would take an *swr* of approximately 8.5 to 1 to *add* a detectable loss per 100 feet when operated at 7 *mc*. By "detectable" I mean noticeable to the ear.

As the frequency increases, the normal line losses increase quite rapidly. At 30 *mc*, for example, RG-8/U has 1 *db* loss per 100 feet when flat. The additional loss caused by an *swr* of 1.5 to 1 is still too low to be measurable. However, with an *swr* of 2 to 1 the added loss is double the 7 *mc* figure, or 0.2 *db*, making the total of 1.2 *db* per 100 feet of line. This shows that it would take approximately 500 feet of RG-8/U with an *swr* of 2 to 1 to show a perceptible decrease in volume at the receiving end over the same line when flat. An *swr* of 8.5 to 1 however, will give an added loss of approximately 2 *db* which will then bring the total line loss to 3 *db* for 100 feet at 30 *mc*.

To summarize, any frequency to which RG-8/U could be used with any degree of efficiency, an *swr* of 1.5 to 1 is of no concern from the added loss aspect. It is, in fact, necessary to reach the ratio of 2.5 or 3 to 1 before concern need be aroused.

This is from the loss standpoint only. Making your low pass filter operate satisfactorily with an *swr* of 2 or 3 to 1 is another matter which will not be discussed here other than to say that if your filter seems ineffective check your *swr*.

One final point, in connection with *swr*, which should be mentioned, is that a high reflected power figure (*swr*) does not mean, in itself, a high *rf* power loss. The only loss experienced is increased line losses which are due to higher current, higher voltage etc. The reflected power going back into the transmitter is not lost power in itself. It means simply that the antenna is not transferring power and will not load properly.

While all this is something everyone knows, and is readily available in text books, it seems to be fairly widely ignored among the amateur and experimenter fraternity. While the pure theorist might find some fault with a statement or two made in the foregoing I believe that it is sufficiently accurate and clear to satisfy and perhaps answer a question or two for the average ham or experimenter, like you and me. ■

The Heath "Twoer"

Lee Aurick, W2QEX
Technical Editor, CQ

IN appearance the Twoer is identical to its close cousins, the "Sixer" and "Tener." It does, however, contain one extra tube in the frequency multiplying section of the transmitter. The modulator/audio amplifier, speech amplifier/audio driver, and the receiver r.f. amplifier and detector follow closely the successful design of the previous units.

Transmitter

It doesn't take a very practiced eye to see at first glance that a great deal of thought has gone into the transmitter setup. In fact, things get a little crowded with all the by-passing around the two tube sockets that comprise the r.f. section. While the newcomer to v.h.f. techniques should work perhaps a little more carefully than he may be accustomed to with lower frequency transmitters, no trouble should be encountered. As with all kit construction, read the instructions, go through the motions of making the connection, make the connection, and then check again with the instructions to determine that your work agrees with the book. If this seems like a lot of bother, just try to shoot trouble on a piece of gear where this simple advice hasn't been followed. A great many hours have been spent trying to undo careless moments in kit construction.

Two 6BA8 tubes comprise the transmitter section. The pentode section of the first tube is the oscillator/tripler and the triode half of this tube triples again. The triode section of the second tube doubles to 144 Mc., and the pentode half works straight through as the final amplifier. Power input is approximately 5 watts. The output signal is derived from an 8 mc crystal. Several 8 mc crystals have been used and each one oscillated vigorously. The stability of this little transmitter and its freedom from annoying parasitics can only be due to a fine layout job and the observance of good design practice. No opportunity has been wasted in by-passing any spot that could be potentially troublesome.

Each successive stage quickly and easily tunes to its required harmonic, and the final amplifier,



when tuned to resonance, nearly blows the #47 pilot lamp used as a dummy load during the initial tune up operation. A grid-dip meter is particularly useful during this period as an aid to approximating the settings of the various slugs. However, plenty of instructions are supplied to permit the beginner to do this job without such equipment.

Receiver

A 6BS8 double triode functions as the r.f. amplifier and superregenerative detector. As in the transmitter, by-passing and filtering provide a unit that meets every requirement of v.h.f. design. The detector regenerates smoothly over the entire band, and once the regeneration control on the rear apron is adjusted it may be forgotten. Considerable pains have been taken to eliminate some of the more trying problems associated with this type of detector. The output circuit of the r.f. amplifier is impedance coupled to the cathode circuit of the superregenerative detector, effectively eliminating the "suck-out" condition which can occur when a tuned circuit is not properly isolated from the detector. The r.f. amplifier also isolates the antenna from the oscillating detector, reducing, to a negligible level, re-radiation from the detector. Three microvolts input will almost completely quiet the receiver, and usable signals may be derived from only 1/2 microvolt.

Audio Section

A 12AX7 and a 6AQ5 comprise the audio section which is nearly identical to the circuits used in the "Sixer" and "Tener." One half of the 12AX7 functions as the audio driver to drive the 6AQ5 audio output stage. In the transmit position, the first half of the 12AX7 is called into play as a microphone pre-amplifier to drive the second half as the audio driver. The 6AQ5 then becomes the modulator.

Power Supply

The internal power supply provides approximately 260 volts at 45 ma during receive, and 90 ma during transmit. Silicon diodes perform



CQ Reviews:

The Auto-Mate Keyer

IT ISN'T very difficult in these technically sophisticated days to get the feeling that there has been a general neglect of the basic mode of operation for which we are all licensed. If there ever was an item that promised to get more hams back on c.w., the electronic keyer is it. Recently, your reviewer had an opportunity to build and operate the K 5/50 keyer kit marketed by Ben Woodruff, 6140 North Harding Avenue, Chicago 45, Illinois. Ever have a tiger by the tail? If you've never used such a keyer before, that's exactly what it feels like. We have the impression too that it might be even easier to acquire a mastery of this device without previous semi-automatic key experience. At least you have nothing to unlearn. However, our experience with the unit demonstrated that only a few evenings, at most, are required to produce a level of proficiency only slightly lower in speed than with the customary bug. Within a week, the previous level of speed with the old bug had been passed. What was even more surprising though, receiving speed had climbed as well.

While not new in essential circuit details, there

the job of rectification when the unit is operated from 117 volts a.c. The power connector on the rear chassis permits the "Twoer" to be operated from any power supply capable of providing the voltages and currents indicated above. The filaments may be operated from either 6 or 12 volt systems, depending upon which power cable is used.

On The Air

As soon as the power supply had been checked for possible shorts, no time was lost in getting the rig "fired-up." Like most amateurs, your reviewer couldn't wait to connect a suitable fitting to the regular 2 meter antenna. A quick estimate

have been a few contributions made by the manufacturer. He readily admits that the circuit has been around for a few years. Long enough to be widely tested and built from scratch by any number of amateurs. Ben's contributions have been to add a dual range control thereby making the unit valuable to the Novice as well as to the Old Timer, and a "hold" feature that corresponds to the blocking-lever function of a conventional key or bug.

The K 5/50 comes complete except for tubes and two neon lamps and is 5½" high, 4⅛" wide and 8½" deep. It may be purchased without the mercury relay if you already possess any of these Western Electric relays (D-168479, D-171584, or GA-50143). If not, there is only a very small difference in the price of the kit, with or without the relay.

The tubes and neon lamps that are required and not supplied are 4-5963's, 1-0A2, 1-0B2, 1-NE-51, and 1-NE-2. Though 5963's are preferred, 12AU7's may be used. The 5963 is a computer type tube that is designed for long periods of operation under cut-off conditions. The essentially ON-OFF, computer type operation of this keyer is just the kind of application for which the 5963 was intended. It generally may be expected to give better service than the 12AU7.

Construction

To facilitate construction, all tube sockets and terminal strips are already installed and riveted
[Continued on page 106]

of 19 inches was made and the first handy piece of hook-up wire was pressed into service as a quarter wave antenna mounted directly on the rear apron. With power on, a station about 9 miles away was heard as soon as the receiver came to life. He was just finishing a CQ. A "Three by Three," and back he came. Somehow, your reviewer managed to retain his precariously balanced position. This from a poorer than average v.h.f. location, too. Since then, many contacts have been made with a variety of antennas, and S9 reports from 20 miles away have become commonplace. For high-fun power, and a very respectable introduction to 2 meters, the "Twoer" has a great deal to offer. ■

AMATEUR RADIO LEGAL NOTES

Maurice J. Hindin, W6EUV

6505 Wilshire Blvd.
Los Angeles 48, Calif.

From time to time, AMATEUR LEGAL NOTES has reported cases in which cities, counties, and other political subdivisions of a state have attempted to impose restrictions upon amateur radio. A new and different threat has reared its menacing head. That is the deed restriction or restrictive covenant directly affecting real property or its use.

While this latest attack on free use of radio equipment may affect only a relatively small number of the licensed amateur radio operators, it is of sufficient importance, we think, to alert the amateur radio fraternity as a whole. Specifically, any amateur operator who is contemplating the purchase of a new home or contemplating the leasing of a new home or, in fact, contemplating any move, can avoid the pitfalls of the so-called "deed restriction" against amateur radio. This pitfall, however, can be avoided only if the amateur is aware that such a danger exists and is alerted to rule out its presence. A number of amateurs who have recently purchased new homes have been made sharply aware of the potential danger and, in some instances, have become involved in extensive litigation to avoid the consequences of the so-called "deed restriction."

The Problem

When a person buys a piece of real property, title or ownership to the property is transferred to him by a legal instrument known as a deed. The deed transfers ownership of the land, but the deed is given subject to existing covenants, conditions, and restrictions of record. Covenants, conditions, and restrictions of record mean that at some time prior to the immediate purchase of the land, previous owners entered into an agreement whereby they agreed that the land would never be used in a particular way or for particular purposes. Typical of these deed restrictions or covenants running with the land are restrictions that the property may never be used except as a single dwelling house or that no commercial business will ever be conducted on the premises, or that no building will ever be constructed with less than a given number of square feet, or that no fences will ever be constructed higher than a specified height, or that these premises will never be occupied by persons of a particular race or color.

These restrictions or covenants running with the land are treated by the courts as a binding contract between the original owner and each subsequent owner of the property. The deed restrictions may be enforced, with certain exceptions, by the courts. If a person buys a piece of

property with a deeded restriction of record, and he violates the deeded restriction, at least three legal actions may be taken against him. They are: (1) An injunction can be sought through the courts by either the original owner or a prior owner or other neighbors to enjoin or prevent him from violating the restrictive covenant; (2) An injunction can be sought through the courts to require him to abate or remove the thing which represents the breach of the restrictive covenant; or (3) An action may be maintained to declare a forfeiture of the property, thereby causing the title to revert to the original owner.

It can be readily seen, therefore, that a person who buys a piece of property may inadvertently find himself involved in litigation which could jeopardize his investment, as well as preventing him from making a particular use of the property. The danger arises because the average purchaser of real property has never informed himself of the actual existing restrictions, covenants, and conditions affecting his land. They do not normally ever appear in a deed and, likewise, they are generally of no concern to a lending institution which may finance the purchase of the property. A person may readily buy a piece of property and never be aware that the property is subject to any particular restrictions as to its use.

Within the last six or seven years, a number of amateurs have been suddenly confronted with the problem of a deed restriction actually prohibiting their use of the land for an amateur radio station, or imposing such additional restrictions as to make it virtually impossible for them to operate an amateur radio station without being in violation of a deed restriction.

Amateurs so affected have, in many instances, been confronted with deed restrictions or restrictive covenants which: (1) Expressly prohibit the operation of an amateur radio station on the property. (2) Prohibit the use of the property for an amateur radio station unless and until an association of land owners approves the use and design of such equipment. (3) Prohibit the erection of any radio transmitting or receiving antennas unless the design of the antenna is approved by the board. (4) Restrict the height of an antenna to a specified height, very often twenty or thirty feet. (5) Require in addition to a Federal Communications Commission license, a permit from the land owners association board or other specified group.

The experience of many amateurs has been that wherever permission to operate an amateur radio station is required, all types of unreasonable restrictions have been imposed by the various boards or property owners' committees.

While the stated purpose of the restrictive covenants is to preserve the property values and integrity of the community, the actual purpose is to prevent amateur radio operators from operating in those districts.

The Prevention

The existence of restrictive covenants presents certain legal problems which are unique and extremely difficult to correct. While restrictions on amateur radio activities, which are imposed by cities, counties, or other political subdivisions of a state, are to be tested by the courts primarily with reference to their relation to interstate commerce, no such safeguard exists with reference to restrictive covenants. A restrictive covenant is, in effect, a private contract between the owner of the property and former owners. If a person, by contract, agrees to forego his right to participate in amateur radio activity, that, in effect, is a matter of private contract, and it is quite different from the situation where a city or county imposes against his will a restriction against his participation in his hobby. The legal problems, therefore, attendant to a restrictive covenant which prohibits amateur radio activity or imposes excessive burdens on it, become an extremely difficult problem. It would, therefore, seem that prevention of the problem is to be desired rather than attempting a cure. Prevention is not only the smart thing to do, but it is likewise the economical thing to do. Several specific suggestions with reference to the pre-

vention of entanglements with restrictive covenants might be helpful.

If you plan to buy a home or move to a new location, take the following steps: (1) Before you purchase a new home or property upon which you plan to build a new home, secure from either the person selling you the property or from the County Recorder where the land is purchased, a complete set of the covenants, conditions, and restrictions affecting the property of record. (2) Read the conditions, covenants and restrictions carefully, and if there is anything in the restrictions which refers to height limits of structures, use of the property, whether or not it directly mentions amateur radio, discuss the meaning of the restrictions with either an attorney or a representative of a title company, or someone well versed in the technical meaning of the covenants, conditions, and restrictions. (3) If there is any doubt as to whether or not the restrictions could be reasonably construed as preventing the erection of an adequate antenna or the use of the property for amateur radio use, do not buy the property unless you are willing to take the risk of litigation. The old adage "An ounce of prevention is worth a pound of cure" is equally true with reference to this practical problem.

In a subsequent issue, Amateur Legal Notes will discuss what can be done if you have already purchased a home where there is a deed restriction or a covenant limiting or affecting your right to use your property for an amateur radio station. ■

French Amateurs Honor W6QLV

The French Radio Amateur Society, the R.E.F. (Réseau des Emetteurs Français) awarded the Bronze Medal of Merit to *CQ*'s "Mr. HAM CLINIC," Charles J. "Chuck" Schauers, W6QLV, ex-F7FE prior to his departure for the United States.

At a surprise gathering, Chuck was presented the medal and certificate at his home by Dr. Jacques Simonnet, F9DW, an R.E.F. Council Member and Treasurer of the I.A.R.U. (International Amateur Radio Union). Witnessing the presentation were F3VH, Dr. Sayac; F8RB, present head of the 21st R.E.F. section to which Chuck belongs and F8IW, past president of the section. Also on hand was the sous-préfet (Lt. Governor) of the area, Mr. Krieger.

The first American to receive the award, Chuck was told that his efforts to tighten the bonds of

Franco-American amateur friendship by his active participation in all of the R.E.F.'s activities (including publication of his writing in the official organ *Radio REF* in the French Language); helping amateurs the world-over with their technical problems and internationally creating goodwill and a better understanding of amateur radio were considered in making this rare presentation.

We at *CQ* and hamdom-at-large congratulate Chuck and extend our hand of friendship to the R.E.F. and all French amateurs.

Chuck is now in transit from his French assignment to somewhere in the United States where he will be permanently assigned. We ask those who have written to Chuck in con-

nection with *HAM CLINIC* to be patient, as he will answer correspondence as soon as possible.



DX DX DX DX DX DX DX DX

URBAN LE JEUNE, JR., W2DEC

BOX 35, HAZLET, NEW JERSEY

The following certificates were issued between the period from December 12th, 1960 to and including January 12th, 1961:

WAZ

1472	W6KZL	Glen C. Tillack
1473	DL9KP	Paul Kleinholz
1474	K#PEF	L. W. Robson
1475	UA3KND	Vlad Uirgorodsky
1476	ZL1AV	Dave Tremayne
1477	ZL4CK	William F. Self
1478	OH3OD	T. Lujanen
1479	DL9EH	Alfred Pichetta
1480	G3LET	Peter A. Hobbs
1481	G3AGN	C. J. Curtis
1482	DL1IN	Hansbeinrich Heider
1483	JA6NW	Kano Kamijo
1484	K2PFC	Duane H. Harris
1485	W1CKU	Charles J. Burton
1486	W9ZRG	O. M. Arnold

CW WPX

151	SM7CNA	Yngve Tröjer
152	PA#ZL	J. Smit
153	W3GAU	Joseph L. Gillson
154	K2QXG	Lauren L. McMaster
155	W1HGT	Ralph Green
156	W4DKP	William H. Aycock
157	W8ONA	Theodore C. Groat
158	W2KIR	Alex Ekblad
159	W2DEC	Urban A. LeJeune

PHONE WPX

23	SP7HX	Roman Izykowski
----	-------	-----------------

SSB WPX

46	PZ1AX	H. W. Green
47	W5PQA	H. W. Meredith, M.D.

BAND ENDORSEMENTS

14 Mc.	VE3HB
PA#ZL	W6NWI
W4DKP	W2DEC

CONTINENT ENDORSEMENTS

EUROPE	K2PFC
W2GVZ	DL3RK

Letters

Received the following letter and picture from Brian, 5N2ATU:—"From January 1st, 1961, we will all be 5N2, *not* ZD2, and I will continue as active as I have managed to do so far this year.

"I do a fair amount of c.w. work (20, 15 and 10) with occasional trips to 40 c.w., though this means too much midnight oil burning, hi! I am also on fone but no s.s.b. as yet. That will have

to wait for my next trip home to U. K. about the end of 1961.

"Also thought you might be amused by enclosed photo of Angus (5N2AMS) on left and I (5N2ATU) on the right, with the QRM Devil himself. Angus in on U. K. vacation at the moment.

"Last year I was 9G1BM and it seems a lot of my QSL's from there went astray. I am having some extra 9G1 cards printed and hope to catch up on all those who did not get one from me there.

"Finally, a plea for W7 activity—I'm sure those W7 boys just don't realize how comparatively rare they are for DX, so please, for QSL's work both ways!

"Enjoyed the few hours I spent in the c.w. end of the WWDX contest but it sure brings out the beast in some of the boys."

Brian's QTH is P. O. Box 38, Jos Northern Nigeria.

W3AYD, who won last year's VP9 contest relates his experience during his week trip to Bermuda, which was the first prize in the contest.

"Had a wonderful week in VP9 land—really received the 'red carpet' treatment. Visited VP-9AZ/BN/DC/DL/EI/FR/G/L shacks. There was a cocktail party meeting of the Radio Society of Bermuda, appeared on a local TV station as co-guest with VP9G, president of the Society. We answered questions put to us by a beautiful red-head MC, and you can bet the answers were designed to boost ham radio there. It was my first experience before the TV cameras. No, the mike didn't bother me, but those lights sure were hot and glaring. There must have been an audience, because four strangers stopped me in the streets of Hamilton the next day to say they had seen me on TV yesterday. Besides the antique map award for the highest W/K3, which was advertised, and is it a beauty, I received a

Silent Keys

The DX Fraternity will greatly feel the loss of three prominent members. I am sorry to record the passing of W4FU, W2GVZ, and KP4KD. We would be very hard pressed to name three finer operators and true sportsmen. Their many fine accomplishments will remain with all of us for a long time to come.



Roger, 9U5DM, and his XYL in their Usumbura, Ruanda Urundi QTH. Roger has been very active on 21 mc fone furnishing many of the boys with a new country. (Tnx K9EAB)



From left to right Bob, K2GMO, Vic, WA2DIG, and Gus, W4BPD during a little get together at W2JT's after Gus' return from his recent expedition. (Tnx WA2DIG)

surprise award, a sterling silver cup, matching the one presented to VP9DL, the local winner. By the way, VP9DL's victory was quite an achievement. He runs only 40 or 50 watts input."

Get your rigs ready. The VP9 boys are running the contest again in May.

Bits and Pieces

AC4 Tibet—The following letter from AC4AX was received by W5ASG:

"Have just returned to Lhasa after a vacation in VU land. Please no mail or telegrams to be sent via China or any Chinese Post Office under any circumstances but rather to the following address only—D. S. Seal, WO Consulate General of India, c/o Political Officer in Sikkim, Gangtok, Sikkim, Via Siliguri Calcutta, India. (Tnx WGDXC)

AC5 Bhutan—AC5PN continues to be active on 14 mc c.w. around 1200 to 1300 GMT. He is now using a home-brew 500 watt transmitter. His QTH is Chhawna, Thimphu, Bhutan via Bhutan House Post Office Kalimpong, India.

CR10 Portuguese Timor—W4DPF is now in Darwin, Australia and has been issued the call

VK8 TB. He is with the military and flies around that part of the world quite a bit. He has applied for a CR10 license. He has his KWM-1 with him and a beam on order. (Tnx WGDXC)

ET3 Ethiopia—HB9RS has been licensed as ET3RS and he will join ET3AZ and ET3MA as the only active Ethiopian stations at present. His QTH is M. deHenseler, Box 3001, Addis Ababa, Ethiopia. (Tnx DXer)

UA1 Franz Josef Land—UA1ZEC and UA1ZEA are reported to be licensed and due to start operation shortly. (Tnx WGDXC)

VK2 Lord How Island—Trevor, VK2FR, will be on 14060 kc crystal each Tuesday between 0430 and 0600 GMT. (Monday night in the states) (Tnx WGDXC)

VQ4 Kenya—We were sorry to hear that Leny, VQ4GT of VQ8CB and VQ8AB fame was seriously injured in an automobile accident and is expected to be in the hospital for at least three months. I am sure he would be pleased to hear from his many friends.

VR6 Pitcairn—Tom, VR6TC, has returned to the air and is on every night with the exception of Sundays and Mondays at 0600 GMT around 14170 kc a.m. fone.



Here we have two of the Big Guns from W9 way. Skip, W9YSX, on the left and W9WHM's station, on the right. College homework has been cutting Skip's operating time lately.

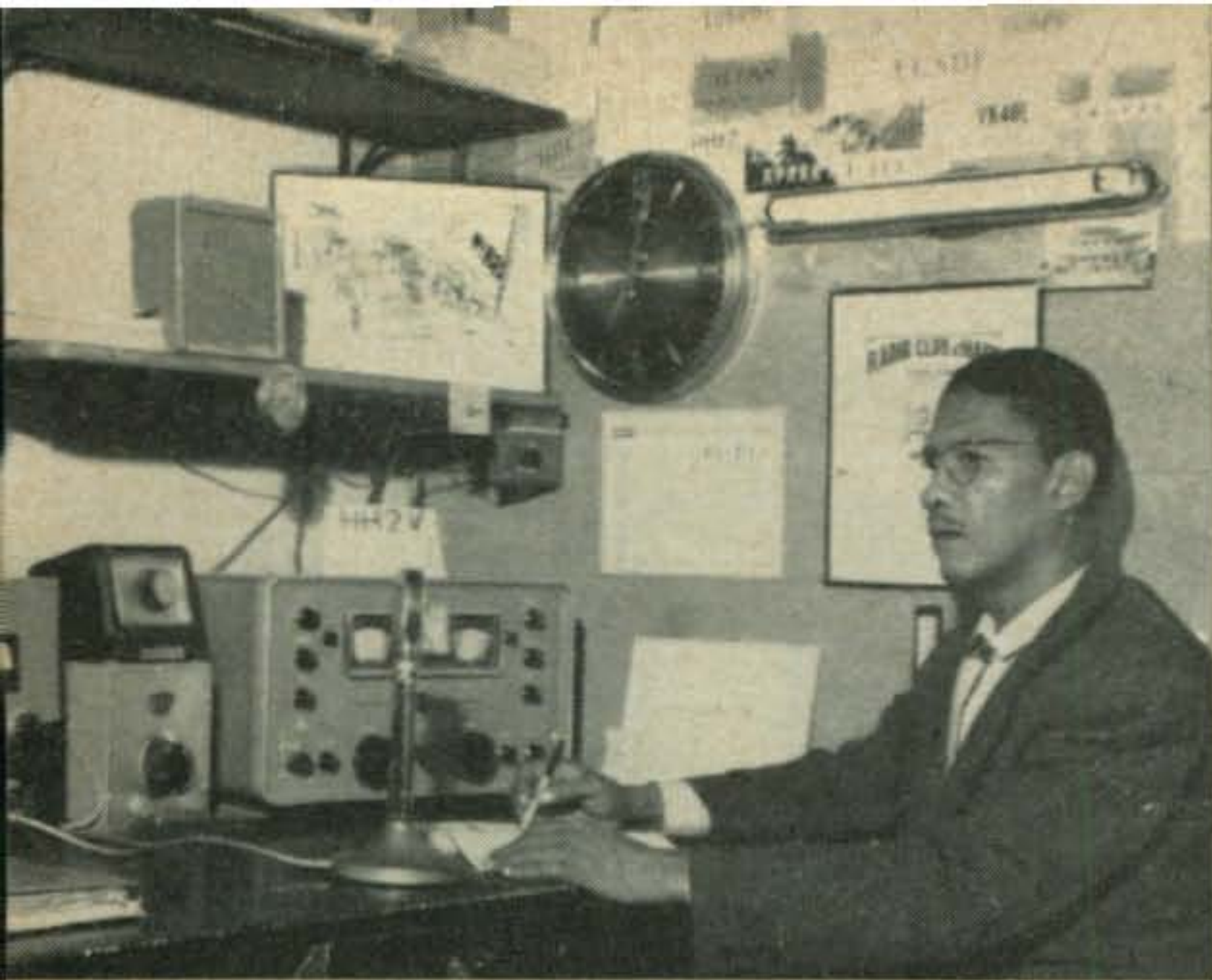

Vic, HH2V, in his attractive shack in Port-au-Prince. When Vic worked W1BB on 160 meters in November, it was the first QSO between the two countries on 160 meters. (Tnx W1BB)



This is where the big signal of KX6BQ emanates. Ralph, K6KQO, is the chief operator there.



The ceremonies commemorating the inauguration of DU1BSP the official station of the Boy Scouts of the Philippines. Shown from left to right Rear Admiral Arthur F. Springs, Commander of the U.S. Naval Station at Subic Bay; DU1MPH, DU1RTI and DU1CV. (Tnx DU1RTI)

ZD7 St. Helena—John, VP7BT/W6MHB, (see last month's column) has moved to ZD7 land with hopes that he may get a ticket from there. (Tnx DXer)

ZD9 Gough Island—The following information from Mac, K2QXG, is self explanatory. "In QSO with Marge, ZS1RM, she asked me to get word to all possible, relative to working ZD9AM on Gough Island. He will be there six months and very active. Boys been complaining he only works African and Europe boys. Reason is W/K calling on freq while he is in QSO.

"For W/K wanting this country—Tuesday & Thursday, look for him 14,018 from 1900 or 1930 GMT to 2000. Those days Marge probably will be MCing. When she is QRX for calls, call Marge but only call *twice*—No long calls. She will pick the W/K and give his call to ZD9AM who will call the W/K on her freq. Acknowledge with RST, State and name ONLY. He will then give you a report and go back to Marge who will give next one to be called.

"If the W/K tail end him or break while he is in QSO he will *lower the boom* on W/K and not work them. If Marge is *not* MCing, call him 3 or 4 kc UP. *not* on his freq. He is very weak, around 449."

Although the sked has been set for Tuesday and Thursday, they have also been heard on other days at the same time and frequency.

ZS2 Marion Island—ZS2MI has been active on 14,170 kc a.m. fone on Fridays, starting at 2000 GMT with ZS6ANE acting as MC.

ZS7 Swaziland—Colan, ZS7L, is looking for Idaho, Wyoming, Utah and North Dakota to complete his WAS. He prefers 10 meter a.m. fone. (Tnx WGDXC)

5A Libya—Andy Goodwin, ex MP4DAA has been issued the call 5A3CAA. He is presently using 5A3TQ's rig while the latter is on vacation in the U. K. Andy will be on s.s.b. very shortly. His QTH is P. O. Box 263, Benghazi, Libya. (Tnx DXer)

K6BX and Telrex are co-sponsoring a world wide contest that will run throughout 1961. The first prize, in addition to a certificate, will be a TM-30 six element tri-band beam. Drop K6BX a s.a.s.e. at Box 385, Bonita, California for the full details.

160 Meters

ZC4AK/Cyprus/Steve—Writes that he is still getting into G land regularly. Best signal he hears is G2PU. Recently put up 5/8 wave 335' antenna held by 3 balloons but was disappointed w/results—Steve is on watch for W/VEs especially and is willing to sked any experienced 160 meter DXer. Write him. He operates not from his own call sign but from R.A.F. Akrotiri, Amateur Radio Club, and is the only member interested in 160.

WNA-160 Award Certificate—W1BB has had the privilege of seeing one of these in the flesh, and wishes to say that it is an extremely excellent job—well done on parchment by Dick Caruthers, K7HDB and the "South Shore MF Society"—Something you 160 meter boys will really love. Write Dick for further information.

W5SOT/Charles has been putting out a v.f.b.

signal as usual and is very active again this year having worked a fine string of Ws already—says signal peak for 30 minutes at sundown or an hour before. KH6DVD comes in v.f.b. at 0800 GMT for 10 to 30 minutes. Charles works in Materials Testing for Nuclear Engines at famous Los Alamos Nuclear Labs with 160 meter DX for relaxation. W7LNG "Bud" sends another v.f.b. "recording" of his QSO with KH6DVD—thus seeing to it that the East Coast really knows what the West Coast sounds like—must say the signals and background noise seem about the same, but thrilling to hear KH6DVD—wish it were "The real McCoy" on the airwaves on the East Coast. . . . W0CDP-Bing of LaJunta Colorado says Alex, VP9EP, will be on this year. (Tnx to W1BB for 160 info)

Certificates

The SP-DX Club will award an attractive certificate attesting honorary membership to any licensed amateur (other than SP) having two-way communication with fifteen (for European operators) or ten (for DX) or more regular SP-DXC members. NØ QSL need be submitted but listed contacts shall have been confirmed by QSL and verified by SP-DXC and shall have been made after October 1st, 1959.

Applicants for this certificate should submit their lists and ten IRC to the SP-DX Club, The Secretary, Post Office Box 424, Lodz 1, Poland.

Some SPDXC members are: SP2AP, 2BE, 2LV, 3PL, 5GX, 5HS, 6BZ, 6FZ, 7HX, 8AG, 8CK, 8CP, 8EV, 8HR, 9DT, 9EU, 9RF, SP6-AAT, AP8MJ, SP8HU, SP 7 AZ, SP9TA. (Tnx SP2AP)

OH-Award

In order to develop co-operation and friendship between foreign and Finnish Radio Amateurs, Suomen Radioamatöörilitto, SRAL, has decided to publish the OH-Award. Here are the rules:

1. The OH-Award is available to licensed amateurs all over the world.

2. All contacts with Finnish amateur stations (except as par. 4) made after June 10, 1947 will count for the Award.

3. a. The applicants in LA, OZ AND SM will have to produce evidence of contacts with at least 50 different OH stations including at least 8 OH call areas on one band plus 8 different OH call areas together on other band(s).

3. b. The European applicants (except as in 3 a.) will have to produce evidence of contacts with at least 20 different OH stations including at least seven OH call areas. Maximum QSO number per band is 15 so at least two bands must be used.

3. c. Non-European (DX) applicants will have to produce evidence of contacts with at least 15 different OH stations including at least 5 OH call areas. The contacts may be made on one band but 3,5, mc QSO's will count as two contacts on other bands.

4. C.w. or phone or both mixed are allowed. The minimum reports are RST 338 and RS (M) 33 (M). Contacts with Finnish Marine-Mobile stations will not count.

5. Applications and a list of the stations will be sent to the OHA-Manager, Post Box 306, Helsinki, Finland. It is requested that a fee of 5 International Reply Coupons be enclosed to cover the postages. Decisions of the OH Award Committee will be final and definite.

footnote: The stations: OH8, ND, NJ, NS,



Duane, K2PFC, in the process of working a new one. (Tnx K2UKQ)



5N2AMS, Angus, and Brian, 5N2ATU, with QRM devil himself between them. (Tnx 5N2ATU)



Mario, YU2IU, was the operator at YU7LAA in the U.S. pavilion at the International Trade Fair in Zagreb, Yugoslavia. (Tnx K9EAB)

NV, NX, OA, OB, OC, OG, OI, ON, OP, OQ, OR, OU, OX, OZ, PA, PB, PD, PF, PL, PM AND PQ are counted as OH9 stations if contacted before June 1st, 1954. (Tnx K9IAP)

Rules for W.A.G.I. Certificate

This certificate is issued by the *Gee Eye Magazine* to promote contacts with Northern Ireland Amateurs. The rules are as follows:-

1. Stations outside Europe to submit Five cards in all—One from Co. Antrim, Co. Armagh, Co. Derry, Co. Down and One from either Co. Tyrone or Co. Fermanagh.

2. European stations to submit ten cards in all—Two from each of the above areas.

3. Belfast is divided by the River Lagan into Counties Down and Antrim.

4. Operation may be on any band and/or any mode of transmission.

5. Certificates will be endorsed for one band and/or one mode of transmission. Unendorsed certificates will indicate mixed operation.

6. Cards are valid for contacts made on or after 1st January, 1959.

7. The cost which must be included with each application is 5/-, one dollar or 10 IRC's.

8. All applications and inquiries to be addressed to the Certificate Manager, Stan Orr, GI3KVQ, 63 Union Place, Dungannon, Co. Tyrone, N. Ireland. (Tnx GI3KVQ)

Requirements for Okinawa A.R.C. Award

This award is given for having made contacts with amateur radio stations located on Okinawa by either phone (A3) or c.w. (A1) or combination thereof. The certificate will be endorsed accordingly. The number of contacts required is determined by the zone in which you are located as indicated below. QSL cards need not be sent in to obtain this award. An extract of your log showing date, time, call sign and mode of operation, which has been certified by one of your radio club official, will be acceptable.

25 contacts required from zones 24, 25 and 27.

10 contacts required from zones 1, 3, 4, 5, 10, 11, 12, 13, 14, 15, 16, 17, 18, 19, 20, 21, 22, 23, 26, 28, 29, 30, 31, 32, 37, 38, 39 and 36 south of the equator.

5 contacts required from zones 2, 6, 7, 8, 9, 33, 34, 35, 40 and 36 north of the equator.

5 contacts required from any zone for the following only:

- Two-way single side bands;
- Above 50 mc;
- Mobile to KR6 fixed station;
- Fixed station to KR6 mobile; or K36 portable;
- Mobile to KR6 mobile.

QTH's and QSL Managers

K1DRN is very sorry but he will not be able to act as QSL manager for FM7WQ. After much effort and time Vernon has received only one brief log sheet from FM7WQ.

AP2Q Box 65 Lahor, Dest
Pakistan
CN8MB David Minton
Navy 214 Box 16 c/o
Fleet Post Office, N.Y.,
N.Y.
CN90K Box 124 Tetuan
Morroco
CR9AH via W7ZAS
DL4BM Merle Anclair 181
USAS Co. APO 108
N.Y., N.Y.
EA8BA via W4MXL
EP2AF c/o American
Embassy APO 205 N.Y.,
N.Y. or American
Embassy, Tehran, Iran
FF8BF Charles Tenot Box
971 Dakar Senegal,
W. Africa
FF8CW via W2VCZ
FK8AS Achille Poulet
Aerodrome de Tontouta,
New Caledonia
FQ8AW Box 298
Brazzaville, Rep
de Congo
FQ8HO via K6EC
FQ8HP Box 41
Brazzaville, Rep
de Congo
FY7YI via W3AYD
JT1KAB Box 639 Ulan
Bator M.P.R.
K6OQV/KS Box 11 Pago
Pago
K#SLD/KW6 box 68
Wake Is.
KA5MC MARS Radio
Station, Special
Services 1st MAW c/o
FPO San Francisco,
Calif.
OR4TX via ON4 Bureau
OR4TZ via ON4 Bureau
PY7LJ Alvaro C.
Pimental, CIA Guardas,
Fernando de Noronha
Island Brazil
PZ1AX via W2CTN
SM5BUG/9Q5 via SSA
SV#WR Larry Mennitt,
USCGC Courier WAGR
410, FPO, New York,
N.Y.

SSV#WZ Via W7FTU
UO5PK George A.
Pozernir, Tiraspol,
Moldavia
VK8GU Henry Meyer,
W1MFI, c/o Pickard &
Burns, Inc., 240
Highland Ave.,
Needham 94, ass.
VP2DU via W3AYD
ex-VP2LU, VP5FP, FM
Perkins, PAA/ROA
Grand Turk, Patrick
AFB, Fla.
VP2VH via W2YTH
VP5AB via W3AYD
VP6WD via W4OPM
VP7NT c/o PAA/GE, San
Salvador, AAFB, c/o
Patrick AFB, Fla.
VP9QQ Box 275,
Hamilton, Bermuda
VQ2AB via W6ZAF
VQ4RF via W4MCM
VQ9A via W4TO
VR3L Christmas Is. Radio
Club, British Forces
Post Office Box 170,
c/o Postmaster,
Honolulu, Hawaii
VS1GZ via W4YWX
VS9AAC via W3KVQ
VS9OC
via RSGB or ISWL
VU2JA via W4YWX
YS1MM Box 1561 San
Salvador
ZB1HC via W4MS
ZD9AM via W2CTN
ZS5KB 801 Umgeni Road,
Durban, South Africa
ZS1RM/8 via K2QXG
3V8CA via W4YWX
5N2ATU Box 38, Jos
North Nigeria
6O1MT Box 397,
Mogadiscio
9G1BQ via W2CTN
9Q5EH Box 2124
Elizabethville,
Kantanage The Congo
9Q5YM via W8TMA
9U5MC Box 78, Kigali,
Ruanda Urundi
9U5PD Box 110 Astrida,
Ruanda Urundi
73, Urb, W2DEC

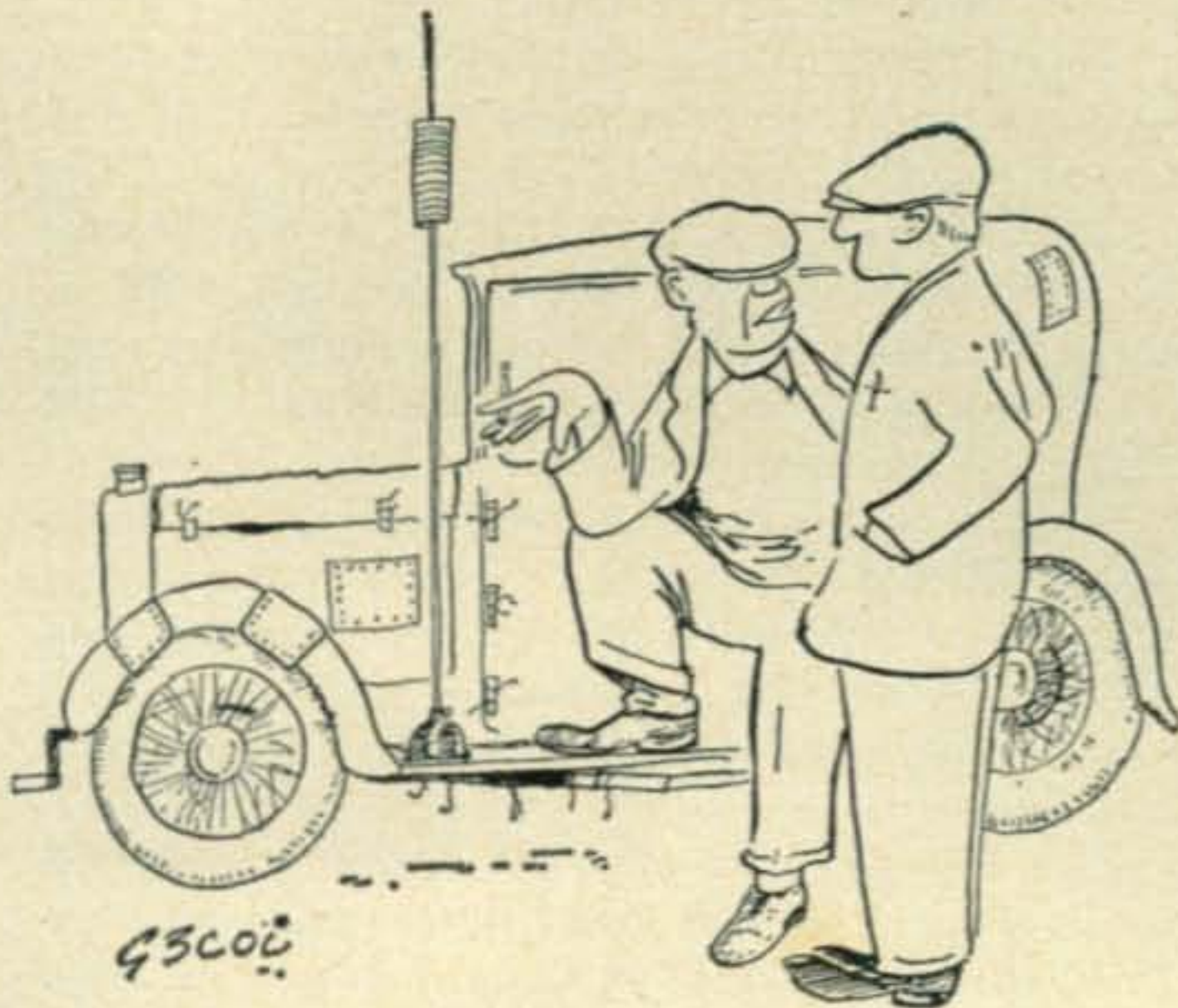

"I would have put it on the roof but it would spoil the resale value of the car."

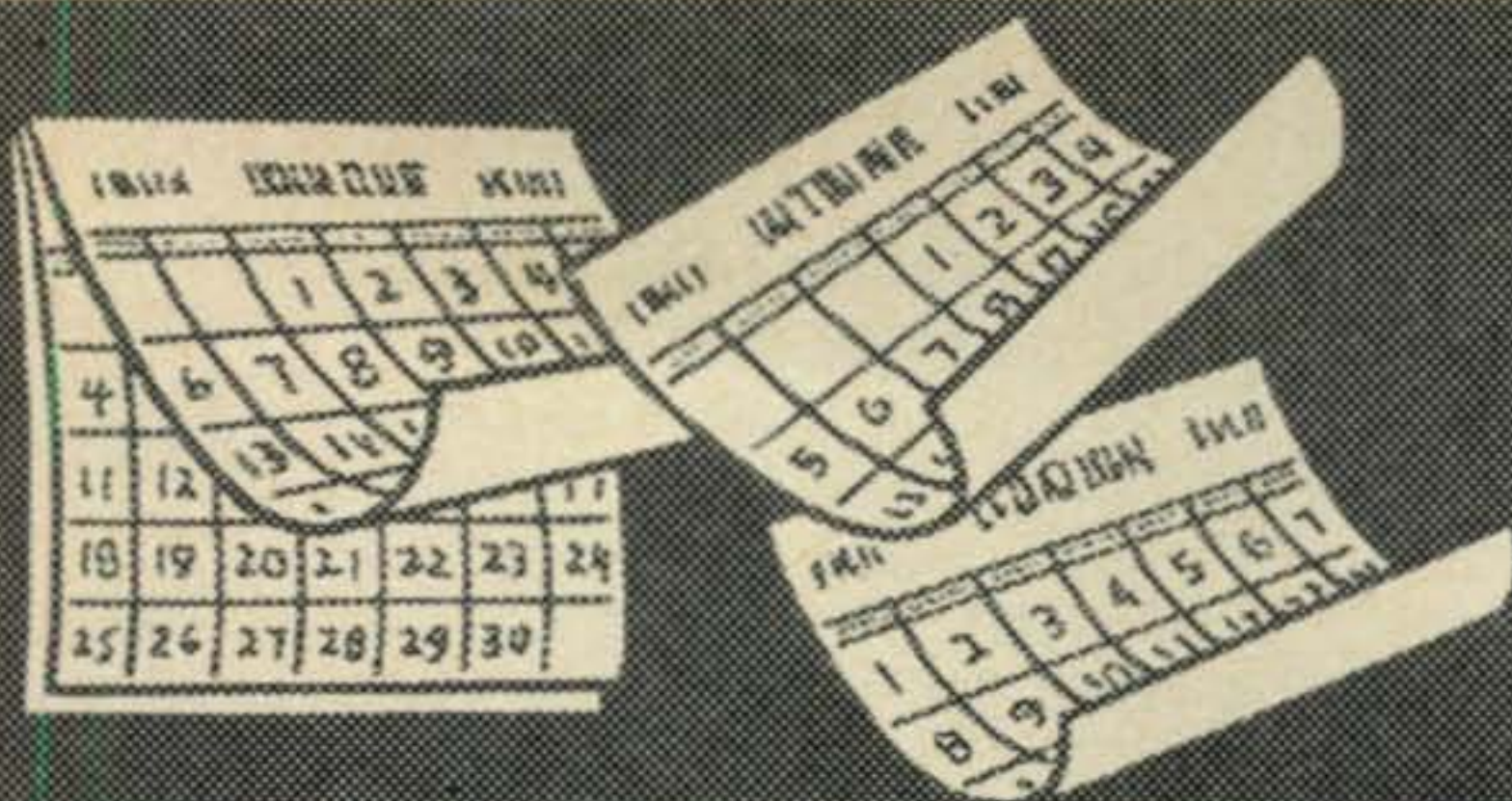

CONTEST CALENDAR

by Frank Anzalone, WIWY

14 Sherwood Road, Stamford, Conn.

CALENDAR OF EVENTS

March 3—5	ARRL DX Phone
March 11—12	BERU
March 11—12	YL/OM C.W.
March 17—19	ARRL DX C.W.
April 12—13	YL V.H.F.
April 15—16	REF Phone
April 15—16	Helvetia 22
April 29—30	PACC C.W.
May 6—7	PACC Phone

ARRL DX Phone

Starts: 2400 GMT Friday, March 3rd.
Ends: 2400 GMT Sunday, March 5th.

C.W.

Starts: 2400 GMT Friday, March 17th.
Ends: 2400 GMT Sunday, March 19th.

The first section of this two month marathon is already history. If you didn't make hay last month you might try catching up this month. Don't send your logs to us, we would only have to forward them to West Hartford.

BERU

This contest is for resident of the British Empire, so unless you are eligible don't go answering that juicy MP4 or VQ8 when he calls CQ BERU. You might end up in the "Dog House."

YLRL YL/OM CW

Starts: 1300 EST Saturday, March 11th.
Ends: 2400 EST Sunday, March 12th.

Louisa Sando covered this one in her YL Column last month so check it for details.

YL V.H.F.

Starts: 1200 EST Wednesday, April 12th.
Ends: 2400 EST Thursday, April 13th.

This is a new contest for YL (and ex-YLs) only. Being a middle of the week affair the OM would not be able to participate anyway, he's

out bringing home the bacon.

Louisa, W5RZJ will carry the rules in her YL COLUMN this issue.

REF Phone

Starts: 1400 GMT Saturday, April 15th.
Ends: 2200 GMT Sunday, April 16th.

Rules were covered in last month's CALENDAR. They are quite simple, the usual progressive serial number, each contact counts one point. The multiplier is also one point for each French Department or country (DUF list) worked on each band. i.e. F8DU/78, FA, FB and etc. Your final score of course will be the total QSO points times the total multiplier on all bands.

Your logs go to the R.E.F. Contest Committee, Boite Postale 42-01, Paris RP, France.

Helvetia 22

Starts: 1500 GMT Saturday, April 15th.
Ends: 1700 GMT Sunday, April 16th.

The date for this year's contest has been made later than in past years to avoid it falling on Easter Sunday.

The object of the contest of course is to work as many stations as possible in each of the 22 Swiss Cantons.

1. Use all bands, 3.5 thru 29.7 mc, c.w./c.w. or phone/phone.

2. Serial numbers will be the usual five or six digit variety, signal report plus a progressive 3 figure contact report.

3. Each contact counts 3 points and the same station can be worked twice on each band, once on c.w. and again on phone.

4. The multiplier is the sum of Swiss Cantons worked on each band, c.w. plus phone, making a possible multiplier of 44.

5. Your final score therefore will be the sum of QSO points on all bands, multiplied by the number of Cantons worked on each band.

6. Use a separate log sheet for each band and only one side of the paper.

7. Certificates will be given to the two highest scorers in each country. Each district in the

United States and Canada will be considered as a separate country.

8. Your logs must be postmarked no later than April 31st and should be sent to: The USKA Contest Committee, Knutwil/LU, Switzerland.

Zurich	ZH	Scaffhouse	SH
Berne	BE	Appencell	AR
Lucerne	LU	St. Gall	SG
Uri	UR	Argovie	AG
Schwyz	SZ	Thurgovie	TG
Unterwald	NW	Tessin	TI
Glaris	GL	Vaud	VD
Zoug	ZG	Valais	VS
Fribourg	FR	Neuchatel	NE
Soleure	SO	Geneva	GE
Basle	BS	Girsson	GR

Names and abbreviations of Cantons

**P A C C
C.W.**

Starts: 1200 GMT Saturday, April 29th.
Ends: 2000 GMT Sunday, April 30th.

Phone

Starts: 1200 GMT Saturday, May 6th.
Ends: 2000 GMT Sunday, May 7th.

This is the 6th Annual PACC Contest held by the VERON, in which the outside world is invited to work as many PA stations as possible during the contest period.

1. Activity on all bands, 3.5 thru 28 mc.
2. Usual five and six digit serial number, RS or RST report plus a progressive QSO number starting with 001.
3. Three points per QSO, and each station can be worked once on each band.
4. The multiplier is determined by the number of provinces worked on each band.
5. The final score therefore will be the sum of QSO points times the number of provinces worked on each band.
6. Certificates will be awarded to the highest scorer in each country. In the case of CE, PY, VE/VO, W/K, ZL and ZS each district will receive an award.

7. The PA stations will identify their provinces by two letters after their number. The provinces, eleven in all are:

FR	Friesland	UT	Utrecht
GR	Groningen	LB	Limburg
DR	Drente	NH	Noord-Holland
NB	Noord-Brabant	ZH	Zuid-Holland
OV	Overijssel	ZL	Zeeland
GD	Gelderland		

Contest contacts can also be applied toward the PACC Certificate which requires proof of having worked 100 different PA stations.

Mail your logs no later than June 15, 1961 to: P.v.d.Berg, Contest Manager, Keizerstraat 54, Gouda, Netherlands.

That's about it for this month. I'll have a

preliminary report on our own contest next month.

73 for now, Frank, W1WY

**Results 1960 REF Contest
C.W.**

USA Entries and Winners

W1WY	201	K4HPR	36
W1AQE	189	K1DRX	24
WA2DGG	150	K2YAZ	24
W4HQN	129	W2CVW	21
W8AYS	90	W5LCF	15
W8RQ	87	W5KC	12
K9GVE	84	W8KC	12
K4TFL	60	W1NLM	9
W8TQY	60	W6BIL	9
W0MCX	51	W3YHR	3
W7PQE	42		

European Winners

UB5WF	363	UC2KAA	172
DM2ABL	306	UN1KAA	99
HB9DX	278	SM3VE	84
UR2KAE	249	TF3AB	84
SP6FZ	240	OH2FS	51
UA1KAQ	213	HA8KCU	45
OK1RX	204	PA0WAC	45
YU1SF	204	OZ4RT	21
G3EYN	174	YO3AC	18
UP2AC	174		

All Other Countries

VE1FK	90	XE1PG	48
VE1AE	75	VE1DB	42
PY4AO	57	VE2AFC	30

Phone

Winners—All Countries

OQ5VH	920	SM5BPJ	138
OQ0PD	840	HA5DG	126
I1FMC	480	HB9DX	90
4X4FZ	402	LA5IG	81
EA7JT	222	DM3FE	66
SP5XM	218	G3NAC	39
CT1KF	210	GW3LAD	24
PA0NN	162	VQ8BA	12
YU1SF	153		



"Should I put out the carbon or crystal mike M'lord?"

PROPAGATION

George Jacobs, W3ASK
11307 Clara St., Silver Spring, Md.



LAST MINUTE FORECAST

The forecast indices for the month of March, shown in the Propagation Charts following the predicted times of openings, are expected to be related to day-to-day propagation conditions in the following manner:

Forecast Indices	Above Normal	Normal	Below Normal	Disturbed
	Days March 1-2	Days March 3-10, 22-31	Days March 11-13, 19-21	
(1)	C-D	D-E	E	E
(2)	B-C	D	E	E
(3)	A-B	C	D-E	E
(4)	A	A-B	B-C	C-D

Where:

- A—Excellent circuit with strong steady signals.
- B—Good circuit, moderately strong signals, with some fading and noise.
- C—Fair circuit, signals fluctuating between moderately strong and weak, with moderate fading and noise.
- D—Poor circuit, signals weak, with considerable fading and very high noise level.
- E—Circuit not possible.

During March, especially on disturbed or below normal days, there is a tendency for widespread auroral displays to occur.

FLASH

As predicted in this column, DX conditions on 160 meters are improving rapidly. WIBB reports conditions as "hot as a firecracker" during January with several openings to



Europe and Latin America. Contact for the first time on this band was made between the eastern

USA and the Soviet Union (WIME-UB5WF) and between the eastern USA and Haiti (W1-BB-HH2V). More on this next month.

General Conditions

During the months of March and April, the sun is overhead in equatorial regions as it continues its apparent travels into northern skies. This solar phenomenon has a significant influence on shortwave (high frequency) radio propagation conditions.

As the sun rises higher into northern skies, it has a much greater heating effect on the earth's atmosphere. As the temperature of the ionosphere in the northern hemisphere increases, gases existing in this region of the earth's atmosphere expand. This expansion results in a decrease in ionospheric density, with a corresponding decrease in the ability of the ionosphere to reflect high frequency radio waves during the daytime hours. For this reason, considerably fewer 10 meter openings are expected to many areas of the world than occurred during the winter months.

While 15 meters is expected to be the best band for DX during the daytime hours, fewer openings also are predicted for this band. Peak conditions on both 10 and 15 meters should occur somewhat later in the day than during the winter months.

The increasing hours of daylight, as the sun rises higher in the northern sky, brings with it greater ionospheric absorption and higher static levels. This is expected to result in weaker signals, and somewhat poorer DX conditions, on 40, 80 and 160 meters, although some fairly good openings still should be possible on these bands during the hours of darkness.

With longer hours of daylight, 20 meters is expected to remain open later into the evening hours during March and April. This will probably be the best band for DX during the sunrise and sunset periods.

During the spring months (autumn in the southern hemisphere), somewhat of an "equalization effect" takes place for propagation conditions between the northern and southern hemispheres. DX openings between both hemispheres are expected to improve during March and April, with the improvement most likely to occur on 20 and 40 meters during the sunrise and sunset periods, and to a lesser extent on the other bands.

MARCH-APRIL, 1961

TIME ZONE: CST & MST, Con'd.

EASTERN USA TO:

	10 Meters	15 Meters	20 Meters	40/80* Meters
Western Europe	8 A - 10A (1) 10A - 2 P (2) 2 P - 4 P (1)	7 A - 8 A (1) 8 A - 11A (2) 11A - 1 P (3) 1 P - 3 P (4) 3 P - 4 P (3) 4 P - 5 P (2) 5 P - 7 P (1)	5 A - 7 A (2) 7 A - 1 P (1) 1 P - 4 P (2) 4 P - 6 P (4) 6 P - 8 P (3) 8 P - 11P (2) 11P - 2 A (1)	5 P - 7 P (2) 7 P - 10P (4) 10P - 11P (3) 11P - 2 A (2) 2 A - 4 A (1) 8 P - 11P (2)* 11P - 1 A (1)*
Eastern Europe	9 A - 1 P (1)	7 A - 9 A (1) 9 A - 12N (2) 12N - 3 P (1)	7 P - 11P (1)	8 P - 11P (1)
North Africa	7 A - 11A (1) 11A - 2 P (2) 2 P - 4 P (1)	6 A - 12N (2) 12N - 1 P (3) 1 P - 3 P (4) 3 P - 4 P (3) 4 P - 5 P (2) 5 P - 7 P (1)	5 A - 7 A (2) 7 A - 1 P (1) 1 P - 3 P (2) 3 P - 7 P (4) 7 P - 9 P (3) 9 P - 10P (2) 10P - 2 A (1)	6 P - 8 P (2) 8 P - 11P (3) 11P - 1 A (2) 1 A - 2 A (1) 7 P - 11P (2)* 11P - 12M (1)*
South Africa	7 A - 9 A (1) 9 A - 11A (2) 11A - 1 P (3) 1 P - 3 P (2) 3 P - 4 P (1)	6 A - 10A (1) 10A - 3 P (2) 3 P - 4 P (4) 4 P - 5 P (3) 5 P - 6 P (2) 6 P - 8 P (1)	1 P - 3 P (1) 3 P - 4 P (2) 4 P - 8 P (3) 8 P - 10P (2) 10P - 12M (1) 12M - 3 A (2) 3 A - 5 A (1)	7 P - 10P (1) 7 P - 9 P (1)*
Eastern Mediterranean	9 A - 1 P (1)	7 A - 9 A (1) 9 A - 11A (2) 11A - 1 P (3) 1 P - 2 P (2) 2 P - 5 P (1)	11A - 5 P (1) 5 P - 9 P (2) 9 P - 12M (1)	6 P - 11P (1)
Central Asia	9 A - 12N (1) 5 P - 7 P (1)	8 A - 12N (1) 5 P - 8 P (1)	6 A - 9 A (1) 6 P - 11P (1)	6 P - 9 P (1) 4 A - 6 A (1)
Southeast Asia	1 P - 4 P (1)	10A - 1 P (1) 6 P - 8 P (1)	7 A - 9 A (2) 9 A - 10A (1) 5 P - 8 P (1)	NIL
Far East	5 P - 7 P (1)	8 A - 10A (1) 4 P - 5 P (1) 5 P - 7 P (2) 7 P - 8 P (1)	10P - 7 A (1) 7 A - 9 A (2) 9 A - 11A (1)	4 A - 8 A (1)
Pacific Islands	12N - 3 P (2) 3 P - 5 P (1) 5 P - 7 P (2) 7 P - 8 P (1)	8 A - 10A (2) 10A - 6 P (1) 6 P - 9 P (2) 9 P - 11P (1)	7 P - 9 P (1) 9 P - 1 A (2) 1 A - 4 A (3) 4 A - 7 A (2) 7 A - 9 A (3) 9 A - 10A (2) 10A - 12N (1)	3 A - 6 A (2) 6 A - 8 A (1) 3 A - 5 A (1)*
Australia	9 A - 11A (1) 3 P - 4 P (1) 4 P - 7 P (2) 7 P - 9 P (1)	9 A - 11A (2) 11A - 6 P (1) 6 P - 9 P (2) 9 P - 11P (1)	10P - 12M (1) 12M - 7 A (2) 7 A - 8 A (3) 8 A - 9 A (2) 9 A - 12N (1)	4 A - 8 A (2) 8 A - 9 A (1) 5 A - 7 A (1)*
New Zealand	2 P - 5 P (1) 5 P - 7 P (2) 7 P - 9 P (1)	8 A - 10A (1) 3 P - 6 P (1) 6 P - 10P (2) 10P - 3 A (1)	7 P - 9 P (1) 9 P - 12M (2) 12M - 2 A (3) 2 A - 7 A (2) 7 A - 8 A (3) 8 A - 9 A (2) 9 A - 1 P (1)	2 A - 6 A (2) 6 A - 7 A (1) 3 A - 6 A (1)*
South America	7 A - 2 P (2) 2 P - 3 P (3) 3 P - 5 P (4) 5 P - 6 P (3) 6 P - 7 P (2) 7 P - 9 P (1)	6 A - 7 A (2) 7 A - 9 A (3) 9 A - 2 P (2) 2 P - 4 P (3) 4 P - 7 P (4) 7 P - 10P (3) 10P - 2 A (2)	4 A - 8 A (2) 8 A - 3 P (1) 3 P - 6 P (2) 6 P - 9 P (3) 9 P - 1 A (4) 1 A - 4 A (3)	7 P - 9 P (2) 9 P - 3 A (3) 3 A - 4 A (2) 8 P - 3 A (2)*
McMurdo Sound, Antarctica	4 P - 8 P (1)	2 P - 5 P (1) 5 P - 7 P (2) 7 P - 8 P (3) 8 P - 10P (2) 10P - 12M (1)	4 P - 6 P (1) 6 P - 9 P (2) 9 P - 12M (3) 12M - 6 A (2) 6 A - 9 A (1)	10P - 1 A (1)

TIME ZONE: CST & MST

CENTRAL USA TO:

	10 Meters	15 Meters	20 Meters	40/80* Meters
Western Europe	10A - 2 P (1)	8 A - 10A (2) 10A - 12N (3) 12N - 3 P (2) 3 P - 5 P (1)	5 A - 7 A (1) 1 P - 4 P (1) 4 P - 6 P (2) 6 P - 12M (1)	8 P - 12M (2) 9 P - 11P (1)*
Eastern Europe	9 A - 11A (1)	8 A - 9 A (1) 9 A - 11A (2) 11A - 1 P (1)	12N - 3 P (1) 3 P - 5 P (2) 5 P - 12M (1)	8 P - 12M (1)

CENTRAL USA TO:

	10 Meters	15 Meters	20 Meters	40/80* Meters
North Africa	8 A - 10A (1) 10A - 1 P (2) 1 P - 3 P (1)	7 A - 10A (1) 10A - 12N (2) 12N - 2 P (3) 2 P - 4 P (2) 4 P - 6 P (1)	10A - 12N (1) 12N - 2 P (2) 2 P - 3 P (3) 3 P - 5 P (4) 5 P - 6 P (3) 6 P - 9 P (2) 9 P - 2 A (1)	7 P - 10P (2) 8 P - 10P (1)*
Central Africa	8 A - 12N (2) 12N - 3 P (3) 3 P - 5 P (2)	7 A - 11A (1) 11A - 2 P (2) 2 P - 3 P (3) 3 P - 5 P (4) 5 P - 6 P (3) 6 P - 8 P (2) 8 P - 9 P (1)	11A - 3 P (1) 3 P - 7 P (2) 7 P - 10P (3) 10P - 12M (2) 12M - 2 A (1)	8 P - 11P (1) 9 P - 10P (1)*
Eastern Mediterranean	8 A - 12N (1)	8 A - 9 A (1) 9 A - 12N (2) 12N - 2 P (1)	3 P - 5 P (1) 5 P - 7 P (2) 7 P - 12M (1)	7 P - 10P (1)
Central Asia	8 A - 10A (1) 7 P - 9 P (1)	8 A - 10A (2) 10A - 12N (1) 7 P - 9 P (1)	7 A - 9 A (2) 9 A - 11A (1) 7 P - 8 P (1) 8 P - 9 P (2) 9 P - 10P (1)	7 P - 9 P (1) 4 A - 6 A (1)
Southeast Asia	10A - 2 P (1) 5 P - 8 P (1)	10A - 12N (2) 12N - 5 P (1) 5 P - 7 P (2) 7 P - 9 P (1)	7 A - 9 A (2) 9 A - 11A (1) 9 P - 12M (1)	NIL
Far East	3 P - 5 P (1) 5 P - 7 P (2) 7 P - 9 P (1)	8 A - 11A (1) 3 P - 4 P (1) 4 P - 6 P (2) 6 P - 8 P (3) 8 P - 9 P (2) 9 P - 11P (1)	11P - 7 A (1) 7 A - 8 A (2) 8 A - 12N (1)	3 A - 7 A (1)
Pacific Islands	11A - 2 P (2) 2 P - 6 P (1) 6 P - 8 P (2) 8 P - 10P (1)	10A - 1 P (2) 1 P - 5 P (1) 5 P - 7 P (2) 7 P - 9 P (3) 9 P - 11P (2) 11P - 3 A (1)	10A - 8 P (1) 8 P - 11P (2) 11P - 5 A (3) 5 A - 7 A (2) 7 A - 8 A (3) 8 A - 10A (2)	12M - 6 A (3) 6 A - 8 A (1) 1 A - 6 A (2)*
Australia	8 A - 11A (1) 1 P - 3 P (1) 3 P - 5 P (2) 5 P - 7 P (3) 7 P - 8 P (2) 8 P - 10P (1)	8 A - 11A (2) 11A - 5 P (1) 5 P - 11P (2) 11P - 1 A (1)	11A - 9 P (1) 9 P - 1 A (2) 1 A - 4 A (3) 4 A - 7 A (2) 7 A - 8 A (3) 8 A - 11A (2)	5 A - 7 A (2) 7 A - 9 A (1) 5 A - 7 A (1)*
New Zealand	11A - 4 P (2) 4 P - 7 P (3) 7 P - 8 P (2) 8 P - 9 P (1)	7 A - 11A (1) 11A - 1 P (2) 1 P - 5 P (1) 5 P - 7 P (2) 7 P - 9 P (3) 9 P - 11P (2) 11P - 3 A (1)	11A - 8 P (1) 8 P - 11P (2) 11P - 3 A (4) 3 A - 8 A (3) 8 A - 11A (2)	12M - 7 A (2) 1 A - 7 A (1)*
South America	7 A - 10A (3) 10A - 1 P (2) 1 P - 3 P (4) 3 P - 5 P (3) 5 P - 7 P (2) 7 P - 8 P (1)	6 A - 7 A (2) 7 A - 9 A (3) 9 A - 2 P (2) 2 P - 4 P (3) 4 P - 7 P (4) 7 P - 10P (3) 10P - 1 A (2) 1 A - 2 A (1)	8 A - 2 P (1) 2 P - 6 P (2) 6 P - 11P (4) 11P - 3 A (3) 3 A - 8 A (2)	7 P - 9 P (2) 9 P - 1 A (3) 1 A - 4 A (2) 9 P - 2 A (2)*
McMurdo Sound, Antarctica	1 P - 4 P (1) 4 P - 7 P (2) 7 P - 8 P (1)	12N - 4 P (1) 4 P - 7 P (2) 7 P - 9 P (3) 9 P - 10P (2) 10P - 12M (1)	4 P - 6 P (1) 6 P - 9 P (2) 9 P - 2 A (3) 3 A - 7 A (2) 7 A - 11A (1)	8 P - 12M (1)

TIME ZONE: PST

WESTERN USA TO:

	10 Meters	15 Meters	20 Meters	40/80* Meters
Western Europe	8 A - 12N (1)	6 A - 8 A (1) 8 A - 9 A (2) 9 A - 11A (3) 11A - 12N (2) 12N - 2 P (1)	6 A - 9 A (2) 9 A - 1 P (1) 1 P - 4 P (2) 4 P - 2 A (1)	7 P - 12M (1) 8 P - 11P (1)*
Eastern Europe	NIL	6 A - 7 A (1) 7 A - 9 A (2) 9 A - 11A (1)	6 A - 8 A (2) 8 A - 1 P (1) 1 P - 5 P (2) 5 P - 10P (1) 10P - 12M (2) 12M - 2 A (1)	7 P - 10P (1)
North Africa	9 A - 12N (1)	7 A - 9 A (2) 9 A - 12N (3) 12N - 1 P (2) 1 P - 3 P (1)	6 A - 11A (1) 11A - 3 P (2) 3 P - 6 P (3) 6 P - 8 P (2) 8 P - 2 A (1)	7 P - 9 P (1) 7 P - 9 P (1)*

WESTERN USA TO:

	10 Meters	15 Meters	20 Meters	40/80* Meters
South Africa	7 A - 9 A (2) 9 A - 11A (3) 11A - 12N (2) 12N - 2 P (1)	6 A - 9 A (1) 9 A - 1 P (2) 1 P - 3 P (3) 3 P - 5 P (1)	10A - 12N (1) 12N - 4 P (2) 4 P - 7 P (3) 7 P - 9 P (1) 9 P - 11P (2) 11P - 1 A (1)	7 P - 9 P (1)
Eastern Mediterranean	8 A - 11A (1)	7 A - 8 A (1) 8 A - 10A (2) 10A - 12N (1)	6 A - 8 A (1) 8 A - 10A (2) 10A - 7 P (1) 7 P - 9 P (2) 9 P - 10P (1)	NIL
Central Asia	9 A - 11A (1) 5 P - 6 P (1) 6 P - 7 P (2) 7 P - 8 P (1)	8 A - 11A (1) 4 P - 5 P (1) 5 P - 8 P (2) 8 P - 9 P (1)	7 A - 8 A (2) 8 A - 10A (1) 5 P - 6 P (1) 6 P - 7 P (2) 7 P - 9 P (1)	NIL
Southeast Asia	9 A - 12N (1) 3 P - 5 P (2) 5 P - 8 P (1)	8 A - 9 A (1) 9 A - 12N (2) 12N - 4 P (1) 4 P - 9 P (2) 9 P - 10P (1)	12M - 7 A (1) 7 A - 9 A (3) 9 A - 11A (2) 11A - 1 P (1)	4 A - 7 A (1)
Far East	1 P - 2 P (1) 2 P - 3 P (2) 3 P - 5 P (3) 5 P - 7 P (2) 7 P - 8 P (1)	7 A - 9 A (1) 1 P - 3 P (1) 3 P - 5 P (2) 5 P - 6 P (3) 6 P - 7 P (4) 7 P - 8 P (3) 8 P - 9 P (2) 9 P - 10P (1)	7 A - 8 A (1) 8 A - 10A (4) 10A - 11A (3) 11A - 1 P (2) 1 P - 7 P (1) 7 P - 9 P (2) 9 P - 11P (3) 11P - 3 A (1)	2 A - 6 A (3) 6 A - 8 A (1) 3 A - 6 A (2)*
Pacific Islands & New Zealand	9 A - 10A (1) 10A - 1 P (3) 1 P - 6 P (2) 6 P - 8 P (4) 8 P - 9 P (3) 9 P - 11P (1)	8 A - 9 A (1) 9 A - 1 P (2) 1 P - 5 P (1) 5 P - 7 P (2) 7 P - 10P (4) 10P - 1 A (2) 1 A - 3 A (1)	11A - 6 P (1) 6 P - 9 P (2) 9 P - 2 A (4) 2 A - 4 A (2) 4 A - 7 A (1) 7 A - 9 A (3) 9 A - 11A (2)	11P - 5 A (3) 5 A - 7 A (1) 12M - 5 A (2)*
Australia	8 A - 10A (1) 12N - 1 P (1) 1 P - 5 P (2) 5 P - 7 P (3) 7 P - 8 P (2) 8 P - 10P (1)	8 A - 10A (2) 10A - 12N (1) 12N - 7 P (2) 7 P - 10P (3) 10P - 11P (2) 11P - 2 A (1)	7 A - 9 A (3) 9 A - 12N (2) 12N - 9 P (1) 9 P - 12M (2) 12M - 2 A (4) 2 A - 5 A (2) 5 A - 7 A (1)	3 A - 6 A (3) 6 A - 8 A (1) 4 A - 6 A (2)*
South America	6 A - 8 A (1) 8 A - 9 A (3) 9 A - 1 P (2) 1 P - 3 P (4) 3 P - 5 P (2) 5 P - 8 P (1)	5 A - 7 A (2) 7 A - 1 P (1) 1 P - 3 P (2) 3 P - 6 P (4) 6 P - 8 P (3) 8 P - 9 P (2) 9 P - 2 A (1)	2 P - 4 P (2) 4 P - 7 P (3) 7 P - 11P (4) 11P - 2 A (3) 2 A - 6 A (2) 6 A - 2 P (1)	8 P - 12M (3) 12M - 2 A (2) 2 A - 3 A (1) 9 P - 2 A (2)*
McMurdo Sound, Antarctica	10A - 2 P (1) 2 P - 6 P (2) 6 P - 8 P (1)	10A - 4 P (1) 4 P - 6 P (2) 6 P - 9 P (3) 9 P - 10P (2) 10P - 12M (1)	4 P - 6 P (1) 6 P - 8 P (2) 8 P - 12M (3) 12M - 3 A (2) 3 A - 10A (1)	8 P - 6 A (1)

FORECAST INDICES

Circuits Forecast to open:

- (1) Less than 7 days during each month of forecast period.
- (2) Between 8 and 13 days during each month of forecast period.
- (3) Between 14 and 22 days during each month of forecast period.
- (4) For more than 22 days during each month of forecast period.

A - A. M. P - P. M. N - Noon M - Midnight

See "Last Minute Forecast" in the text for the relationship between the Forecast Indices and the day-to-day propagation conditions expected during the month.

* Indicates expected 80-meter openings. On nights when atmospheric noise conditions are exceptionally quiet, 160-meter openings are likely to occur on circuits during those times 80-meter openings are rated (2) or higher.

The CQ DX Propagation Charts are based upon a CW effective radiated power of 150 watts at radiation angles less than thirty degrees. The Eastern USA chart can be used in the W 1, 2, 3, 4 and 8 areas; the Central USA chart is the W 5, 9 and 8 areas, and the Western USA chart in the W 6 and 7 areas. The charts are valid through April 30, 1961. Propagation forecasts contained in these charts are derived from basic ionospheric data published by the Central Radio Propagation Laboratory of the National Bureau of Standards, Boulder, Colorado.

Auroral displays are known to occur more often during March and April than during the winter months, and coincident with these displays there is a greater tendency for severe and prolonged ionospheric disturbances, or radio storms, to take place. During auroral displays, ionospheric openings for distances up to approx-

imately 1300 miles may be possible on the 6 and 2 meter bands.

Although it is not yet certain, there appears to be a definite tendency for trans-equatorial scatter openings to increase sharply during March and April, resulting in 6 and 10 meter openings to South America (from the USA) during the early evening hours.

Meteor-type ionospheric openings are likely to occur on both 10 and 6 meters during March 10-12 and March 20th, when minor meteor showers are expected.

This month's *Propagation Charts* contain predictions for the major DX paths for the months of March and April. See the "Last Minute Forecast" appearing at the head of this column, for day-to-day conditions expected during March.

Sunspot Number

The Zurich Solar Observatory reports a monthly average sunspot number of 83 for December, 1960. This results in a 12-month running smoothed number of 112, centered on June, 1960. A smoothed sunspot number of 87 is predicted for March 1961, as the present cycle continues to decline.

The Sunspot Story

In 1956¹, *CQ* featured a two-part article by its Propagation Editor entitled, "The Sunspot Story; Cycle 19—Once In a Lifetime Conditions." The article discussed the then approaching solar maximum and its possible influence on conditions in the various amateur bands. The author predicted that the peak of cycle 19 would be of unprecedented intensity, and would result in shortwave radio conditions that would be better than they had ever been in the history of radio.

Among the more daring predictions made, and all of which eventually came to pass between 1957 and 1960, were included the possibilities of world-wide DX on six meters, around-the-clock DX on twenty meters, direct reception of European and Latin American TV broadcasts causing interference in the USA, and in general, conditions which occur very seldom, perhaps only once in a lifetime.

With record-breaking solar activity now a matter of history, the present sunspot cycle has started to decline, and it is natural to ask "what now?", and "where do we go from here?". To answer these questions, and to give as complete a picture as possible as to what conditions might be like on the amateur bands in the years ahead, *CQ* has commissioned its Propagation Editor, W3ASK, to collaborate with Stanley Leinwoll on a sequel to the 1956 report. Mr. Leinwoll is the author of the popular book, *Shortwave Propagation*.²

The Jacobs-Leinwoll report is now complete. [Continued on page 108]

¹Part I appeared in March, 1956; Part II in June, '56.
²Leinwoll, S., *Shortwave Propagation*, published by J. F. Rider, N. Y.



ham clinic

CHARLES J. SCHAUERS, F7FE/W6QLV

C.Q. Magazine, 300 West 43rd St., New York 36, N. Y.

What Questions?

Evidently there are some hams who read HAM CLINIC who wonder how the questions which appear in this column are chosen. Well, first of all, we try to keep track of "major interest" queries; and as soon as we receive at least ten letters on a subject, it is given priority of publication. Then we consider the unusual questions which we believe to be of general interest. Next in line are the questions which seem to indicate considerable interest in a specific piece of equipment. Then as we sort through incoming correspondence, we keep in mind the *service* aspects of the column.

Some of the questions received are hum-dingers! These are the questions which require more than just a little research and often, much letter writing. Sometimes the answer is in the negative, for if we could answer *every* technical question asked, we would no doubt now be in heavenly orbit! Being human we can and do make mistakes.

But usually, if the question is on ham radio, there is an answer somewhere and we try to find it. Our technical information resources are numerous, and for the stickiest questions we depend upon expert ham friends who are engineers, instructors and electronic specialists. (And believe it or not, they are sometimes stumped too—which indicates that no one can know it all!)

I think what frustrates us more than anything is to receive a letter containing a question which has already been answered in the column. This extra work of making reference to already published material denies someone else a quick reply.

Then there are questions which are adequately covered in the ARRL *Handbook* or other readily available texts. Of course, we realize that not every ham has a handbook, but we feel he should have one.

Many questions are received from commercial firms . . . these are simply *not* answered, even for a fee.

HAM CLINIC service is free to all hams and one need not be a regular subscriber to enjoy it.

Now we have a question to all of you: how would you like to be able to buy for a very

small amount of money, a book containing all of the HAM CLINIC material (as re-edited) which has appeared in *CQ*? If you think this is a good idea, drop the editor a card telling him so. Only *he* can decide whether or not the venture is worthwhile.

We feel that because of the gigantic increase in *CQ* readership, those new subscribers who have missed many of the columns would indeed be interested; as well of course, as the old faithful readers who want all the HAM CLINIC information under one cover. If such a book comes out it would be revised from year to year.

On Taylor Modulation

Evidently those interested in the old as well as the new *do* read HAM CLINIC. Our request for more information on the modulation system by Taylor certainly brought in the mail—gobs of it!

Most of those writing in said they had not tried the system but were still interested. Others said they had heard it and it was terrific!

Because of the large number of letters on the subject, we will not answer them via private correspondence, but will in future issues include as much *new* information as we can round up on actual practical utilization.

Thank you so much fellows, for coming to our rescue. Our research did miss the articles in *Radio News* (now *Electronics World*) and it's a nice feeling to know that we can depend upon our readers to give us a helping hand now and then.

Questions

Heath TX-1—"What is the probable cause of the final grid current changing value even when there is no modulation and the final amplifier plate voltage is not on? I have a Heath TX-1. I thought it might be a bad clamp tube or gassy 6146's but evidently not. What should I check?"

Replace that little 47 mmf bypass condenser on the choke in the grids of the final 6146's. Bet this is your trouble.

Voltage Divider—"Why are individual resistors usually used in some high voltage power supply divider systems?"

To prevent arc-over of the bleeder resistors.

Beam Use—"Any regulation that says I can't use my 10 meter beam antenna for 11 meter C.B. work?"

No, but remember that the antenna when thus used cannot be over 20 feet above supporting structures.

Little Space Antenna—"Would you recommend an antenna to me (not a beam) which I can mount in my attic for 10, 15 and 20 meters? I have exactly 42 foot of attic space. My transmitter is a Lafayette Voyager."

Try Mosley's TD-3 Jr. It will mount in 24 feet of space, weighs 1 $\frac{3}{4}$ pounds, and sells for only \$12.50. You can obtain either a 10, 15 and 20 meter model or a 10, 15 and 40 meter model.

V.F.O. Microphonics—"I note that when I zero beat my receiver to my v.f.o. frequency that when I tap the v.f.o. case I can hear the pounding in the receiver loudspeaker. Set seems to work fine though. What gives here?"

Probably a microphonic tube and/or poor mechanical component mounting. "Vibrational modulation" is not unknown. Suggest you replace the tube first and then check all connections. Seems to me that you might have some frequency instability along with this too.

Connections (Breadboard)—"Besides using alligator clips and twisting wires together when working on breadboard models in the school electronics lab, do you have any other suggestions for joining wires?"

Yes. I use short "gold-plated" bobby pins and dress eye fasteners (plain) to which leads of various lengths have been carefully soldered. They work fine.

Ranger and SB-10—"How does the Viking Ranger work with the Heath SB-10 adaptor for s.s.b. operation? Is the matching job a difficult one?"

It works fine and it's difficult to distinguish the fine signal it puts out from a rig using two 6146's in the final.

The instructions for combining the DX-40 and the SB-10 are, in general, applicable to the

Ranger. I do, however, advise the use of a good sturdy ceramic section switch for a.m., c.w. and s.s.b. switching.

I have had so many letters relative to using the SB-10 with various transmitters that I have decided to give you what I consider to be the *easiest* approach to marrying the SB-10 to nearly any transmitter which requires less than 10 watts of r.f. drive to the final amplifier tube grids (class AB-1).

First of all, you must have for the SB-10, 350 volts d.c. at a minimum of 140 ma (85 ma average). Filament voltage requirements are 6.3 volts a.c. at 3.5 amps. The power supply should be well filtered and for good dynamic regulation should have at least 40 mf output capacitance.

After you have made the necessary power supply connections to the SB-10, you are now ready to make some slight modifications in your transmitter.

The first thing to do is mount two female coaxial connectors on the transmitter chassis so that one is close to the output (plate) circuit of the driver (the tube driving for example: 6146's, 4D32, 807's, 829, 6DQ6's, 813 etc.). The other connector should be installed close to the grid input of the final amplifier tube(s).

Now, if you want to retain a.m. capability, you must be able to switch the output of the driver to either the grid of the final *or* to the SB-10. At the same time, switch connections should be made so that the final can be placed in AB-1 operation with the connection of bias (depending on the final tube). The screen voltage to the final *must* be stabilized. A couple of regulator tubes such as the OB2, VR105 etc. can be used in series to accomplish this.

Final amplifier operating bias may be obtained (in most cases) from a small transformer and a couple of silicon diodes.

All of the tubes mentioned above can be driven easily with the SB-10. Keep in mind however, that too much drive deteriorates s.s.b. operation and does not accomplish a thing. As long as the relative power output meter on the SB-10

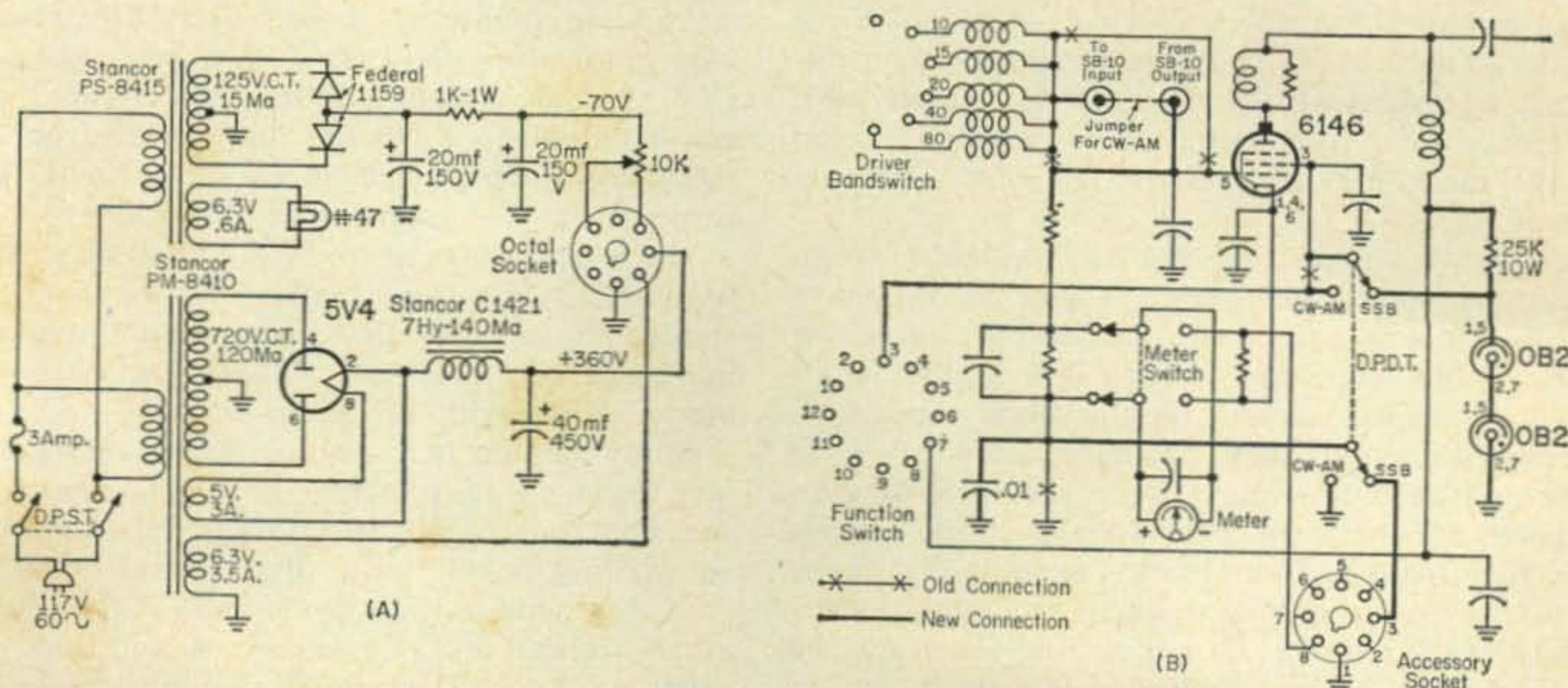

Fig. 1—(A) Power supply suitable for use with the Heath SB-10 and DX-40. (B) Diagram illustrating changes necessary in the Heath DX-40 for use with the SB-10.

reads up to 50 when driving a pair of 6146's, s.s.b. output will be clean.

Then, of course, switch connections are made between the coaxial connectors, driver plate, final grid and SB-10 output.

Referring to the modifications for converting the Heath DX-40 transmitter for s.s.b. operation (fig. 1), you will see that the separate power supply furnishes high voltage and filament voltage to the SB-10 and bias voltage to the DX-40. Nothing complicated about this. The modifications in the final and driver stages of the transmitter require little effort.

Remember that oscillator stage frequency stability is a *must!* If you are in doubt as to the stability of your v.f.o., use crystals! However, in transmitters like Collins 32V series and other fine sets, there is no worry about frequency stability.

To determine how much bias is needed for your particular transmitter output stage to run it class AB-1, refer to a radio handbook or Stoner's *S.S.B. Handbook* which I heartily recommend everyone read before trying s.s.b.

The vox control circuits in the SB-10 present no problem and there is sufficient information supplied with the SB-10 to connect them up so that any receiver may be used with any transmitter.

For more information on the SB-10, see *HAM CLINIC* for October 1959 and November 1959. **HT-32**—"How come the final 6146's in the HT-32 require only a -49 volts bias while another transmitter using the same tubes provides for a -52 volts for s.s.b. operation?"

I don't think the difference is enough to quibble about. Both evidently are operating in Class AB-1 and are adjusted to take maximum advantage of the 6146's maximum plate dissipation. **HQ-170**—"I have a Hammarlund HQ-170 receiver, and like many others, I must say I am very pleased with the set. However, the other day just before it went dead, an awful scratchy hum came from the loudspeaker and a recently installed fuse blew. I thought it might be a little line trouble so I installed another fuse. With the set out of the cabinet I turned it on and there was some flashing in the rectifier tube then this fuse also went west! I changed the rectifier tube, replaced the fuse and it blew again. Can you give me some info relative to what I should look for?"

First, I would advise you to take the set to an authorized service agency if you do not have sufficient test equipment and overall know-how to trouble shoot this set. The first components I would suspect would be the filter capacitors. First discharge them with a screwdriver to ground; then disconnect them. Take a good ohmmeter and check them for a major short. Bet this is your trouble. If it is not, I suggest you check each power supply component (including transformer) for shorts. Of course, the short may be in another section of the set too (if it isn't in the power supply). But I am inclined to think it is a shorted filter capacitor.

Oscillation—"I built up a little pre-selector using a 6C4, but all it does is oscillate. Any hints as to what might be wrong?"

My crystal ball is a little fogged up on this one. I would suggest first that you consider neutralizing the little triode. Next, make sure input and output circuits are properly shielded from each other. Next, make certain that your plate voltage is not too high. I'd advise using a tube like the 6BA6 which would not need neutralization.

S.S.B. Final—"I have a little s.s.b. exciter which I designed and constructed that has a little more than 5 watts output. I'd like to build up a final using only one tube in class AB-1. I have 1300 volts at 250 ma available and up to 600 volts regulated for the screen of a final. I also have up to -125 volts for bias. Please suggest a tube which will give me the "mostest for the leastest."

Sure. Try RCA's 7270. This high perveance tube will work like a charm with your little rig.

Observation

The world knows that the United States of America has helped many nations in need with millions of dollars. With but few exceptions the little people of these nations *know* from where their help came. Our foreign aid program is geared to helping less fortunate nations stay free and independent, and out of the clutches of certain nations whose aims are tied in with world domination.

In addition to the help extended overseas by our government as a whole, America's hams have been and *are* doing their share. Not only through the taxes they must pay but also on a very personal basis, America's hams not only create goodwill through their DX contacts (person-to-person) but many of them are actually helping less fortunate hams in other lands to operate on the ham bands and pursue a hobby that contributes to international goodwill and understanding.

In the October 1960 issue of *CQ* (page 97), we asked for the names of those DX hams interested in obtaining Barker and Williamson's 2Q4 phase shift network so that they could try s.s.b. We also suggested that American hams could volunteer (over the air) to send one of these fine little gadgets to overseas hams. The response was overwhelming!

Many hams wrote in saying that they were sending a 2Q4 to a particular overseas ham and wanted us to know that they thought this was indeed a fine program. Others requested the names of deserving DX hams.

Many foreign hams wrote in requesting 2Q4 help (and we request that they continue to do so). Our backlog of foreign requests at the present writing is not large, but if you American hams will send us your name and QTH and volunteer to send a 2Q4 overseas, we will send you original letters of interested overseas hams (as long as they last). The price of a 2Q4 is small, but the rewards could be great!

Observed: hams the world over (with few exceptions) are interested in creating international goodwill and friendship, as well as increasing their technical proficiencies; but HAM CLINIC makes a bow to the American ham for being so generous.

Tip of the Month

From K8JTT comes a tip for those who own Johnson KW Match Boxes. The Johnson KW Match Box has band switching from the front panel, except that for 10 and 15 meters operation, a ground strap must be disconnected from one of the feed-through insulators on the back depending on whether coaxial cable or balanced transmission lines are used.

To overcome this inconvenience, K8JTT mounted a heavy ceramic rotary switch (a surplus item) on an aluminum bracket cut in an inverted "U" form and attached fairly high above the front of the MATCHING capacitor. This bracket was secured to the two top screws of the capacitor frame (which is itself insulated from ground). Number 10 wire rod was then used to accomplish a ground circuit back to the inside connection to the feed-through insulator and to the Match Box cabinet. A shaft, isolated with a small ceramic connector was brought through the front panel. With pointer knob and decals attached, it even improved the appearance of the panel. Thank you, Everett M. Hawley, Jr. Grosse Pointe Woods, 36, Michigan.

Non-Technical Department

Ham Neighbors—"I have been living at the same location for over 15 years without any interference, then along comes a fellow ham with an a.m. k.w., a 60 foot tower and lots of stray r.f. Because he works the same hours I do on the job and then uses his station at approximately the same hours, we have a heck of a time.

"I suggested that we split our operating time but he was adamant about this. So then I suggested that he cut his power down (I only use 100 watts), but he only got angry.

"I have tried operating on other bands when he is on 20 meters but our antennas are just too close; too much shock-excitation I guess.

"Have any of your readers brought you this problem and what did you advise them?"

Well, unless you have a "wonderful" 100 watts, you no doubt interfere with him too. I think you two "birds" can still get together on this and split your operating time. On the other hand, there are a few hard-headed characters who *are* hams and whom *no one* can deal with except the FCC.

I suggest that you get to know the guy and ask him for his advice and assistance from time to time on other than ham projects. Before you know it you may be friends and may be able to work something out that will permit both of you to enjoy your hobby.

Anyone have any other suggestions for this reader (that are printable)?

Needed: A Tower

The St. Xavier High School at 600 North Bend Road, Cincinnati 24, Ohio needs a tower for its club station antennas. The tower should be about 30 to 35 feet in length and should be one that can be mounted on a building roof.

If you have such a tower that you are willing to donate to a very worthy cause, write the Club Station Moderator, Donald Brezine, S. J.

Here is an opportunity for someone to do a group of fine boys (as well as ham radio) a very big favor.

Let us remember international goodwill, but let us not forget that we must look around at home and help our own too.

I shall publish full credit for that tower in the column; in so doing everyone will know that we American hams *do* take care of our own too. That is the way it should be.

Thirty

Until we are resettled here in the States again, we must ask that you be patient with us relative to correspondence. Moving across the sea and getting resettled is not easy. But oh how wonderful it is to be back!

For now, 73 and 75 and a big 72 to all our French and foreign ham friends who made us realize that peace is everyone's business.

73, Chuck.

New Amateur Products

Dummy Load



COLLINS Radio Company has introduced the DL-1 Dummy Load which may be switched instantly in or out of an amateur radio station circuit for transmitter tuning and testing operations. The 100 watt resistive load may be used with transmitters of 100 watt output power and may also be used for brief tuning periods with higher powered amplifiers.

Collins DL-1 may be mounted on a table or desk top or may be mounted on any chassis or rack frame by means of two tapped holes in the bottom of the cabinet. The four rubber feet may be removed and the unit may be mounted on a flat plate with four screws. The DL-1 is 5¹¹/₁₆" wide, 3¹/₂" high and 7⁵/₁₆" deep. More information may be obtained by circling E on page 126.



Novice

Did you ever wonder why one meter might read a power supply voltage of 270 volts, while another indicates the same point is 255 volts? To make it even more mystifying both meters may be perfectly accurate! This condition is usually brought about by voltage dividers in the equipment being measured. The circuit resistance, plus the resistance of the meter making the measurements, from a voltage divider. If the meter has a low resistance (low sensitivity, say 1,000 ohms per volt) it will read lower than a high resistance unit such as a vacuum tube voltmeter (v.t.v.m.). Let's see what happens when we make a voltage divider out of the bleeder resistance connected across the output of the power supplies we have been discussing over the past few months.

Voltage Dividers—A resistor almost always is used across the output terminals of a rectifier power supply. The name applied to such a resistor depends on its principal use. If it serves the purpose of bleeding off the charge on the filter capacitors when the rectifier is turned off, the resistor is called a **bleeder resistor**. If it serves the purpose of applying a fixed load to a filter circuit to improve the voltage regulation (an example might be the choke input supply, which requires the small fixed load), the resistor is called a **load resistor**. Naturally a bleeder and load resistor can be the same thing if it does both jobs at the same time.

If leads are connected to the resistor at various points to provide a variety of voltages, or if two or more resistors are connected in series, the resistor(s) is called a **voltage divider**.

In general, a resistor placed across the output terminals of a power supply may fulfill all of these functions. However, if the resistor is to be a bleeder resistor only, it usually has a very high resistance so that it will draw a negligible current from the rectifier. If the resistor is to serve as a load resistor, it should be of such value that it will draw approximately 10% of the full load capabilities. For example, if the power supply is rated at 100 ma maximum, 10 ma of this current should flow through the load resistor. The value can be computed from ohms

law when the voltage and current are known. The wattage can also be computed and it should be sufficient to dissipate the heat produced by the current flowing through it when the supply is on.

A resistor which is used as a load resistor also may be used as a voltage divider because the current flowing through the resistor produces a voltage drop across its equal to the supply voltage. Here's how it works. In fig. 1, three identical resistors are connected in series. So long as

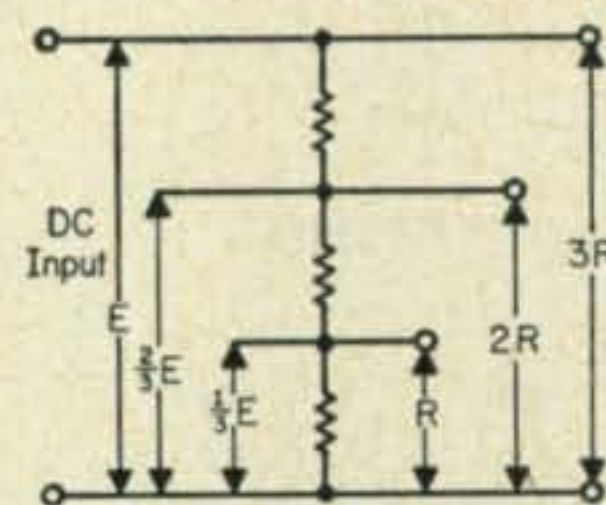
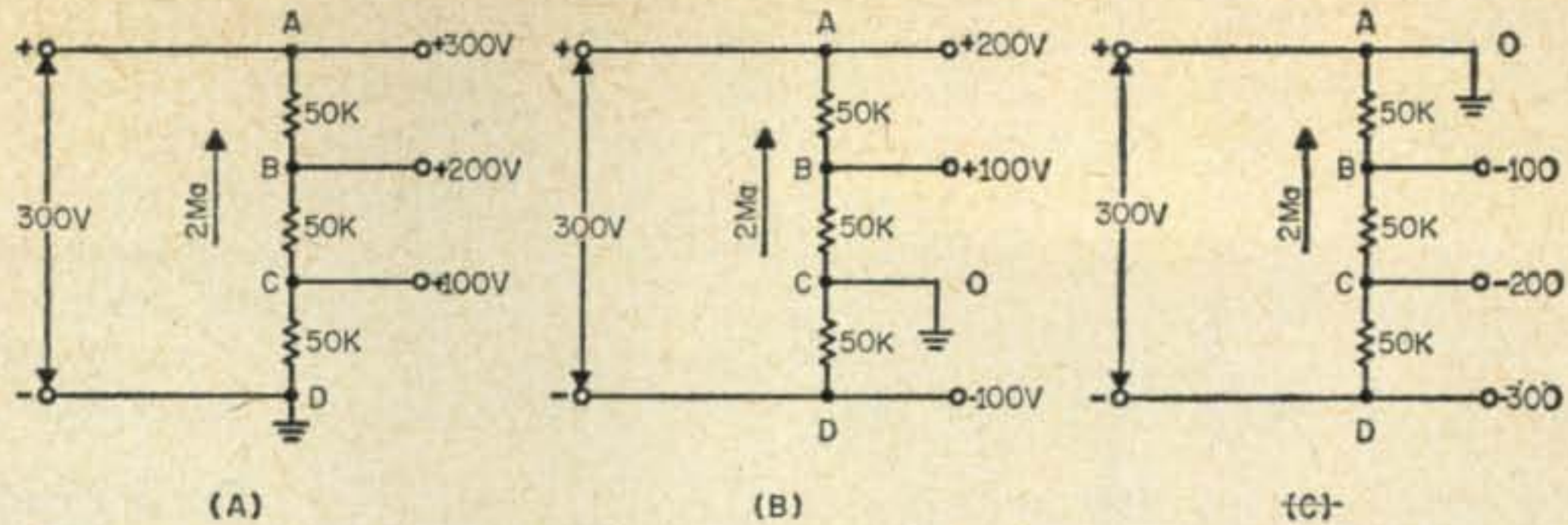

Fig. 1 — The relationship between voltage and resistance in a typical voltage divider circuit.

no load is drawn from any terminal except the top, or load terminal, the voltage across the resistors will divide proportionally to the resistance of each. For example, if each resistor was 10K, and the power supply was 300 volts, each resistor would have 100 volts impressed across it. Thus $\frac{1}{3}E$ would be 100 volts, $\frac{2}{3}E$ would be 200 volts, and of course E would be 300 volts.

At this point it might be a good idea to digress and mention the subject of common grounds. Did you ever wonder why there were so many connections soldered to the chassis of a receiver or transmitter? It is common practice to ground one side of most circuits. Thus ground potential is normally used as a reference for measurement of voltage. In this case ground is zero volts reference, as at point "D" in fig. 2a. If a rectifier and its filter are connected so that no parts are grounded, it is possible to ground the circuit at any point without affecting the operation of the supply. Thus in fig. 2b, if point "C" is grounded then point "D" becomes negative with respect to ground. Such a circuit is frequently used to furnish both plate (positive) and bias (negative) voltages from the same power supply. In the third drawing, point "A" is grounded and all voltage along the divider is negative with respect to ground. If point "B" had been grounded, the

Fig. 2 — Ground or common is an arbitrary word. It can be placed anywhere in a voltage divider circuit to supply a variety of output voltages and polarities.



power supply would have produced minus 100 and 200 volts in addition to plus 100 volts. It should be pointed out that in fig. 2c, point "A" will always be more positive than the other points even though they are negative with respect to ground (which is point "A"). The same is true for the other circuits also, no matter which point is grounded, point "A" will always be more positive than point "D" and "D" will always be more negative than "A".

Let's see why a voltage divider will cause two accurate meters to read the same voltage differently. It has been assumed in fig. 1 and fig. 2 that no load was attached to the divider except across the load terminals "A" and "D", and that voltages could be measured without drawing appreciable current. As soon as a load is attached to the divider at any intermediate terminal ("B" or "C"), the voltage division shown no longer is correct. This is because the resistance of the attached load forms a parallel circuit with the part of the divider across which it is placed. This changes the total resistance between the terminals concerned.

For example, let's say that two loads are placed across our divider, as in fig. 3. A load of 150K is placed across B-D and a load of

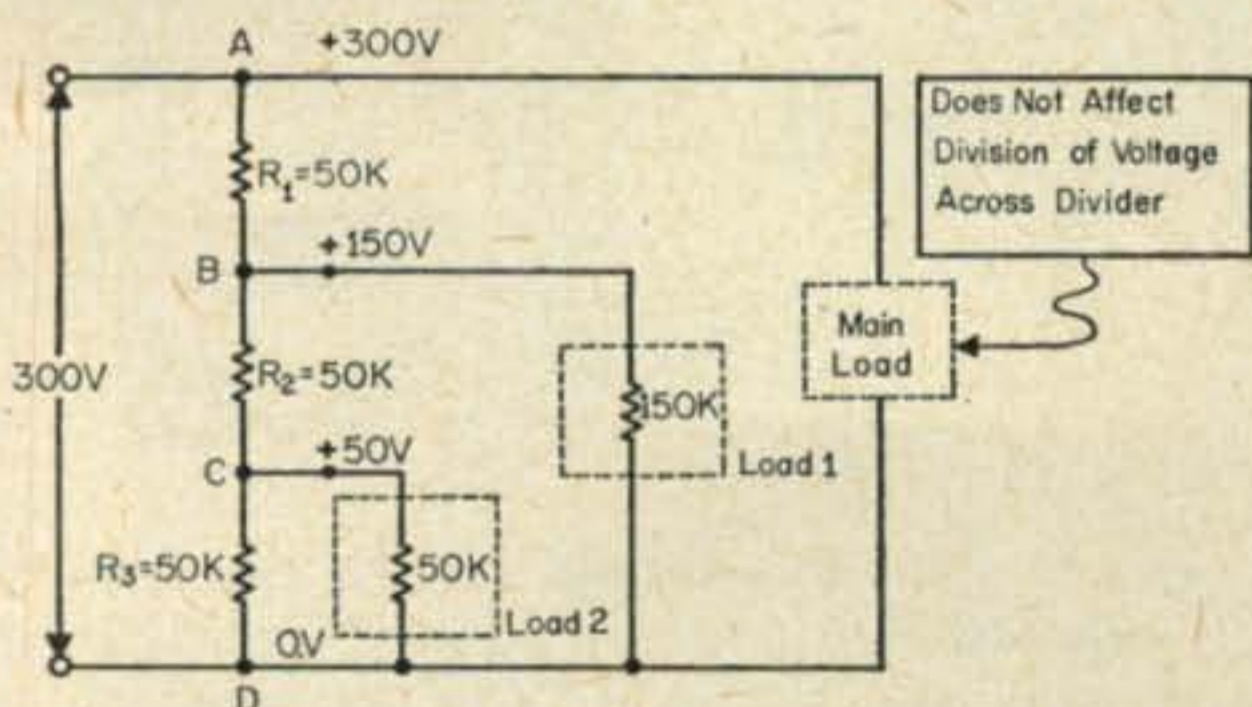

Fig. 3—The voltage relationships shown in fig. 1 cannot be maintained when a load is placed on the divider, as shown here and discussed in the text.

50,000 ohms (50K) across C-D. The resistance between D and C can be determined by Ohms Law and the formula for parallel resistors:

$$R_{total} = \frac{R_1 \times R_2}{R_1 + R_2}$$

The resistance between points C and D would be:

$$R_{CD} = \frac{50K \times 50K}{50K + 50K} = 25K$$

To compute the resistance between points B and D we must add the above 25K to R_2 which is

a 50K resistor. Thus we have 75K in parallel with load 1 (150K) between points B and D. Again the parallel resistor formula comes in handy:

$$R_{BD} = \frac{75K \times 150K}{75K + 150K} = 50K$$

Thus the resistance between points B and D, with the loads attached is actually 50K.

Now let's figure the total resistance of the divider. The resistance between point A and D would be the above 50K plus the resistance of R_1 (which is 50K), or 100K.

If you would like to know the voltage which now appears at points B and C, we must know the current through the divider. This can be determined by Ohms Law:

$$I = \frac{E}{R}$$

$$I = \frac{300 \text{ volts}}{100,000} = .003 \text{ amperes or}$$

$$I = 3 \text{ milliamperes}$$

Since we know that 3 ma is flowing in R_1 (50K) we can determine the voltage developed across it:

$$E = IR$$

$$E = .003 \times 50,000$$

$$E = 150 \text{ volts}$$

You can see that when loads 1 and 2 have the values shown, resistor R_1 drops one-half of the available voltage instead of one-third as in the no-load case in fig. 2. Thus point B will be 150 volts positive with respect to point D, rather than the 200 as before.

Let's see what happens at point C. The 3 ma current flowing in R_1 divides at B and flows through load 1 and R_2 . Since we know that 150 volts is developed across R_1 , there can only be 150 volts (300 minus 150 v.) from point B to point D. The current through load 1 would then be:

$$I = \frac{E}{R}$$

$$I = \frac{150 \text{ volts}}{150,000}$$

$$I = .001 \text{ amperes, or}$$

$$I = 1 \text{ ma}$$

If there is 3 ma flowing in the divider string, and one ma is flowing in load 1, then the remainder (2 ma) must flow through R_2 and R_3 plus load 2. The 2 ma flowing in R_2 will again produce a voltage drop which is:

$$E = IR$$

$$E = .002 \times 50,000$$

$$E = 100 \text{ volts}$$

Thus the voltage remaining to be applied across CD is the 100 volts developed across R_2 subtracted from the voltage between B and D (150 volts) or 50 volts across points C and D.

The current in load 2 is then:

$$I = \frac{E}{R}$$

$$I = \frac{50 \text{ volts}}{50,000}$$

$$I = .001 \text{ amperes, or}$$

$$I = 1 \text{ ma}$$

The 2 ma which flows through R_2 divides between R_3 and load 2. Since there is 1 ma flowing in load 2, there must also be 1 ma flowing in R_3 . This is a logical assumption since they are both the same value. However, to prove it, the voltage drop across R_3 can be found:

$$E = IR$$

$$E = .001 \times 50,000$$

$$E = 50 \text{ volts}$$

Since this is the same as the voltage determined to be across C-D previously, the value of current must be correct.

Instead of a voltage of 200 volts at B and 100 volts at C, as in fig. 2, the voltage is now 150 volts at B and 50 volts at C with the loads as shown in fig. 3. Thus you can see that the voltage appearing across the intermediate terminals of a voltage divider will divide proportionally to the values of the divider resistors only *so long as no appreciable load is drawn from these terminals*. Under loaded conditions the voltages at these terminals will have various values, depending upon the resistance of the loads. *A voltage divider must therefore be designed for the particular load conditions under which it is to operate.*

The test meter mentioned earlier may repre-

sent a load resistance. If it is v.o.m. type (volts-ohms-milli-amperes), it draws current from the circuit to actuate the meter pointer and therefore has resistance. If it has resistance, it is the same as placing an extra load in the circuit and consequently the voltage will drop, as in the above example. Because of this effect, we term the error *meter loading*. Class dismissed!

Code Practice Oscillator

Need a good code practice oscillator? Try the circuit shown in fig. 4, submitted by John Creamer, KNØBVR. It has both headphone and speaker output. Note that only one wire plugs into the 117 volt line. The common chassis ground circuit is connected to an outside ground, preferably a water pipe. This eliminates the shock hazard customary with a.c./d.c. or transformerless equipment. The transformer can be any old push-pull plate to 8 ohm speaker transformer. The tubes, common types, are found in most five tube radios. The miniature 35Z5 and 50B5 equivalents may also be used.

Educational Kit

Designed as a follow-up to their earlier EK-1, the new Heathkit EK2-A Educational Kit is an excellent starting point in learning basic radio theory. The student starts by learning the four basic parts of a crystal radio: antenna, ground, detector and earphone. With this ground-work

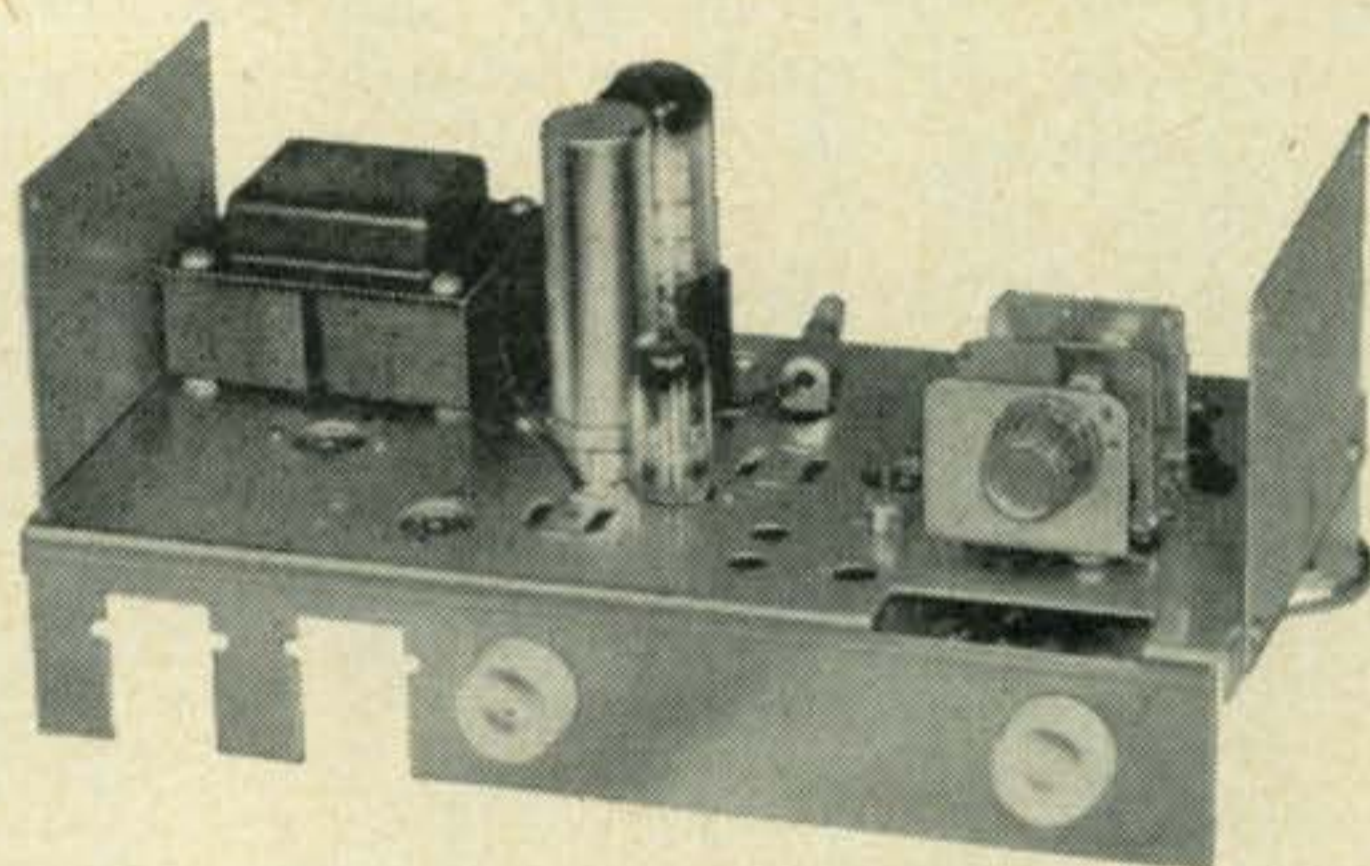

he actually builds a simple crystal receiver and then improves it by adding a tuned circuit, tubes, transformer and power supply. The final circuit of the EK-2A is a regenerative receiver. A soon to be released kit, the EK-2B will advance this knowledge of radio theory and provide additional components which result in a fine super-heterodyne receiver.

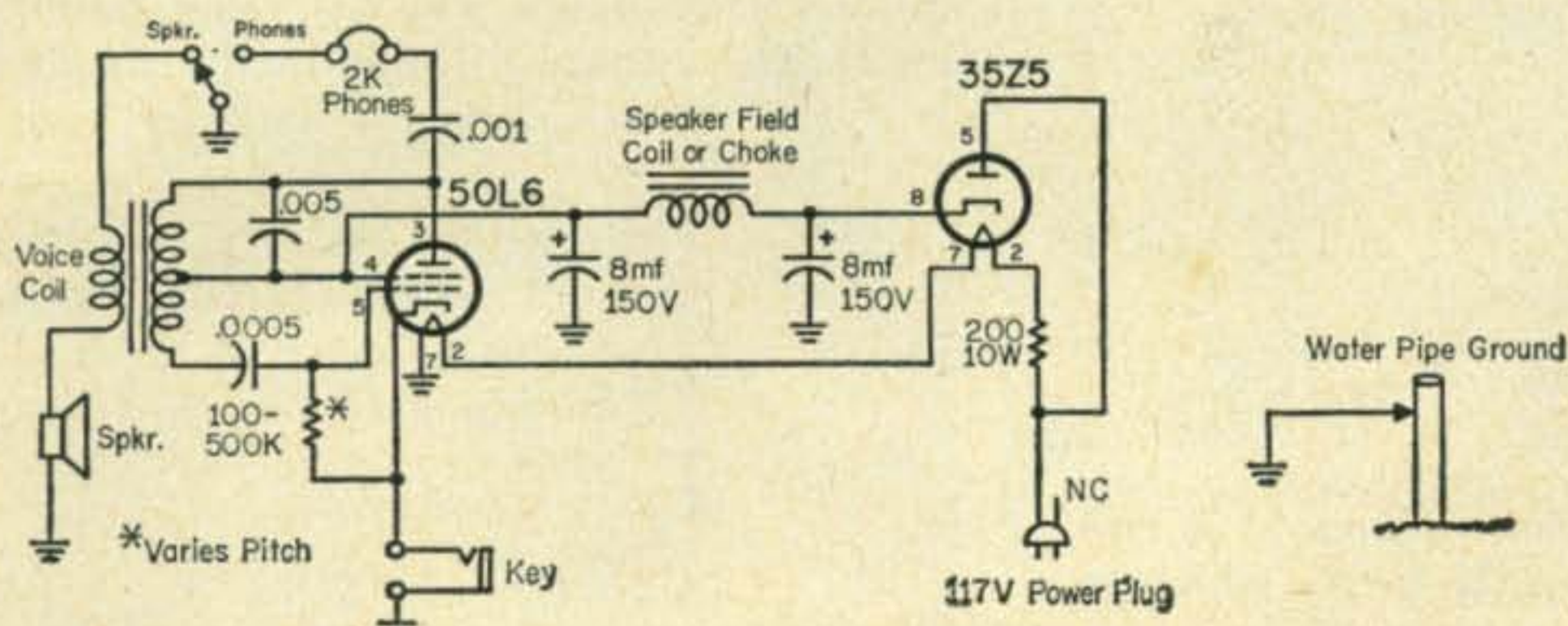

Fig. 4 — A two tube code practice oscillator designed by John Creamer, KNØBVR. If the tubes do not light, simply reverse the plug in the wall.

SIDEBAND

Irv and Dorothy Strauber, K2HEA/K2MGE

12 Elm Street, Lynbrook, New York

SSB DX HONOR ROLL

T12HP	223	4X4DK	161
W6UOU	218	K2FW	160
W4IYC	214	W1OOS	155
VQ4ERR	212	W4OPM	153
W8PQQ	206	W5KFT	151
W6PXH	200	K8RTW	151
PY4TK	200	W5RHW	150
W6RKP	196	K8CTL	150
K2MGE	194	K2HEA	150
W7VEU	191	W6VUW	136
W8QVZ	190	W2YBO	135
W6BAF	188	W6YMV	130
W6WNE	187	W2MAF	129
HB9TL	186	K1IXG	126
VK3AHO	185	W8ACT	125
K9EAB	181	W2NUT	125
W5AFX	177	K6MLS	125
TG9AD	176	K2TDI	125
MP4BBW	174	W1JSS	125
W2LV	174	W1AOL	125
W5IYU	174	W6UPP	122
K4TJL	173	W2ATJ	121
W8CVU	170	W7DLR	121
W2FXN	169	W4UWC	119
W3MAC	165	ZL3AB	117

PY4TK First South American for "200"

Art Cattoni, PY4TK, skipped ahead of all South American sideband competitors when he submitted the last of his confirmations for the "Worked 200" Award and was airmailed Certificate #9. Art, who has distinguished himself by his wonderful cooperation and courteous operating practices, is an able representative of all our neighbors to the South. A civil engineer, whose specialty is road construction, Art's business activities call him away from his shack for many periods during a month. Being such a good operator, Art is able to utilize his limited operating time to best advantage and work most of the new countries on sideband as they come along. Congratulations, Art, for a fine job well done.

Art, W5AFX, brought his listing up to date and received his stickers for "Worked 175," "Worked 150" and "Worked 125," all at one time! K2TDI, W1JSS, W1AOL, and K1IXG added "125" stickers to their certificates while "Worked 100" Certificates were mailed to K1EJO, W0BSK, G3KHE, and W0PGL. Other activity this month included the issuance of "Worked 75" Certificates to W1UOP and W0MLY with G8KS in a class by himself for the "Worked 50" Certificate. Congratulations to one and all and we look forward to seeing your totals rise from month to month.

S.S.B. Hamfest-Banquet

Make your reservations *now* for the 10th Annual Sideband Hamfest-Banquet, sponsored by the Single Sideband Amateur Radio Association, which will take place on Tuesday, March 21, 1961, from 10 A.M. to 12 Midnight at the Statler Hilton Hotel, New York City. The outstanding event of the year for sidebanders, this year's Hamfest will feature exhibits of the latest in sideband equipment and accessories, a fabulous get-together of sidebanders from all over the country, and a super Banquet at which you'll be entertained by the tops in Broadway talent. William B. Williams, famous New York disc jockey of Radio WNEW, will be Master of Ceremonies. Tables of ten may be reserved in advance when accompanied by full remittance for the reservations. Admission to the Hamfest is \$1 per person payable at the door. Admission to the Hamfest-Banquet is \$10 per person with advance reservations heartily recommended. Send your reservations and check to the Single Sideband Amateur Radio Association, Box 54, Rockville Centre, New York and look forward to enjoying the time of your sideband life.

Focus on Christina, EA8CT

We are happy to turn the spotlight this month on Christina, EA8CT, who has been very active on 10, 15, and 20 since December of last year. In writing about herself, Christina mentions that she is married to "Paco," a Spanish doctor from Madrid and they have resided in the Canary Islands for over 20 years. Mother of three most attractive children, Maria, Roberto, and Lili, Christina teaches languages (French, German, and English) at the "Gymnasium." She operates



Christina, EA8CT whose activity from the Canary Islands has added so much enjoyment for the sideband fraternity.

out of the station of her uncle, Pablo, in whose name the call is listed. According to Spanish regulations, a close member of the family is permitted to operate the station provided he or she has also passed the examination, as was the case with Christina. According to her, the Spanish call signs are not personal but rather belong to the station as in the U.S.A.

A woman of great charm and enthusiasm, it is indeed a great pleasure to welcome Christina to the ranks of amateur radio operators and we hope that she enjoys her contacts as much as we enjoy ours with her.

DX on 75 Meters

Some of the DX focus has shifted from 20 meters to 75 meters as reports of increasing contacts with overseas stations started to filter down through the ranks. And all of the reports were true! In the forefront of this movement, to entice more DX operation to 75 and 80 meters were WIBU, WIFOS, W1FRR, and W8LIO, all well known for their v.h.f. activities (WIBU by any other call is still Sam Harris!). Entered in their logs were such familiar calls as PAØFM, YN1TAT, GW3EHN, DL7BA, G3AWZ, DL4PI, G2HX, 4X4DK, ZC4AK, and DL1VR, among others—all of these garnered on 80 meters. The Stateside stations ranged themselves on frequencies from 3.803 to 3.810 while the DX boys transmitted in the area from 3.760 to 3.795 (they are not permitted to operate above 3.800!). After WIBU or one of his cohorts had made the initial contacts, other W/Ks were invited to try their luck at an exchange of reports and—by golly—most of them made it!

As most seasoned DX chasers will realize, it's the challenge to be met in searching out DX on 80 which makes the hunt exciting; certainly not the necessity for adding a new country to the list. The 75-80 meter activity gives one the opportunity to study propagation under changing conditions and discover how, within the sunspot cycle, a band normally useful only for local contacts, can be put to work for long haul communication.

There was some grumbling on the part of 75-



Here's a fine father-son team—Frank, K4YWX, and Harry, K4YWW, who put out a beautiful sideband signal from Miami, Florida.

meter roundtable members who resented the sudden and unexpected encroachment of DX hounds on the frequencies formerly used for their ragchewing over the past years. While we certainly agree that roundtables should not be summarily ignored or stomped on just for the sake of making a quick DX contact, we must point out that there are enough frequencies available on 75 for everyone's use. Neither the ragchewers nor DXers need start squabbling. With the signals put out by some of the leaders in this DX activity, it really couldn't matter less if they transmitted on 3.803 or 3.810 or in-between. We hope that any difference of opinion will have been speedily resolved so that each group will be able to pursue the particular facet of the hobby which it enjoys most without detracting from the pleasure of others.

Pile-ups Or QRT?

We'd like to share with you a letter received from Charlie, WIBAN, which points up the difficulties experienced by a new DX station on sideband: "Hugo, CP5EA, obtained his own 10-B and 814 linear there in Bolivia. He was helped very much in this by Hans, CP5EK. I obtained and converted for him a BC-458 and also sent a Central Electronics QT-1. He is running about 90 watts p.e.p. to the linear to a Hi-Gain tribander up 60 feet.

"Hugo has been on the 20 meter band only on occasions up to now. He has a terrible time in the pile-ups, what with the QRM and his difficulty with the English language. He much prefers to complete each QSO without tail-enders or breakers; these modes of operation only confuse him to the point where he closes down and tries it again later. Yes, I too believe the master of ceremony deal would work out the best if it could be handled with a firm control. I will make an effort to set schedules with him and see if something along this line can be arranged. I don't want him to become discouraged with 20 s.s.b. operation. This is the band where he is needed the most now."



One of sideband's most glamorous couples—Henny, WA2DLK, and Raoul, K2AOS of New Hyde Park, New York.

As with our other able Verification Managers, it is necessary to submit cards with a listing thereof *only* for the "Worked 100" and "Worked 200" Awards. For the other awards and stickers, a listing only, verified by another ham, and sent directly to us will be sufficient.

Both Jack and Jock now have a supply of awards rules and confirmation listing forms and will be happy to send them out upon receipt of a stamped, self-addressed envelope.

We are, of course, very grateful to Jack and Jock for volunteering their time and effort to be of service to the sideband fraternity.

Sideband Around the World

Thanks to Bill, VE3BQP, we have further news of Bert, ex-ZS3ES, who is now in Sierra Leone. According to Bill: "Bert is comfortably installed in the bush (miles from Freetown) and miles away from a.c. power. However, there is another ham at the mines (also miles away) but it is hoped that, between the two of them, they will eventually be able to generate the necessary power to be on the air before Spring!" Bert hopes to use the call ZD1ES but we probably won't know definitely until he is on the air. . . . Russ, DL4BS informed us about the DARC National Convention which is being held in Dortmund, Germany from May 19 to May 22. Russ listed the tentative program as consisting of a continuous industrial exhibition of commercial and amateur radio equipment; several mobile competitions; lectures on specialized subjects; meetings of specialist groups (v.h.f., DX, s.s.b., etc.) and a Grand Hamfest with musical and other entertainment in addition to a lottery with many attractive prizes. Russ invites all amateurs, who plan to be in the vicinity of Dortmund at that time, to contact him or DL2AL for accommodations which he guarantees are plentiful. . . . Mac, VP6WD, who, at present, is the only Barbados s.s.b. station, has designated Joe, W4OPM, Rt. 1, Box 152, Bayside, Va., as his QSL manager. . . . Thanks to Steve, G2BVN, we are pleased to pass along the QSL address of EP1AD (who will also accept cards for any



A well known Midwestern sidebander is Orrie, W8BF, shown with his charming XYL, Dorothy.

other EP station): MAAG, APO 205, New York, N.Y. . . . Still another certificate has been brought to our attention by Earle, KL7AWR. It is issued by the Kodiak Amateur Radio Club and is yours when you submit QSLs from five Kodiak Island licensed amateur radio stations to Kodiak Amateur Radio Club, Navy # 127, Box 37, c/o P.M., Seattle, Washington.

Ian, MP4BBW, is making another trip to the States this Spring and plans to attend the Dayton

Worked 100 and 200 Certificates

All stations must submit QSL cards, clearly marked 2-way S.S.B., together with an alphabetized list and sufficient return postage for these certificates and your cards. Listing forms will be sent by Sideband Editors and below listed stations upon receipt of your self-addressed envelope, stamped or with IRC's.

Worked 50 and 75 Certificates Stickers for 125, 150, 175 etc. Countries

All stations must submit only an alphabetized listing of confirmed 2-way S.S.B. contacts verified and attested to by another amateur. No cards need be submitted. Include letter postage.

African Stations

Send cards with lists to ZS6AMV, A. J. Louw, 52 Wargrave Ave., Auckland Park, Johannesburg, Tvl., South Africa from the following call areas: All ZS's, ZE, VQ2, ZD6, CR6 and CR7.

All sideband stations in the other African call areas send cards with lists to Awards Manager, R.S.E.A., QSL Bureau, Box 30077, Nairobi, Kenya.

United Kingdom and Ireland

R. F. Stevens, G2BVN, 51 Pettits Lane, Romford, Essex, England, will verify your cards provided they are accompanied by listings.

Europe

All European sidebanders may send their cards to Jakob Laib, HB9TL, Weinfelderstr. 29, Amrisweil, TG, Switzerland.

Australia, New Zealand and other Oceania

All sideband stations in these areas may send their cards to Jock White, ZL2GX, 86 Lytton Road, Gisborne, New Zealand.

Other Areas

Direct to the Sideband Editors, 12 Elm Street, Lynbrook, L.I., N.Y.

In every area, return postage must be included!

Hamvention on April 28-29 where we shall look forward to meeting him (also just heard that Les Earnshaw, ZL1AAX, will be at Dayton also!). On the way over, Ian had planned to visit and operate from Pakistan (AP2CR) on Feb. 21-22 and also put a new country on sideband on March 25 for one week—the British Phoenix Islands—where he and Bill, VE7ZM, look forward to operating as VR1W and VR1Z respectively. . . . A hearty welcome to Sam, EL2Q, whom many will remember as EL8F and who has recently joined us on sideband. . . . Other newcomers on sideband include ZC4AK, LZ1WD, UC2AA, HA9OZ, 9G1CY, and CP5EA. It was rumored that UA3FE would take a small s.s.b. rig to Tannu Tuva during the s.s.b. contest weekend, using the call UA3FE/UAØ or UAØKYA. This is the hard-to-get Zone 23 and now that UAØOI is on s.s.b. from Zone 18, this makes WAZ-s.s.b. possible. Look out, Urb, much more work coming your way. . . . You're probably wondering how you can work these new rare stations. Well according to band conditions in January, the "U" stations were often workable either about 0100 GMT or 1200 GMT, sometimes with fairly strong signals. Since few signals outside of the States are now coming in with the strength heard in past years, it is up to you to dig down a little deeper and try to hear them under the stronger W/K stations. Requires a bit more listening but it pays off if you want to keep adding new countries to the list.

At this writing, VQ9TED still had not left the Seychelles to visit those rare islands, Algalega, Amirante, and Farquhar but the whole DX world was waiting breathlessly to get the news that Ted was on his way. There seems to be many a slip between plans and a trip, for the Laccadives and Malpelo DXpeditions were also postponed; the former till late February if Raju's ship bookings were confirmed and the latter till mid-March.

Joss, ZS6L; Van, ZS6BB, and Dennis, ZS6VX, got quite a kick out of working their first state-side aeronautical mobile, WA2JOI, Robbie, over Plattsburgh AFB in up-state New York. Signals both ways were tremendous and promises of QSLs were also flying high!

Band Hopping

It was sure good to hear the familiar voice and powerful signal of Larry, W4HNW, back on the air again after a week's stay in the hospital. We join his many, many friends in wishing him the best of health in the future. . . . At last, we had the pleasure of contacting Frank, K5YYY, of Blytheville, Ark., on the air during the first week of the New Year. So many sidebanders had mentioned him to us as being an outstanding personality that we were curious to hear for ourselves and sure enough they were right. . . . Bing, W2CMM; Mike, WA2BLH; and Stan, WA2GFV, have been spearheading the ticket reservations for the S.S.B. Dinner, along with co-chairman, Irv, W2IVW, and prize

chairman, Mort, W2KR, all of whom have been devoting themselves to these same tasks for the past number of years. . . . That gal, Alice!! Why, K4TGA of course—whose presence on any frequency, be it 14.315 or 3.995, is sure to add lots of fun and excitement and charm to the conversation. Remember when Alice used to wistfully check into the s.s.b. YL Net on a.m. and what a joy it was to finally welcome her to s.s.b. She and OM Ham, K4TGB, are wonderful examples of the very best you can meet in amateur radio. . . . Speaking of the best in amateur radio, 3.803 boasts of a number of top-notch s.s.b. operators, among them, Glen, W3AQT; Bernie, W9HTF; Bud, K2PMA; Steve, W2CWB; Morey, W2DXZ; Tom, W3MFD; Les, W3MTM, and a host of others. Here is a very lively but friendly group, always willing to welcome anyone who wishes to join them on frequency. . . . Don, WØUUV, is busy building a new all-transistorized exciter; this, of course, only when he's not busy chasing DX. . . . Al, K7AM, was on vacation in Depoe Bay from his home QTH in Portland, Ore. when we contacted him on 20. There he was with his KWM-2 set out on a card table but connected to his car's Heli-whip and what a fine signal he had! Then, practically the minute he returned home the next night, Al pulled the rig from the car, hooked it up to the fixed antenna and was back on the air with not a minute lost. . . . Murray, K6CQU/MM, aboard the Horace Luckenbach, has been having himself a time, working coast to coast from Southern California waters. Another popular maritime mobile signal comes from Guy, W1ONZ, who is always monitoring the bands for stations in the Boston area. . . . Congratulations to Bob, K4AJ, and XYL whose son, Mark, was married on Jan. 28 with Bob, of course, acting as Best Man. . . . Jeff, K4LLB, now operating portable in Orlando, Fla., was anxiously awaiting a reunion with his XYL and four youngsters from Nashville, Tenn. . . . Cal, W4ANE, will act as QSL manager for the Laccadive DXpedition when and if it finally comes off. . . . Frank, W2AMJ, and Ed, W2KPQ, oiled up the hinges, applied a heavy dose of rust remover and zoomed down the band from 3.999 to 3.803 one recent evening, much to the surprise and delight of the gang at the low end of 75. . . . If you'd like weekly propagation forecasts, a postcard to Central Radio Propagation, Radio Warning Service, National Bureau of Standards, Boulder, Colorado, will bring them to you. . . . Phil, K2HU, is another of the old timers who was away from radio for 20 years till the fellows in his office at the Bell Tel. Co. aroused his curiosity with their talk of the wonders of s.s.b. Now Phil is back on the air and just as excited as a kid with a new toy. . . . All Jim, W4FBZ, wanted for Christmas was his two front teeth; hope the man in the red suit was good to him. . . . Dick, K2RTI, was heard locally with a fine signal from his homebrew

[Continued on page 124]

Space Communications

GEORGE JACOBS, W3ASK

11307 CLARA STREET
SILVER SPRING, MARYLAND

Space Recap

This month's column will be devoted to a recapitulation of the entire space picture as it looked as of January 4, 1961. Complete information will be given concerning all objects successfully placed in orbit; those which have burned-up; those retrieved, and those which are still in orbit.

Since October 4, 1957, that historic day when the first artificial earth satellite was successfully launched, 70 objects have been blasted through the earth's atmosphere into outer space. Of these, 44 have been satellites designed for one particular scientific purpose or another, while the remaining 26 have been either the rockets which carried the satellite into orbit, or debris from the rocket carrier or satellite. In the language of today's space-age, this debris is generally referred to as "space garbage."

Of the 44 artificial satellites rocketed into space, 21 are still in orbit either around the earth or around the sun, and one rests on the surface of the moon.

Three satellites have been launched for communication experiments, while the transmitters of 7 satellites presently in orbit are still on the air.

Space Catalog

A complete listing of successful satellite launchings, and what has happened to the satellites since launching, is given in the tables beginning on the next page. This catalog of space objects is compiled from data collected by the National Surveillance Control Center, and released by the National Aeronautics and Space Administration (NASA). The National Surveillance Control Center is responsible for keeping a constant radar watch on outer space, so that this country knows the whereabouts of every object in orbit.

Each successful space launching is designated officially in alphabetical order, in accordance with the Greek alphabet. Each year the designations begin over again with ALPHA, the first letter in the Greek alphabet. For example, the first successful launching in 1961, regardless of which country achieves it, will be designated 1961 ALPHA. If more than a single object orbits as a result of the launching, the designations are broken down further in numerical sequence.

For example; if, as a result of the first successful launching in 1961, a satellite, its rocket carrier, and a miscellaneous piece of metal all go into orbit, they would be designated 1961 ALPHA 1, 1961 ALPHA 2 and 1961 ALPHA 3 in that order.

Besides its official designation, which is recognized internationally, each satellite usually has a common name, or project name, given to it by the launching country. Sputniks and Luniks have been the common names so far chosen by the USSR for their satellites, while the U.S. satellites bear their project names, such as Discoverer, Explorer, Echo, Transit, etc.

Also shown in the Space Catalog are the periods for those satellites still in orbit and the inclination, apogee and perigee of the orbit. The *period* of the satellite is the time it takes to complete its orbit around the earth. Periods vary between approximately 92 and 138 minutes. The *apogee* is the point on the satellite's orbit farthest from the earth, while *perigee* is the orbit's closest point to earth. *Inclination* is the angle the satellite's orbit makes with the equator.

The Score

Of the 44 satellites placed successfully into orbit through January 4, 1961, 35 are credited to the United States and 9 to the Soviet Union. The U.S. has orbited 35 satellites with the 34 successful launchings, having on one occasion placed two satellites into orbit with a single launching (1960 ETA 1 and 2). Nineteen of the American satellites are still in orbit, as are 2 of the Russian's.

The U.S. has brought back to earth successfully four of its satellites, while the Russians have retrieved one of theirs.

Both the United States and the Soviet Union have placed a satellite into orbit around the sun, but Russia so far has been the only country to land a satellite on the surface of the moon.

Space Communications

The United States leads in the field of space communications. Project Score (1958 ZETA) was the first satellite to relay a voice message by radio back to earth (President Eisenhower's 1958 Christmas Greetings to the world).

On August 12, 1960 the U.S. launched the first passive communications satellite, the 100-

Objects In Orbit
(As of January 4, 1961)

Object	Name	Launched By	Launch Date	Period (Mins.)	Inclination (degrees)	Apogee Perigee (statute miles)	Transmitting freq. (Mc)
1958 ALPHA	Explorer I	US	1 Feb 58	106.9	32.22	1138 217	
1958 BETA 1	Rocket Body	US	17 Mar 58	138.3	34.27	2687 406	
1958 BETA 2	Vanguard I	US	17 Mar 58	133.9	34.25	2454 406	108.022
1959 ALPHA 1	Vanguard II	US	17 Feb 59	125.3	32.86	2042 348	
1959 ALPHA 2	Rocket Body	US	17 Feb 59	129.6	32.90	2284 344	
1959 DELTA	Explorer VI	US	7 Aug 59	Position Uncertain			
1959 EPSILON 2	Capsule	US	13 Aug 59	93.0	78.94	395 123	
1959 ETA	Vanguard III	US	18 Sep 59	129.8	33.34	2320 316	
1959 IOTA 1	Explorer VII	US	13 Oct 59	101.1	50.31	670 344	19.9904
1959 IOTA 2	Rocket Body	US	13 Oct 59	101.0	50.31	661 343	
1960 ALPHA*	Pioneer V	US	11 Mar 60	311.6D	3.351	.9931AU .8061AU	
1960 BETA 1	Rocket Body	US	1 Apr 60	99.1	48.41	464 429	
1960 BETA 2	Tiros I	US	1 Apr 60	99.1	48.39	467 429	107.997
1960 GAMMA 1	Rocket Body	US	13 Apr 60	92.9	51.25	343 179	
1960 GAMMA 2	Transit IB	US	13 Apr 60	95.2	51.28	429 231	
1960 EPSILON 1	Sputnik IV	USSR	15 May 60	93.2	65.02	359 175	
1960 EPSILON 3	None †	USSR	15 May 60	93.7	64.89	391 172	
1960 EPSILON 4	None †	USSR	15 May 60	93.3	64.89	363 176	
1960 ZETA 1	Midas II	US	24 May 60	94.3	33.00	332 282	
1960 ETA 1	Transit 2A	US	22 Jun 60	101.6	66.77	650 389	54:162:216:324
1960 ETA 2	Greb ‡	US	22 Jun 60	101.6	66.77	657 381	
1960 ETA 3	Rocket Body	US	22 Jun 60	101.3	66.77	638 383	
1960 IOTA 1	Echo I	US	12 Aug 60	117.1	47.20	1313 620	107.94
1960 IOTA 2	Rocket Body	US	12 Aug 60	118.0	47.28	1031 950	
1960 IOTA 3	Metal Object	US	12 Aug 60	118.2	47.20	1050 941	
1960 IOTA 4	Metal Object	US	12 Aug 60	118.2	47.20	1044 950	
1960 IOTA 5	Metal Object	US	12 Aug 60	118.3	47.20	1060 940	
1960 NU 1	Courier 1B	US	4 Oct 60	106.9	28.30	769 586	107.97
1960 NU 2	Rocket Body	US	4 Oct 60	106.4	28.30	735 591	
1960 XI 1	Explorer VIII	US	3 Nov 60	112.6	50.00	1419 259	
1960 XI 2	Rocket Body	US	3 Nov 60	112.5	50.00	1415 259	
1960 PI 1	Tiros II	US	23 Nov 60	98.2	48.57	463 378	108.0
1960 PI 2	Rocket Body	US	23 Nov 60	98.1	48.57	458 378	
1960 SIGMA §	Discoverer XVIII	US	7 Dec 60	92.8	81.50	366 143	
1960 TAU	Discoverer XIX	US	20 Dec 60	91.9	83.40	323 128	

*Period in days, aphelion and perihelion in astronomical units, inclination to ecliptic.
 †Unidentified metal objects, may be debris from either rocket carrier or satellite.
 ‡Piggy-back shot with Transit 2 A.
 §Capsule, ejected from satellite, successfully recovered from orbit.

Lunar And Space Probes

Name	Launched By	Launch Date	Status
Pioneer IV	US	3 Mar 59	Orbiting Sun
Lunik I	USSR	2 Jan 59	Orbiting Sun (First Space Probe)
Lunik II	USSR	12 Sep 59	Hit Moon—13 September 1959

Space probes launched after October 1, 1959 are shown in the Objects In Orbit Table.

**The above listing is a summary of the satellite and probe launchings since October 4, 1957.
 Data for Echo I will be given net month.**

foot balloon, Echo. Echo has made possible experimental u.h.f. communications over great distances, and is still in orbit.

Courier, the first active radio relay satellite was launched by the U.S. on October 4, 1960. This satellite stored tremendous amounts of communication data received while over one transmitting station, and upon command, released the data while over another communication station great distances away. The Courier satellite is still in orbit, but its communication

equipment is now inoperative due to power supply exhaustion.

Echo and Courier, although experimental communication satellites, are vanguards of the globe-girdling space communications systems which may be in operation in the not-too-distant future.

Satellite Frequencies

Each satellite placed into orbit carries a transmitter for tracking purposes and for telemetering

Burned-Up Objects
(As of January 4, 1961)

<i>Object</i>	<i>Name</i>	<i>Launched By</i>	<i>Launch Date</i>	<i>Burn-Up Date</i>
1957 ALPHA 1	Rocket Body	USSR	4 Oct 57	1 Dec 57
1957 ALPHA 2	Sputnik I	USSR	4 Oct 57	Early Jan 58
1957 BETA	Sputnik II	USSR	3 Nov 57	14 Apr 58
1958 GAMMA	Explorer III	US	26 Mar 58	28 Jun 58
1958 DELTA 1	Rocket Body	USSR	15 May 58	3 Dec 58
1958 DELTA 2	Sputnik III	USSR	15 May 58	6 Apr 60
1958 EPSILON	Explorer IV	US	26 Jul 58	23 Oct 59
1958 ZETA	Atlas-Score	US	18 Dec 58	21 Jan 59
1959 BETA	Discoverer I	US	28 Feb 59	Early Mar 59
1959 GAMMA	Discoverer II	US	13 Apr 59	26 Apr 59
1959 EPSILON 1	Discoverer V	US	13 Aug 59	28 Sep 59
1959 ZETA	Discoverer VI	US	19 Aug 59	20 Oct 59
1959 THETA	Lunik III	USSR	4 Oct 59	Apr 60 ?
1959 KAPPA	Discoverer VII	US	7 Nov 59	26 Nov 59
1959 LAMBDA	Discoverer VIII	US	20 Nov 59	8 Mar 60
1960 GAMMA 3	Metal Object	US	13 Apr 60	Jul 60
1960 DELTA	Discoverer XI	US	15 Apr 60	26 Apr 60
1960 EPSILON 2	Rocket Body	USSR	15 May 60	17 Jul 60
1960 EPSILON 5	None*	USSR	15 May 60	Sep-Oct 60
1960 EPSILON 6	None*	USSR	15 May 60	Sep-Oct 60
1960 EPSILON 7	None*	USSR	15 May 60	24 Sep 60
1960 EPSILON 8	None*	USSR	15 May 60	Sep-Oct 60
1960 EPSILON 9	None*	USSR	15 May 60	Sep-Oct 60
1960 ZETA 2	Metal Object	US	24 May 60	5 Dec 60
1960 THETA	Discoverer XIII	US	10 Aug 60	14 Nov 60†
1960 KAPPA	Discoverer XIV	US	18 Aug 60	16 Sep 60†
1960 LAMBDA 1	Sputnik V	USSR	19 Aug 60	20 Aug 60†
1960 LAMBDA 2	Rocket Body	USSR	19 Aug 60	23 Sep 60
1960 MU	Discoverer XV	US	13 Sep 60	18 Oct 60
1960OMICRON	Discoverer XVII	US	12 Nov 60	29 Dec 60†
1960 RHO 1	Sputnik VI	USSR	1 Dec 60	2 Dec 60
1960 RHO 2	Rocket Body	USSR	1 Dec 60	2 Dec 60

*Unidentified metal objects, may be debris from either rocket carrier or satellite.

†Capsule, ejected from satellite, successfully recovered from orbit.

Listing of all burned up space objects complete as of January 4, 1961.

scientific information back to earth. Signals from some of the satellites (especially the Russian Sputniks) have been received on rather simple receiving installations, while reception of others may require a more elaborate setup.

The transmitters on the following seven satellites presently in orbit are still active, but a rather elaborate receiving setup may be required to copy them:

TRANSMITTING SATELLITES

Vanguard I	108.022 Mc
Explorer VII	19.9904 Mc
Tiros I	107.997 Mc*
Transit 2A	54; 162; 216; 324 Mc
Echo I	107.94 Mc
Courier 1B	107.97 Mc
Tiros II	108.0 Mc

*The transmitter on Tiros I was designed to be shut off from the ground. Efforts to silence the transmitter, however, have so far been unsuccessful. Future attempts will be made in order that the frequency can be assigned to another space project.

The *Space Catalog* appearing in this month's column reflects the complete space picture as of January 4, 1961. Amendments and revisions to this *Catalog* will appear periodically in this column.

Project Haverford

Space communication techniques are now in their infancy. At the present time the equipment needed for moon or Echo-bounce communications is elaborate, complicated and very costly. No doubt, in time, as simplifications are found in techniques and equipment, space communications will be within the reach of many radio amateurs. At the present time, however, it looks as if the reasonable way for radio amateurs to get into space communications is by a group effort through a large and active radio club, or similar organization.

Recently some students at Haverford College, Haverford, Pennsylvania, set up a Satellite Tracking Station under the direction of Professor T. A. Benham of the Department of Physics. The station is to be used for tracking satellites, and for attempting communication by reflection from the moon and Echo type passive satellites.

Despite an initial setback, when fire destroyed much of the equipment the night before the Echo



Interior view of the Haverford College Satellite Tracking Station. Professor T. A. Benham (center), faculty project leader, is shown at the controls of one of the receivers.

tracked the unsuccessful NASA moon satellite attempt from the time the satellite appeared above the horizon at Cape Canaveral to when it disappeared over Africa (see Photos). As soon satellite was launched, the tracking station is now almost complete.

The students at Haverford College have already participated in some interesting projects with their tracking station. This past fall they

as Professor Benham can obtain a klystron he needs, they plan to conduct moon and Echo-bounce experiments.

Since the formation of the Haverford College Satellite Tracking Station might set a pattern for the formation of similar projects at amateur radio clubs associated with other educational institutions, *CQ* has invited Professor Benham to tell the complete Project Haverford story in an upcoming issue.

73, George, W3ASK

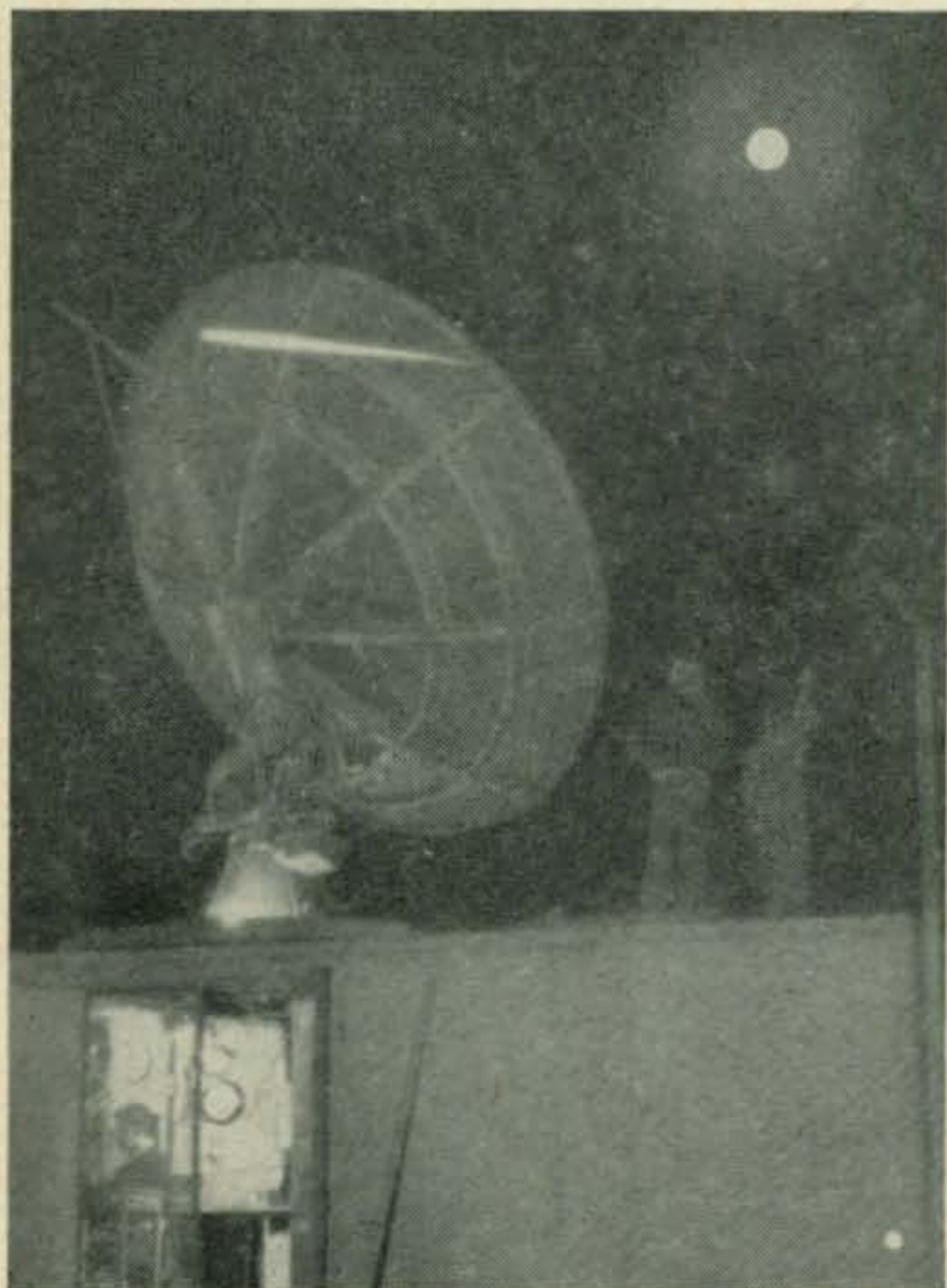

Haverford College Satellite Tracking Station. Dish antenna oriented to receive signals from NASA's unsuccessful moon satellite shot this past fall. Dish will also be used for moonbounce and communications by reflection from the Echo satellite.

Ham Hints

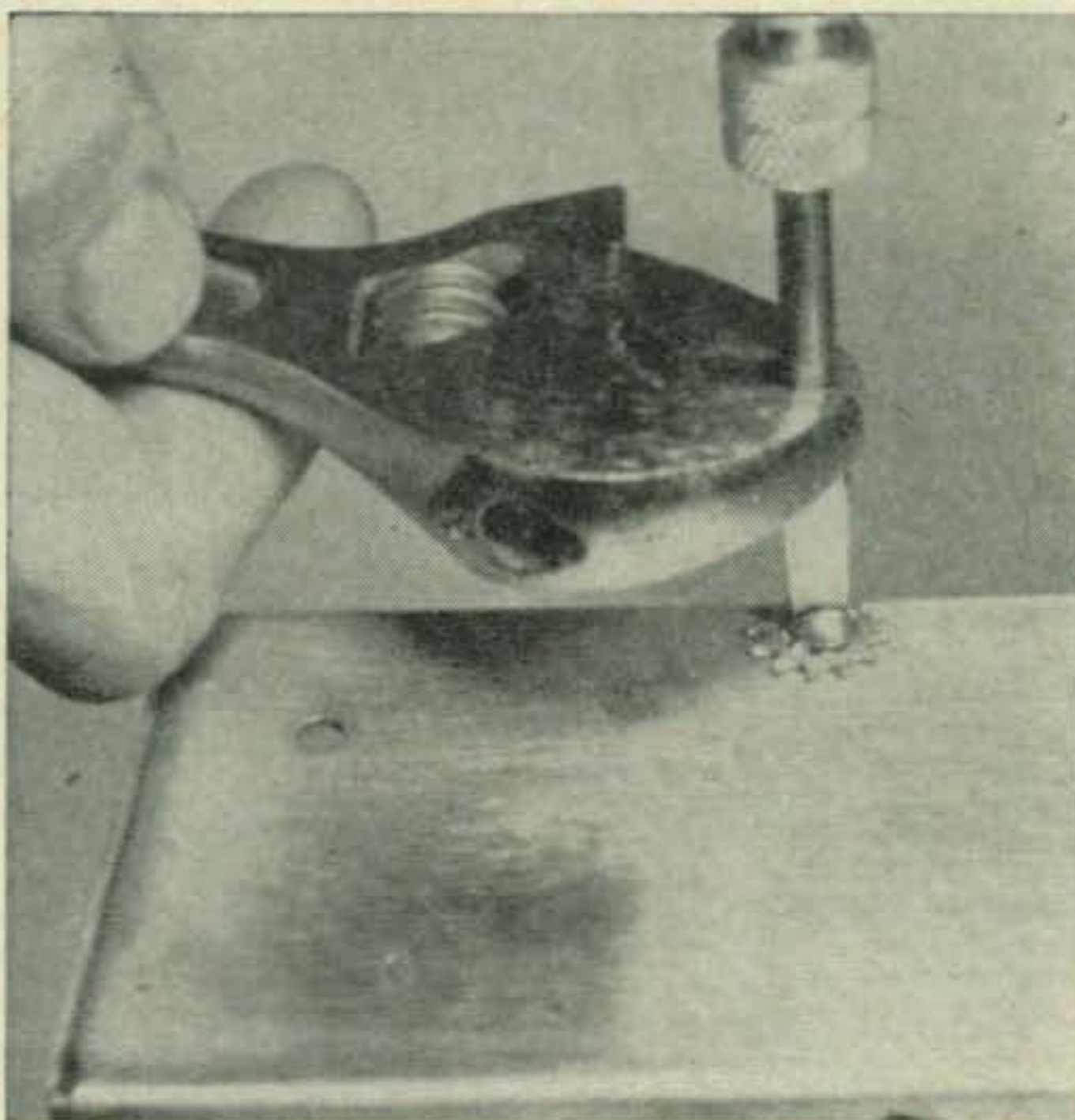

Extra Leverage For Tough Screws

When you need some extra leverage for loosening or tightening a screw, use the screwdriver and adjustable wrench technique shown. Tighten the wrench down onto the flat portion of the screwdriver tip and rotate driver and wrench together.

VHF

50mc. 144mc. 220mc. 420mc. and above

BOB BROWN, K2ZSQ
67 RUSSELL AVENUE
RAHWAY, NEW JERSEY

CQ WW V.H.F. Contest

I only hope you fellows had as much fun as we did in our February *CQ* World Wide V.H.F. Contest! We thought there were a lot of stations on from this area, but when we saw the logs coming in it really made us wonder! Six meters, as usual, seemed to be jam-packed with contesters, but what really surprised us was the 2 meters and up activity. In the past contest activity on the u.h.f. bands was at a bare minimum, but we're glad to see some of the u.h.f.'ers giving it a real run for its money.

This last contest gives us a chance to hear from you for possible changes of rules, improvements, etc. As we well know, its impossible to please everyone. This last contest was more or less a trial or experiment. The big ARRL contest (such as last January's) puts the multiple-banders and club groups into real competition with each other. This results in huge amounts of v.h.f.-u.h.f. men competing for the big title. This also gives individual v.h.f. clubs and societies added incentive and an annual "project" of trying to beat other club's scores. From these viewpoints I think we'll all agree that the ARRL V.H.F. Department is rendering a great service.

For the *CQ* gang to run the same kind of contest would just be duplication of the ARRL objective. So we turn to the other side of the story: The individual operator. We are all aware of the fact that a great many of us are not members of v.h.f. clubs and that a lot of these clubs do not participate in contests anyway. There is also the added factor that all of us cannot operate all v.h.f. bands. So it was decided to sponsor a contest that would rate individual 50, 144, 220, 432, and 1296 mc men against each other individually. This means a separate contest for each band. Our prime objective is to prove the operating skill! of low power, single band v.h.f. men. The reception by the fraternity of this idea was overwhelming! They liked the idea of being able to win a contest by themselves, developing ease and skill of operation. Over the years *CQ*'s v.h.f. contest rules have changed, and rightly so, as more and more fellows joined in asking, "What about mobile operations," etc. We also instituted a separate group of regulations for those stations wishing to operate multiband—whereby they would be classified in a division by themselves in the final printed results. These changes in the rules were brought about by you through your letters and comments. This brings us to the ques-

tion at hand: What changes would you like to see in the next *CQ* World Wide V.H.F. Contest? For a detailed report of our present rules, check the regulations on page 77 in the January '61 issue. We have another contest coming up on August 26 and 27, 1961. We would like to hear from you before May with your suggestions so that we can make up the new rules for an announcement page. Your ideas and comments will affect the next contest! Let us hear from you today! One final reminder: Contests logs must be in to us no later than March 15th for printing of results in the July issue. Don't delay! Get them in now!

Flash

Bill Brady of Selsey, England reports "G2HCG, who developed the slot antenna, is preparing some 2 meter experiments with the serious expectations of bridging the North Atlantic from northern England to North America. More details later." *Via George Jacobs, W3ASK.*

Correction—KL7FLC

You may remember a letter which was printed in our January column by M.Sgt. Freiberg of the Alaskan Air Command mentioning that to his knowledge the call letters KL7FLC had not been legally issued. This was a grave error. We don't know how the mix-up occurred, but we received a correction with proof from Bob Mellen of his authorization to operate under the call letters of KL7FLC. Our sincere apologies.

CQ's Century Club Awards

A large majority of the mail we've been receiving lately concerns our *CQ* Century Club Awards. Every day another bundle of applications and QSL cards come in. Between these certificates and our recent contest logs, we've had little time to answer letters of inquiry. Last year we printed the rules covering these awards, but due to a typographical error the ROHO certificate rules were inserted in the middle of our CCC regulations. At this time we'd like to restate our Century Club Award rules for new applicants:

A. The *CQ* Century Club Award is offered to those who have met with the following qualifications in one year's time. (This award is open to v.h.f. men anywhere in the world.)

1. 50 mc entrants must show a list of 150 contacts within one year with the proper QSL's on

hand to present as verification if requested. This list must consist of just those whose cards you have received. Each entry must have the call of that station and the date worked. Number them one to one hundred fifty (preferably in chronological order). Make sure that the two dates furthest apart do not exceed one year between. Each list must be headed by these two dates showing the space of time covered in the entries.

2. 144 mc entrants must show a list of at least 100 *confirmed contacts* with the information above.

3. 220 mc entrants must show a list of at least 50 *confirmed contacts* with the information given under the 50 mc award.

4. 432 mc entrants must show a list of at least 25 *confirmed contacts* with the information given under the 50 mc award.

B. Each list must be accompanied by a statement reading, "We, the undersigned, hereby verify that John Doe, K5XXX, displays the cards listed from actual on-the-air contacts." This statement must be signed by at least two witnesses (preferably licensed amateurs).

1. The cards themselves may be sent instead of a list but adequate postage must also be included for their return. (This seems to average out to about 96¢ first class mail. When you mail your cards, note how much it takes and include the same amount of stamps or cash with your application.)

2. There is no limit to how many certificates you may earn. How many can you get in a year's time?

3. There is no charge for this award. This *CQ* award is free to all who qualify.

4. Lists and statements should be mailed to: *CQ* Century Club Awards, c/o Bob Brown, K2ZSQ, 67 Russell Avenue, Rahway, New Jersey.

The certificates themselves are real beauts, well worth working for. They will be dated according to the dates you present on your list so that you can take off on a new award from the date appearing on the last. Good luck with the certificates boys



Here's an excellent idea of what the turn-out was like at the Syracuse V.H.F. Roundup. (Photo by K2AVA)

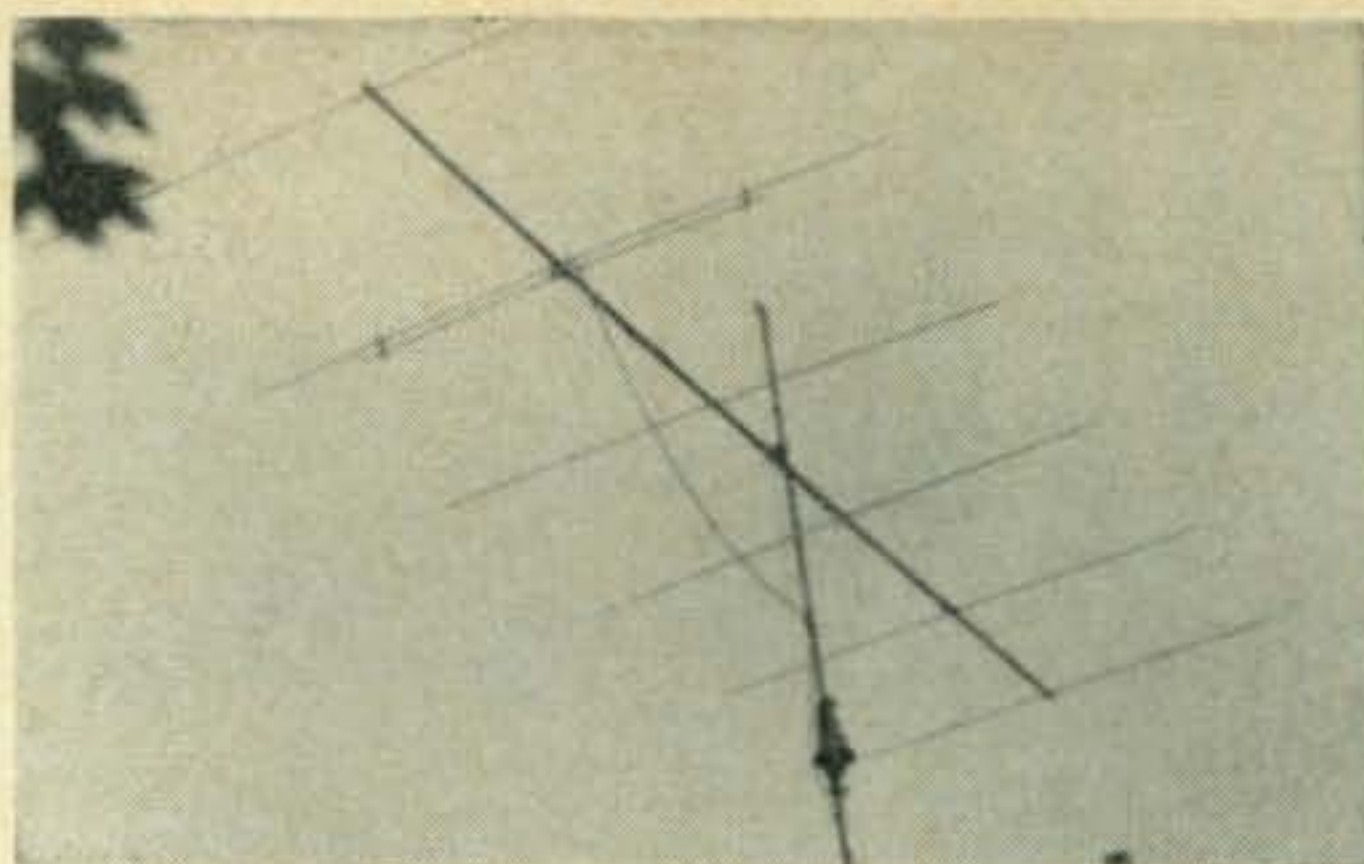

This is the antenna at WA2JQC.

Attention V.H.F. Clubs!

We are preparing a list to be published soon in this column concerning the v.h.f. clubs and societies for the benefit of the readers. Have your club secretary write us concerning membership requirements, where the club meets, when, and who to contact regarding application. This will aid prospective members in finding a local group he can join and find the satisfaction of participating in club affairs. Let's hear from you now!

Man of the Month

Our feature v.h.f. man this month is Conrad Holdorf, PY5GK, of Parama, Brasil, South America. Michael, LU3DCA, advised us of Conrad's activities. PY5GK started his amateur work on v.h.f. in 1952. In 1954 he had his first QSO on 144 mc over 70 miles with a portable rig running only $\frac{1}{3}$ of a watt into a $\frac{1}{4}$ wave antenna! Since then he has worked the following countries on 50 mc: KH6, XE, W4, TI, HC, OA, CE, LU, CX, ZP, YV, FM7, PJ, KP4, CO, CT3, FF8, and PY's 1, 3, 4, 6 and 7! Quite an impressive list!

Until 1959 he used the following equipment: A 25 watt transmitter with a 6146 in the final, a 6AQ5 as a doubler-driver and a 6AU6 as a crystal oscillator. The receiver was a HQ-140 XA with a 4 tube crystal controlled converter.

Now the transmitter has been changed to a new one running 150 watts to a 4-65A driven by a 2E26 and two 6CL6 tubes in the oscillator and multiplier stages. The receiver is a homebrew double conversion job with 18 tubes.

On 144 mc the transmitter runs 15 watts and the receiver is also of the double conversion type, with 21 tubes. All the transmitters, receivers, converters, antennas, and even the 35 foot tower are homemade—an impressive job really well done!

Free Hi-Pass Filters

Being v.h.f.'ers, with a large percentage of us operating 6 meters, we are frequently troubled by Television Interference (TVI). Many shun 6 meter operation for that very reason! Reports of 6 meter TVI have been blown way out of proportion in recent years by hams who have been worried over phone calls from neighbors annoyed by TVI. Most of us are aware of the fact that this is a problem quite easily solved by in-



"Geel! Look what Joe's got in the trunk!" More hamming it up at Syracuse. (Photo by K2AVA)

stalling a good high pass filter on the television receiver. An excellent filter for that purpose is the Drake TV-300-HP. This filter has a cut-off frequency of 52 mc and sells for anywhere from \$3.50 to \$5.00. Over recent years television companies have realized that the amateur operator is not necessarily causing the interference but rather the television's inability to reject nearby amateur signals. For this reason the television companies themselves have taken on the task of giving these filters to TVI recipients through their distributors. A certain form is required, indicating the make, model number, and serial number, as well as call letters of the intercepted amateur station. I have made up copies of these forms plus lists of distributors supplying the filters (in most cases R. L. Drake TV-300-HP). These have been duplicated and handed out to hams in need. If you'd like some of these forms and lists, send 25¢ (to cover printing costs, paper, envelopes, and postage) to: TVI, 67 Russell Avenue, Rahway, New Jersey.

Geminids Meteor Shower

Of tremendous interest to the 2 meter fraternity was our recent Geminids meteor shower occurring on December 10 through 14, 1960. These showers are the result of meteor trails which tend to ionize layers of our upper atmosphere giving us a reflecting element off which to bounce our v.h.f.-u.h.f. signals. The other big shower which occurs annually and right on schedule is the Perseids meteor shower, during the summer.

Jack, W8PT, reports, "December 12th brought a long sought contact with Georgia—W4LNG. Ruddy's signals were really pounding in here . . . The best Geminids I've ever heard!"

Walt, W4LTU, sends us the following, "We came very close to making it with W0YSJ, a real near miss over a 1120 mile path. Some signals were heard from W0RSP in South Dakota but nil from W0MOX in Colorado, a tantalizing 1450 mile path. W0MOX indicated by postcard, however, that he heard on December 11 an extremely weak but continuous sequence of signals! This could be something other than meteor and certainly bears looking into."

Ernie, W5FYZ, reports, "On the 11th W0IC

received my call and many short bursts. His signal level was high. Good QSO with Claude on the 12th; signals peaking S-8 with several long bursts. His signals were copied by other stations in this area during our skeds.

"Worked K5TQP, Albuquerque, New Mexico, for my first N.M. contact and state number 26. I was rather pessimistic about our chances, but his signals were very good and were copied by other stations in this area, including one in Texas! On the 10th I heard a few pings and letters; same on the 11th. On the 12th, identification was made early on a 10 second burst, and the QSO wrapped up just as sked time ended.

"Also worked Tom, W0IUF, of Boulder, Colorado, on the 12th. Pings and short bursts with parts of calls on the 9th and 10th; nil on the 11th. Good solid QSO on the 12th, with several 10-15 second bursts, and completed in 13 minutes of the second sked.

"In conclusion, the shower seemed to peak on the night of the 12th, with all three QSO's being made during the period from 10 P.M. to 12 M. CST. All three QSO's were in a WNW to NW direction and all were about 800 miles from Minden, Louisiana. Conditions to the NE were very poor and in no way comparable to the Perseids."



Charlie Sellwood, W2RHQ, with donations (?) for prizewinners inside at Syracuse. (Photo by K2AVA)

In addition to the above, W0BFB in Iowa worked W4AIB in South Carolina, while K2LMG in Ithaca, New York, put it across with W0YSJ in North Dakota, a 1000 mile path. W0YSJ also worked VE3DIR in Toronto, Canada. VE3DIR made it with W4FWH in Georgia for what Tony described as his easiest meteor contact ever; it took only 15 minutes. W4LTU tried, but in vain. Other skeds that we are aware of at this moment were between WA6MLX, W3BYF, W1AZK, K1LSY, K1CRN, K4EUS, W1JDF—W5FYZ.

Echo Bounce Analysis—K1LKK

Received a very interesting letter from Peter Olendzenski, K1LKK, concerning possible Echo bounce QSO's . . .

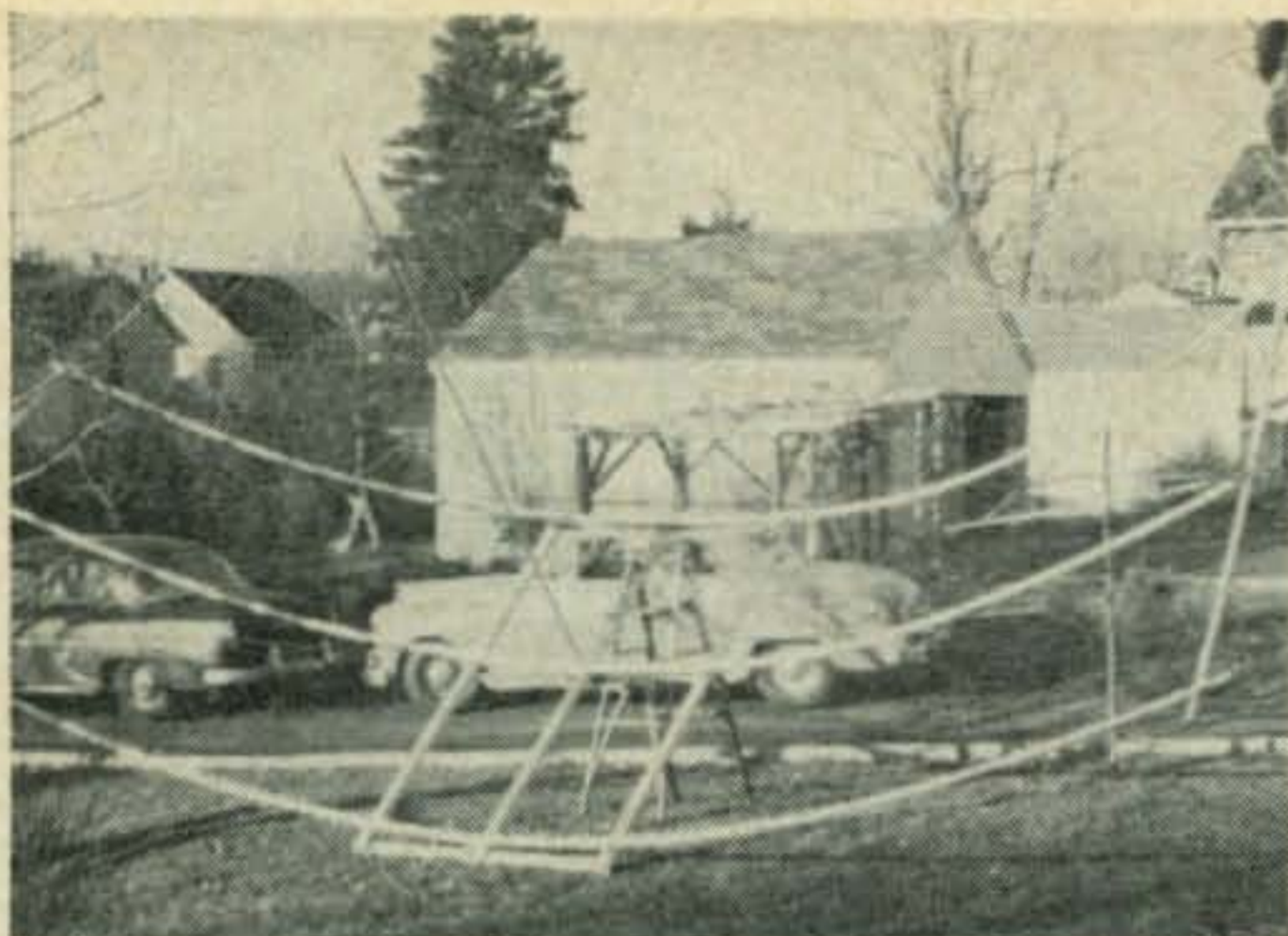

When Al's (K2UYH) parabola blew down, he got busy and built this 27 footer as a replacement.

"I was very much interested in your article in the November 1960 *CQ* concerning the possible Echo bounce QSO's of W7RT and W3AGT. After discussing the possibility of Echo bounce with a couple of friends and after a little work with a slide rule, encyclopedia, and the figures on Echo given in the W3ASK SPACE COMMUNICATIONS column, I derived the following figures, formulae, and conclusions:

"For any wave front of signal reaching Echo and the moon, the amount of signal reflected by each will be in the same ratio as their areas or the square of their diameters. The diameter of the moon is 1.4×10^7 feet and the diameter of Echo is 1.0×10^2 feet; using these figures the following formula represents the relative amounts of energy reflected by each sphere:

$$\frac{\text{Energy reflected by Moon}}{\text{Energy reflected by Echo}} = \frac{(1.14 \times 10^7)^2}{(1.0 \times 10^2)^2} = \frac{(1.3 \times 10^{14})}{(1.0 \times 10^4)} = \frac{1.3 \times 10^{10}}{1}$$

"The relative intensities per square unit area received by the moon and Echo from a transmitter on the Earth are inversely proportional to the square of the ratio of the distances and can be expressed as:

$$\frac{\text{Field strength at Echo}}{\text{Field strength at Moon}} = \frac{(1.0 \times 10^3)^2}{(2.38 \times 10^5)^2} = \frac{(1)^2}{(2.38 \times 10^2)^2} = \frac{1}{5.66 \times 10^4}$$

"In the above equation, 1.0×10^3 is the distance from the Earth to Echo in miles, and 2.38×10^5 equals the distance from the earth to the moon in miles.

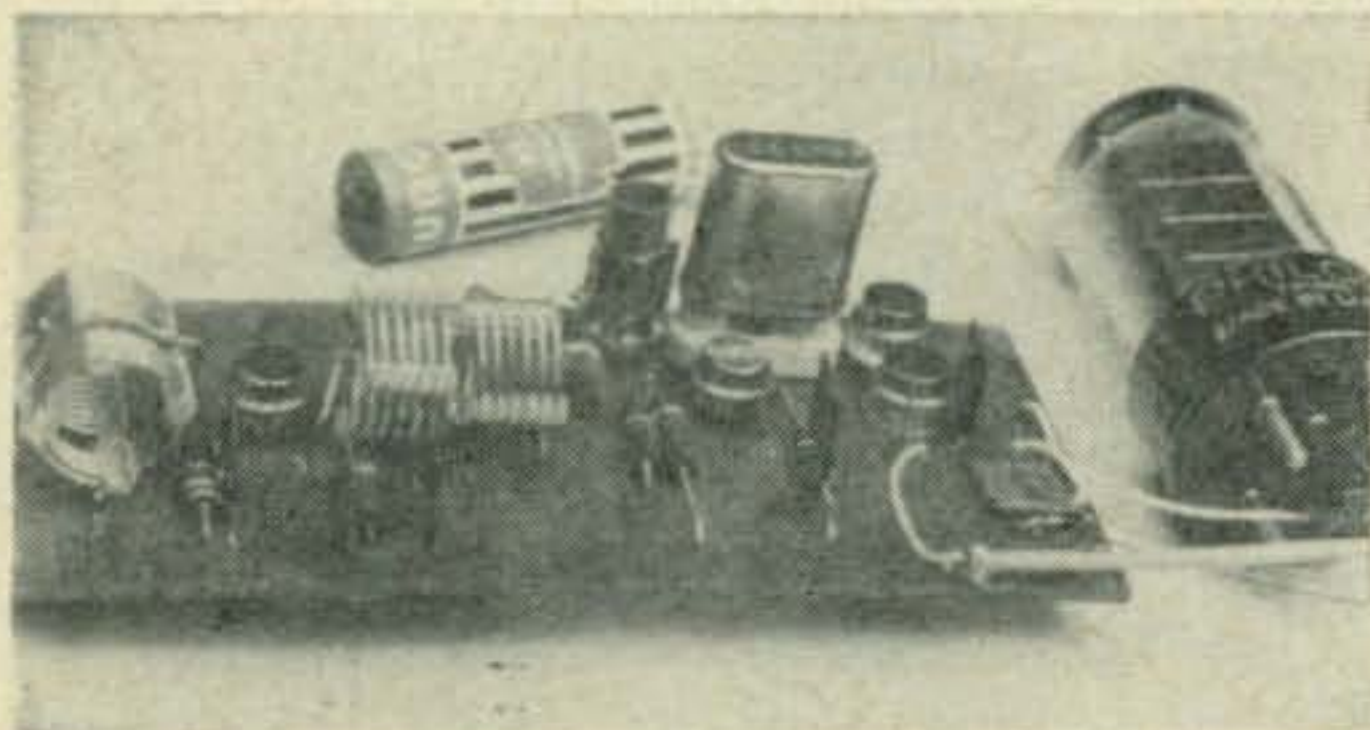

Here's a sampling of the handiwork at K2IUU. Looks like a nifty 2 meter converter—transistorized!

"Combining these two equations and taking the second as a factor twice, because the signals are diminished by the same degree on the return strip from the moon and Echo as they are on the incident trip, one may obtain the following equation showing the ratio of the strengths of the received signals after they have been reflected by the moon and Echo:

$$\frac{\text{Signal returned from the Moon}}{\text{Signal returned from the Echo}} = \frac{1.3 \times 10^{10}}{1} = \frac{1}{5.66 \times 10^4} = \frac{1}{5.66 \times 10^4} = \frac{1.3 \times 10^{10}}{32.03 \times 10^8} = \frac{1.3}{.32} = \frac{4.35}{1}$$

or the moon would have a returned signal of 6.4 db over that of Echo.

"These figures show that if W7RT or W3AGT actually did work Echo bounce on 6 meters, their rigs would have no trouble producing a 6 meter moon bounce signal, because the moon would return a stronger signal, it can be tracked more easily than Echo, and the position of the moon

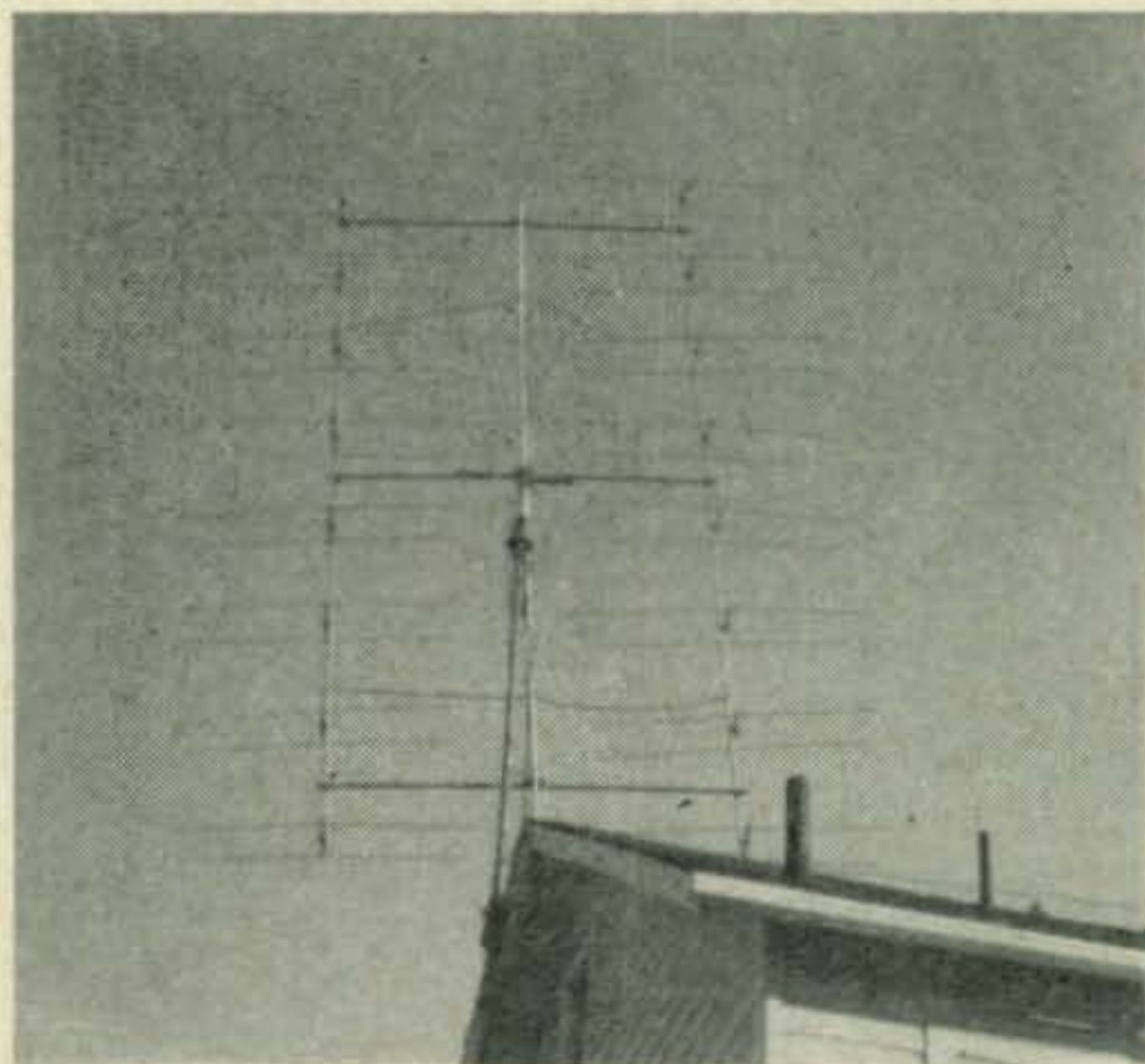

K2UYH's collinear array. Looks like 32 elements for 144 mc.

is known almost exactly at all times. It is, of course, ridiculous to assume that anybody could work 6 meter moon bounce with any run-of-the-mill kw; for that matter, nothing Sam, W1FZJ/WIBU, has dreamed up yet has been able to send a 6 meter signal to the moon and back either. If we hold that 6 meter moon bounce is impossible for W7RT and W3AGT, then we must assume that whatever they heard on those nights was something other than Echo bounce.

"In the equations used in this letter many variables, such as atmospheric loss and ionospheric reflection, have been disregarded because they would be in the ratio of one to one and would not change the result. The imaginary stations used for this experiment were assumed to be identical, and all variable conditions were defined as being equal in both the moon bounce and Echo bounce shots."

I think you'll agree that this is certainly the most complete analysis ever presented in this column and is a definite aid in the solving of

Echo-moon-bounce problems. Many thanks to you, Pete, for your invaluable information, and we hope to be hearing from you again from time to time.

More Moonbounce—VE7AIZ/VE3BZS

Alan Goodaire, VE7AIZ/VE3BZS/VE2, *big one, eh?*), sent along a huge letter, chock full of detailed reports on his 1959-1960 50 mc moonbounce attempts with W7RDY from VE7AIZ. W7RDY ran 800 watts to a six over six. The reception checks were at VE7AIZ through an elaborate set-up.

To quote, "The echos obtained by the 50 mc experiments show a retardation by the ionosphere. This is by an amount of say 100 times that to be expected by using a simplified formula to calculate this.

"However 50 mc is a bit too low for the frequencies the formula I was using to be used at. The delay is about $\frac{1}{10}$ of a second or so and indicates a terrific amount of Faraday rotation took place. The m.u.f. was quite close to 50 mc during most of the experiments so the ionosphere no doubt had a profound effect on the signal.

"Because of low S/N ratio, definite conclusions are hard to reach. S/N of individual echos average about 1:1 I would say.

"VE7AIZ looks out to the east on several miles of salt water and elevation was about 200 feet.

"W7RDY had wood to the east but an otherwise clear shot.

"Horizon at each location was provided by the Coast Range of mountains in Washington about 9000 feet high and 70 to 100 miles away.

"I am now at VE3BZS and will be building some new moonbounce equipment for 220 mc or possibly 144 mc.

"I feel personally that 1296 mc is impractical from a financial point of view and believe that 220 moonbounce will be successful at much lower cost.

"Ross, W4AO, has corresponded with me a lot and has been interested and very helpful in moonbounce problems.

"Bob, K6RNQ, also has shown much interest and we may do some 220 mc work. We had one unsuccessful 50 mc try but did some meteor scatter work.

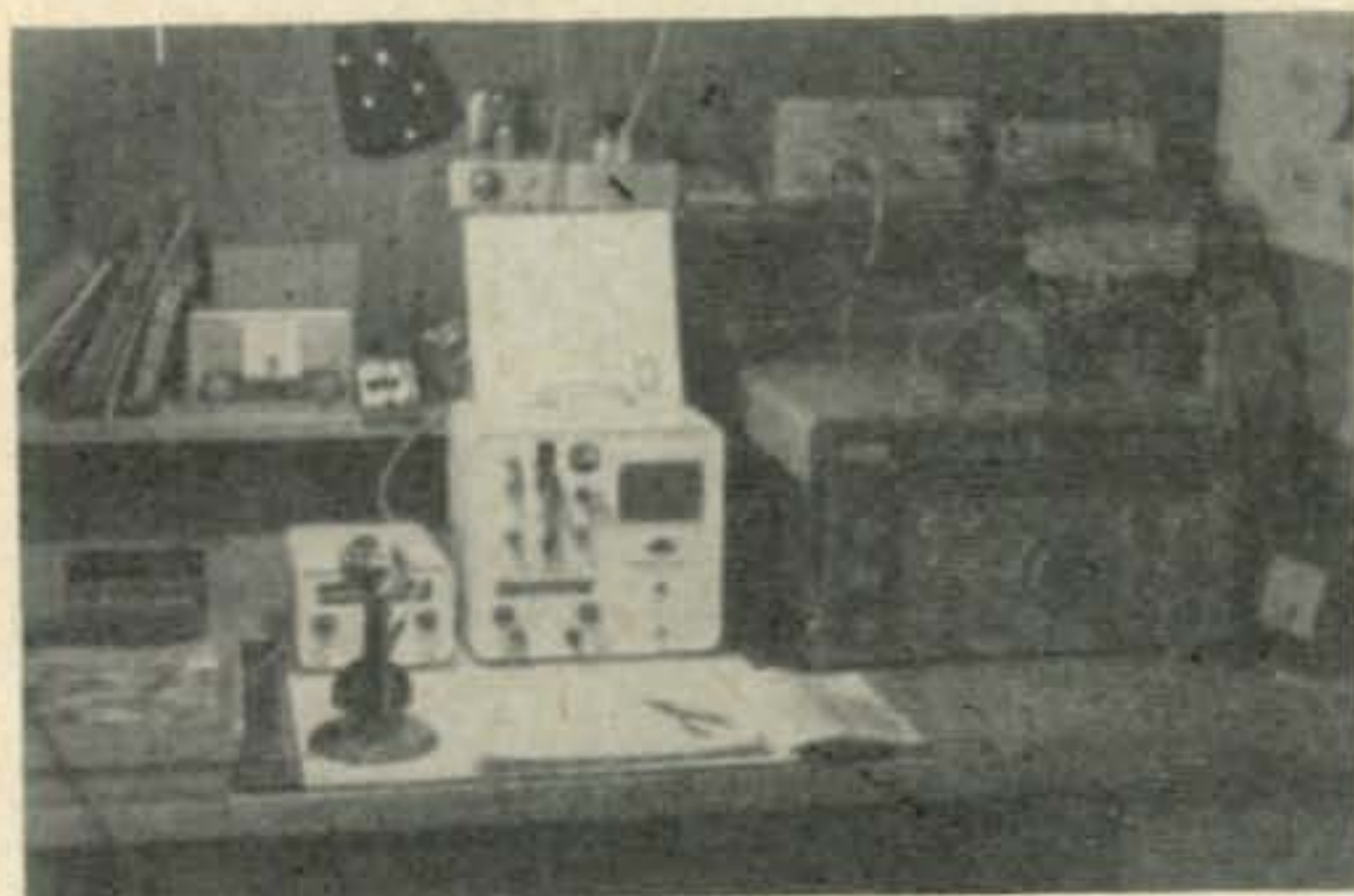

WA2JCQ, Jay Gross's, 6 meter station located in Westfield, New Jersey.

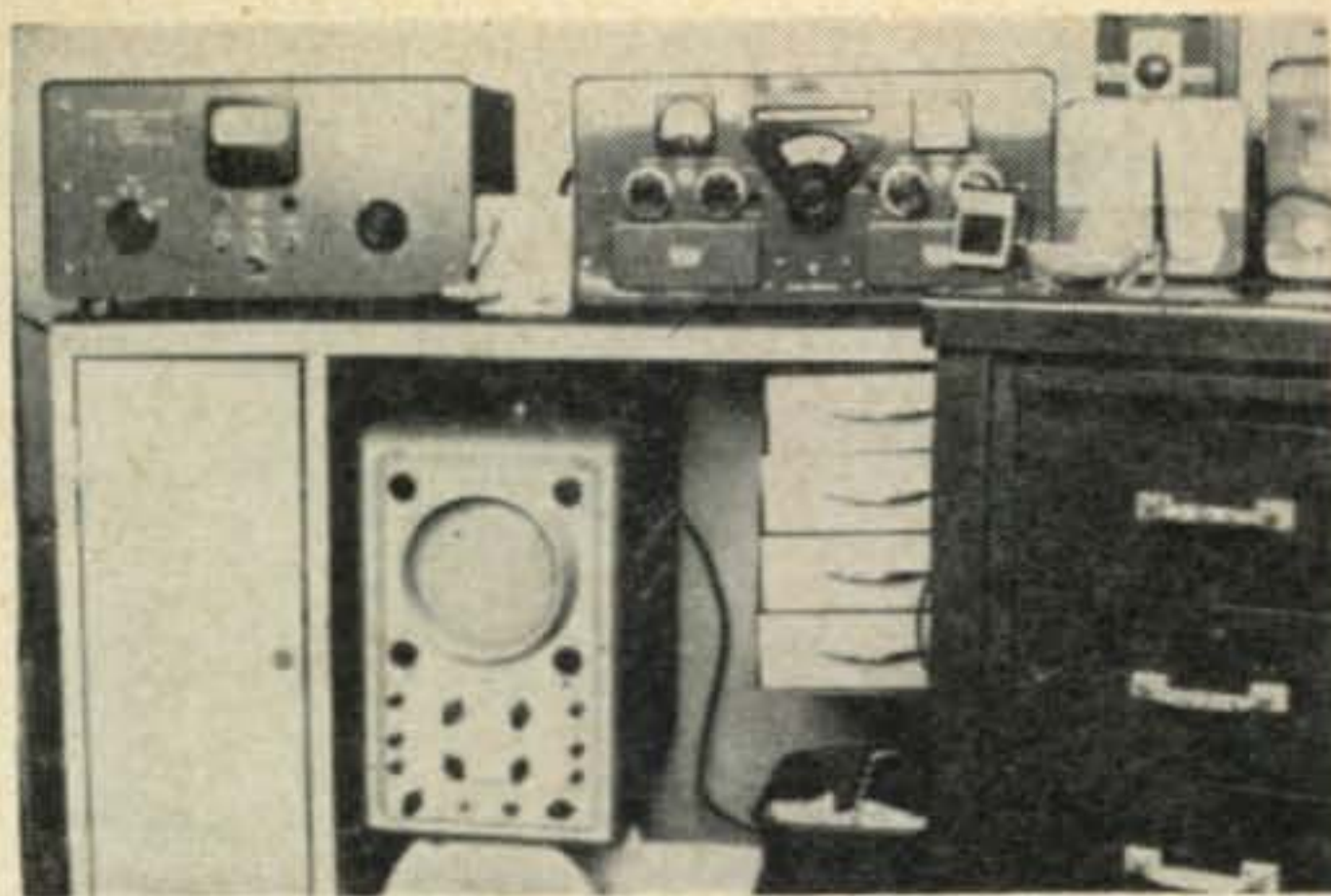

Here's a partial view of the shack at KP4CK, Puerto Rico.

"Jud, K2CBA, wants to do some 220 mc moonbounce and I hope we can try this spring or summer if I can get over being lazy and get the gear built.

"Just thought I'd mention Gail's and my efforts regarding 50 mc moonbounce in case anyone else you know may be interested and also if any appreciable delay in echo return has been noticed in any "low" v.h.f. amateur (or professional) tries.

"I should think the main reason for lack of echo most of the time on 50 mc tests occurs from a combination of ionospheric effects as well as antenna pattern and ground reflection effects.

"My address is 2211 Greenlands Road, Victoria, British Columbia, Canada, and would appreciate hearing from anyone interested."

New Antenna Releases!

The Cush Craft boys (621 Hayward Street, Manchester, New Hampshire) have come out with a beautiful new line of v.h.f.-u.h.f. antennas. These are collinear arrays, 16 elements, for 144, 220, and 432 mc. They are made of aluminum tubing, made to take the weather, and have a claimed gain of 13.2 db. Cost? 2 meter array \$16.00, 220 mc \$12.85, and 432 mc \$9.85. Write for further information.

A new company in the v.h.f. antenna production business is the J. C. Mac Elroy Co., Inc., 74 Trinity Place, New York 6, New York. They are producing, among others, the "Cor-Mac 2 Meter Cubical Quad" which is a two element quad built from aluminum, requiring only pliers and a screw driver for assembly. I have seen this antenna at a local dealer's, and must say that if it works as well as it looks, it ought to be darned good. Gain figures and such are not available at this writing, so why not drop them a line for further info? Price is \$12.50.

Thirty

Well, this once again brings us to the "bottom of the stack." Let's make it bigger and more complete next issue, eh? Sit down and write us that letter you've been thinking about writing for such a long time and fill us in on the "doings" out your way. Remember: It's all up to you. Drop us a line now!

73, Bob, K2ZSQ



semiconductors

It has been some time since a piece of test equipment has been featured in the SEMICONDUCTOR COLUMN. The small test set to be described has two functions. First, it can be used to test the activity of various crystals and second, it can be used to check the operating frequency and performance of an unknown transistor. Both of these checks are not made as precise measurements, but more for comparison purposes.

How it Works—The oscillator is a familiar Pierce type with an untuned load in the collector circuit. With a 10 millihenry r.f. choke as a load, it has been found that crystals from 1 mc to 20 mc will oscillate with no capacity across the inductance. By adding a small 40 mmf capacitor, oscillation of crystals as low as 300 kc may be obtained. This may not be the most efficient circuit which could be used, however it is quite adequate for the purpose of testing crystals and transistors.

The amplifier, Q_2 , operates class B and uses the drive from the crystal stage to bias the base. As the amplifier receives more drive, it draws more current and produces a higher meter reading.

A 2500 ohm potentiometer is connected across the battery leads, and acts as a voltage divider for the d.c. delivered to the oscillator. By

marking the potentiometer dial from 0 to 9, the rotation of the potentiometer will provide a close approximation of the voltage applied to the oscillator. A rough idea of the sensitivity of the transistor can be obtained by noting how much voltage is required for oscillation. For surface barrier transistors, the potentiometer must be reduced to 4.5 on the dial to prevent exceeding their voltage rating.

Three types of crystal mountings are provided in this tester. A nine prong miniature socket is used for the small HC-6 types (metal can), while the FT-241 and DC-34 types plug into regular crystal sockets.

Checking Crystals—Crystals in the lower frequency range (300 to 500 kc) can be checked for activity by direct meter reading. The actual frequency of these crystals can be measured by listening to a broadcast band receiver. A 450 kc crystal has a second harmonic falling at 900 kc, for example. By connecting the antenna of the receiver to any point on the tester case, most crystals will provide sufficient output to be read up to the 10th harmonic. Thus, a 450 kc crystal could be measured at a frequency of 4.5 mc, which can be heard on any communications receiver.

When checking for comparison frequencies between two crystals at a harmonic frequency, remember to multiply the frequency difference times the frequency multiplication. As an ex-

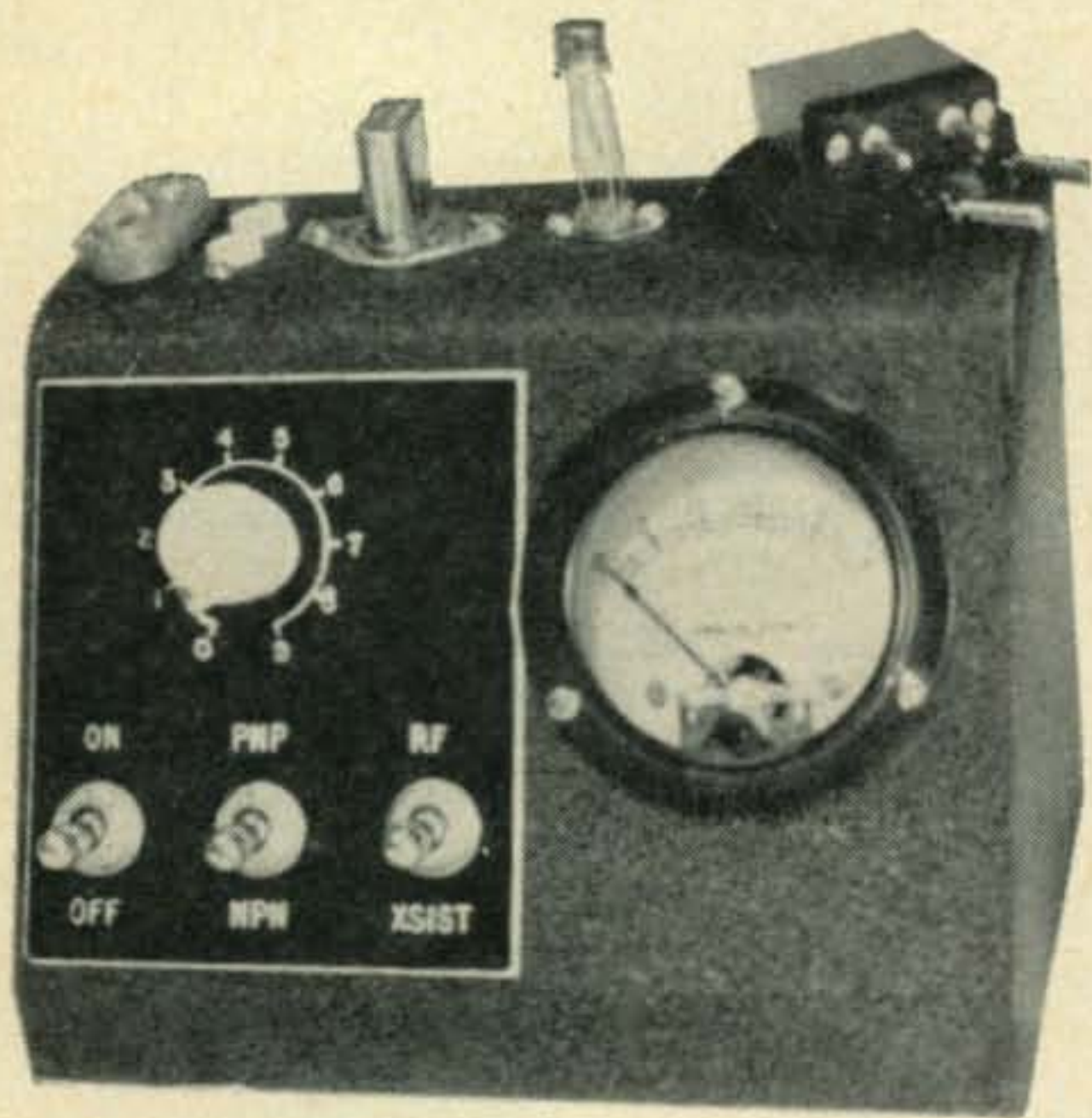

Front view of Stuart C. Rockafellow's transistor and crystal tester.

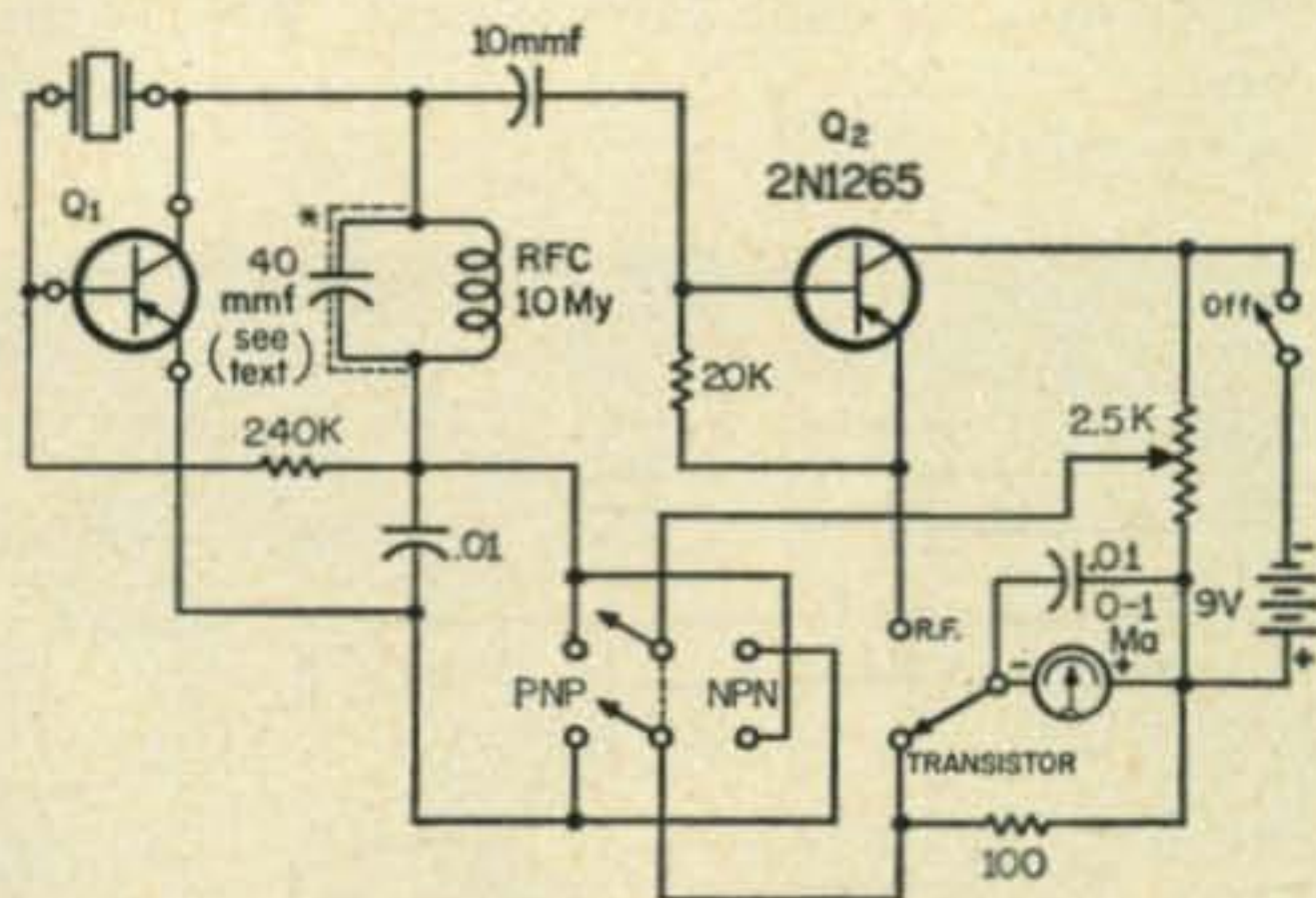

Fig. 1—Schematic diagram for the crystal and transistor tester by W8NJH. The PNP-NPN switch is a double-throw, while the switch used to connect the meter for r.f. or current measurement is a single-pole, double throw type.

ample, two 450 kc crystals are to be compared for frequency. By checking at the 10th harmonic we find that the frequency difference is 5 kc. The actual difference, then between the two crystals, is 500 cycles. Most crystals which are compared on their fundamental frequency can be measured by using the pitch control of the receiver.

Because of the nature of the circuit, some low frequency crystals may have to be "shocked" into oscillation. This can be done by flipping the power switch off and on.

Transistor Checking—Both PNP and NPN r.f. type transistors can be tested for functional operation in this tester. Any results from a particular transistor should not be indicative of that particular transistor as an r.f. amplifier. These tests will be more of a comparative nature and should be used as such. As an example, the 2N-1264 performs the same in these tests as a 2N-384, which costs several times as much. This does not mean that they are equal in their use but only that under these test conditions, they are similar.

It is very interesting to note that many audio type transistors, which are rated with a cut-off frequency of only 20 kc, will operate to 500 kc. Some oscillate as high as 7 mc!

Using the Tester—For comparison check, adjust the voltage dial to the same value for each transistor or crystal to be tested. Only with comparative voltage can the results be evaluated. Transistors that are rated to operate at 5 volts maximum (such as the surface barrier type) can be tested at this voltage by adjusting the voltage dial to only 5. A check for oscillation may be made by noting the amplifier current, or a change in oscillator current when the crystal is removed.

After using the tester for awhile, the reader will no doubt think of many other uses for it. For example, by connecting a short whip antenna to the base of the oscillator, it can be used as a field strength meter.

No construction details are provided for each reader will have his own ideas as to how it should be laid out. There is nothing critical about the circuit, but of course, short leads

should be used in the oscillator. If you would like to make it cover the full range from 300 kc to 20 mc, it might be an excellent idea to add an additional socket for connecting a 40 mmf capacitor in parallel with the collector inductance. Possibly a switch, at the "cold" end of the coil, could be used to place the capacitor in the circuit.

I would like to thank Stuart C. Rockafellow, W8NJH, 43450 Reservoir Rd., Plymouth, Michigan, for providing this information on his transistor and crystal tester.

Two-Tone Oscillator

While on the subject of test equipment, I believe many readers will be interested in the two-tone oscillator to be described. Actually the circuit first appeared in an article by D. W. Richards, W7UPF (Dec. 59, CQ). The circuit (fig. 2) was modified slightly to provide higher output and easier starting with less expensive and more readily available transistors. It consists of two transistors connected in a phase shift circuit. Signals appearing at the collector of the transistor are coupled through the associated capacitor to a three-element phase shifter consisting of 10K resistors and either .002 or .005 mf capacitors. In the .002 section, the phase shift is exactly 180° at 2500 cycles. The phase shifted signal appears at the base of the transistor and due to the action of the transistor, the signal is again shifted 180° in phase. The total shift of 360° permits the circuit to oscillate at 2500 cycles. A phase shift of 180° in the .005 section occurs at 1000 cycles, and the circuit oscillates at this frequency. These two audio frequency sources are mixed in the output and applied to a single sideband generator for two-tone linearity measurements.

Experiments by the author indicate that very high gain transistors are required for proper oscillation. The NPN type 2N169, recommended by W7UPF, and PNP type 2N217 provide satisfactory gain. Low cost transistors, such as the 2N1380, do not seem to perform properly. If the 2N169 is used, the emitter arrow in fig. 2 should

[Continued on page 116]

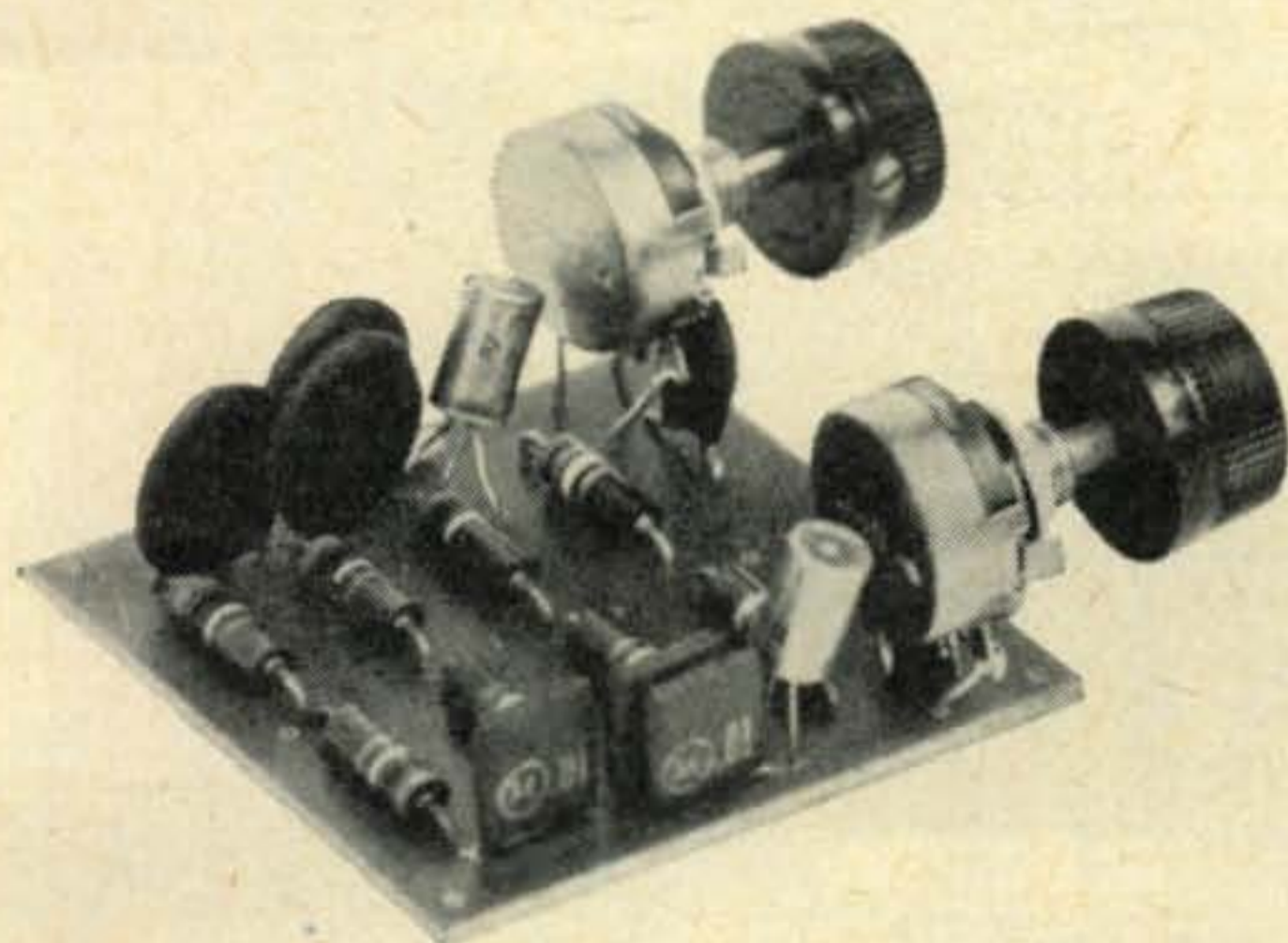

This two-tone single sideband test oscillator is smaller than a package of cigarettes. See text for circuit details.

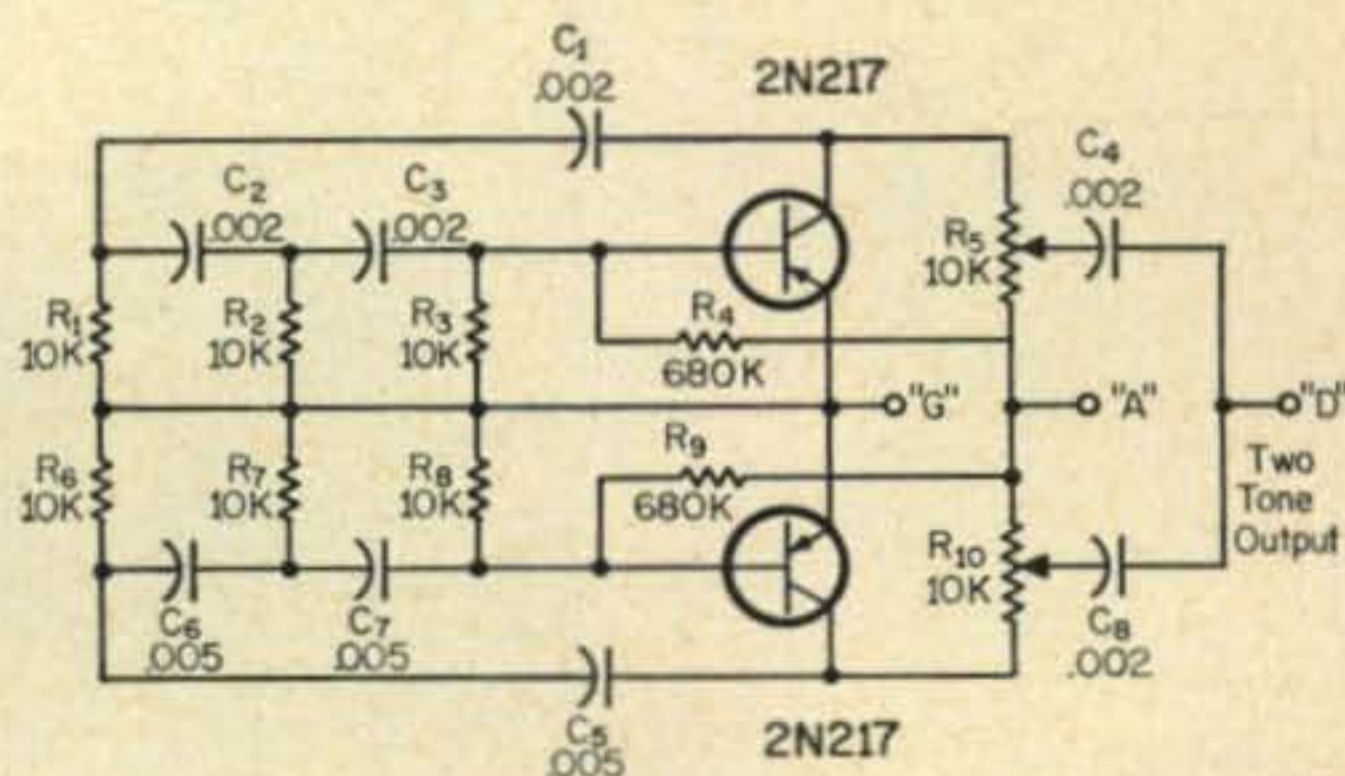

Fig. 2—A two-tone audio oscillator for s.s.b. exciter alignment. For best results, a 22.5 volt battery should be connected between "G" (positive) and "A" (negative). Output is taken between "G" and "D".

RTTY

Byron H. Kretzman, K0WMR

108 W. Teresa Drive
West St. Paul 18, Minn.

Last month we discussed radioteletype converters (TU's) in rather general terms, and we discussed in more detail the signal requirements of the receiving part of the machine. If you read that portion of the column carefully you learned that the teleprinter machine only requires 20% of each selecting pulse to print the correct character. "If that is the case," you might ask, "do we really need a complicated (and expensive to build) TU?" The answer is, you *don't*, if you just want to get acquainted with RTTY with the minimum of expense, or if you just intend to work a.f.s.k. on v.h.f.

So many letters from newcomers have asked us to recommend a simple TU with which to get started that we decided to give the matter of the design of such a unit considerable thought. First of all, it should be as simple as possible to build and to adjust, and secondly, it should cost as little as practicable. Other requirements considered were: it should be usable on either a.f.s.k. or f.s.k., it should provide for the use of an oscilloscope as a tuning indicator, and it should be possible to add easily such desirable features as plug-in filters (for band-pass and narrow shift), autostart, and an a.f.s.k. oscillator for v.h.f. use. So, keeping all of these things in mind, especially the 20%, we created this TU, for you, the newcomer.

The Twin City TU

The Twin City TU, named for the Twin Cities of Minneapolis and St. Paul, is quite simple, employing only three tubes. It is an audio type of TU complete with the usual limiter and discriminator. A polar relay, the readily available

and inexpensive Western Electric 255-A, is used to key a local loop to operate the printer. A power supply is included, but any receiver supply that can provide about 250 volts at 50ma could be used. The plug-in channel "filters" are single L-C tuned circuits each with a single telephone loading coil as the "L." Not counting the few components in the channel filters, only 13 resistors and 11 capacitors are used, including those in the power supply! Only two transformers are used, a 49¢ surplus audio transformer and the power transformer. If you have been a ham for several years you should be able to build this TU right out of your junk box, except possibly for the toroid loading coils and the polar relay, which might be easily obtained if you have friends in the local telephone company. If you had to buy *everything*, at the usual radio parts store prices, the parts would cost you only about \$33.

The Circuit

Figure 1 shows the complete schematic diagram of the Twin City TU. Octal based tubes were used as they are more likely to be found in the junk box. If you wish, you can substitute miniature tubes; a 12AX7 for the 6SL7, a 6C4 for the 6C5, and a 12AU7 for the 6SN7. In addition, 1N54's or 1N69's may be substituted for the 1N64 diodes. An octal socket at the rear of the chassis is provided for the input connections. 150 or 600 ohm input impedances are available. The "accessory socket" on the top of the chassis is available for the possible future addition of a band-pass input filter or an a.f.s.k. oscillator. (The empty socket on the top of the

Fig. 1—Schematic diagram of the Twin City TU.

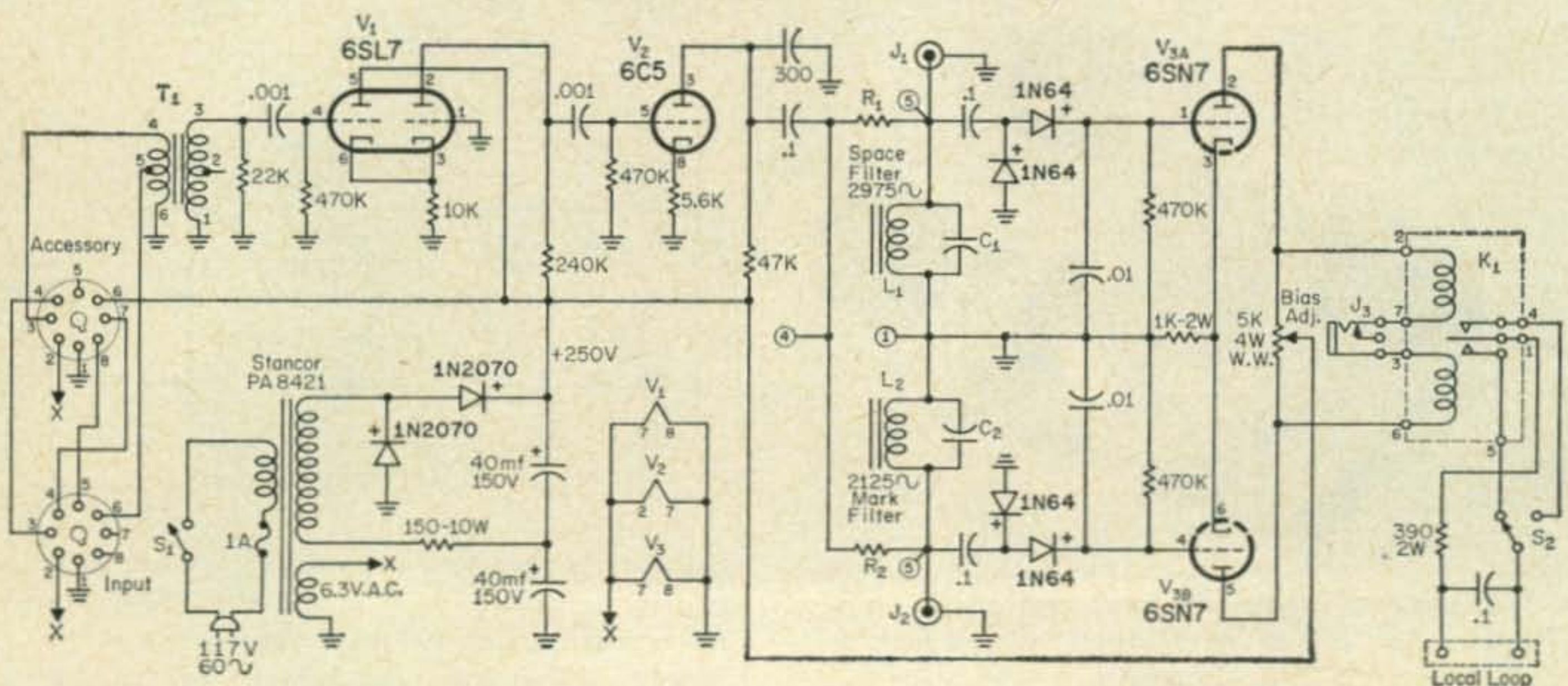

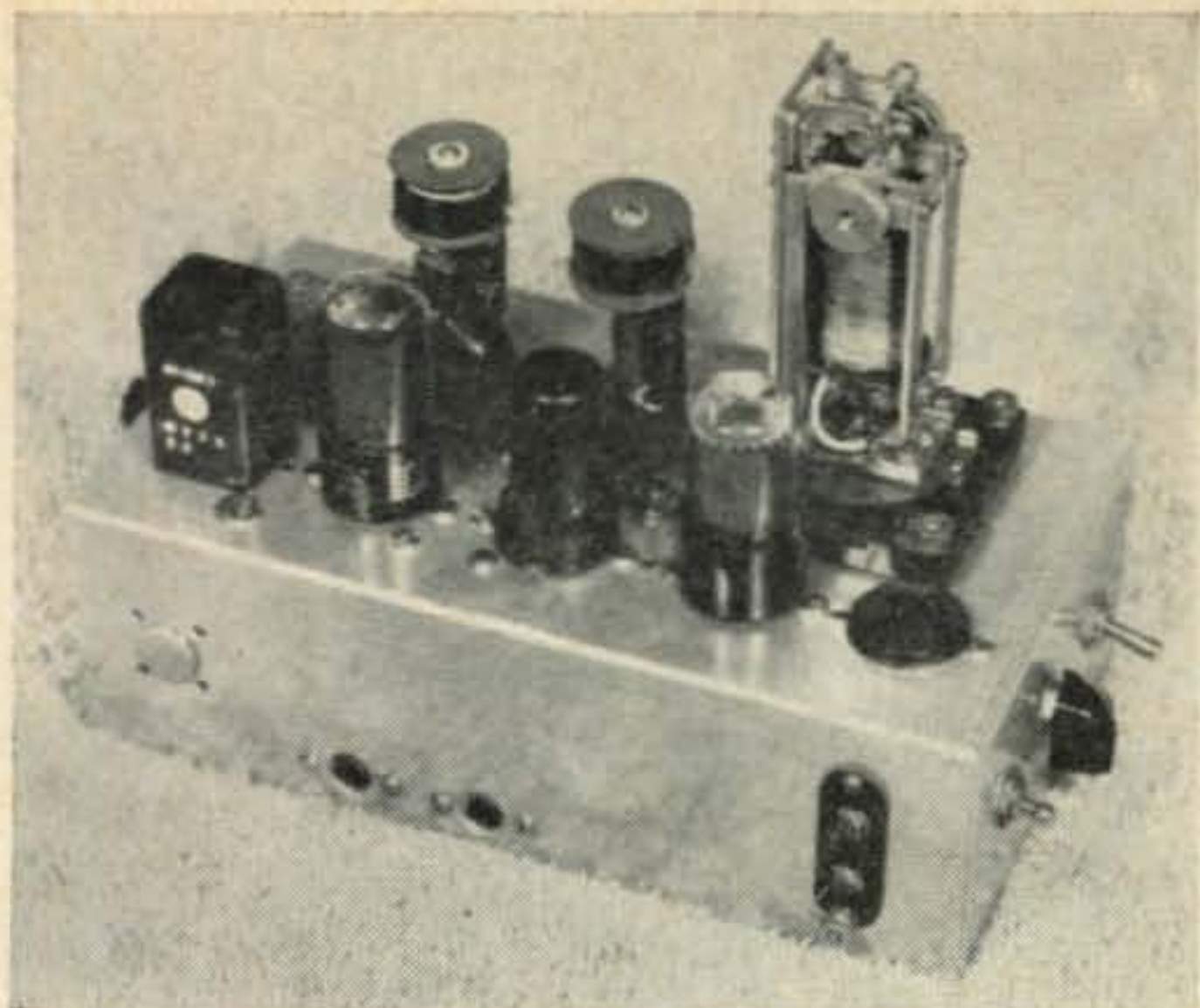

The Twin City TU, a simple RTTY converter.

chassis, visible in the photo, is for the future addition of another tube for autostart.)

The circuit, as you can see, is not complicated. The first tube, a 6SL7 dual triode, is connected as a cathode coupled limiter. With the input transformer used, complete limiting takes place at about -4dbm , or 0.5 volts r.m.s. input across 600 ohms. If we rate the TU at 100mw input ($+20\text{dbm}$) and operate it with that amount of input we have a range of limiting of about 24 db. The 6C5 is an audio amplifier used to bring up the limited audio to a suitable value for the discriminator. The channel filters are made plug-in for convenience. Normally, the MARK filter is tuned to 2125 cycles and the SPACE to 2975 cycles. Each tuned circuit is isolated with a series resistor, part of the plug-in filter assembly. The values of these resistors are chosen to provide equal d.c. voltages across each associated 470K discriminator load resistor. It will be noticed that a pair of diodes are used in each side of the circuit. These are connected in a voltage doubler arrangement in order to supply a relatively large d.c. voltage to swing each grid of the 6SN7 d.c. amplifier. The polar relay is connected in the plate circuit of the 6SN7, with positive high voltage fed to the arm of a 5000 ohm wire wound pot to permit balancing of the plate currents of the two triodes to balance the polar relay. Jack J_3 permits plugging in a zero center meter to check this balance. The contacts of the polar relay are connected to the LOCAL LOOP terminals through an R-C filter consisting of just one resistor and one capacitor. Switch S_2 is a reversing switch, a very handy device when someone is inadvertently sending upside down. Jacks J_1 and J_2 are used to connect an oscilloscope to use as a tuning indicator.

Plate and filament power for the TU are obtained from a Stancor PA-8421 transformer. This gives 6.3 volts at 2 amps for the heater circuit and 125 volts a.c. at 50ma for the two Texas Instruments 1N2070 silicon rectifiers which are connected in a voltage doubling circuit to supply 250 volts d.c. for the plate circuits. 100ma selenium rectifiers could be used in place of the silicon rectifiers, of course.

The Channel Filters

The channel filters were made plug-in for several reasons. First of all this makes it real easy to change values of the padding capacitors or the series resistor while you are in the process of tuning up. This wouldn't be easy if the filters were buried under the chassis. Second, the plug-in feature makes it possible to almost instantaneously plug in another set for other tone frequencies or to copy different values of shift.

The plug could be made from an old octal based tube but we used the Amphenol 86-CP8. The bakelite center locating pin was drilled out to pass a #6 round head wood screw $1\frac{1}{2}$ inches long which screws into the bottom end of a $1\frac{1}{2}$ inch long piece of $\frac{3}{8}$ inch hardwood dowel. The toroid then is fastened to the top of the dowel, between two heavy cardboard washers, with another #6 round head wood screw, this one about $1\frac{1}{4}$ inch long. A soldering lug was put in between the dowel and the bottom washer to serve as a common connection. The padding capacitors and the resistor then lie against the wood dowel. The pin connections are the same for each filter: pin 4 is the input to the isolating resistor, pin 5 goes to the "hot" side of the L-C circuit for connection to an oscilloscope through J_1 , and J_2 , and pin 1 is the "low" side of the L-C circuit, which connects to ground.

Telephone loading coils about an inch in diameter are used as the tuned inductors L_1 and L_2 . Each toroid has two windings on it which are series connected for our purpose to give an inductance of about 88 mhy. The two coils on a toroid are usually separated by a plastic separating barrier. The two wires, one on each side of one of the barriers, are connected together to series the coils. The two wires on each side of the *other* barrier are then used for the external connections.

For the standard 850 cycle shift, the SPACE filter is tuned to 2975 cycles. This takes a total capacity of about 0.035 mf for C_1 . Use mylar, mica, or paper capacitors. *Do not use ceramic capacitors.* The isolating resistor R_1 is about 150K ohms. The MARK filter, tuned to 2125 cycles, took about 0.067 mf for C_2 . The isolating resistor was about 47K ohms.

Input Circuit

When no band pass input filter is used, a jumper plug with a jumper between pins 3 and 4 should be plugged into the ACCESSORY socket. Transformer T_1 has 600 ohms or 150 ohms impedance input (The secondary of the surplus transformer used was 19,000 ohms.) The INPUT socket provides either the 600 ohms or 150 ohms, with one side grounded. The 150 ohm connection can be used conveniently (without the jumper plug) to bridge across the voice coil output circuit of a receiver. The other connections not used for audio input are for future use of additional features.



by Louisa B. Sando, W5RZJ
212 Sombrio Drive, Santa Fe, N.M.

YLRL 21st A.P. Scores

Phone

W1ICV	3916*	K6VUE	1645*	K1EKO	78*
K1LCI	4353*	K6YOA	450*	K1DWH	356*
K1ADY	3936*	K6RLR	8456*	K2UKQ	1260*
K1IZT	11,285*	W7OUE	4410*	W4HWR/2	356*
W1ZEN	2640*	K7MRX	4830*	K2JYZ	2186*
K1EKO	1762*	W7TGG	6545	WA2LOZ	CFM
W1YPT	5832*	K7CHA	5253	W2RUF	306
K1DWH	925*	W7CSQ	6180*	W3TSC	162*
W2EWO	3212	K7ADI	5640*	K3NLU	CFM
K2ETC	CFM	W7DIC	3895*	K4ZNK	25
K2JYZ	8960*	W7HHH	1144	K4RNS	1703*
WA2GPT	1323	W7DIF	787*	K4DNL	165*
W20WL	CFM	K7JPI	373*	K4BKT	CFM
W4HWR/2		W7NJS	170*	K4LSI	1080*
	1762*	K7CPB	1102	K4TFL	560
W5RFK/2	325*	K7HSB	1050*	K5TXQ	3601*
K3NMD	6062*	K8MZT	7280*	W4KZT/5	2021*
W3MDJ	CFM	K8LHF	5940*	K5BNQ	2880*
K4ZNK	7980	W8VRH	3277*	K5LIU/5	4860*
W4CWV (op		W8WUT	1781*	K5BJU	3485*
W4LKM)		W8HWX	5312*	K5YIB	3087*
	13,282*	K8ITF	3468*	K6QPG	2380*
K4RNS	8480*	K8MQB	20*	W6QGQ	1537*
K4DNL	8302*	K9CQF	7353*	K6OWQ	1440
K4BKT	CFM	K9TRP	4132*	WA6AOE	920*
K4LSI	2850*	K9UJT	1072*	WA6CCR	446*
K4CZP	4418*	K9TUD	4050*	W6JZA	87*
W4HLF	CFM	K0EVG	3312	W6PCA	1282*
W4TVT	CFM	K5OPS/β	CFM	K6VUE	806*
K5JXD	8612*	K0HEU	7215*	K6OQD	400*
K5TXQ	5750*	K0GIC	5346*	W7PUV	1343*
W4KZT/5	4891*	K0TBV	3071*	K7ADI	123*
K5SBN	5700	K0IKL	7735*	W7DIF	31*
W5RZJ	1788*	K0JFO	6565*	K7HSB	1125*
K5BNQ	14,300*	W0ZWL	3587*	K8LHF	1938*
K5YIB	13,920*	KH6DLD	4095*	K8MKG	1860*
W5HWK	3277*	KH6CKO	1667*	K8ONV	1320*
K5MTF	594*	KL7BJD	3330*	W8WQE	891*
K5BJU	13,735*	KL7ALZ	1656*	K8HKU	1400*
K5OPT	10,465	KL7BBL	CFM	W8NAL	1225*
W5ZPD	9610*	KPAPX	4485*	W8HWX	650*
K5PFF	2970*	XE1VS	162*	K8MQB	1080*
K5OPV	1380*	CT1YE	1596	W9MLE	3360*
K5MXO	CFM	OA4GR	1364	K9TUD	2612*
W6QGQ		ZS5OB	977*	K0EVG	408
	10,620	ZS2MH	151*	K0GIC	2700*
WA6AOE	6750*	SZ6GH	CFM	R0IKL	4125*
WA6CCR	5625*	VE3DDA	488*	K0JFO	137*
W6WBH	4515*	VE6YW	736*	W0ZWL	593*
W6JZA	3150*	G8LY	11*	KH6DLD	513
K6OQD	2025*	OH5SM	20*	KL7ALZ	925
K6EXV	5170*	JA1YL	1050*	VE5DZ	768*
K6TFN	CFM	JA1AEQ/β	60*	VE6ABV	770*
W6GAI	CFM			VE6YW	280*
W6VSL	6693*			VE7ADR	1035*
WA6EVU	3105*			JA1YL	31*
K6UHI	968			JA1AEQ/β	1*
K6KCI	11,210*				
		CW			
		W1ICV	168		
		K1LCI	805*		

and the gold cup went to K5BNQ, Doris Anderson (YLRL president for '61). Doris placed first last year also. She had 176 contacts in 65 sections for 14,300 points (a phenomenal performance considering Doris was stalling her doctors until the contest was over before undergoing major surgery). K5YIB, Barbie Houston, placed second with 174 contacts in 64 sections for 13,920 points. Barbie has participated in every A.P. since '51, placing first in phone in '54, '55 and '56 as W3OQF, and the other years placing either within the top three on phone or c.w., or high score for her district, in '57 and '58 as K0LYV. In third place K5BJU, Harriett Woehst, earned 13,735 points for 164 contacts in 67 sections.



Dreaming over her mike? Not during the YLRL A.P., for sure, for K5BNQ, Doris, was winner in the phone section of this contest. YLRL president for '61, see write-up about Doris in CQ Nov. '60, p. 127.

W5IWL photo.

Results YLRL 21st Anniversary Party

Hats off to the gals who "battled it out" in YLRL's 21st Anniversary Party! In the Phone section of this contest particularly, the scores are always close and this year was no exception. In this section, held Nov. 2-3, 1960, top place



K5YIB, Barbie, placed second in the phone section of YLRL's 21st A.P. Since our last write-up, Barbie and Dick have added the S-line gear, but she still likes a.m. Barbie is custodian for WAC/YL. Send applications for this award to her at Box 652, Richardson, Texas.

In the c.w. section, held first this year, on Oct. 19-20, K5LIU/5, Mildred Wright, won the gold cup with 4,860 points earned for 81 contacts in 48 sections. She placed third high on c.w. in '56. KØIKL, Joyce Polley, came in second with 4,125 points for 75 contacts in 44 sections. Joy placed first last year and second in '58. In third place was K5TXQ, Evalyn Ewing, with 3,601 points for 67 contacts in 43 sections.

Congratulations also to K5BJU, Harriett, for winning the Corcoran Award, a handsome copper plaque donated by W8TPZ and her OM and awarded for the first time last year to K5BNQ (it takes a three-time win to retain it). The award is given for the highest combined phone/c.w. score. To her 13,735 points earned on phone, Harriett added 3,485 on c.w. for a total score of 17,220.

The YLs with the highest phone and c.w. scores in each section, U.S. possession, VE district and country will receive a certificate. Contest scores are in the box. Asterisk indicates low power multiplier. K3NLU, Lillian, YLRL's V.P. for '60, did the tremendous job of checking logs. She reports 367 YLs gave contacts in the Phone section; she received logs from 107. In the c.w. section 132 YLs gave contacts; 59 logs were received. There were many comments—such as why can't more YLs get on c.w., and why is everyone within a 10 kc spread—10 kc away on either side and you can get no one. But, we sure had a ball!

YL VHF Contest

W1ZEN, Onie, YLRL V.P. for '61, announces the first YL VHF Contest. Dates are April 12-13, 1961, and all licensed YL and XYL operators are invited to participate. Certificates will be awarded to the high scorers, and the YLRL member with the highest score will receive an award from WRONE. Complete rules in separate box.

Chix on Six

No doubt some of the YLs you'll be working in this v.h.f. contest will be members of Chix on Six. This is the only organized YL group in Northeastern Ohio and came into existence in June '59, after much work by K8MZT, W8WRH, W8VLF and W8OIS. The group meets on the air at 2100 EST every Wednesday from September through June and every other Wednesday during the summer. YLs from different areas

YL VHF Contest

- Time:** Start Wed. Apr. 12, 1961 at 12 noon EST.
End Thurs. Apr. 13, 1961, 12 midnight EST.
- Eligibility:** All licensed YL and XYL operators are invited to participate. YLRL members only are eligible for the WRONE award. Non-member high scorers will receive certificates. Contacts with OMs will not count.
- Operation:** Bands: 50 mc and above are to be used, phone and/or c.w. Crossband operation is not permitted. Only one contact with each station will be counted. A section may be counted only once as a multiplier.
- Procedure:** Call "CQ YL."
- Exchange:** Station worked, QSO number, RST report, ARRL section, U.S. possession, VE district or country. Entries in log should also show band worked at time of contact, whether A1 or A3, time of contact, date, transmitter and power.
- Scoring:** Multiply number of contacts by the total number of ARRL sections, U.S. possessions, VE districts or countries worked. Contestants running 50W input or less at all times may multiply the above result by 1.25 (low power multiplier).
- Awards:** Highest score—WRONE award (to a WLRL member only)
Top 3 scores will receive certificates.
Highest score in each ARRL section, U.S. possession, VE district and country will receive a certificate.
Highest Novice score will receive a certificate.
- Logs:** Copies of all logs must show claimed score, be signed by operator and be postmarked not later than April 28, 1961, and received not later than May 12, 1961. Send copies of log to W1ZEN, Onie Woodward, 14 Emmett St., Marlboro, Mass. No logs will be returned. Be sure it is a copy of log you send.

are called on 50.7 and 51.3 Mc. and then all join on 51.3. They also hold monthly meetings in members homes from April through Oct., with a party in Feb. Officers: Pres., W8OIS, Gerty; V.P., W8VLF, Joye; treas., W8WRH, Jackie;



K5TXQ, Evalyn, made third high score on c.w. in the A.P. Her QTH is Shreveport, La., and she's been on the air only since Jan. '59, starting as a Novice. She loves DXing on 20 c.w. and does some s.s.b. phone on 10. K5TXQ holds WAS, WAC, WAC/YL, DX-YL, RCC, KG1-apprec. certificate, YLCC, many club certificates, and DXCC is close. Her OM is W5PJW and son Mark, aged 5, completes the family.

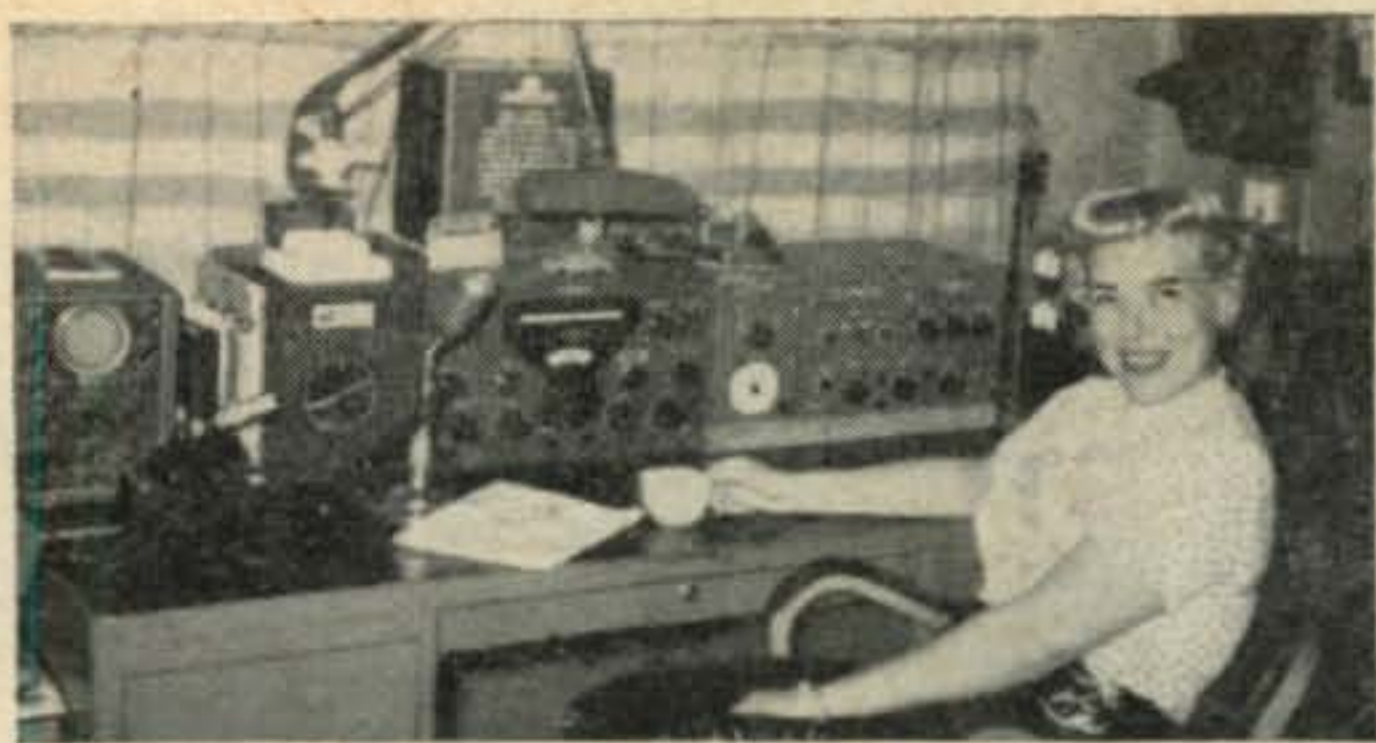

K5BJU, Harriett, placed third on phone in the A.P., and also won the Corcoran Award for combined high phone/c.w. score. Harriett started as a Novice in '55 with General a year later. She was founder and first president of GAYLARK. K5BJU operates all bands 80 through 10, with 15 her favorite, and prefers s.s.b. She and OM W5VWF can run a maximum of a kw and use a 75A4 receiver and 43-ft. tower with tri-bander beam and doublets on 80 and 40. K5BJU holds DXCC, WAS/YL, DX-YL, WAS, WAC, YLCC, YL-OM, WAC/YL, RCC and many club certificates. She is NCS for the YL S.S.B. net.

secy, K8MZT, Shirley; NCS for Cleveland area, K8IGD, Harriett; NCS for Akron area, K8PSE, Donna.

The Chix on Six offer a certificate for working eight members, and a sticker for each additional four YLs worked. Certificate custodian is K8PSE. At present there are 35 members: W8's EFB, OIS, SND, WRH, VLF; K8's DAW, IGD, JQH, KEW, KKP, MZT, NQD, OMT, ONA, OVC, PRY, PSA, OVF, PSE, PXH, RGY, TCI, UEY, TUK, UOJ, VHG, VKT, VMV, VMY, VNZ, WFM, VMW, WUO, TCG; KN8SEC. The

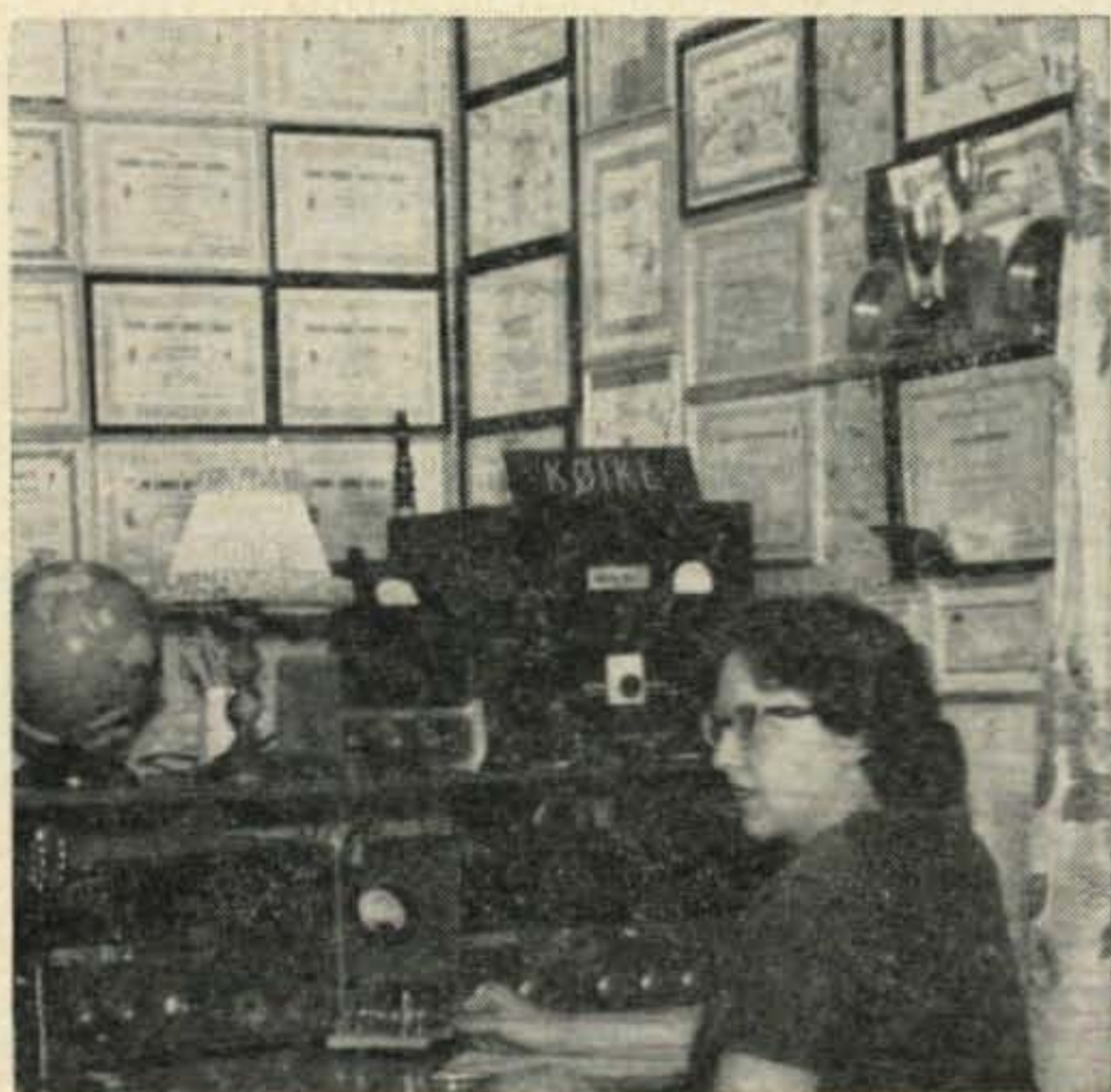

KØIKL, Joy, placed second on c.w. in the A.P. She placed first last year and second in '58. Since these write-ups Joy has added (to her WAS, WAC, YLCC-350, DX-YL and KKK) P-6-K (from Russia), United Nations Award—Class 3, WAC-YL, and she has sent for Worked All Canada, Keystone, and WAS-YL. She chases DX on c.w. and s.s.b. and has 117 countries worked, 93 confirmed. On Nov. 15 a little jr YL arrived to join the two boys in the KØIKL-VE1EG family.

Chix on Six were official hostesses at the Cleveland Convention last fall and already are planning for the next one. They also help other gals master theory and code to obtain licenses. Most of the girls are active in net or traffic work. W8OIS is NCS for the Cleveland Thunderhead Net, a weather net very valuable to the area. W8WRH is NCS, using call W8BSH, for Akron CD and active on MARS-Air Force net. K8PSE also is active with this group. K8KKP and her OM K8KKO have several awards for rescue work done in Cleveland area during flood and disaster of last spring. W8EFB monitors a mobile frequency in Painsville area and handles weather and accident messages. Many belong to the Apricot Net, an emergency net ready at all times. K8MZT handles much traffic and phone patches from KG1FR and other military bases.

Here and There

Remember the dates of the 12th Annual YL-OM Contest: Phone—Feb. 25-26; C.W.—Mar. 11-12. Complete rules in February CQ.

Our condolences to the families of the following YLs. Pita Gilchrist, ZL2ABJ, was drowned in a rescue attempt on January 1st. Pita had been "adopted" as a DX YL member of YLRL by the Chirps for several years. . . . Also from K6ENK we learn of another YL who has become a Silent Key. Dora Abbott, K6KCI, died December 24th of a kidney infection resulting from a Caesarean section, leaving OM Neil, K6SYE, with several jr. ops.

And on the nets we learn that W9RUJ, Mary, suffered a stroke in Dec. Come on, Mary, we're all plugging for you—just gotta hear that cheery voice on the air again!



K5LIU, Mildred, won the c.w. section of the 21st A.P. Mildred got her ticket in '54 and has been active mostly in contests and on 20 c.w. She has placed third high twice in c.w. section of the YL-OM contests. Mildred served as YLRL V.P. in '57 and at the time her call was W3YTM. This photo was snapped at the end of the 1960 YL-OM contest.

Do You Have . . .

. . . your copy of "CQ YL", the one and only book about the YLs? 18 chapters, over 500 photos, it covers all phases of YL participation in Ham radio. Order from W5RZJ (QTH at head of column, \$3, postpaid.

33, W5RZJ



by **KEN GRAYSON, W2HDM**
Care of CQ 300 West 43rd Street,
N. Y. C. 36, N. Y.

Well, if you were reading the column last month you know that this is the last one of the SURPLUS COLUMN series. From now on, all conversions will be by articles, not column. This should promote a lot more interest in surplus from one point of view. It will allow the reader the chance of thinking that he can contribute. Actually, readers contributions were always welcomed, although we didn't get too many surplus conversions.

After three years it seems a little strange not having to meet deadlines, and rack your brain trying to solve Joe Ham's conversion problem by remote control. Frankly, we don't know what we are going to do with the spare time that we are going to have on our hands, such as Sunday mornings at 3 AM, when we manage to stagger home from a date and decide that such and such can be converted a new way, and then do it. We won't miss the thousands of letters that we have answered, or the many offers of surplus we have had to refuse. Some day the family will say, "Thank God the ham station's out of the house."

Surplus equipment has become much too sophisticated for many hams. We tried to point this out last month. New equipment is constantly being designed which, in years to come will make the ham shack more like a laboratory. Take the 3 to 36 mc transceiver we worked on, for example. No bigger than a modern receiver, this is a full kilowatt on c. w. or s.s.b. and a fine receiver, plus the fact that the single crystal controlled synthesizer allows the user to select any frequency within the operating range in multiples of 1 kc. The final was liquid cooled by being completely immersed in a flourine compound with the final and all transmitter stages automatically tuned. Clever eh! This is not science fiction, but something that is here right now. Or how about a receiver that is no bigger than a tenth of a cubic foot that covers 1.7 to 2.3 kilomegacycles (thousands of megacycles) with a noise figure of less than 16 db and can operate on any of ten crystal controlled channels for a.m. or f.m. applications. (see Space-Aeronautics, Jan. 1961 p. 134). This is the kind of stuff our surplus is going to be in the not too

distant future. This is, therefore, the reason why the column is going, going, gone. The time it takes to convert the latest surplus is longer than can be satisfactorily done in one month intervals.

Surplus has grown a lot in the last fifteen years since we got out of the service and there is a lot more growing to do. Right now, we have to keep running to keep up with it. Right now we have about three really nice conversions that should be in print in the very near future. About all that we can say is that it is a shame that we have to take so long in the development of the conversion, but we feel that they are worthwhile waiting for.

Surplus Dealers

We have often been asked for a list of addresses of reliable surplus dealers. Just about now we managed to come up with such a list and feel that there couldn't be a more appropriate time to list them than in our last column, so here they are:

- ~~1. G & G Radio Supply Co., 75-77 Leonard St., New York 43, N. Y.~~
- ~~2. Arrow Electronics, 7035 Laurel Canyon Blvd., N. Hollywood, California*~~
- ~~3. E. E. Goodheart Co., P.O. Box 1220, Beverly Hills, California~~
- ~~4. Rex Radio Supply Co., 84 Cortlandt St., New York 7, N. Y.*~~
- ~~5. Herbach & Rademan Inc., 1204 Arch St., Phila. 7, Pa.*~~
- ~~6. Selectronics, 1206 S. Napa St., Phila. 46, Pa.*~~
- ~~7. Quaker Electronics, Plymouth, Penna.*~~
- ~~8. Alltronics-Howard Co., Box 19, Boston 1, Mass.*~~
- ~~9. Fair Radio Sales, 2133 Elida Road, Box 1105, Lima, Ohio*~~
- ~~10. Spera Electronic Supply, 37-10 33rd St., LIC 1, N. M.*~~
- ~~11. Barry Electronics, 512 Broadway, N. Y. C. 12, N. Y.*~~
- ~~12. Atlantic Industrial Company, 101-38 91st St., Ozone Park 17, N. Y.~~
- ~~13. Electronic Research Labs., 715 Arch St., Phila. 6, Pa.*~~
- ~~14. U.S. Number 1 Electronics, 1920 Edgar Rd., Linden, N. J.*~~
- ~~15. AlvaRadio, 5205 Lankershim Blvd., N. Hollywood, California*~~
- ~~16. Columbia Electronics, 4365 W. Pico Blvd., Los Angeles, California*~~
- ~~17. L & R Electronics, 3529 East Colorado, Pasadena, California*~~

- 15 ~~S. J. Candee Co., 509 N. Victory Blvd., Burbank, California*~~
- 16 ~~Globe Electronics, 3103 Pico Blvd., Santa Monica, California*~~
- 17 ~~FAB, 111 Liberty St., New York 6, N. Y.*~~
- 18 ~~R. W. Electronics, 2430 S. Michigan, Chicago 16, Illinois*~~
- 19 ~~Joe Palmer, P.O. Box 6188, Sacramento, California~~
- 20 ~~Murray Brothers, 12 Adams St., Charlestown 29, Mass.*~~
- 21 ~~Mesina, 580 Lynn Street, Malden 48, Mass.*~~
- 22 ~~Bill Step, P.O. Box 178, Ellenton, Fla.*~~
- Algeradio Electronics Co., 37 Greenwich St., Hempstead, N. Y.*
- Atlantic Surplus Sales, 181 Sackett Street, Brooklyn, N. Y.
- Communications Equipment Co., 343 Canal St., New York 13, N. Y.
- Telemarine Communications Co., 140 W. Broadway, N. Y. City 7, N. Y.

*Has catalog or catalog sheet on request.

Using the APS-4

The APS-4 indicator is useful around the shack as a modulation monitor. As it stands, this device consists of a scope assembly, ID-11/APS-4 and the amplifier AM-5A/APS-4. We originally mentioned this equipment a few months ago and apparently were in error about Rex Radio having the conversion as well as the units. As a result we figured one out and present it now in an effort to clean up last minute business. The conversion itself is relatively simple. We make use of the bleeder circuit of the original unit and add a power supply and a few parts. The bleeder sits across 1500 volts and supplies the necessary voltages for the scope tube. The scope tube is a 3FP7 long persistence type tube. It comes in a housing that includes a magnetic shield, as well as the housing for two 6J6 tubes and a method of mounting in a meter hole of a panel. A heavy cable connects to the amplifier unit which houses the bleeder string as well as the video amplifier and sweep amplifiers, both of which serve no purpose in the conversion. We left the amplifiers alone and merely built a power supply to operate the scope, on top of the amplifier housing. A better solution would be to remove the bleeder components and place them within the transmitter, which may also be able to supply the necessary voltages for the bleeder, about 2 ma at 1500 volts. The filament transformer within the unit is designed for 400 cycle operation and must be replaced with

another. For safety's sake, the positive side of the bleeder is grounded, and the negative side well insulated from the chassis. This is important from several points of view, but especially because the centering controls, which we have to add, should be close to ground to avoid any possible shock hazard, and also because this will simplify the coupling capacitor voltage requirements, although it is possible to salvage a pair of 0.0051 mfd 2500 volt mica capacitors, from the indicator unit. If a separate chassis is desired for the power supply components it would be wise to observe the focus control assembly within the amplifier chassis as this is very well designed for high voltage protection. This should be copied for safety.

As mentioned before, the positive side of the bleeder voltage is grounded. The negative side of the 1500 volts is connected to the control grid lead of the scope tube which is a heavy insulated gray wire with a blue and yellow tracer which is connected to the 0.0051 mfd high voltage mica capacitor. The filament transformer will have to be replaced with one for 60 cps and a good one is the Stancor P-8190. Under no circumstances should any other tubes be operated from this transformer, since it will be at a very high negative voltage across the output to ground.

The horizontal and vertical centering controls were replaced by 1 megohm 2 watt potentiometers, wired as shown in figure 2. The original ones would not function since they were for a different type circuit. The original tubes were used to accept sweep signals from the main radar and are therefore not usable as is.

A Stancor P-8150 transformer is used for the high voltage. This together with the rectifier and filter could have been mounted within the amplifier, with a little effort, but since this is going to be redesigned for a more permanent installation here at W2HDM, we left it in a safe status for later, by mounting the parts on the amplifier cover.

Once wired, we connected the scope as described in the ARRL handbook, E and E, and other manuals for a trapazoidal pattern, and adjusted the intensity and focus to get a fine

(Continued on page 118)

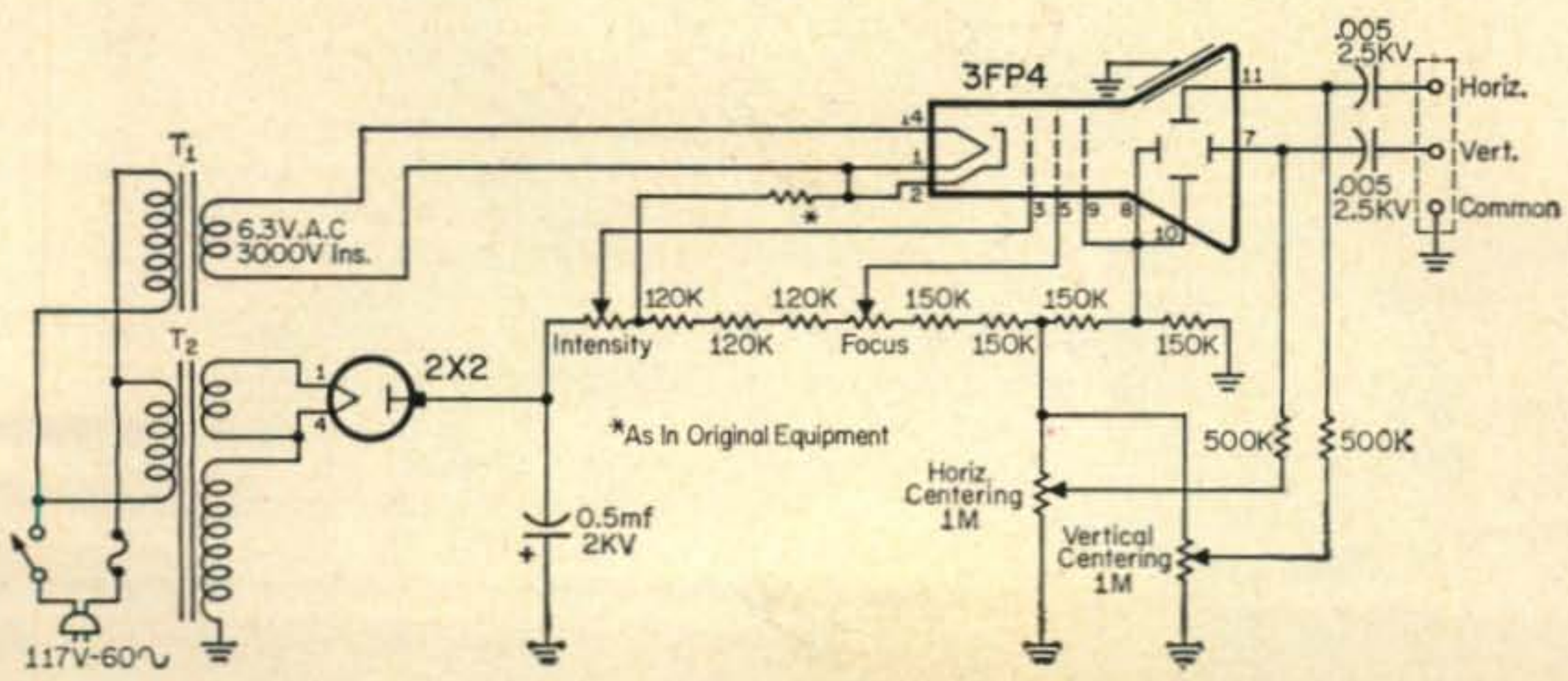

Fig. 1—Power supply and modified bleeder circuit used with APS-4. The amplifiers (horizontal and vertical) remain unused.

New Amateur Products

Power Meter

A NEW line of r.f. power meters for the frequency range of 100 kc to 200 mc is announced by Electro Impulse Laboratory, Inc., 208 River St., Red Bank, N. J. These Power Meters, both feed-through and terminative type, are similar to the company's regular line of r.f. power meters for the limited frequency range, which makes them considerably lower in price. Ten models from 1½ watts full scale to 1500 watts full scale are available. Prices start at \$60.00 and go up to \$250.00 for a six scale Power Meter covering 1½ watts full scale to 600 watts full scale. Two models are available in the feed-through power monitor type from 15 watts up to 150 watts at \$115.00 and \$135.00. More information may be received by circling A on page 126.



Mobile Alarm

ZIMCO Alarms at 2005 Atlantic Avenue, Brooklyn 33, New York is manufacturing a siren alarm which is housed in a tamper proof cast aluminum housing. The alarm can be ordered with 6, 12, 24, or 32 volt d.c. motors or 115 v.a.c. Six push button switches are included which can be mounted on the door post, trunk lid etc. Once the siren is actuated it must be turned off with a key which is also supplied. The unit can be purchased as a kit or installed by the manufacturer. For more information circle B on page 126.

Noise Generator

A NEW reasonably priced random-noise generator has been announced by Gonset. Intended for operation in the v.h.f. range, this new generator provides direct readings of sufficient accuracy for average laboratory use. The noise-generating head is a separate compact assembly which connects to the main housing by a flexible cable. This arrangement allows the head to be attached directly to the receiver under test and eliminates long connecting leads which can make accurate noise measurements difficult due to stray signal pickup. The type 5722 noise diode and associated circuitry is located within this external head which fits into a clamp on the side of the housing when not in use.

The instrument provides direct reading to 25 db into 50 ohm impedances. The large-scale panel meter facilitates accurate reading of low noise figures. Filament of the noise generating diode and random-noise output, is controlled by a variable autotransformer. Rapid checking of residual starting noise is expedited by a panel switch which temporarily cuts off diode current without need to change filament voltage settings.

A self-contained power supply operates from 117 volts a.c., and uses diode rectifiers, providing regulated d.c. operating voltage. Noise diode with quick-heating filament and semi-conductor diode rectifiers in power supply virtually eliminate warm up time.

Additional information may be obtained by circling C on page 126.



"On The Air"

STEELER Electronics, at 1621 Winn Joyce Road, Box 82, Garland Texas is manufacturing an "On The Air" sign which lights up when attached to antenna relay or other switching device which will supply 6-12 or 110 volts a.c. or d.c. The voltage requirements must be specified when ordering. Designed for table-top or wall mounting the unit is constructed of heavy gauge steel and has a snap-out back plate for easy removal of the long life bulbs. Dimensions are 10½" long, 3½" high and 3" deep. A choice of black or gray finish is offered. Check D on page 126 for more information.

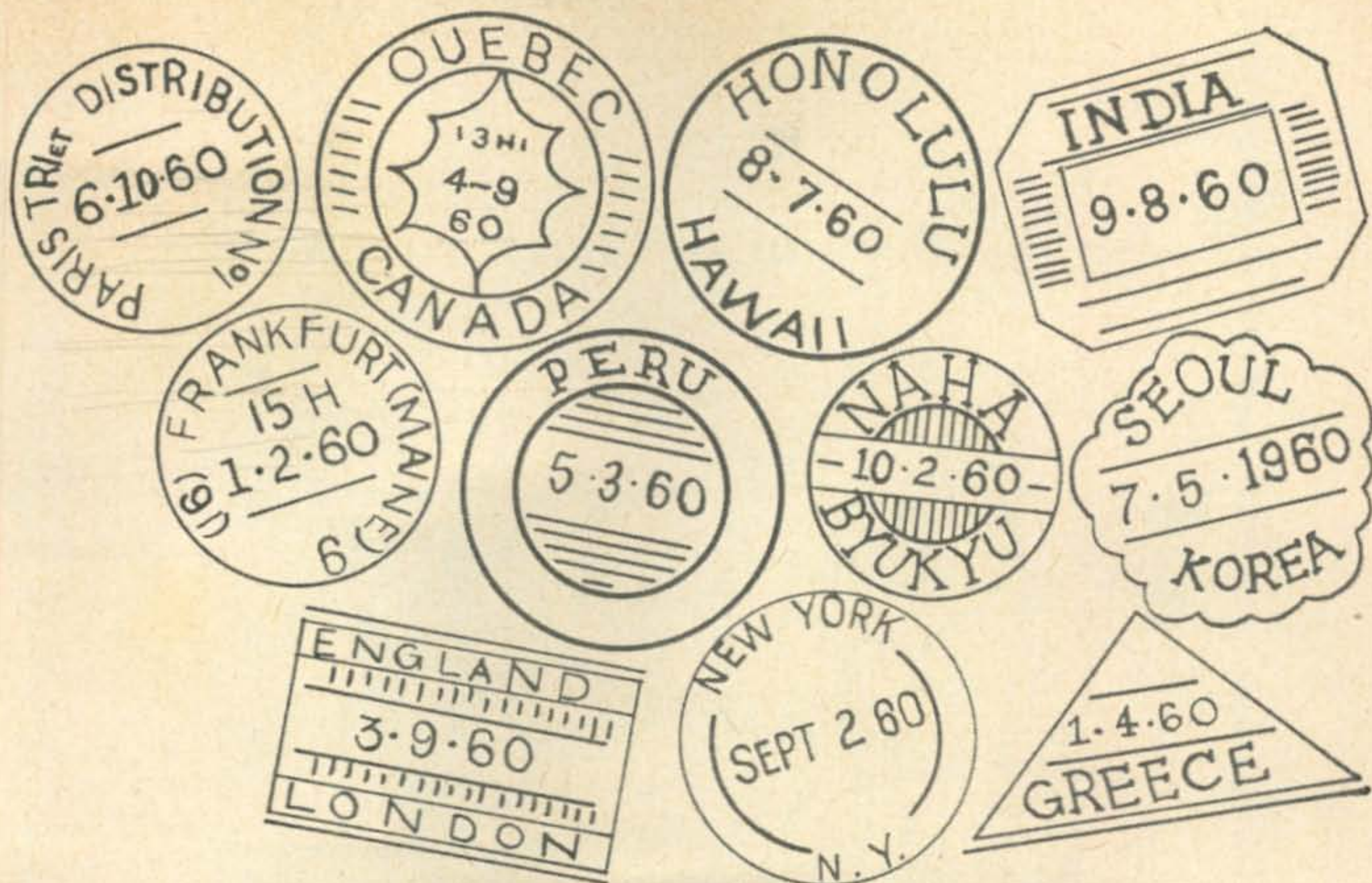

the hams from Harvey serve the world!

Hams the world over know and value the Harvey reputation of service and reliability. For 34 years Harvey has served every corner of the globe filling every Ham equipment requirement.

At Harvey's, all orders for ham equipment are personally supervised and handled in all phases by hams. W2DIO and his ham associates devote immediate attention to your order. Your instructions — in any language — are followed meticulously.

Upon your instructions, Harvey's will open the original factory sealed cartons and give the equipment complete inspection and checkout. And there is no charge for this extra service, for Harvey's policy is "satisfaction always guaranteed."

Always ready to discuss your ham problems, always ready to supply your exact requirements—Harvey talks the language of hams — wherever they are.



Authorized Distributor

Harvey Radio carries a complete stock of RCA tubes for every power tube requirement.

Partners in Dependable Global Service

HARVEY RADIO CO., INC. ESTABLISHED 1927

103 WEST 43rd STREET, NEW YORK 36, N. Y. • JUdson 2-1500

For further information, check number 38, on page 126

From the Boys in the Back Room



HERE'S big news that should really be well-received by all readers. By carefully negotiating with our printer, we've been able to cut production costs for classified advertising (Ham Shop) and can pass the savings along to readers who use this popular section. Effective with the April issue, rates for *Non-Commercial* classified ads will be slashed to 5¢ per word. In addition, the minimum charge of \$1.00 has been dropped, so you can get your message across to fellow hams for pennies, if you wish.

We expect this action to result in thousands of new classified advertisers, so please make sure that your ads are carefully typed or neatly printed wherever possible.

Remember, this section belongs to you! Use it often and use it wisely. It's your best method of selling or buying the gear you want.

10
15
20
40

AND NOW **40 METERS WITH THE**
NEW Hy-gain "hy-seven"

**40 METER MONOBANDER WITH THE REVOLUTIONARY NEW
"LINEAR LOADING"**

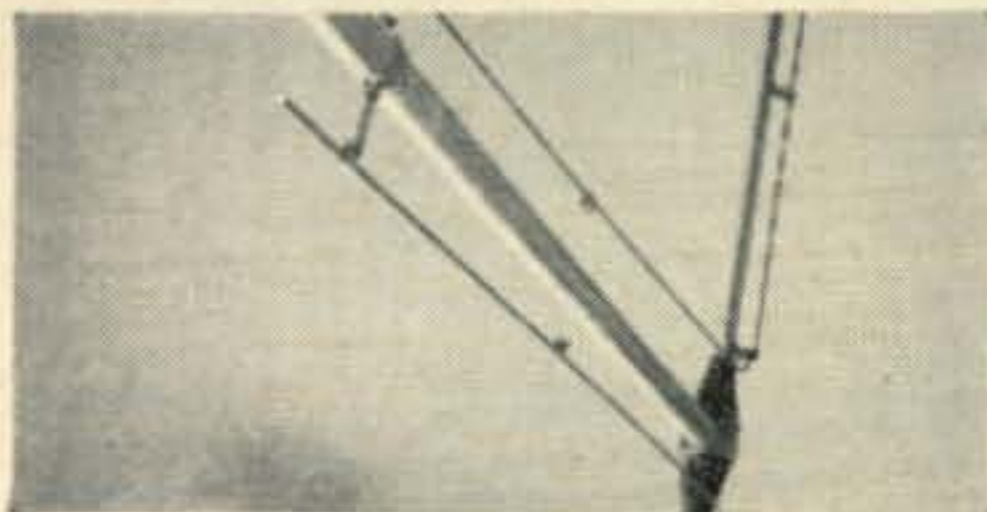

The Beta Match—The famous Hy-Gain Beta matching system is factory pretuned. SWR guaranteed less than 1.5 to 1. Without further adjustment.



Linear Loading—The new linear loading concept reduces element length and maintains higher efficiency than coil loading.

Stacking—because of its light weight and convenient size, the Hy-Seven may be easily stacked with your existing tri-bander installation. Complete data furnished for proper installation.

NO COILS

Now you can make 40 meters come alive with true beam performance for your rig. For the first time the Hy-Gain Hy-Seven two element 40 meter beam develops excellent forward gain and front to back in a reduced size, light weight antenna without the use of lossy loading coils. Reduction in element length is accomplished by the introduction of the new concept of linear loading. It results in three important new advantages:

1. A small easy to install antenna, that stays up!
2. Much higher efficiency than coil loaded types.
3. Virtually impervious to all weather conditions.

Like all Hy-Gain beams, the Hy-Seven is factory pretuned ready for quick and easy assembly. It's also tops in mechanical construction — with a 1 year guarantee to prove it!

SPECIFICATIONS

Mechanical: Boom, 16' x 2" O.D.; Longest Element, 43'; Material, all aluminum, high impact; Cyclocac plastic and irridite treated steel hardware. Net weight only 24 pounds.

Electrical: Element spacing .13 wave lengths; Matching system, adjustable Beta; SWR at 52 ohms, 1.0 to 1.

Wt. 27 lbs. \$9975 Ham Net

also available on commercial frequencies

Hy-gain antenna products

1135 NO. 22nd ST • LINCOLN, NEBRASKA

THE CQ HAM MART



19" GLOBE

Here is a chance to preserve your breath for posterity! This beautiful World Globe, made by Hammond, is a must for every hamshack. Plain for \$19.95 or lighted for \$24.95. The first 10,000 people who jump at this bargain will get a year of CQ at no extra charge.

ATLAS

What! You don't know where Nicobar Island is? Incredible! And with the CQ deal on the Hammond Atlas so reasonable too. This is a reference book that will get good usage around your house if you have any kids. 7 lbs. of colored maps and a gazetteer for only \$12.50... and you get a year of CQ.

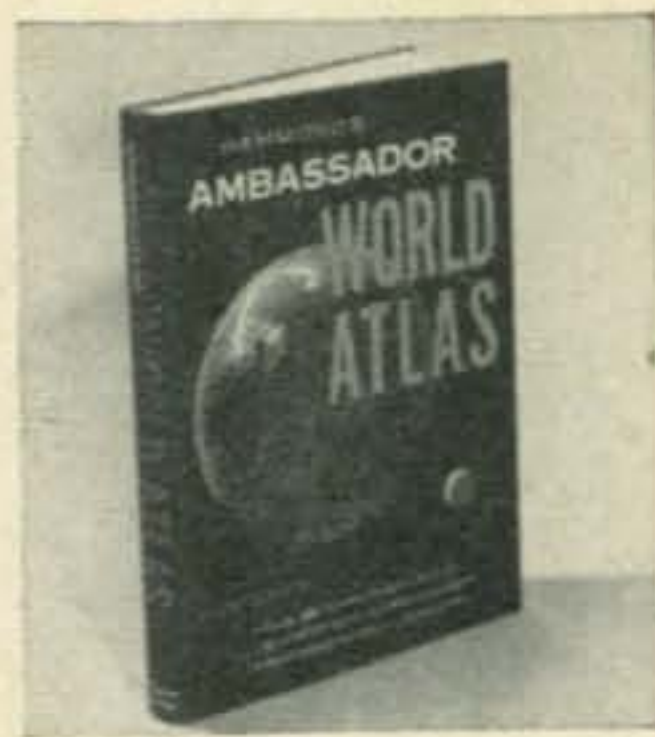

COMMAND SETS

This IS a collection of reprints, containing all of the available information on the conversion of the popular "Command" transmitters and receivers into good ham transmitters and receivers. Invaluable for Novice, Technician, General, Advanced and Extra class operators. 136 fabulous, amazing terrific pages for only \$1.50 postpaid.



MOBILE HANDBOOK

Anyone who tries to go mobile without getting this book should register for a sanity hearing. Bill Orr, W6SAI has put everything you need to know in this book. Build-its by the dozen... solutions to ignition problems, keeping the battery charged, noise... only \$2.95 postpaid.



CODE RECORD

Learning code is a snap with this record. Speeds from 3 to 16 WPM, depending upon turntable speed. This 12" LP record has on it all you need to learn the code for both the Novice and General License. \$3.50 each.

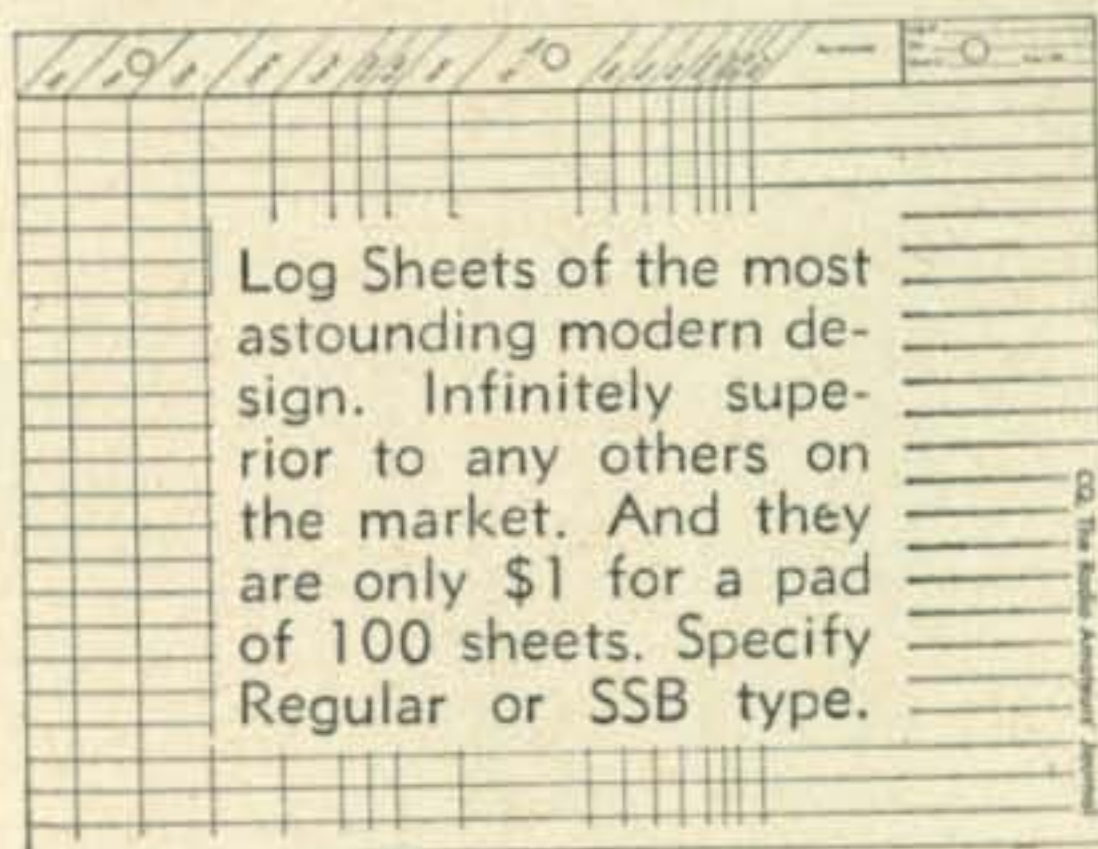

Log Sheets of the most astounding modern design. Infinitely superior to any others on the market. And they are only \$1 for a pad of 100 sheets. Specify Regular or SSB type.

HAM'S INTERPRETER

Now you can talk in broken French, Spanish, Italian, German, Swedish and Finnish. This handy little book gives all the popular ham conversation in seven languages, including letters and numbers. Only \$1.50 postpaid.



TVI HANDBOOK

WIDBM's newly written TVI book (2nd edition) covers all aspects of curing TVI from both the Ham's viewpoint and that of the TV viewer or the TV serviceman. It includes 2- and 6-meter TVI as well as Citizen's Band, Industrial, Medical and Utility TVI. Profusely illustrated with diagrams, photos, charts, tables and FCC regulations pertaining to radio and television interference. Price \$1.75 postpaid, USA, \$2.00 Foreign.



BINDER

There is no other good way to keep your back issues. Make 'em neat. We supply the binder, with the year embossed in gold, not merely a sticker which will come off later. Specify what year you want stamped on your binder. \$3.50 each.

BOUND VOLUME

By far the handiest way to keep your library. Why not go first-class? This impressive volume is only \$10.00. We only made a few of them this year, so Don't expect to get one later.





CQ ANTHOLOGY

Most amateurs do not have a good file of back issues of CQ. So we've looked back through the years 1945-52 and assembled all in one place the articles that have made a lasting stir. The issues containing most of these articles have long ago been sold out. The price is a paltry \$2.00.

DX ZONE MAP

Brand New! Amateur Radio World-Wide DX & Zone Map complete, accurate and up to the minute with Prefix, Zone Boundaries, Great Circle beam bearings. 4 Colors, 36 by 42 inches on heavy vellum map paper. Mailed in heavy cardboard mailing tube. Only \$3.00.

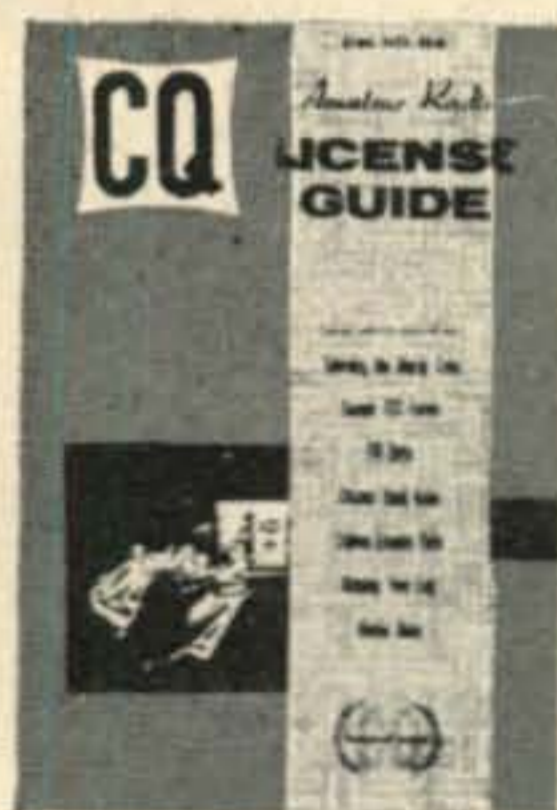

CQ LICENSE GUIDE

212 pages of everything the Amateur must have to get his license and progress toward the general class ticket. Plus many additional pages of vital information for the ham operator. All this for only \$2.50.

SURPLUS SCHEMATICS HANDBOOK

This is a book literally loaded with schematics for all the currently popular pieces of surplus gear. Most amateurs are well aware of the problems encountered in purchasing seemingly inexpensive surplus units, only to find that no schematic diagram is available. Trying to figure out the circuitry cold turkey can be many times more difficult than the most involved puzzle, and purchasing a single instruction book can run as high as \$3.50. Why knock yourself out when you can have a book with complete coverage on hand in your library? All this for only \$2.50.

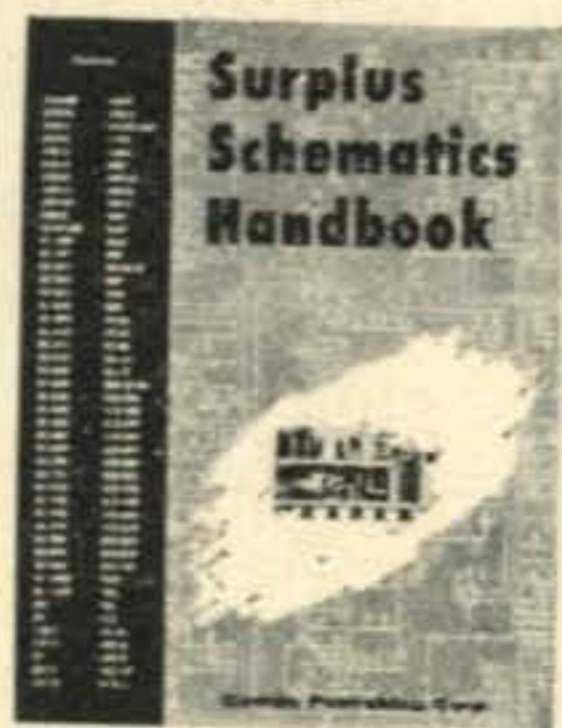

HI-FI BOOK

This nifty volume contains the latest dope on amplifiers, preamplifiers and equalizers plus a buyer's guide of component manufacturers! Over 150 — 5½" x 8½" pages of heavily illustrated descriptions covering Hi Fi Audio Components—the greatest publication value in its field today. Only \$2.50 per copy.



SIDEBAND HANDBOOK

Written by Don Stoner, W6TNS, was almost one full year in the preparation of this terrific volume. This is not a technical book. It explains sideband, showing you how to get along with it... how to keep your rig working right... how to know when it isn't... and lots of how to build-it stuff, gadgets, receiving adaptors, exciters, amplifiers. Price, only \$3.00.

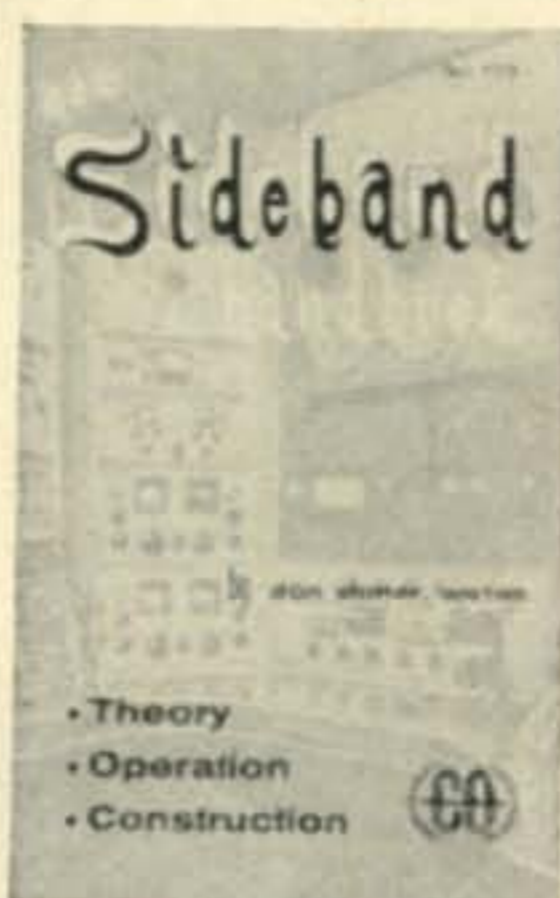

COWAN PUBLISHING CORP. CQ-3

Book Division
300 West 43rd Street
New York 36, N. Y.

LIGHTED GLOBE	\$24.95	<input type="checkbox"/>
UNLIGHTED GLOBE	19.95	<input type="checkbox"/>
ATLAS	12.50	<input type="checkbox"/>
COMMAND SETS	1.50	<input type="checkbox"/>
MOBILE HANDBOOK	2.95	<input type="checkbox"/>
CODE RECORD	3.50	<input type="checkbox"/>
REGULAR LOG SHEETS (100)	1.00	<input type="checkbox"/>
SSB LOG SHEETS (100)	1.00	<input type="checkbox"/>
HAM'S INTERPRETER	1.50	<input type="checkbox"/>
TVI HANDBOOK	1.75	<input type="checkbox"/>
BINDER—YEAR WANTED	3.50	<input type="checkbox"/>
BOUND VOLUME	10.00	<input type="checkbox"/>
CQ ANTHOLOGY	2.00	<input type="checkbox"/>
HI-FI BOOK	2.50	<input type="checkbox"/>
SIDEBAND HANDBOOK	3.00	<input type="checkbox"/>
CQ LICENSE GUIDE	2.50	<input type="checkbox"/>
SURPLUS SCHEMATICS HANDBOOK	2.50	<input type="checkbox"/>
DX ZONE MAP	3.00	<input type="checkbox"/>

SIRS: My check (money order) for \$_____ is enclosed. Please send the following items to:

Name _____

Address _____

City _____ Zone _____ State _____

New York City Residents Add 3% Sales Tax



The Radio Amateur's BOOKSHELF

Here is a selection of basic books that belong in every hamshack. Use coupon below to order; money refunded if not completely satisfied.

1. RADIO OPERATING QUESTIONS AND ANSWERS

Prepare to pass license examinations quickly and easily with this reliable question and answer book By J. Hornung, M.I.T., and A. McKenzie, McGraw-Hill Book Co. 12th Ed., 571 pp., 142 illus., over 1900 answers. \$6.25

2. ELECTRONIC COMMUNICATION

Fundamental theory and practice for modern electronic communication—a basic "how-to" guide to operation, maintenance, professional and amateur license examinations. By R. Shrader, Oakland Junior College. 936 pp., 771 charts, graphs, tables, and illus., \$13.00

3. BASIC ELECTRONICS

This easy-to-read book covers everything from basic electricity to tubes and transistors. Helps you learn electronics from A-to-Z at home! By B. Grob, RCA Institutes, Inc. 524 pp., 376 illus., \$9.25

4. APPLICATION OF ELECTRONICS

This big guidebook gives you the electronic know-how that helps you perform better, faster technical work. By B. Grob, RCA Institutes, Inc.; and M. Kiver. 618 pp., 495 illus., \$10.00

5. BASIC MATHEMATICS FOR ELECTRONICS

Gives you a sound mathematical background needed for working in today's electrical and electronics fields. By N. Cooke, Cooke Engineering Co. 2nd Ed., 679 pp., 373 illus., \$10.75

6. ELECTRONICS AND NUCLEONICS DICTIONARY

An illustrated dictionary giving up-to-date definitions, abbreviations, and synonyms for over 13,000 terms used in television, radio, radar, industrial electronics, medical electronics, avionics, space electronics, nuclear science, and nuclear engineering. By N. Cooke, Cooke Engineering Co.; and J. Markus, McGraw-Hill Book Co. Over 13,000 terms, 452 illus. and diagrams, \$12.00

7. TWO-WAY RADIO

This book clearly explains how to install, service, and maintain two-way radio sets for top efficiency. By A. Lytel, Avco Manufacturing Co. 281 pp., 283 illus., \$9.50

8. ELEMENTS OF ELECTRONICS

Gives you, without the use of difficult mathematics, all the basic theory you must have to go on to advanced work in radio, television, radar, sonar, or industrial control. By H. Hickey, Chief Electronics Technician, USN; and W. Villines, Jr., Lt., USN. 549 pp., 482 illus., \$8.75

9. RADIO ENGINEERING HANDBOOK

Solve your radio engineering problems more quickly, easily, and accurately with the reliable data and practice in this modern handbook. Edited by K. Henney, McGraw-Hill Book Company. 5th Ed., 1775 pp., over 1500 illus., \$25.00

10. TRANSISTORS IN RADIO, TELEVISION, AND ELECTRONICS

Provides a simplified summing up of facts about transistors and transistor circuits—how they are designed and work, and their use and maintenance. By M. Kiver, 2nd Ed., 423 pp., 337 illus., \$7.95

11. RADIO ENGINEERS' HANDBOOK

Represents an organized and substantially complete interpretation of the engineering literature of radio that has appeared in English. By F. Terman, Stanford University. 1019 pp., 869 illus., 84 tables, \$14.00

SEND CHECK OR MONEY ORDER TO:

CQ, BOOK DEPT.

300 West 43rd St., N. Y. 36, N. Y.

Send me book(s) whose numbers I have circled below, for which I enclose check or money order in full payment.

1 2 3 4 5 6 7 8 9 10 11
(PRINT)

Name

Address

City Zone State

Money refunded if not completely satisfied C-3

★ WANTED ★

LAFAYETTE

"VOYAGER"



HE-25

**6 to 80 meter
TRANSMITTER
by AMATEURS
EVERYWHERE**

for

- ★ SINGLE KNOB BANDSWITCHING 80 THROUGH 6 METER
 - ★ 120 WATTS CW INPUT 80-10 METERS
90 WATTS ON 6 METERS
75 WATTS PHONE 80-10 METERS
 - ★ PI-NETWORK OUTPUT -40-600 OHMS
 - ★ "STRAIGHT THROUGH" OPERATION EVEN ON 6 METERS
 - ★ SHAPED KEYING - ELIMINATES CHIRPS AND CLICKS
 - ★ OUTSTANDING TVI SUPPRESSION
 - ★ HIGH GAIN CLAMP TUBE MODULATION (UP TO 100%)
- ★ TUBE LINEUP—6AU6 Oscillator, 6DQ6A Buffer, 2-6DQ6A—Final Amplifier, 12AX7—Cascaded High Gain Speech Amplifier, 6AQ5—Clamper & Modulator, 5U4GB Rectifier

REWARD! OUTSTANDING PERFORMANCE AND UNMATCHED VERSATILITY AT A SENSATIONAL LOW PRICE

HE-25 "VOYAGER" TRANSMITTER Completely wired and tested with tubes, less crystal, key, and microphone.

5.00 Down

109⁵⁰

LAFAYETTE RADIO
165-08 LIBERTY AVENUE, JAMAICA 33, N. Y.

OTHER LOCATIONS

NEW YORK, N. Y. 100 6th Avenue	NEWARK, N. J. 24 Central Avenue	BRONX, N. Y. 542 E. Fordham Rd.
PARAMUS, N. J. 182 Route 17	BOSTON, MASS. 110 Federal Street	PLAINFIELD, N. J. 139 W. 2nd Street



Lafayette Radio, Dept. CC-1
P.O. Box 190
Jamaica 31, New York



★ Send me the FREE Lafayette 324 page 1961 catalog 610

Name

Address

City..... Zone..... State.....

For further information, check number 20, on page 126



SURPLUS RADIO CONVERSION DATA

—now 4 volumes . . .
hundreds of instructions,
diagrams and
photographs

SURPLUS RADIO CONVERSION MANUALS—3 Volumes—\$3.00 ea.

Conversion data in these volumes has become standard for the most commonly available surplus items. Each conversion shown yields a useful piece of equipment . . . is practical, and proved by testing.

VOLUME I

BC-221; BC-342; BC-312; BC-348; BC-412; BC-645; BC-946; SCR-274 (BC-453A Series); SCR-274 (BC-457A Series); SCR-522 (BC-625, 624); TBY; PE-103A; BC-1068A/1161A; Electronics Surplus Index; Cross Index of A/N Vac. Tubes; Amateur Freq. Allocations; TV and FM Channels.

VOLUME II

BC-454 or ARC-5; AN/APS-13; BC-457 or ARC-5; ARC-5 V.H.F.; GO-9/TBW; BC-357; BC-946B; BC-375; LM Freq. Meter TA-12B; AN/ART-13; Simplified Coil-Winding Charts; Selenium-Rectifier Power Units; AVT-112A; AM-26/AIC; Surplus Beam Rotating Mechs.; Prim. Power Requirements Chart; ARB Rcvr. (Diagram only).

VOLUME III

701-A; APN-1; APN-4; ARC-4; ARC-5; ART-13; ATA; BC-191, 312, 342, 348, 375, 442, 456-459, 609, 624, 696, 950, 1066, 1253; COL-43065; CRC-7; DM-34; DY-2; DY-8; FT-241A; LM; MBF; MD-7/ARC-5; R-9/APN-4; R-28/ARC-5; RM-52; RM-53; RT-19/ARC-4; RT-159; SCR-274N, 508, 522, 528, 538, T-15 to T-23/ARC-5; URC-4. Diagrams only: APA-10; APT-2; APT-5; ARR-2; ASB-5; BC-659; BC-1335A; CPR-46ACJ.

THE SURPLUS HANDBOOK (Receivers and Transceivers) \$3.00

VOLUME I Schematic Diagrams and large photographs only APN-1; APS-13; ARB; ARC-4; ARC-5 (L.F.); ARC-5 (V.H.F.); ARN-5; ARR-2; ASB-7; BC-222, 312, 314, 342, 344, 348, 603, 611, 624, 652, 654, 659, 669, 683, 728, 745, 764, 779, 794, 923, 1000, 1004, 1066, 1206, 1306, 1335; BC-AR-231; CRC-7; DAK-3; GF-11. Mark II; MN-26; RAK-5; RAL-5; RAX-1; SCR-522; Super Pro; TBY; TCS.



**EDITORS and
ENGINEERS, Ltd.**

P.O. Box 193, Summerland, 3 Calif.

Announcements [from page 16]

16th Annual Old Timer's Nite Round-Up

The 16th *Original* Old timers Nite Round-Up and banquet will be held on a Saturday evening, April 29th, 1961, in the Terrace Room of the Hotel Stacy-Trent in downtown Trenton. As in the past the party will be stag.

This annual event, sponsored by the Delaware Valley Radio Association is held during the month of April, to honor the living pioneers of the radio and wireless art, and to reminisce on their experiences of yesteryear.

A turkey dinner will be served promptly at 6:30 P.M., and the program will include personalities prominent in early radio history. Bring along your oldest amateur and commercial licenses, as awards will be made to those holding the earliest dates. A special Silver Cup Award will go to the "Grand OM", whose radio operating experiences date back to earliest days of wireless.

Tickets are by reservation only, and may be obtained by mailing a self-addressed envelope, on or before April 24th, with your remittance of \$6.00 per man, to Ed G. Raser, W2ZI, 19 Blackwood Drive, Trenton 8, N.J., the General Chairman. Late comers will be assessed \$7.00 at the door. Plan to bring along as many guests as you wish, everyone is welcome.

Auto-Mate [from page 53]

to the chassis when you receive the kit. The remaining parts are mounted in a few minutes, and almost immediately the builder commences the wiring operation. Working very carefully so as to observe any ambiguities in the instructions, your reviewer took about seven hours to complete the keyer. Happily, no ambiguities were found. In fact, the instructions are unusually complete and very detailed.

All connections are made at the rear of the keyer. With the exception of the a.c. line cord, connections may be made through a single 9 pin chassis socket. Two jacks are provided, additionally. One is a 2 conductor jack for high impedance headphones, or speaker, for side-tone monitoring. The other is a 3 conductor jack for a key-lever. The key-lever is, of course, not included in the kit. Controls for d.c. balance, adjustment and side-tone volume are also provided.

Controls

The MARK/SPACE control on the front panel changes the ratio of DOT to SPACE (Not DOT to DASH). At MARK the dots are quite heavy. At SPACE the dots are very light. As suggested in the instructions, a mid-point setting was found satisfactory. At high speed settings, though, the dots should be set on the heavy side to compensate for the inherent inertia of the relay armature.

The RANGE switch selects either the 5 to 17 w.p.m. speed or the 15 to 50 w.p.m. speed. Within the range selected, the SLOW/FAST knob smoothly varies the speed of dot and dash completion. The dots and dashes are "self-completing," and with the keyer adjusted for the very slowest speed it is interesting to hit the dash side of the key-lever and "walk away" while the keyer lazily completes an extraordinarily long dash.

The keyer quickly indicates sloppy practice by sending characters never before heard. ■

For further information, check number 36, on page 126

**"CALL ME
for
Personal Service"**

**"CALL ME
for
Personal Service"**

Bob Henry
WØARA
Butler, Mo.
ORchard 9-3127



ON

Ted Henry
W6UOU
Los Angeles
GRanite 7-6701



Collins
S/LINE

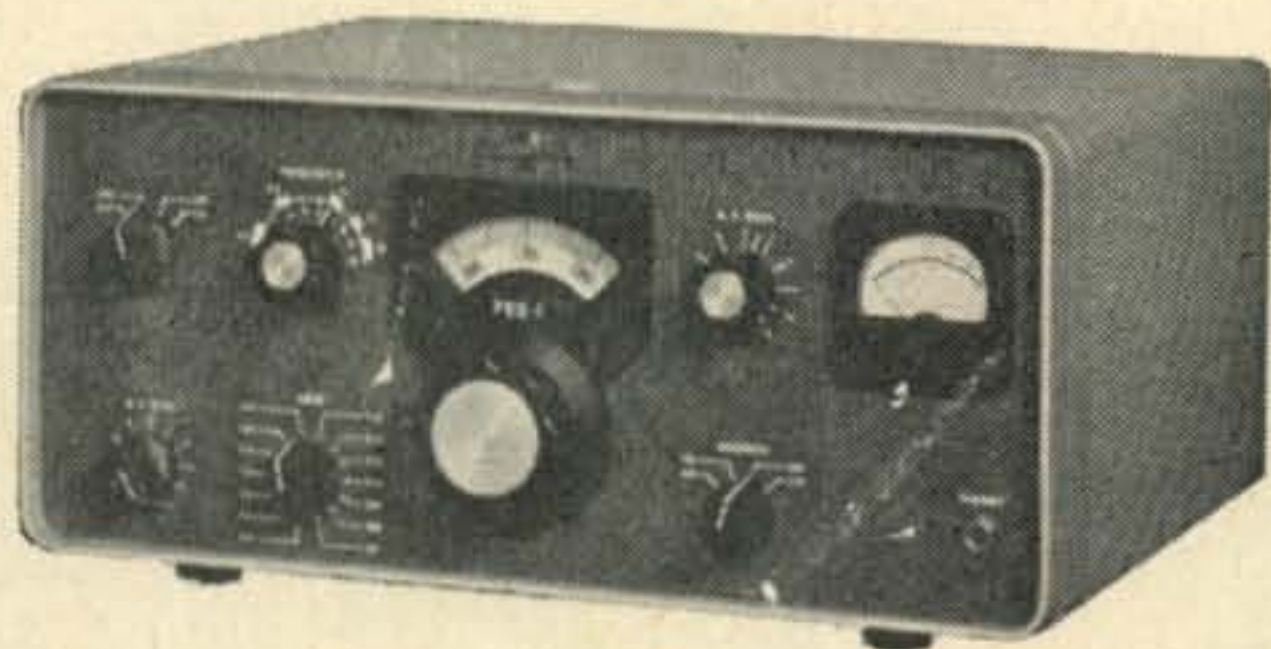

**WORLD'S
BEST TERMS**

**Because we finance
our own terms...**

- Only 6% a year finance cost
- 20 months or longer to pay
- Only 10% down (or your trade-in as down payment)
- No finance charges if paid within 90 days
- Reduced charges if paid off ahead of time
- You get more flexibility of financing in the future (such as re-financing) because we handle our own financing

**A-1 Reconditioned
Apparatus**

Nearly all makes and models. Big savings!
Ten day trial—90 day warranty. 90 day full
trade back on new apparatus. Write for
bulletin.

KWM-2 Transceiver	\$1150.00
32S-1 Transmitter	666.00
516F-2 AC Power Supply	115.00
516E-1 12 V DC Power Supply	270.00
75S-1 Receiver	520.00
312B-3 Speaker	29.00
312B-4 Speaker Console	195.00
30S-1 Linear Amplifier	1556.00

Write, phone or visit either store today!
Inquiries & orders from military men
and others outside USA wanted.

Butler 1, Missouri
ORchard 9-3127



Henry Radio Stores

11240 West Olympic Blvd.

Los Angeles 64 Ph. GRanite 7-6701



BIG

TRADE-INS

World's Largest Distributors of Short Wave Receivers

For further information, check number 22, on page 126

CANADIANS

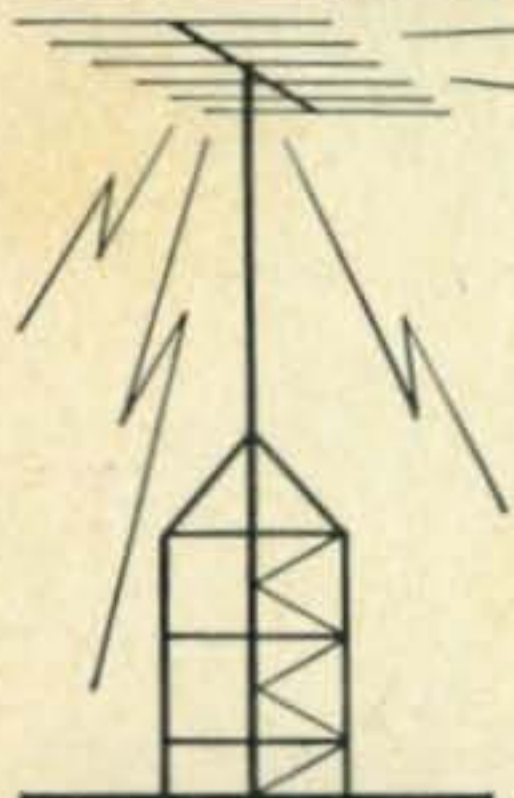

Complete stocks of nationally advertised products always available at SMALLEY'S — ham headquarters for Western Canada. Ten licensed hams on our staff to serve you.

- TRADE-INS ACCEPTED
- USED HAM EQUIPMENT
- SEND FOR SPECIAL FREE HAM BULLETIN

FLASH!
ALL ORDERS
SHIPPED ON
DAY RECEIVED

Pioneer ham suppliers since 1920. Specialists in HI-FI, TELEVISION and INDUSTRIAL ELECTRONIC EQUIPMENT.

Smalley's
RADIO LTD.

1105 - 7th Ave., S.W., Calgary, Alta.

For further information, check number 23, on page 126



VIBRO-KEYER

Only \$15.95

The Vibroplex Company has a boon for those amateurs that need the mechanical end of an electronic keyer. The Vibro-Keyer is constructed in line with the high-quality workmanship for which Vibroplex has long been famous. The unit has large, non-corroding contacts, heavy beige colored base, colorful red finger and thumb pieces, and smooth, easy operating trunion lever. It is adjustable to any amateur's taste. Only \$15.95. THE VIBROPLEX CO., INC., 833 Broadway, N. Y. 3, N. Y.

LOWEST PRICED ELECTRONIC ASSORTMENTS IN AMERICA!

RADIO - TV PARTS BY THE POUND in **JUMBO PAKS**

<input type="checkbox"/> ONE POUND PRECISION RESISTORS WORTH \$100	<input type="checkbox"/> ONE POUND Discs, Ceramics, PRECISIONS WORTH \$70
<input type="checkbox"/> ONE POUND DISCS & CERAMICS WORTH \$75	<input type="checkbox"/> ONE POUND CERAMIC CONDENSERS WORTH \$85
<input type="checkbox"/> ONE POUND DISC CONDENSERS WORTH \$50	<input type="checkbox"/> BUY 4 PAKS for \$11.00

500-1000 PCS. PER POUND!
\$3.00
Clip out & mail per pound
MONEY-BACK GUARANTEE!

Free catalog Write!

LEKTRON

HOW TO ORDER: Include check or M.O. with sufficient postage; excess returned. C.O.D. orders, 25% down; rated, net 30 days. INCLUDE POSTAL ZONE in address.

241C Everett Ave., Chelsea 50, Mass.

Letters [from page 14]

20 db is the top signal. Likewise, if he reported S9 + 20, S9 + 20, it would mean his signal was equal to the top signal he is hearing. If he reported S9 + 20, S9 + 30, it would mean he is 10 db better than the top signal heard at that time. This type of report would be of value to someone testing a new rig or antenna, etc.

When using such a system we would not hear these ridiculous reports such as: "Your signal is S6, but my meter is very scotch." Or, "You are S9 + 60, but I have a liberal meter." Or, "You are only S5, but S5 is the strongest signal I have ever heard on this receiver." Or, "I have a poor receiving antenna", etc., etc. This type of suggested report would take into consideration: (1) Location, (2) Receiver, (3) Antenna system, (4) Even cockpit trouble; and would eliminate lengthy questioning of the operator desiring a report, and would help the receiving station to give a report without making excuses for his equipment, location, antenna, etc.

Please give this some thought, and if possible, ask the gang to consider this method or some method which would make our report system of some value.

Charles Endres, W6PJ

Propagation [from page 65]

It is entitled, "The Sunspot Story; Cycle 19—End Of An Era," and will appear in three parts beginning with the April issue of CQ.

Part I will deal with the ionosphere in general, and how skywave propagation takes place. Part II, appearing in May, will discuss sunspots, their influence on radio propagation, and their general behavior. Included in Part II will be a sunspot forecast for the remainder of the present cycle, and for the remainder of the century! Part III, appearing in June, will contain a band-by-band forecast of propagation conditions expected during the next five years, including a summary for the v.h.f. bands. The article will conclude with a brief look beyond the present cycle, through the remainder of the century.

It is believed that the Jacobs-Leinwohl report will be the most comprehensive ever written on the subject of the solar cycle and its influence on conditions in the various amateur bands. *Don't miss it.*

TENTH ANNIVERSARY

Ten years ago this month I took on the task of CQ's Propagation Editor. My first column, appearing in March 1951, attempted to carry on the excellent work of Perry Ferrell, who had inaugurated the column in CQ a few years earlier.

A very large number of sunspots have passed across the face of the sun during the past ten years (one complete cycle, in fact) and much propagation history has been made (record breaking solar activity, world-wide DX on 6 meters, satellite and moon-bounce, etc.). But my most rewarding experience as Editor of this column has been the warm response the column has received over the years from its readers.

I want to take this opportunity, on the tenth anniversary of my Editorship, to thank all of you who, through the years, have taken the time

38 Tube Aircraft Electronic Gun Control

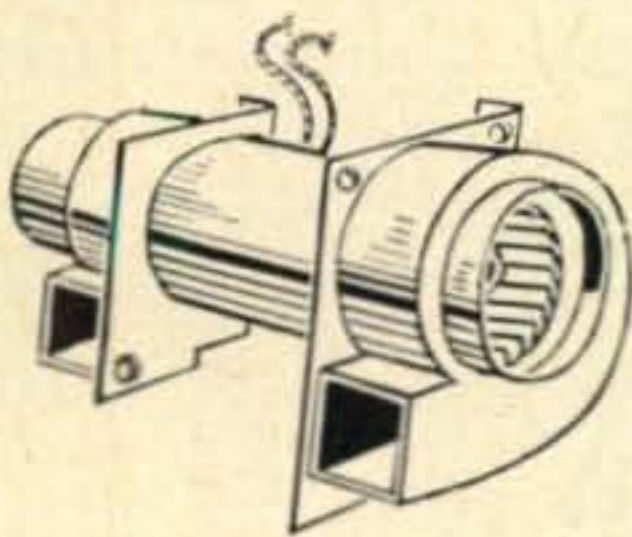

(BLOWER)

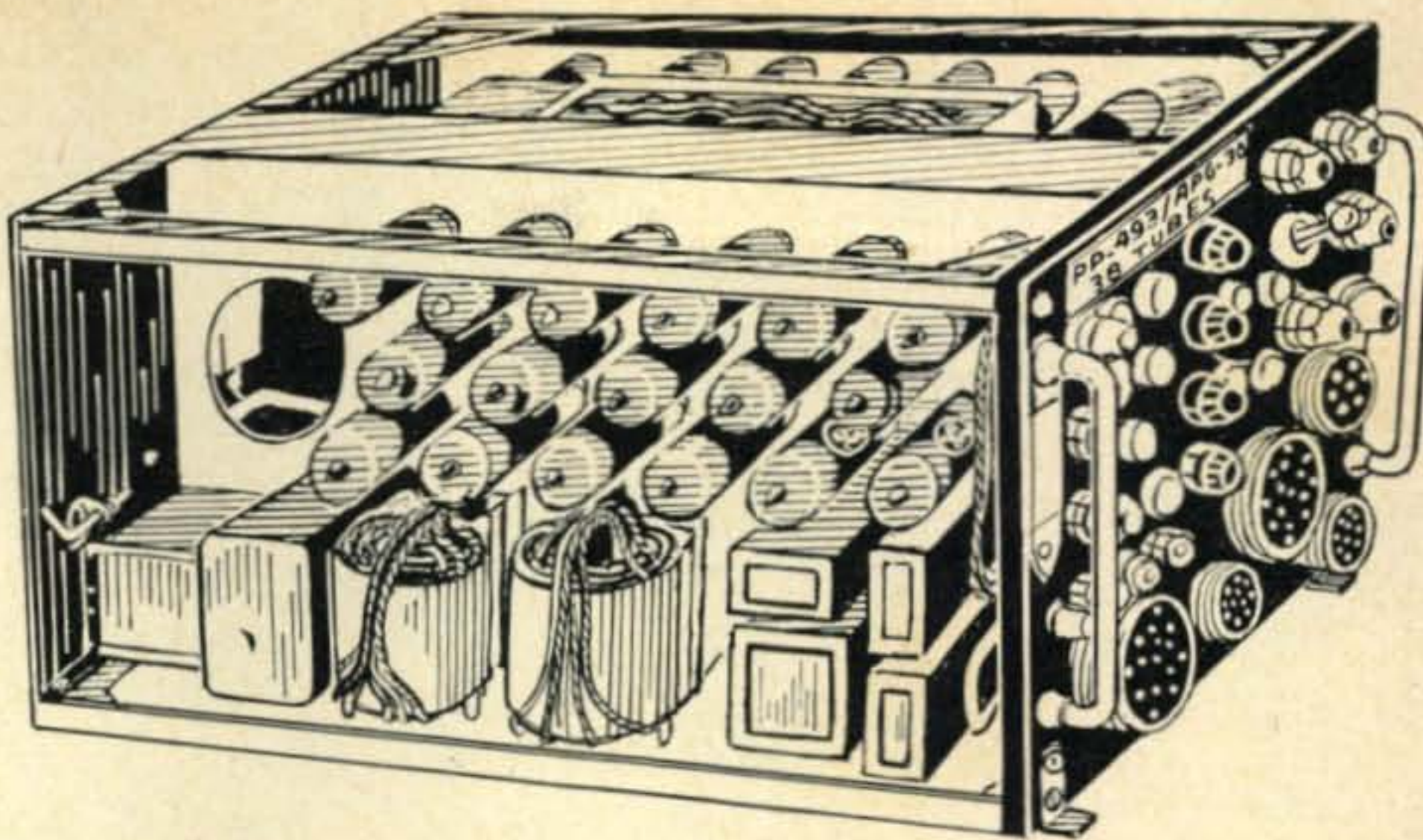

Unit contains many precision parts for the experimenter. Tubes include: (1) 0A2, (1) 2D21, (1) 6AQ5, (2) 6AH6, (1) 6AS6, (2) 6J6, (5), 6X4W, (2) 12AT7, (5) 12AX7, (2) 5654, (4) 5670, (1) 5725, (3) 5726, (8) 6005/6AQ5W. Parts include (6) tube 30 Mc. I. F. Strip, 28 VAC or DC dual squirrel cage blower with R. F. filter, (5)

hermetically sealed relays, (11) potentiometers, (5) BNC chassis connectors, 5 & 10% Allen Bradley resistors. Metallized paper capacitors, silver mica capacitors, 1% precision resistors and many other parts too numerous to mention. Good used condition. Furnished complete with removable cover.

Type #PP493/APG30. Size: 8 3/4"H x 10-5/16"W x 16 1/2"D. Wt.: 35 lbs.
Cat. #4-APG3. FOB. Georgia or NYC.

If you wish unit shipped via prepaid parcel **\$15.95**
post add \$3.95 each unit for shipment.

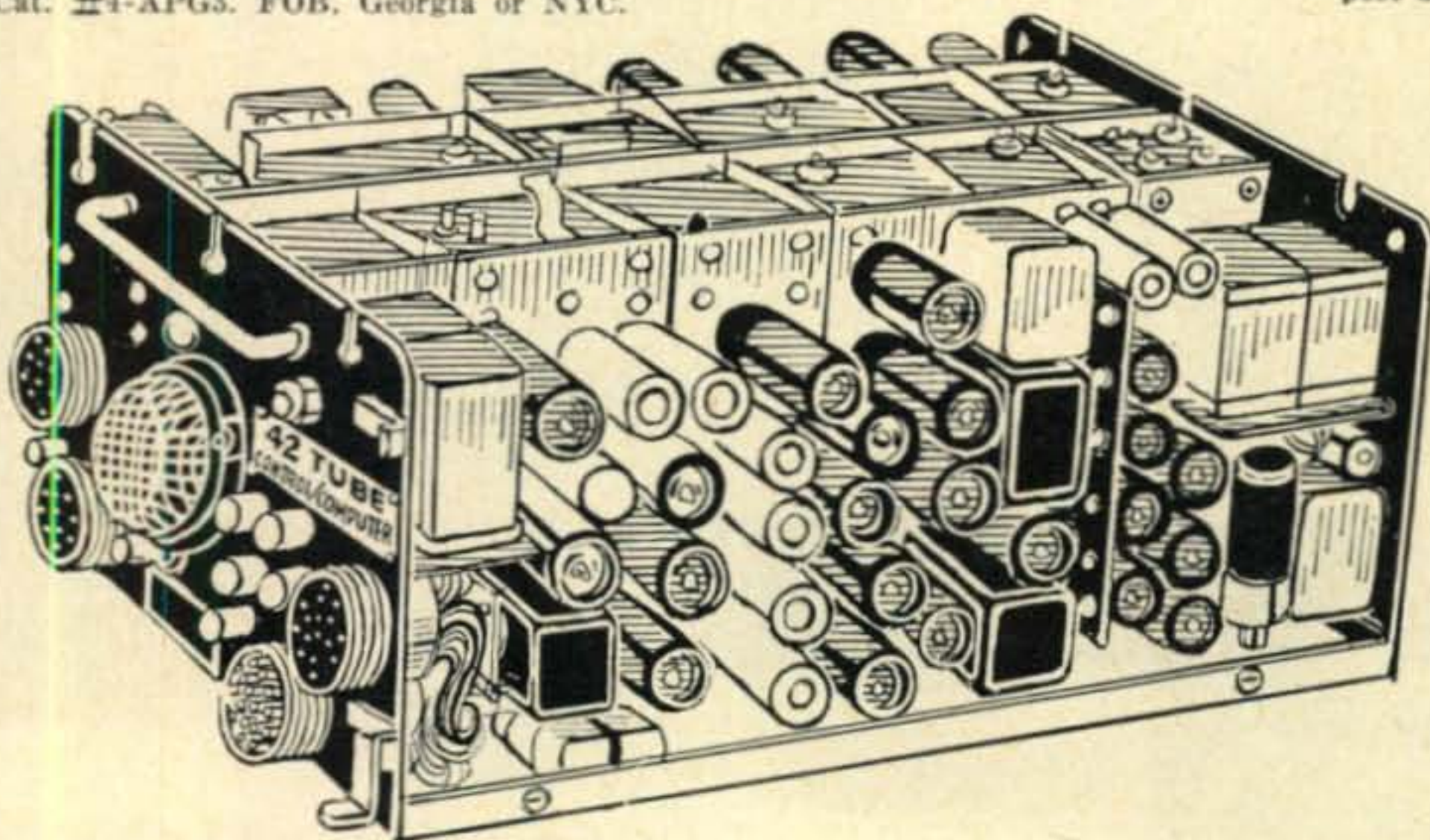

42 Tube Control- Computer

If you wish unit shipped via prepaid parcel
post add \$3.95 each unit for shipment.

If both the 42 Tube Control/Computer
and 38 Tube Aircraft Electronic Gun
Control units are ordered, both units
can be shipped for the same low, low
economical motor truck for the 100 lb.
wt. minimum.

This extremely compact and modern unit consists of 42 late-type miniature tubes and components. At a very modest cost you get a windfall of useful parts. Ideal for the modern experimenter or R & D Lab.

Unit has following tubes: (3) 56S7, (1) 6J6, (14) 12AT7, (10) 6AL5W, (4) 12AU7, (2) 6AH6, (3) 12AY7, (2) 12AX7 (1) 6AK6, (2) 6AS6. In addition, unit has (10) compact hermetically-sealed relays, (10) each "BNC" Type Panel Coax connectors, more than (15) "Pots" and several Delay Lines. You also get over (100) Mica capacitors, and over (100) Resistors, plus 42 Miniature Tube Sockets (Steatite Type) with copper Berellium contacts. Sockets are finest

type which cost Gvt. over \$1.00 each. These sockets are excellent for "low-loss" VHF use. Most tubes come with modern heat-leak shields. Interesting, plug in, sectionalized construction. (4 Basic units). Units are in good condition, removed from equipment, complete with all tubes. There are many, many other useful and valuable components such as connectors, blower, xfmrs, Vitamin Q Capacitors, etc., etc. This unit is one of the best values we have advertised in some time. Wt.: 28 lbs.—Size: 7 1/2"H x 10"W x 17 1/2"D. Furnished complete with removable cover. (Gvt. cost \$1068.00 each). Tubes alone worth almost twice our low price of **\$19.95**

FOB. Atlanta, Ga., or NYC.

Mobile Transmitter. Uses 5618 Crystal oscillator into CBS 5516 amplifier. Modern design. Only 7 lbs. net wt. including built-in 6 V. vibrator pwr supply, with 8 silicon rectifiers. Complete enc. in an aluminum cabinet (5 1/2"H x 7"W x 8"D). Furnished with crystal that doubles near 10 meter band. Requires slight & easy modification for 10 meter operation. (See pg. 98, Jan. 61 CQ). A real deal. Order No. 5618/5516 Mobile Xmtr. **\$13.95**

SPECIAL OF THE MONTH

RCA Precision 500Kc Crystal Oscillator. Accuracy 0.0012%. Hermetically sealed case. Plugs in 7-pin miniature socket, W/XTAL, 5840 tube and schematic. Postpaid **\$3.75**

BARRY ELECTRONICS CORP.

512 BROADWAY, NEW YORK CITY 12, N. Y.

- Please send me the 1961 Catalog on tubes and equipment . . . Free!
- I am herewith enclosing money order, certified, cashier's or regular check in the amount of \$.....for the following:
- 38 Tube Aircraft Electronic Gun Control. Mobile Xmtr.
- 42 Tube Control/Computer. Xtal Oscillator.

NAME

TITLE

ADDRESS

CITY

STATE

COMPANY AFFILIATED WITH

For further information, check number 24, on page 126



pi-network coils provide complete line



Model 851
\$16.50

Model 850A
\$35.00

Model 852
\$39.50

Now—Pi-Network inductors specially tailored for your needs. Here are highly-efficient, super compact tank coils incorporating the unique feature of integral band switching.

Model 850A and Model 852, now complement the famous B&W Model 851. All are designed for single or parallel tube operation on 80, 40, 20, 15, 11 or 10 meters, with top efficiency in Class "C" or linear operation. Windings give ample current carrying capacity with optimum "Q" over the entire operating range.

See these superior B&W inductors at your dealers now, or write B&W direct for detailed information.



Barker & Williamson, Inc.

Bristol, Penna.

For further information, check number 25, on page 126

THE *Only Complete Line* OF V. H. F. ANTENNAS

$\frac{3}{4}$ — $1\frac{1}{4}$ — 2 — 6 METERS

- BEAMS
- DUAL STACKS
- QUADS
- COLINEAR ARRAYS
- MOBILE HALOS

See your distributor or write for Free Catalog

CUSHCRAFT

621 HAYWARD ST.
MANCHESTER, N. H.

U. S. #1 ELECTRONICS

a division of AMBER INDUSTRIAL CORP.

1920C E. Edgar Rd., Linden, N. J.—on Highway U.S. 1
cor. Park Avenue

OPEN FOR RETAIL—PLENTY OF FREE PARKING

THIS MONTH'S CHOICE SURPLUS SPECIALS

R8/ARN-8	receiver 75 mcs. 7 tubes	exc.	\$4.95
BC-458	Xmtr. 5.3-7.0 mcs. w/tubes	new	8.95
GO-9	Xmtr. 0.3-0.6 & 3-18.1 mcs. w/tubes	new	69.95
SCR-522	xeceiver w/tubes	exc.	22.50
BC-1206	beacon rec., 195-420 kcs w/tubes	exc.	3.45
BC-620, 659	xevrs 20-27.9, 27-38.9 mcs resp. ea.	exc.	10.95
BC-603	receiver 20-28 mcs w/tubes	exc.	12.95
MP-22	mobile mast base mtg., heavy duty	5/8.00 new	1.95

Write for Free Listing — Thousands of Bargains!
25% dep. on C.O.D. orders—Min. \$5.00—All prices fob Linden

to drop me a line expressing your thoughts and ideas about the column. I also feel that special thanks should go to the publishers of *CQ* for recognizing the importance of propagation forecasts, and for leading the field of technical publications in bringing this information to radio amateurs.

Beginning my second decade with *CQ*, I'm looking forward with great excitement to reporting on these pages the spectacular events that are certain to unfold in the field of radio propagation during the years ahead, as man unlocks more and more of nature's secrets.

73, George, W3ASK

Mobile Selectivity [from page 35]

The two crystals should be one kc apart at the output frequency of the converter. This will result in a passband of approximately two kc (about the sharpest useable for phone reception). Some of the advertisers in this magazine will grind these crystals to order for less than ten dollars for the pair. If surplus crystals are used, be sure they have matching characteristics.

The resistor should be hand picked for the individual filter. Too low a resistance will result in a dip in the middle of the passband. Too high a resistance will result in poor skirt selectivity. In my case, the optimum resistance was 2,200 ohms.

This filter has a flat passband of approximately two kc with steep skirt selectivity and negligible ringing. I have found it to be the best solution to the problem of mobile selectivity. ■

Novice [from page 73]

and in the process I have given about 300 Novices their first VK on 7 mc. I am OK for skeds with Novices in any state, and as usual will be on 7148-7150, every day at 0330 EST during February through June. I will welcome skeds with Utah Novices and will send my "special" home brew handpainted card to those I work. You can see how anxious I am to make that WAS-Hi. Meanwhile, here is my list of Novices called or worked between Aug. 5th and Dec. 9th: KN1MXR, NOT, NSH, OLP, WV2KKB, LEY, OAC, KN3KSN, KTT, LET, LEO, LGJ, LSC, LXW, MPT, NFO, KN4BAQ, BTU, UXD, WKE, WKO, WMY, WNA, WVK, YEJ, YPN, YXN, KN5ARG, BDQ, BMJ, CGS, SHG, SDI, DUI, EJR, ZOS/7, WH6DSF, DUG, DUL, DWT, DVJ, WV6DUL, JCF, KRY, KCL/4, KEQ, KJN, KXN, LAM, LKZ, LPW, MVF, MWG, MZU, NCU, NOP, NUH, TRJ, KN7KPT, KXG, LGS, LHE, LPF, LSM, LUX, NIE, NGO, NNX, MEG, MJR, KN8LMJ, RHV, RXC, SBU, SLW, TDF, TLX, UGL, UJK, KN9AIB/9, VWC/9, WMH, WYI, YDH, YMI, YNI, YNU, YPW, ZHN/9, ZLF, ZWH, KN0ALX, BNF, DDT, YET. Good luck, Ivor, on that 50th state- Hello Utah!



THIS is the microphone for mobile use

THE TURNER 350C

Good performance on mobile operations — citizen's band, 2-way commercial radio and amateur radio — requires a microphone designed for mobile use. Tape recorder type mikes can't do the job. The Turner 350C is a reasonably priced, ceramic microphone especially designed for quality voice reproduction. DPST switch is wired for relay operation with easily reversible terminals to allow modification (if necessary). A wiring diagram is enclosed with each microphone. Hanger button and standard dash bracket are included for mobile rig mounting. Microphone furnished with 11' retracted (five foot extended) Coiled Kord. Response: 80 to 7000 cps. Output: -54 db. List price: \$16.80 complete. See your electronic parts distributor. He has the Turner 350C in stock.



THE TURNER MICROPHONE COMPANY

925 17th Street NE
Cedar Rapids, Iowa

For further information, check number 26, on page 126

ARMCHAIR PHOTOGRAPHER



In this hectic era of space stations and amphibious autos, far be it from us to criticize progress. And yet, we shake our cranium a bit sadly, and we reminisce a bit remorsefully to the days not so long ago when we hadn't yet traded our souls for do-it-yourself kits. And looking back, we remember when the pioneer of the do-it-yourself phaze was the died-in-the-wool ham who built and serviced his own station.

Even so, we must force a faint smile as we remember that even the true-blue old timer occasionally referred to CQ to solve a tricky problem or refresh his memory on a technical point.

Mind you, we're not opposed to progress. We just realize that there are so many new phases of our hobby being developed today that CQ has become a second right arm to its regular readers. And those hams who only occasionally happen to browse through a copy of CQ... oh, well! Some hams still like to do things the hard way.

CQ Magazine C3
300 West 43rd St. 1 year, \$5; 2 years, \$9; 3 years, \$13
New York 36, N.Y. in U.S. Possessions, APO & FPO,
Canada & Mexico

Enclosed is \$..... for a..... year new
subscription to CQ, to be sent to: renewal

Name..... Call.....

Address.....

City..... Zone..... State.....

Pan-America and all other foreign: 1 yr. \$6; 2 yrs. \$11; 3 yrs. \$16.

EXCLUSIVE!

NEW WRL COMET KIT



SELF-POWERED Q-MULTIPLIER MODEL SS-3

The new SS-3 Q-Multiplier is a complete slicer kit for selecting desired signals or rejecting undesired signals 60 db. It is self-powered. Variable selectivity 300c-10kc. No receiver modification to use! Only one simple connection to receiver. Simply plug into Collins "S" Line. Use with any AC/DC Superhet receiver having 455kc IF. Heavy gauge modern cabinet. Neon glow indicator. Three controls. Comprehensive assembly manual.

Special Price **\$14⁹⁵**

WRL-EV Microphone

IDEAL FOR SSB or AM
FIXED or MOBILE
Push-to-talk or Switch Lock
HAND HELD
OR DESK MOUNT

ONLY
\$11⁹⁹



Made
Exclusively
for WRL by
Electro-Voice



FREE 1961 CATALOG
200 pages of Bargains

WRL

WORLD RADIO LABORATORIES

3415 W. BROADWAY • PHONE 32 8-1851
COUNCIL BLUFFS, IOWA

Enclosed is my check for the () SS-3 —

() WRL-EV Mike.

Please send your 1961 Catalog ().

NAME: _____

ADDRESS: _____

CITY & STATE: _____

C3

For further information, check number 27, on page 126

112 • CQ • March, 1961

Help Wanted

W2—Al Beck, 3003 Pacific Ave., Wildwood, N. J. (WI 2-7917)

W9—Norman Wagner, 4736 Monticello, Chicago 25, Illinois

Letters

Joseph E. Trahan, KN1NIB, RFD 2, Goffstown, New Hampshire, wonders about using the Lyco 40 watt tank coils in the "Novice Kilo-watt," featured some months ago. Sure Joe, they will work fine, just use the same pin connections as in the Lyco. The capacitors may be any ole variables taken out of a discarded radio.

Thomas H. Whiteley, Box A-992, Orlando A.F.B., Florida has graduated from the Novice ranks and now holds call letters WA6FCO/4. Since his Novice days, Tom has gone into the A.F. as a radio operator, and during the New Year's weekend was on the air for 20 hours and 30 minutes and worked 30 states plus three countries. He is trying for WAS and would like skeds with 1's, R. I. Wisc., Ark, all 7's, 0's, KL7 and KH6. Tom can get on anytime and will sked anyone needing Florida.

WV2MHY, 16 Coolidge St., Larchmont, N. Y. neglected to send along his handle but did say that he is 14 and in the ninth grade. OM MHY pumps away on 3721, 3735, and 7182 with a DX-20 and S-38E into a dipole with traps for 40 meters, and will sked anyone for any reason. He hopes a magic wand will soon change them into a DX-60 and SX-140 feeding a beam! WA-2MHY says for a cheap Conelrad alarm, take an old B.C. radio and replace the speaker with two parallel connected pilot lamps. As long as they keep flashing, you know the radio station is on the air.

Bud Hart, K6MQX, 1157 French St., San Luis Obispo, Calif., is no longer a Novice, but still eavesdrops on the column. His lashup includes an RME4350, plate modulated DX-35, 10-15-20 meter trap vertical, 40 meter vertical, 20 meter dipole, 40 meter doublet, and an 80 meter doublet (wadda antenna farm!). On the credit side Bud has a WAS of 46/43, DXCC 16, including ZL, VK, LU, and KS4. Sound like a "going concern?" Well Bud is 15 and ended his Novice days at 12!

Want to work the North Pole? Dick Taylor, K1IFS/KL7, Box 1570, Fairbanks, is stationed at North Pole, Alaska, a small town about 12 miles SE of Fairbanks. Dick operates with a GSB-100 and NC-300 operating into a TA-33 beam and says that the best time for Novices to work is around 1800- 2100 GMT near 21.150 mc.

That crimps our key for this month. Fold your dipole long enough to drop a line and photograph to let me know what's cooking at your station.

73, de Don, W6TNS

JAMES KNIGHTS CRYSTALS

AMATEUR TYPES

Transmitter and Receiver Crystals

H-43 or H73 low drift fundamental oscillator crystals. Will withstand high drive conditions. 20 mmf load 1800 to 3000 kc $\pm .01\%$ \$2.95; 3000 to 9000 kc $\pm .01\%$ 2.95; 9000 to 15000 kc $\pm .01\%$ 3.95.

Type H173 plated, high stability oscillator crystals. 20 mmf or series load 1800 to 3000 kc $\pm .01\%$ \$4.95; 3000 to 9000 kc $\pm .01\%$ 4.95; 9000 to 21 mc $\pm .01\%$ 4.95; 21 mc to 40 mc $\pm .01\%$ 4.95; 40 mc to 54 mc $\pm .01\%$ 5.95; 54 mc to 75 mc $\pm .01\%$ 5.95.

Special close tolerance crystals for the amateur. 20 mmf or series load .005% H43 or H73 1800 kc to 18 mc \$4.80; H173 1800 kc to 75 mc 5.95.

MARINE CRYSTALS Type H-4 or H-7 marine tolerance high drive crystals. Frequency range 2 mc to 7 mc \$4.95.

AIRCRAFT CRYSTALS—All types available. State holder size, pin dimensions, and spacing, equipment model and manufacturer, crystal frequency and channel frequency. If receiver, specify IF frequency.

CITIZENS BAND

Transmitter and Receiver Crystals

Standard Transmitter Crystals. Type H-17 (H-C-6/U) 20 mmfd load, .005% tolerance. Crystal on any FCC channel frequency (C.B. only) \$2.00

Standard Receiver Crystals. Type H-17 (HC-6/U), 20

mmfd load. Crystal 455 KC lower than FCC channel frequency. $\pm .005\%$ tolerance (C.B. only) \$2.00

Special Transmitter Crystals. Type H-17 (HC-6/U), H-3 with pins, or H3W (HC-18/U) with wire leads. Any practical load, crystal on $\frac{1}{2}$ or $\frac{1}{3}$ FCC channel frequency. Give holder, load, frequency, and make of equipment. Also includes control frequencies of 26.995, 27.045, 27.095, 27.145, 27.195, and 27.255 MC. $\pm .005\%$ tolerance (C.B. only) \$2.95

Special Receiver Crystals. Same holders and loads options as special transmitters crystals but crystal frequency for IF other than 455 KC lower than channel frequency. Give holder, crystal frequency, load, IF frequency, and make of equipment. $\pm .005\%$ tolerance (C.B. only) \$2.95

MARS AND CAP—Type H-7 available on assigned frequencies. Calibrated to $\pm .005\%$. Frequency Range 2 mc to 10 mc \$4.80

TV & MARKER CRYSTALS

Calibrated $\pm .005\%$; Type H7, 3 mc to 18 mc \$4.80; Type H17, 4 mc to 30 mc 4.95; Type H17 3579.545 kc 4.80; Type H173, 1000 kc 7.95; Type H17TL, 100 kc 6.95. All prices postage paid. Send cash, check, or M.O. No COD's. Distributor inquiries invited.

THE JAMES KNIGHTS COMPANY
SANDWICH, ILLINOIS

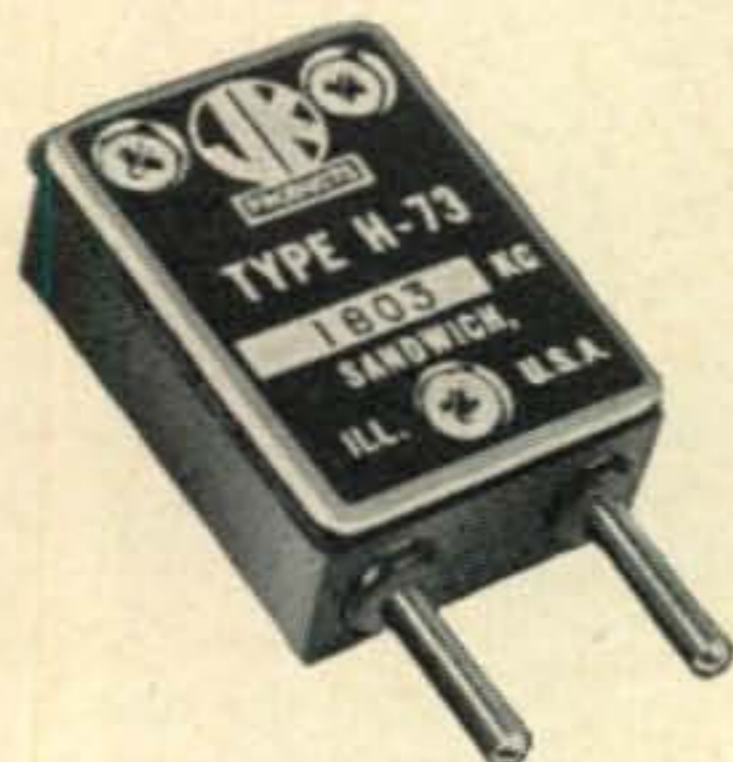

H-73 or H-7 (FT-243).
Pin Dia. .090" Pin Spacing
.486"

H-43 or H-4 (HC-1/U).
Pin Dia. .125". Pin Spacing
.750"

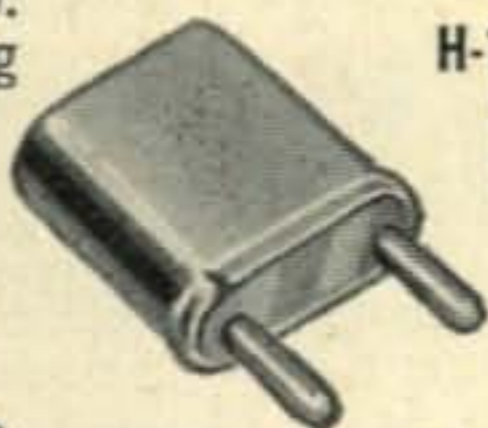
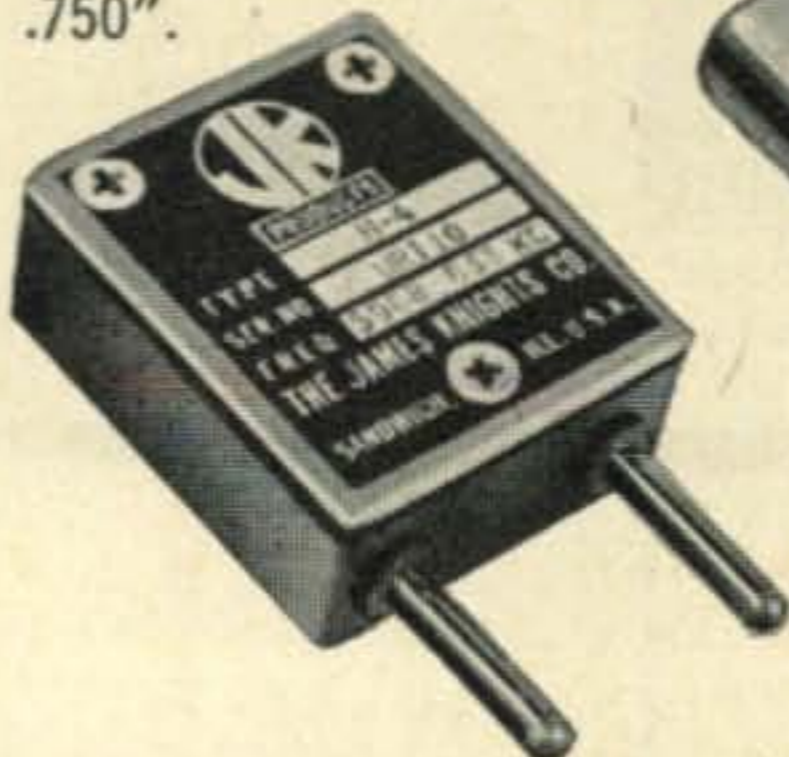

H-173 or H-17 (HC-6/U). Pin
Dia. .050". Pin Spacing .486".
H-17W (HC-6/U With Wire Leads)

H-17TL (HC-13/U). Pin
Dia. .090". Pin Spacing .468"



For further information, check number 28, on page 126

CITIZENS BAND TRANSCEIVER

Model VCB-1

ORDER
NOW

\$19⁹⁵
each

With Crystal Ready To Use

LIMITED
SUPPLY

2-WAY COMMUNICATION SYSTEM

Sends and receives Communicate with neighbors
Dozens of uses in homes, warehouses, factories,
offices. NO LICENSE REQUIRED

Terms: F.O.B Chicago, Ill C.O.D. 20%
minimum deposit required.

Write
Dept.1-A

SPECIFICATIONS
Receiver: 12AT7 ground
grid ampl-super Regen
detector 12AU6 audio
ampl and 50C5 beam
power output trans-
mitter Crystal controlled
50C5 Heising modula-
tor using 12AU6 and
50C5 — utilizing selen-
ium rectifier



VICTORY ELECTRONICS and RESEARCH CORP.
2517 South Michigan Ave., Chicago 16, Illinois

VHF AMATEUR

Printed Exclusively for the VHF man

6, 2, 220 and 432 plus extra features on 1296 mc! Page after
page of construction items, propagation reports, DX, news,
and loads of pictures. Only \$2.00 a year for the ONLY VHF
Magazine! Send your \$2.00 to . . .

THE VHF AMATEUR

67 Russell Avenue, Rahway, N. J.



Don't Gamble with your Valuable
Mobile Equipment!! You can protect
your rig with a ZIMCO burglar alarm.
Easily installed under the hood of any
vehicle or boat. The siren and relay
mechanism are enclosed in a heavy
tamper proof cast aluminum housing.
6-12-24-32 V. D. C. and 115 A. C.
Only \$59.95

Dealer Inquiries Invited
ZIMCO ALARMS
2005 Atlantic Avenue
Brooklyn 33, New York
Wire or call Herb K2PAT
Dickens 2-9121 or Jackson 2-2857

NON-METALLIC GUY LINE — PERFECT FLEXIBLE INSULATOR — REVOLUTIONIZES HAM RADIO & TV ANTENNA SYSTEMS

Non-inductive, non-conducting, non-absorbing Glas-Line isolates systems from directional arrays, rhombics, etc.



The new main insulator of W3UCT. The Glas-Line is between the two egg insulators running to the lower left. The copper link between the center egg insulator and the upper right egg insulator is for the dead-end feeder of a Zepp antenna.



View of an open thimble and eye bolt for coupling the Glas-Line wire to a tree. GLAS-LINE cannot rot, will not shrink, stretch or sag . . . has high breaking strength of over 500 pounds with proper use.

100' SPOOL **\$3⁷⁵** Plus 50¢ for postage & handling
600' REELS **\$17⁸⁴** Plus \$1.00 for postage & handling

'SUPER' GLAS-LINE

with 1,000 lb. TENSILE STRENGTH with proper use.

100' SPOOL **\$6⁹⁵** Plus \$1.00 for postage & handling
600' REELS **\$34⁷⁵** Plus \$2.00 for postage & handling

Send check or M.O. No C.O.D.'s please.
DEALER & DISTRIBUTOR INQUIRIES INVITED.

THE GLAS-LINE CO.

2751 NOSTRAND AVE., DEPT. 1, B'KLYN 10, N. Y. • CL 2-9851

For further information, check number 29, on page 126

TELETYPEWRITER EQUIPMENT

Collins 51J Receiver .50-30.5 Mc

Model #14, 15, 19, 26 & 28 Teletype machines, Telewriter Receiving Converter and others. For general information & equipment list write:

Tom WIAFN, ALLTRONICS-HOWARD CO.
Box 19, Boston 1, Mass. Richmond 2-0048

FREE Catalog

OF THE WORLD'S FINEST
ELECTRONIC GOV'T
SURPLUS BARGAINS

FM RECEIVER R-48A/TRC-8

FM RADIO RECEIVER R-48A/TRC-8—Designed for high fidelity FM reception, this set has variable frequency control from 230 to 250 MC 1 Band 115/230 V, 60 cyc. Complete with 15 tubes: 8/6AG5, 1/9002, 1/5U4, 1/OD3/VR-150, 1/6V6, 1/6SN7, 1/6N7, & 1/6AL5. Test switch enables checking outputs of various stages on 2½" meter which has micro amp. & DB scale. Also

has squelch circuit with adj., tune test switch, 4" PM speaker, vol. control, coaxial antenna input, & headset jack. Size: 20 x 9 x 16". Wt.: 67 lbs.

Price—Used: **\$18.95**

Address Dept. CQ • Prices are F.O.B., Lima, O. • 25% Deposit required on C.O.D. Orders



FAIR RADIO SALES
2133 ELIDA RD. • Box 1105 • LIMA, OHIO

Diode Gate Keying [from page 34]

key-up condition surpassed that obtained with the final circuit of fig. 2, but the loading effect on the oscillator due to keying was of the order of five hundred cycles per second frequency shift which was felt to be intolerable. Possibly circuit refinements could eliminate this effect, but it was assumed that capacitive coupling between the two tube sections in a single envelope was responsible for the difficulty and the idea was abandoned.

In addition to the laboratory tests performed, the circuit is currently being used to key a three hundred watt transmitter. Several contacts have been made at both distant and close ranges to determine if any chirps, clicks, or frequency drift are noticeable. A specific request has been made on each contact for a critical report. So far none have been received. ■

"All Around" [from page 29]

natural for double sideband generation at high level. A pair of 813's, for example, can be driven, with a suitable screen step up transformer, directly from this modulator. Jack, J_3 may be used to read the final plate current by inserting a 0-200 *ma* meter, as shown in fig. 5.

The large coax connector of the three, (SO-239) mounted on the vertical strip at the rear of the cabinet is the antenna connector. This connector was mounted at the top, so that with a right angle fitting, a small base loaded whip could be used. The two connectors under the antenna connector are jumpered together to use the internal receiver.

The built in receiver is a superregenerative type primarily for simplicity. This receiver has exceeded expectations for its usefulness as N.C.S. in local C.D. activity. The broad band characteristics of this type of receiver limits its usefulness when the band is wide open but is just the ticket for net operation. The sensitivity of this receiver is adequate for most portable work. By way of comparison, a signal that is Q5 and S1 on my Collins 75A-4 is also Q5 on this little receiver.

The annoying hiss, characteristic of a superregenerative receiver with no signal received, can be substantially reduced by the bridge circuit between the voice coil and speaker. By proper adjustment of the volume control, the noise level raises the resistance of the pilot bulb to 5 ohms thus balancing the bridge. When a signal is received, the output level changes and the unbalanced condition of the bridge causes the signal to appear across the speaker.

The "All Around" has been in service at the fixed station for the past 6 months and I have had many enjoyable contacts with completely trouble free operation. ■

**THE ONE MICROPHONE THAT IS A
SYMBOL OF AMATEUR RADIO
THE WORLD OVER**

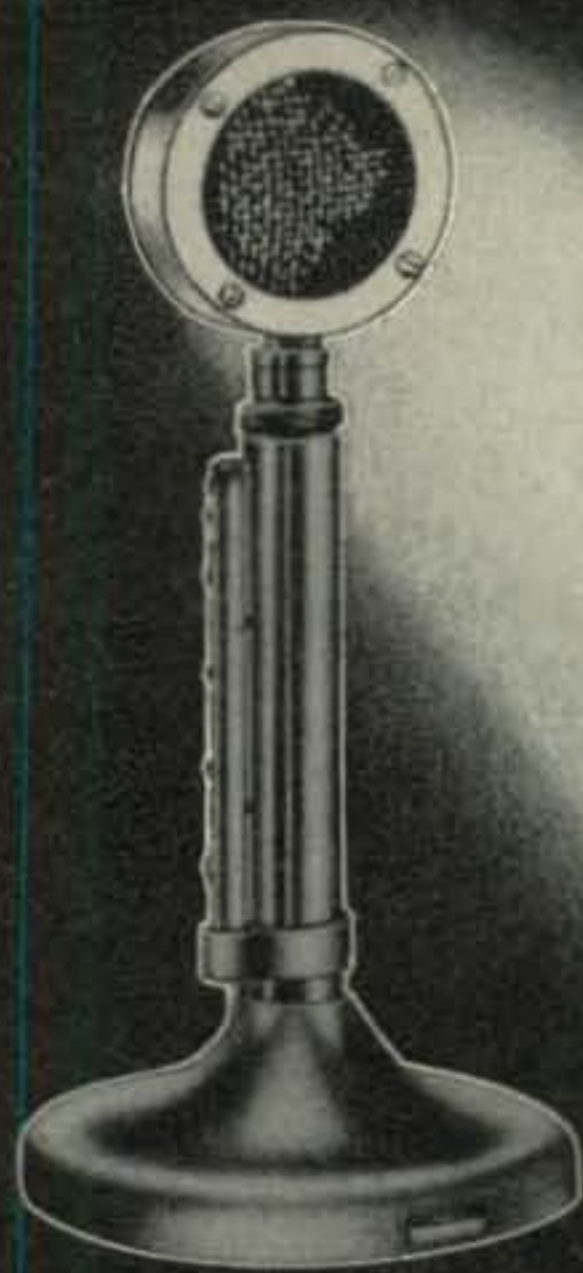

For more than two decades the Astatic D-104 has been top choice of ham operators everywhere

AND NOW
ASTATIC BRINGS YOU 2 NEW MIKES DESTINED TO BECOME
EQUALLY FAMOUS IN SINGLE SIDE BAND TRANSMISSION
THE MODEL 10-C CERAMIC AND 10-D DYNAMIC

You'll prefer the 10-D or 10-C for their more intelligible signal, higher talk power, tailored response, less splatter, greater attenuation of unwanted side band.

MODEL 10-D RECOMMENDED FOR USE WITH HT-32.

Model	Net Price	Model	Net Price
10-C	\$17.82	10-D	\$23.82
G10-C*	\$29.94	G10-D*	\$35.94

*Complete with G-stand

For complete information write for Astatic Microphone Catalog.

THE **Astatic** CORPORATION • CONNEAUT, OHIO
ASTATIC
 In Canada: Canadian Astatic Limited, Toronto, Ontario
 Export Sales: Roburn Agencies Inc., 431 Greenwich St., N.Y. 13, N.Y.
 U. S. A.

FROM WHAT
YOU HEAR



**SUPERIOR ENGINEERING IS TYPICAL OF
THE COMPLETE ASTATIC MICROPHONE LINE**

For further information, check number 32, on page 126

GOOD BUYS — ALL NEW

Extraordinary values await you in government surplus components. Our specialty is components; we have many of those hard to find items that you just won't see advertised elsewhere in surplus materials. Don't buy anything until you have our "Bargain Bulletin"; write for it today, it's free. New material is available to you for mere nickels and dimes on the dollar value. Here are some typical values:

RELAYS, all are beautifully constructed to govt specs.
 13 VAC coil, DPDT + SPDT, 10 amps, ceramic..... 1# \$2.89
 12 VDC, 64Ω coil, DPDT, 20 a + SPST, 6 a. cer..... 1# \$1.89
 Differential, 2-9000Ω coils, 2-SPDT sect, 2 a..... 1# \$3.39
 115 VAC coil, DPDT at 5 amps, hermetic seal..... 3/4# \$1.95
 Min. DPDT, 3800Ω coil, 1 amp cont, 28 VDC..... 1/2# 89c

AUDIO TRANSFORMERS, a few typical values, many more.
 5 w output, 5KΩ:15Ω, ±1/2 db 16-18,000 cps, per pr..... 3# \$2.22
 Line match, 15KΩ to 600Ω, 50-10,000 cps, pot..... 1 1/2# 69c
 25 w output, 8,000Ω ct, 15/125/250Ω, potted..... 4# \$1.95
 Line to v c, Thord. 2-16Ω v c to 500Ω line..... 2# \$1.39

PLATE & FILAMENT POWER TRANSFORMERS, 115 volt, 60 cycle.
 720 vct/135 mils, 5/3 and 6.3/3, potted..... 12# \$3.79
 490 vct/130 mils, 5/2, 6.3/3, potted..... 9# \$3.19
 800 ct/175, 80 v tap, 5/3, 6.3/2.5, 6.3/2.5..... 9# \$4.44
 600 vct/350 mils, 12.6 v/11 amps, potted..... 18# \$4.29
 Auto, 115 to 230 volts, 90 watts, potted..... 7# \$2.29
 HV scope, 4500 volts/5 mils, 10 KV RMS ins..... 10# \$1.95

FILAMENT TRANSFORMERS, 115 volt unless otherwise shown.
 5 vct/30 amps, 215/230 pri., 15 KV ins., Chi..... 20# \$6.45
 6.3/0.6 potted, uses only 3 sq in chassis areal..... 1 1/2# 79c
 6.3/27 amps, four windings, 3 amps are ct..... 9# \$3.29

MISCELLANEOUS VALUES, all are outstanding.
 CW "Dream Filter", bandwidth 200 cps down 20 db..... 4# \$6.95
 Oil cond., 15 mfd/330 VAC, HV ceramic terms..... 3# \$2.29
 BC-610 40 meter coils, C-390-A, three for..... 1# \$1.79
 3AP1 cathode ray tubes..... 2# \$1.45
 3C24 triodes, Lewis and Kauffman, a pair..... 2# \$5.55

and hundreds of other equal values appearing in the "Bargain Bulletin". Write for yours today!

Send adequate postage with orders. We refund any overage. All prices are FOB Sacramento. \$3.00 minimum order please.

JOE PALMER

PO BOX 6188 CCC, SACRAMENTO, CALIF.

For further information, check number 31, on page 126

Look for this emblem on CQ Handbooks in your favorite bookshop or ham dealer.



ARE YOU MOVING?

If you expect to move, and IF you know your new address now, and IF you don't want to miss any issue of CQ here are three things you can do right now!

1. Tear your name and address label off the wrapper of this issue and paste it in this box right over these words, or make a complete and accurate copy of your old address label
2. Print your name and NEW post office address in the lines below

(Name)

(Number and street—or Route)

(City)

(Zone)

(State)

3. Cut out this whole box and mail it to: CQ Magazine, 300 W. 43 St., New York 36, N. Y.

SEMICONDUCTORS [from page 89]

be reversed. For this transistor, connect the minus 22.5 volt lead to point "G" and plus to point "A". If the 2N217 transistor is used, point "G" should be positive with respect to point "A". The output, which is variable, is connected to point "D".

The components were mounted on a circuit board etched for the purpose. However, if you do not have the facilities for constructing boards, the same results can be obtained by drilling tiny holes in micarta or fiber board and soldering the components together on the underside. The board may be mounted in a small chassis box along with the battery, potentiometers, and the output jack. If small *Centralab* potentiometers are used, they may be mounted directly on the circuit board. To turn the unit off and on, you can either install a toggle switch in the case, or use a switch on the rear of R_5 , R_{10} , or both.

Semiconductor News

Bendix Corporation, Red Bank Division, Holmdel, New Jersey, has greatly reduced prices on their line of transistors. Introduced are new high-speed diffused alloy power (DAP) transistors for switching and sweep applications. An excellent buy for experimenters is their 2N1136, a 40 volt, 6 ampere type capable of 60 watts dissipation and priced at only \$2.70. A pair will switch 400 watts! Need anodized aluminum, teflon or fiberglass insulating heat-sink washers? Your Bendix distributor has them.

General Electric Co., Auburn, N. Y., has introduced a complete new line of high current silicon controlled rectifiers, their type C-50. The eight models, which are useful in power control and switching, motor control, inverters, frequency converters and light dimmers, have PIV ratings from 25 volts to 400 volts and are rated to 70 amperes.

The latest issue of General Instruments *Semiconductor Bulletin* contains a discussion of diode and transistor logic circuits. If you are not on the mailing list, drop a line on your letterhead to General Instrument Corp., 65 Gouverneur St., Newark 4, N. J.

International's latest *Rectifier News* discusses silicon rectifier reliability and protection of silicon rectifier cells during dielectric testing of equipment. Subscriptions to this publication are also free, by requesting it on your letterhead. Write to International Rectifier Corporation, El Segundo, California. Don't miss buying a copy of IR's new *Solar Cell and Photocell Handbook*. It is absolutely the last word on the subject of photovoltaic energy conversion, and contains many circuits of interest to amateurs and experimenters. The price is \$2.00 and may be obtained at the above address.

RCA, Sommerville, New Jersey, has devel-

FIELD ENGINEERS

ACF

ELECTRONICS

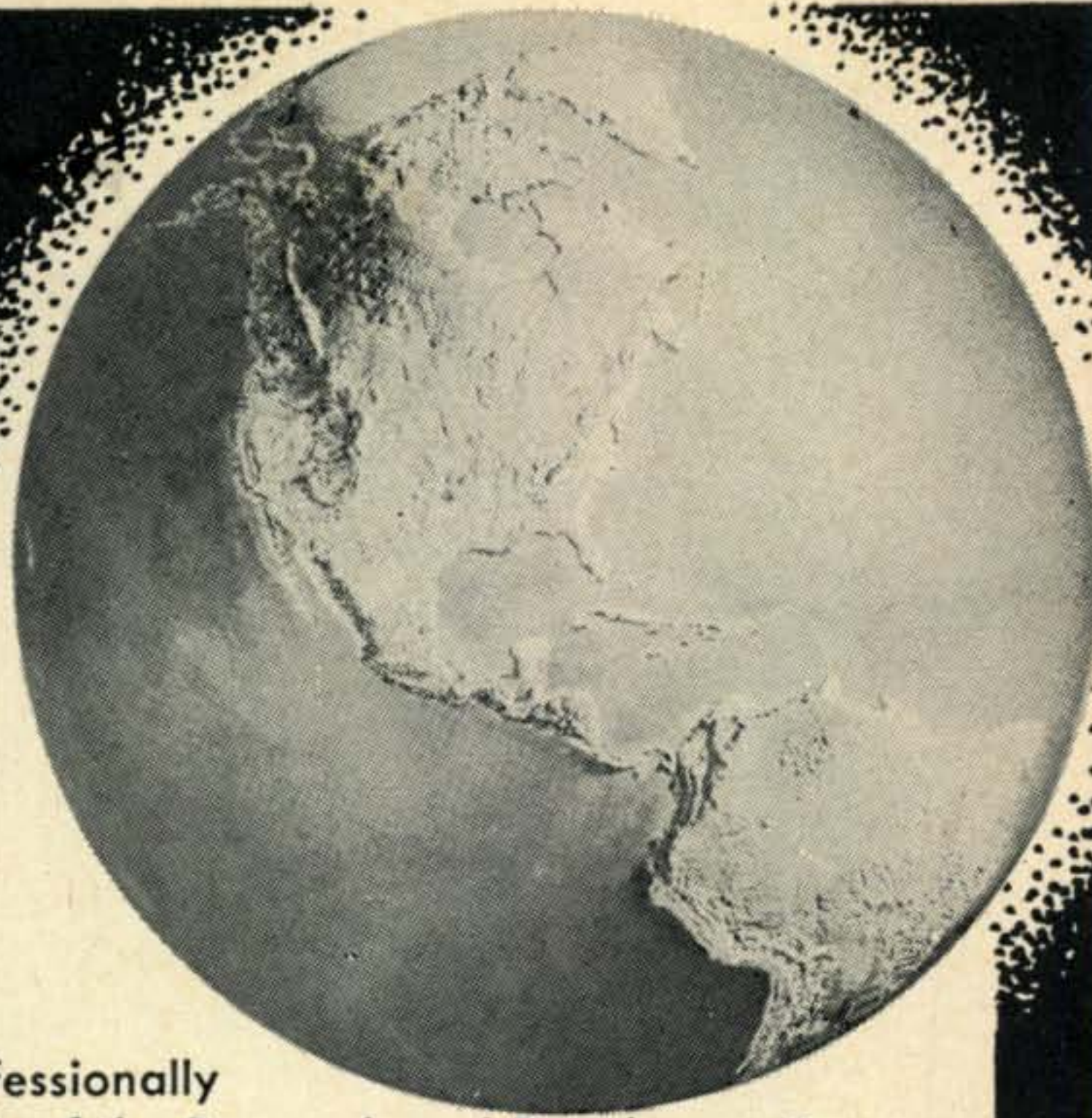

COMMUNICATIONS FIELD STATION ENGINEERS

Qualified engineers will develop a background in Ionospheric Physics and the study of Backscatter Phenomena through a training program in our Hyattsville, Maryland, Electro-Physics Laboratories. Engineers selected will have ample opportunity to develop professionally as part of a team extending experiments of the Research and Development Department to the field in both domestic and overseas assignments.

EE degree or equivalent, consisting of combined civilian or military technical school is required. Experience as a Field or Project Engineer with valid 1st or 2nd class FCC license is essential for senior level positions. A good command of some of the following is most desirable:

Radar; HF Long Distance or Meteor-burst Communications Systems; Scatter Systems; Propagation Prediction; Ionospheric Sounder Operations; RDF Systems; Short Wave (Amateur) Radio.

Interested engineers must be willing to accept assignments in areas where dependents are not permitted for periods up to one year. Differential paid for overseas assignments.

FLIGHT SIMULATORS / COMPUTERS FIELD SERVICE ENGINEERS

Experienced engineers can enhance their careers in this expanding program by providing professional engineering services on complex electronic and electro-mechanical devices at military installations throughout the United States and overseas.

Background should include experience in electronics plus a minimum of 3 years engineering or physics study. Challenging positions are available for those who have related experience and a Bachelor of Science degree. Knowledge of the following is desirable:

Analog Computers, principles of flight characteristics, fire control systems, radar navigational aids.

*Please send resume to: Mr. Robert J. Reid
Professional Employment Supervisor
at our Riverside facility, Dept. 413*

ACF ELECTRONICS DIVISION
ACF INDUSTRIES

RIVERDALE, MARYLAND • HYATTSVILLE, MARYLAND • PARAMUS, NEW JERSEY



EVANS OFFERS

COMPLETE SERVICE

- To HAMS - - - By HAMS
(12 licensed employees)
- EQUIPMENT and COMPONENTS
(Ham - Electronic - Electrical)
- TRADE-INS
(on new or used units)
- TIME PAYMENTS
(flexible, financed ourselves)
- ENGINEERING DEPARTMENT
(backing all equipment sales)
- RECONDITIONED EQUIPMENT
Largest inventory in the Northeast
- EXPERIENCE - - - 26 years as:

"YOUR FRIENDLY SUPPLIER"

Evans RADIO

CA 5-3358 • ROUTE 3A • BOW JCT.
BOX 312 • CONCORD, N. H.

For further information, check number 33, on page 126

Mars

AMATEUR
EQUIPMENT

HYBRID PHONE PATCH

\$27⁹⁵



Operates with any transmitter, any mode . . . Side band, AM, Push to Talk, Built-in R.F. filter

system . . . Gain control, null controls, VU meter. There is no finer patch regardless of price.

SEE YOUR DEALER OR WRITE DIRECT

PAUSAN COMPANY • SAN RAFAEL, CALIF.

"HOW TO MAKE MONEY IN Mobile Radio Maintenance"

AUTHORITATIVE GUIDEBOOK
ABOUT THE BOOM IN TWO-WAY MOBILE-RADIO:
GIVES FACTS, FIGURES, PAY RATES,
WRITE TODAY!

FREE



LAMPKIN LABORATORIES, INC. Electronic Div. BRADENTON, FLA.

PRECISION OILER

FILLED WITH
FINE OIL
\$1.00 PPD.

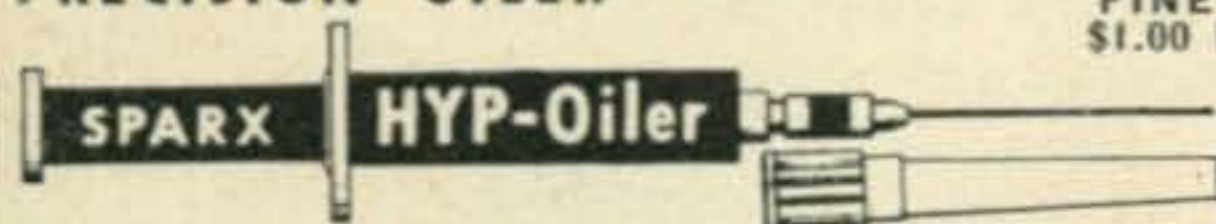

A MUST FOR EVERY HAM SHACK!

Precision one drop or fractional drop oiling. Perfect for relays, dials, sw., recorders, instr. ect. Refillable, unbreakable & leak-proof. Fully guaranteed. Holds 400 drops. Folder on request. Sparx Industries, Dept. CQ, Grand Rapids, Minn.

oped a tiny varactor diode for operation between 2 and 20 kmc, but it is priced beyond the amateur or experimenter. Data may be obtained from RCA at the above address.

Rheem Semiconductors, 350 Ellis St., Mountain View, Calif. are marketing a high frequency silicon diode, type JAN 1N251 with a 0.15 μ sec reverse switching time, 0.1 microamperes reverse current at -10 v, 150 milliwatts dissipation and 30 volts reverse breakdown. New Rheem silicon mesa transistors include types 2N497, 2N498, 2N656, and 2N657. Designed for switching applications, these mesa types are fast and carry a 4 watt dissipation rating.

Texas Instruments, Box 312, Dallas 21, Texas, have upgraded their 2N250 and 2N511 series and now guarantee a thermal resistance of 0.5°C/watt which permits an increased dissipation rating of 150 watts at 25°C! Bargain priced, these transistors range from \$2.77 to \$17.50.

For another month, 73, de Don, W6TNS

SURPLUS [from page 97]

small dot with no signal applied and then adjusted the centering controls to locate the dot on the center of the screen. Then the transmitter is operating, the usual trapezoid appears and a simple triangle is indicative of 100% modulation. The VIDEO HORIZ. AMP. and VERT. AMP. controls have no effect since they are out of the circuit.

Mail

This month we have a request from Wallace Haines, 630 Erie St., South Haven, Michigan for the BC-638A Frequency meter. Francis W. Morton, 96 Warren Avenue, Cranston 10, R.I. wants information on the conversion of the RBV-1 Navy panadapter. Dr. V. Victoroff, 2231 Taylor Road, Cleveland 12, Ohio wants conversion information on the BF-77B Wheatstone Bridge. Mike Kuehl, 1418 N. Stevens St., Rhineland, Wisconsin is looking to anyone for a BC-604 c.w. conversion. Melvin Saur, 87 College St., Kent City, Michigan is in need of handbooks on the BC-1000 and BC-1335. Herbert Breese, 21 Walnut St., Moravia, N.Y. (Box 288) is asking for the manuals on the R-274/FRR and the R-383/CRD-2A. Marshall Snapp, 10656 So. Oakley Avenue, Chicago 43, Illinois wants handbooks on the RT-48/TPX-1

Merlin Schumacher, Lomira, Wisconsin is seeking the BC-223-AX transmitter handbook. G. Stonehocker, 605 South 44 St., Boulder, Colorado wants schematics etc. for the BC-1000 and the BC-647.

Well that closes shop for us, but one thing. Don't think that we have abandoned those who seek catalogs, handbooks, manuals etc., on surplus equipment. CQ will still retain the catalog request service and to request a manual all you have to do is drop a postcard to CQ, 300 West 43 Street, N.Y.C. 36, N.Y.

73, Ken, W2HDM

THE SIGN OF RAD-TEL'S QUALITY PERFORMANCE

**BUY DIRECT FROM
RAD-TEL!!
ORDER RAD-TEL'S
FIRST QUALITY TUBES TODAY!**

**NOT USED!! NOT PULLED OUT OF SETS!!
SERVICEMEN: HUGE SAVINGS!! COMPARE!!
FAST ONE DAY SERVICE.**



GUARANTEED ONE FULL YEAR UP TO 75% OFF ON BRAND NEW TUBES

**SEND FOR FREE TROUBLE SHOOTER
GUIDE AND NEW TUBE & PARTS CATALOG**

TRANSISTORS — AT FABULOUS DISCOUNTS

PRICE	TYPE	RATING	ELECTRICAL CHARACTERISTICS		hfe
			1CBO max.	1EBO max.	
RF 49¢ AF 39¢	GE PNP ALLOY JUNCTION GENERAL PURPOSE RF/AF	200 MW	20 μ a VCB = -3V	20 μ a VEB = -3V	VCE = -1.5 Ib = 5 ma 20 min
80¢ ea.	Power AF Mgd. Freq. to -3		20 ma VCB = -16V	20 ma VEB = -16V	VCE = -1.5 Ib = 1 ma 40 min
140¢ ea.	Hi Power 15 AMP to 36	MIN. POWER OUTPUT 2.25 W	40 ma VCB = -100	40 ma VEB = -100	VCE = -1.5 Ib = 1 ma 30 min

SILICON RECTIFIER

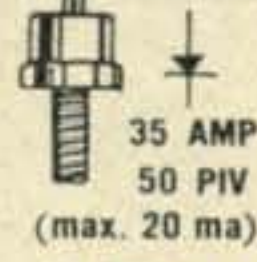

35 AMP
50 PIV
(max. 20 ma)

\$2.50 ea.
Lots of 10
\$2.25 ea.
(No Hardware)

EACH TUBE INDIVIDUALLY & ATTRACTIVELY BOXED

Qty.	Type	Price	Qty.	Type	Price	Qty.	Type	Price
—	0Z4M	.79	—	6AW8	.89	—	12AF6	.49
—	1AX2	.62	—	6AX4	.65	—	12A16	.46
—	1B3GT	.79	—	6AX7	.64	—	12A15	.45
—	1DN5	.55	—	6BA6	.49	—	12A18	.95
—	1G3	.73	—	6BC5	.54	—	12A05	.52
—	1J3	.73	—	6BC7	.94	—	12A16	.43
—	1K3	.73	—	6BC8	.97	—	12A17	.76
—	1L6	1.05	—	6BD6	.51	—	12A16	.50
—	1LN5	.59	—	6BE6	.55	—	12A17	.60
—	1R5	.62	—	6BF6	.44	—	12AV5	.97
—	1S5	.51	—	6BG6	1.66	—	12AV6	.41
—	1T4	.58	—	6BH6	.65	—	12AV7	.75
—	1U4	.57	—	6BH8	.87	—	12AX4	.67
—	1U5	.50	—	6BJ6	.62	—	12AX7	.63
—	1X2B	.82	—	6BK7	.85	—	12A27	.86
—	2AF4	.96	—	6BL7	1.00	—	12B4	.63
—	3AL5	.42	—	6BN4	.57	—	12BA6	.50
—	3AU6	.51	—	6BN6	.74	—	12BD6	.50
—	3AV6	.41	—	6BQ5	.65	—	12BE6	.53
—	3BA6	.51	—	6BQ6GT	1.05	—	12BF6	.44
—	3BC5	.54	—	6BQ7	.95	—	12BH7	.73
—	3BE6	.52	—	6BR8	.78	—	12BL6	.56
—	3BN6	.76	—	6BU8	.70	—	12BQ6	1.06
—	3BU8	.78	—	6BY6	.54	—	12BY7	.74
—	3BY6	.55	—	6BZ6	.54	—	12BZ7	.75
—	3BZ6	.55	—	6C27	.97	—	12C5	.56
—	3CB6	.54	—	6C4	.43	—	12CA5	.59
—	3CF6	.60	—	6CB6	.54	—	12CN5	.56
—	3CS6	.52	—	6C06	1.42	—	12CR6	.54
—	3CY5	.71	—	6CF6	.64	—	12CU5	.58
—	3DK6	.60	—	6CG7	.60	—	12CU6	1.06
—	3DT6	.50	—	6CG8	.77	—	12CX6	.54
—	3Q5	.80	—	6CM7	.66	—	12DB5	.69
—	3S4	.61	—	6CN7	.65	—	12DE8	.75
—	3V4	.58	—	6CR6	.51	—	12DL8	.85
—	4BC5	.56	—	6CS6	.57	—	12DM7	.67
—	4BC8	.96	—	6CU5	.58	—	12DQ6	1.04
—	4BN6	.75	—	6CU6	1.08	—	12OS7	.79
—	4BQ7	.96	—	6CY5	.70	—	12OZ6	.56
—	4BS8	.98	—	6CY7	.71	—	12EL6	.50
—	4BU8	.71	—	6DA4	.68	—	12EG6	.54
—	4BZ6	.58	—	6DB5	.69	—	12EZ6	.53
—	4BZ7	.96	—	6DE6	.58	—	12F5	.66
—	4CS6	.61	—	6DG6	.59	—	12F8	.66
—	4DE6	.62	—	6DQ6	1.10	—	12FM6	.45
—	4DK6	.60	—	6DT5	.76	—	12K5	.65
—	4DT6	.55	—	6DT6	.53	—	12SA7M	.86
—	5AM8	.79	—	6EU8	.79	—	12SK7GT	.74
—	5AN8	.86	—	6EA8	.79	—	12SN7	.67
—	5AQ5	.52	—	6HGGT	.58	—	12SQ7M	.73
—	5AT8	.80	—	6ISGT	.51	—	12U7	.62
—	5BK7A	.82	—	6J6	.67	—	12V6GT	.53
—	5BQ7	.97	—	6K6	.63	—	12W6	.69
—	5BR8	.79	—	6S4	.48	—	12X4	.38
—	5CG8	.76	—	6SA7GT	.76	—	17AX4	.67
—	5CL8	.76	—	6SK7	.74	—	17BQ6	1.09
—	5EAB	.80	—	6SL7	.80	—	17C5	.58
—	5EUB	.80	—	6SN7	.65	—	17CA5	.62
—	5J6	.68	—	6SQ7	.73	—	17O4	.69
—	5T8	.81	—	6T4	.99	—	17DQ6	1.06
—	5U4	.60	—	6U8	.78	—	17L6	.58
—	5U8	.81	—	6V6GT	.54	—	17W6	.70
—	5V6	.56	—	6W4	.54	—	19AU4	.83
—	5X8	.78	—	6W6	.69	—	19BG6	1.39
—	5Y3	.46	—	6X4	.39	—	19T8	.80
—	6AB4	.46	—	6X5GT	.53	—	21EX6	1.49
—	6AC7	.96	—	6X8	.77	—	25BQ6	1.11
—	6AF3	.73	—	7AU7	.61	—	25C5	.53
—	6AF4	.97	—	7A8	.68	—	25CA5	.59
—	6AG5	.65	—	7B6	.69	—	25C06	1.44
—	6AH6	.99	—	7Y4	.69	—	25C06	1.11
—	6AK5	.95	—	8AU8	.83	—	25D06	1.42
—	6AL5	.47	—	8AW8	.93	—	25EH5	.55
—	6AM8	.78	—	8BQ5	.60	—	25L6	.57
—	6AN4	.95	—	8CG7	.62	—	25W4	.68
—	6AN8	.85	—	8CM7	.68	—	25Z6	.66
—	6AQ5	.50	—	8CN7	.97	—	35C5	.51
—	6AR5	.55	—	8CX8	.93	—	35L6	.57
—	6AS5	.60	—	8EB8	.94	—	35W4	.52
—	6AT6	.43	—	11CY7	.75	—	35Z5GT	.60
—	6AT8	.79	—	12A4	.60	—	50B5	.60
—	6AU4	.82	—	12AB5	.55	—	50C5	.53
—	6AU6	.50	—	12AC6	.49	—	50DC4	.37
—	6AU7	.61	—	12AD6	.57	—	50EH5	.55
—	6AU8	.87	—	12AE6	.43	—	50L6	.61
—	6AV6	.40	—	12AF3	.73	—	117Z3	.61



NOT AFFILIATED WITH ANY OTHER MAIL ORDER TUBE COMPANY

RAD-TEL TUBE CO.

55 CHAMBERS STREET, NEWARK 5, N. J. DEPT. CQ-361

TERMS: 25% deposit must accompany all orders, balance COD. Orders under \$5: add \$1 handling charge plus postage. Orders over \$5: plus postage. Approx. 8 tubes per 1 lb. Subject to prior sale. No COD's outside continental USA.

R W BARGAINS!

BC-603 FM Receiver 20-27.9 Mc Complete. New	\$14.95
BC-603 plus 6 spare tubes	\$16.95
DM-34 Dynamotor 12v. New	\$ 2.95
BC-604 FM Transmitter 20-27.9 Mc. New....	\$ 4.95
DM-35 Dynamotor 12v. New	\$ 7.95
FT-237 Rack for BC-603 & BC-604. New.....	\$ 2.95
Antenna Mount with four mast sections. New	\$ 2.95
Manual TM11-600 for BC-603 & BC-604	\$ 2.00

Send Money Order or Check with order.

Write for Flyer—LOADS OF BARGAINS!

R W ELECTRONICS

2430 S. MICHIGAN AVENUE • DEPT. CQ
Phone: CAumet 5-1281 CHICAGO 16, ILL.

SSB — Just a Few Left of this Special Offering of the

Famous Central Electronics

100-V TRANSMITTER

Regularly \$795.00 **\$599⁷⁵**
—special—only . . .

Only the partial cancellation of a foreign government order with us before shipment makes possible this sensational saving on one of these scarce, highly wanted sets . . . Standard construction. Latest modifications and serial numbers. Fully factory guaranteed. In factory sealed crates.

ORDER TODAY from W9ADN

ORGANS & ELECTRONICS Box 117
Lockport 4, Ill.

EASY TO LEARN CODE

It is easy and pleasant to learn or increase speed the modern way—with an Instructograph Code Teacher. Excellent for the beginner or advanced student. A quick, practical and dependable method. Available tapes from beginner's alphabet to typical messages on all subjects. Speed range 5 to 40 WPM. Always ready, no QRM, beats having someone send to you.



ENDORSED BY THOUSANDS!

The Instructograph Code Teacher literally takes the place of an operator-instructor and enables anyone to learn and master code without further assistance. Thousands of successful operators have "acquired the code" with the Instructograph System. Write today for full particulars and convenient rental plans.

INSTRUCTOGRAPH COMPANY

4711 SHERIDAN RD., CHICAGO 40, ILL.
4700 Crenshaw Blvd., Los Angeles 43, Calif.

Are You TRADING?

Let me make you a trade-in offer on your used amateur equipment. All name-brand merchandise—late serial numbers assured. Quick delivery.



WRITE TODAY! Bill W9ZSO-KØIUH

COMMUNICATIONS EQUIPMENT CO.

518 State St., LaCrosse, Wis.
Phone 4-7373

Ham Shop

Rates for the HAM SHOP are 5¢ per word for advertising which, in our opinion is obviously of a non-commercial nature. A charge of 25¢ per word is made to all commercial advertisers or business organizations.

Your copy should be preferably typewritten, double spaced on one side of the page only.

We do not bill for advertising in the HAM SHOP. Full remittance *must* accompany all orders.

Closing date is the 20th of the 2nd month preceding date of publication.

We reserve the right to reject advertising which we feel is not of an amateur radio nature.

Because the advertisers and equipment contained in the HAM SHOP have not been investigated, the publishers of CQ cannot vouch for the merchandise listed therein.

For Sale: TV Cameras, Teletype, Panadaptors, Transmitting Tubes, Transistors, SSB gear. Write for list. Spera Electronics, 37-10 33 Street, L.I.C., N.Y. Stillwell 6-2199.

PRESERVE YOUR HAM TICKET, Social Security Card, small photo, passes and anything else of value that is wallet-size. We will laminate it in clear plastic, guaranteed for life. Lamination will prevent it from getting torn, soiled or frayed. Send your ticket or anything of value with \$1 in stamps or cash for each item that you want preserved. 24-hour service. Send to C. Lee, P.O. Box 395, Times Square Station, New York 36, N.Y.

CALL LETTERS may be applied to any surface. 2" sets 60¢, 3" set 80¢. Send to C. Lee, P.O. Box 395, Times Square Station, New York 36, N.Y.

ONE THIN DIME brings 50 page eye-popping war surplus electronics catalog. Fabulous bargains. Meshna, Malden 48, Mass.

TOROIDS: Uncased 88 mhy like new. Dollar each. Five \$4.00 PP. DePaul, 309 South Ashton, Millbrae, Calif.

BEGINNERS: Code bothering you? Now learned in one hour. New Method. Quick approach towards your ham ticket. Used in Armed Services, Ham Radio, Scouting. Ketchum's One Hour Code Course \$1.00 postpaid. MONEY BACK GUARANTEED—O. Ketchum, 10125 Flora Vista, Bellflower, California.

FREE! 1961 catalogs for newest, best electronic bargains available. Stereo, hi-fi, ham radio, 1000 other items, Alco Electronics, Lawrence 5, Mass.

WANTED: Teletype printers, perforators, reperforators, transmitter-distributors, test equipment: Model #14, #15, #19, #26, #28, GRC, TT, TGC, GGC, etc. All types Collins receivers, 51J, R-388, R-390, 75A, etc. Cash, or trade for NEW amateur equipment. Write Tom, W1AFN, Alltronics-Howard Co., Box 19, Boston 1, Mass. (Richmond 2-0048).

WANTED: Military and Commercial laboratory test and measuring equipment. Electronicraft, Box 399, Mount Kisco, N.Y.

WANTED: TELETYPE TG-7 and Model 15 and parts, printers and reperforators, etc.; COMM'S REC'V'RS AND XMTRS, e.g. BC-610-E, -I, BC-399A, Collins 51J, 17L3, -4; R-388 and R-390/URR; 18S-2, -3; ARN-14 and -30; APR-9, -10, ARC-21, 27, etc.; APS-31, -33, and TEST EQP'T, with TS- or 1-prefix. We pay freight. AMBER INDUSTRIAL CORP., 75 Varick St., N.Y. 13, N.Y.

"The VHF Amateur"—At last a magazine for VHF'ers! Don't miss a single issue! Send \$2.00 for year or \$1.00 for six big issues . . . 67 Russell, Rahway, N. J.

Interrogation: Applications are now being accepted for Election into our Research and Administration staff. The function of the organization is non-profit in nature, and will work under contributions and grants. The purpose of the organization is Research in Extra-Terrestrial phenomena; i.e. Radio Astronomy, Propagation, Scatter, etc. If you are seriously interested and would like more information write: Radiometric Research, Ltd., P.O. Box 4335-Annex, Las Vegas, Nevada.

FOR COLLINS in Detroit area it's Michigan Ham Headquarters. Also large selection of trade-ins on display. M. N. Duffy Ham & Electronics, 2040 Grand River, Detroit 26, Michigan. WO 3-2270.

HAM SHACK NOVELTY: Authentic-looking, two-color certificate claiming tongue-in-cheek ownership of an acre on the Moon's surface. Ideal humorous gift or conversation piece for shack, bar, den or office. With gold seal and name and call inscribed only \$1.00. Six for \$5.00. Send check or M.O. only to—Box DXG, 1738 201st Street, Bay-side 60, New York. (See Pg. 119, Jan. '61—CQ).

CASH for surplus tech manuals — W4FXQ, Box 2513, Norfolk, Va.

ATTENTION Mobileers! Leece-Neville 6 volt 100 amp system, \$50; 12 volt 50 amp system \$50; 12 volt 60 amp system \$60; 12 volt 100 amp system \$100. Guaranteed no ex-policar units. Herbert A. Zimmermann, Jr. K2PAT, 115 Willow St., Brooklyn 1, N.Y. Tel. Dickens 2-9121 or J Jackson 2-2857.

WANTED: World War I French L-3 Amplifier, Mu-Rad receivers and R.F. Transformers for electrical test. Buy, borrow, trade. Also UV206, UV208 tubes. Grote Reber, Research-Cottrell, Bound Brook, New Jersey.

AUCTIONFEST—Broward Amateur Radio Club's fifth annual auction and get-together, Saturday, Mar. 11, Armory, S. W. 4th Ave. & 24th St., Ft. Lauderdale, Fla. Doors open 8 a.m., auction at 10, free lunch at noon.

TRADE—Ham Radio—Citizens Band equipment for Hi-Fi equip. or vice-versa. Amateur Radio Exchange, Div. of Audio Exchange, 153-21 Hillside Avenue, Jamaica 32, New York. AX 7-7577.

Viking Ranger and Heath DX-40. Priced Low. Gerst—2674 W 25th St., Cleveland 13, Ohio.

RECONDITIONED! Terms! Full guarantee! Dynamotors 200ma. 400v. 12V new \$5.95; Carbon Mobile Mic. PTT cc \$6.00; 24 hr. clocks 15" face \$6.95; Heath Comanche \$119.00 slicer \$7.50; HRO-1 \$169.50; HQ 129X \$139.50; 140X \$179.59; Super Pro 400X \$199.50; NC-173 \$129.50; 109 \$129.00; 240D ws \$139.95; 300 \$229.00; 57 \$49.95; 20-A \$179.50; MM-1 \$79.50; Model B slicer \$39.95; Viking II \$209.00; Navigator \$129.95; Valiant \$325.00; Adventurer \$29.95; RME 4300 \$149.00; DSB 100 \$109.00; Globe King 500A \$395.00; Chief 90 \$49.95; 90 \$49.95; 90A Kit \$39.95; Scout 680A \$79.00; KWM-1 WPS new \$695.00; 75A4 \$595.00; S40 \$79.00; SX71 \$139.00; 99 \$99.00; 32V II \$350.00; Gonest 6 meter linear \$89.95; Comm III 2 meter \$239.95; Lakeshore Band hopper \$79.95; Lysco 600 \$59.00; Harvey Wells TBS 50D \$49.95; James C 1450 \$39.95; PMR 6 \$79.95; 7 \$99.95; Knight World Wide receiver w/S-meter \$69.50. Ken, WØZCN, Harold WØZVB, Ken-Els Radio, 428 Central Avenue, Fort Dodge, Iowa.

QSL Cards printed. Send dime for samples. QSL Printing Co., 4319 Wuthering Heights, Houston 45, Texas.

QSL for less with post card size rubberstamps. Your name, address, call, stock information set permanently in rubber. Save 3¢ or more per QSL. Send for free sample . . . to Jim, WØAYW, Will-Stamp, 1102 State, Brookfield, Missouri.

Cards: WPE-QSL-GAG, business. Photo, rubber stamps. Labels, stationary. Samples dime. Riesland, Del Mar, California.

CANADIANS . . . QSL's in fluorescent colors by silk screen process. Free samples. Martin, 8 Kensington St. Woodstock, Ontario.

QSL's . . . Sparkling new patterns . . . Dime . . . Film-crafters . . . Martins Ferry, Ohio.

QSLs, Large selection styles including photos. Lowest prices. Fast service. Samples dime. Ray. K7HLR. 679 Borah, Twin Falls, Idaho.

RELIGIOUS QSL's (with bible designs) samples 10¢. Regular QSL samples 20¢. (refundable). Sackers, W8DED, Holland, Michigan.

QSL's—"Brownie" W3CJI, 3110 Lehigh, Allentown, Pa. Samples, 10¢, with catalogue, 25¢.

QSL's-SWL's: 100 2-color glossy \$3.00; 100 QSO file cards \$1.00; Sample 10¢. Rusprint, Box 7507, Kansas City 16, Missouri.

QSL's four colors glossy stock forty design send \$5 for 200 and get surprise of your life. 48 hour service satisfaction guaranteed, Constantine Press, Bladensburg, Md.

QSL's. Samples 15¢. Sims, 3227 Missouri Ave., St. Louis 18, Mo.

QSL's: Samples, dime. Print Shop, Corwith, Iowa.

DOW-KEY DK60 SERIES

4 VERSATILE MODELS
A.C. or D.C.



Small, Compact,
Light Weight,
Less than 9 oz.

COAXIAL
RELAYS

Also Available
with Type C,
TNC, BNC, N &
UHF Connectors

Outstanding favorite for amateurs . . . Versatile combinations for industrials! Low VSWR — less than 1.15:1 from 0 to 500 mc. LOW LOSSES . . . High Contact Pressures. LOW CROSS-TALK through use of patented "isolated connector" arrangement. HIGH POWER RATING. All coils encapsulated in epoxy resin for quieter operation and resistance to moisture.

★ UNCONDITIONAL GUARANTEE for one year. (We will repair if faulty within 1 year.)

STANDARD RELAYS: DK60, DK60-G, DK60-2C and DK60-G2C — Priced from \$12.45.

Also available with Type C, TNC, BNC, N & UHF Connectors.

★ See one of our 700 dealers and distributors in U. S. and Canada for catalog sheets or write:

May be had with weatherproof boxes for exterior use. Also with ganged, multiple switch arrangement for remote control selection of antennas.

PRICED FROM . . . \$12.45

DOW-KEY COMPANY

Thief River Falls, Minnesota

For further information, check number 36, on page 126



Jelectro QRP-60
Phone-CW Xmitter
ONLY
\$79⁵⁰

80-40-20-15-10 meters
90 Watts input CW or PEP controlled
carrier phone—Xtal control or External VFO
Simplified Tuning-Pi coupling—Also Grid dip
meter—\$24.50

Some Dealerships available

CHRISTY ELECTRONICS CO.
6865 Andasol Ave., Van Nuys, Calif.

ALL BAND TRAP ANTENNA!



Reduces interference and Noise on All Makes Short Wave Receivers. Makes World Wide Reception Stronger, Clearer on All Bands!

For ALL Amateur Transmitters. Guaranteed for 500 Watts Power for Pi-Net or Link Direct Feed, Light, Neat, Weatherproof

Complete as shown total length 102 ft. with 87 ft. of 72 ohm balanced feedline, HI-impact molded resonant traps. (Wt. 3 oz. 1" x 5" long). You just tune to desired band for beamlike results. Excellent for ALL world-wide short-wave receivers and amateur transmitters. For NOVICE AND ALL CLASS AMATEURS! NO EXTRA TUNERS OR GADGETS NEEDED! Eliminates 5 separate antennas with excellent performance guaranteed. Use as Inverted V for all band power gain. NO HAYWIRE HOUSE APPEARANCE! EASY INSTALLATION!

80-40-20-15-10 meter bands. Complete . . . \$14.95
40-20-15-10 meter bands. 54-ft. ant. (best for w-w swl's) . . . 13.95
20-15-10 meter bands. Dual Trap. 24-ft. antenna . . . 19.95

SEND ONLY \$3.00 (cash, ck., mo) and pay postman balance COD plus postage on arrival or send full price for postpaid delivery.

Available only from:
WESTERN RADIO • Dept. AC-3 • Kearney, Nebraska

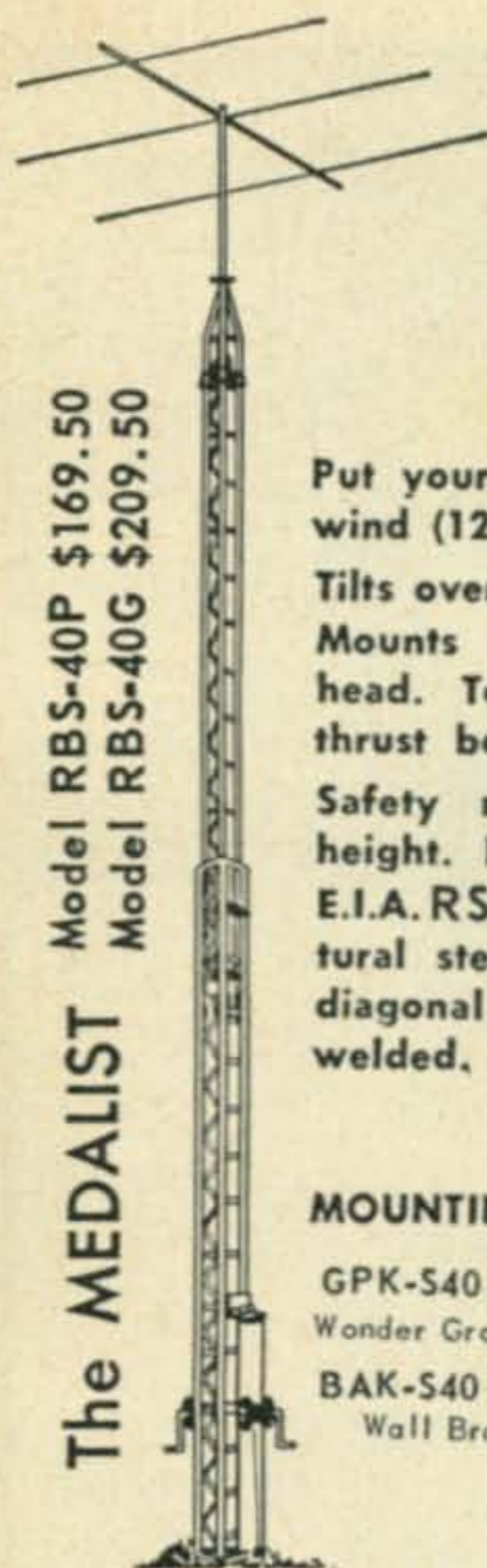

Model RBS-40P \$169.50
Model RBS-40G \$209.50

The MEDALIST

STURDY E-Z WAY TOWERS

Put your Tribander at 41' in 70 mph wind (125 mph cranked down to 24').

Tilts over for E-Z access to array.
Mounts Ham-M Rotor inside tower head. Top radial bushing - vertical thrust bearing.

Safety rest locks tower at desired height. No weight on cables.

E.I.A. RS-222 specs. Heavy wall structural steel tube legs, solid steel rod diagonal & horizontal bracing - arc welded. Sold by Top Flight Distributors

Everywhere!

MOUNTING KITS:

GPK-S40 \$75.00
Wonder Ground Post

BAK-S40 \$10.50
Wall Bracket



Write for Catalog 22-1

P.O. BOX 5767 TAMPA 5, FLORIDA

For further information, check number 37, on page 126

DON'T GAMBLE!

SOME CAN AFFORD TOO— ÷ IF YOU CAN'T—
—DEAL WITH A DEALER YOU CAN TRUST

By popular request we have added the Telrex and Hygain Lines.

G4ZU 10-15 @ 20 Minibeam	\$89.50
G4ZU 20-40 Meter Birdcage	87.25
25 foot "zoom up mast" to match	7.25
HyGain TH4 Thunderbird	117.50
HyGain TH3 Thunderbird	89.95
Telrex TC 99 Challenger	159.50
Telrex TC 88	87.25

We also carry the famous Rohm Towers suitable for any possible installation be it amateur or commercial. Cornell Dubilier rotators, cable, relays, switches, SWR meters, hi and low pass filters, mobile antennas and other apparatus.

FREE SPECIAL OFFER FREE

You have requested that we continue issuing a foreign edition of the Radio Call Book with every purchase over \$25.00. Your wish is our command.

Let us quote on any installation you have in mind—amateur or commercial. Let our experts explain our packaged systems.

Immediate Delivery

What do you want? What do you need?

Let us be your

Credit Available Antenna Headquarters

HOUSE OF ANTENNAS

Master Service Co.
Phone Southshore 8 9282
1155 East 82nd Street
Chicago 19, Illinois



Groth TURN COUNT DIAL

Registers Fractions to 99.9 Turns

FOR roller inductances, INDUCTUNERS, fine tuning gear reducers, vacuum and other multivary variable condensers. One hole mounting. Handy logging space. Case: 2" x 4". Shaft: 1/4" x 3". TC 2 has 2 1/2" dial—1 1/2" knob. TC 3 has 3" dial—2 1/2" knob. Black bakelite.

TC 2 \$5.50—TC 3 \$6.50—Spinner Handle 75c extra

Add 12¢ for Parcel Post

R. W. GROTH MFG. CO.

10009 Franklin Ave. Franklin Pk., Illinois

QSL's, SWL's, XYL-OM's. (Sample assortment approximately 9 3/4¢). Covering designing, planning, printing, arranging, mailing, eye-catching, comic, sedate, fantabulous, DX-attracting, prototypal, snazzy, unparagoned cards. (Wow!) Rogers KØAAB, 737 Lincoln Avenue, St. Paul 5, Minnesota.

GLOSSY 3-color QLS cards 100—\$4.50. Free sampler. Rutgers Vari-Typing Service, 7 Fairfield Road, New Brunswick, N. J.

QSL's - \$1.75 per 100 postpaid U.S. only. Glossy, red and green. All orders mailed within 10 days. Free sample. Hobby Print Shop, Umatilla, Florida.

QSL's you'll like. Samples 10¢. Dupli-Press, 1367 Gary Street, Merritt Island, Fla.

QSL's-SWL's, samples 10¢. Malgo Press, 1937 Glendale Avenue, Toledo 14, Ohio.

QSL's—Photographic and regular. Samples 10¢. Dick W8VXK, Rt. 1, Gladwin, Michigan.

TOWERS: Crank up tilt type forty and sixty footers. Realistically priced. Apeekay Towers, 1509 Broad St., Rome Ga.

INSTRUCTIONS for APR-5A receiver. Barker, West Drive, North Haven, Sag Harbor, N. Y.

75A-4 will take clean Drake 1-A and \$300. KWS-1 late serial like new will take KWM-2 and \$250. Collins 3.1 kc mechanical filter 465 kc adapter plugs in octal socket fits Super Pro or others with 1F frequency above, manufactured by Collins. \$45 prepaid. WØBNF, Box 105, Kearney, Nebr.

Highly effective home-study review for FCC commercial phone exams. Free literature. Wallace Cook (CQ3), Box 10634, Jackson 9, Miss.

HAM license prep, resident courses, Novice and General classes; 3 evenings weekly. Delehanty Institute, 117 East 11 St., N. Y. 3, GR 3-6900.

FOR SALE: KWS-1 #1573 like new \$12.00 will take KWM-2, HT-32, or HT-37 in trade. Have extra 75A-4 for \$475. WØBNF, Box 105, Kearney, Nebraska.

Any microwave test sets and equipment including klystrons covering 1 kmc all the way up. Diamond, 749 W. End Avenue, New York City.

Aluminum for every ham need. Write to Dick's, 62 Cherry Avenue, Tiffin, Ohio, for list of tubing, angle, channel, castings, plain and perforated sheet, and complete beam kits.

Ham Radio Instructor & Counsellor for intellectually gifted young people 9-16 years, summer session July 2—Aug. 27, college campus 100 miles NYC, own equipment essential, write details, Guido Brand, 2835 Webb Ave., N.Y. 68, N.Y., Call KI 9-6440.

SELL: HQ-110-C perfect \$175.00 W2PWF, 78-42 264th St., Floral Park, N. Y. Tel. FI 3-9382.

FOR SALE: Hammarlund HQ-140X excellent condition, tape recorder, new BC-659K, and instructograph machine with tapes. Best offer. Grinnell, 54 1/2 Concord Street, Nashua, New Hampshire.

H & H offers more for less. Send for bargain list. We buy ham gear for cash, as well as sell and trade. H & H Electronic Supply, 506 Kishwaukee St., Rockford, Illinois.

FOR SALE OR SWAP. Electronic equipment. Tape recorders, receivers, geiger counters, old magazines, QST, CQ. Meters, generators, antique tubes, high power tubes, shallow water diving gear, telephone sets, typewriter, recording tape, CQP radio, lots more. Moving to house trailer, must sell out. Send for full list. David Hale, 635 S. 21st Ave., Maywood, Ill.

FOR SALE: Lysco Transmitter, model 600. 40 watts, VFO-crystal, TVI'ed. 10 thru 160 meters. \$60.00; RME HF 10-20 Converter. Covers 10, 11, 15, and 20 meters. \$45.00; All A-1 condition. Shipping extra. Bob Hartman, W9RQY, Ce darville, Illinois.

Heathkit "Sixer" HW-29A with 12v mobile power supply and Saturn Six antenna. Best offer, need money for college. Donald Hartman, 1264 Chenango Street, Binghamton, N.Y.

FOR SALE: DX-40 \$60., perfect condition. Used very little. K7IMA, St. Johns, Arizona.

A-1 reconditioned equipment. On approval. Trades, Terms. Hallicrafters S-40B \$69.00, SX-99 \$109.00, SX-100 \$199.00, HT-37, S-85, SX-110, SX-111, SX-101A, HT-32, HT-32A, HT-33A; Collins 75A-1, 75A-2, 75A-3, 75A-4, KWM-1, 32S-1, 75S-1, KWS-1; Central 20A \$159.00; Elmac PMR-6 \$69.00, AF-67 \$109.00; Gonset G-66B, G-77A, G-50, GSB-100, GSB-101; Hammarlund HQ-100 \$129.00, HQ-110 \$179.00, HQ-129X, HQ-140X, HQ-140XA, HQ-150, HQ-160, HQ-170, HQ-180; Johnson Adventurer \$29.00, 6N2 \$99.00, Viking II \$179.00, National NC-98 \$89.00, HRO-50T \$199.00, NC-300, HRO-60, NC-183D, NC-303; HRO-60, NC-183D, NC-303; Heath, Globe, RME, and other items. List free. Henry Radio, Butler, Missouri.

WANTED: 15 meter bandspread coil AC-15 for National HRO-50 T-1, S/Sgt. A. Hope, 1989th AACSRON, Box 7976, APO 283, N. Y. N.Y.

FOR SALE: Viking IXmtr \$100.00, HT-18 VFO \$30.00, Gonset G-66B rcvr and G-77A xmtr both w/3 way pwr supply, Shure P/T mike, mobile mounting brackets, heli-whip triband mobile antenna and all cables FB fixed or mobile all for \$385.00. FOB Chicago. Jim K9PNG, 309 So. Oak St., Palatine, Ill.

DX-20 and AR-3 w/o cabinet for sale. Used less than 40 hours. \$25 and \$20 respectively. Mike, 1418 Stevens, Rhinelander, Wis.

HQ-110, clock, speaker, perfect, \$190.00. Hallicrafter S-85 \$75.00. K4WWL, 312 Bryant, Dalton, Georgia.

HEATH GC-1A, two power supplies less than 150 hours. Best offer over \$125. Paul Monte, 35-50 159th Street, Flushing 58, N. Y. FL 3-3750.

BC-603 Rec parts coils and complete parts LCU3-B \$1.50 each new boxed. For list of rec's and parts send 10¢ to cover mailing etc. Manuals for same \$1.50 each new. Murray Bros, 12 Adams St., Charlestown, Mass.

SELL: Complete 500 Watt SSB Station, Collins 75A-2 receiver with Universal Product detector \$280.00. Central Electronics 20-A Exciter with BC-458 VFO \$200.00. 500 Watt Linear. Eldico SSB-500 with 2 spare 4X250-B tubes \$265.00. Hy-Gain TH-3 and Rohn tower six months old, write. Tubes: 304TL \$30.00, 4-250-A \$20.00, 4-65-3 \$12.00. 4X150-A \$9.00, 4X250B \$25.00. Also gun collection and cameras and lens. PATTERSON 2660 Galewood St., Dayton 20, Ohio.

FOR SALE: Hallicrafters SX-101 Mk III and matching speaker, \$295. Collins 32S-1 and 516F-2, \$590. K9BJM, Hoopston, Ill.

SAVE ON CITIZENS RADIO. Dealer discounts—Write Promotion Engineering, Box 84, Waseca, Minnesota.

With "Dip-A-Cap" and your Grid Dip Meter, range 1.7 to 85 mc, measure capacity 3.0 to 7000 micromicrofarads easily and quickly. \$3.50 each. E. M. Shook, W5IT, 227 West Woodin Blvd., Dallas 24, Texas.

TOWER: Self supporting and telescoping. All controls, Boston Ratio Motor (115/220V) included. Raise antenna from 20 feet to 55 feet. W6SAI design CQ Nov. 54. Cost over \$855.00. Made offer. Inquiries answered. Irwin Tryon, W3WFR, 1245 Earlford Drive., Pittsburgh 27, Pennsylvania.

SELL: NC-300 w/spkr, DX-100, matchbox; D-104 mike, Vibroplex bug, SWR bridge, etc. \$425.00. Complete specs and immaculate. K2RVY, Mel Weiner, 5714 Farragut Road, Brooklyn 34, N. Y.

ATTENTION: Mobileers! Leece-Neville 6 volt 100 amp system, \$50.00; 12 volt 50 amp system \$50; 12 volt 60 amp system, \$60; 12 volt 100 amp syst. \$100. Guaranteed no ex-police car units. Herbert A. Zimmerman, Jr., K2PAT, 115 Willow St., Brooklyn 1, N.Y. Tel. Dickens 2-9121 or Jackson 2-2857.

Collins 75S-1 \$385., 51J-3 \$675., 51J-2 \$495., 75A-2 \$295., SP-600 \$495., HQ-150 \$175., HQ-160 \$295., Valiant \$299., Ranger \$210., Teletype machines, R-390A/URR. Alltronics-Howard Co. Box 19, Boston 1, Mass. (Richmond 2-0048).

FOR SALE: Complete instructions for converting the ART/13 transmitter. Consists of 28 page booklet with pictures and drawings and a 22 x 36" schematic. Send \$2.50 to Sam Appleton, K5MKI, Box 717, Tullia, Texas.

BACK ISSUES

FOR SALE \$1.00 per copy

- 1950—Jan., July, Oct., Nov.
- 1951—All issues, except Nov.
- 1952—All issues, except Aug.
- 1953—All issues, except May, July, Dec.
- 1954—All issues, except Feb.
- 1955—All issues, except Nov.
- 1956—All issues, except April
- 1957—All issues, except Jan., Feb. and Nov.
- 1958—All issues, except June, July, Sept., Oct.
- 1959—All issues except Jan. and June
- 1960—All issues
- 1961—All issues, 50¢ Per Copy

BC-603 Conversion article (Sept. & Oct., 1958 CQ)
Reprints available at 50¢ per set.

CQ Magazine

300 West 43rd St., New York 36, N. Y.

FREE

GIANT 1961 204 PAGE CATALOG

BA

1961

ANNUAL CATALOG #11

Guarantee

SINCE 1927

A Complete Buying Guide for Everything in

RADIO TV ELECTRONICS

BURSTEIN-APPLEBEE CO.

Dept CQ, 1012 McGee St., Kansas City 6, Mo.

Send Free 1961 B-A Catalog No. 611

Name

Address

City..... State.....

SAVE UP TO 50% ON B-A SELECTED KITS

HI-FI AND STEREO SYSTEMS & COMPONENTS

TOP VALUES IN POWER AND HAND TOOLS

30 PAGES OF BARGAINS NOT IN ANY OTHER CATALOG

SEND FOR IT TODAY

For further information, check number 39, on page 126

THE NEW **P & H** LA-400-C 800 WATTS PEP SSB LINEAR AMPLIFIER



**NOW 800 WATTS PEP
FOR ONLY \$164.95
THE "BEST BUY" YET**

NEW modern styling! NEW high efficiency 3 element band-switching pi net. Puts more power into any antenna or load from 50-70 ohms. For SSB, DSB, Linear AM, PM, CW and FSK. All bands 80-10 meters. May be driven to 800 WATTS PEP SSB with popular 100 watt SSB exciters. Uses four modified 1625's in grounded grid. On customers order, will be furnished with 837's. (note: 1625's and 837's are not directly interchangeable, since sockets are different.) Typical P&H Low Z untuned input. TVI suppressed. Parasitic Free. Meter reads grid drive, plate current, RF amps output. Heavy duty power supply using 816's. NEW modernistic grey cabinet measures approx. 9" x 15" x 10½". Panel is recessed. **WANT TO SAVE MONEY? BUY IT IN KIT FORM.** It's a breeze to assemble and wire. **BEFORE YOU BUY — SEE THE NEW LA-400-C AT YOUR DEALERS.**

LA-400-C Kit complete with tubes.....\$164.95
LA-400-C Wired and Tested.....\$219.95

P & H ELECTRONICS INC.
424 Columbia Lafayette, Ind

For further information, check number 40, on page 126

NATE'S Special Of The Month!

BC-603 RECEIVER: 20-28 Mc. A terrific buy.....@	\$17.95
WITH KIT of 6 spare tubes and fuses	19.95
BC-604 TRANSMITTER: 50 W. 20-28 Mc	4.95
FT-237 MOUNTING RACK: For above units	2.95
DM-35 DYNAMOTOR	
12 V. in. 625 V. @ 225 mils out. In orig. box	\$7.95
BC-603 DYNAMOTOR: 12 V. Bargain price this month	\$2.95
HS-30-U HEADSET: Brand new and boxed. Only95
9 FT WHIP ANTENNA: Brand new. Only79

FOB Gardena, Calif. Min. order \$3.00. Send cash with order.
No COD. Calif. residents add 4% tax.

SEND FOR FREE BARGAIN FLYER!

NATE BECKERMAN & ASSOCIATES, Dept. CQ.
1703 West 135th St. Gardena, California
Phone: FAcully 1-2318

SIDEBAND [from page 78]

replica of a 10B to a single 6AG7; total 4 watts! . . . Webb, W9VHB, out Indianapolis way, couldn't believe his ears when he got the reports on his signal radiating from a rectangular indoor dipole strung up around the ceiling of his apartment room. It was one of those things "I hear it but I don't believe it!" Honest, Webb, you were doing great. . . . Anytime you hear "chickens, turkeys, and ducks," it's not a pitch for a poultry farm but more likely Bob, W5CTD, in Houston, who uses those distinctive phonetics . . . We, and all his many friends would like to wish Cheever, W8LJ, and his family the best of health and happiness in their new home in Simsbury, Conn., where he'll soon be heard using his W1AZ call. . . . Confidential reports are being eagerly awaited on the big doings in Boca Raton at the end of January when Bill, W2KG/W4VEC held his annual reunion for a group of ham radio's most respected and popular members, among them W2KR, W4HB, W2MDQ, W4CF, K4GG, W2JIO, W2CMM, and others. . . . Say, Buck, W4TO, what's this about you decorating your shack with 75 fruit jars filled with borax and electrodes some time back? That must have been quite a sight to greet your visitors! . . . We heard that W8FYR of the Cesco Co. in Dayton was coming out with a new triband quad; from all indications, it should put out a walloping signal.

With 20 meters rather quiet for the most part in the early morning hours, we have been mobiling to work around 7.210 each morning and enjoying the company immensely. We can usually count on Van, W2LDA, and Don, K9WFG/9, who operates from a transmitter site, the commercial call of which shall be our secret. In fact, one morning we were surrounded by such learned engineers—Don, Van, and Maxey, K9UID, who is a TV engineer . . . that I was afraid to open my BOX for fear of making a technical error! . . . One of the strongest signals on 40 in the small hours of the a.m. comes out of Norfolk, Va., via K4RAS operated by Hal. . . . Made part of one trip with the able assistance of Ralph, W3VVL, who has been driving since 1906. Wonder what was being used mobile in those days? . . . The nice thing about 40 meters is that you can hear both sides of any QSO, making it practical to break in. . . . Between red traffic lights, had a few minutes to chat with Ed, K4WHD, who gets up real early because his XYL, Marilyn, KN4WHC, takes over on c.w. when she gets up. Another rig will solve that problem, Ed! . . . Even got to talk to our 'ole buddy, Irv, W5HHT, a gentleman who formerly was a fixture on 20. . . . Keep your ear open for Jack, K2DFW, who operates from Plattsburg AFB, N.Y. and likes to watch the sun coming up over the lake.

73, Irv and Dorothy

COMPLETELY NEW . . . FROM HORNET

MODEL TB 1000-4
Cash Price
\$119.50

Budget Terms
only \$9.85 per month
Rated 1 KW
Four working elements
on all three bands.

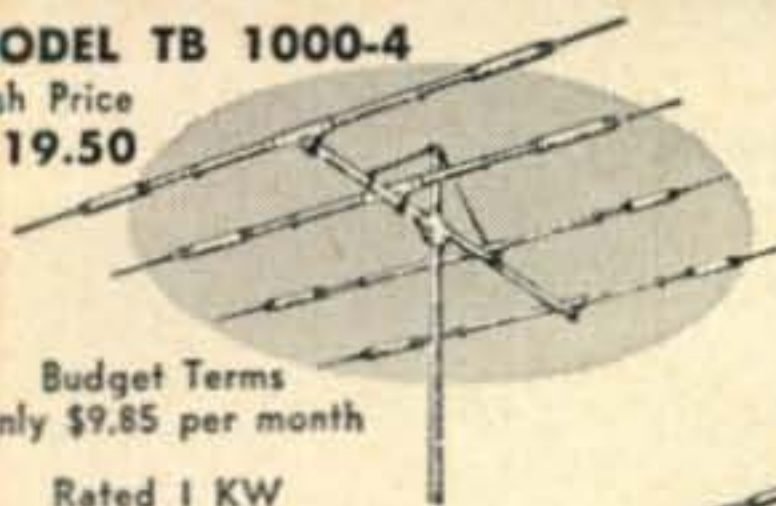

Superb construction and unequalled performance has gained world wide acceptance for Hornet antennas. ASK THE AMATEUR WHO OWNS ONE!

MODEL TB 1000

Cash Price
\$89.75

Budget Terms
only \$8.15 per month
Rated 1 KW

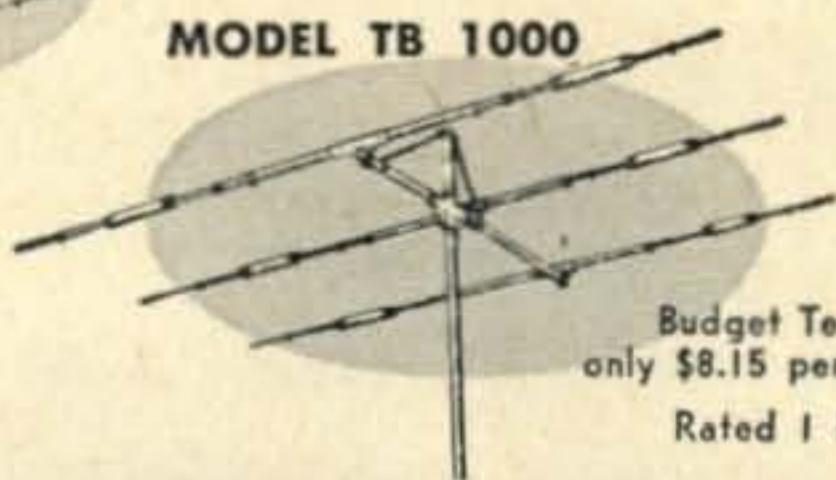

**AND
IT'S SO EASY TO BUY**

- Use the order form below
- Check the model of your choice
- Mail coupon

Your antenna will be rushed to you for 'try-before-you buy' evaluation. Thousands of amateurs who have used this plan have found that there is no better way to investigate value in relation to cost, before buying. If you desire, use time payment plan—low monthly payments.

**HORNET
ANTENNAS**

**HEAVY DUTY
MODEL TB 750**

Cash Price
\$69.95

Budget Terms
only \$6.35 per month
Rated 750 watts



**MODEL
TB 500**

Cash Price
\$59.75

Budget Terms
only \$5.40 per month
Heavy Duty

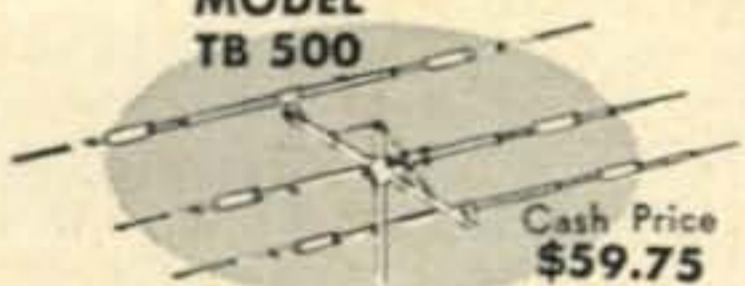

ALL MODELS . . .

- Are Pre-tuned and Easy to Install
- Have Custom Fittings of Cast Aluminum
- Use a Single 52 ohm Coaxial Transmission Line
- Have completely weather-sealed Frequency-Dividers*
- Have 6061-T6 Aluminum in the Elements

*Pat. Pend. Prices subject to change without notice

HORNET ANTENNA PRODUCTS CO. • P. O. BOX 808 • DUNCAN, OKLA.

Please Rush My Hornet Tribander for a 10-Day FREE TRIAL. If Fully Satisfied, I Agree to Pay as Checked Below. If Not Satisfied, I Agree to Return the Beam Prepaid Within 10 Days Without Further Obligation. ALL PRICES F.O.B. FACTORY.

- I prefer the Model TB 1000-4. I will pay cash within 10 days, if fully satisfied. I will pay \$12.00 within 10 days and \$9.85 per month for 12 months.
- I prefer the Model TB 1000. I will pay cash within 10 days, if fully satisfied. I will pay \$9.00 within 10 days and \$8.15 per month for 11 months.
- I prefer the Model TB 750. I will pay cash within 10 days, if fully satisfied. I will pay \$7.00 within 10 days and \$6.35 per month for 11 months.
- I prefer the Model TB 500. I will pay cash within 10 days, if fully satisfied. I will pay \$6.00 within 10 days and \$5.40 per month for 11 months.

MY CALL
LETTERS ARE

NAME _____

ADDRESS _____

CITY _____

STATE _____

ABSOLUTELY NO RISK ON YOUR PART

MAIL YOUR ORDER TODAY — NO MONEY REQUIRED WITH ORDER

For further information, check number 41, on page 126

**NEW Especially Designed for Single Side Band!
HIGH VOLTAGE POWER SUPPLY
DELIVERS 3500 or 4200 VOLTS DC AT 500 MILS**

The high-voltage power supply you've been waiting for! All the power you'll ever need—even for that Alaskan Kilowatt! Especially designed for single side band by one of the leading manufacturers of precision electronic equipment since 1947...No transients due to poor dynamic regulation...No chokes. Write for complete descriptive literature.

MODEL 65A — 4.2 KV — \$365.00

MODEL 65B — 3.5 KV — \$335.00

Send check or money order only—no C.O.D.'s

Amateur Division

**TIC Tel-Instrument
ELECTRONICS CORP.**

728 GARDEN ST., CARLSTADT, N. J.

Specifications:

INPUT: 115, 208, 230 V. AC; 50-60 cps; single phase

OUTPUT: Model 65A—4200 V. DC @ 500 mils, cont. duty
Model 65B—3500 V. DC @ 500 mils, cont. duty
(350, 750 or 1050 V. screen voltages)

REGULATION: 15%, no load to full load

RIPPLE: Nom. 1% at full load

WEIGHT: Model 65A—150 lbs. net
Model 65B—130 lbs. net

SIZE: 17"x17"x8½" high

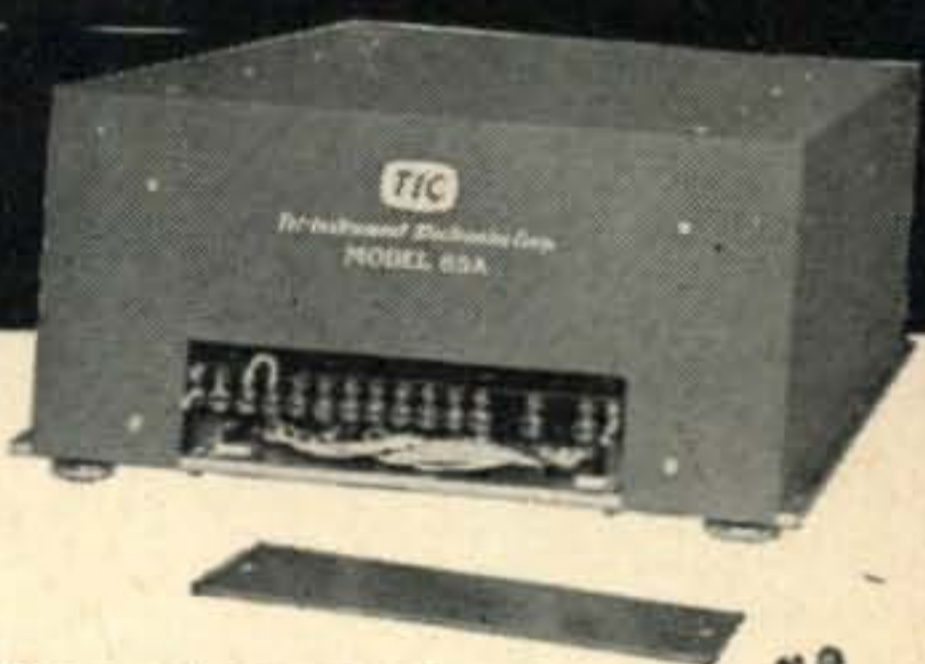

For further information, check number 44, on page 126

C & G WILL SHOW YOU THE ONLY AMATEUR SSB MOBILE TRANSCEIVER MADE.

The versatile Collins KWM-2 SSB Transceiver gives you unexcelled SSB performance whether at home or on the road. Its light weight encourages you to take it with you wherever you go. The KWM-2 covers the amateur bands between 3.4 and 29.7 mc. (Collins KWM-2 weighs only 18 lbs.; you can carry it home from C & G). Be sure to see the Collins S/Line, too.

ELECTRONICS CO.

Northwestern headquarters for Collins
2502 Jefferson Avenue Tacoma 2, Wash. 2221 3rd Ave. Seattle 1, Wash.



For further information, check number 45, on page 126

EUROPEAN HAM TOUR

ENGLAND
FRANCE
SWITZERLAND
GERMANY
THE NETHERLANDS

- ★ BOAC JET BOTH WAYS
- ★ CONDUCTED TOURS OF ELECTRONICS PLANTS
- ★ EYE-BALL QSO'S WITH FOREIGN AMATEURS
- ★ REVERSE DX

SIGHTSEEING OVER THE CONTINENT
WITH SPECIAL ENTERTAINMENT FOR THE XYL'S

20 DAYS

APRIL 22 TO MAY 12, 1961

EVERYTHING INCLUDED FROM NEW YORK

COMPLETE INFORMATION WITH A REQUEST
ON YOUR QSL CARD TO:

HUGH TINLEY, KØGHK
TRAVEL & TRANSPORT, INC.
FIRST NATIONAL BANK BUILDING
OMAHA, NEBRASKA

For further information, check number 44, on page 126

READER SERVICE

CQ Magazine, Dept. RS

300 WEST 43rd STREET
New York 36, N. Y.

Coupon C
Void after
Mar. 25, 1961

Please send me more information on your
ads in the Mar. 1961 CQ keyed as follows:

1	2	3	4	5	6	7	8	9	10	A
11	12	13	14	15	16	17	18	19	20	B
21	22	23	24	25	26	27	28	29	30	C
31	32	33	34	35	36	37	38	39	40	D
41	42	43	44	45	46	47	48	49	50	D
51	52	53	54	55	56	57	58	59	60	E

NAME _____

(Please Print)

Call _____ Engineer

Type of work (specify) _____

ADDRESS _____

CITY _____

ZONE _____ STATE _____

ADVERTISING INDEX

ACF Industries, Inc.	117
Allied Radio Corporation	128
Alltronics-Howard Company	114
Astatic	115
Barker & Williamson Incorporated	110
Barry Electronics Corporation	109
Beckerman, Nate & Assoc.	124
Burstein-Applebee Company	123
C & G Electronics Company	125
Central Electronics Incorporated	21
Christy	121
Cleveland Institute of Electronics	16
Communications Equipment Company	120
Communication Products Company, Inc.	6
CQ Back Room	100
CQ Ham Mart	102, 103
CQ Back Issue	123
CQ Subscription	111
CQ Circulation	116
Cush Craft	110
Dow-Key Company, Incorporated	121
E-Z Way Towers, Incorporated	122
Editors & Engineers Limited	106
EICO	23
Evans Radio, Incorporated	118
Fair Radio Sales	114
Finney	20
Glas-Line Company	114
Globe Electronics (WRL)	4
Gonset Company	13
Groth, R. W. Manufacturing Company	122
Hallcrafters Company	2
Hammarlund Manufacturing Company	5
Harvey Radio Company, Incorporated	99
Heath Company	9, 10, 11
Henry Radio Stores	107
Hornet Antenna Products Company	125
The House of Antennas	122
Hy-Gain Antenna Products	101
Instructograph Company	120
International Crystal Manufacturing Co.	15
Johnson, E. F. Company	24, 25
James Knights Company (The)	113
Lafayette Radio	105
Lampkin Laboratories, Incorporated	118
Lektron, Incorporated	108
Master Mobile Mounts, Incorporated	22
McGraw Hill	104
Millen, James Manufacturing Co., Inc.	12
Mosley Electronics, Incorporated	8
Organ & Electronics	120
P & H Electronics	124
Palmer, Joe	116
Pausan	118
Petersen Radio Company, Incorporated	1
RW Electronics	120
Rad-Tel Tube Company	119
Shure Brothers, Incorporated	17
Smalley's Radio Limited	108
Sparx	118
TAB	127
Tel Instrument Electronics	125
Telrex, Incorporated	19
Travel & Transport	126
Turner Microphone Company	14, 111
U.S. 1 Electronics	110
Vibroplex Company, Incorporated	108
Victory	113
VHF	113
Western Radio Company	121
Westinghouse Electric Corp.	18
World Radio Laboratories, Inc.	112
Zimco Alarms	113

NEW POWER CONVERTER
12VDC to 500VDC
up to 200MA
100 Watts; Tap at 250VDC
*Type C1250E \$35



Hi efficiency, low ripple, low idle current-Silicon rectifiers! Toroidal HiEff! (Mu-Metal) tape wound transformer, fused & short circuit proof, small in size! Quiet! Light weight! C1250EE built, ready to go. Conservatively Rated. Delco Transistors *Heavy Duty Finned Delco Heatsinks.

TYPE C650E FOR 6VDC INPUT \$35

Hi efficiency, low ripple, low idle current-Silicon rectifiers! Toroidal HiEff! (Mu-Metal) tape wound transformer, fused & short circuit proof, small in size! Quiet! Light weight! C650E built, ready to go. Conservatively rated. Delco Transistors Heavy Duty Finned Delco Heatsinks.

12VDC to 250VDC up to 150MA
Type C1225E \$30

C625E for 6VDC input \$30

TOROID TRANSFORMER FOR TRANSISTOR POWER SUPPLY APPLICATION

T6-500E/6VDC Impt, 500VDC & Tap, Max 200Ma \$15. T12-500E/12VDC Impt, 500VDC & Tap, Max 200Ma \$15. T6-250E/6VDC Impt, 250VDC, Max 150Ma \$14. T12-250E/12VDC Impt, 250VDC, Max 150Ma \$14.

Add \$5 for matched pair Power Transistors.

8 TOPHAT SILICON DIODES EXPERIMENTERS KIT. USE AS STABISTORS, ZENER DIODES & METER PROTECTION, CLIPPER & RECTIFIERS! \$10 VALUE, \$1.

"VACDAC" SILICON TUBE REPLACEMENTS

WITH BUILT IN RF SURGE & SERIES BALANCING PROTECTION

TYPE	VRMS/PIV	AMPS	PRICE
ST866	5000/10400	0.3	\$20.00
ST816	5000/7000	0.3	\$16.00
ST5R4	1900/2800	0.5	\$15.00
ST5U4	1120/1600	0.6	\$ 8.00



!!! TUBE SPECIAL !!!

4X1500 — Removed from Govt. equipment. Tested. \$3 ea., 2 for \$5. Filament Xfmr \$2. First come, first served.

NEW BATTERY CHARGER BC6-12V FOR 6V OR 12 VOLT BATTERIES, TRICKLE & FULL CHARGE up to 4 AMP

Charges 6 & 12 volt batteries.



Built BC6-12V \$10.00

HDQTRS. TRANSISTORS & ACCESSORIES

2N441/\$2.80; 2N442/\$4; 2N277/\$4; 2N278/\$5; 2N155/\$1.39; 2N176/\$1.80; 2N177/\$1; 2N178/\$1.75; 2N247/\$1.50; 2N255/\$1.20; 2N270/.95; 2N274/\$1.25; 2N408/.80; 2N554/\$1.20; 2N578/\$1.80; 2N579/\$2.20.
DIAMOND BASED MICA MTG KIT.....30
DELCO ROUND BASED MICA KIT .30
DELCO POWER HEAT SINK 80 sq." \$1.00

SELENIUM F.W. BRIDGE RECTIFIERS

DC AMP	18VAC		36VAC		72VAC		130VAC	
	14VDC	28VDC	28VDC	54VDC	54VDC	100VDC	100VDC	100VDC
1/2	\$1.00	\$1.90	\$3.85	\$5.00				
1	1.30	2.00	4.90	8.15				
2	2.15	3.00	6.25	11.10				
3	2.90	4.00	8.60	13.45				
6	4.15	8.00	18.75	31.90				
10	6.10	12.15	26.30	41.60				
12	7.75	14.90	30.95	43.45				
20	12.85	24.60						
24	15.00	29.45						

Send 25¢ for Catalog

SELENIUM RECTIFIERS 130/RMS HALF WAVE

75Ma 49c, 5 for \$2; 100Ma 59c, 6 for \$3
130Ma 70c, 8 for \$5; 250Ma 79c, 6 for \$4
300Ma 88c, 5 for \$4; 350Ma \$1.00, 8 for \$7
500Ma \$1.35, 5 for \$5

This Item P.Pd. on orders \$5

WE BUY! SELL & TRADE
Send 25¢ for Bonus Catalog!



"TAB" THAT'S A BUY

"TAB" Tubes Tested, Inspected, Boxed

Six Months Guaranteed! No Rejects!
GOVT & MFGRS Surplus! New & Used

0A2	.89	6B27	1.25	We Buy & Sell	
0A3	.80	6C4	.45	43	.75
0B2	.65	6C5	.69	45	.49
0C3	.70	6C6	1.08	50L6	.69
0D3	.50	6C8	1.08	RK59	1.39
0Z4	.79	<i>We Trade!</i>		RK60	1.17
1A7	.90	6CB6	.89	HY69	2.20
1B3	.59	6CD6	1.49	75	.81
1L4	.82	6CF6	.85	HY75	5.00
1R4	5/\$1	6CL6	1.40	83V	.95

We Swap Tubes! What Do/You Have?

IR5	.78	6CB6	.89	4PR60A	37.50
IS4	.78	6CG8	1.12	4-125A	27.50
IS5	.68	6CM6	.79	4X150G	15.00
IT4	.85	6CS6	.70	4X250B	41.00
IT5	.95	6CU6	1.29	4-400A	41.75
IU4	6/\$1	6D6	.99	4E27A	39.00
IU5	.75	6E5	.79	250TL	19.45
IX2	.99	6F4	2.49	307A	2/\$1
2C39A	Q	6F5	.63	316A	5/\$1
2C40	5.50	6F6	.99	VR92	5/\$1

Send 25¢ for Catalog!

2C43	6.50	6F7	.99	388A	3/\$1
2C51	2.00	6F8	1.39	350A	2.45
2D21	.65	6H6	.59	350B	1.75
2E22	1.75	6J4	1.72	371B	.95
2E24	1.90	6J5	.59	5146	3.90
2E25	2.50	6J6	.59	416B	16.00
2E26	2.75	6J7	.99	450TH	43.00
2E30	Q	6J8	1.39	450TL	43.00
2E35	1.60	6K6	.59	460	11.50
2K25	9.75	6K7	.79		

All Tubes Stocked at Low Prices!

2K26	34.00	6K8	.99	703A	Q
2K28	30.00	6L6	1.19	707B	3.50
2V3	2/\$1	6SN7	.72	715C	10.90
2X2	.48	6T8	.98	717A	5/\$1
3A4	.70	6V6GT	.90	723AB	7.20
3A5	1.00	6X5	.49	725A	2.75
3API	5.95	12AT6	.59	803	3.50
3BPI	3.99	12AT7	.89	804	8.85
3C24	3.50	12AU6	.63	805	6.00
3D23	3.95	12AU7	.69		

3E29	6.00	12AX7	.79	807	1.10
3Q4	.68	12AY7	1.29	5/\$5, 10/\$12	
3Q5	.86	12B4	.95		
4-65A	13.50	12BA6	.65	811	3.45
4-125A	27.50	12BA7	.99	811A	4.41
4-250A	34.00	12BD6	.59	812	3.30
4X150A	Q	12BE6	.59	813	8.00
4X250	36.00	12BH6	.79	815	1.75
4X500	37.00	12BH7	.99	826	.99
5API	2.95	12BY7	1.00		

5BPI	7.95	12BZ7	.99	828	9.00
5BP4	7.95	12H6	.75	829B	8.00
5CPI	4.99	12J5	.69	832A	6.00
5CP7	9.00	12J7	.69	833A	36.00
5R4	1.00	12J8	1.35	837	2/\$2
5T4	.90	12K8	.89	866A	2.45
5U4	.99	12SA7	.69	954	10/\$1
5V4	.89	12SC7	.89	955	3/\$1
5Y3	.60	12SF5	.69	957	3/\$1
5Z3	.89	12SG7	.89	958A	2/\$1

Wanted Test Sets and Equipment

15GP22	89.00	12SH7	.89	991	5/\$1
6A7	1.00	12SJ7	.75	1614	2.75
6A8	.99	12SK7	.75	1619	5/\$1
6AB4	.59	12SL7	.79	1620	2.00
6AC7	.72	12SN7	.69	1625	3/\$1
6AG5	.65	12SQ7	.69	1626	5/\$1
6AG7	.75	12SR7	.69	1629	4/\$1
6AK5	.69	15E	1.19	2050	1.25
6AL5	.59	15R	4/\$1	5517	1.25
6AQ5	.86	FG17	Q	5608	3.95

Top \$\$\$ Paid for 304TL, 726B Tubes

6AR6	1.95	19T8	1.16	5618	3.25
6AS7	3.49	24G	3.50	5651	1.35
6AT6	2/\$1	25A6	1.19	5654	1.20
6AU6	.79	25A7	2.19	5656	4.25
6B8	1.35	25C5	.81	5663	1.15
6BA6	.59	25L6	.72	5670	.90
6BE6	.59	25T	4.00	5686	1.75
6BG6	1.49	25Z5	.72	5687	1.15
6BH6	.79	25Z6	.75	5691	4.70
6BJ6	.72	26A7	3.69	5725	1.95

Top \$\$\$ Paid for XMTR Tubes!

6BK7	.99	FG27	8.28	5732	2.00
6BL7	1.35	HV27	19.39	5736	85.00
6BN4	.69	28D7	.89	5749	1.95
6BN6	1.08	FG33	15.00	5750	2.75
6BN7	1.99	EL34	3.49	5751	1.25
6BQ6	1.19	35A5	.69	5814	1.20
6BQ7	.99	35L6	.59	5879	1.20
6BX7	1.11	35T	4.49	5894	\$12.00
6BY5	1.19	35Z5	1.25		
6BZ6	.91	RK39	2.99	No See—Write!	

"TAB"

TERMS: Min Order \$3—25% with order F.O.B. New York. Ten day guarantee, price of mdse. only. Our 16th year.

Prices shown are subject to change.

111CC Liberty St., N. Y. 6, N. Y. RE 2-6245

For further information, check number 42, on page 126

"TAB" FOR THE BEST KITS!

Each "TAB" Kit Contains The Finest Selection!!!

Kit 35 Precision Resistors	Kit 75 Mica Condensers	Kit 100 Self-Tap Screws	Kit 12 Binding Posts Asstd
Kit 10 Switches	Kit 8 Crystal Diodes	Kit 4 Selenium "Suncells"	Kit 12 Binding Posts Asstd
Kit 75 Resistors 1/2/1&2W	Kit 200ft Hook Up Wire	Kit 4 Adj Wire Stripper & Cut	Kit 12 Binding Posts Asstd
Kit 12 Electrolytic Cond's	4 Rolls, 50ft/ea. Asstd. Color	Kit Hi Gain Xtal Mike	Kit 2 pair SO239 & PL59
Kit 15 Volume Controls	Kit 100 Ceramic Condensers	Kit 6 Insult Tuning Tools	Kit 4 "Suncells" Asstd.
Kit 55 Tube Sockets	Kit 5 FT243 Xtal Holders	Kit 5 Sub-Min Tubes	
Kit 65 Tubular Condensers	Kit 5 Microswitches		
Kit 500 Lugs & Eyelets	Kit 8 Xtal Osc-Blanks		
Kit 10 Bathtub Oil Cond's	Kit 4 Asstd Rectifiers		
Kit 5 lbs. Surprise Package	Kit 5 UG/Connectors		
Kit 10 Transmit Mica Cond's	Kit 100 Self-Tap Screws		
Kit 3 Phone/Patch Xfms	Kit 4 Selenium "Suncells"		
Kit 4 AN/Reflector Lites	Kit Adj Wire Stripper & Cut		
Kit 6 Insult Tuning Tools	Kit Hi Gain Xtal Mike		
Kit 4 "Suncells" Asstd.	Kit 2 pair SO239 & PL59		
Kit 5 Sub-Min Tubes	Kit 12 Binding Posts Asstd		

99¢

Order Ten Kits We Ship Eleven!!!
ONE EACH ABOVE KIT ONLY

SPECIAL! SPECIAL! SPECIAL!

TRANSISTORS
Computer Grade—Tested Guaranteed
For General Purpose Use
Amplifiers - Oscillators - HiFi
Logic - Servoamps - Power Supplies
Pulse Amp or High Current
Switch Circuits
PNP — TYPE 2N670 — 300MW
Absolute Max Ratings at 25°C
Vcb approx — 40v Ic approx max — 2A
Vce approx — 40v Hfc approx 40 to 250
Veb approx — 40v Diss approx 300Mw
Full Length Leads. Regularly
Cost \$3.38
"TAB" SPECIAL 95¢ ea., 4 for \$3,
8 for \$5
PNP — TYPE 2N671 — One Watt*
ABSOLUTE MAX RATINGS AT
25°C on * Heatsink
Vcb, Vce, Veb approx — 40v
Ic approx — 2A
Hfc approx 40 to 250
Diss * heatsink Mtd 1 Watt
Full Length Leads. Regular Cost \$4.13
"TAB" SPECIAL \$1.15, 2 for \$2,
5 for \$4

"TAB"—THAT'S A BUY!—BARGAINS!!

New Variacs/or equiv 0-135V/7.5A \$15.30
New Variacs/or equiv 0-135V/3 Amp \$10.65
New Variacs/or equiv 0-132V/1.25A \$7.25
RF-MTG GE/475 Ma & 5 Amp \$4@, 2/\$7
DC-METER DeJur 800 Ma/3 1/2" \$3@, 2/\$5
DC-METER One Ma/4" Rd. \$5@, 2/\$8
RF-HTR Weston 750Ma/TC...\$4@, 2/\$6
DC MTR 100Ma/2 1/2" \$3@, 2/\$5
CONDENSER OIL/W.E. 2mfd@600WVDC 6/\$1
SNOOPERSCOPE TUBE 2" \$5@, 2/\$9
MINI-FAN 6 or 12VAC/60 Cys \$2 @ 3/\$5
NEW PRINT CKT-PANEL, 11x12x.062" \$2
IRISH TAPE 1200' HiQty, 3 for \$5
BANDPASS 60 or 90 or 150 Cys...each \$2
IN34A 45¢@, 15/\$5; IN35 \$1; IN38 70¢@;
XTAL OVEN—115V&Thermostat \$3.98
Blower 24VDC/100CFM \$3.98
Xmitting Mica's .006 @ 2500V, 5 for \$1.00
AN-ARR2/RCVR less tubes A-1 condn \$1.95
829B Socket 85¢, 183 Socket \$1
4x150 Ceramic/LOKAL 2 for \$1.00

Leece Neville Charger Systems
"SILTAB" Silicon Rectifier Replacement
Non-Aging Hermetically Sealed
FOR 6 or 12VDC @ 100A. Type YJ9 \$24
NEW "SILICON 750 Ma TOP HATS!"

17.5/25	35/50	70/100	140/200
rms/piv	rms/piv	rms/piv	rms/piv
14¢	19¢	29¢	34¢
210/300	280/400	350/500	420/600
rms/piv	rms/piv	rms/piv	rms/piv
43¢	55¢	70¢	\$1.00
490/700	560/800	630/900	700/1000
rms/piv			

big **ALLIED** clearance sale of reconditioned equipment...

biggest trading in our history
brings you top values like these...

ALL WITH 90-DAY
NEW EQUIPMENT
WARRANTY!

B & W	
5100 Transmitter.....	\$219.00
Central Electronics	
20-A Exciter.....	164.50
GC-1 Gated Amplifier.....	29.00
600-L Amplifier.....	279.00
Collins	
32V-1 Transmitter.....	225.00
32V-2 Transmitter.....	249.00
32V-3 Transmitter.....	329.00
KWM-1 Transceiver.....	475.00
310-B Transmitter.....	99.00
75A-3 Receiver.....	349.00
75A-4 Receiver.....	495.00
Eico	
720 Transmitter.....	79.00
730 Modulator.....	49.00
Elmac	
A-54H Transmitter.....	54.00
PMR-7 Receiver.....	109.00
Globe	
LA-1 Amplifier.....	69.00
Chief 90A Transmitter.....	32.50
Champ 300A Transmitter.....	259.00
Scout 680 Transmitter.....	69.00
Scout 680A Transmitter.....	79.00
755 VFO.....	32.50
DSB 100 Transmitter.....	89.00
Knight	
R-100 Receiver.....	79.00
C-11 CB Transceiver.....	29.00
Lakeshore	
Phasemaster IIB.....	199.00
400GG Amplifier.....	149.00

Gonset	
6 Meter Converter.....	\$ 49.00
G-28 Transceiver.....	169.00
Communicator III 6 Meter.....	189.00
Communicator II 2 Meter.....	149.00
GSB-100 Exciter.....	379.00
GSB-101 Amplifier.....	359.00
G-77 Transmitter.....	169.00
G-77A Transmitter.....	179.00
G-66B Receiver.....	129.00
Hallicrafters	
S40-B Receiver.....	59.00
SX-43 Receiver.....	79.00
S-77A Receiver.....	59.00
SX-100 Receiver.....	189.00
SX-101 MK-1 Receiver.....	199.00
SX-101 MK-2 Receiver.....	239.00
SX-101A Receiver.....	299.00
SX-104 Receiver.....	59.00
SX-62 Receiver.....	169.00
SX-99 Receiver.....	114.00
HT-30 Transmitter.....	199.00
HT-31 Amplifier.....	199.00
HT-33 Amplifier.....	299.00
SR-34 AC-DC Transceiver.....	329.00
Hammarlund	
HQ-129X Receiver.....	129.00
HQ-150 Receiver.....	199.00
HQ-160 Receiver.....	269.00
HQ-180 Receiver.....	329.00
HQ-180C Receiver.....	339.00
Heath	
RX-1 Mohawk Receiver.....	249.00
TX-1 Apache Transmitter.....	229.00
MT-1 Mobile Transmitter.....	89.00

Johnson	
Mobile Transmitter.....	\$ 49.00
Challenger Transmitter.....	99.00
Adventurer Transmitter.....	29.00
275W Match Box Indicator.....	39.00
6N2 Converter.....	49.00
Viking I Transmitter.....	99.00
Viking II Transmitter.....	159.00
Pacemaker Exciter.....	199.00
Thunderbolt Amplifier.....	399.00
Courier Amplifier.....	169.00
Morrow	
MBR-5 Receiver.....	99.00
Falcon Receiver W/BC Band.....	109.00
MB-560 Transmitter.....	119.00
MB-560A Transmitter.....	129.00
MB-565 Transmitter.....	159.00
MB-6 Transmitter.....	129.00
National	
NC-88 Receiver.....	69.00
NC-98 Receiver.....	89.00
NC-173 Receiver.....	119.00
NC-183 Receiver.....	139.00
NC-183D Receiver.....	199.00
NC-188 Receiver.....	89.00
NC-303 Receiver.....	329.00
HRO-50TI Receiver.....	229.00
HRO-50T Receiver.....	199.00
HRO-60T Receiver.....	329.00
P & H	
LA-400 Grounded Grid Linear.....	79.00
RME	
4301 Sideband Selector.....	49.00
4300 Receiver.....	129.00
4350A Receiver.....	149.00

EASIEST TERMS: Available on all orders over \$20; only \$2 down up to \$50; \$5 down from \$50-200; only \$10 down from \$200 up. Up to 24 months to pay. Fast handling—no red tape.

15-DAY FREE TRIAL: Try any of this equipment under your own conditions; if in 15 days you're not completely satisfied, return it for full refund, less only transportation costs.

90-DAY WARRANTY: Allied Reconditioned equipment is covered by the same 90-day warranty against defects in material or workmanship which covers brand-new equipment.

SELECT YOUR NEW GEAR
from our complete 1961
444-page value-packed
catalog. If you haven't a
copy, write for it today.



IMPORTANT: Some items above are one of a kind... all items are subject to prior sale... send deposit to hold any item.

For reconditioned or new equipment, write to Jim Sommerville, W9WHF, c/o Allied, or stop in and meet Joe Huffman, W9BHD; Joe Gizzi, W9HLA, Burt Fischel, W9VOB; Jack Schneider, W8CZE.

ALLIED RADIO

100 N. Western Ave., Dept. 16-C1 Chicago 80, Ill.

For further information, check number 43, on page 126

built-in **PRODUCT DETECTOR**

NC

270

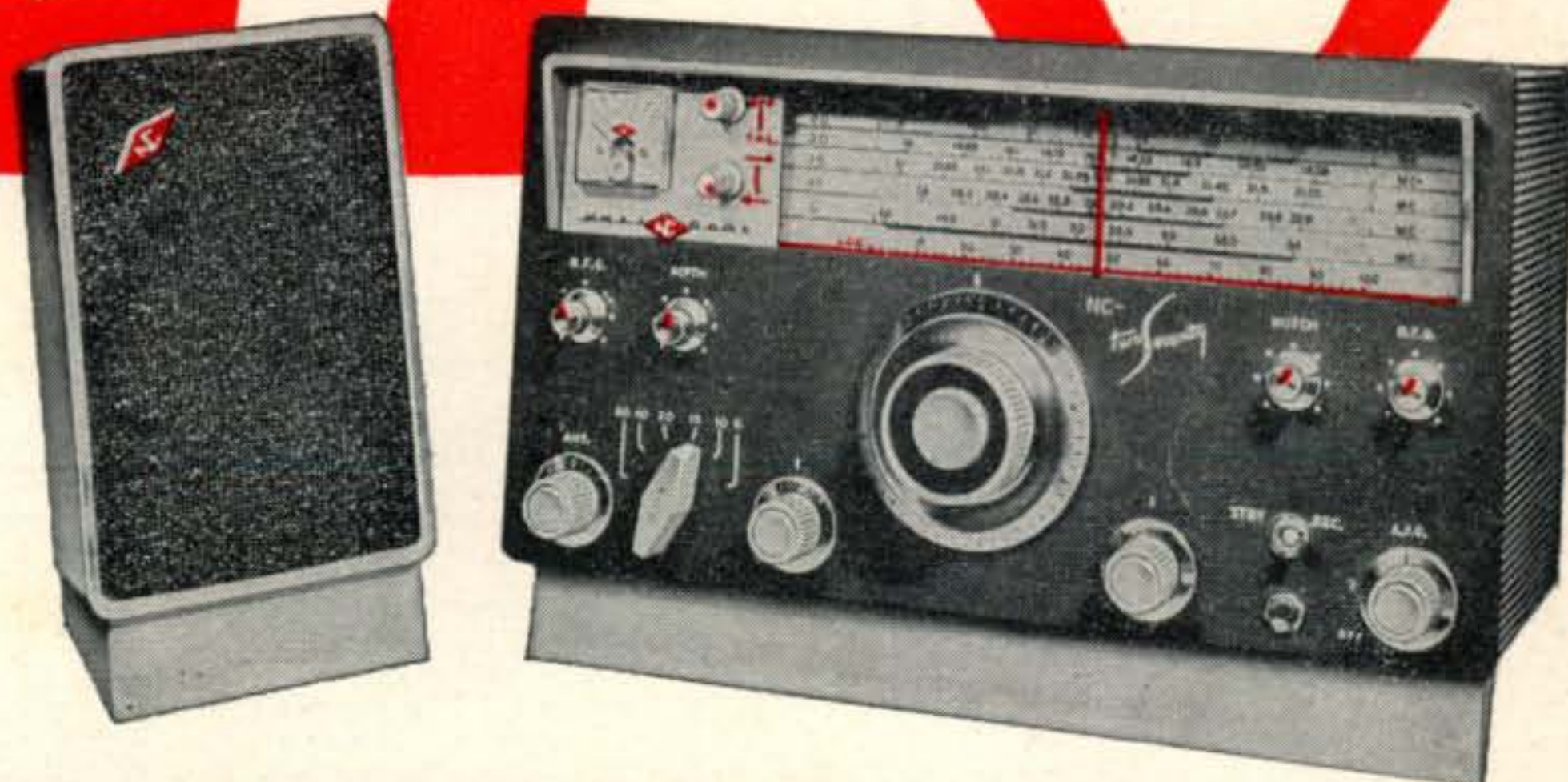

THE "COSMIC BLUE" NATIONAL'S NEW HAMBAND RECEIVER

This newest and finest precision double conversion amateur receiver with 6 meter coverage, brings you an ease of sideband tuning previously available only in the most expensive equipment. The NC-270 features an exclusive "Ferrite Filter" for instant upper-lower SSB selection and a degree of selectivity to conquer even the toughest AM and CW signal conditions. The solid $\frac{1}{8}$ " steel panel, ceramic coil forms, double-spaced tuning gang, and full ventilation cabinet combine to give mechanical and thermal stability that will surprise even the most critical operator. Even the color of the NC-270 is outstandingly different, National's new duo-tone "Cosmic Blue." Write for detailed specifications.

Only \$24.99 down*

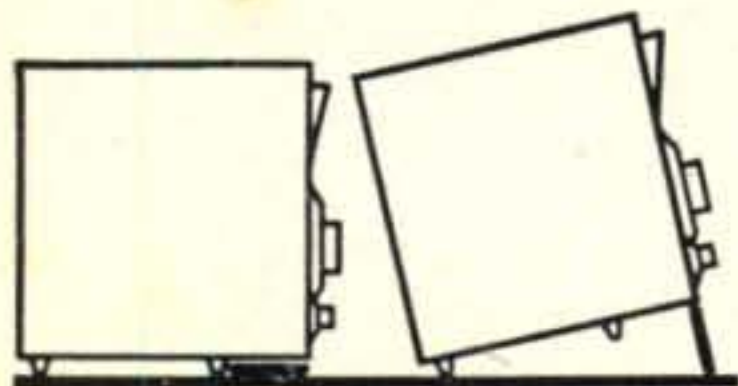

And National Radio's patented "Flip Foot" makes operating the NC-270 so easy.

Suggested cash price: \$249.95. NTS-3 Matching Speaker: \$19.95 (slightly higher west of the Rockies and outside the U.S.A.). *Most National distributors offer budget terms and trade-in allowances.

NATIONAL RADIO COMPANY, INC.



A WHOLLY OWNED SUBSIDIARY OF NATIONAL CO., INC.

MELROSE 76, MASS.

Export: AD AURIEMA, INC., 85 Broad St., New York, N. Y.

Canada: CANADIAN MARCONI CO., 830 Bayview Ave., Toronto 17, Ont.

SPECIFICATIONS SUBJECT TO CHANGE WITHOUT NOTICE

CQ's 50-Watt 6-Meter Exciter... uses RCA Tubes throughout

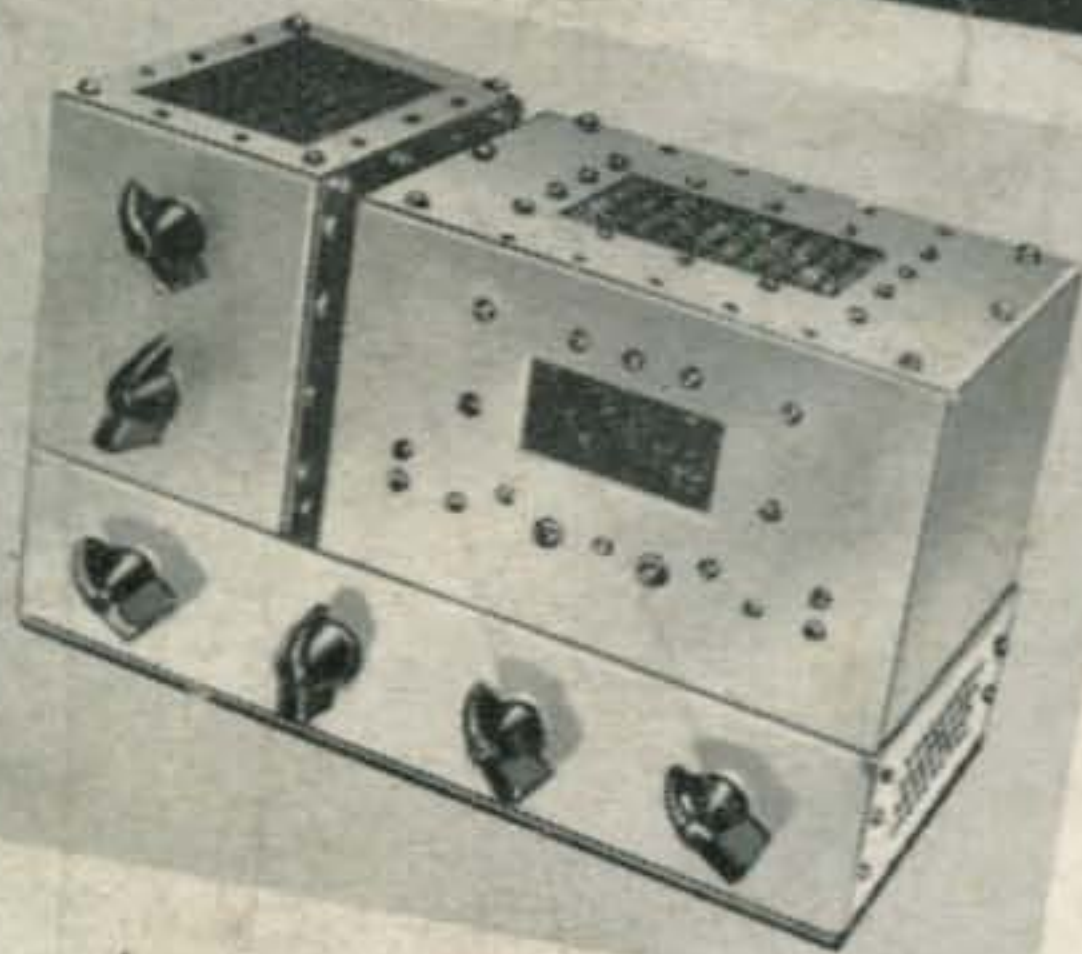

Front view of the 50 mc exciter showing arrangement of tuning controls and three major elements of the unit. Controls, from upper left to lower right are: 6146 plate tuning, antenna loading, meter switch, 5763 plate tuning, 6AG7 plate tuning and crystal f.o. switch. The 4 x 3 x 6" utility cabinet on the right houses the crystals, low level preamp, meter and clamp tube. The left hand utility cabinet 3 x 4 x 5" houses the 6146 r.f. amplifier circuit components. The basic chassis is only 5 x 9 1/2 x 2".

A 50 Watt, 50 Mc. Exciter A Neat Installation For the 6 Meter Enthusiast

Irving B. Mickey, W2LCB
1247 Baker Avenue
Schenectady 9, New York

The following pages describe a 50 watt exciter for 6 meters using the popular 6146 in a well shielded, pi-network amplifier. The final is not neutralized and besides an unusual method of parasitic suppression, careful consideration has been given to produce a clean, stable c.w. signal.



Designed and built by W2LCB—and described in detail in CQ for December 1960—this neat, compact 50-Mc exciter offers new possibilities for the 6-meter man who is looking for a clean, stable signal on VHF. Noteworthy is the fact that every tube in the rig is an RCA type—from the rf power amplifier to the power-supply rectifier.

Preferred by amateurs ever since the early days of CW, RCA tubes have earned a field-proved reputation for top performance. Emission capability is outstanding—even after long hours of operation under extreme conditions. Conservative ratings pay off in more operating hours per tube dollar invested.

It makes no difference if your rig is "home-brew" or commercial, you'll do better every time—with "RCA's" in the sockets. Your RCA Industrial Tube Distributor is the man to see for every RCA type you need.

- RCA-6AG7**
Beam Power
Oscillator-Tripler
- RCA-5763**
Beam Power
Frequency Doubler
- RCA-6AQ5-A**
Beam Power
Clamp Tube
- RCA-6146**
Beam Power
RF Amplifier
- RCA-816**
Half-Wave
Mercury-Vapor
Rectifier

10th Annual SSB Dinner, March 21, 1961



The Most Trusted Name in Electronics
RADIO CORPORATION OF AMERICA